



10222





1:1
2X LR 41 1.5V

EN

Important information about batteries

Never use different types of batteries together, or a combination of old and new batteries. Always remove the batteries if the product is not to be used for a long time or if the batteries have run down. Never use damaged batteries. Only use batteries of the type recommended, or a corresponding type. Insert the batteries so that the poles are correctly positioned. Rechargeable batteries must be recharged using the correct battery charger under the supervision of an adult. You cannot recharge batteries while they are still in the product, and you must never try to do so. Never attempt to recharge non-rechargeable batteries. Never short-circuit the battery holder.

DE

Wichtige Information zu Batterien

Benutzen Sie niemals unterschiedliche Arten von Batterien oder alte und neue gleichzeitig. Nehmen Sie stets die Batterien heraus, wenn mit dem Modell längere Zeit nicht gespielt wird oder wenn die Batterien leer sind. Verwenden Sie niemals beschädigte Batterien. Verwenden Sie ausschließlich empfohlene bzw. geeignete Batterien. Achten Sie beim Einsetzen der Batterien auf die richtige Polung. Wiederaufladbare Batterien sollten mit einem geeigneten Ladegerät aufgeladen werden – unter der Aufsicht eines Erwachsenen. Batterien können und sollten niemals aufgeladen werden, während sie sich im Modell befinden. Versuchen Sie unter keinen Umständen, „normale“ Batterien wieder aufzuladen. Schließen Sie das Batteriefach niemals kurz.

FR

Informations importantes concernant les piles

Ne jamais utiliser un mélange de différents types de piles, ou de piles neuves et de piles anciennes ou déjà utilisées. Toujours retirer les piles si le produit n'est pas utilisé durant une période prolongée ou si les piles sont vides. Ne jamais utiliser de piles endommagées. Utiliser uniquement des piles du type recommandé ou d'un type équivalent. En insérant les piles, respecter scrupuleusement le sens d'orientation des pôles (+/-). Les piles rechargeables doivent être rechargées en utilisant un chargeur de piles adéquat et sous la surveillance d'un adulte. Il est impossible de recharger les piles quand elles sont installées dans le produit. Ne jamais tenter de le faire. Ne jamais essayer de recharger des piles non-rechargeables. Ne jamais court-circuiter le compartiment des piles.

IT

Importanti informazioni sulle batterie

Non usare mai contemporaneamente batterie di tipo diverso o batterie nuove e usate insieme. Rimuovere sempre le batterie qualora il prodotto non venga utilizzato per periodi prolungati, oppure se le batterie sono esauste. Non utilizzare mai batterie danneggiate. Usare esclusivamente batterie del tipo raccomandato o un equivalente. Inserire le batterie avendo cura che la loro polarità sia corretta. Le batterie ricaricabili vanno ricaricate in un caricabatterie di tipo idoneo e con la supervisione di un adulto. Non è possibile e non bisogna mai tentare di ricaricare le batterie mentre queste sono inserite nel prodotto. Non tentare mai di ricaricare le batterie non ricaricabili. Non cortocircuitare mai il portabatterie.

NL

Belangrijke informatie over batterijen

Gebruik nooit verschillende soorten of nieuwe en oude batterijen tegelijkertijd. Verwijder de batterijen altijd als je het product lange tijd niet wilt gebruiken of als de batterijen leeg zijn. Nooit beschadigde batterijen gebruiken. Uitsluitend batterijen van het aanbevolen of overeenkomstige type gebruiken. Leg de batterijen met de polen in de juiste richting. Opladbare batterijen moeten in een voor dit doel bestemde oplader en onder toezicht van een volwassene opnieuw worden opgeladen. Opladbare batterijen kunnen niet in het product worden opgeladen en je mag dit ook niet proberen te doen. Probeer nooit niet-oplaadbare batterijen op te laden. Nooit de batterijhouder kortsluiten.

ES

Importante información sobre las baterías

No mezclar nunca diferentes tipos de baterías, ni utilizar baterías antiguas y nuevas a la vez. Sacar siempre las baterías, si el producto no se utiliza por un largo período de tiempo o si las baterías están desgastadas. No utilizar nunca baterías dañadas. Utilizar solo el tipo de baterías recomendado o uno correspondiente. Colocar las baterías de manera que los polos estén en su posición correcta. Las baterías recargables deben cargarse con un cargador adecuado bajo la supervisión de un adulto. Las baterías no pueden, ni deben recargarse mientras permanecen en el producto. No intentar nunca recargar baterías no recargables. Asegurarse que no se produzca un cortocircuito en el porta baterías.

DA

Viktig information om batterier

Brug aldrig forskellige typer batterier sammen, eller nye og gamle batterier samtidig. Tag altid batterierne ud, hvis du ikke skal bruge produktet i længere tid, eller hvis batterierne er brugt op. Anvend aldrig beskadigede batterier. Der må kun anvendes batterier af samme eller tilsvarende type som anbefalet. Batterierne skal vende rigtigt ned i sættes. Genopladelige batterier skal oplades i en dertil beregnet oplader under opsyn af en voksen. Genopladelige batterier kan og ikke forsøges opladet i produktet. Forsøg aldrig at genoplade ikke-genopladelige batterier. Kortslut aldrig batterikassens kontaktflader.

FI

Tärkeää tietoa paristoista

Älä koskaan käytä erityyppisiä paristoja yhdessä. Älä myöskään käytä samassa laitteessa sekä vanhoja että uusia paristoja. Poista paristot tuotteesta aina, kun se on pitemmän aikaa käytettämättä, tai kun paristot ovat tyhjentyneet. Älä koskaan käytä viallisia paristoja. Käytä vain tuotteesta suositeltuja tai vastaaventyypisiä paristoja. Aseta paristot siten, että navat osoittavat oikeaan suuntaan. Ladattavat paristot on ladattava oikeanlaisella laaturilla aikuisen valvonnassa. Ne on poistettava tuotteesta lataamisen ajaksi. Älä koskaan yritä ladata paristoja, joita ei ole tarkoitettu ladattaviksi. Älä koskaan aiheuta oikosulkuja pariston kosketinten välillä.

SV

Viktig information om batterier

Använd aldrig olika sorters batterier samtidigt, och inte heller en kombination av gamla och nya batterier. Ta alltid ur batterierna om produkten under en längre tid inte ska användas eller om batterierna är slut. Använd aldrig skadade batterier. Använd bara batterier av den typ som rekommenderats, eller av en motsvarande typ. Sätt i batterierna så att polerna hamnar i rätt läge. Laddningsbara batterier måste laddas med rätt slags batteriladdare och under en vuxens överinnsyn. Du kan inte ladda batterierna medan de fortfarande sitter i produkten, och du får heller aldrig försöka göra det. Försök aldrig ladda icke laddningsbara batterier. Kortslut aldrig batteriutrymmets kontaktytor.

PT

Informações importantes acerca das pilhas

Nunca use tipos diferentes de pilhas em conjunto, nem uma combinação de pilhas velhas e novas. Retire sempre as pilhas se o produto não vai ser utilizado durante muito tempo ou se as pilhas se tiverem gasto. Nunca use pilhas danificadas. Use apenas pilhas do tipo recomendado ou de um tipo correspondente. Introduza as pilhas de forma a que os seus pólos fiquem correctamente posicionados. Pilhas recarregáveis deverão ser recarregadas utilizando o recarregador de pilhas correcto sob a supervisão de um adulto. Não é possível recarregar pilhas recarregáveis enquanto elas ainda se encontram dentro do produto, e nunca devem ser feitas tentativas nesse sentido. Nunca tente recarregar pilhas não recarregáveis. Nunca faça curto-circuito do compartimento das pilhas.

EL

Σημαντικές πληροφορίες για τις μπαταρίες
Μη χρησιμοποιείτε ποτέ διαφορετικούς τύπους μπαταριών, ή παλιές και καινούριες μπαταρίες μαζί. Βγάλτε πάντα τις μπαταρίες αν δεν χρησιμοποιήσετε το προϊόν για αρκετό καιρό ή αν οι μπαταρίες έχουν αδειάσει. Ποτέ μη χρησιμοποιείτε χαλασμένες μπαταρίες. Χρησιμοποιείτε μόνο μπαταρίες του συνιστώμενου τύπου, ή αντίστοιχου τύπου. Βάλτε τις μπαταρίες με την σωστή πολικότητα. Θα πρέπει να φορτίζετε τις επαναφορτιζόμενες μπαταρίες χρησιμοποιώντας τον κατάλληλο φορτιστή μπαταριών υπό την επίβλεψη ενός ενήλικου. Δεν μπορείτε να επαναφορτίζετε τις μπαταρίες όταν αυτές βρίσκονται μέσα στο προϊόν, και ποτέ μην επιχειρήσετε να κάνετε κάτι τέτοιο. Μην επιχειρήσετε ποτέ να επαναφορτίσετε μη επαναφορτιζόμενες μπαταρίες. Ποτέ μη βραχυκυκλώνετε τη θήκη των μπαταριών.

JA

電池の取り扱いに関する注意

異なるタイプの電池や、古い電池と新しい電池を混ぜて使用しないで下さい。長時間鳴きを使用しない時や電池が切れた時は、必ず電池を取り外してください。電池は推奨されている種類か、もしくは対応する種類のみを使用してください。電極を確認して正しい方向に電池を入れてください。充電電池を使用する際は保護者の監督の元、正しく充電をして使用してください。商品の中に入れたまま電池を充電することは絶対に避けてください。充電電池ではない電池を充電したり、電極をショートさせたりしないでください。

ZH

電池使用須知

切勿將不同種類的電池一起使用，亦不要把舊電池與新電池混合使用。如有一段長時間不會使用本產品或電池已耗盡，請把電池拆除。切勿使用已損壞之電池。只可使用建議中之電池型號，或其他兼容式型號。請根據指示安裝電池。

你可以使用充電的循環電池，但必須採用適當的充電器，並在成年人的指導下方可進行充電。電池仍在產品內是不能充電的，請勿強行嘗試。切勿強行為非循環電池充電。亦切勿自行接駁電池箱的兩極，以免產生短路。

KO

간접지 사용자 주의 사항

다른 전지(마리, 또는 새 전지)와 구 전지를 혼합해서 사용하지 마십시오. 장기간 제품을 사용하지 않을 경우는 전지를 제품에서부터 제거해 주십시오. 재생가능전지(rechargeable battery)는 어린이의 동적 하에 충전이 이루어지지 않습니다. 또한 재생가능전지(rechargeable battery)는 제품 안에서 충전을 할 수 없으므로, 절대로 충전해서는 안됩니다. 그리고, 재생가능전지(rechargeable battery)가 아닌 전지를 충전해서는 안됩니다.

RU

Необходимая информация об элементах питания

Ни в коем случае не используйте одновременно элементы питания различных типов, а также элементы питания с разным сроком годности. В обязательном порядке вынимайте элементы питания из терминалов в случае, если вы не используете прибором в течение долгого времени либо в случае, если в элементах питания закончился заряд. Ни в коем случае не используйте поврежденные элементы питания. Используйте только рекомендуемые элементы питания, либо элементы питания соответствующего типа. Установите элементы питания, соблюдая указанную полярность. Акумуляторные элементы питания должны подзарядиться в соответствующем зарядном устройстве под наблюдением взрослого. Ни в коем случае не пытайтесь подзарядить элементы питания, находящиеся в приборе. Ни в коем случае не пытайтесь подзарядить перезаряжаемые элементы питания. Ни в коем случае не пытайтесь замкнуть полюса в устройстве для элементов питания.

PL

Ważne informacje dotyczące baterii

Nigdy nie należy stosować razem różnych rodzajów baterii ani stosować równocześnie starych i nowych baterii. Jeżeli produkt nie jest używany przez dłuższy czas lub jeżeli baterie się wyczerpały, należy wyjąć baterie. Nigdy nie należy stosować uszkodzonych baterii. Należy stosować wyłącznie zalecany rodzaj baterii lub rodzaj mu odpowiadający. Przy wkładaniu baterii należy zwrócić uwagę na właściwe położenie biegunów. Baterie akumulatorowe należy ładować w odpowiedniej ładowarce pod nadzorem osoby dorosłej. Nie można naładować baterii bez wyjścia ich z produktu i nigdy nie należy tego próbować. Nigdy nie należy próbować ładowania baterii jednorazowych. Nigdy nie należy doprowadzać do zwarcia w gnieździe baterii.

CZ

Důležitá informace o bateriích

Nikdy nepoužívejte najednou různé typy baterií nebo kombinaci starých a nových baterií. Nebudete-li výrobek delší dobu používat nebo jsou-li baterie vybité, vždy je vyjměte z výrobku. Nikdy nepoužívejte poškozené baterie. Používejte pouze doporučené nebo odpovídající typy baterií. Baterie instalujte se správnou orientací pólů. Nabíjecí baterie musí být nabity ve vhodné nabíječce pod dohledem dospělé osoby. Nabíjecí baterie nelze nabíjet, jsou-li umístěny ve výrobku, a nesmíte se o to ani pokoušet. Nikdy se nesnažte nabíjet baterie, které nejsou nabíjecí. Nikdy nezkratujte kontakty v prostoru pro baterie.

SK

Dôležitá informácia o batériách

Nikdy nepoužívajte naraz odlišné typy batérií ani nekombinujte staré batérie s novými. Batérie vždy vyberte, ak sa výrobok nebude dlhšie používať, alebo ak sa batérie vybili. Nikdy nepoužívajte poškodené batérie. Používajte len odporúčané alebo zodpovedajúce typy batérií. Batérie vkladajte so správnou orientáciou pólou. Dobíjateľné batérie sa musia nabíjať vo vhodnom nabíjači pod dozorom dospelého osoby. Dobíjateľné batérie sa nesmú nabíjať, ak sú umiestnené vo výrobku, a nesmiete sa o to ani pokúšať. Nikdy sa nesnažte nabíjať batérie, ktoré nie sú dobíjateľné. Nikdy neskratuje kontakty v priestore pre batérie.

HU

Fontos tudnivalók az elemekről

Soha ne használjunk különböző típusú elemeket, illetve ne használjunk új és használt elemet egyszerre. Mindig távolítsuk el az elemeket, ha a készüléket előre láthatóan hosszú ideig nem fogjuk használni, vagy ha az elem lemerültek. Soha ne használjunk megromlódot elemet. Csak az ajánlott típusú, vagy annak megfelelő elemet használjuk. Az elemeket a polaritásuknak megfelelő módon helyezük be. Az akkumulátorokat csak a megfelelő akkumulátortöltővel szabad feltölteni, egy felnőtt segít felügyelet mellett. Az akkumulátorokat nem tölthetjük fel úgy, hogy azok a termékben vannak, ezt meg sem szabad próbálnunk. Soha ne próbáljuk meg feltölteni a nem tölthető elemet. Soha ne hozzunk létre rövidzárlatot az elemtartó kivezetései között.

UA

Необхідна інформація про батареї

Ніколи не використовуйте одночасно батареї різних типів або батареї з різним строком вживання. Обов'язково вилучайте батареї з прибору якщо довгочасно не користуватесь їм, або якщо в батареї вже скінчився заряд. Ніколи не використовуйте пошкоджені батареї. Використовуйте батареї лише рекомендованого або відповідного типу. Вставляйте батареї, враховуючи задану полярність. Акумуляторні батареї повинні заряджатись у відповідному зарядному приладі під наглядом дорослого. В будь-якому випадку не намагайтесь підзарядити батареї, що знаходяться в приборі. В будь-якому випадку не намагайтесь підзарядити батареї, що не підлягають підзарядці. В будь-якому випадку не намагайтесь зробити коротке замикання в приладі для батарей.

HR

Važne informacije o baterijama

Nikada ne koristite različite vrste baterija zajedno, kao niti kombinaciju starih i novih baterija. Uvijek izvadite baterije ako uređaj neće biti korišten duže vrijeme ili ako su baterije prazne. Nikada ne koristite oštećene baterije. Upotrebljavajte samo preporučenu vrstu baterija ili njima ekvivalentni tip. Umetnite baterije tako da su im polovi ispravno orijentirani. Baterije koje se mogu puniti moraju biti punjene u odgovarajućem punjaču baterija pod nadzorom odrasle osobe. Ne možete puniti baterije dok su umetnute u uređaj i to nikada niti ne pokušavajte. Nikada ne pokušavajte napuniti baterije koje se ne mogu puniti. Nikada kratkim spojem ne spajajte polove baterija.

SR

Важне информације о батеријама

Nikada ne koristite različite tipove baterija zajedno, i ne kombinujte stare baterije sa novima. Uvek izvadite baterije ukoliko proizvod nećete koristiti duže vreme ili ako su baterije ispraznile. Nikada ne upotrebljavajte oštećene baterije. Koristite isključivo tip baterija koji se preporučuje ili odgovarajuću zamenu. Prilikom stavljanja baterija pazite da polovi budu pravilno postavljeni. Baterije na punjaci se moraju puniti uz upotrebu odgovarajućeg punjača i pod nadzorom odrasle osobe. Baterije se ne mogu puniti dok su u proizvodu, i to ne smete ni da pokušavate. Nikada ne pokušavajte da napunite baterije koje se ne pune. Nikada ne prespajajte polove kućišta za baterije.

SL

Pomembna informacija o baterijskih vložkih

Nikoli ne uporabite različne vrste baterijskih vložkov skupaj ali pa nove vložke skupaj z rabljenimi. Če so se baterijski vložki izpraznili ali če izdelka ne boste uporabljali dlje časa, morate vložke vedno odstraniti. Nikoli ne uporabite poškodovanih baterijskih vložkov. Uporabite samo priporočene tipy baterijskih vložkov ali enakovredne vložke. Baterijske vložke vstavite tako, da sta pola plus in minus pravilno usmerjena. Baterijske vložke za ponovno polnjenje morajo otroci polniti z ustreznim polnilcem samo pod nadzorom odrasle osebe. Pred polnjenjem morate vložke vedno izvelči iz igrače. Nikoli ne smete polniti baterijskih vložkov, medtem ko so še vedno v igrači. Nikoli ne poskušajte polniti baterijske vložke, ki niso namenjeni za ponovno polnjenje. V prostoru za baterijske vložke ne smete nikoli povzročiti kratkega stika.

RO

Informații importante cu privire la baterii

Nu folosiți niciodată împreună tipuri diferite de baterii și nici combinații de baterii noi și vechi. Îndepărtați întotdeauna bateriile dacă produsul nu este folosit timp îndelungat sau dacă bateriile s-au epuizat. Nu folosiți niciodată baterii deteriorate. Folosiți numai baterii de tipul recomandat, sau de un tip corespunzător. Introduceți bateriile astfel ca poliul să fie în poziție corectă. Bateriile reincărcabile trebuie reincărcate utilizând un dispozitiv de încărcare adecvat, sub supravegherea unui adult. Bateriile nu pot fi reincărcate cât timp sunt încă în produs, și nu încercați niciodată să le încărcați astfel. Nu încercați niciodată să reincărcăți baterii care nu sunt reincărcabile. Nu scurtcircuitați niciodată bornele suportului bateriei.

BG

Важна информация за батериите
Не използвайте различни типове батерии едновременно, нито комбинация от стари и нови батерии. Винаги изваждайте батериите, ако изделието няма да се използва продължително време или ако батериите са се изтозили. Не използвайте повредени батерии. Използвайте само батерии от препоръчания тип или съответстващ на него тип. Поставайте батериите така, че полюсите да са разположени правилно. Аккумуляторните батерии трябва да се зареждат с подходящо зареждащо устройство под надзора на възрастни. Батериите не могат да се зареждат, докато са поставени в изделието, така че не трябва да се опитвате да правите това. Не се опитвайте да зареждате батерии, които не са акумулаторни. Не свързвайте в късо съединение клемите на батериите.

LV

Svarīga informācija par barošanas elementiem

Nekad vienlaikus nelietojiet dažādu tipu, kā arī jaunu un vecu barošanas elementus. Arvien izņemiet barošanas elementus, ja tie izlādējušies vai to darbinātais izstrādājums ilgāku laiku netiek lietots. Nekad nelietojiet bojātus barošanas elementus. Lietojiet tikai ieteicamā tipa barošanas elementus vai tiem atbilstošus analogus. Ievietojot barošanas elementus, jāievēro pareiza to pievienojuma polaritāte (+/-). Uzlādējumu barošanas elementu lādēšanai jāizmanto atbilstošs barošanas elementu lādētājs, uzlādēšana jāveic pieaugušo uzraudzībā. Izstrādājumā ievietotus barošanas elementus uzlādēt nav iespējams, mēģinājumi to darīt nav pieļaujami. Nekad nemēģiniet uzlādēt neuzlādējamus barošanas elementus. Nekad nepieļaujiet īsslēgumu starp barošanas elementu tilpnes kontaktiem.

ET

Oluline teave patareide kohta

Mitte kunagi ära pane mänguasja sisse koos erinevat tüüpi patareisid, samuti vanu ja uusi patareisid. Kui mänguasja ei kasutata pika aja jooksul, võta patareid sellest välja. Ka tühjakssaanud patareid tuleb mänguasjast välja võtta. Ära kasuta kahjustatud patareisid. Kasuta ainult ettenähtud tüüpi või neile samaväärseid patareisid. Pane patareid mänguasja sisse nii, et pluss- ja miinuskllemi asend oleks õige. Akusid tuleb laadida ainult nendele ettenähtud akulaadija abil täiskasvanu järelevalve all. Akusid ei saa laadida sel ajal, kui need on mänguasja sees. Ära kunagi püüa nii teha. Ära mitte kunagi proovi akulaadijaga laadida tavalisi patareisid. Patareipesa klemmide vahel ei tohi tekkida lühisid.

LT

Svarbi informacija apie elementus

Nesinaudokite vienu metu skirtingų tipų elementais, taip pat su naujais elementais nenaudokite senų elementų. Išimkite elementus iš įdėklo, jeigu nesinaudosite gaminiu ilgą laiką arba jeigu elementai išsiseikvojo. Nesinaudokite sugadintais elementais. Naudokitės tik rekomenduojamo arba atitinkamo tipo elementais. Įdėkite elementus taip, kad atitiktų teigiami ir neigiami poliai. Akumuliatorinius elementus galima įkrauti tik tinkamu elementų krovikliu, prižiūrint suaugusiųsiems. Elementų negalima įkrauti, neišėmus jų iš įdėklo, ir nebandykite to daryti. Nebandykite įkrauti neakumuliatorinio tipo elementų. Nedarykite trumpo jungimo elementų įdėklo.

TR

Piller hakkında önemli bilgiler

Hiçbir zaman değişik tipte pilleri ya da eski pillerle yeni pilleri bir arada kullanmayın. Pili ürün uzun süre kullanılmayacaksa ya da piller bitmişse, pilleri çıkarın. Hiçbir zaman zedelenmiş piller kullanmayın. Yalnız önerilen tipte piller ya da bunların dengi olan piller kullanın. Pilleri kutupları doğru konumda olacak şekilde yerleştirin. Bitince yeniden doldurulabilen piller doğru pil doldurucuyu kullanarak, bir yetiskinin denetiminde alında doldurulmalıdır. Doldurulabilen pilleri ürününcin denetimden dolduramazsınız; hiçbir zaman bunu yapmaya çalışmayın. Hiçbir zaman, bitince doldurulamayan tip pilleri yeniden doldurmaya çalışmayın. Hiçbir zaman pil kutusunda kısa devre yapılmayın.



EN	Protect the environment by not disposing of this product with your household waste (2002/96/EC). Check with your local authority for recycling advice and facilities.
DE	Schützen Sie die Umwelt und entsorgen Sie dieses Produkt nicht mit Ihrem Hausmüll (2002/96/EC). Informationen zu Recycling-Möglichkeiten erhalten Sie bei den örtlichen Behörden.
FR	Protégez l'environnement : ne jetez pas ce produit avec vos autres déchets ménagers (Directive européenne 2002/96/EC). Contactez les autorités locales pour obtenir des informations sur le recyclage et connaître les points de collecte.
IT	Proteggi l'ambiente! Non smaltire questo prodotto con i rifiuti domestici (2002/96/EC). Per consulenza sul riciclaggio dei rifiuti e le strutture di riciclaggio, rivolgersi alle proprie autorità locali.
NL	Bescherm het milieu: gooi dit product niet samen met het andere huisvuil weg (2002/96/EC). Raadpleeg de plaatselijke instanties voor locaties van milieustation en advies over hergebruik.
ES	Proteja el medio ambiente no deshaciéndose de este producto junto con sus residuos domésticos (2002/96/EC). Solicite a su autoridad local consejos e información sobre instalaciones de reciclado.
DA	Beskyt miljøet! Smid ikke dette produkt ud sammen med husholdningsaffaldet (2002/96/EF). Få vejledning om genbrug og genbrugsstationer hos din kommune.
FI	Tämä tuote on hävitettävä ympäristönsuojelun vuoksi asianmukaisesti talousjätteistä erillään (2002/96/EC). Tietoja kierrätyspisteiden sijainnista saa kunnan tai kaupungin teknisestä virastosta.
SV	Skydda miljön genom att inte kasta denna produkt bland ditt hushållsavfall (2002/96/EC). Kontakta din kommun för frågor om återvinning och miljöstationer.
PT	Proteja o ambiente não eliminando este produto com o seu lixo doméstico (2002/96/CE). Consulte as autoridades locais para informação sobre reciclagem e sistemas de recolha.



EL	Προστατέψτε το περιβάλλον. Μην πετάτε αυτό το προϊόν μαζί με τα συνηθισμένα οικιακά απορρίμματα (2002/96/EC). Επικοινωνήστε με τις τοπικές αρχές σχετικά με συμβουλές και εγκαταστάσεις ανακύκλωσης.
PL	Aby chronić środowisko naturalne, nie należy wyrzucać tego produktu wraz z odpadkami z gospodarstwa domowego (2002/96/WE). W celu uzyskania wskazówek dotyczących recyklingu oraz adresów zakładów należy skontaktować się z lokalnym urzędem.
CZ	Nevyhazujte tento produkt do domácího odpadu, chraňte životní prostředí (2002/96/EC). Zjistěte si prosím u místních úřadů možnosti recyklace a dostupná zařízení.
SK	Nevyhádzajte tento produkt do domáceho odpadu, chráňte životné prostredie (2002/96/EC). Zistite si prosím na miestnych úradoch možnosti recyklácie a dostupné zariadenia.
HU	Környezetét óvja, ha ettől a terméktől nem a háztartási hulladékkal együtt válik meg (2002/96/EC). Érdeklődjék a lakóhelyéhez közel eső hatóságnál az újrahasznosítás módjáról és lehetőségeiről.
SL	Zaščitite okolje! Okolje varujte tako, da tega izdelka ne zavržete skupaj z gospodinjскими odpadki (v skladu z direktivo 2002/96/ES). Pri krajevni upravi preverite, kakšne možnosti in kateri obrati za recikliranje obstajajo v vaši okolici.
LV	Lai saudzētu vidi, neizmetiet šo izstrādājumu kopā ar sadzīves atkritumiem (2002/96/EC). Vērsieties vietējās varas iestādēs, lai noskaidrotu, kur un kā tas nododams pārstrādei.
ET	Keskkonda saate kaitsa nii, et ei kõrvalda seda toodet koos olmejäätmetega (2002/96/EÜ). Nõuandeid toote taaskasutusse võtmise ja ümbertöötlemispunktide kohta saate asjaomaset kohalikult asutuselt.
LT	Saugokite aplinką – nemeskite šio produkto kartu su buitinėmis atliekomis (2002/96/EB). Atsižvelkite į savo vietos valdžios rekomendacijas dėl pakartotinio panaudojimo ir sąlygas.

1

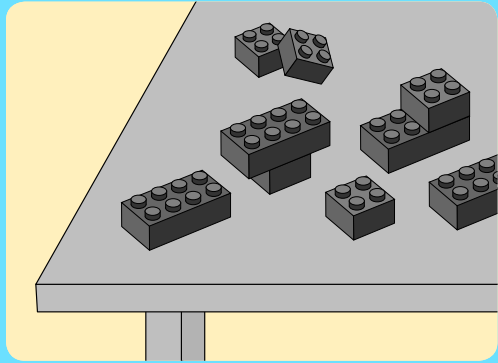
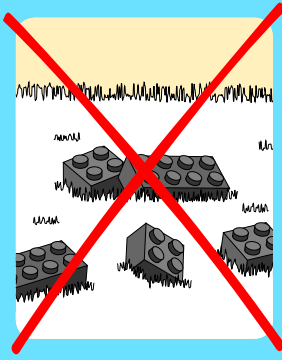

2

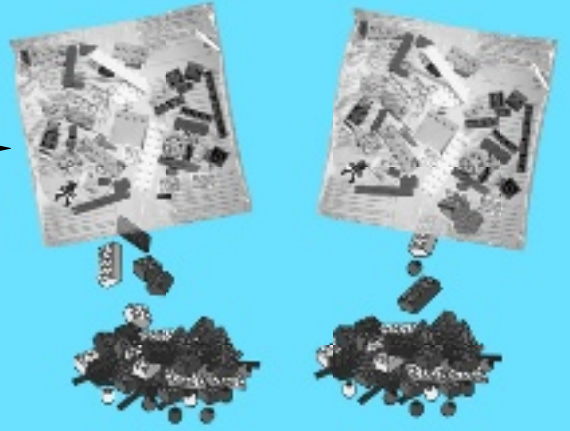



1

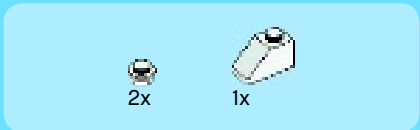
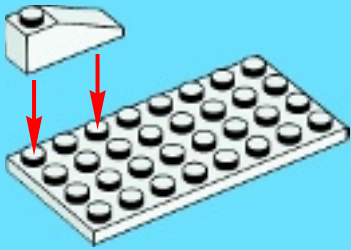

2

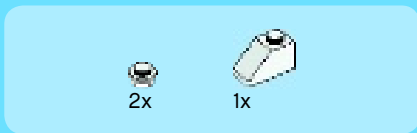

3

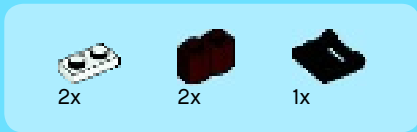

4

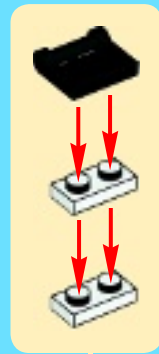

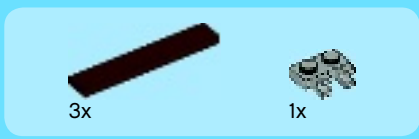

5

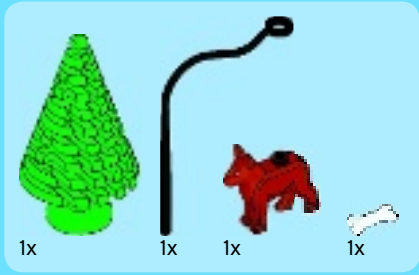
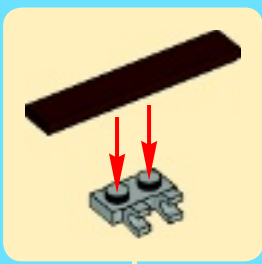

6



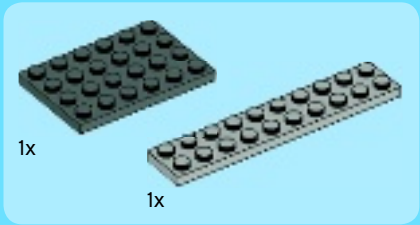

1

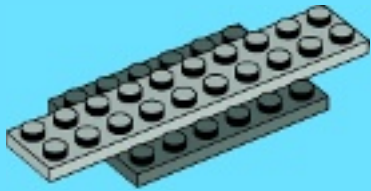

2

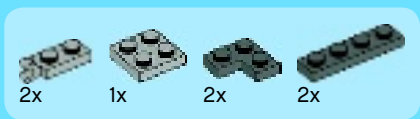

3

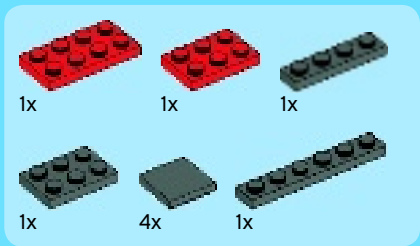
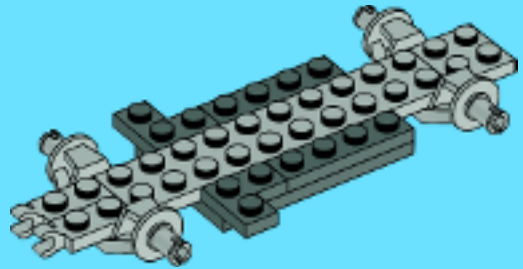

4

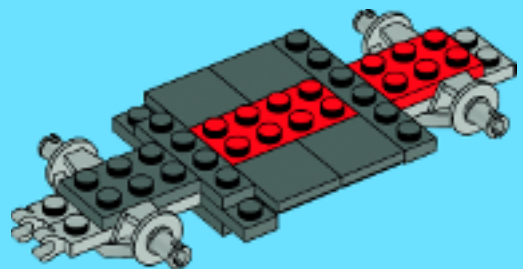

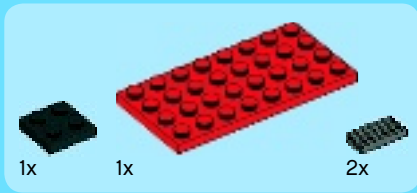

5

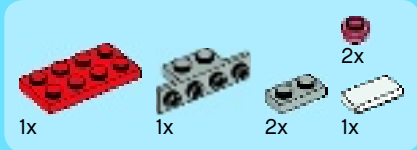
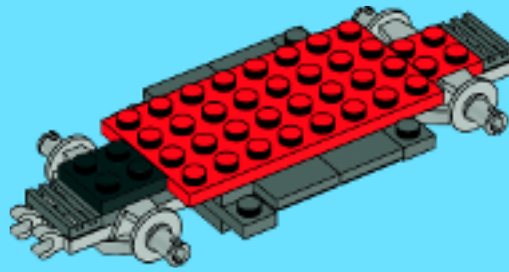

6

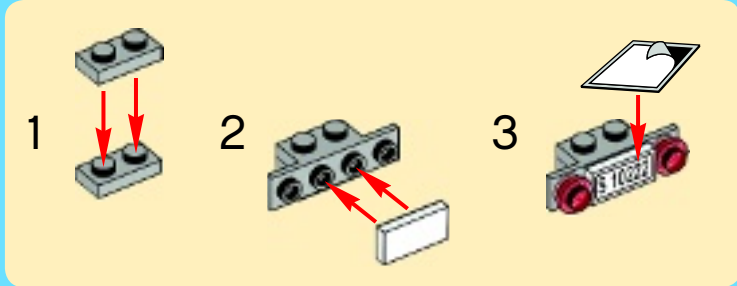

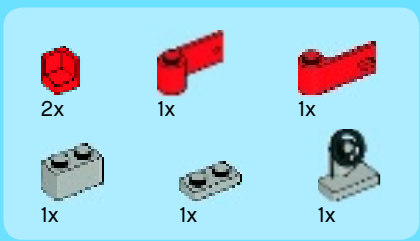

7

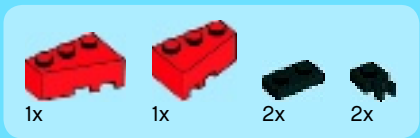
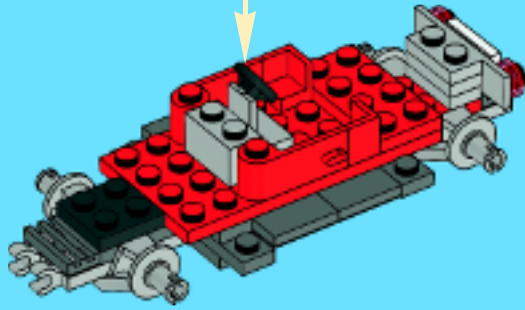
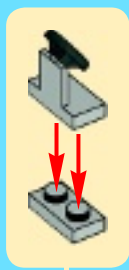

8

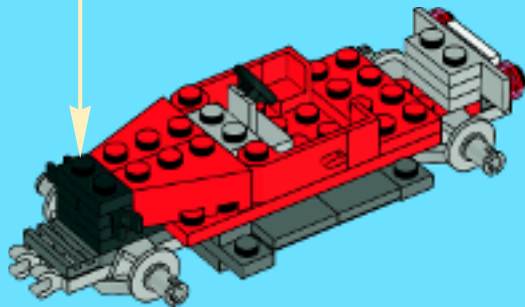
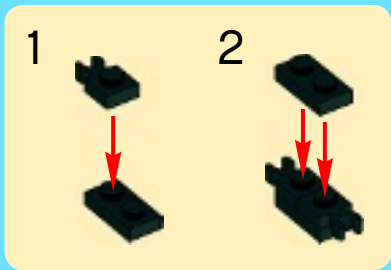

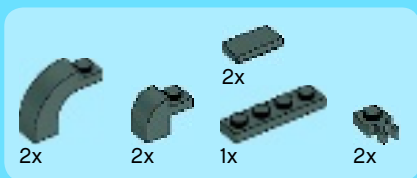

9

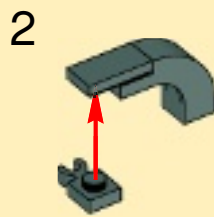
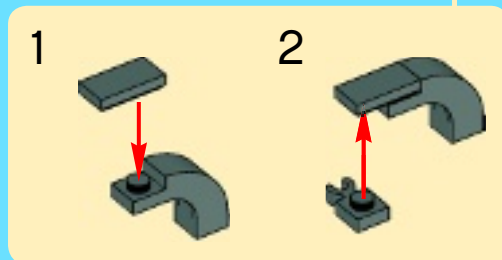
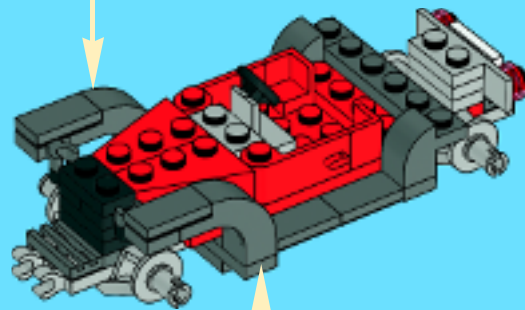
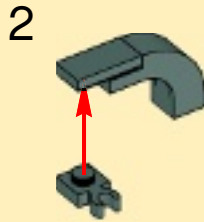
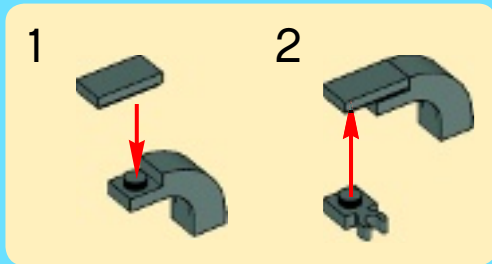



2x



1x



2x

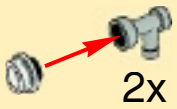

2x

10

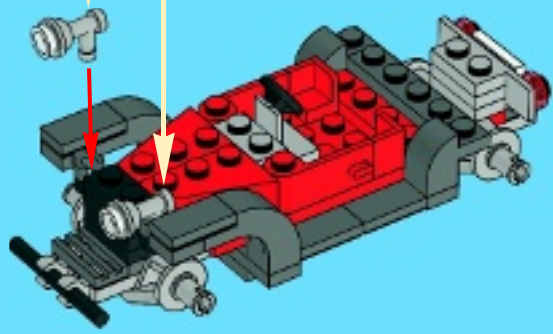

1x



1x



1x



1x



1x

11

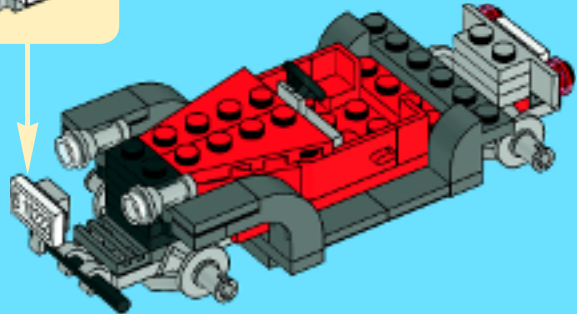
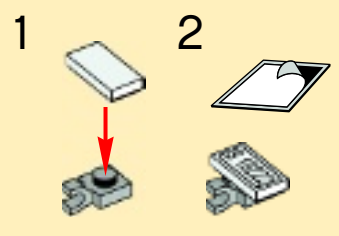

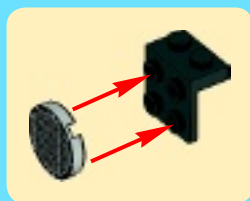
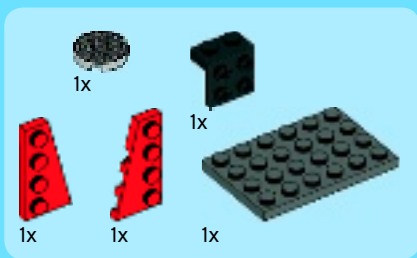

12

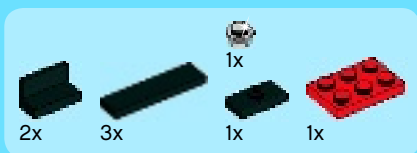
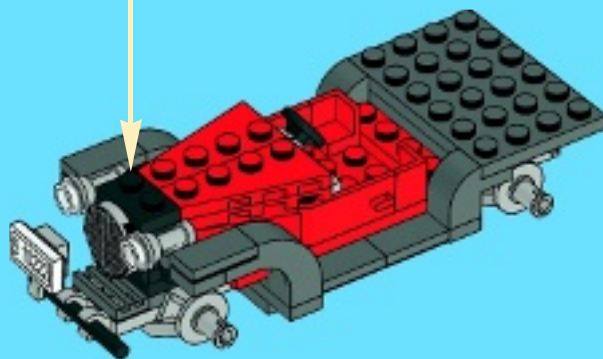

13

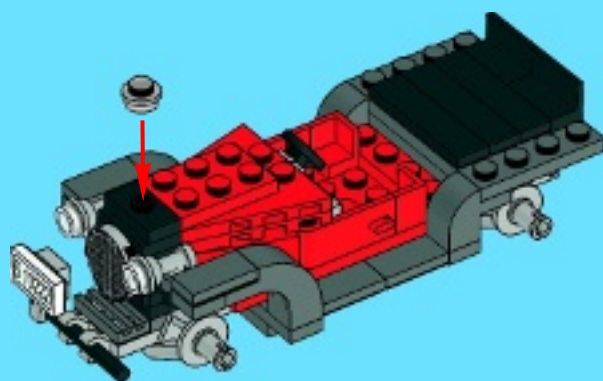



1x



1x

1

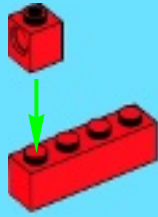

1x



1x

2

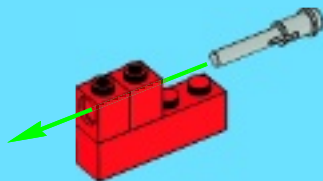

2x



1x

3

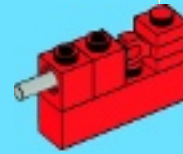
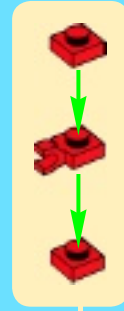

1x



1x

4

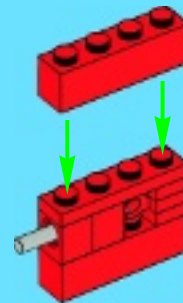



2x



1x

5

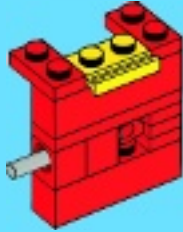

2x



2x

6

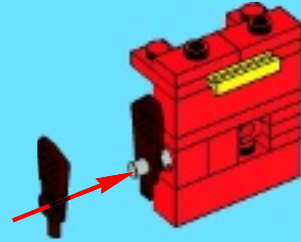

14

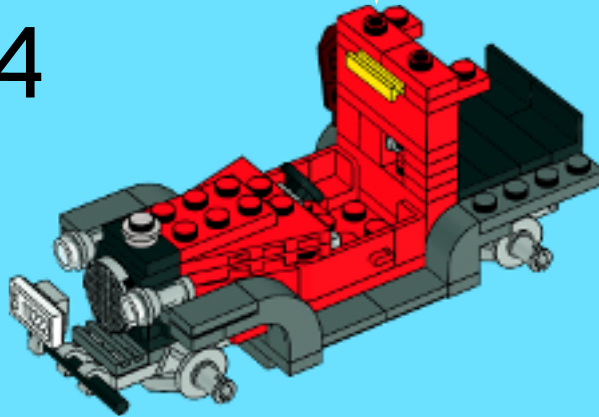



2x

15

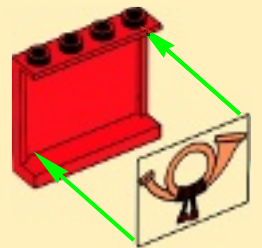
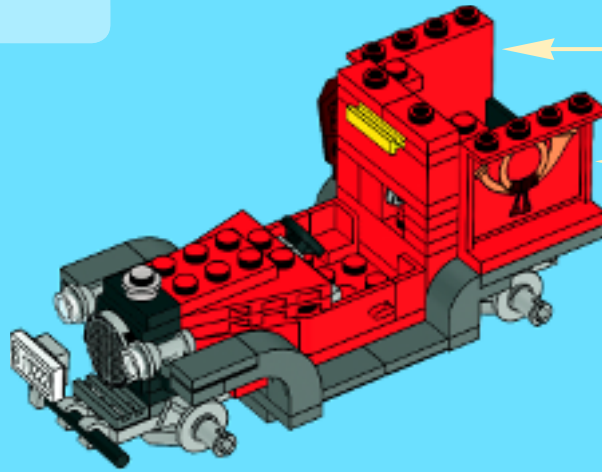

2x



16

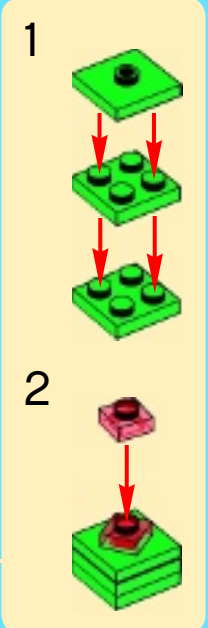
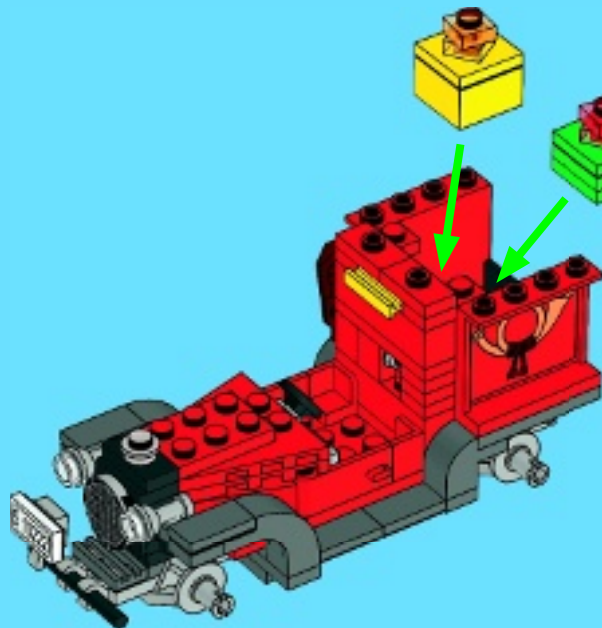
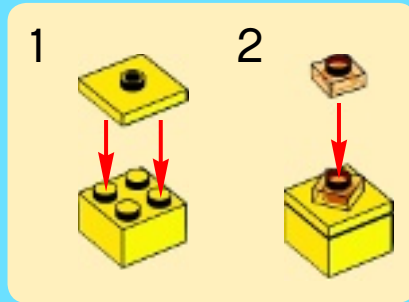



1x

17

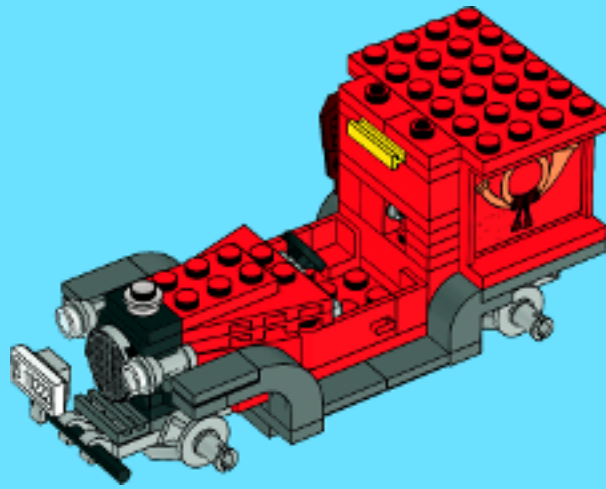

8x



1x

18

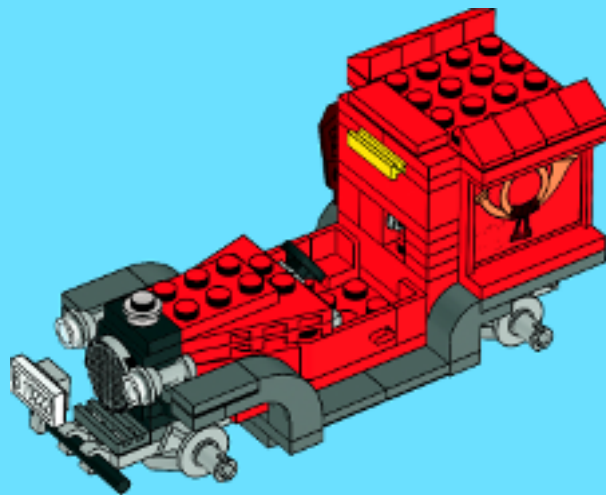



2x



2x



1x

19

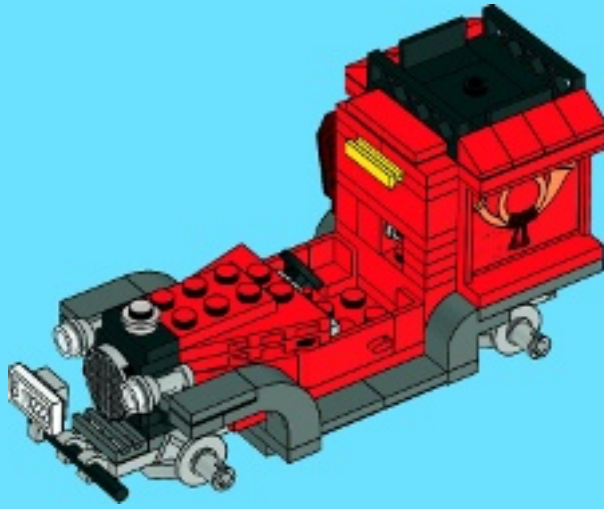

2x

20

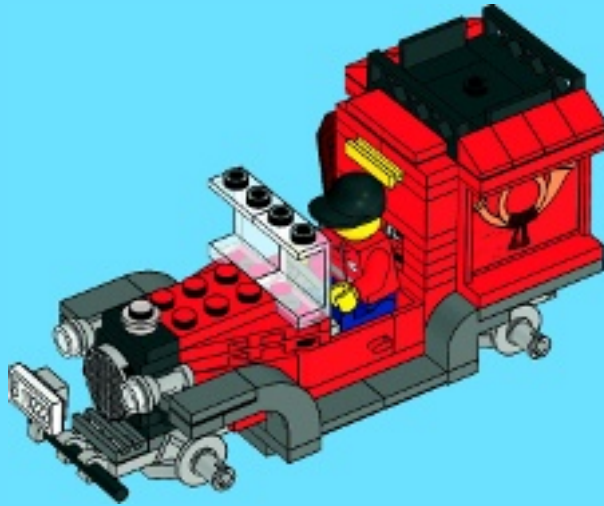



1x



1x

21

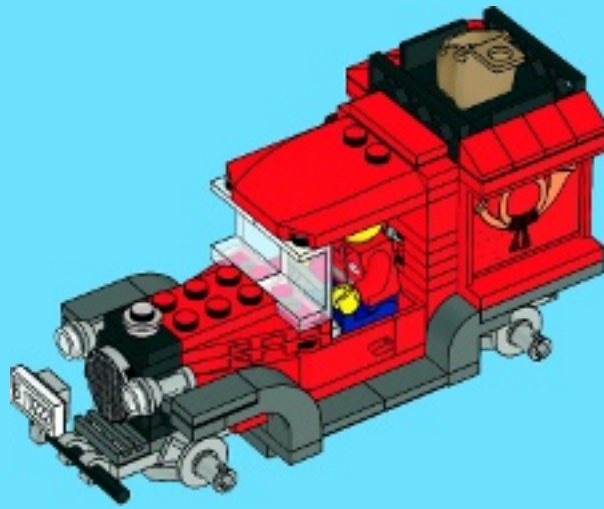

4x



4x

22



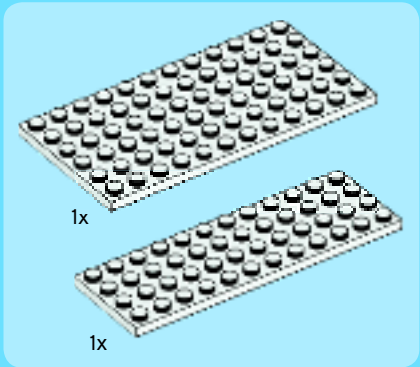

1

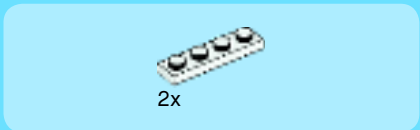
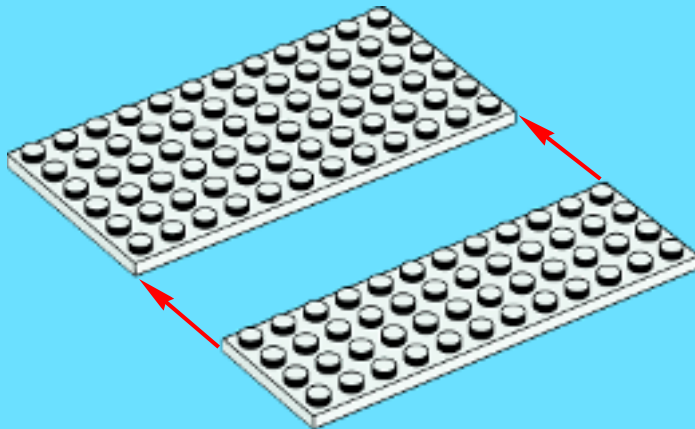

2

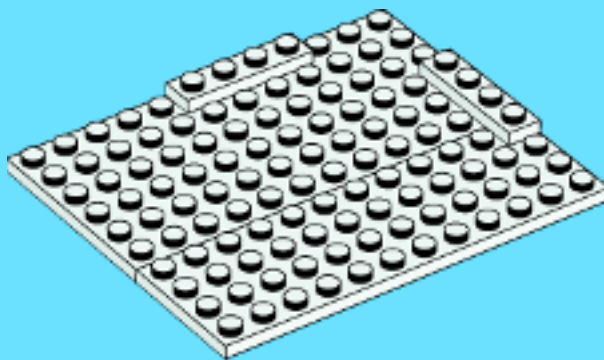



3x

3

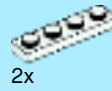
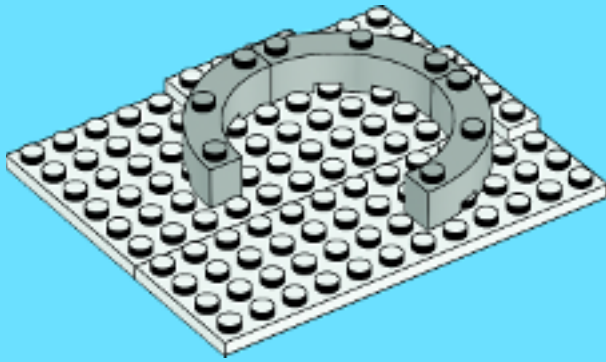

2x



1x



1x

5

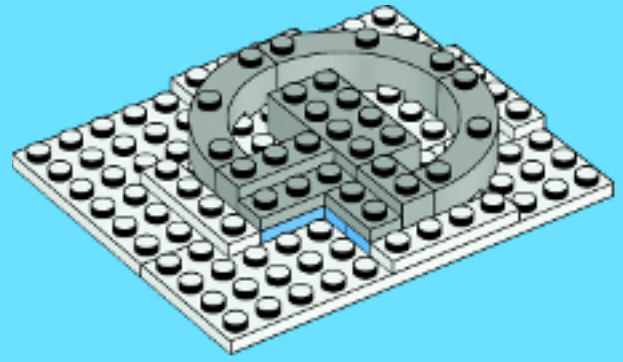

2x



1x



1x



1x



1x

4

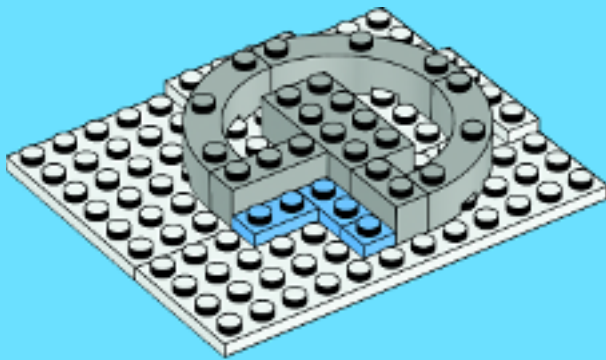

4x



1x



2x



1x

6

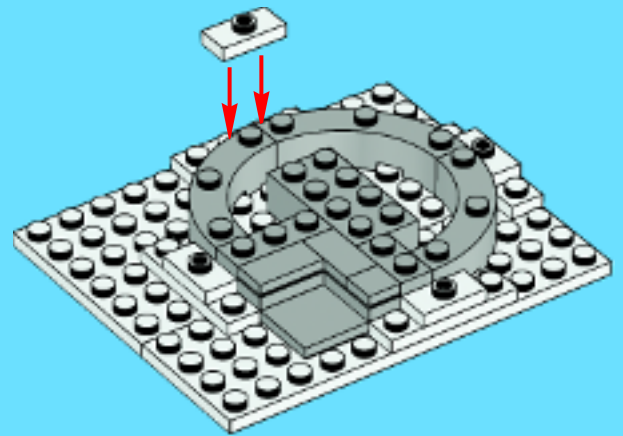



3x



1x



3x

7

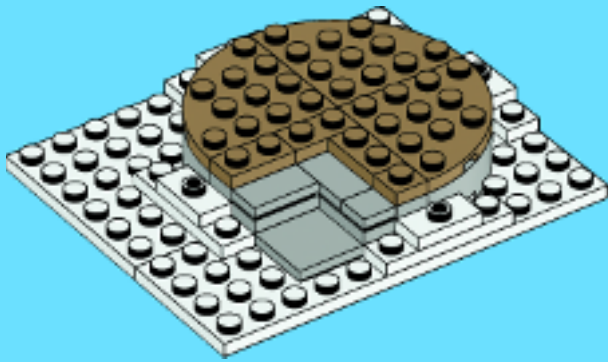

4x



3x

9

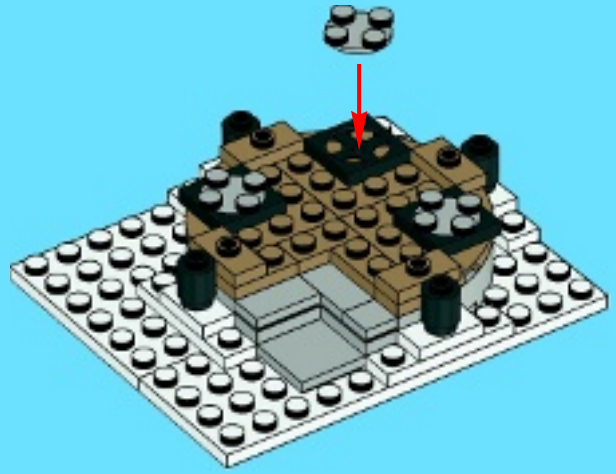

3x



4x

8

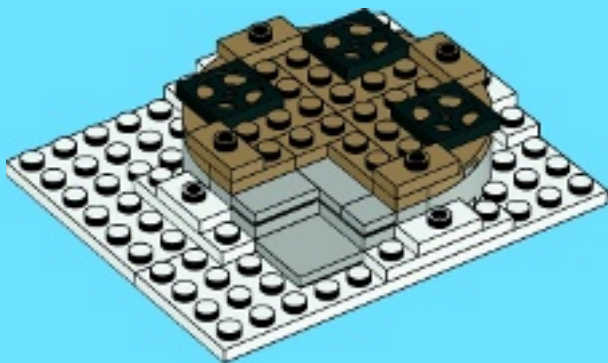

3x

10

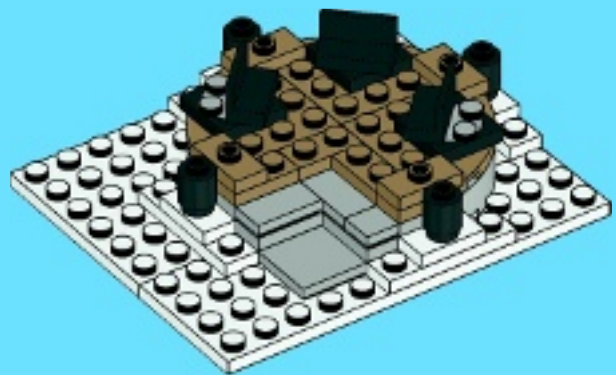



1

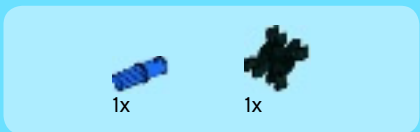
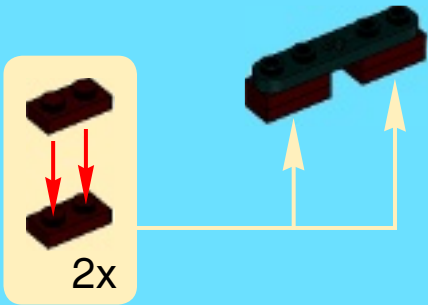

2

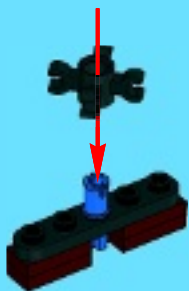

3

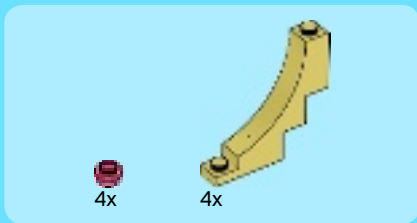
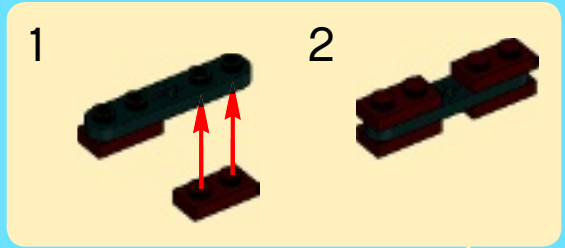

4

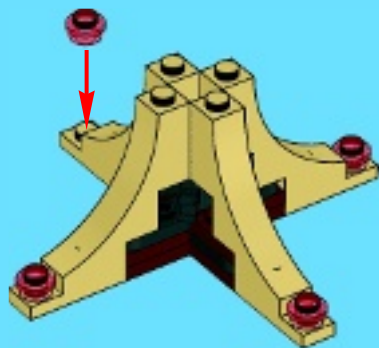

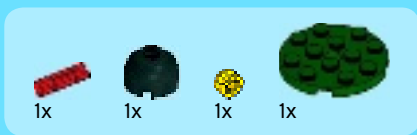

5



13



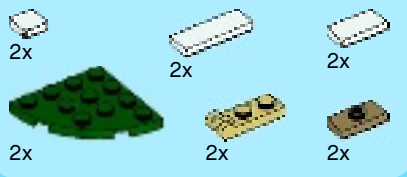

14

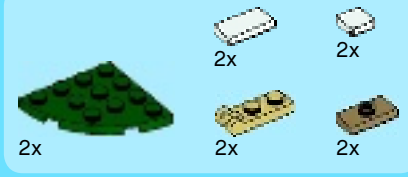
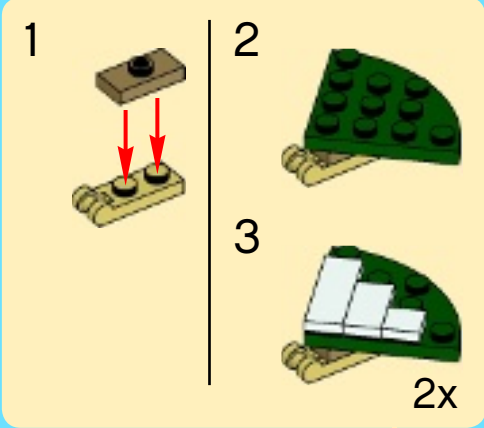

15

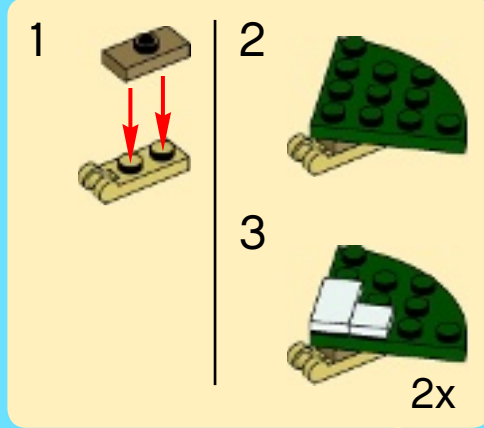



2x



1x

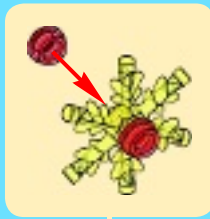

16



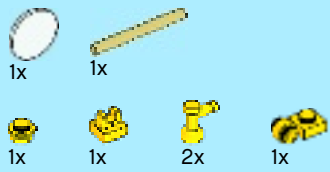

17

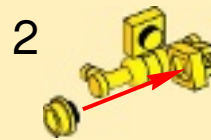
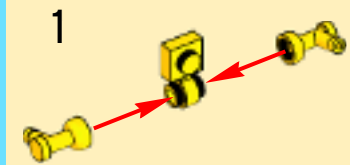
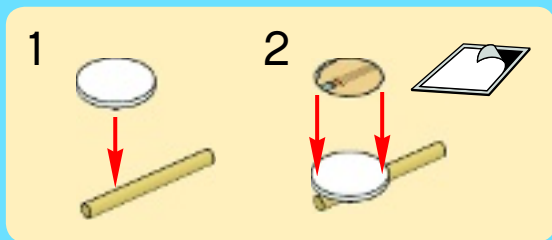

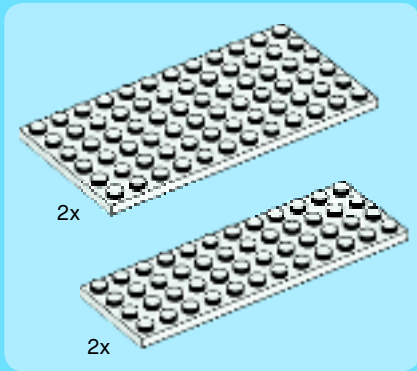

1

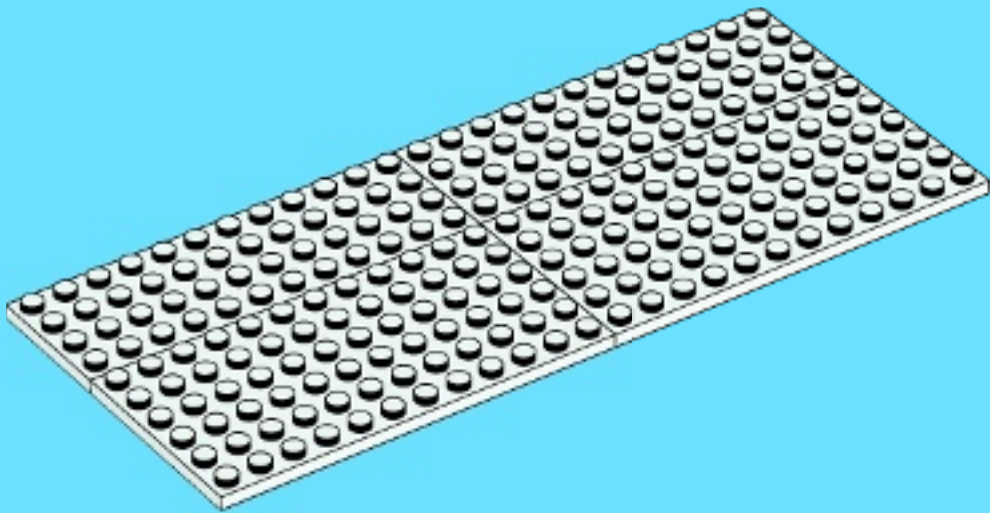



1x



1x

2

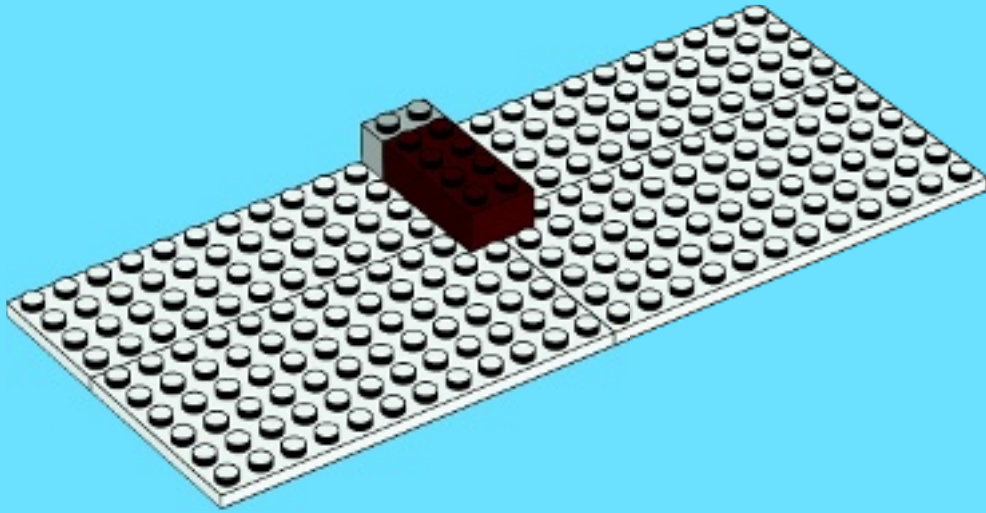

5x



5x



5x



6x

3

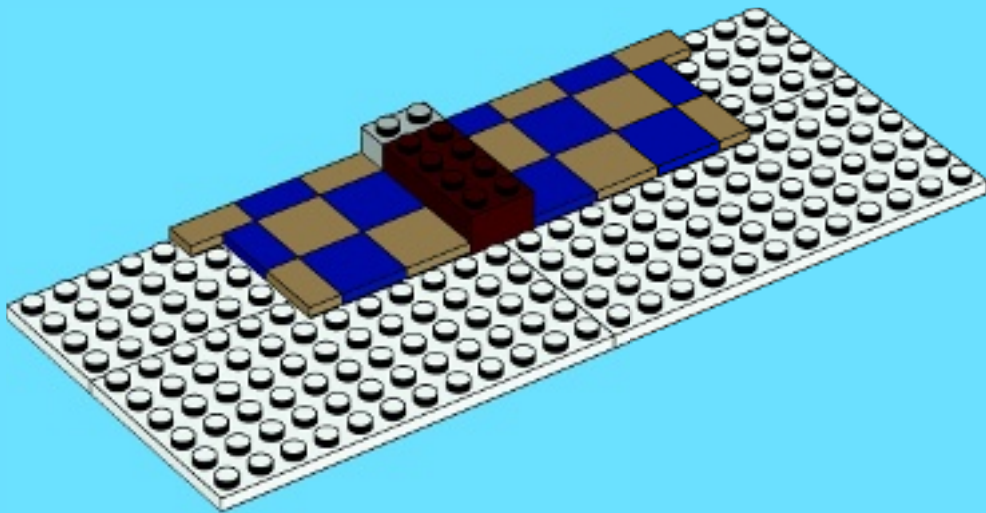

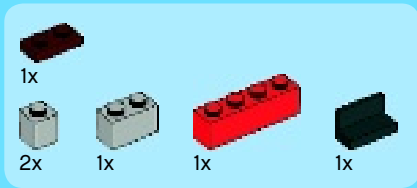

4

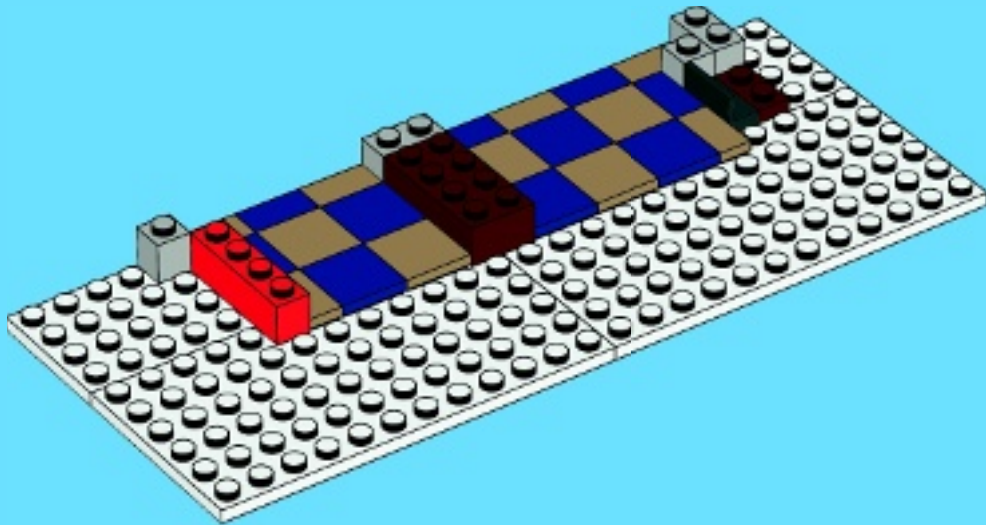

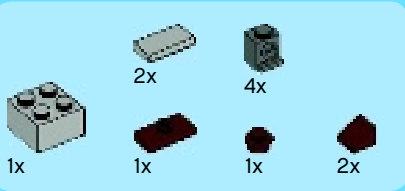

5

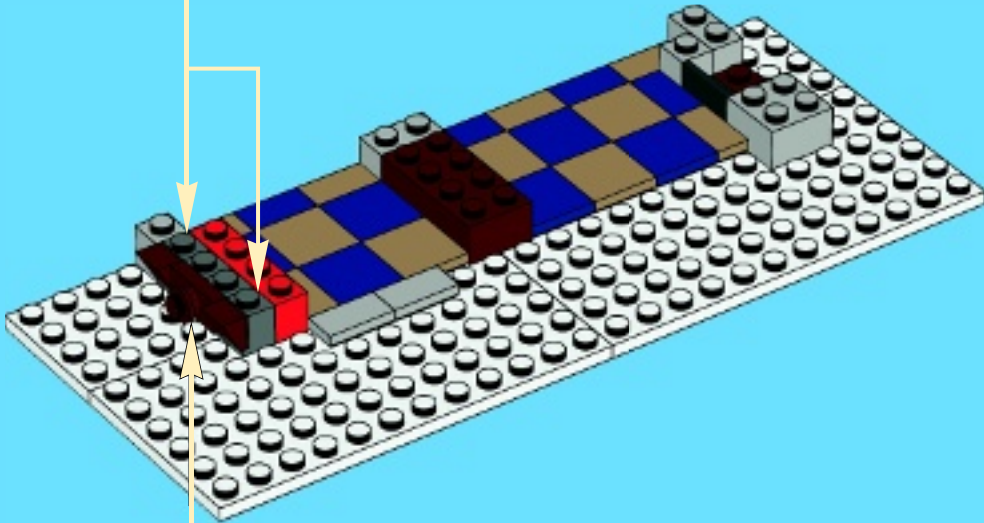
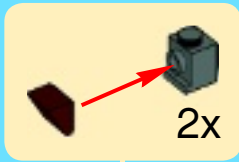

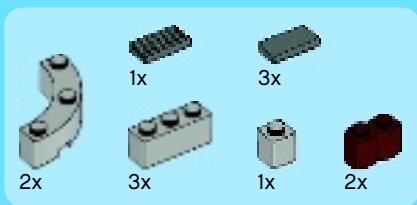

6

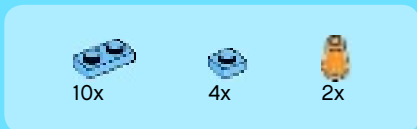
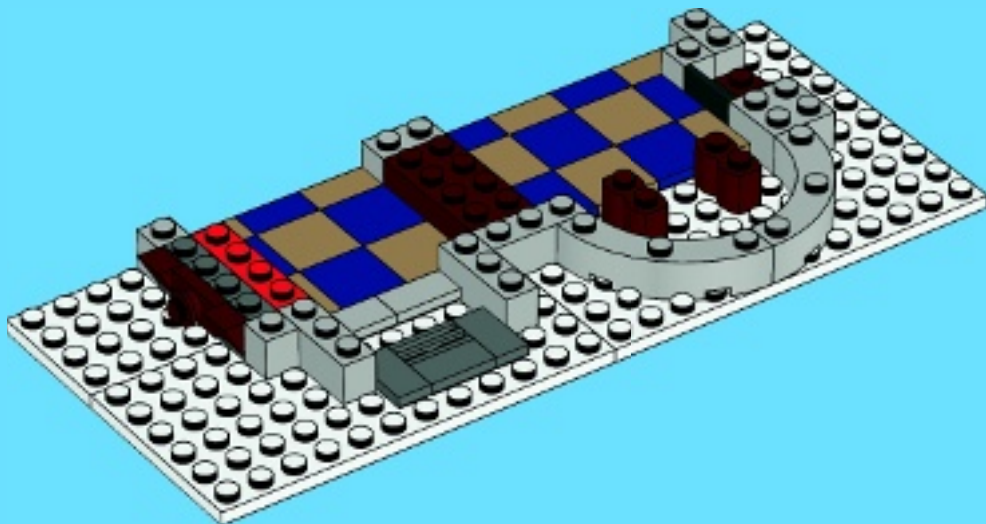

7

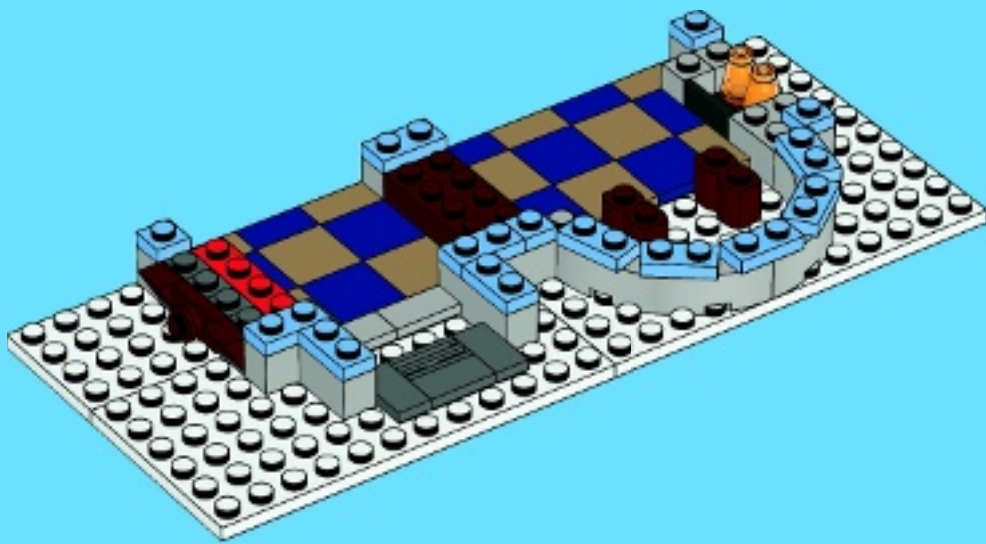



1x



2x



1x

8

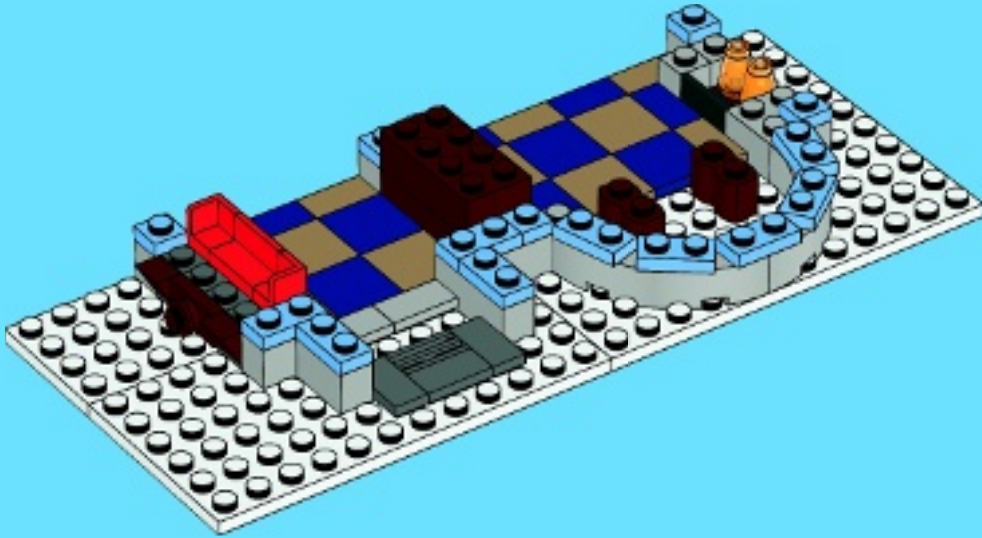

2x



3x



2x



1x



1x



9

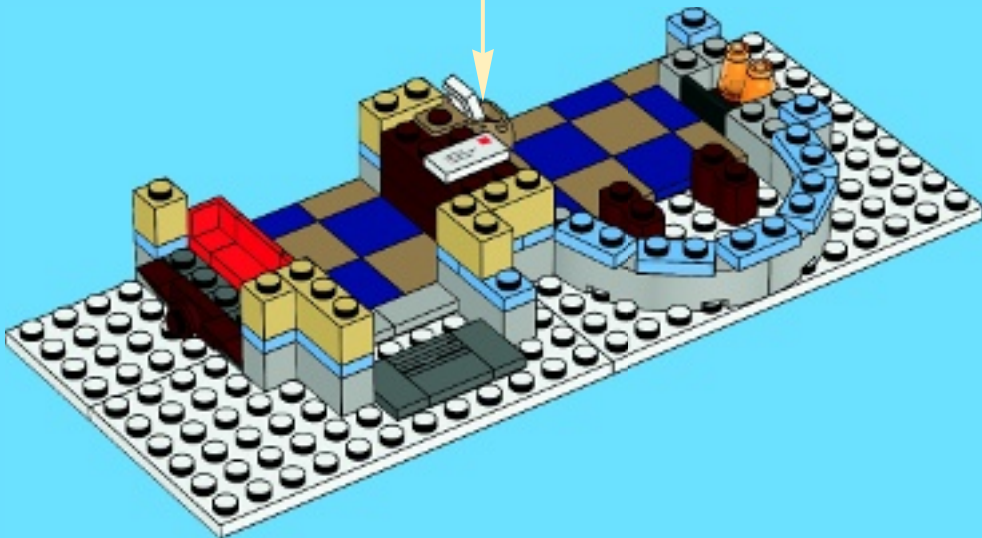

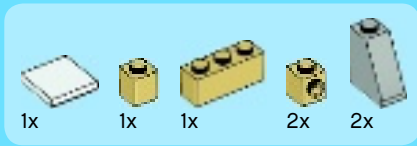

10

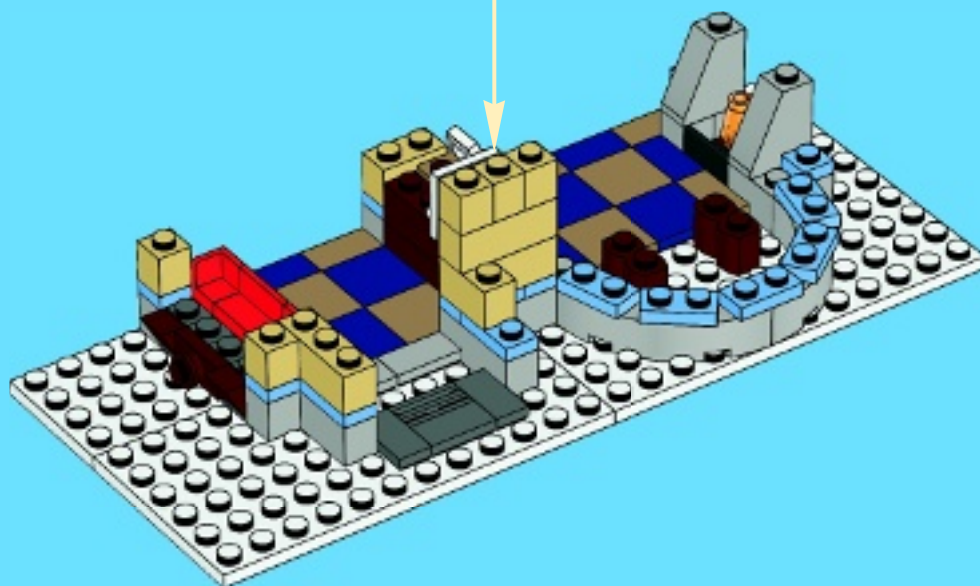
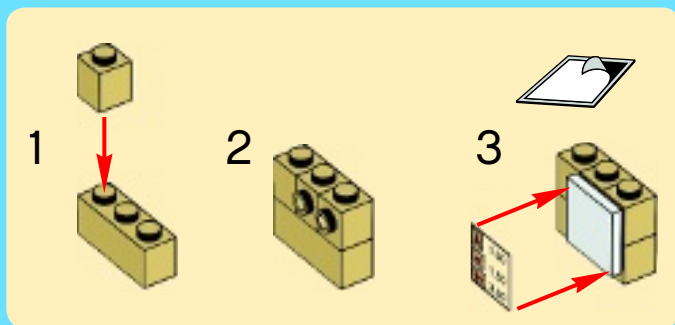

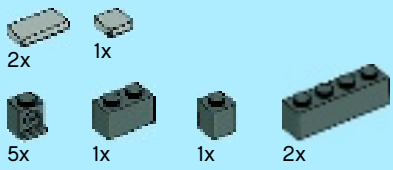

11

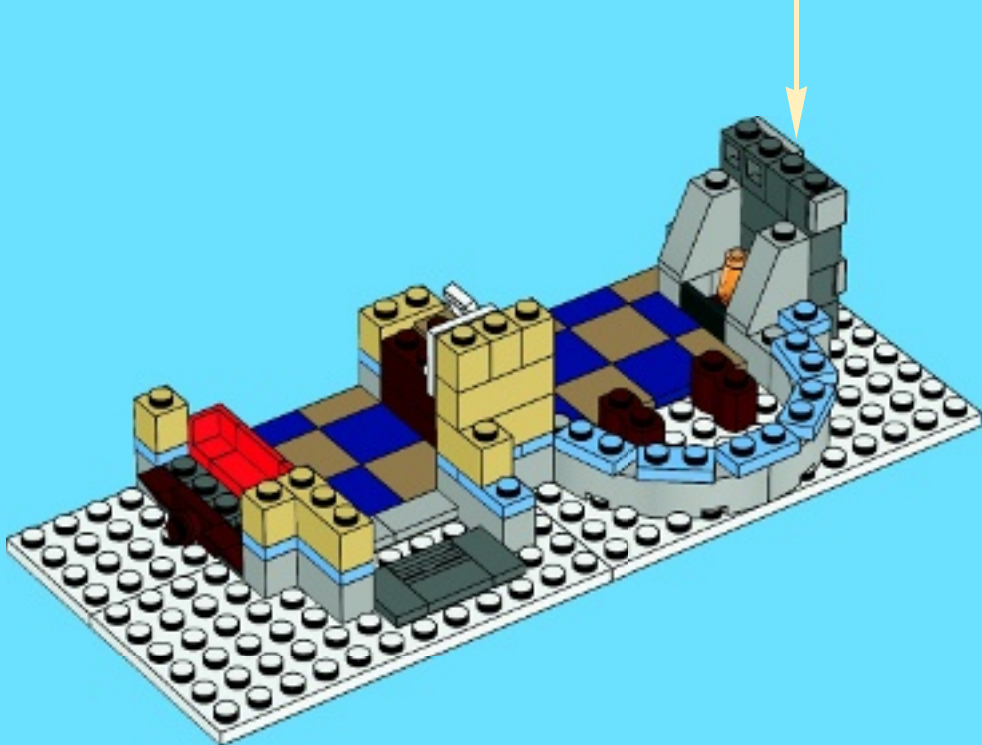
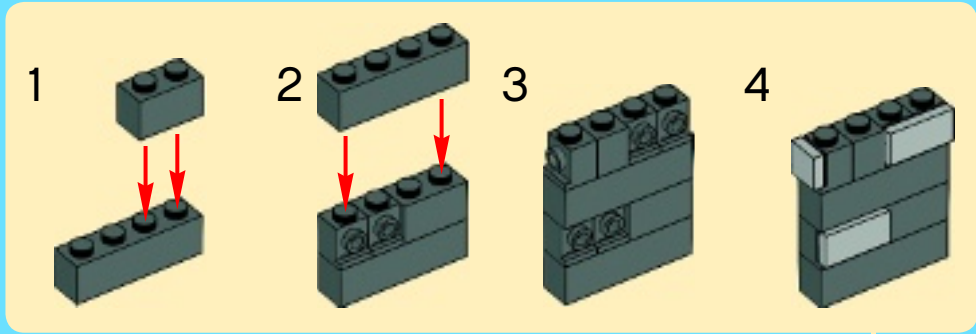

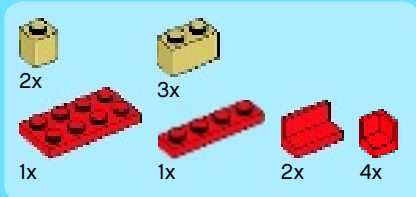

12

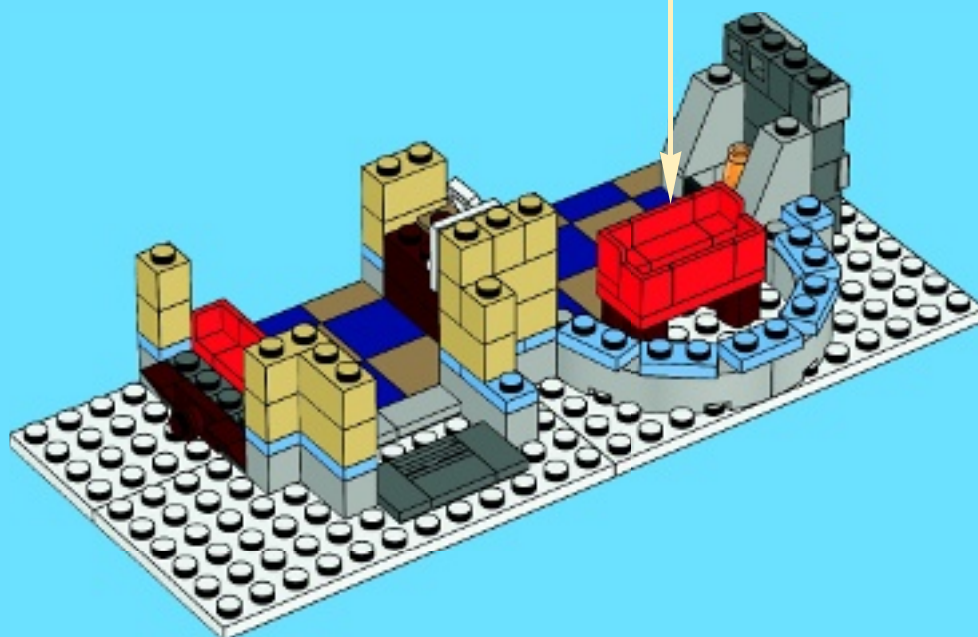
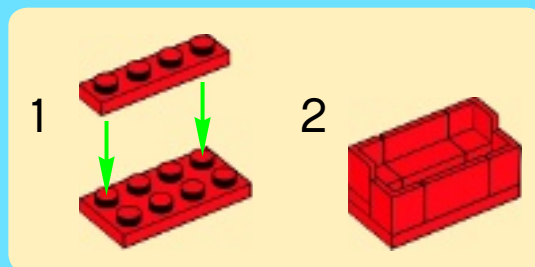

13

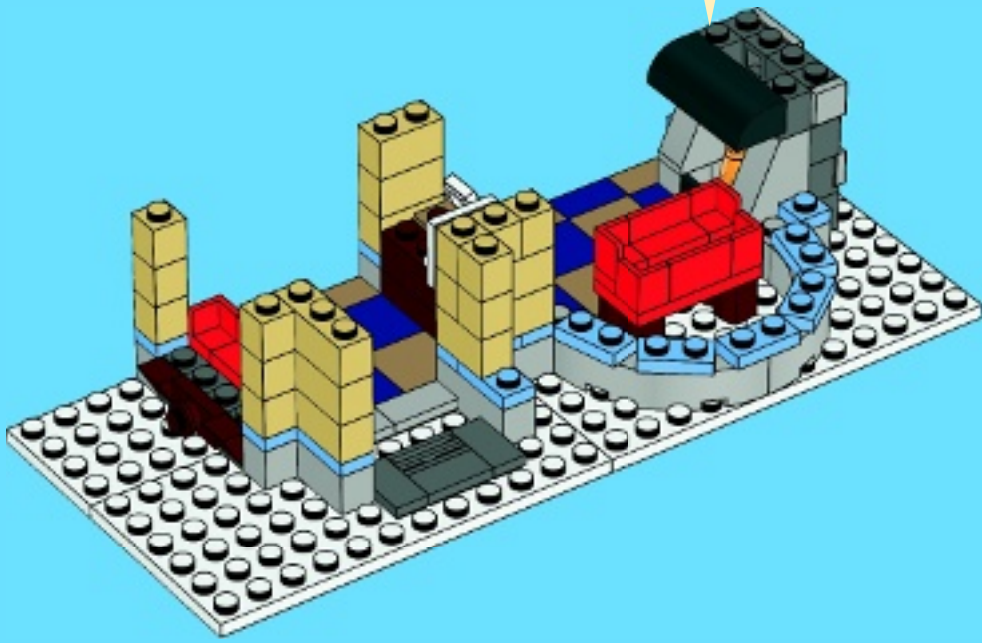
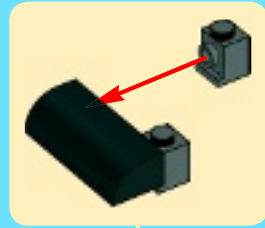
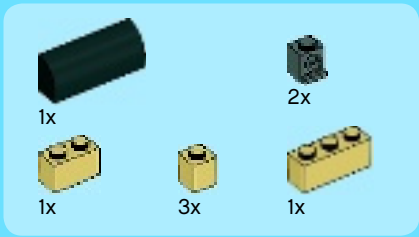



14

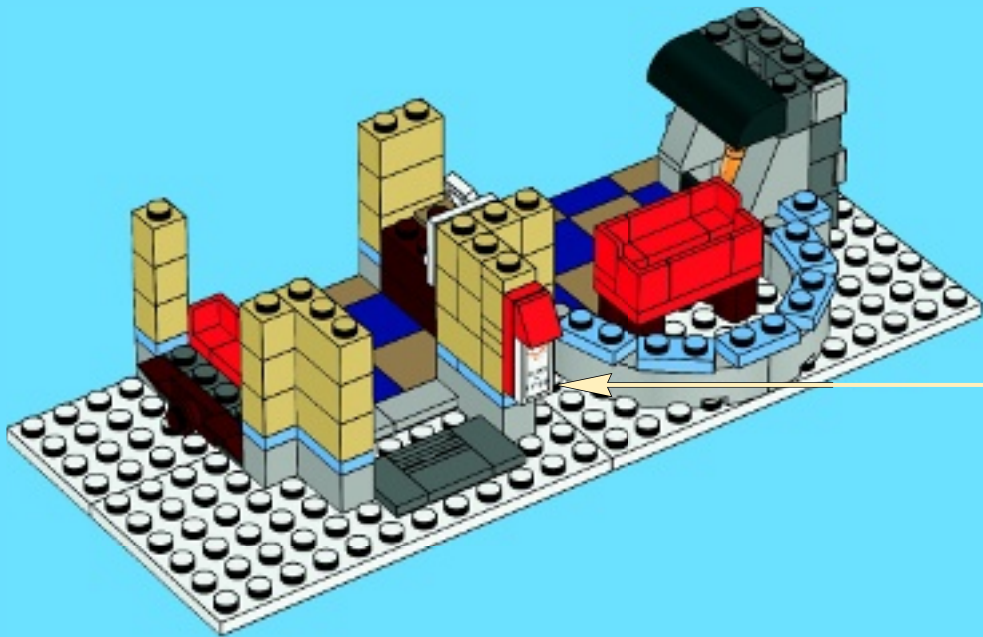
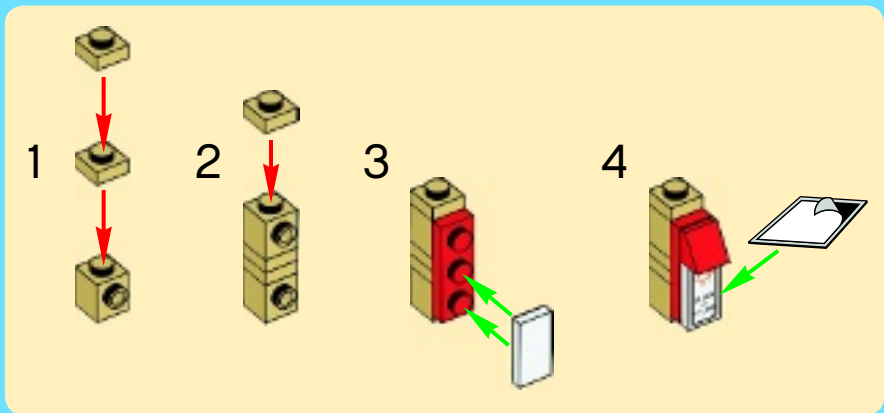



6x



1x

15



2x

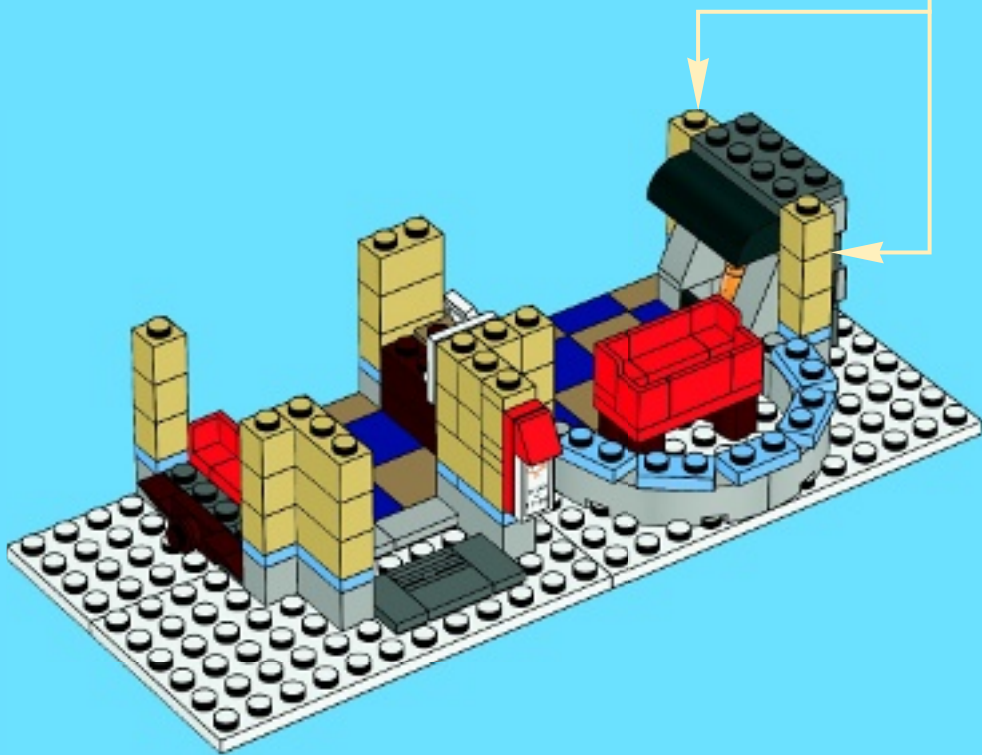



1x



2x



2x

16

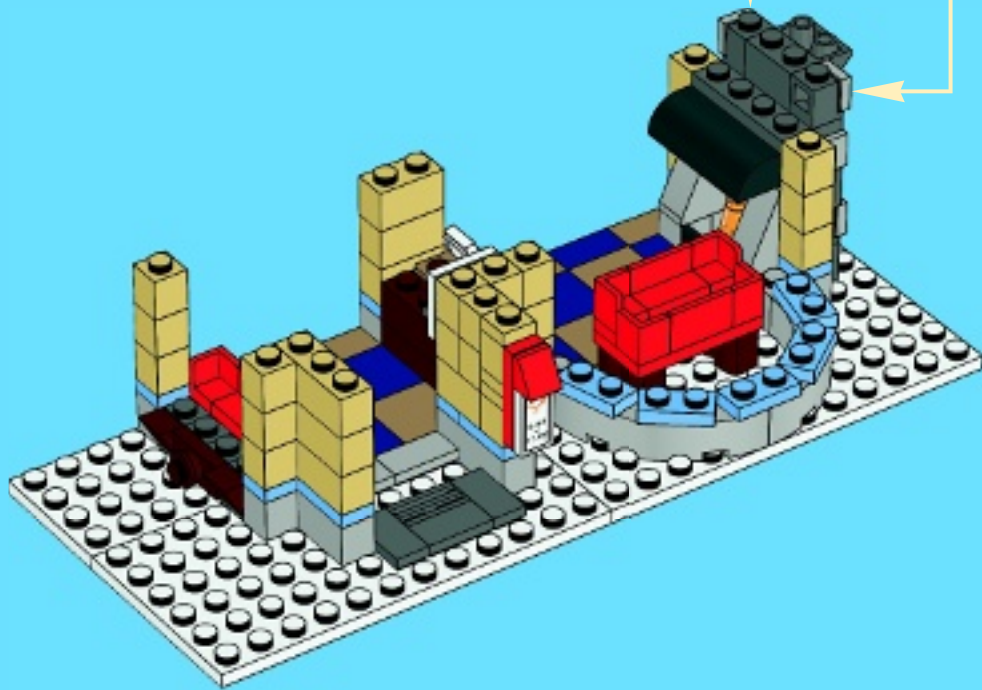
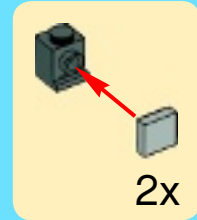

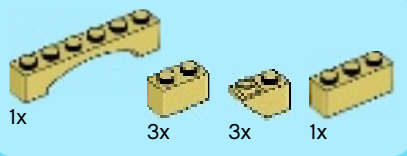

17

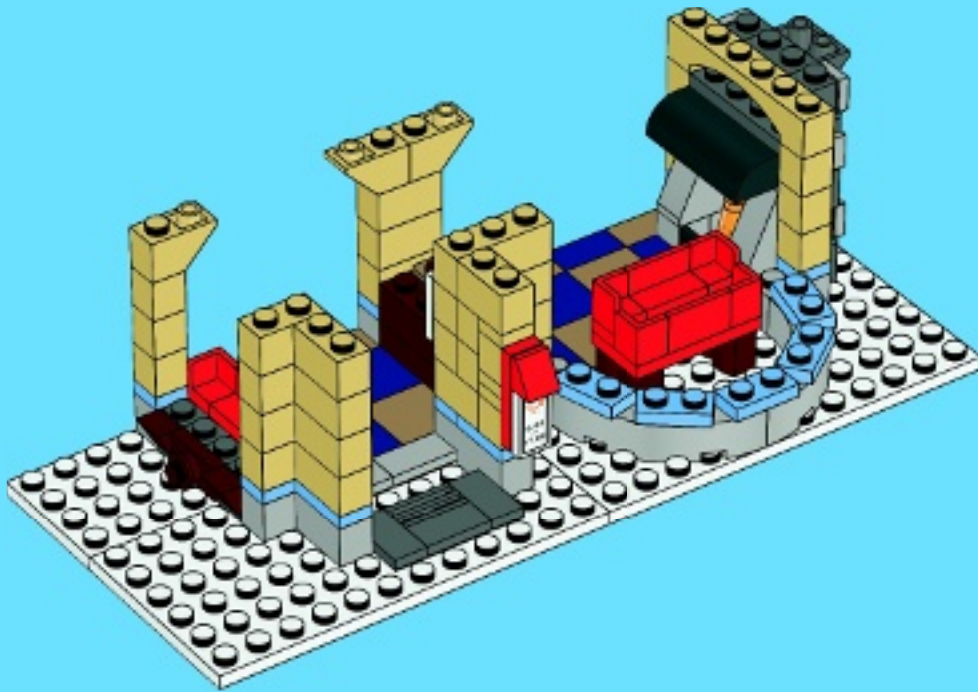



14x



14x

18

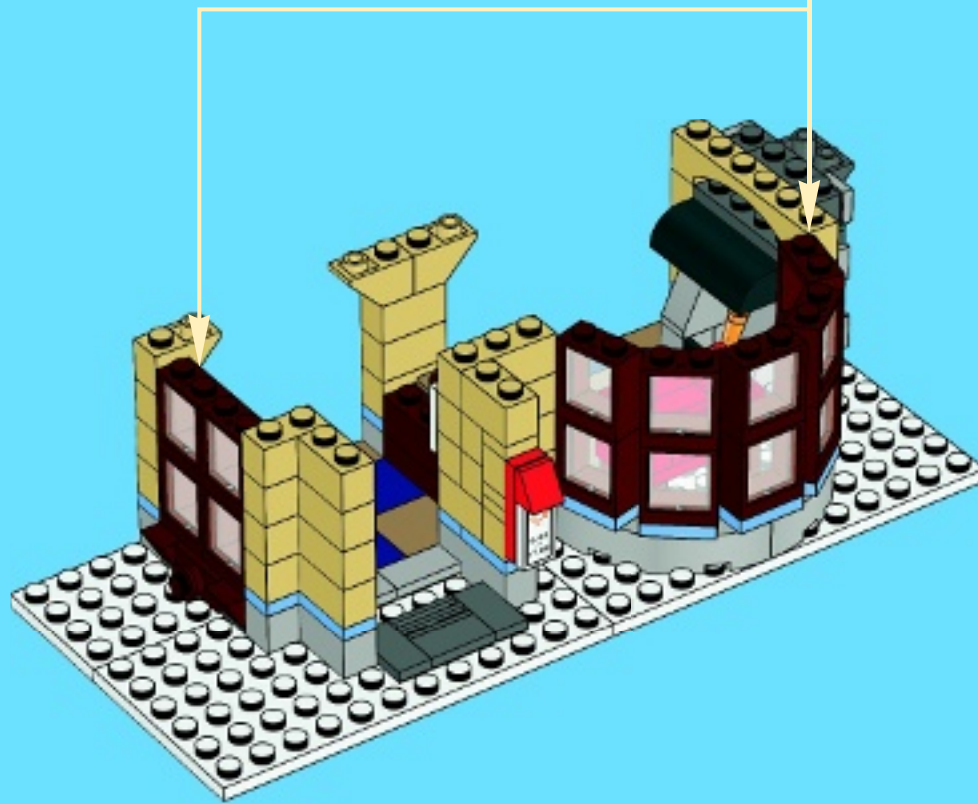
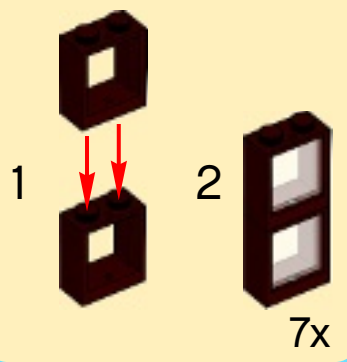

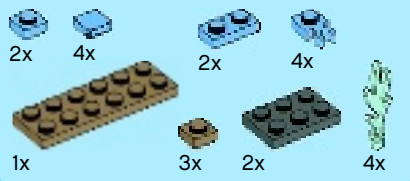

19

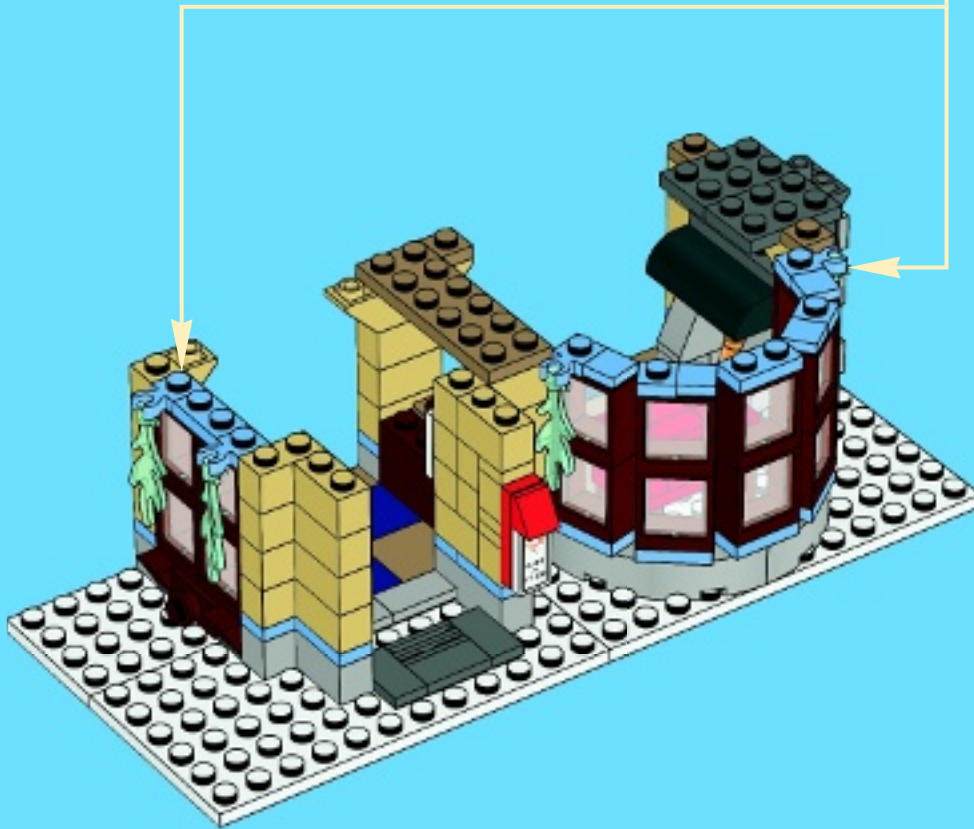
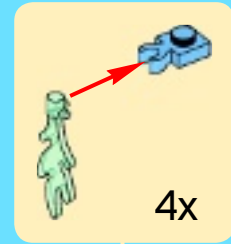



20

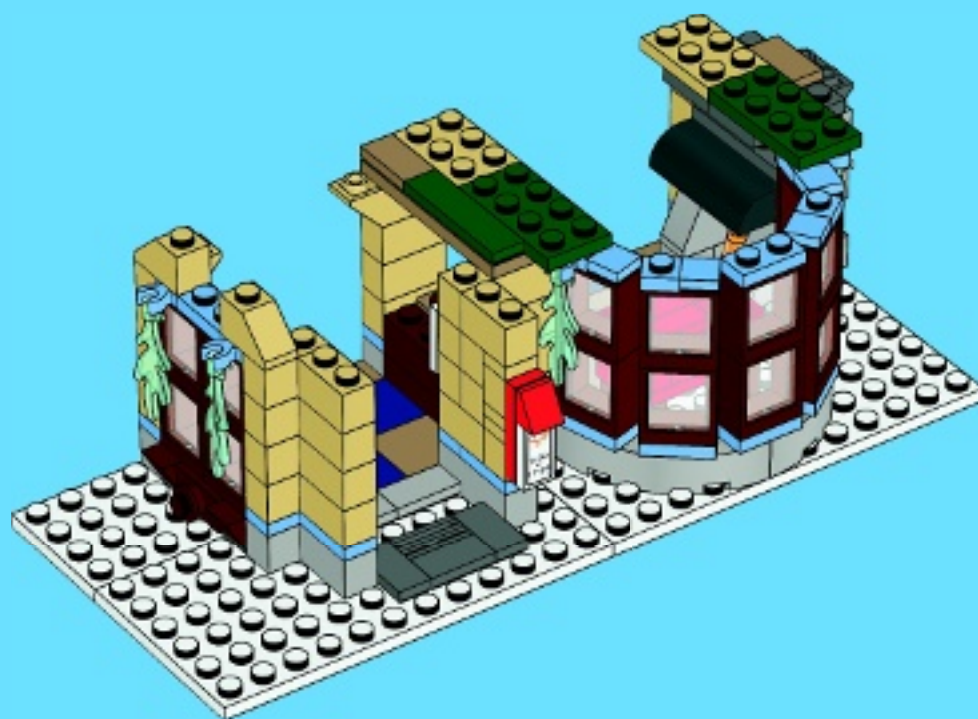

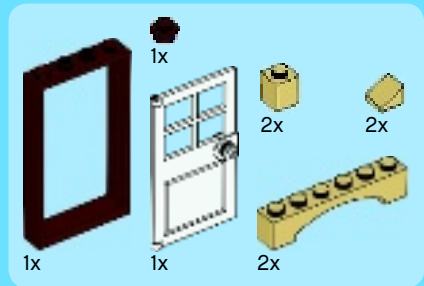

21

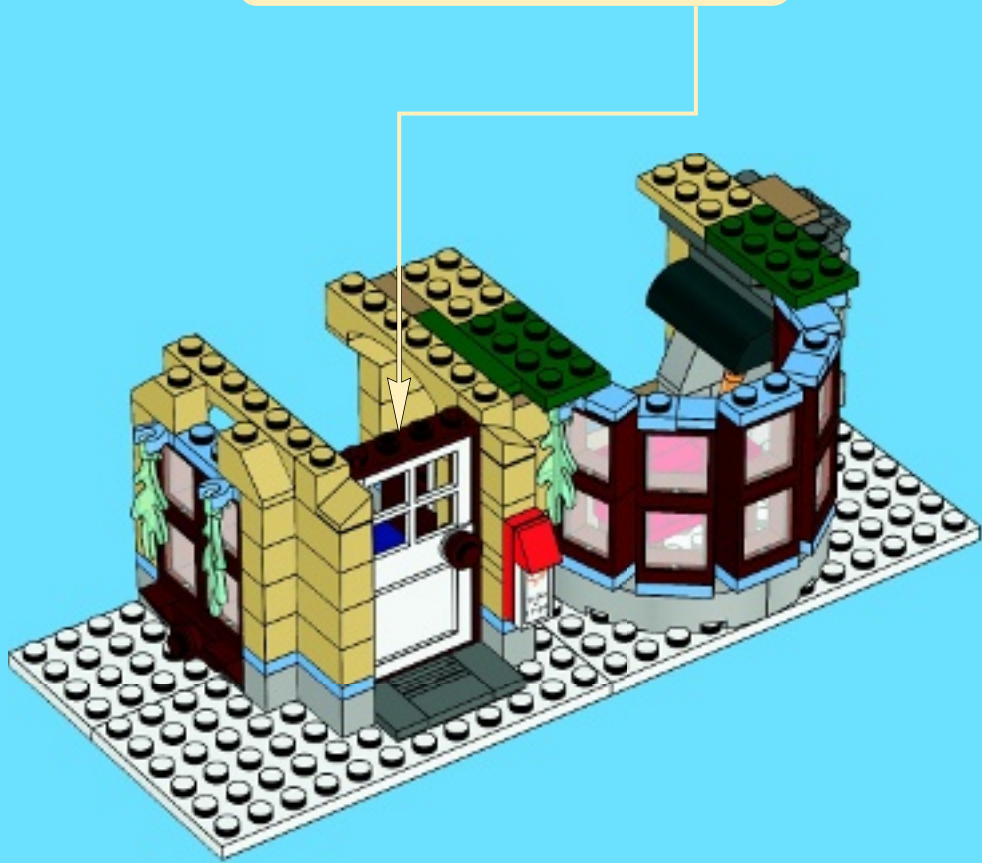
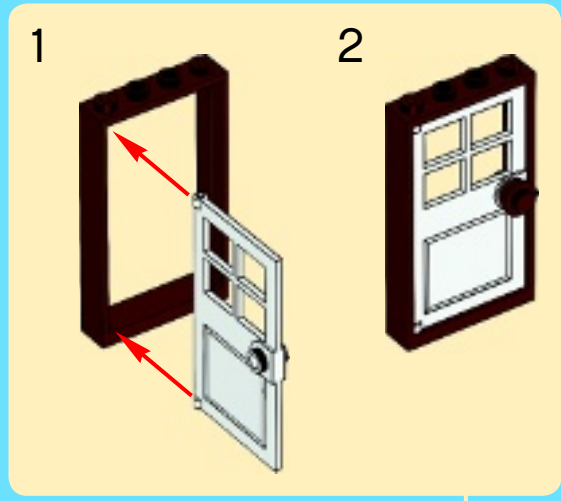

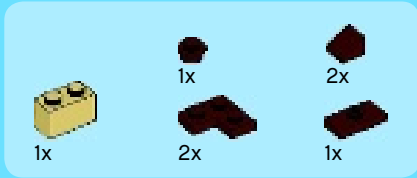

22

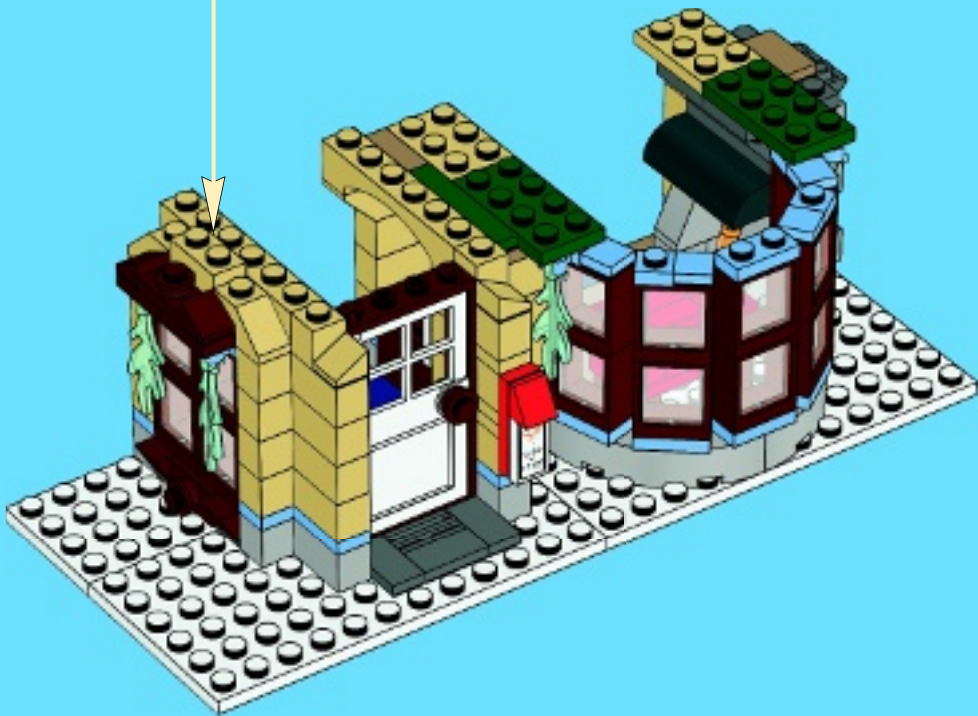
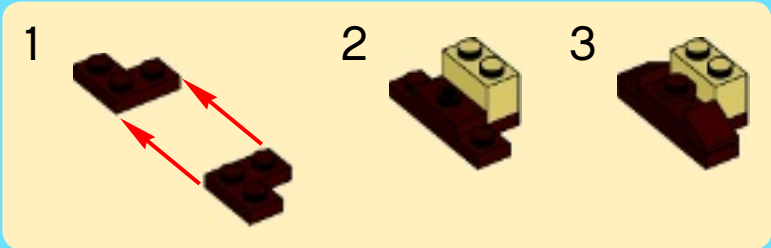

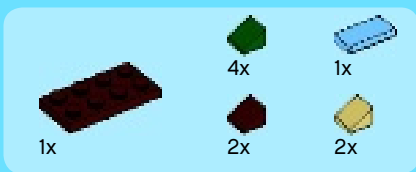

23

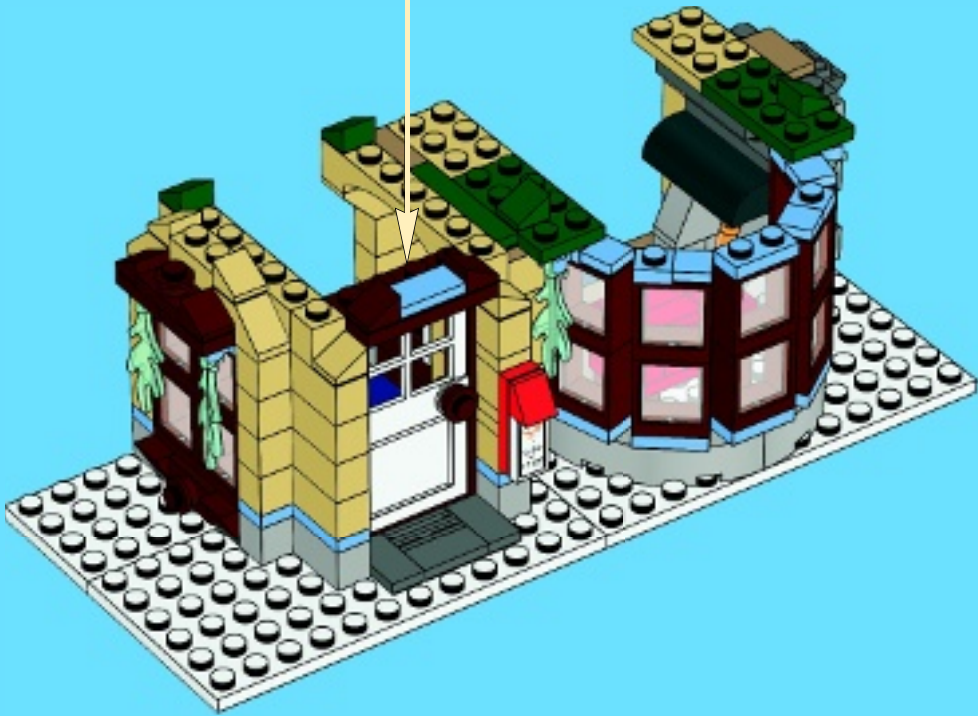
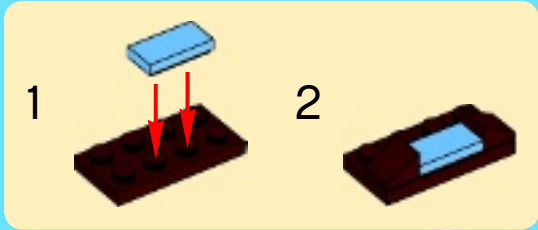

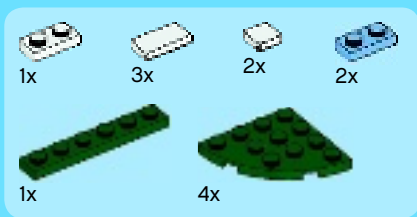

24

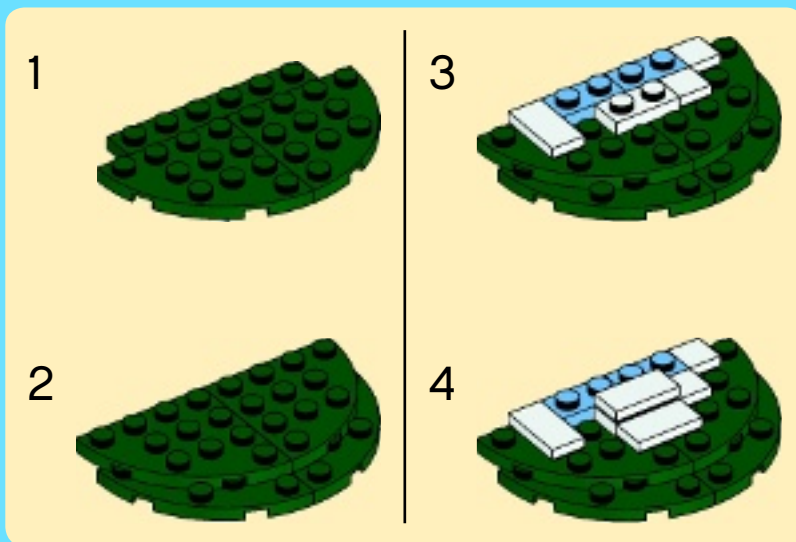



2x

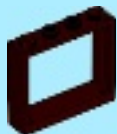

1x

25

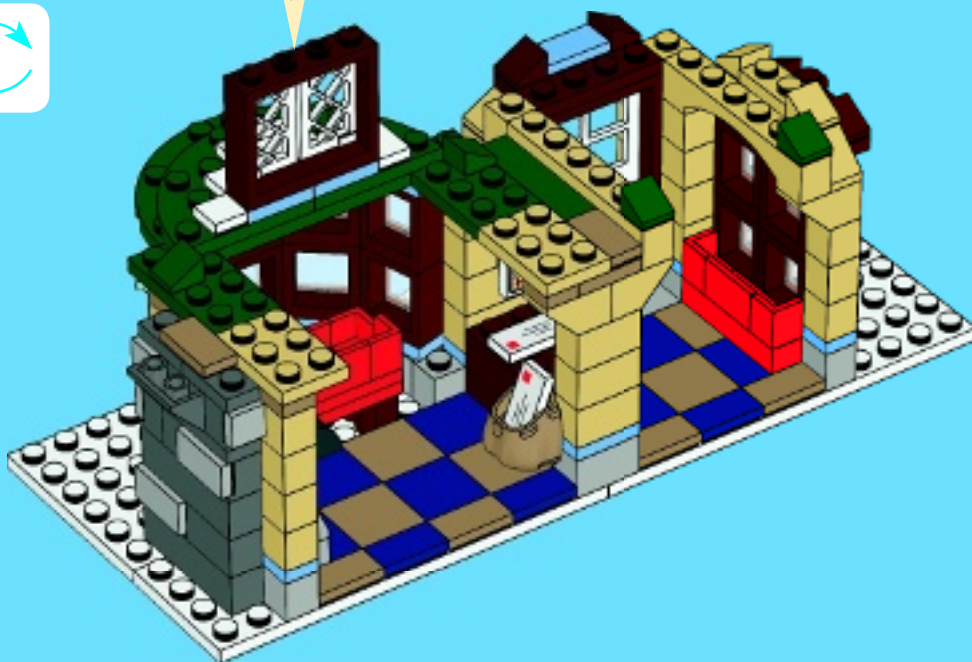
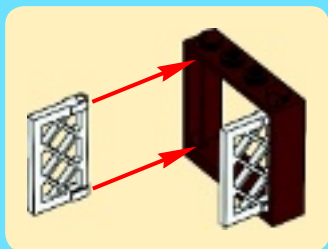

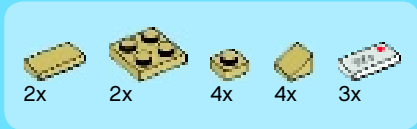

26

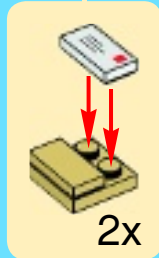
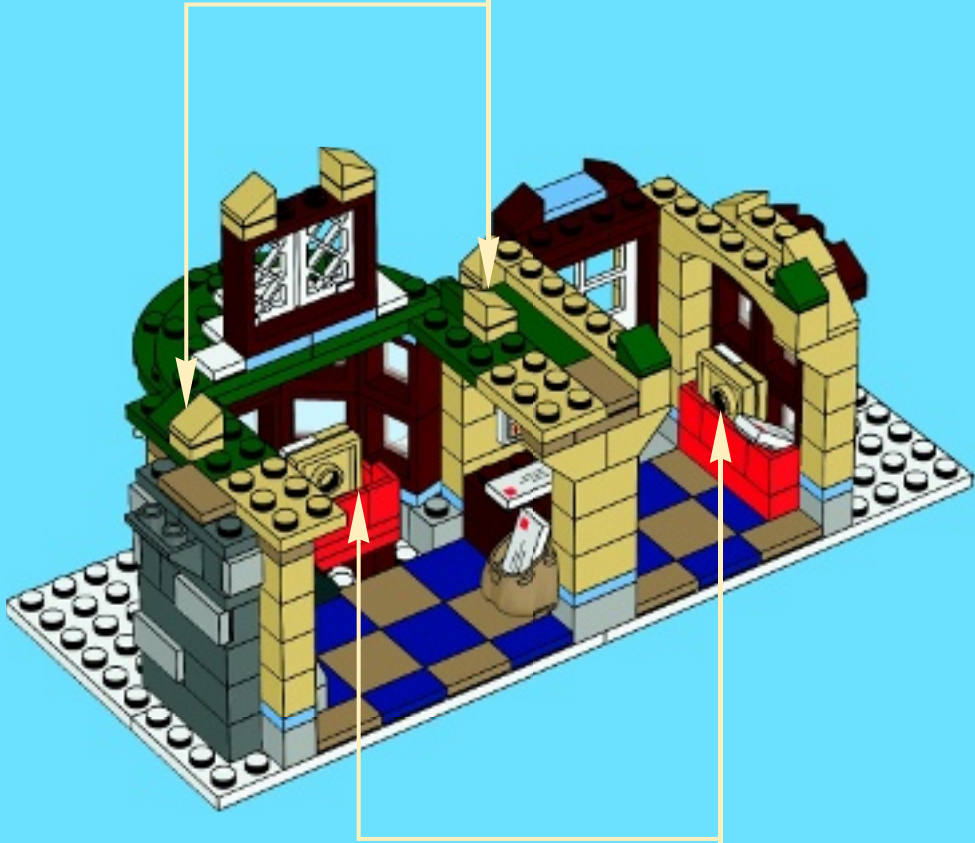
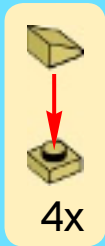

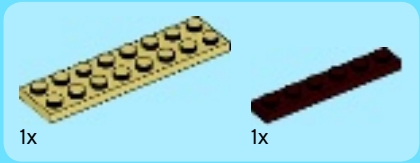

1

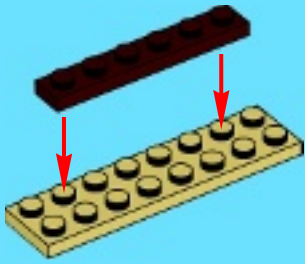

2

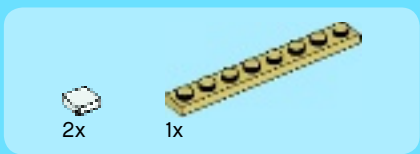
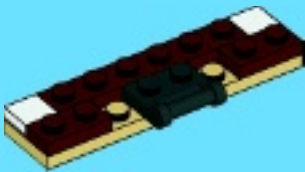

3

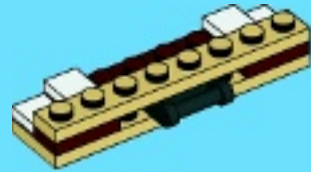

4

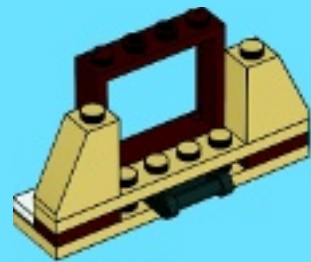



1x



2x

5

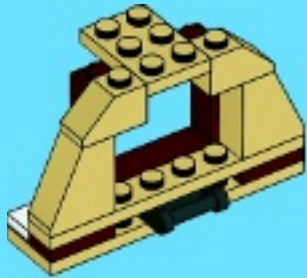

1x



2x

6

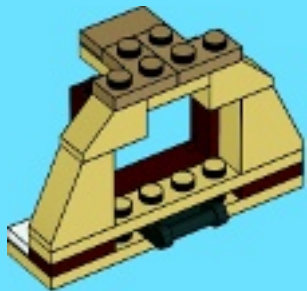

1x



2x



2x



1x



2x



1x

7

1

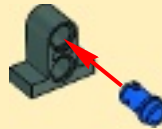

3



2

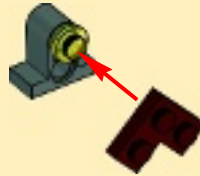

4





2x



1x

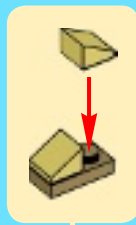

8



27



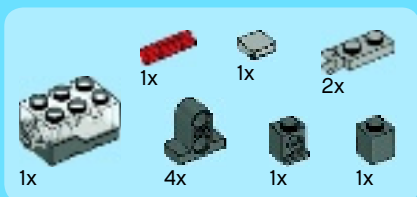

28

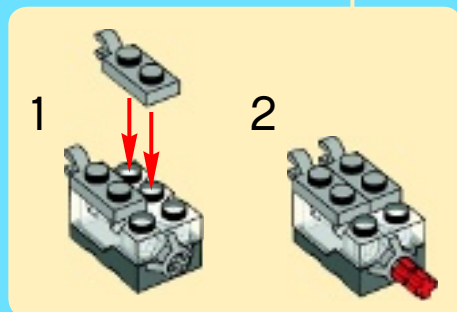
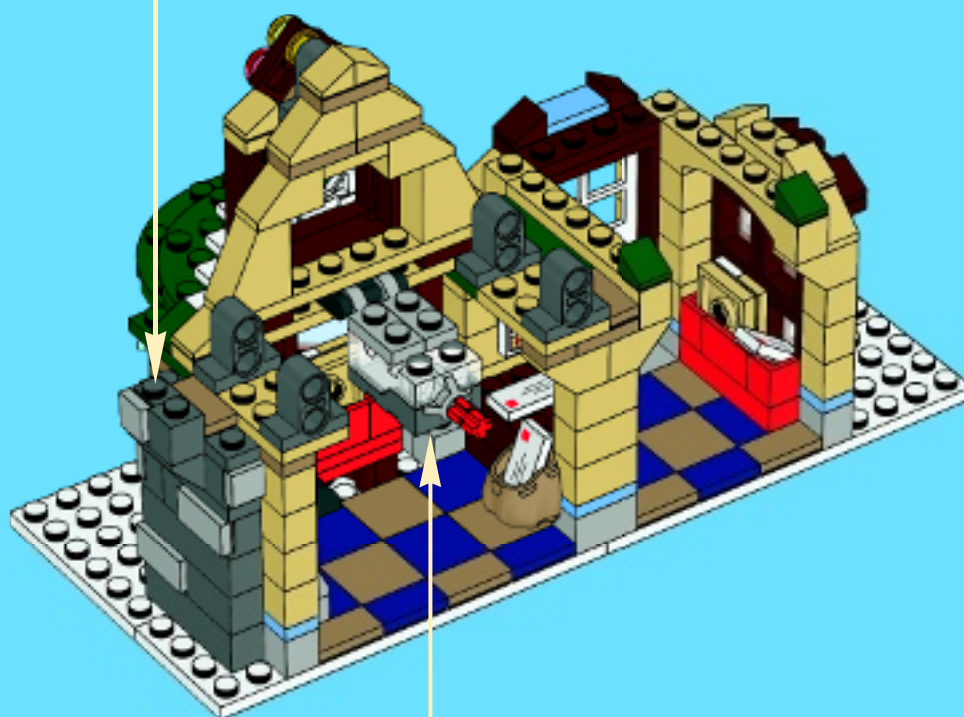
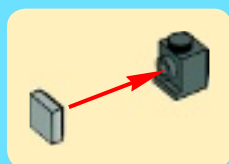
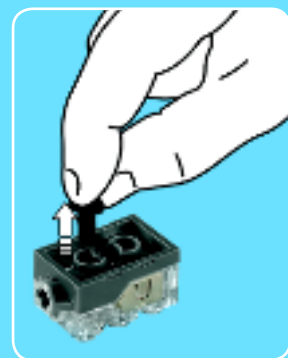

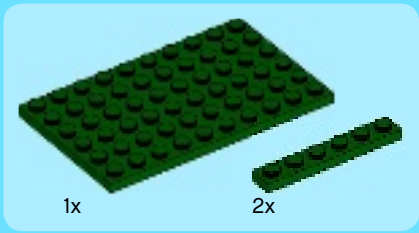

1

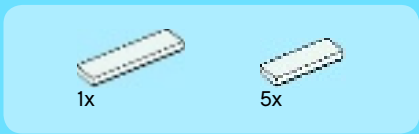
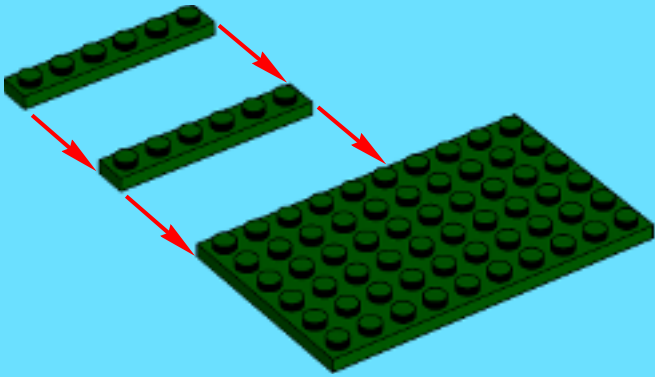

2

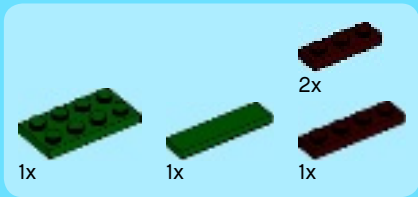
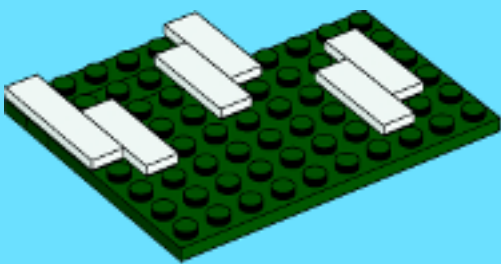

3

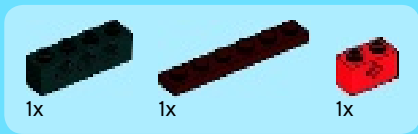
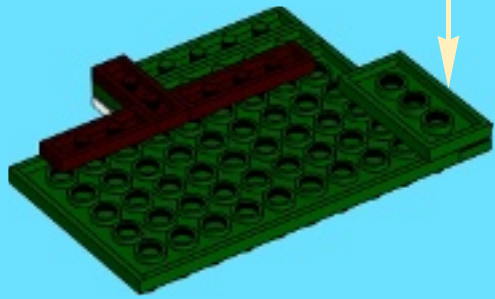
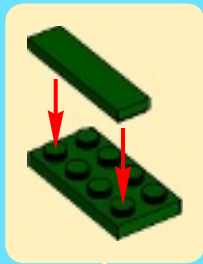

4

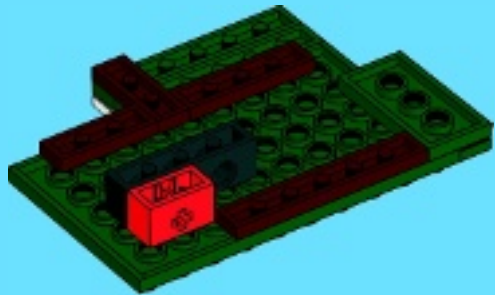



1x

29

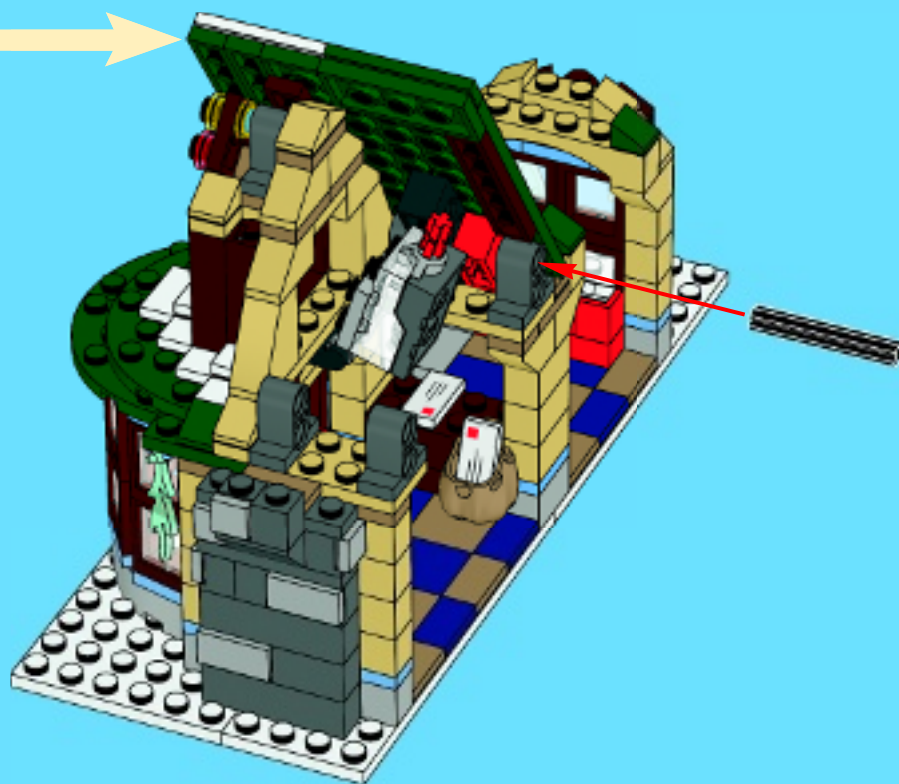

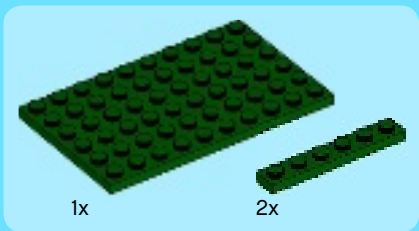

1

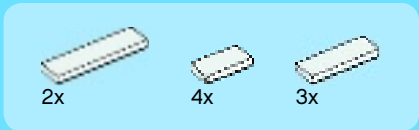
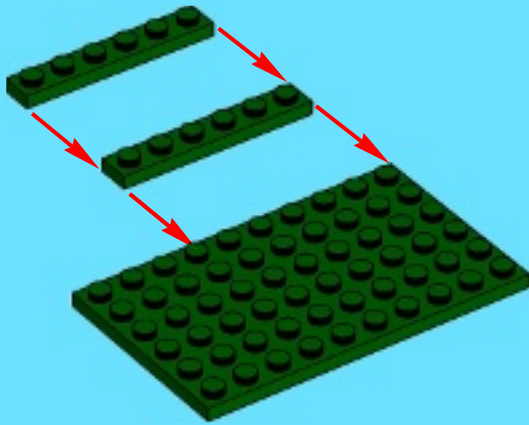

2

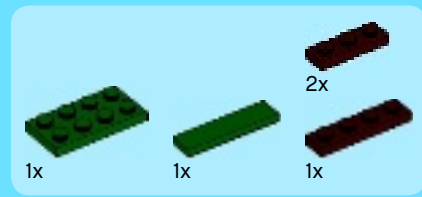
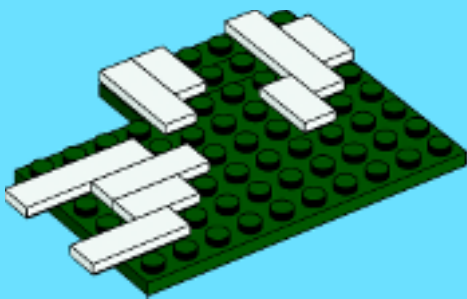

3

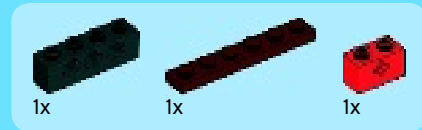
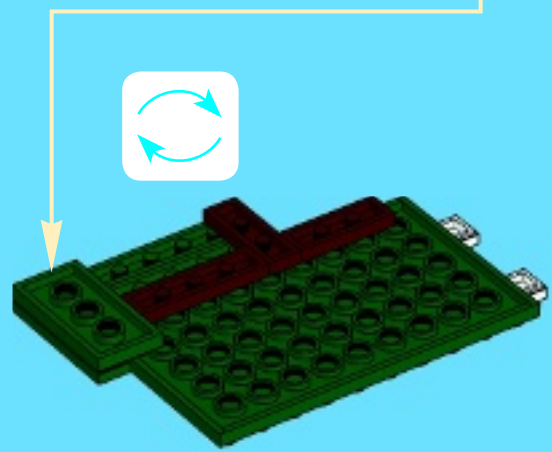
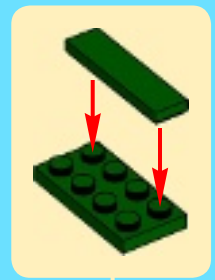

4

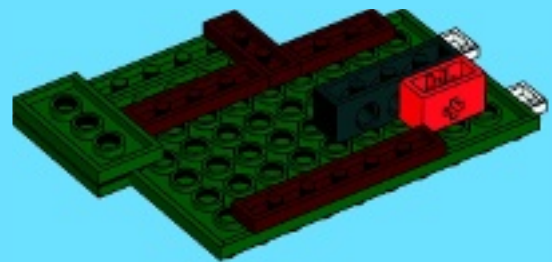



1x

30

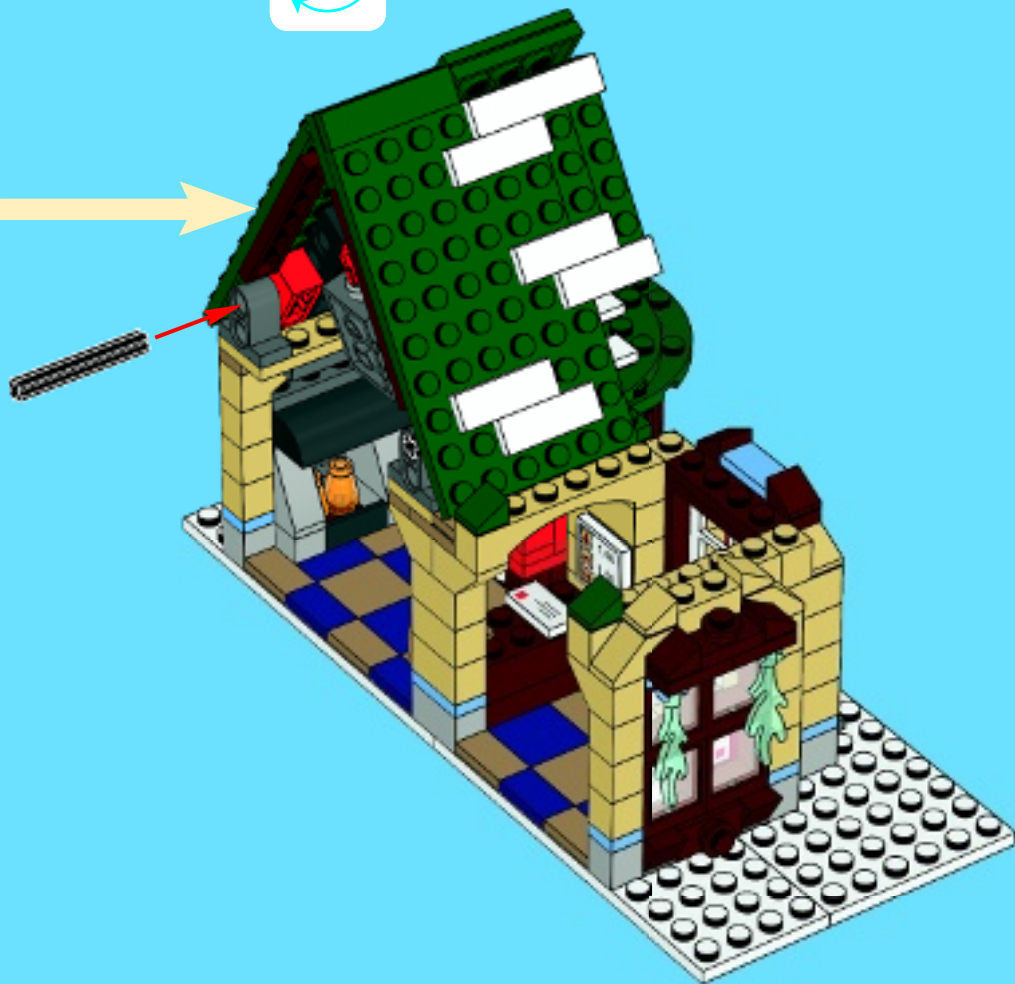



3x

31

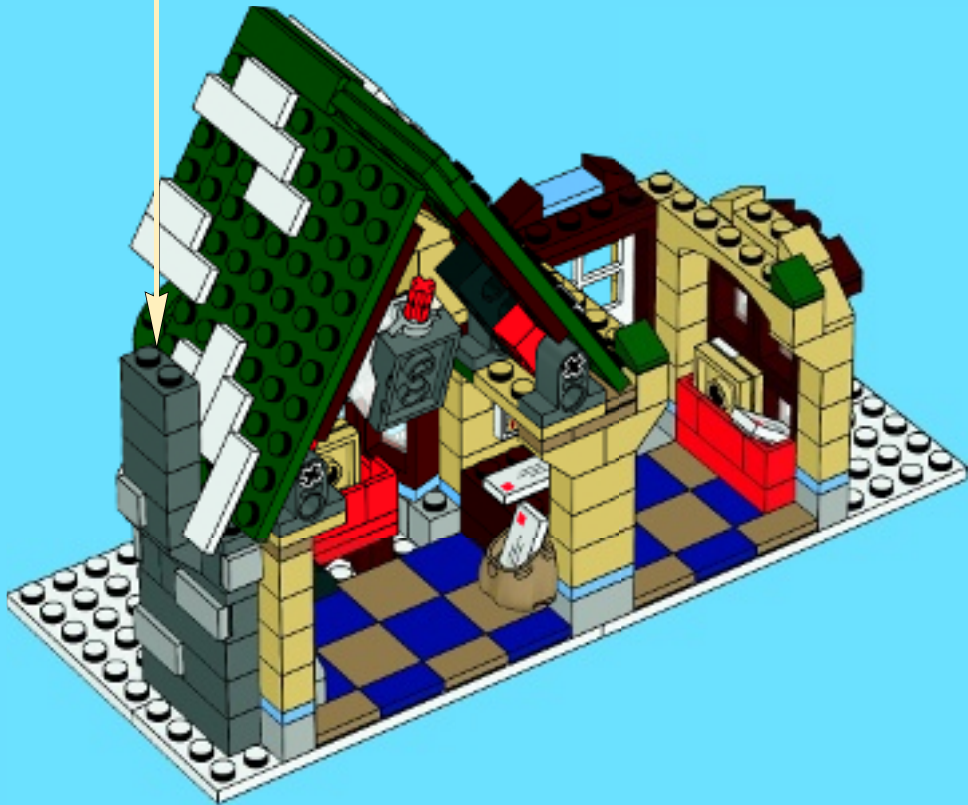
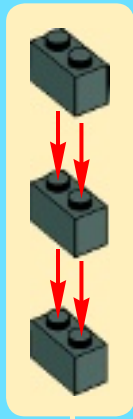

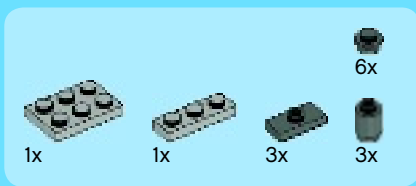

32

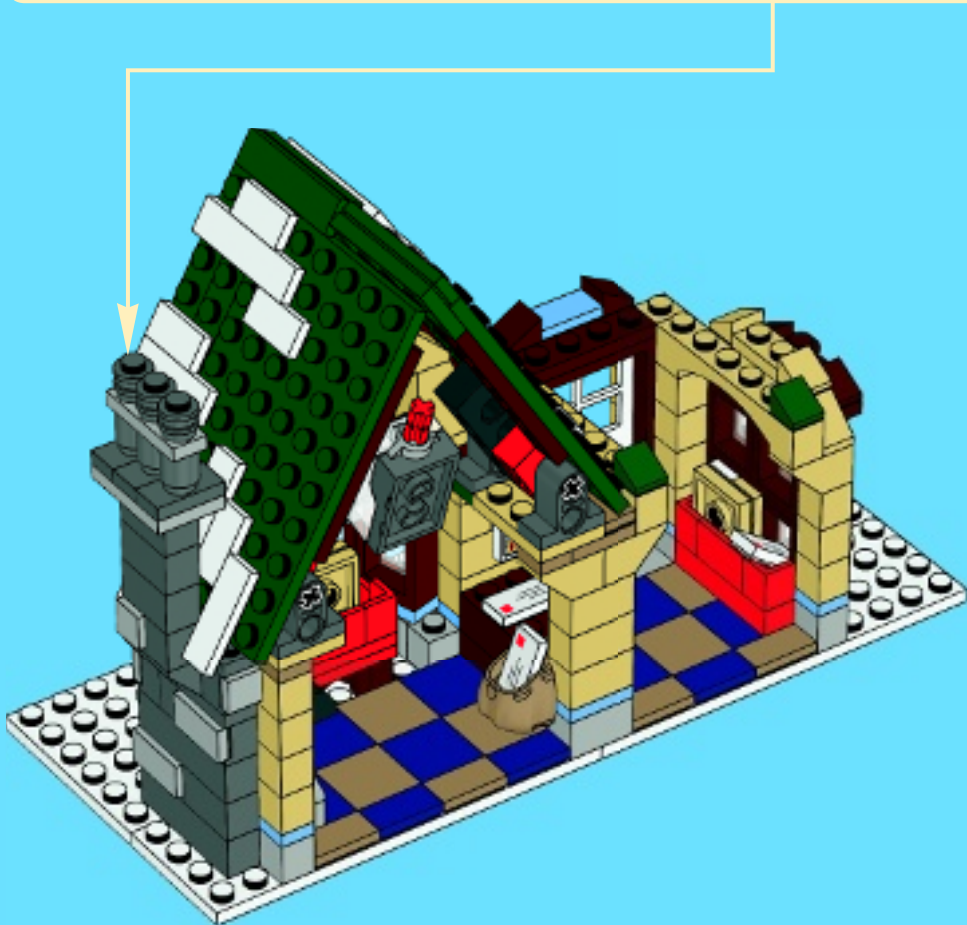
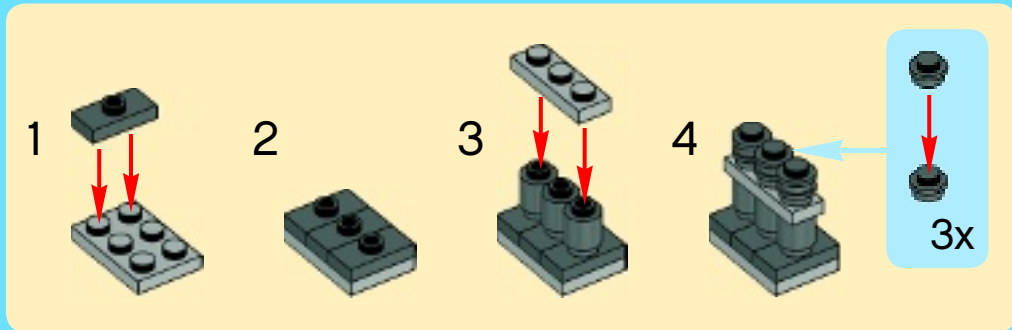



1x



1x

1



2x



2x



2x

3

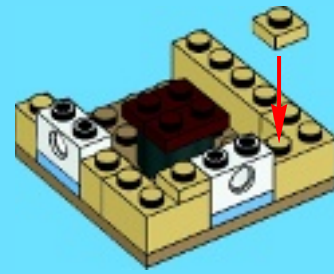

1x



4x



2x



2x



3x

4

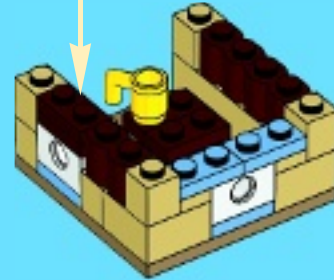
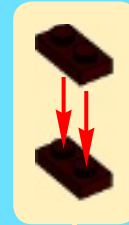

2x



1x



2x



2x

2



2x



2x

5





2x



4x

6

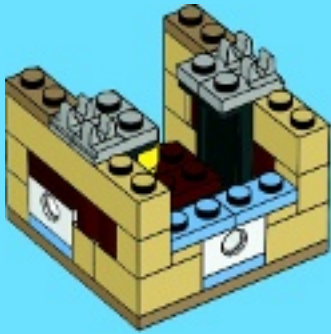

2x



2x

8

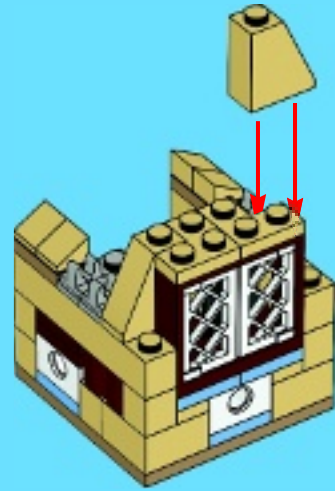

4x



2x



1x

7

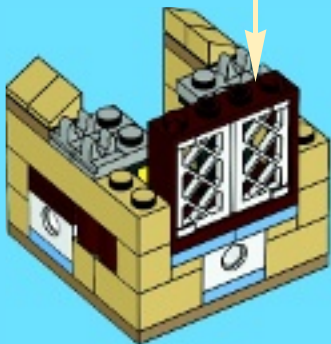
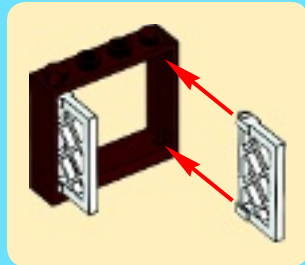

2x



4x



2x

9



2x

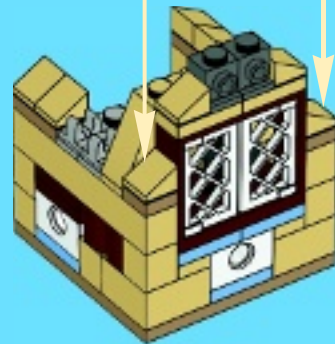



2x



1x

10

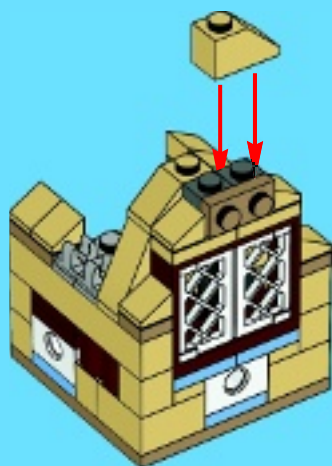

33





1



2

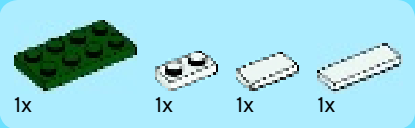

3

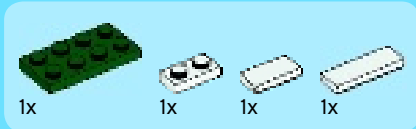

4

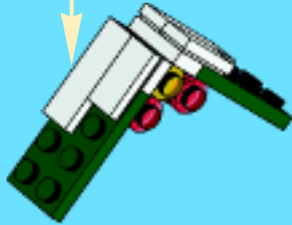
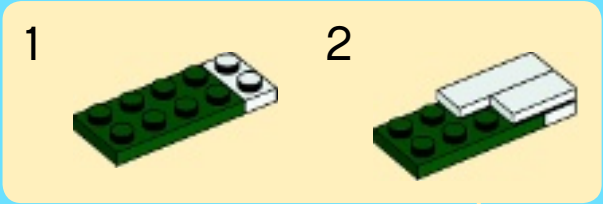

2x

34





2x



1x



1x

35

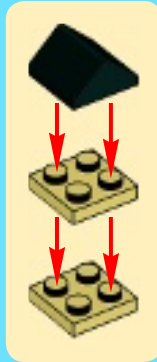

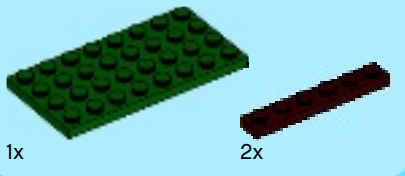

1

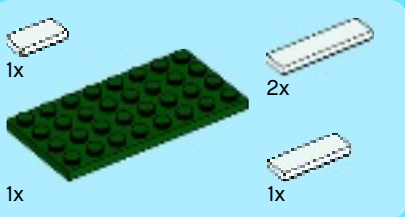
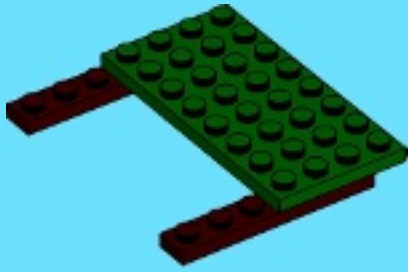

2



3

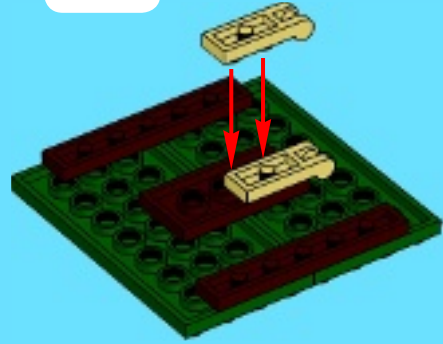

4

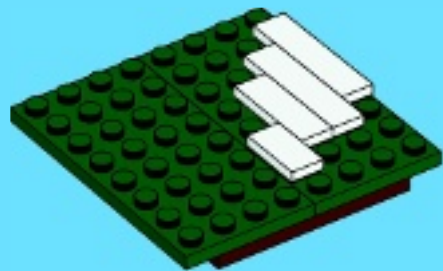

36





1x

2x

1

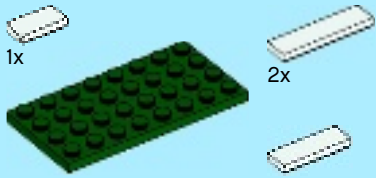
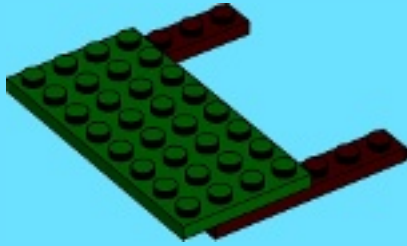

1x

2x

1x

1x

2



1x

2x

3

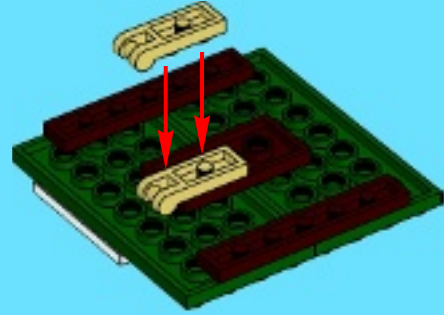

4



37

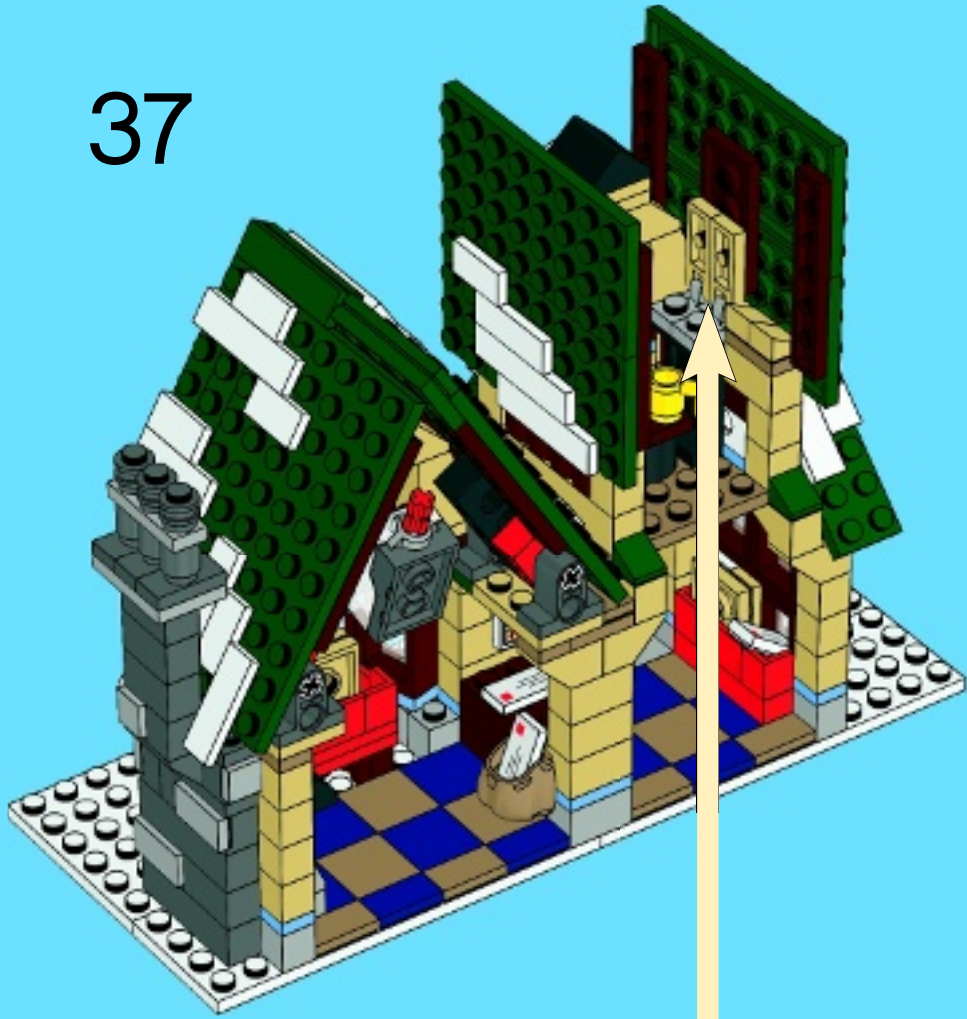

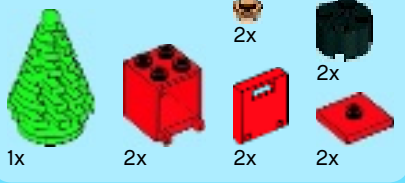

38

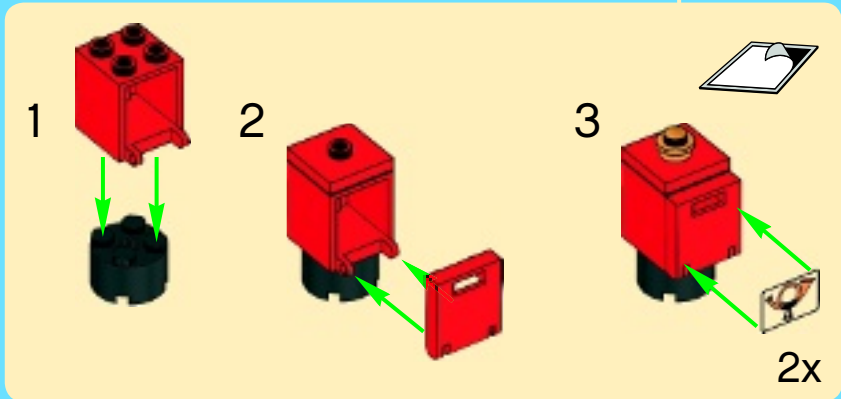



1

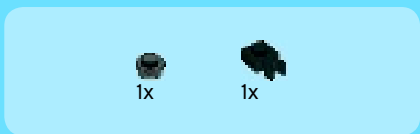

2



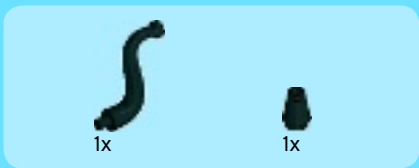

3



4



39





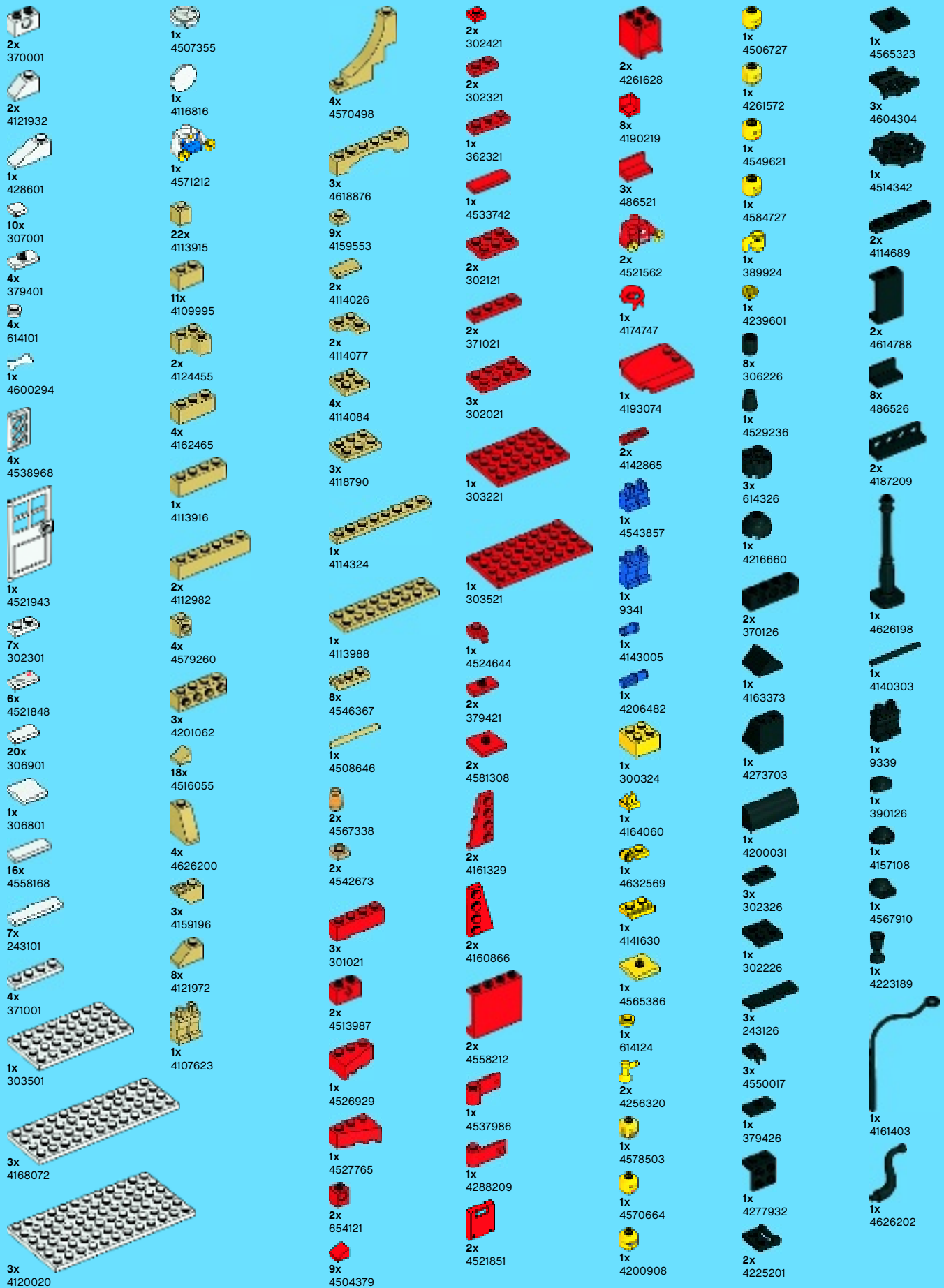

2x 370001
2x 4121932
1x 428601
10x 307001
4x 379401
4x 614101
1x 4600294
4x 4538968
1x 4113916
1x 4521943
7x 302301
6x 4521848
20x 306901
1x 306801
16x 4558168
7x 243101
4x 371001
1x 303501
3x 4168072
3x 4120020

1x 4507355
1x 4116816
1x 4571212
22x 4113915
11x 4109995
2x 4124455
4x 4162465
1x 4113916
2x 4112982
4x 4579260
3x 4201062
18x 4516055
4x 4626200
3x 4159196
8x 4121972
1x 4107623

4x 4570498
3x 4618876
9x 4159553
2x 4114026
2x 4114077
4x 4114084
3x 4118790
1x 4114324
1x 4113988
8x 4546367
1x 4508646
2x 4567338
2x 4542673
3x 301021
2x 4513987
1x 4526929
1x 4527765
2x 654121
9x 4504379

2x 302421
2x 302321
1x 362321
1x 4533742
2x 302121
2x 371021
3x 302021
1x 303221
1x 303521
1x 4524644
2x 379421
2x 4581308
2x 4161329
2x 4160866
2x 4558212
1x 4537986
1x 4288209
2x 4521851

2x 4261628
8x 4190219
3x 486521
2x 4521562
1x 4174747
1x 4193074
2x 4142865
1x 4543857
1x 9341
1x 4143005
1x 4206482
1x 300324
1x 4164060
1x 4632569
1x 4141630
1x 4565386
1x 614124
2x 4256320
1x 4578503
1x 4570664
1x 4200908

1x 4565323
3x 4604304
1x 4514342
2x 4114689
2x 4614788
8x 486526
2x 4187209
1x 4626198
1x 4140303
1x 9339
1x 390126
1x 4157108
1x 4567910
1x 4223189
1x 4161403
1x 4626202

1x 4565323
3x 4604304
1x 4514342
2x 4114689
2x 4614788
8x 486526
2x 4187209
1x 4626198
1x 4140303
1x 9339
1x 390126
1x 4157108
1x 4567910
1x 4223189
1x 4161403
1x 4626202

1x 4565323
3x 4604304
1x 4514342
2x 4114689
2x 4614788
8x 486526
2x 4187209
1x 4626198
1x 4140303
1x 9339
1x 390126
1x 4157108
1x 4567910
1x 4223189
1x 4161403
1x 4626202

1x 4565323
3x 4604304
1x 4514342
2x 4114689
2x 4614788
8x 486526
2x 4187209
1x 4626198
1x 4140303
1x 9339
1x 390126
1x 4157108
1x 4567910
1x 4223189
1x 4161403
1x 4626202

1x 4565323
3x 4604304
1x 4514342
2x 4114689
2x 4614788
8x 486526
2x 4187209
1x 4626198
1x 4140303
1x 9339
1x 390126
1x 4157108
1x 4567910
1x 4223189
1x 4161403
1x 4626202

1x 4565323
3x 4604304
1x 4514342
2x 4114689
2x 4614788
8x 486526
2x 4187209
1x 4626198
1x 4140303
1x 9339
1x 390126
1x 4157108
1x 4567910
1x 4223189
1x 4161403
1x 4626202

1x 4565323
3x 4604304
1x 4514342
2x 4114689
2x 4614788
8x 486526
2x 4187209
1x 4626198
1x 4140303
1x 9339
1x 390126
1x 4157108
1x 4567910
1x 4223189
1x 4161403
1x 4626202

1x 4565323
3x 4604304
1x 4514342
2x 4114689
2x 4614788
8x 486526
2x 4187209
1x 4626198
1x 4140303
1x 9339
1x 390126
1x 4157108
1x 4567910
1x 4223189
1x 4161403
1x 4626202

1x 4565323
3x 4604304
1x 4514342
2x 4114689
2x 4614788
8x 486526
2x 4187209
1x 4626198
1x 4140303
1x 9339
1x 390126
1x 4157108
1x 4567910
1x 4223189
1x 4161403
1x 4626202

1x 4565323
3x 4604304
1x 4514342
2x 4114689
2x 4614788
8x 486526
2x 4187209
1x 4626198
1x 4140303
1x 9339
1x 390126
1x 4157108
1x 4567910
1x 4223189
1x 4161403
1x 4626202

1x 4565323
3x 4604304
1x 4514342
2x 4114689
2x 4614788
8x 486526
2x 4187209
1x 4626198
1x 4140303
1x 9339
1x 390126
1x 4157108
1x 4567910
1x 4223189
1x 4161403
1x 4626202

1x 4565323
3x 4604304
1x 4514342
2x 4114689
2x 4614788
8x 486526
2x 4187209
1x 4626198
1x 4140303
1x 9339
1x 390126
1x 4157108
1x 4567910
1x 4223189
1x 4161403
1x 4626202

1x 4565323
3x 4604304
1x 4514342
2x 4114689
2x 4614788
8x 486526
2x 4187209
1x 4626198
1x 4140303
1x 9339
1x 390126
1x 4157108
1x 4567910
1x 4223189
1x 4161403
1x 4626202

1x 4565323
3x 4604304
1x 4514342
2x 4114689
2x 4614788
8x 486526
2x 4187209
1x 4626198
1x 4140303
1x 9339
1x 390126
1x 4157108
1x 4567910
1x 4223189
1x 4161403
1x 4626202

1x 4565323
3x 4604304
1x 4514342
2x 4114689
2x 4614788
8x 486526
2x 4187209
1x 4626198
1x 4140303
1x 9339
1x 390126
1x 4157108
1x 4567910
1x 4223189
1x 4161403
1x 4626202

- 4x 4541455
- 6x 4273590
- 1x 4584126
- 4x 4569407
- 3x 368026
- 2x 370526
- 1x 4614107
- 4x 4504375
- 3x 4543949
- 8x 4586057
- 5x 4245566
- 1x 4612728
- 8x 4629681
- 4x 4505051
- 2x 4549214
- 2x 3000841
- 17x 3005741
- 4x 4155537
- 7x 3005744
- 1x 4549435
- 7x 4179826
- 4x 4527526
- 1x 4168345
- 20x 4179825
- 4x 4529115
- 1x 4629943
- 5x 4528488
- 5x 4205004
- 1x 4162916
- 1x 4275888
- 1x 4275821
- 1x 4541496

- 2x 302228
- 1x 4565321
- 1x 243528
- 3x 242328
- 1x 347128
- 1x 4619699
- 6x 4549436
- 7x 4528604
- 9x 4496699
- 5x 4507045
- 2x 4550168
- 1x 4550329
- 1x 4530712
- 8x 4266902
- 3x 4570451
- 2x 4598955
- 1x 4549990
- 2x 4523159
- 1x 4249039

- 2x 4211201
- 7x 4211180
- 6x 4504376
- 15x 4211150
- 5x 4211257
- 4x 4211152
- 2x 4211190
- 3x 4211194
- 3x 4211186
- 7x 4221590
- 3x 4211204
- 2x 4219726
- 3x 4216581
- 14x 4595814
- 3x 4595889
- 1x 4623513
- 1x 4211158
- 2x 4626199

- 3x 4211389
- 4x 4211388
- 1x 4211387
- 4x 4211428
- 1x 4211385
- 2x 4211511
- 5x 4215472
- 2x 4515374
- 5x 4211415
- 4x 4211398
- 6x 4211414
- 1x 4211397
- 1x 4211413
- 2x 4211429
- 1x 4211396
- 1x 4556157
- 1x 4541978
- 4x 4598526
- 1x 4211462

- 4x 4535738
- 1x 4282740
- 2x 4529120
- 1x 4221881
- 2x 4211503
- 1x 4292298
- 4x 4499259
- 1x 4226995
- 3x 4540203
- 1x 4520320
- 2x 4211098
- 4x 4211088
- 2x 4211103
- 20x 4211044
- 3x 4211090
- 1x 4211000
- 2x 4210797
- 2x 4618881
- 5x 4211052
- 4x 4211055

- 2x 4210635
- 3x 4211043
- 4x 4211001
- 1x 4211065
- 1x 4211056
- 2x 4211115
- 2x 4587212
- 3x 4211119
- 3x 4210631
- 5x 4210763
- 7x 4210633
- 1x 4211006
- 1x 4624374
- 1x 4113949
- 2x 3005740
- 14x 4552035
- 2x 4113028
- 1x 3001140
- 1x 4526177

 **Customer Service**
Kundenservice
Service Consommateurs
Servicio Al Consumidor
www.lego.com/service or dial
 00800 5346 5555 :       
 1-800-422-5346 :  

10216



+



10222



10197

10218

10211





CREATOR

5770

5771



creator.LEGO.com



10220





FREE! GRATIS! GRATUIT!



www.LEGOclub.com



LEGO® Club Magazine



LEGO® Club Email

SIGN UP ONLINE!

www.LEGOclub.com

VISIT THE WORLD'S BIGGEST LEGO® SHOP!

www.LEGOshop.com



GO TO

www.LEGOclub.com

00800 5346 5555*



1-866-534-6258 • 1-877-518-5346

US & Canada only

Canada seulement



* Freephone. Mobile charges may apply. * Numéro sans frais. Des frais peuvent s'appliquer avec les téléphones cellulaires. * Gebührenfrei, Kosten für Anrufe aus Mobilfunknetzen können abweichen. * Gratis telefoonnummer vanaf vaste lijn. * Det er et gratis nummer, når du ringer fra fasttelefon. * Det är gratis, när du ringer från en fast telefon. * Numéro sans frais. Des frais peuvent s'appliquer avec les téléphones portables.



WIN!

Go to www.LEGOsurvey.com/product
to fill out a survey for a chance
to win a cool LEGO® Product.
No purchase necessary.
Open to all residents where not prohibited.



www.LEGO.com



www.LEGOsurvey.com/product

GEWINNE!

Nimm an der Umfrage auf www.LEGOsurvey.com/product teil und hab die Chance ein cooles LEGO® Produkt zu gewinnen!

Die Teilnahme am Gewinnspiel führt zu keinerlei Kaufverpflichtungen. Teilnahme in allen nicht ausgeschlossenen Ländern möglich.

WIN!

Ga naar www.LEGOsurvey.com/product, vul een enquêteformulier in en maak kans op een cool LEGO® product.

Geen aankoopverplichting.
Iedereen mag deelnemen, uitzonderend ingezetenden van landen waar een enquêteverbod geldt.

GAGNE!

Visite www.LEGOsurvey.com/product pour répondre à un questionnaire et avoir une chance de gagner un produit LEGO® très cool!

Aucune obligation d'achat.
Ouvert à tous les résidents des pays autorisés.

当てよう!

www.LEGOsurvey.com/product にアクセスして、アンケートにご記入ください。当選者にはレゴ®製品を差し上げます。

お買い上げの必要はありません。
禁止されていない限り、すべての皆様にご利用いただけます。

Trademarks, design patents and copyrights are used with the approval of the owner Volkswagen AG./

Les marques déposées, les brevets de conception et les copyrights sont utilisés avec l'autorisation du propriétaire Volkswagen AG./

El uso de las marcas comerciales, patentes de diseño y derechos de autor se realiza con el consentimiento de su propietario, Volkswagen AG.

LEGO and the LEGO logo are trademarks of the/son des marques de commerce de/son marcas registradas de LEGO Group. ©2011 The LEGO Group.