

LEGO[®]

10224

3

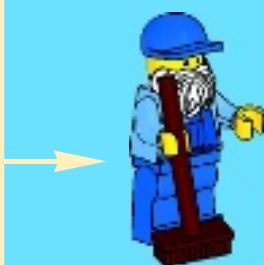

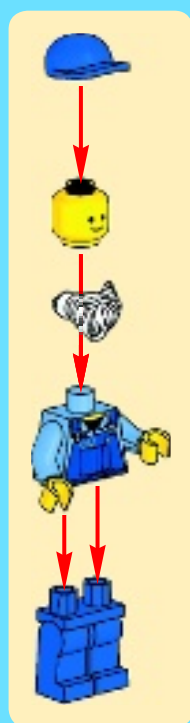

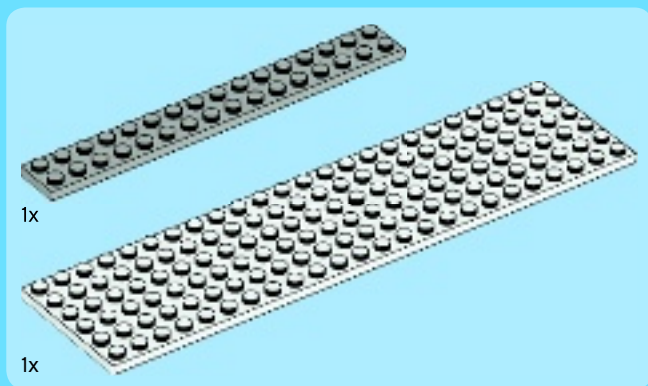

1

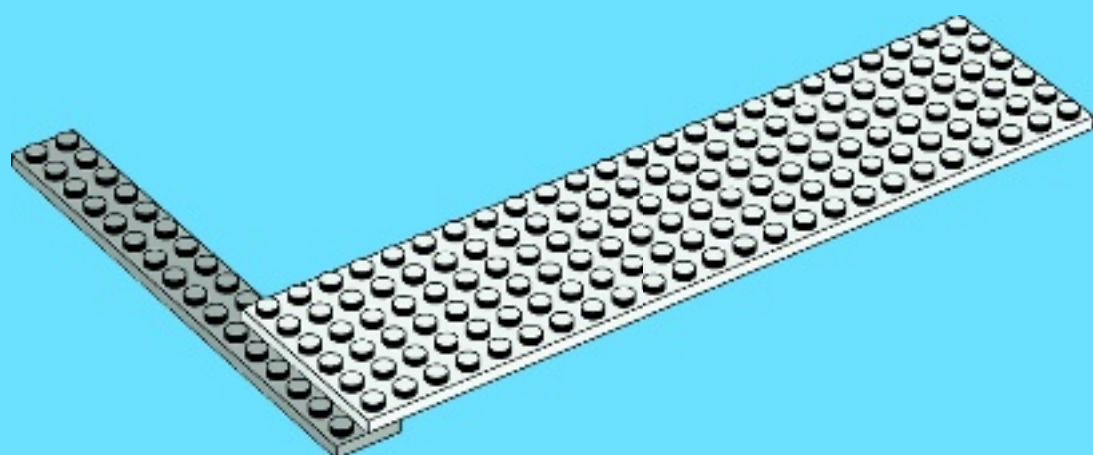

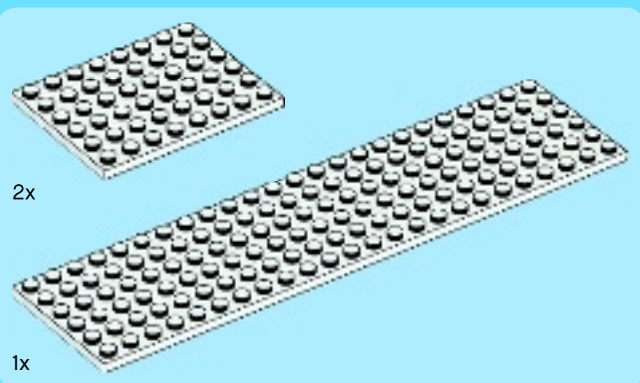

2

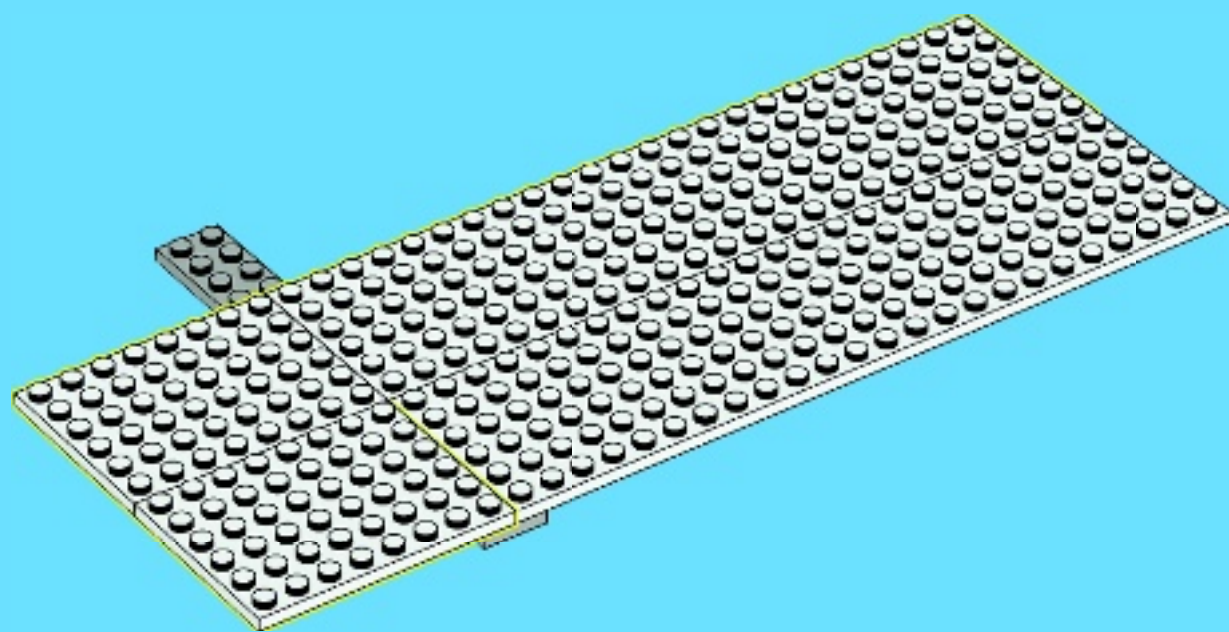

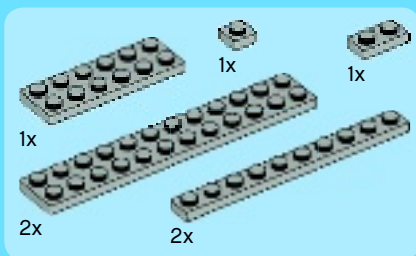

3

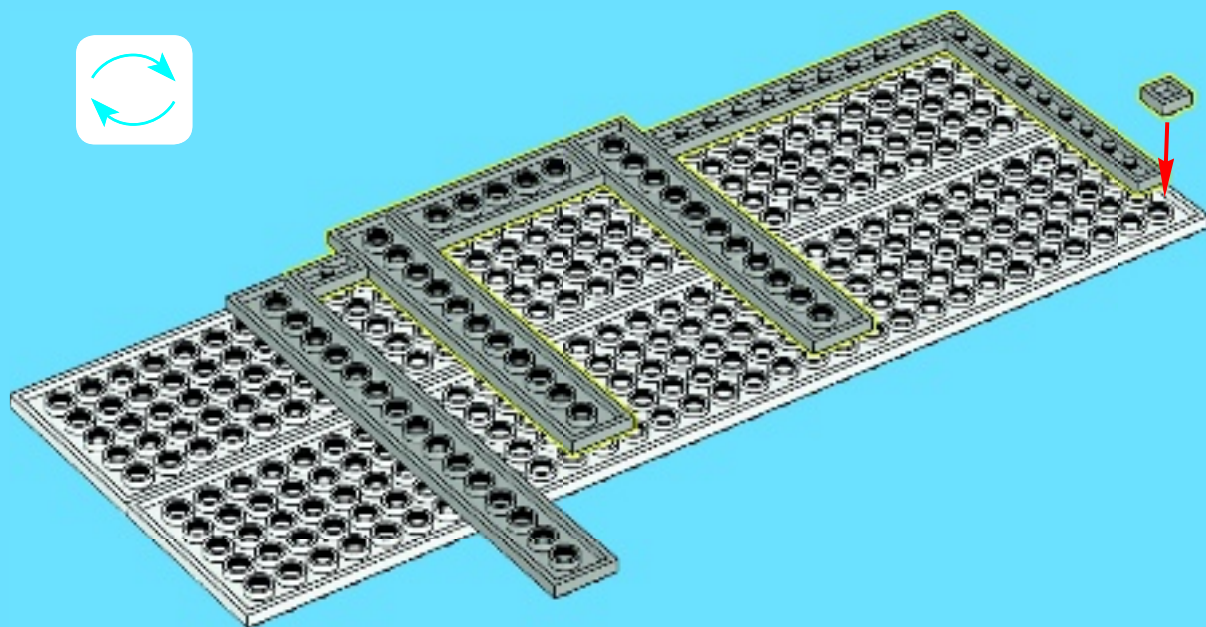

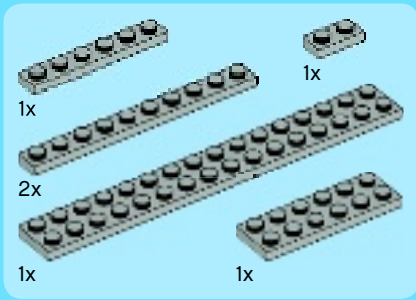

4

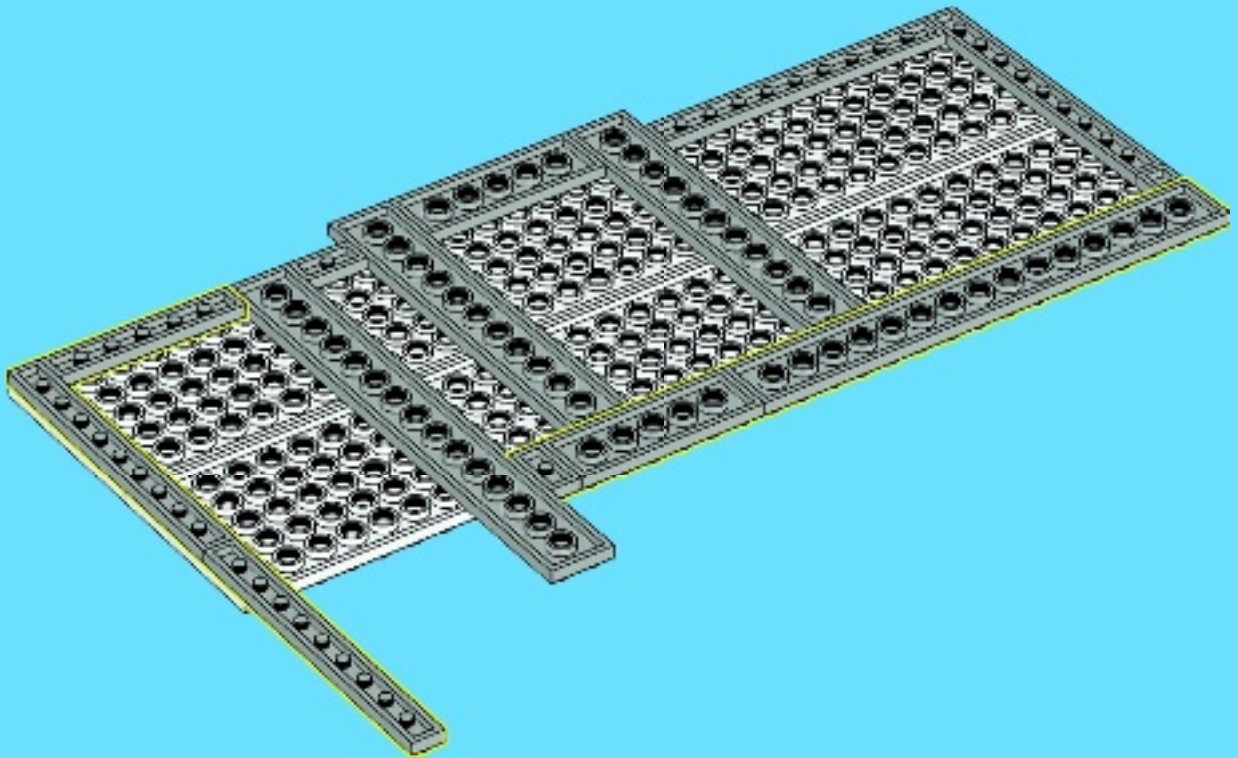

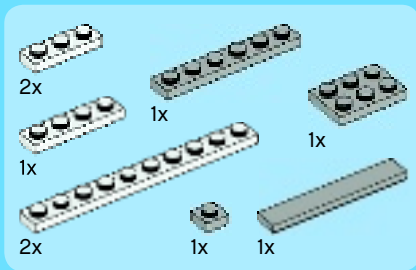

5

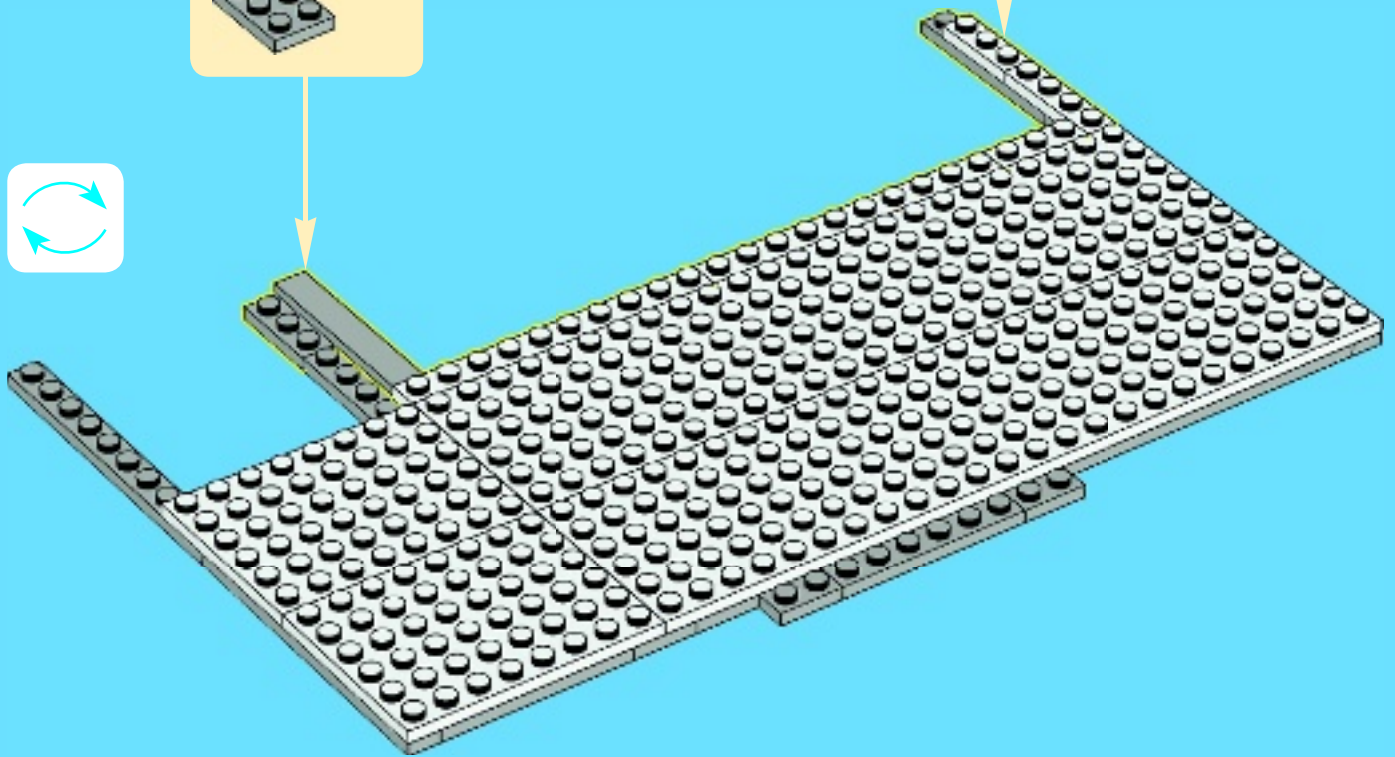
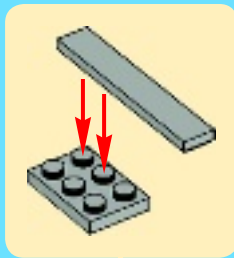
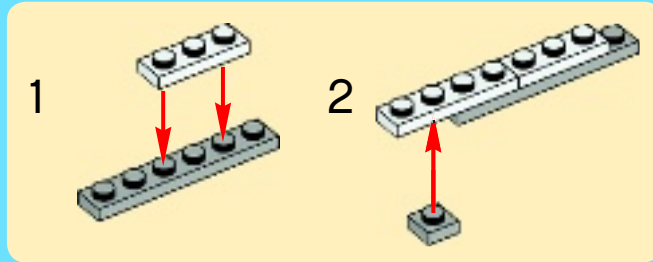

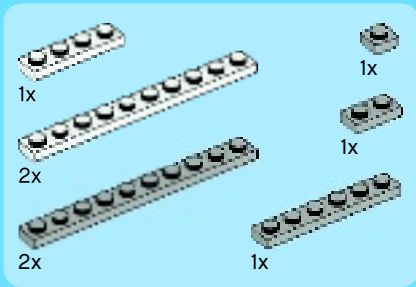

6

1

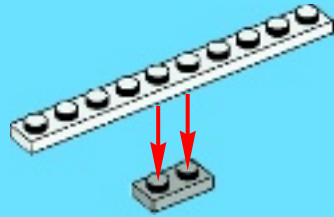

2

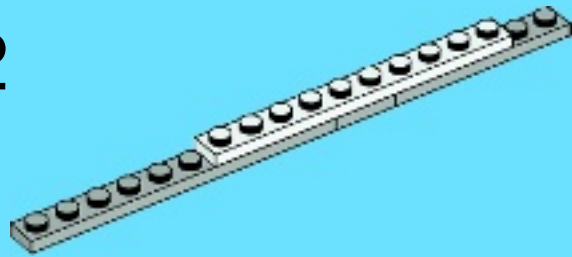

3

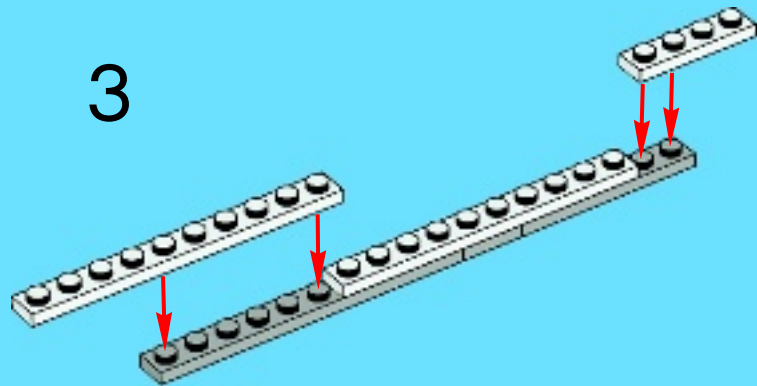

4

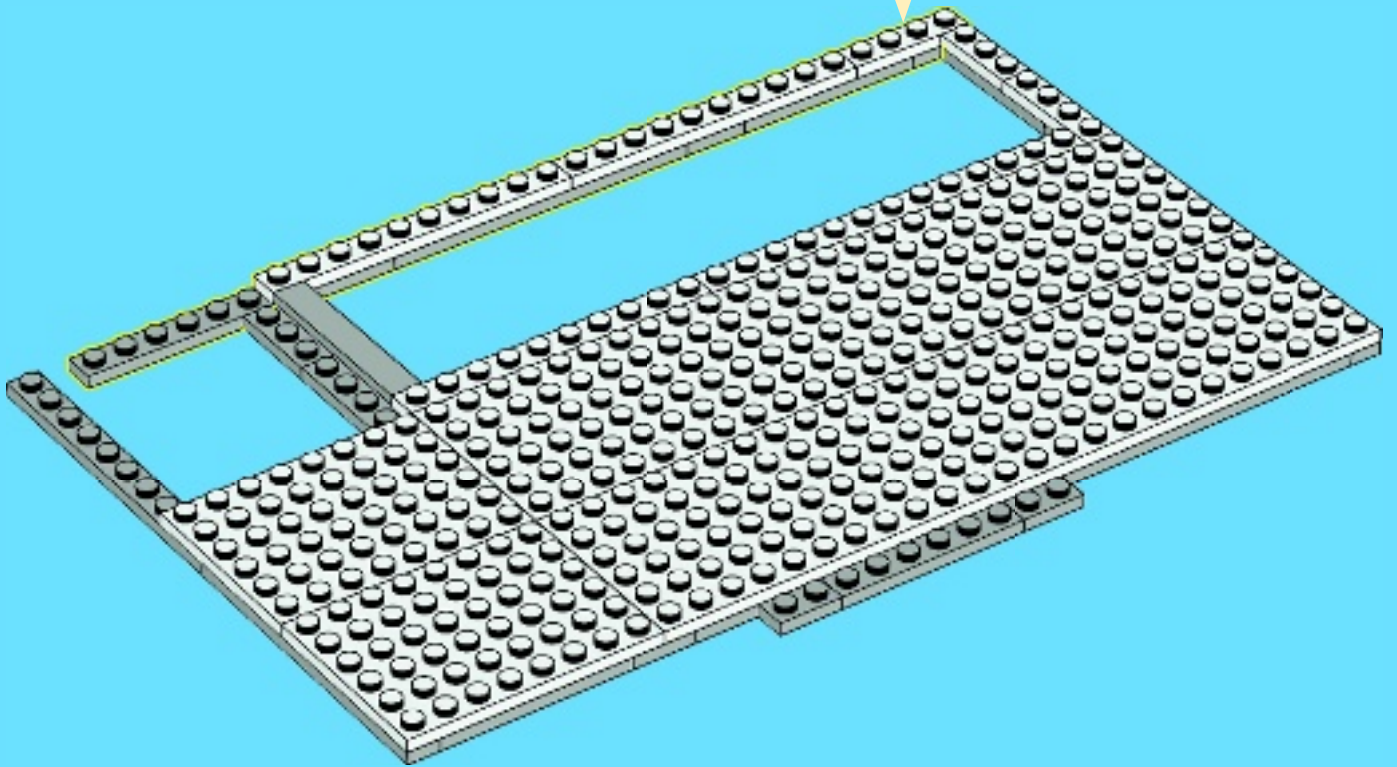
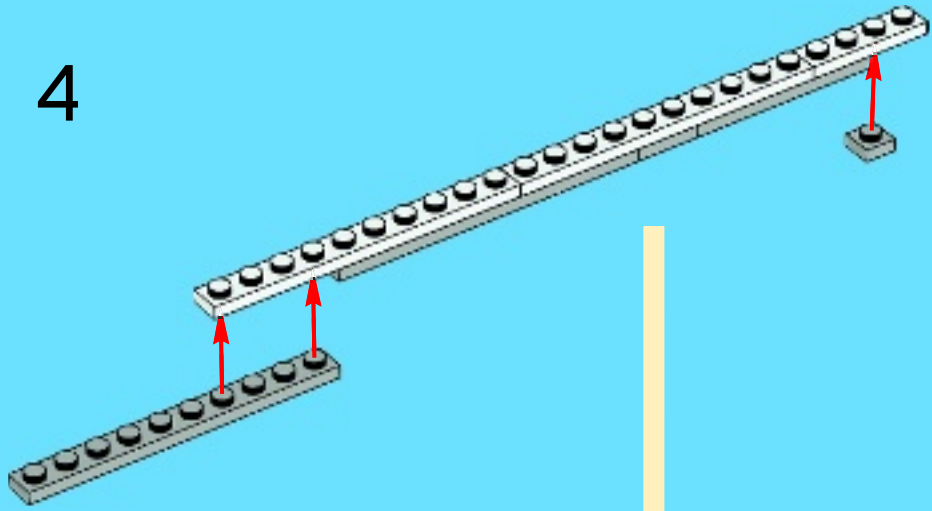

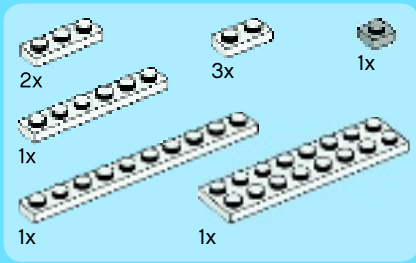

7

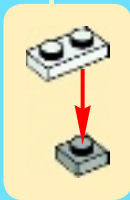
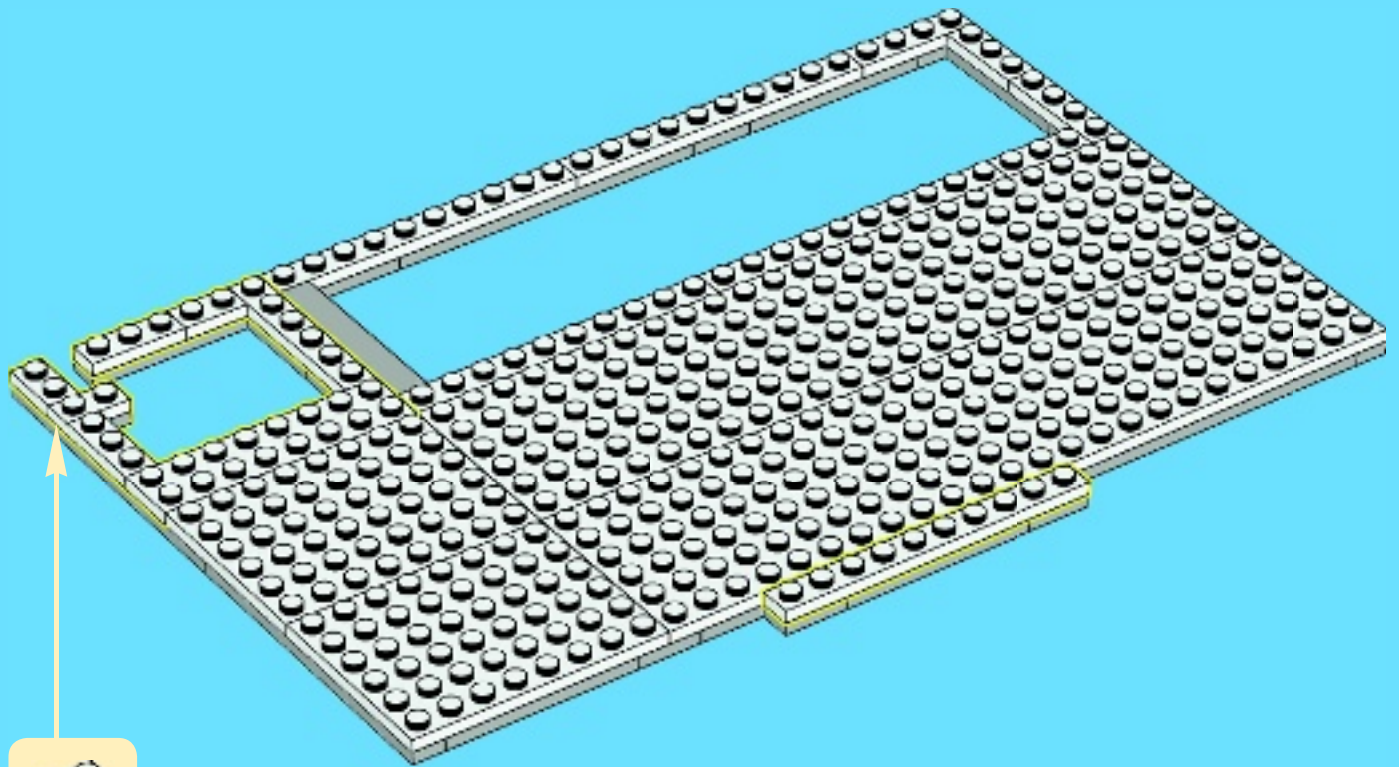

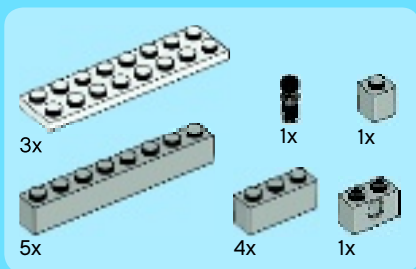

8

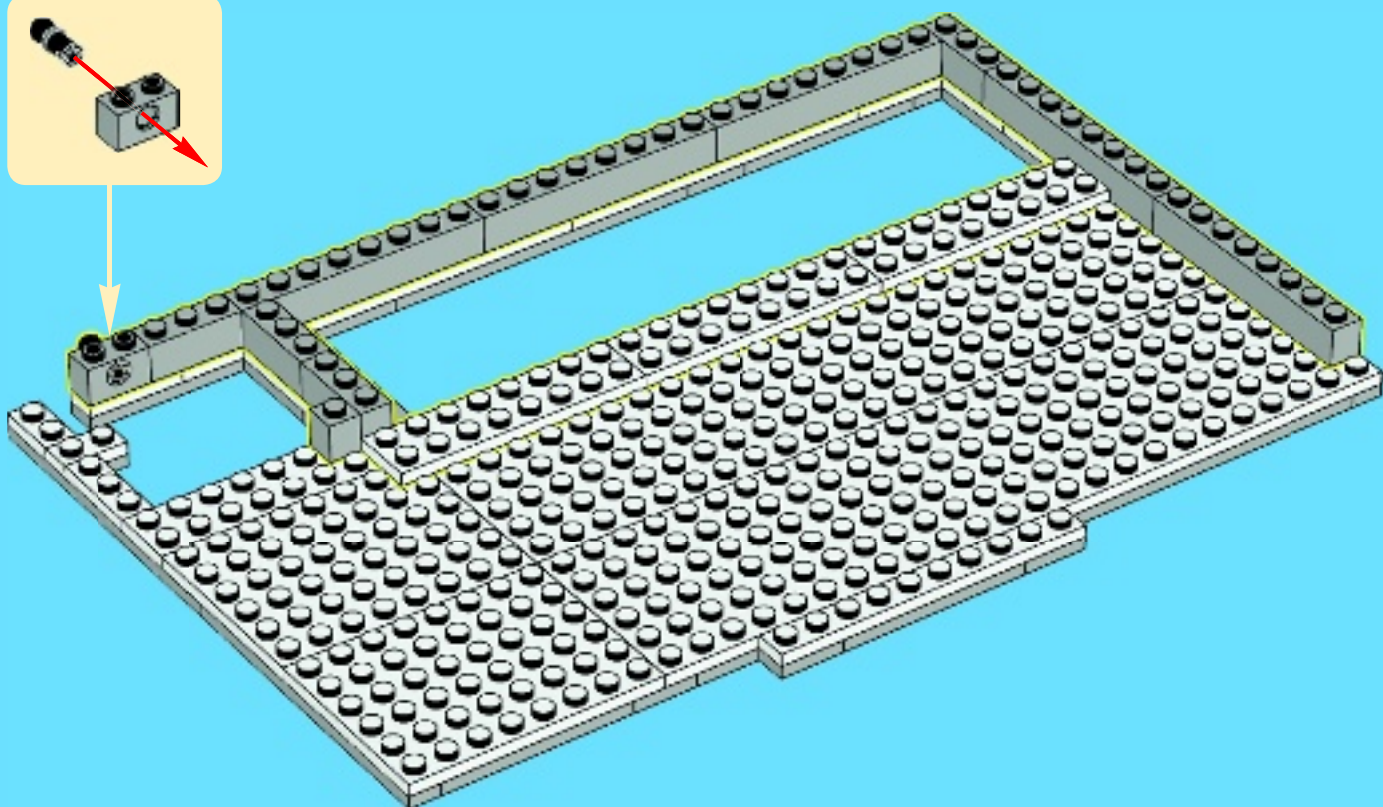
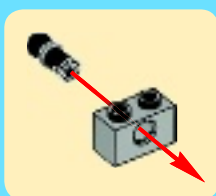

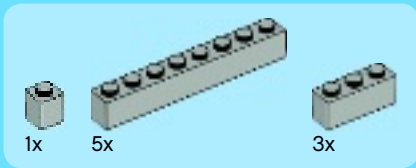

9

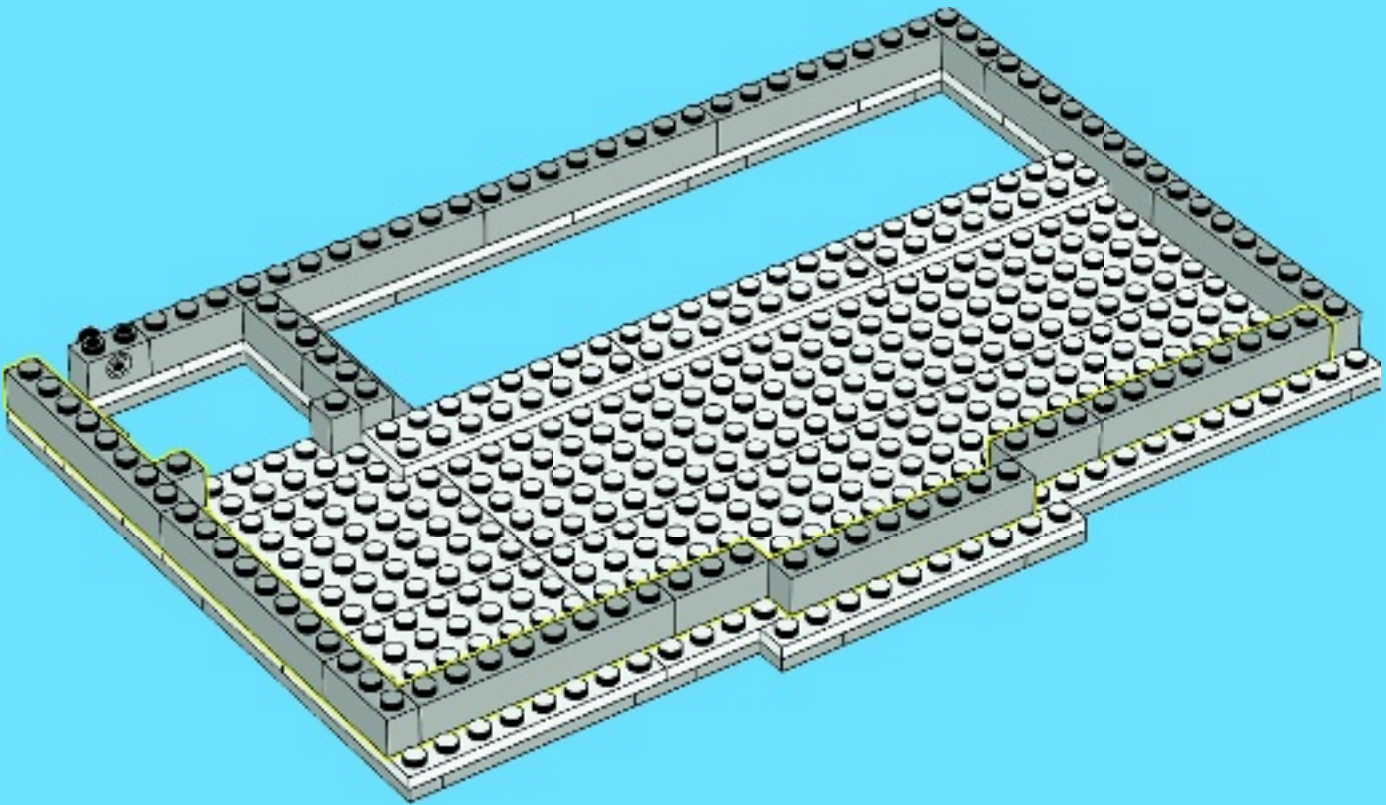



10x



6x



2x



2x



1x



2x

10

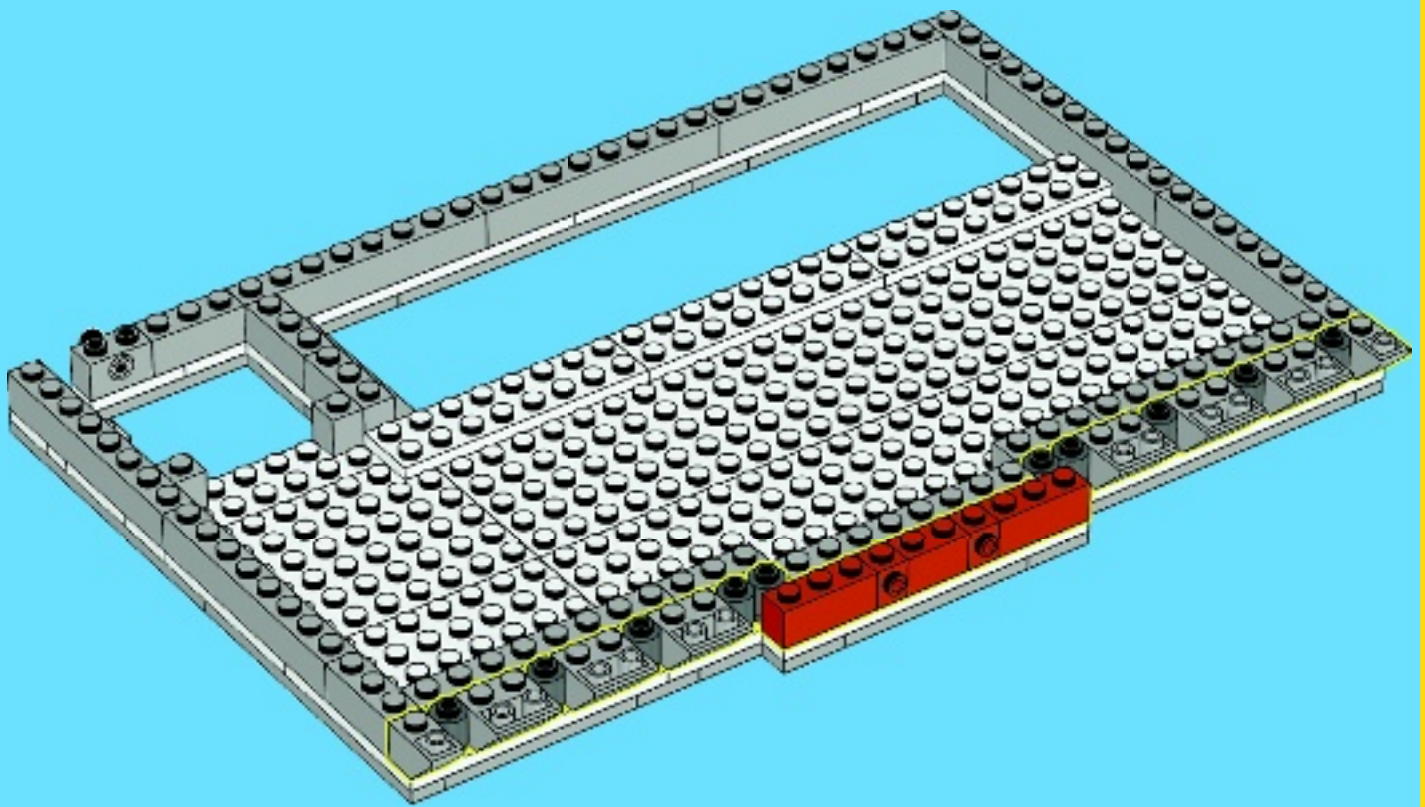

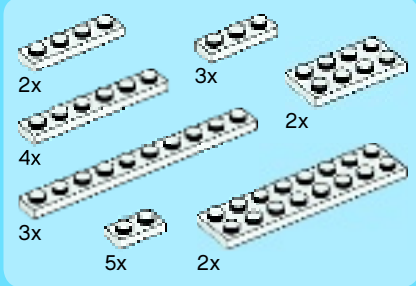

11

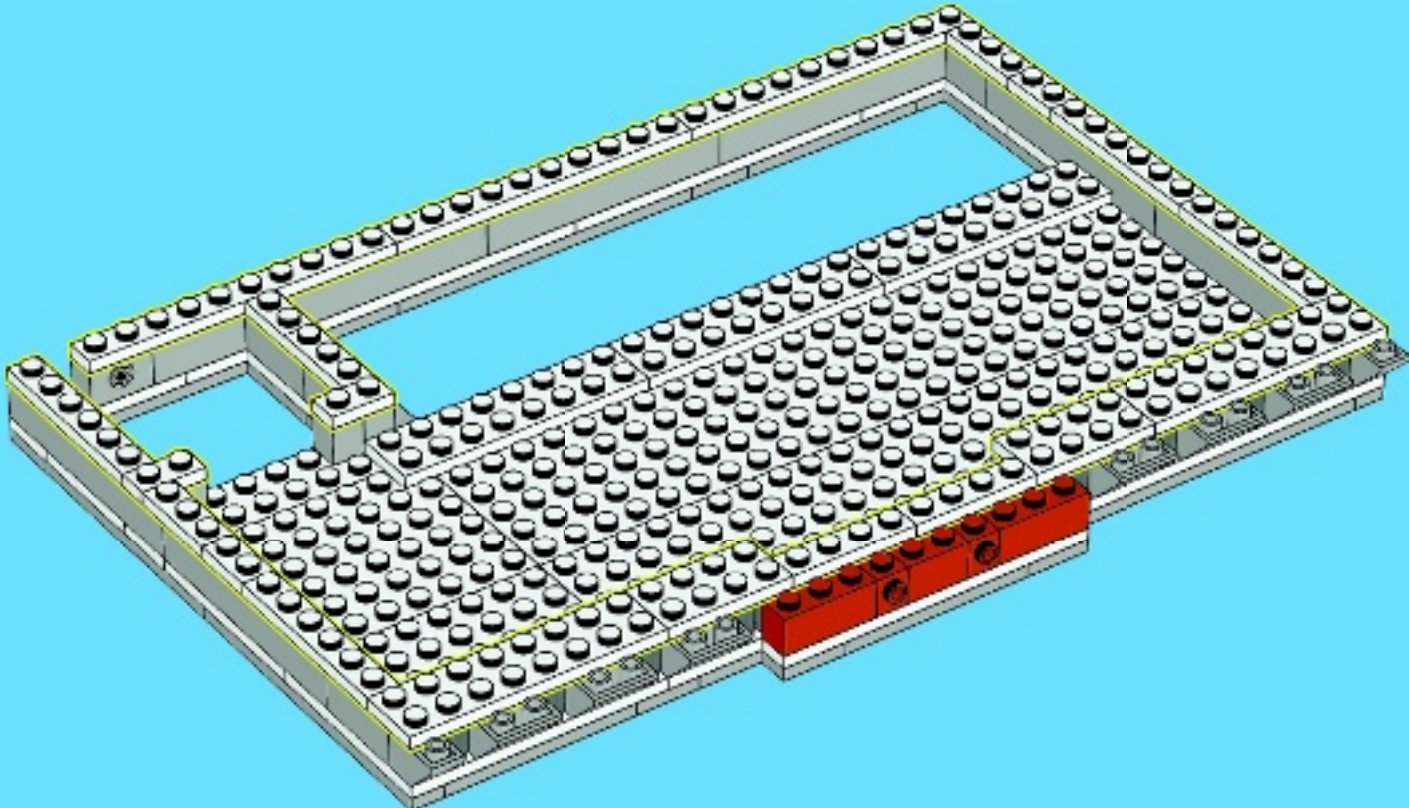

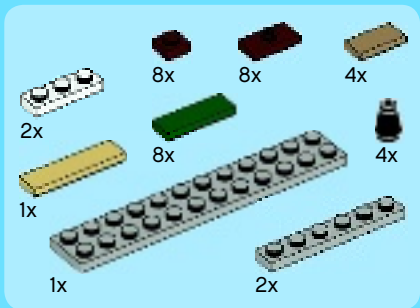
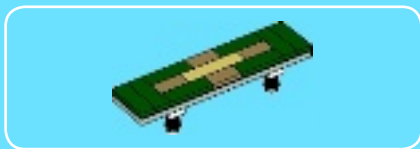

12

1

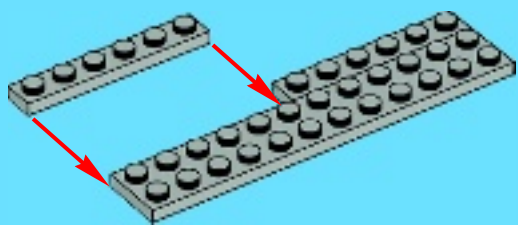

2

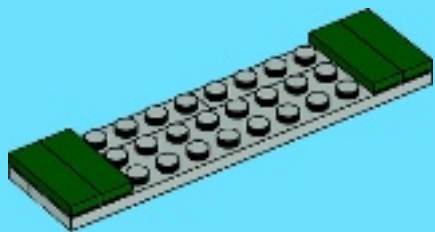

3

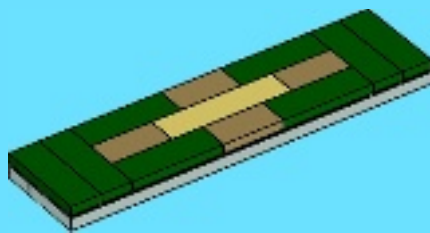

4

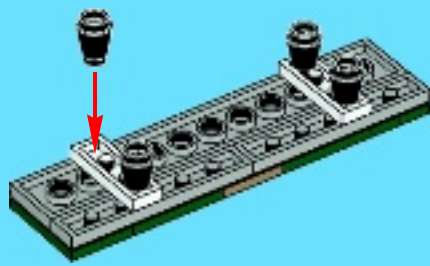

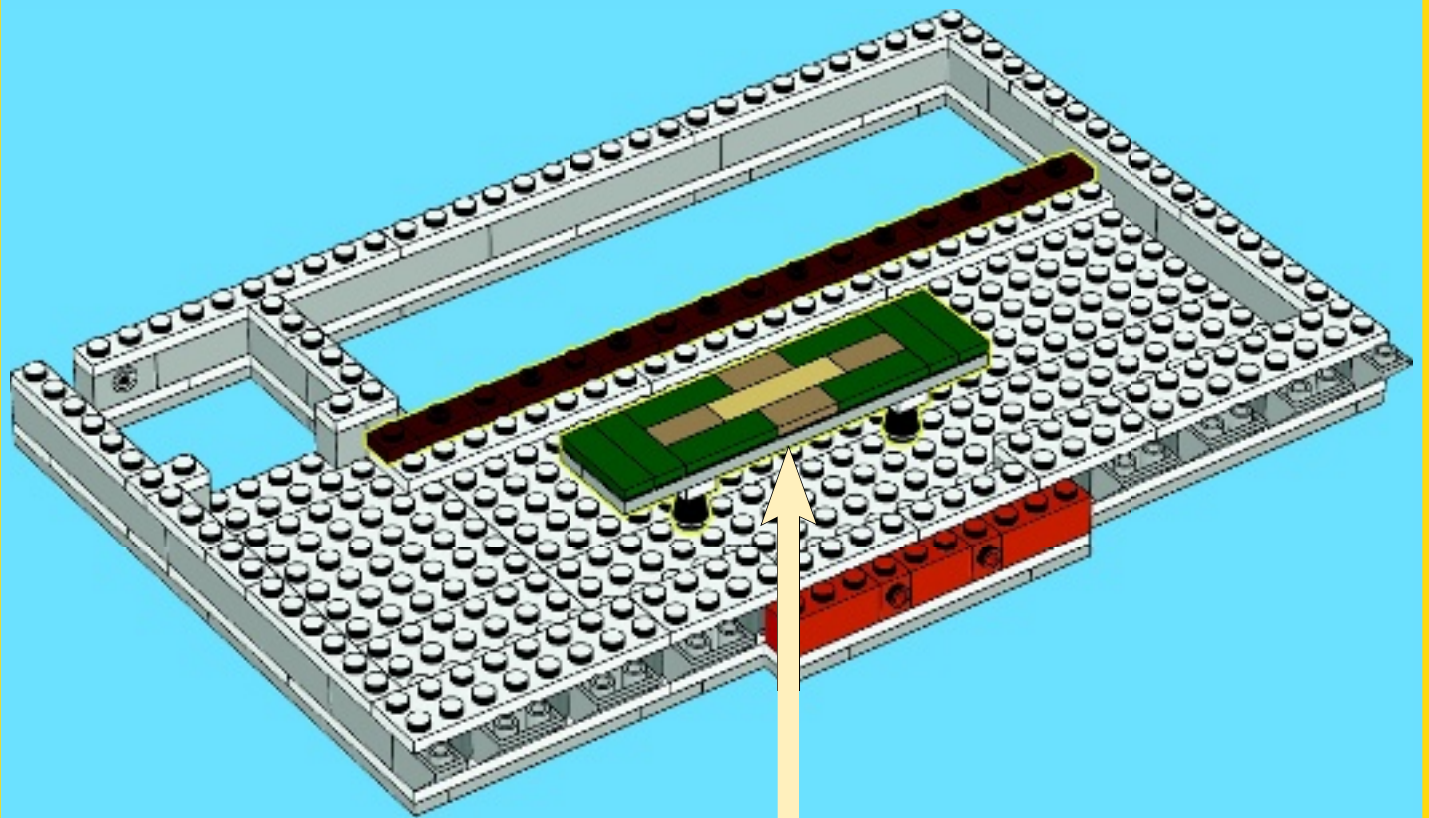

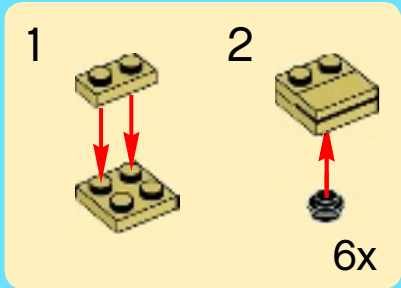
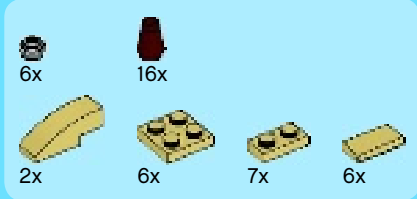

13

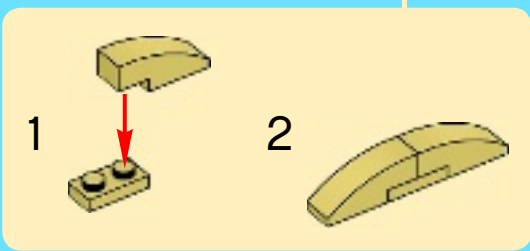
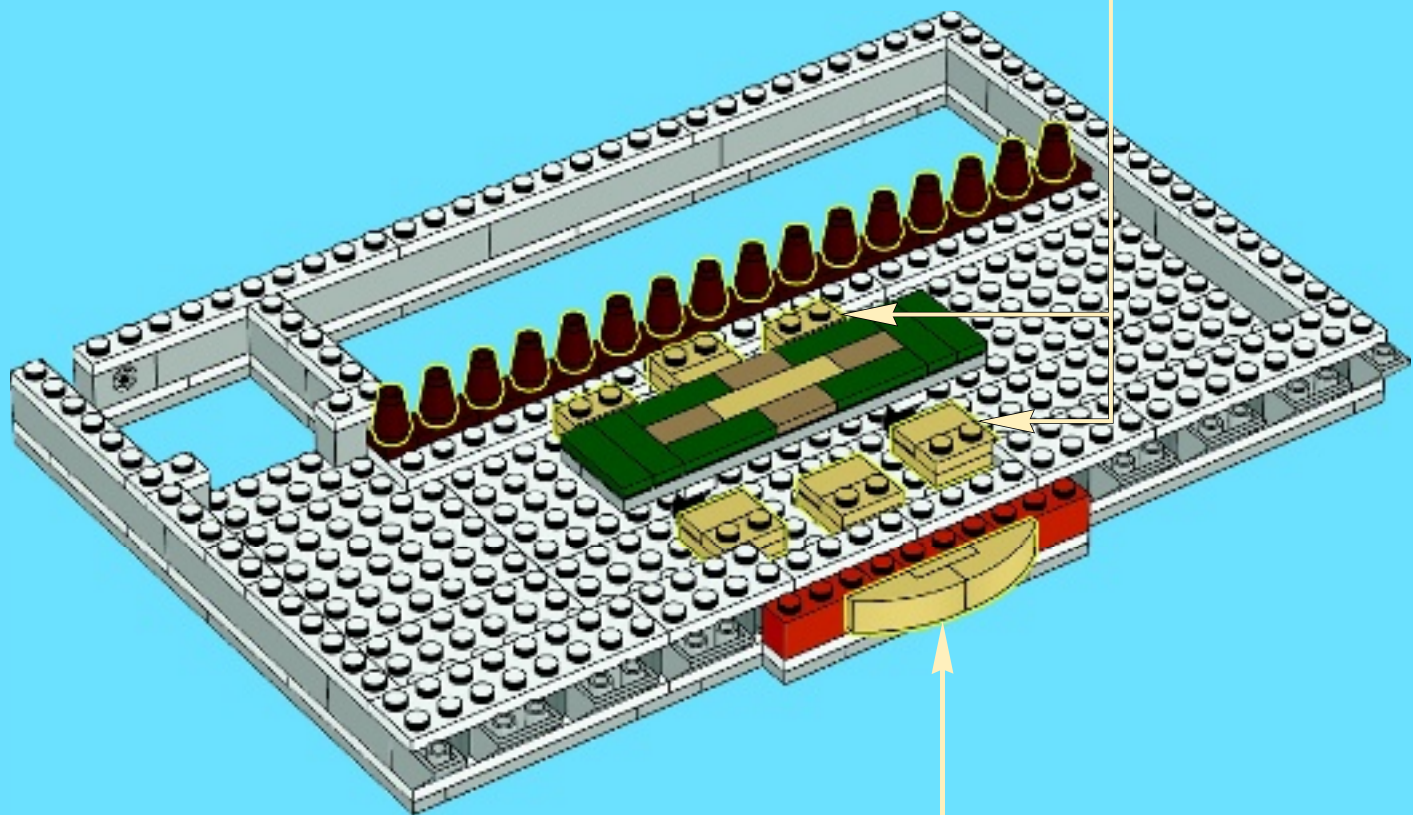

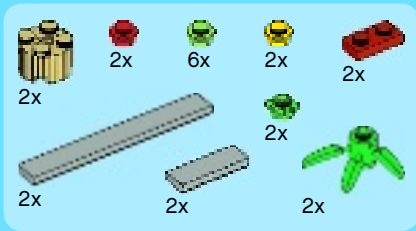

14

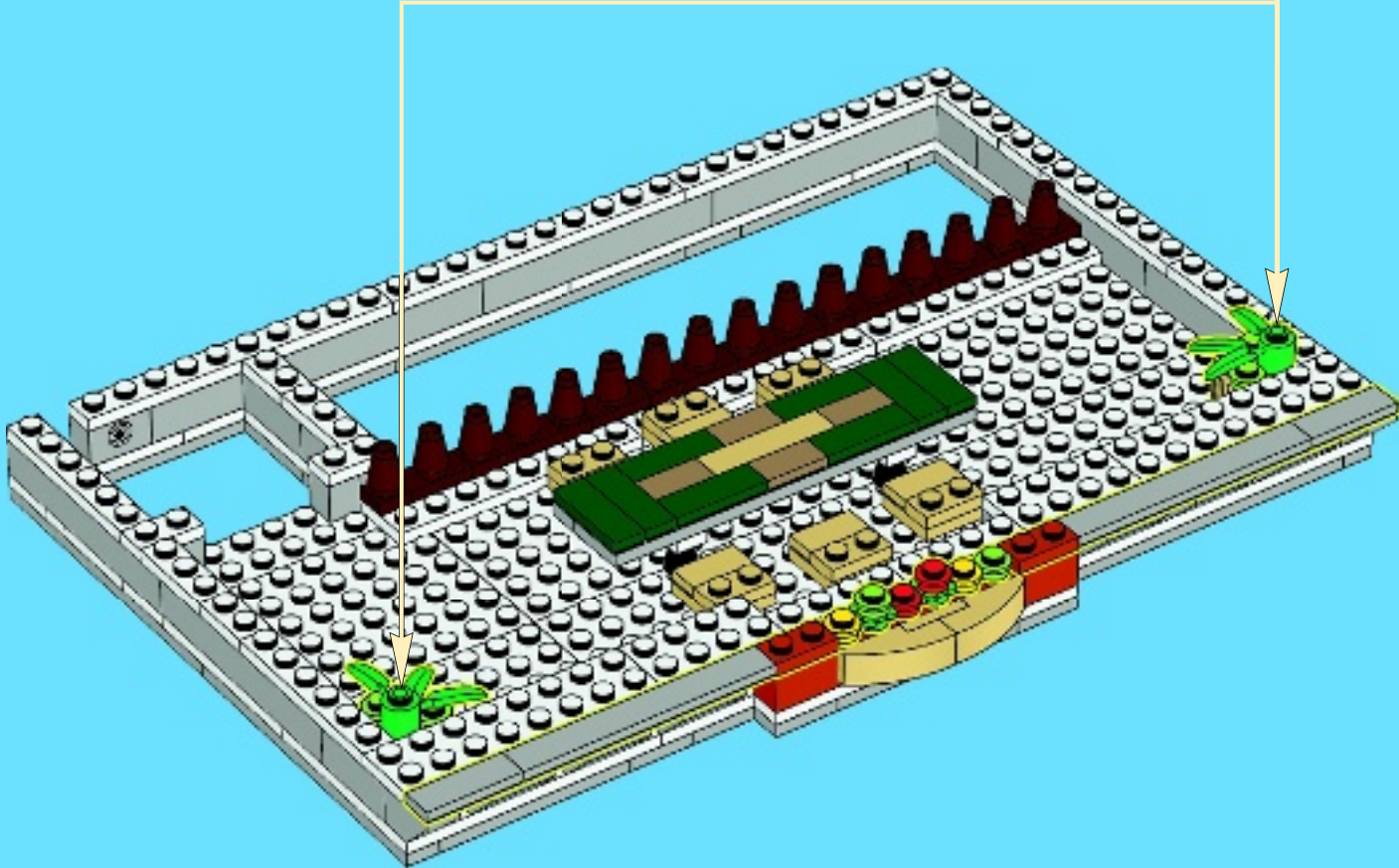
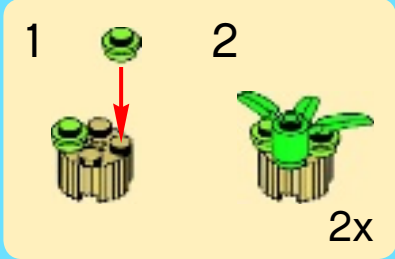

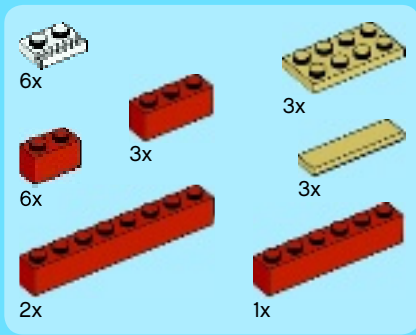

15

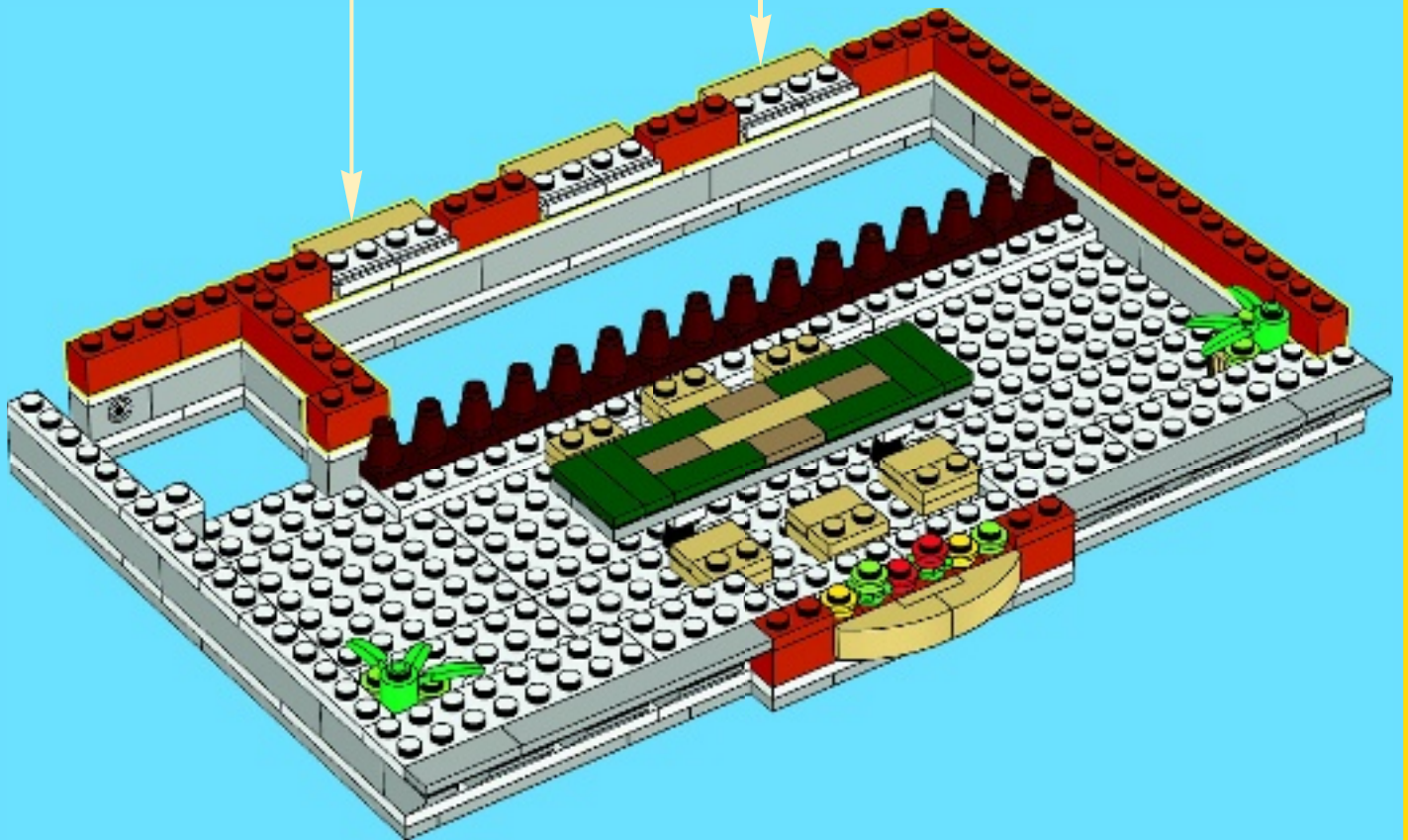
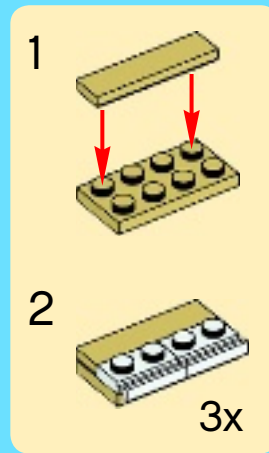

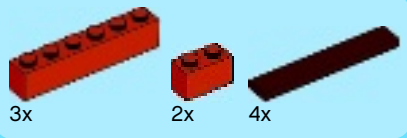

16

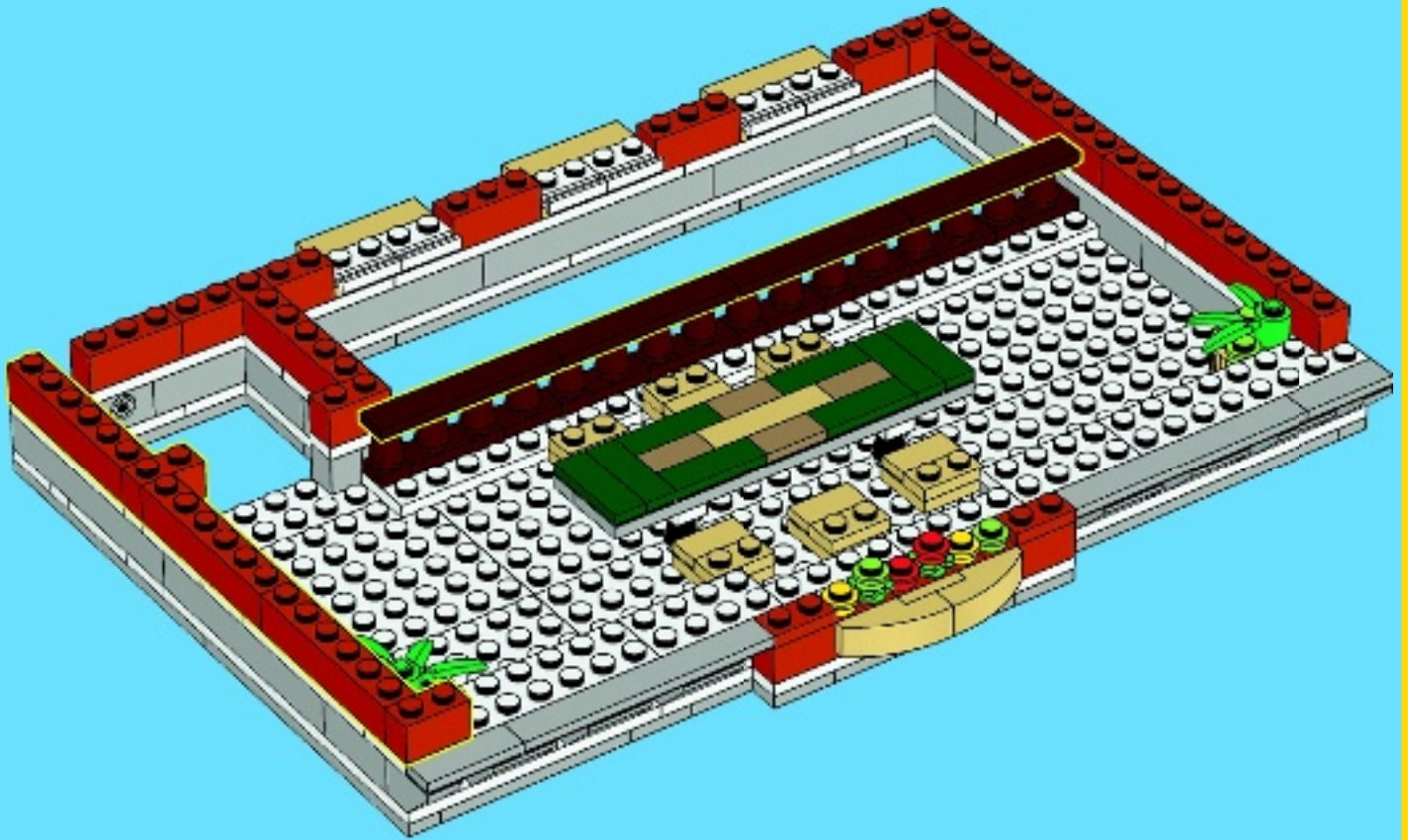

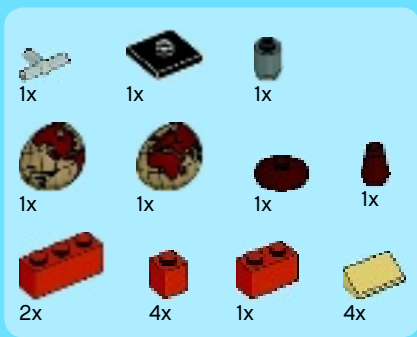

17

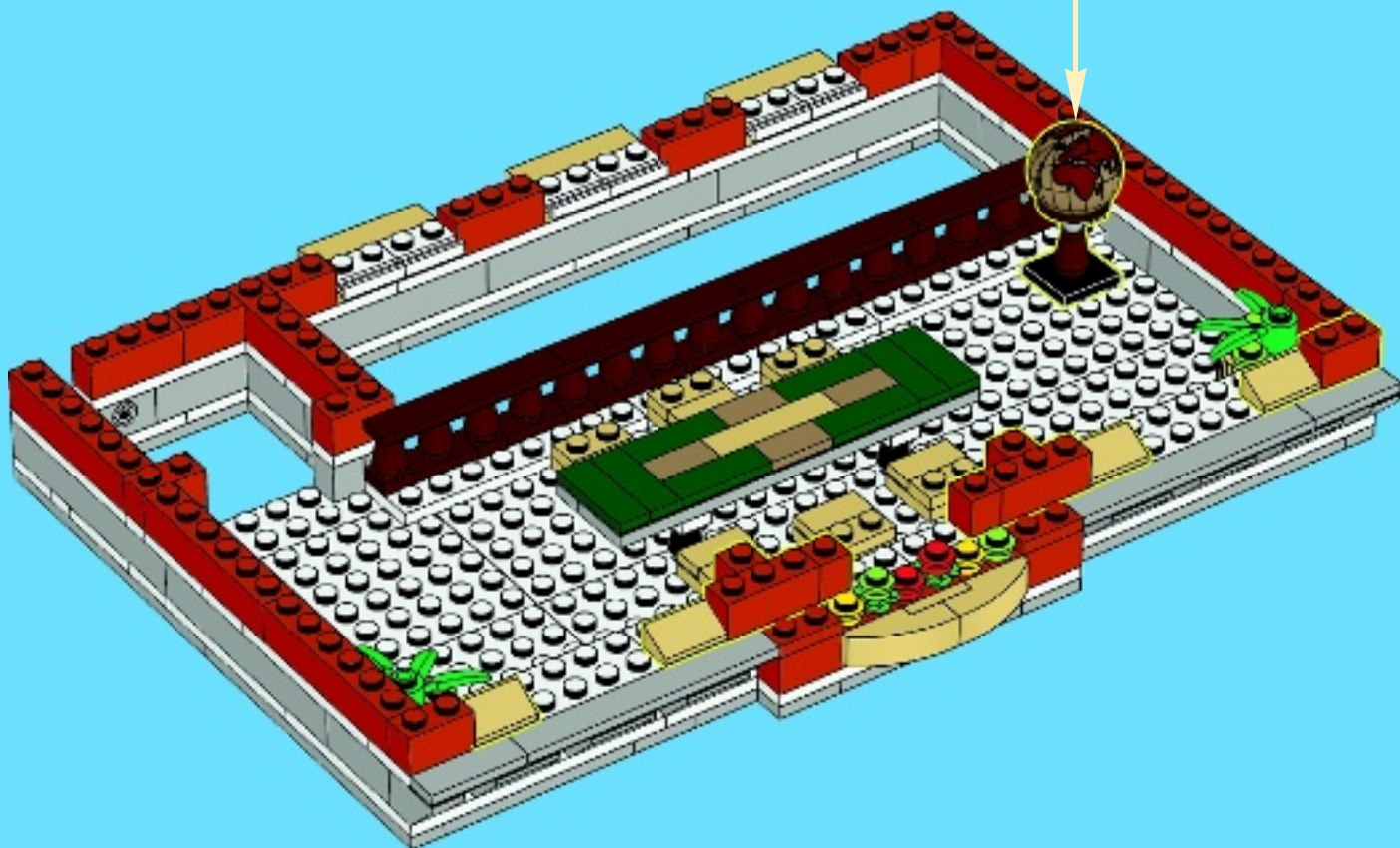
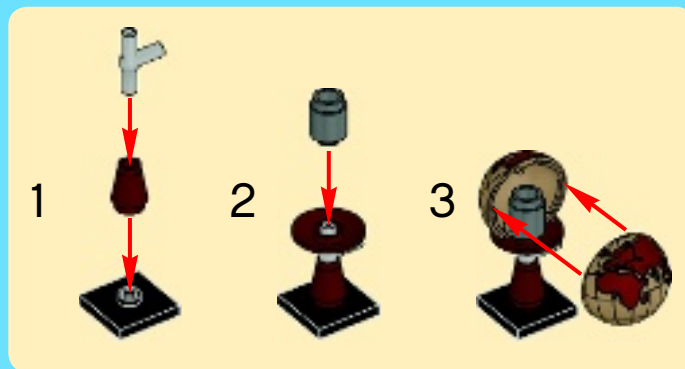



1x



1x



4x



1x



2x



4x



4x



1x



2x

18

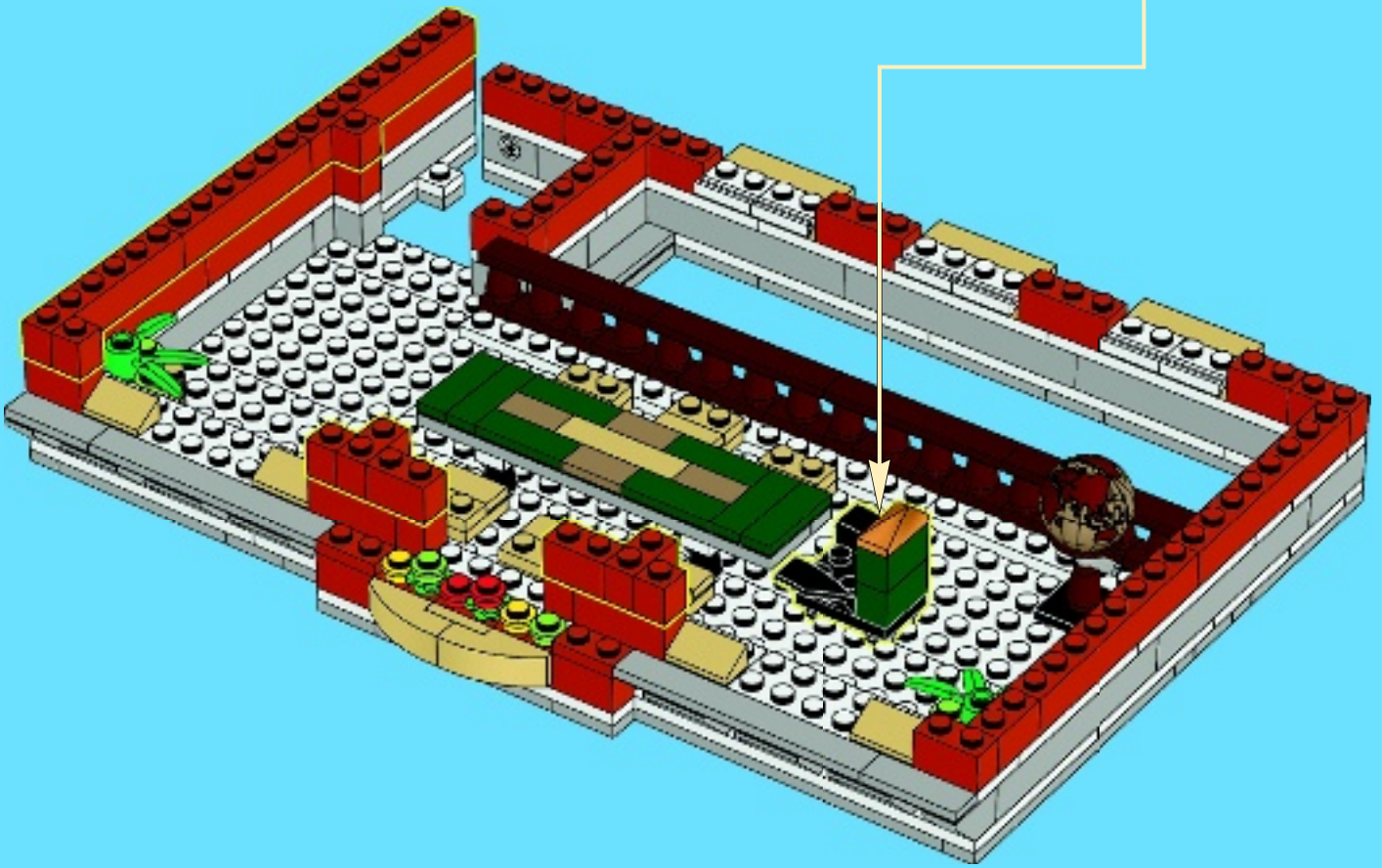
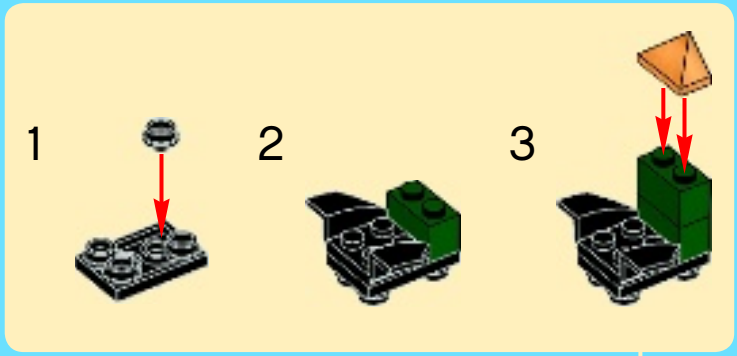

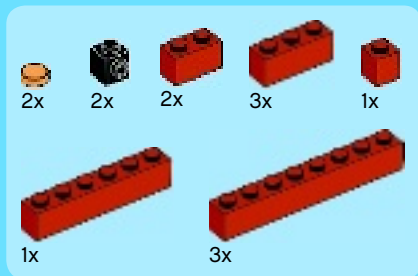

19

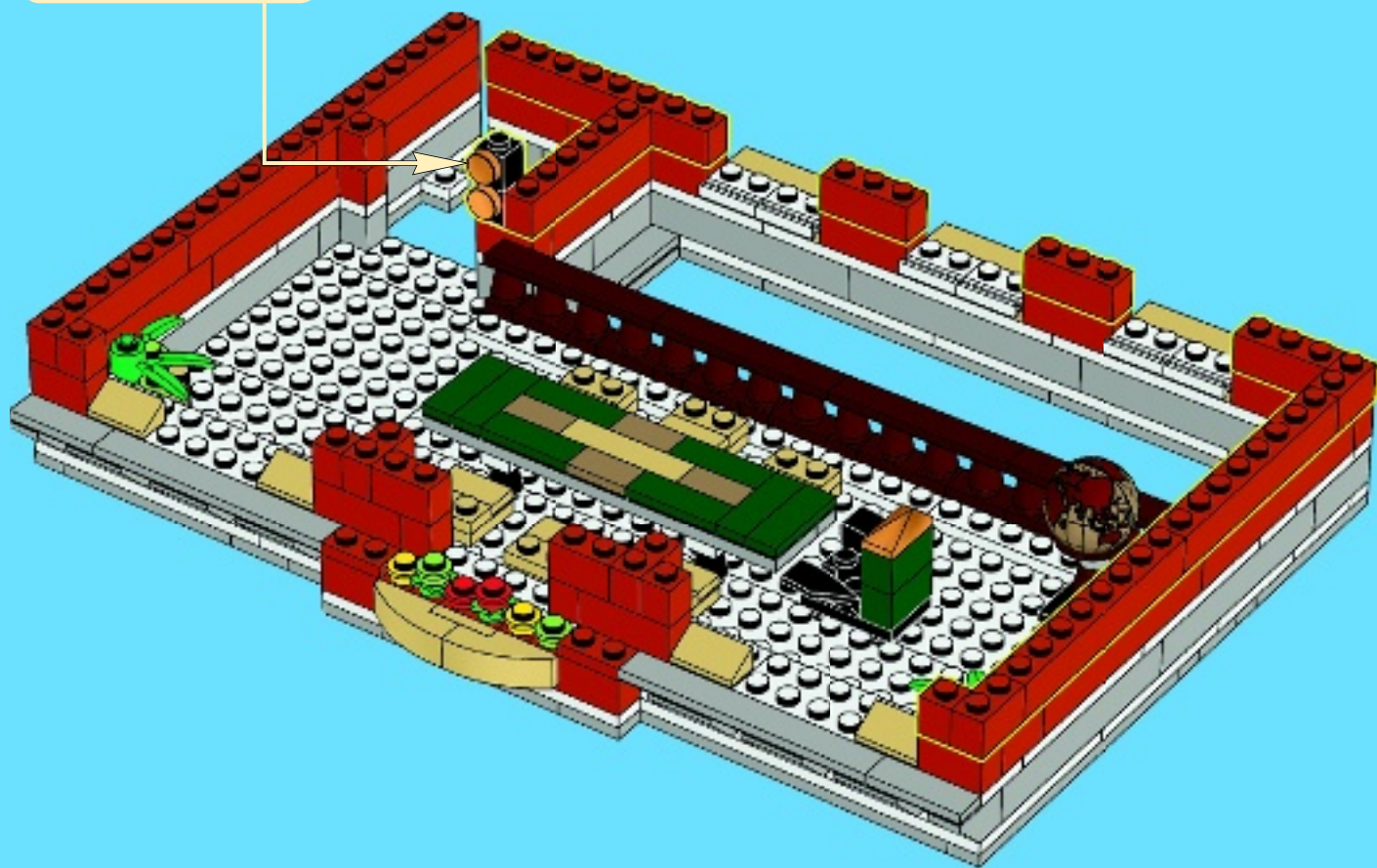
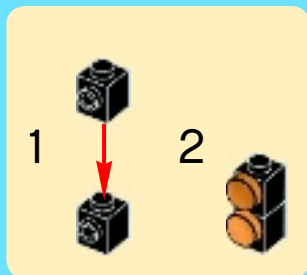

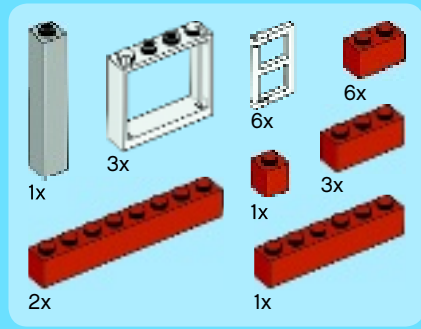

20

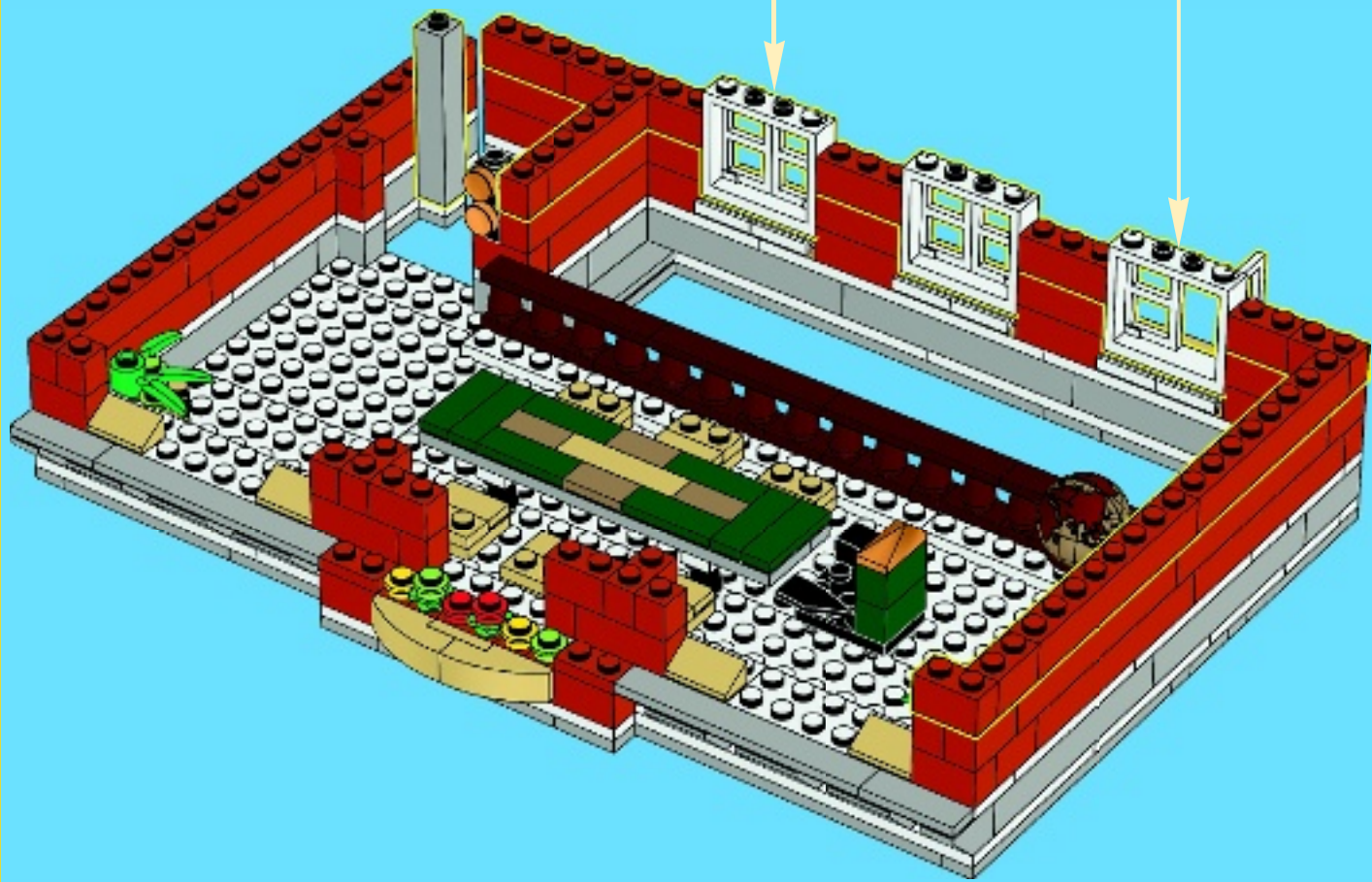
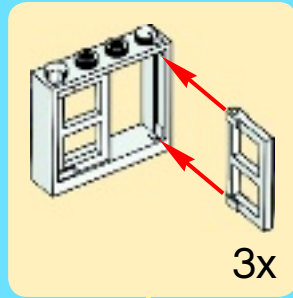

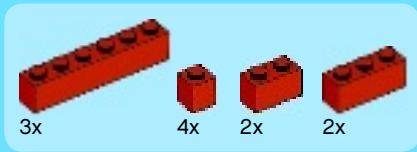

21

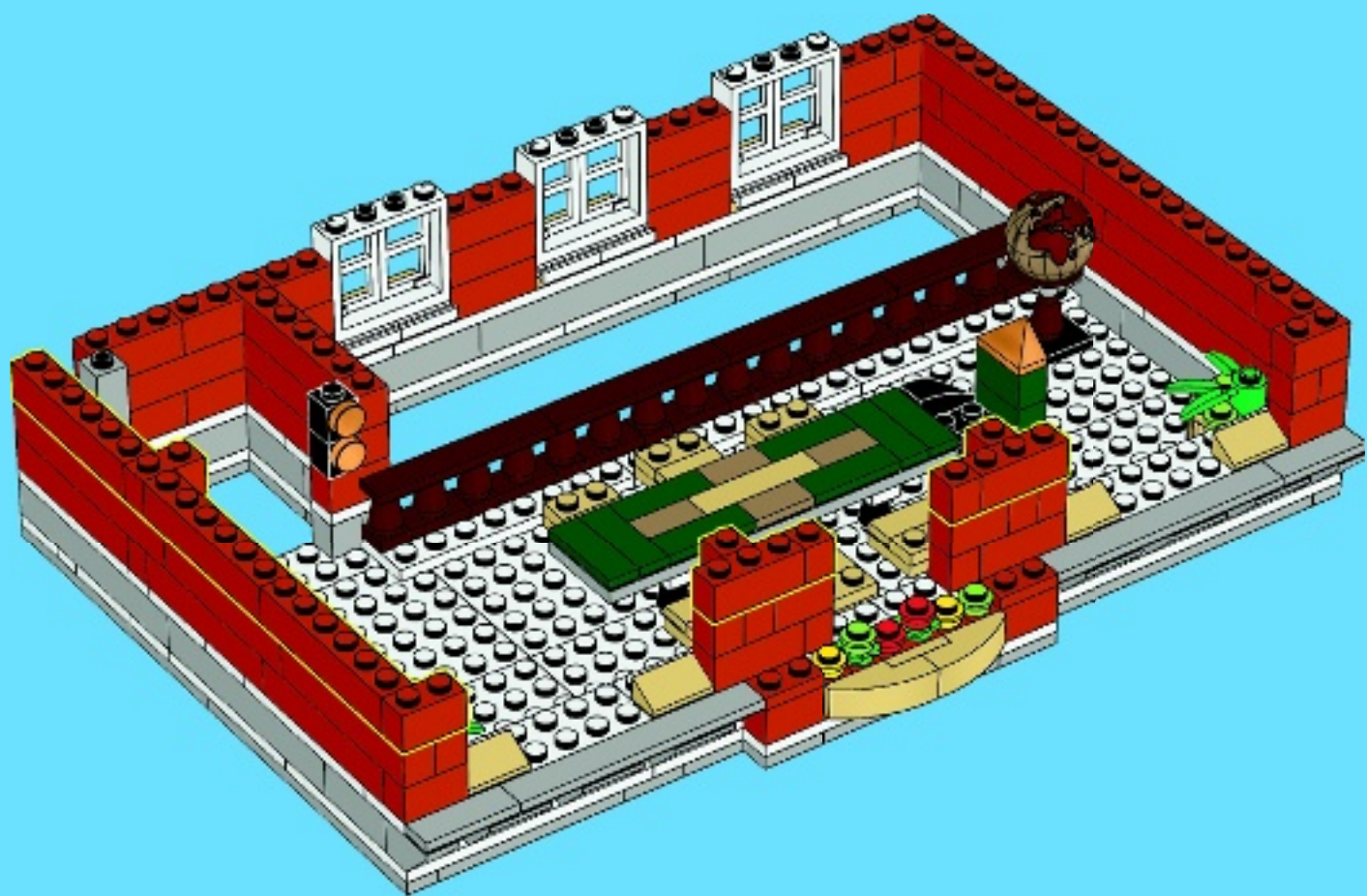



20x



20x



4x

22

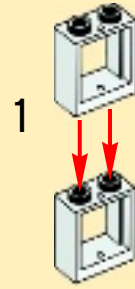

1

2

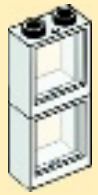

10x

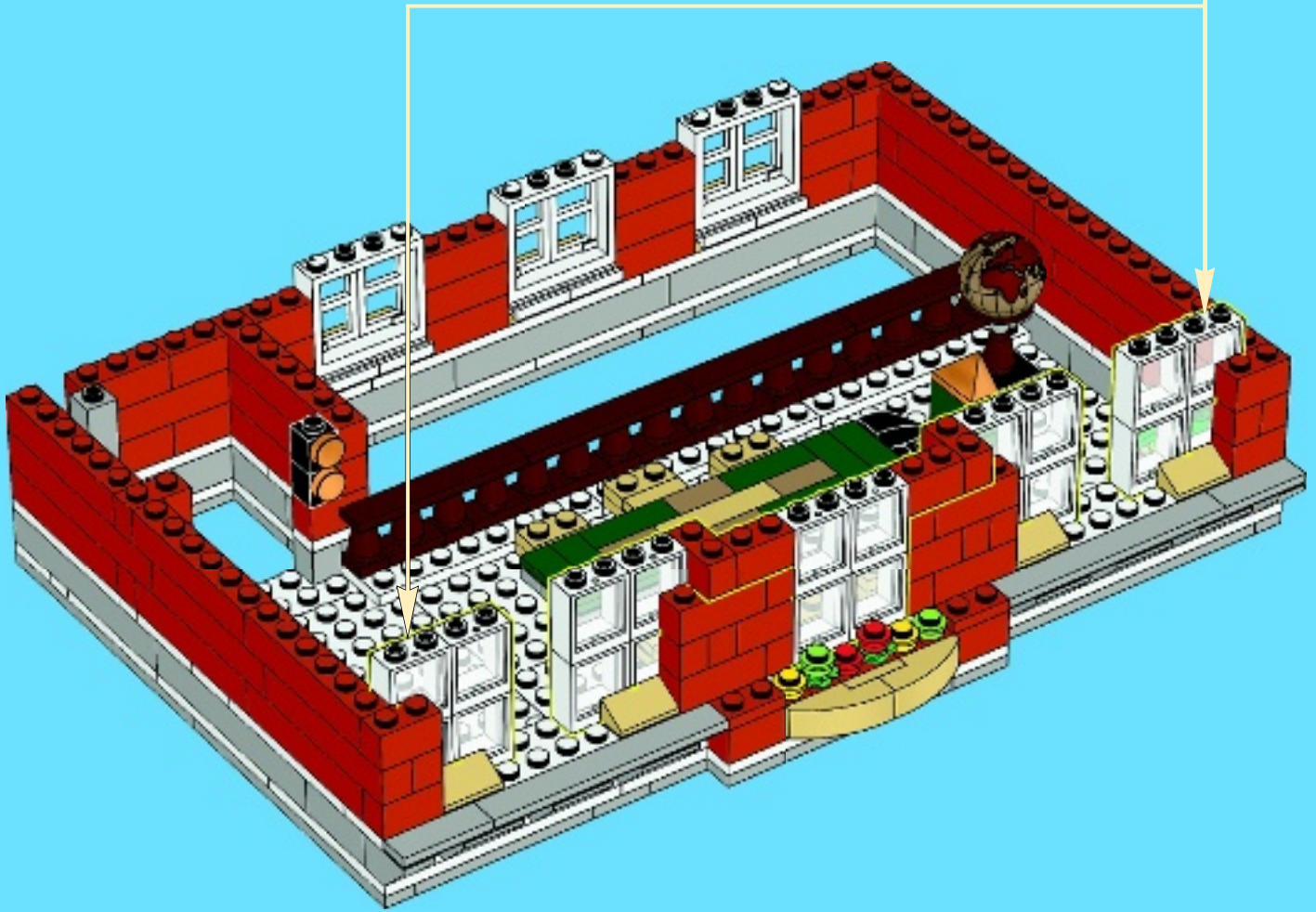

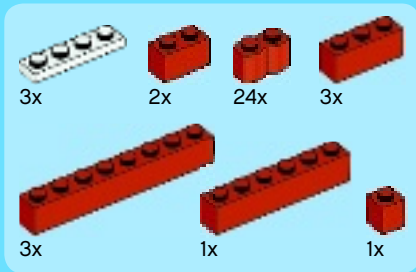

23

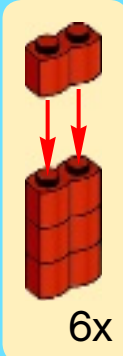
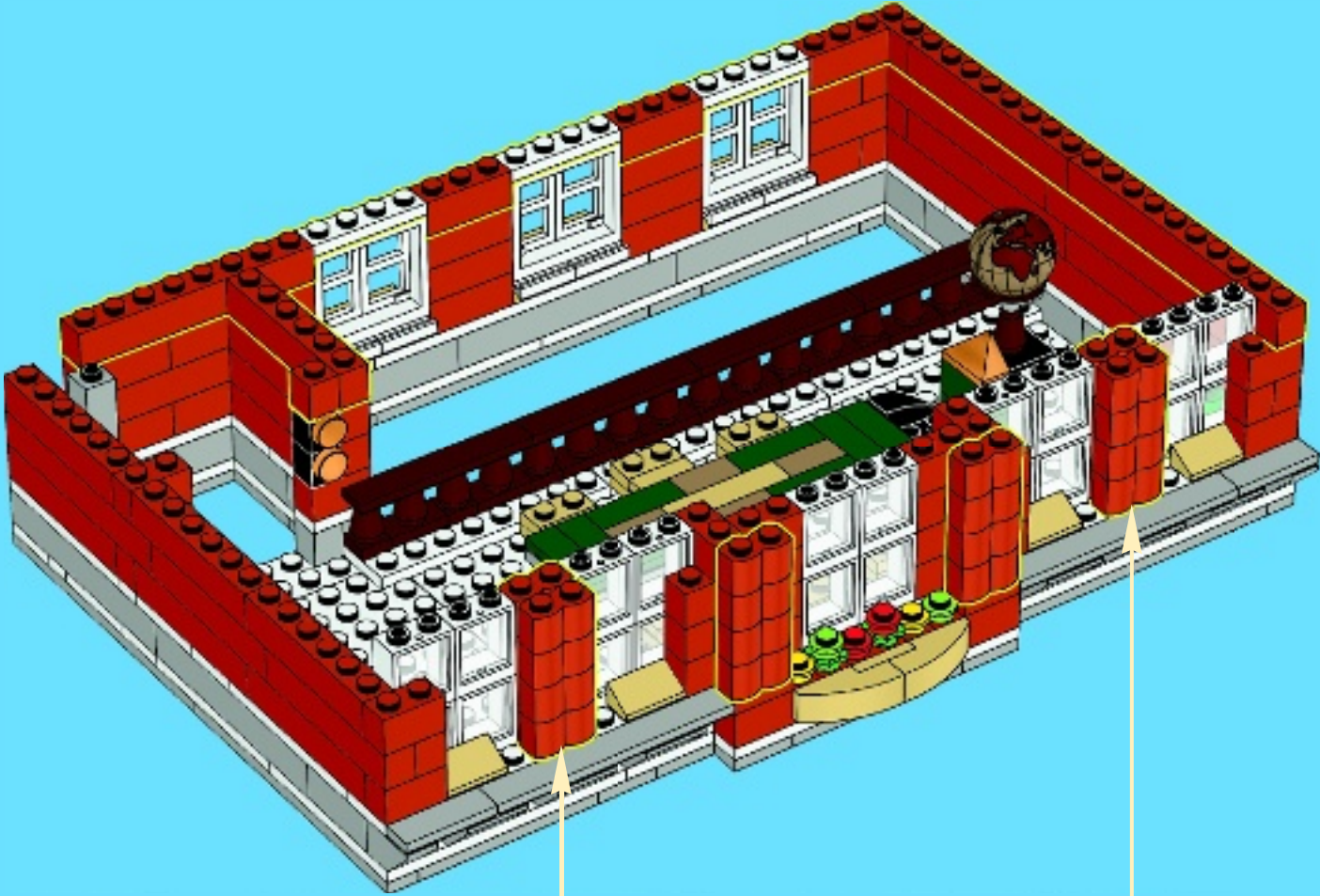

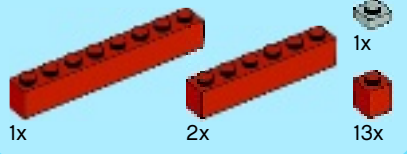

24

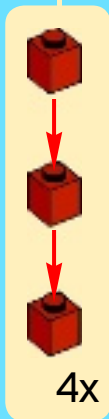
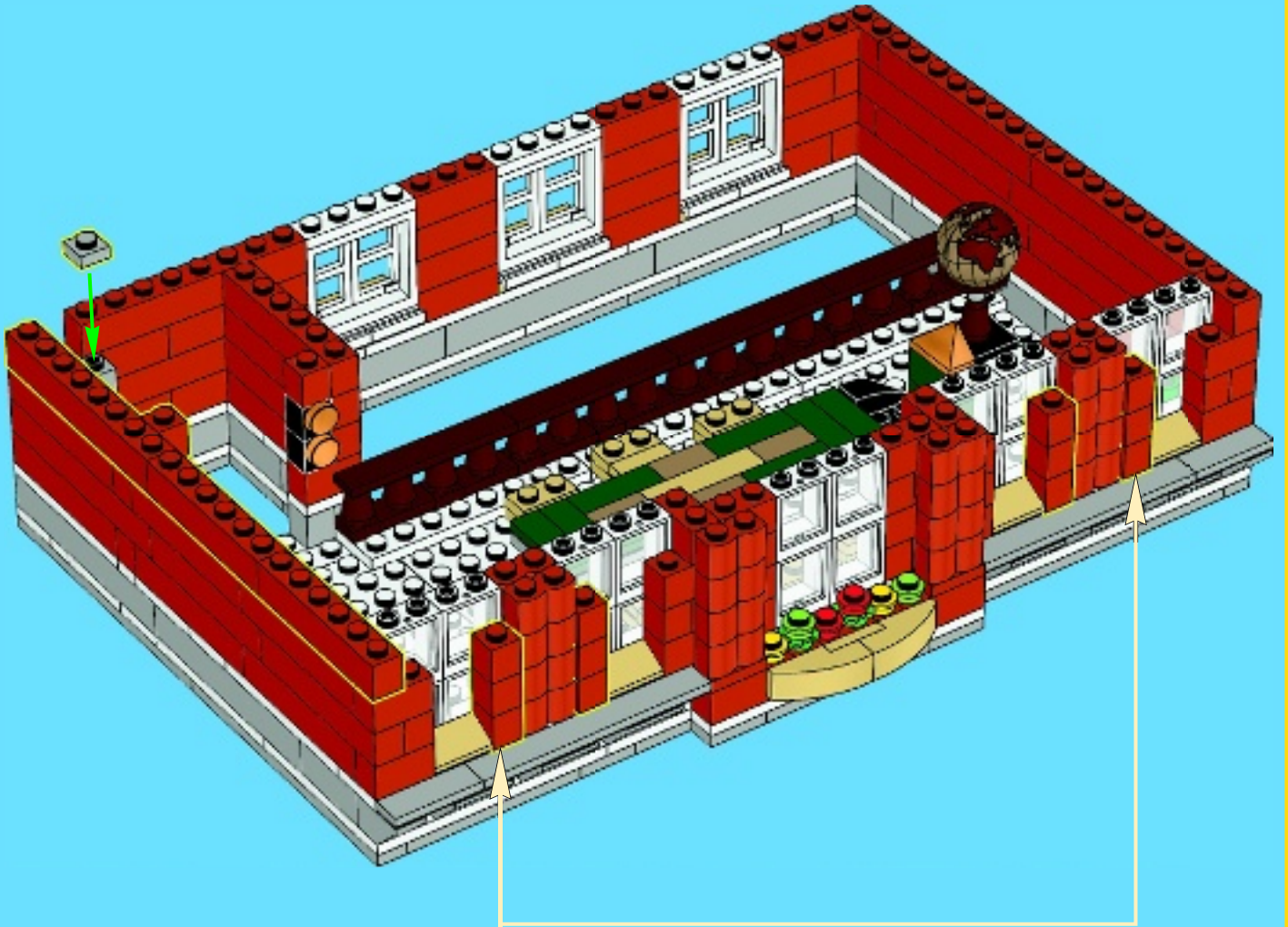

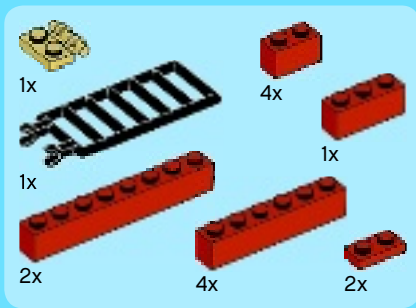

25

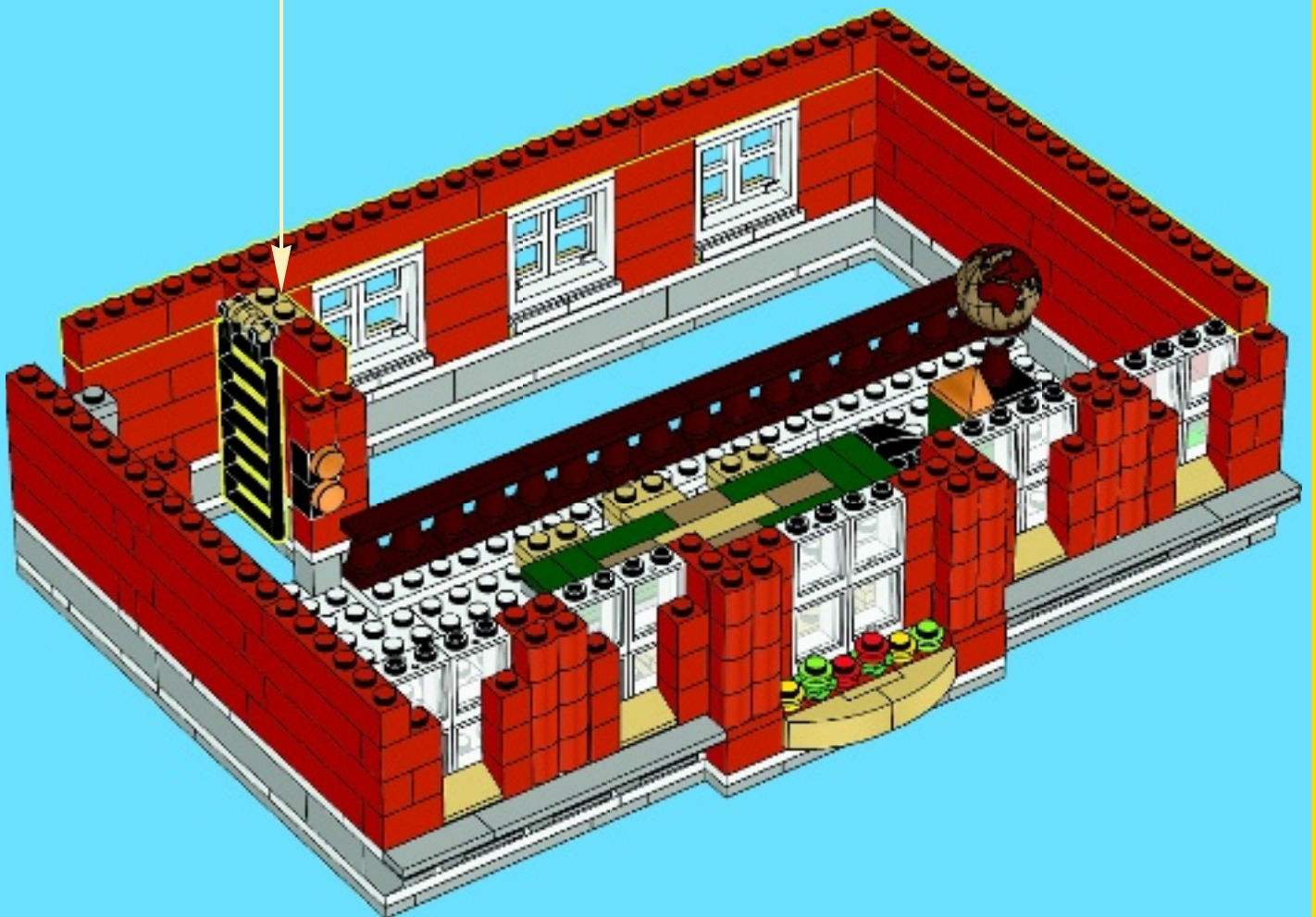
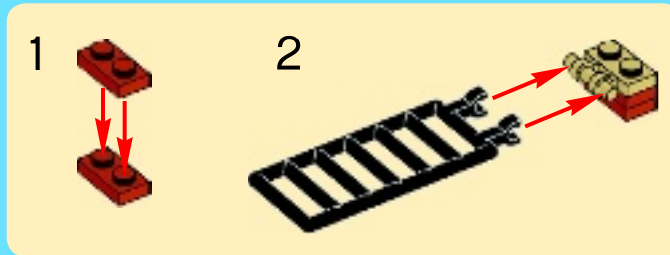

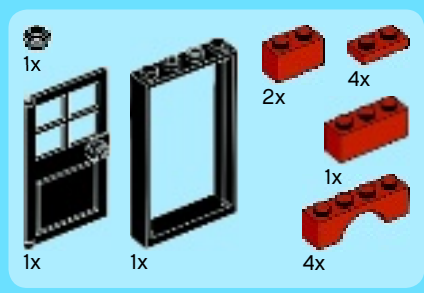



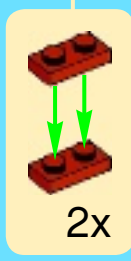
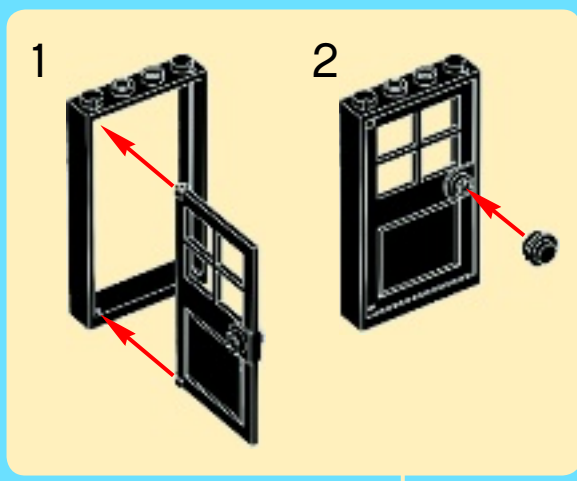

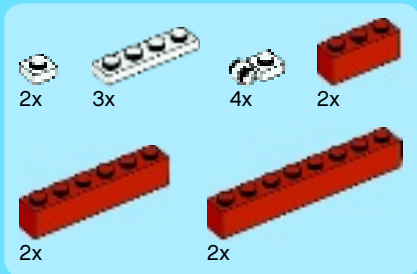

26

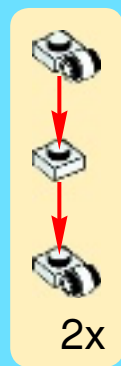



27



- 2x 
- 8x 
- 2x 
- 2x 
- 4x 

28

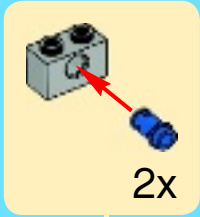

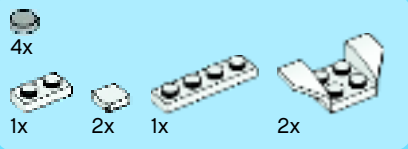

29

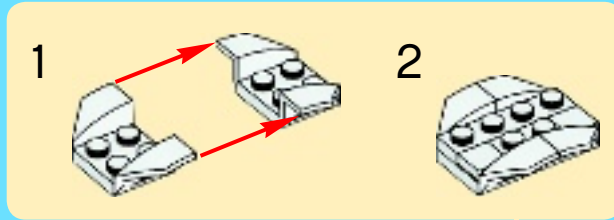

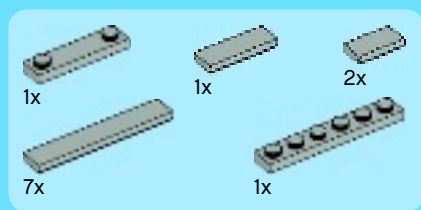

30

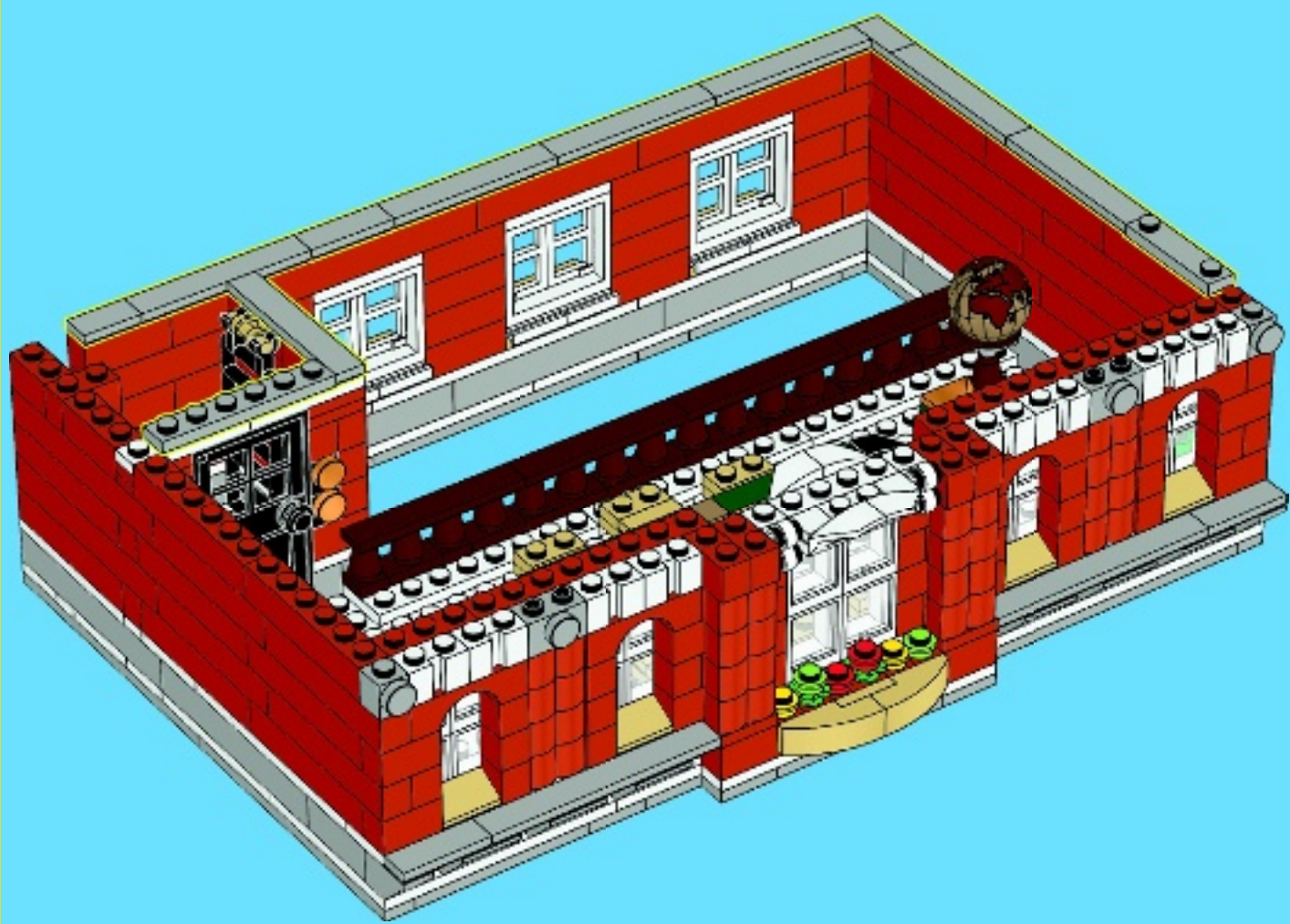

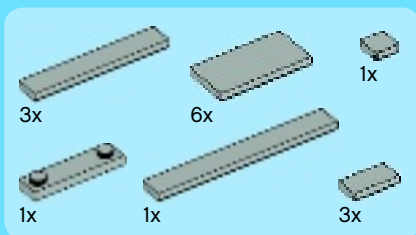

31

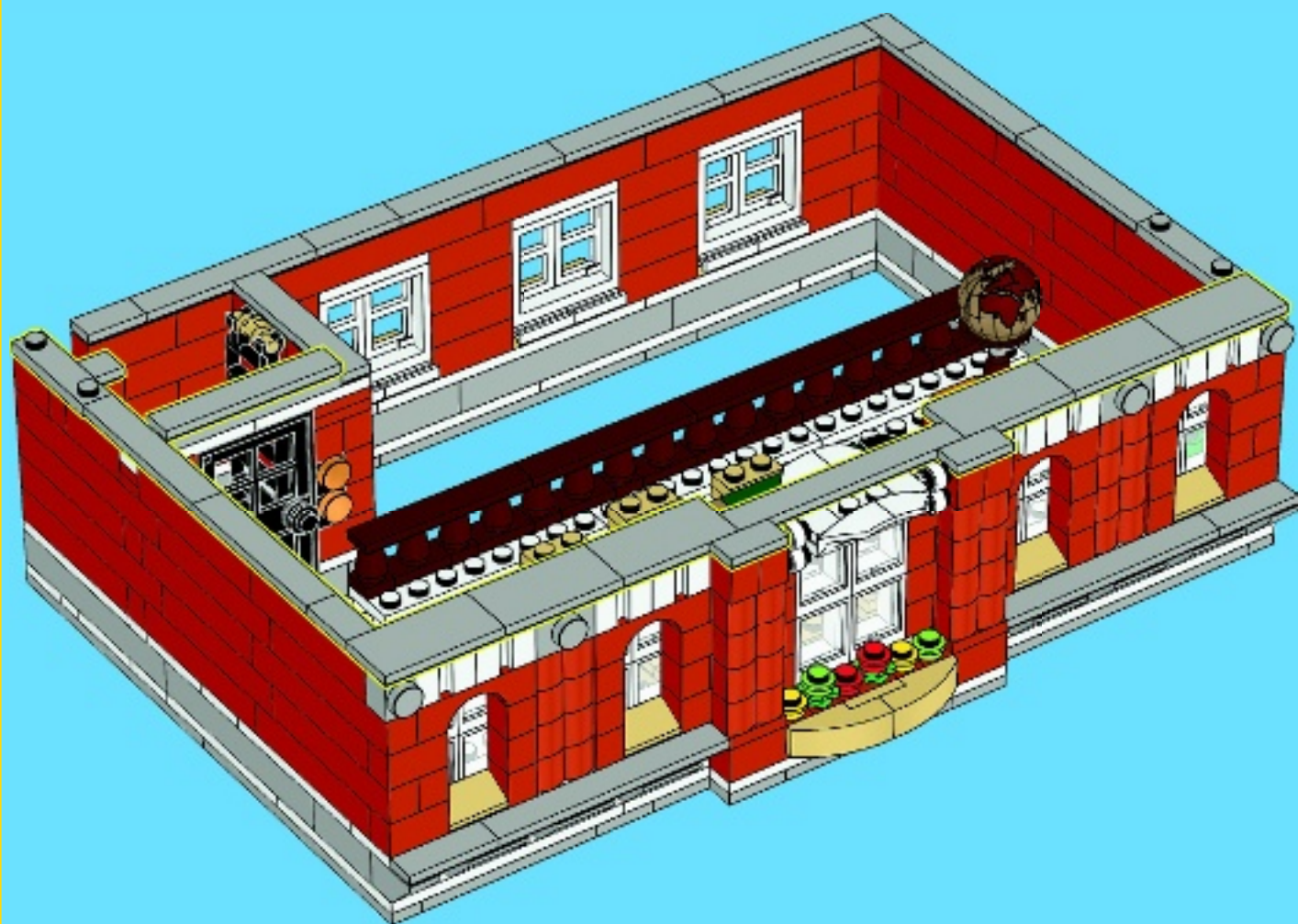

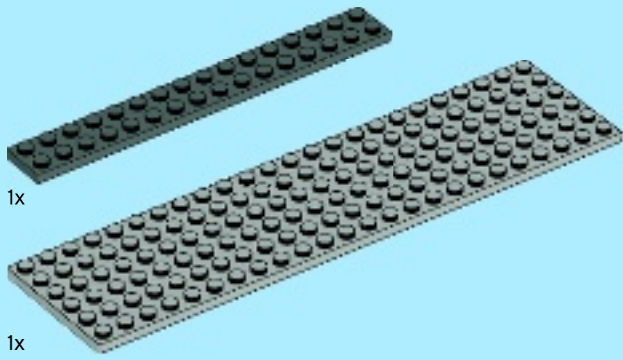

1

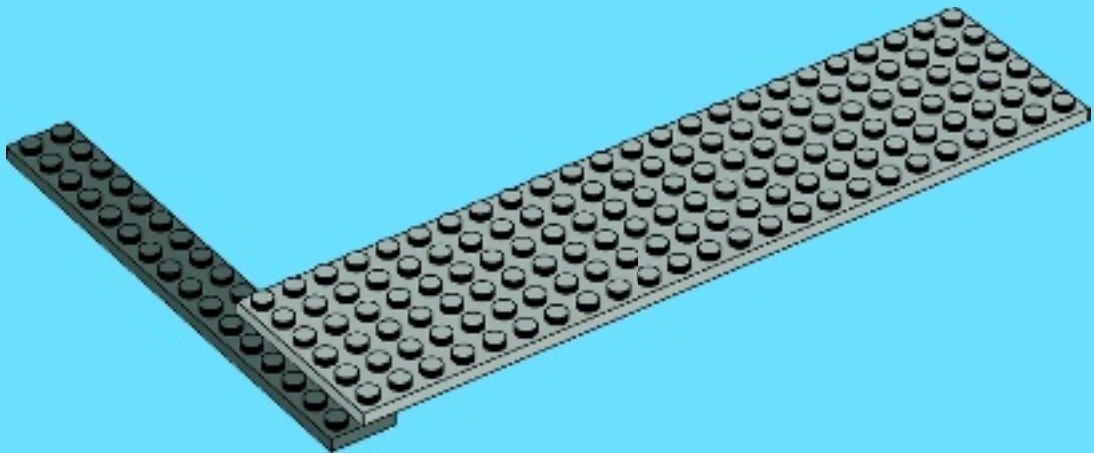

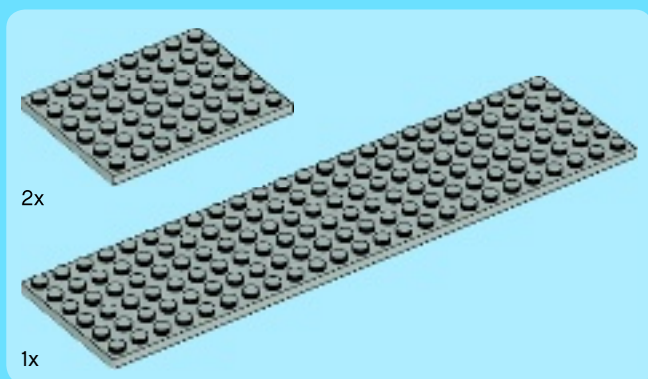

2

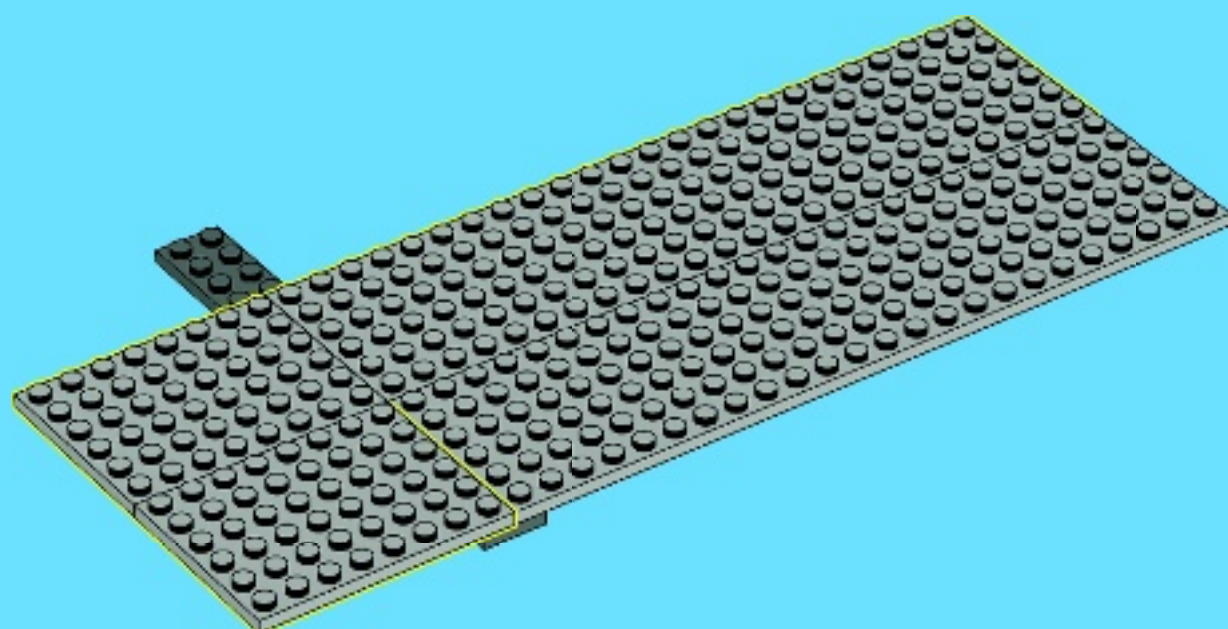

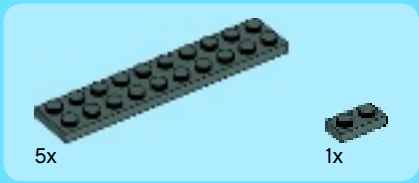

3

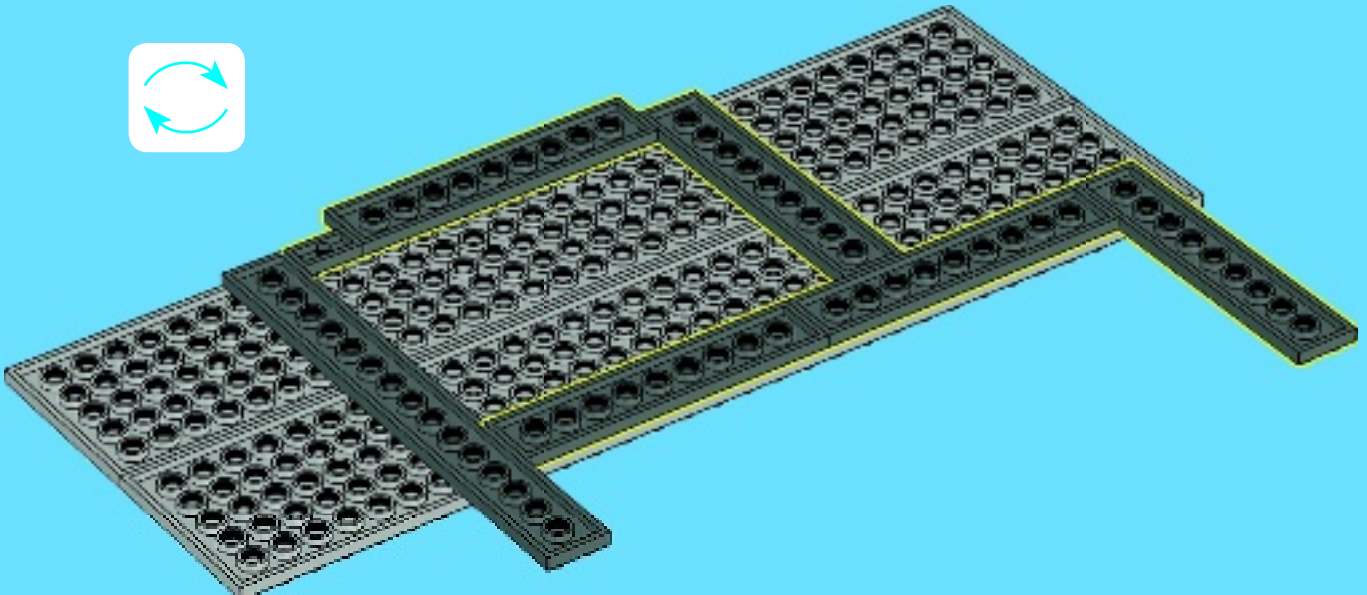

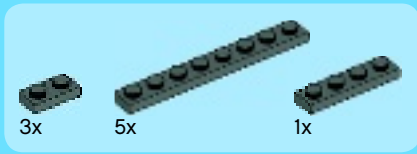

4

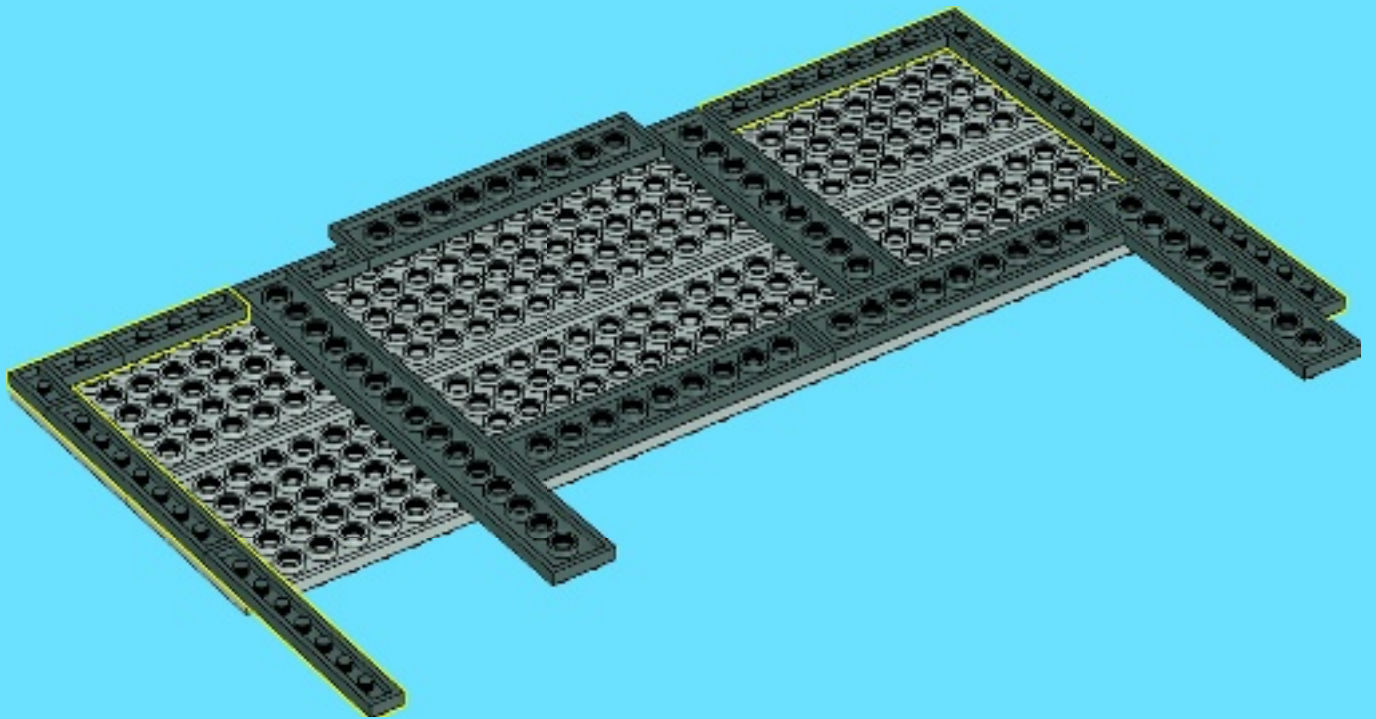

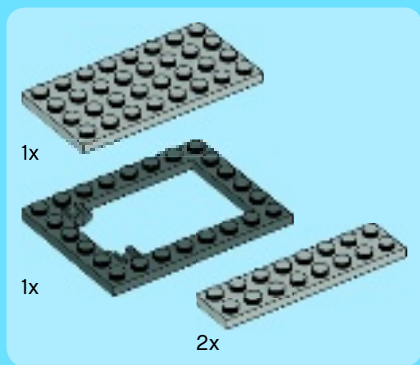

5

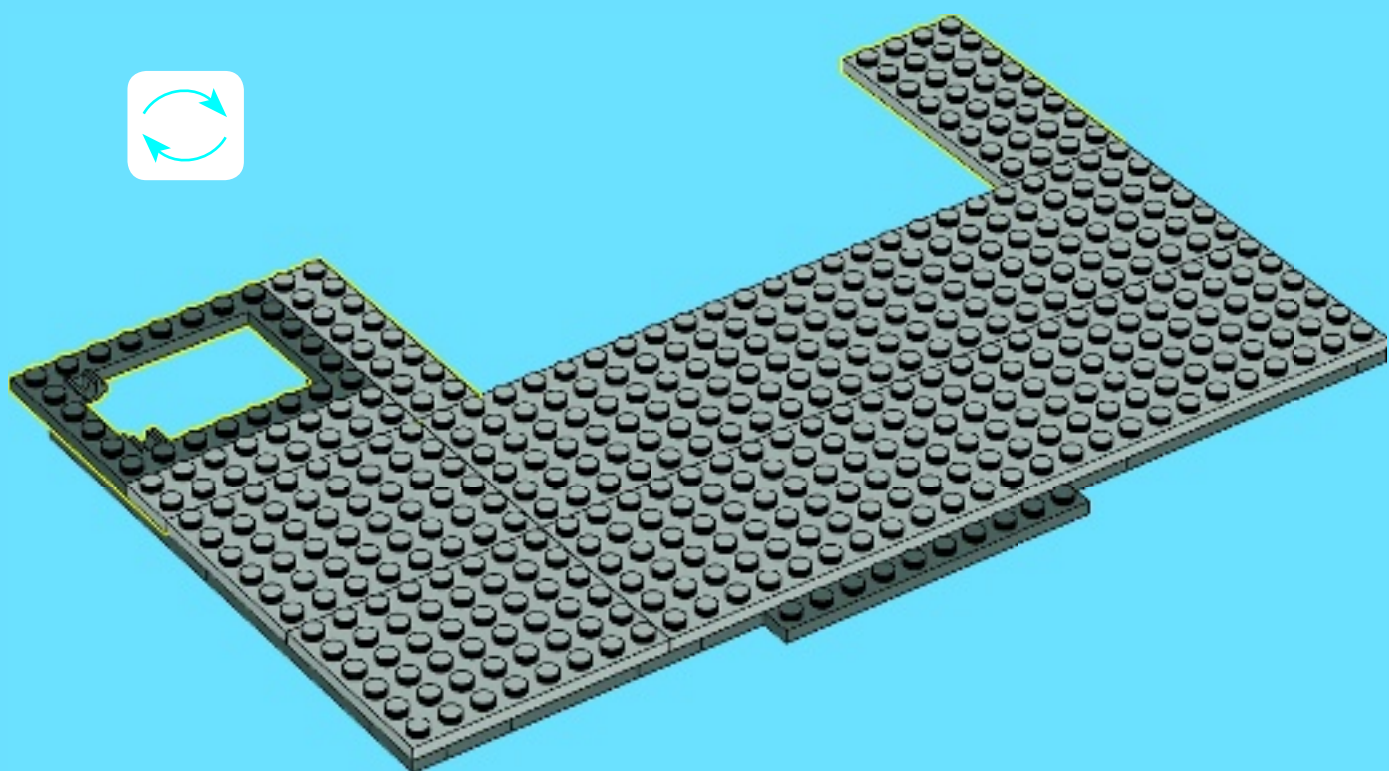

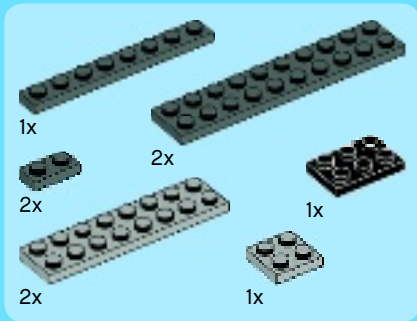

6

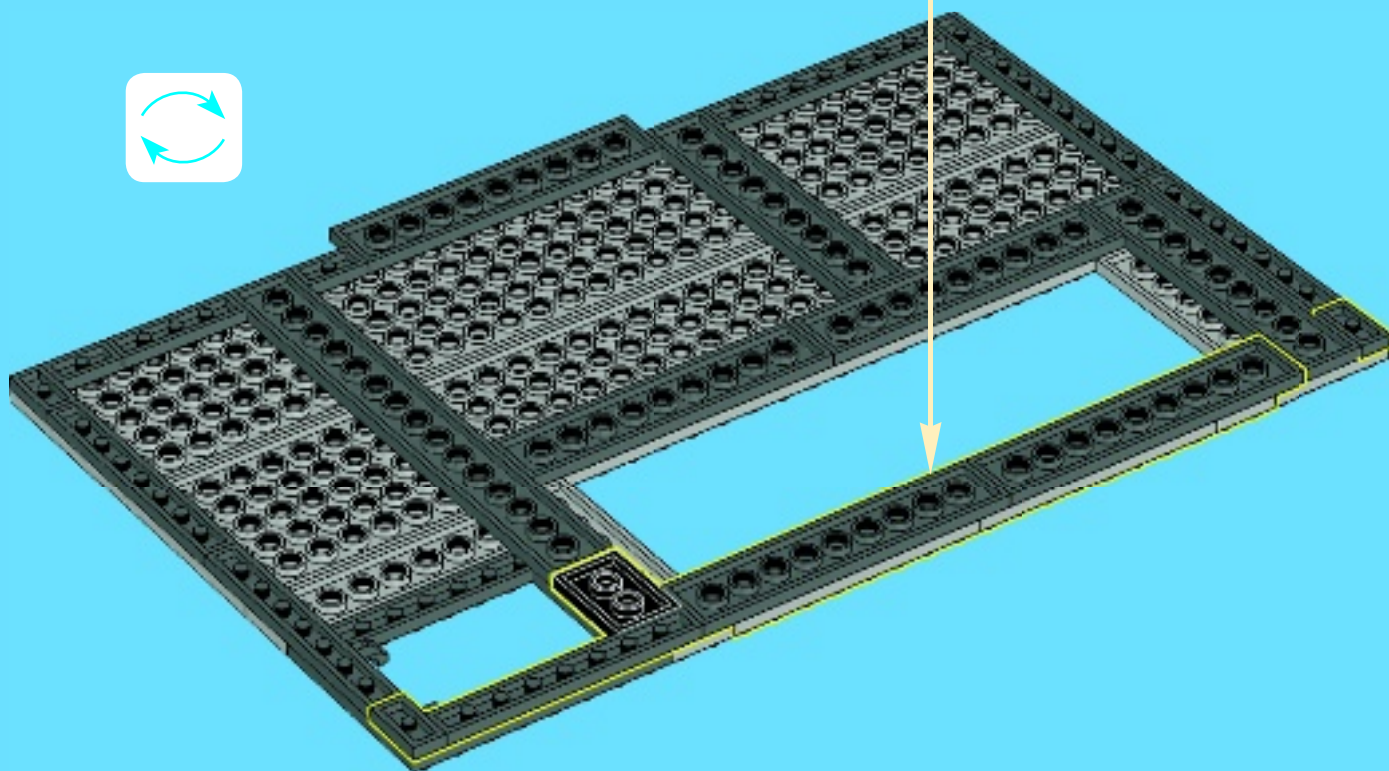
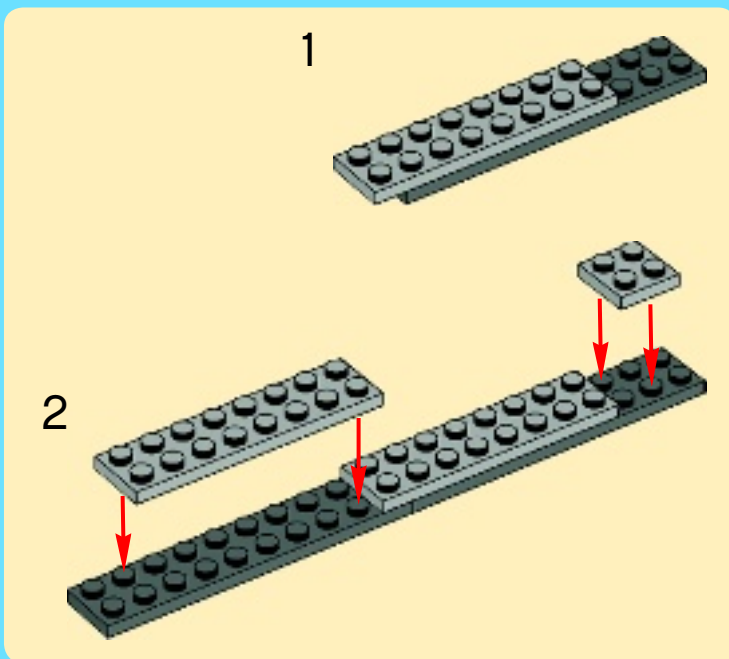

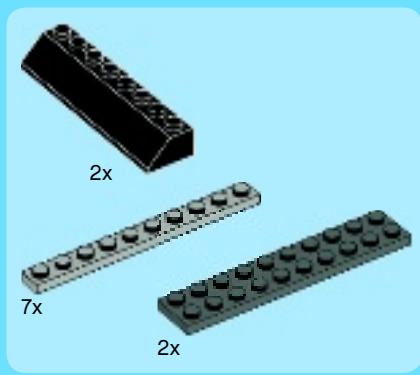

7

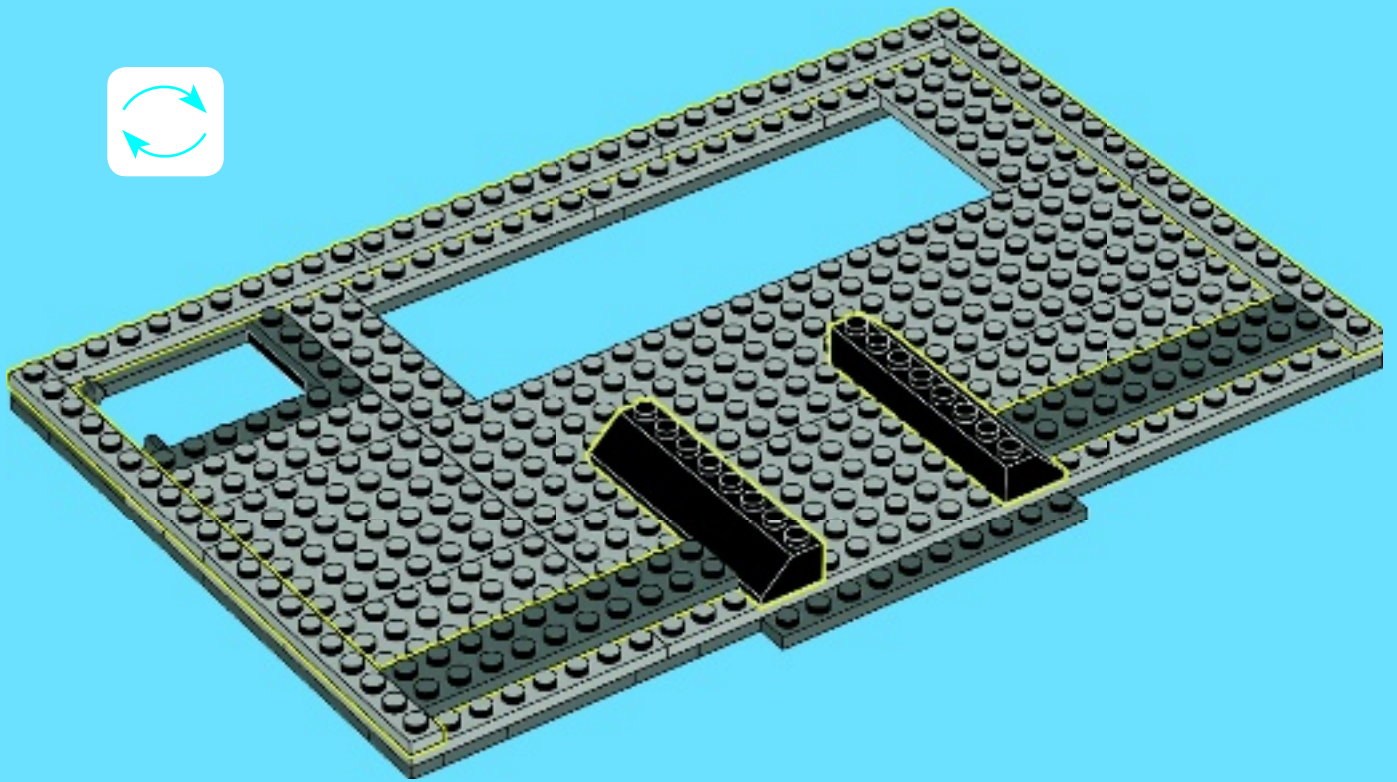

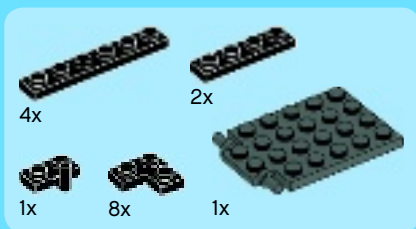

8

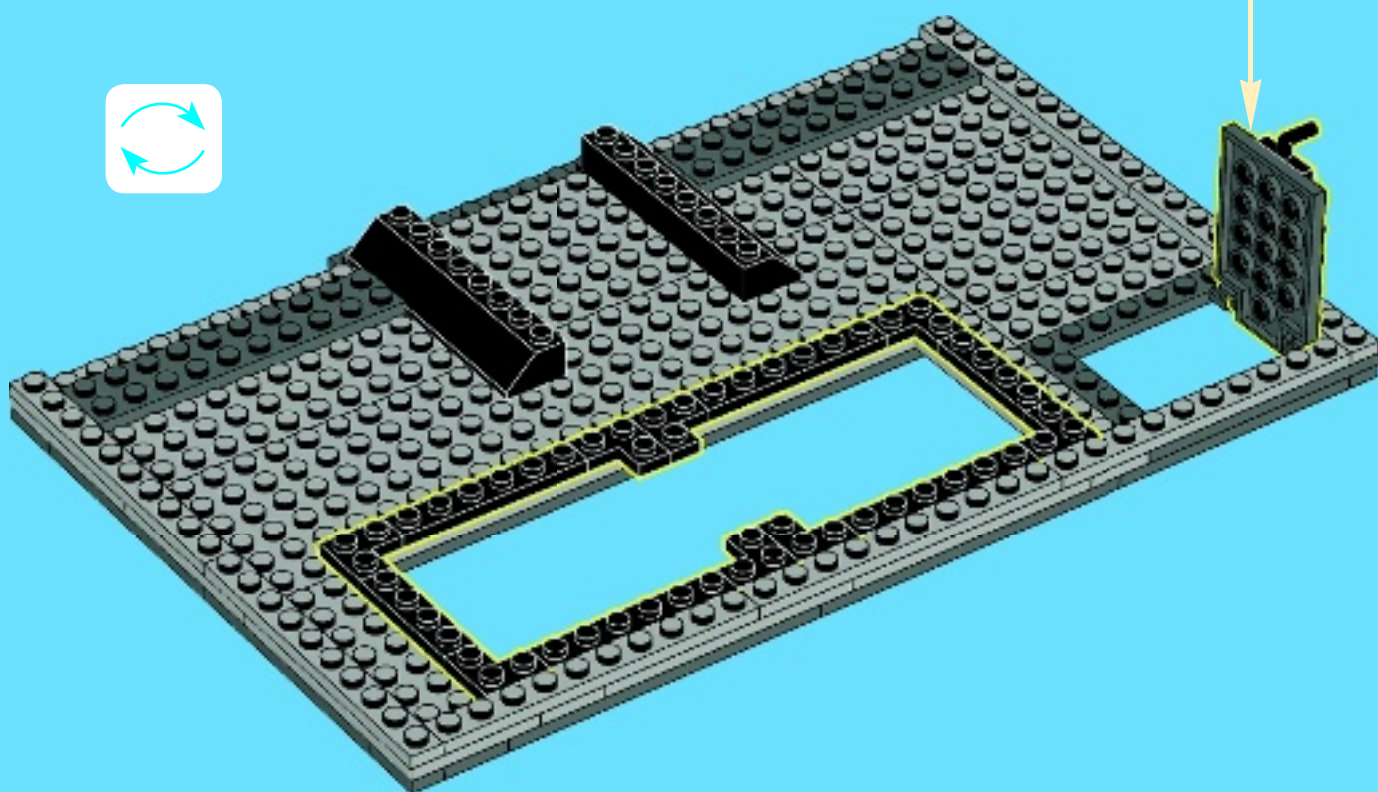
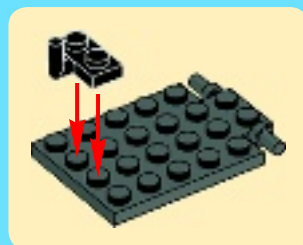



8x

9

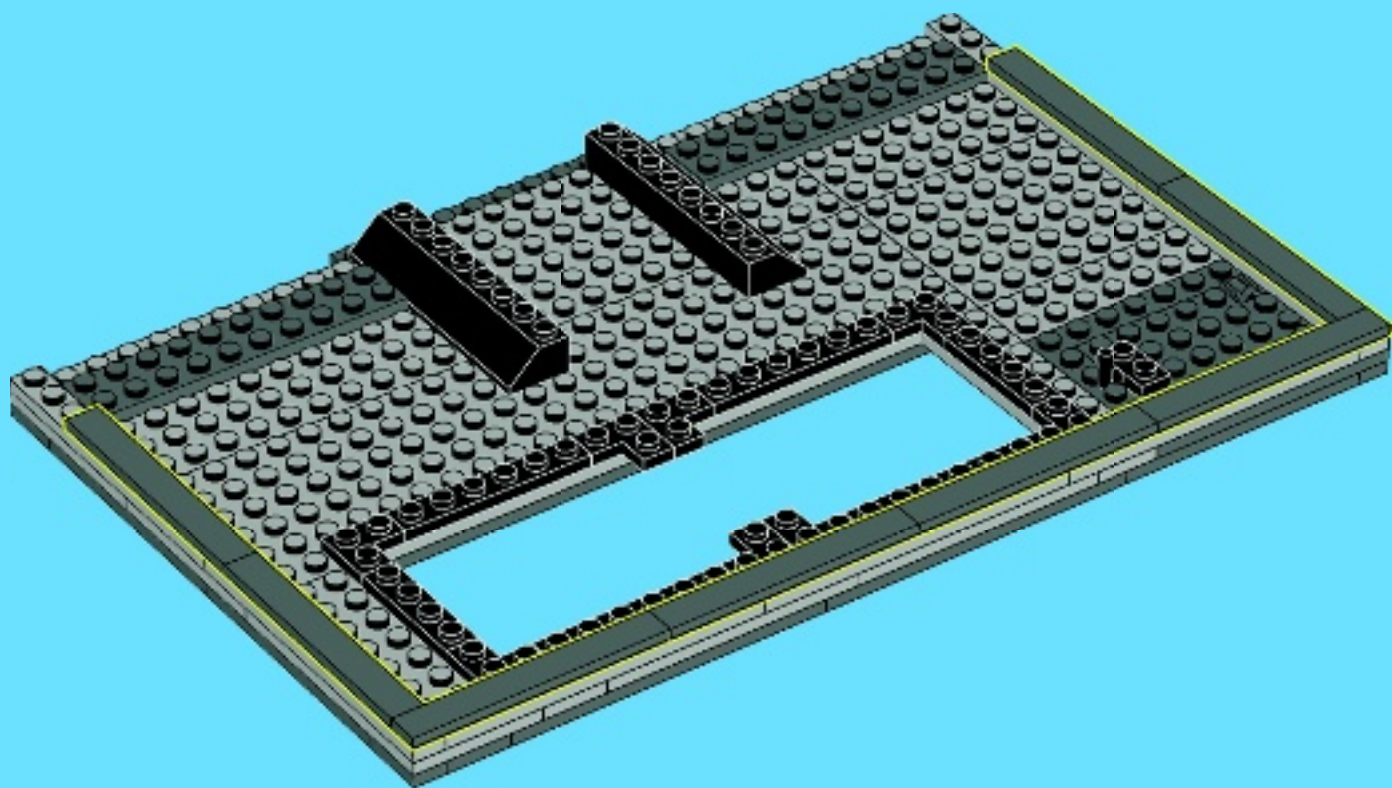



8x

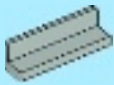

2x



8x

10

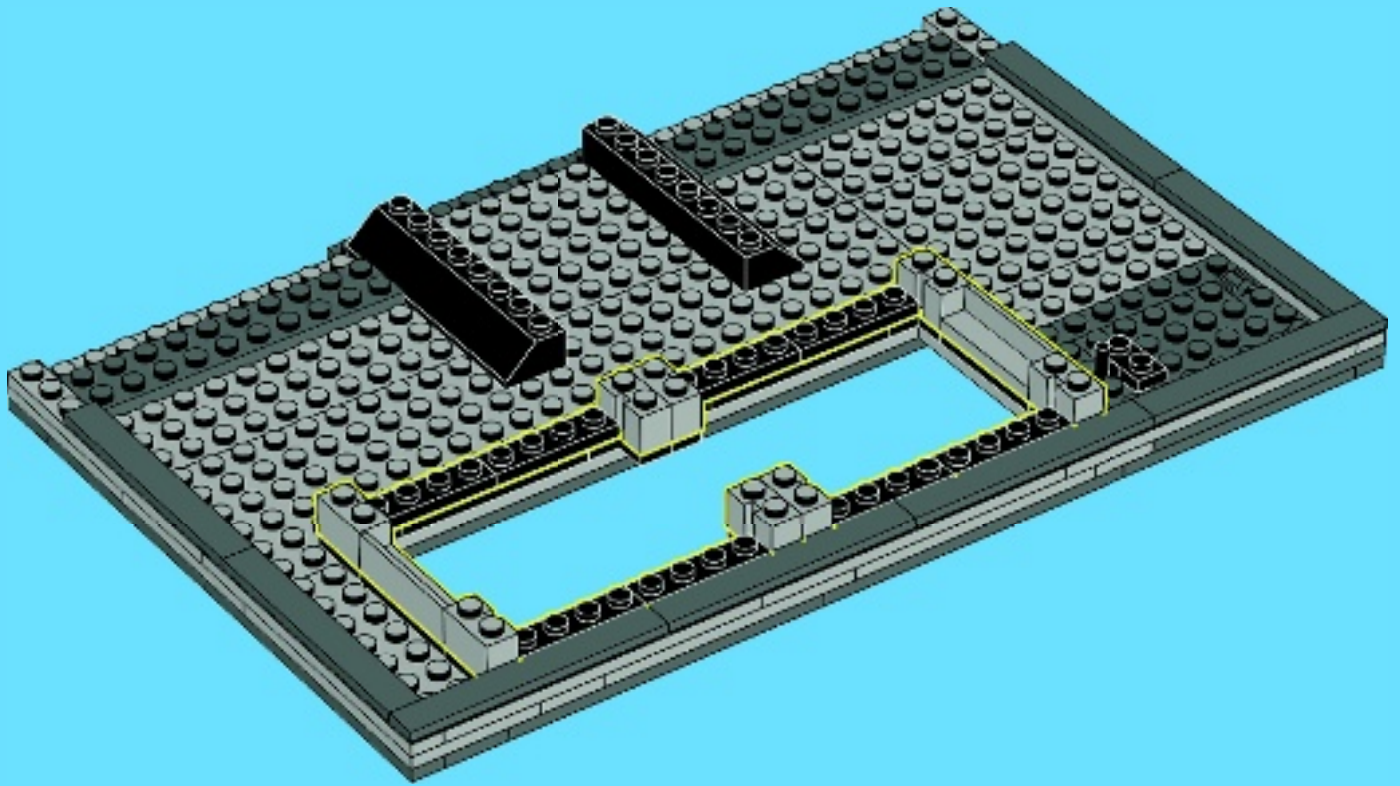

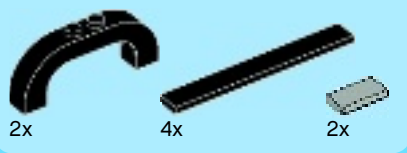

11

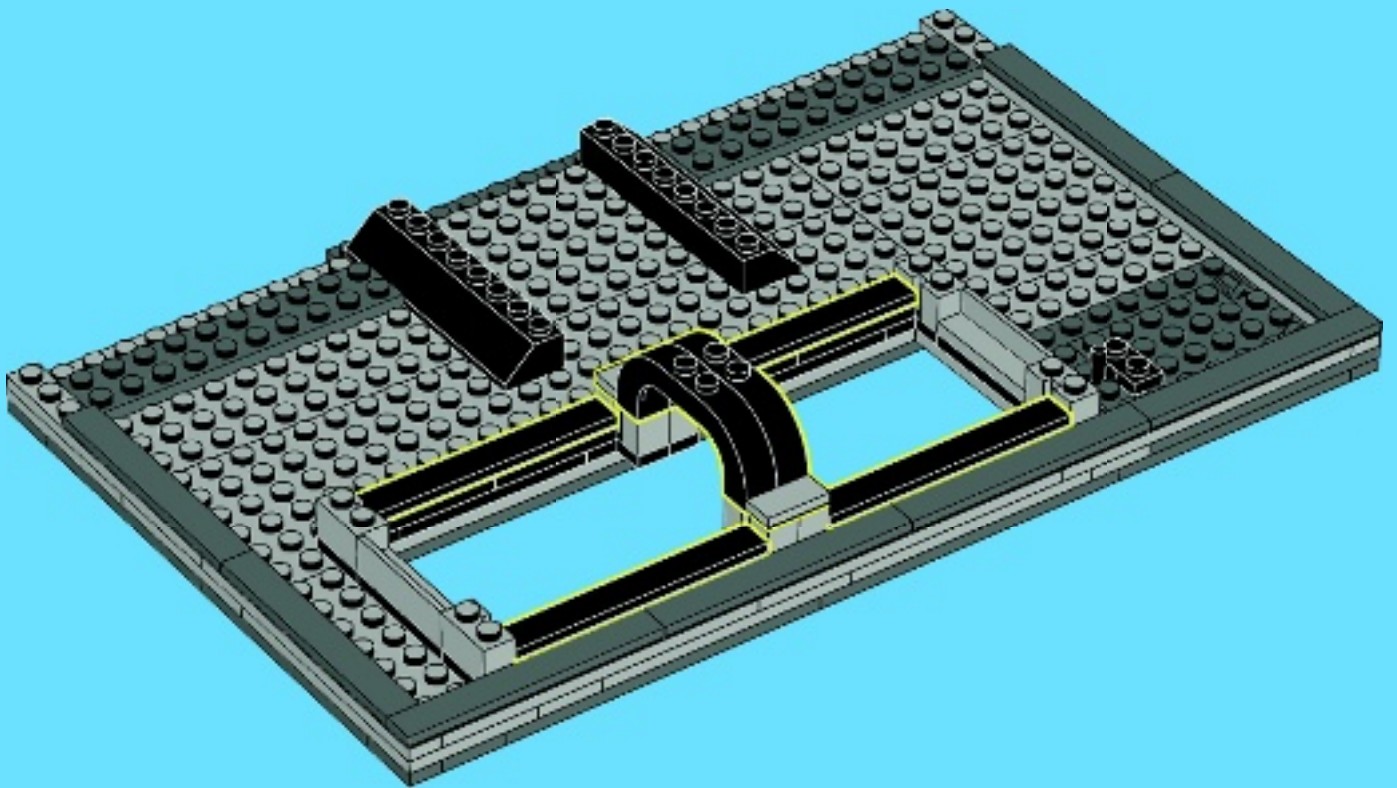

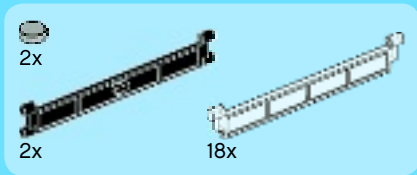

12

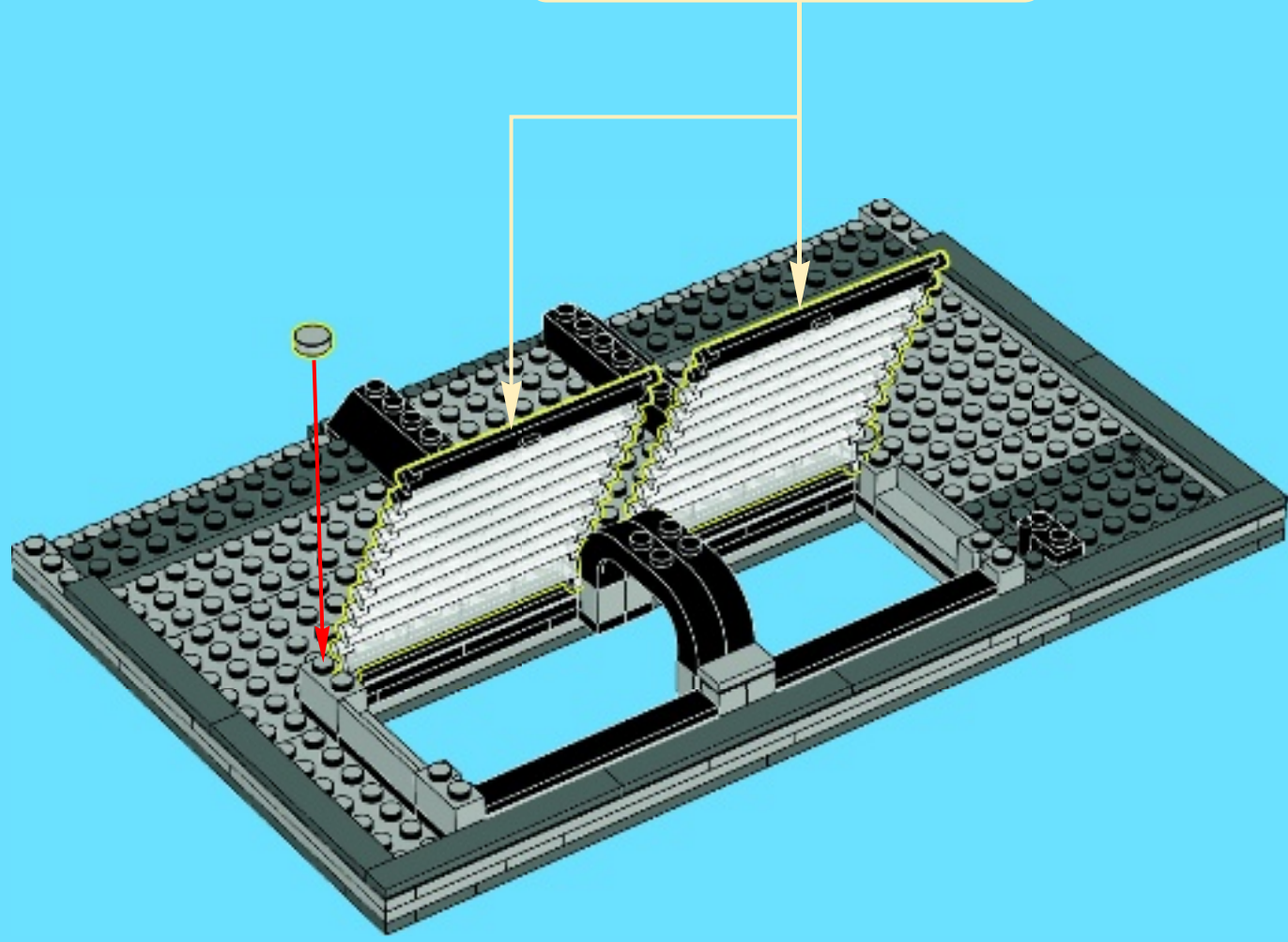
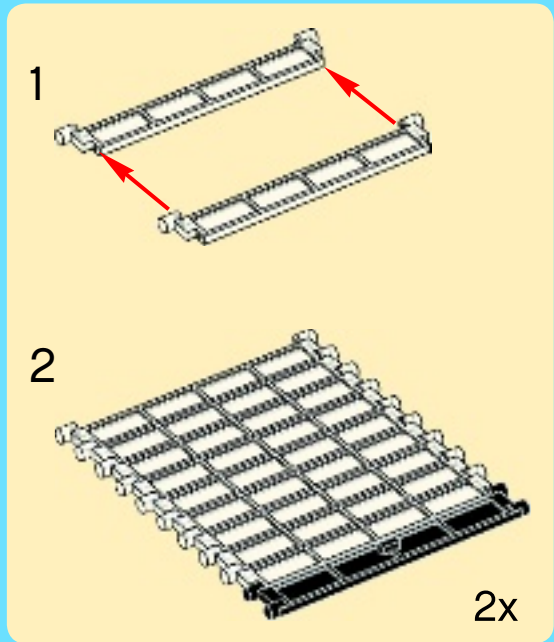



2x

13

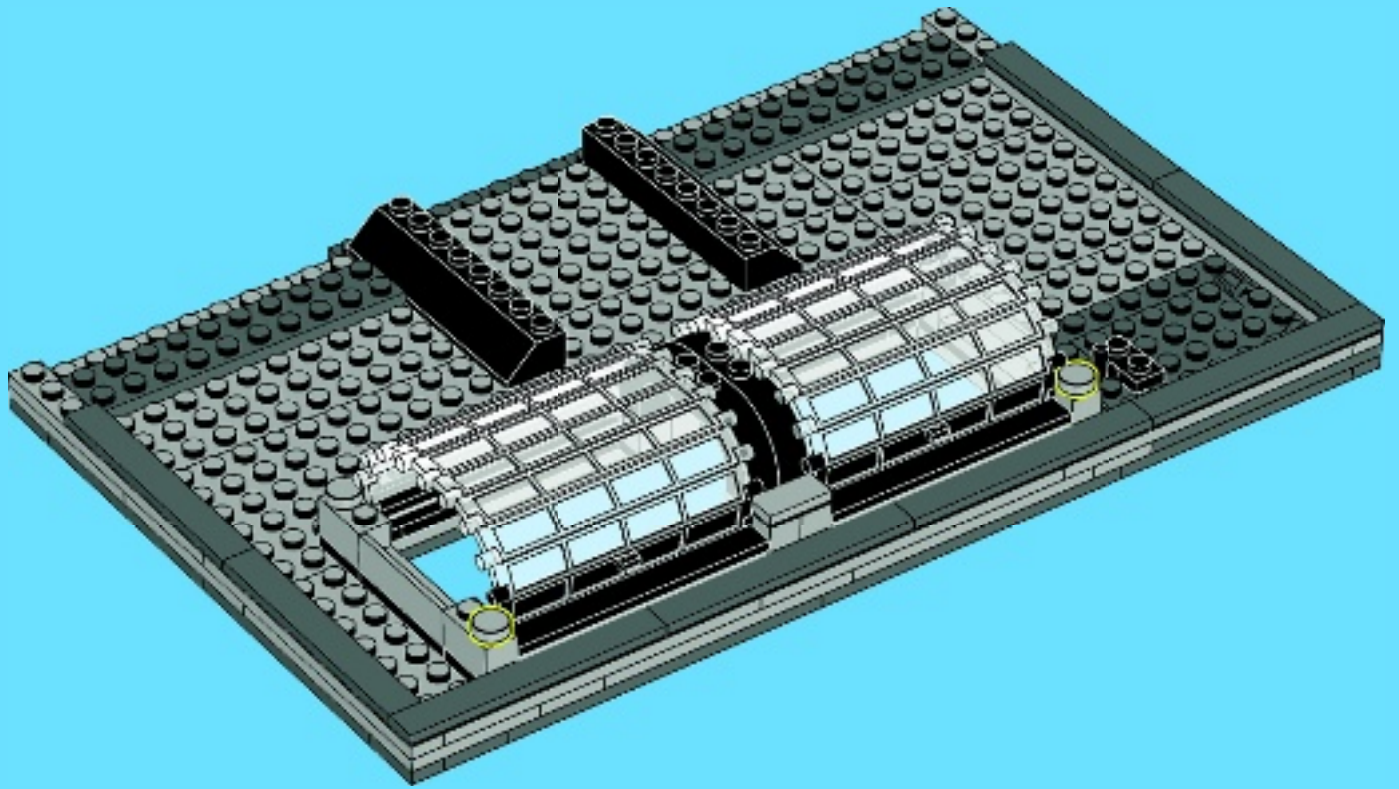

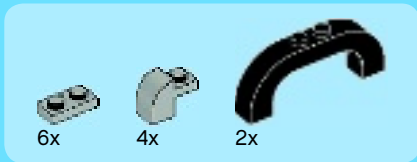

14

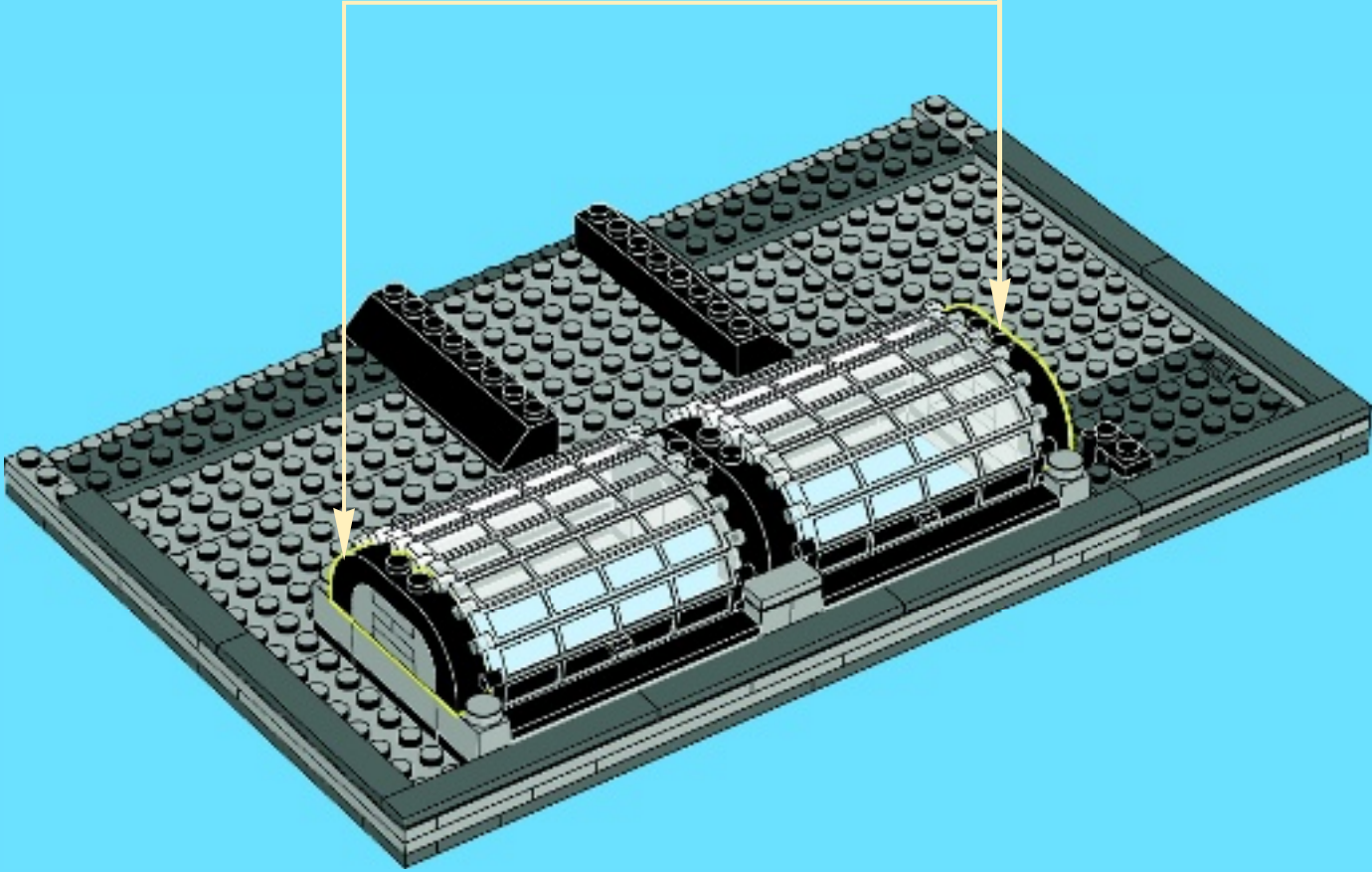
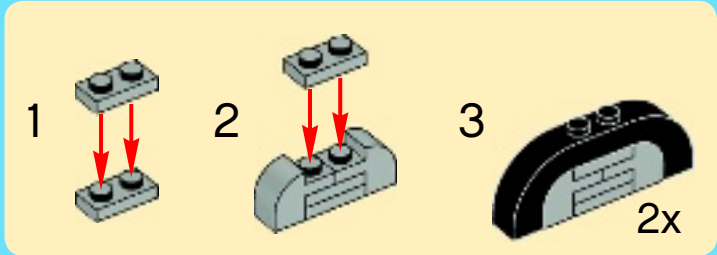

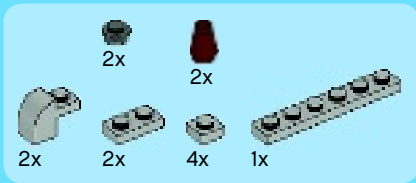

15

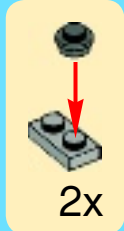
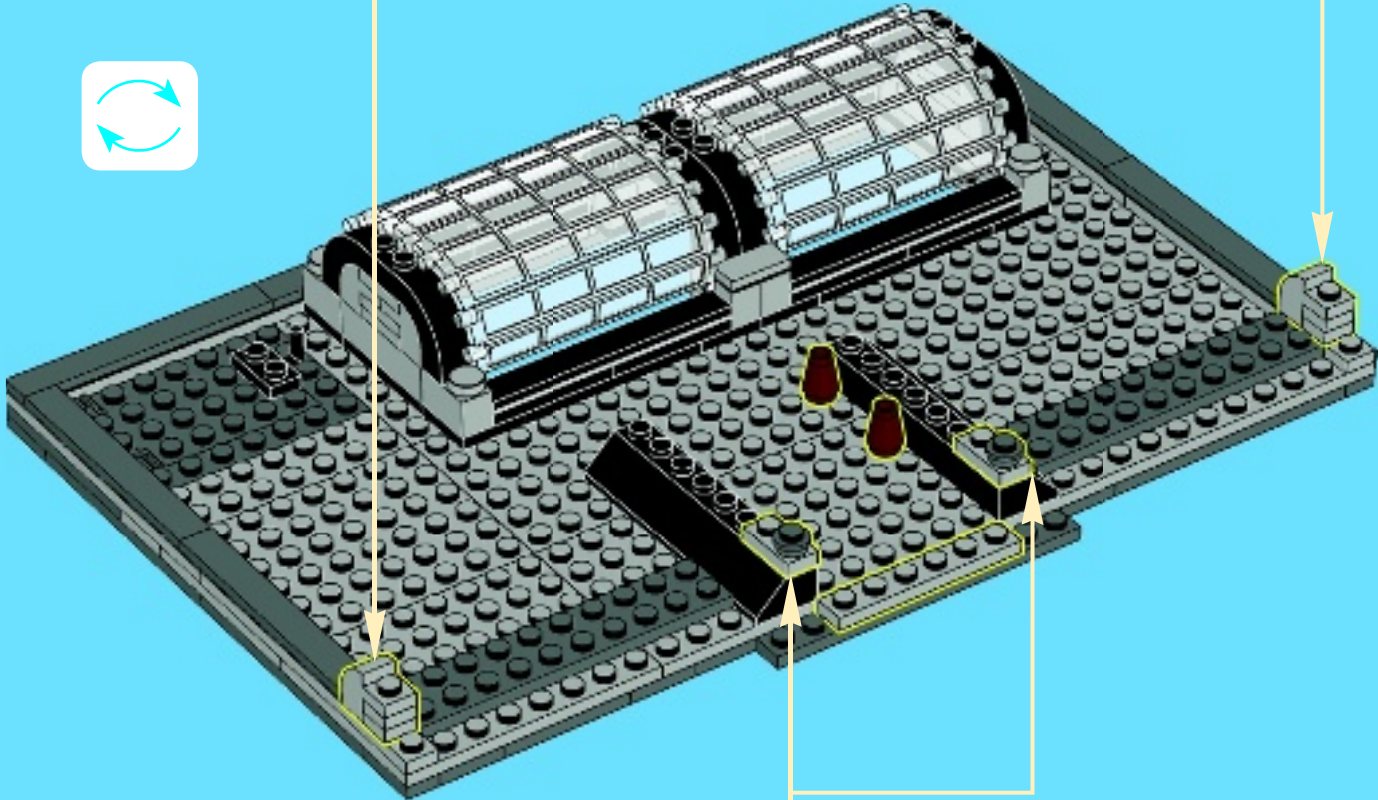
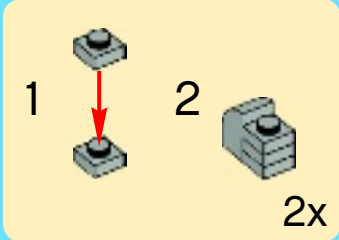

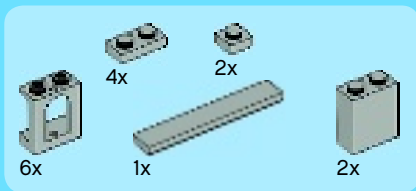

16

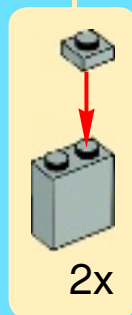
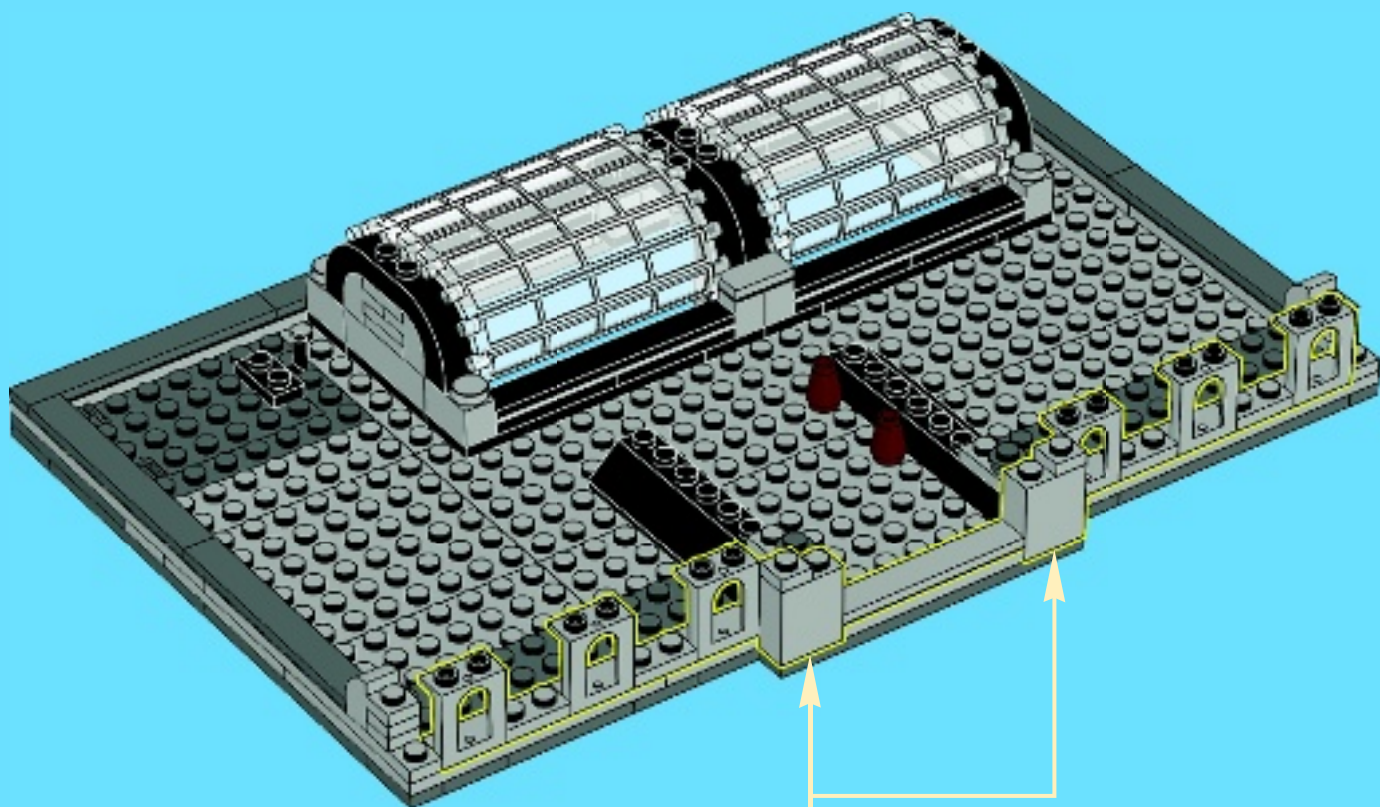



6x



6x



6x

17

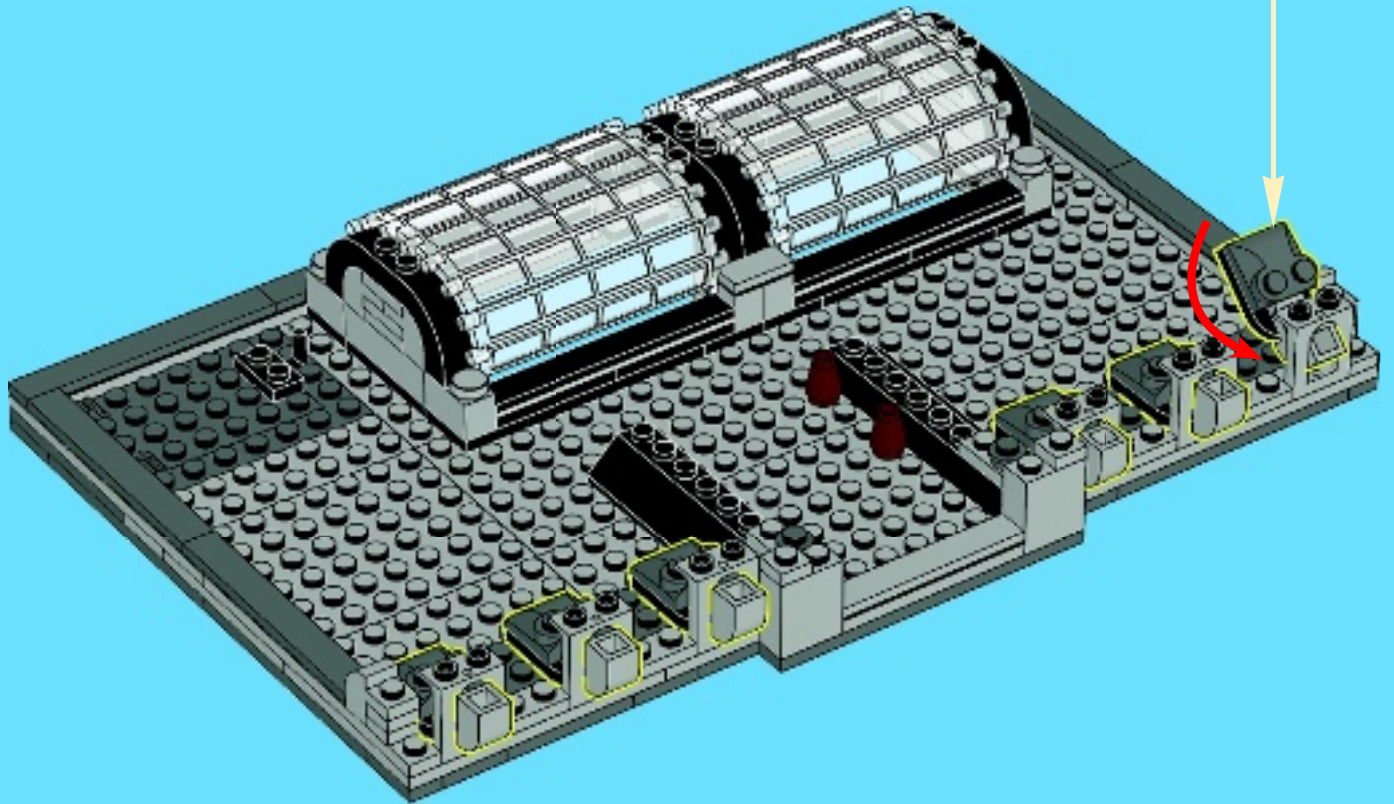
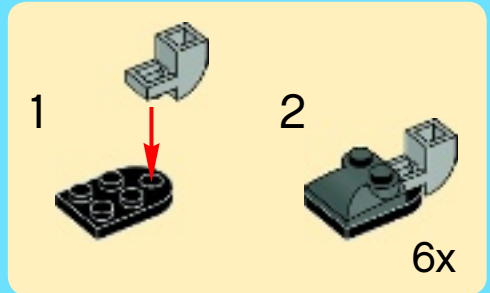



8x



4x



6x

18

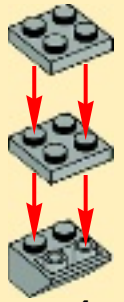

4x

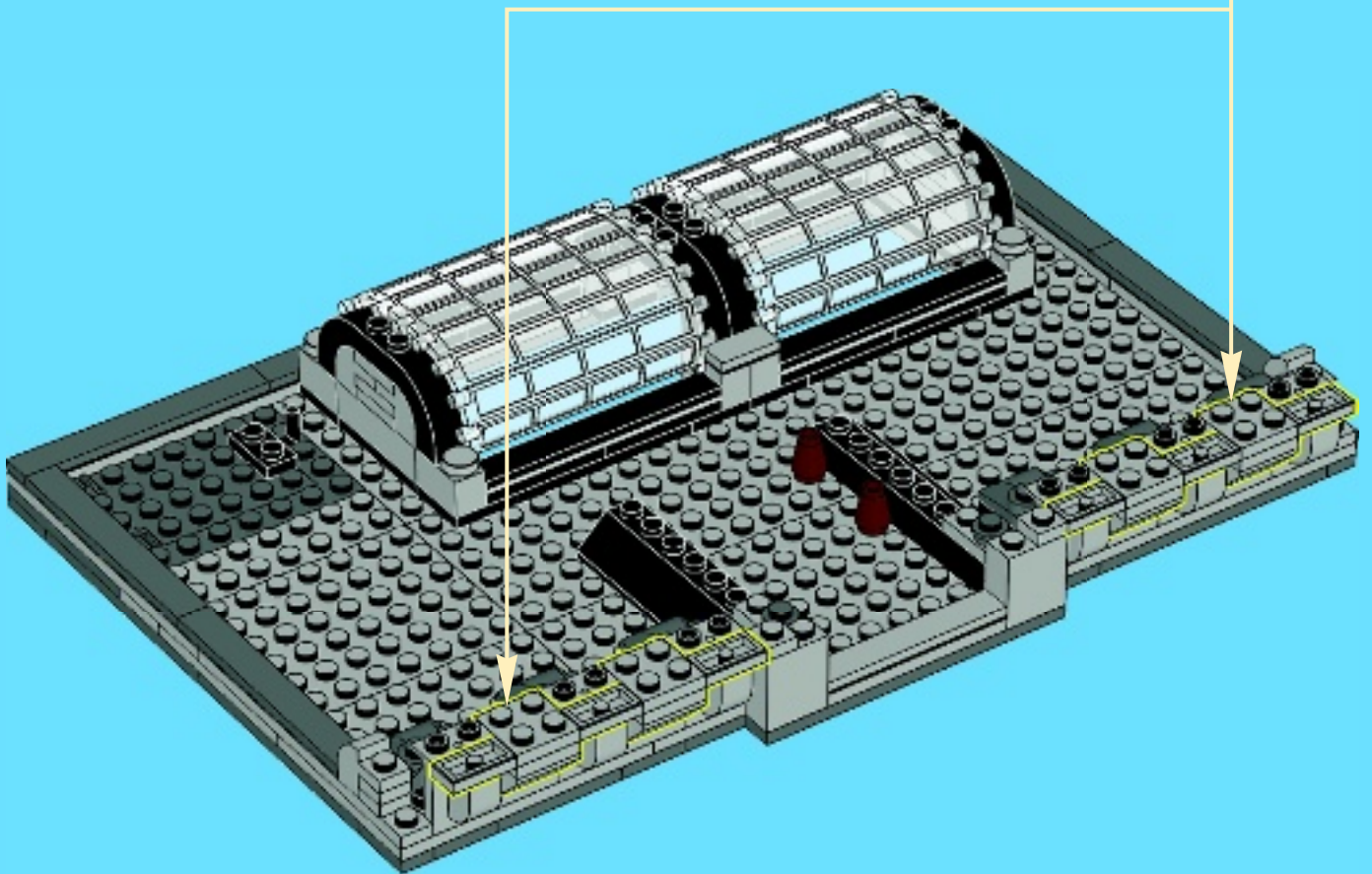

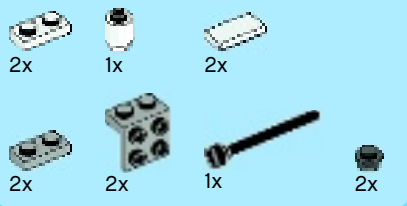

19

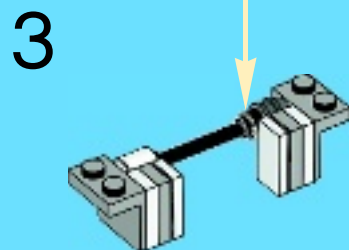
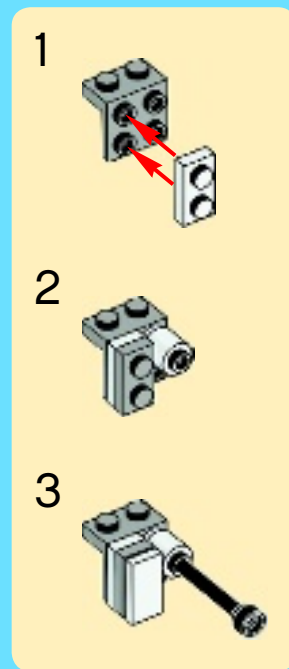
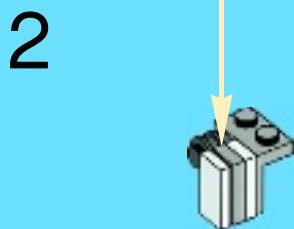
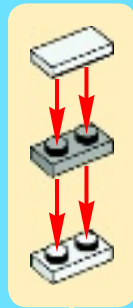
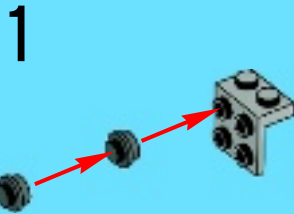

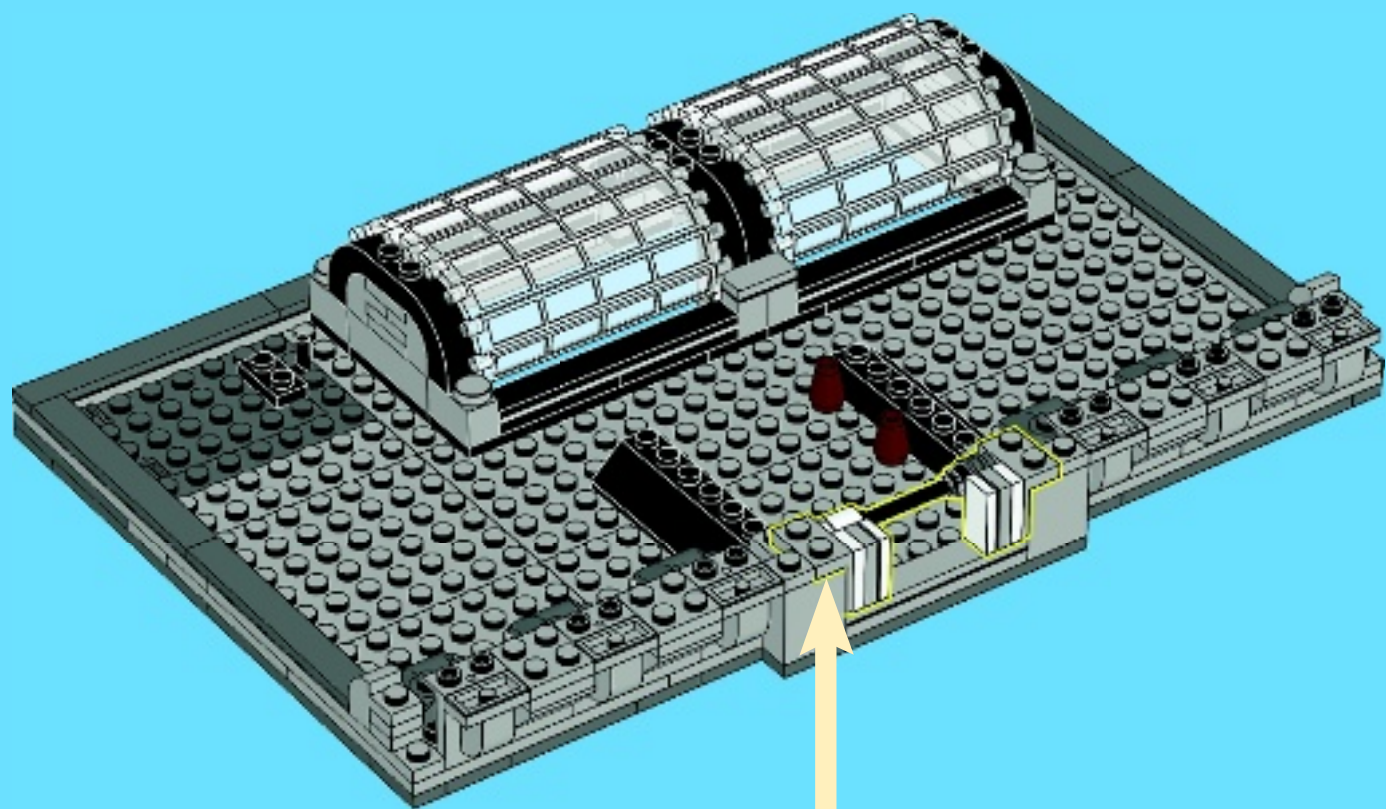



2x



3x



1x



1x



4x



1x



2x

20

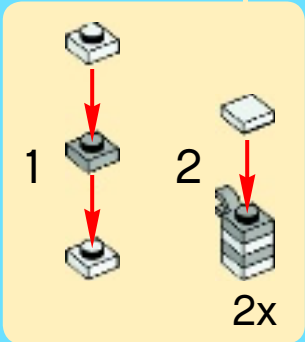
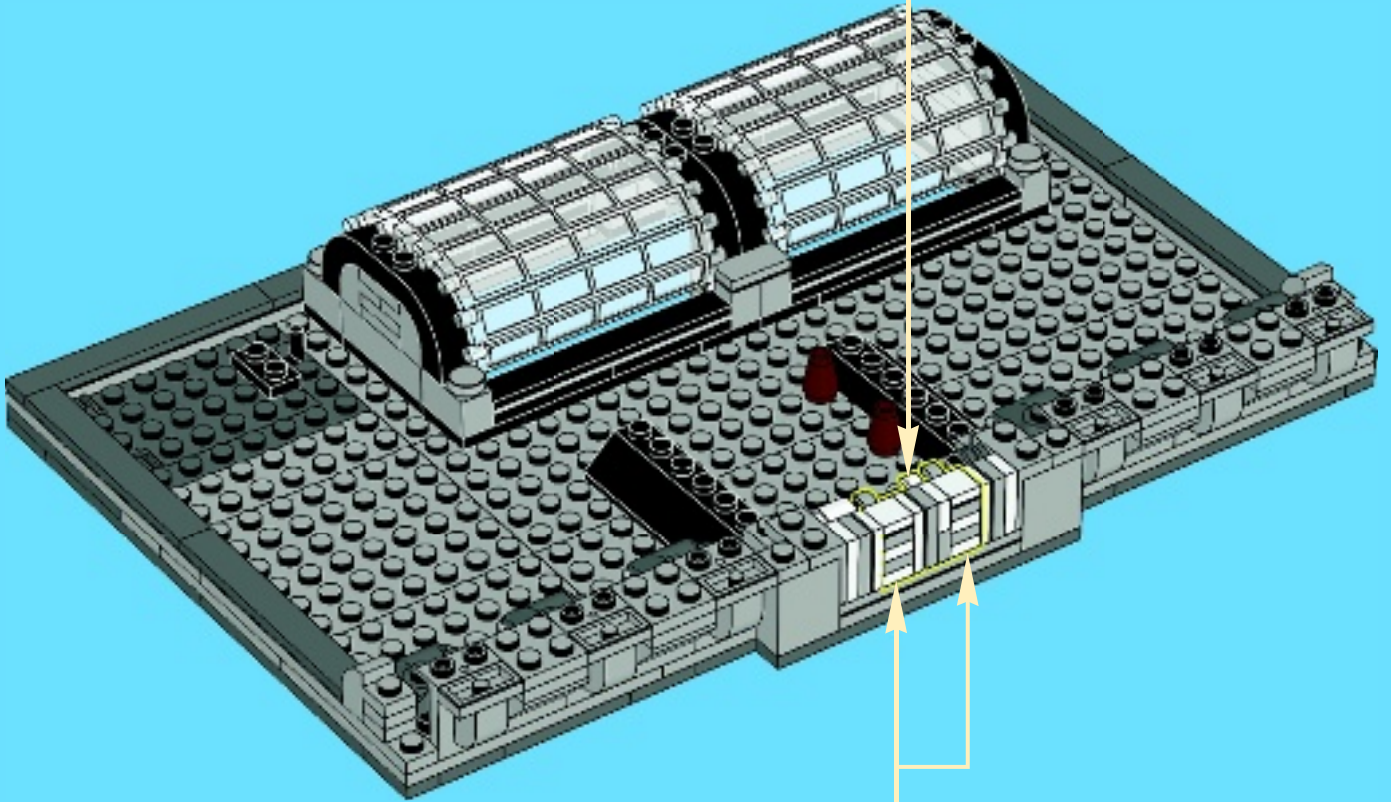
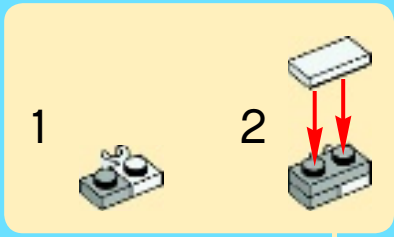

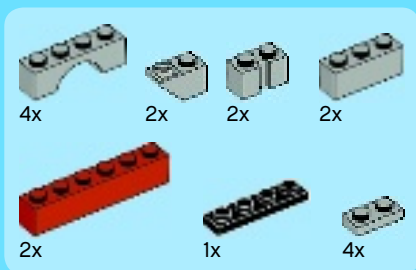

21

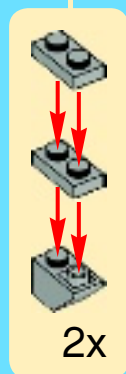
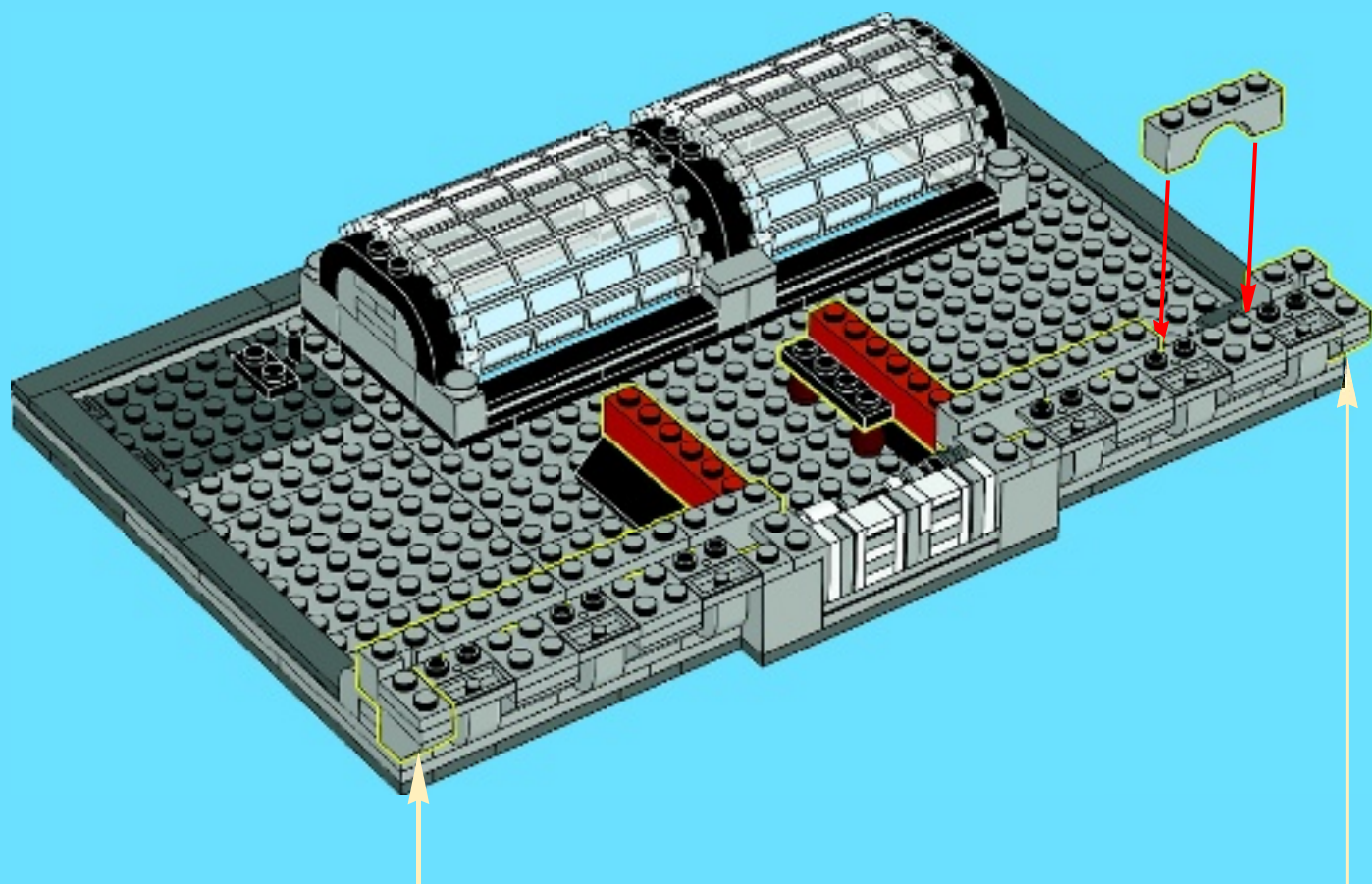



4x

22

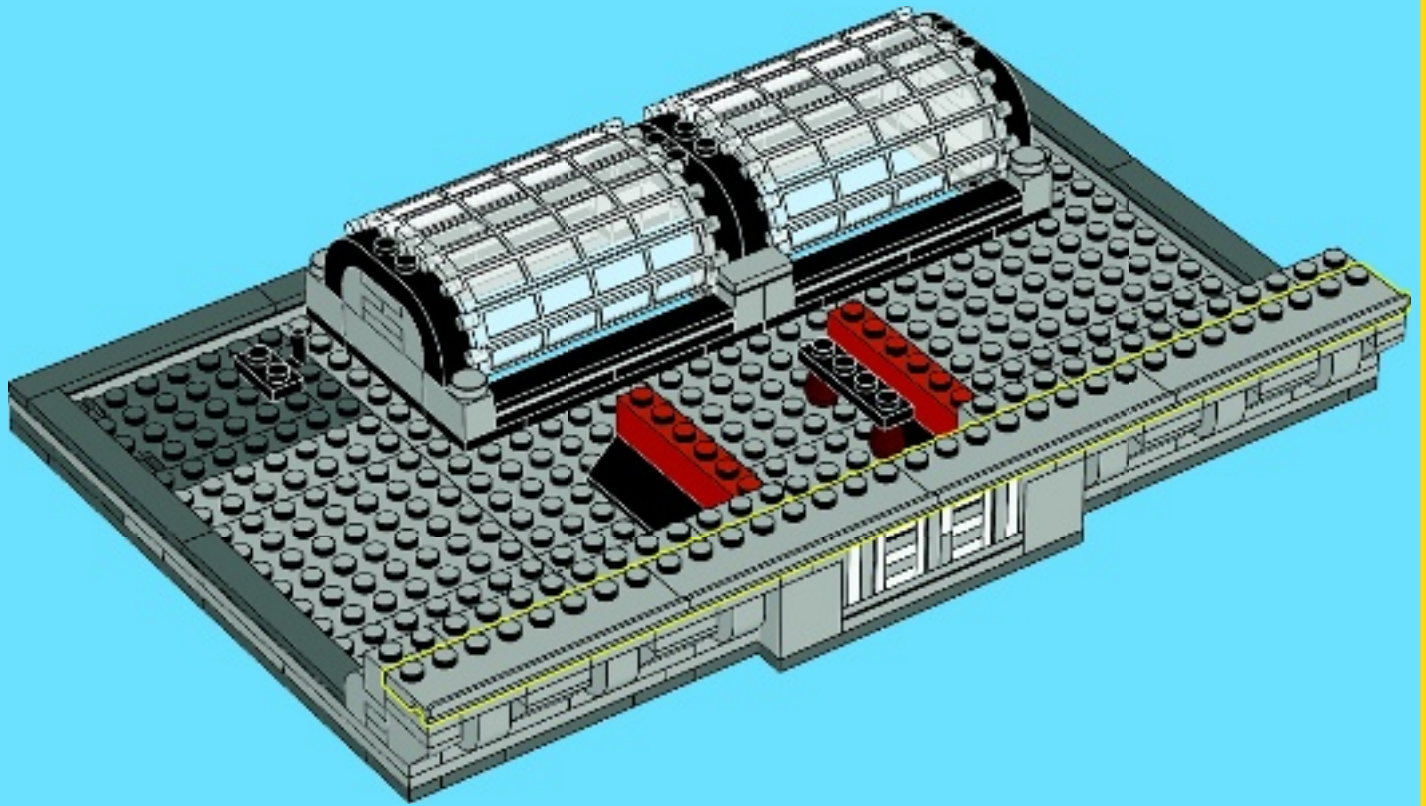

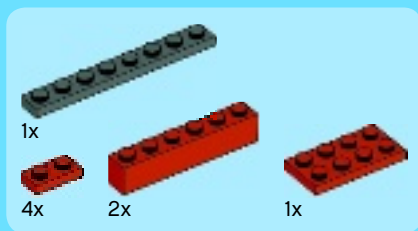

23

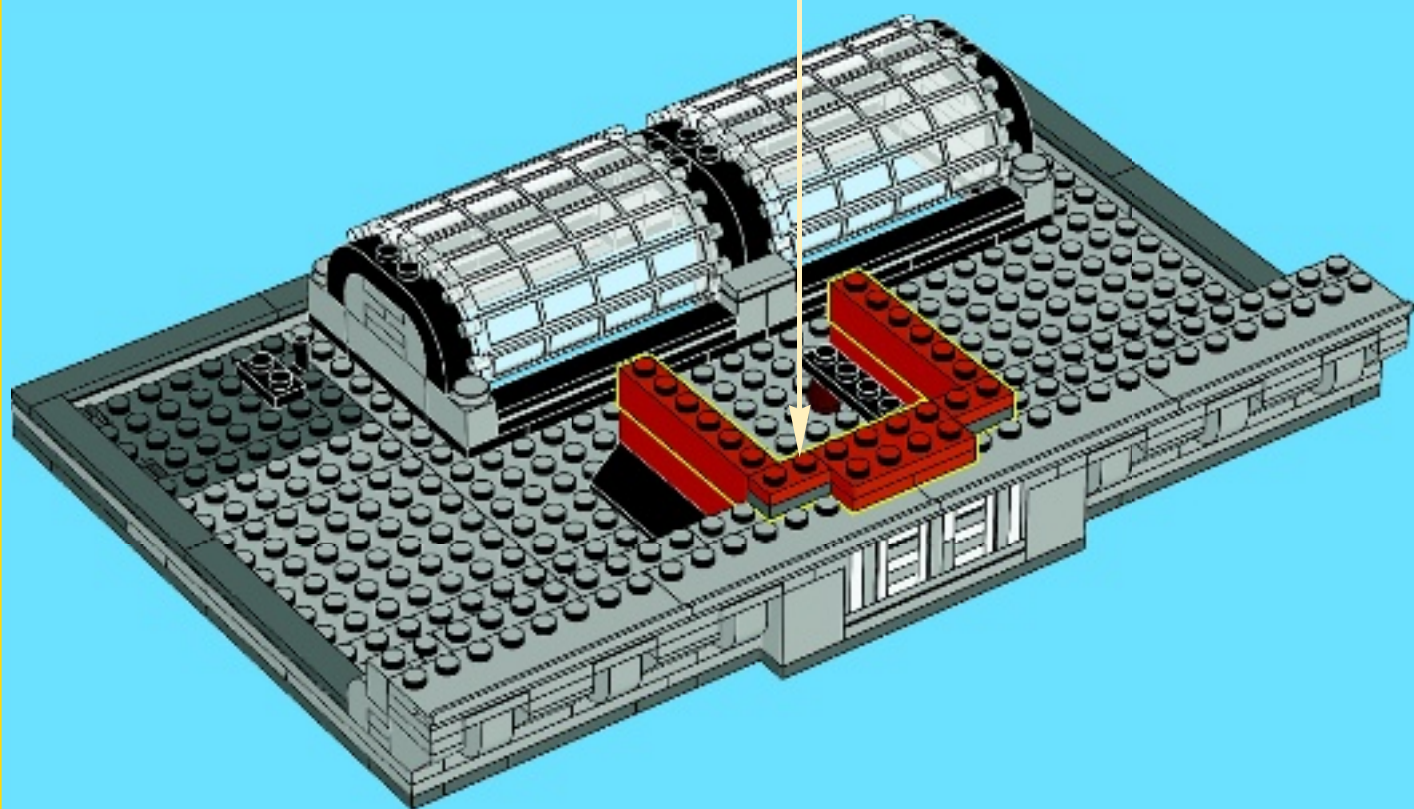

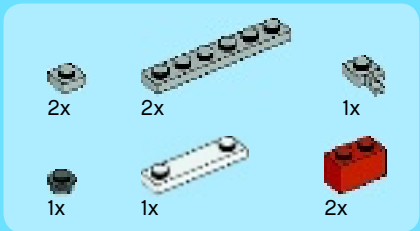

24

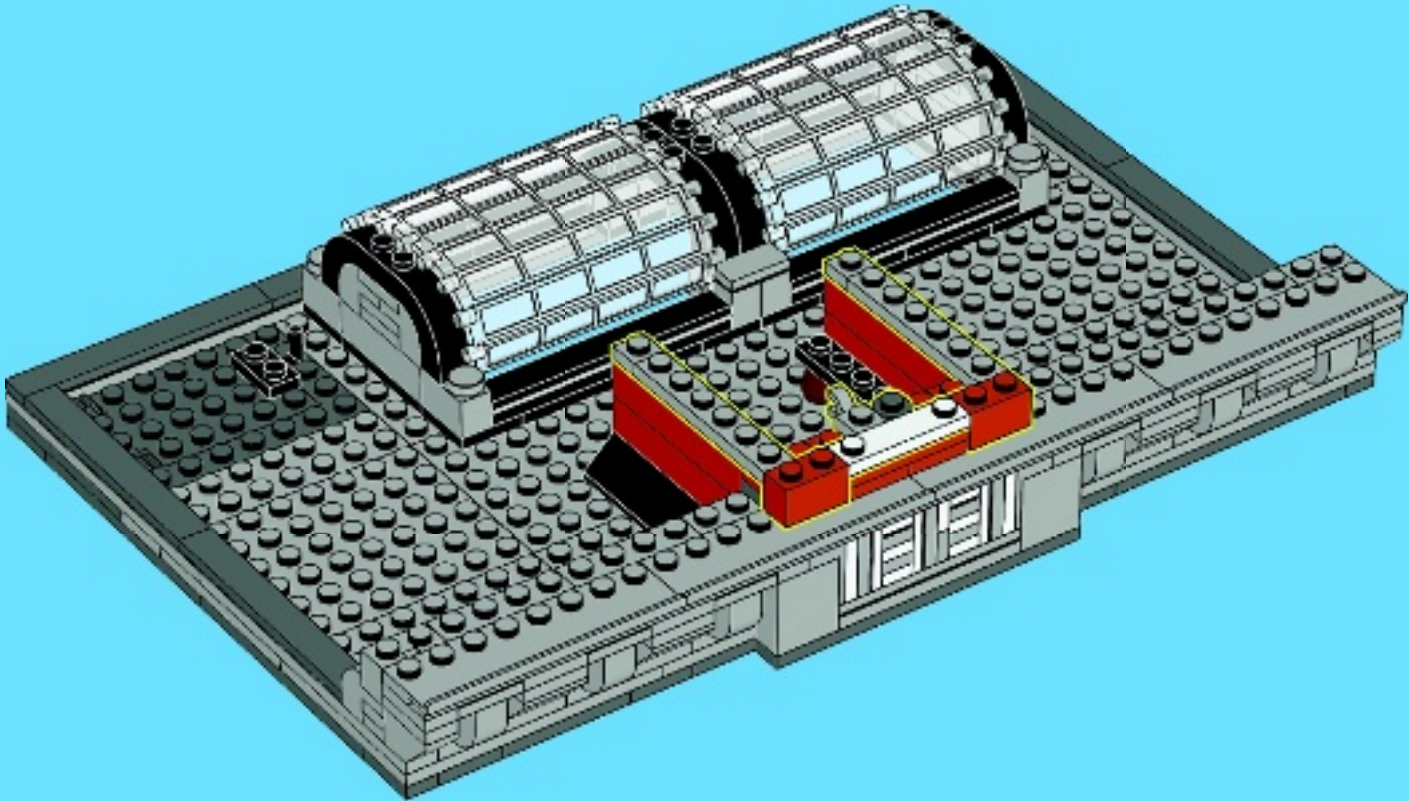



2x



6x



12x

25

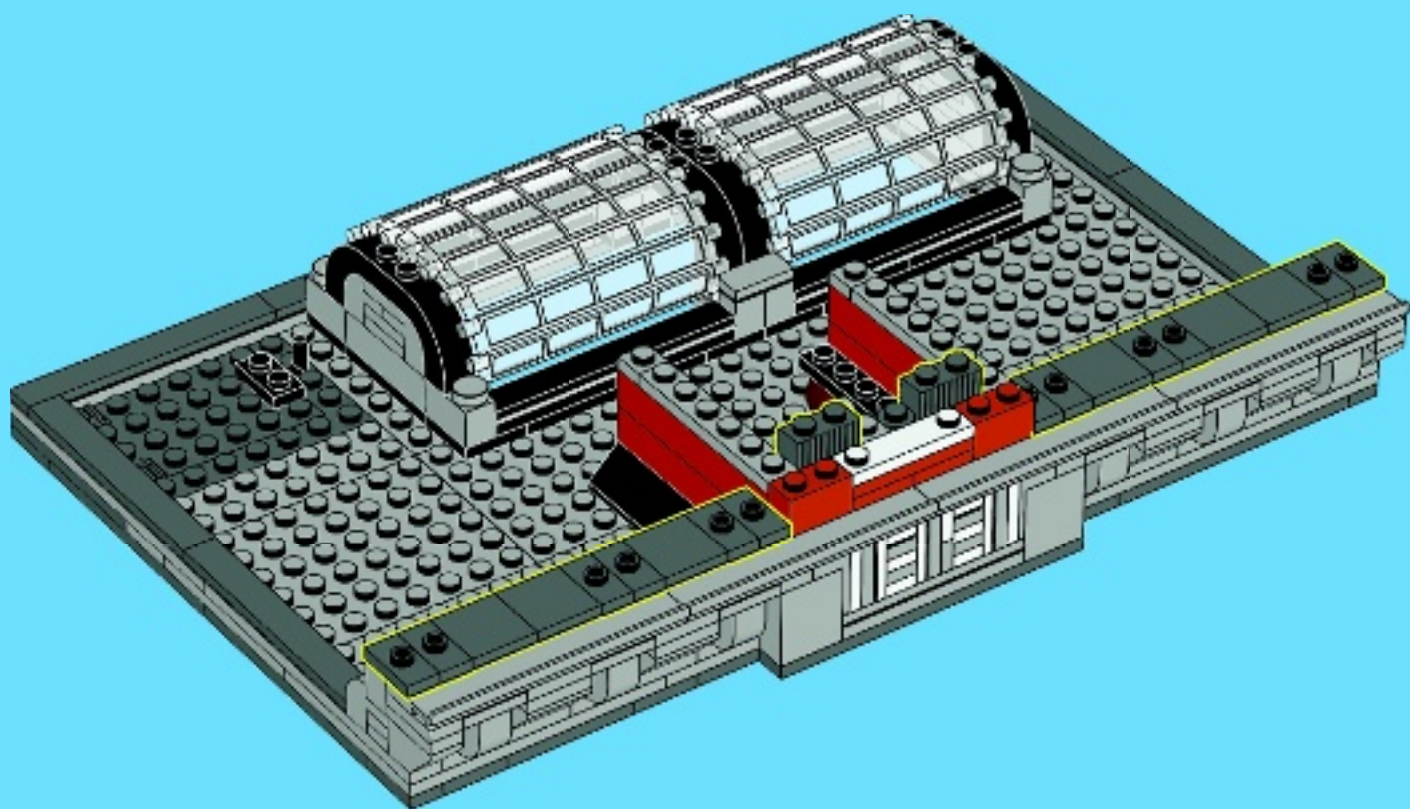

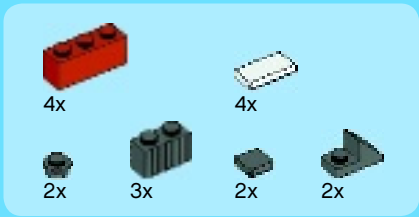

26

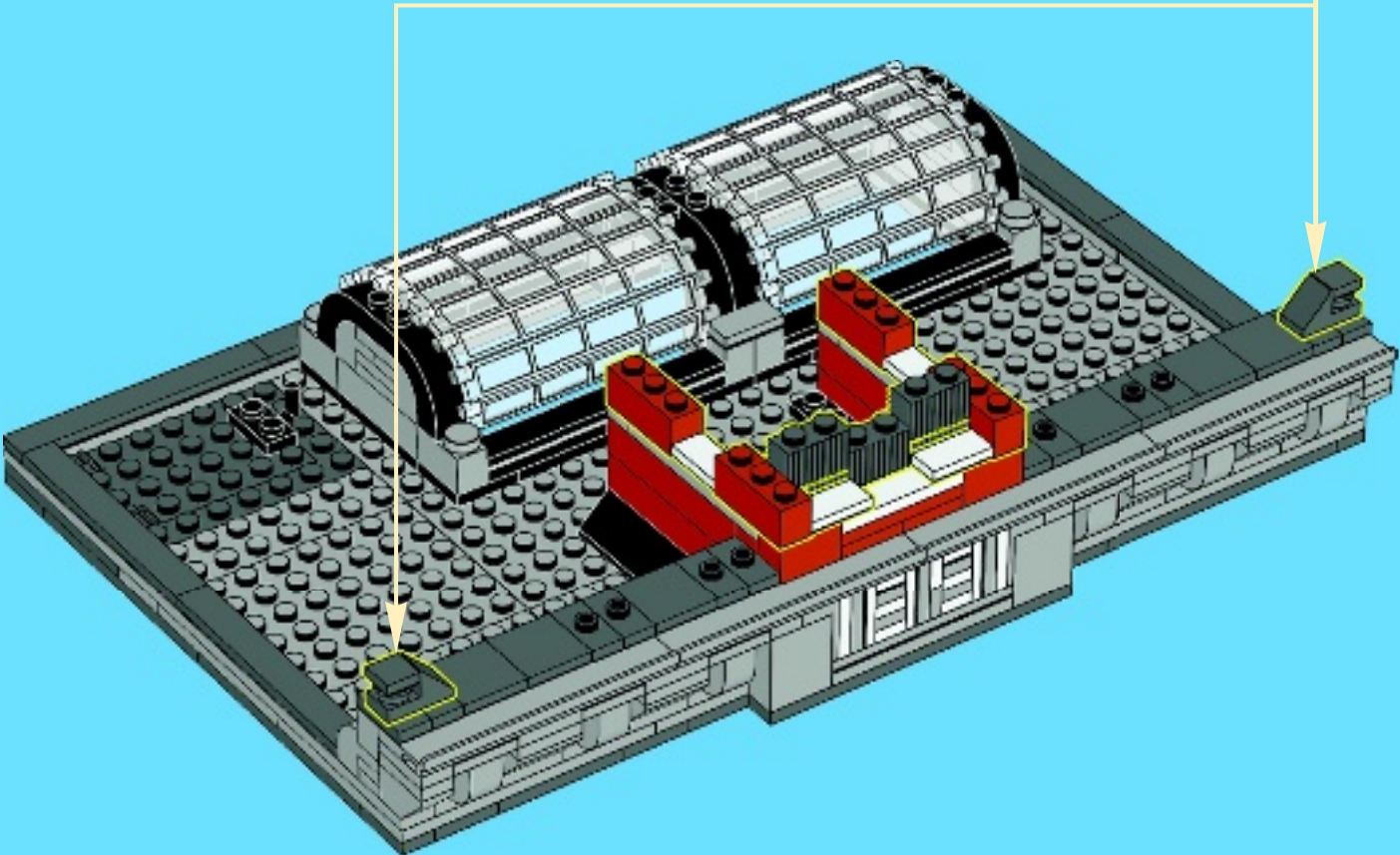
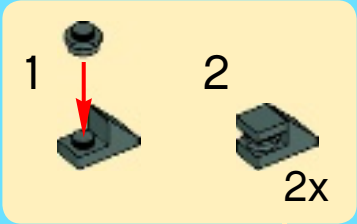

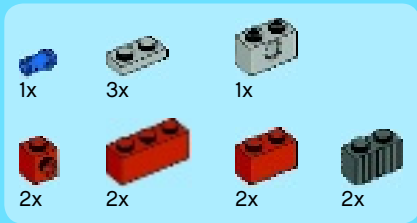

27

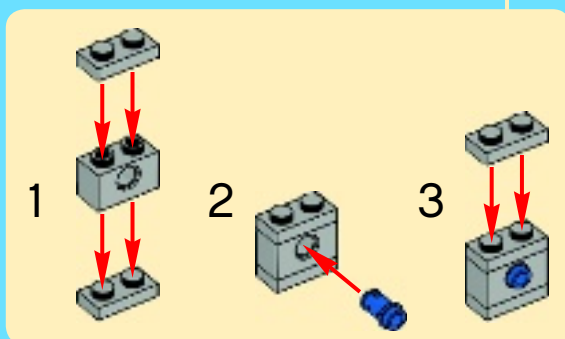
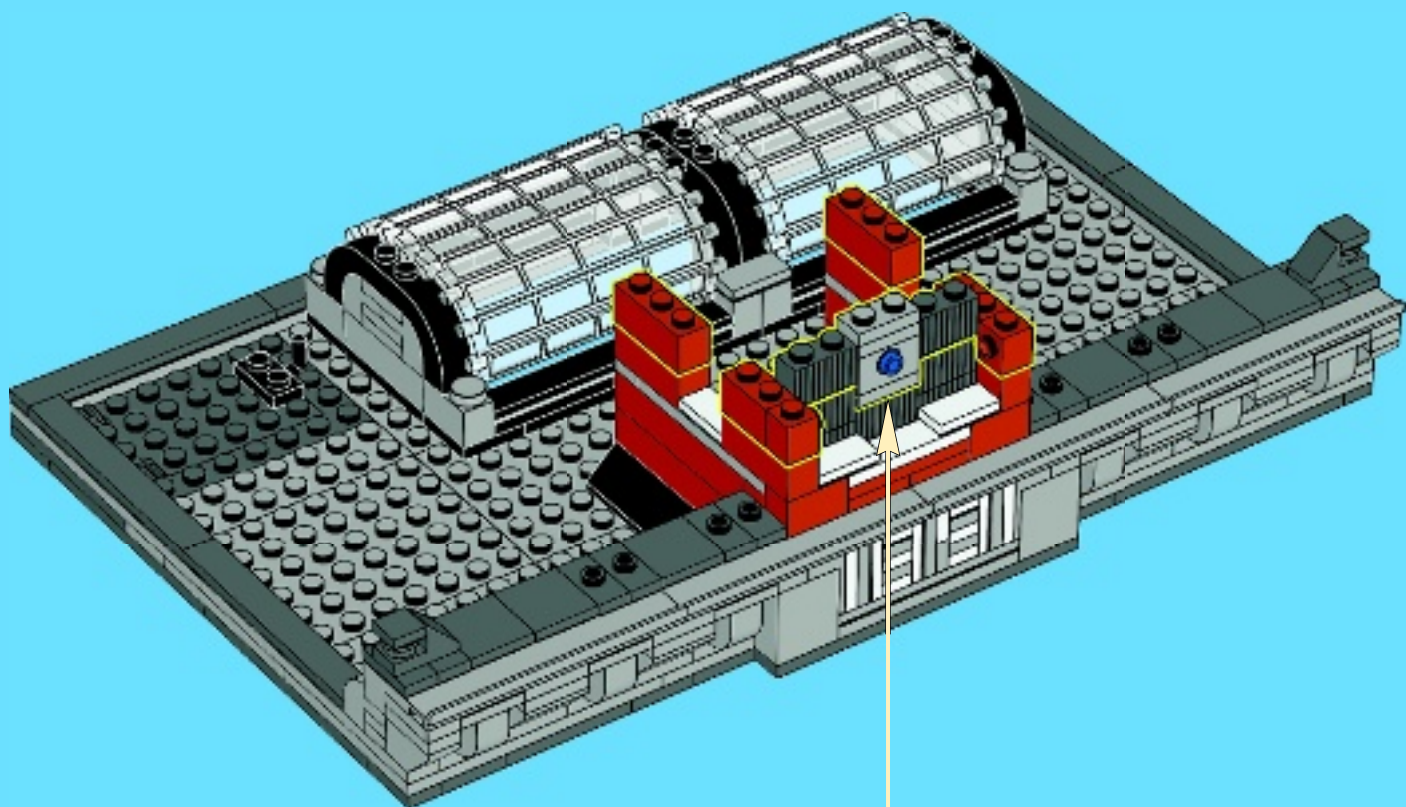

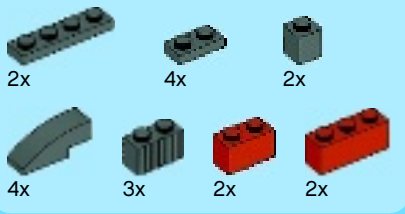

28

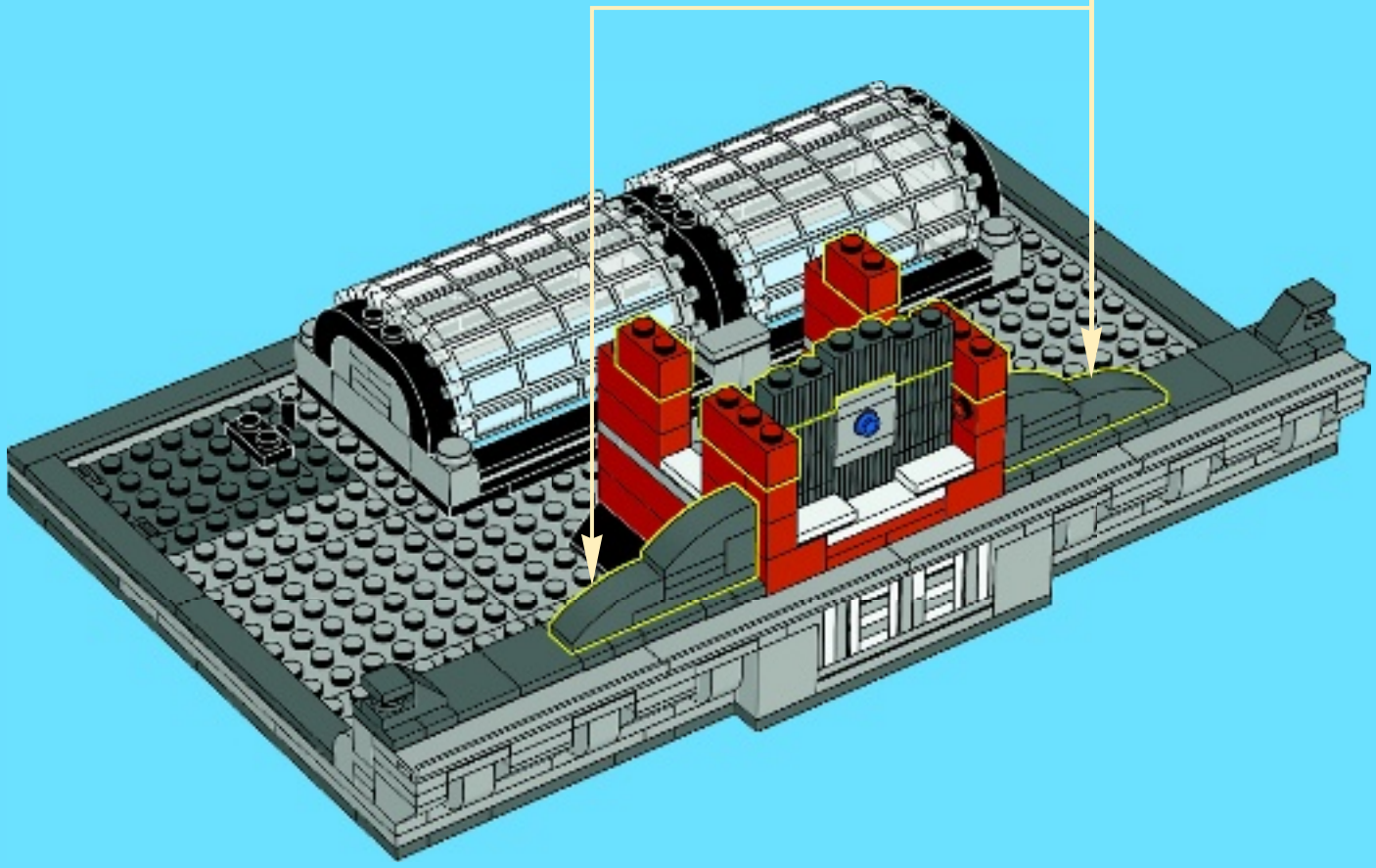
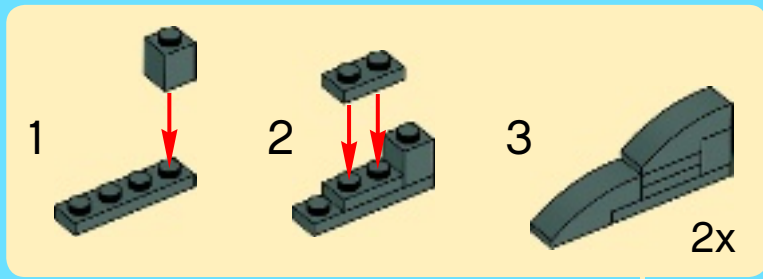

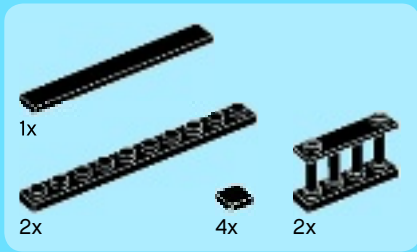

29

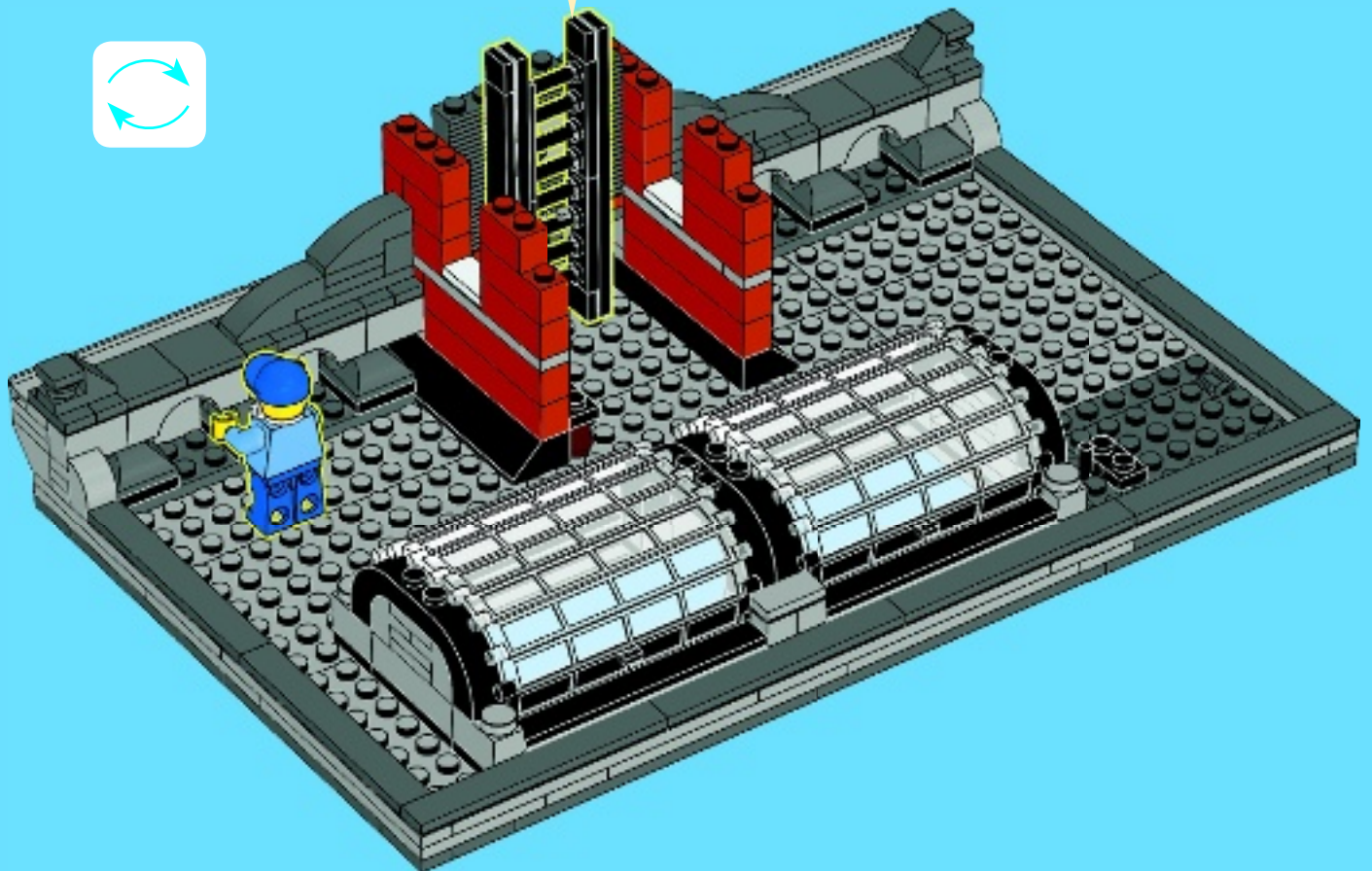
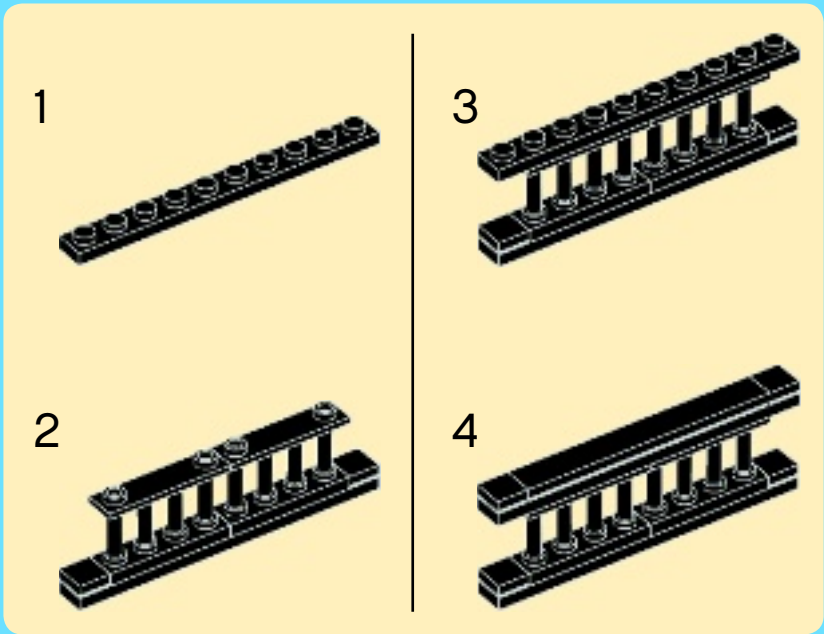

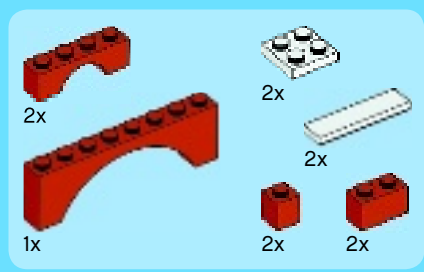

30

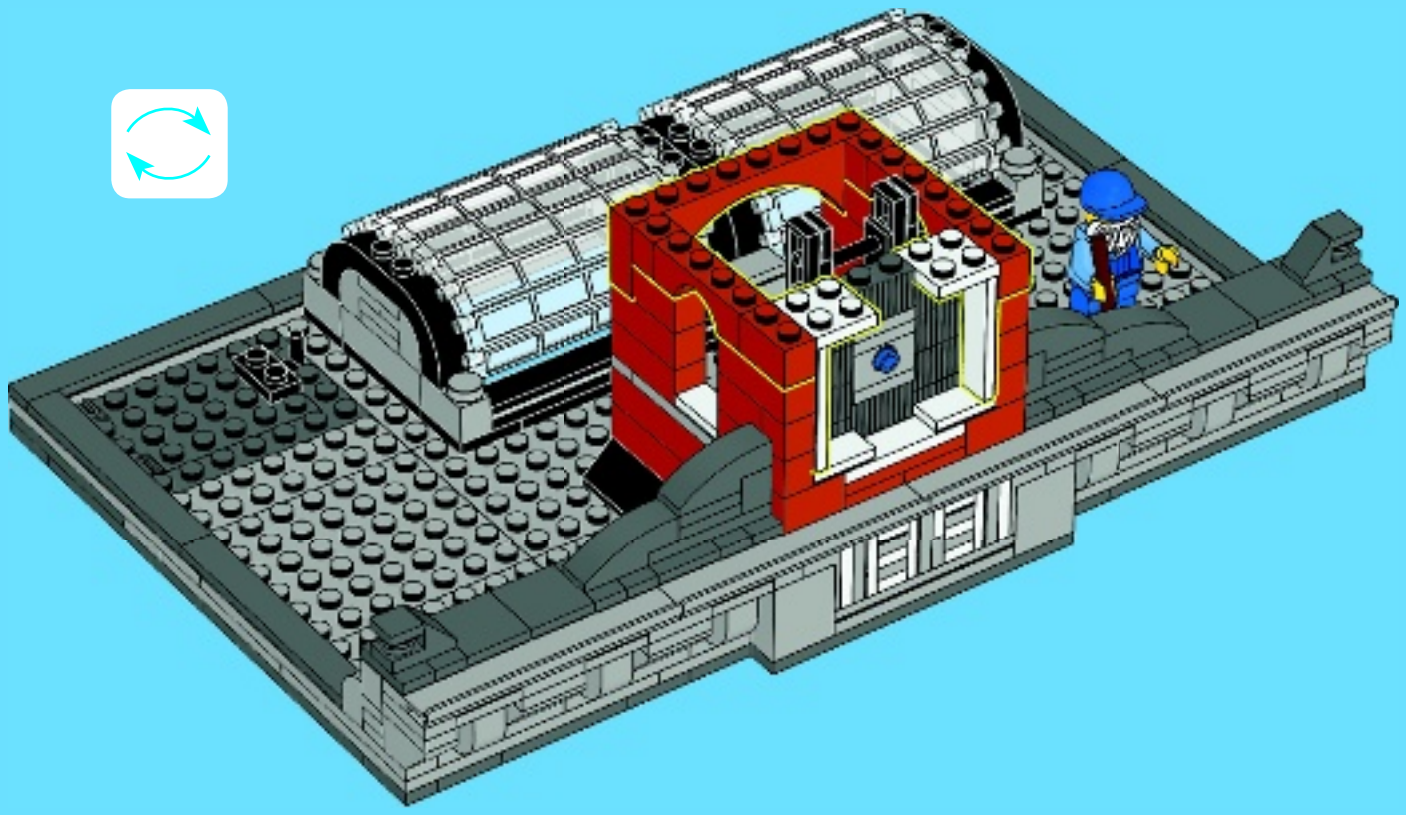

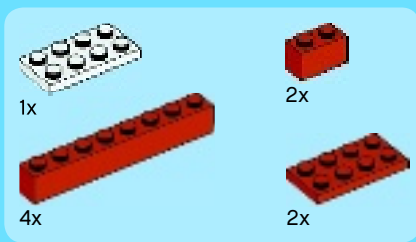

31

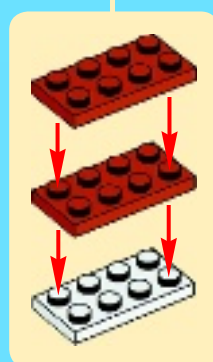
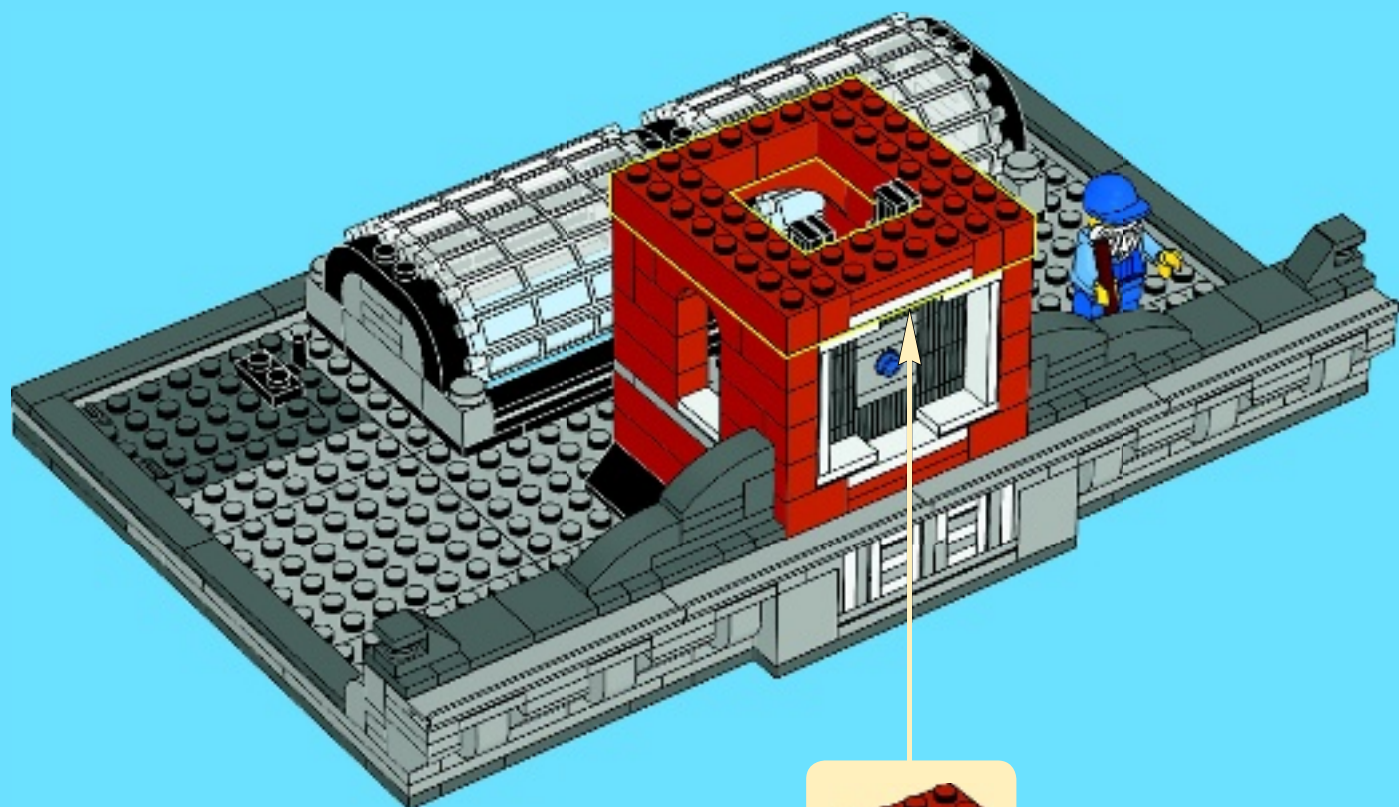



1x



12x

32

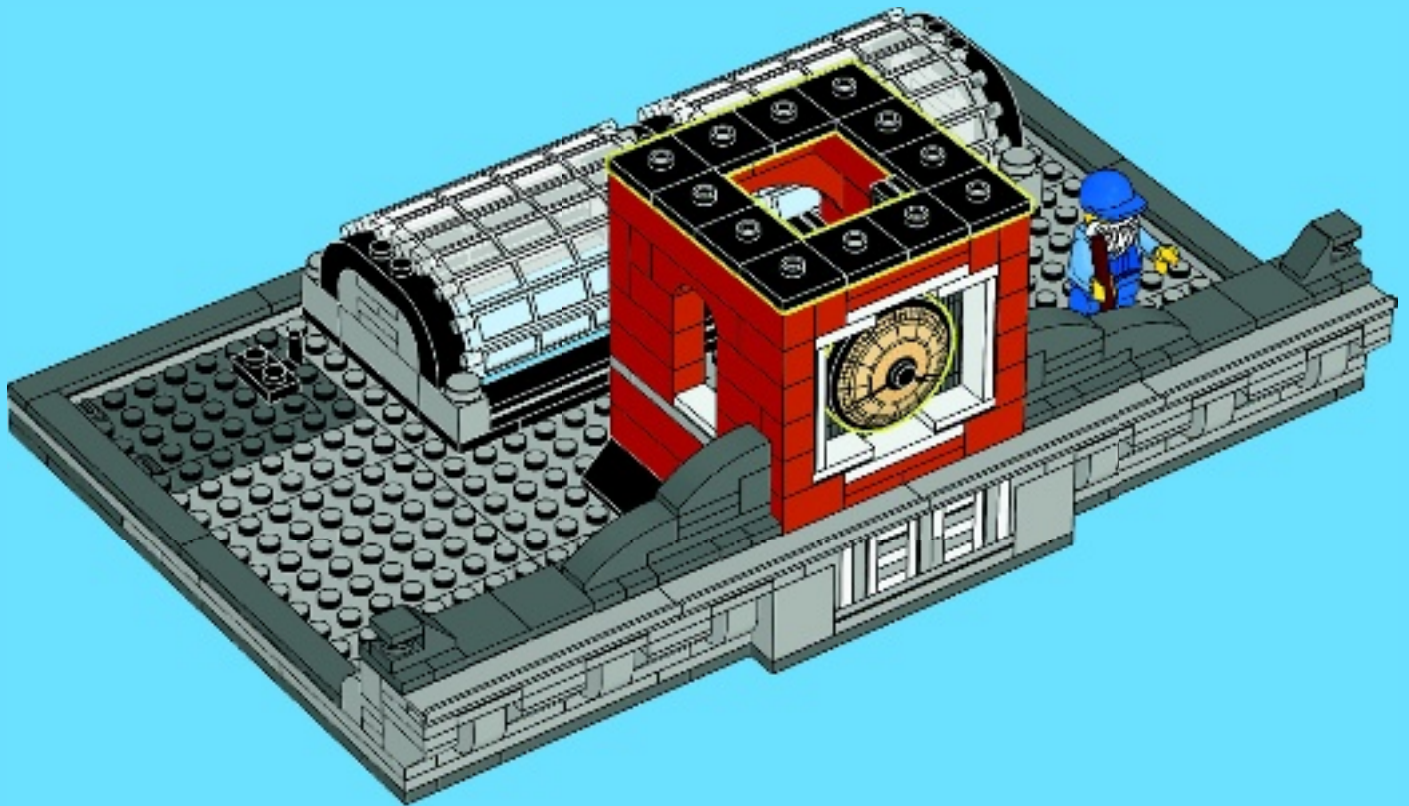



4x



4x



4x

33

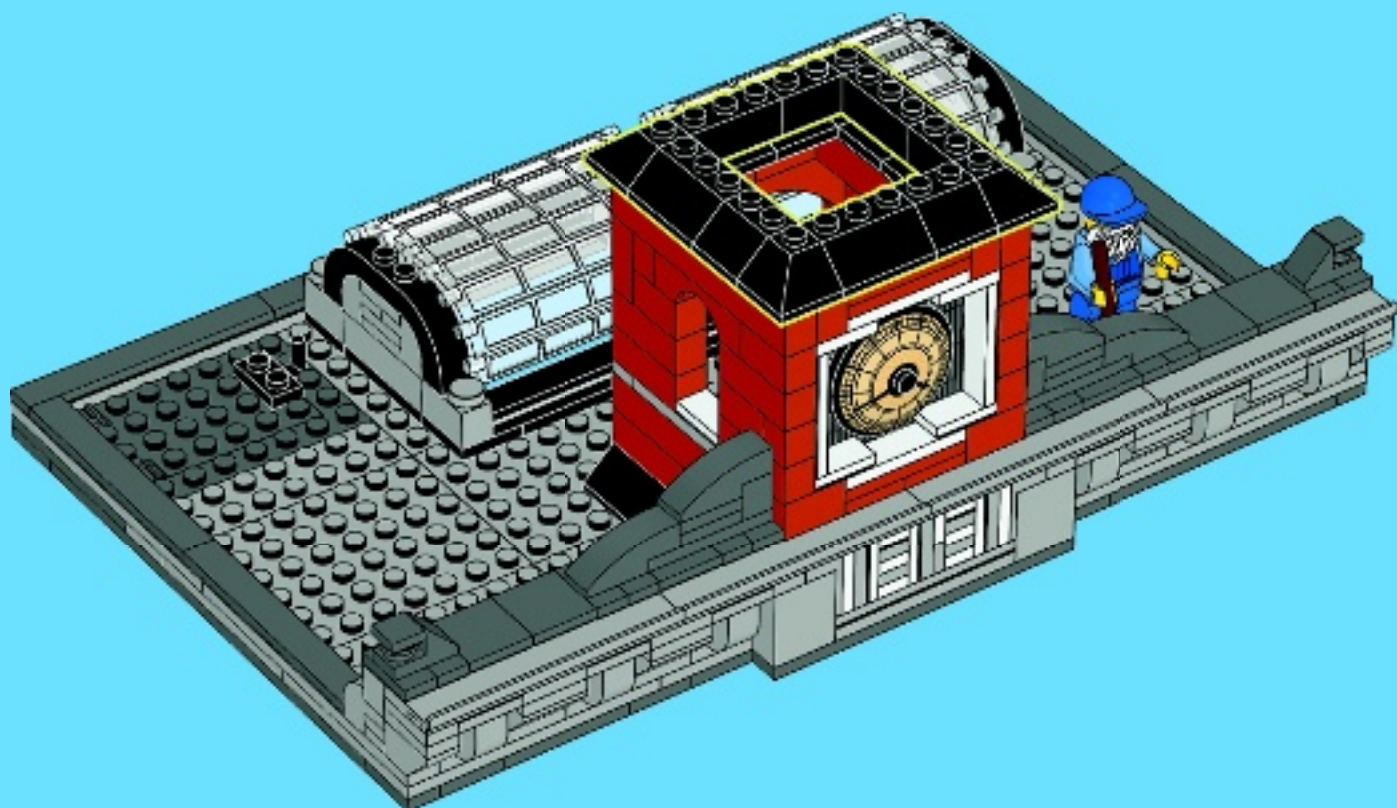



4x



4x

34

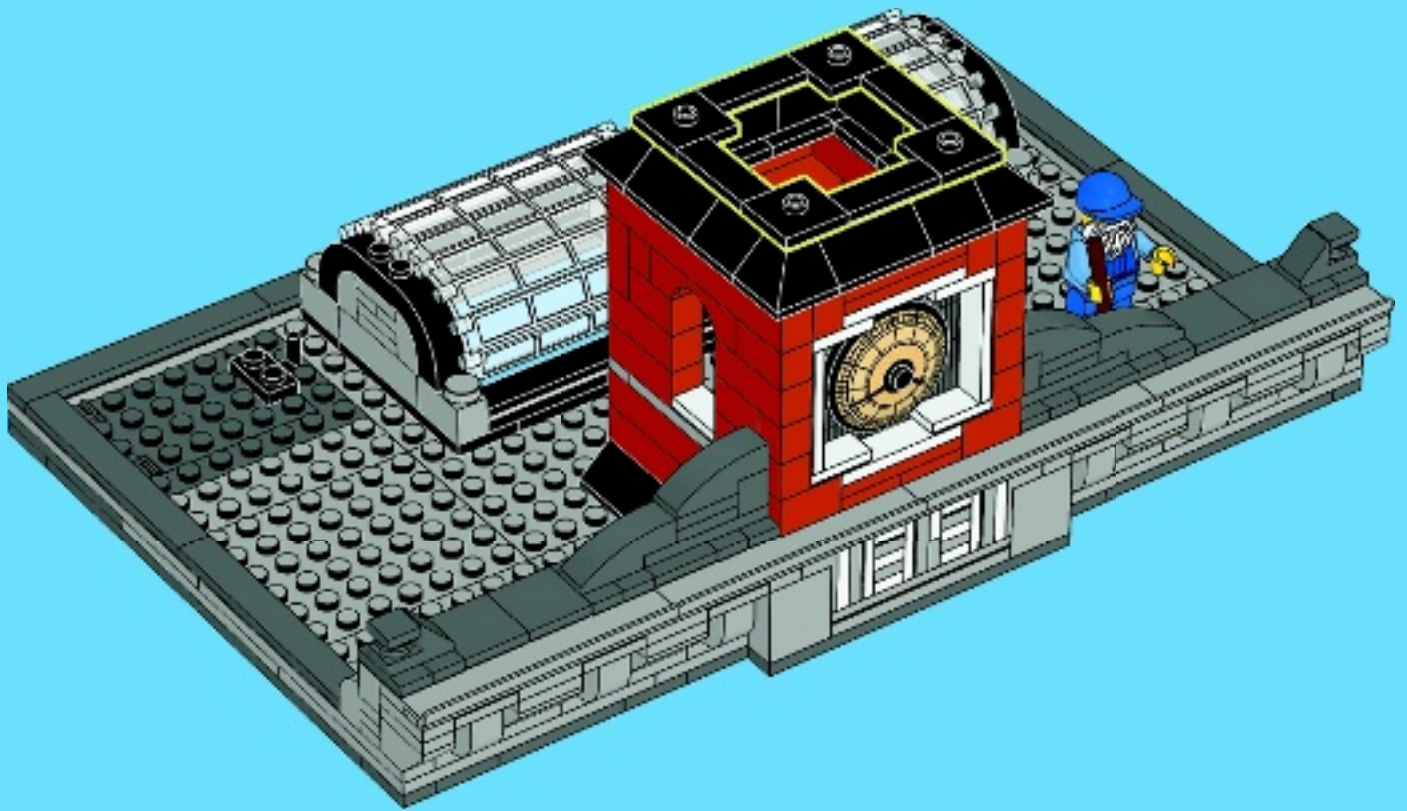

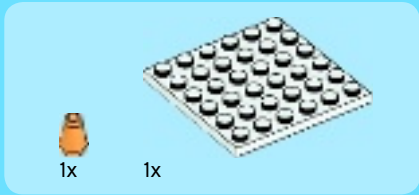

1

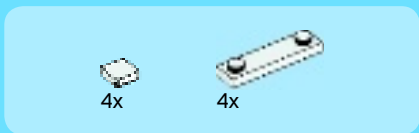

2

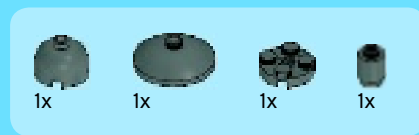

3

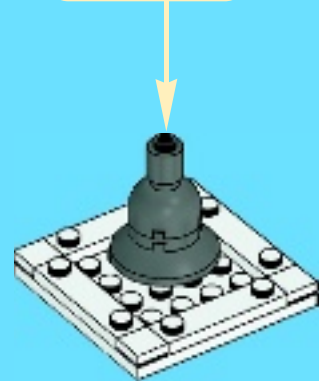
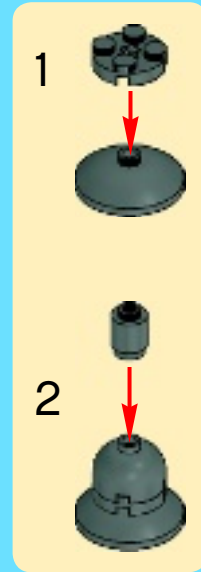



4

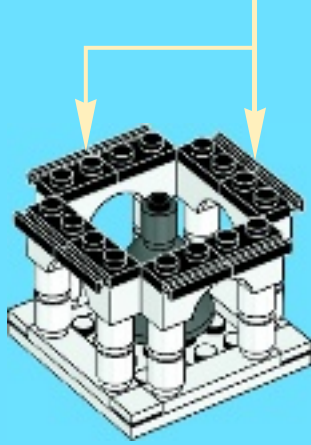
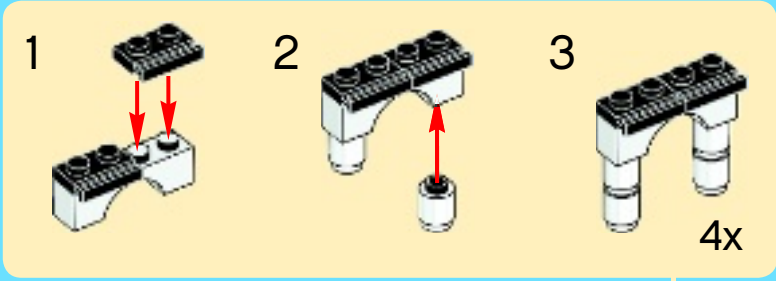

5





4x



4x

6

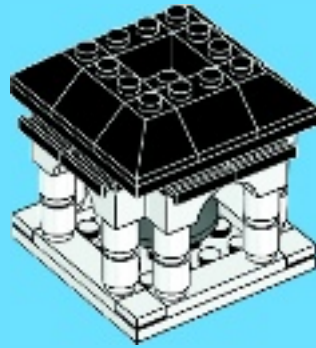

2x

7





4x

8



1x

9



35



36



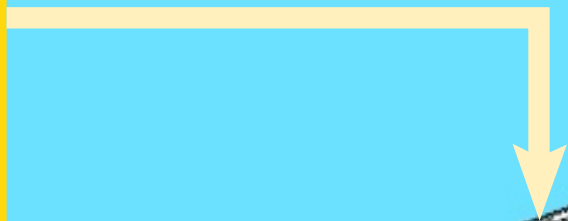

- 19x 307001
- 1x 4613256
- 12x 4632566
- 15x 379401
- 1x 4119410
- 34x 302401
- 27x 302301
- 11x 302201
- 28x 362301
- 4x 302101
- 5x 4597131
- 26x 371001
- 10x 302001
- 28x 366601
- 10x 303401
- 1x 4144012
- 32x 447701
- 4x 303601
- 4x 4652480
- 11x 300501
- 11x 300401
- 11x 362201
- 7x 300201
- 8x 300901
- 7x 300801
- 8x 4264360
- 3x 4143254
- 17x 306201
- 4x 4650644
- 26x 4504369
- 1x 4234525
- 4x 4515359
- 4x 365901
- 31x 4249563
- 1x 4289304
- 1x 4293350
- 20x 306901
- 5x 306801
- 4x 4558168
- 2x 243101
- 2x 4549393
- 7x 663601
- 16x 416201
- 22x 4501853
- 2x 614101
- 2x 474001
- 2x 4550745
- 12x 4520842
- 14x 4536521
- 8x 4585458
- 49x 4521210
- 2x 4541956
- 6x 4530590
- 5x 4520636
- 1x 4619665
- 1x 4119500
- 1x 6000844
- 1x 4549942
- 1x 362601
- 4x 626601
- 1x 4610044
- 6x 4646576
- 10x 4213568
- 2x 4650647
- 2x 4523145
- 12x 4624086
- 2x 4624088
- 4x 4666611
- 2x 4159553
- 17x 4113917
- 6x 4114084
- 2x 4121921
- 6x 4114309
- 26x 4114026
- 9x 4155708
- 1x 4140593
- 9x 4550324
- 12x 4157277
- 1x 4558611

8x
614121
 3x
4106915
 2x
4619543
 1x
4617549
 1x
4624686
 1x
4142865
 1x
302323
 2x
4613257
 3x
306923
 2x
4514398
 1x
317623
 1x
4543857
 1x
9341
 1x
4567909
 1x
393723
 1x
368023
 3x
4143005
 9x
614124
 8x
9336
 1x
4568173
 1x
4288003

5x
300226
 5x
300126
 3x
4617860
 14x
4558954
 18x
4529236
 2x
4159550
 1x
6000644
 8x
4189064
 4x
4614804
 8x
303926
 4x
303826
 1x
303726
 2x
4163334
 4x
4299388
 8x
242026
 3x
302226
 17x
4565323

10x
362326
 2x
302126
 11x
371026
 2x
302026
 4x
366626
 1x
395826
 2x
447726
 4x
307026
 2x
4144575
 4x
306926
 1x
4569733
 2x
4556158
 8x
4107761
 4x
306826
 20x
4558170
 6x
317626
 1x
4184813
 2x
4560182
 5x
416226

53x
614126
 2x
474026
 1x
6000850
 3x
4521208
 5x
4535834
 2x
4667008
 2x
4185652
 1x
4294570
 1x
602026
 1x
395726
 1x
9339
 1x
4275535
 1x
4526110
 1x
4652469
 1x
4105175
 1x
4114128

1x
4623154
 5x
4537551
 1x
4106552
 2x
4598897
 2x
4289538
 4x
4141580
 1x
4515185
 2x
4184169
 7x
4121715
 3x
4645394
 1x
3006840
 4x
3005740
 52x
4552035
 14x
4536998
 1x
4521504
 18x
4522255
 1x
3001140
 1x
4580475
 1x
4654448

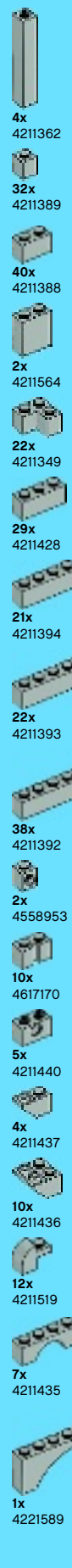
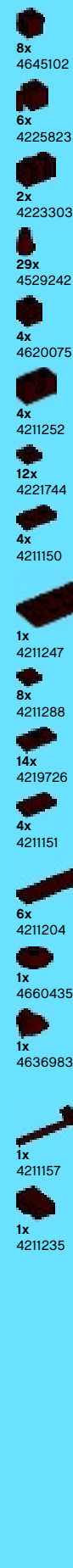

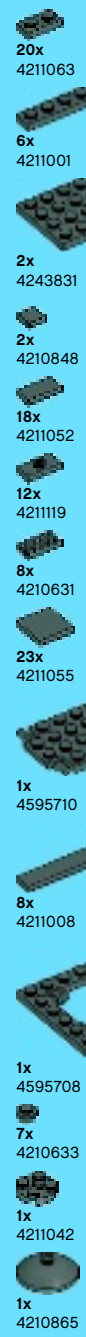
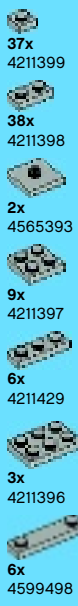
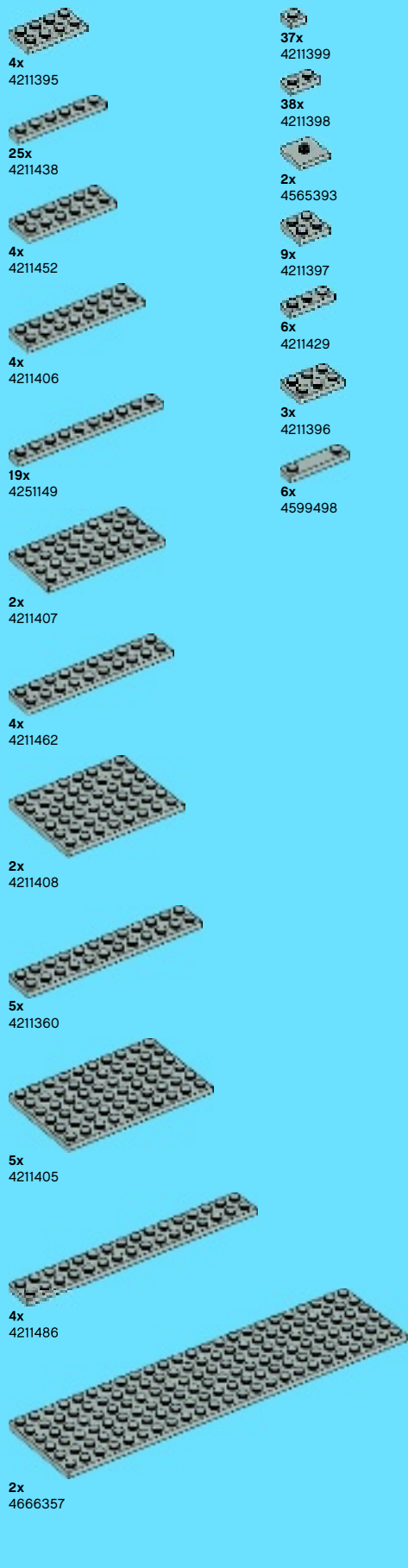

Customer Service
Kundenservice
Service Consommateurs
Servicio Al Consumidor

www.lego.com/service or dial



: 00800 5346 5555
: 1-800-422-5346



FREE! GRATIS! GRATUIT!



www.LEGOclub.com



LEGO Club Email



LEGO Club Magazine



VISIT THE WORLD'S BIGGEST LEGO SHOP!

www.LEGOshop.com

GO TO

www.LEGOclub.com

00800 5346 5555



1-866-534-6258 • 1-877-518-5346

US & Canada only

Canada seulement



* Freephone. Mobile charges may apply. * Numéro sans frais. Des frais peuvent s'appliquer avec les téléphones cellulaires. * Gebührenfrei, Kosten für Anrufe aus Mobilfunknetzen können abweichen. * Gratis telefonnummer vanaf vaste lijn. * Det er et gratis nummer, når du ringer fra fasttelefon. * Det är gratis, när du ringer från en fast telefon. * Numéro sans frais. Des frais peuvent s'appliquer avec les téléphones portables.

YES! I want to join the LEGO Club FREE! OUI! Je veux m'abonner au LEGO Club GRATUITEMENT! Ja! Ich möchte Mitglied im kostenlosen LEGO Club werden. Ja! Ik wil graag GRATIS lid worden van de LEGO Club. Ja! Jeg ønsker å melde meg inn i LEGO Club gratis! Ja! Jag vill gå med i LEGO Club GRATIS!

Registration form with fields for name, address, birth date, gender, and email.

Mail to / Poster à: LEGO Club, P.O. Box 1157, Enfield, CT USA 06083-1157. Skickas till: LEGO Club Sverige, 33 Bath Road, Slough SL1 3UF, United Kingdom. Per Post an: LEGO Club, Postfach 14 15, D-36243 Niederaula. Stuur op naar: LEGO Club, Postbus 40250, 3504 AB Utrecht.

- Fill in your email address and we will send you a membership confirmation and monthly email newsletters. If you do not wish to receive the newsletters please tick here. Remplis ton adresse e-mail et nous t'envoyons une confirmation d'adhésion ainsi que le bulletin e-mail mensuel. Si tu ne désires pas recevoir le bulletin, coche cette case. Vül je e-mailadres in en we sturen je een bevestiging van je lidmaatschap en maandelijkse e-mail nieuwsbrieven. Als je geen e-mail wilt ontvangen, kruis dan dit vakje aan. Ich möchte per E-Mail den monatlichen LEGO Club Newsletter erhalten. Önsker du at vi skal sende en liten hilsen til barnet ditt for å bekrefte medlemskapet, ber vi deg krysse av i feltet, samt oppgi e-postadressen som hilsen skal sendes til. Om du vill att vi ska skicka en bekräftelse på ditt barns medlemskap, ber vi dig sätta ett kryss i rutan och skriva den e-post adress som bekräftelsen ska skickas till.

- If you do not wish to receive additional mailings from the LEGO Club please tick here. Si tu ne désires pas recevoir de courrier supplémentaire du Club LEGO, coche cette case. Als je geen verdere post van de LEGO Club wilt ontvangen, kruis dan dit vakje aan. Om du vill få annan information från LEGO Gruppen, sätt ett kryss här. Dersom du ønsker å motta annen informasjon fra LEGO Gruppen, setter du et kryss her.

The English language version of the magazine can only be mailed to addresses in the US, Canada, the UK, and Republic of Ireland. Club membership is valid for two years and includes free copies of the LEGO Club Magazine and e-mail newsletters. In the US and Canada please allow up to 6 weeks for delivery of your first magazine. In the UK and Republic of Ireland please allow six to 14 weeks for delivery of your first magazine. By signing this form you consent the LEGO Club to use your child's data for LEGO mailings. The data will only be used for LEGO mailings and will not be sold, rented or otherwise disclosed to any company outside the LEGO Company except for disclosure to companies acting as our agents to help us provide services requested by the child. This coupon is valid for one free membership per person, group or organization. Photocopied coupons are accepted. La version française du magazine peut être postée uniquement au Canada. L'abonnement est valide pour 2 ans et inclut des exemplaires gratuits du Magazine LEGO. Aux E-U et au Canada, allouer 6 semaines pour la livraison initiale. En remplissant ce formulaire, vous consentez à ce que LEGO utilise les informations de votre enfant pour des envois postaux de LEGO. L'information sera utilisée uniquement pour des envois postaux par LEGO et ne sera en aucun cas, vendue, louée, échangée ou divulguée à d'autres compagnies autres que la compagnie LEGO, à l'exception des compagnies affiliées qui nous procurent des services auxquels l'enfant en a fait la demande. Formulaire photocopié accepté. Mit der folgenden Unterschrift erkläre ich, für mein Kind den Beitritt als Mitglied zum kostenlosen LEGO Club, der von der LEGO GmbH, D-85627 Grasbrunn, betrieben wird. Die Mitgliedschaft beinhaltet die Zusendung des LEGO Club Magazines und kann beiderseits jederzeit beendet werden. Mit der Mitgliedschaft im LEGO Club sind keinerlei Verpflichtungen verbunden. Das deutschsprachige LEGO Club Magazin wird nur an Adressen in Deutschland, Österreich und der Schweiz versendet. Eine Anmeldebestätigung kann nur per E-Mail geschickt werden. Das Magazin erscheint fünfmal jährlich. Daher kann die Zustellung des ersten Heftes bis zu drei Monate dauern. Die Mitgliedschaft ist beidseitig jederzeit kündbar, ohne dass Ihnen Kosten entstehen. Sie können der werblichen Nutzung Ihrer Daten jederzeit widersprechen. Kündigung und Widerspruch können Sie telefonisch erklären (00800 / 5346 5555, Anruf gebührenfrei, Kosten für Anrufe aus dem Mobilfunknetz können abweichen) oder an die LEGO GmbH senden. Het lidmaatschap kan op ieder moment opgezegd worden en kan na 2 jaar gratis worden verlengd, tenzij LEGO met deze activiteit stopt. Uw gegevens worden uitsluitend gebruikt voor mailings van LEGO en zullen niet worden verkocht, verhuurd of op welke wijze dan ook verstrekt aan derden buiten de LEGO Groep, uitgezonderd de organisaties die namens ons optreden om de informatie te sturen waarvoor toestemming is verleend. Den norske utgaven av magasinet sendes kun til adresser i Norge. Medlemskap i klubben gjelder 12 år og inkluderer gratisutgaver av LEGO Club Magazine. Påregnet minimum oppbitt seks ukers leveringstid for første magasin. Ved å undertegne dette skjemaet, gir du ditt samtykke til at LEGO Club kan bruke opplysningene om barnet ditt i LEGO foresendelser. Dataene vil utelukkende bli brukt i LEGO foresendelser og vil ikke bli solgt, utleid eller på annen måte gjøres tilgjengelig for selskaper utenfor LEGO gruppen, unntatt selskaper som er våre agenter og som hjelper oss å tilby tjenestene barnet etterper. Dette skjemaet gjelder for ett gratis medlemskap per person, gruppe eller organisasjon. Den svenske versionen av tidningen kan endast skickas till adresser i Sverige. Club-medlemskapet är giltigt i 2 år och innefattar gratis exemplar av LEGO Club Magazine. Vänligen räkna med minimum 6 veckor för leverans av din första tidning. Genom att skicka in det här formuläret godkänner du att LEGO Club använder barnets uppgifter för LEGO utskick. Uppgifterna kommer bara att användas för LEGO utskick och kommer inte att säljas, hyras ut eller vidarebefordras till något företag som inte tillhör LEGO Gruppen, med undantag av företag som agerar som våra ombud för att tillhandahålla tjänster som barnet har begärt. Den här kupongen gäller för ett gratis medlemskap per person, grupp eller organisation. En komplett en bulletin d'adhésion, vous acceptez que LEGO Club utilise les données relatives à votre enfant pour l'envoi de courriers concernant LEGO. Ces données seront uniquement utilisées pour l'envoi d'information concernant LEGO et ne seront ni vendues, ni louées, ni utilisées par d'autres sociétés que le groupe LEGO, à l'exception des sociétés agissant pour le compte de LEGO en tant que sous-traitant de services divers. L'abonnement au LEGO Club est valable pour une période de 2 ans. Il inclut l'envoi par courrier du magazine LEGO Club et par email des newsletters. Un délai de 6 à 14 semaines est à prévoir pour la réception de votre premier magazine. Ce bulletin d'adhésion gratuit est valable pour l'inscription d'une seule personne. Les photocopies sont acceptées. ATTENTION! Le bulletin d'adhésion doit être rempli et signé par un parent ou un tuteur.

Parent's signature - Signature d'un parent ou d'un tuteur - Unterschrift Erziehungsberechtigter / Handtekening ouders - Foreldres/foresettes underskrift - Förälders / förmyndares underskrift

Date Datum Date



VIP Program Programme VIP



Earn VIP Points every time you shop directly with us and enjoy valuable rewards

Gagnez des points VIP à chaque achat et profitez de Formidables avantages

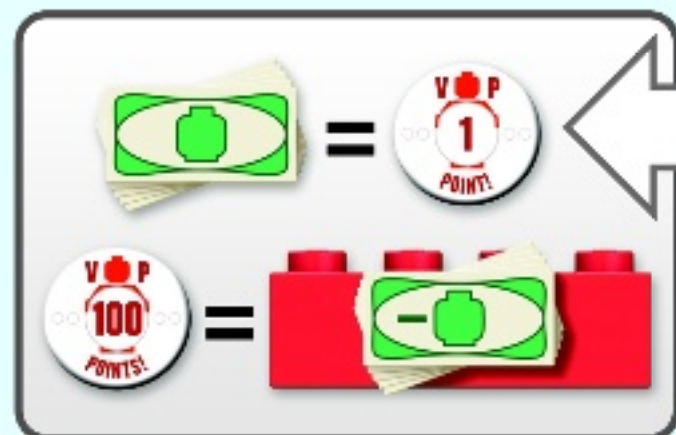

Earn 100 VIP Points and get a reward off your next purchase!

Gagnez 100 points VIP et bénéficiez d'une réduction sur votre prochain achat !



Access exclusive LEGO® sets just for VIPs

Accédez aux ensembles LEGO® exclusifs réservés aux membres VIP



VIP.LEGO.com





WIN!

Go to www.LEGOsurvey.com/product to fill out a survey for a chance to win a cool LEGO® Product.

No purchase necessary.

Open to all residents where not prohibited.



www.LEGO.com



www.LEGOsurvey.com/product

GEWINNE!

Nimm an der Umfrage auf www.LEGOsurvey.com/product teil und hab die Chance ein cooles LEGO® Produkt zu gewinnen! Die Teilnahme am Gewinnspiel führt zu keinerlei Kaufverpflichtungen. Teilnahme in allen nicht ausgeschlossenen Ländern möglich.

WIN!

Ga naar www.LEGOsurvey.com/product, vul een enquêteformulier in en maak kans op een cool LEGO® product. Geen aankoopverplichting. Iedereen mag deelnemen, uitgezonderd ingezetenden van landen waar een enquêteverbod geldt.

GAGNE!

Visite www.LEGOsurvey.com/product pour répondre à un questionnaire et avoir une chance de gagner un produit LEGO® très cool! Aucune obligation d'achat. Ouvert à tous les résidents des pays autorisés.

当てよう!

www.LEGOsurvey.com/product にアクセスして、アンケートにご記入ください。当選者にはレゴ®製品を差し上げます。お買い上げの必要はありません。禁止されていない限り、すべての皆様にご利用いただけます。