

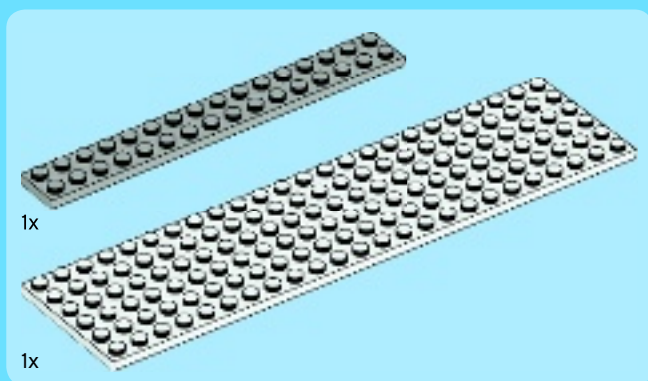

10224







1

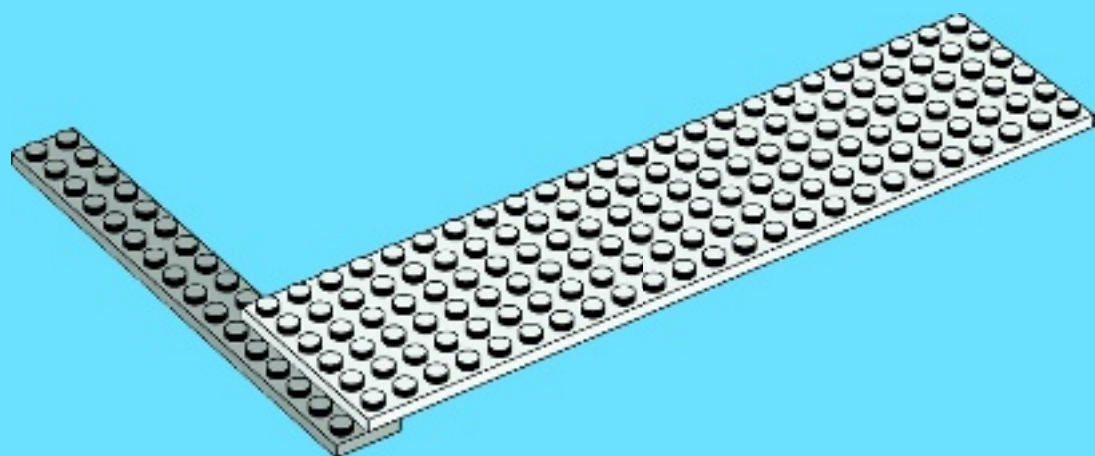

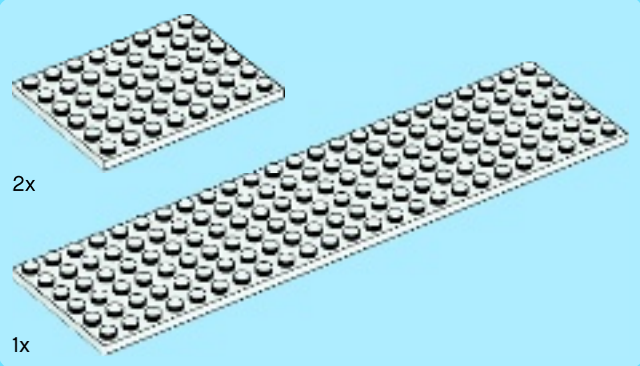

2

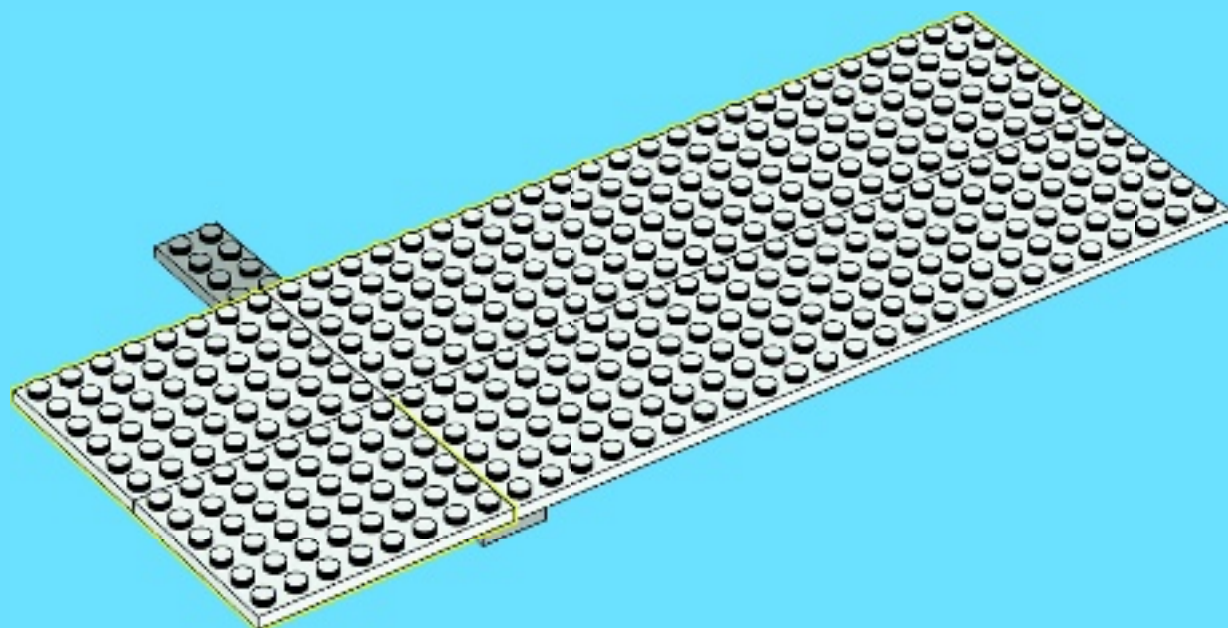

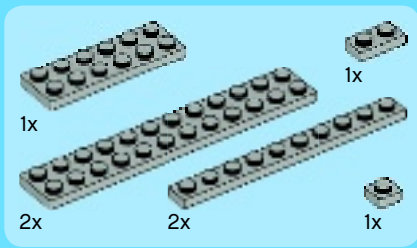

3

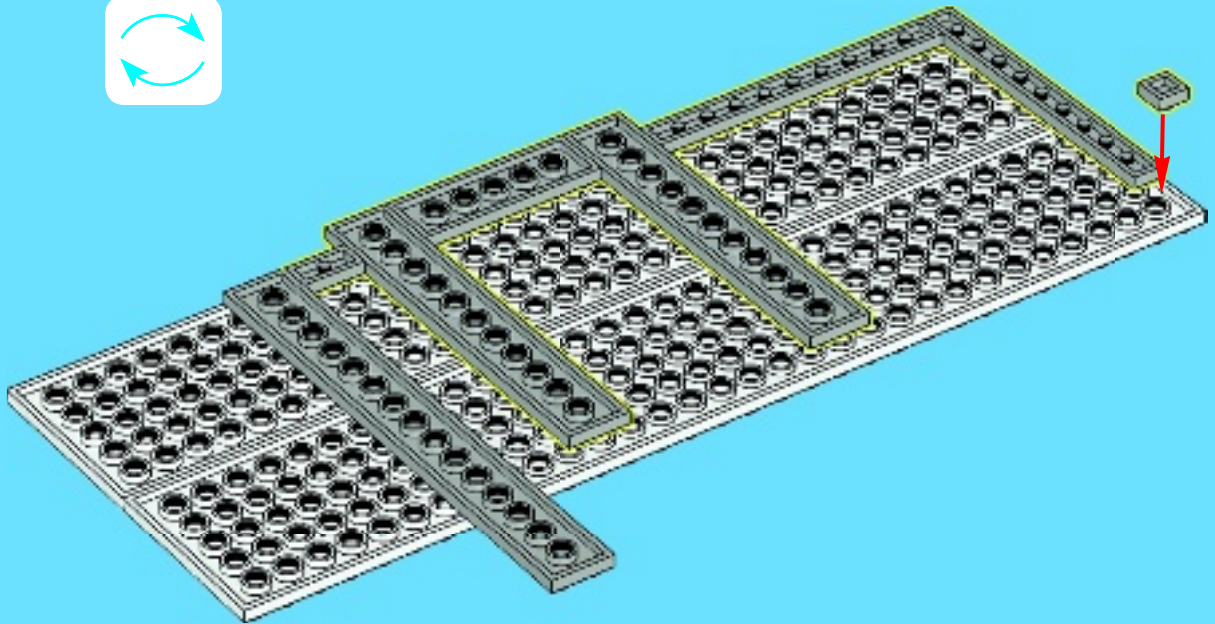

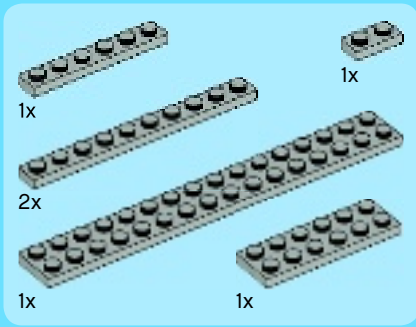

4

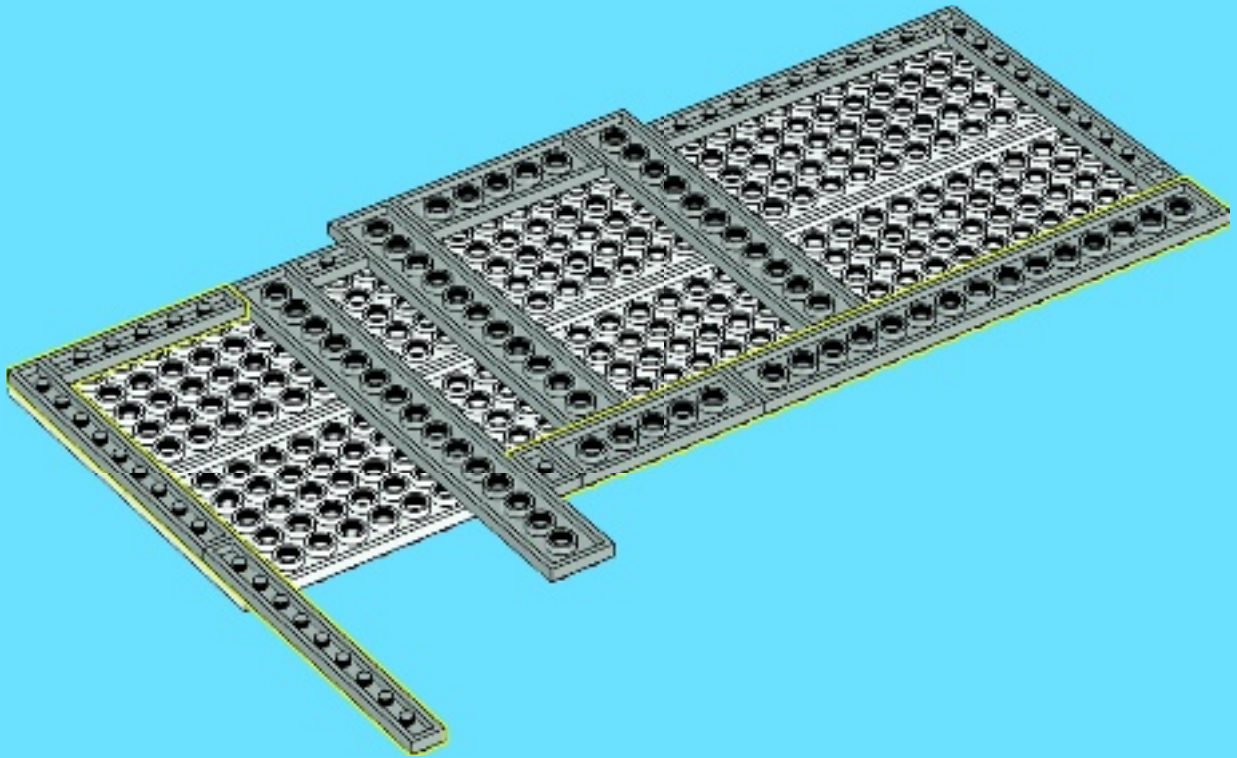

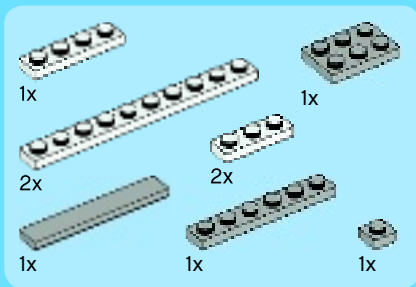

5

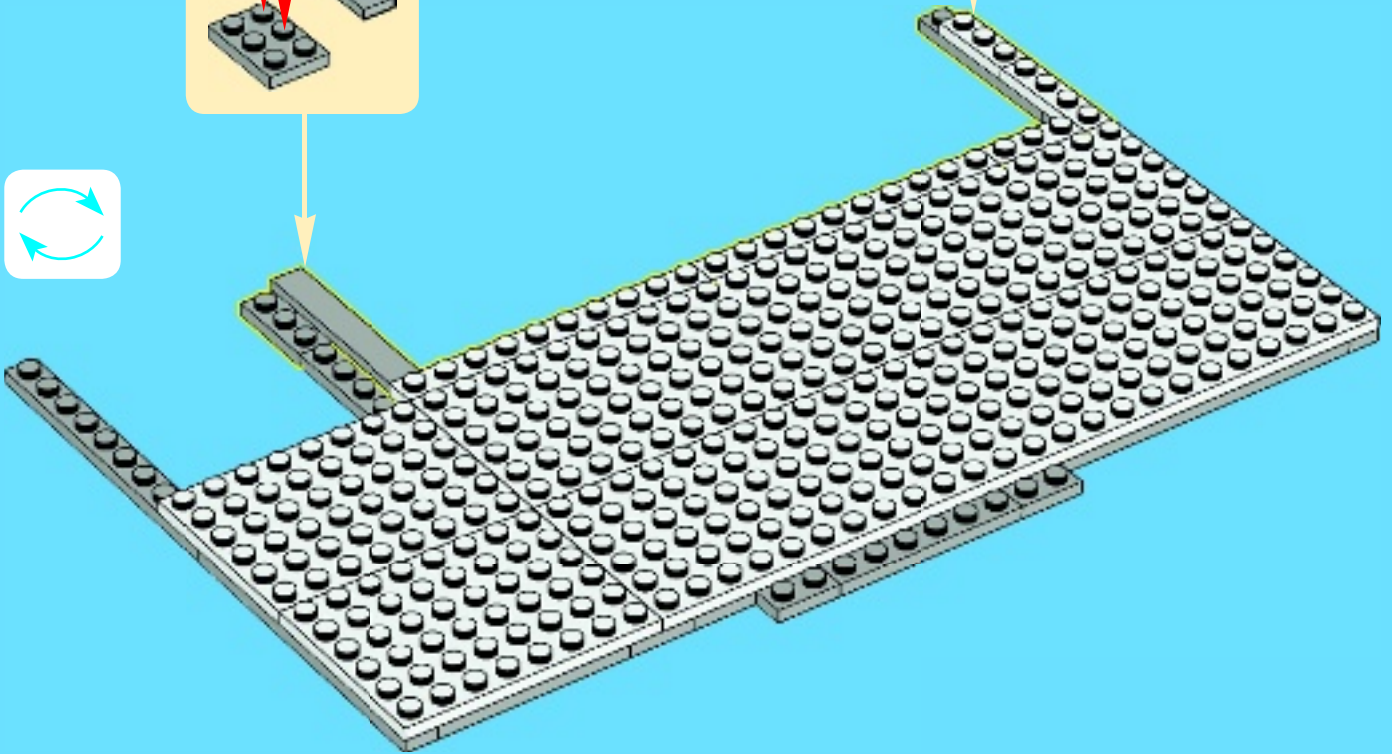
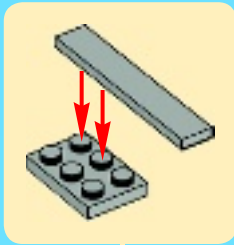
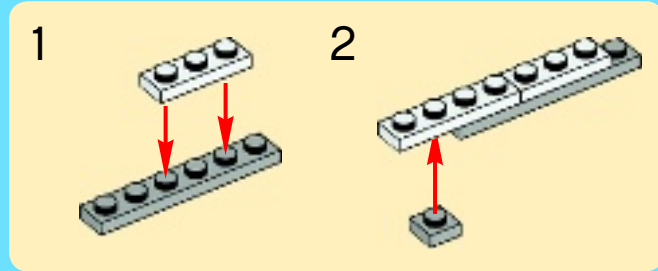

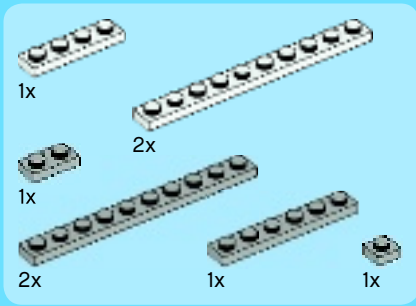

6

1

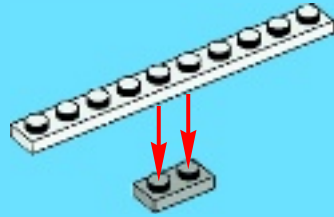

2

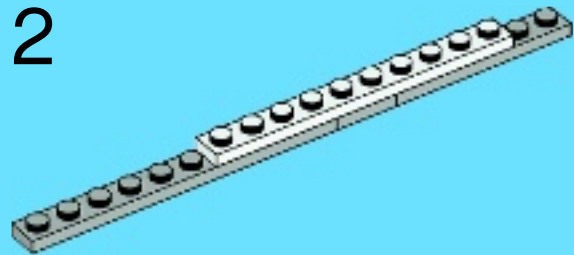

3

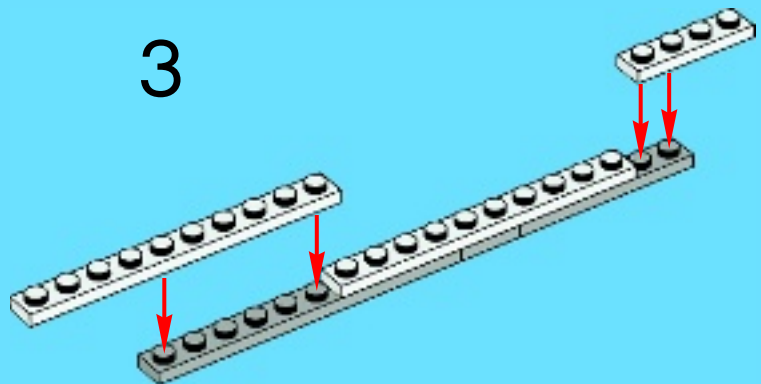

4

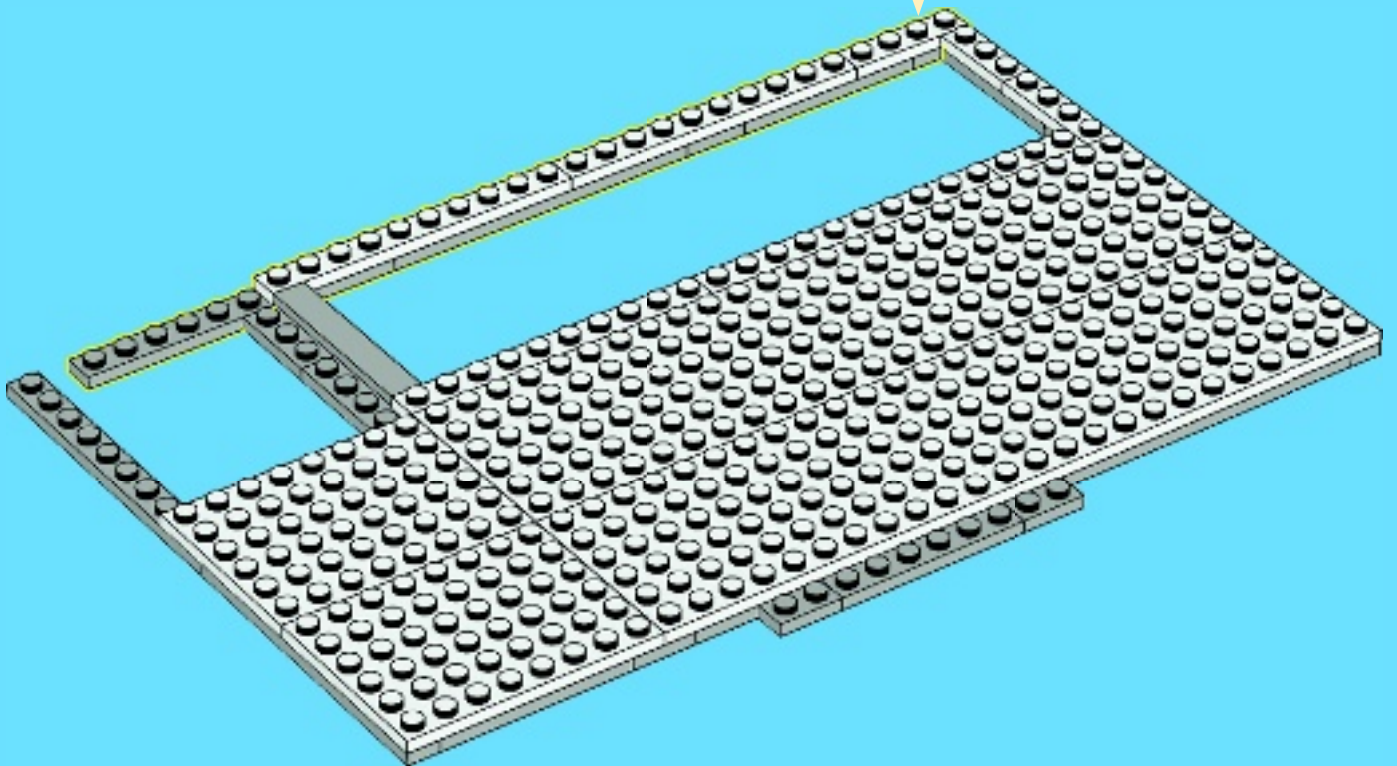
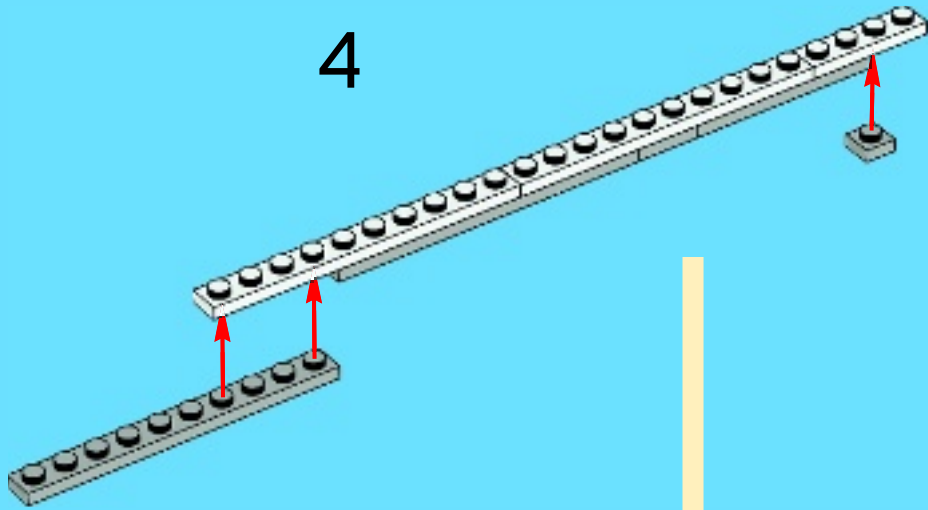

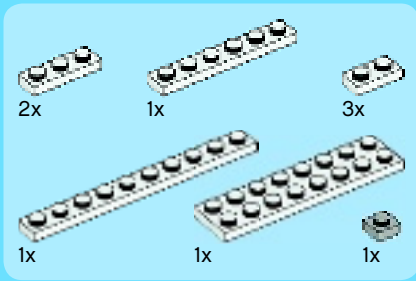

7

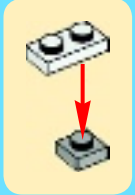
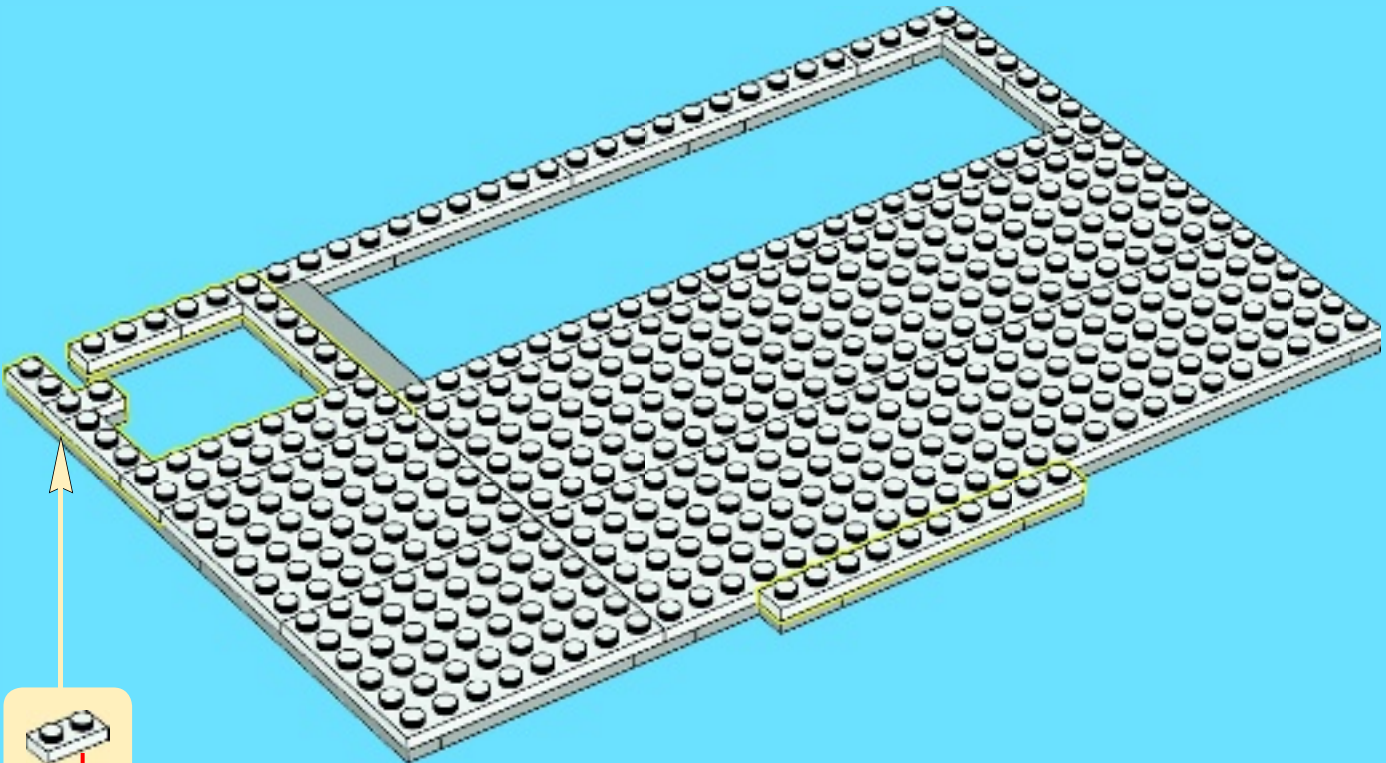

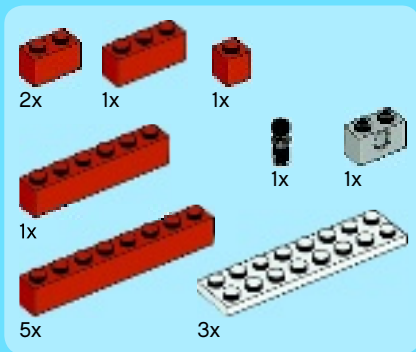

8

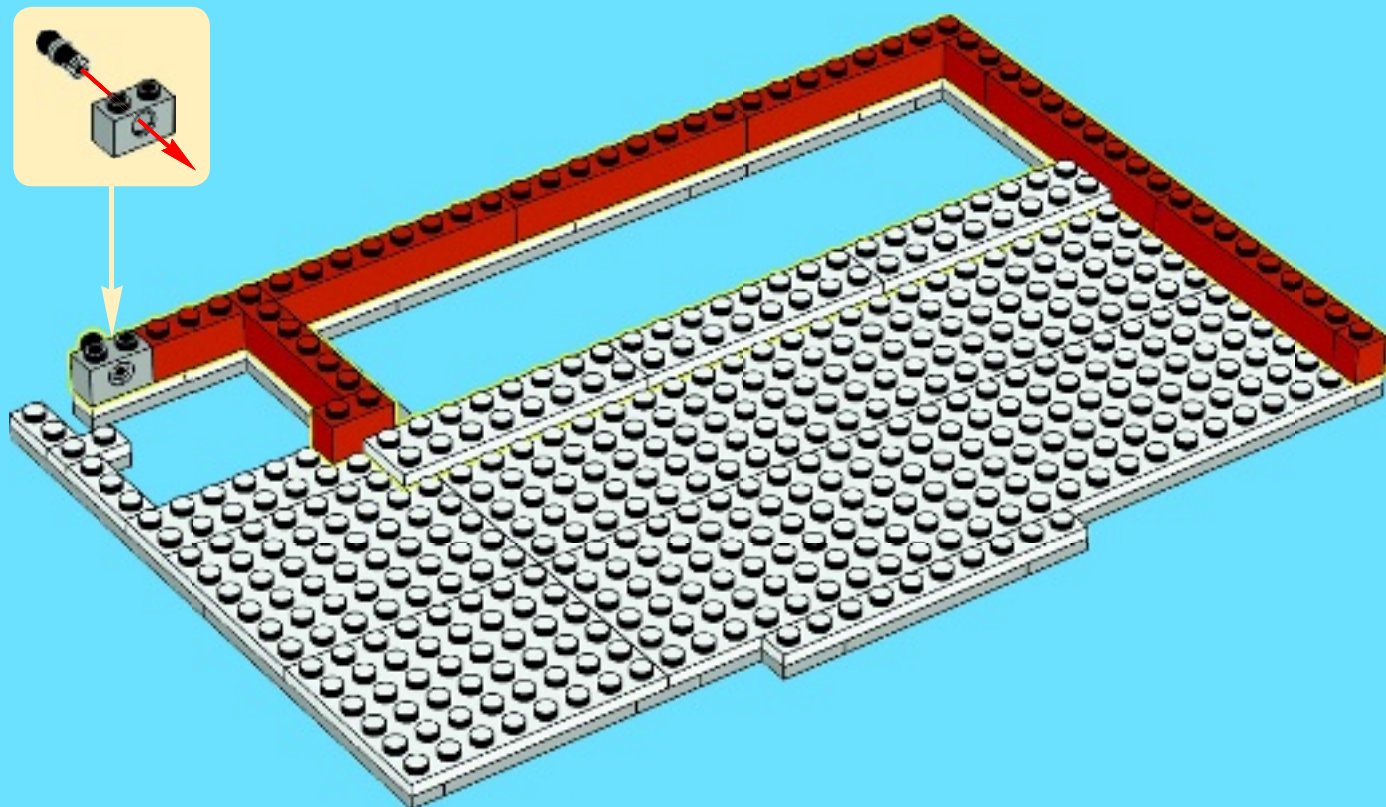
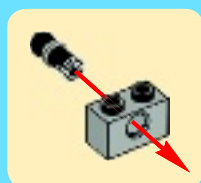



11

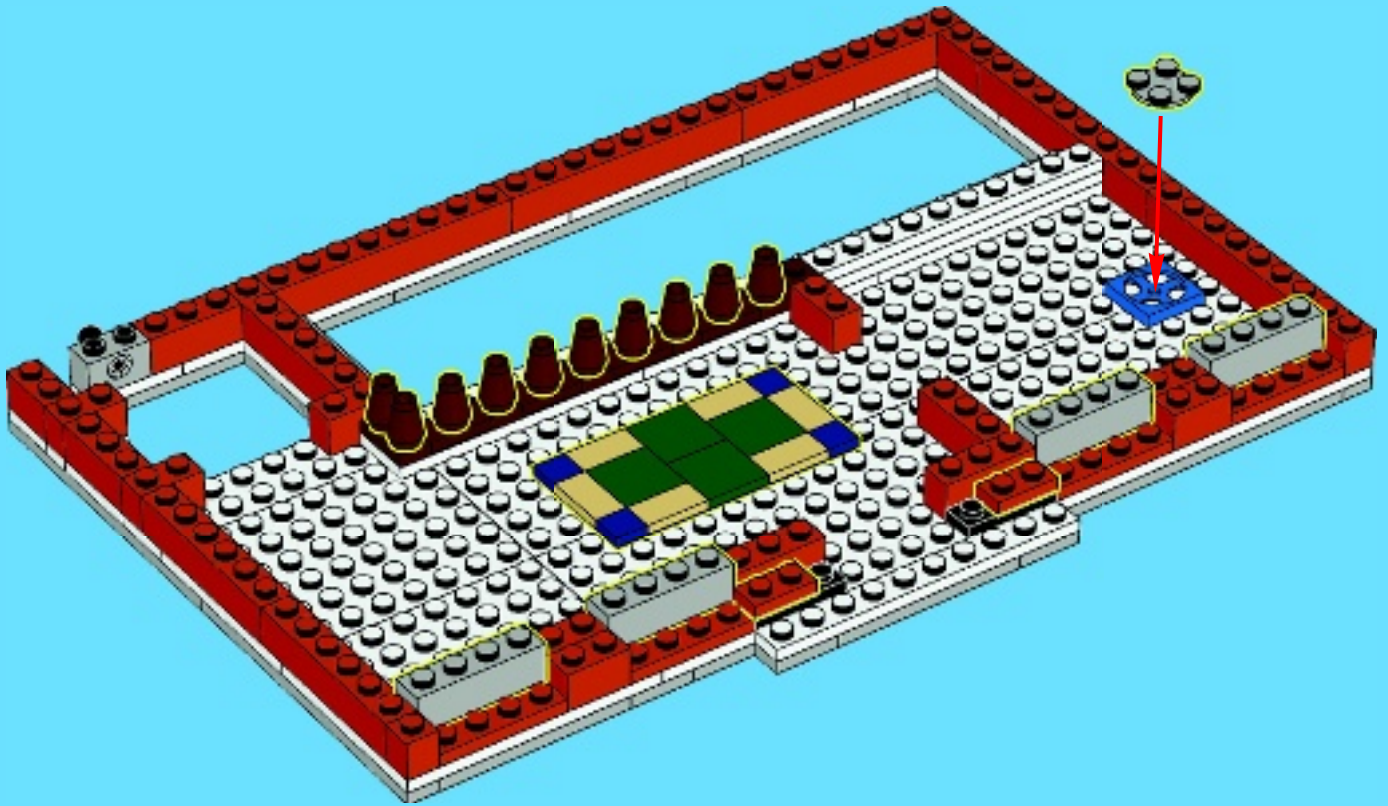

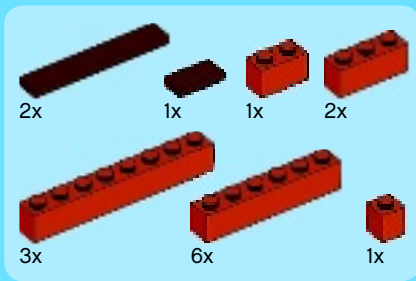

12

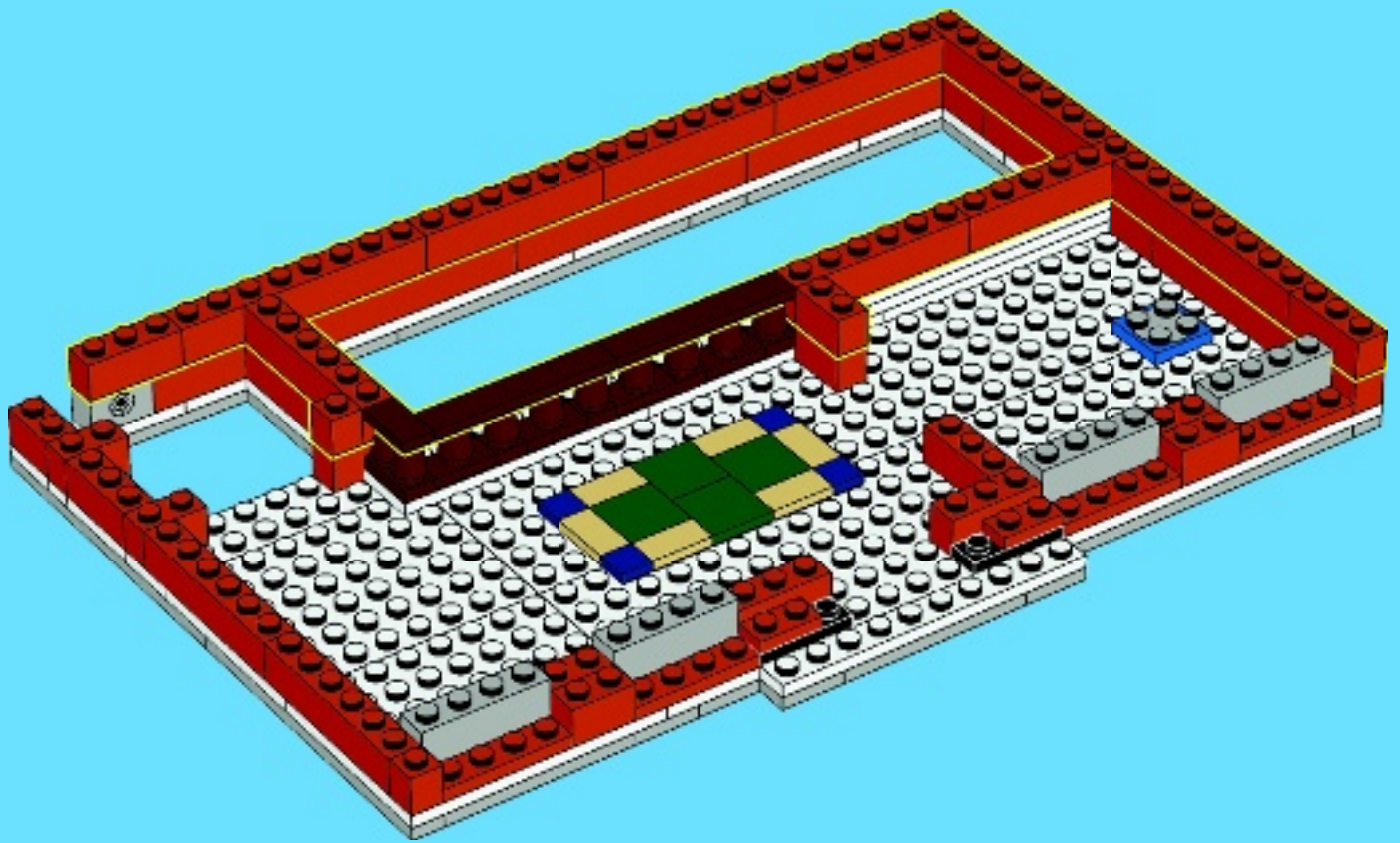



4x



8x



8x

13

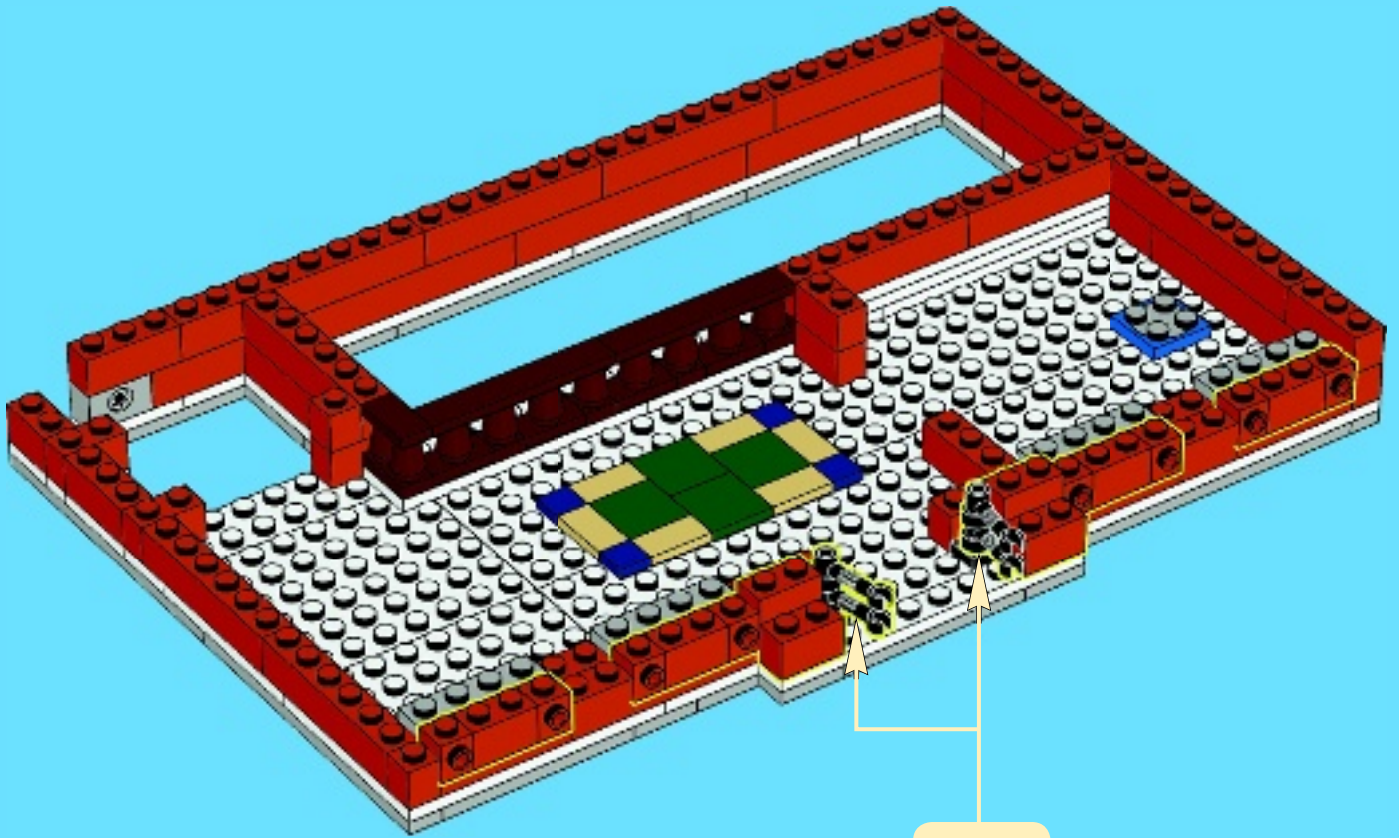

2x

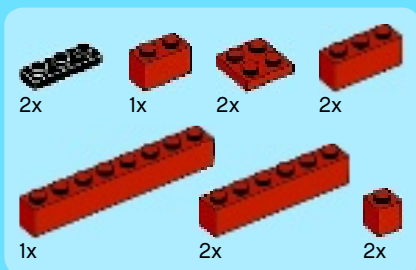

14

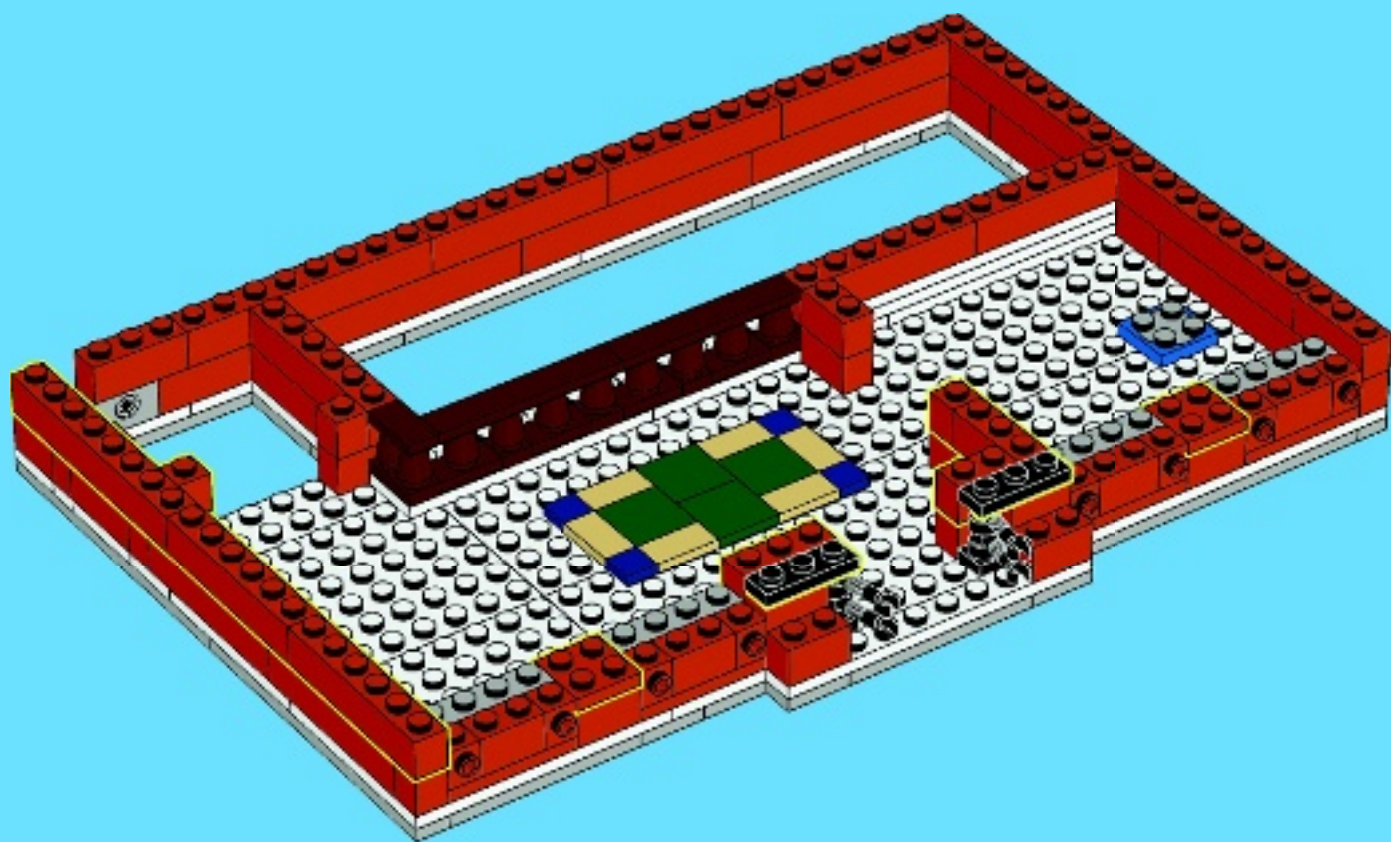

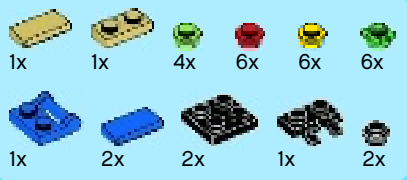

15

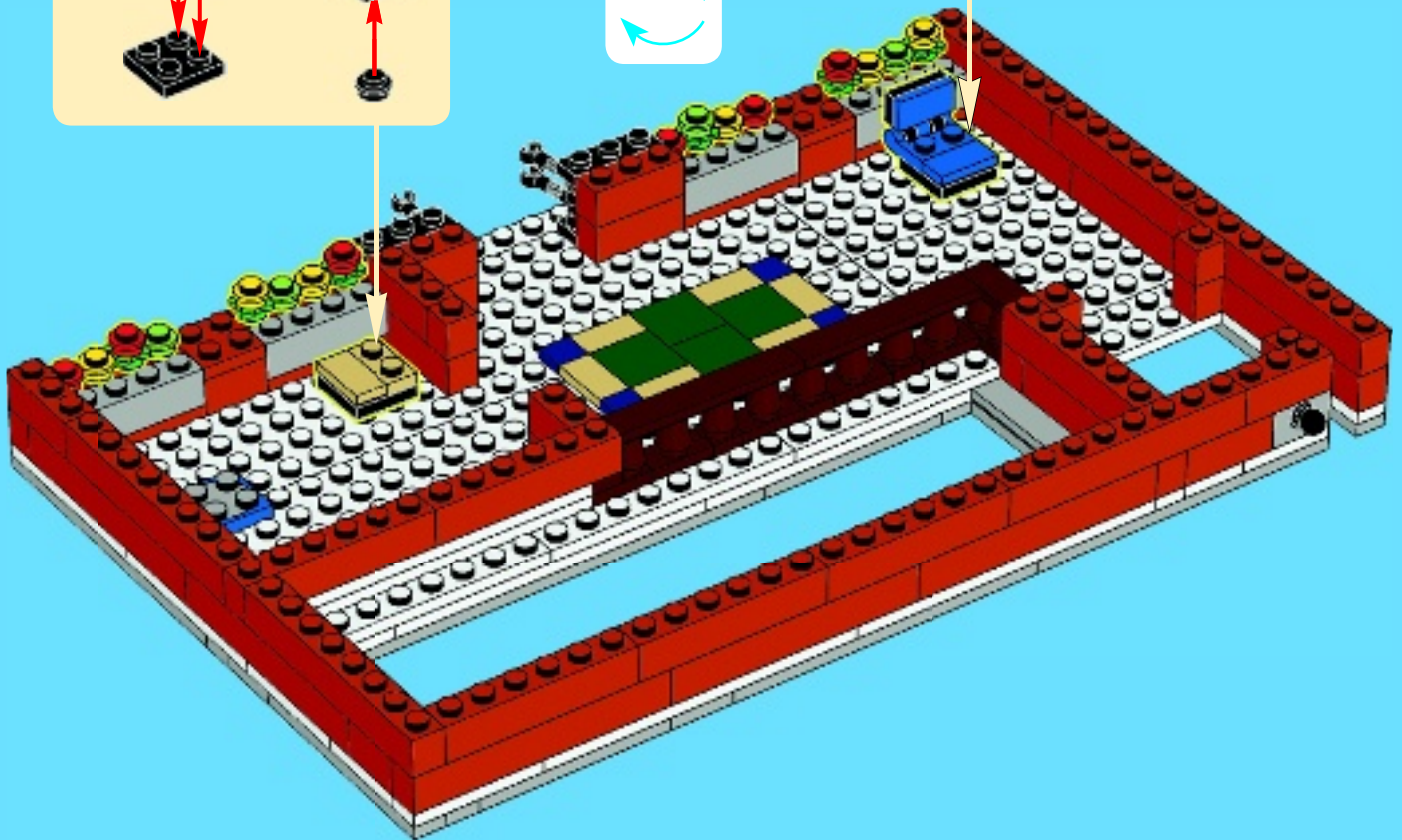
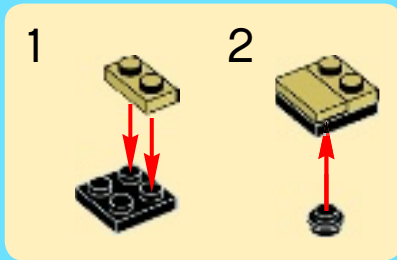
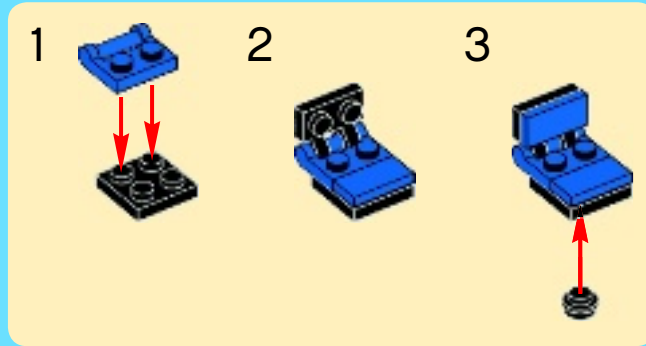

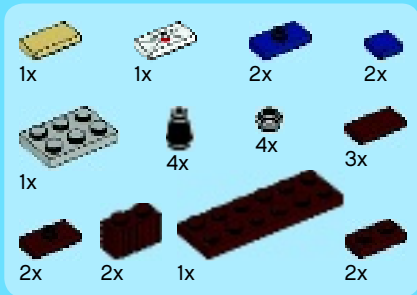

16

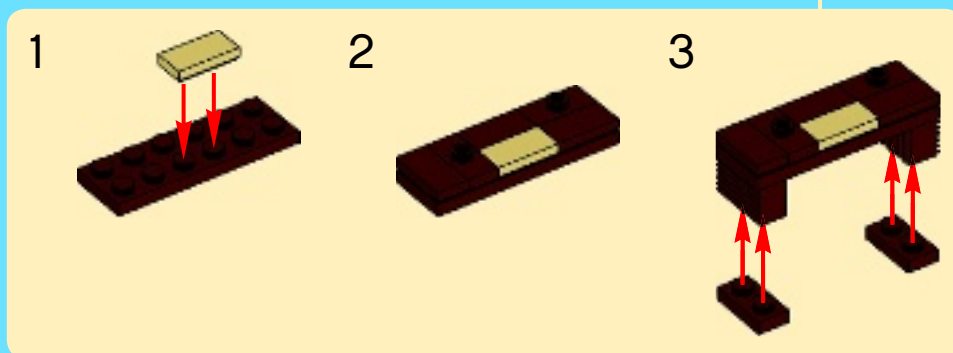
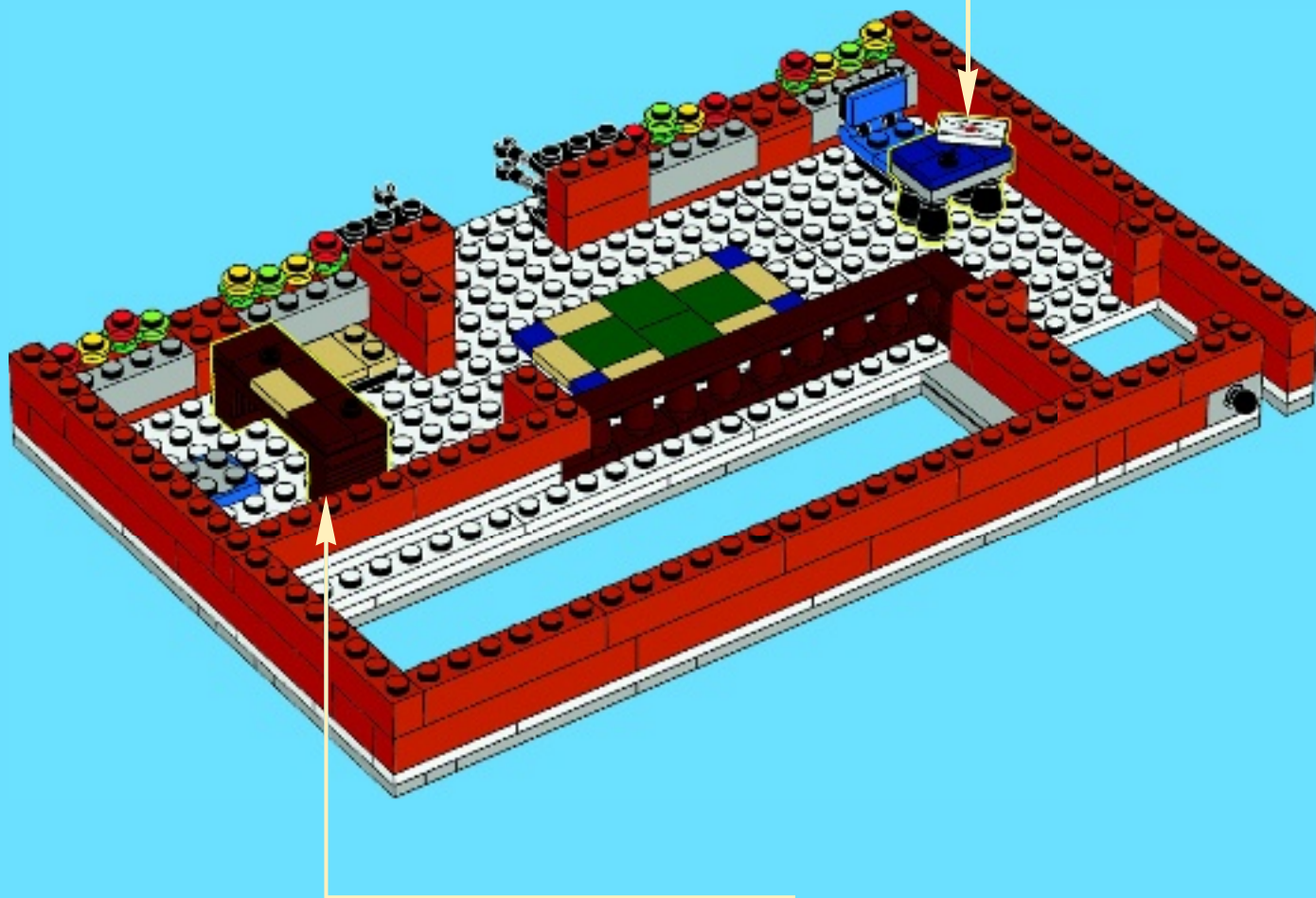
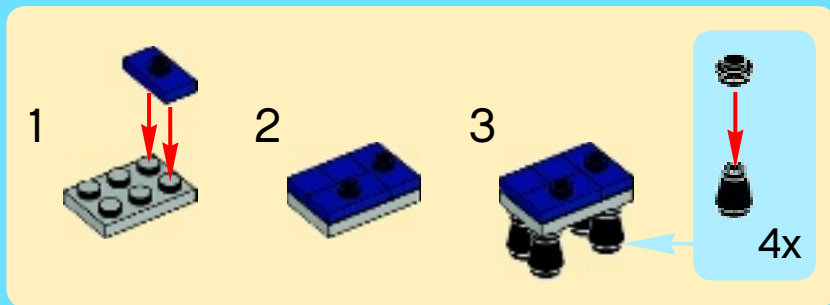

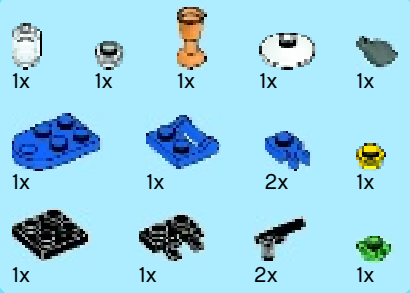

17

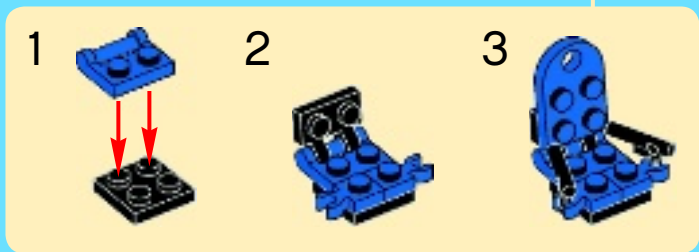
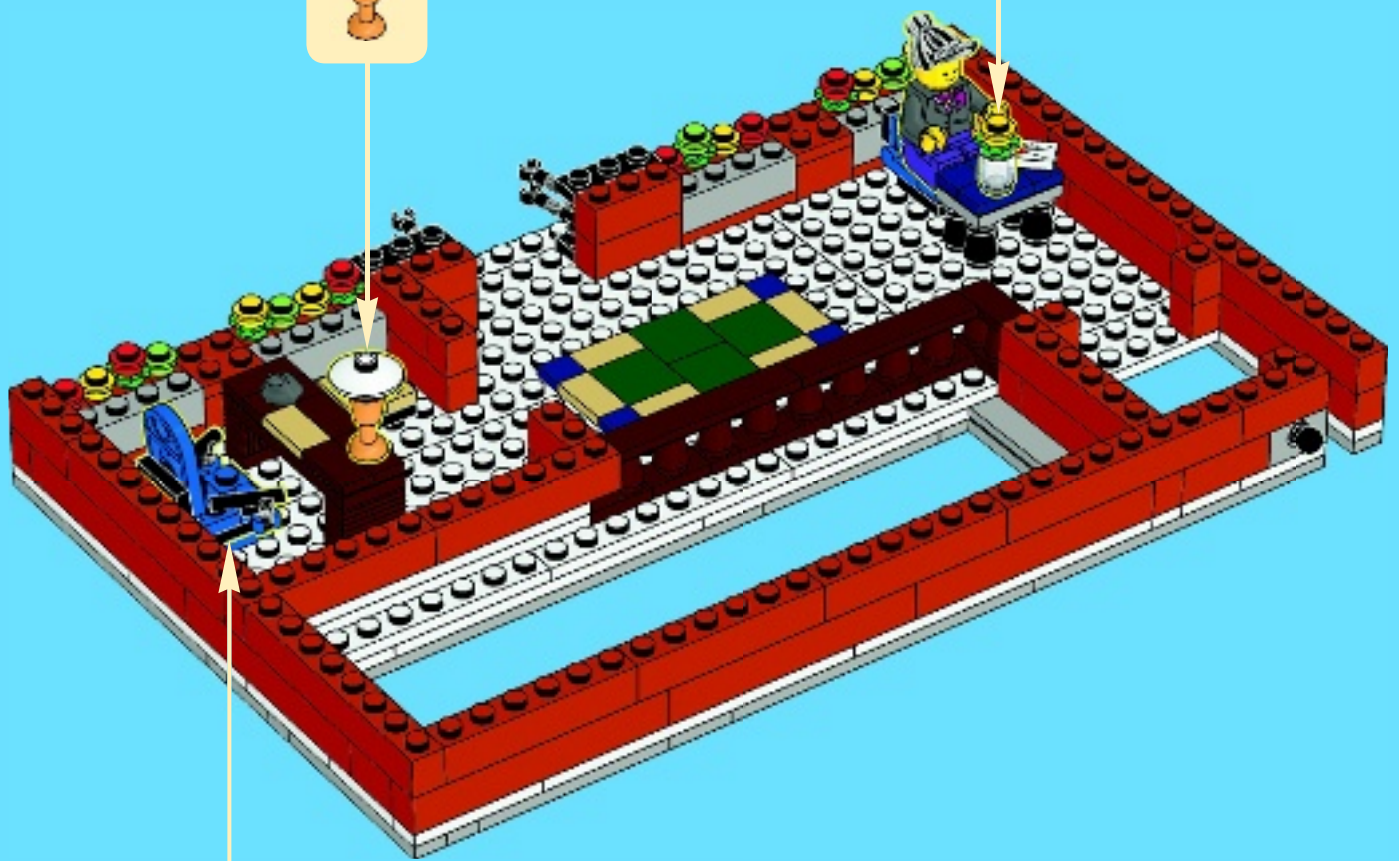
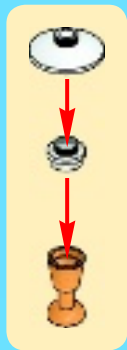

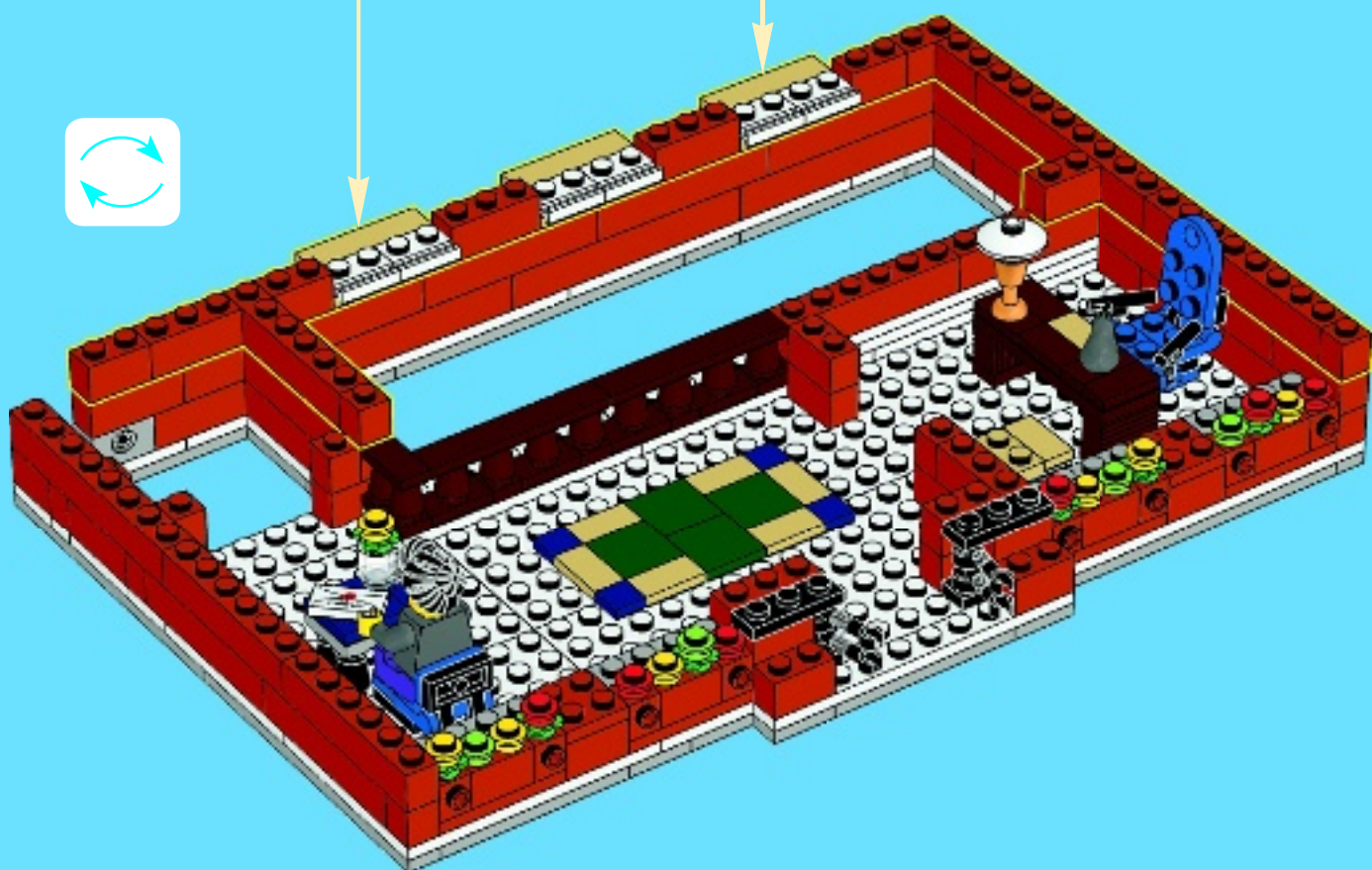
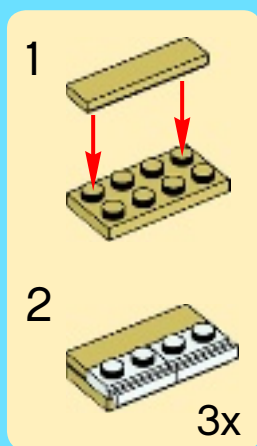
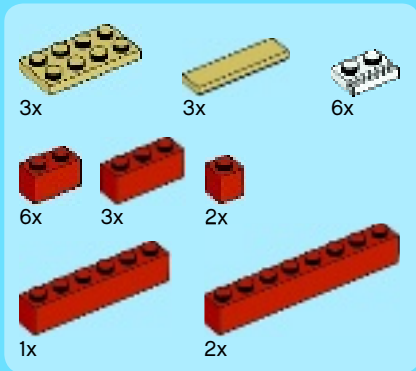

18

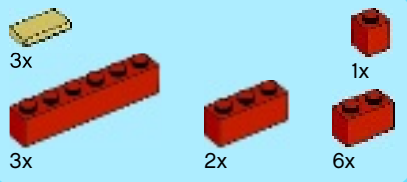

19

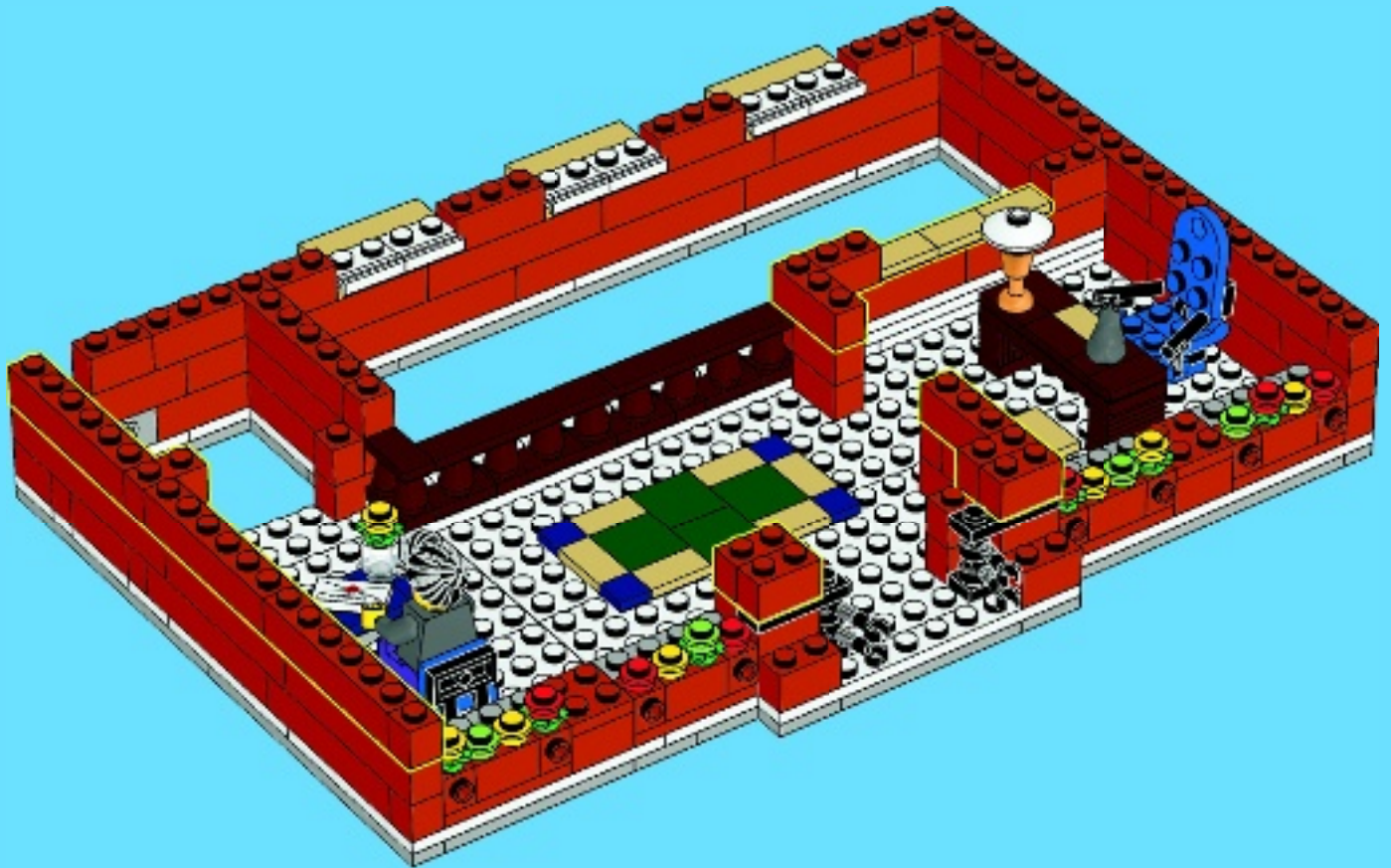

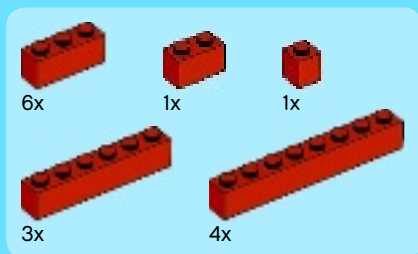

20

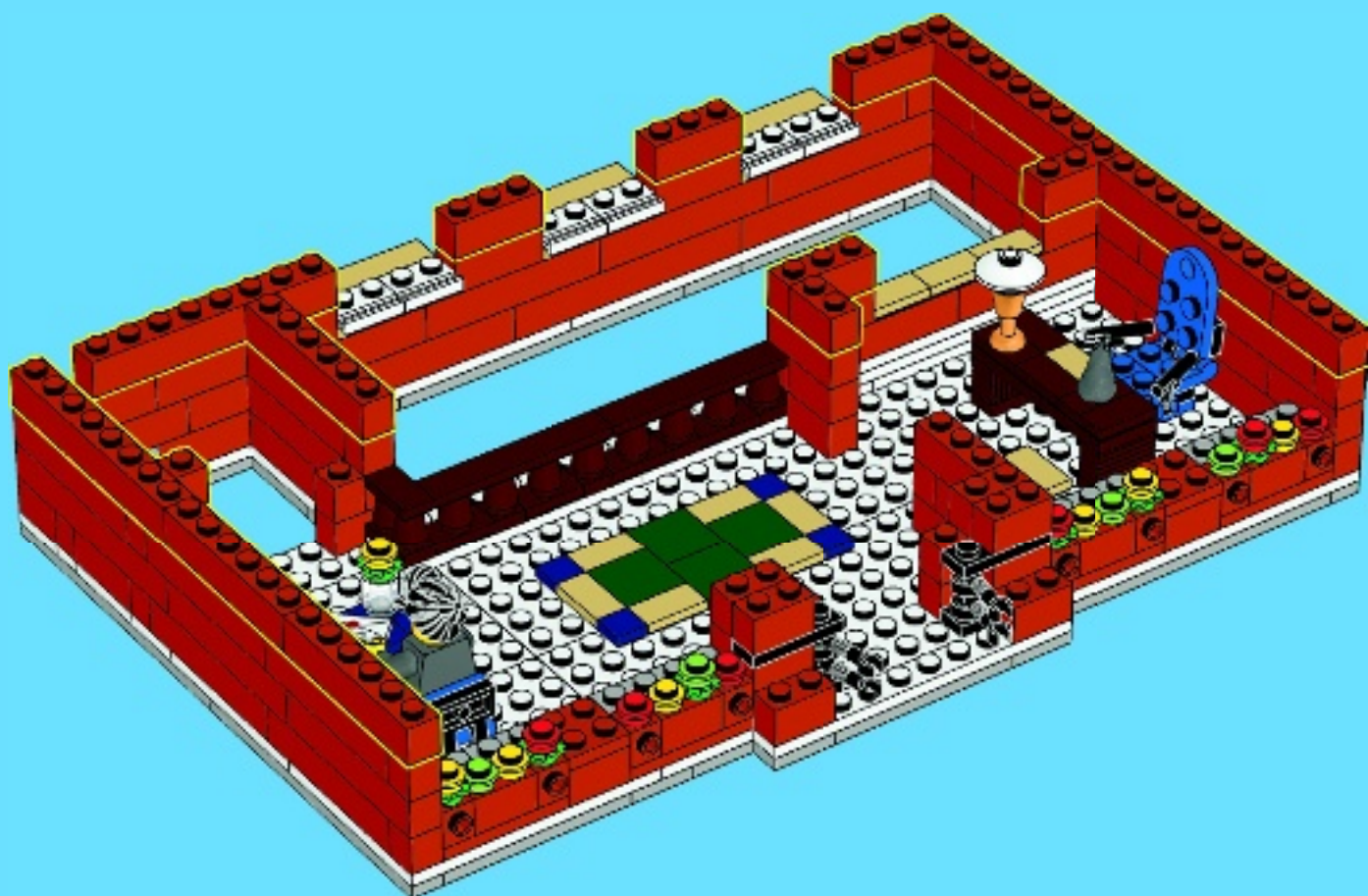

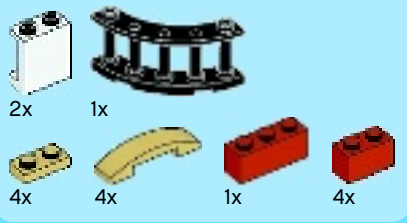

21

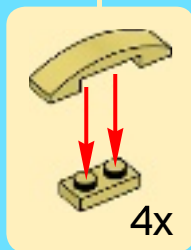
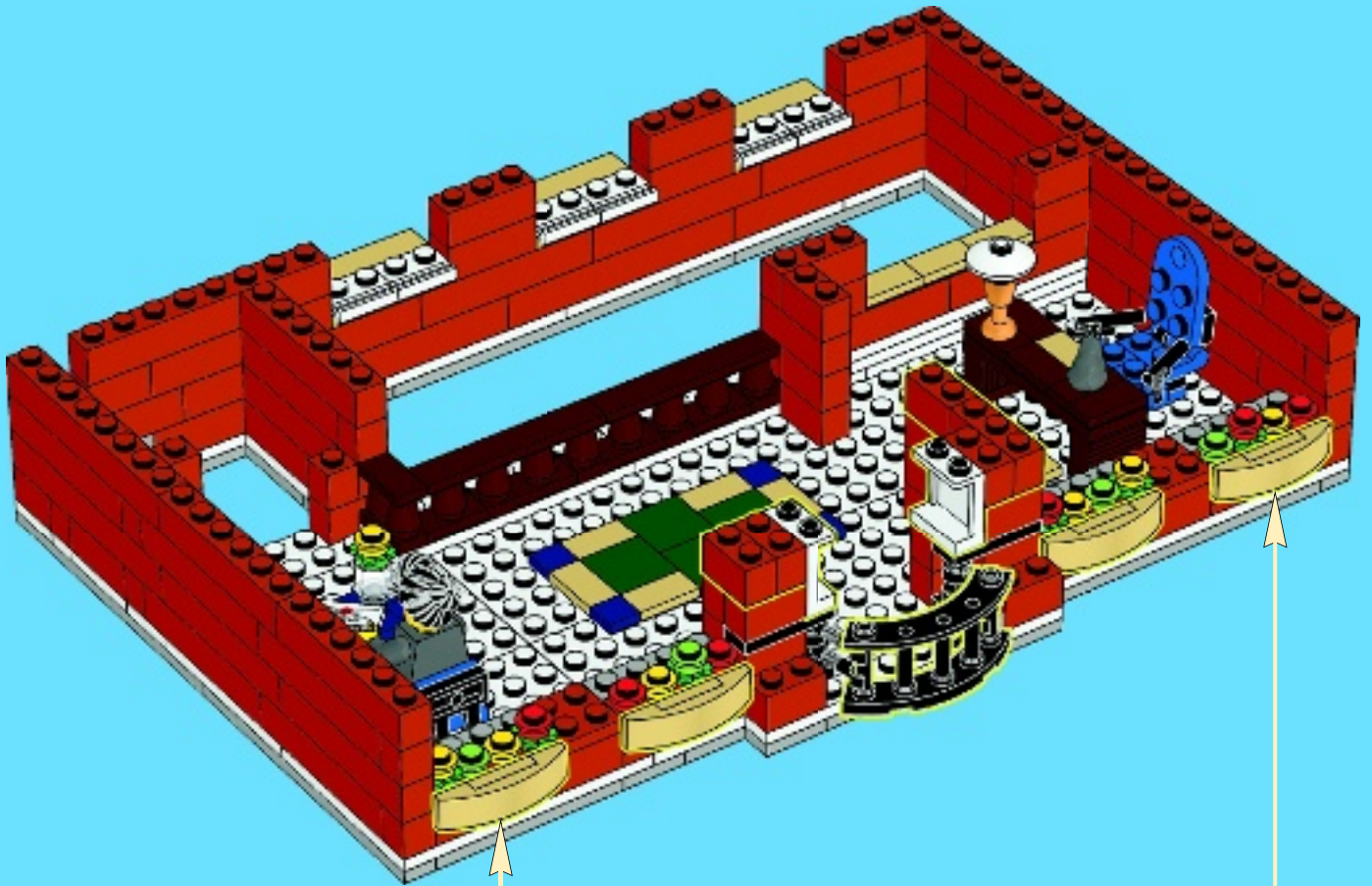

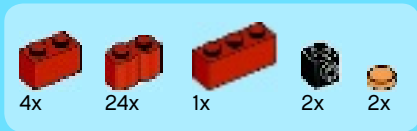

22

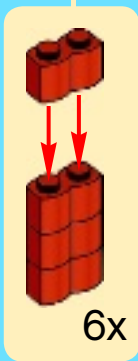
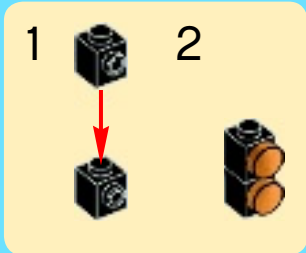

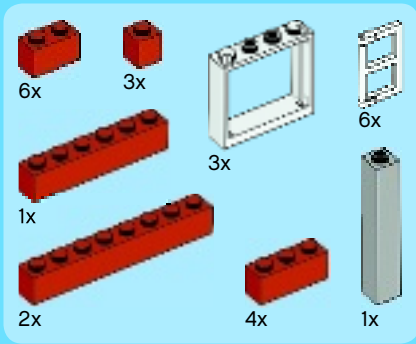

23

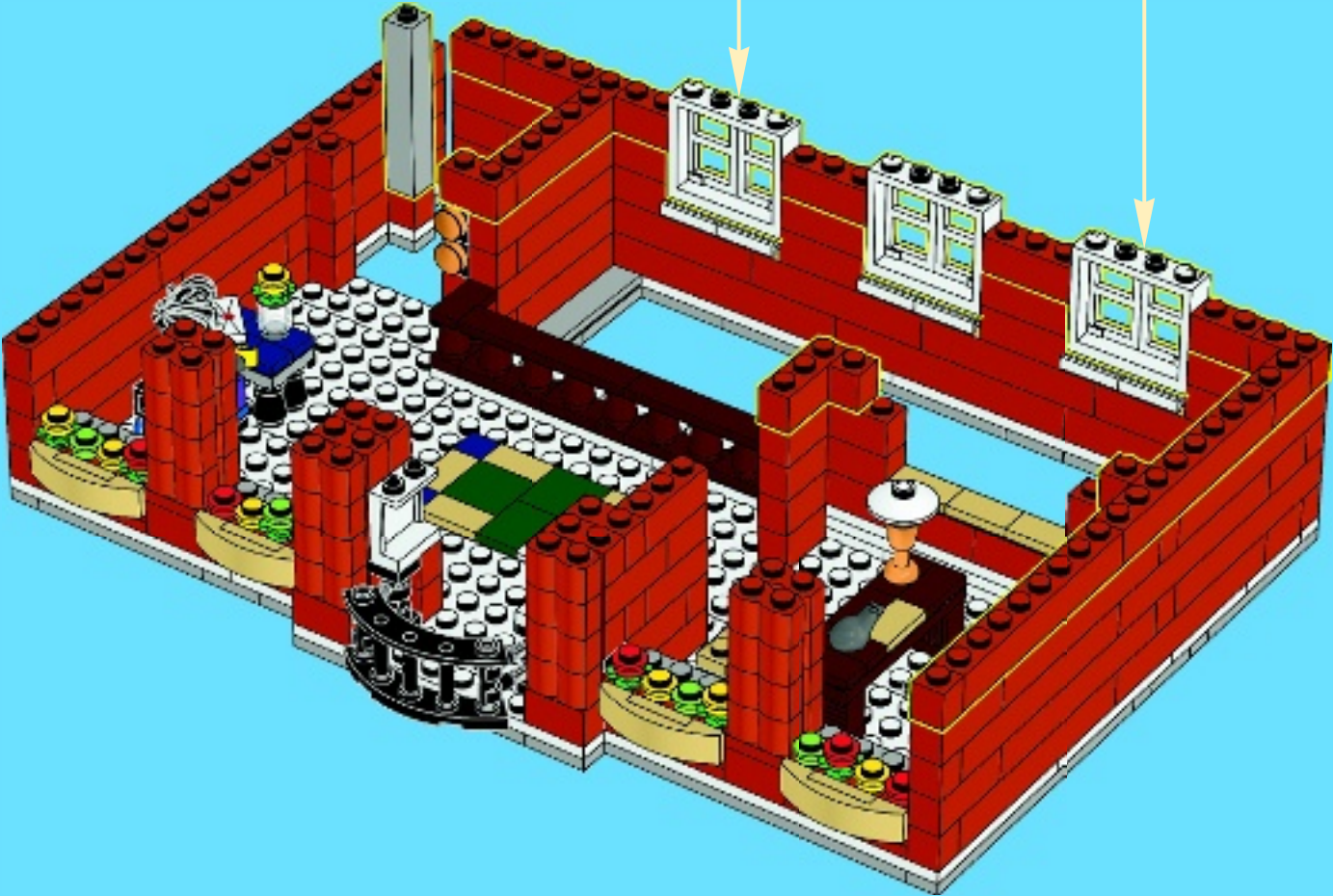
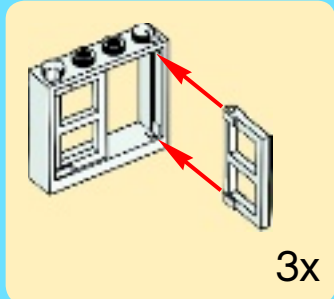

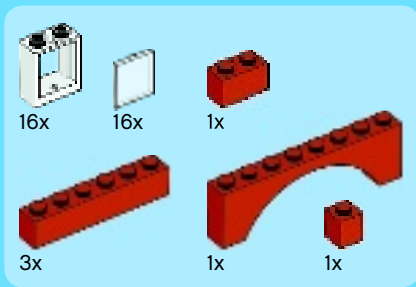

24

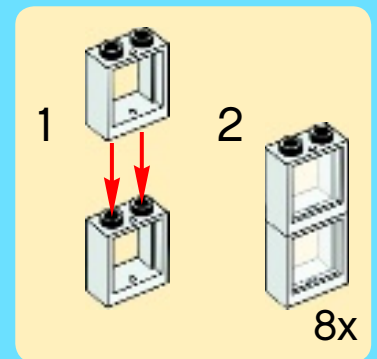

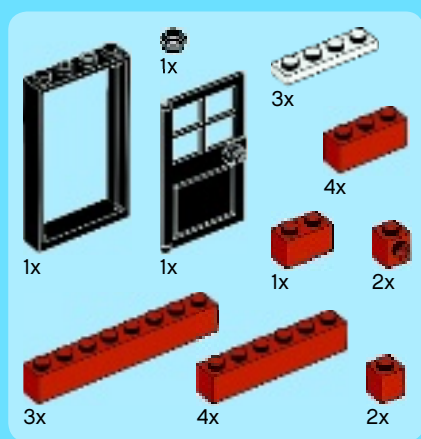

25

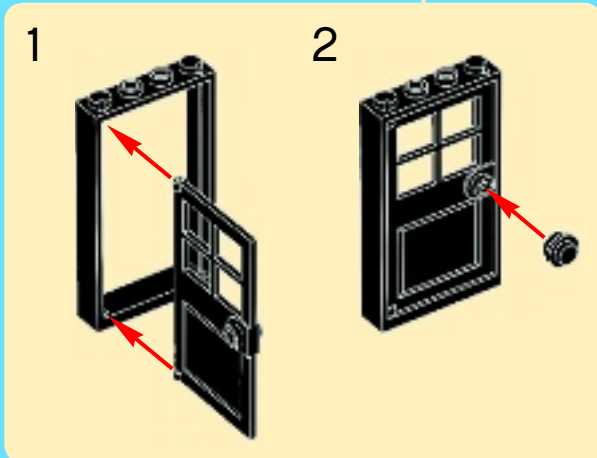

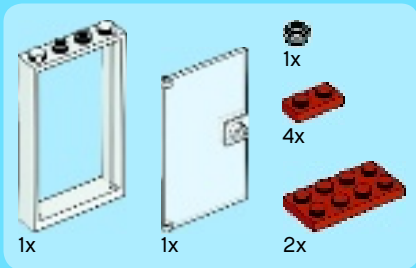

27

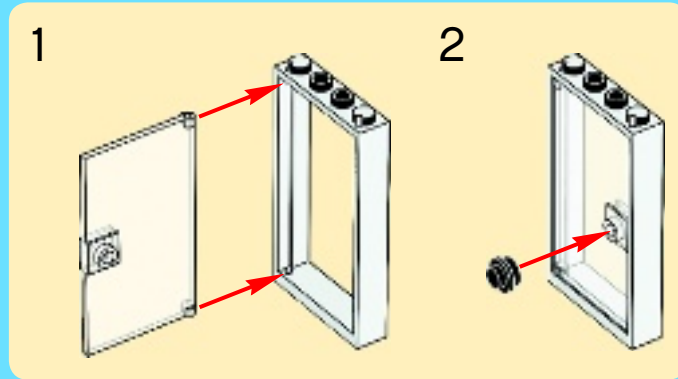

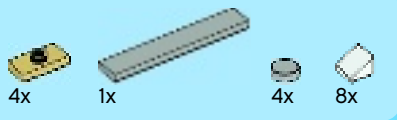

28

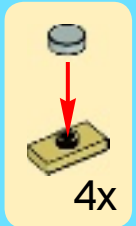

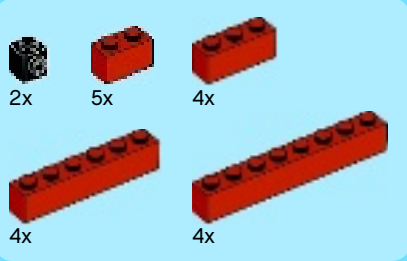

29

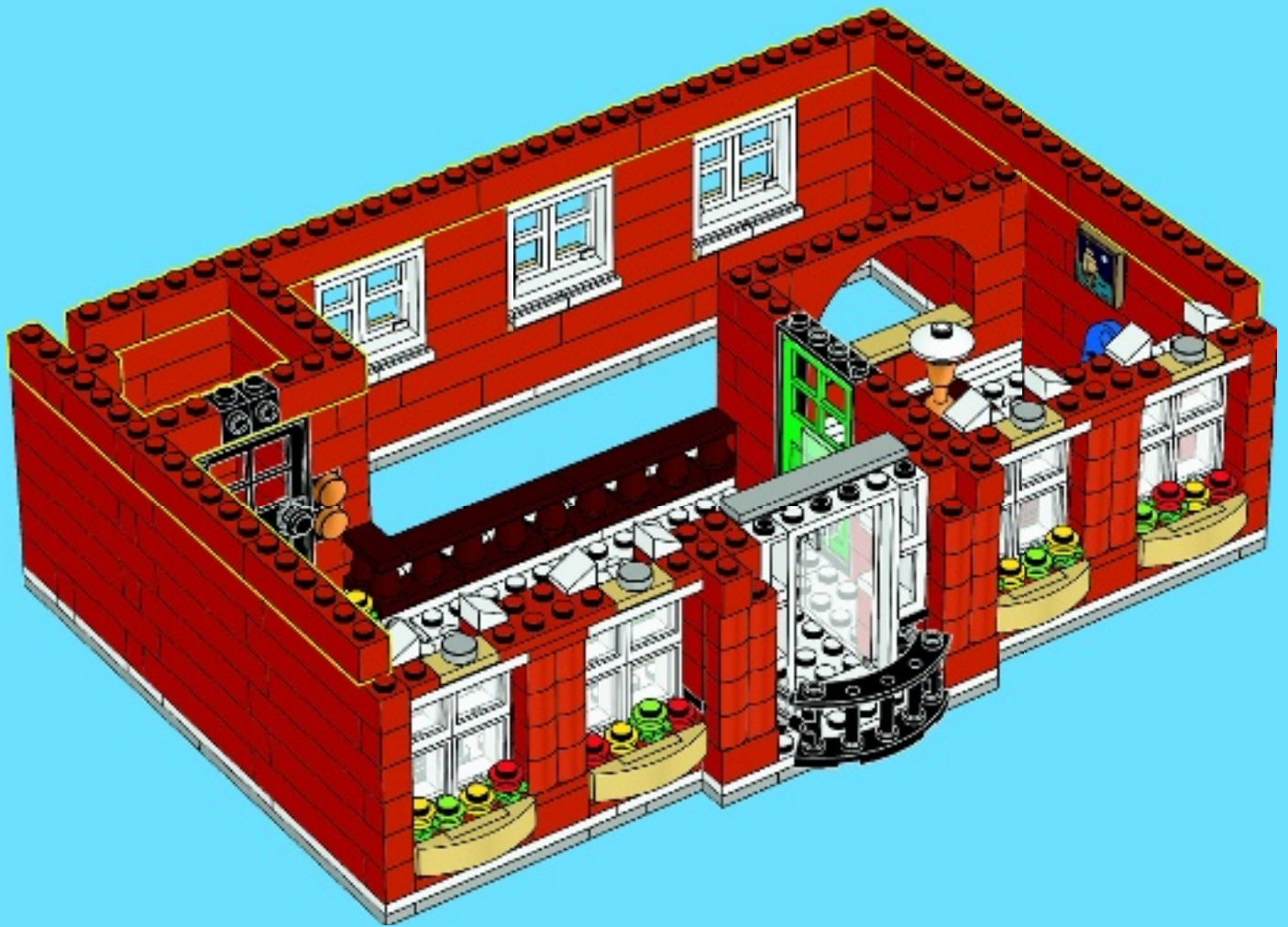

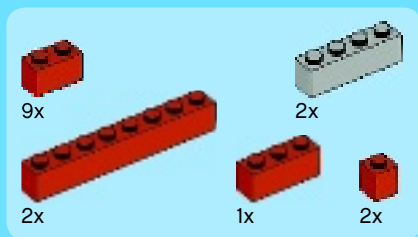

30





31

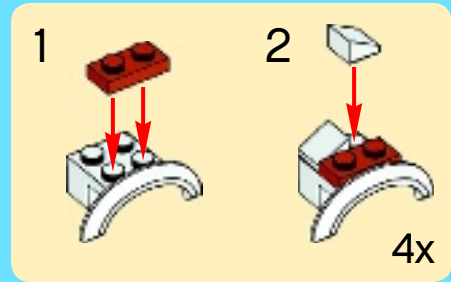

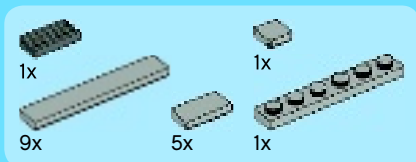

32



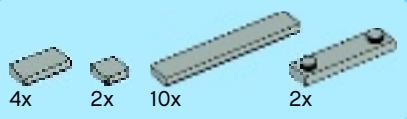

33





LEGO

10222



10220



Trademarks, design patents and copyrights are used with the approval of the owner Volkswagen AG./Les marques déposées, les brevets de conception et les copyrights sont utilisés avec l'autorisation du propriétaire Volkswagen AG./El uso de las marcas comerciales, patentes de diseño y derechos de autor se realiza con el consentimiento de su propietario, Volkswagen AG.



CREATOR

5770

5771



 www.LEGO.com

LEGO and the LEGO logo are trademarks of the/sont des marques de commerce de/son marcas registradas de LEGO Group. ©2012 The LEGO Group. 6020962 / 6020965

creator.LEGO.com

