

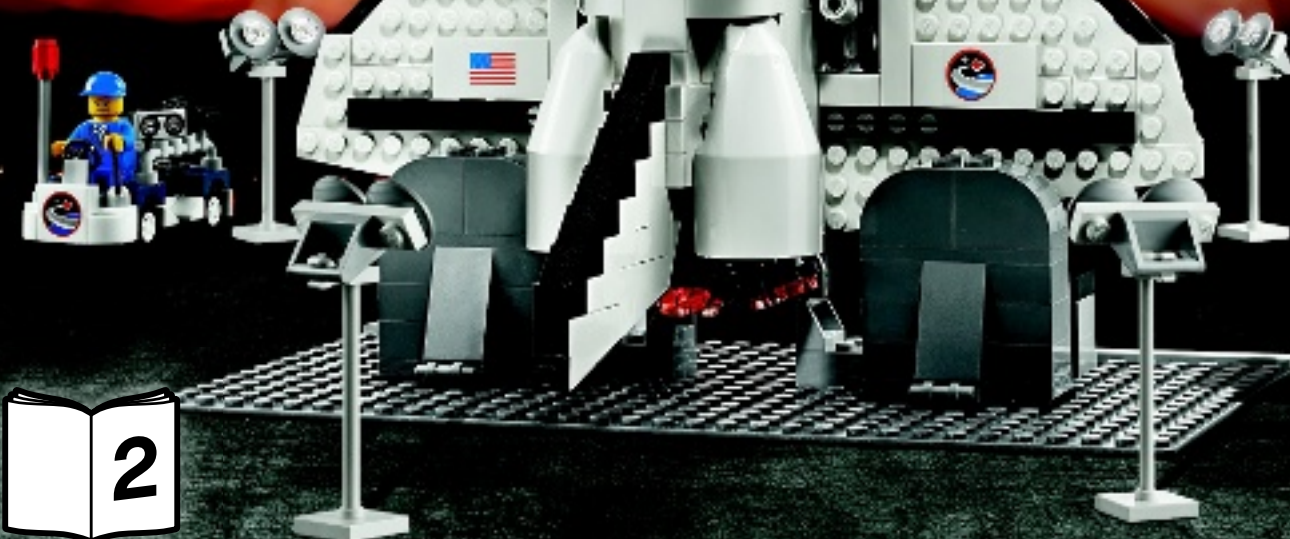

10231



2

- 2x
- 2x
- 1x
- 1x
- 4x

61

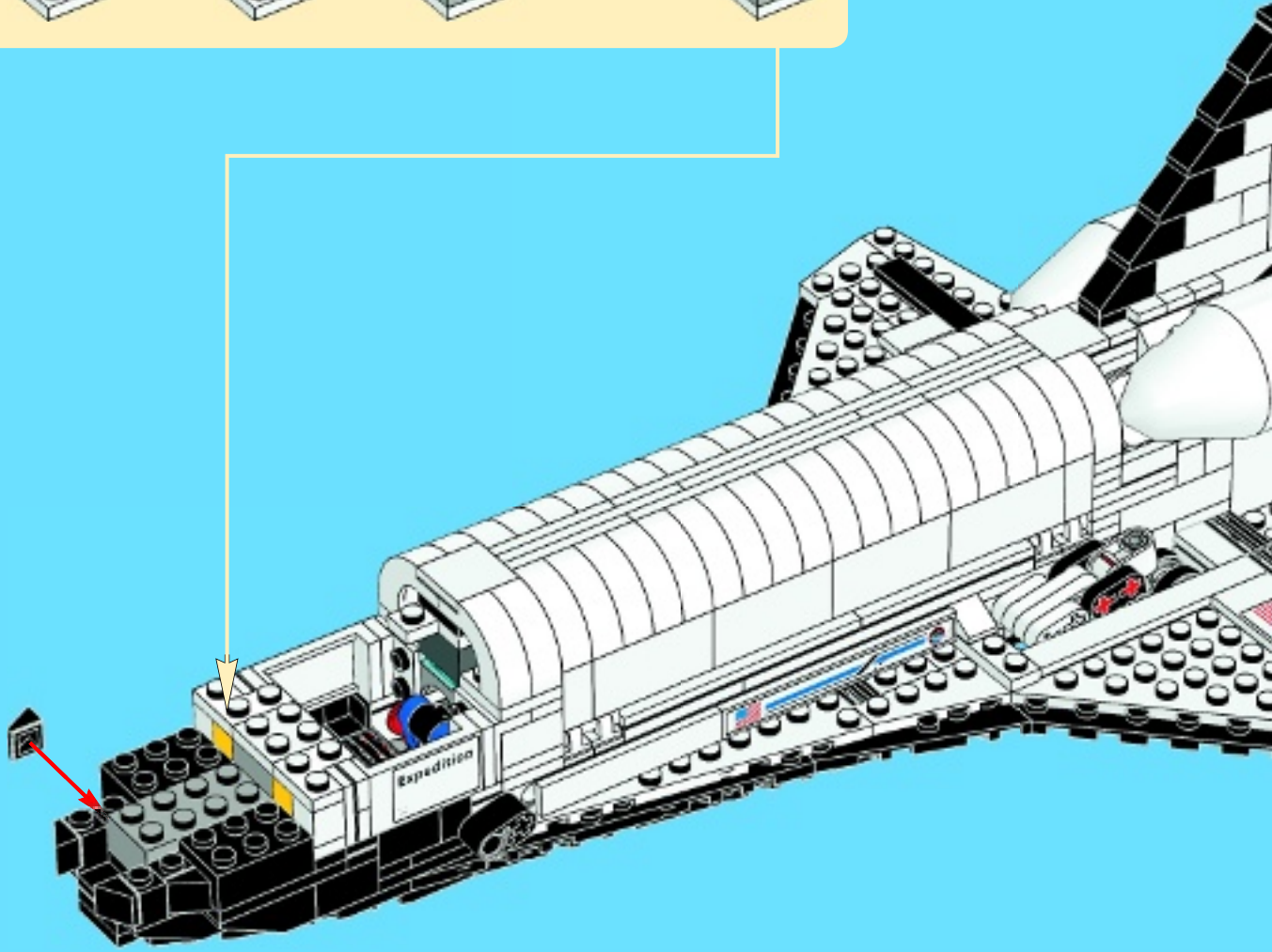
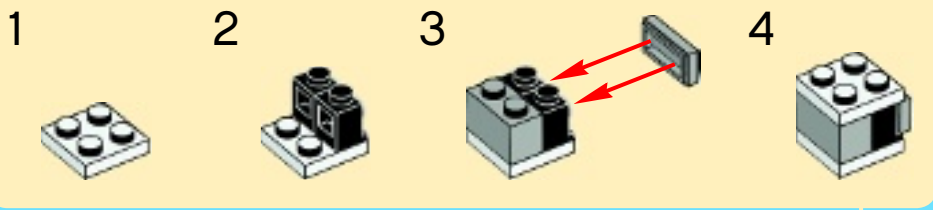



2x



2x

62

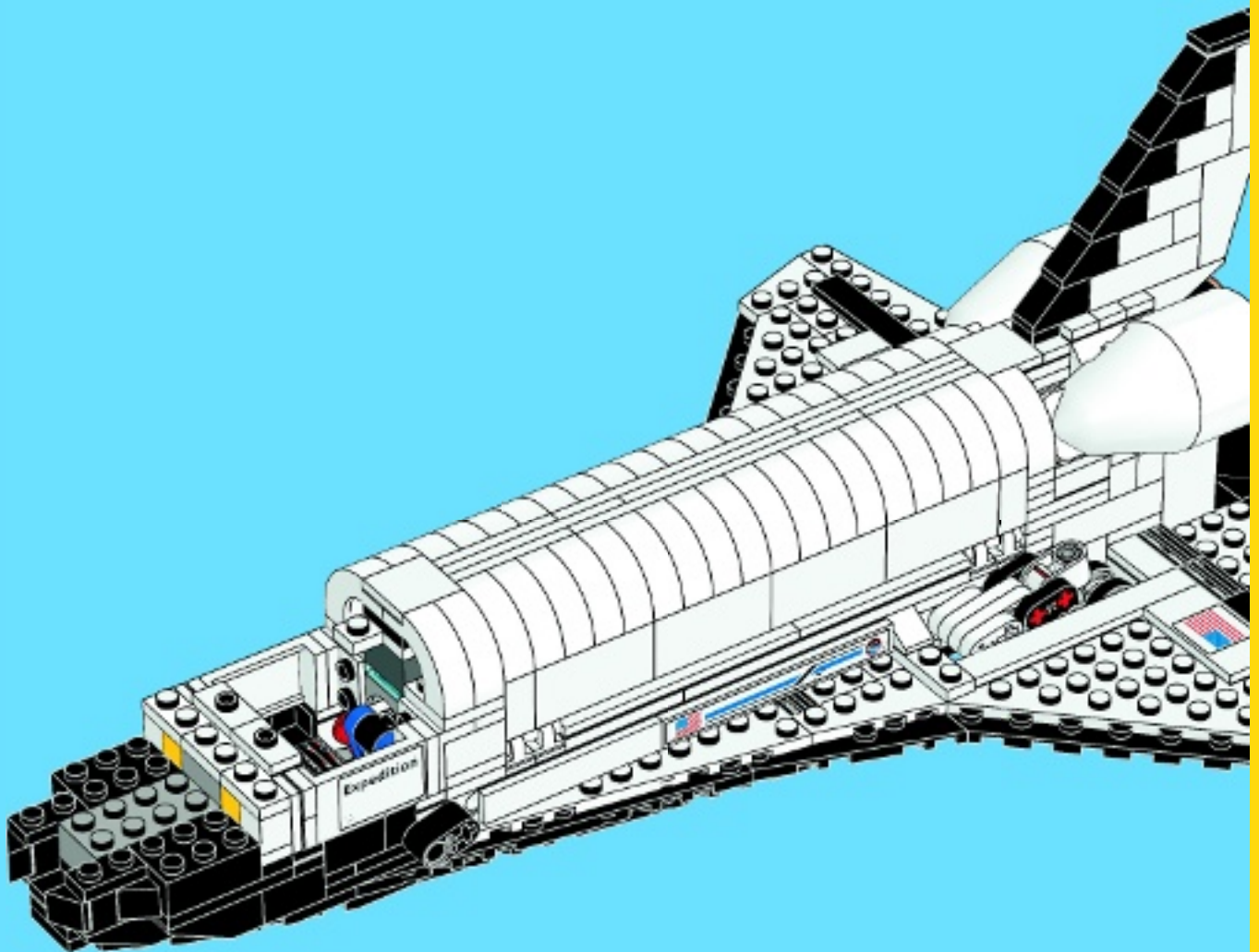



2x



2x



2x

63

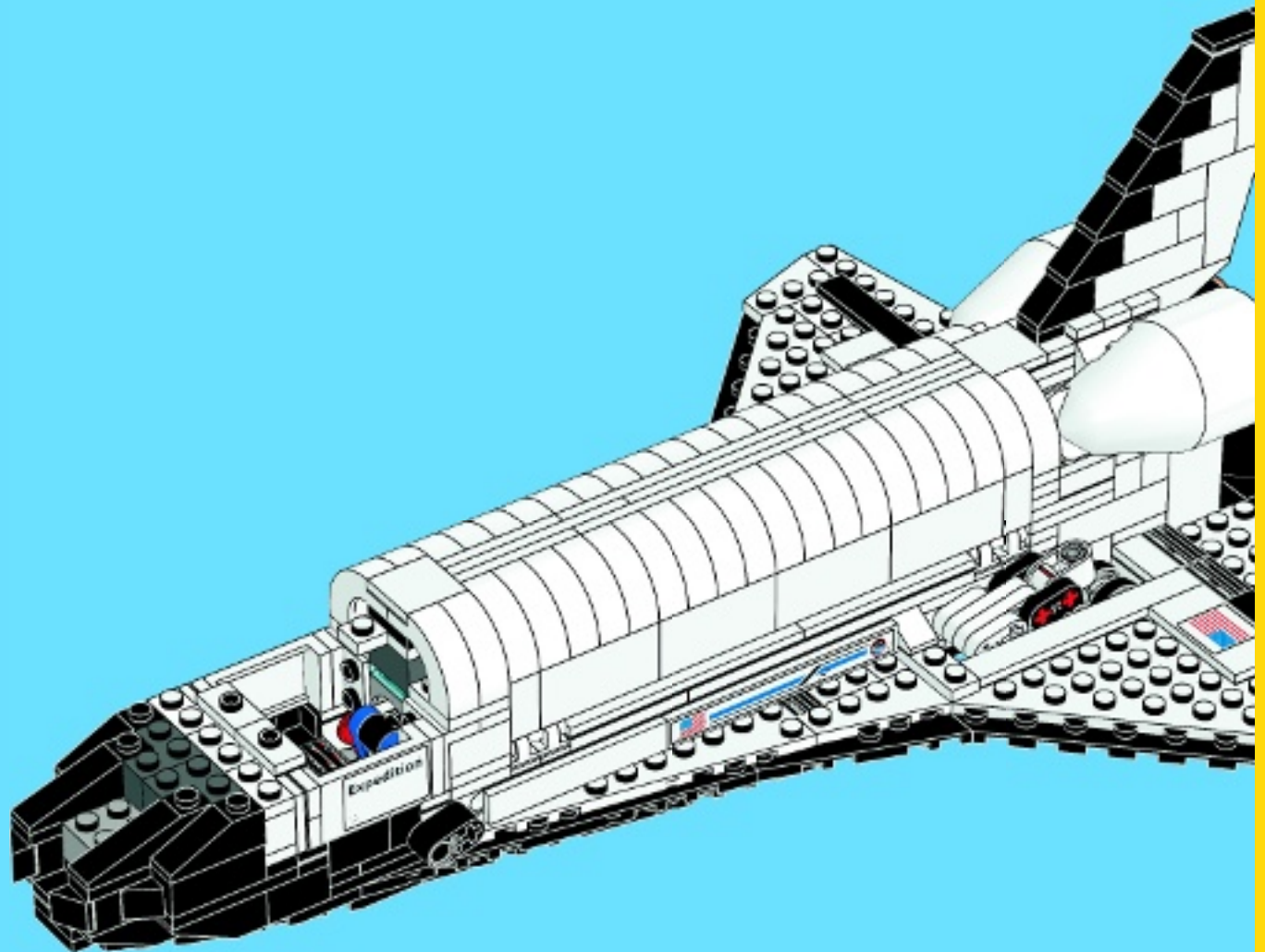



64

1



2



3



4

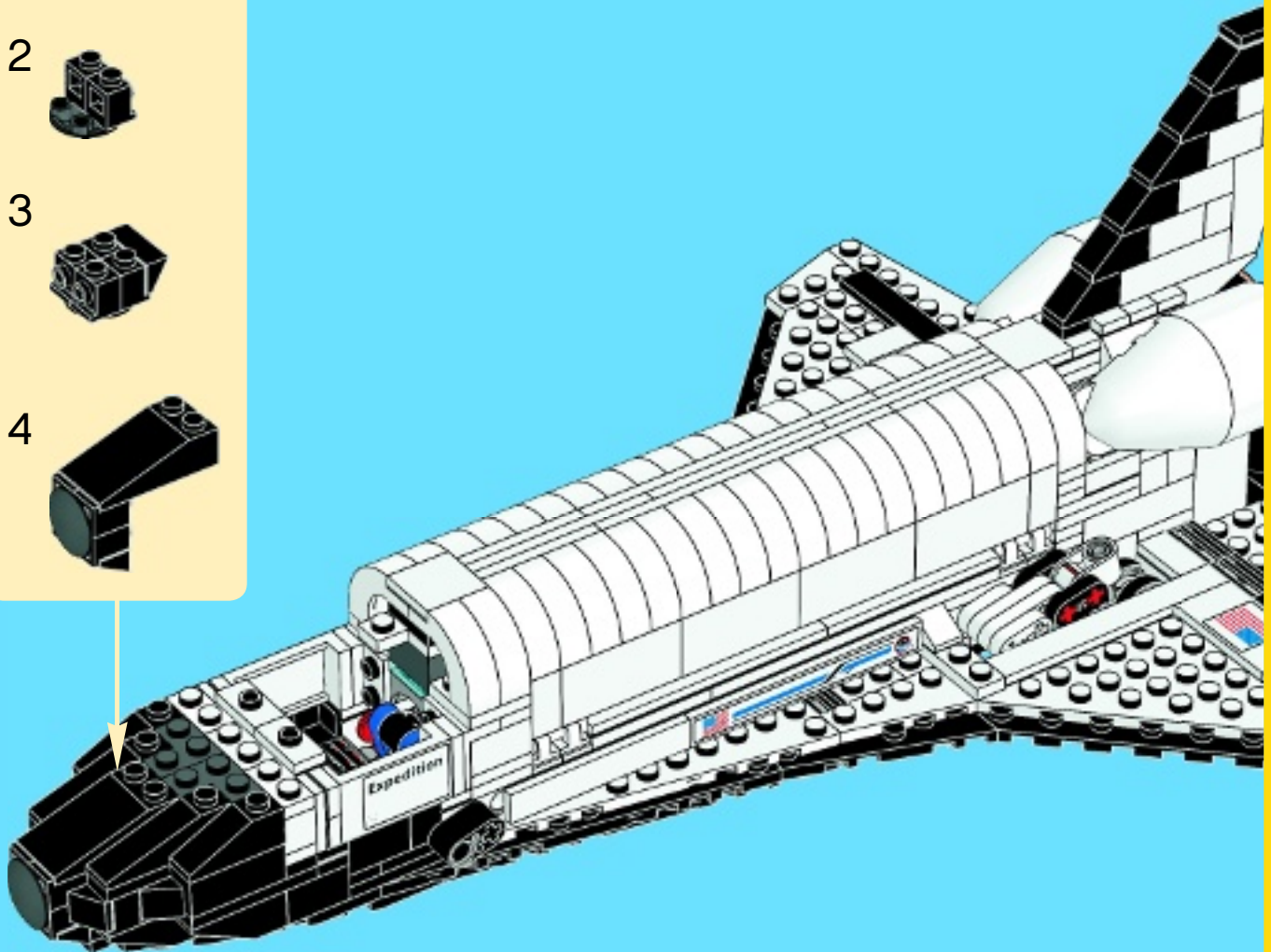



2x



1x



2x

65

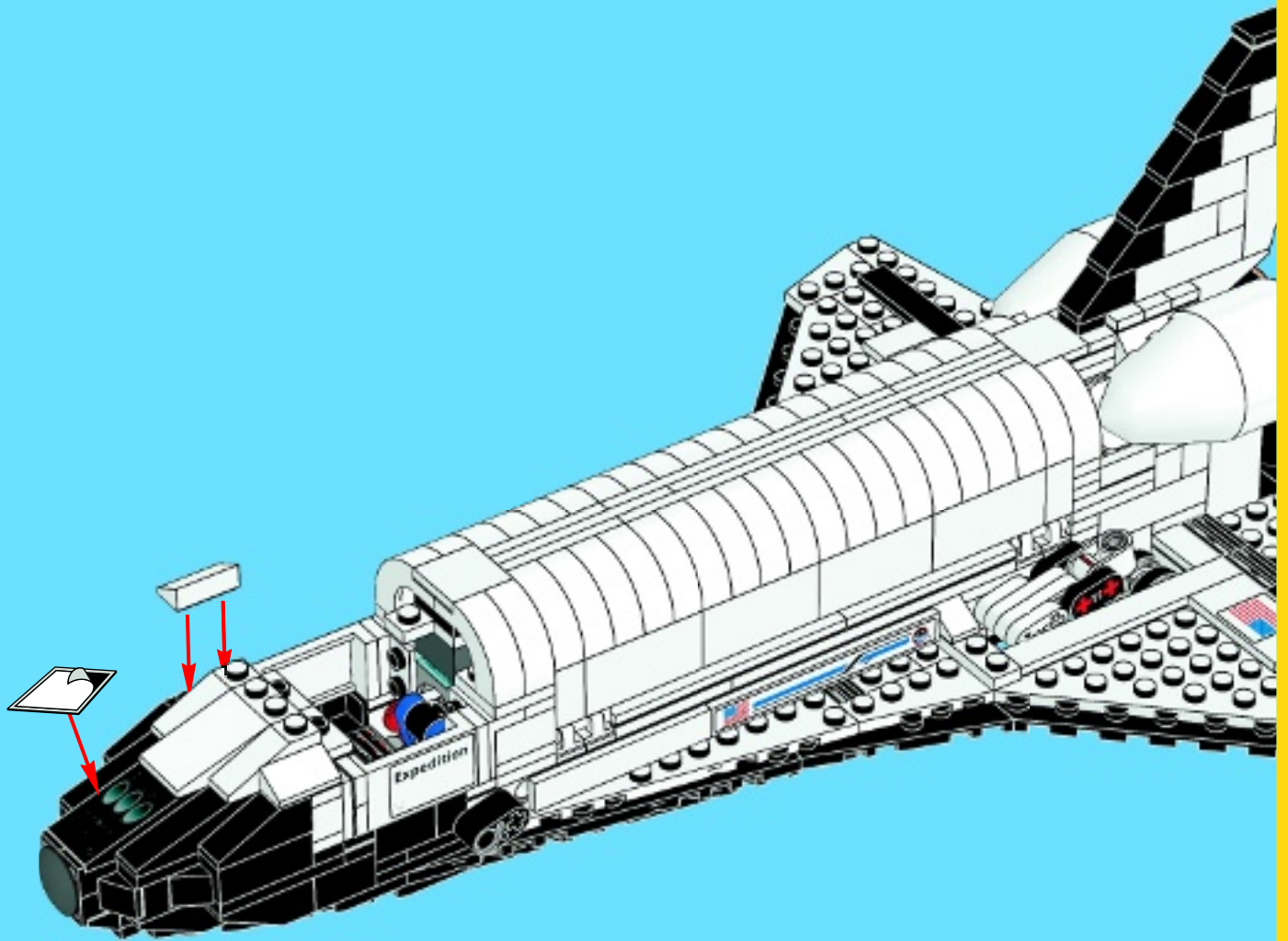



4x

66

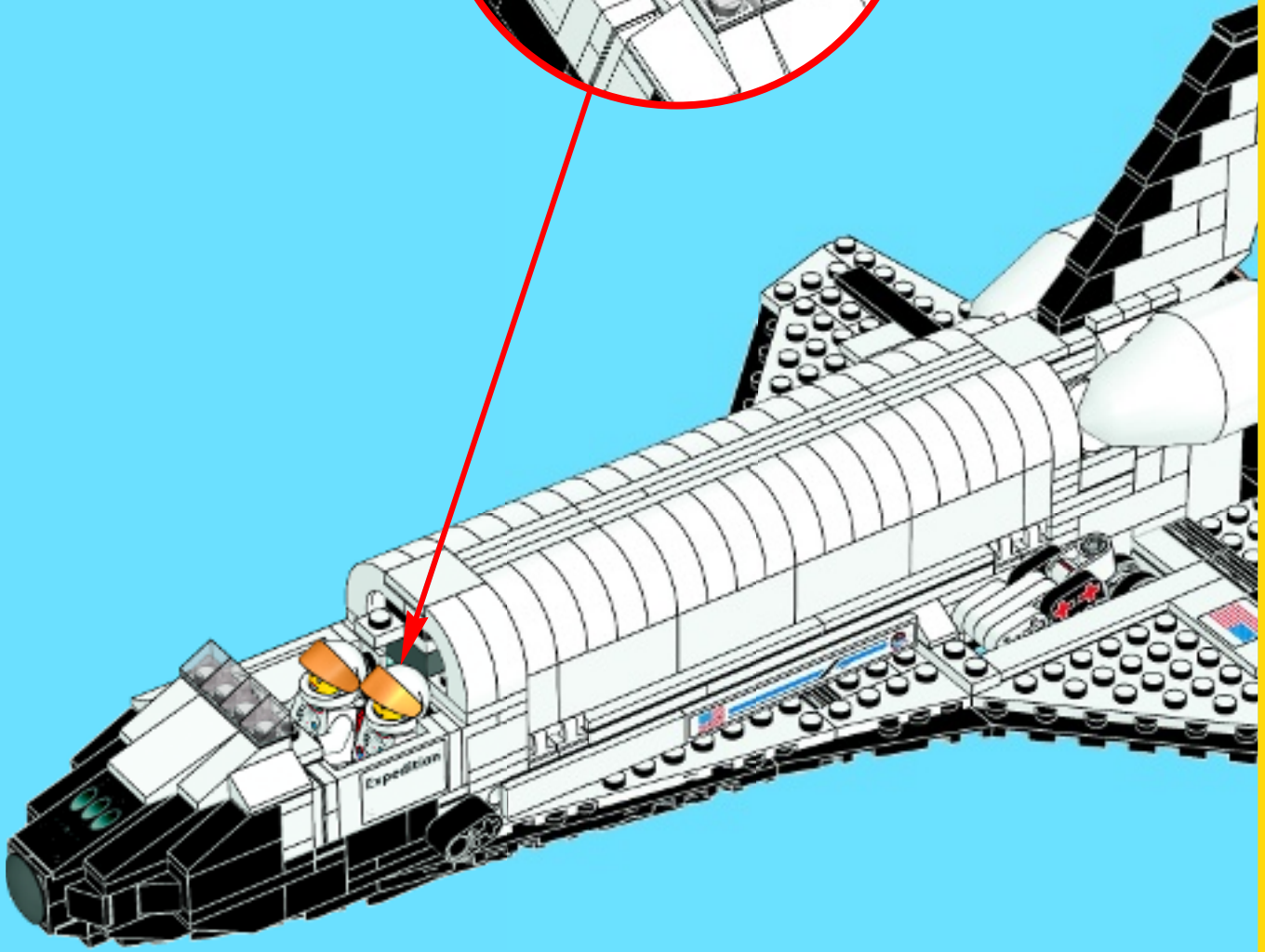
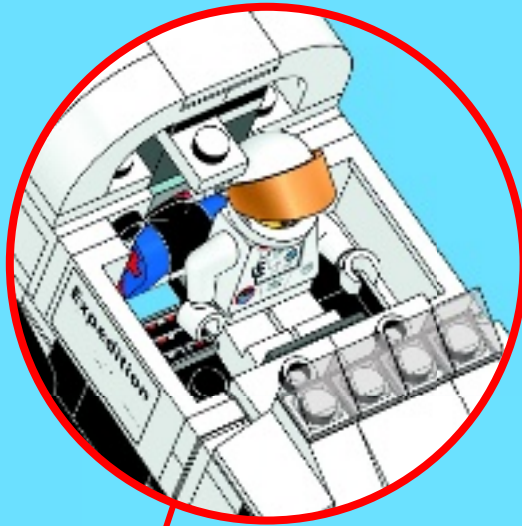

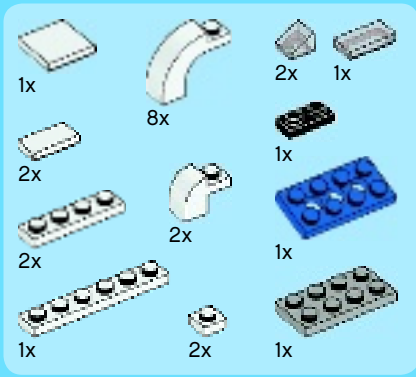

67

1

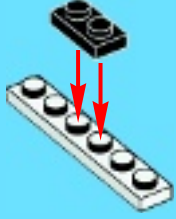

2



3



4



5

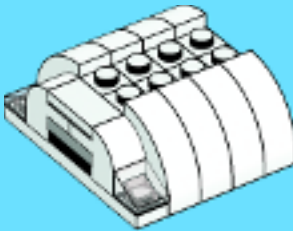

6

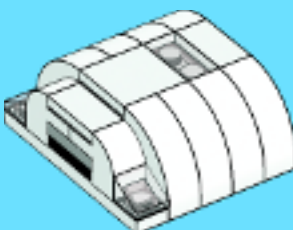

7

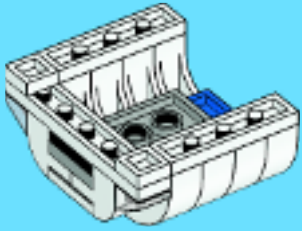

8

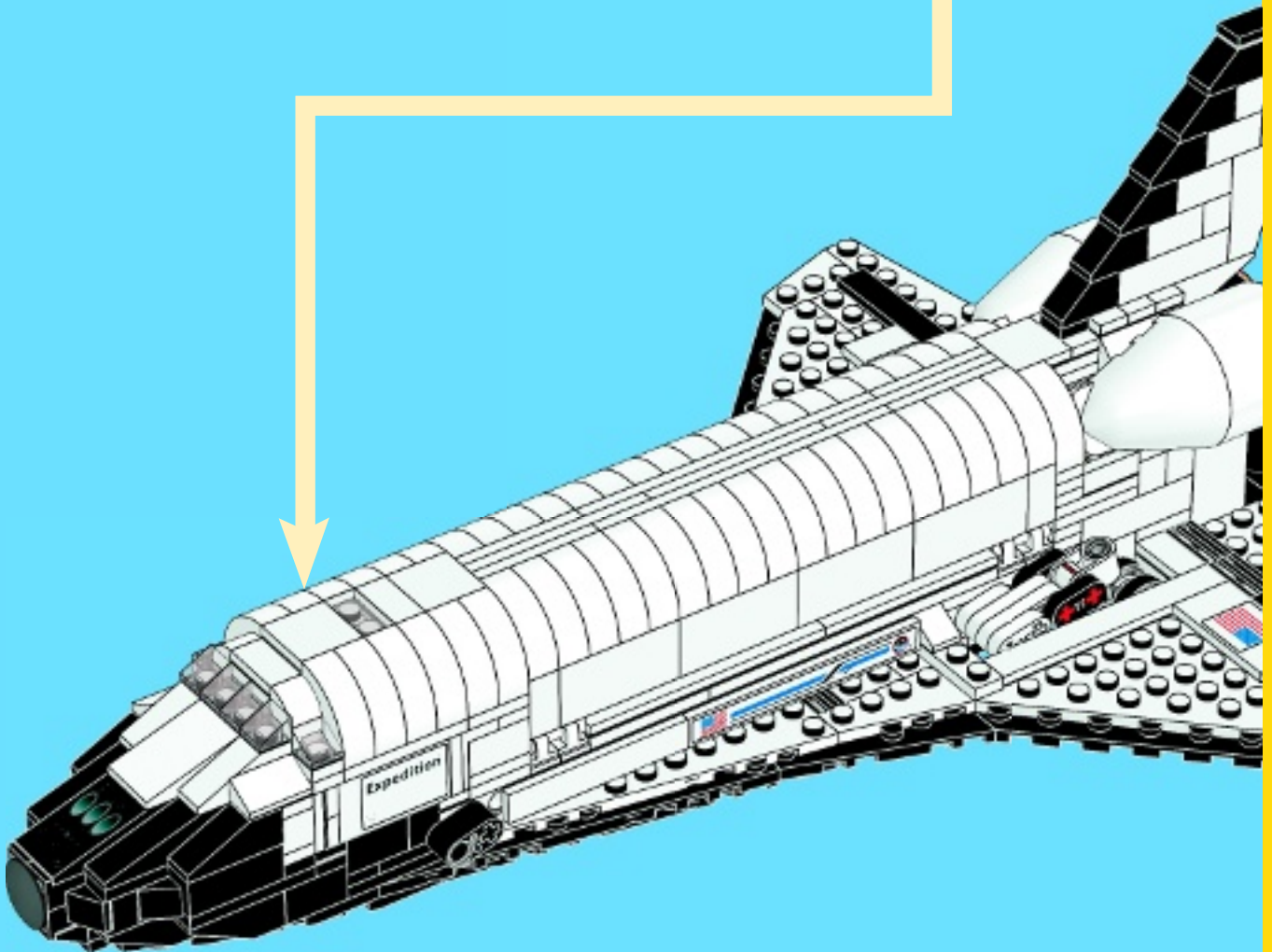
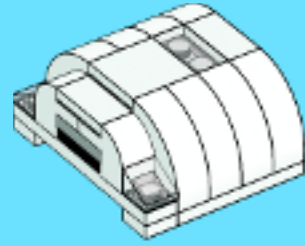

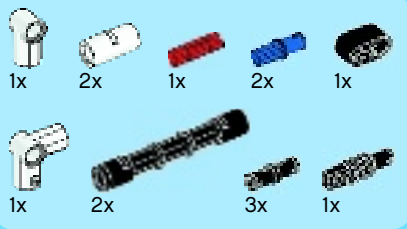

68

1



2

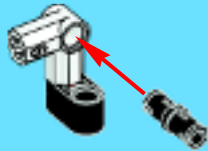

3

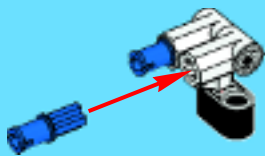

4

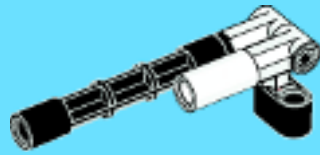

5

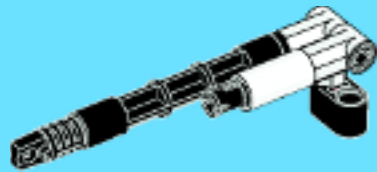

6

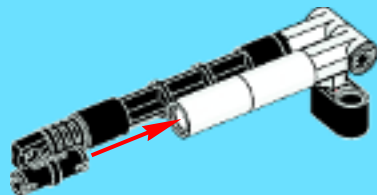

7

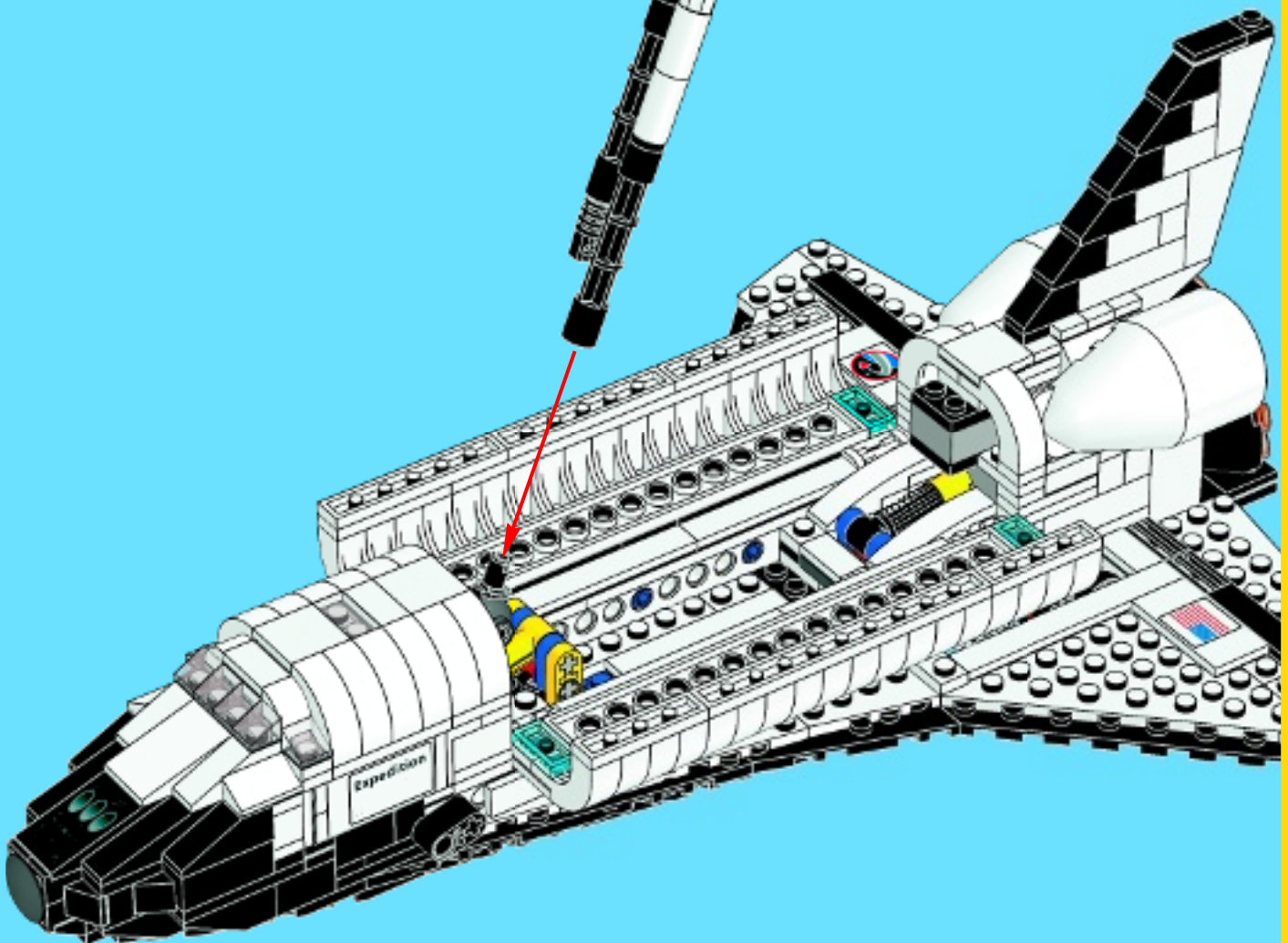
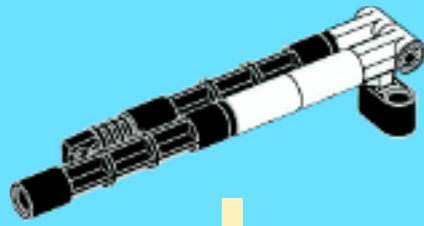



1

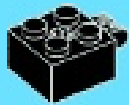

2

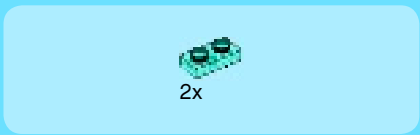

3

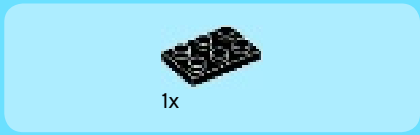
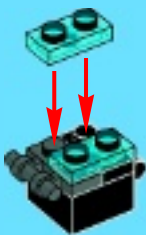

4

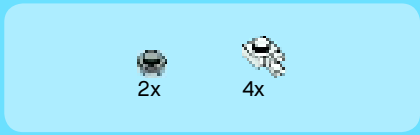

5

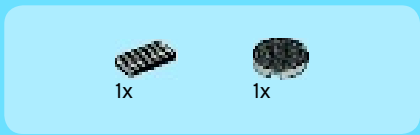

6





7

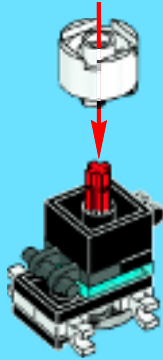

8



9



10

1



2



3

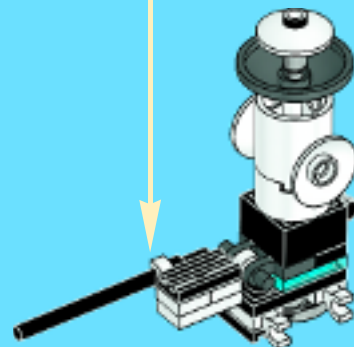

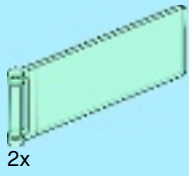

11

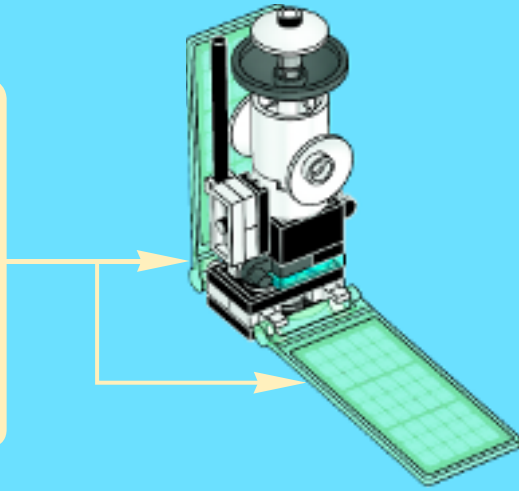
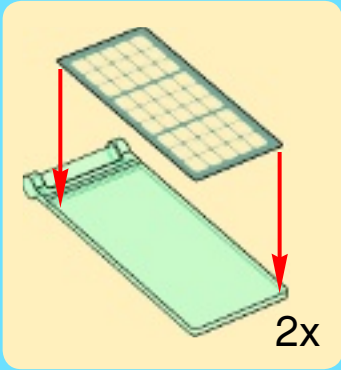

12

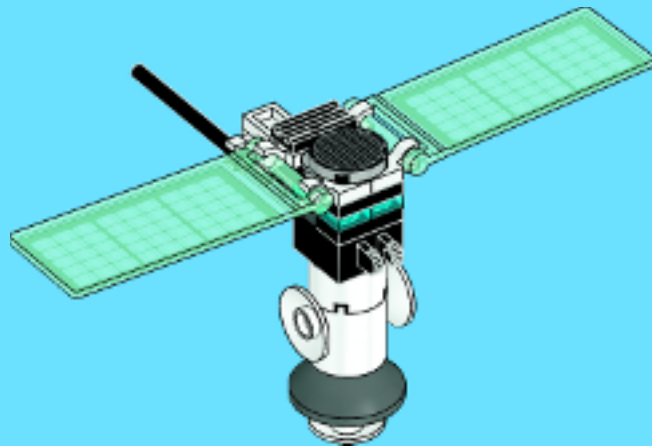

69

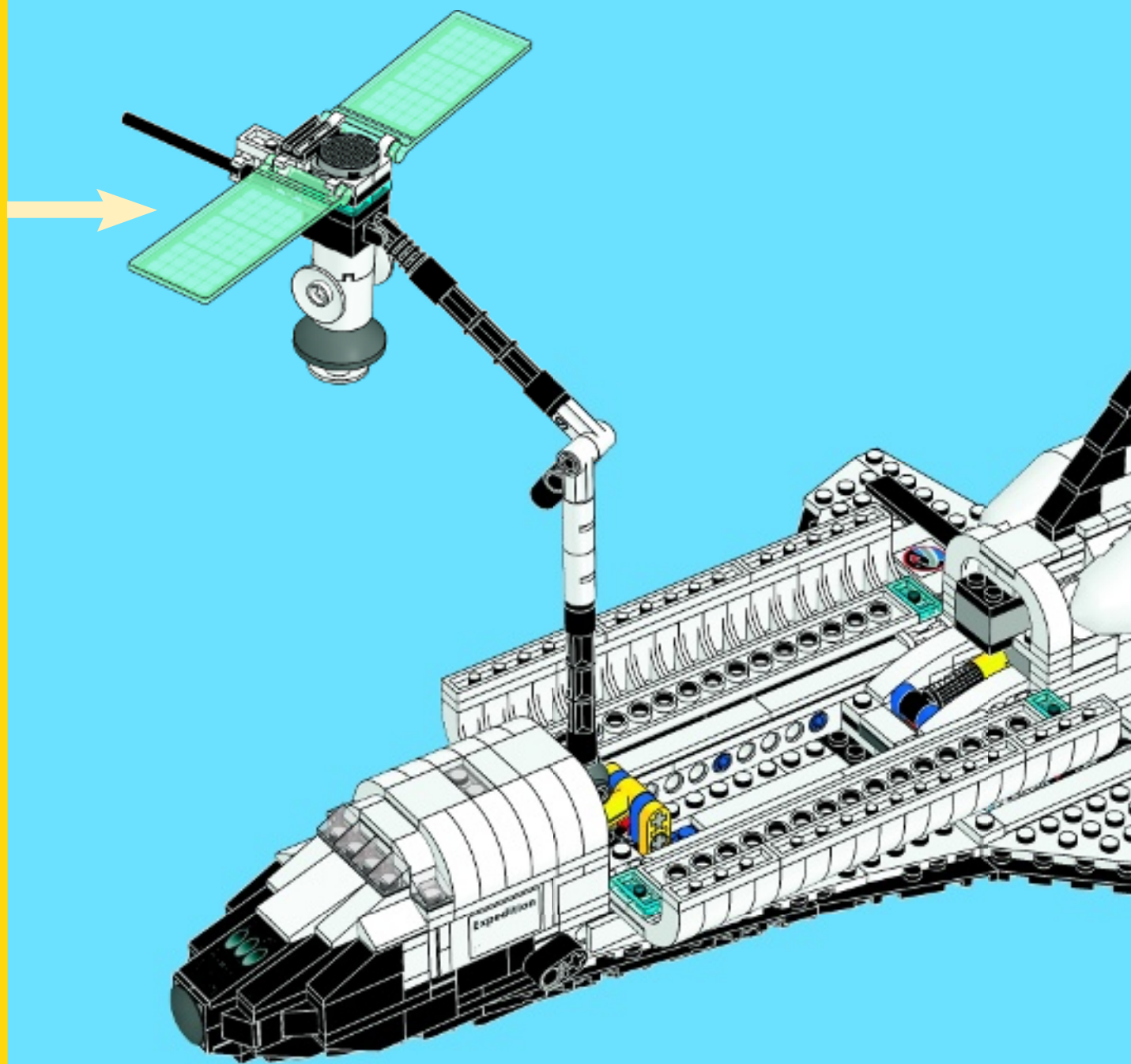

70

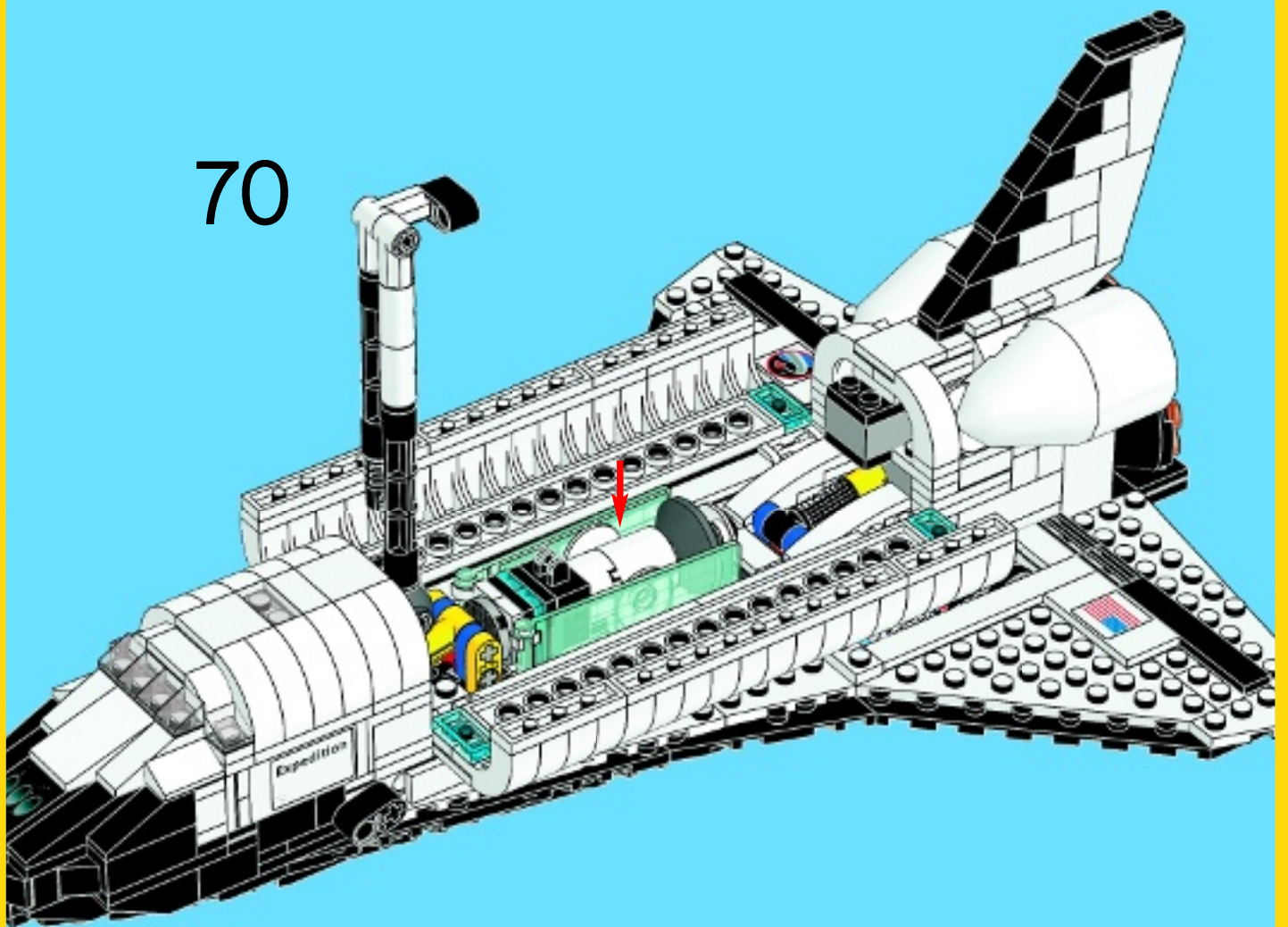

71

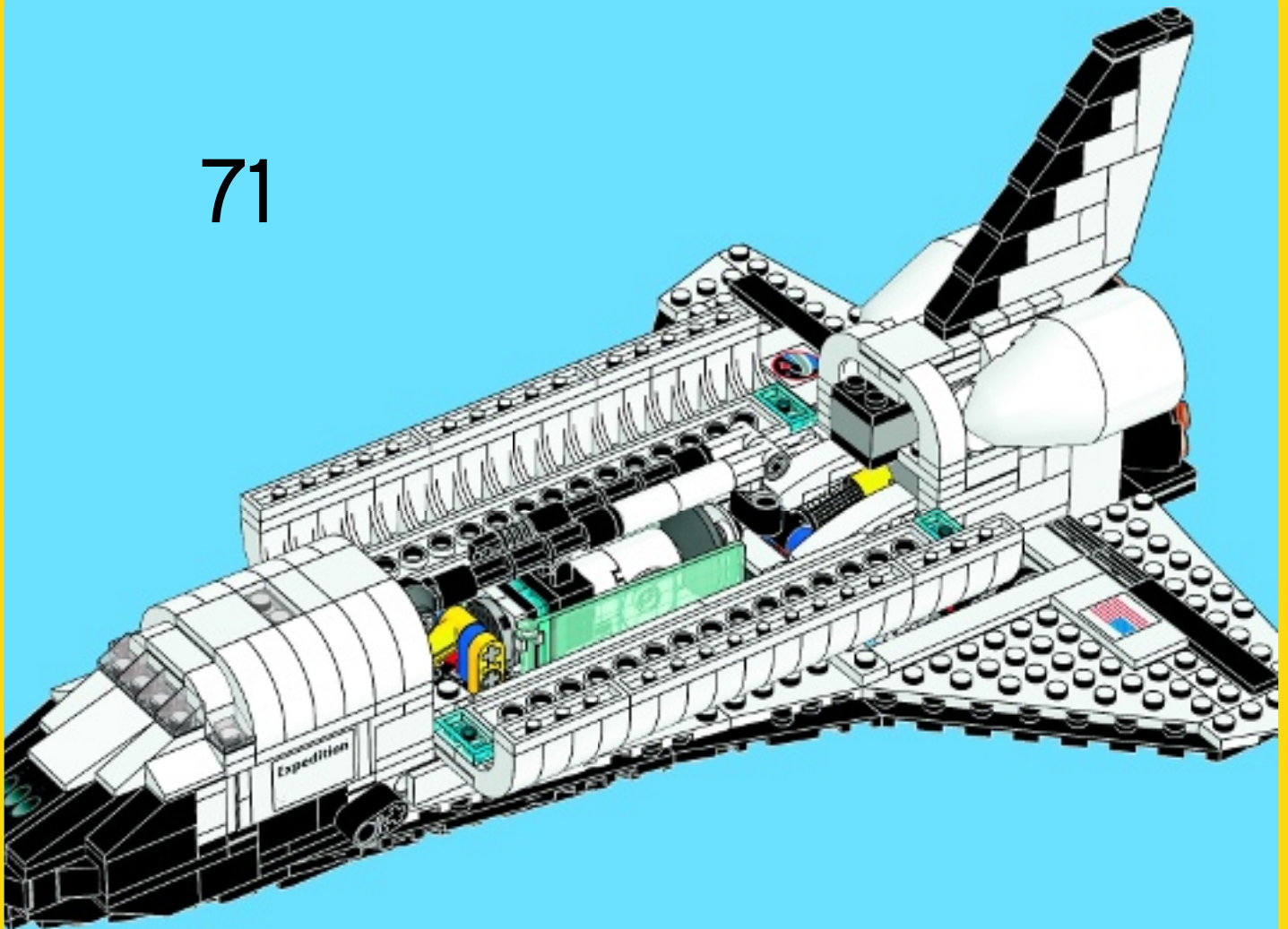

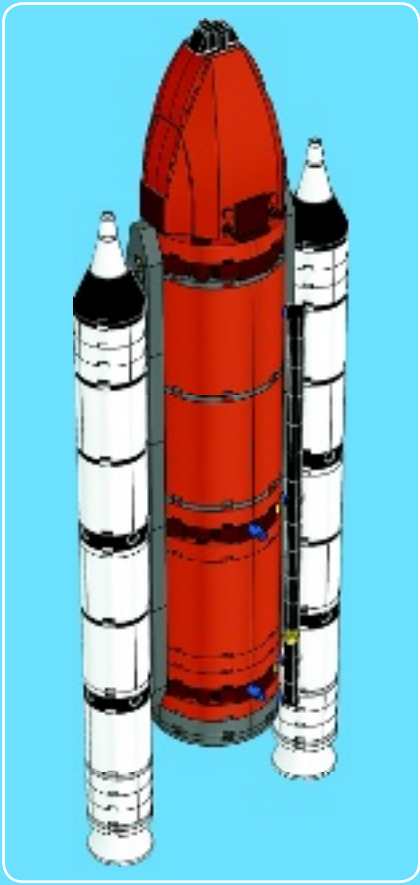

1

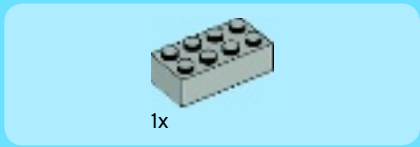
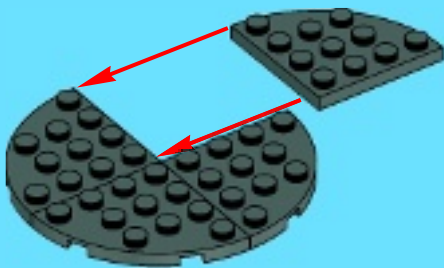

2



3

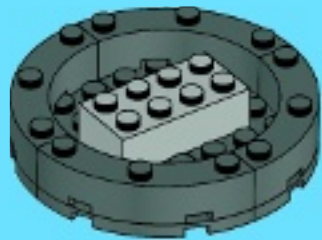



4x

4

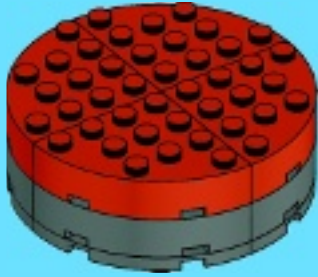

8x

6

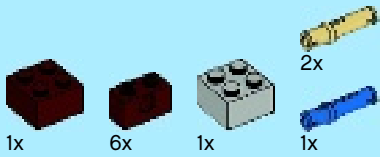
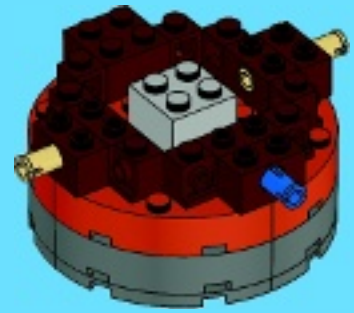

5

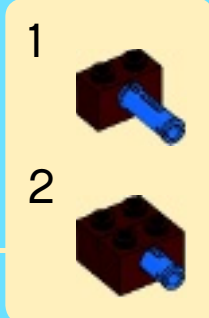
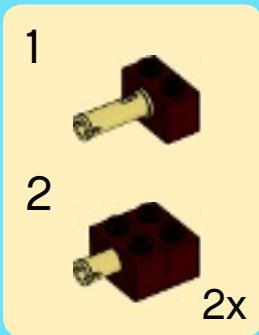

7

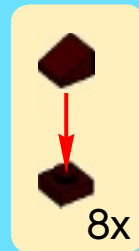



4x

8

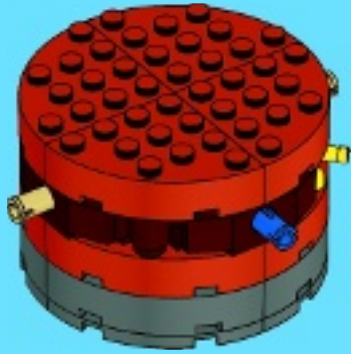

4x

9

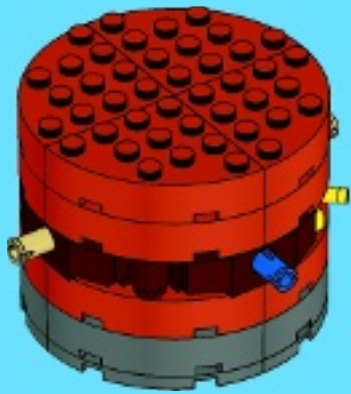

1x



1x

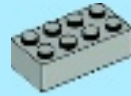

2x

10

1

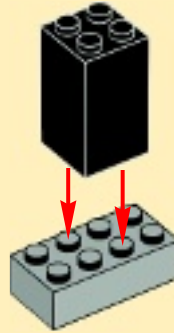

2

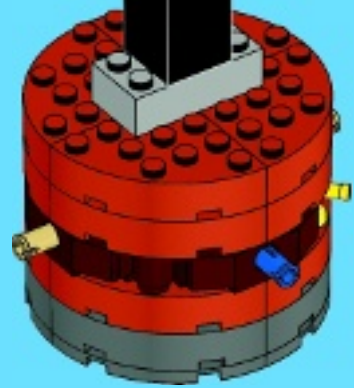
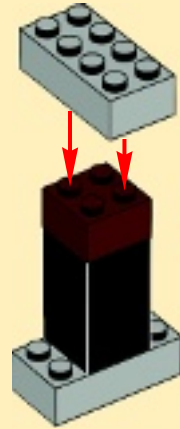



4x

11

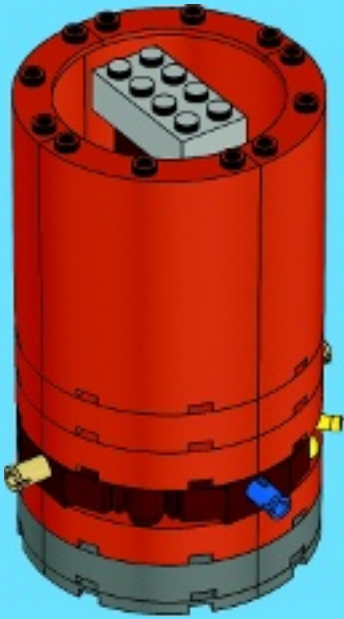

4x

12

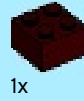

1x

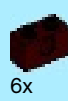

6x

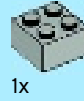

1x



2x



1x

13

1



2



2x

1



2

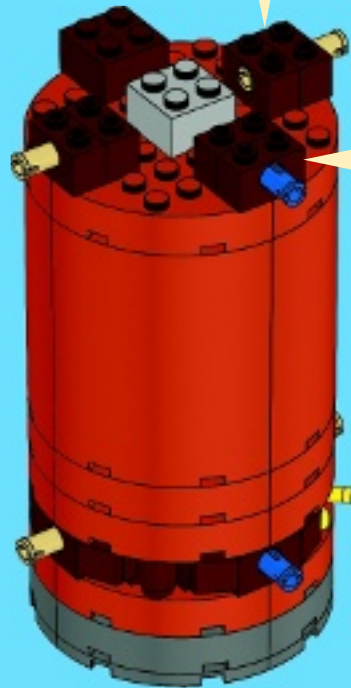



8x

14

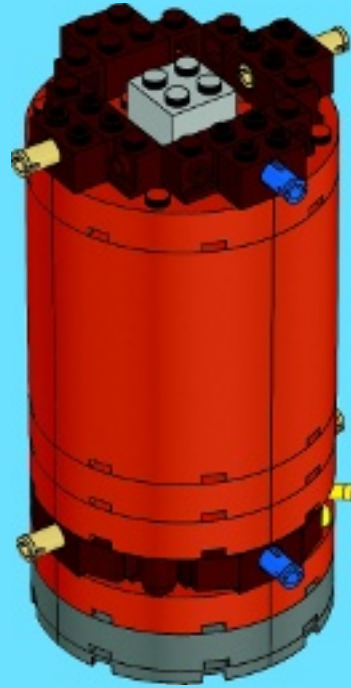

8x



3x



8x



1x

15

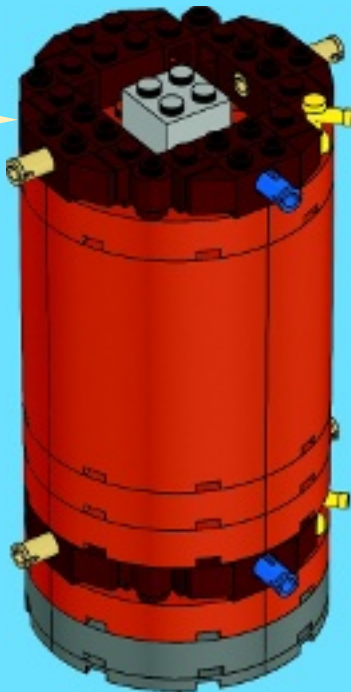
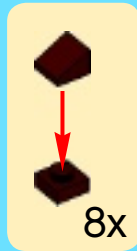



4x

16

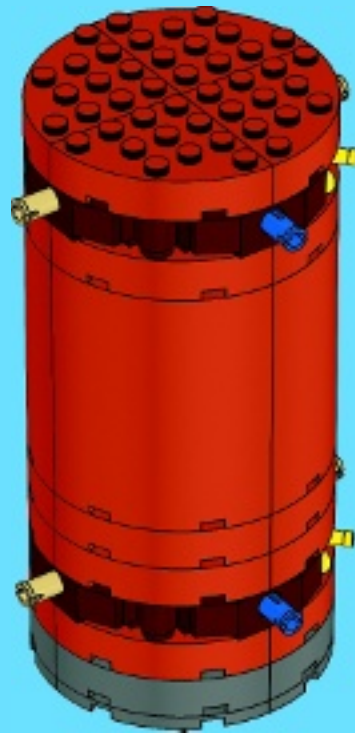

4x

17





1x



1x

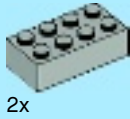

2x

18

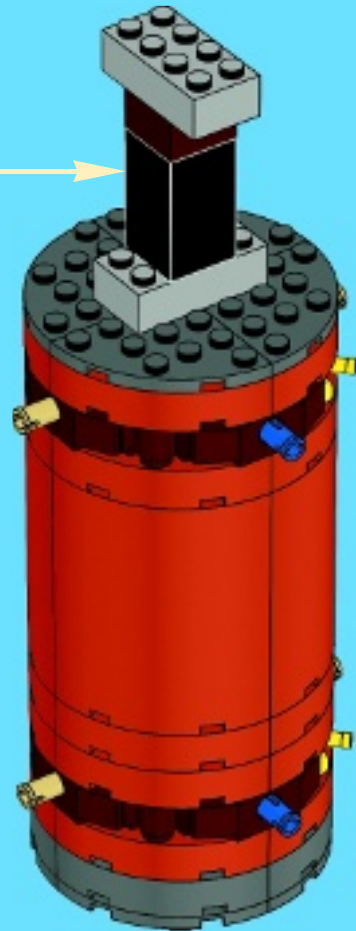
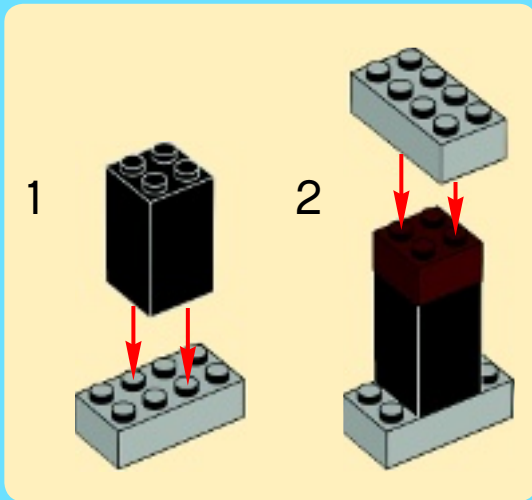



4x

19

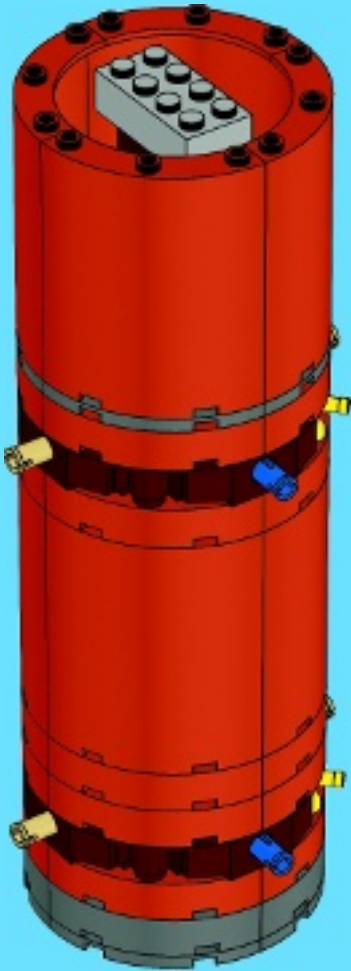

4x

20

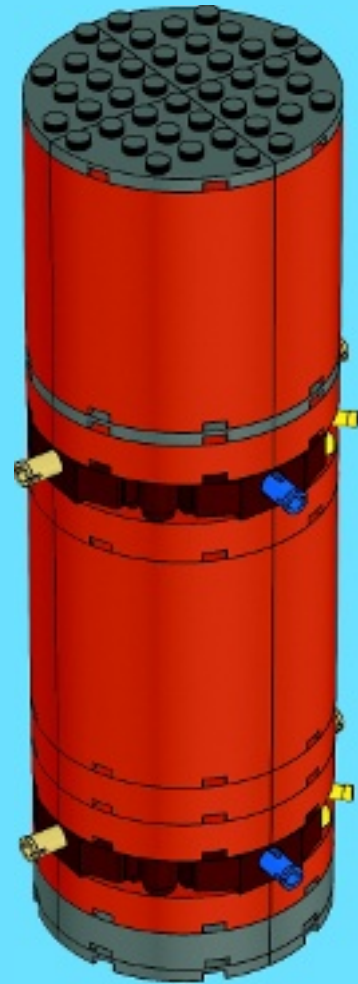



1x



1x

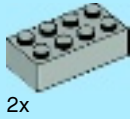

2x

21

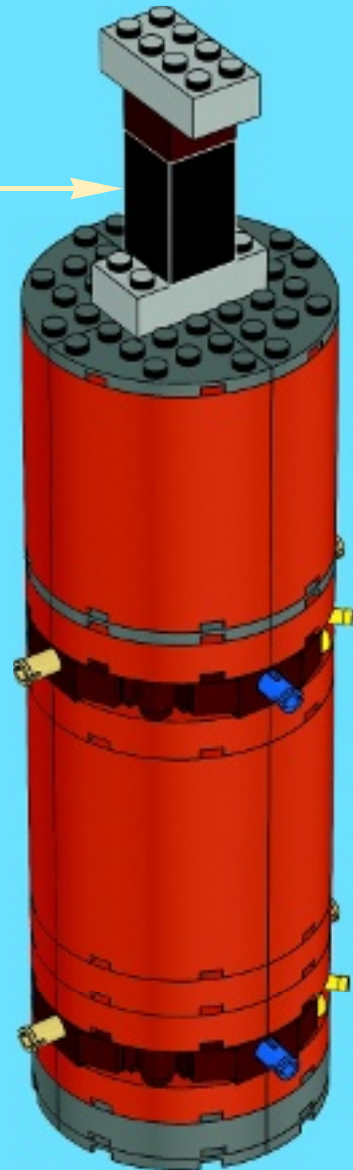
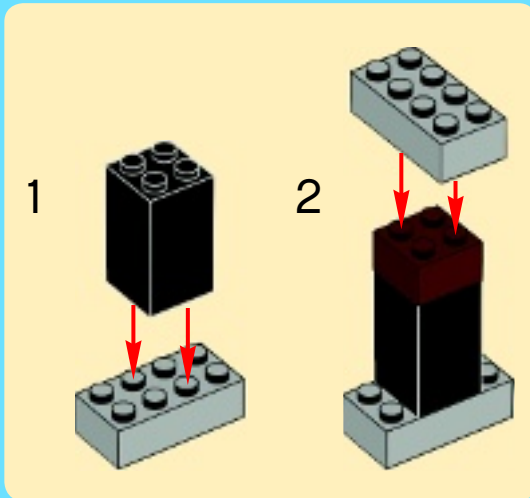



4x

22

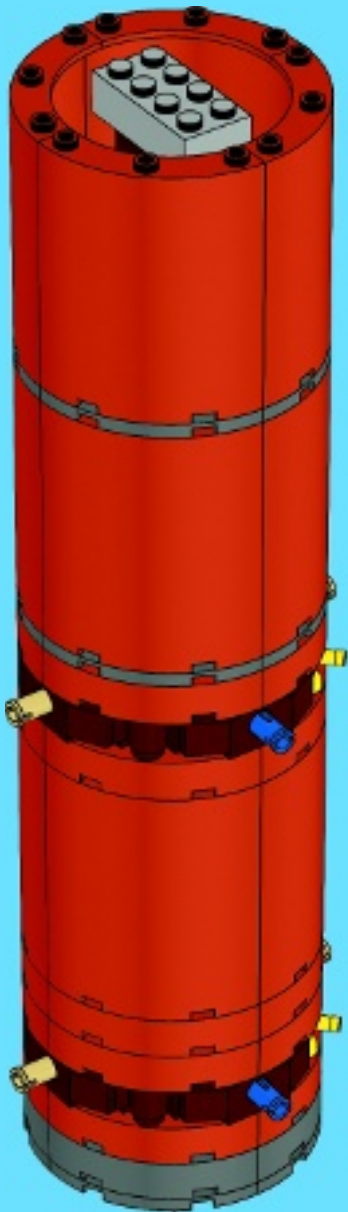

4x

23

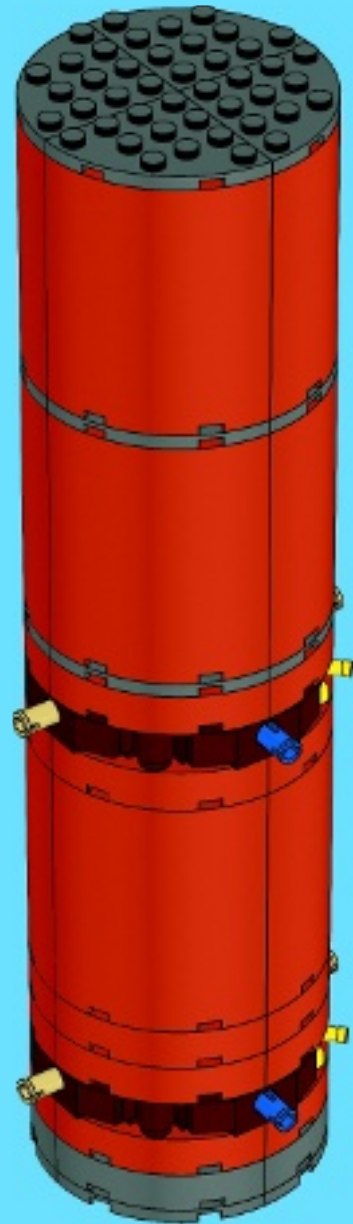



2x



4x



1x



2x

24

1



2



2x

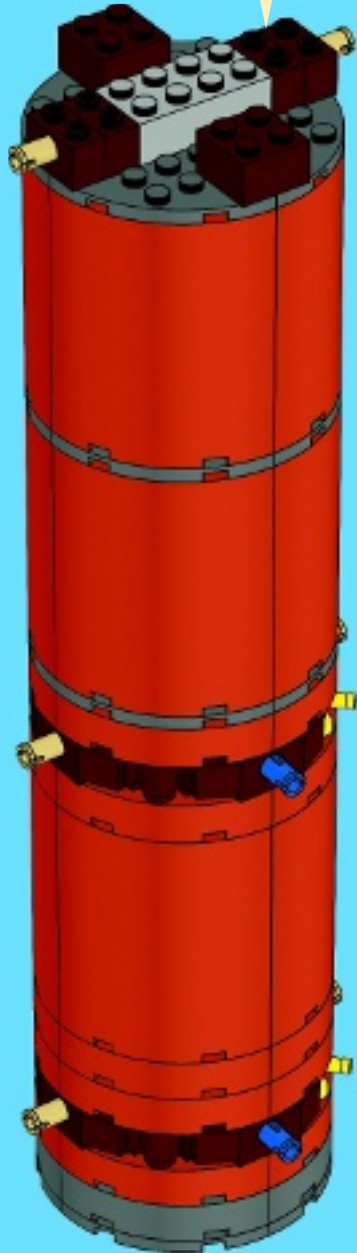



8x

25

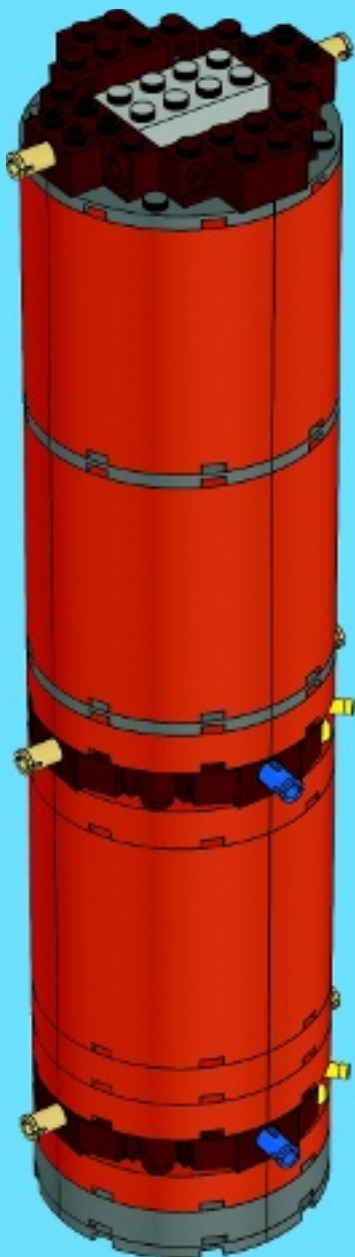



8x



4x



8x

26

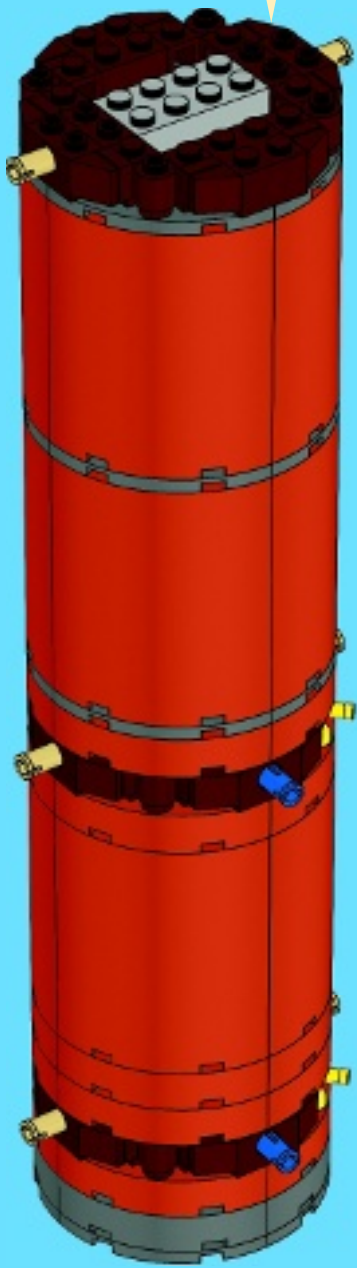
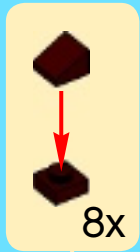

4x

27

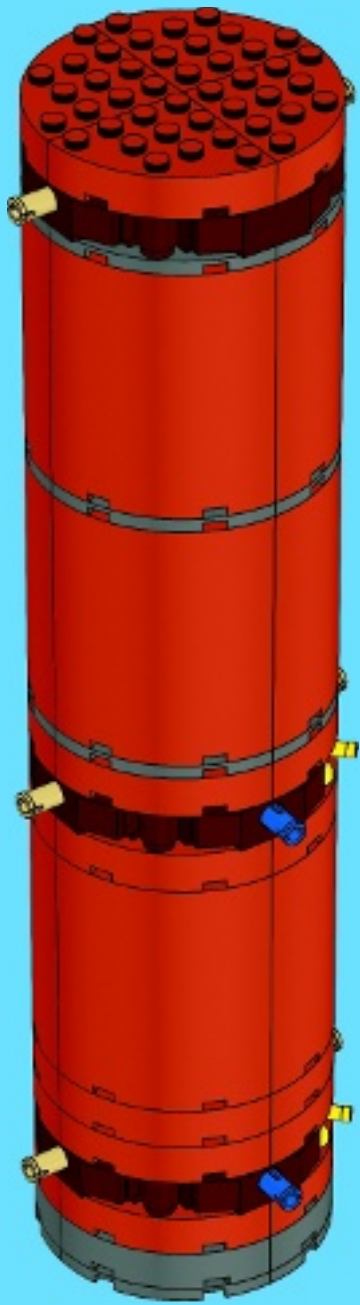



4x



4x

28

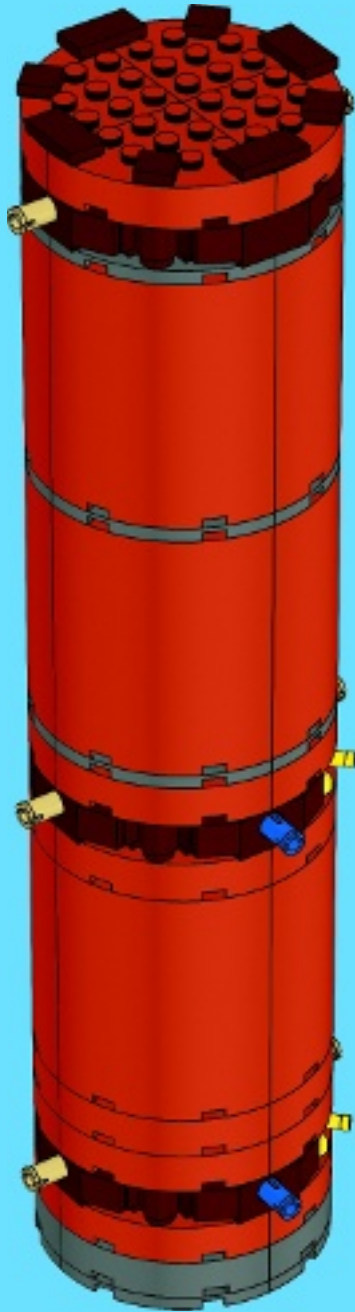



29

1



2



3



4





5

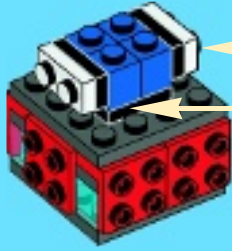

6



- 1 
- 2   2x

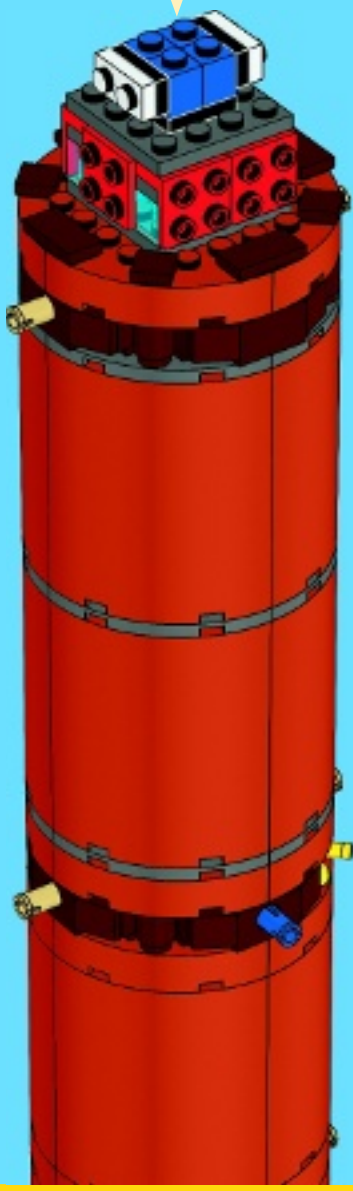

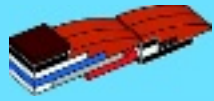

2x



2x



2x



8x



2x



2x



2x



4x



2x



2x



2x



2x

30

1

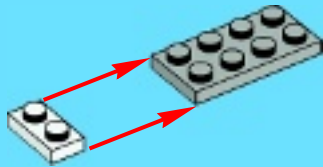

2



3



4

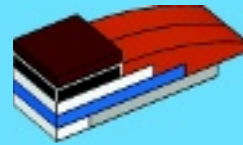

5



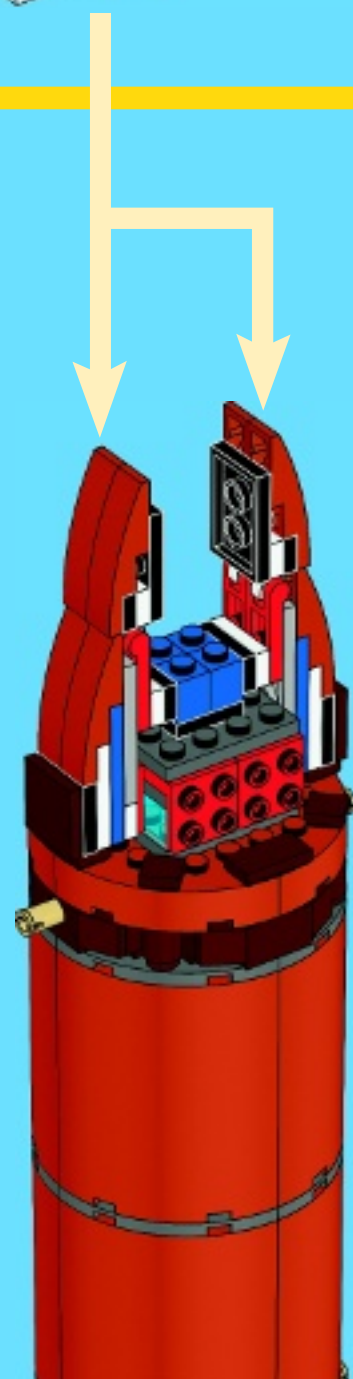
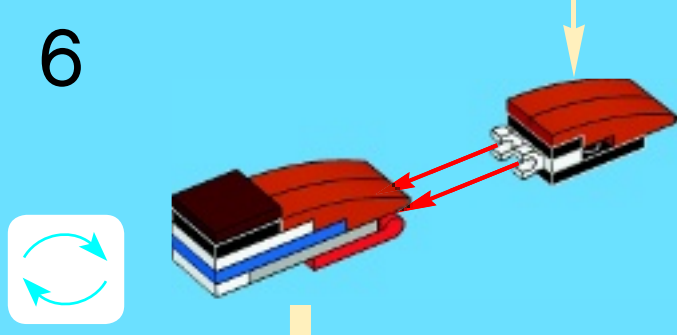
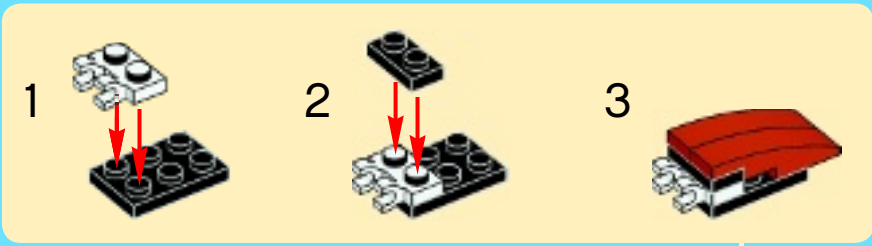

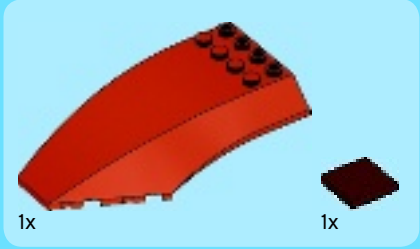

1

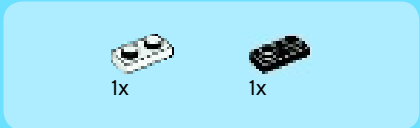
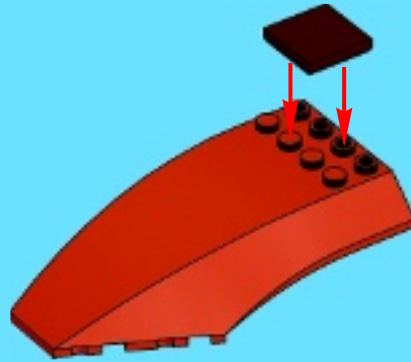

2

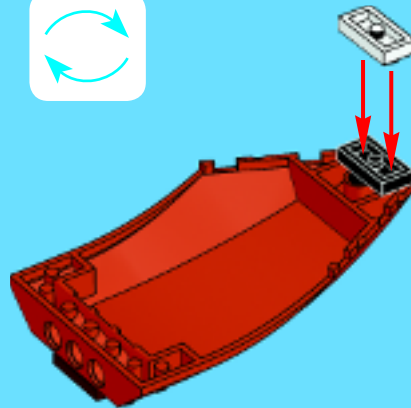



1x



1x



1x

3

1



2



1x



1x

4





1x



1x

5



1x



1x

6

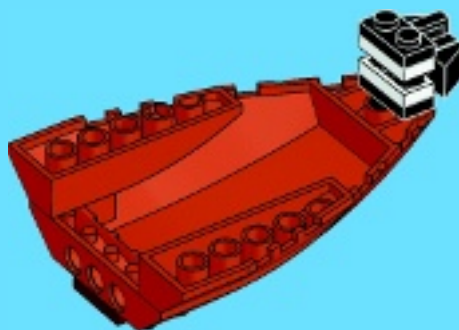

31

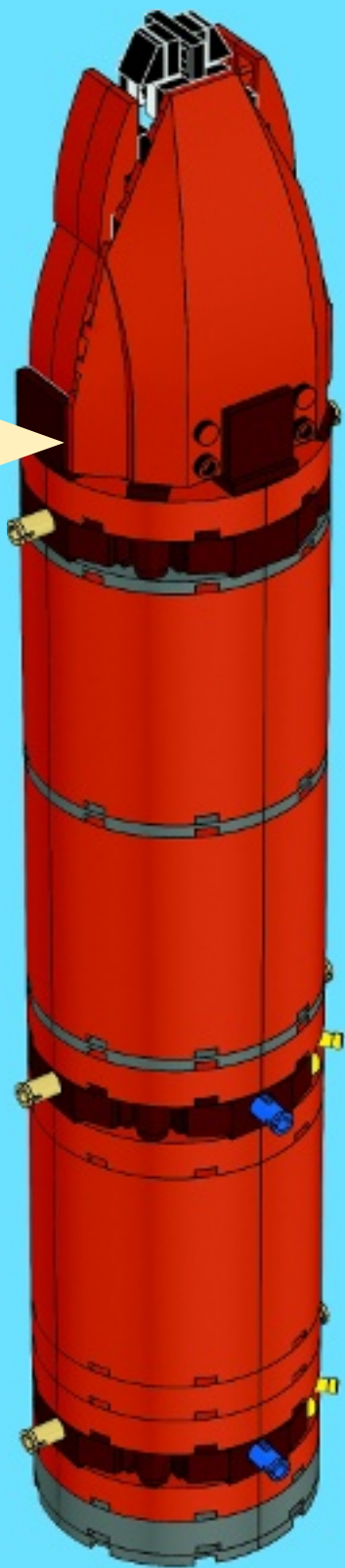

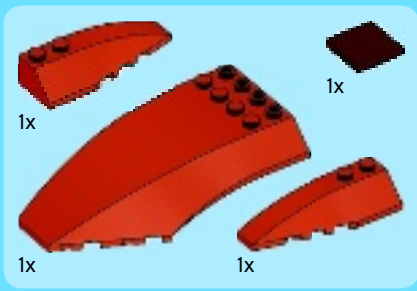

32

1

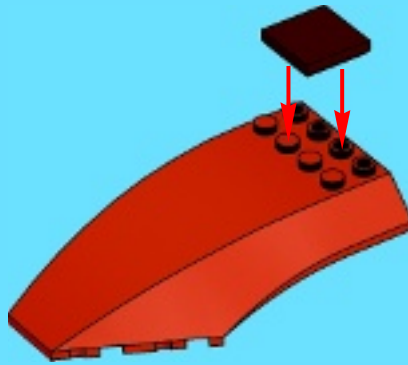

2

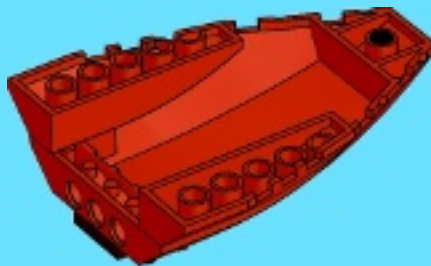

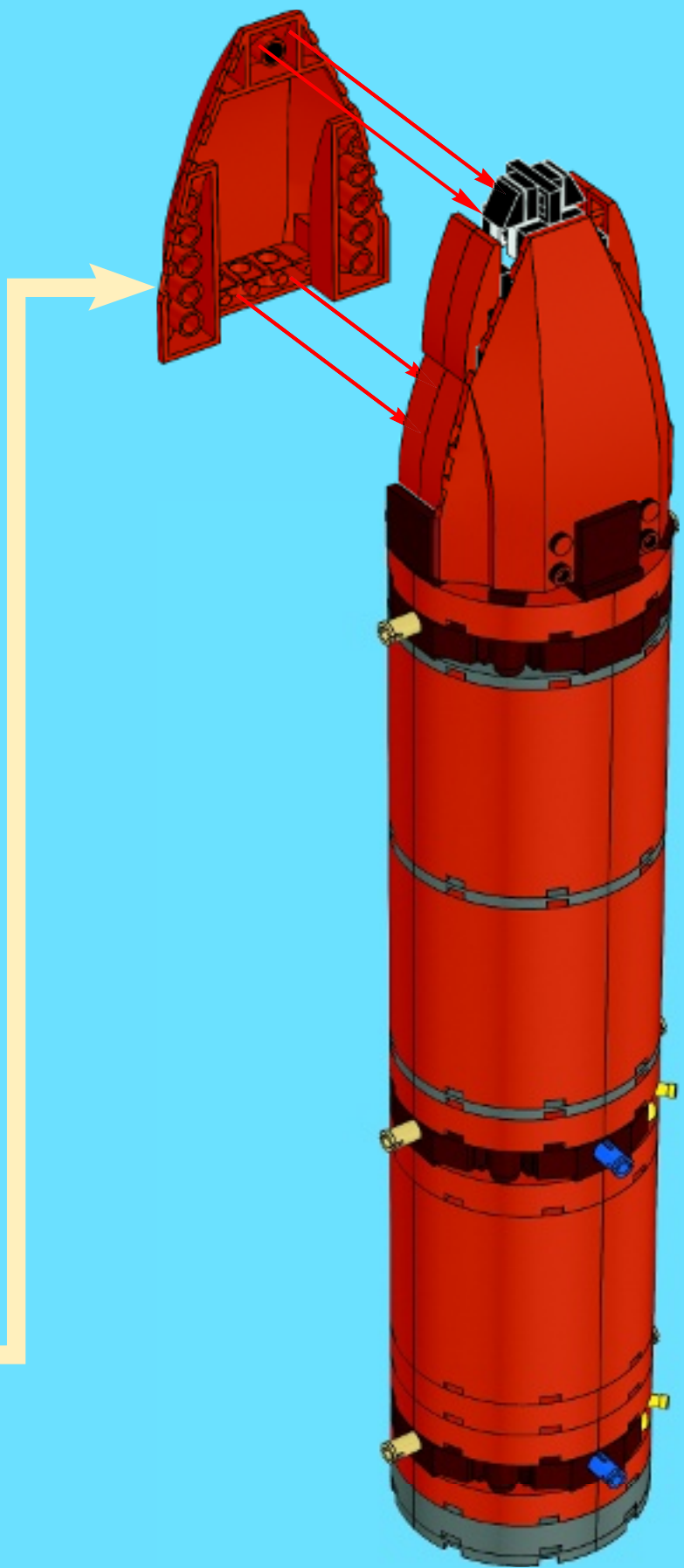

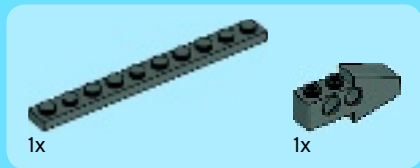
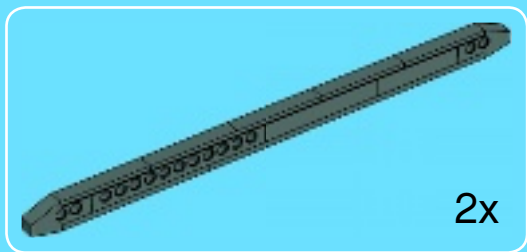

1

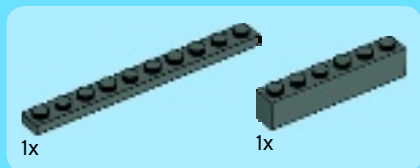
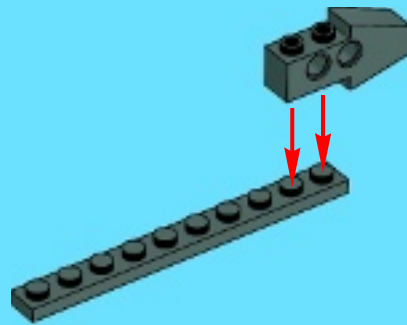

2

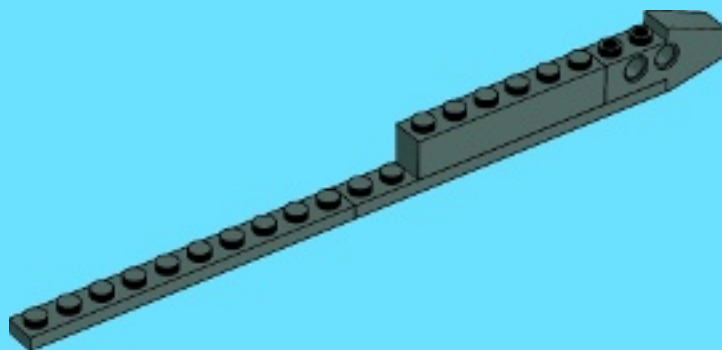

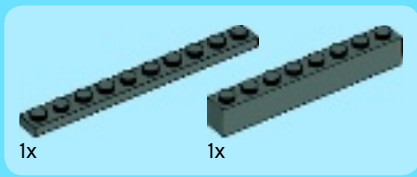

3

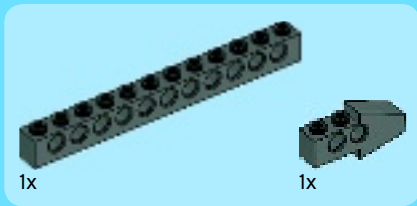
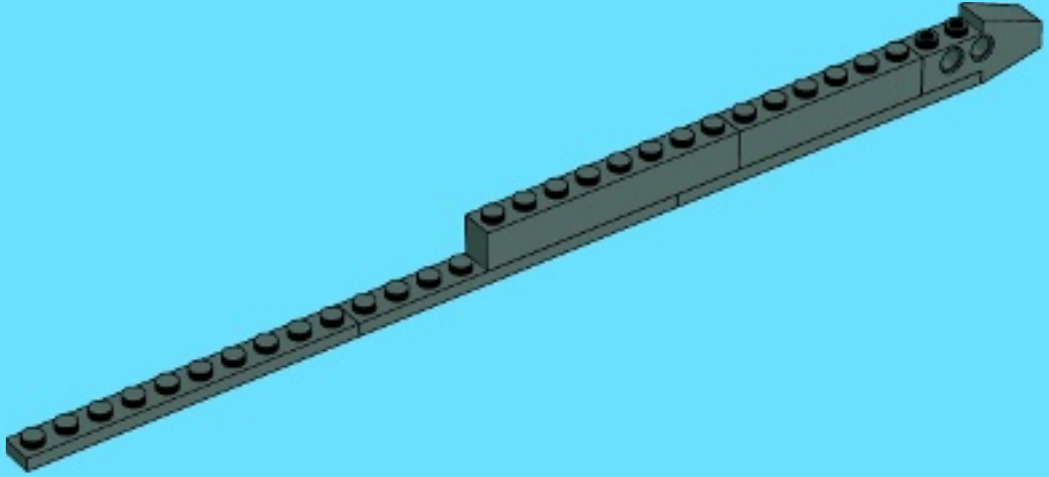

4

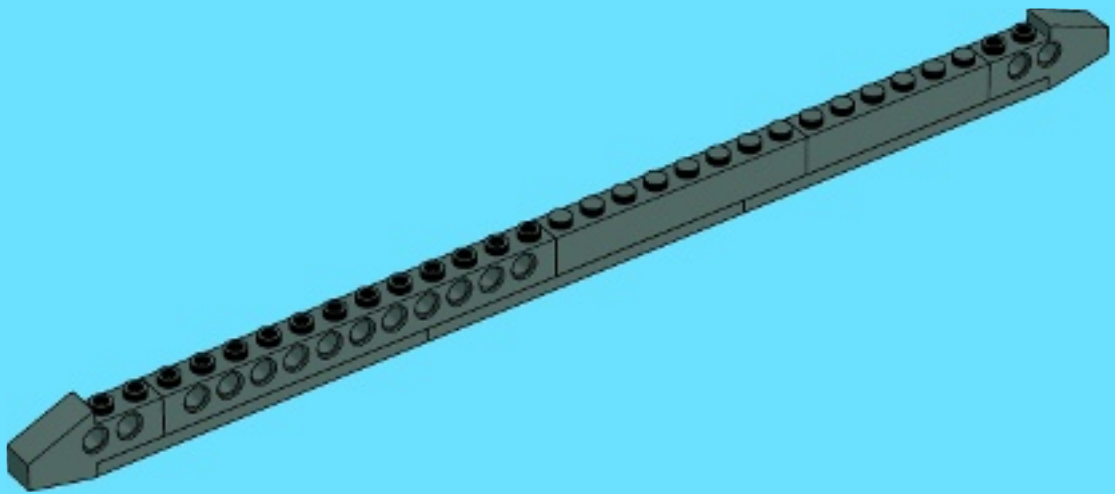



5x

5

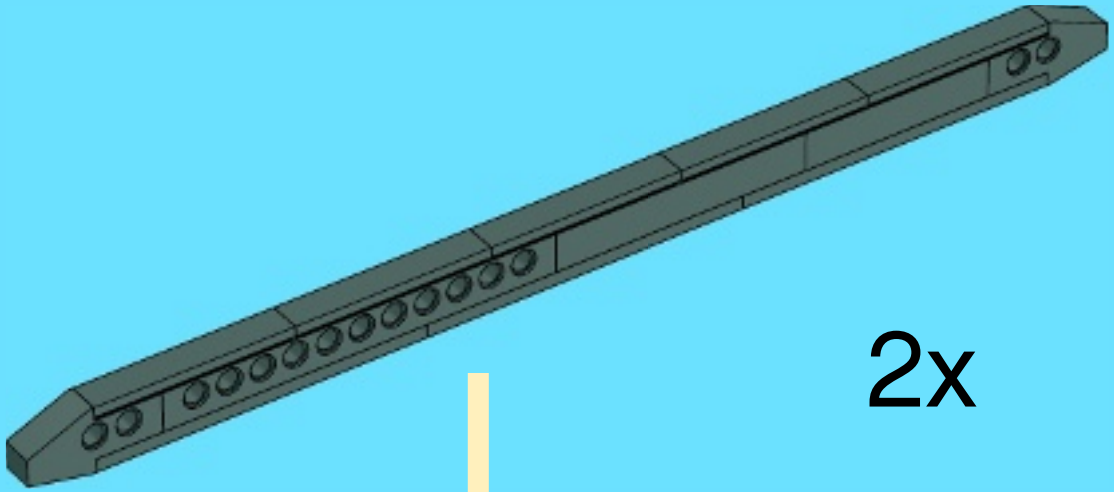

2x

33

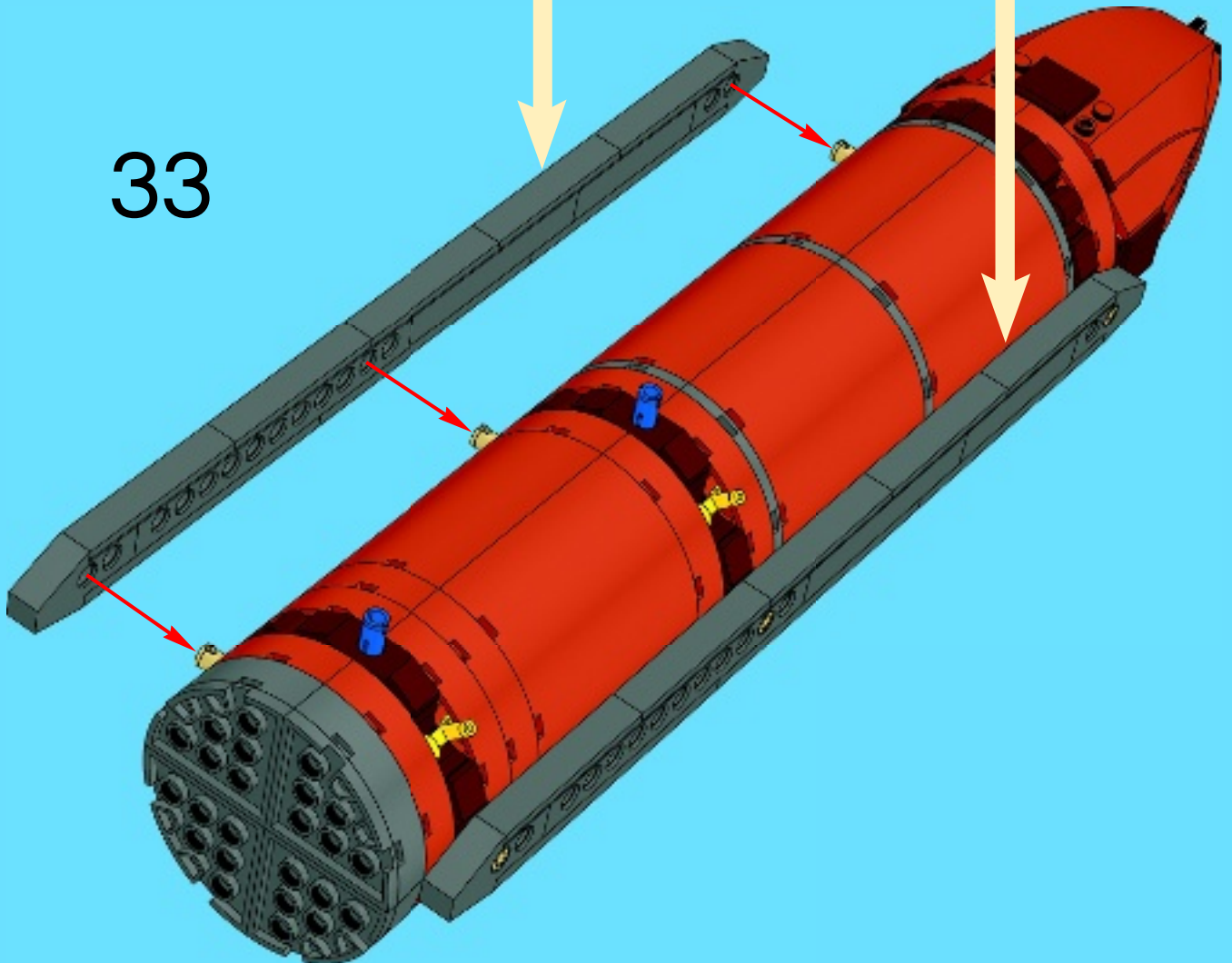

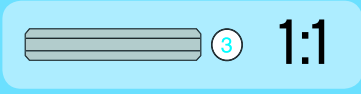
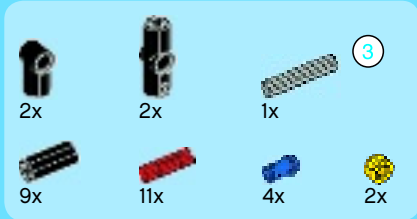

34

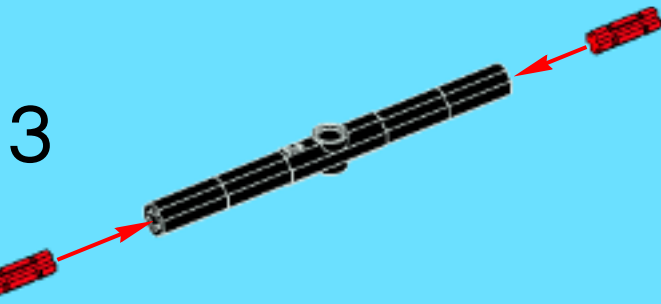
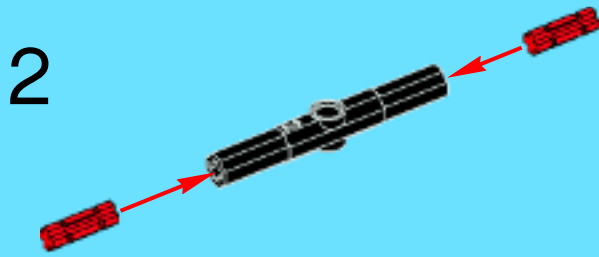
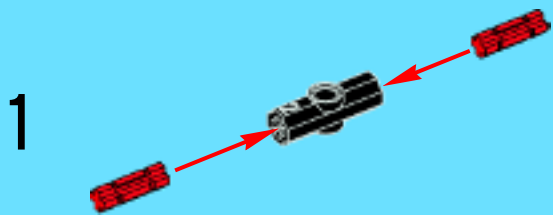

4

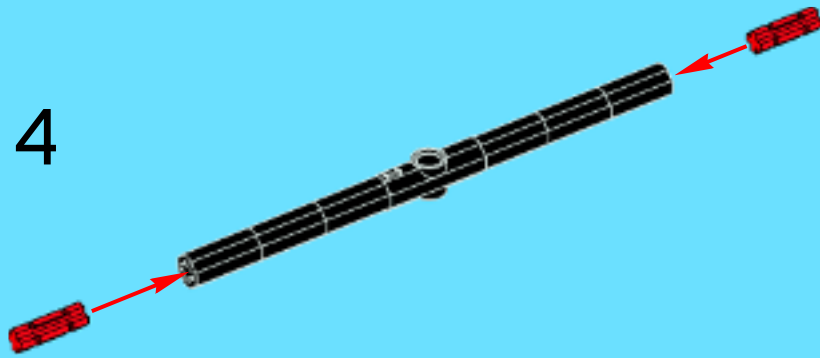

1

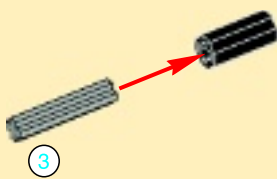

3



2

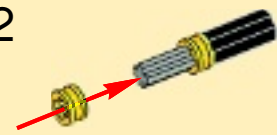

4



5

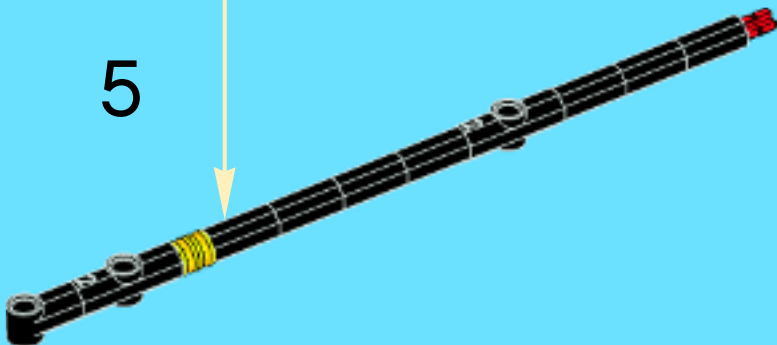

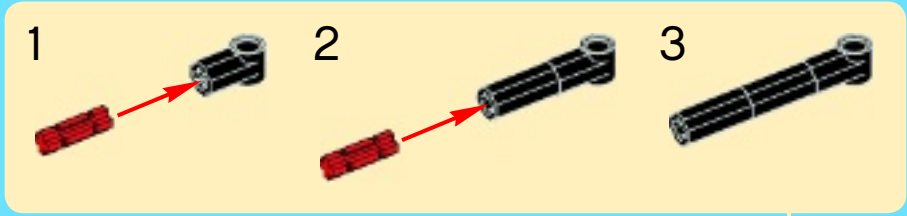

6

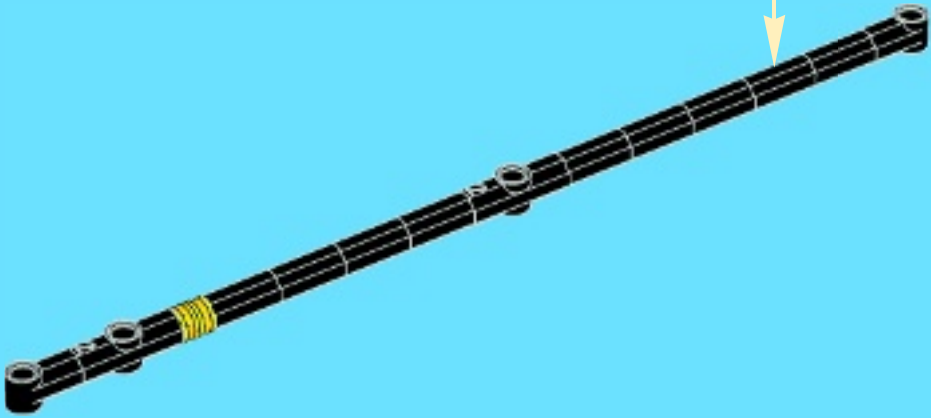

7



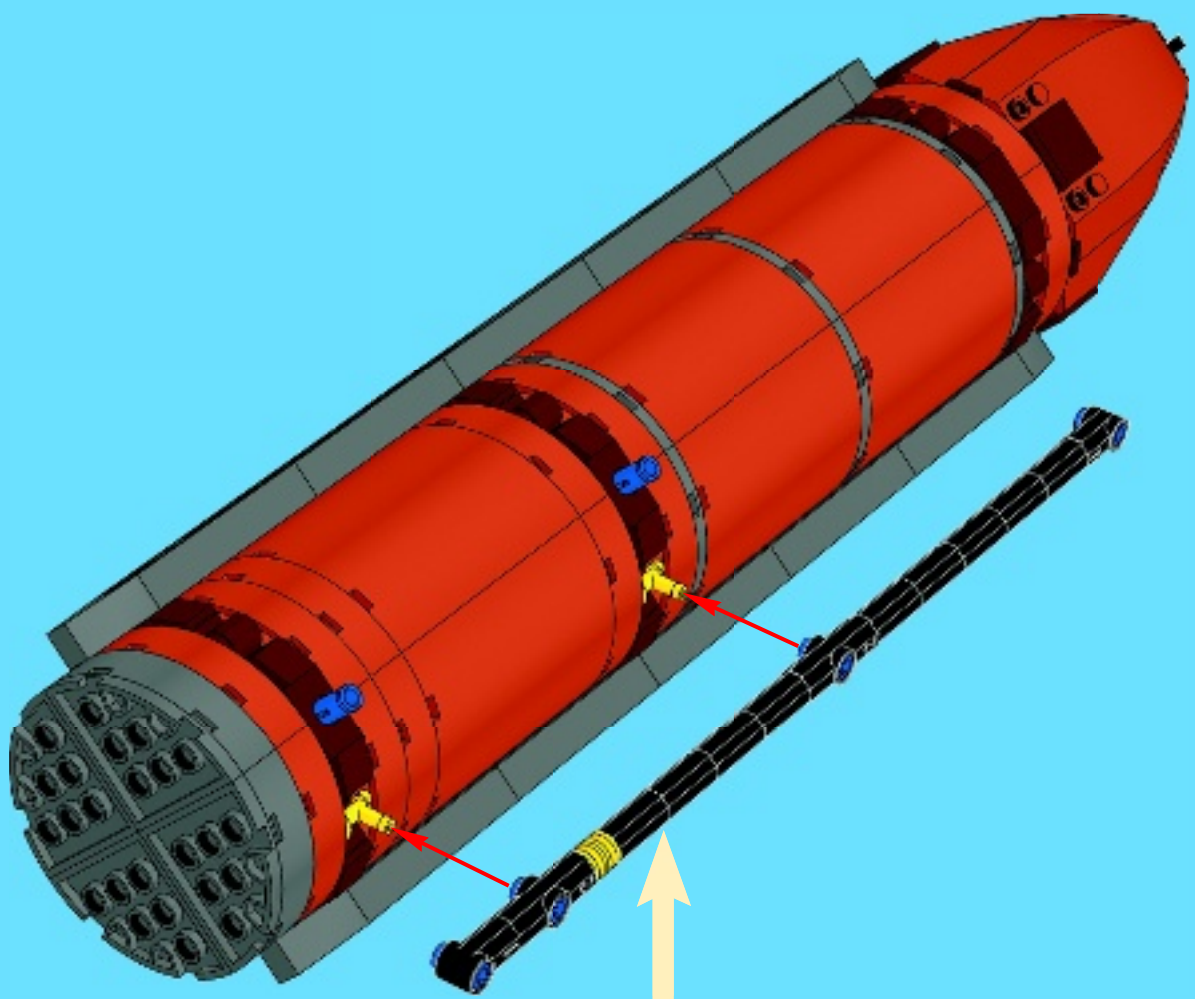



1x

35

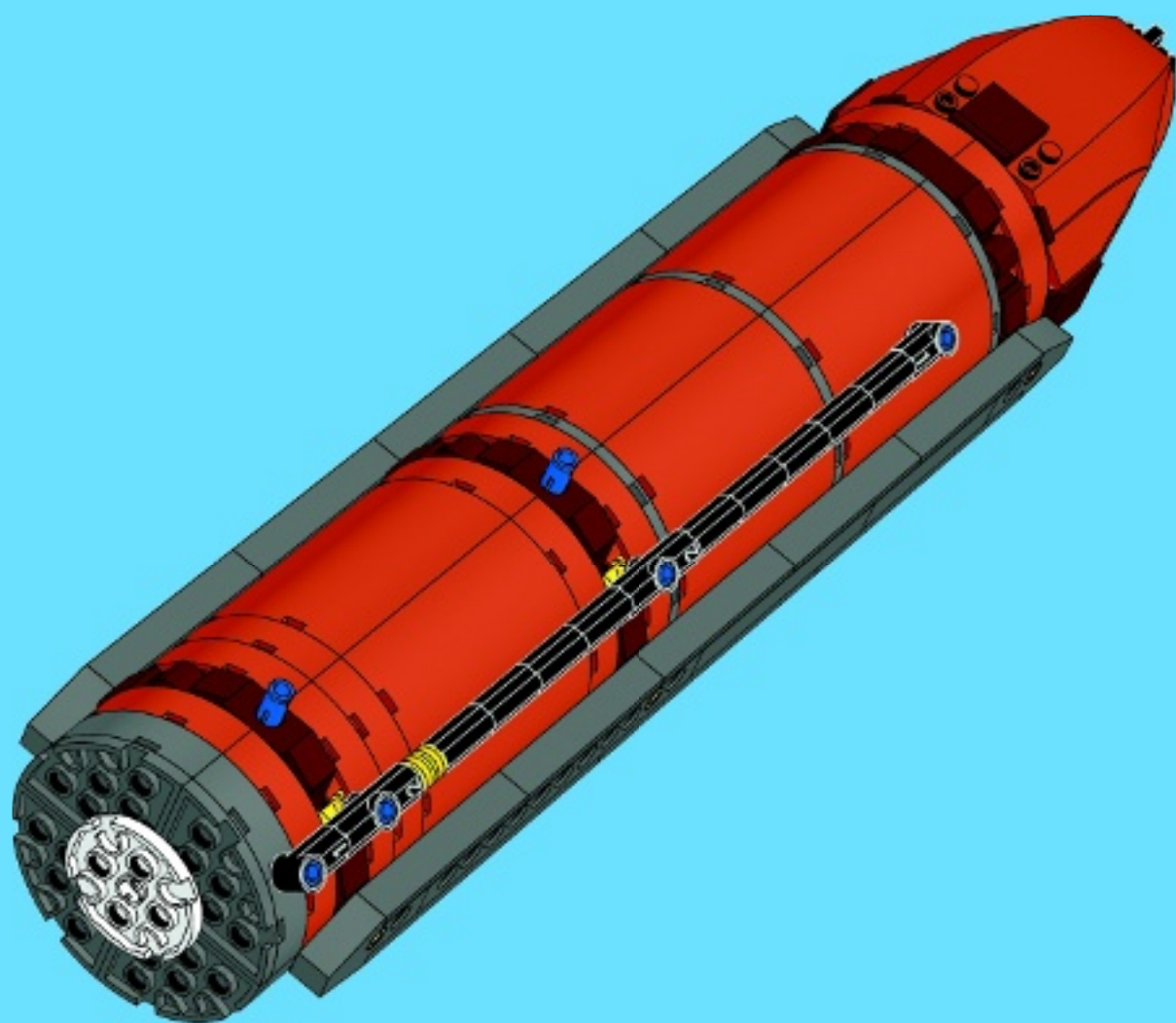



1x



1x

36

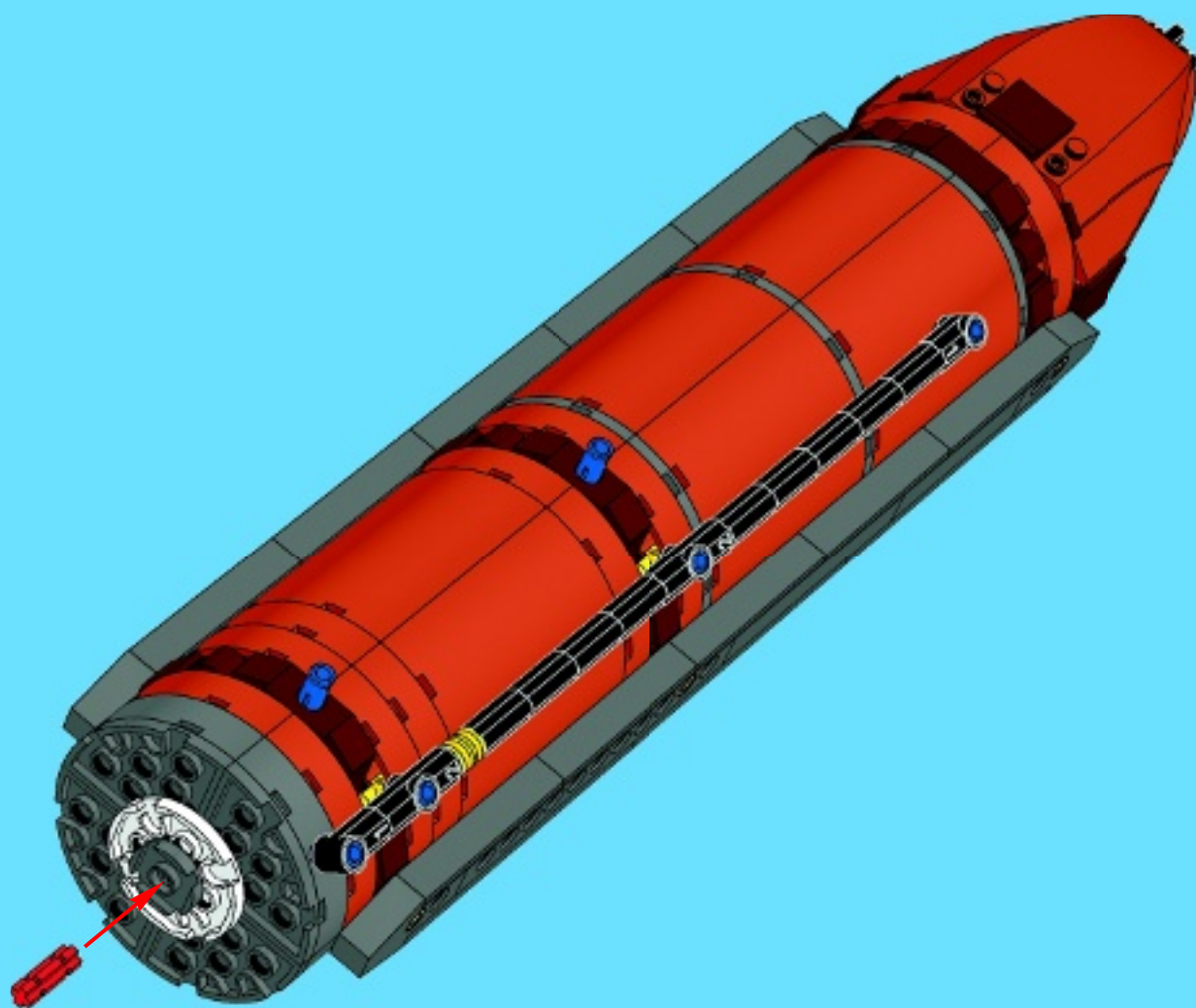

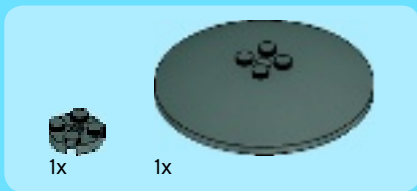

37

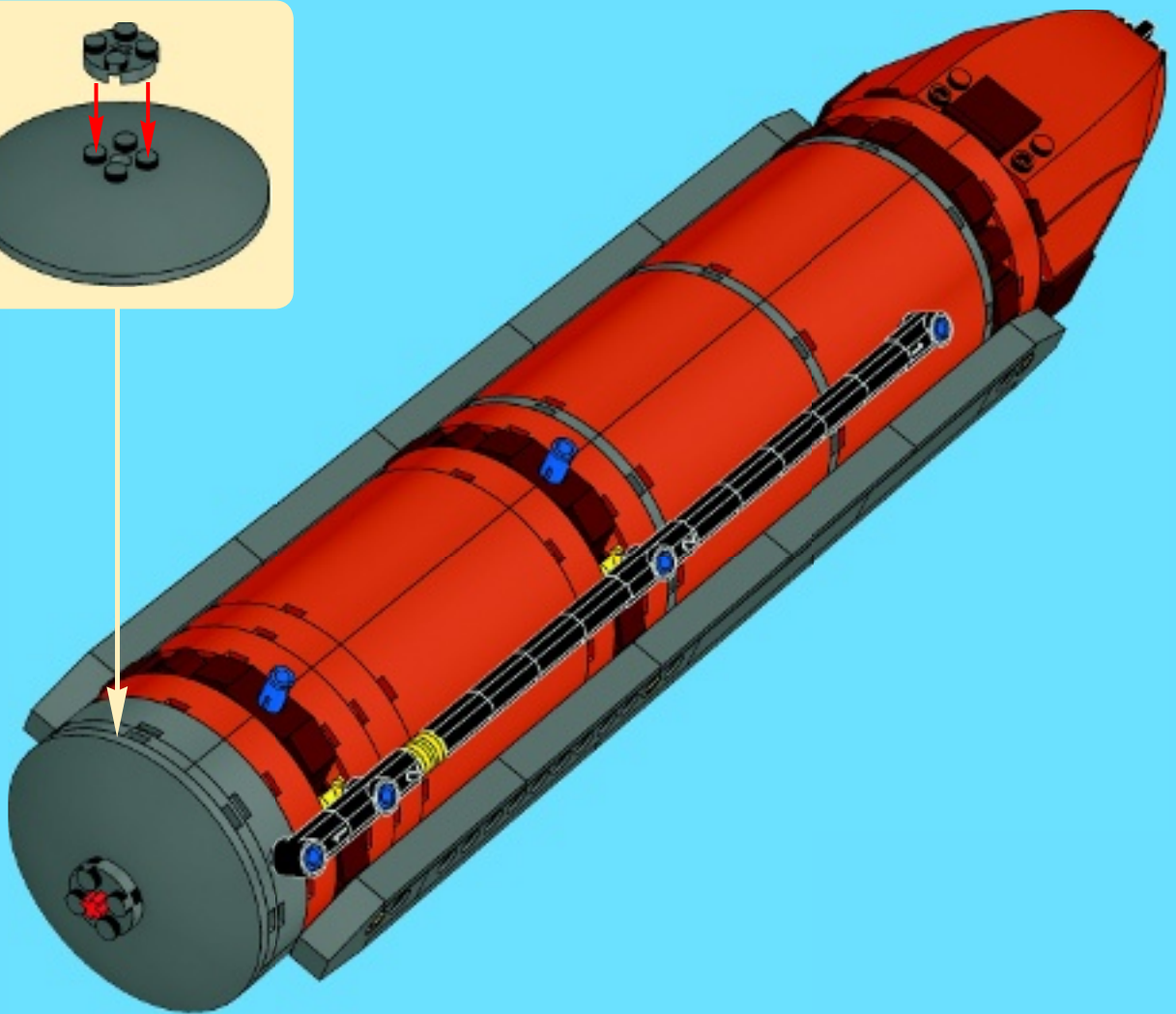
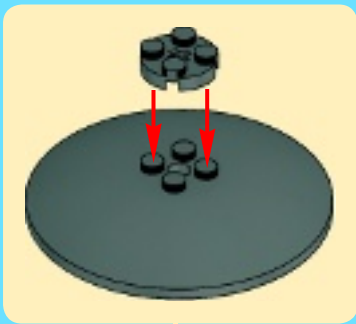

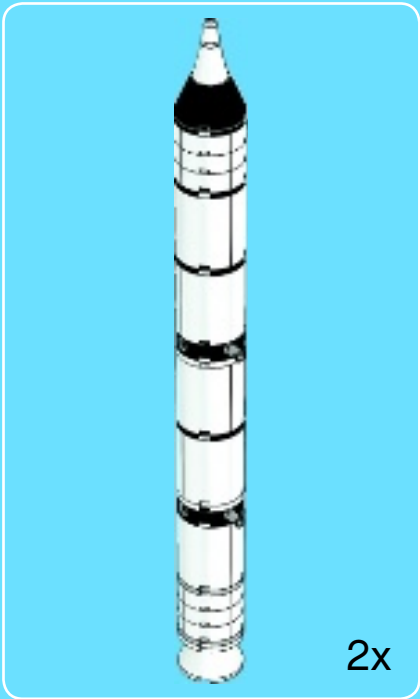

1

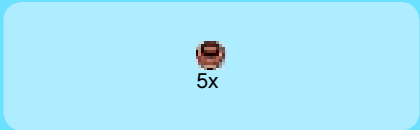

2

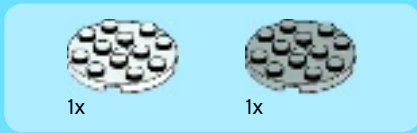

3

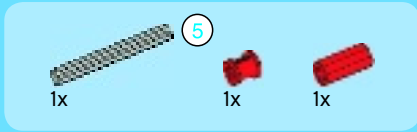
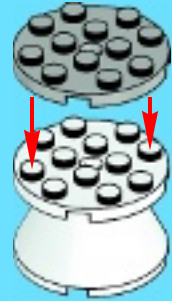

4

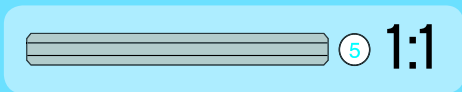
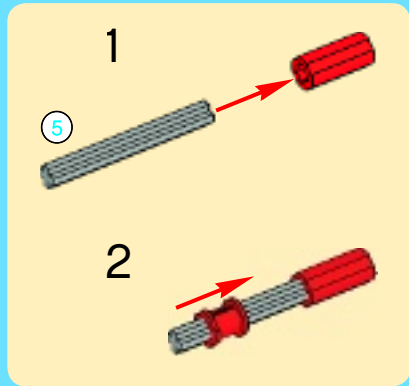



12x

5

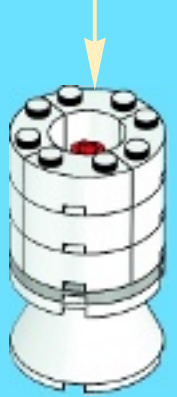
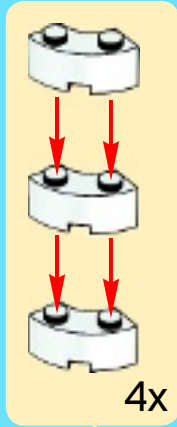

1x

6

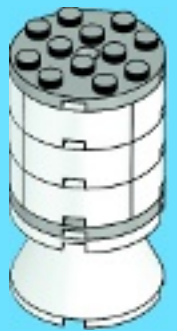

2x



1x

7



1x

8

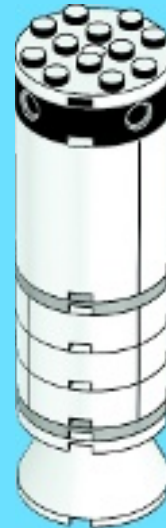

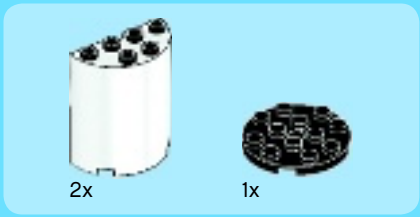

9

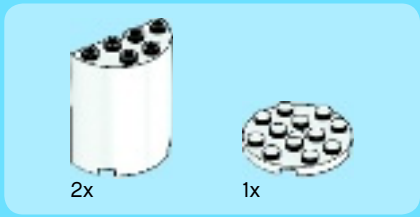

10



2x



1x

11

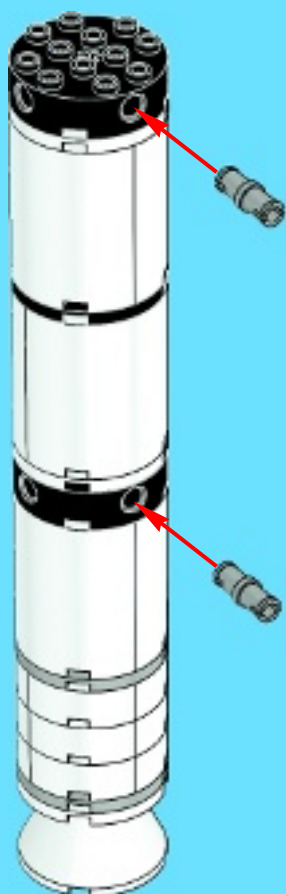

2x



1x

12



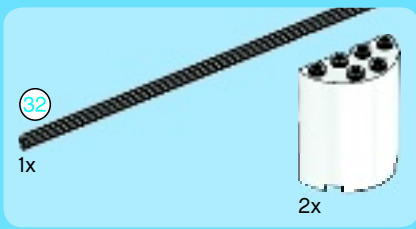

13

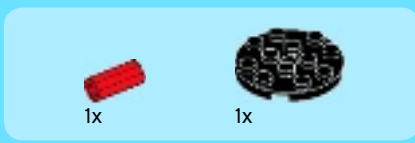

14





12x

15

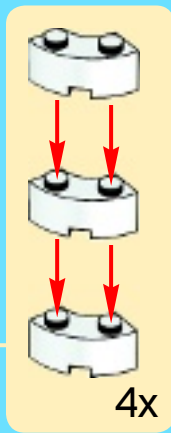

4x



1x

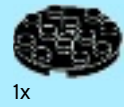

1x

16



6



6

1:1

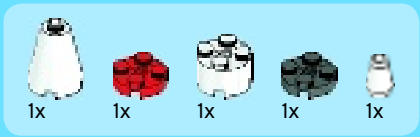

17

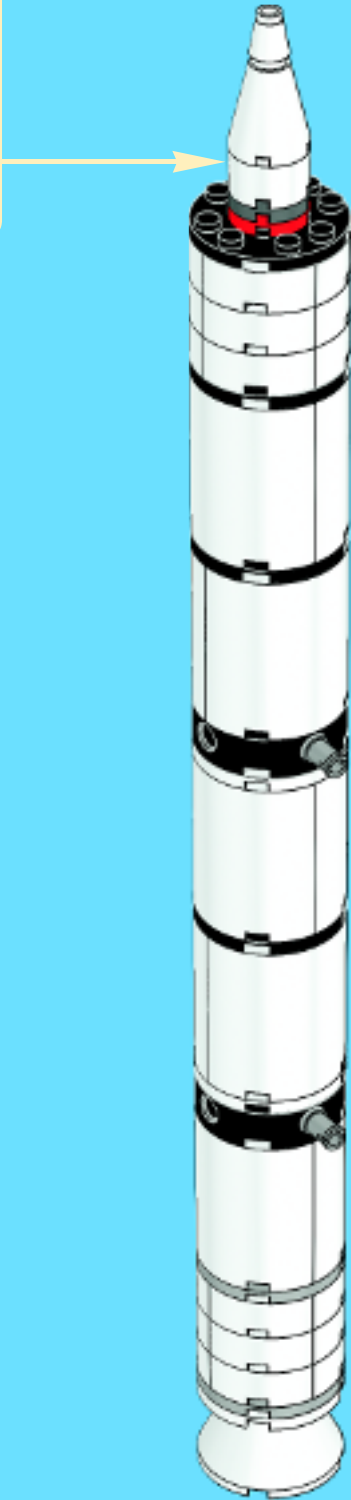
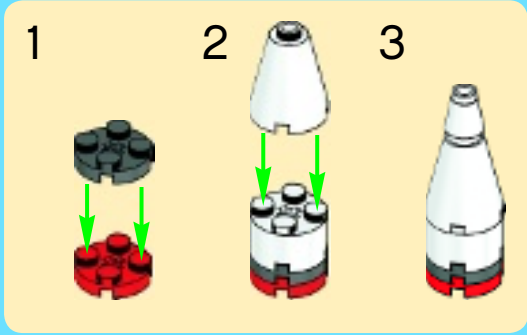



1x

18



2x

38

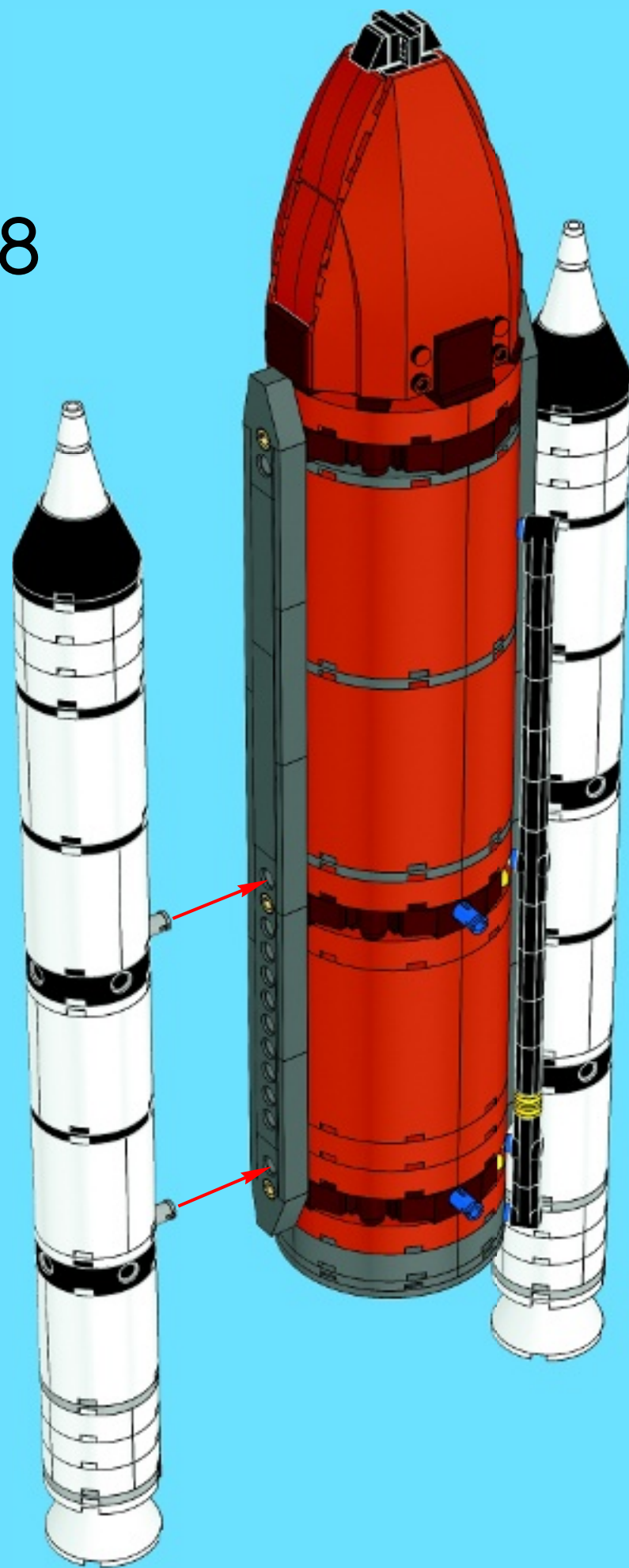

39

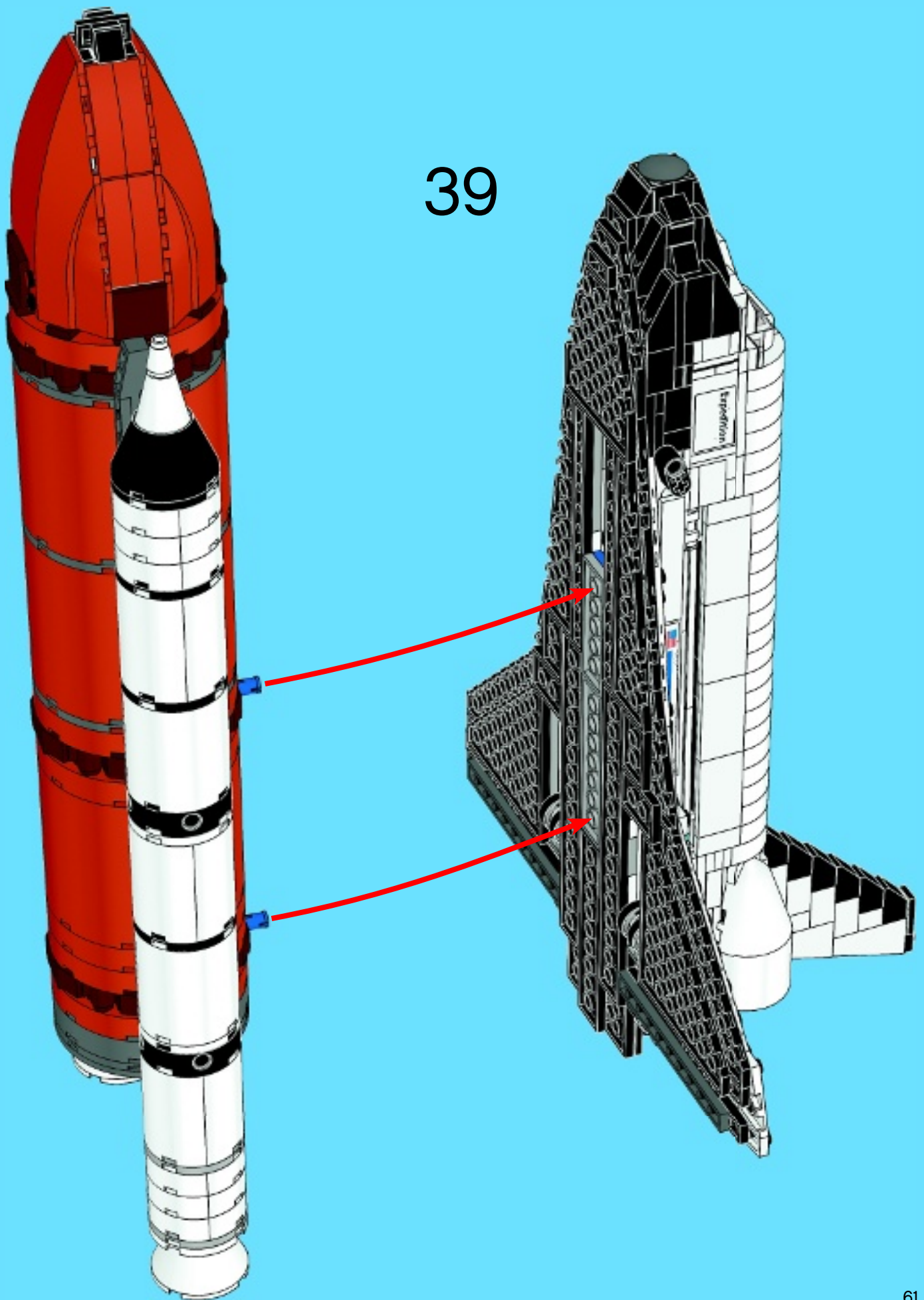

40

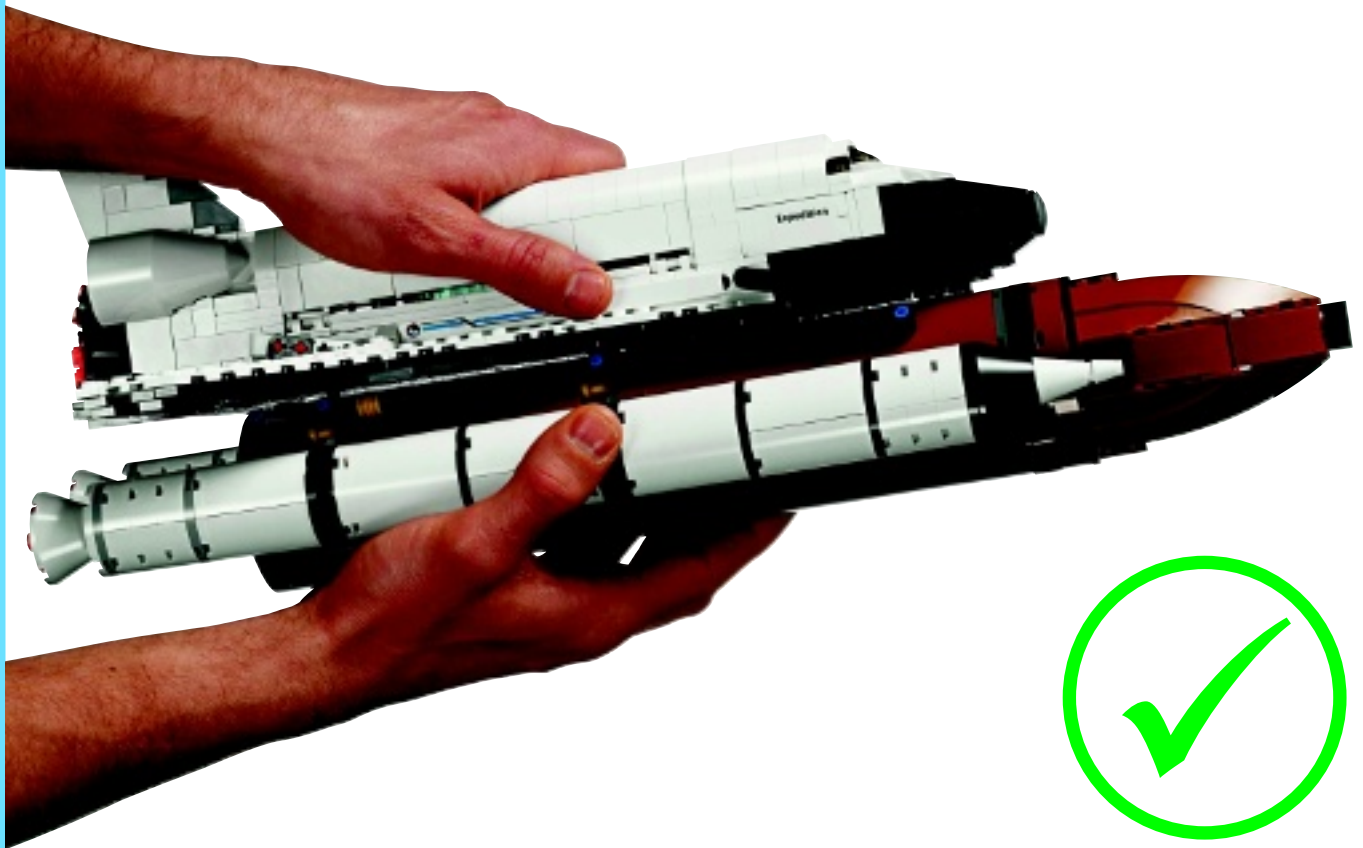

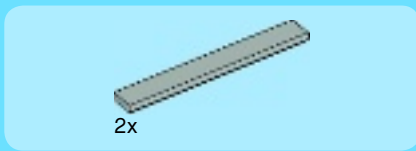
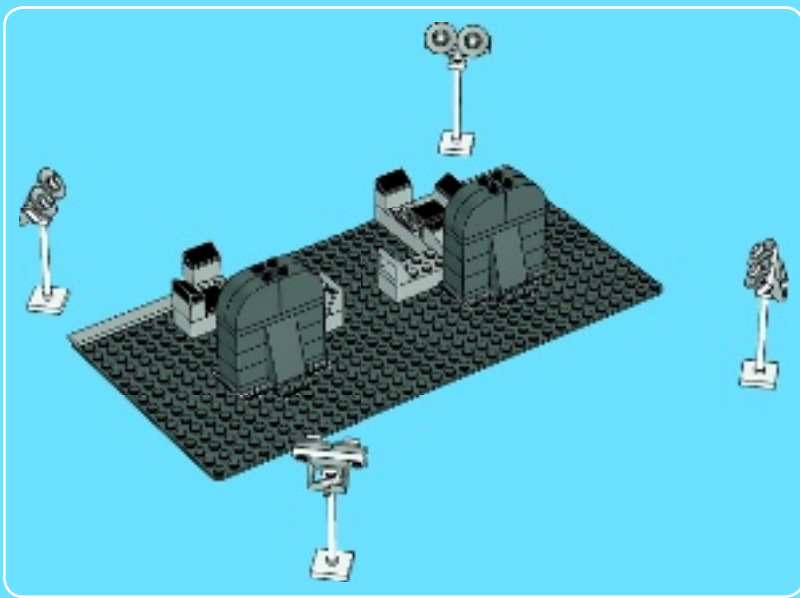

1

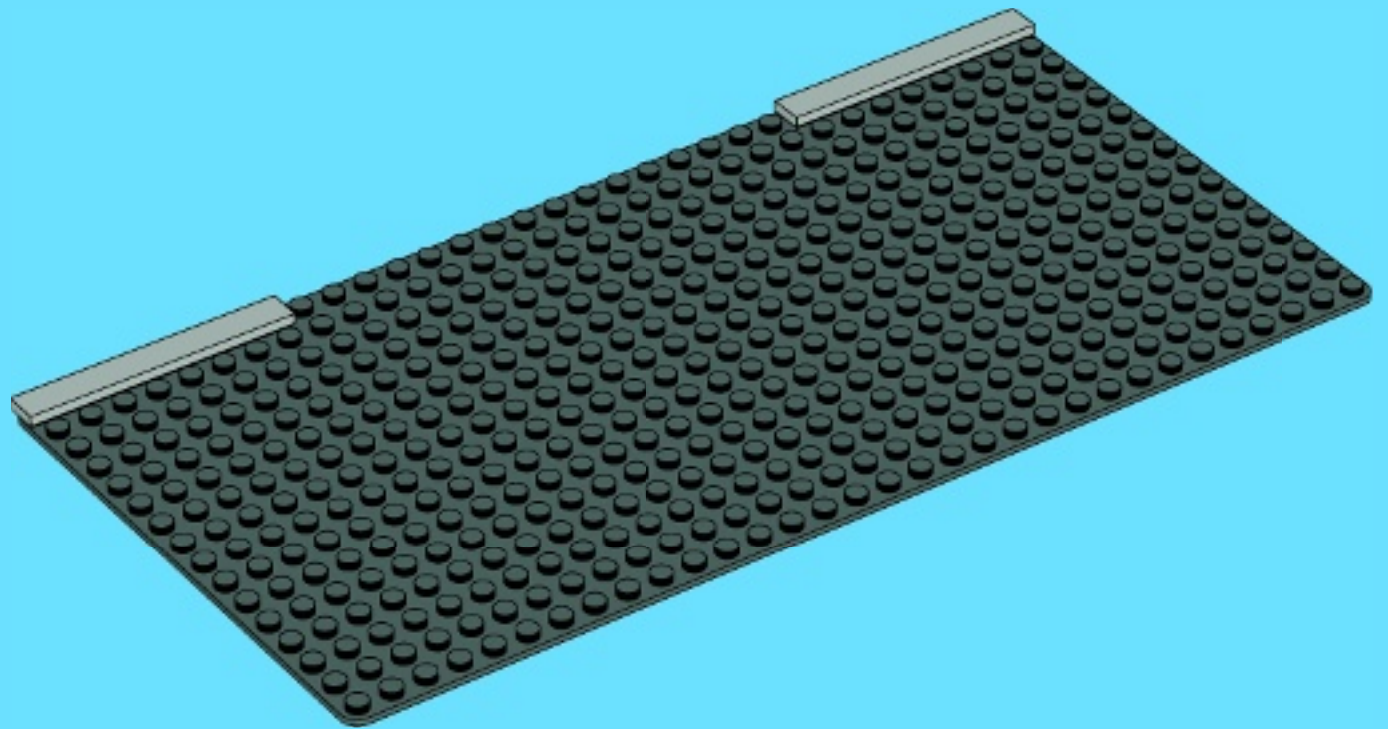



2x

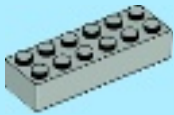

4x

2

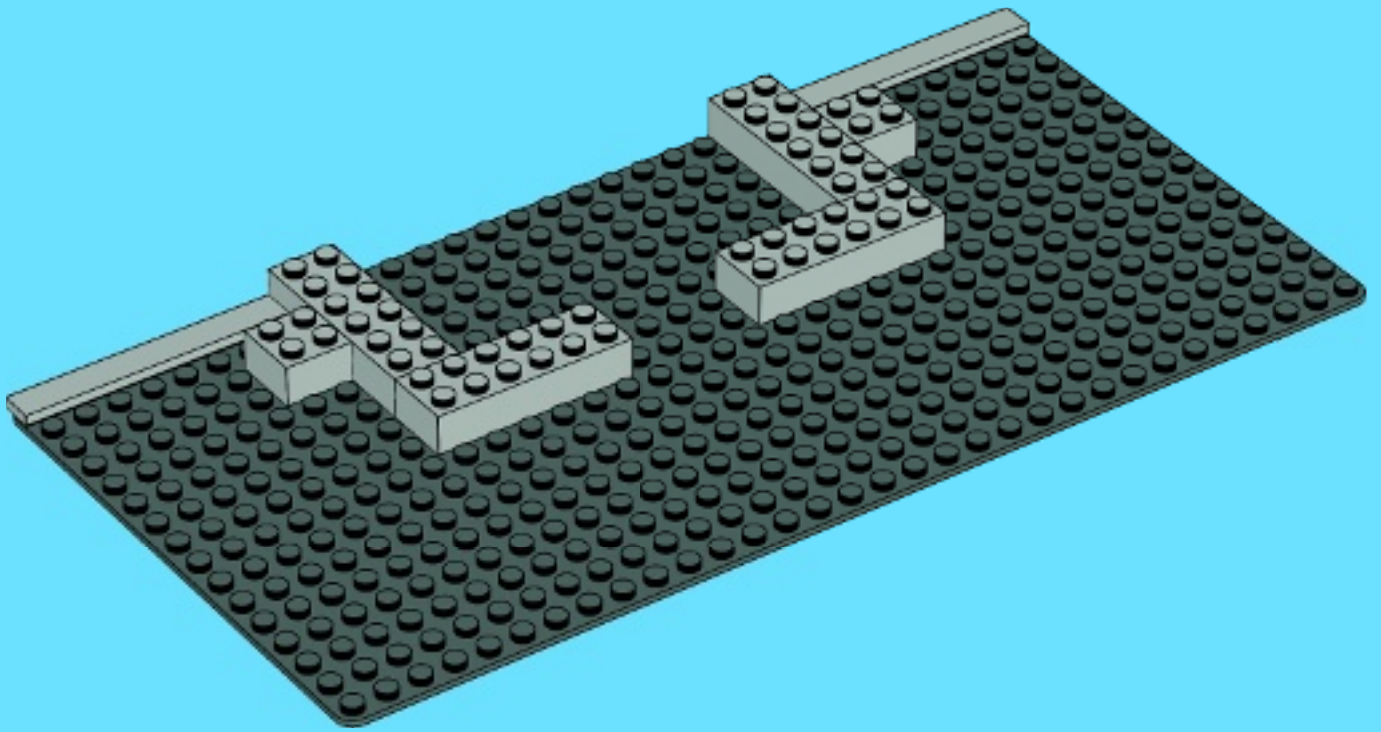



2x



2x



4x

3

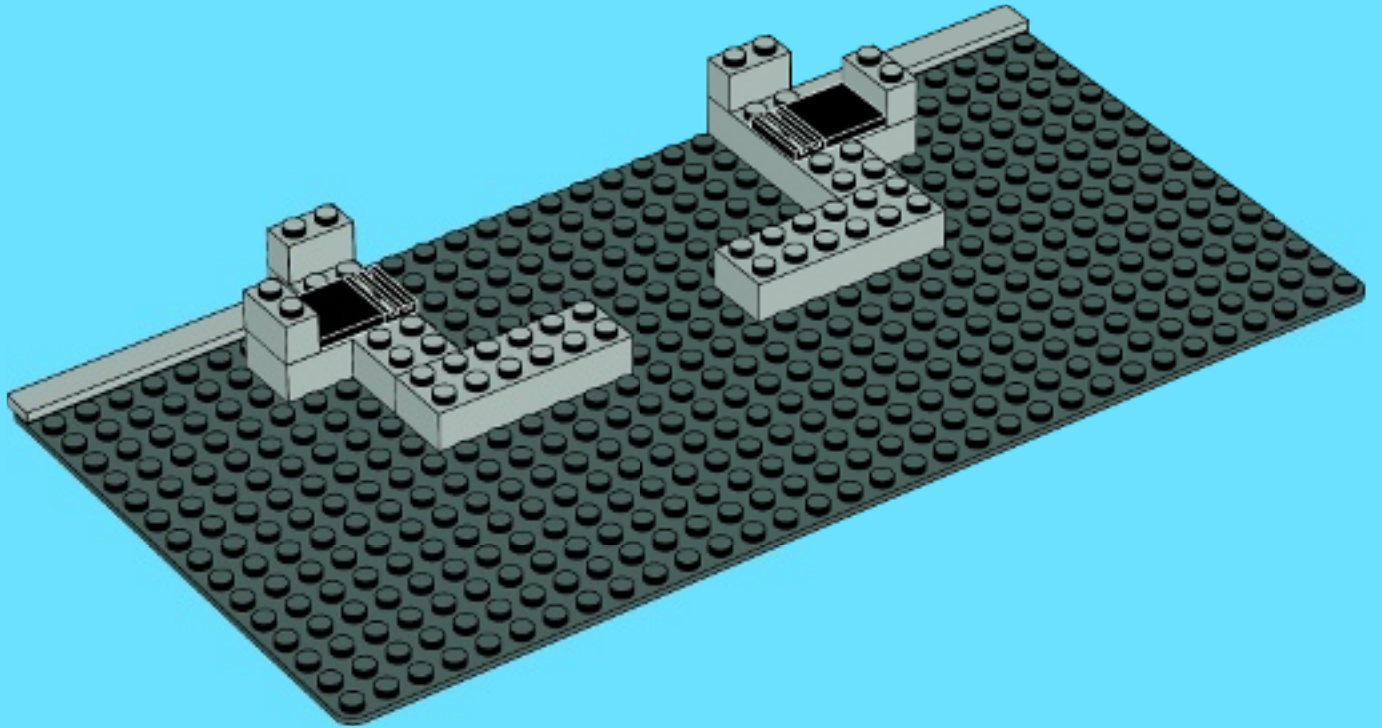



4x



16x



2x



2x

4

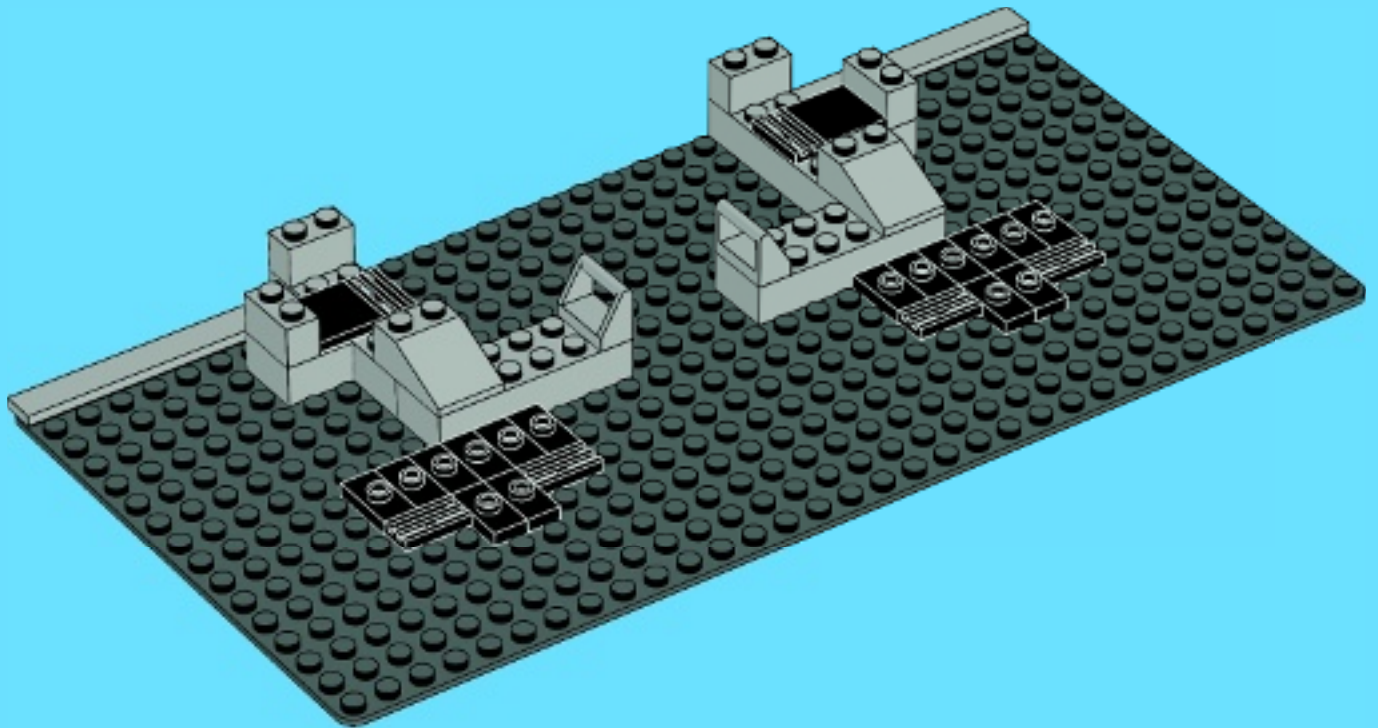



6x

5

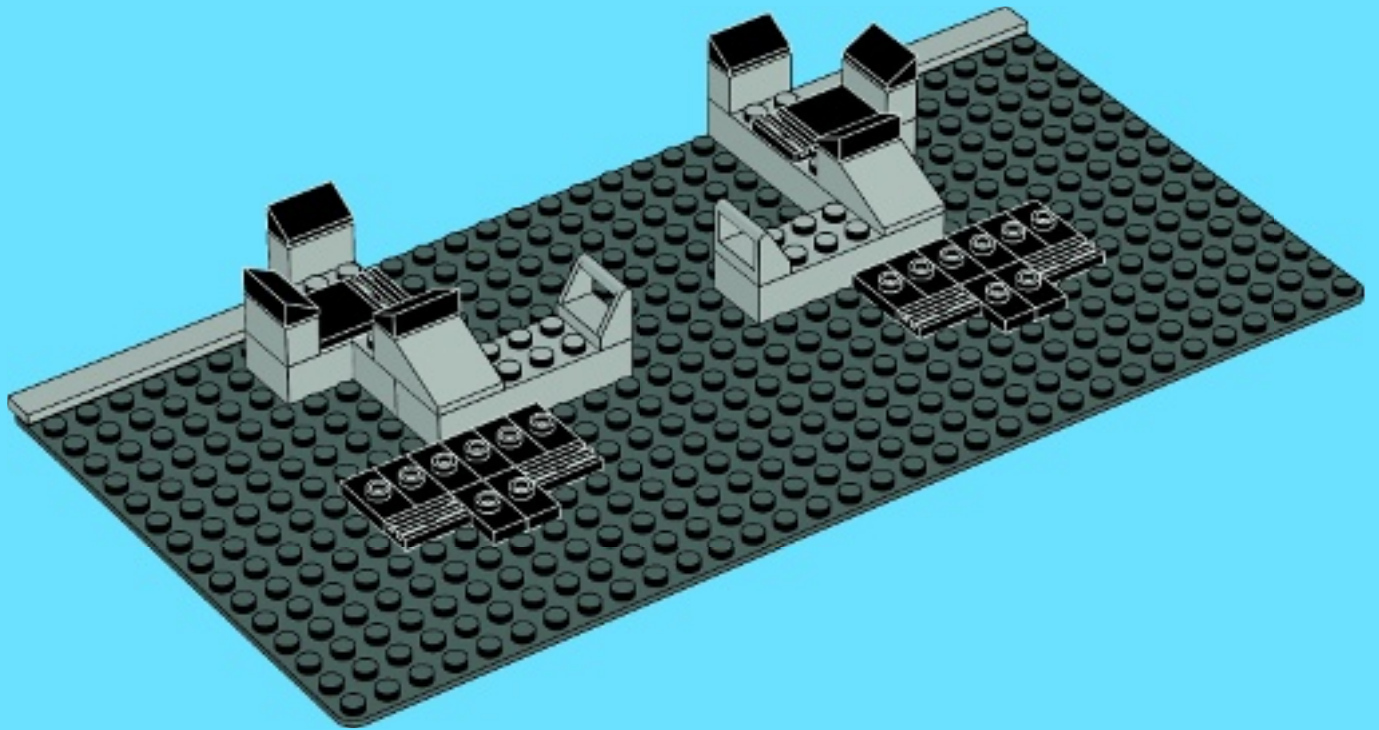

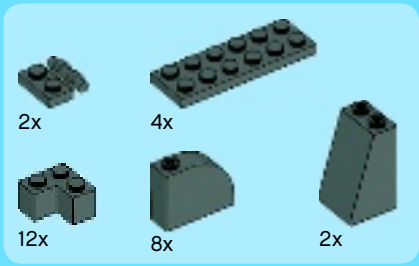

6

1



2



3

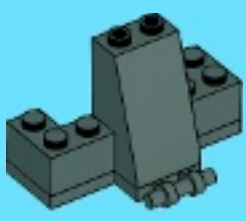

4

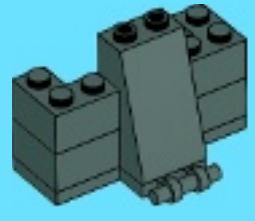

5



6

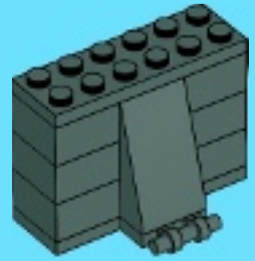

7



2x

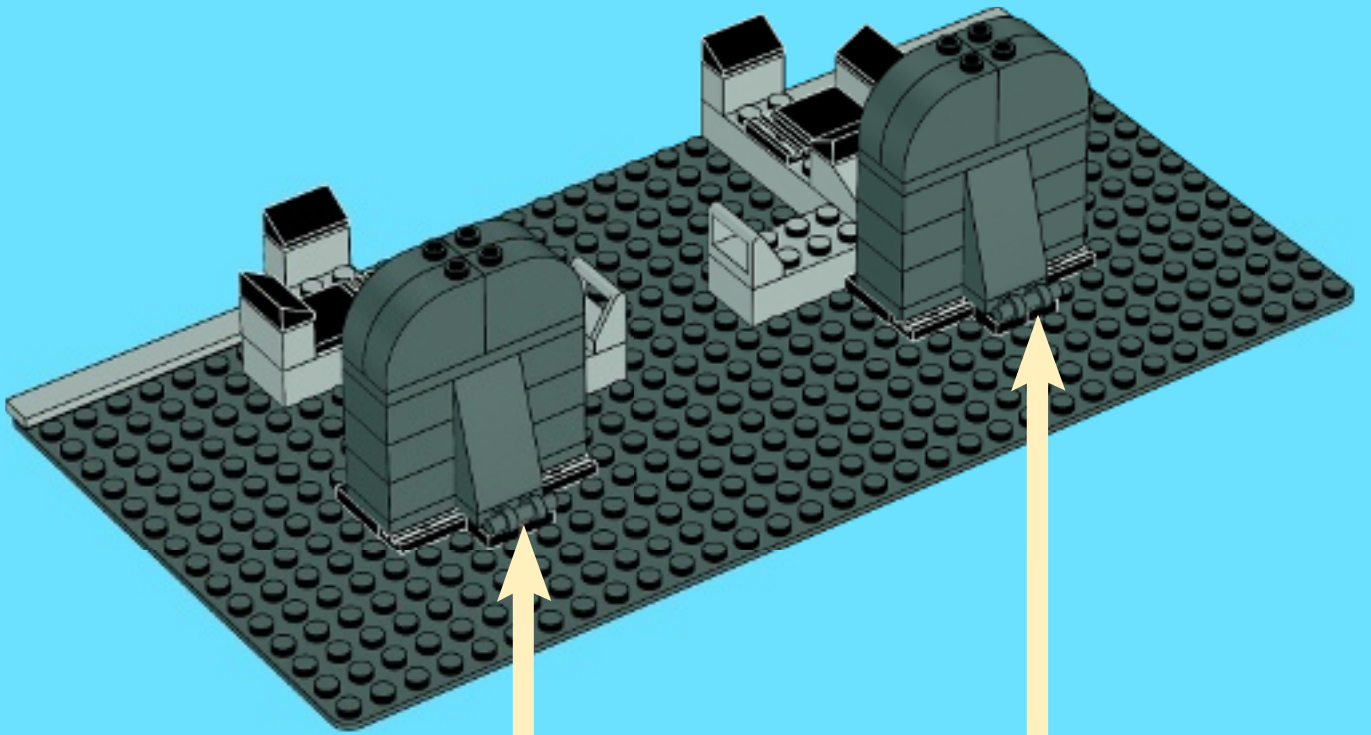

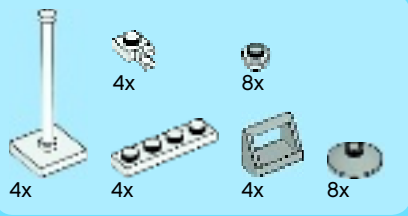

7

1

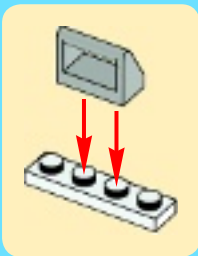

2



3

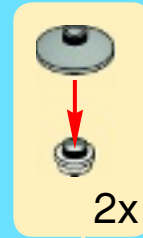

2x

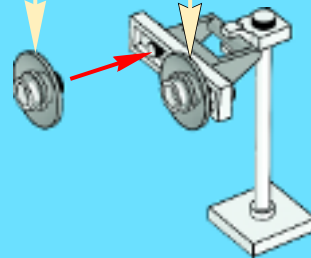

4



4x

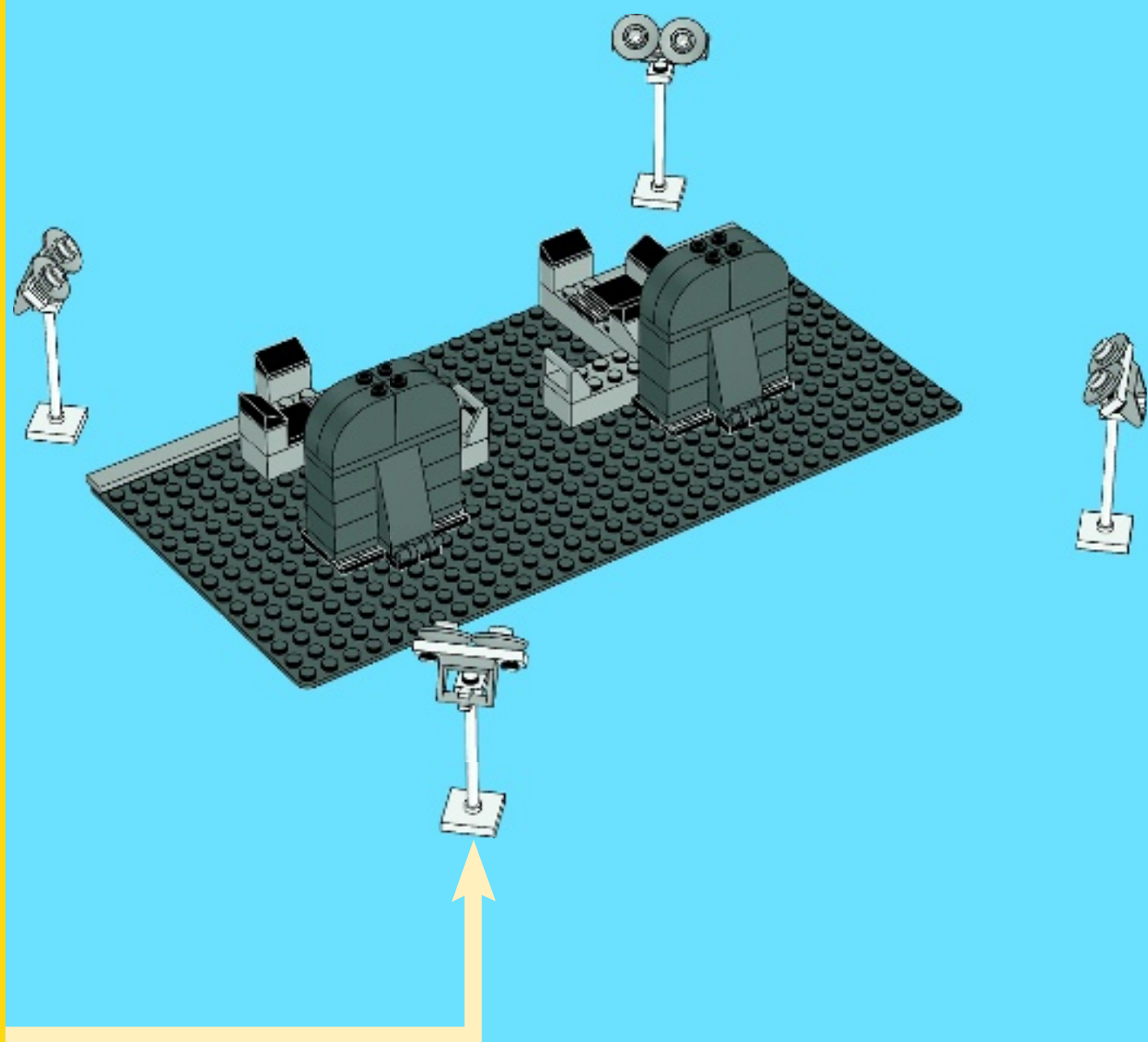

41

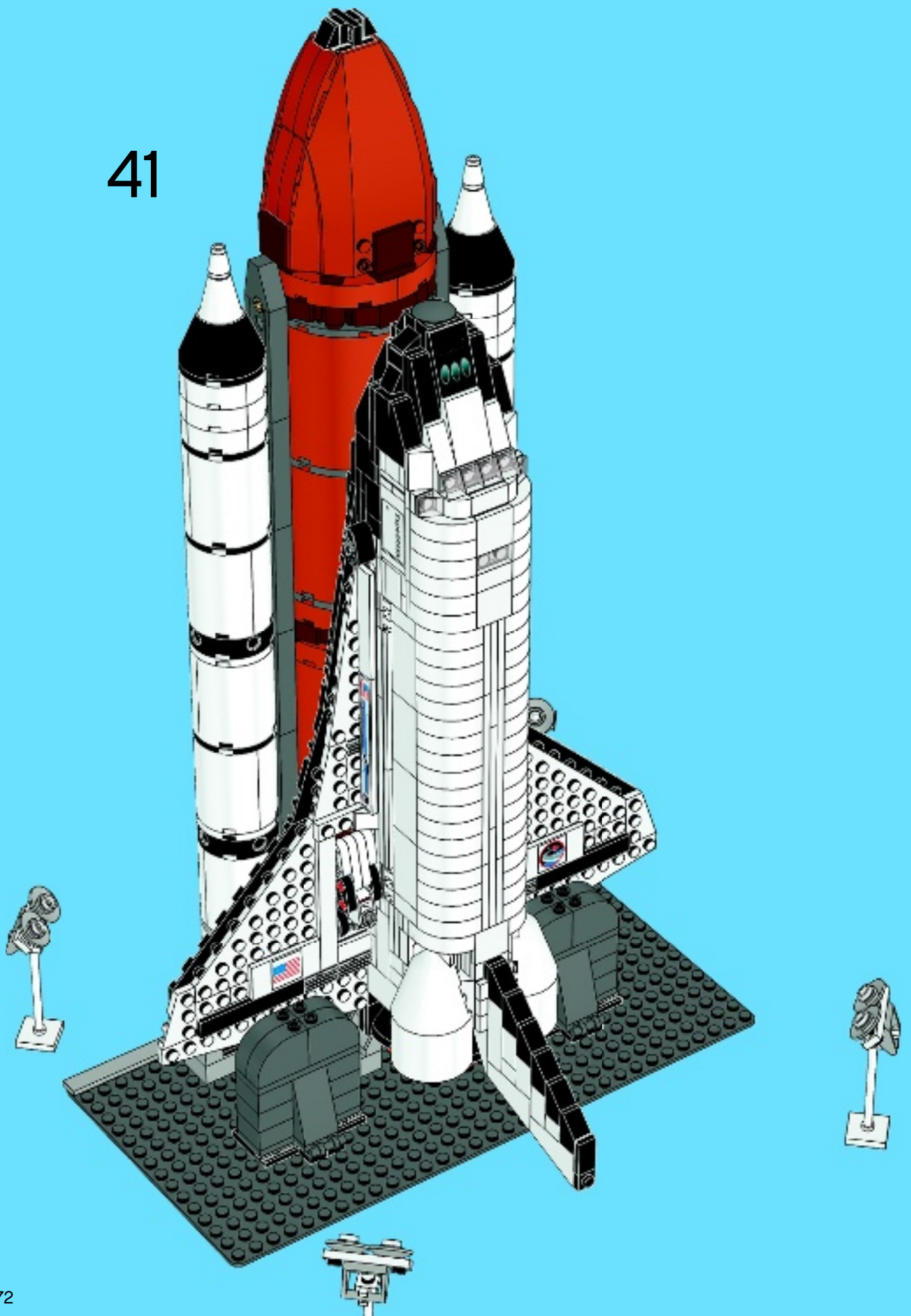

42

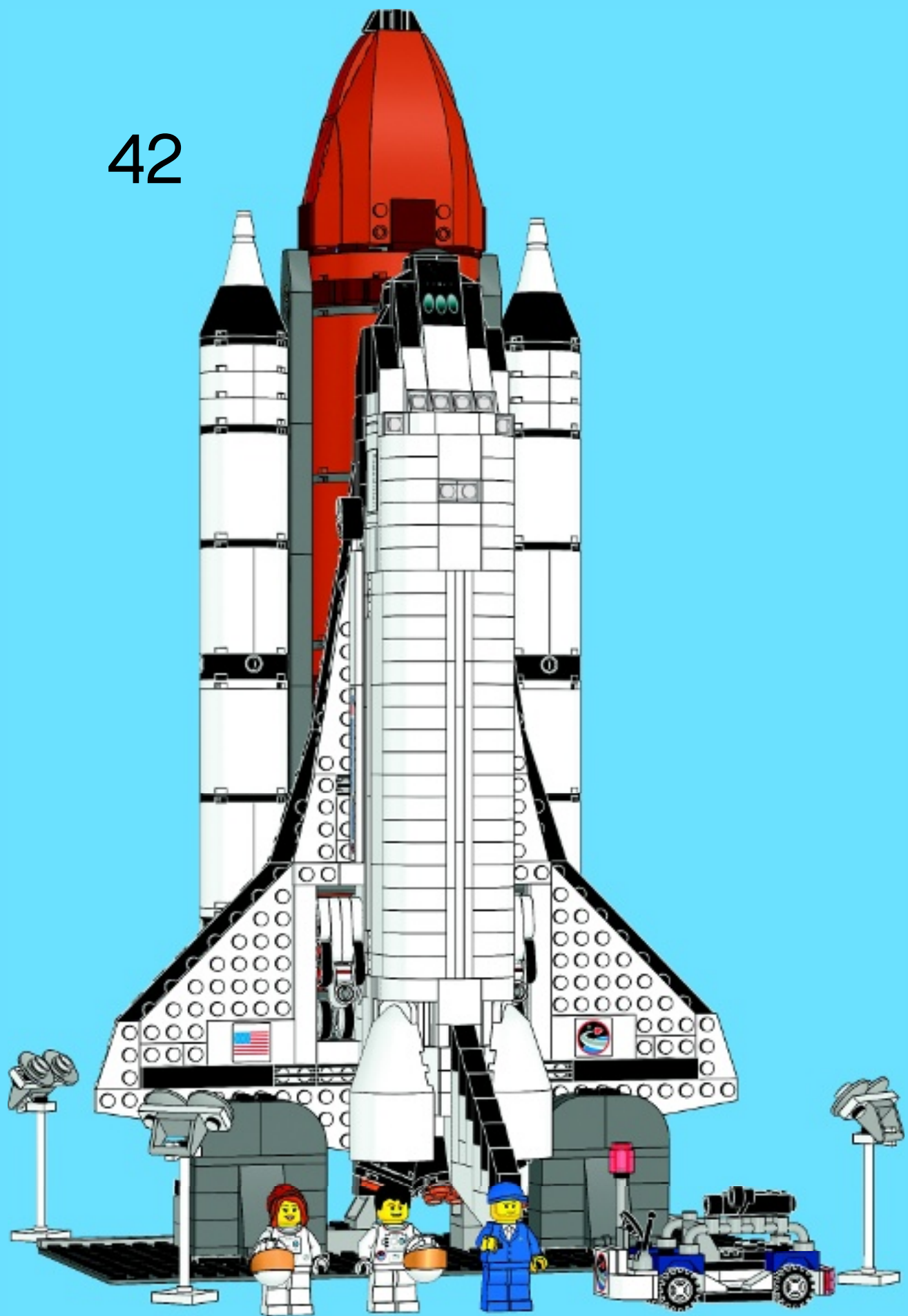

6x 300501
 5x 300401
 3x 301001
 2x 4518400
 48x 4567449
 3x 614301
 2x 394201
 1x 4194010
 2x 4288051
 3x 3200001
 5x 389401
 2x 273001
 6x 4504369
 4x 4547489
 2x 366501
 2x 4532972
 1x 428701
 2x 428601
 2x 4258358

1x 4143000
 6x 609101
 50x 4629913
 2x 4518992
 2x 307001
 12x 302401
 20x 302301
 13x 306901
 4x 306801
 13x 242001
 11x 302201
 4x 362301
 9x 302101
 16x 371001
 10x 4560178
 9x 366601
 6x 663601
 8x 379501
 6x 416201
 6x 447701

2x 4119227
 12x 4538353
 7x 379401
 8x 4598527
 2x 4615649
 2x 4556152
 4x 4222017
 2x 244401
 3x 4282737
 1x 4179874
 1x 4179875
 1x 4161326
 1x 4160857
 3x 474001
 2x 4208987
 2x 4209005

7x 4515347
 2x 4585737
 4x 4585448
 20x 4163987
 4x 4117032
 2x 9327
 2x 4654341
 2x 4298609
 10x 462401
 2x 4581453
 2x 4173670
 4x 4163533
 10x 4107826
 1x 4118981
 2x 4526981
 1x 4654049
 6x 4514554

6x 4277933
 4x 4515365
 2x 403221
 8x 4227155
 21x 4142865
 4x 4513174
 4x 4583862
 4x 370923
 1x 9341
 1x 4287488
 1x 4567909
 6x 4186834
 12x 4143005
 9x 4206482
 2x 4514553
 2x 4262786
 4x 4256320
 1x 4261572
 1x 4506727
 1x 4651443
 4x 4112289
 4x 4239601

2x 300526
 2x 300426
 3x 4113241
 2x 300226
 10x 407026
 1x 4162235
 2x 394226
 3x 4500978
 4x 4290056
 2x 4550922
 8x 4504382
 6x 4121966
 7x 4548180
 6x 428726
 2x 428626
 2x 4515362
 1x 4185583
 2x 302426
 2x 306926

24x 302326
 5x 306826
 4x 302226
 2x 362326
 10x 302126
 7x 366626
 4x 663626
 7x 379526
 1x 303226
 1x 395826
 2x 383226
 2x 4514845
 2x 428226
 2x 4632571
 4x 4515340
 17x 379426
 18x 241226
 1x 244126

1x 4161332
 1x 4160869
 1x 4283047
 2x 4209003
 1x 4283046
 2x 4209013
 8x 4515350
 2x 4550190
 4x 4205347
 2x 4106347
 2x 486526
 2x 4233937

1x 4538722
 1x 436026
 4x 4578677
 6x 4516843
 1x 4159335
 1x 4213374
 2x 4155558
 3x 4515185
 3x 4610371
 2x 4107783
 2x 4107085
 9x 4121715
 9x 4512363
 2x 370626
 1x 370726
 1x 373726
 2x 4142622



24x
4654110



8x
4582992



2x
4582987



2x
4582984

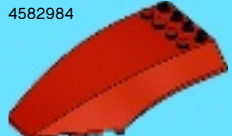

2x
4654114



12x
4654111



1x
4614107



2x
4654119



8x
3005740



3x
3006841



2x
4244363



2x
4508534



4x
4144387



7x
4260426



22x
3005747



6x
4244368



1x
4529685



7x
4211210



24x
4225469



10x
4211183



16x
4211252



24x
4504376



24x
4221744



4x
4211288



4x
4211151



4x
4271949



3x
4610666



6x
4211388



4x
4211387



10x
4211385



4x
4211795



2x
4211421



3x
4211435



2x
4212363



1x
4654046



3x
4211395



2x
4211481



8x
4211425



1x
4211408



2x
4211840



2x
4211542



1x
4211449



2x
4211525



1x
4221881



8x
4211512



4x
4515351



7x
4211357



2x
4211524



1x
4221775



1x
4211473



3x
4519013



1x
4226995



1x
4520320



4x
4211807



7x
4211815



2x
4211639



16x
4211109



2x
4211100



2x
4211099



1x
4225975



4x
4535931



4x
4273814



2x
4210963



2x
4210696



8x
4654039



1x
4493478



10x
4210651



3x
4243831



4x
4211002



8x
4257526



3x
4543086



3x
4210660

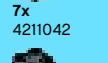

7x
4211042



1x
4278274

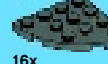

1x
4210865



16x
4222042

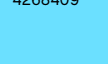

1x
4268409

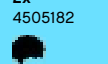

2x
4505182



1x
4535553

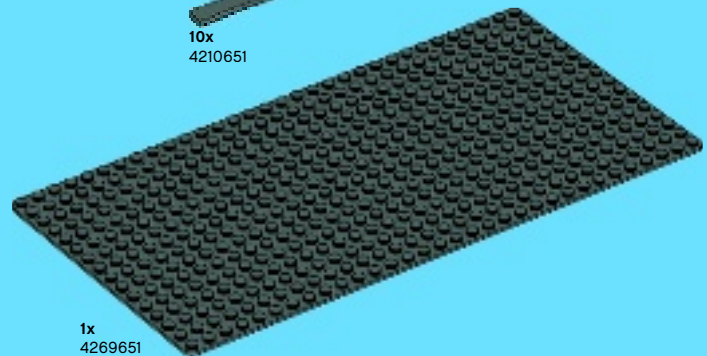

1x
4269651



Customer Service
Kundenservice
Service Consommateurs
Servicio Al Consumidor
www.lego.com/service or dial

00800 5346 5555 :     

1-800-422-5346 :  



10211

10197

10135



10220



LEGO club™

FREE! GRATIS! GRATUIT!



www.LEGOclub.com



LEGO® Club Magazine



LEGO® Club Email

SIGN UP ONLINE!

www.LEGOclub.com

VISIT THE WORLD'S
BIGGEST LEGO® SHOP!

www.LEGOshop.com



GO TO

www.LEGOclub.com

00800 5346 5555*



1-866-534-6258 • 1-877-518-5346

US & Canada only

Canada seulement



* Freephone. Mobile charges may apply. * Numéro sans frais. Des frais peuvent s'appliquer avec les téléphones cellulaires. * Gebührenfrei, Kosten für Anrufe aus Mobilfunknetzen können abweichen. * Gratis telefoonnummer vanaf vaste lijn. * Det er et gratis nummer, når du ringer fra fasttelefon. * Det är gratis, när du ringer från en fast telefon. * Numéro sans frais. Des frais peuvent s'appliquer avec les téléphones portables.



WIN!

Go to www.LEGOsurvey.com/product to fill out a survey for a chance to win a cool LEGO® Product. No purchase necessary. Open to all residents where not prohibited.

 www.LEGO.com



www.LEGOsurvey.com/product

GEWINNE!

Nimm an der Umfrage auf www.LEGOsurvey.com/product teil und hab die Chance ein cooles LEGO® Produkt zu gewinnen!

Die Teilnahme am Gewinnspiel führt zu keinerlei Kaufverpflichtungen. Teilnahme in allen nicht ausgeschlossenen Ländern möglich.

WIN!

Ga naar www.LEGOsurvey.com/product, vul een enquêteformulier in en maak kans op een cool LEGO® product.

Geen aankoopverplichting. Iedereen mag deelnemen, uitgezonderd ingezetenden van landen waar een enquêteverbod geldt.

GAGNE!

Visite www.LEGOsurvey.com/product pour répondre à un questionnaire et avoir une chance de gagner un produit LEGO® très cool!

Aucune obligation d'achat. Ouvert à tous les résidents des pays autorisés.

当てよう!

www.LEGOsurvey.com/product にアクセスして、アンケートにご記入ください。当選者にはレゴ®製品を差し上げます。

お買い上げの必要はありません。禁止されていない限り、すべての皆様にご利用いただけます。