



CREATOR

10247



EXPERT



LEGO.com/creator

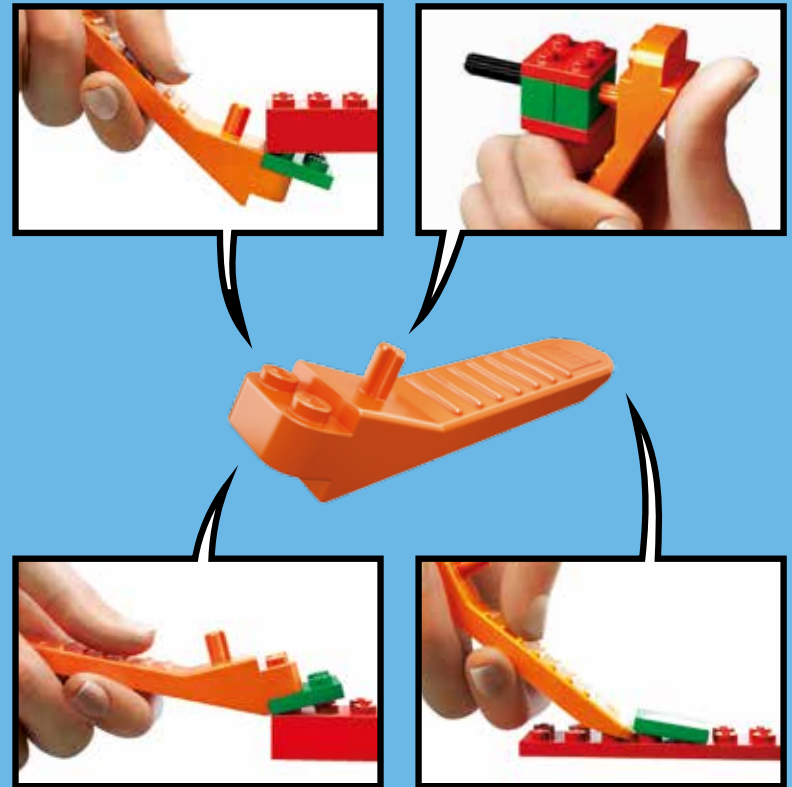

[LEGO.com/brickseparator](https://www.lego.com/brickseparator)

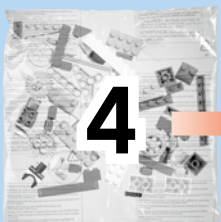
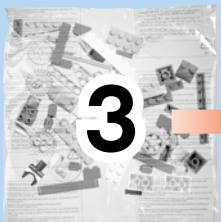
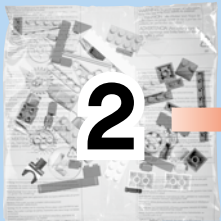
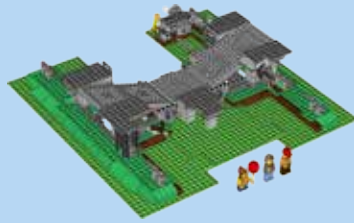

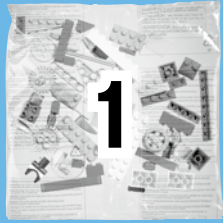

+

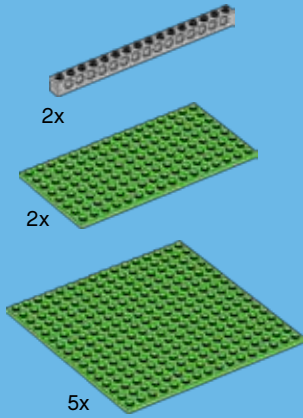

2x

2x

5x

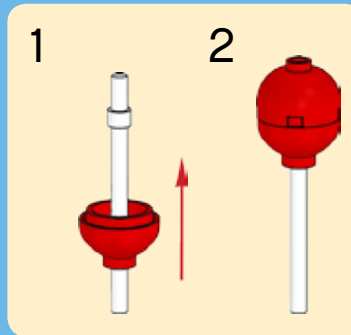
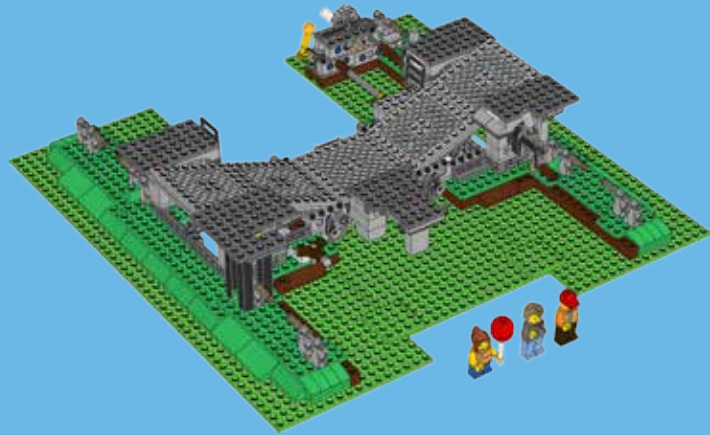



4x

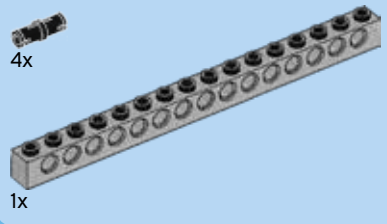

1x

1

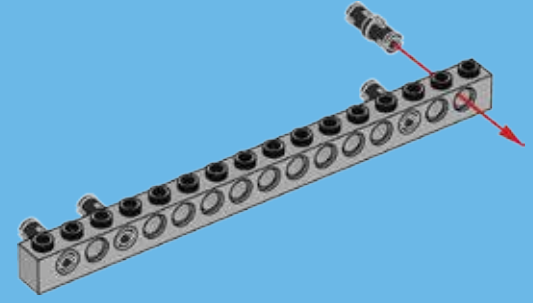

2x

2

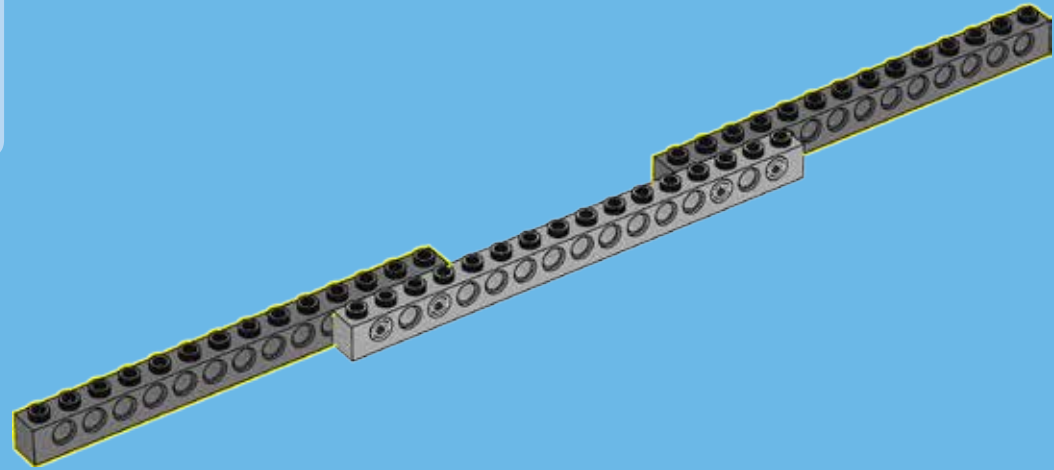

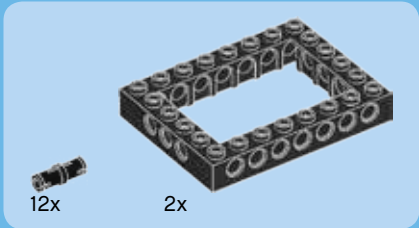

3

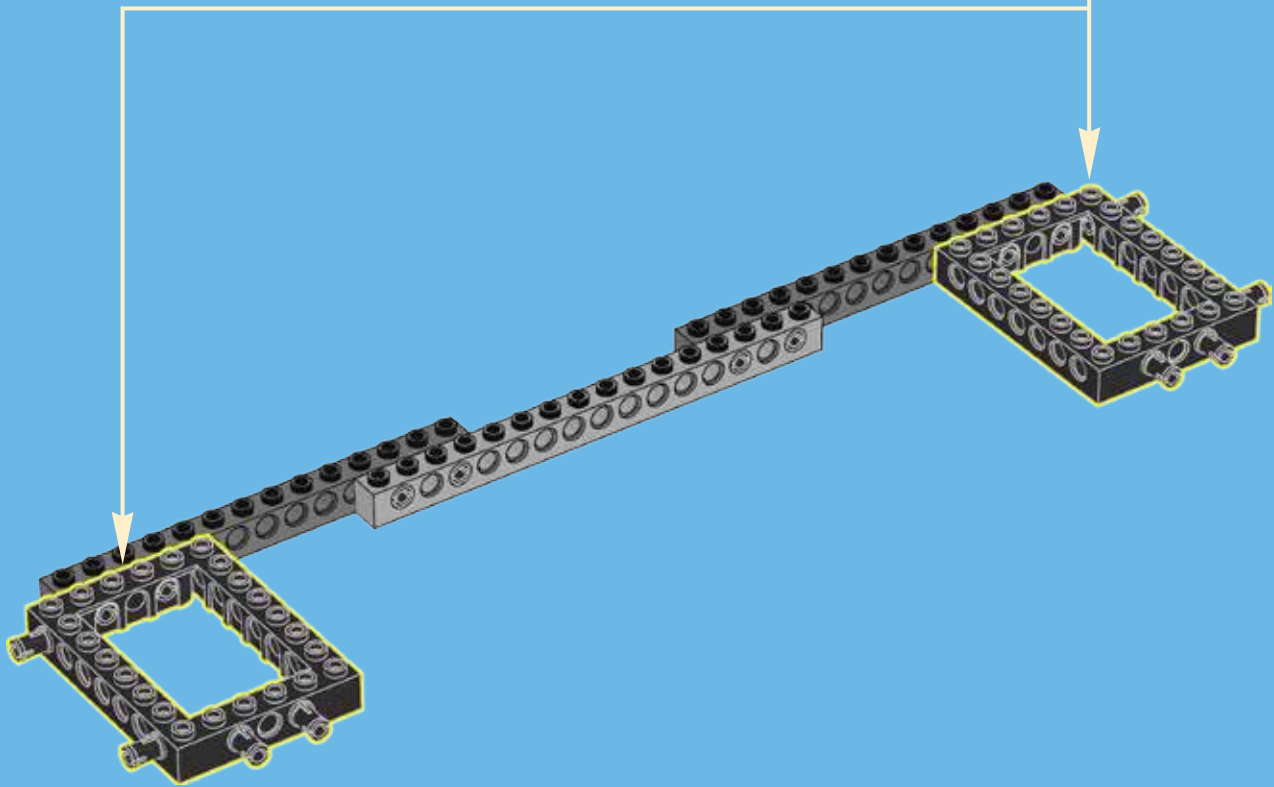
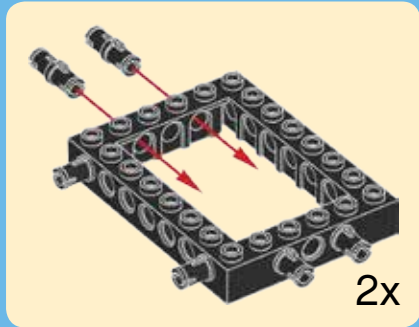



4x



2x

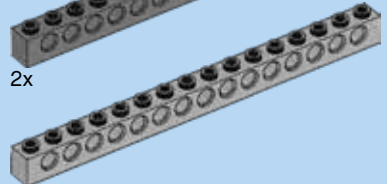

1x

4

1

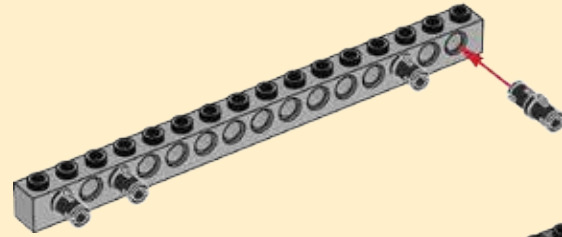

2

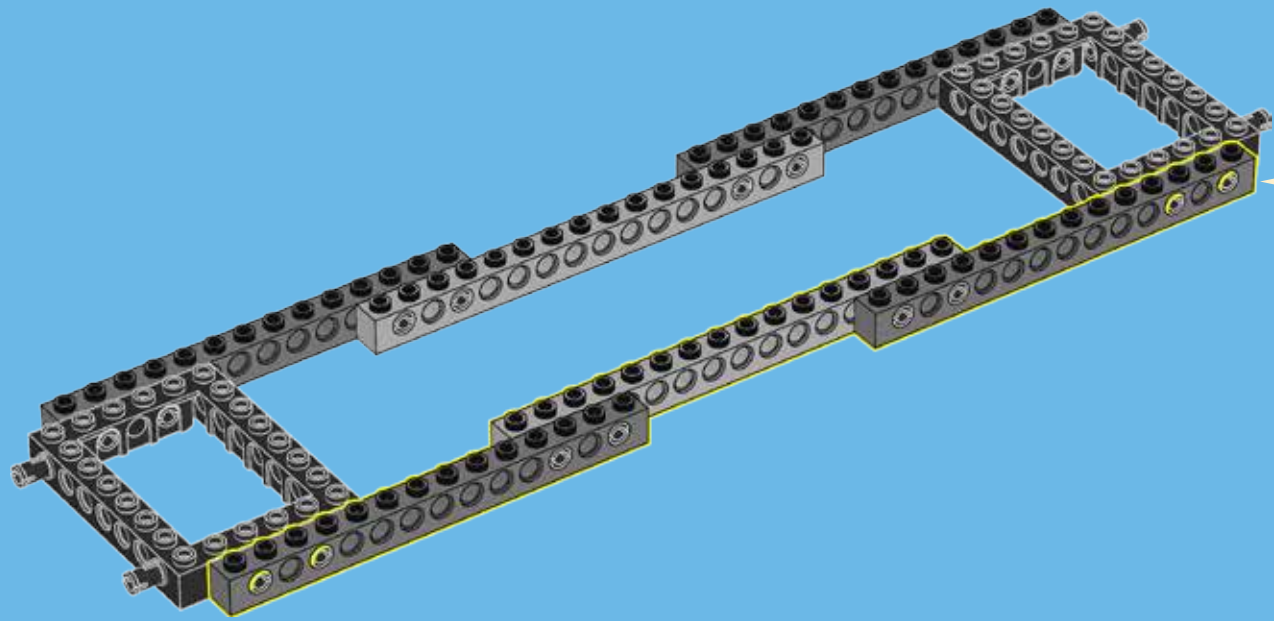
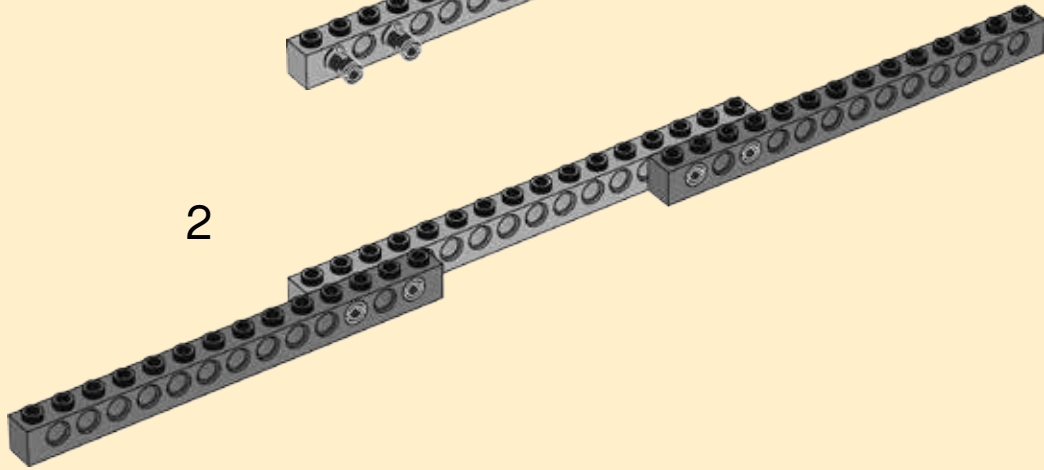

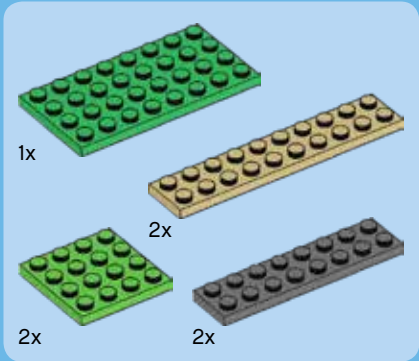

5

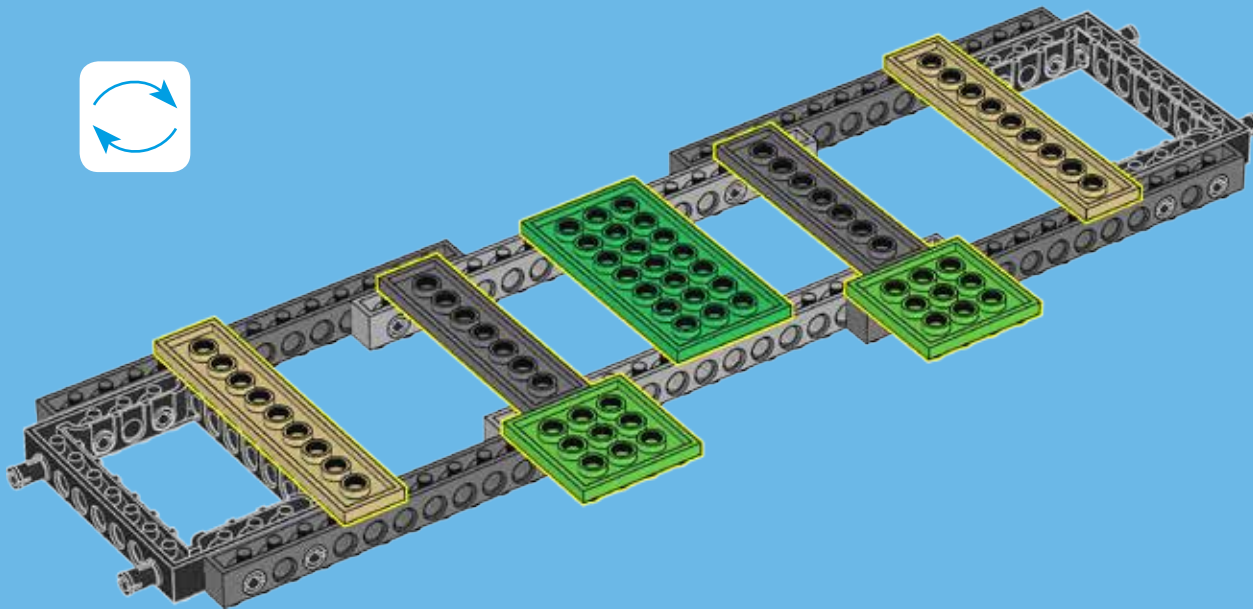

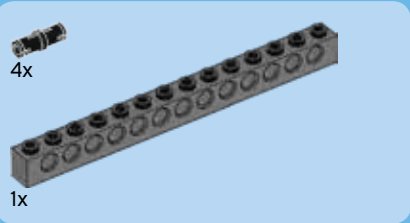
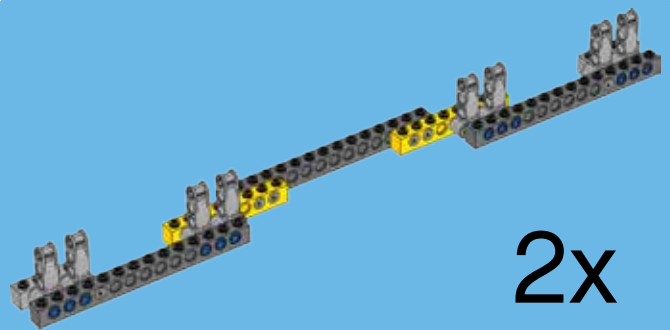

1

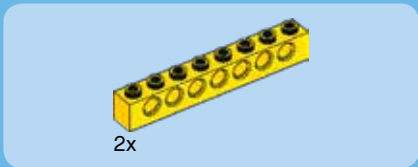
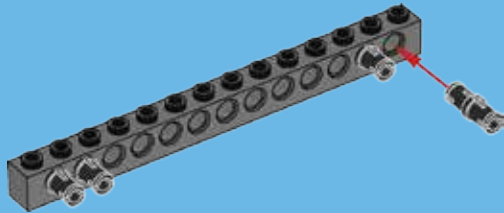

2

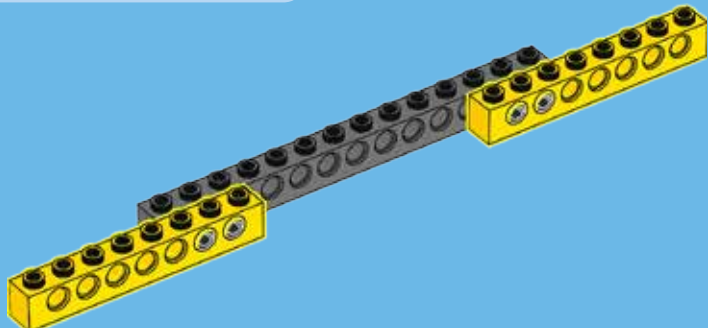

3

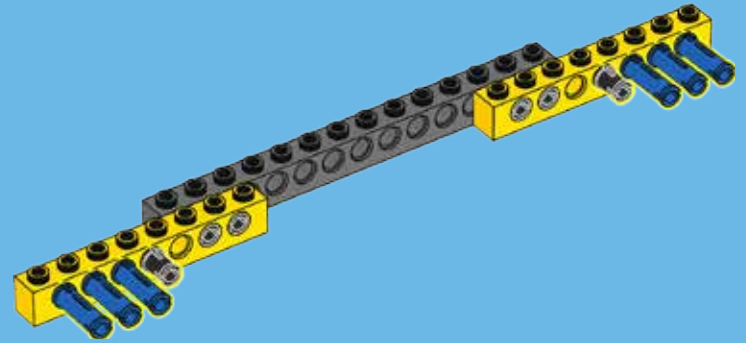

4

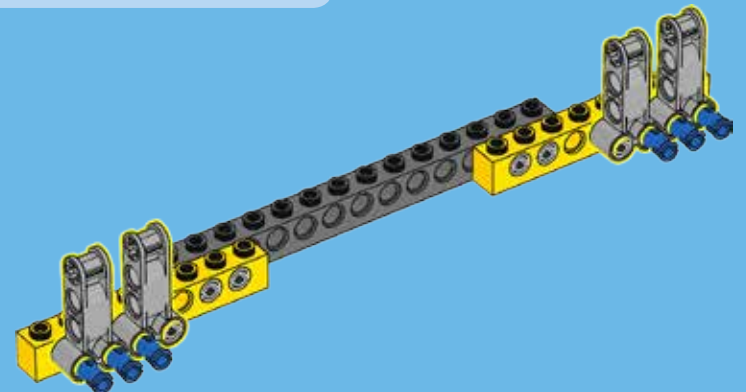

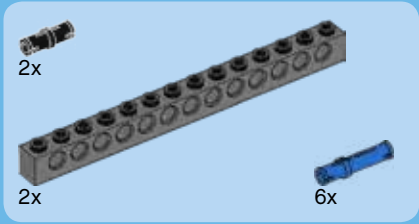

5

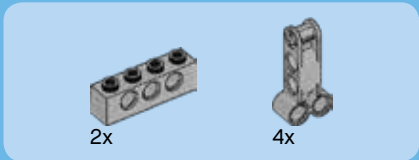
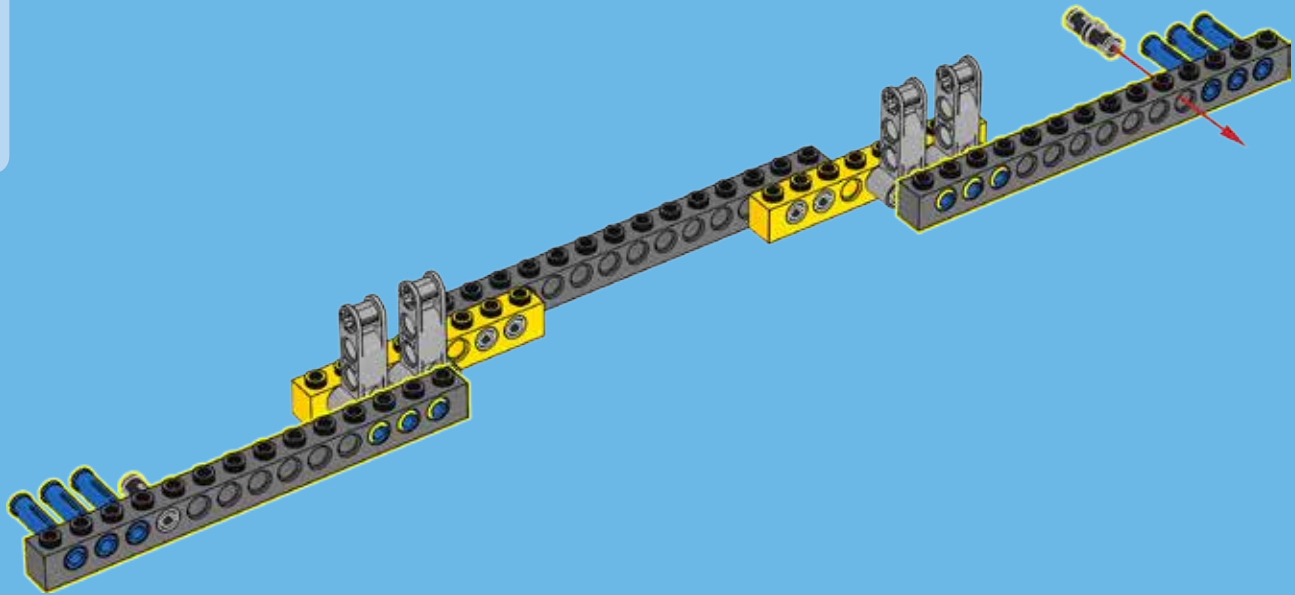

6

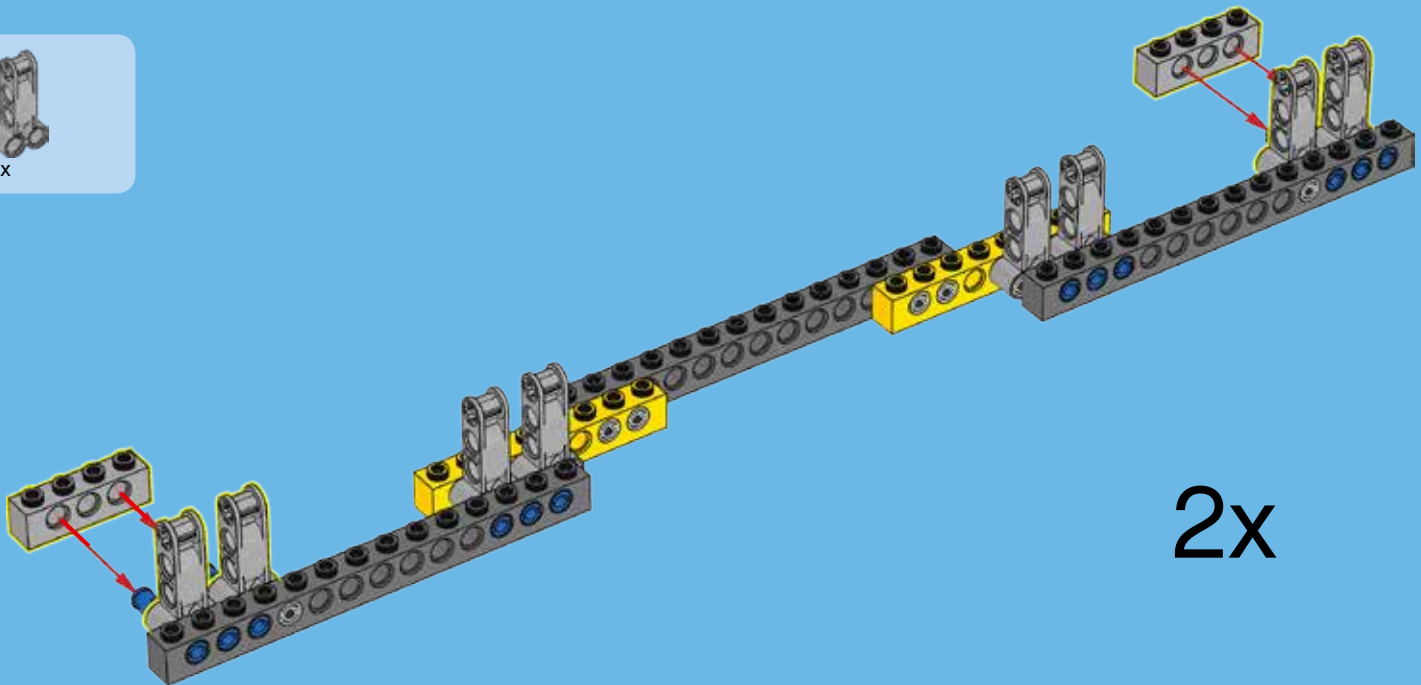

2x

6

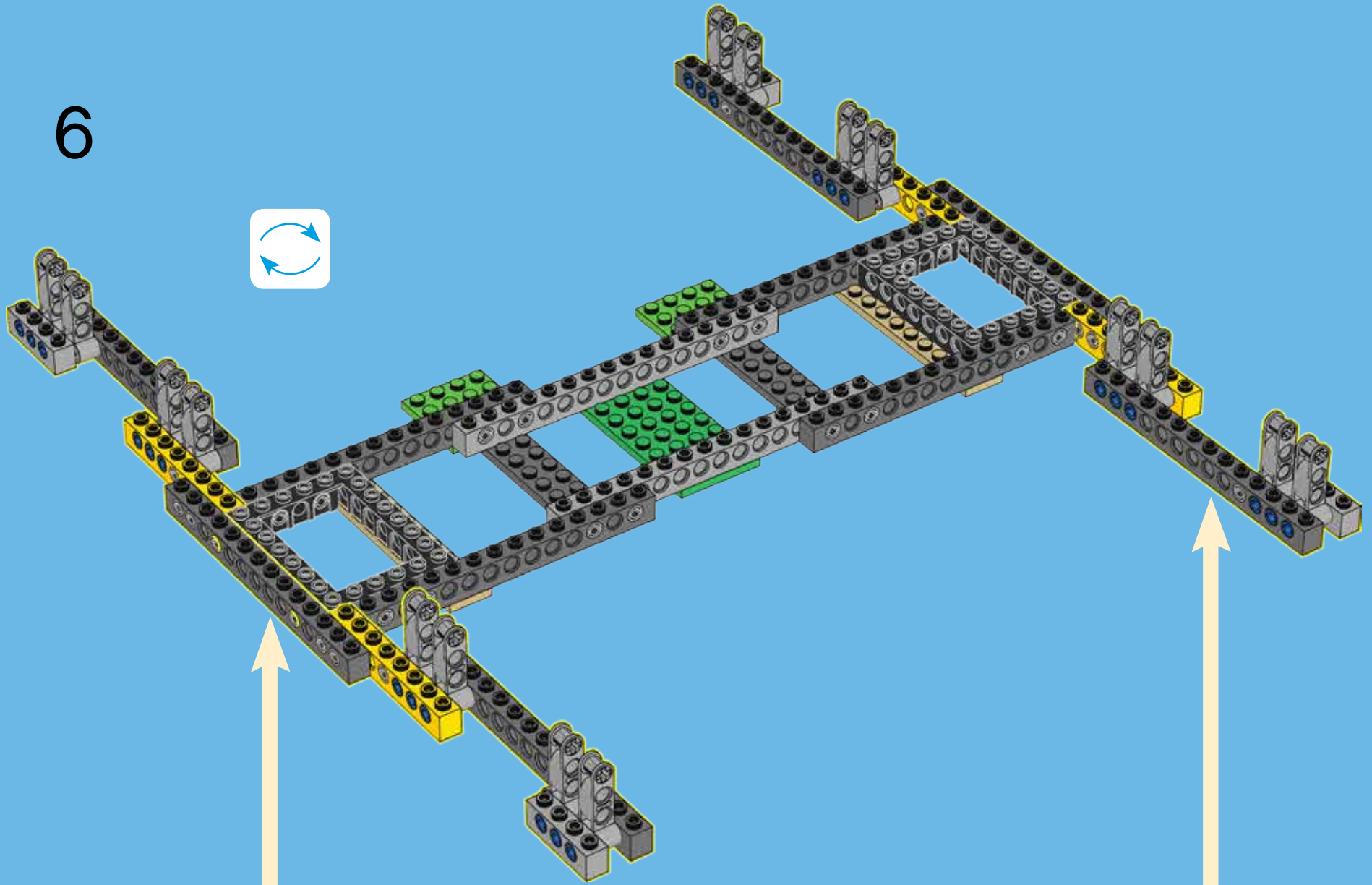

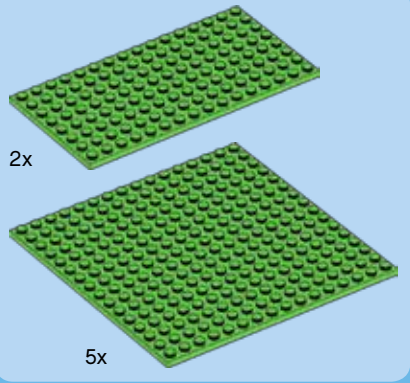

7

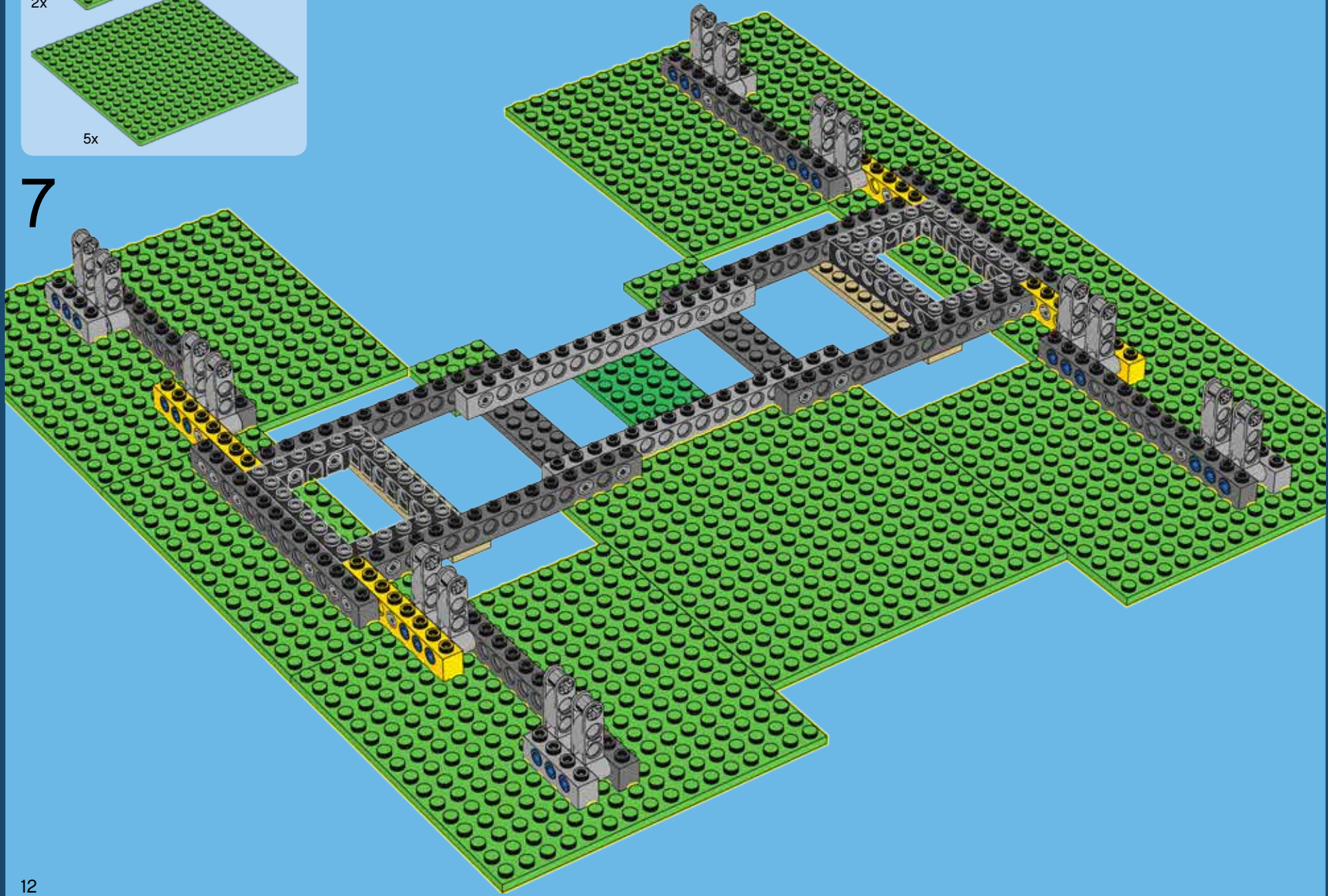

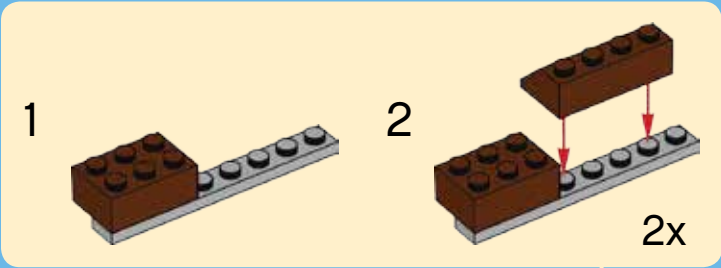
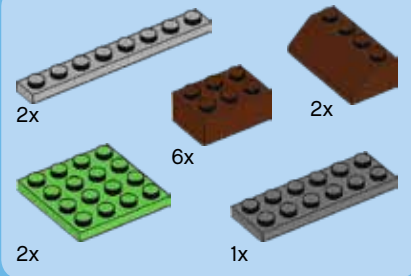

8

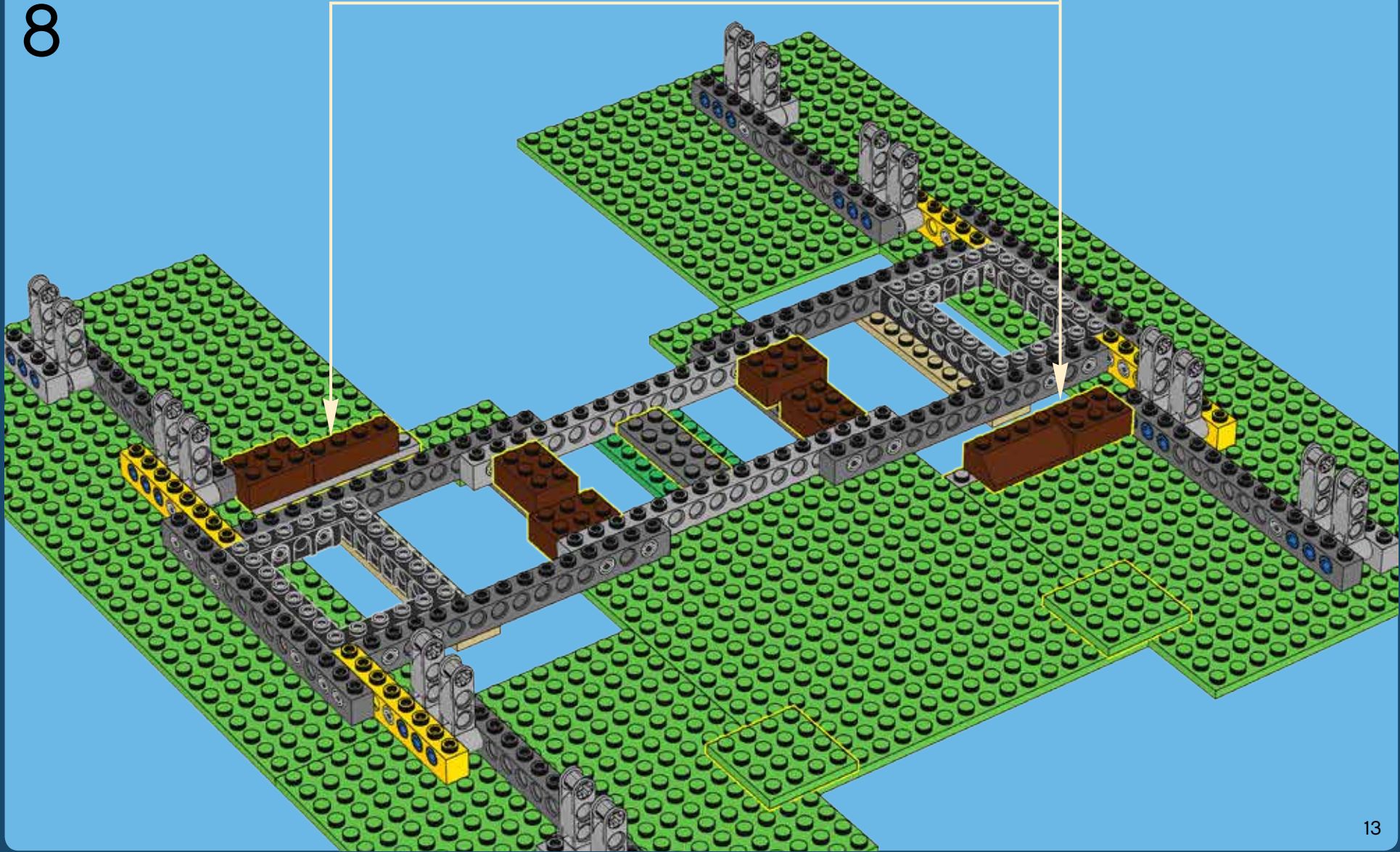

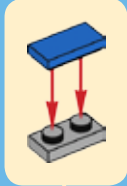
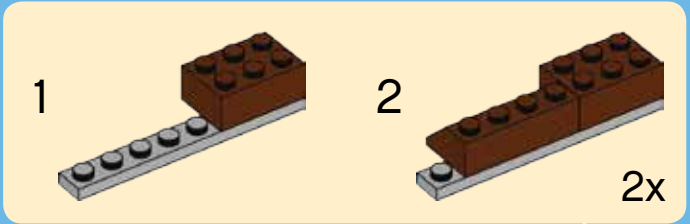
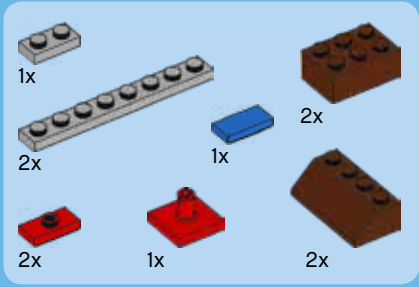

9

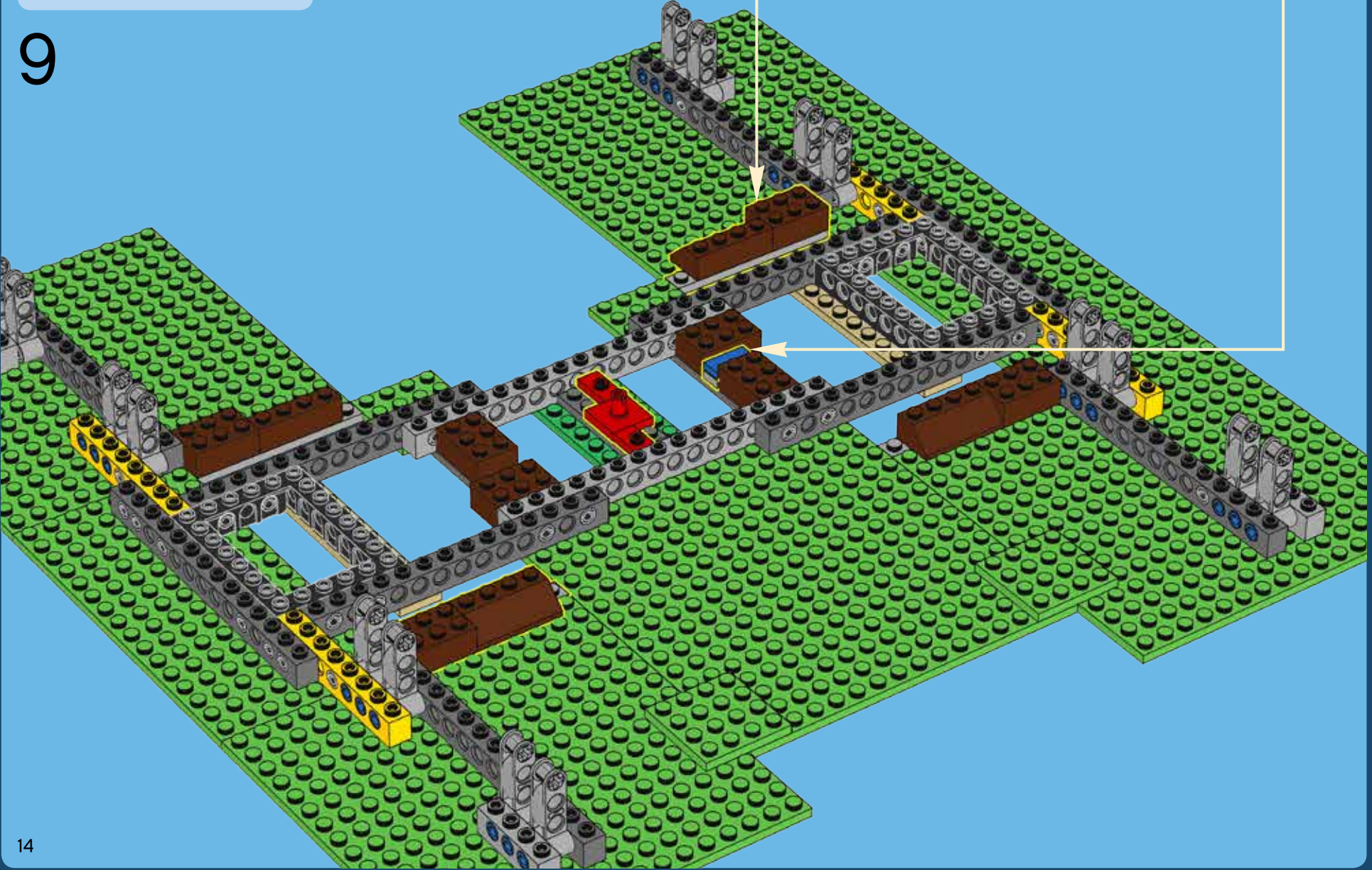

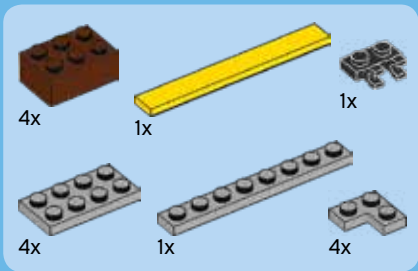

10

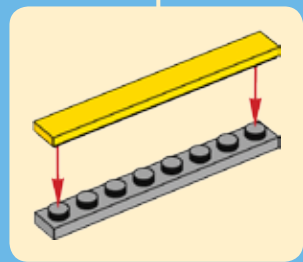

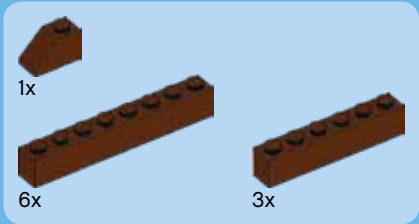

11

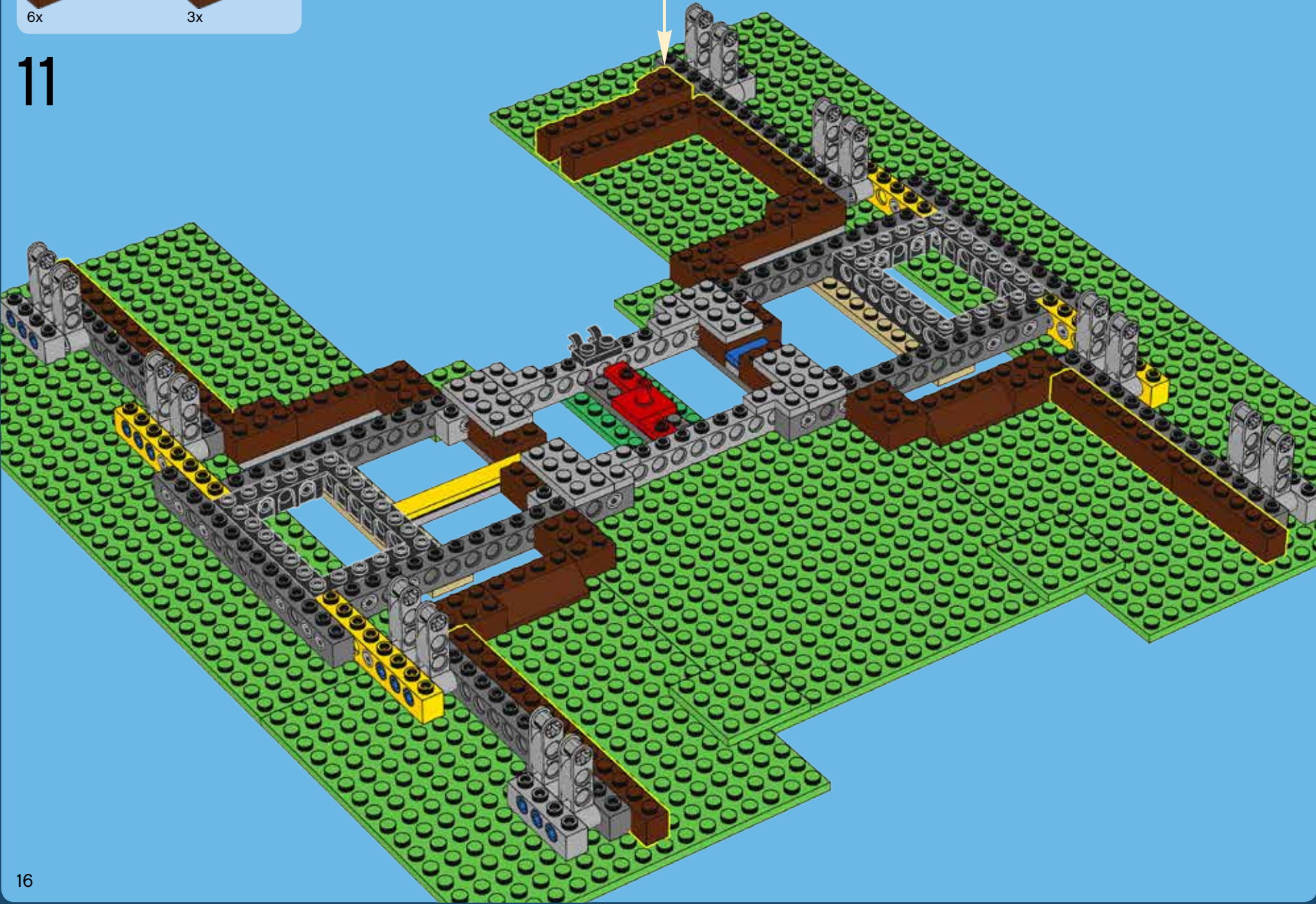

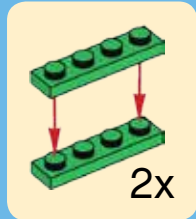
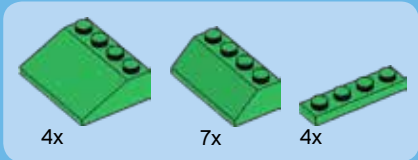

12

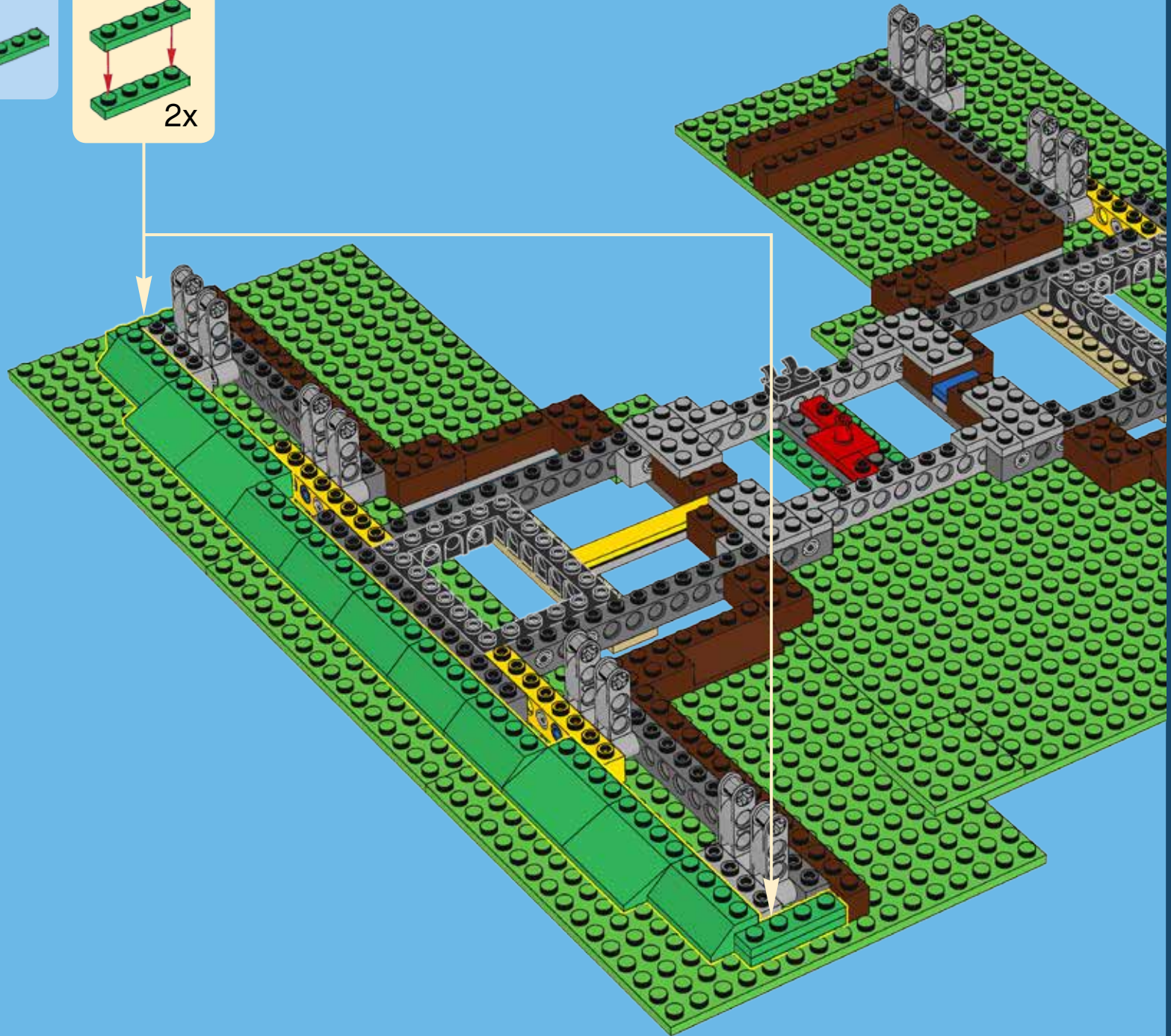

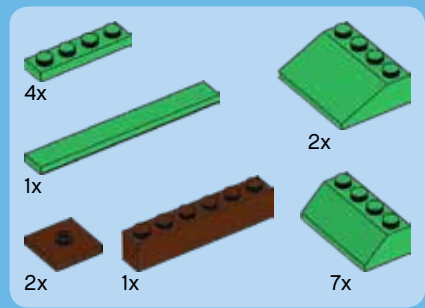

13

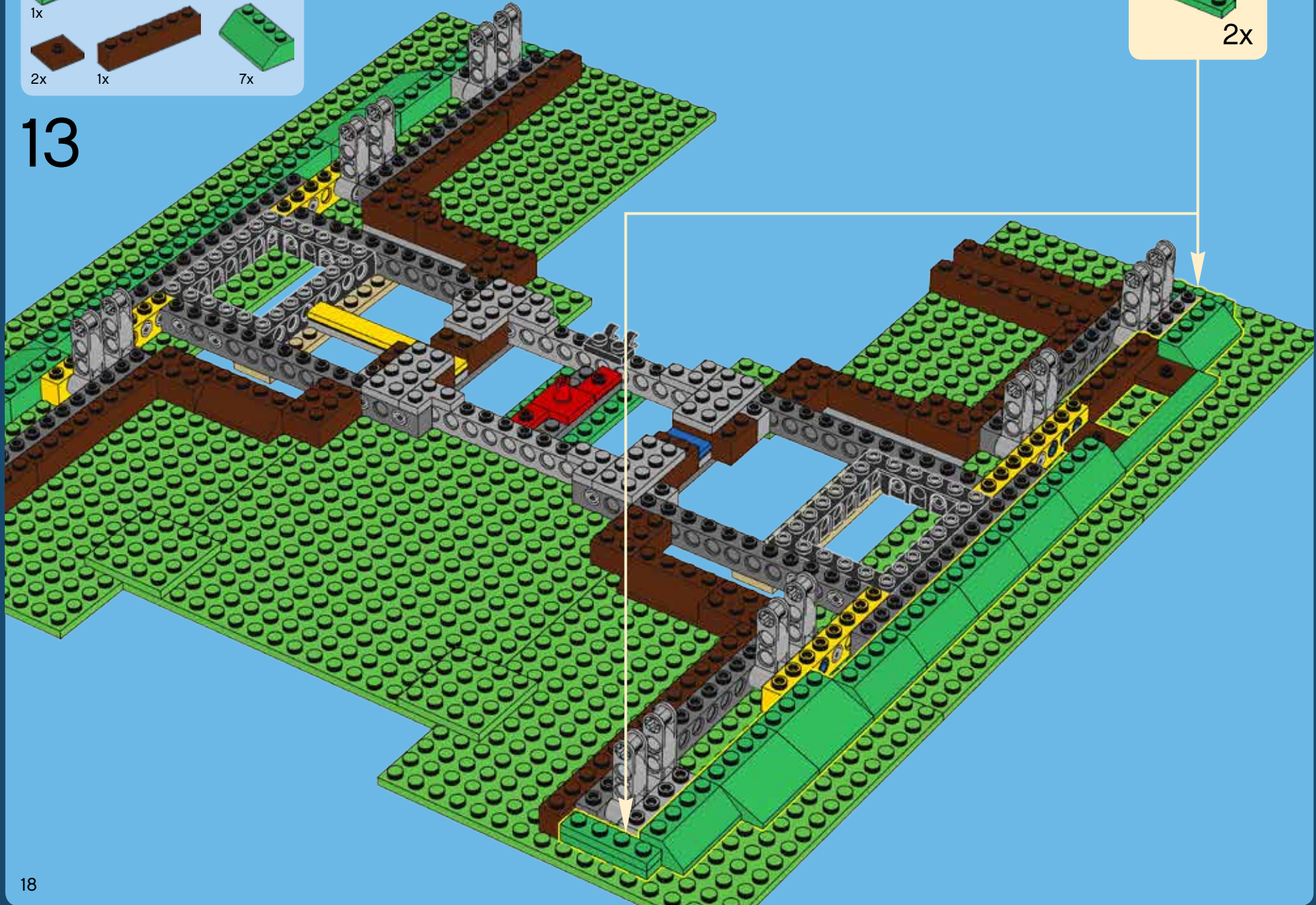
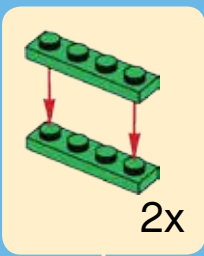



4x

8x

14

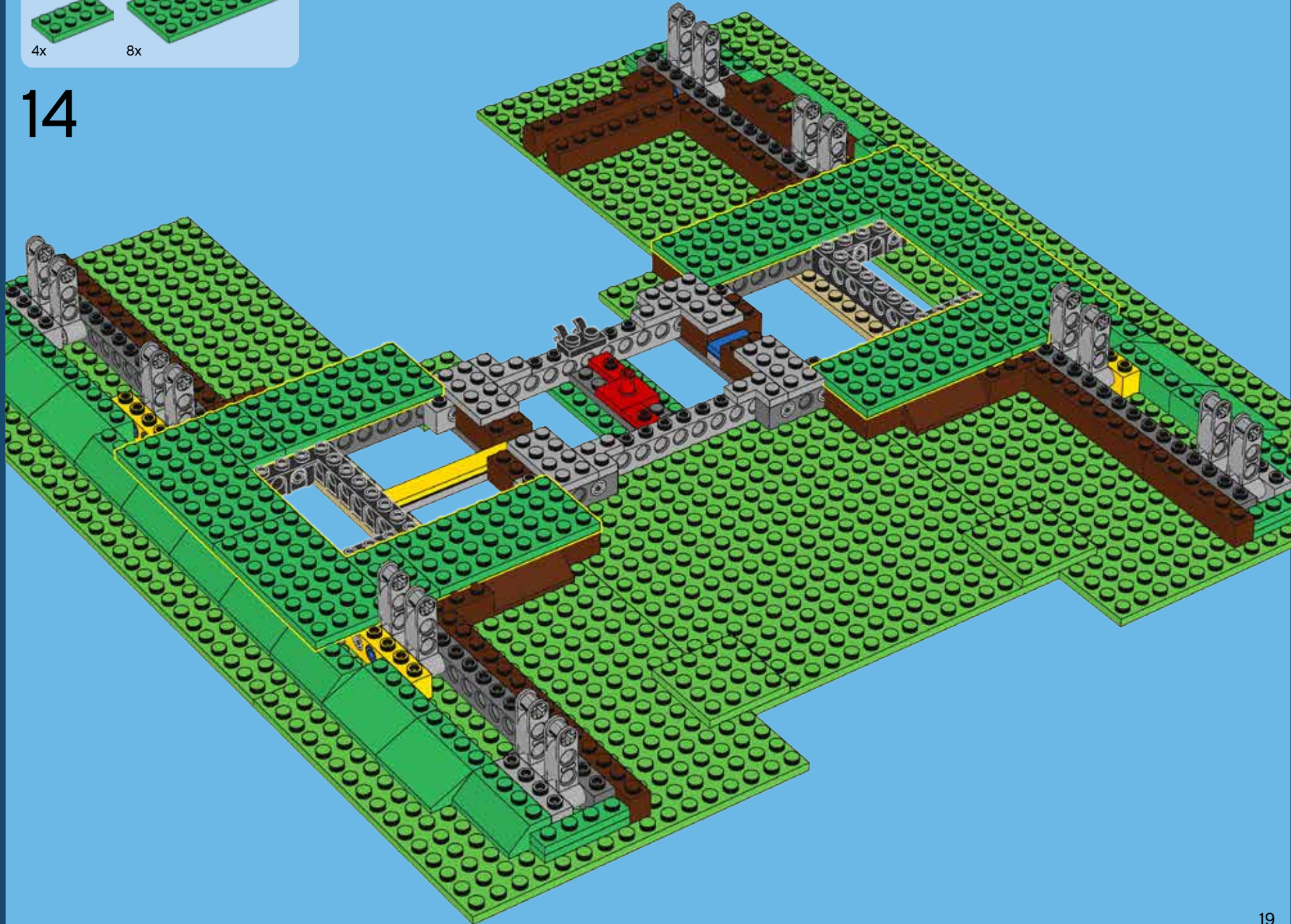

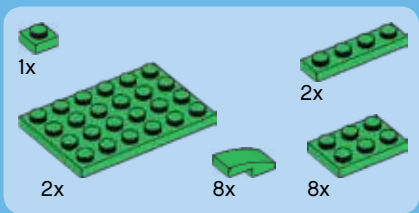

15



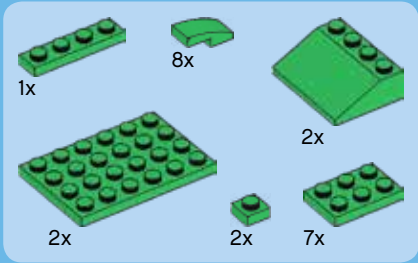

16



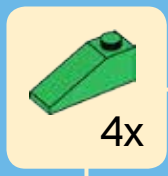
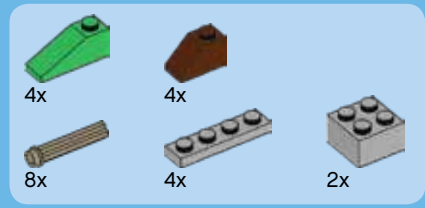

17



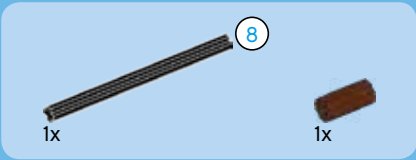
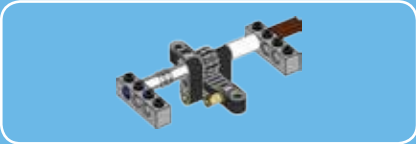

1

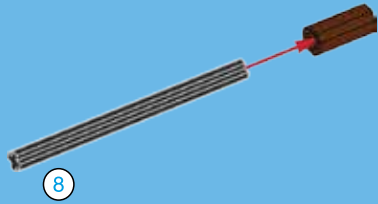

2

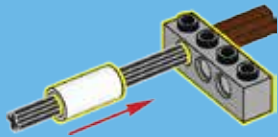

3

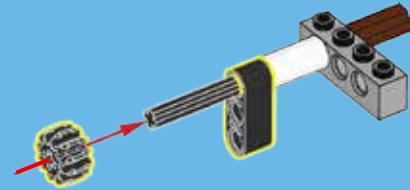

4

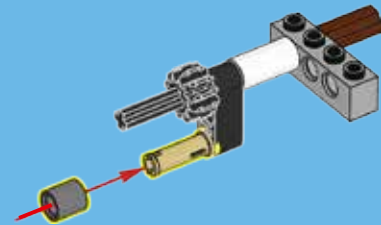

1x

1x

5

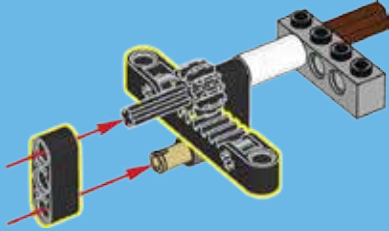

1x

1x

1x

6

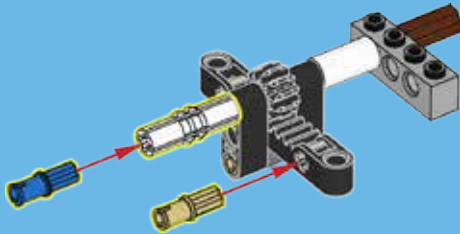

1x

7

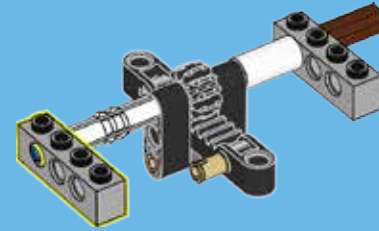

18



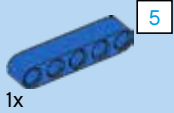

1:1

1

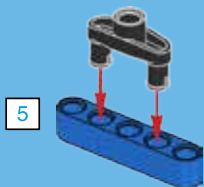

2x

2

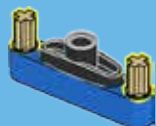

2x



2x

3

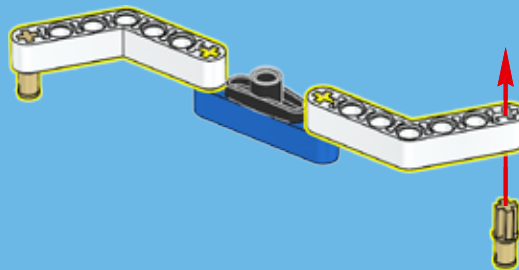

1x



1x

4

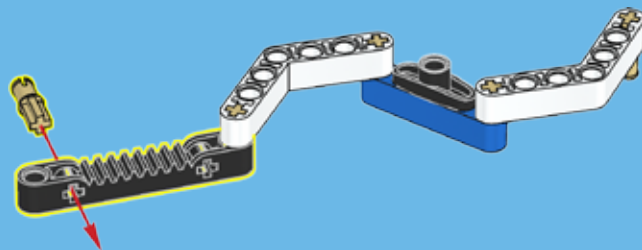

19



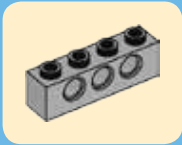
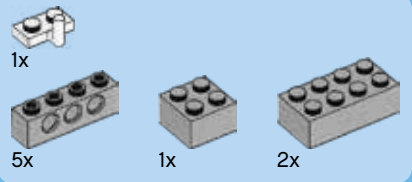

20



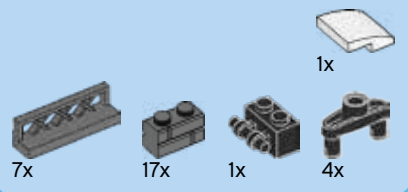

21

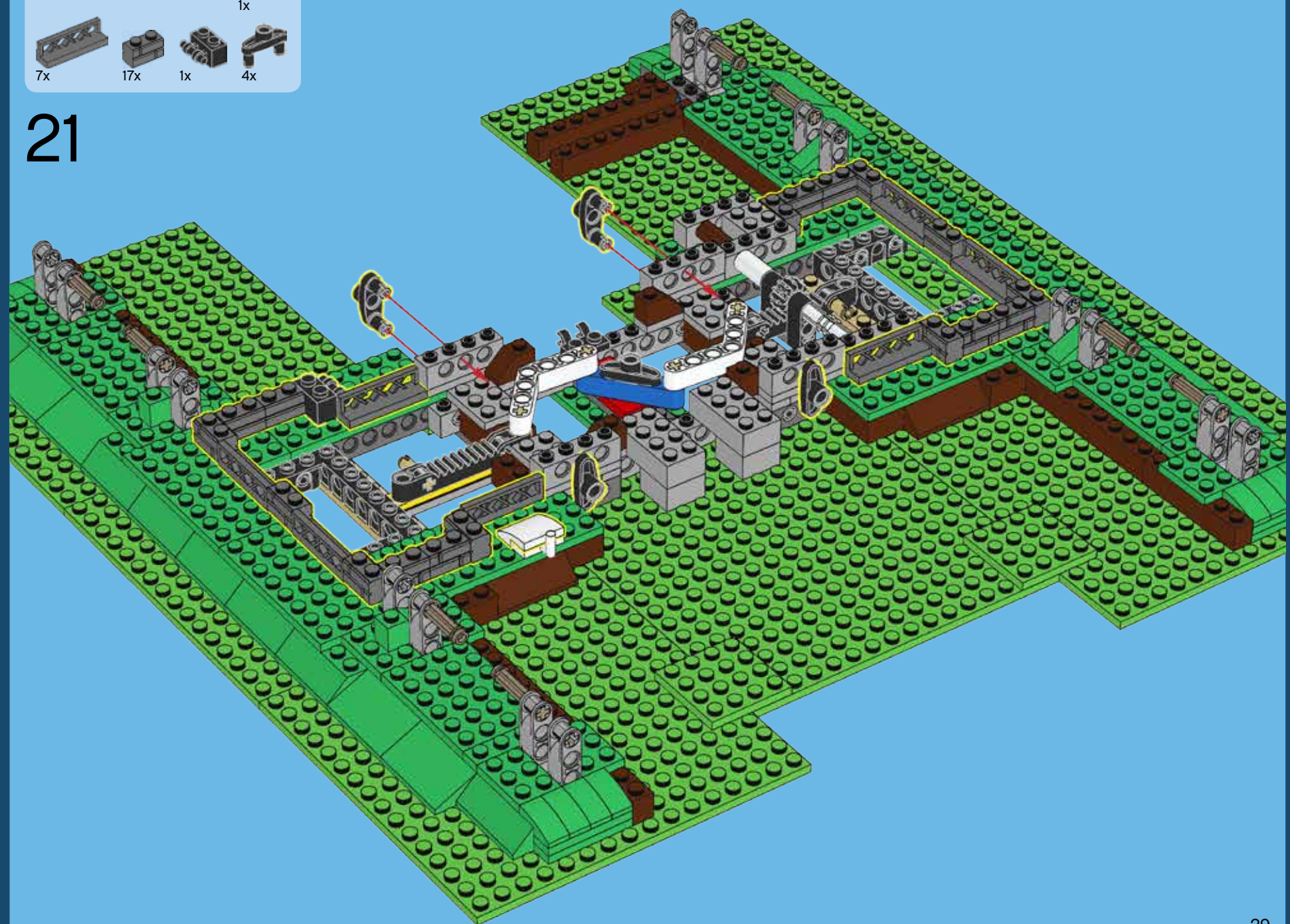

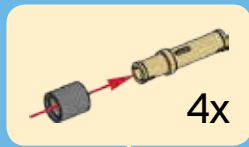
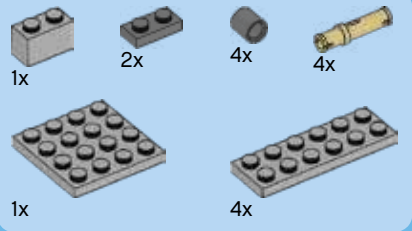

22



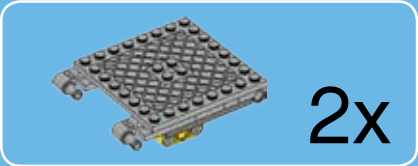

2x

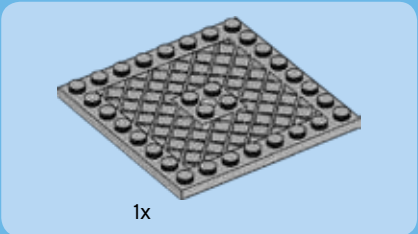

1x

1

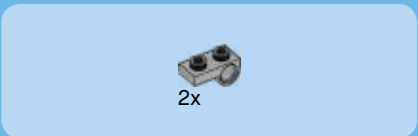
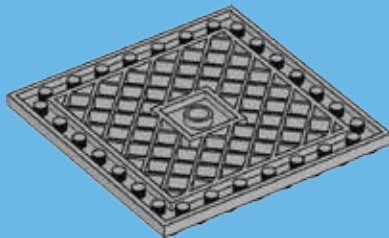

2x

2

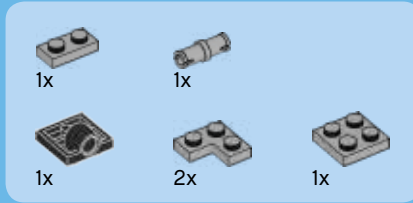
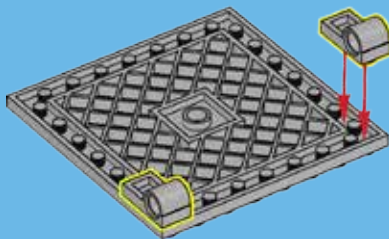

1x

1x

1x

2x

1x

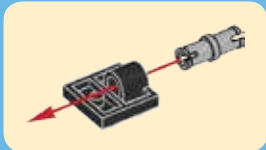

3

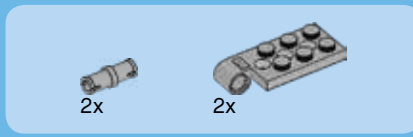
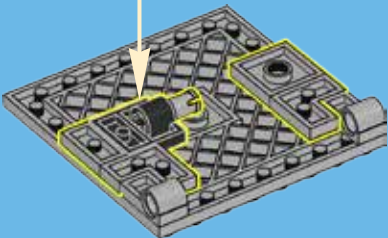

2x

2x

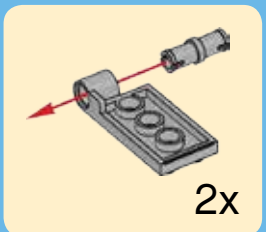

2x

4

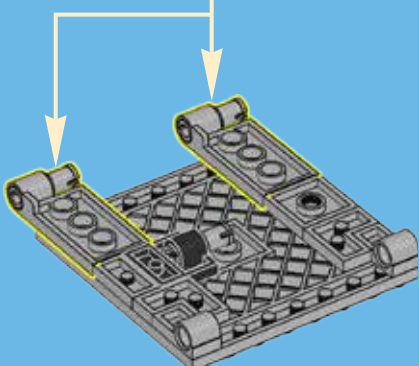



2x

5

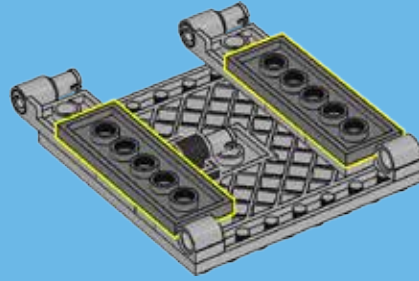

1x



1x

6

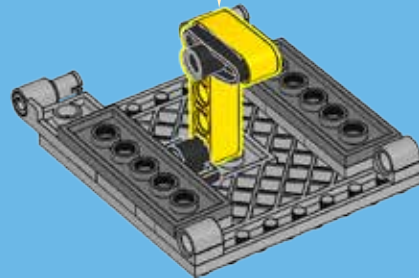
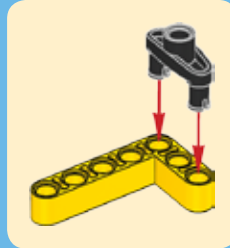

2x

23



24



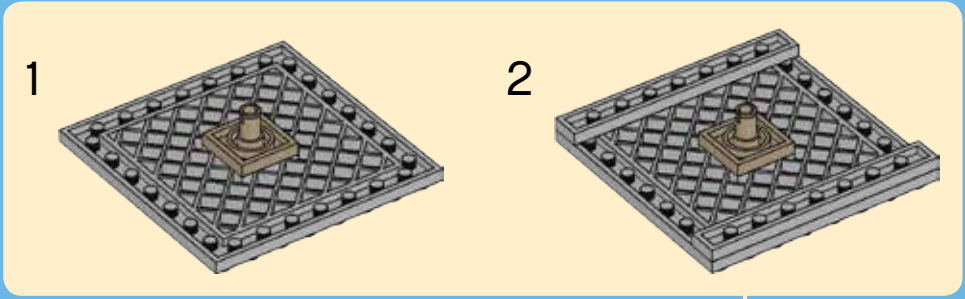
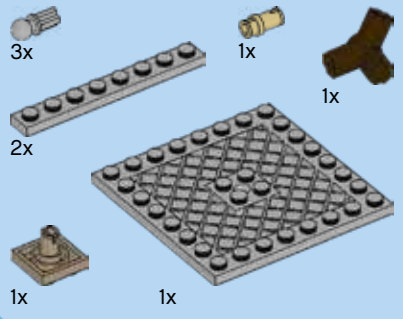

25

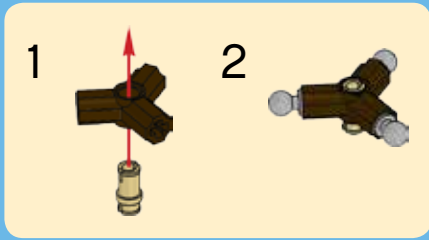

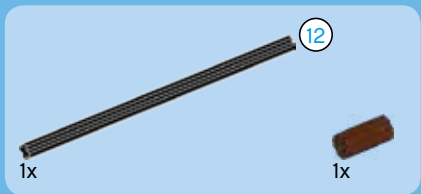
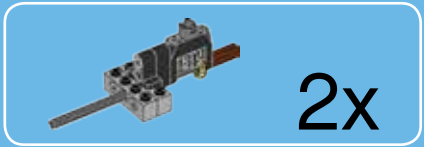
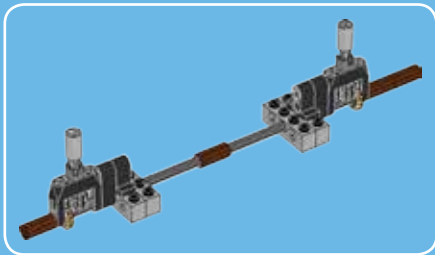

1

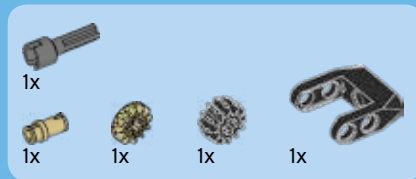
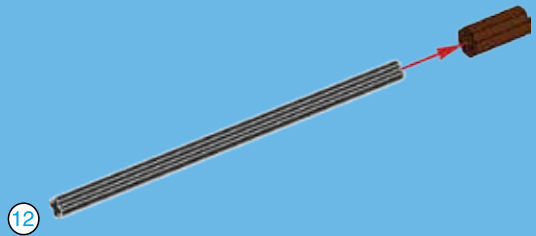

2

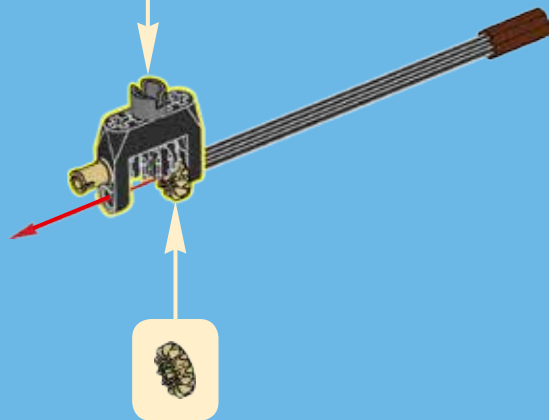
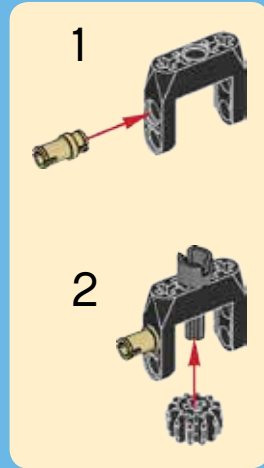

1x

1x

3

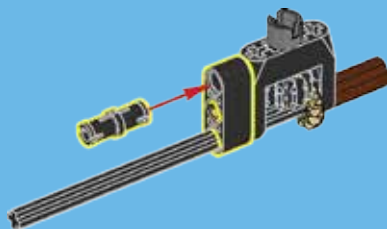

2x

1x

2x

4

1

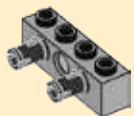

2

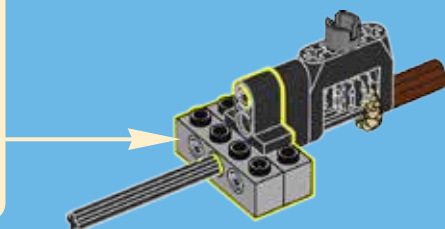
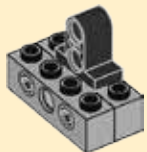

2x

1x

5

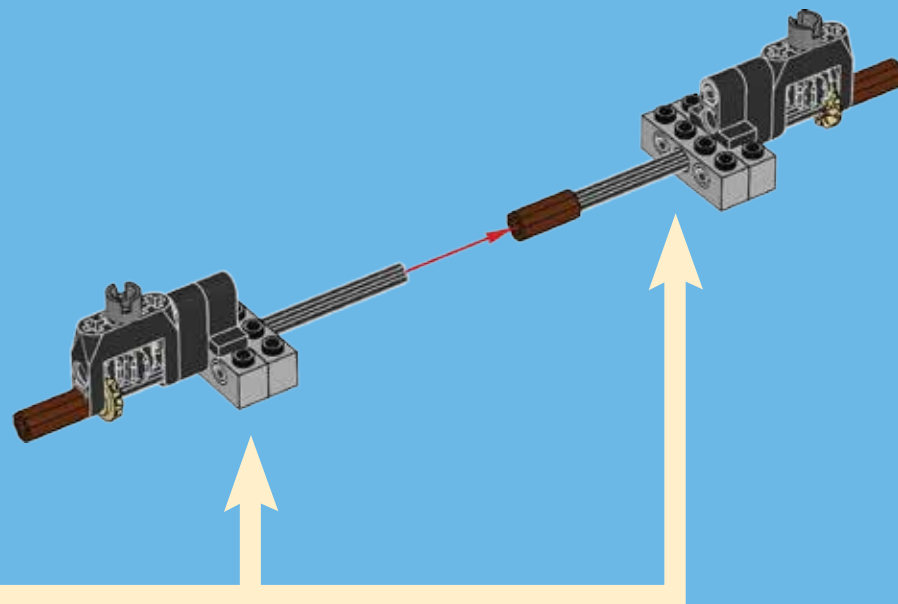

1x

2x

1x

6

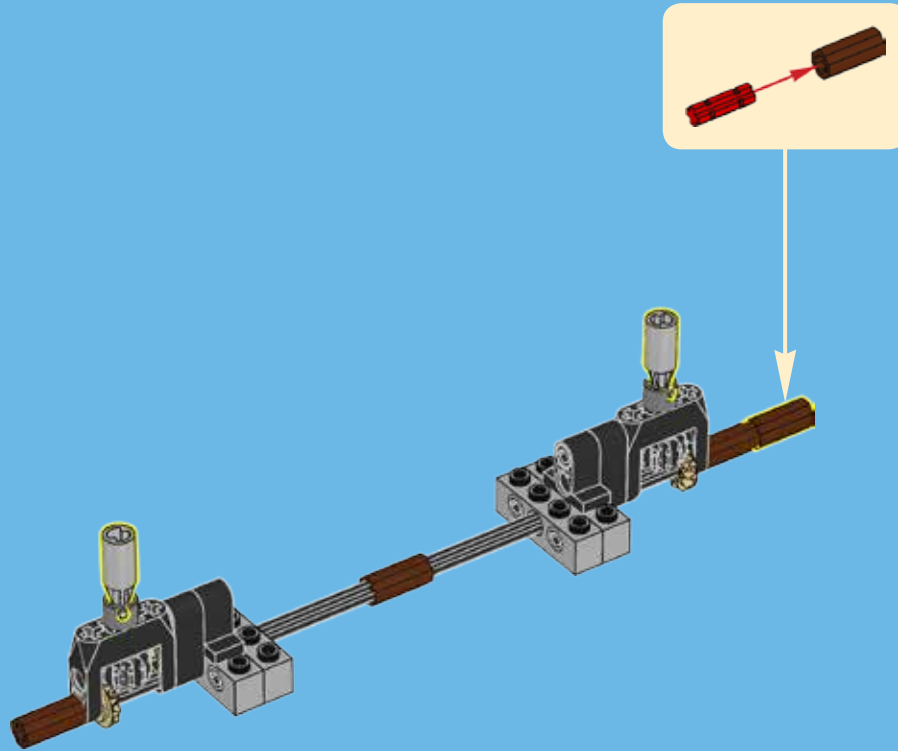

26

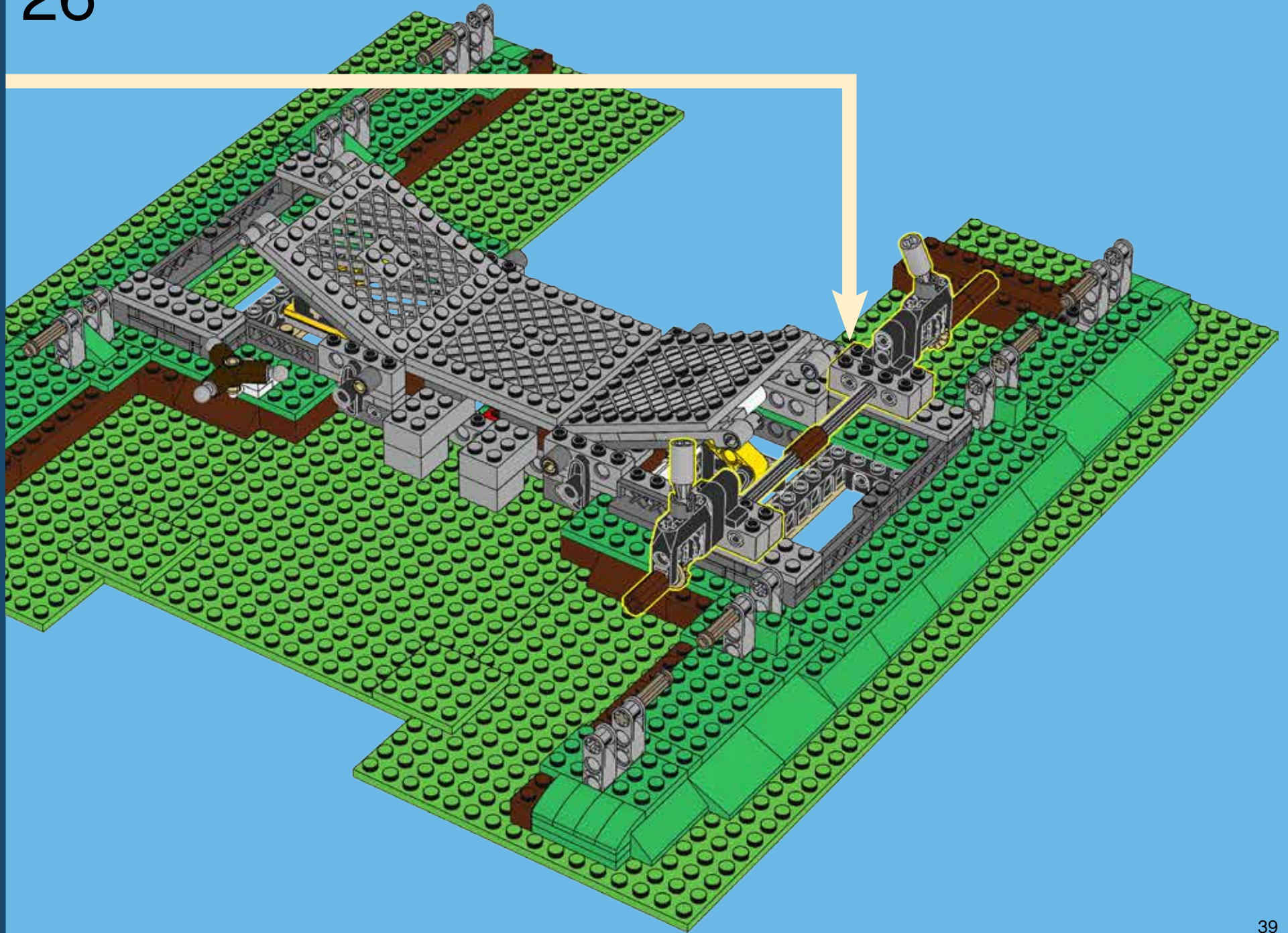

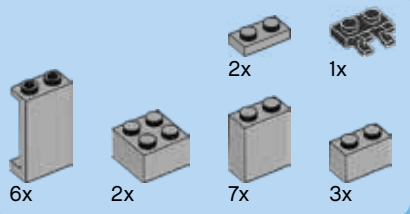

27

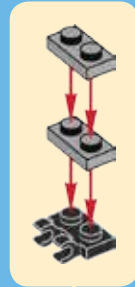



14x



4x

28





4x

29

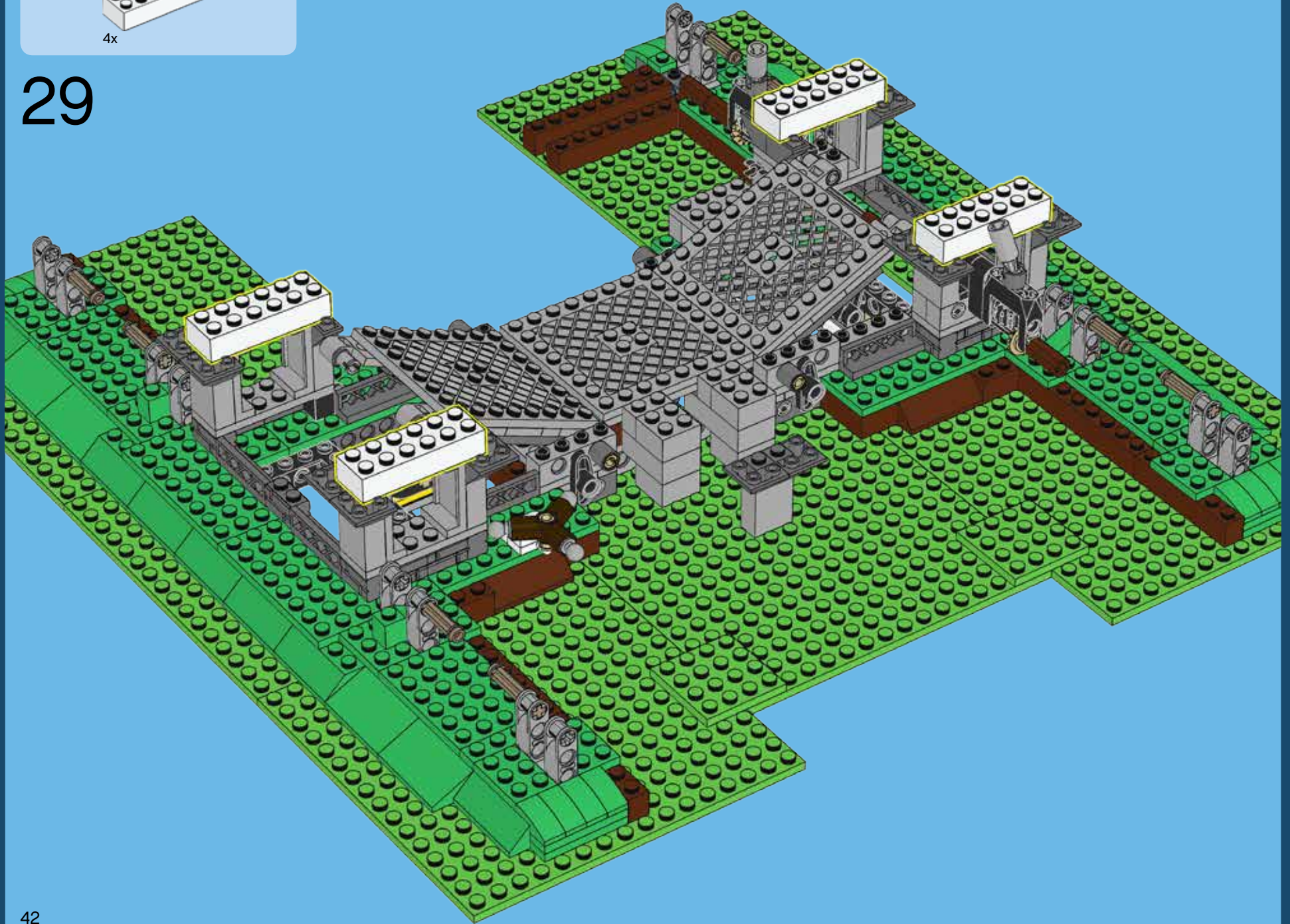

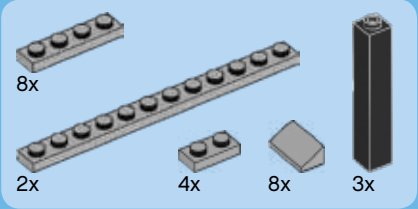
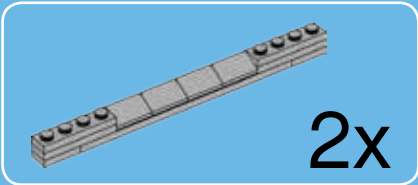

30

1

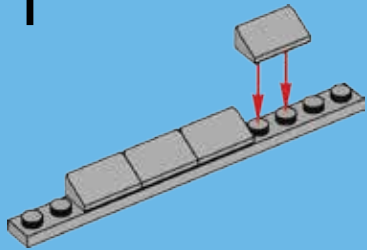

2

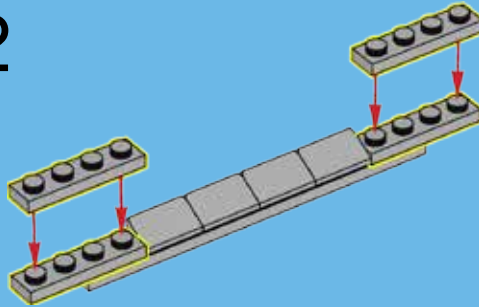

3

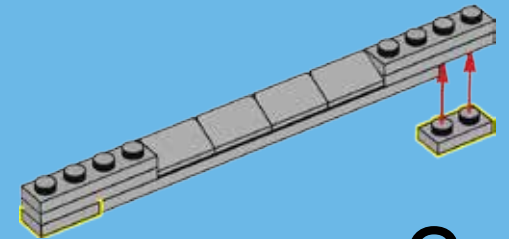

2x



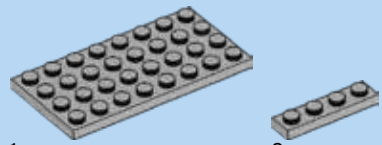

1x

2x

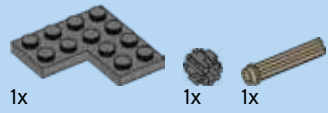

1x

1x

1x



1:1

31

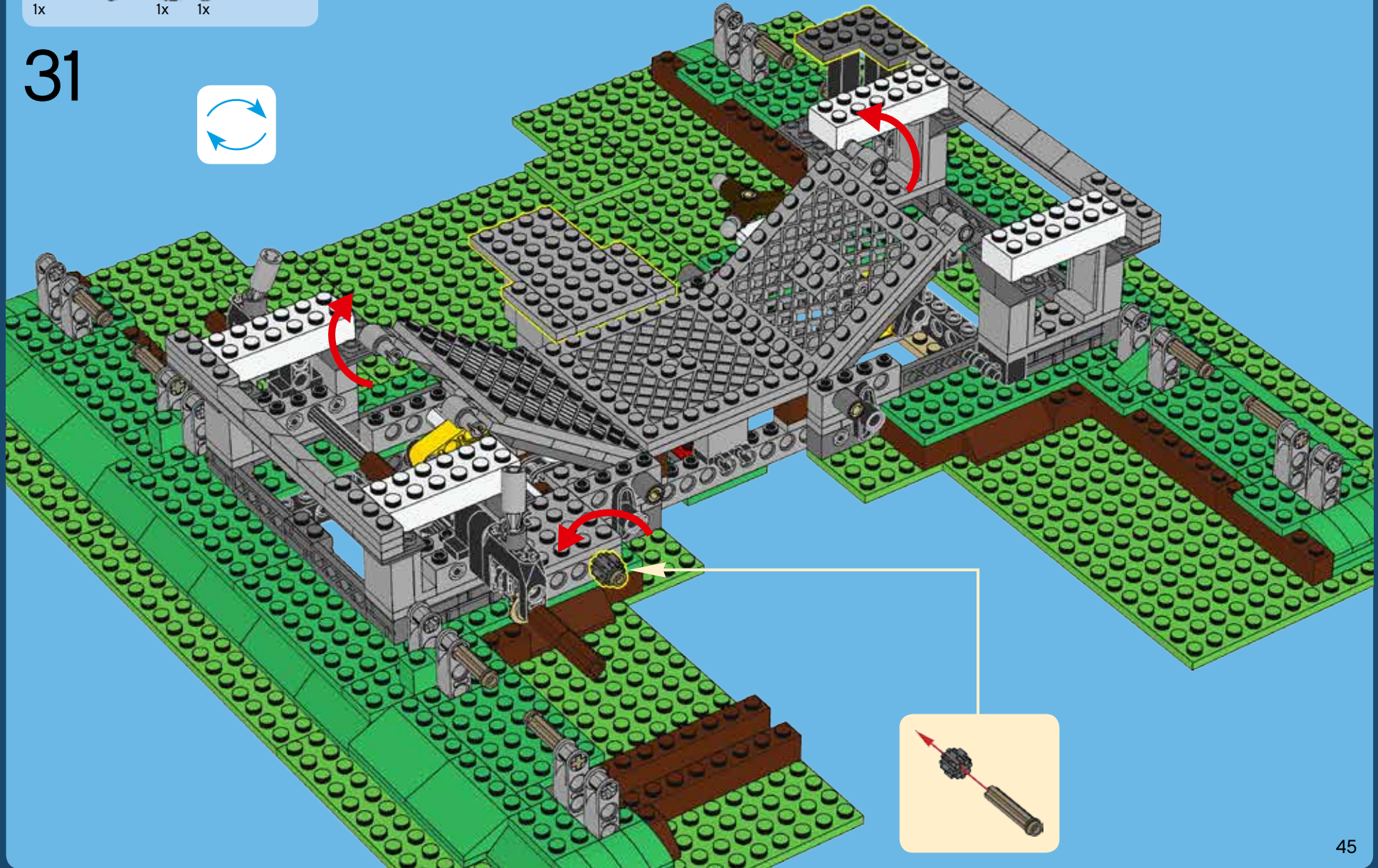

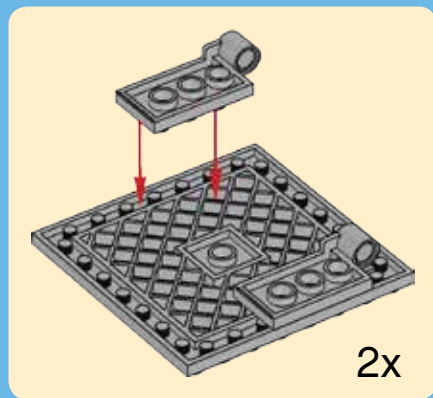
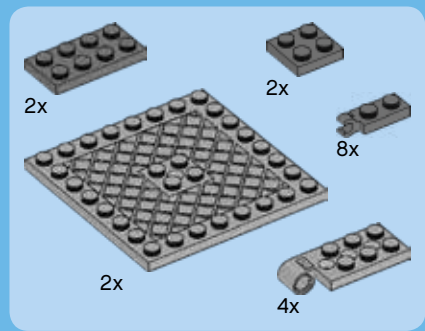

32





4x



8x

33

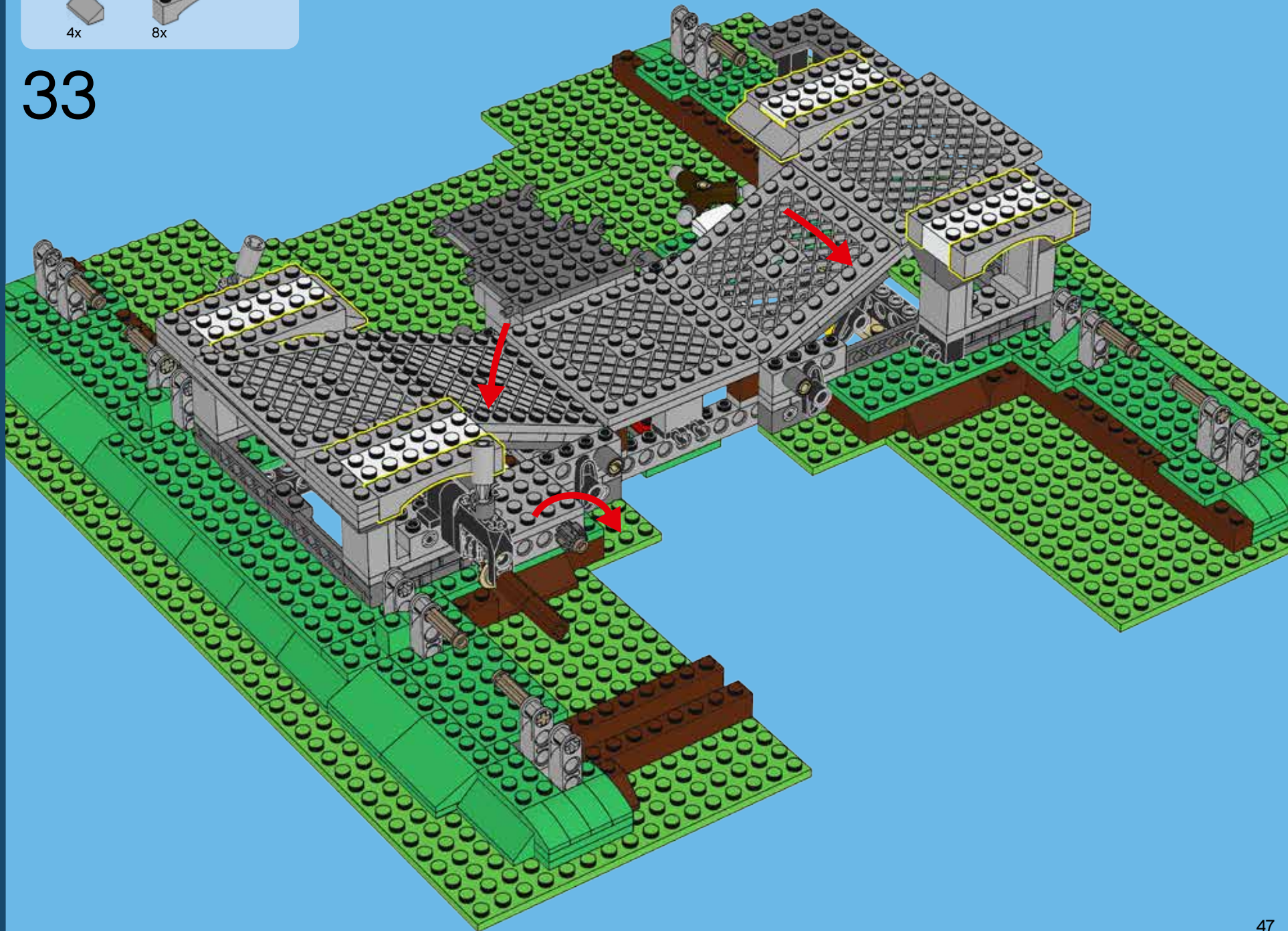

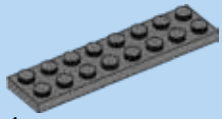

4x

34





1x



7x



6x

35

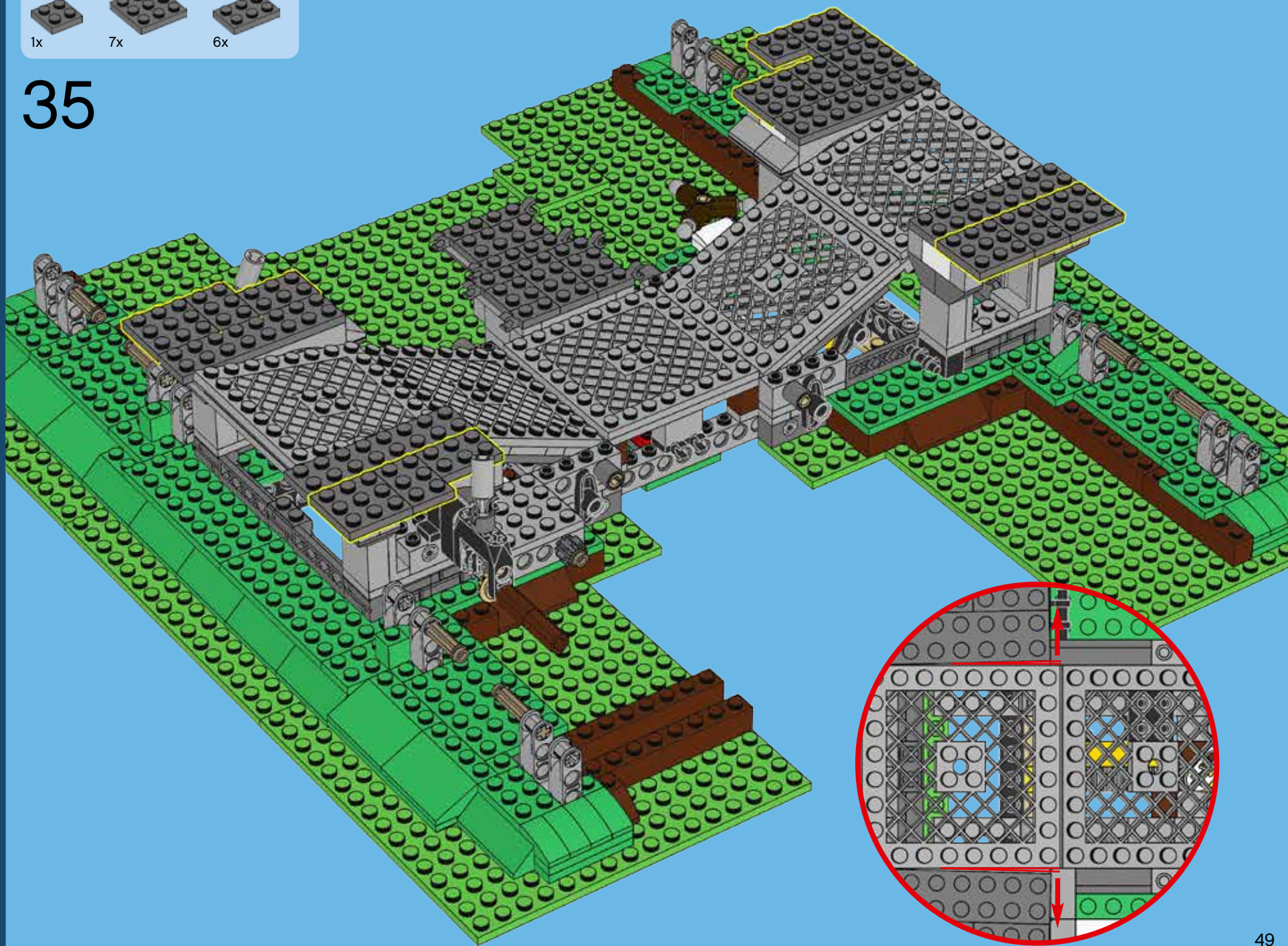

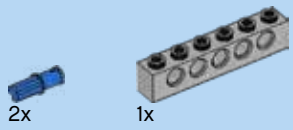

1

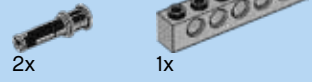
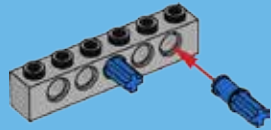

2

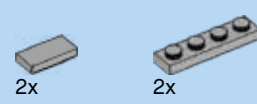
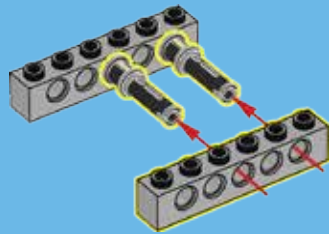

3

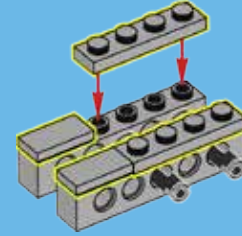

4

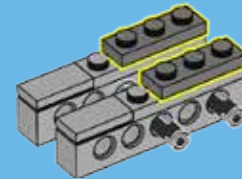



1x



2x

36



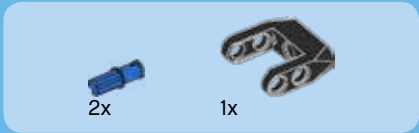
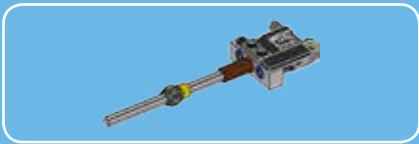

1

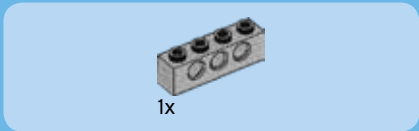
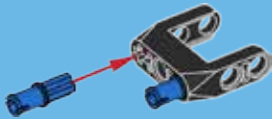

2

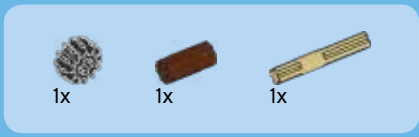

3

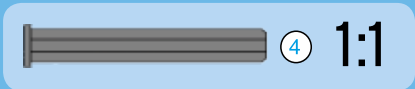
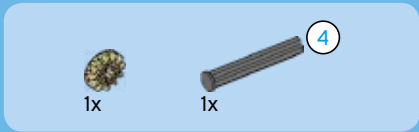
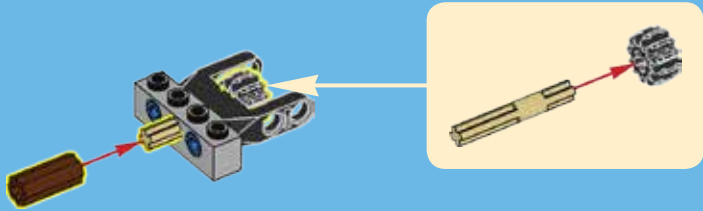

4

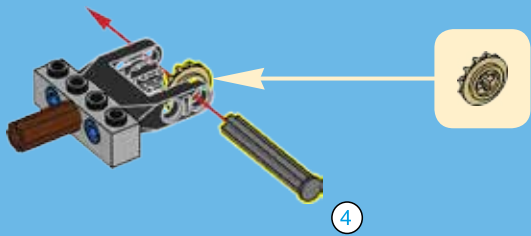

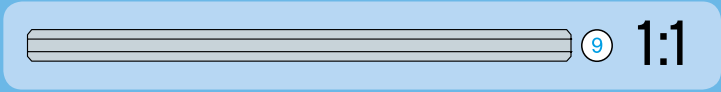
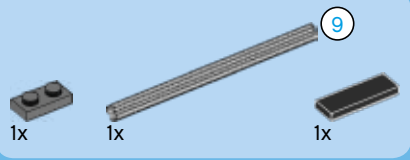

5

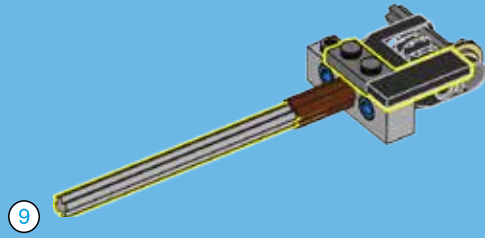

6

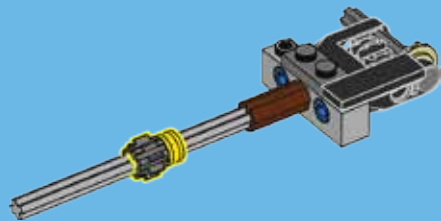

37





1

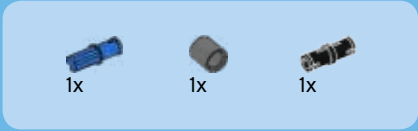
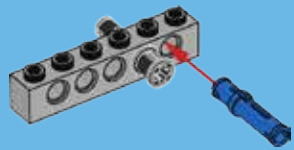

2

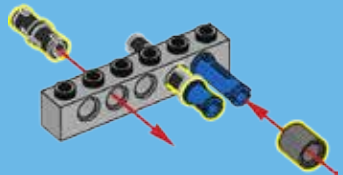

3

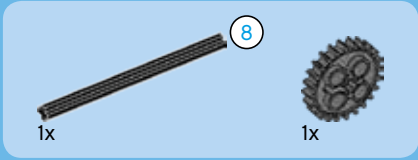

4

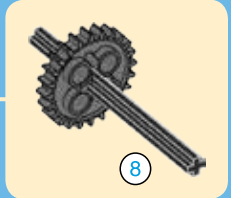



1x

5

38

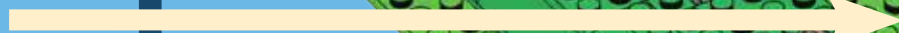
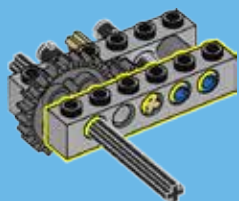

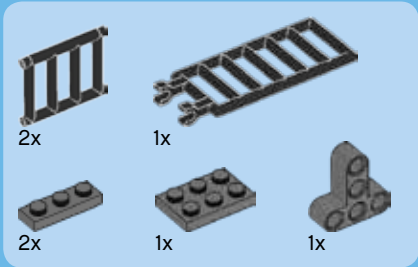

39

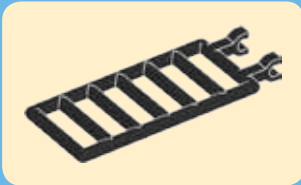
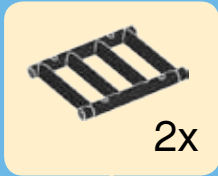

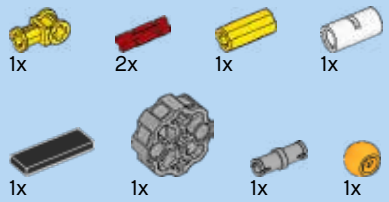

40

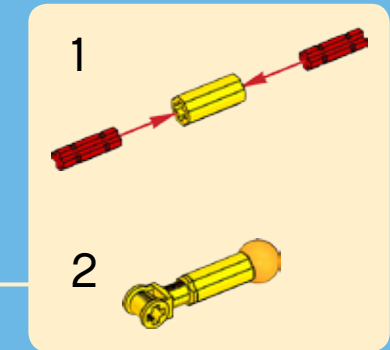
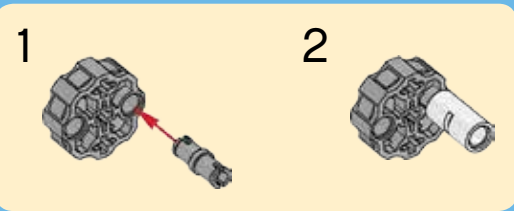
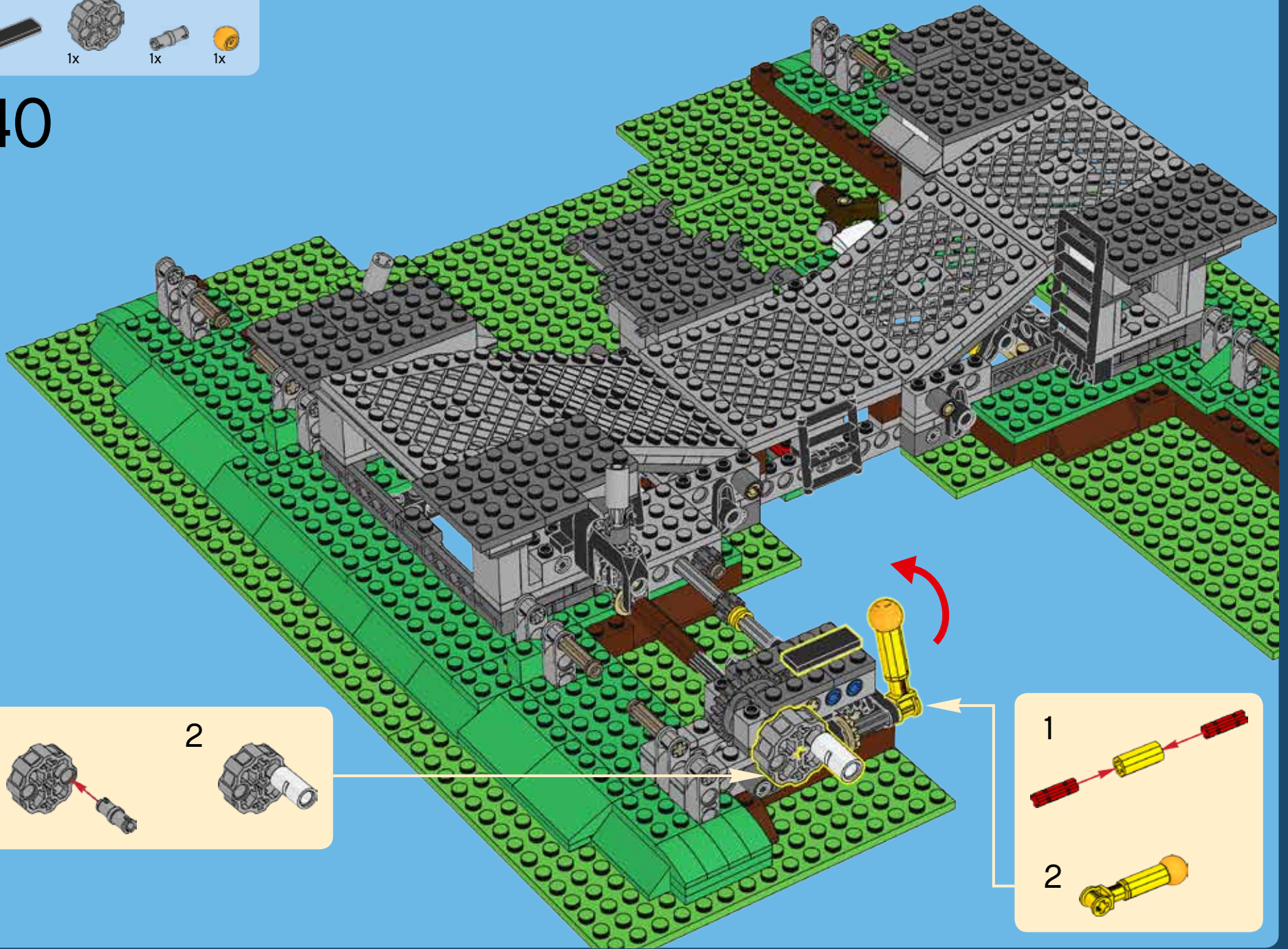

41

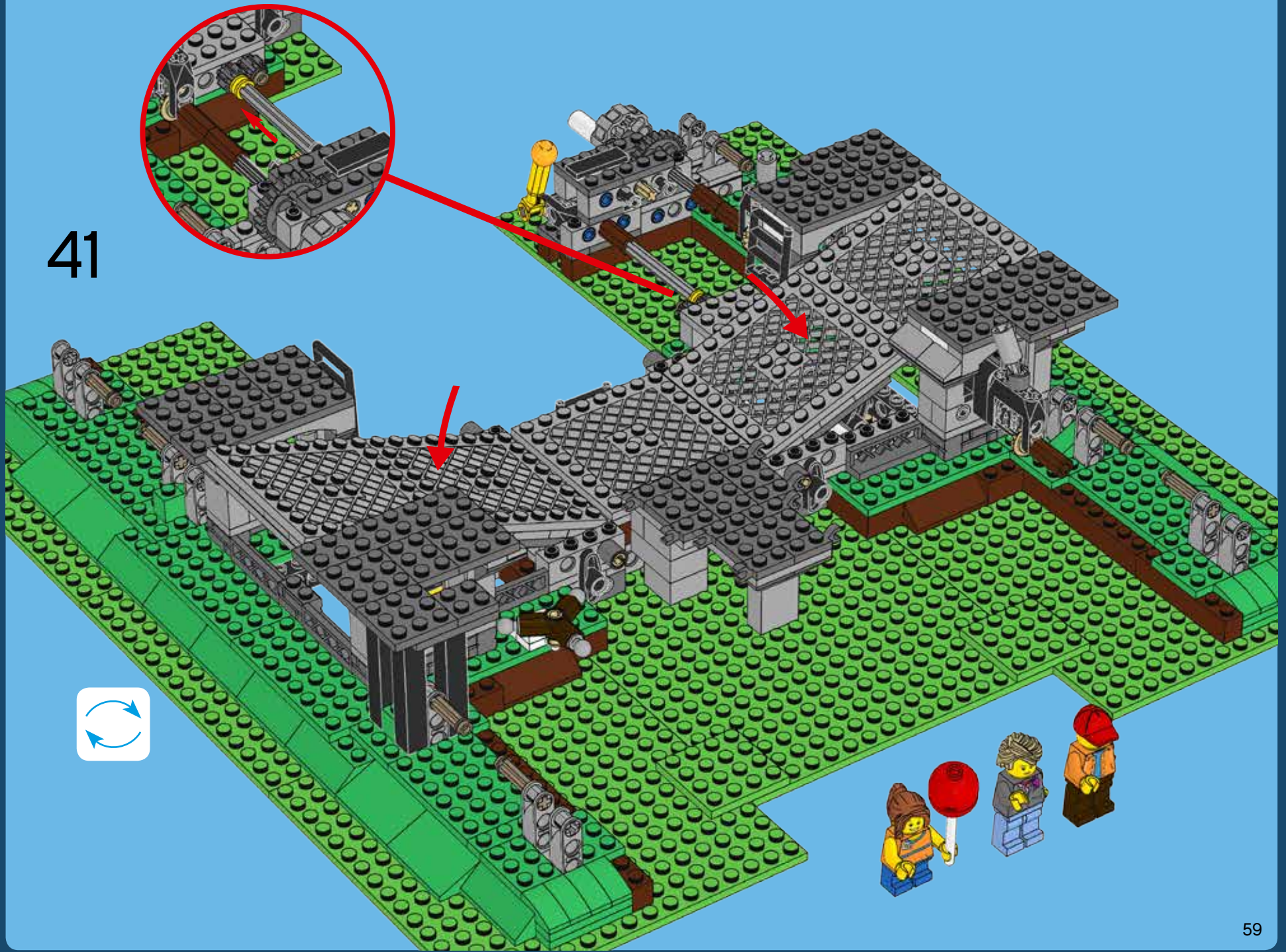

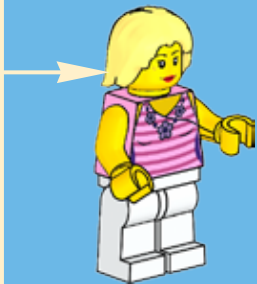
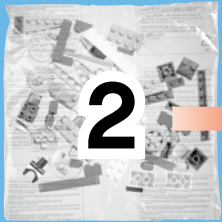

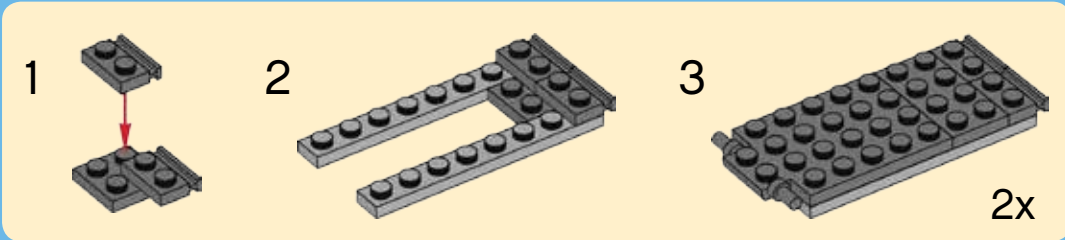
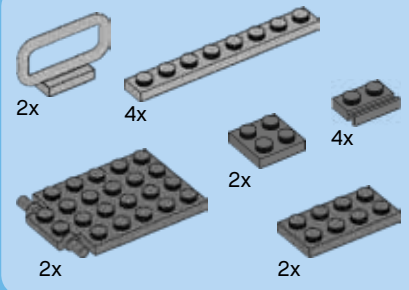

42



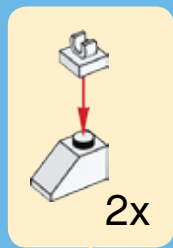
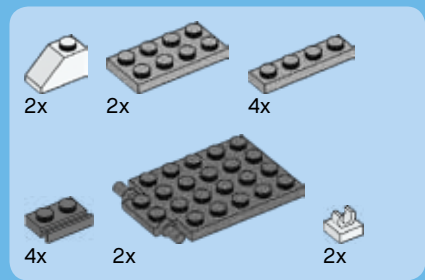

43

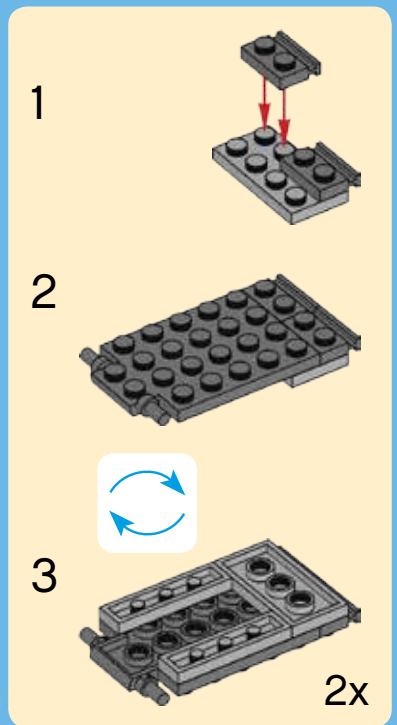

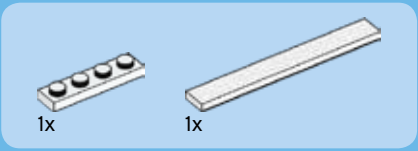
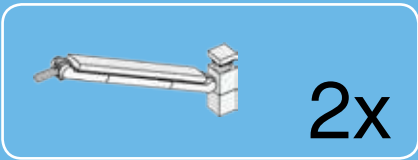

1

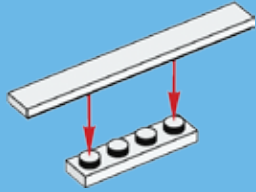

2

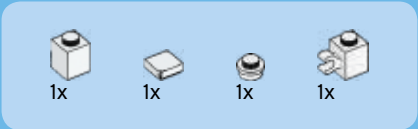
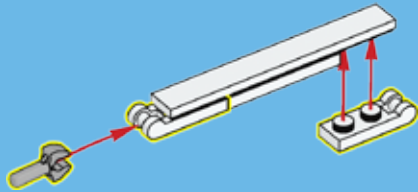

3

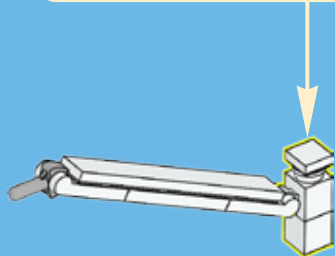
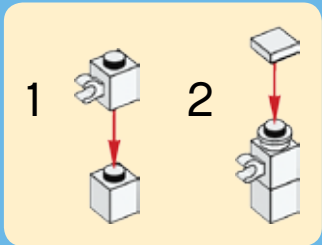

2x



1x



2x



1x



1x

44



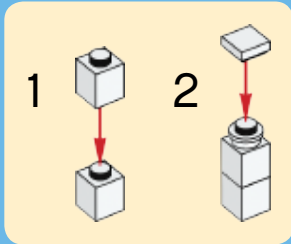
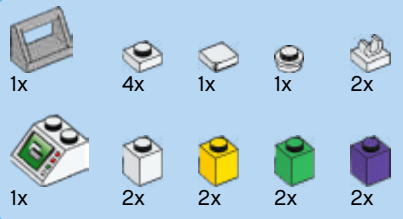

45

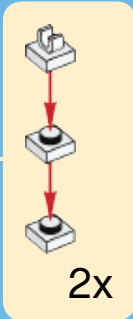



2x



1x



1x

1

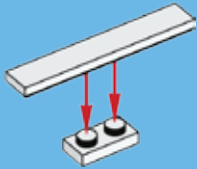

2x



1x

2

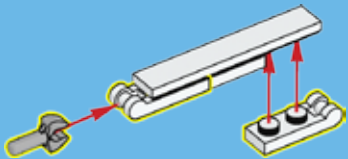

1x



1x



1x



1x

3

1



2

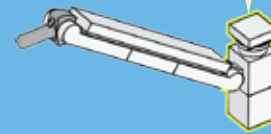

2x

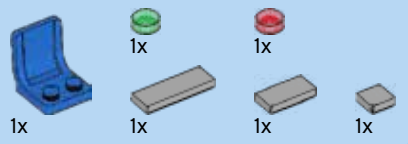

46



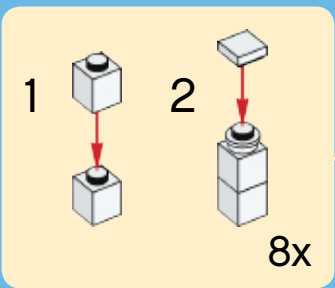
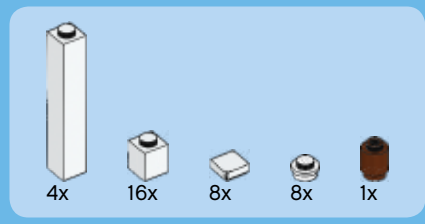

47





1x

1

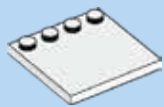
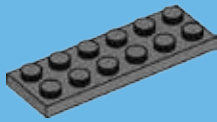

1x



2x

2

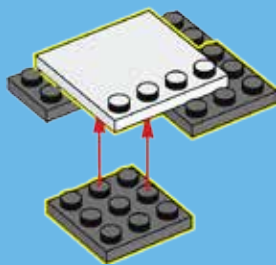

2x

3

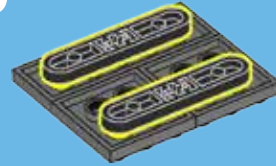

2x

4

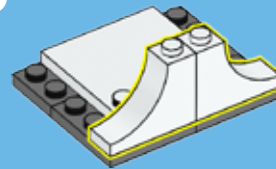

1x



1x

5

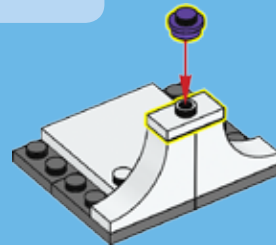



9x

48

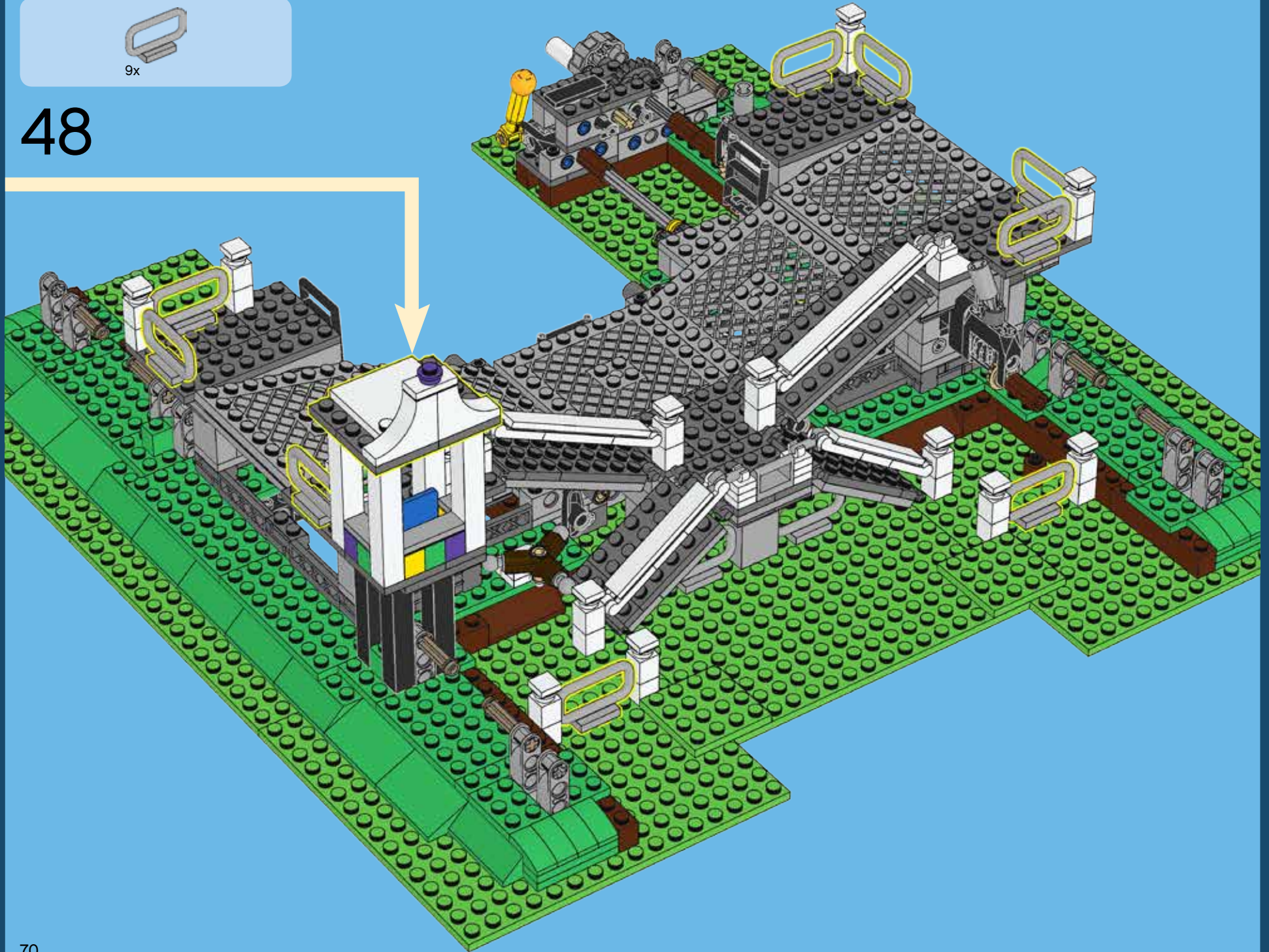



1x

1x

1

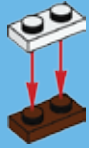

2x

2

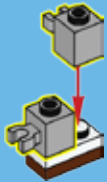

1x

3



1x



1x

4

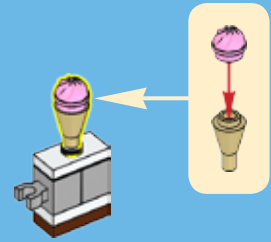

1x



1x



1x

5

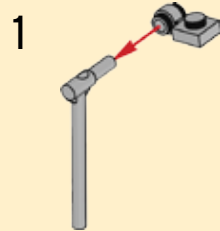

1

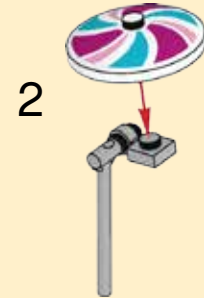

2

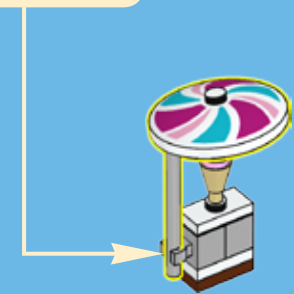



2x

49

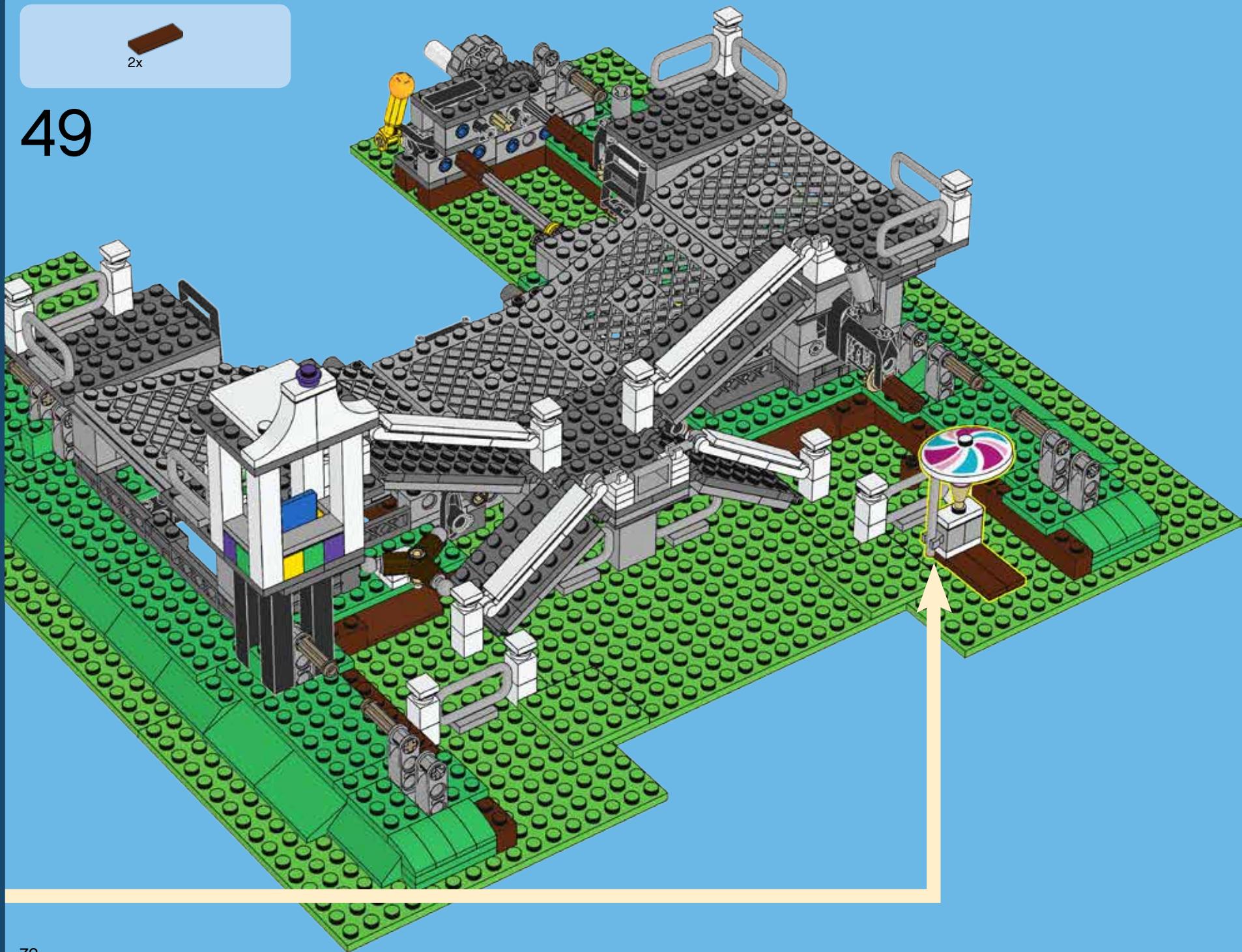

- 4x 
- 1x 
- 1x 
- 1x 
- 1x 
- 1x 

50



- 
- 
- 



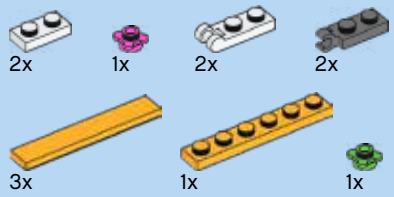

51

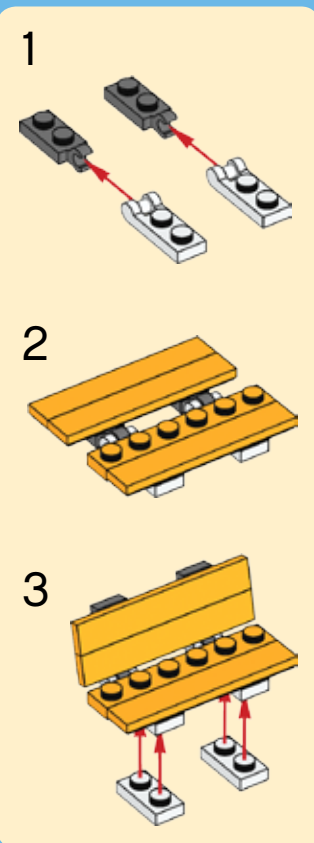

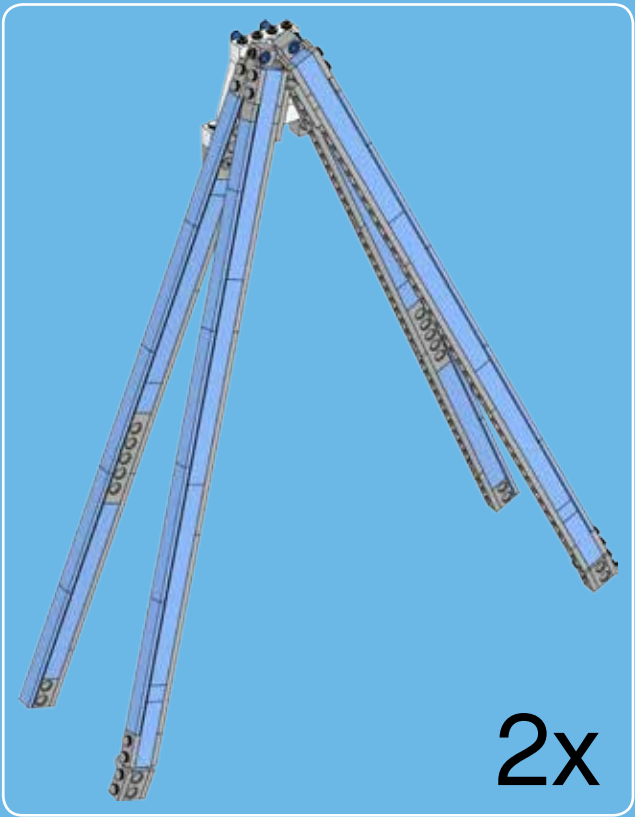

2x

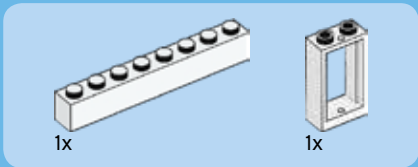

1

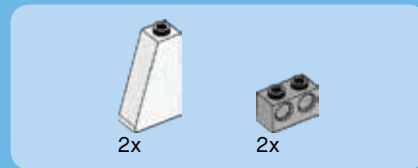
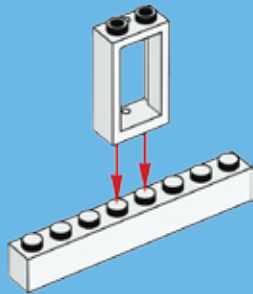

2

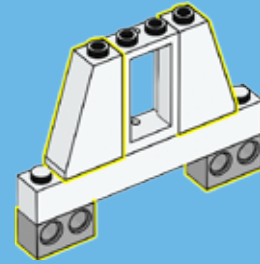

3

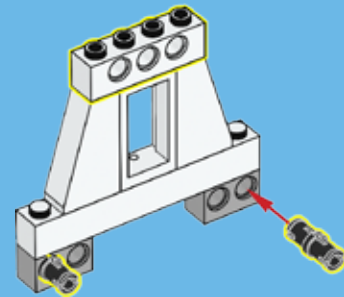

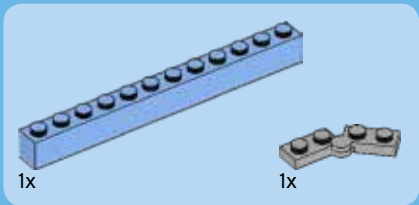
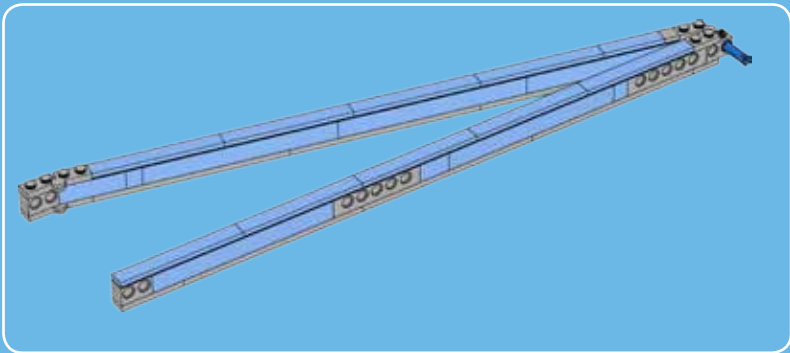

1

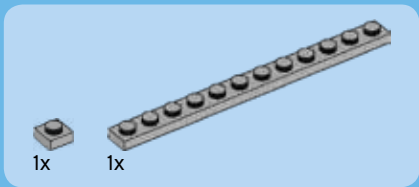
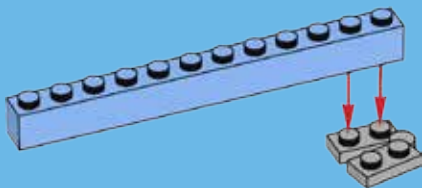

2

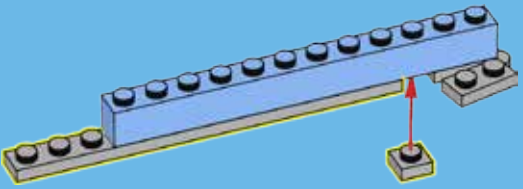

3

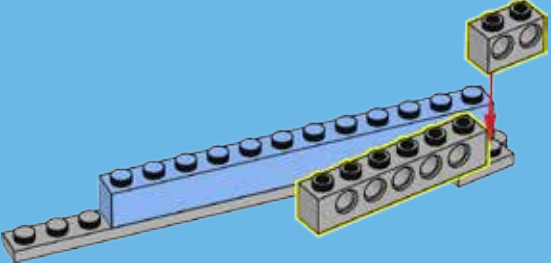

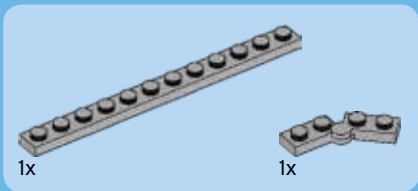

4

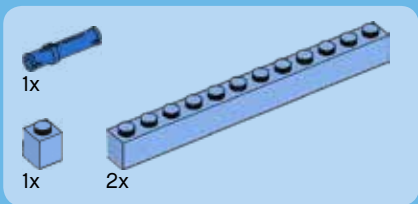
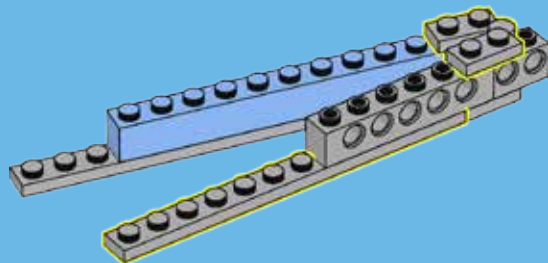

5

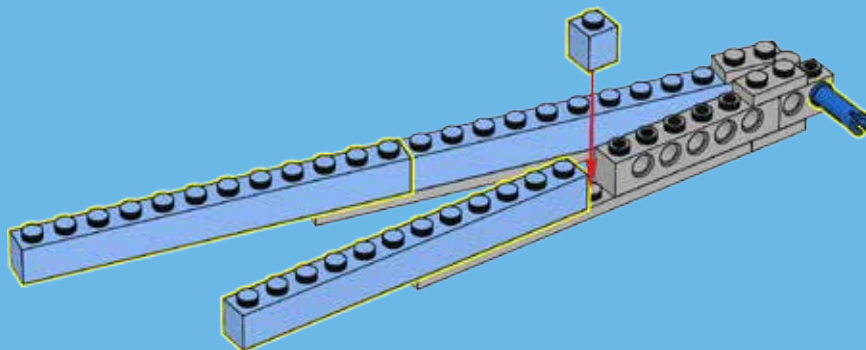

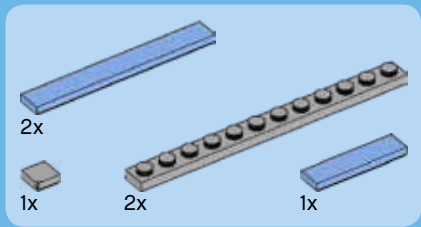

6

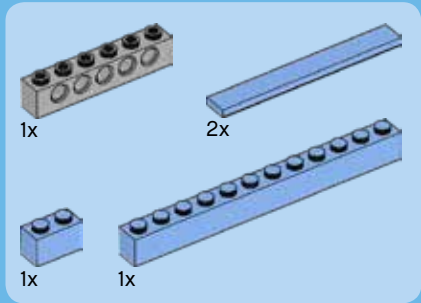
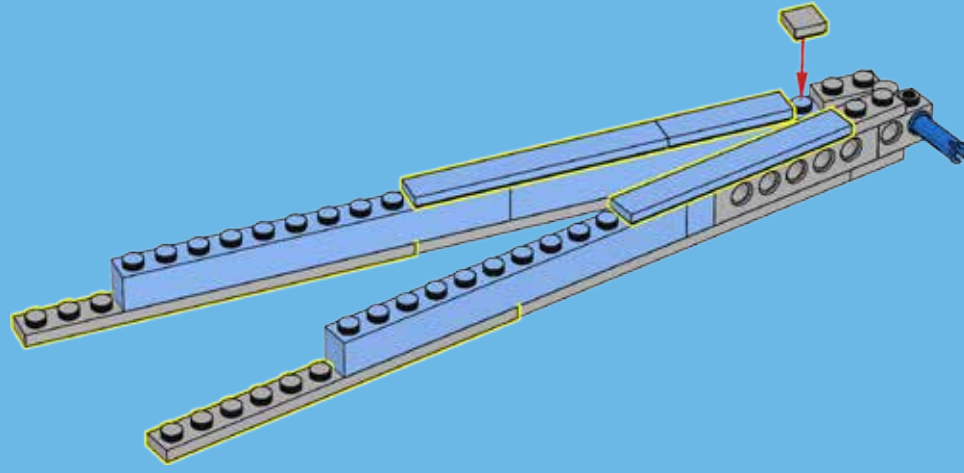

7

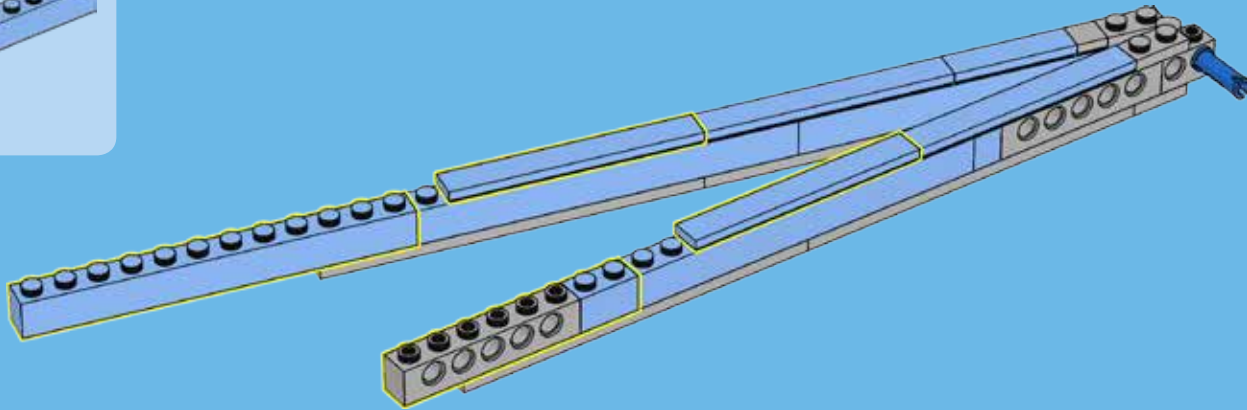

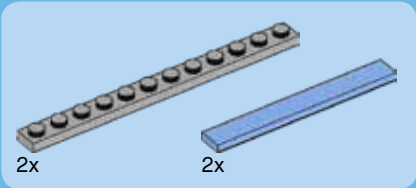

8

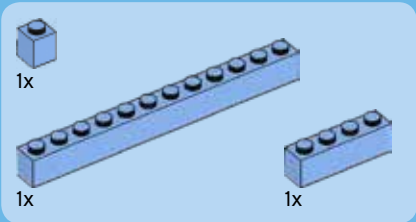
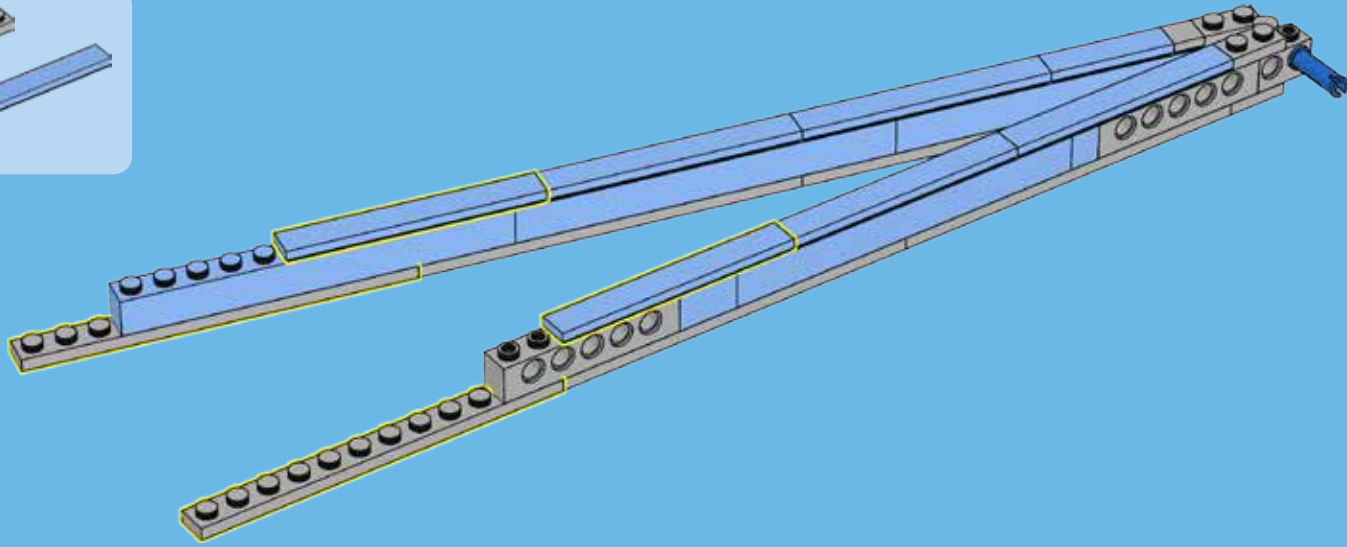

9

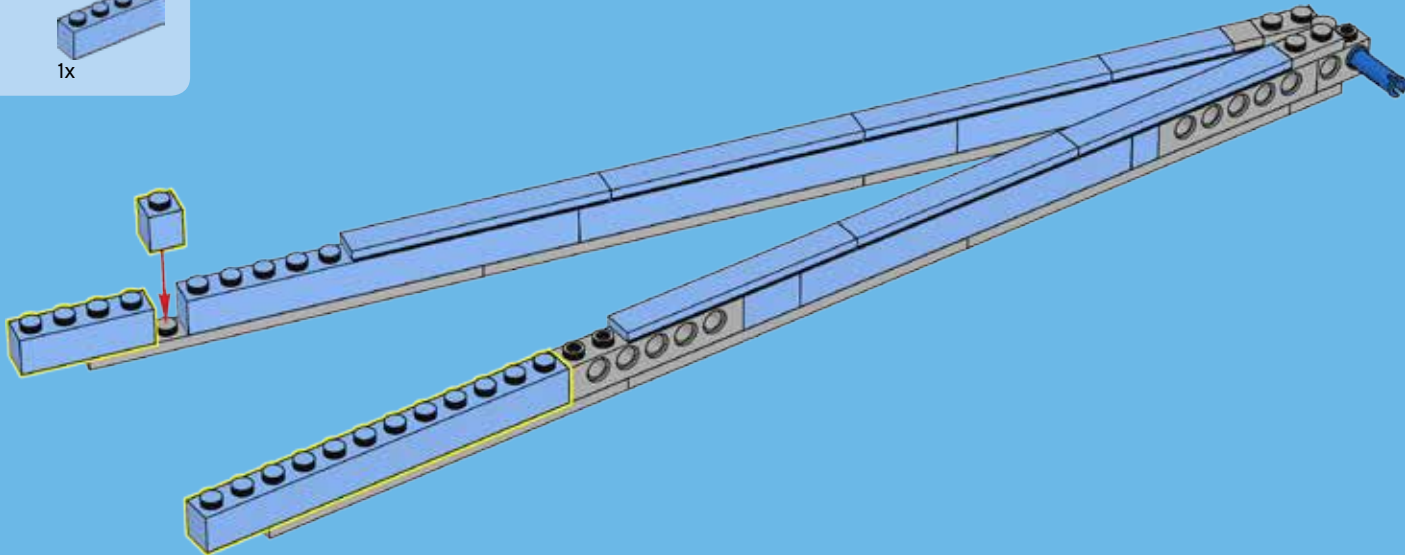

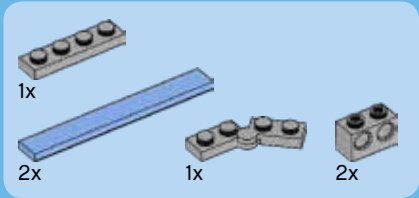

10

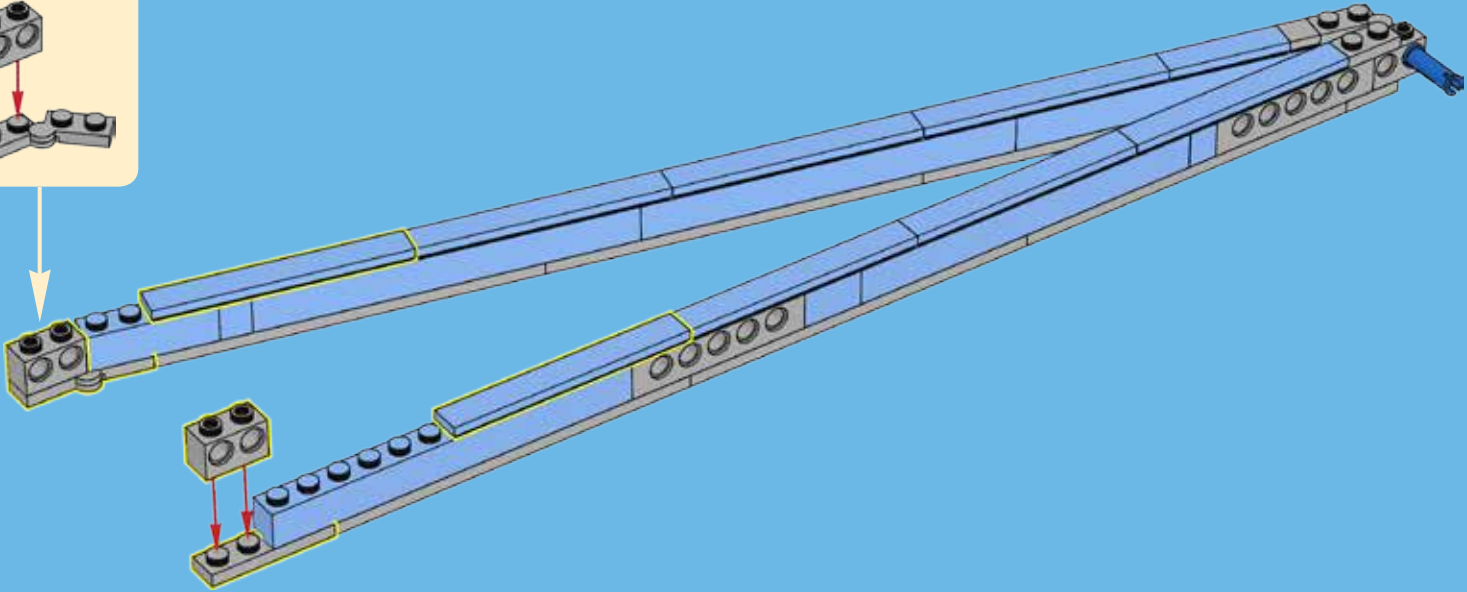
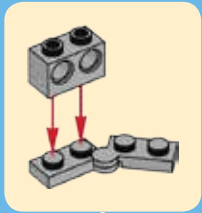

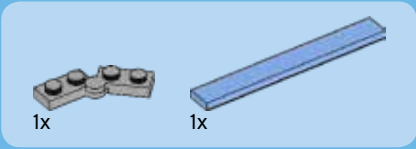

11

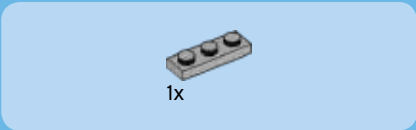
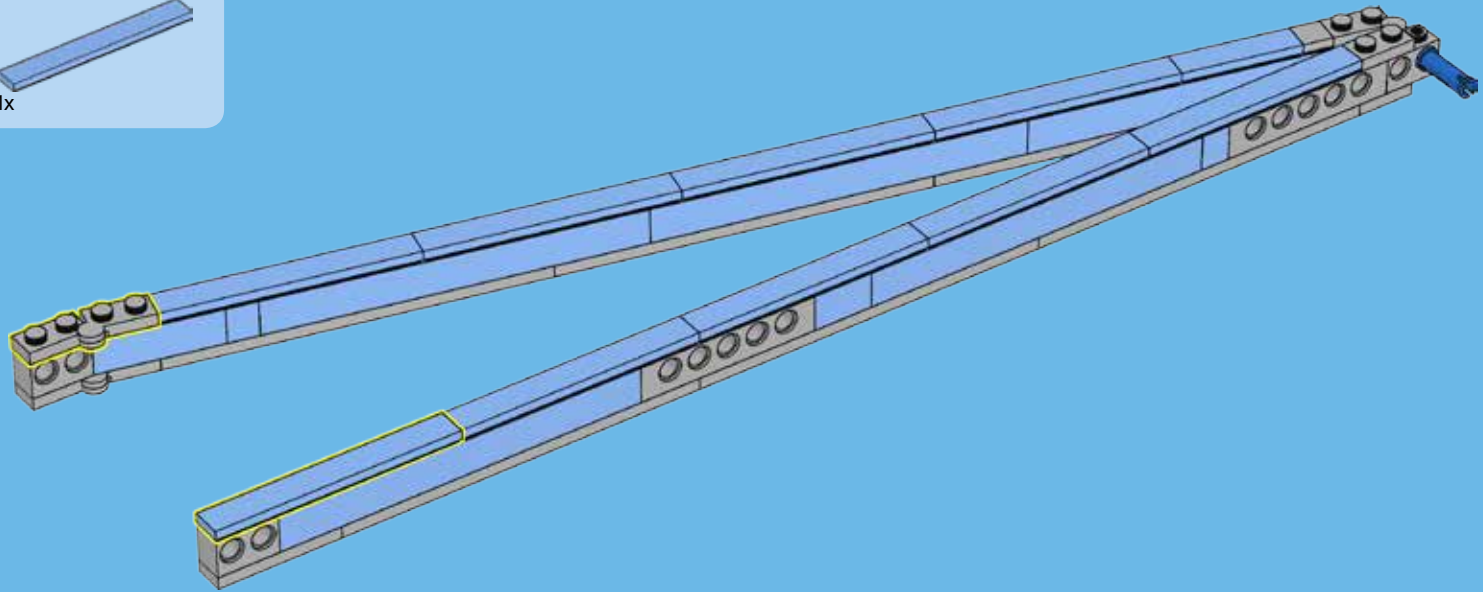

12

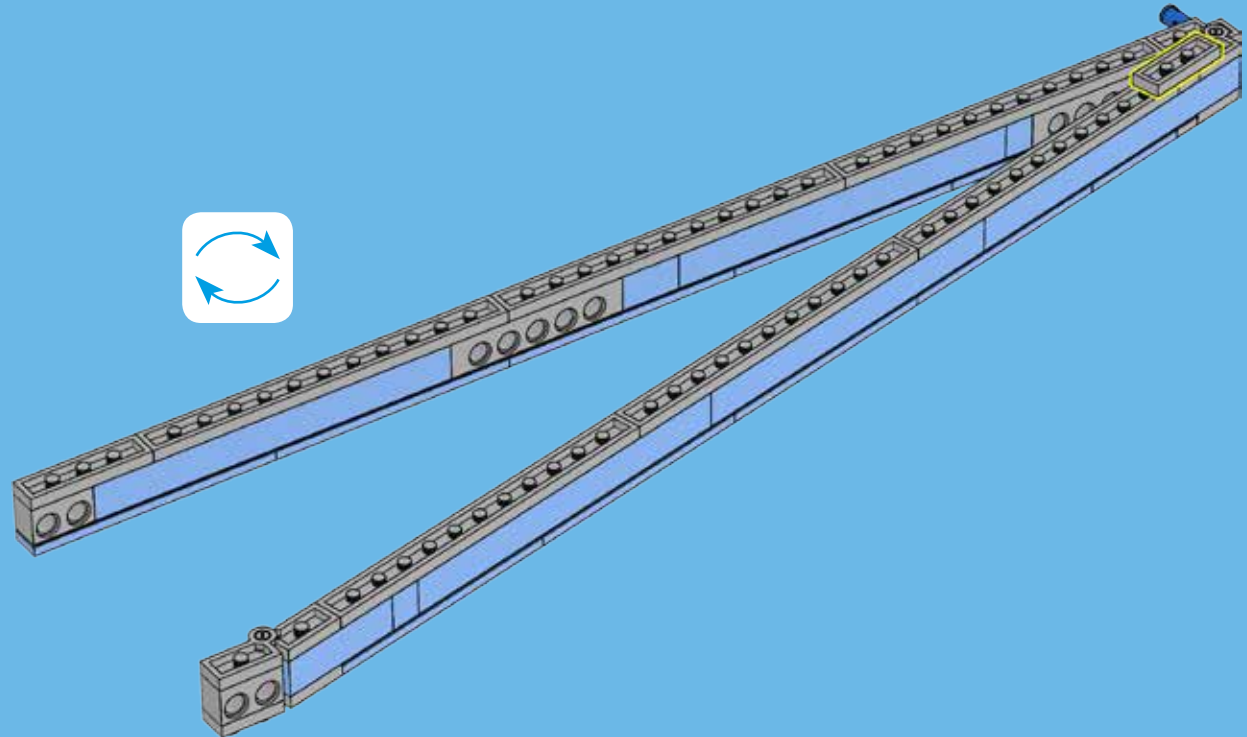

13

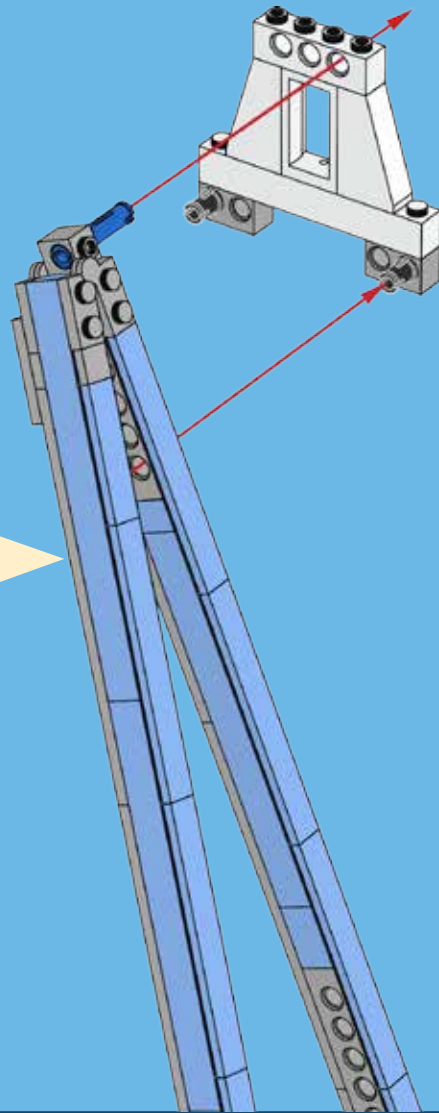

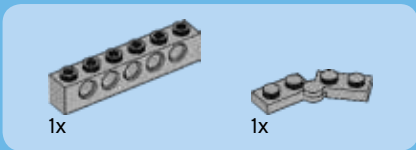
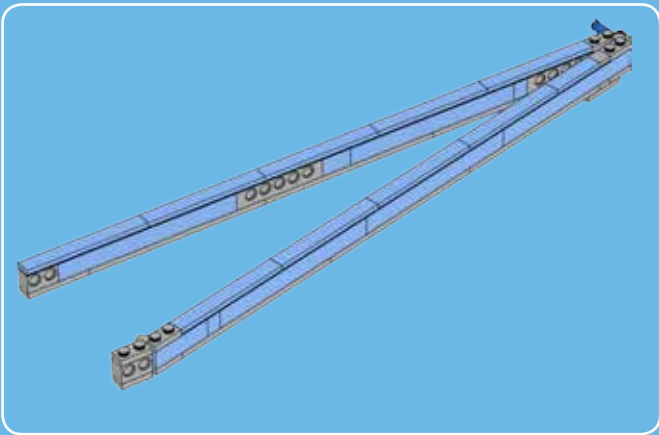

1

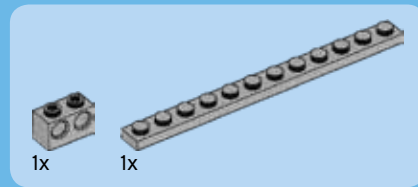
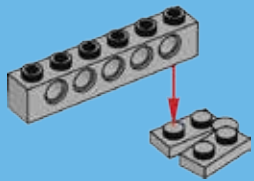

2

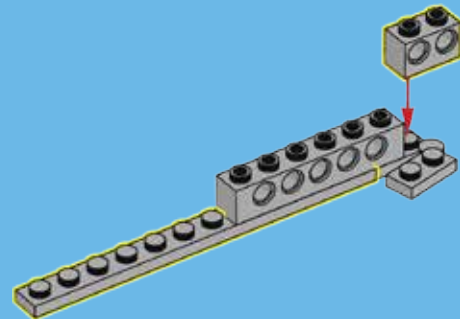

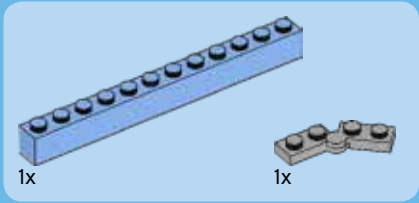

3

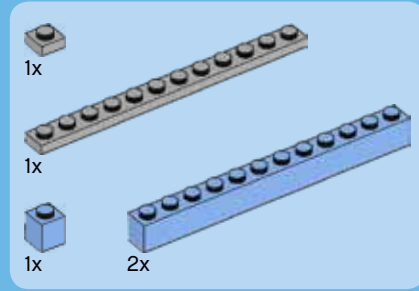
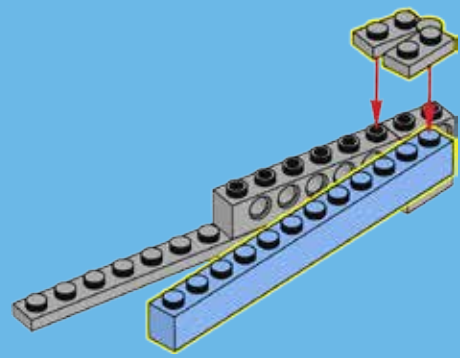

4

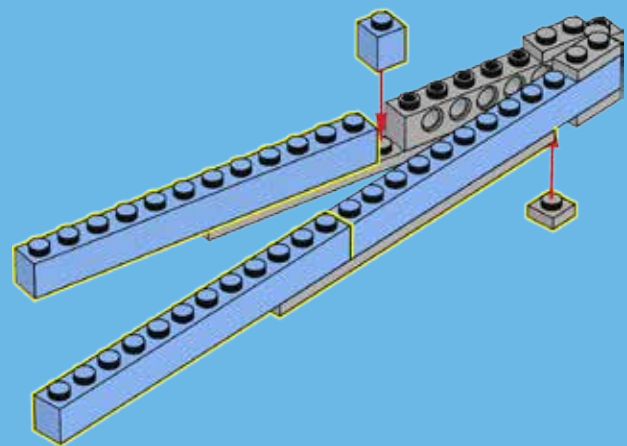

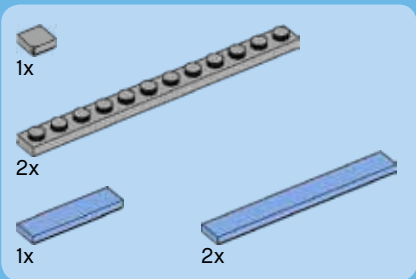

5

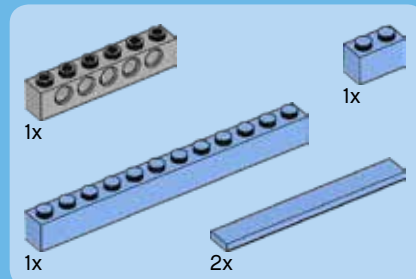
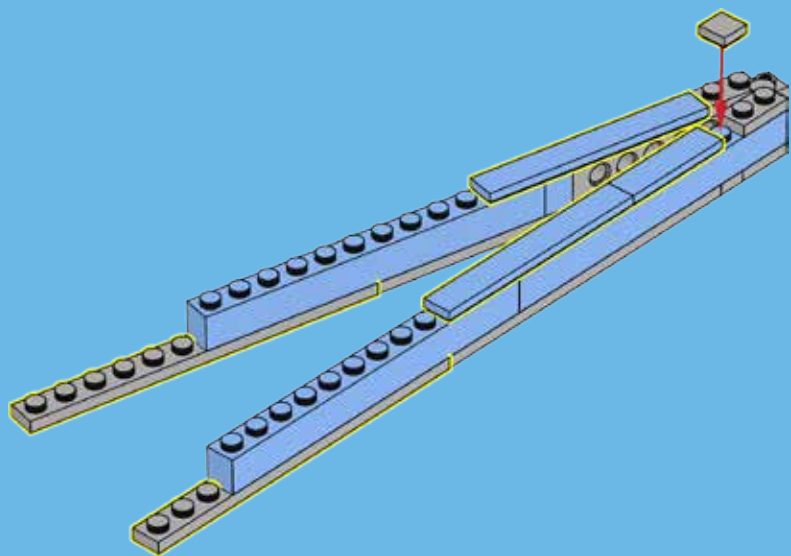

6

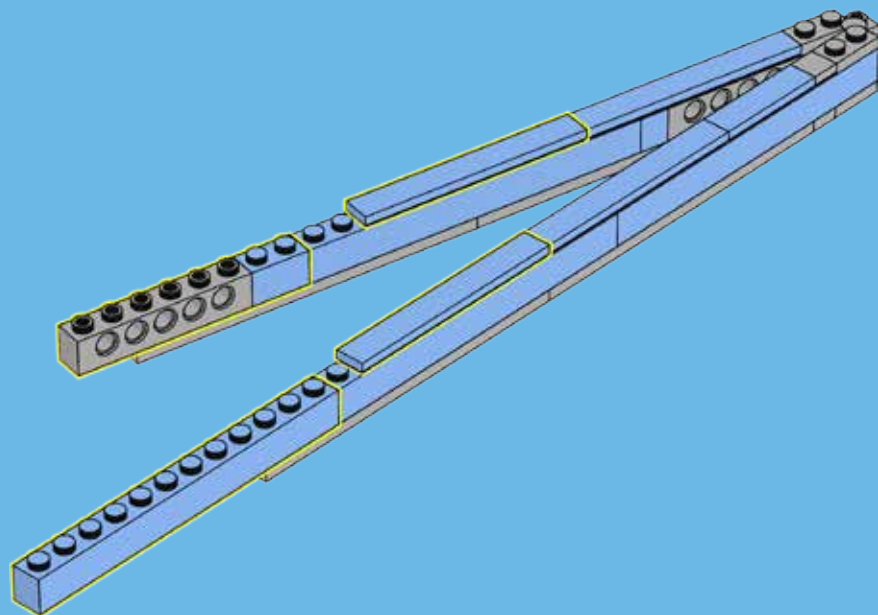

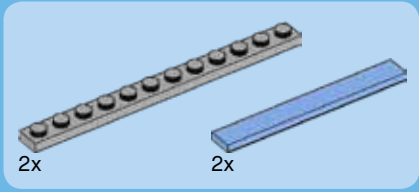

7

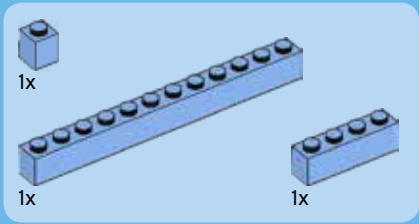
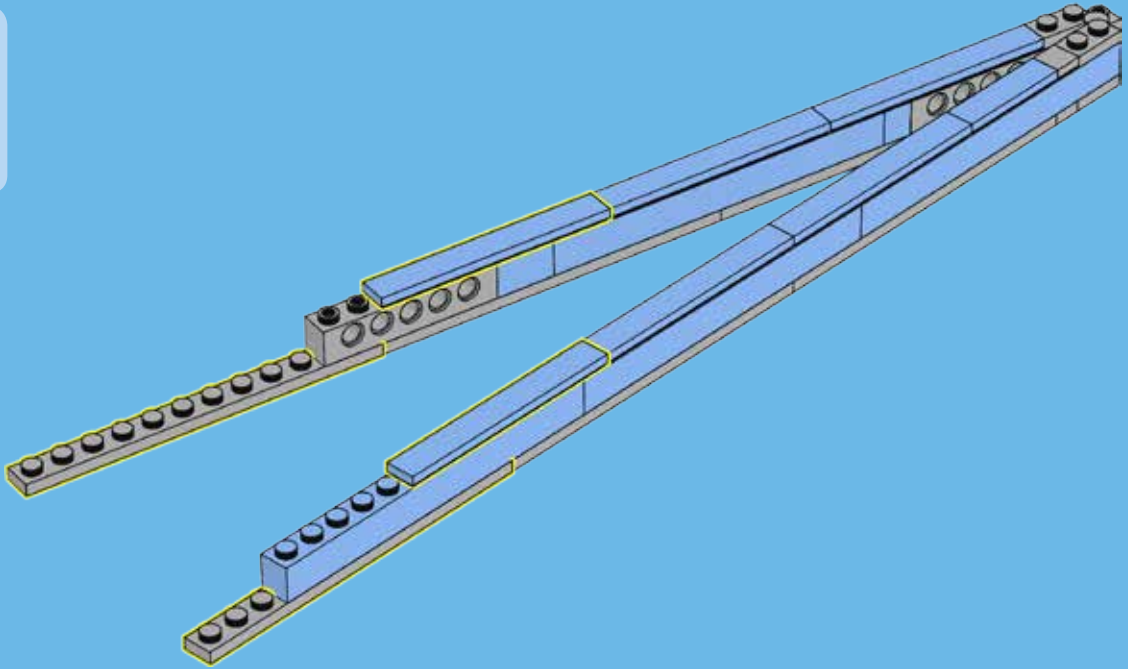

8

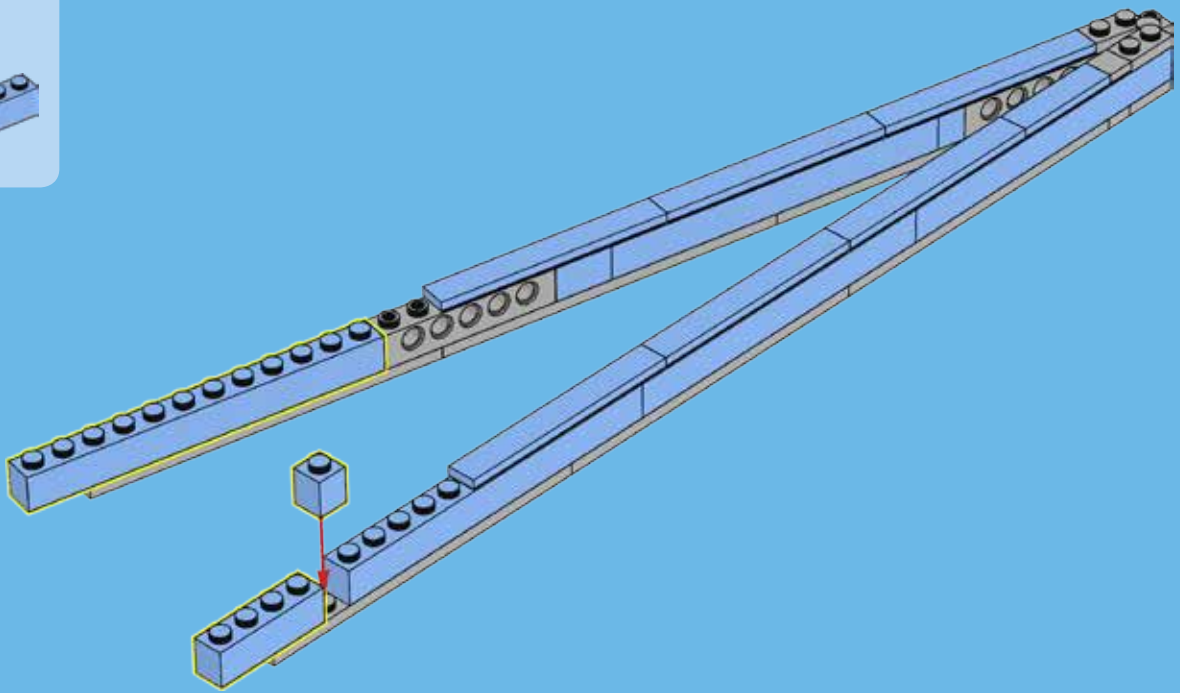

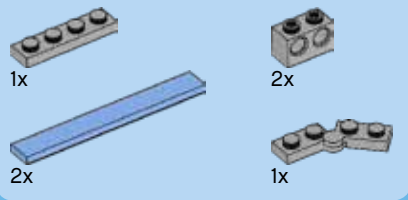

9

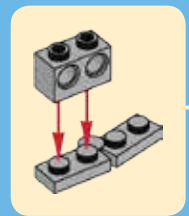
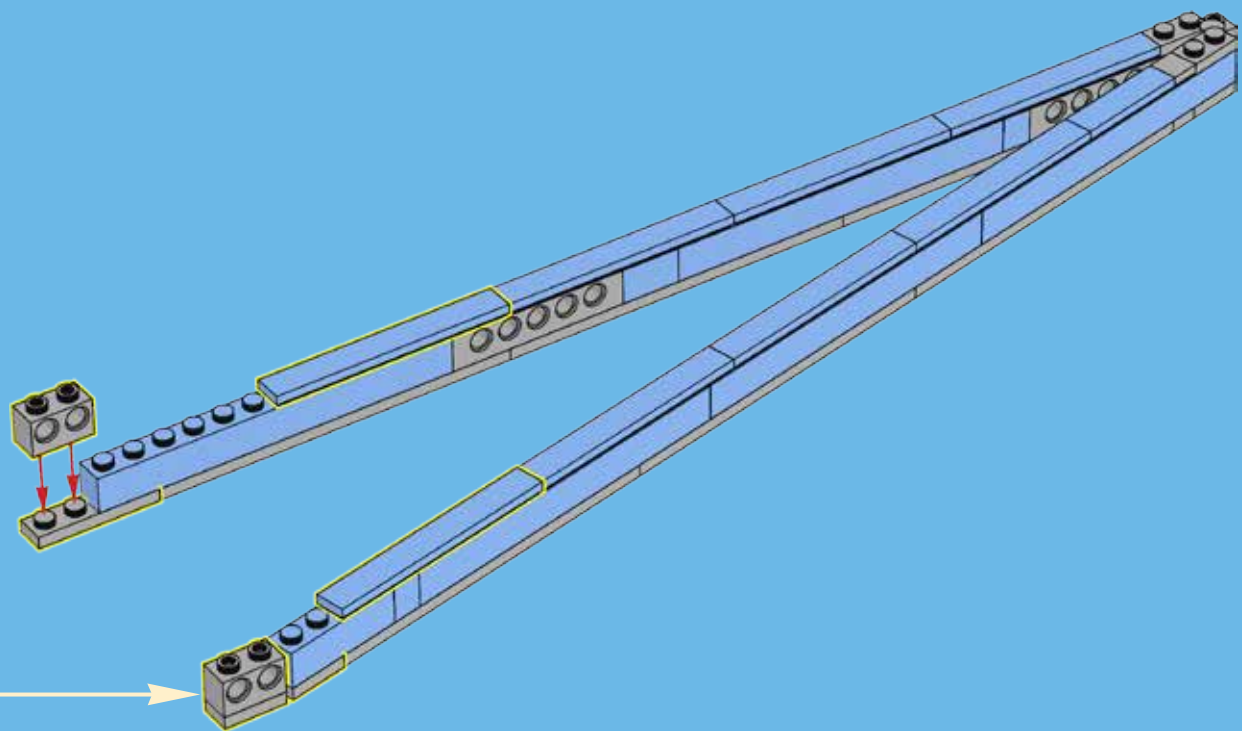

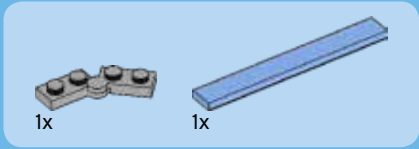

10

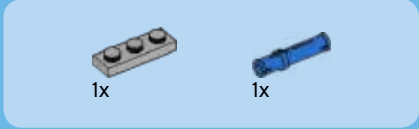
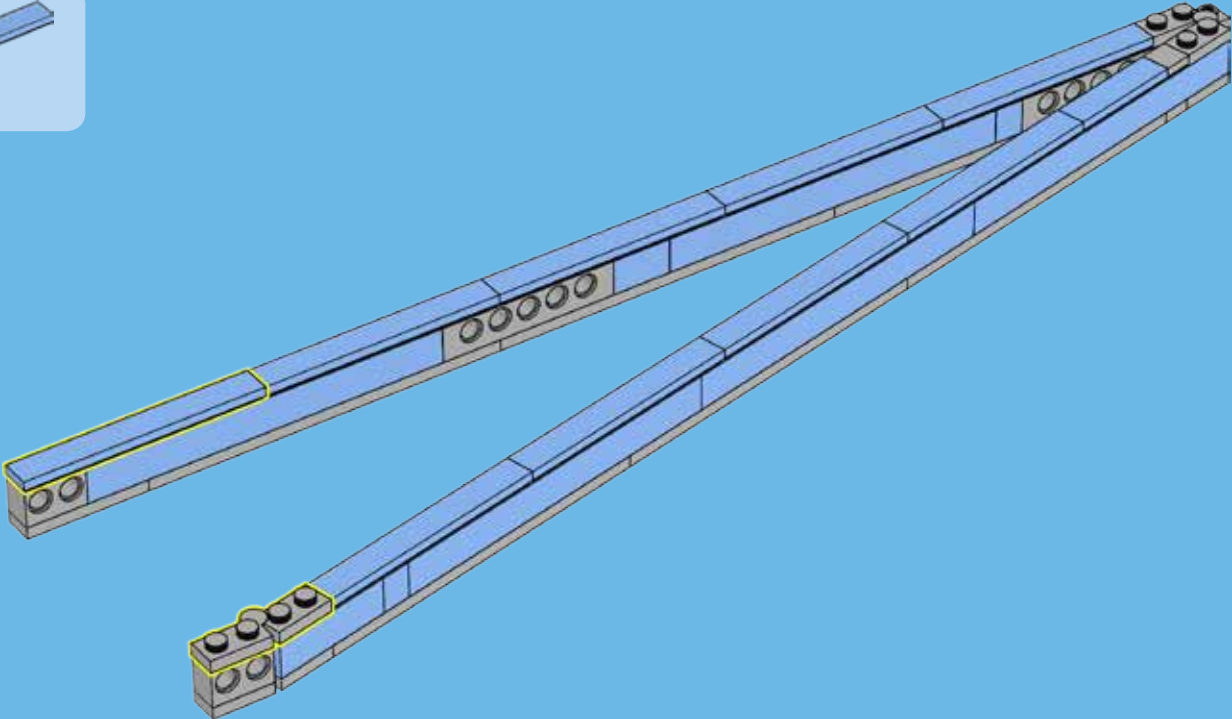

11

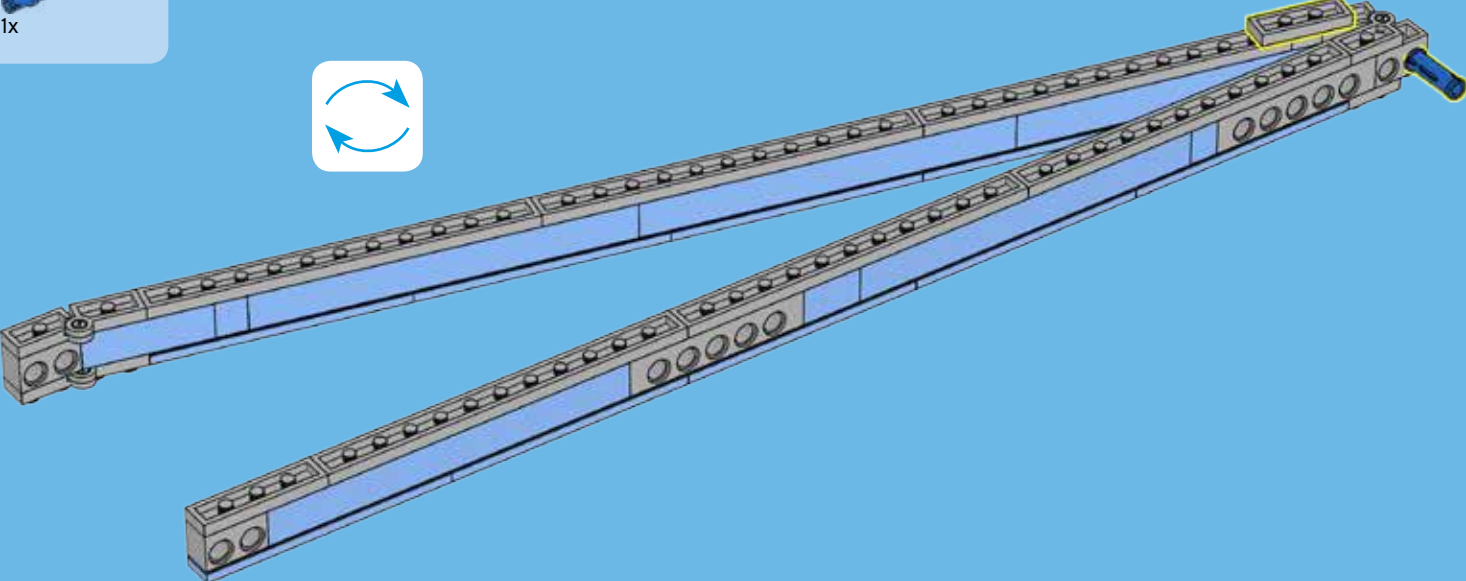

12

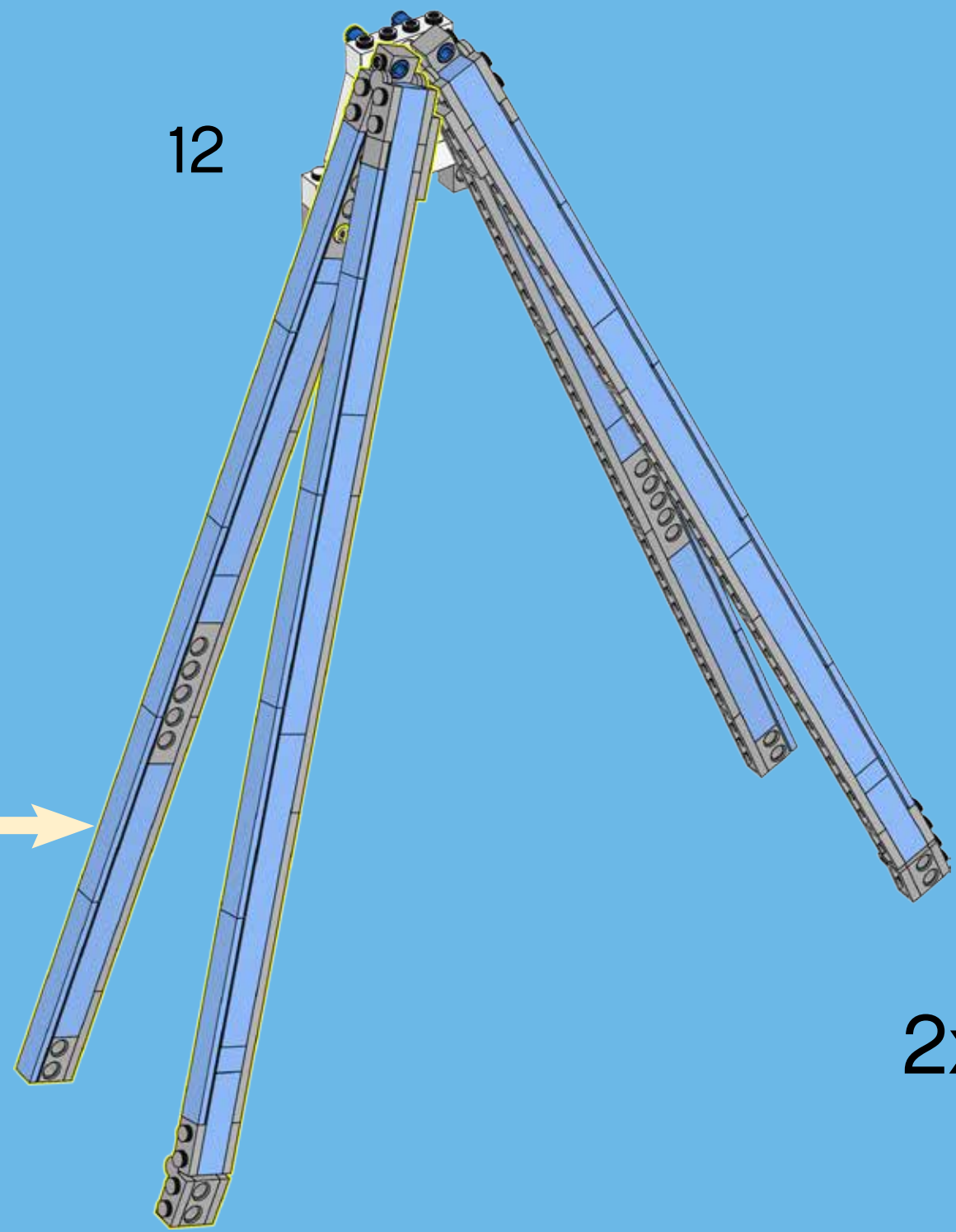

2x





2x



4x

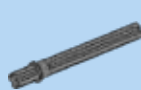

4x

5.5

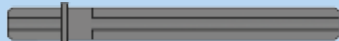

5.5

1:1

53

1



2



5.5

5.5

2x



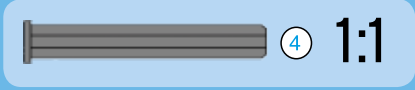
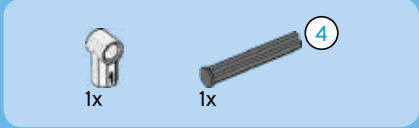
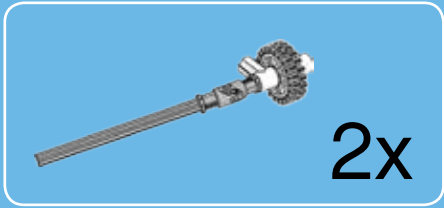

1

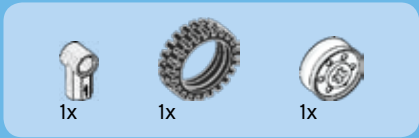
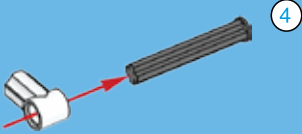

2

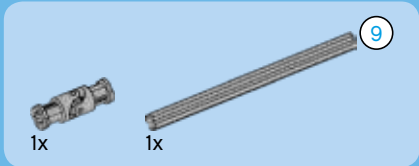
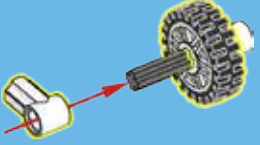

3

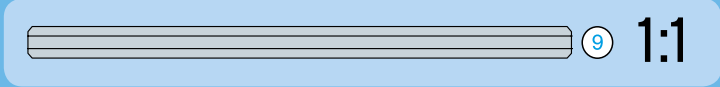
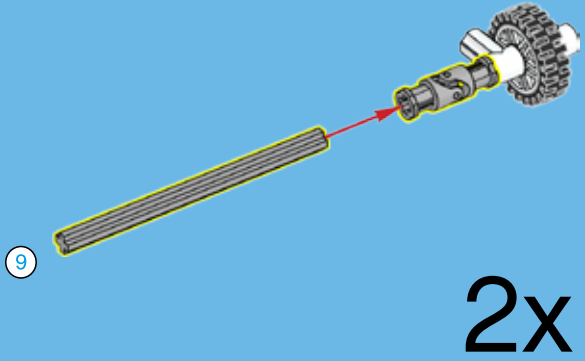

54





5x



5x



10x

55



5x





6x



6x



12x

56



5x

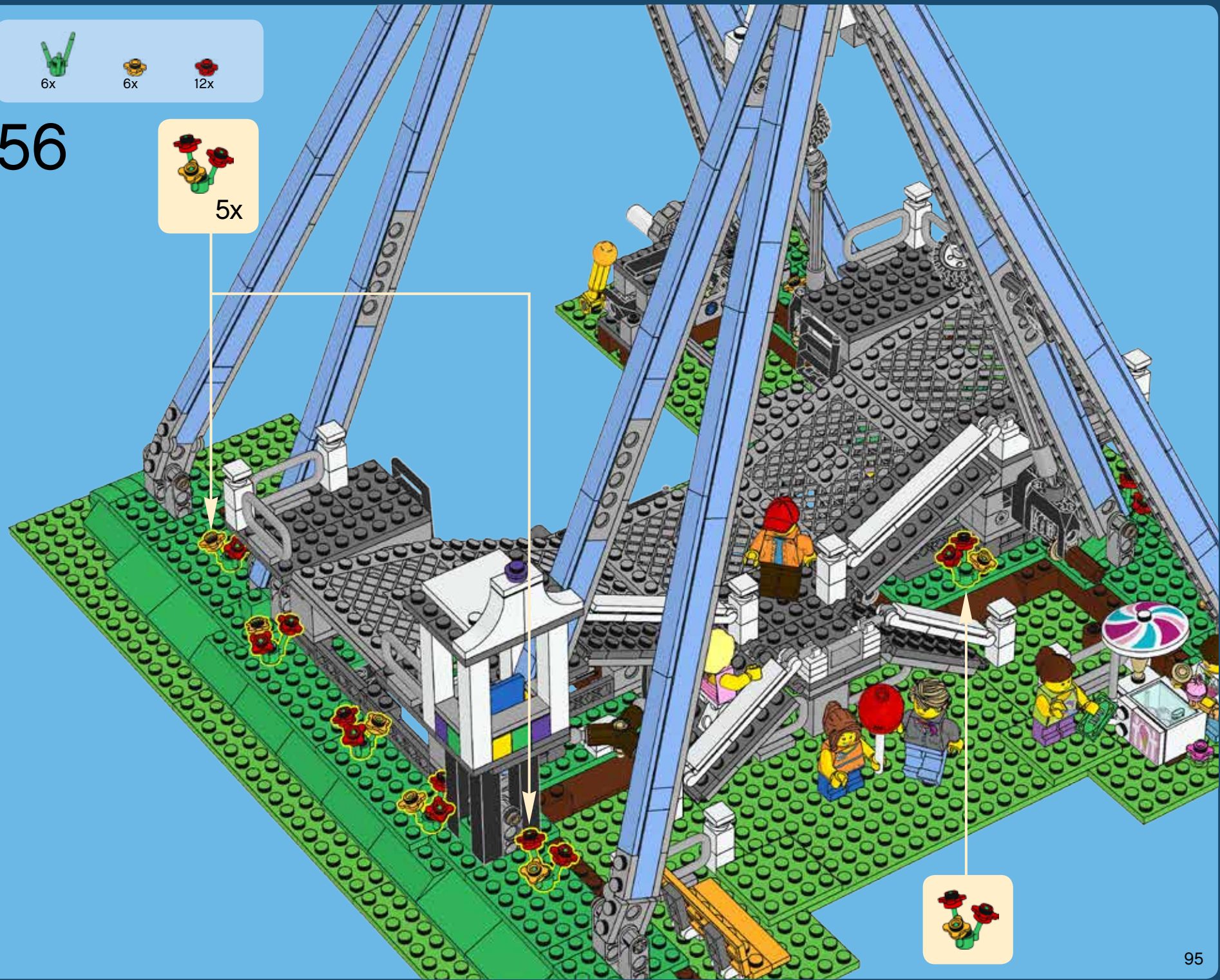

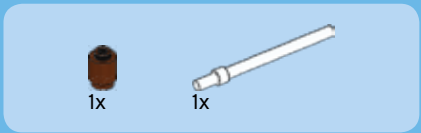

1

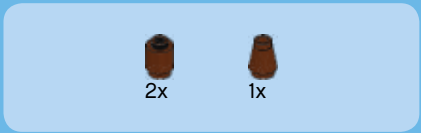

2



3

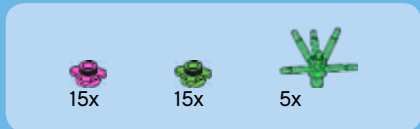

4



2x

57



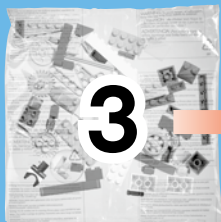

3

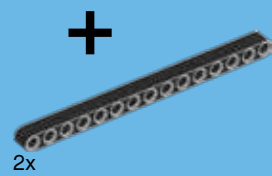

2x



2x



2x



1x

1



1x



2x

2



3x

3

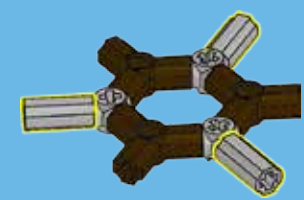

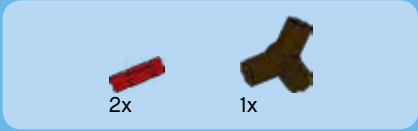

1



2



3

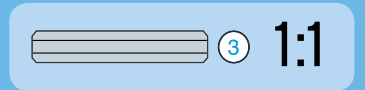
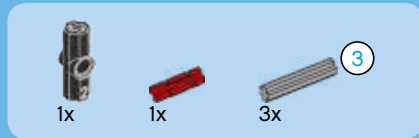

4

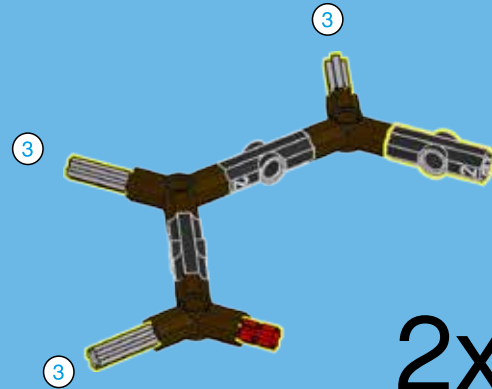

5

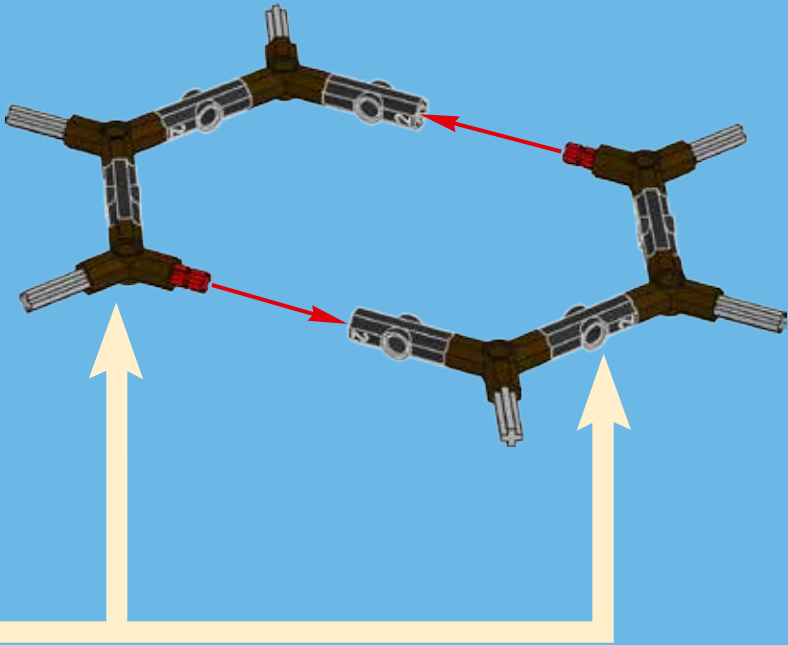

4

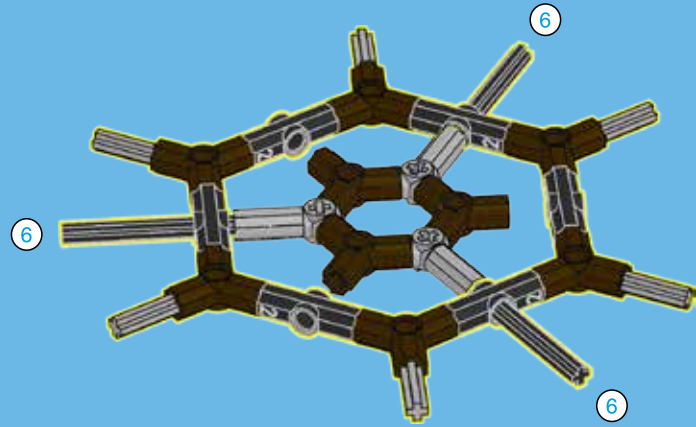
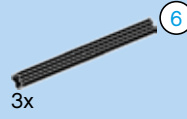

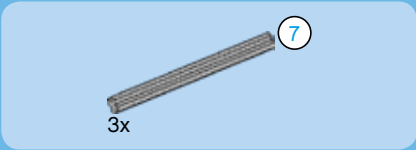

5

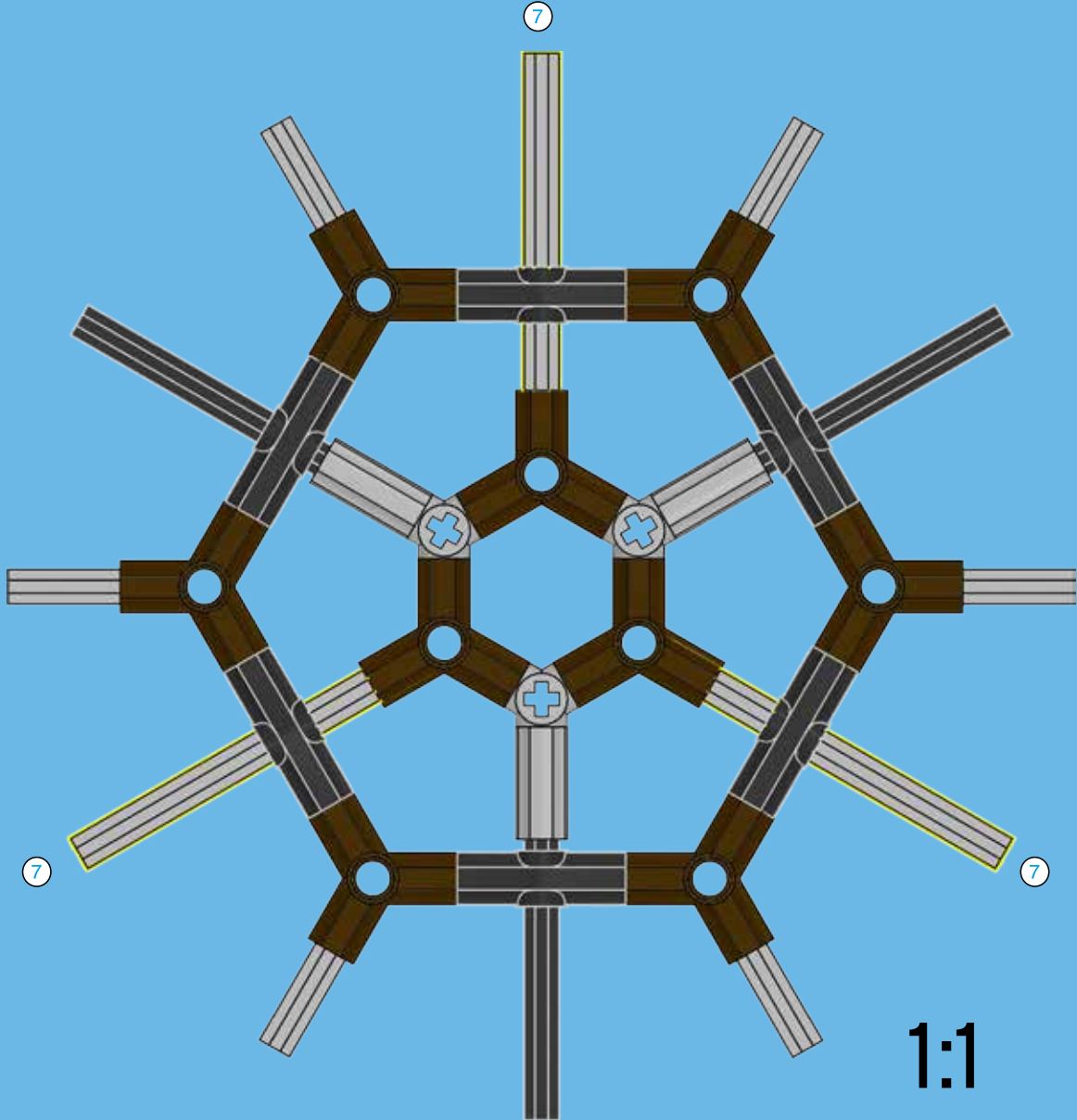



9x

6

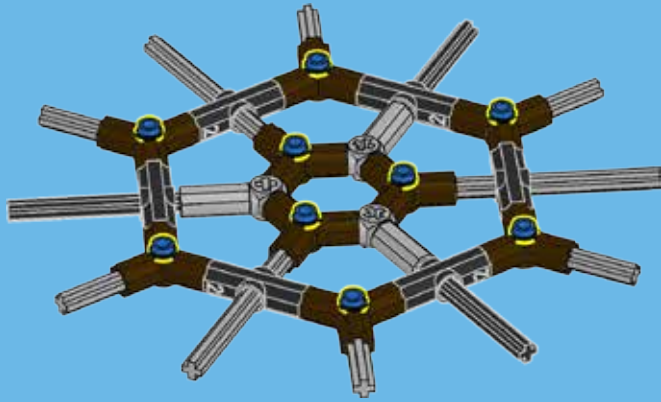

6x



1x

7

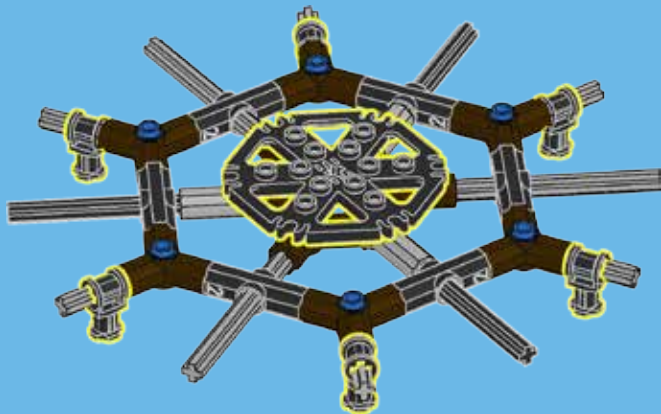

12x



12x

8

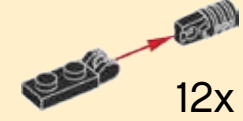

12x

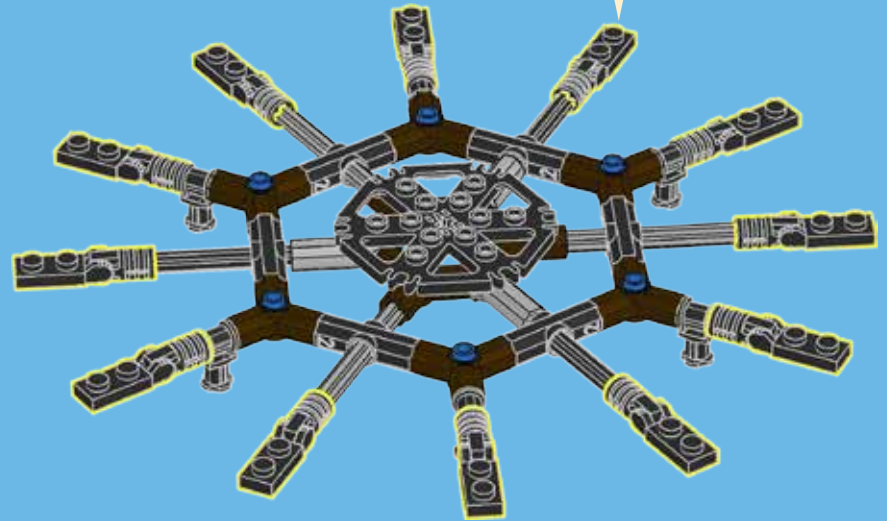

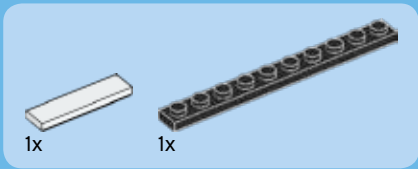
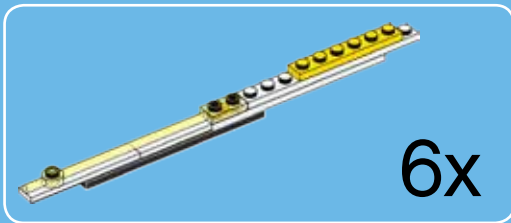

1

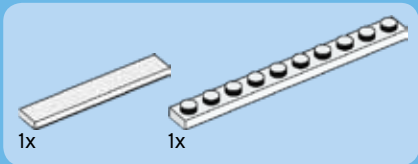
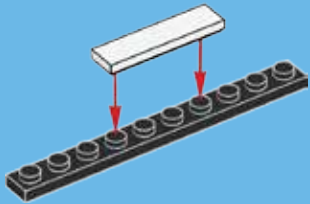

2

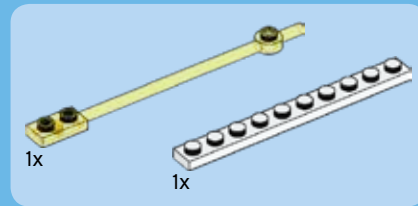
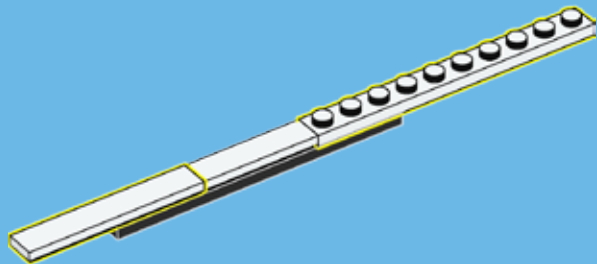

3

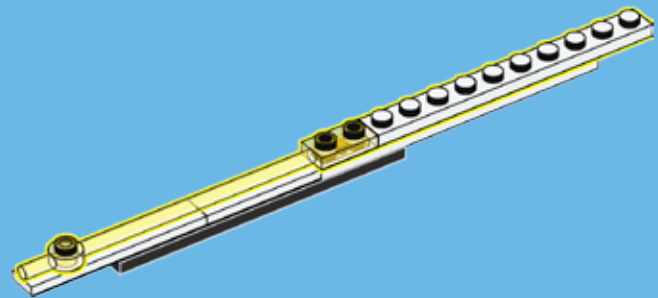

4

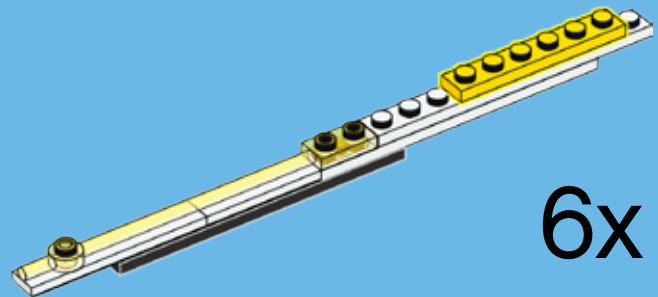

9

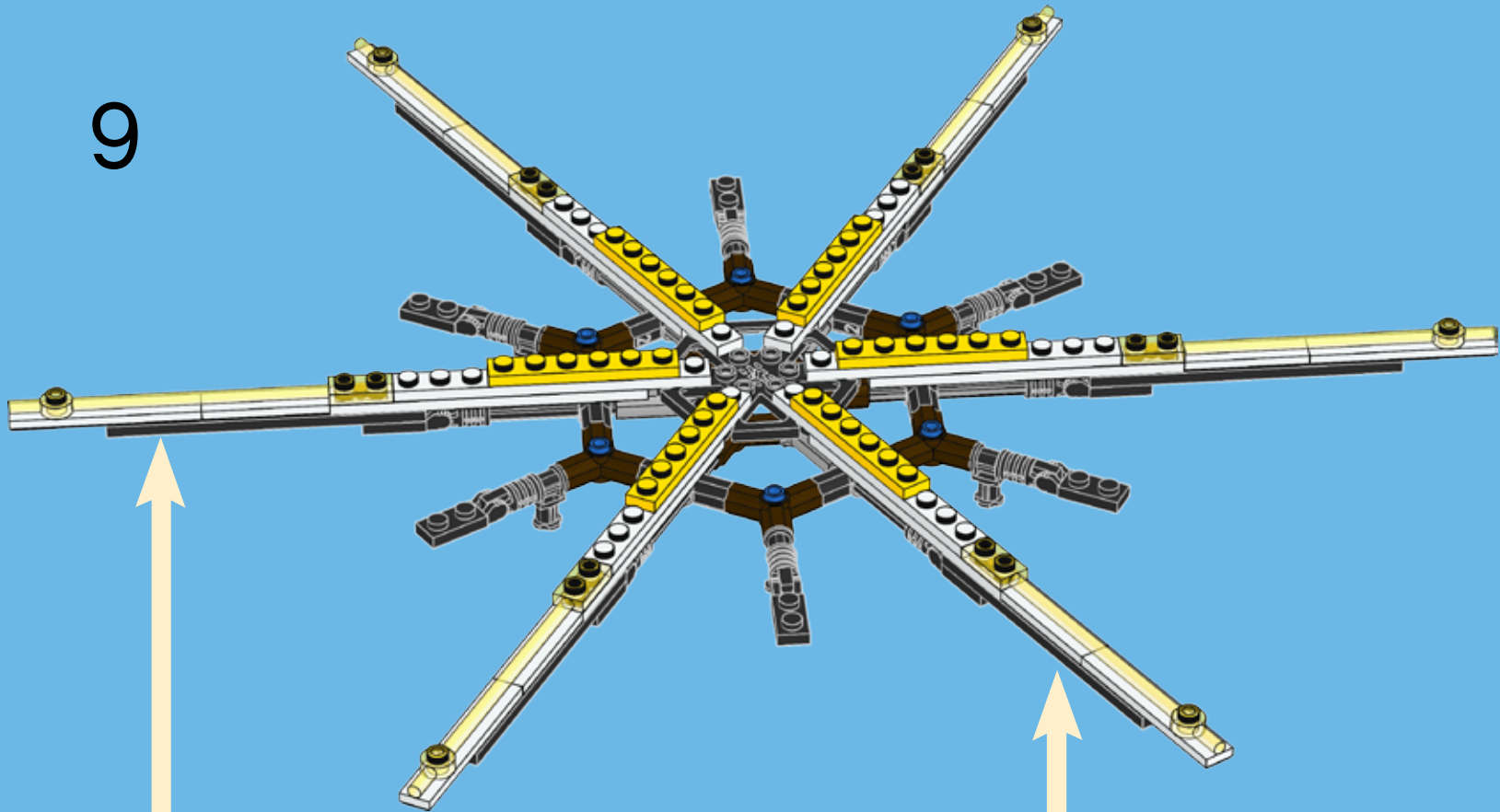

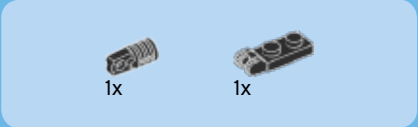
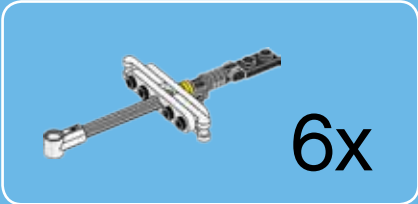

1

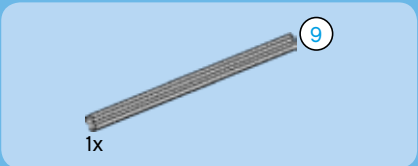

2

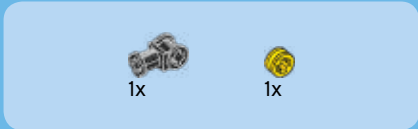
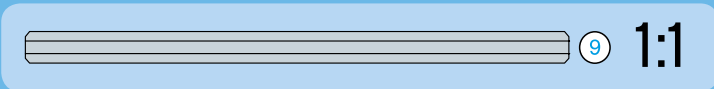
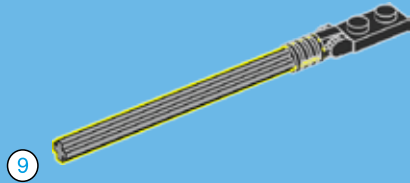

3

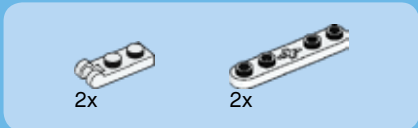
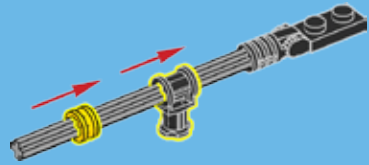

4

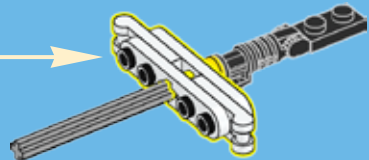
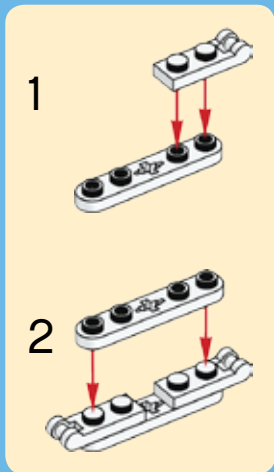



1x

5

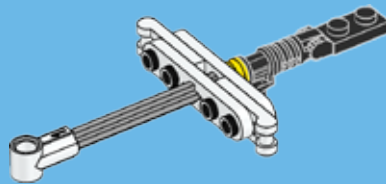

6x

10

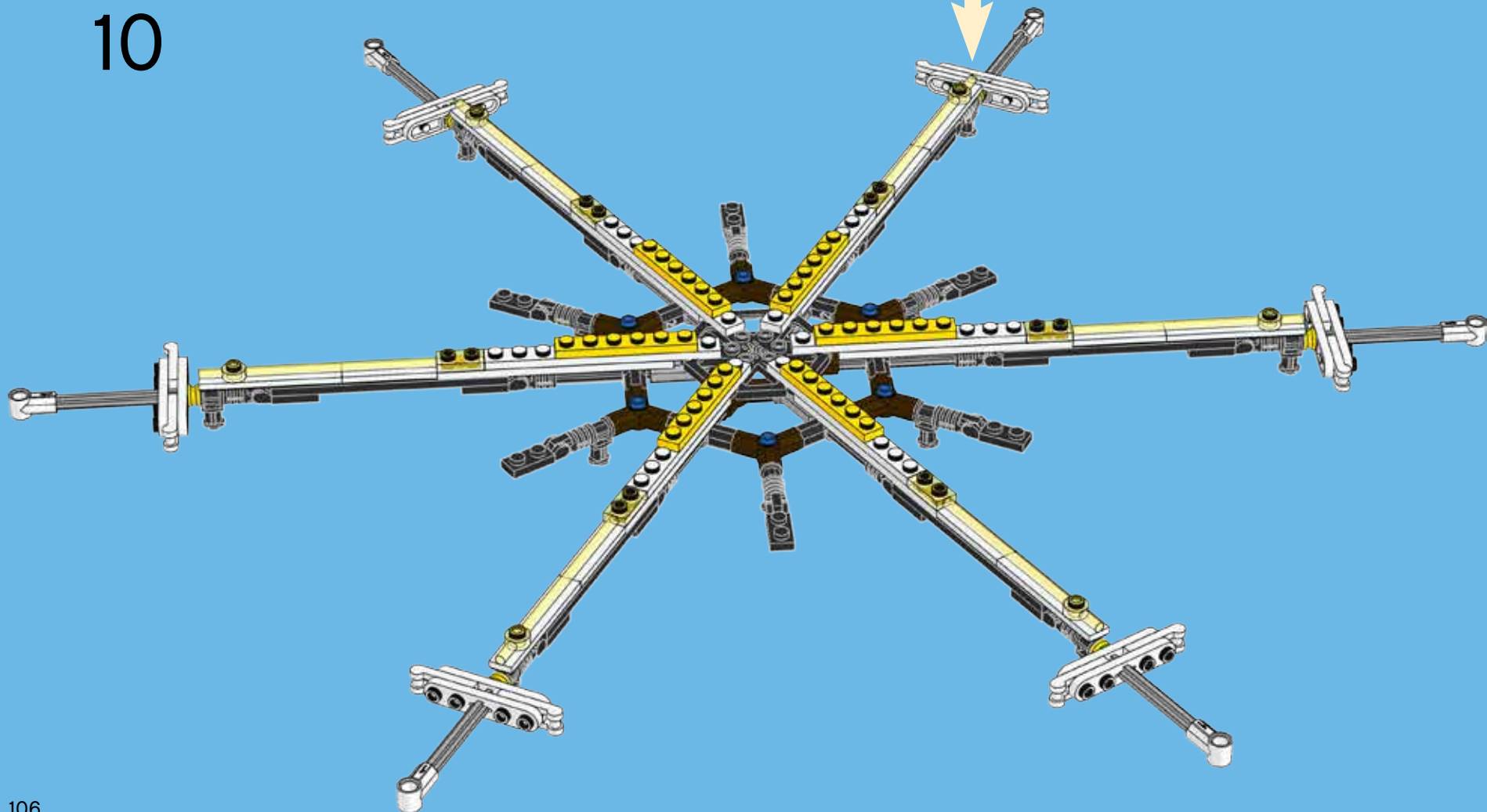

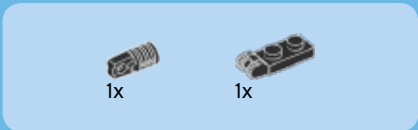
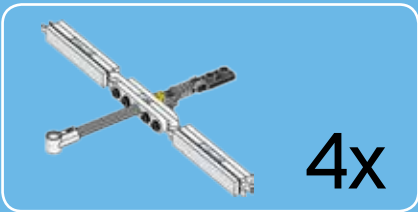

1

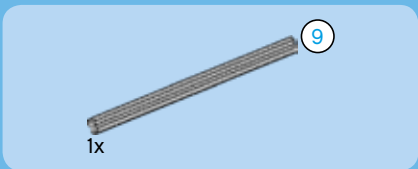

2

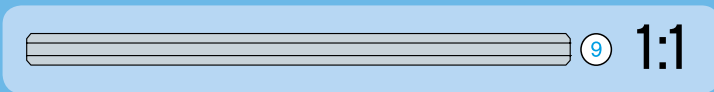
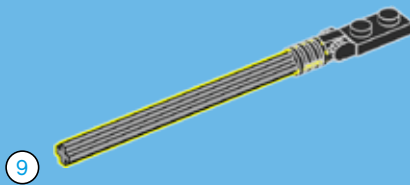

3

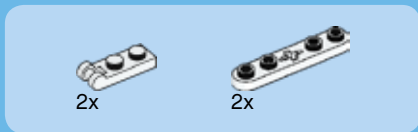
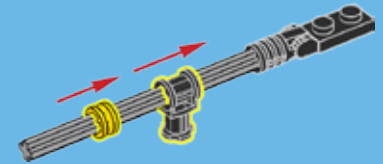

4

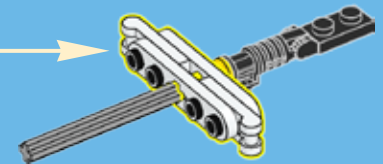
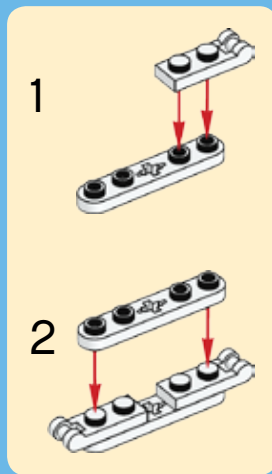



1x

5

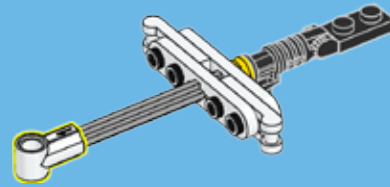

2x



2x



2x



4x

6

1

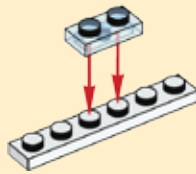

2

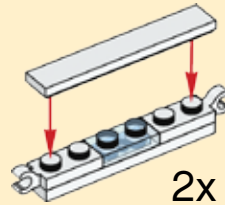

2x

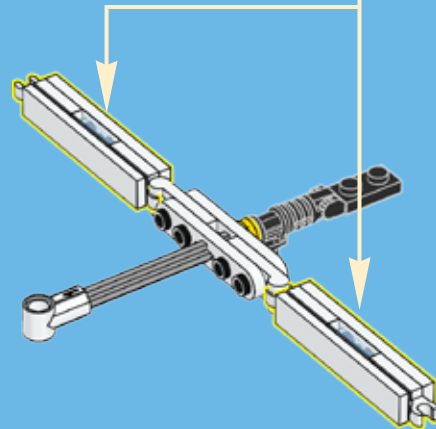

4x

11

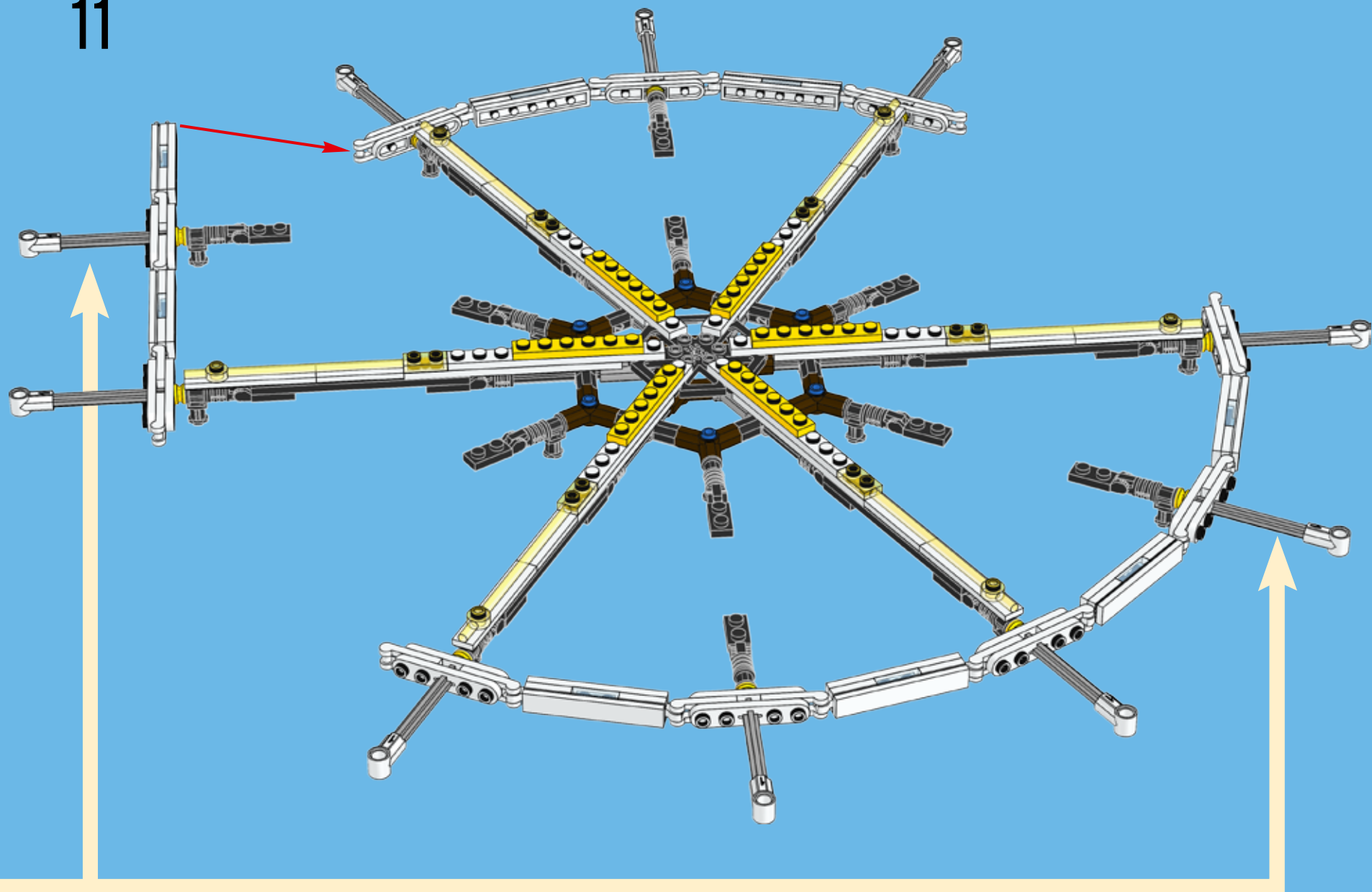

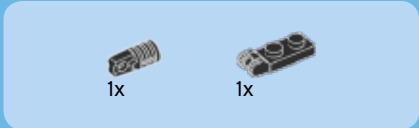

1

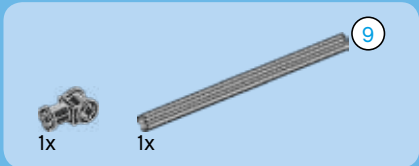

2

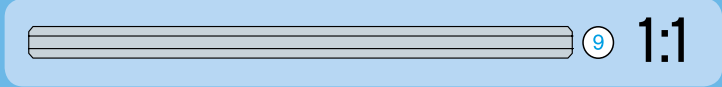
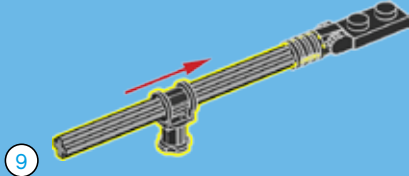

3

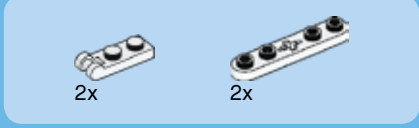
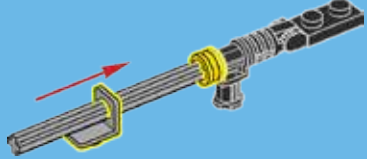

4

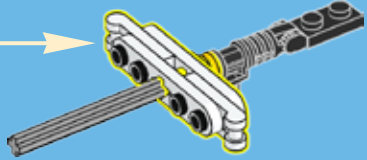
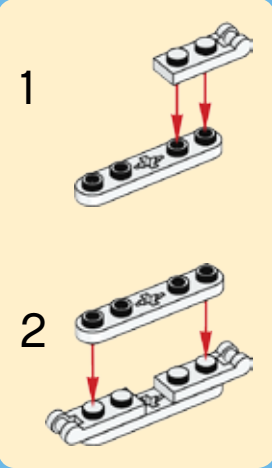



1x

5

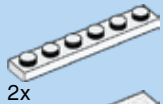
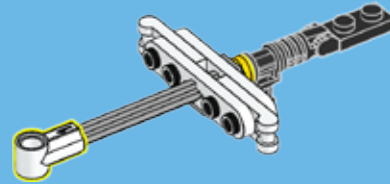

2x



4x

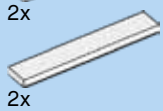

2x



2x

1

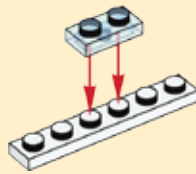

2

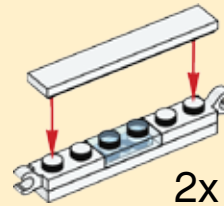

2x

6

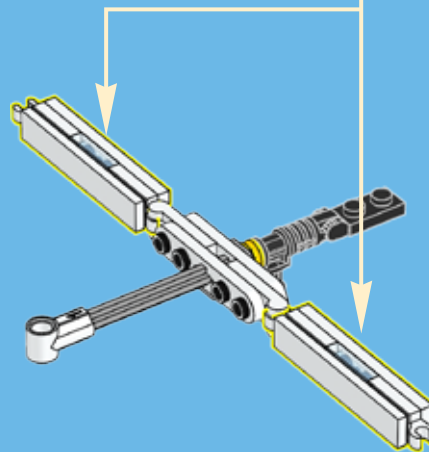

2x

12

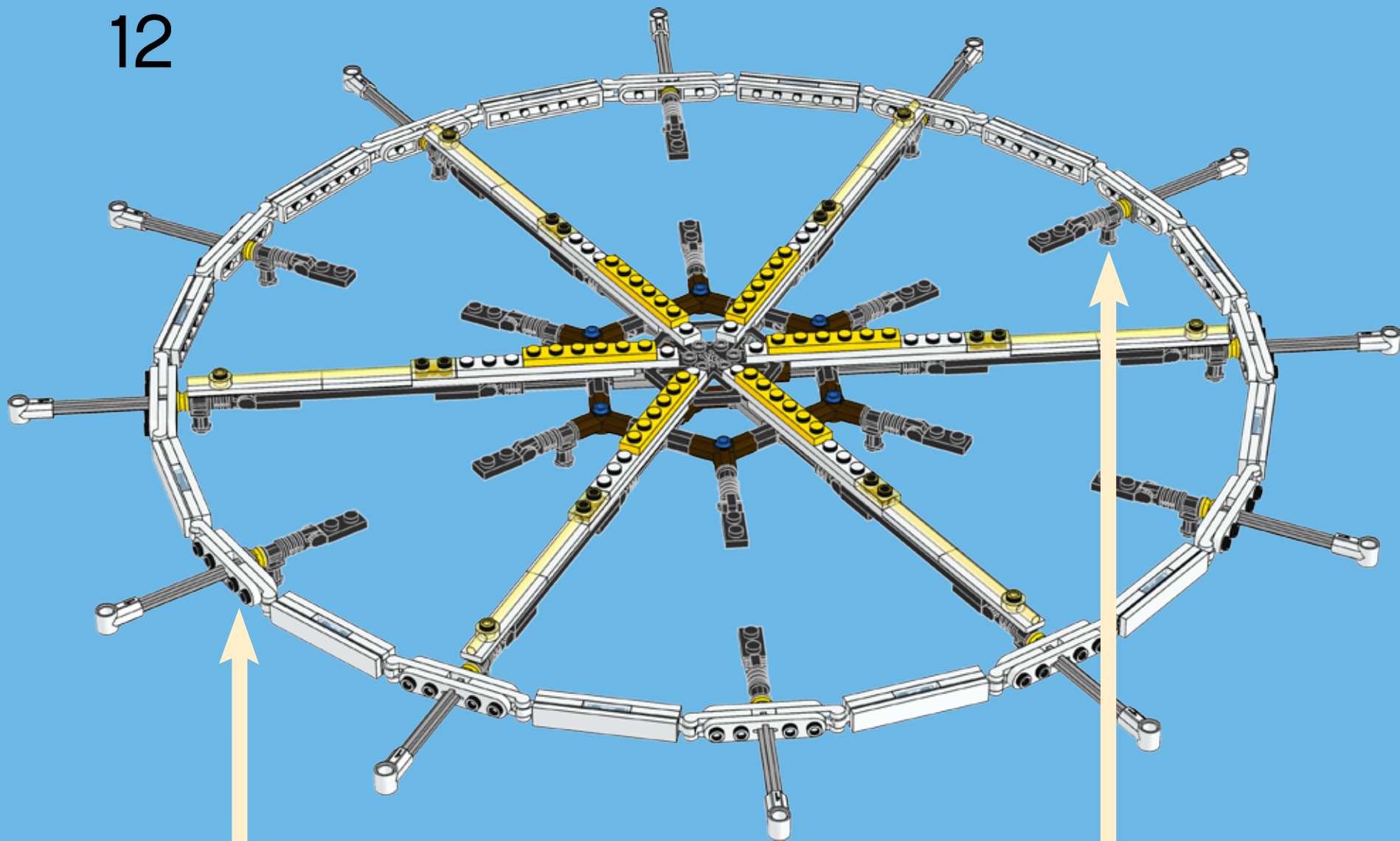

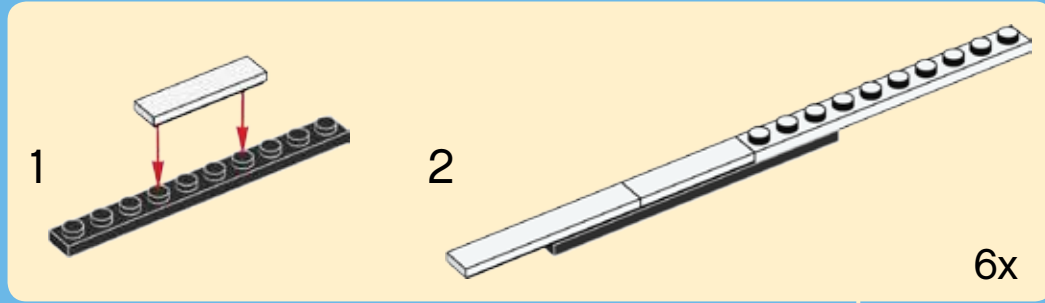
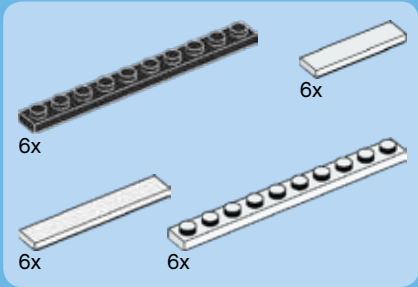

13

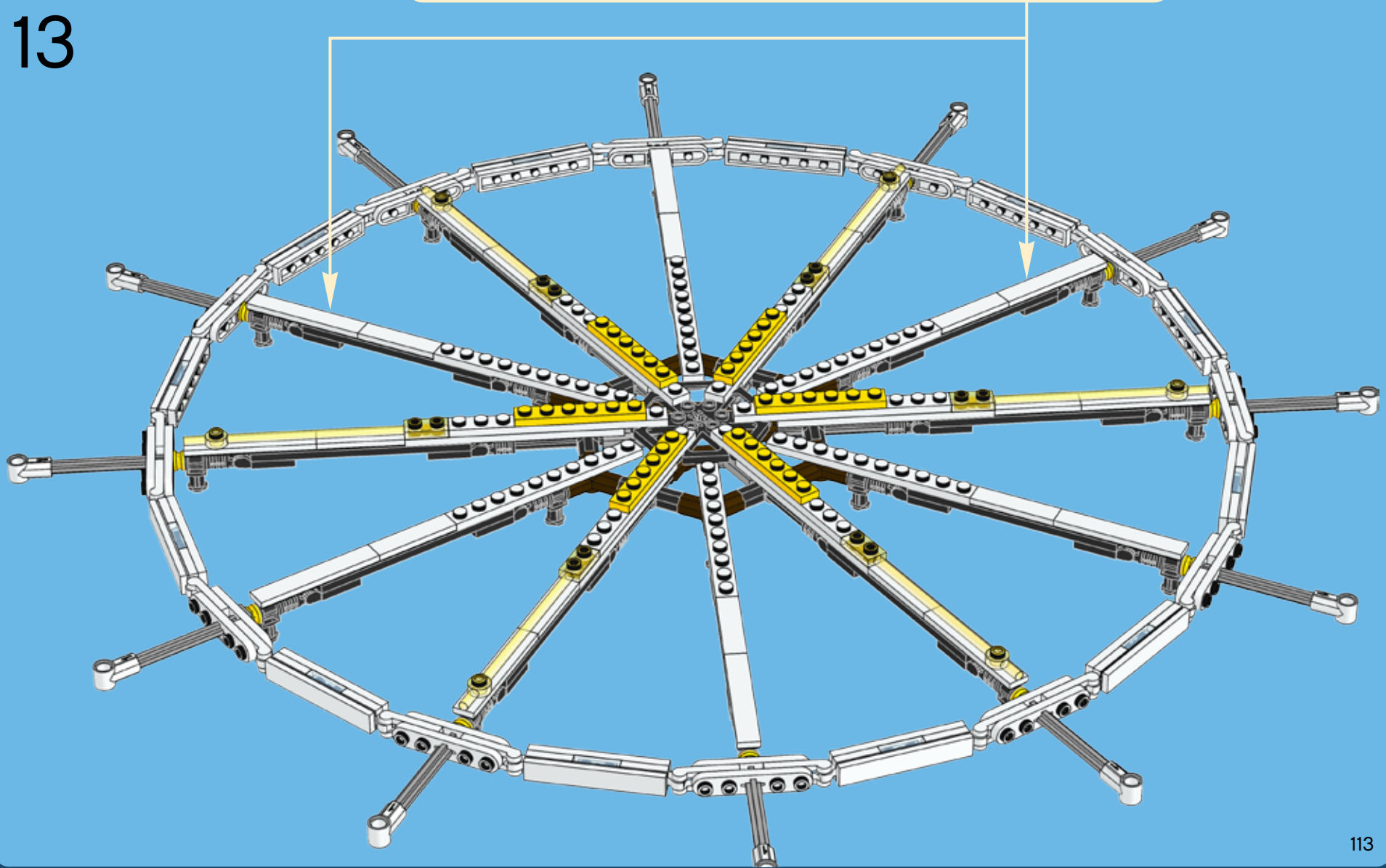

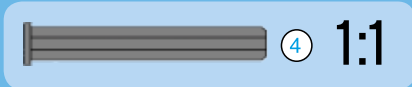
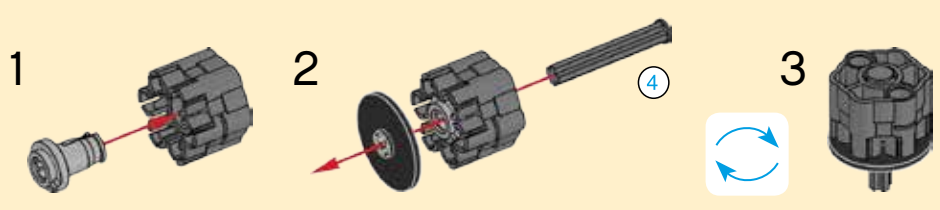
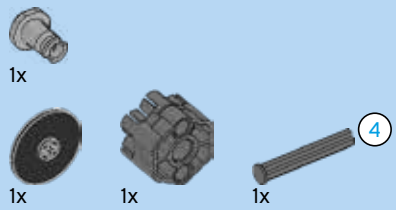

14





1x

15

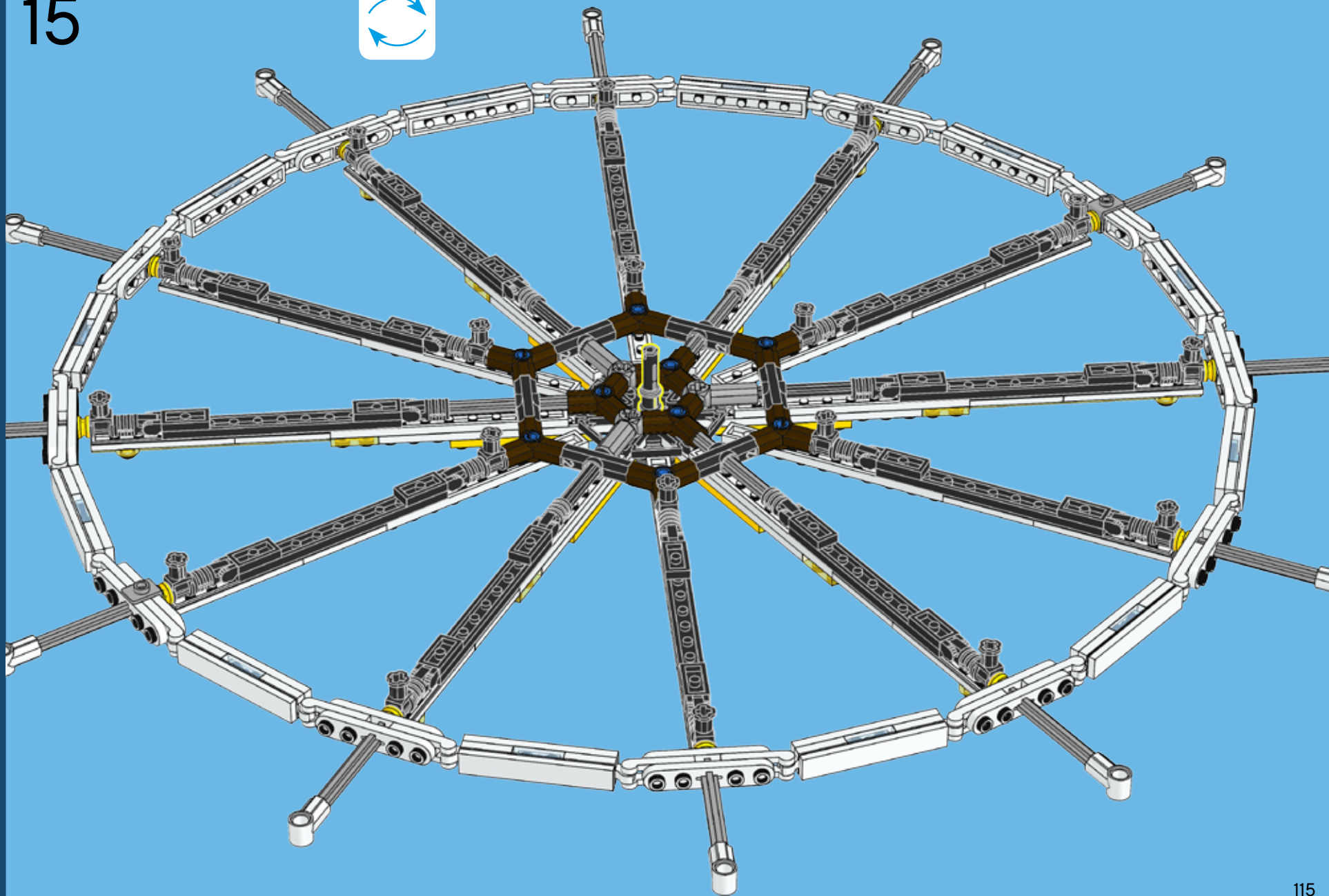

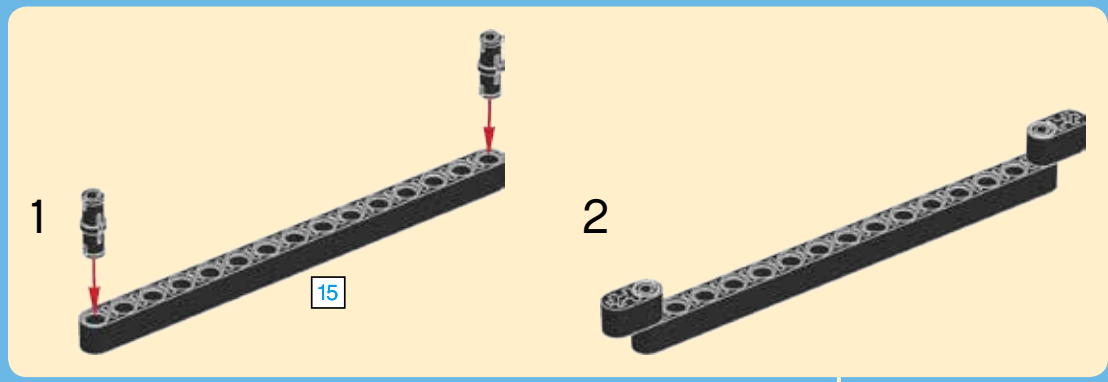
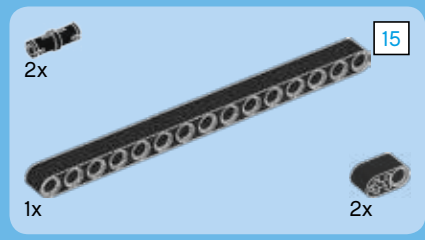

16

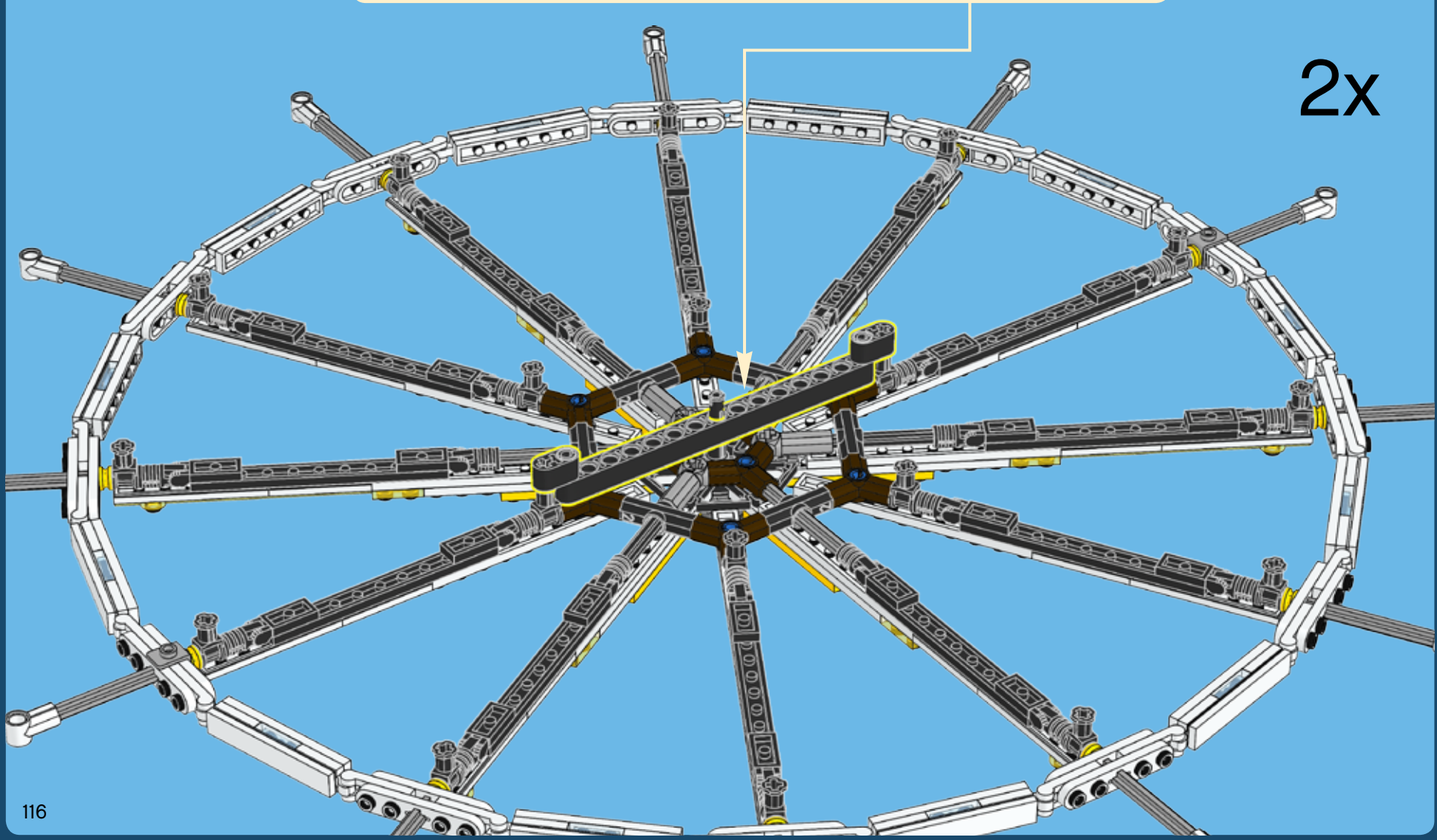

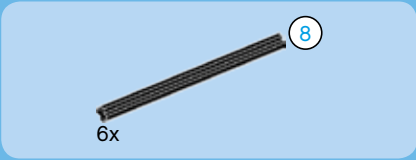

17

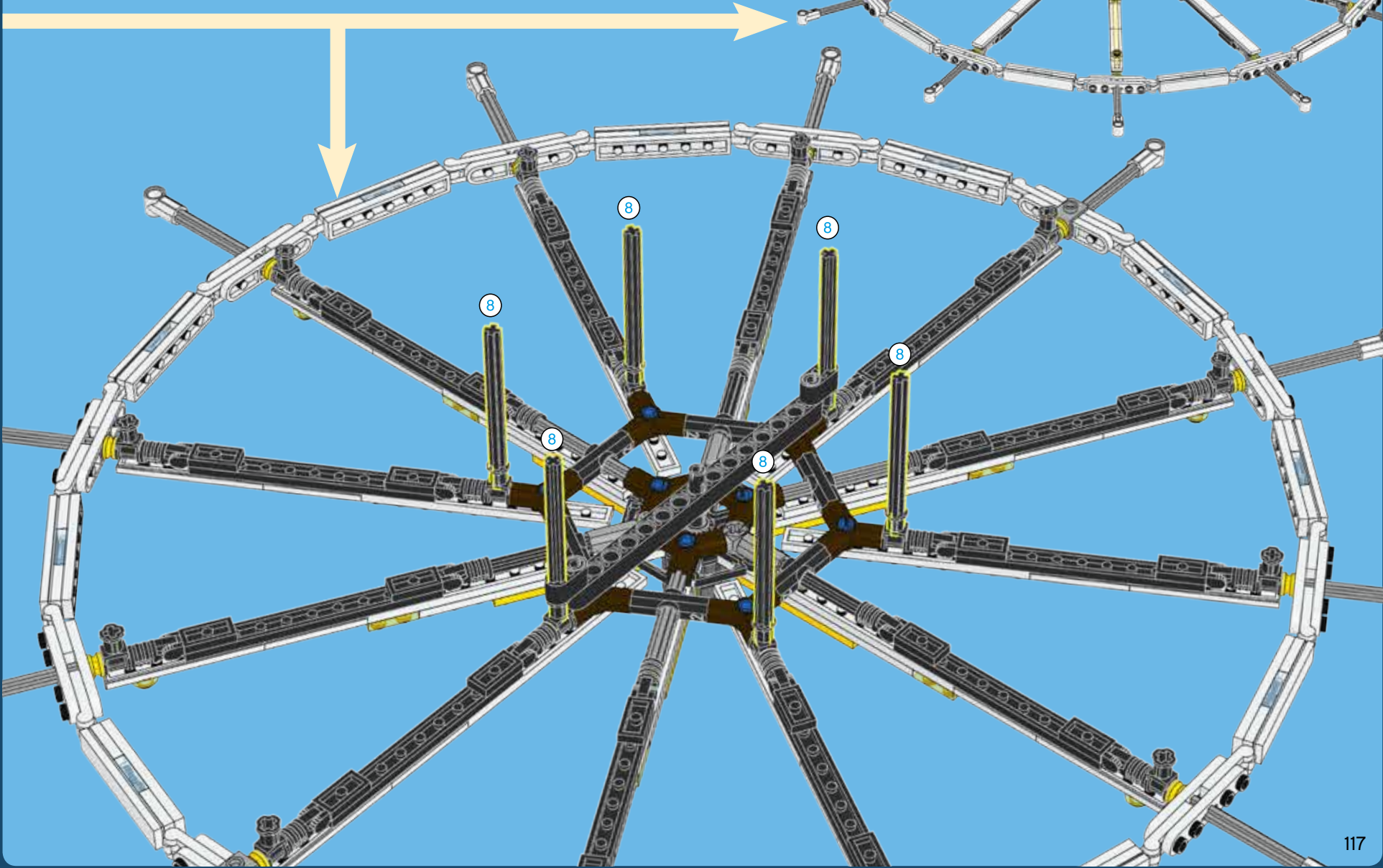

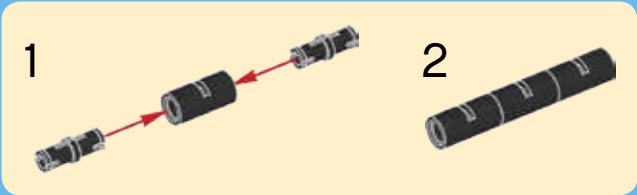

18

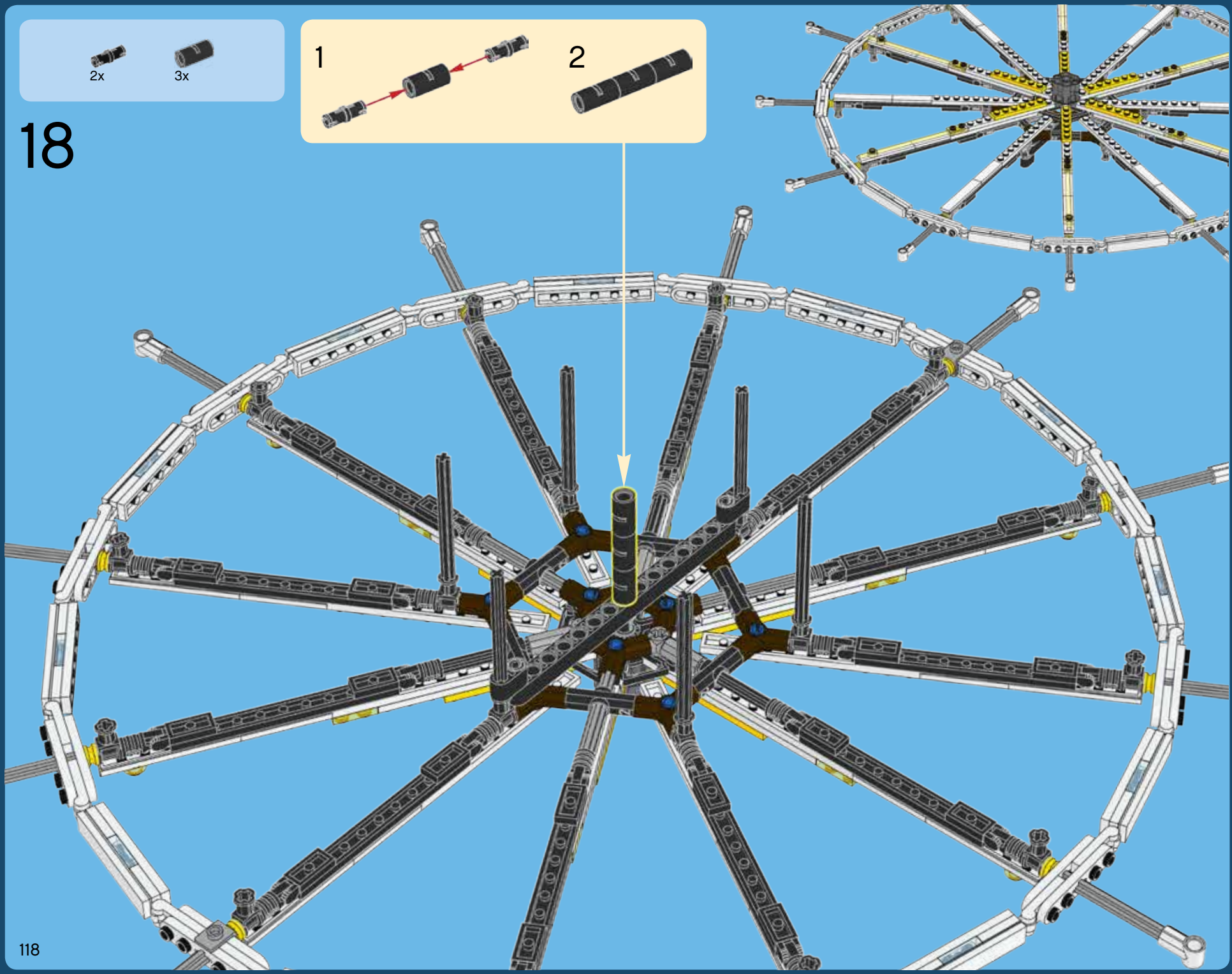

19

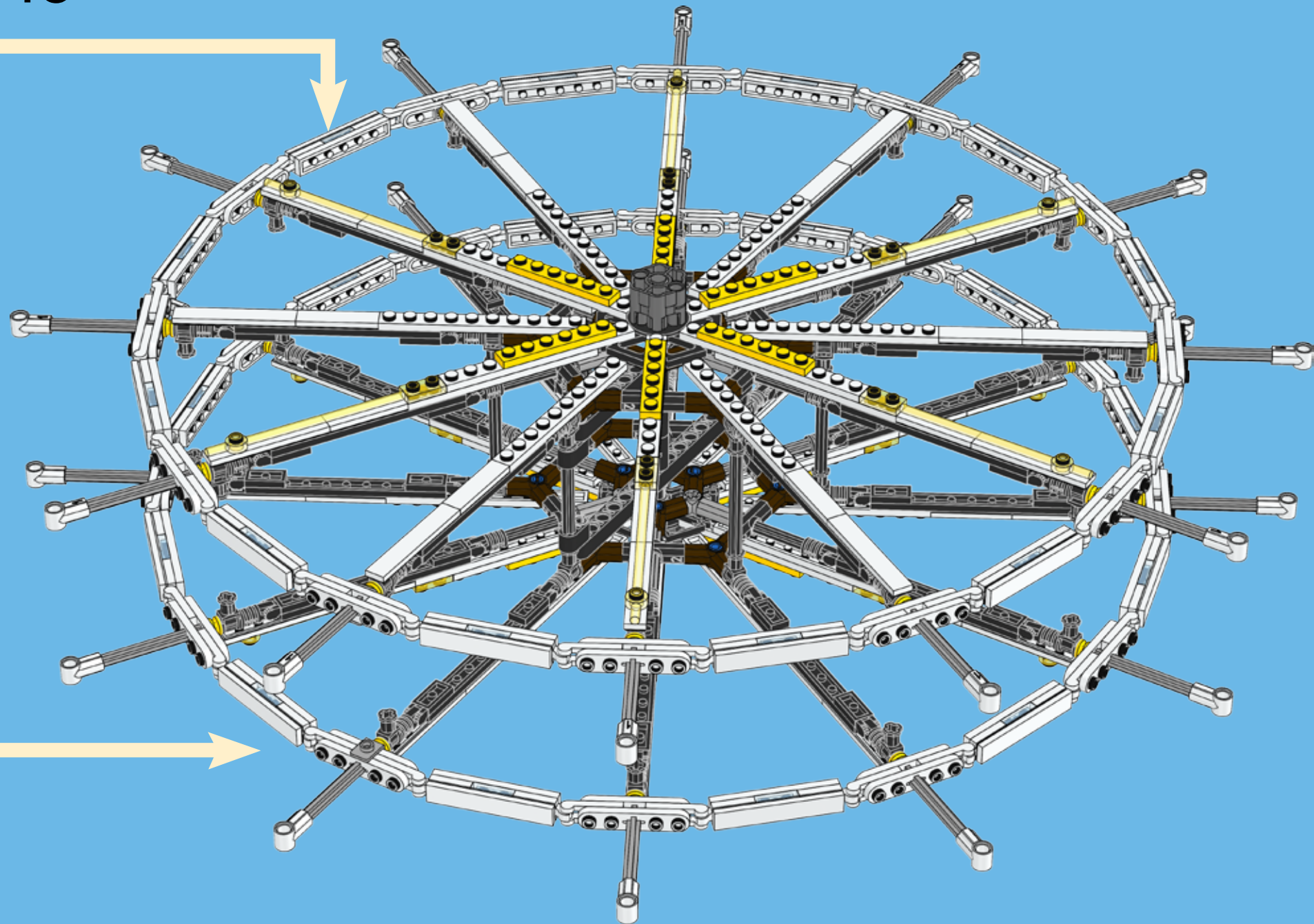

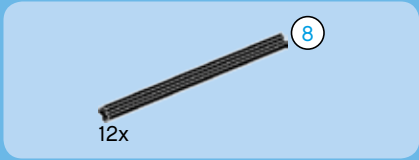

20



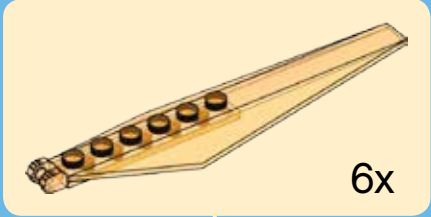
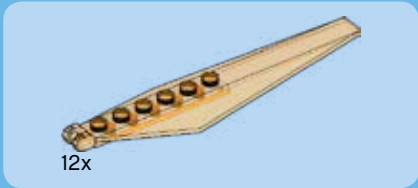

21





12x

22

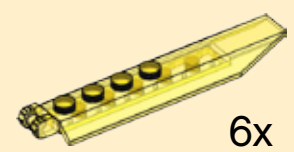

6x

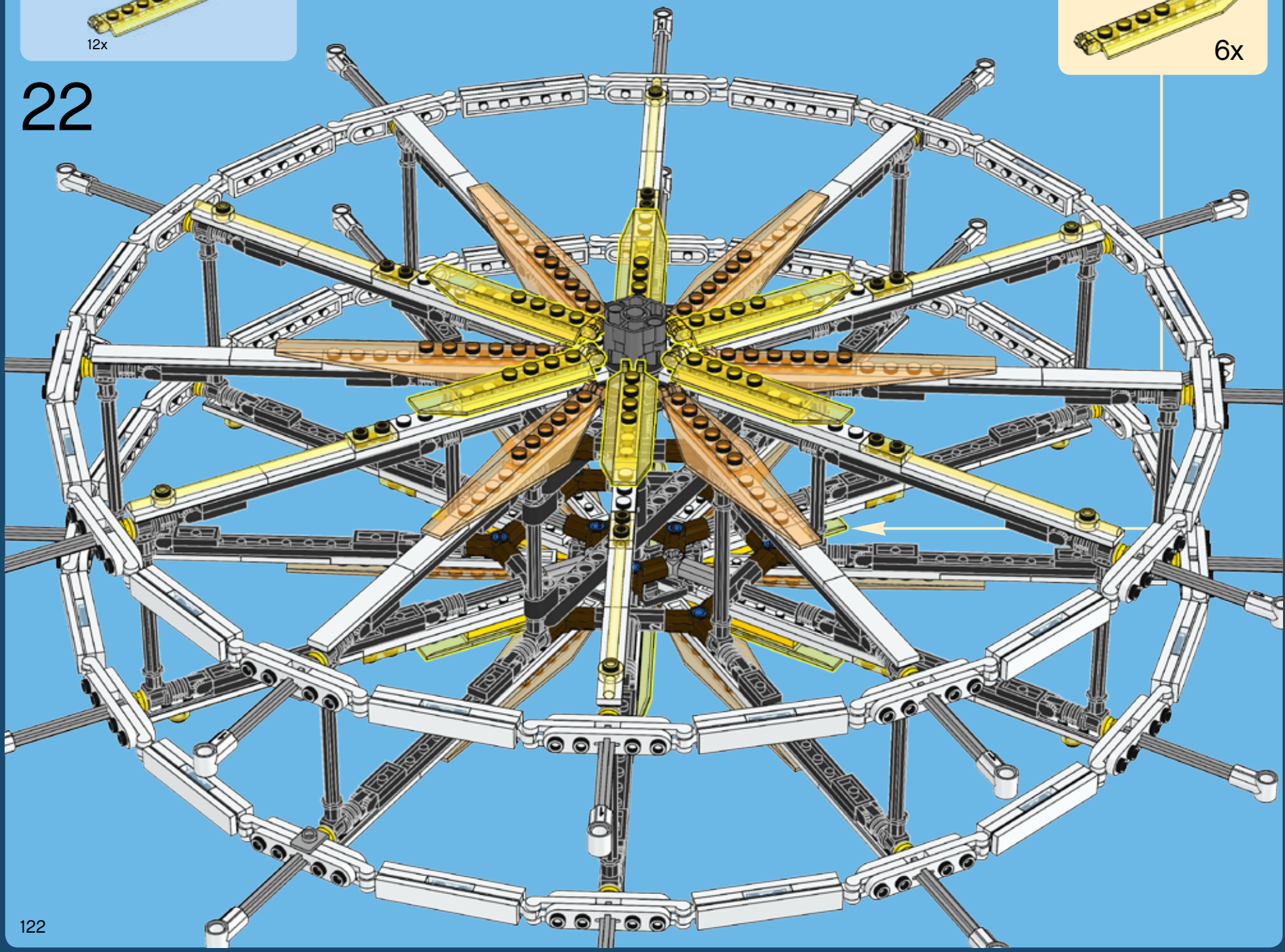

58



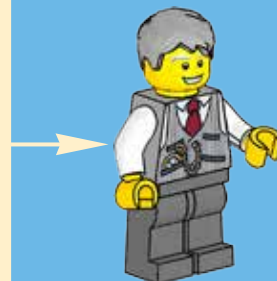
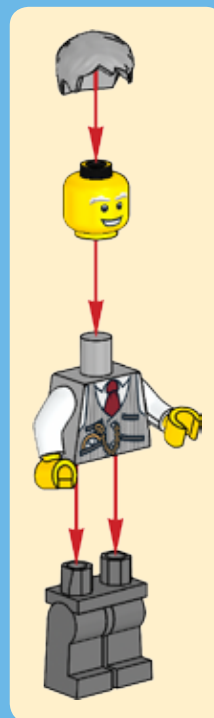
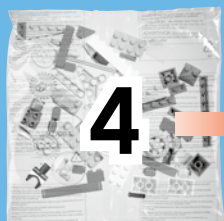

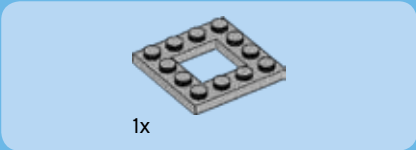
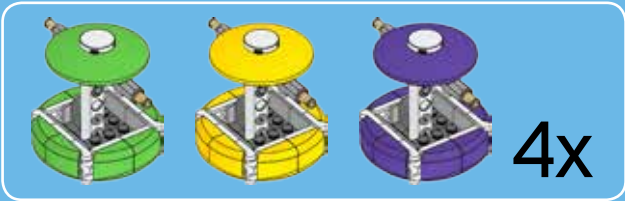

1

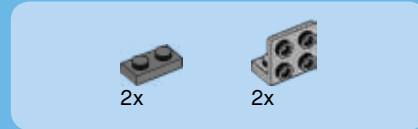
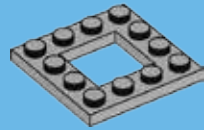

2

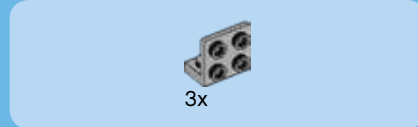
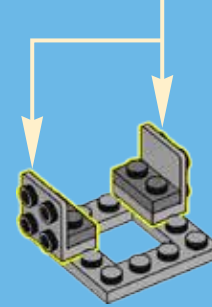
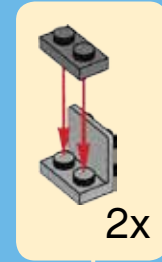

3

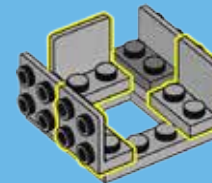

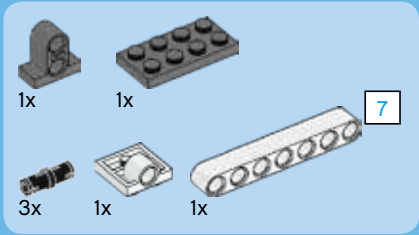

4

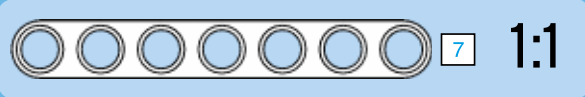
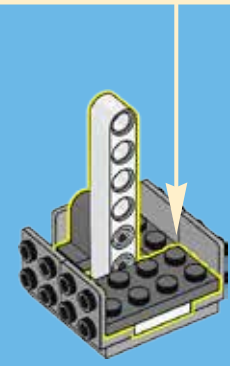
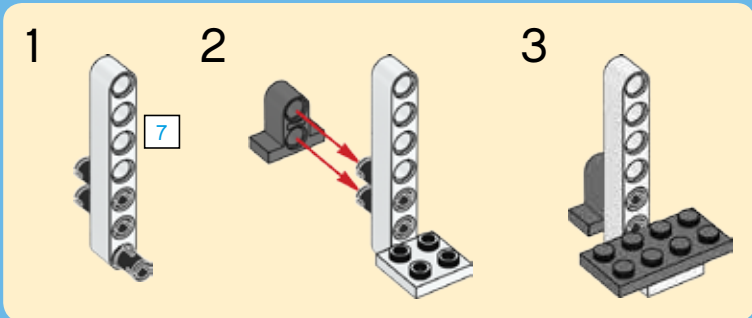

5

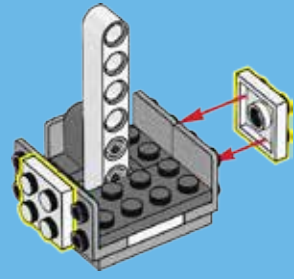

6

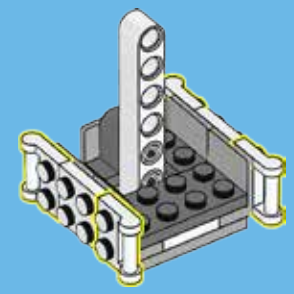



4x

7

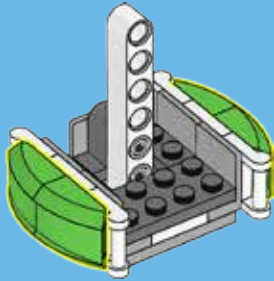

8x



4x

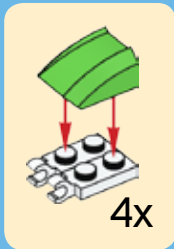

4x

8

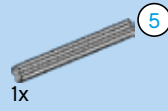
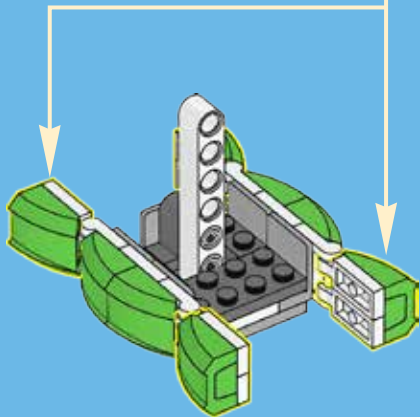

1x



1x



1x



5

1:1

9

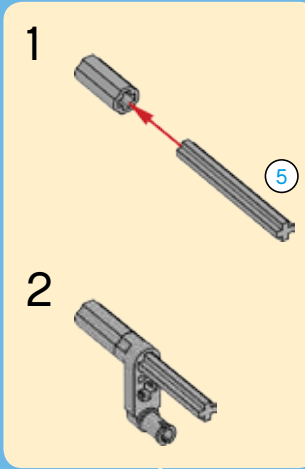

1

5

2

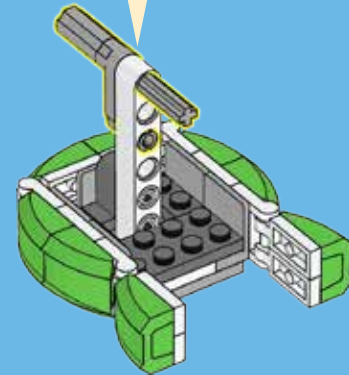



1x



1x

10

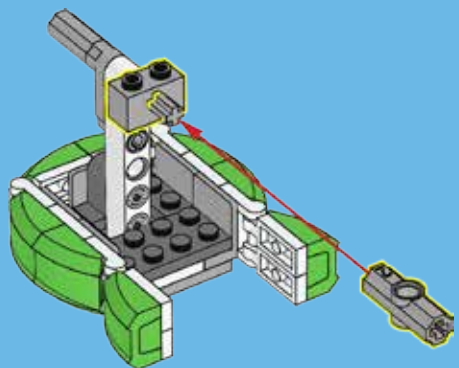

1x



2x

11

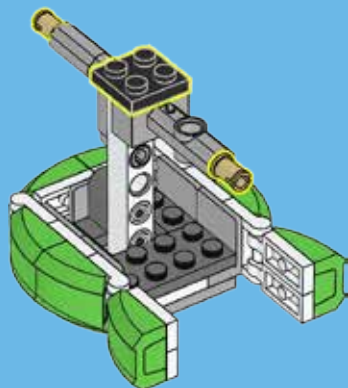

1x



1x

12

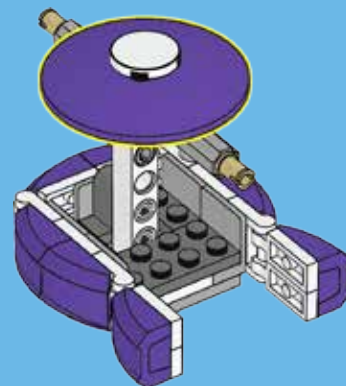
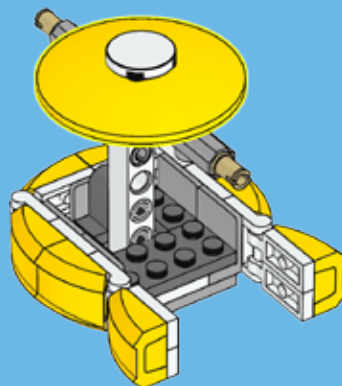
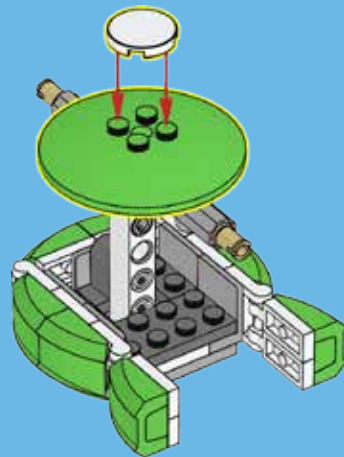

4x

59





2x

60





22x 300501
4x 245301
4x 4181142
2x 300801
4x 4567891
2x 370101
4x 446001
2x 4121932
1x 4195657
1x 6047220
2x 6110019
13x 307001
4x 302401
2x 6051511

5x 302301
24x 302201
1x 6117629
24x 243101
2x 371001
24x 366601
50x 663601
1x 617901
2x 416201
36x 447701
4x 6054551
1x 4611700
1x 4556152
144x 4535737
48x 4222017

12x 6061024
58x 4515364
48x 4527839
13x 614101
12x 6044691
1x 6068033
2x 4536521
1x 4619665
3x 6081986
1x 9327
1x 6103208
2x 6013484
2x 4544140
2x 4509912

12x 4495927
28x 4118981
2x 4526981
1x 6100932
2x 4249019
1x 4107623
1x 6054819
3x 6017003
3x 6013938
30x 4666579
5x 4514554
2x 4666999
3x 4565452

7

1x 6065839
1x 4216657
2x 6092565
1x 246021
22x 6035617
1x 4617549
1x 6032178
27x 4142865
1x 306923
1x 407923
1x 4543857
1x 6055507
1x 4142134
18x 4143005
6x 4206482
29x 4514553

5

2x 300524
4x 370224
12x 366624
1x 4189400
4x 6110037
1x 6121896
1x 4506727
1x 6100203
1x 6029773
1x 6112623
1x 6039464
2x 4584727
1x 6112633
1x 6123705
32x 4144412

2x 4144022
25x 4239601
1x 4519010
1x 4107800



3x
4566308



2x
473326



1x
4288212



2x
4188143



12x
302226



2x
4558170



24x
447726



2x
4144024



2x
4556158



2x
6061032



48x
4183060



2x
4114689



2x
4539442



2x
4521681



1x
602026



1x
6079894



2x
4541455



48x
4158848



4x
4142822



2x
4542573



4x
6006140



2x
4121667



3x
4558692



12x
4107783



4x
4184169



89x
4121715



36x
4107081



3x
4526982



7x
6055630



5x
4140801



6x
370626



20x
370726



2x
370826



4x
4177431



2x
4562009



2x
4218868



1x
4296081



1x
4295260



11x
374128



1x
4614107



1x
6093518



2x
300528



4x
4107637



14x
4141737



8x
4296132



16x
6047426



3x
302428



15x
302128



11x
371028



4x
302028



1x
4296081



1x
4295260



11x
374128



10x
6097232



1x
4586882



4x
6117758



31x
4619599



32x
6117748



4x
4617799



4x
4116671



9x
4277361



2x
4610353



5x
4611777



1x
4646864



1x
4218499



12x
6121435



12x
6117724



1x
4646860

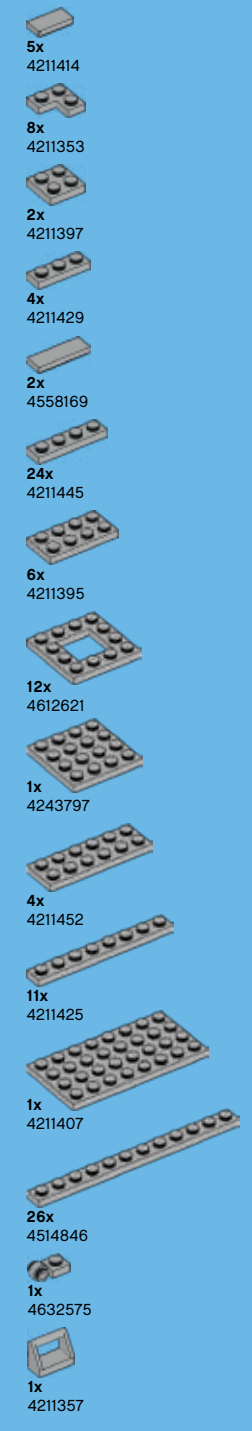



1x
6039505



12x
4563045



12x
4211567



3x
4211375



7x
4211807



18x
4512360



6x
4502595



2x
4525904



12x
4211815



12x
4211639



6x
4211805



27x
4535768



2x
6097090



2x
6122217



17x
6000311



10x
4211137



4x
4211096



14x
4210862



28x
4211063



5x
4211094



6x
4211133



7x
4211043



9x
6039176



16x
4211065



1x
4539429



6x
4211002



6x
4210997



12x
4210763



8x
4543086



10x
4581225



4x
4595710



7x
4219725



1x
4222693



1x
4570666



6x
6100030



1x
4552349



5x
6083620



4x
4508553



2x
4610374



2x
6100488



3x
6012451



1x
4514558



31x
4216479



1x
6107399



7x
6060795



1x
6004439



2x
6084028



2x
4566522



4x
6117755



32x
4566523



1x
4640843



1x
4529672



1x
4581313



19x
6005755



1x
6082516



1x
6006758



1x
6104570



1x
6029933

Customer Service

Kundenservice

Service Consommateurs

Servicio Al Consumidor

LEGO.com/service or dial



: 00800 5346 5555

: 1-800-422-5346

power functions™



10247

+



8883

+



88000

=

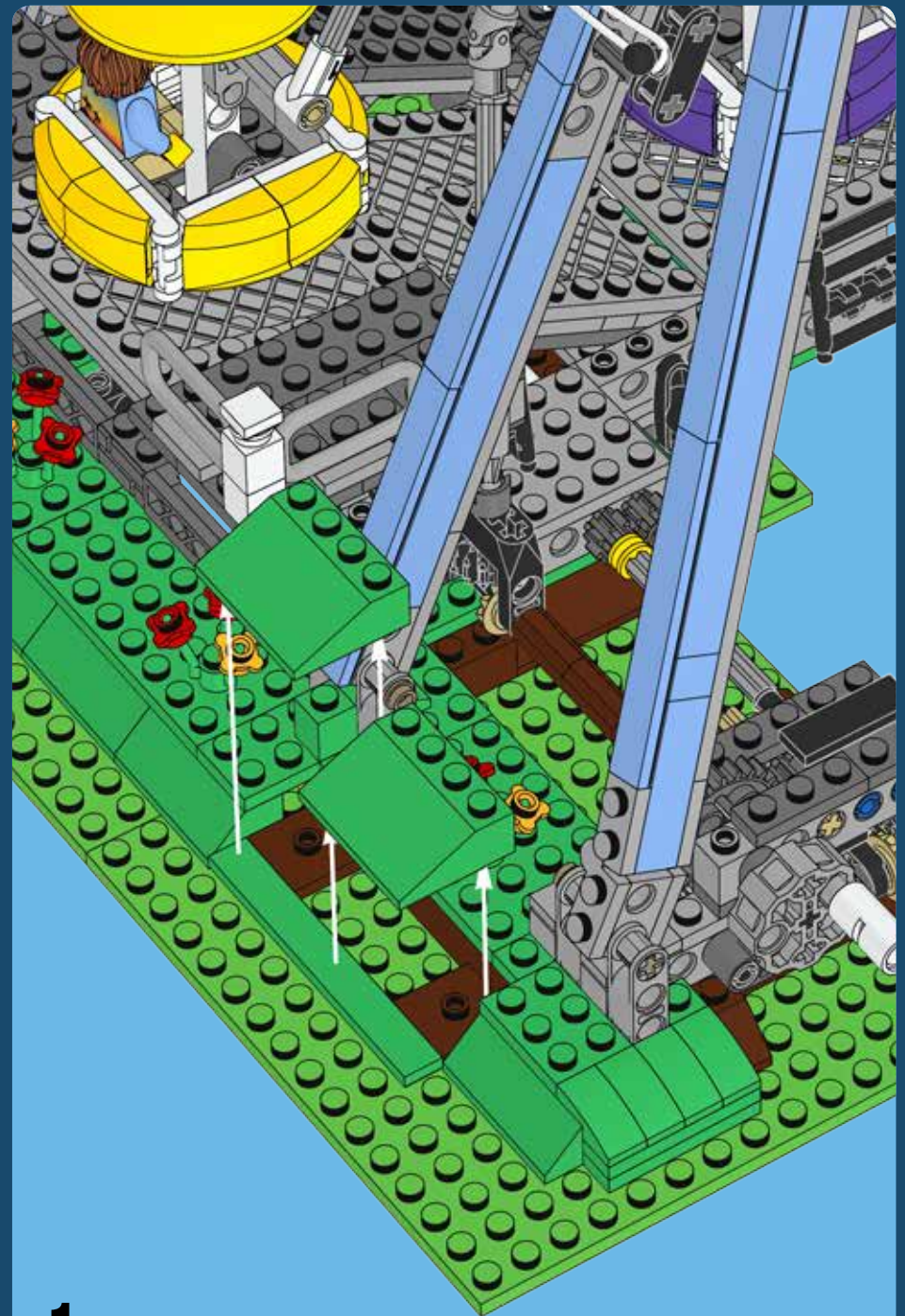

1

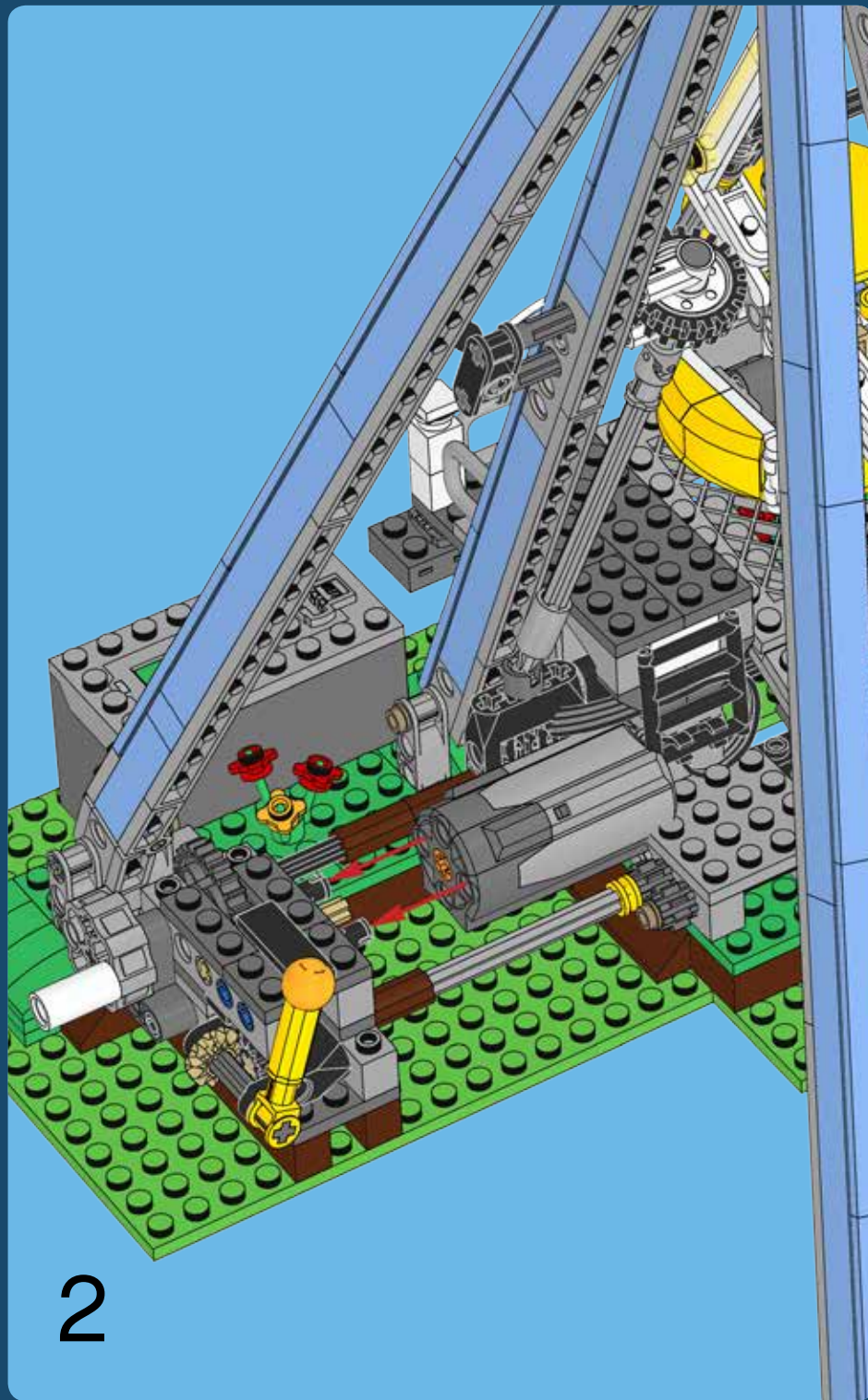



CREATOR

10244





CREATOR



LEGO.com/creator