

S·P·Q·R·

# 罗马斗兽场

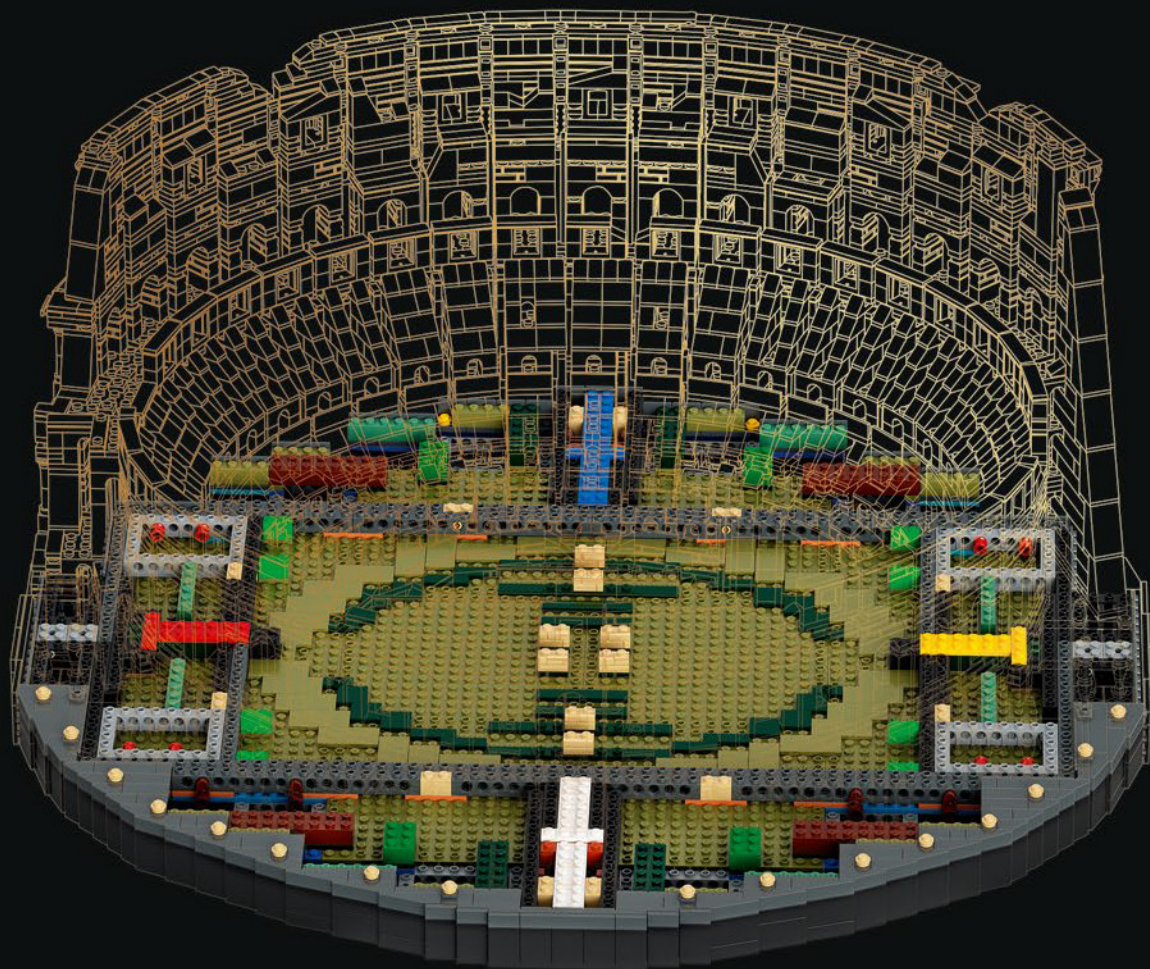

I

## 大家好

很高兴向您介绍我们对世界著名的罗马斗兽场的诠释。无论是重温罗马之旅，还是唤起您对古典建筑的兴趣，亦或者作为您的放松方式，我们希望这款模型都能为您带来数小时愉快的乐高®拼搭体验。

设计负责人 **Jamie Berard**

## 罗马斗兽场

罗马斗兽场位于意大利首都的中心区域，是罗马帝国历史的标志性象征。这座令人叹为观止的露天剧场是当时建造的最大型的建筑，能够容纳 5 万至 8 万名观众。他们聚集在那里，观看角斗士搏斗、角斗士与野兽搏斗，甚至著名的海战表演。罗马斗兽场被誉为世界新七大奇迹之一，也是最受欢迎的旅游景点之一，每年接待游客超过 700 万人次。











早期的希腊剧院都依山而建，而高耸的罗马斗兽场却独自矗立在罗马中部的平坦谷底中。

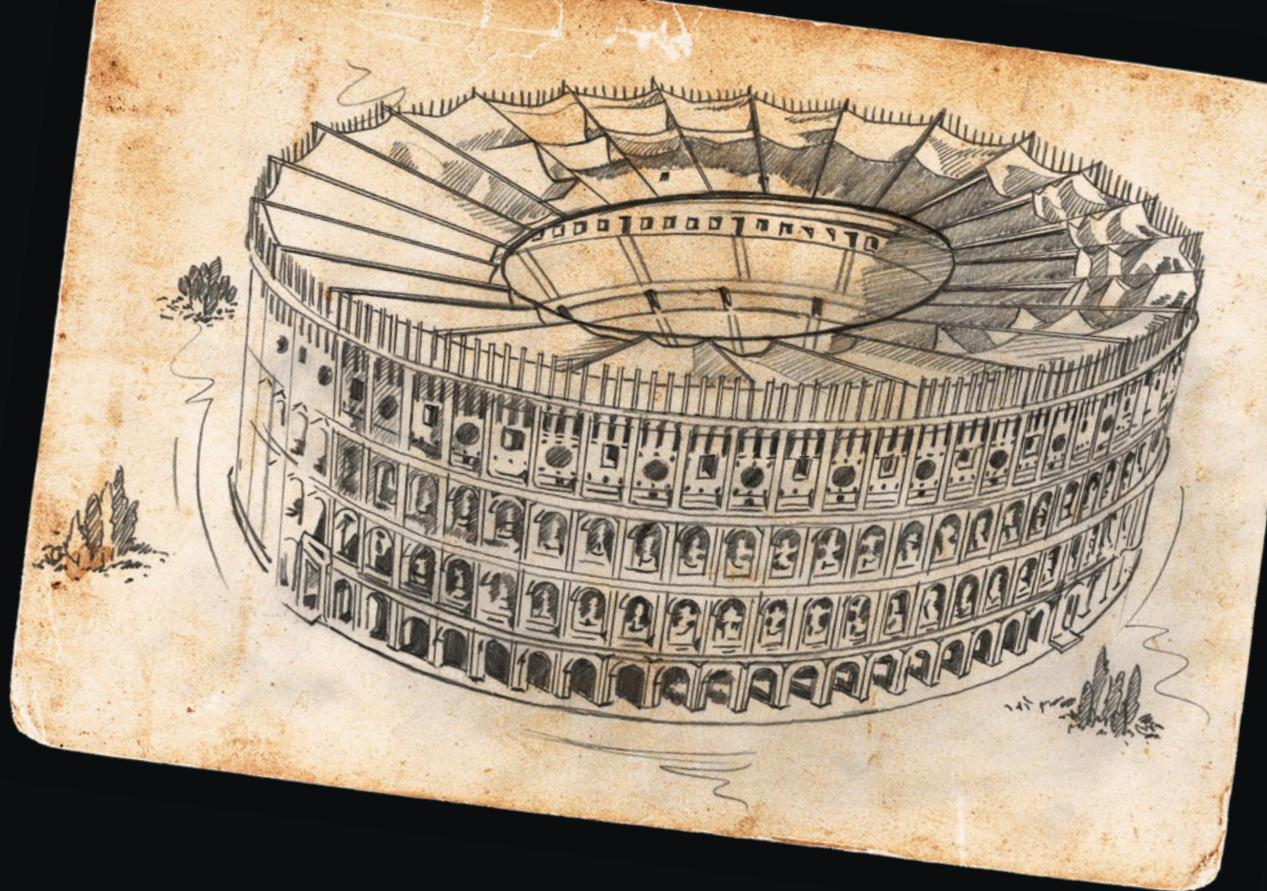

## 露天剧场

罗马斗兽场采用独立式椭圆形结构，长 189 米（615 英尺）、宽 156 米（510 英尺）。椭圆形的内部竞技场长 87 米（287 英尺）、宽 55 米（180 英尺），四周竖立着 5 米（15 英尺）高的围墙，围墙上面是逐级抬升的座席。罗马斗兽场的外墙高达 48 米（157 英尺），再加上当时由绳索和木杆搭起的活动式织物顶篷，它会更高。





这座建筑的第一层环绕着 80 个入口。4 个主要的轴向入口是留给皇帝和城市名流精英的，装饰精美。

## 建造

建造罗马斗兽场耗用了超过 10 万立方米 (3531467 立方英尺)，仅外墙就用去 45000 立方米 (1589160 立方英尺)。建造时使用了 300 多吨 (331 短吨) 铁钩把这些石头连接在一起，而未使用砂浆。这座建筑的外立面由 3 层组成，每层包含 80 个气势恢宏的拱廊。竞技场沙土覆盖的木质地板下方掩盖着精心设计的地下建筑：地下室 (*hypogeum*)。



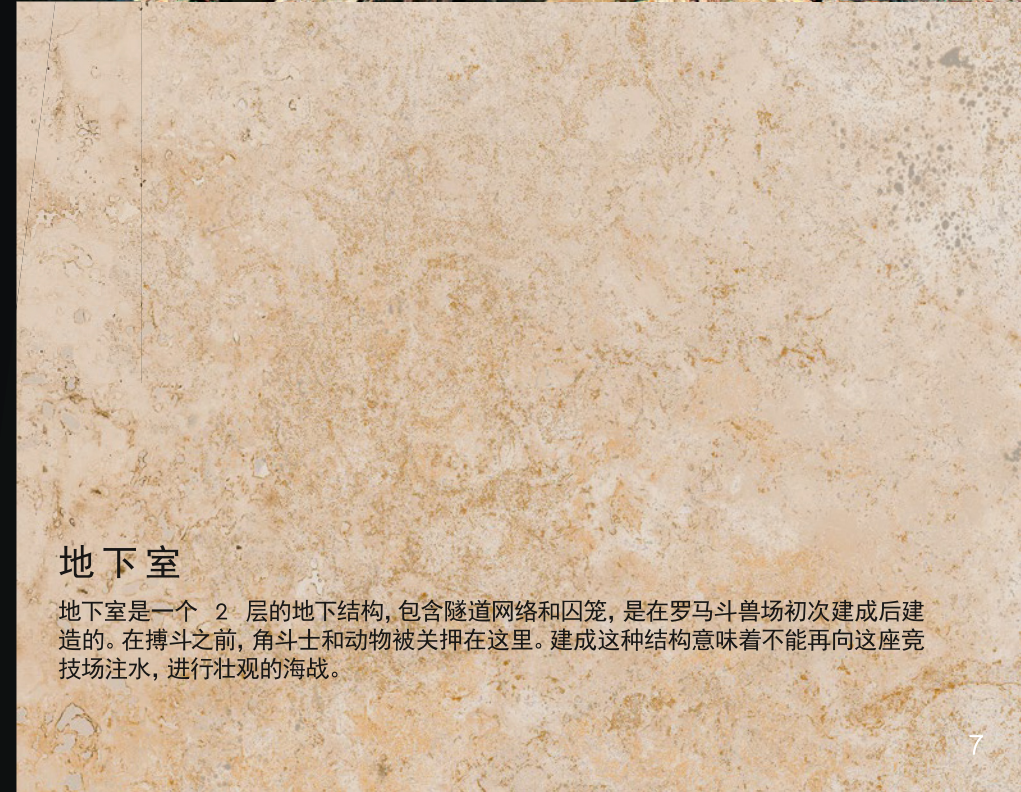

## 地下室

地下室是一个 2 层的地下结构, 包含隧道网络和囚笼, 是在罗马斗兽场初次建成后建造的。在搏斗之前, 角斗士和动物被关押在这里。建成这种结构意味着不能再向这座竞技场注水, 进行壮观的海战。





[LEGO.com/brickseparator](https://LEGO.com/brickseparator)



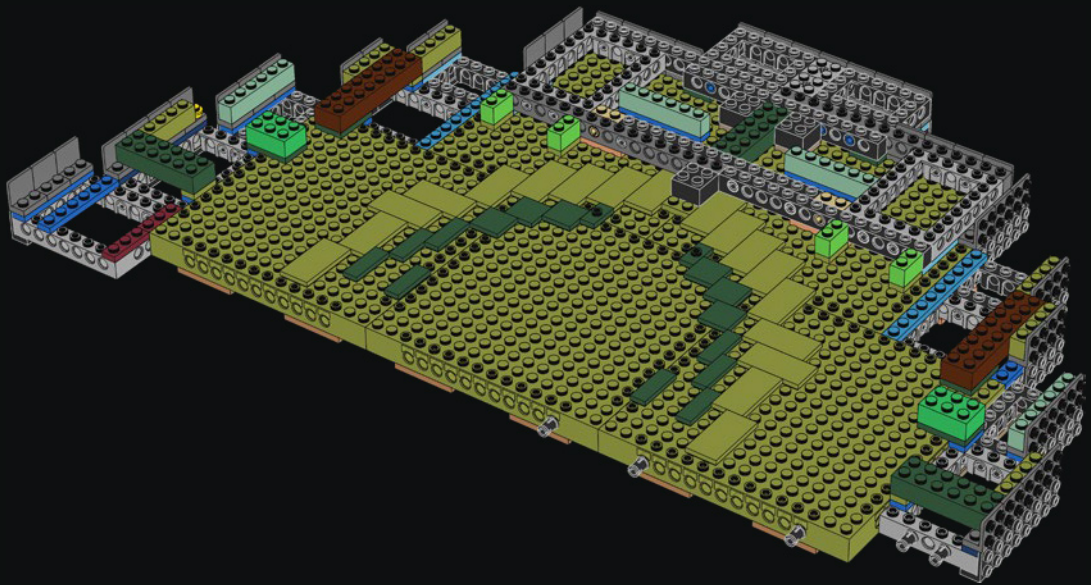

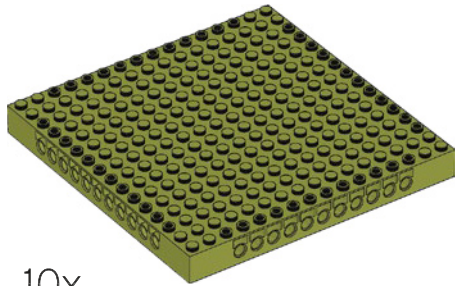

10x

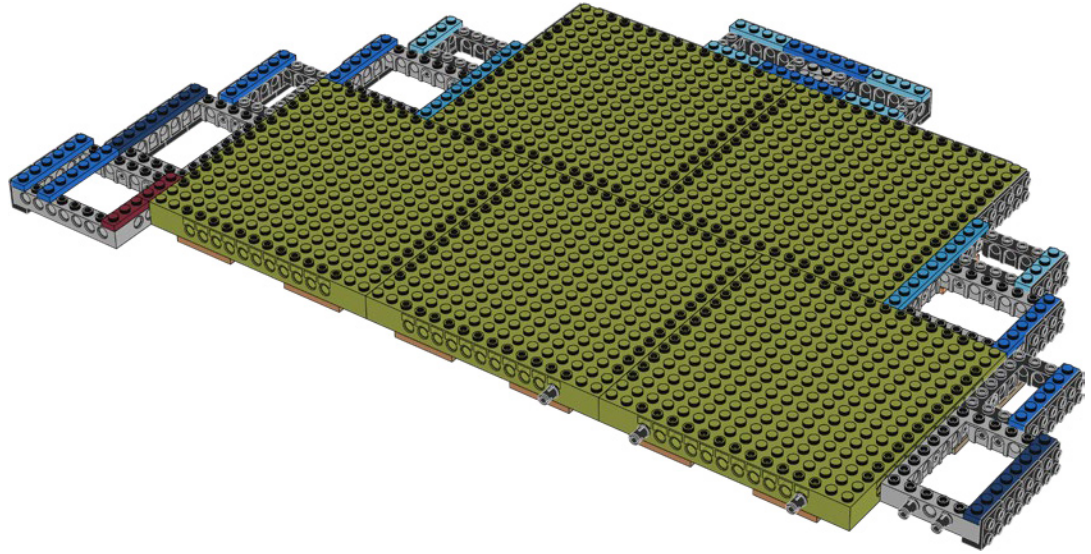
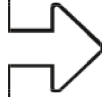

2x





1

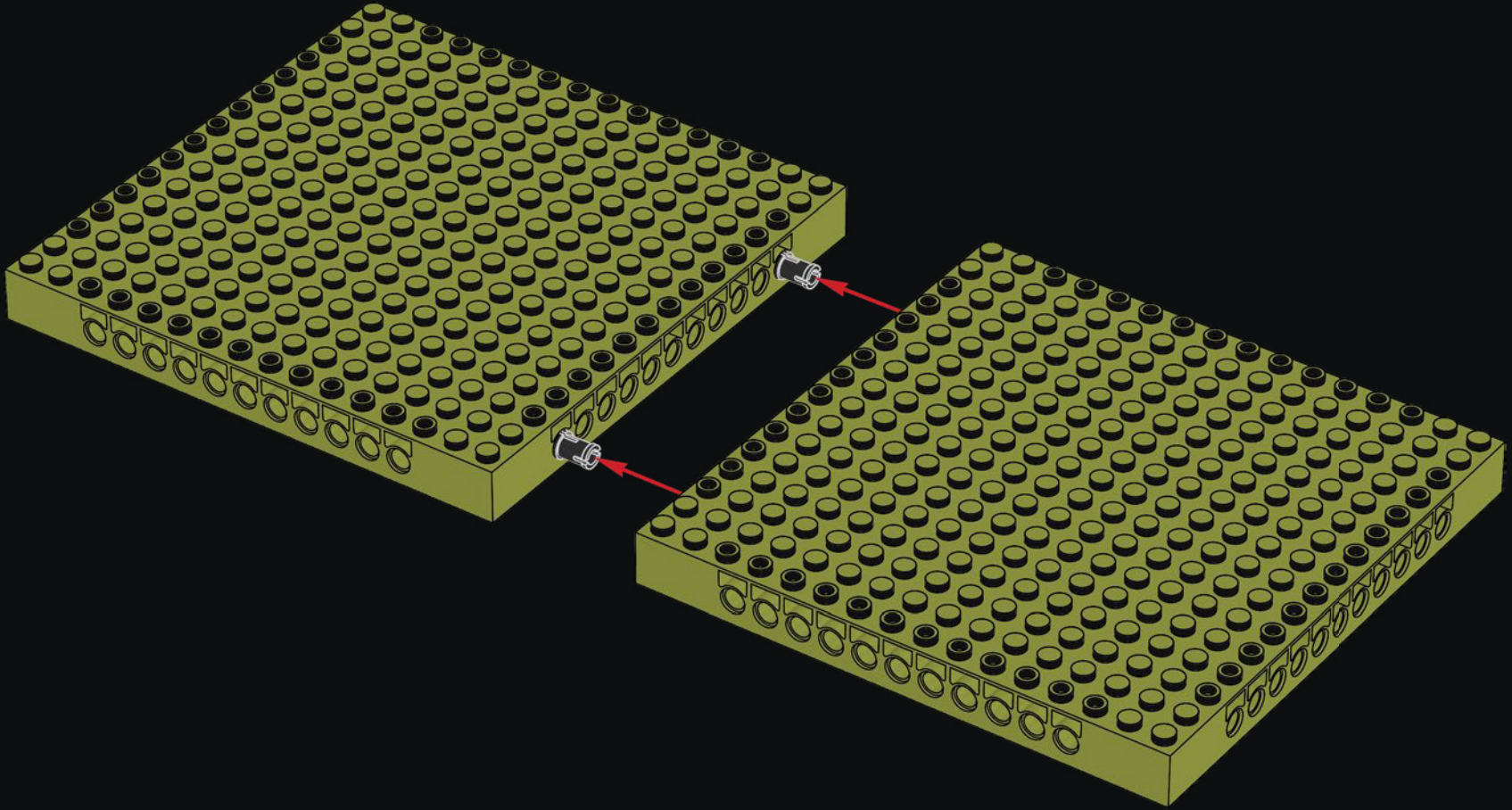



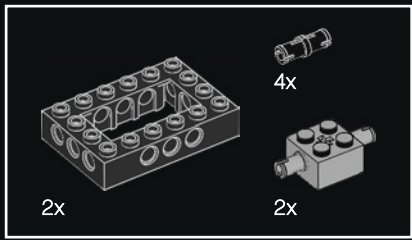

2

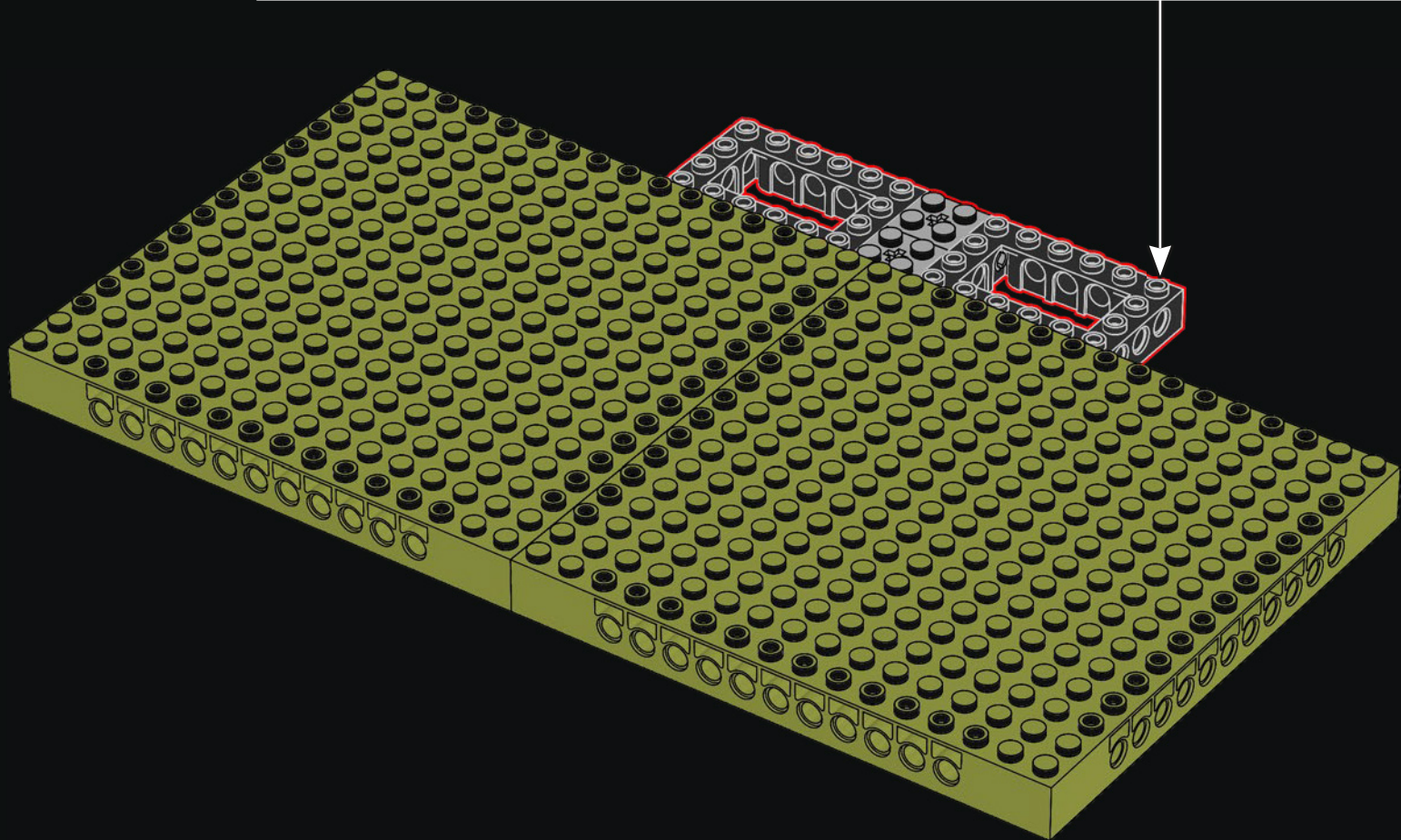
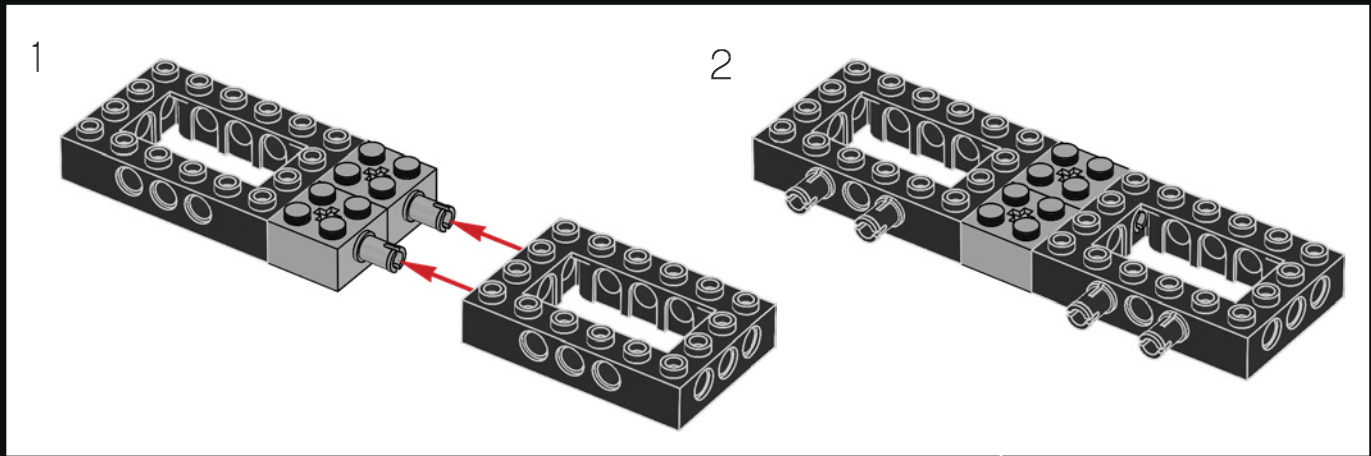



3

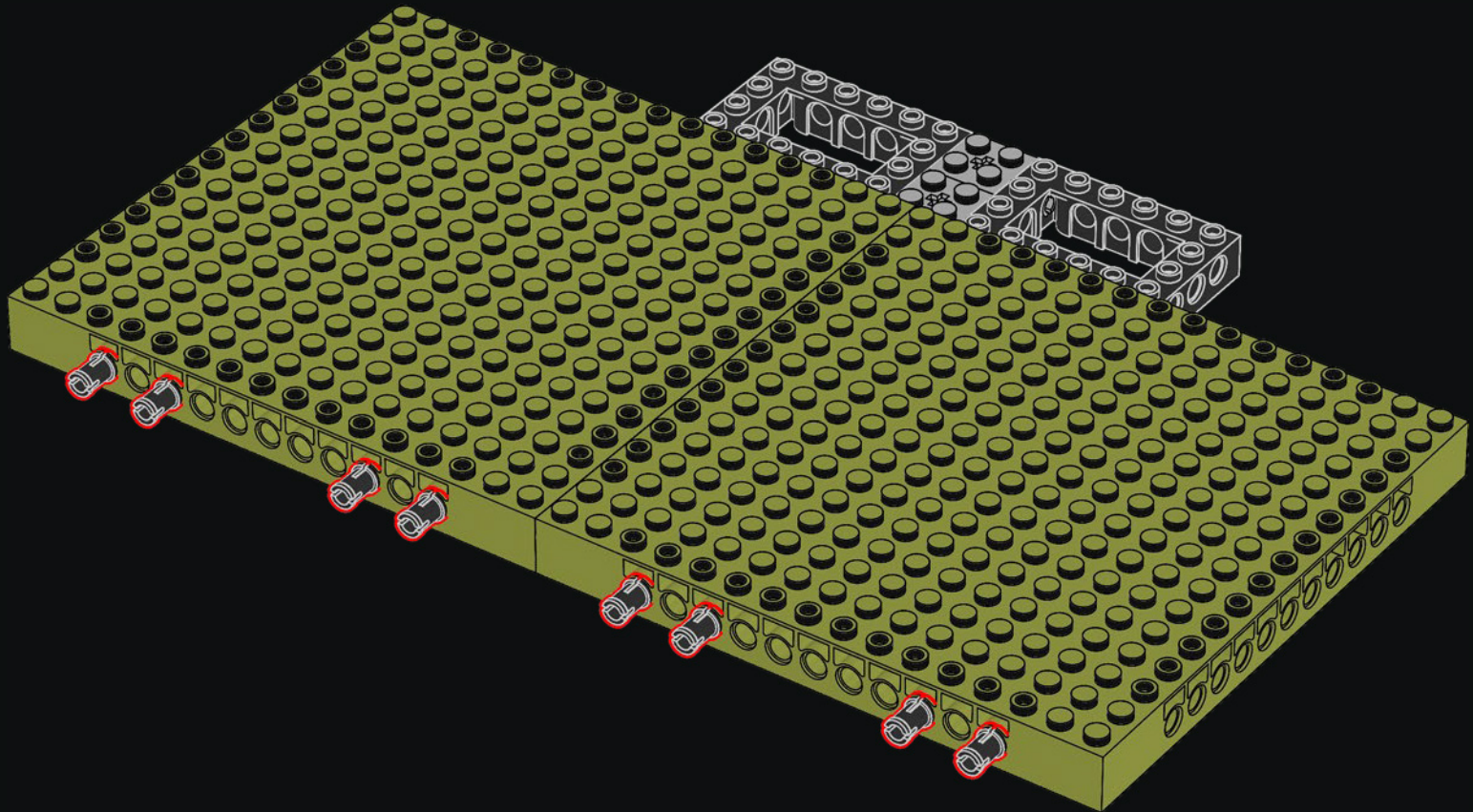



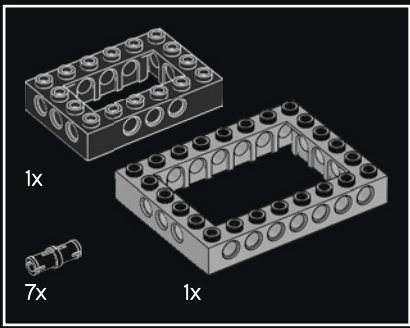

4

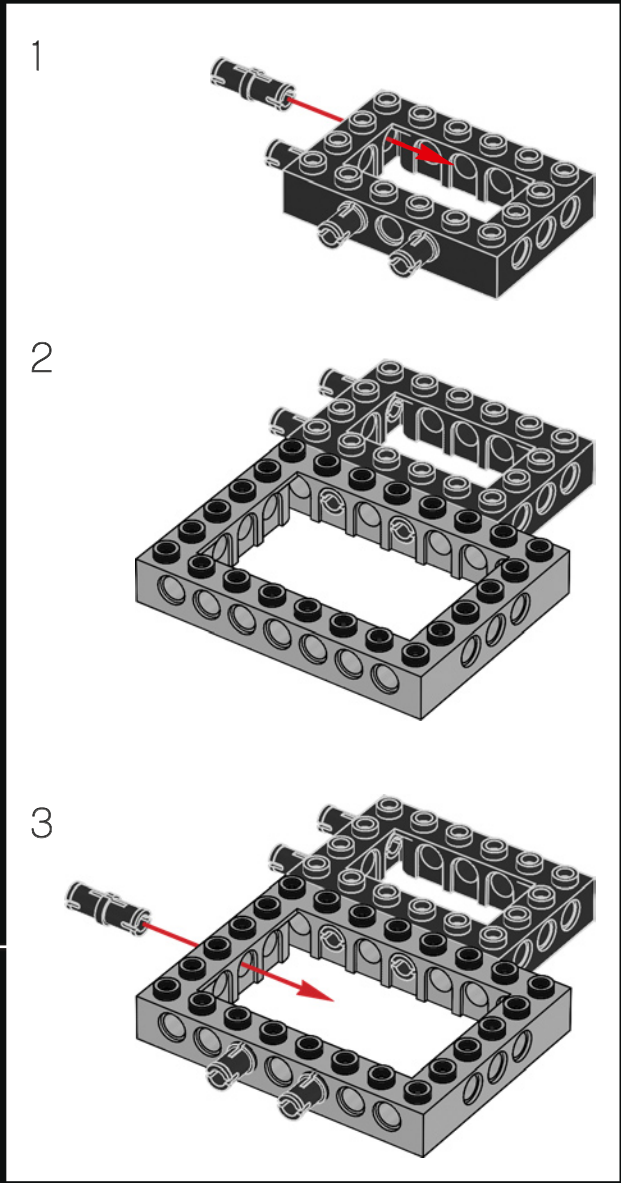
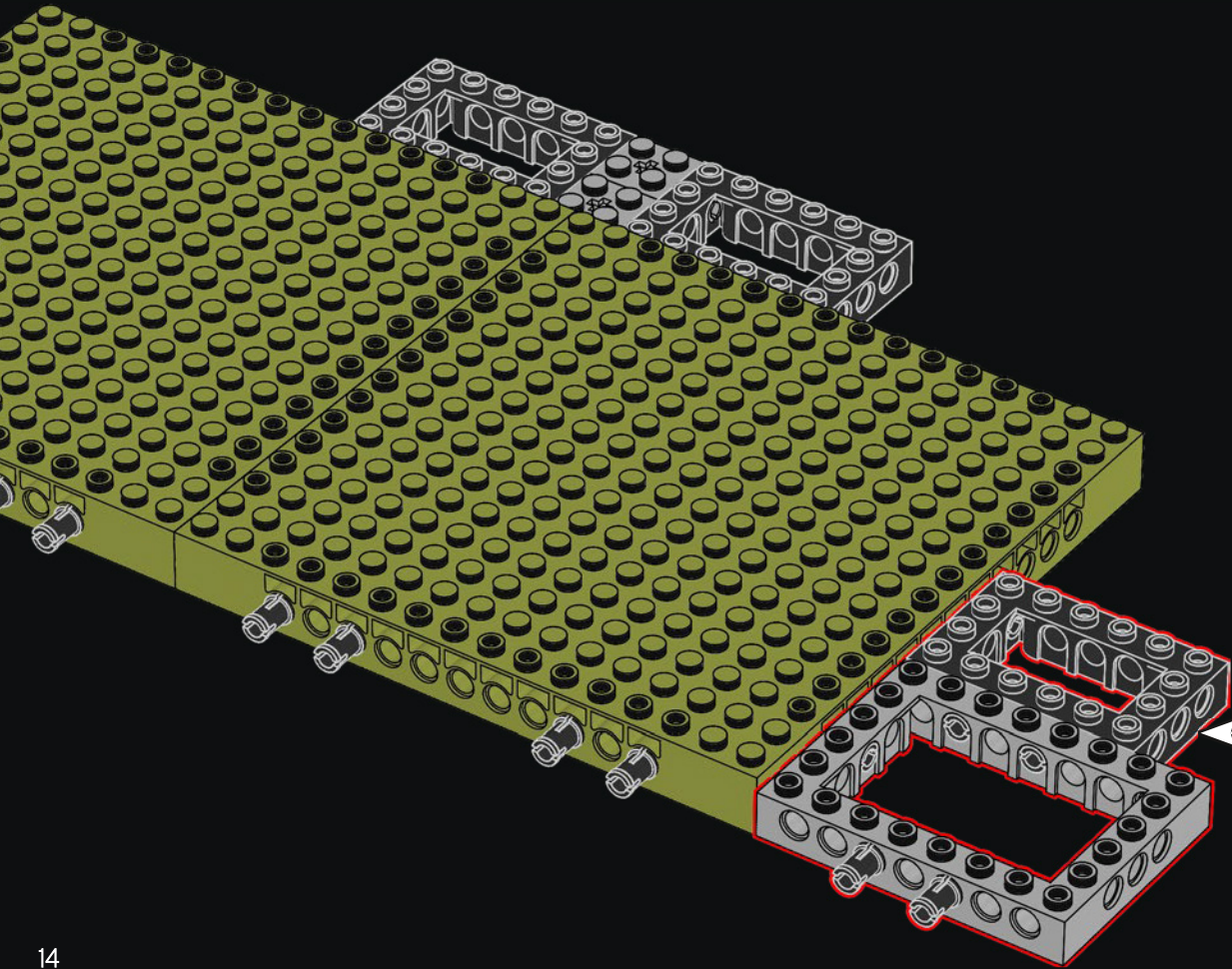



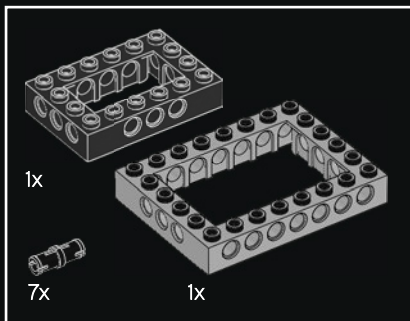

5

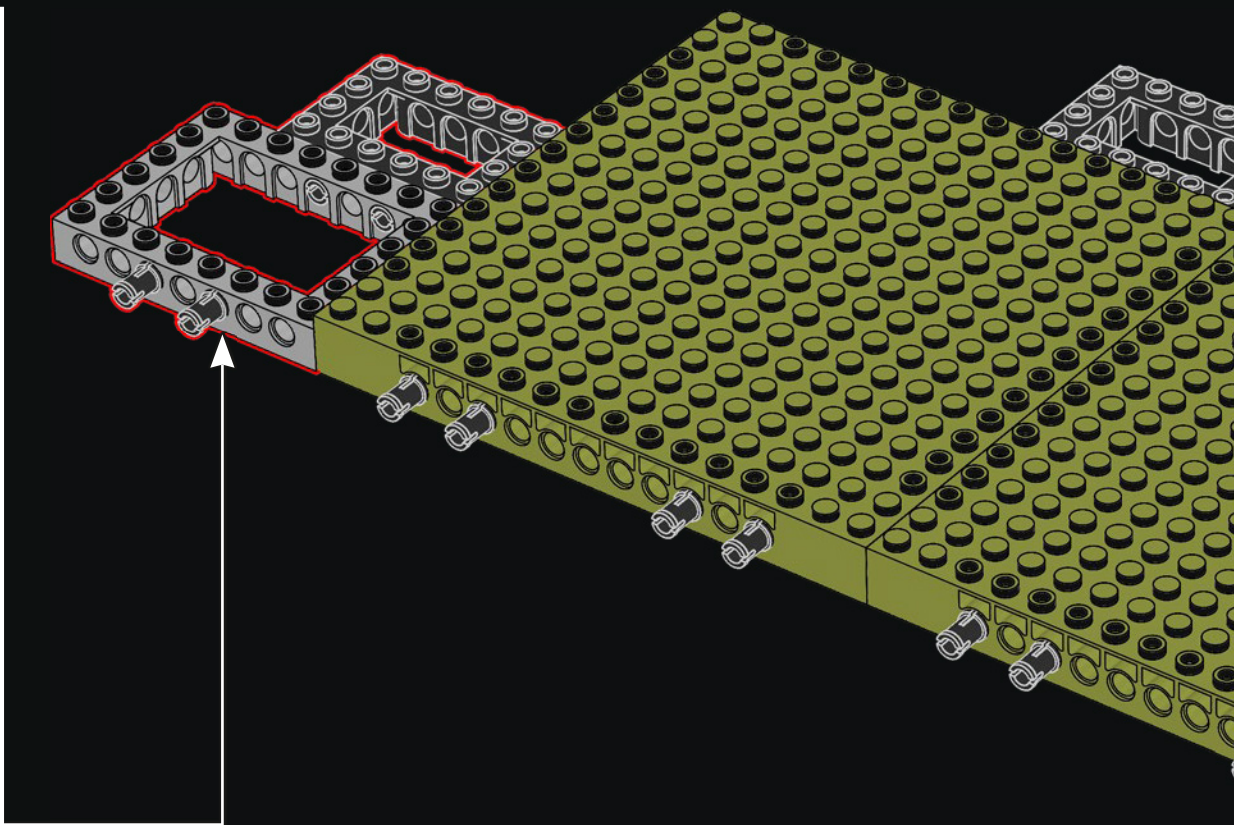
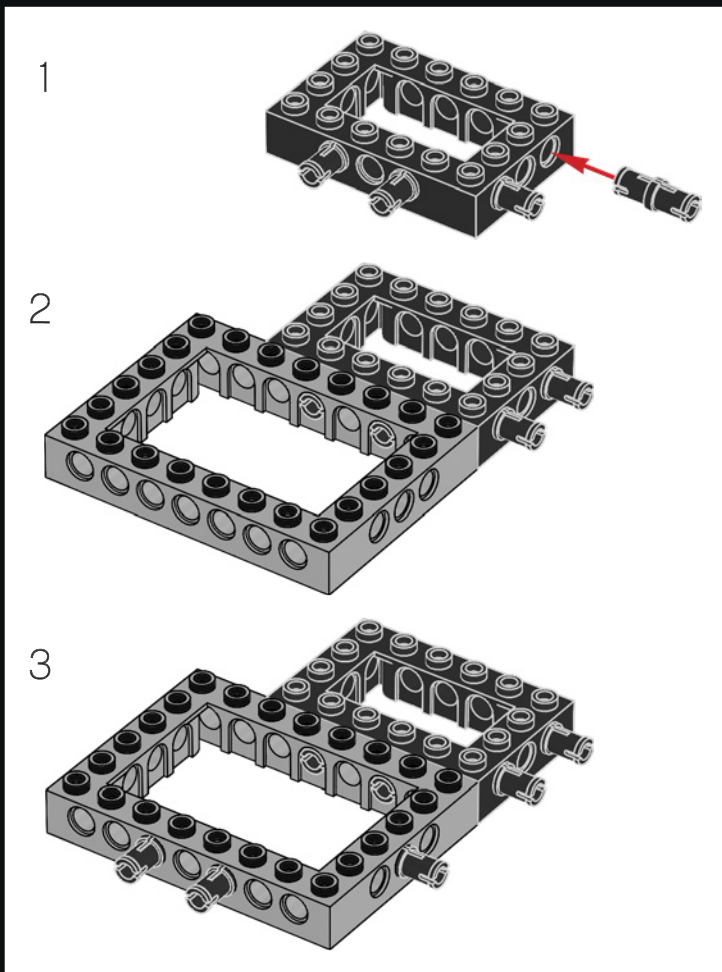



2x

6

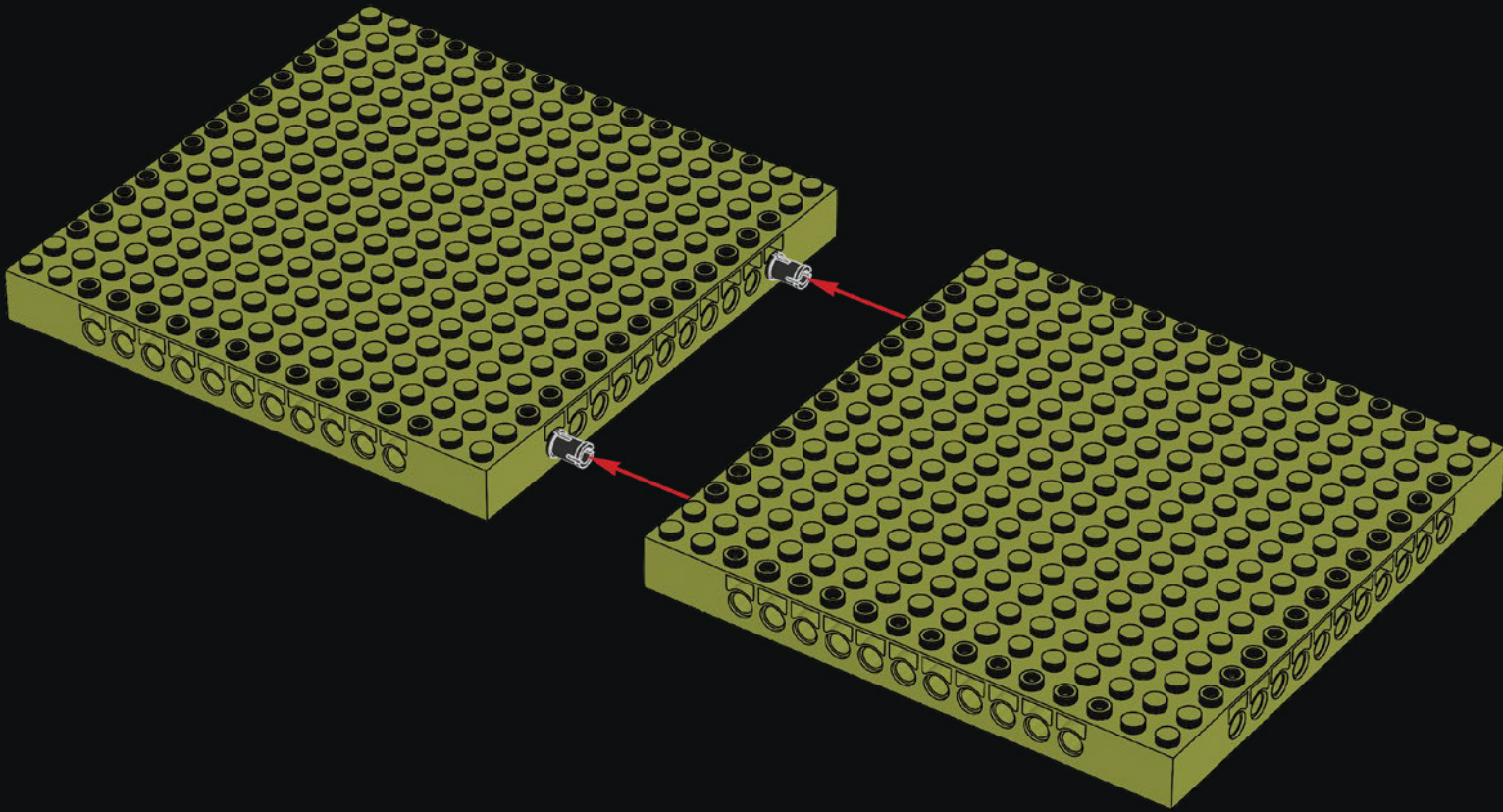





7

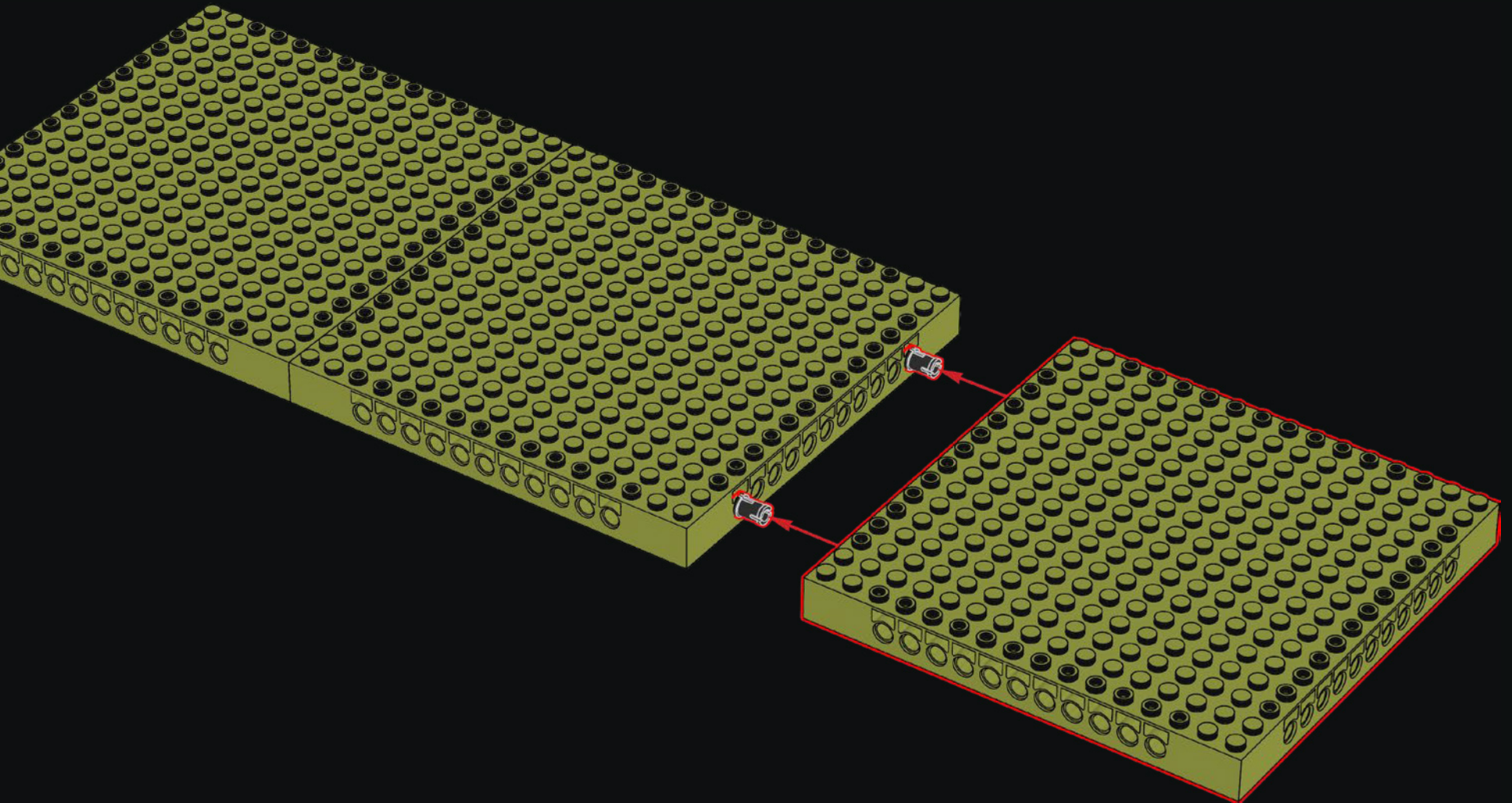



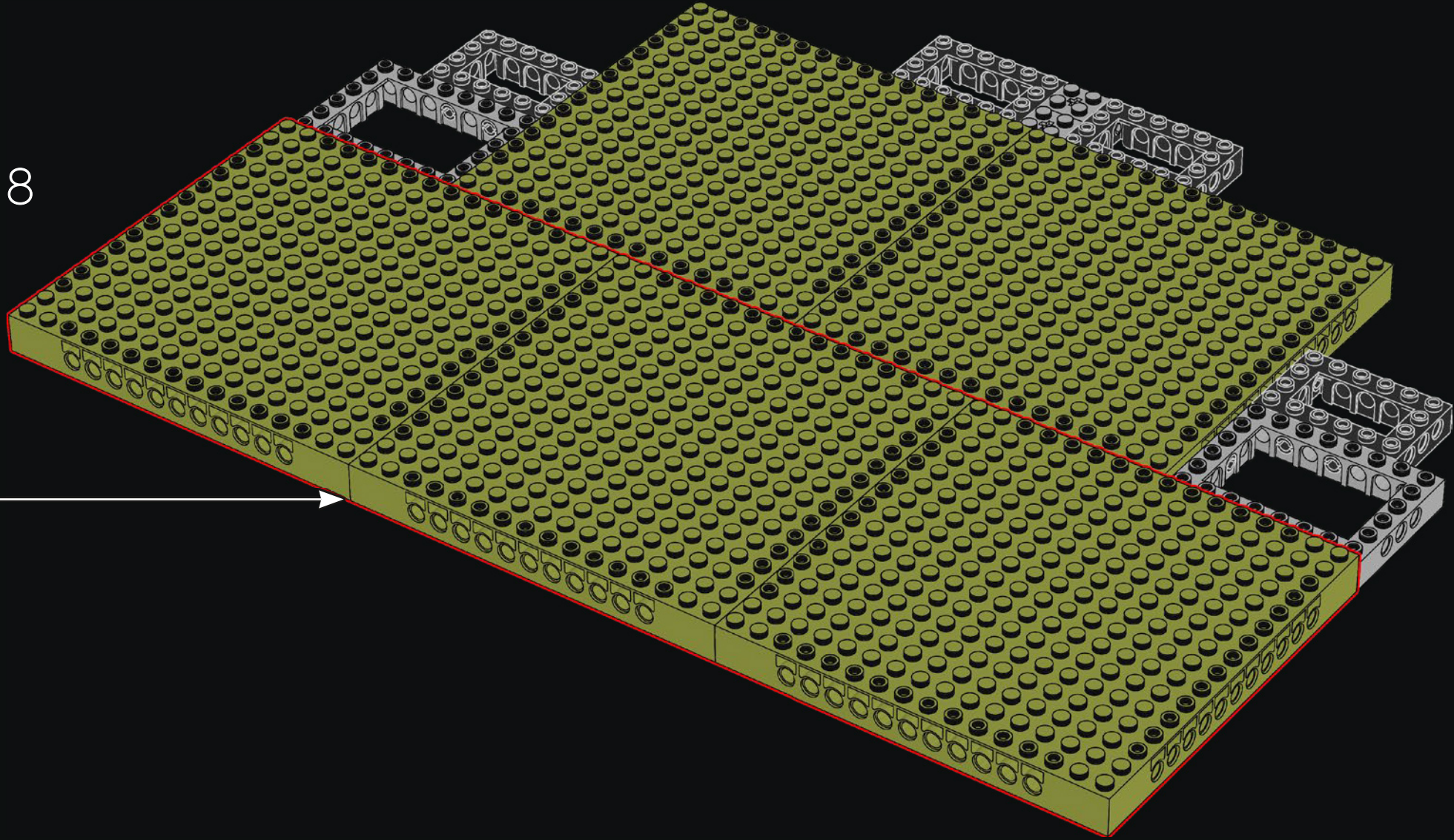

8



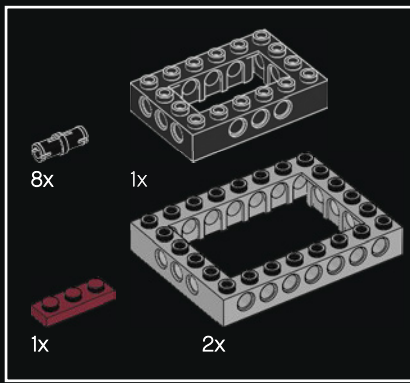

9

1

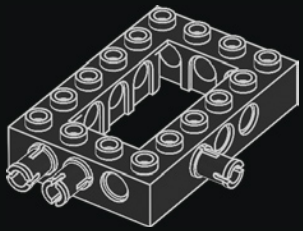

2

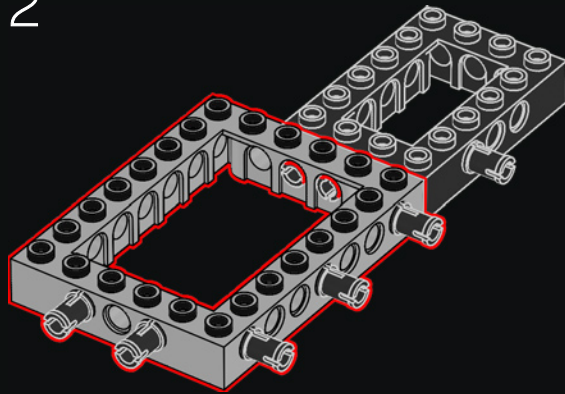

3

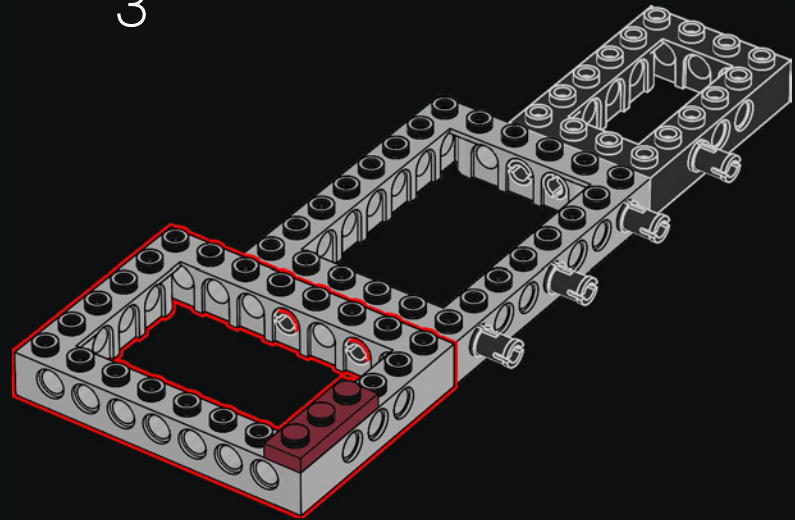



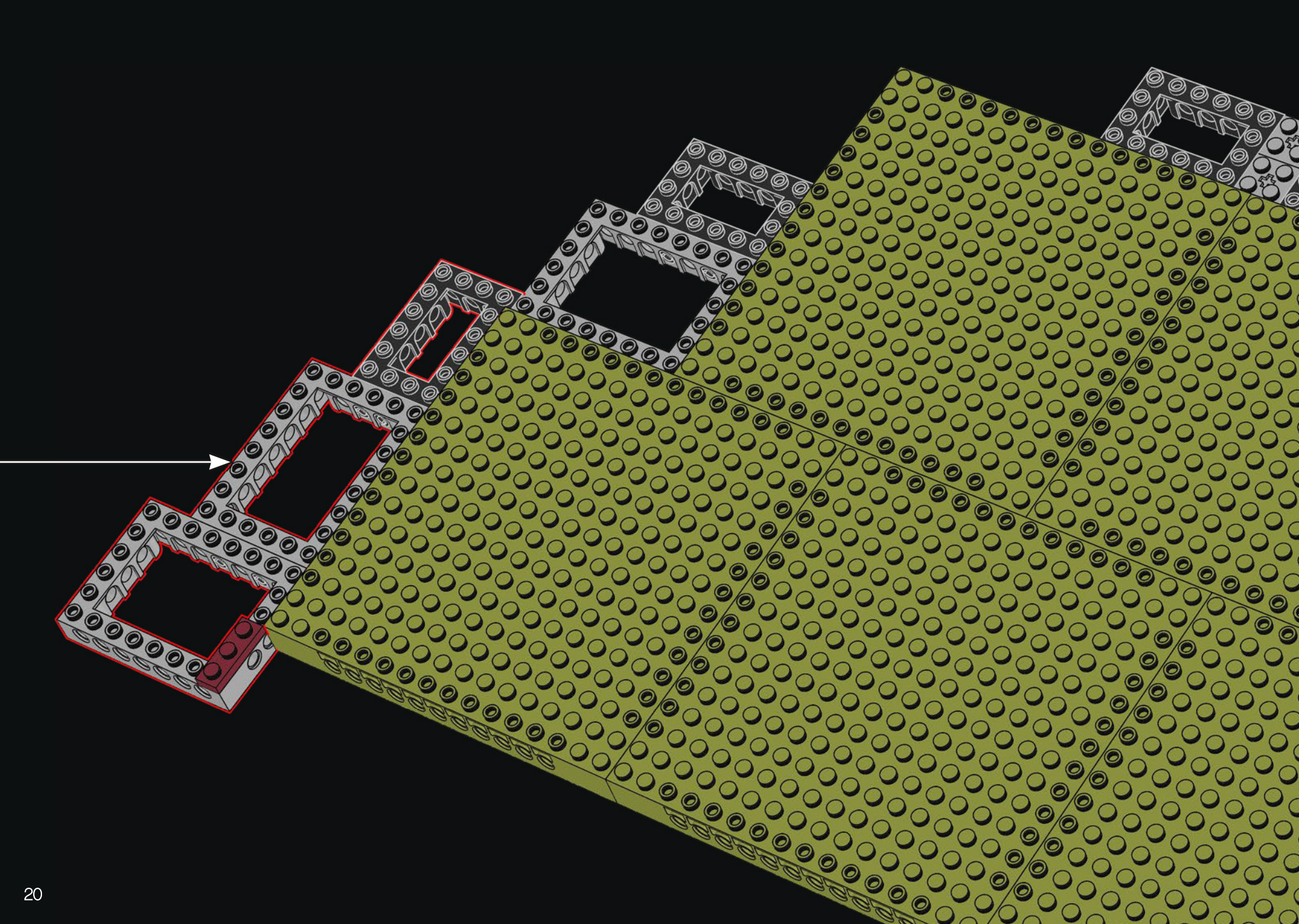



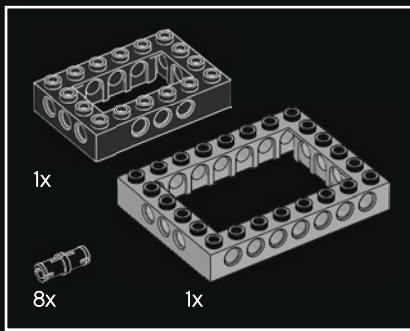

10

1

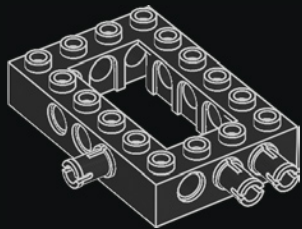

2

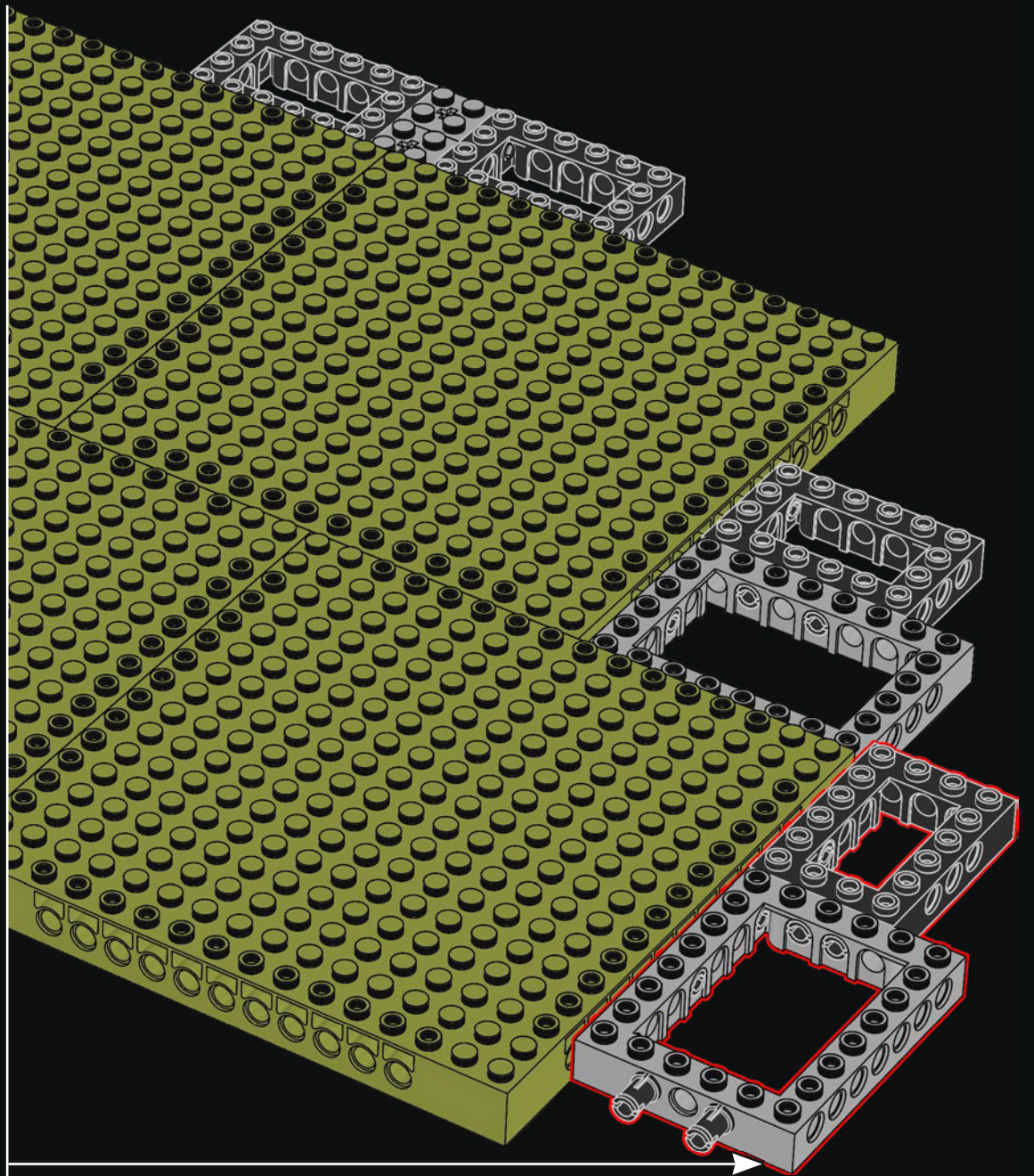
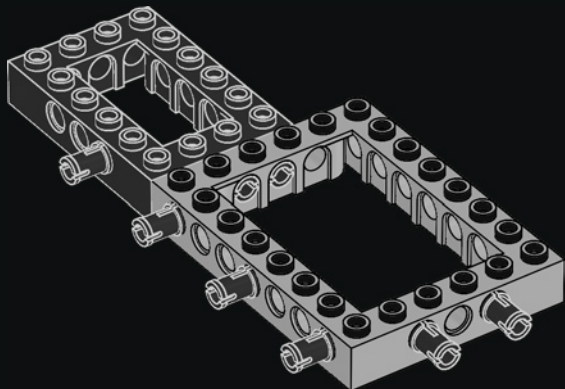



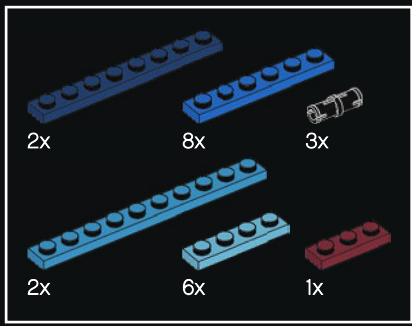

11

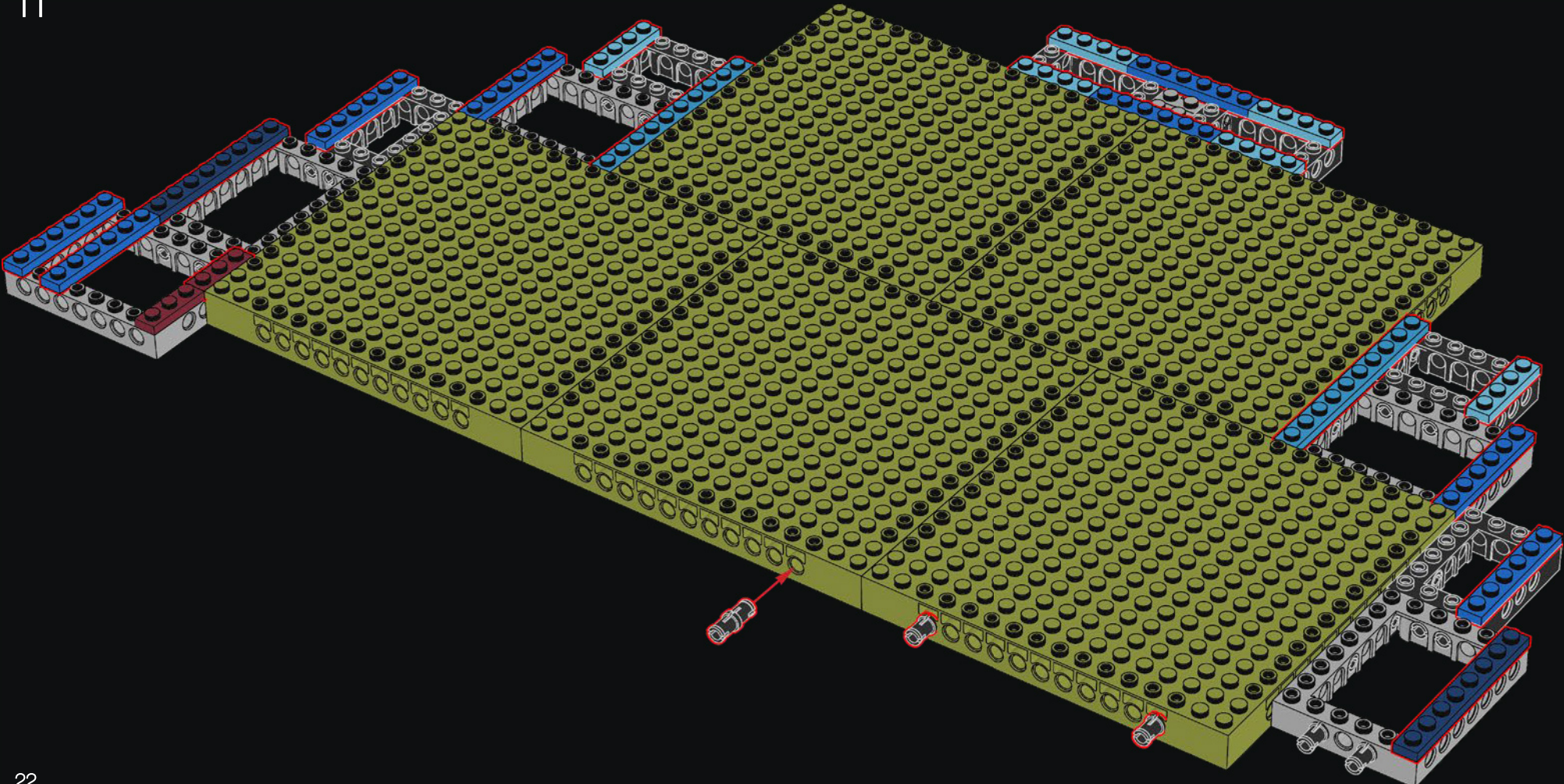



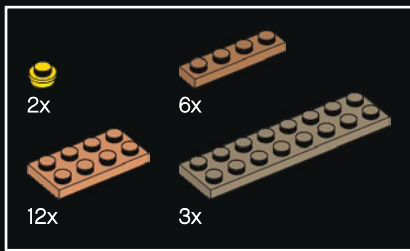

12







46x

13

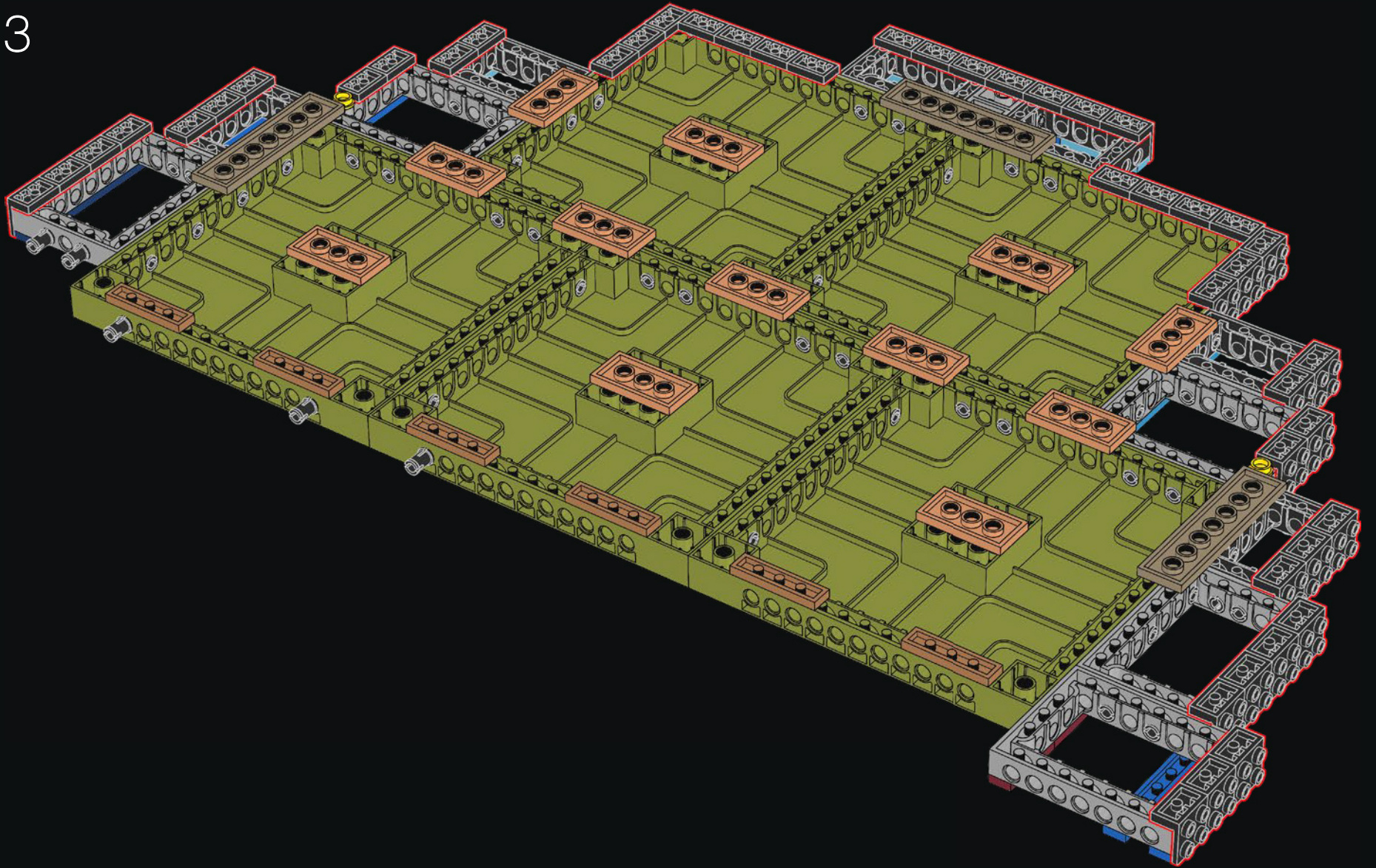



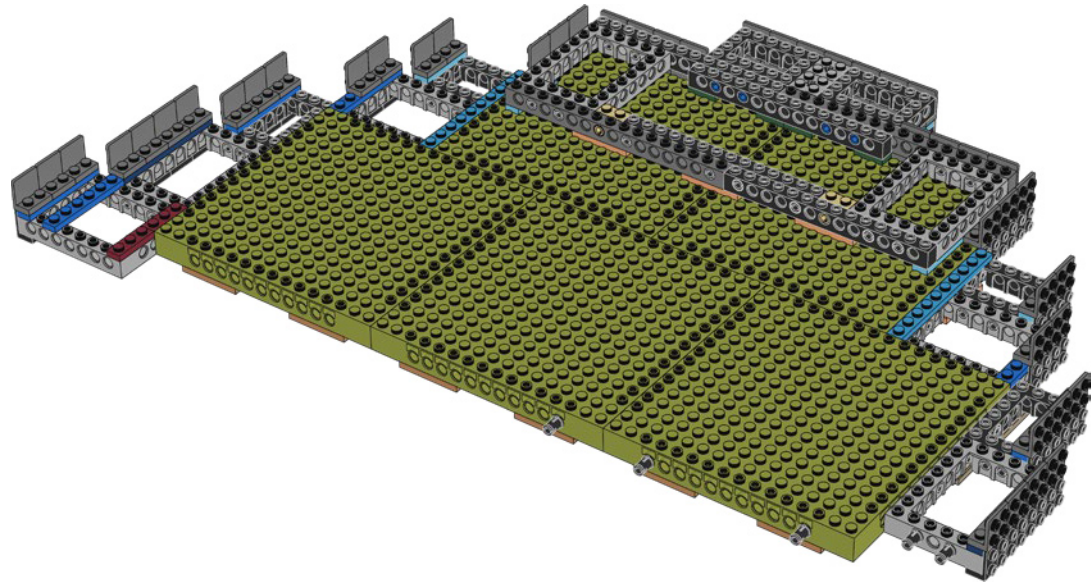
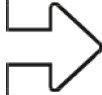



46x

14

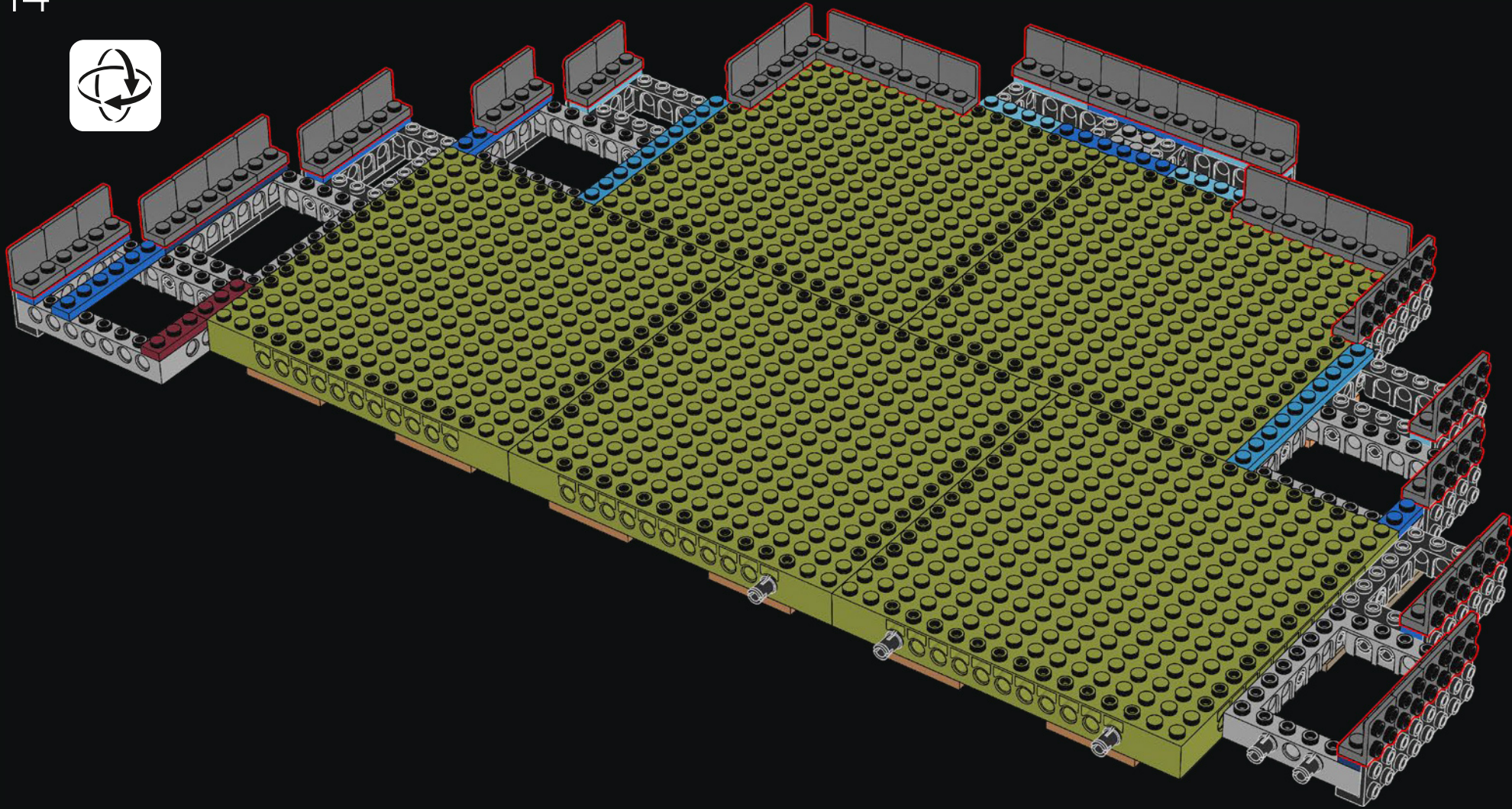



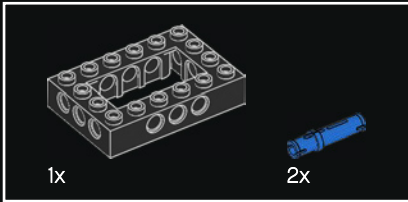
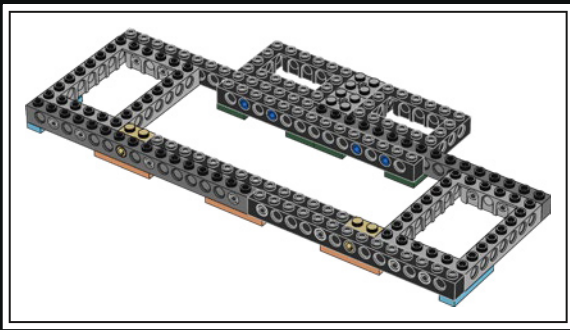

15

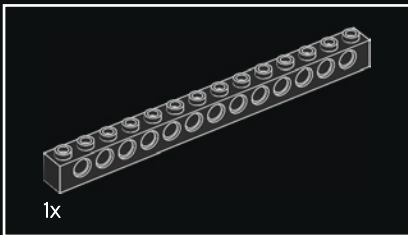
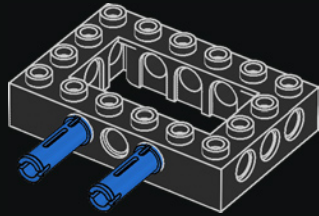

16

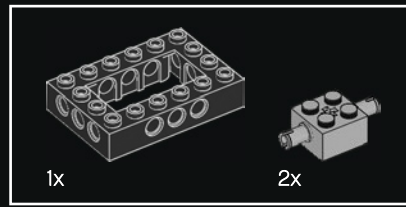
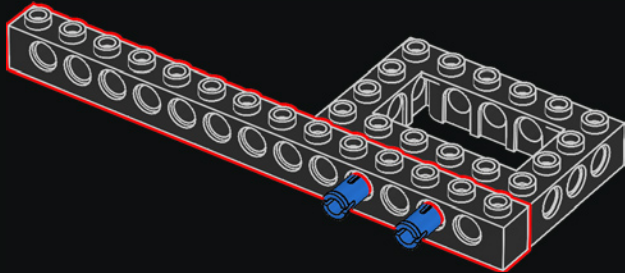

17

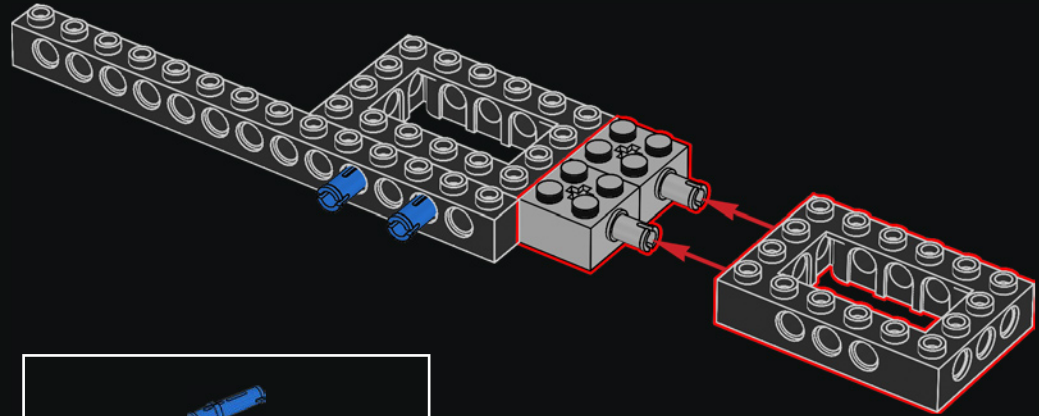

18

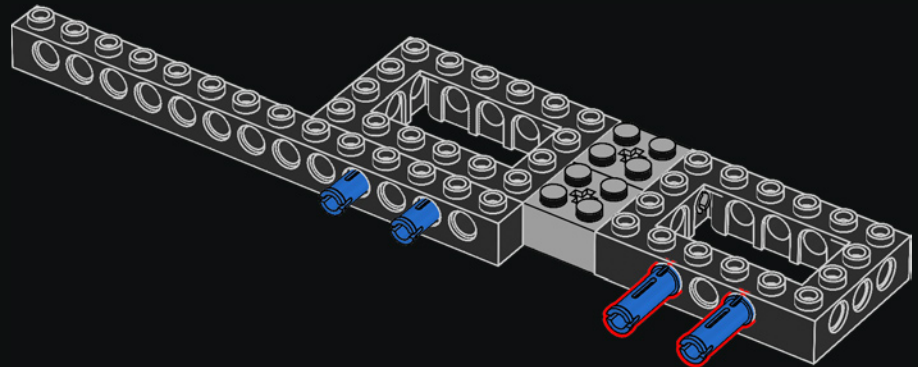

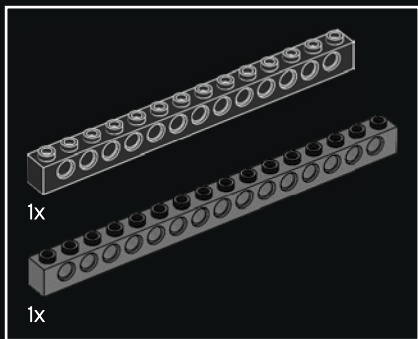

19

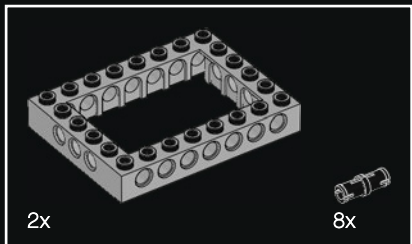
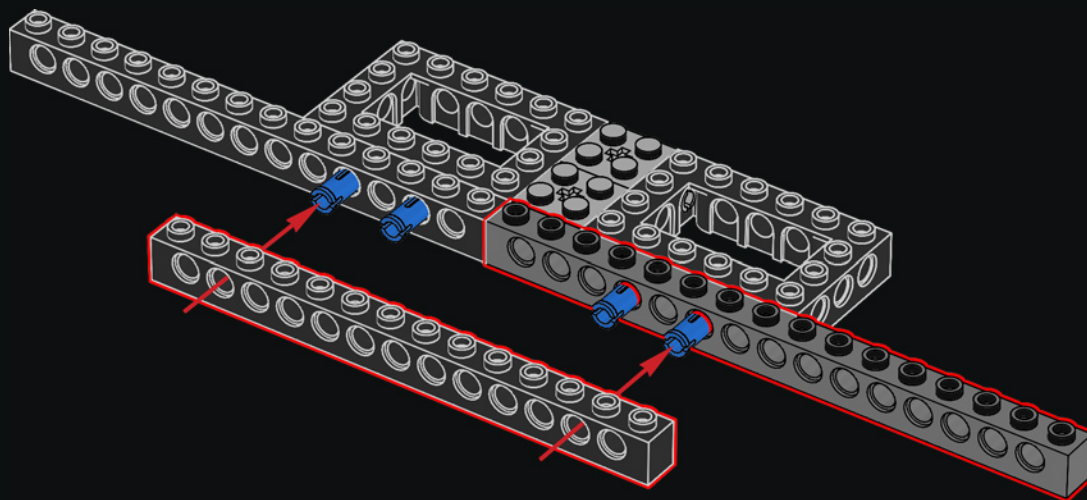

20

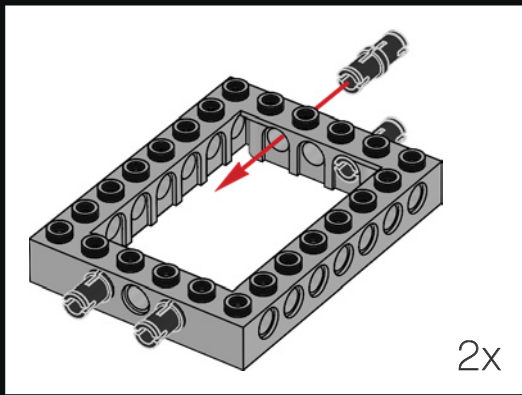
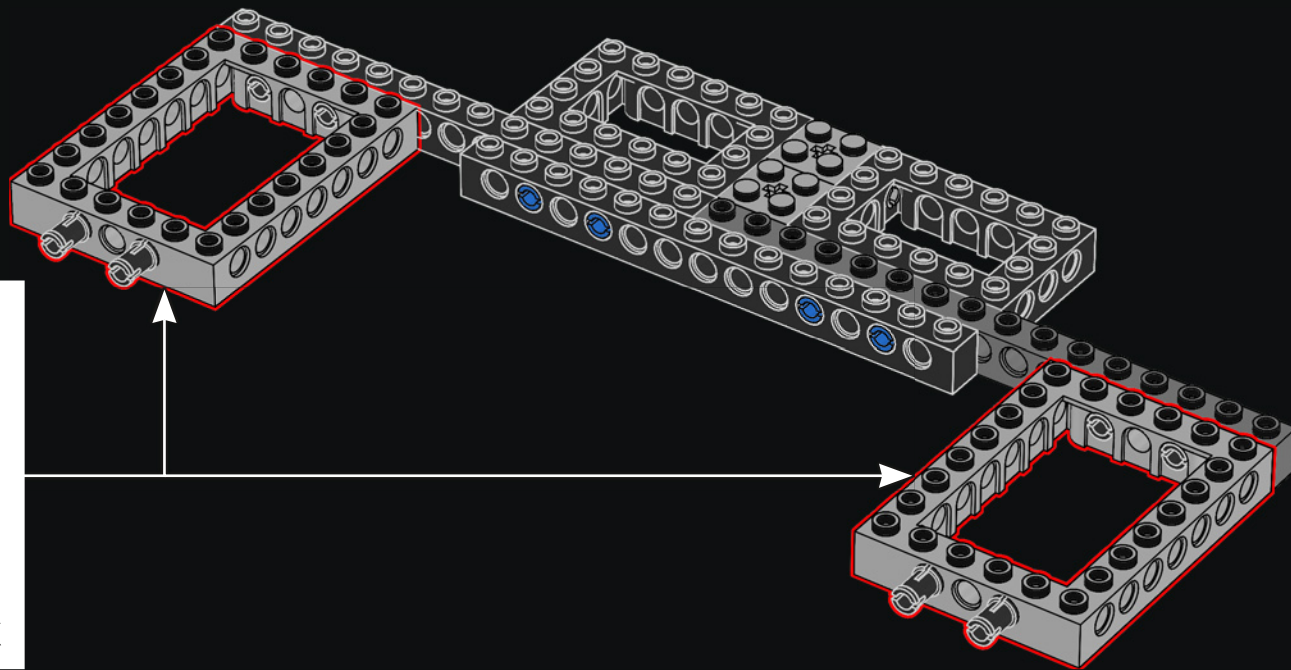

28



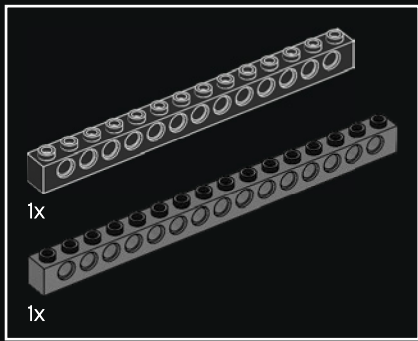

21

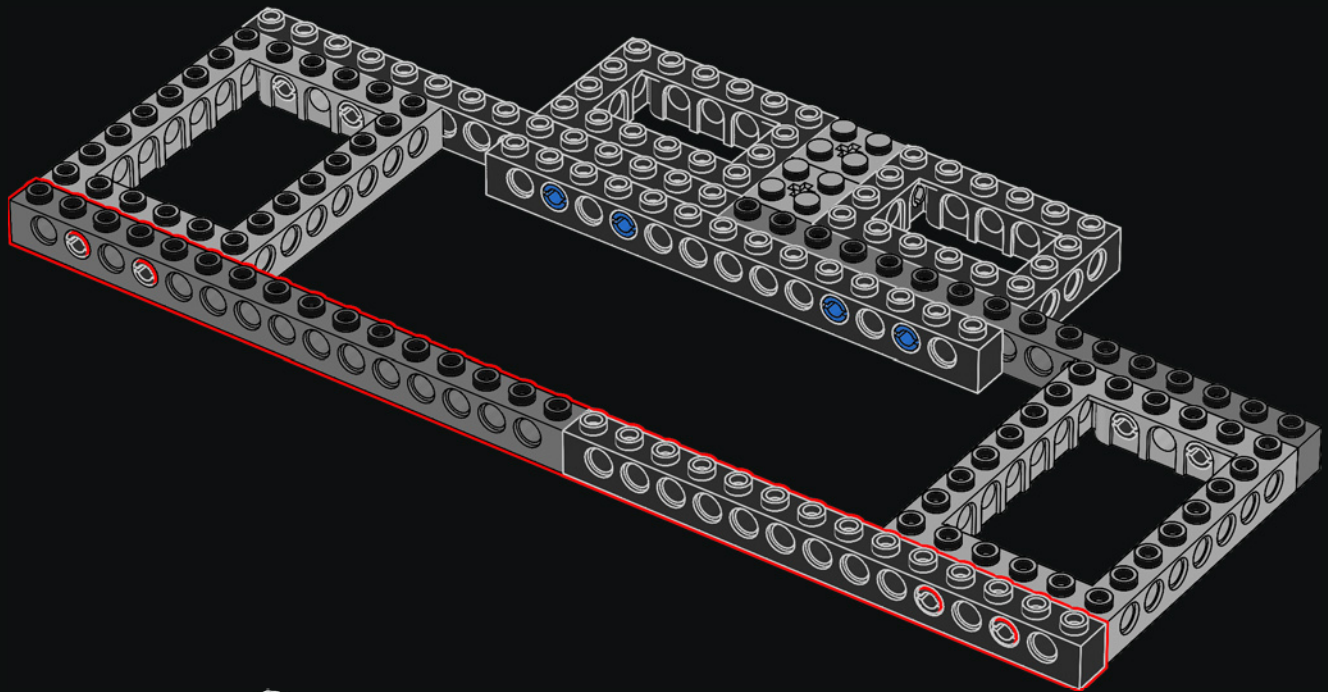

22

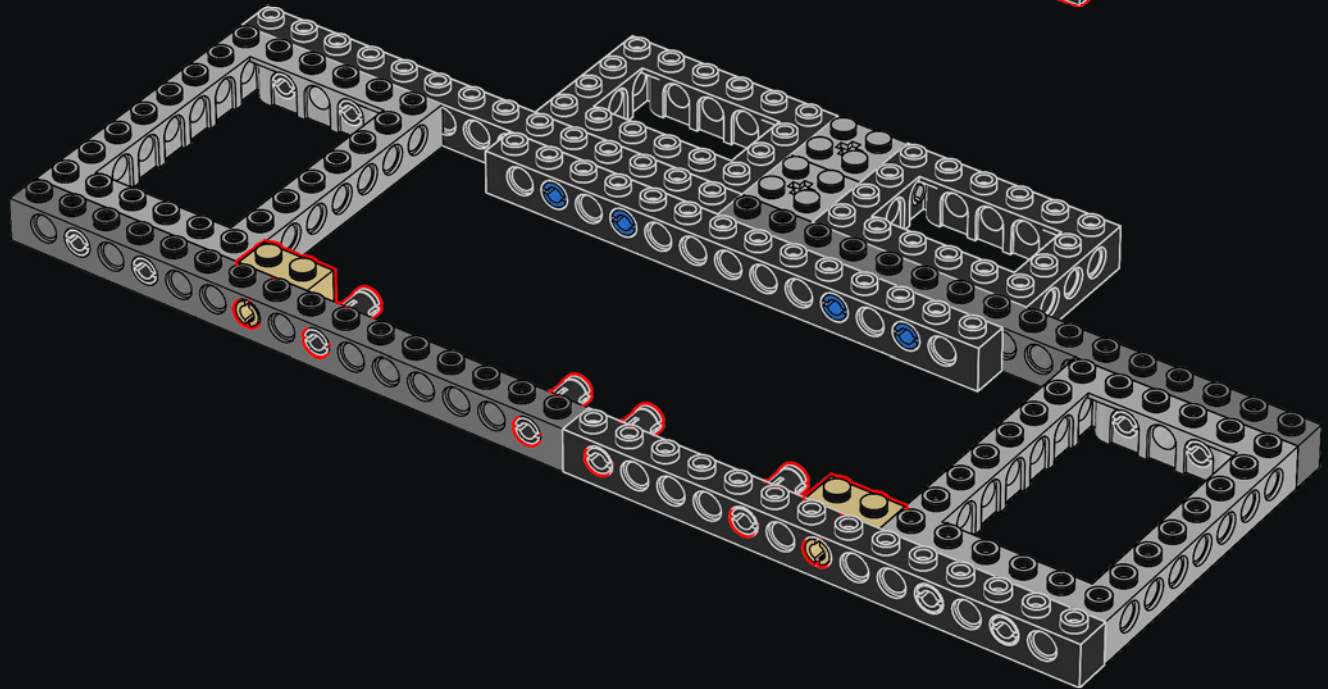



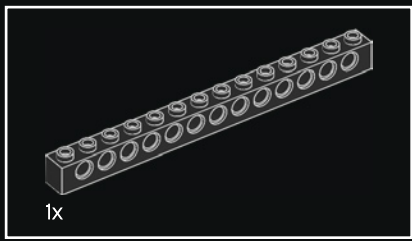

1x

23

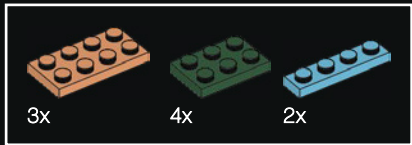
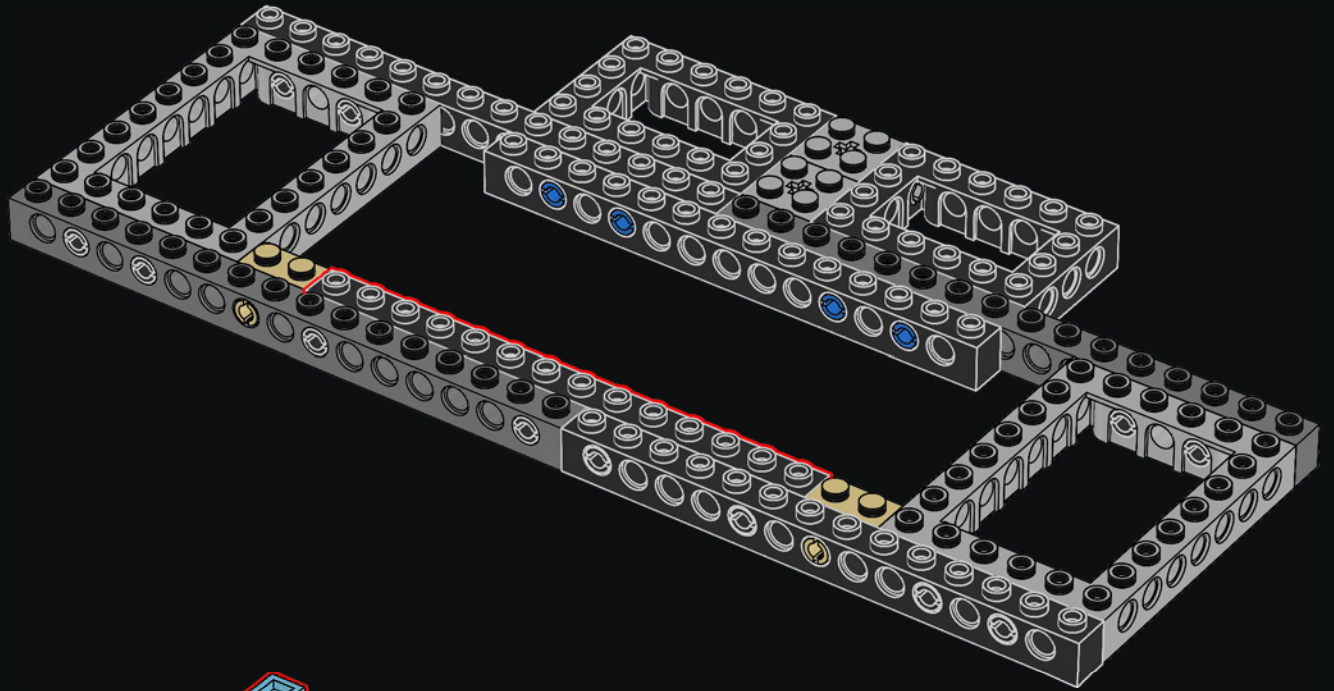

3x

4x

2x

24

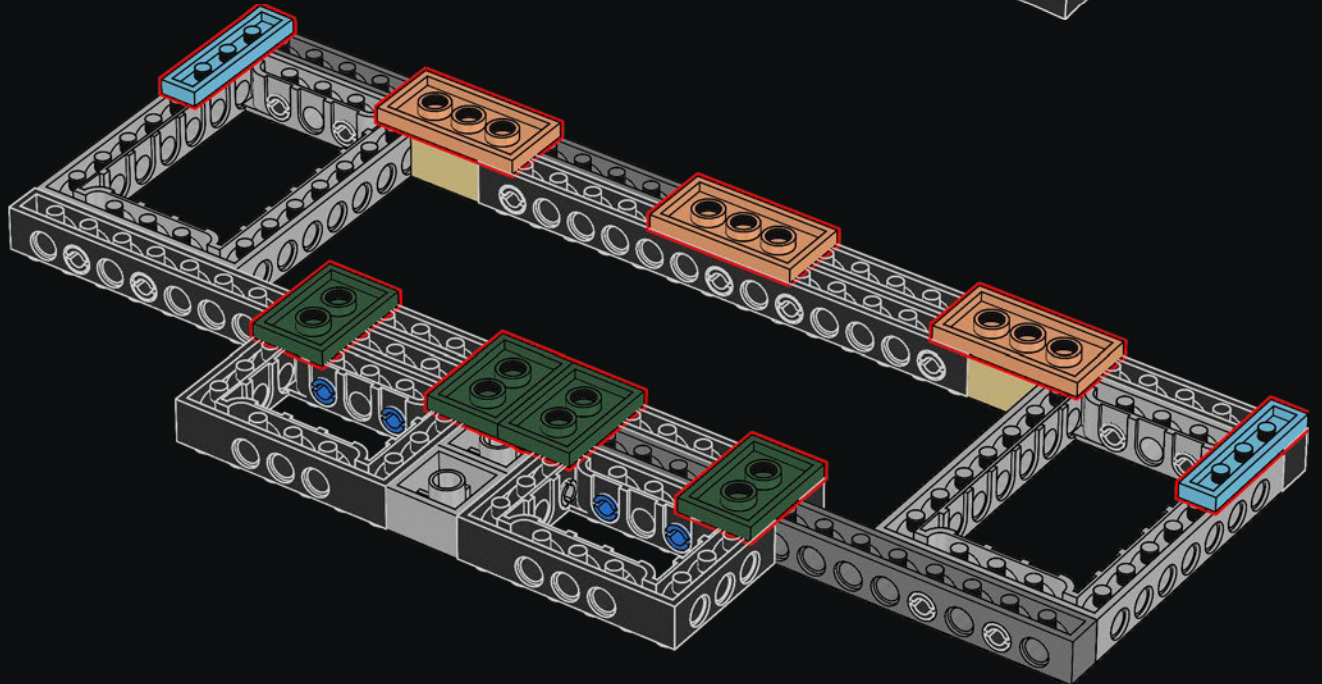



25

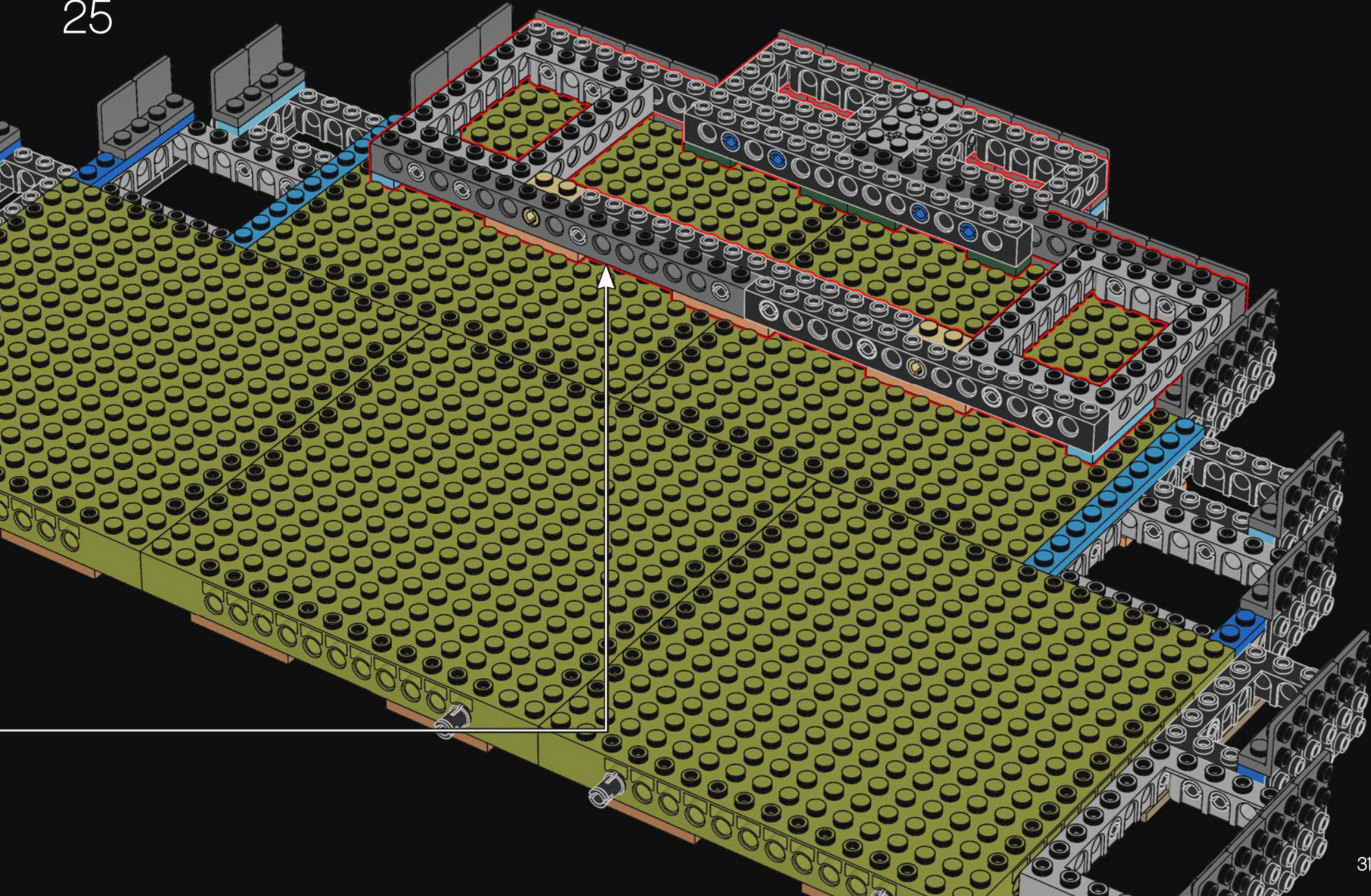



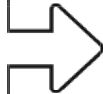



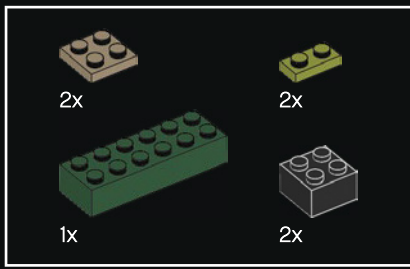

26

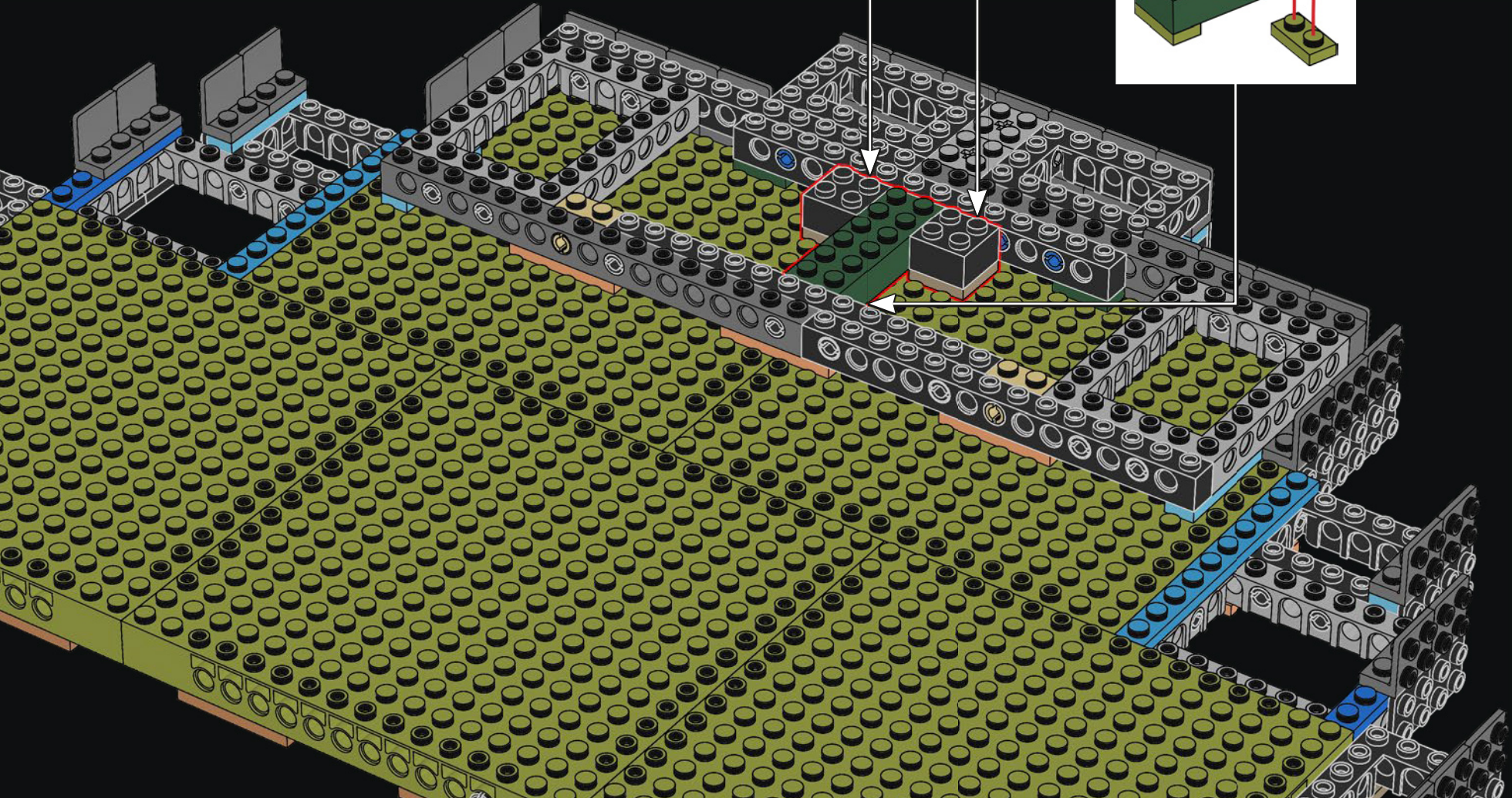
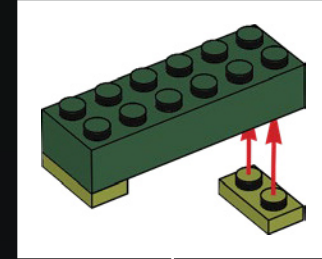
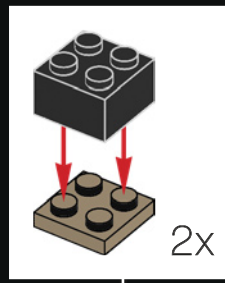



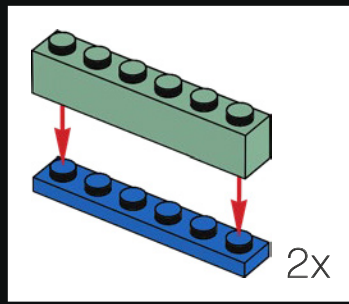
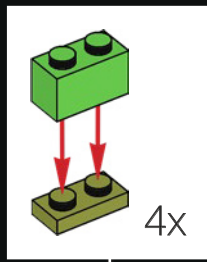
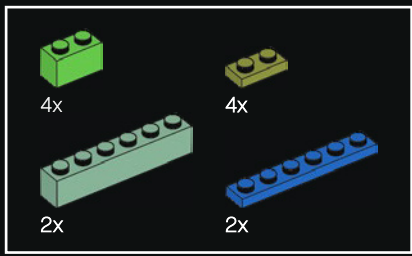

27

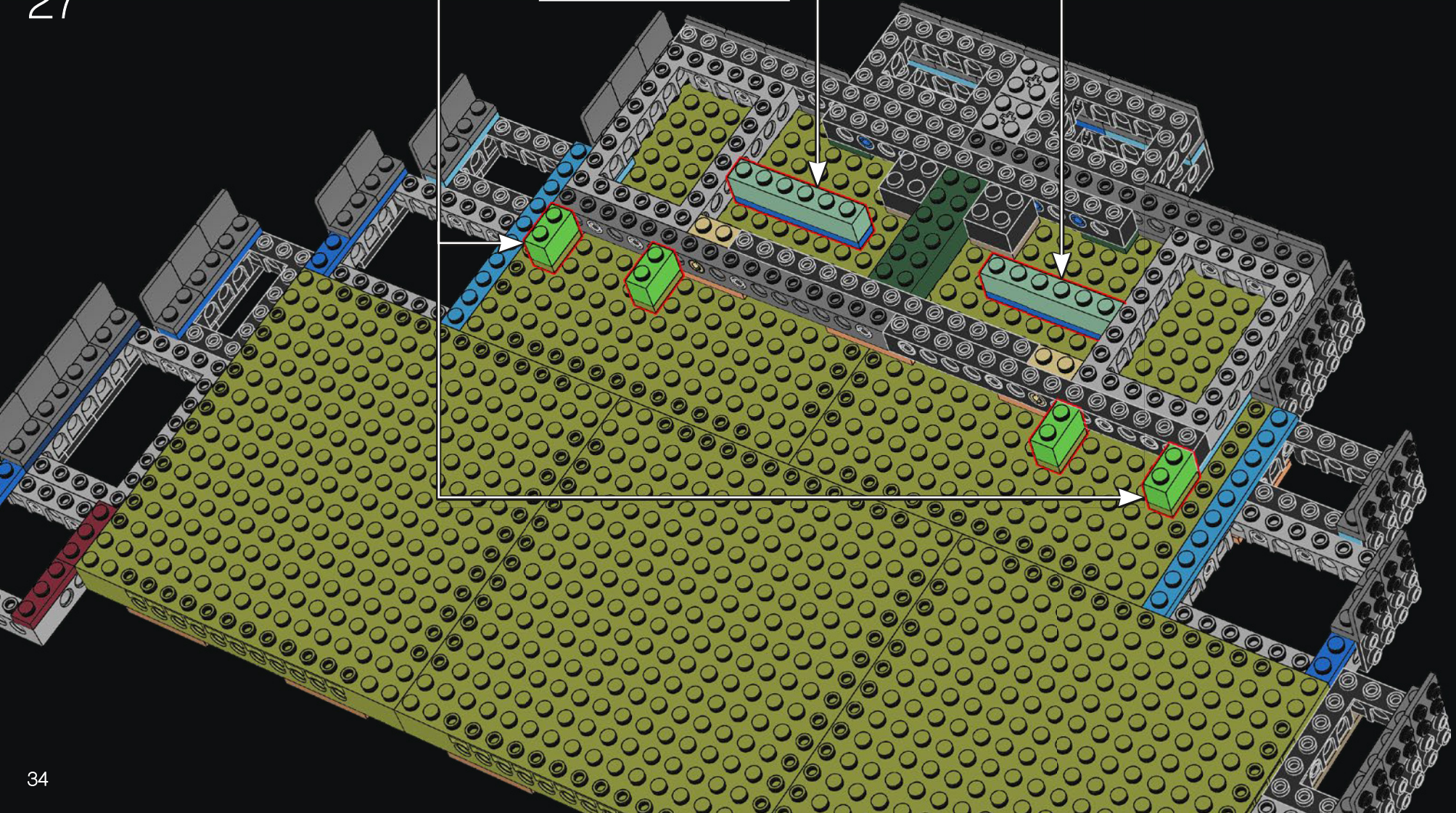



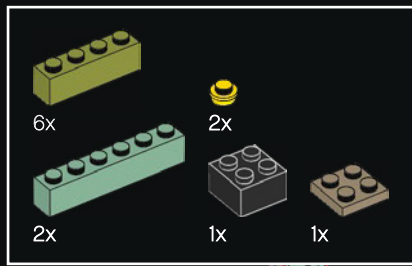

28

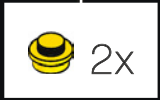
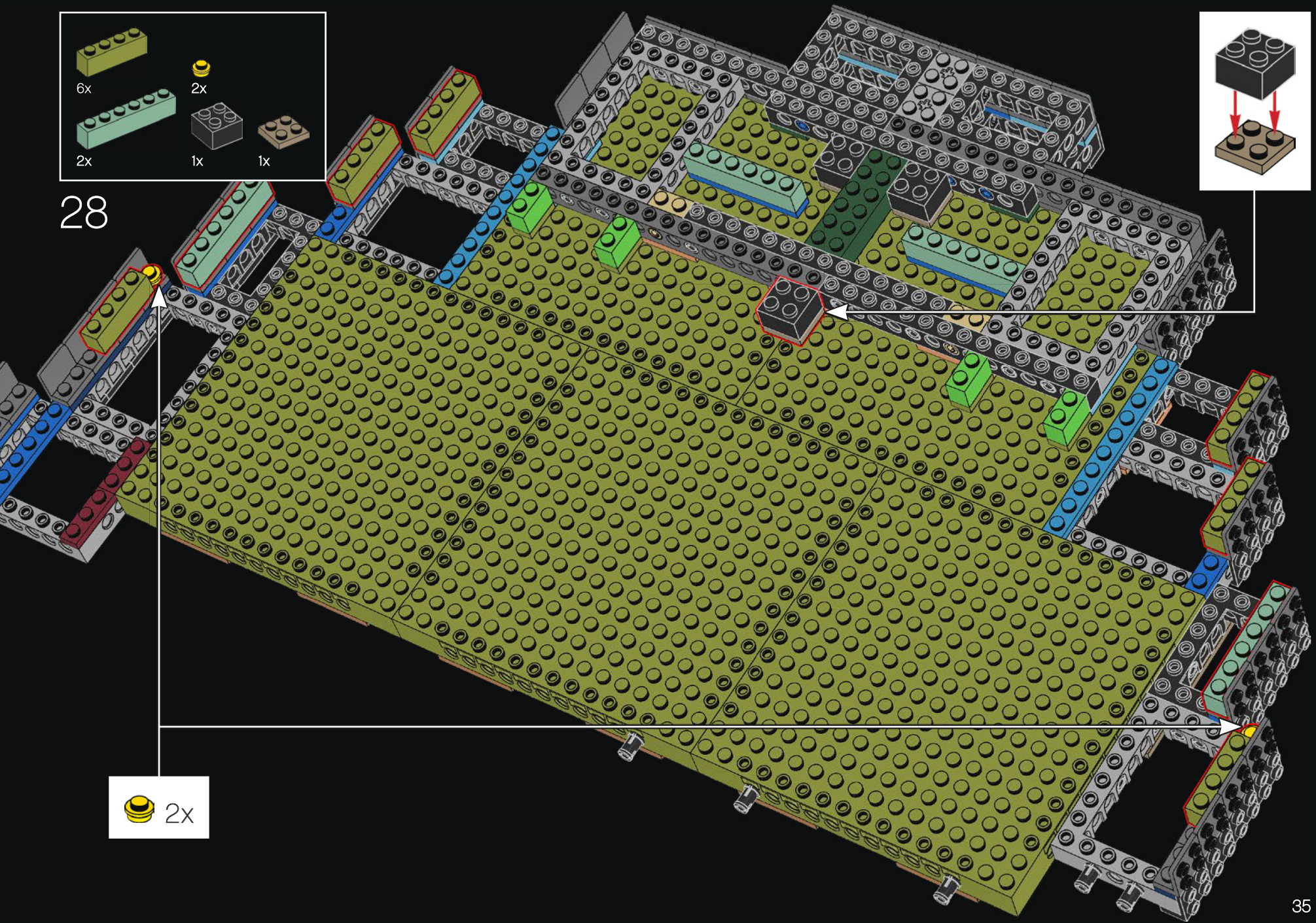
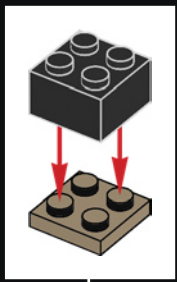



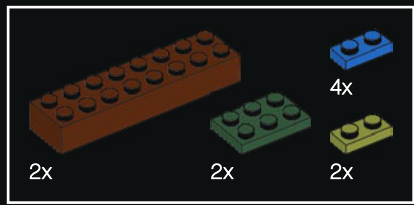

29

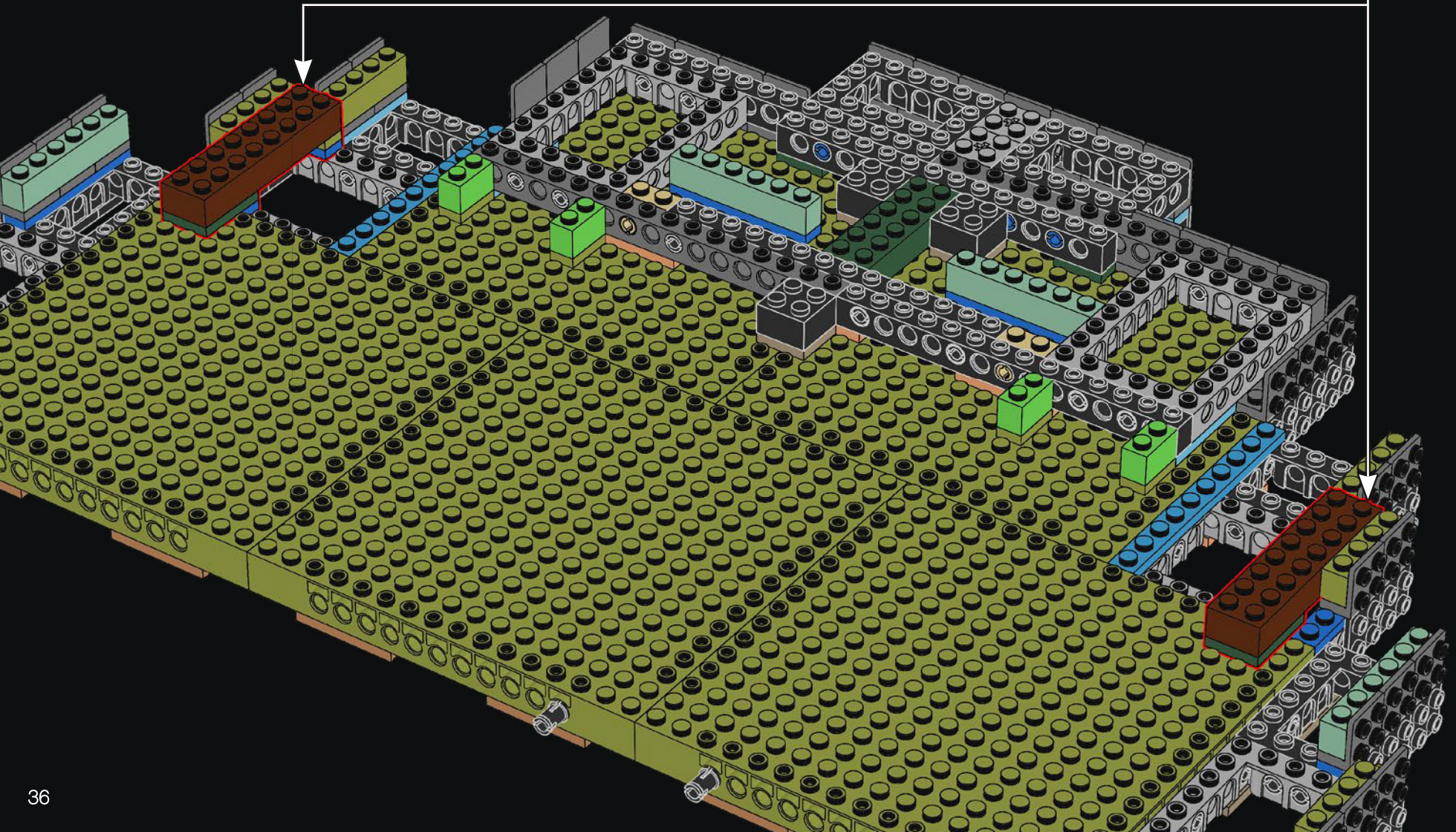
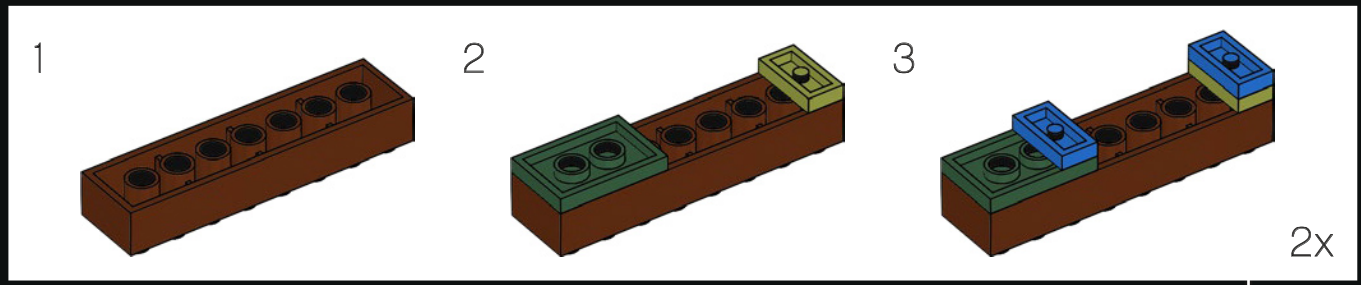



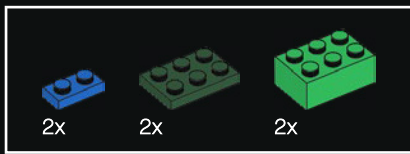

30

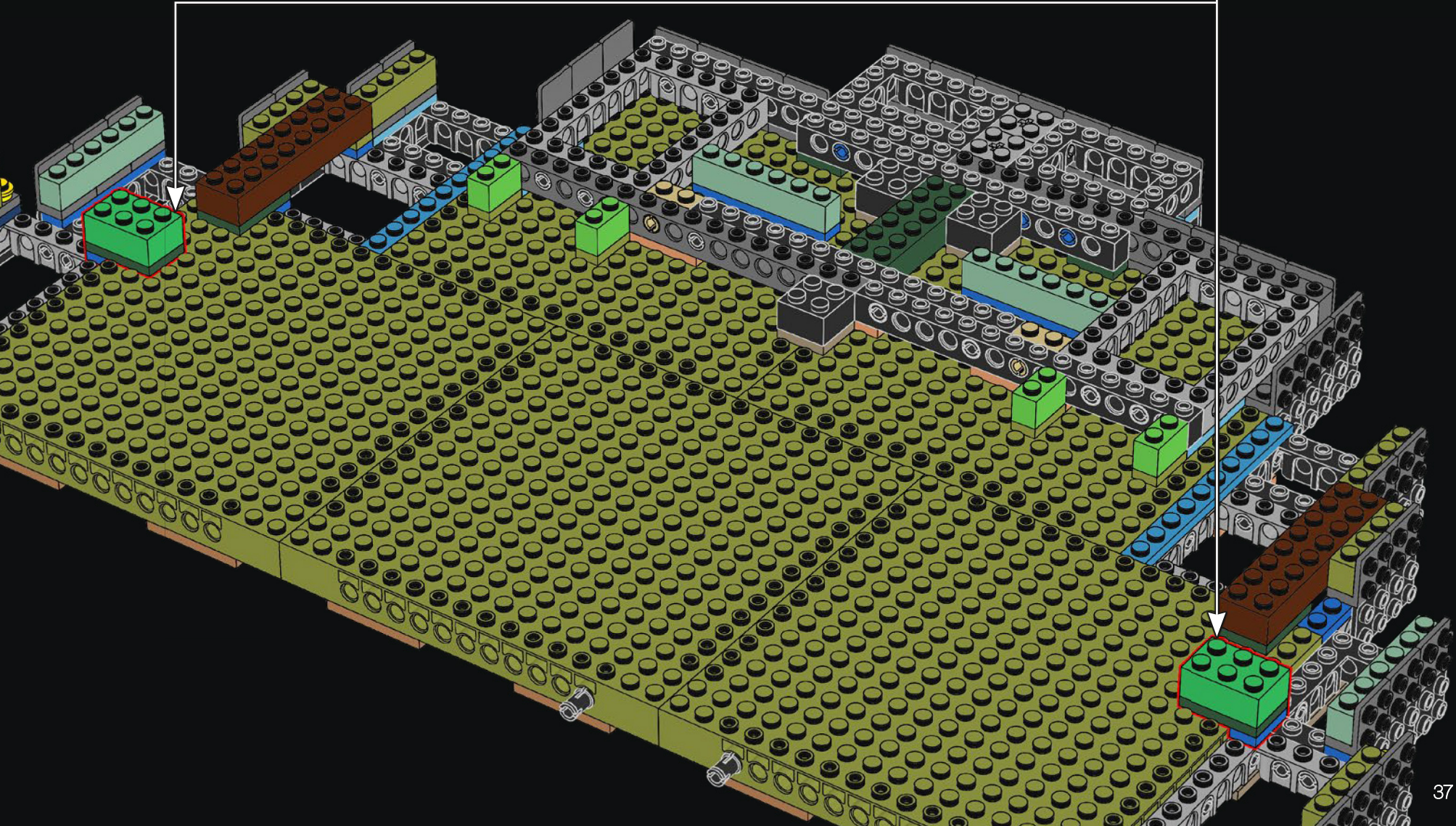
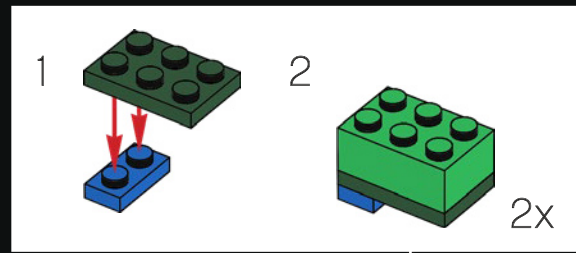



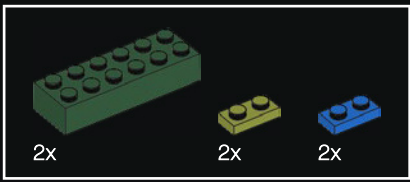

31

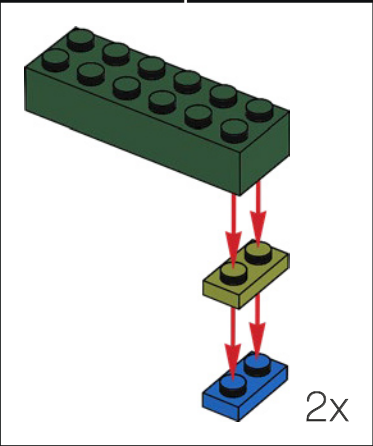
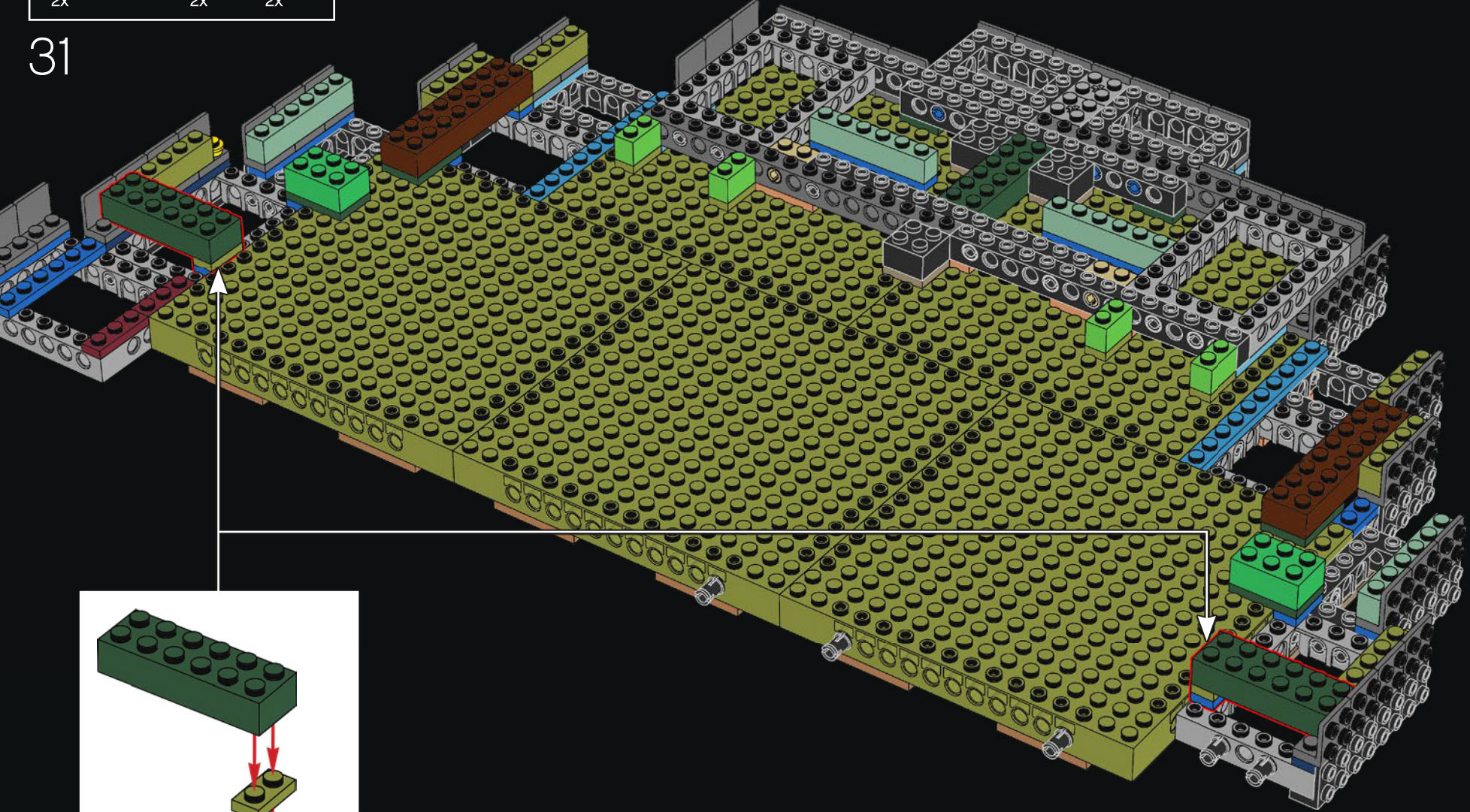



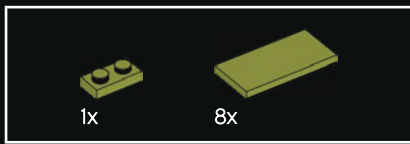

32





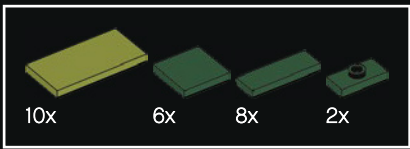

33



2x



34

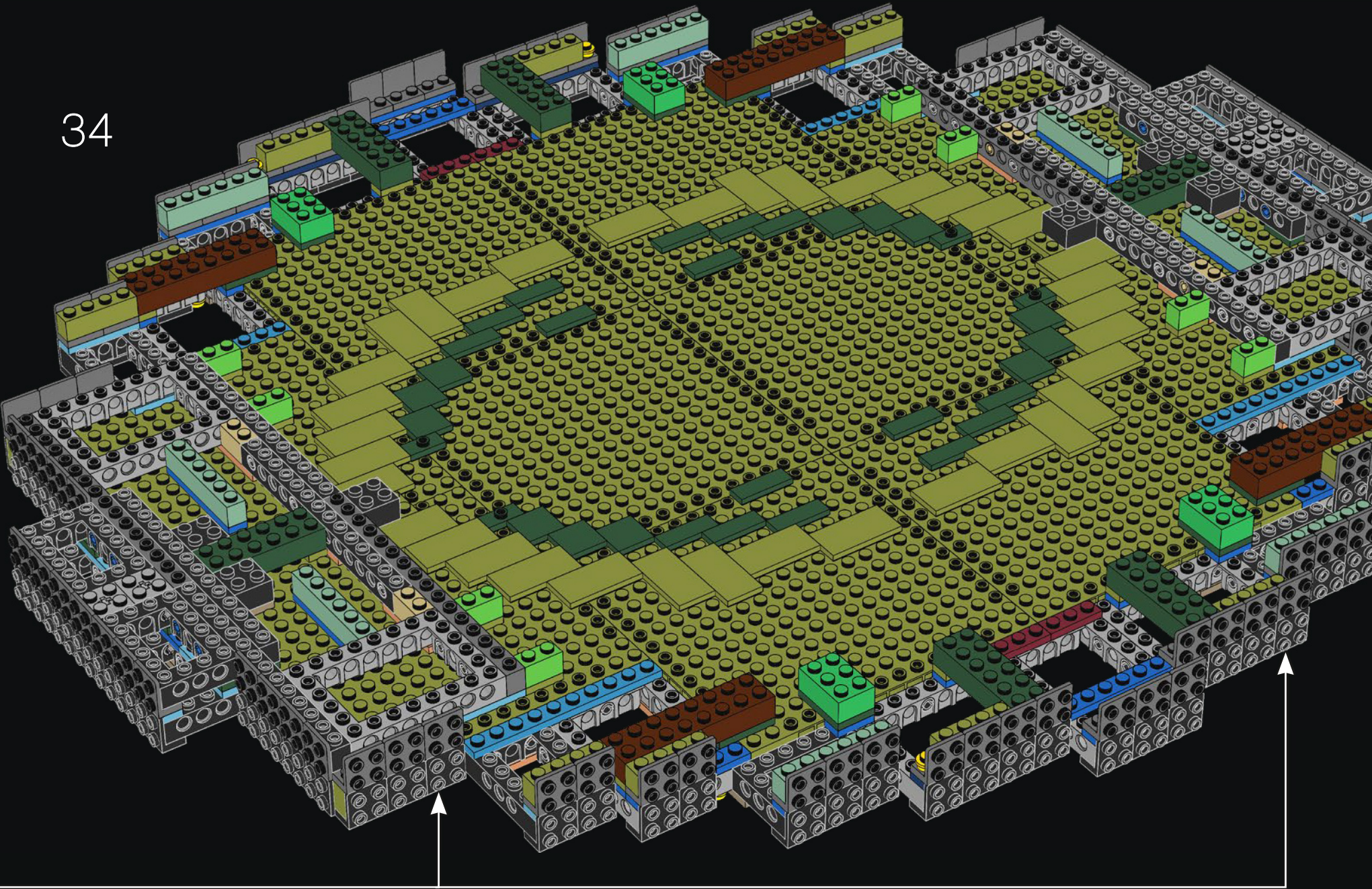



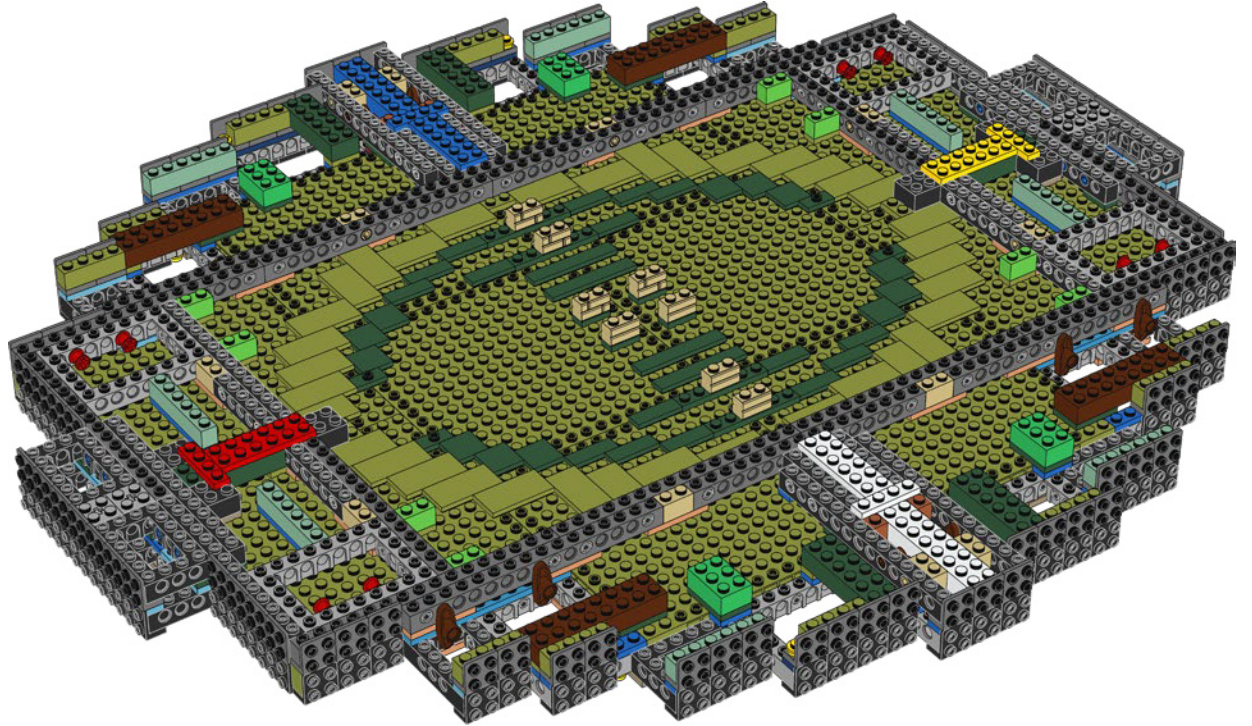
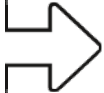



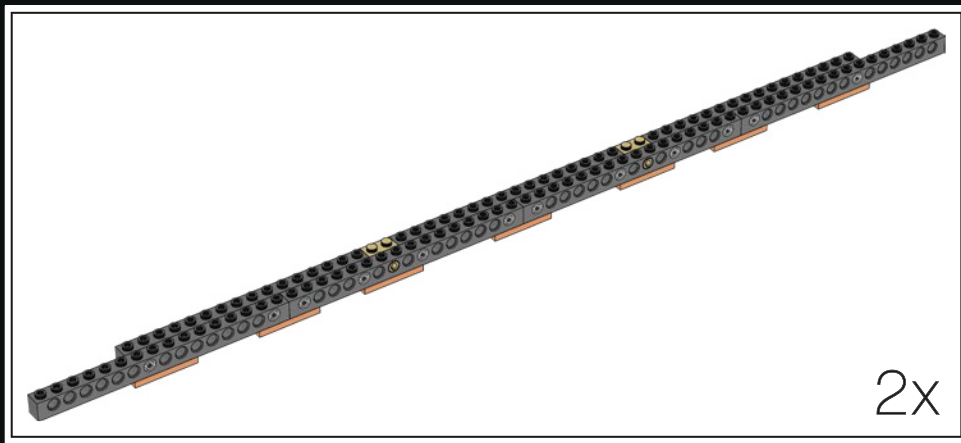

2x

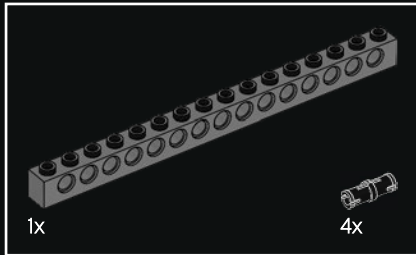

1x

4x

35

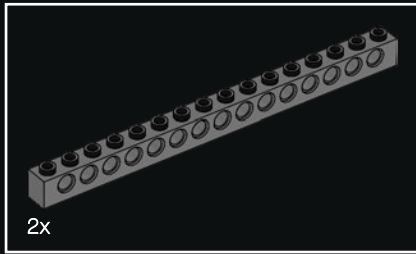
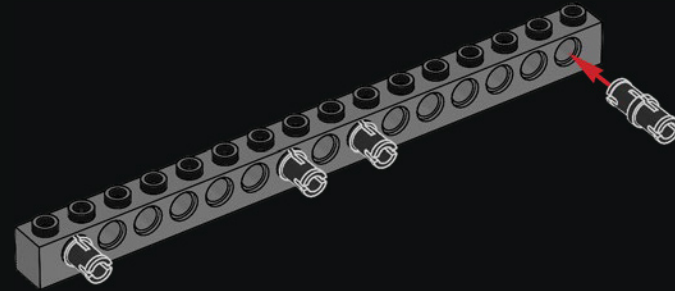

2x

36

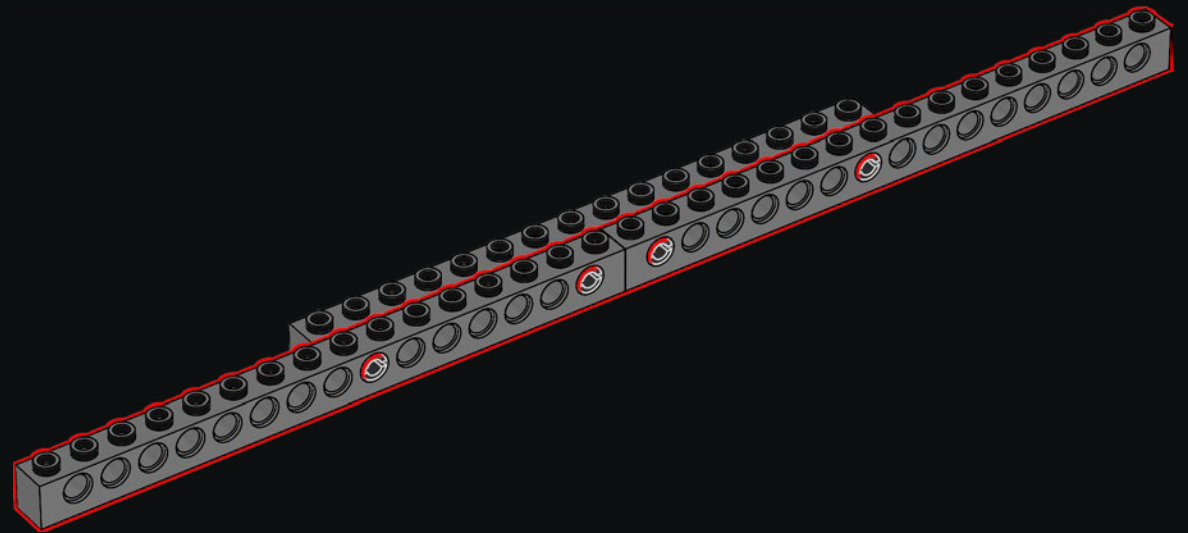





37

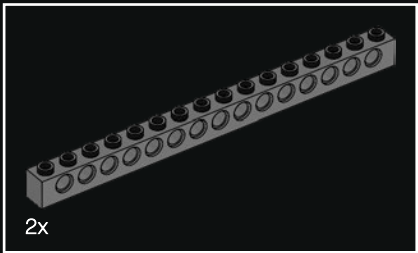
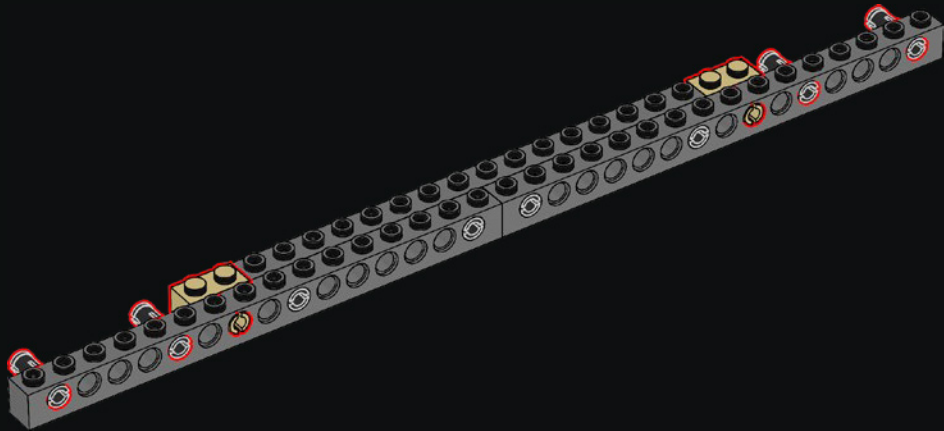

38

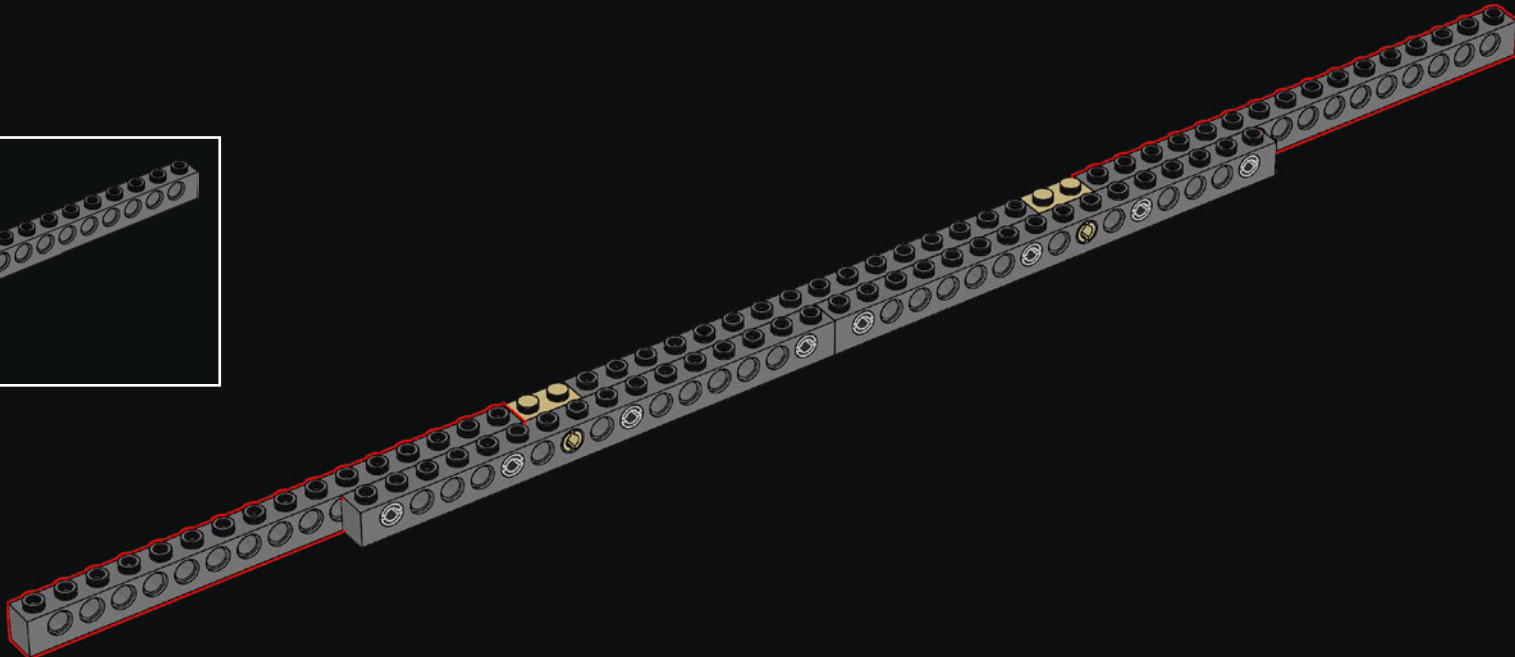





39

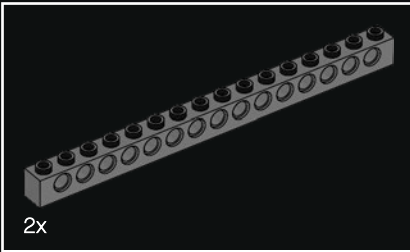
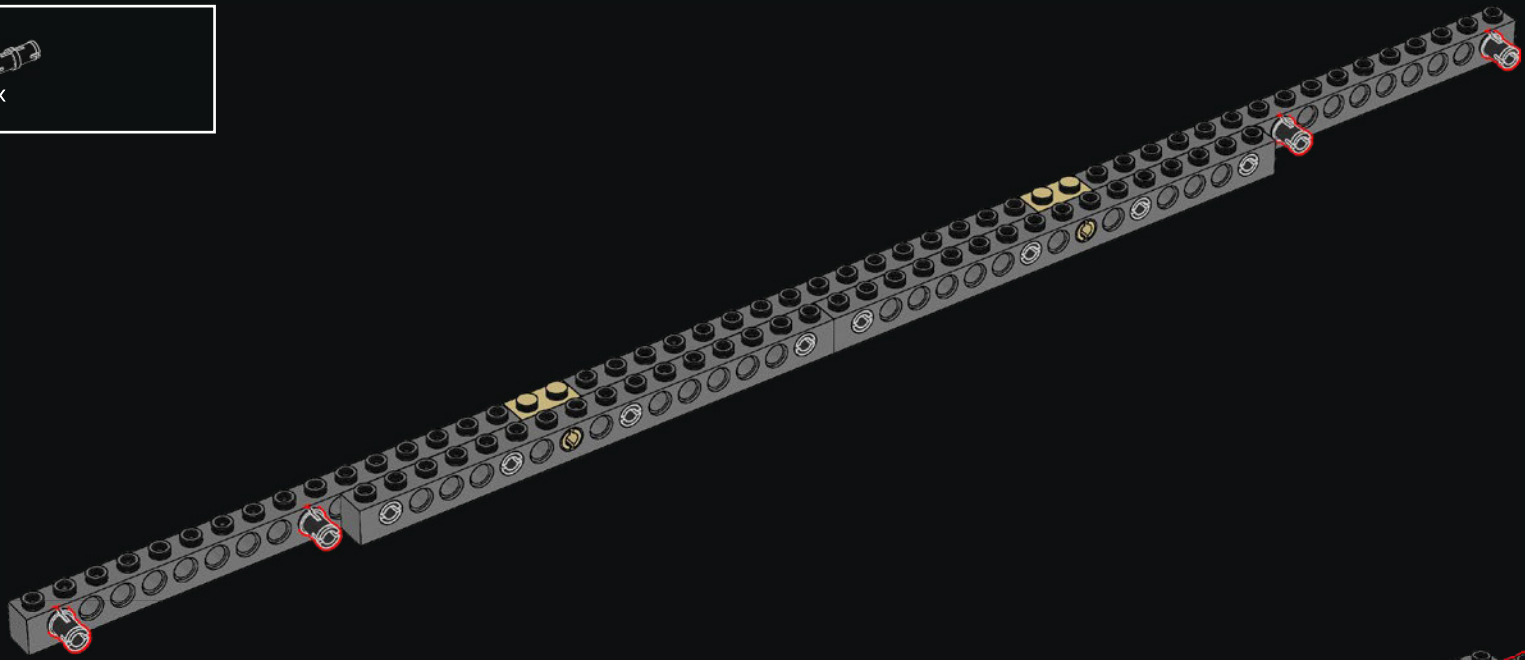

40

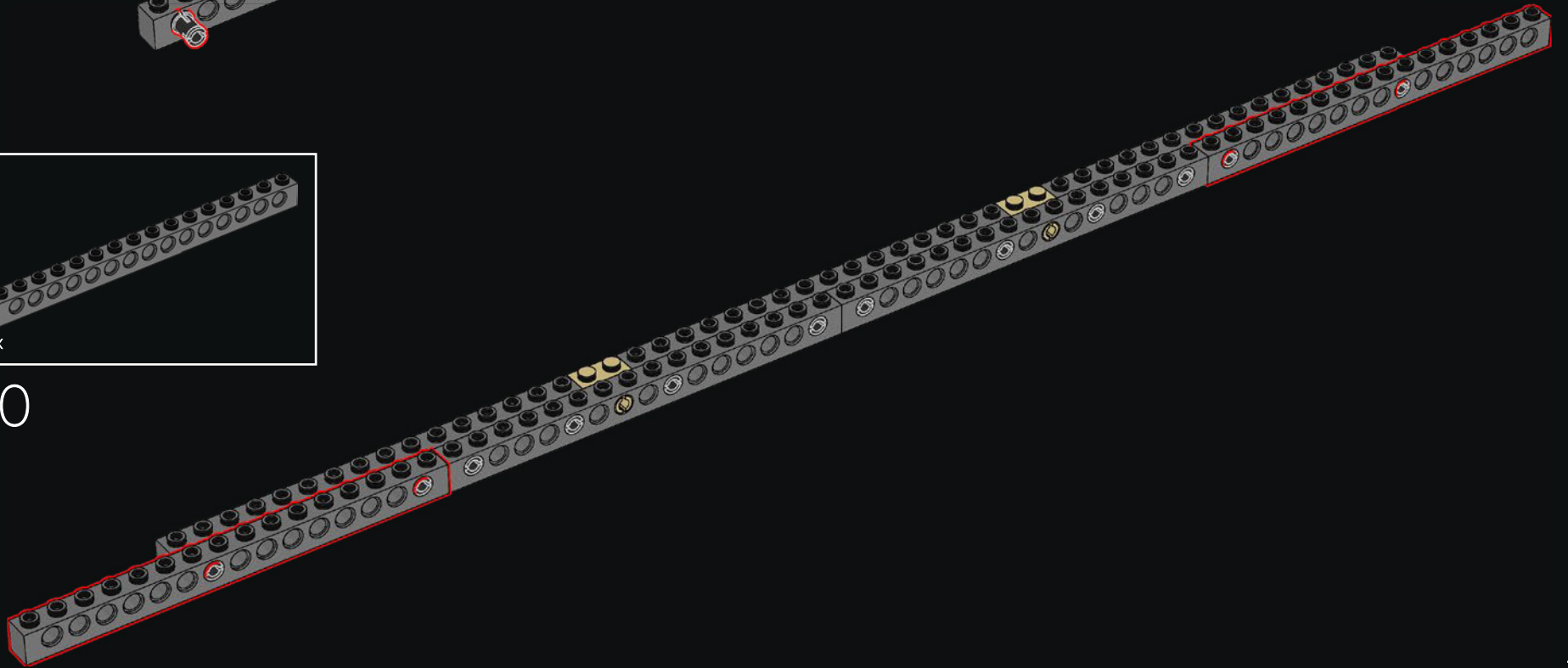



经过弗拉维王朝三位皇帝的建造和改造之后，  
罗马斗兽场还被称为“弗拉维圆形剧场”。



7x

41

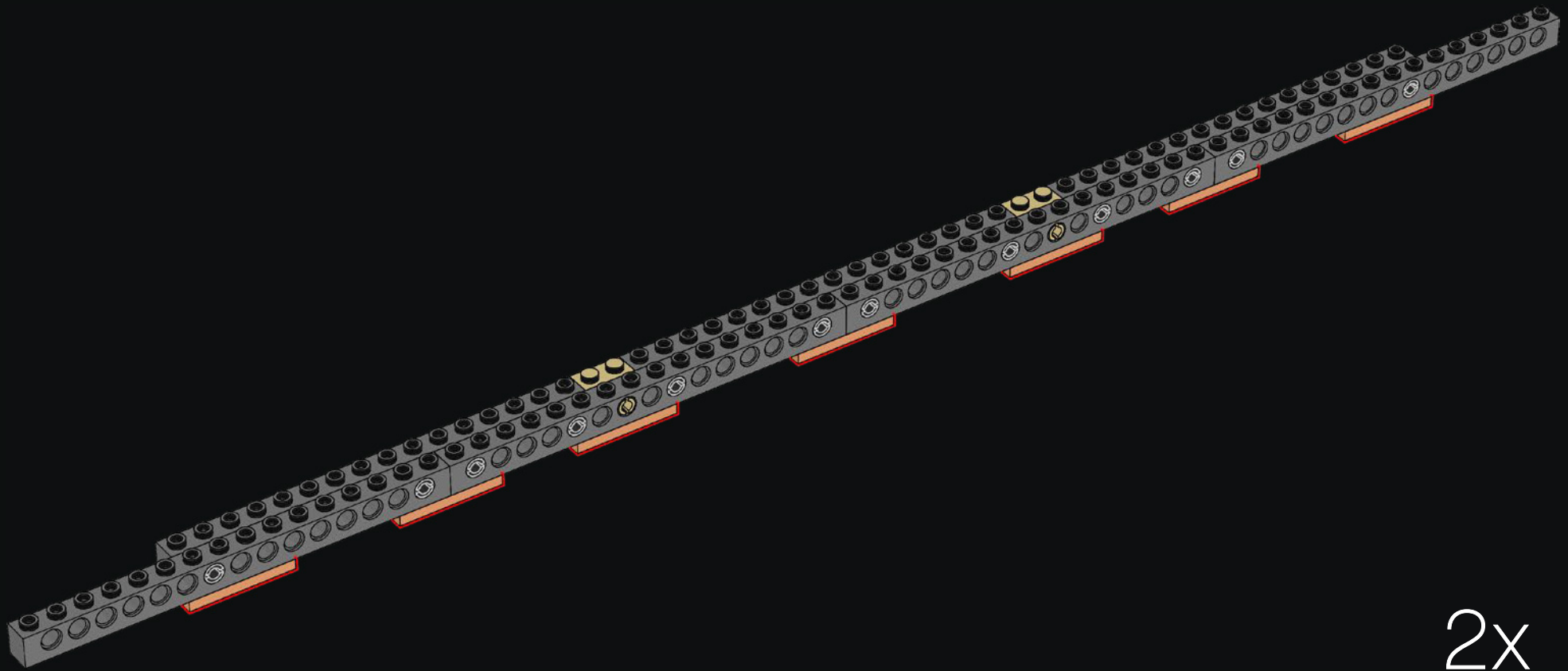

2x



42

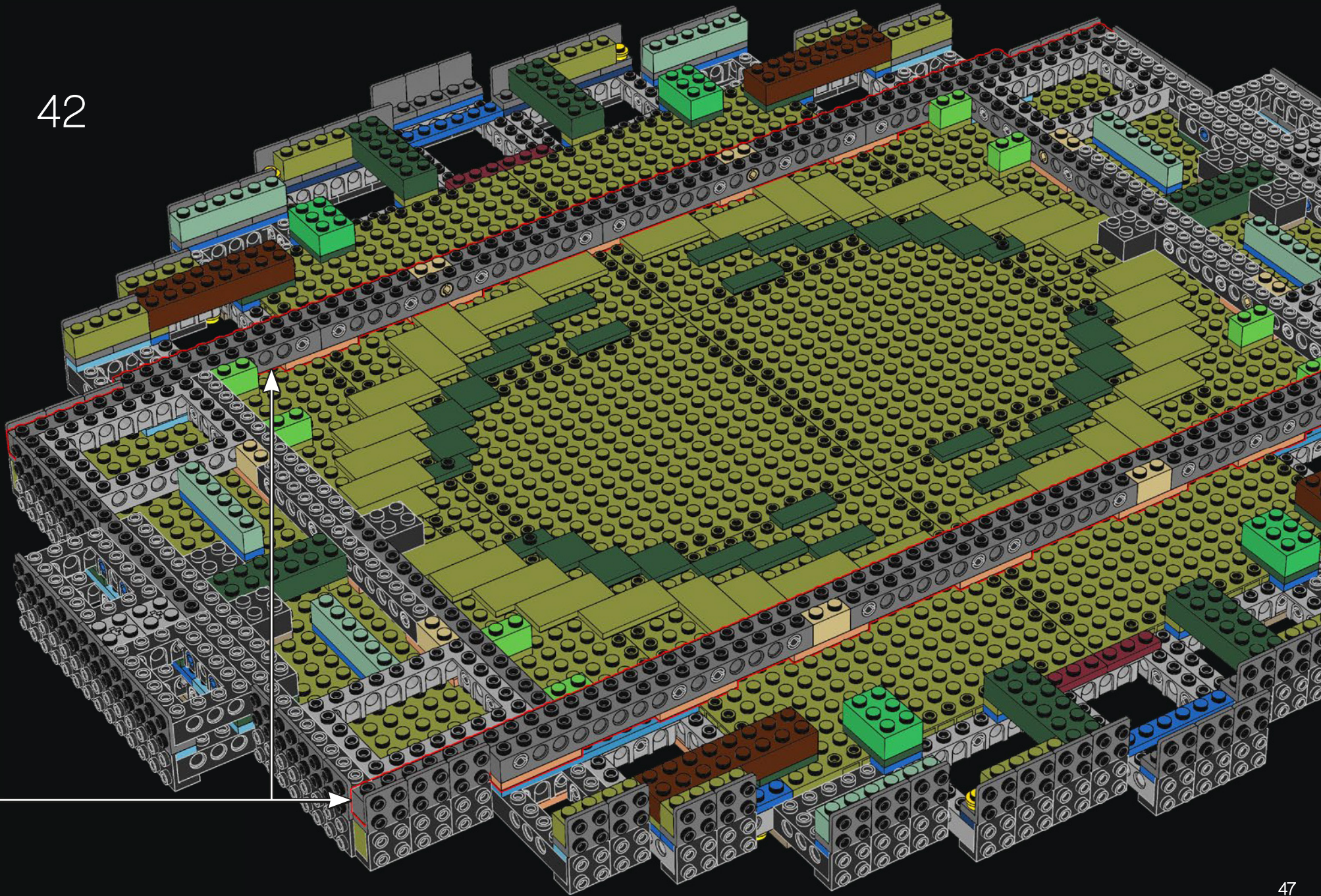





43

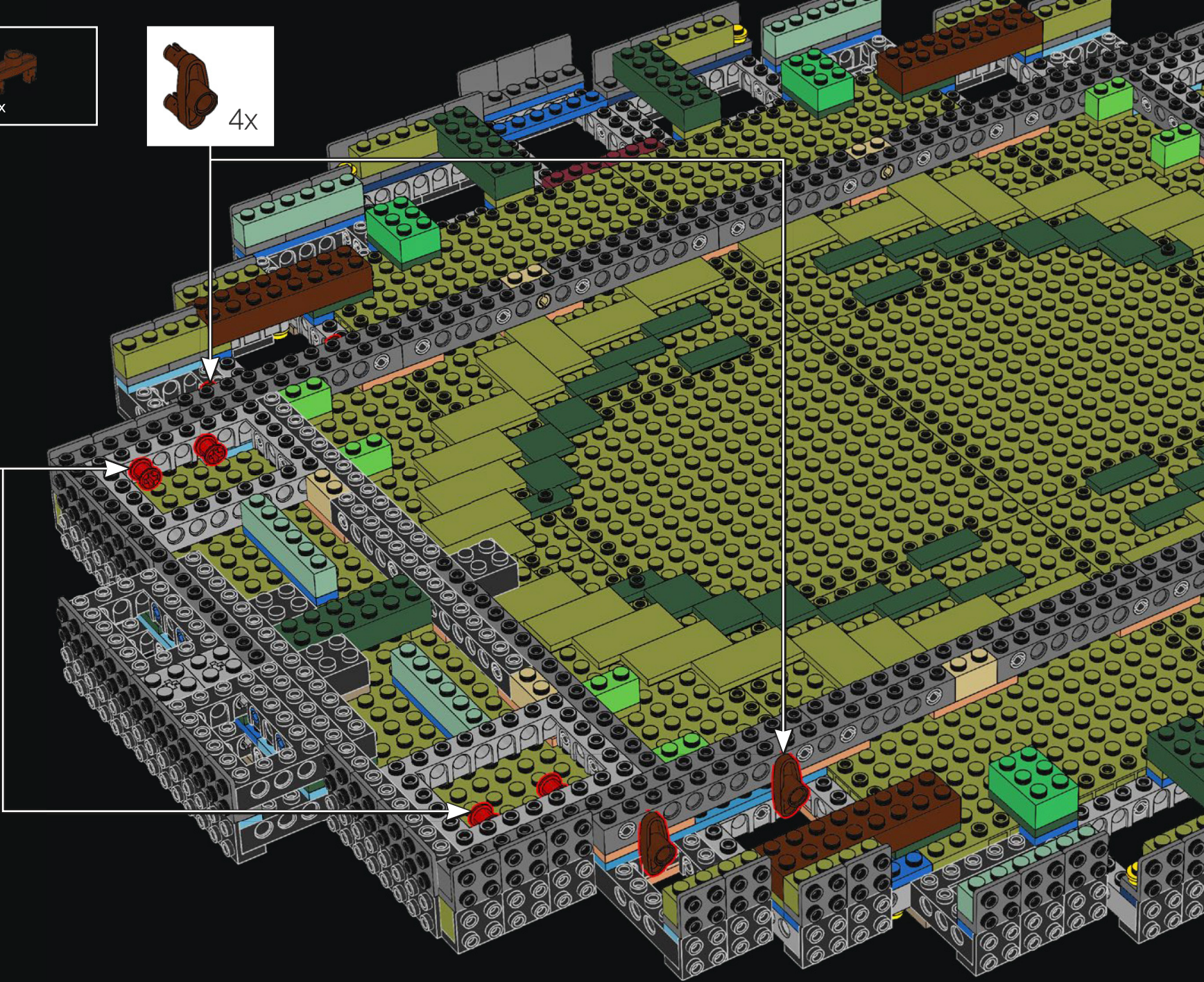





44

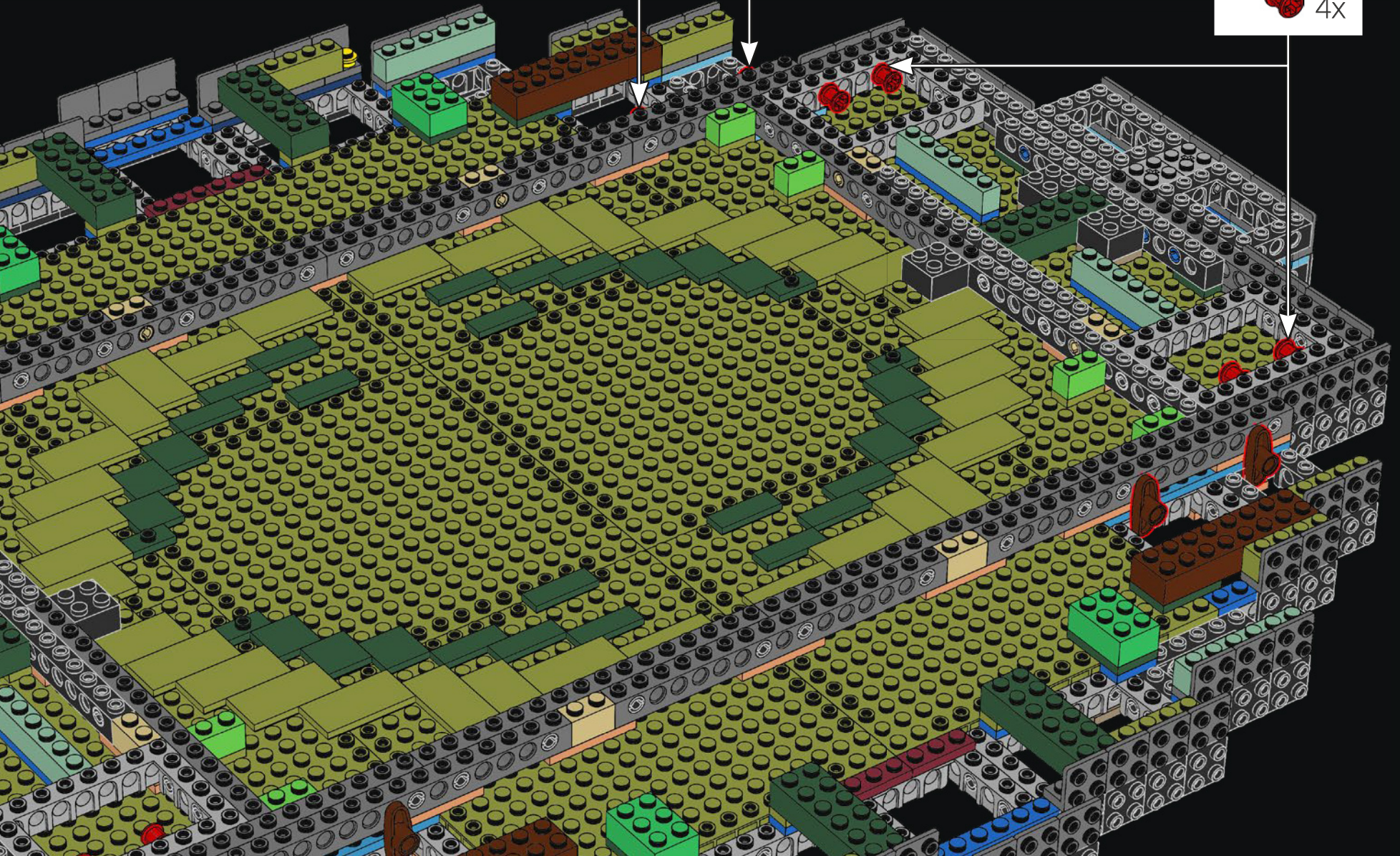







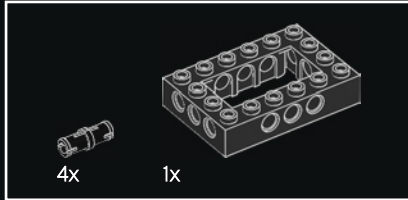
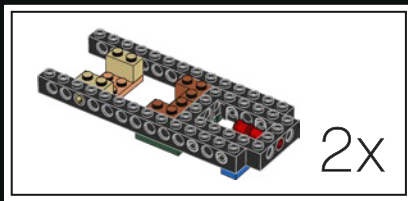

46

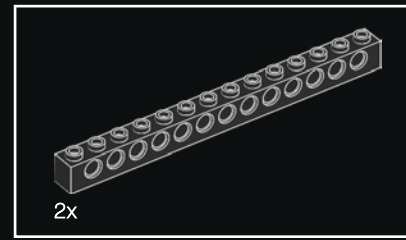
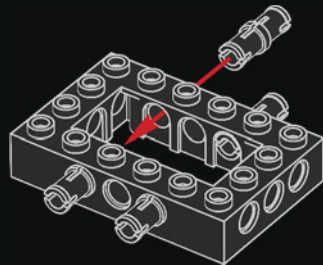

47

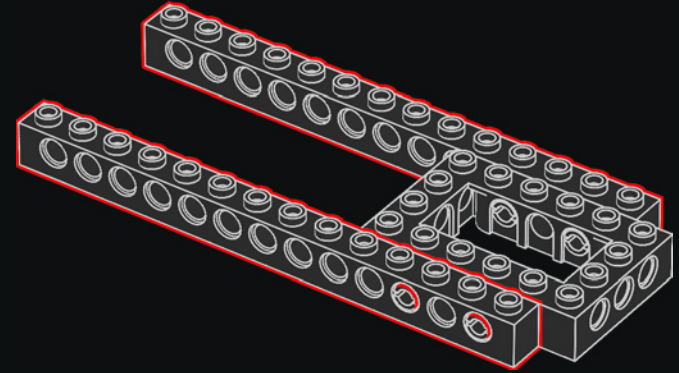

48

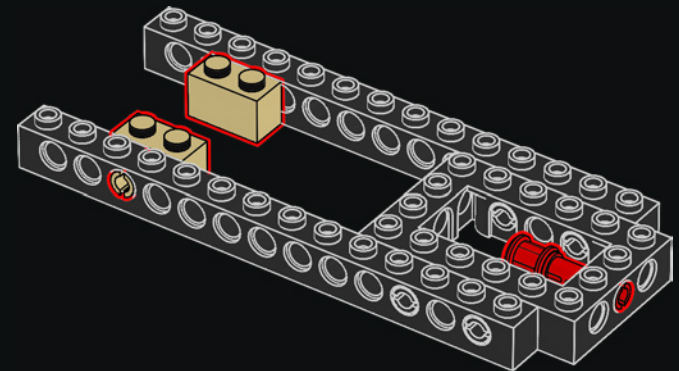



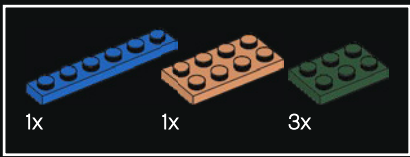

49

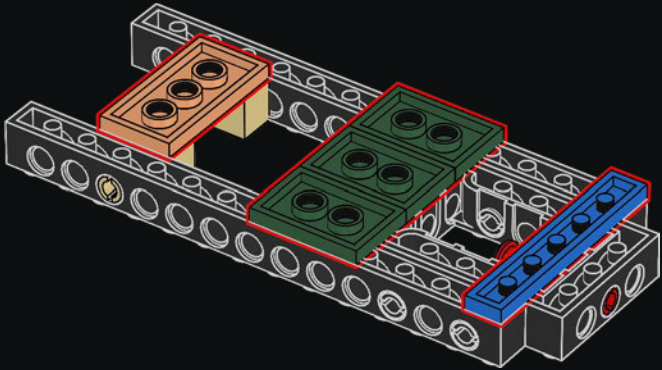

50

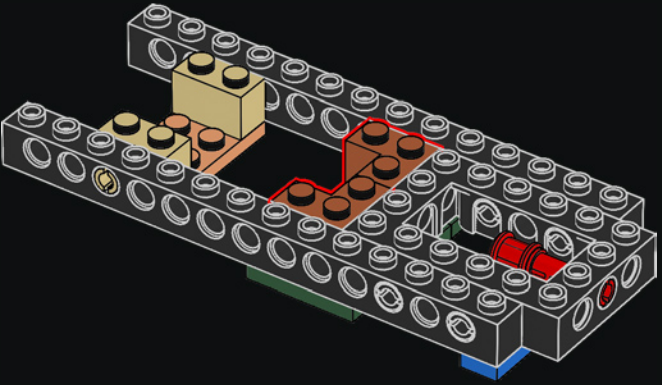

2x



51

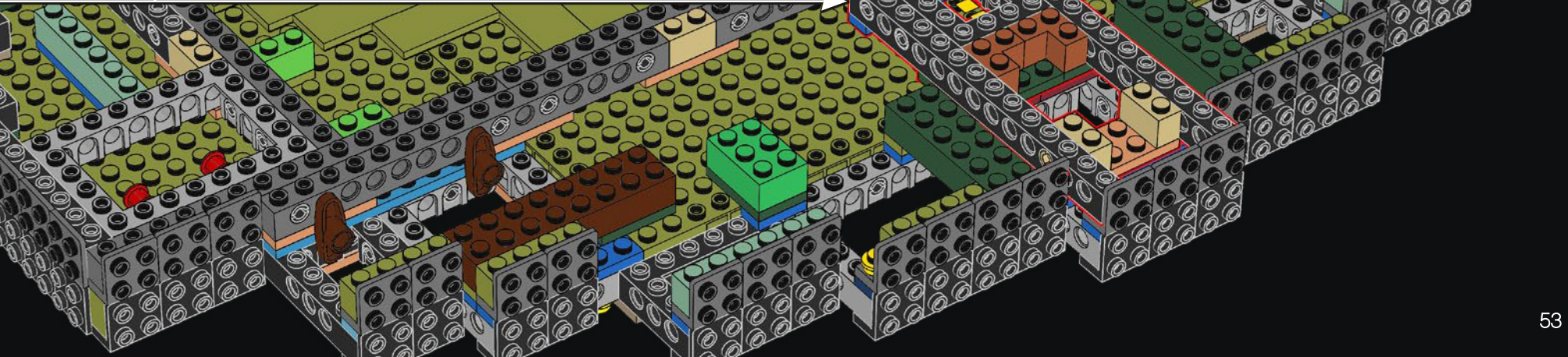
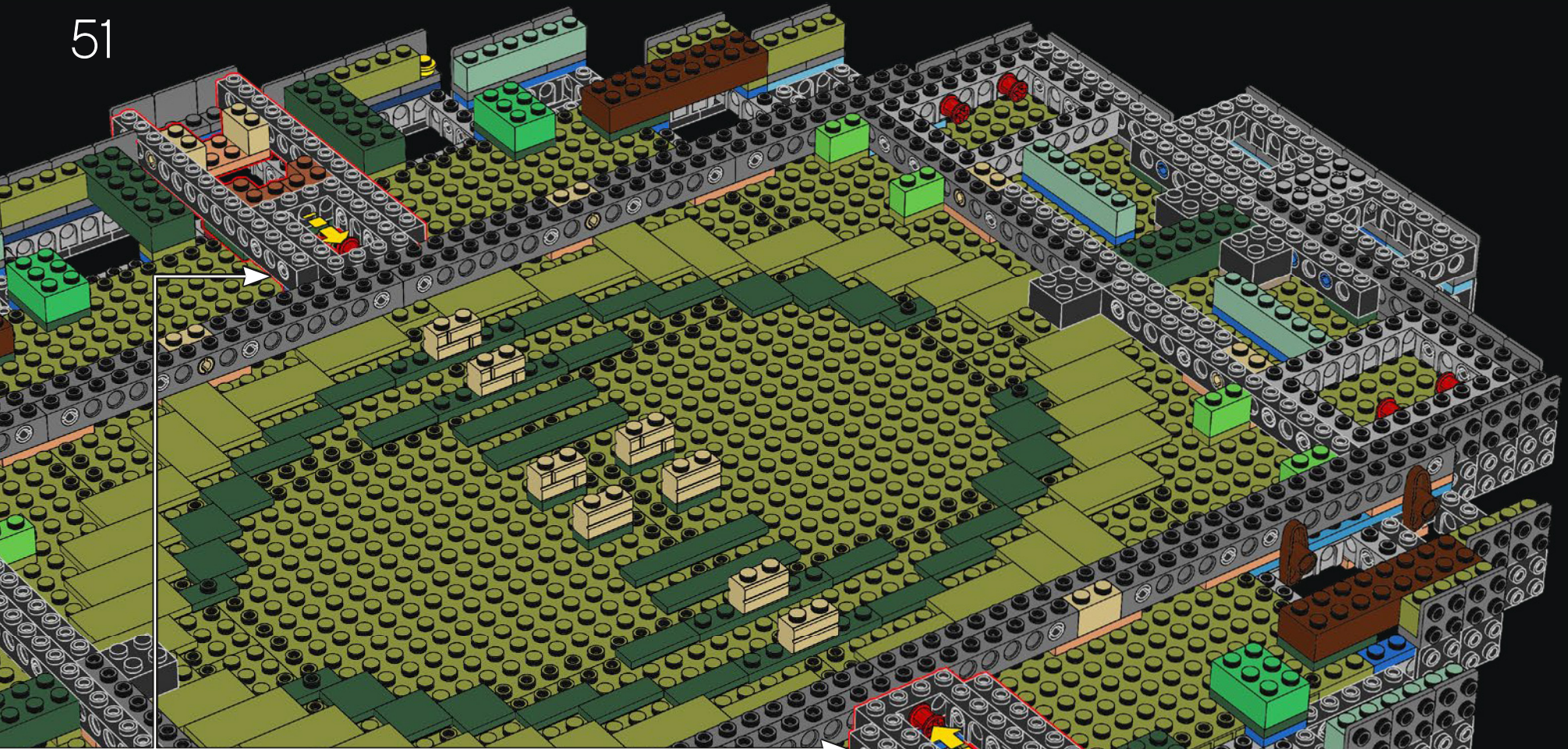

53





52

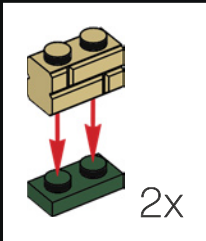
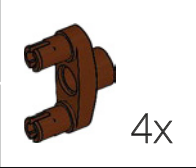

54



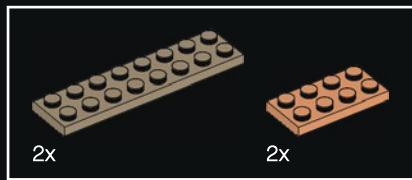

53

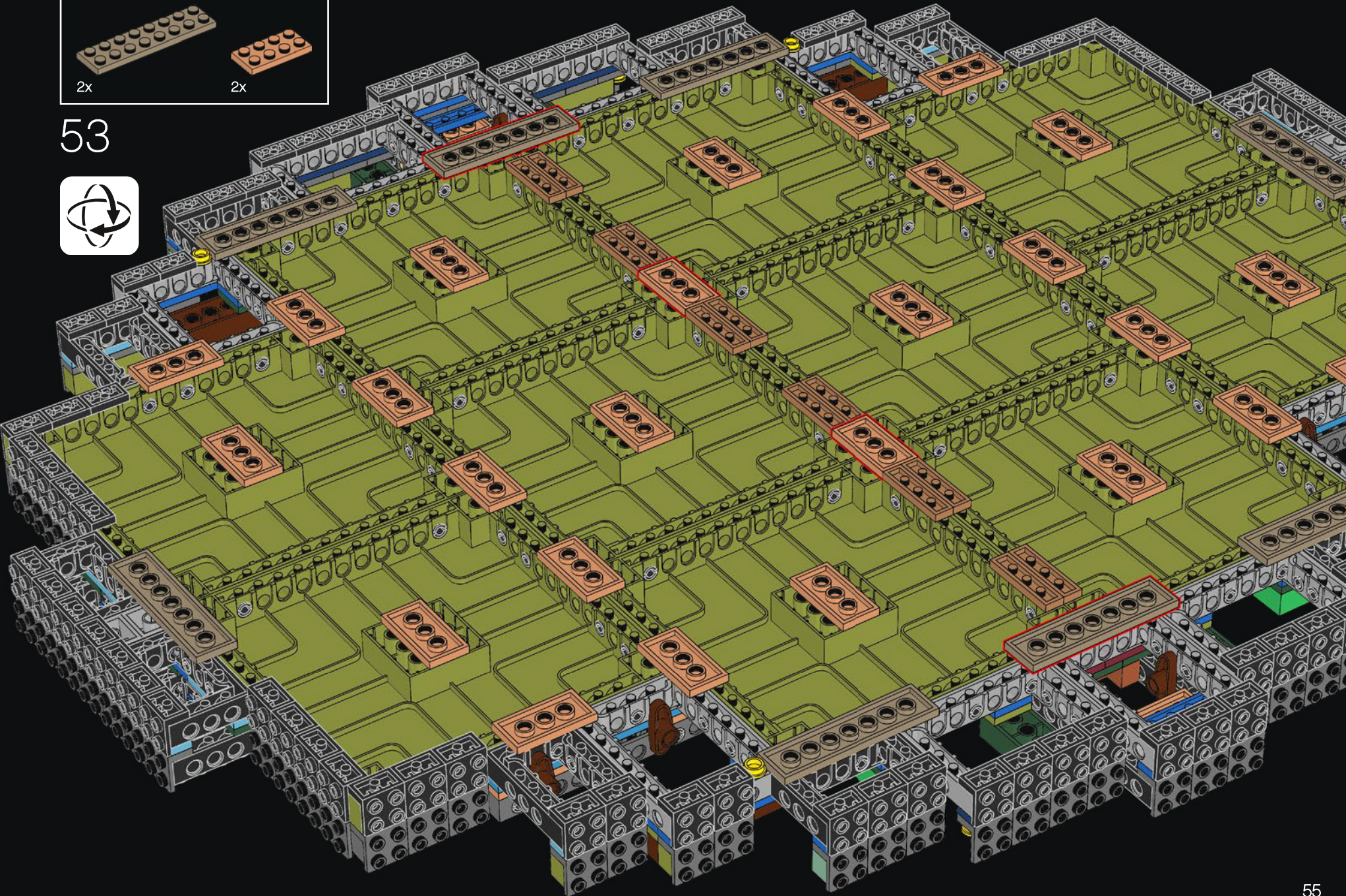



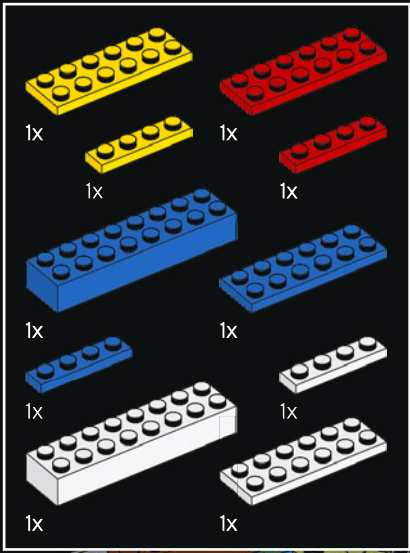

54





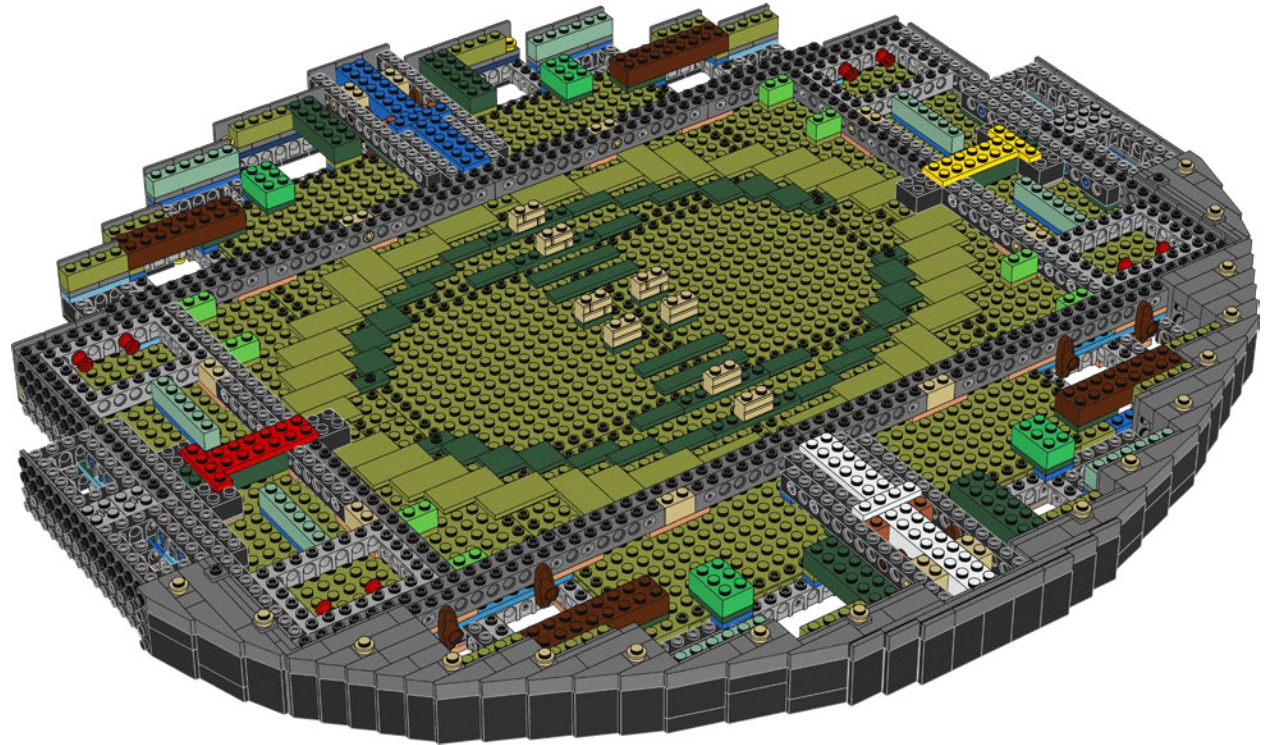
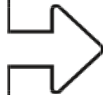



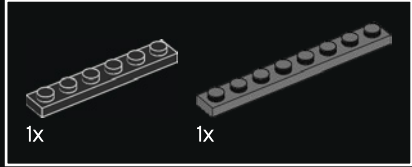
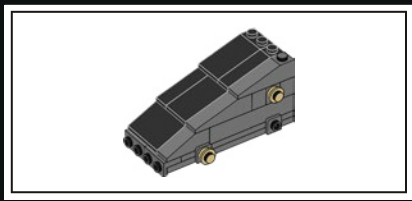

55

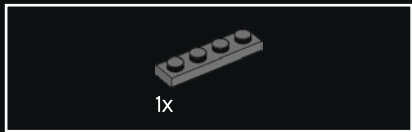
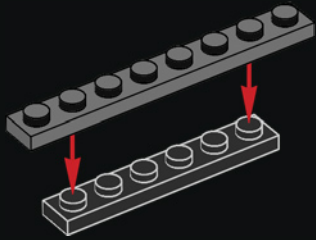

56

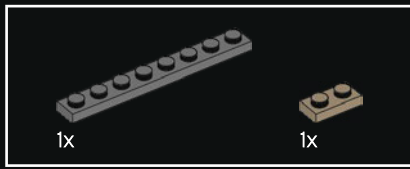
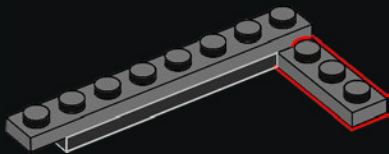

57

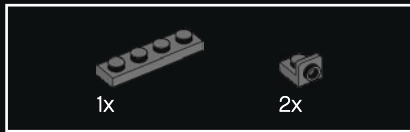
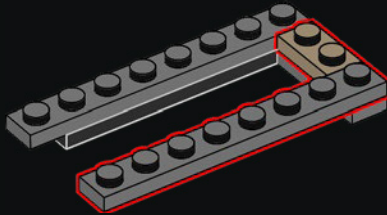

58

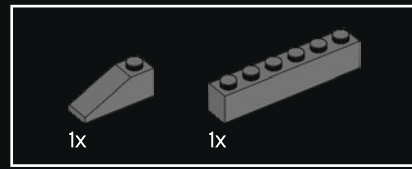
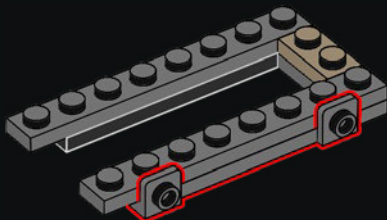

59

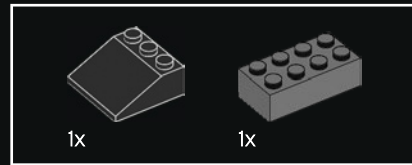
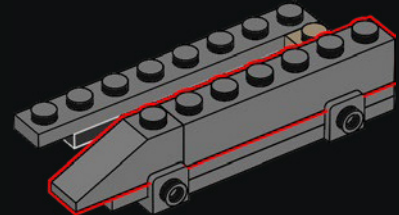

60

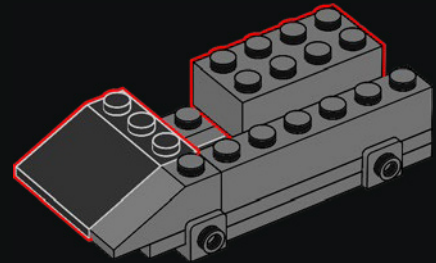



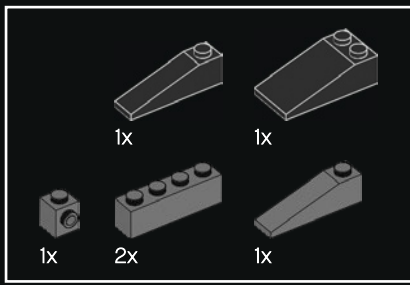

61

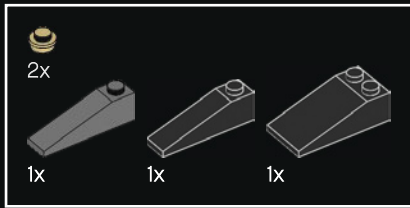
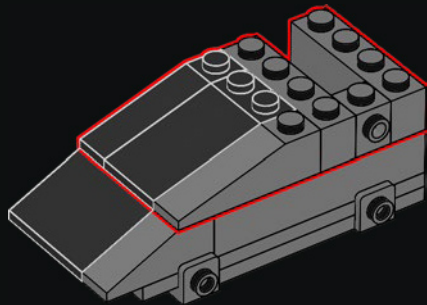

62

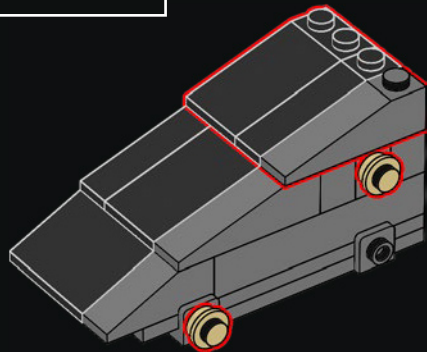

63

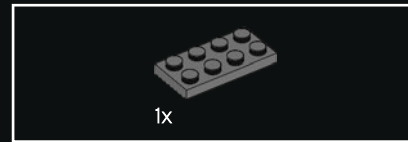
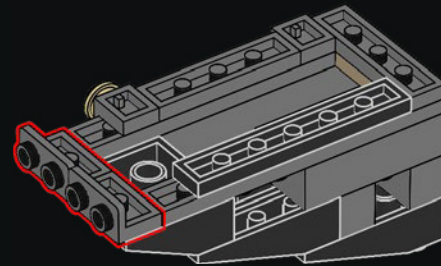

64

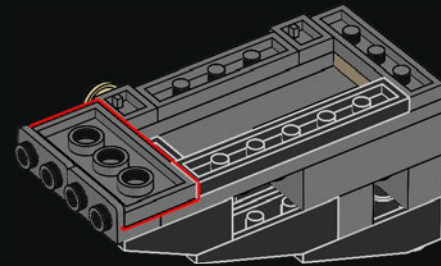



65

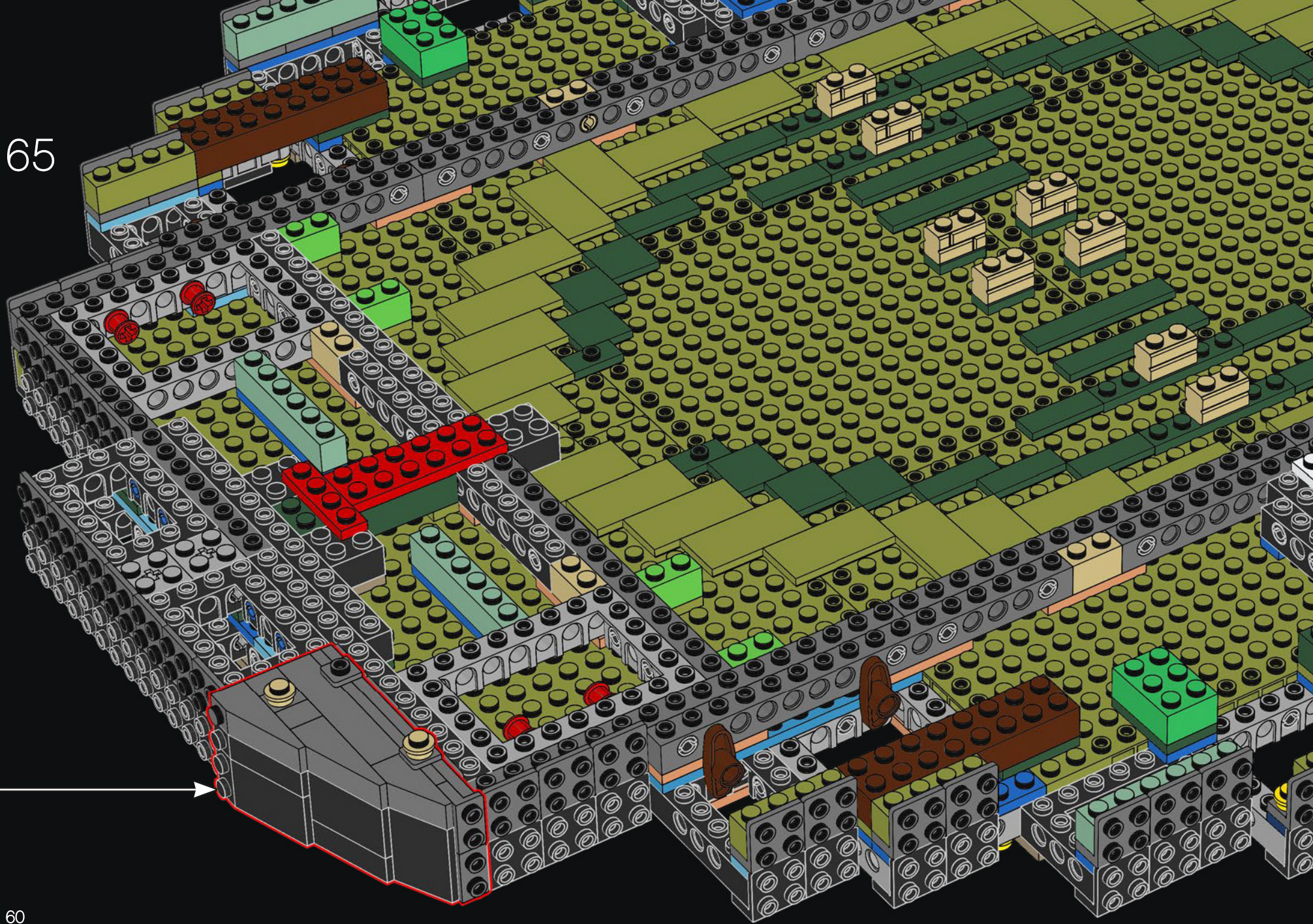

60



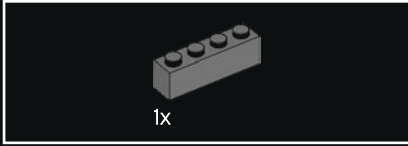
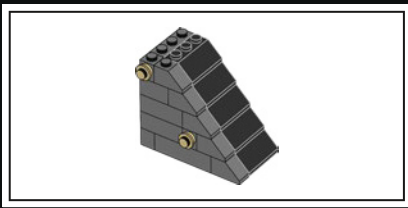

66

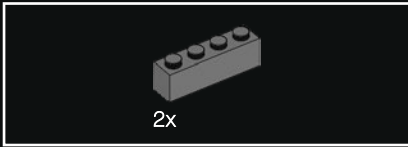

67

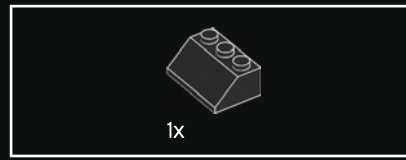
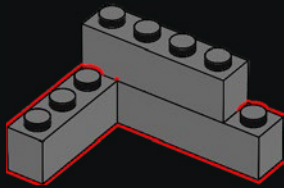

68

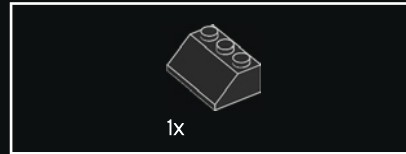
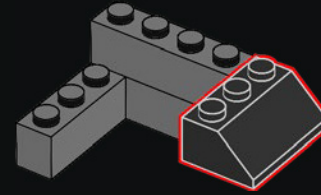

69

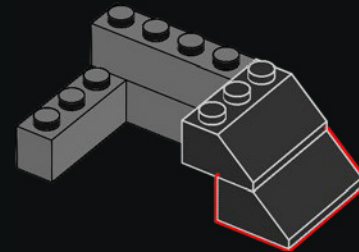



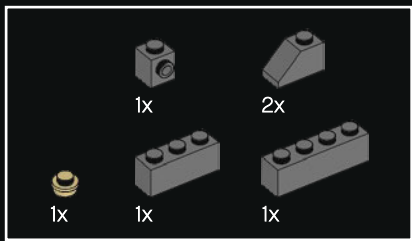

70

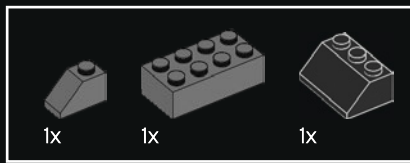
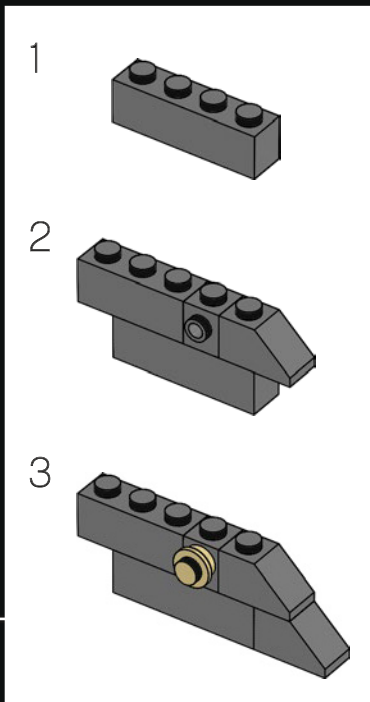
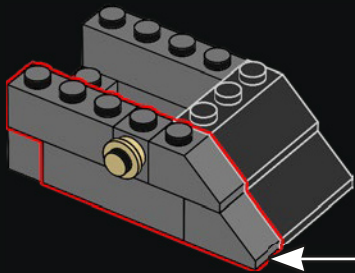

72

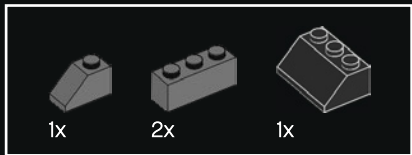
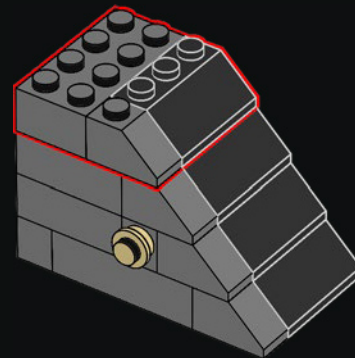

71

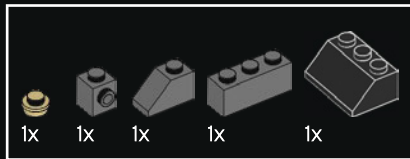
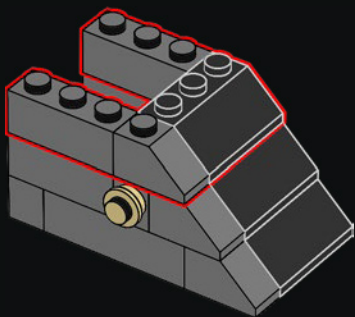

73

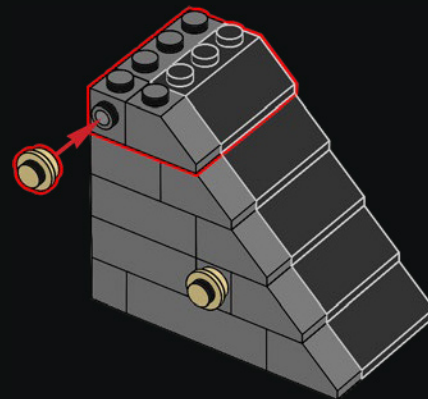



74

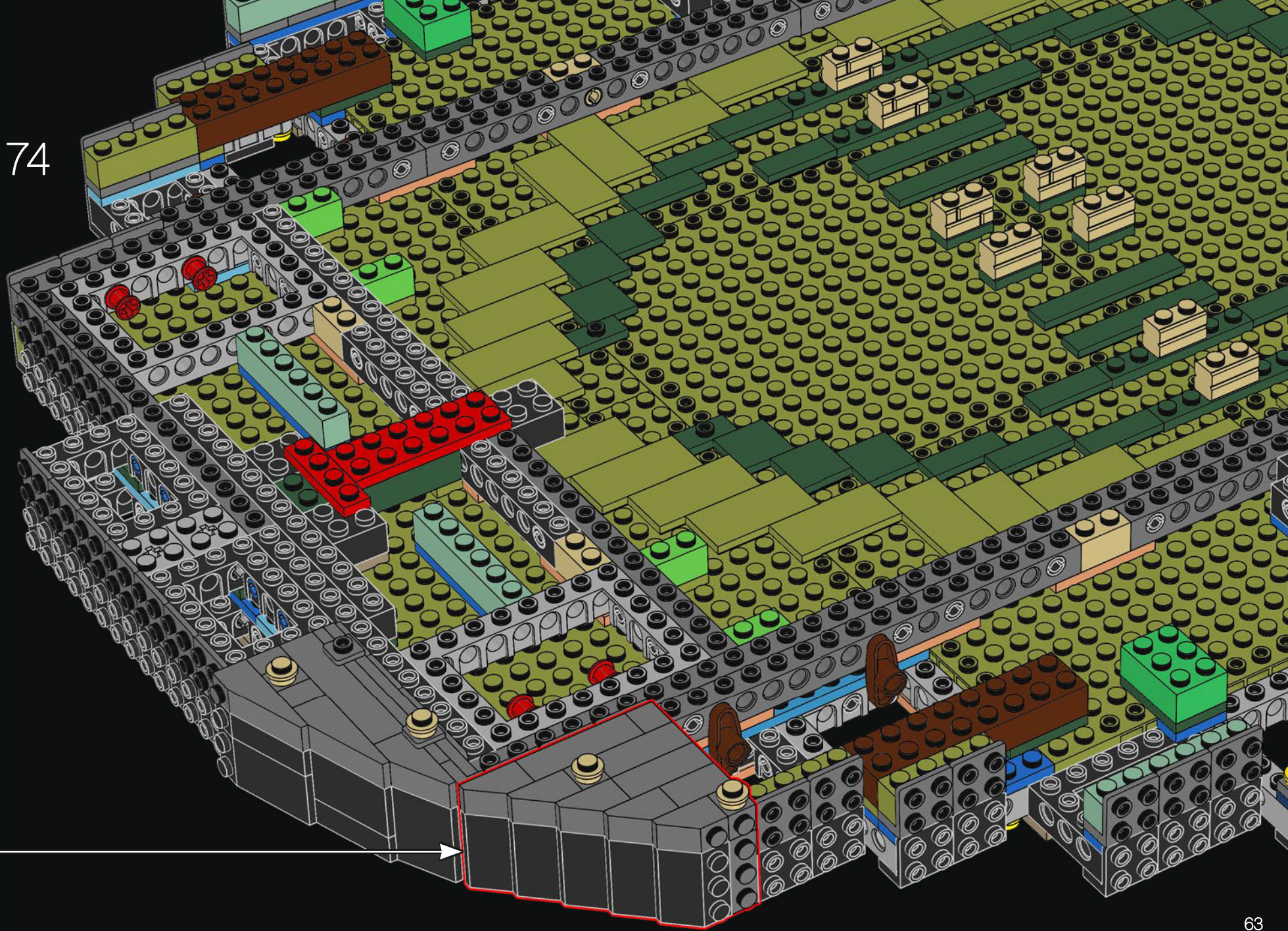



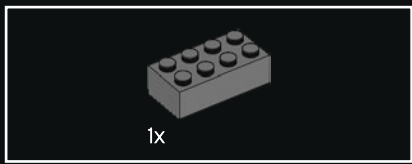

75

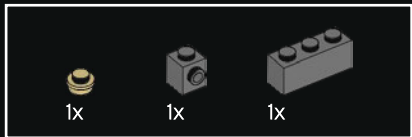
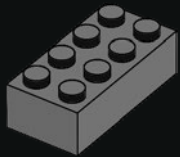

76

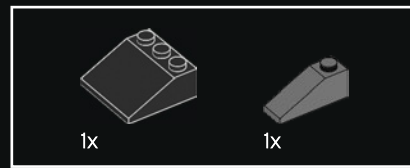
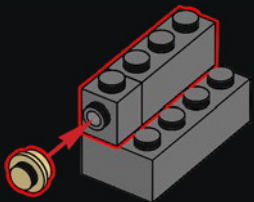

77

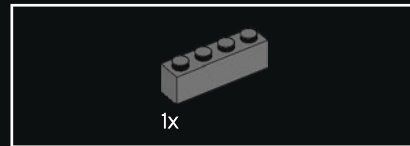
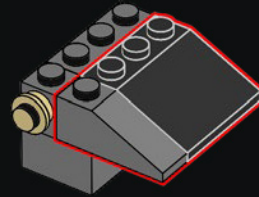

78

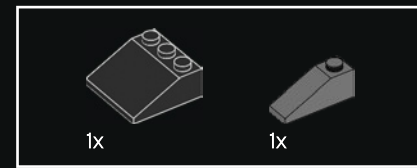
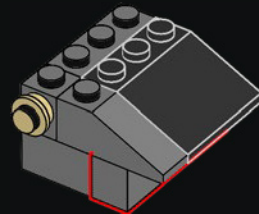

79

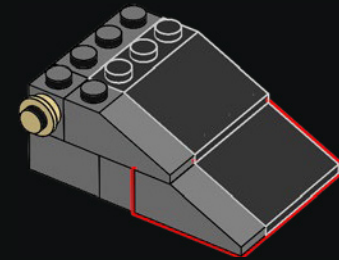



80

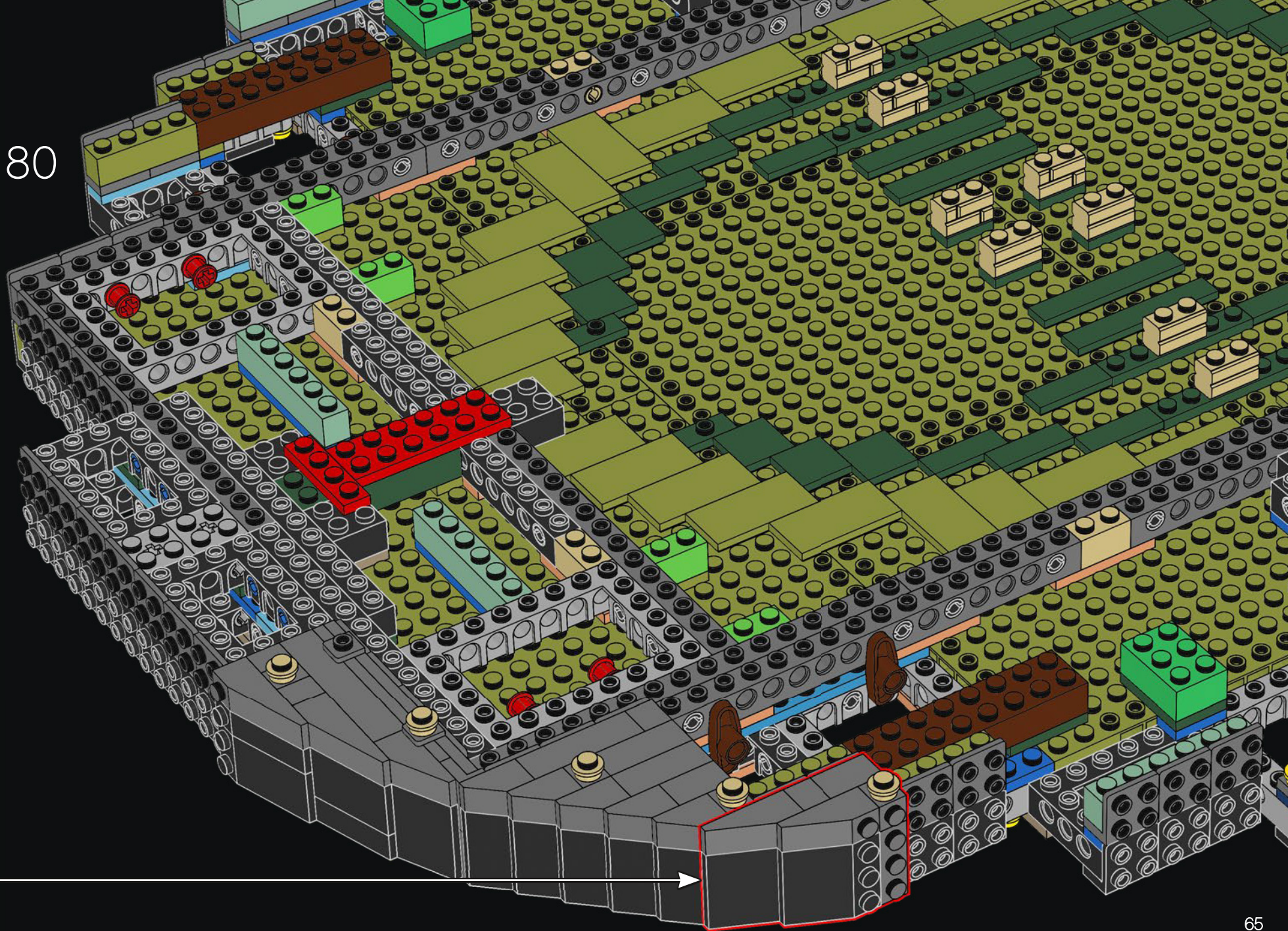



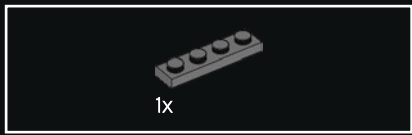

81

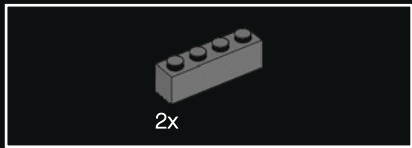
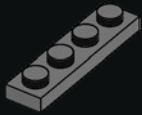

82

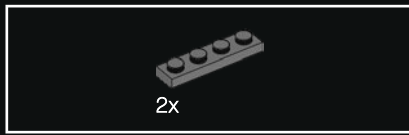
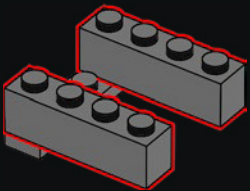

83

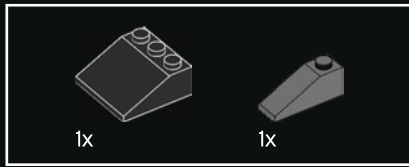
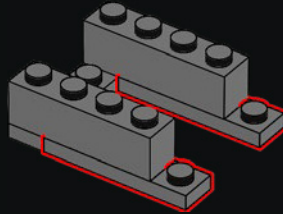

84

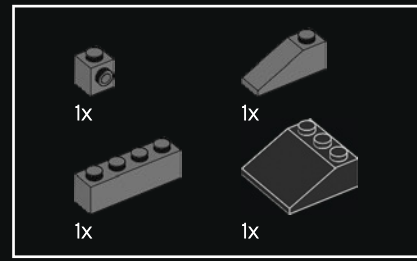
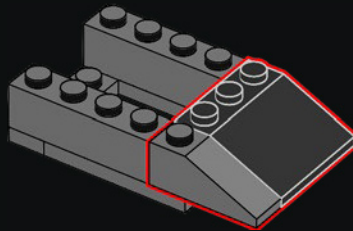

85

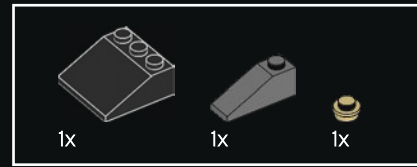
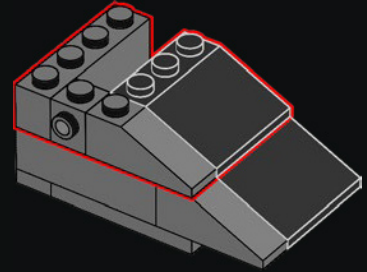

86

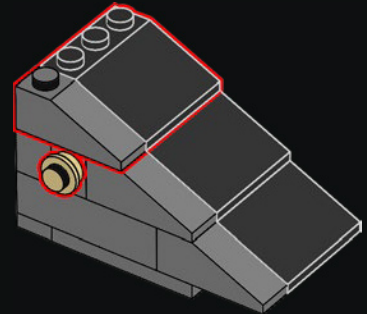



87





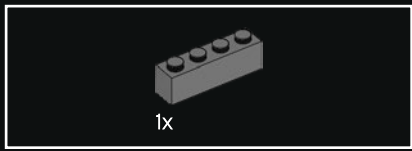

88

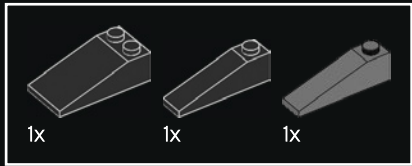
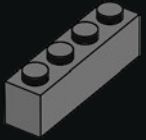

89

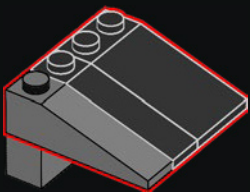

90

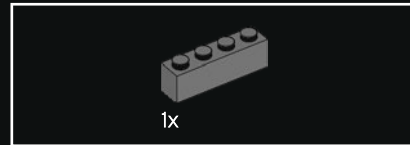
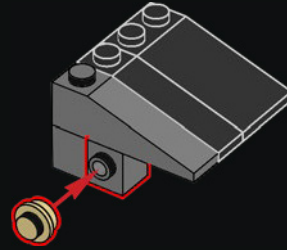

91

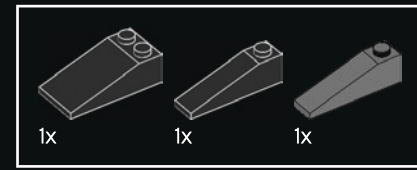
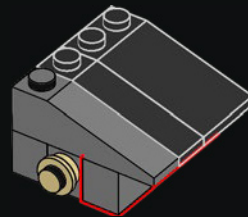

92

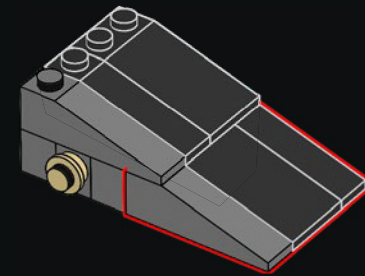



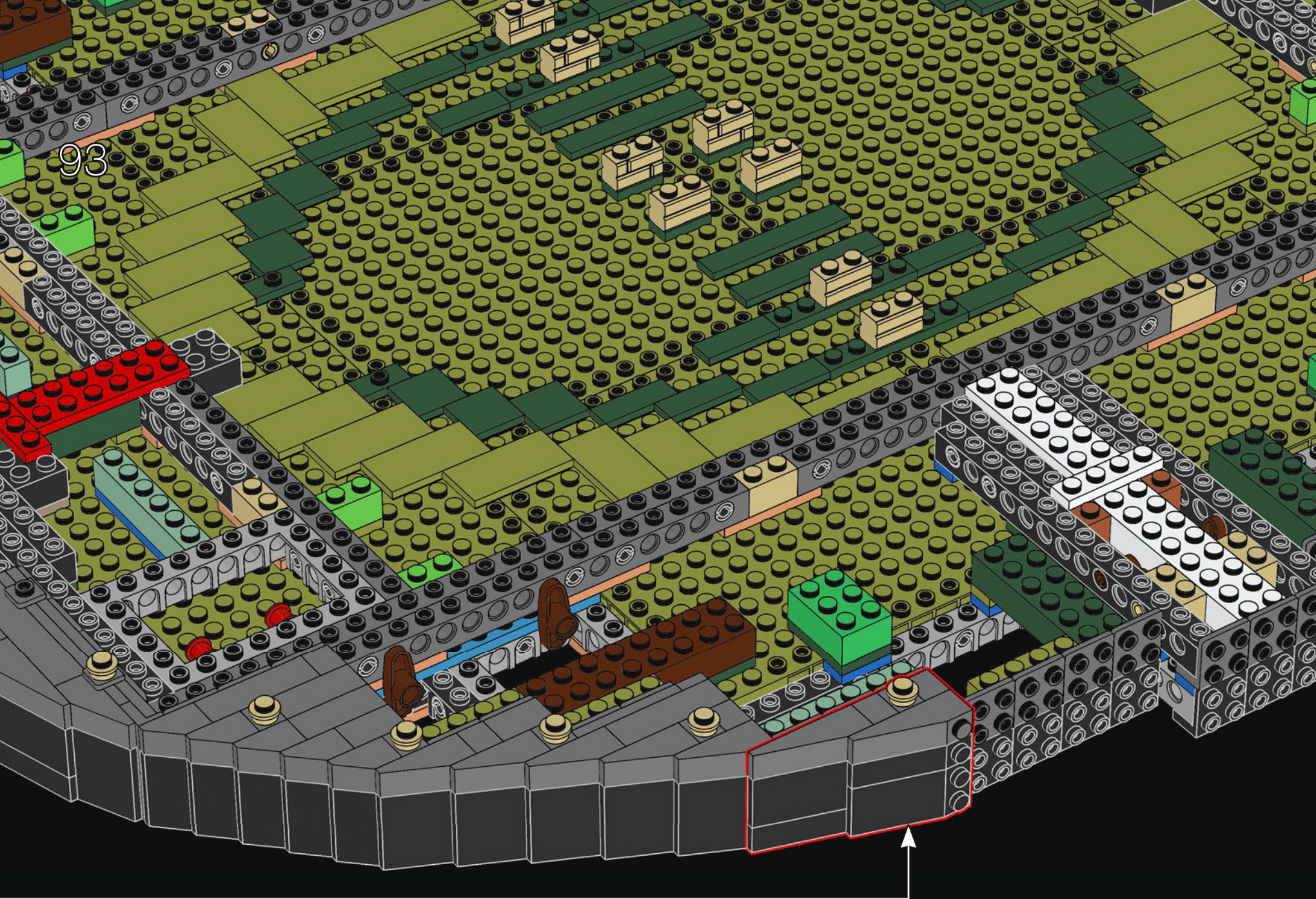

93



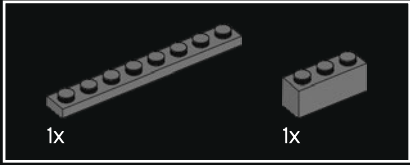
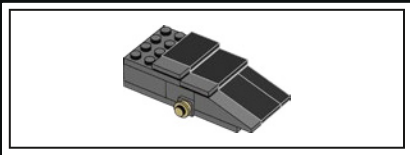

94

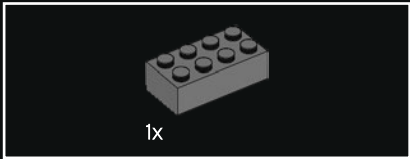
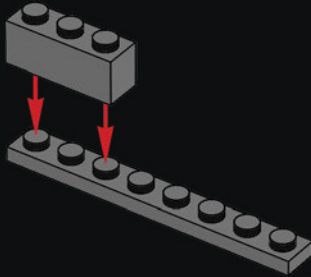

95

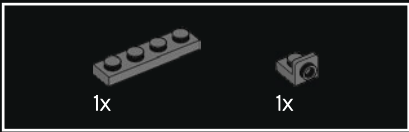
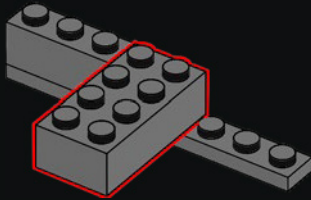

96

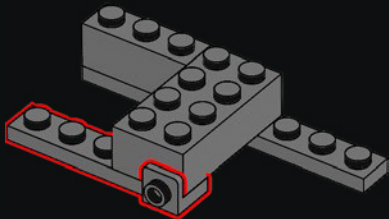

97

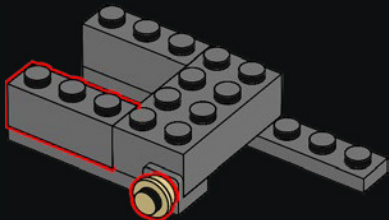



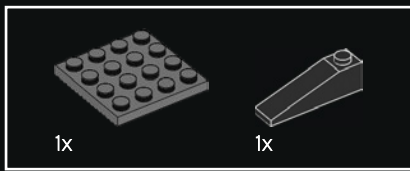

98

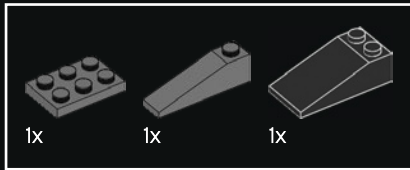
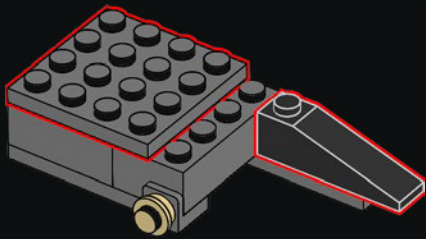

99

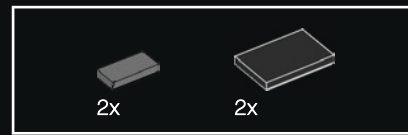
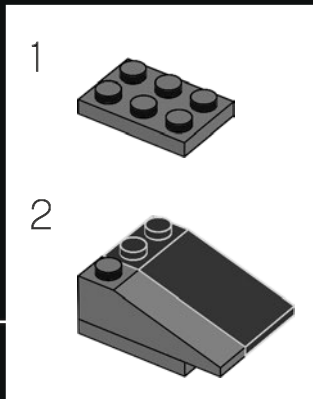
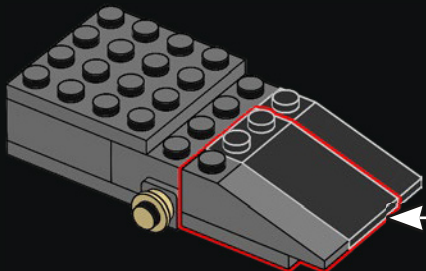

100

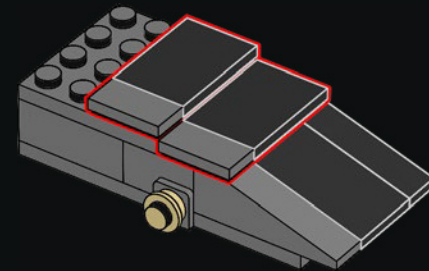



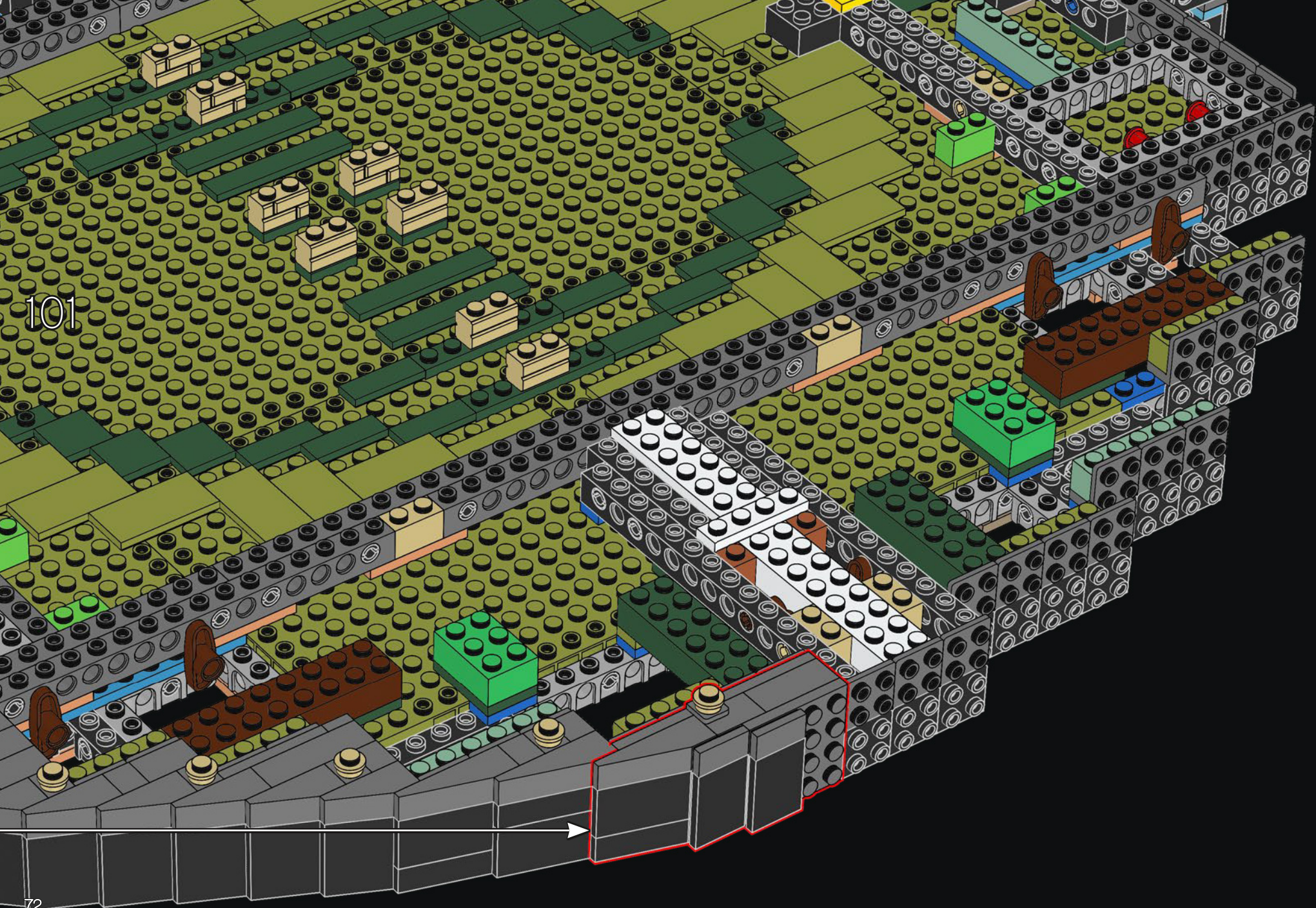

101



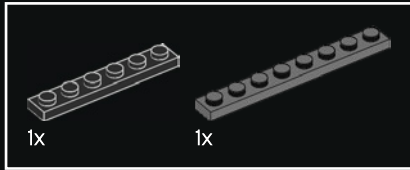
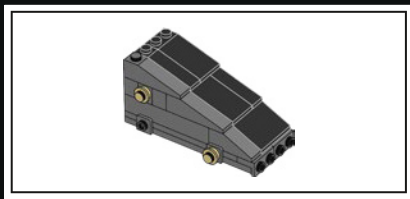

102

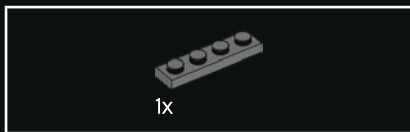
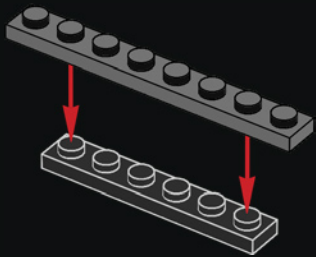

103

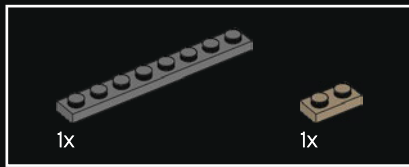
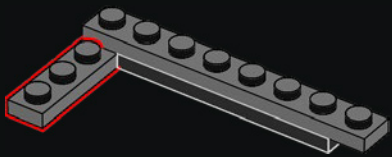

104

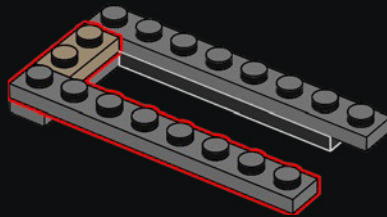

105

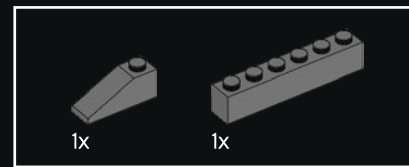
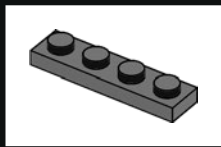
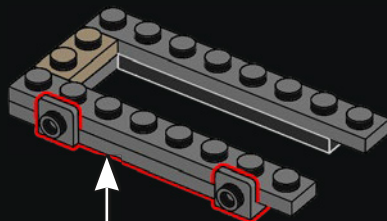

106

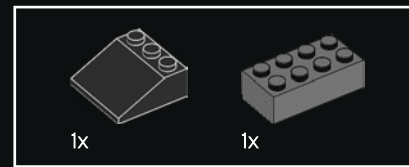
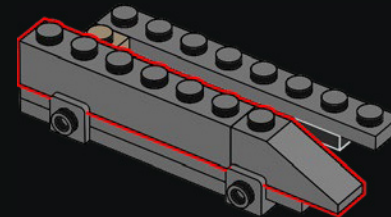

107

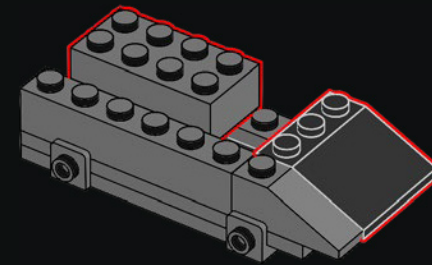



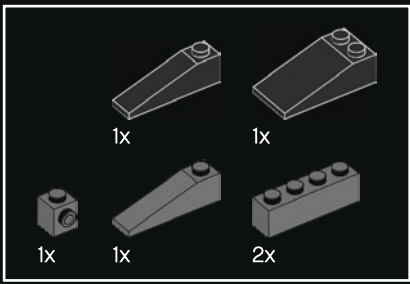

108

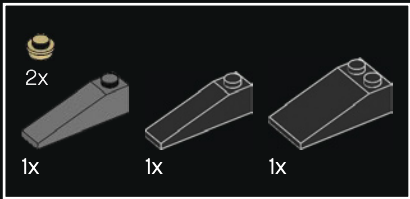
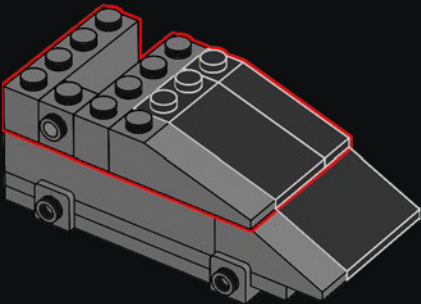

109

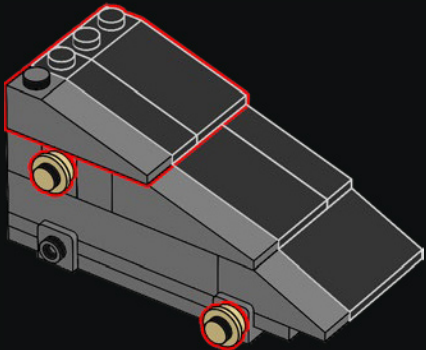

110

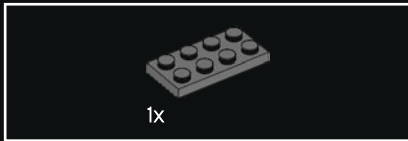
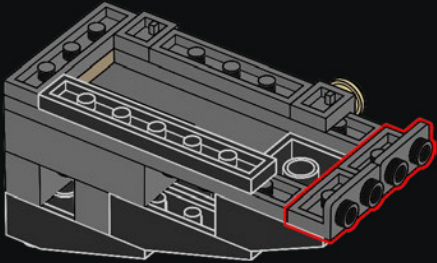

111

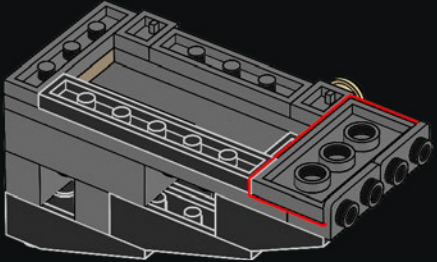



112





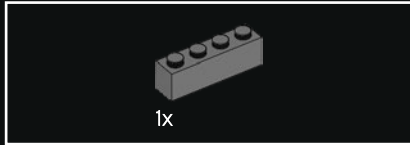
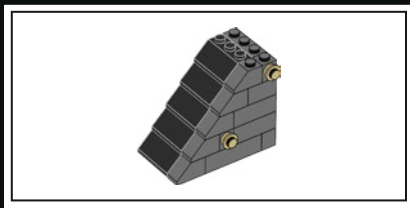

1x

113

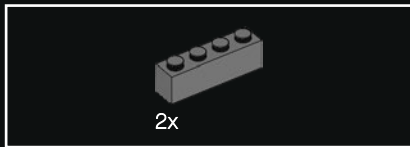
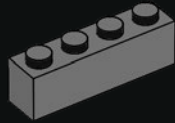

2x

114

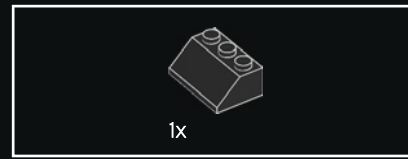
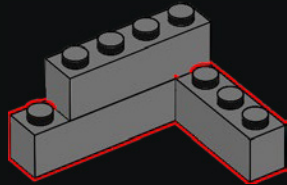

1x

115

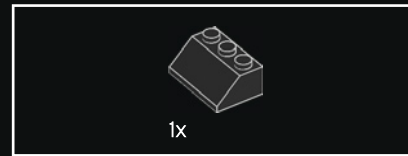
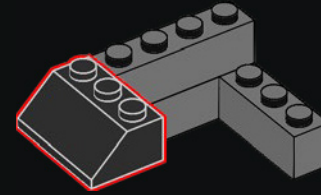

1x

116

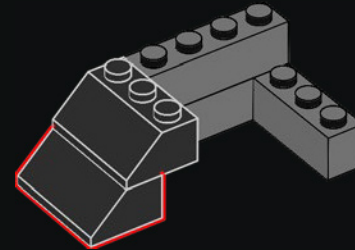



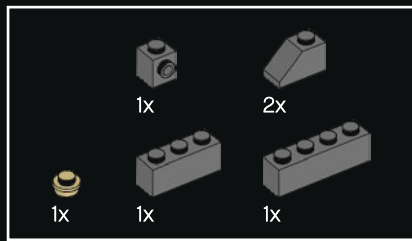

117

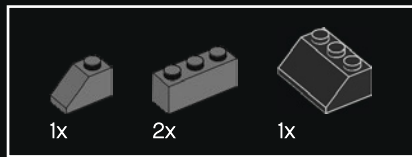
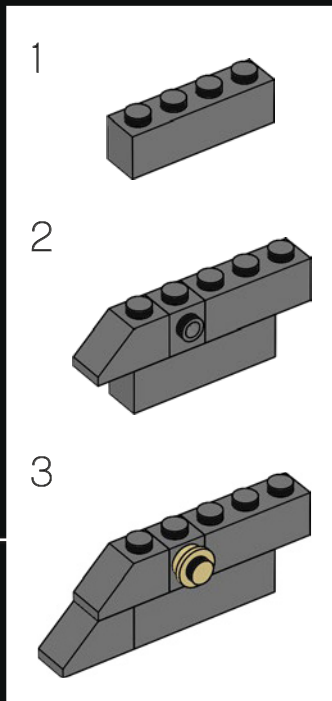
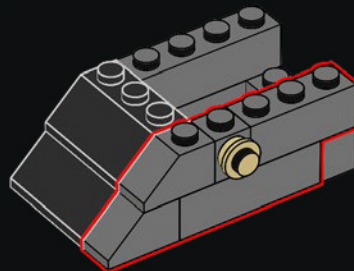

118

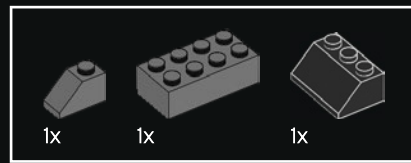
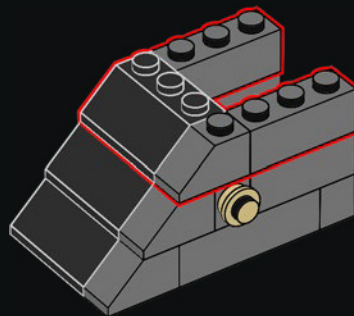

119

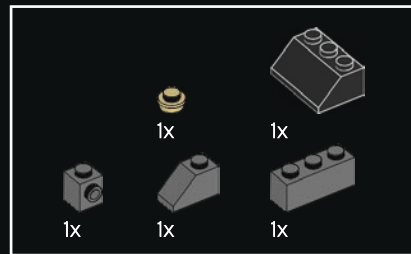
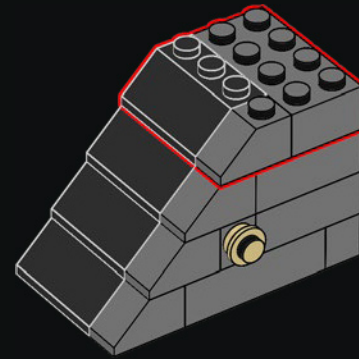

120

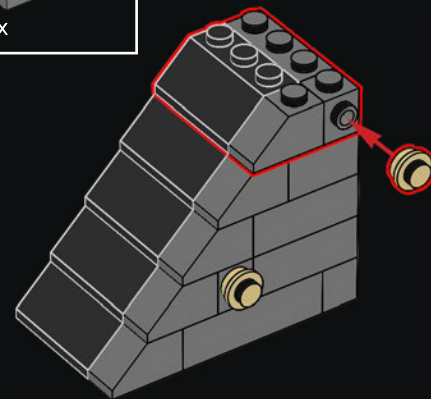







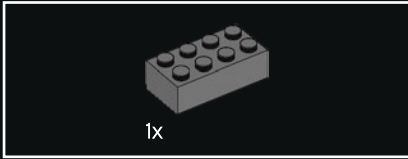
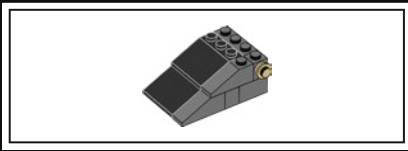

122

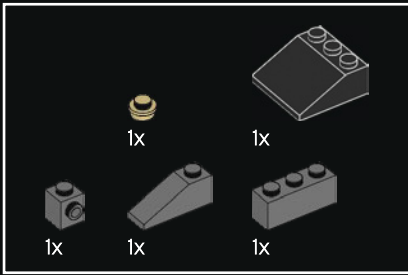
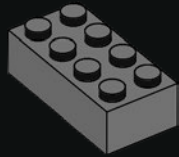

123

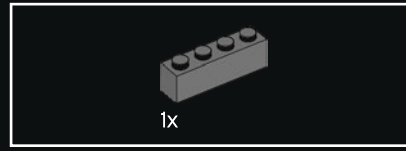
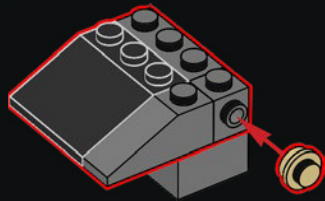

124

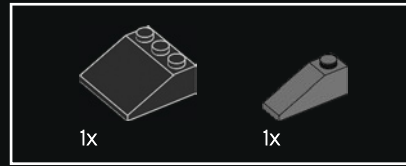
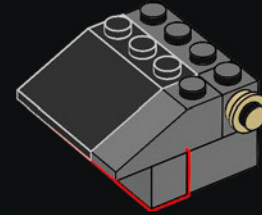

125

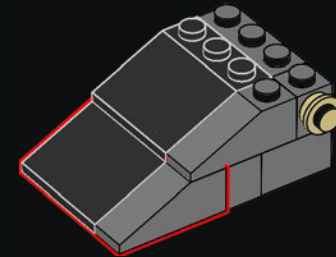







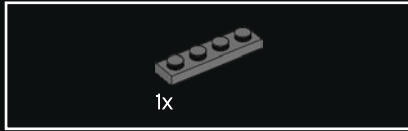
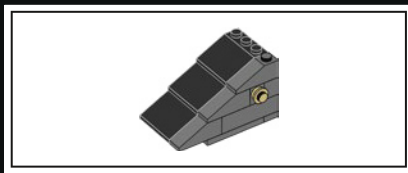

127

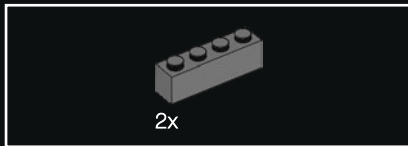

128

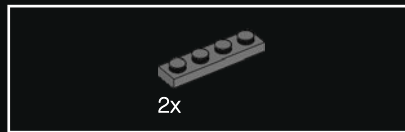
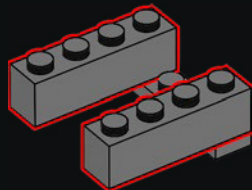

129

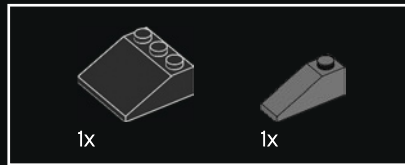
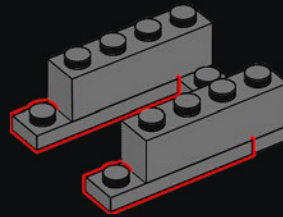

130

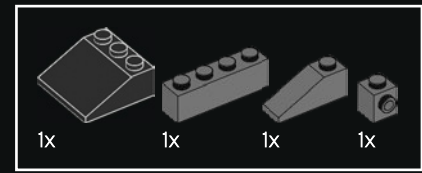
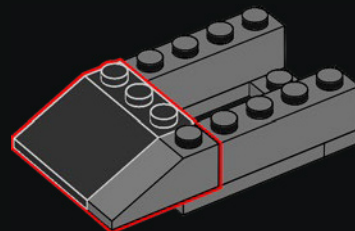

131

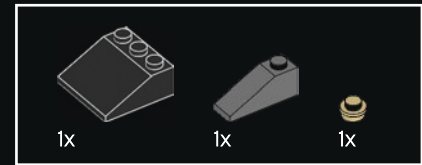
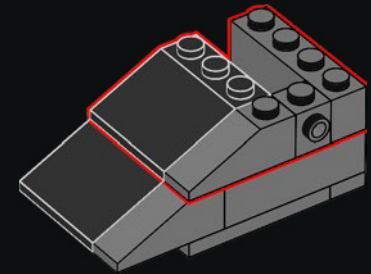

132

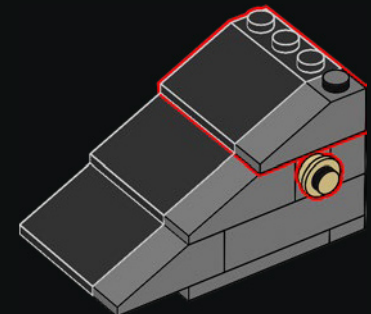







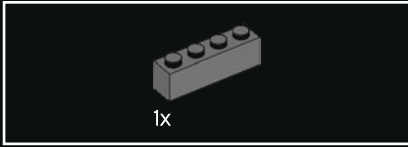
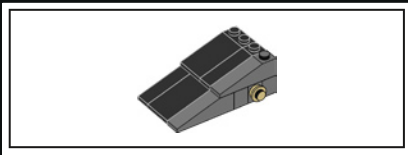

134

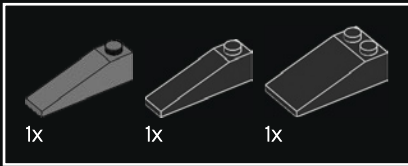
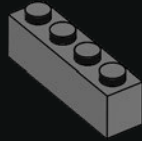

135

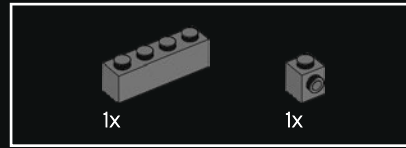
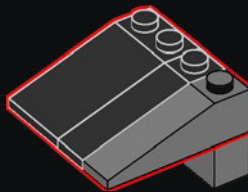

136

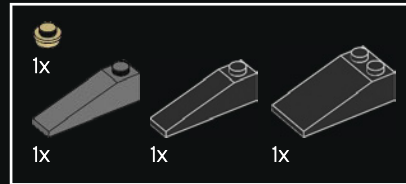
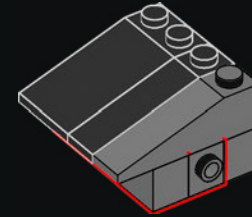

137

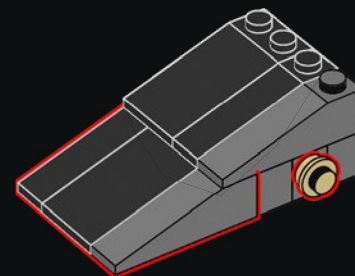







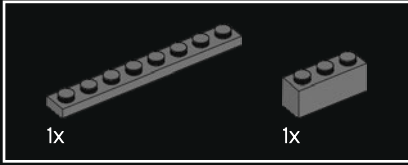
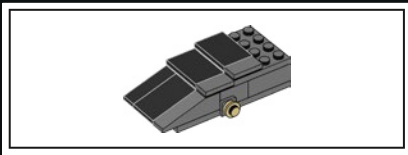

139

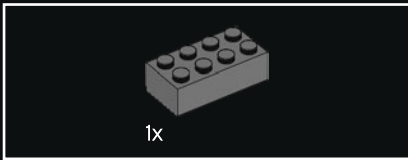
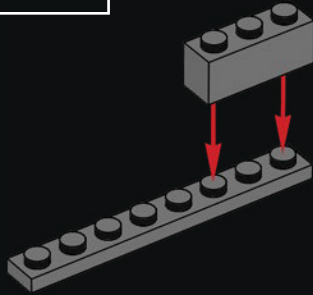

140

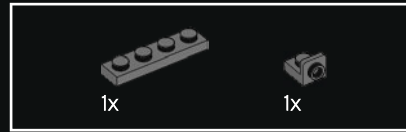
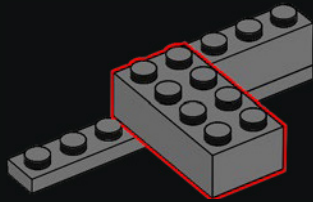

141

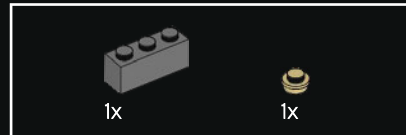
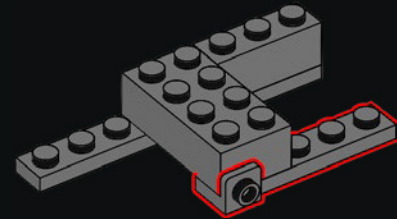

142

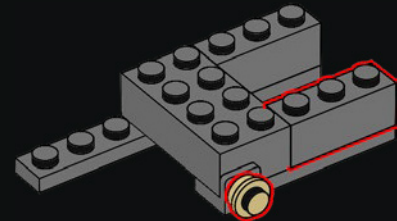



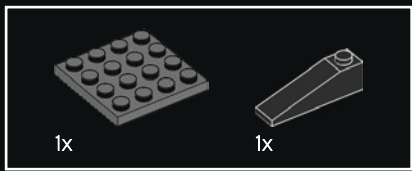

143

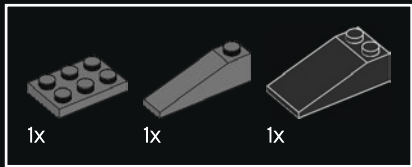
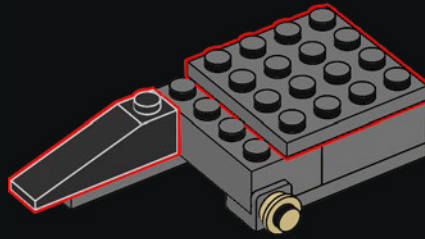

144

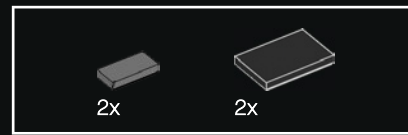
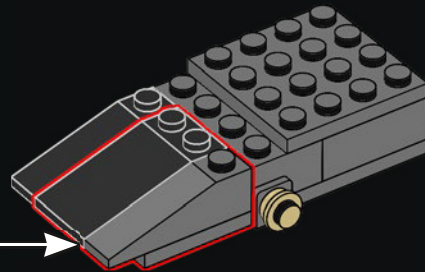
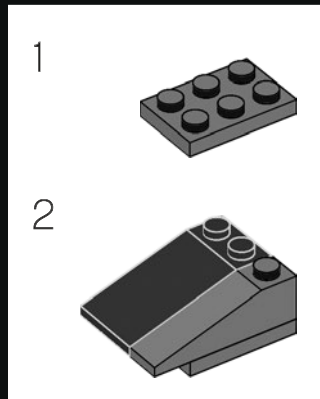

145

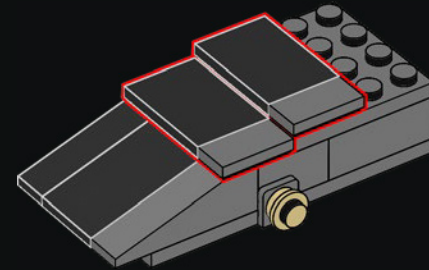



146

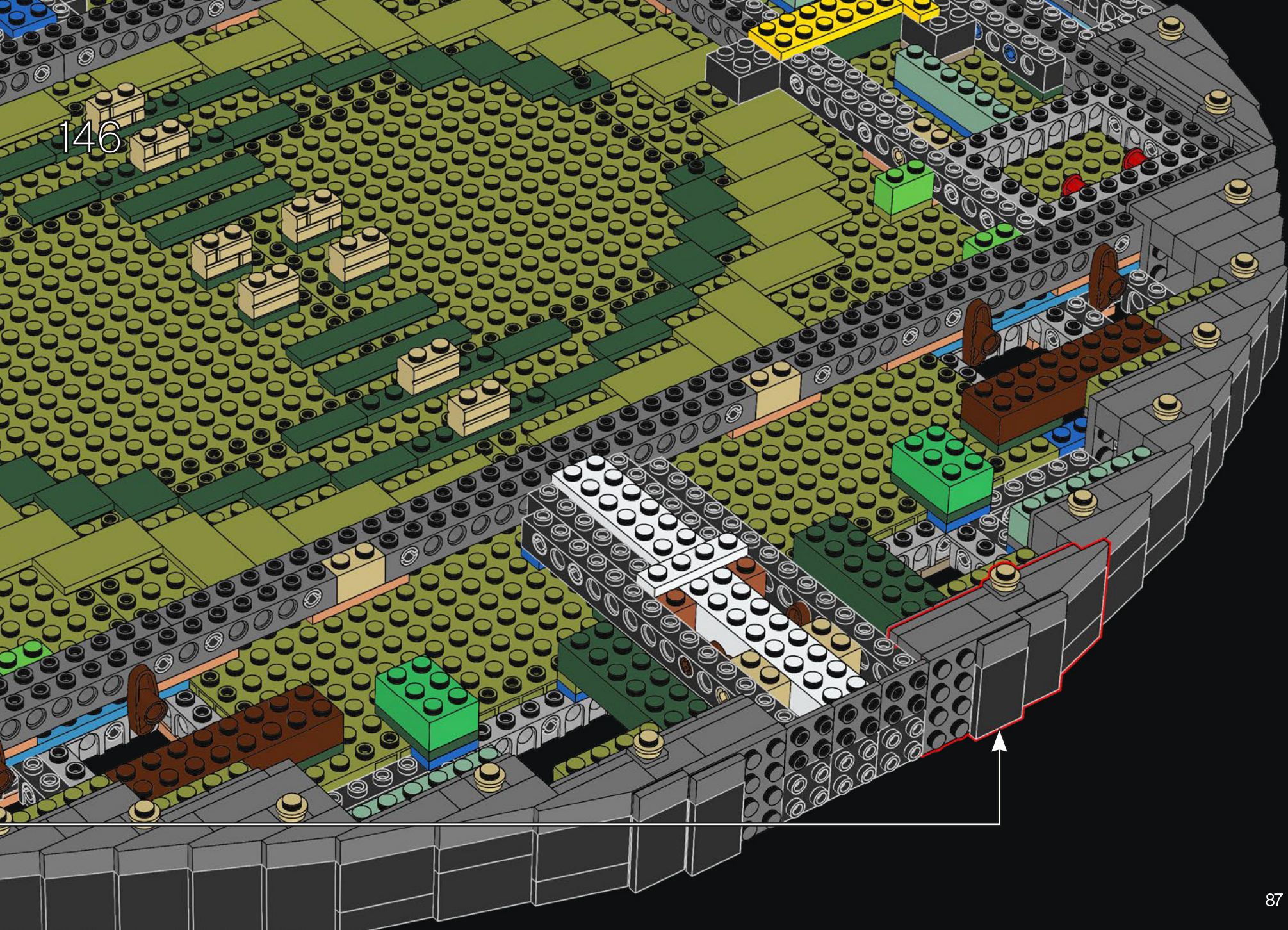



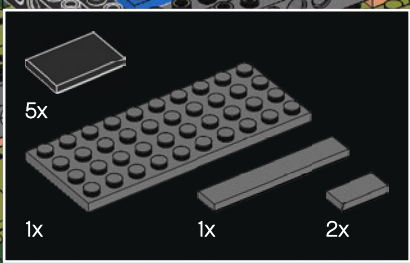

147

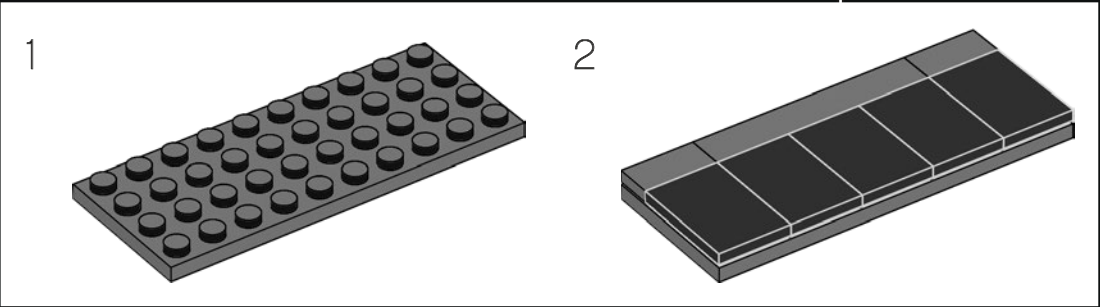



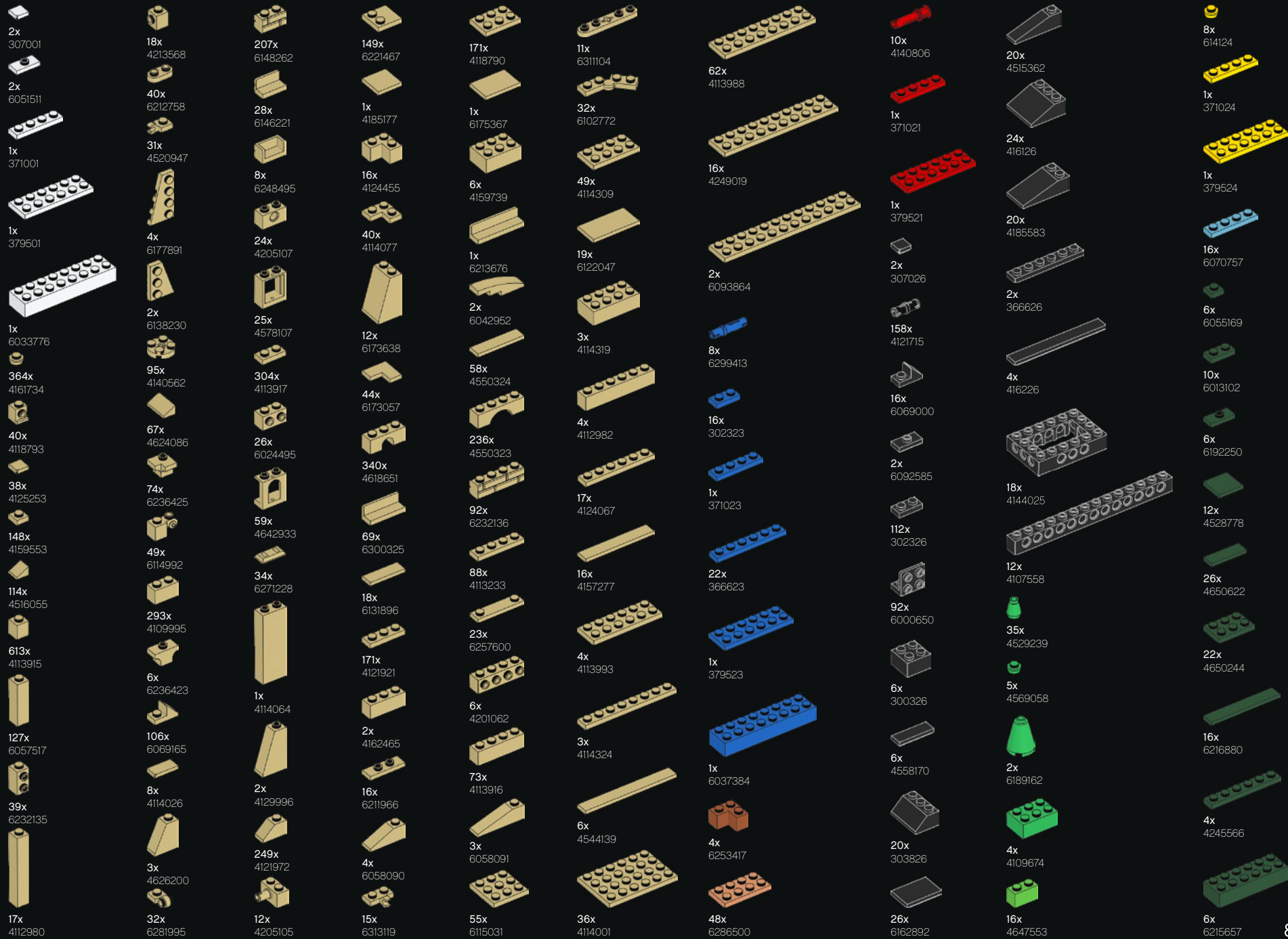



- 32x 6016483
- 10x 6212080
- 12x 6062697
- 36x 6016488
- 1x 6275877
- 1x 6195266
- 12x 6167700
- 1x 6240515

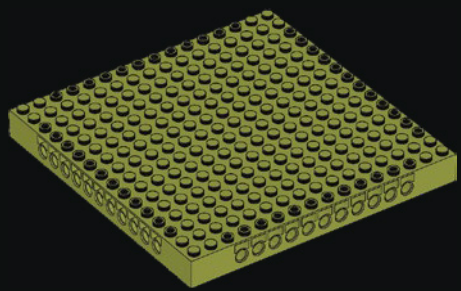

- 10x 6301768

- 115x 6300321
- 96x 6300320
- 133x 6300322
- 18x 6300318
- 36x 6055172
- 91x 4549436
- 14x 6040126
- 35x 6001824
- 239x 6231386
- 35x 6093064
- 142x 4528604
- 237x 6092591
- 35x 4521914
- 5x 4496699

- 17x 6167894
- 8x 4246957
- 115x 4530678
- 213x 4616711
- 36x 6047415
- 81x 4550168
- 40x 6184880
- 7x 6132768
- 14x 6015452
- 23x 6175927
- 23x 4626904
- 4x 4267874
- 1x 4507047
- 3x 6015424
- 1x 4550329
- 14x 6156492

- 56x 4530678
- 213x 4616711
- 36x 6047415
- 81x 4550168
- 40x 6184880
- 7x 6132768
- 14x 6015452
- 23x 6175927
- 23x 4626904
- 4x 4267874
- 1x 4507047
- 3x 6015424
- 1x 4550329
- 14x 6156492

- 19x 6039482
- 12x 4558955
- 6x 6225494
- 11x 6092572
- 79x 6039479
- 18x 4211052
- 20x 4211135
- 8x 6214341
- 92x 6308045
- 9x 6123814
- 8x 6126083
- 4x 4211094
- 2x 4211055
- 66x 4211104
- 24x 4211045
- 19x 6039482

- 12x 4558955
- 6x 6225494
- 11x 6092572
- 79x 6039479
- 18x 4211052
- 20x 4211135
- 8x 6214341
- 92x 6308045
- 9x 6123814
- 8x 6126083
- 4x 4211094
- 2x 4211055
- 66x 4211104
- 24x 4211045
- 19x 6039482

- 6x 4243831
- 18x 6187008
- 6x 4211043
- 48x 4211103
- 13x 6257592
- 24x 4211001
- 20x 4211053
- 20x 4535930
- 33x 4560184
- 2x 4211065
- 22x 4211085
- 4x 4211100
- 22x 4210651
- 6x 4243831

- 16x 4210998
- 2x 4210997
- 28x 6147337
- 2x 4211122
- 2x 6000970
- 18x 4256828
- 4x 6250216
- 4x 6151666
- 8x 6177081
- 4x 4539076

- 1x 6170468
- 12x 6323704
- 11x 6116613
- 4x 6096701
- 20x 6168647
- 6x 4211399
- 75x 6043656
- 4x 6273227
- 9x 6043639
- 126x 6211969
- 8x 4211752
- 14x 4211848

- 1x 6170468
- 12x 6323704
- 11x 6116613
- 4x 6096701
- 20x 6168647
- 6x 4211399
- 75x 6043656
- 4x 6273227
- 9x 6043639
- 126x 6211969
- 8x 4211752
- 14x 4211848

- 14x 4211848



**Customer Service**  
**Kundenservice**  
**Service Consommateurs**  
**Servicio Al Consumidor**

**LEGO.com/service** or dial

00800 5346 5555 : 

1-800-422-5346 : 





# FEEDBACK AND WIN



## FEEDBACK AND WIN

Your feedback will help shape the future development of this product series.

Please visit:

## FEEDBACK UND GEWINNEN

Dein Feedback trägt zur Weiterentwicklung dieser Produktreihe bei.

Geh auf:

## COMMENTEZ ET GAGNEZ

Vos commentaires nous aideront à concevoir les futurs produits de cette gamme.

Rendez-vous sur :

## COMENTA Y GANA

Tu opinión nos ayudará a dar forma al desarrollo de esta serie de productos en el futuro.

Visita:

## 反馈有奖

您的反馈将有助于我们在今后改进本系列产品。

请访问：

[LEGO.com/productfeedback](https://www.lego.com/productfeedback)

By completing, you will automatically enter a drawing to win a LEGO® set.

Terms & Conditions apply.

Durch Ausfüllen nimmst du automatisch an der Verlosung eines LEGO® Preises teil.

Es gelten die Teilnahmebedingungen.

En envoyant vos commentaires, vous serez automatiquement inscrit(e) à un tirage au sort qui vous permettra de remporter un prix LEGO®.

Offre soumise à conditions.

Al contestar, participarás automáticamente en el sorteo y podrás ganar un set LEGO®.

Sujeto a Términos y Condiciones.

完成我们的反馈调查，即可自动进入抽奖环节，赢取乐高®套装。

适用《条款和条件》。



