

S·P·Q·R

# COLOSSEUM

S·P·Q·R

# LE COLISÉE

S·P·Q·R

# COLISEO



Booklet available in English on  
Livret disponible en français sur  
Folleto disponible en español en

[LEGO.com/service/buildinginstructions](https://www.LEGO.com/service/buildinginstructions)



## WELCOME

*We are excited to introduce you to our interpretation of the famous Roman Colosseum. Whether it brings back memories of a visit to Rome, awakens an interest in classical architecture, or is just your way of relaxing, we hope it gives you hours of pleasurable LEGO® building.*

**Jamie Berard, Design Lead**

## BIENVENUE

*Nous sommes ravis de vous présenter notre interprétation du célèbre Colisée de Rome. Qu'il évoque des souvenirs d'un voyage à Rome, qu'il éveille en vous un intérêt pour l'architecture classique, ou qu'il soit tout simplement une façon de vous détendre, nous espérons qu'il vous donnera des heures de plaisir de construction LEGO®.*

**Jamie Berard, responsable de la conception**

## TE DAMOS LA BIENVENIDA

*Nos complace presentarte nuestra interpretación del famoso Coliseo de Roma. Ya sea que te traiga recuerdos de una visita a la Ciudad Eterna, despierte tu interés por la arquitectura clásica o, simplemente, busques una forma de relajarte, esperamos que te proporcione horas de placentera construcción con LEGO®.*

**Jamie Berard, jefe de diseño**

## THE COLOSSEUM

The Colosseum stands in the heart of Italy's capital city and is an iconic symbol of its imperial Roman past. This impressive amphitheater, the largest ever constructed at the time, held between 50,000 and 80,000 spectators. They gathered there to see gladiatorial contests, animal hunts and even reconstructions of famous sea battles. Widely regarded as one of the New Seven Wonders of the World, it is also one of the most popular tourist attractions with over 7 million visitors each year.

## LE COLISÉE

Le Colisée se trouve au cœur de la capitale de l'Italie et est un symbole emblématique de la Rome antique impériale. L'impressionnant amphithéâtre, le plus grand jamais construit à l'époque, pouvait accueillir entre 50 000 et 80 000 spectateurs. Ils s'y réunissaient pour assister à des combats de gladiateurs, à des chasses aux animaux et même à des reconstitutions de célèbres batailles navales. Généralement considéré comme l'une des sept nouvelles merveilles du monde, le Colisée est également l'une des attractions touristiques les plus populaires, avec plus de 7 millions de visiteurs chaque année.

## EL COLISEO

El Coliseo se encuentra en el corazón de la capital de Italia y es un inconfundible símbolo de su pasado como parte del Imperio romano. Este impresionante anfiteatro, el más grande que se construyó en aquella época, podía alojar entre 50.000 y 80.000 espectadores. La gente se reunía allí para ver combates entre gladiadores, cacerías de animales e, incluso, recreaciones de famosas batallas navales. Ampliamente considerado como una de las siete maravillas del mundo moderno, es también una de las atracciones turísticas más populares y recibe más de 7 millones de visitantes cada año.





While earlier Greek theaters were built into hillsides, the towering Colosseum stands alone on a flat valley floor in the middle of Rome.

Alors que les théâtres grecs antérieurs étaient construits à flanc de colline, l'imposant Colisée se dresse seul sur le fond plat d'une vallée au cœur de Rome.

Mientras que los antiguos teatros griegos se construían en las laderas de las montañas, el imponente Coliseo se erige en solitario, sobre el fondo llano de un valle, en el centro de Roma.

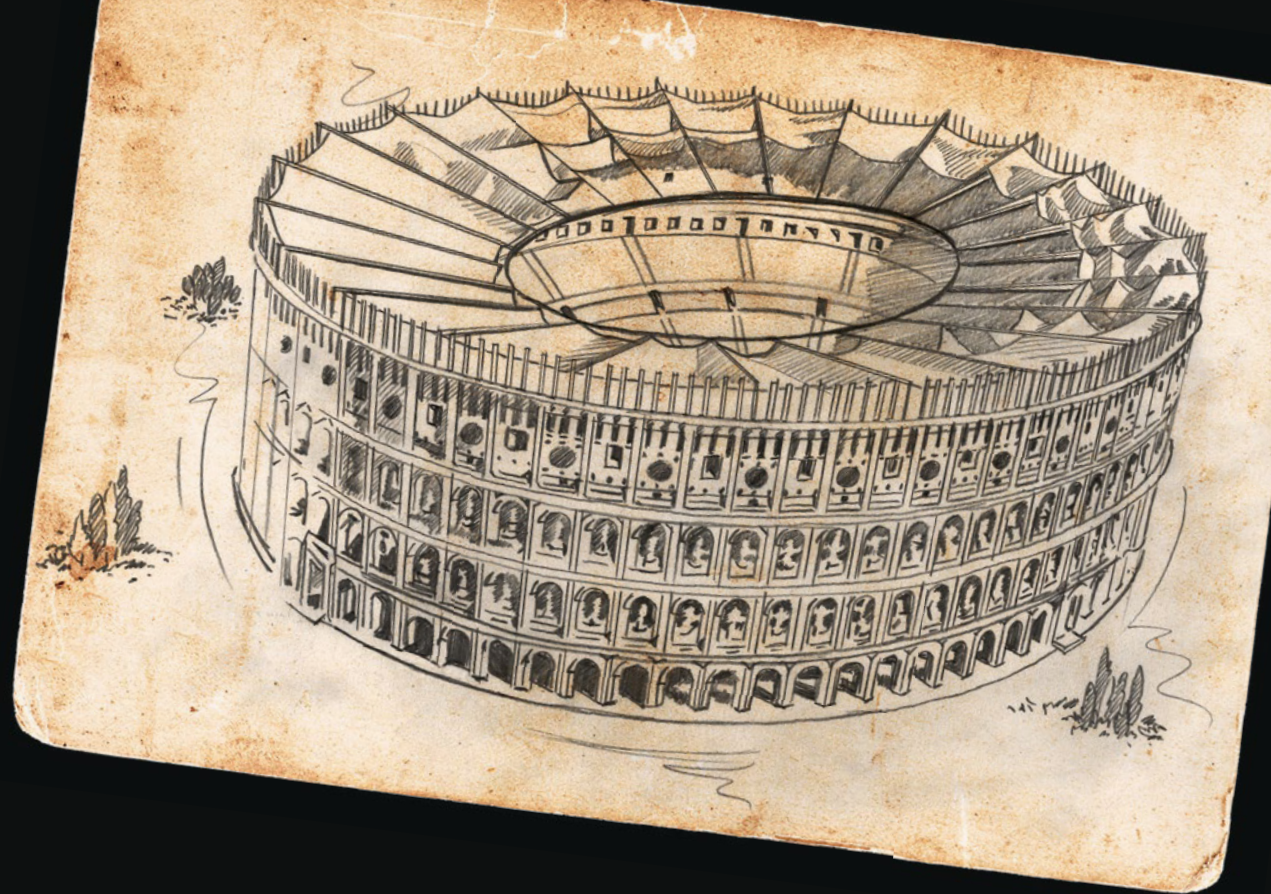

## AMPHITHEATER

The Colosseum is a free-standing elliptical structure that is 615 ft. (189 m) long and 510 ft. (156 m) wide. The oval inner arena is 287 ft. (87 m) in length and 180 ft. (55 m) wide and is surrounded by an imposing 15 ft. (5 m) wall, above which rose tiers of seating. The Colosseum's outer wall rises to an impressive height of 157 ft. (48 m), which would have been even higher when the movable fabric roof supported by rigging and wooden masts was in place.

## AMPHITHÉÂTRE

Le Colisée est une structure elliptique autonome de 189 m (615 pi) de long et de 156 m (510 pi) de large. L'arène ovale intérieure fait 87 m (287 pi) de longueur et 55 m (180 pi) de largeur et est bordée d'un imposant mur de 5 m (15 pi), surmonté de rangées de gradins. Le mur extérieur du Colisée s'élève à une hauteur impressionnante de 48 m (157 pi) et était encore plus haut lorsque le toit mobile en tissu, soutenu par un gréement et des mâts en bois, était en place.

## ANFITEATRO

El Coliseo es una estructura elíptica independiente de 189 m de longitud y 156 m de anchura. La arena interior ovalada tiene 87 m de longitud y 55 m de anchura, y está rodeada por un imponente muro de 5 m, por encima del cual se eleva el espectacular graderío. El muro exterior del Coliseo alcanza una altura de 48 m; aún más si se contemplan los mástiles de madera que sujetaban los toldos móviles que se desplegaban en ocasiones mediante complejos mecanismos.



The structure was ringed by 80 entrances at ground level. The 4 main axial entrances were reserved for the emperor and the city's elites and were richly decorated.

La structure était entourée de 80 entrées au rez-de-chaussée. Les 4 entrées axiales principales étaient réservées à l'empereur et aux élites de la ville et étaient somptueusement décorées.

80 entradas a nivel del piso rodeaban la estructura. Las 4 entradas axiales principales estaban reservadas para el emperador y las élites de la ciudad, y estaban generosamente decoradas.

## CONSTRUCTION

Over 3,531,467 ft<sup>3</sup> (100,000 cubic meters) of travertine stone was used in the construction of the Colosseum, 1,589,160 ft<sup>3</sup> (45,000 cubic meters) for the external walls alone. Instead of mortar, the stones were held together by over 331 tons (300 tonnes) of iron clamps. The structure's outer façade is made up of 3 distinct levels with 80 imposing arcades on each one. In the arena itself, a sand-covered wooden floor concealed an elaborate underground construction known as the *hypogeum*.

## CONSTRUCTION

Plus de 100 000 mètres cubes (3 531 467 pi<sup>3</sup>) de travertin ont été utilisés dans la construction du Colisée, dont 45 000 mètres cubes (1 589 160 pi<sup>3</sup>) seulement pour les murs extérieurs. Au lieu de mortier, plus de 300 tonnes d'agrafes de fer renaient les pierres ensemble. La façade extérieure de la structure est composée de 3 niveaux distincts, chacun doté de 80 imposantes arcades. Dans l'arène, un plancher de bois recouvert de sable cachait une structure souterraine complexe appelée *hypogée*.



## CONSTRUCCIÓN

La construcción del Coliseo requirió más de 100.000 m<sup>3</sup> de travertino (45.000 de los cuales se emplearon en el levantamiento de los muros exteriores). En lugar de usar mortero, las piedras se unieron mediante más de 300 t de abrazaderas de hierro. La fachada exterior de la estructura se compone de 3 niveles, cada uno con 80 imponentes arcadas. En la arena, una plataforma de madera cubierta de tierra ocultaba un elaborado sistema subterráneo denominado *hipogeo*.

## HYPOGEUM

The *hypogeum* was a 2-level subterranean network of tunnels and cages added after the initial Colosseum was completed. It was here the gladiators and animals were held before contests. Its construction meant the arena could no longer be flooded for epic naval battles.

## HYPOGÉE

L'hypogée était un réseau souterrain de tunnels et de cages à deux niveaux, ajouté après l'achèvement du Colisée initial. C'est là que les gladiateurs et les animaux se tenaient avant les spectacles. Suite à la construction de l'hypogée, l'arène ne pouvait plus être inondée pour recréer des batailles navales épiques.

## HIPOGEO

El hipogeo era una red subterránea de 2 niveles compuesta de túneles y jaulas que se agregó después de la construcción original del Coliseo. Era donde se alojaban los gladiadores y animales antes de los combates. Su construcción significó el fin de las espectaculares recreaciones de batallas navales, pues ya no era posible inundar la arena.



[LEGO.com/brickseparator](https://LEGO.com/brickseparator)



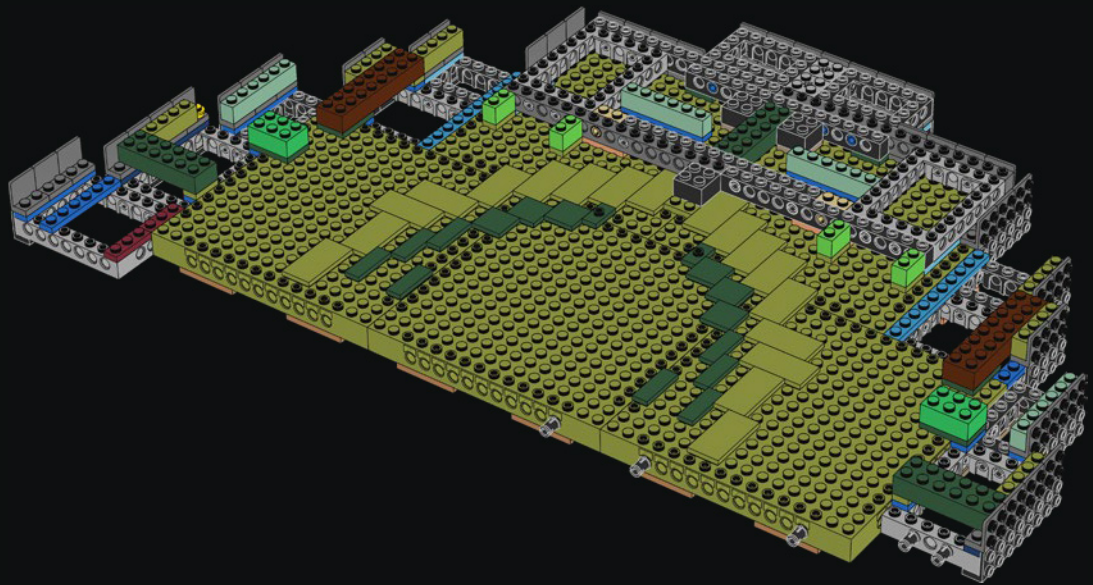

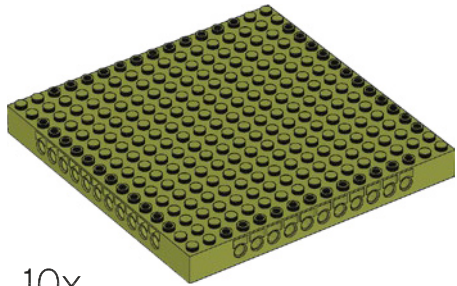

10x

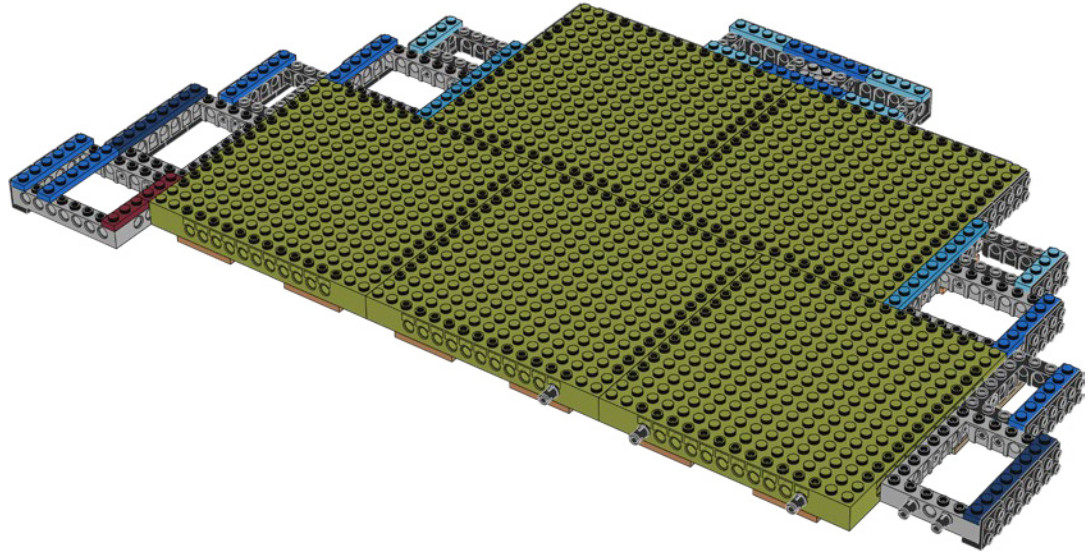
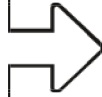

2x



1

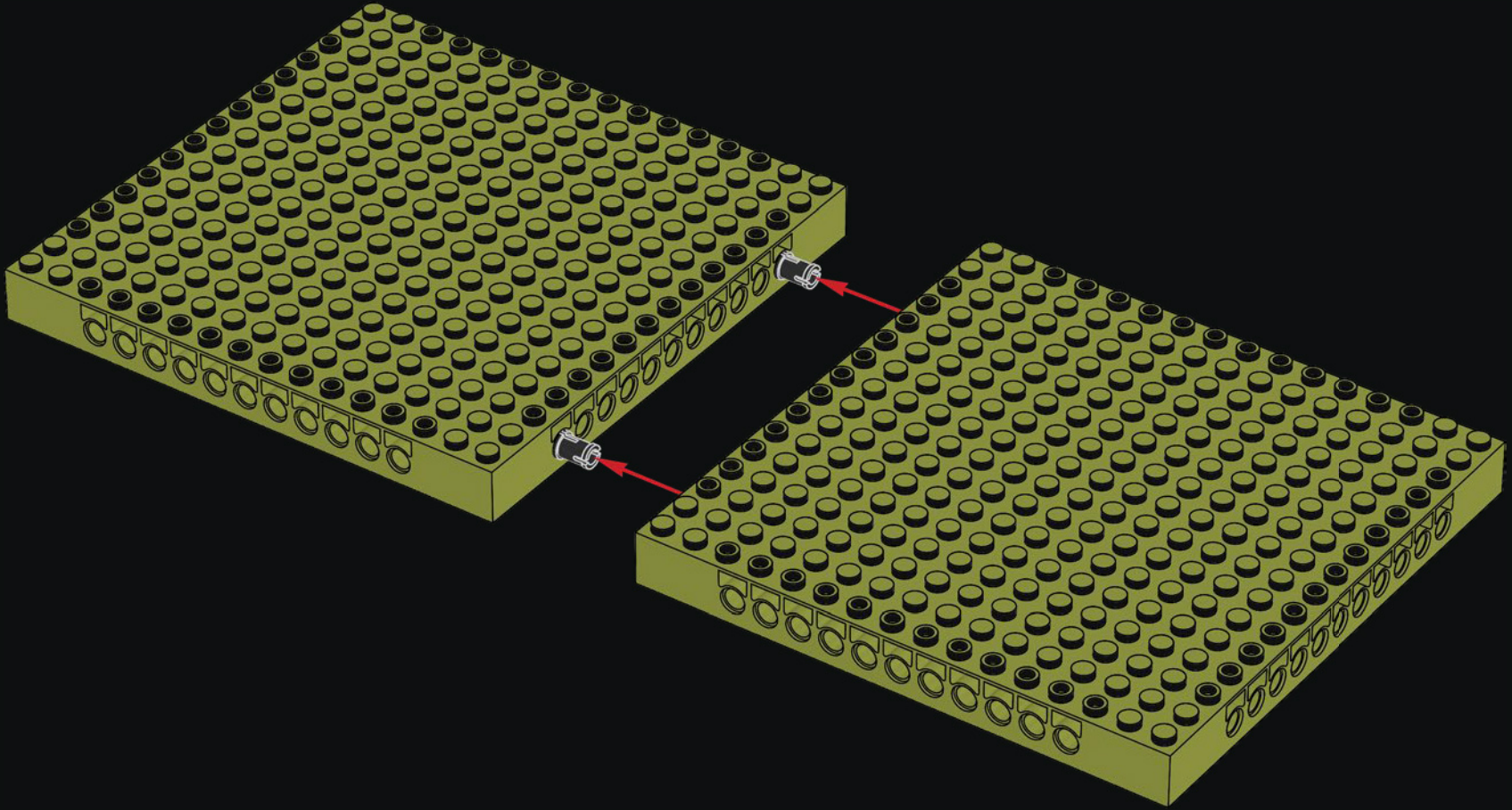

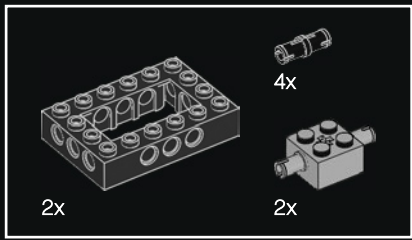

2

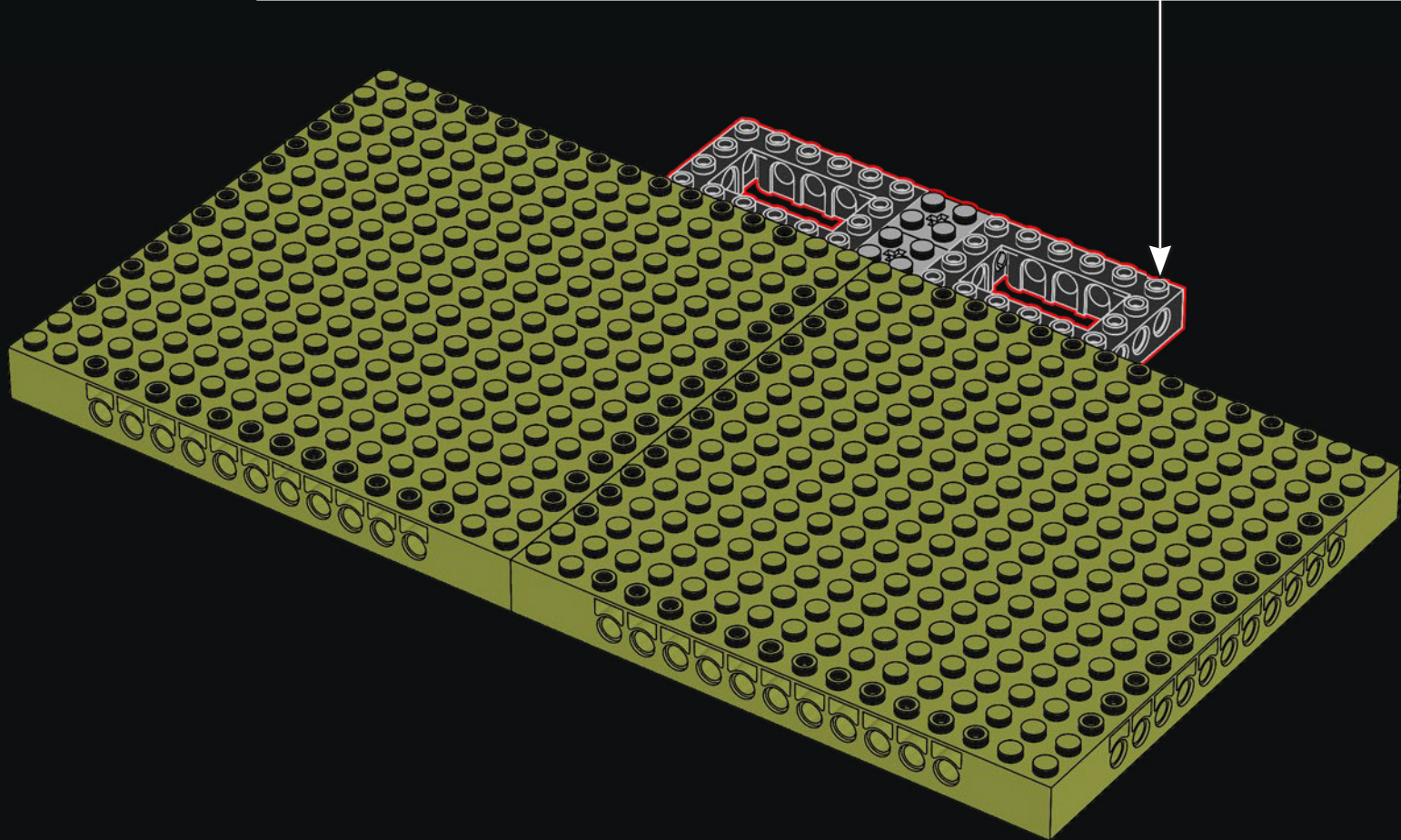
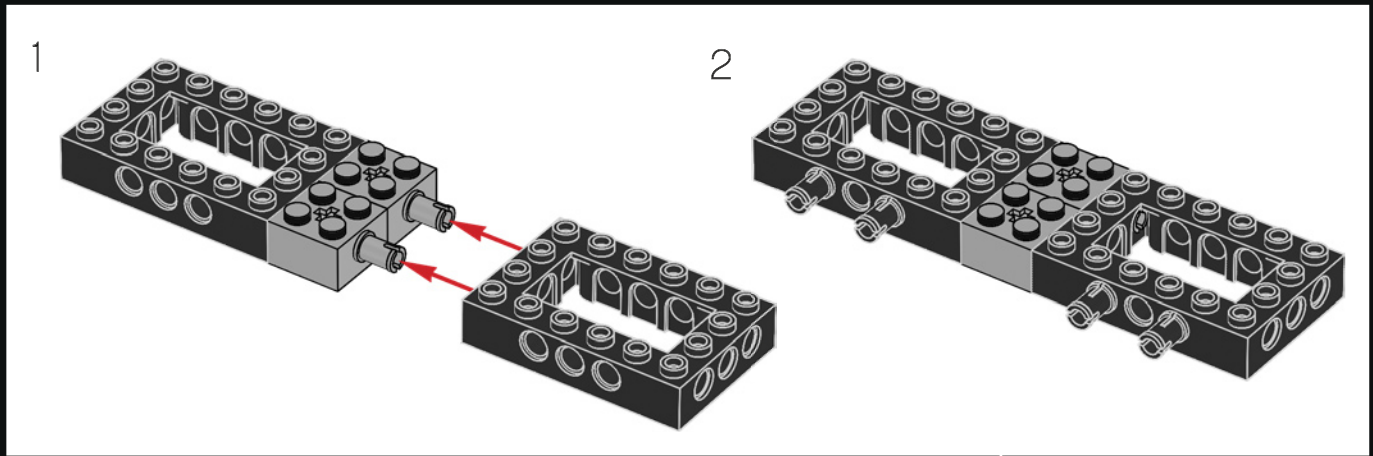



3

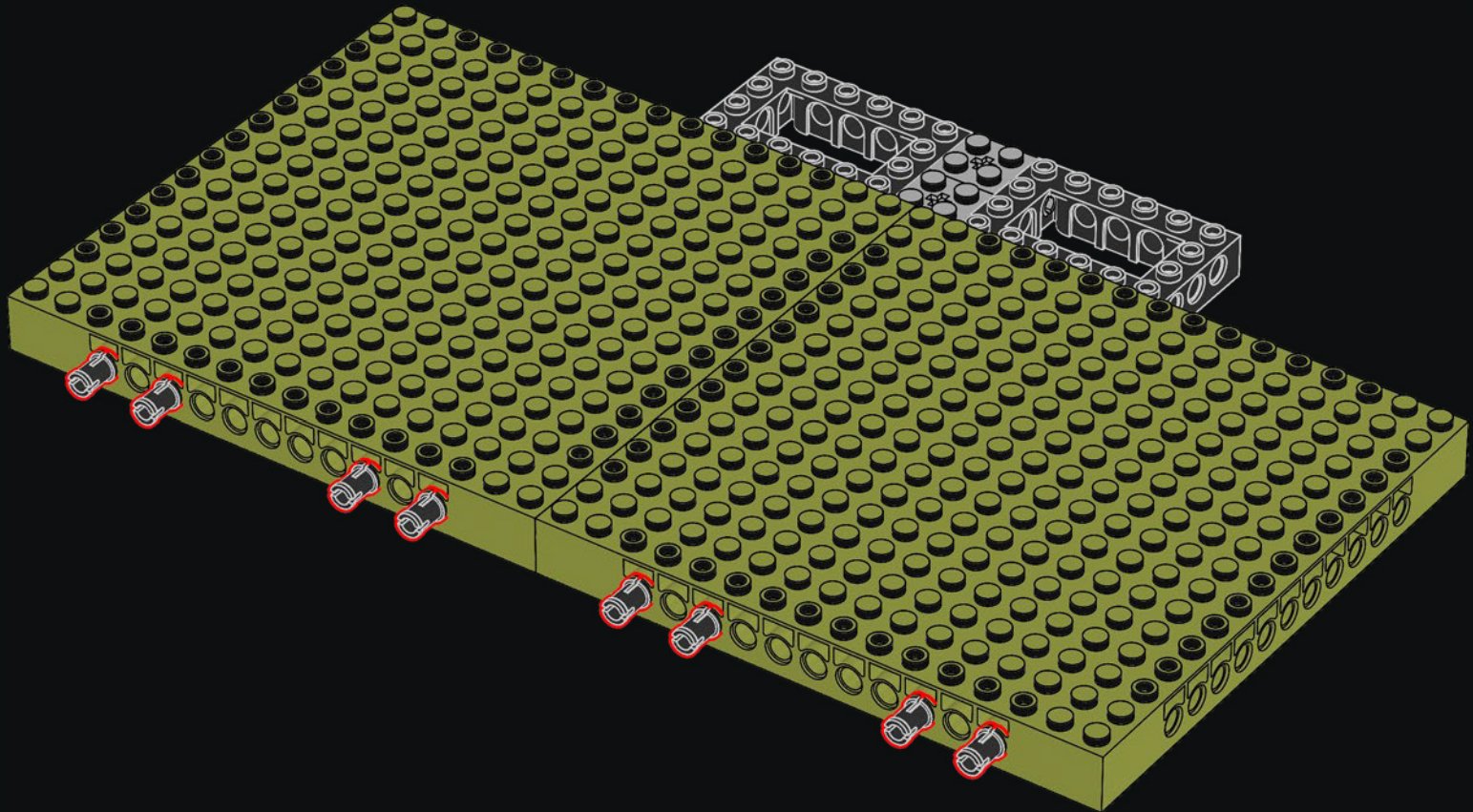

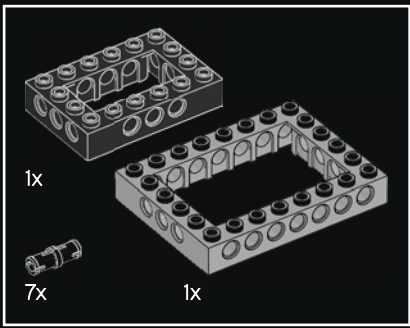

4

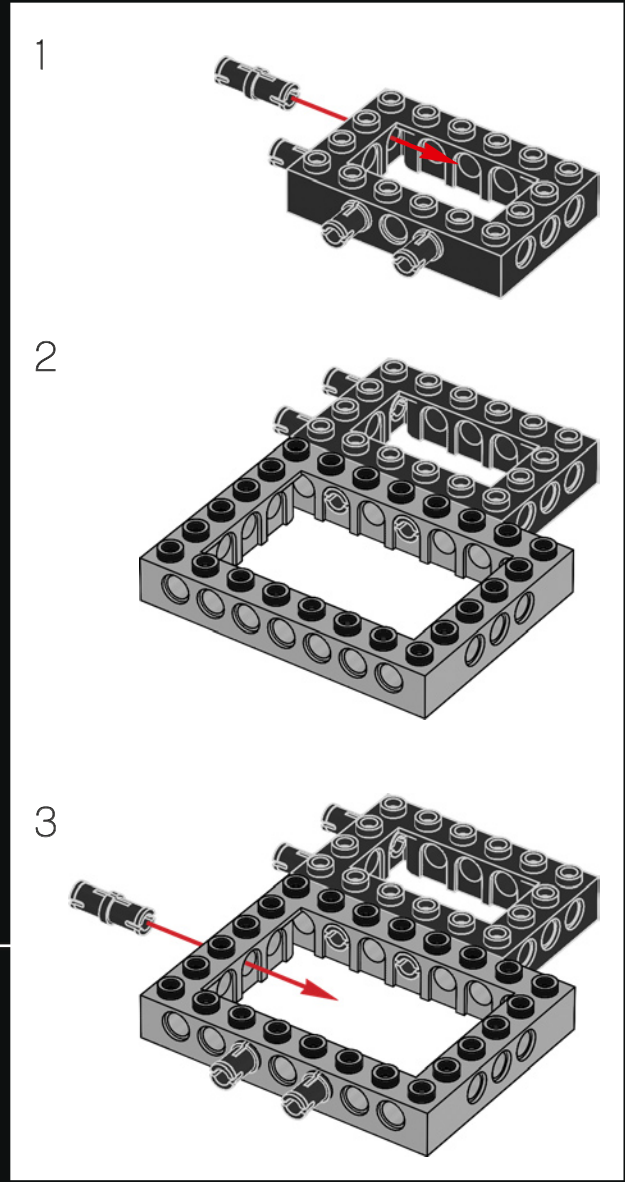
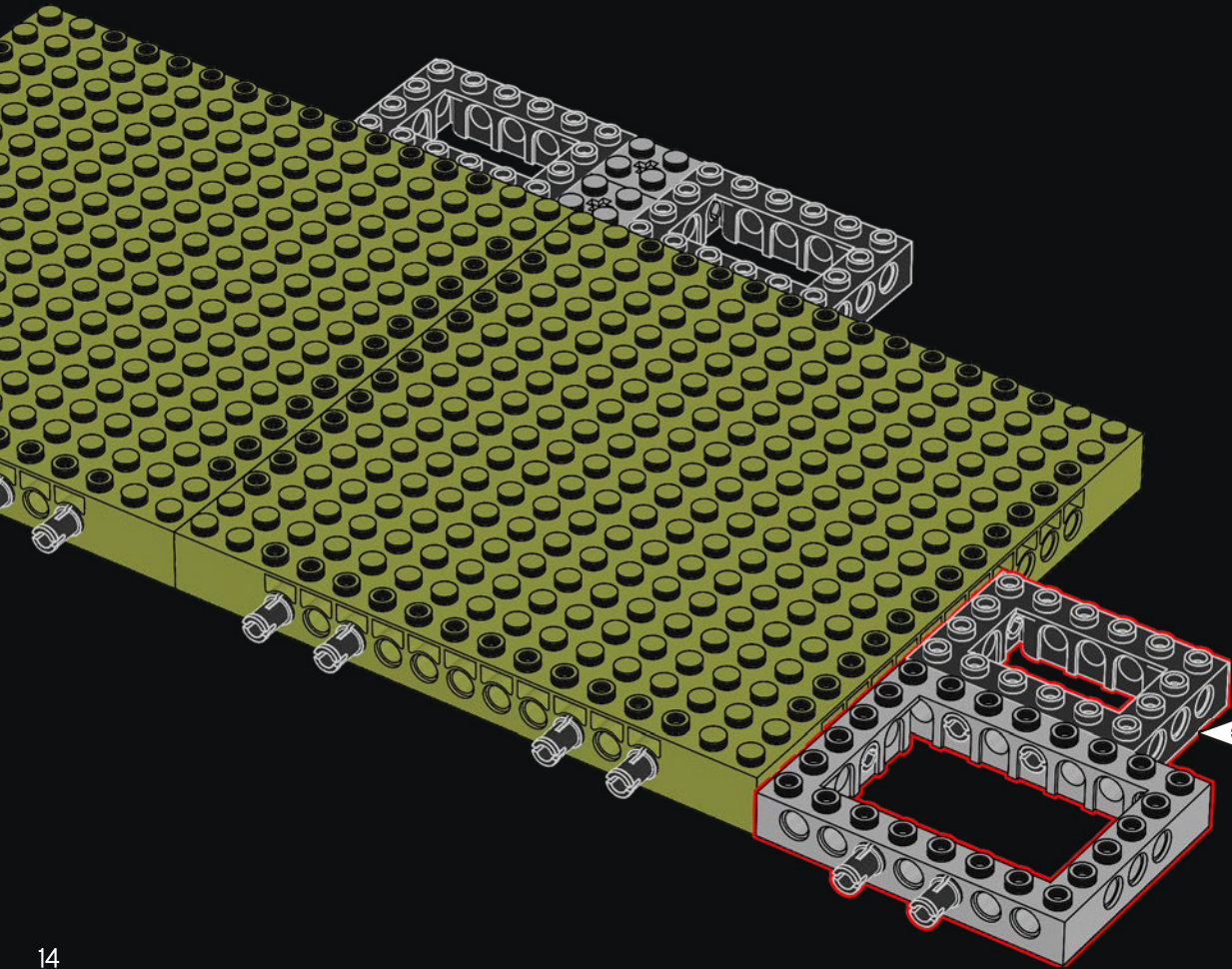

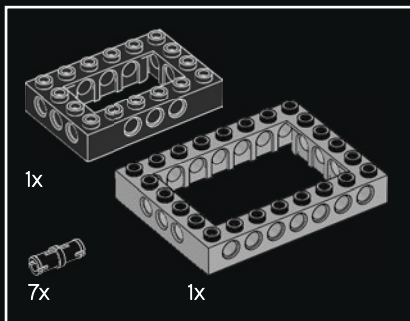

5

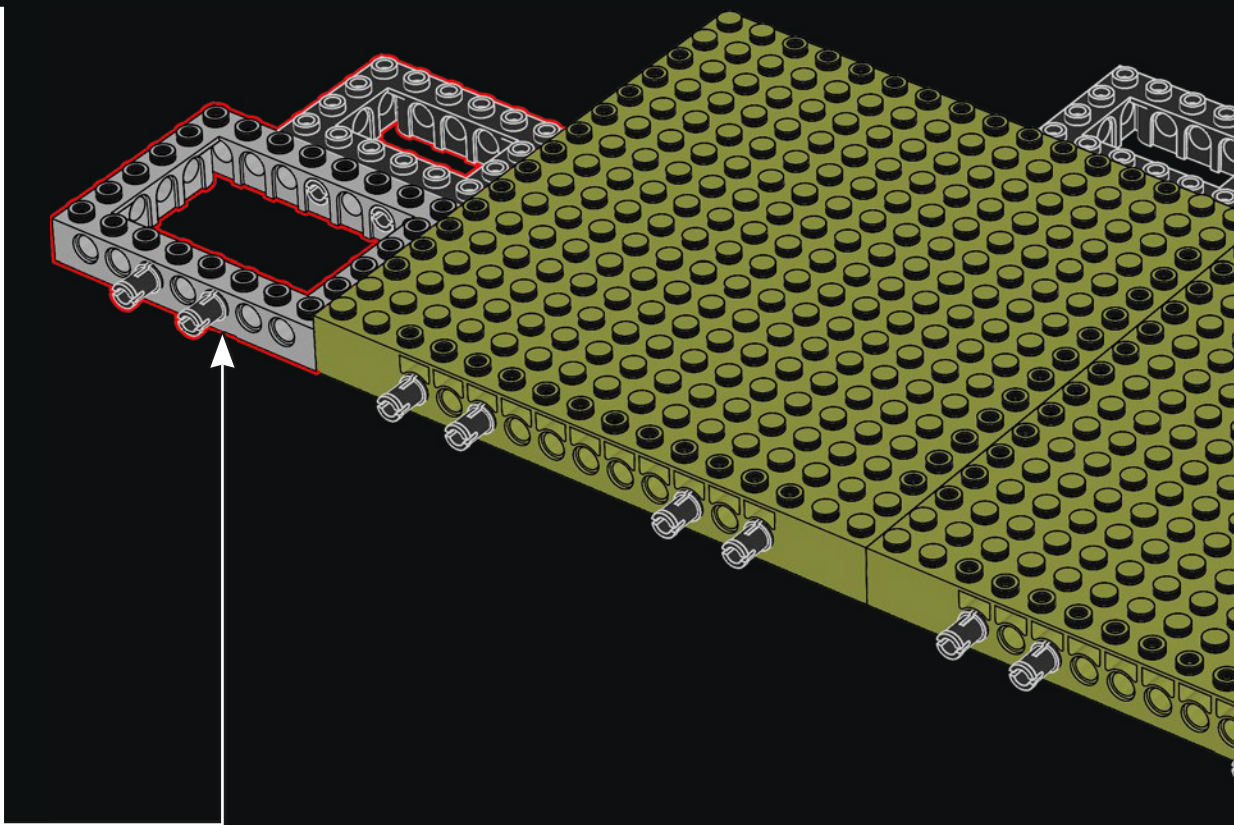
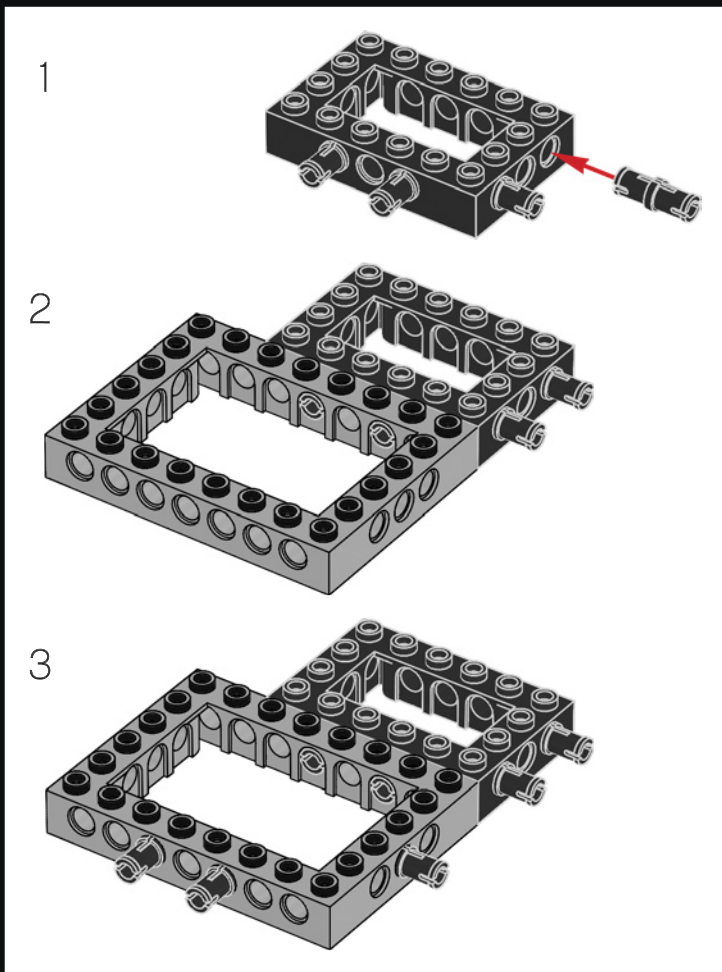



2x

6

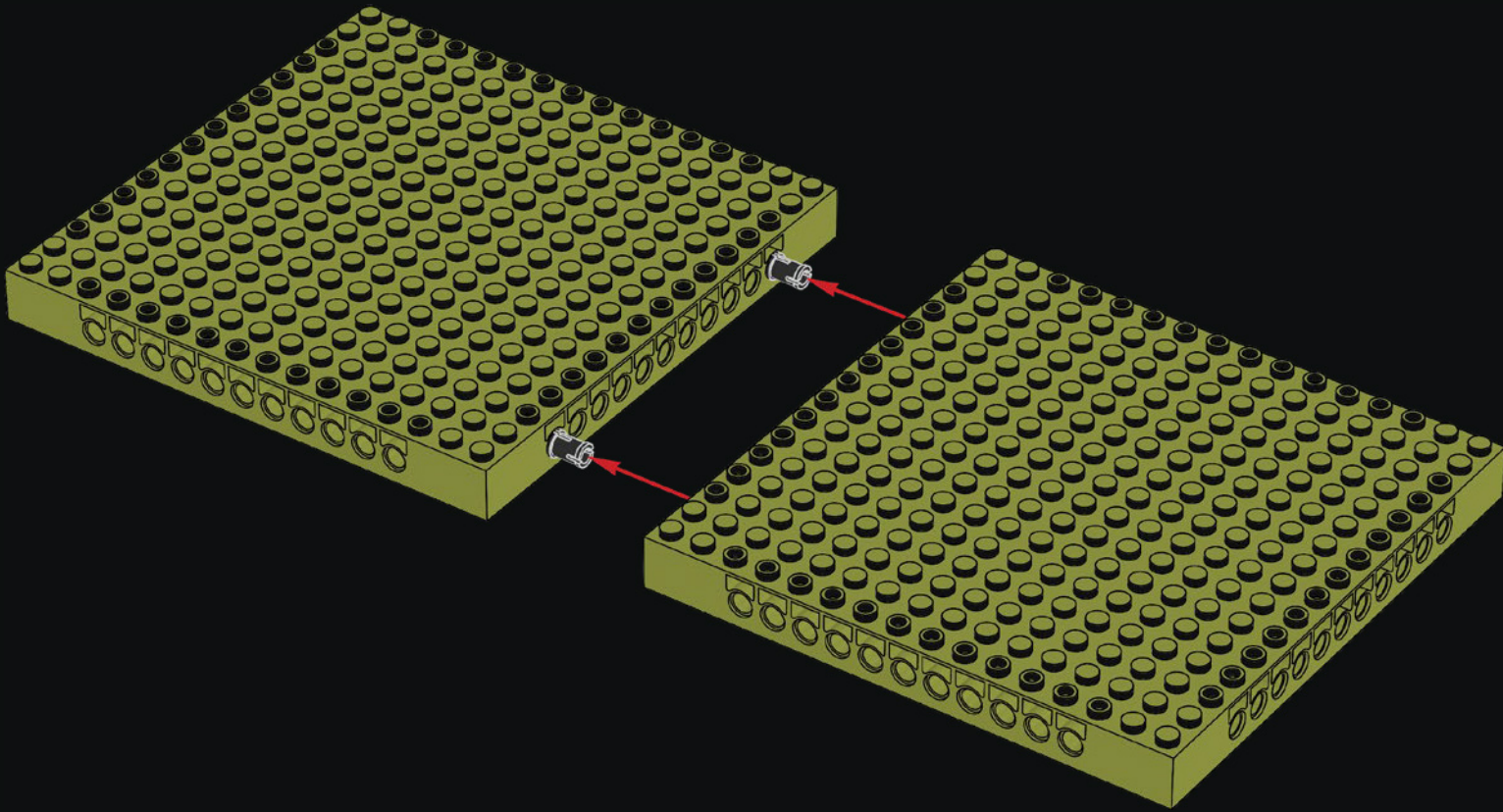





7

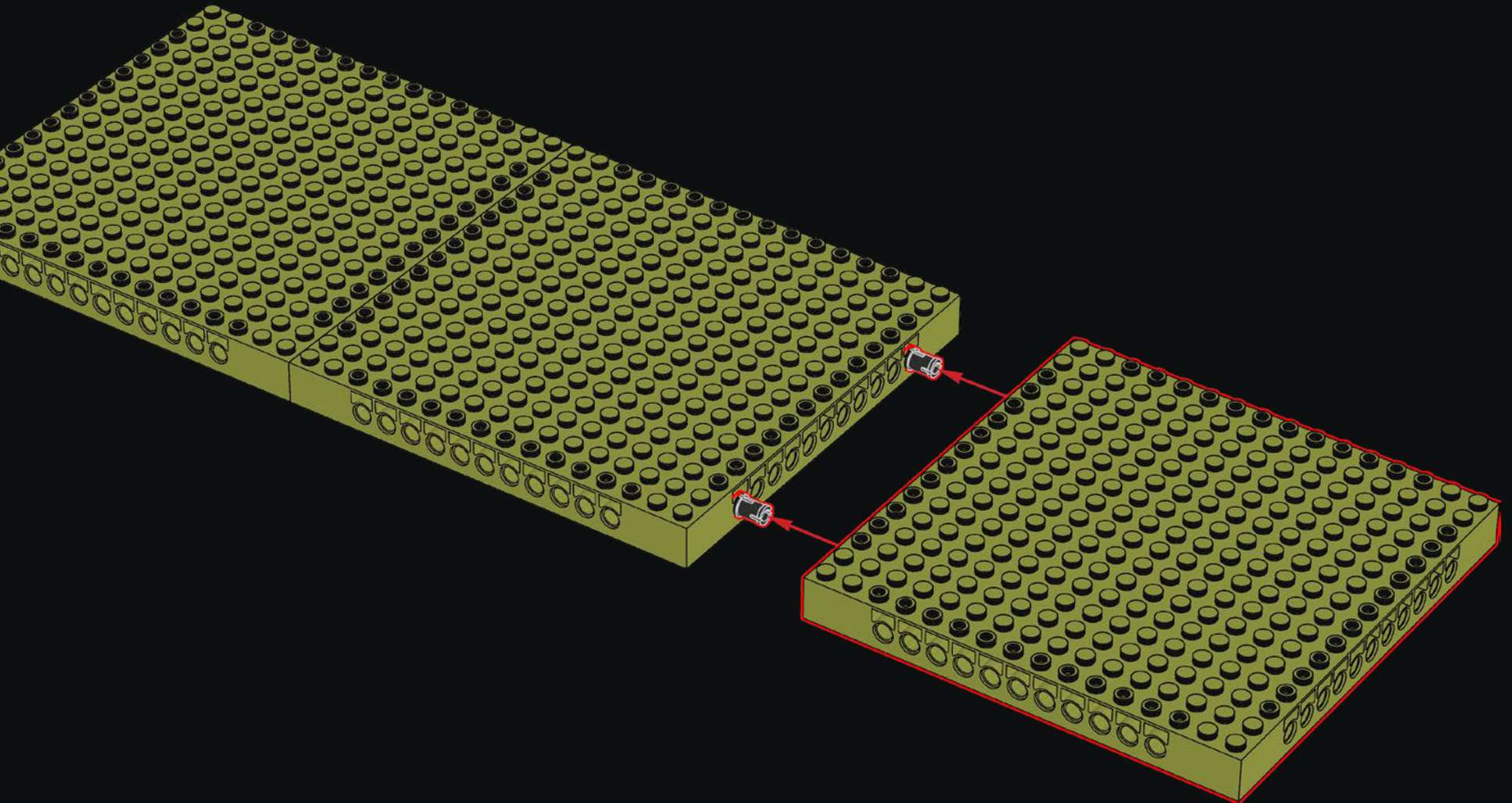

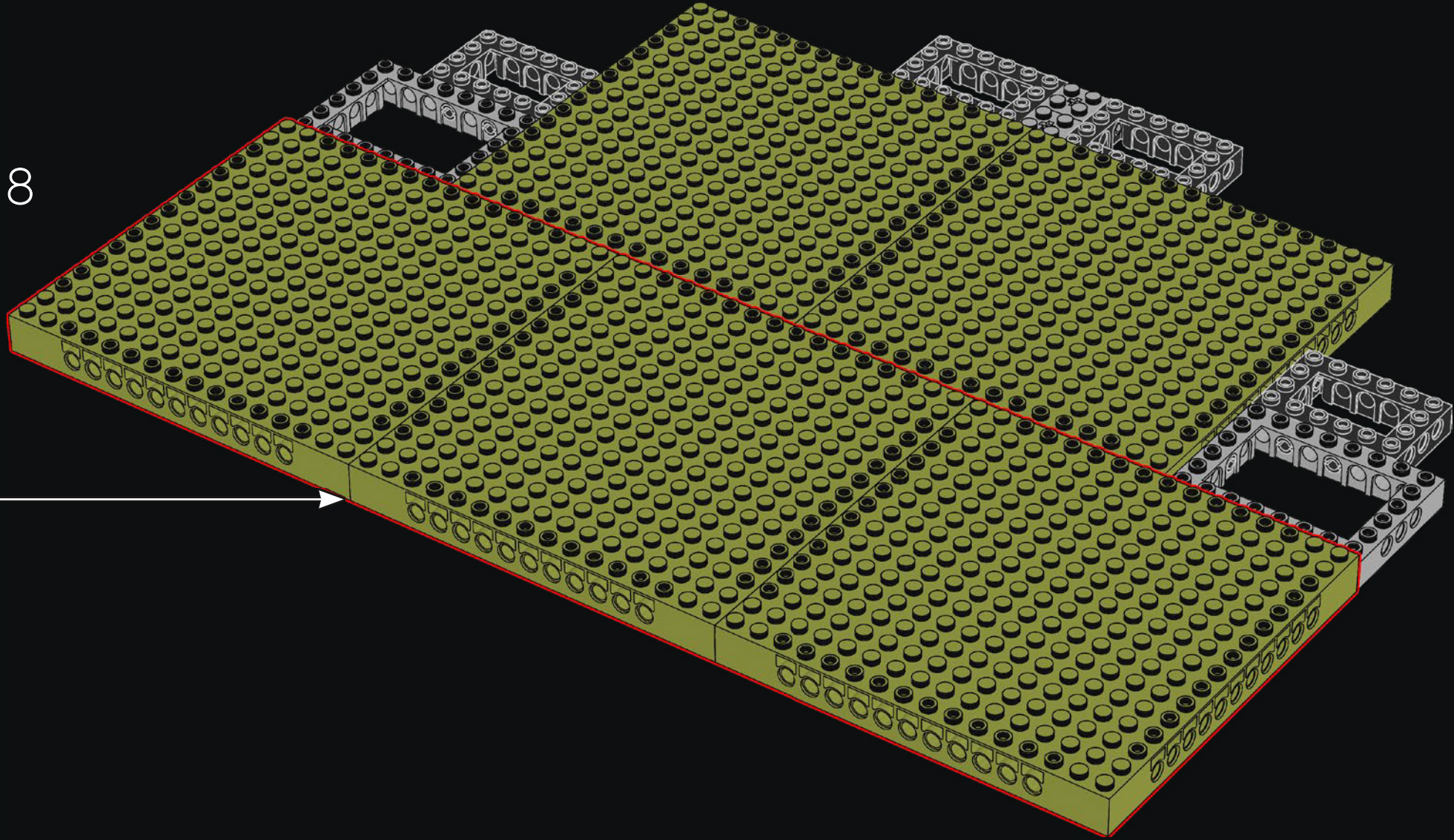

8

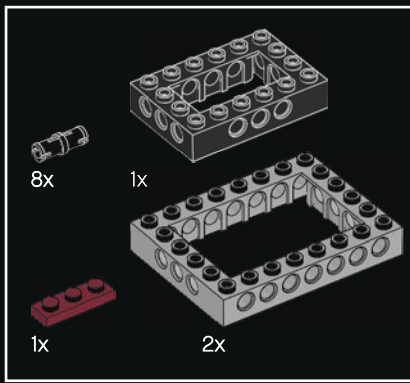

9

1

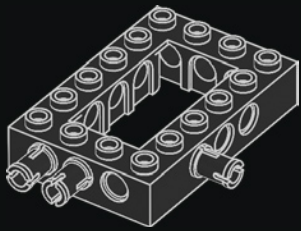

2

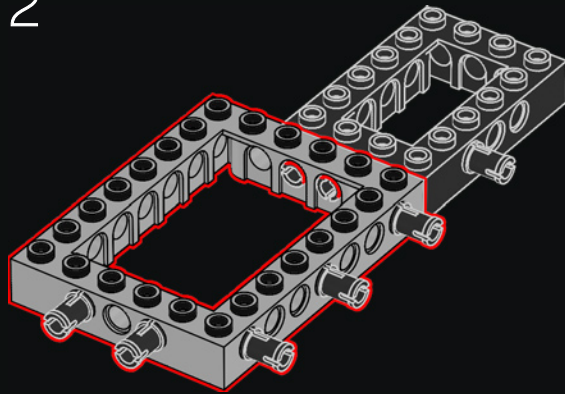

3

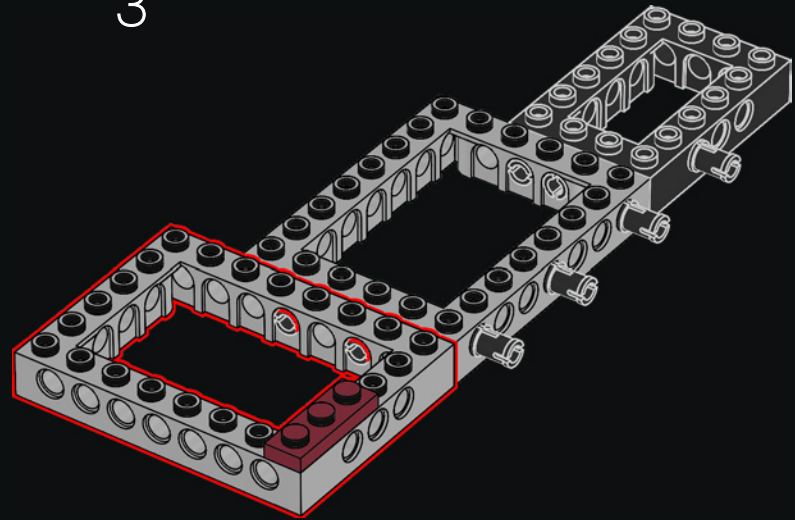

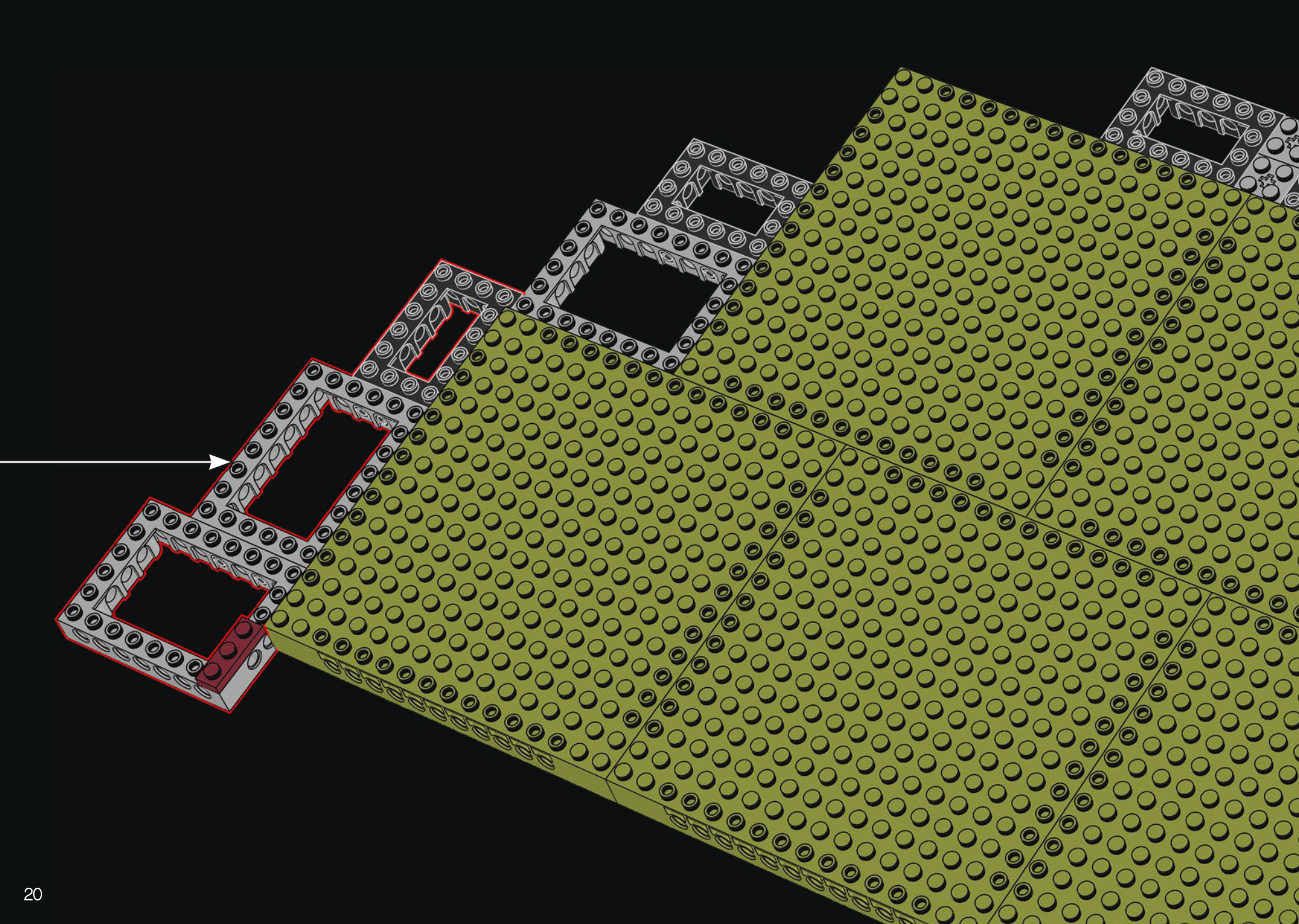

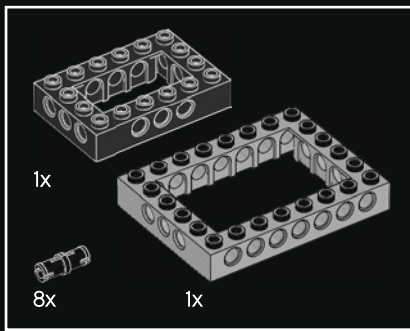

10

1

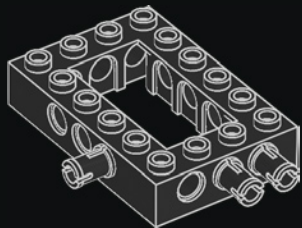

2

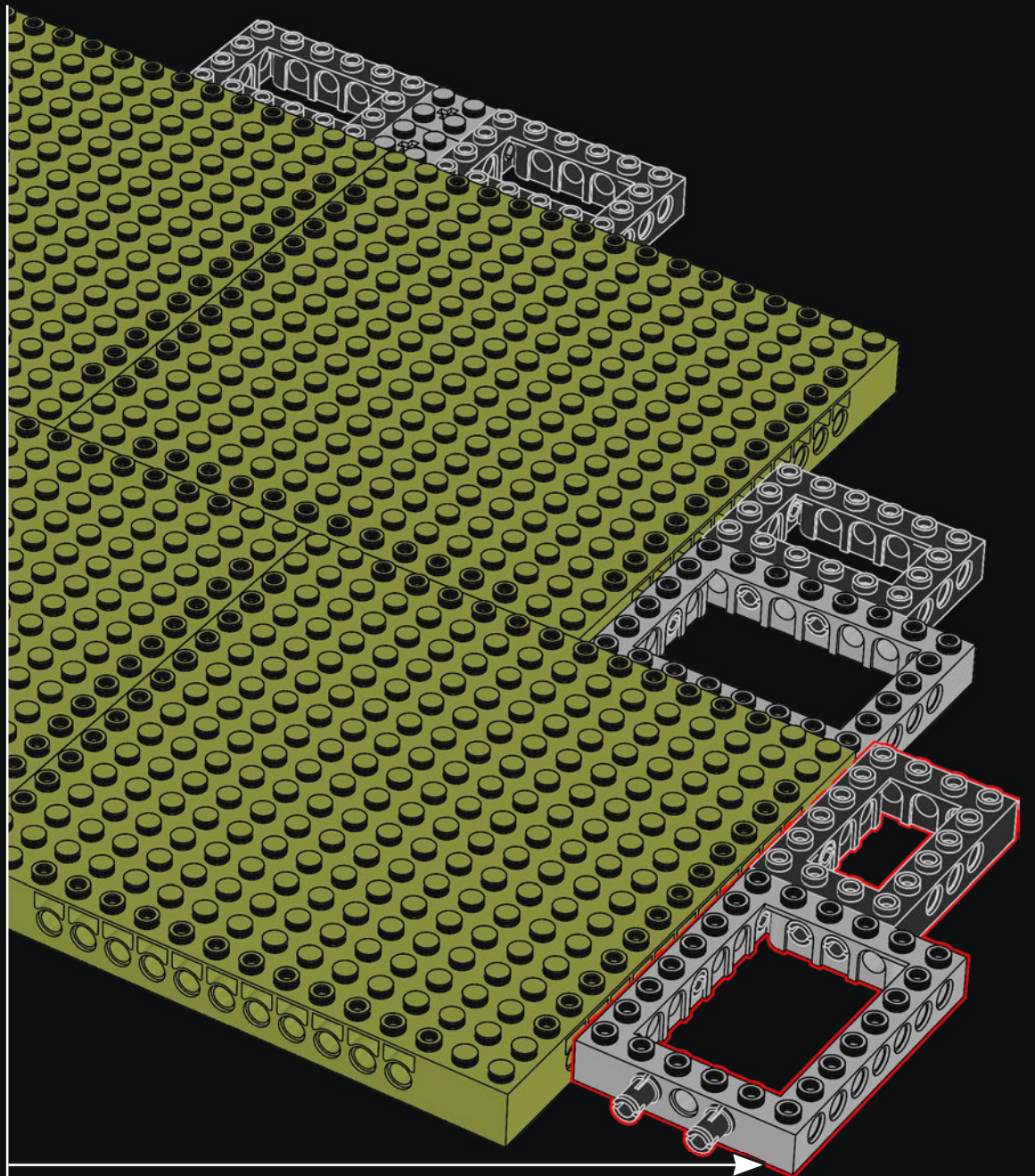
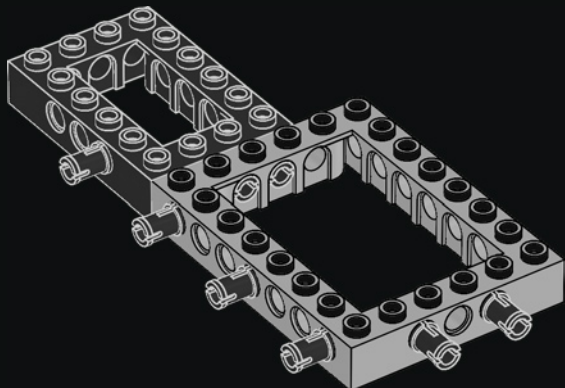

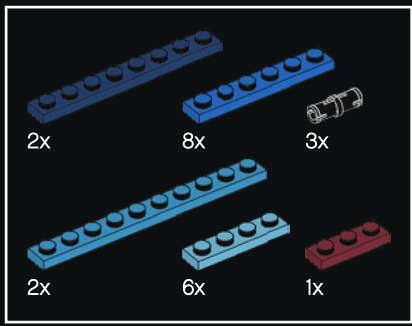

11

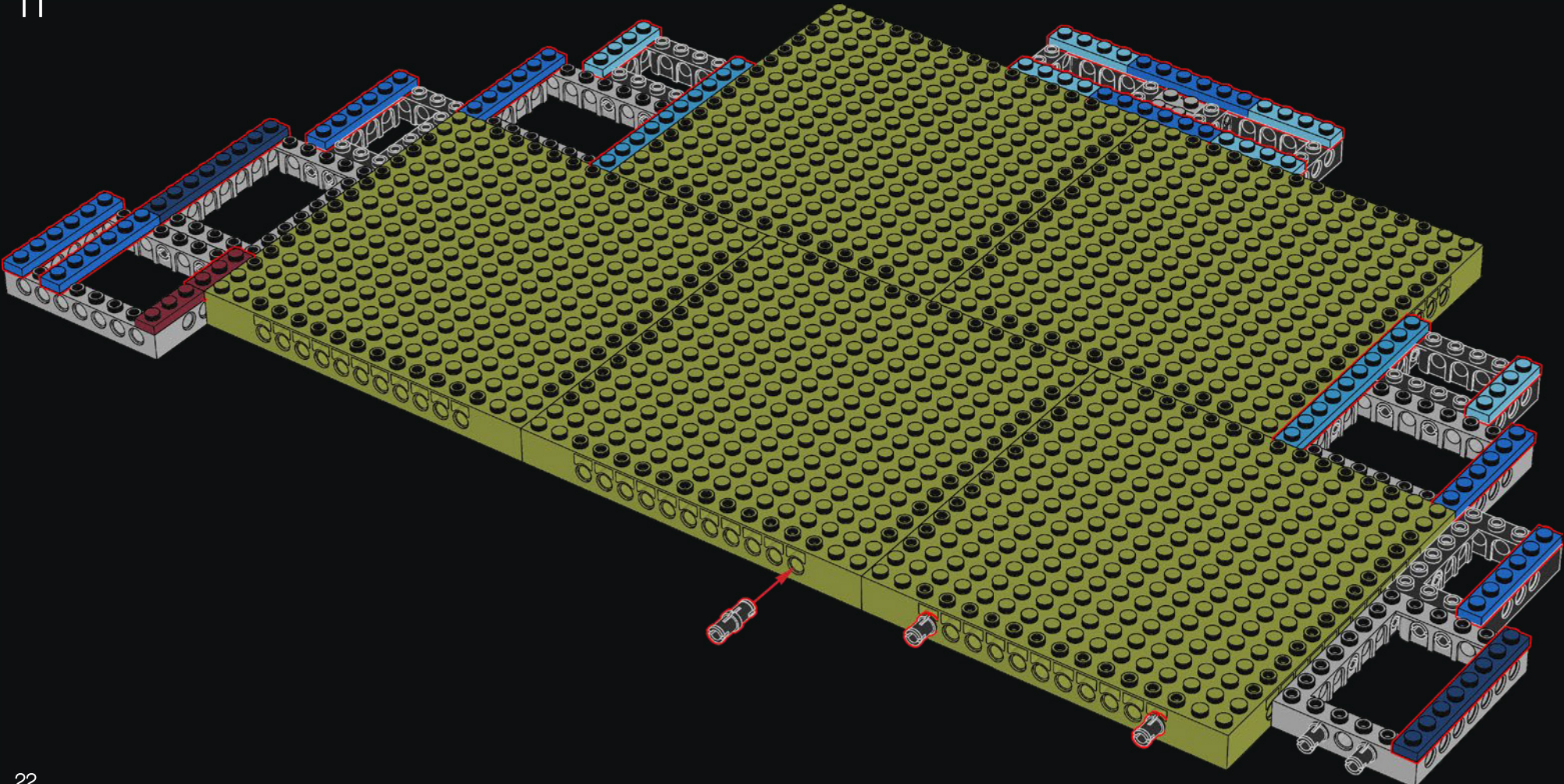

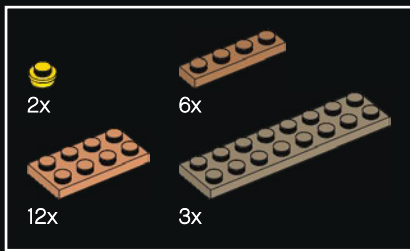

12





46x

13

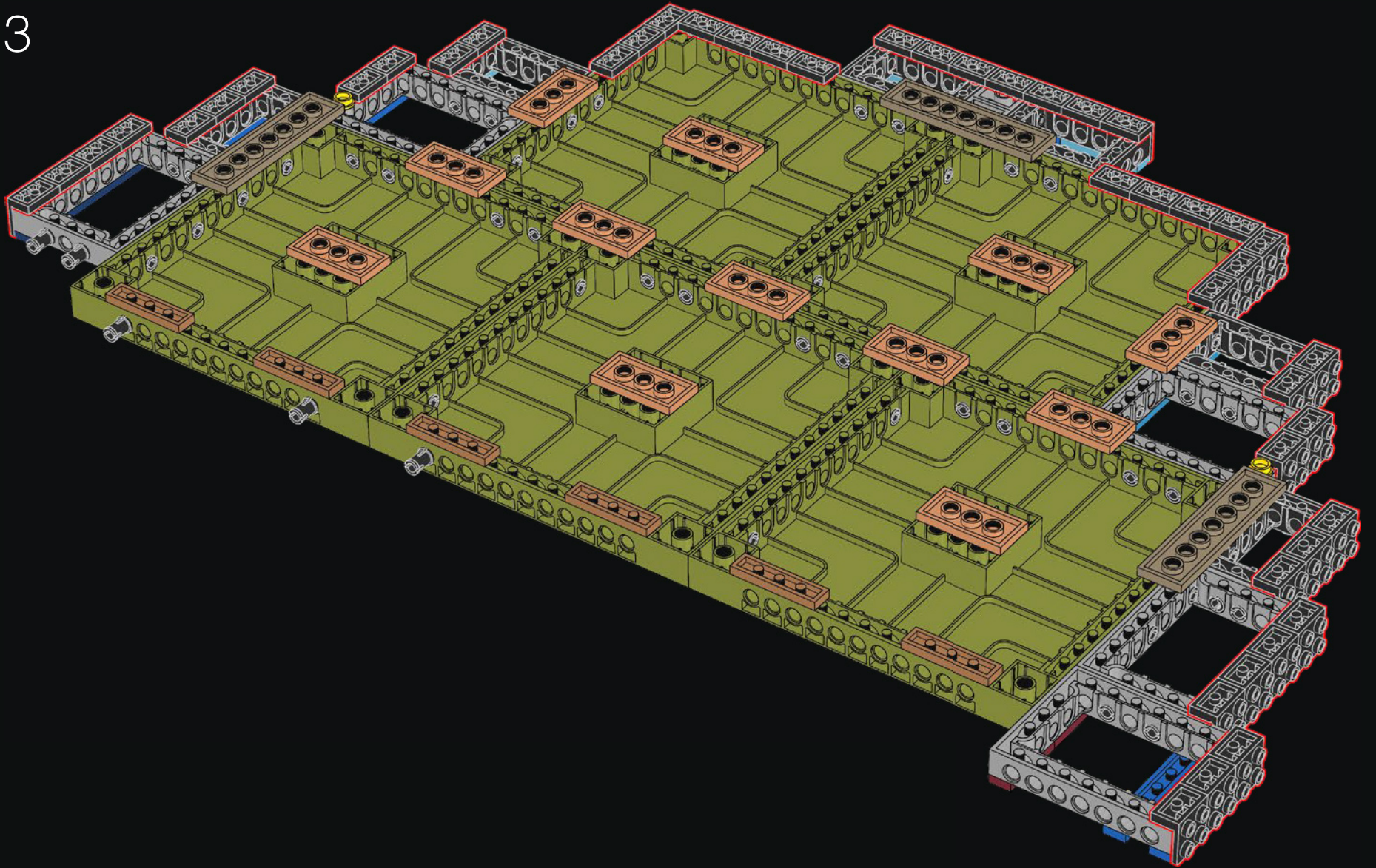



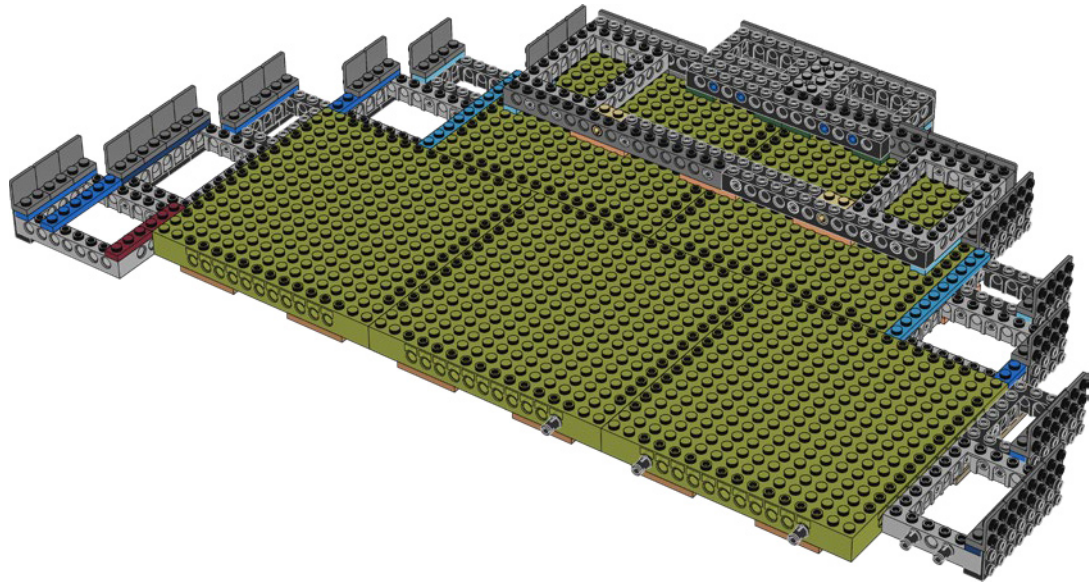
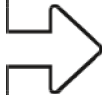



46x

14

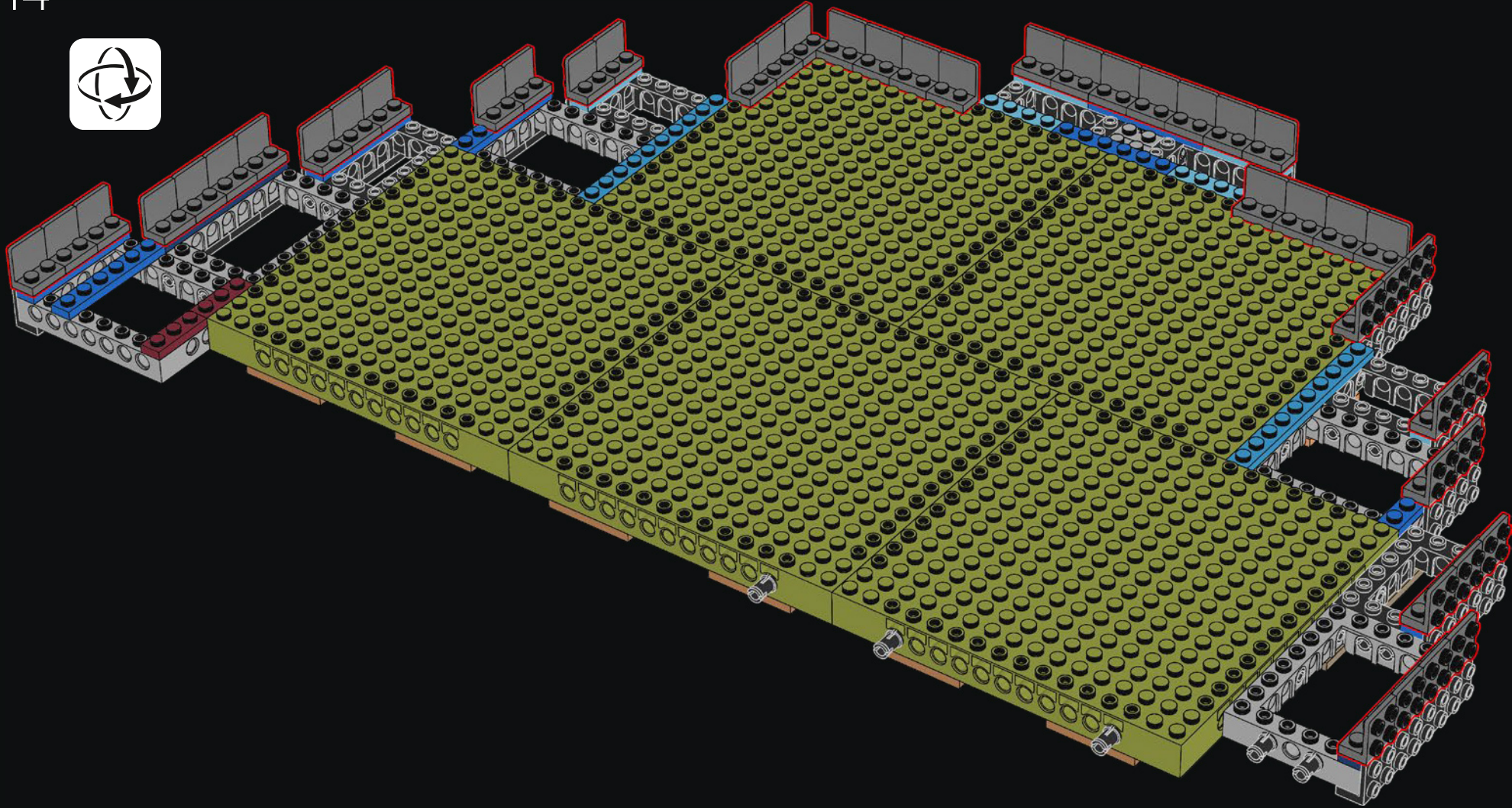

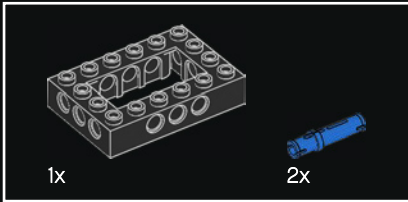
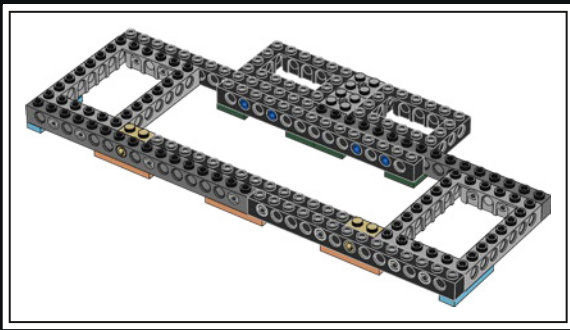

15

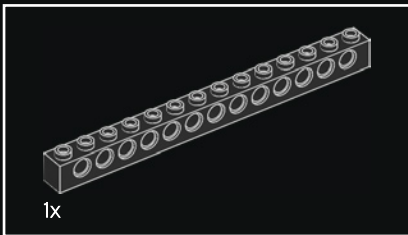
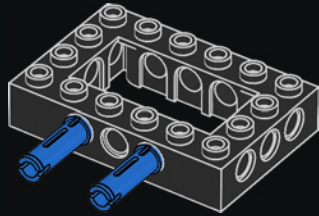

16

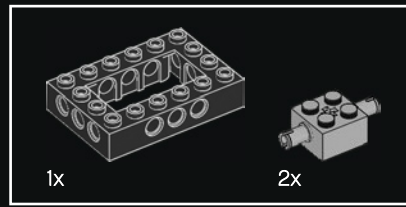
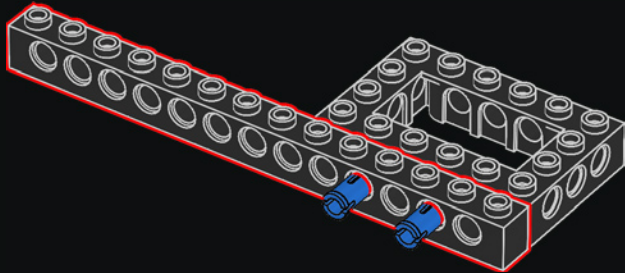

17

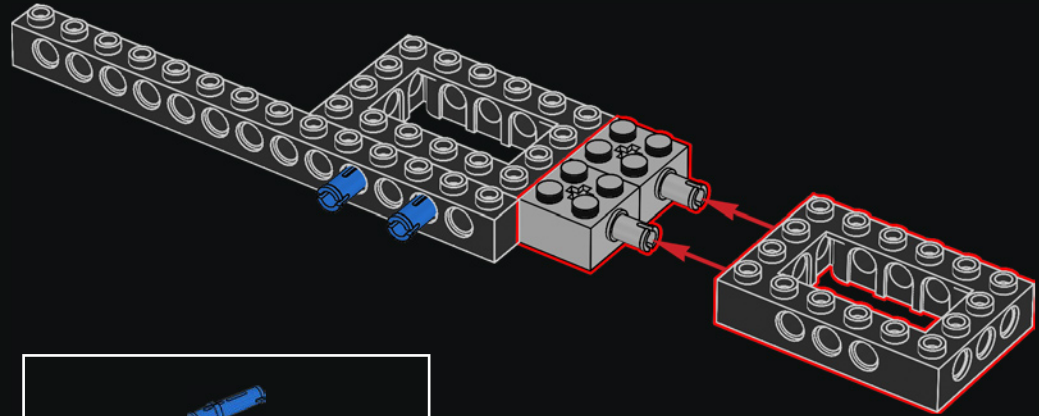

18

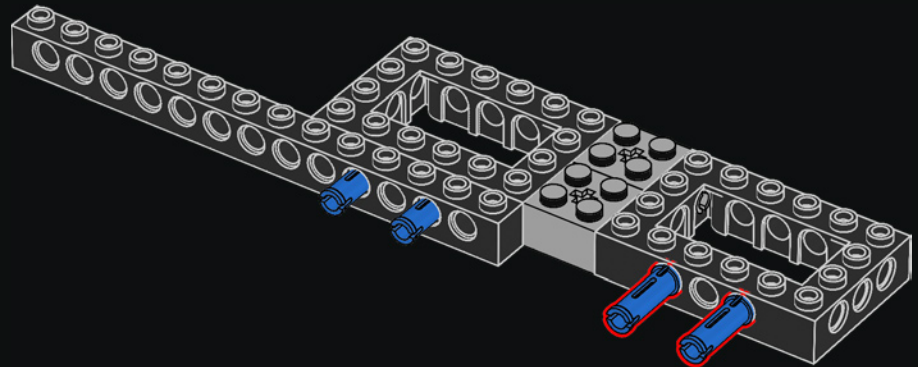

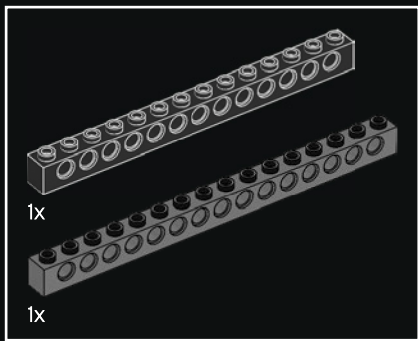

19

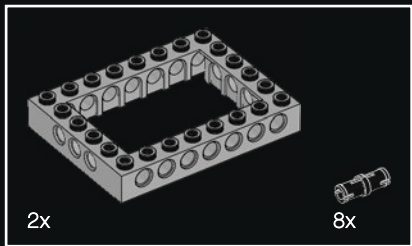
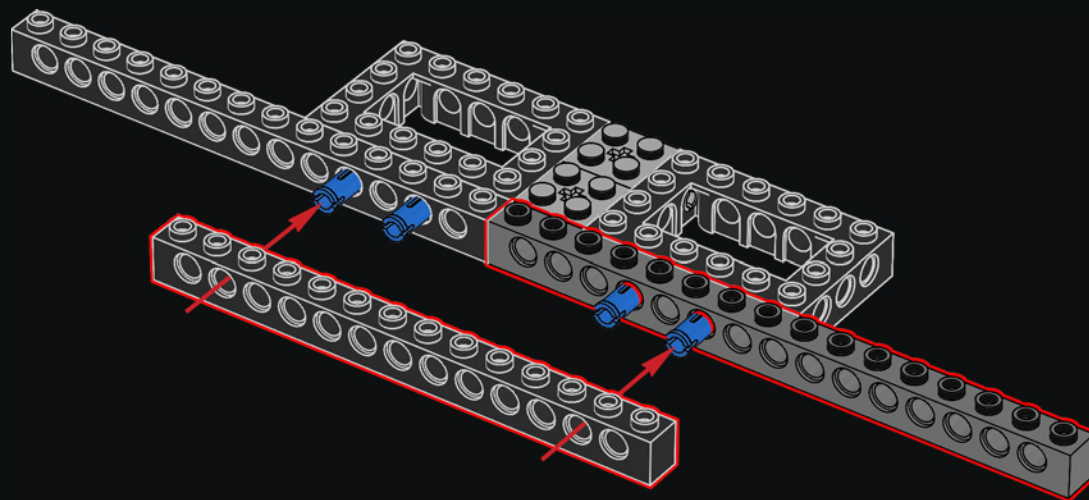

20

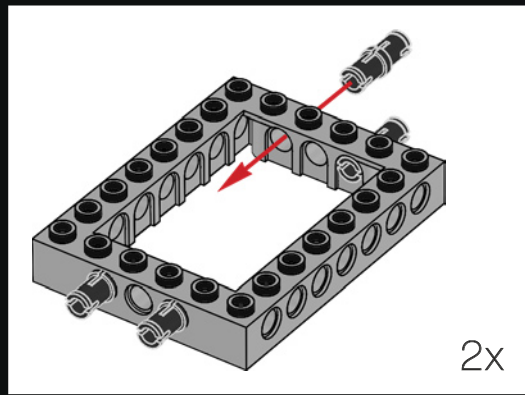
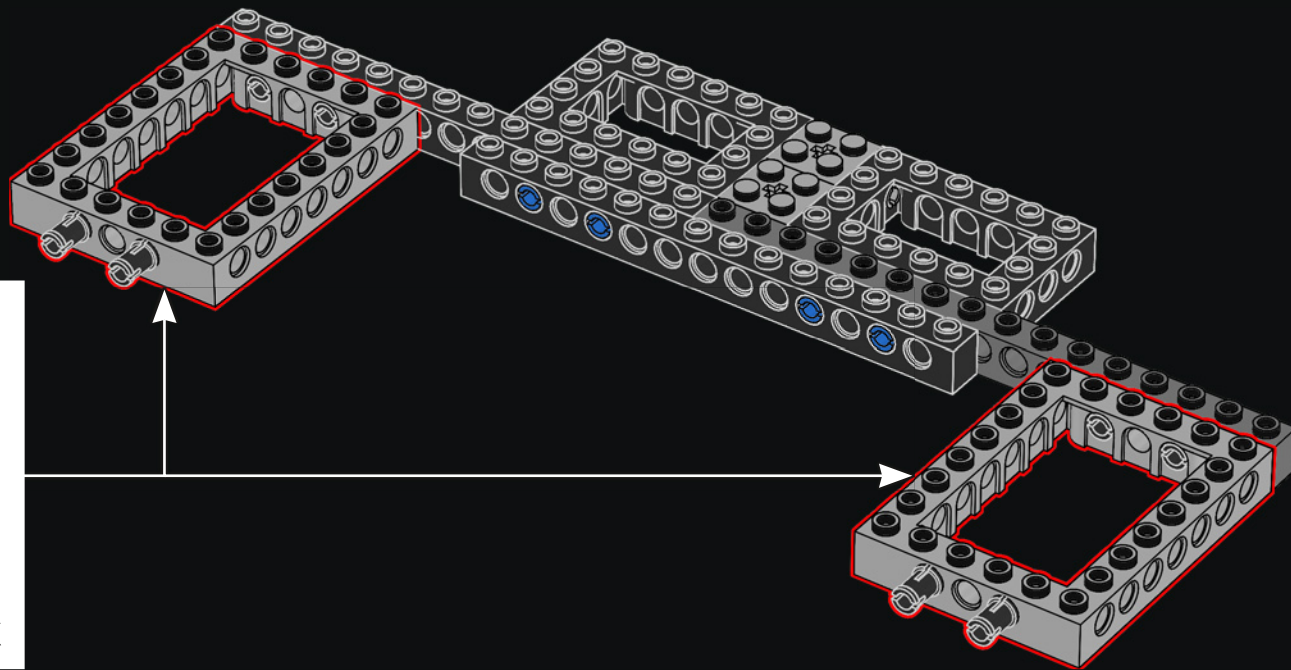

28

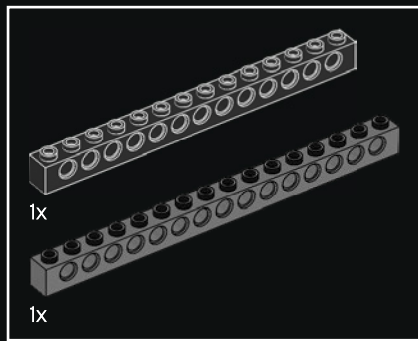

21

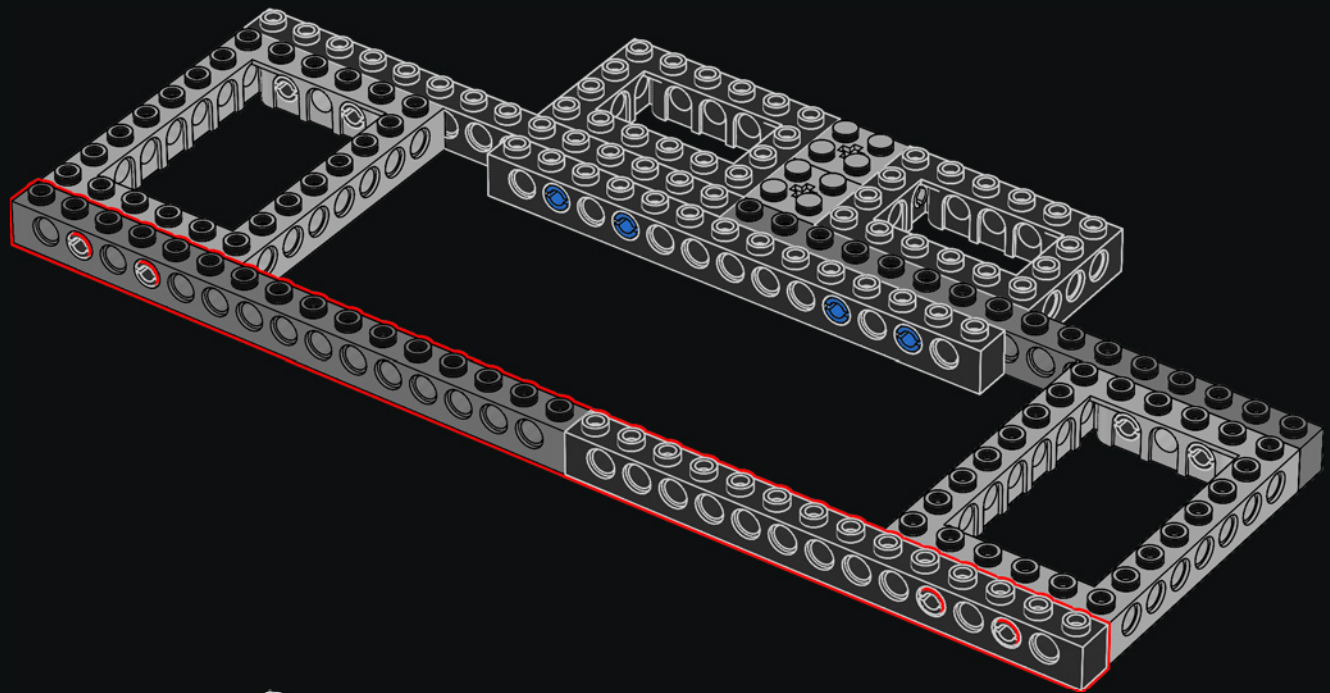

22

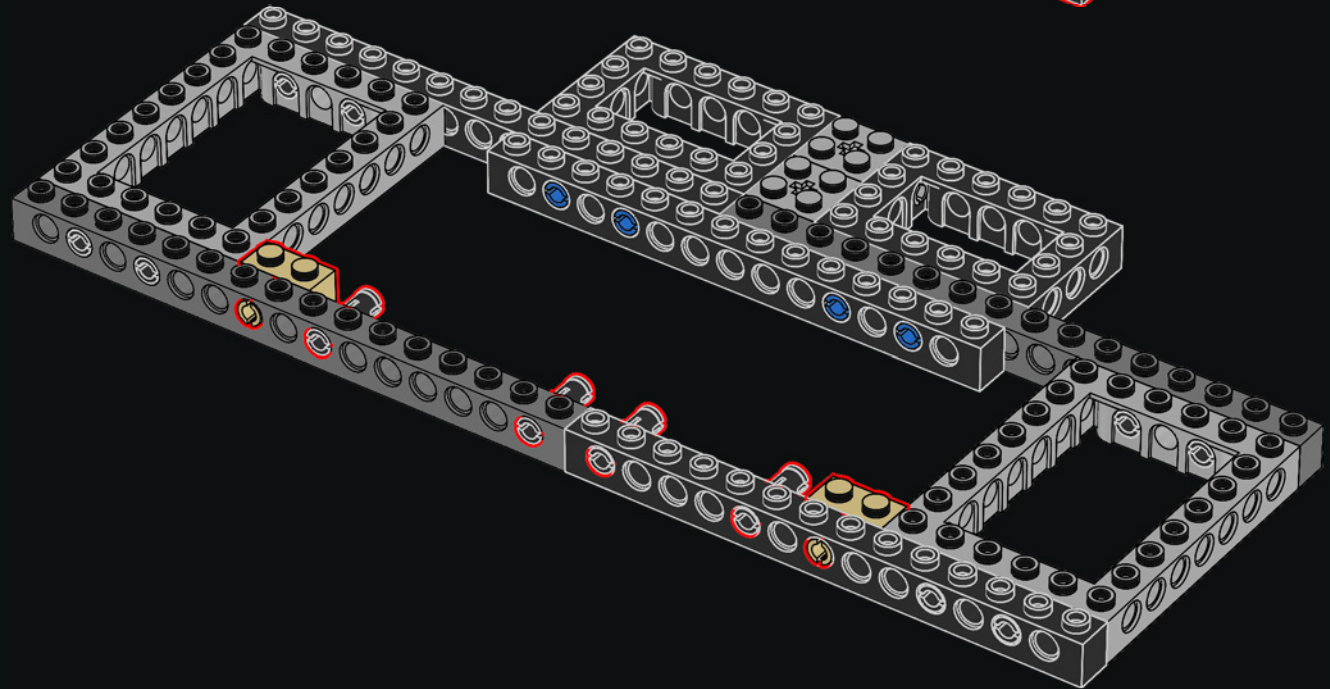

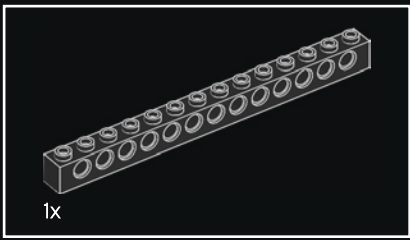

1x

23

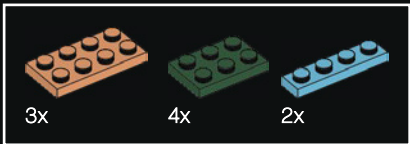
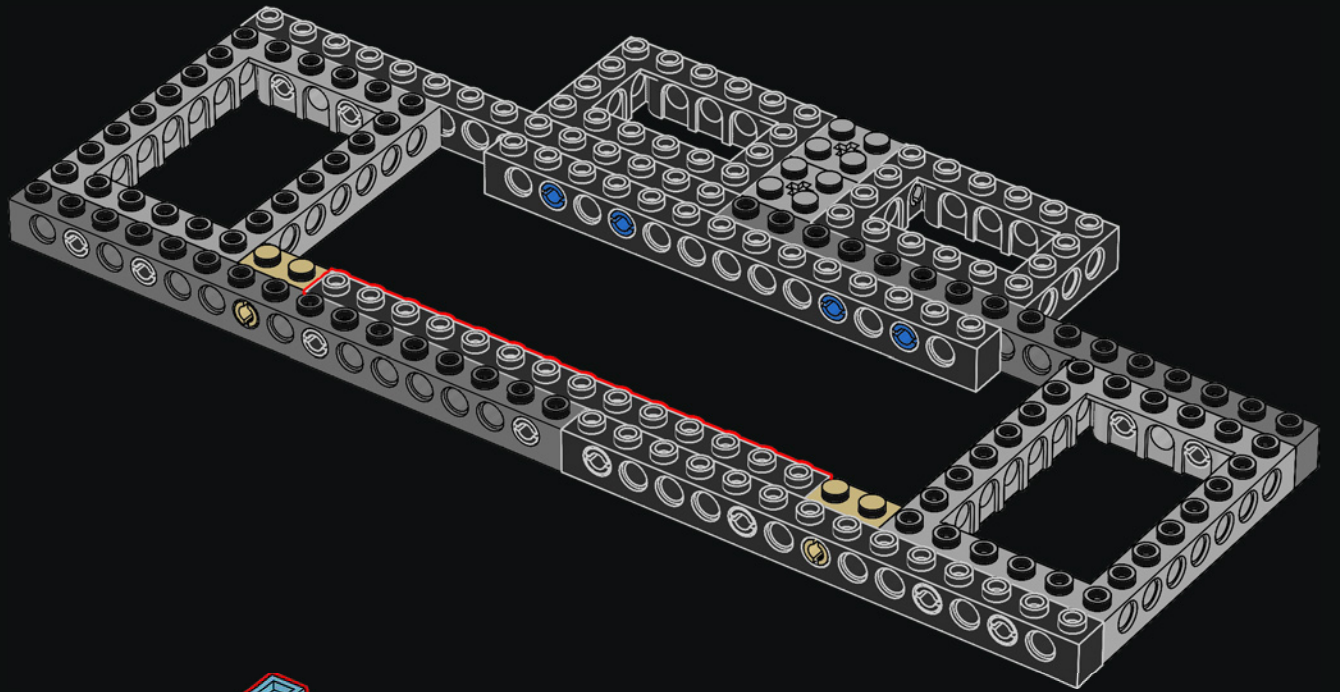

3x

4x

2x

24

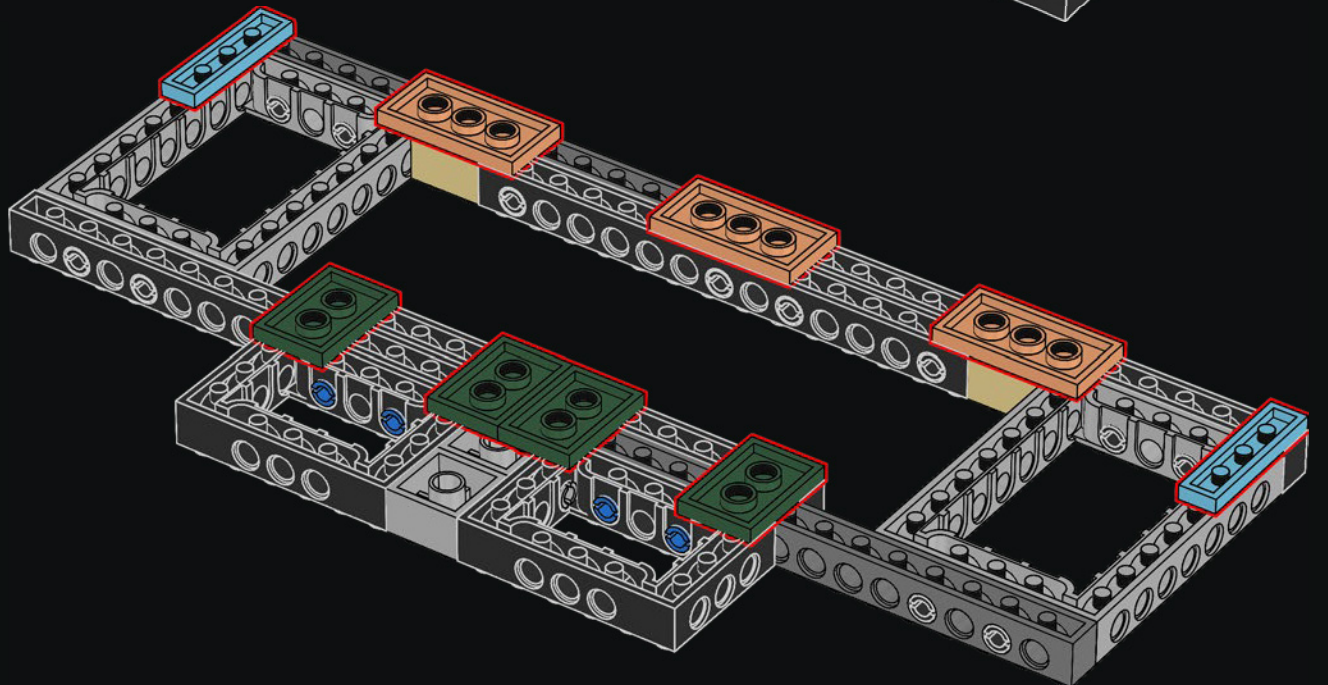

25

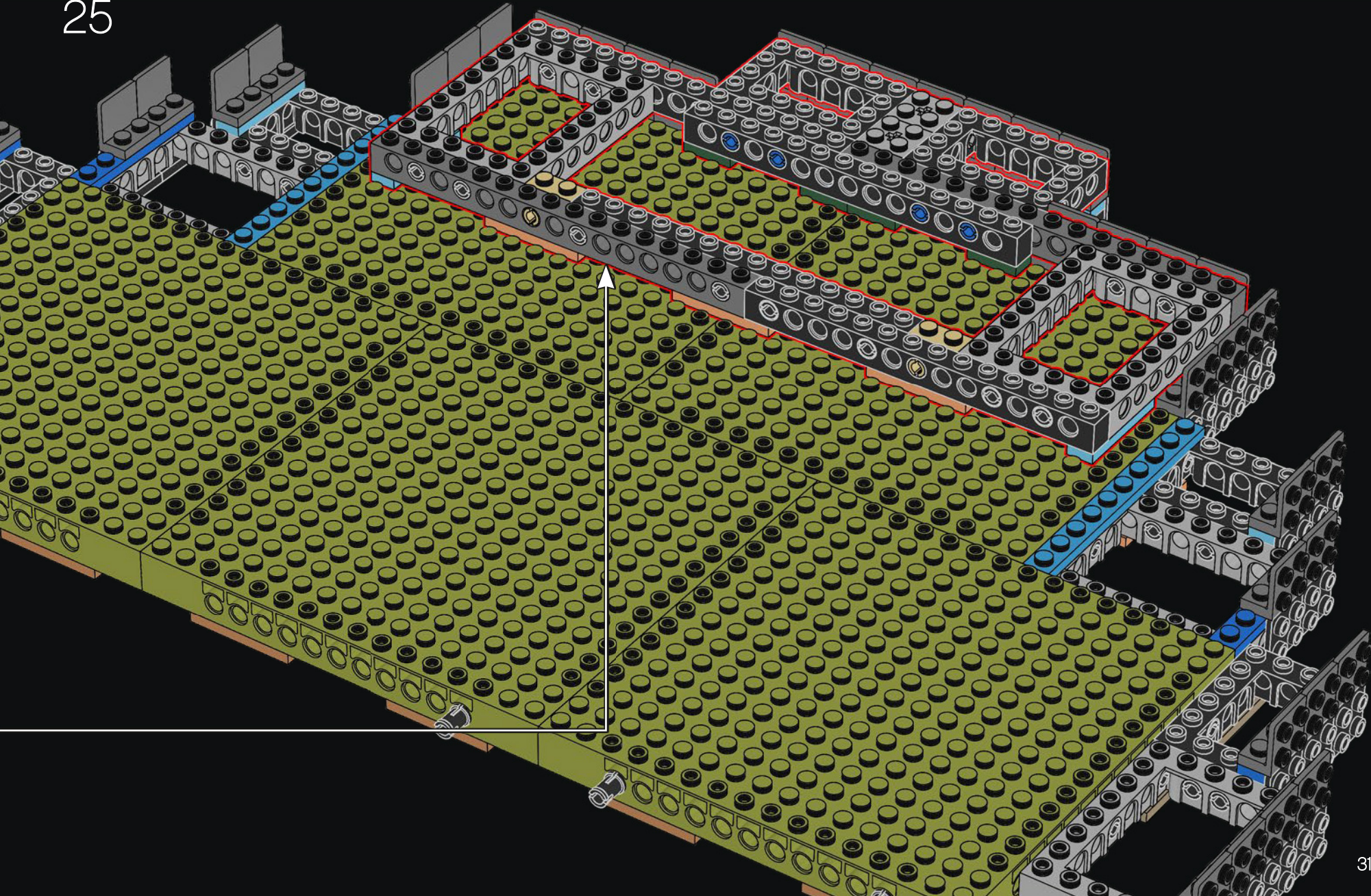

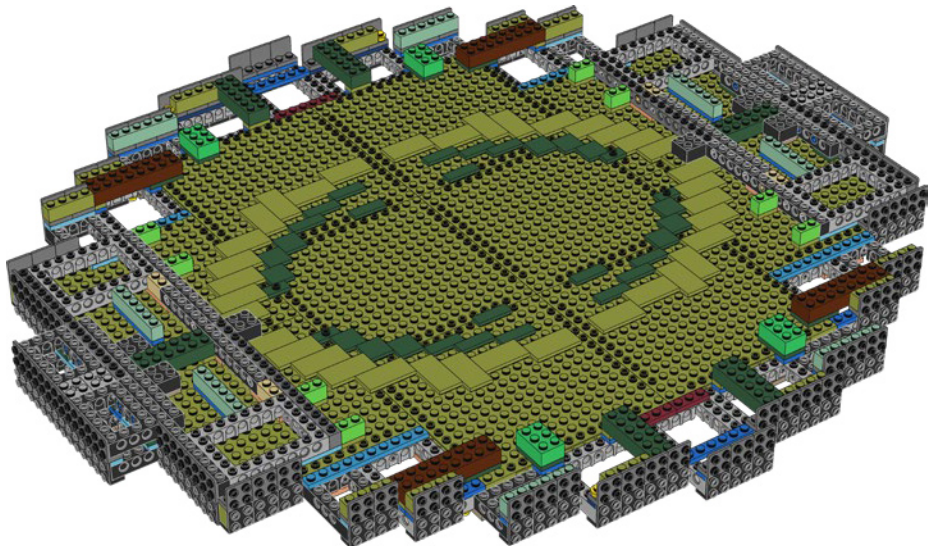



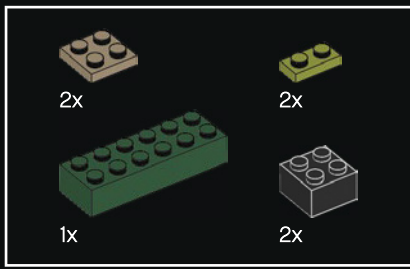

26

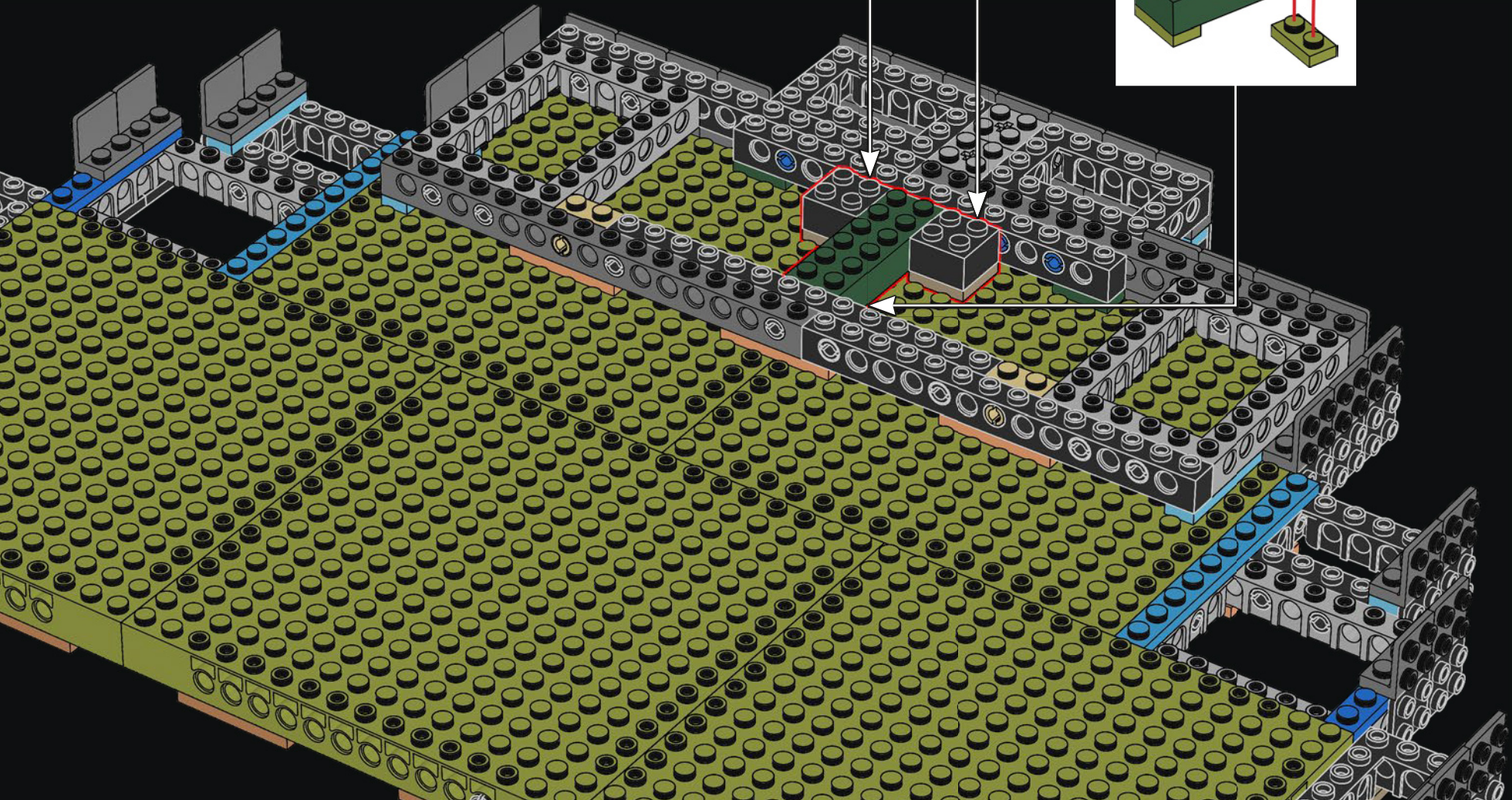
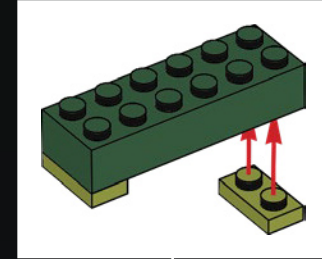
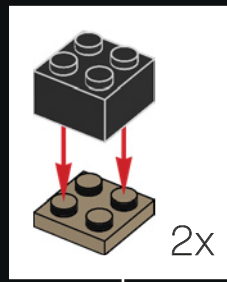

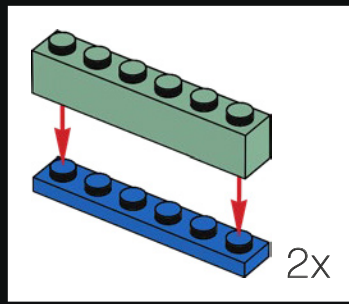
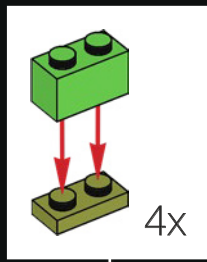
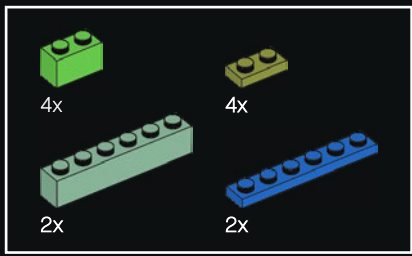

27

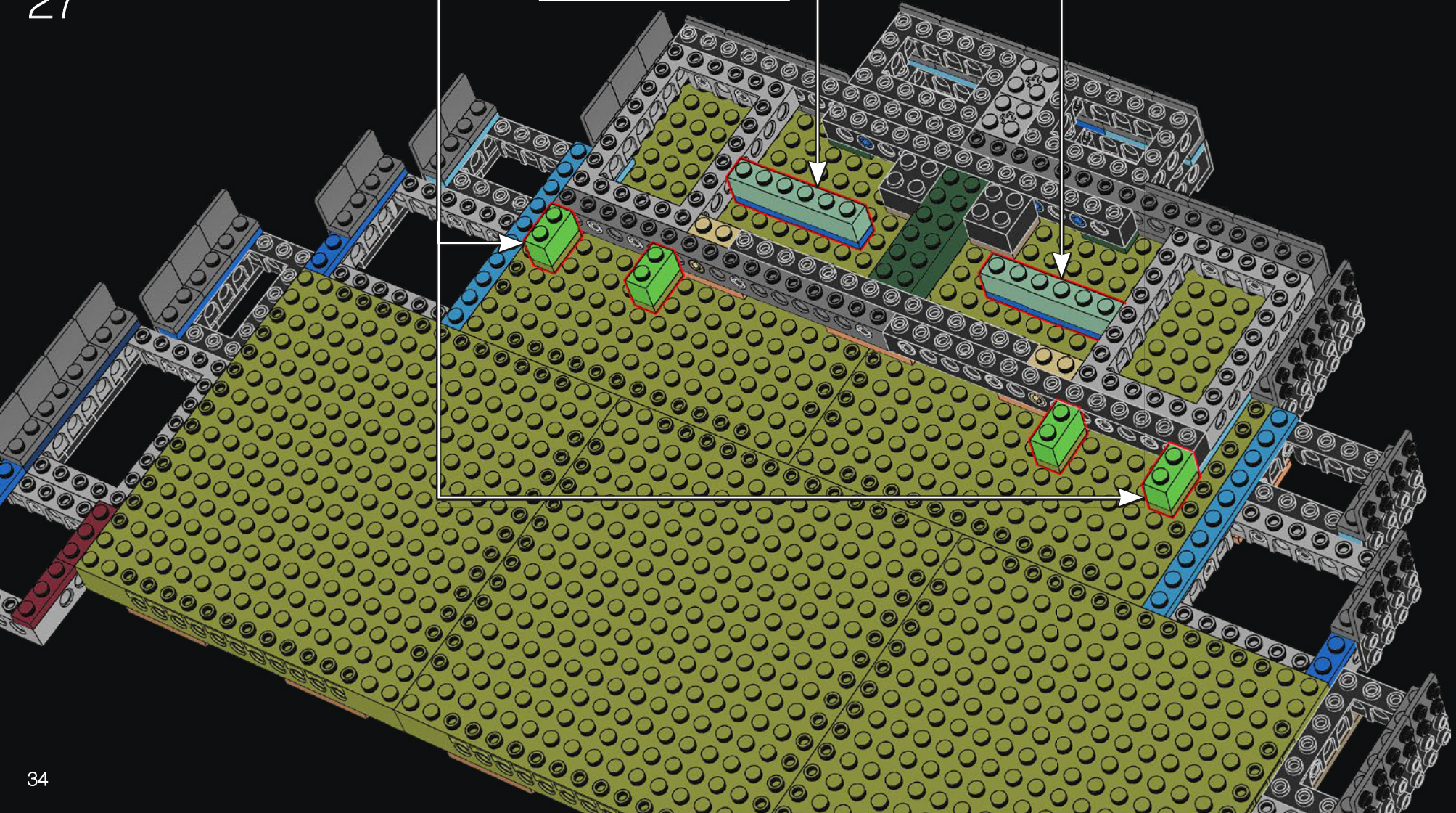

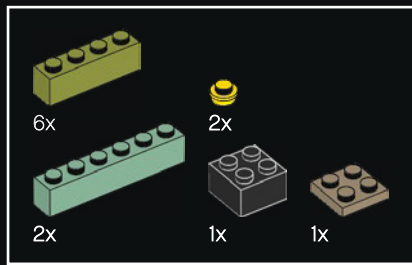

28

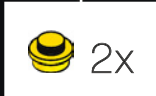
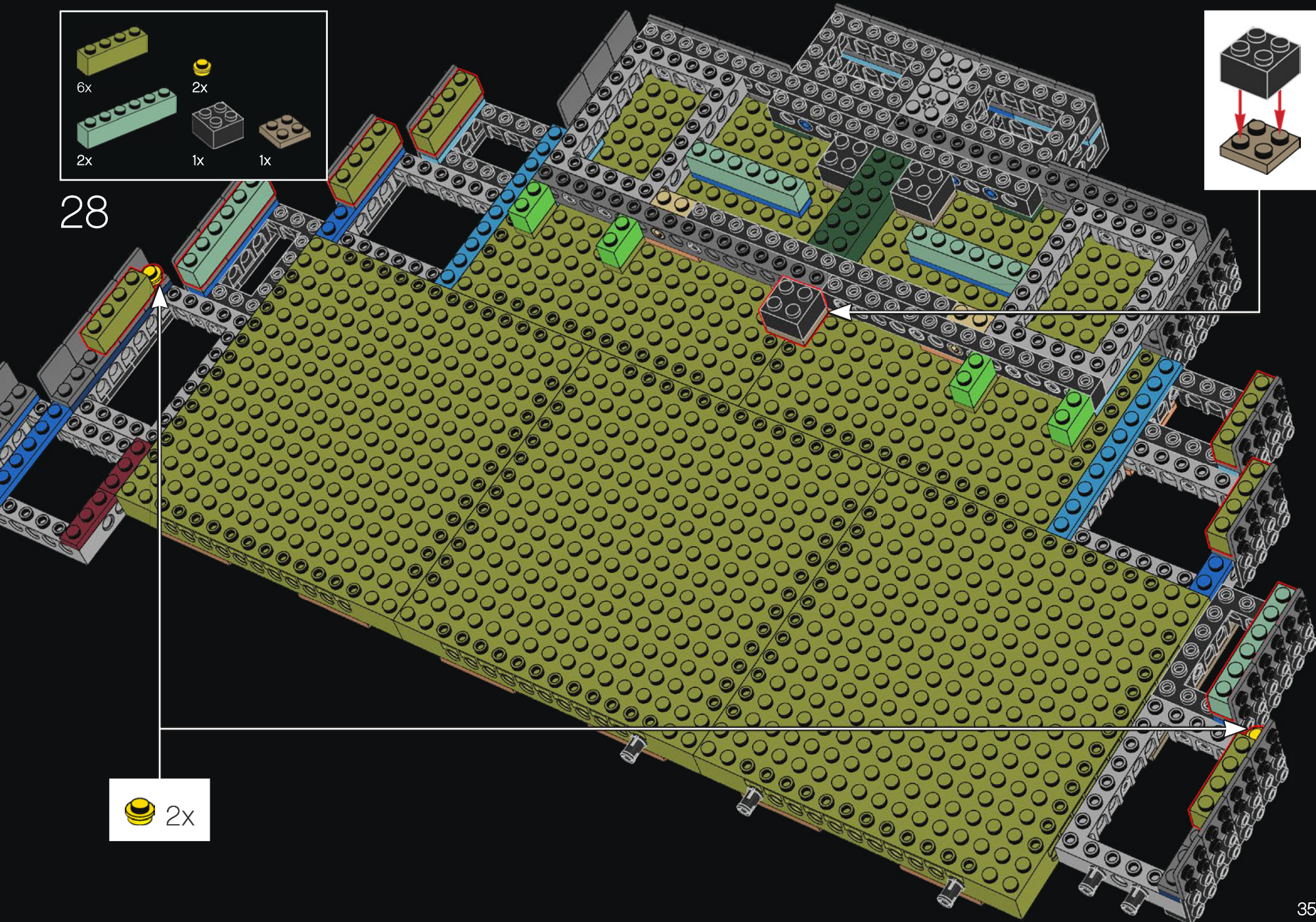
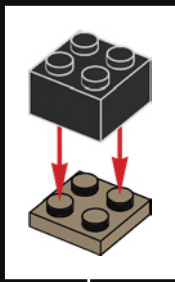

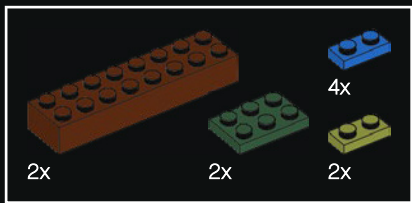

29

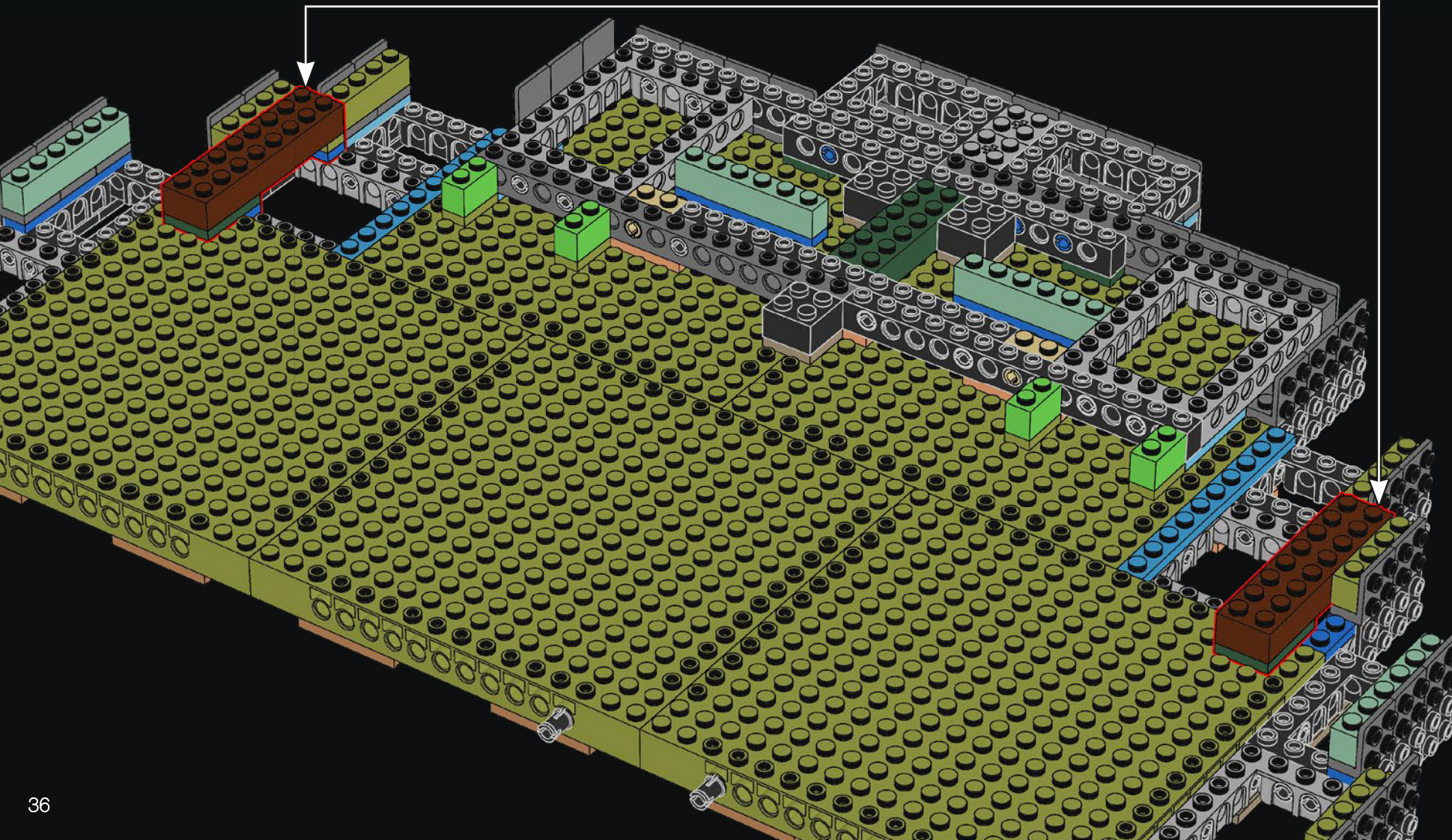
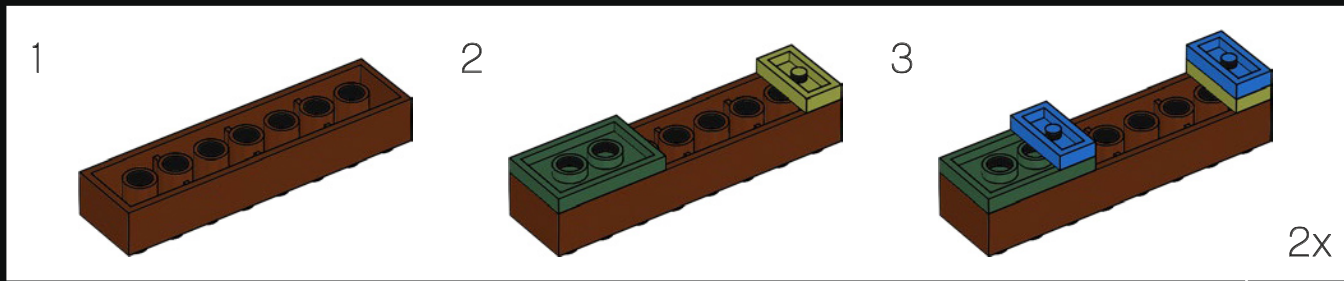

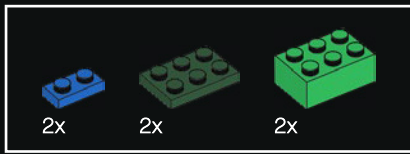

30

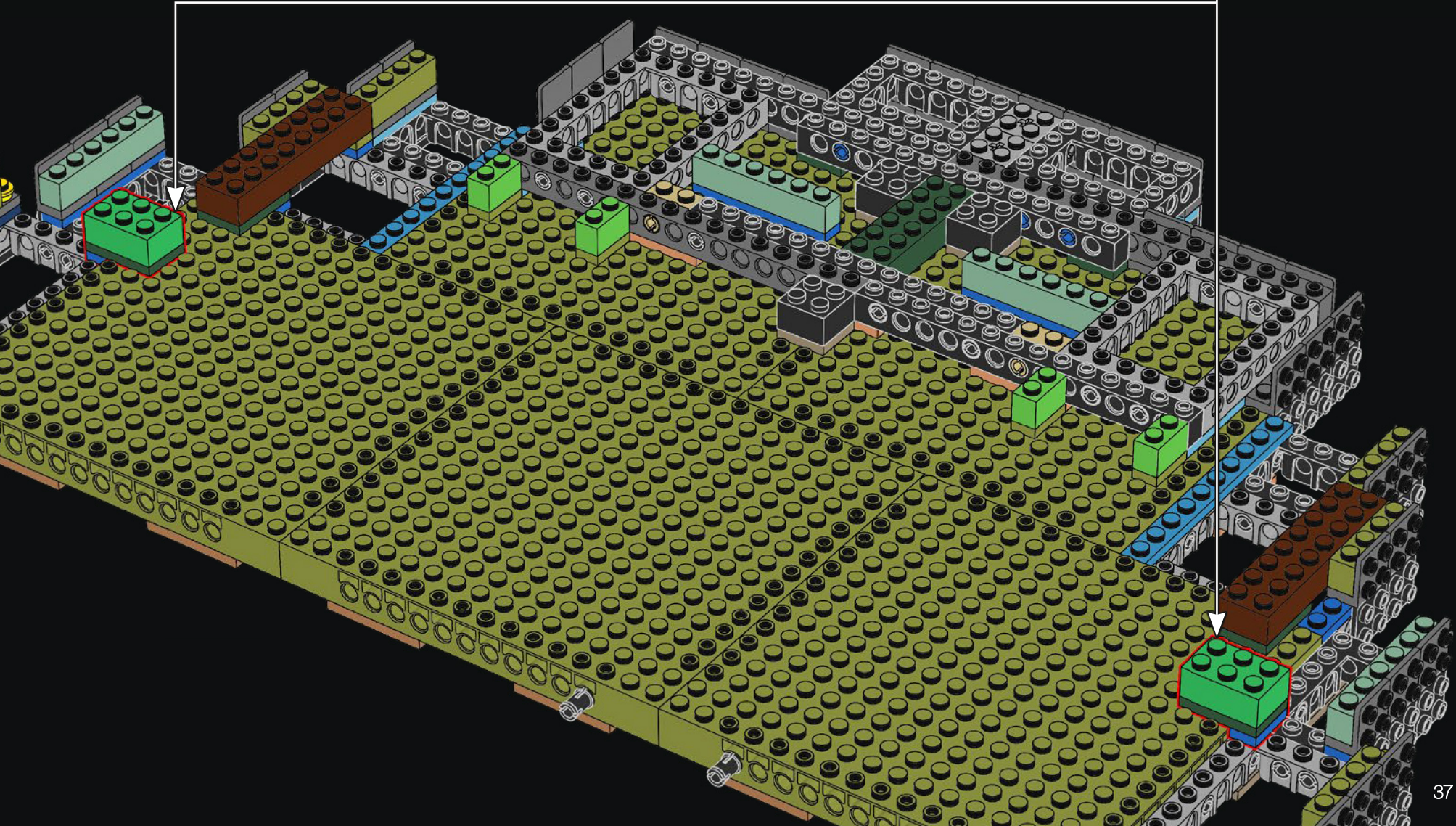
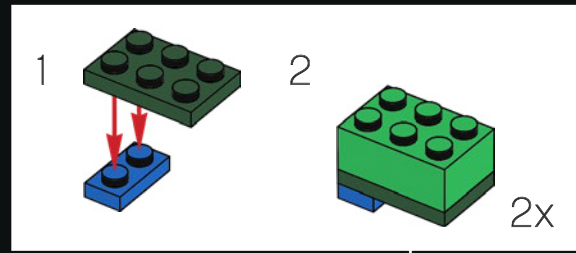

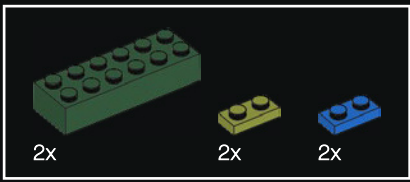

31

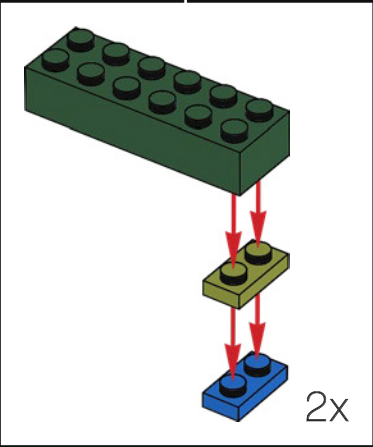
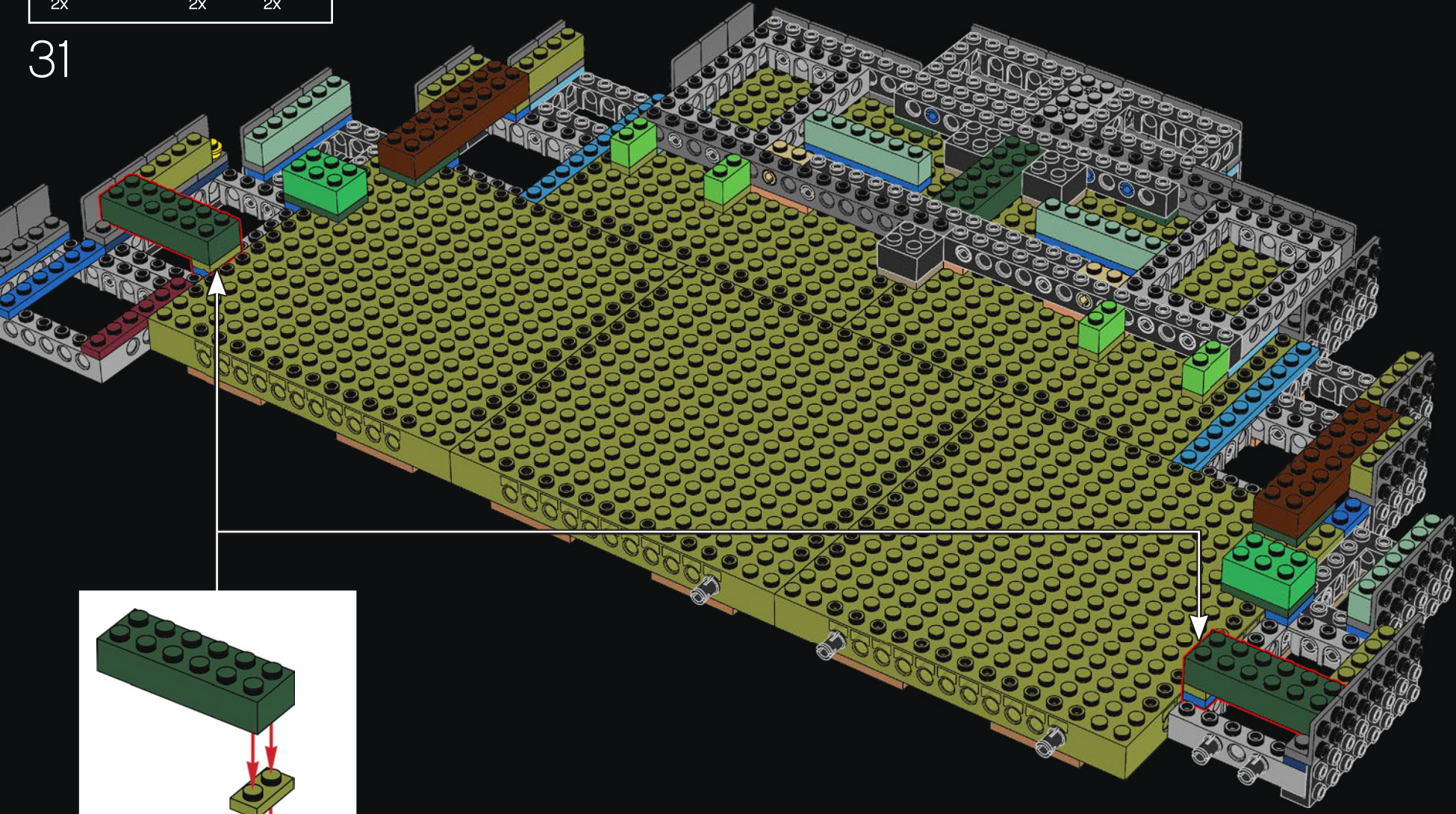

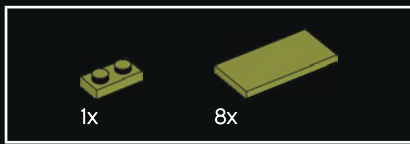

32



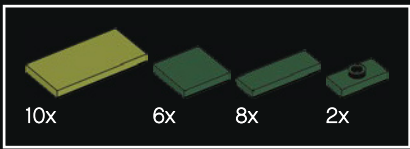

33

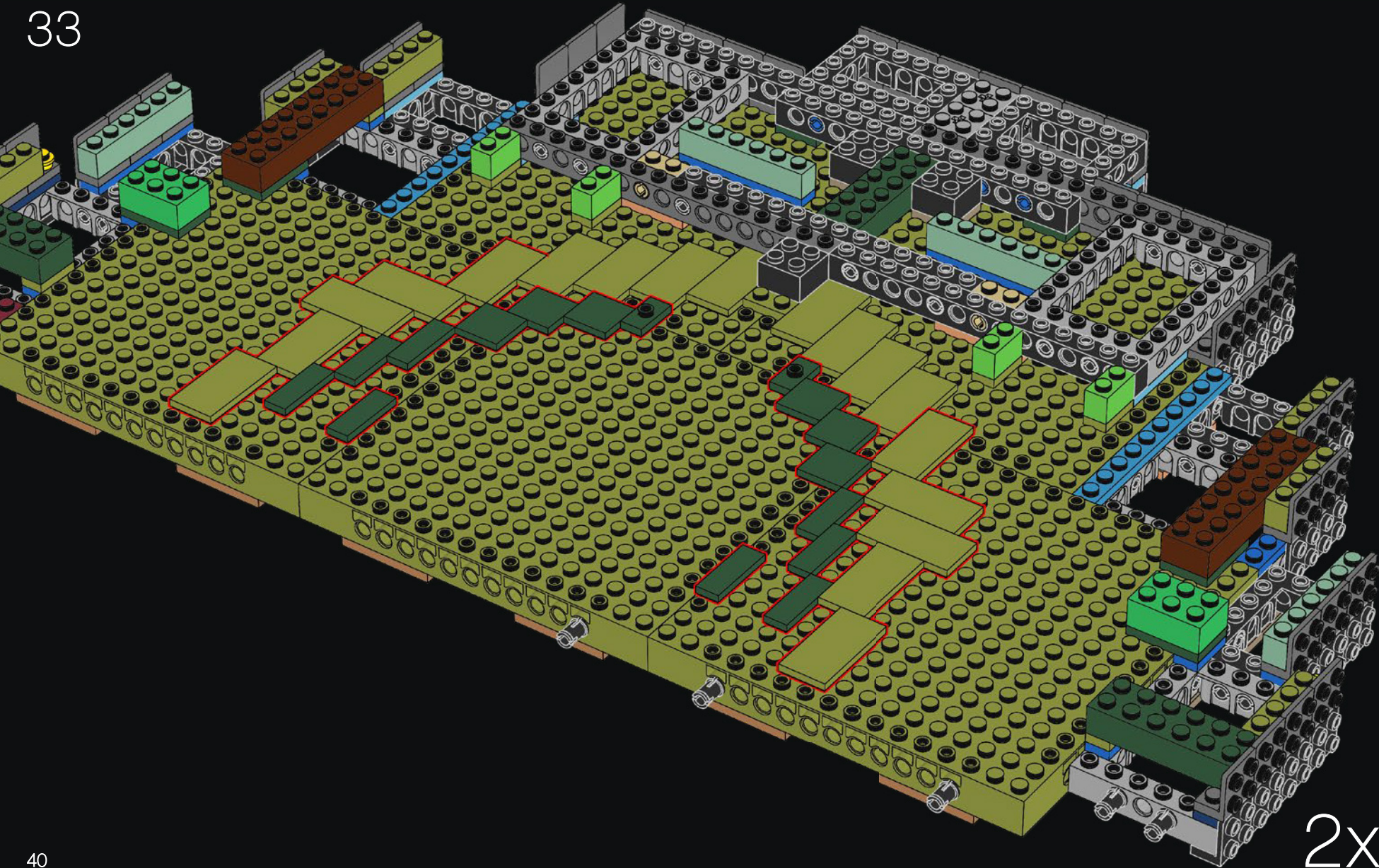

2x



34

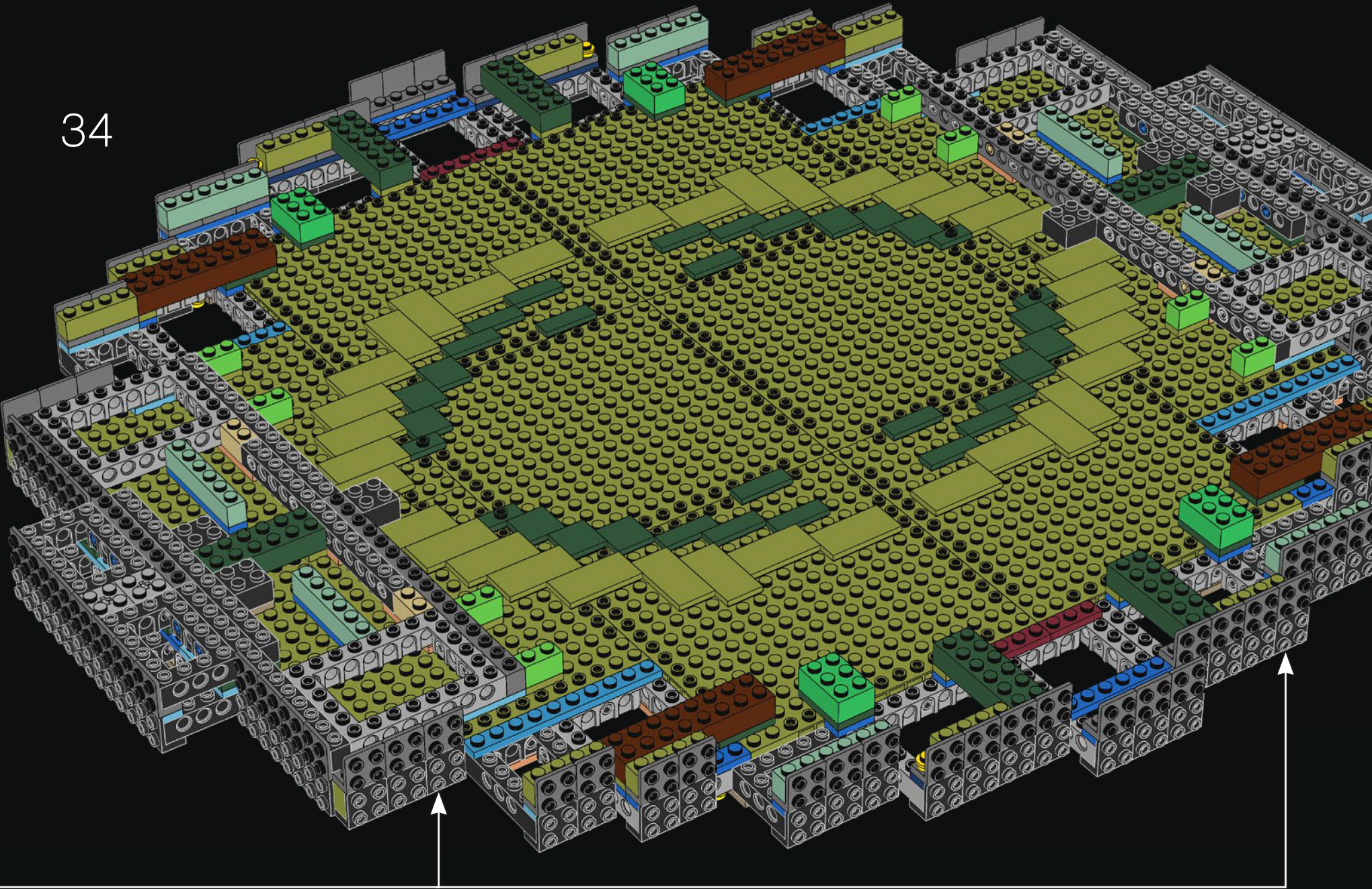

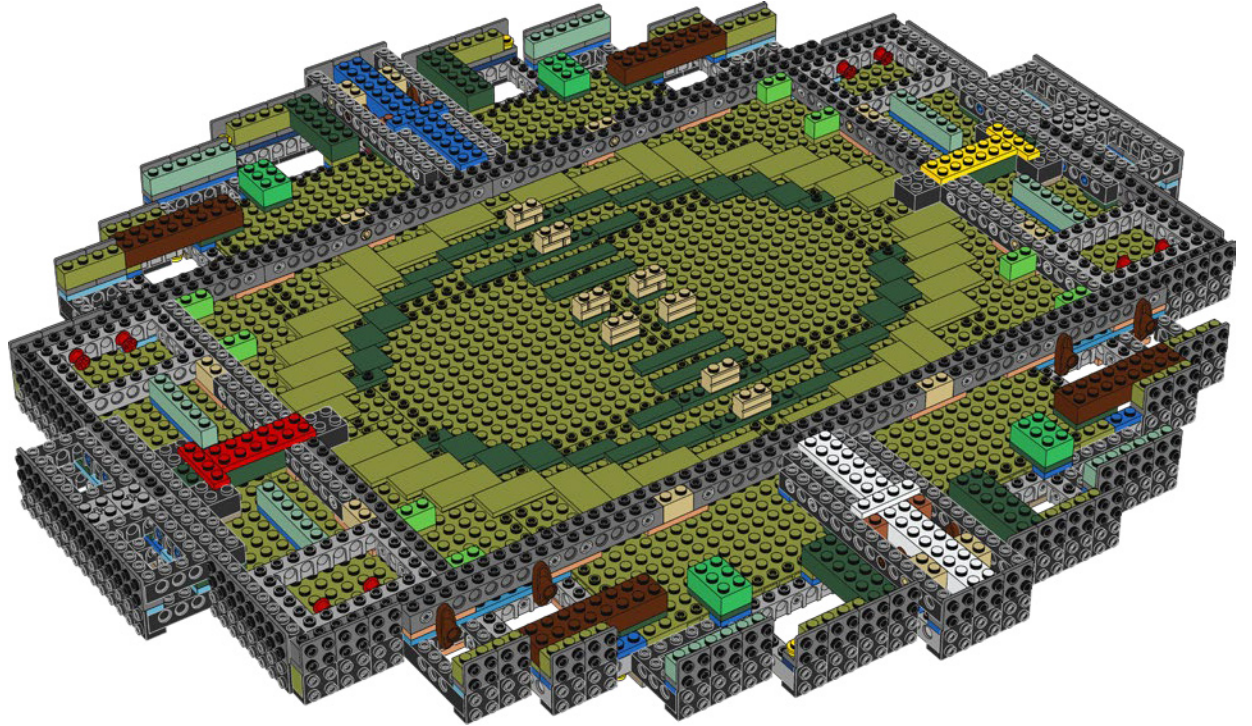

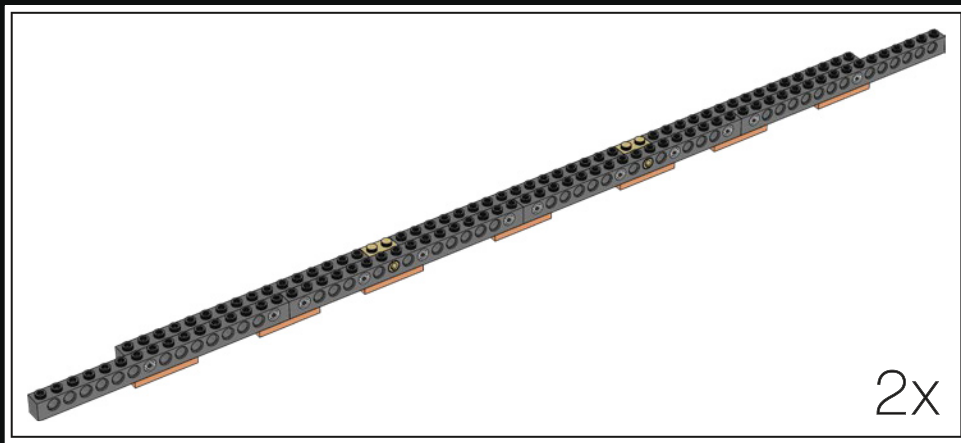

2x

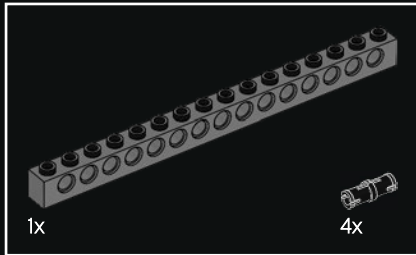

1x

4x

35

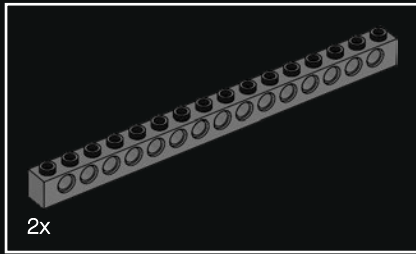
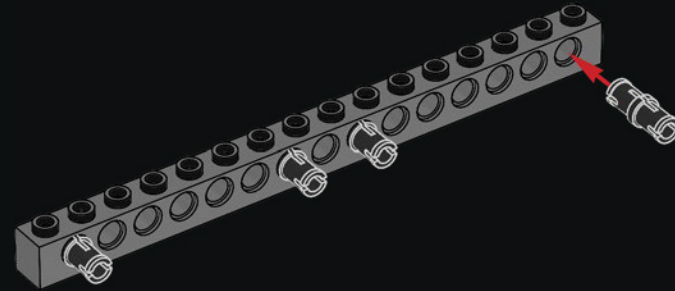

2x

36

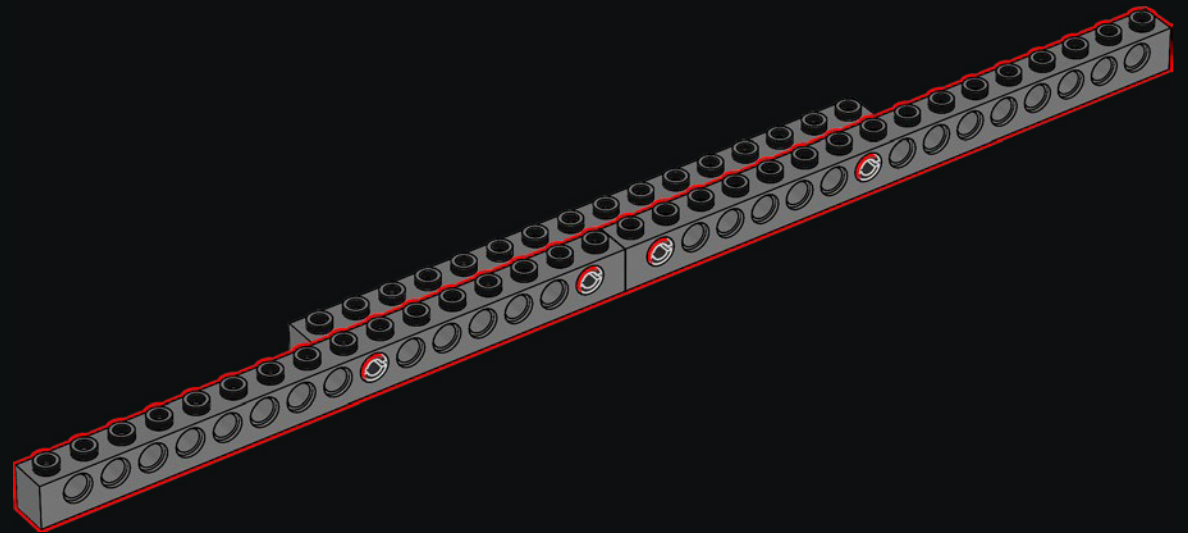



37

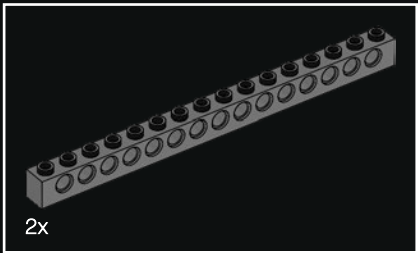
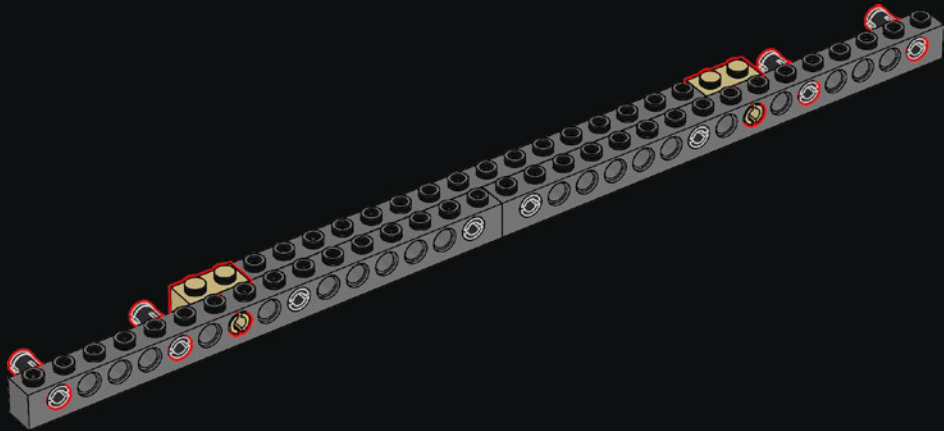

38

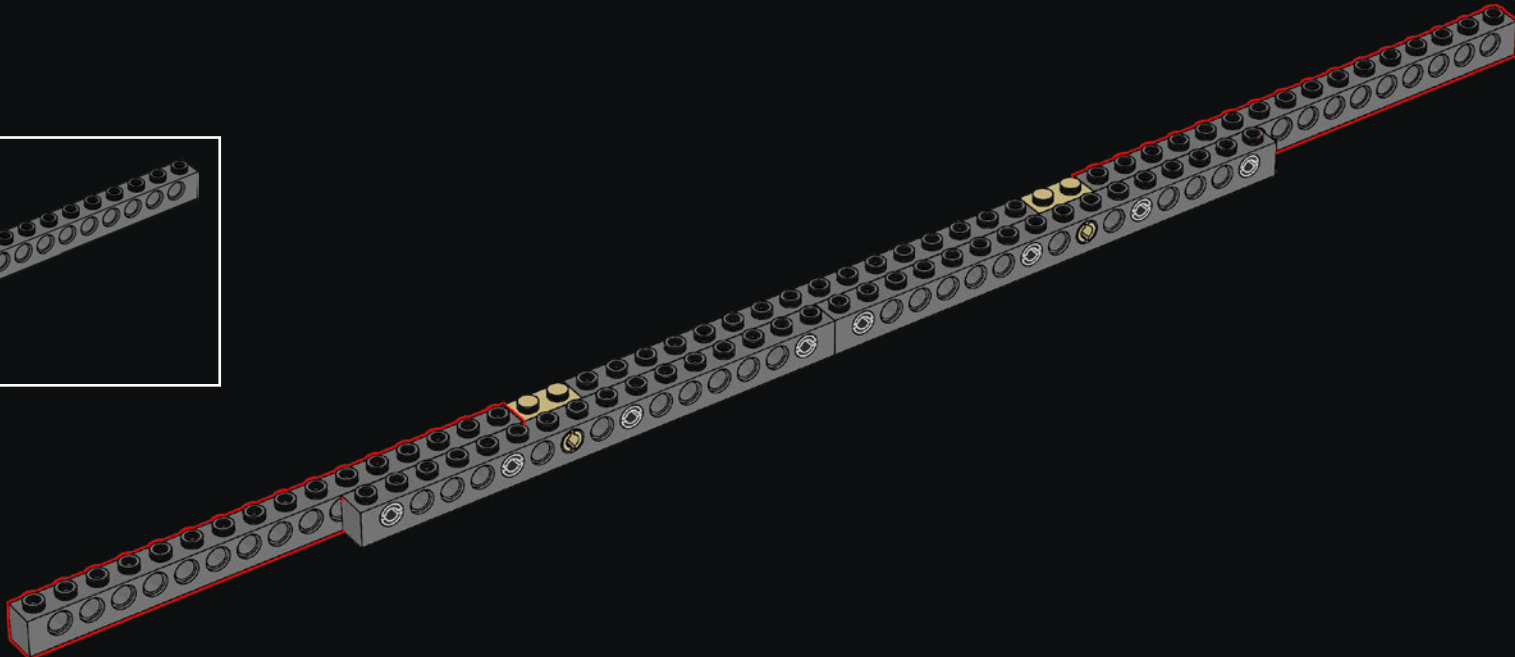



39

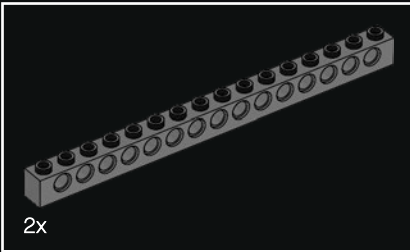
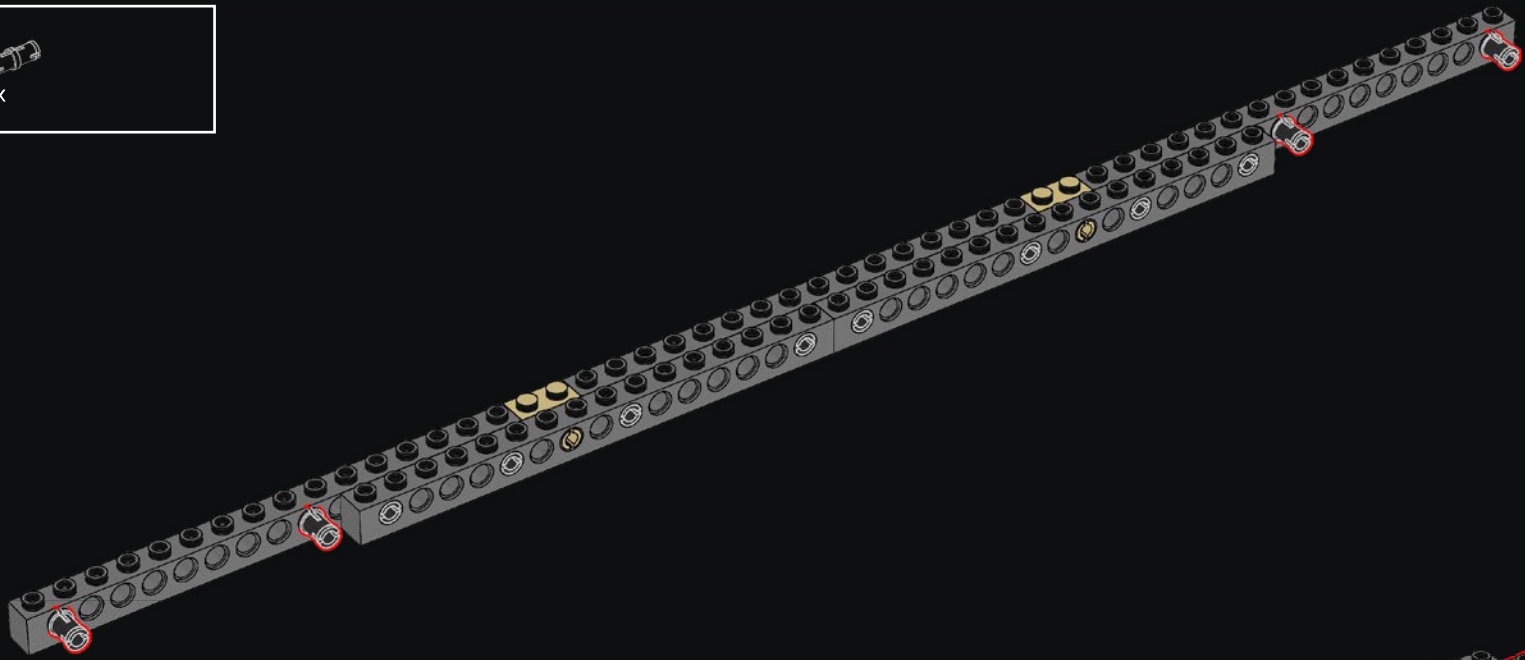

40



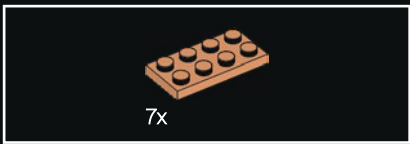

41

The Colosseum is also called the Flavian Amphitheater after the 3 emperors of the Flavian dynasty who built and modified it.

Le Colisée est également connu sous le nom d'amphithéâtre Flavian, d'après les 3 empereurs de la dynastie flavienne qui l'ont construit puis altéré.

El Coliseo se conoce también como *Anfiteatro Flavio* por los 3 emperadores de la dinastía flavia que lo construyeron y reformaron.

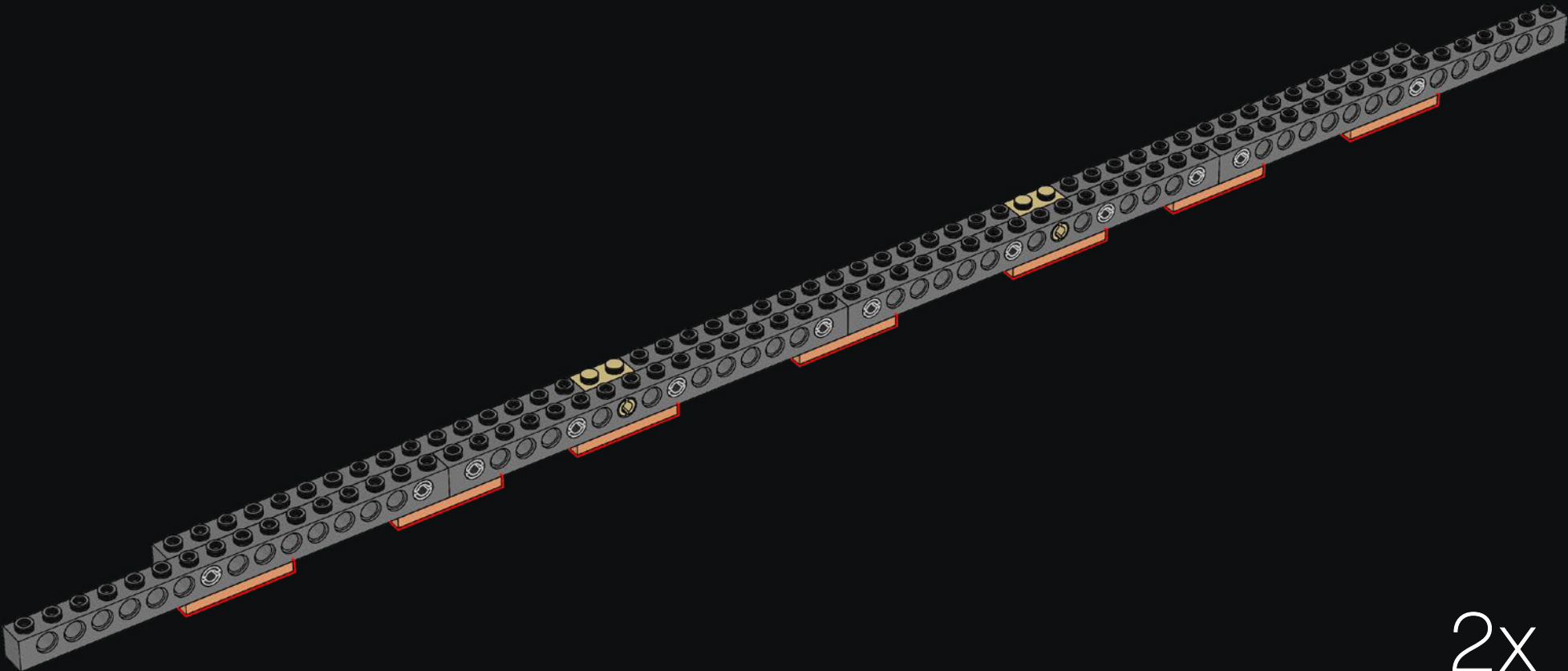

2x

42

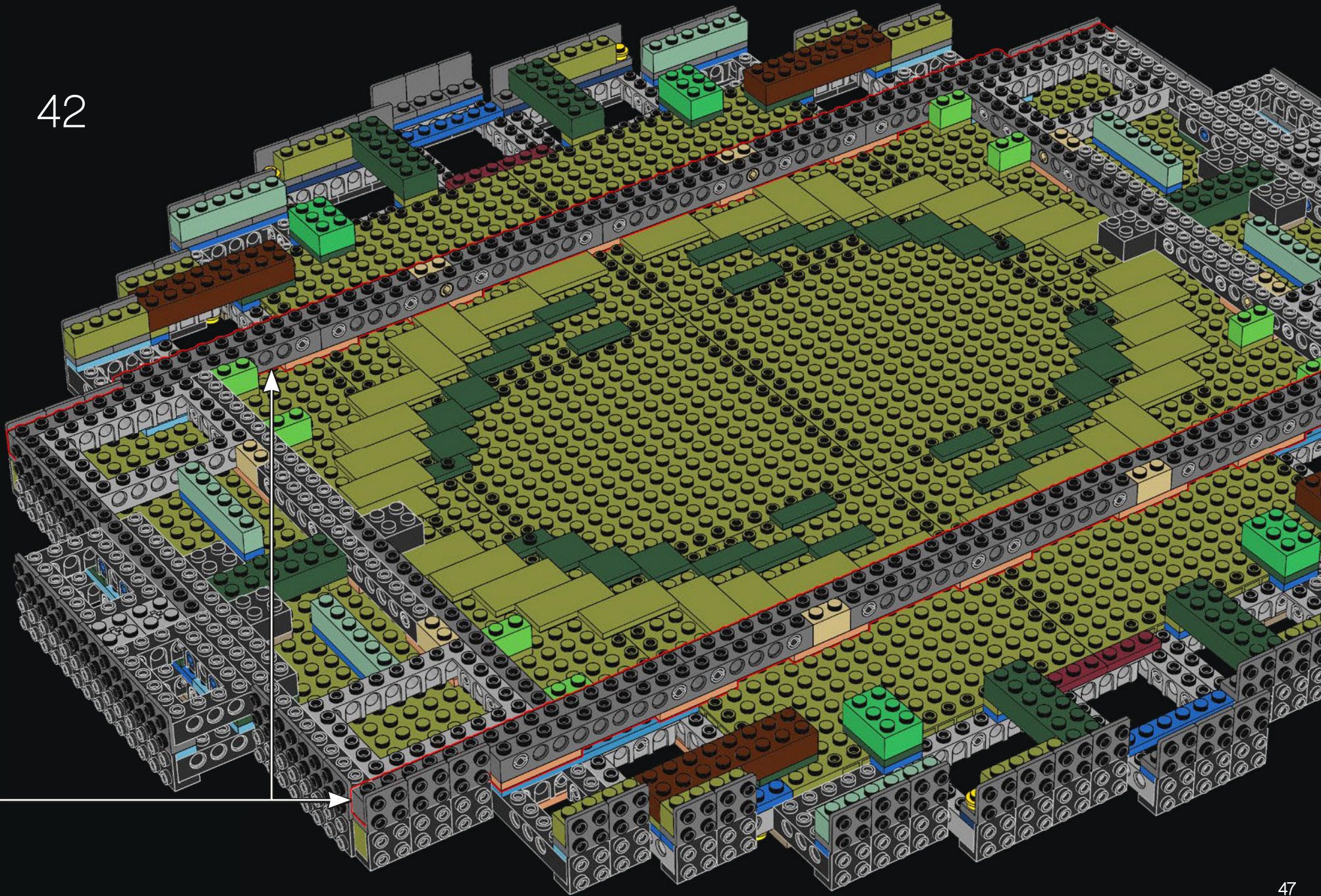



43







44

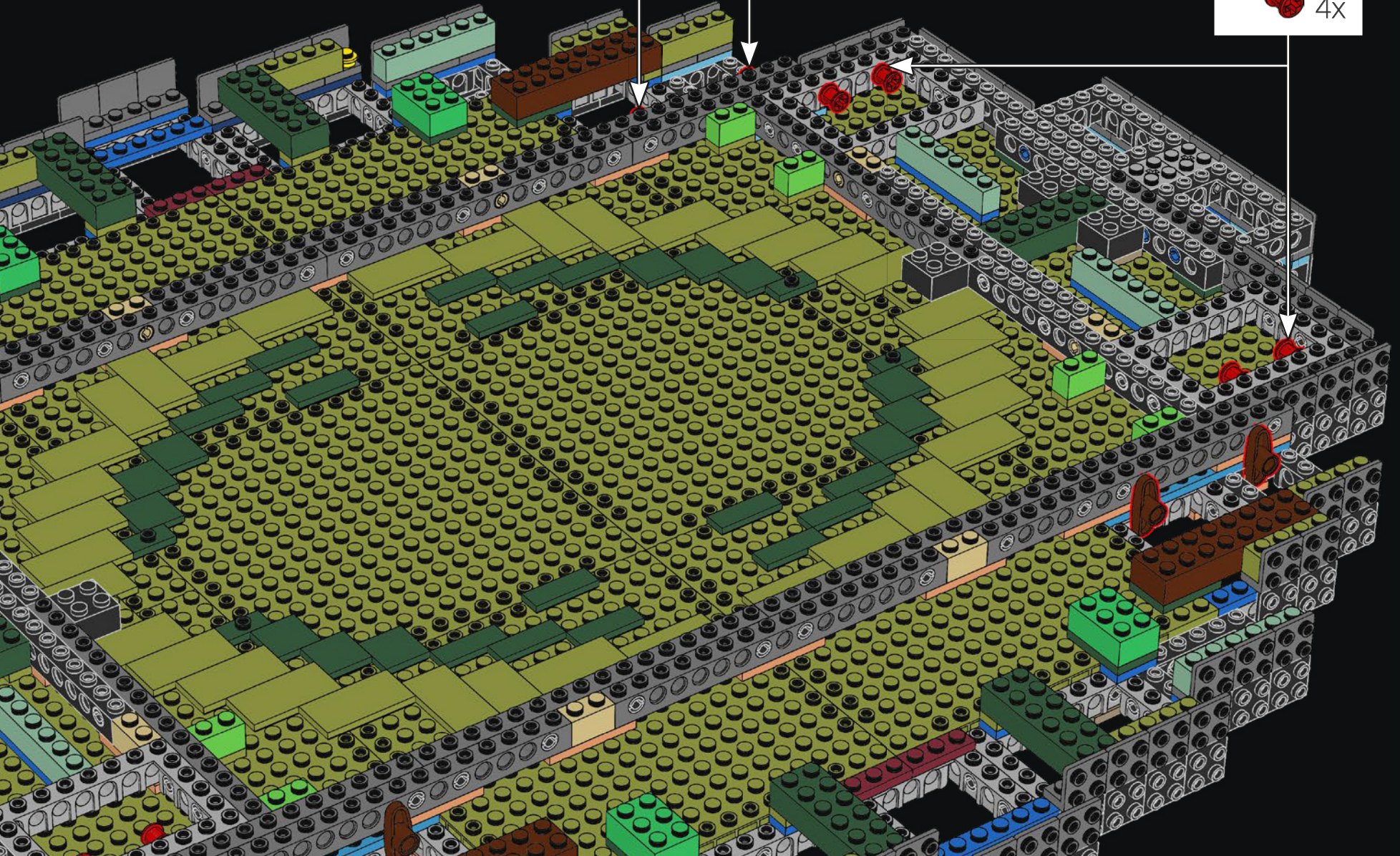

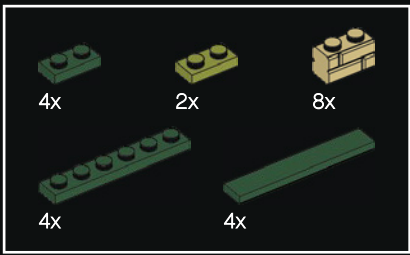

45

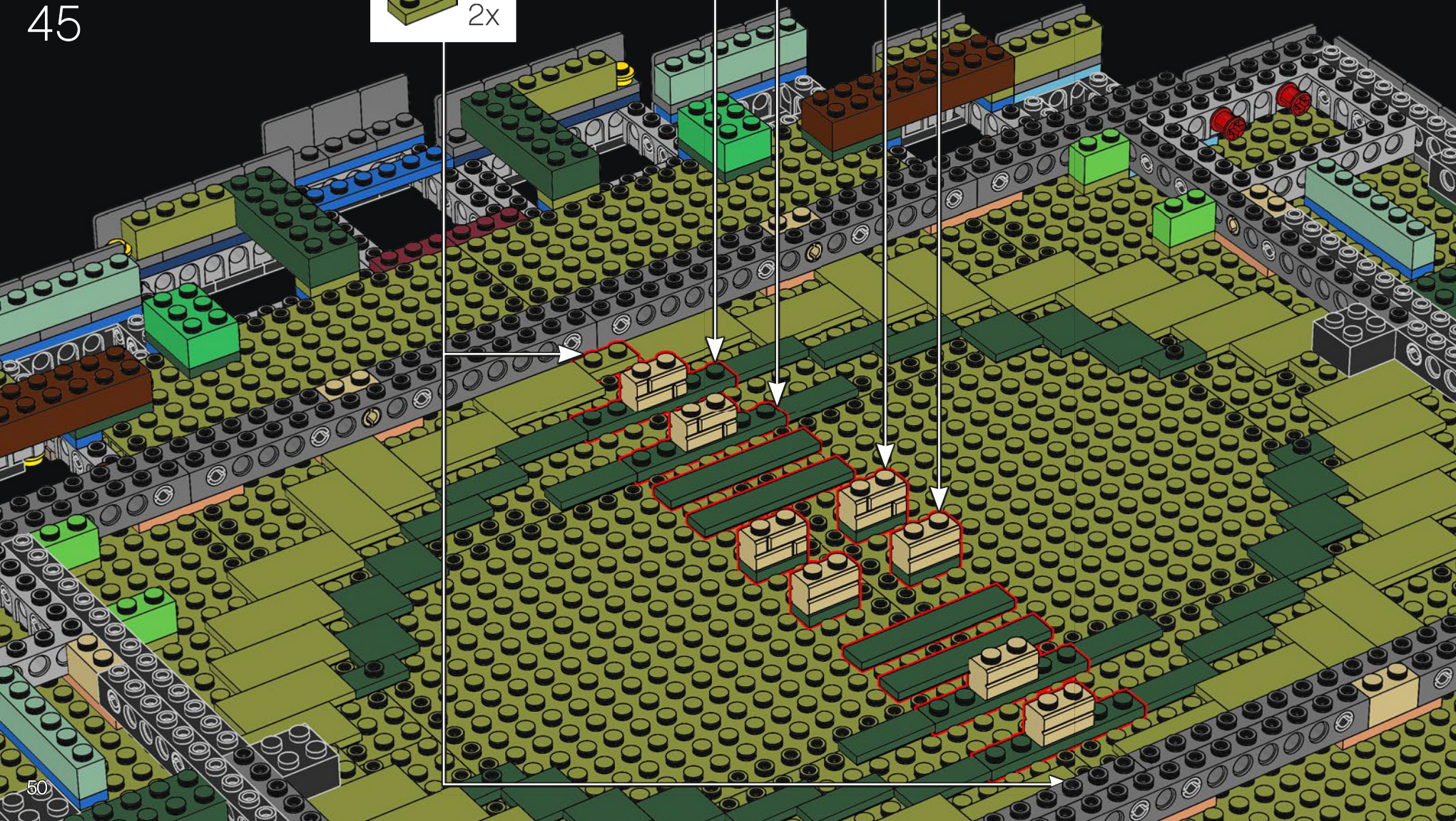
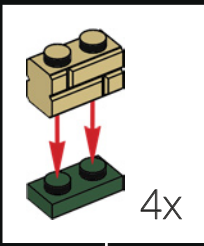
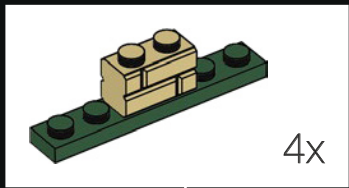
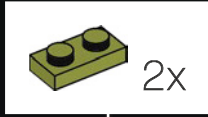

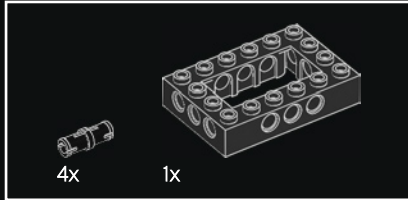
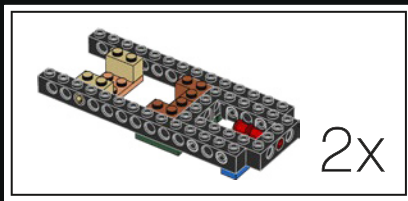

46

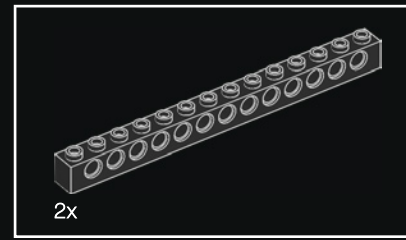
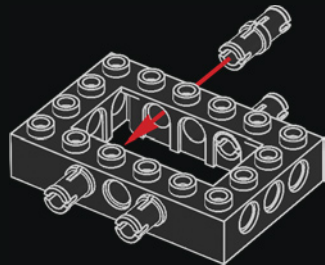

47

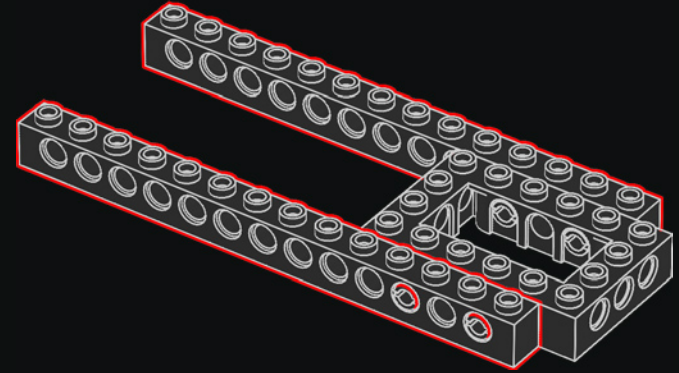

48

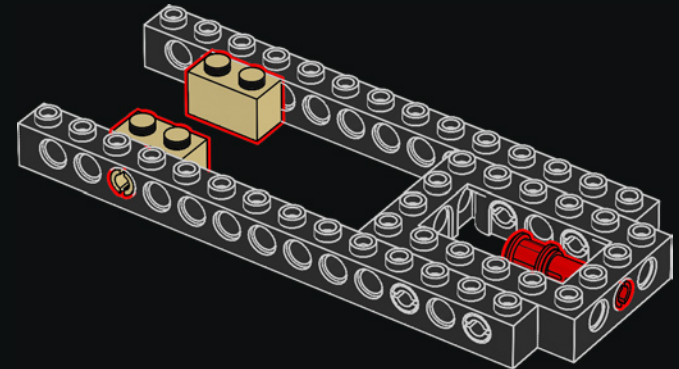

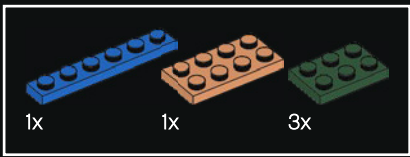

49

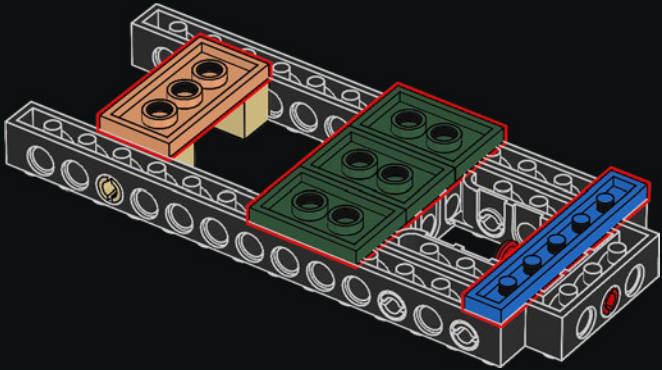

50

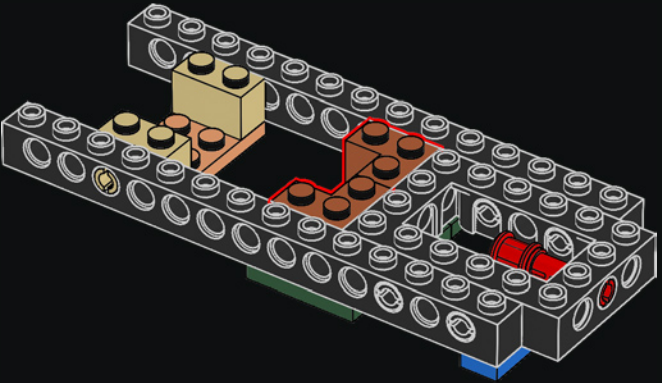

2x

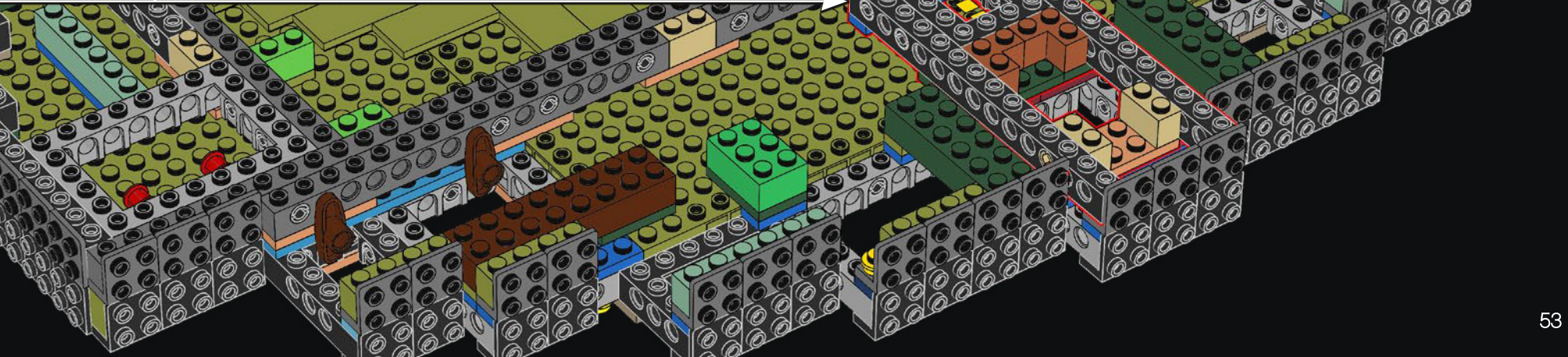
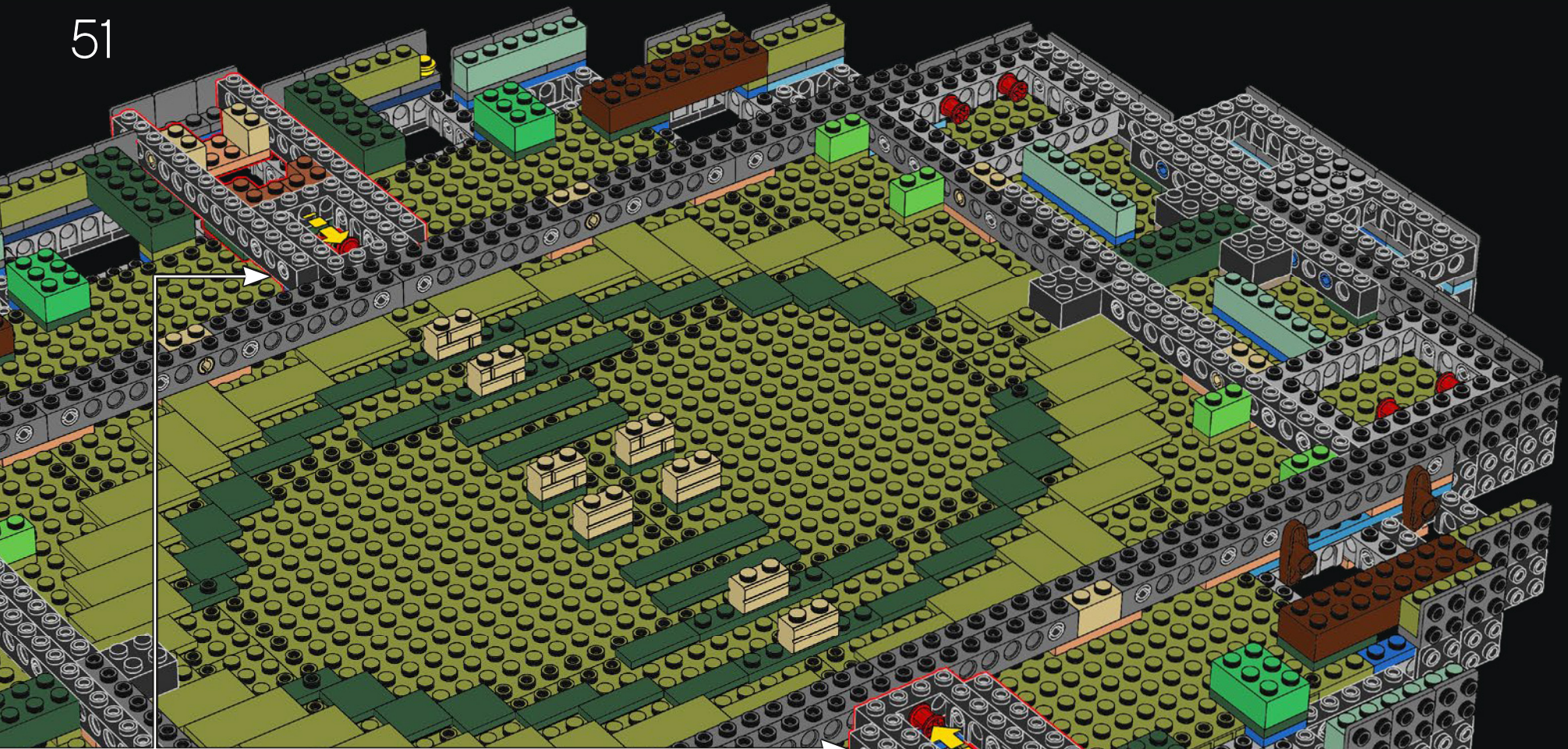



52

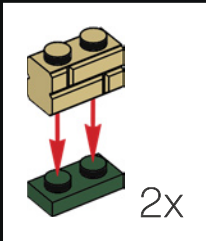

54

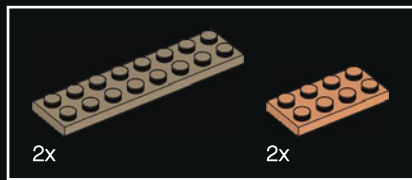

53

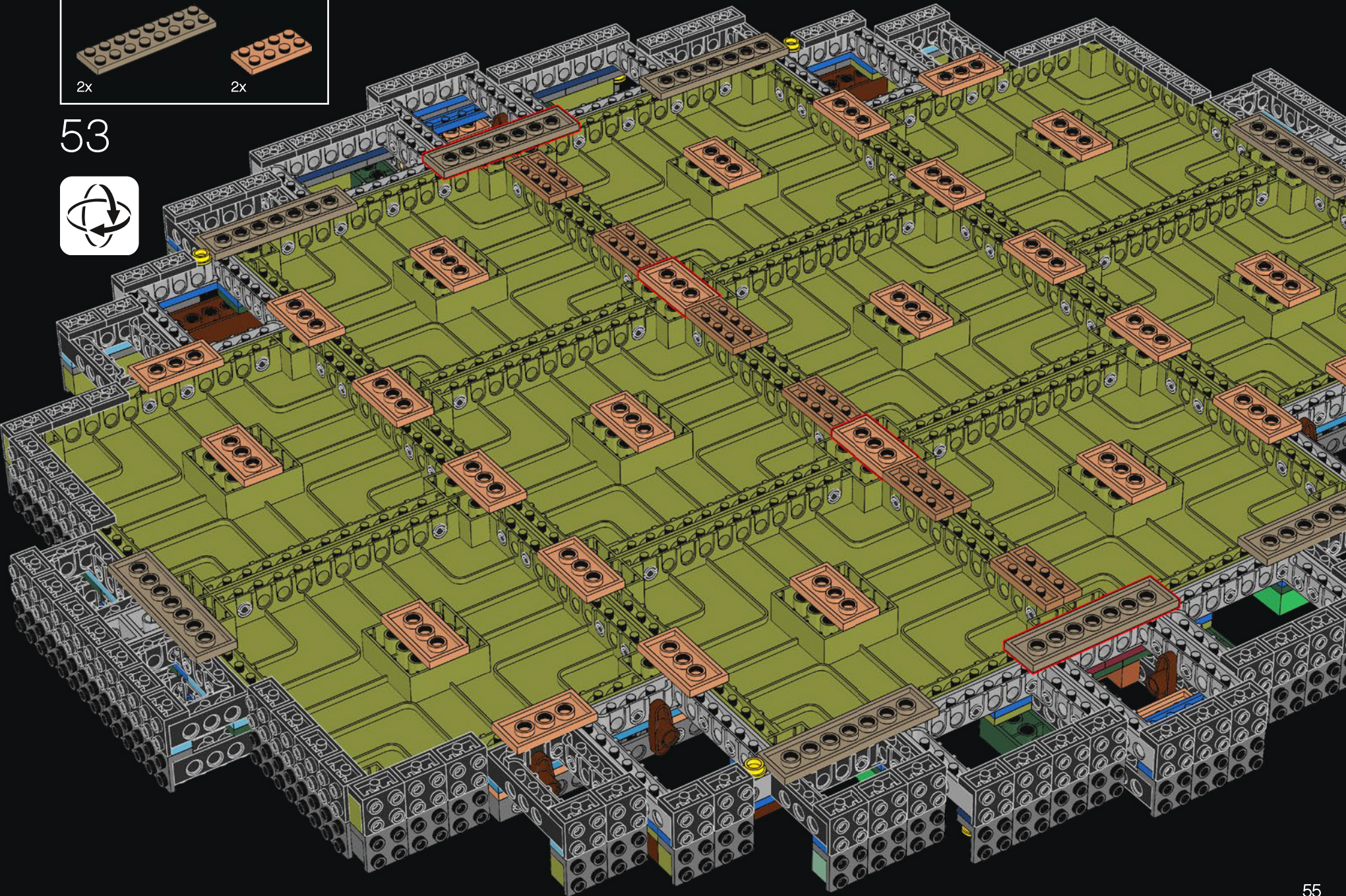

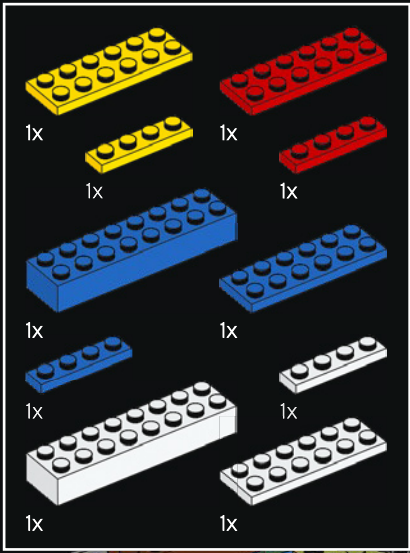

54





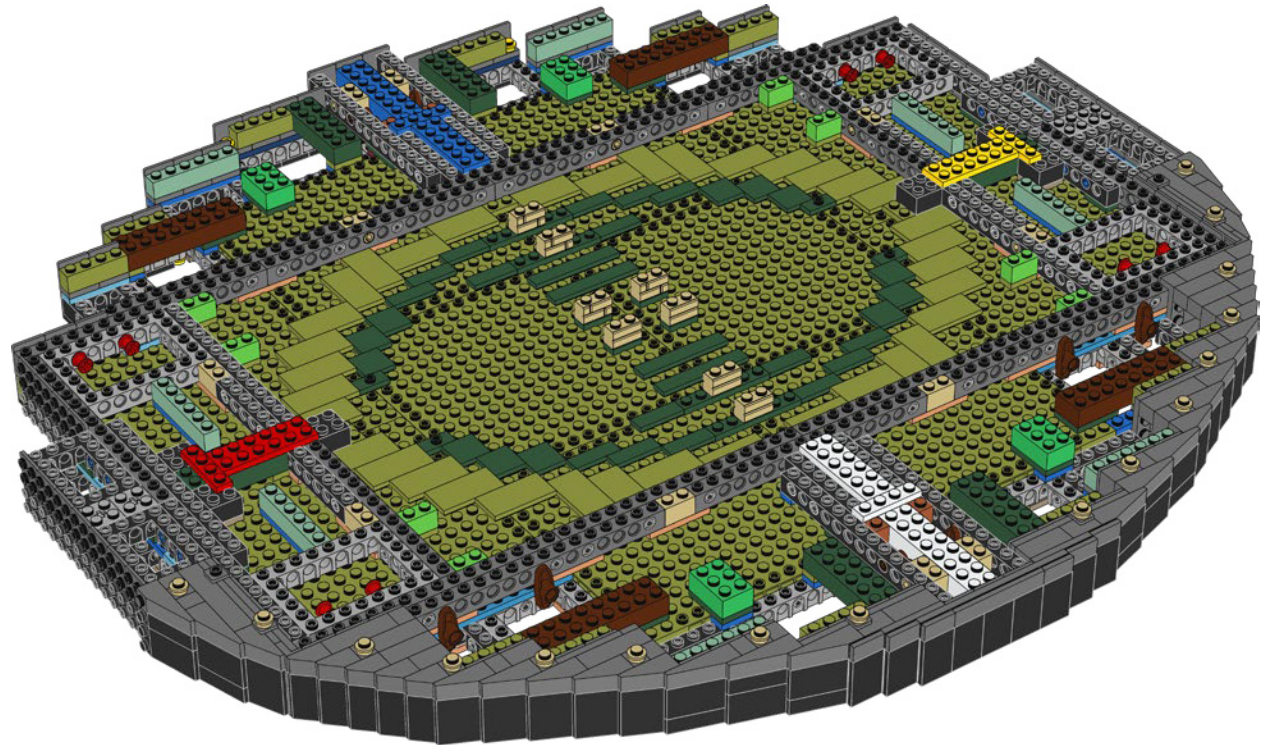
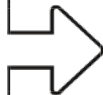

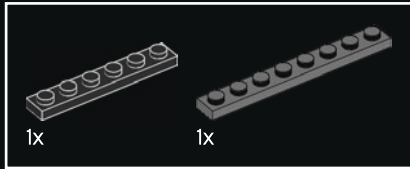
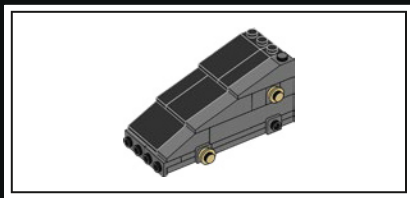

55

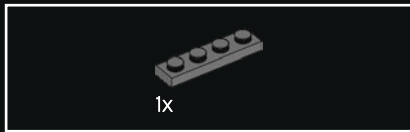
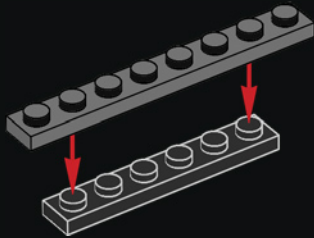

56

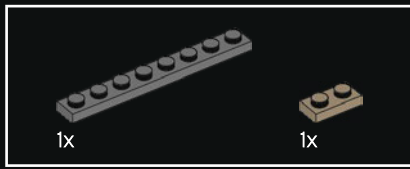
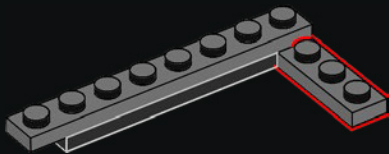

57

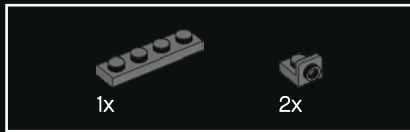
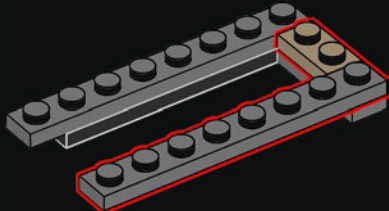

58

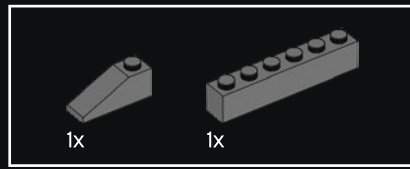
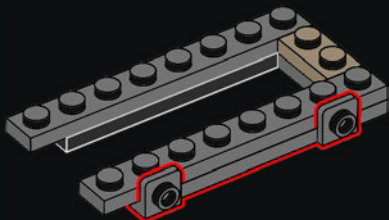

59

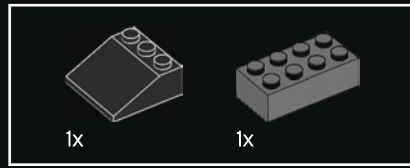
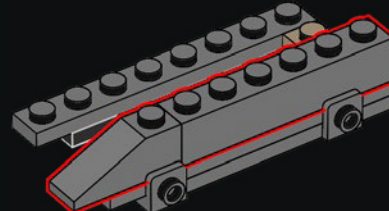

60

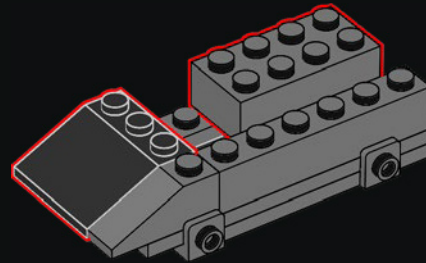

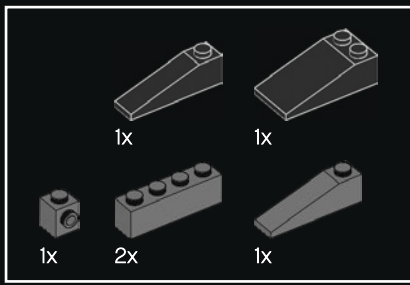

61

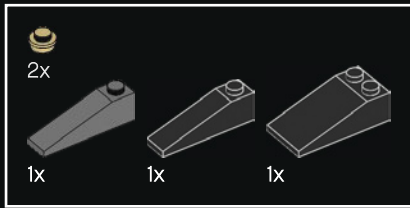
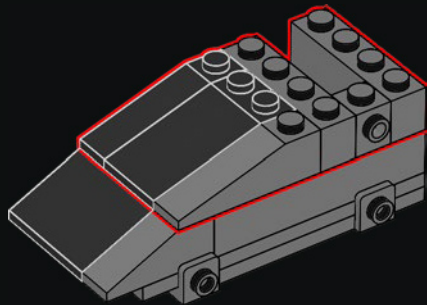

62

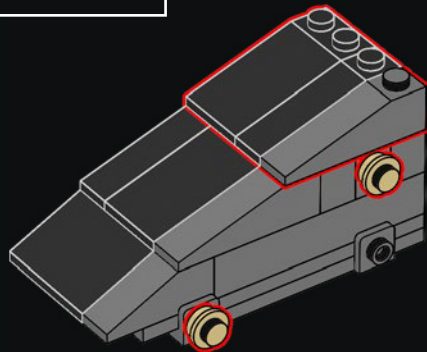

63

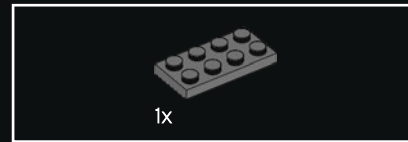
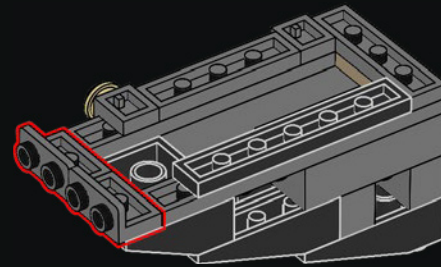

64

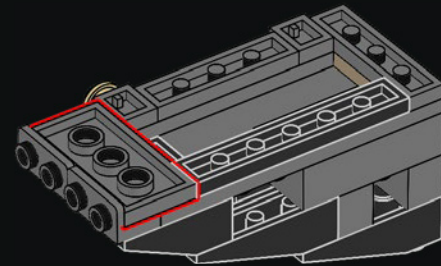

65

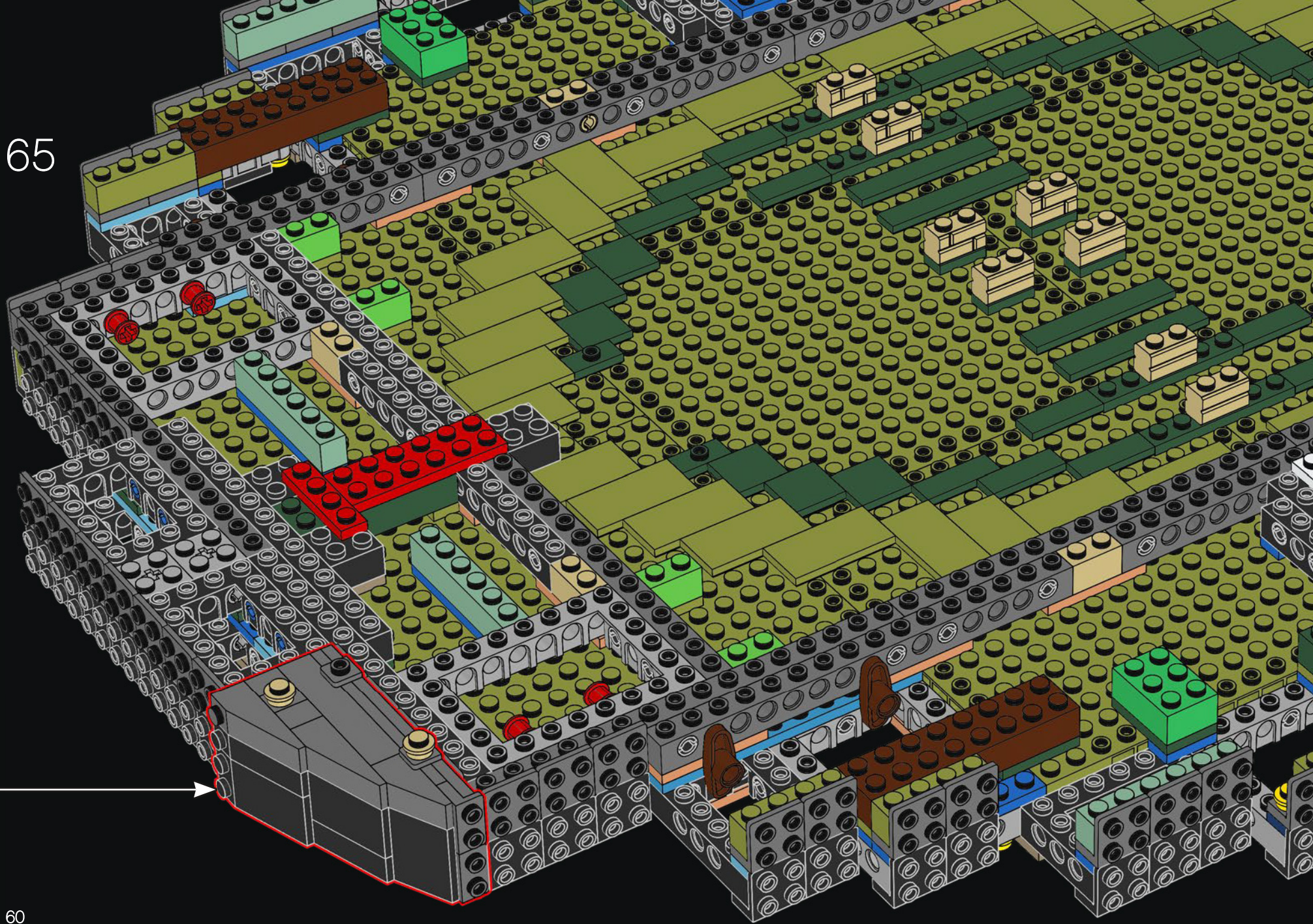

60

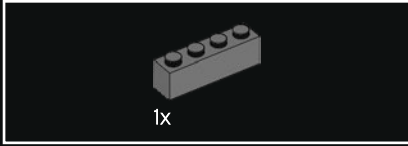
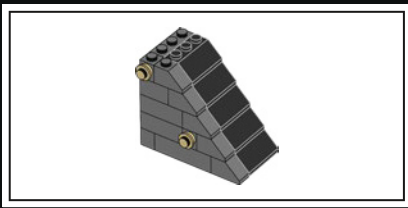

1x

66

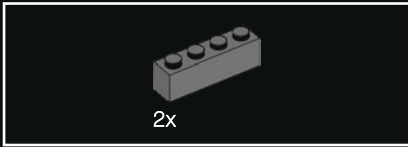

2x

67

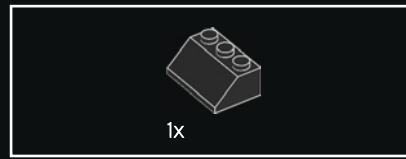
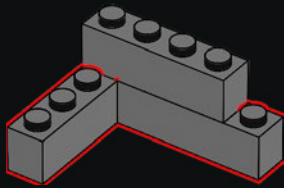

1x

68

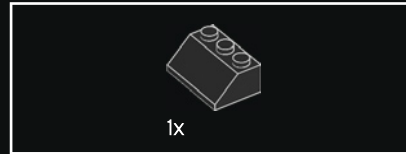
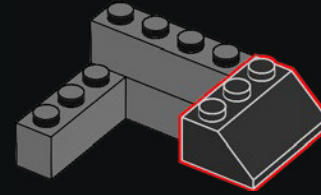

1x

69

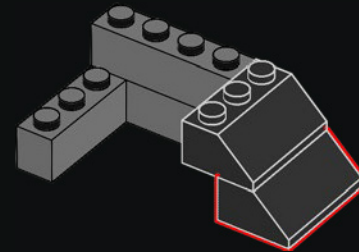

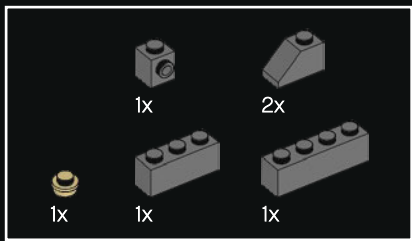

70

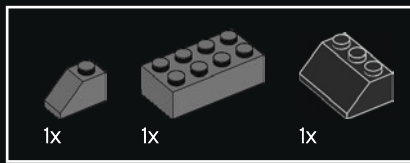
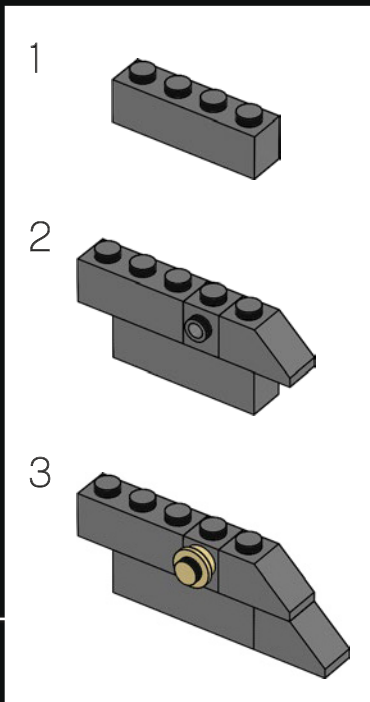
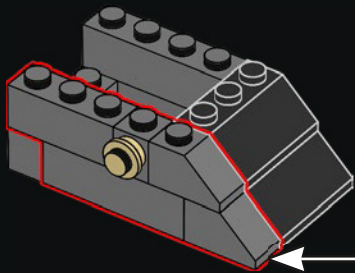

72

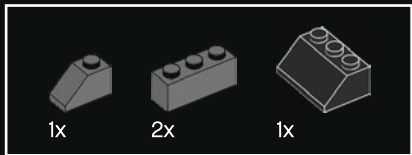
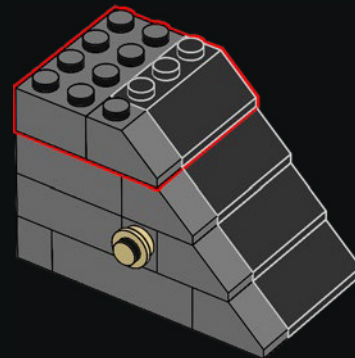

71

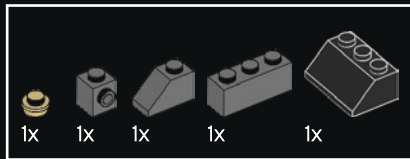
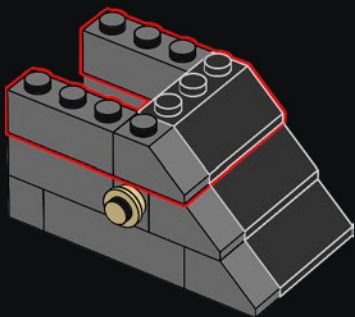

73

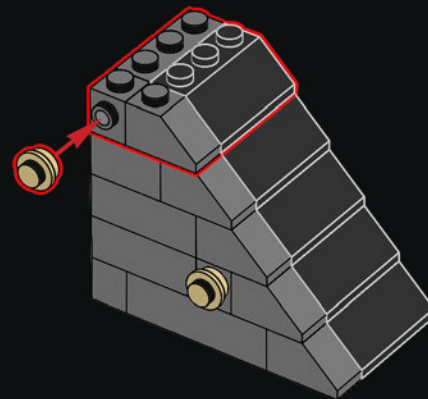

74

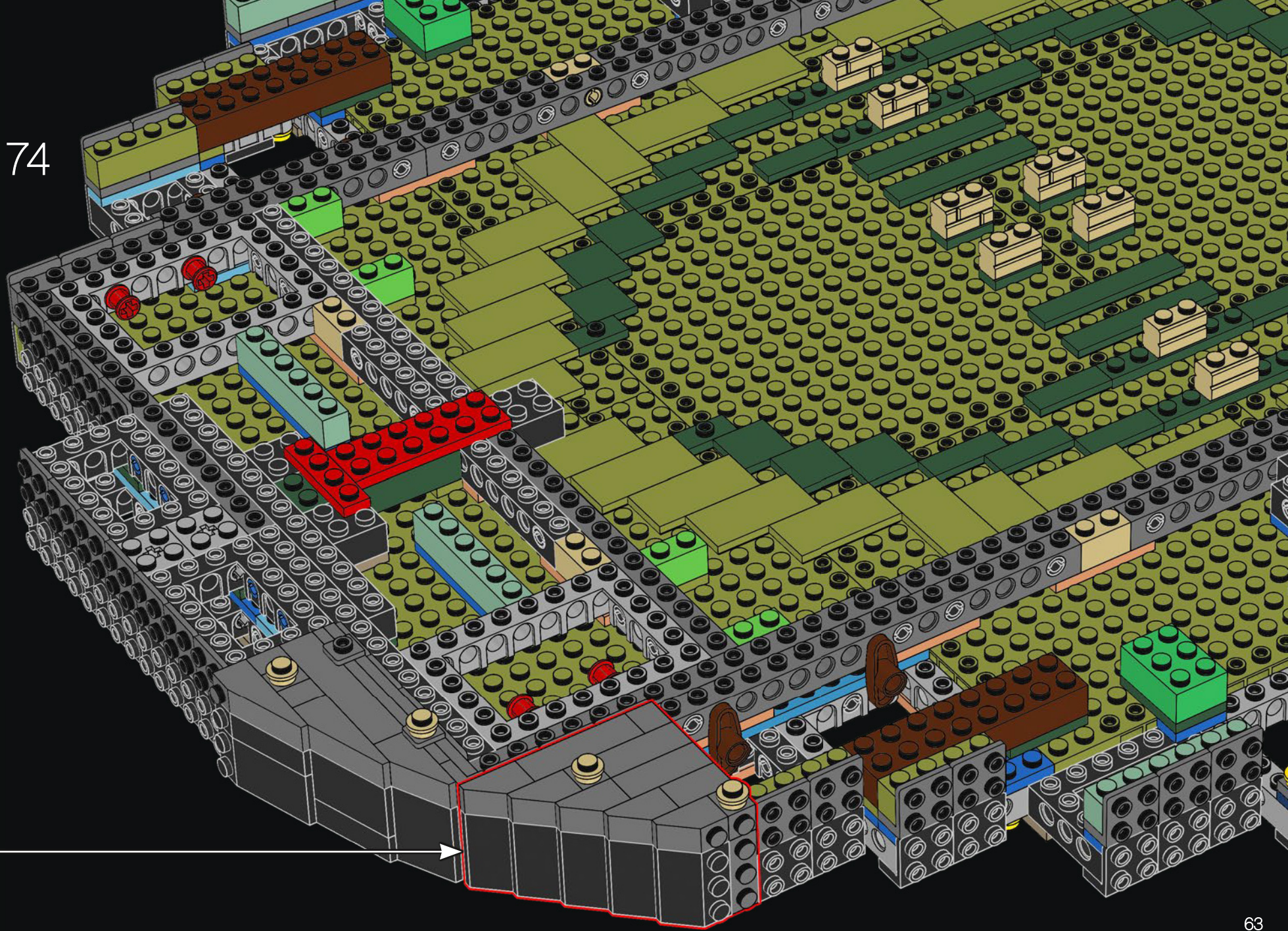

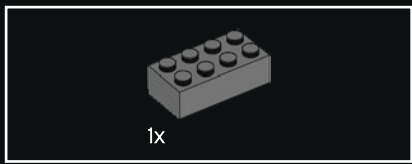

75

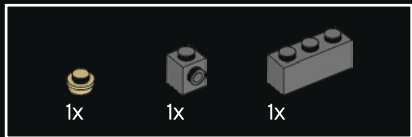
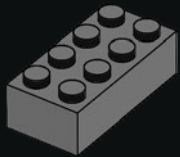

76

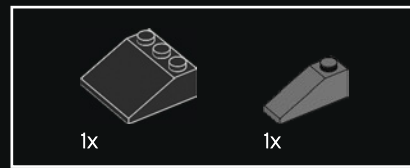
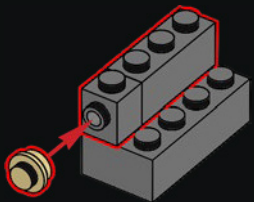

77

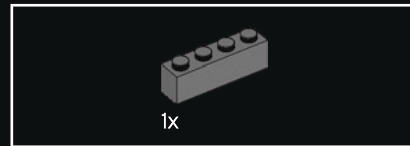
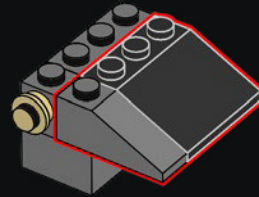

78

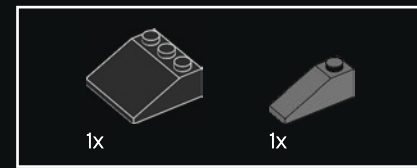
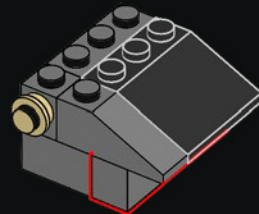

79

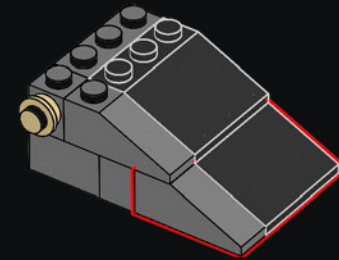



80

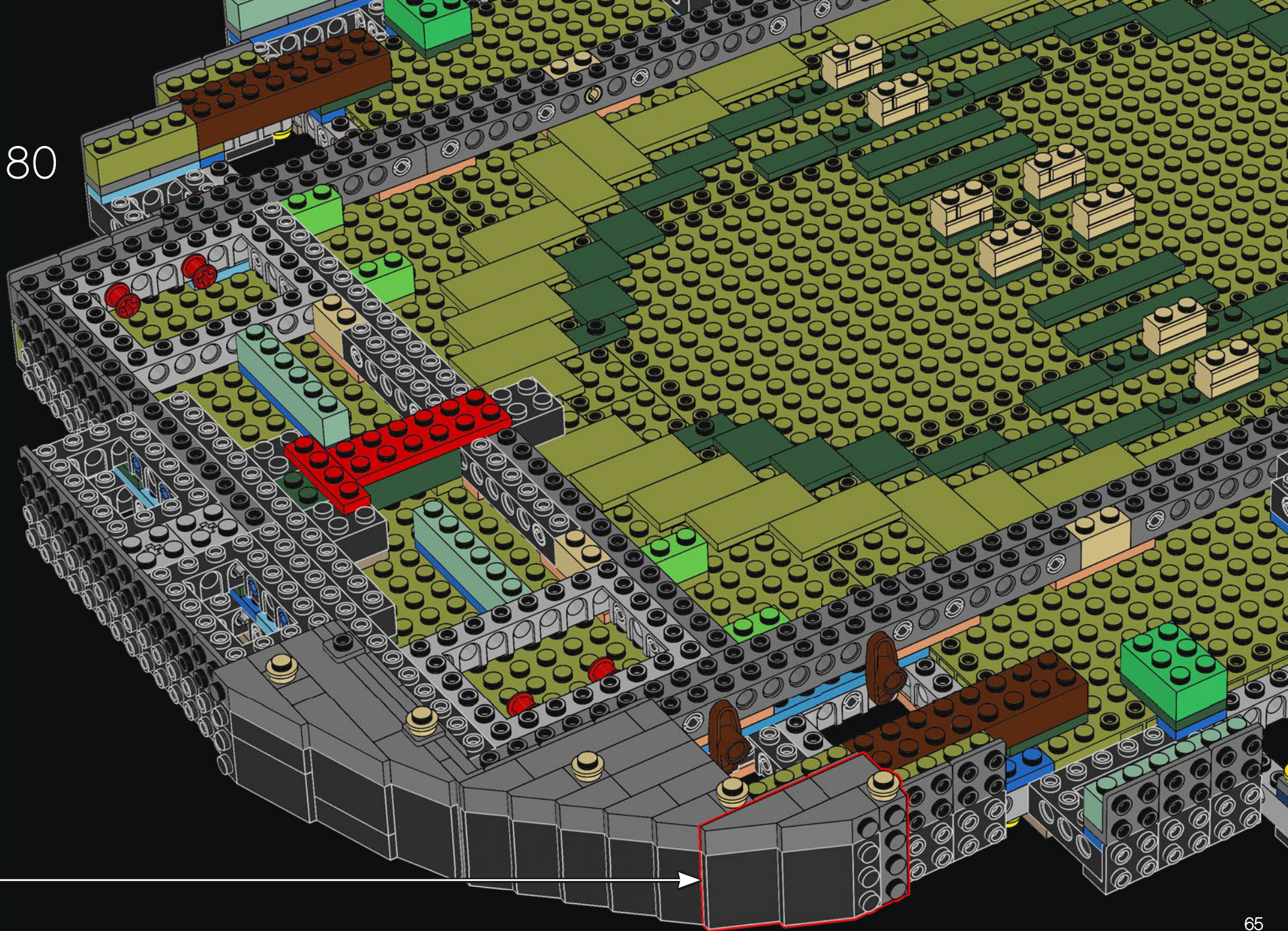

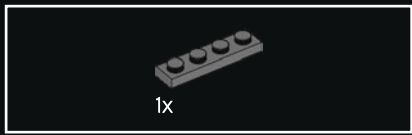

81

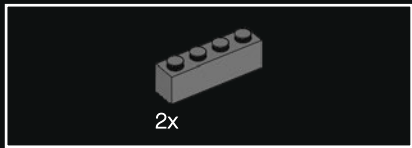

82

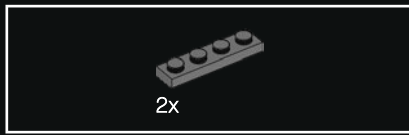
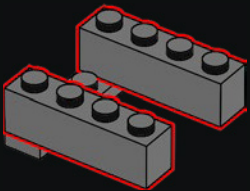

83

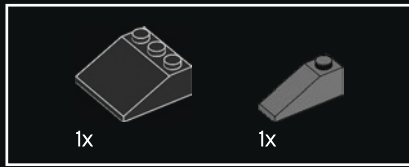
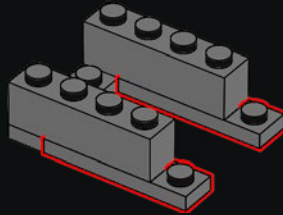

84

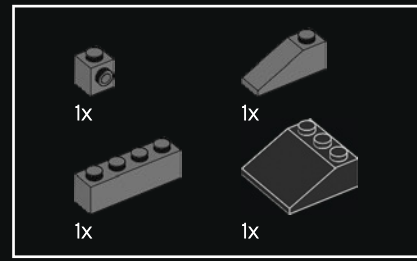
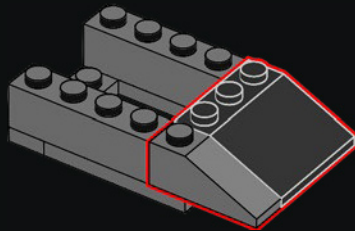

85

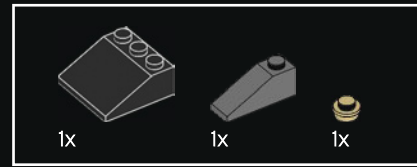
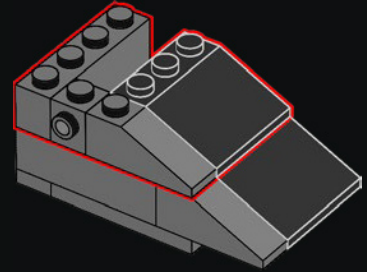

86

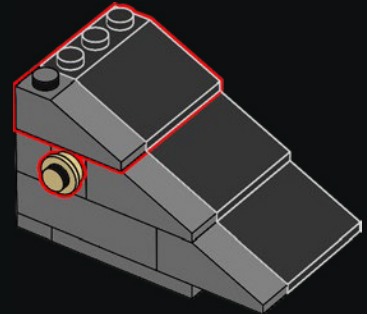

87

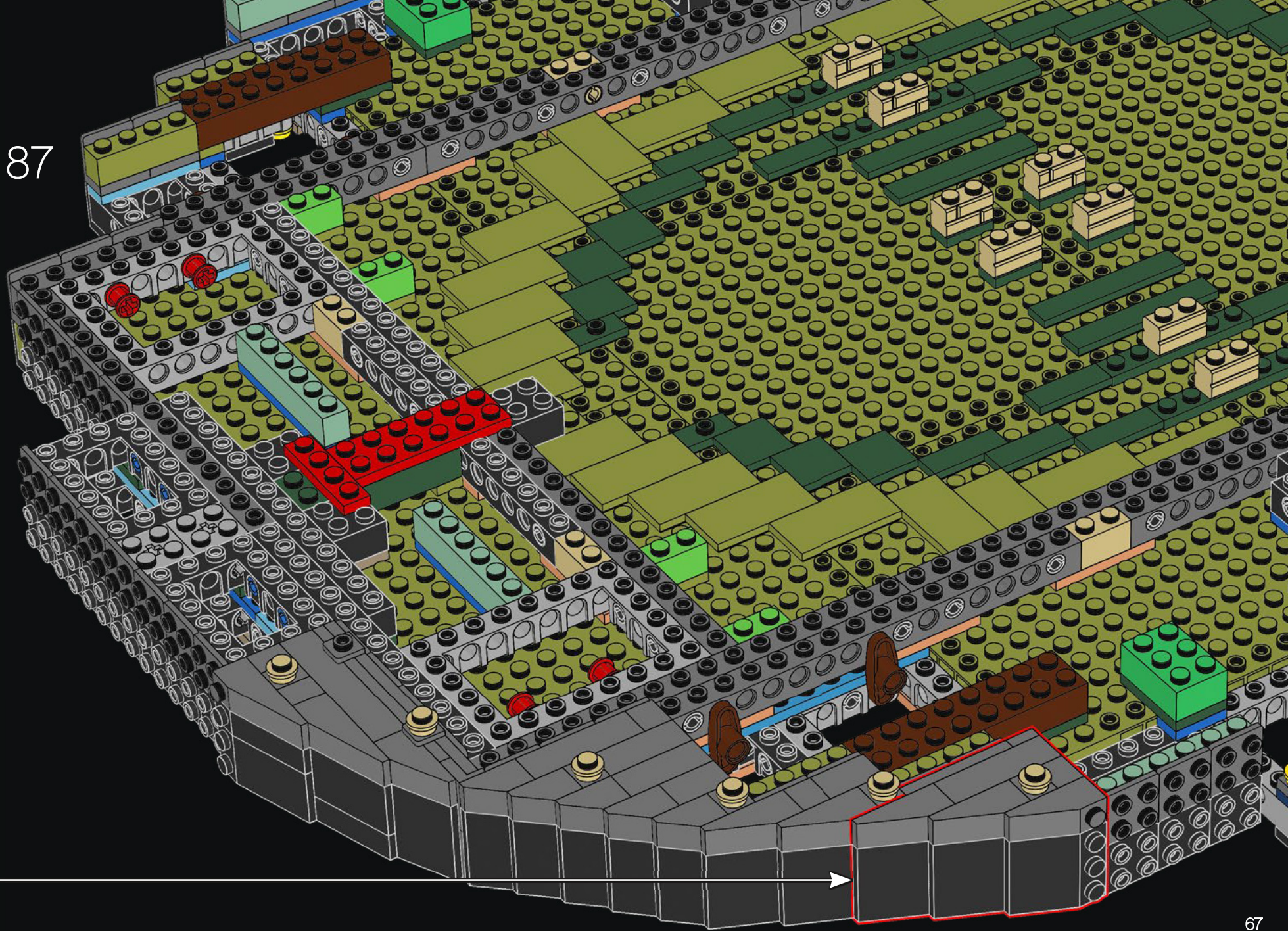

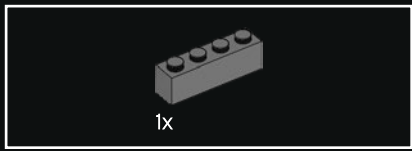

88

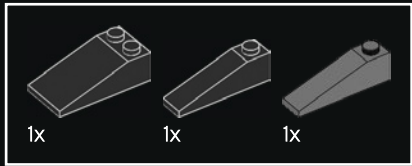
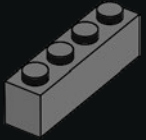

89

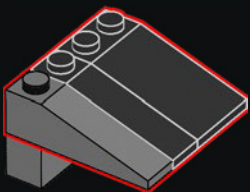

90

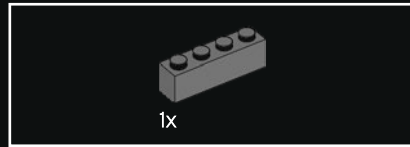
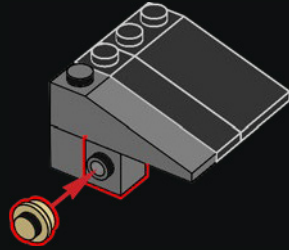

91

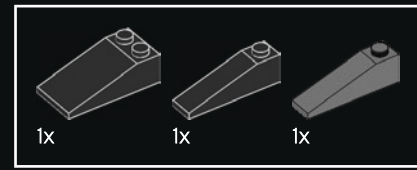
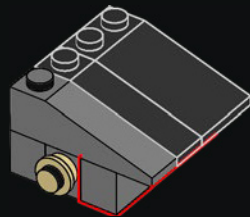

92

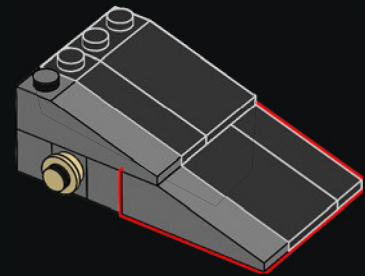

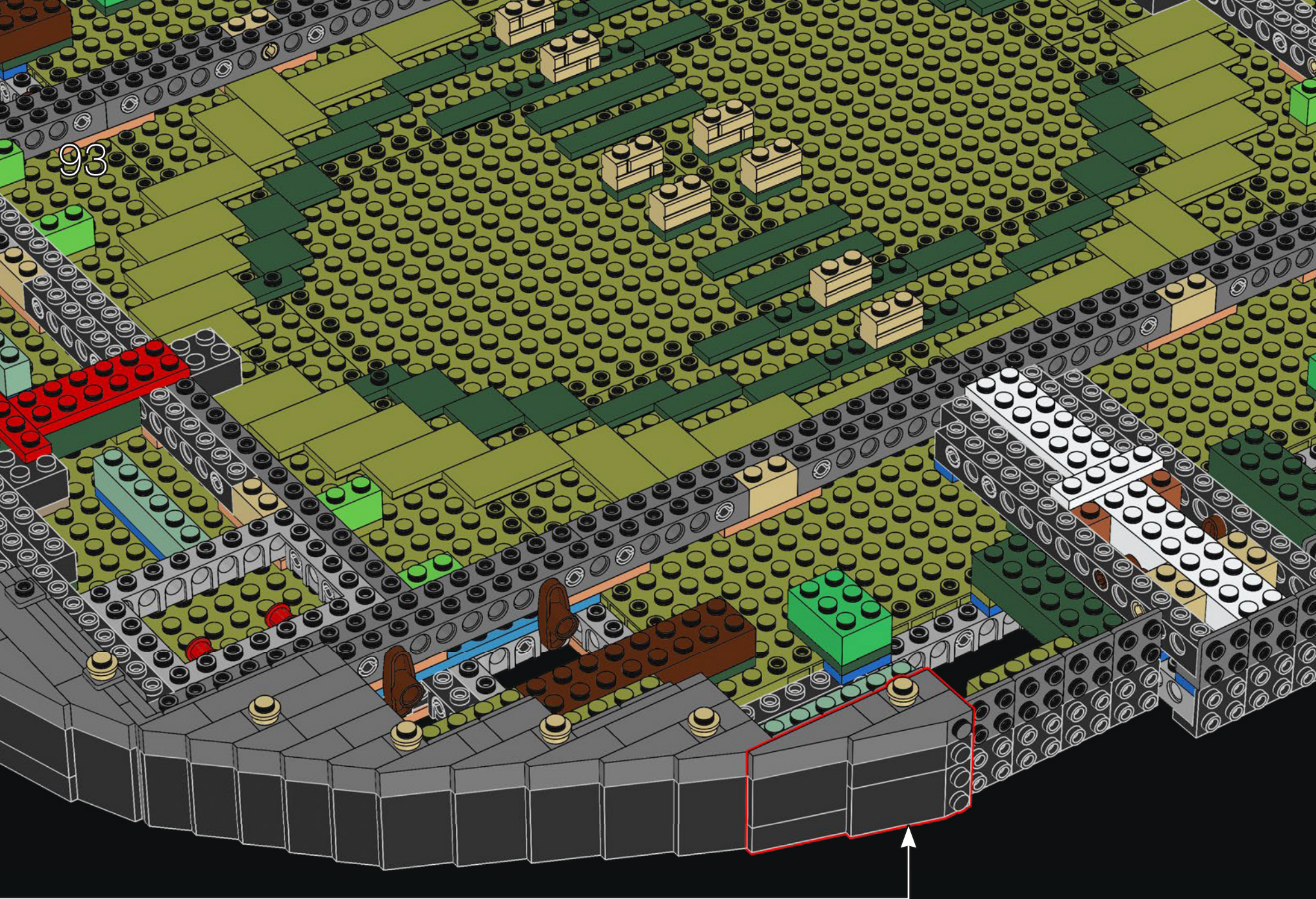

93

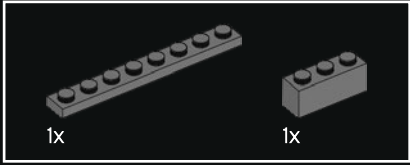
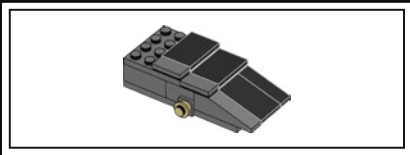

94

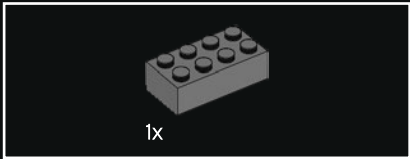
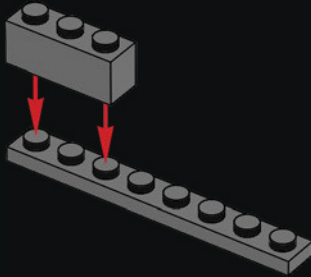

95

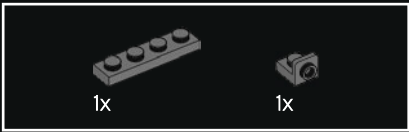
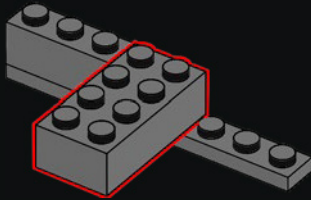

96

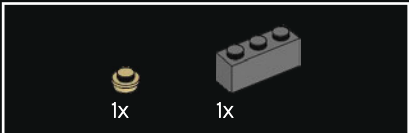
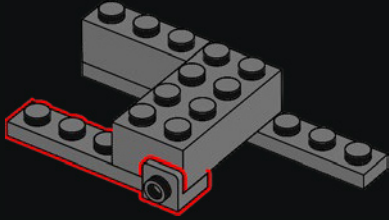

97

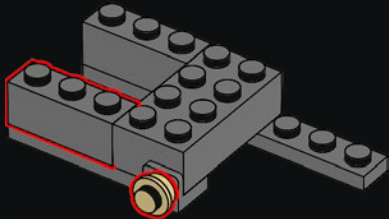

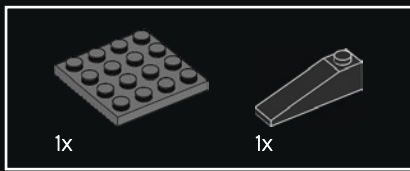

98

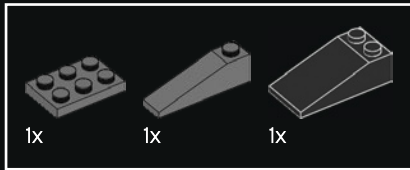
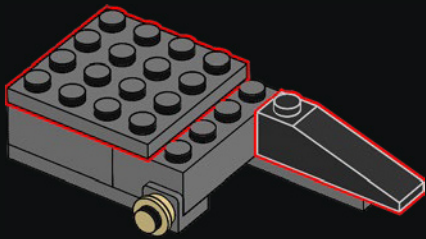

99

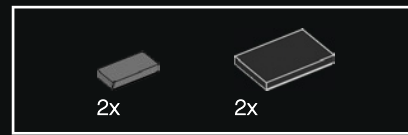
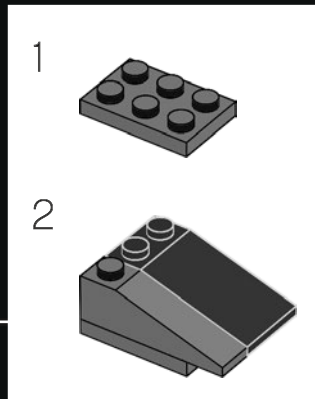
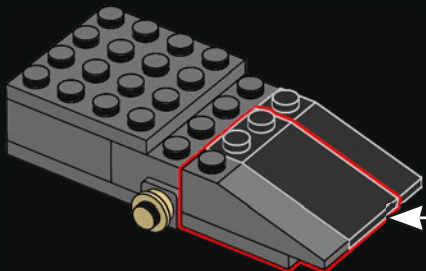

100

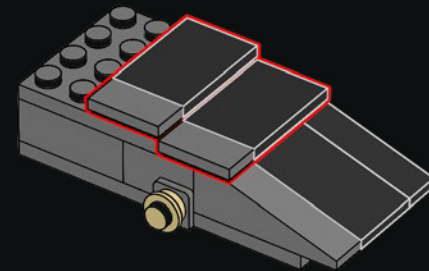

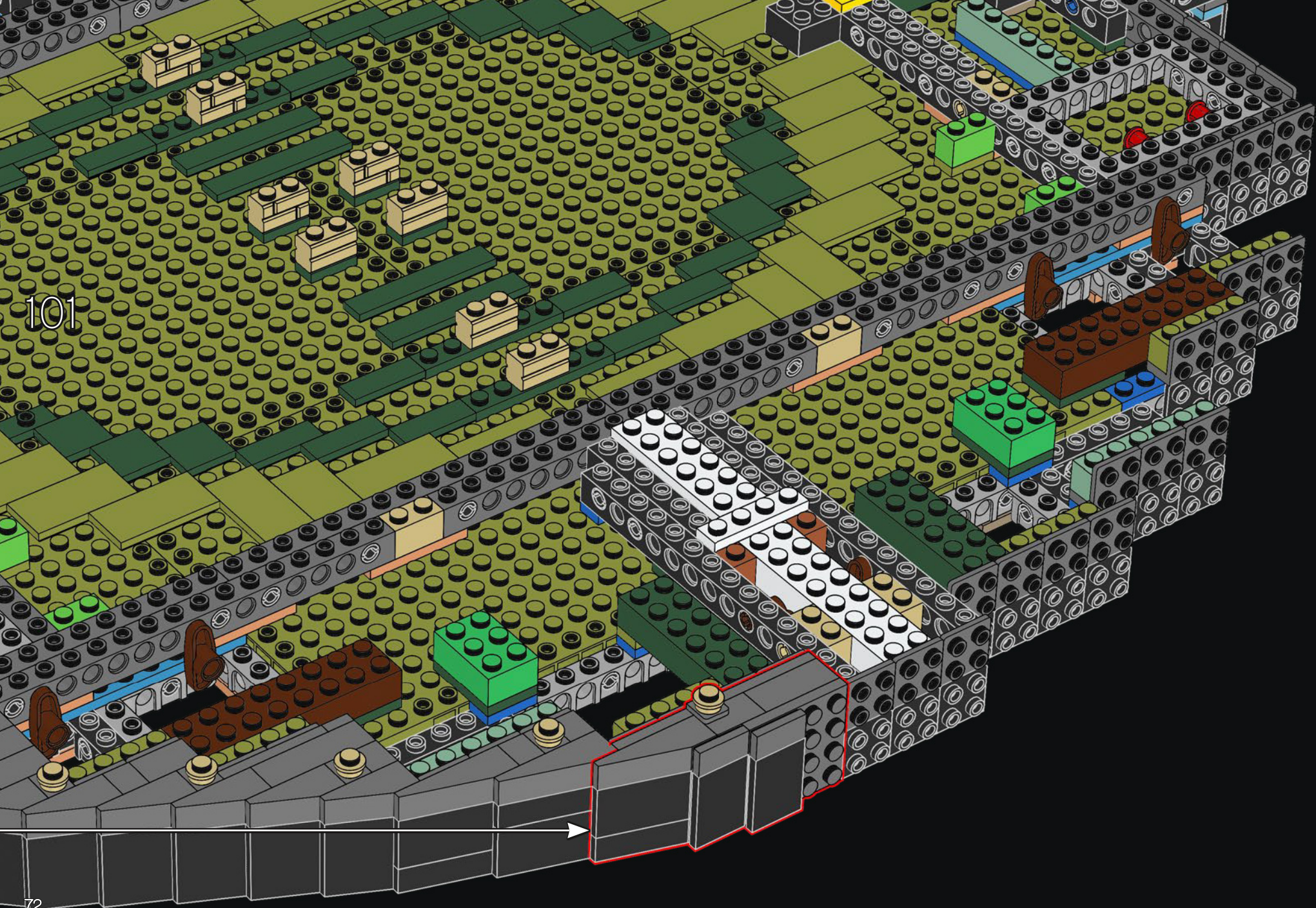

101



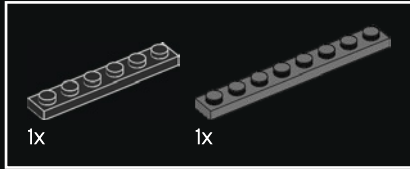
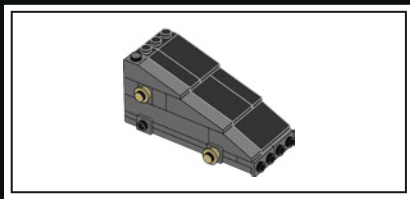

102

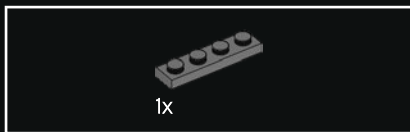
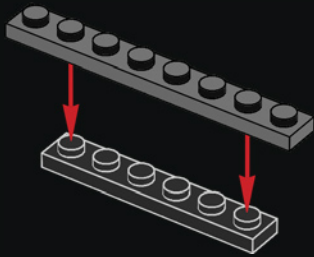

103

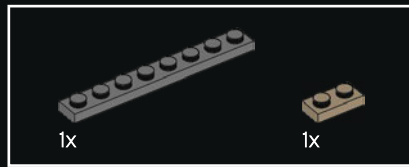
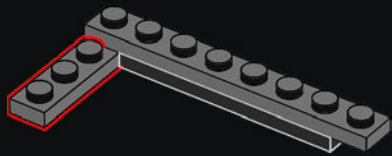

104

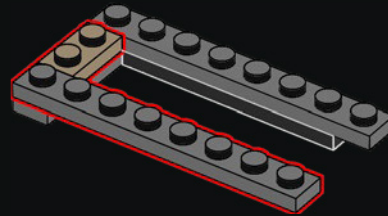

105

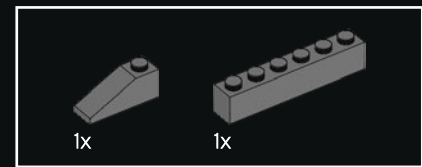
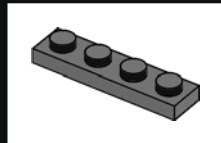
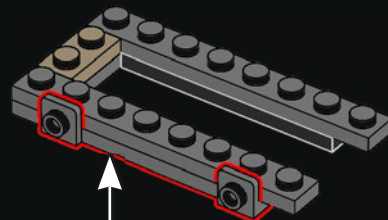

106

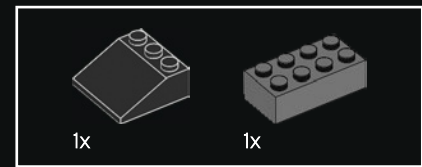
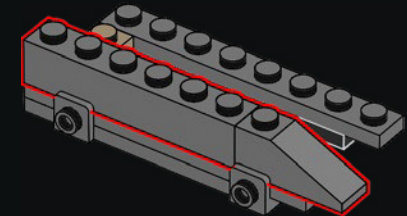

107

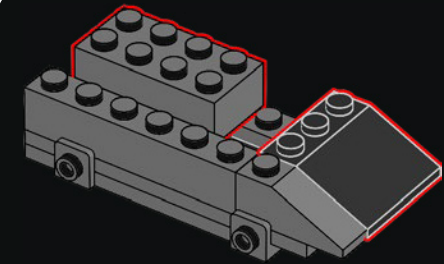

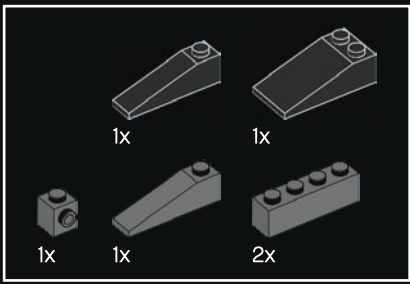

108

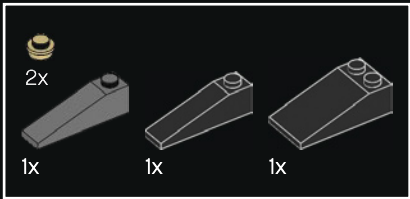
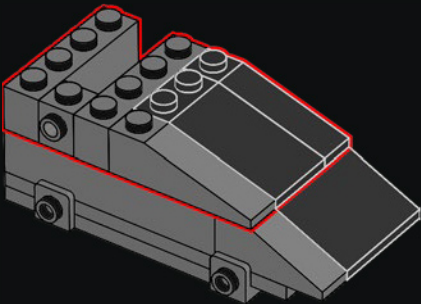

109

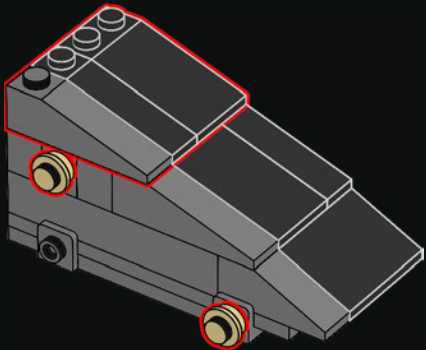

110

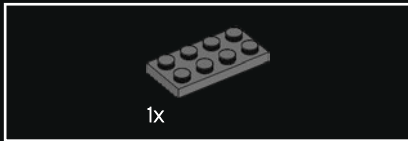
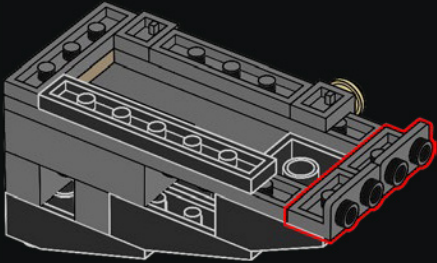

111

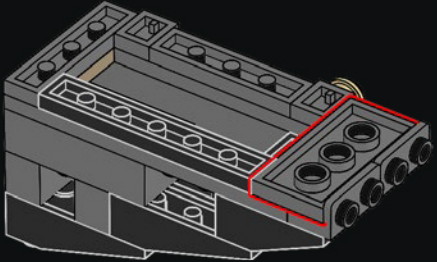

112



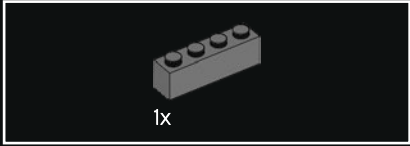
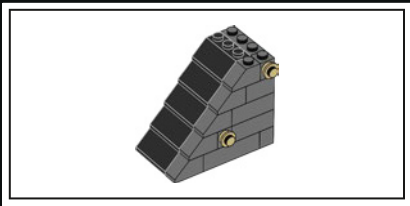

1x

113

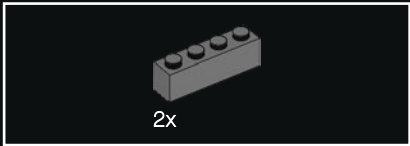
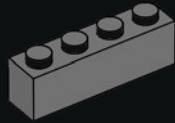

2x

114

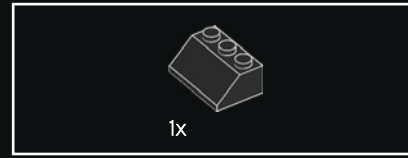
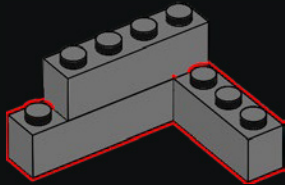

1x

115

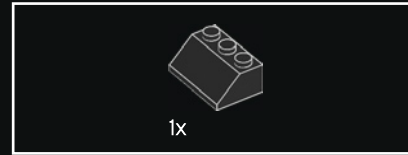
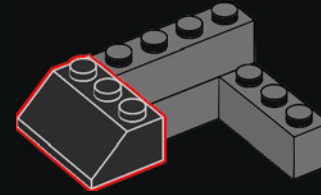

1x

116

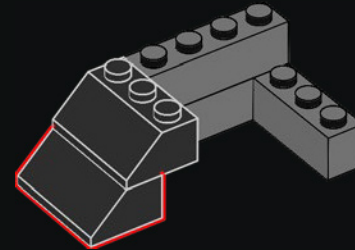

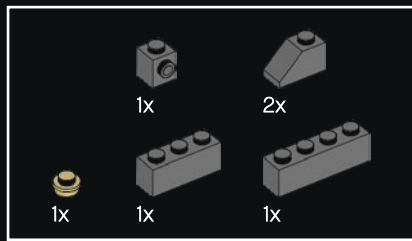

117

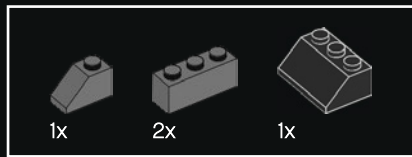
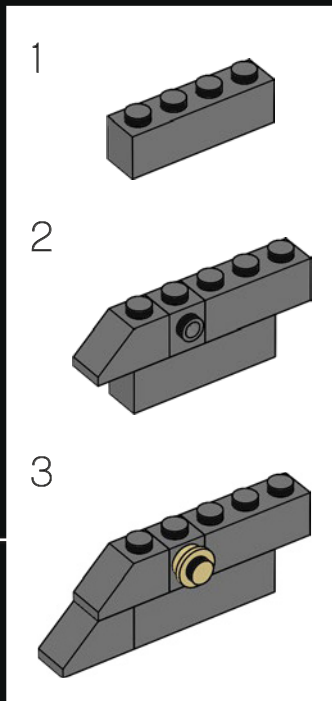
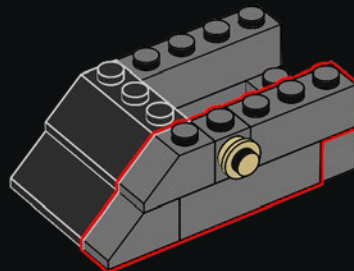

118

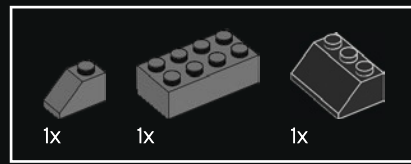
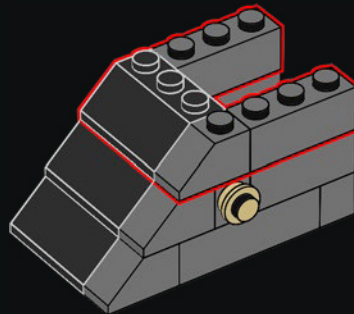

119

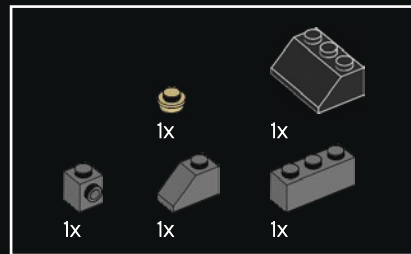
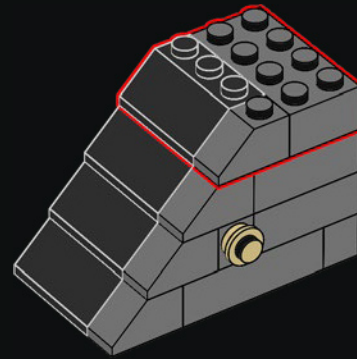

120

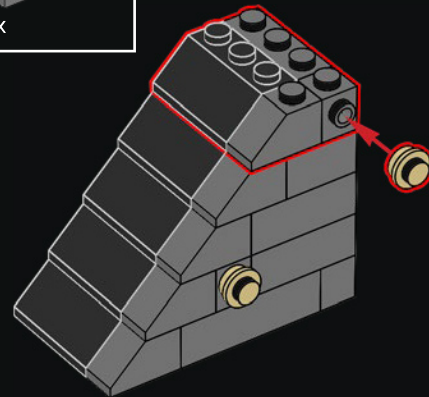

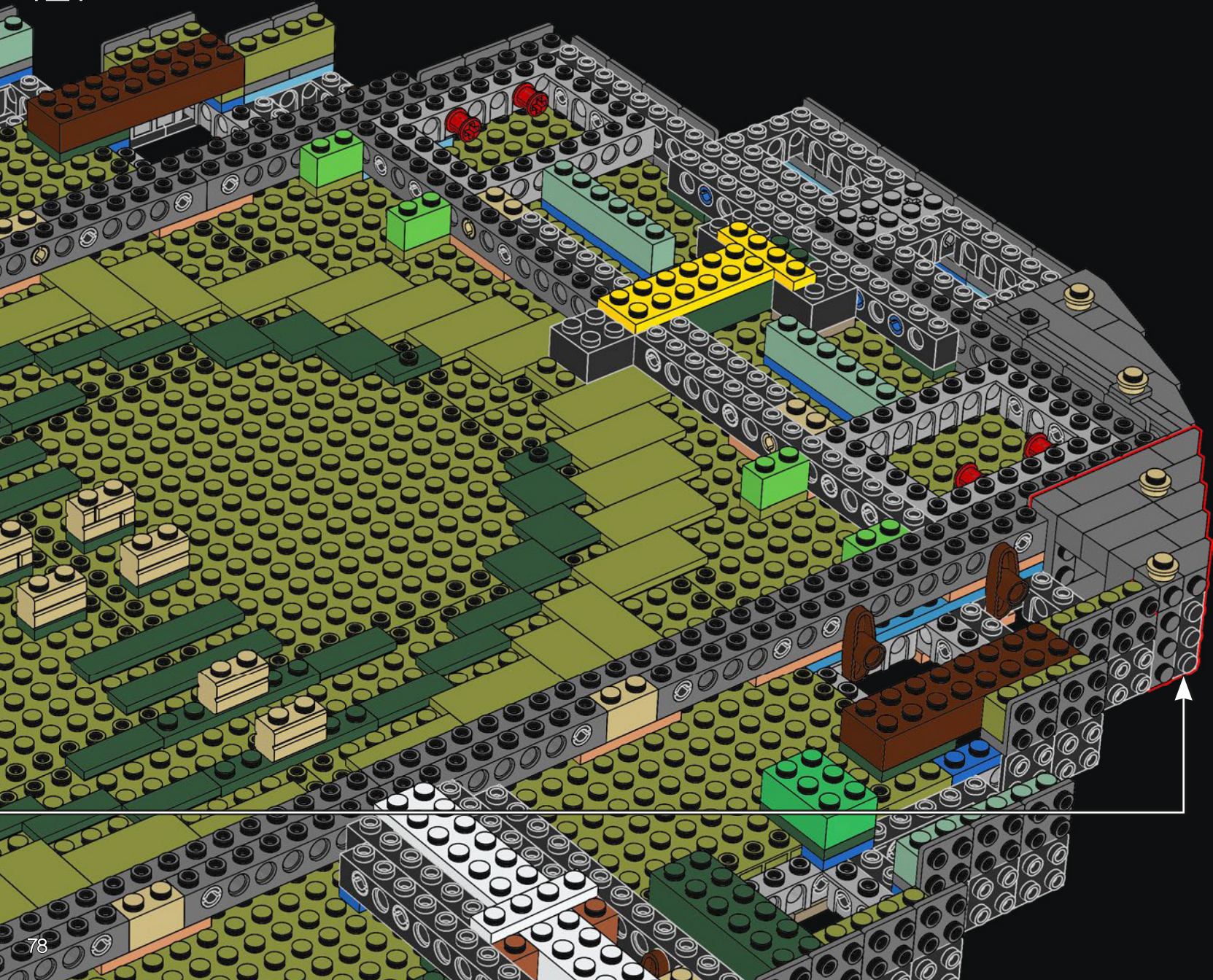

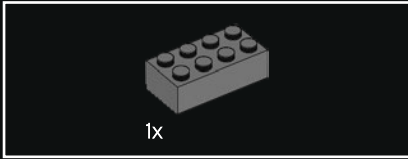
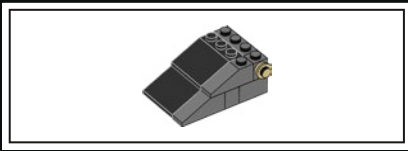

122

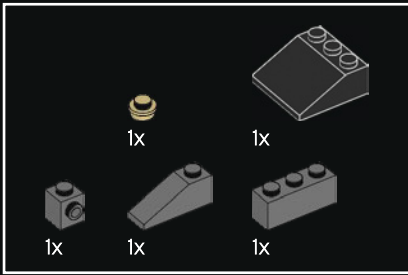
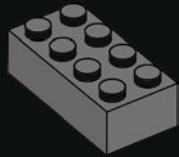

123

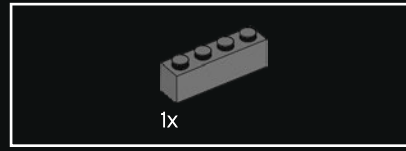
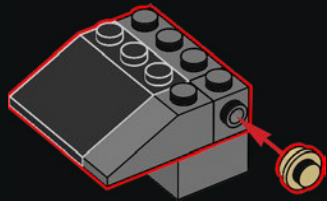

124

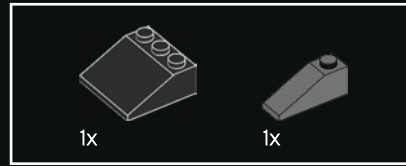
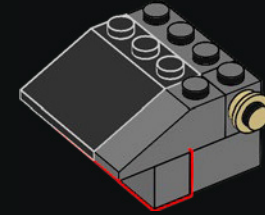

125

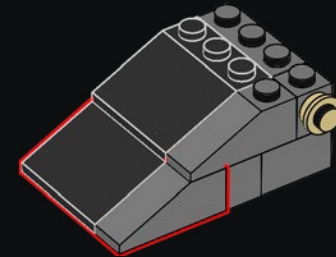





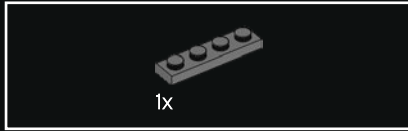
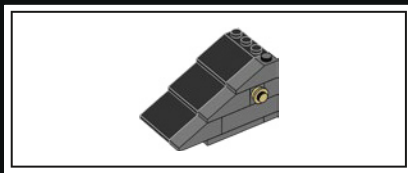

127

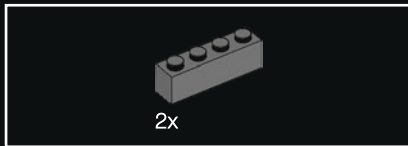
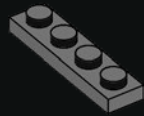

128

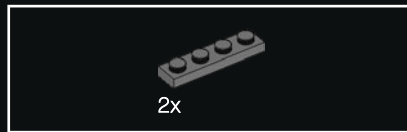
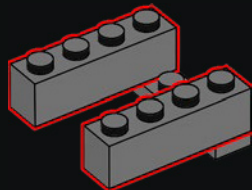

129

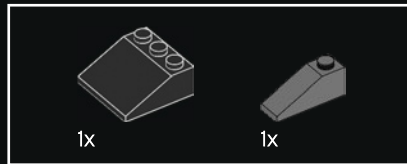
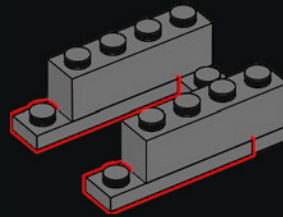

130

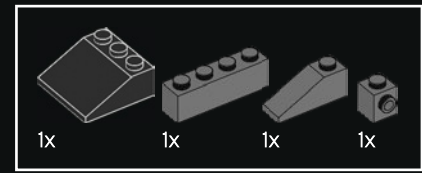
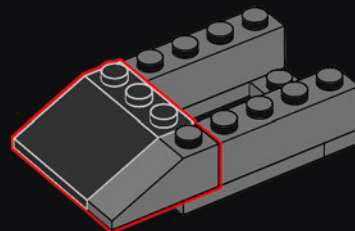

131

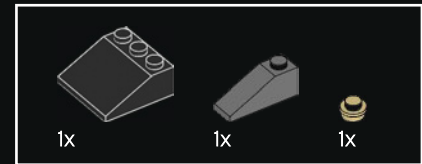
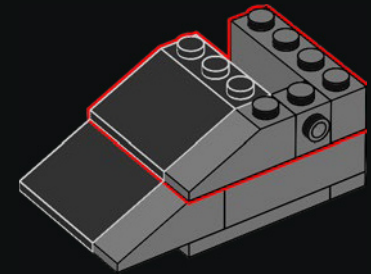

132

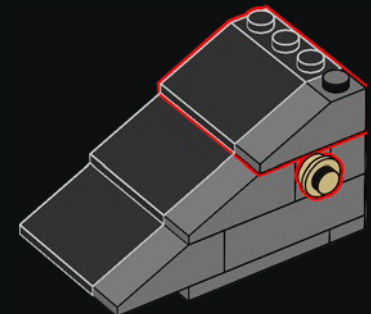



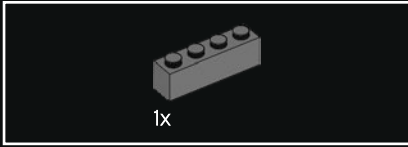
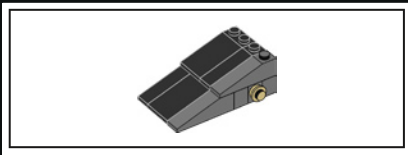

134

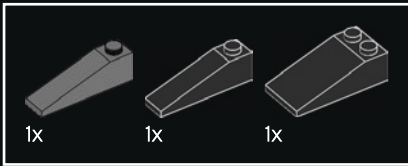
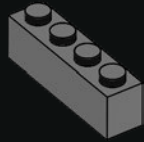

135

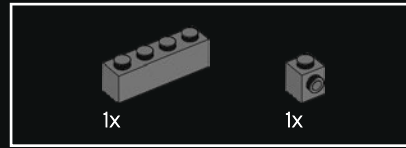
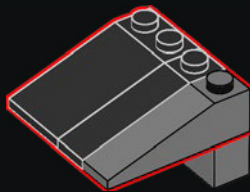

136

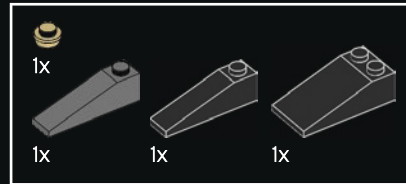
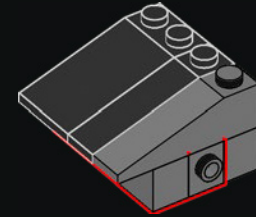

137

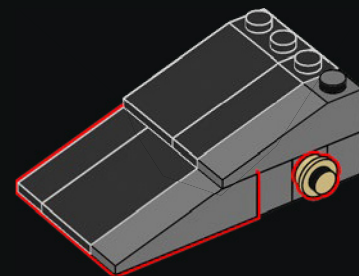



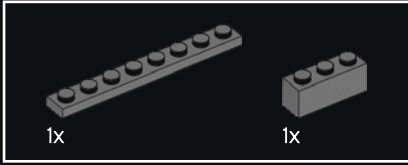
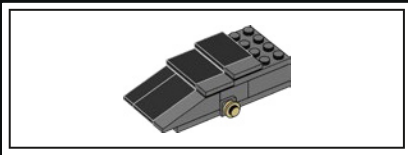

139

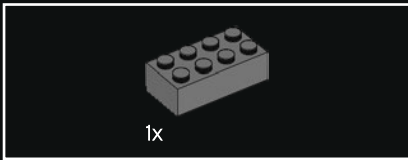
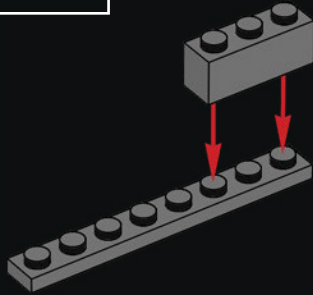

140

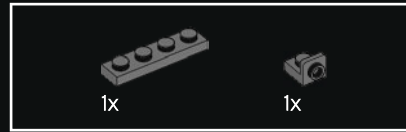
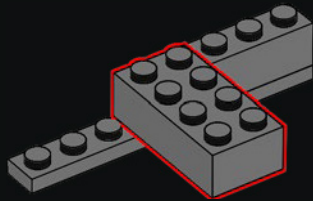

141

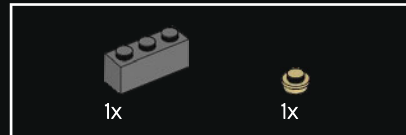
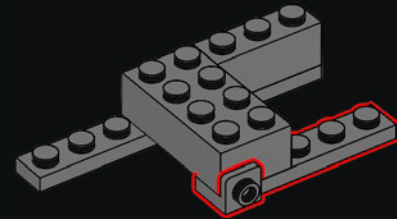

142

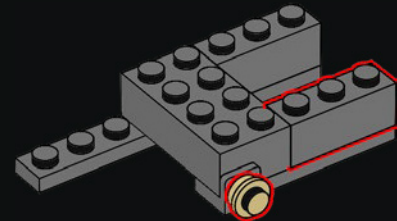

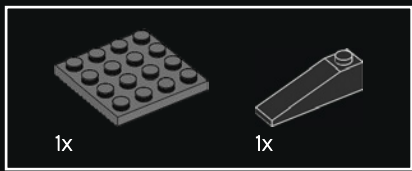

143

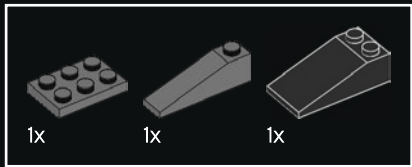
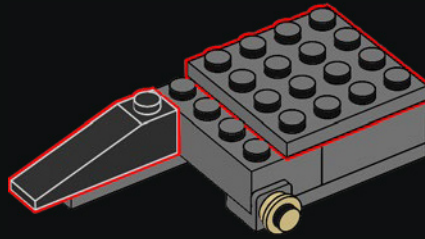

144

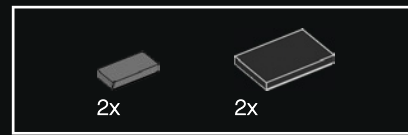
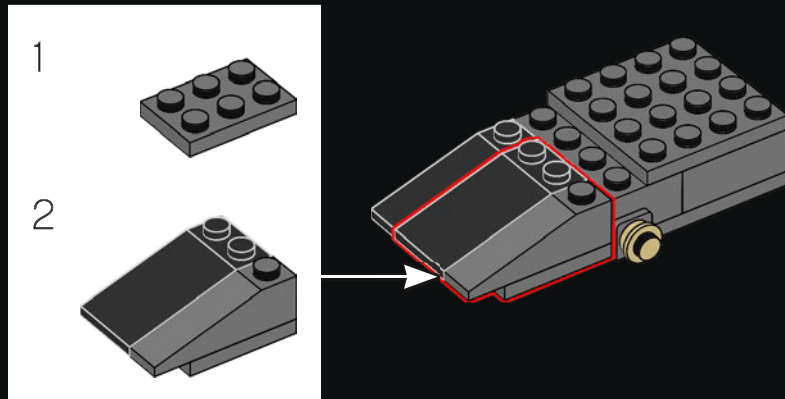

145

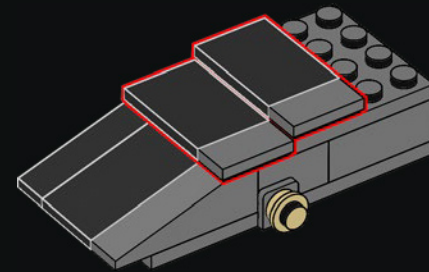

146

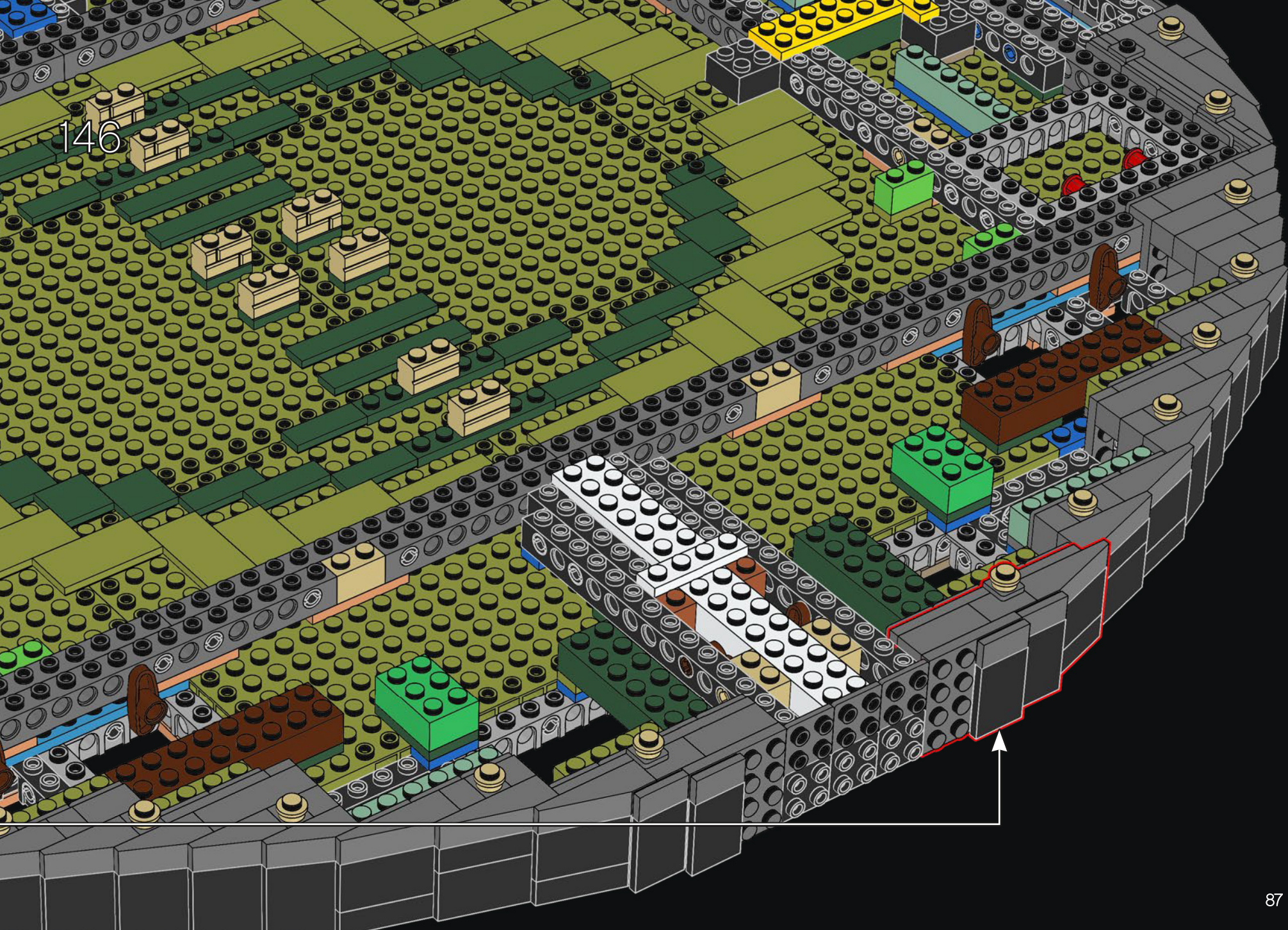

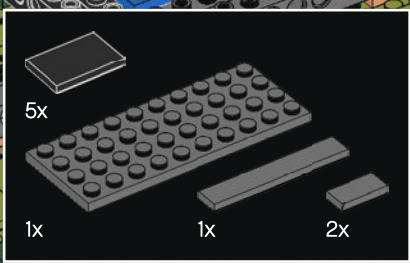

147

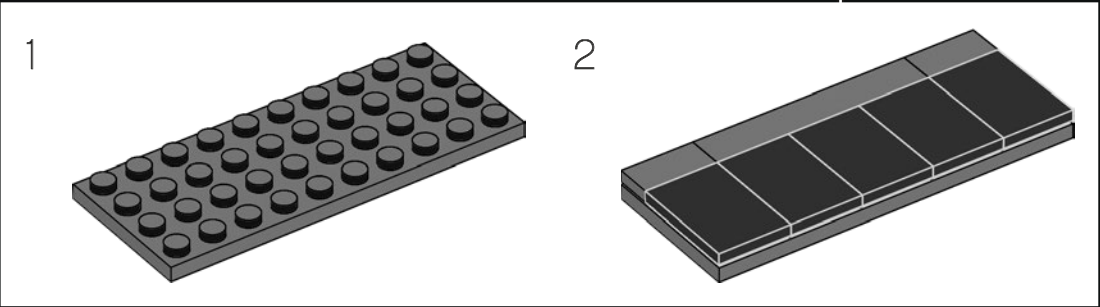



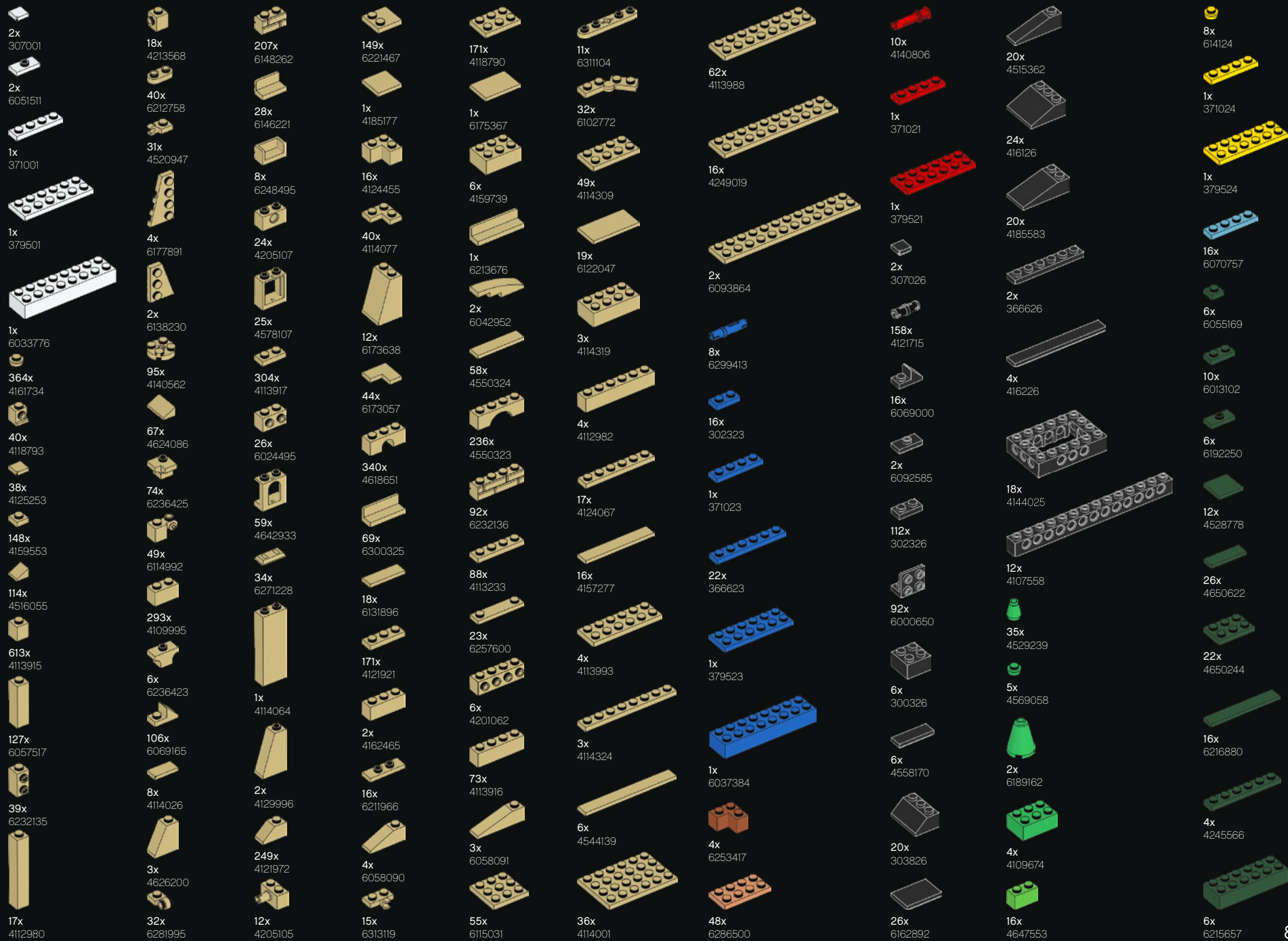



32x  
6016483



10x  
6212080



12x  
6062697



36x  
6016488



1x  
6275877



1x  
6195266



12x  
6167700

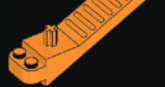

1x  
6240515

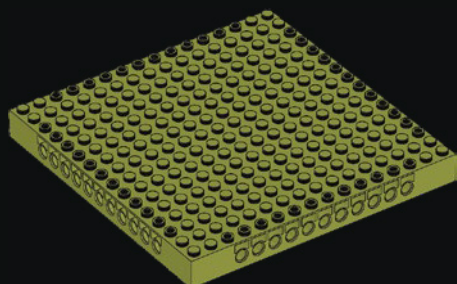

10x  
6301768



115x  
6300321



96x  
6300320



133x  
6300322



18x  
6300318



36x  
6055172



91x  
4549436



14x  
6040126



35x  
6001824



239x  
6231386



35x  
6093064



142x  
4528604



237x  
6092591



35x  
4521914



5x  
4496699



17x  
6167894



8x  
4246957



14x  
6156492



19x  
6039482



56x  
4530678



213x  
4616711



36x  
6047415



81x  
4550168



40x  
6184880



7x  
6132768



14x  
6015452



23x  
6175927



23x  
4626904



4x  
4267874



1x  
4507047



3x  
6015424



66x  
421104



24x  
4211045



19x  
6039482



12x  
4558955



6x  
6225494



11x  
6092572



79x  
6039479



18x  
4211052



20x  
4211135



8x  
6214341



92x  
6308045



9x  
6123814



8x  
6126083



4x  
4211094



2x  
4211055



66x  
421104



24x  
4211045



19x  
6039482



18x  
6187008



6x  
4211043



48x  
4211103



13x  
6257592



24x  
4211001



20x  
4211053



20x  
4535930



33x  
4560184



2x  
4211065



22x  
4211085



4x  
4211100



22x  
4210651



6x  
4243831



16x  
4210998

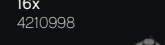

2x  
4210997



28x  
6147337



2x  
4211122

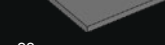

2x  
6000970



18x  
4256828



4x  
6250216



4x  
6151666

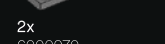

8x  
6177081



4x  
4539076



1x  
6170468



12x  
6323704



11x  
6116613



4x  
6096701



20x  
6168647



6x  
4211399



75x  
6043656



4x  
6273227



9x  
6043639



126x  
6211969



8x  
4211752



14x  
4211848



Customer Service

Kundenservice

Service Consommateurs

Servicio Al Consumidor

LEGO.com/service or dial



00800 5346 5555 :



1-800-422-5346 :





# FEEDBACK AND WIN



## FEEDBACK AND WIN

Your feedback will help shape the future development of this product series.

Please visit:

## FEEDBACK UND GEWINNEN

Dein Feedback trägt zur Weiterentwicklung dieser Produktreihe bei.

Geh auf:

## COMMENTEZ ET GAGNEZ

Vos commentaires nous aideront à concevoir les futurs produits de cette gamme.

Rendez-vous sur :

## COMENTA Y GANA

Tu opinión nos ayudará a dar forma al desarrollo de esta serie de productos en el futuro.

Visita:

## 反馈有奖

您的反馈将有助于我们在今后改进本系列产品。

请访问：

[LEGO.com/productfeedback](https://www.lego.com/productfeedback)

By completing, you will automatically enter a drawing to win a LEGO® set.

Terms & Conditions apply.

Durch Ausfüllen nimmst du automatisch an der Verlosung eines LEGO® Preises teil.

Es gelten die Teilnahmebedingungen.

En envoyant vos commentaires, vous serez automatiquement inscrit(e) à un tirage au sort qui vous permettra de remporter un prix LEGO®.

Offre soumise à conditions.

Al contestar, participarás automáticamente en el sorteo y podrás ganar un set LEGO®.

Sujeto a Términos y Condiciones.

完成我们的反馈调查，即可自动进入抽奖环节，赢取乐高®套装。

适用《条款和条件》。

