



Official Licensed
Product





VOLKSWAGEN T2 CAMPINGBUS

In den späten 1940er-Jahren wollte Volkswagen sein Fahrzeugspektrum erweitern. So entstand die Idee für einen Kleintransporter auf Basis des bereits erhältlichen VW Käfers (Typ 1), das heißt mit demselben Chassis und demselben Motor. In den ersten Entwürfen saß der Fahrer ganz vorne. Eine Nutzlast von 690 kg war vorgesehen.

Nach dem Bau mehrerer Prototypen und einer Optimierung des Konzepts lief der erste VW Typ 2 schließlich im März 1950 vom Band. Die zweite Generation des Typ 2 folgte dann im Jahr 1967.

V O L K S W A G E N





Der neue VW-Achtsitzer.

Sie können ihn wahlweise auch in sieben- oder neun-sitziger Ausführung haben. Sein Innenraum ist 6 Kubikmeter groß. Einen Kubikmeter davon haben wir als Kofferraum eingerichtet.

Der Neue

Neuen Farben.

VW Kästchen
 VW Kombi
 VW Pilschswagen
 VW Doppelkabine

Serienmäßige Lackierungen VW-Achtzitzer
 Bei Achtzitzer 1-Modell zweifarbige Lackierung.
 (Dunkelblau-Weiß außer bei Farbe Schwarz-Blau)

23	hellgrünerhellgrau	Delphinblau	22 22 33 oder 22 22 40
34	hellrot	Blütenblau	67 67 40 oder 67 67 33
42	hellrot	Ernteweiß	42 42 47 oder 42 42 43
47	gelblich	Nachtblau	47 47 31
48	stahlgrün	Leinwandgrün	41 41 31
		Sonnenrot	02 02 34 oder 02 02 40
		Montenrot	68 68 33 oder 68 68 42



Der T2 Transporter des LEGO® Designers



DIE IKONE DER GEGENKULTUR

Die geringen Kosten, die leichte Wartung und die Fähigkeit, außergewöhnlich viele Personen oder jede Menge Ausrüstung zu befördern, machten den VW Typ 2 zum Fahrzeug der Wahl für die Anhänger der Gegenkulturen in den späten 1960er-Jahren. Der geräumige Transporter

besaß ein schlichtes Design. Er war sogar groß genug, um auf längeren Reisen als Wohnmobil zu dienen. Schon bald war der Typ 2 von Musikfestivals und Surferparadiesen nicht mehr wegzudenken. Häufig war er mit extravaganten Designs und knalligen Farben verziert.

**Brick
Stock**



**LOVE
PEACE**



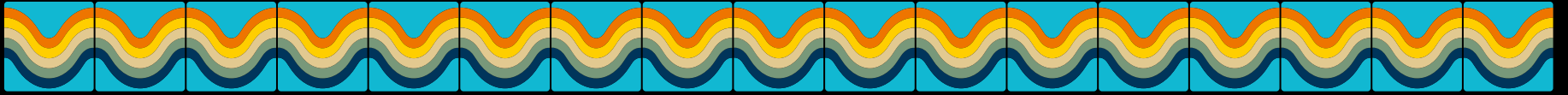

DIE LEGO® VERSION DES KLASSISCHEN VOLKSWAGEN T2 CAMPINGBUSSES SOLL MÖGLICHST VIELE MERKMALE UND FUNKTIONEN DES ORIGINALS NACHBILDEN, ABER AUCH MIT EINIGEN ÜBERRASCHUNGEN AUFWARTEN.



Surfbrett

Aufklappbare Heckklappe und Motorhaube

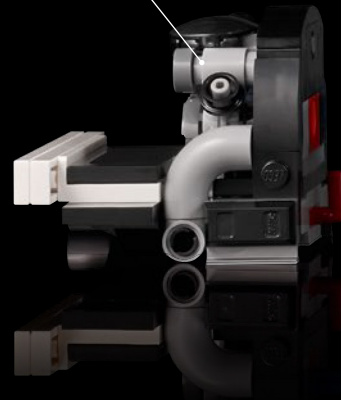

Luftgekühlter Boxermotor

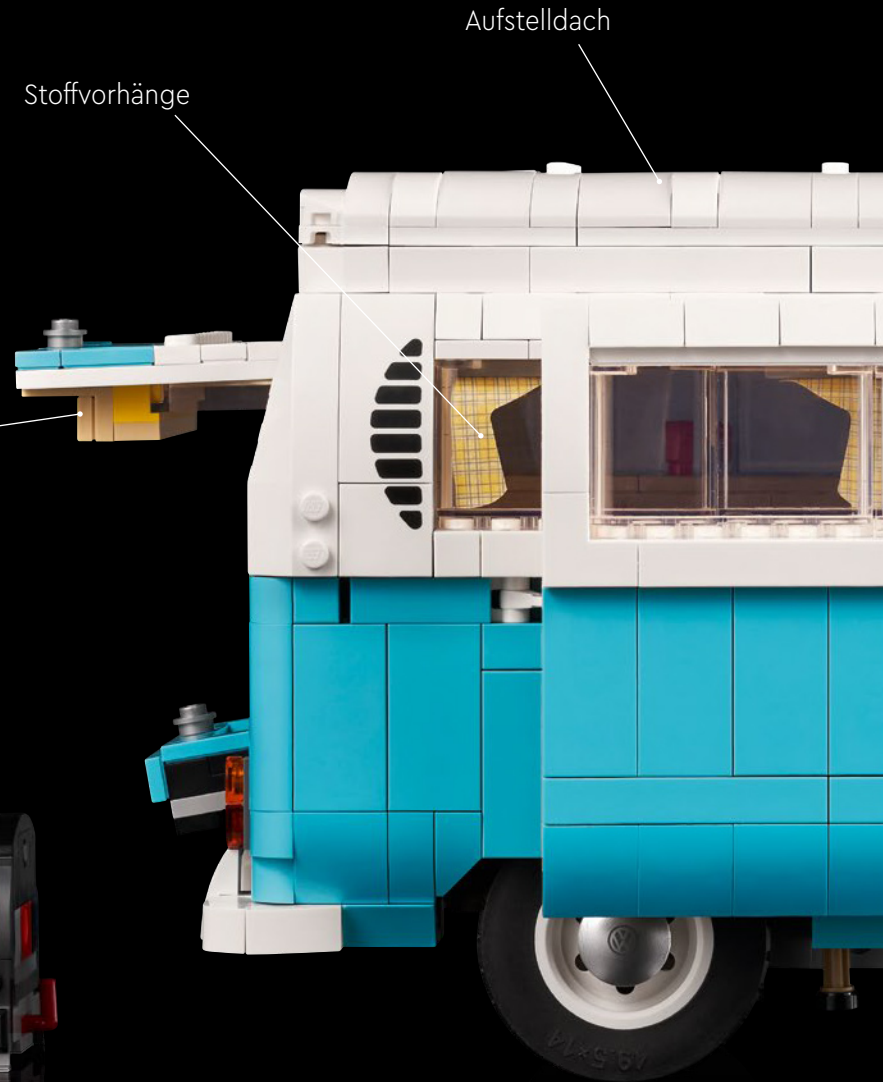

Aufstelldach

Stoffvorhänge



Campingausstattung mit Rock-'n'-Roll-Bett und ausschwenkbarem Tisch

Voll ausgestattete Campingküche mit Gasherd, Spüle und Kühlschrank

Funktionierende Lenkung

Klappstühle

Funktionierende Schiebetür

Aufklappbare Türen

LEGO® VOLKSWAGEN

Dieses neue Modell zählt zu einer ganzen Reihe von früheren und aktuellen LEGO® Sets und ist eine Hommage an die lange gemeinsame Geschichte der beiden Unternehmen. Die ersten vorgeformten VW-Modelle kamen in den 1950er-Jahren heraus –

noch vor dem LEGO System. Es folgten legendäre Modelle wie der VW Käfer (Typ 1) in den Jahren 2008 und 2016 und der originalgetreue T1 Camper mit der geteilten Windschutzscheibe im Jahr 2011.

1957



307

VW Auto Showroom

2008



10187

LEGO® VW Käfer

2011



10220

LEGO Volkswagen T1
Campingbus

2016



10252

LEGO VW Käfer

ANMERKUNGEN DES DESIGNTEAMS

Als großer Fan des VW T2 und erfahrener LEGO® Designer konnte Sven Franic bei diesem Projekt seine beiden größten Leidenschaften unter einen Hut bringen: „Ich hatte bereits mehrere VW Klassiker. Beim Fahren mit diesen Fahrzeugen schwingt definitiv etwas Positives mit.“

Am schwierigsten war es für Sven, die aufklappbaren Elemente des Modells aufeinander abzustimmen: „Der Campingbus ist im Prinzip ein Multifunktionswerkzeug auf Rädern. Alles öffnet sich in eine andere Richtung. Deshalb musste ich deutlich länger an den Scharnieren in diesem Modell tüfteln.“



Der T2 Transporter
des LEGO Designers

LEGO® Designer
Sven Franic



[LEGO.com/brickseparator](https://www.lego.com/brickseparator)

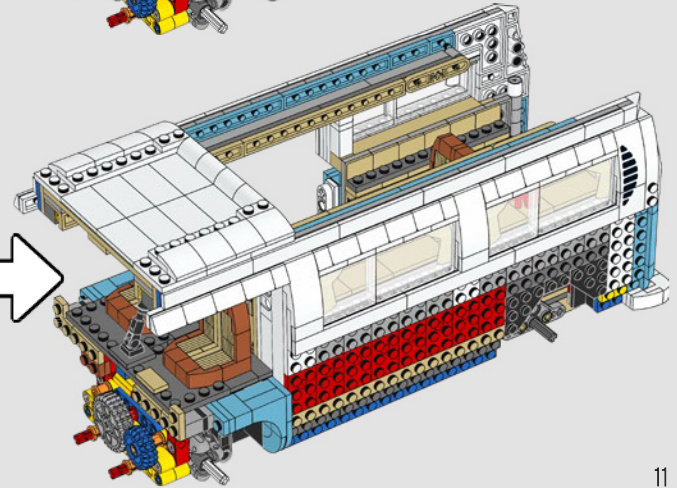
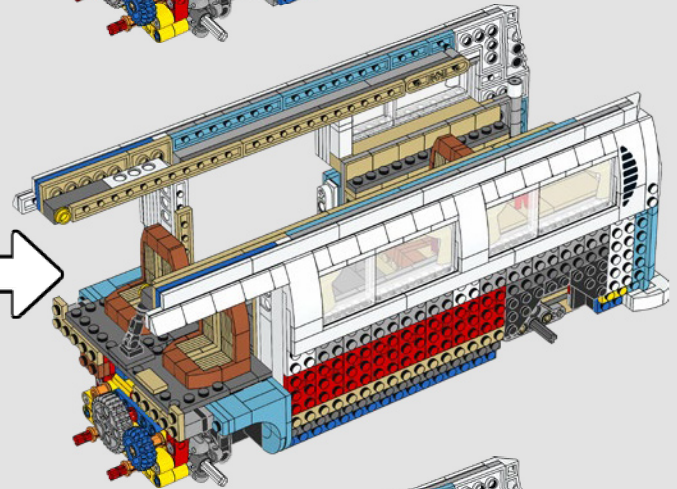
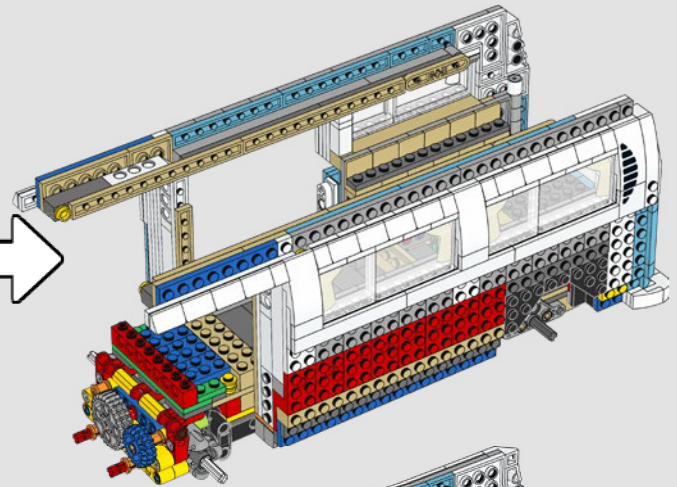
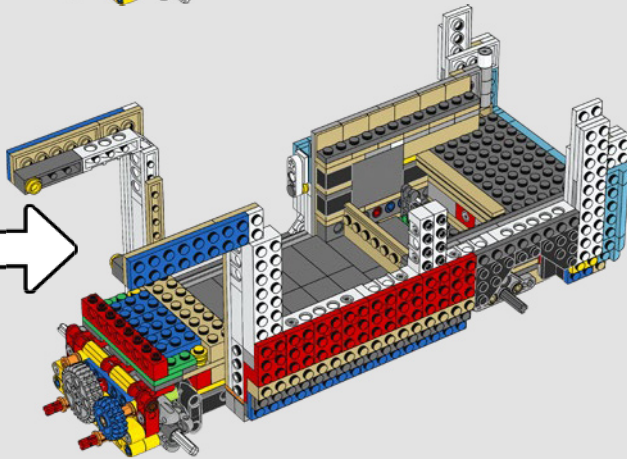
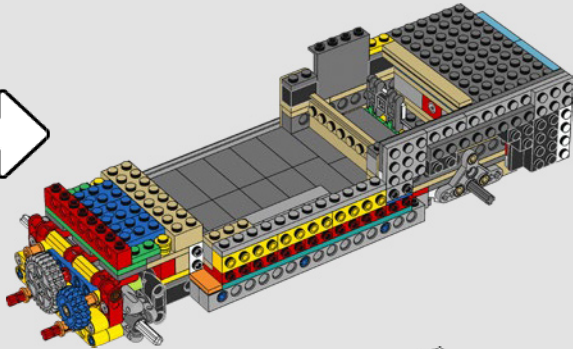
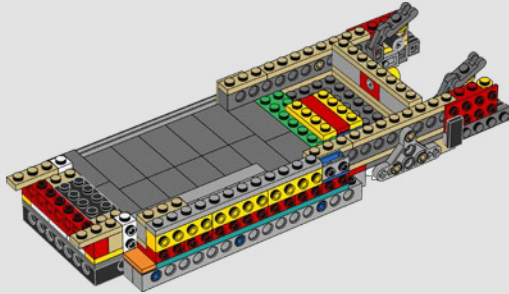

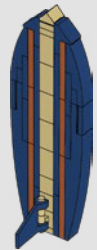
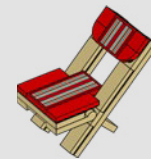
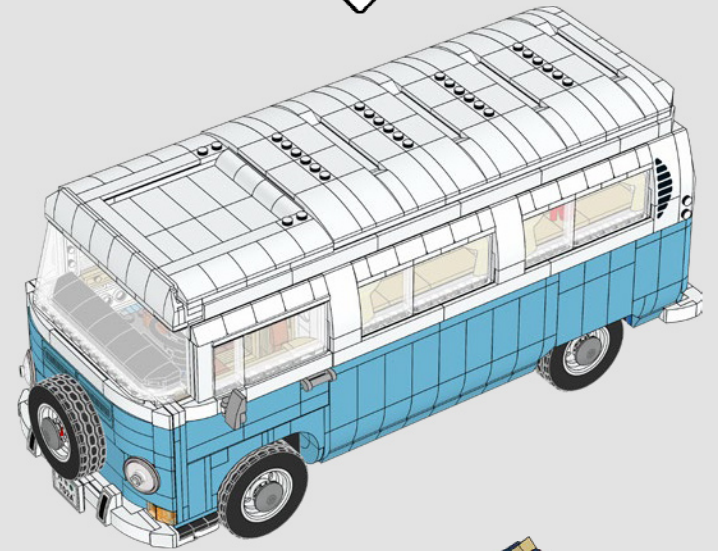
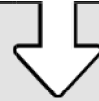
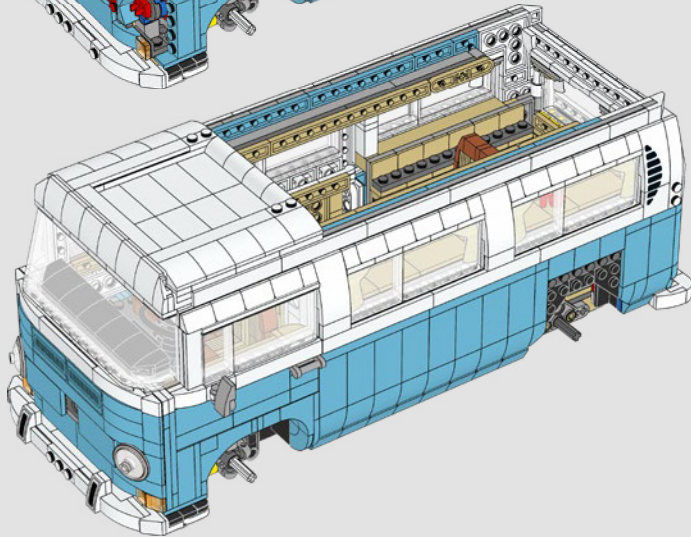
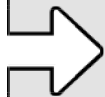
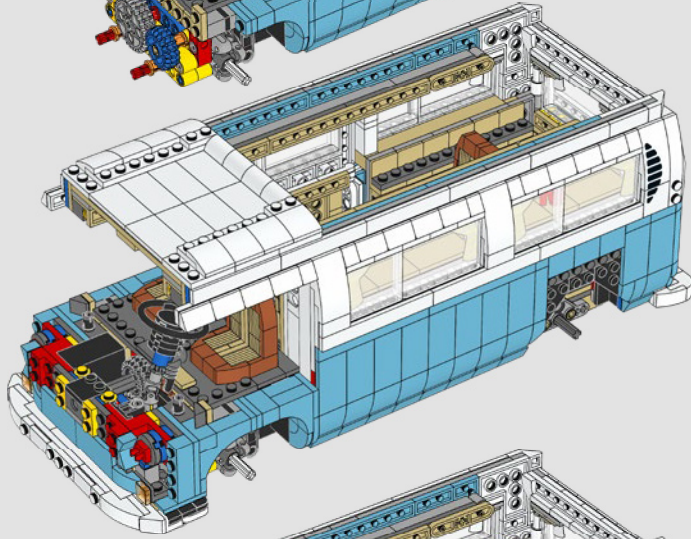
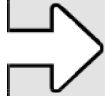
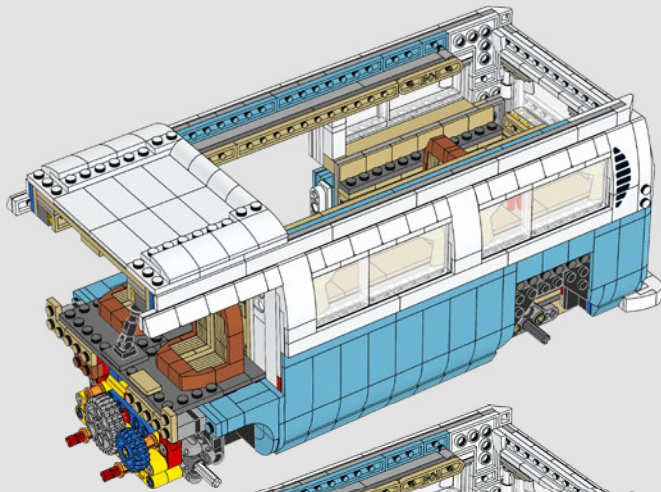
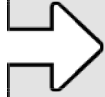

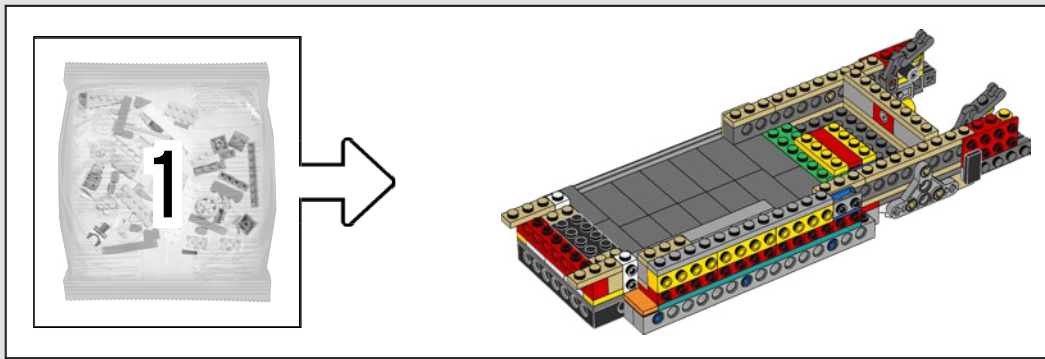

Bereits in den 1950er-Jahren wurden LEGO® Elemente mit vorgeformten VW Modellautos kombiniert. Später ging daraus die Themenwelt „Town Plan“ hervor.

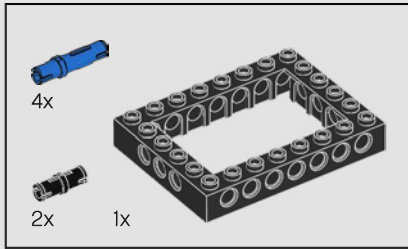

1

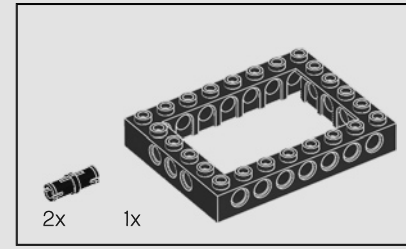
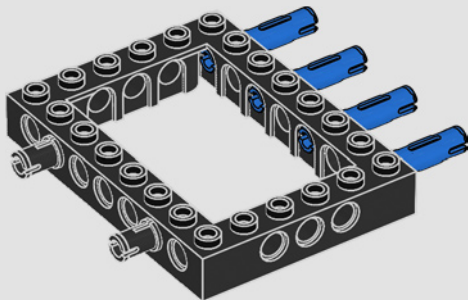

2

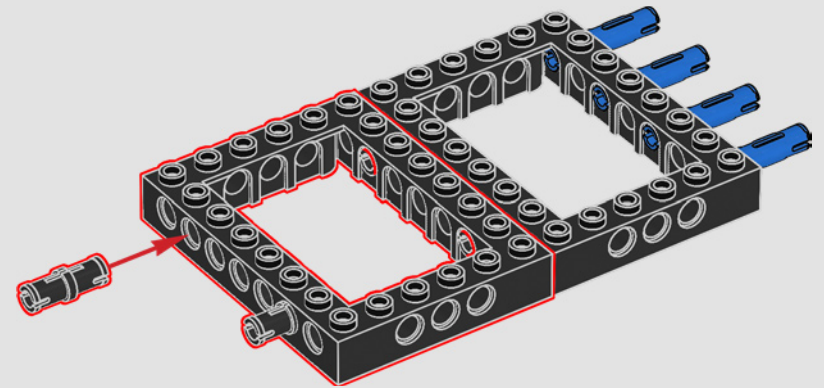

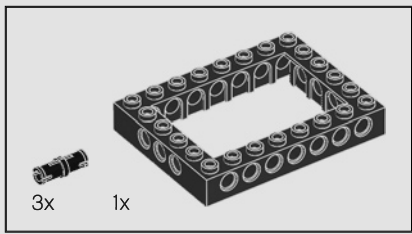

3

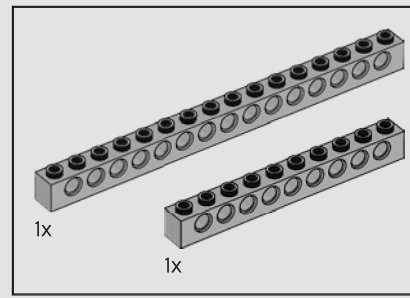
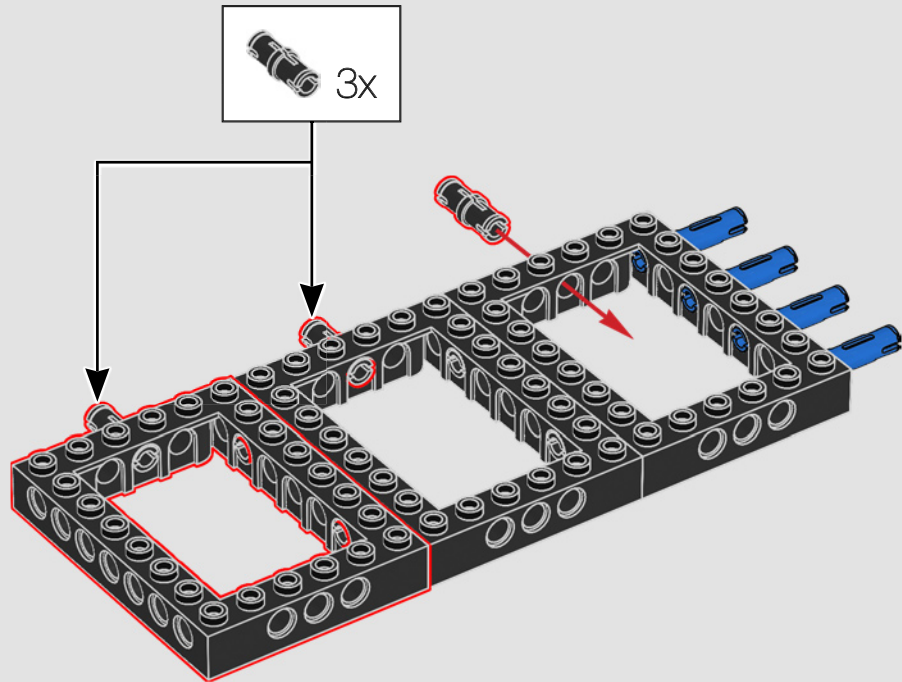

4

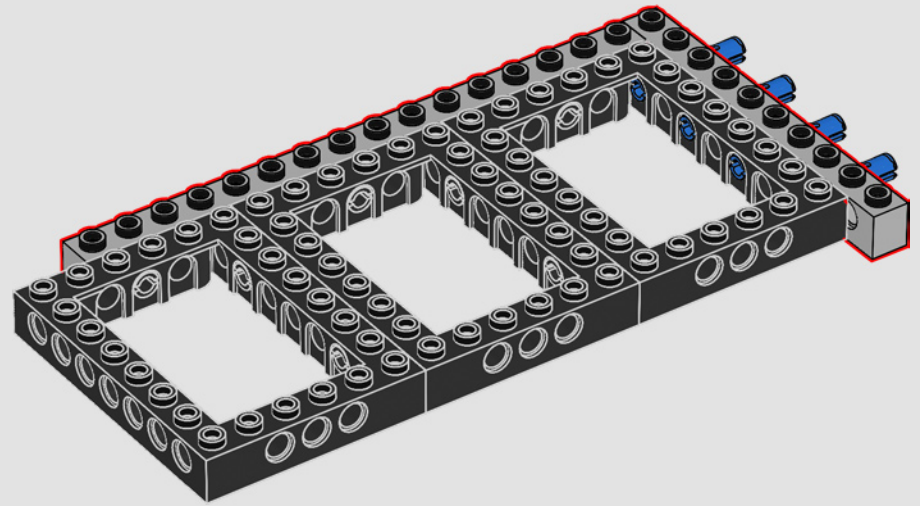

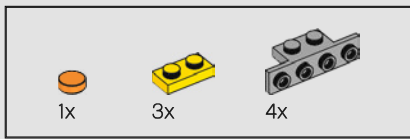

5

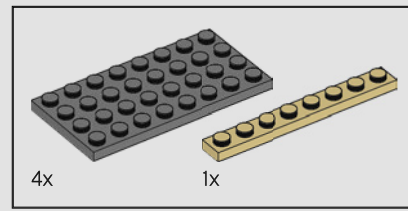
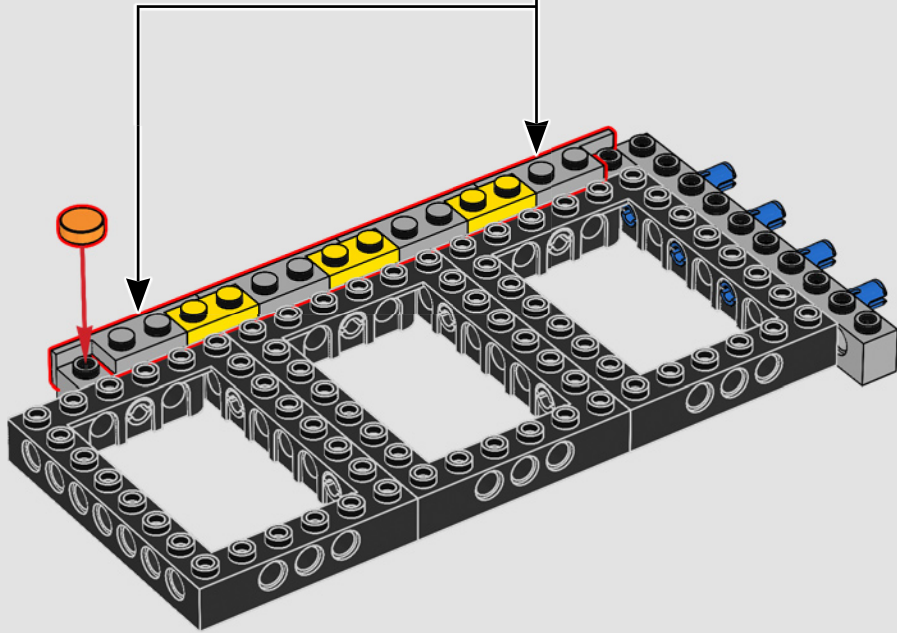
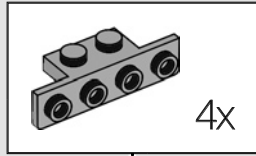

6

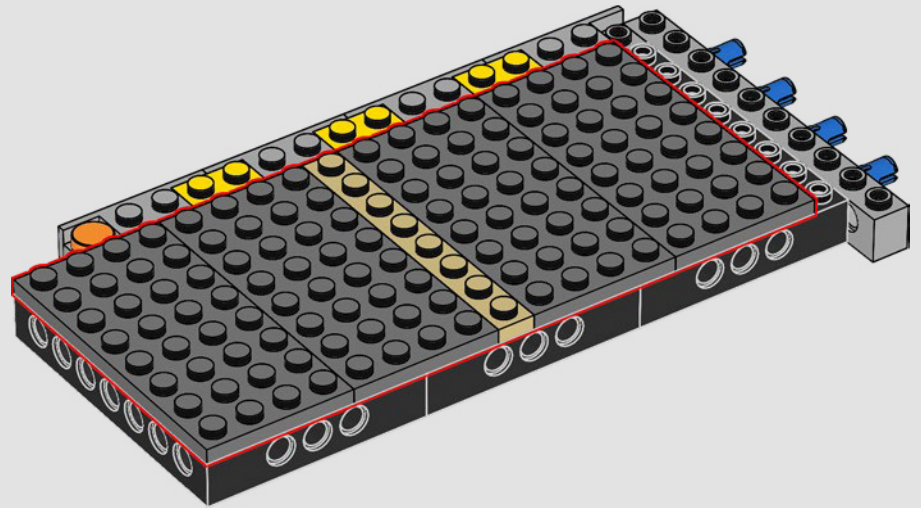

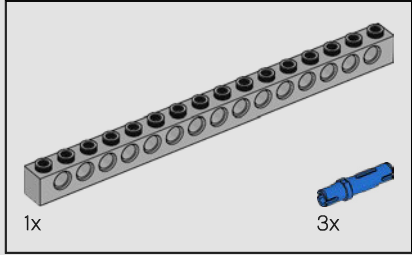
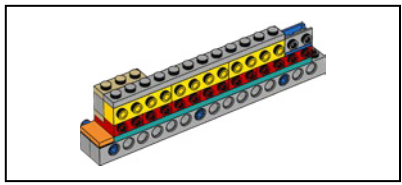

7

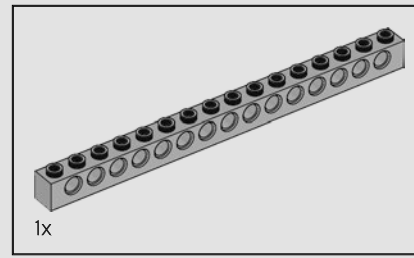
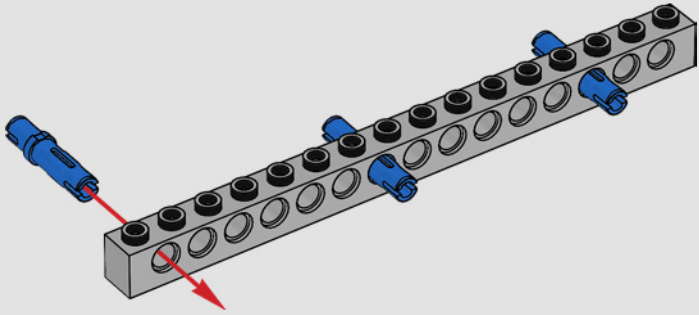

8

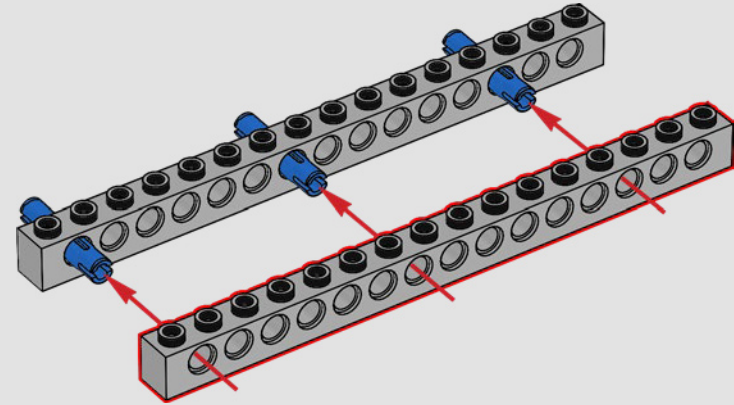

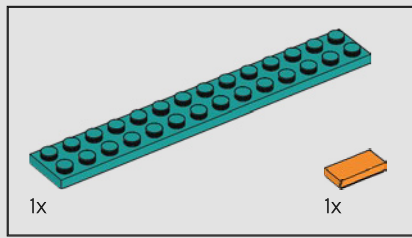

9

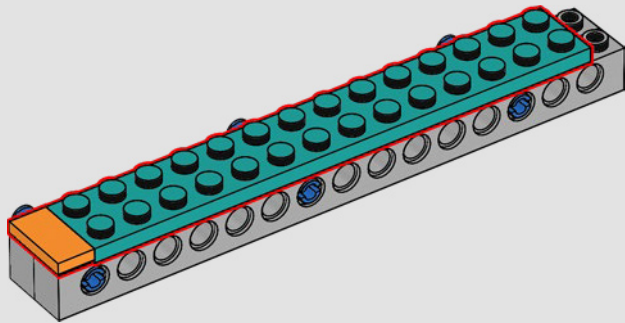

10

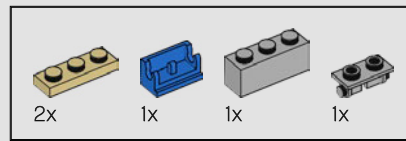
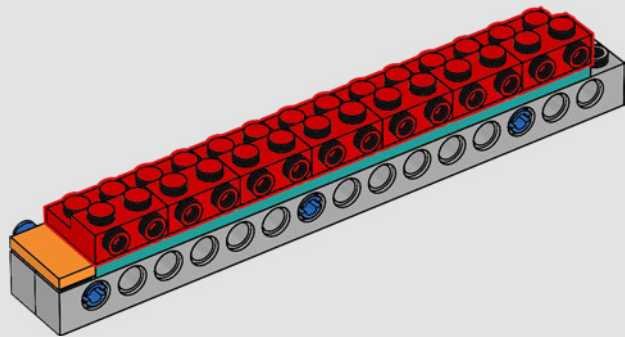

11

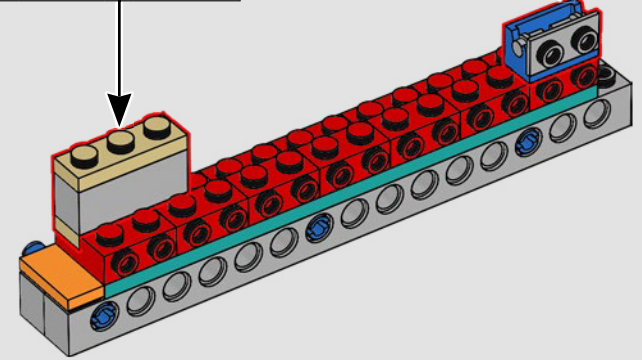
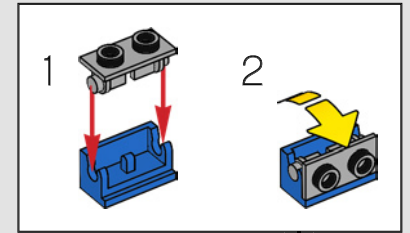
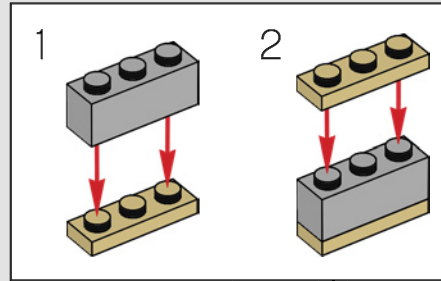

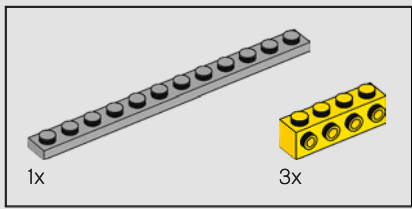

12

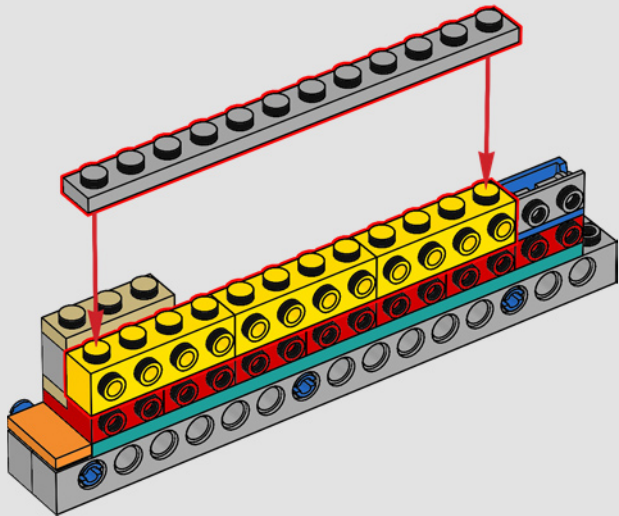

13

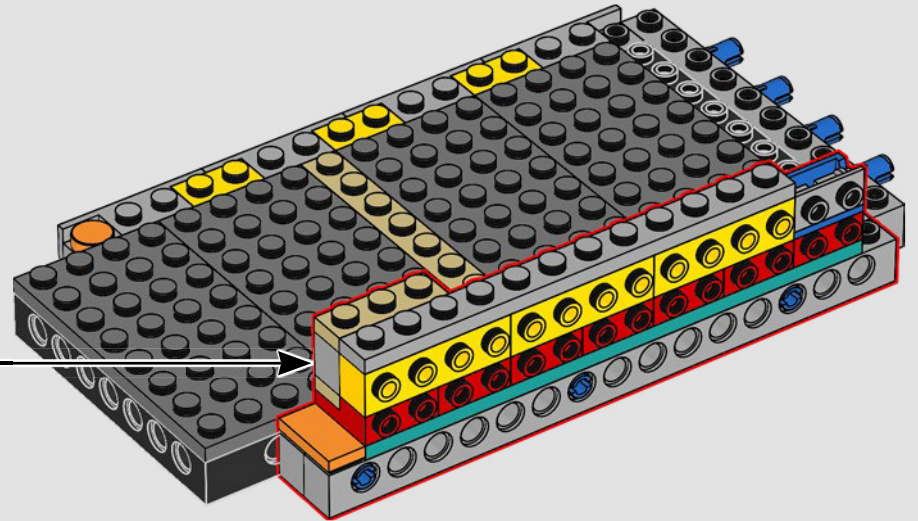

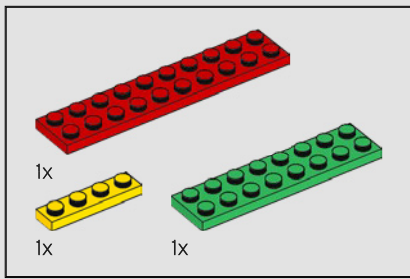

14

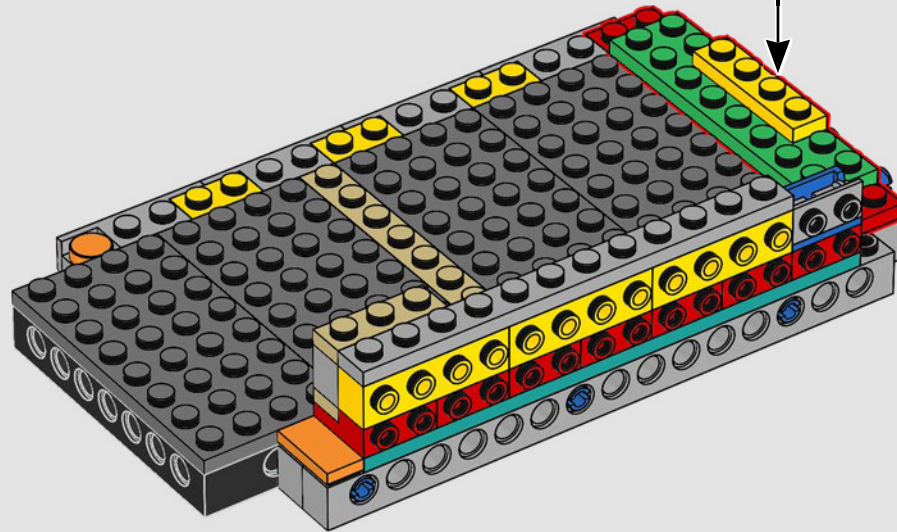
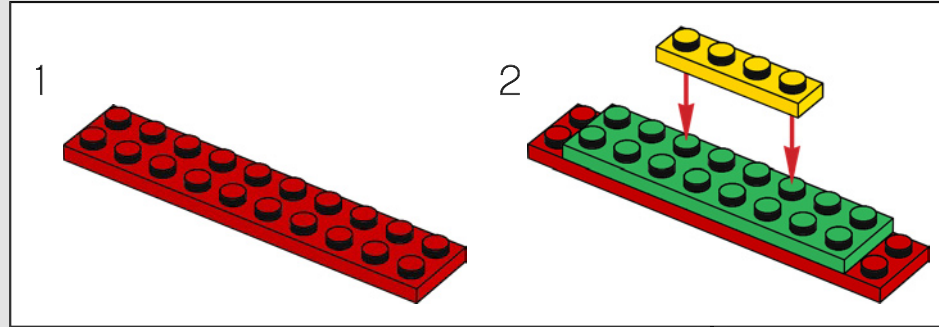

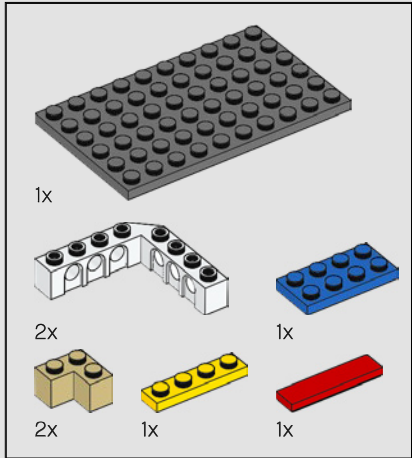
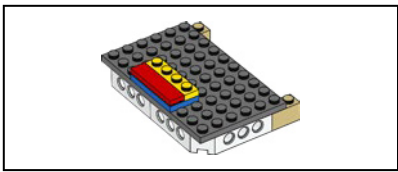

15

1

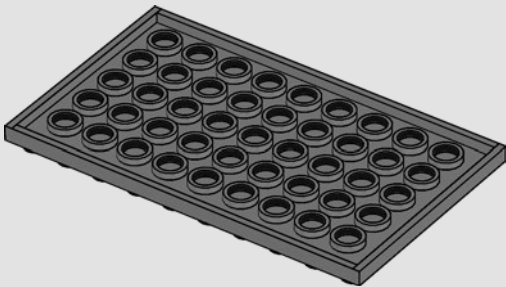

2

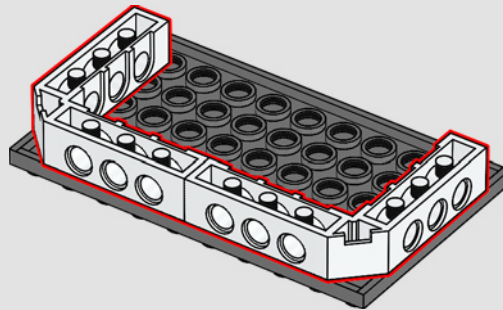

3

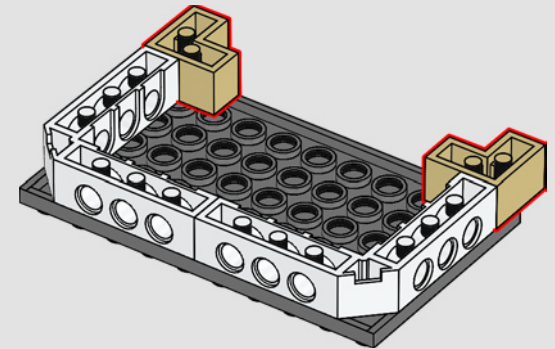

Der VW Käfer aus dem Jahr 2008 war das erste große Automodell, das im Rahmen der Creator Produktreihe herausgebracht wurde. Die Fans konnten für vier potenzielle Automodelle stimmen. Sieger dieser Abstimmung war der VW Käfer.



4

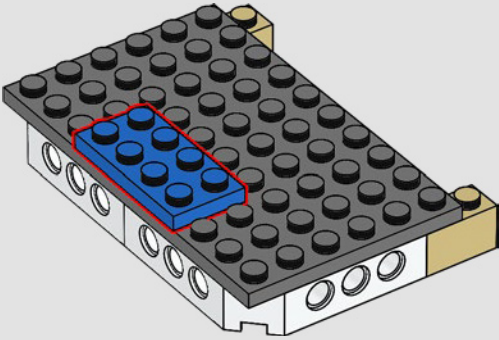

5

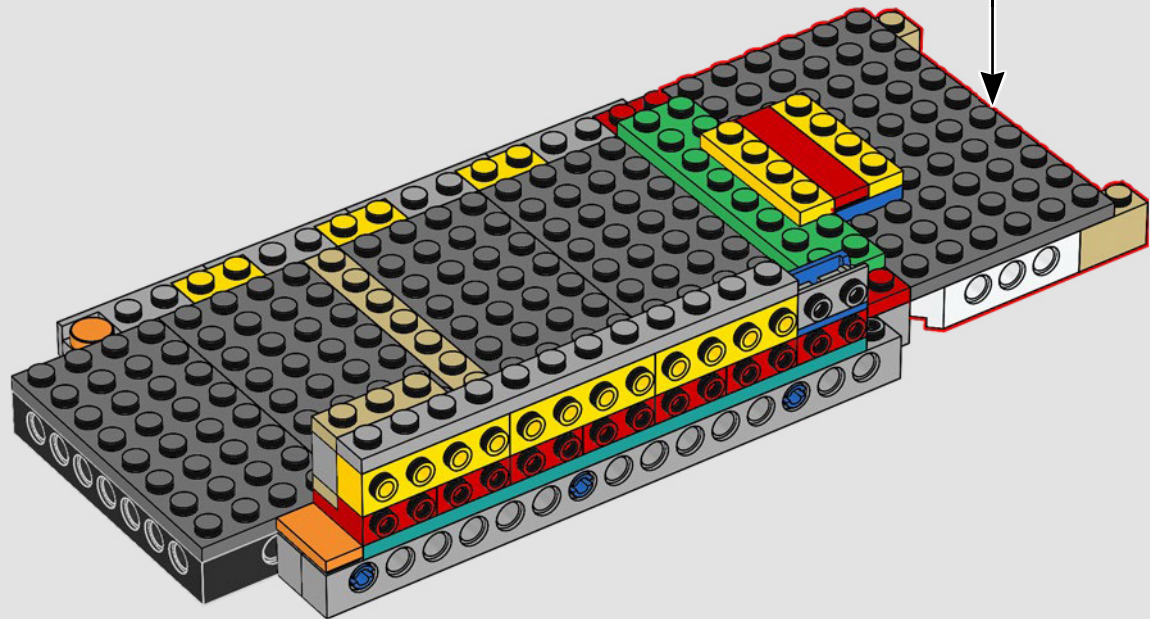
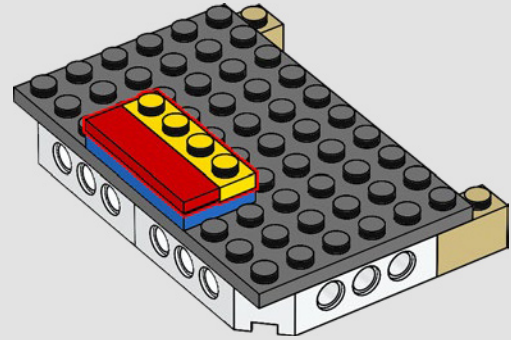

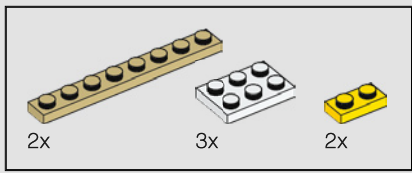

16

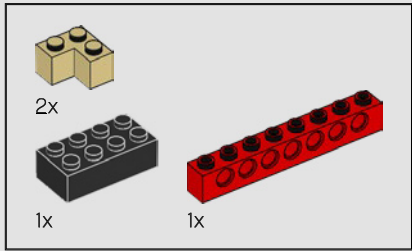
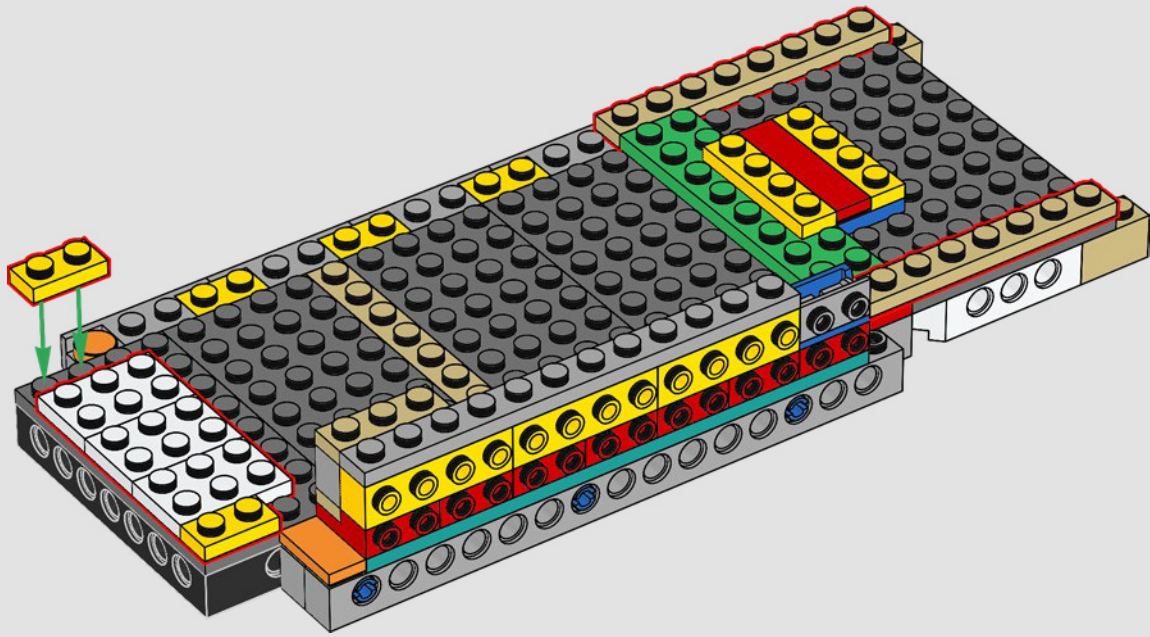

17

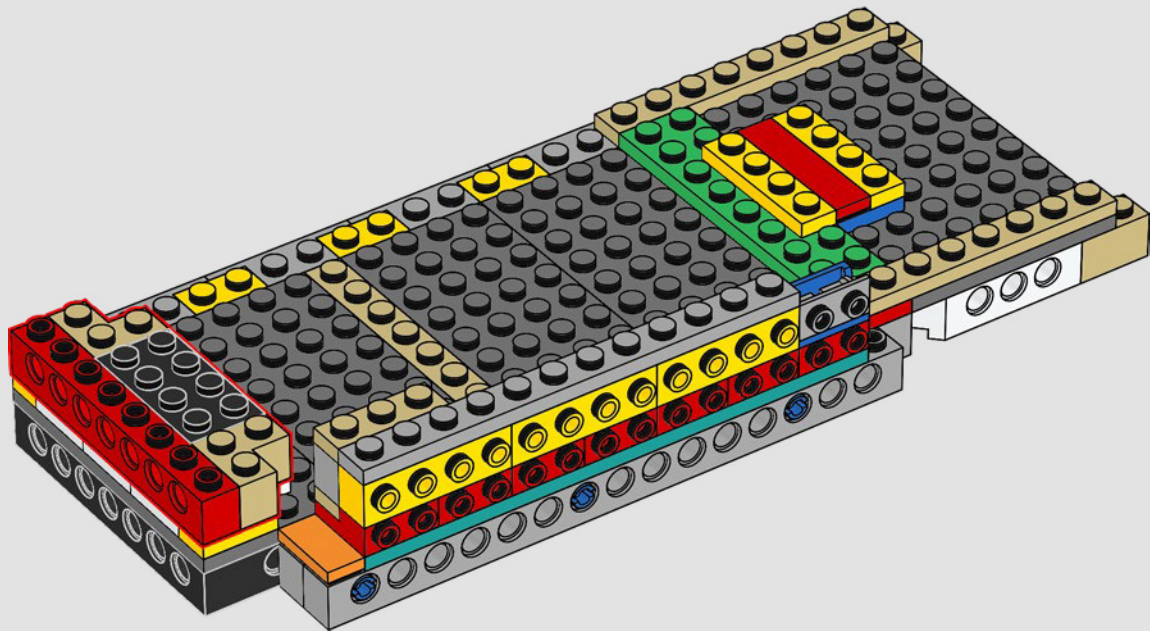

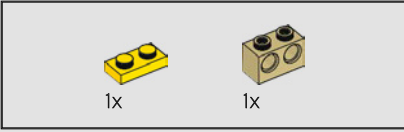
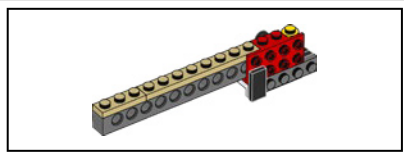

18

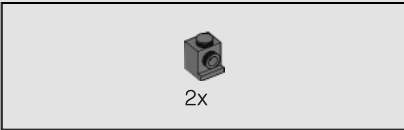
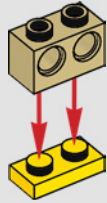

19

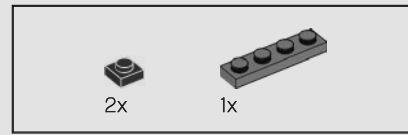
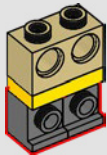

20

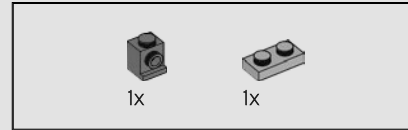
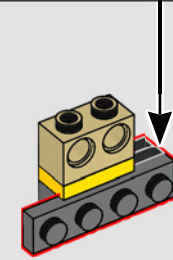
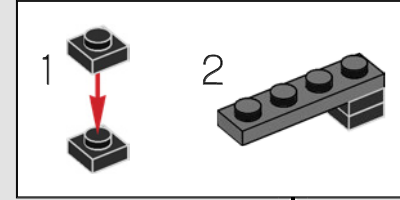

21

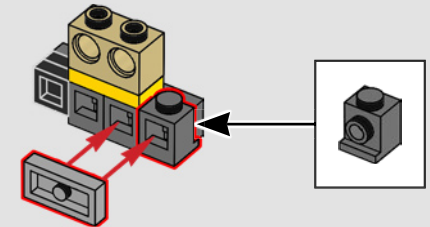
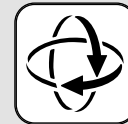

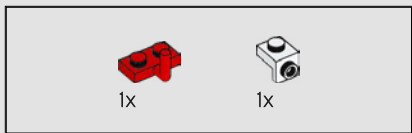

22

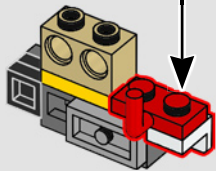
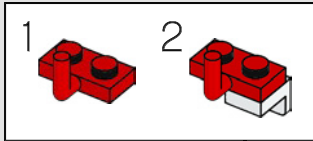

23

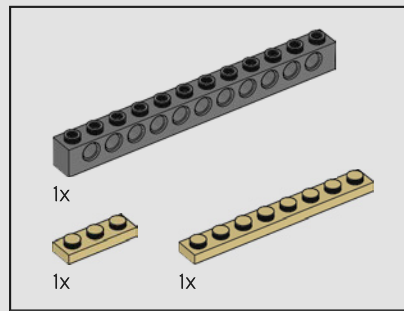
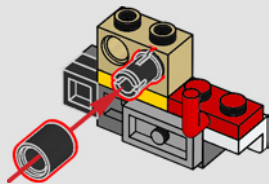

24

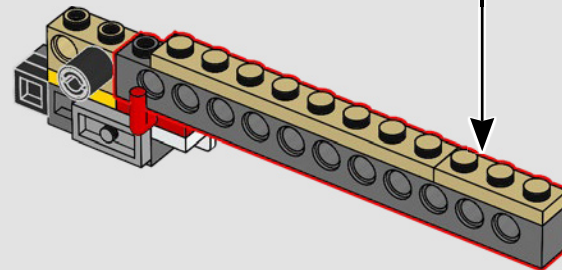
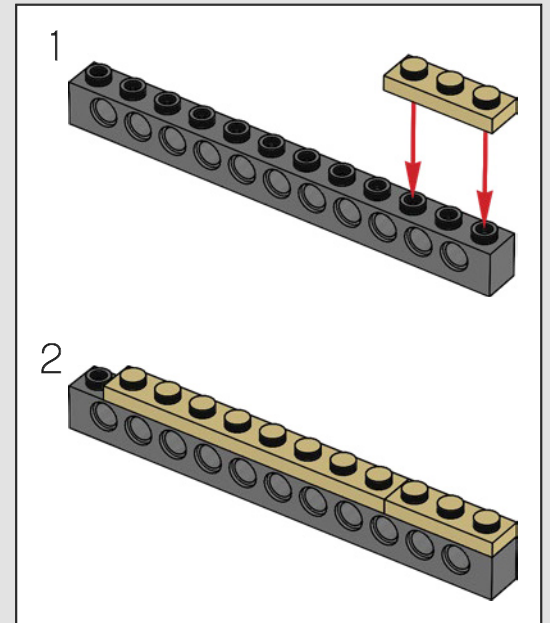

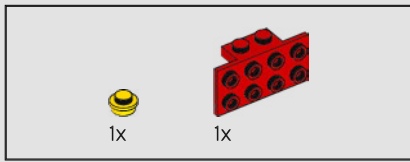

25

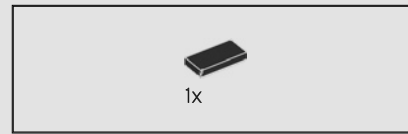
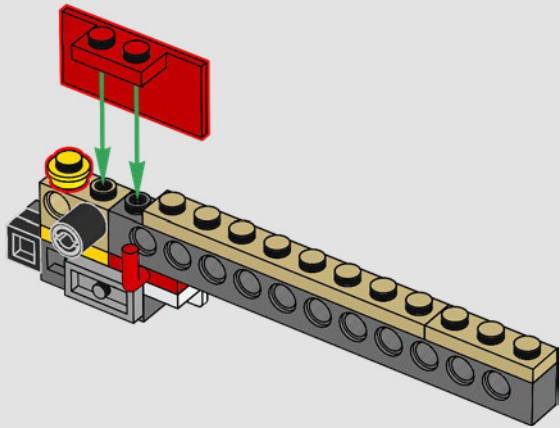

26

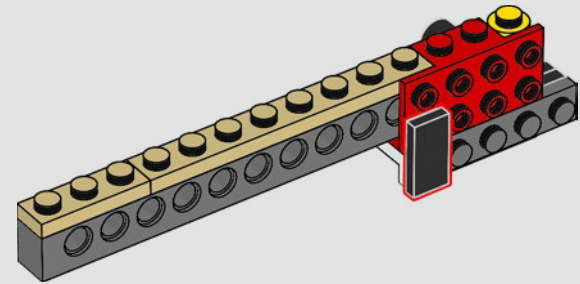
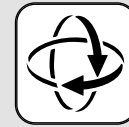

27

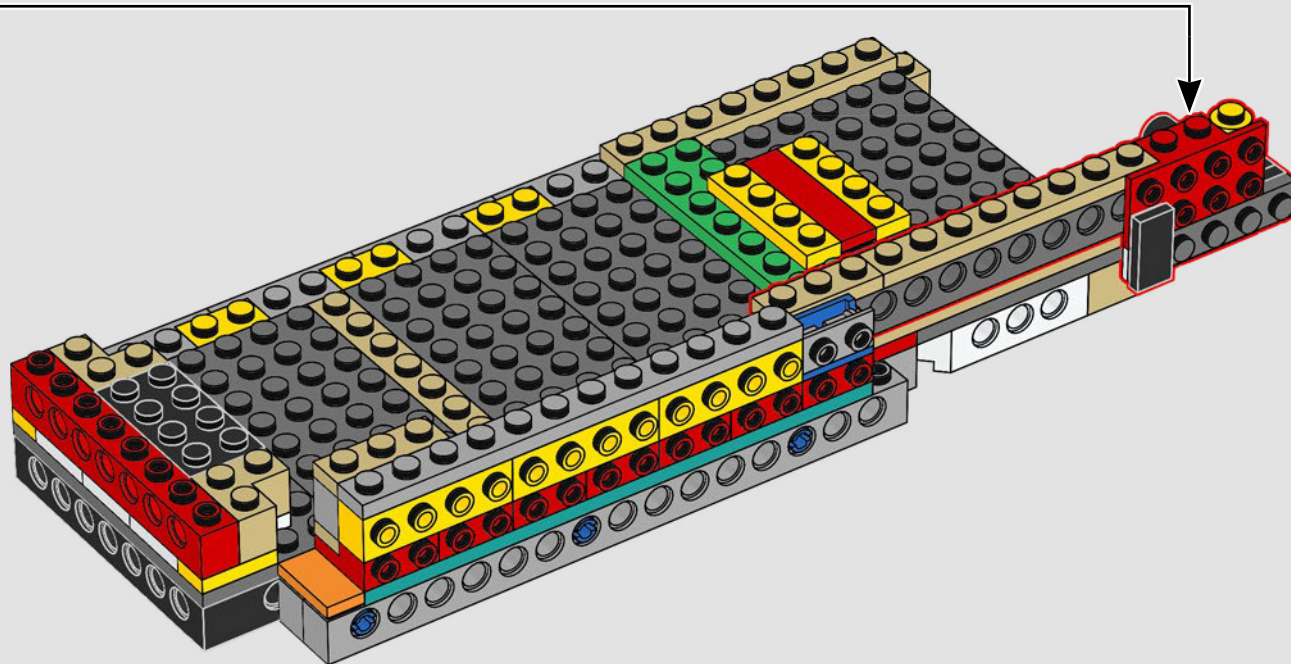

3x

28

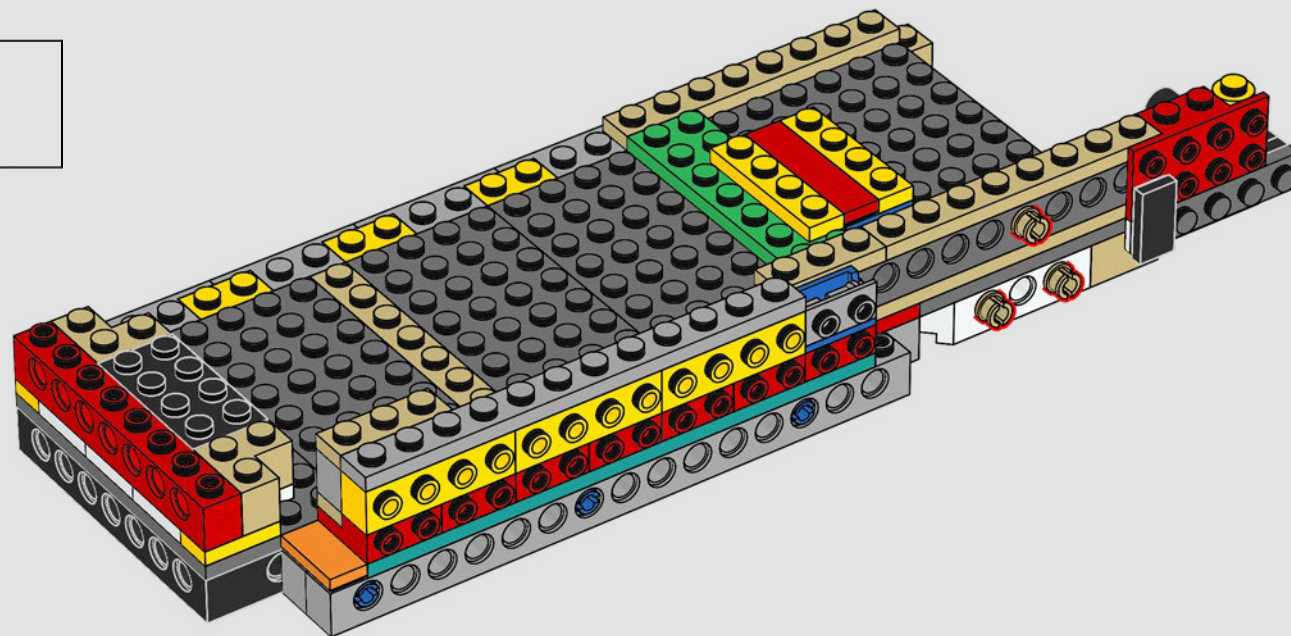

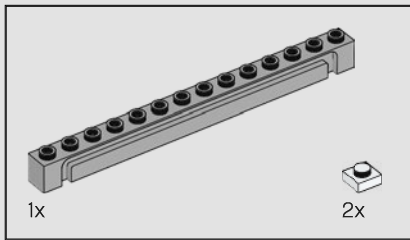

29

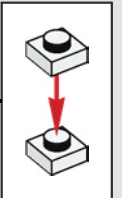
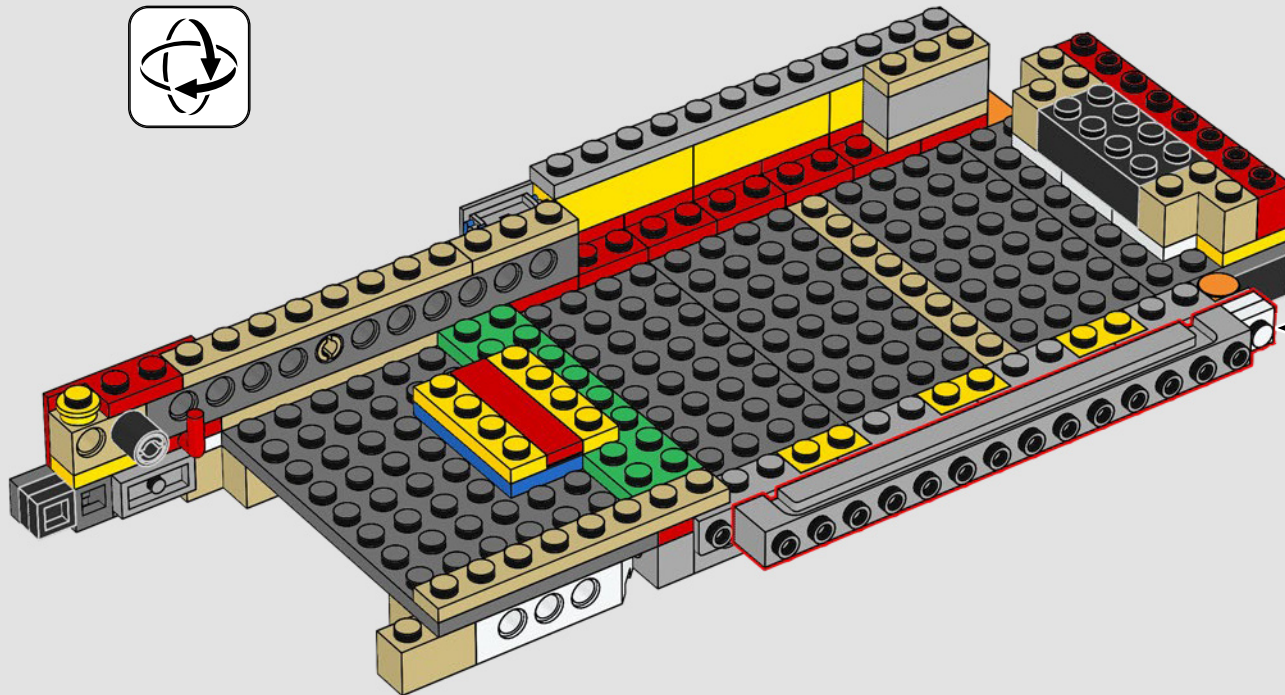

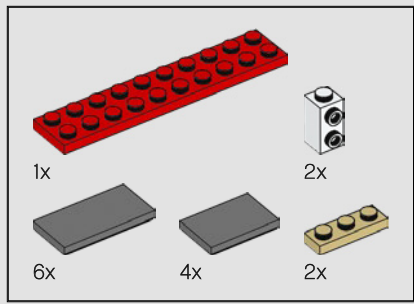

30

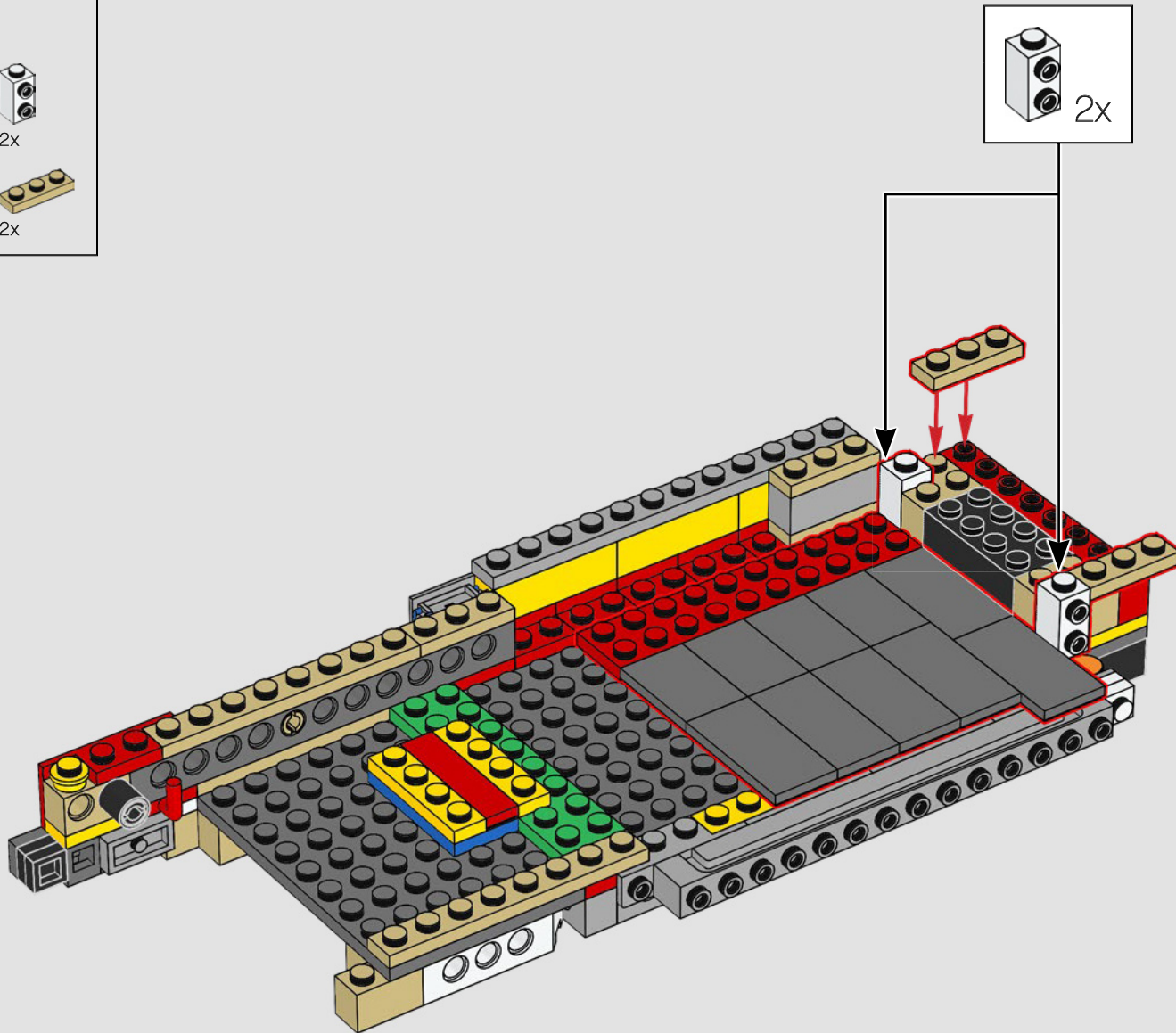

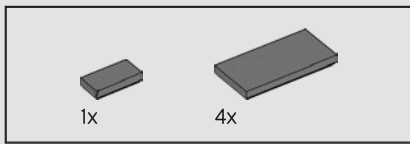

31

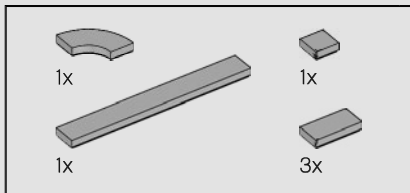
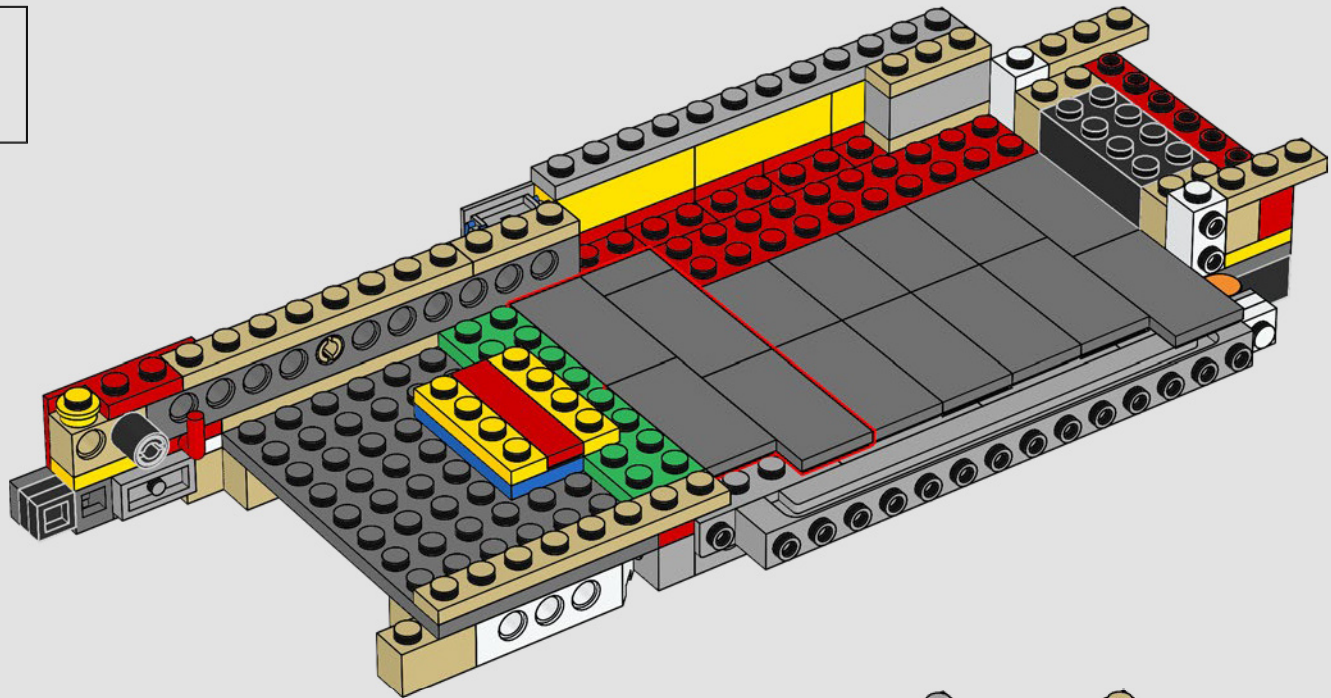

32

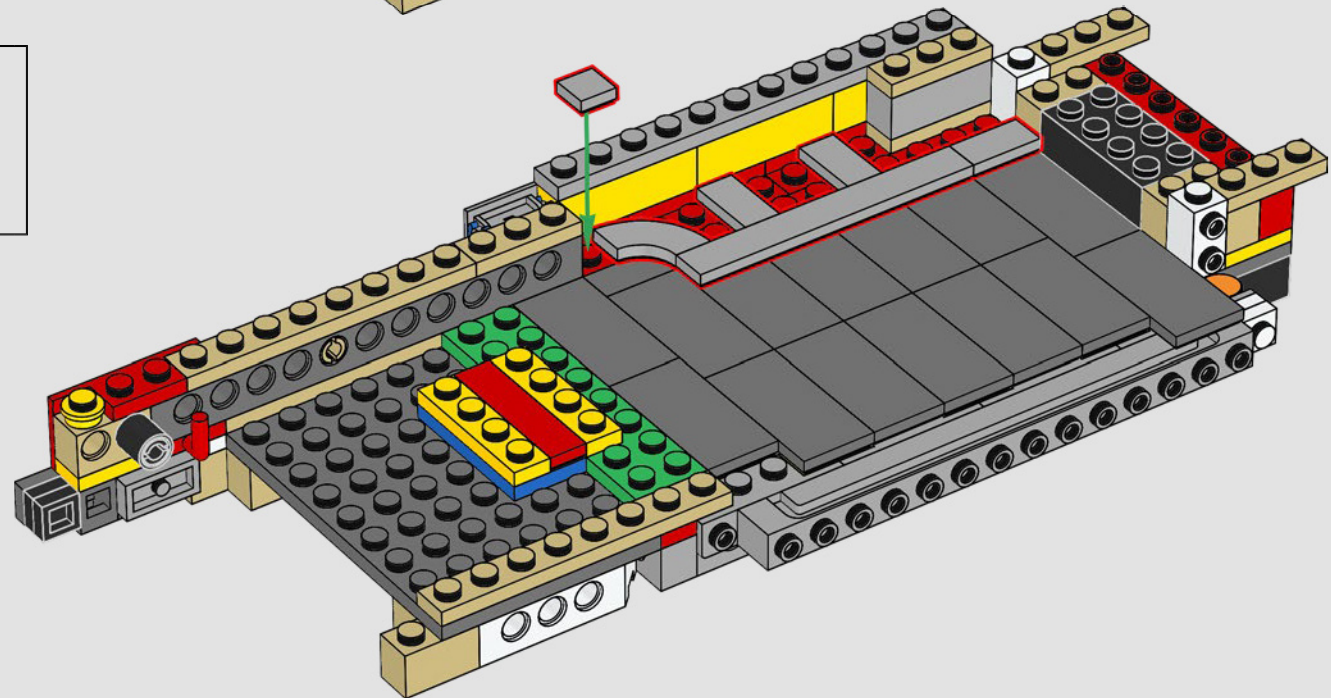

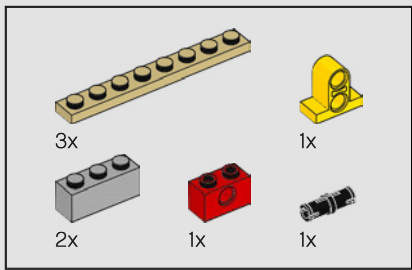

33

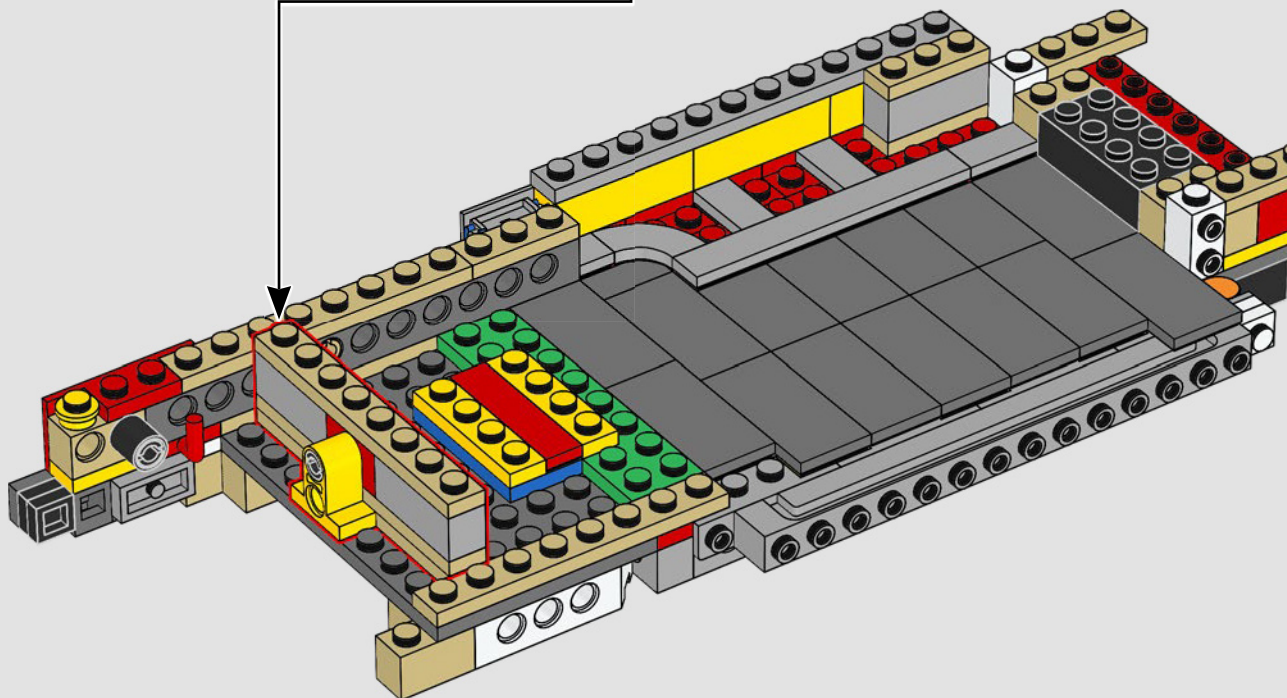
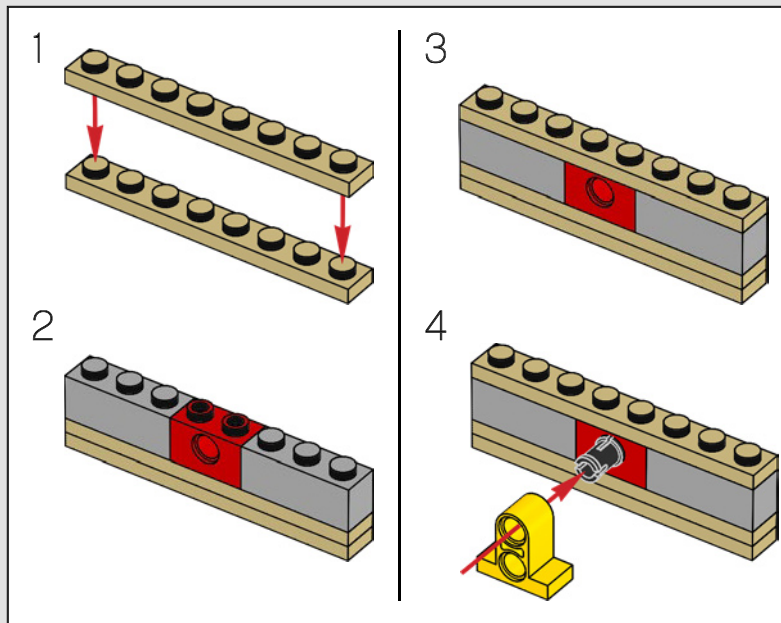

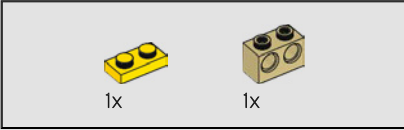
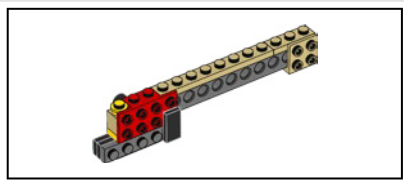

34

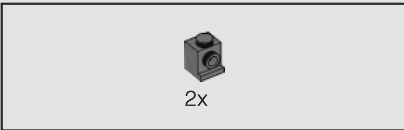
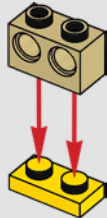

35

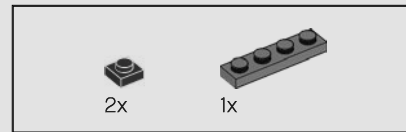
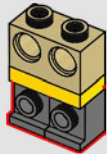

36

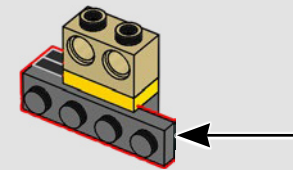
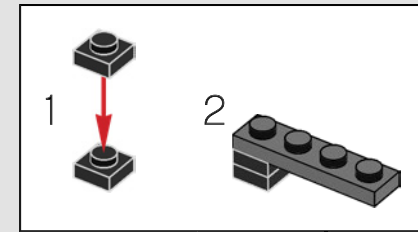

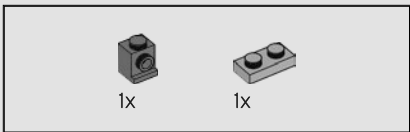

37

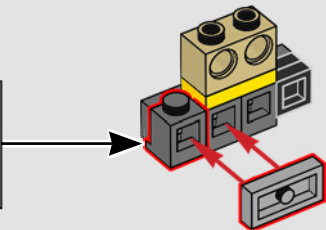
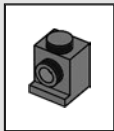

38

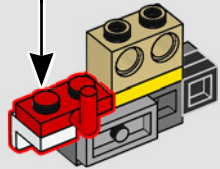
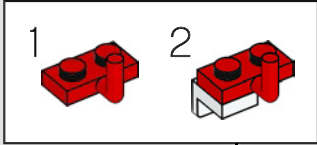

39

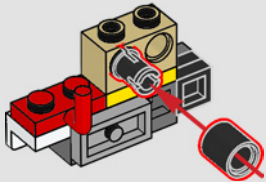

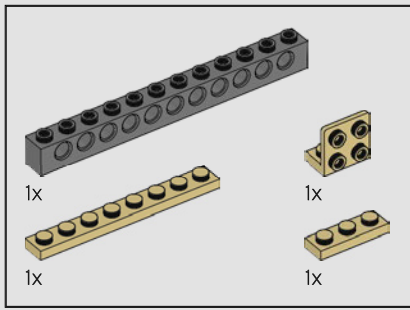

40

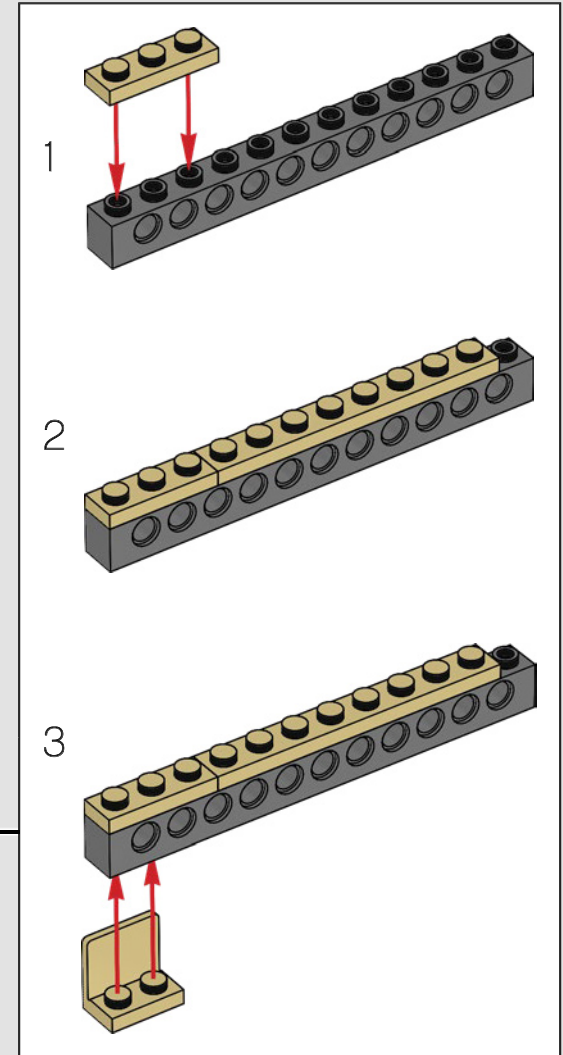
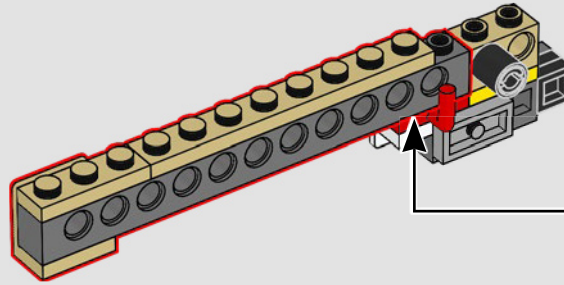

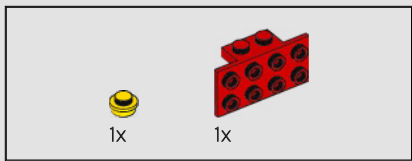

41

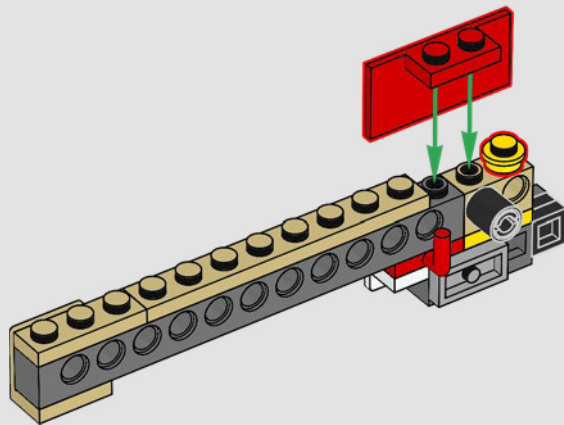

42

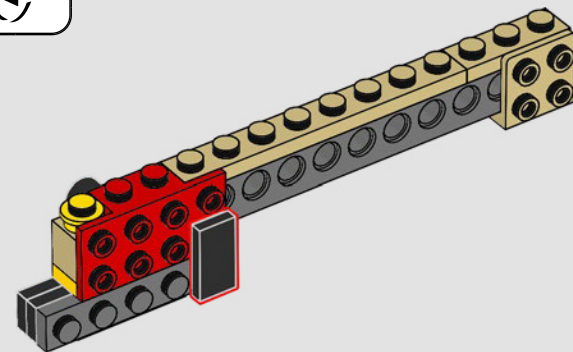
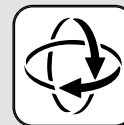

43

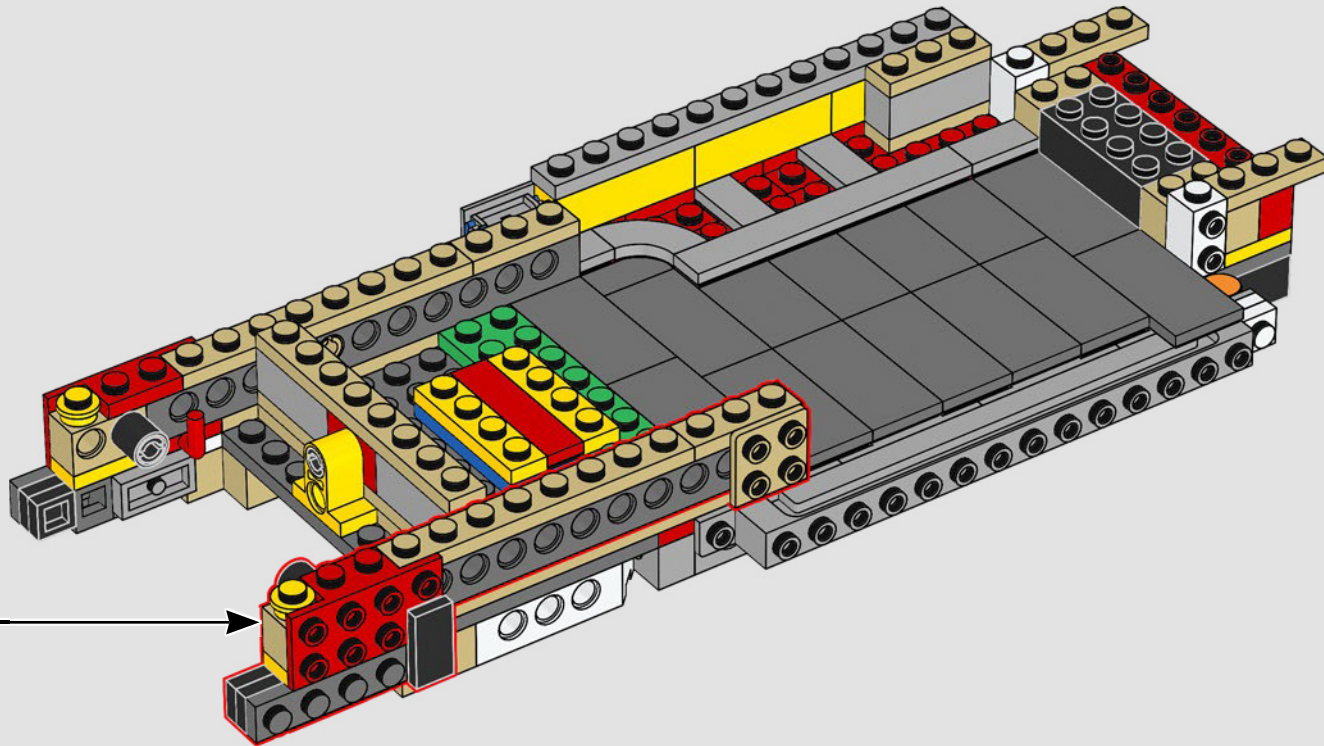



44

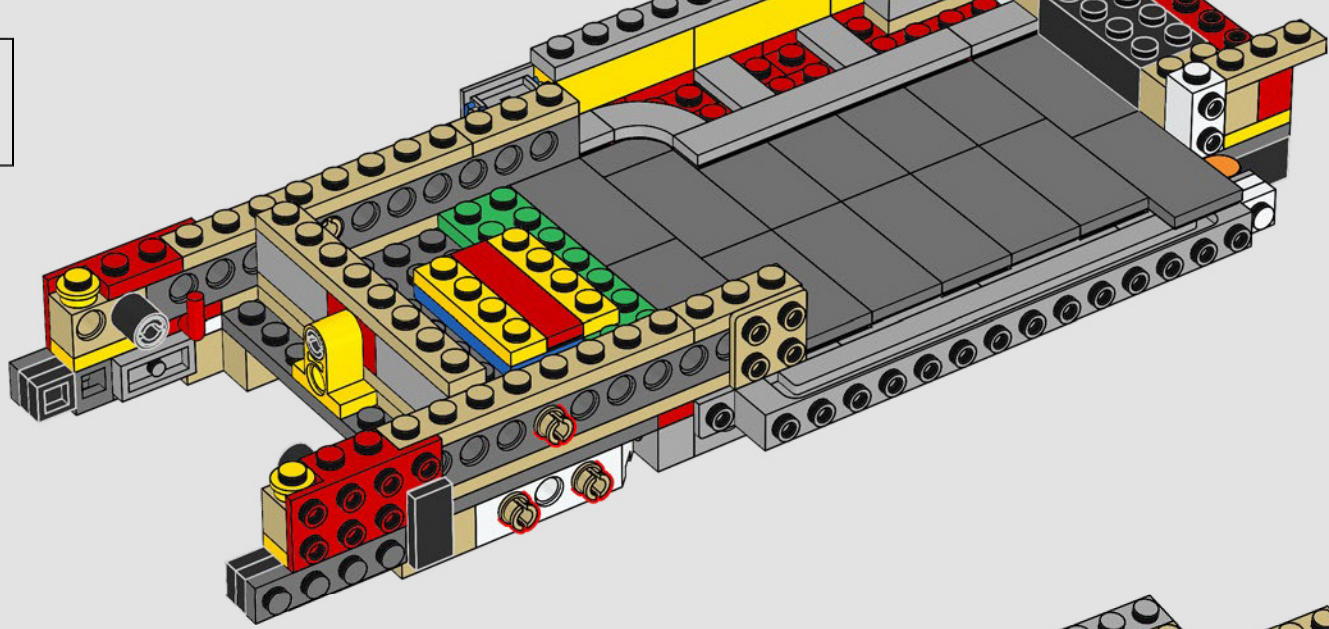

45

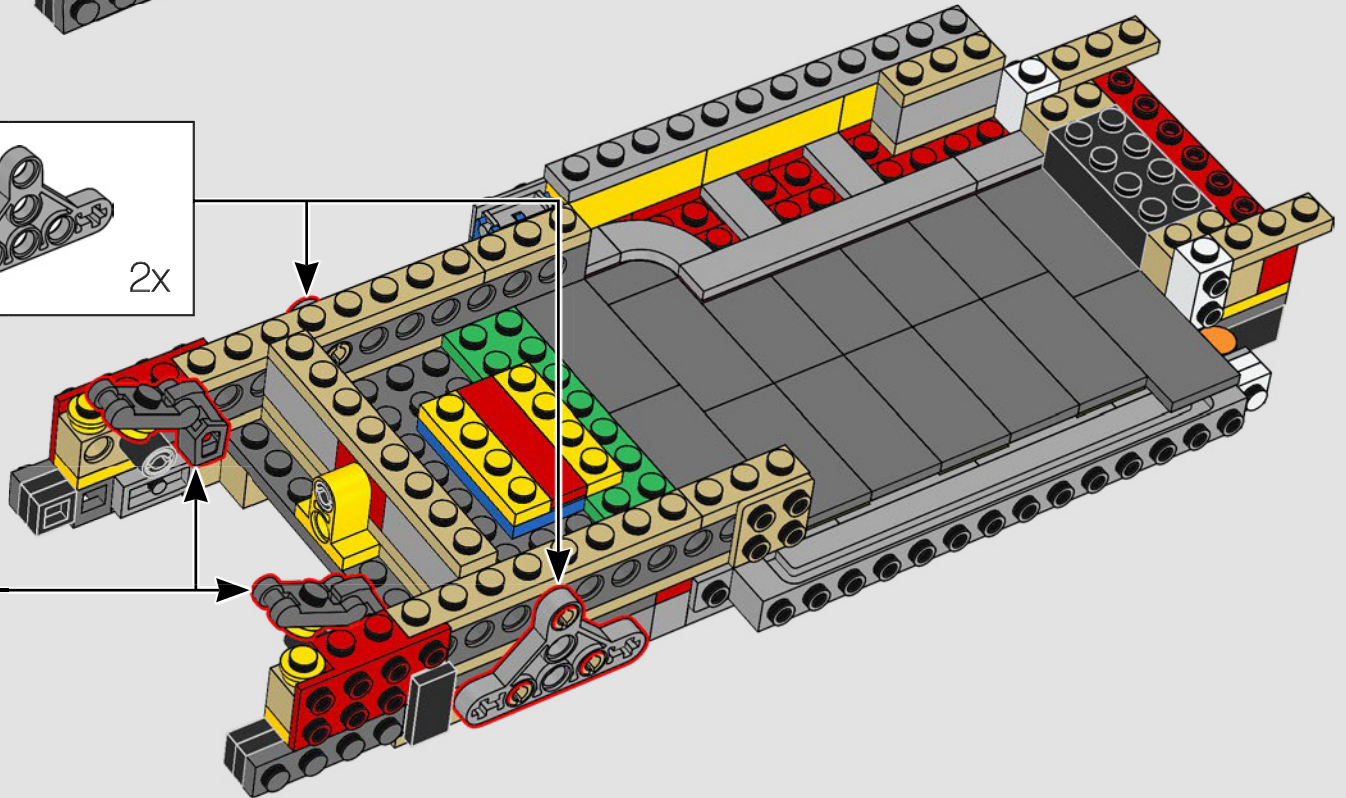
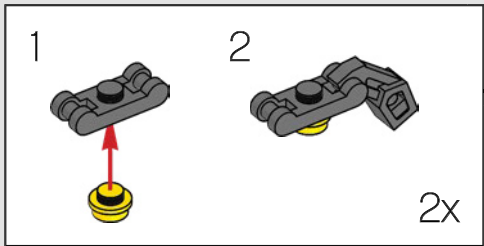
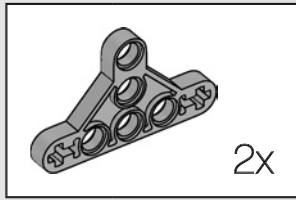

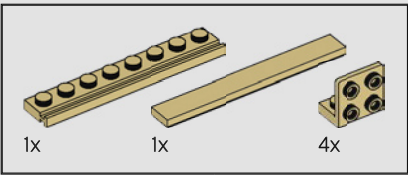
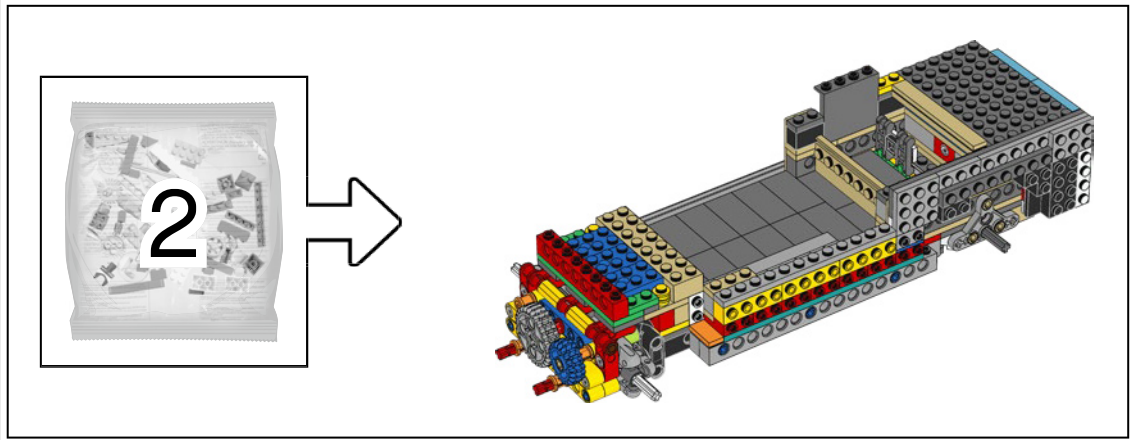

46

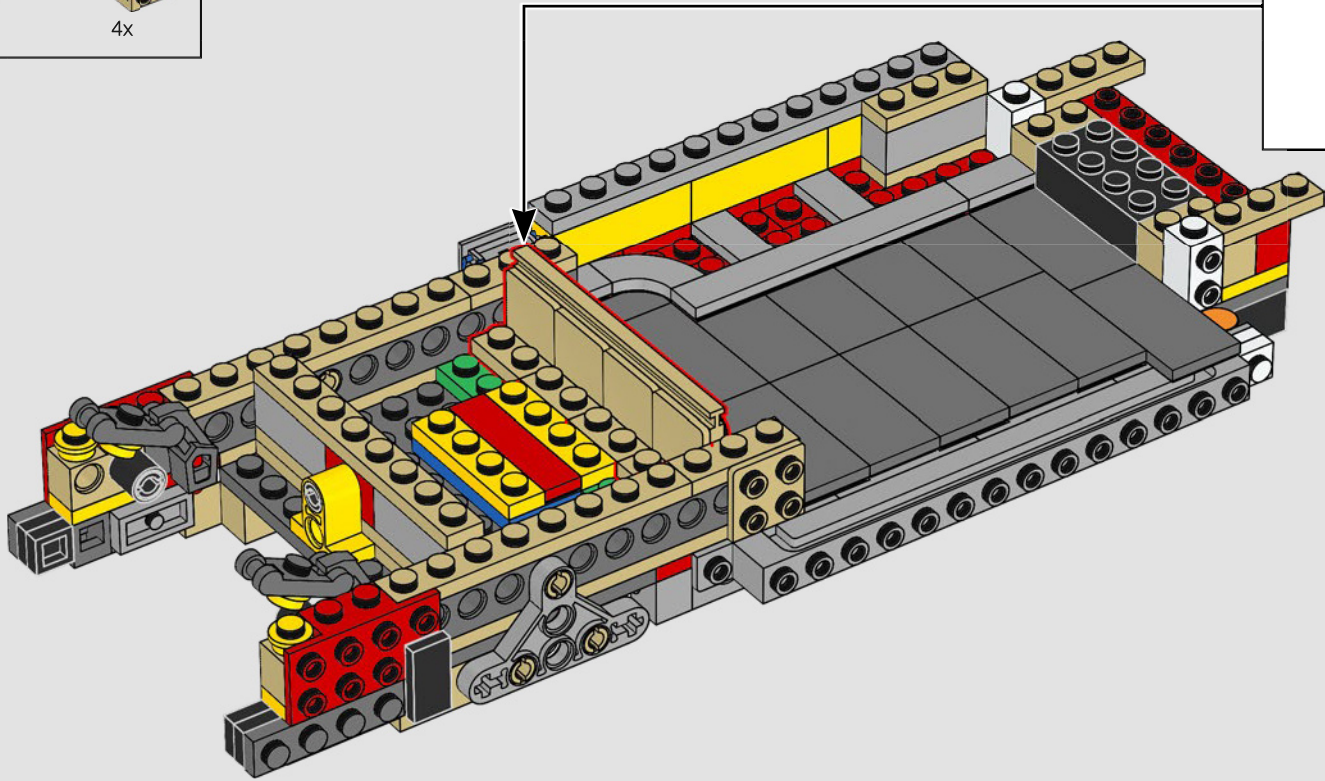
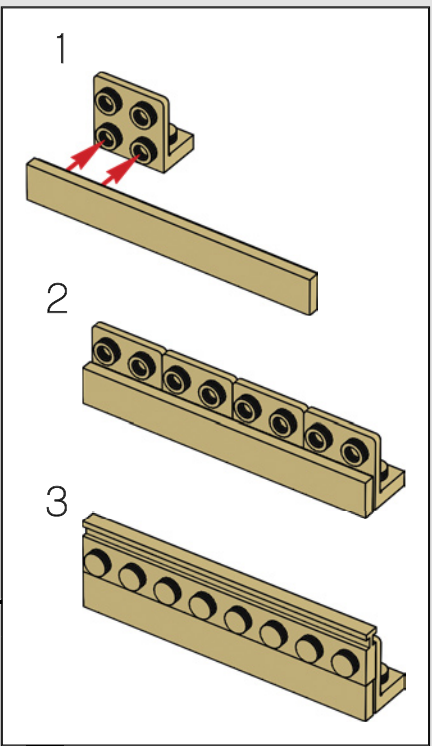

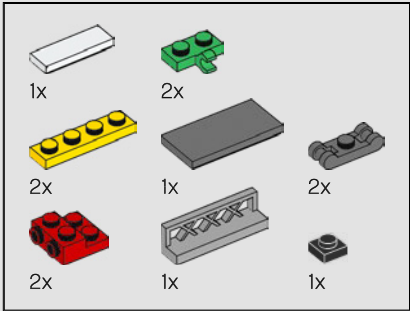
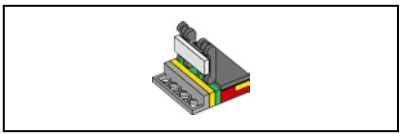

47

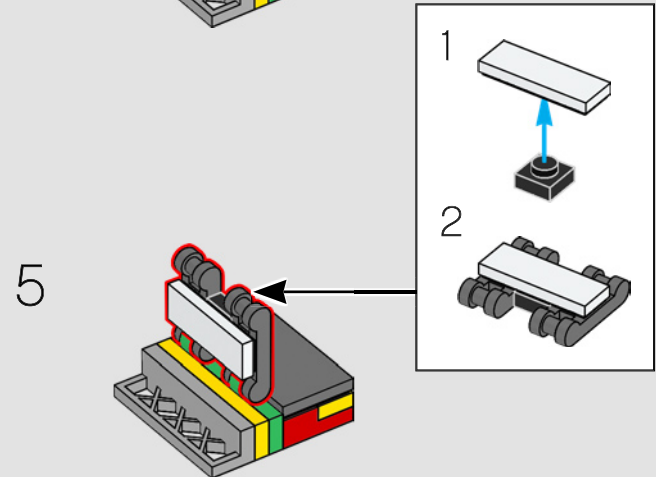
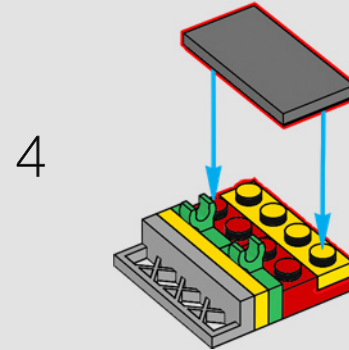
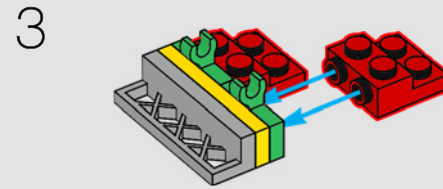
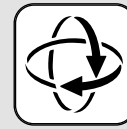
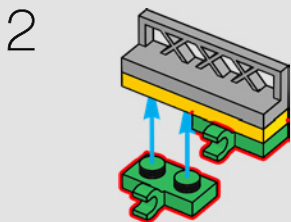
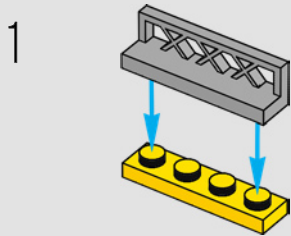

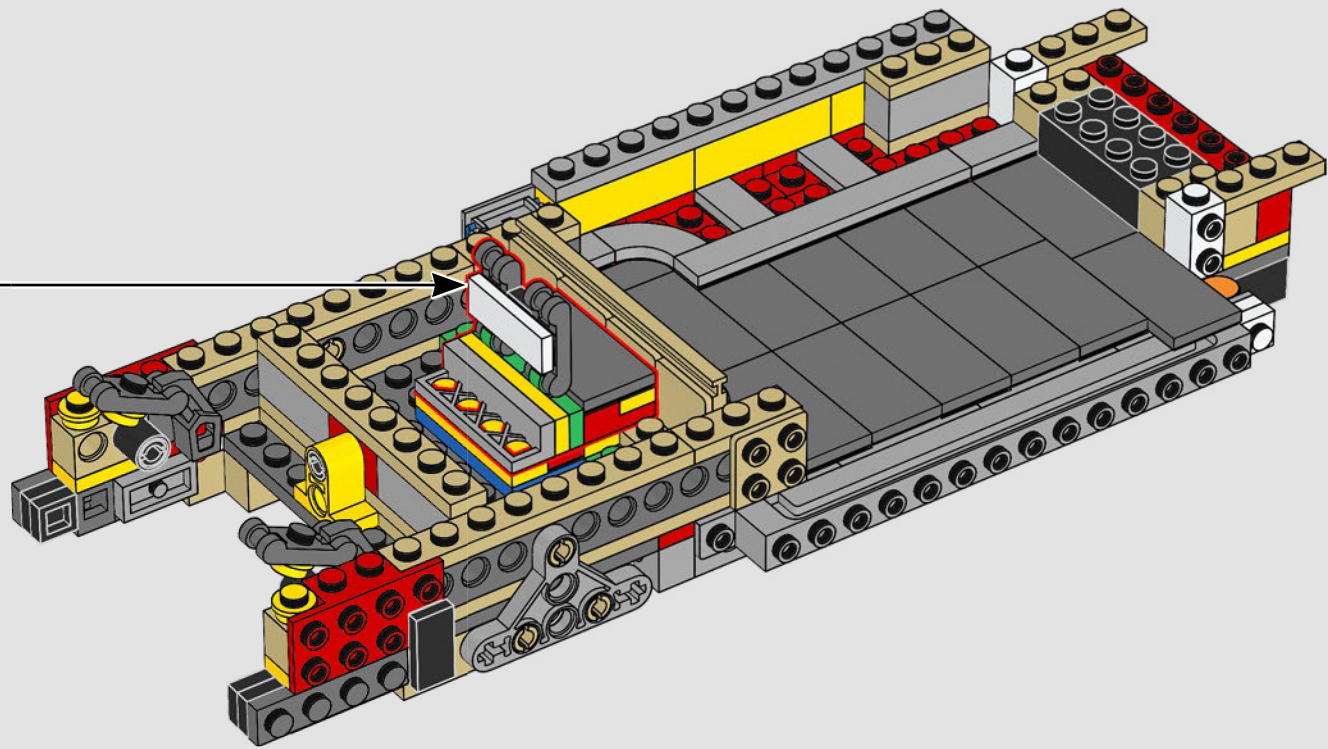

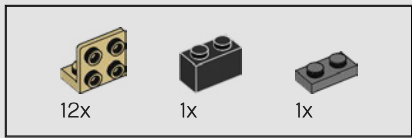

48

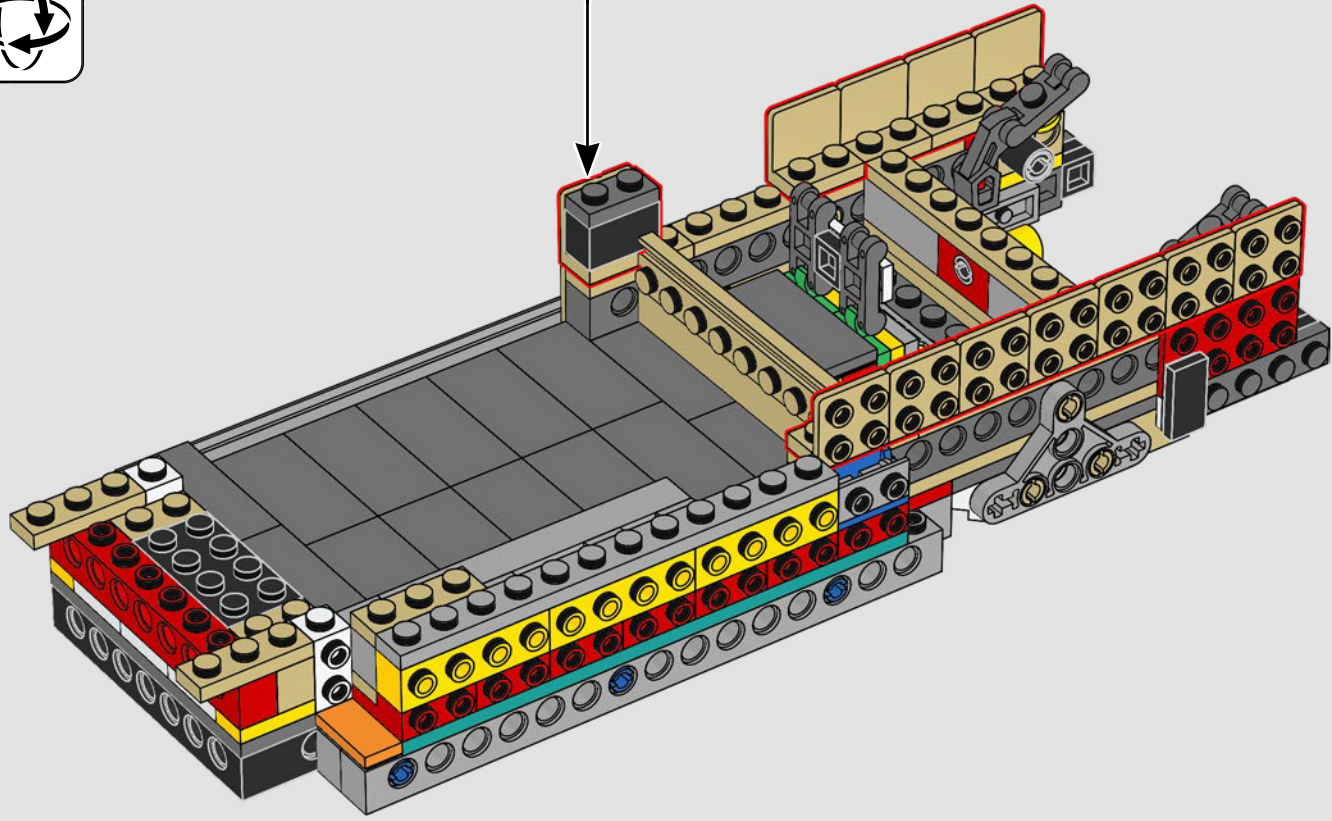
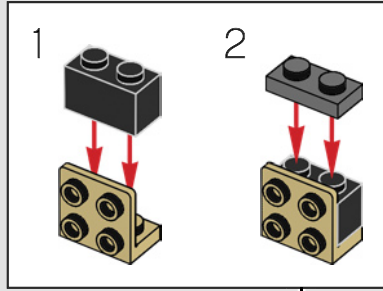

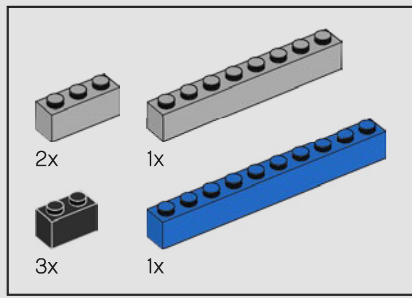

49

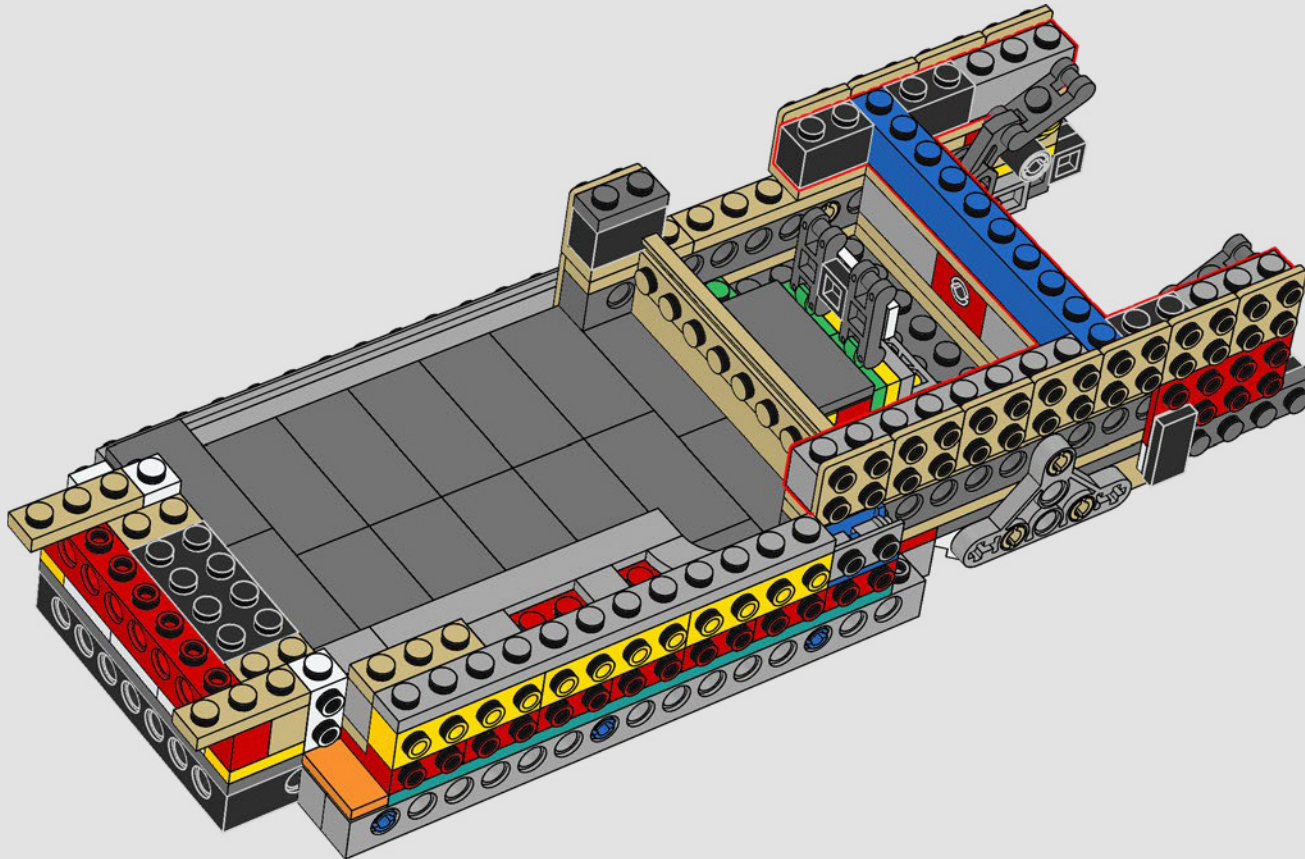

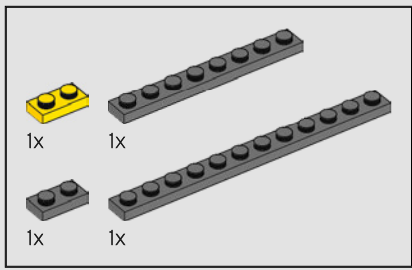

50

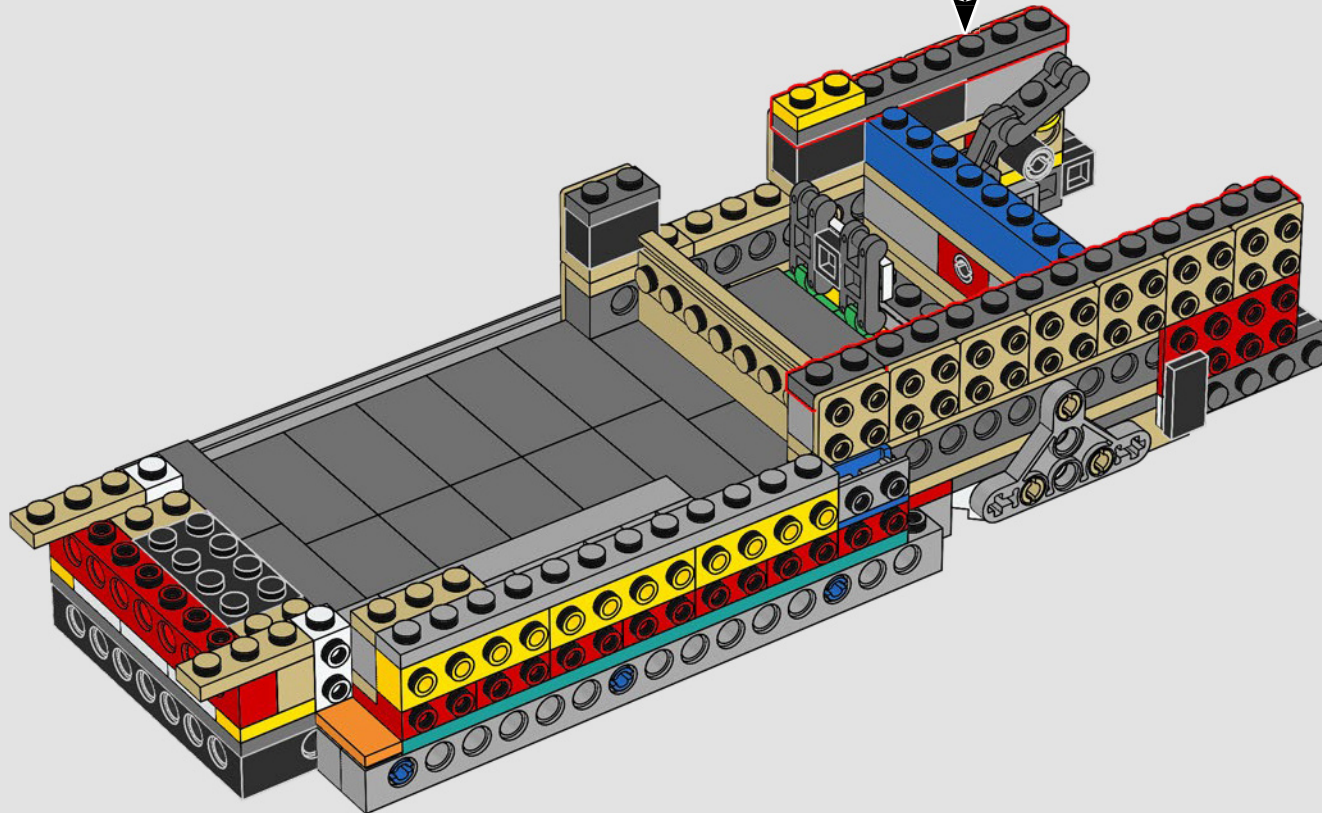
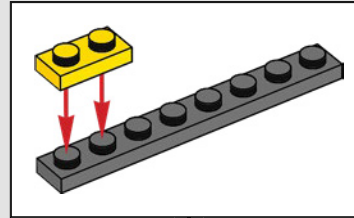

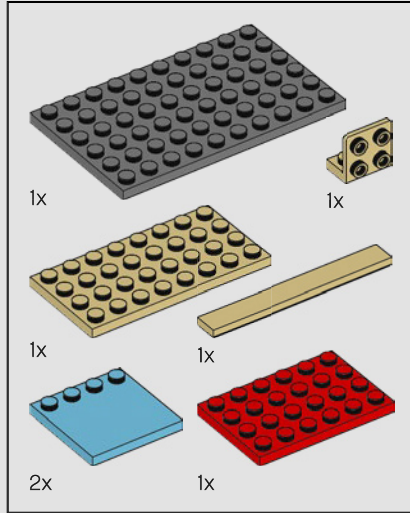
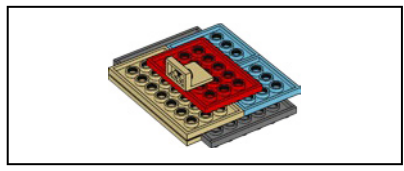

51

1

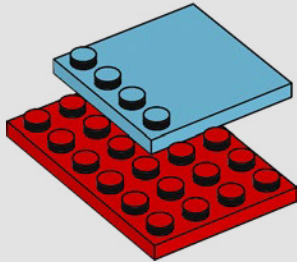

2

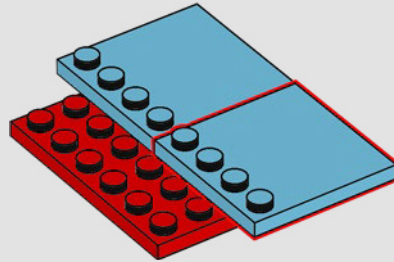

3

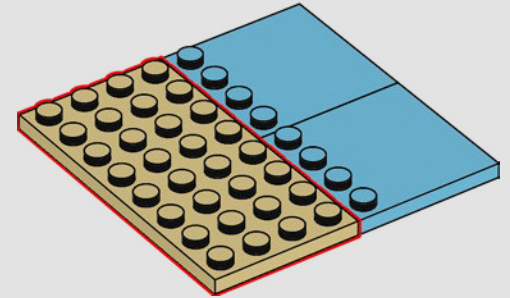

4

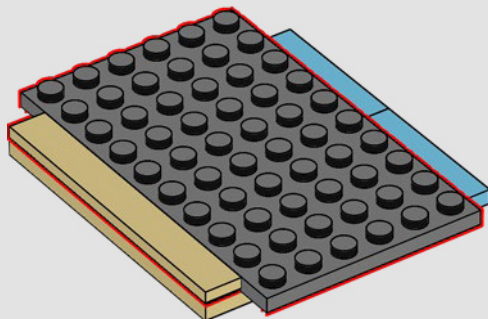

5

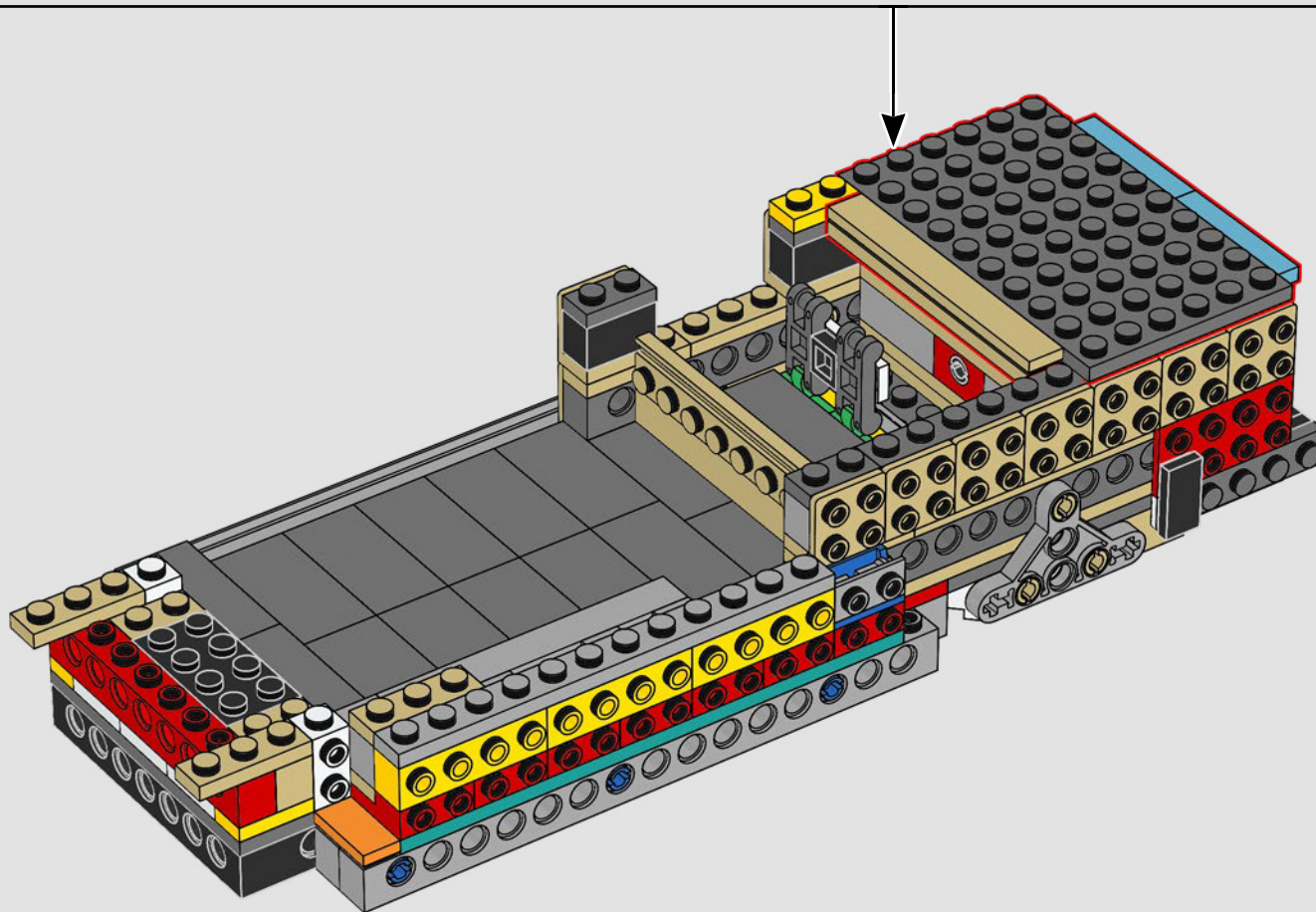
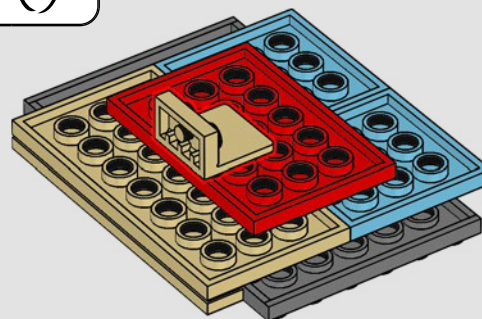

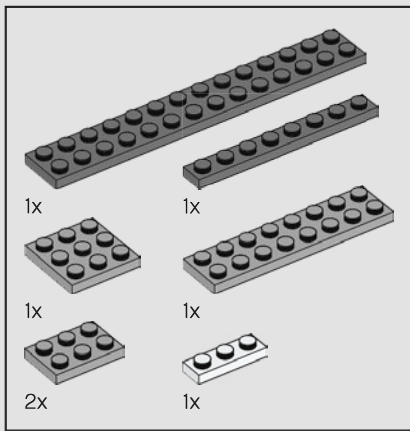

52

1

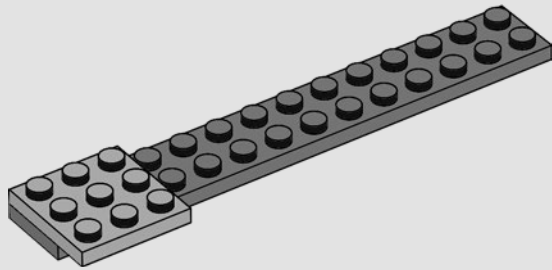

2

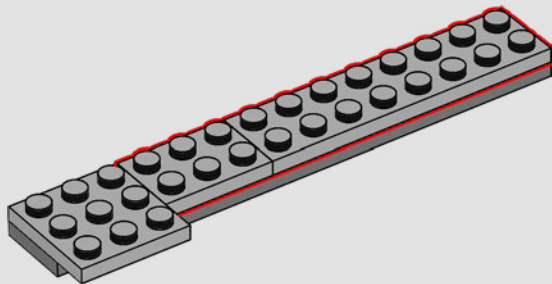

3

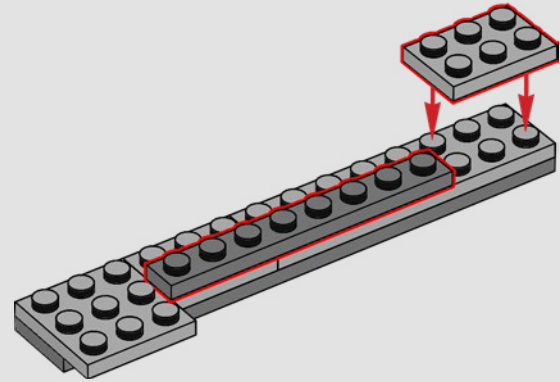

4

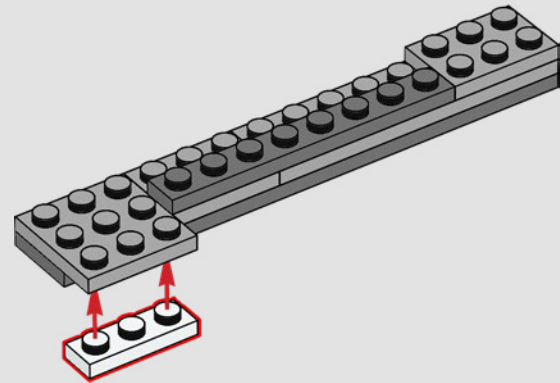

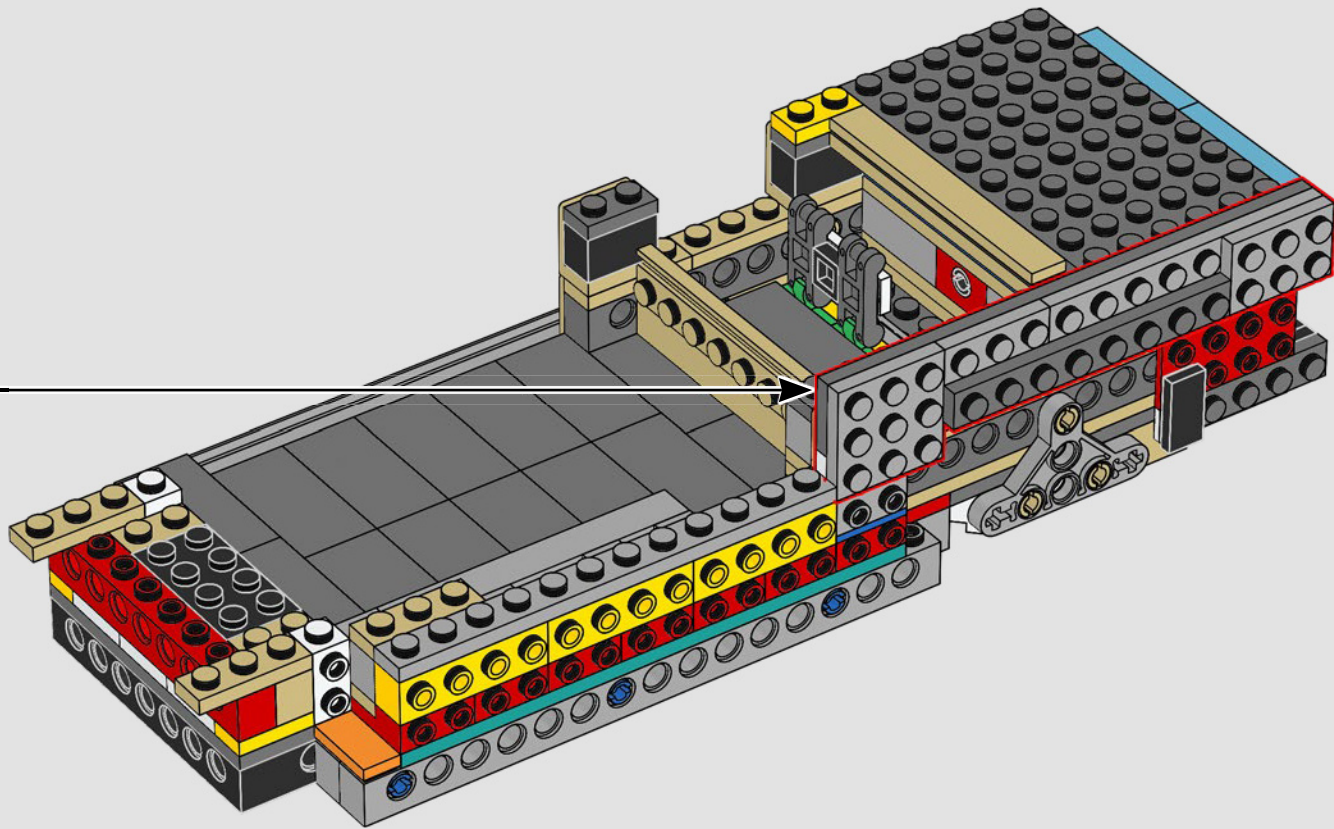

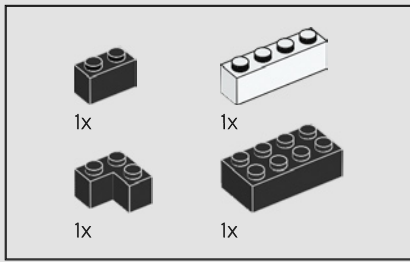

53

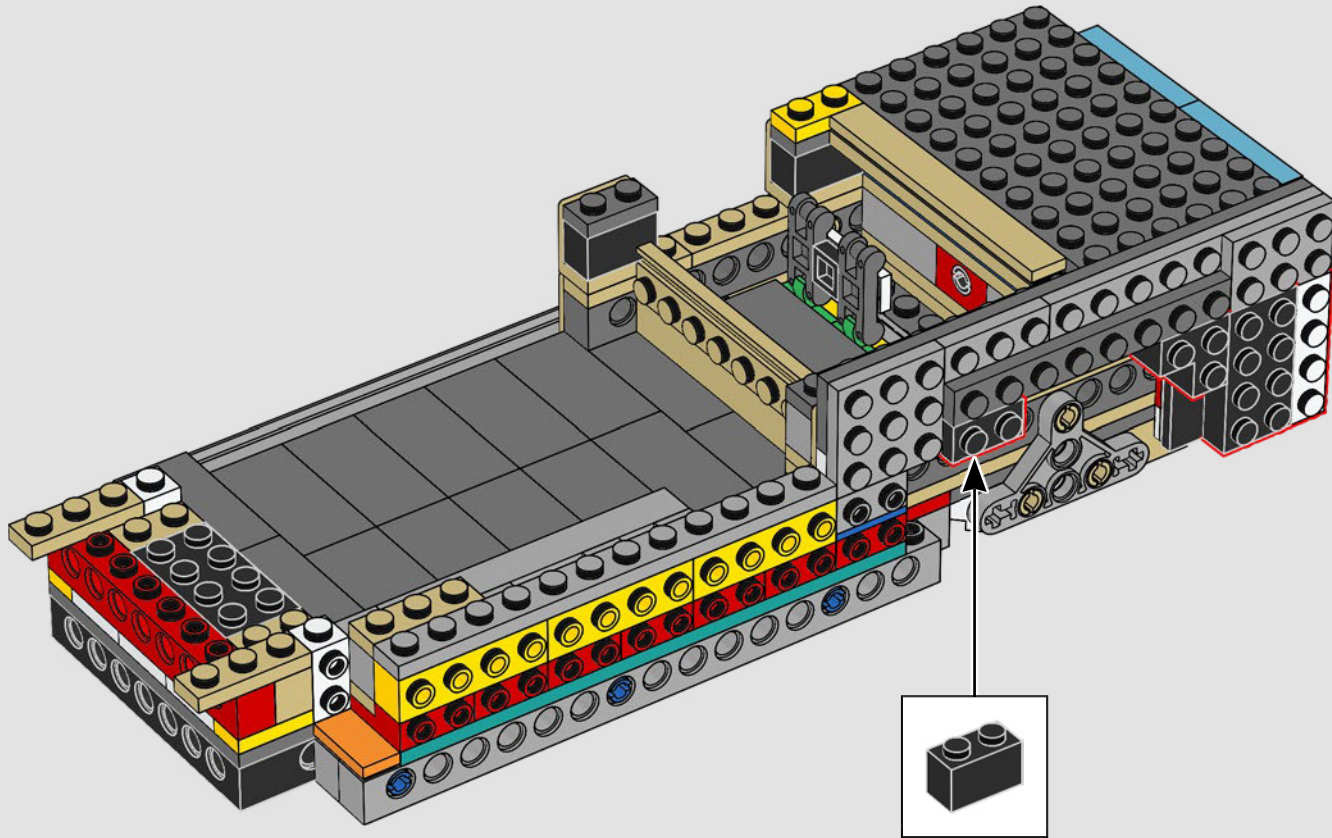

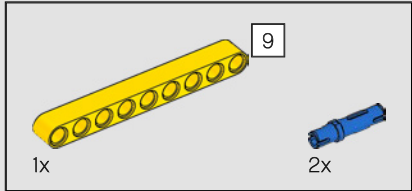
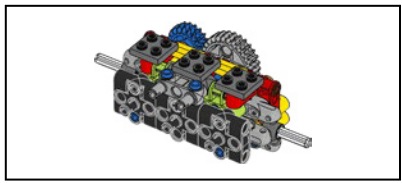

54

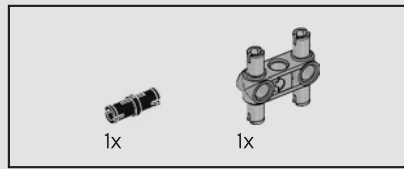
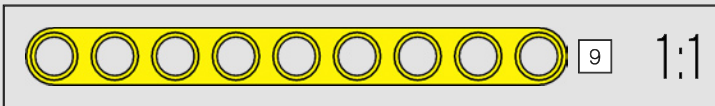
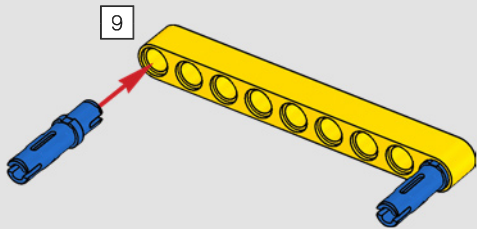

55

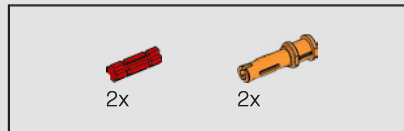
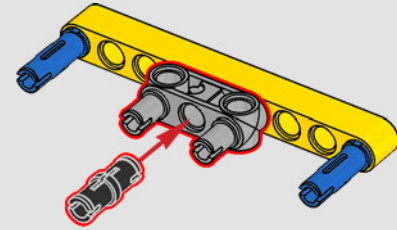

56

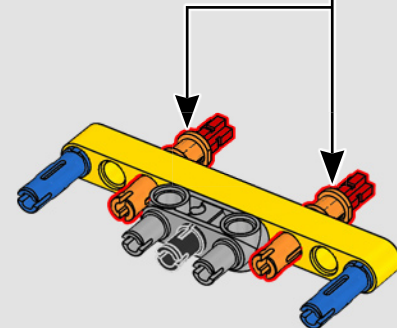
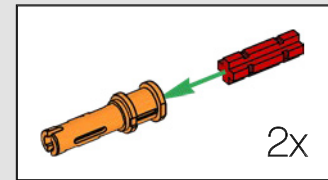

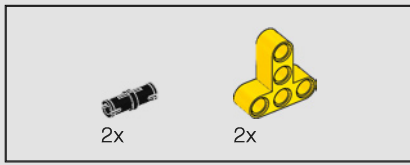

57

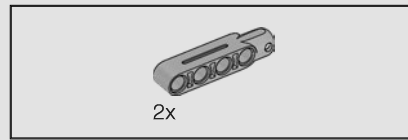
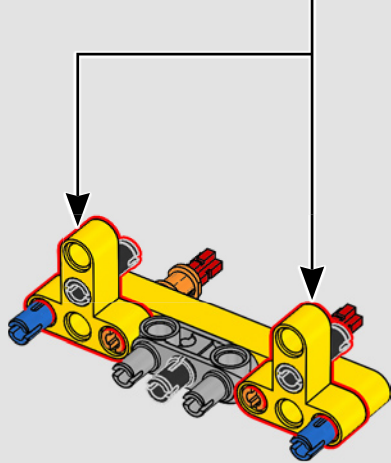
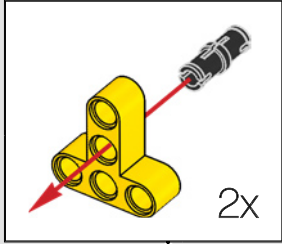

58

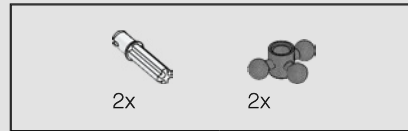
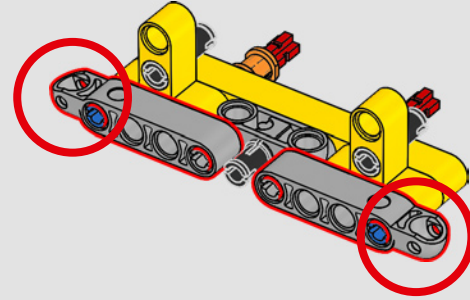

59

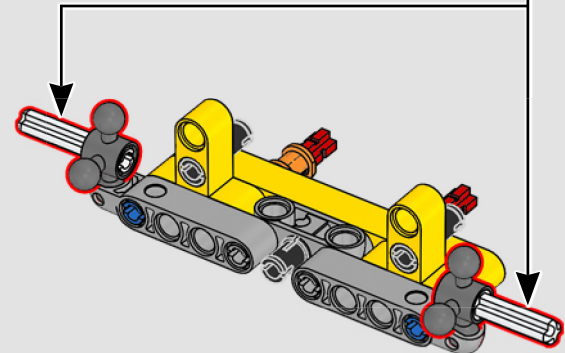
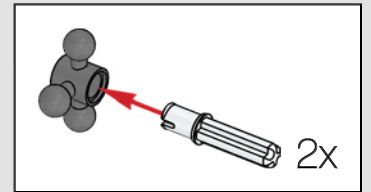

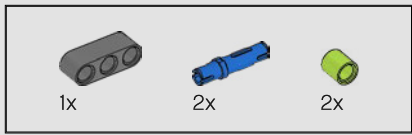

60

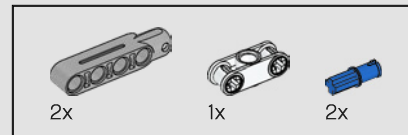
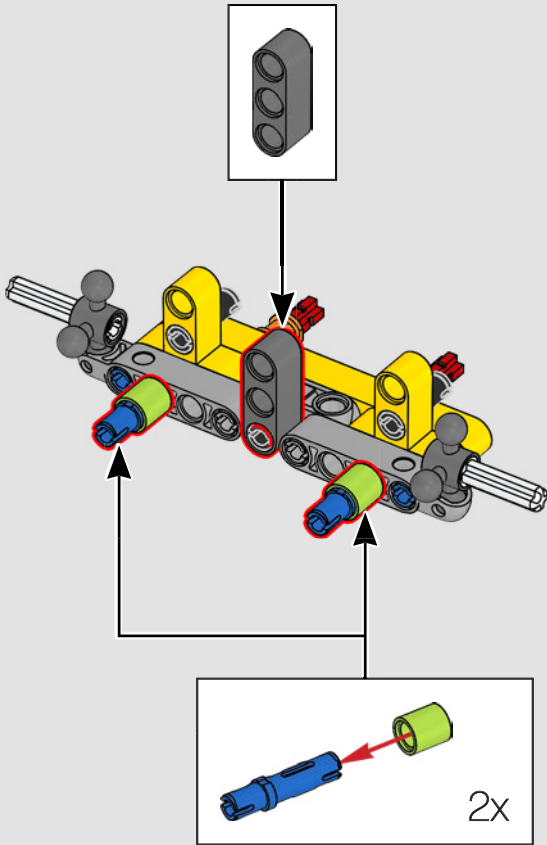

61

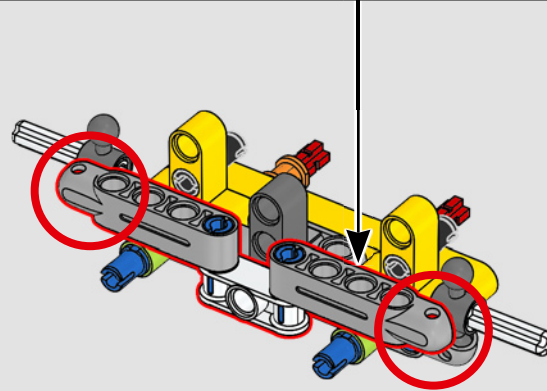
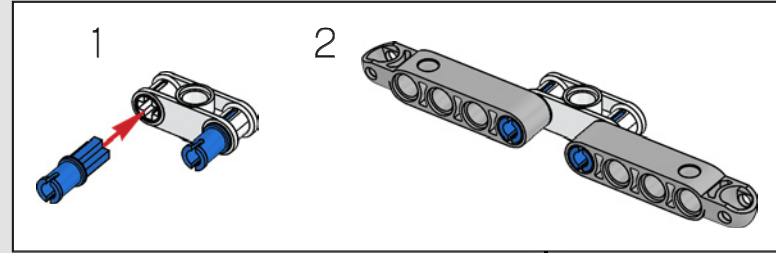

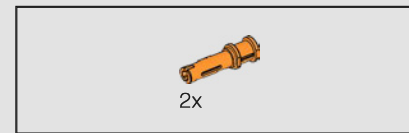
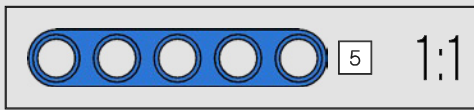
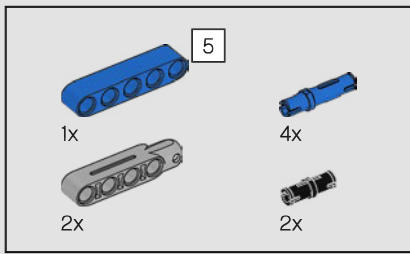

62

63

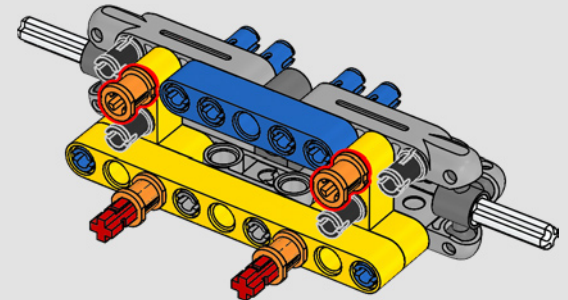
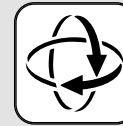
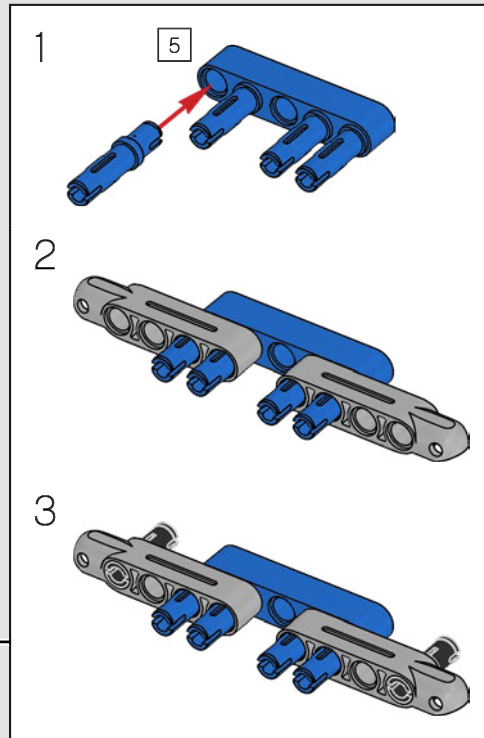
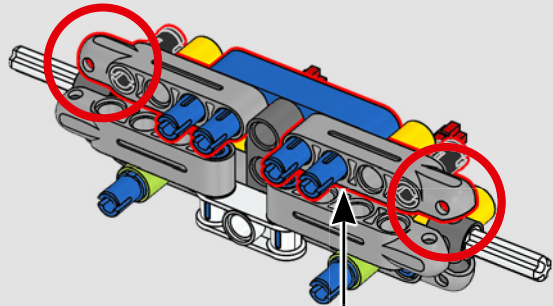

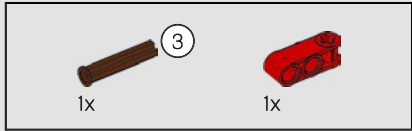
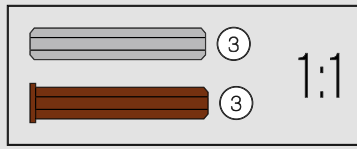
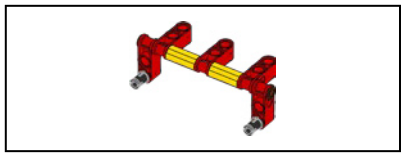

64

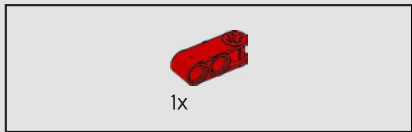
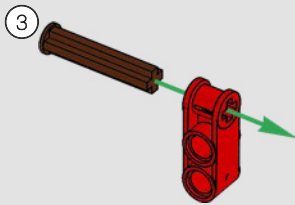

65

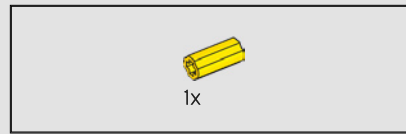
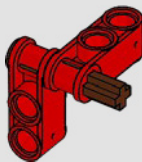

66

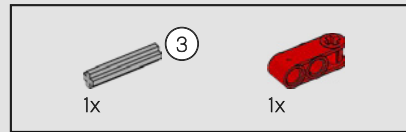
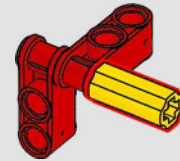

67

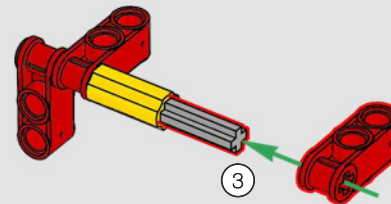

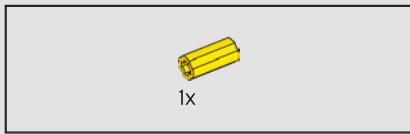

68

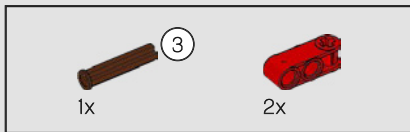
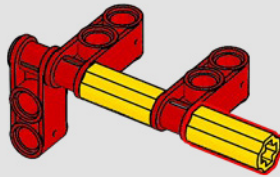

69

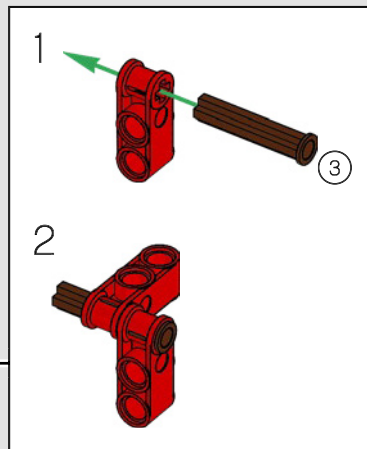
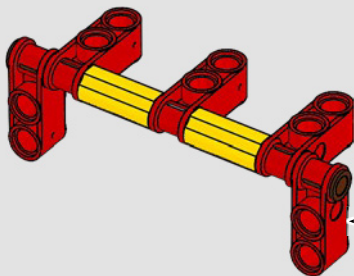

70

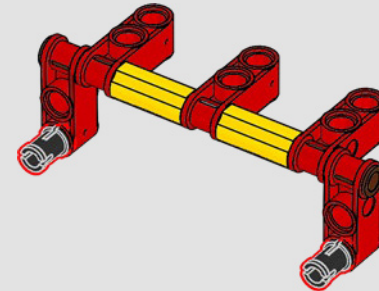

71

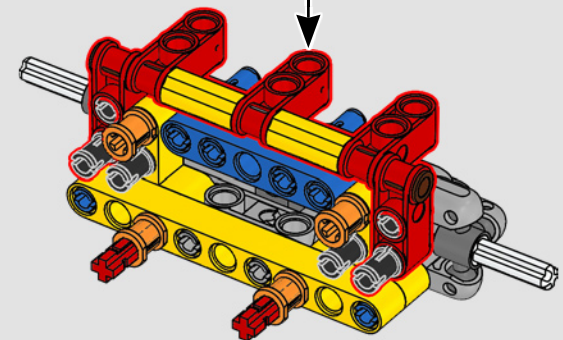

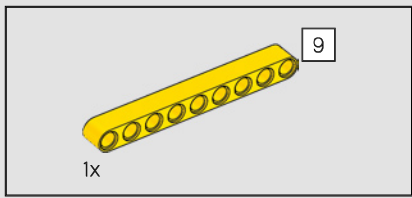

72

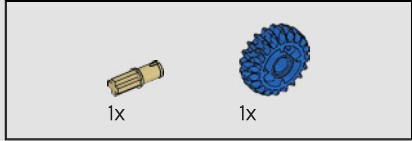
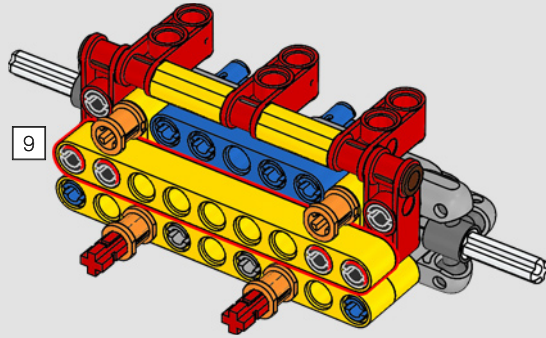

73

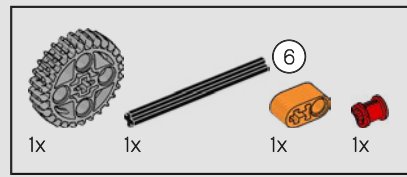
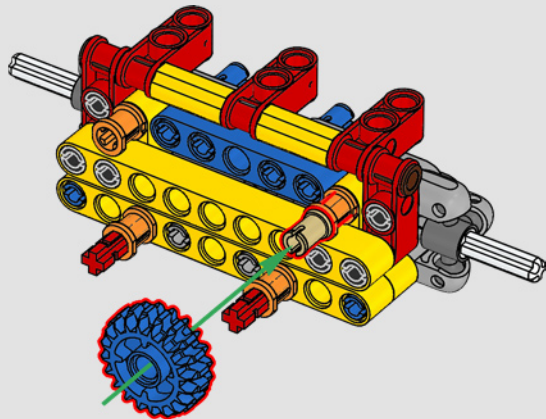

74

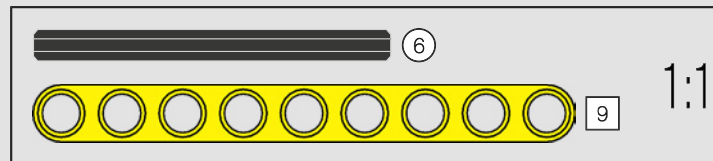
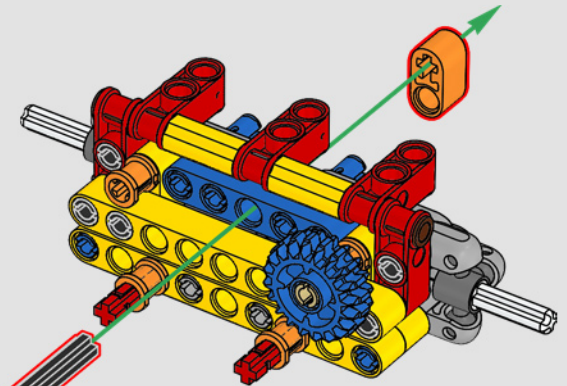
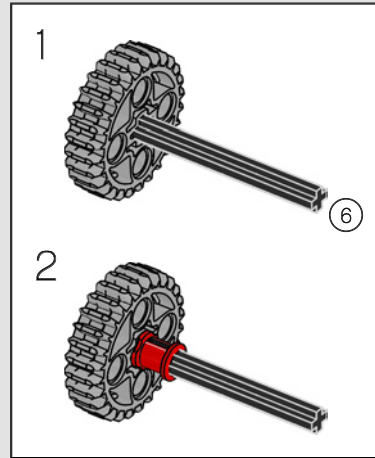

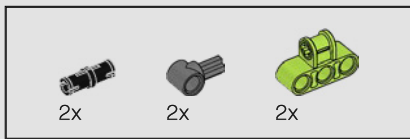

75

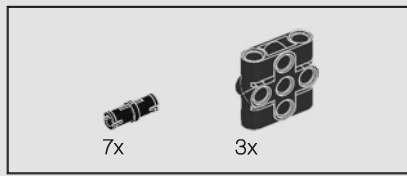
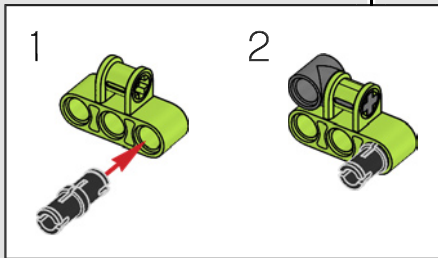
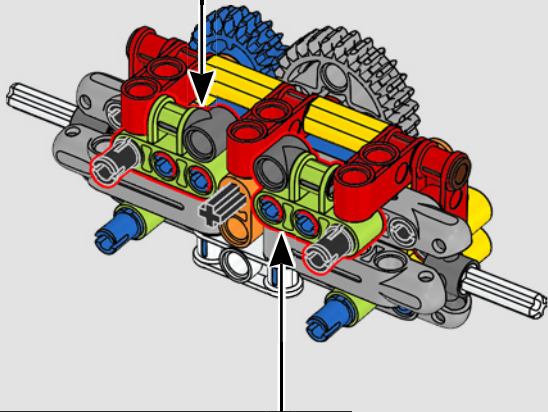
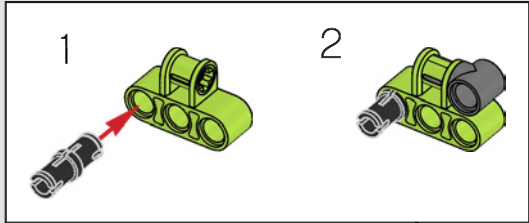

76

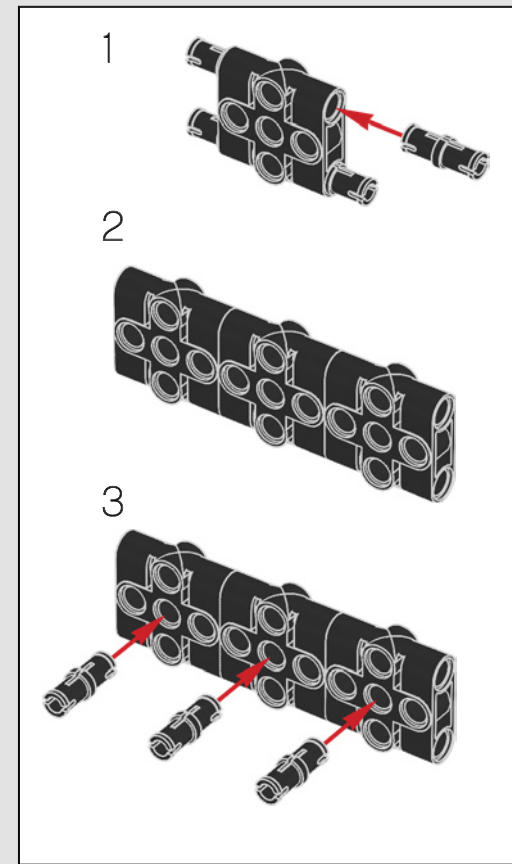
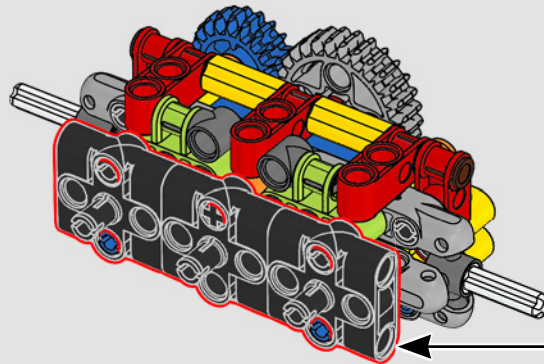

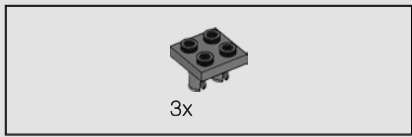

77

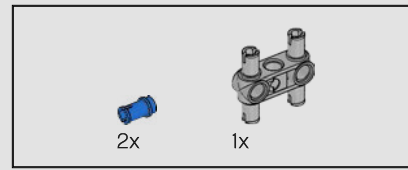
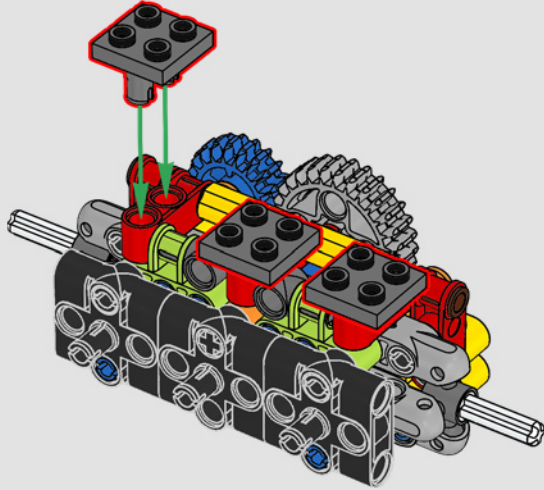

78

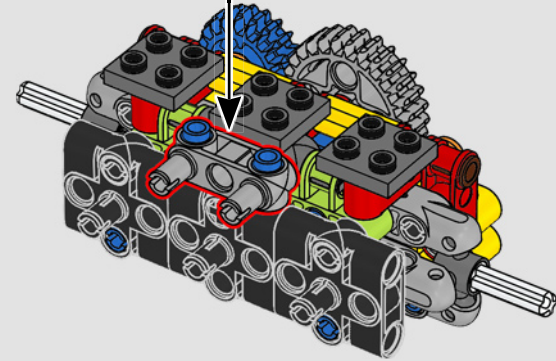
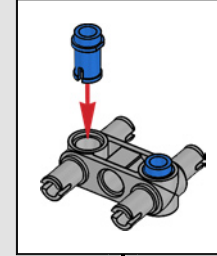

79

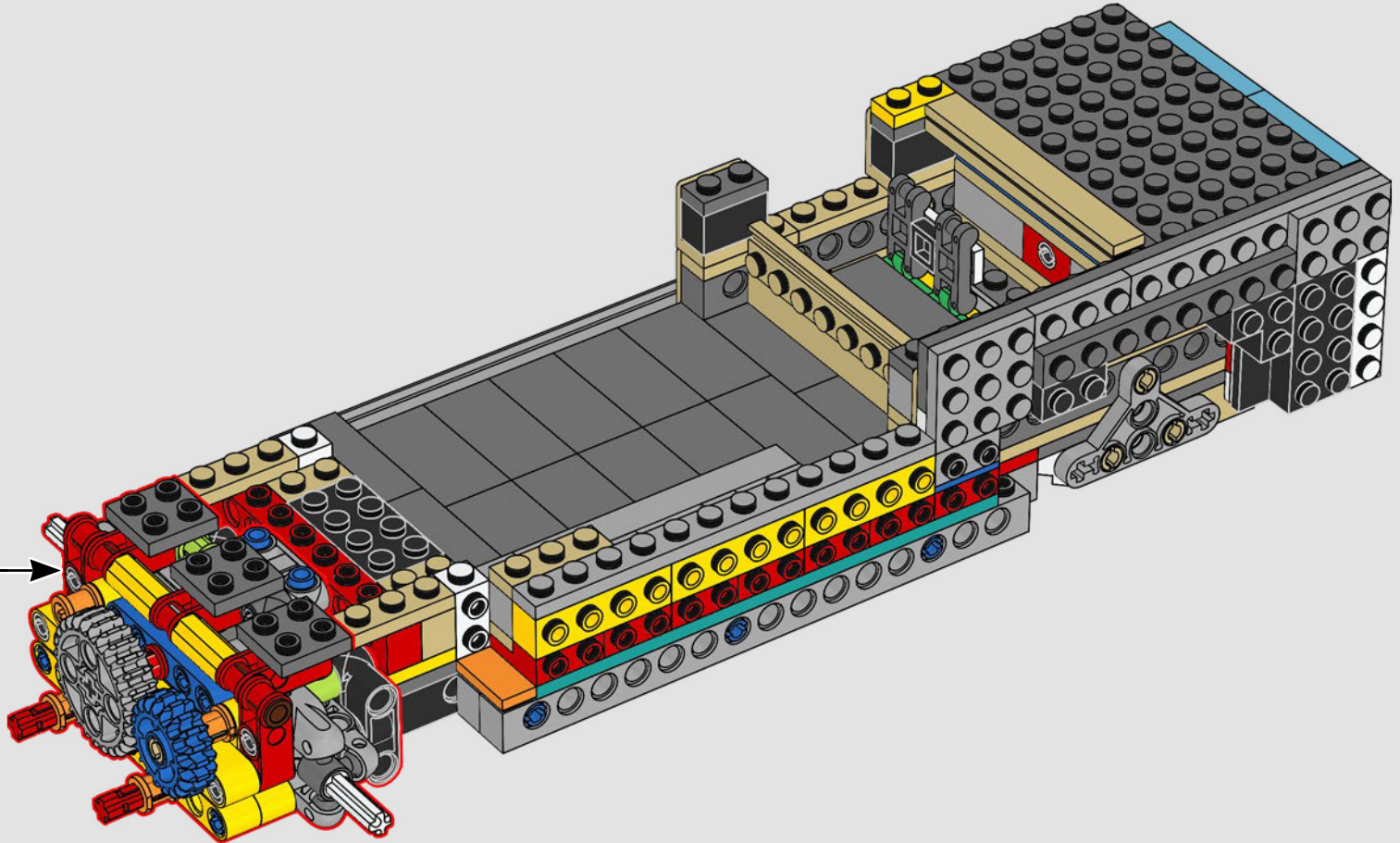

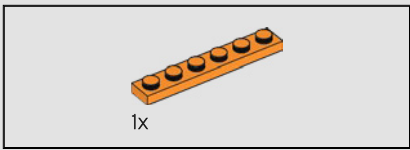

80

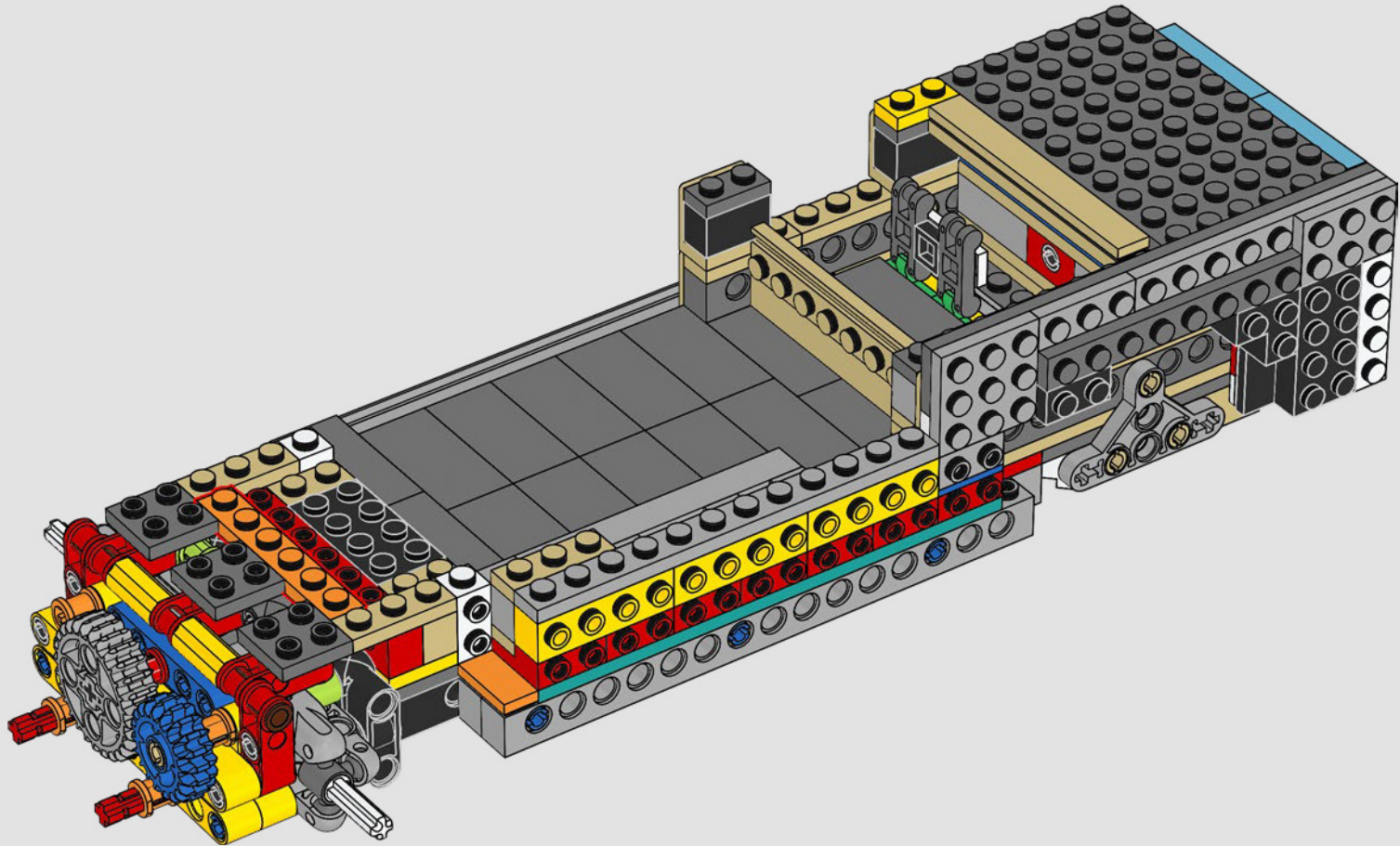

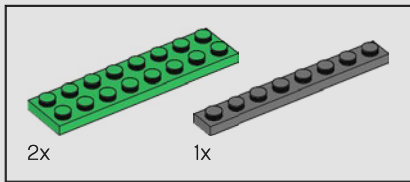

81

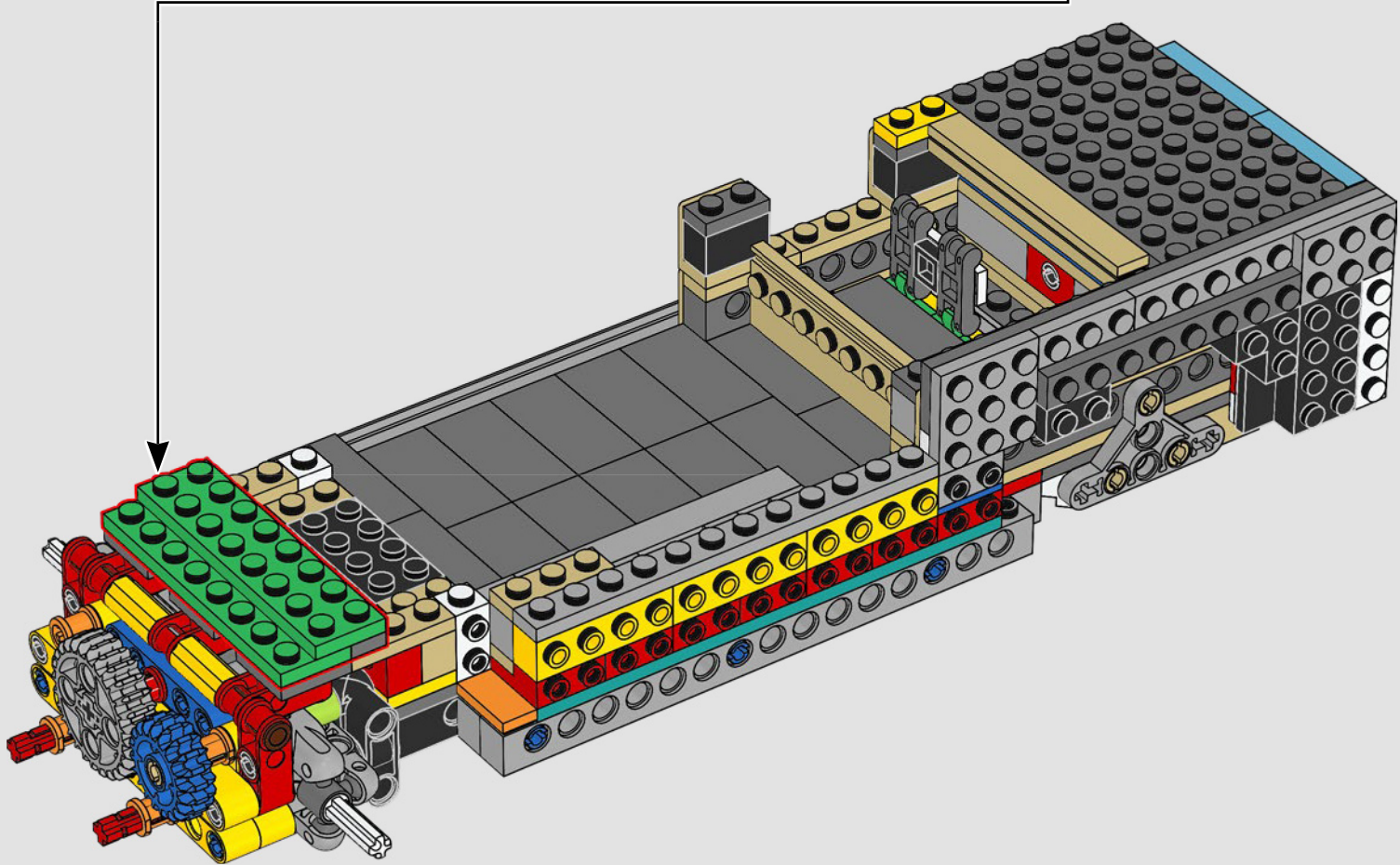
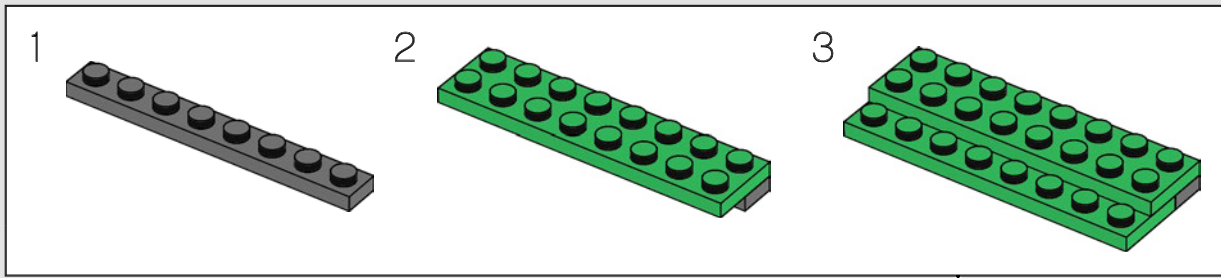

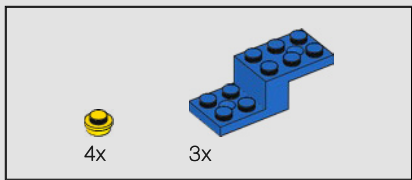

82

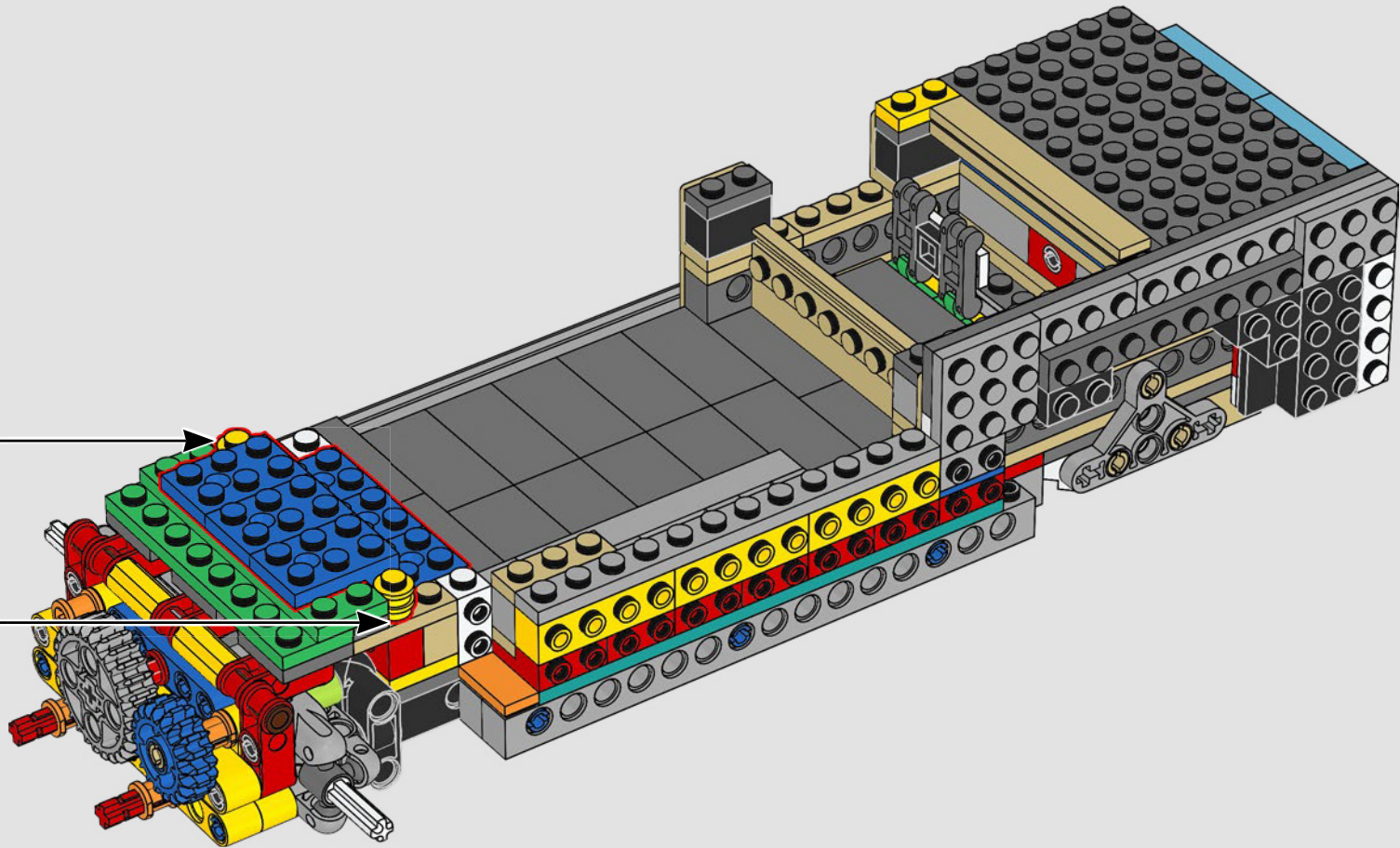
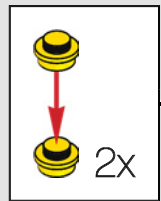

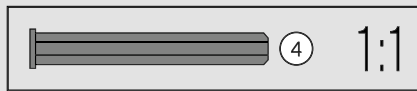
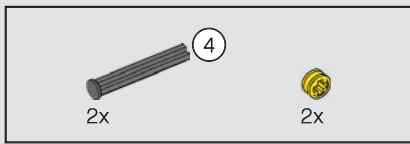

83

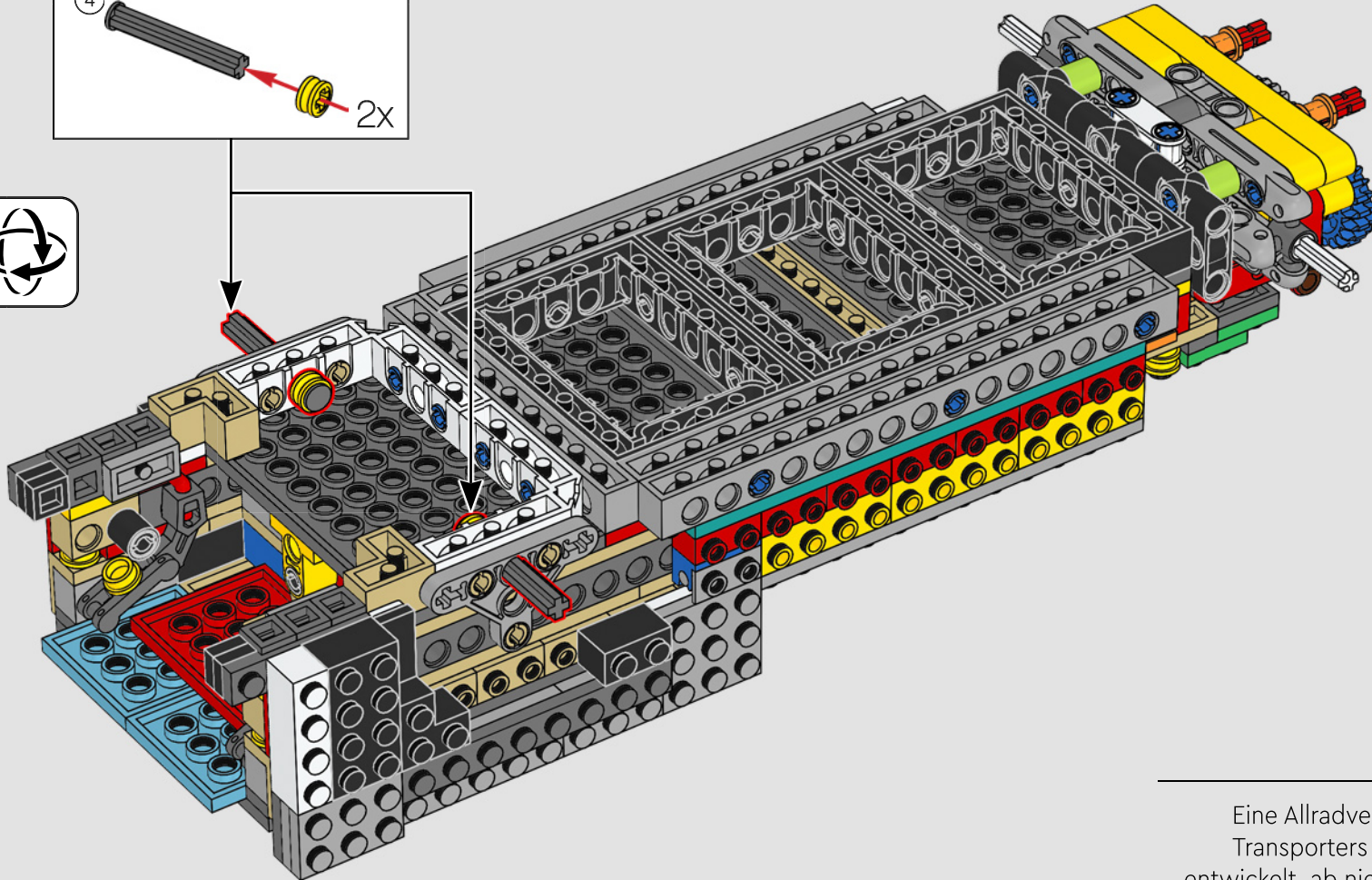
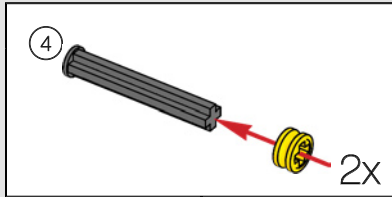

Eine Allradversion des T2 Transporters wurde zwar entwickelt, ab nie produziert. Die Technologie wurde jedoch später in das T3 Modell „Syncro“ übernommen.

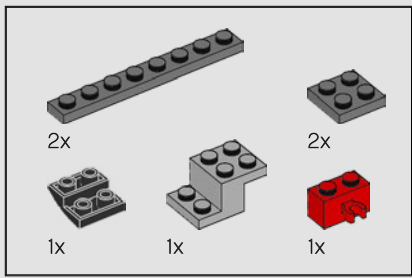

84

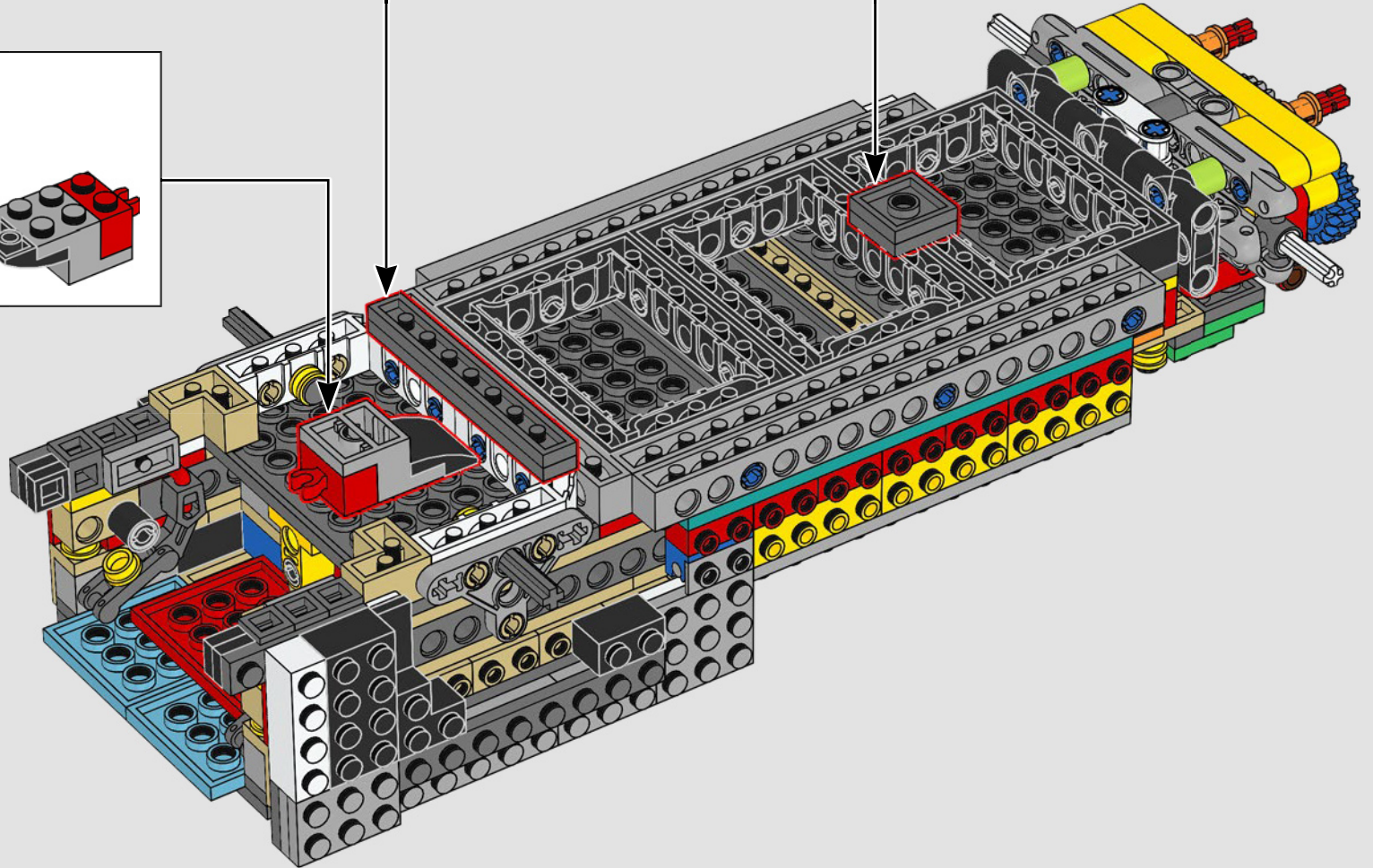
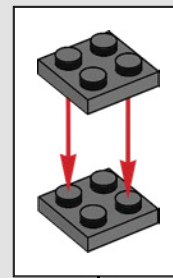
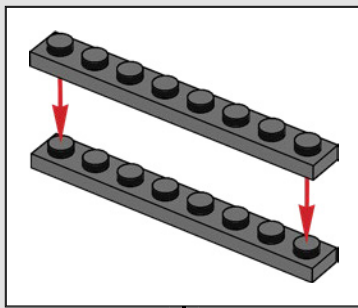
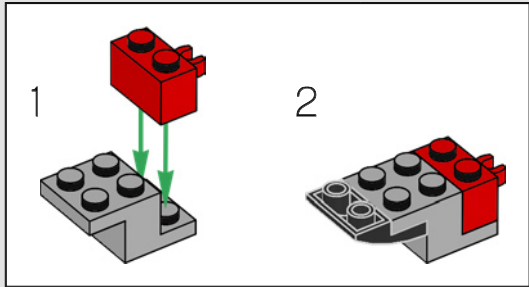

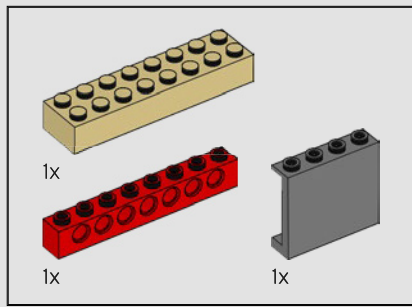

85

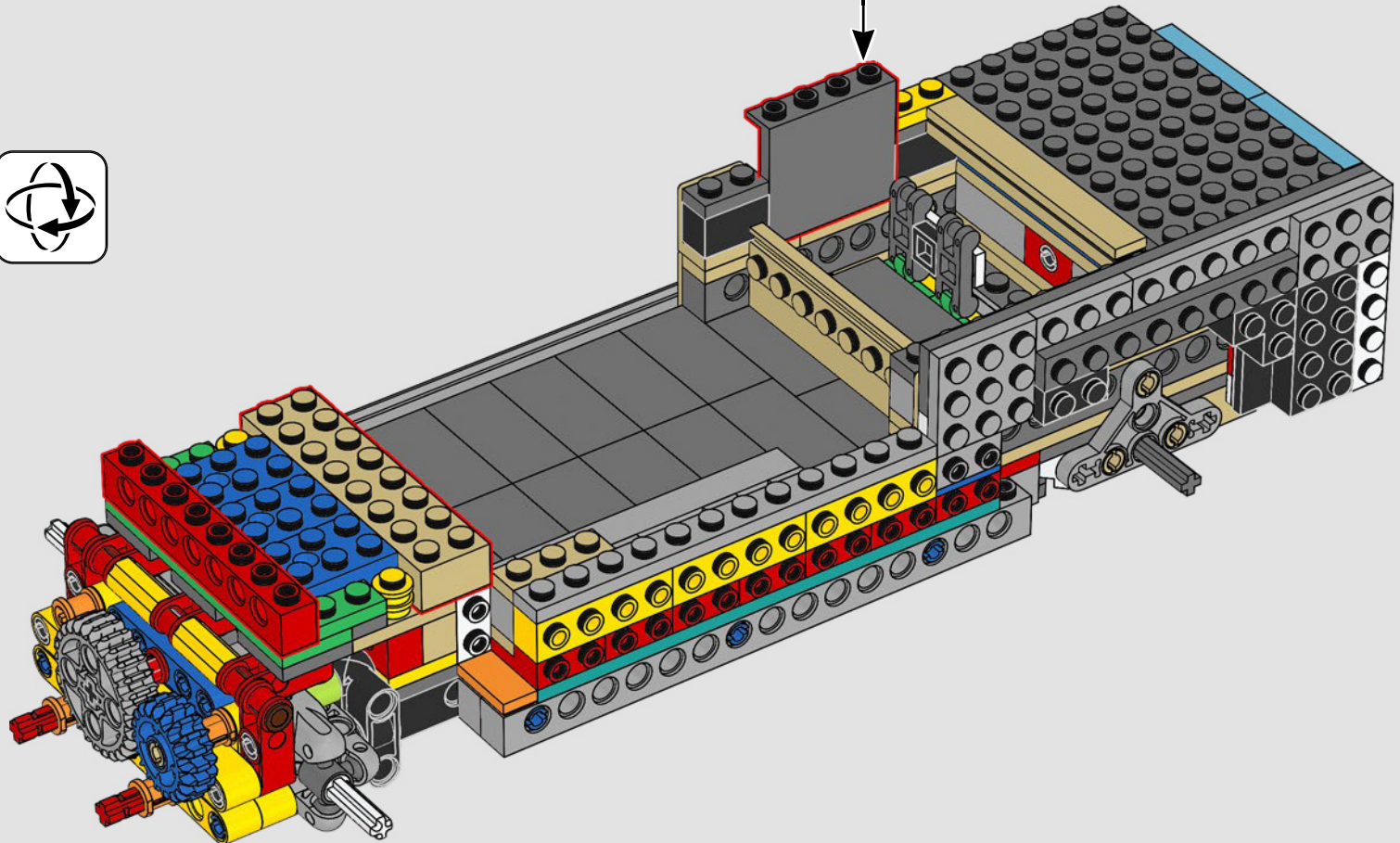
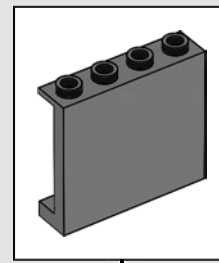

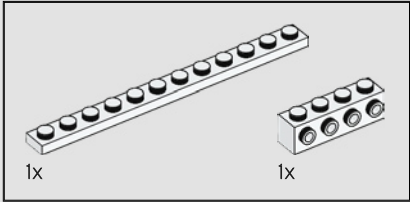
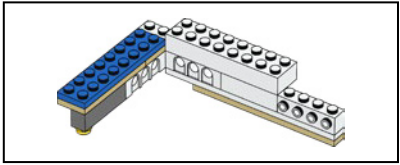
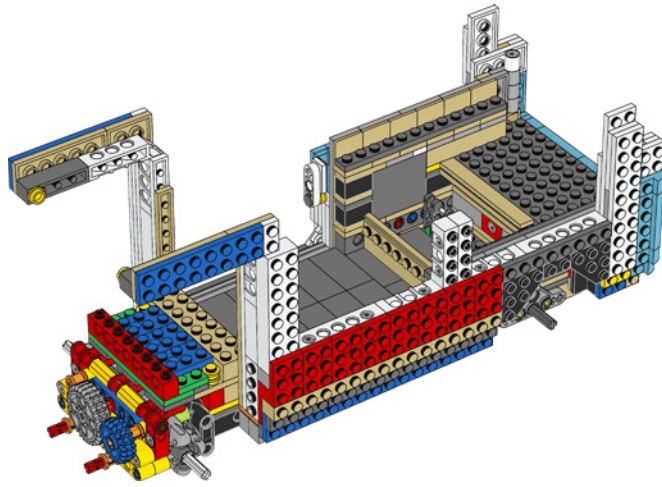
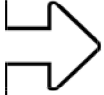

86

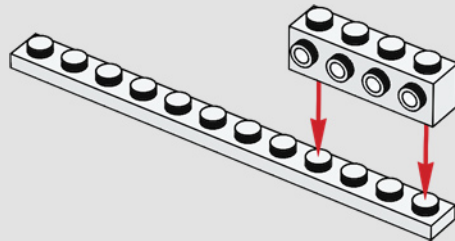

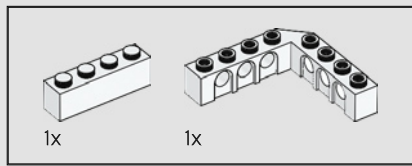

87

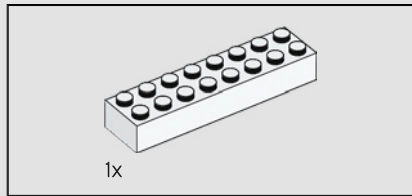
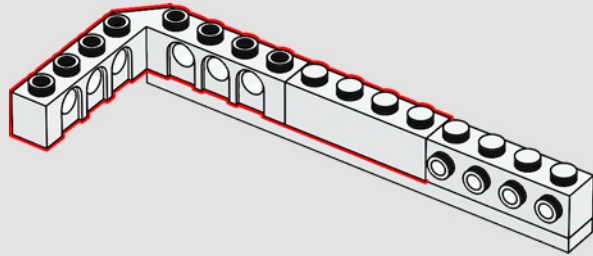

88

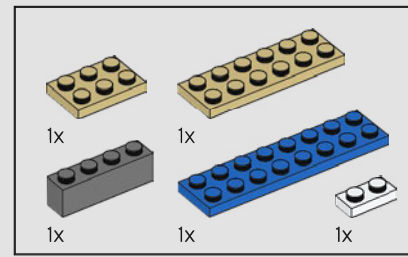
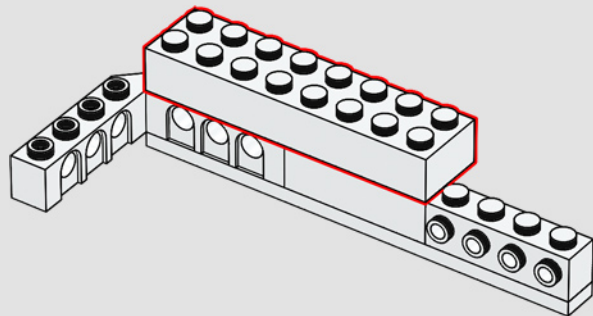

89

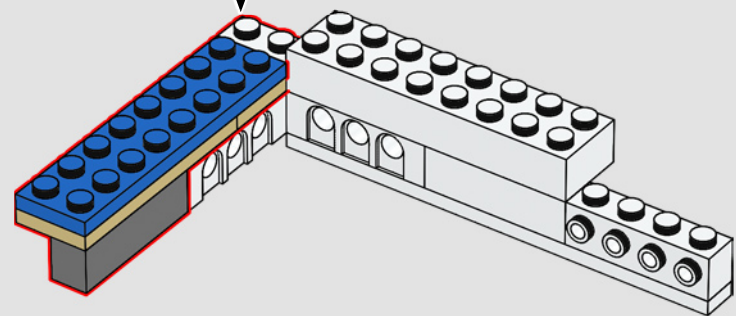
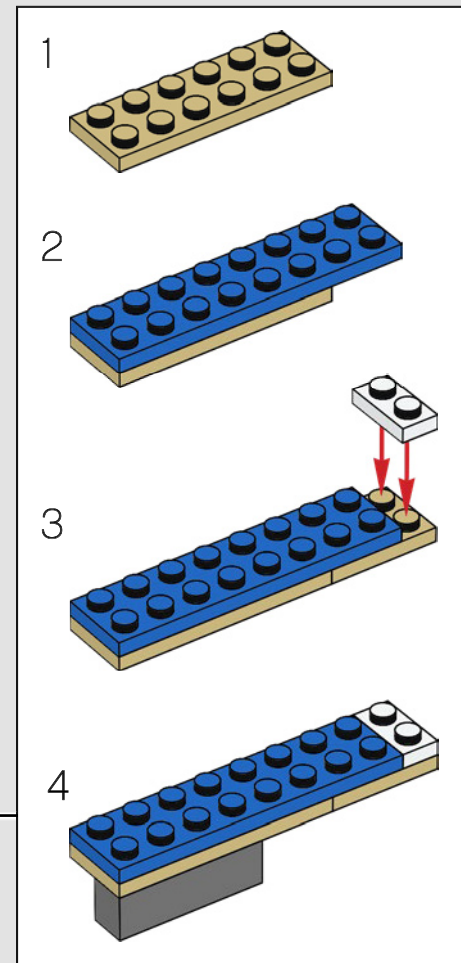

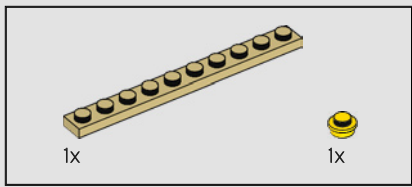

90

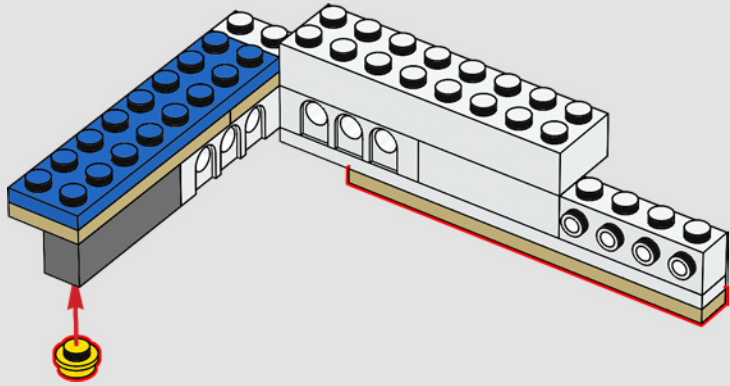

91

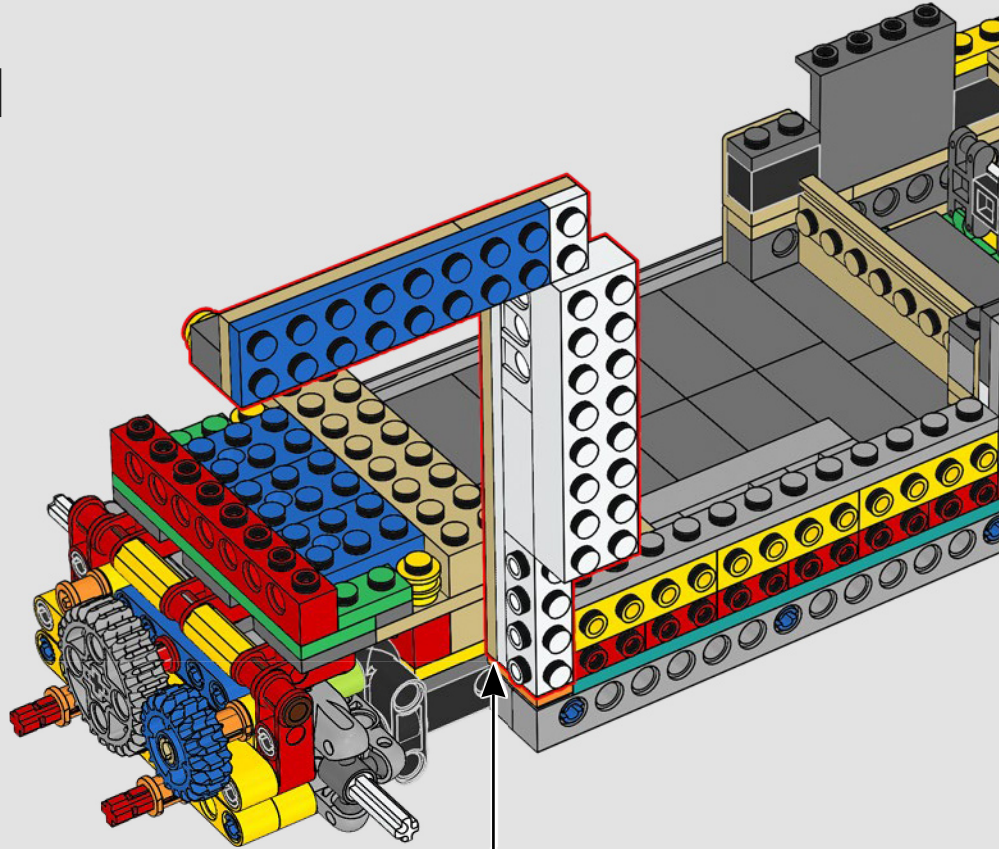

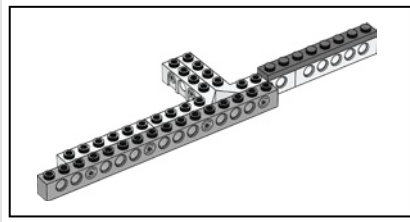

1979 wurde die Produktion des VW T2 eingestellt, als der neue T3 herauskam. In Brasilien lief der T2 jedoch noch bis 2013 vom Band.

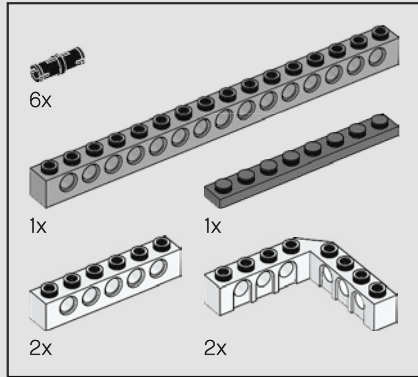

92

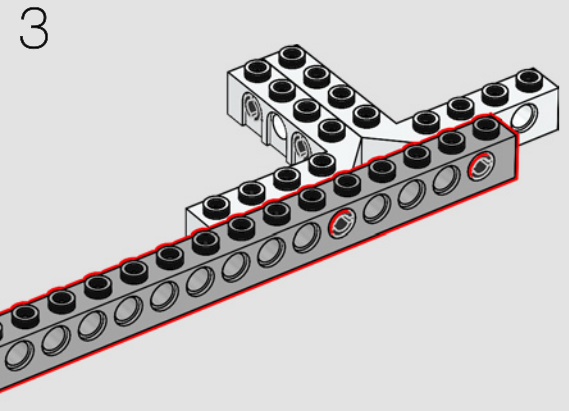
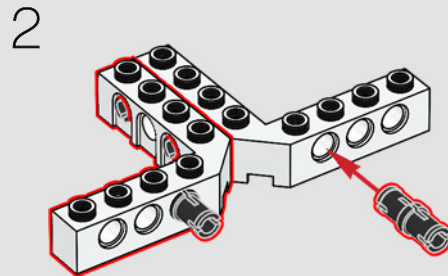
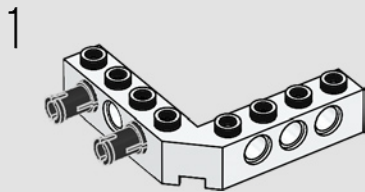

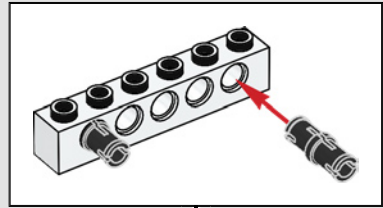

4

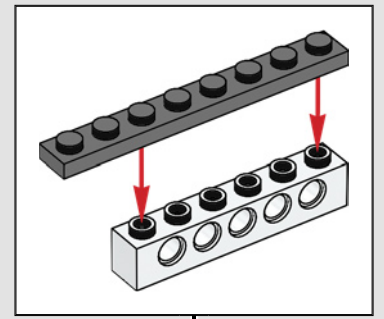
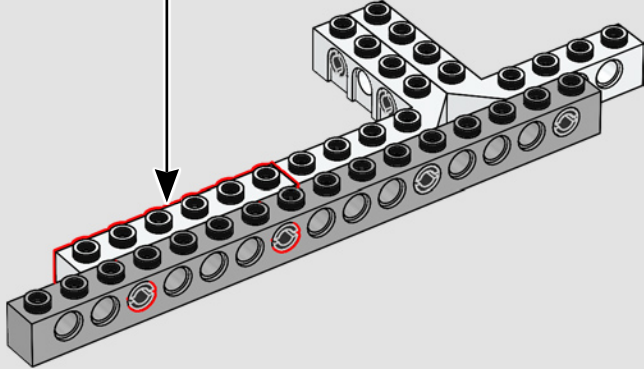

5

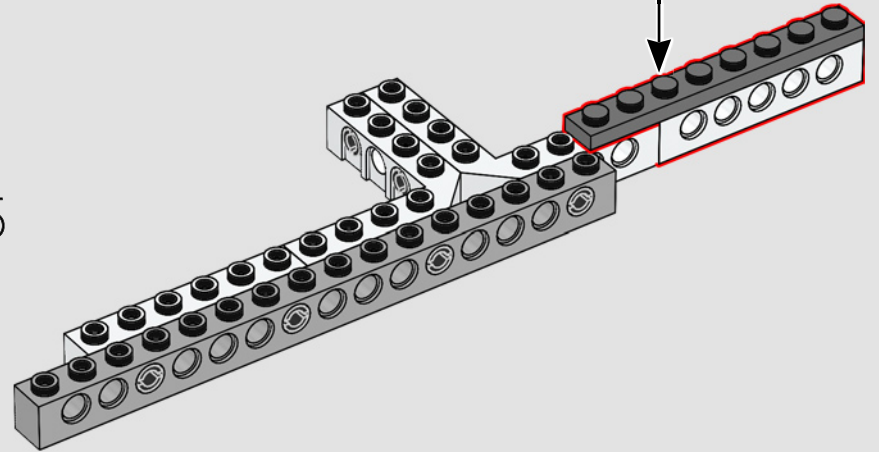

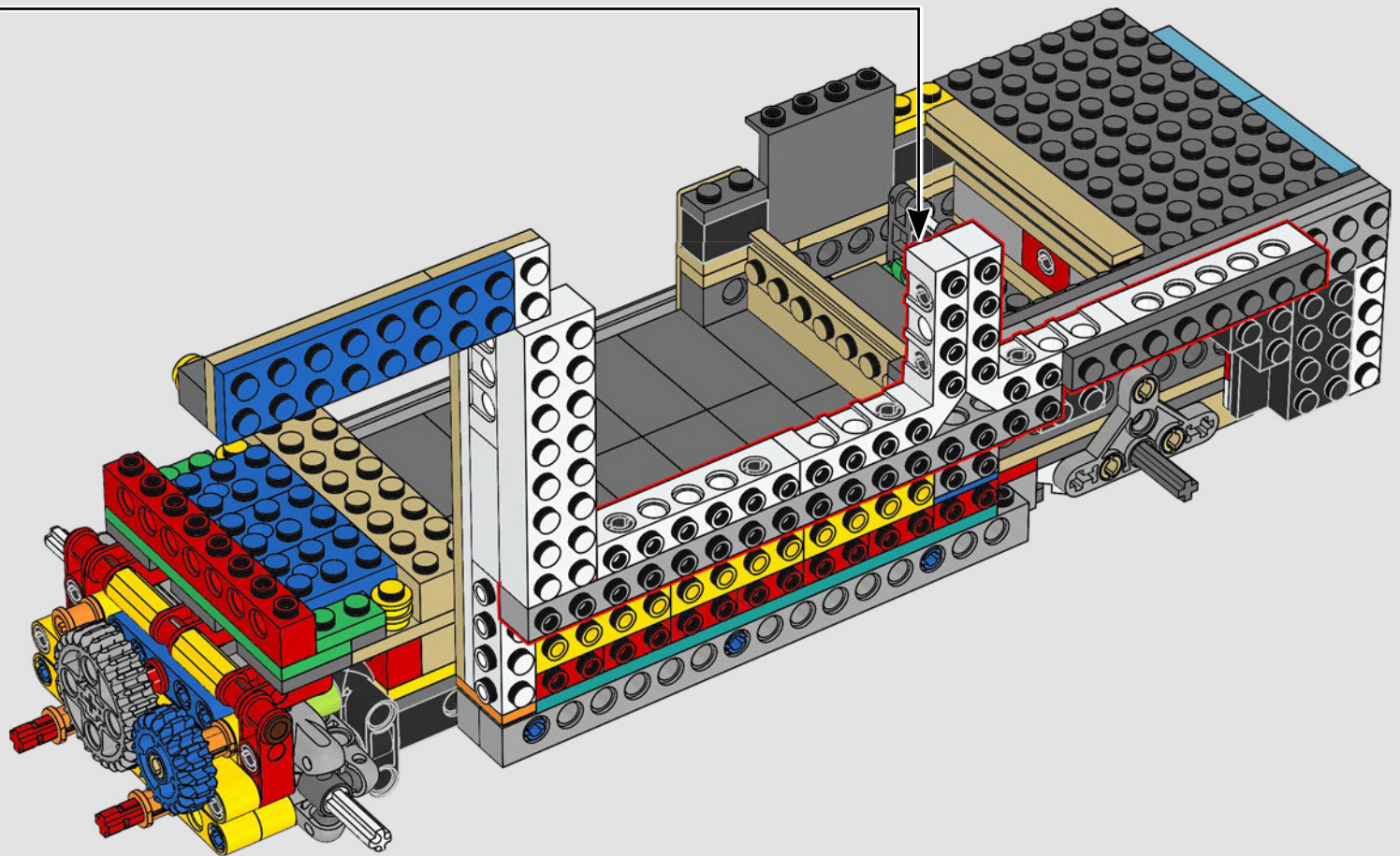

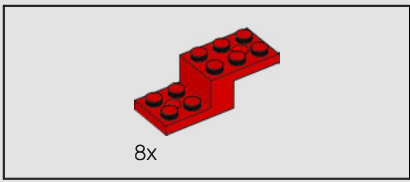

93

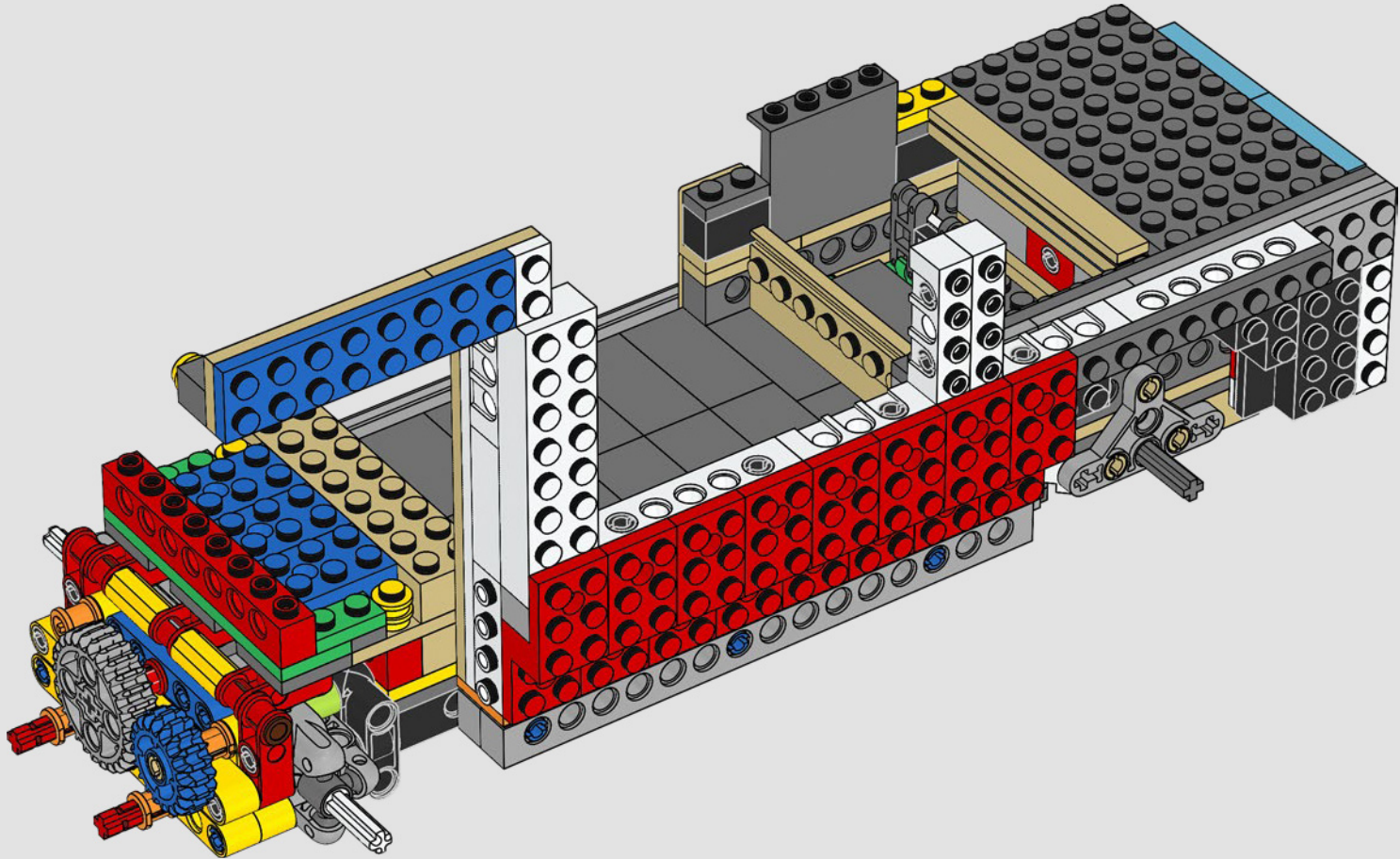

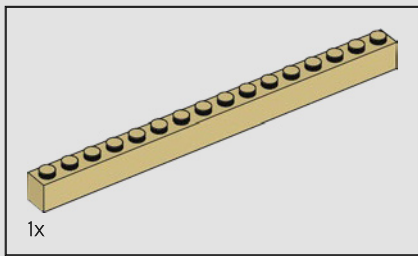

94

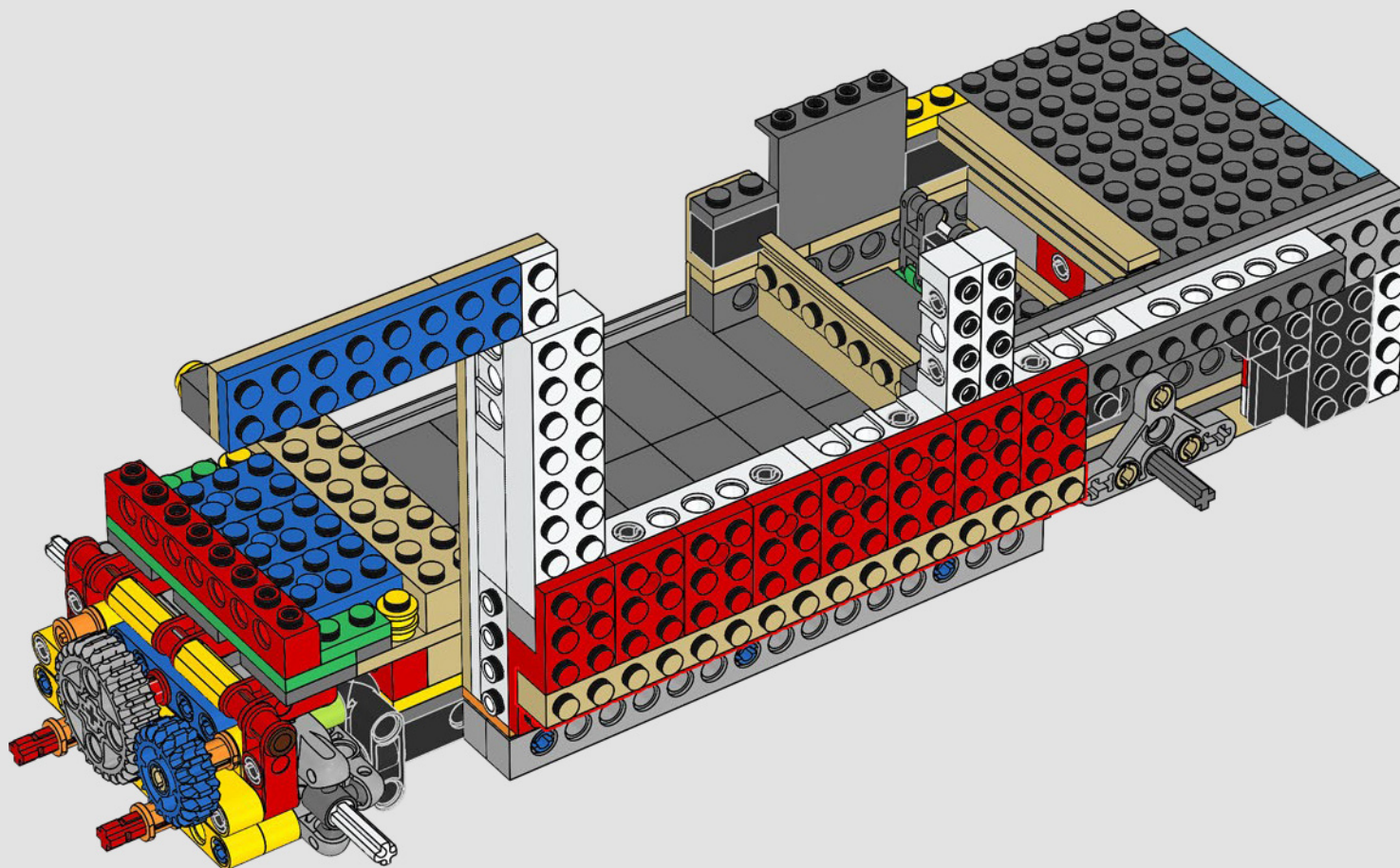

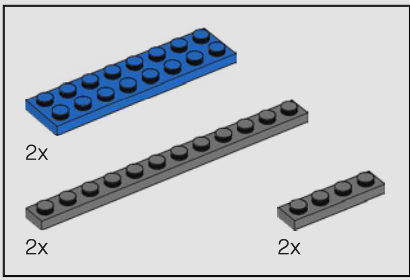

95

1

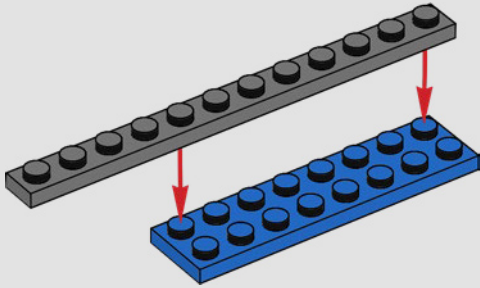

2

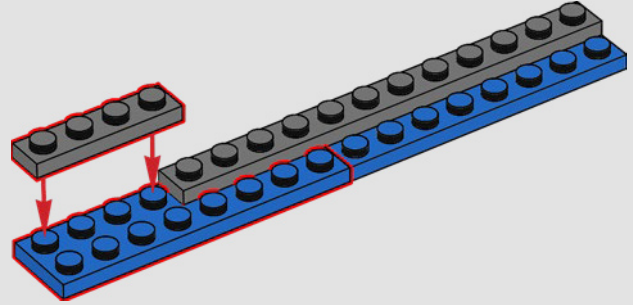

3

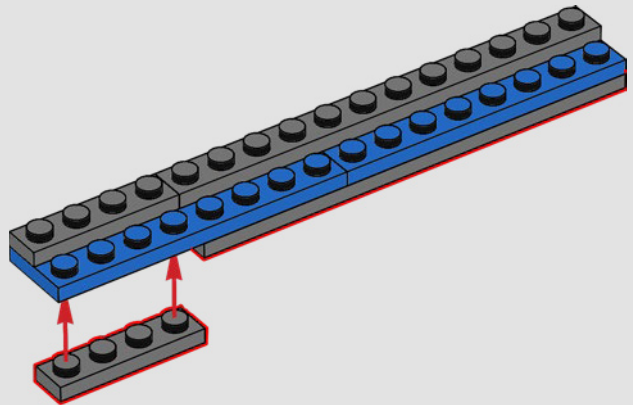

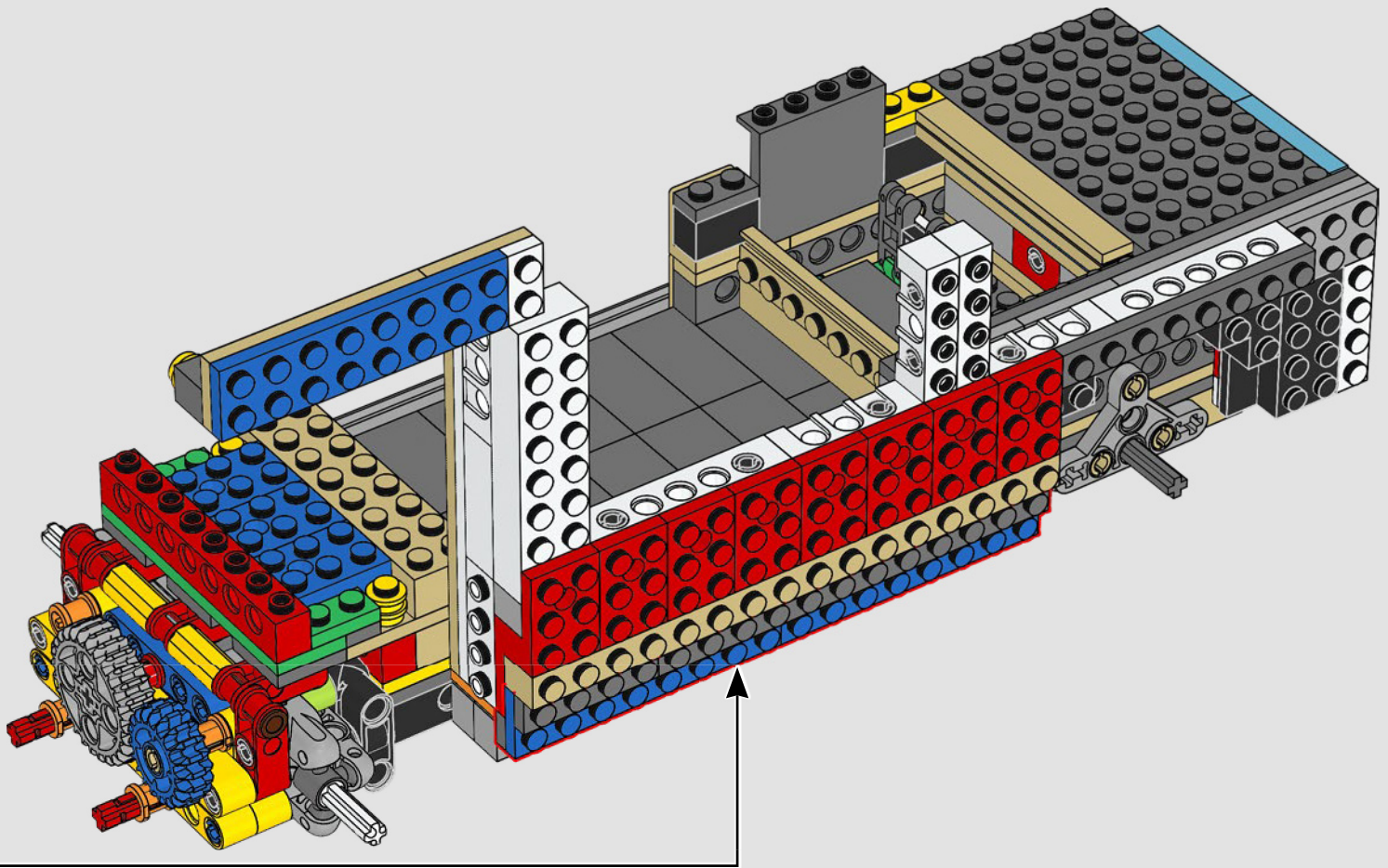

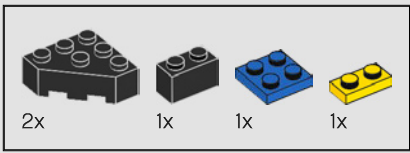

96

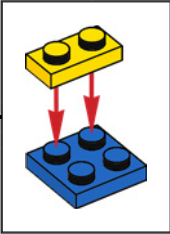
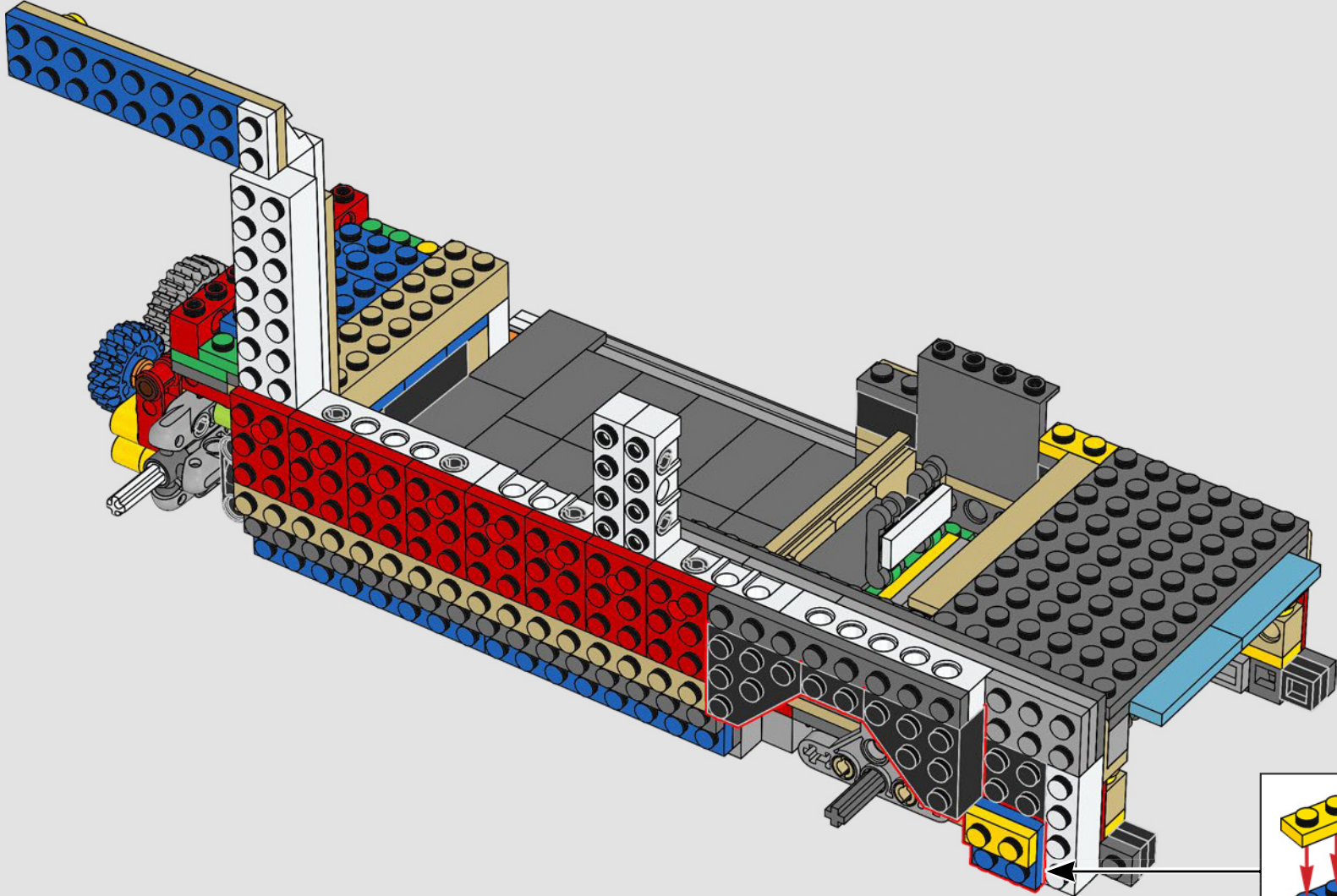

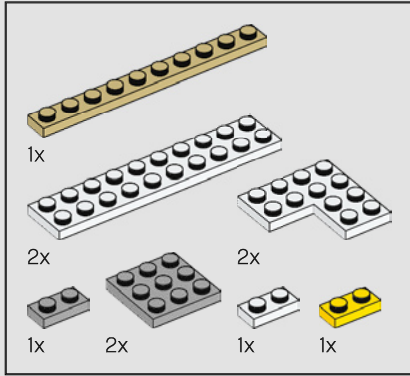
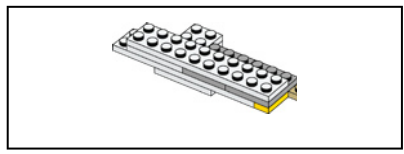

97

1

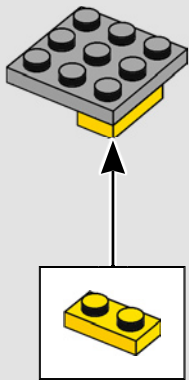

2

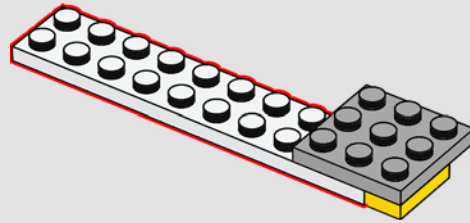

3

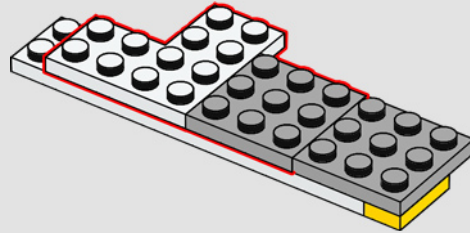

4

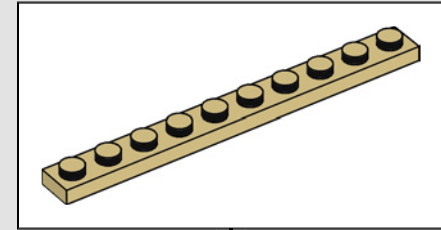
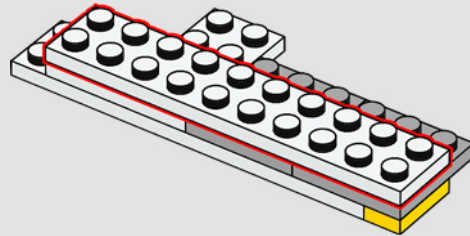

5

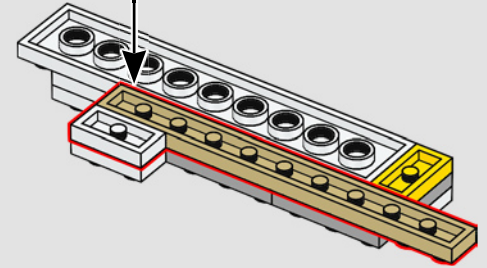

6

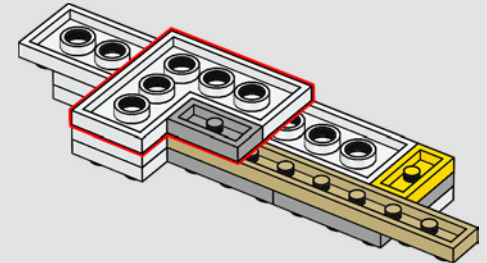

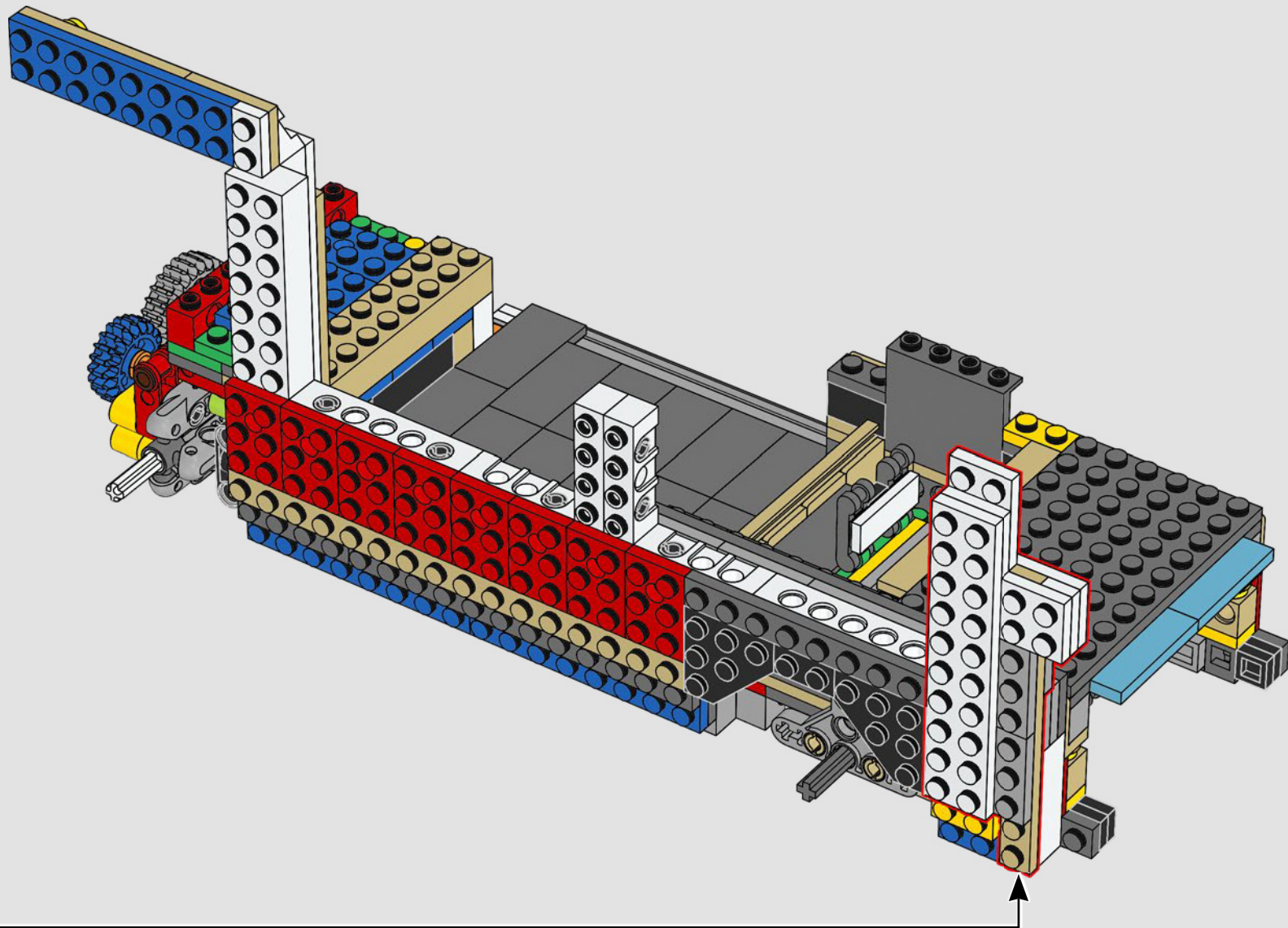

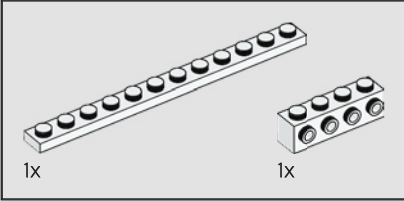
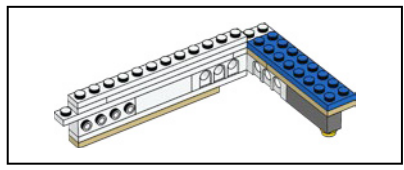

98

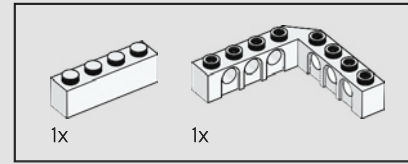
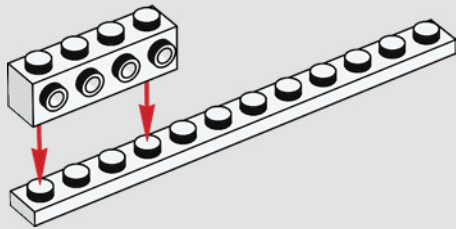

99

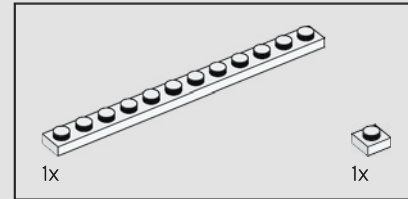
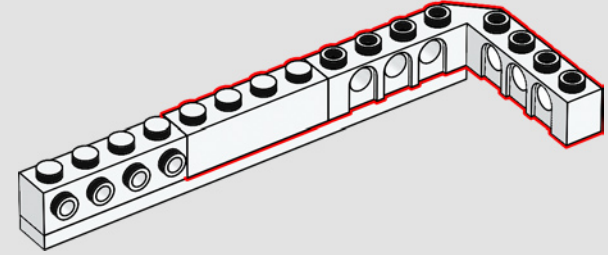

100

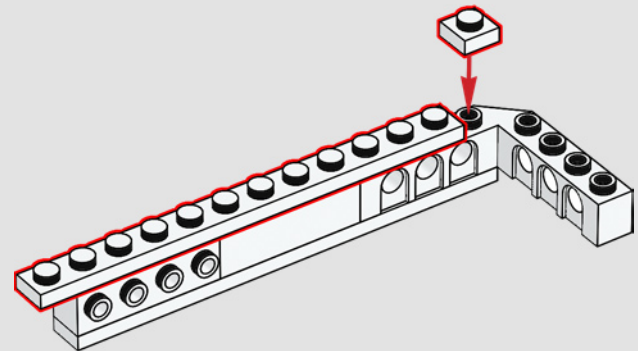

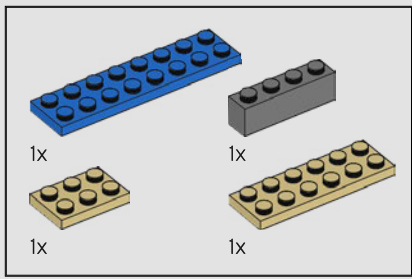

101

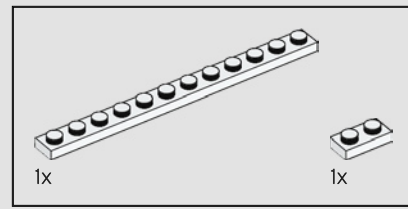
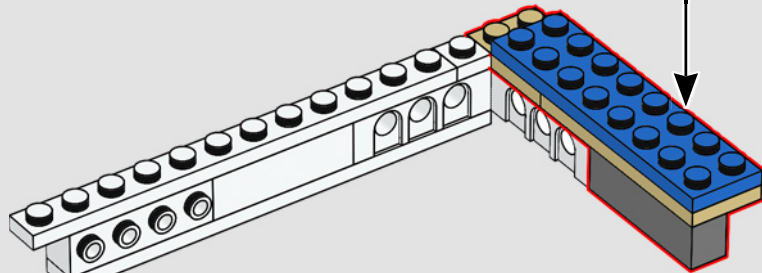
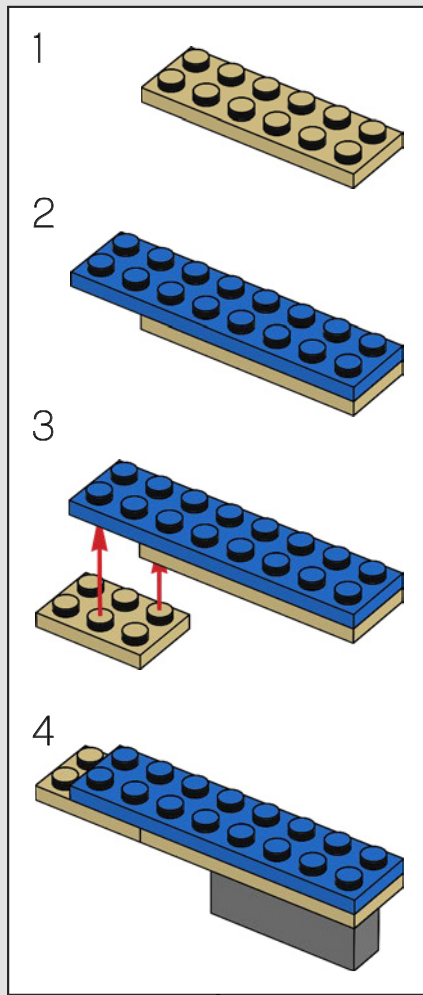

102

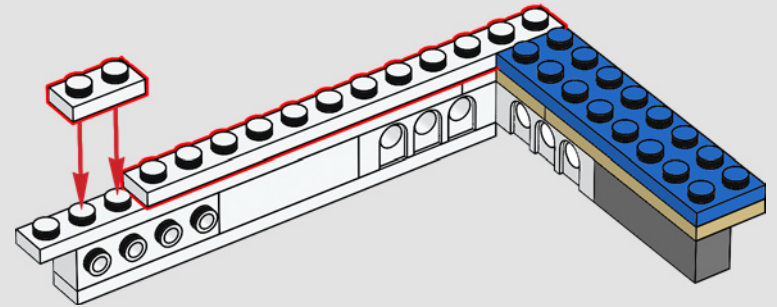

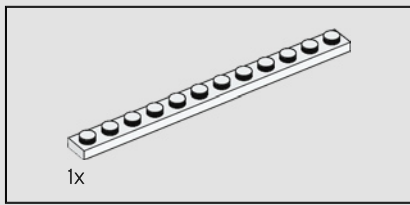

103

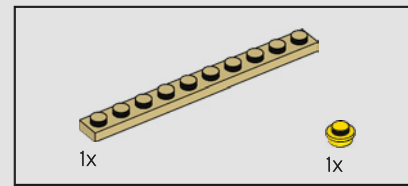
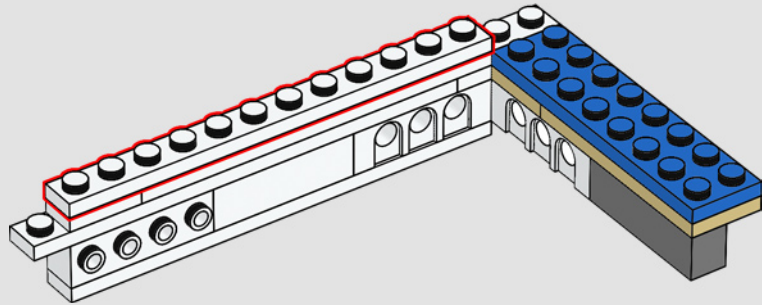

104

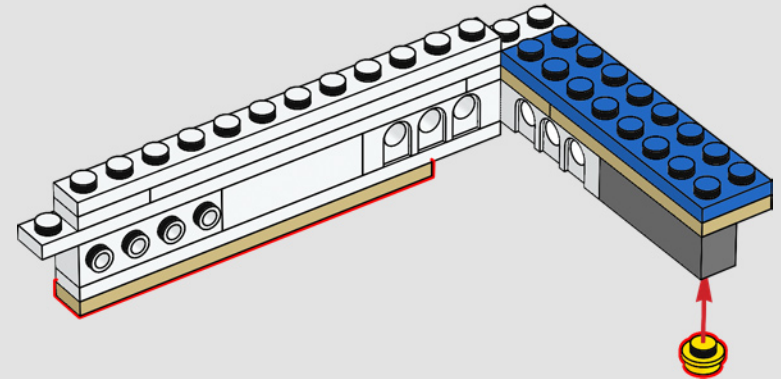

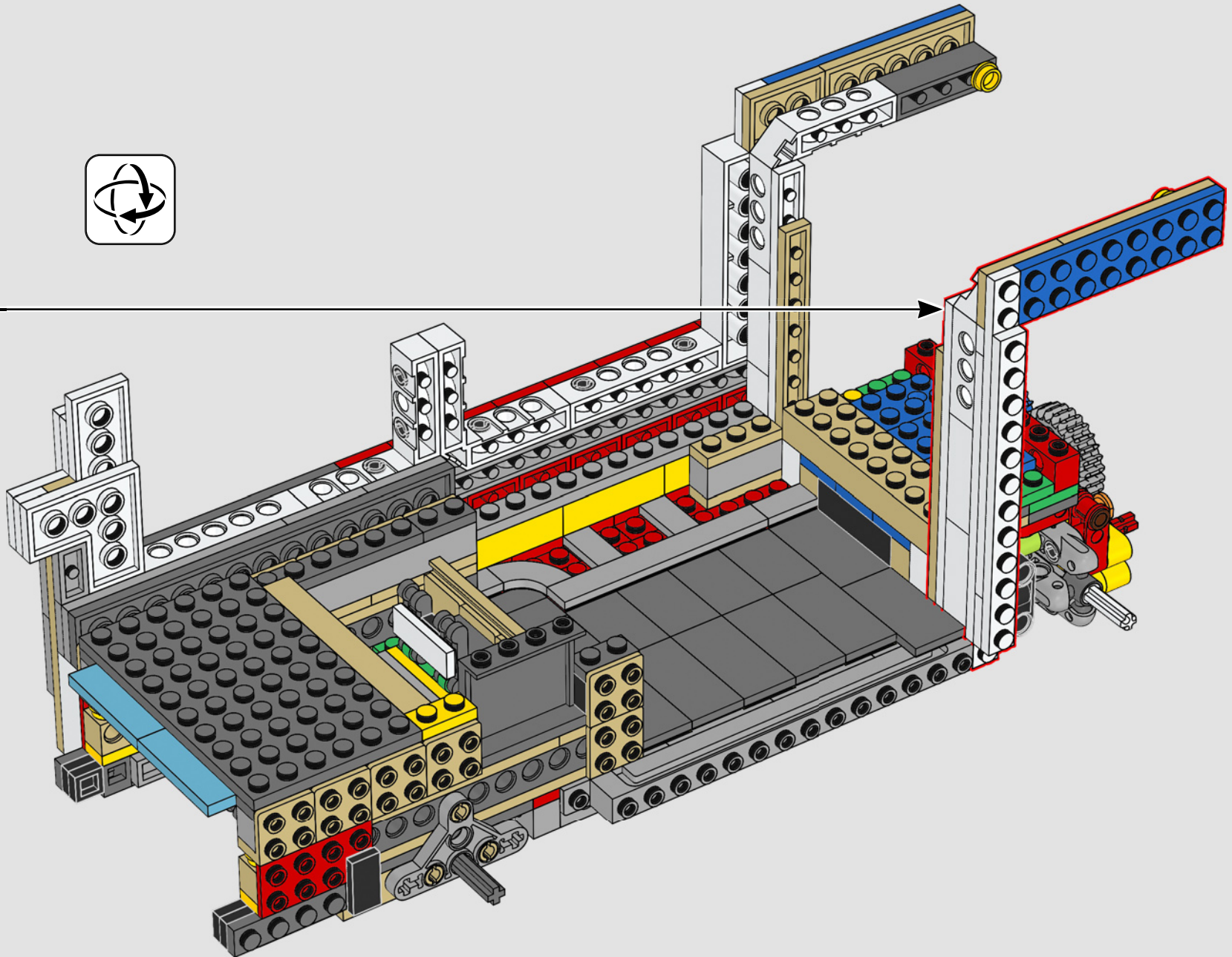

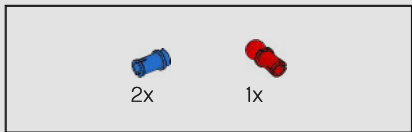

106

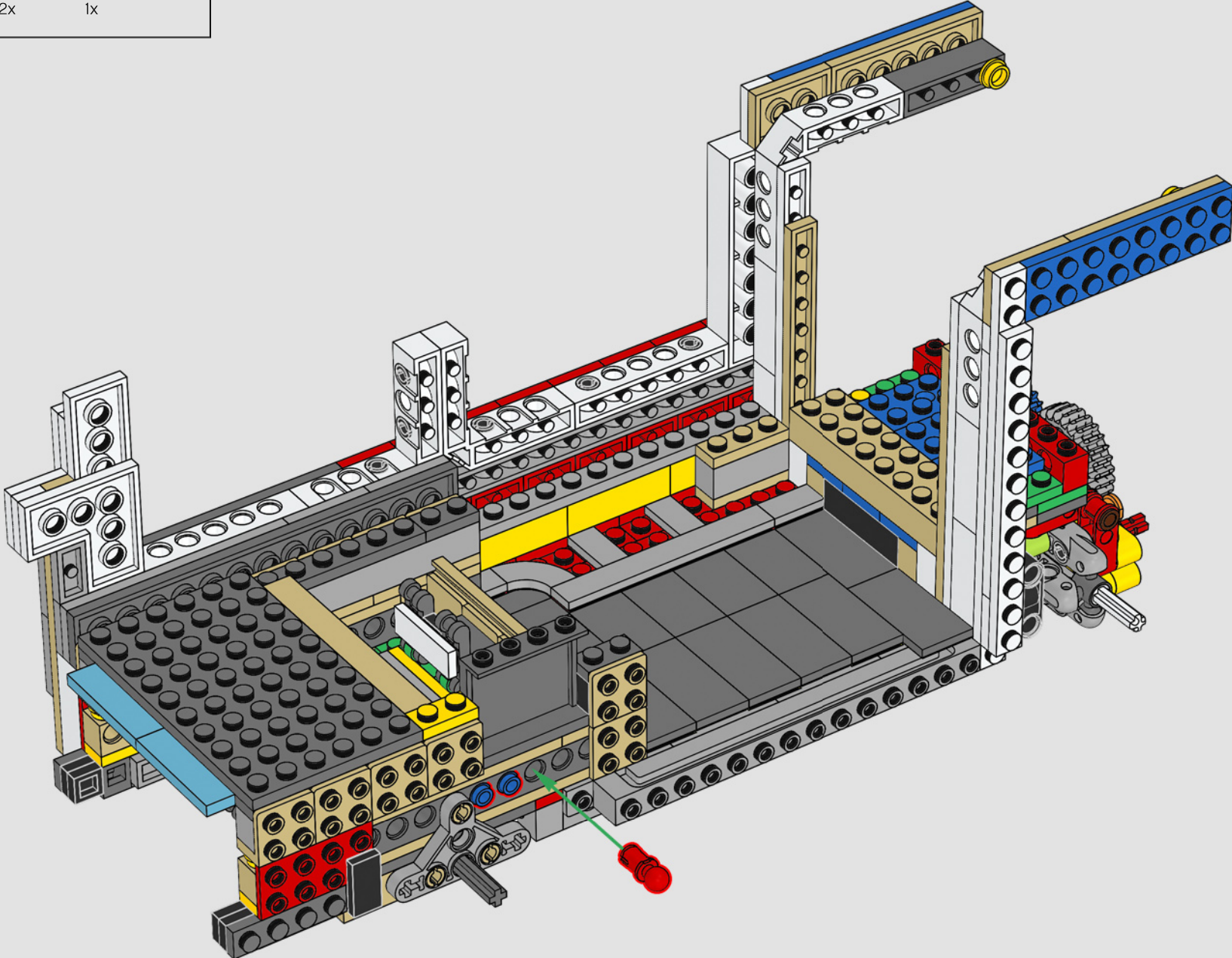

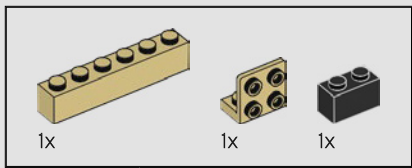

107

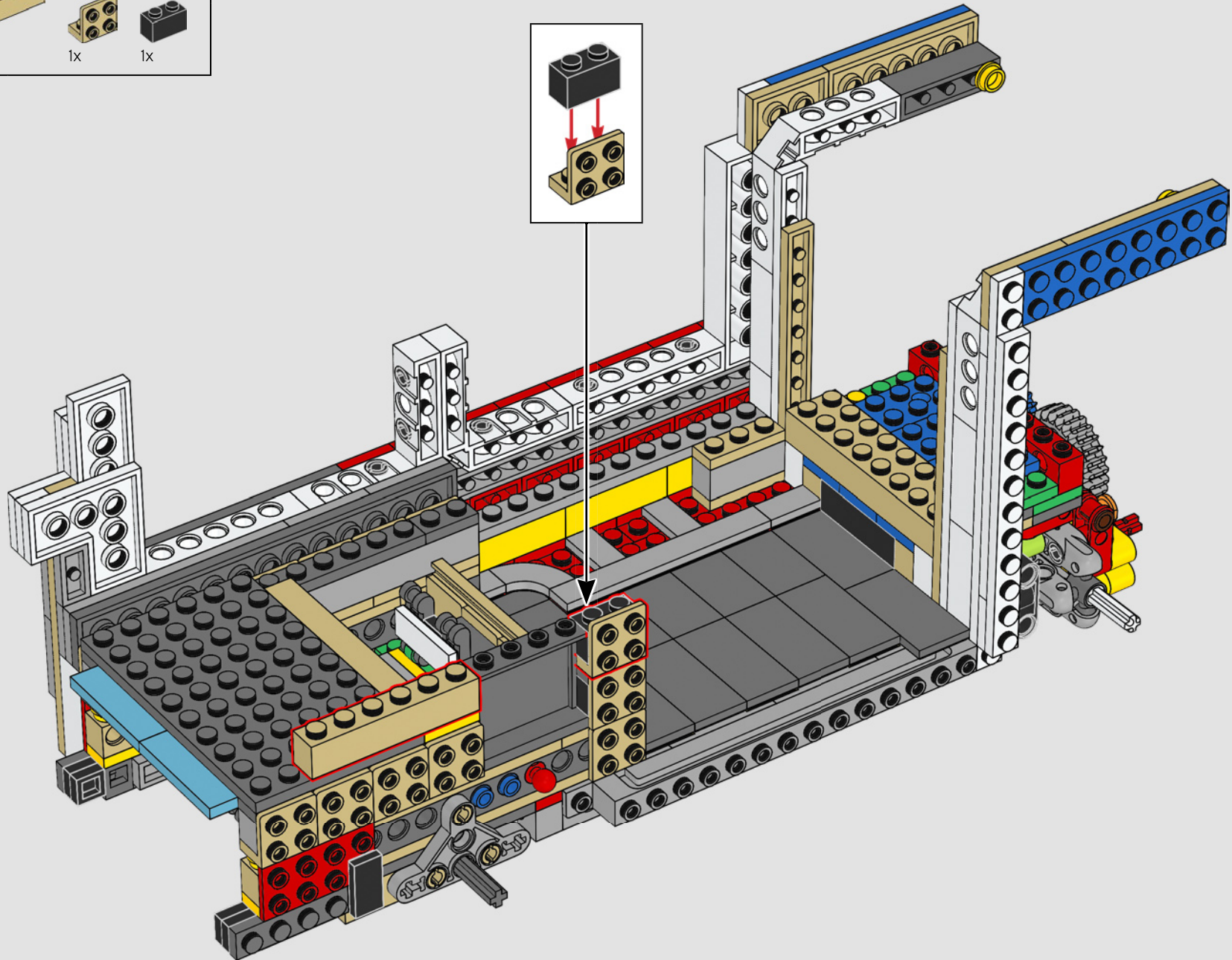
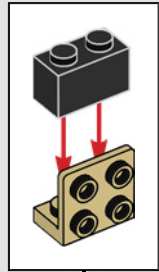

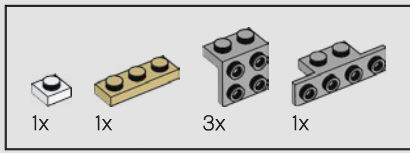

108

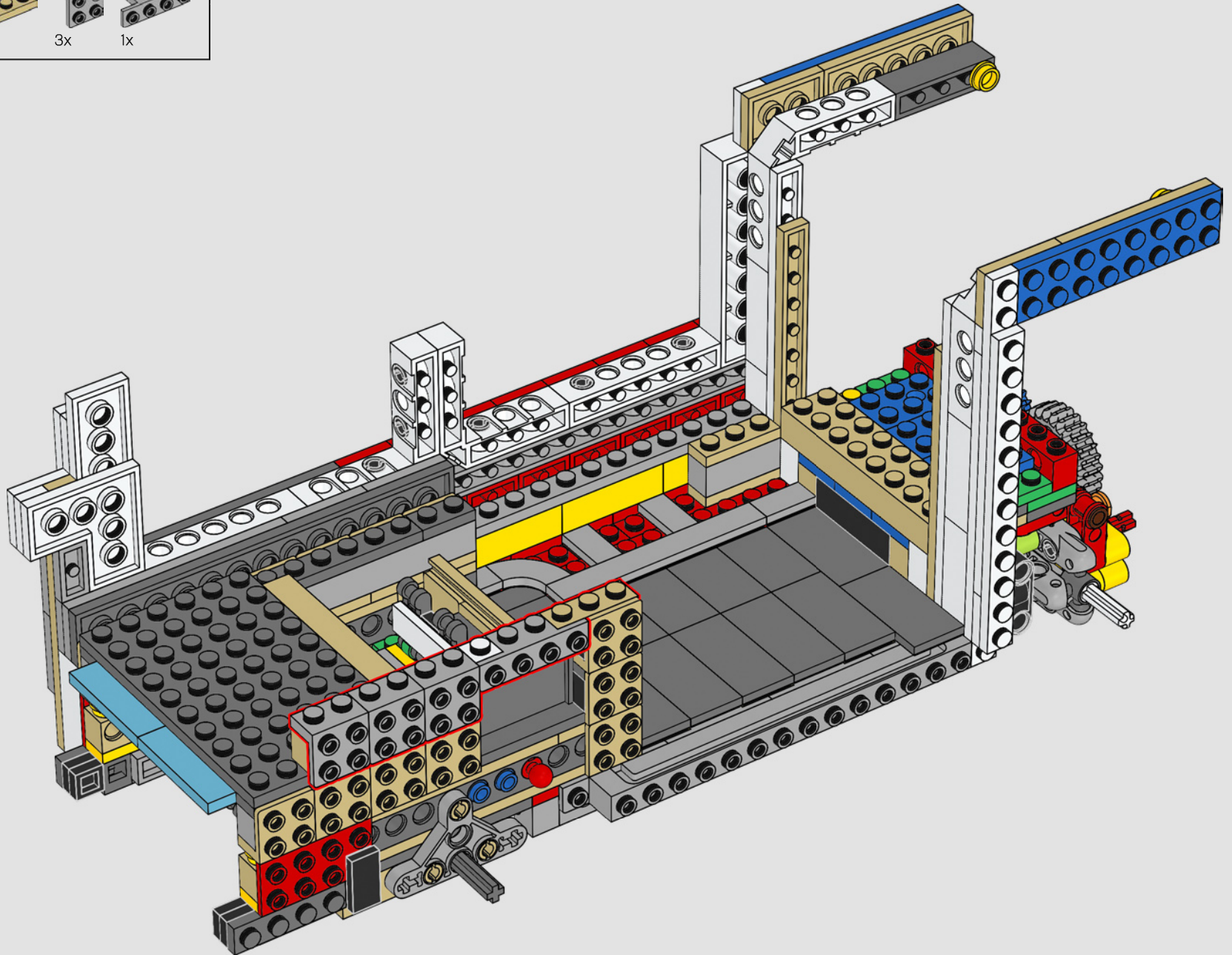

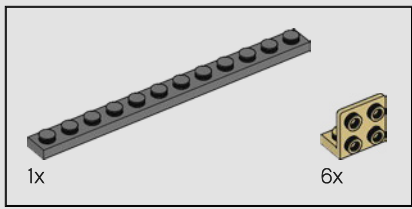

109

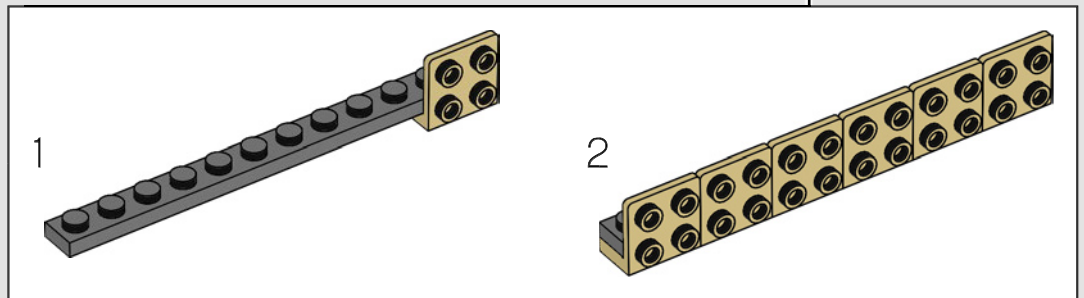
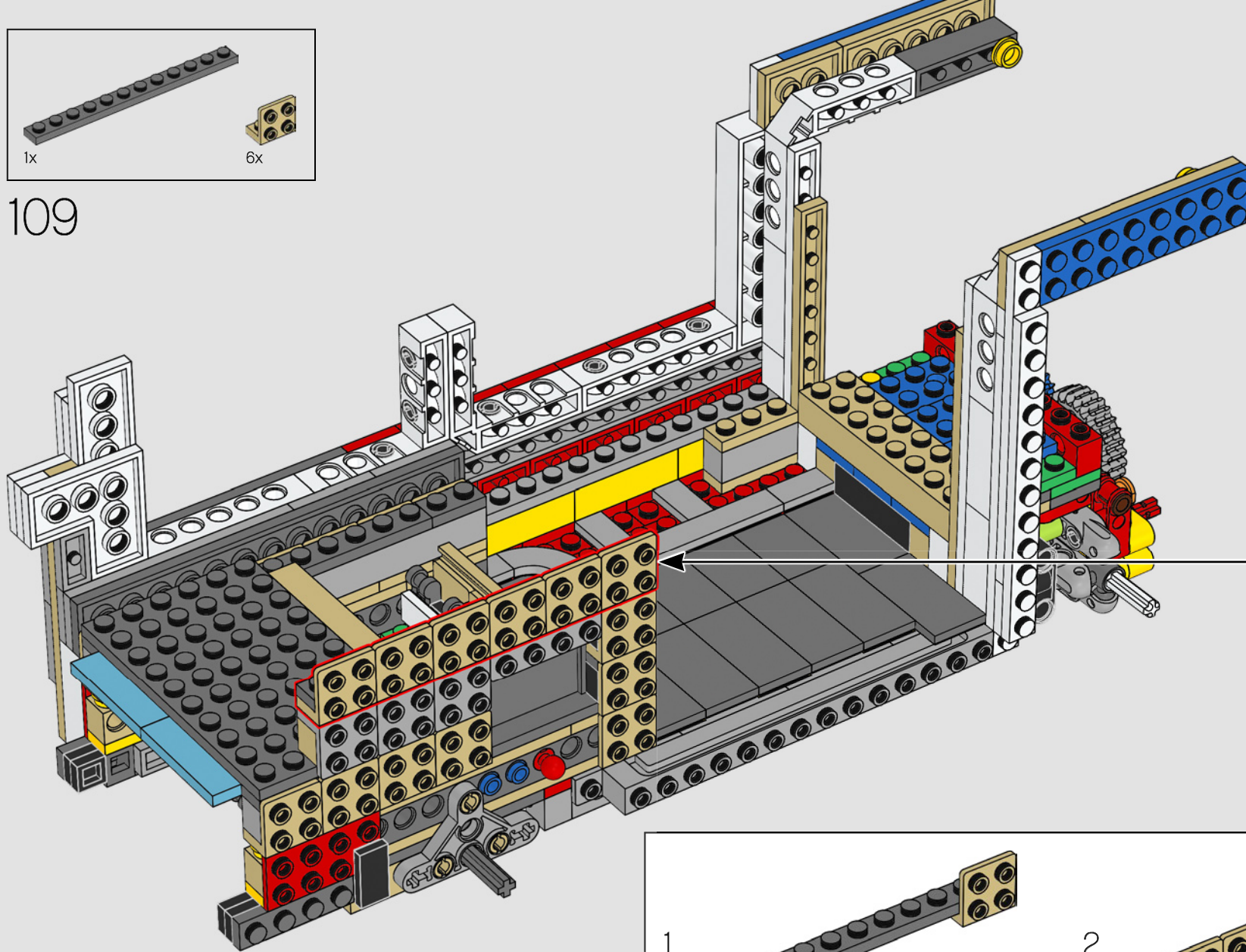

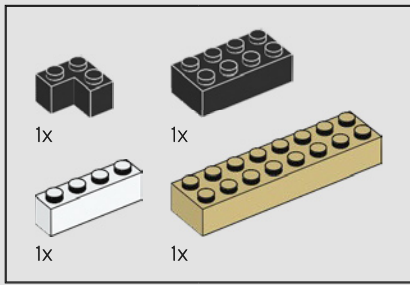

110

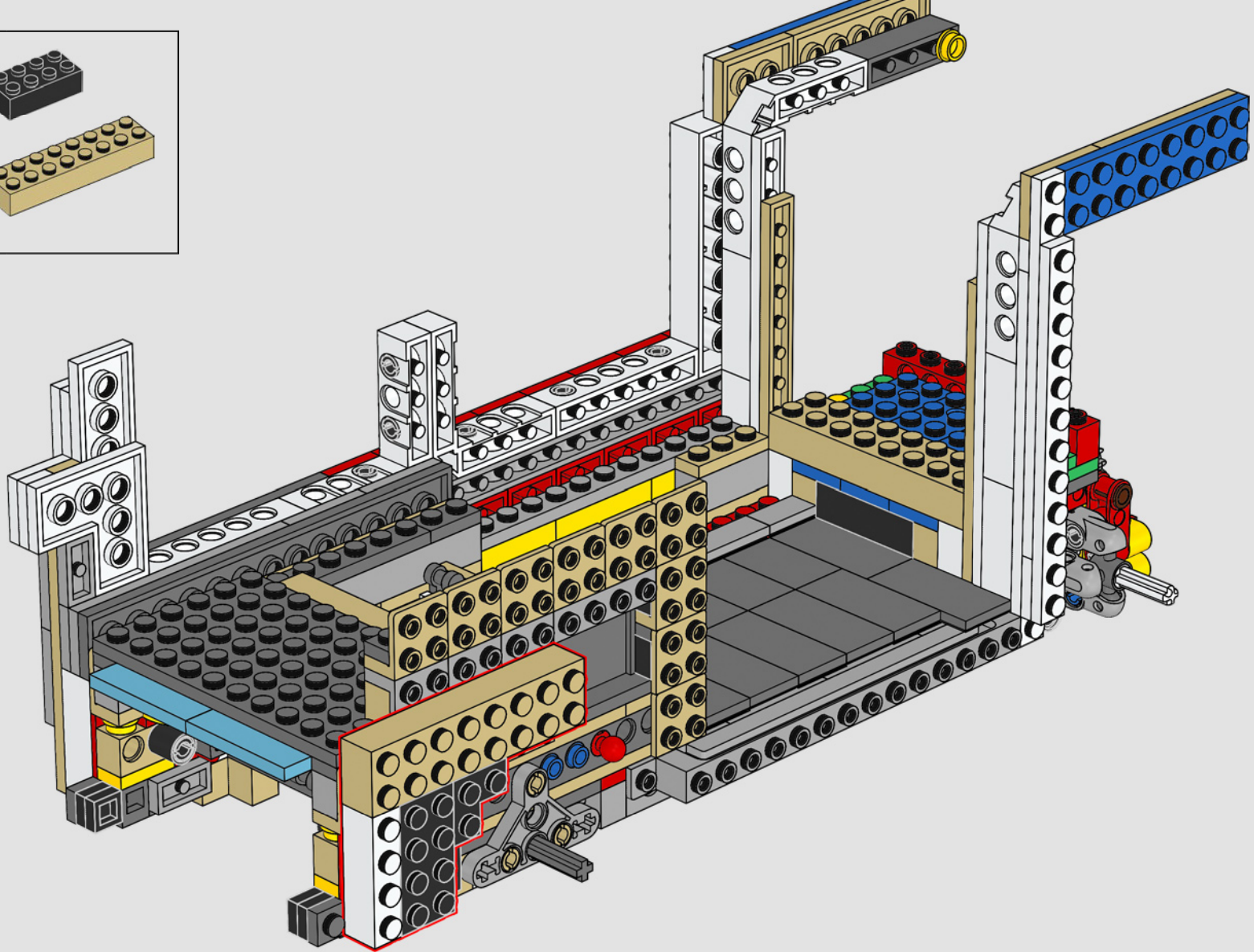

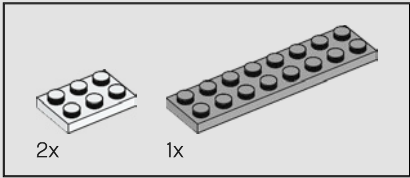
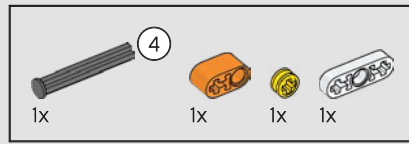
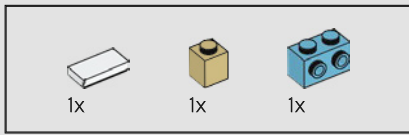
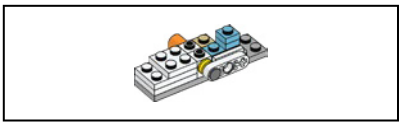

113

115

111

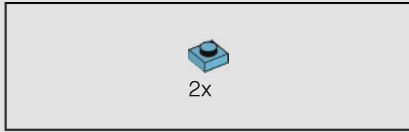
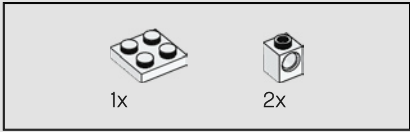
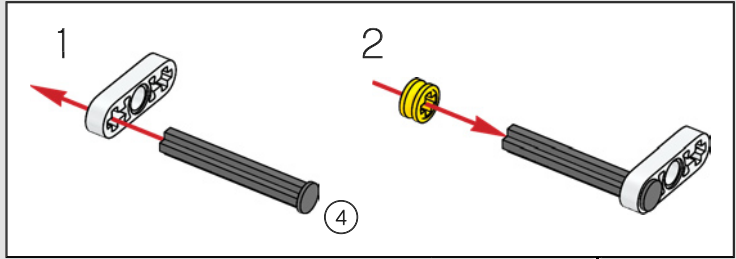
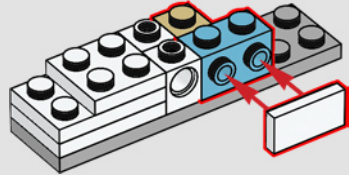
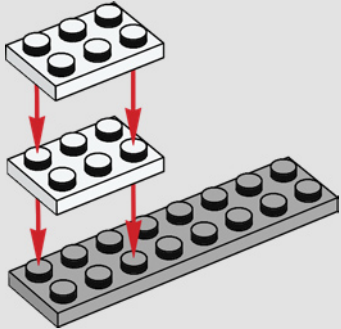

112

114

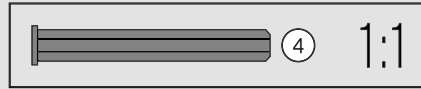
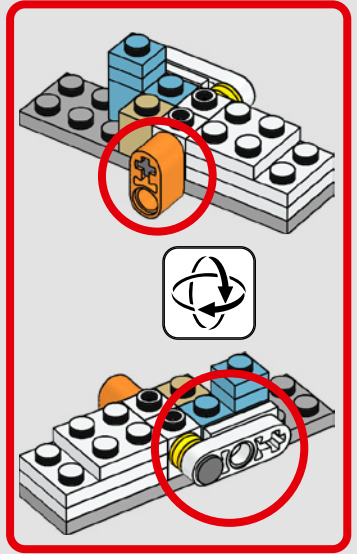
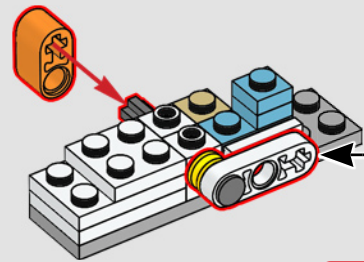
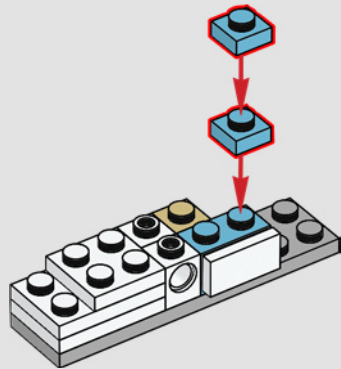
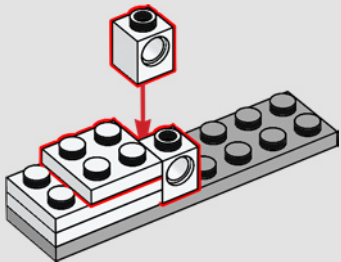

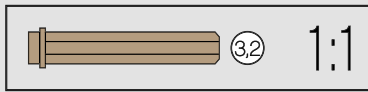
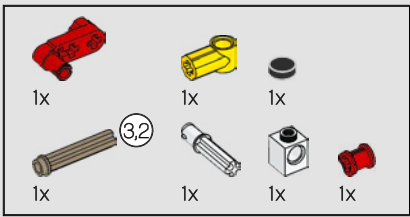

117

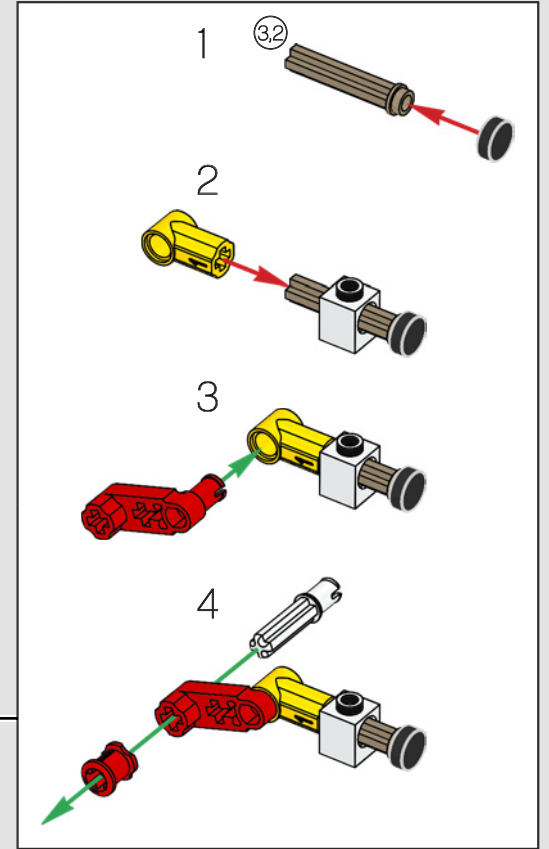
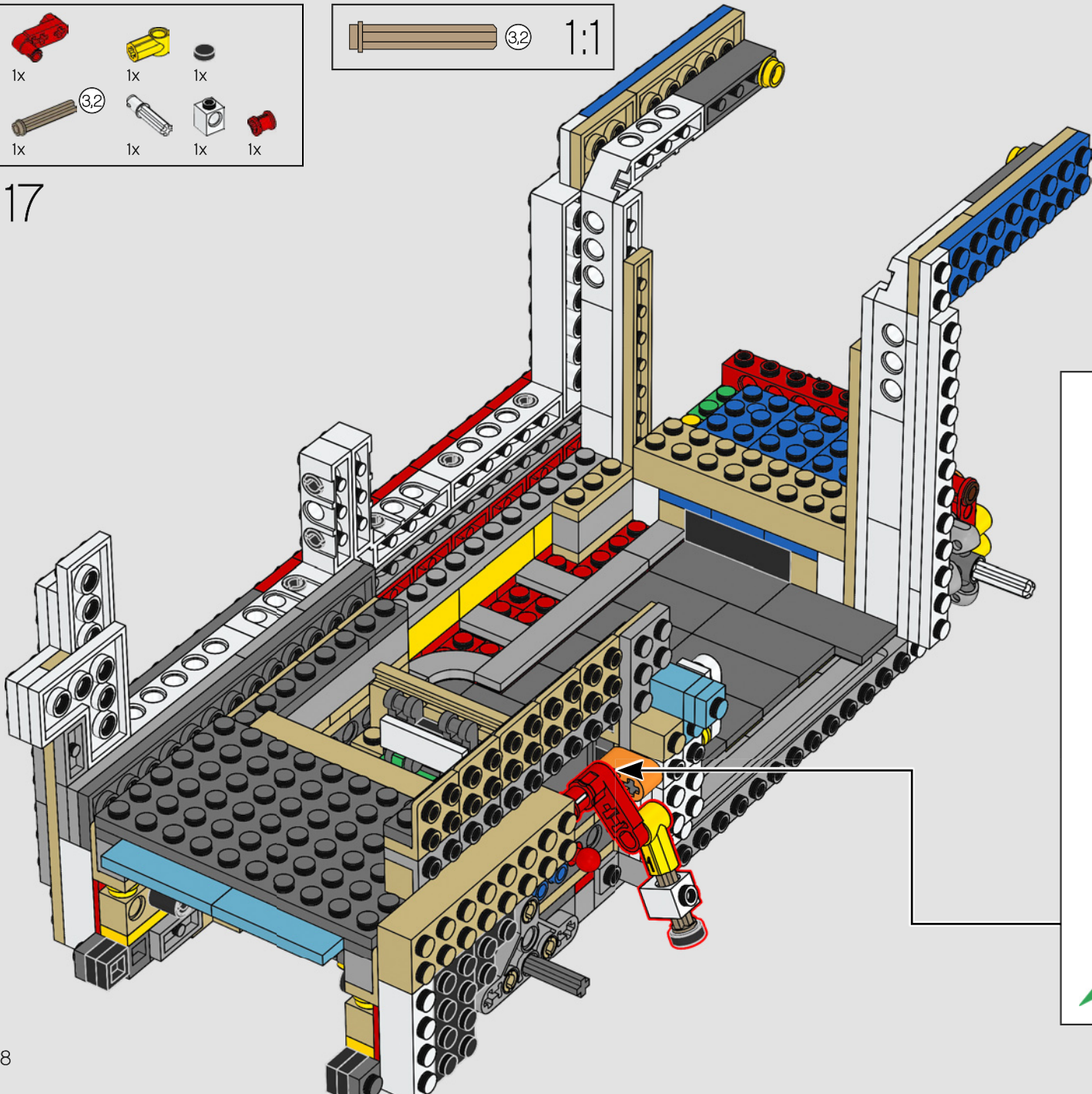

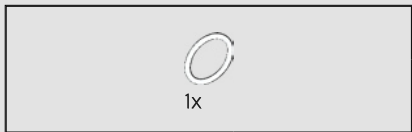

118

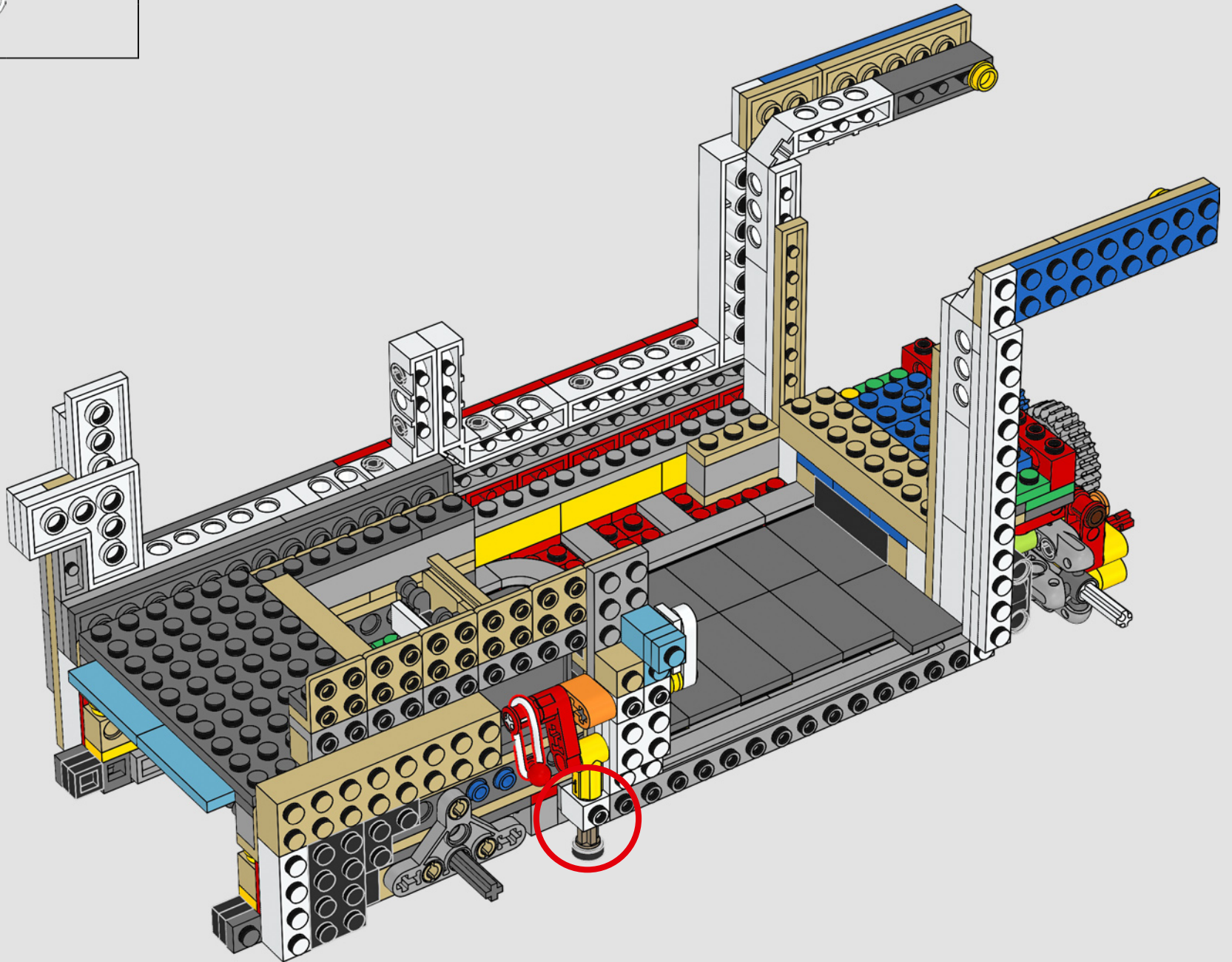

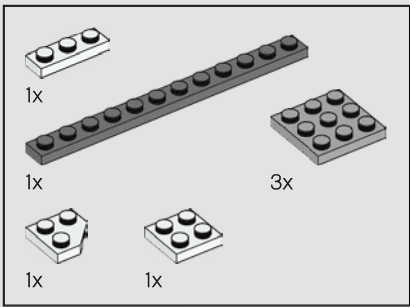

119

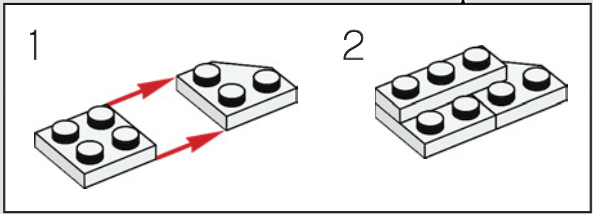
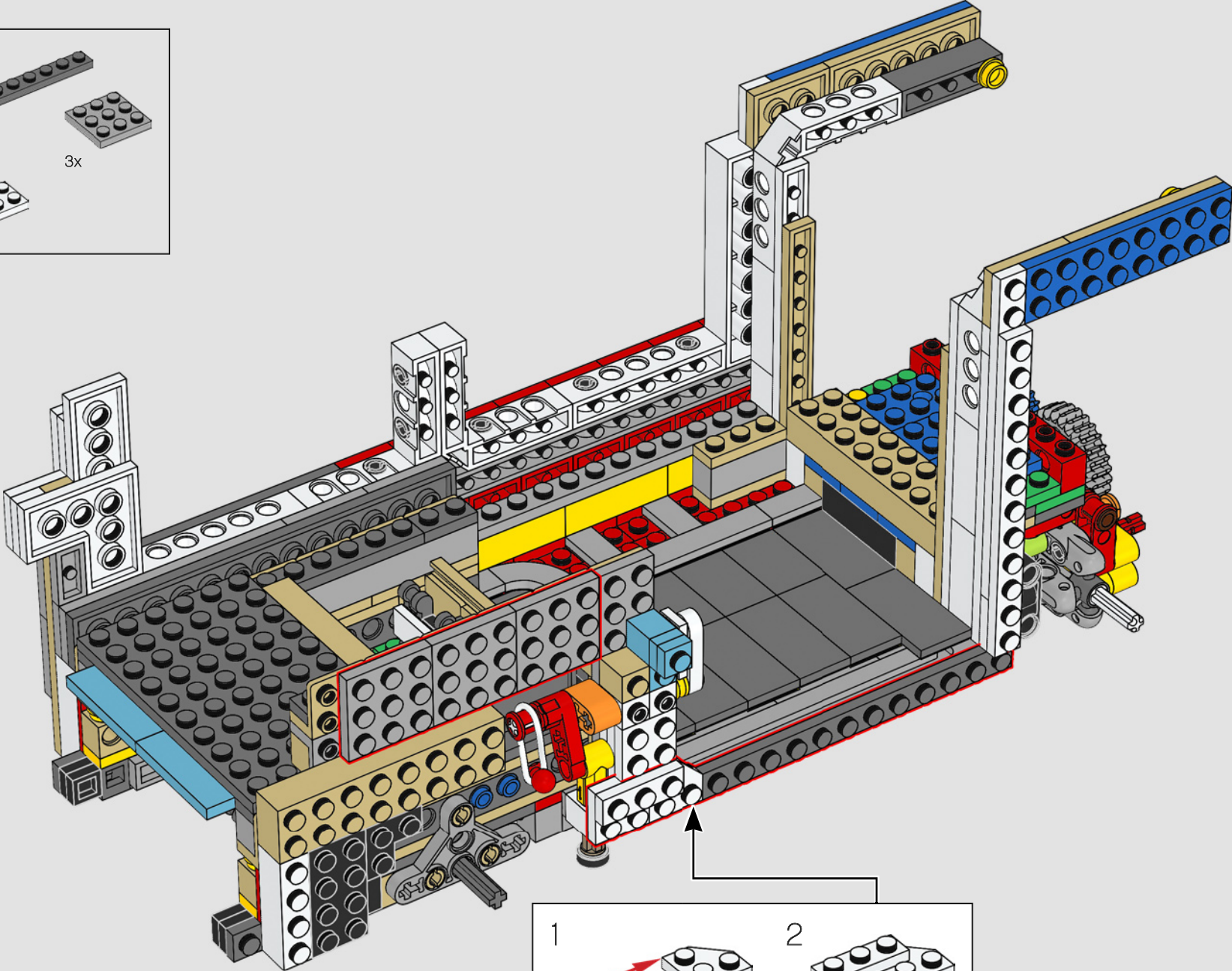

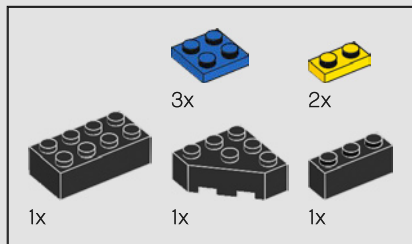

120

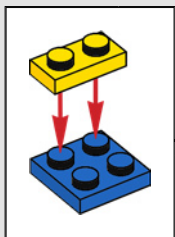
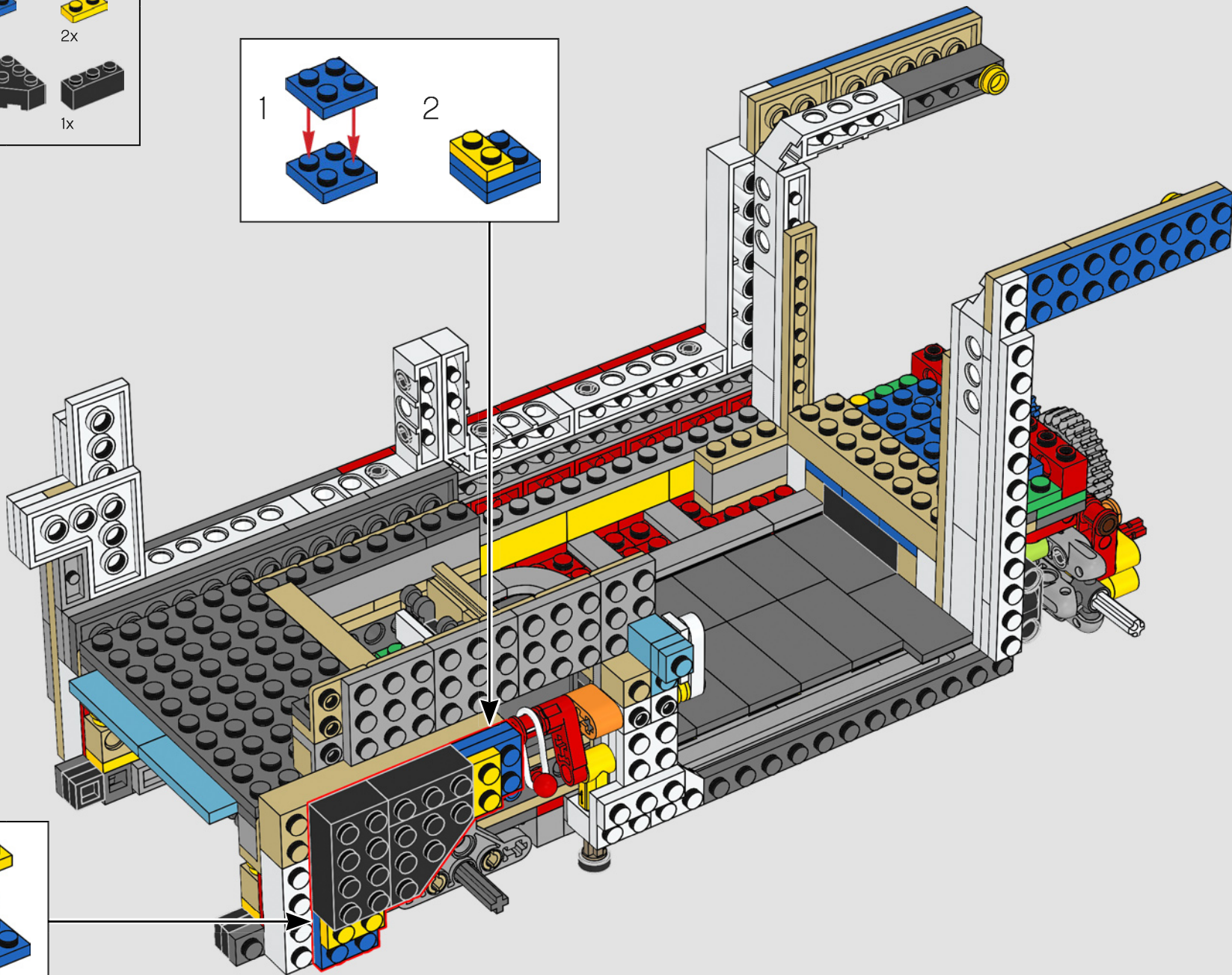
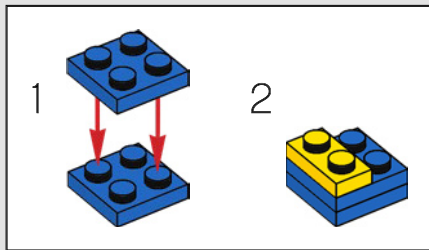

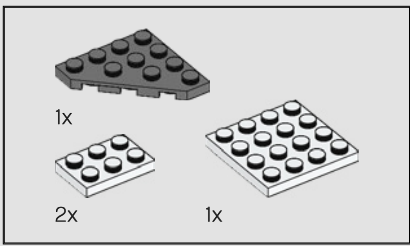

121

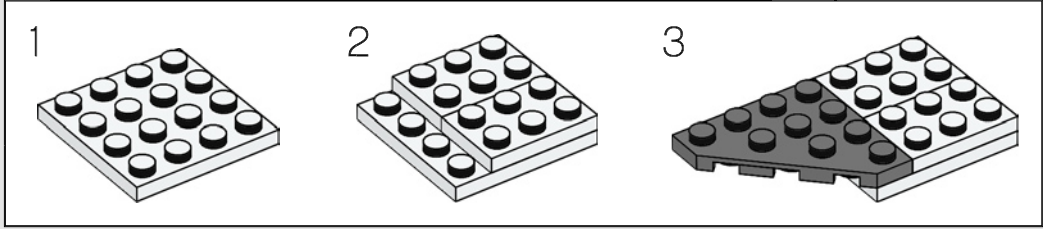
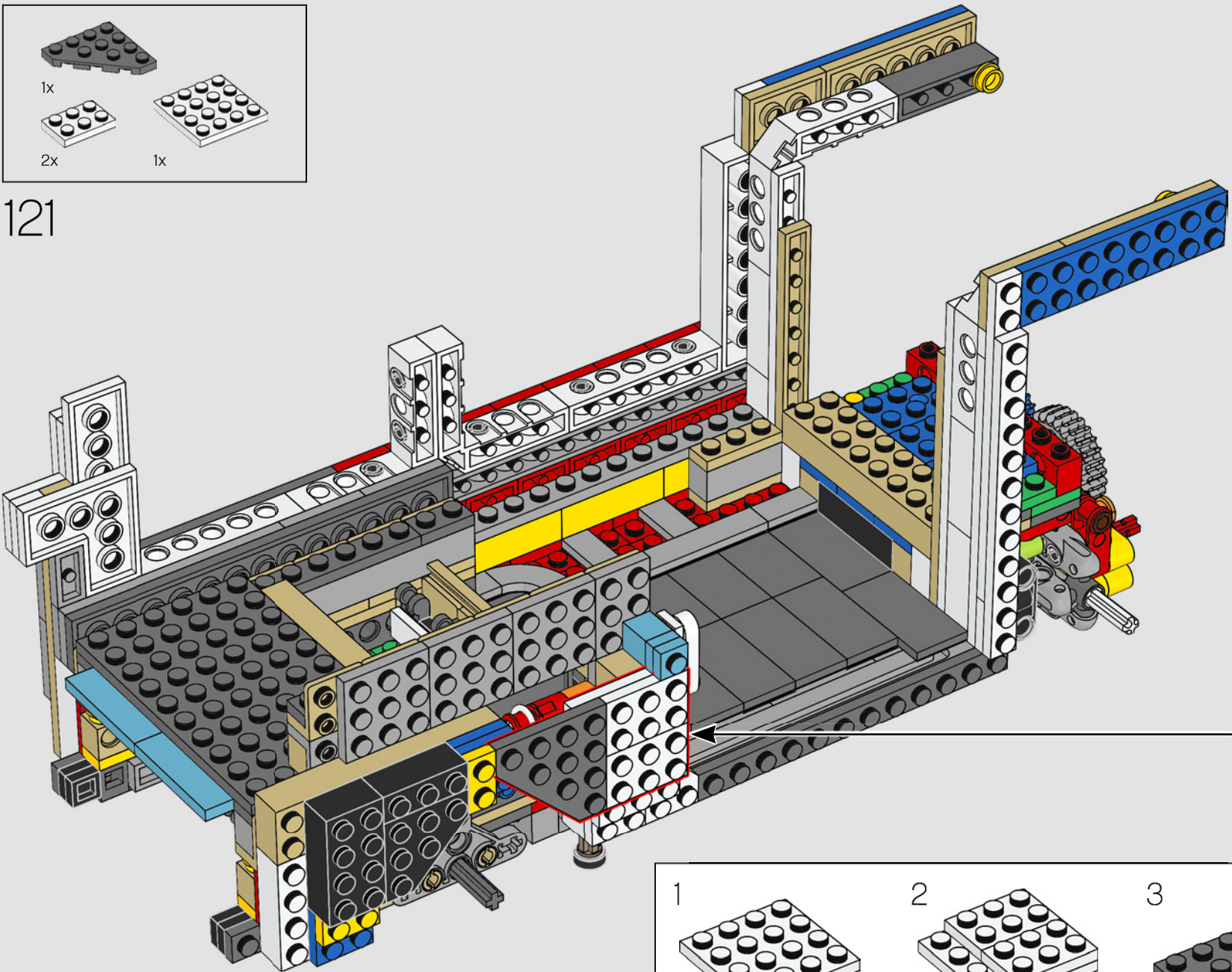

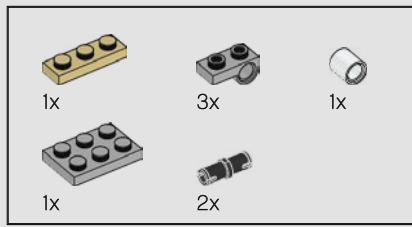

122

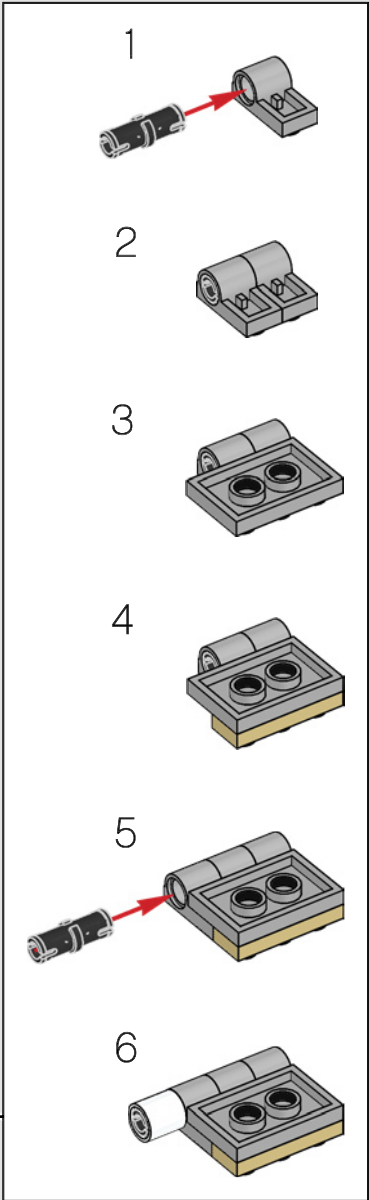
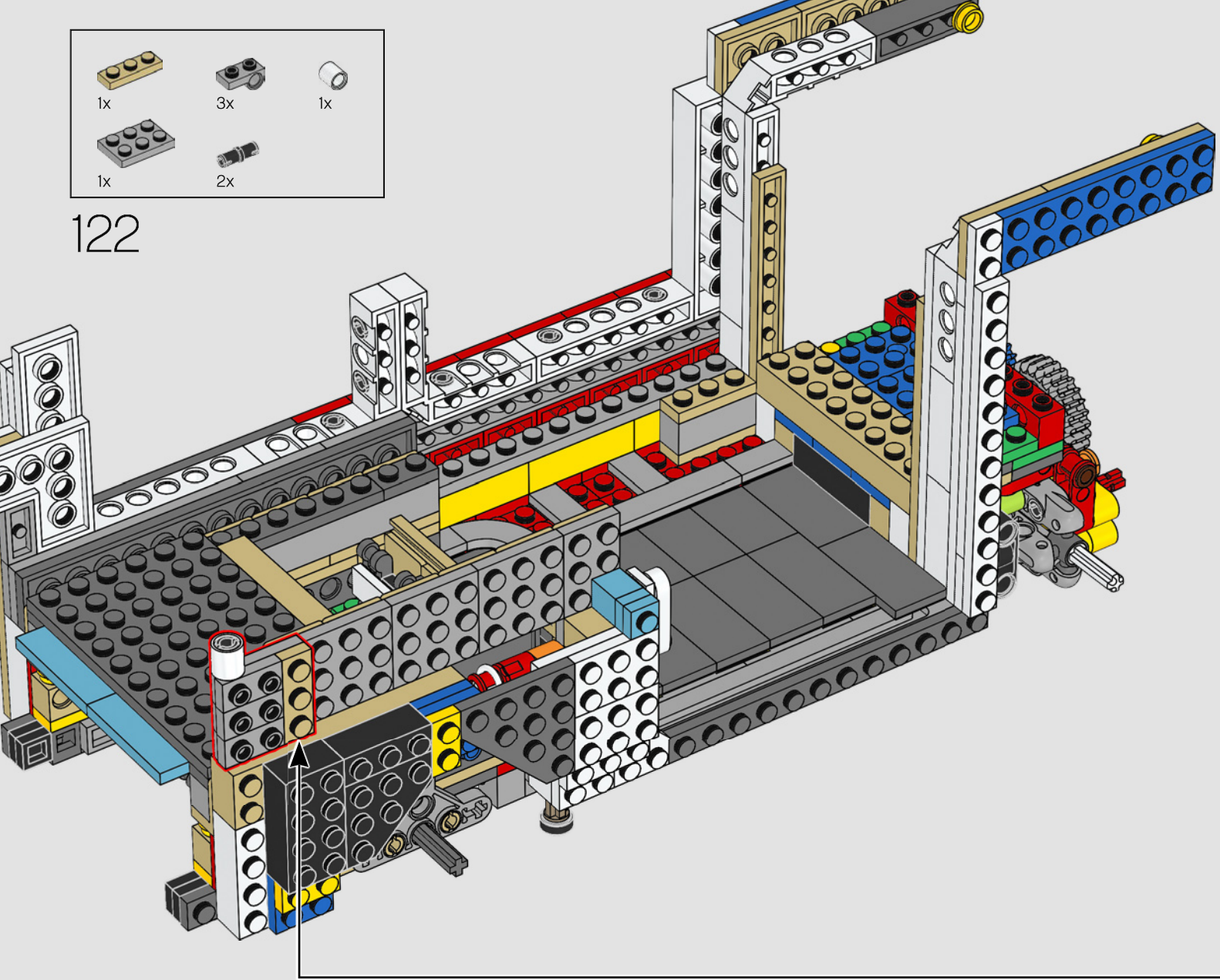

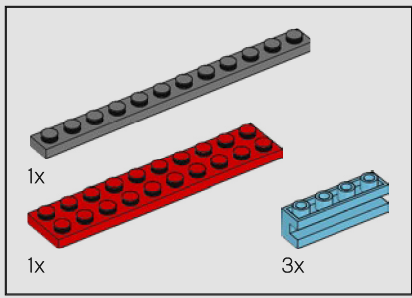

123

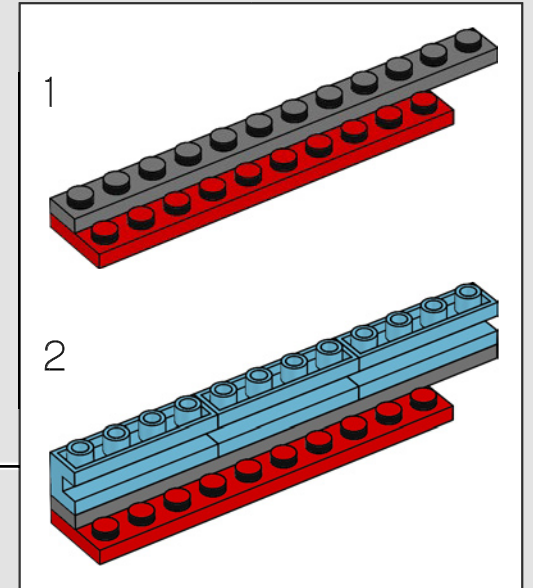
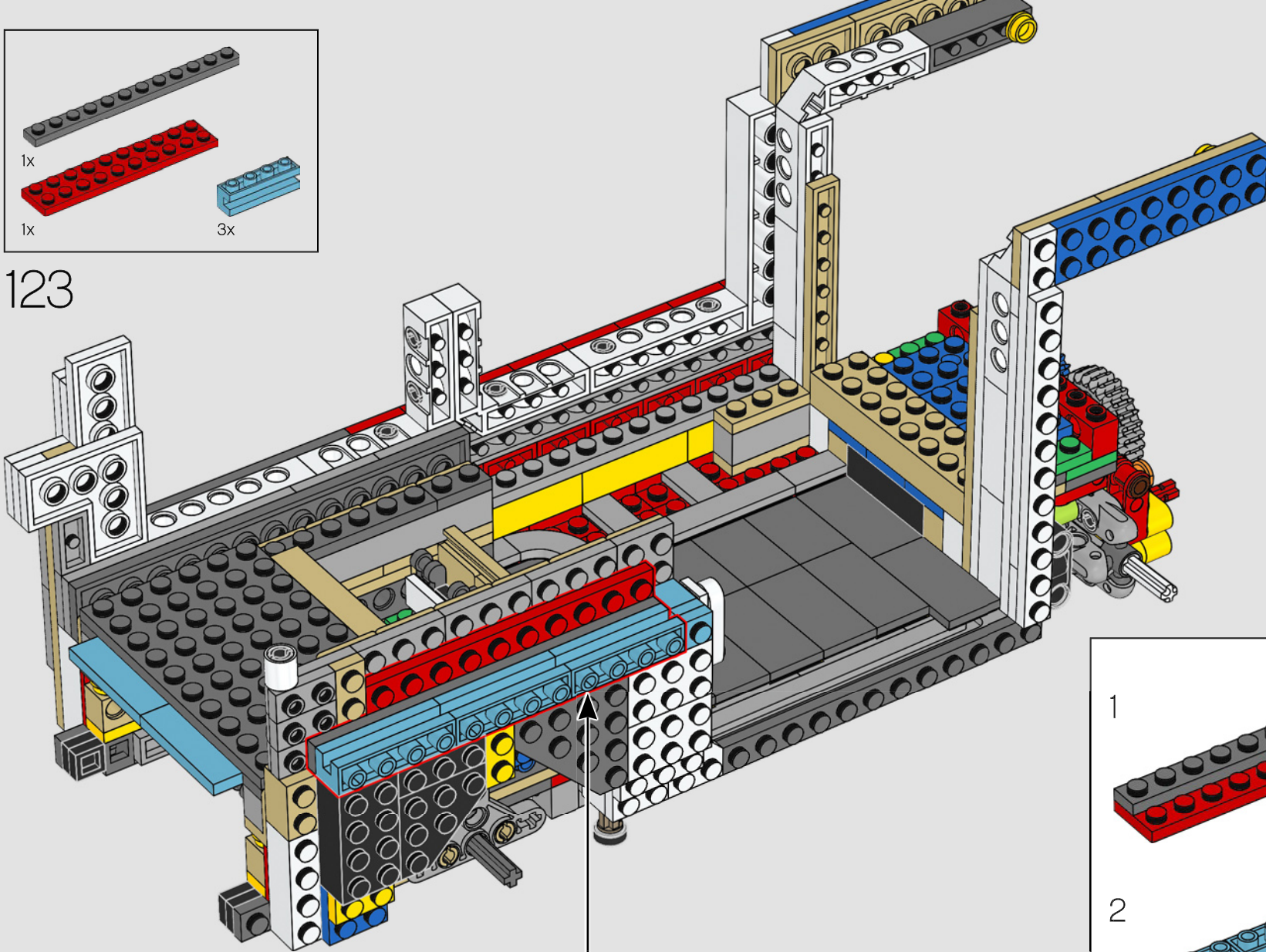

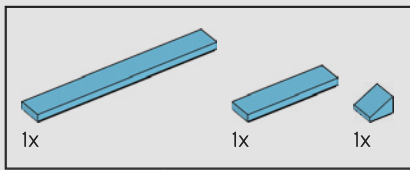

124

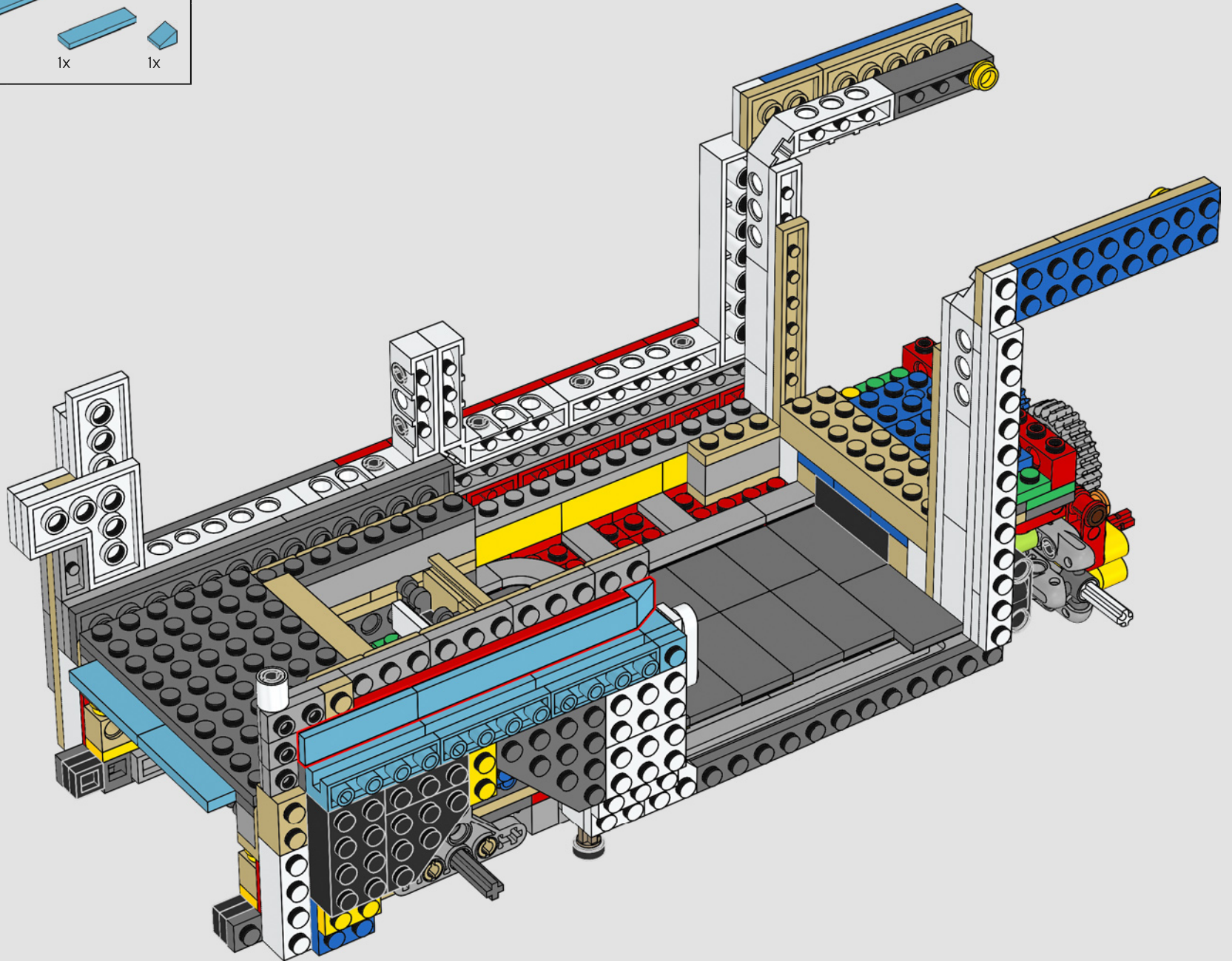

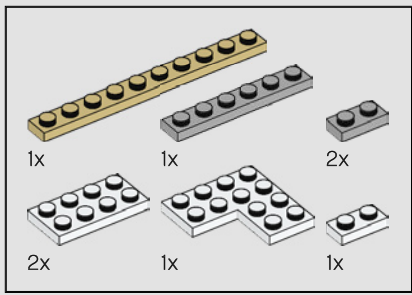

125

1

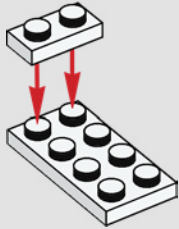

2

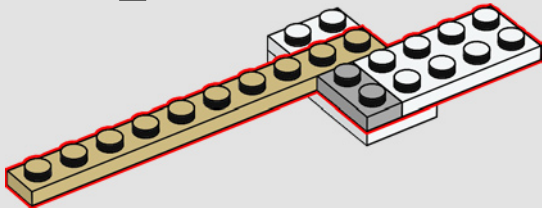

3

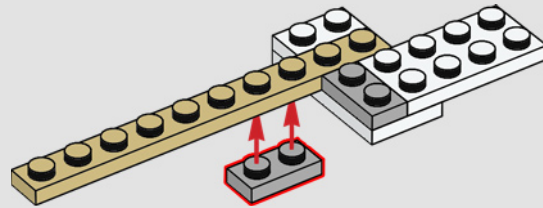

4

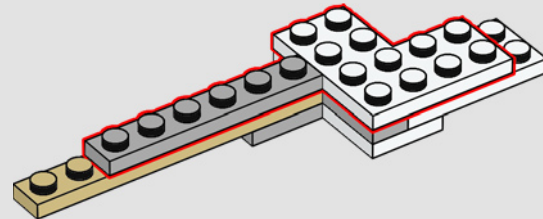

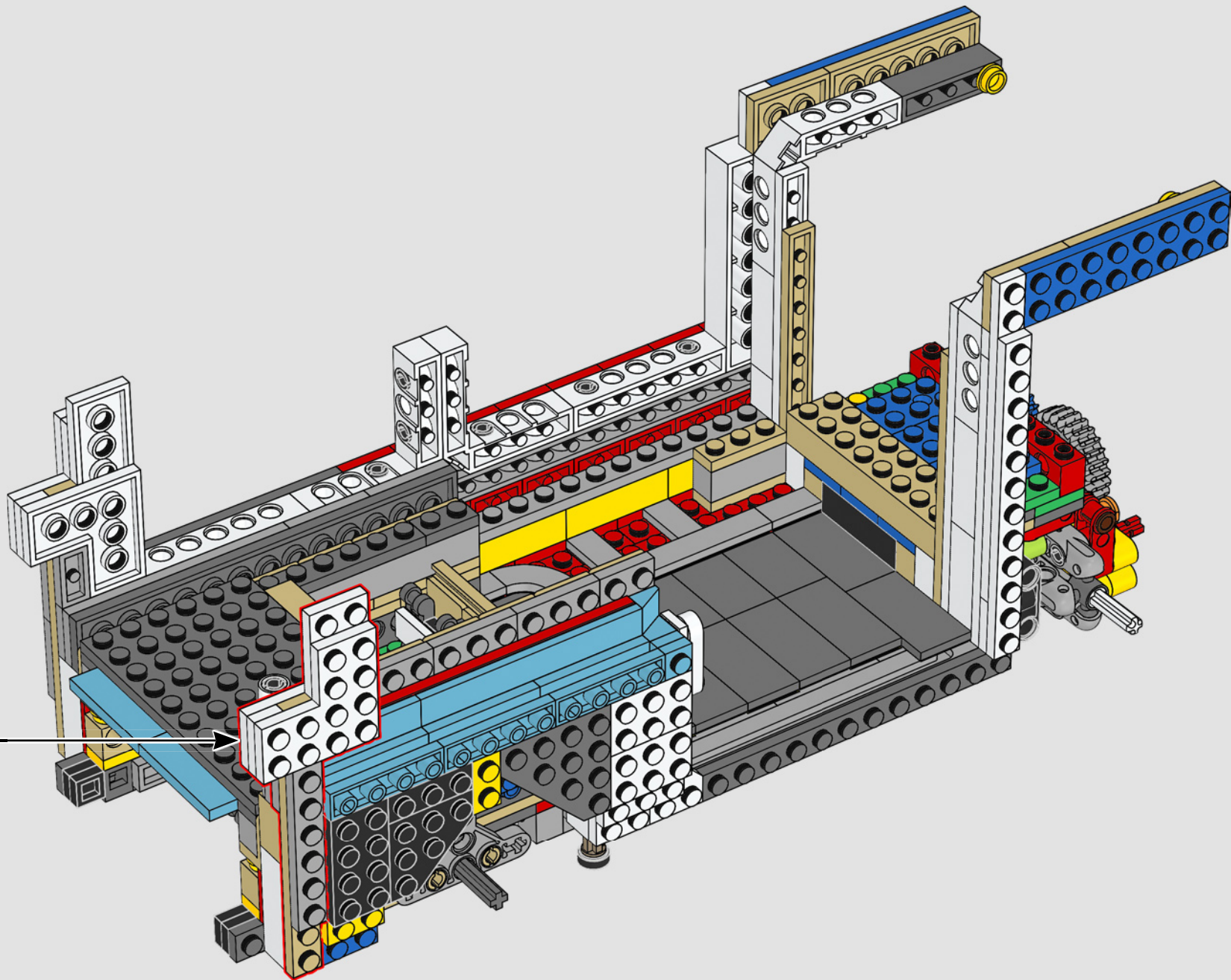

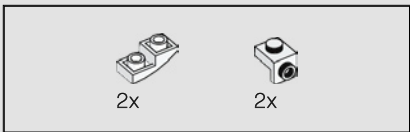

126

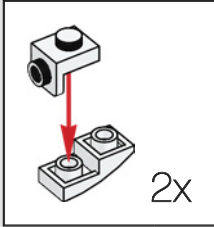
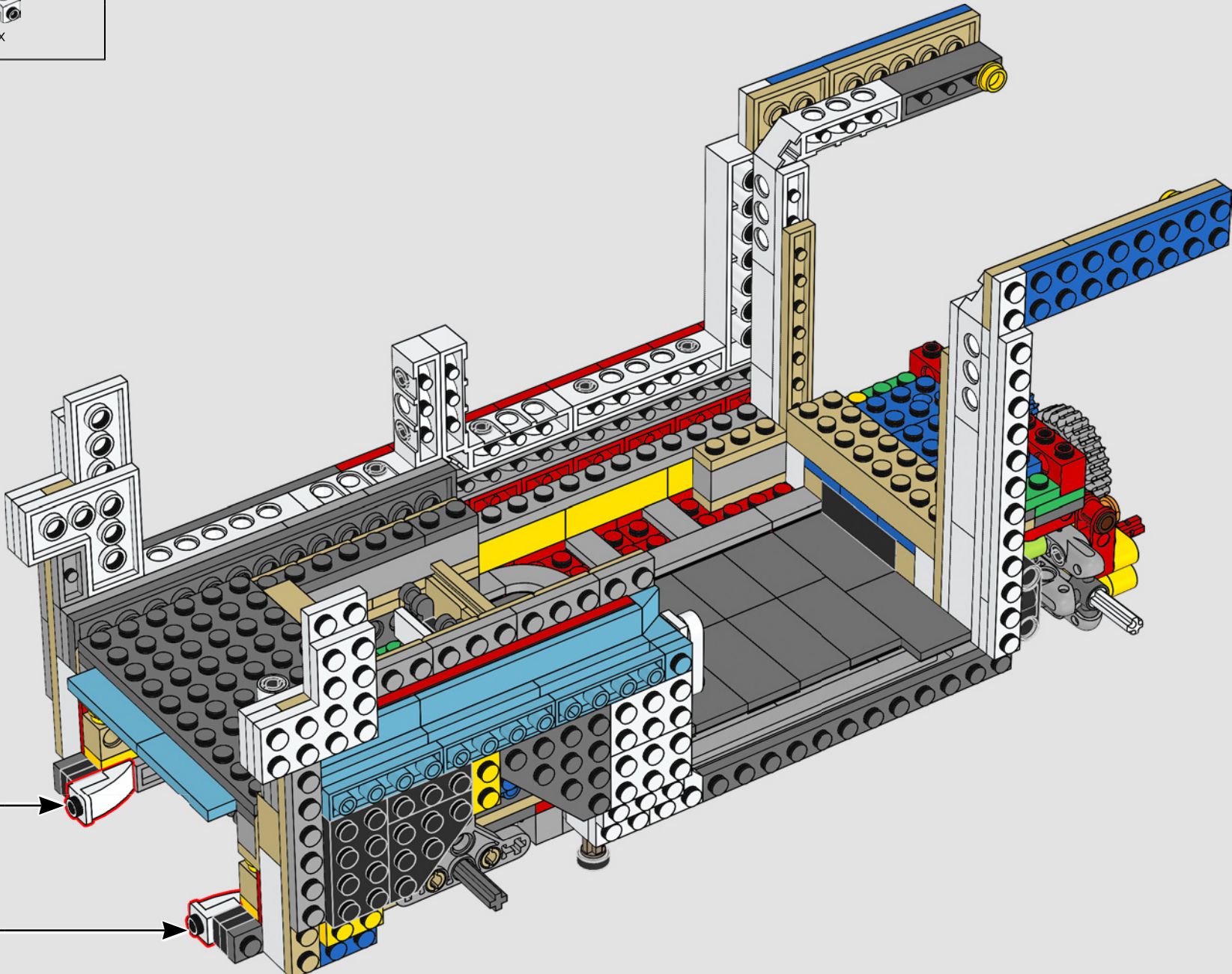

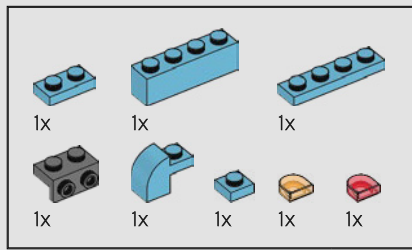

127

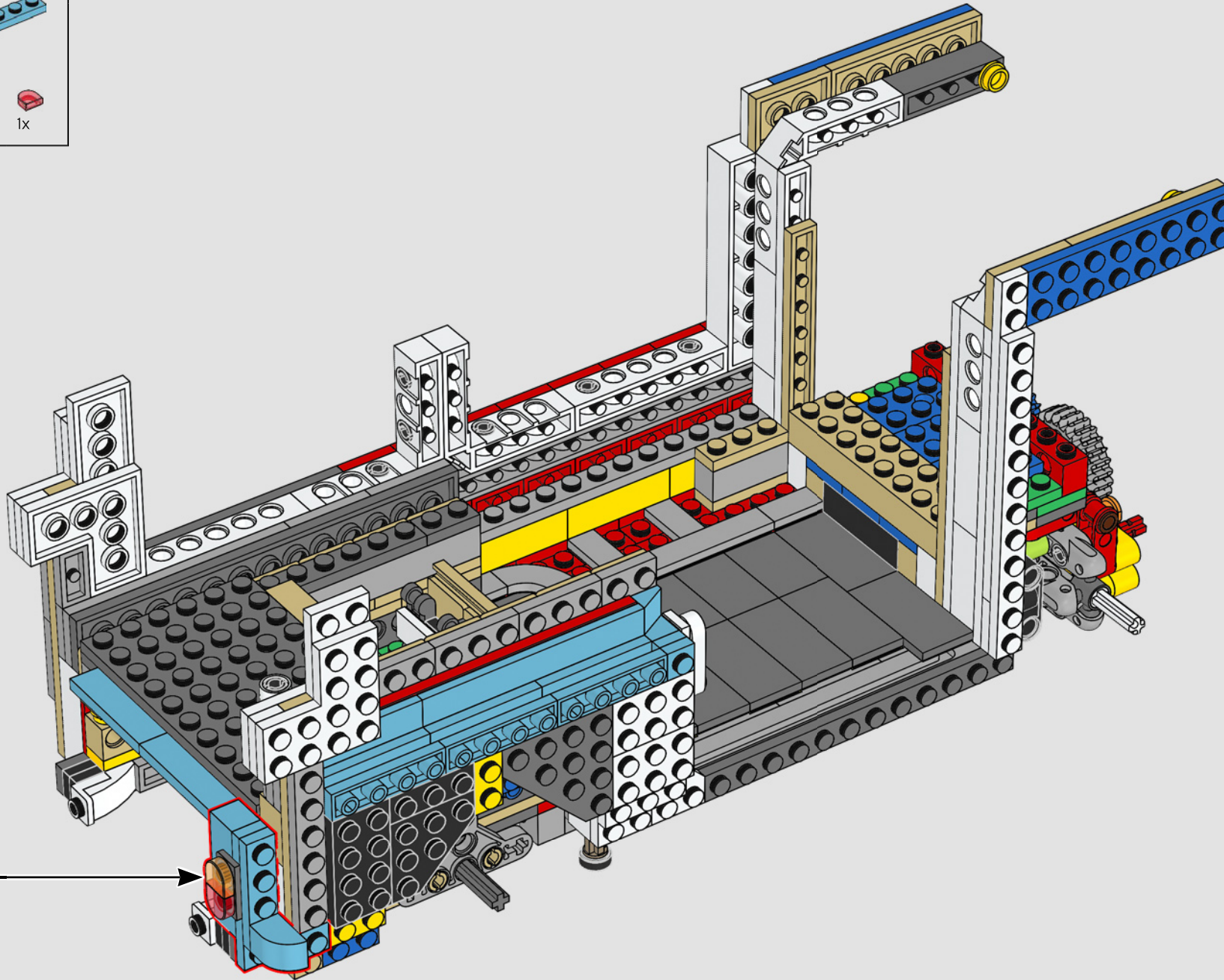
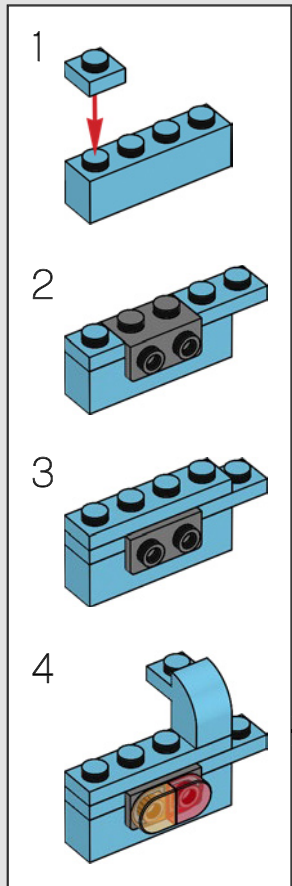

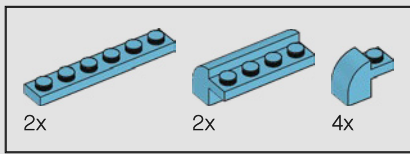

129

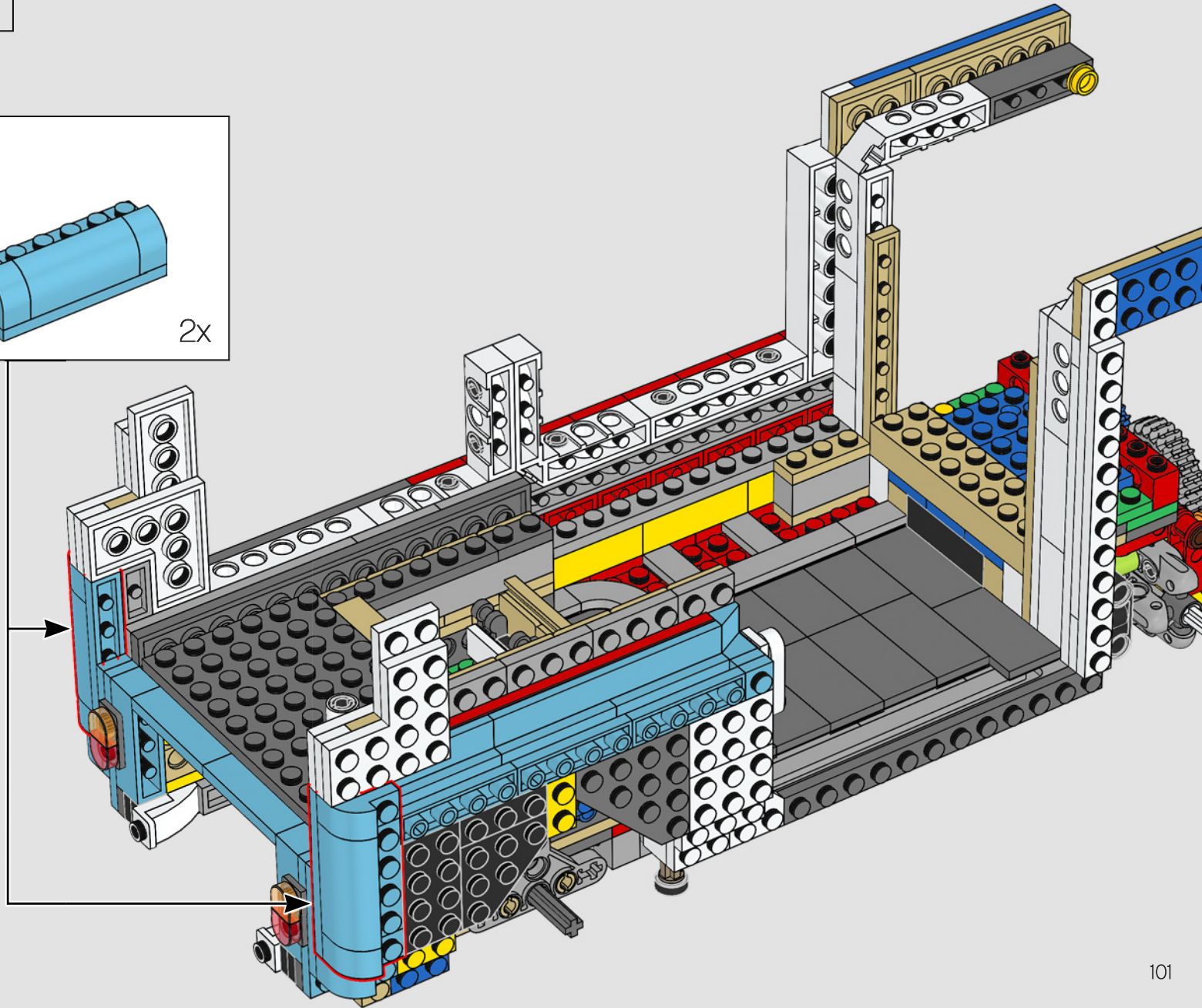
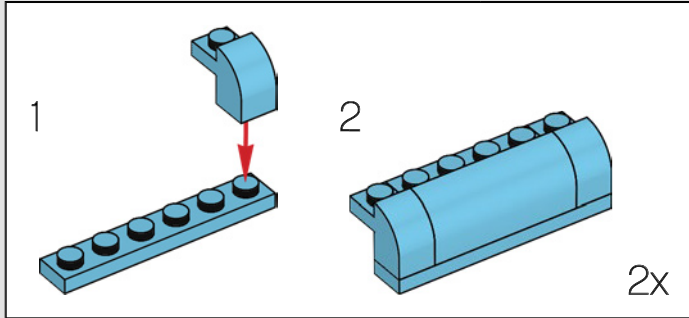

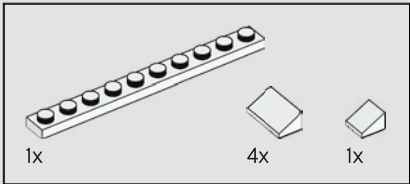
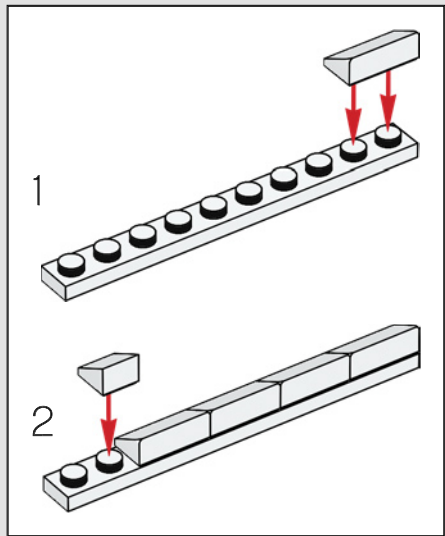
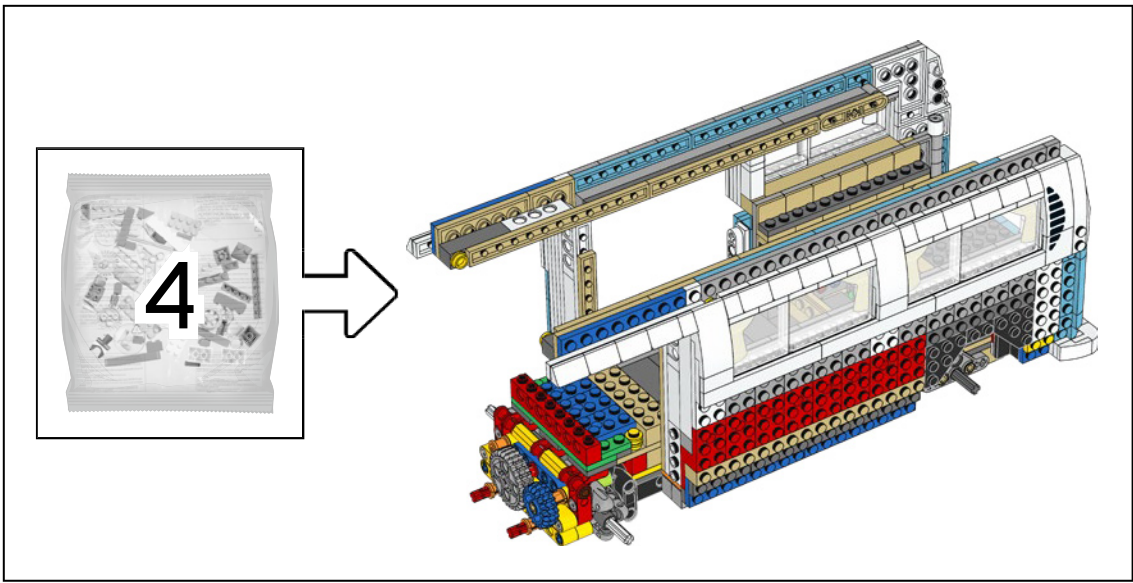

130

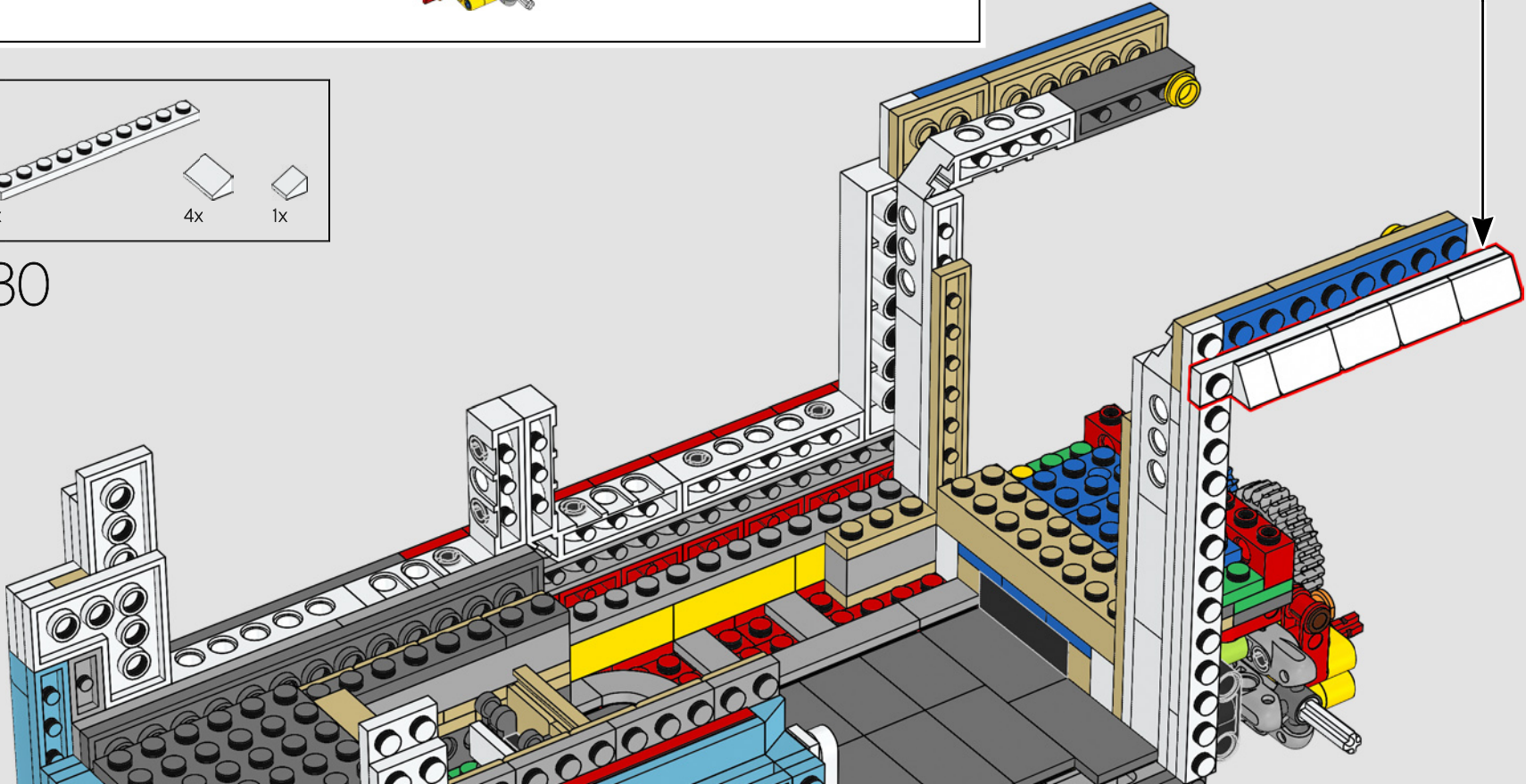

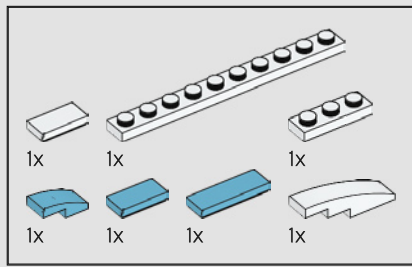

131

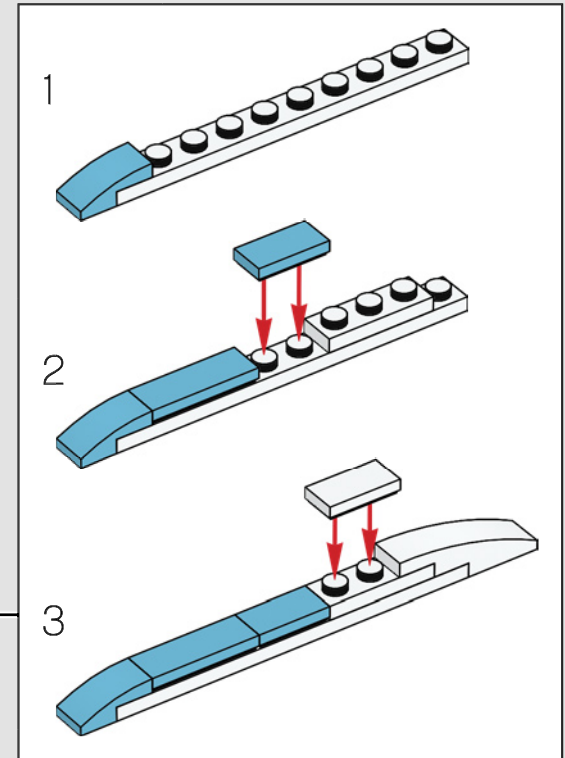
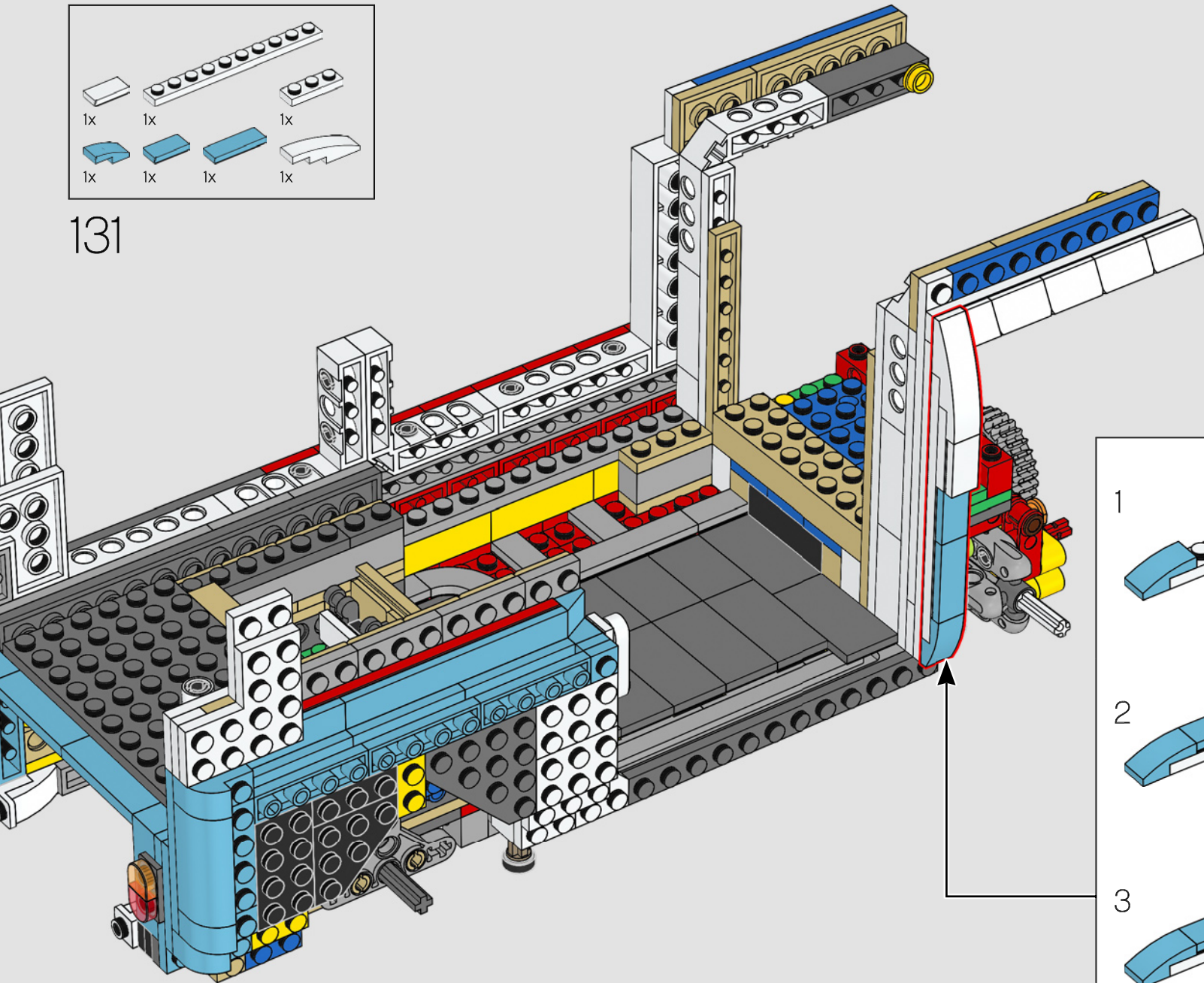

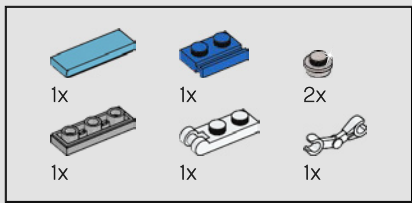

132

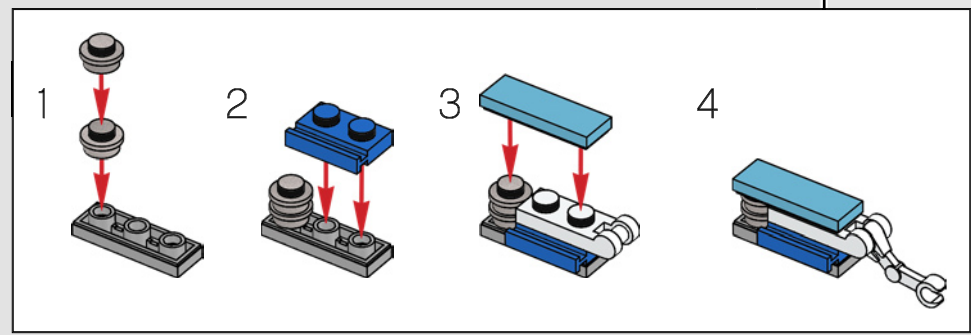
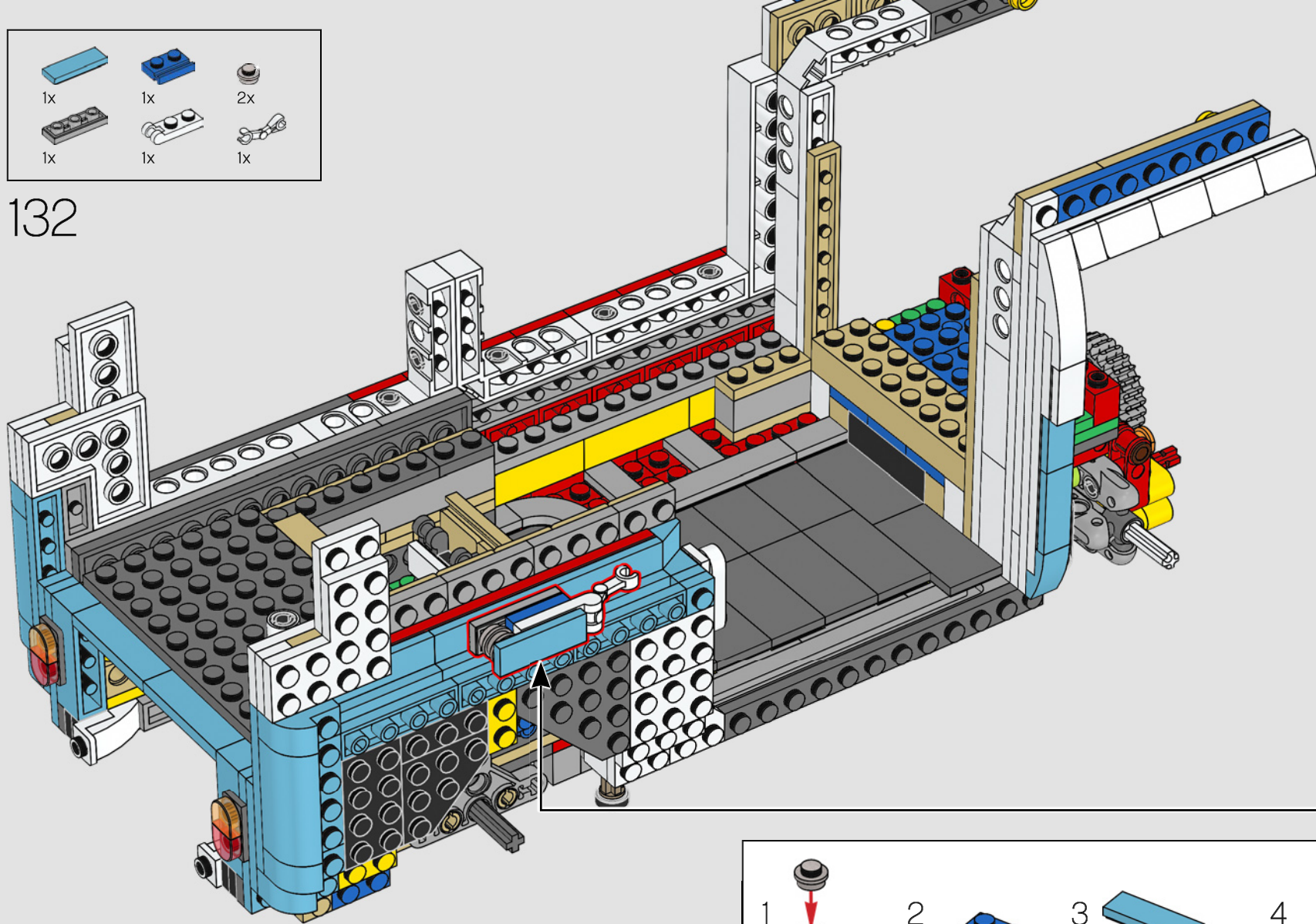

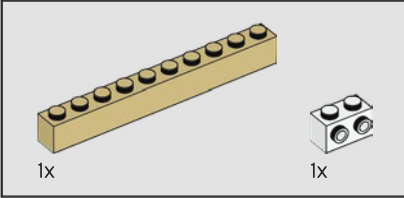
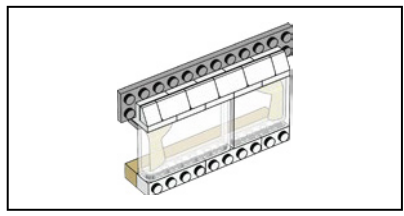

133

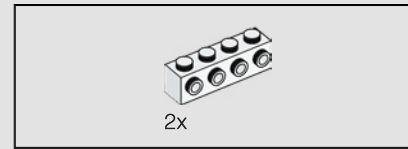
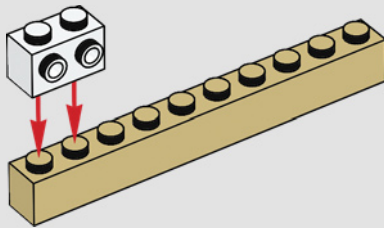

134

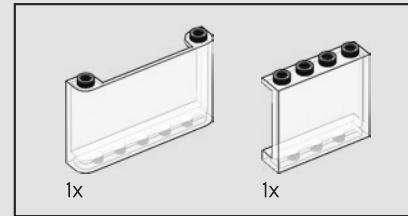
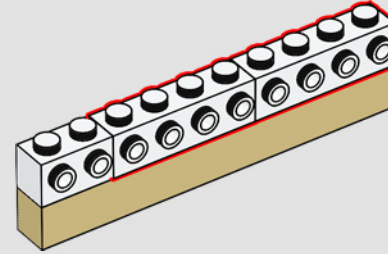

135

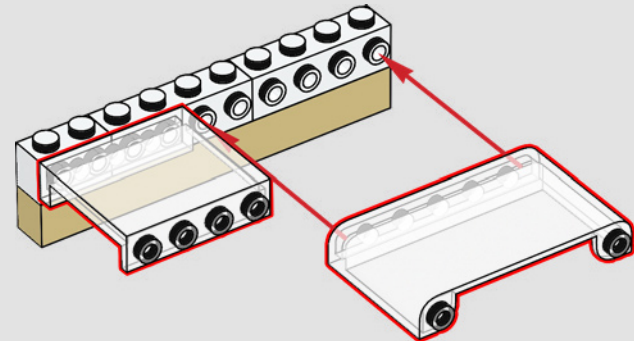

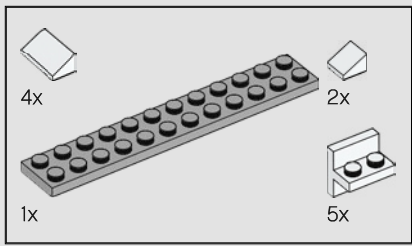

136

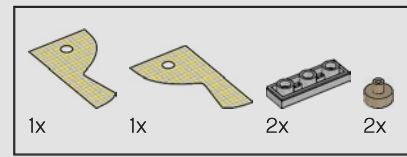
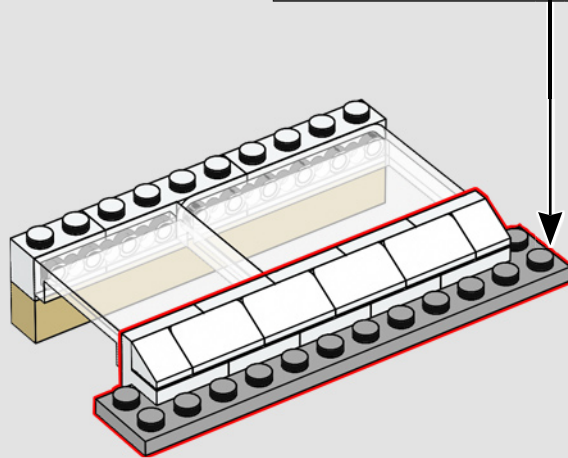
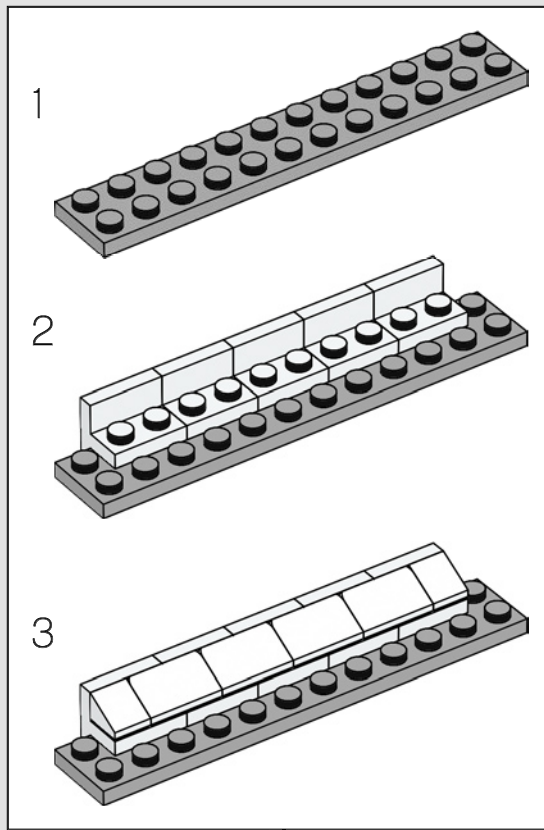

137

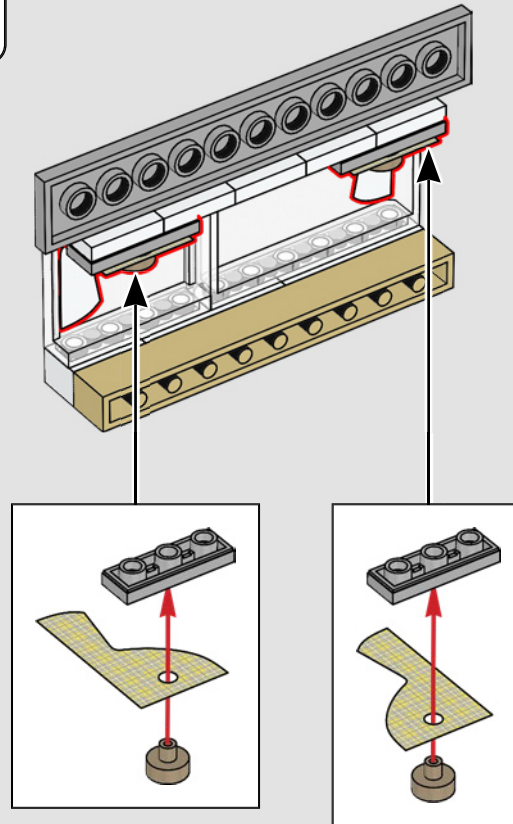

138

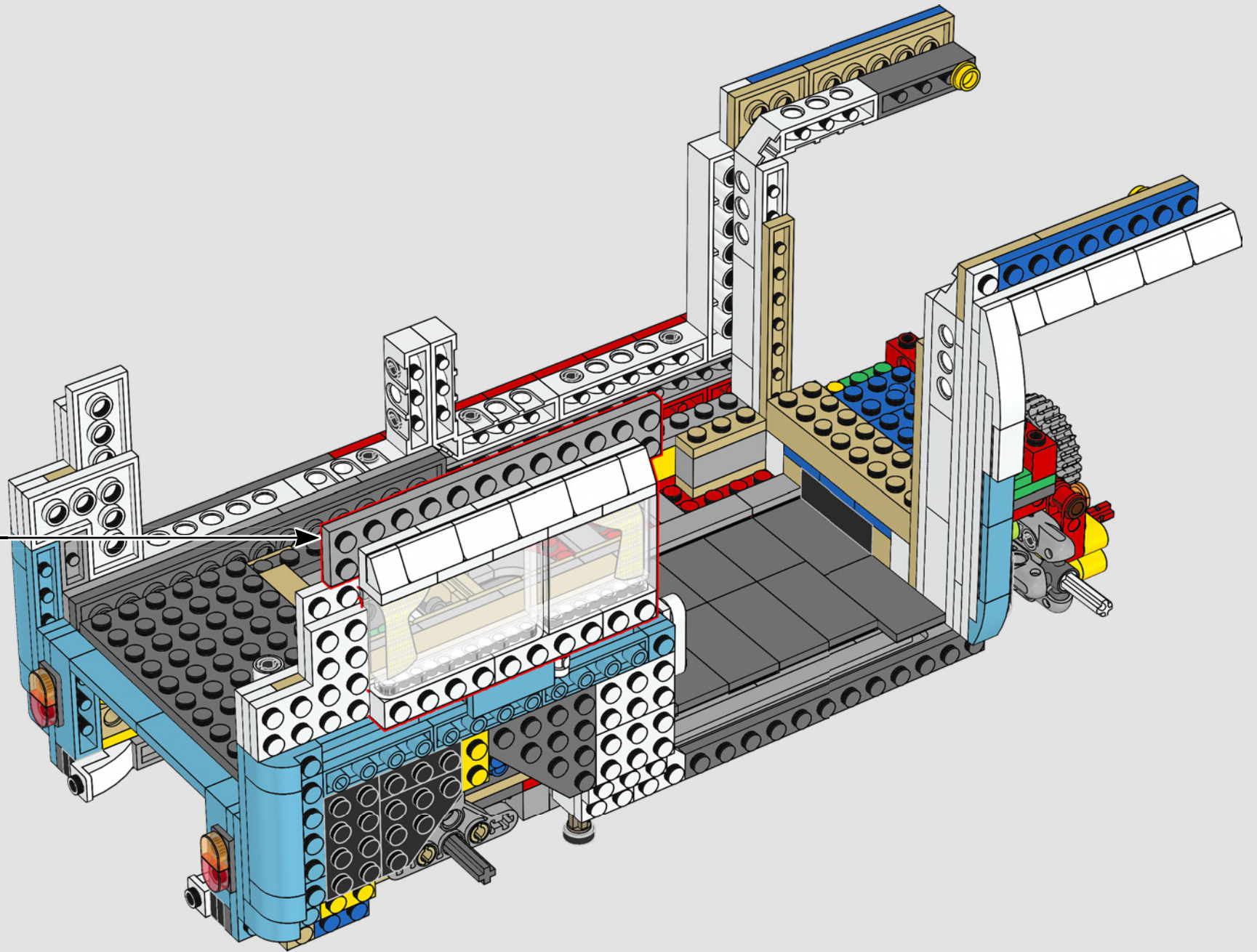

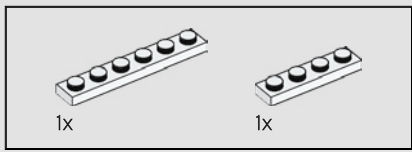

139

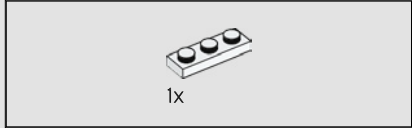
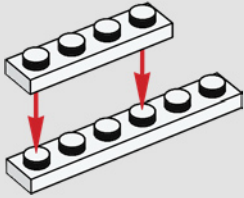

140

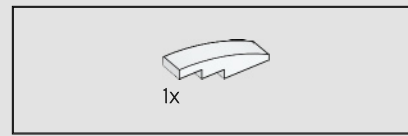
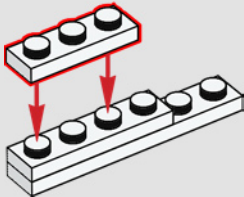

141

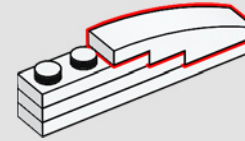

142

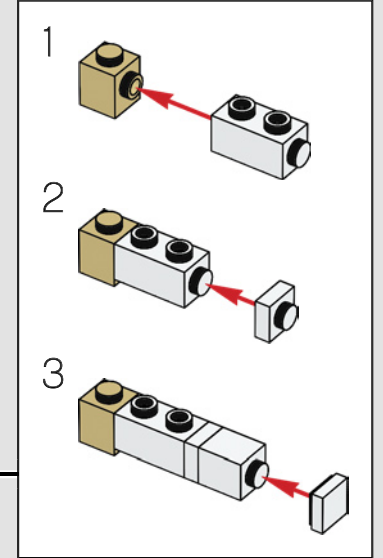
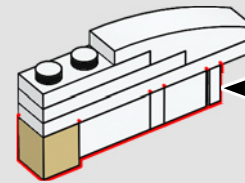

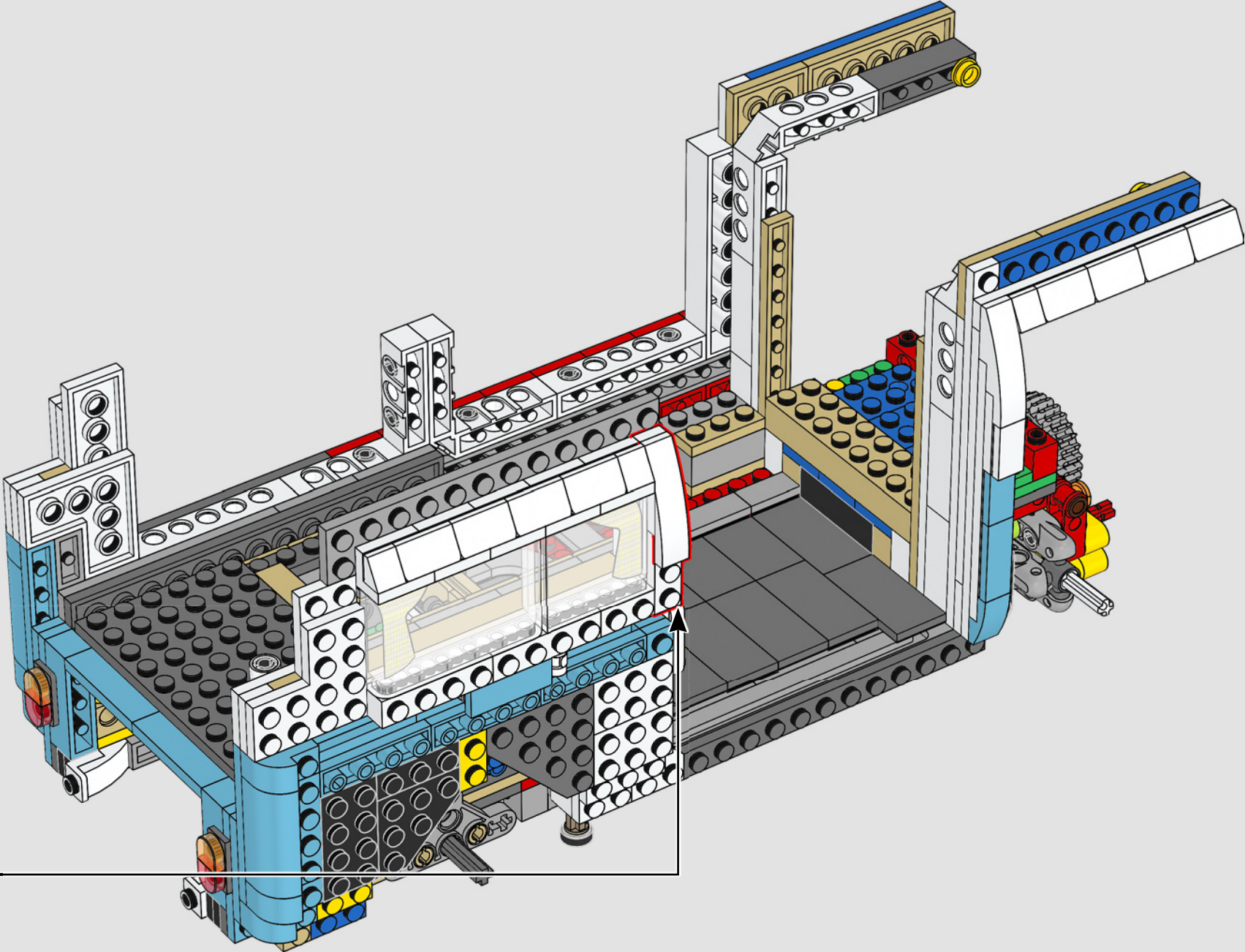

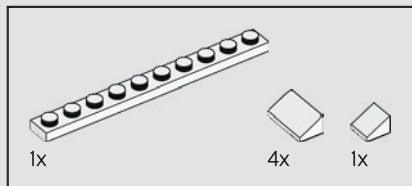

145

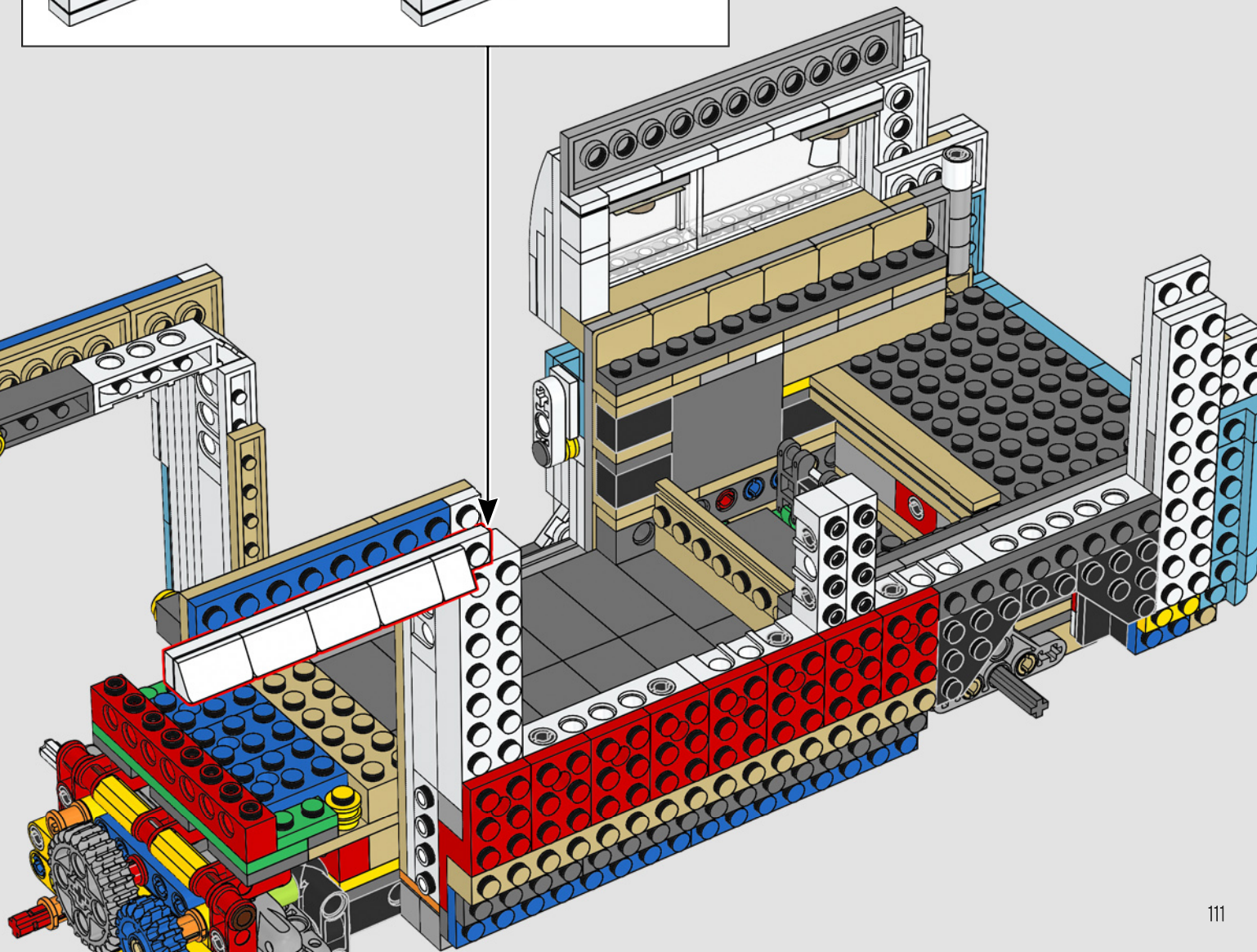
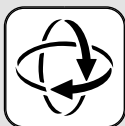
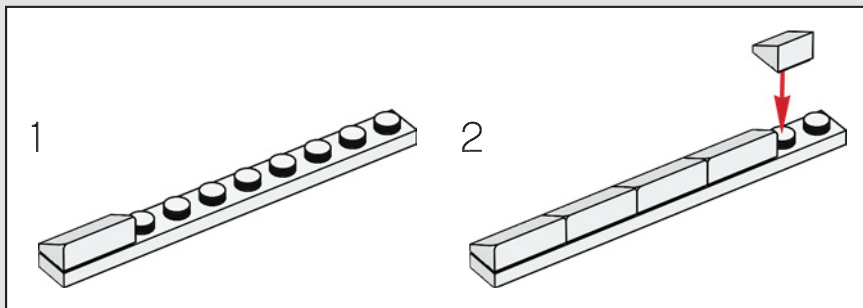

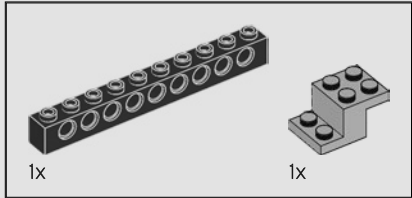
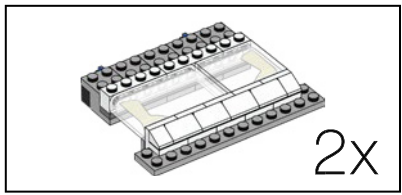

146

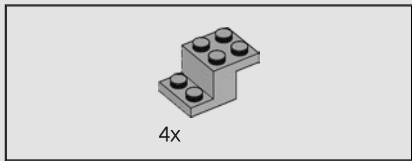
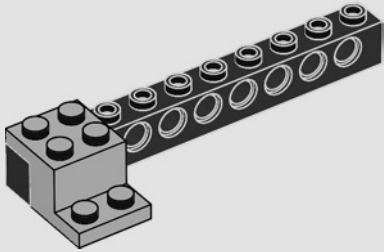

147

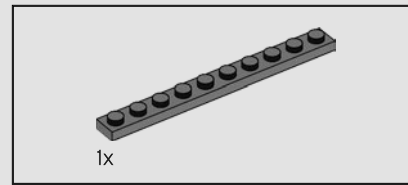
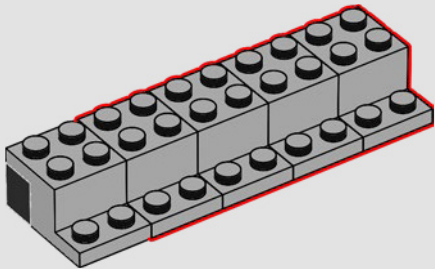

148

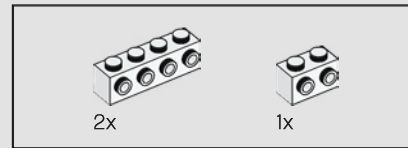
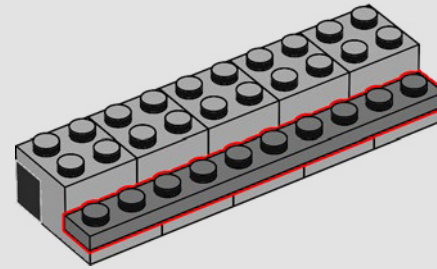

149

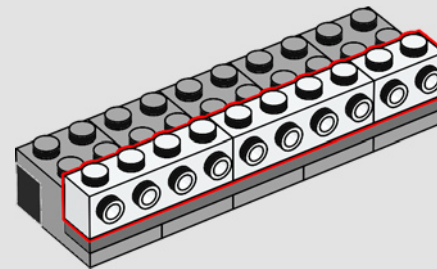

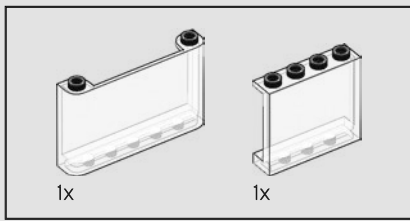

150

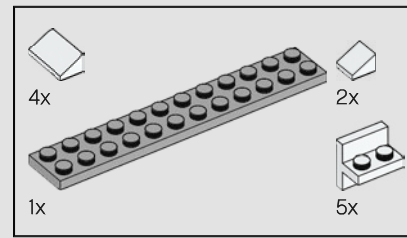
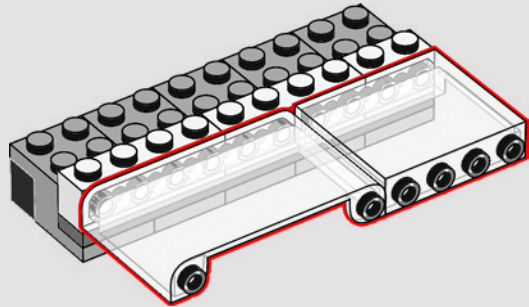

151

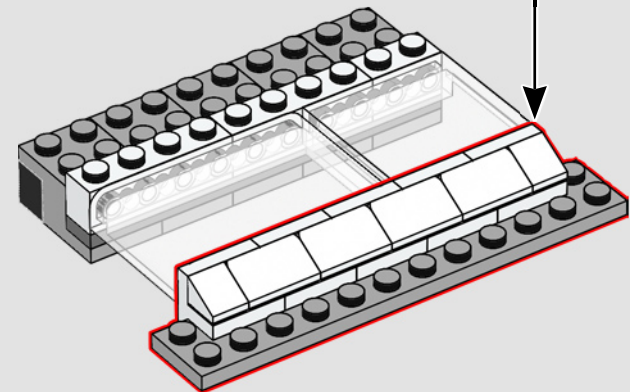
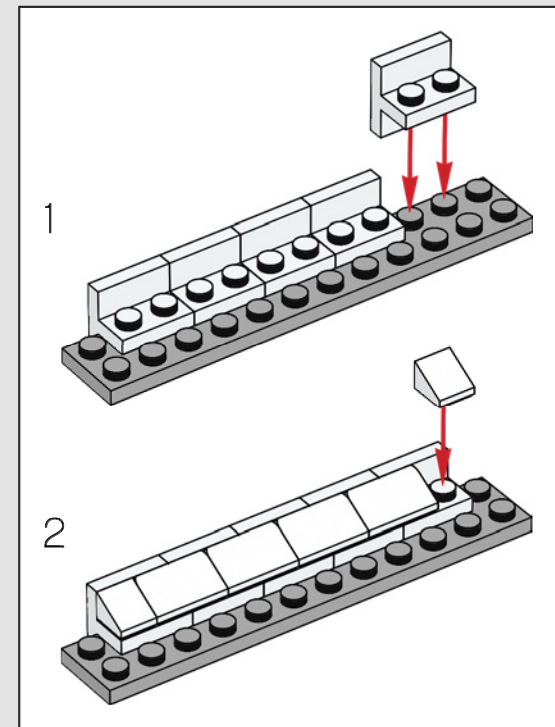

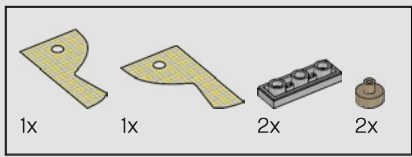

152

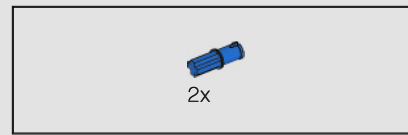
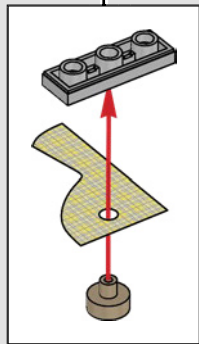
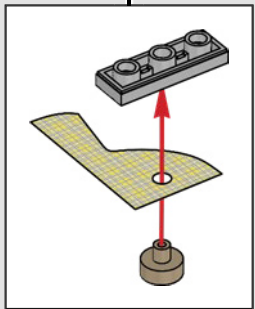
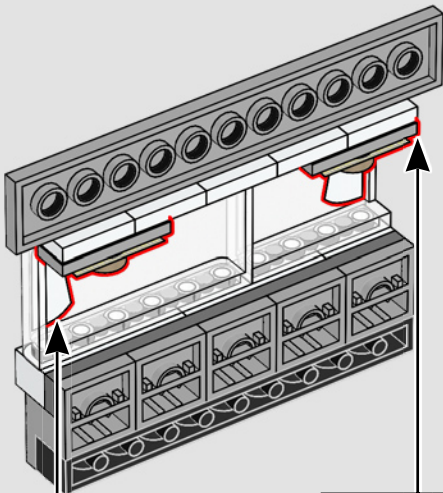

153

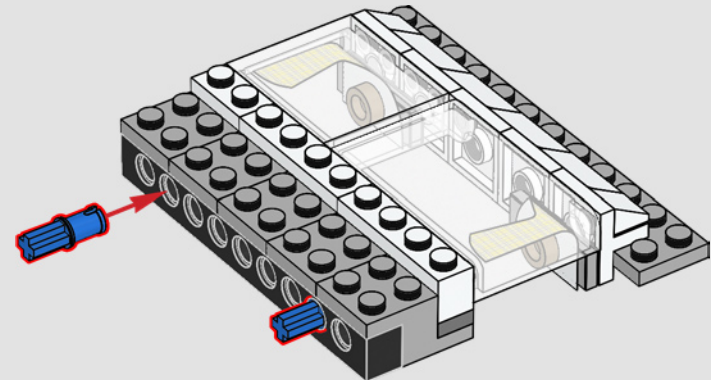
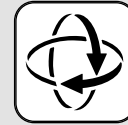

2x

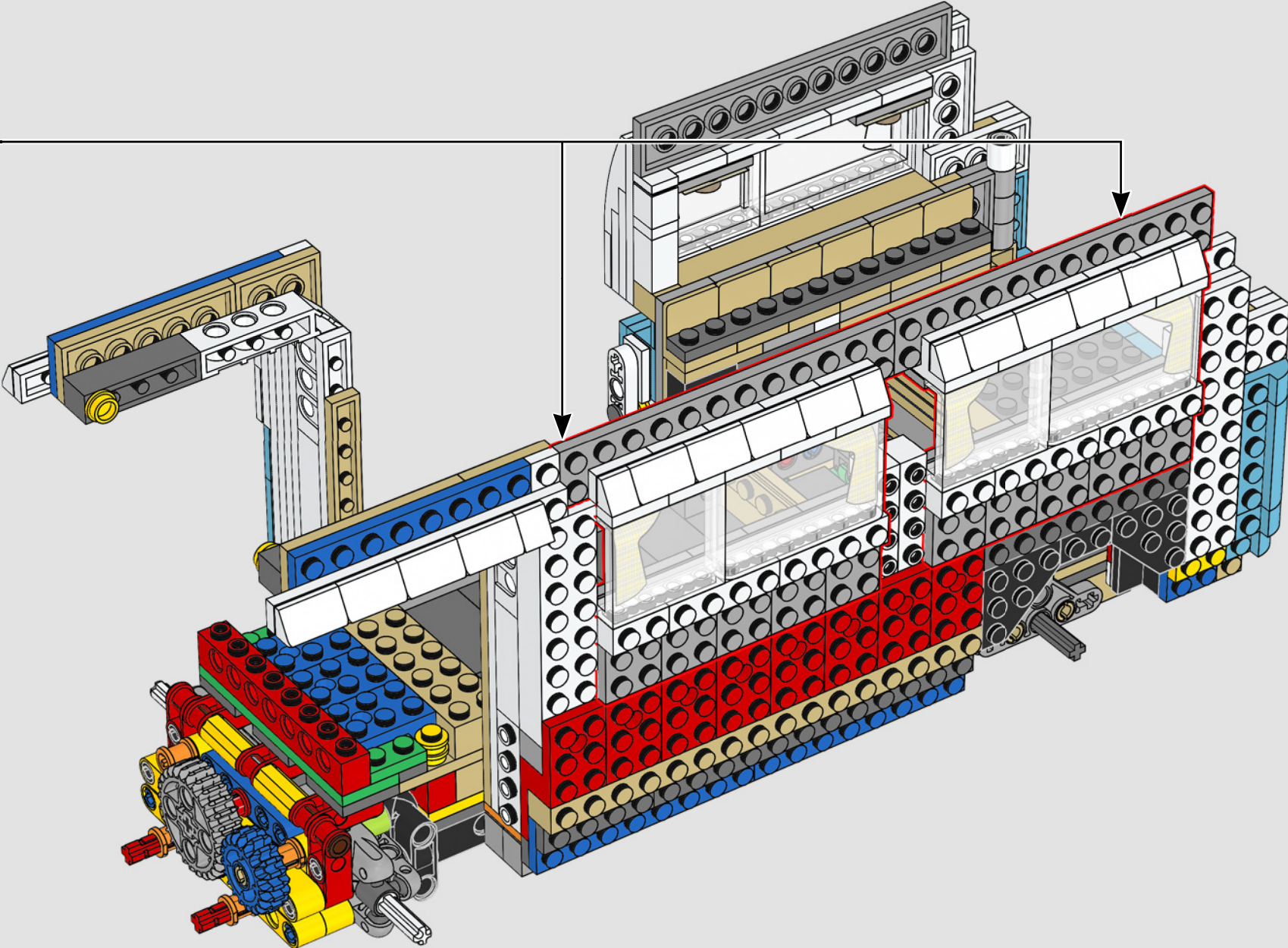

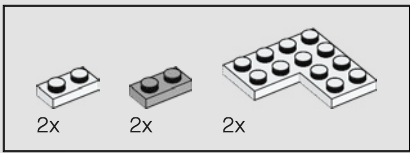

155

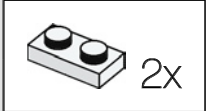
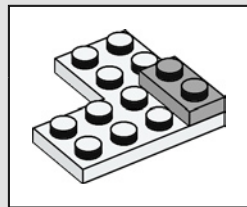
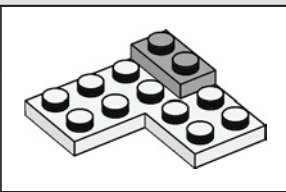
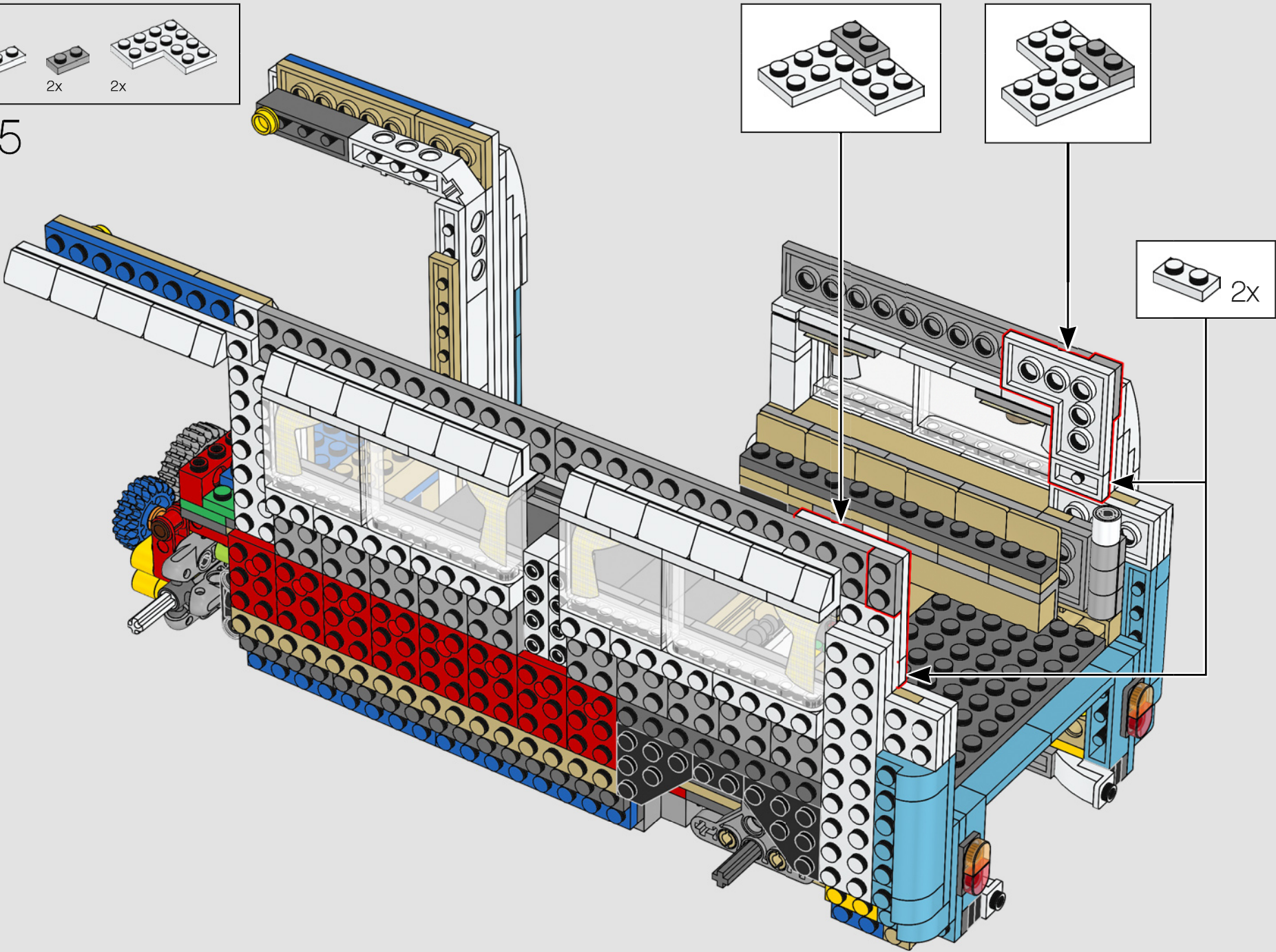

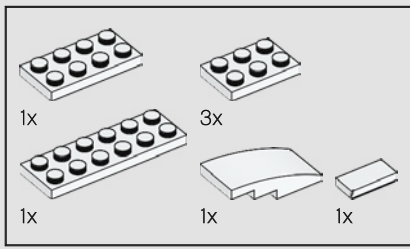

156

1



2

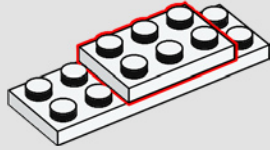

3

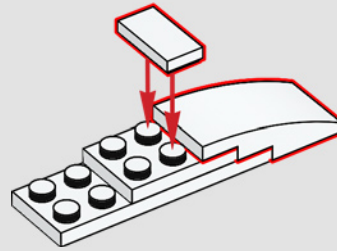

4

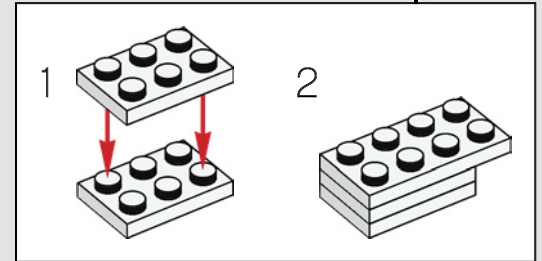
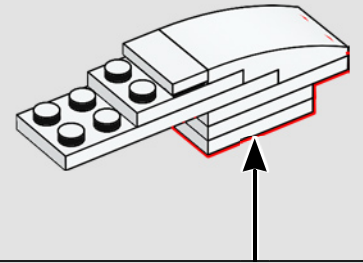

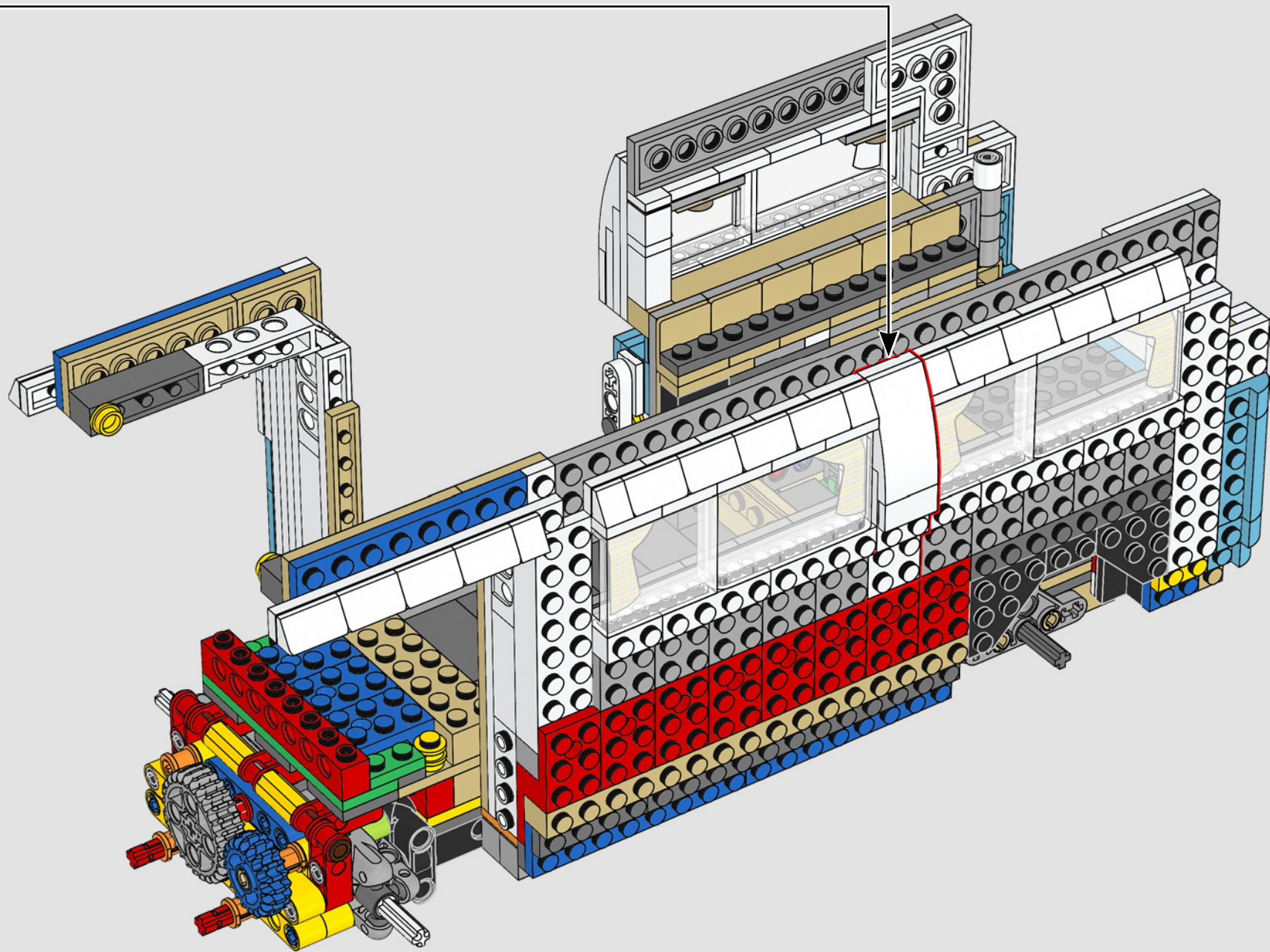

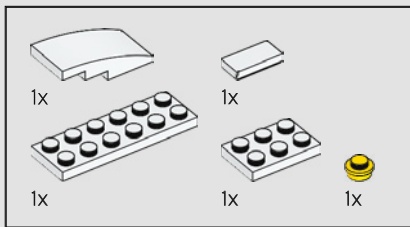

157

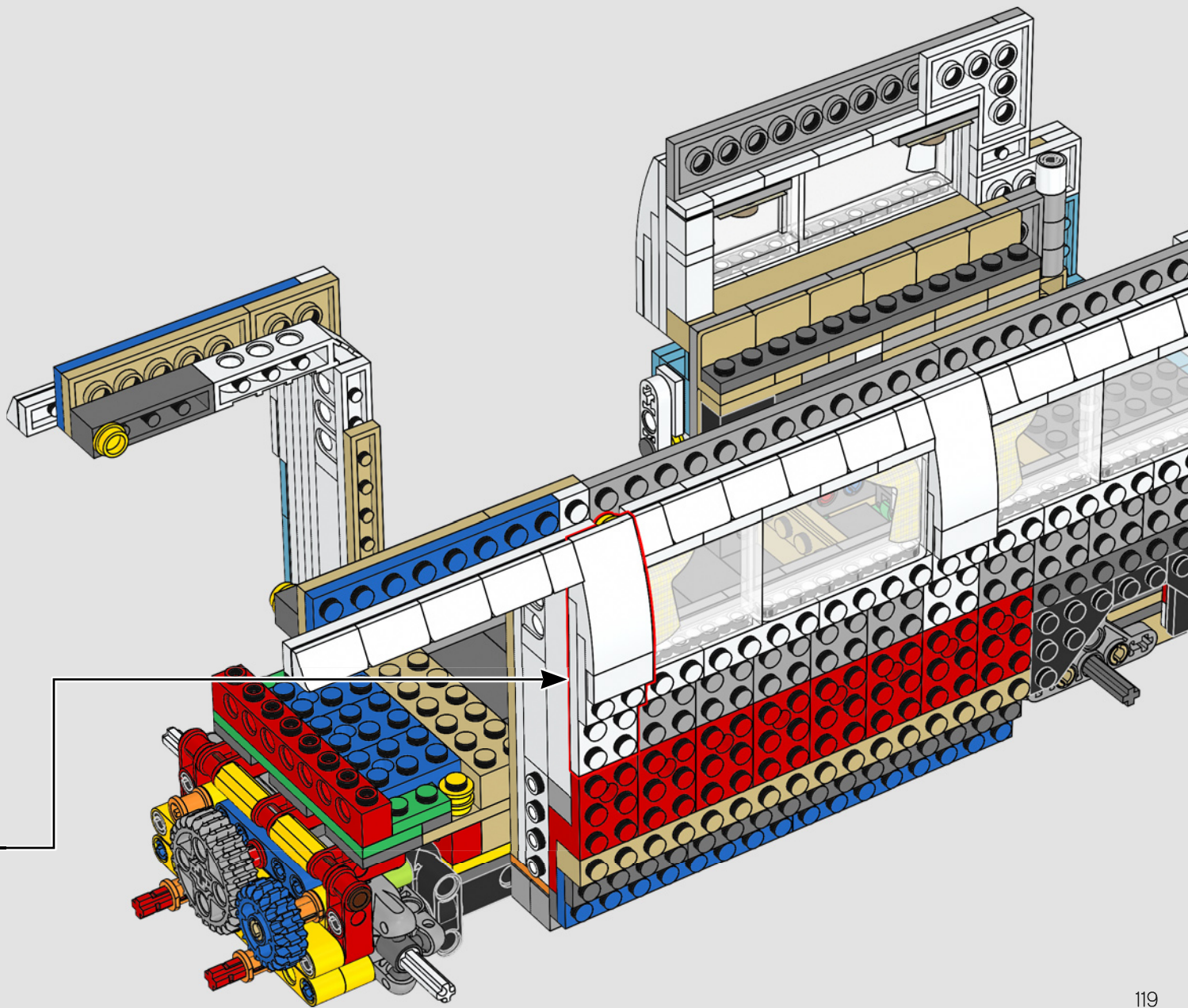
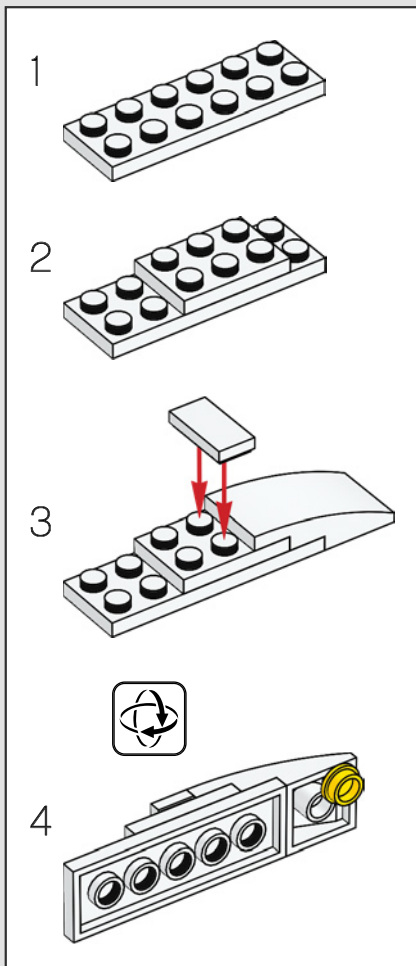

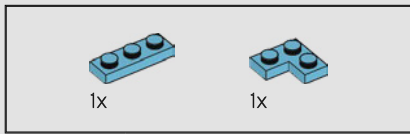

159

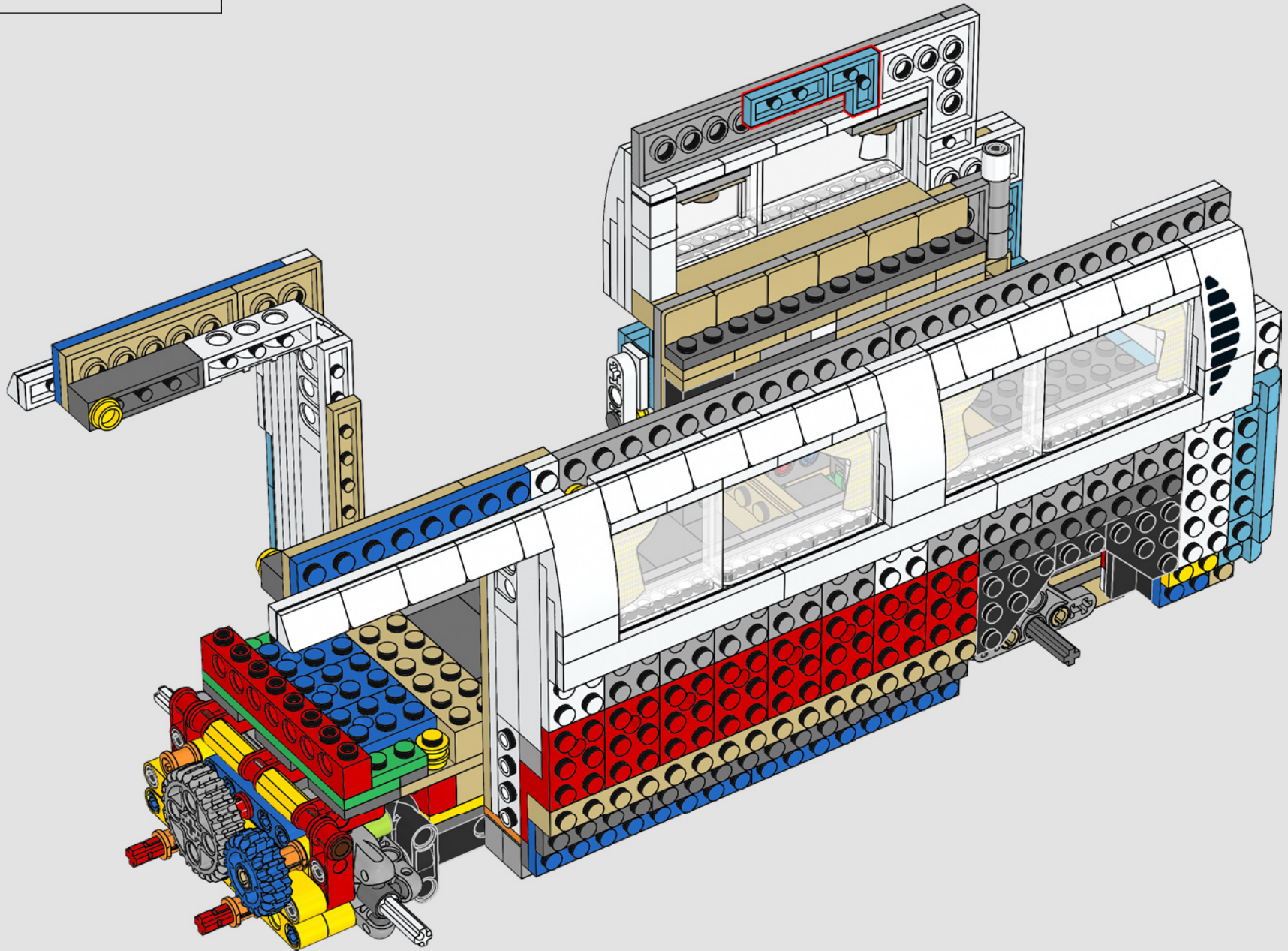

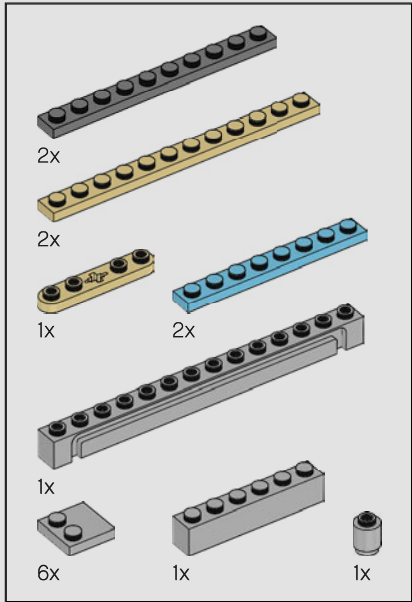
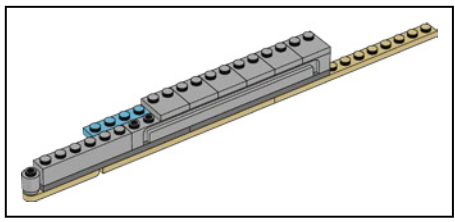

160

1

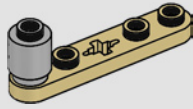

2

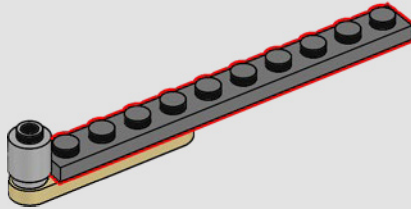

3

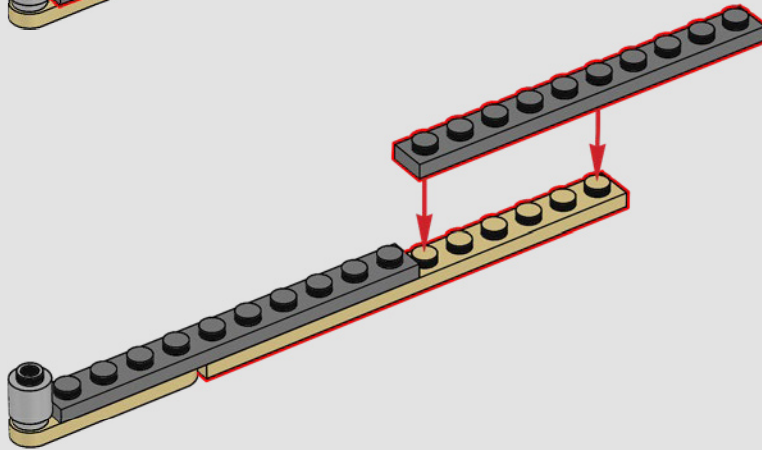

4

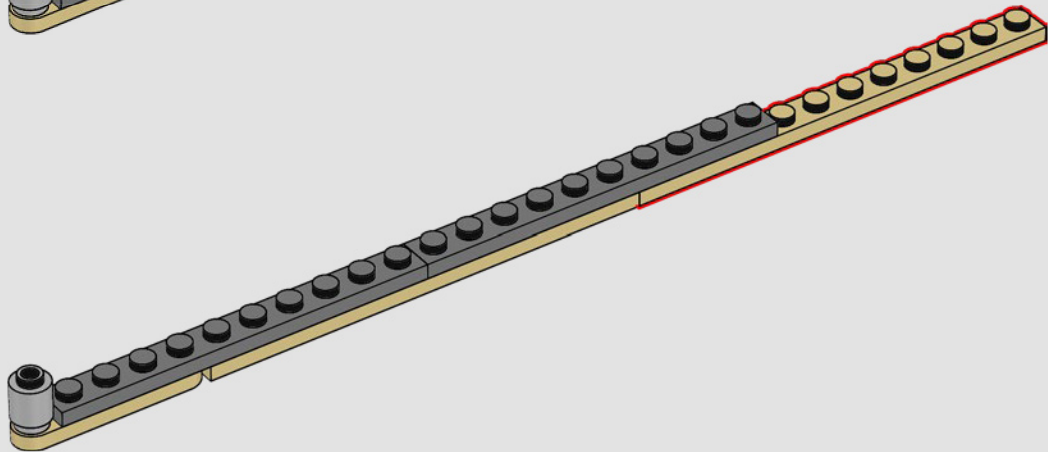

5

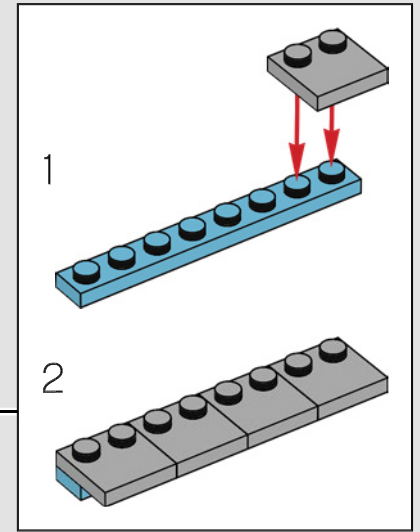
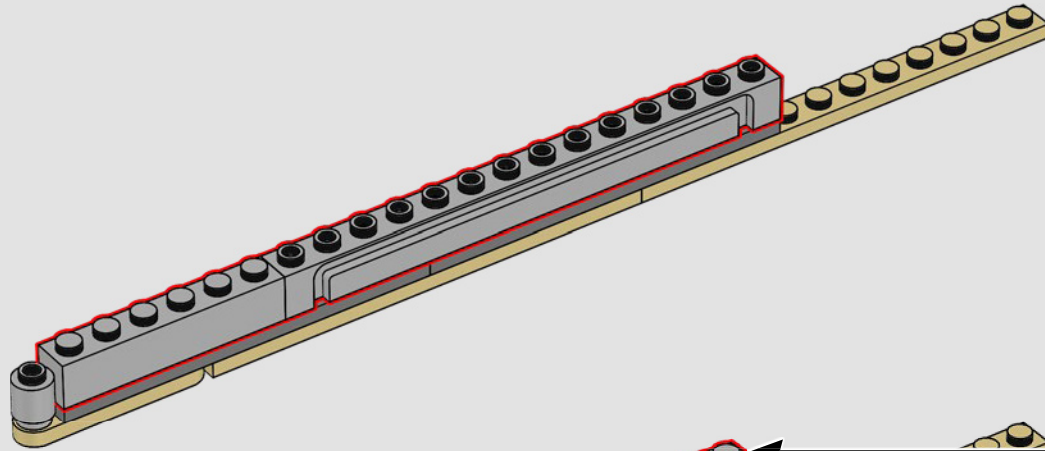

6

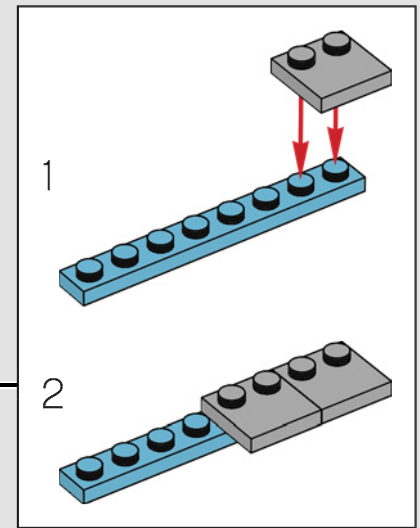
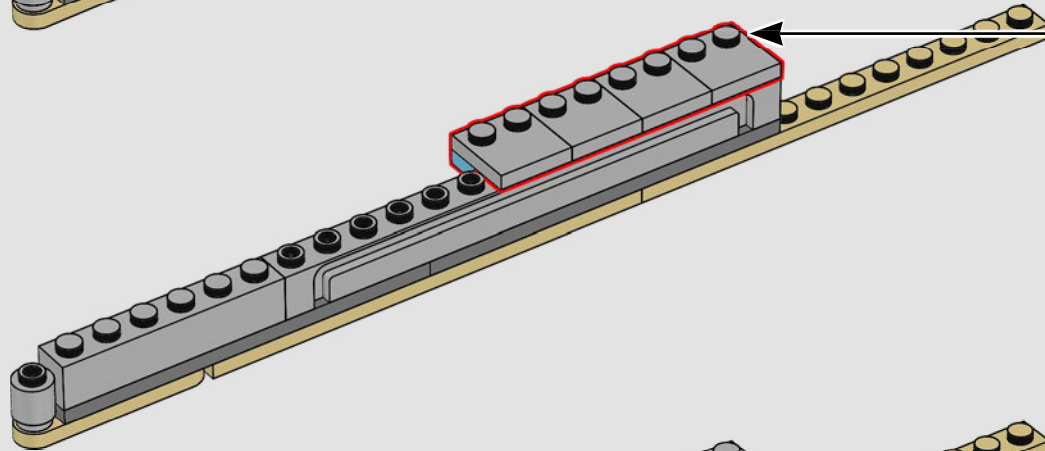

7

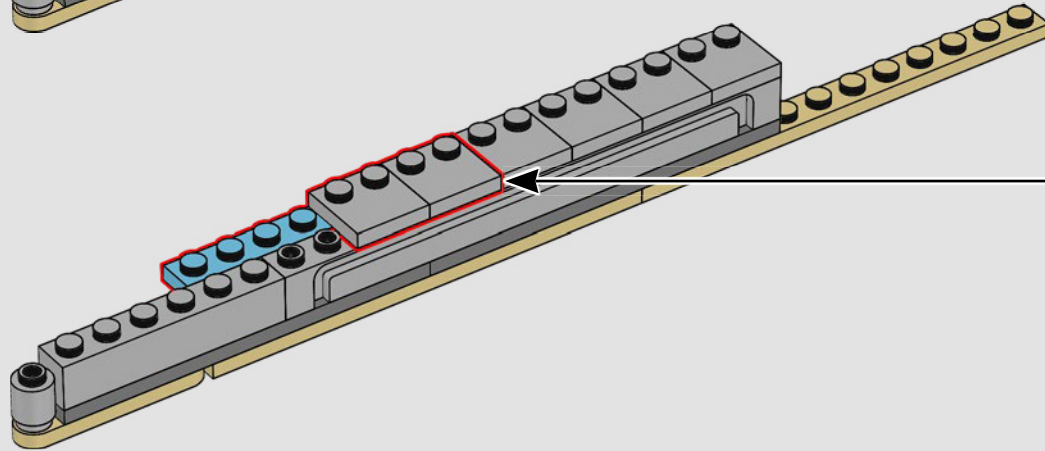

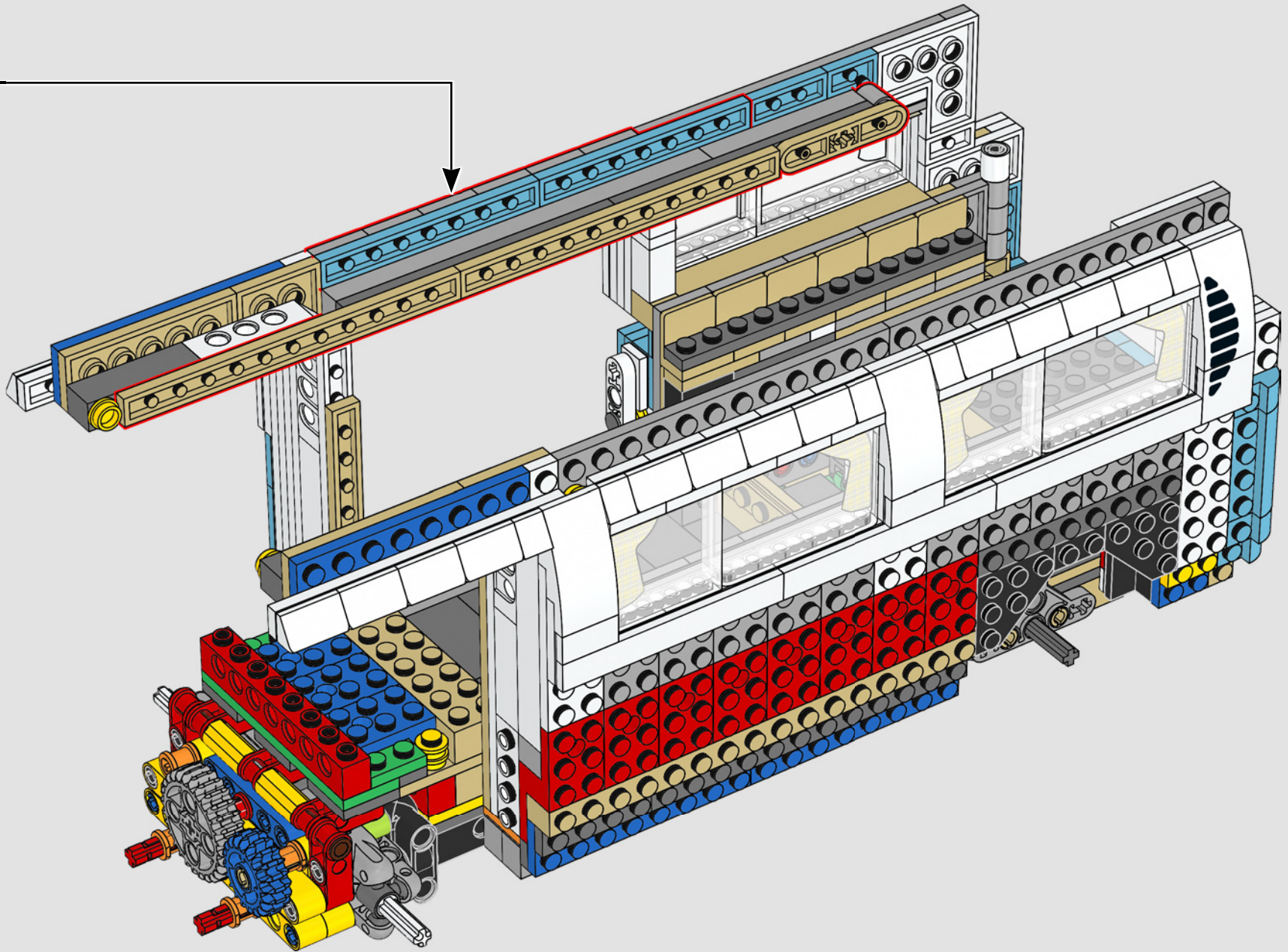

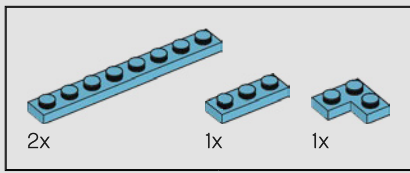

161

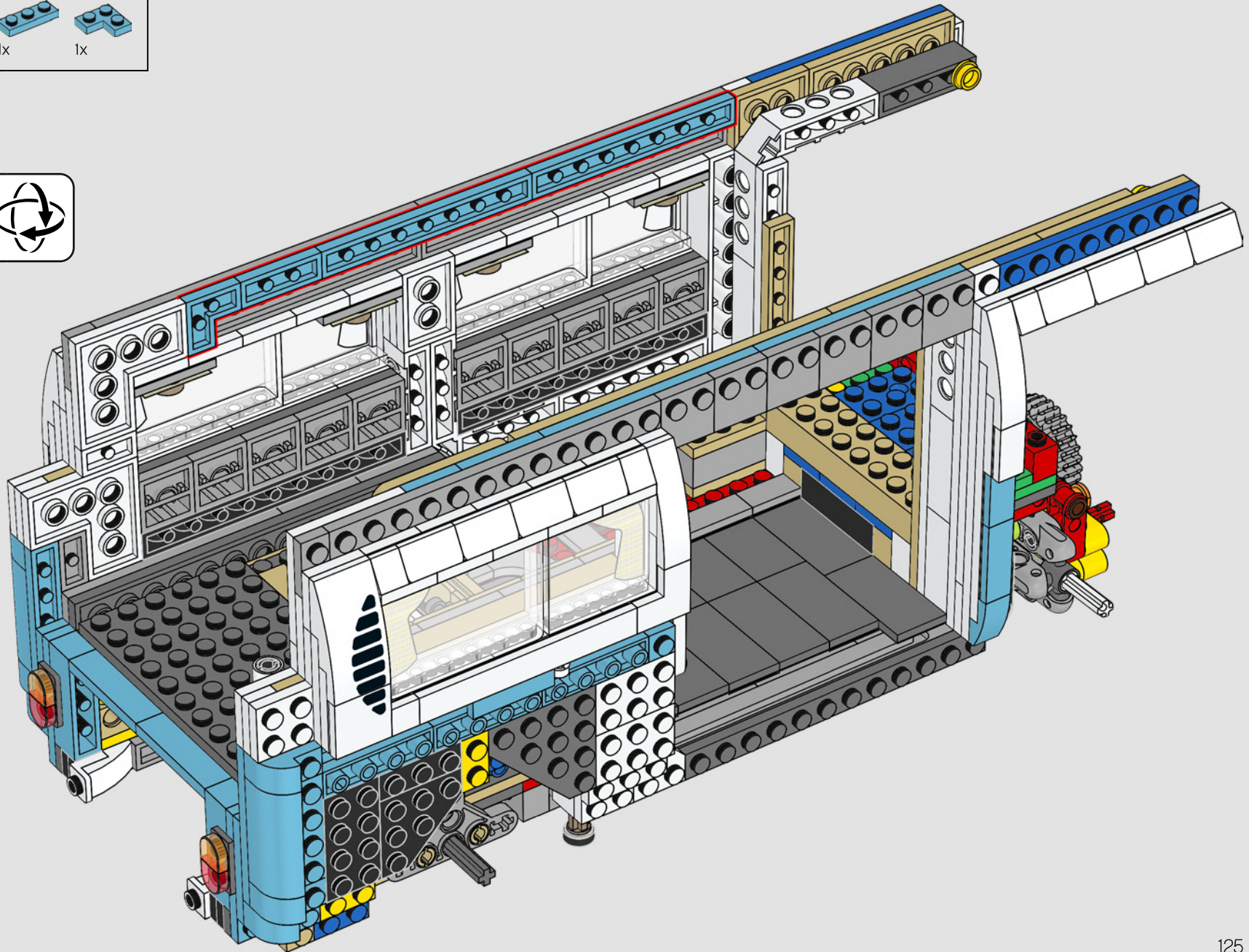

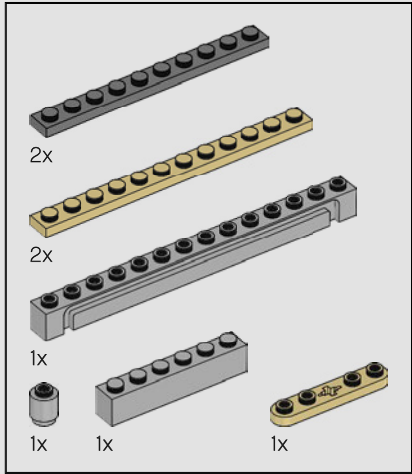
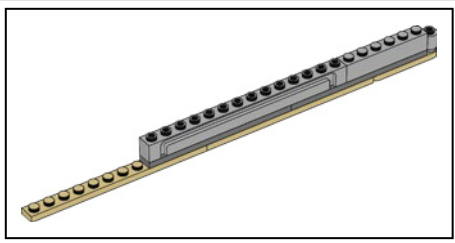

162

1

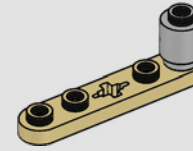

2

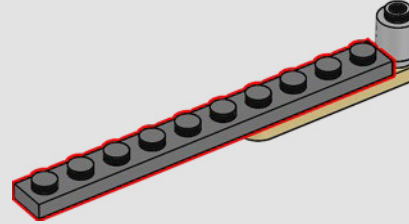

3

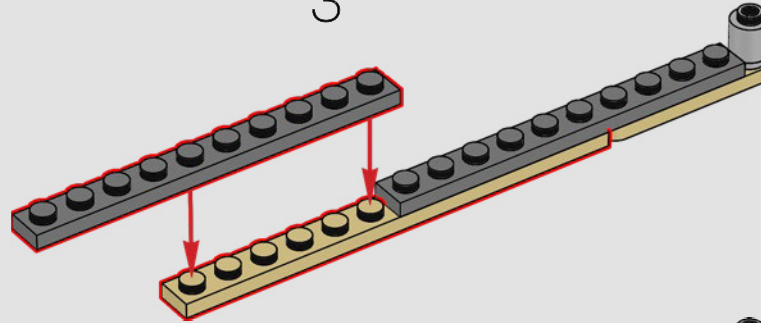

4

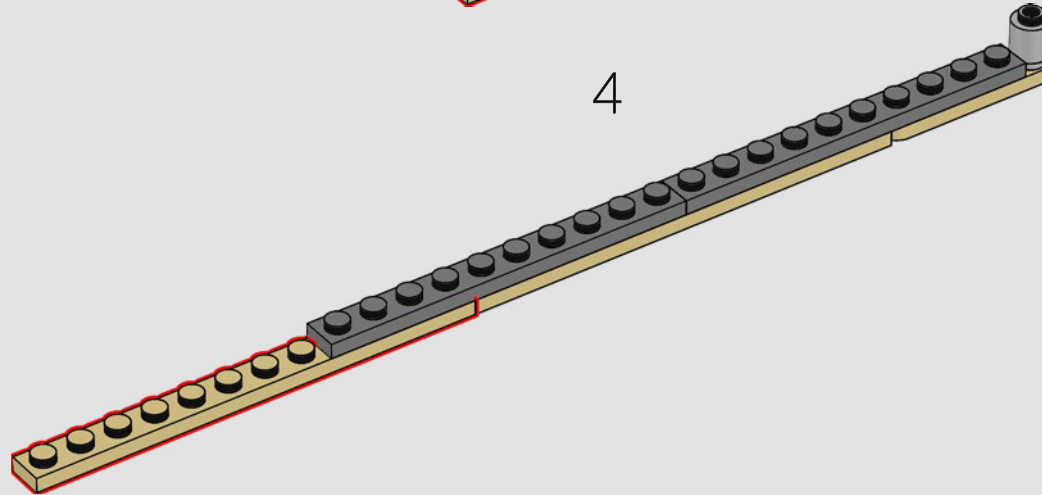

5

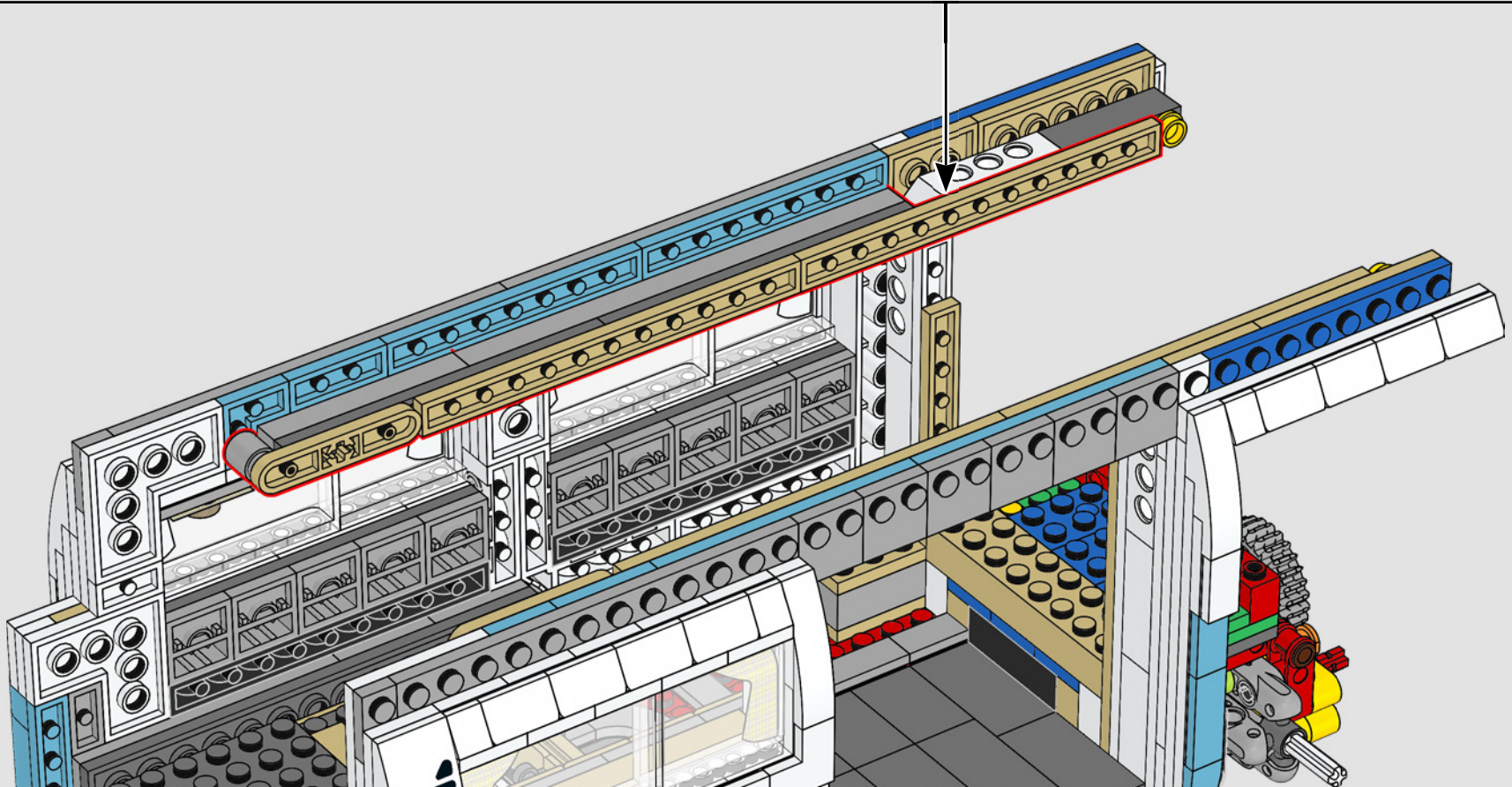
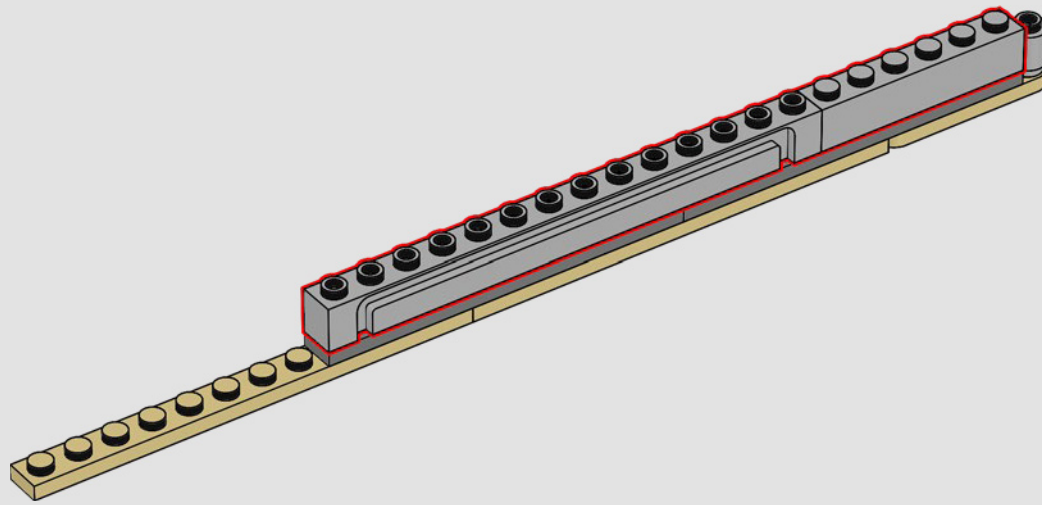

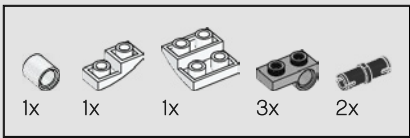

163

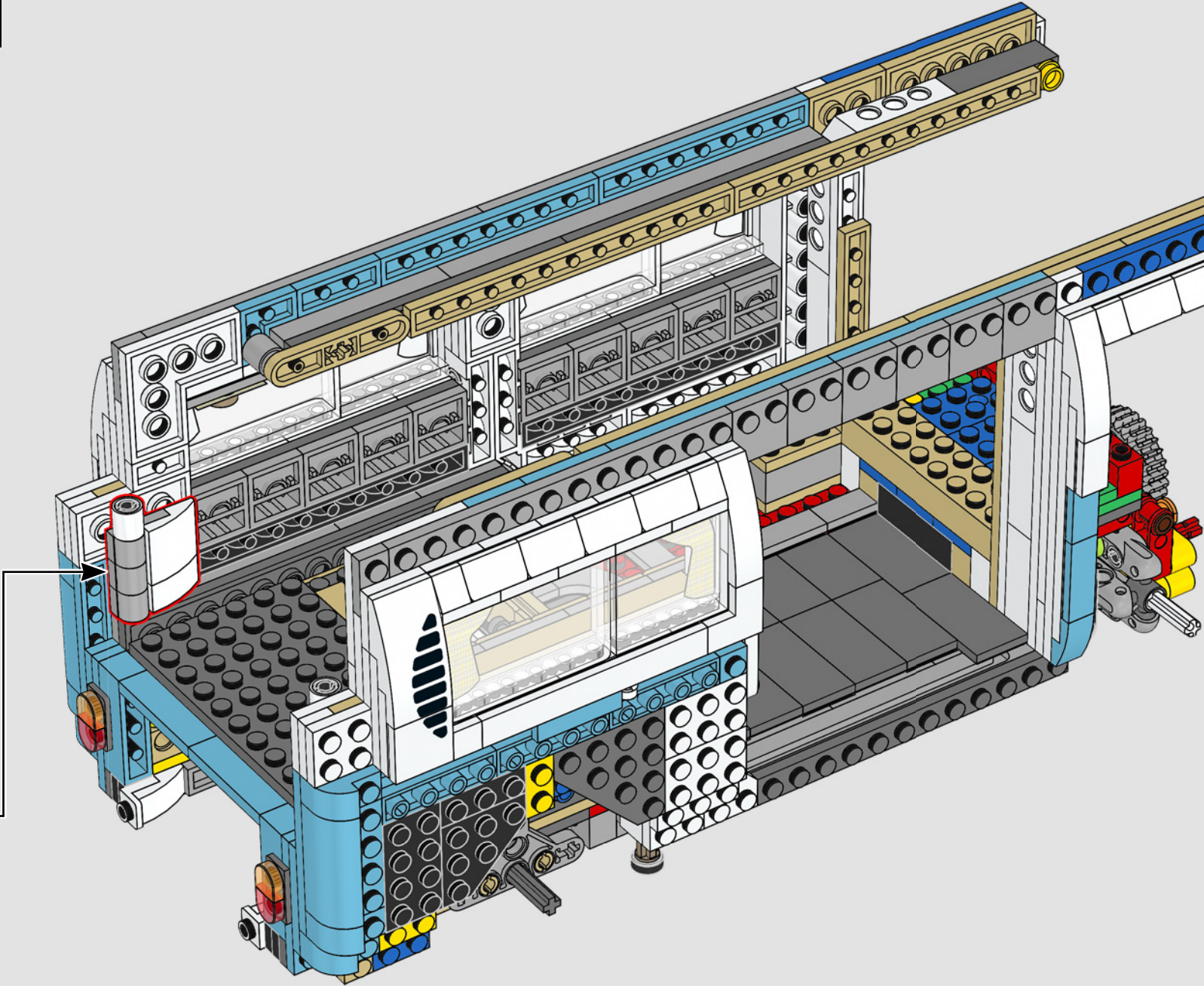
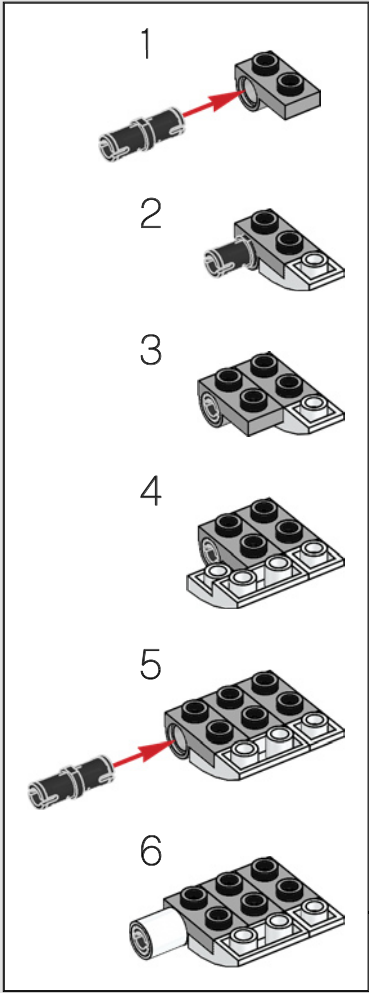

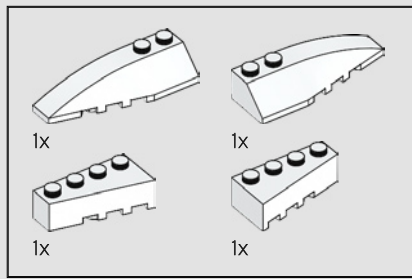

164

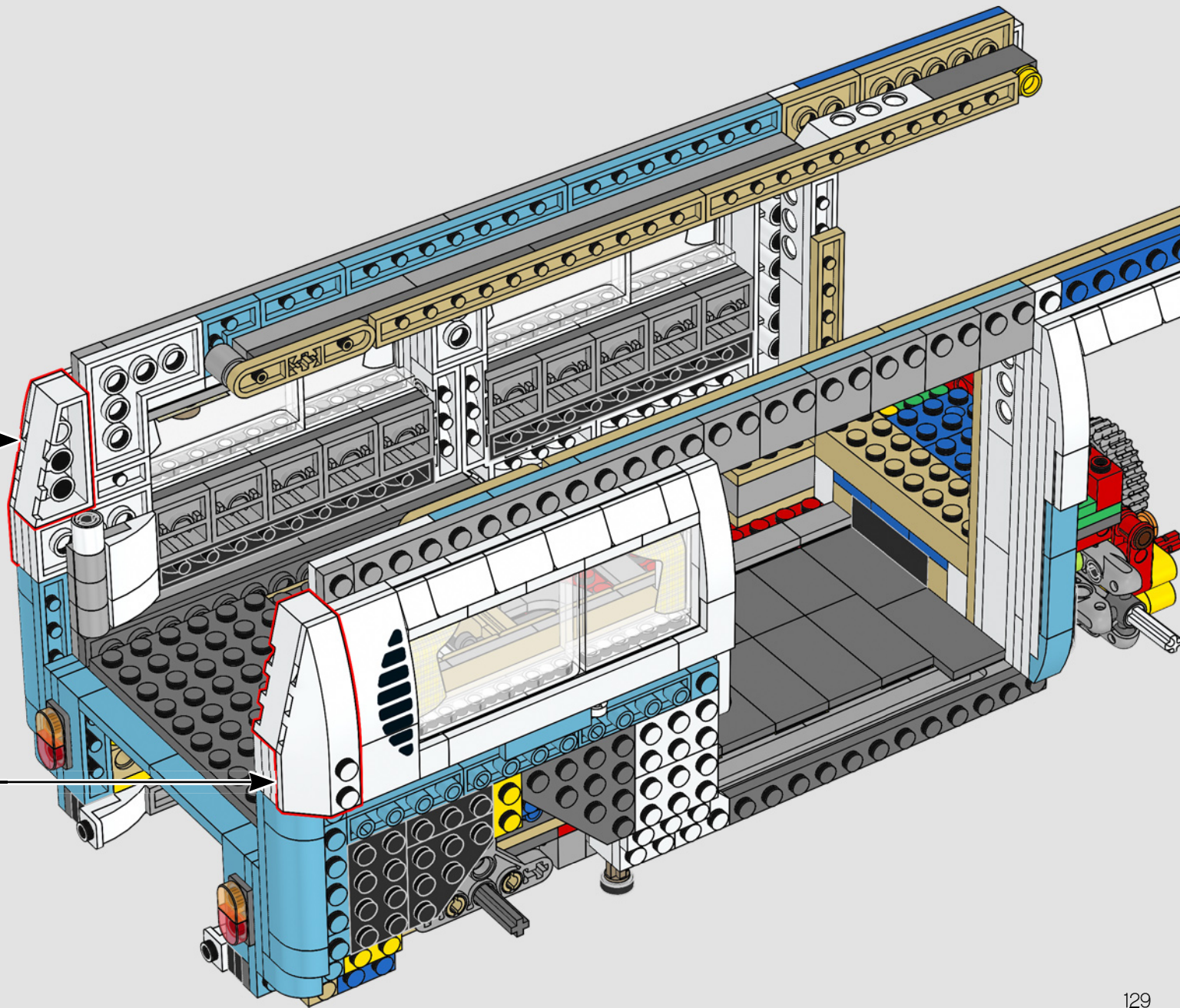
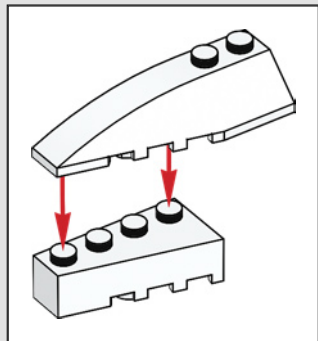
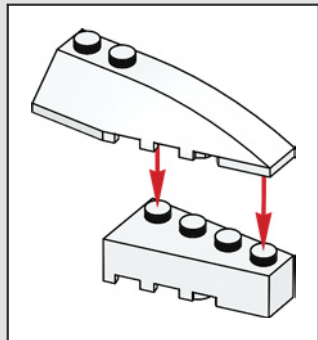

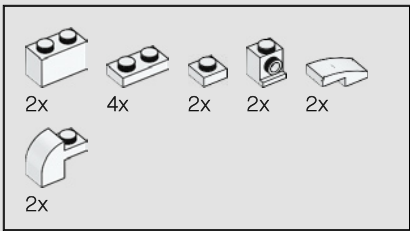

165

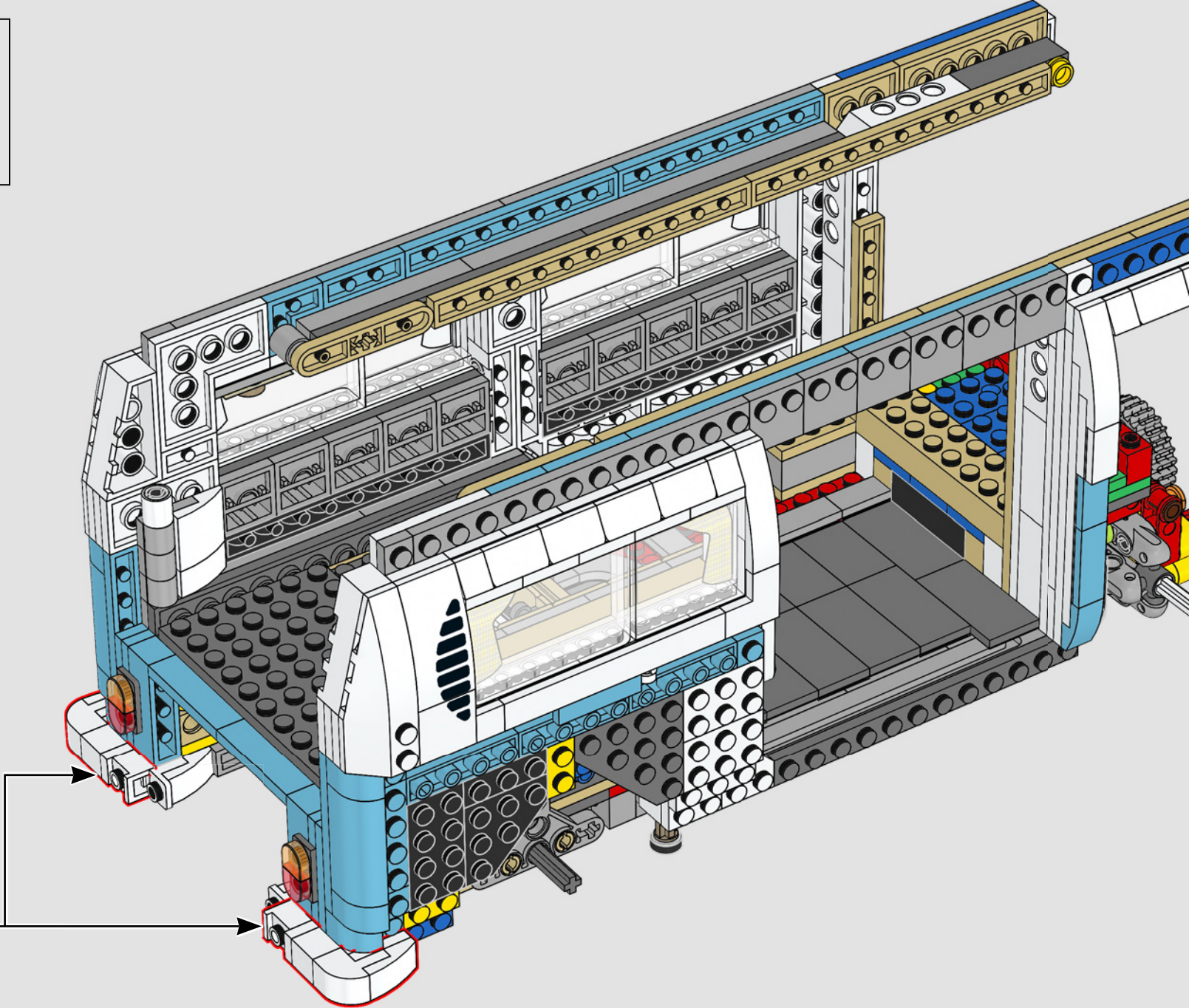
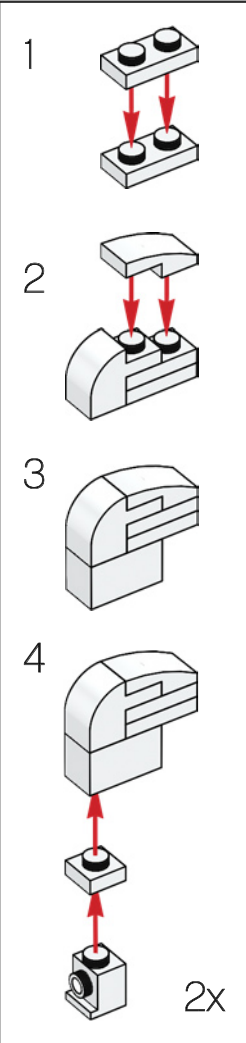



166

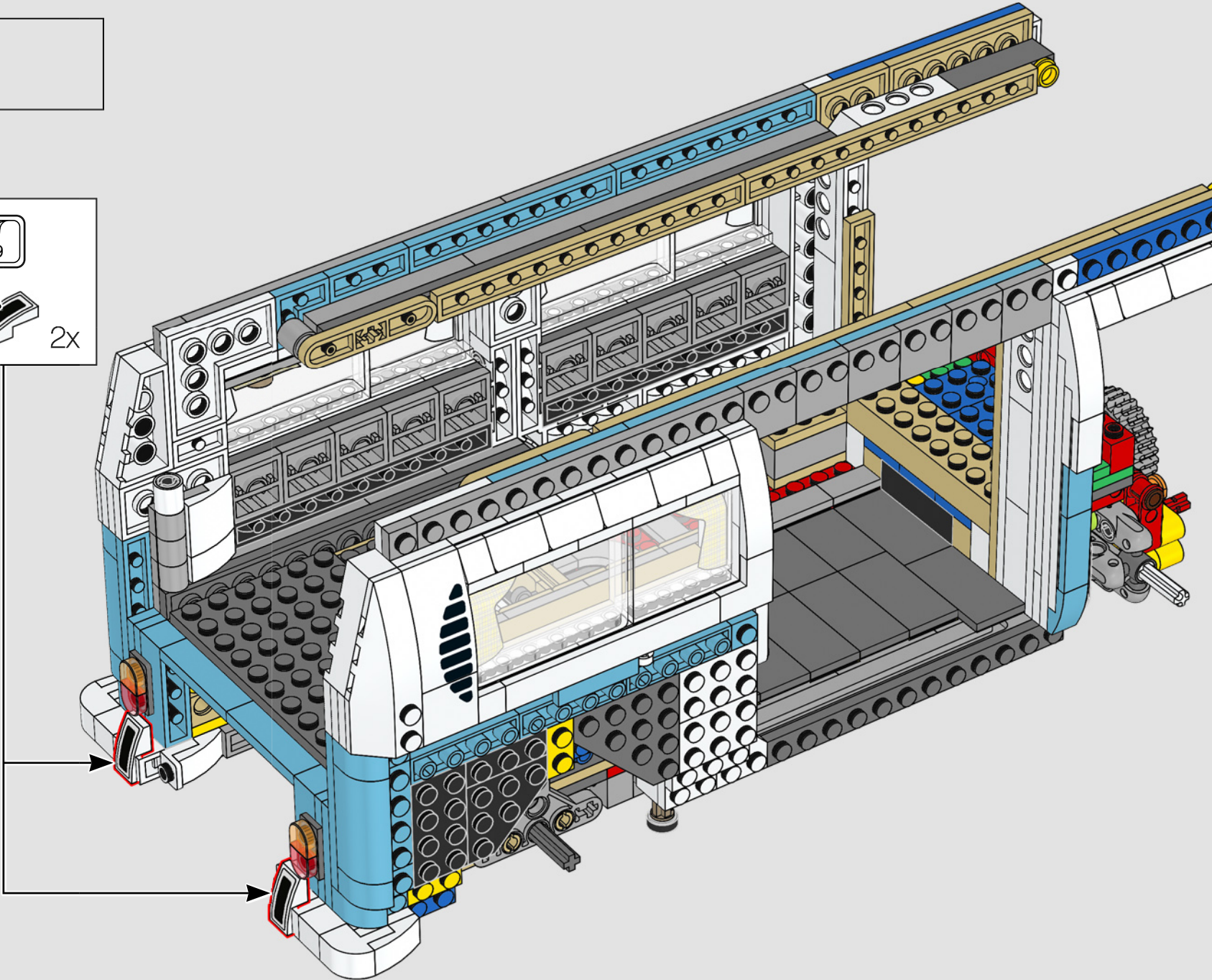
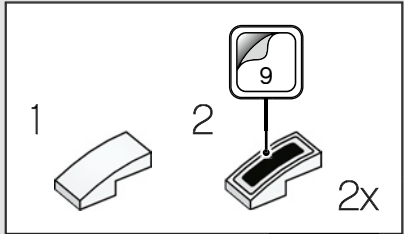

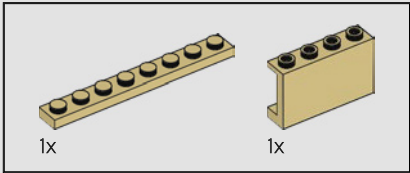
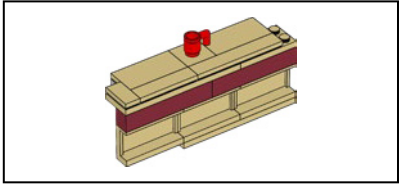
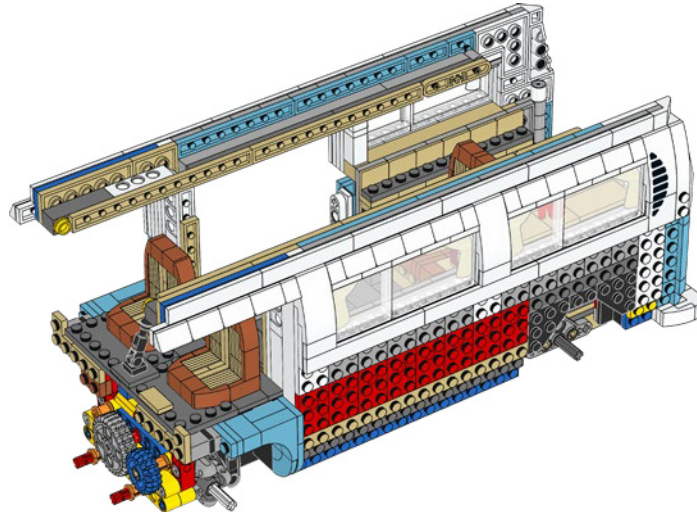
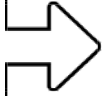

167

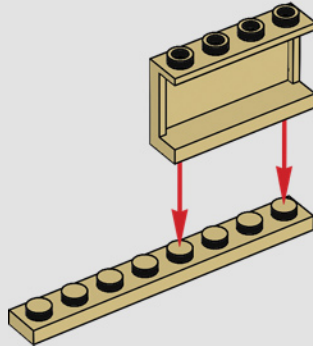

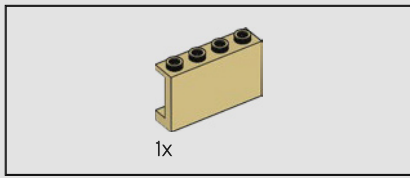

168

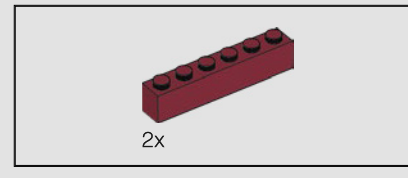
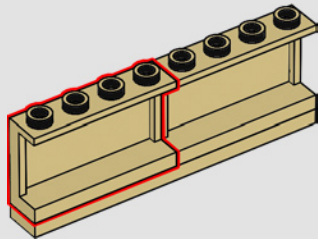

169

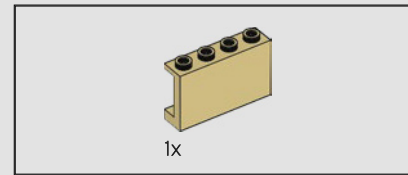
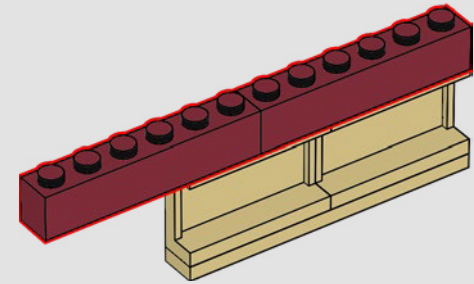

170

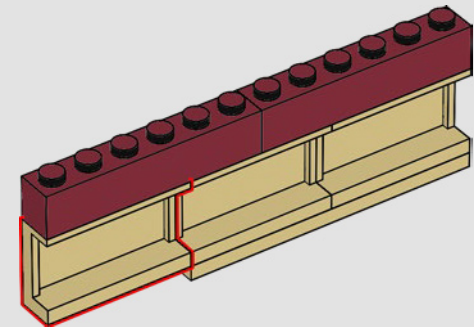

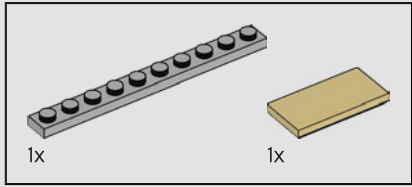
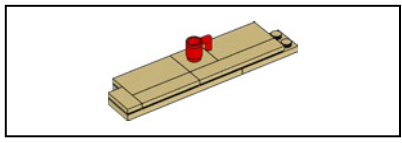

171

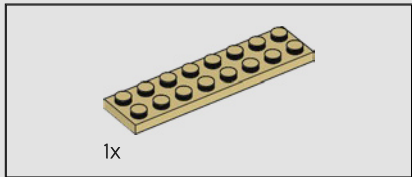
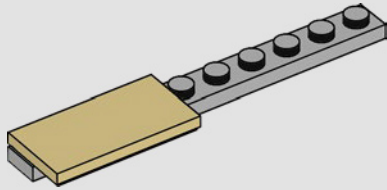

172

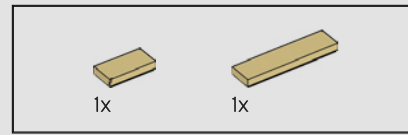
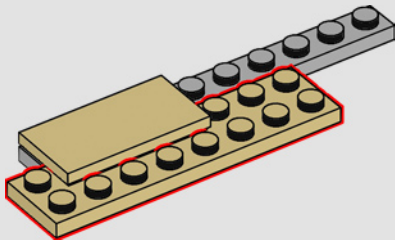

173

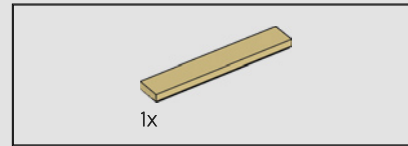
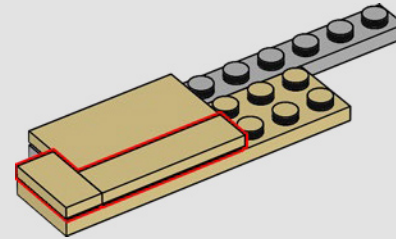

174

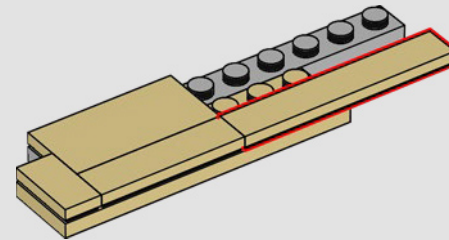

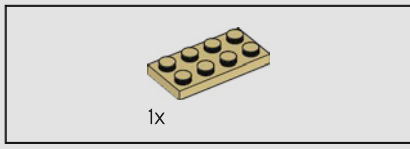

175

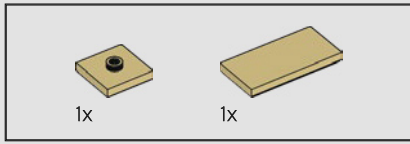
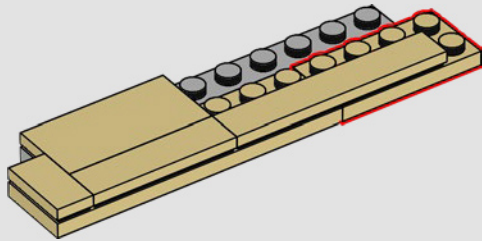

176

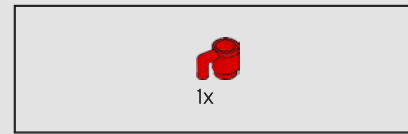
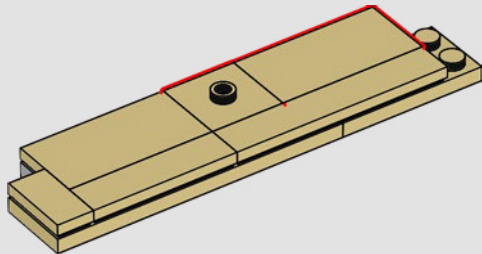

177

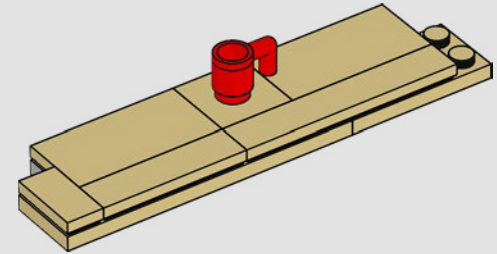

178

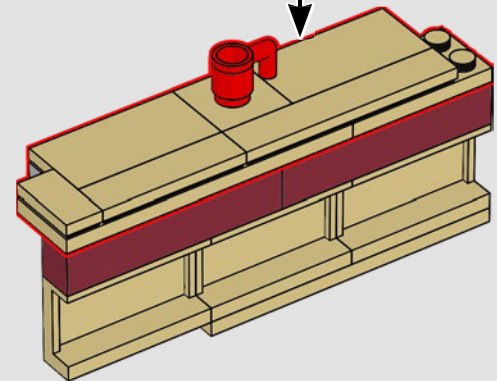

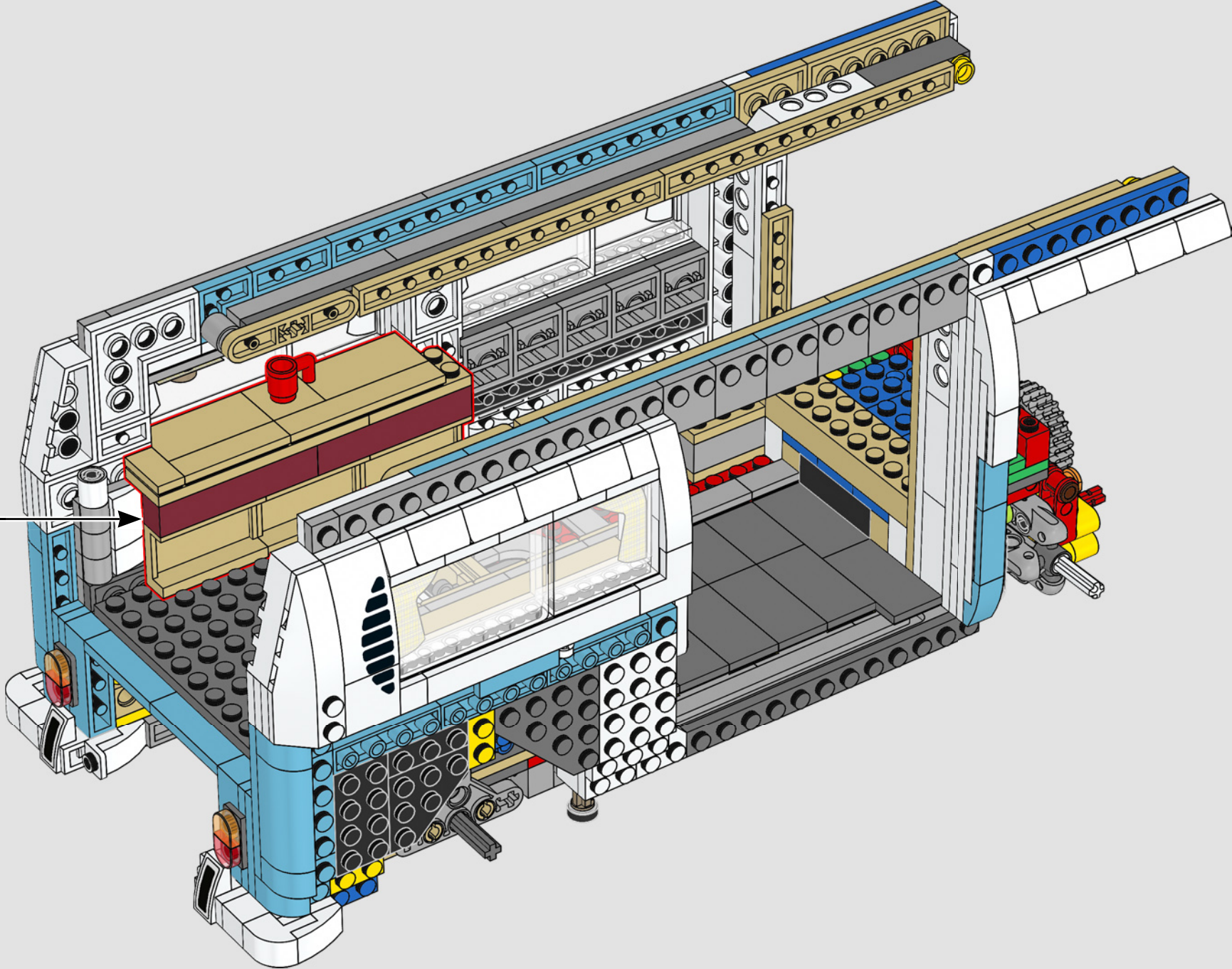

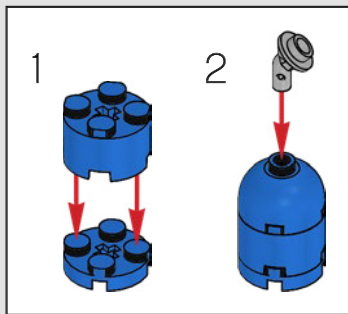
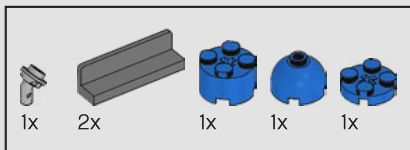

In den 1970er-Jahren wurden Camper-Kühlschränke normalerweise mit demselben Propangas betrieben, das auch für den Herd und die Heizung verwendet wurde.

180

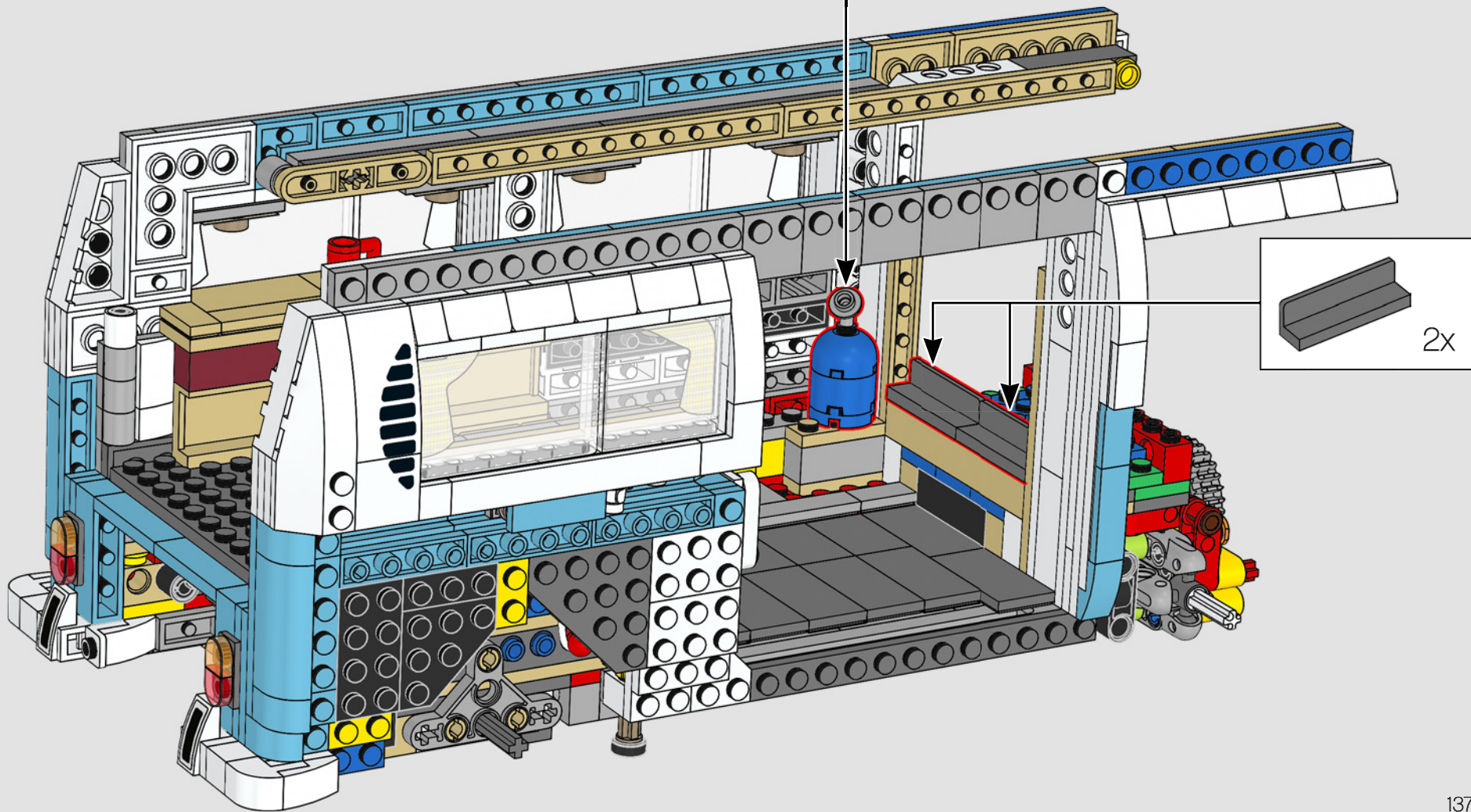

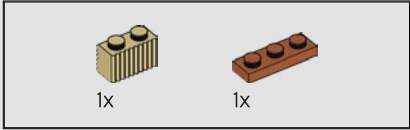
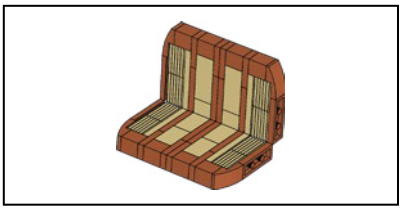

181

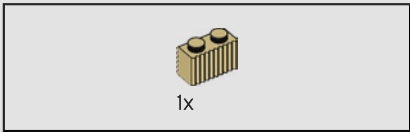
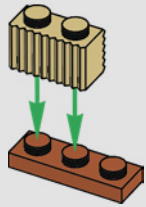

182

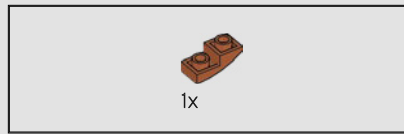
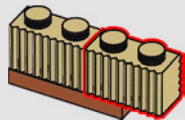

183

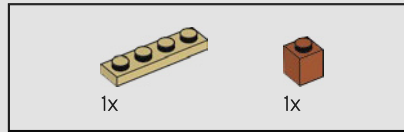
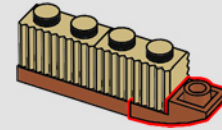

184

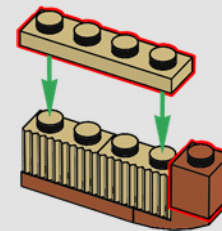

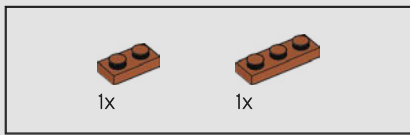

185

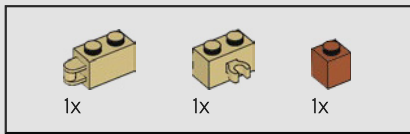
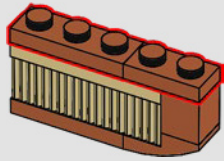

186

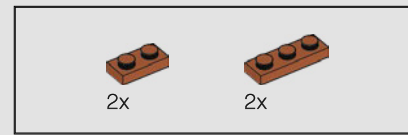
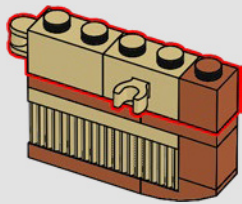

187

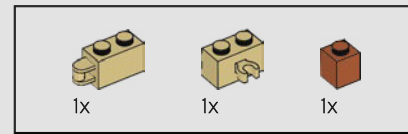
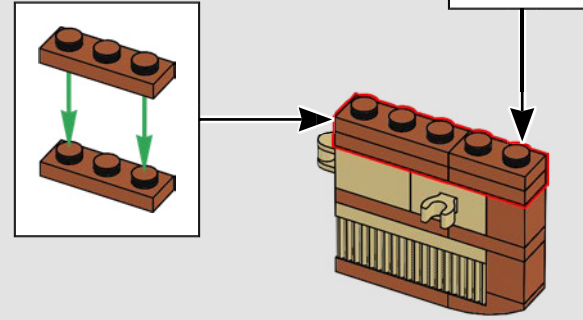

188

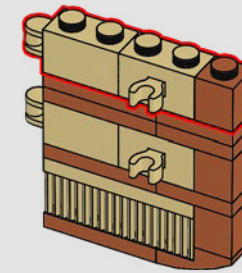

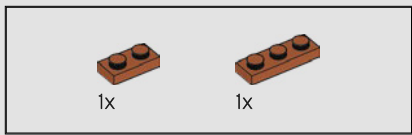

189

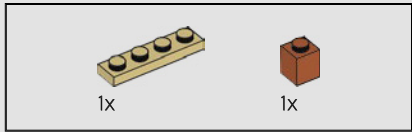
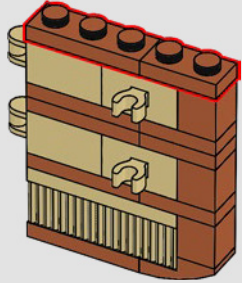

190

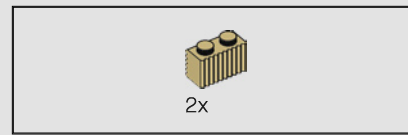
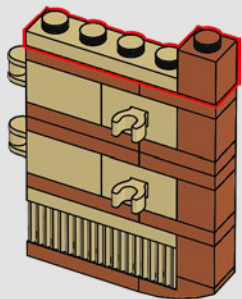

191

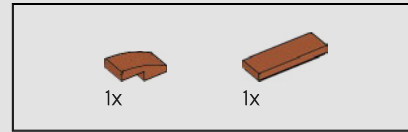
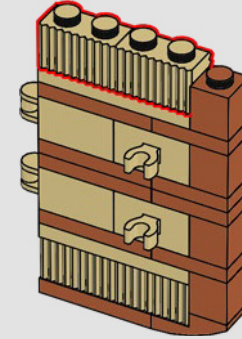

192

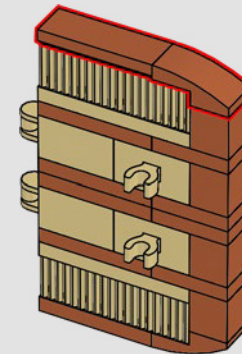

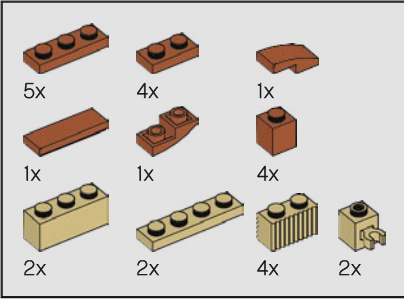
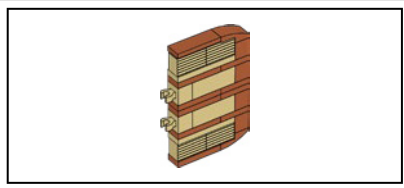

193

1

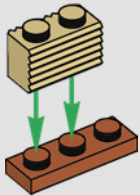

2

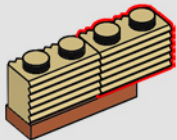

3

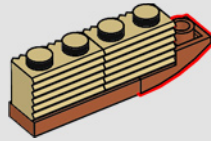

4

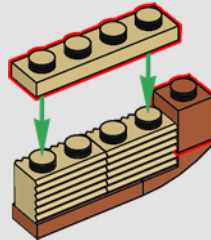

5

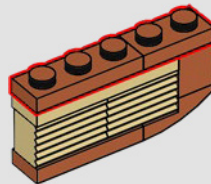

6

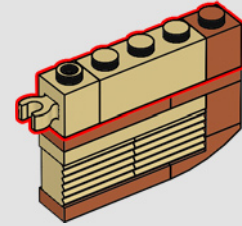

7

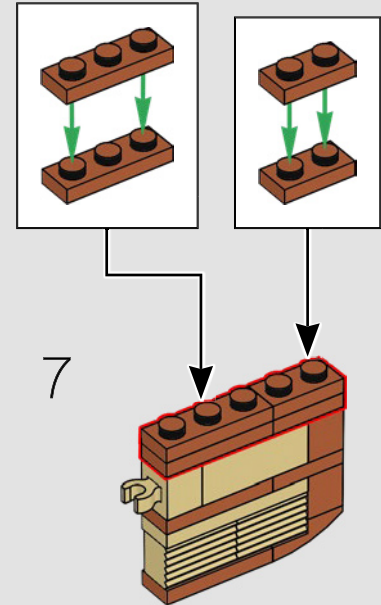

8

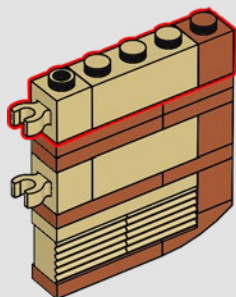

9

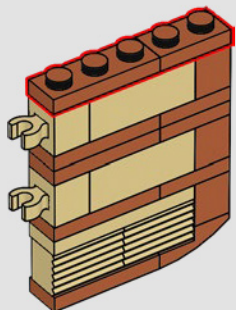

10

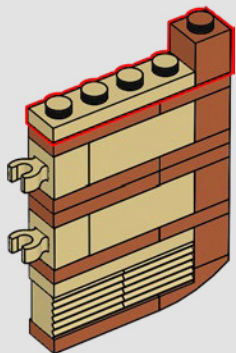

11

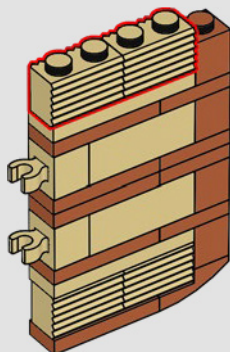

12

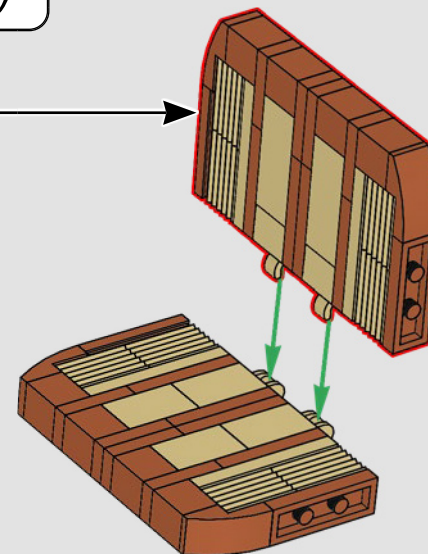
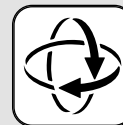
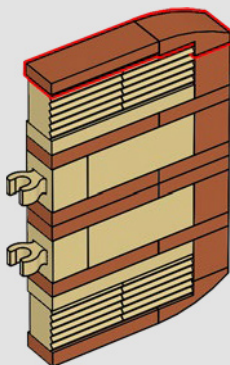

Die Rückbank in der
Campingausführung des
Transporters ließ sich zu einer
Schlaffläche umklappen.
Diese Konstruktion wurde als
„Rock-'n'-Roll-Bett“ bezeichnet.

194

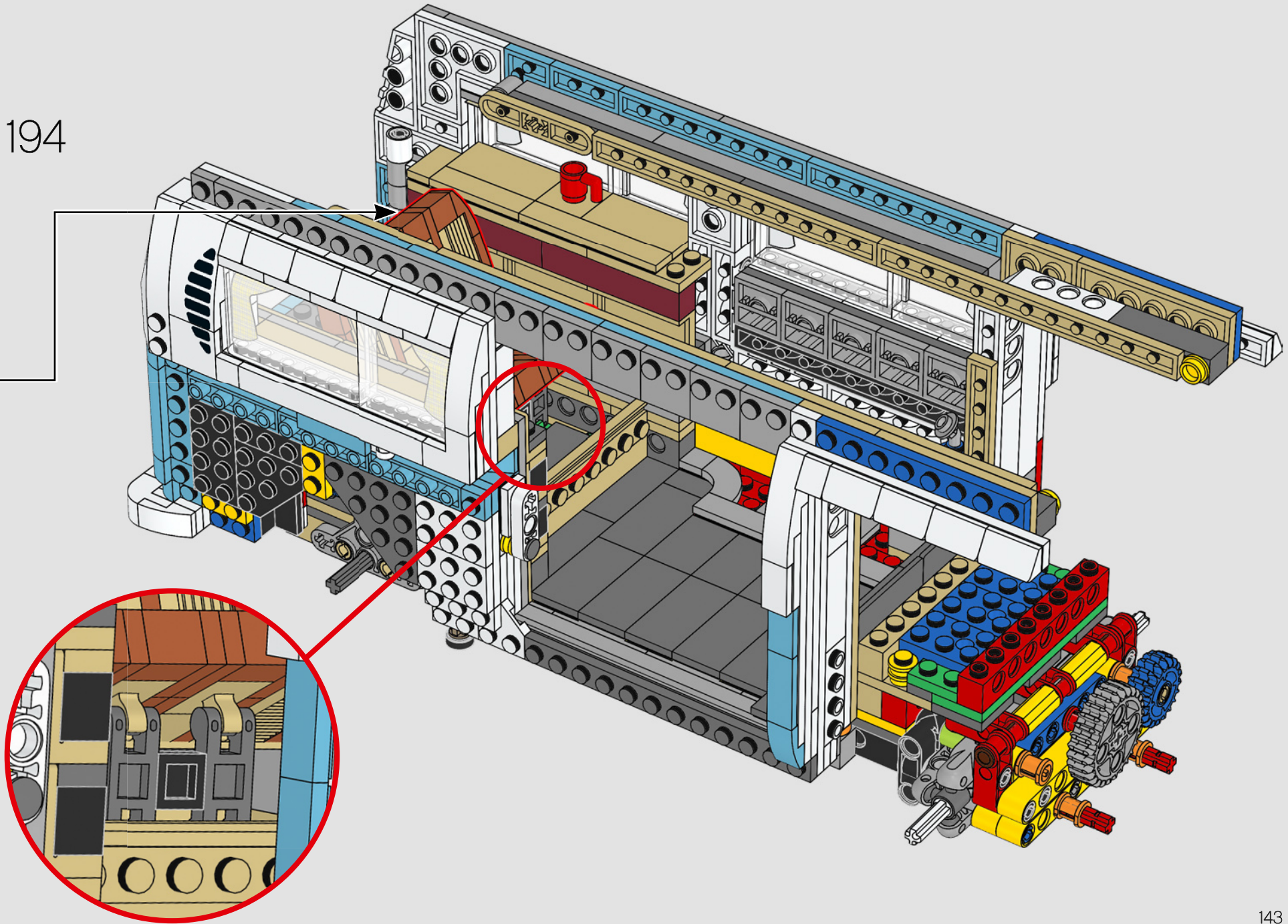

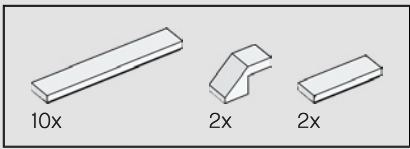

195

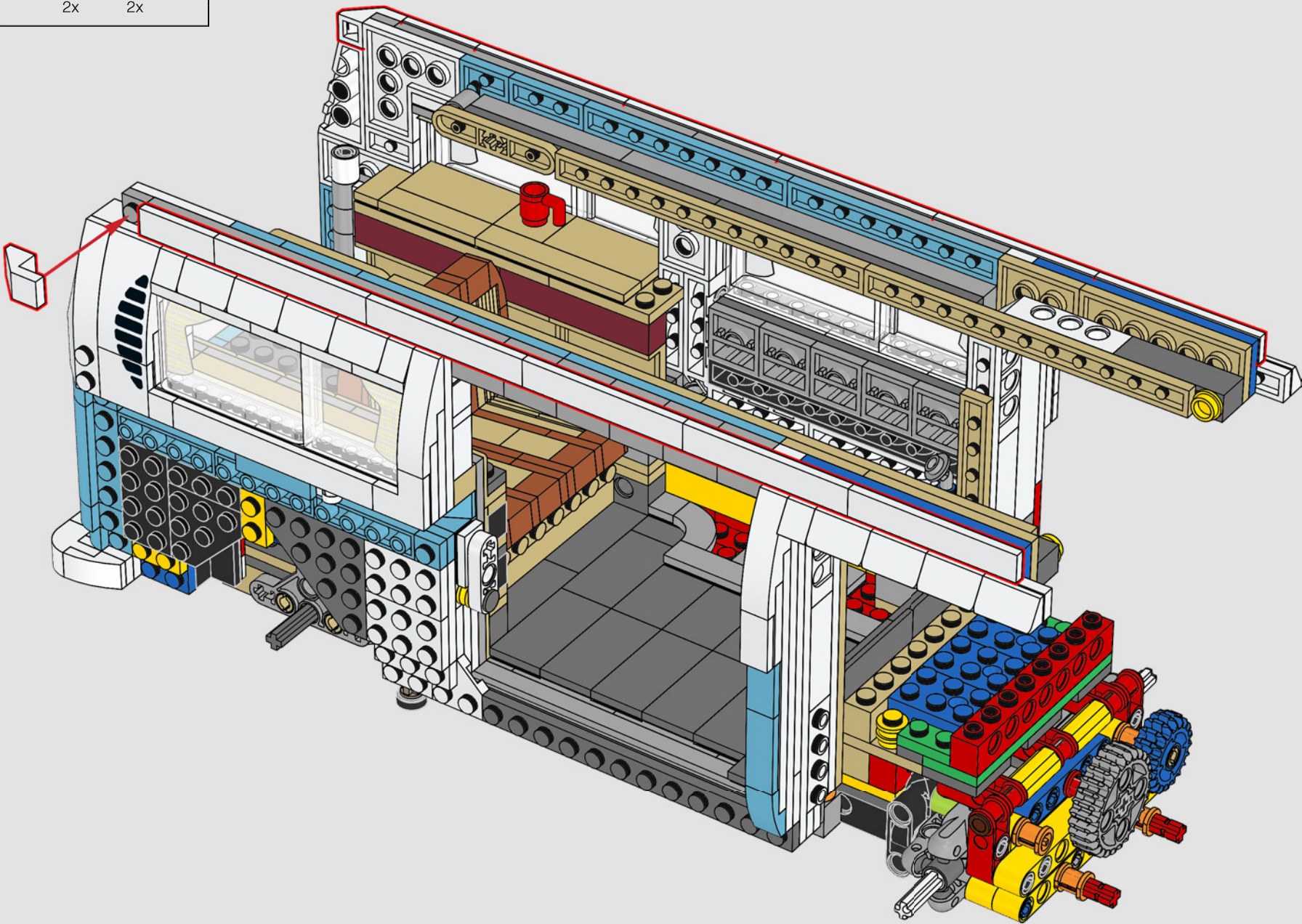

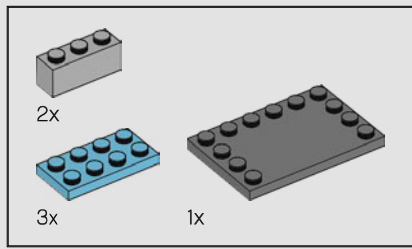

196

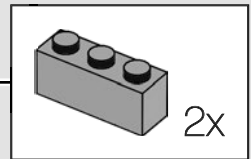
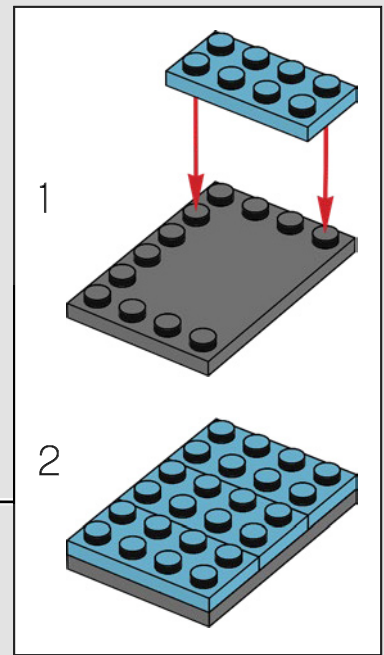
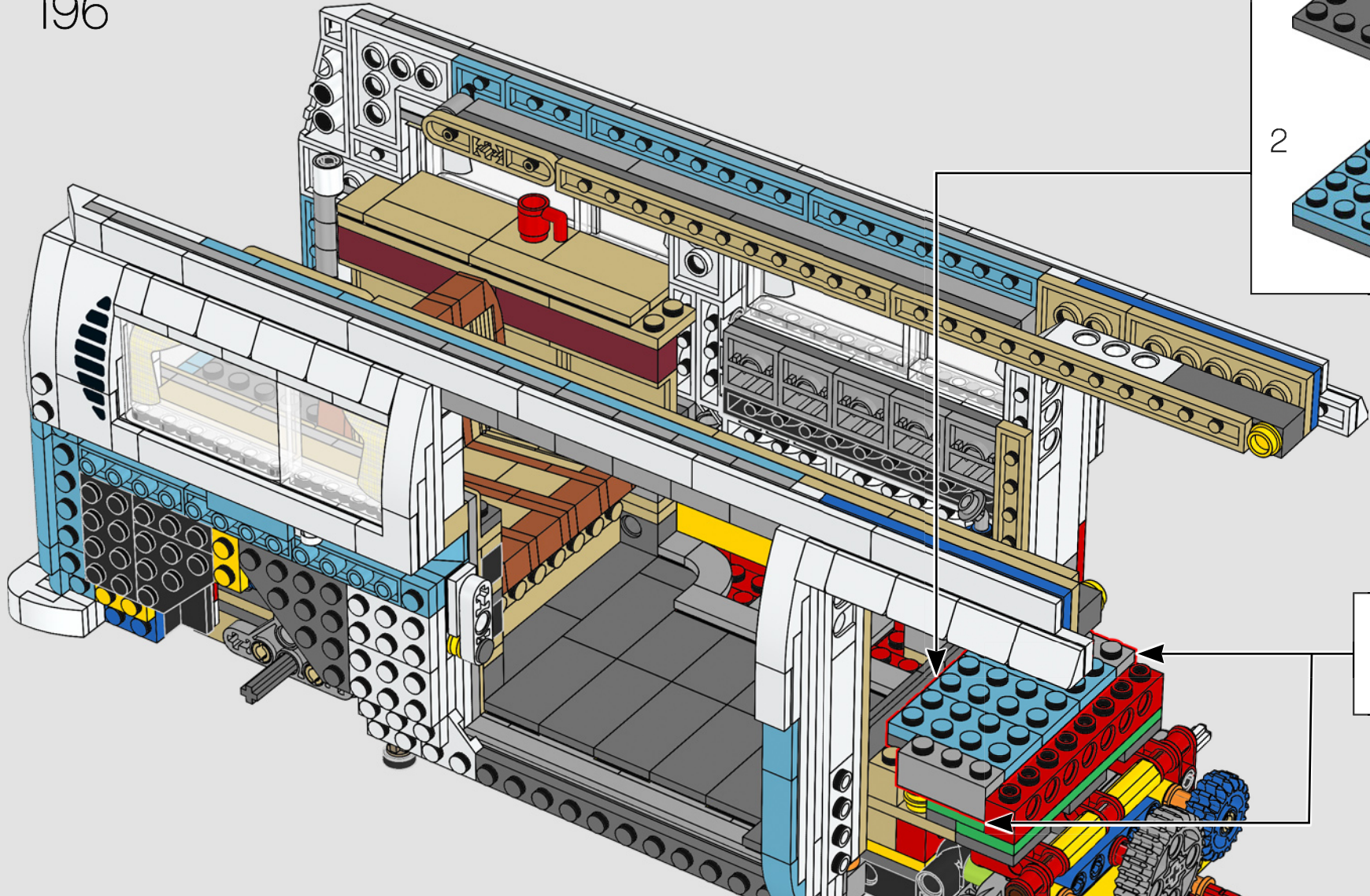

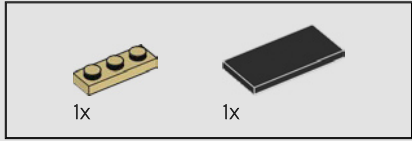
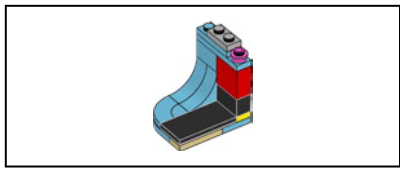

197

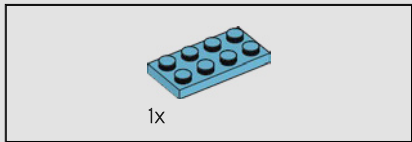
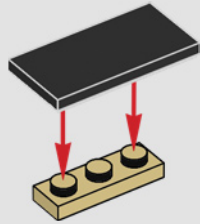

198

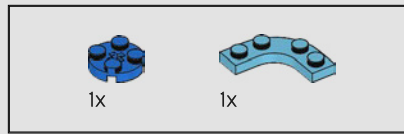
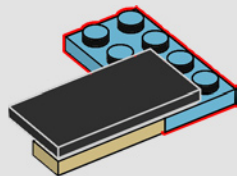

199

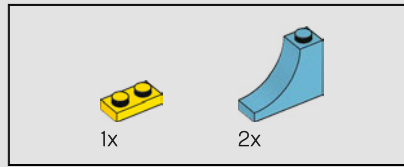
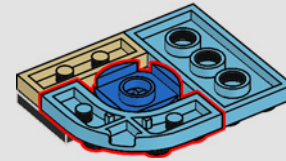
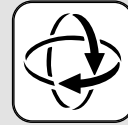

200

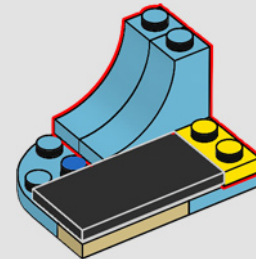

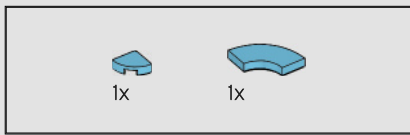

201

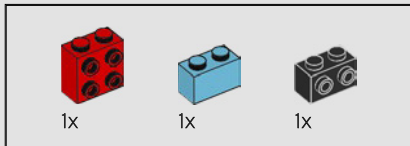
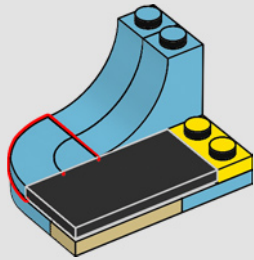

202

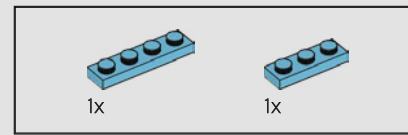
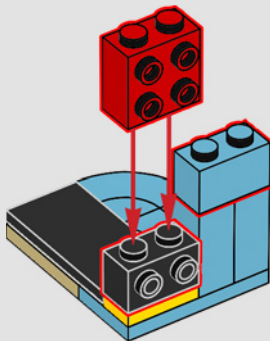

203

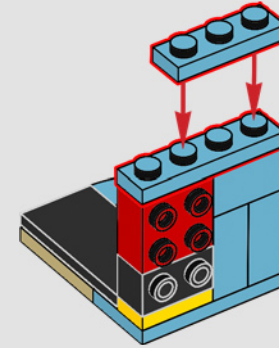

204

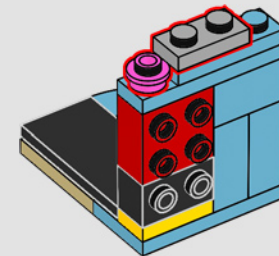

205

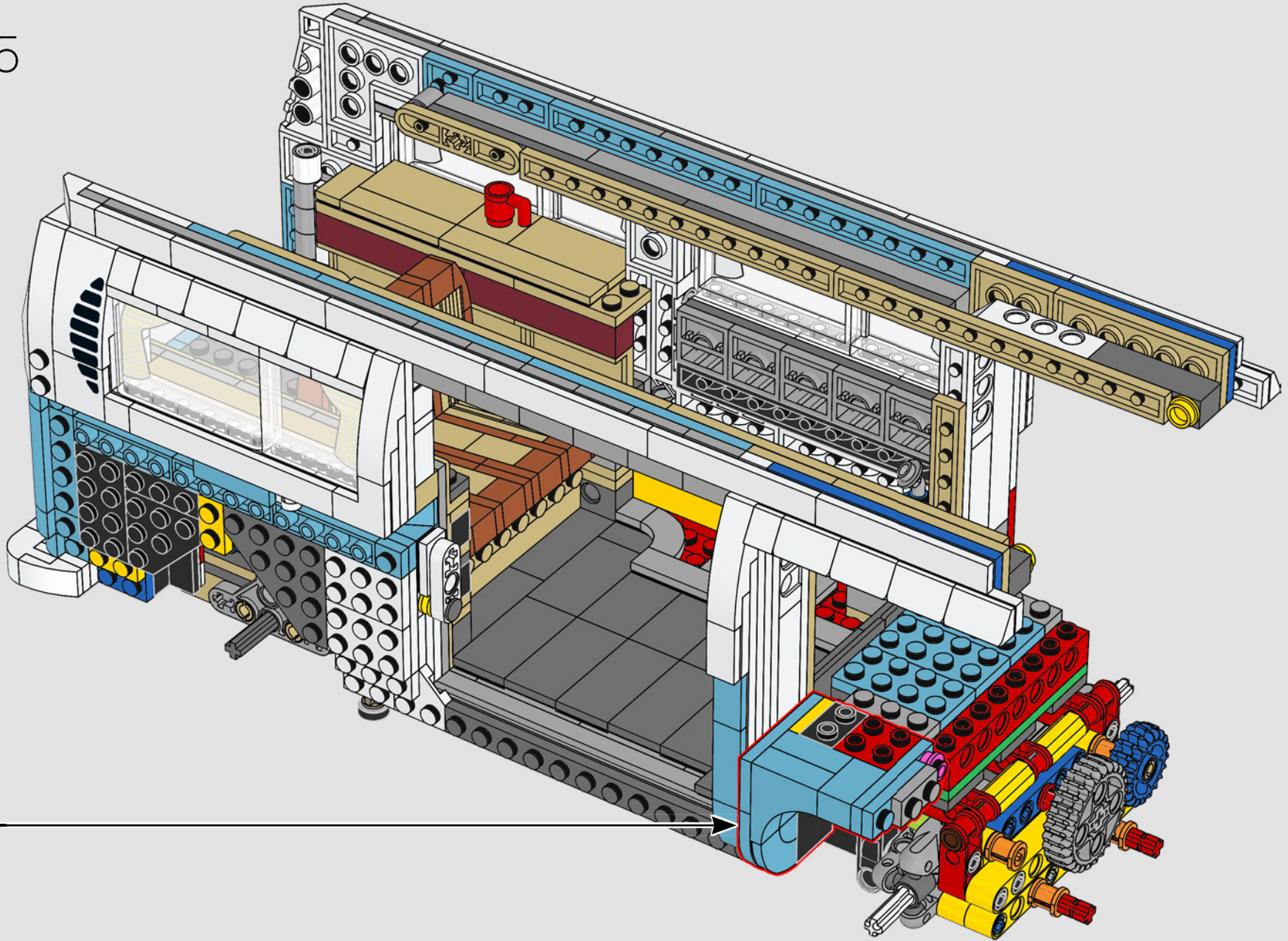

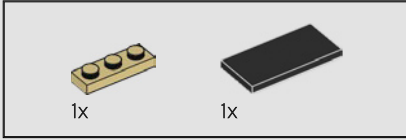
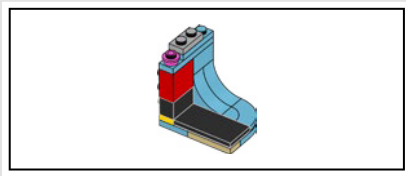

206

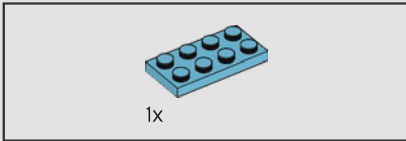
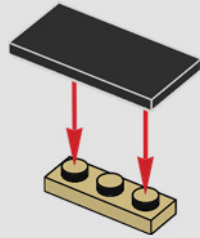

207

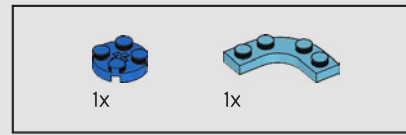
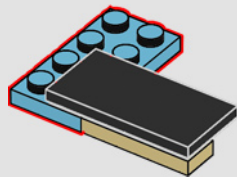

208

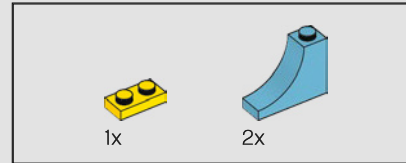
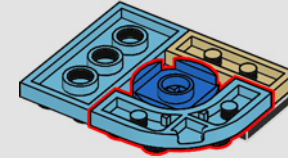
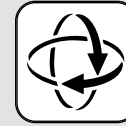

209

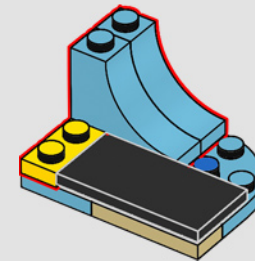
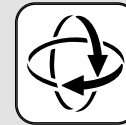

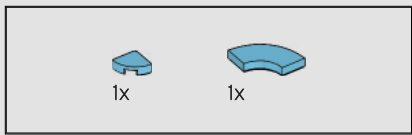

210

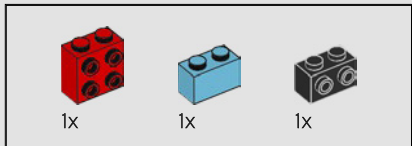
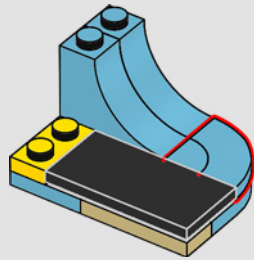

211

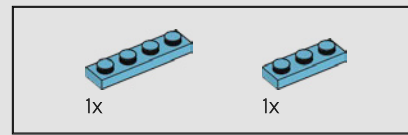
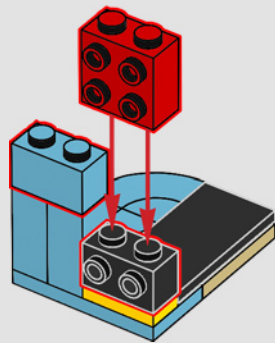

212

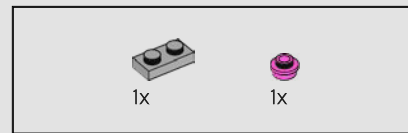
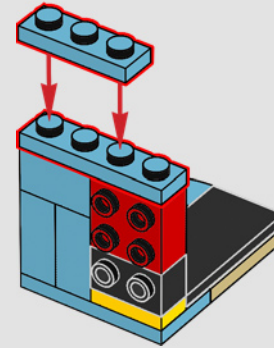

213

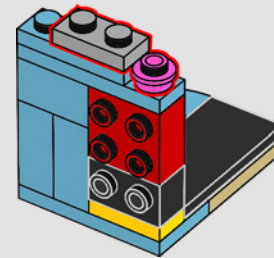

214

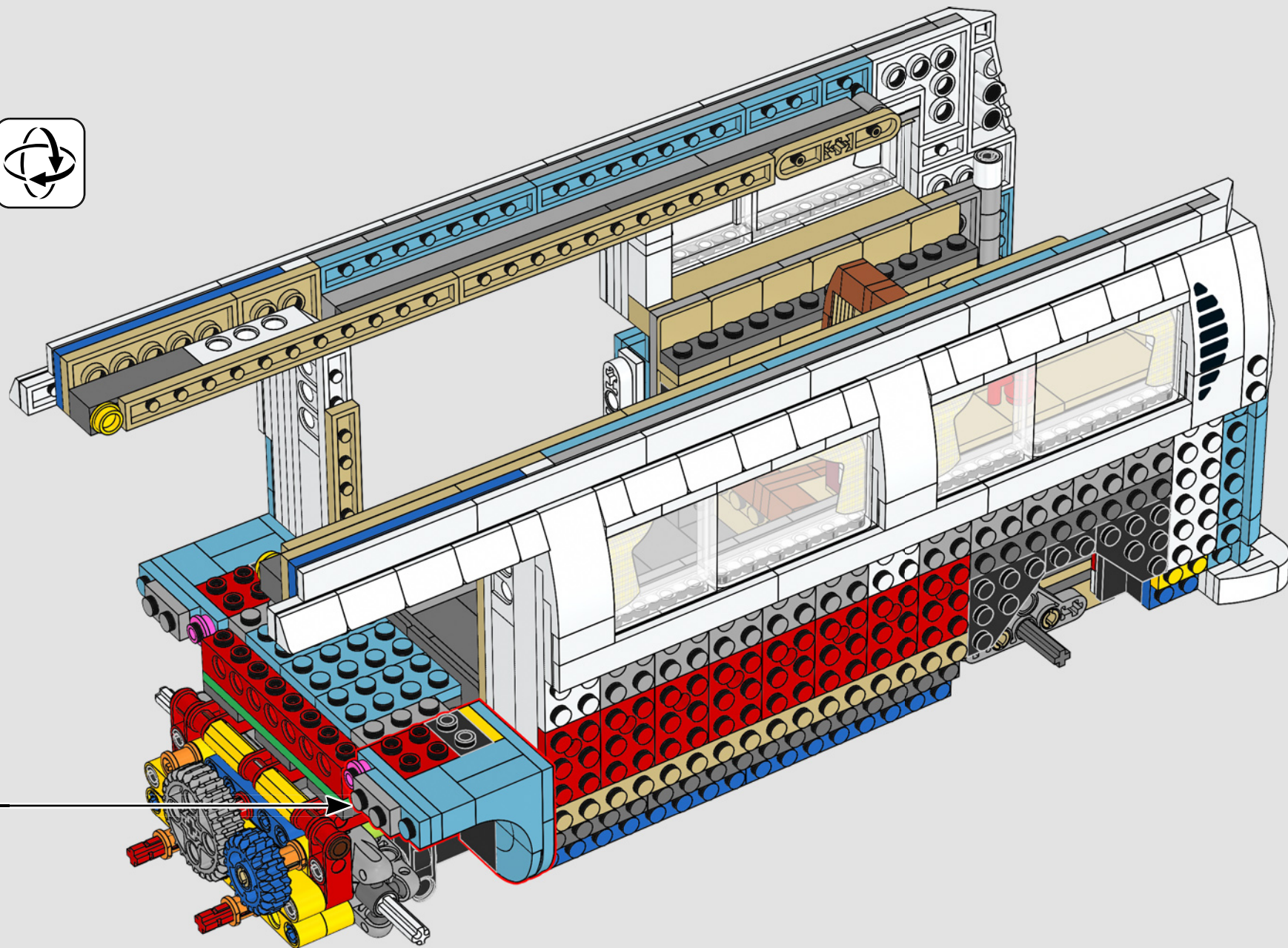

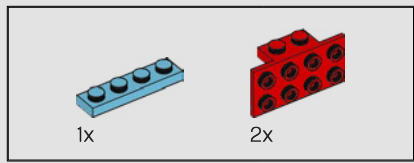

215

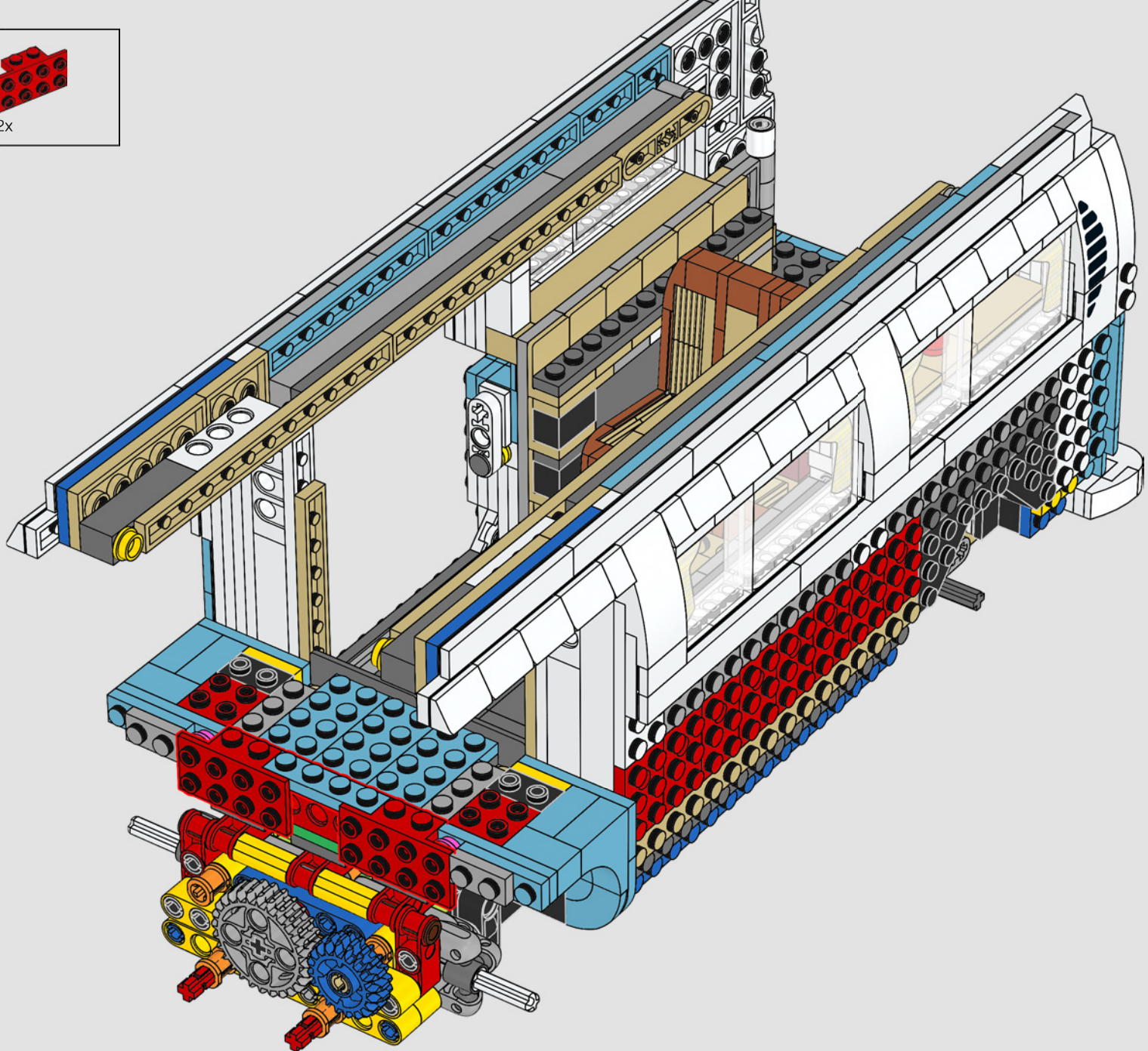

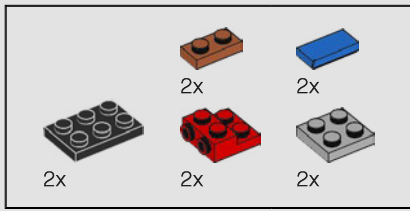

216

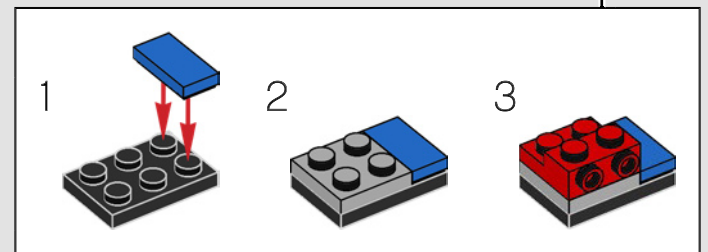
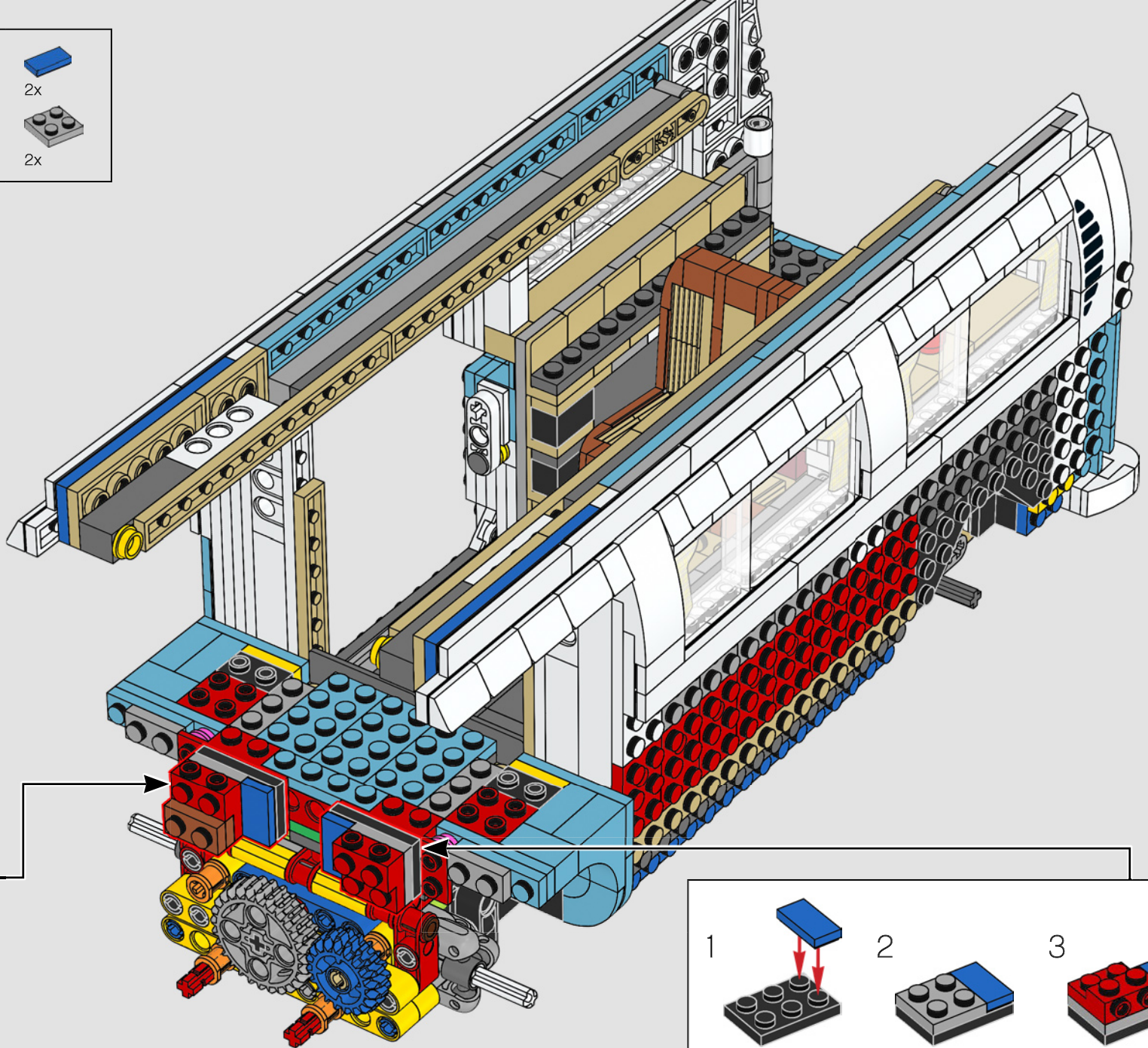
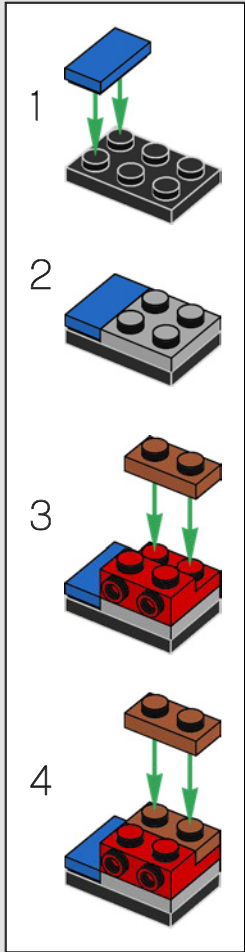

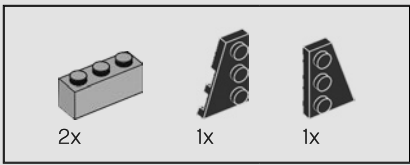

217

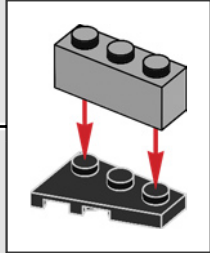
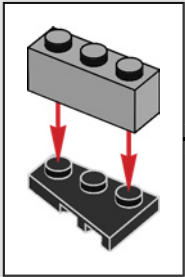
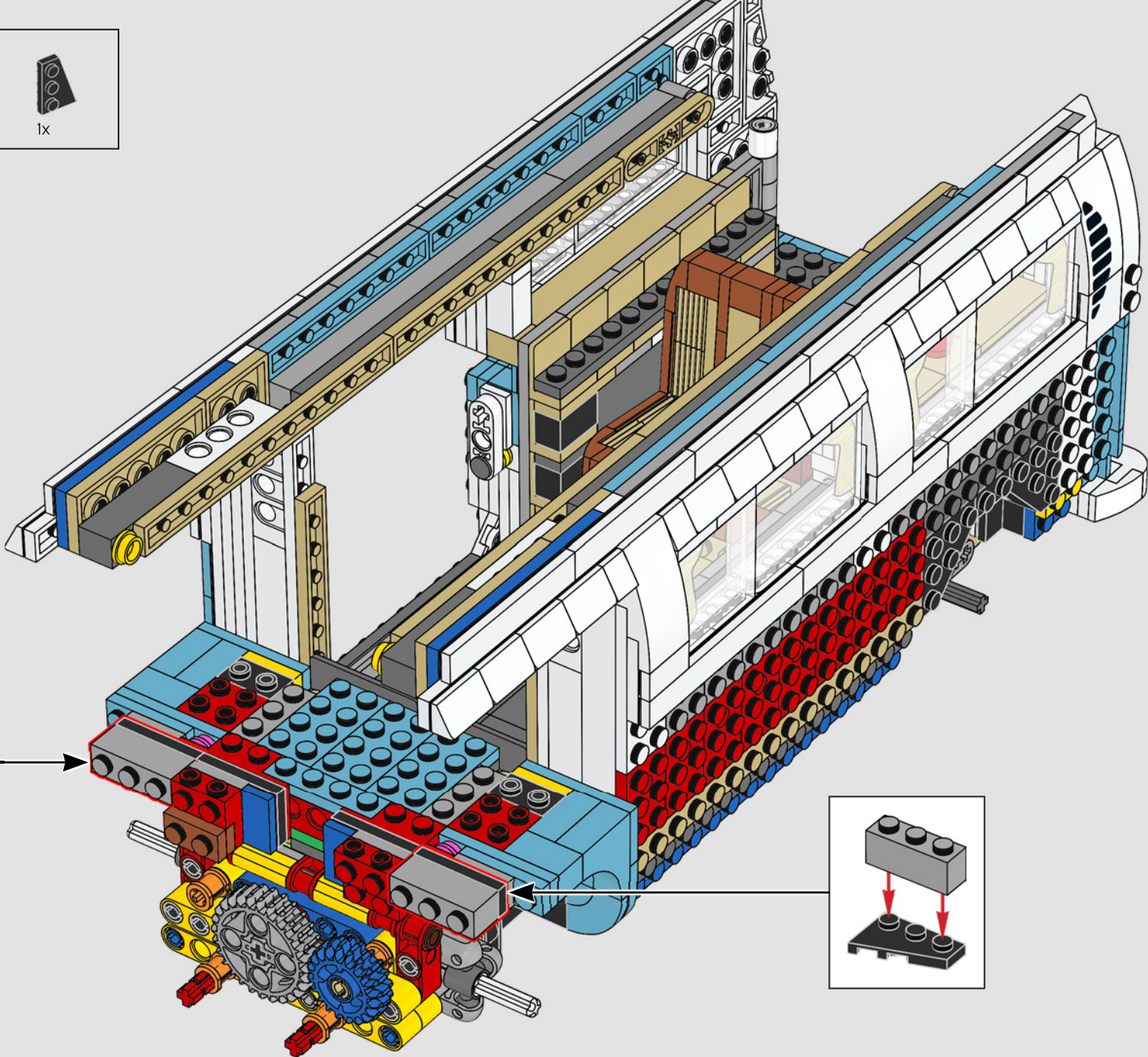

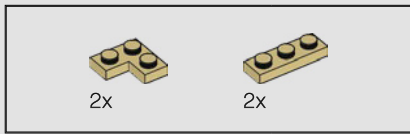

218

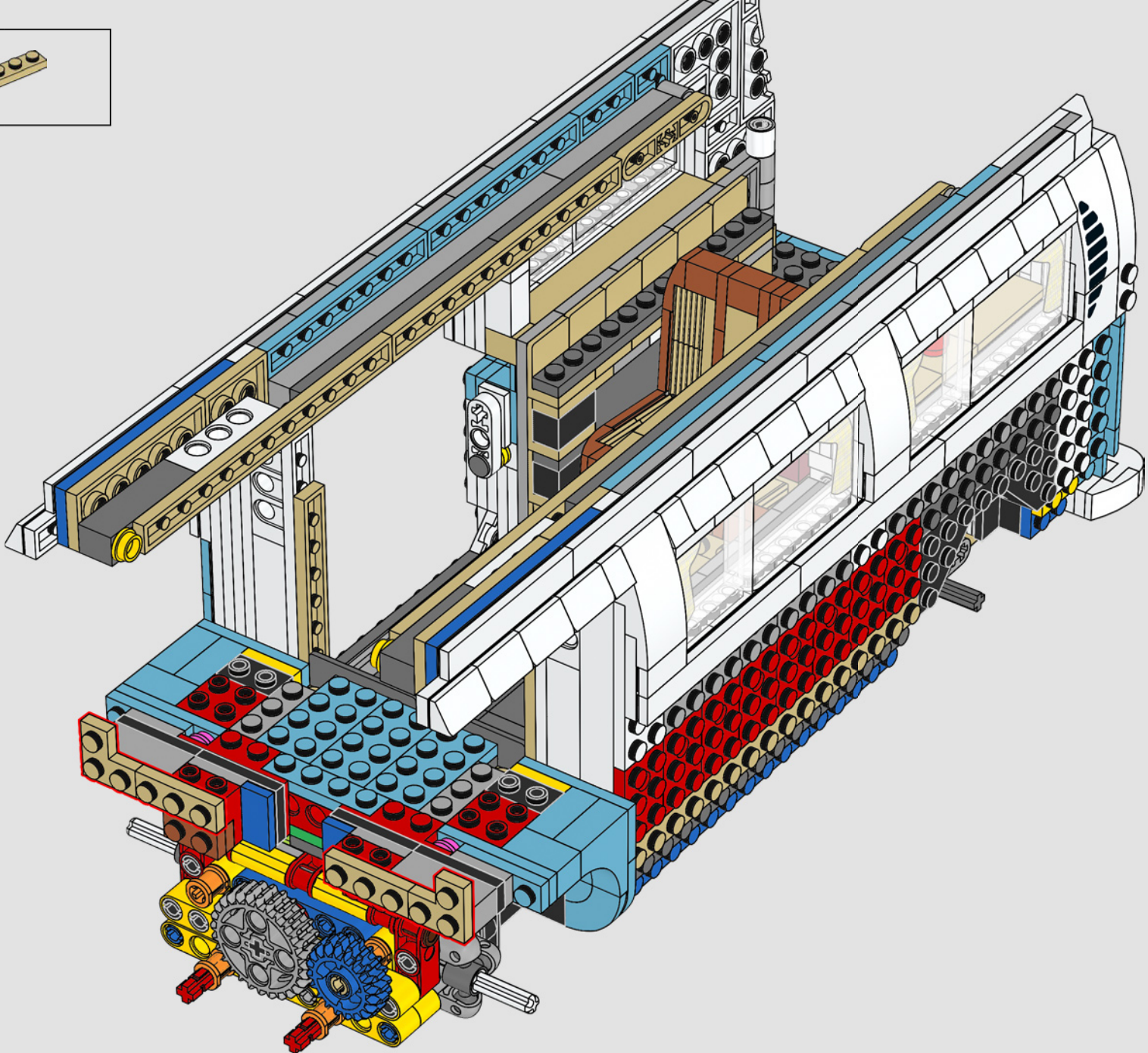

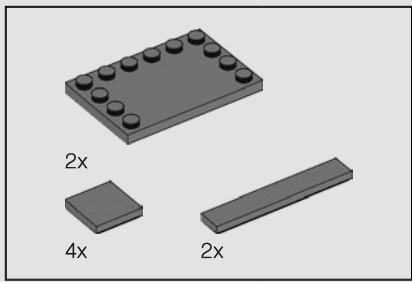

219

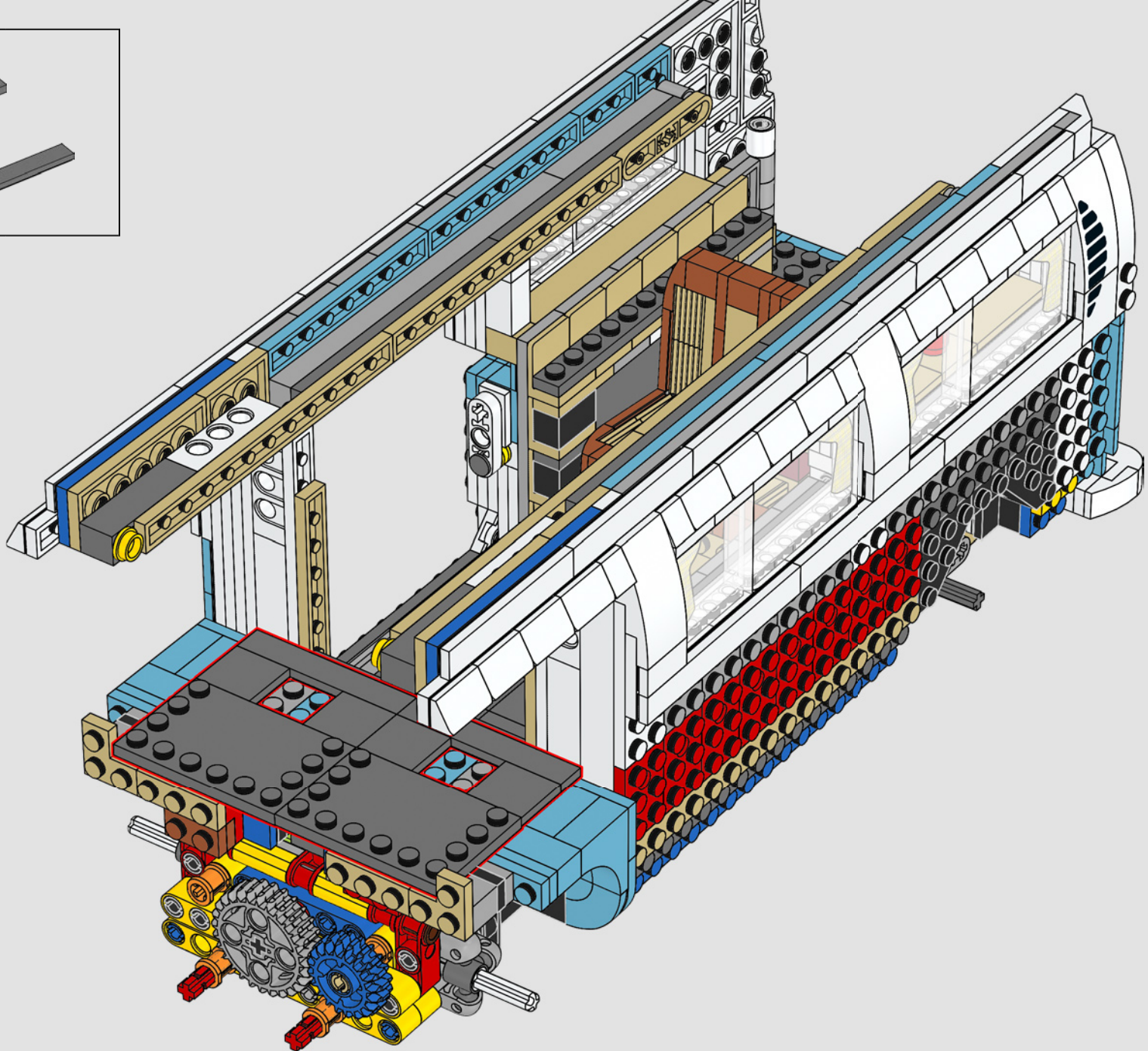

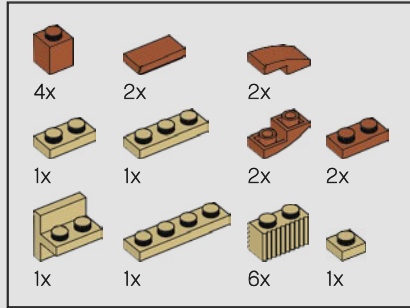
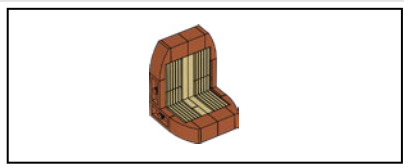

220

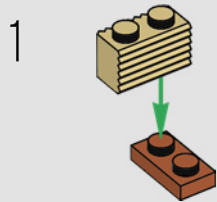

2

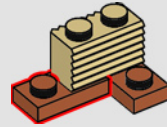

3

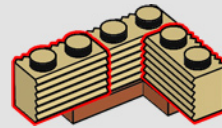

4

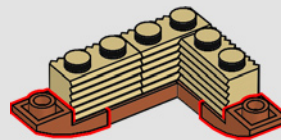

5

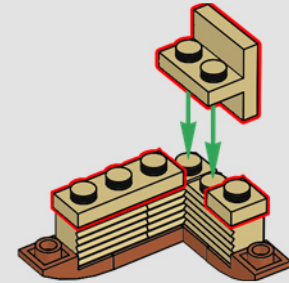

6

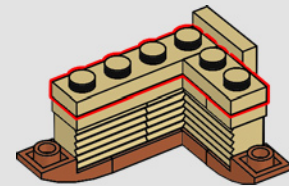

7

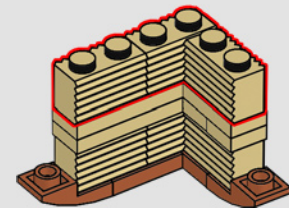

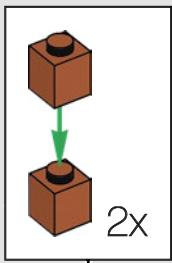

8

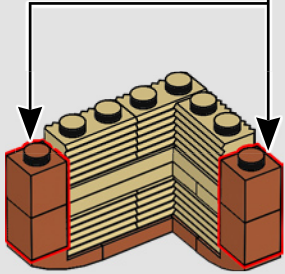

9

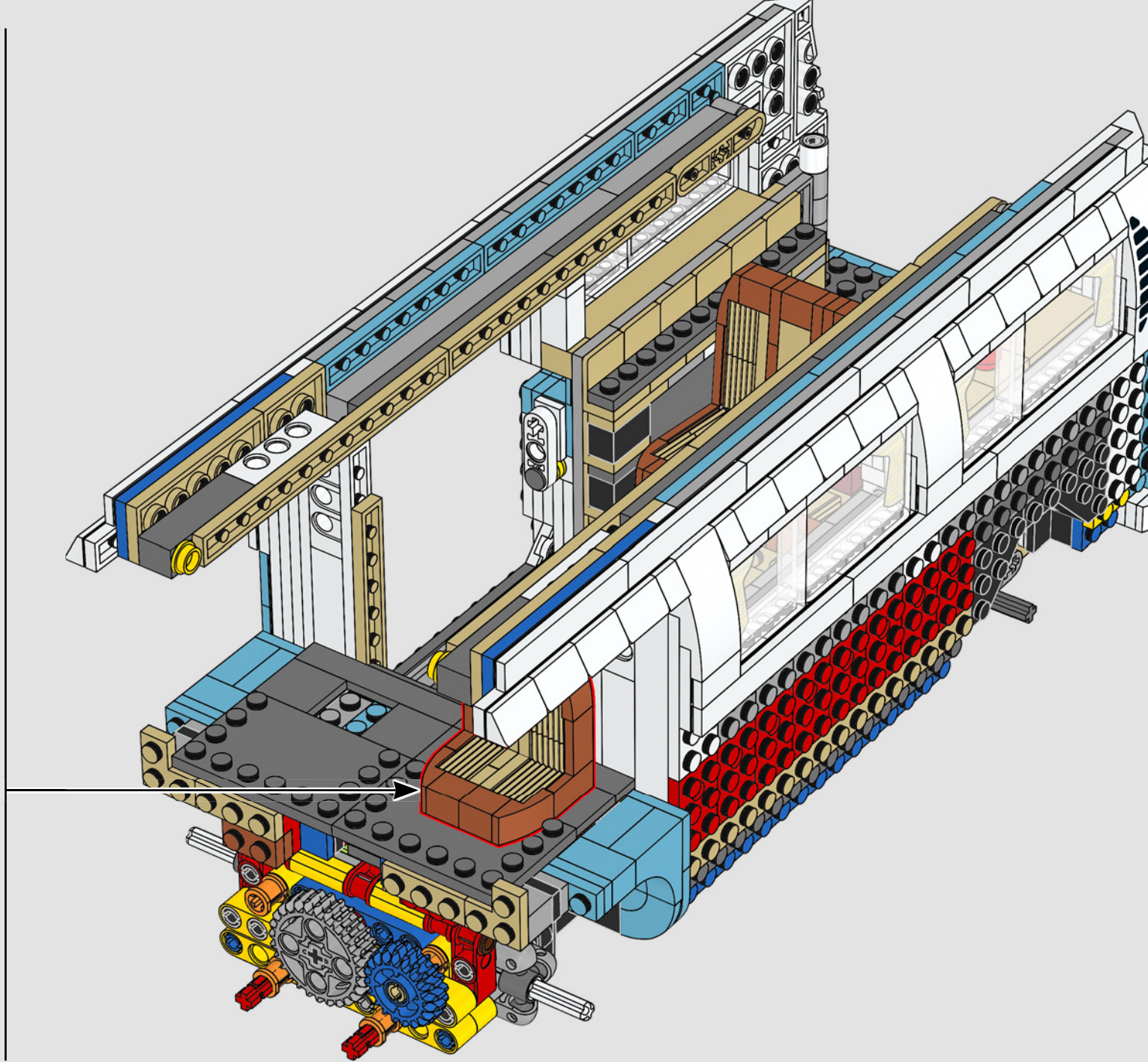
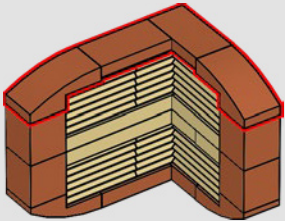

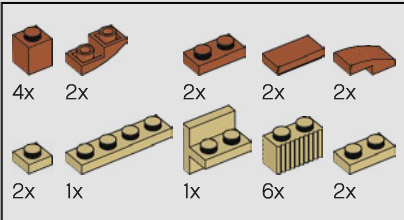
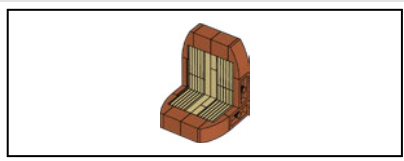

221

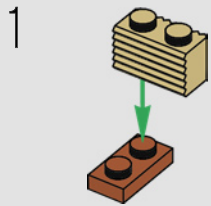

2

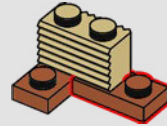

3

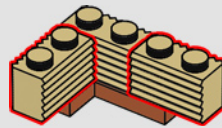

4

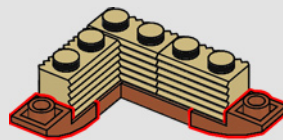

5

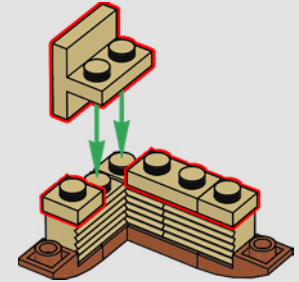

6

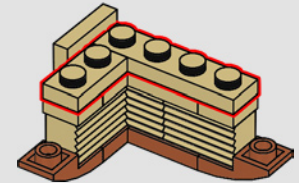

7

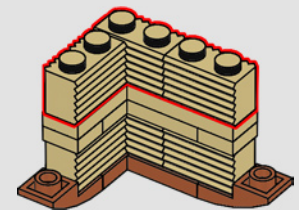

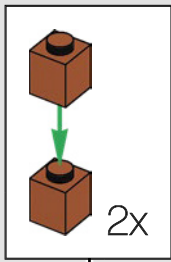

8

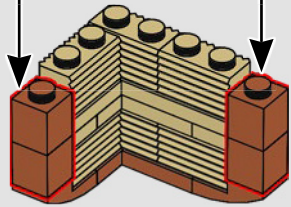

9

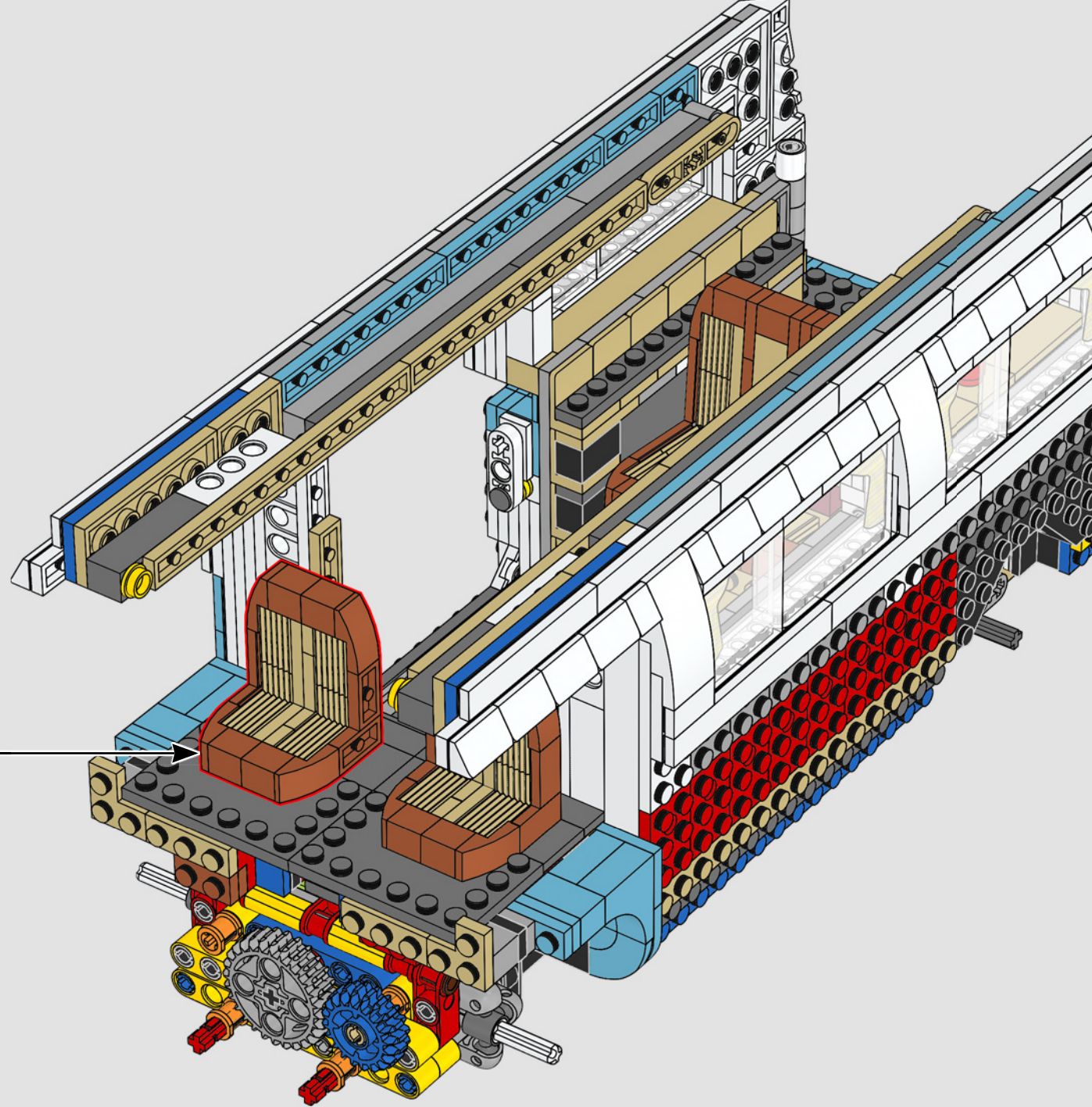
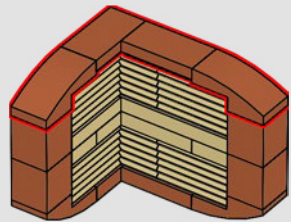

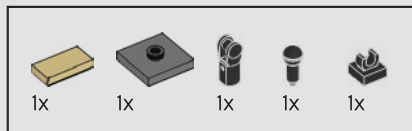

222

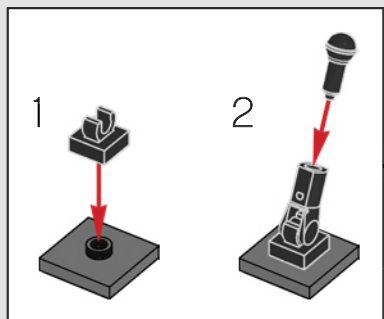
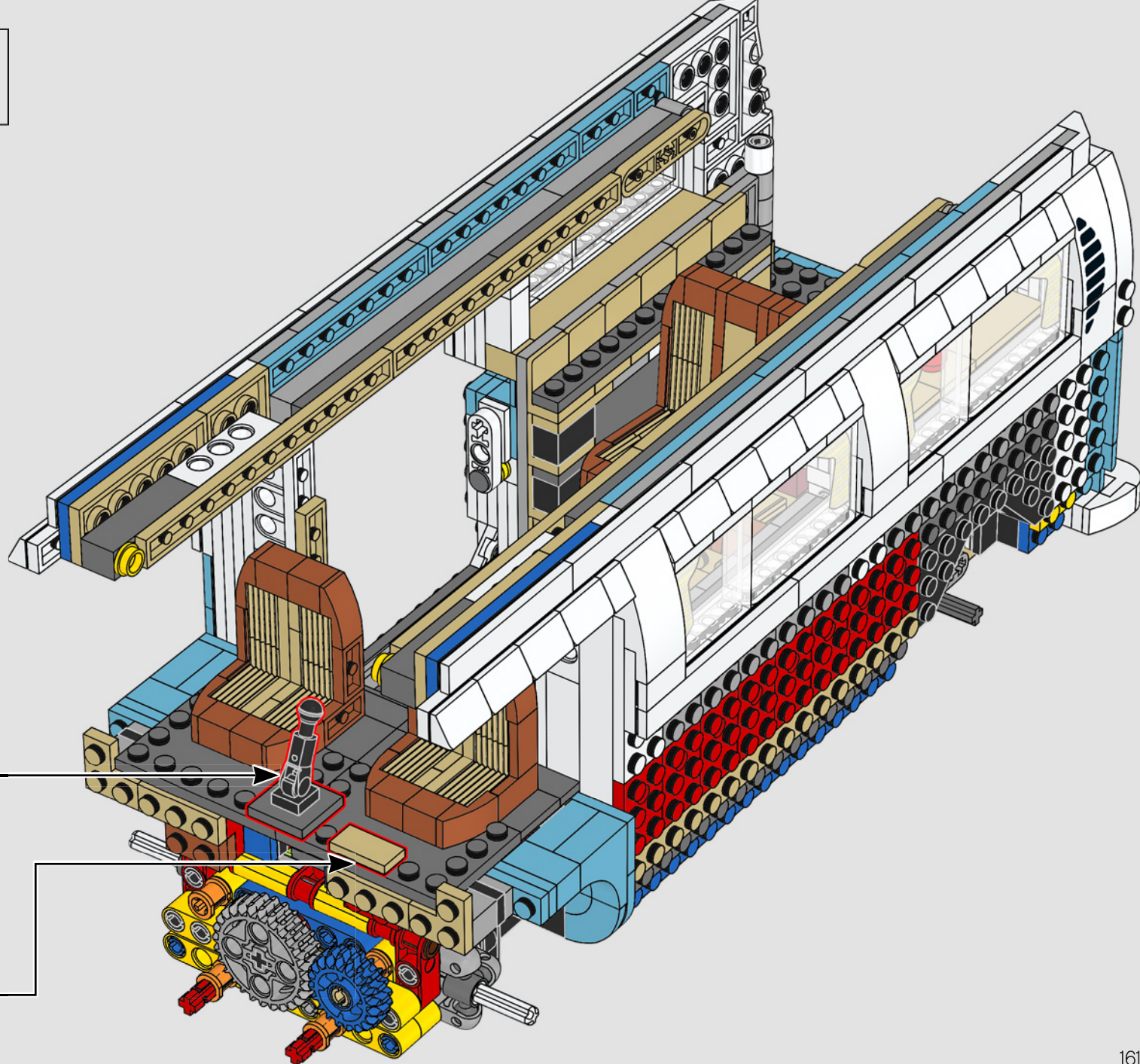

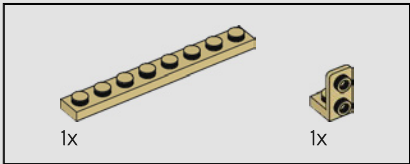
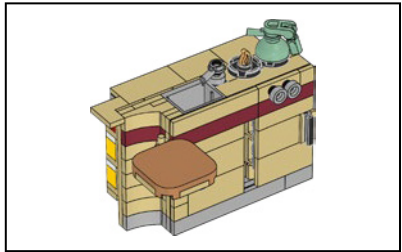
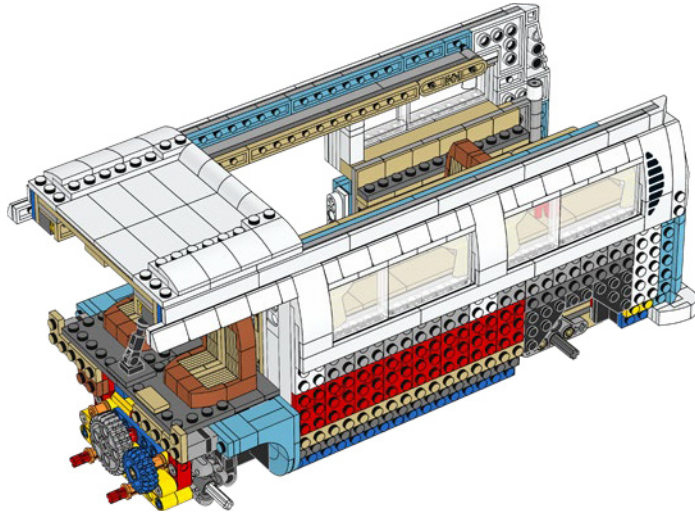
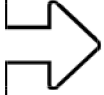

223

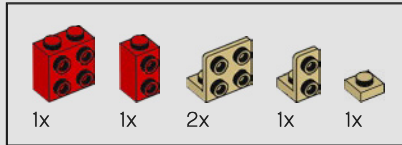
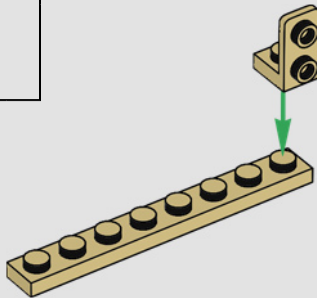

224

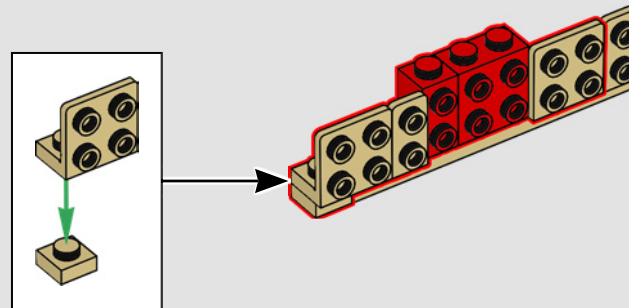

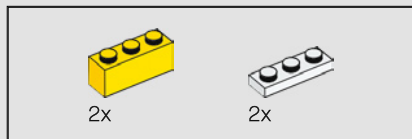

225

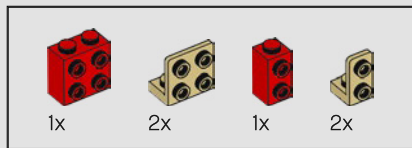
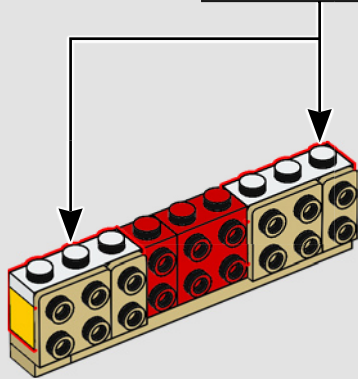
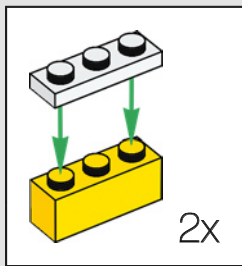

226

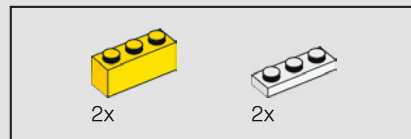
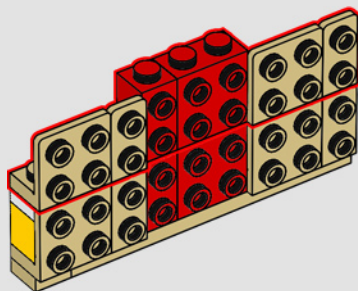

227

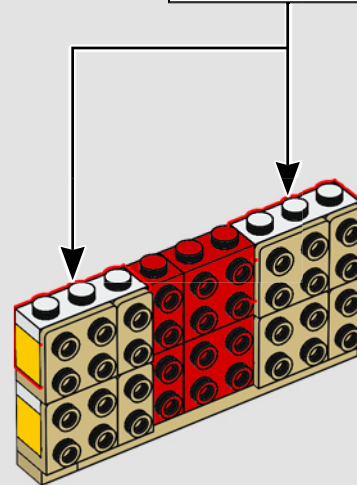
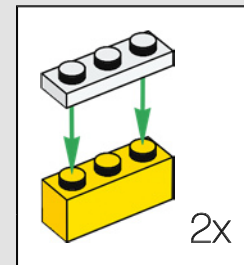

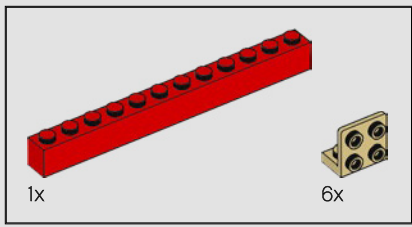

228

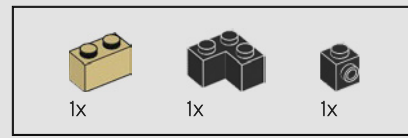
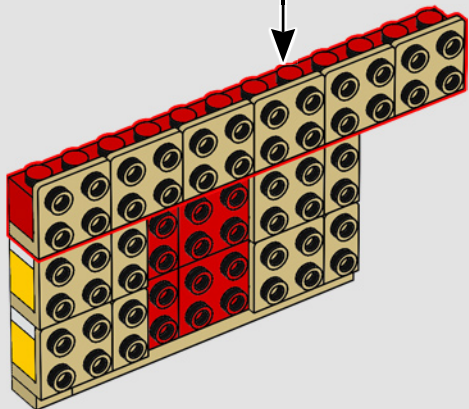
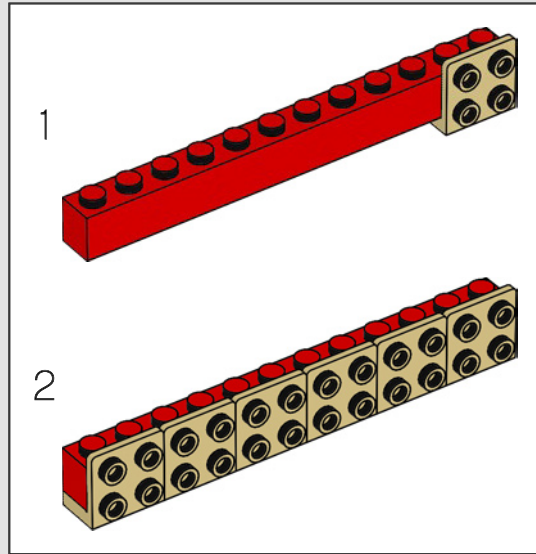

229

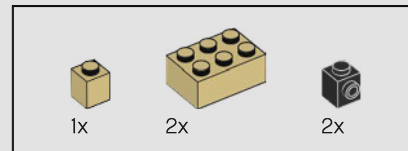
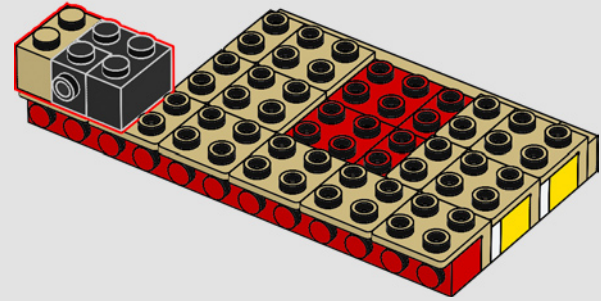
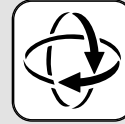

230

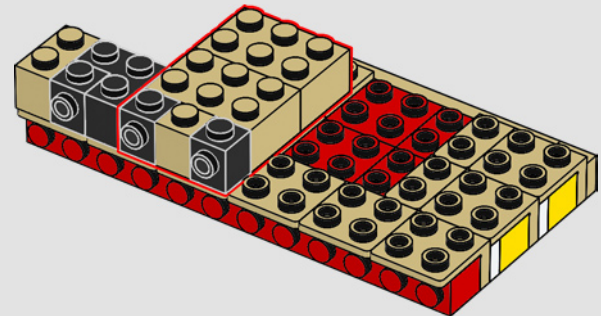

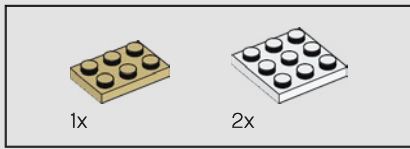

231

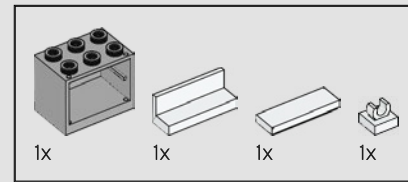
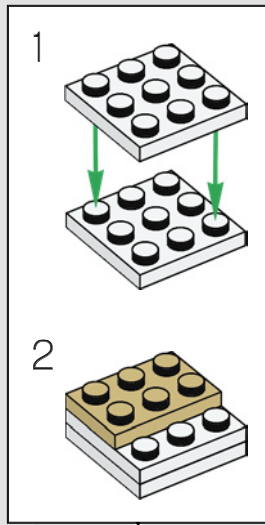
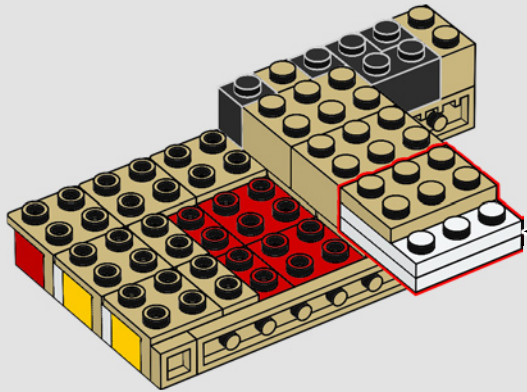

232

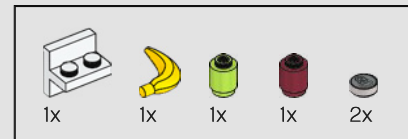
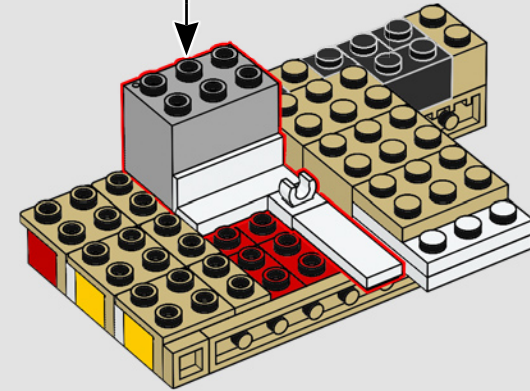
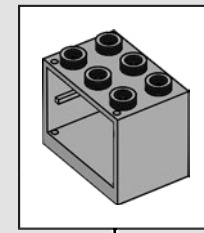

233

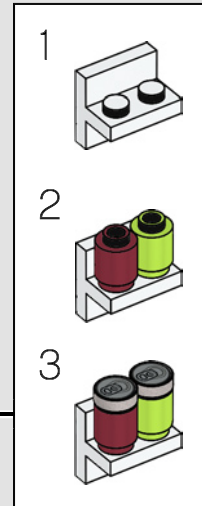
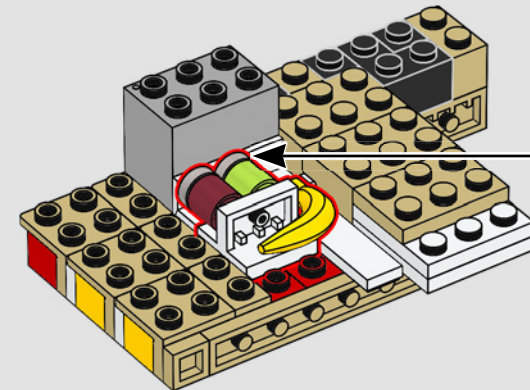

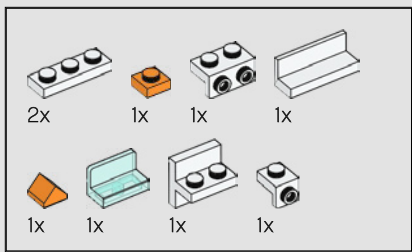

234

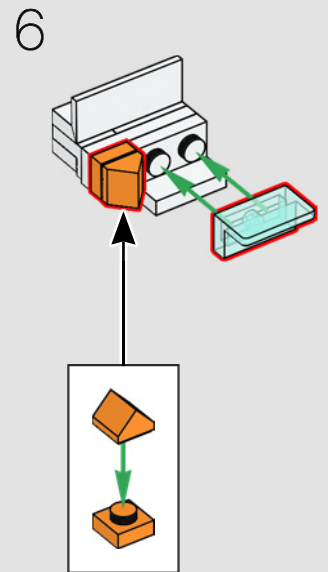
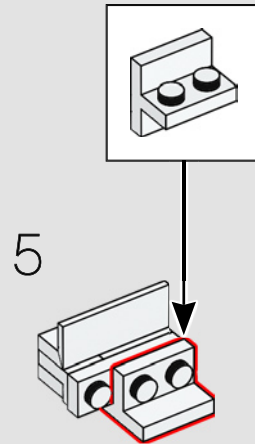
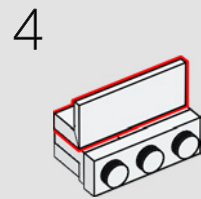
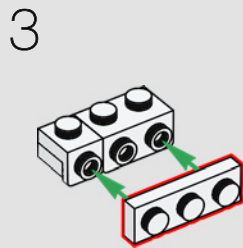
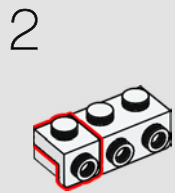
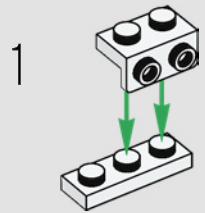

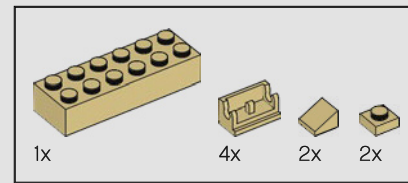
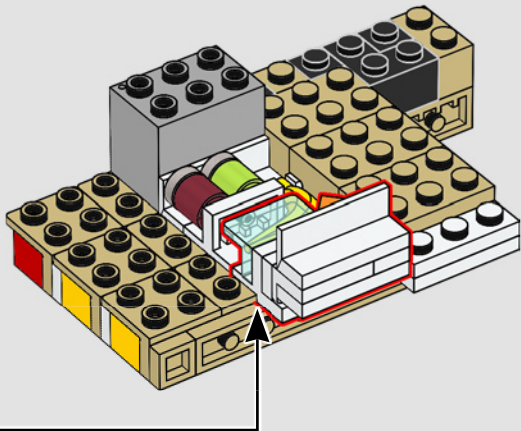

235

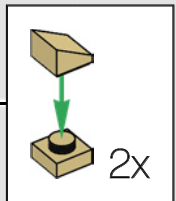
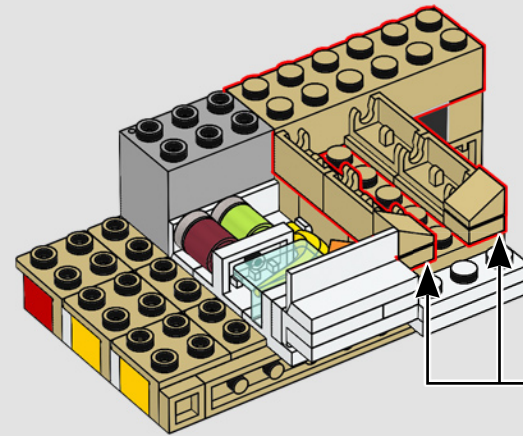

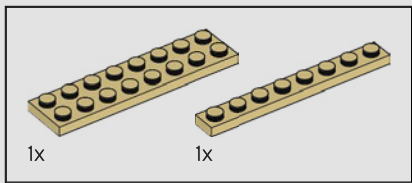

236

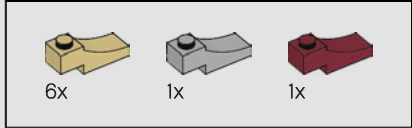
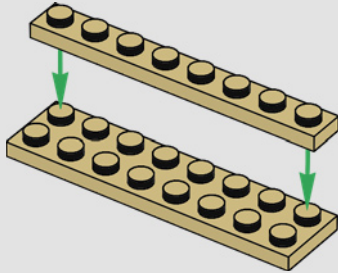

237

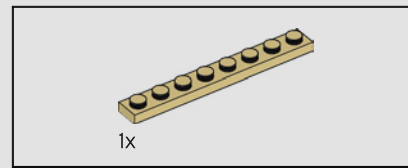
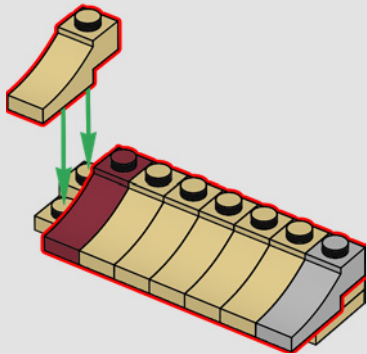

238

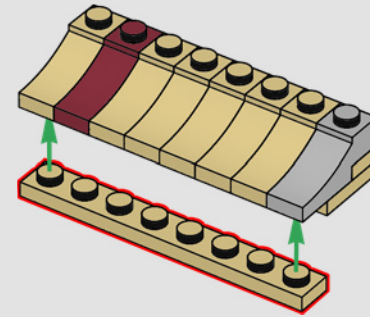

239

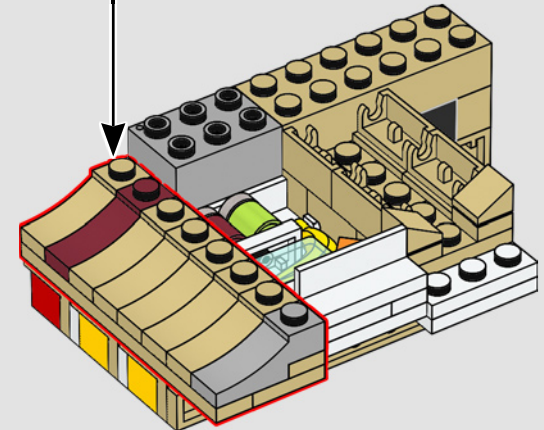

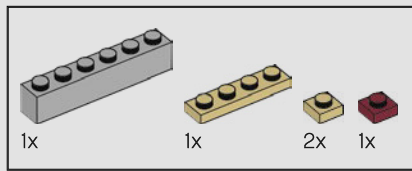

240

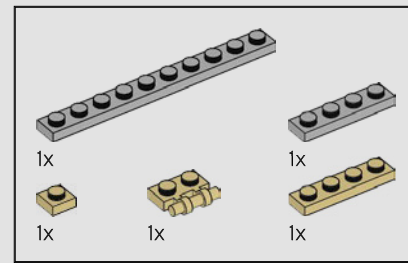
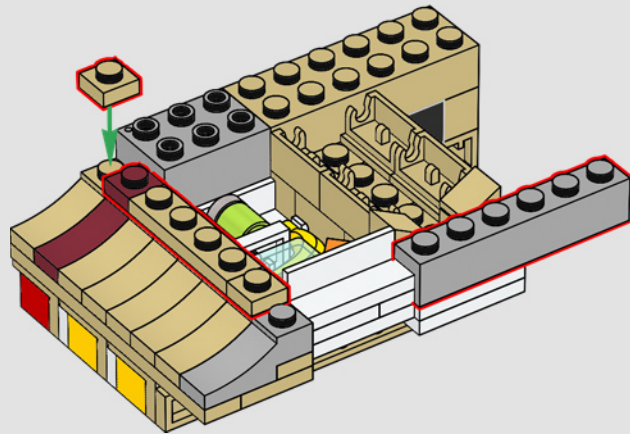

241

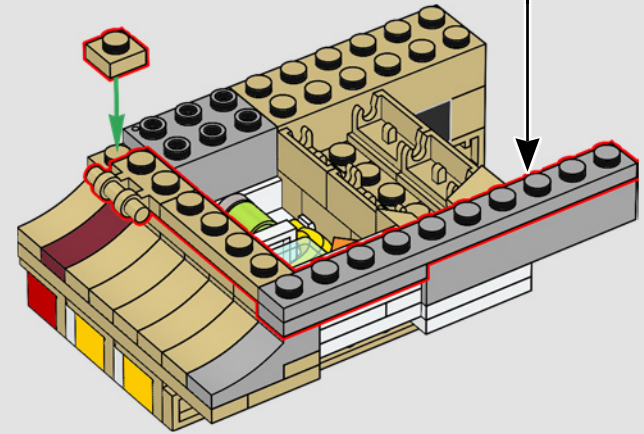
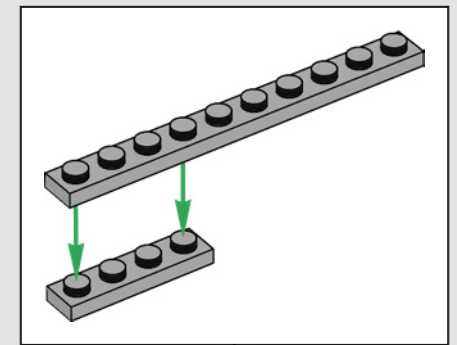

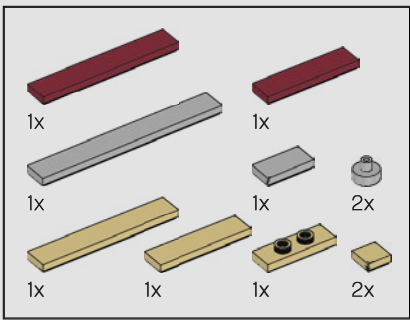

242

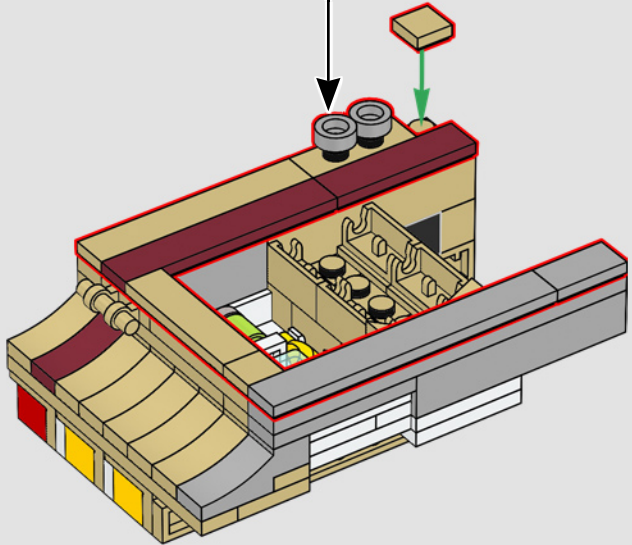
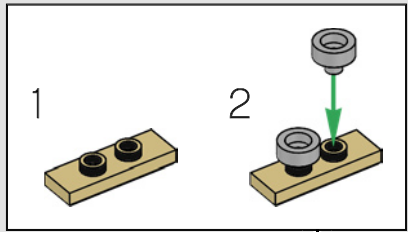

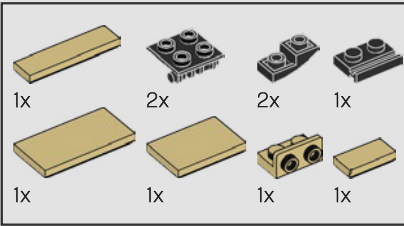
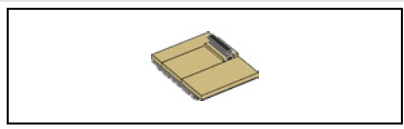

243

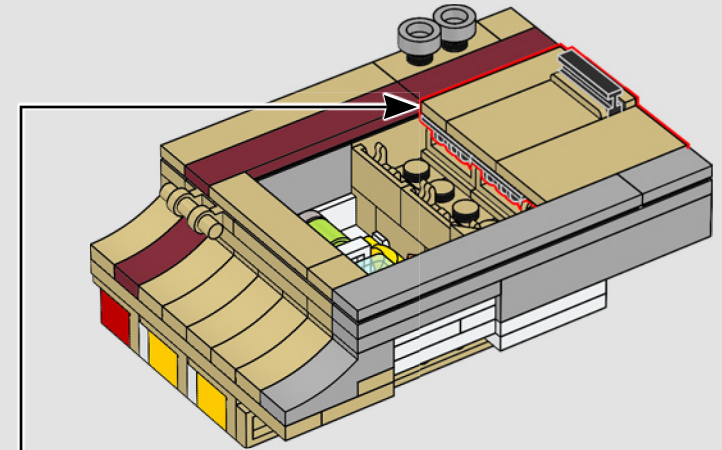
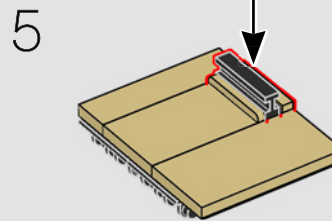
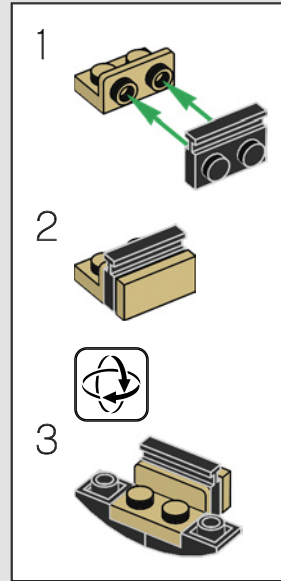
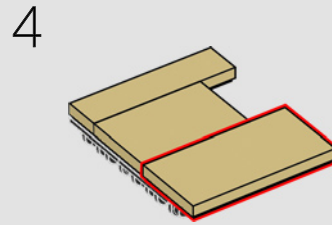
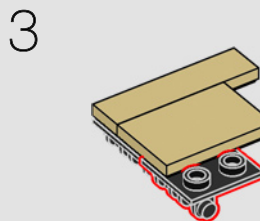
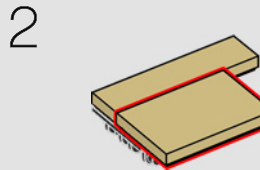
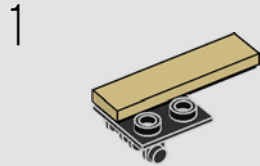

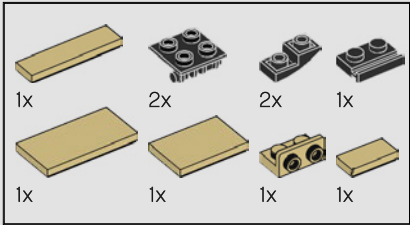
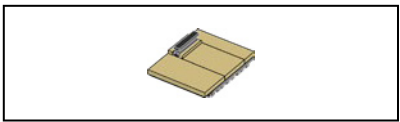

244

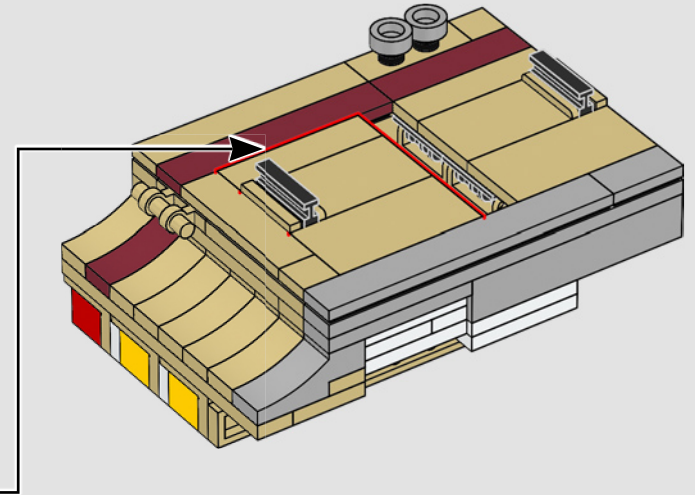
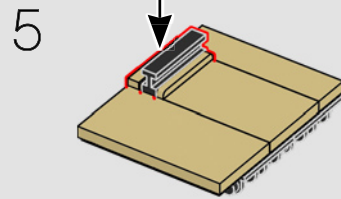
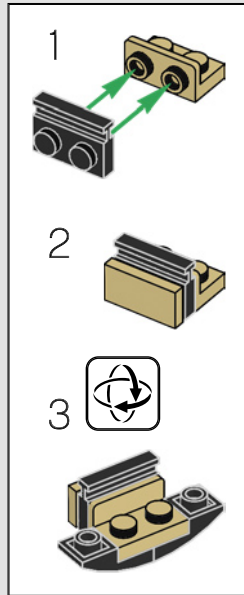
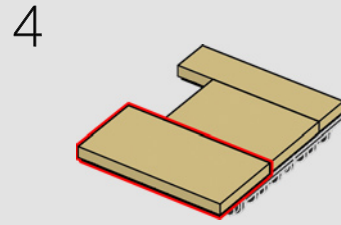
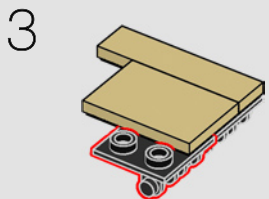
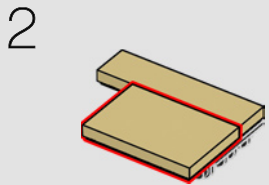
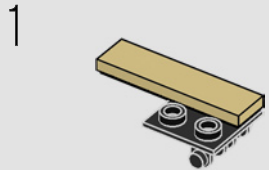

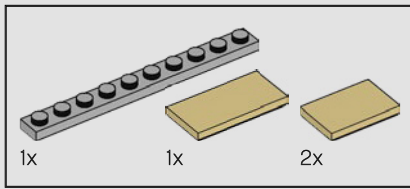

245

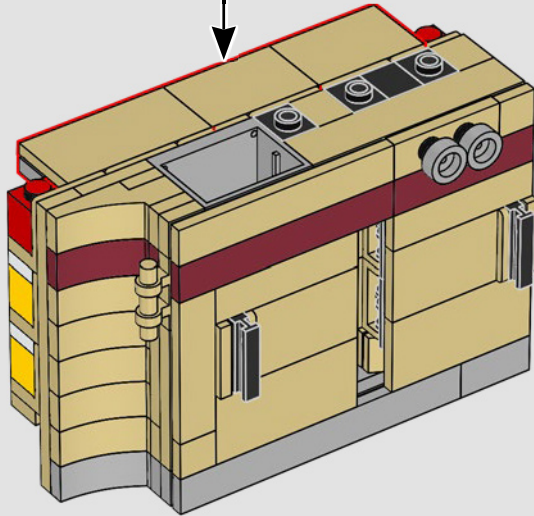
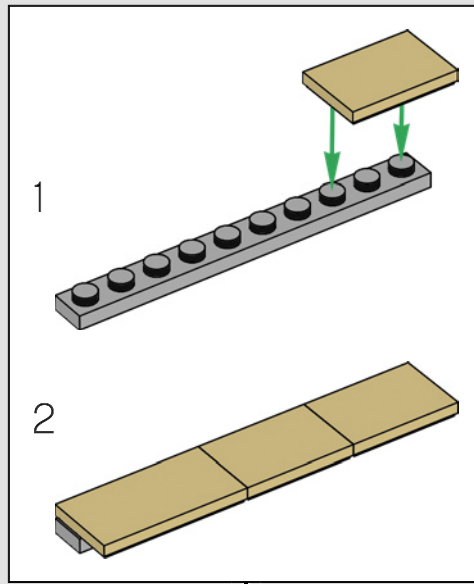

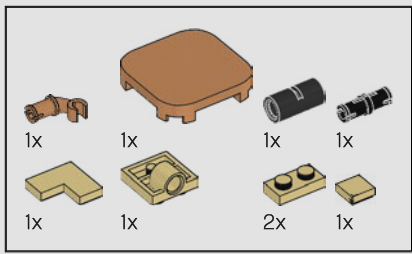

246

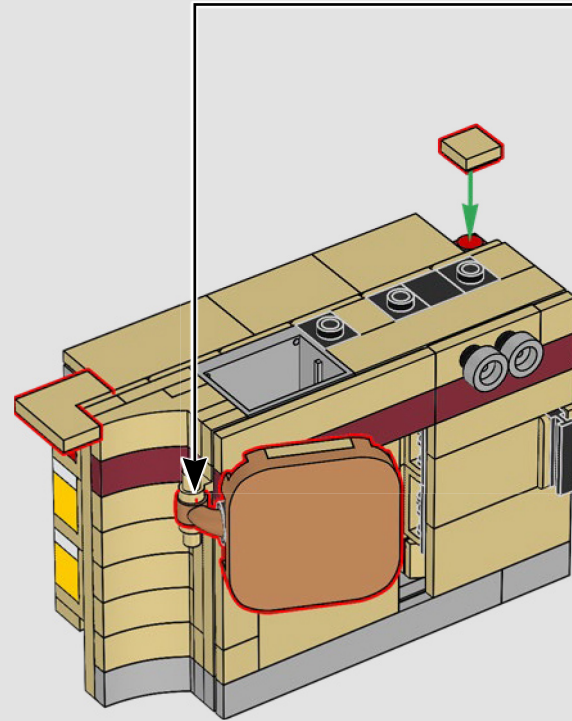
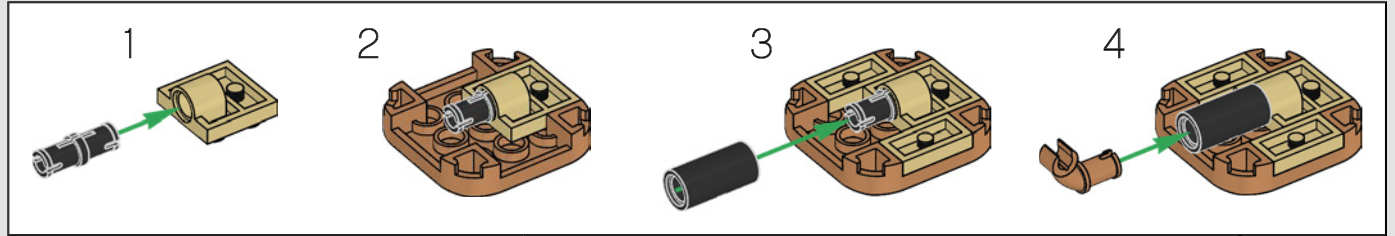

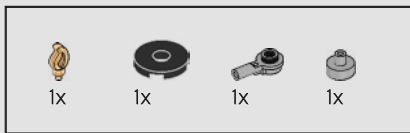

247

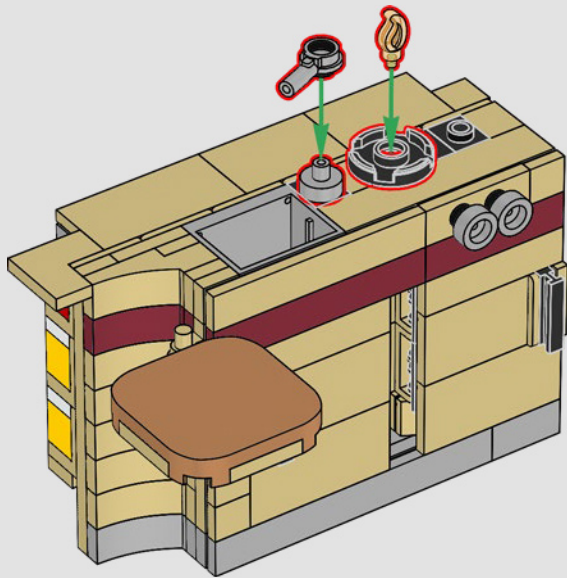

248

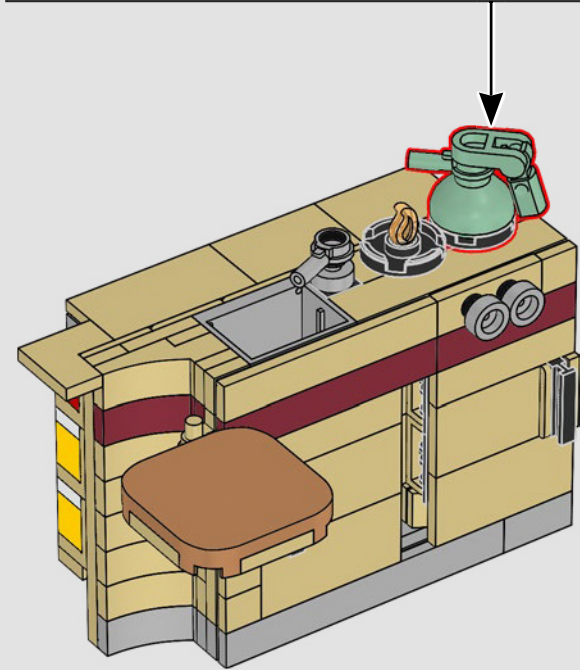
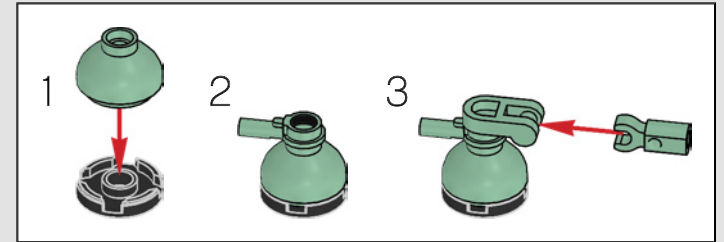

249

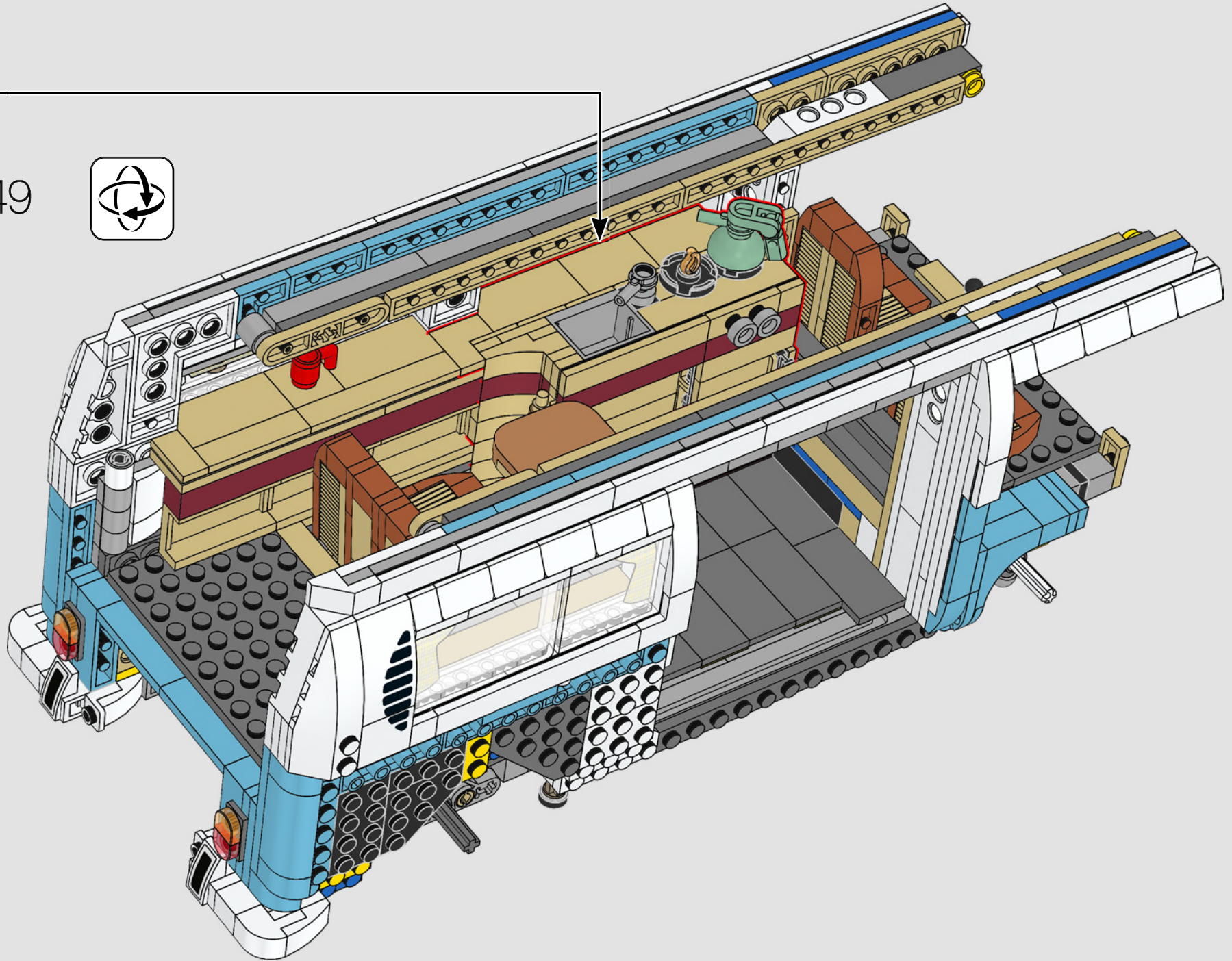

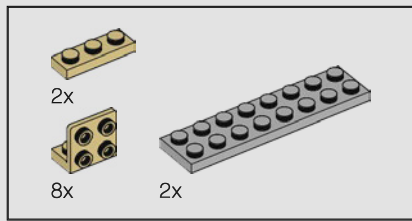

250

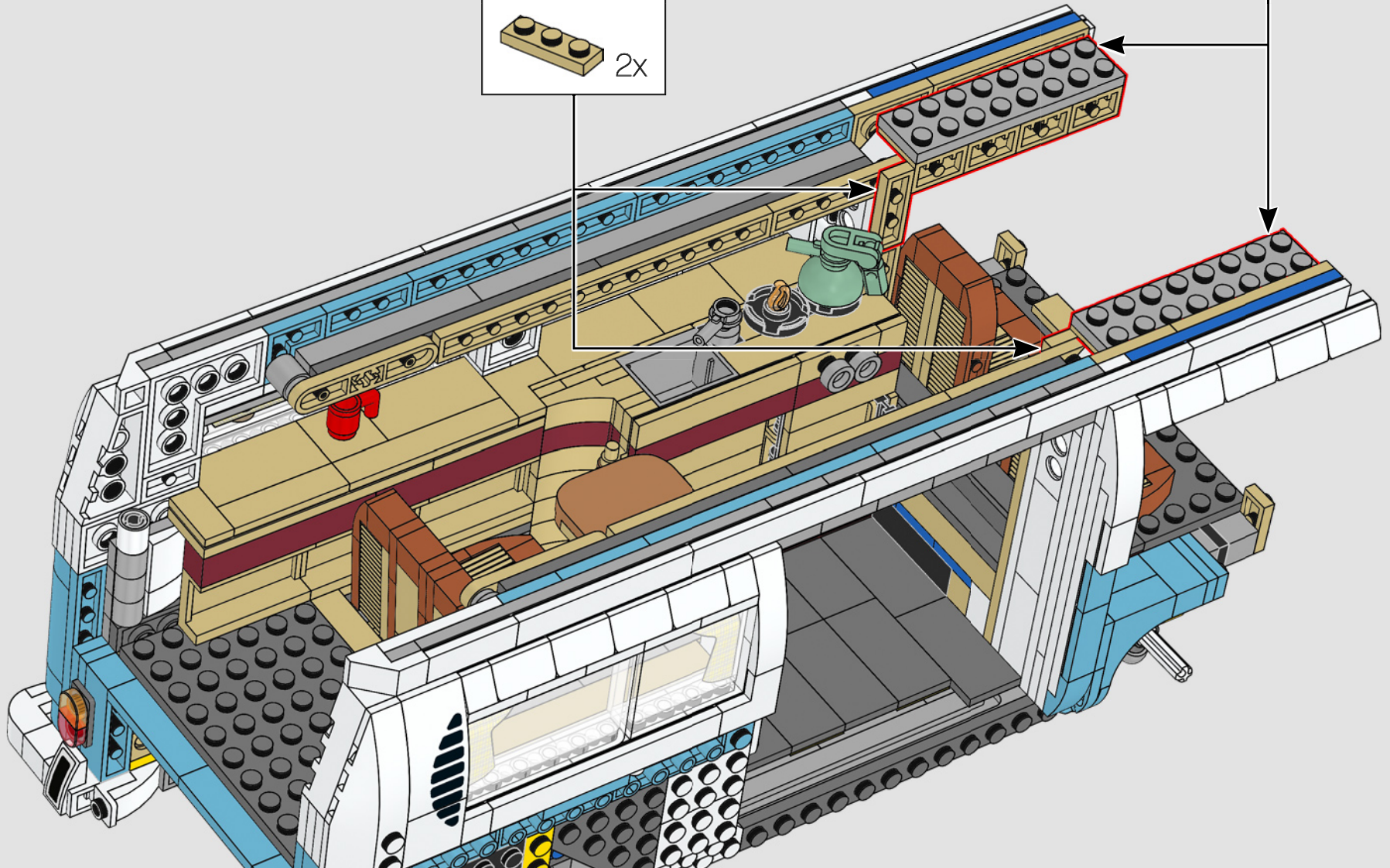
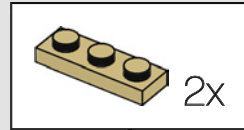
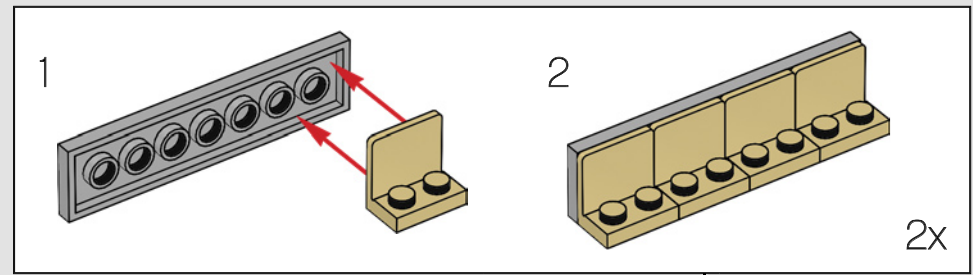

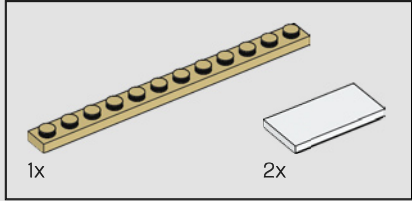
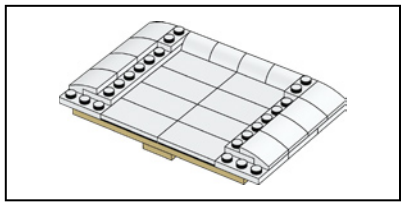

251

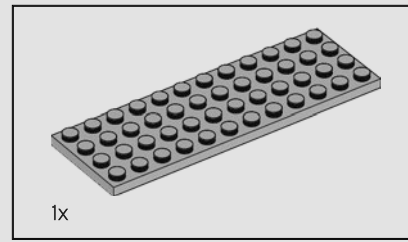
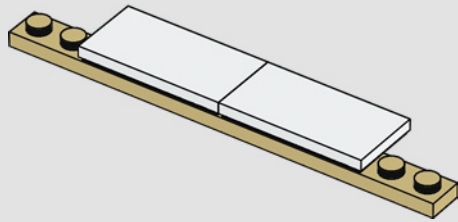

252

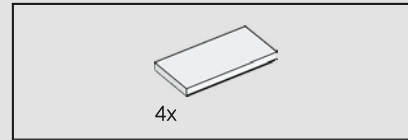
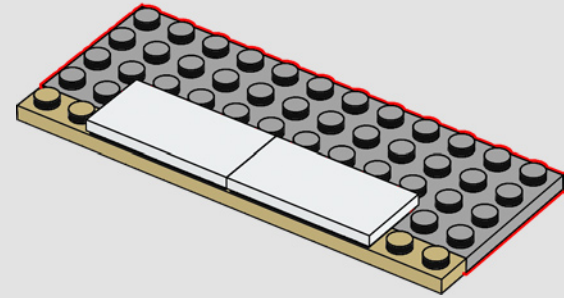

253

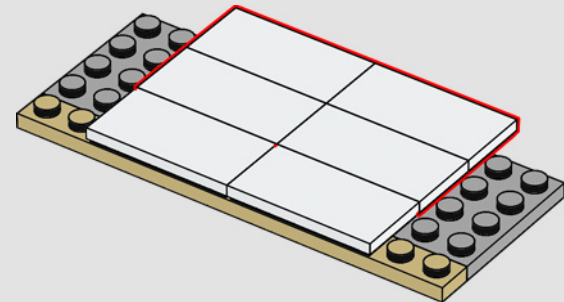

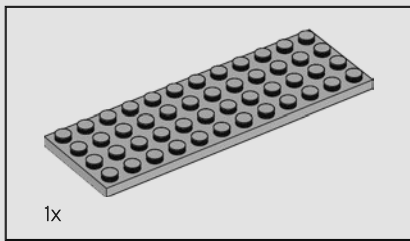

254

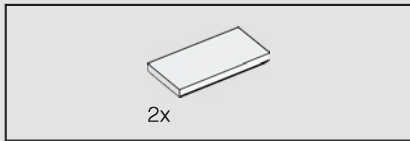
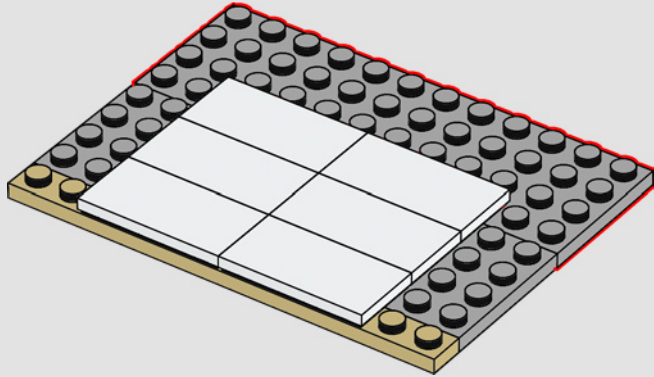

255

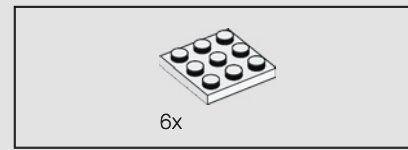
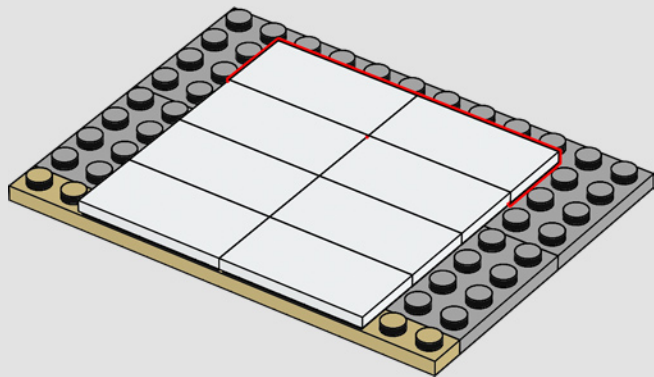

256

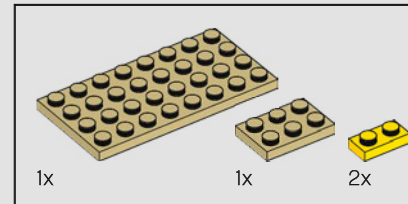
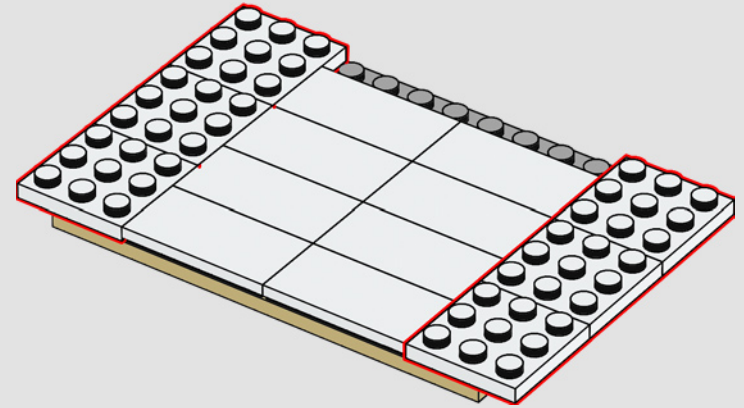

257

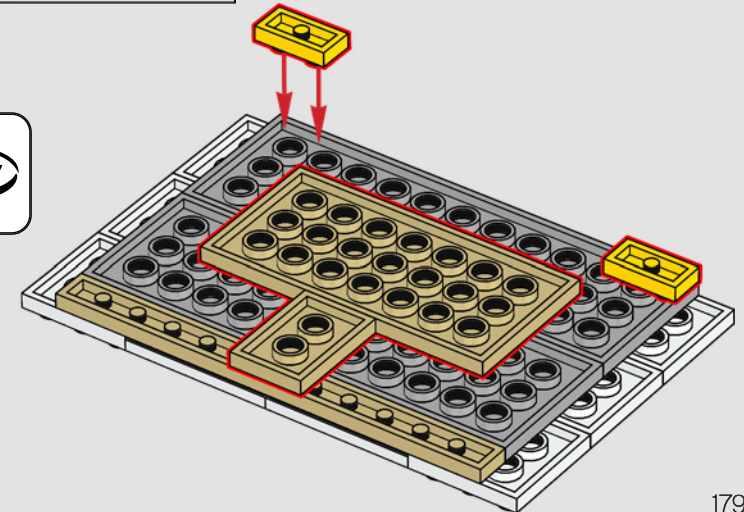
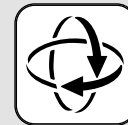

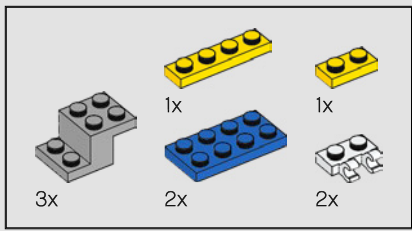

258

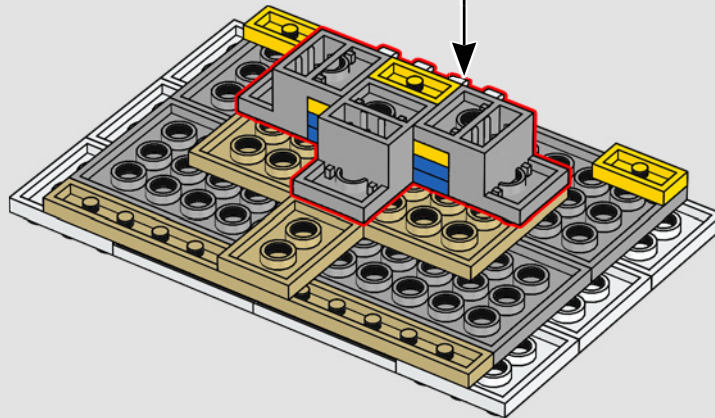
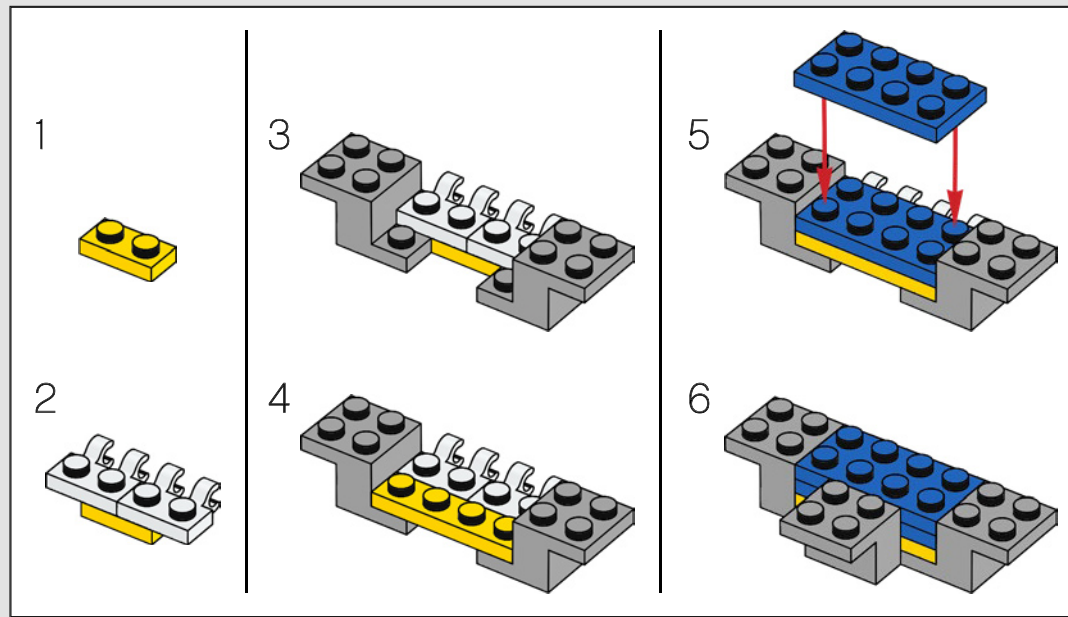

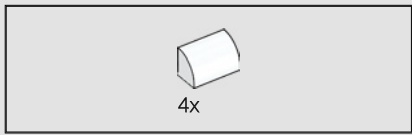

259

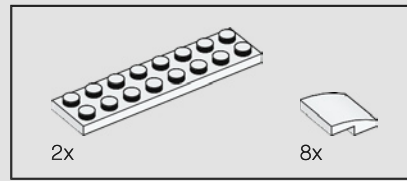
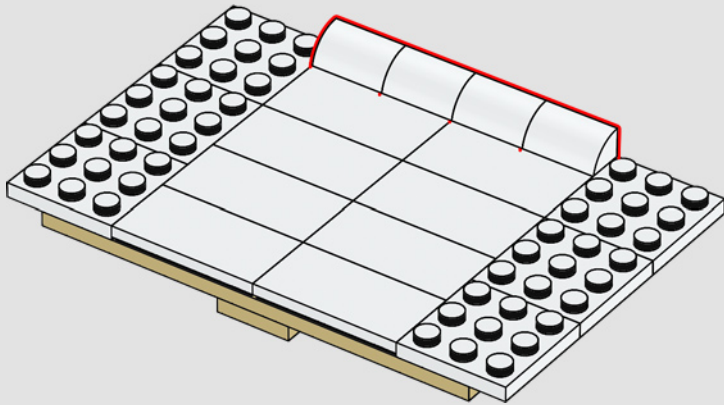

260

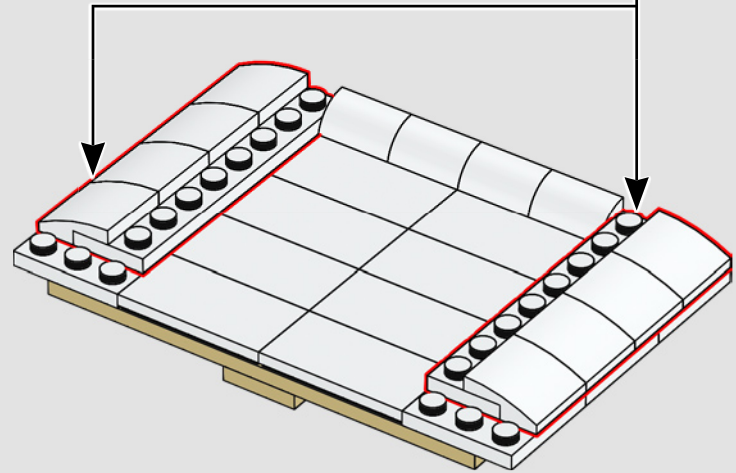
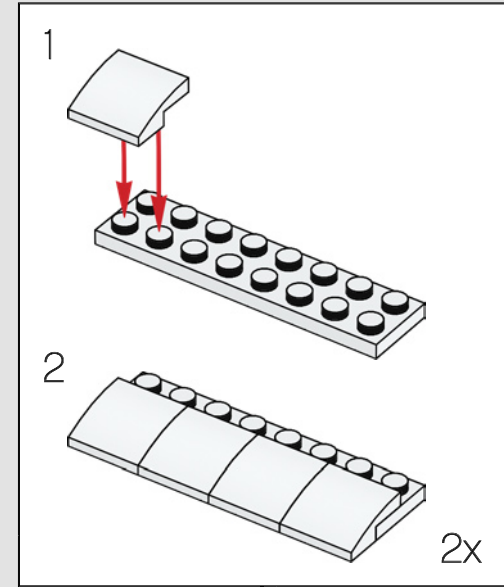



2x

261

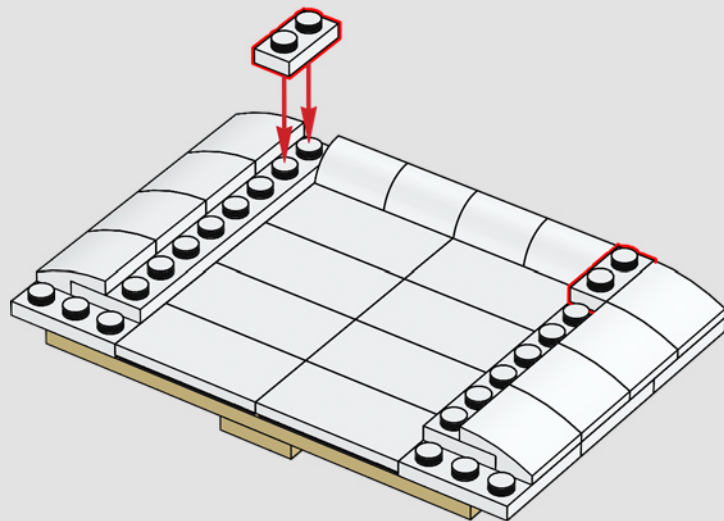

262

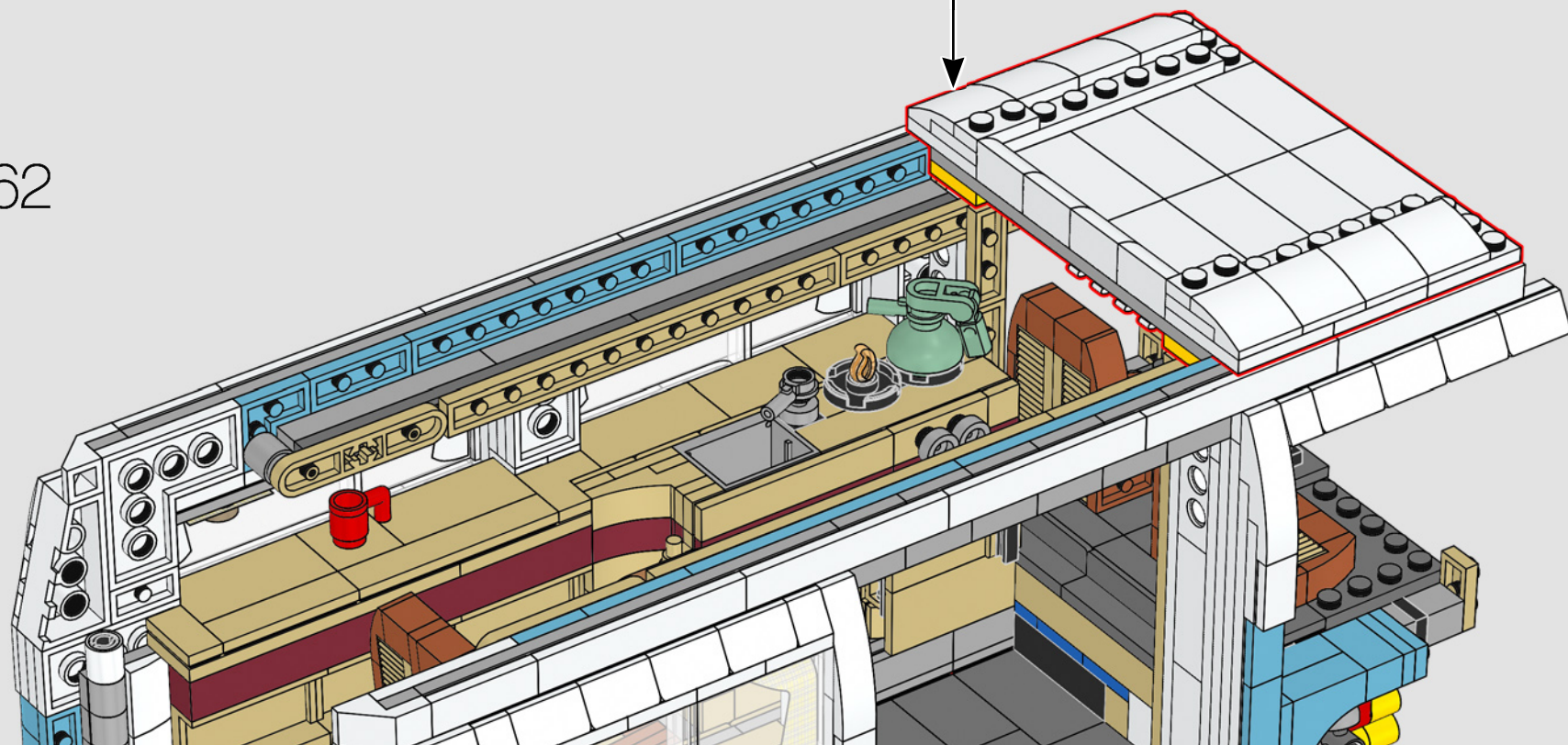

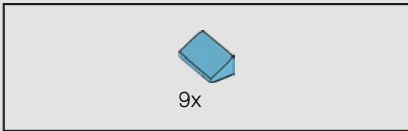
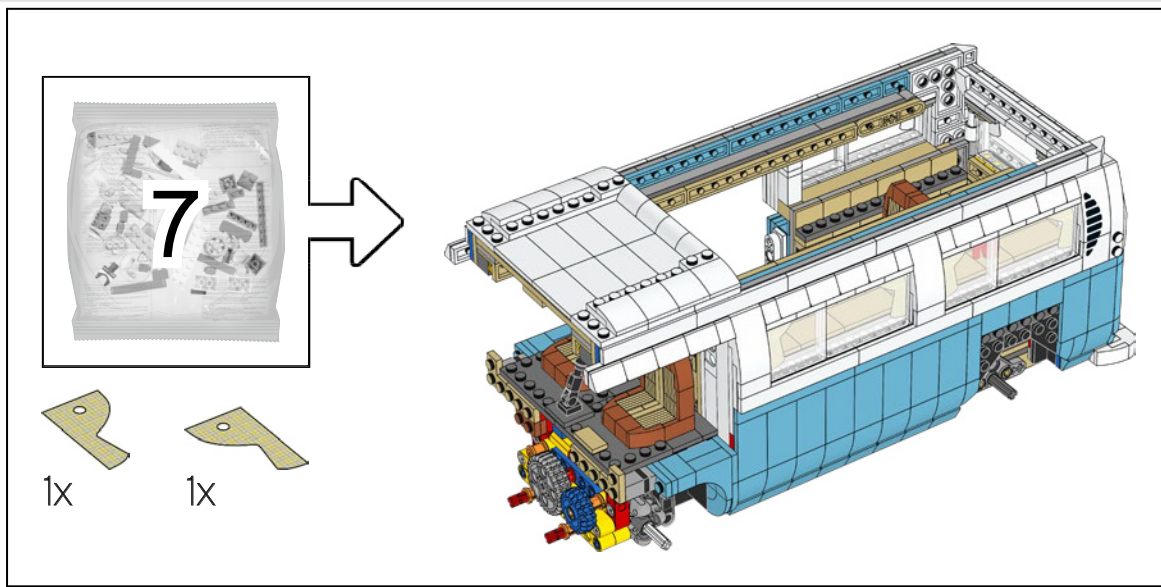

263

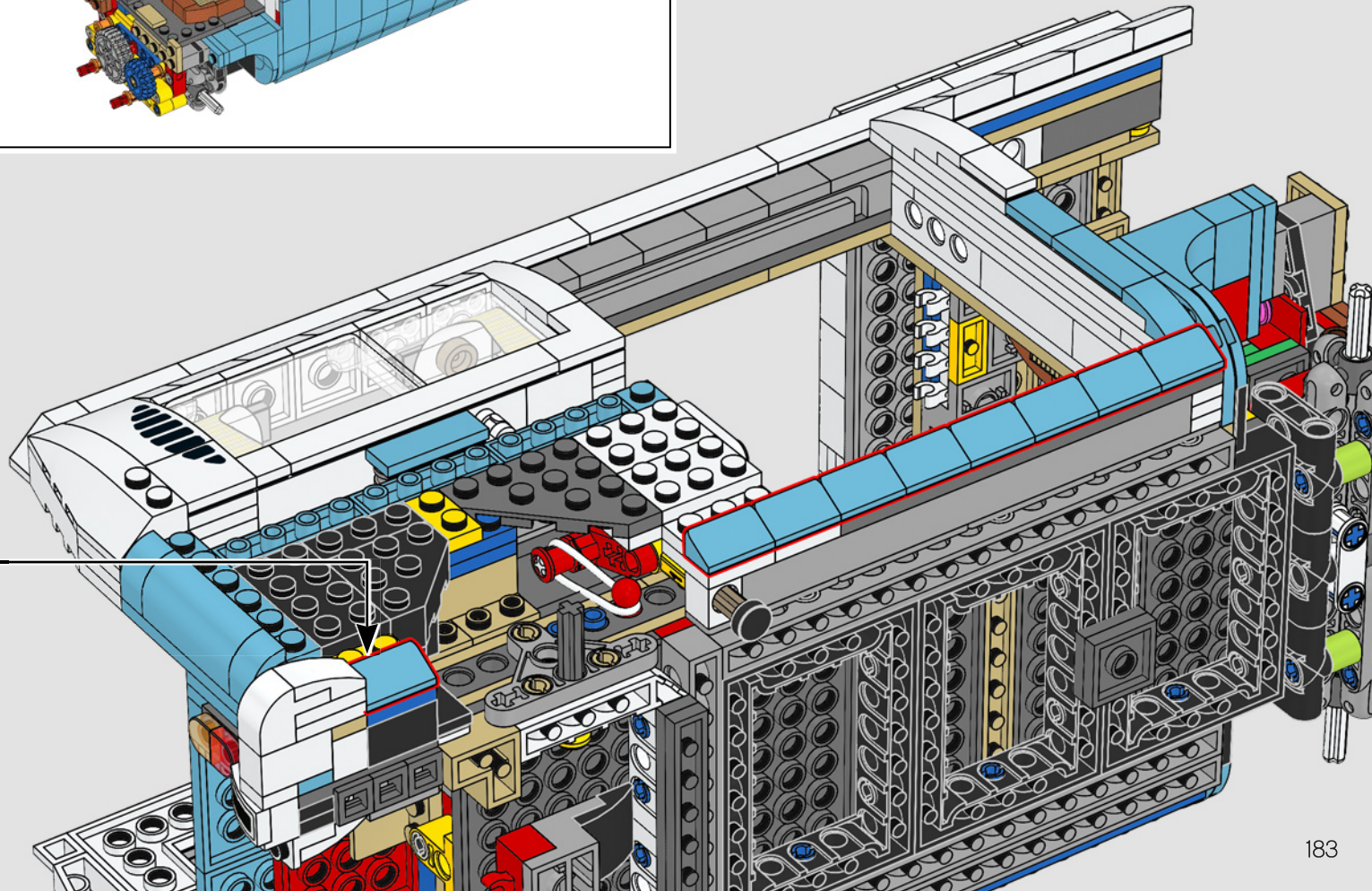
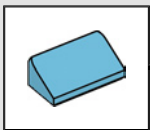

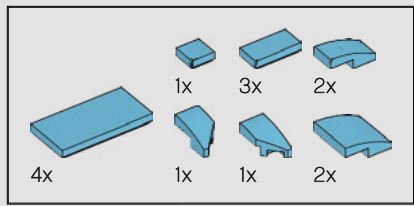

264

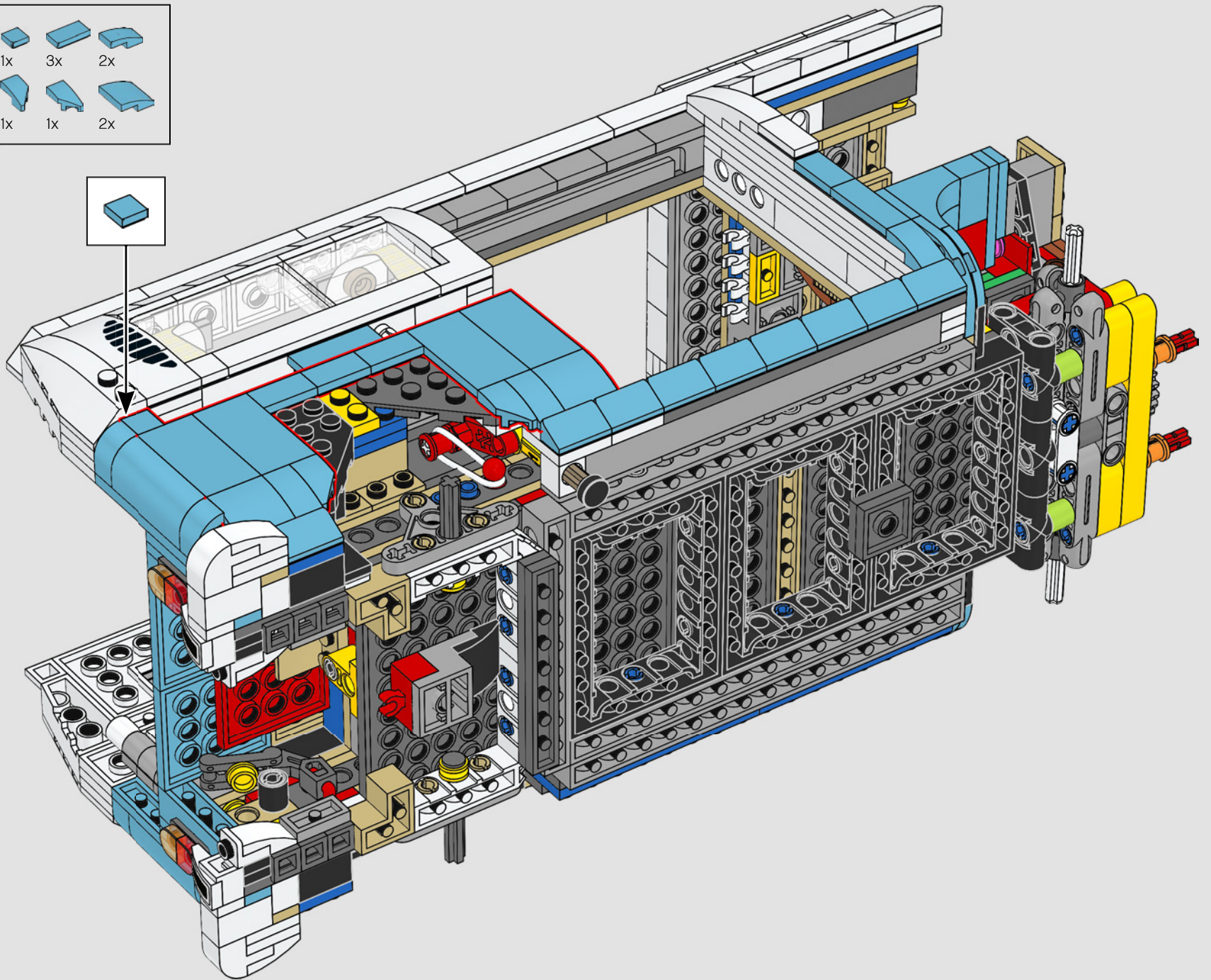
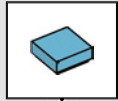

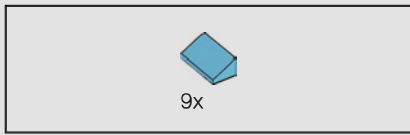

265

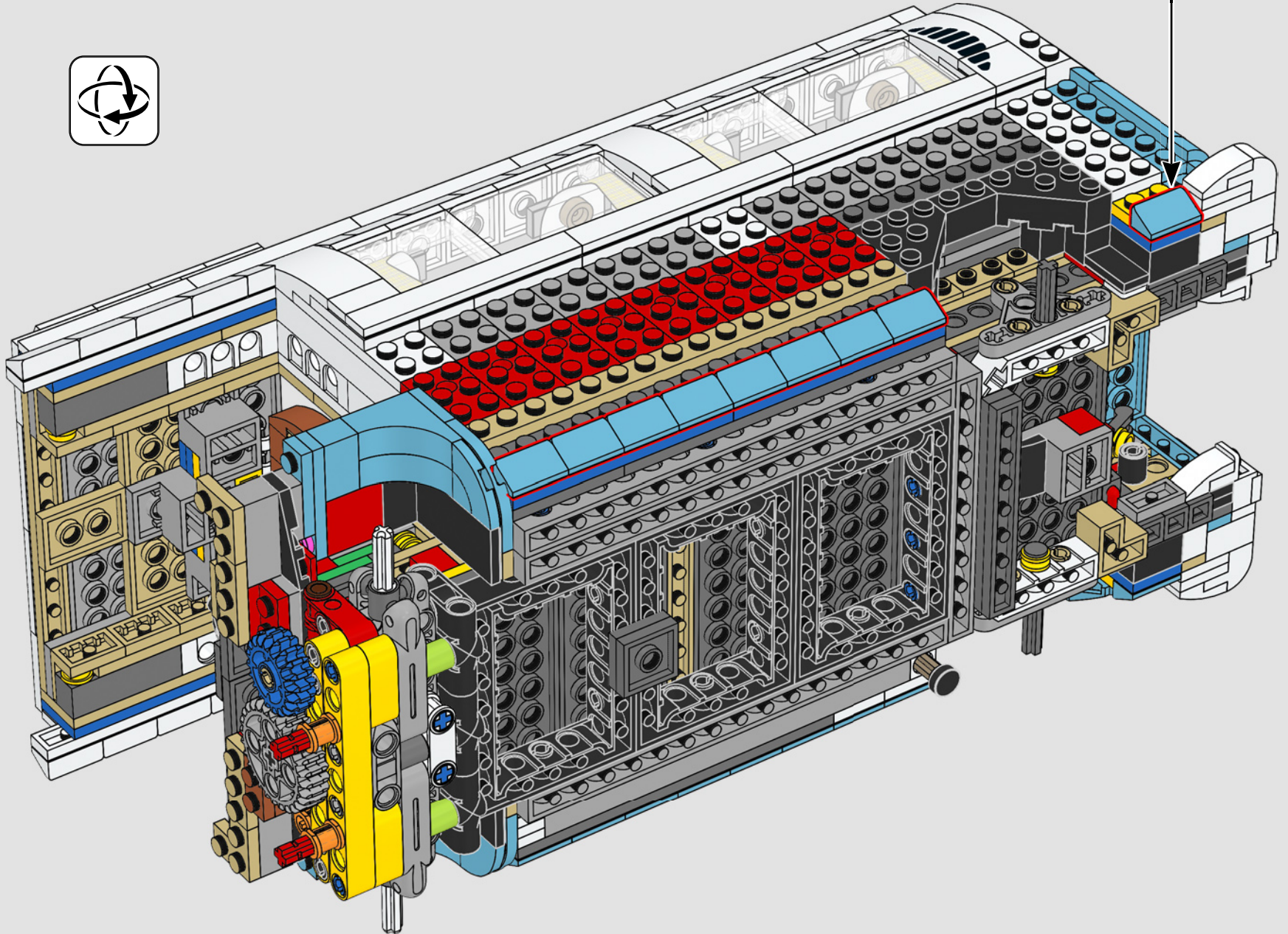
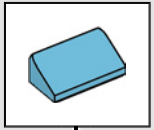

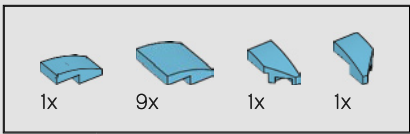

266

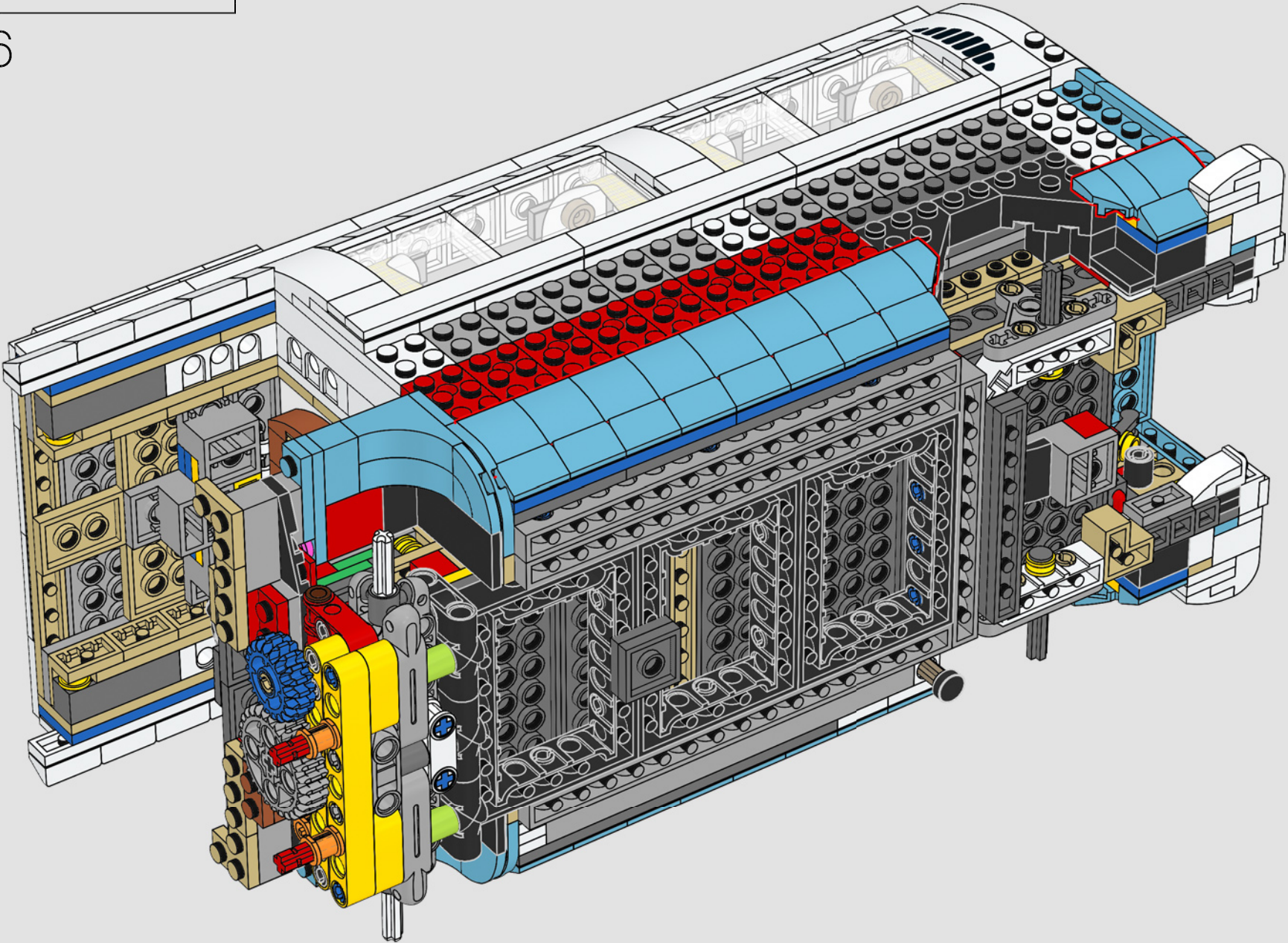

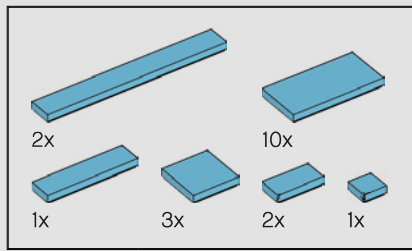

267

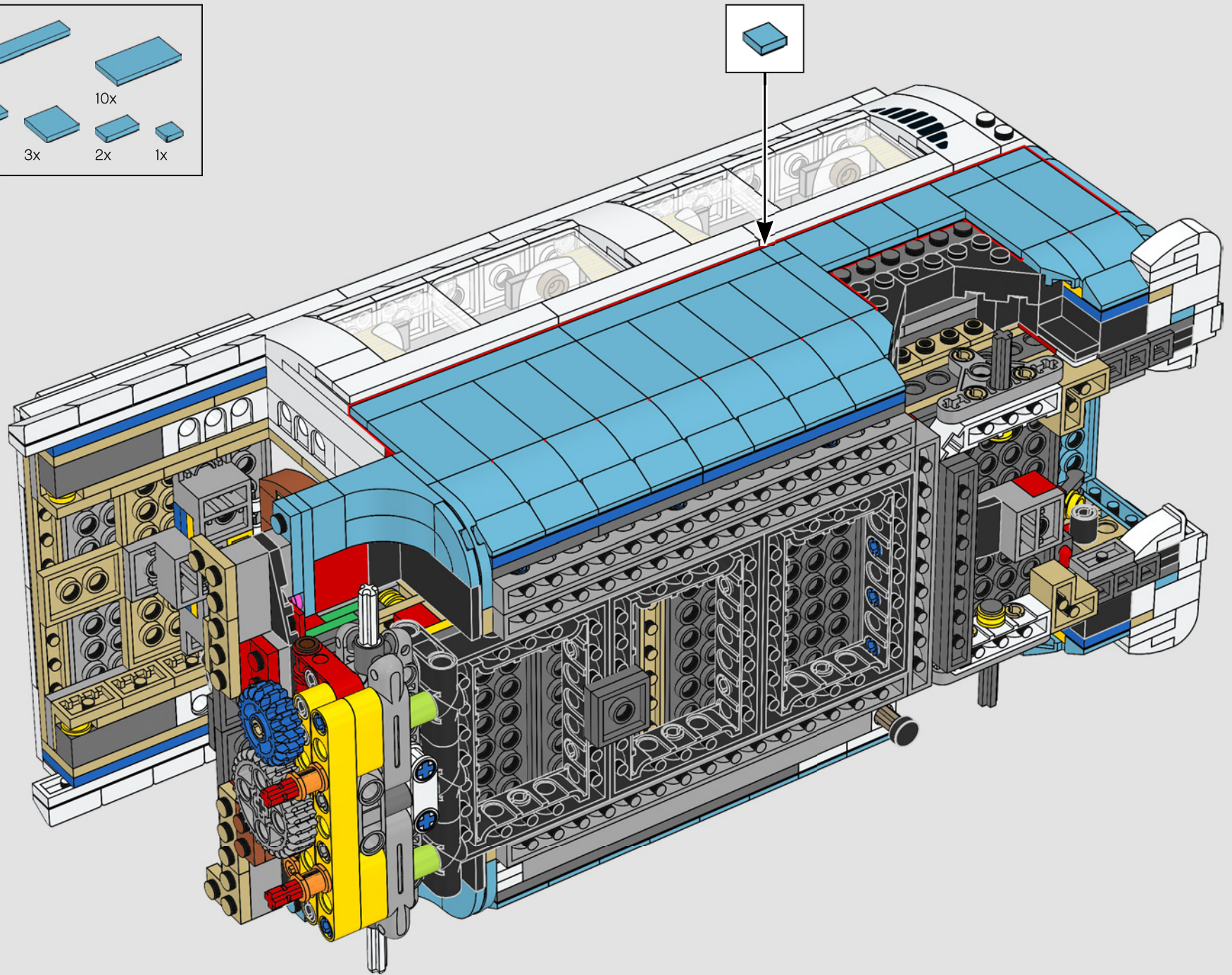

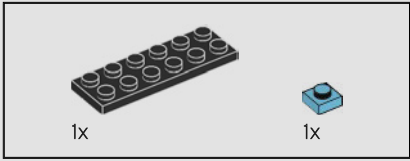
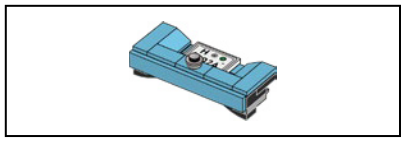

268

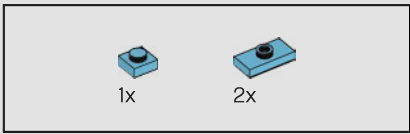
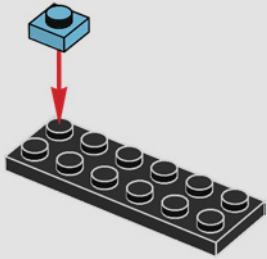

269

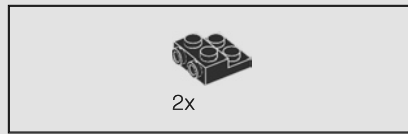
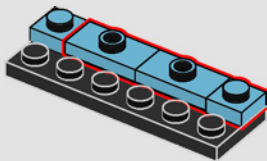

270

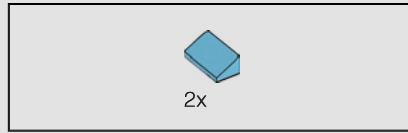
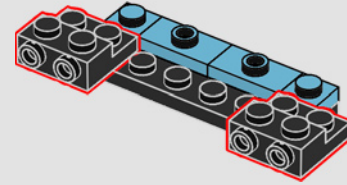

271

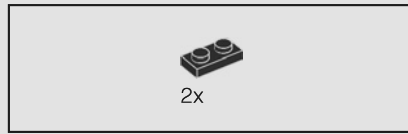
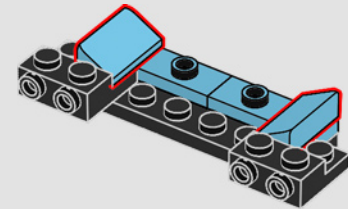

272

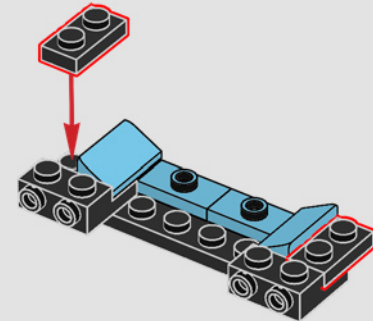

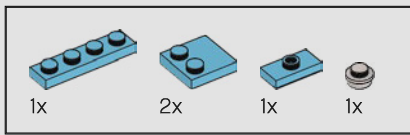

273

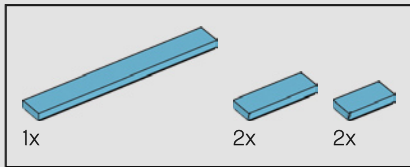
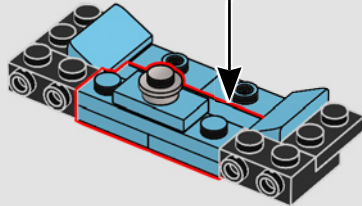
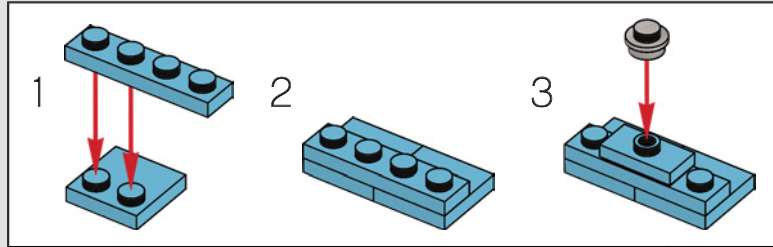

274

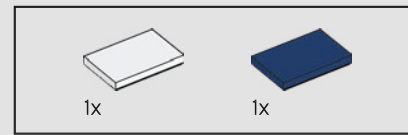
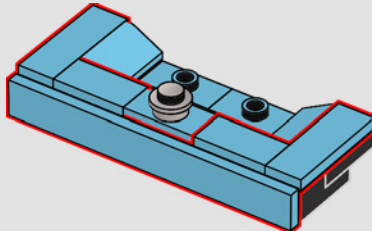

275

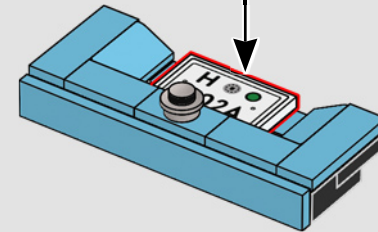
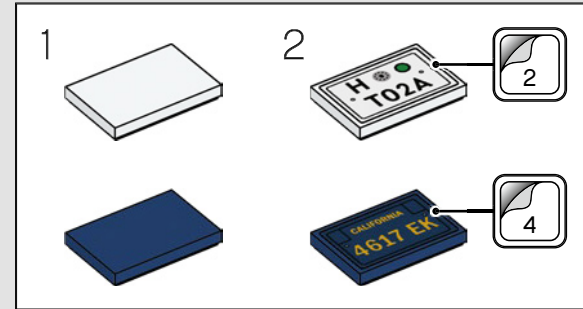

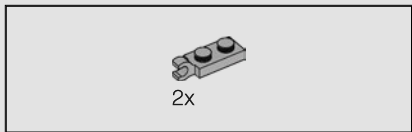

276

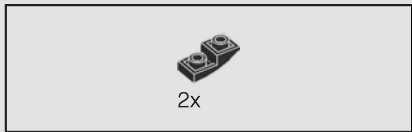
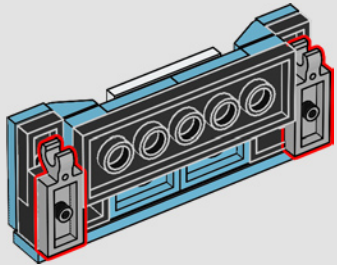

277

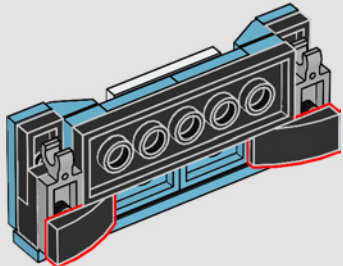

278

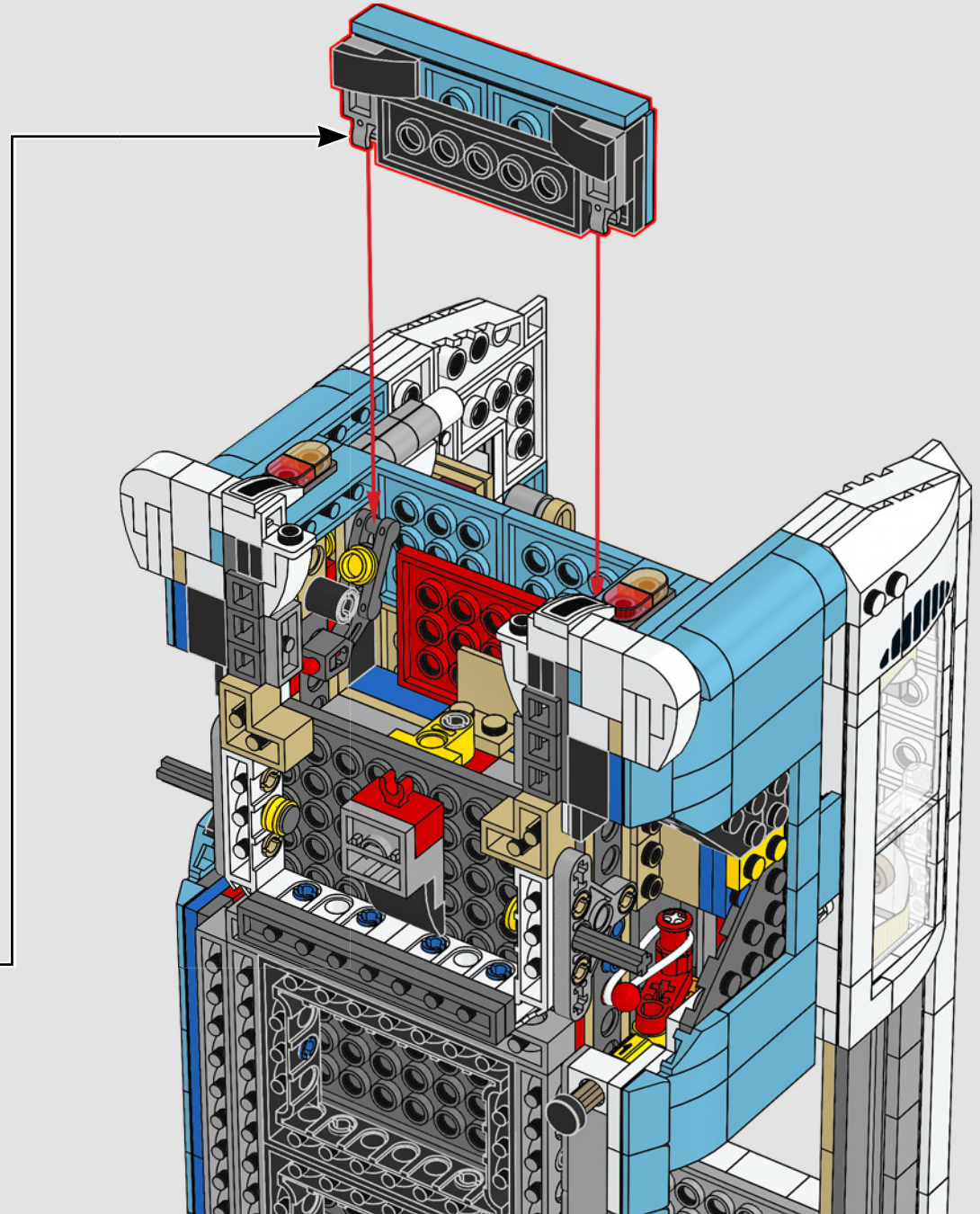

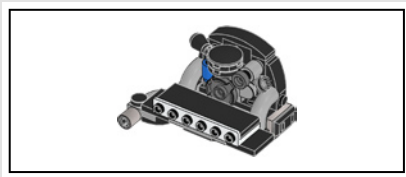

279

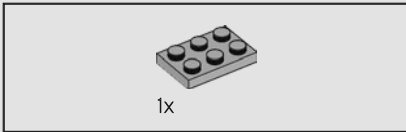
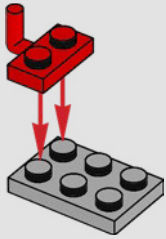

280

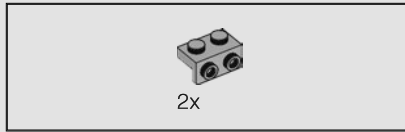
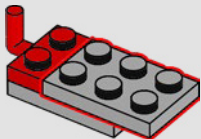

281

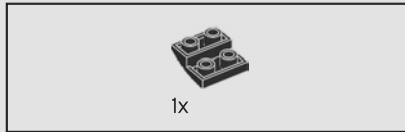
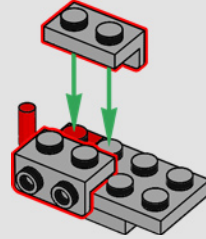

282

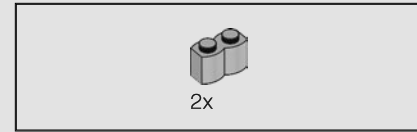
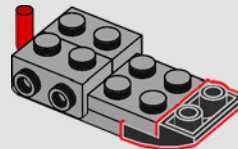

283

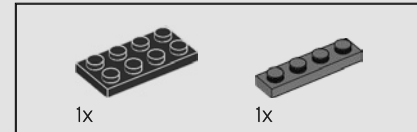
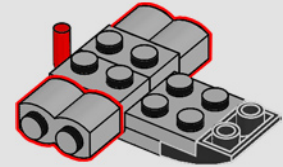

284

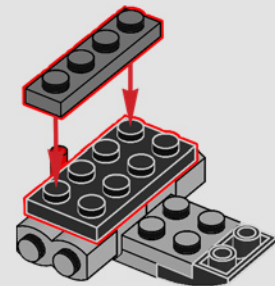

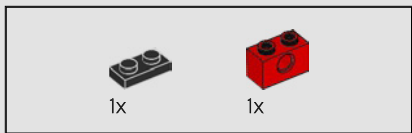

285

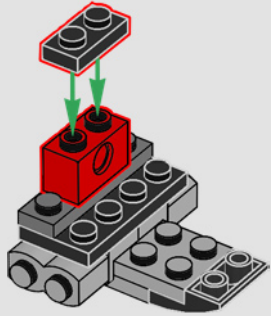

286

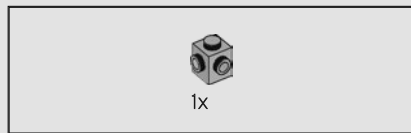
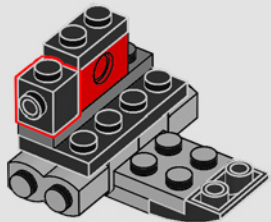

287

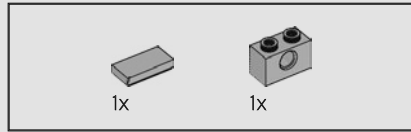
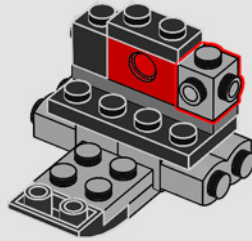
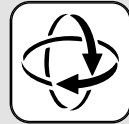

288

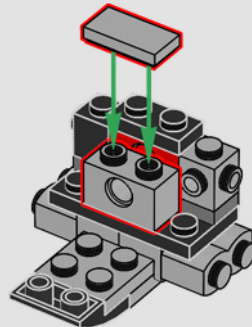

289

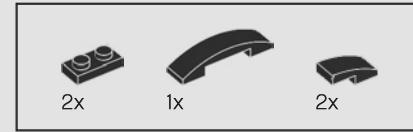
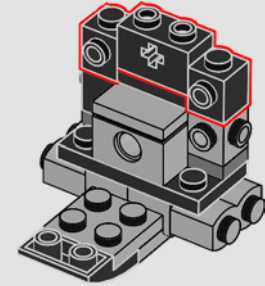

290

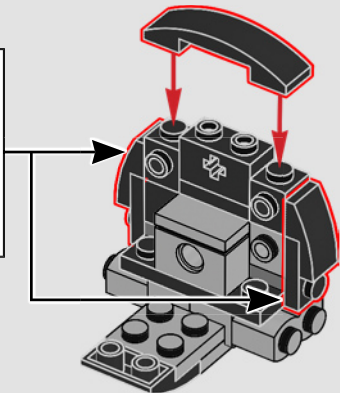
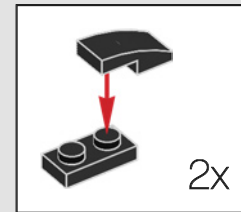



291

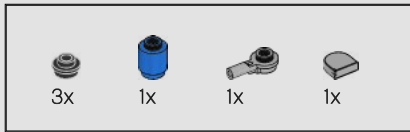
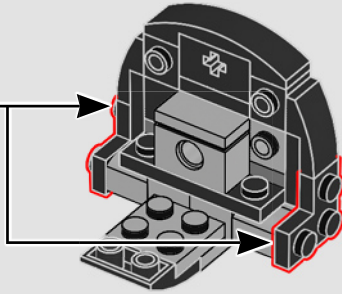

292

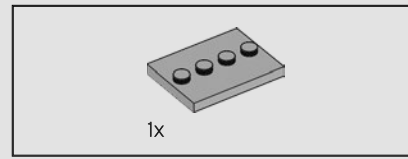
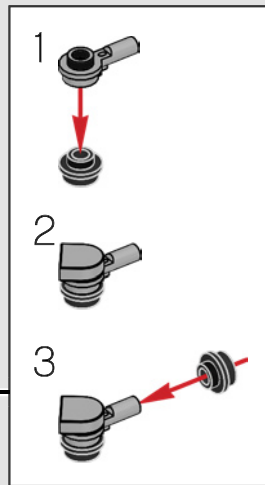
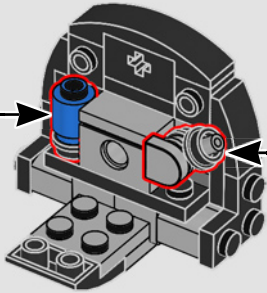
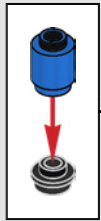

293

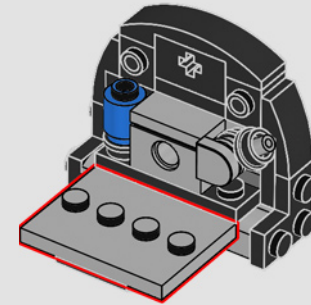

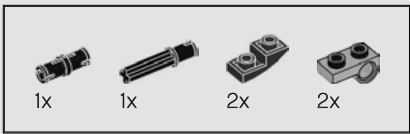

294

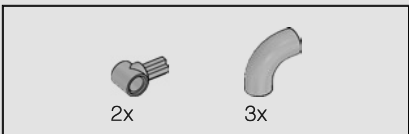
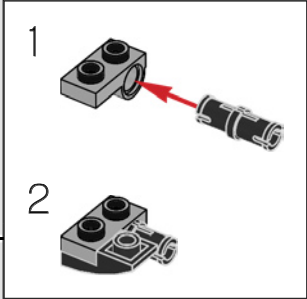
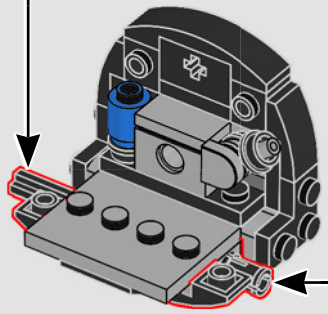
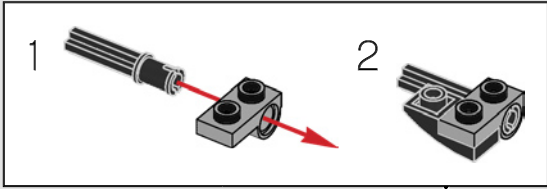

295

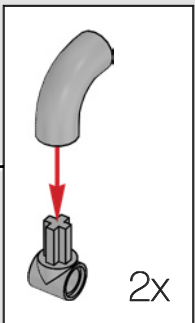
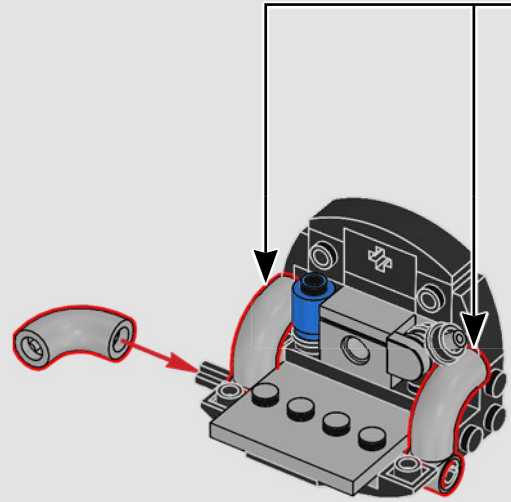

296

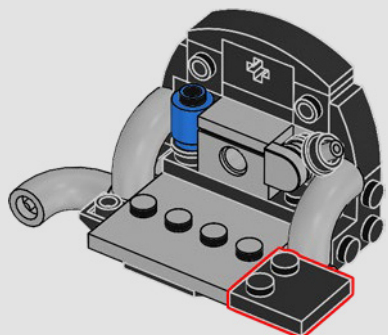

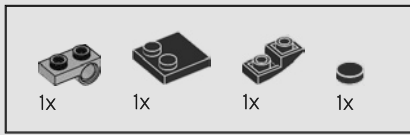

297

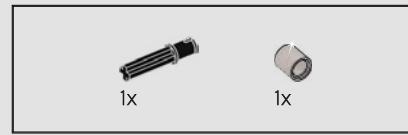
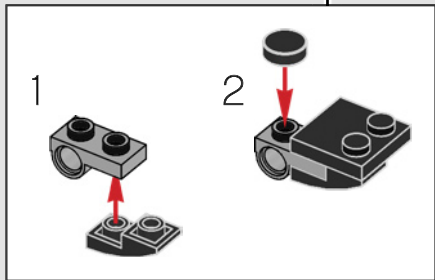
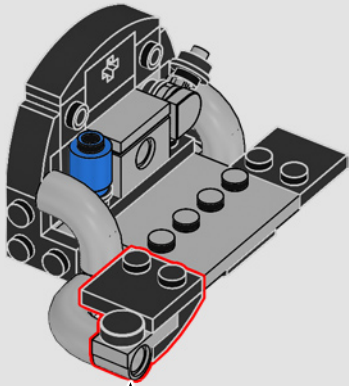

298

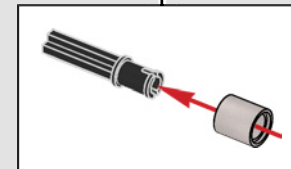
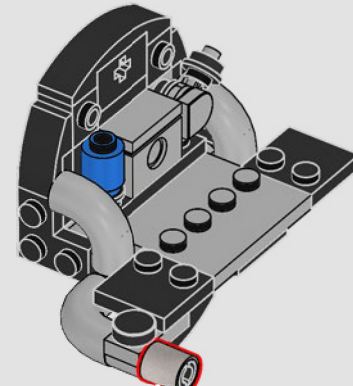

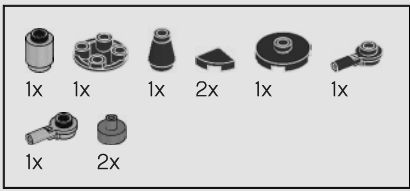

299

1



2



3

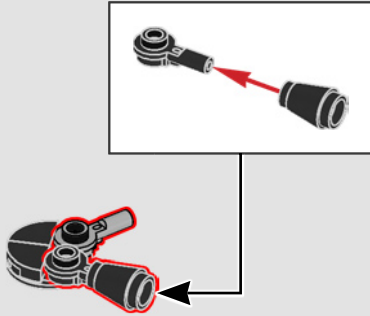

4

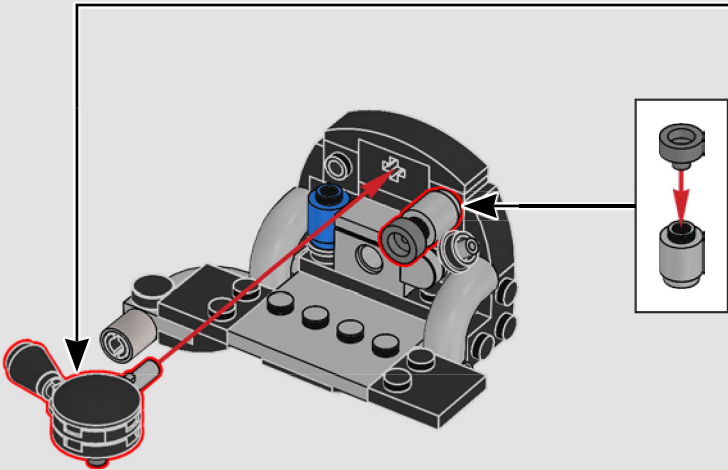



300

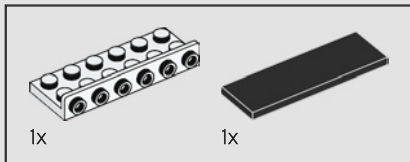
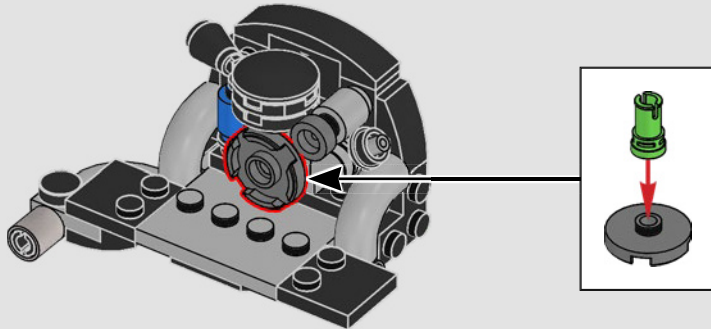

301

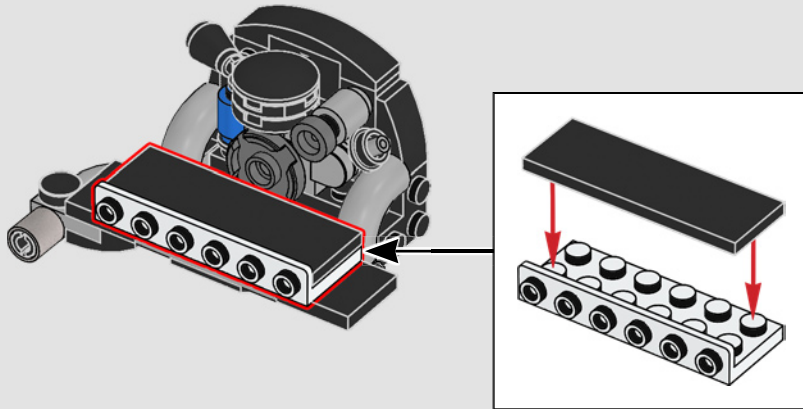

302

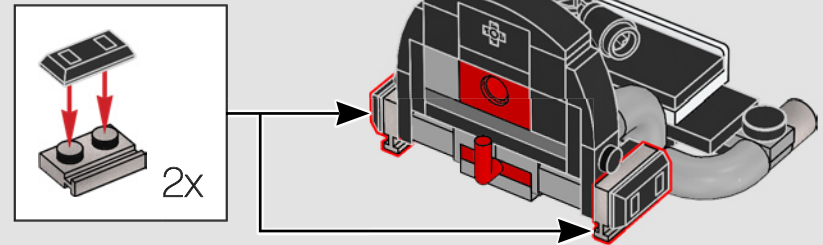
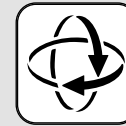

Der luftgekühlte Boxermotor war für seine Zuverlässigkeit, seine überschaubare Leistung und seinen unverwechselbaren Klang bekannt.

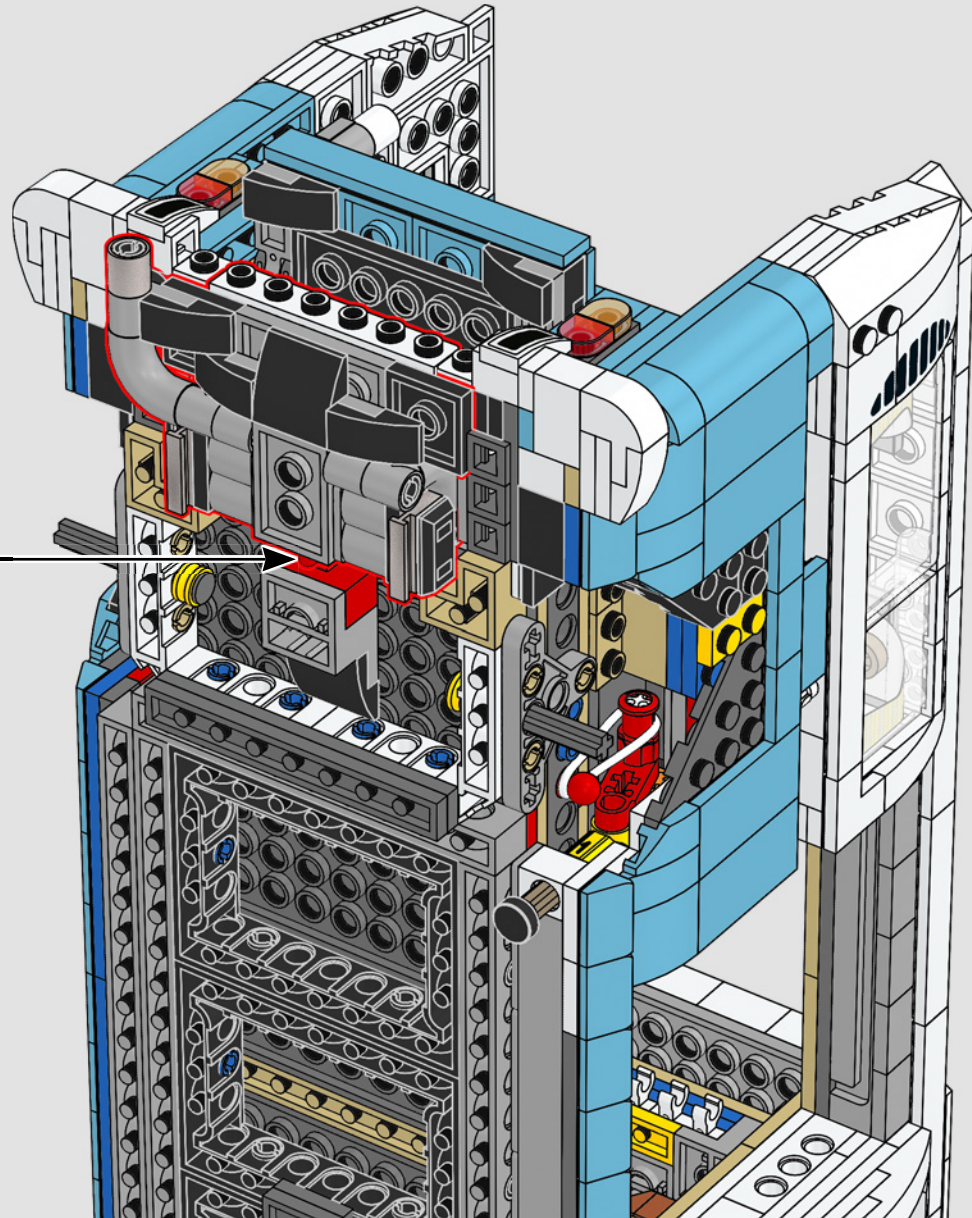

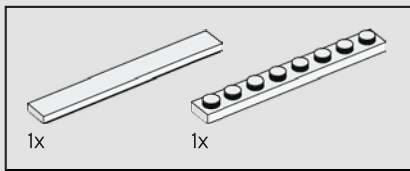

304

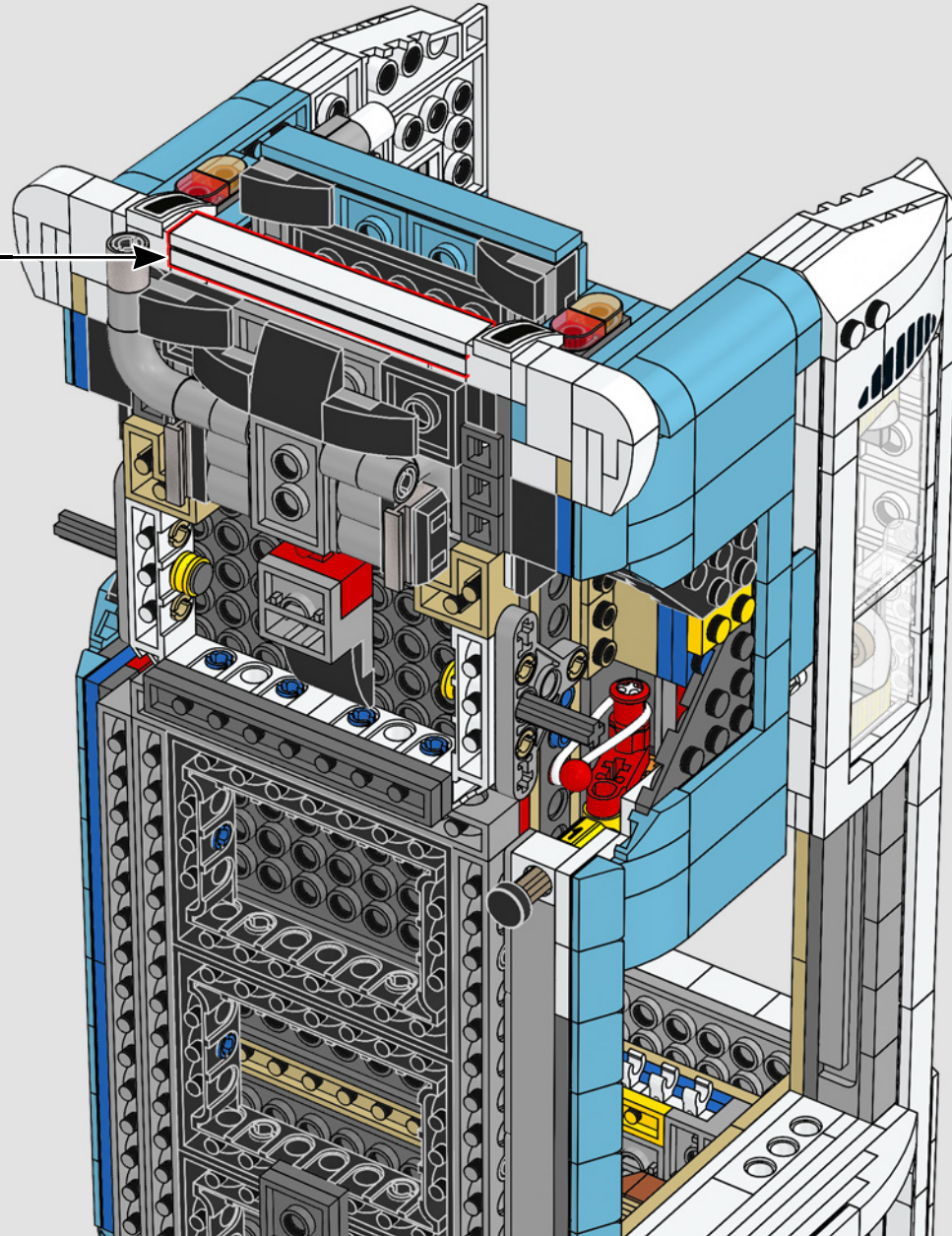
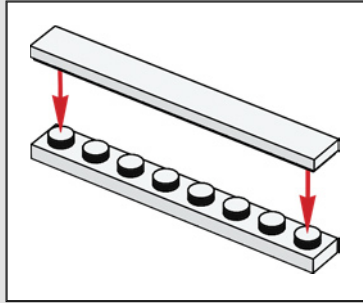

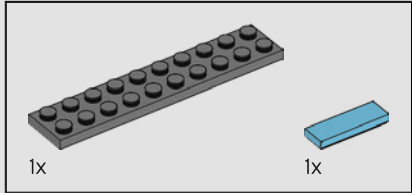
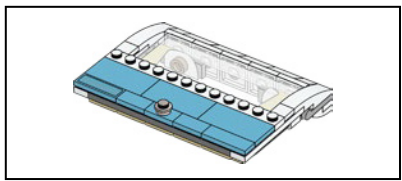

305

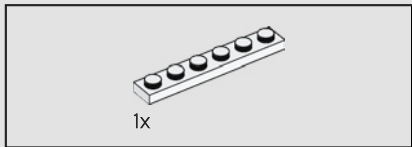
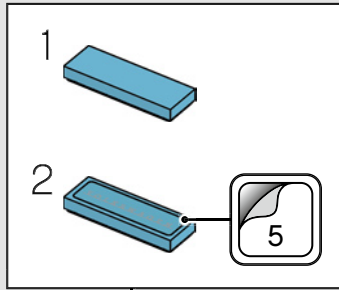
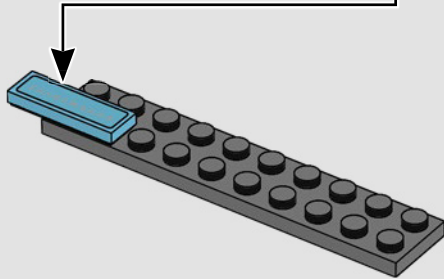

306

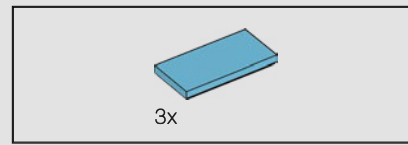
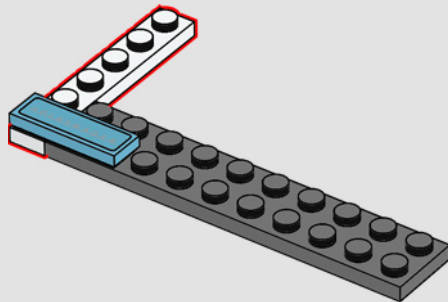

307

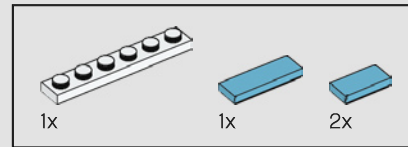
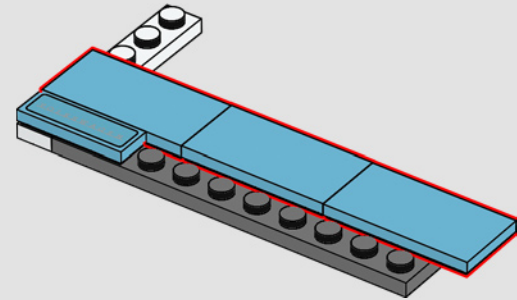

308

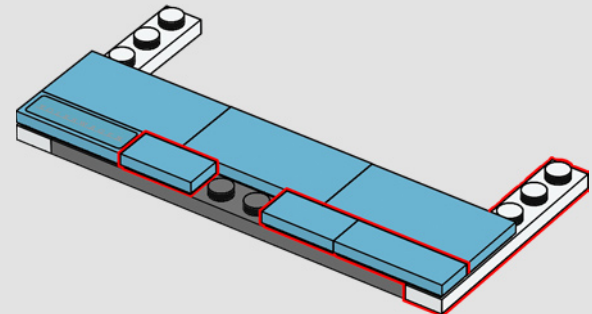

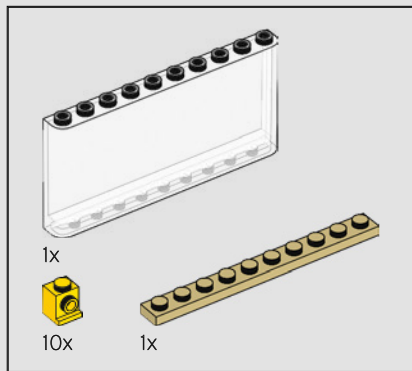

309

1

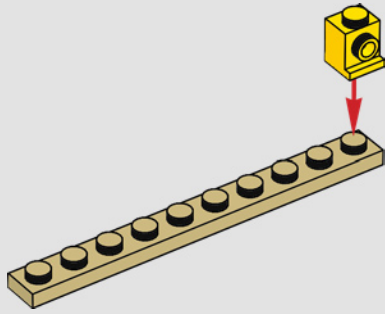

2

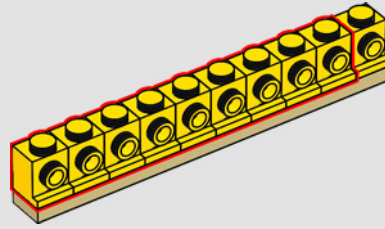

3

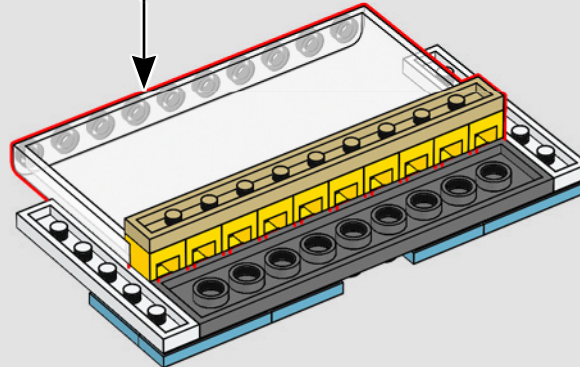
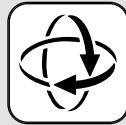
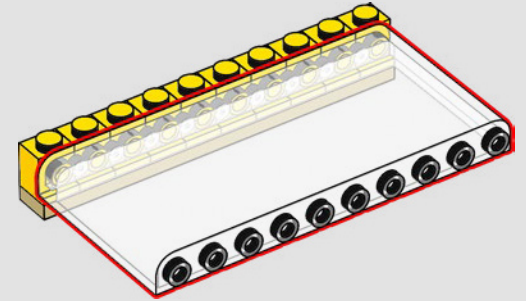

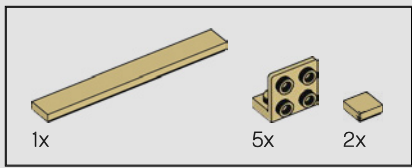

310

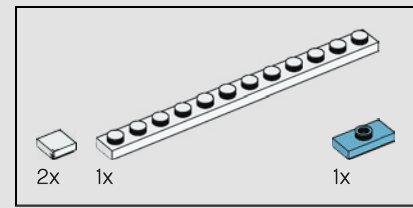
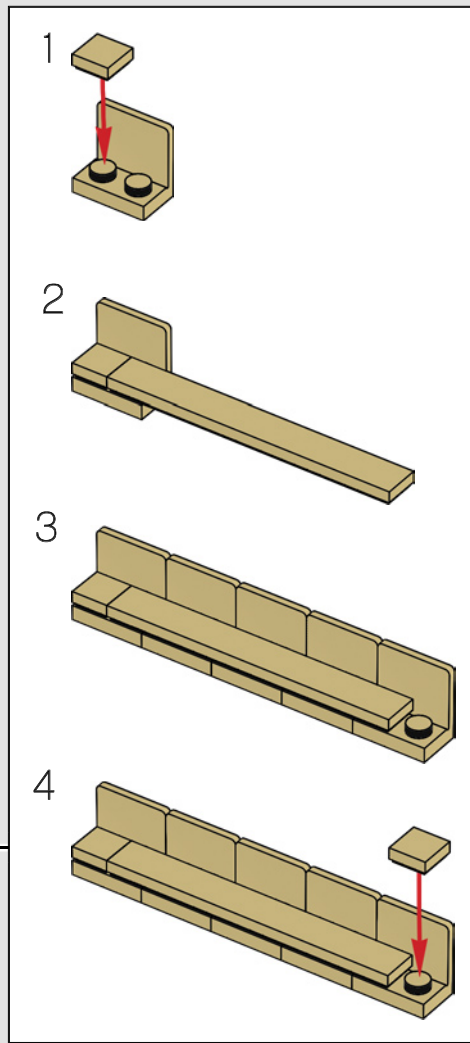
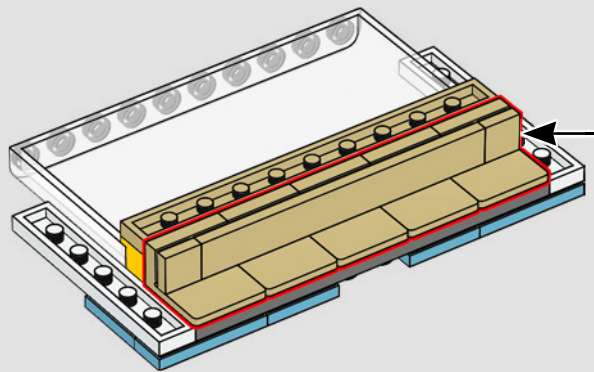

311

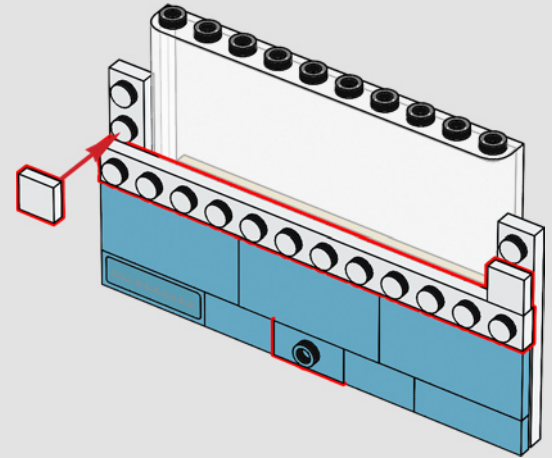

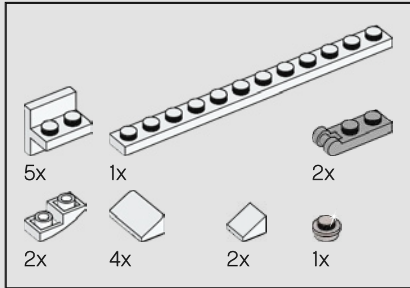
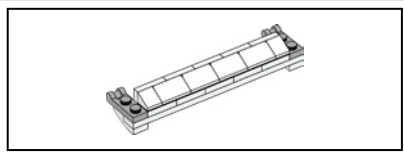

312

1

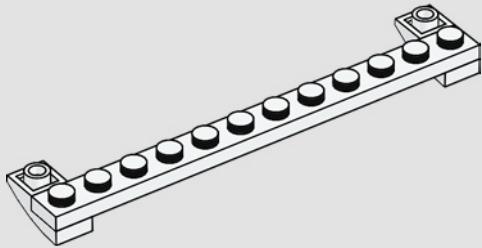

2

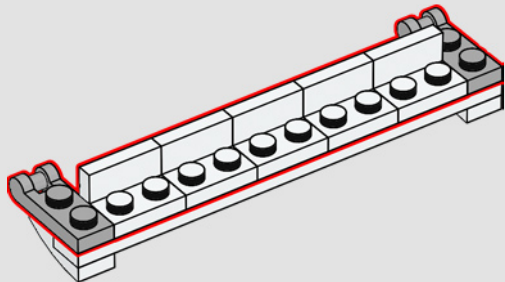

3

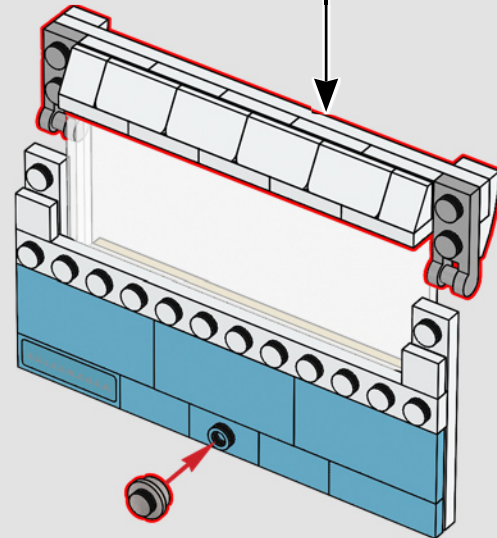
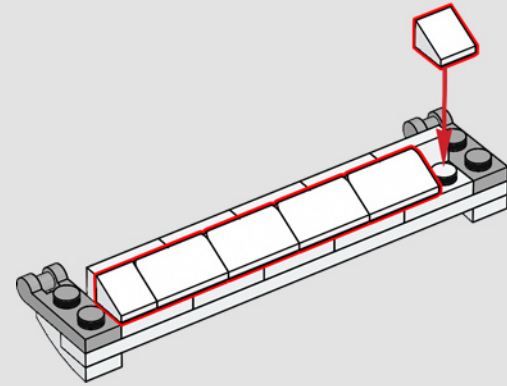

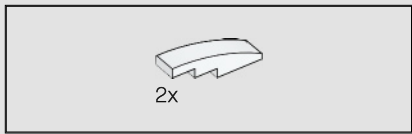

313

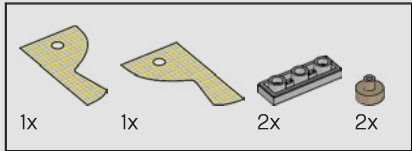
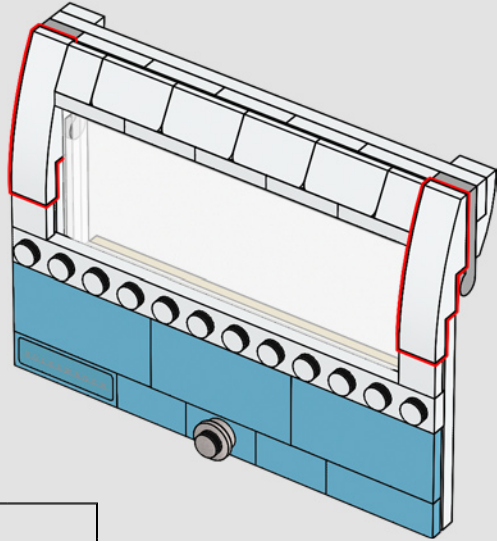

314

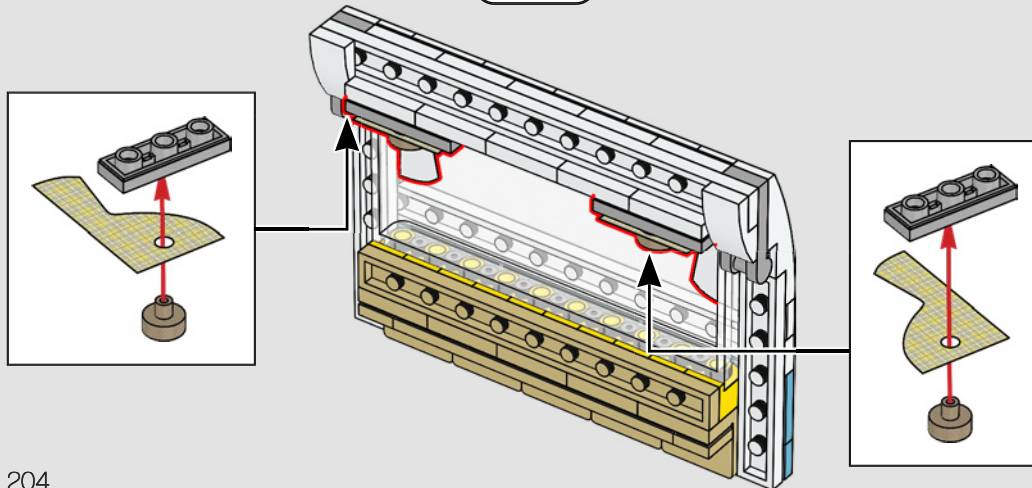

315

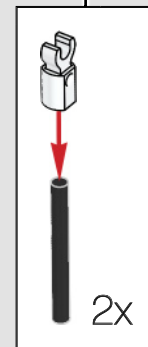
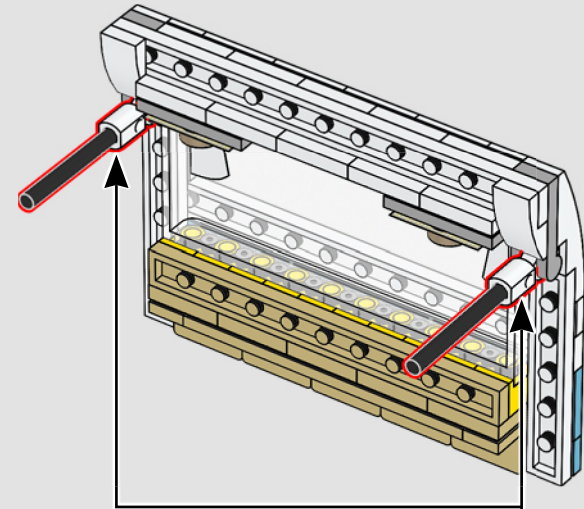

316

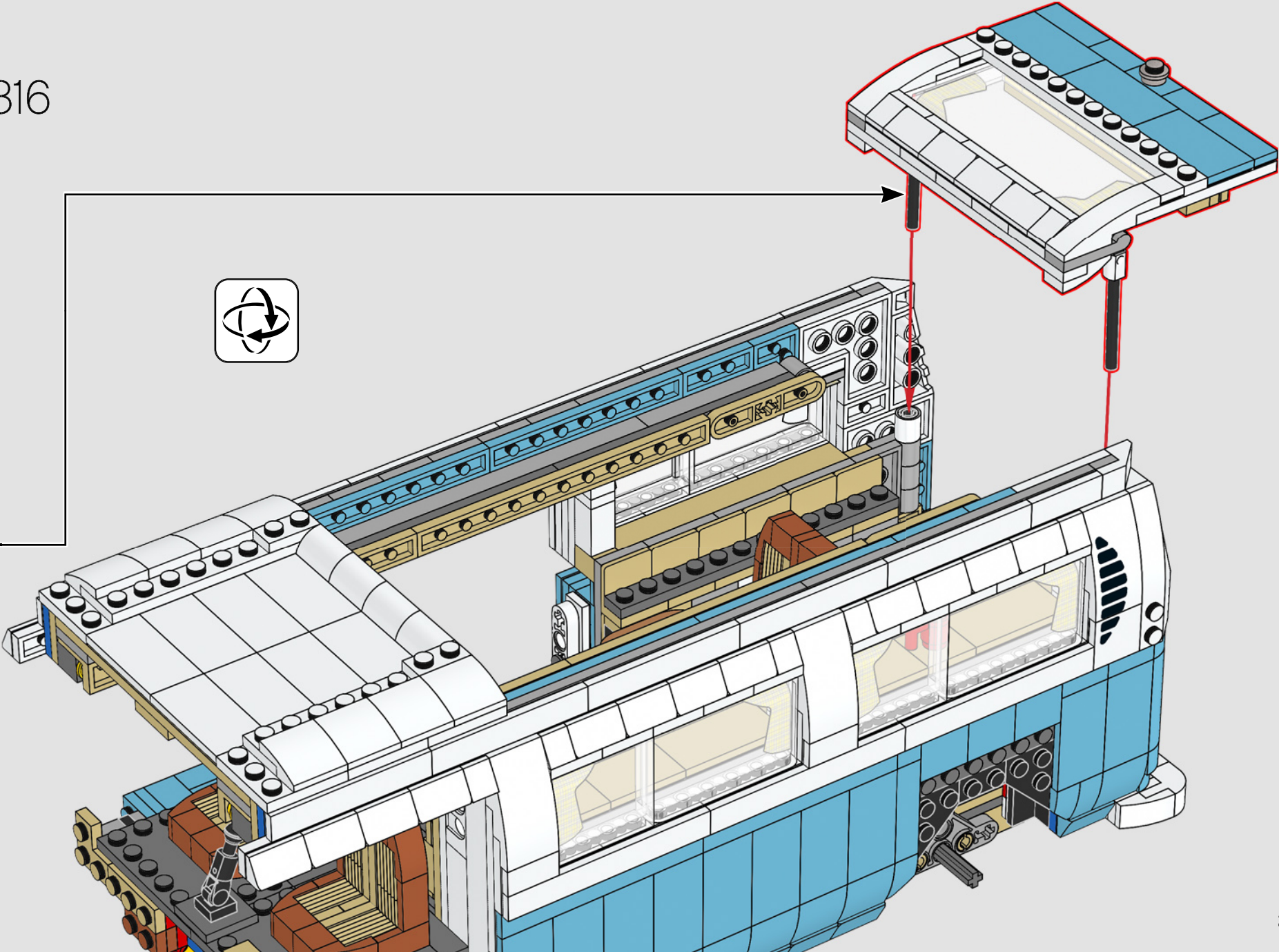

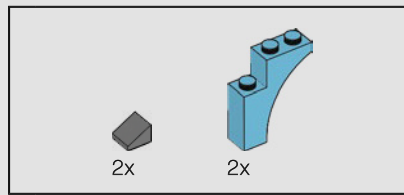
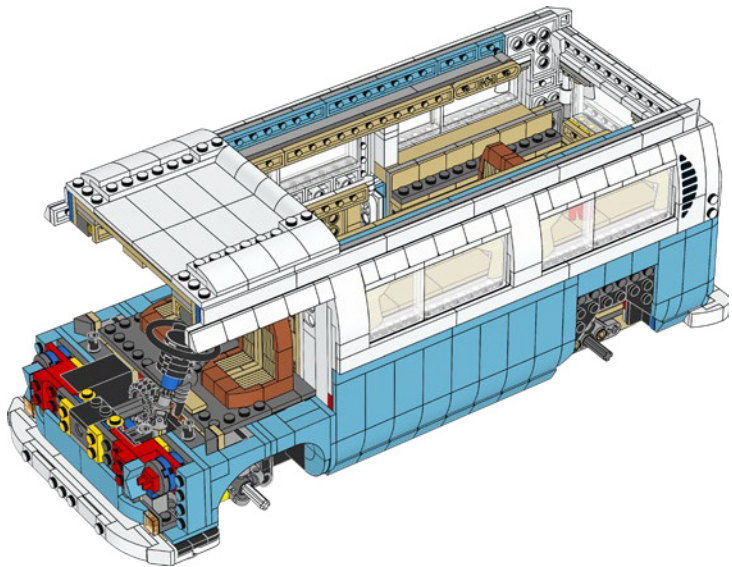
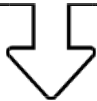

317

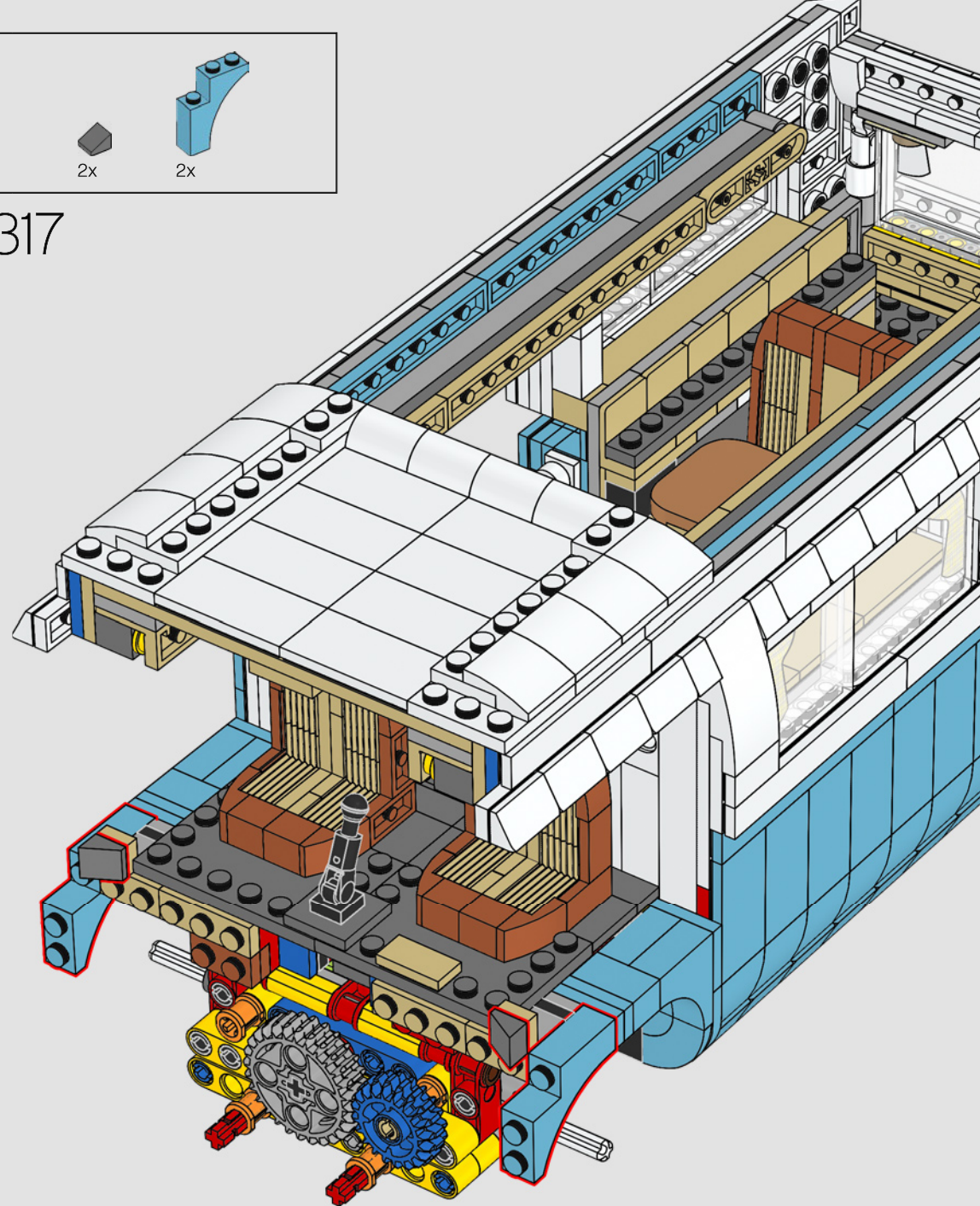

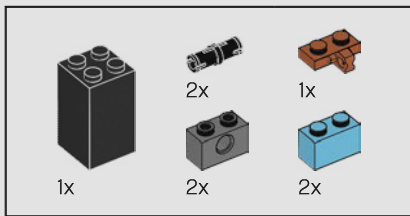

318

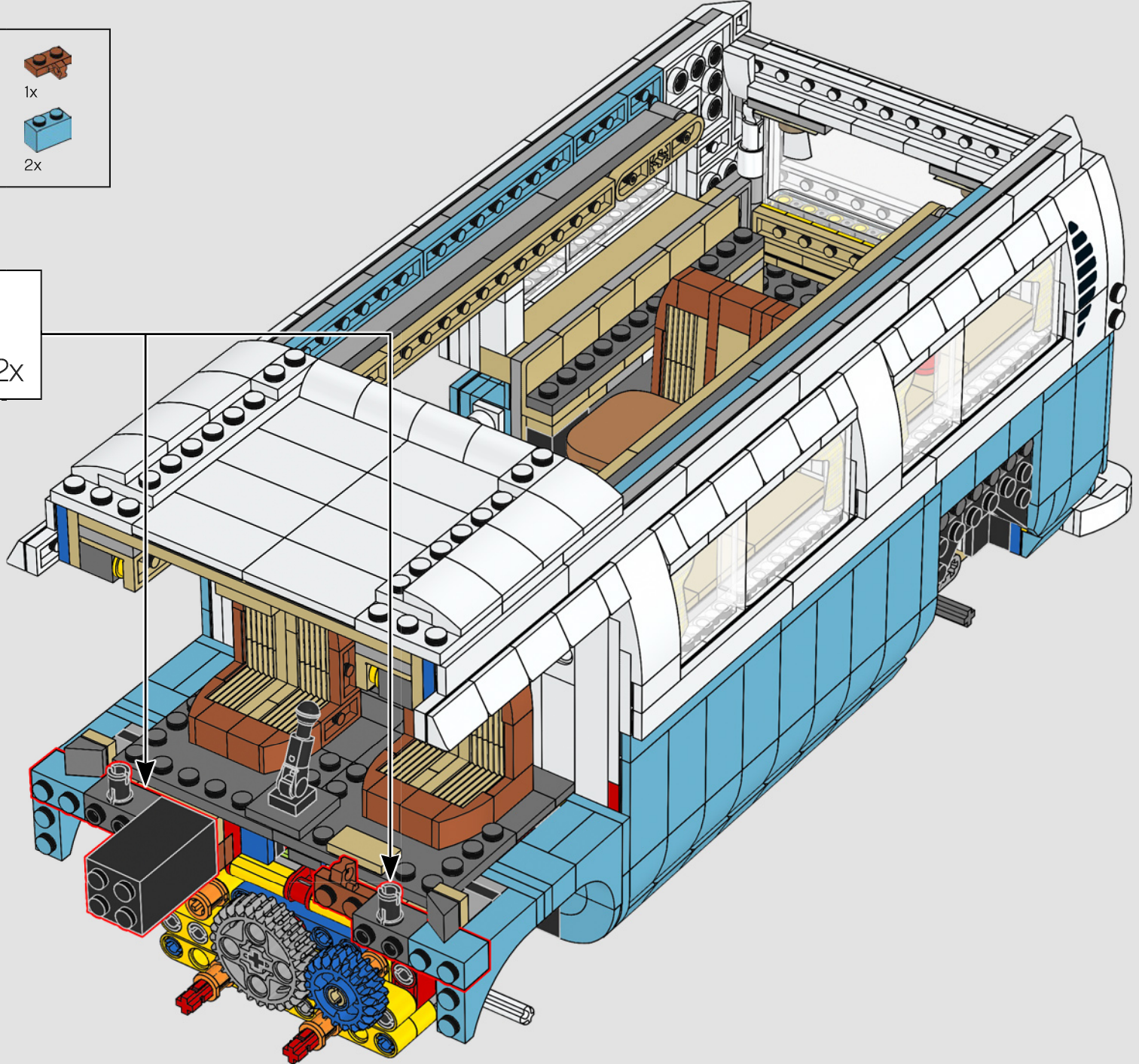
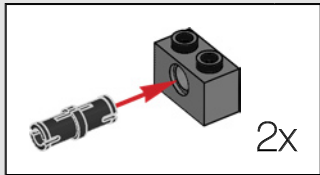

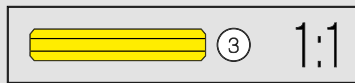
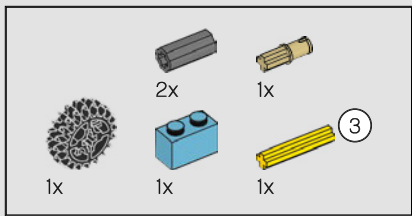

319

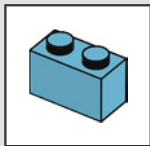
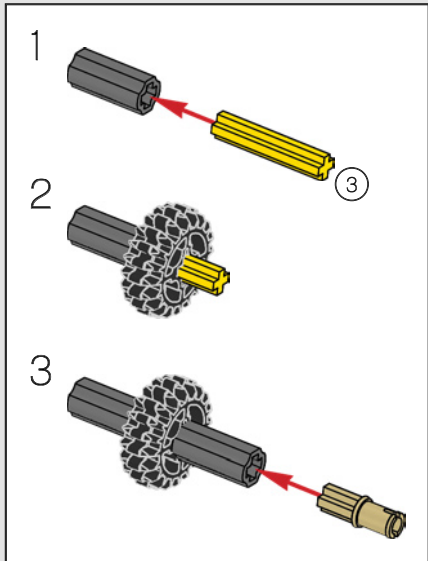
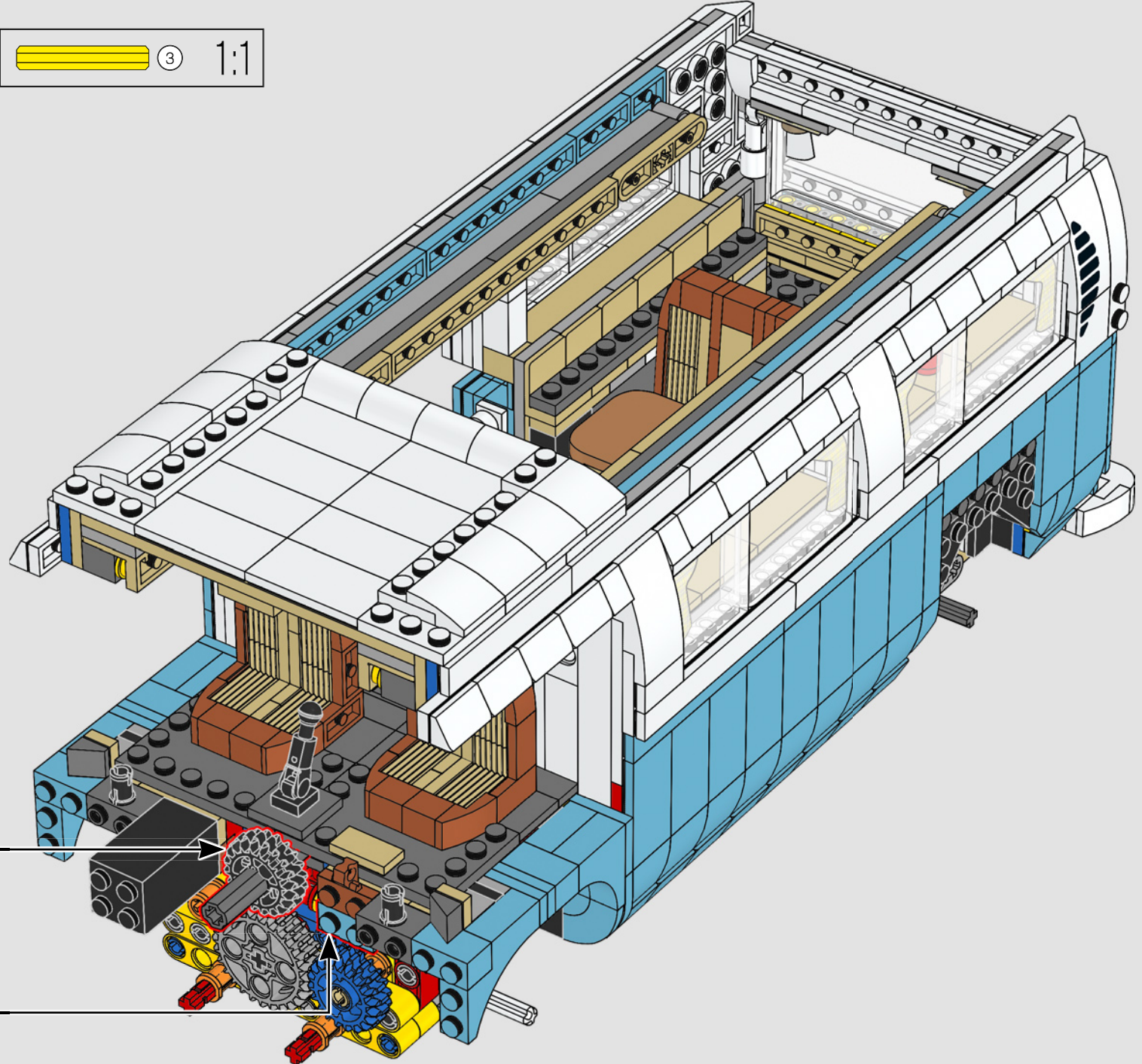

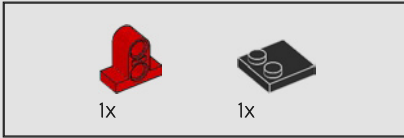
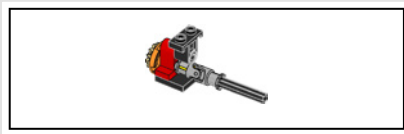

320

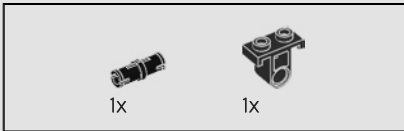
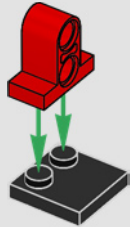

321

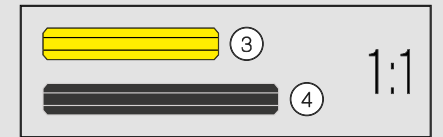
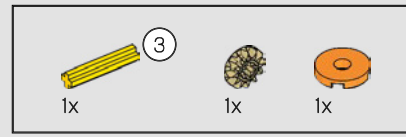
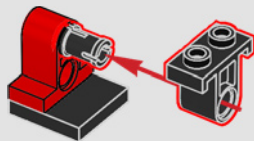

322

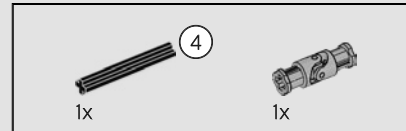
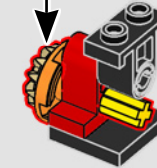
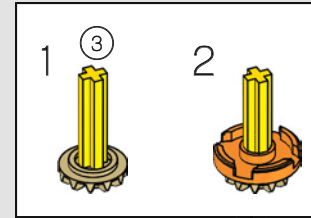

323

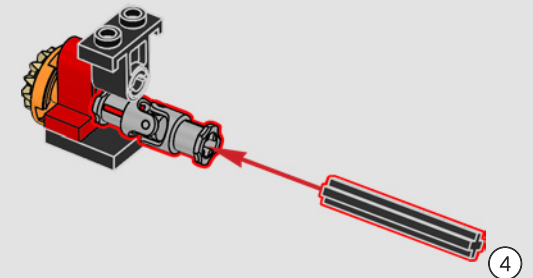

324

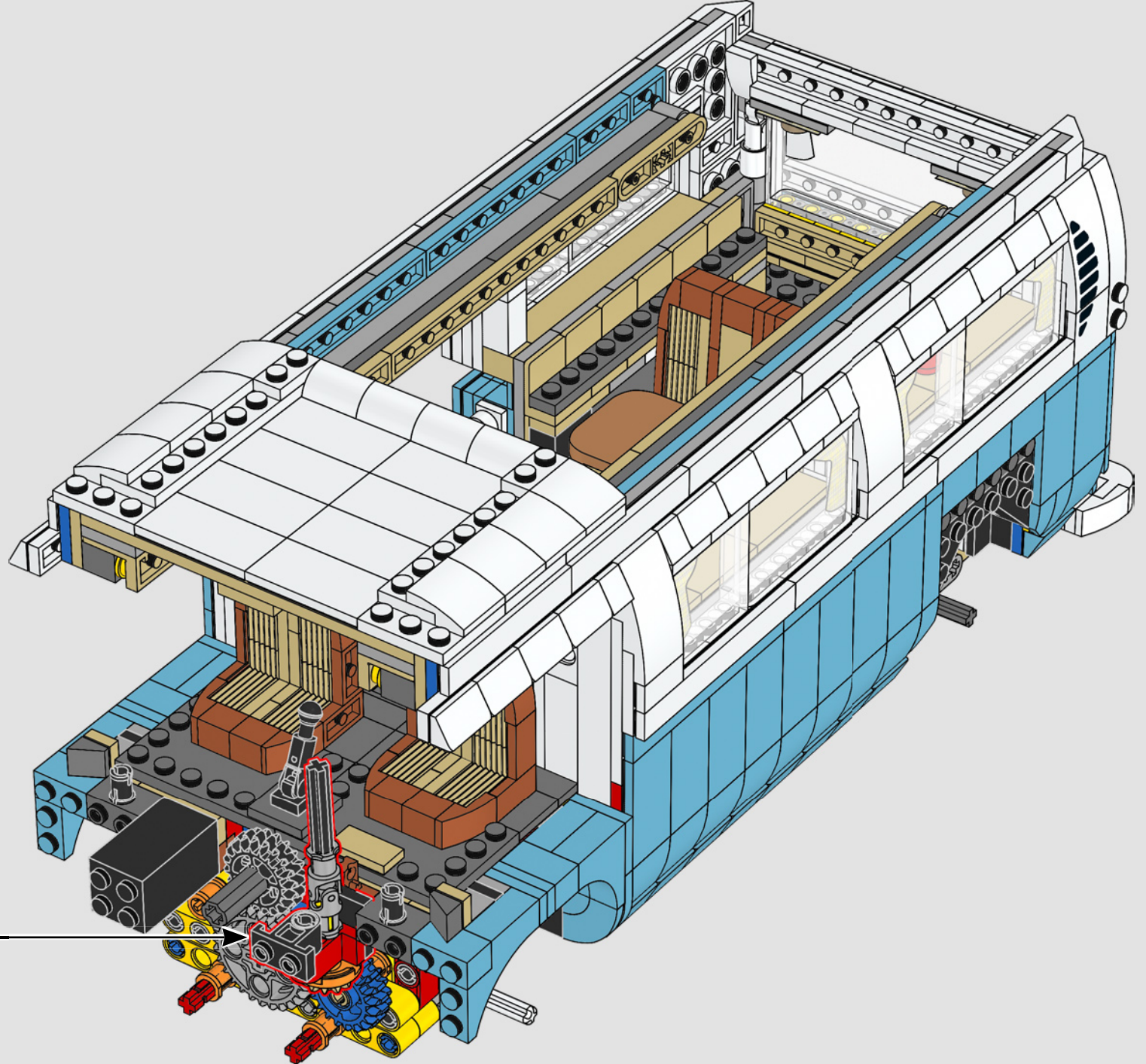

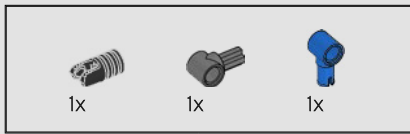

325

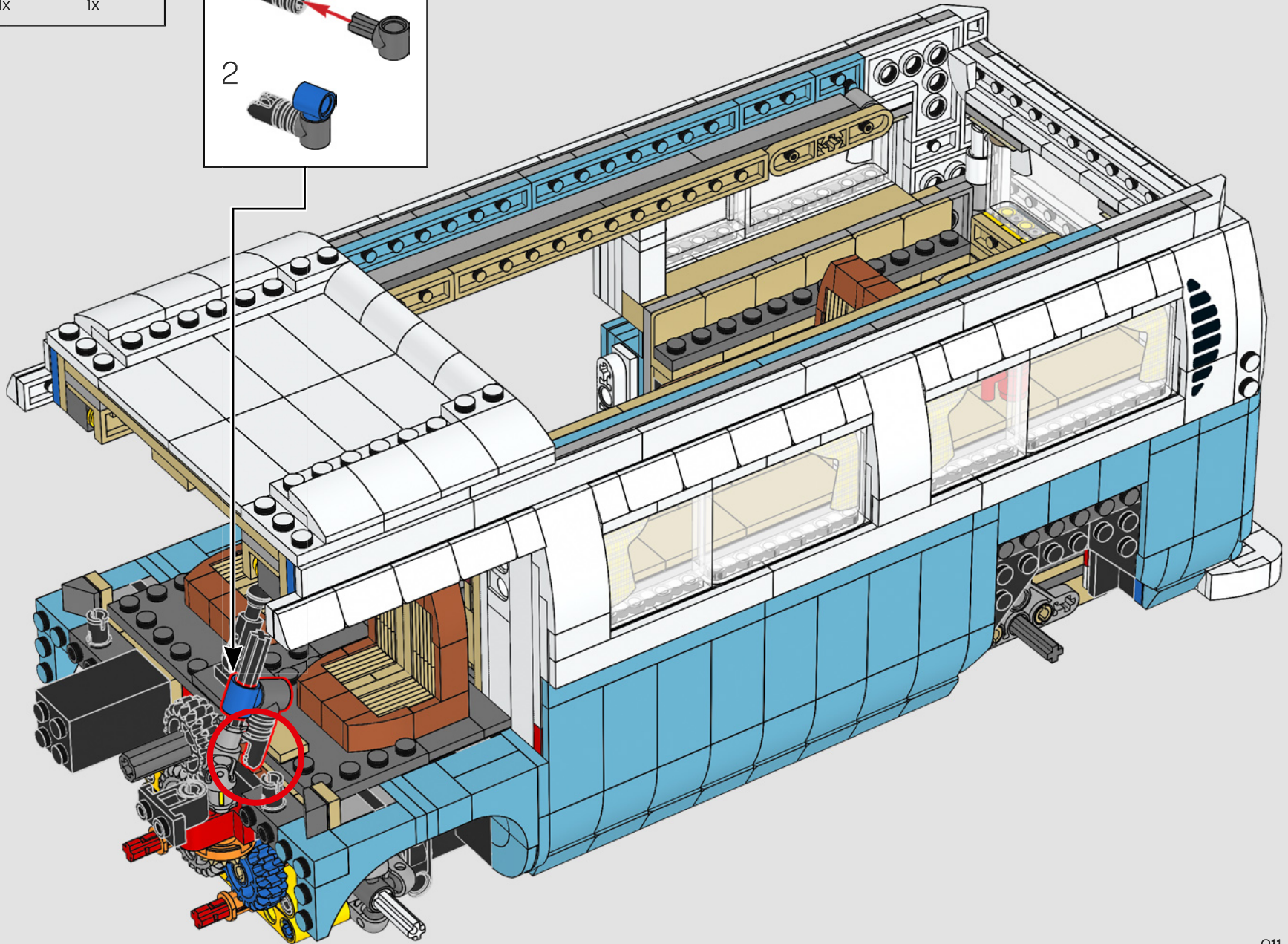
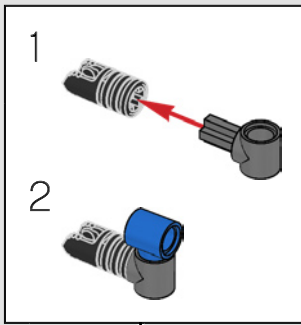

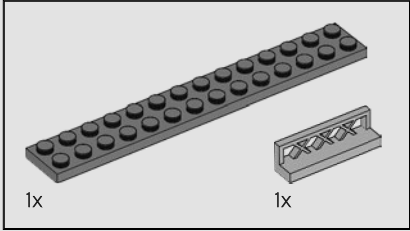
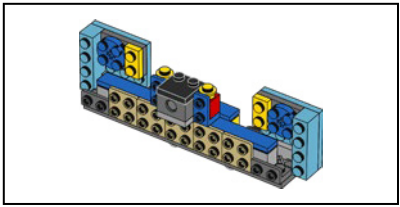

326

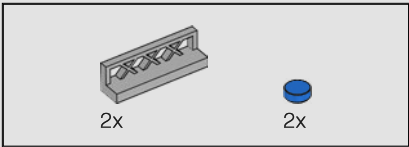
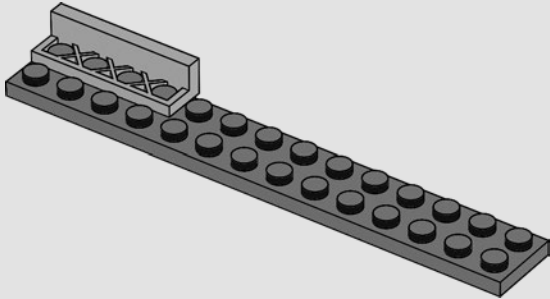

327

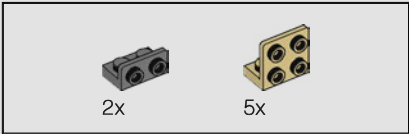
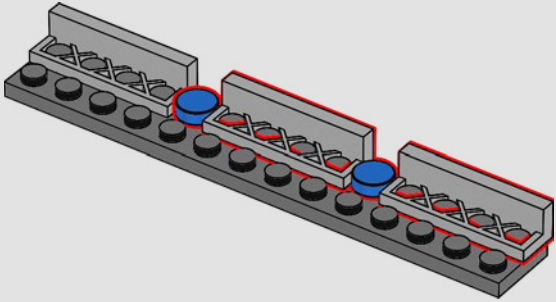

328

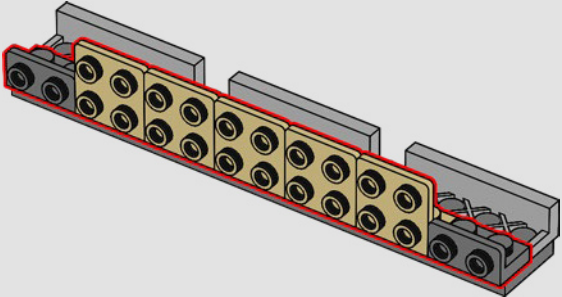

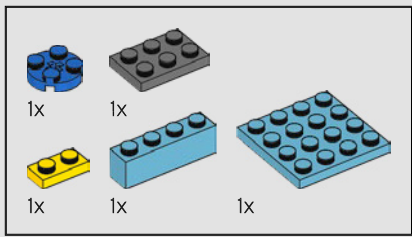

332

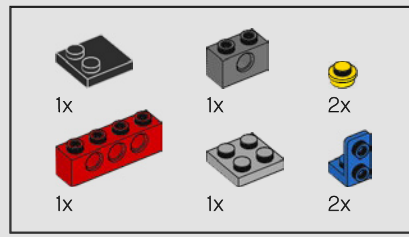
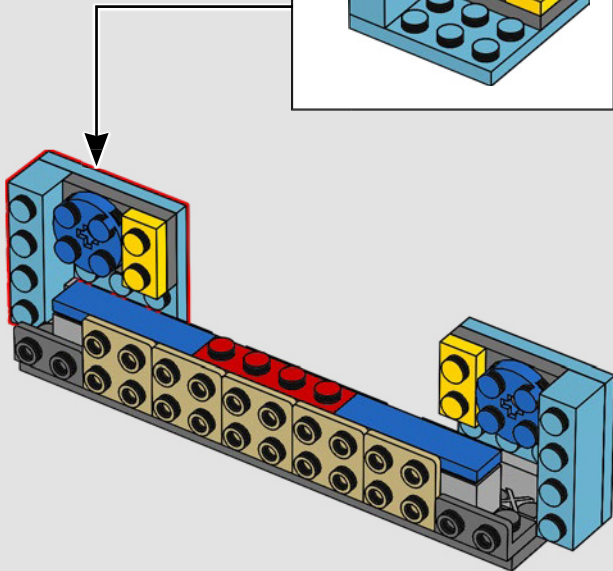
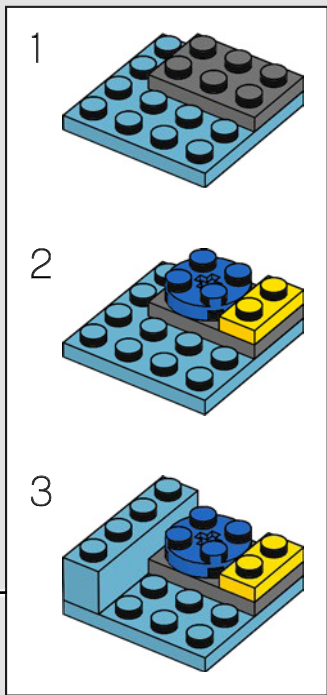

333

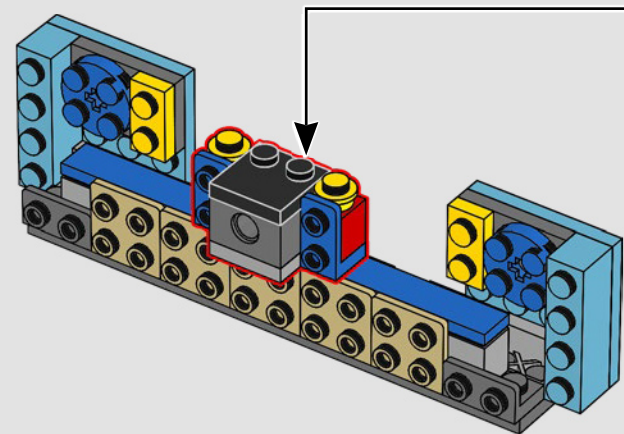
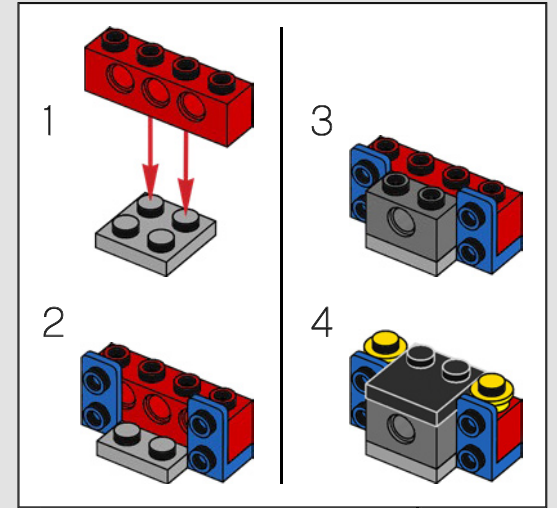



334

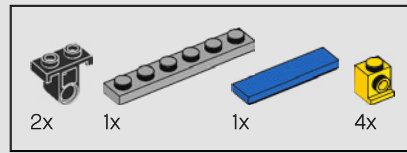
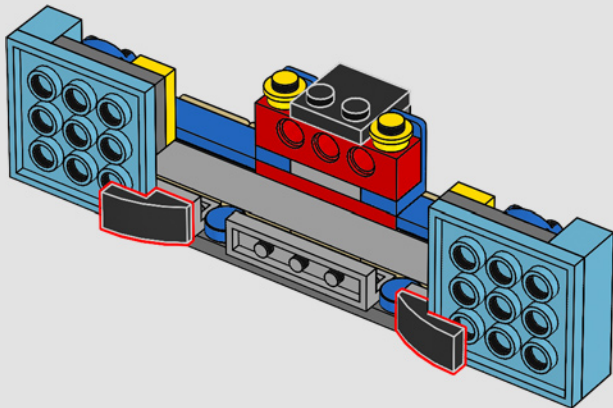

335

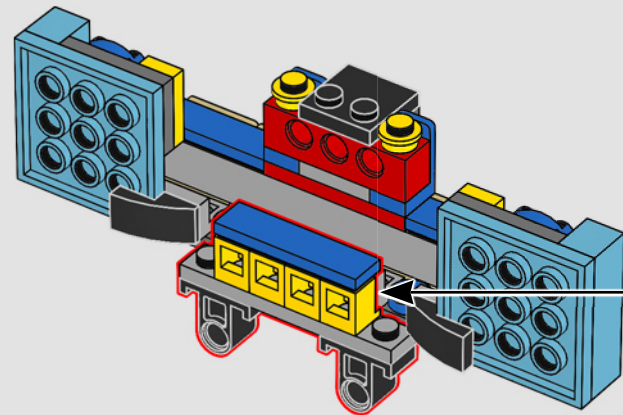
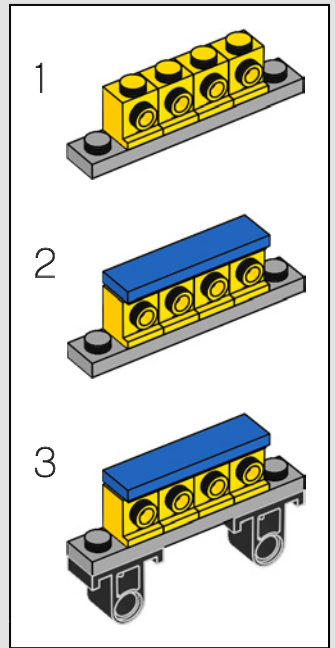

336

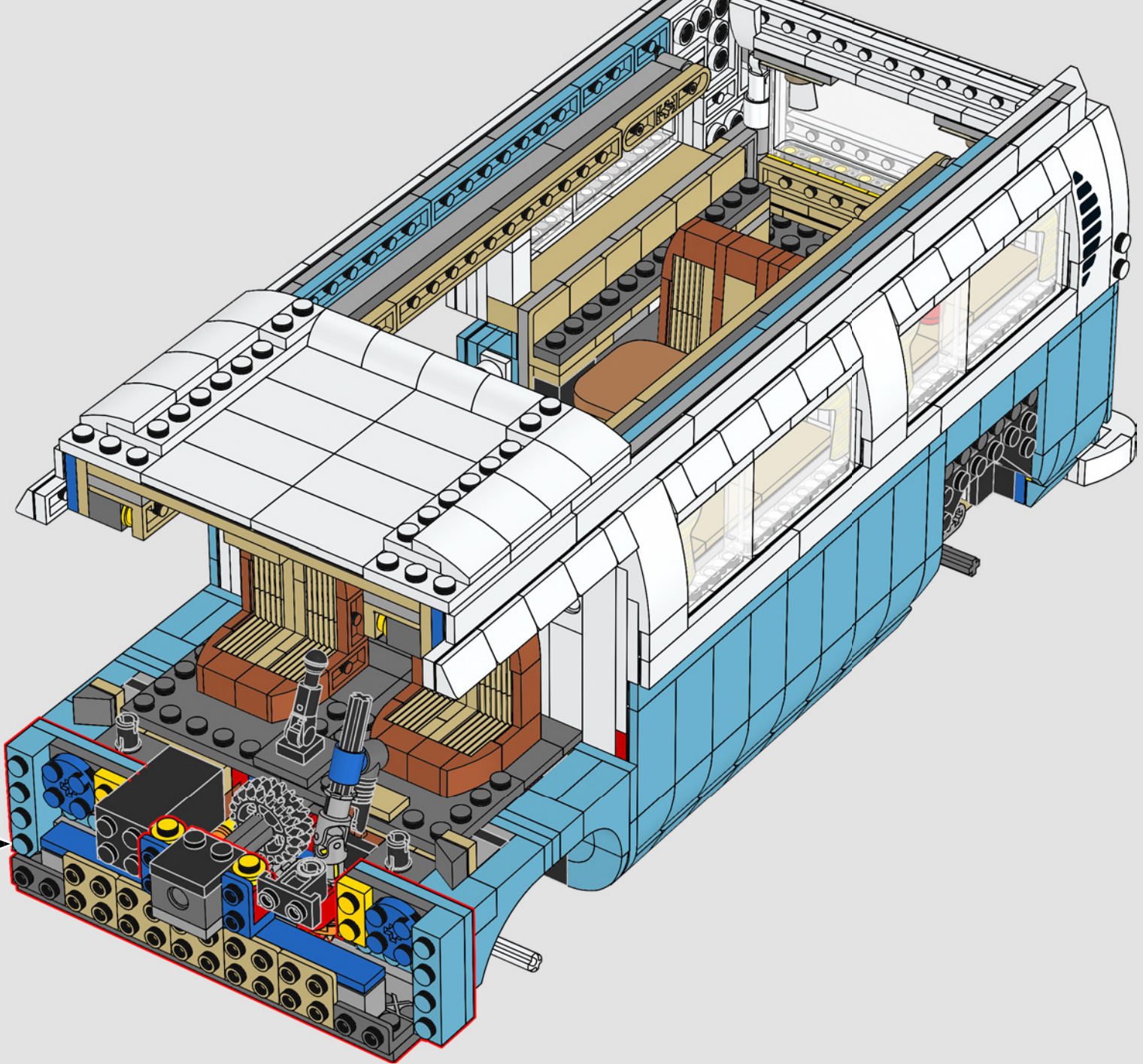

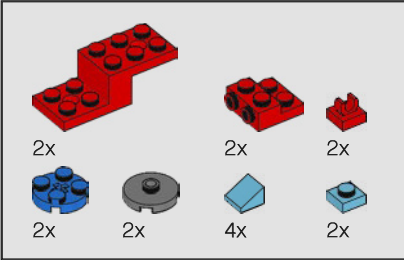
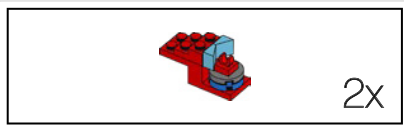

337

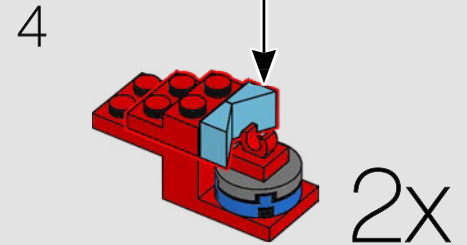
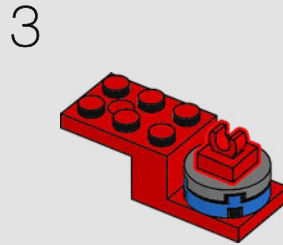
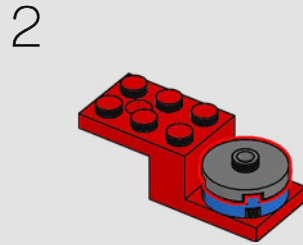
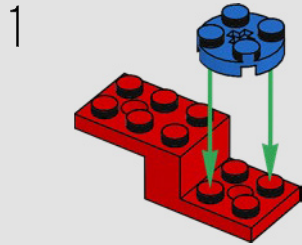
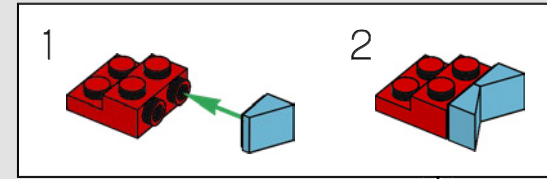

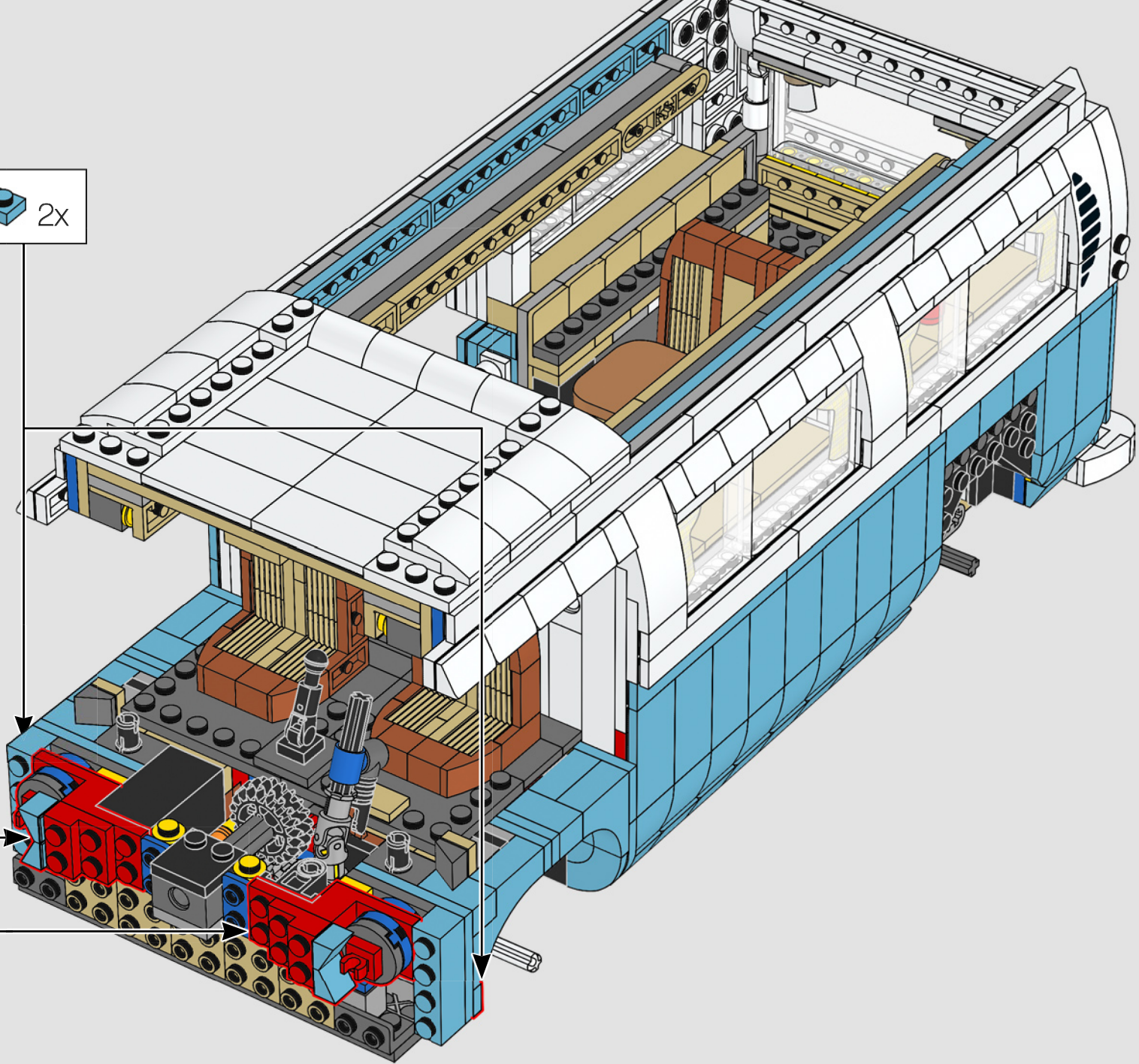
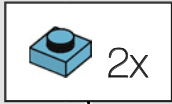

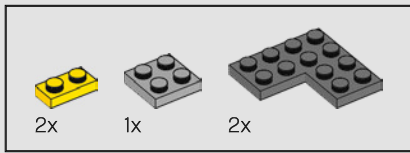

338

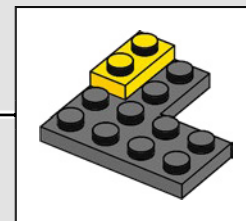
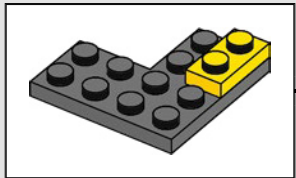
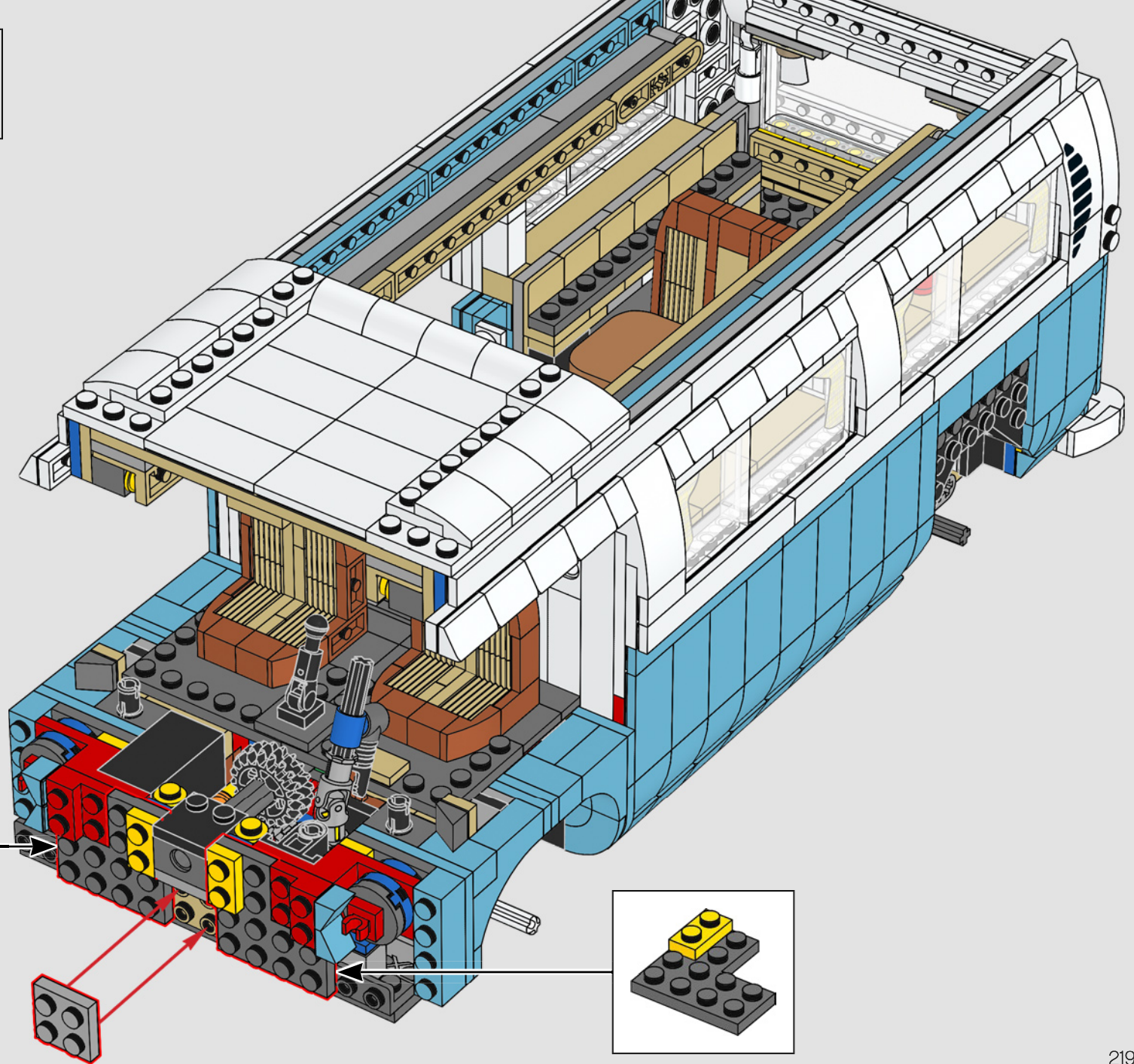

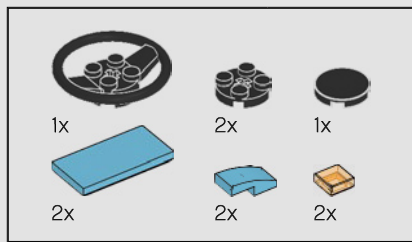

339

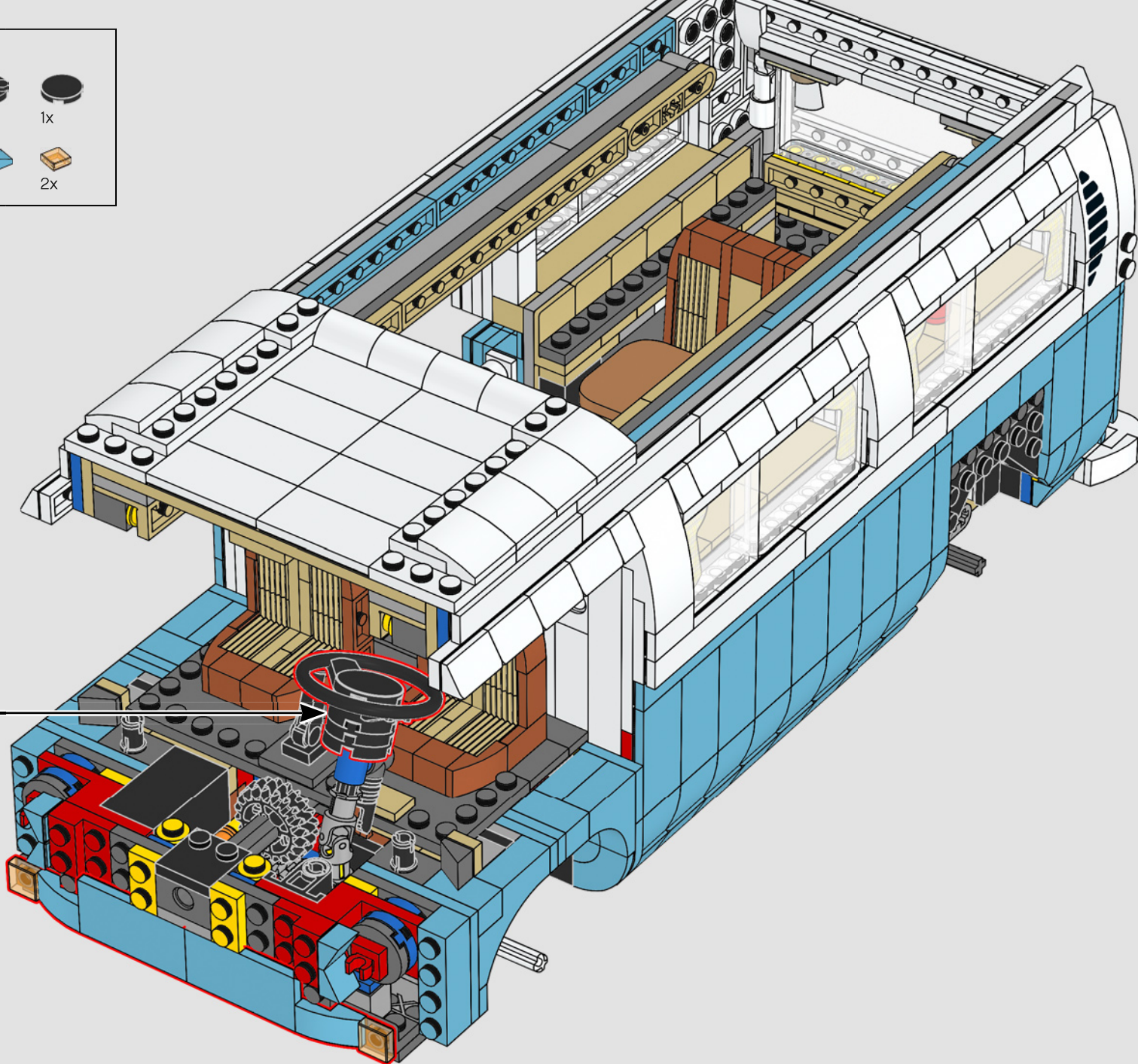
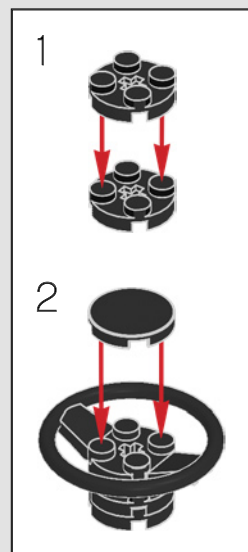

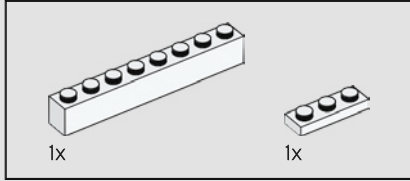
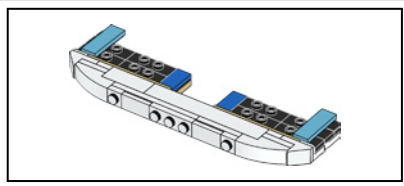

340

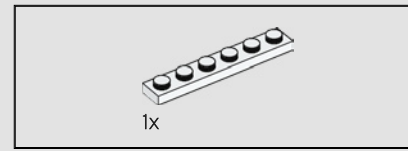
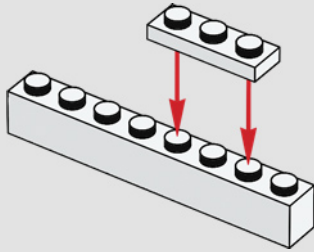

341

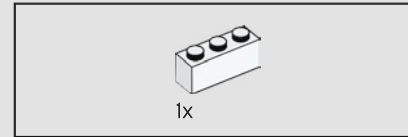
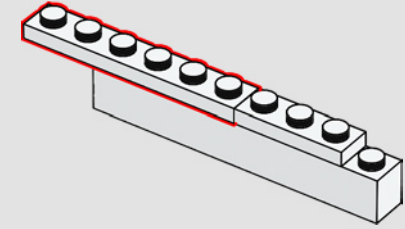

342

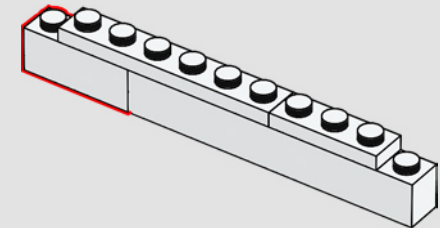

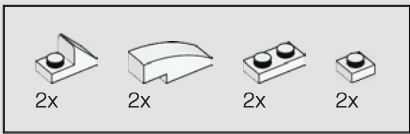

343

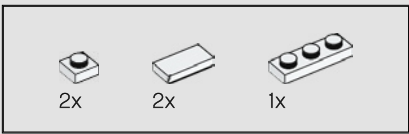
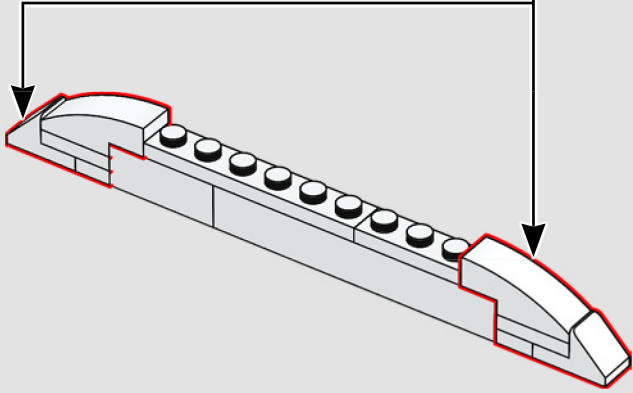
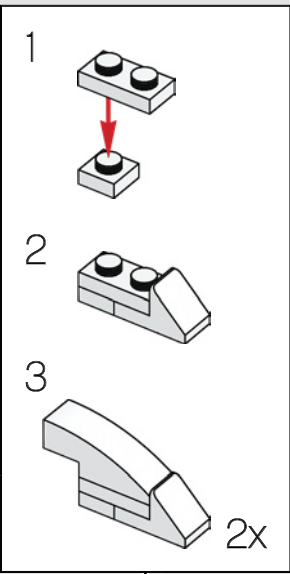

344

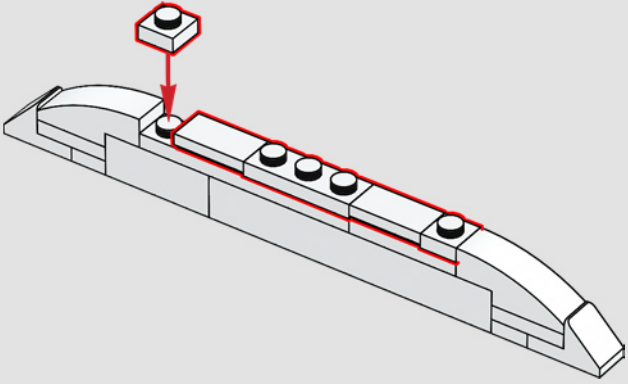

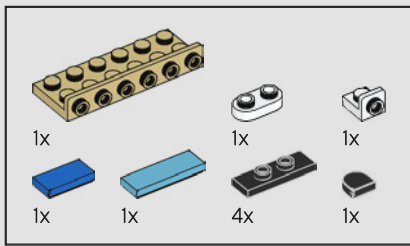

345

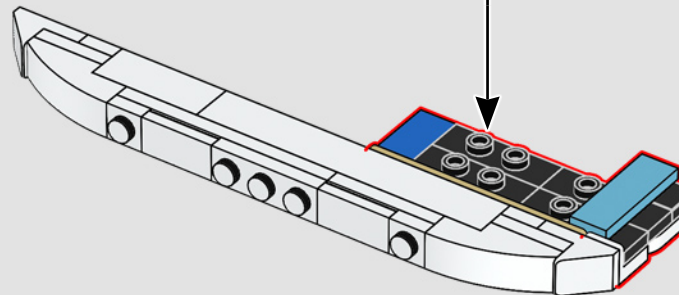
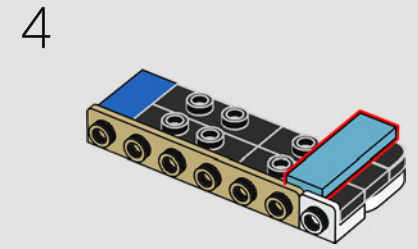
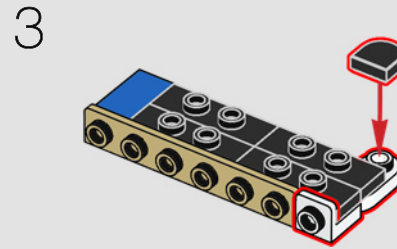
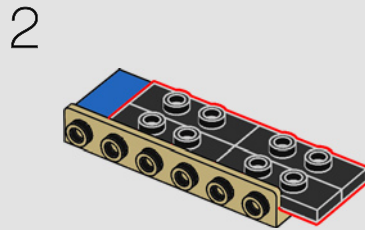
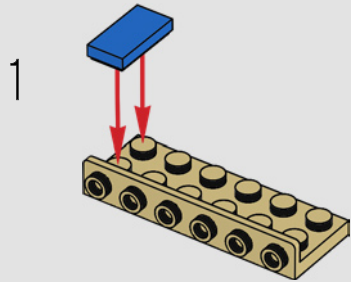

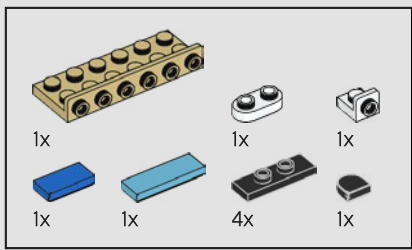

346

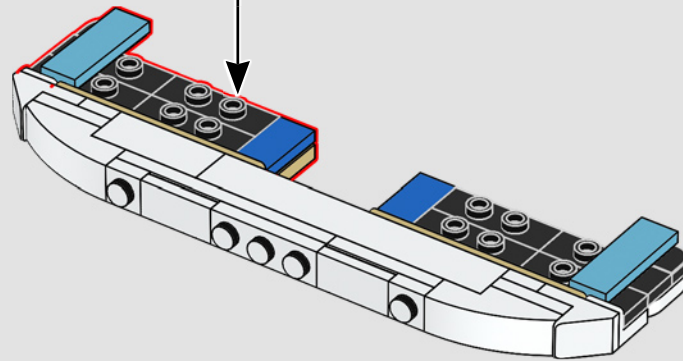
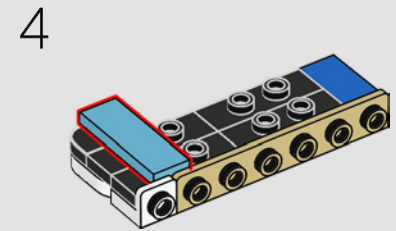
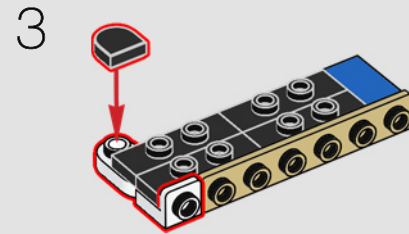
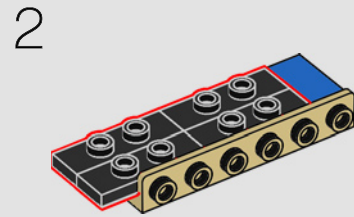
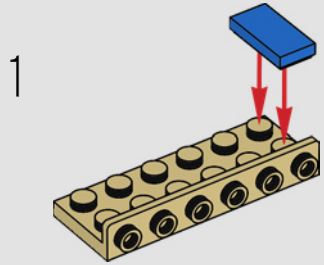



347

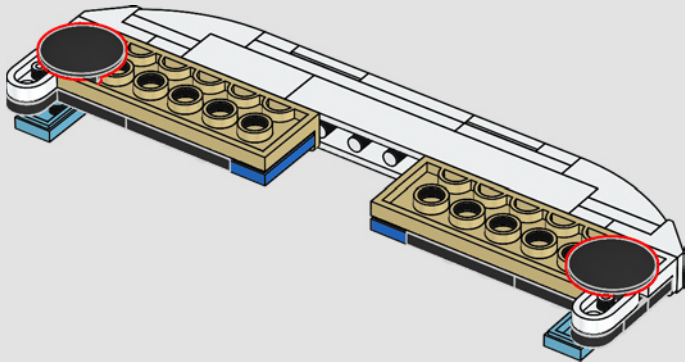

348

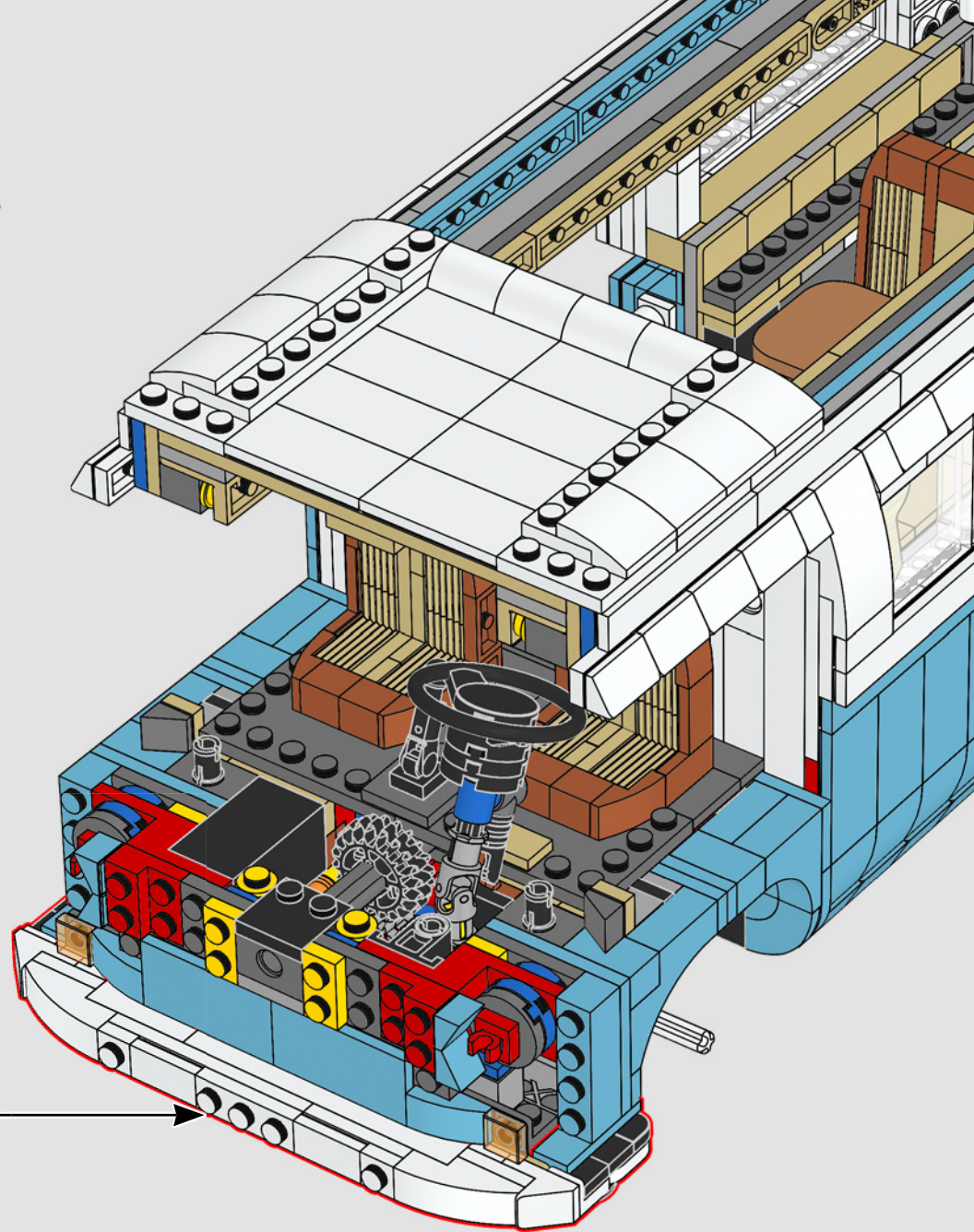

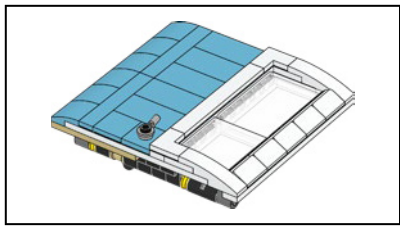

Die meisten VW Transporter hatten die Schiebetür auf der Beifahrerseite. Es war jedoch auch eine Ausführung mit Schiebetüren auf beiden Seiten erhältlich. Diese Variante wurde vor allem von der Feuerwehr und der Post benutzt.

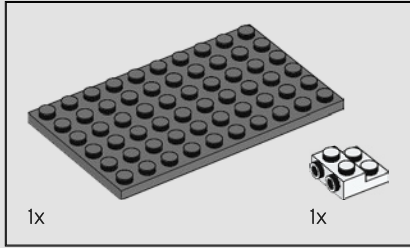

349

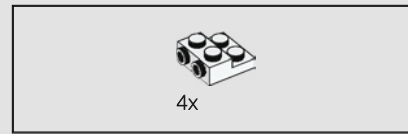
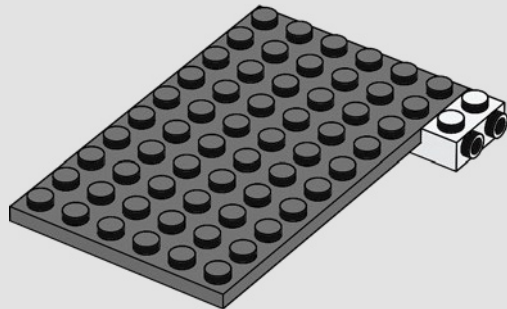

4x

350

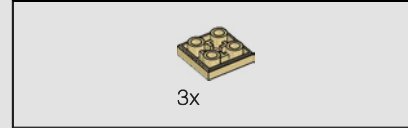
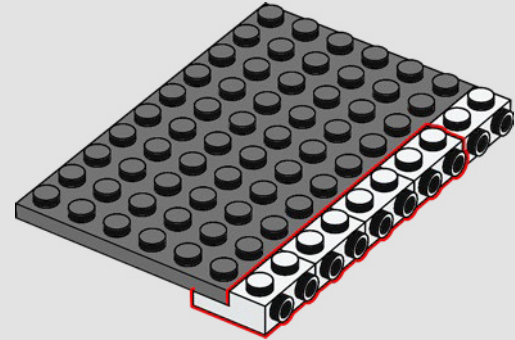

3x

351

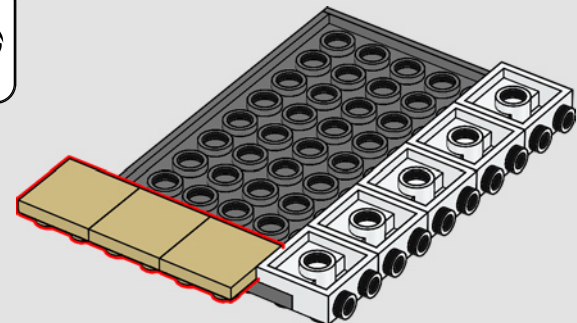
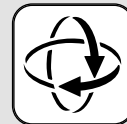

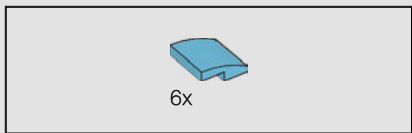

355

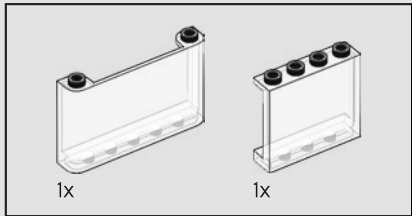
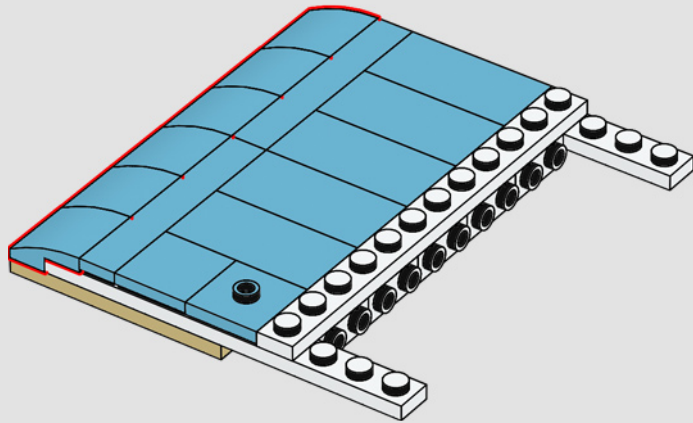

356

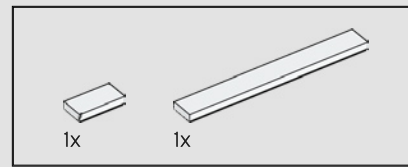
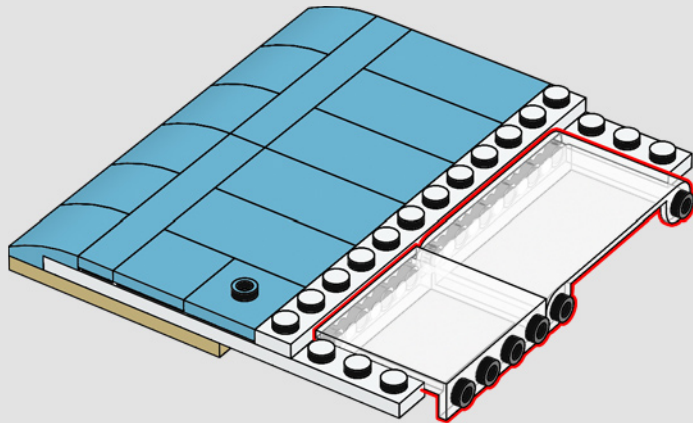

357

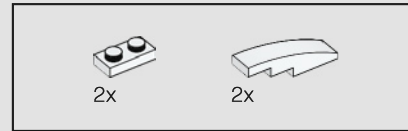
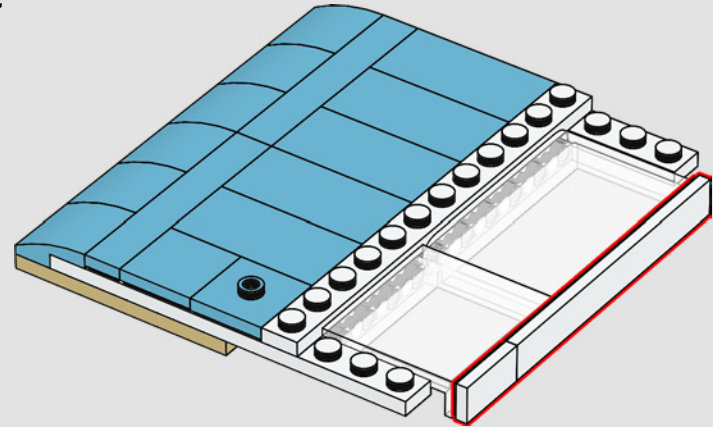

358

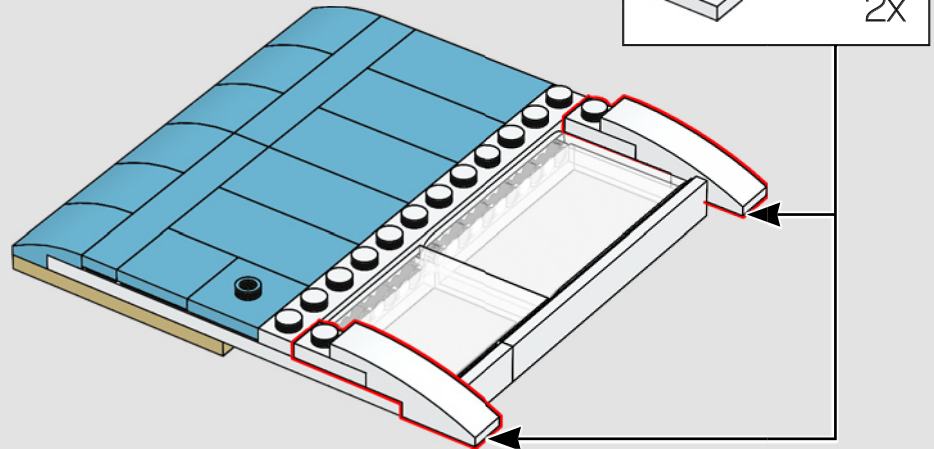

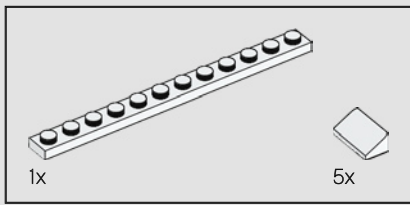

359

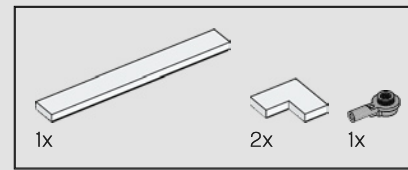
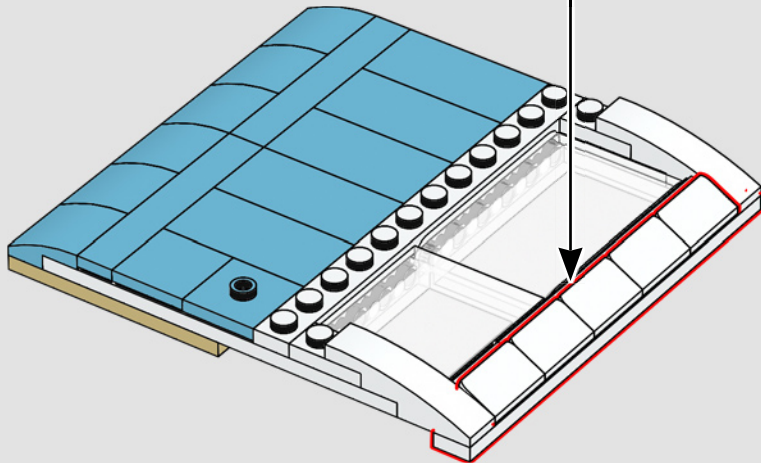
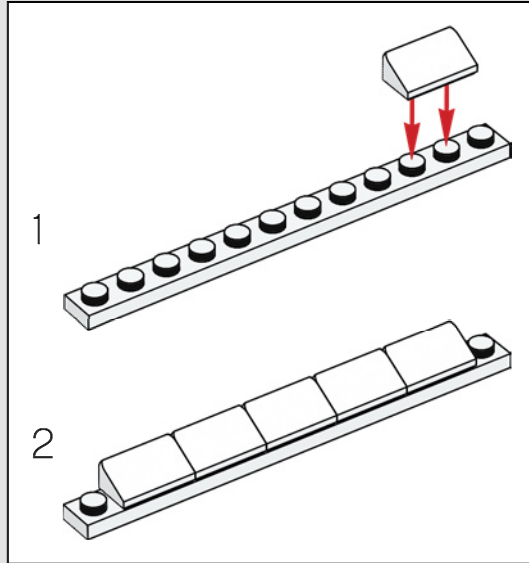

360

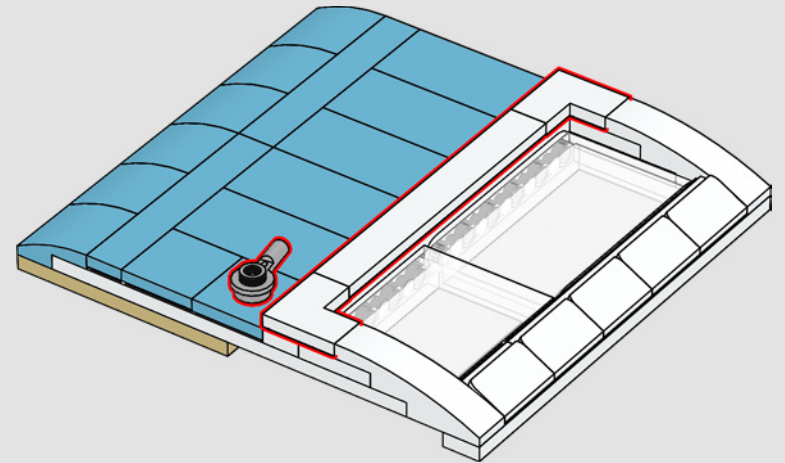

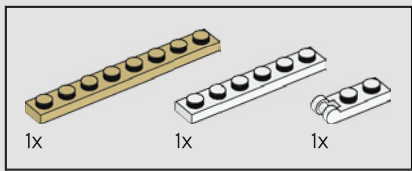

361

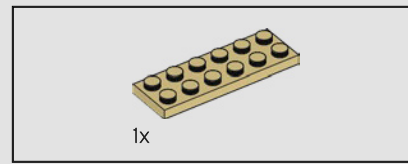
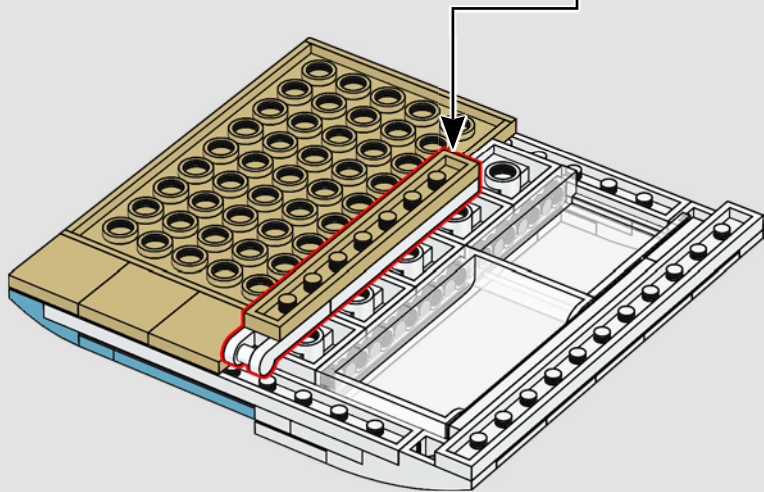
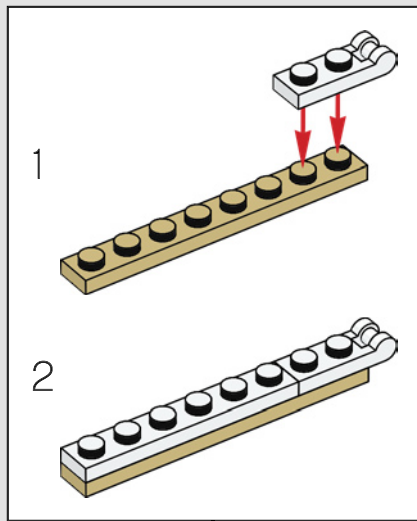

362

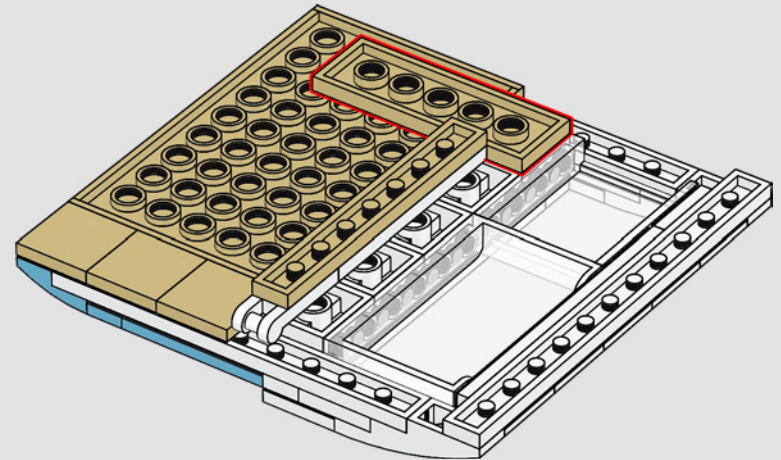

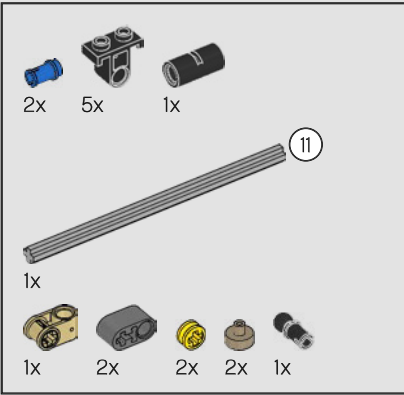
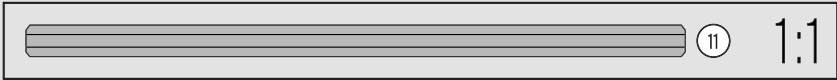
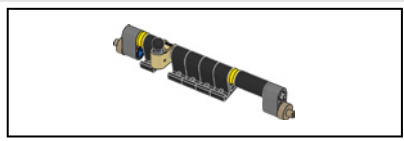

363

1

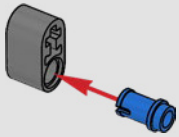

2

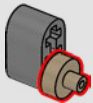

3

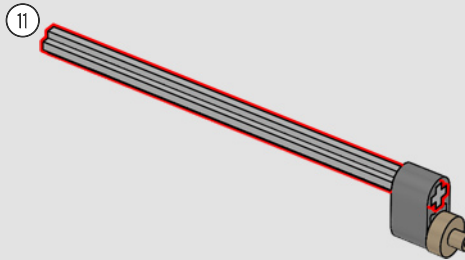

4

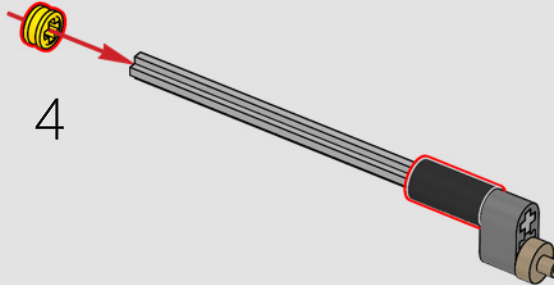

5

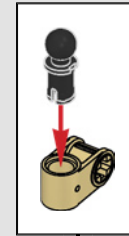
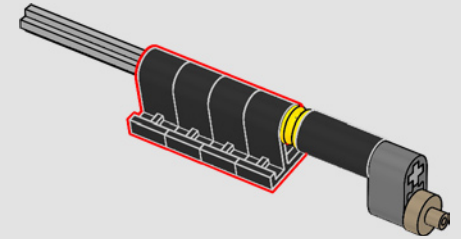

6

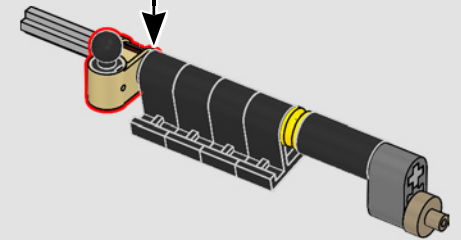

7

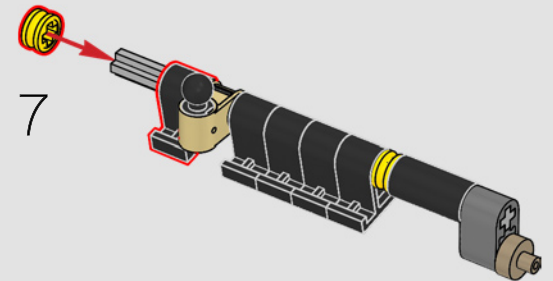

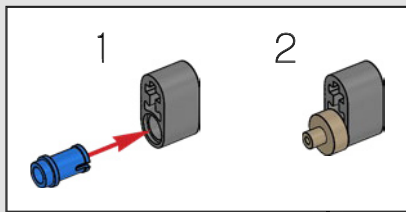

8

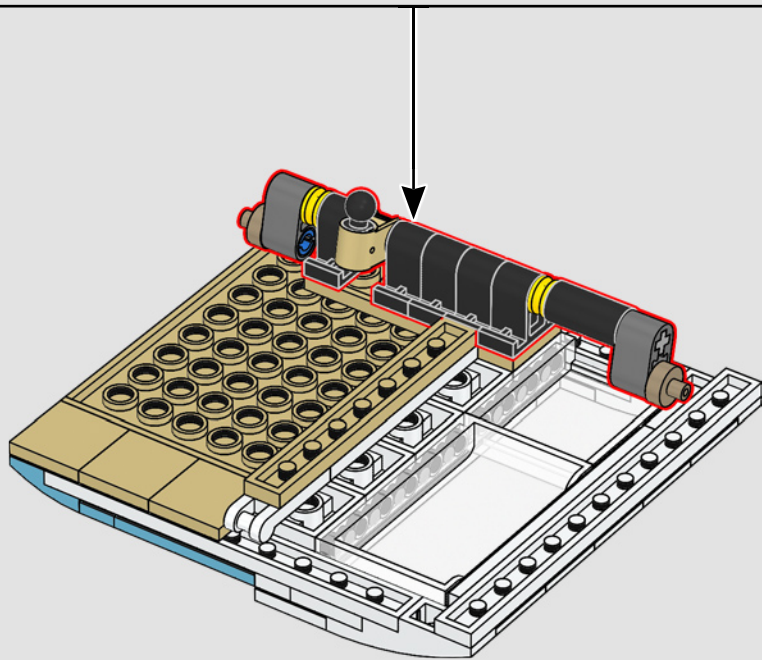
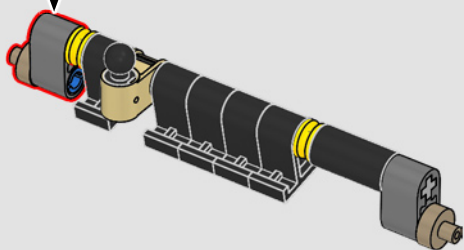

364

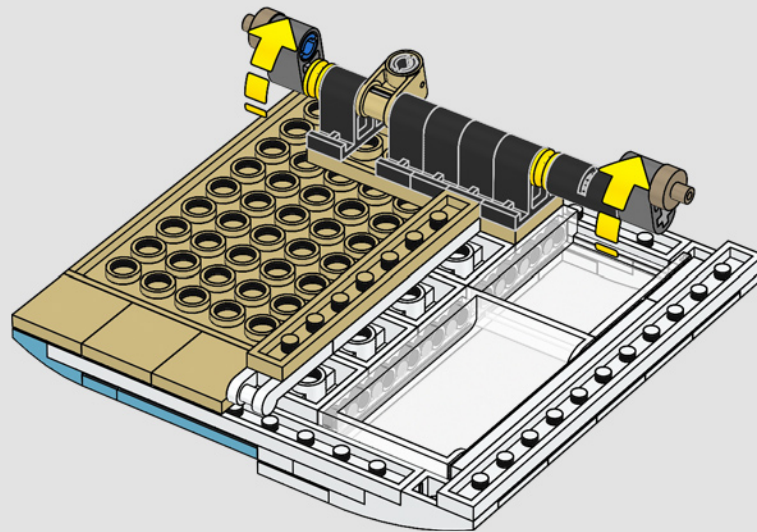

365

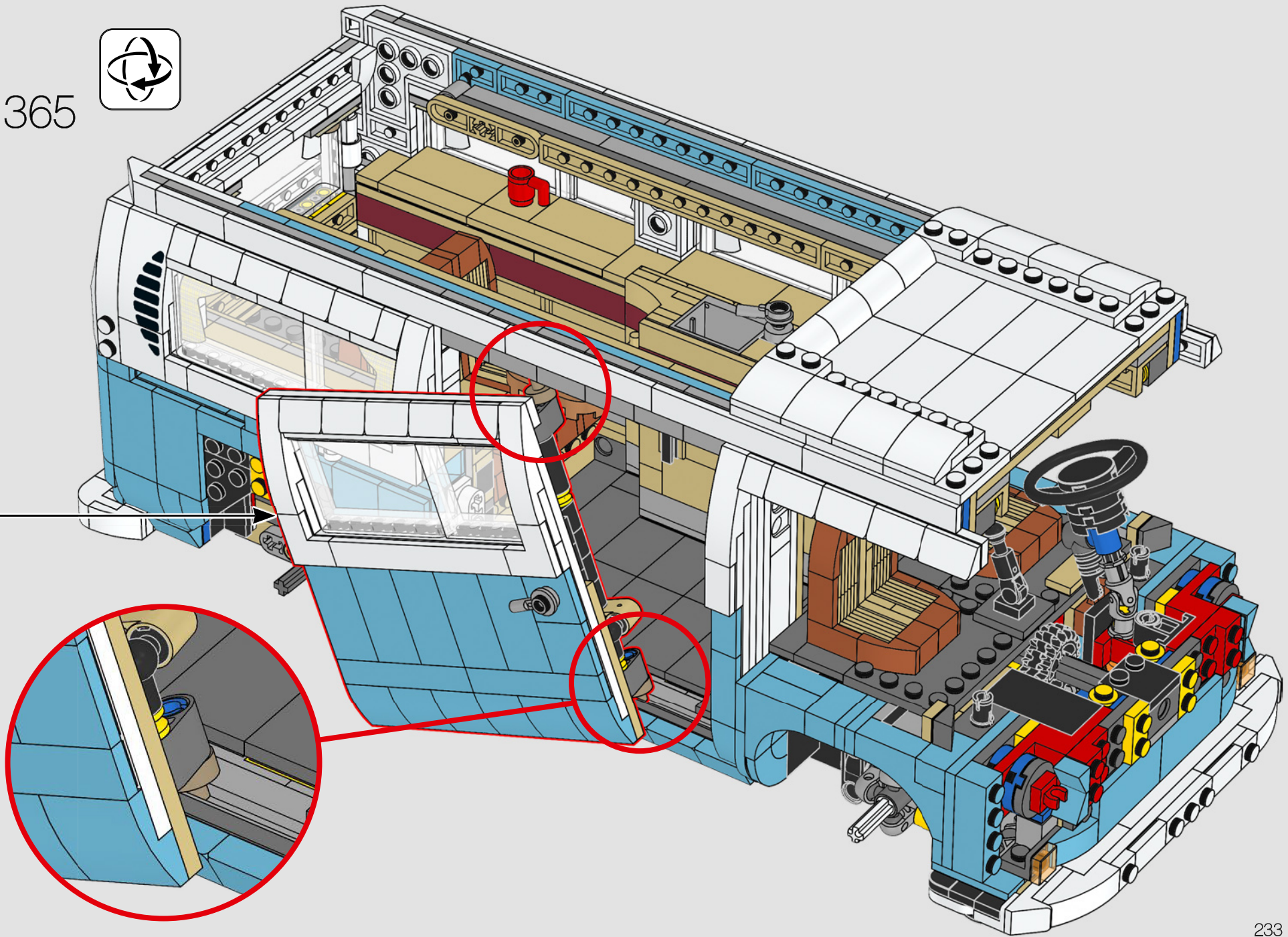

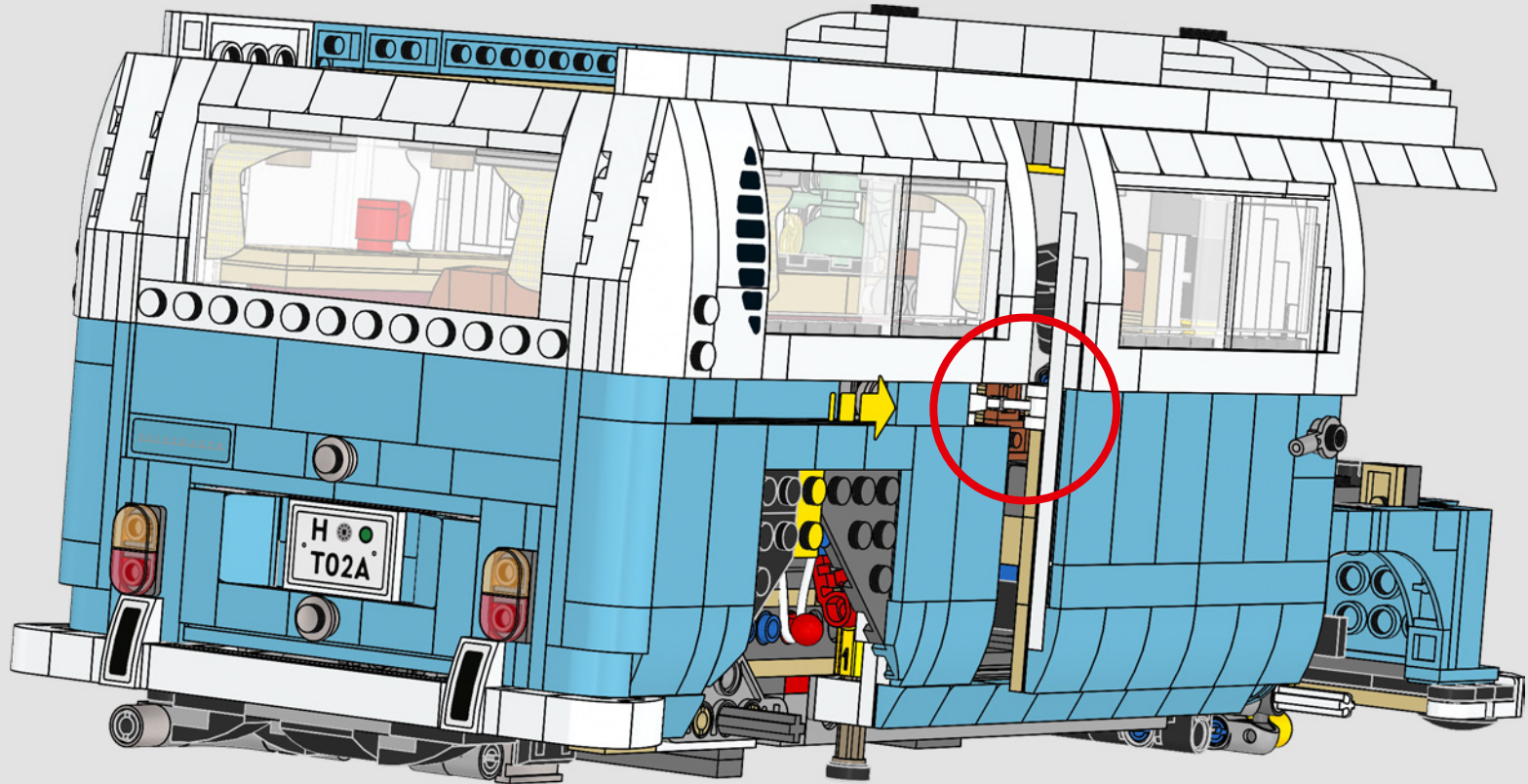

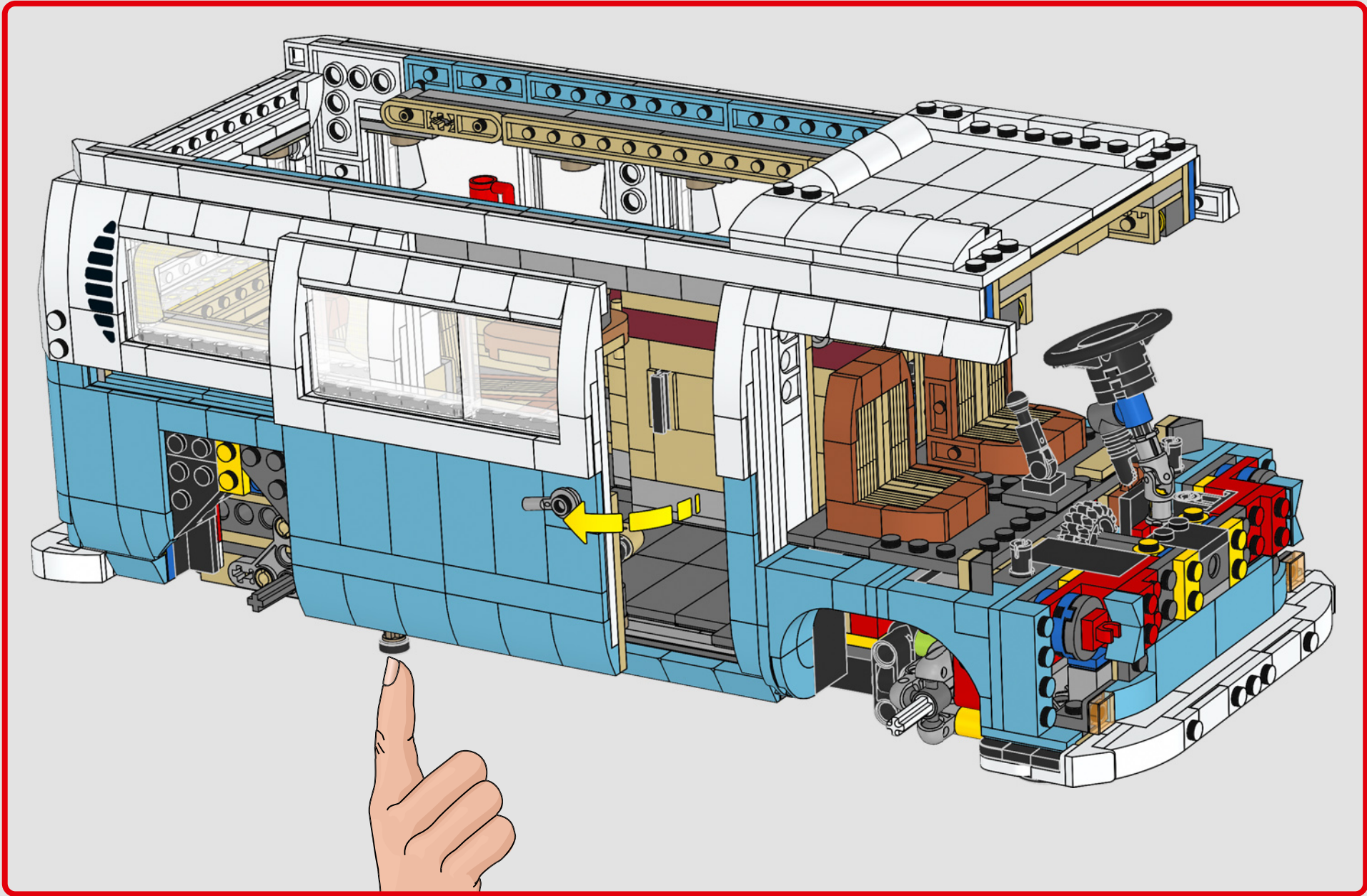



1x

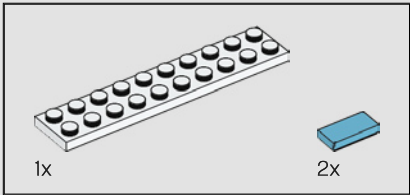
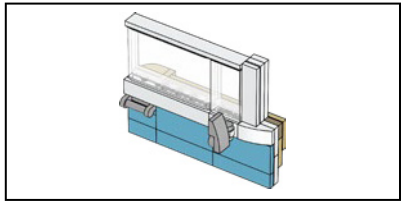
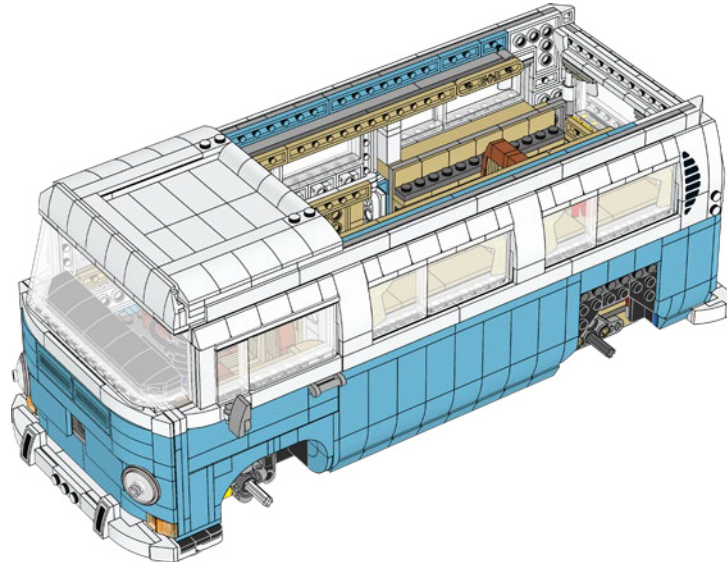
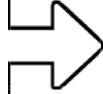

1x

2x

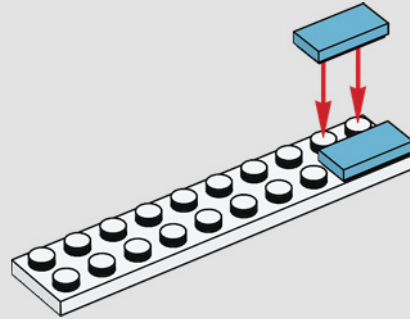

367

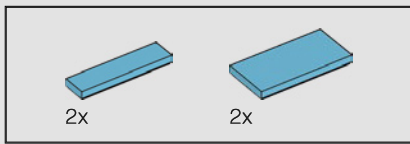

368

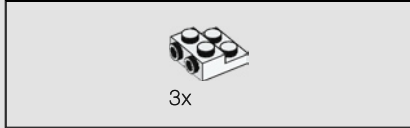
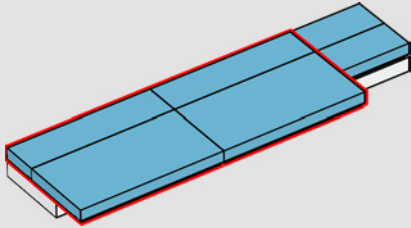

369

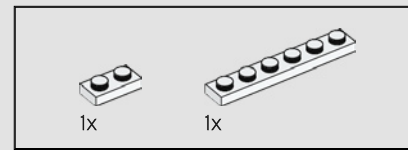
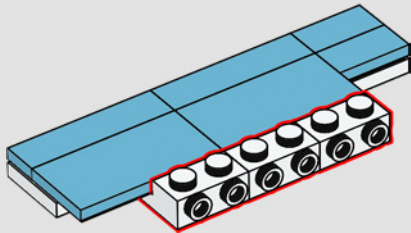

370

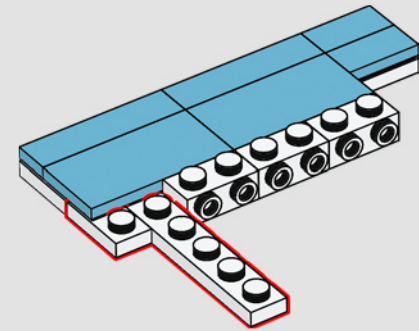

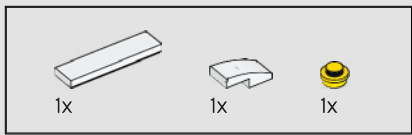

371

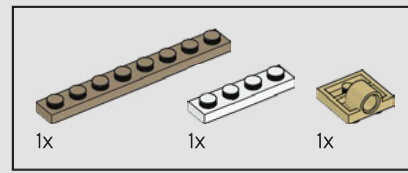
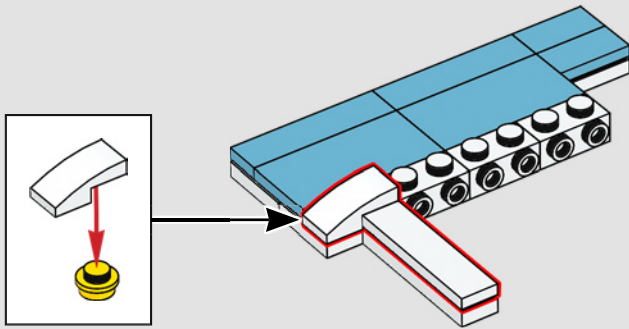

372

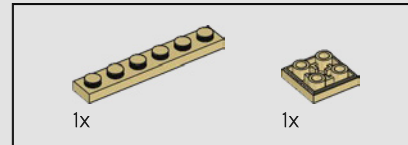
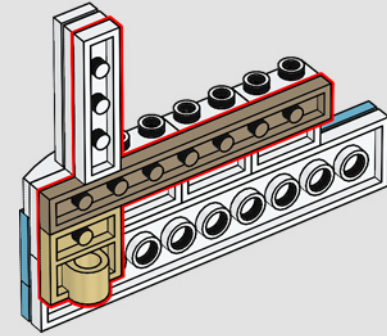
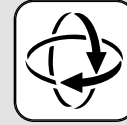

373

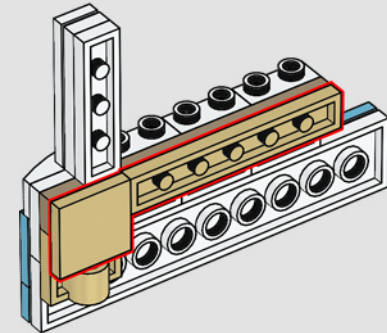

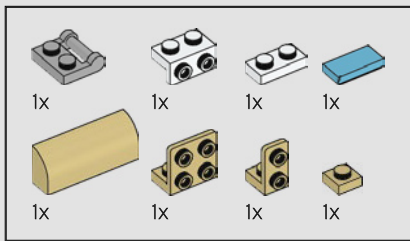

374

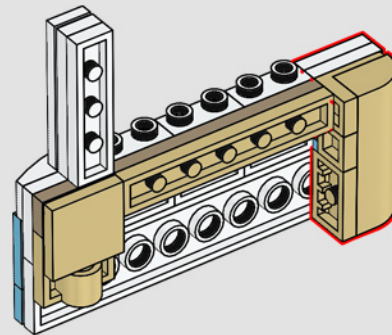
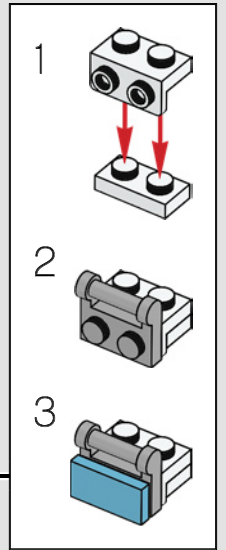
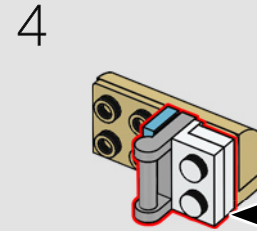
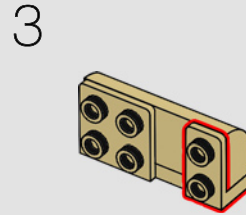
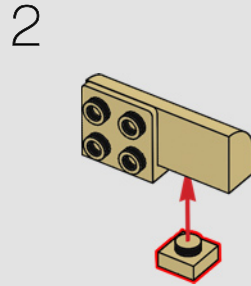
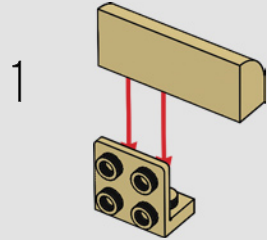

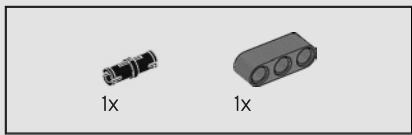

375

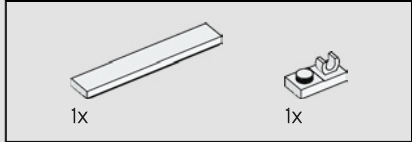
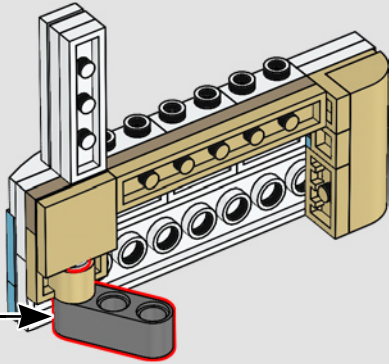
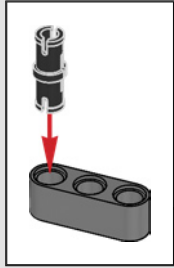

376

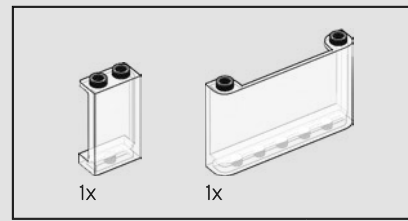
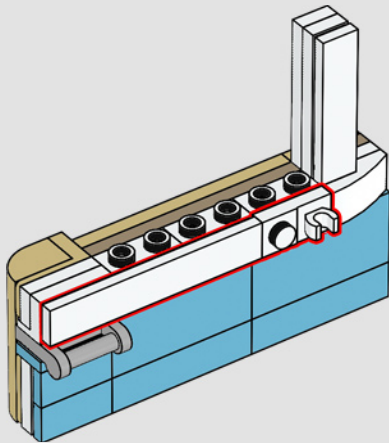

377

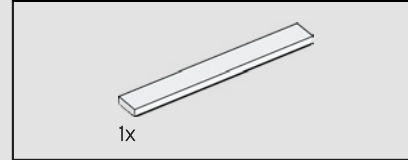
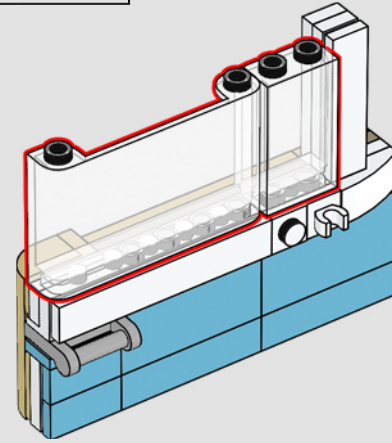

378

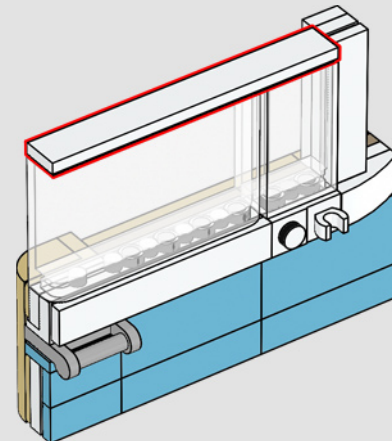

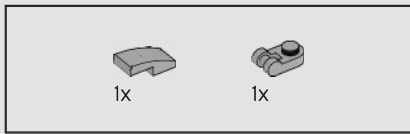

379

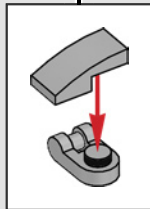
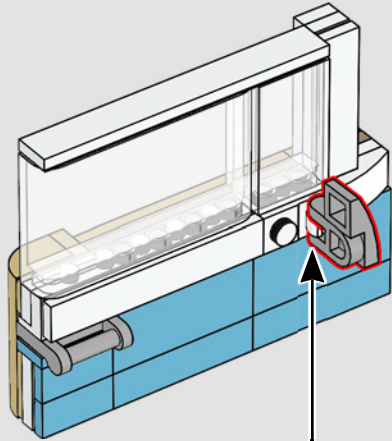

380

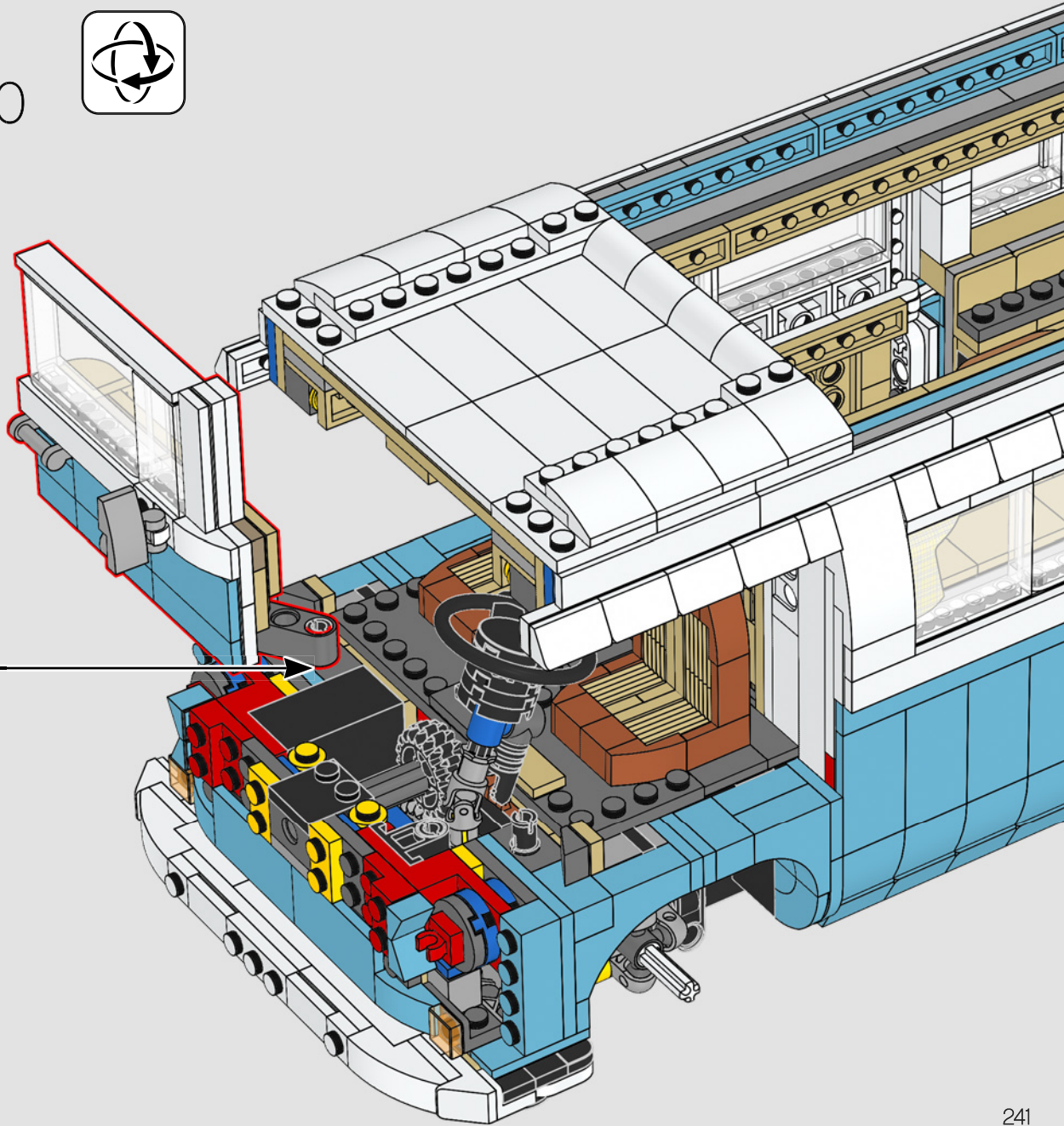

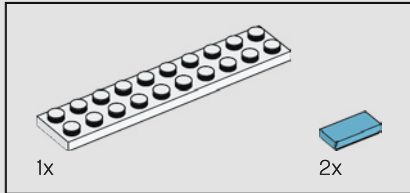
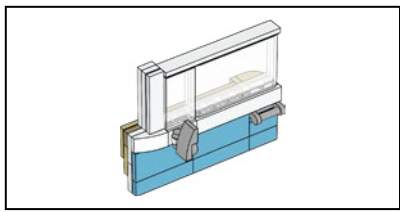

381

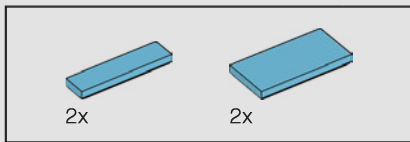
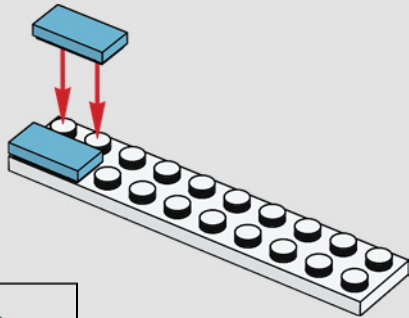

382

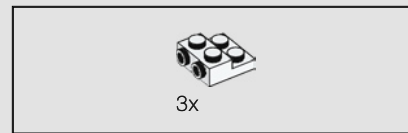
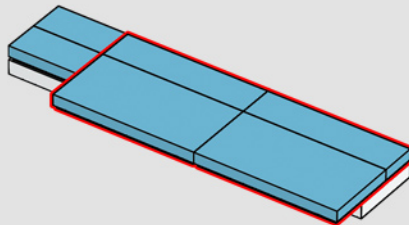

383

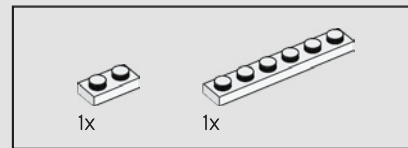
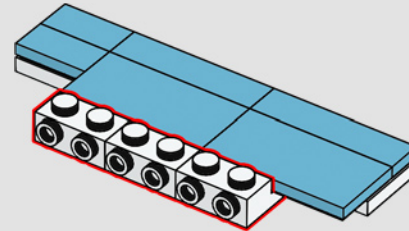

384

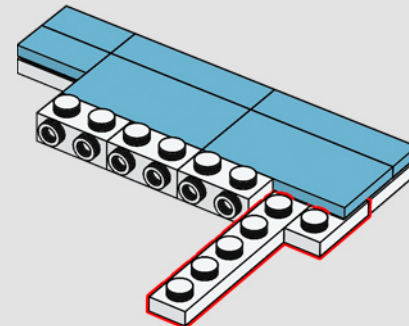

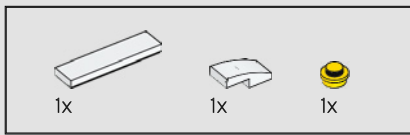

385

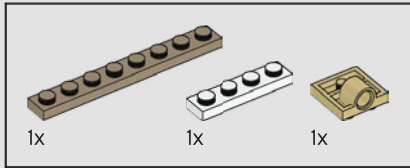
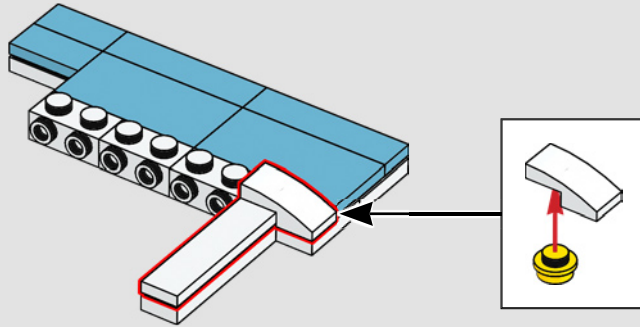

386

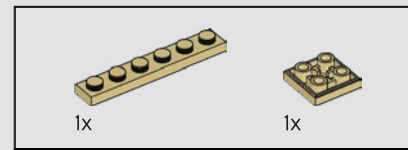
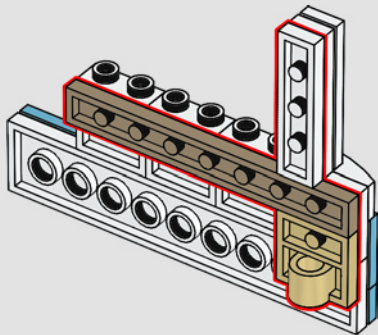

387

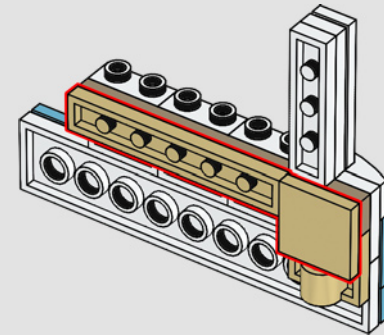

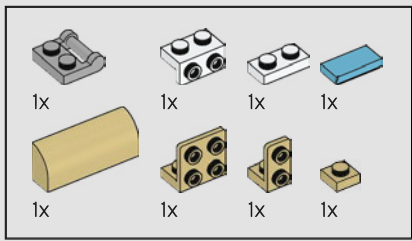

388

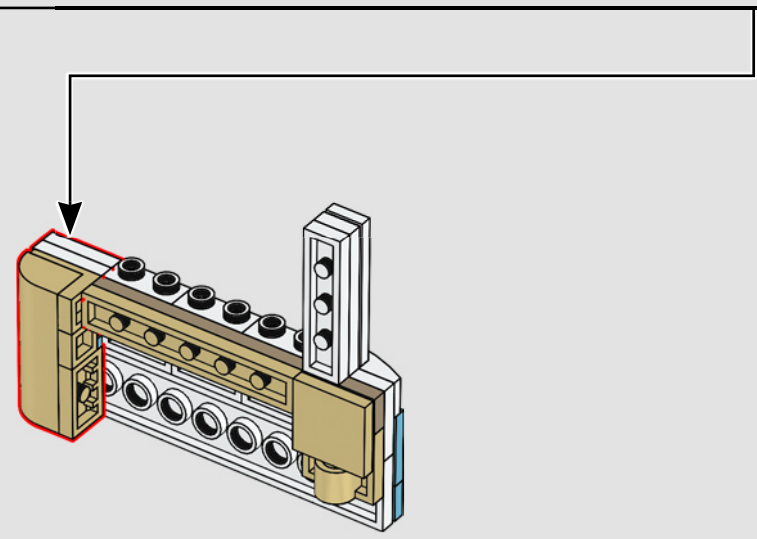
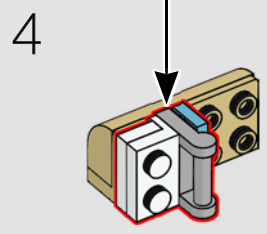
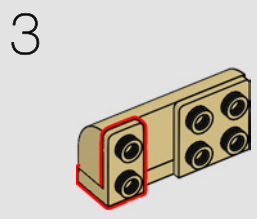
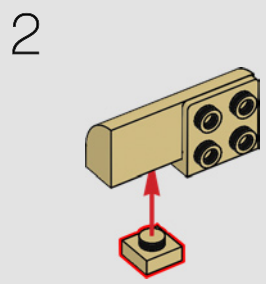
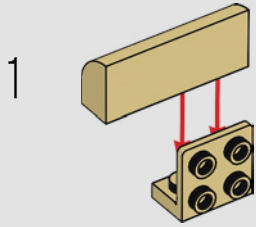
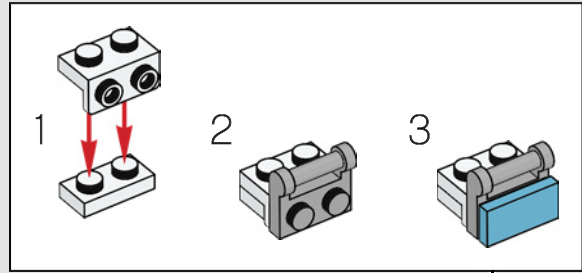

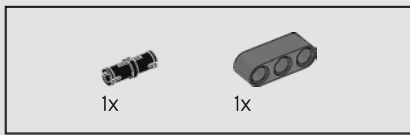

389

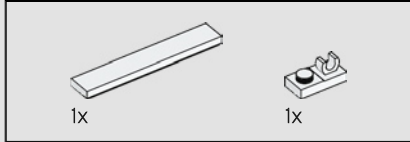
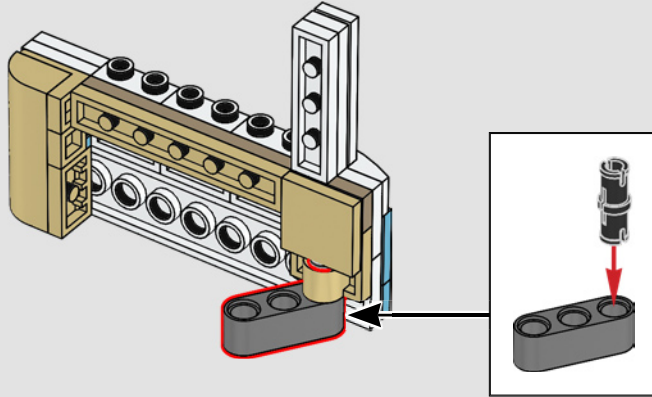

390

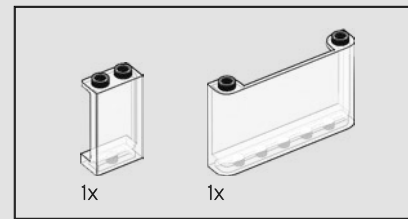
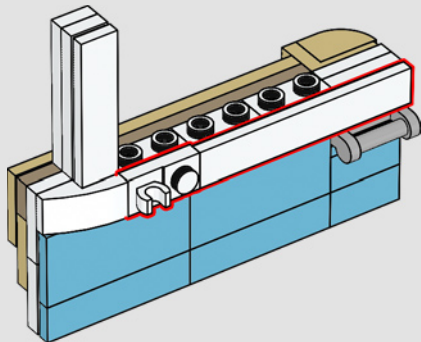

391

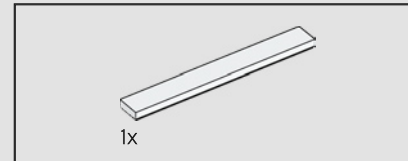
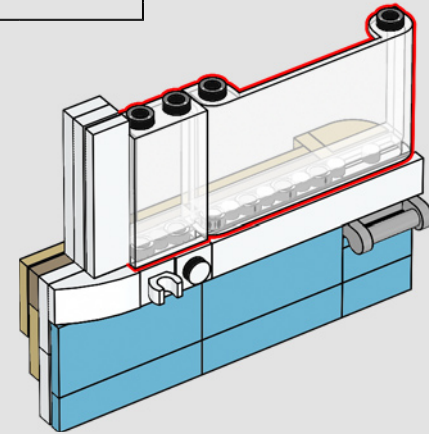

392

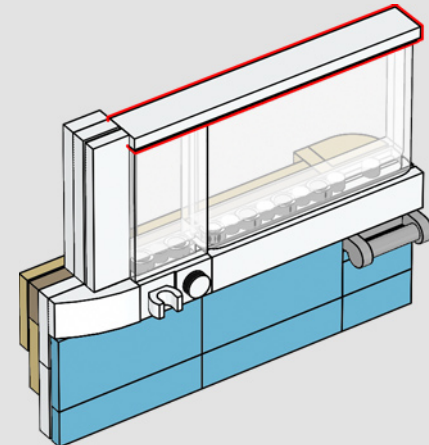

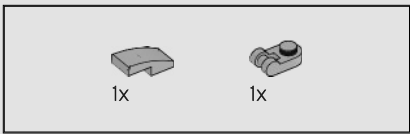

393

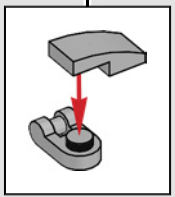
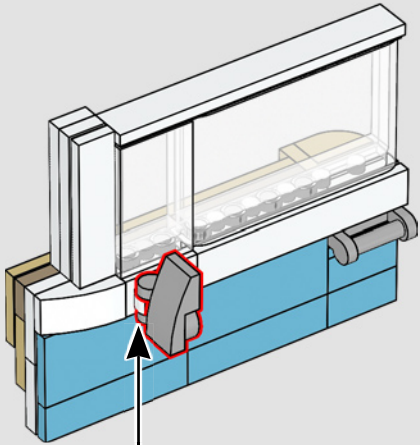

394

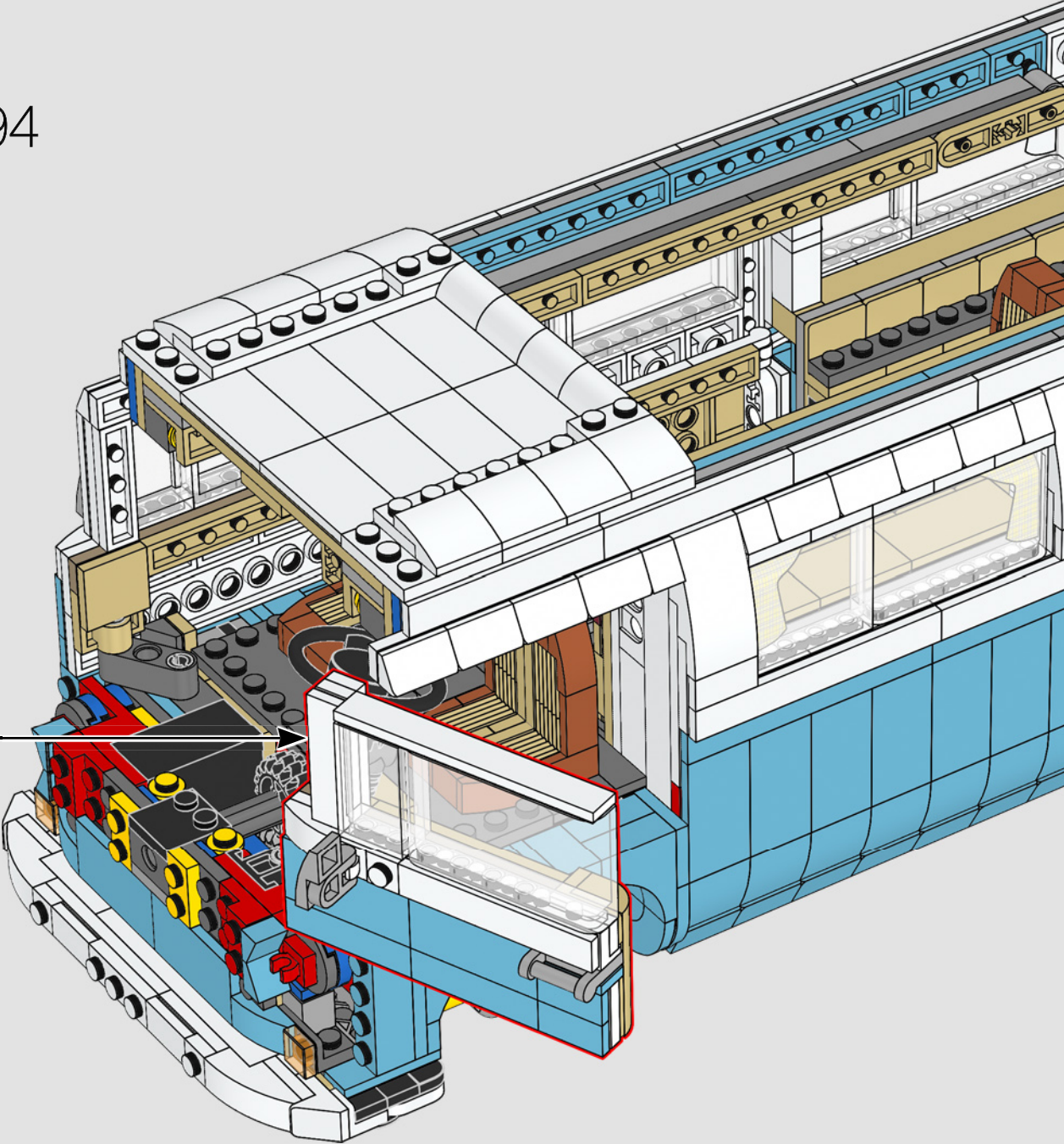

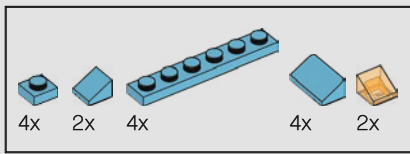

395

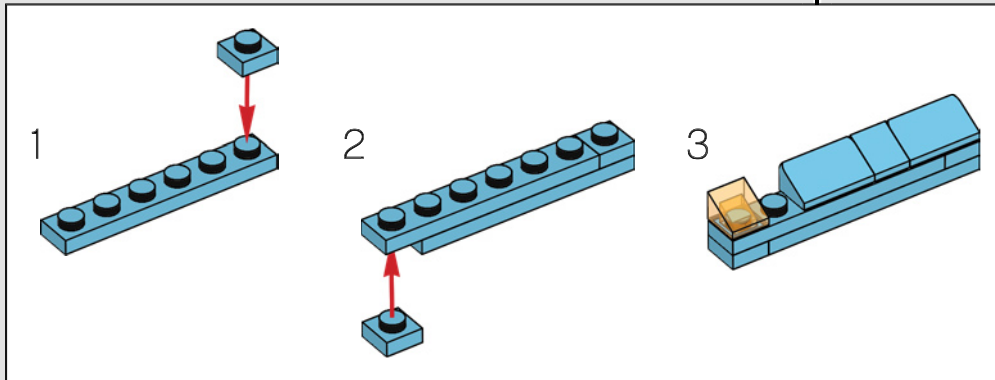
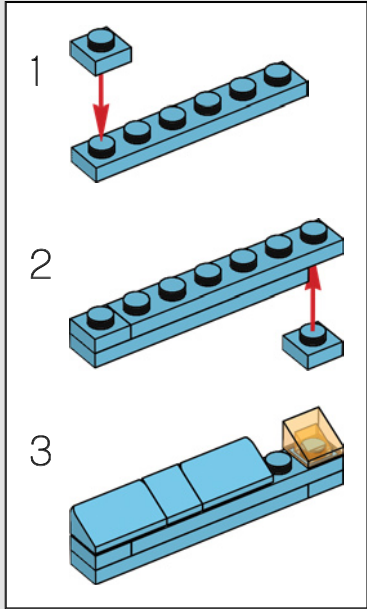

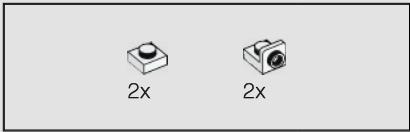

396

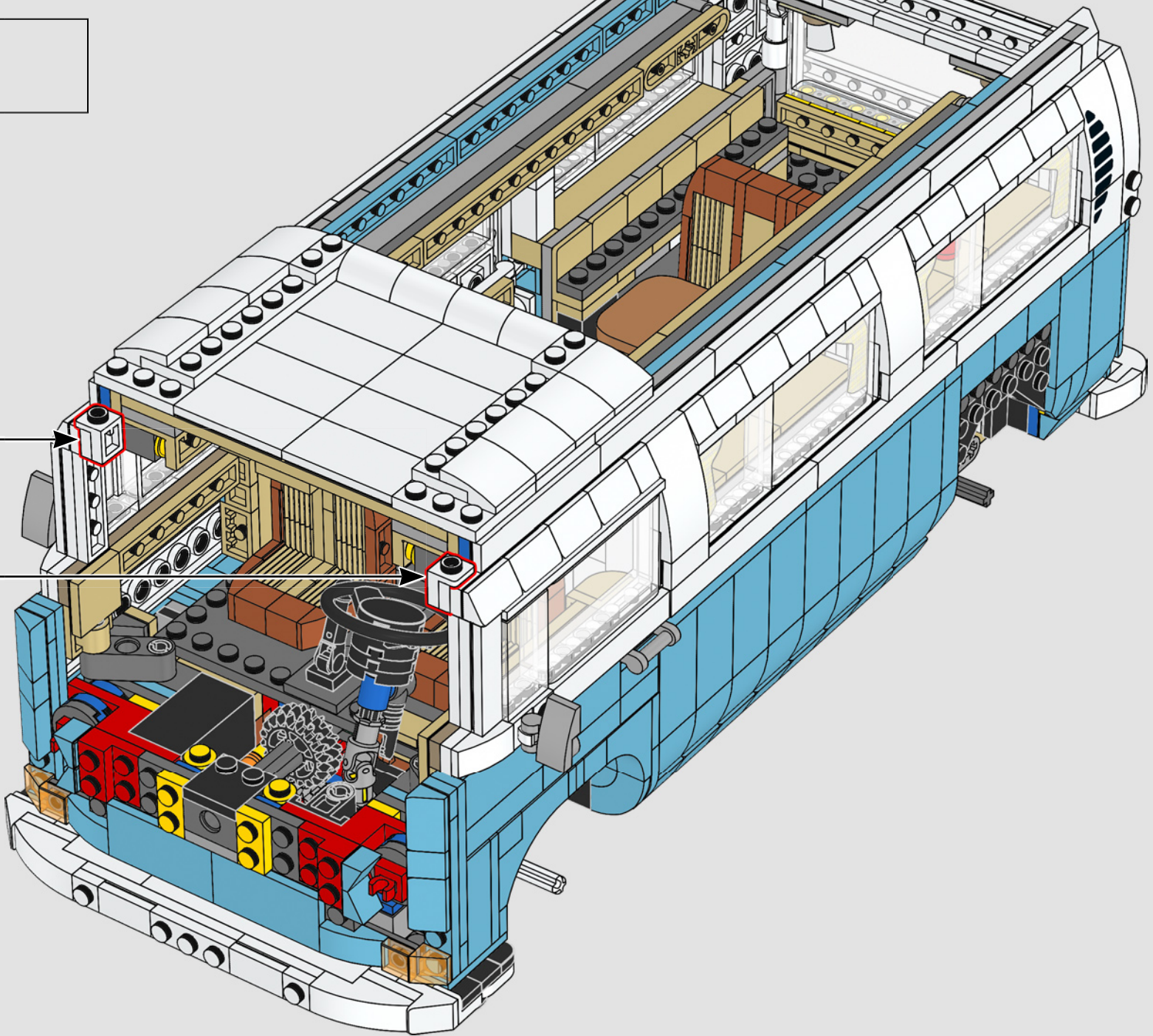
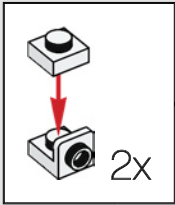

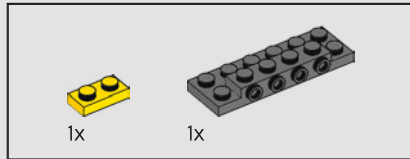
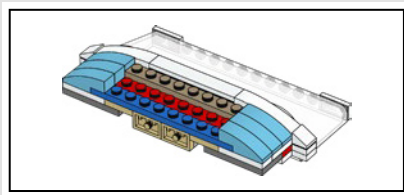

397

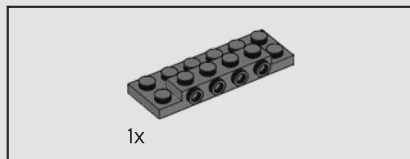
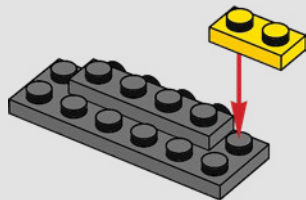

398

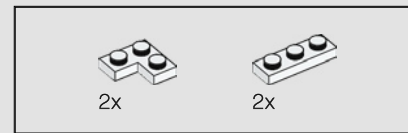
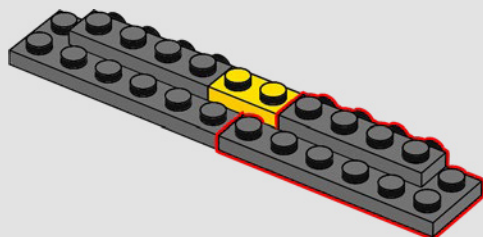

399

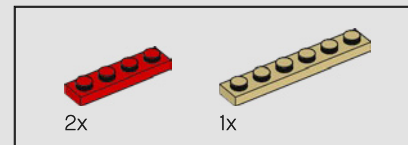
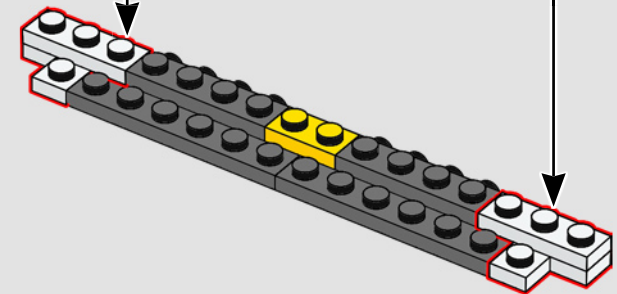
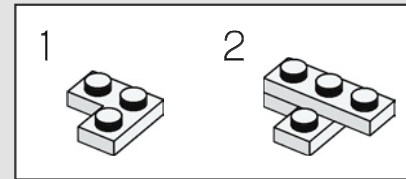
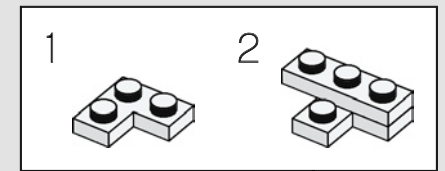

400

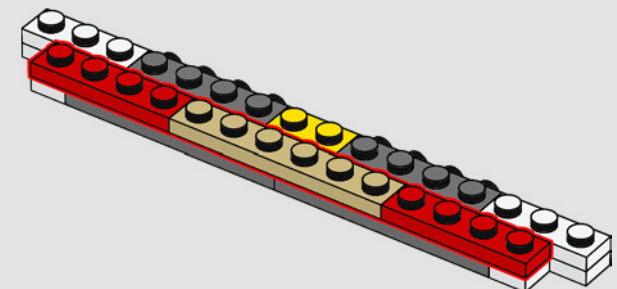

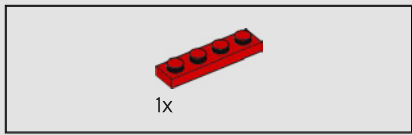

401

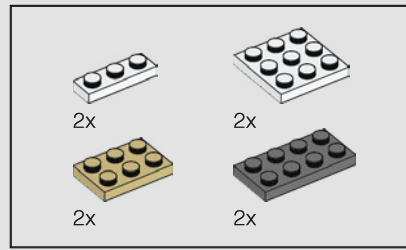
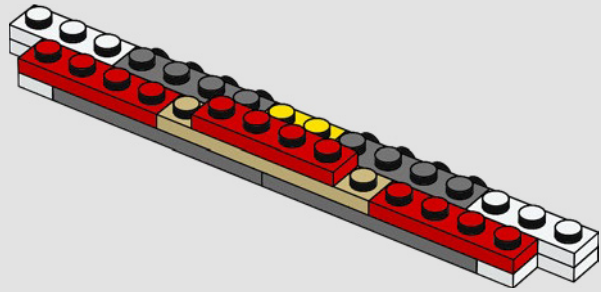

402

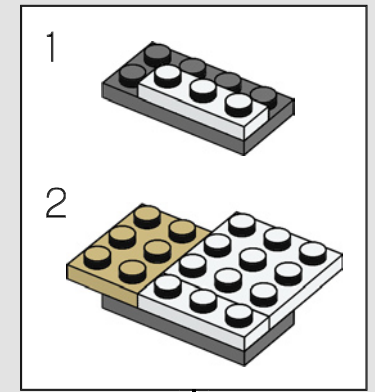
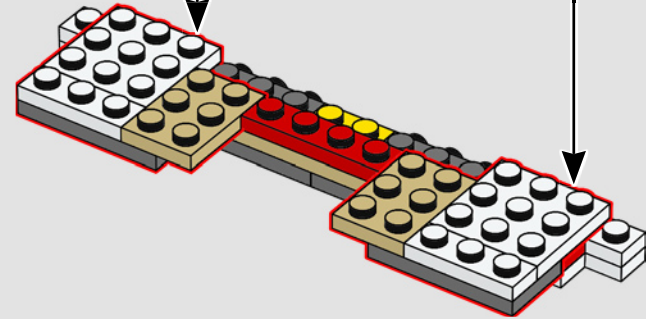
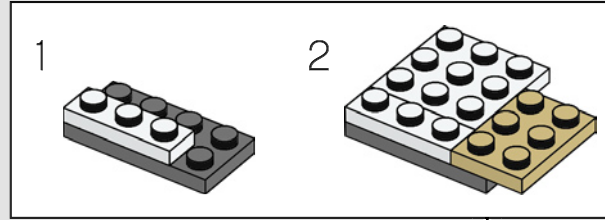

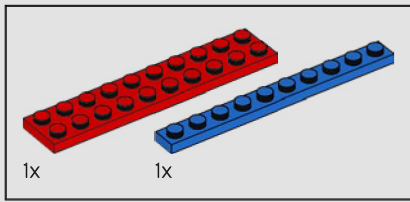

403

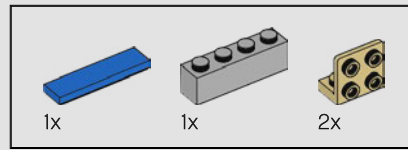
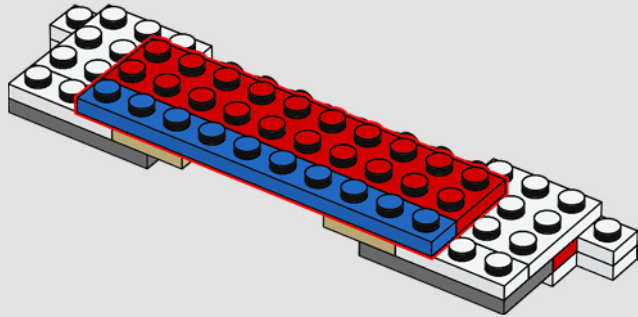

404

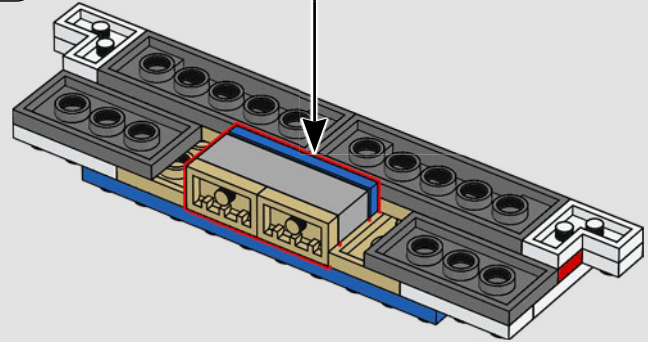
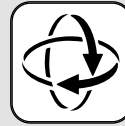
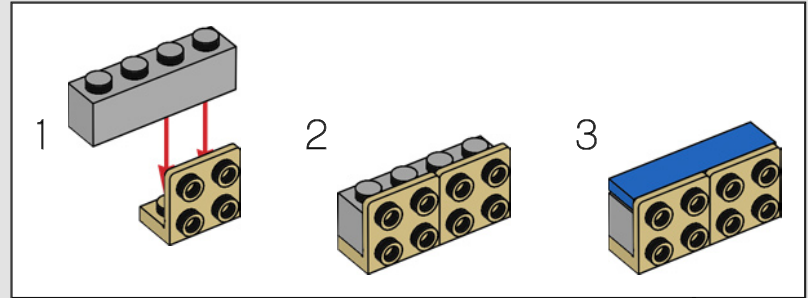

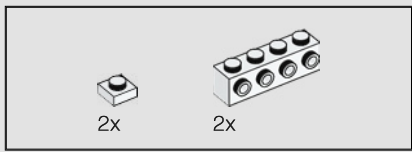

405

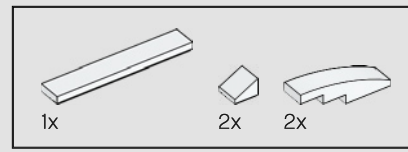
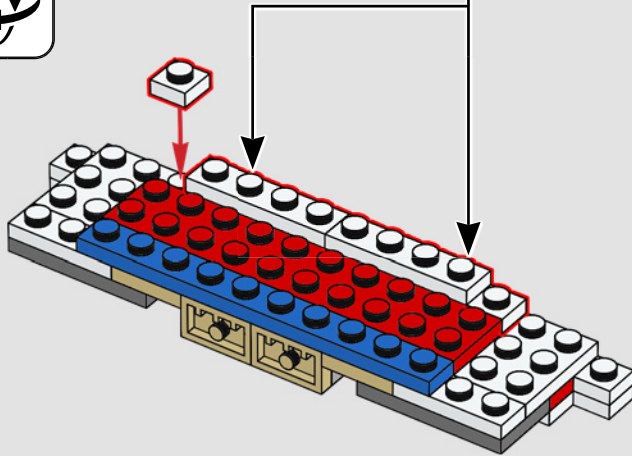
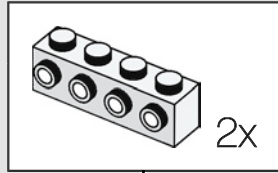

406

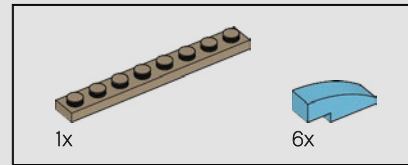
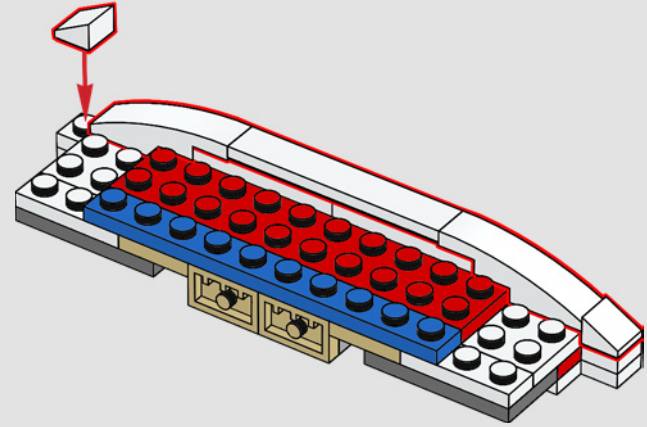

407

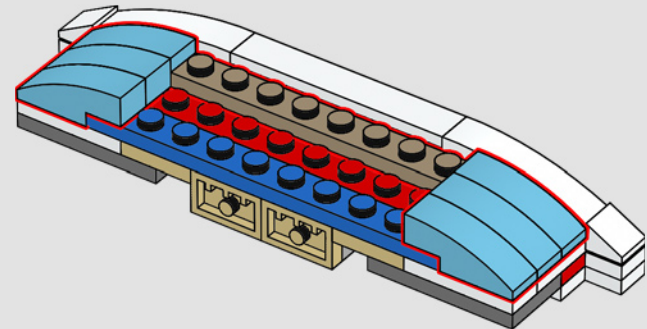

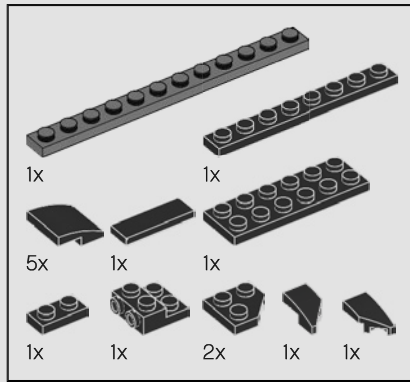
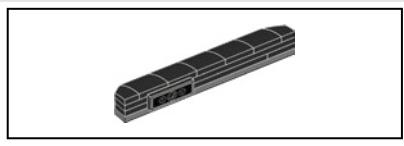

408

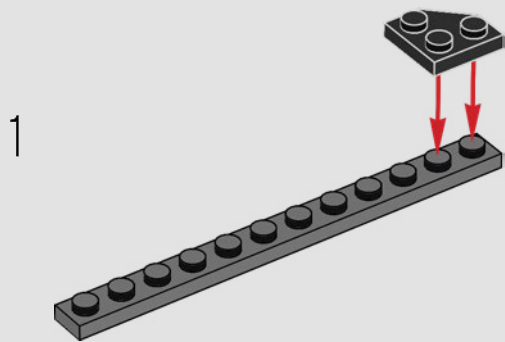

2

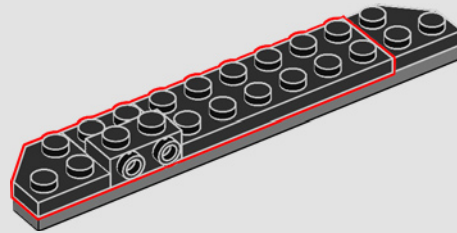

3

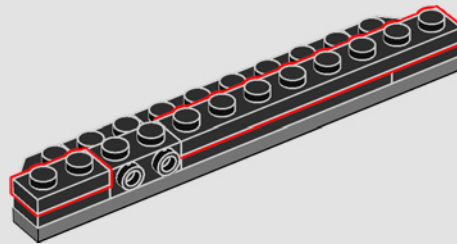

4

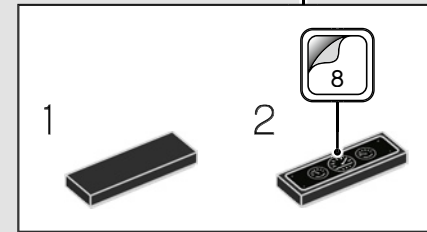
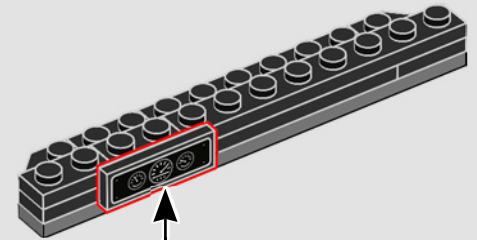

5

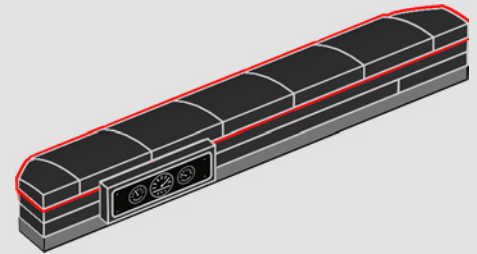

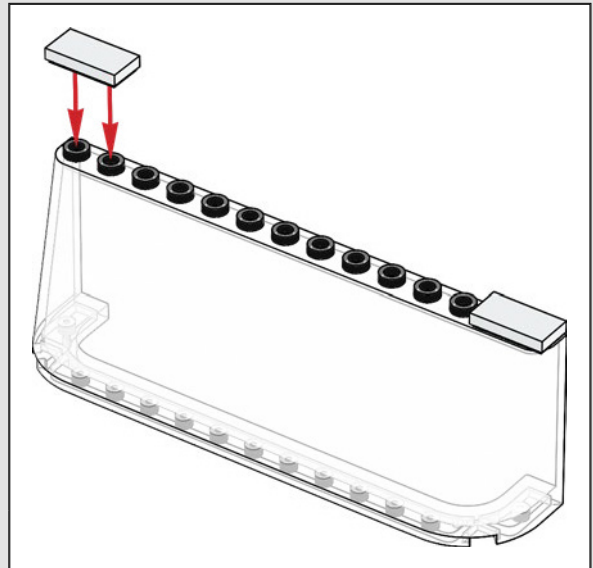
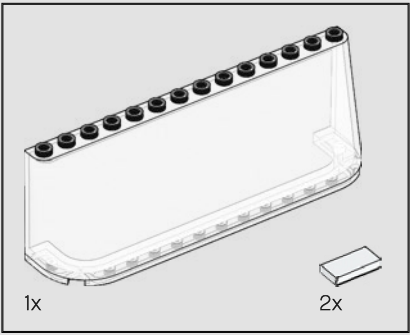

409

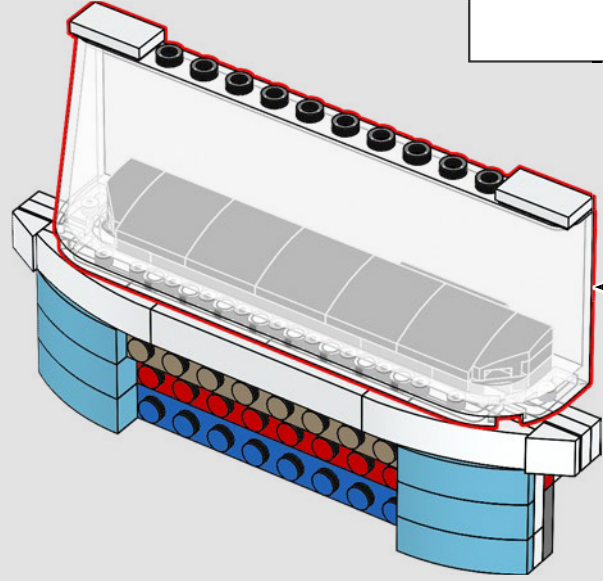
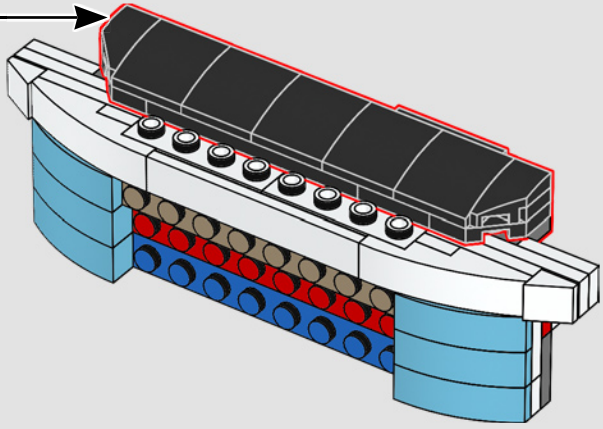

410

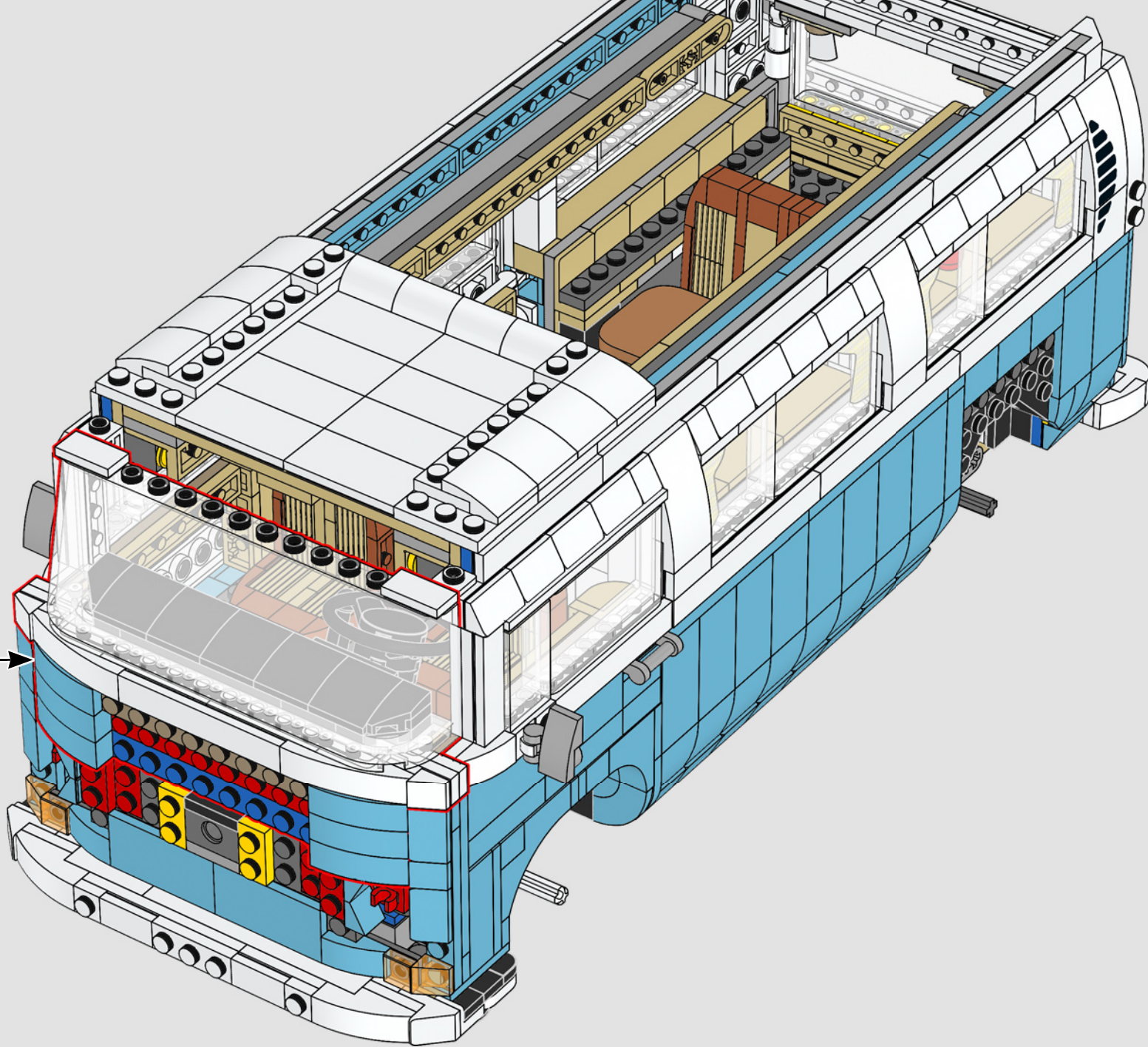

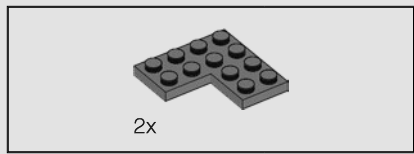

411

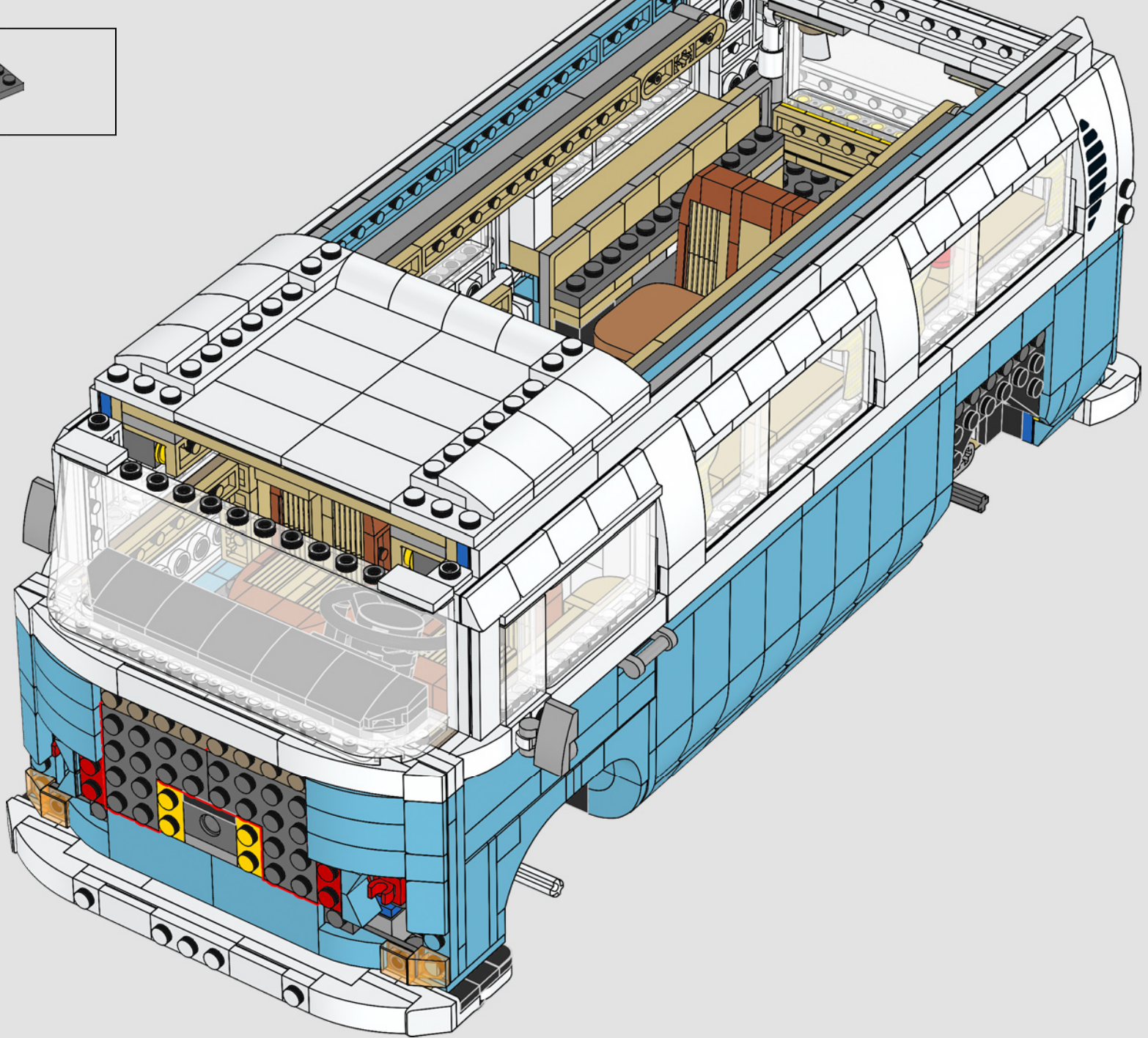

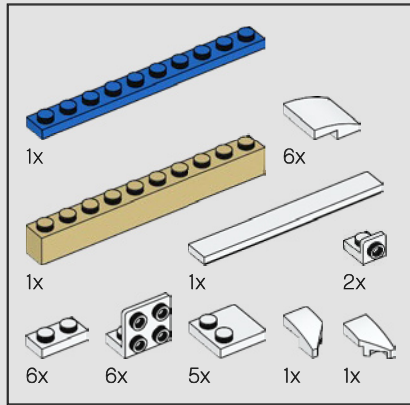
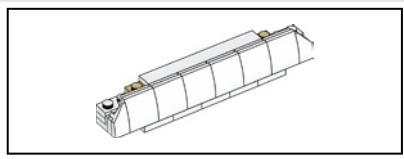

412

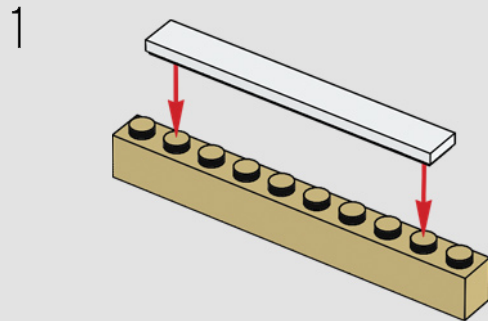

2

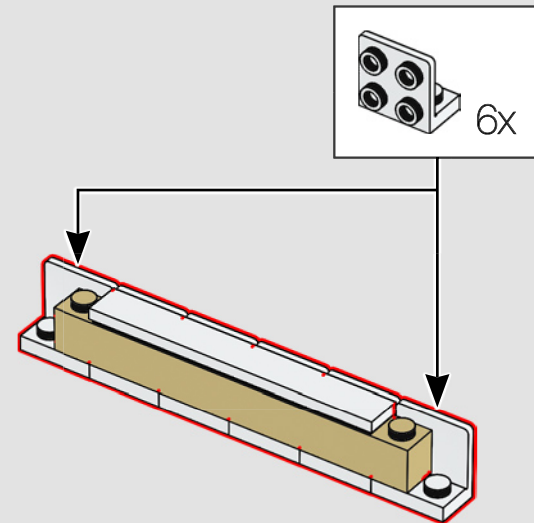

Der VW T2 hatte rund um die Welt die unterschiedlichsten Kosenamen. In Deutschland kennen ihn bis heute viele als „Bulli“.

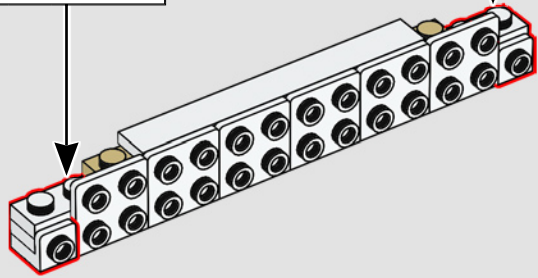
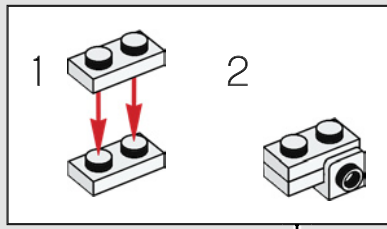
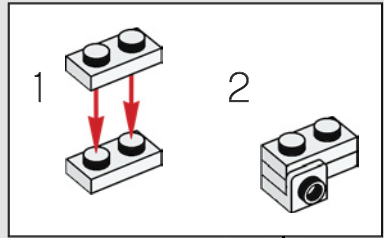

4

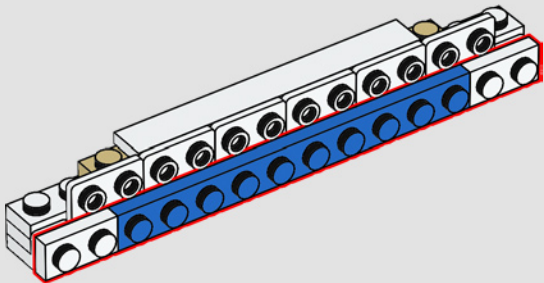

5

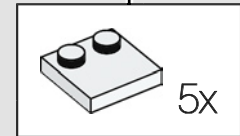
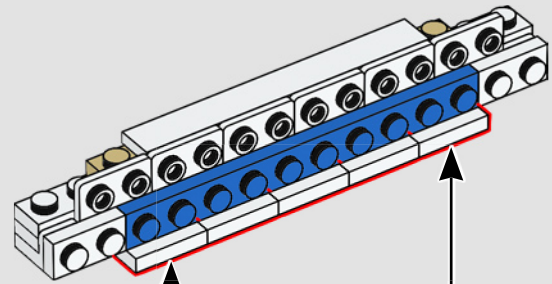

6

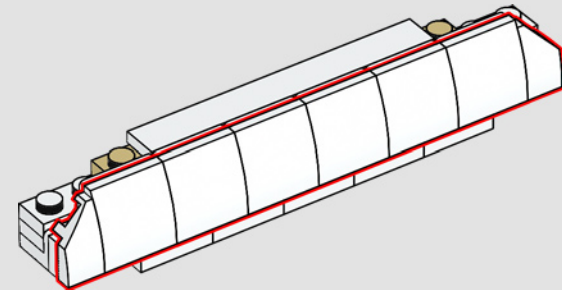

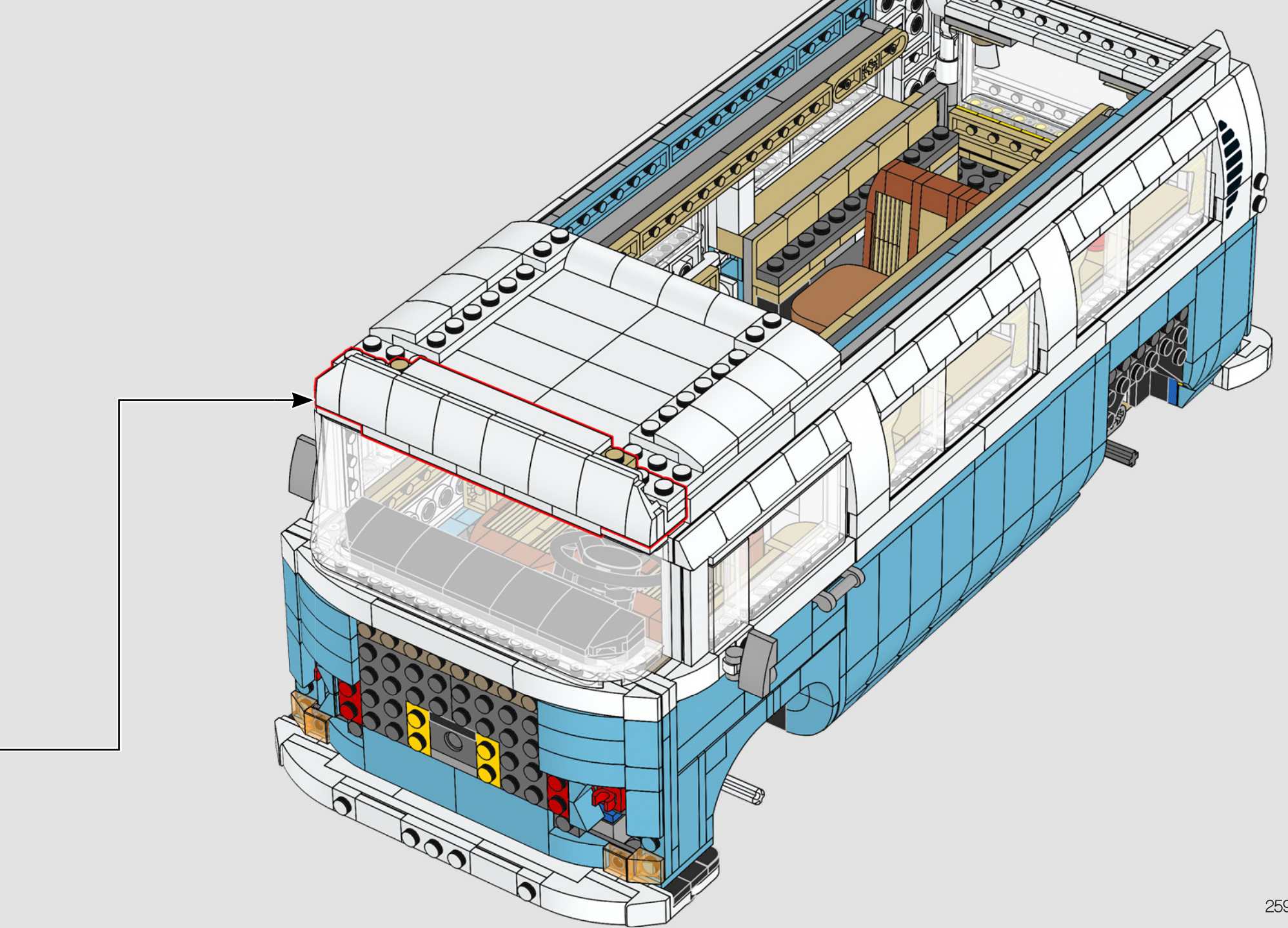

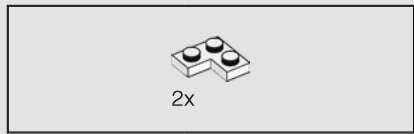

413

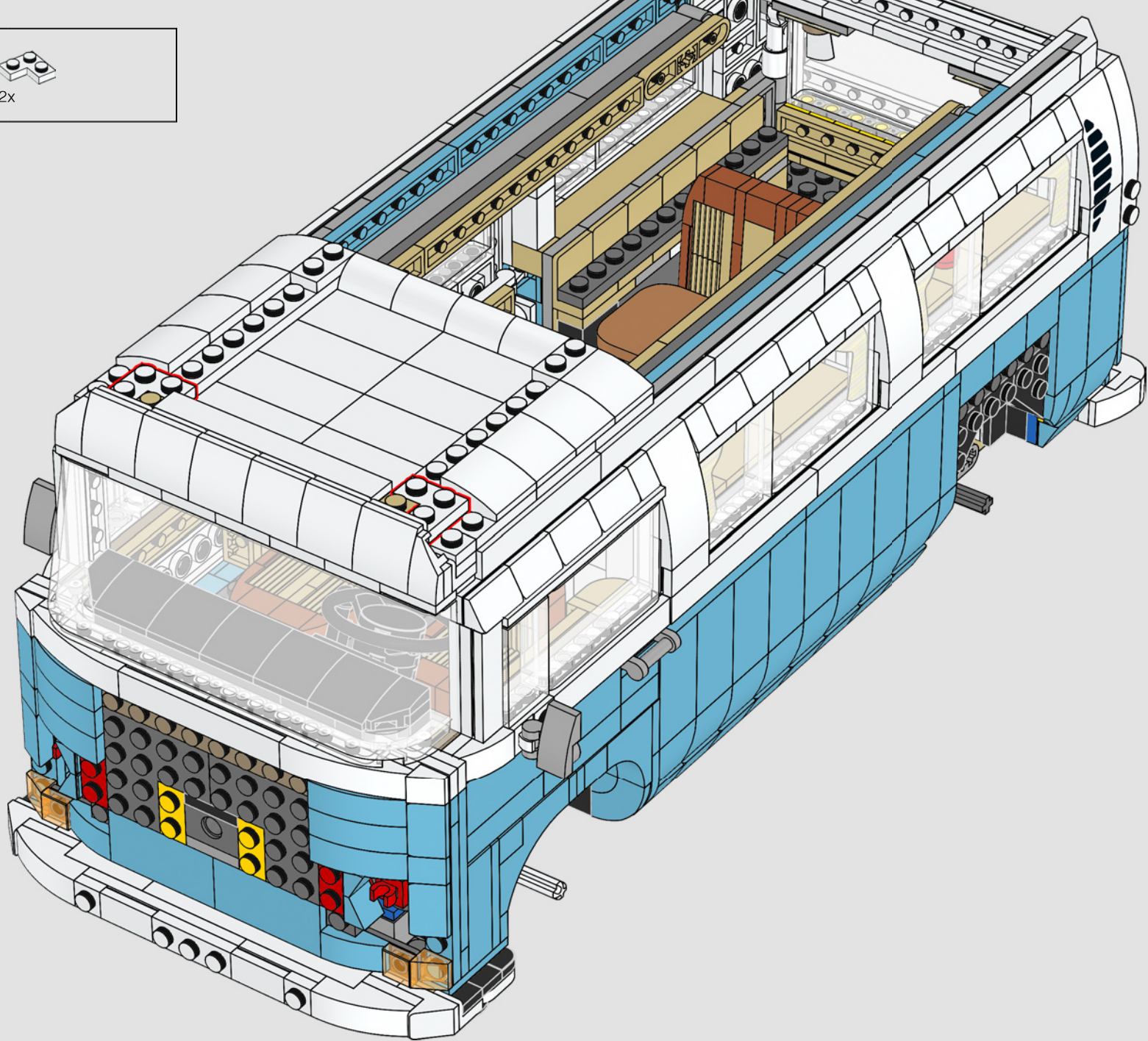

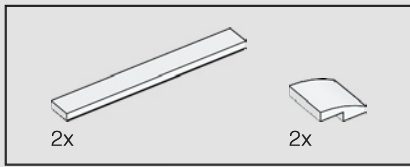

414

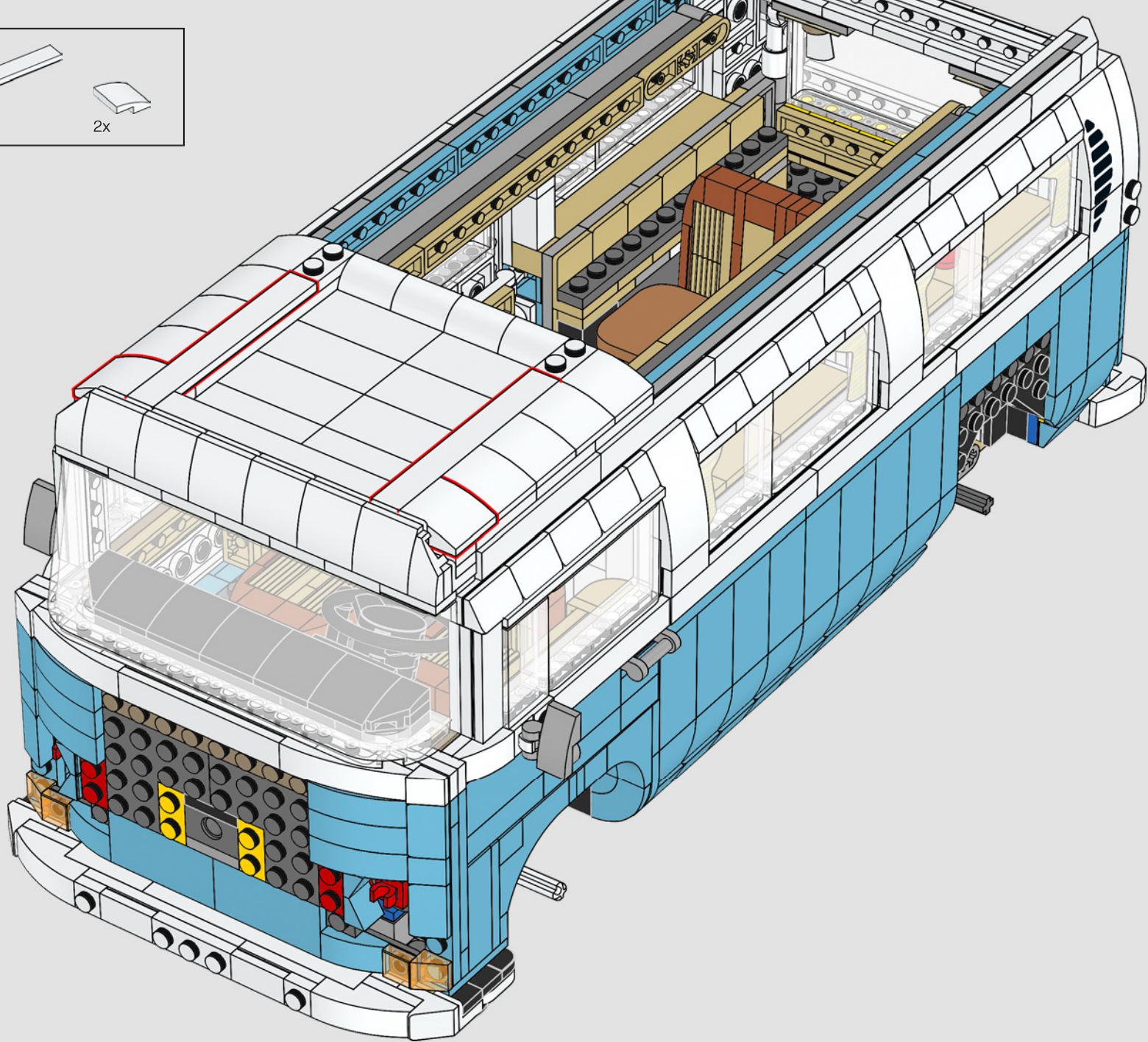

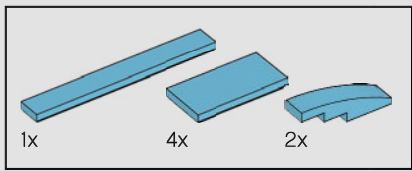

415

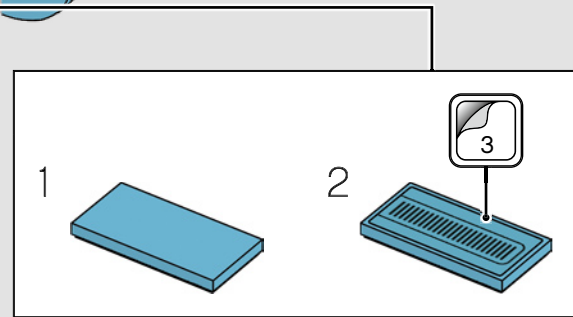
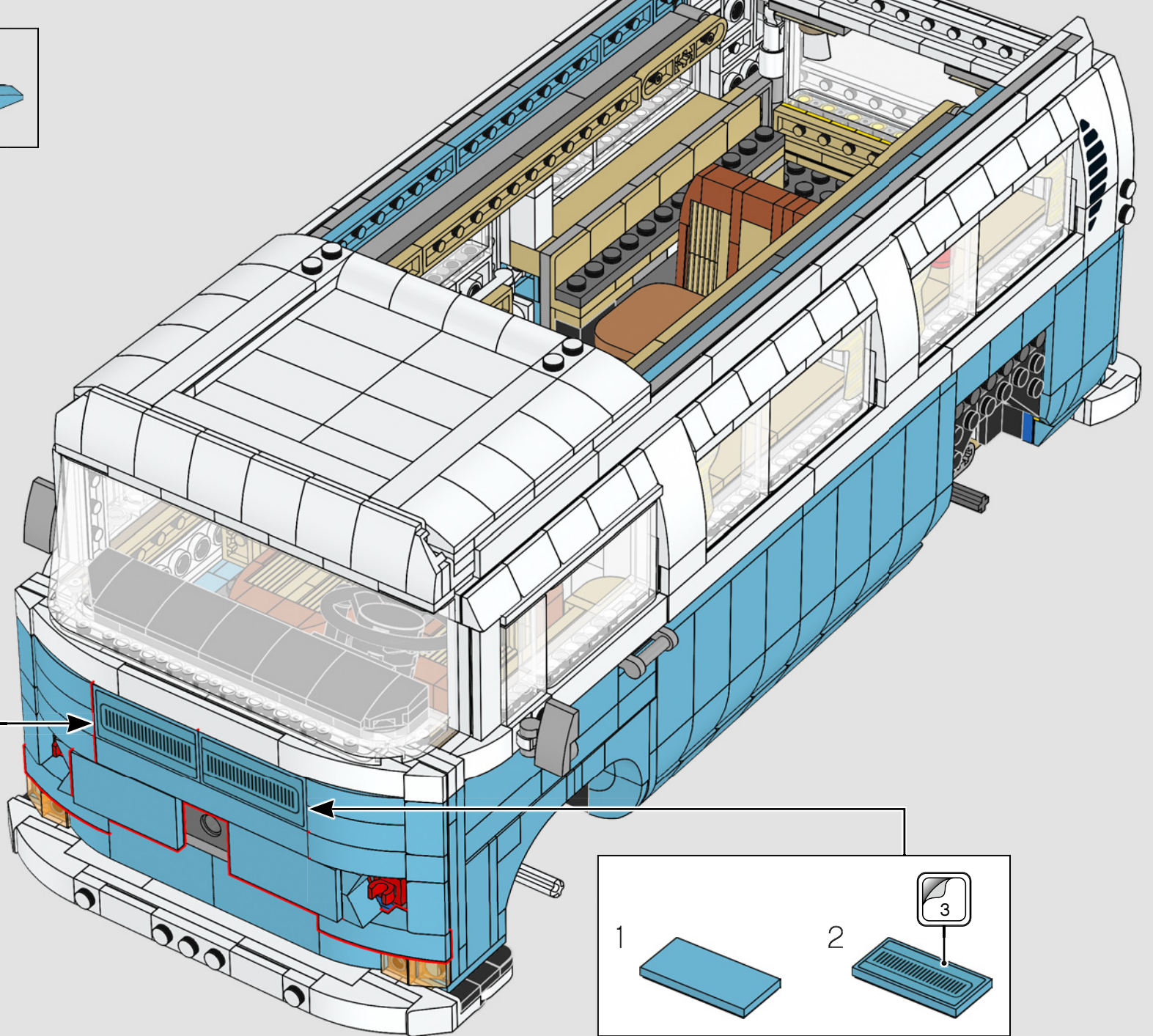
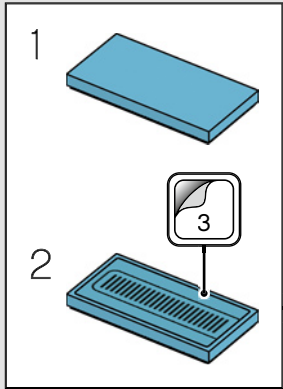

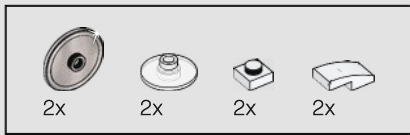

416

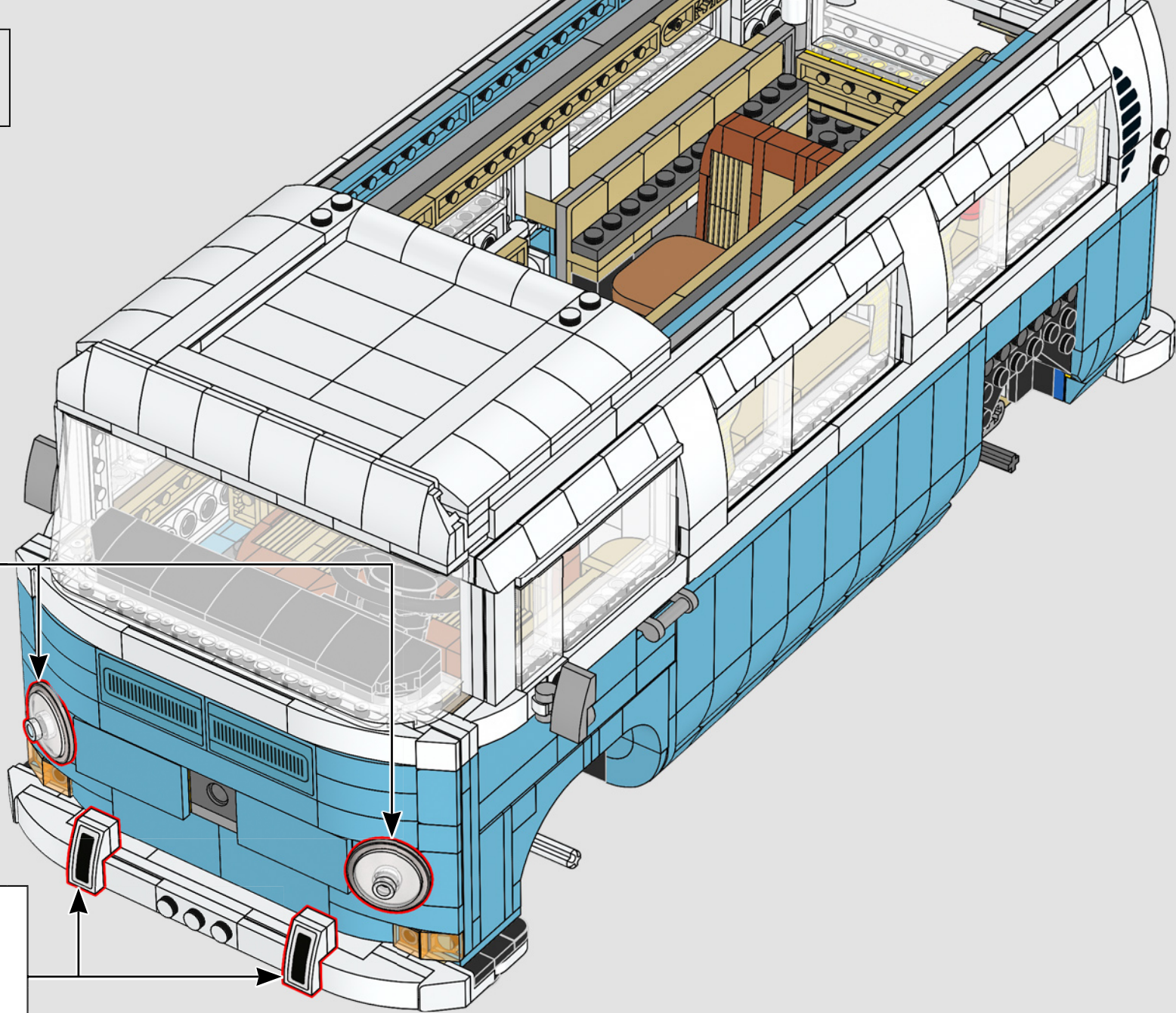
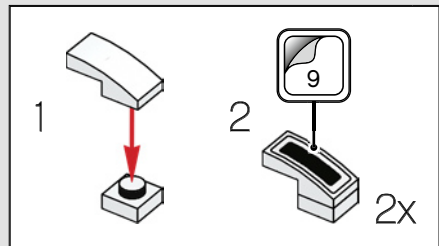
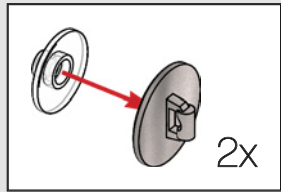

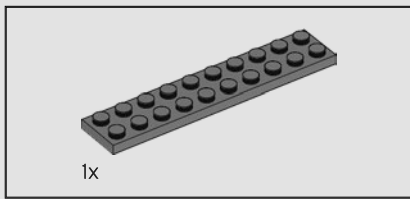

418

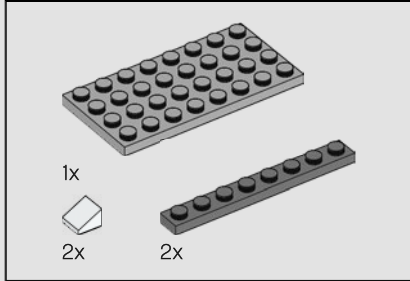
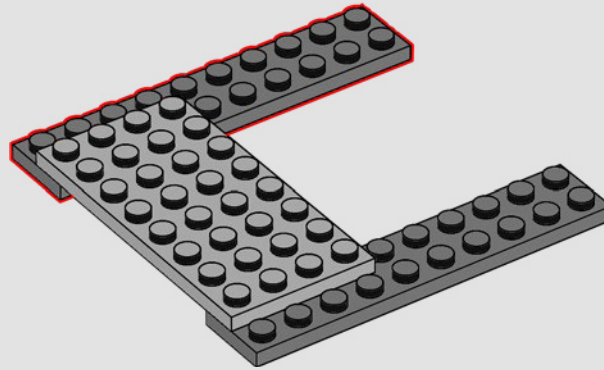

419

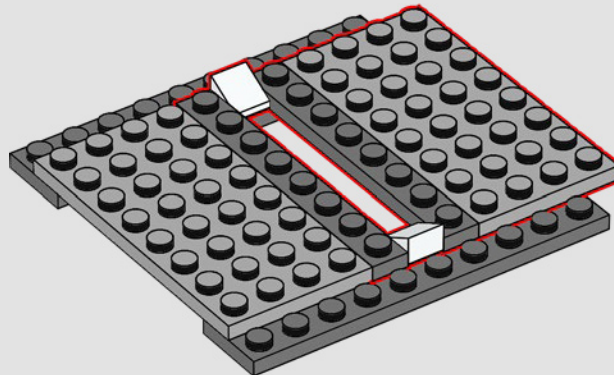

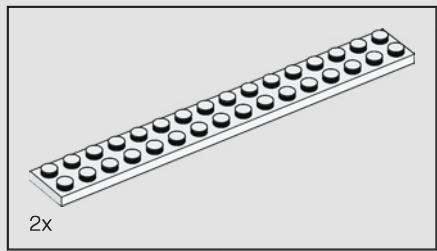

420

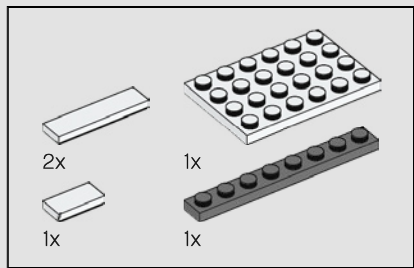
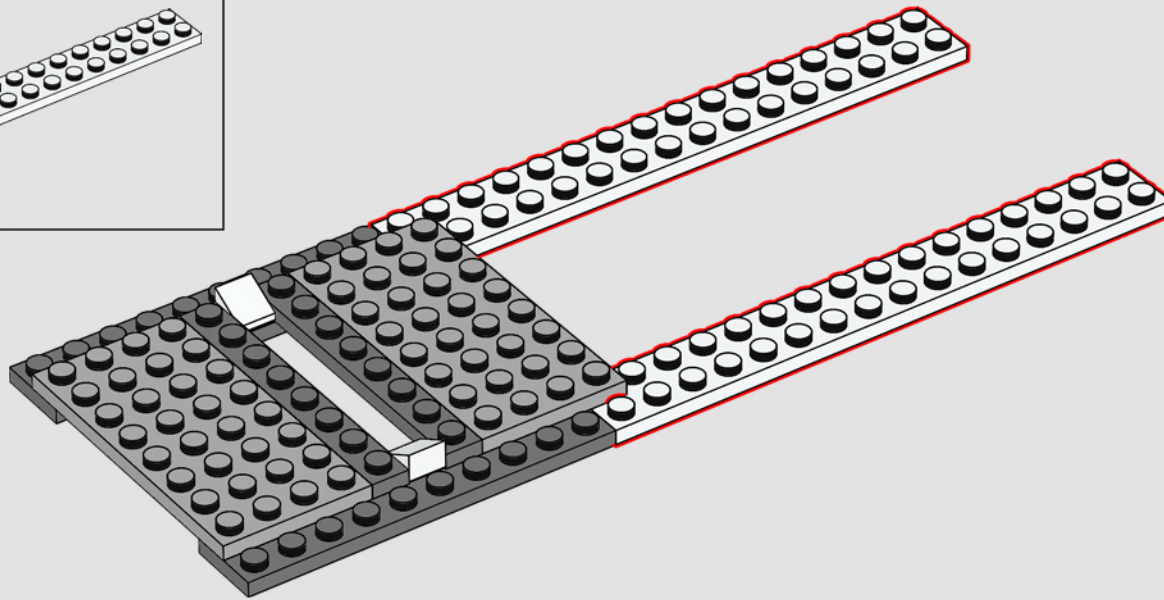

421

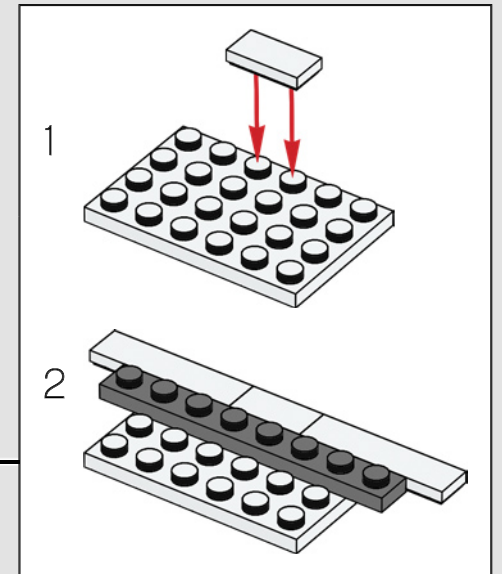
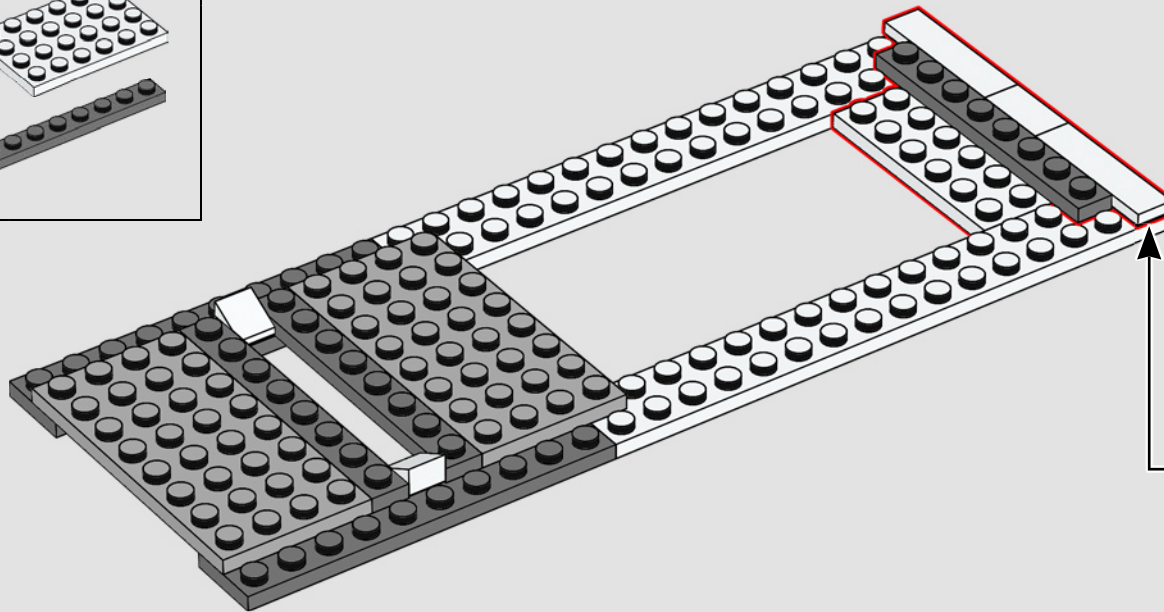

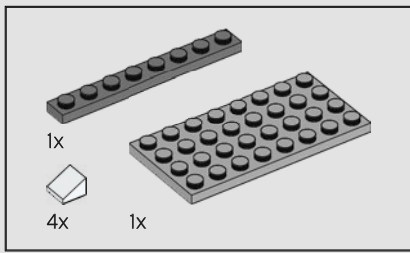

422

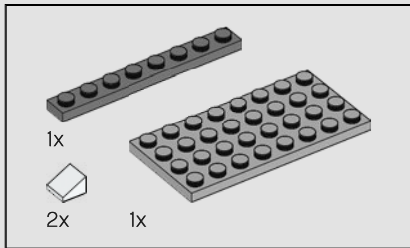
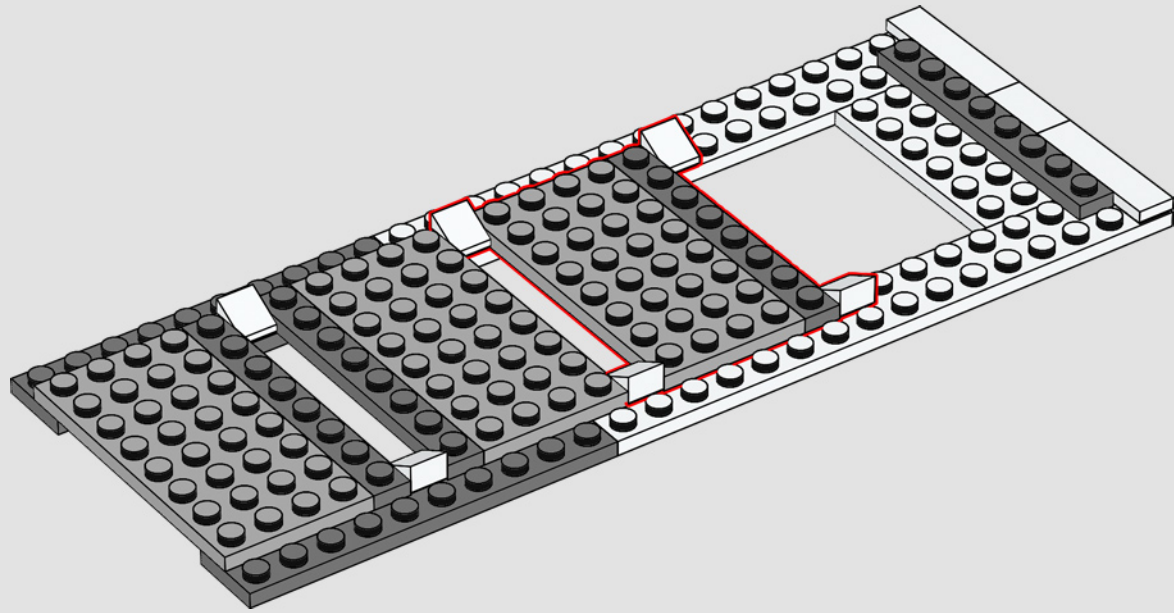

423

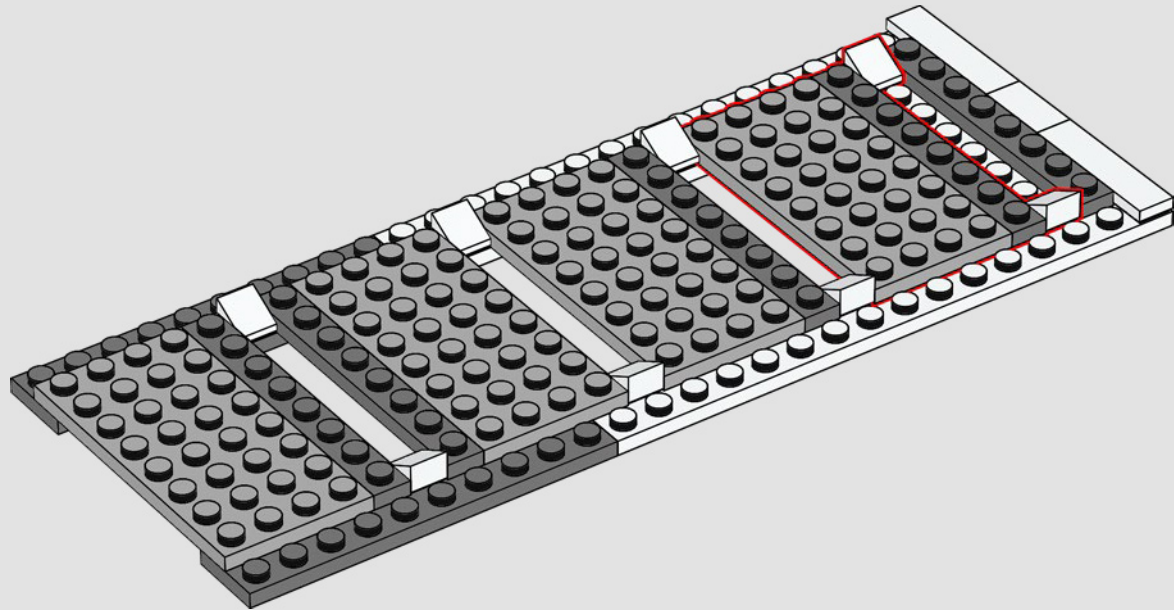

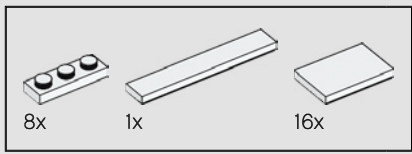

424

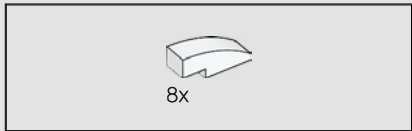
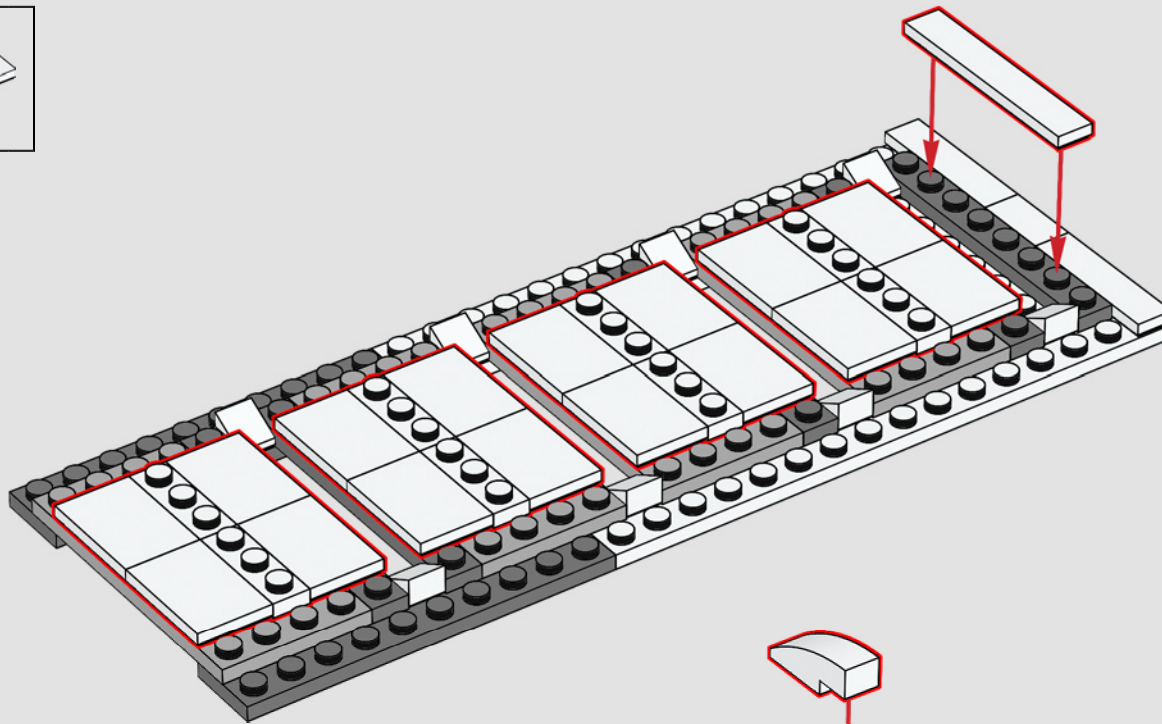

425

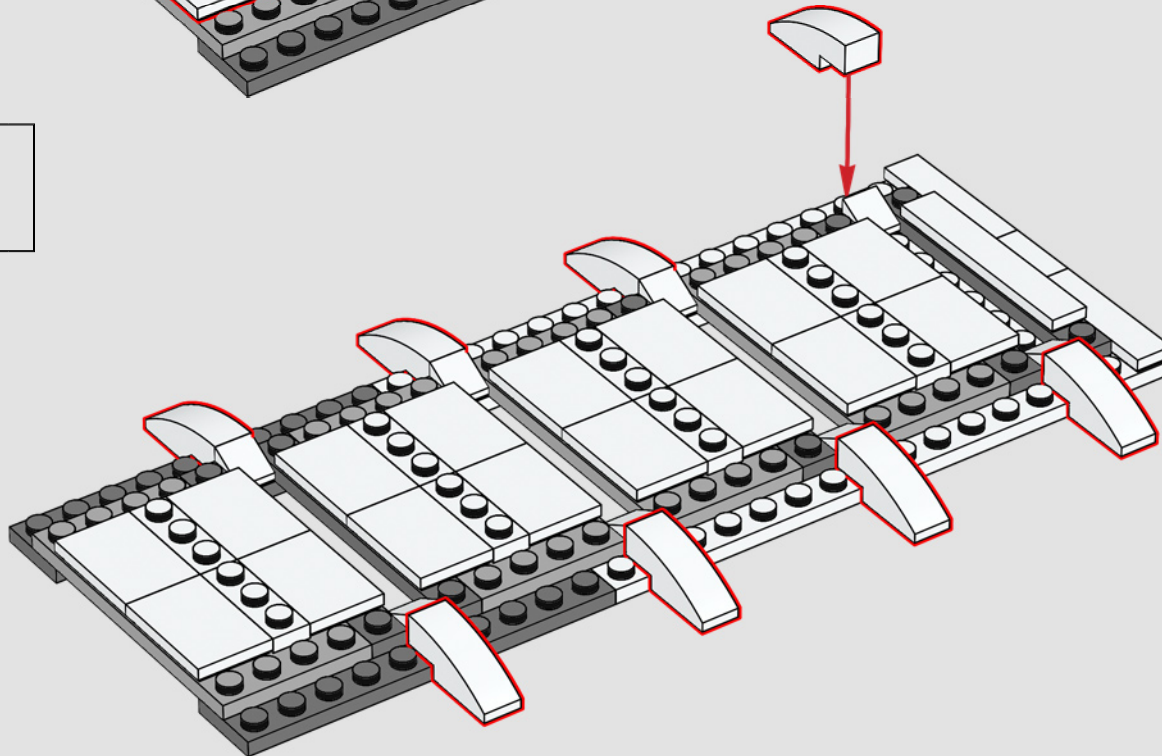

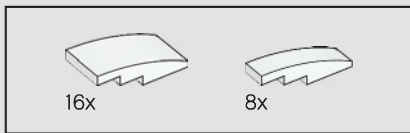

426

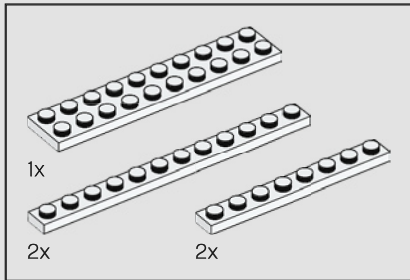
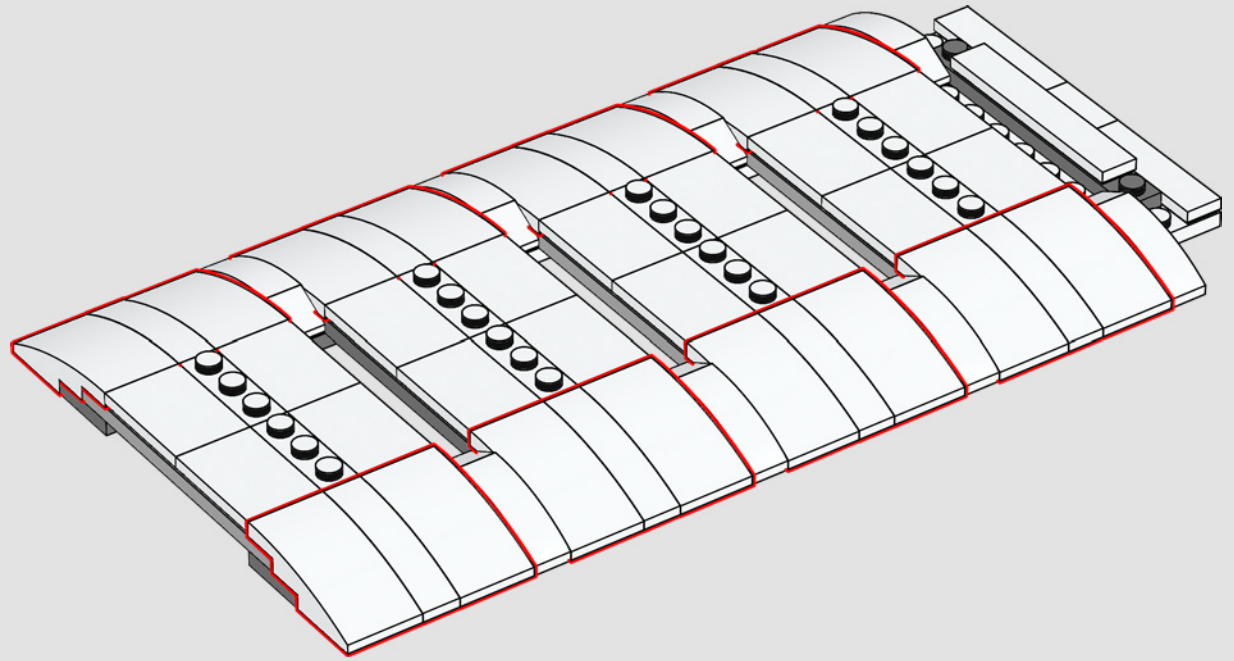

427

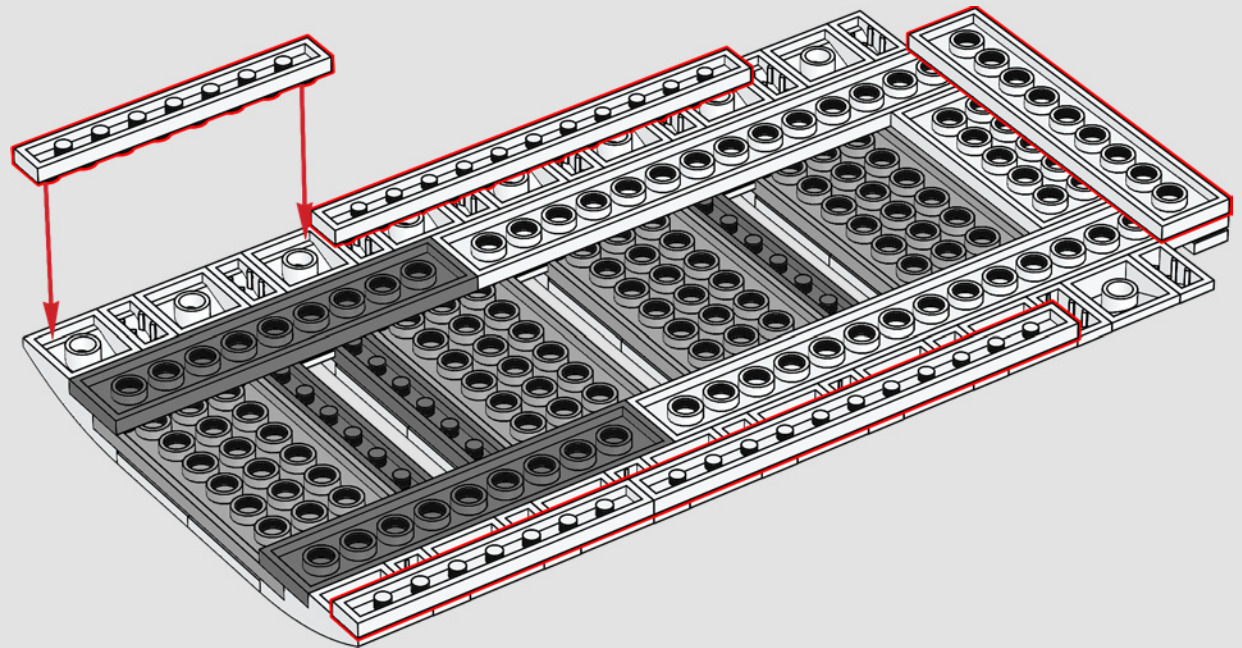

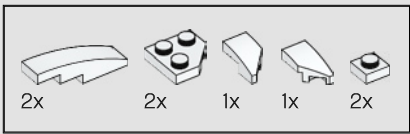

428

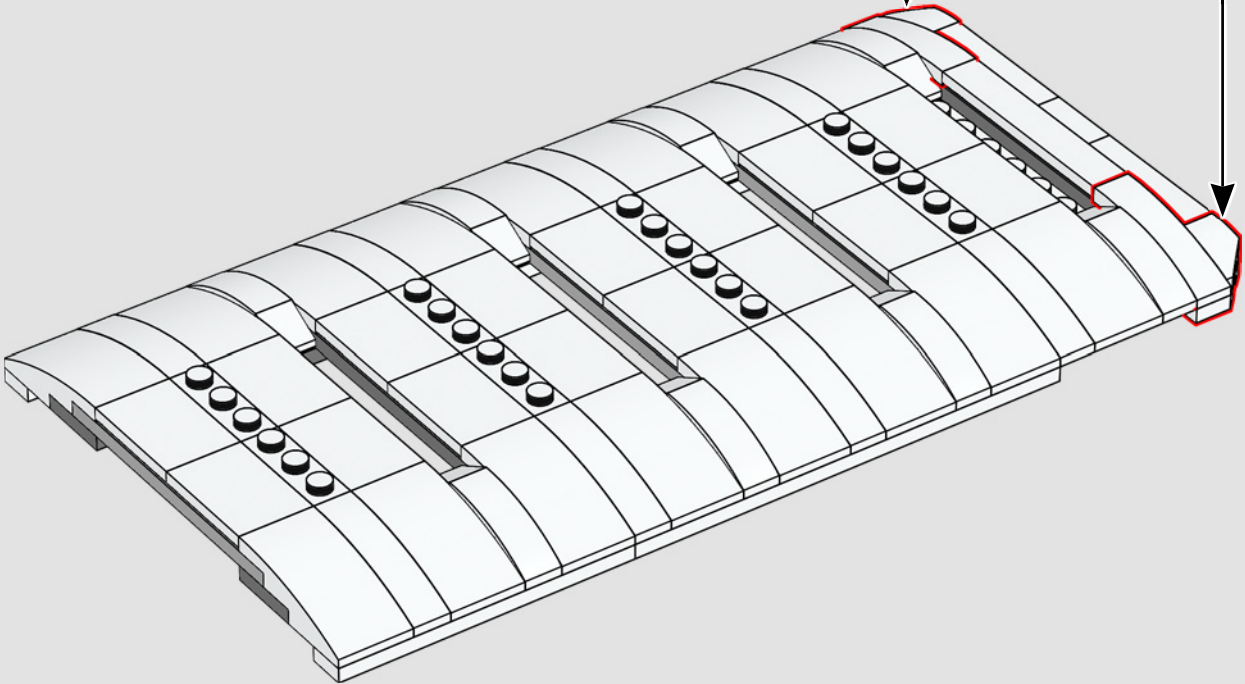
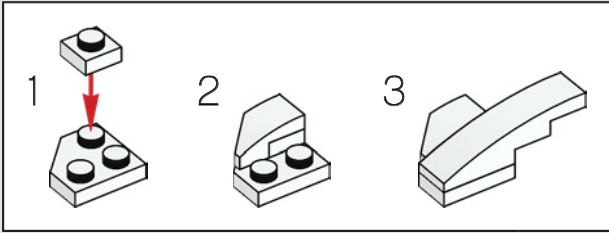
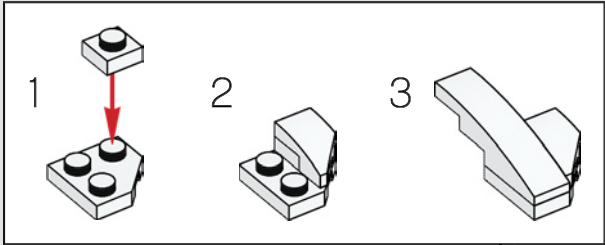

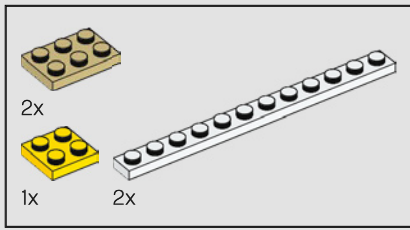

429

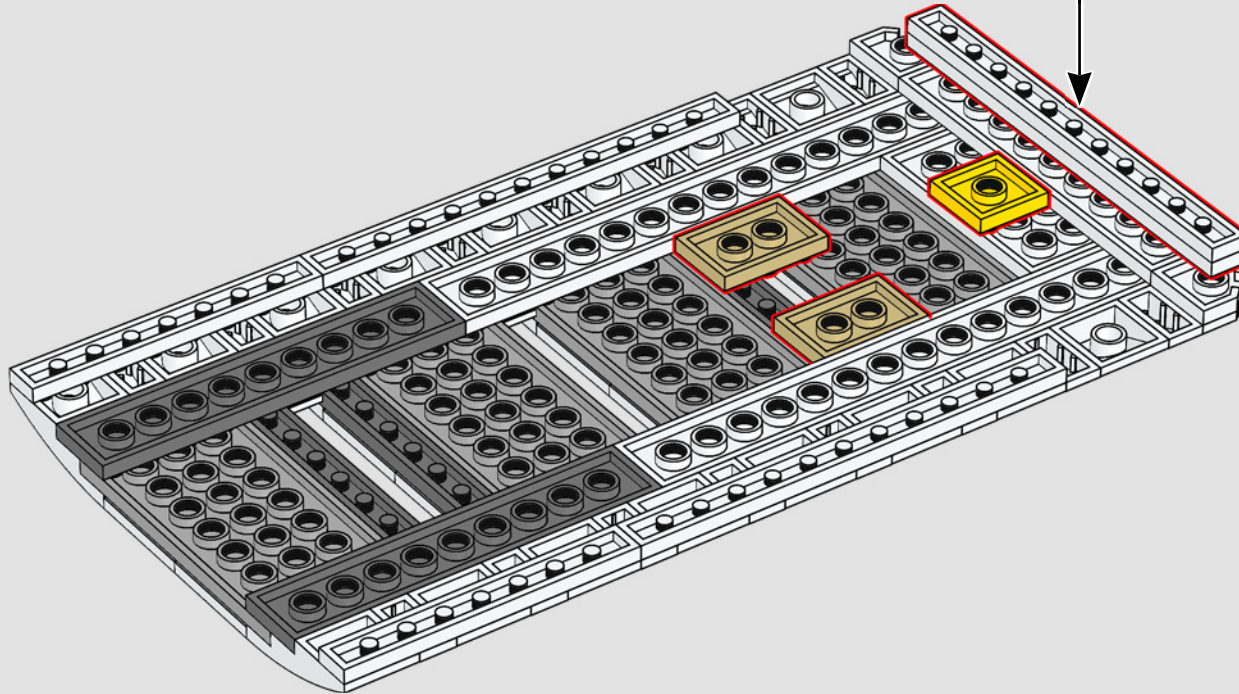
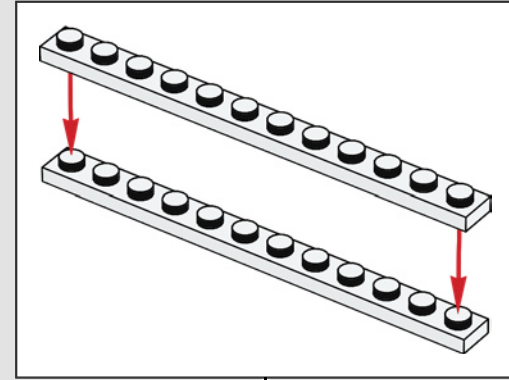

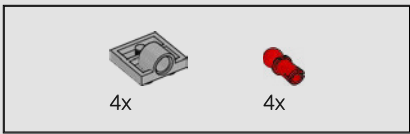

430

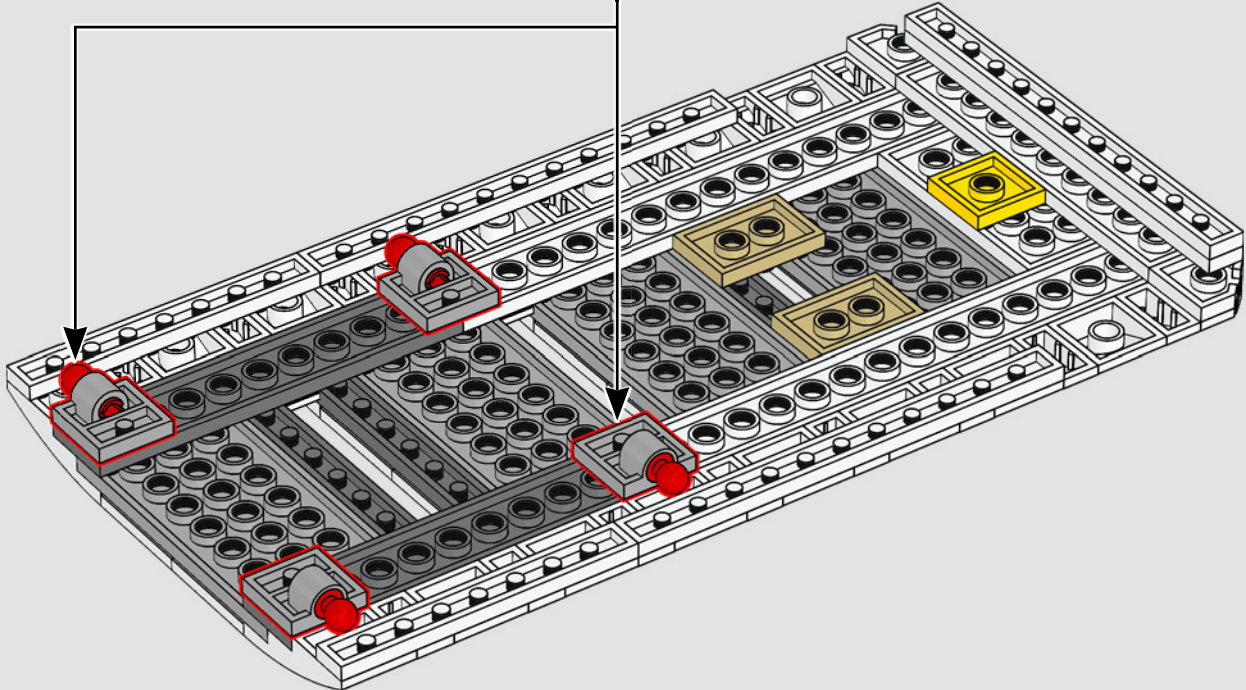
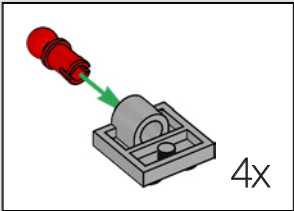

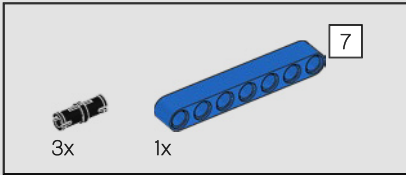
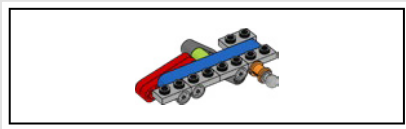

431

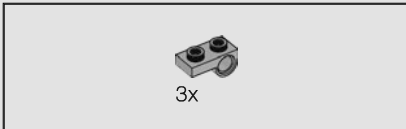
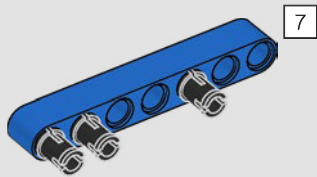

432

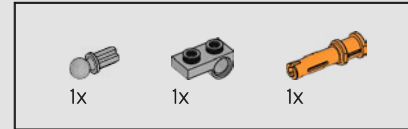
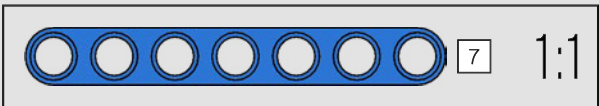
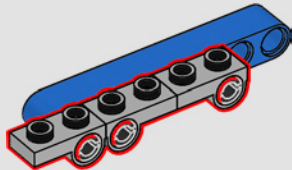

433

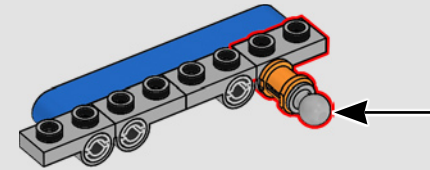
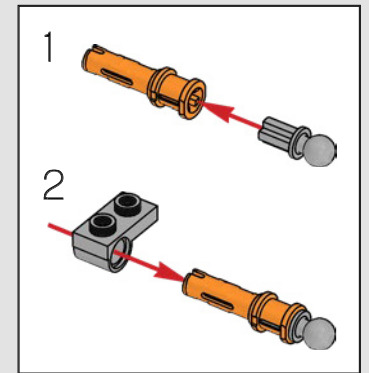

434

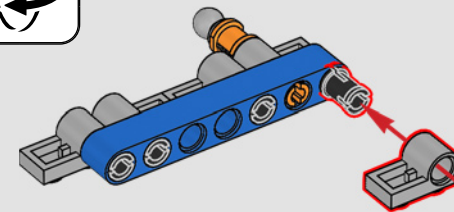
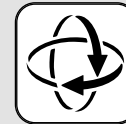



435

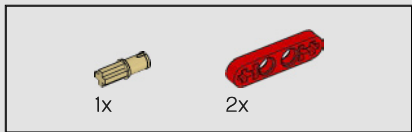
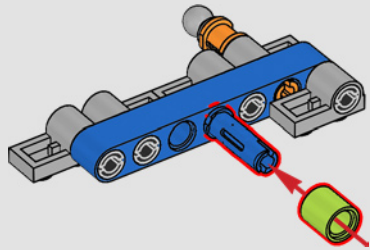

436

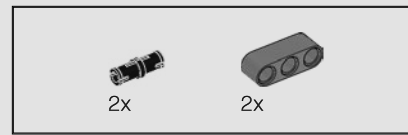
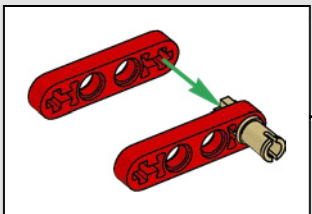
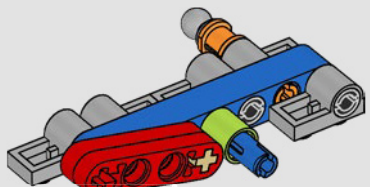

437

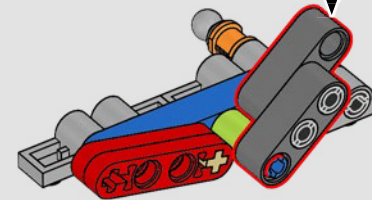
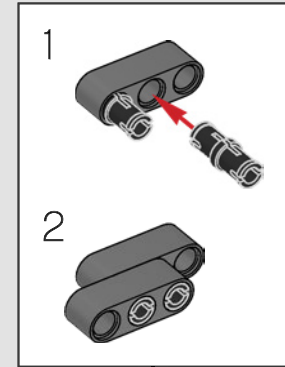

438

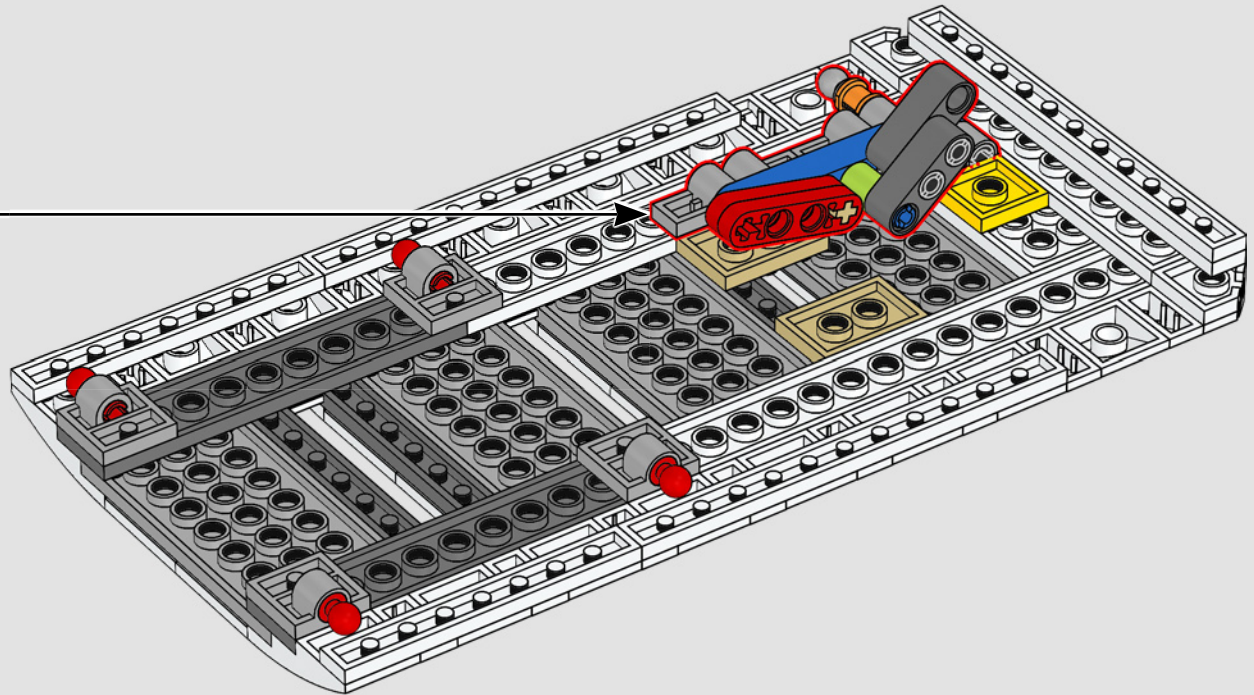

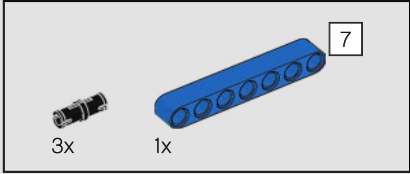
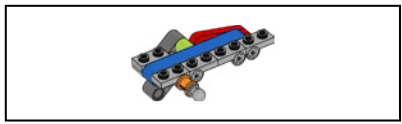

439

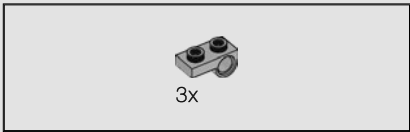
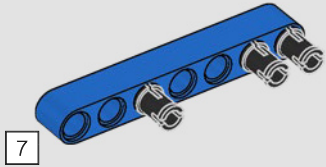

440

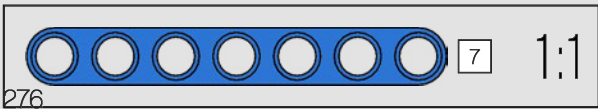
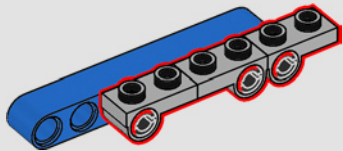

276

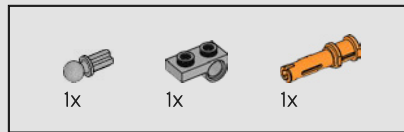

441

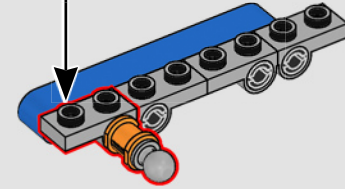
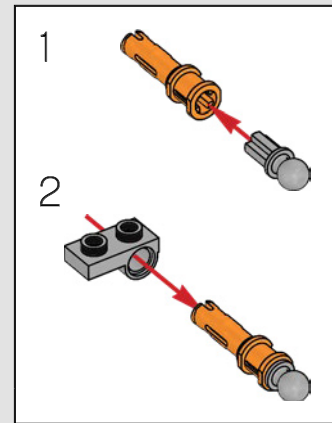

442

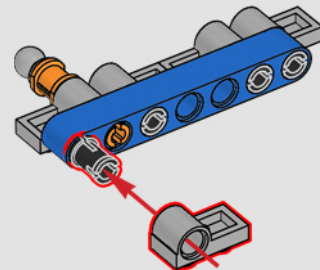

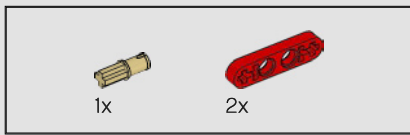

443

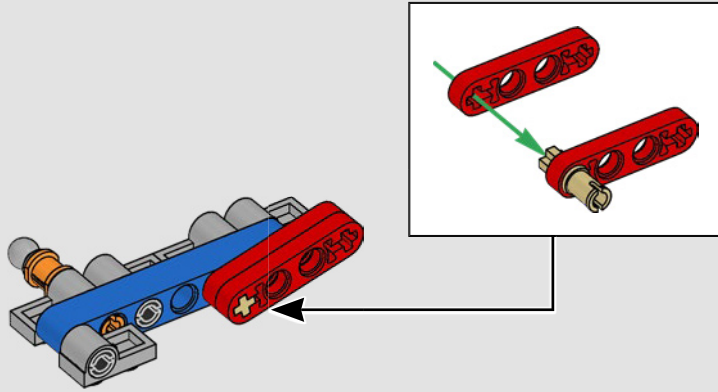

444

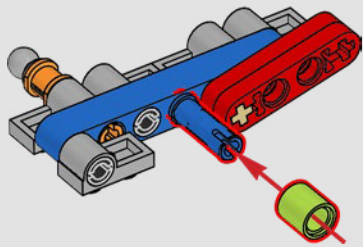

445

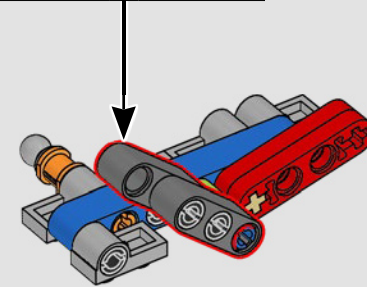
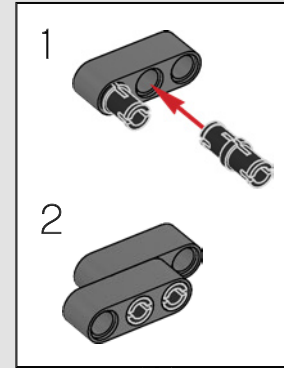

446

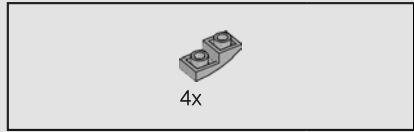
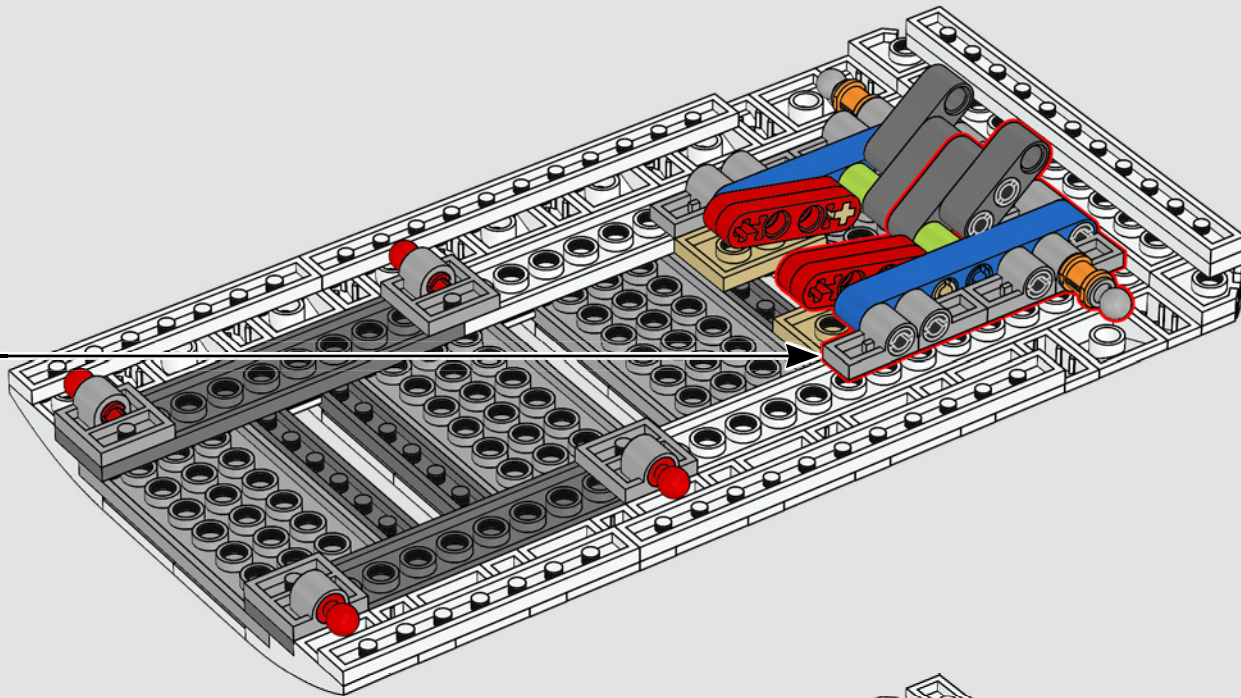

447

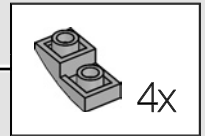
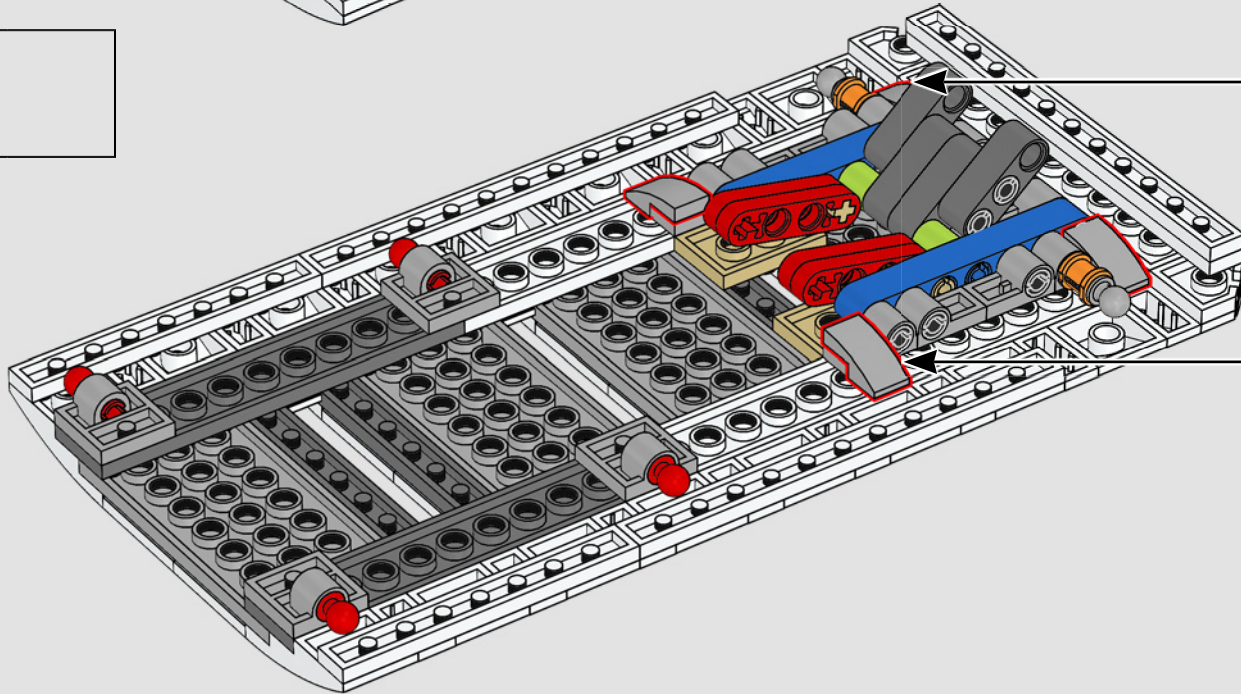

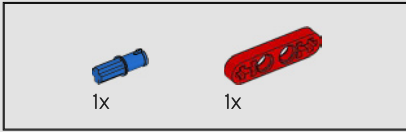
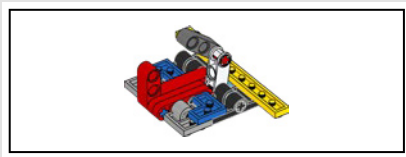

448

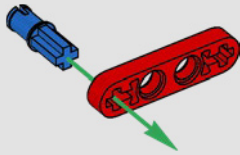

449

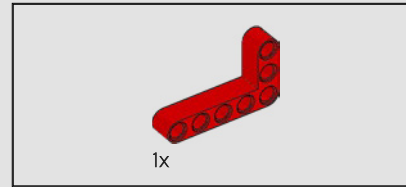
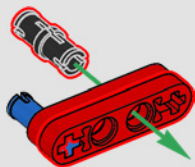

450

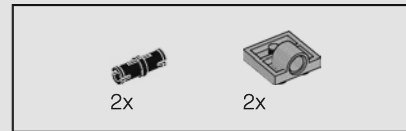
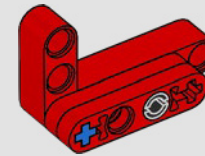

451

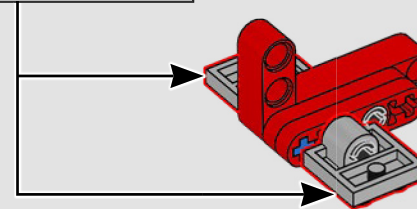
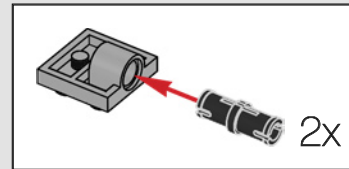

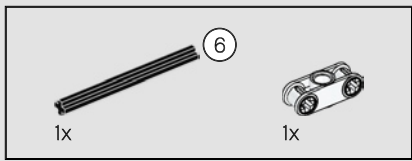

452

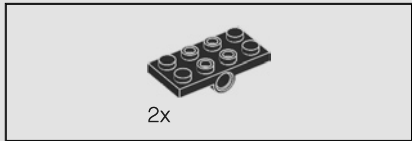
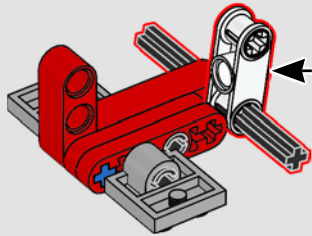
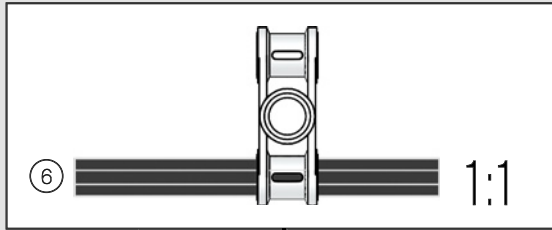

453

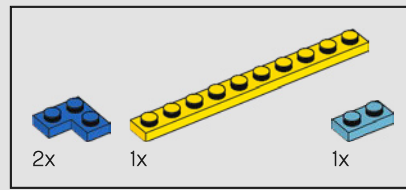
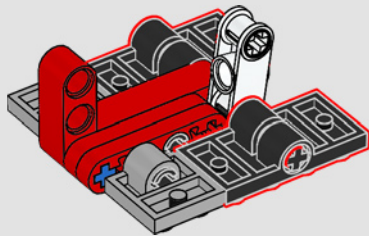

454

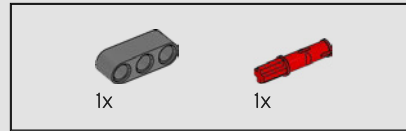
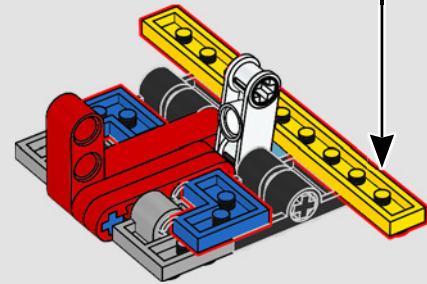
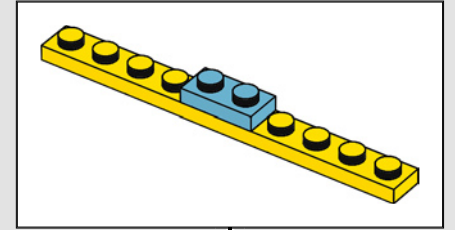

455

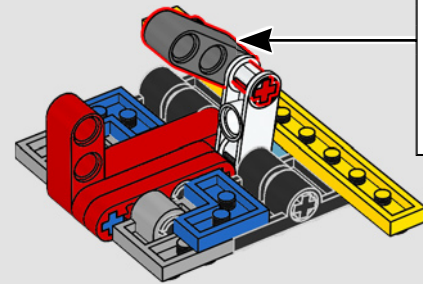
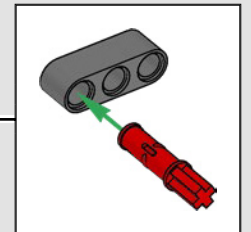

456

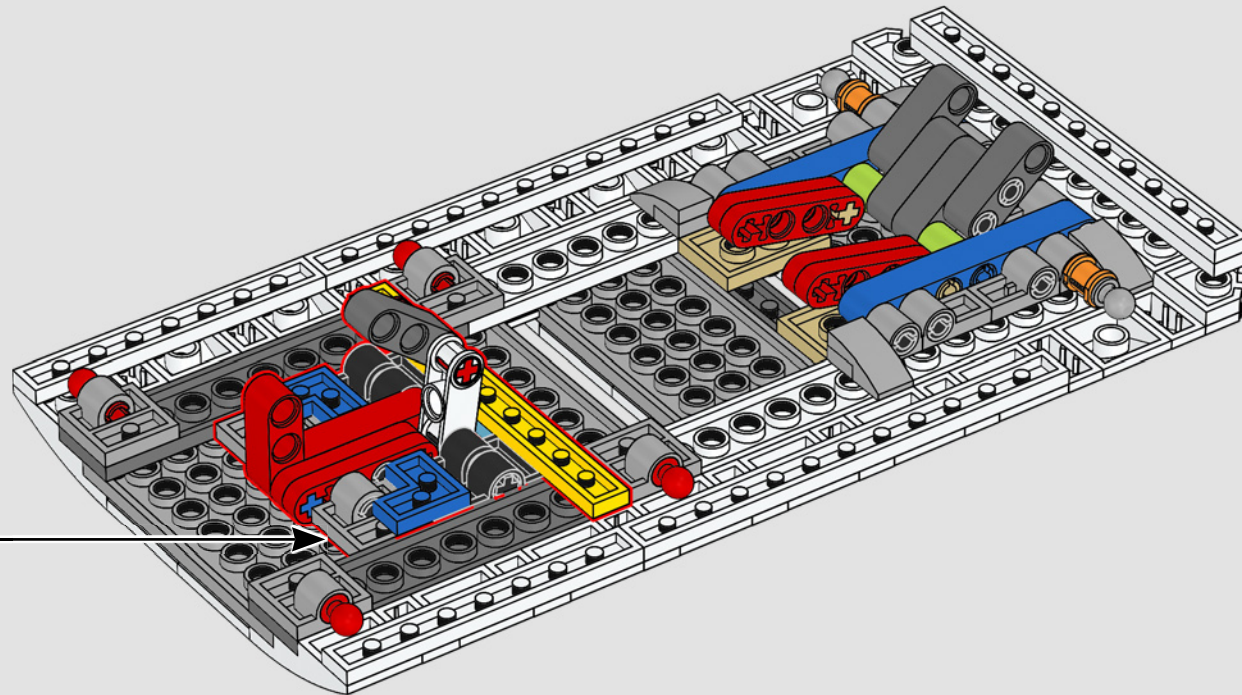

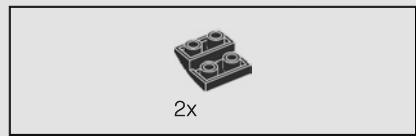

457

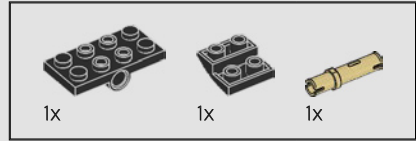
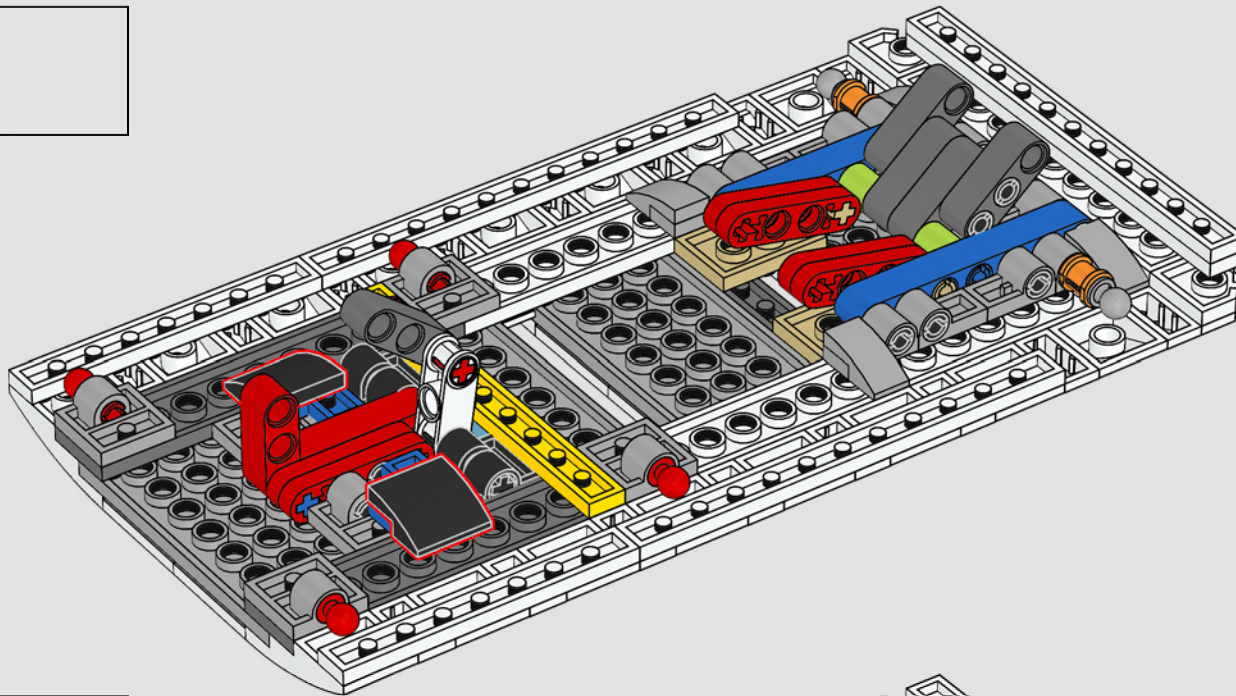

458

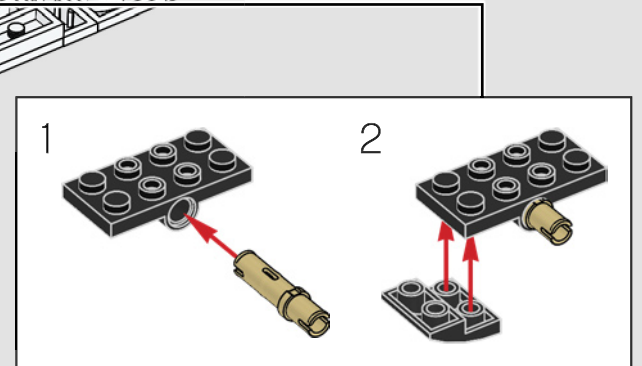
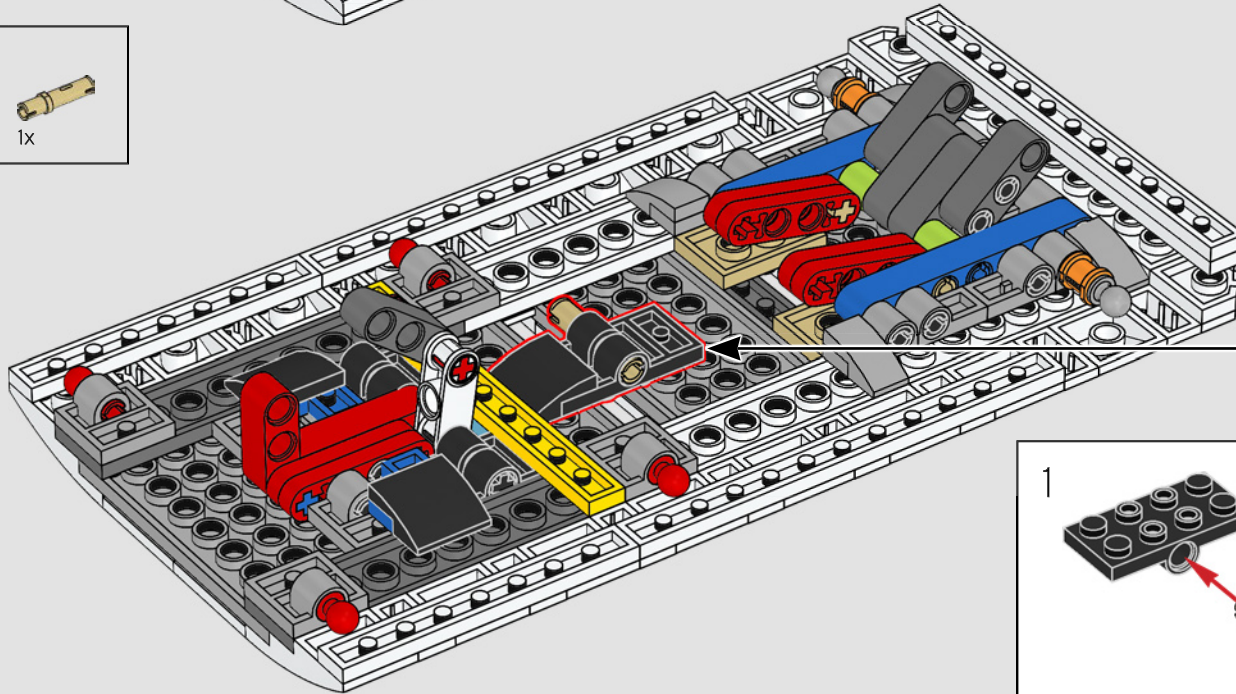

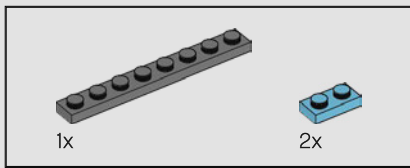

459

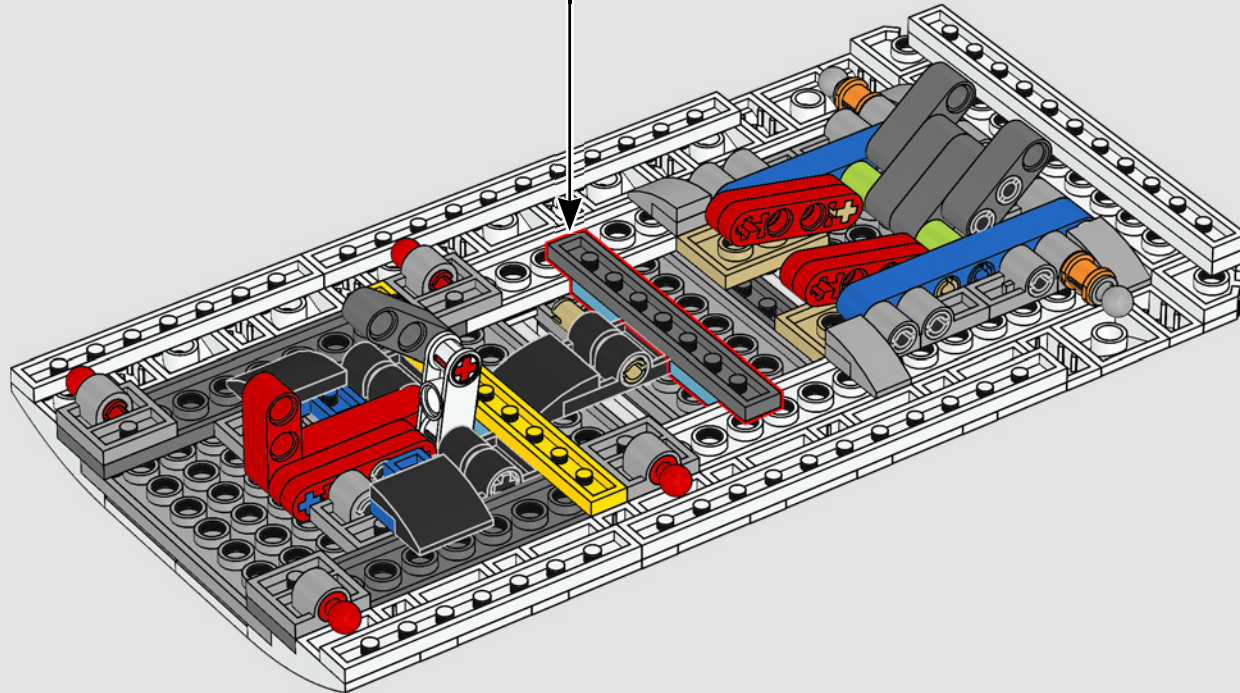
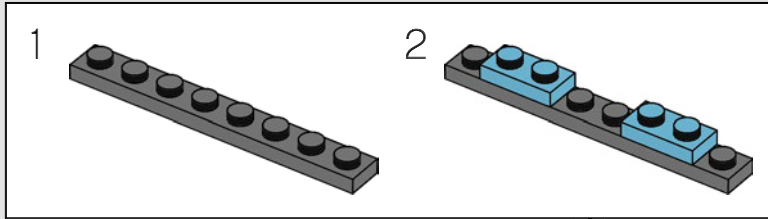

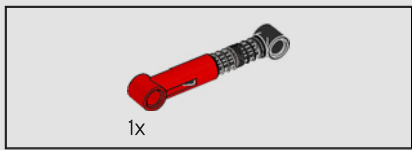

460

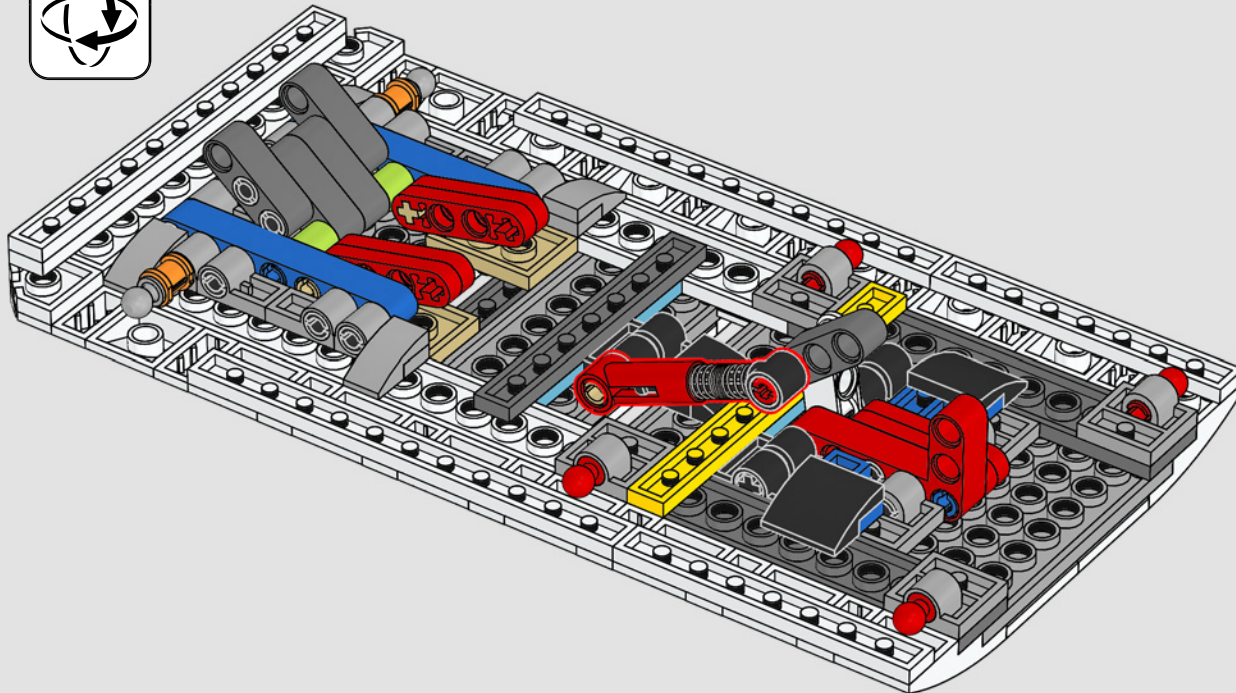

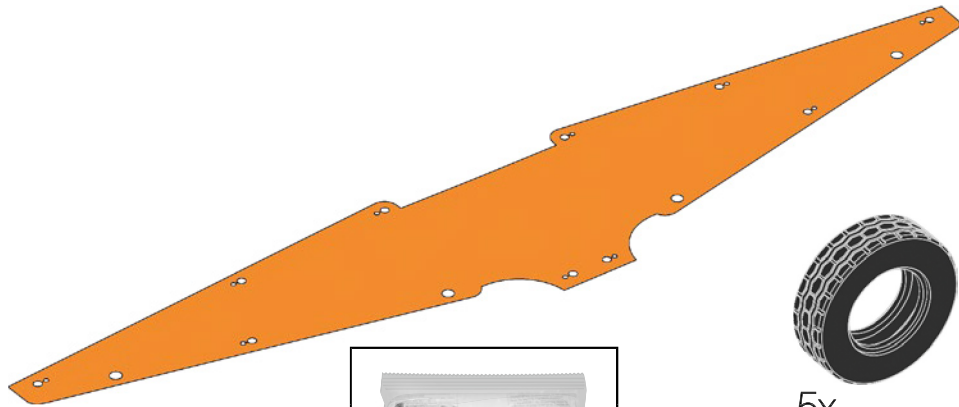

5x

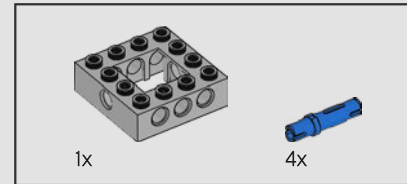
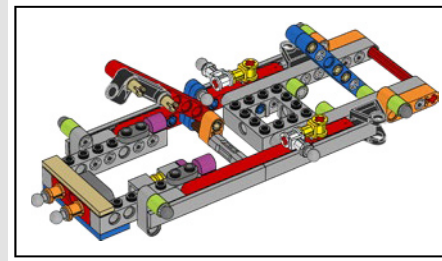
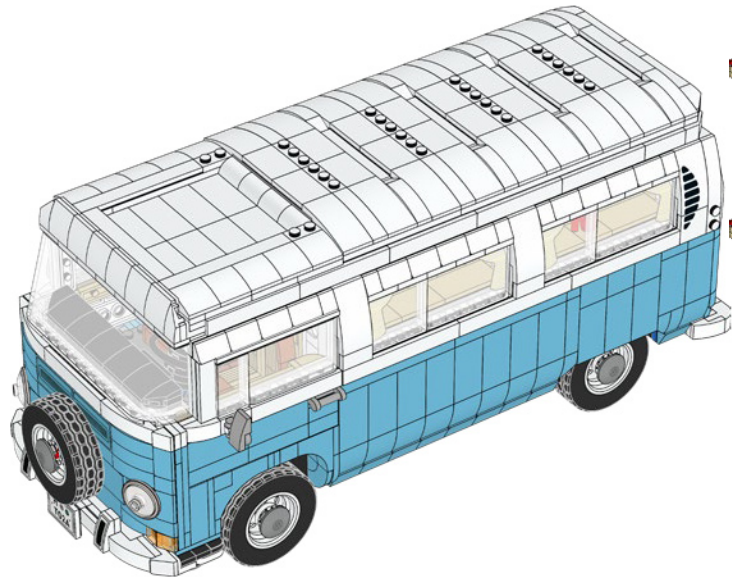
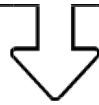

1x

4x

461

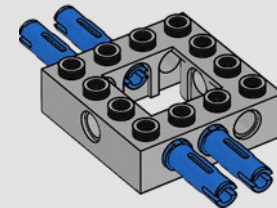



462

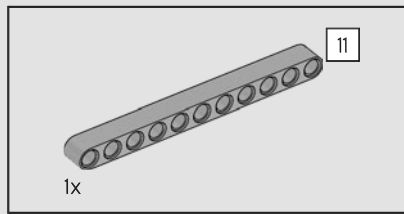
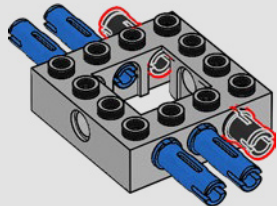

463

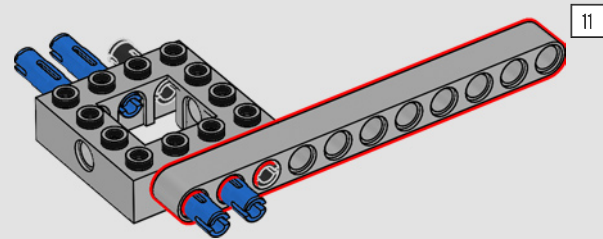

464

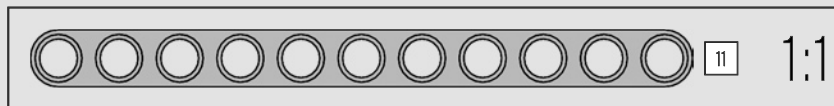
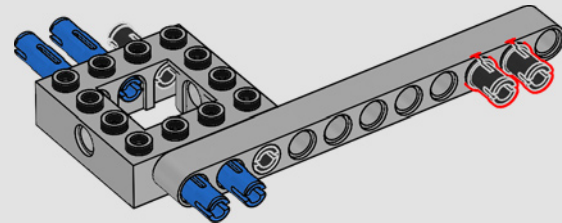

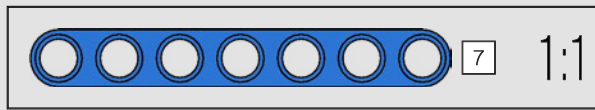
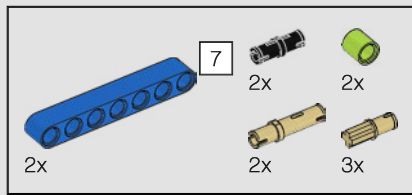

465

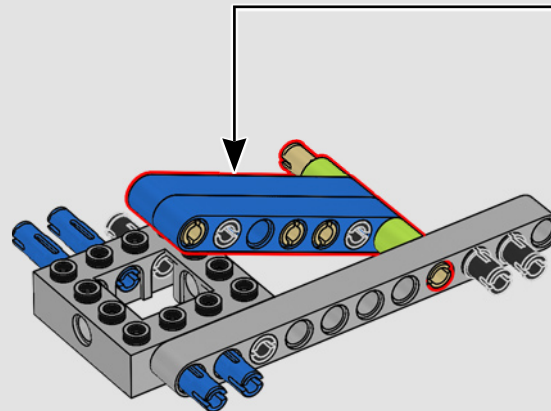
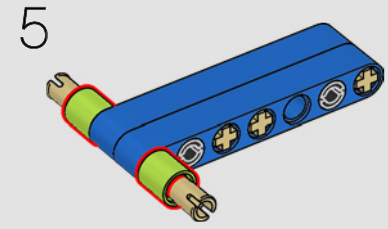
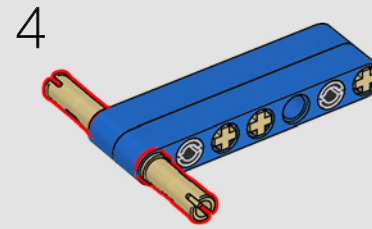
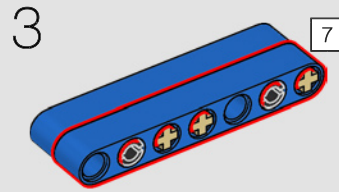
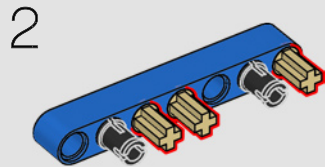
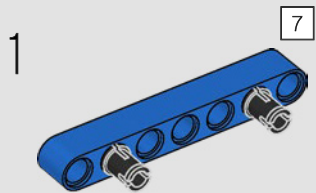

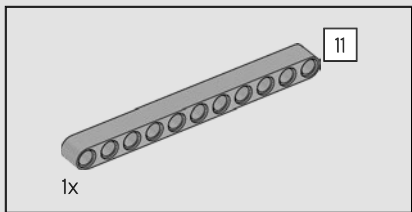

466

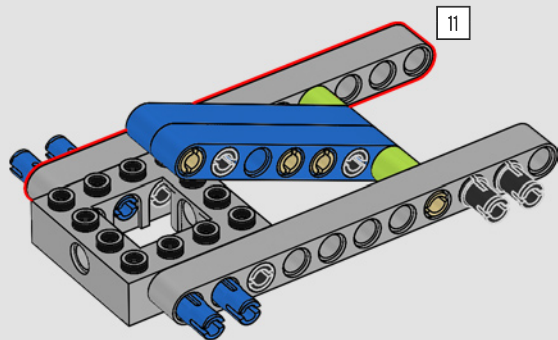

467

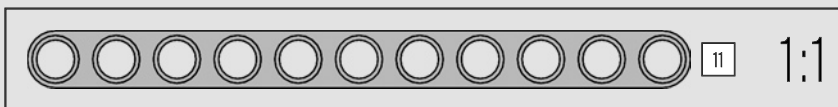
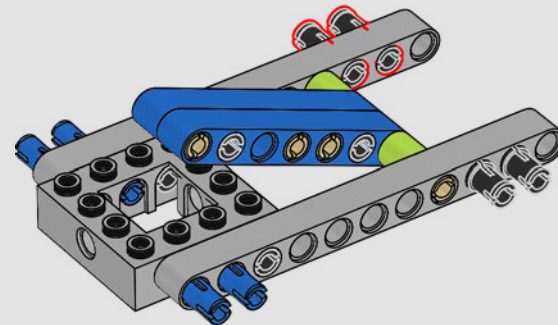

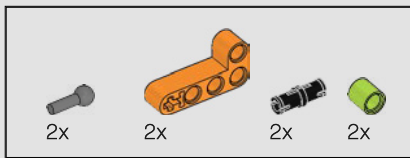

468

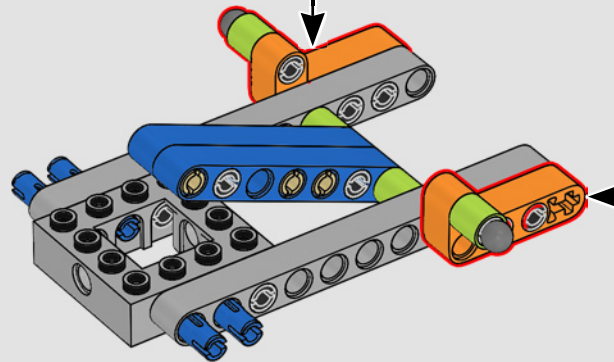
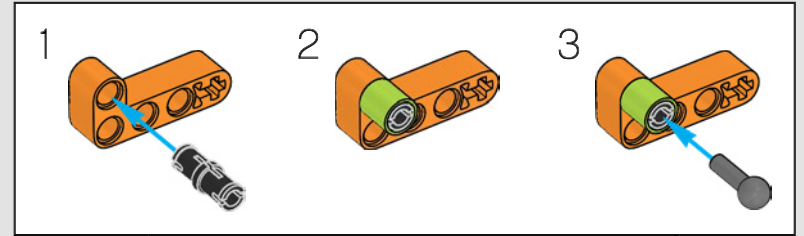
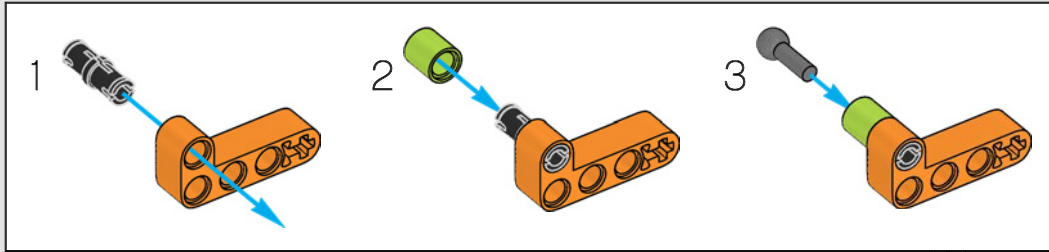



469

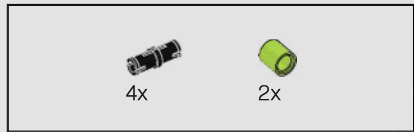
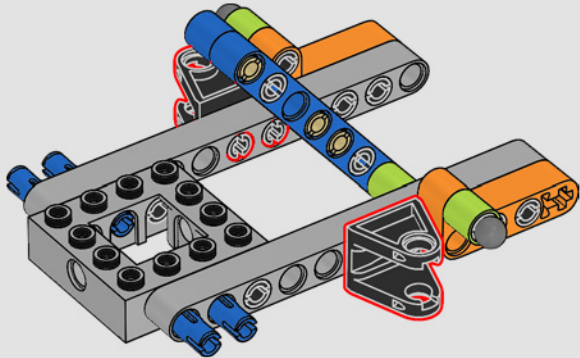

470

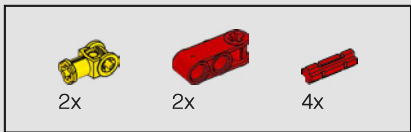
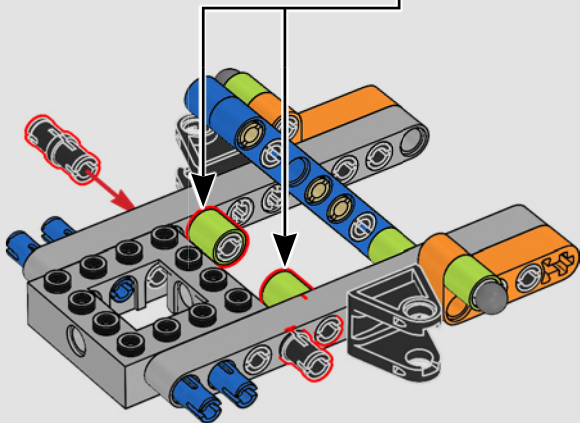
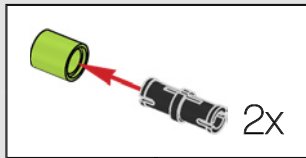

471

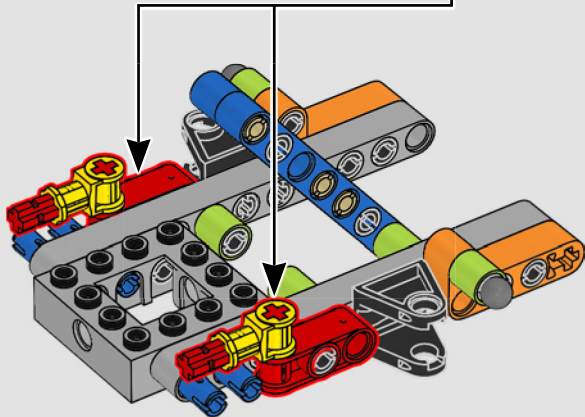
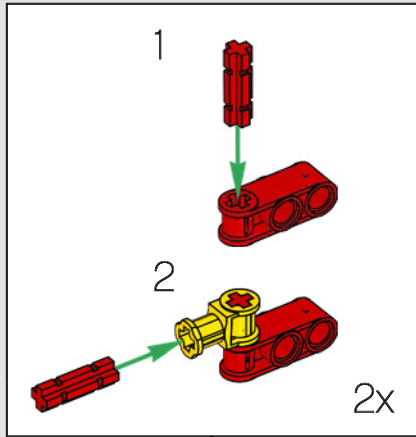

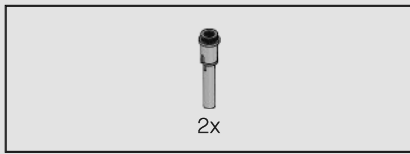

472

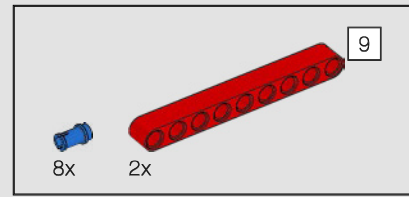
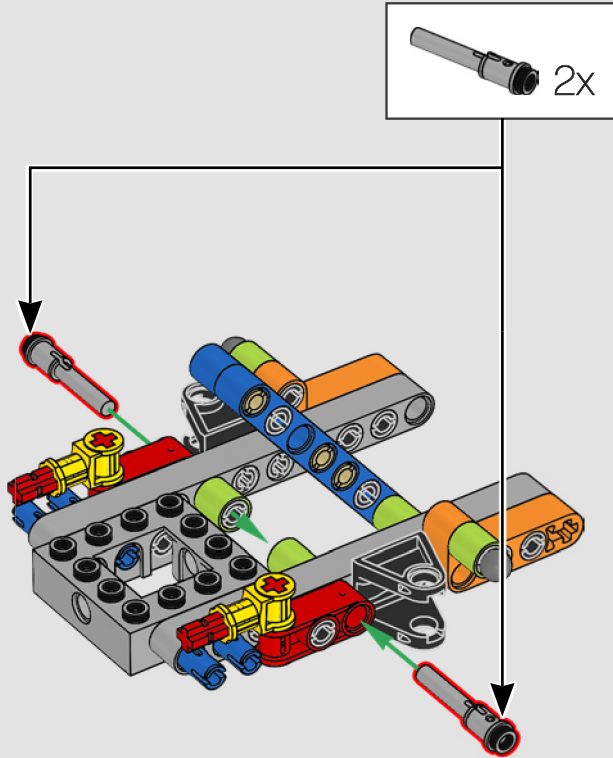

473

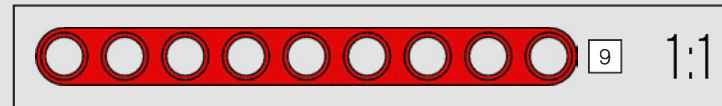
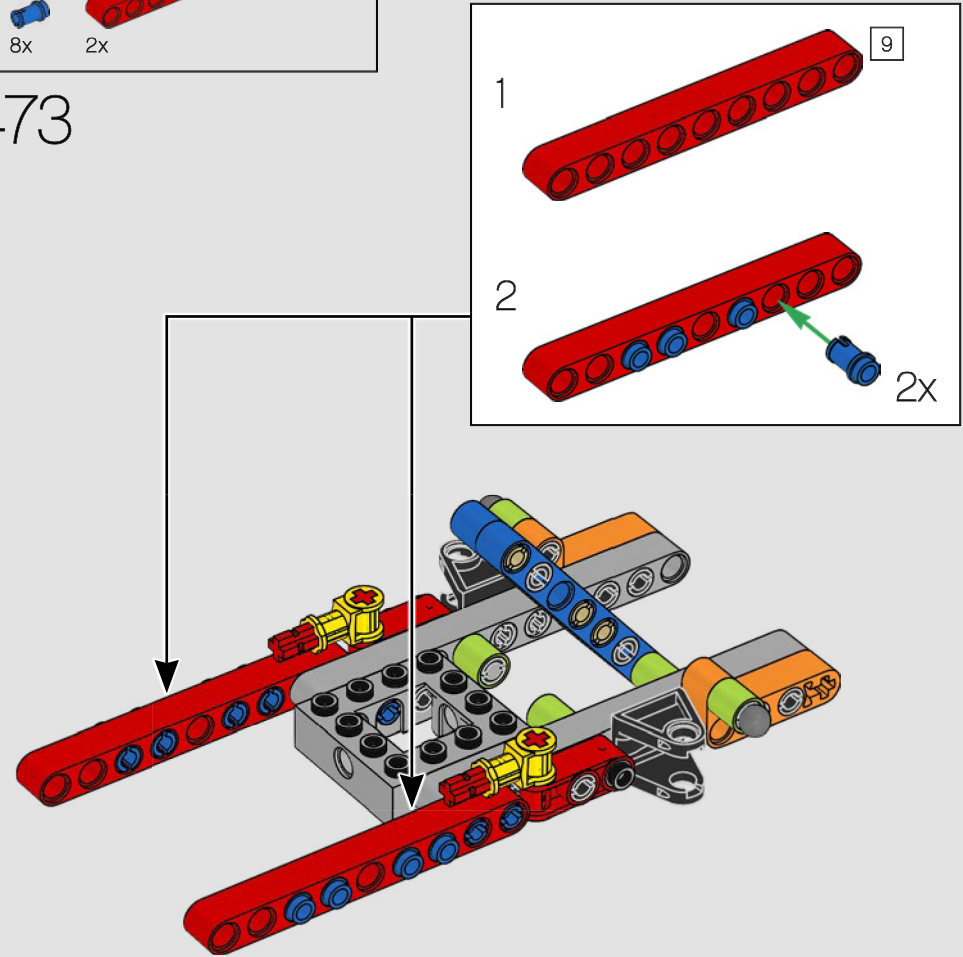



474

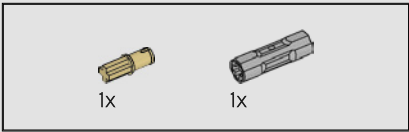
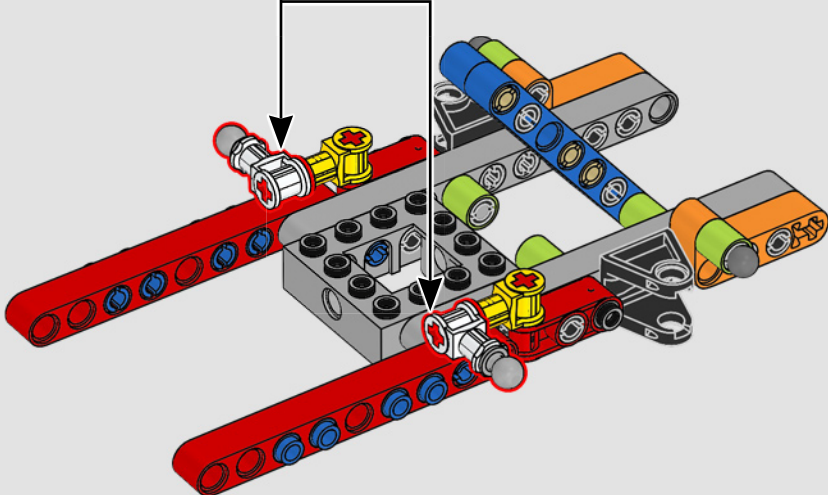
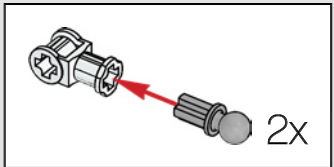

475

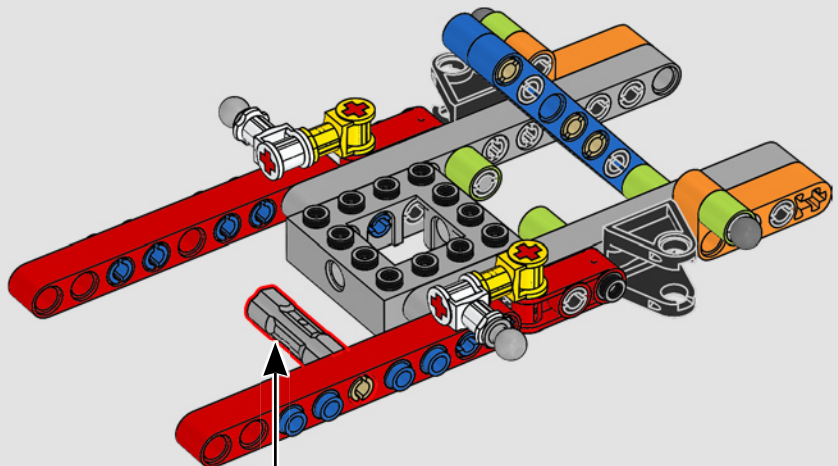
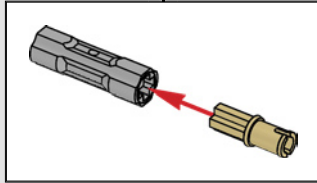

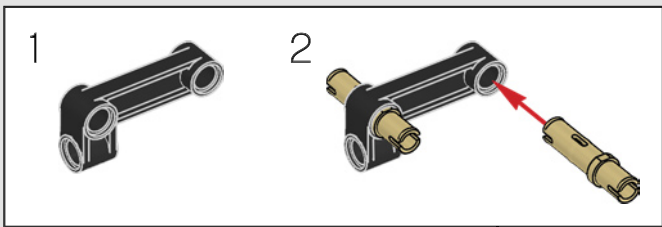

5

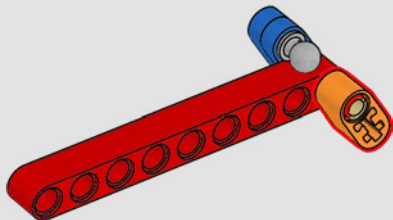

6

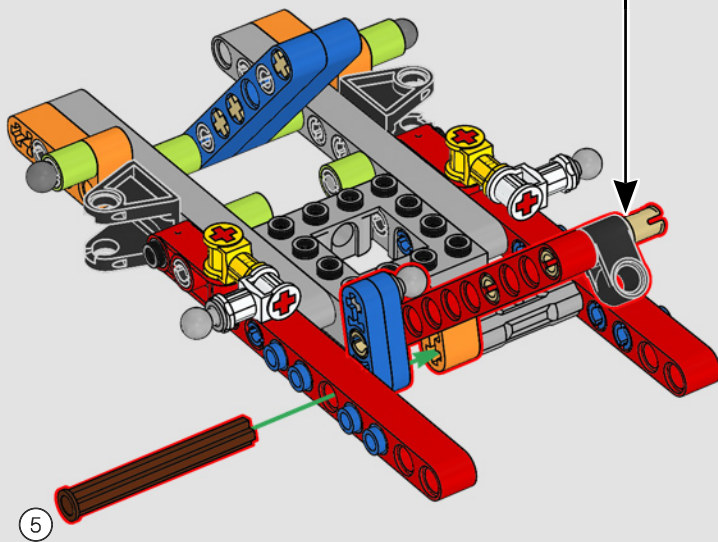
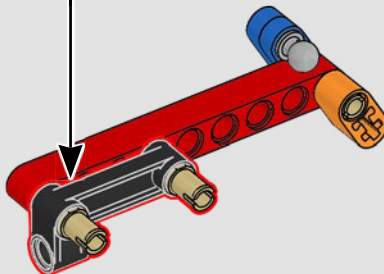

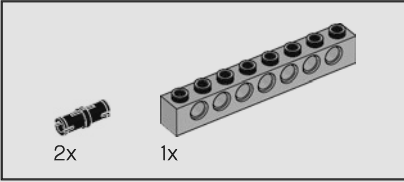
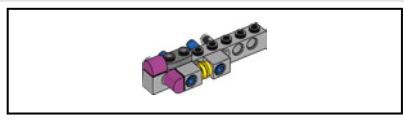

477

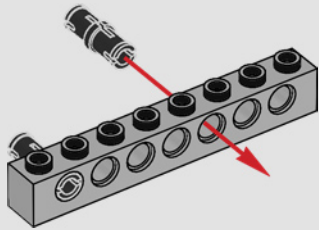

478

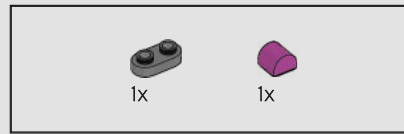
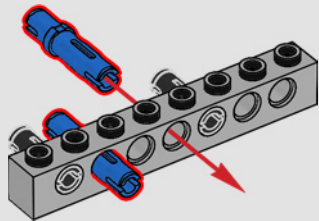

479

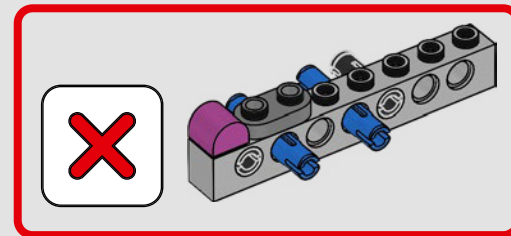
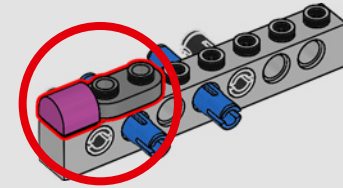



480

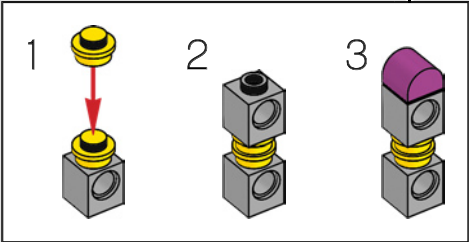
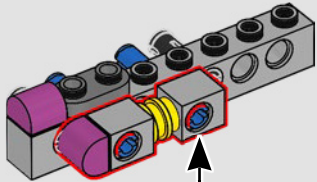
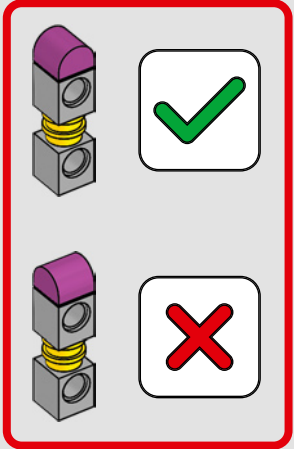

481

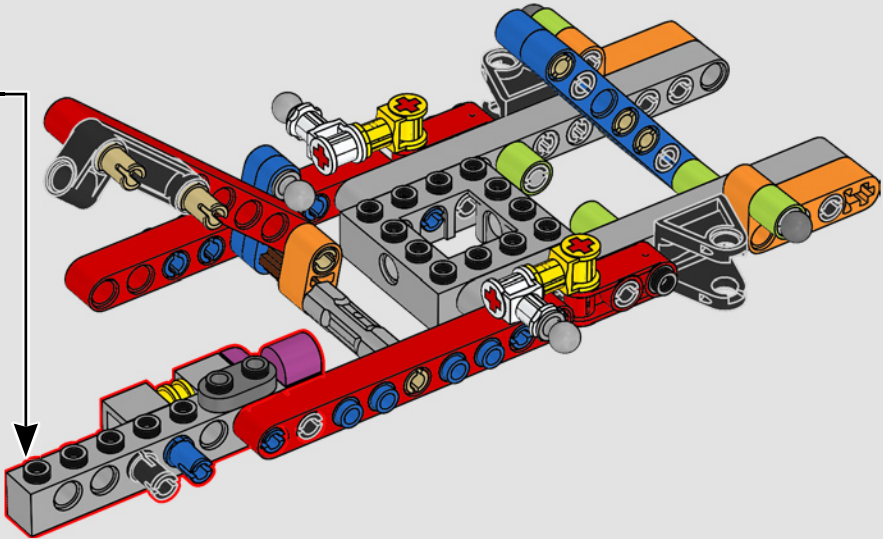

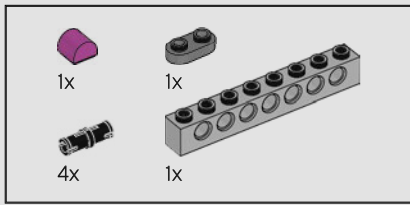

482

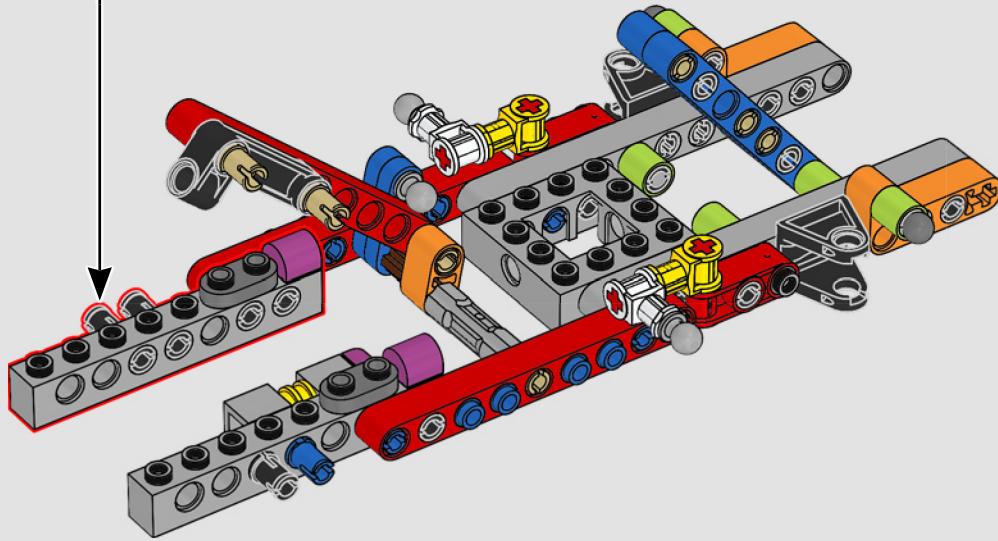
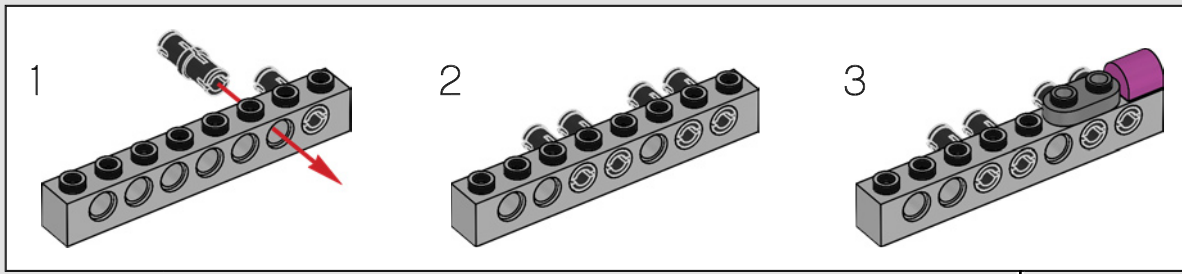

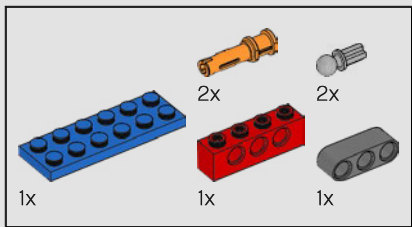

483

1

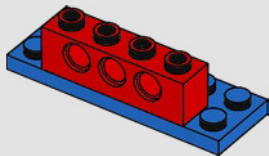

2

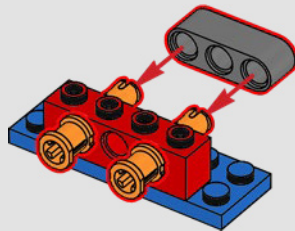

3

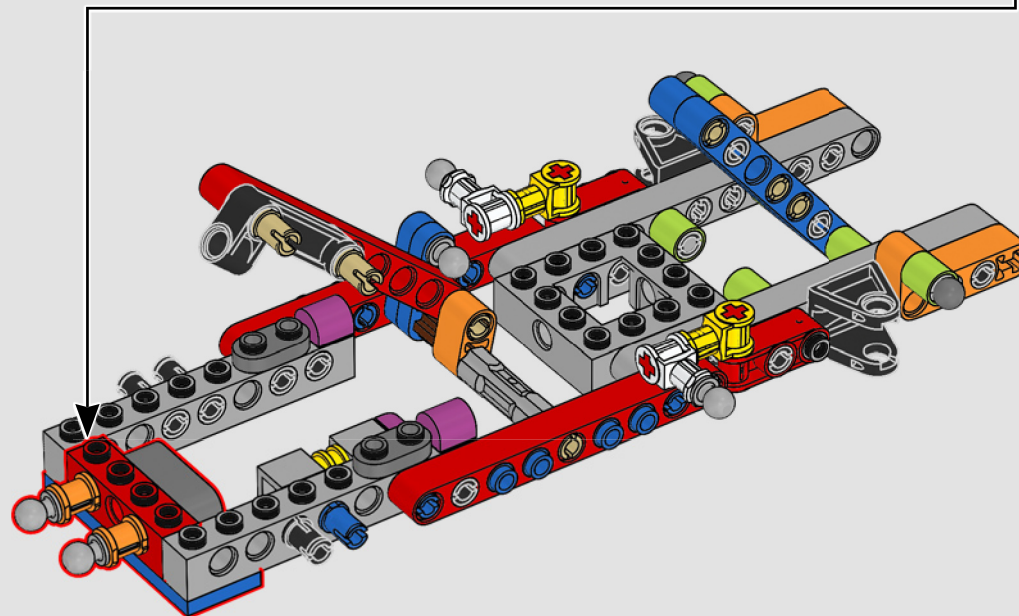
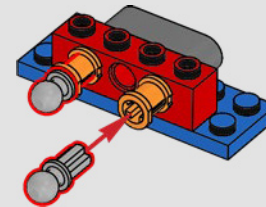

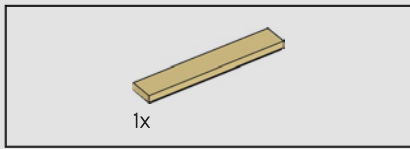

484

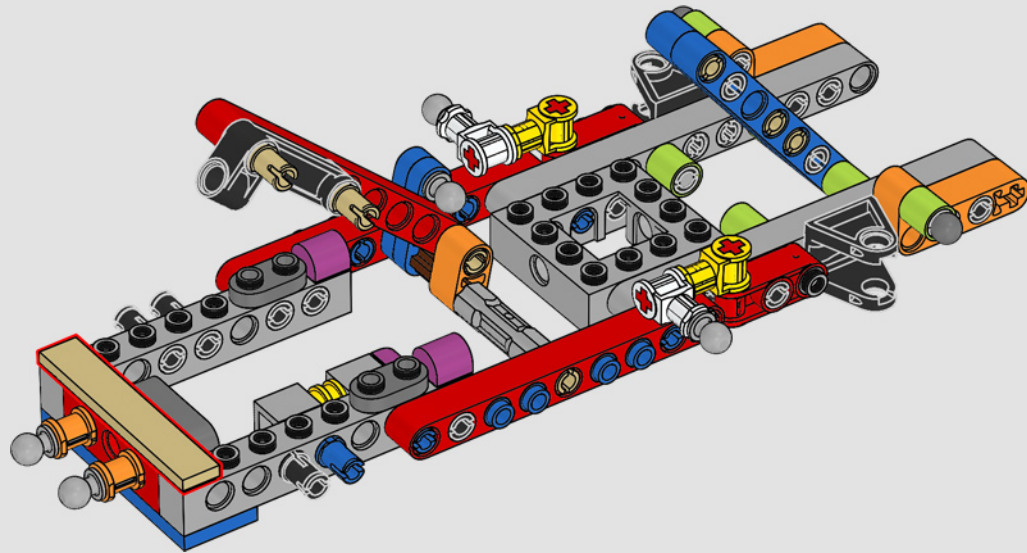

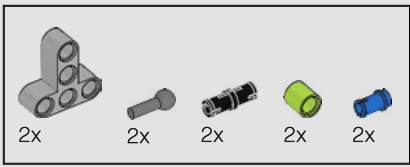

485

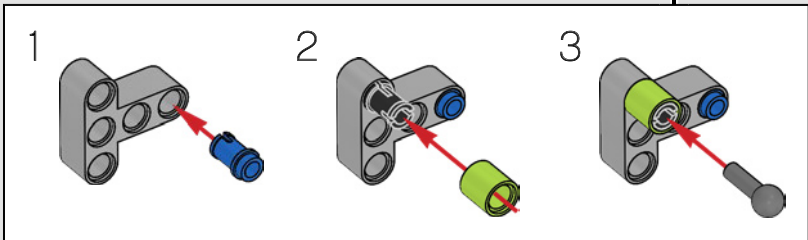
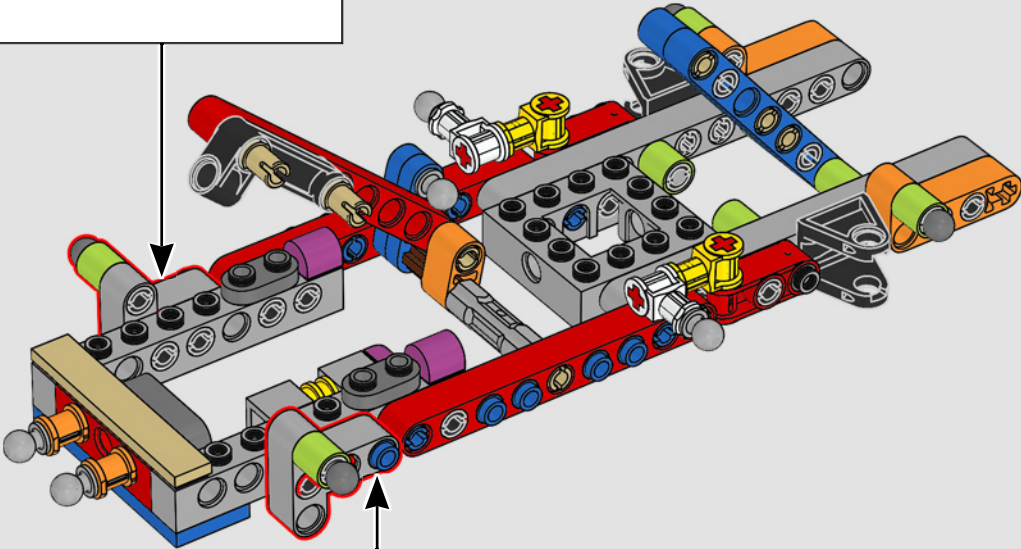
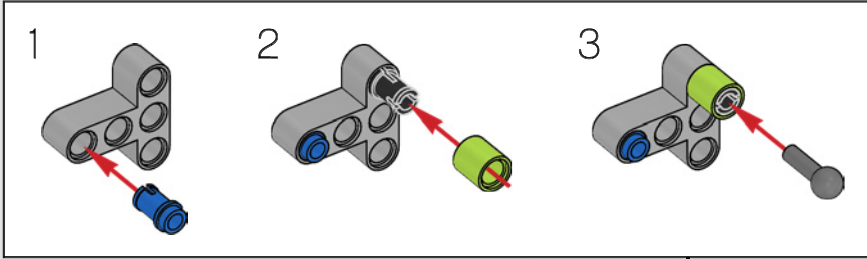

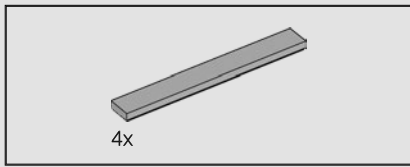

486

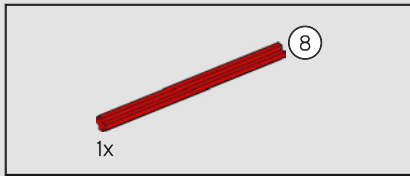
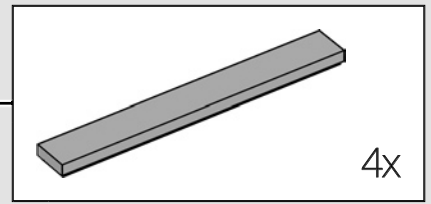
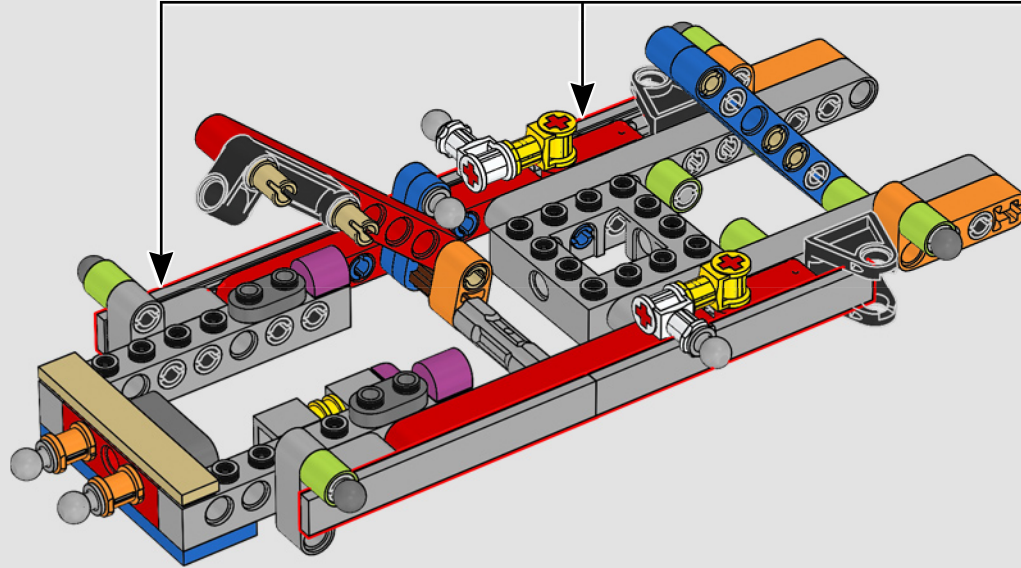

487

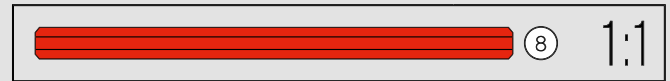
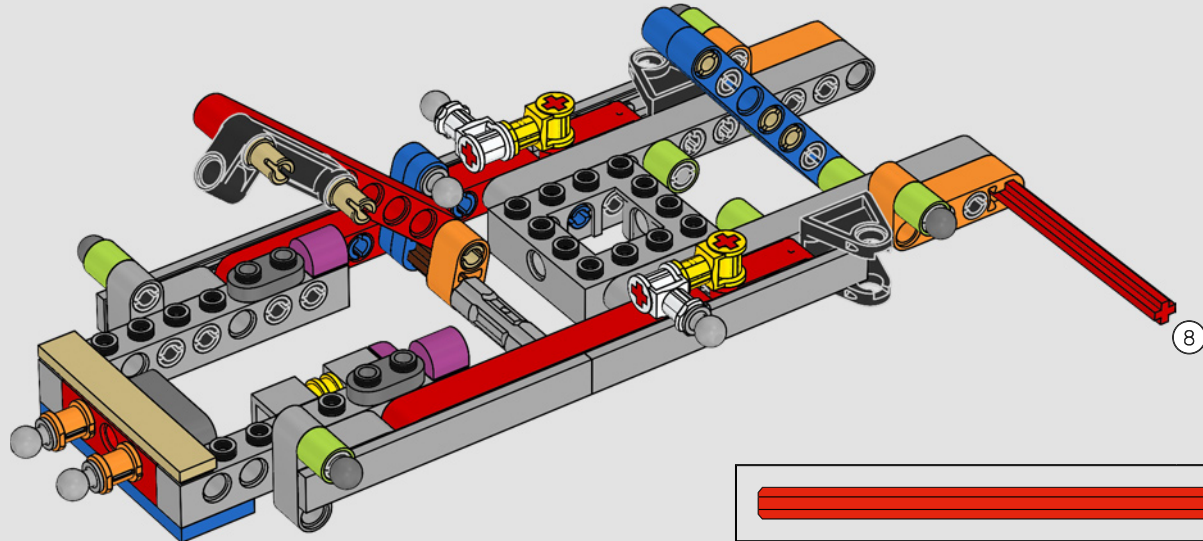

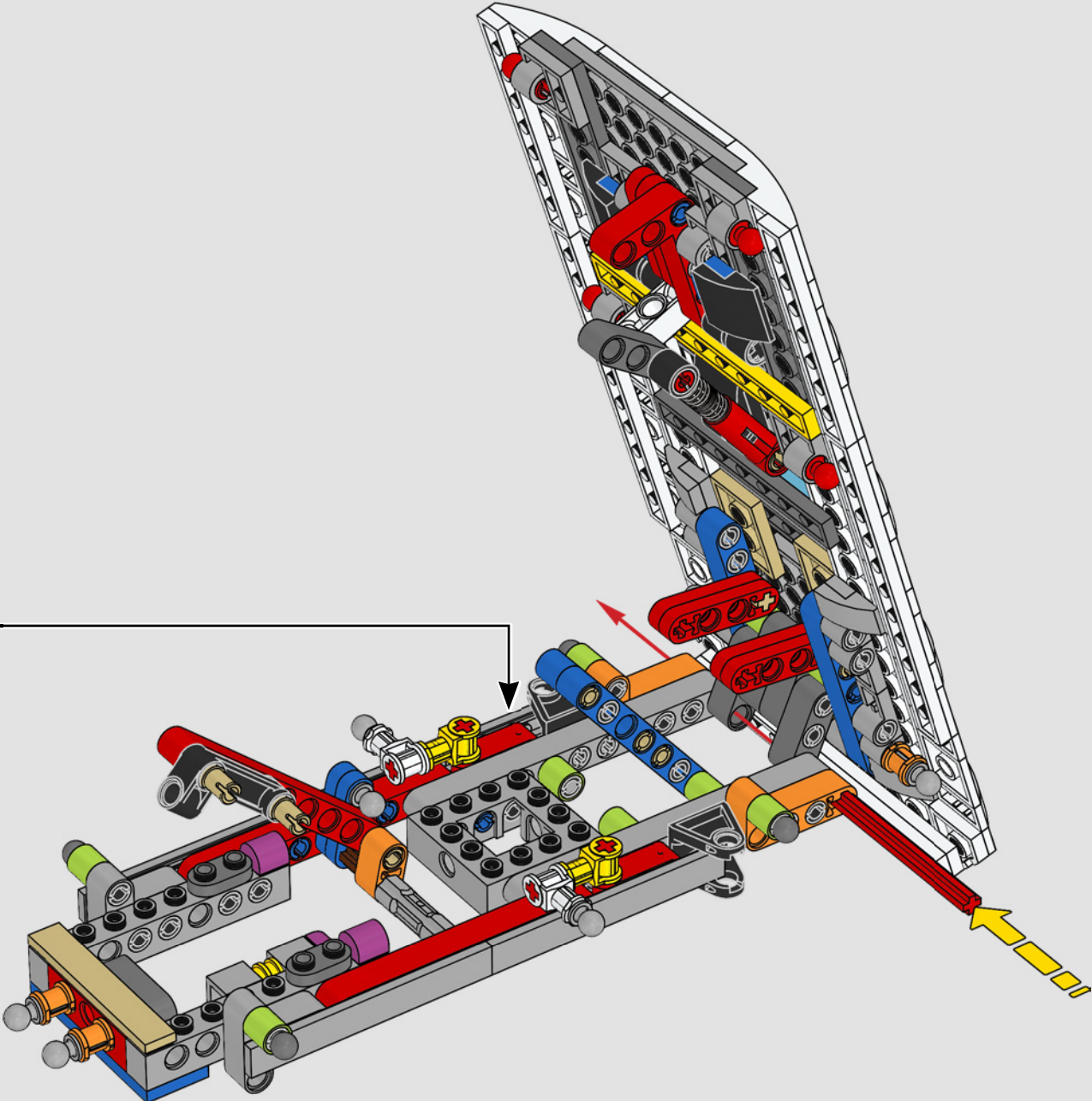

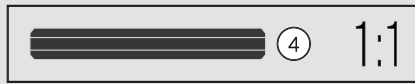
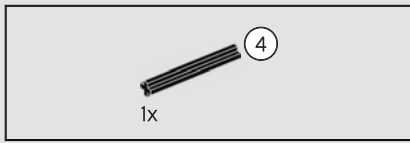

489

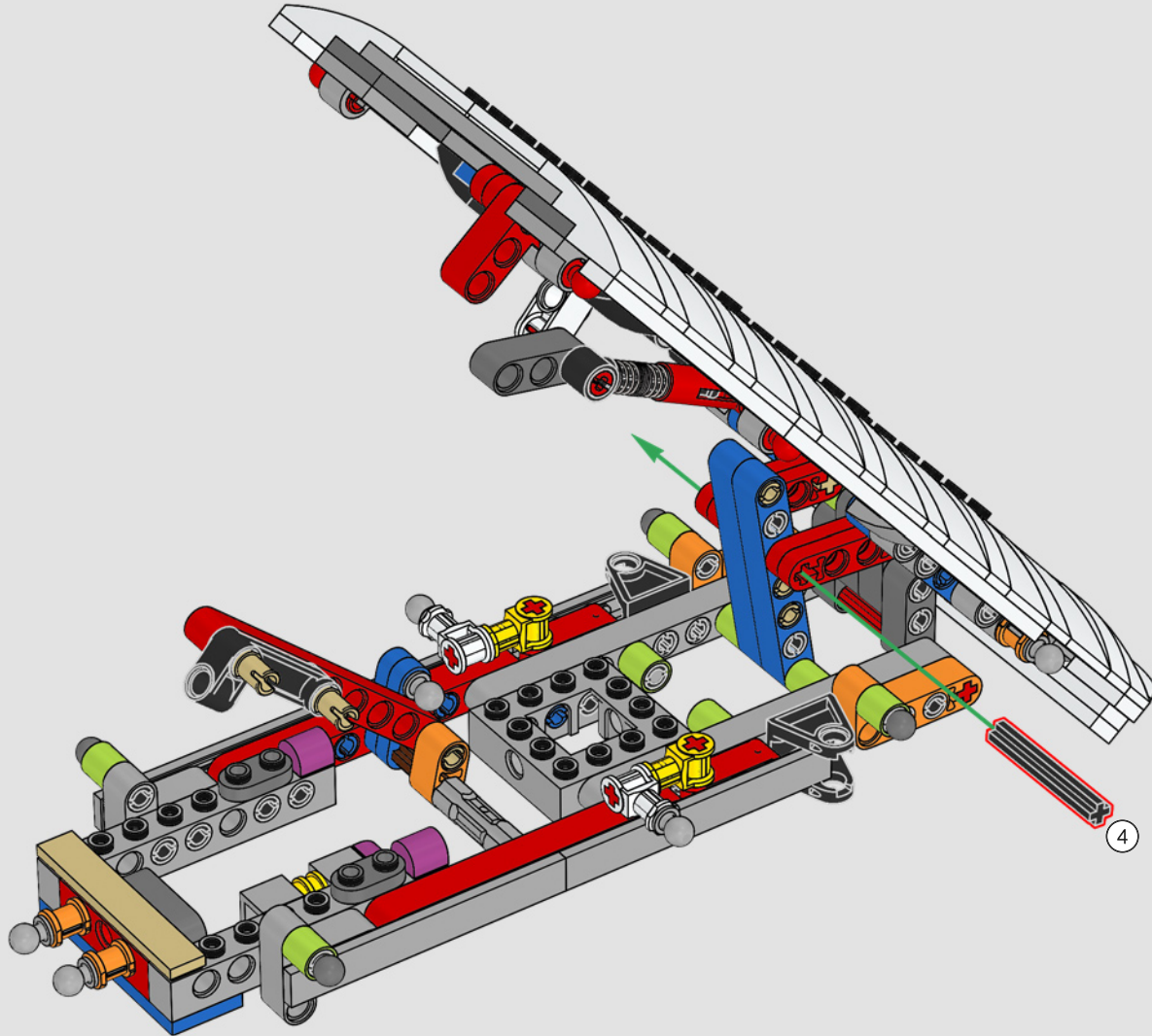

490

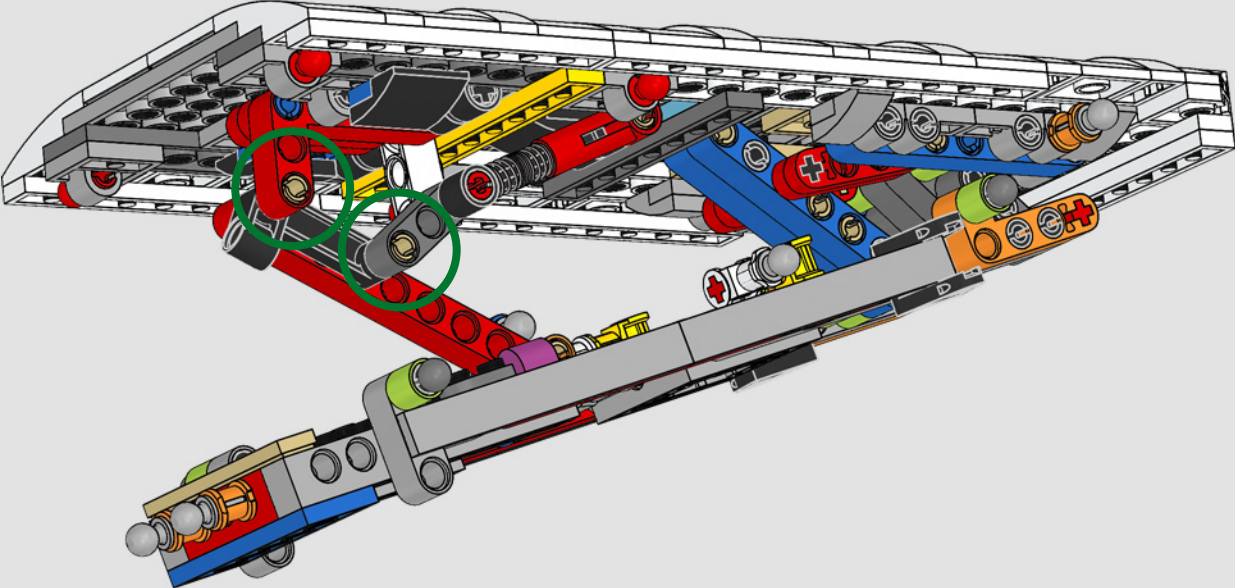

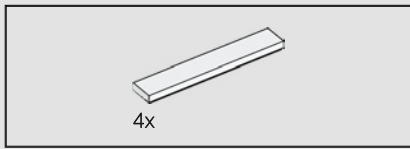

491

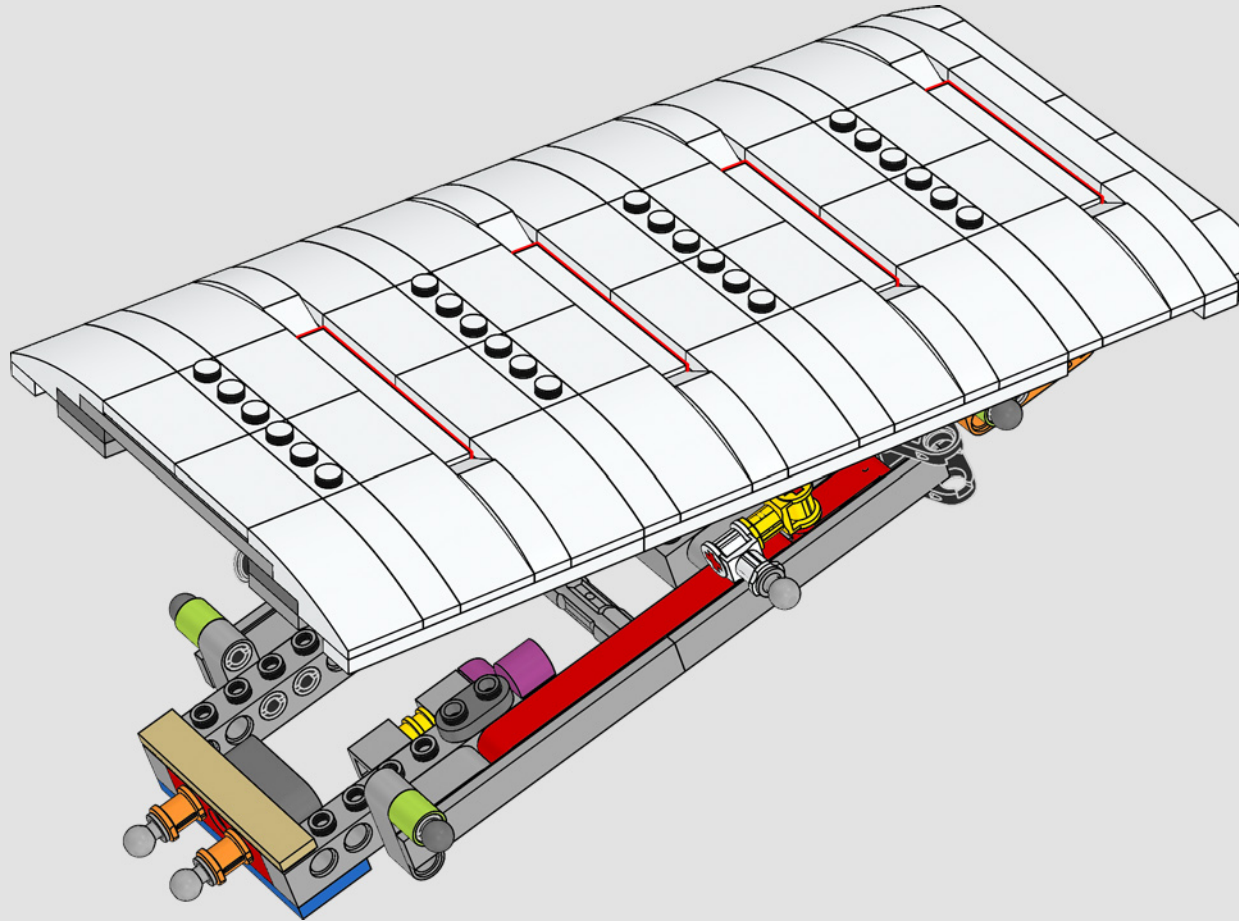

492

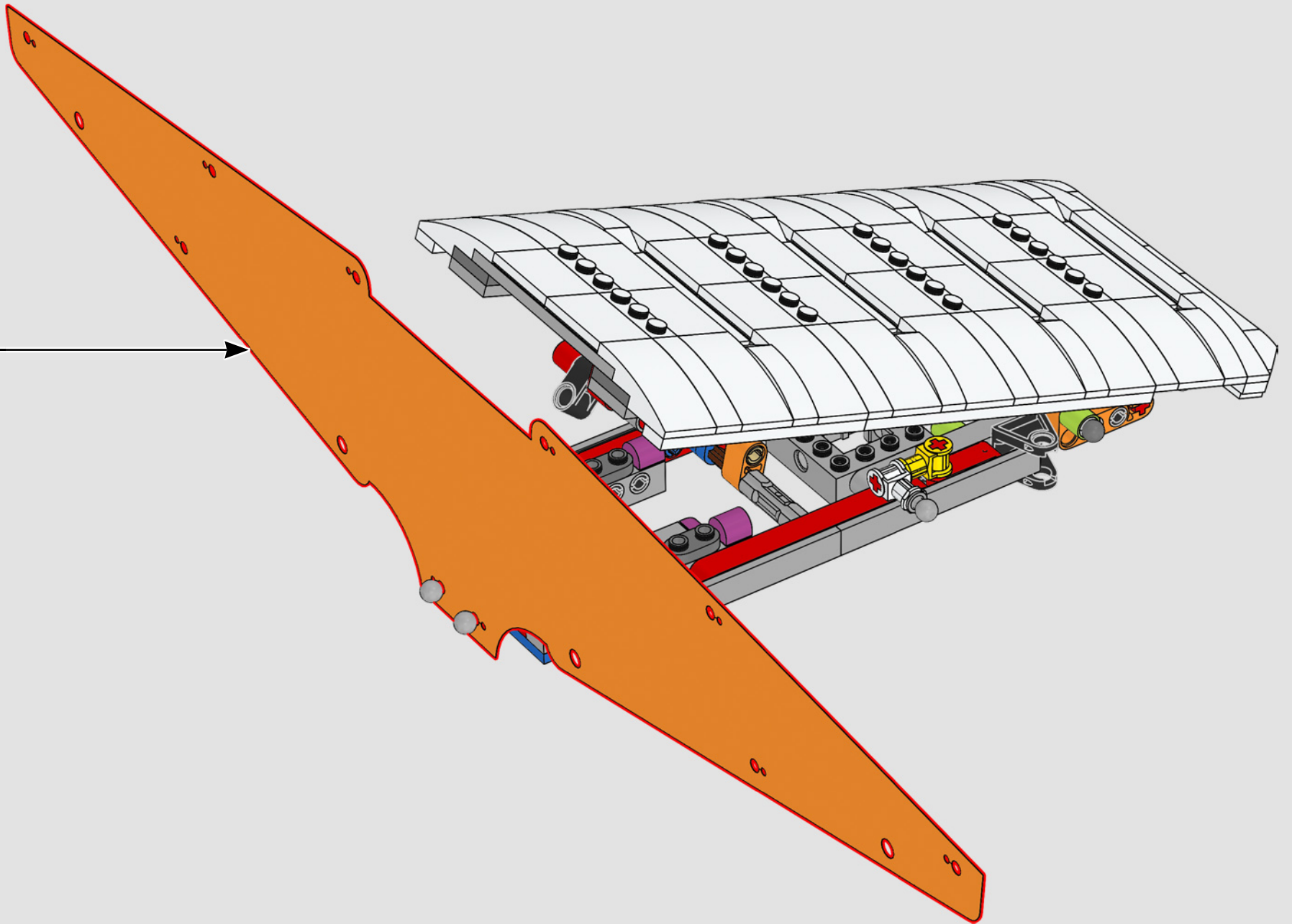

Viele T2 Camper-Umbauten verfügten auch über dieses Aufstelldach, damit man im geparkten Bus stehen konnte.

493

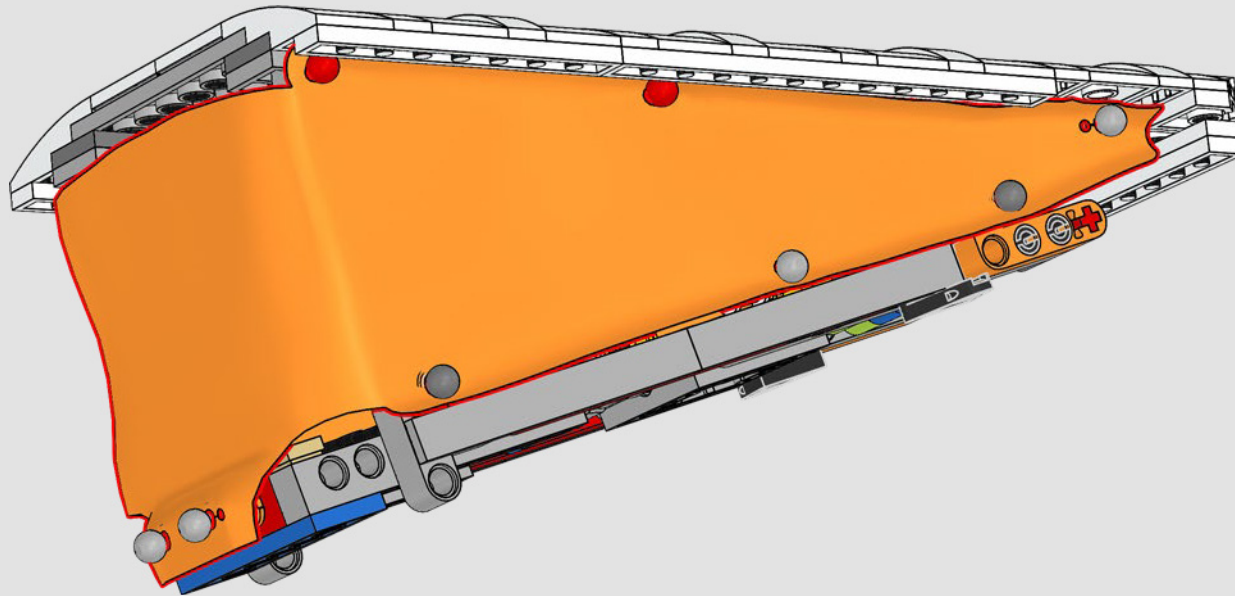

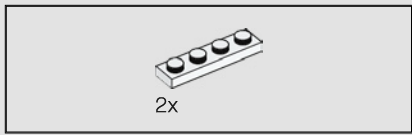

494

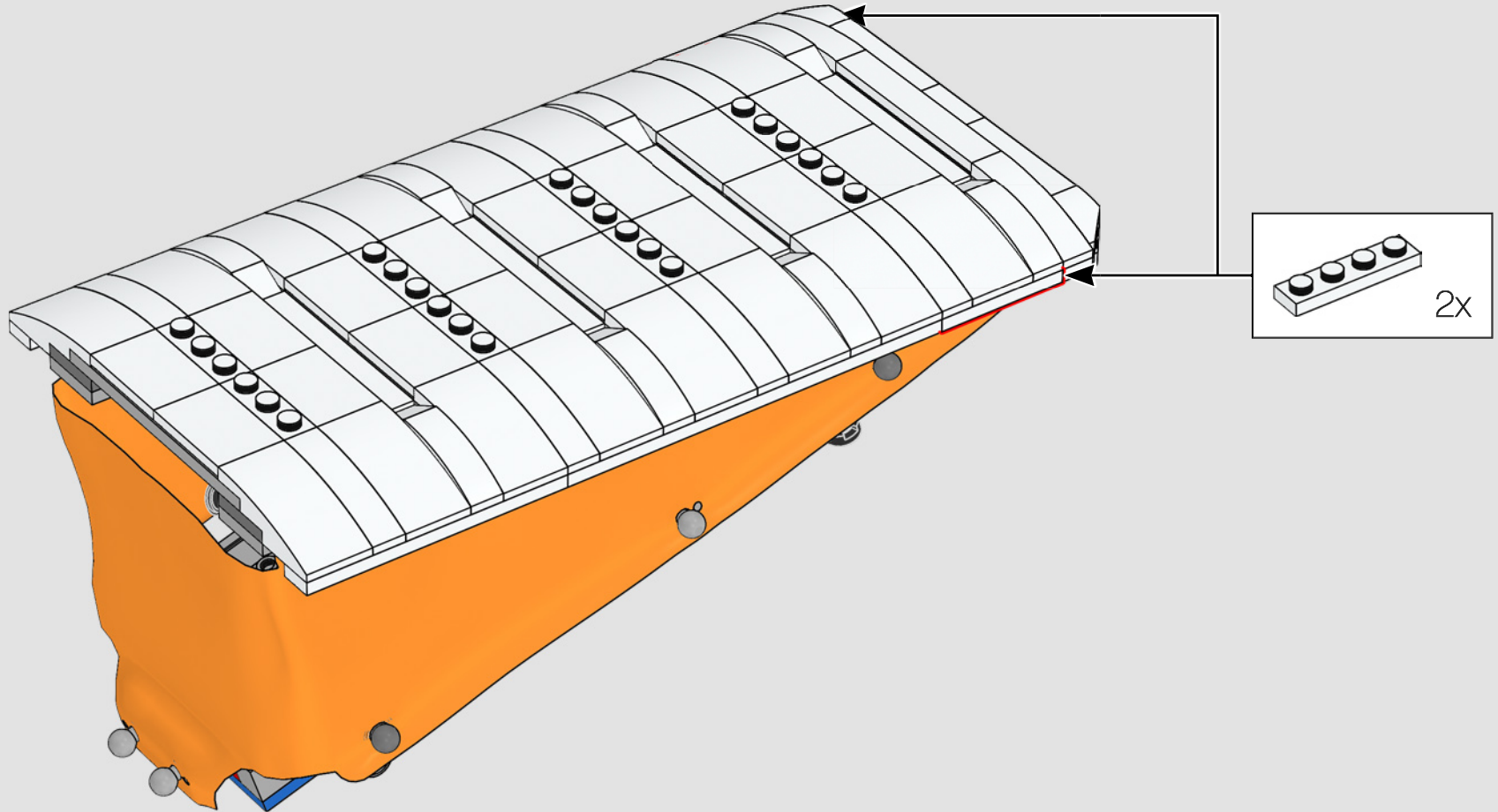

495

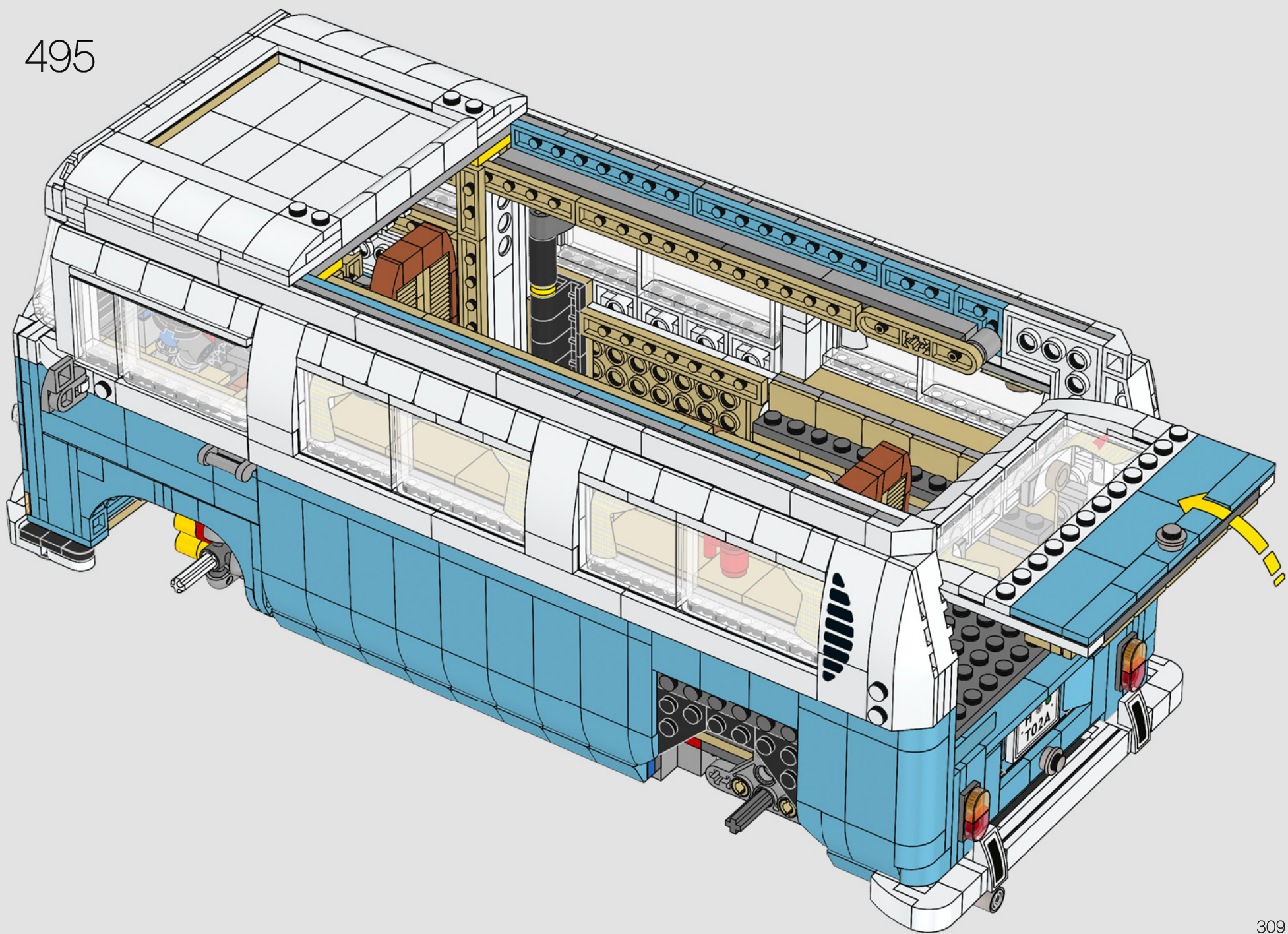

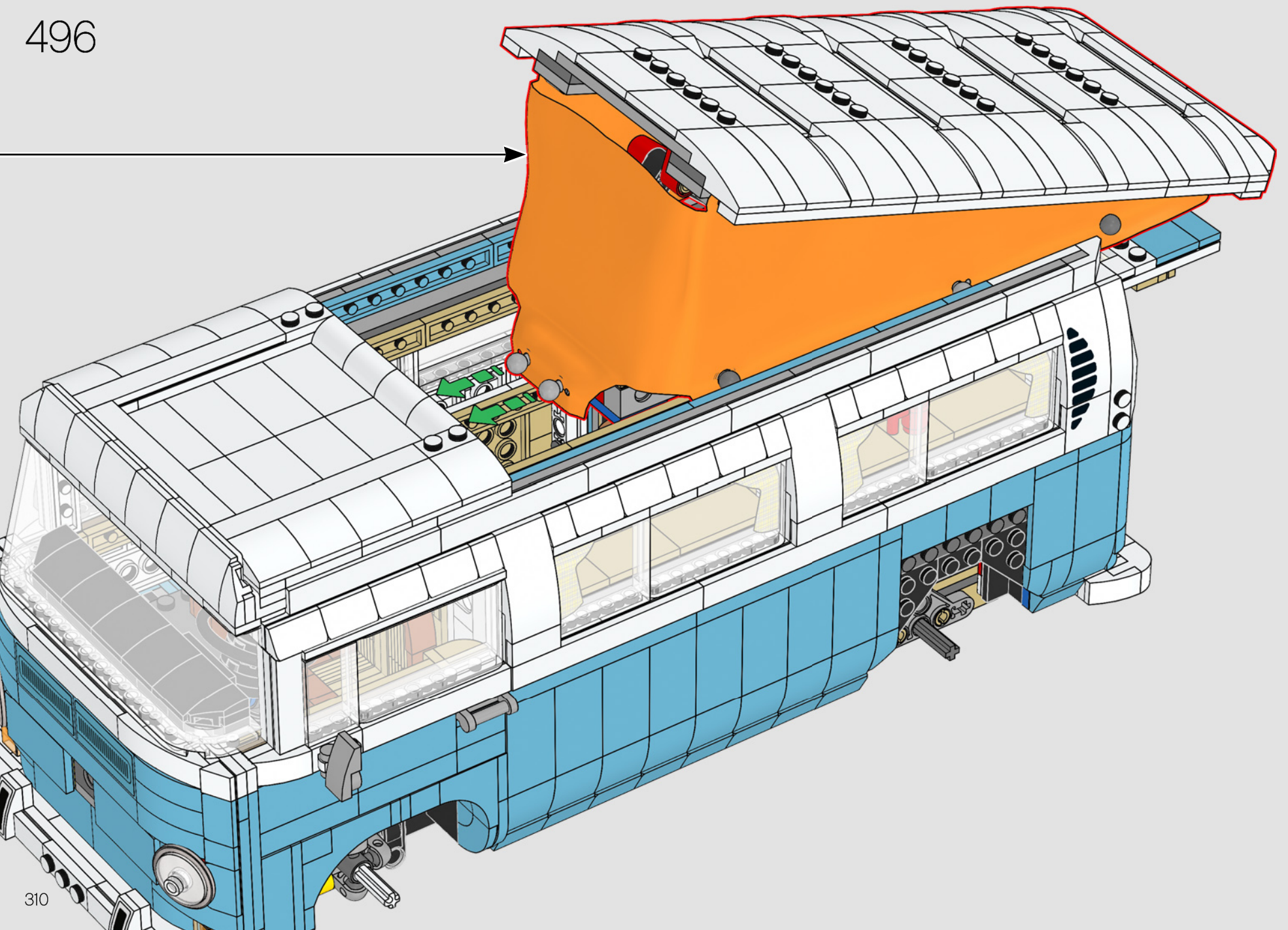

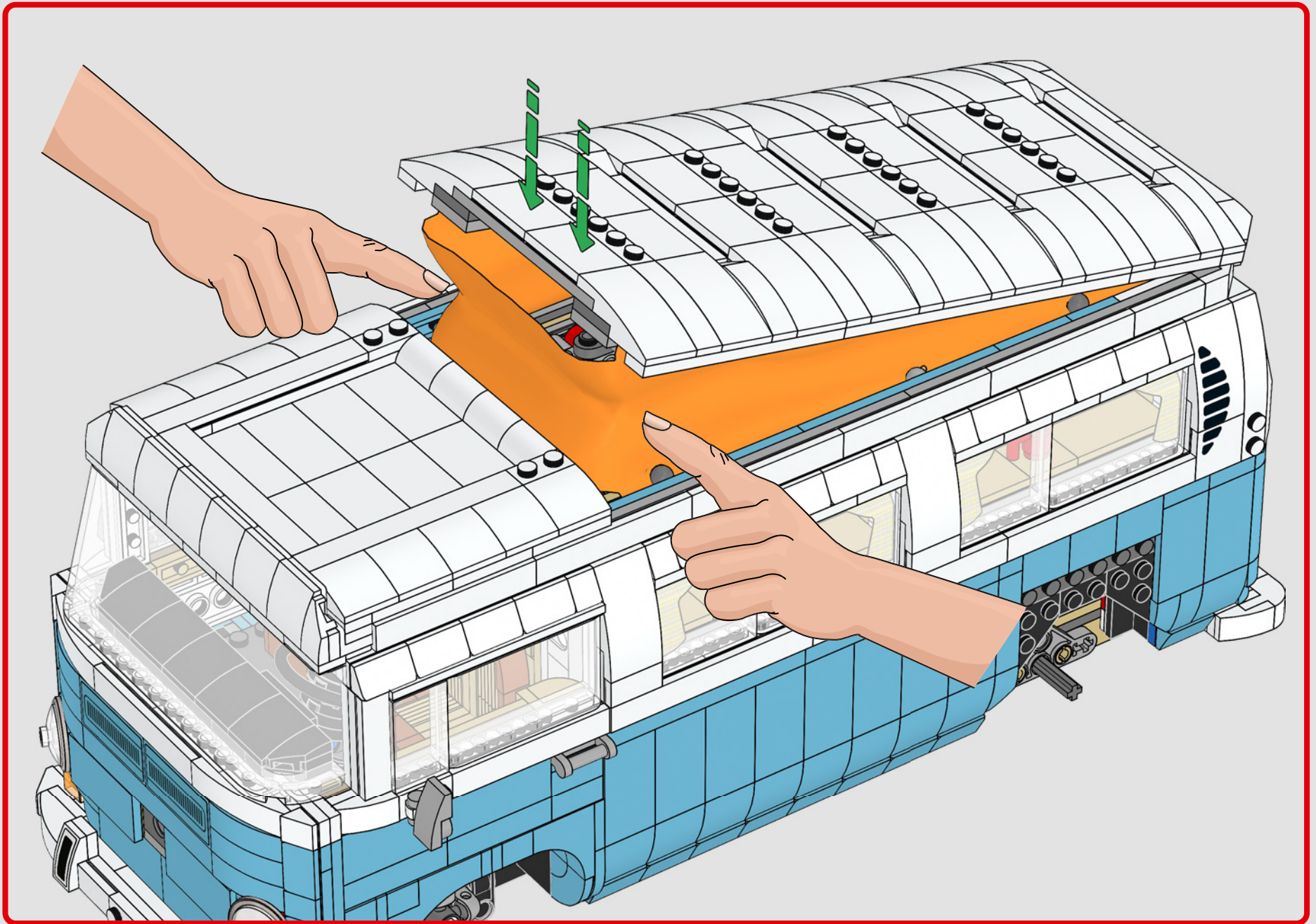

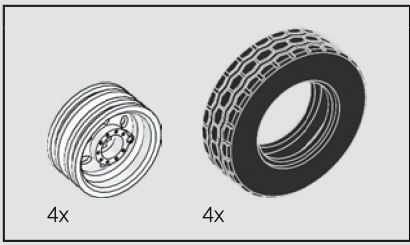

497

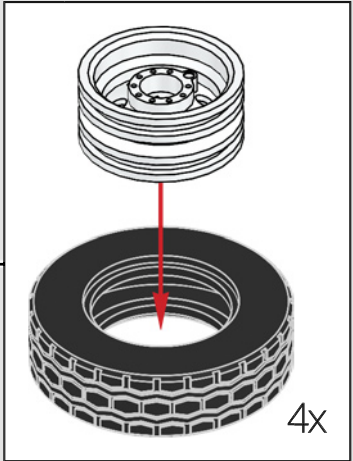
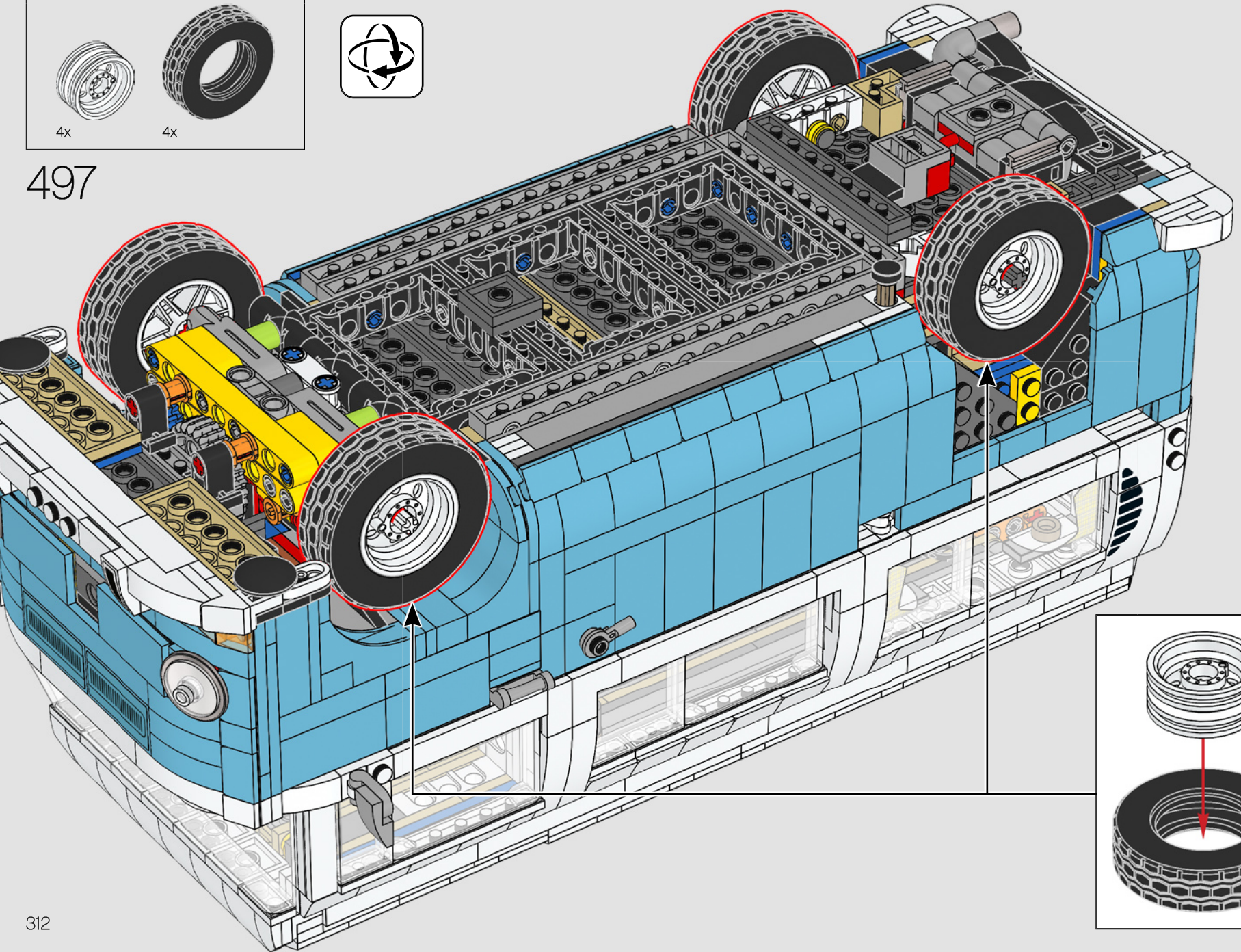



498

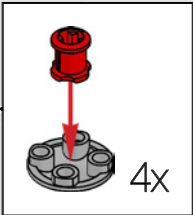
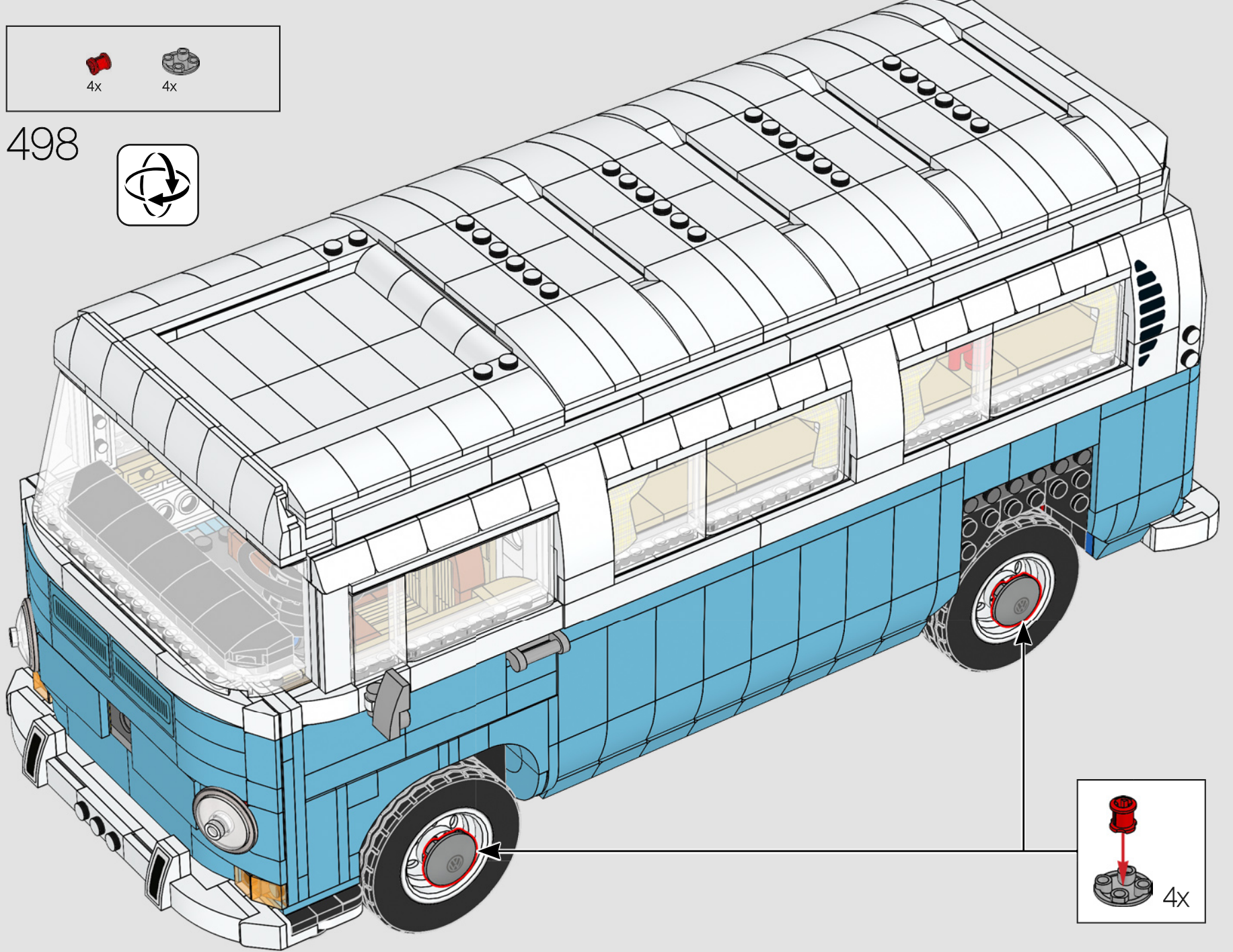

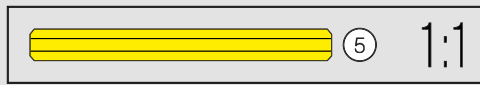
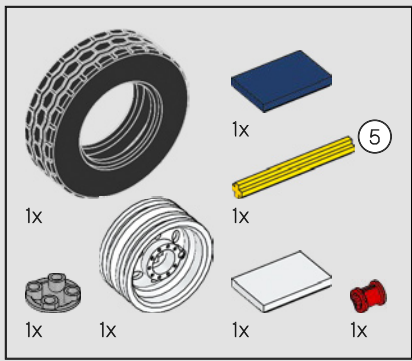



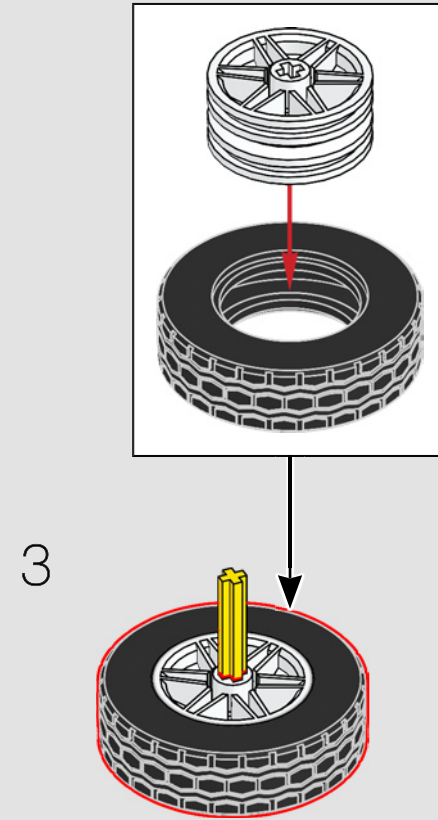
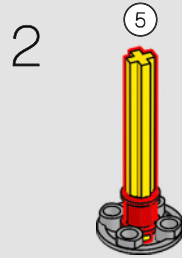
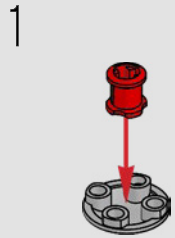

499

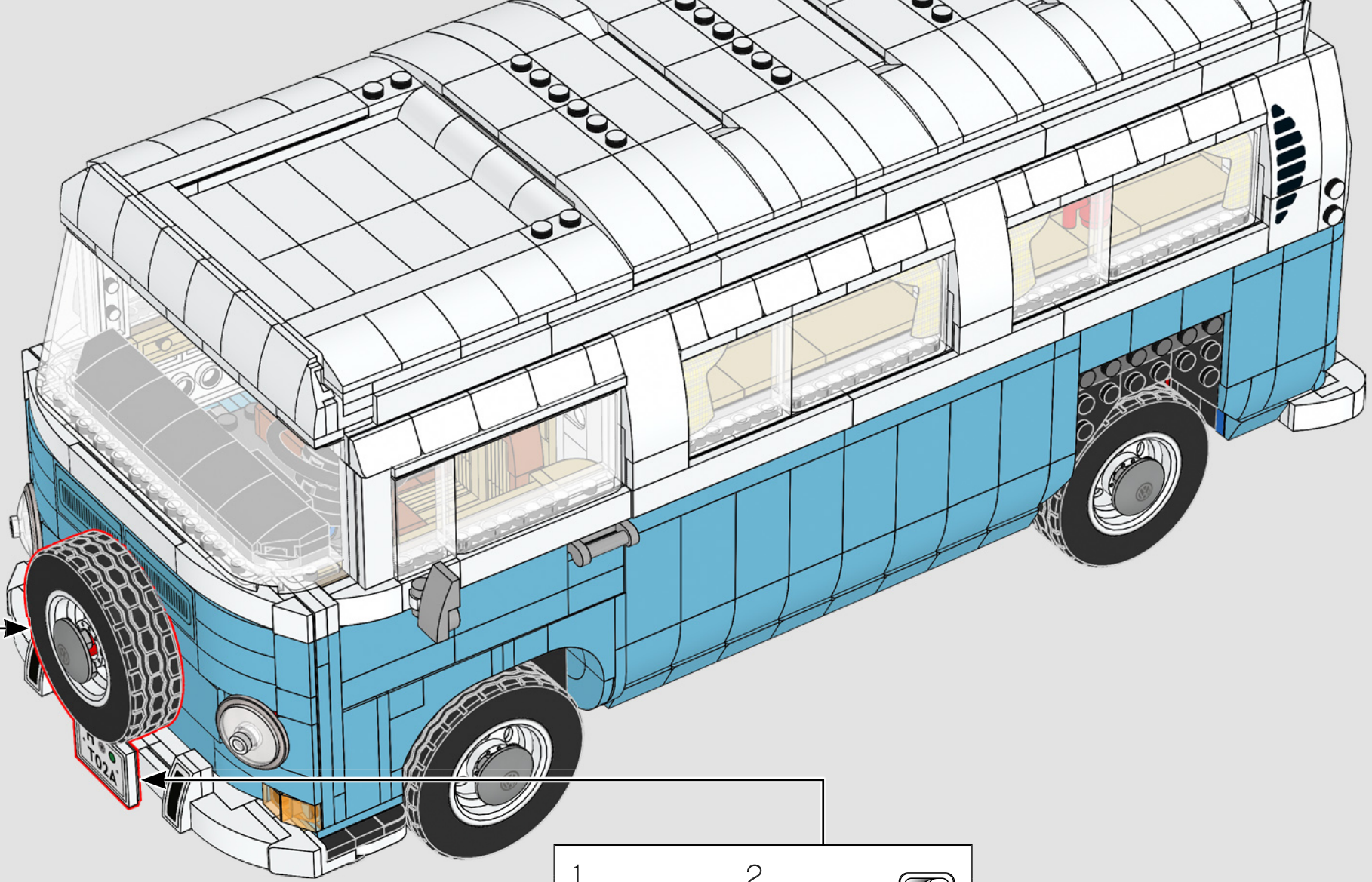

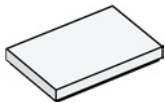
Häufig wurde das Ersatzrad vorne am Fahrzeug befestigt, um möglichst viel Platz in der Kabine zu haben.

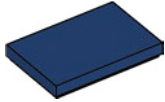

- | | | | | | |
|---|--|---|---|---|---|
| 1 |  | 2 |  |  | 2 |
| |  | |  |  | 4 |

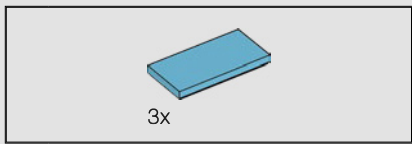

500

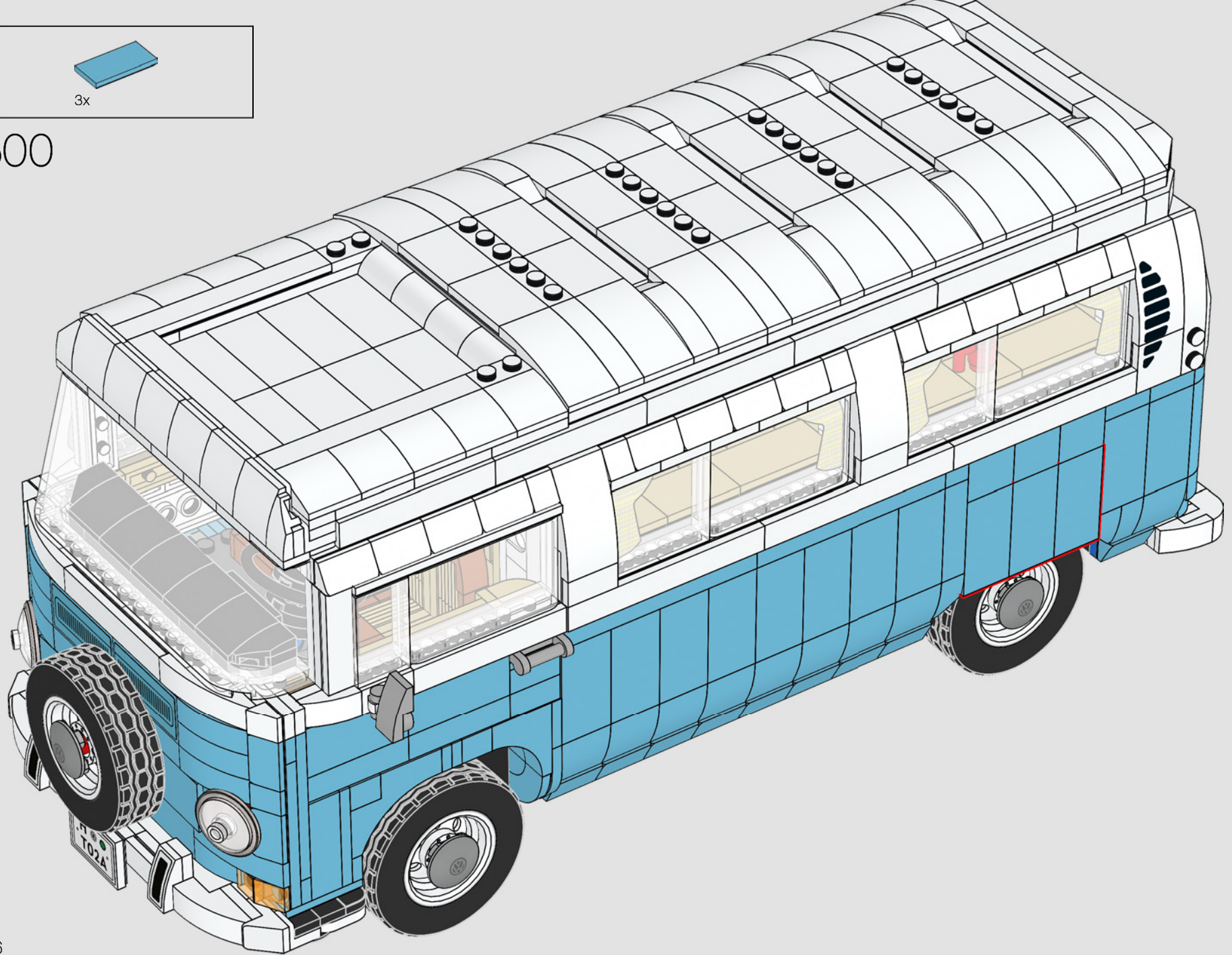

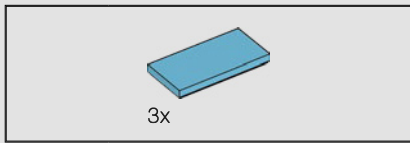

501

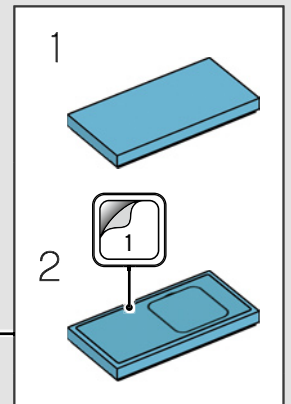
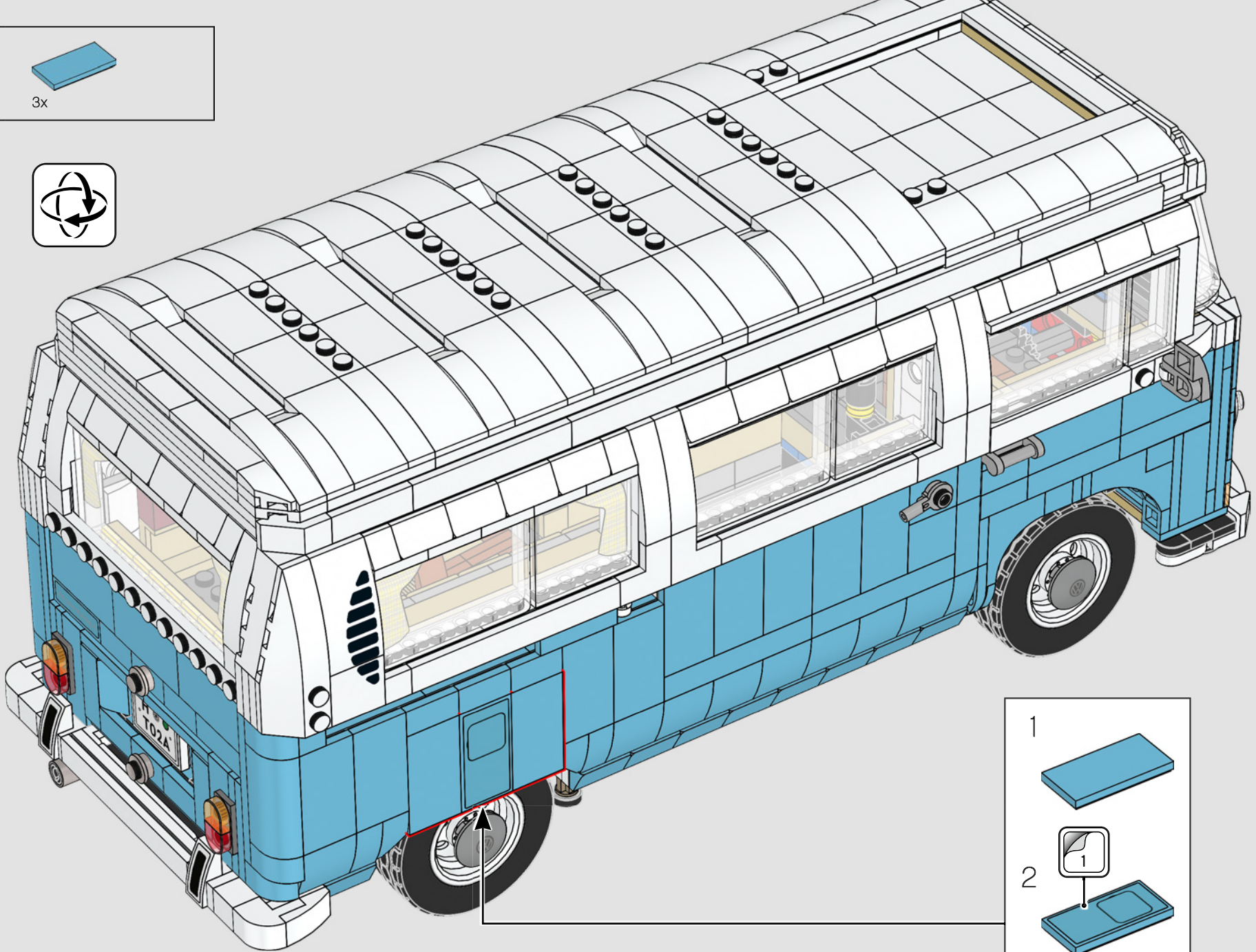

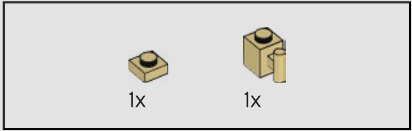
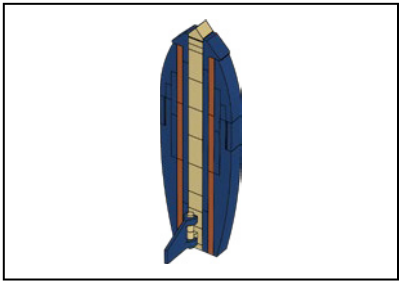

1

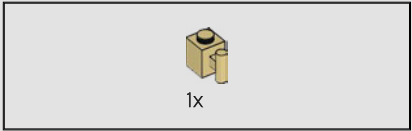
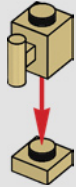

2

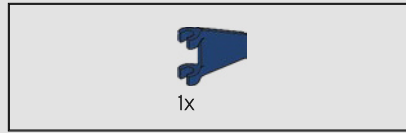
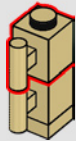

3

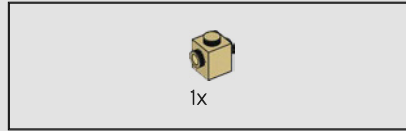
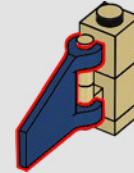

4

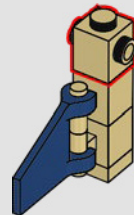

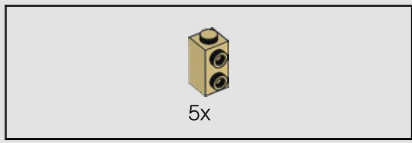

5

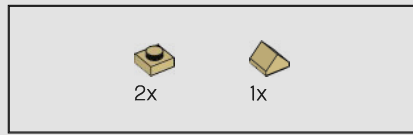
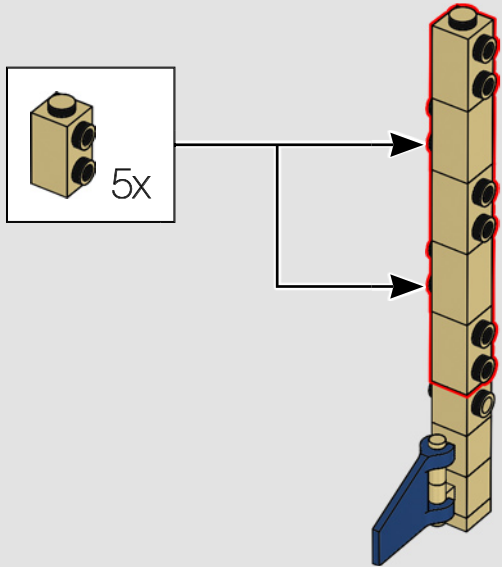

6

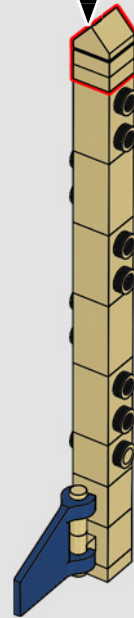
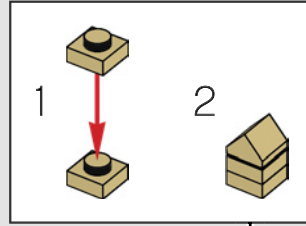

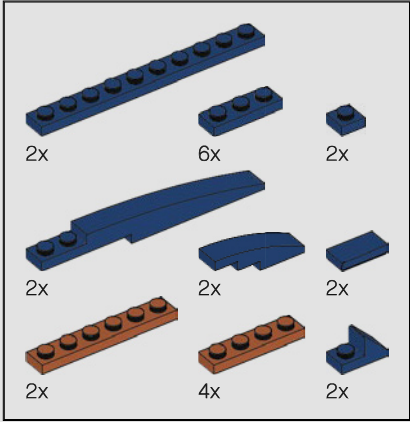
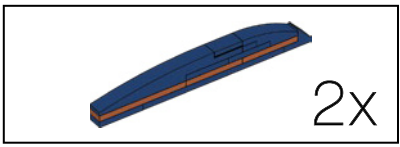

7

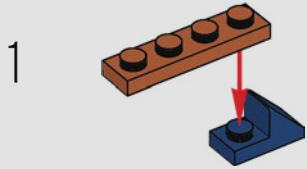

2

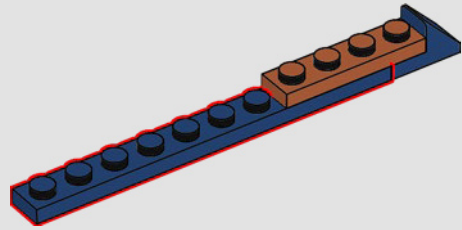

3

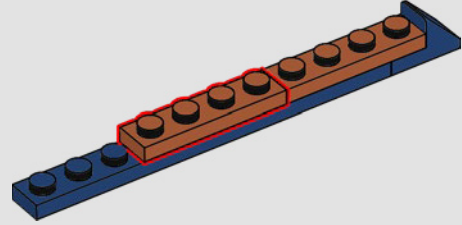

4

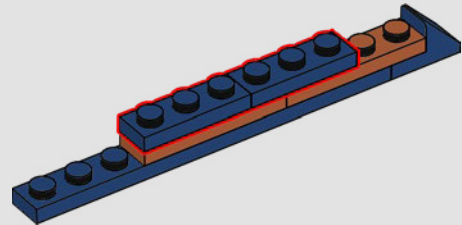

5

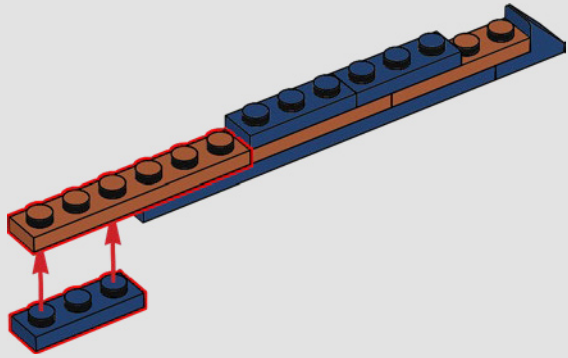

6

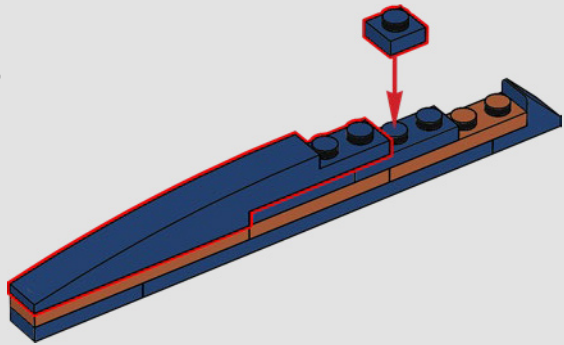

7

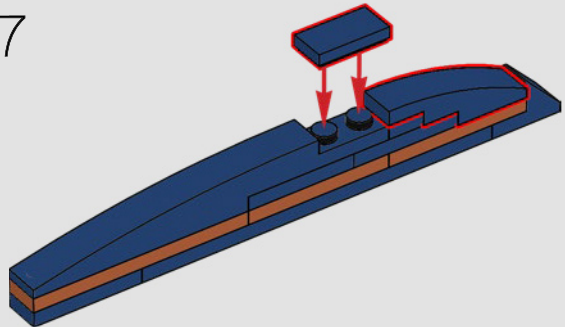

2x

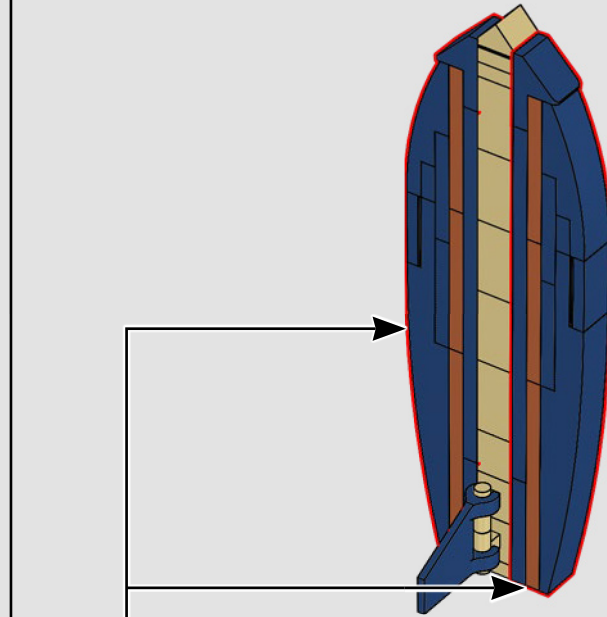

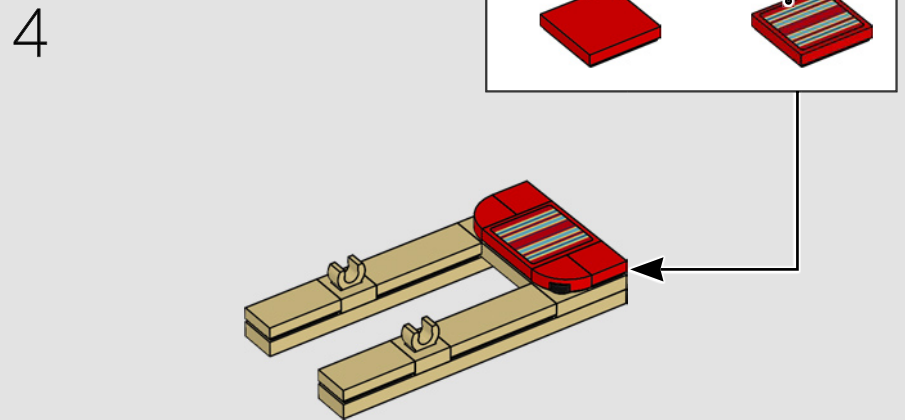
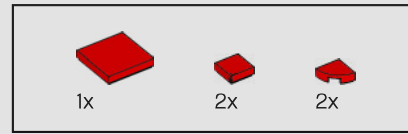
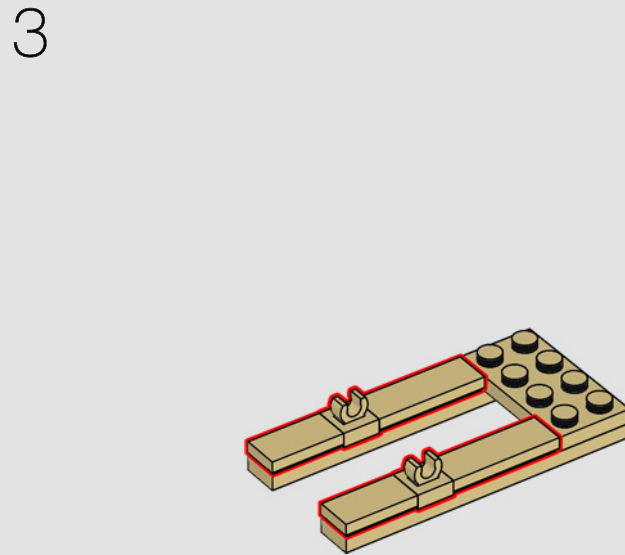
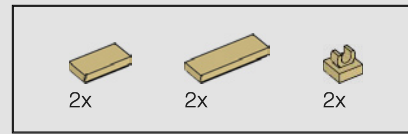
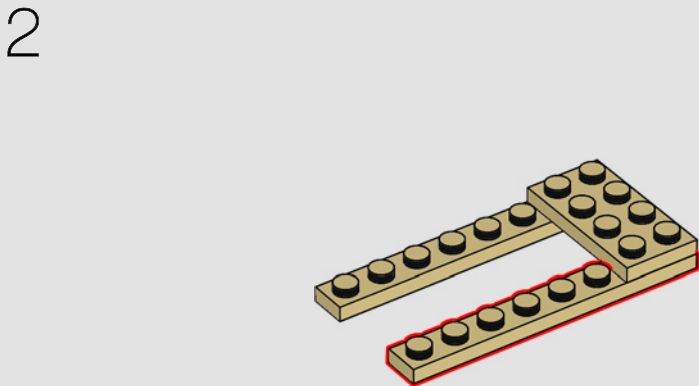
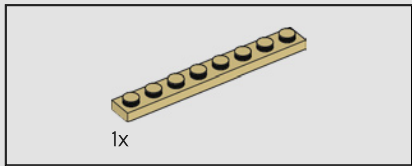
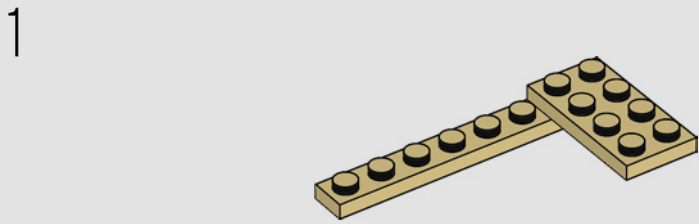
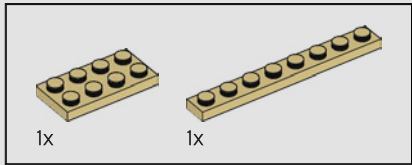
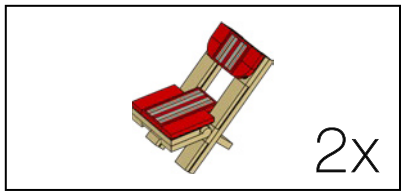

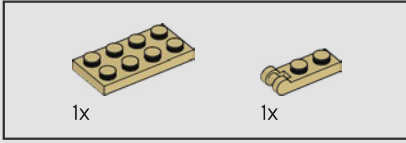

5

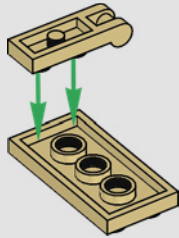

6

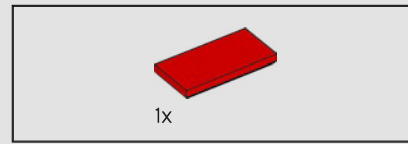
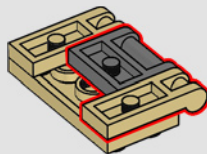

7

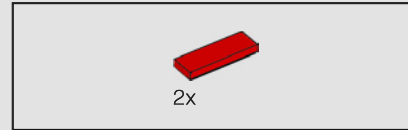
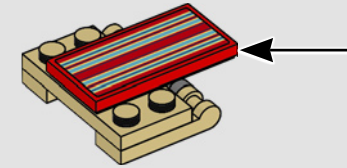
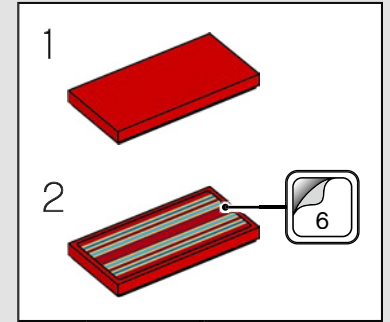
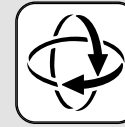

8

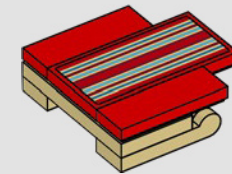



2x

9

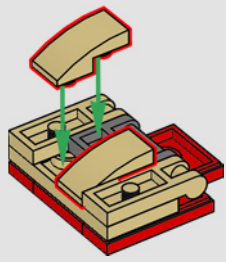

1x

10

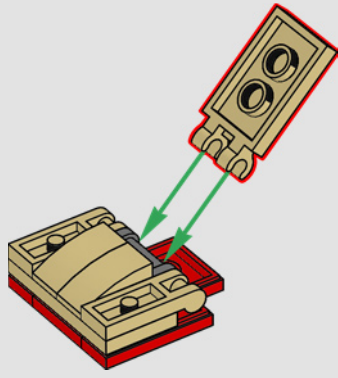

11

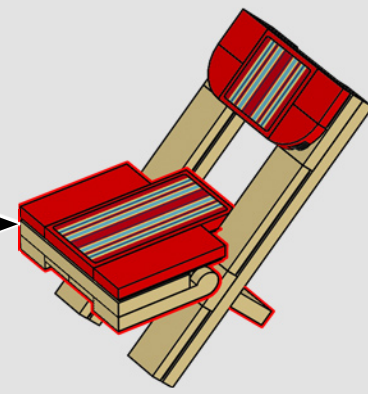
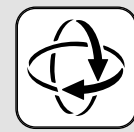

2x

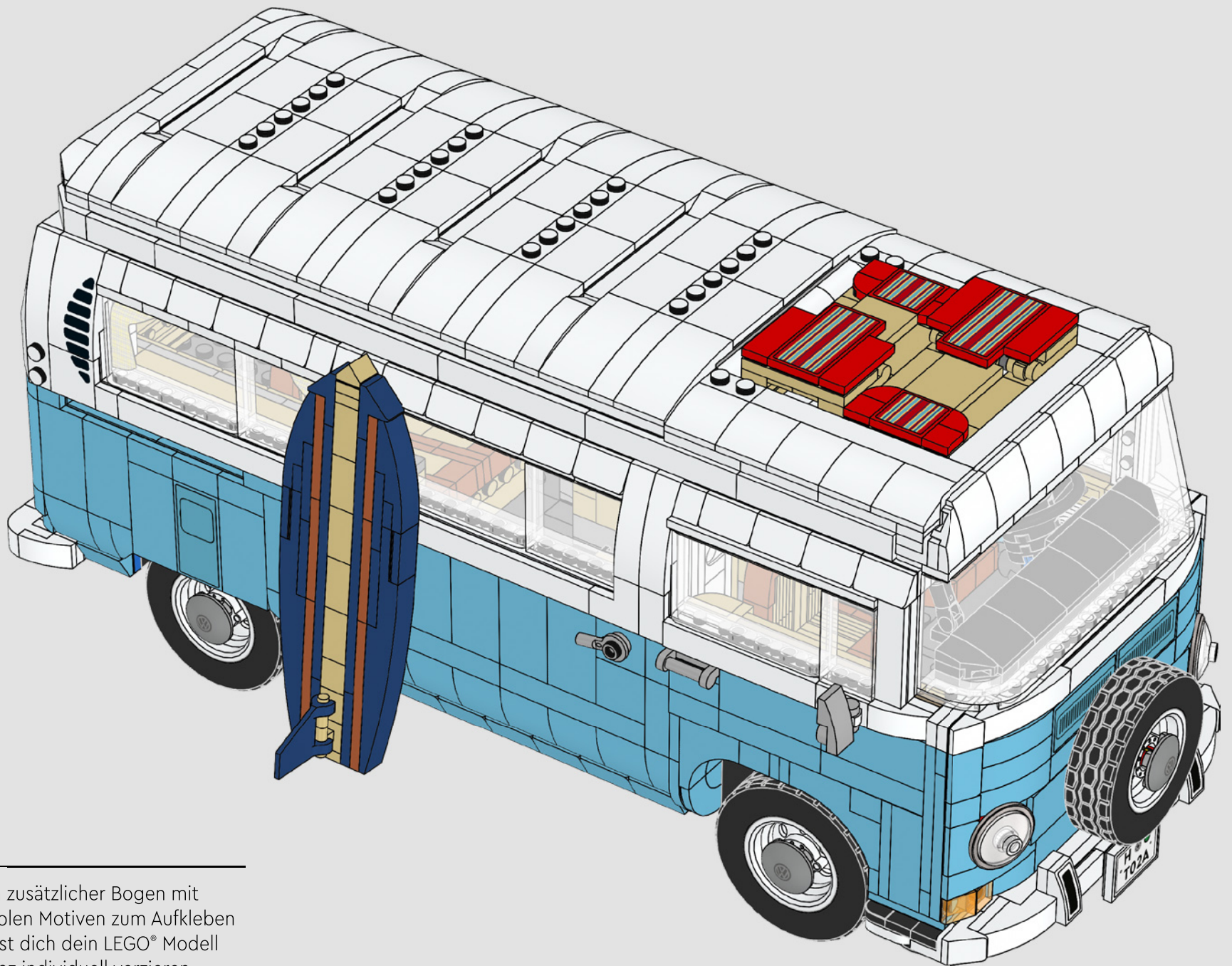

Ein zusätzlicher Bogen mit coolen Motiven zum Aufkleben lässt dich dein LEGO® Modell ganz individuell verzieren.



FEEDBACK AND WIN



FEEDBACK AND WIN

Your feedback will help shape the future development of this product series.

Please visit:

FEEDBACK UND GEWINNEN

Dein Feedback trägt zur Weiterentwicklung dieser Produktreihe bei.

Geh auf:

COMMENTEZ ET GAGNEZ

Vos commentaires nous aideront à concevoir les futurs produits de cette gamme.

Rendez-vous sur :

COMENTA Y GANA

Tu opinión nos ayudará a dar forma al desarrollo de esta serie de productos en el futuro.

Visita:

反馈有奖

您的反馈将有助于我们在今后改进本系列产品。

请访问：

[LEGO.com/productfeedback](https://www.lego.com/productfeedback)

By completing, you will automatically enter a drawing to win a LEGO® set.

Terms & Conditions apply.

Durch Ausfüllen nimmst du automatisch an der Verlosung eines LEGO® Preises teil.

Es gelten die Teilnahmebedingungen.

En envoyant vos commentaires, vous serez automatiquement inscrit(e) à un tirage au sort qui vous permettra de remporter un prix LEGO®.

Offre soumise à conditions.

Al contestar, participarás automáticamente en el sorteo y podrás ganar un set LEGO®.

Sujeto a Términos y Condiciones.

完成我们的反馈调查，即可自动进入抽奖环节，赢取乐高®套装。

适用《条款和条件》。

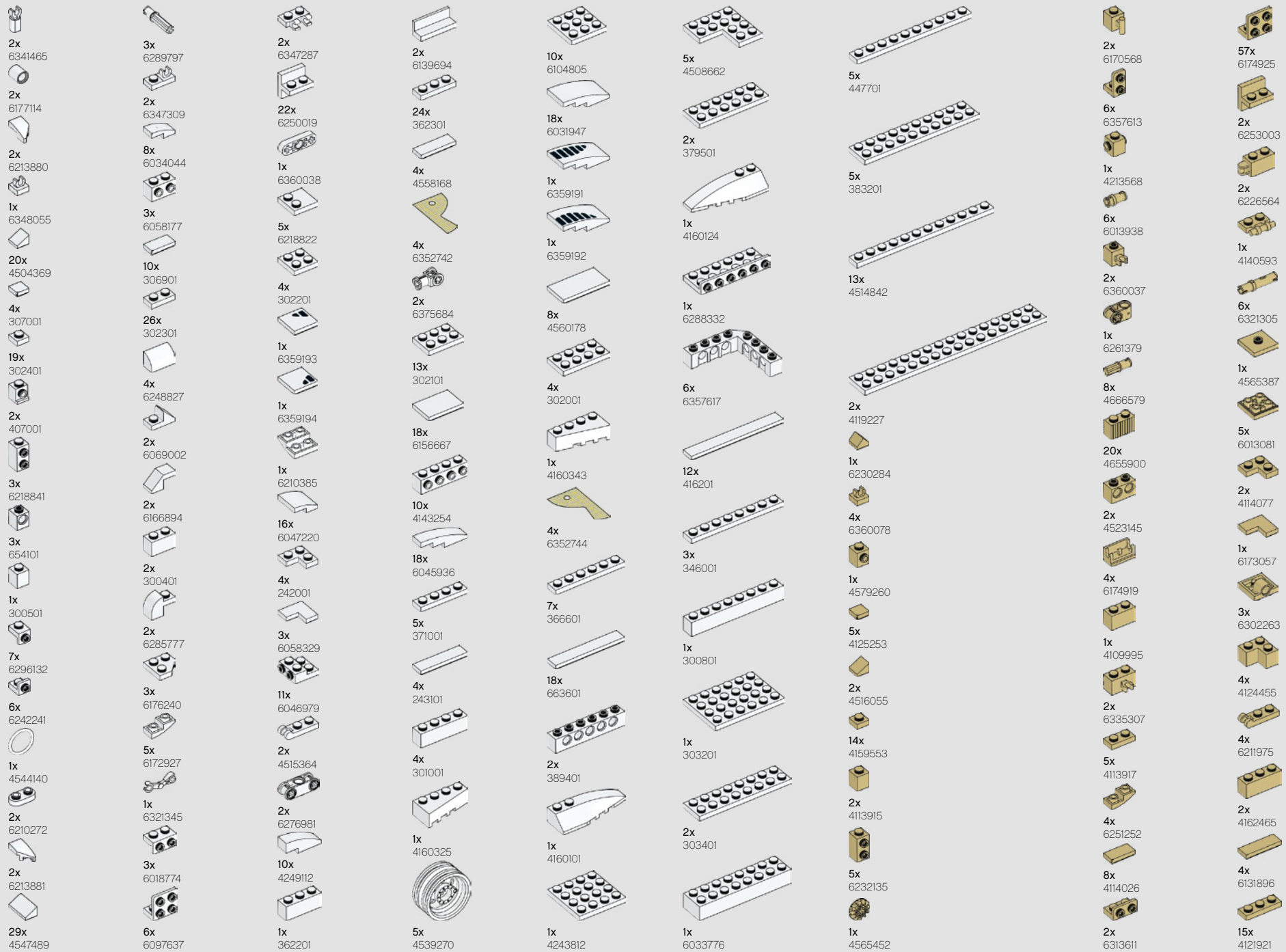

6x
6328182

1x
6211966

2x
6364436

8x
4118790

4x
6175367

2x
4159739

4x
4550324

2x
6019724

8x
4113233

3x
6195544

2x
6311104

5x
4114309

5x
6122047

328

3x
4124067

1x
4112982

3x
4157277

3x
4113993

1x
4181134

2x
6288331

17x
4114324

3x
4544139

1x
4161443

2x
4113988

2x
6037398

5x
4143409

2x
4166138

2x
4509897

5x
6156462

1x
4624185

1x
4295313

7x
6271820

4x
6170390

2x
6348058

4x
307021

2x
6187620

5x
6360104

1x
389921

6x
4142865

1x
6330198

2x
370021

3x
6261351

4x
6135130

1x
4207715

7x
6273712

2x
306821

1x
6209519

13x
6061711

4x
4533742

4x
6118830

1x
6331864

6x
6330205

1x
243121

2x
370121

4x
371021

2x
4560179

1x
4143154

10x
6029952

1x
6144791

1x
6130004

2x
370221

1x
303221

3x
4645733

4x
383221

1x
611221

2x
6284575

1x
306223

1x
6282145

16x
4143005

2x
6344218

7x
403223

7x
4206482

1x
6167491

1x
614323

4x
306923

1x
393723

1x
6179330

1x
6224999

2x
6344176

23x
6299413

4x
302223

2x
242023

4x
243123

3x
302023

1x
4142134

3x
6033353

1x
379523

4x
4506043

4x
303423

1x
6057905

2x
447723

13x
614124

5x
6271167

14x
407024

1x
4114584

1x
6329889

2x
4519010

22x
302324

1x
6247387

1x
302224

2x
6130007

2x
6375678

2x
6072627

4x
362224

3x
4164073

5x
371024

1x
6130008

2x
6115616

1x
6079138

1x 6088550
 1x 6321194
 2x 6284070
 1x 4529236
 3x 6168646
 2x 6256435
 2x 6121485
 1x 6335388
 5x 302426
 1x 6181720
 2x 6172383
 6x 4558954
 1x 6344752
 1x 4180536
 1x 6196548
 1x 6181713
 1x 4180508

80x 6279875
 3x 4278359
 2x 6143850
 2x 403226
 1x 6271535
 1x 6070695
 1x 6195325
 11x 6147050
 2x 6047276
 7x 300426
 8x 4144023
 2x 6174243
 2x 6138173
 2x 6156991
 1x 4113241
 3x 235726

6x 302326
 2x 306926
 2x 6173119
 1x 6178922
 2x 4107761
 1x 6346535
 2x 6278276
 5x 6211476
 4x 6192346
 5x 6053077
 2x 242026
 4x 4124096
 2x 6089119
 8x 6199908
 1x 362226
 1x 4558170

3x 6052126
 3x 6265644
 2x 6116604
 2x 302126
 2x 370526
 1x 6172966
 1x 4613153
 3x 4159550
 1x 6299938
 2x 4560182
 3x 6194233
 1x 302026
 4x 300126
 2x 370626

5x 6319995
 2x 379526
 1x 6318582
 1x 346026
 2x 273026
 3x 4188143
 2x 6313123
 3x 303428
 16x 6254484
 6x 6339914
 1x 6345166
 4x 4614158
 6x 6186009

14x 4570877
 2x 6340118
 10x 6186007
 4x 6074892
 2x 6253418
 1x 6301284
 2x 6264033
 1x 6246890
 2x 6245306
 2x 6211814
 4x 6245269
 6x 6254638
 1x 6288588

1x 6319998
 1x 6270534
 1x 4212454
 12x 6302741
 2x 6334042
 3x 6278442
 1x 6284582
 1x 4524929
 1x 6223631
 1x 6147052
 3x 6265128
 1x 4188771
 8x 6347790



2x
6271832

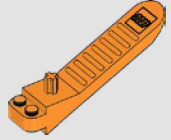

1x
6240515



1x
6352682



1x
4173332



2x
4184108



2x
4528488



2x
6186683



1x
4529551



6x
6042956



2x
6186974



2x
6251378



2x
6200663

330



2x
6135494



1x
6159763



1x
6341975



1x
6357616



1x
6278550



1x
6258323



1x
4539099



1x
4539114



1x
6337786



1x
4539060



1x
4650865



2x
4541528



1x
6357747



2x
6249116



1x
6326748



2x
6347715



3x
4211412



3x
6258831



1x
6250597



1x
4211415



2x
4211535



1x
6267495



7x
4211375



4x
6227897



2x
6225246



3x
6151349



2x
4550325



5x
6359195



2x
6123815



4x
6144138



2x
6028813



1x
4211470



9x
4211398



5x
4211414



19x
6168633



1x
4211440



3x
6117967



2x
4654582



2x
4244627

4x
4211397



2x
6319336



6x
6212077



1x
6163990



6x
6045988



1x
4211815



2x
4515369



2x
4552348



2x
6282158



1x
6273212



1x
6335279



1x
6329117



9x
6251044



9x
4211428



5x
6168615



1x
6259270



5x
4211396



1x
4610112



14x
6347992



1x
4211394



1x
4211445



4x
6230229



6x
6015347



2x
6331428



6x
6247352



1x
6079461



2x
4211438



3x
4211393



1x
4211640

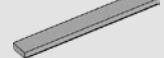

6x
4211481



2x
4211442



1x
4211392



4x
4211406



3x
4251149

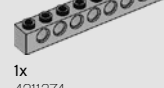

1x
4211374



4x
4211407

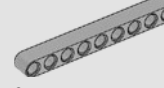

2x
4611705

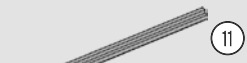

1x
6178172



1x
4514846

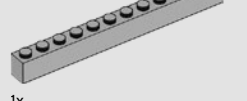

1x
4211522



3x
4211360



3x
6023978



2x
4211401



4x
4211443



10x
6300320



1x
6031821



3x
6156492

3

5

3

11

11

32

2x 6245265
 2x 6254252
 2x 6322904
 4x 4633691
 1x 6161155
 2x 6076677
 2x 6132264
 4x 6074793
 7x 4619520
 2x 6150307
 2x 6296904
 12x 6097493
 2x 4655243
 2x 6296901
 24x 6097444
 6x 6335566

6x 6071246
 1x 6348142
 5x 6092674
 1x 6126090
 4x 6060857
 17x 6119126
 2x 6357615
 2x 6293739
 2x 6258069
 6x 6035598
 4x 6119107
 8x 6097492
 4x 6036238
 2x 6347671
 6x 4624705
 6x 6070757

16x 4649741
 5x 6097419
 4x 6331949
 2x 6056455
 4x 6357619
 3x 6357618
 2x 6357620
 38x 6097042
 5x 4655256
 2x 6345200
 2x 6185309
 6x 4625036
 2x 6357614

2x 6141594
 5x 6078339
 4x 6364352
 2x 6230582
 1x 6259768
 1x 6317938
 2x 6271752
 2x 4504378
 6x 4211044
 2x 6276870
 2x 6221607
 3x 6115080
 3x 6135014
 2x 6265093
 3x 4211111

2x 4516546
 1x 4211052
 2x 4211063
 2x 6214341
 2x 6000606
 2x 6359227
 2x 6146321
 4x 6352600
 1x 6126083
 2x 4211094
 3x 6284702
 4x 4211055
 9x 4210751
 4x 6187008
 2x 4211043
 5x 4211001

3x 6083620
 2x 6092649
 1x 6008715
 11x 4560184
 2x 4211065
 2x 4210651
 4x 4539429
 1x 4210728
 2x 6138633
 12x 4210998
 3x 6199511

6x 4257526
 4x 4211061
 3x 4210678
 7x 6133611
 2x 4210963
 3x 4211114
 2x 6000970

4

Customer Service
 Kundenservice
 Service Consommateurs
 Servicio Al Consumidor
 LEGO.com/service or dial
 : 00800 5346 5555
 : 1-800-422-5346

LEGO and the LEGO logo are trademarks of the LEGO Group. ©2021 The LEGO Group.

Trademarks, design patents and copyrights are used with the approval of the owner Volkswagen AG.