

# TITANIC

BUCH 3

---

# DER UNSINKBARE OZEANDAMPFER

Die RMS *Titanic* hatte zwar jede Menge hochmoderne Sicherheitsausrüstung an Bord, doch aufgrund veralteter Sicherheitsvorschriften für die Seefahrt wurde nur die vorgeschriebene Anzahl von 20 Rettungsbooten mitgeführt. Diese Boote reichten gerade einmal für ein Drittel der Passagiere und der Besatzung. Als der Dampfer kurz vor Mitternacht am 14. April 1912 bei hoher Fahrt mit einem Eisberg kollidierte, begann er rasch zu sinken. Wegen des Mangels an Rettungsbooten überlebten nur 710 Personen, für 1.500 Menschen gab es hingegen keine Rettung. Als direkte Konsequenz aus dieser Tragödie wurden zahlreiche neue internationale Sicherheitsstandards vereinbart, die größtenteils noch heute Gültigkeit besitzen.

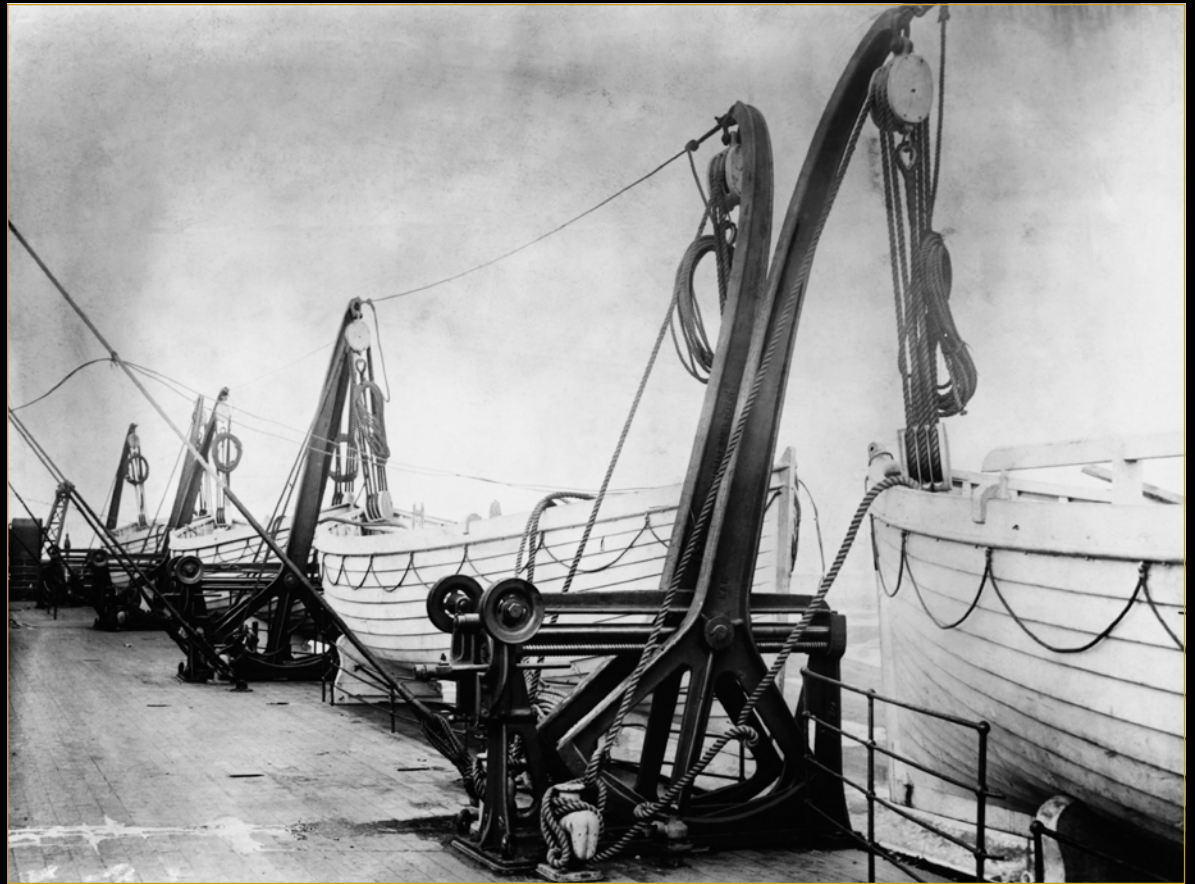

↑ Rettungsboote an ihren Bootskränen auf der *Titanic*.

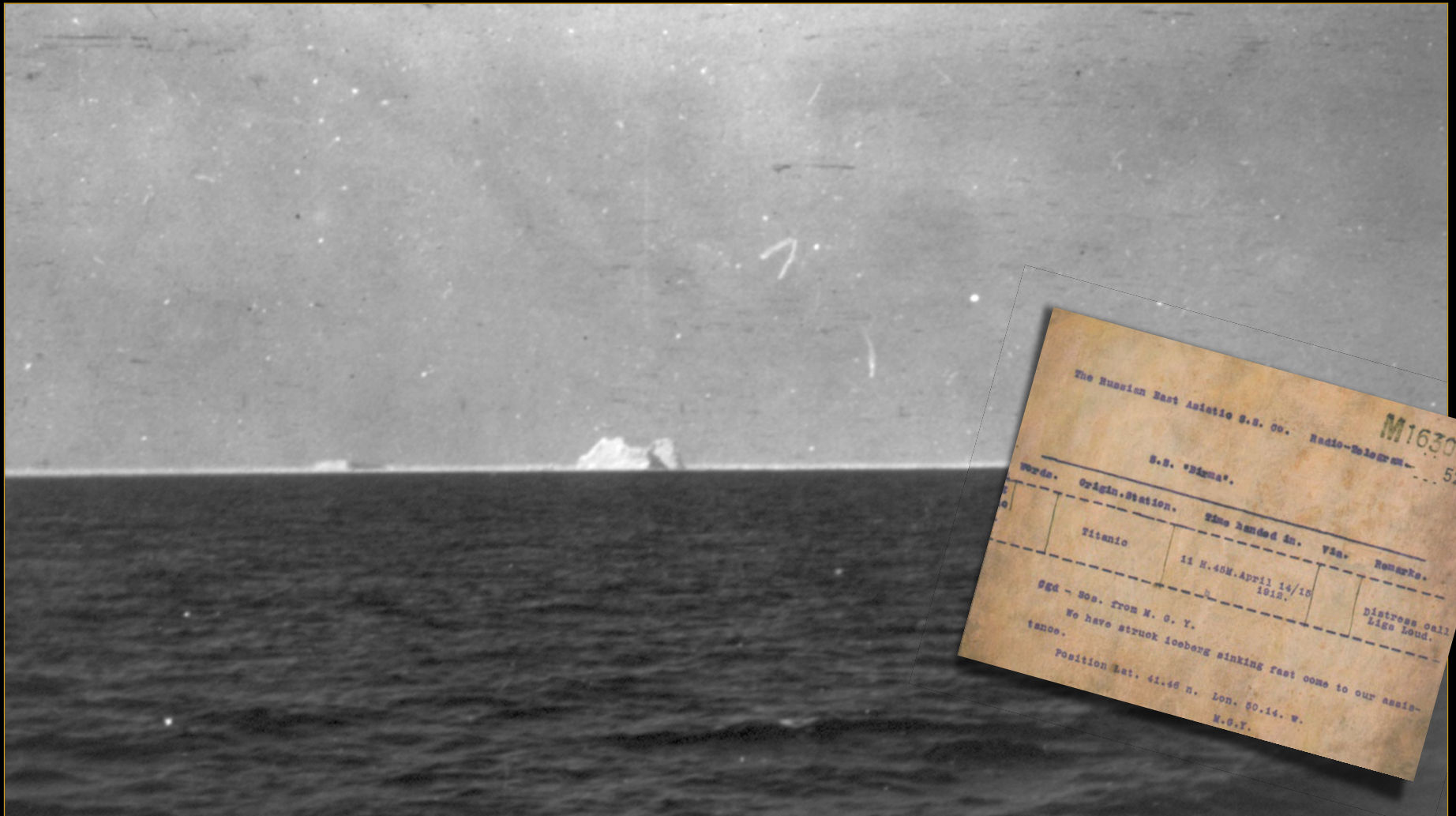

↑ Foto des mutmaßlichen Unglücksorts, das an Bord der SS Carpathia gemacht wurde, die Überlebende von der Titanic aufnahm.

↗ Telegramm von der RMS Titanic, das die SS Birma um Hilfe ersucht.

# IMPOSANTER MASSSTAB

Bei ihrem Stapellauf war die *Titanic* das größte Schiff, das bis dato je gebaut wurde. Sie war 269 Meter lang und vom Kiel bis zur Spitze der Schornsteine 53,3 Meter hoch. Analog dazu ist die LEGO® Version der RMS *Titanic* das längste bisher erschaffene LEGO Modell – und außerdem eines der aufwendigsten.

*Die LEGO Version der Titanic wurde im Maßstab 1:200 gebaut, in dem auch die LEGO Architecture Freiheitsstatue nachgebildet wurde.*

*Die Titanic war 11 Mal so lang wie ein Blauwal. Nach heutigem Wissensstand hat noch nie ein größeres Tier auf der Erde gelebt.*

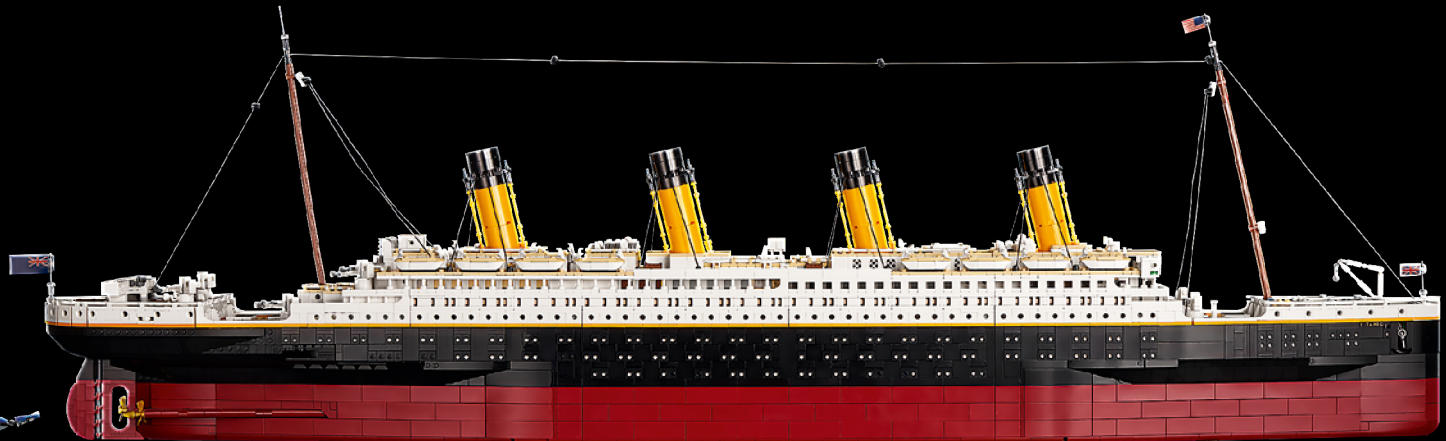

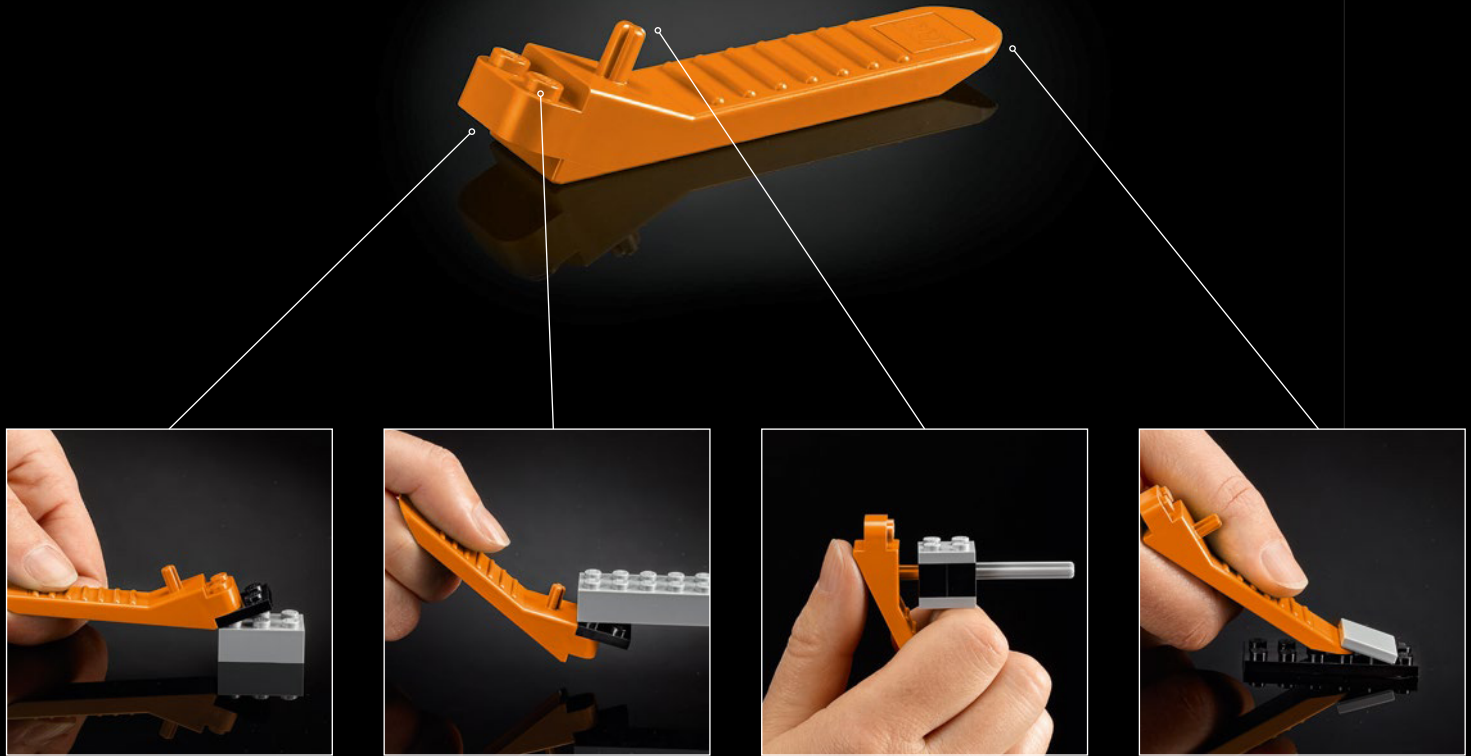

[LEGO.com/brickseparator](https://www.lego.com/brickseparator)

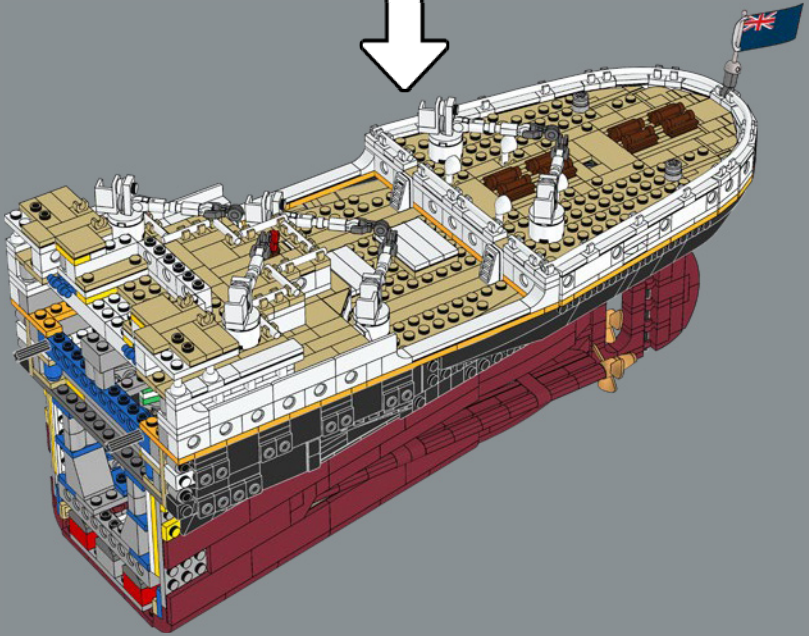
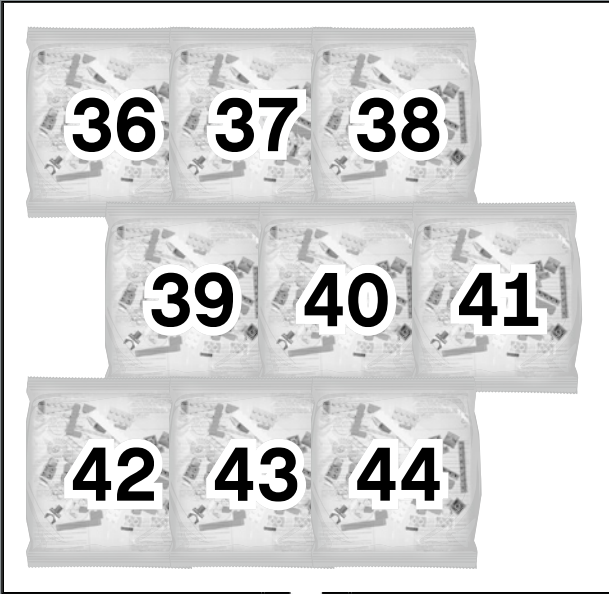
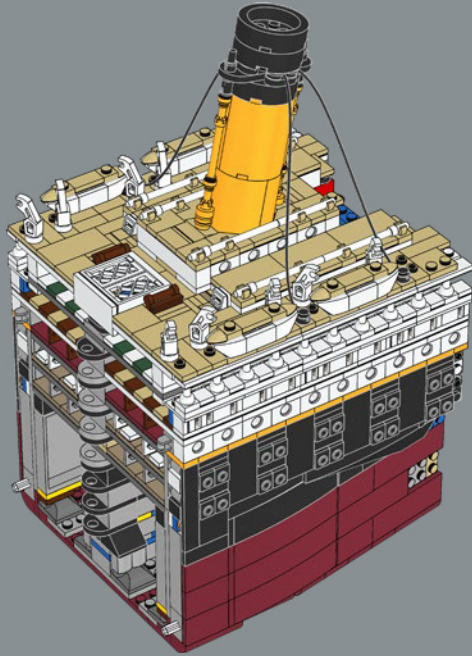
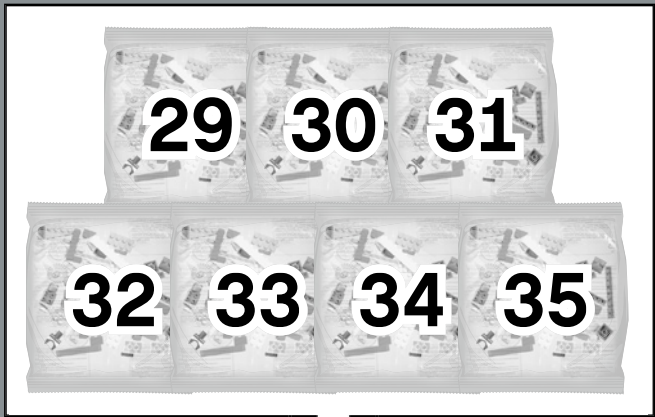

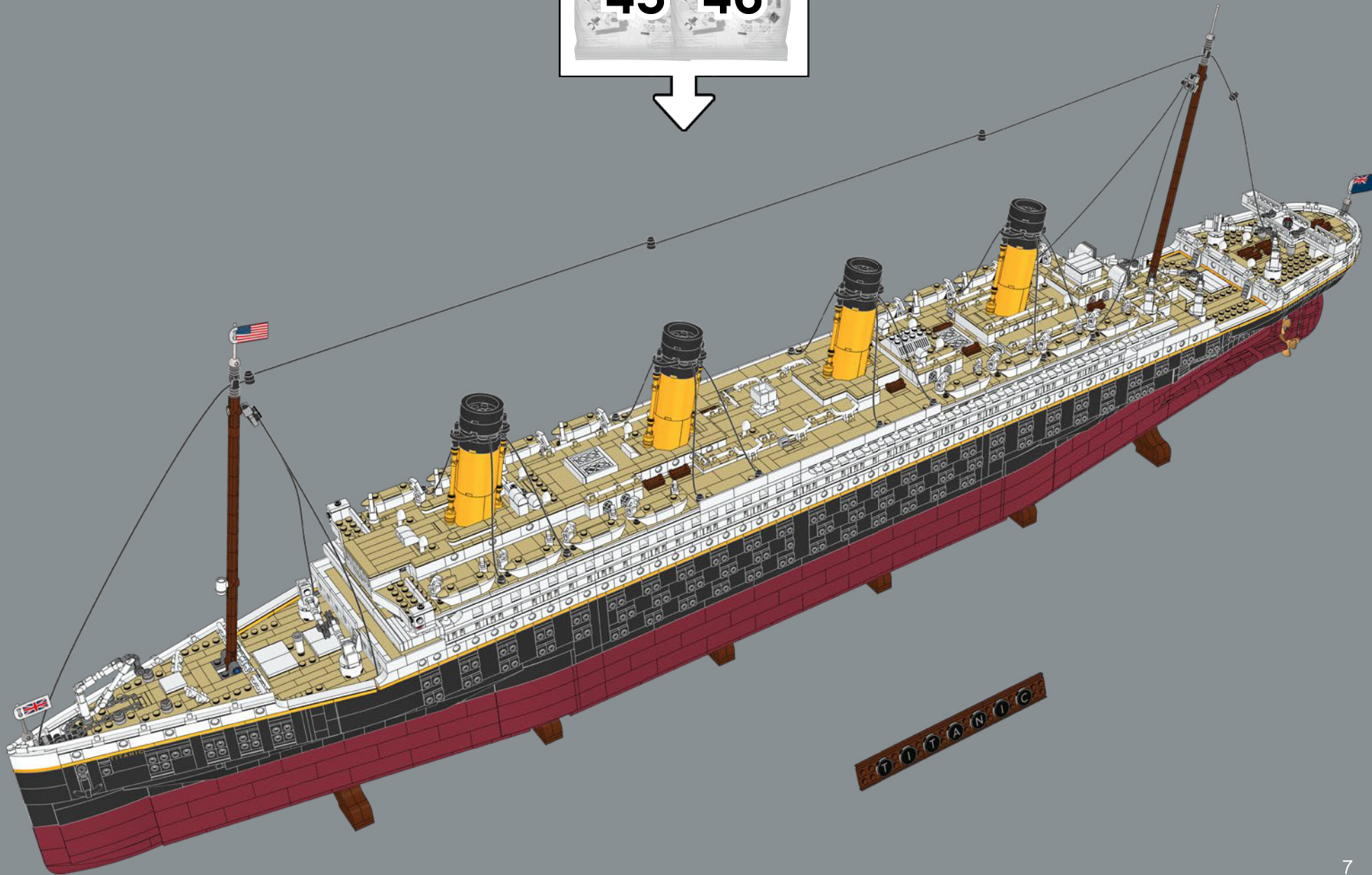
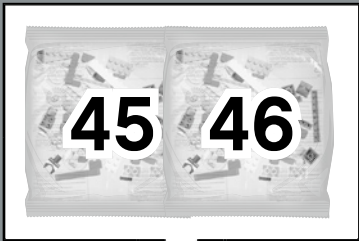

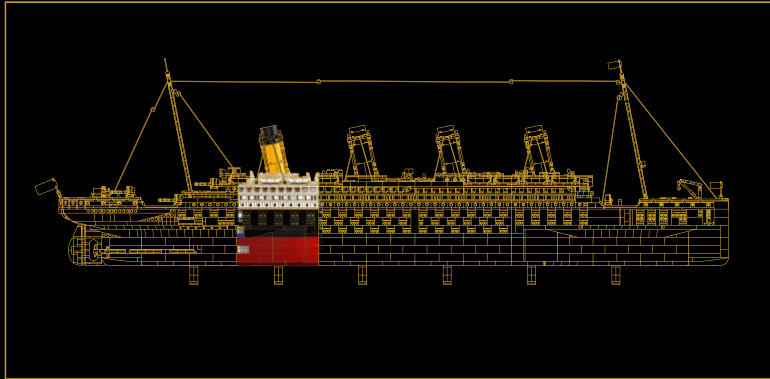

#### ABSCHNITT 5:

# SCHORNSTEIN & MASCHINENRAUM

In diesem Abschnitt verjüngt sich das Modell zu den Propellern und dem Ruder am Heck des Schiffs. Außerdem baust du in diesem Abschnitt den letzten Schornstein. Auf der echten *Titanic* war dieser Schornstein nicht mit Kesseln verbunden. Er diente ausschließlich ästhetischen Zwecken und sollte das Design optisch abrunden.

↓ Oben fügen du hier noch den Lesesalon und einige der Zweite-Klasse-Kabinen hinzu.





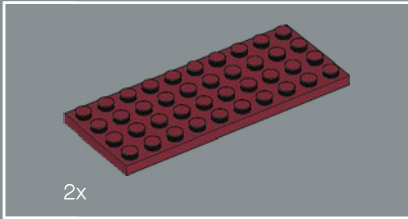
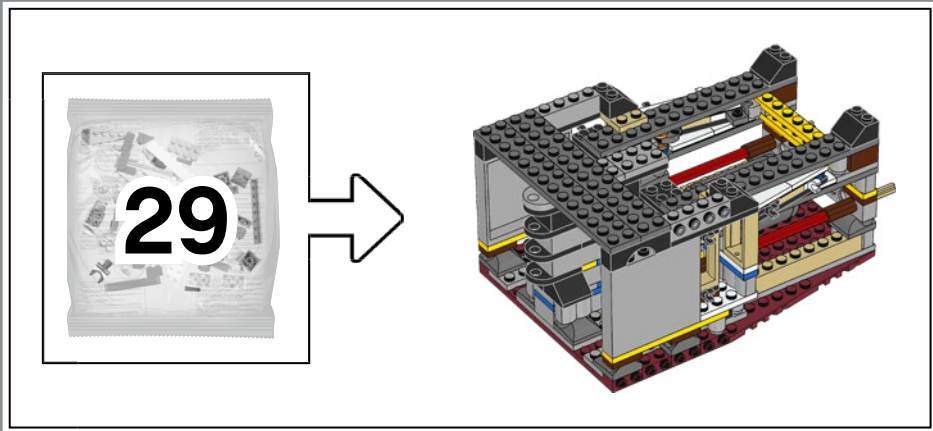

1

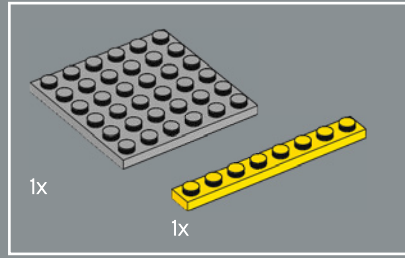
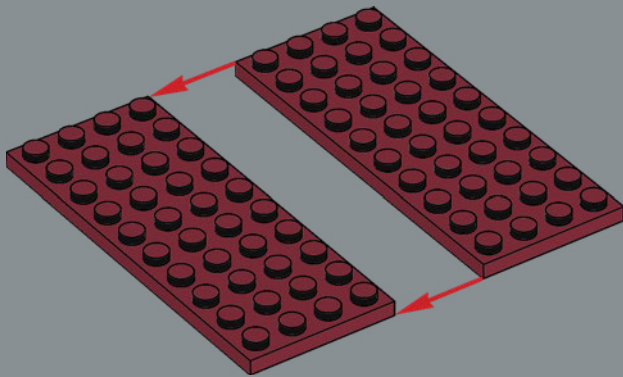

2

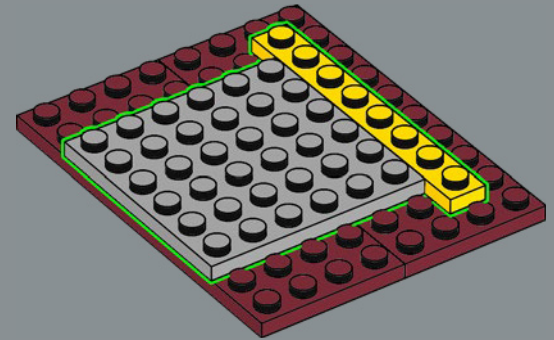

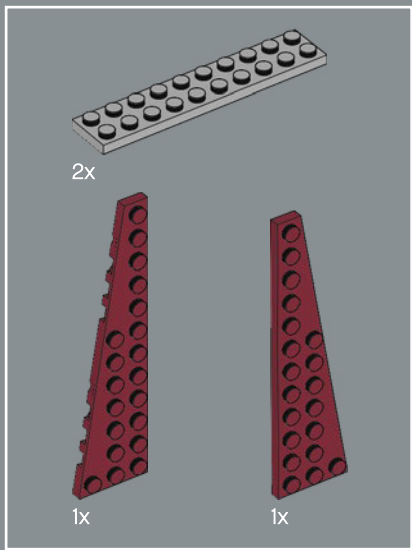

3

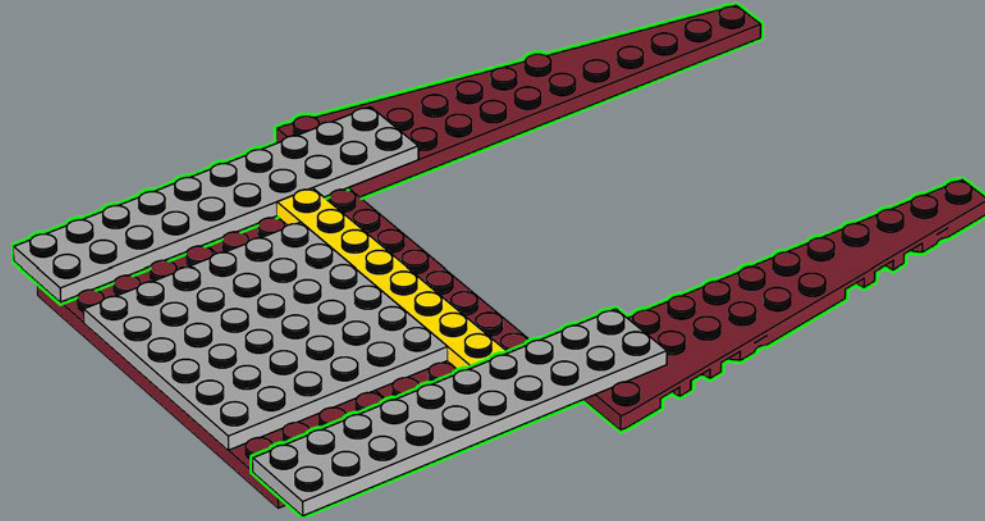

4

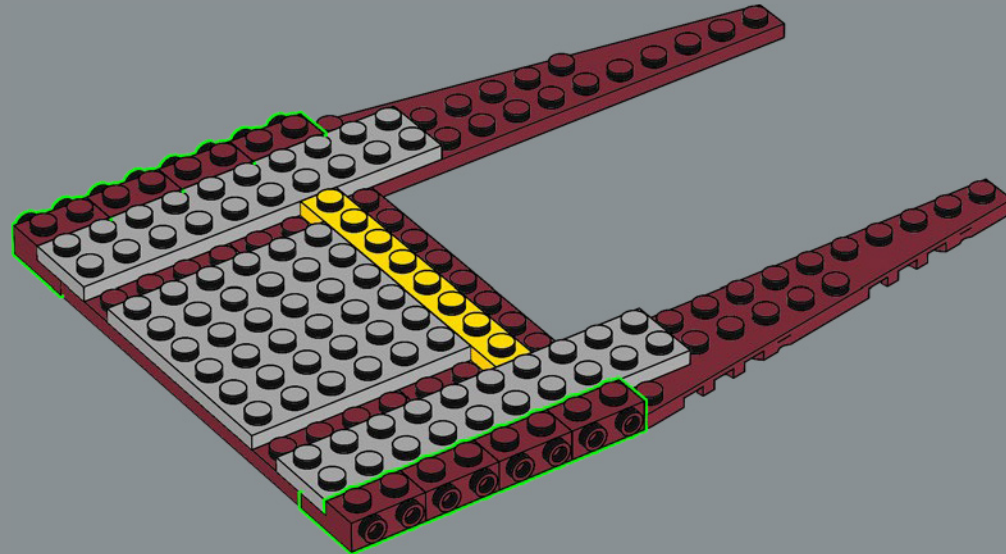

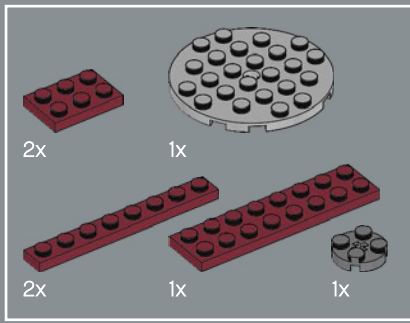

5

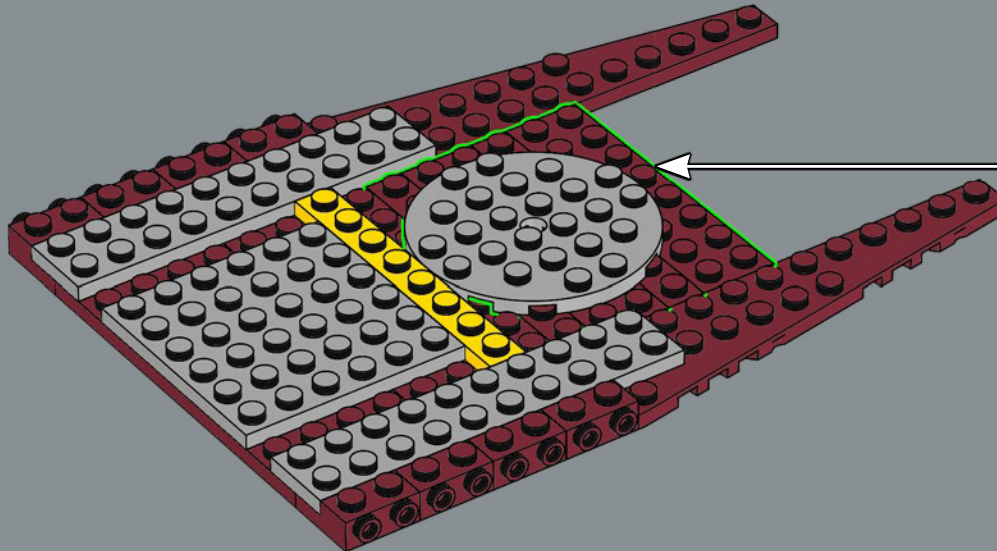
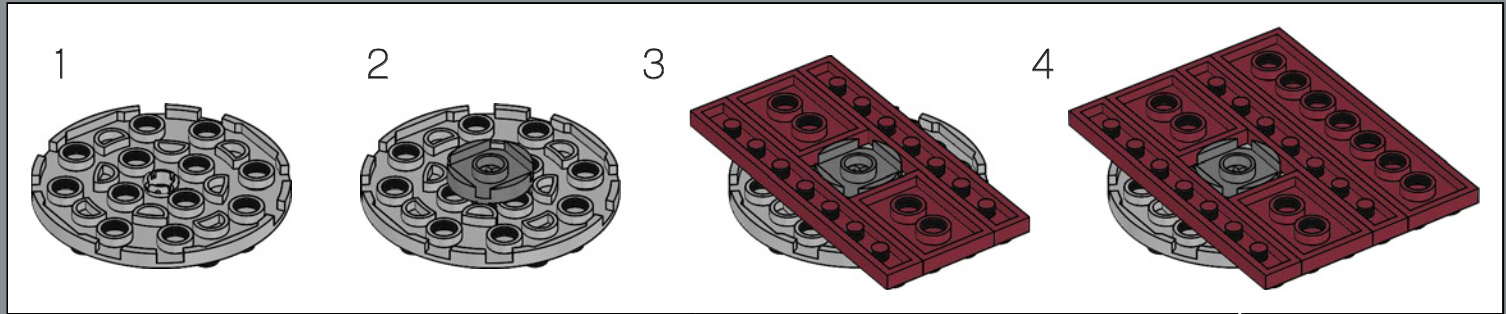

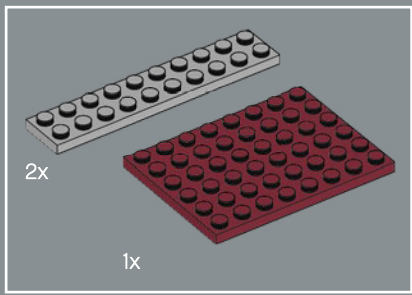

6

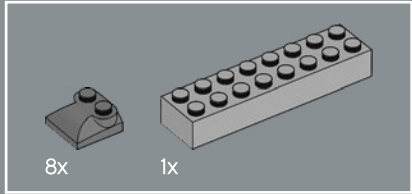
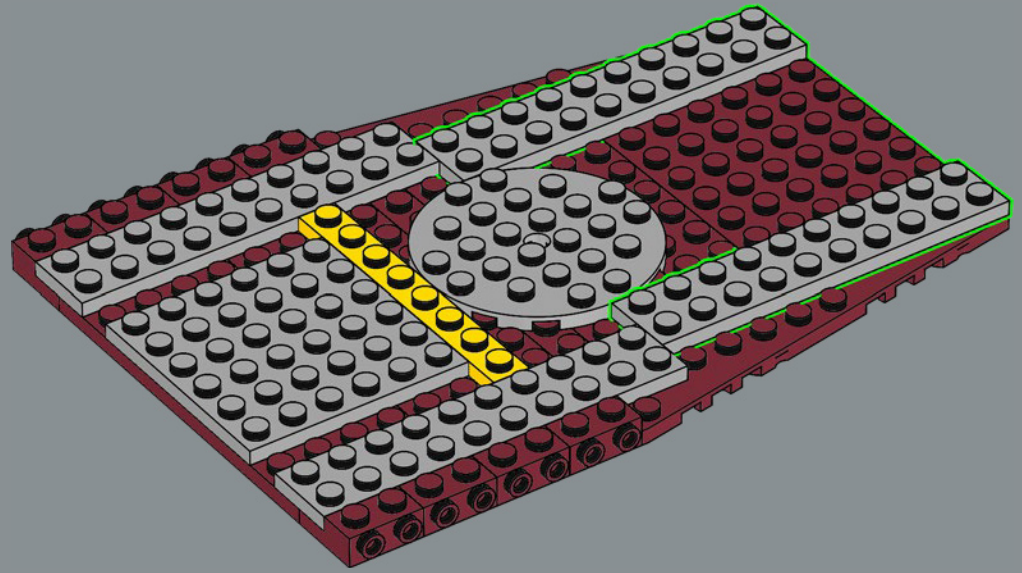

7

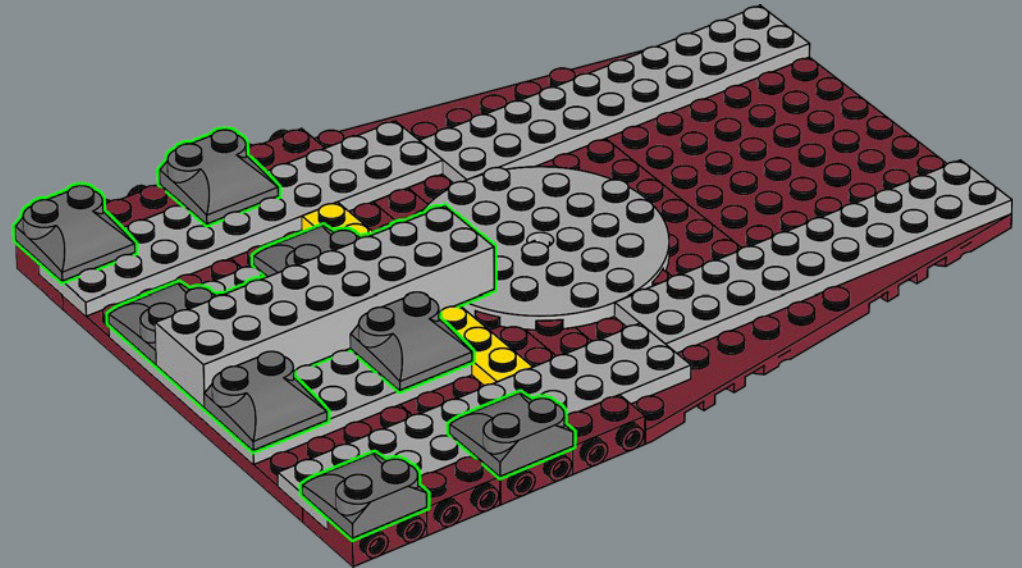



8

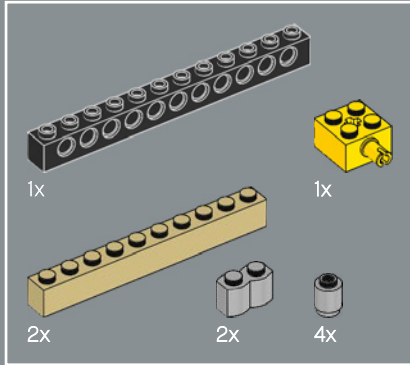
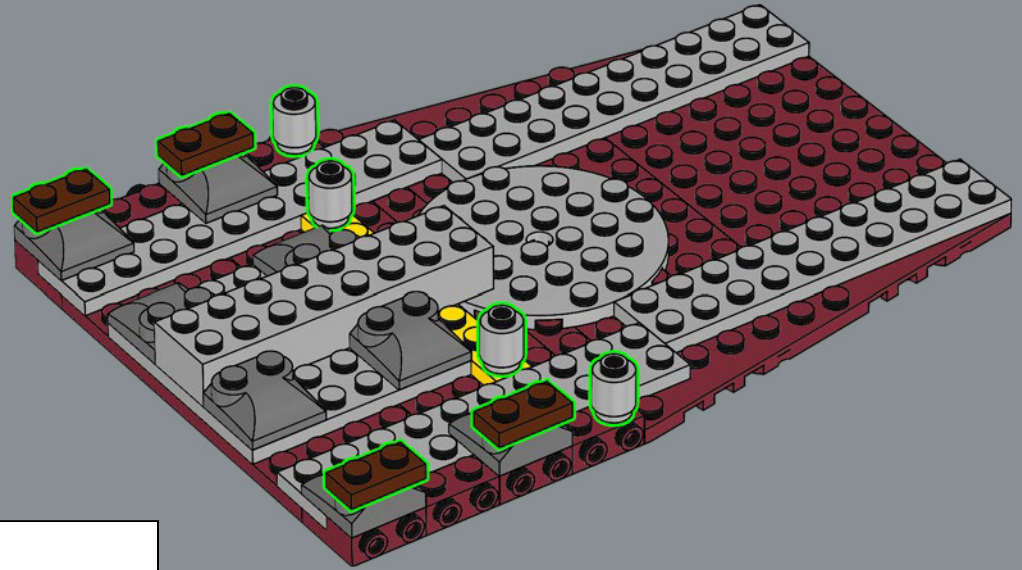

9

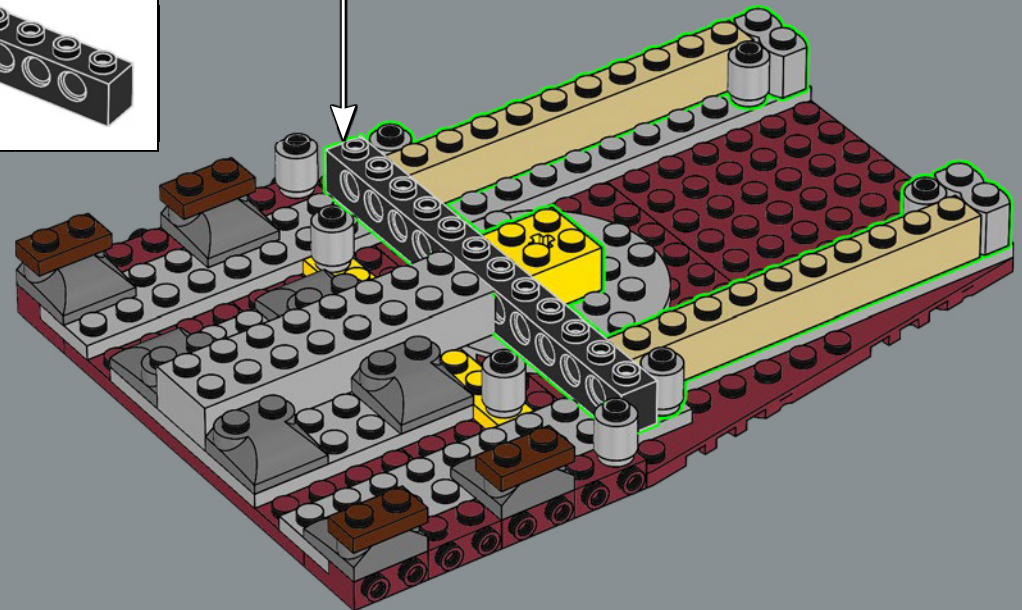
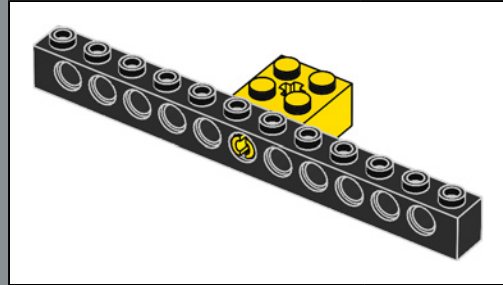

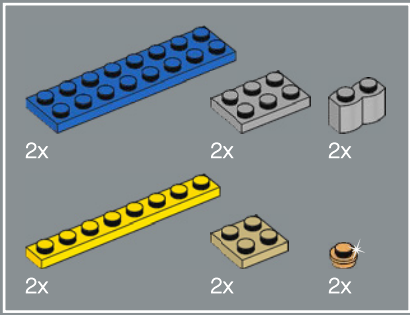

10

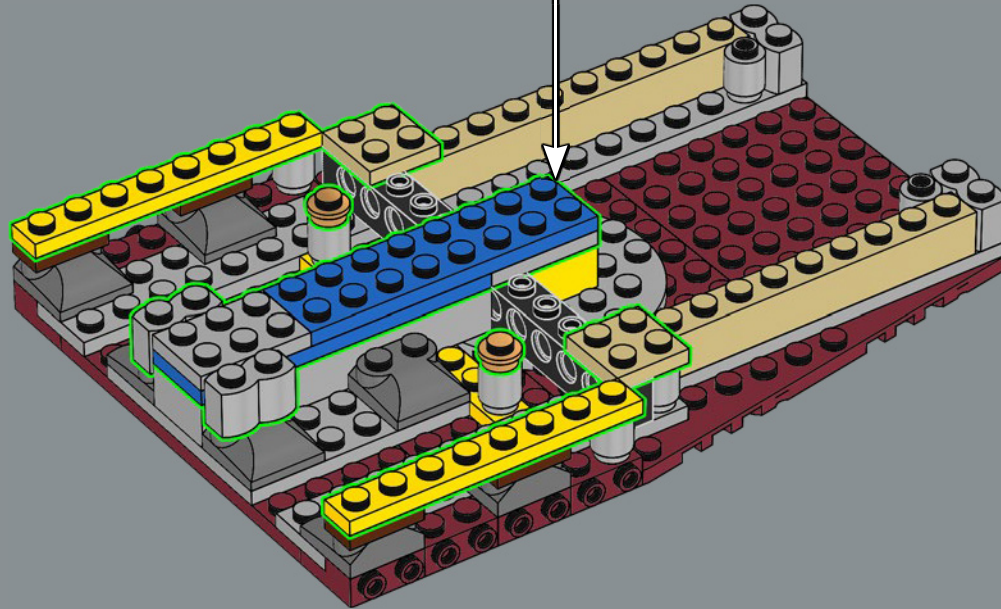
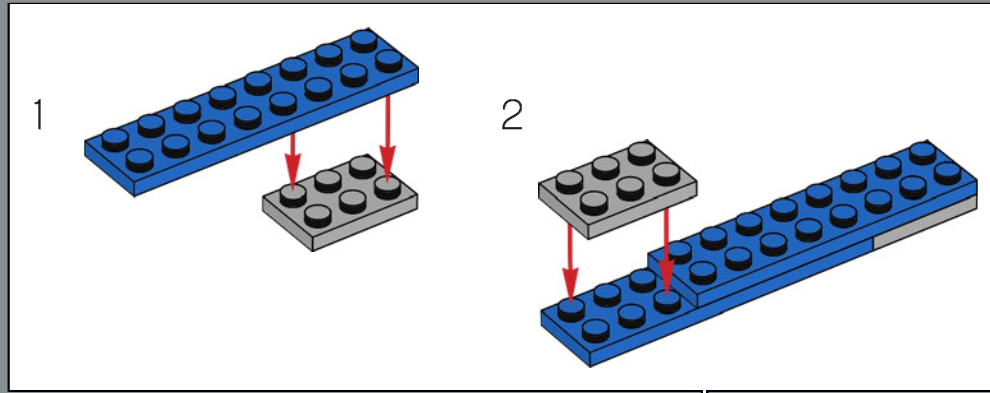

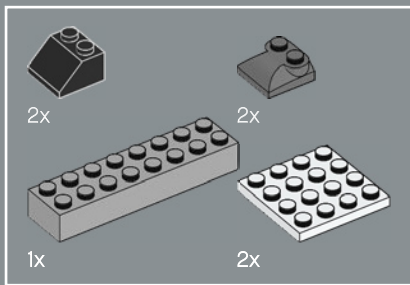

11

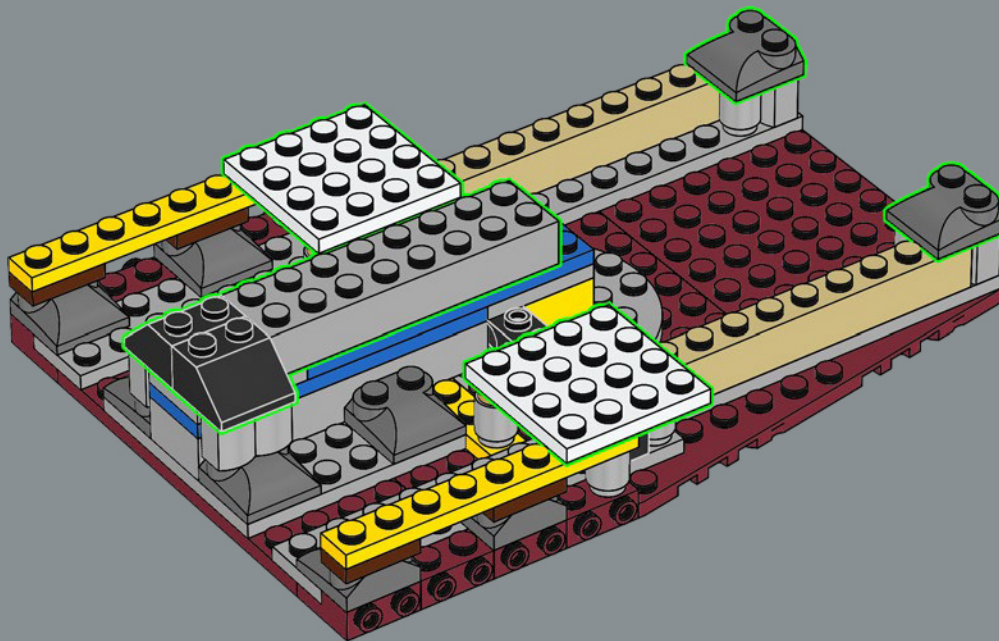

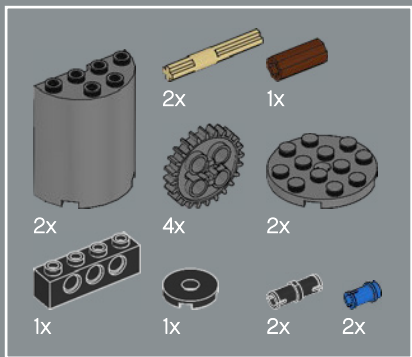

12

1

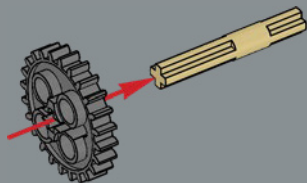

2

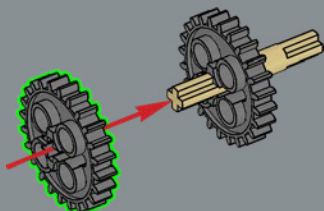

3

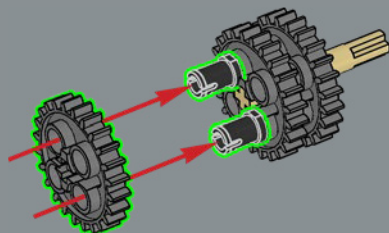

4

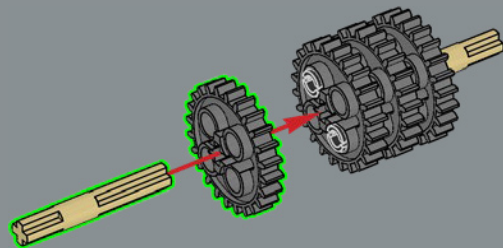

5

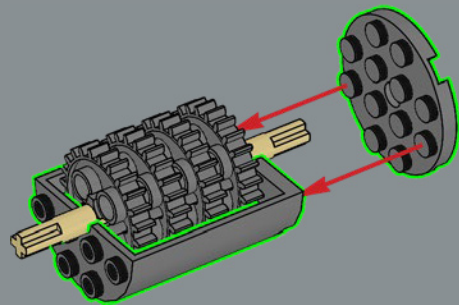

6

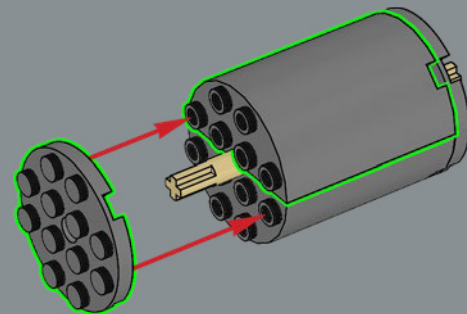

7

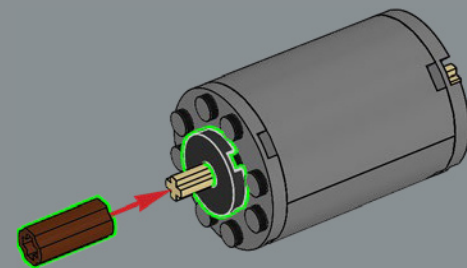

8

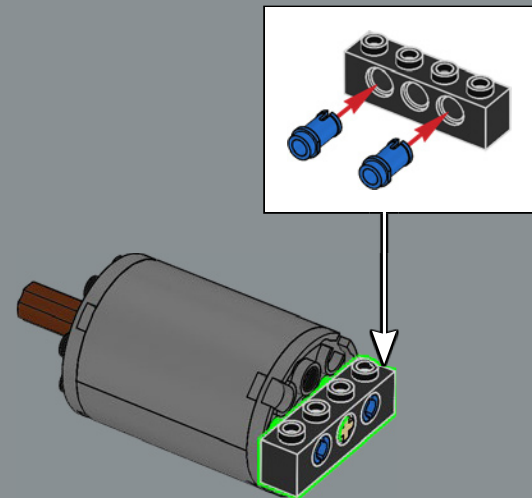



Die Generatoren der *Titanic* konnten mehr Strom erzeugen als ein durchschnittliches städtisches Elektrizitätswerk in jener Zeit.

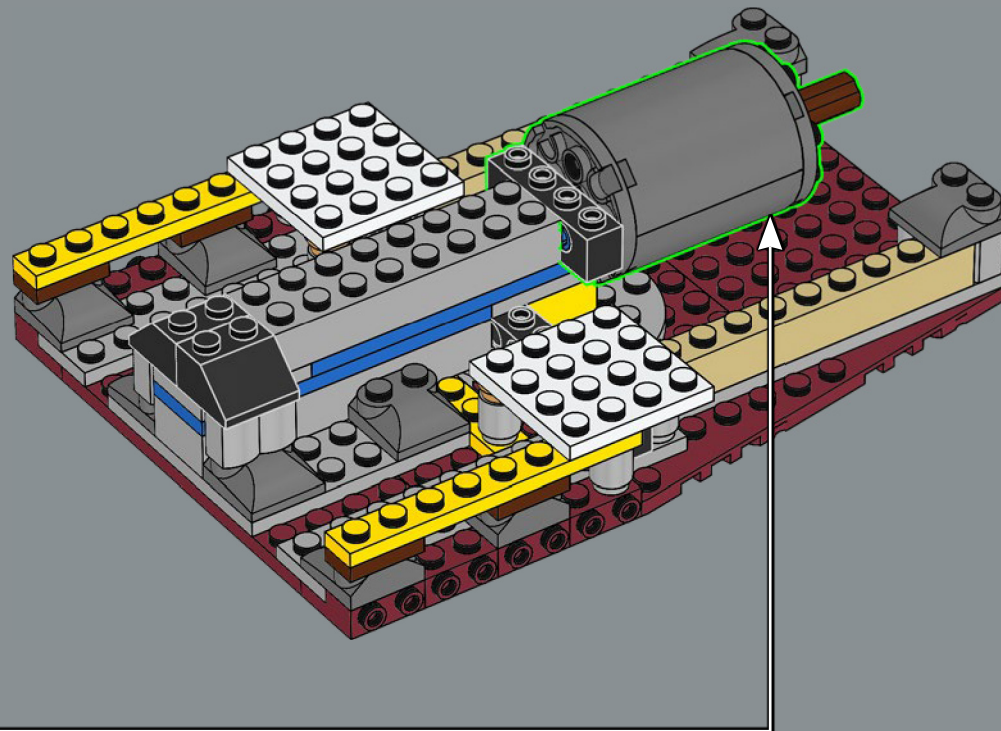

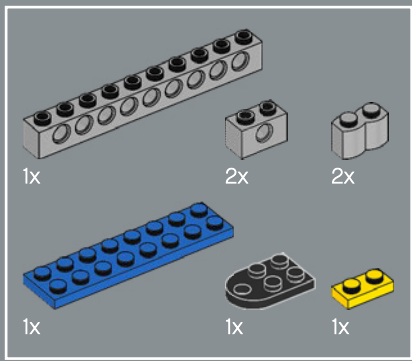

13

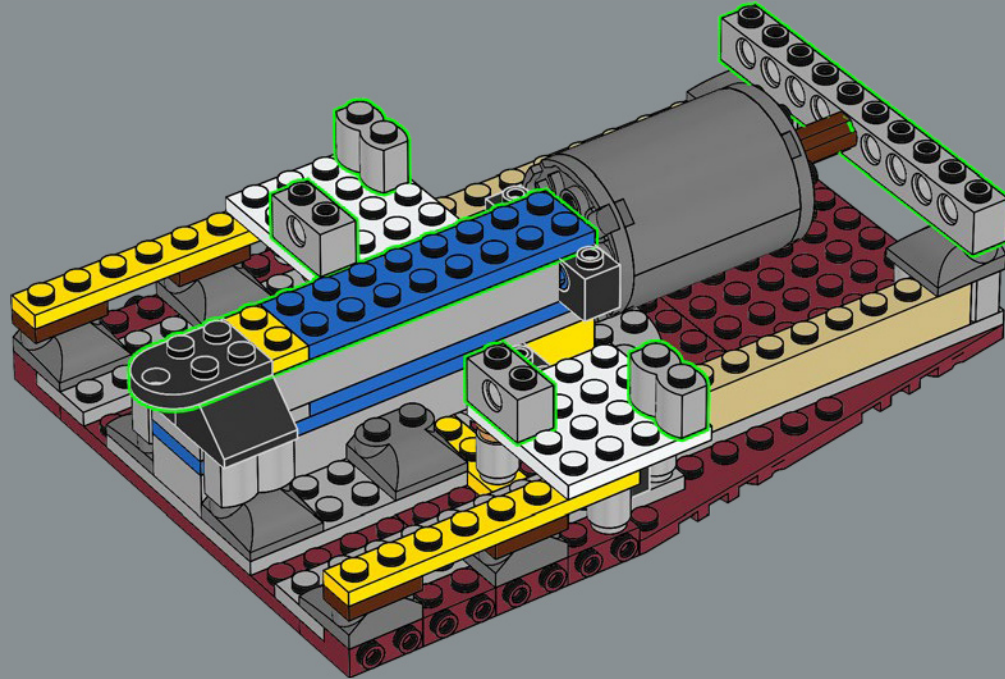

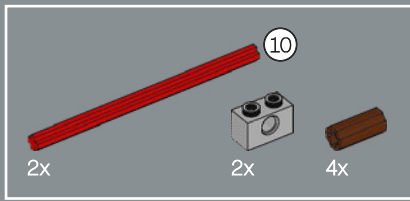

14

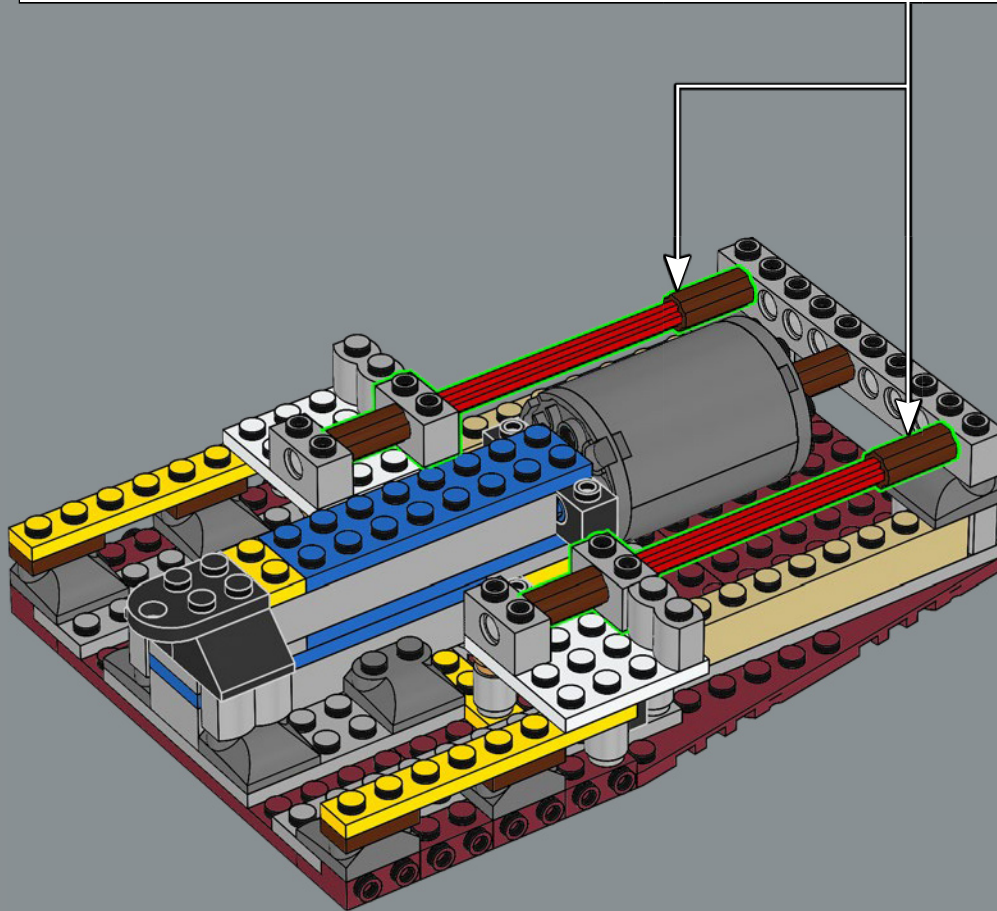
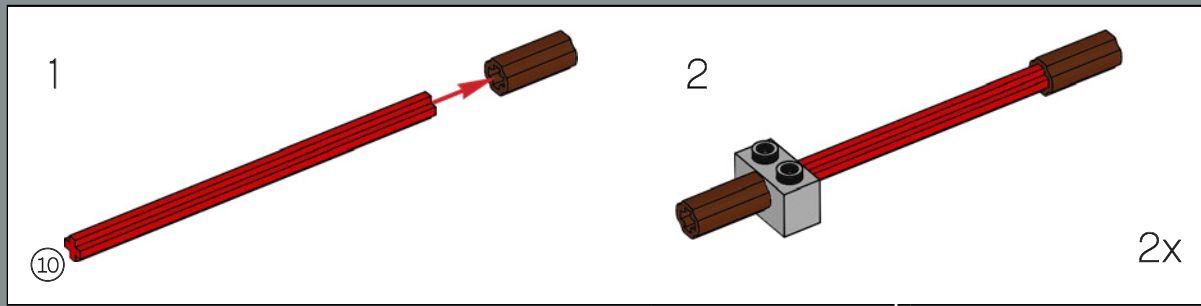

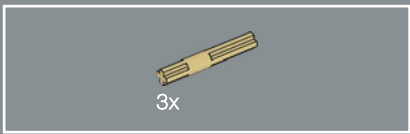

15

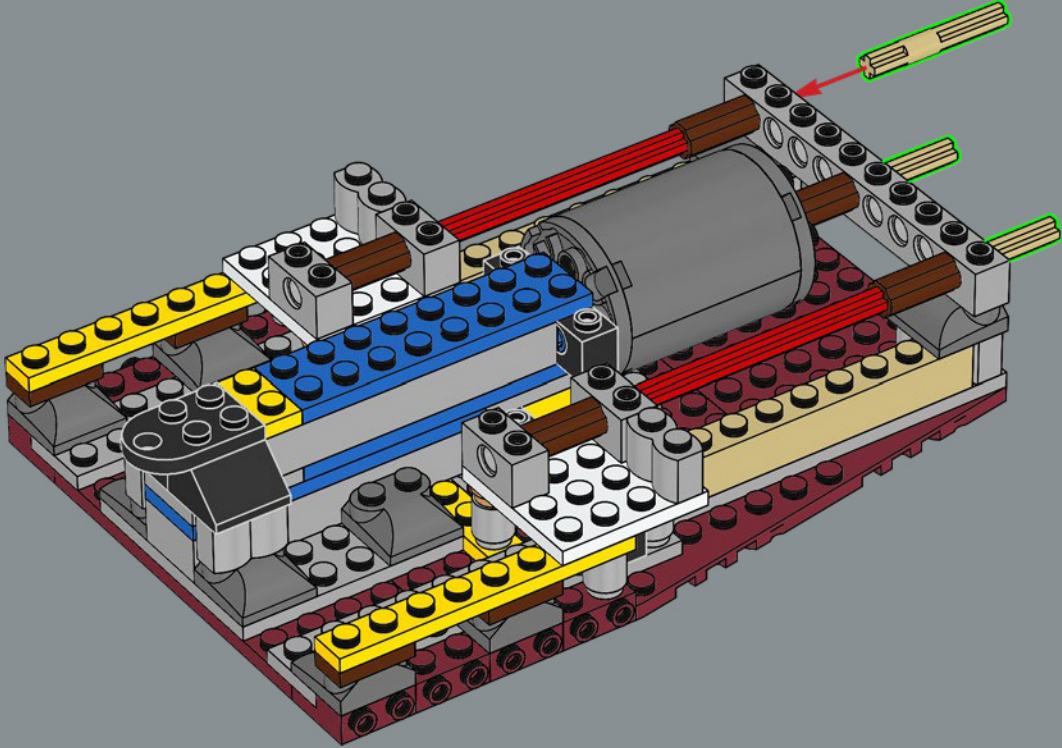

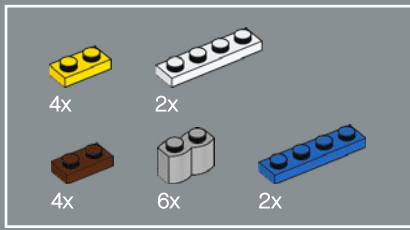

16

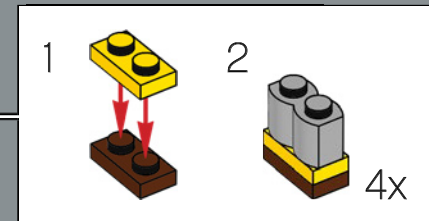
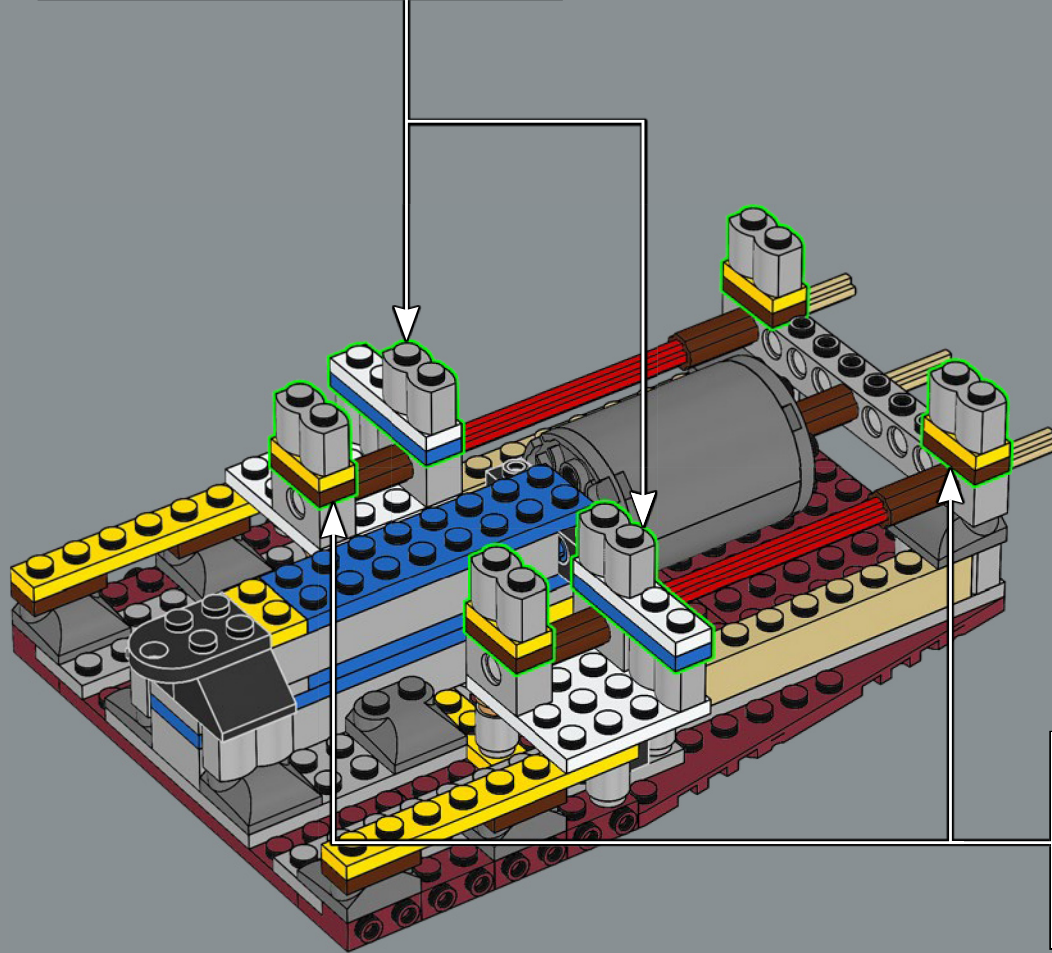
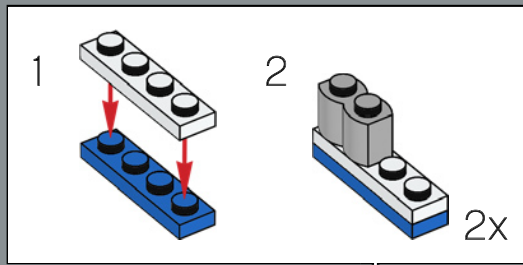

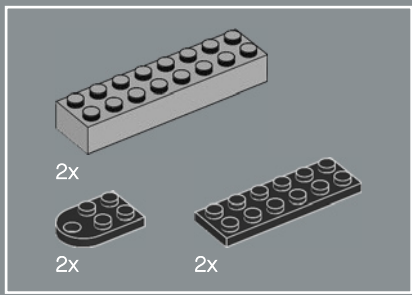

17

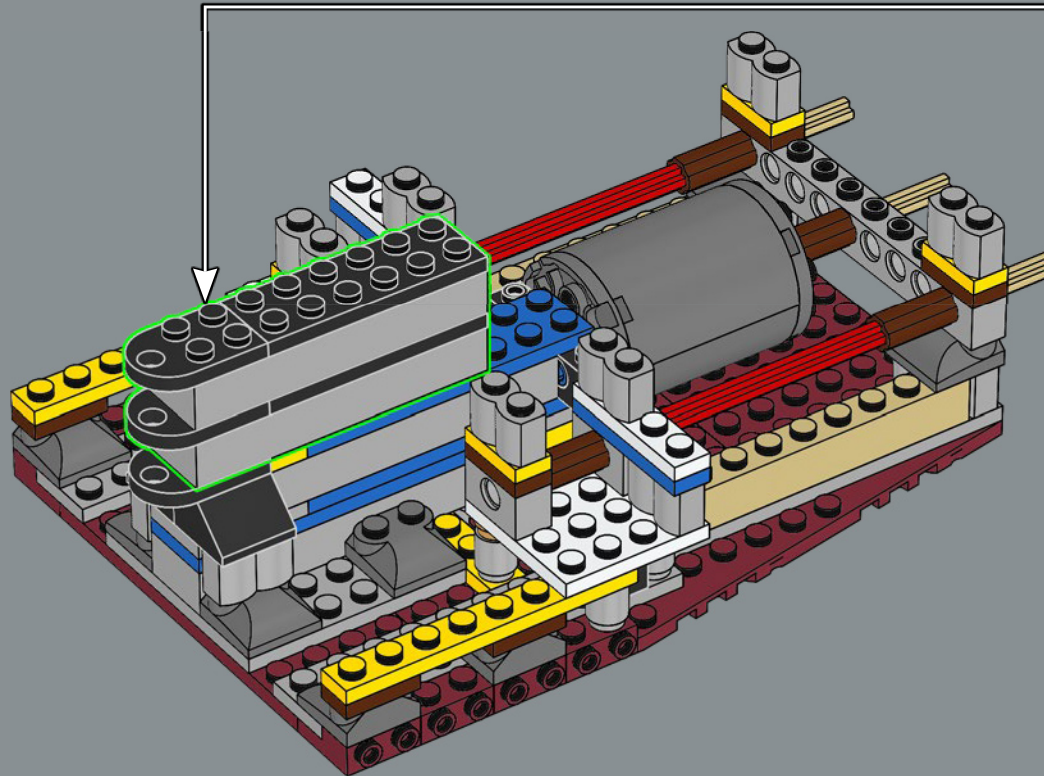
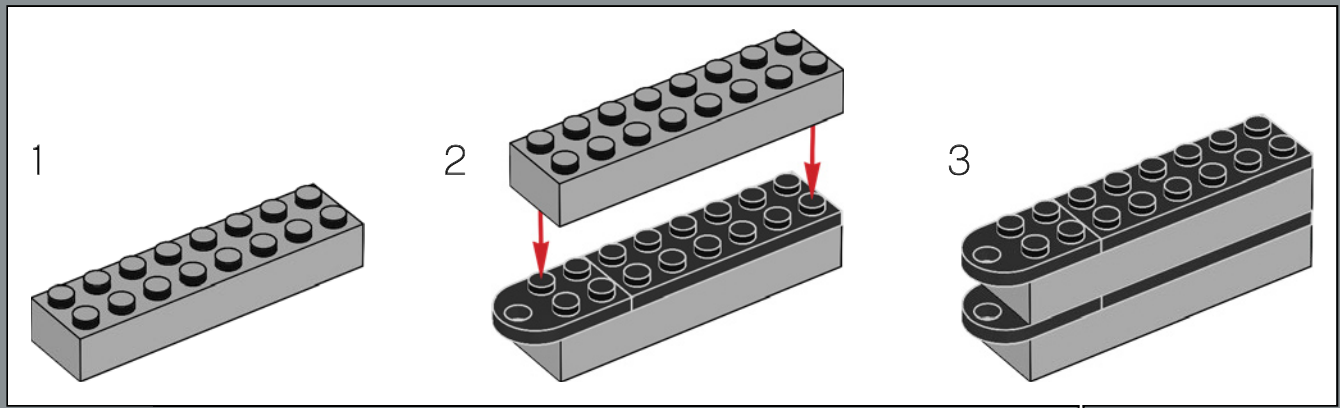

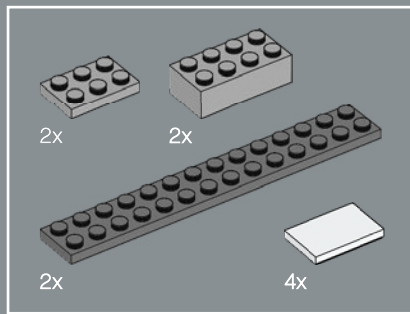

18

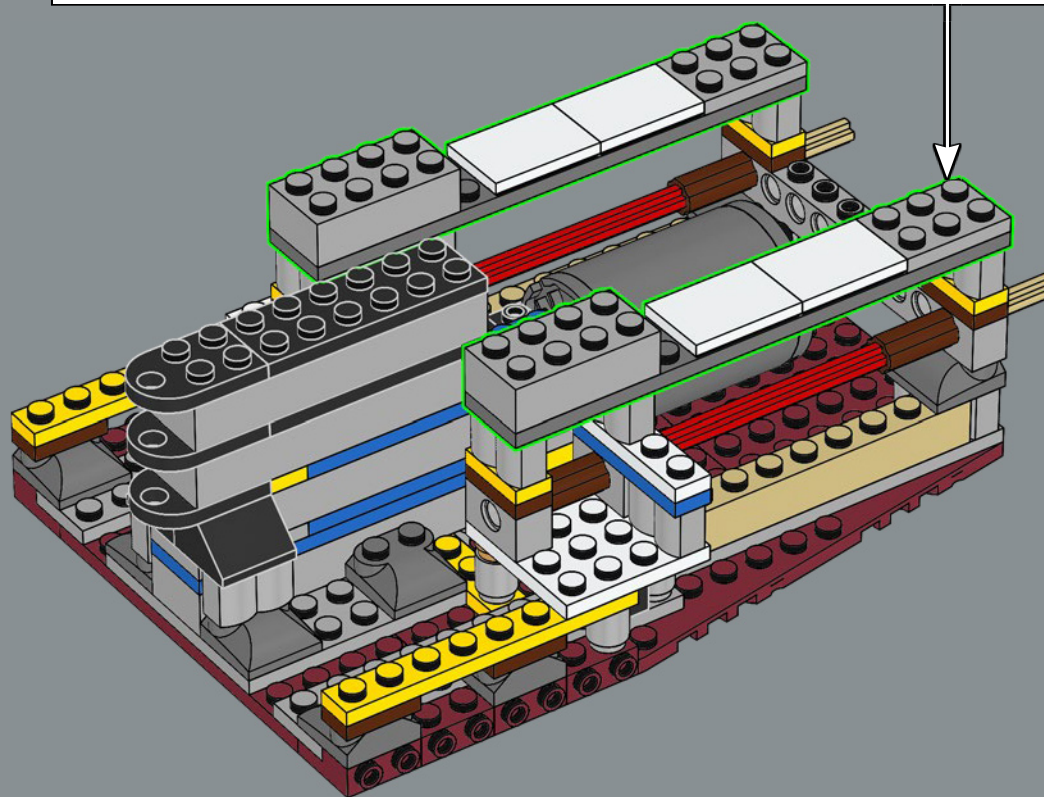
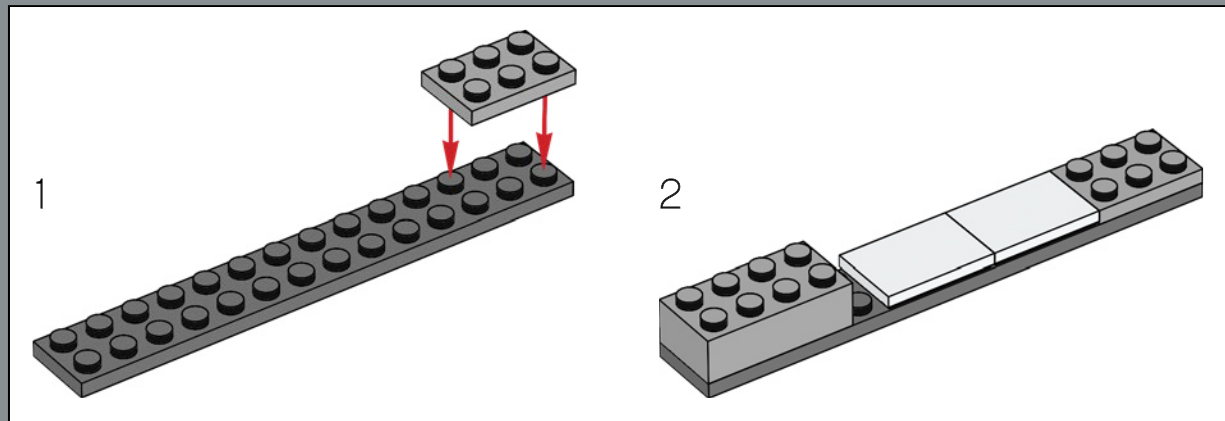



19

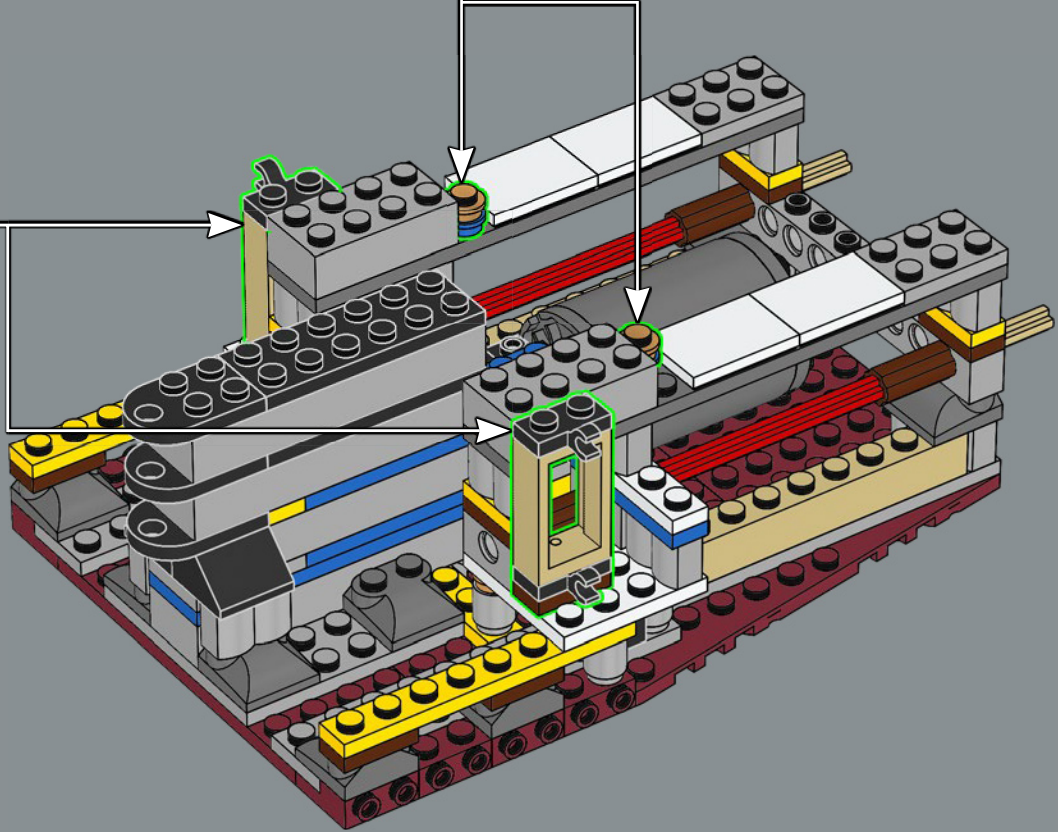
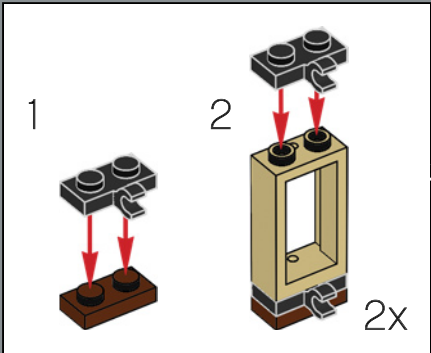
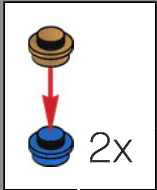



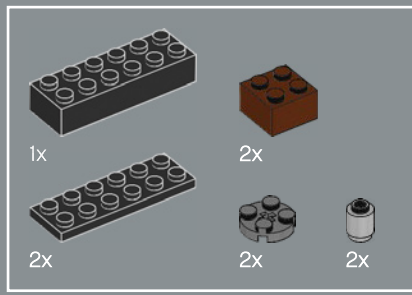

20

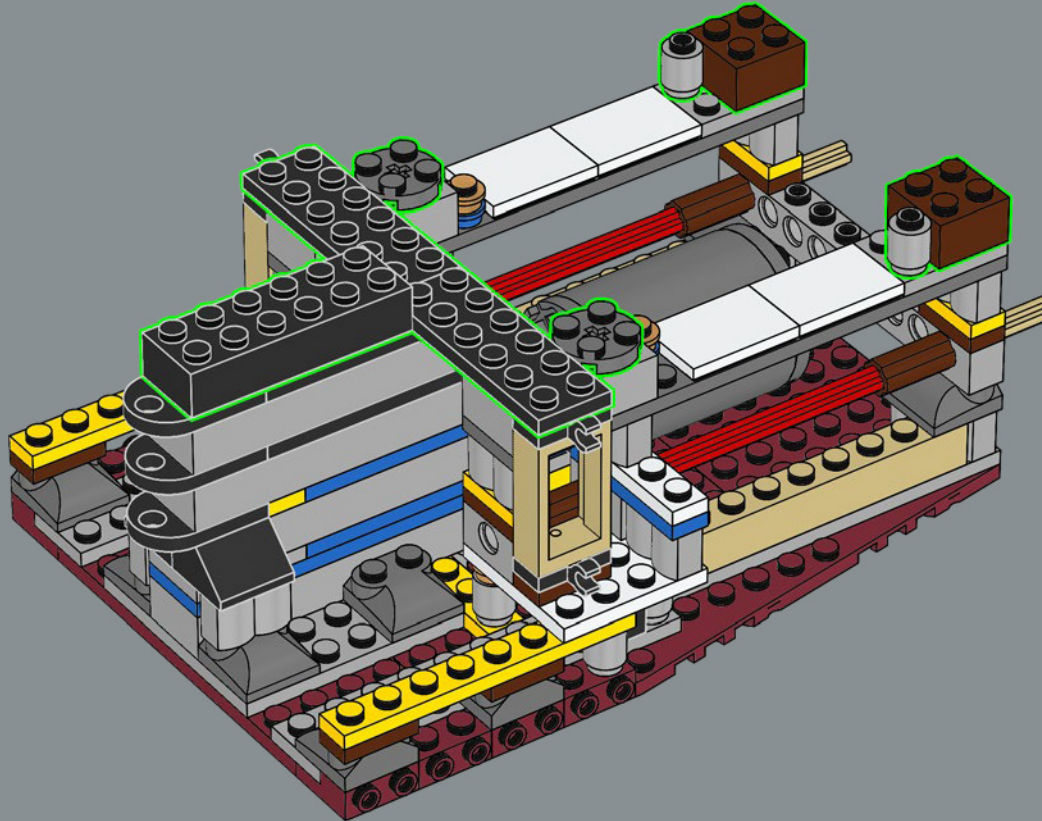

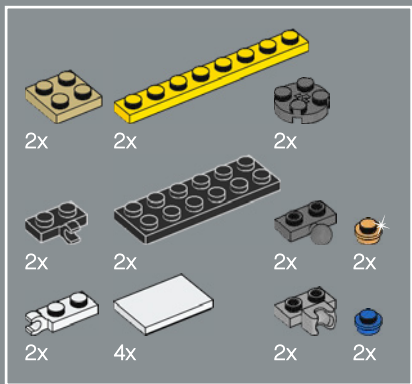

21

1

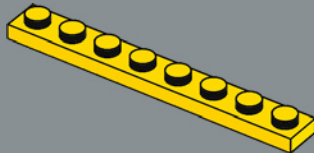

2

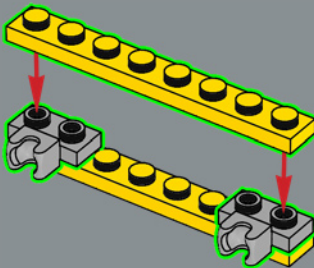

3

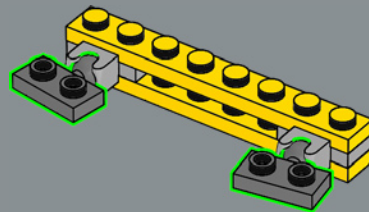

4

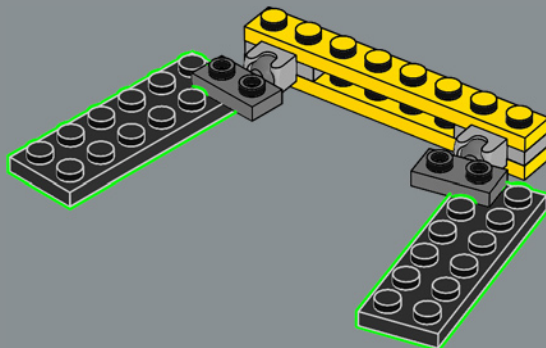

5

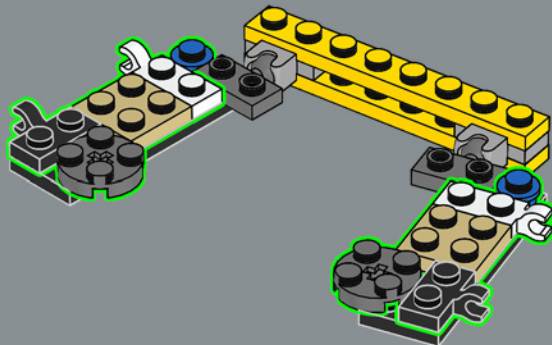

6

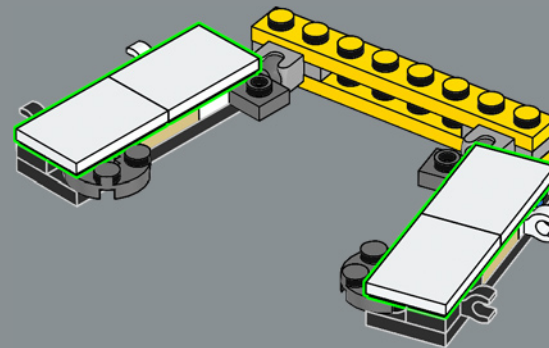

7

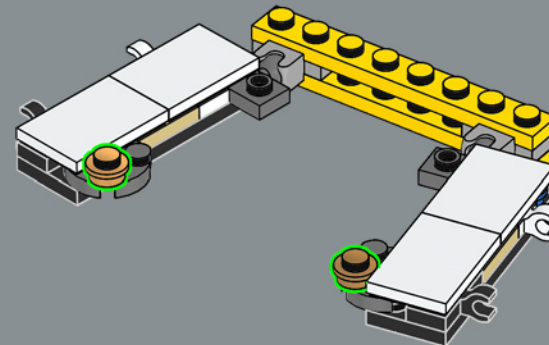

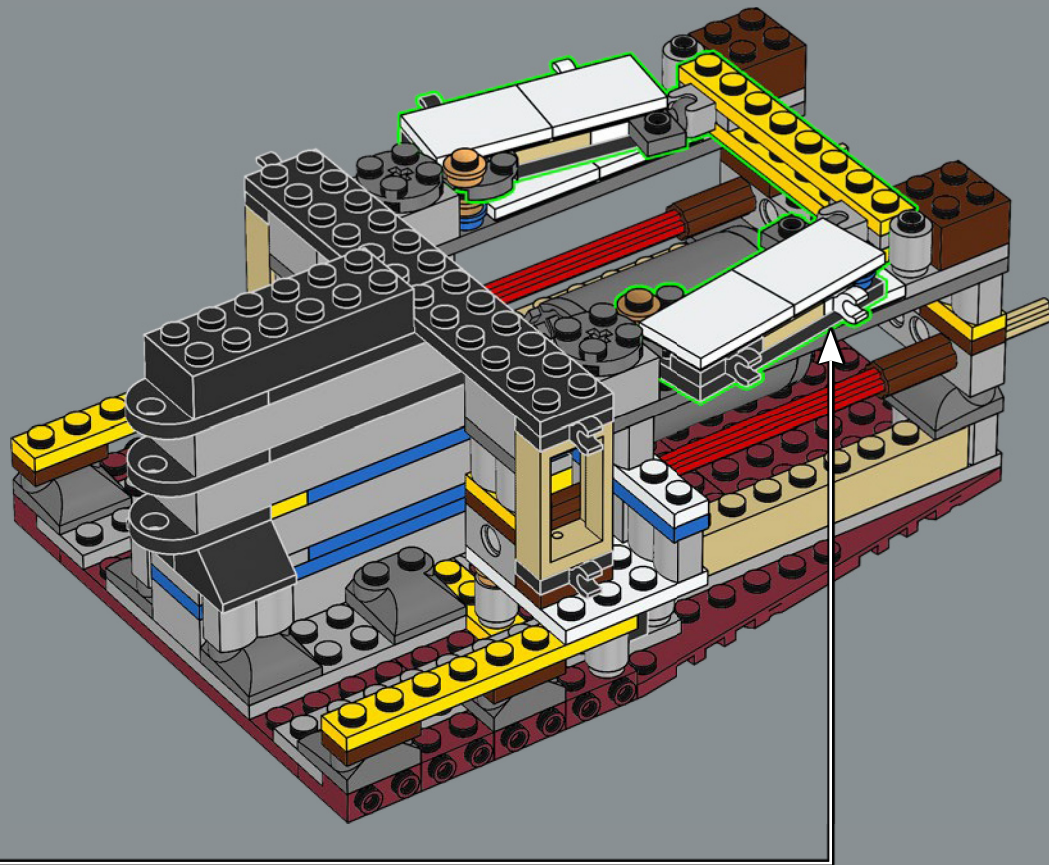

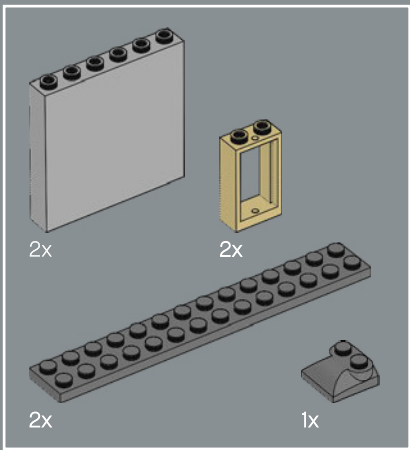

22

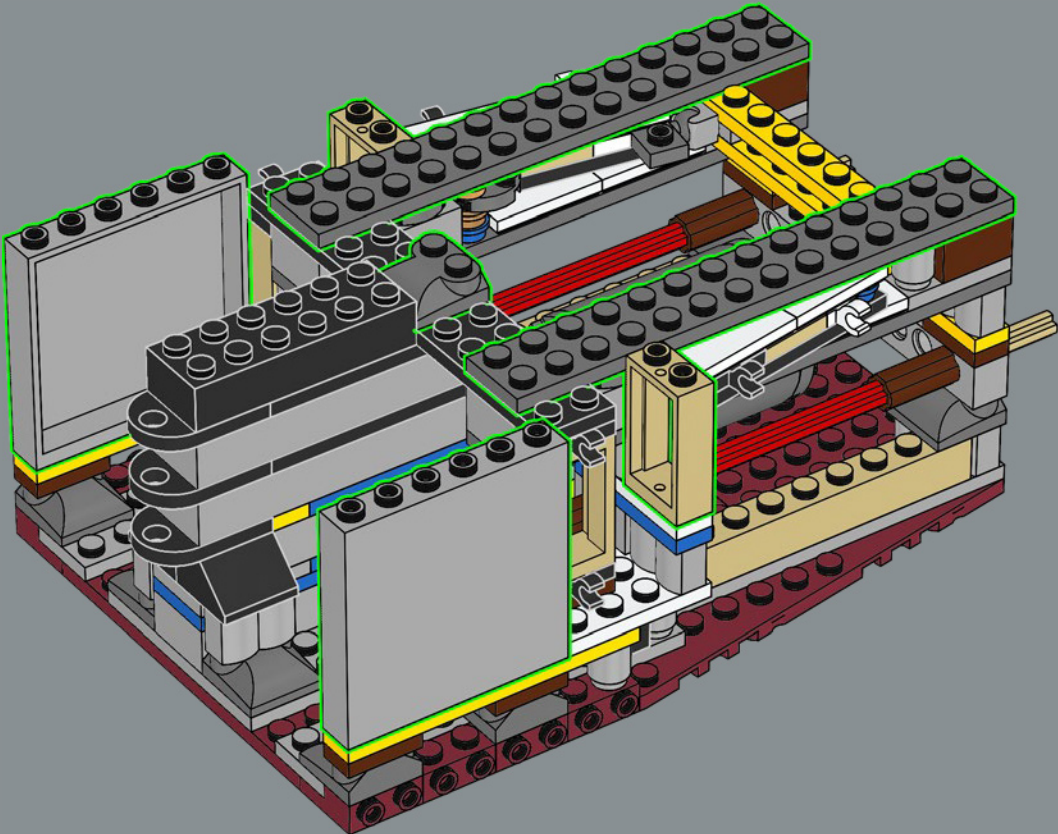

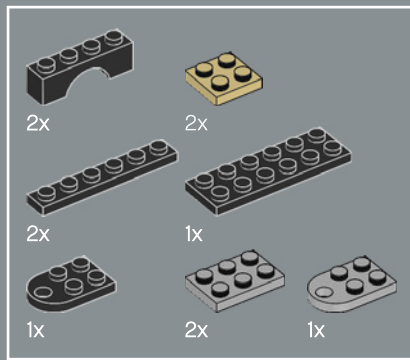

23

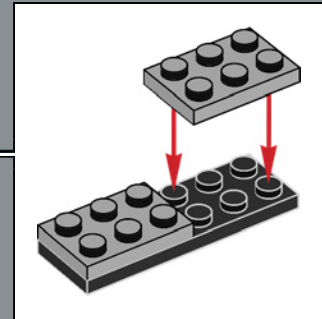
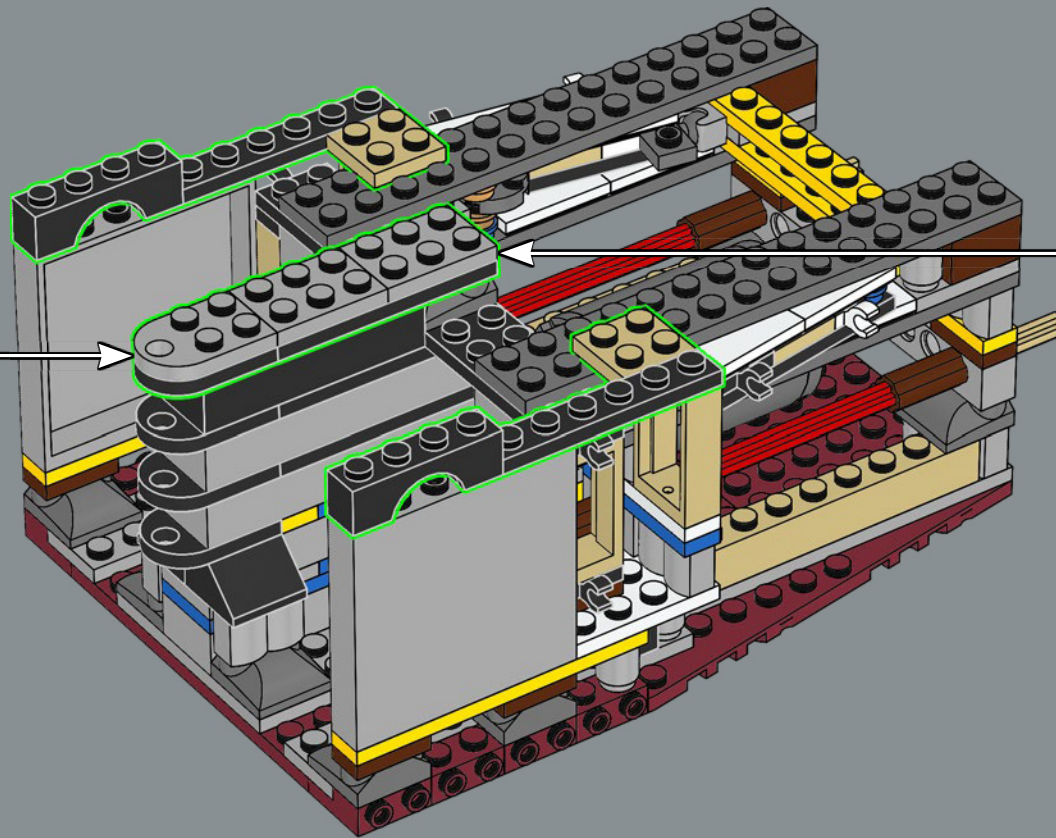
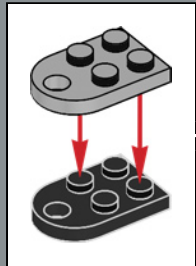

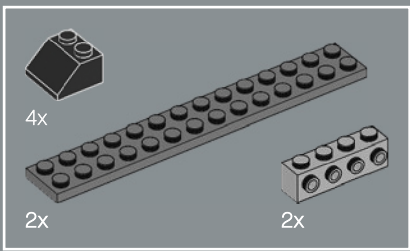

24

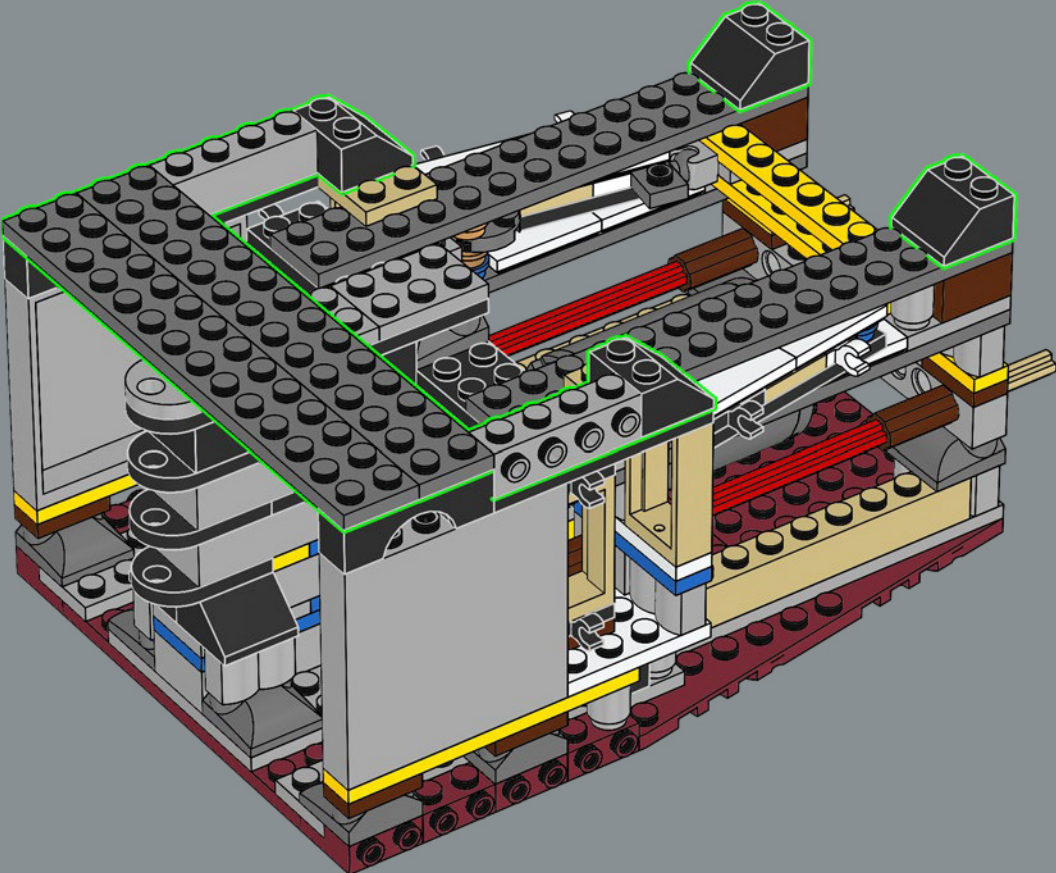

30

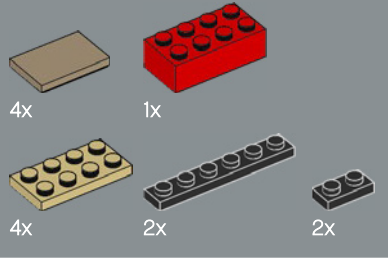
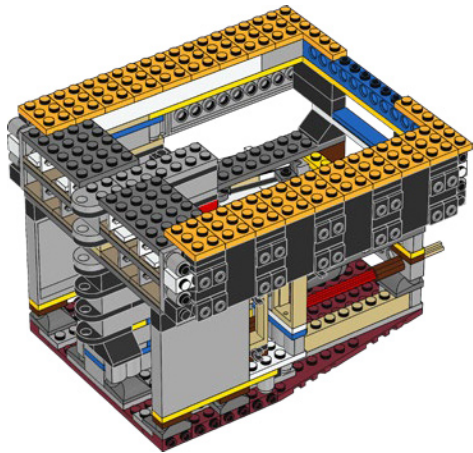
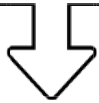

25

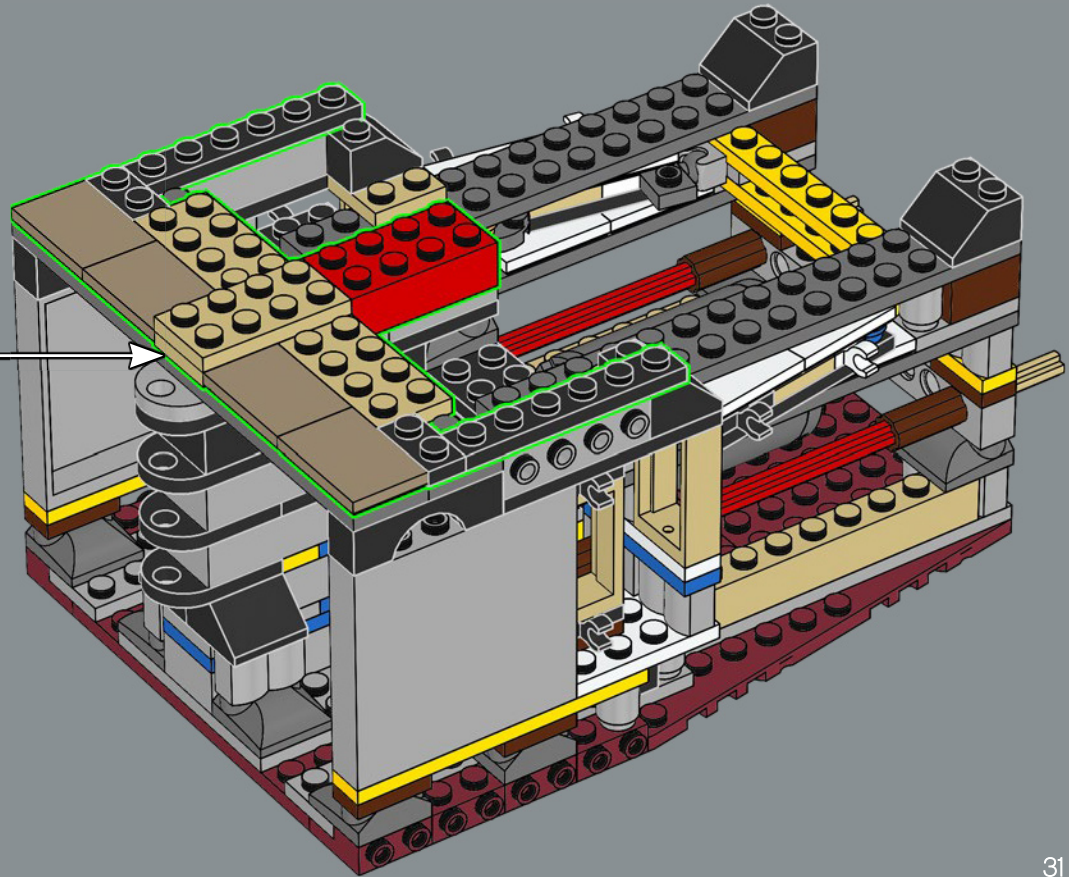
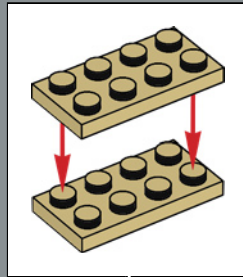

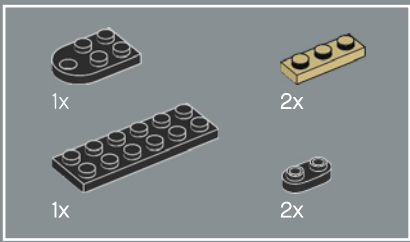

26

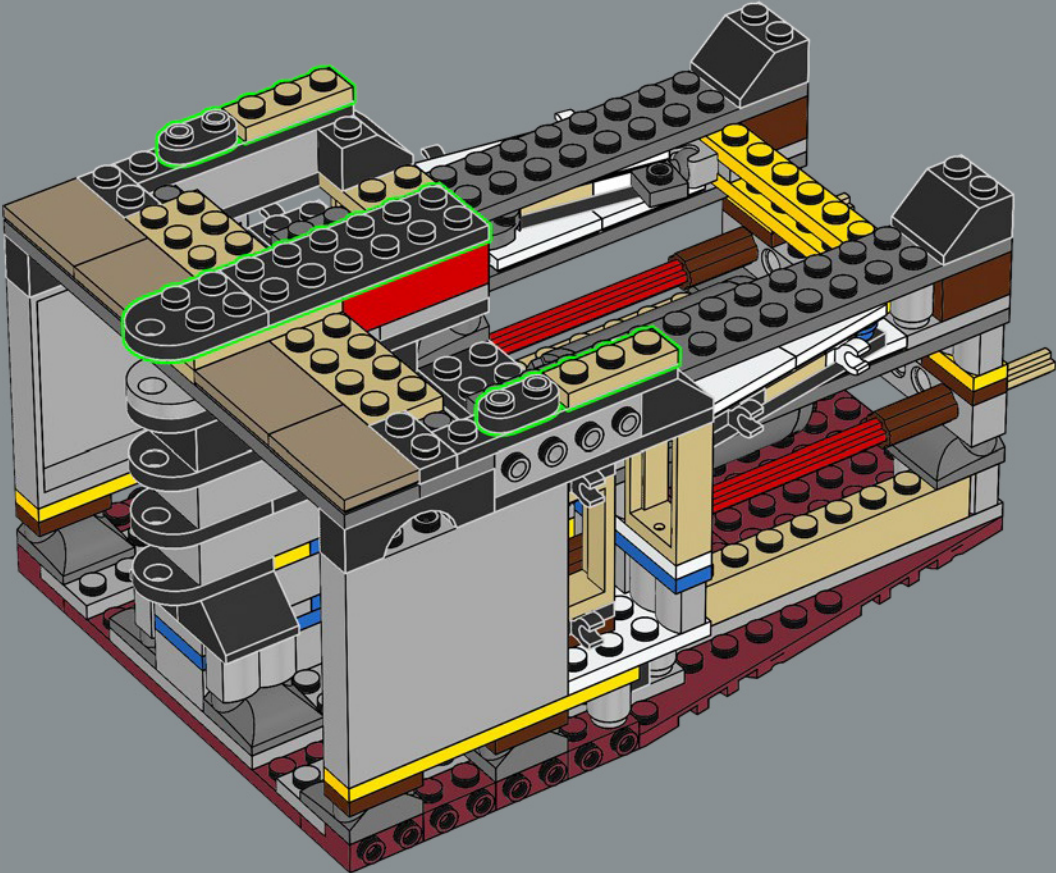



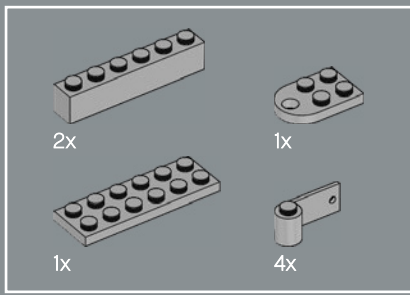

27

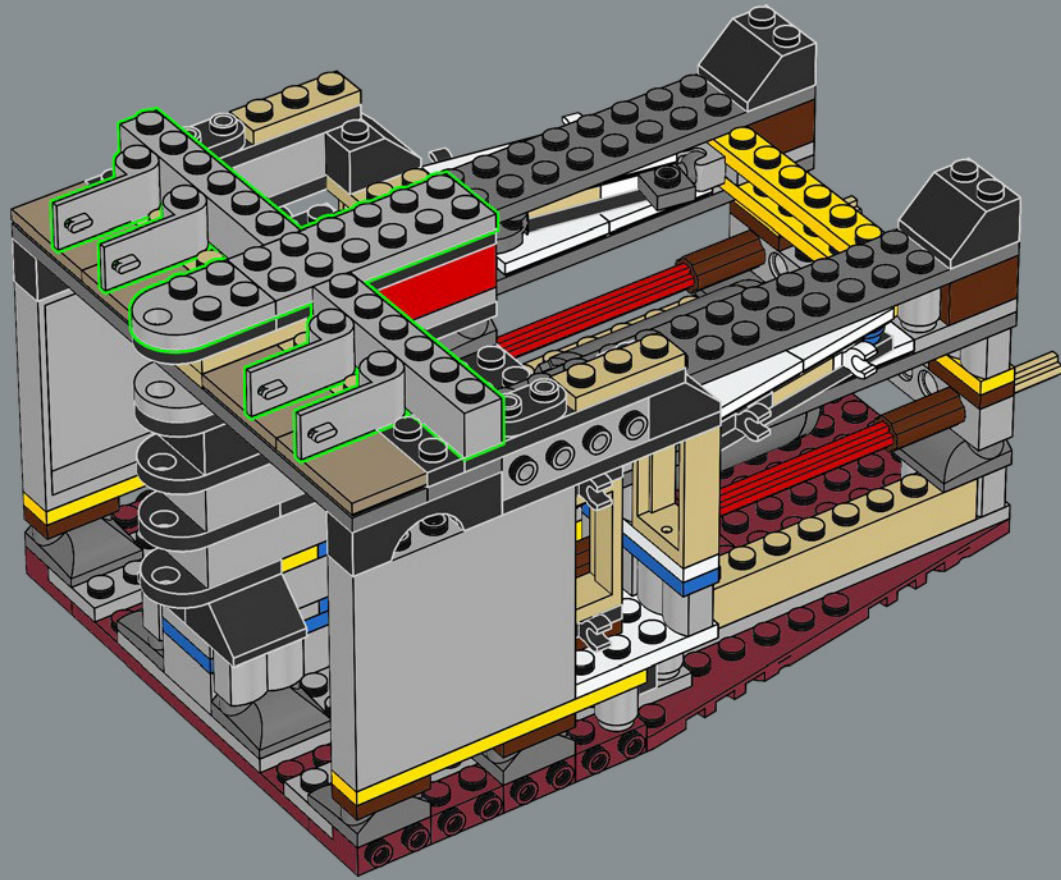

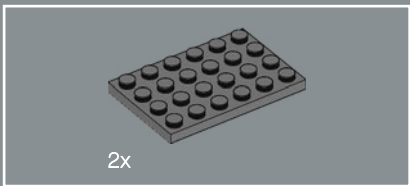

28

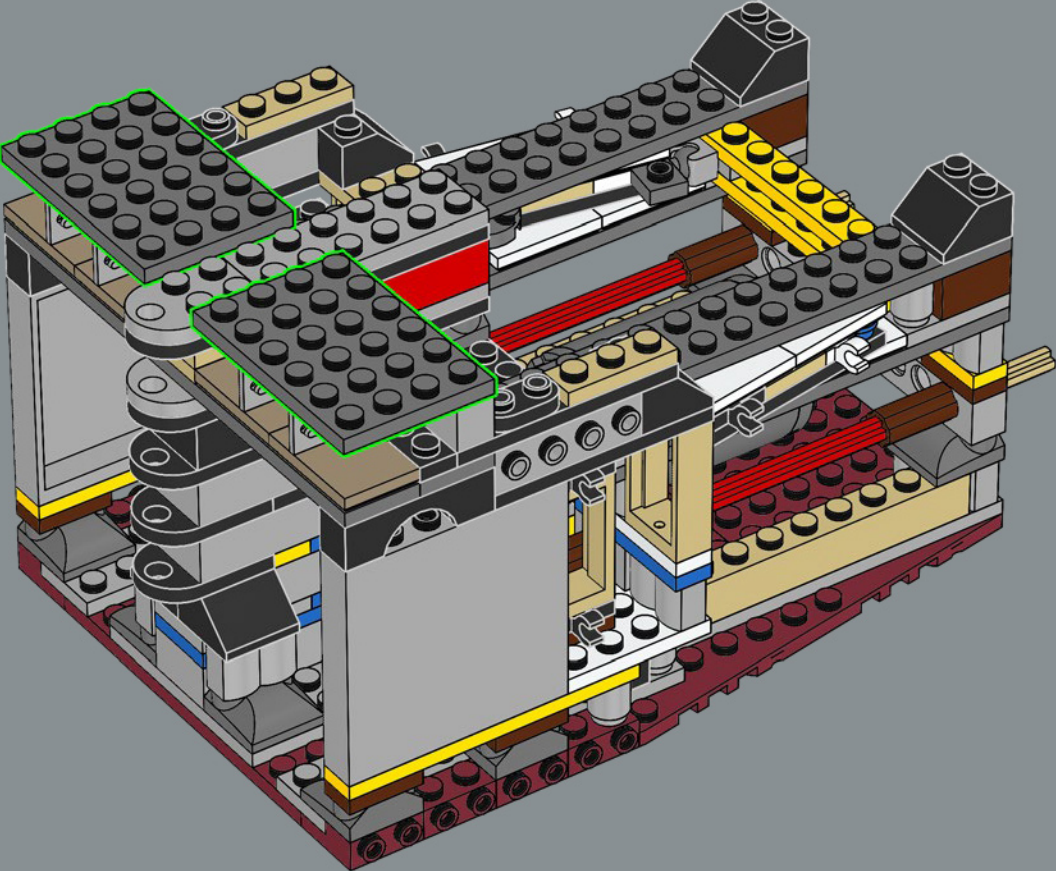

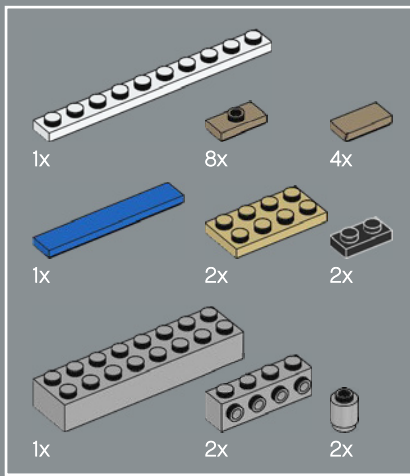

29

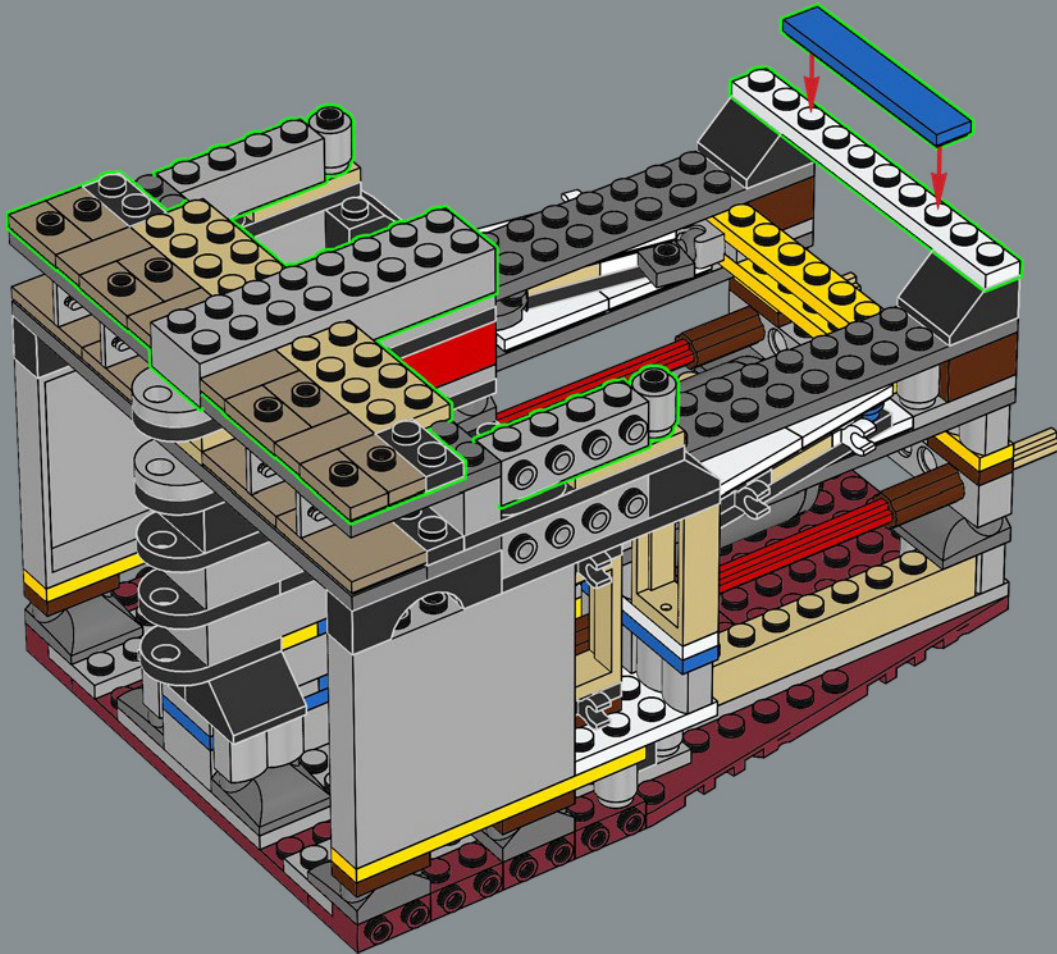

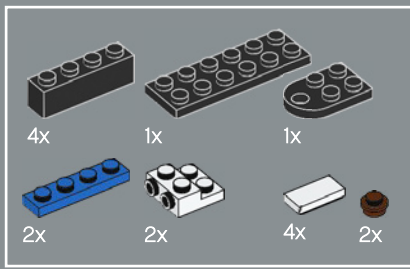

30

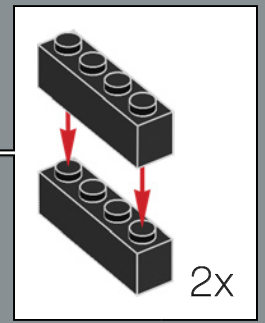
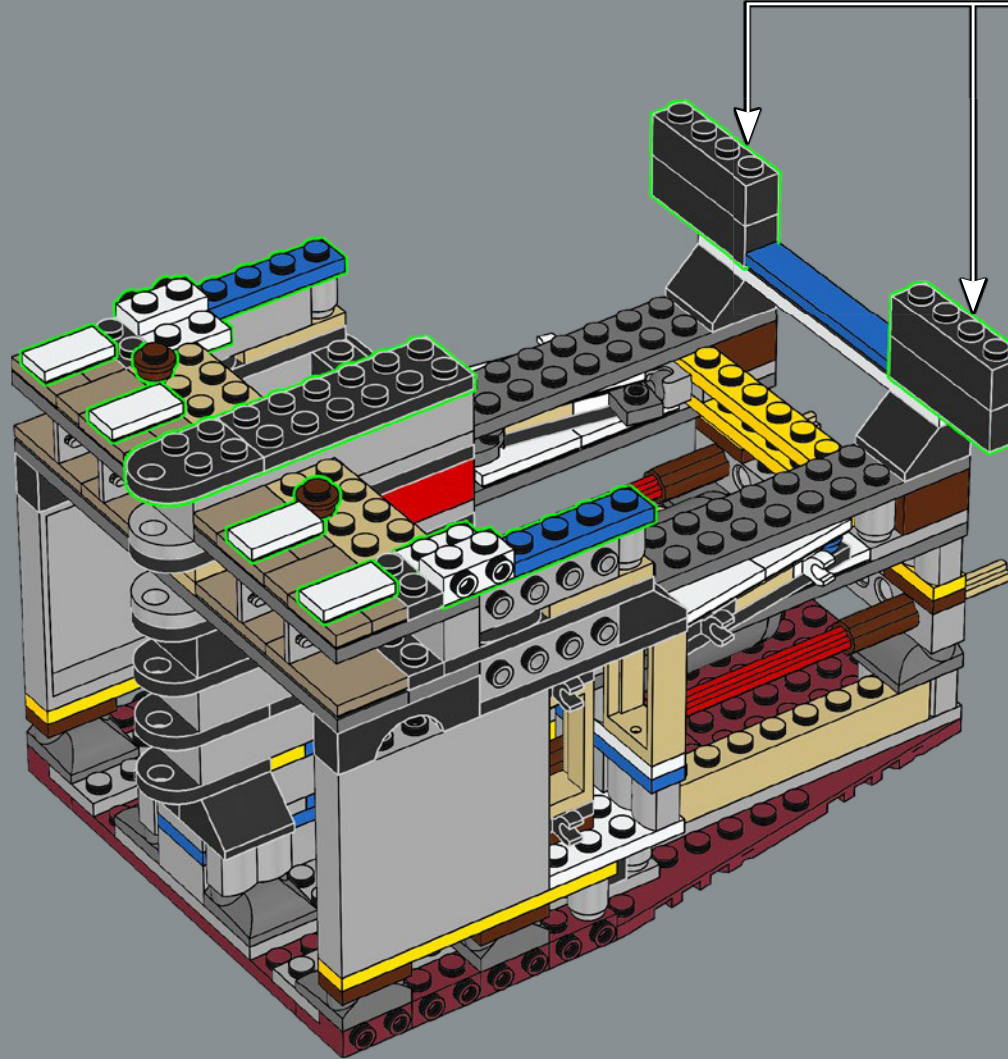

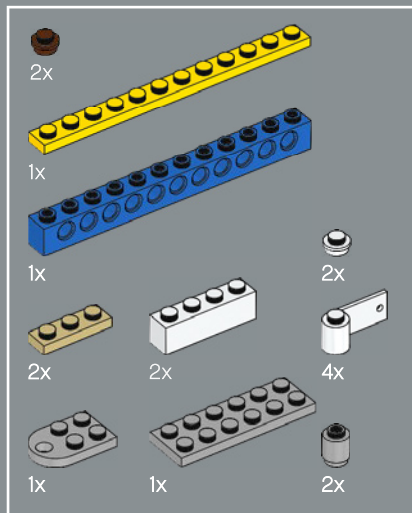

31

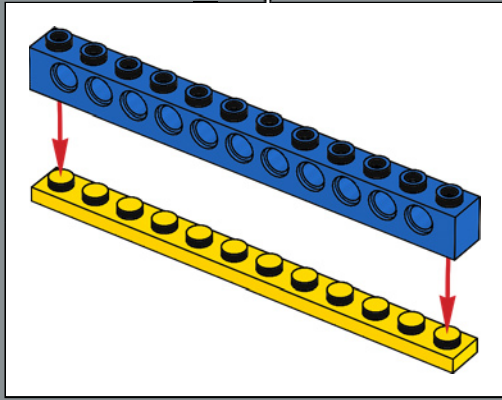
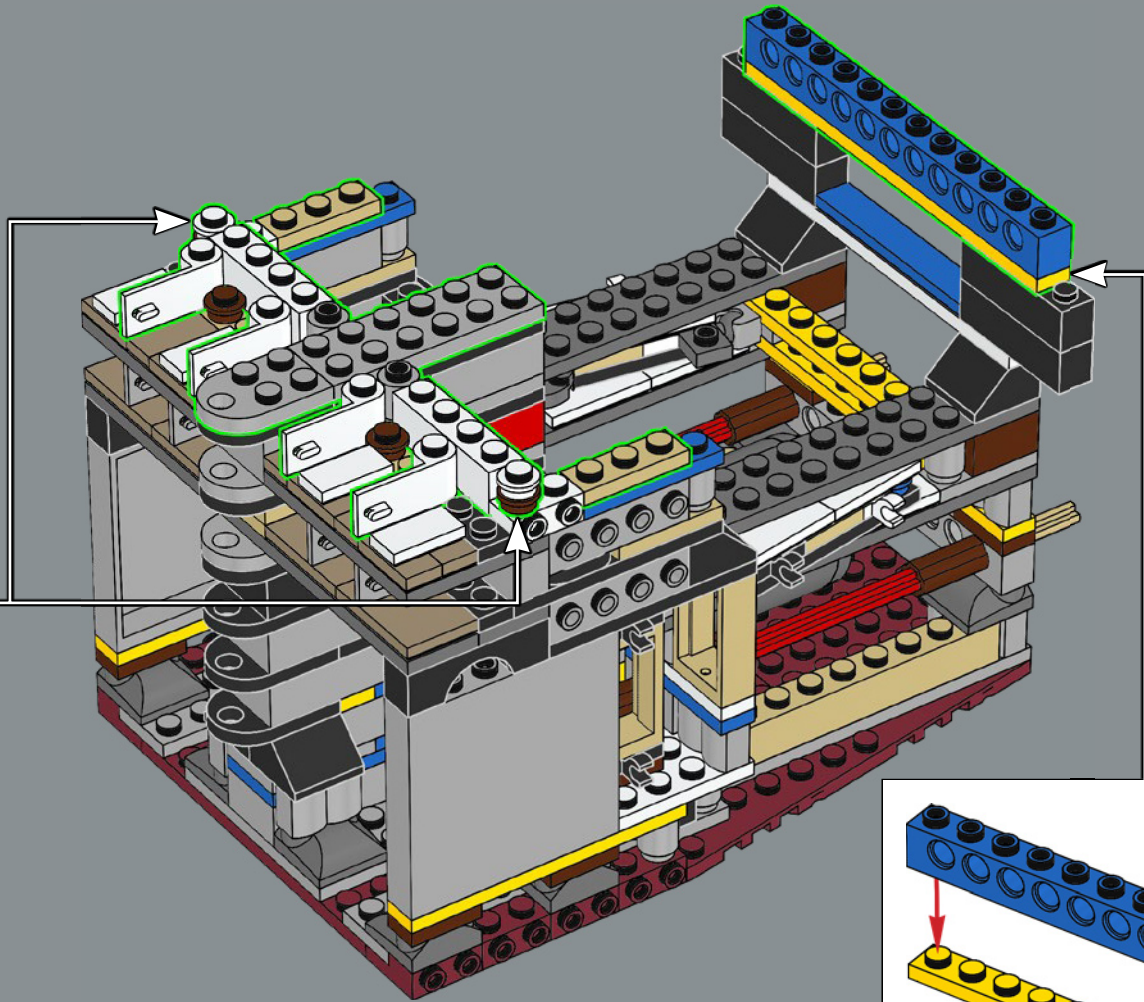
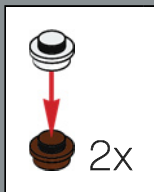

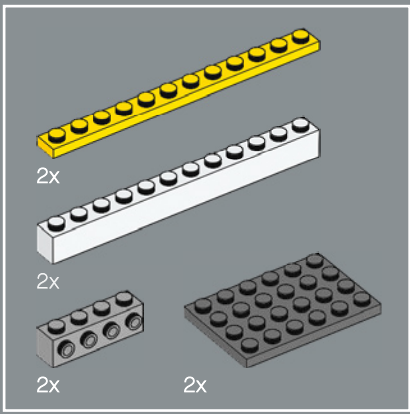

32

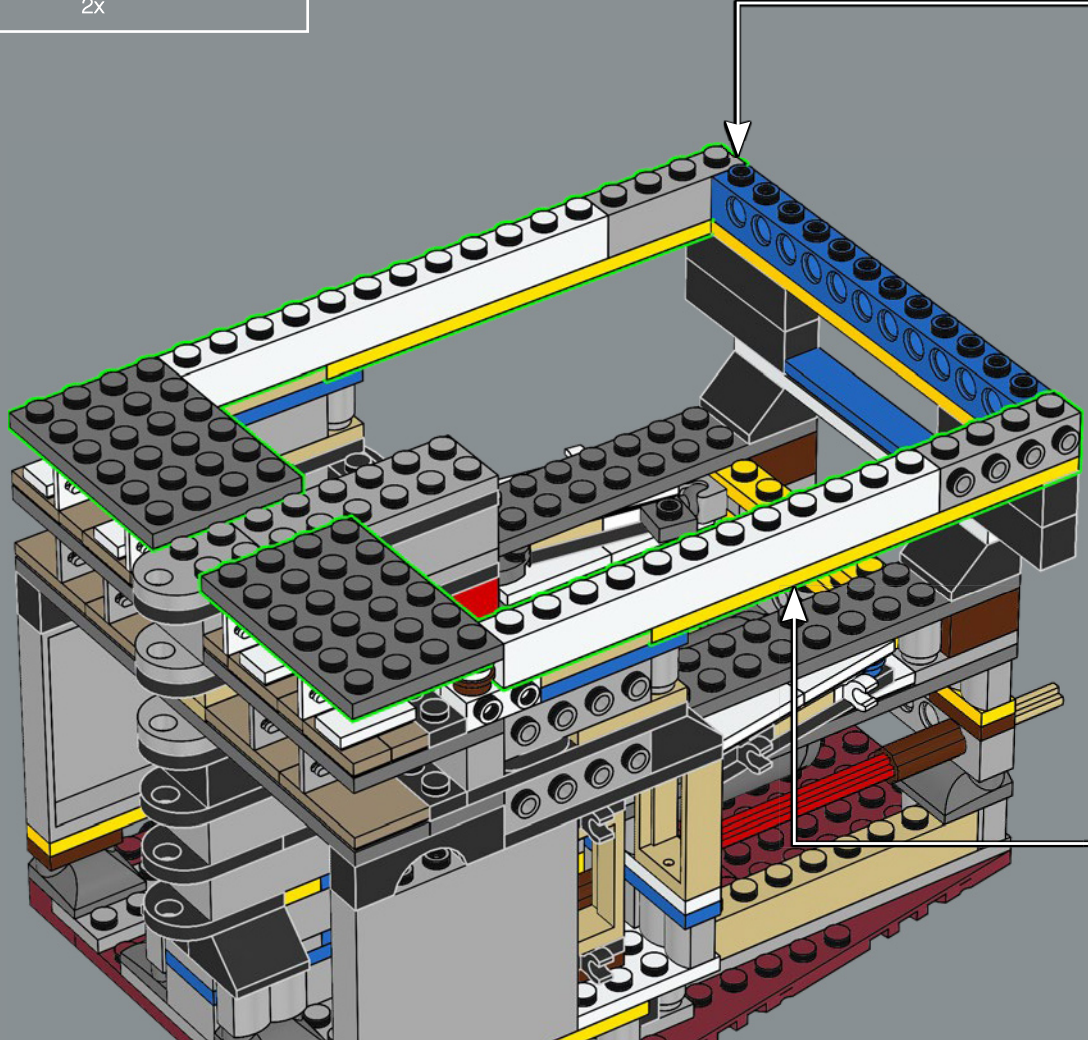
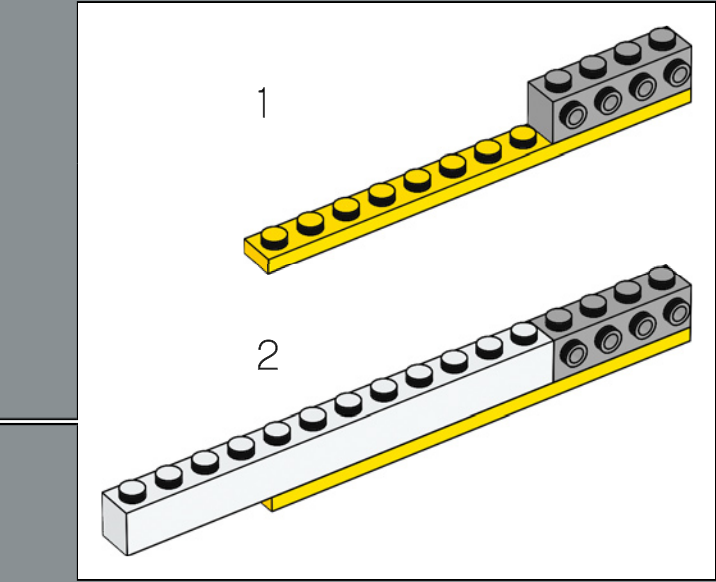
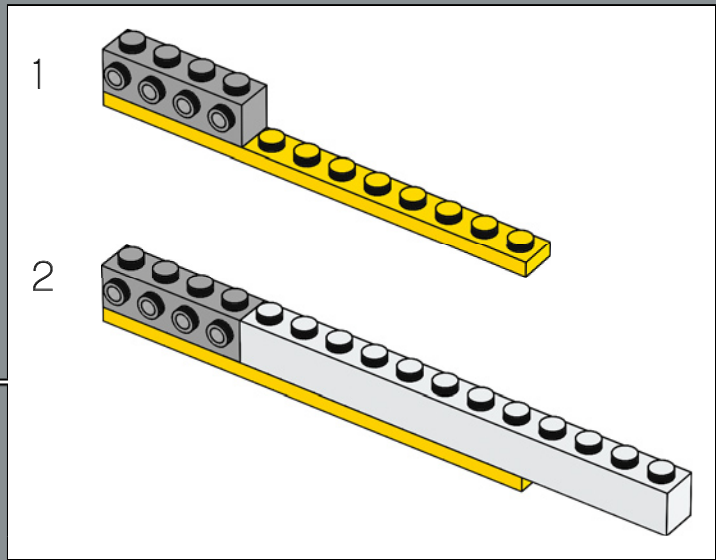

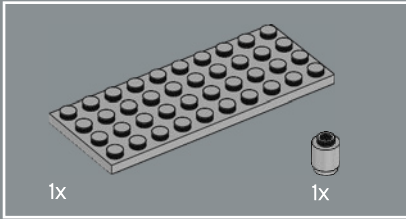
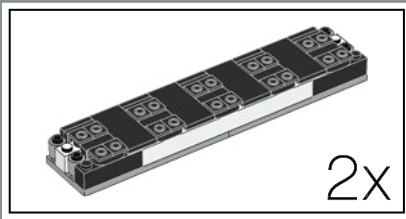

33

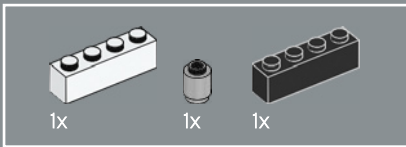
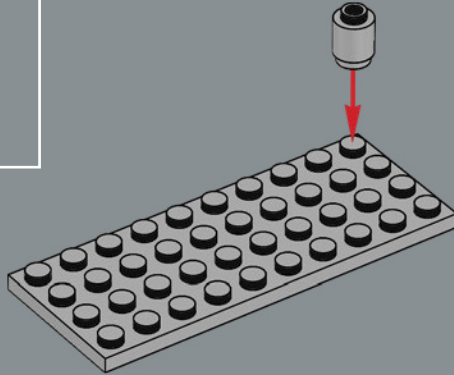

34

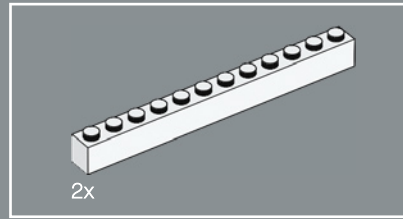
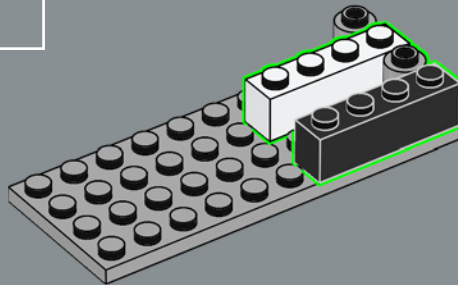

35

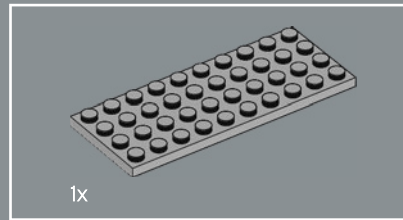
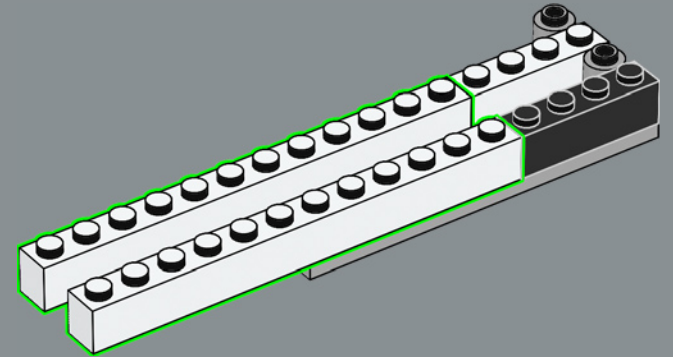

36

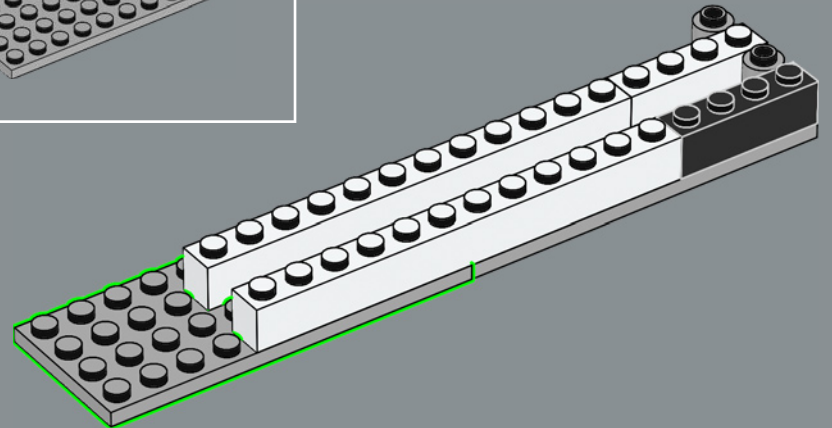

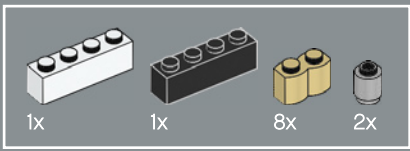

37

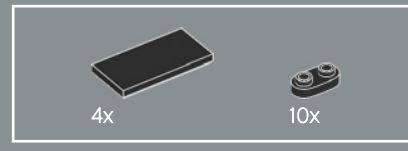
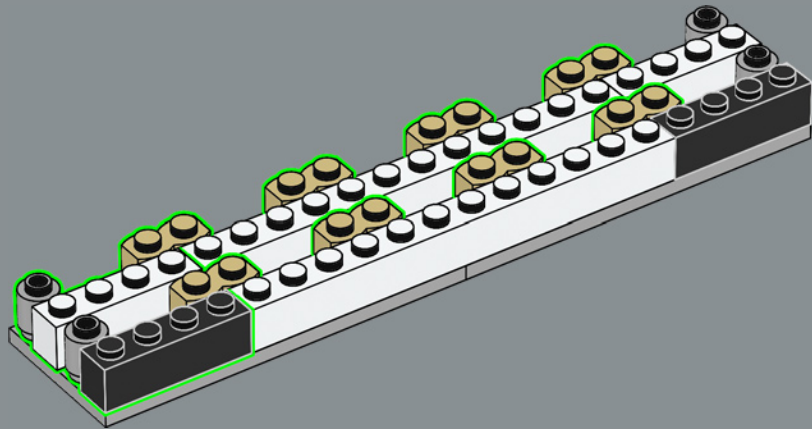

38

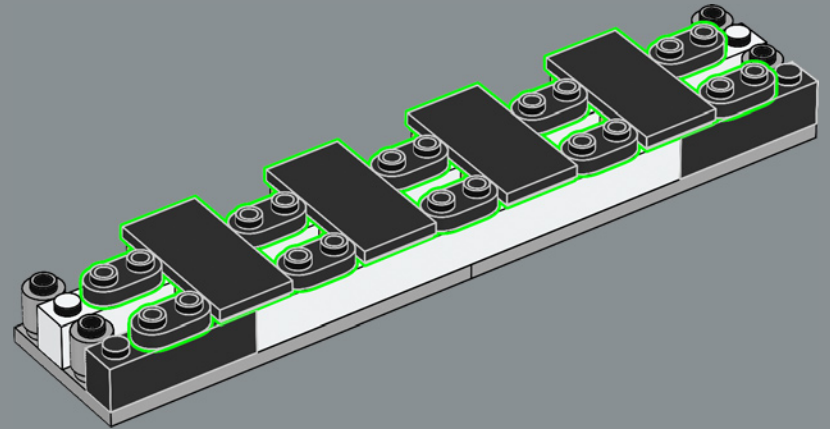





39

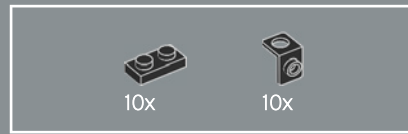
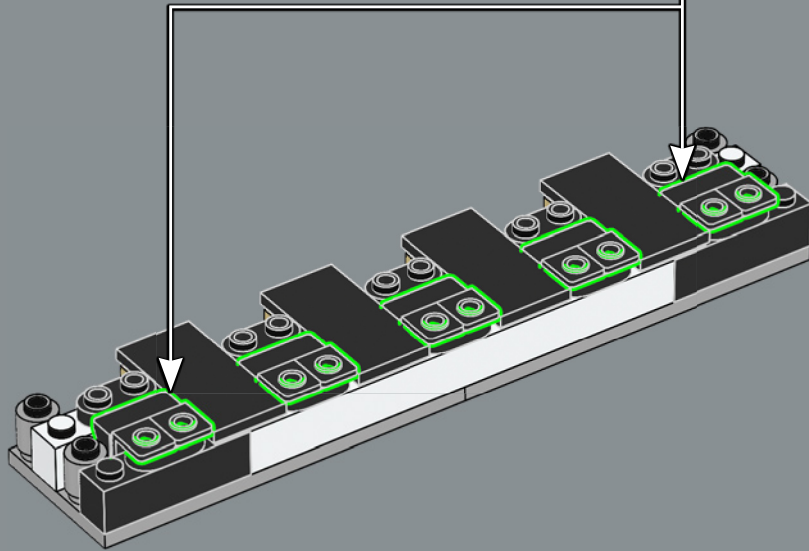
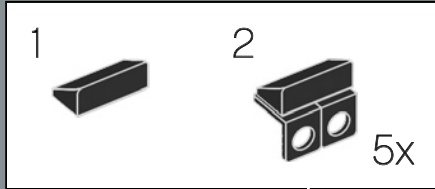

40

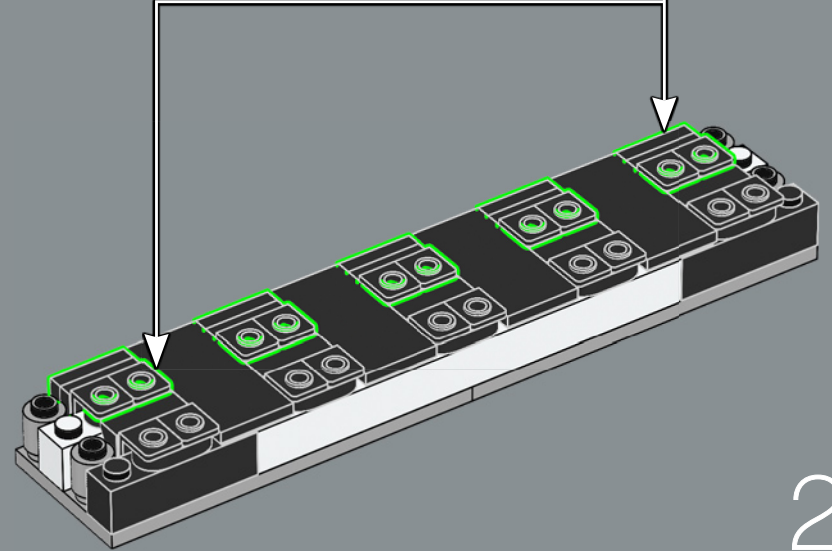
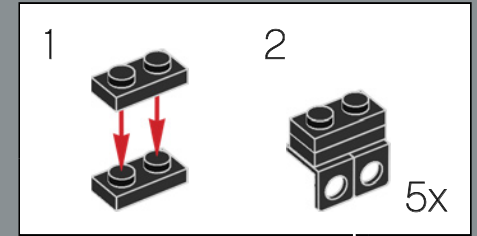

2x

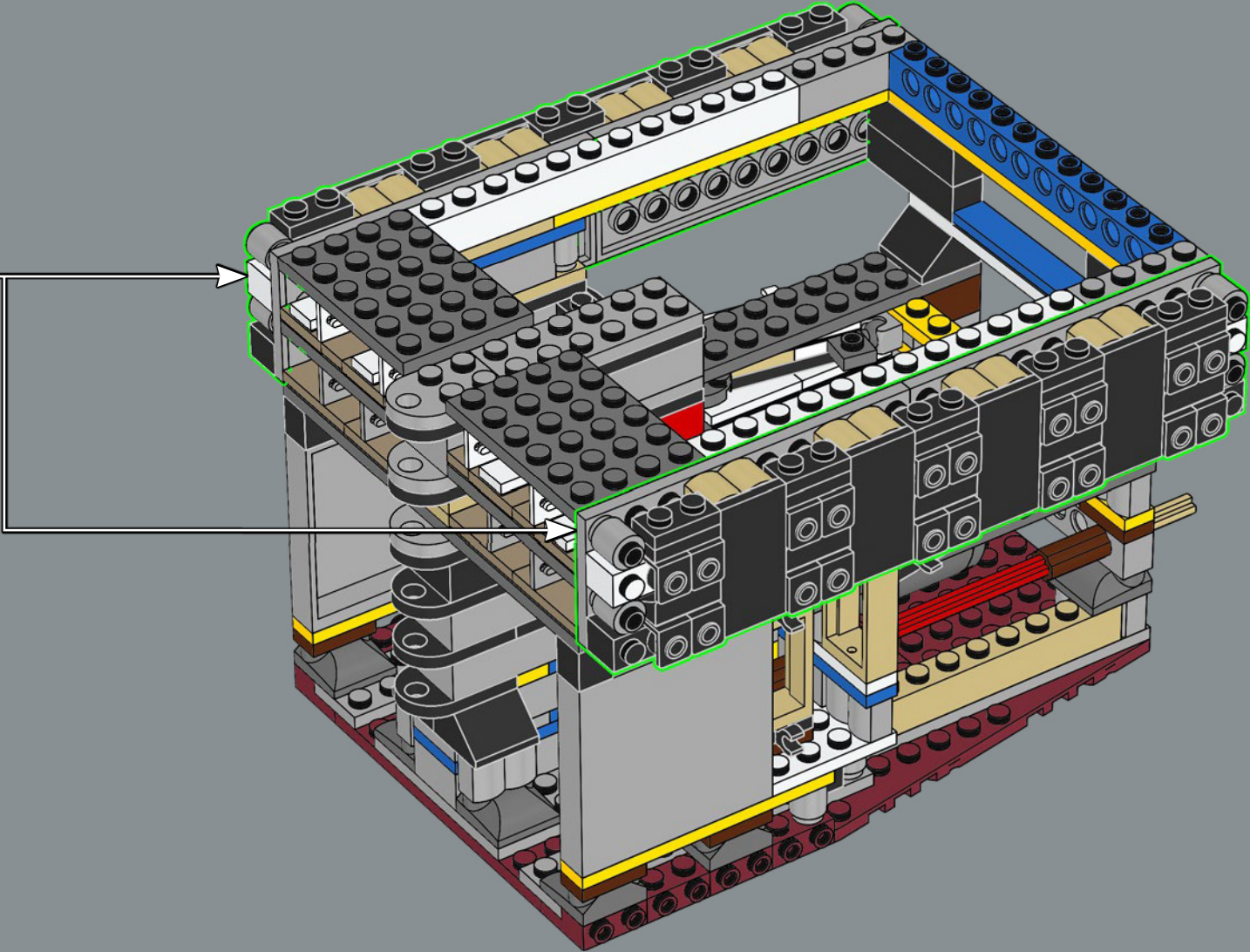

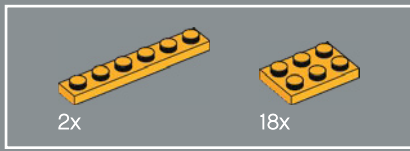

42

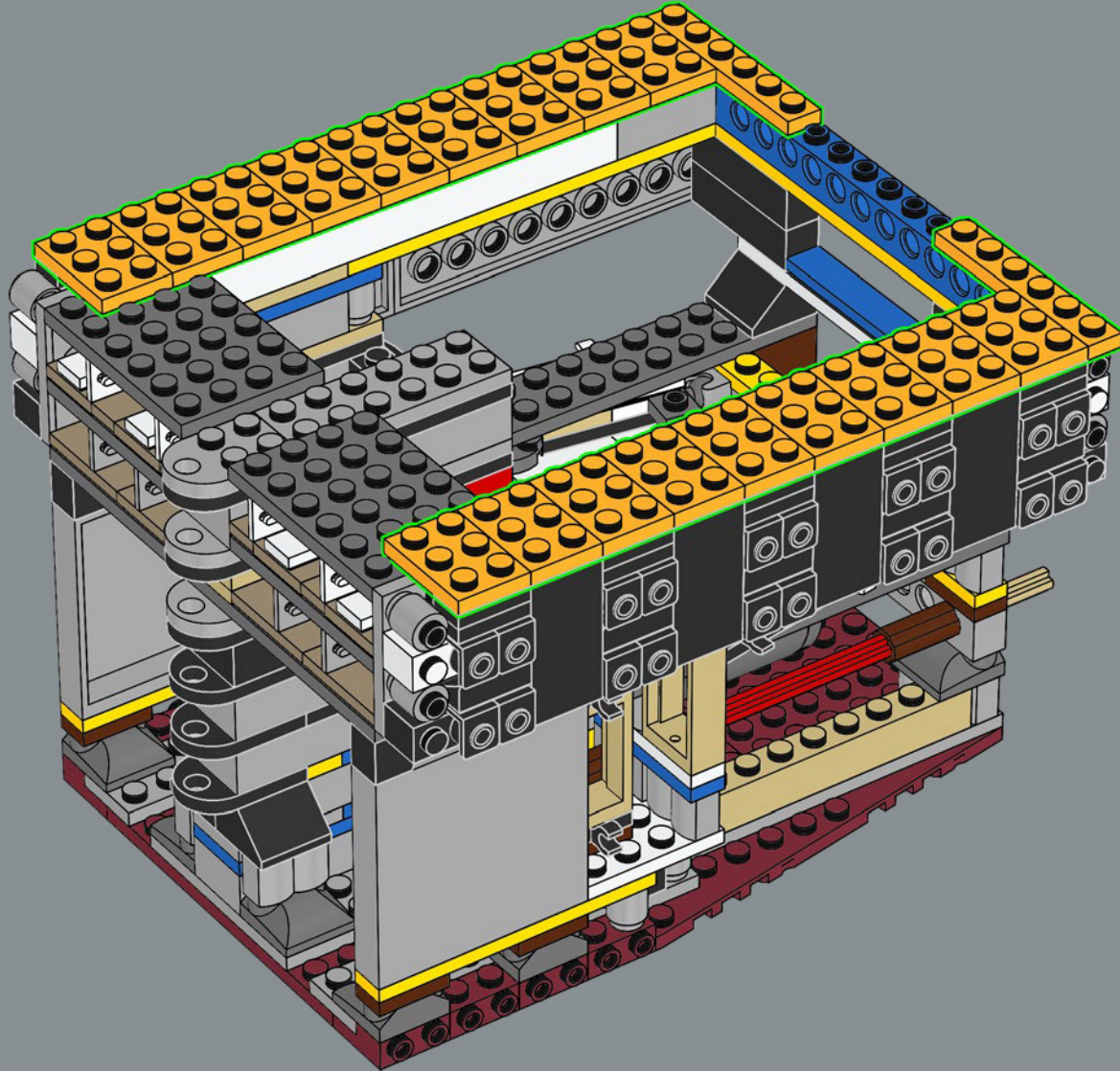

31

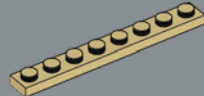
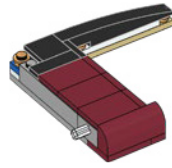
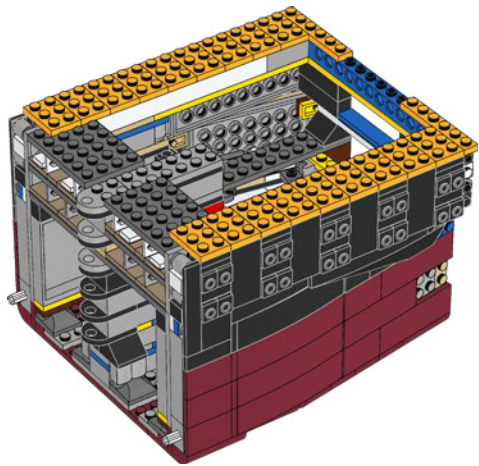
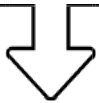

1x



1x

43

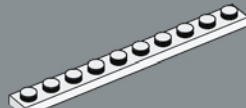
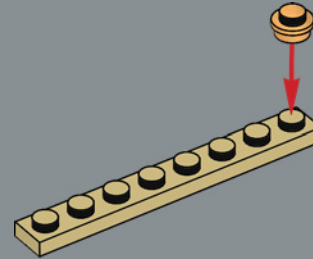

1x

44

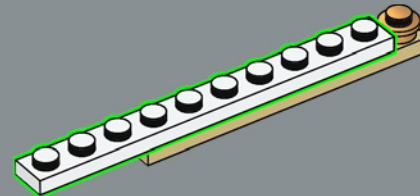

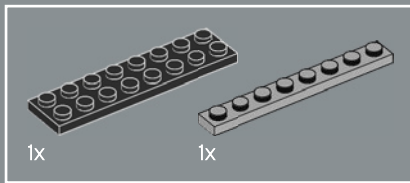

45

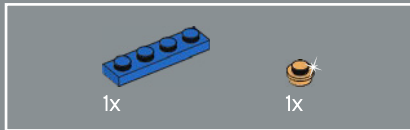
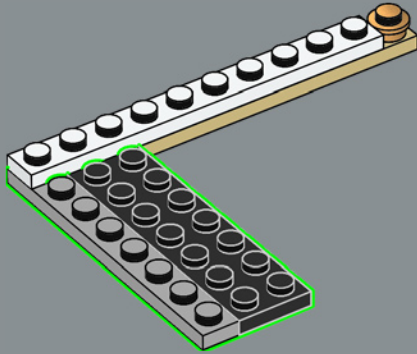

46

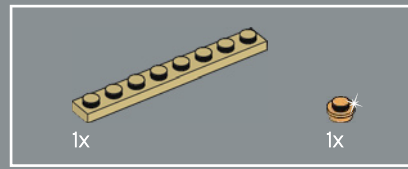
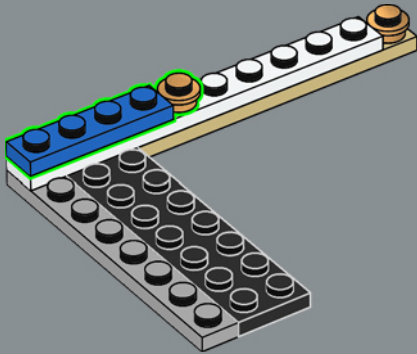

47

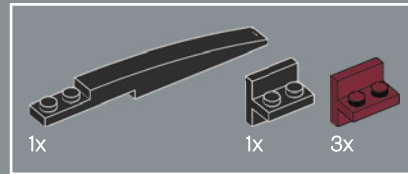
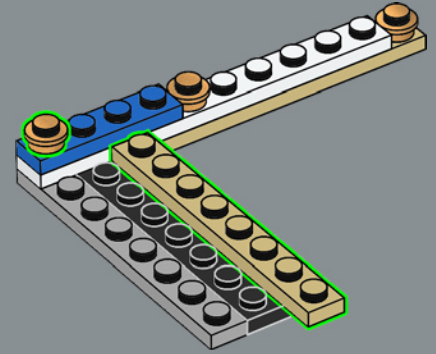

48

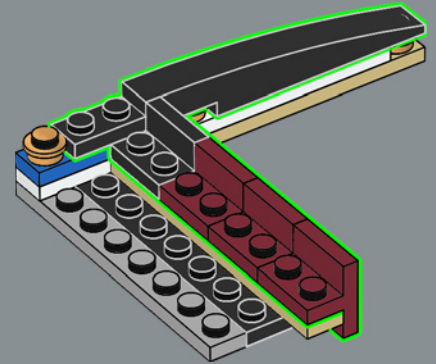

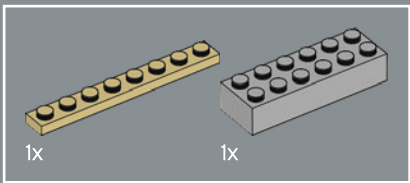

49

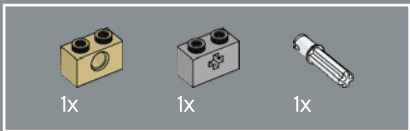
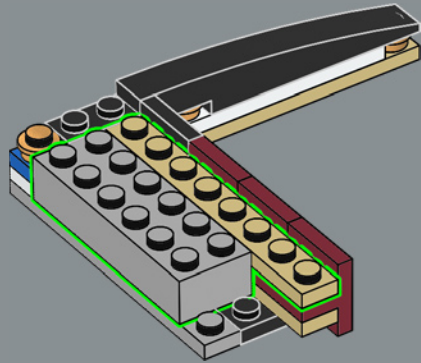

50

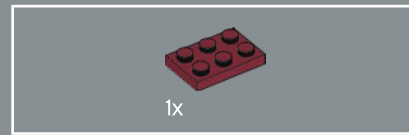
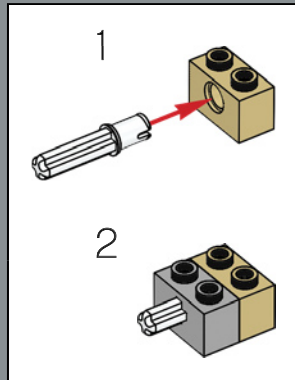
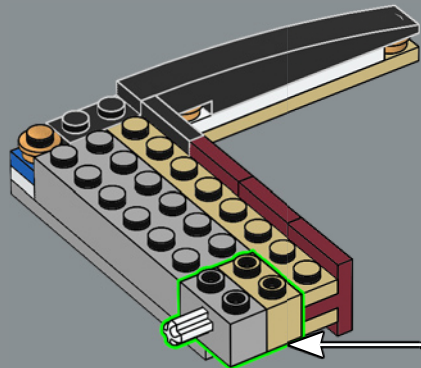

51

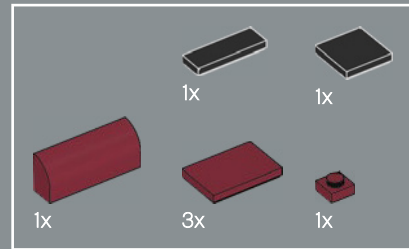
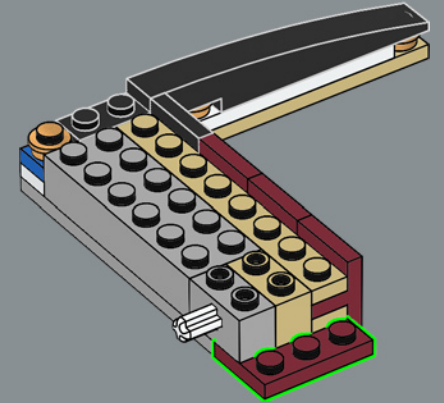

52

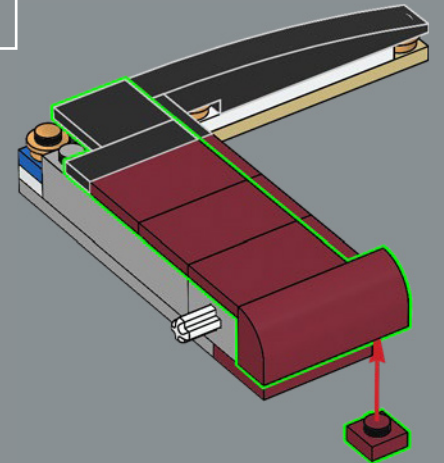

53

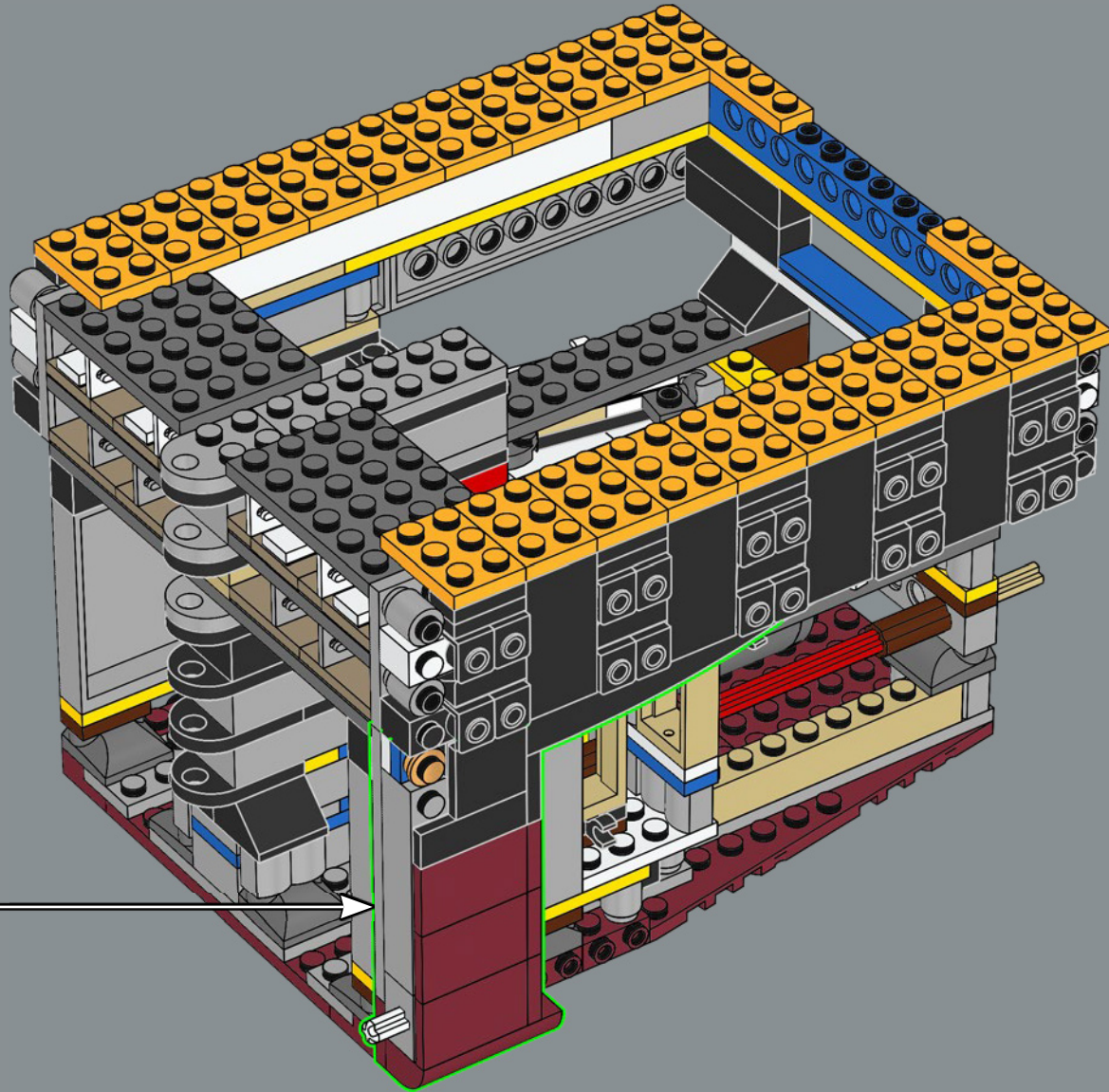

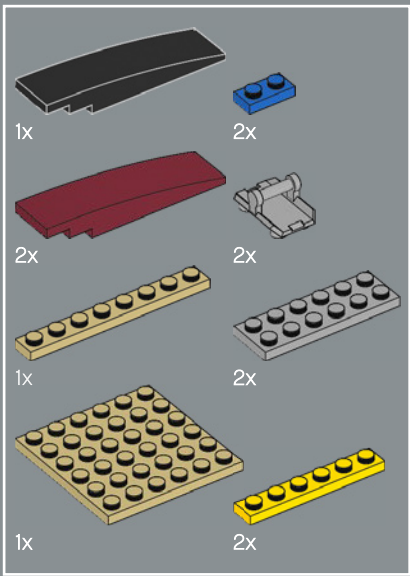

54

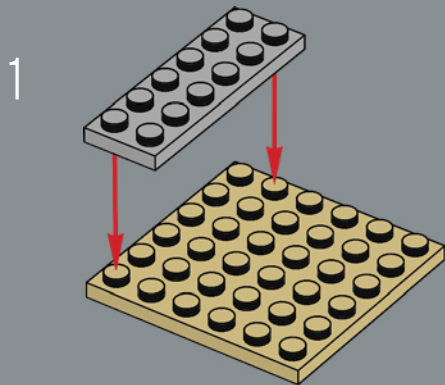

2

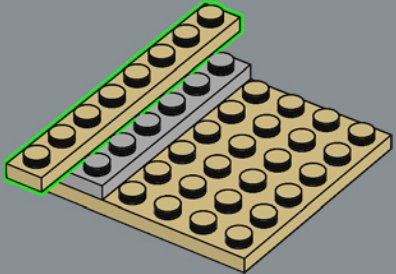

3

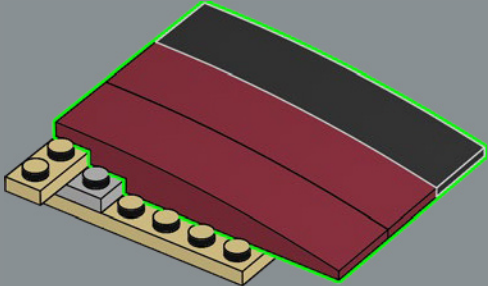

4

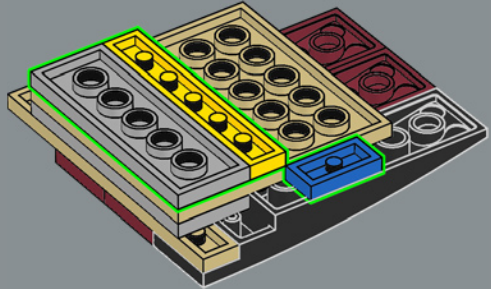

5

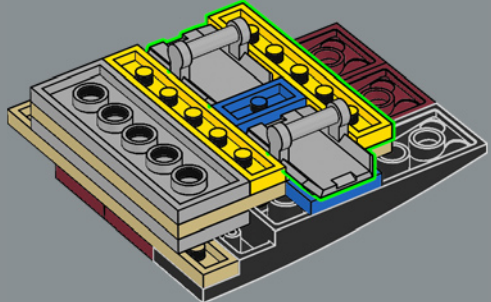



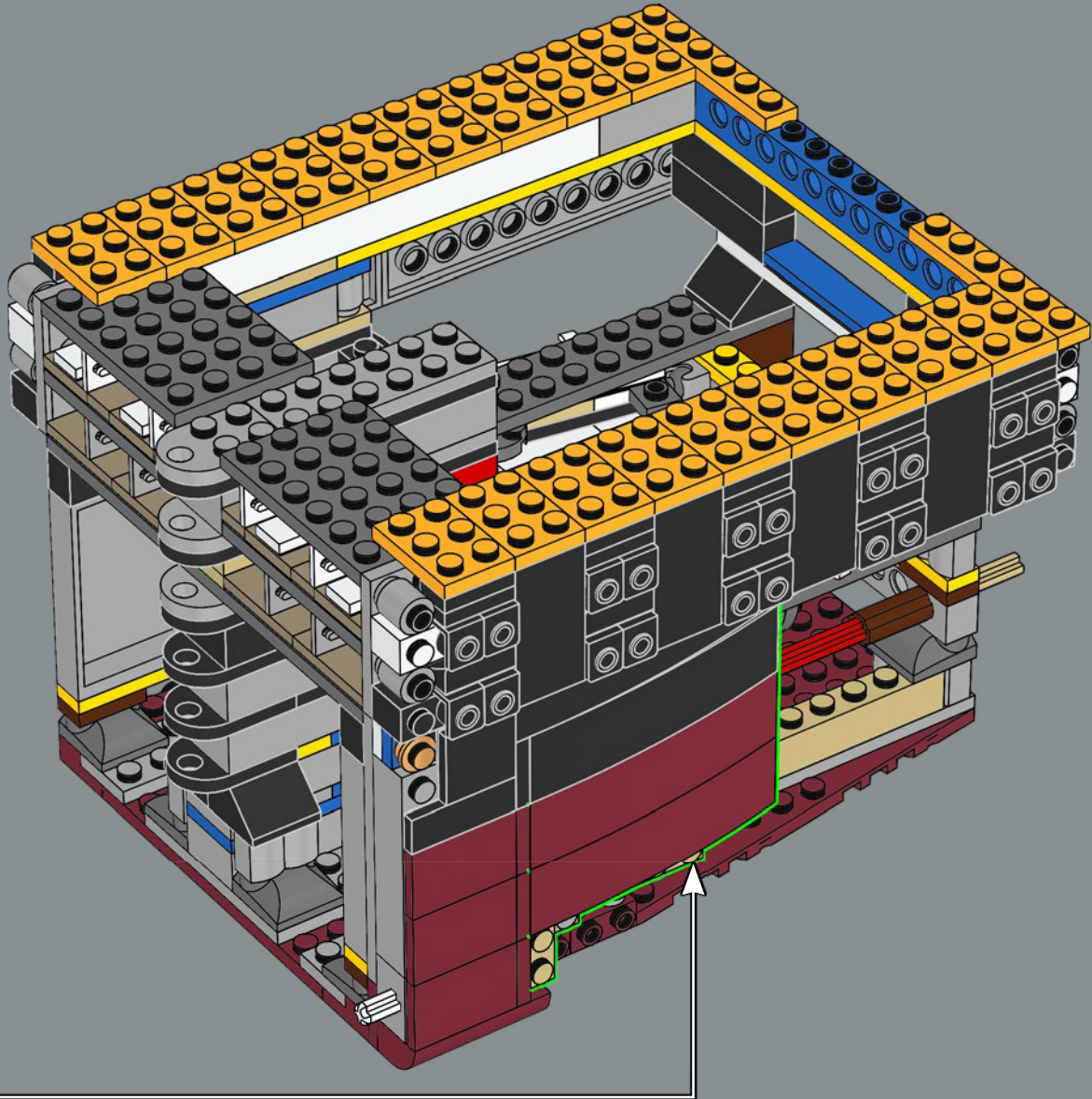

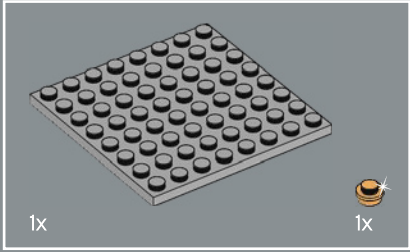
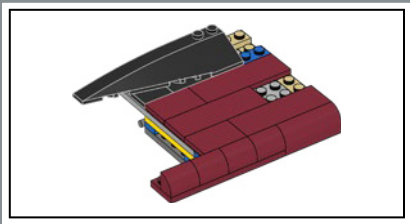

55

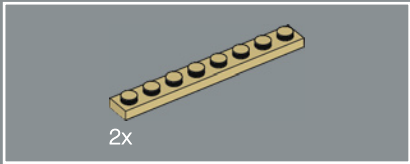
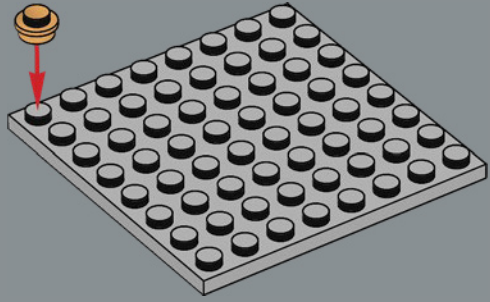

56

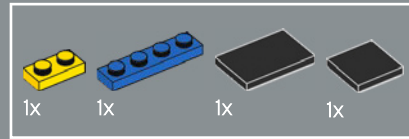
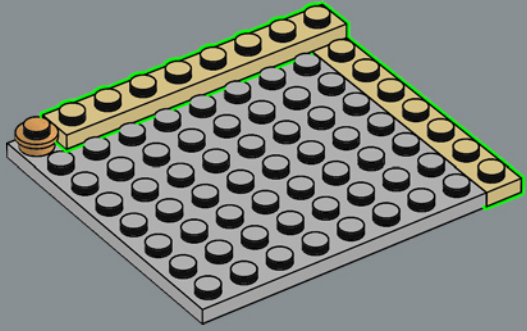

57

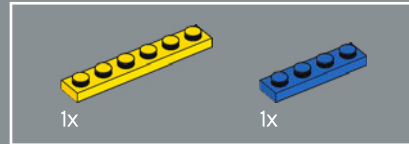
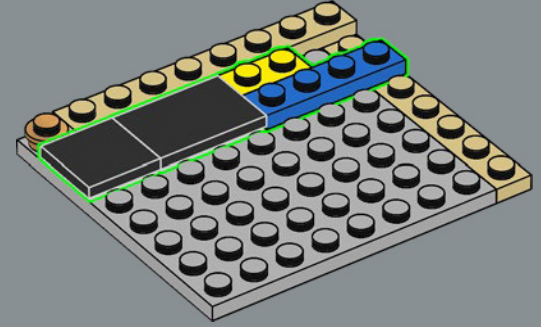

58

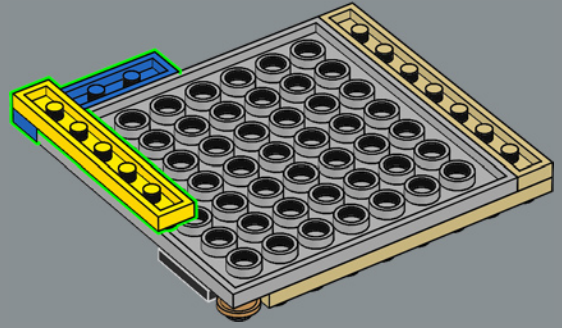

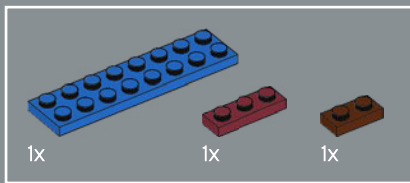

59

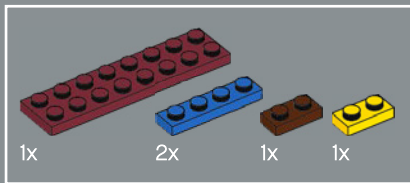
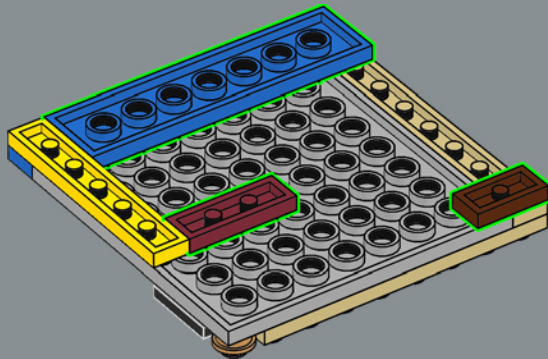

60

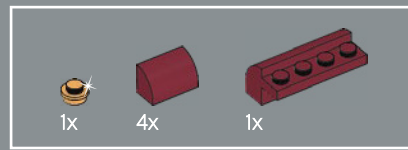
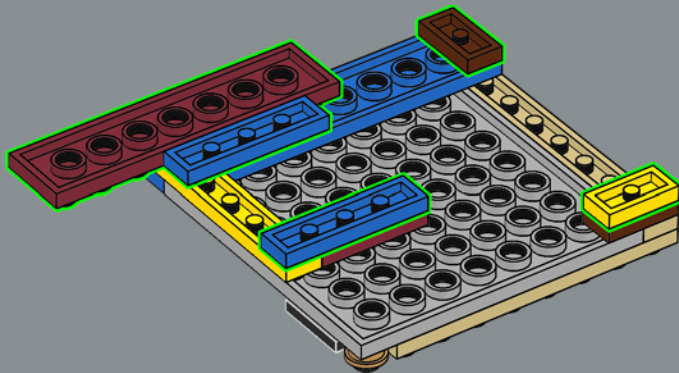

61

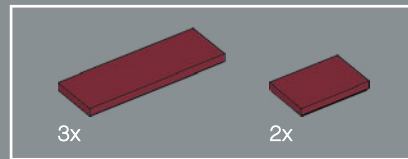
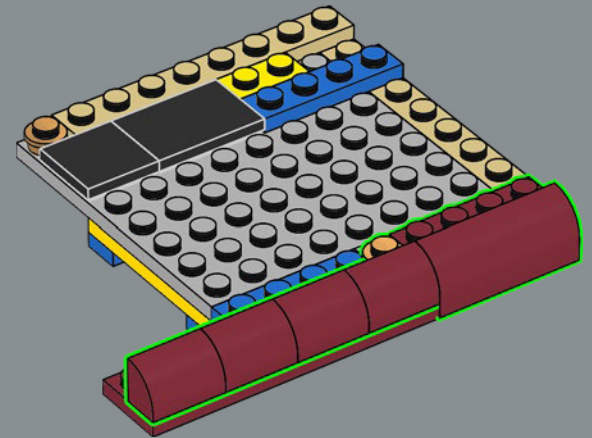

62

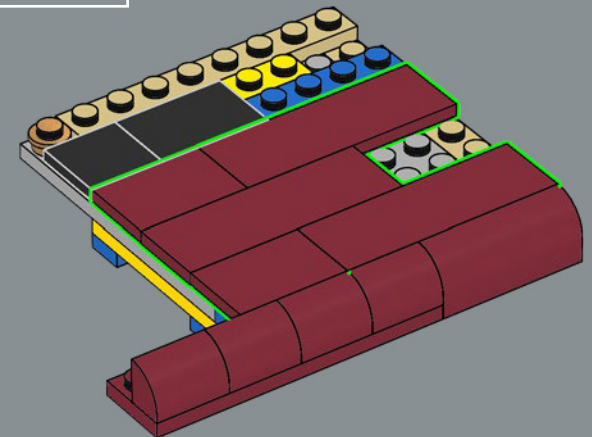

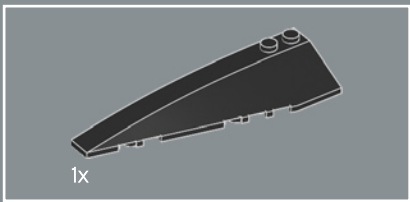

63

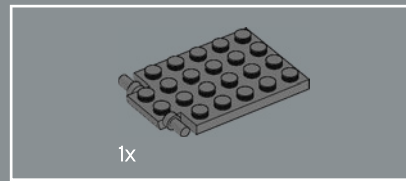
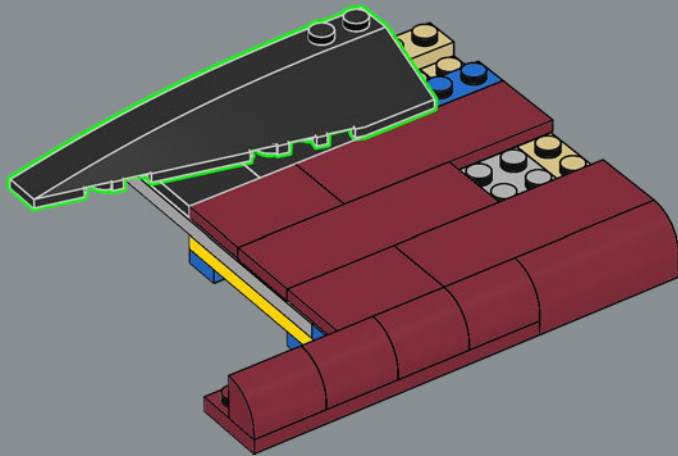

64

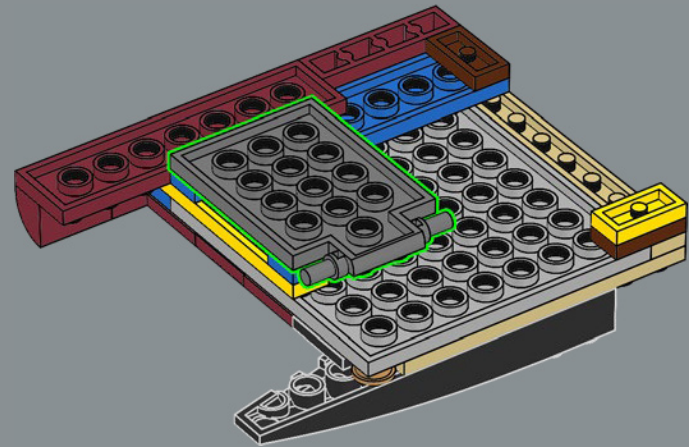

65

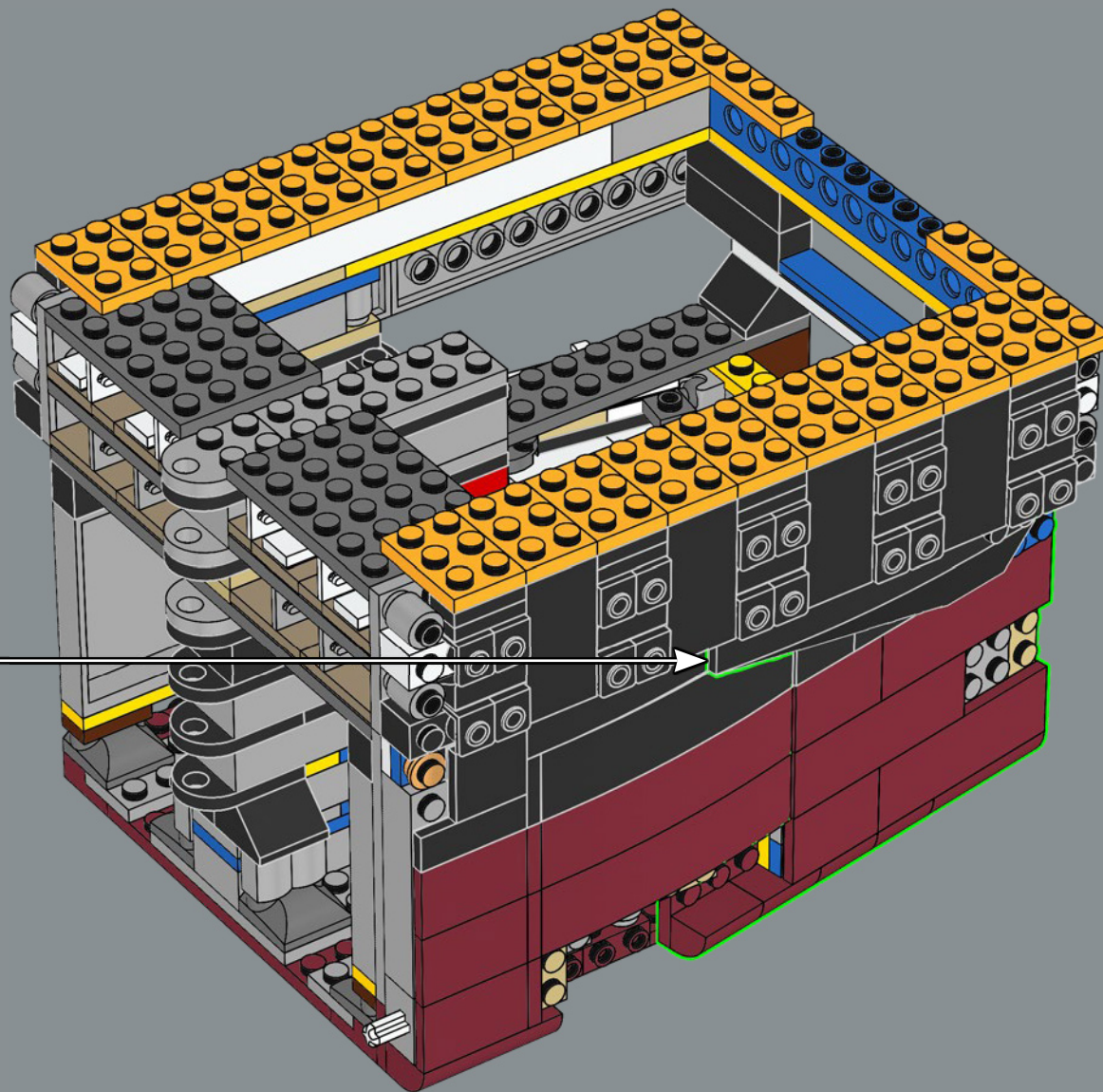

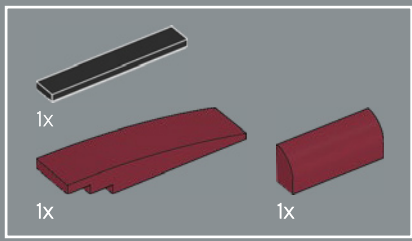

66

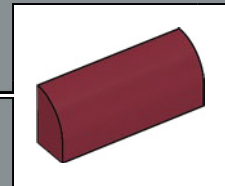
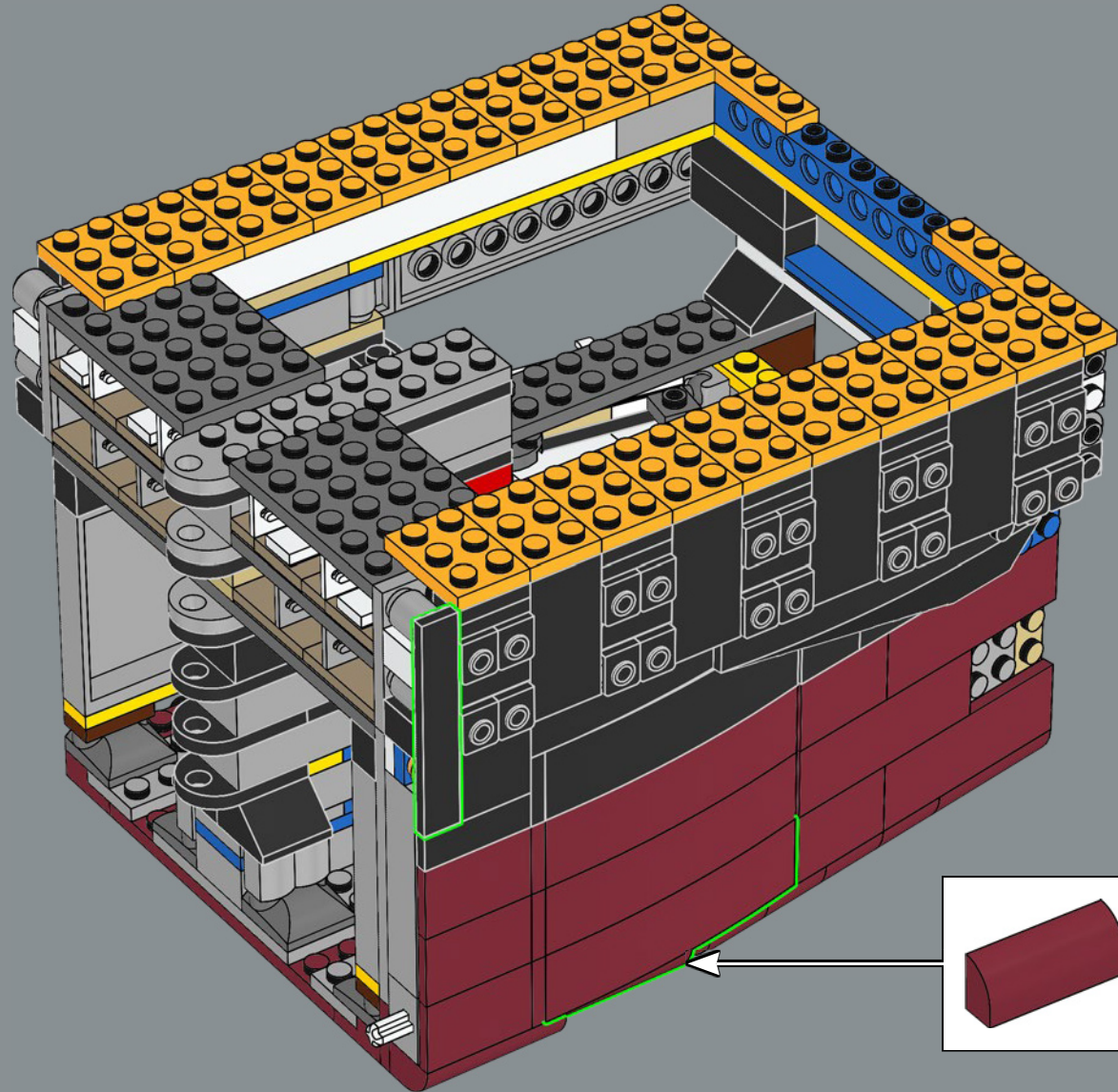

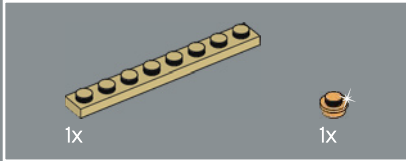
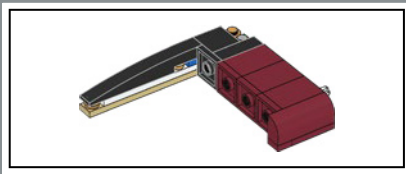

67

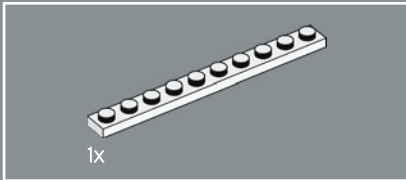
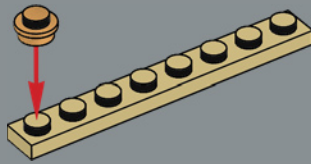

68

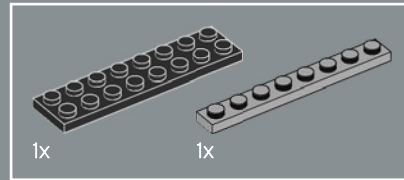
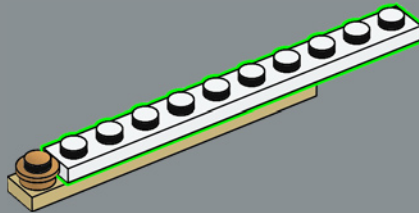

69

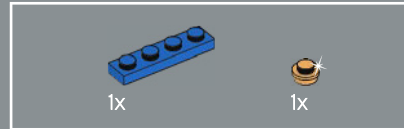
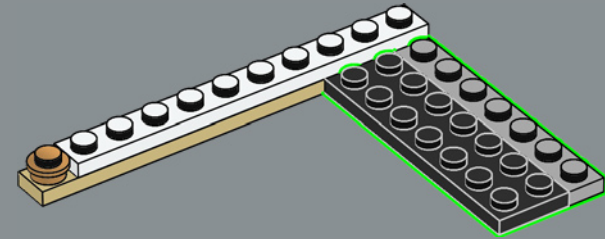

70

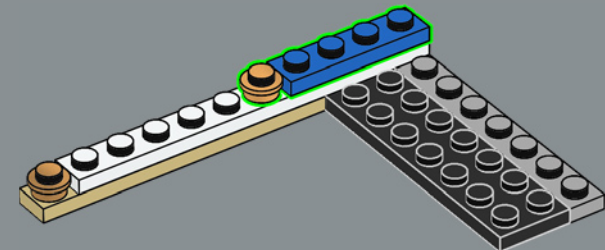

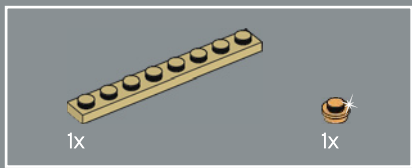

71

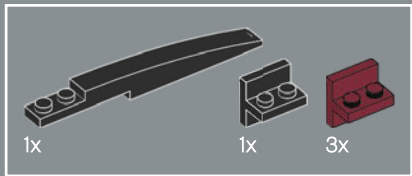
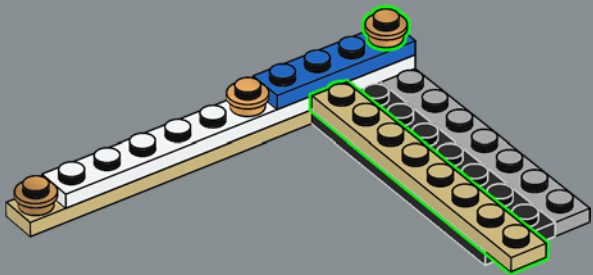

72

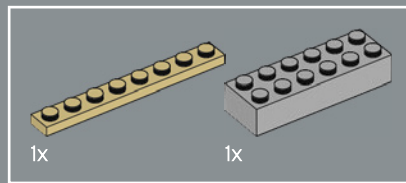
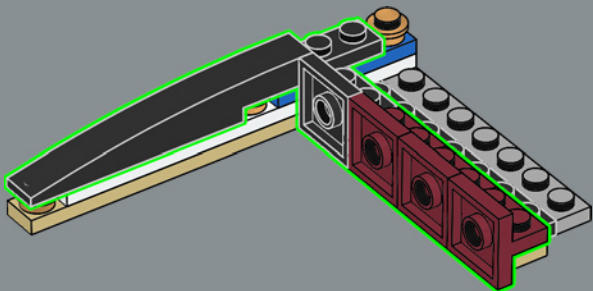

73

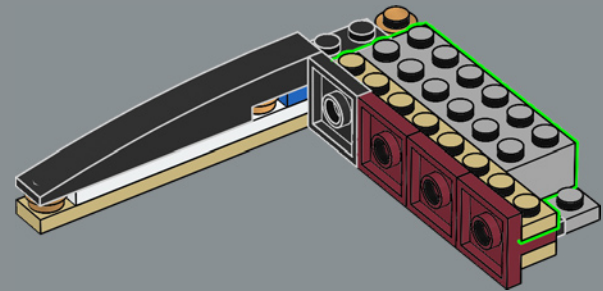



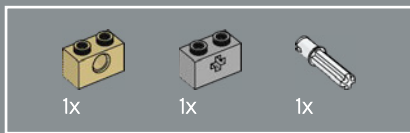

74

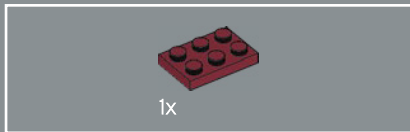
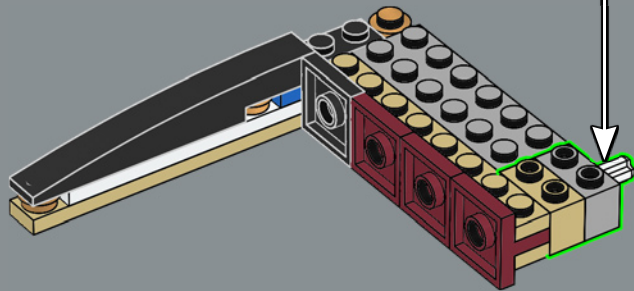
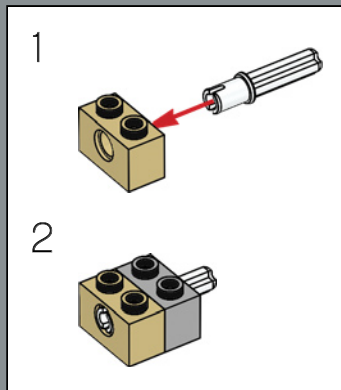

75

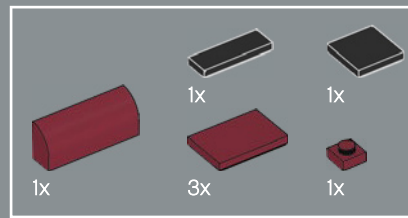
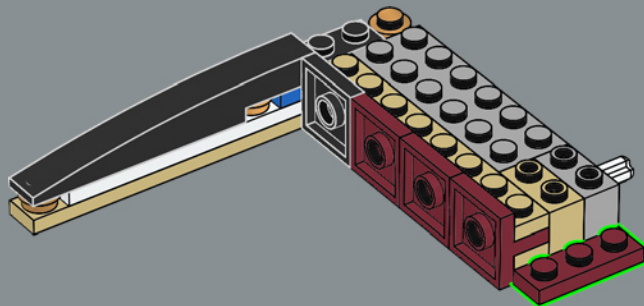

76

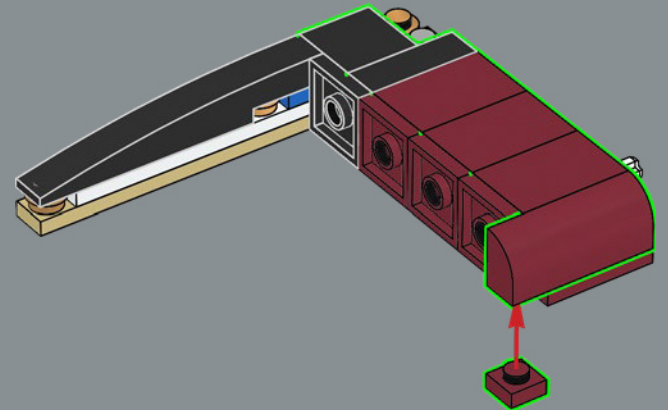

77

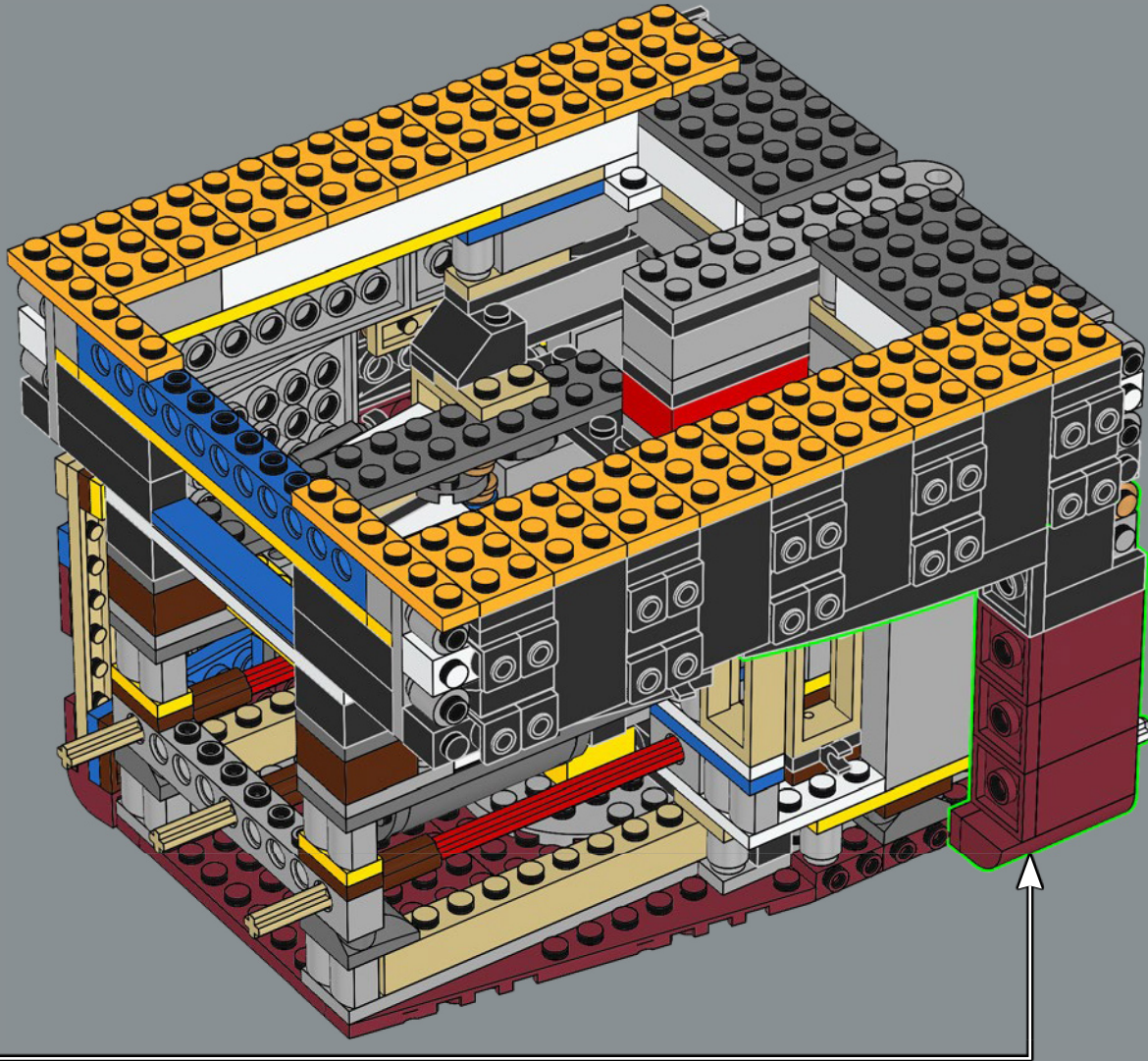

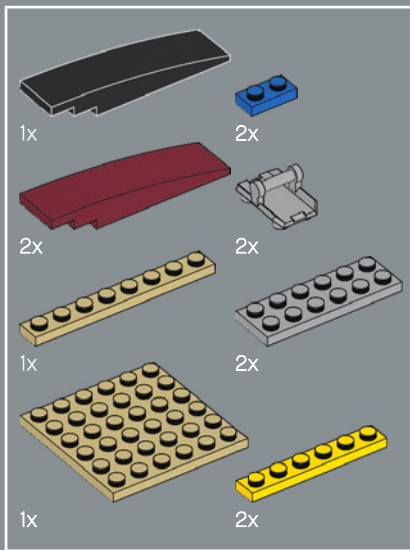

78

1

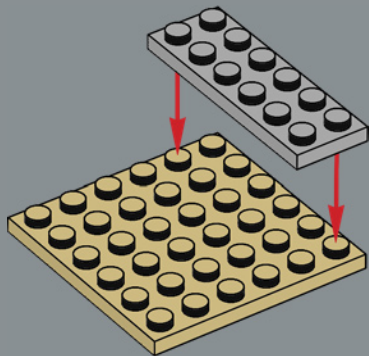

2

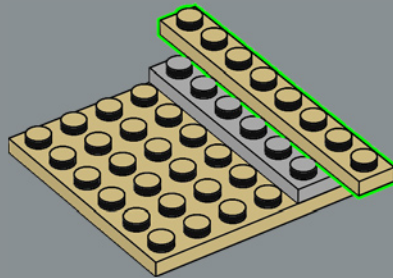

3

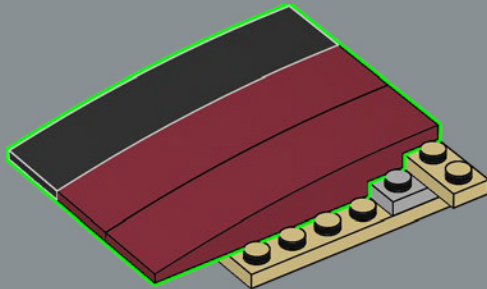

4

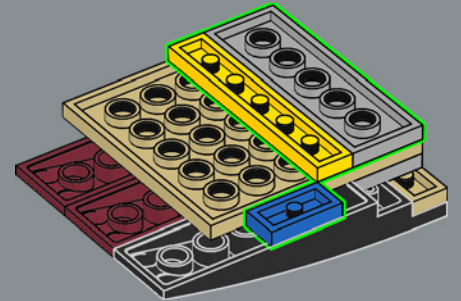

5

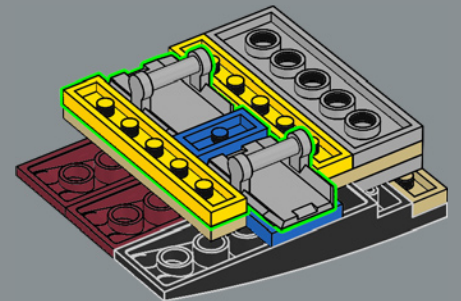

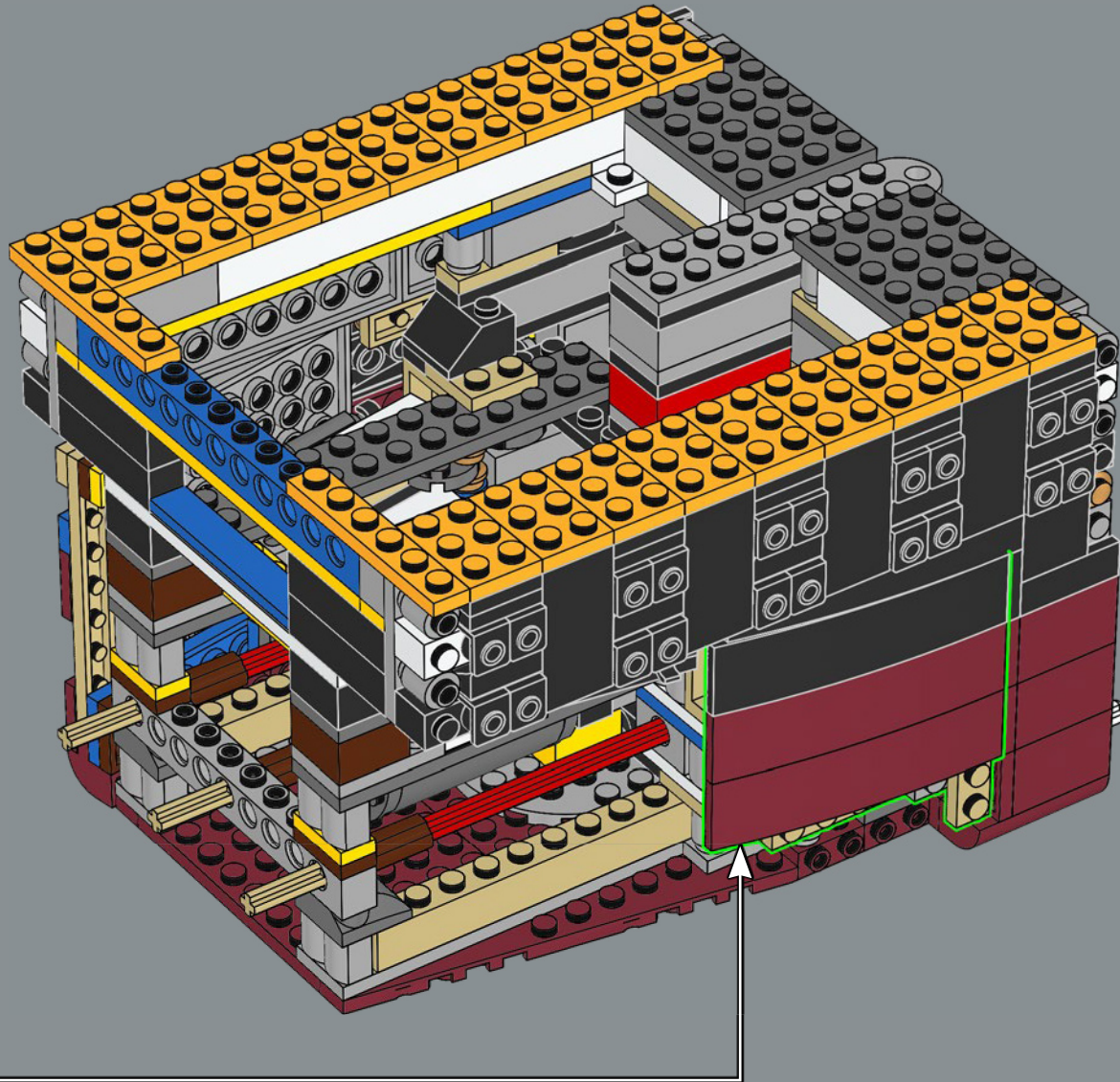

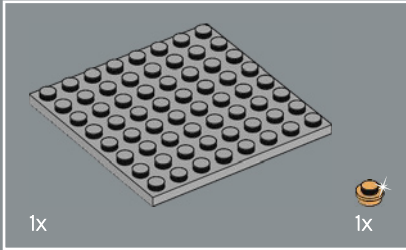
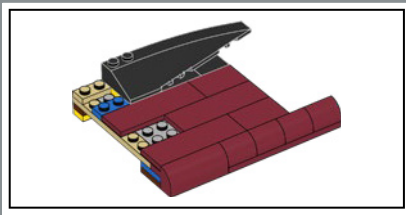

79

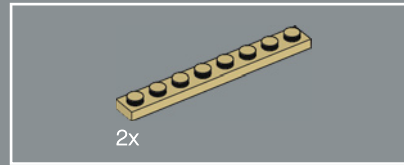
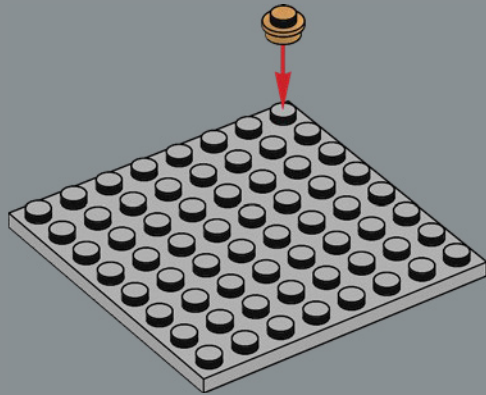

80

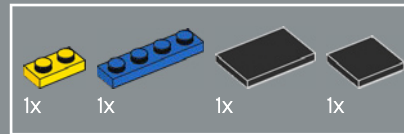
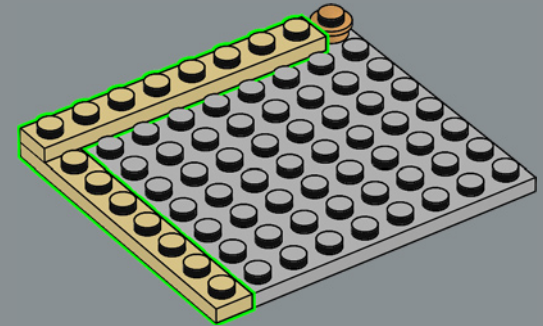

81

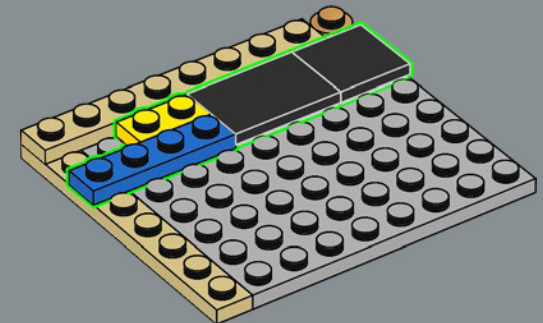

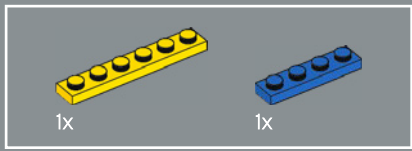

82

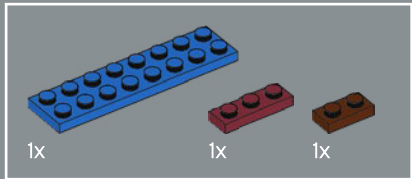
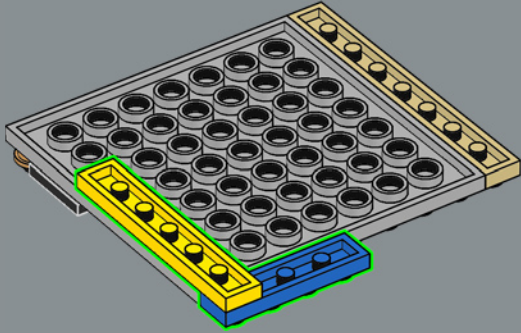

83

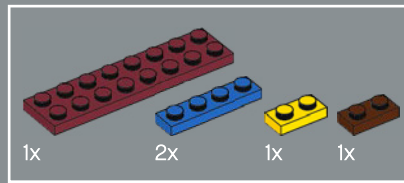
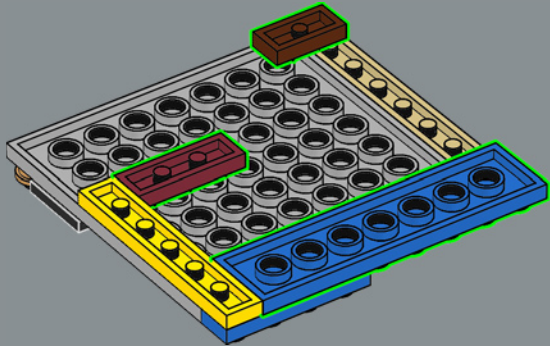

84

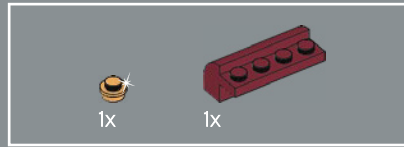
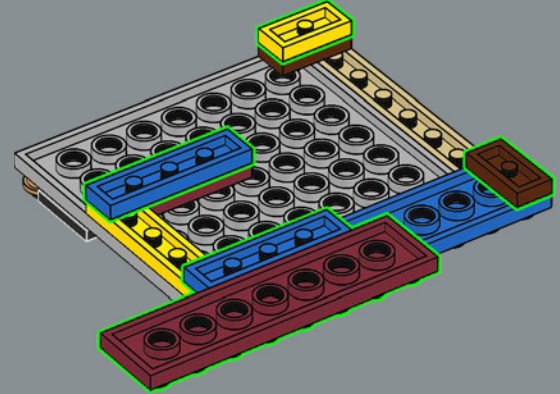

85

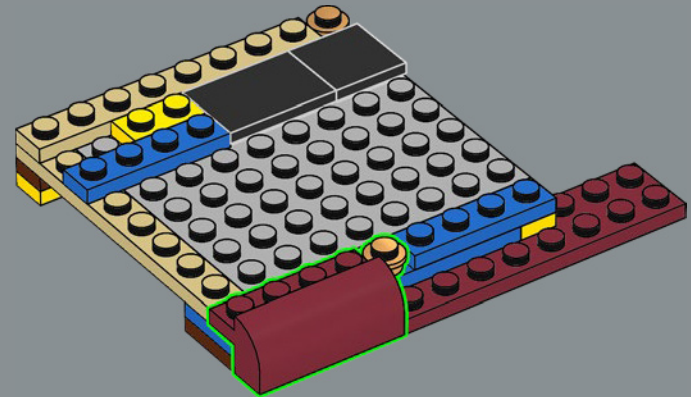

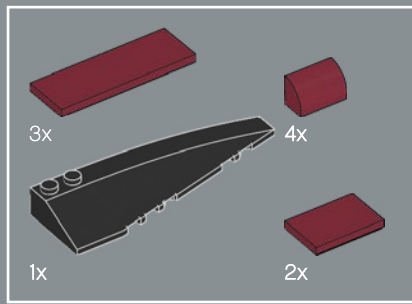

86

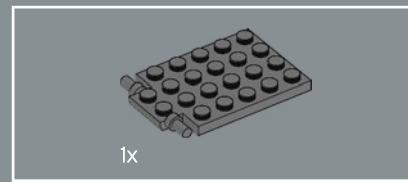
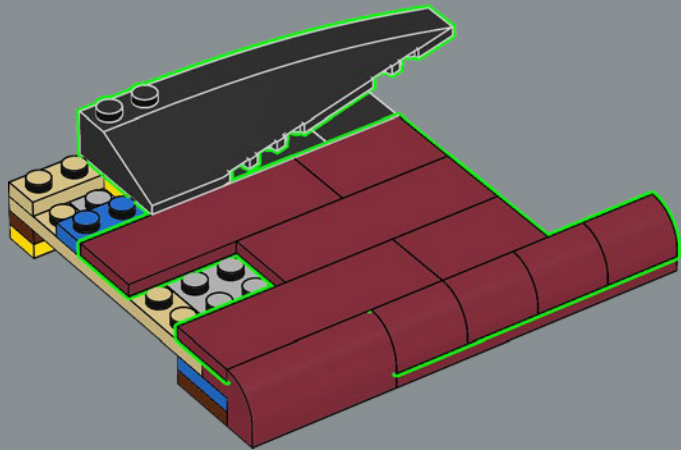

87

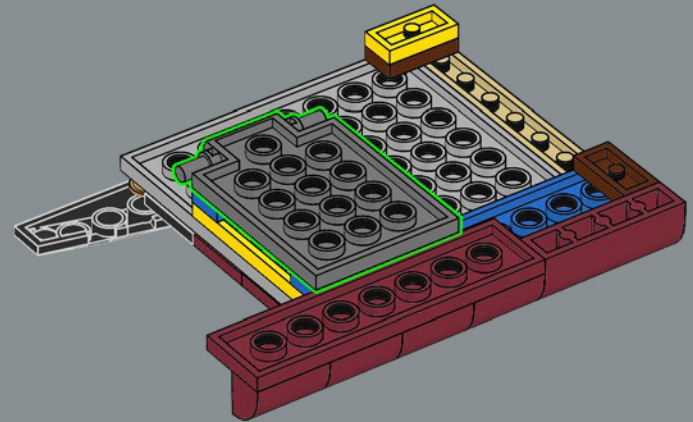

Die *Titanic* war 640 km von Land entfernt,  
als sie mit dem Eisberg kollidierte.

88

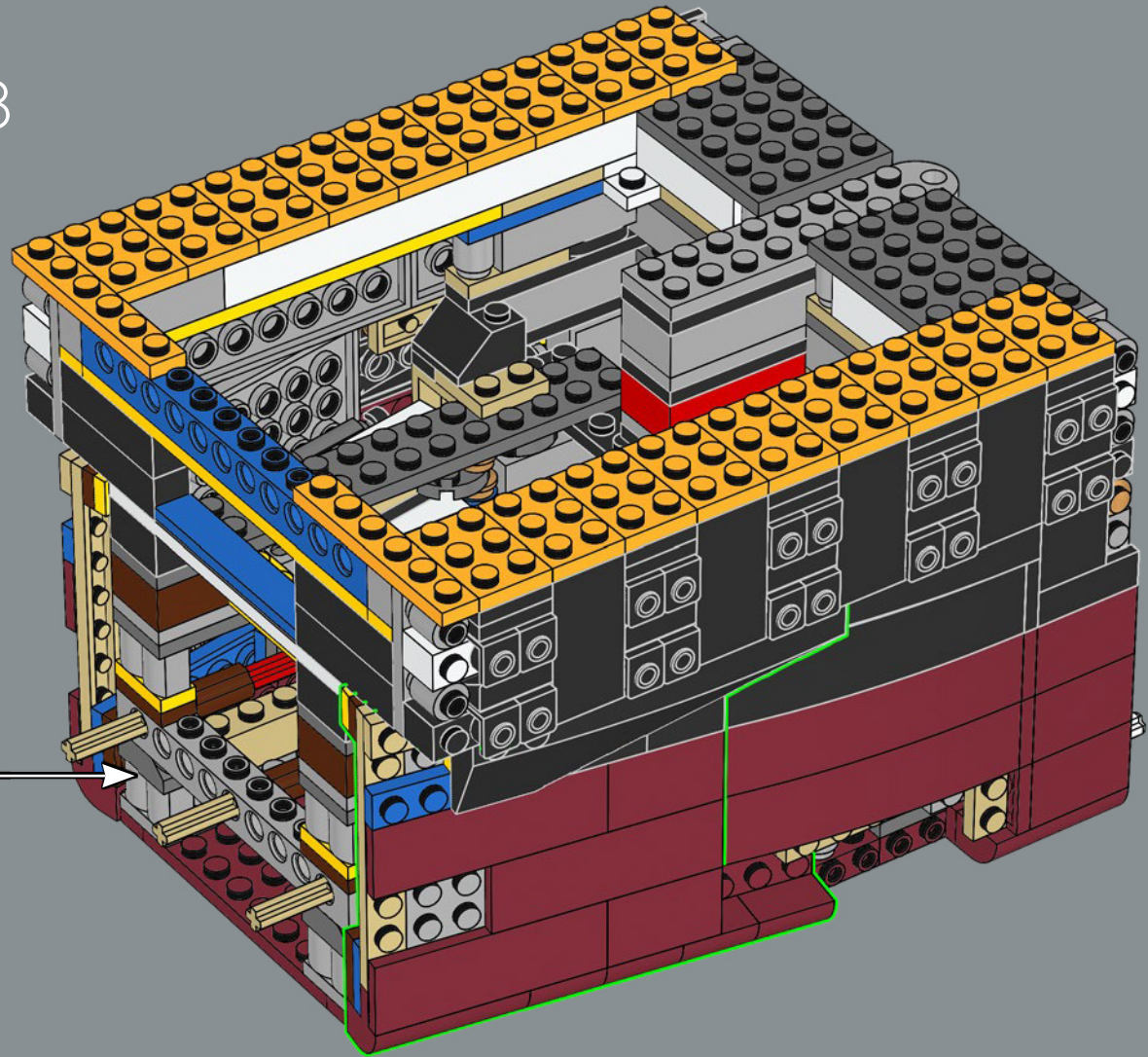



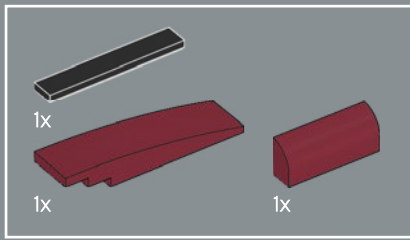

89

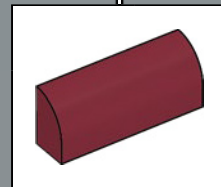
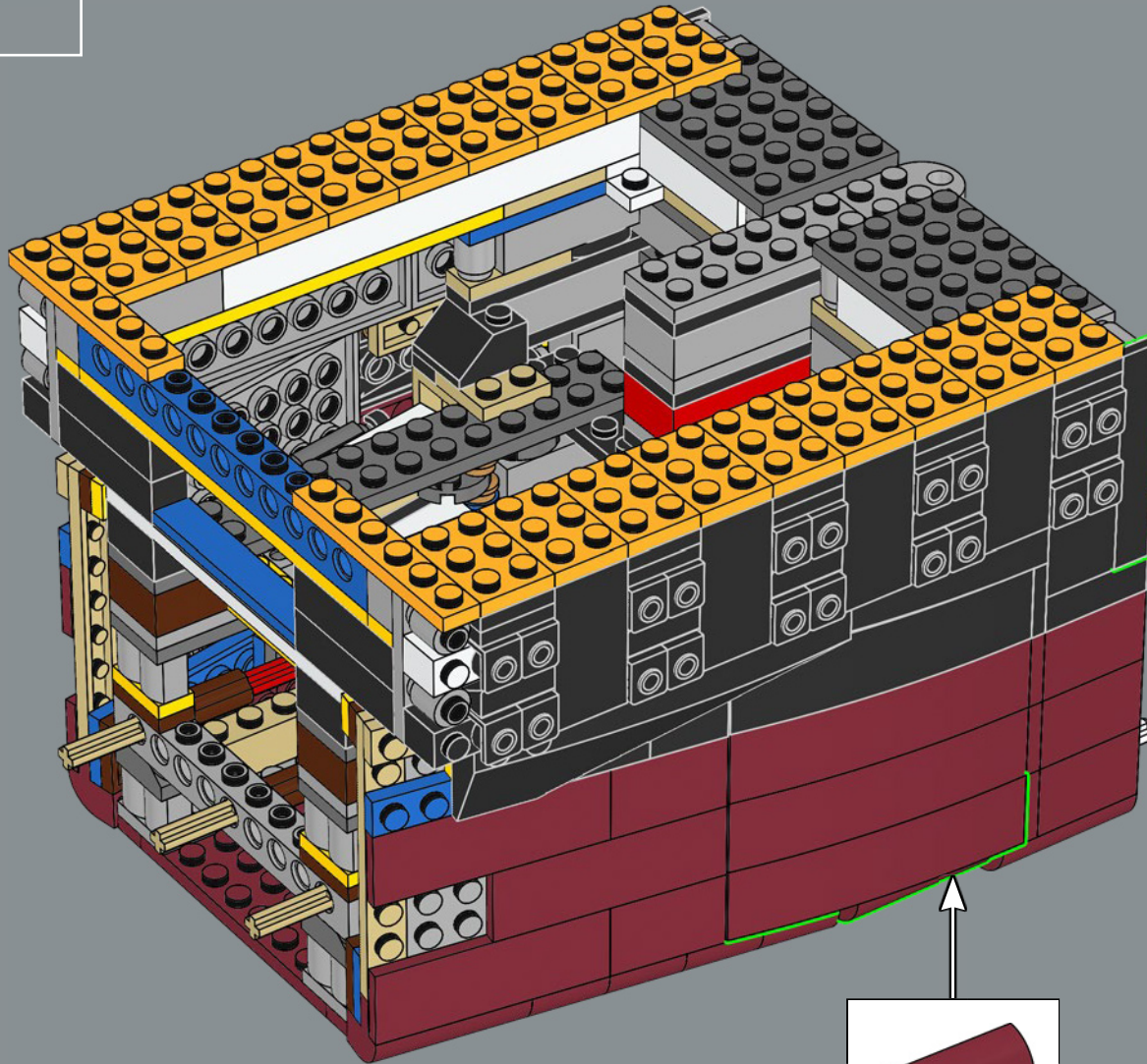

32

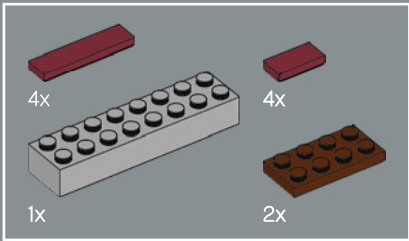

90

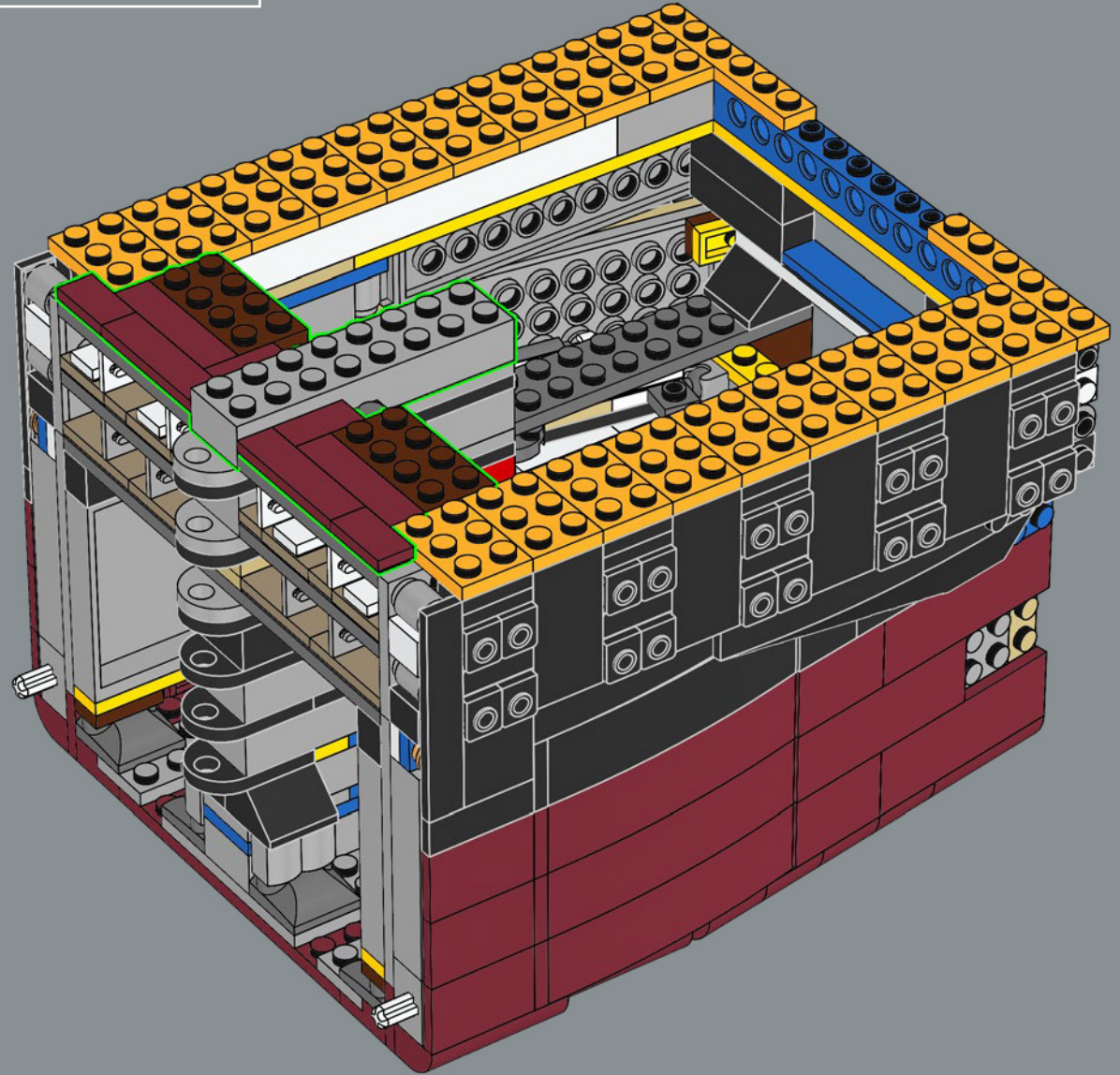

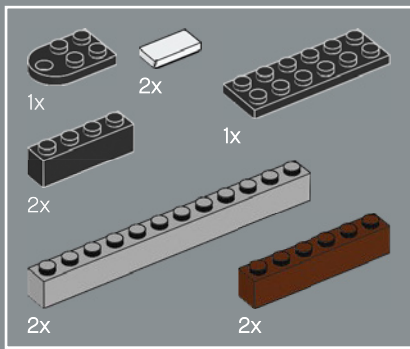

91

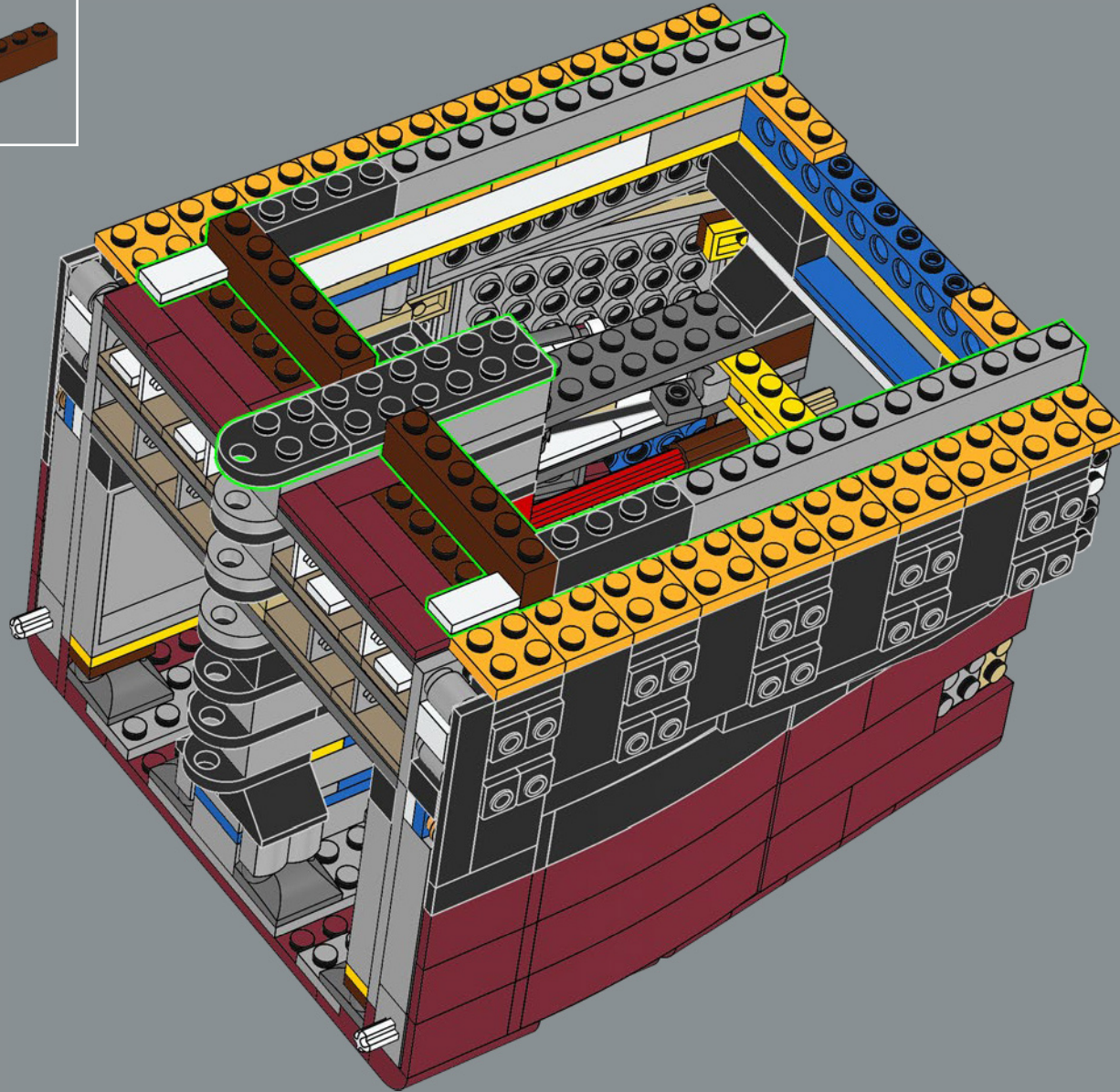

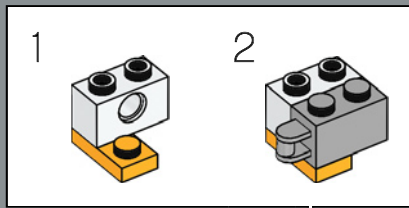
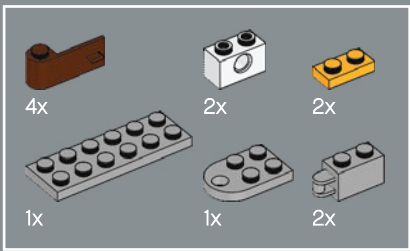

92

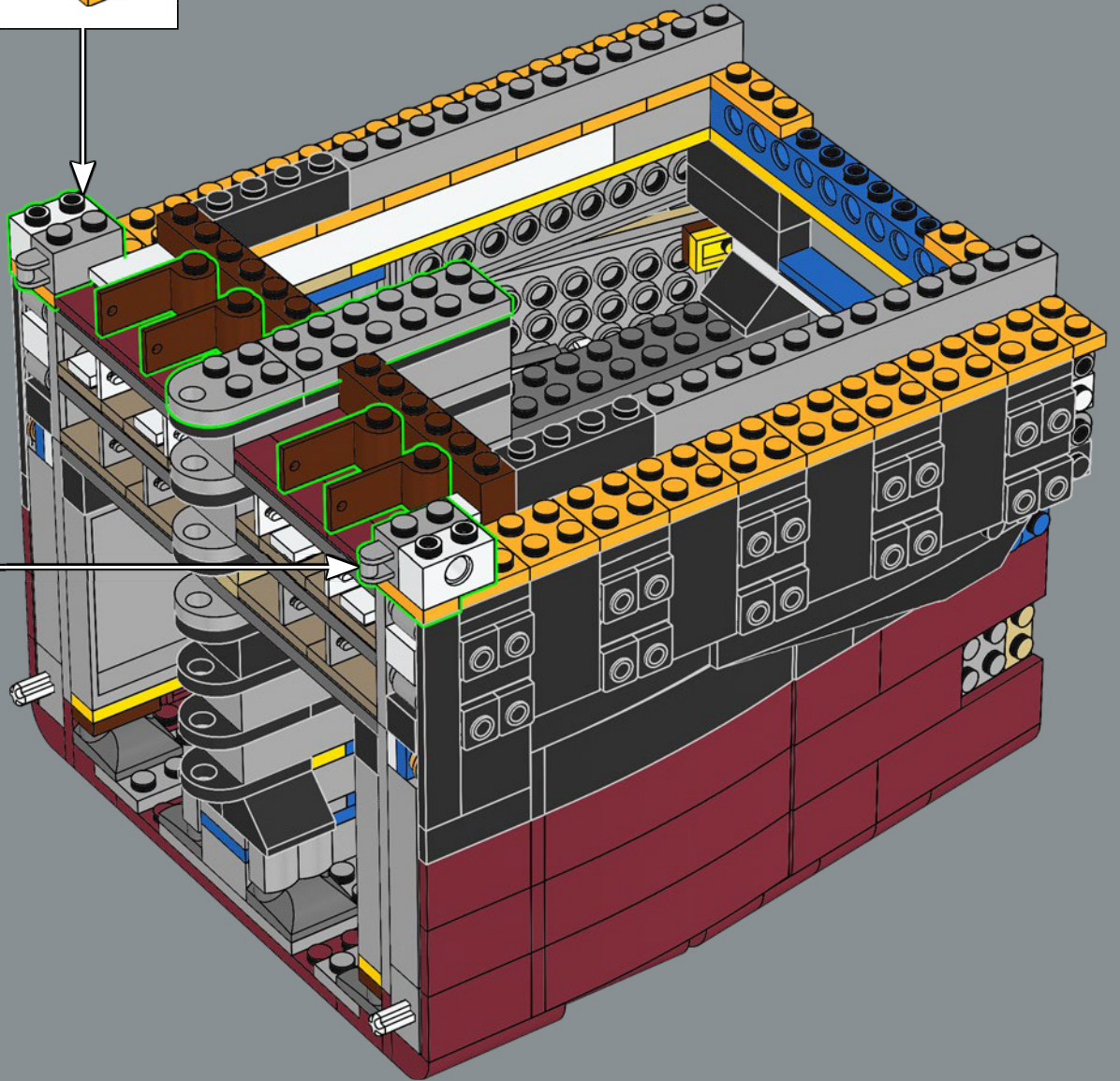
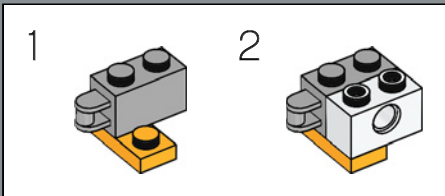



18x

93

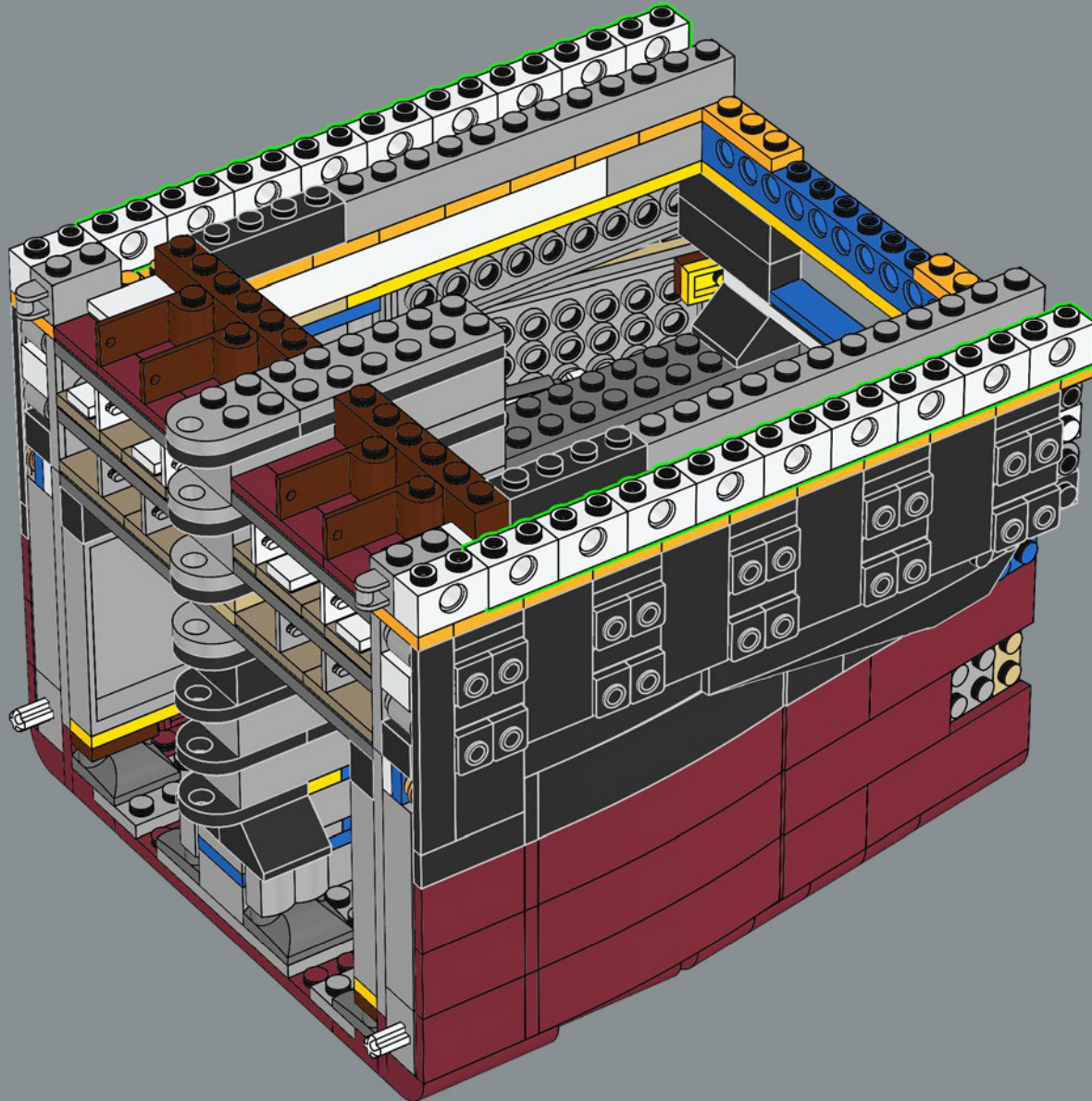

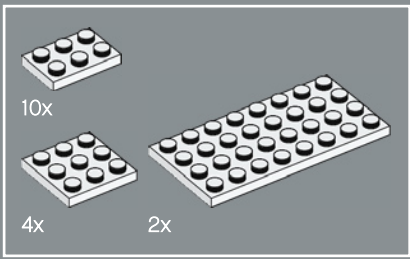

94

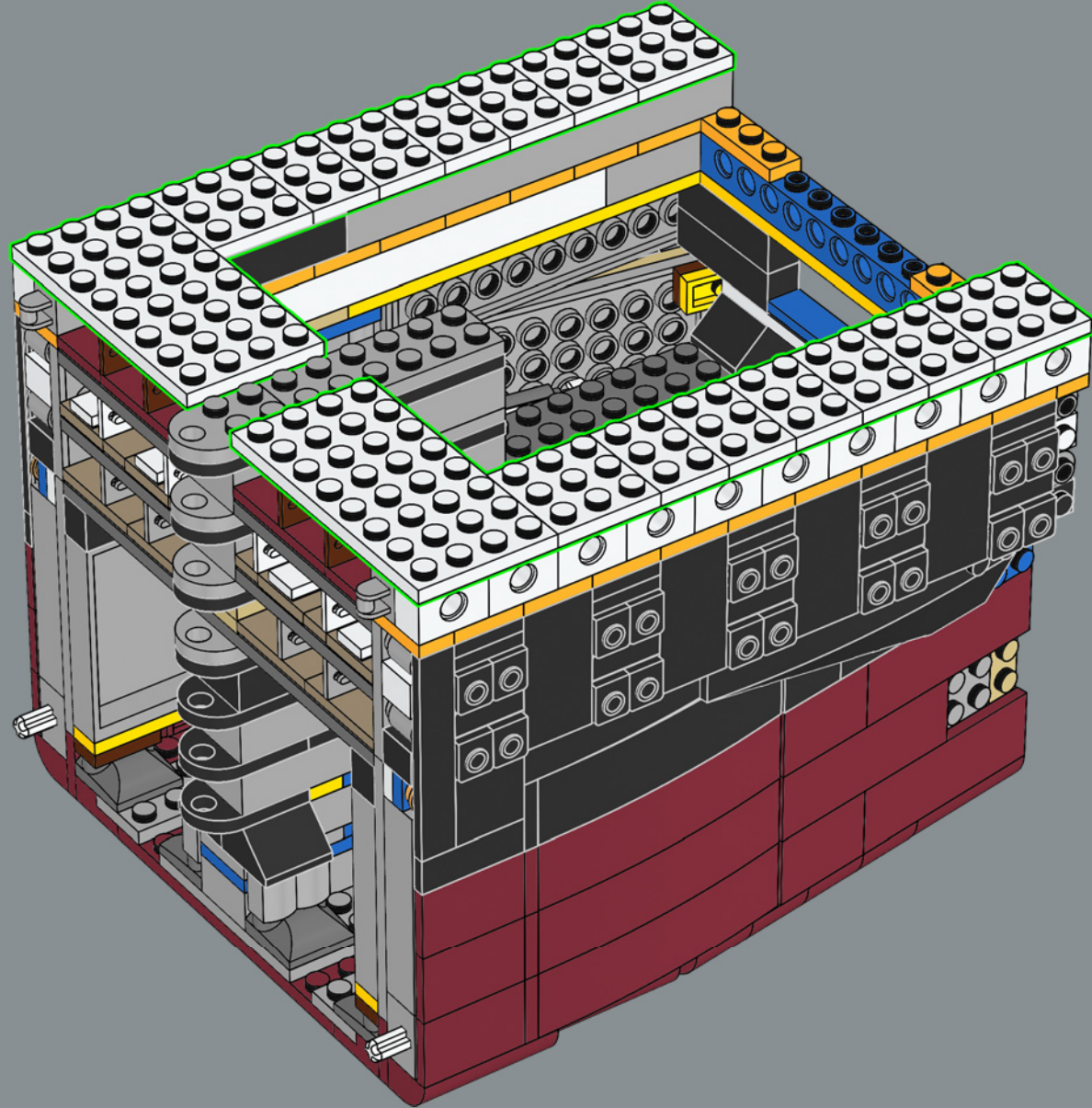

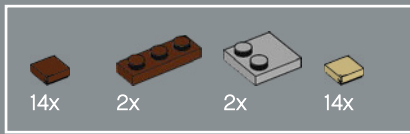

95

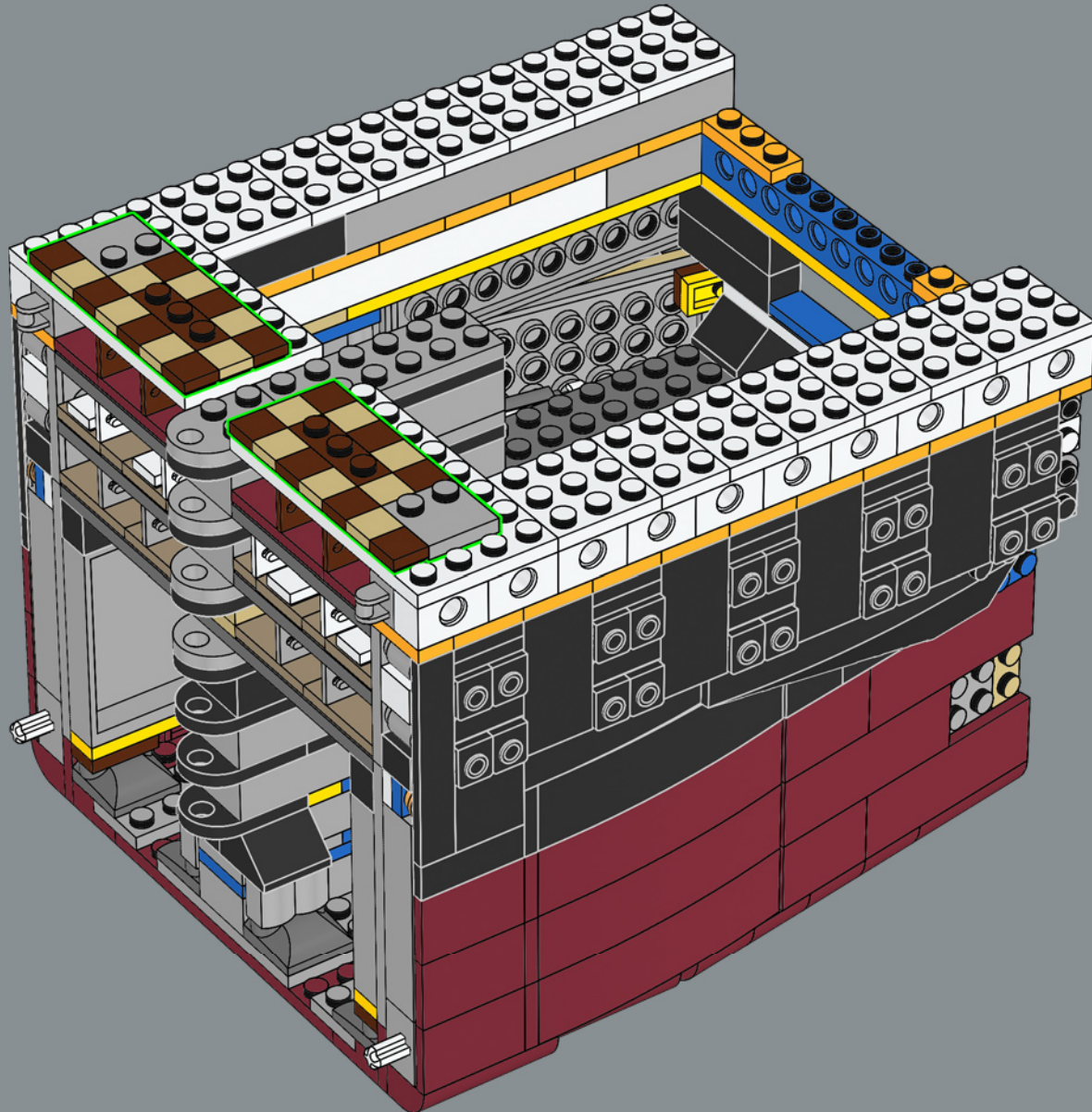

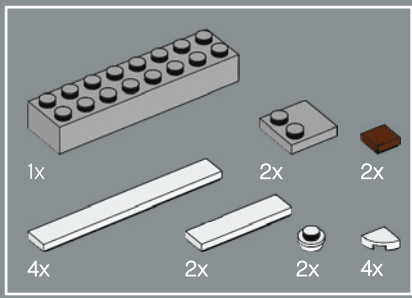

96

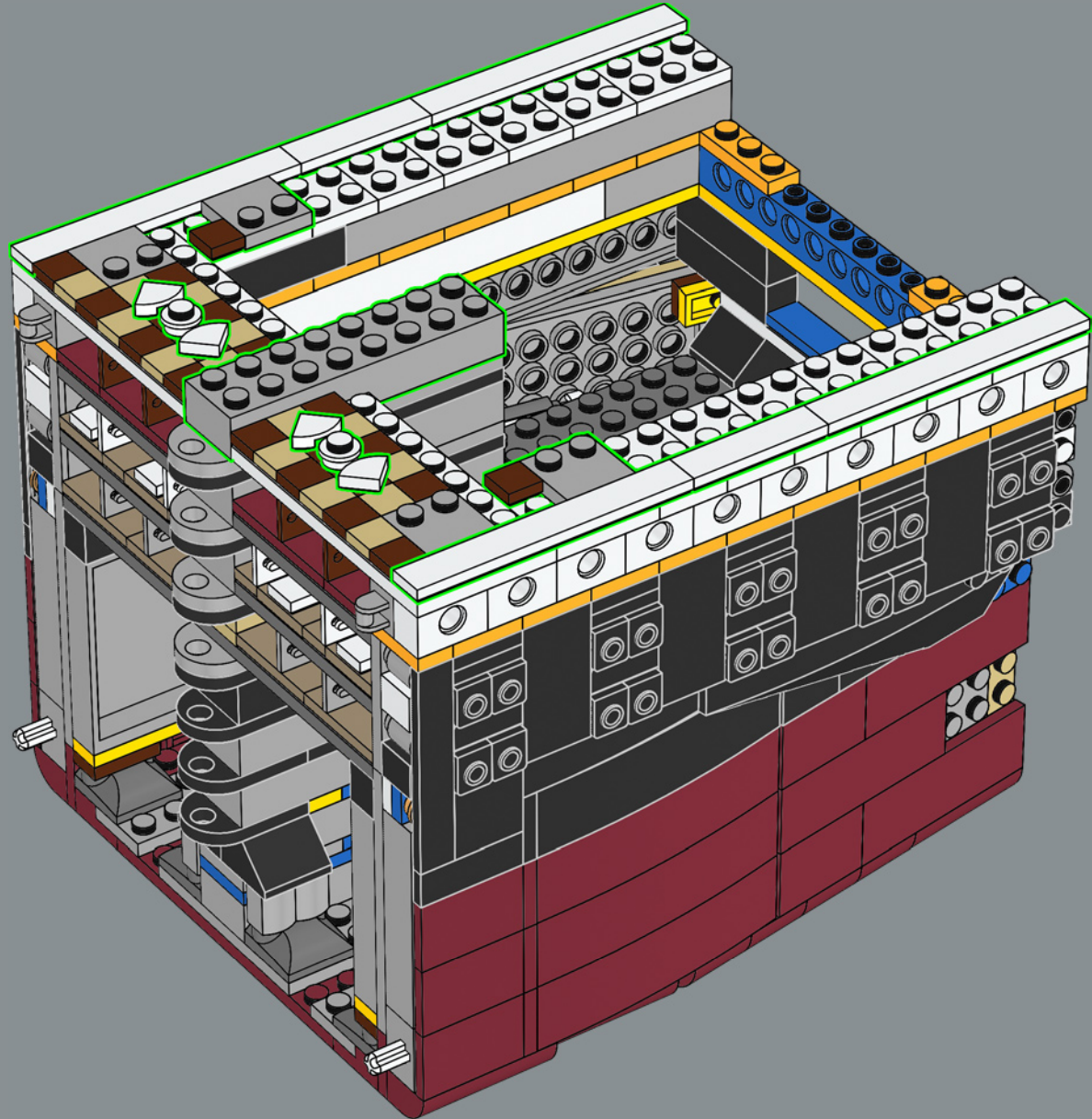



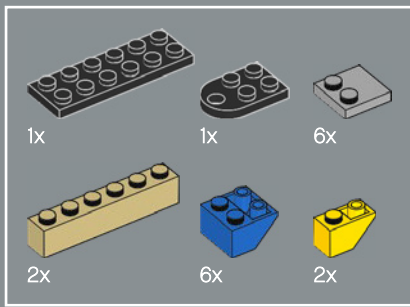

97

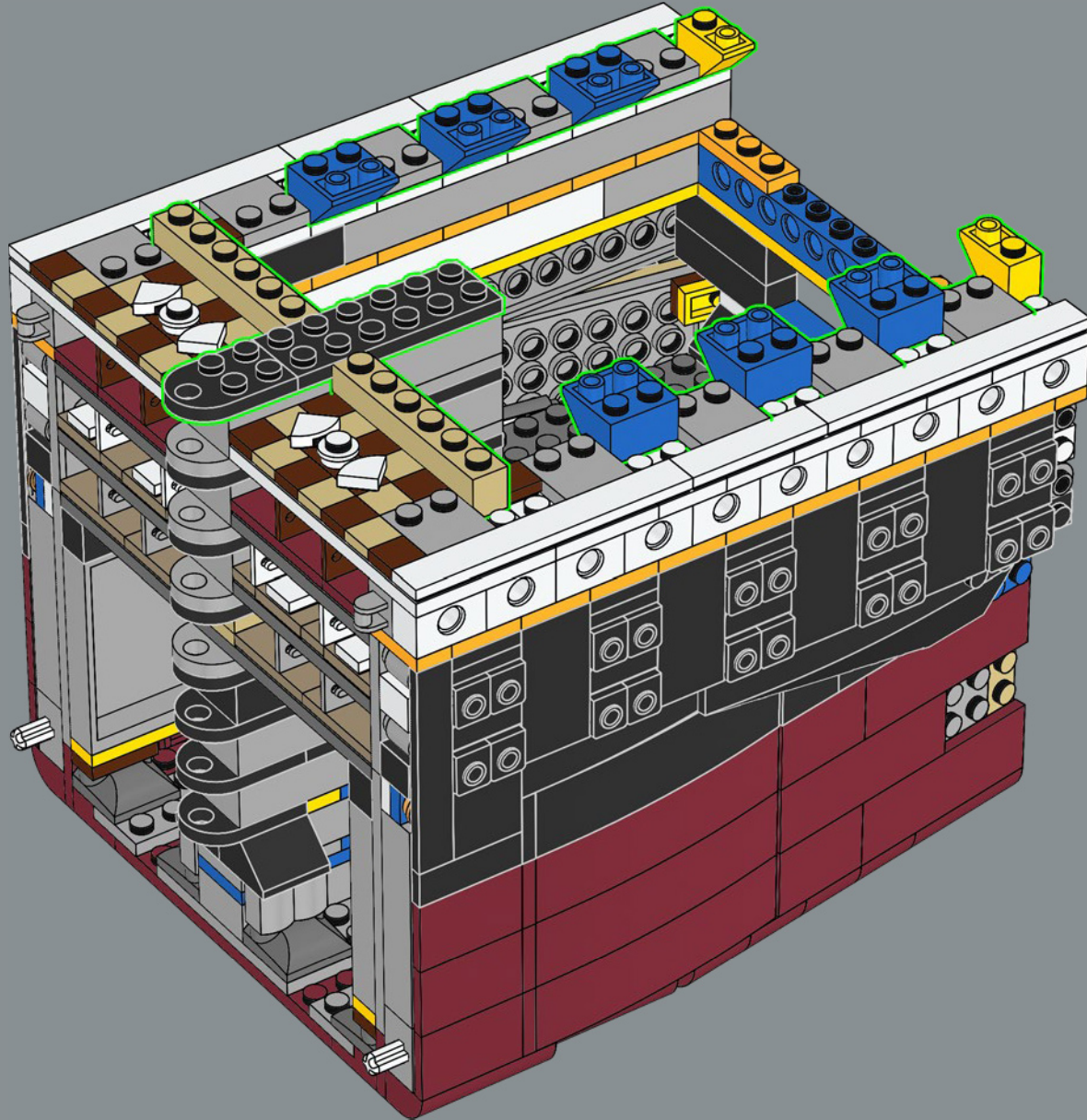

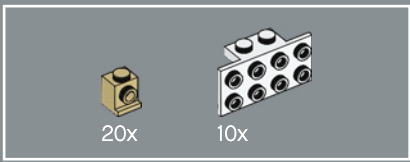

98

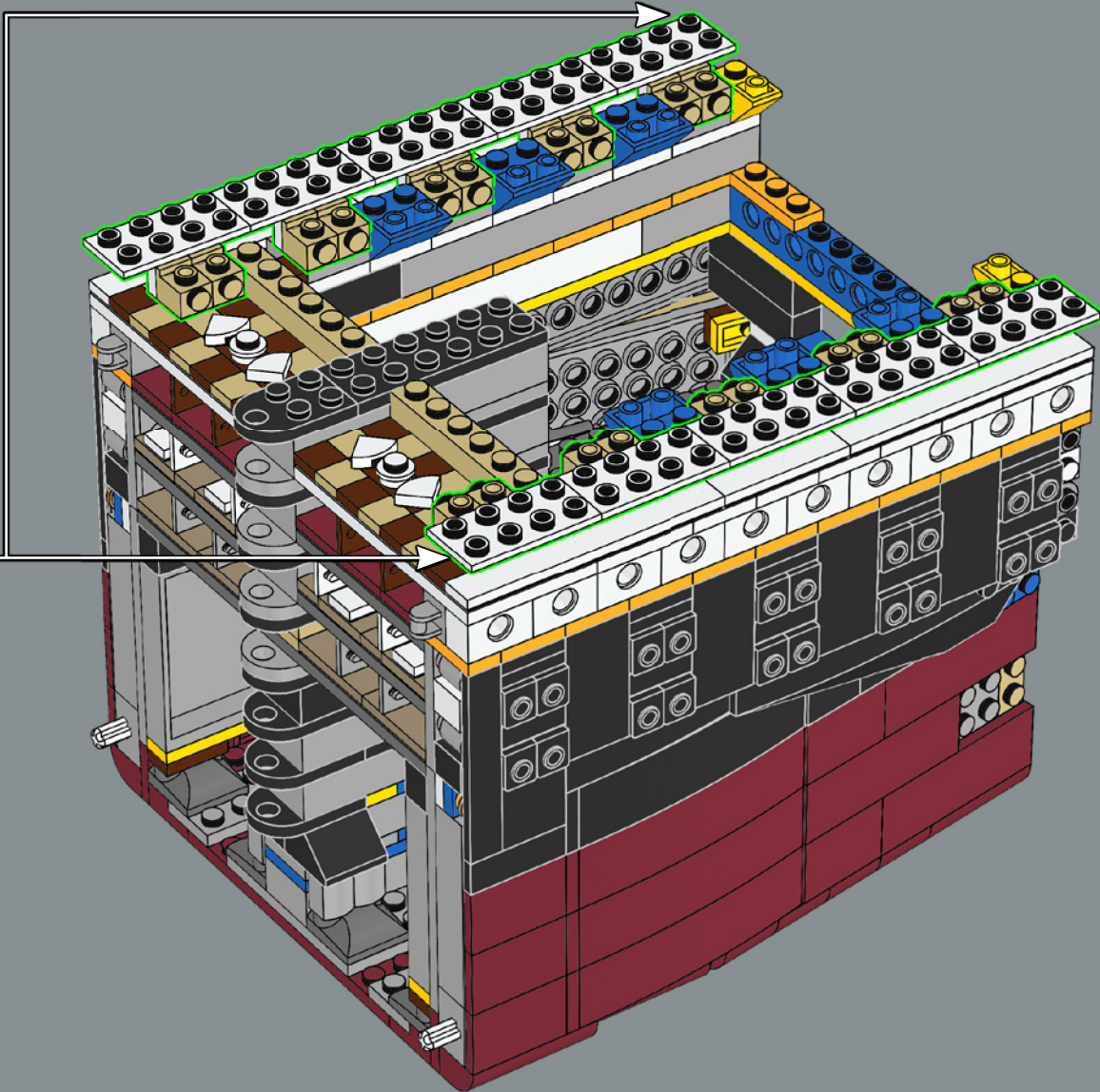
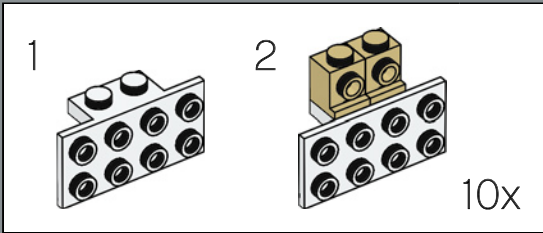

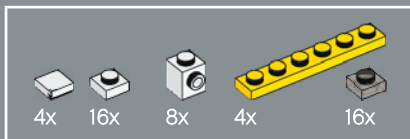

99

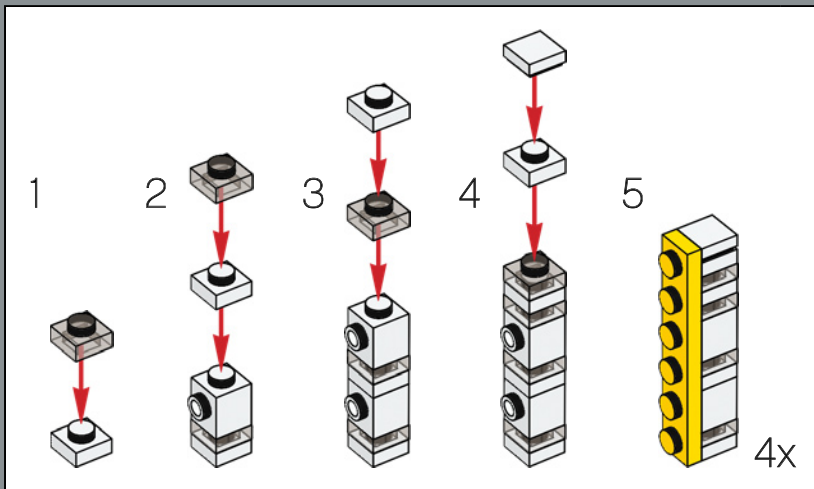
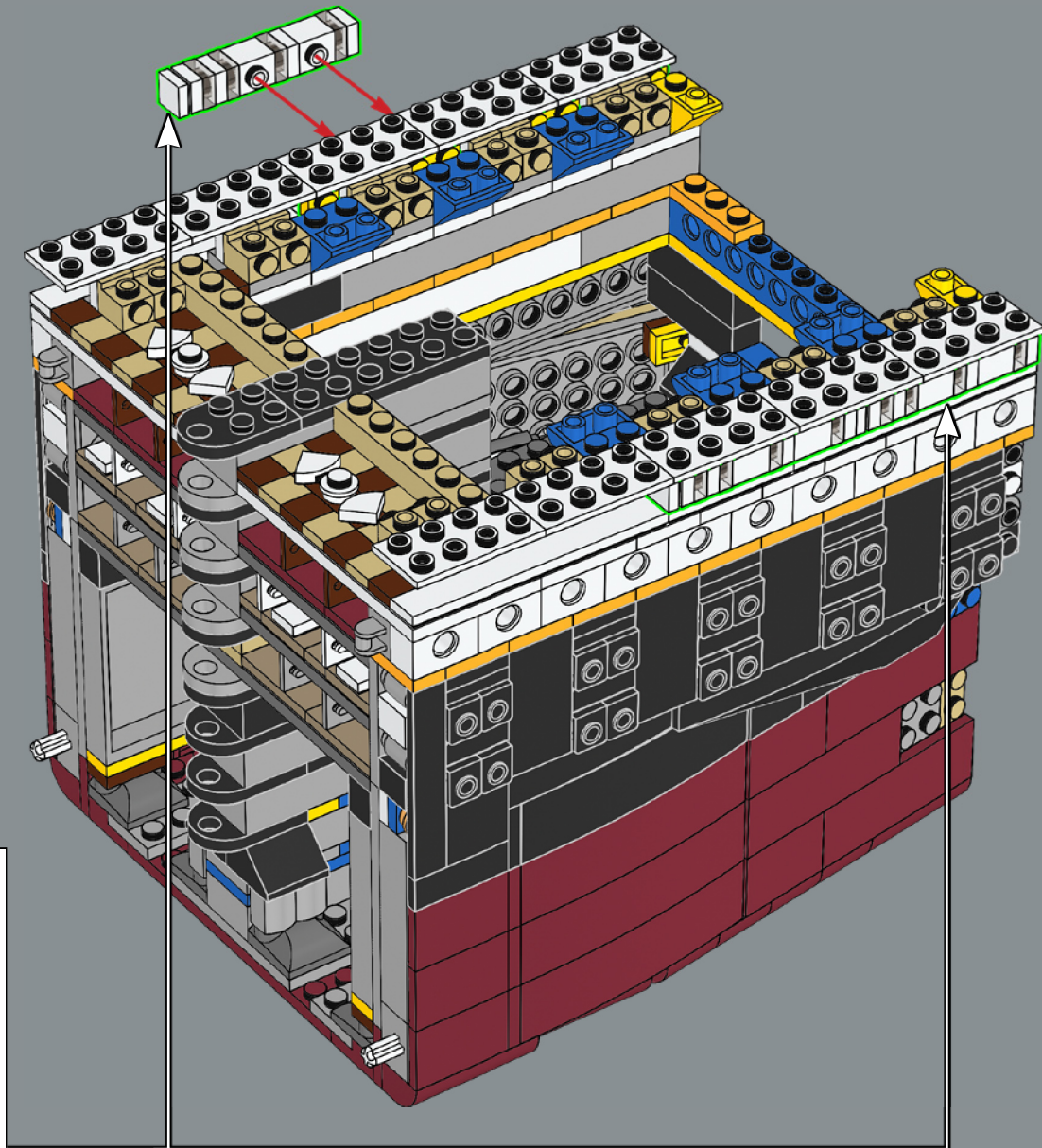

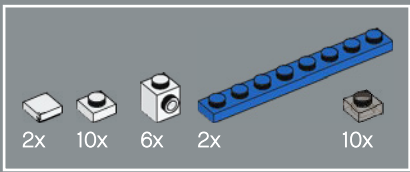

100

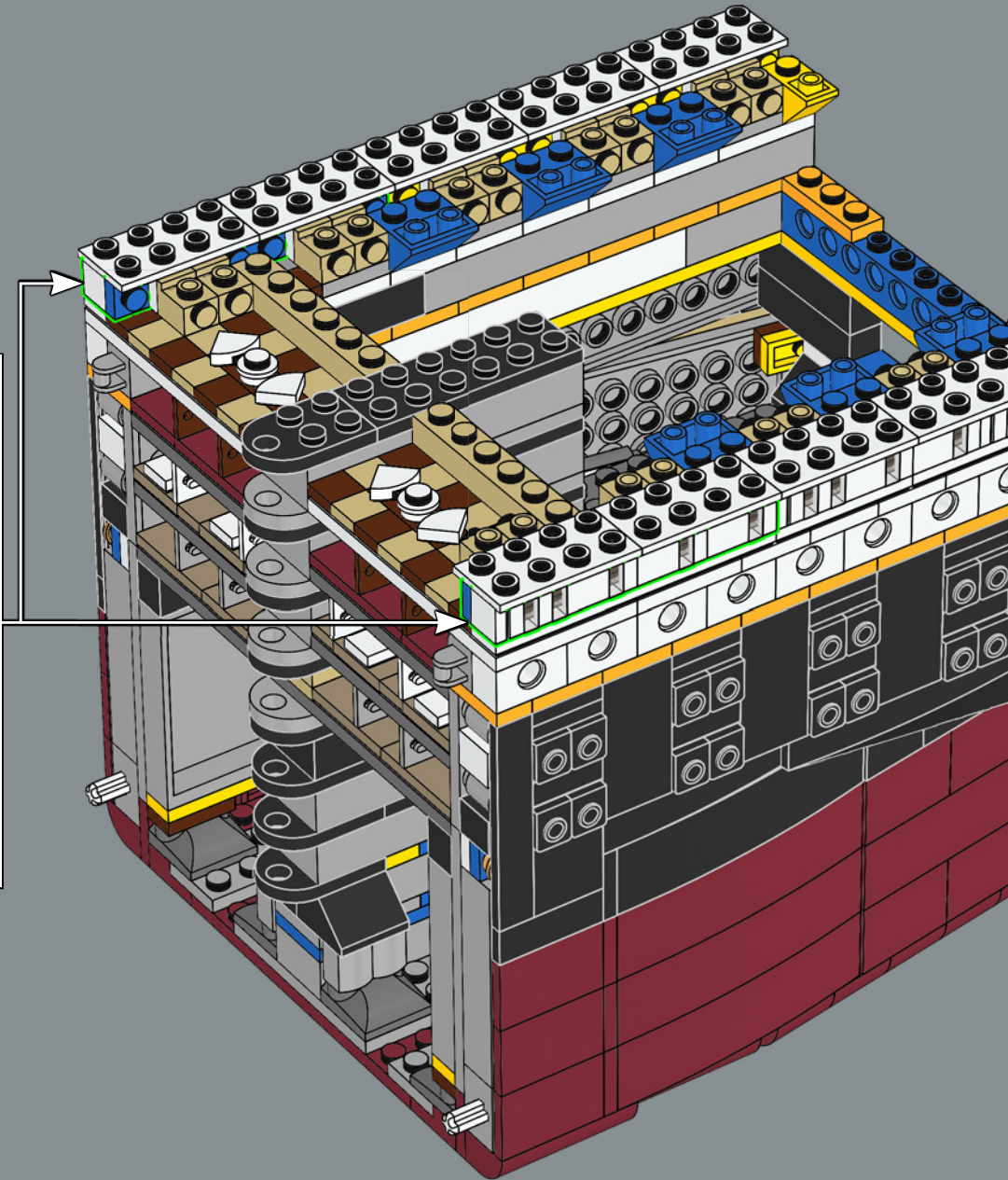
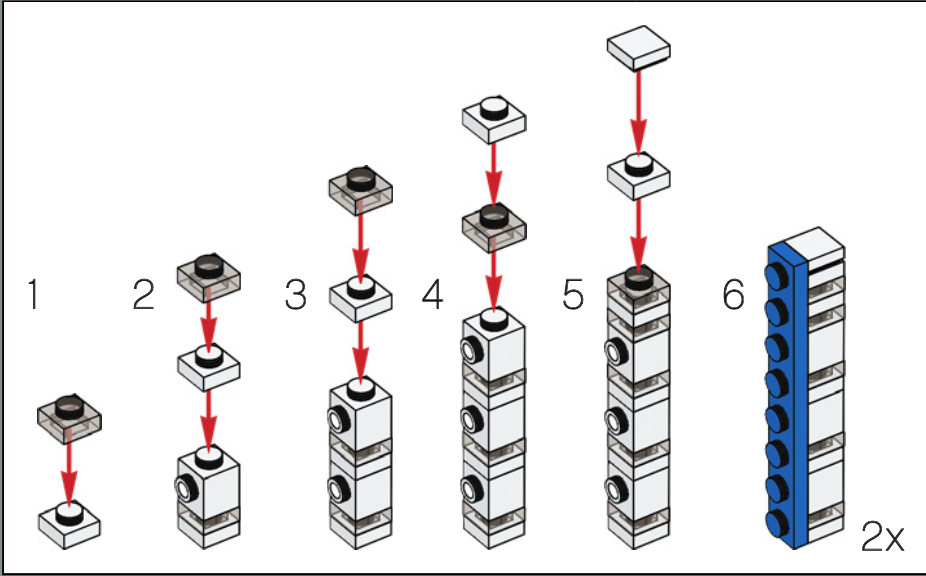

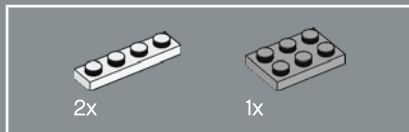
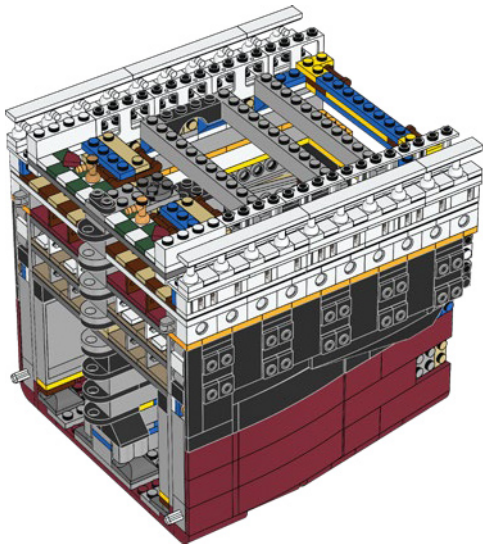
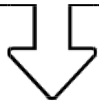

101

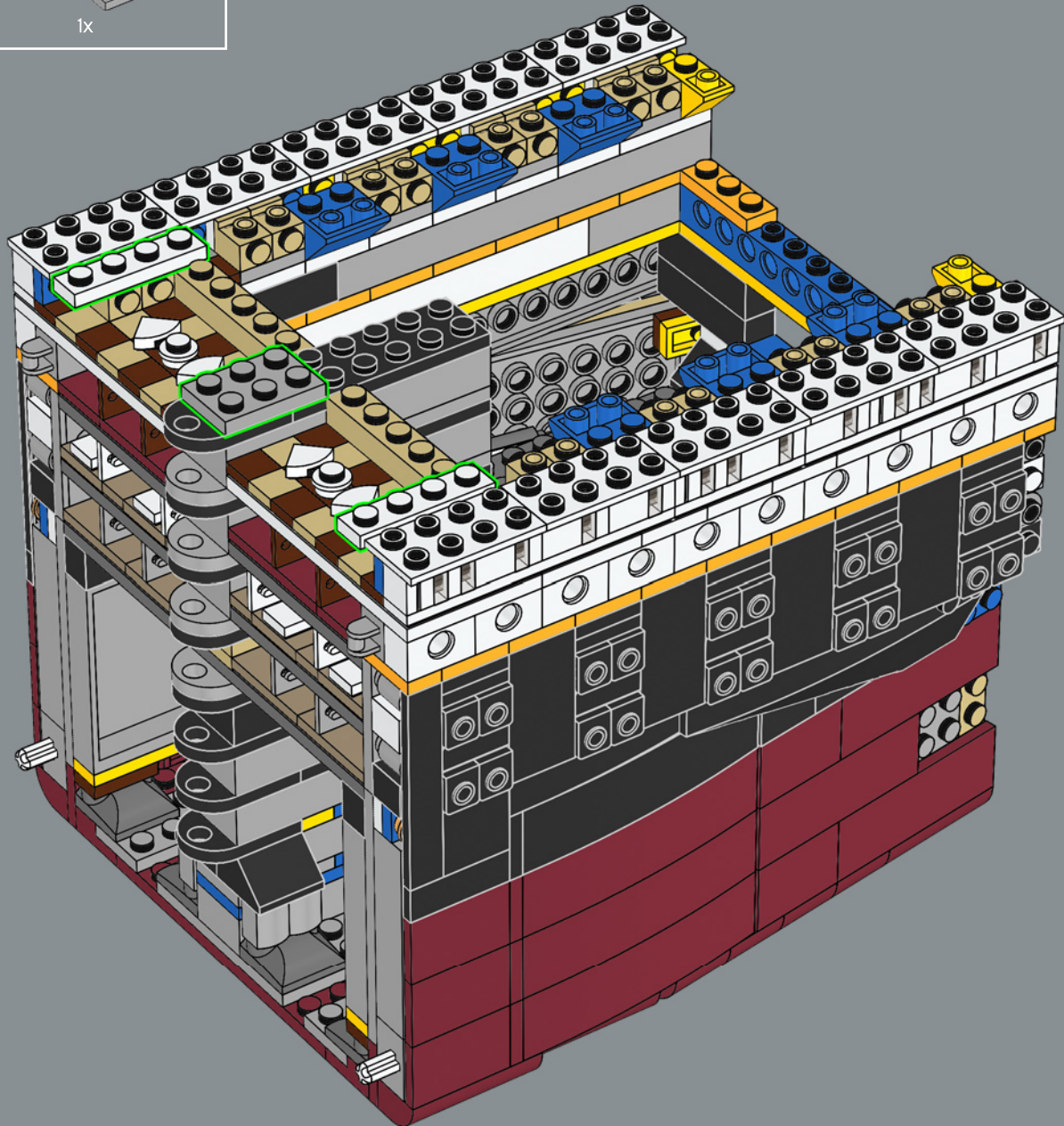

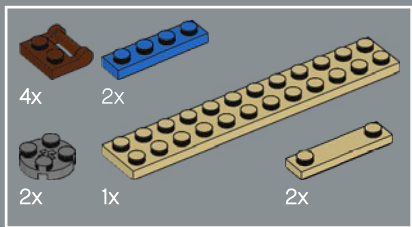

102

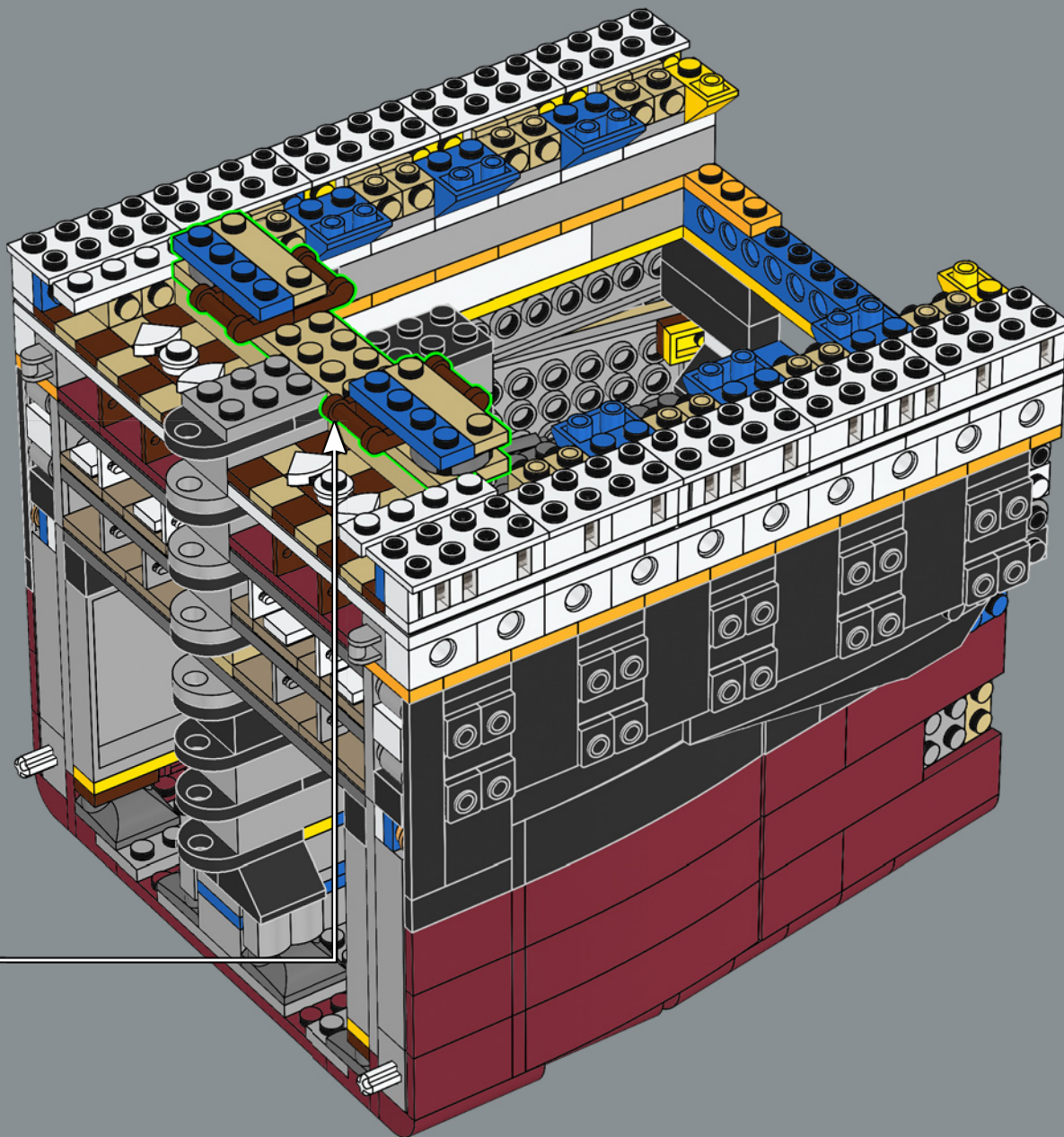
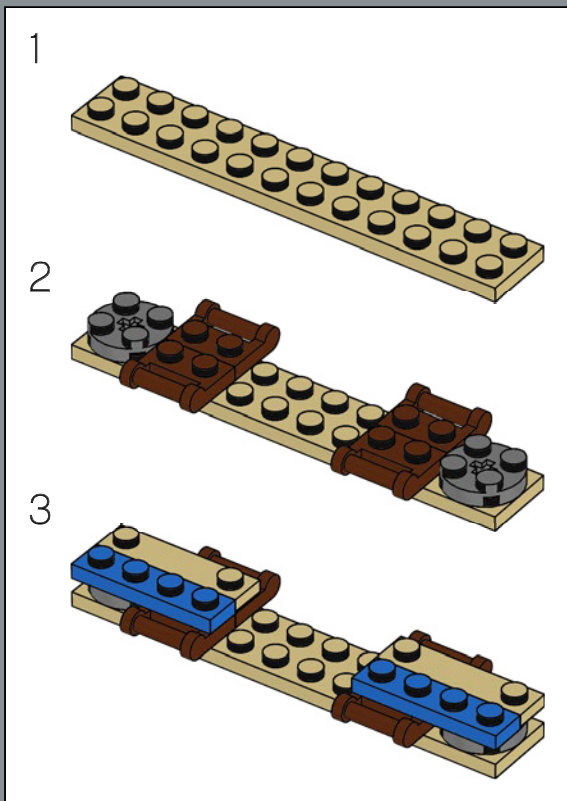

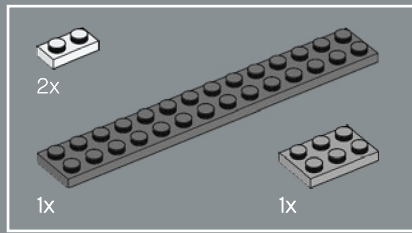

103

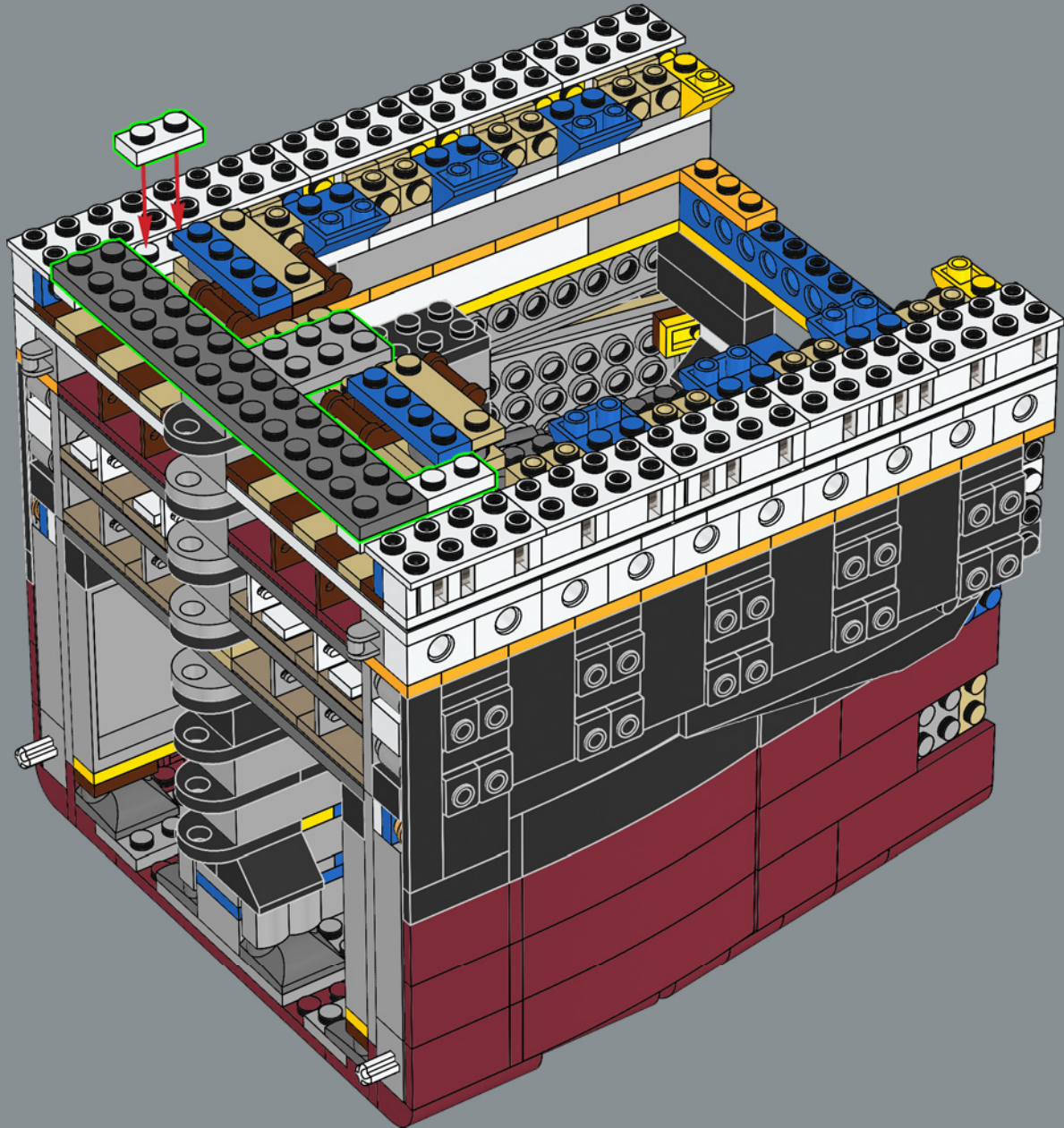

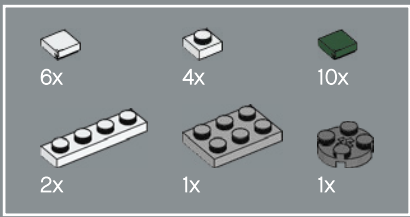

104

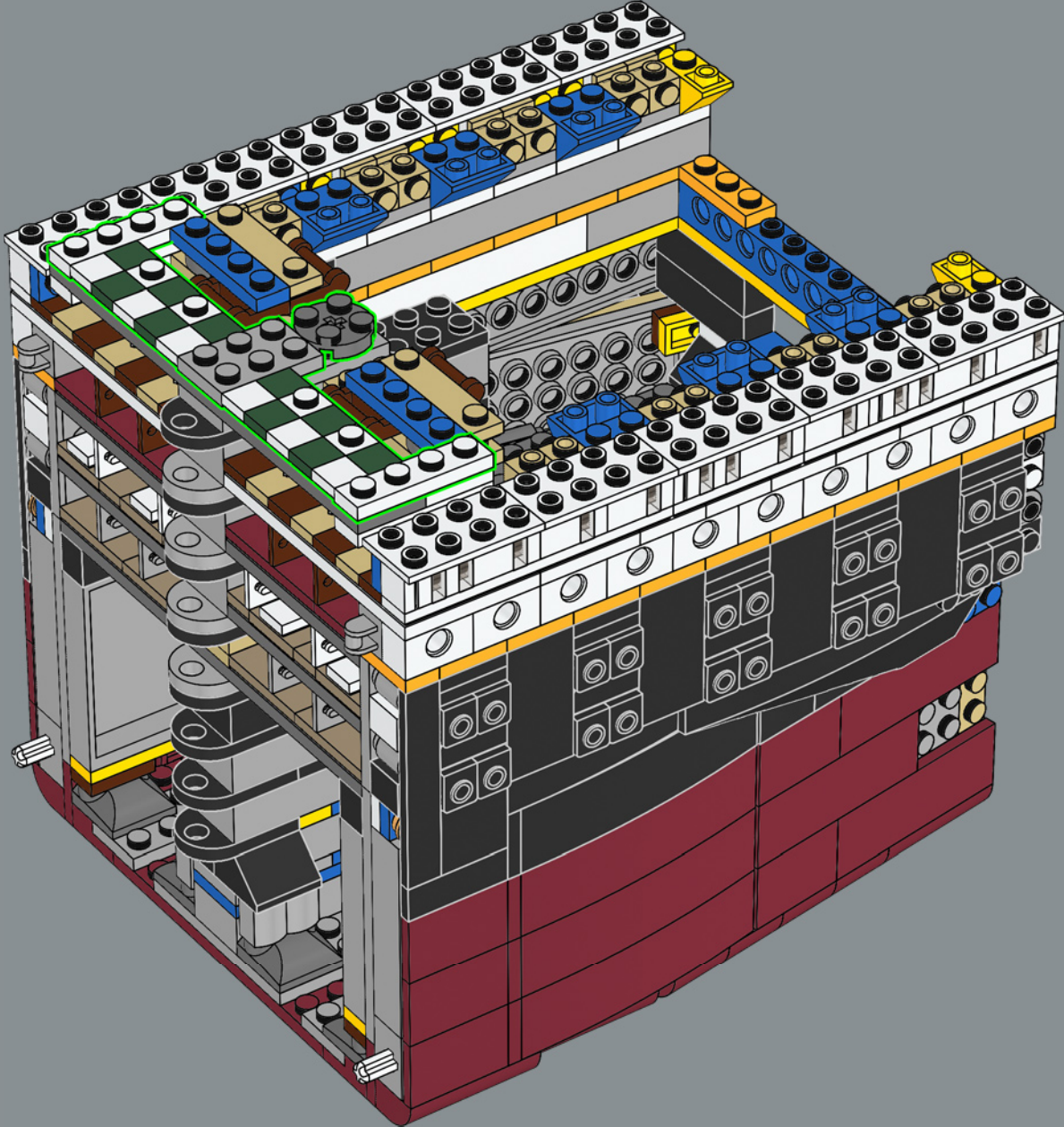



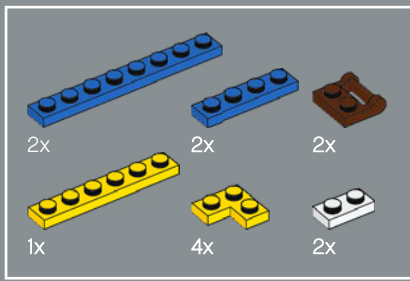

105

1

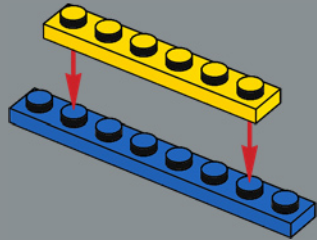

2

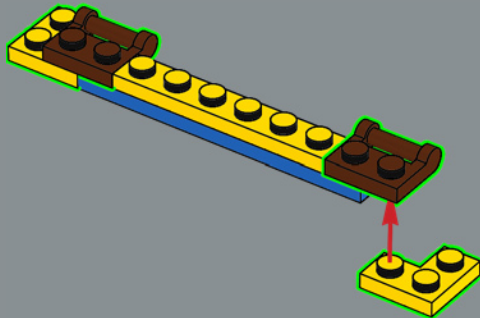

3

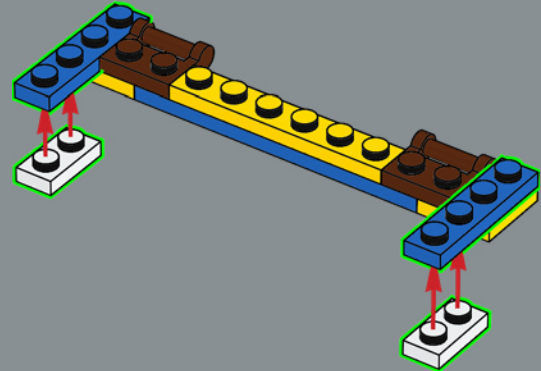

4

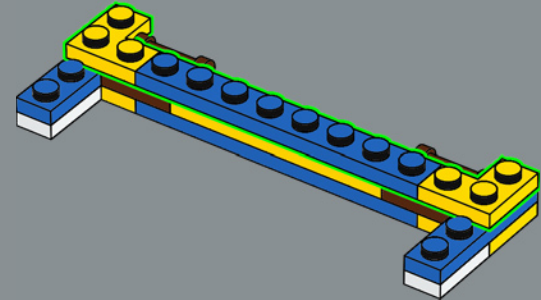

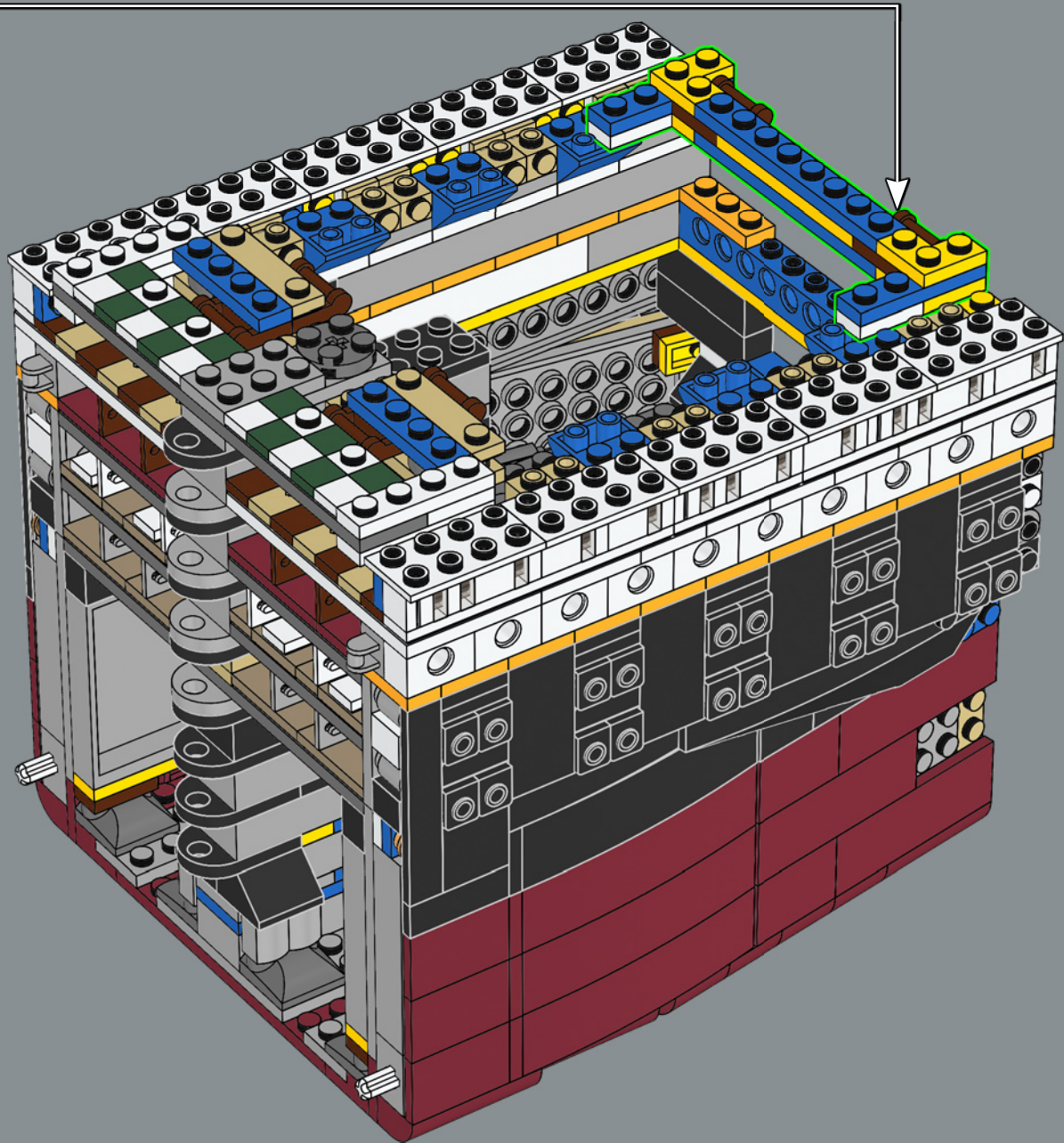

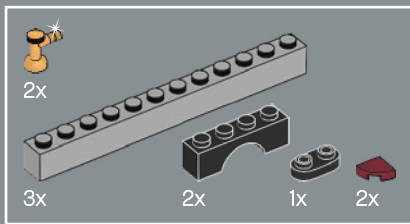

106

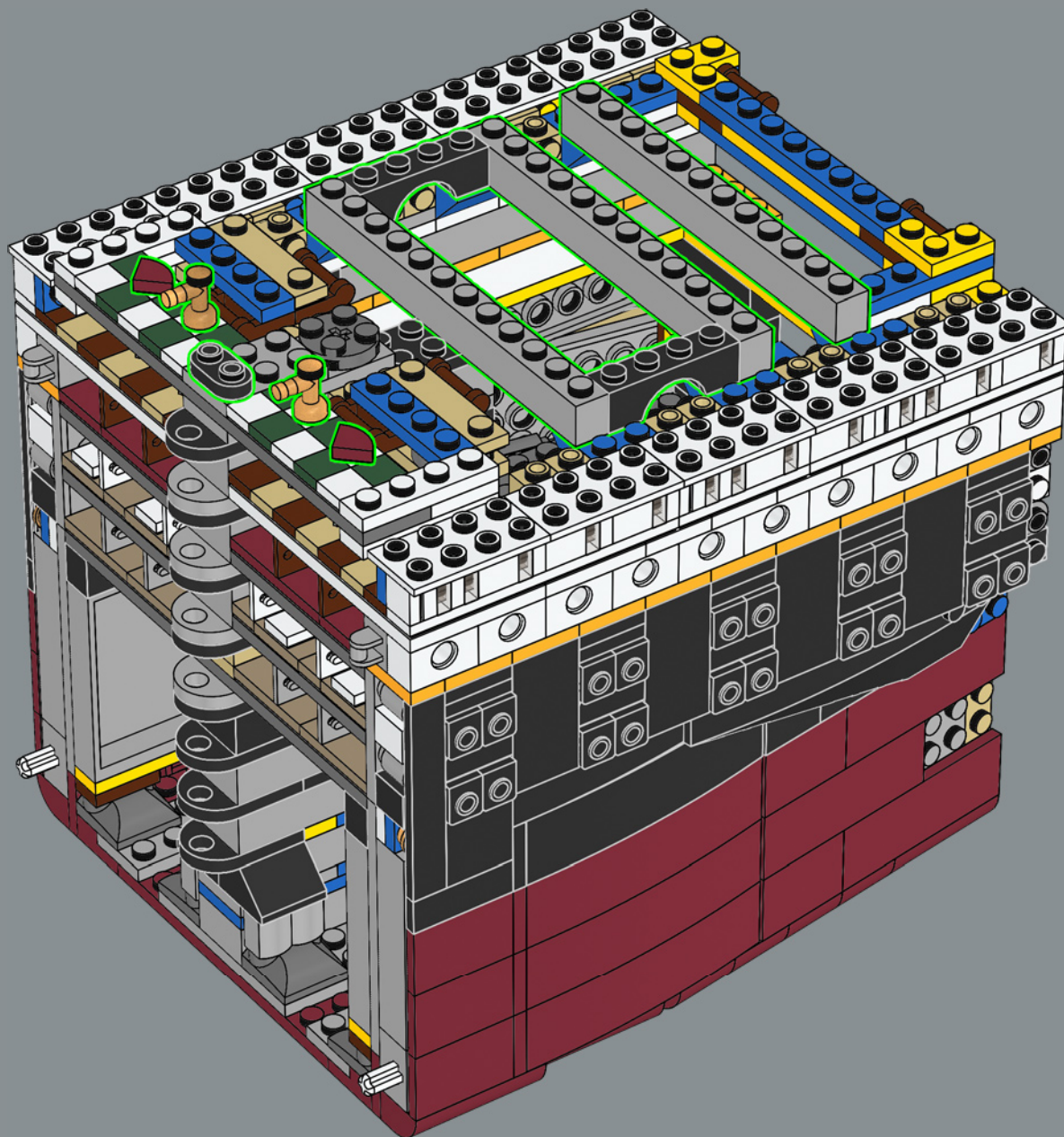

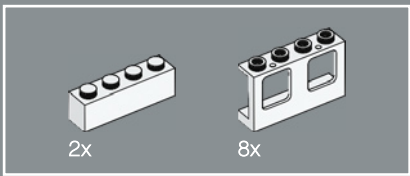

107

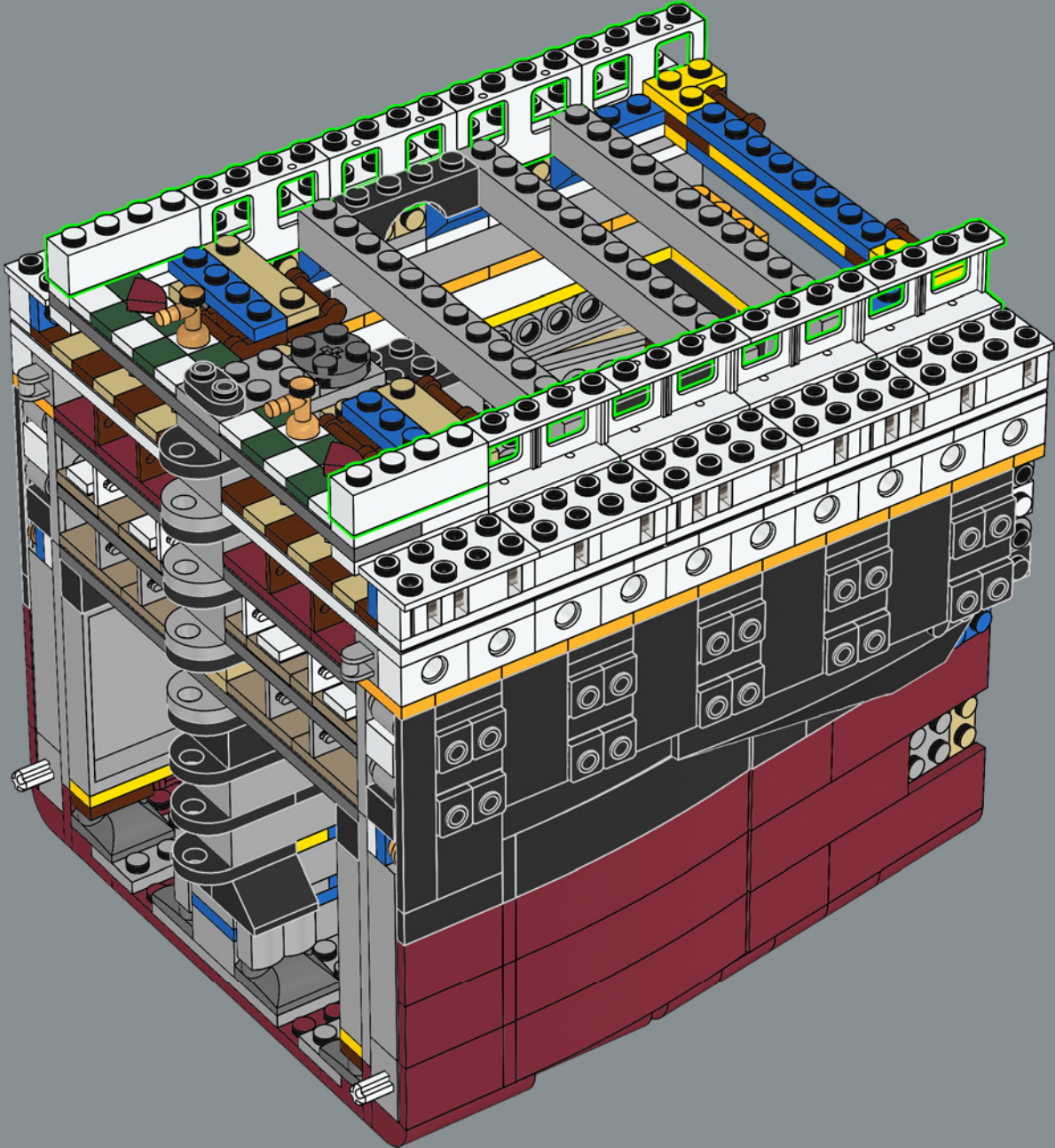

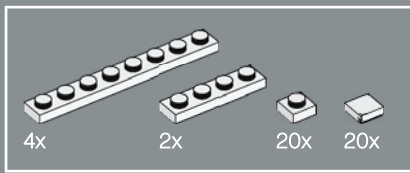

108

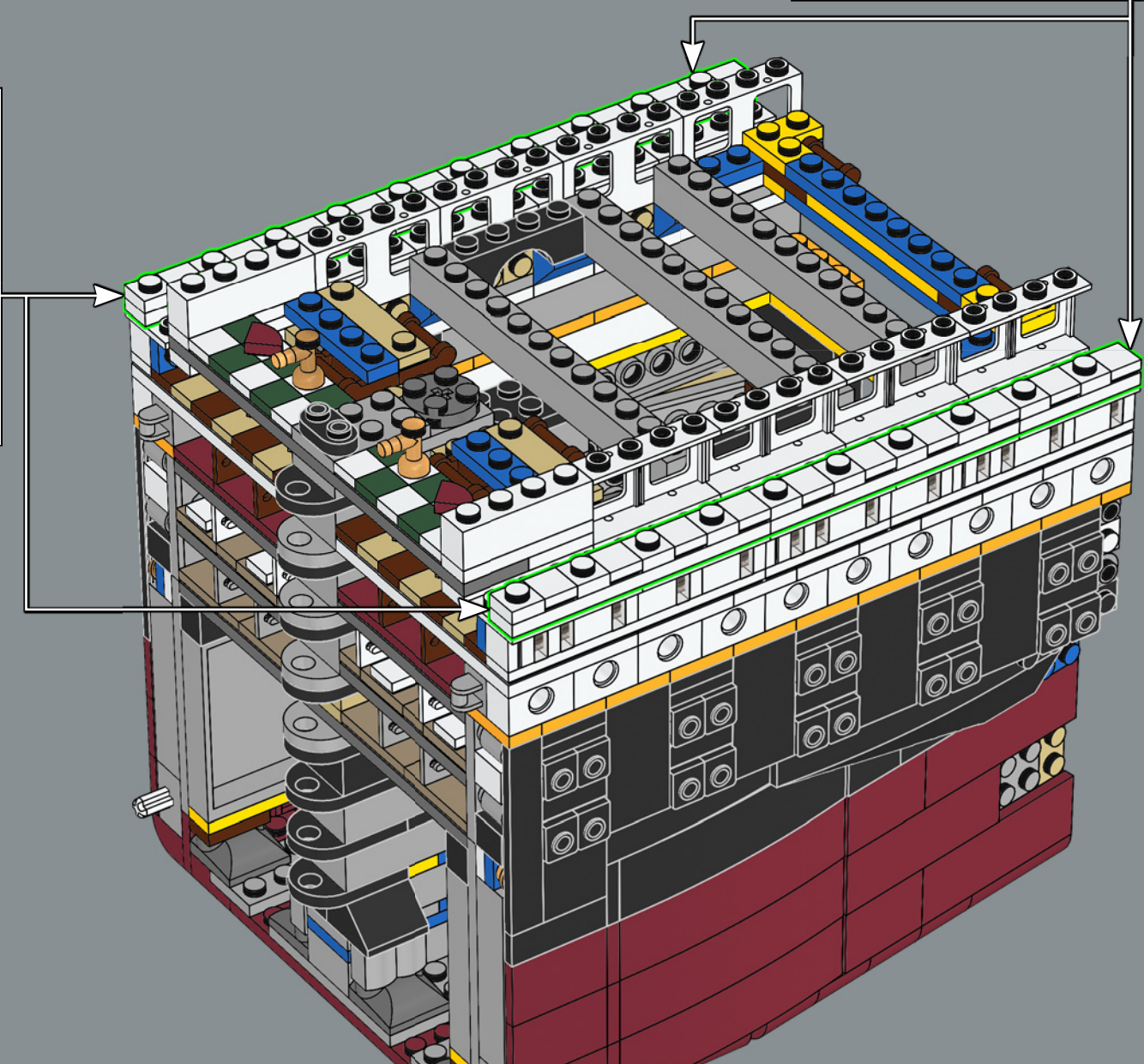
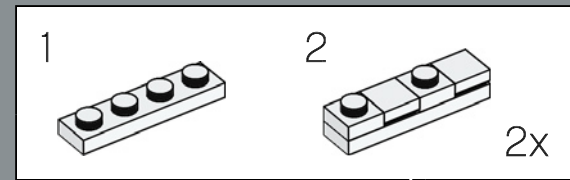
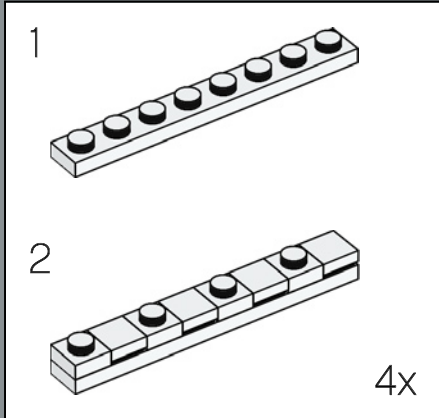



20x

109

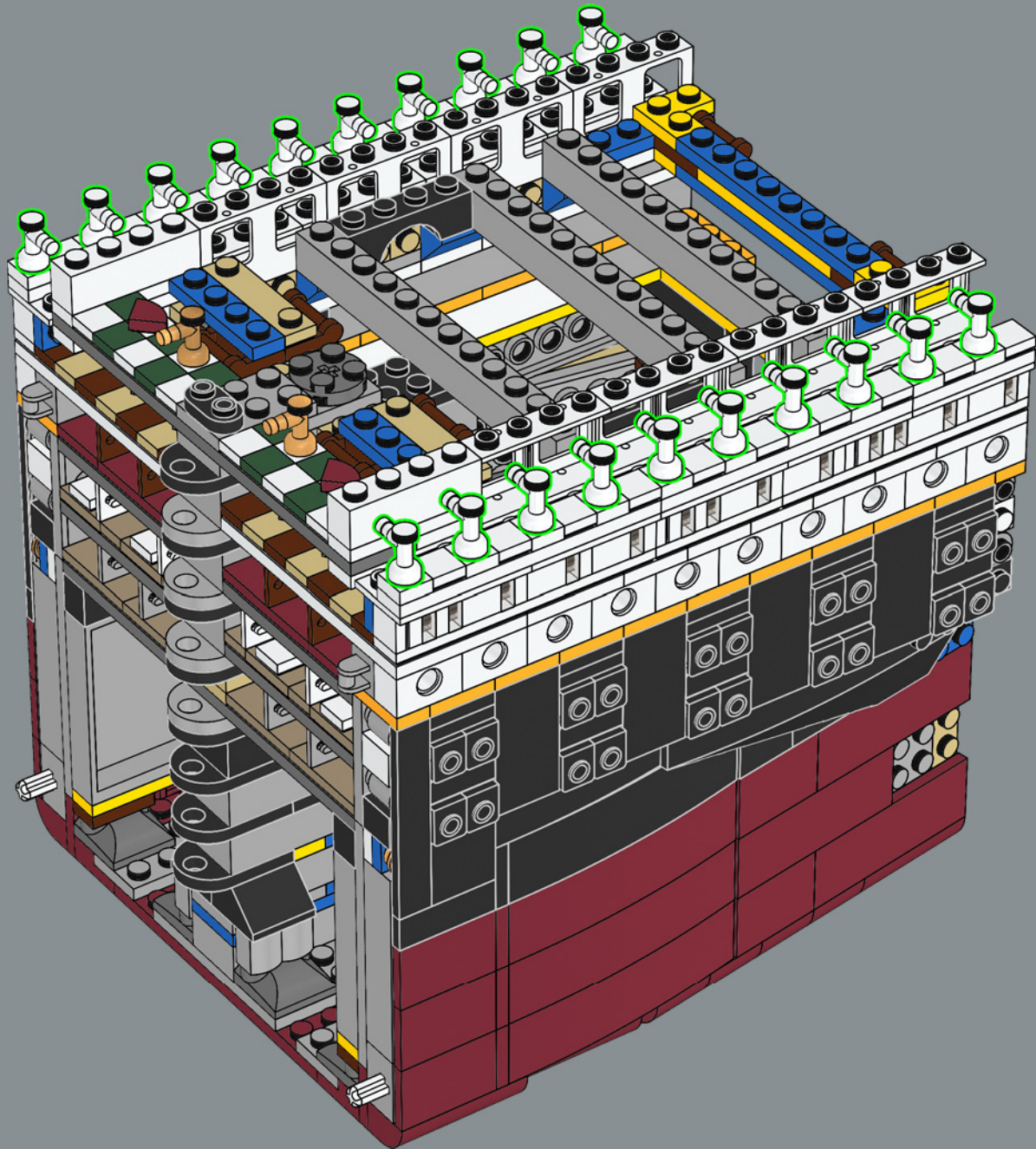

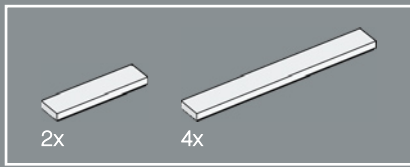

110

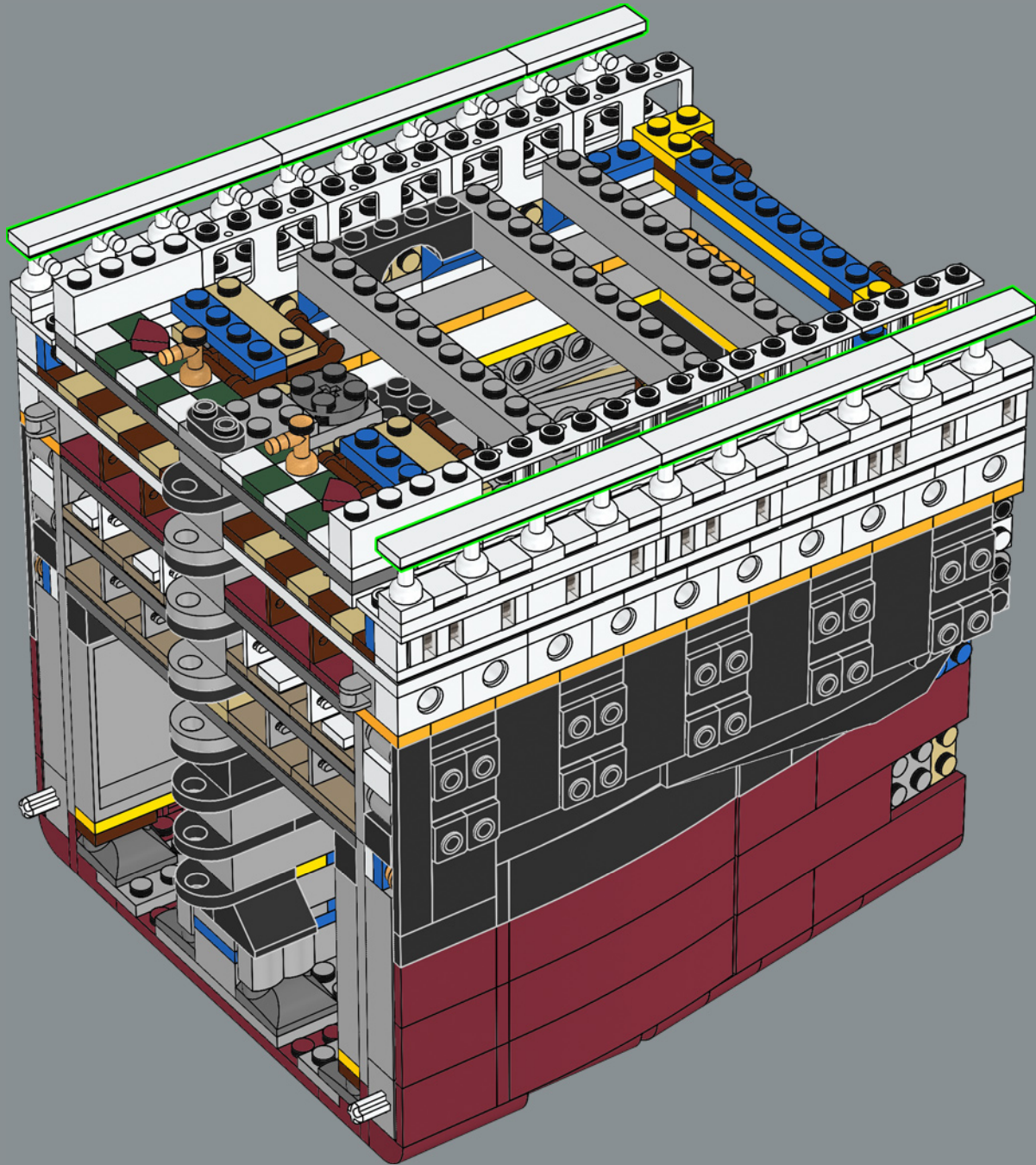

34

2x

4x

2x

111

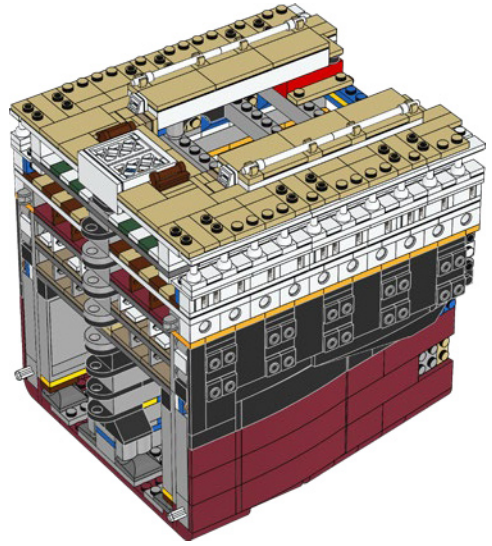
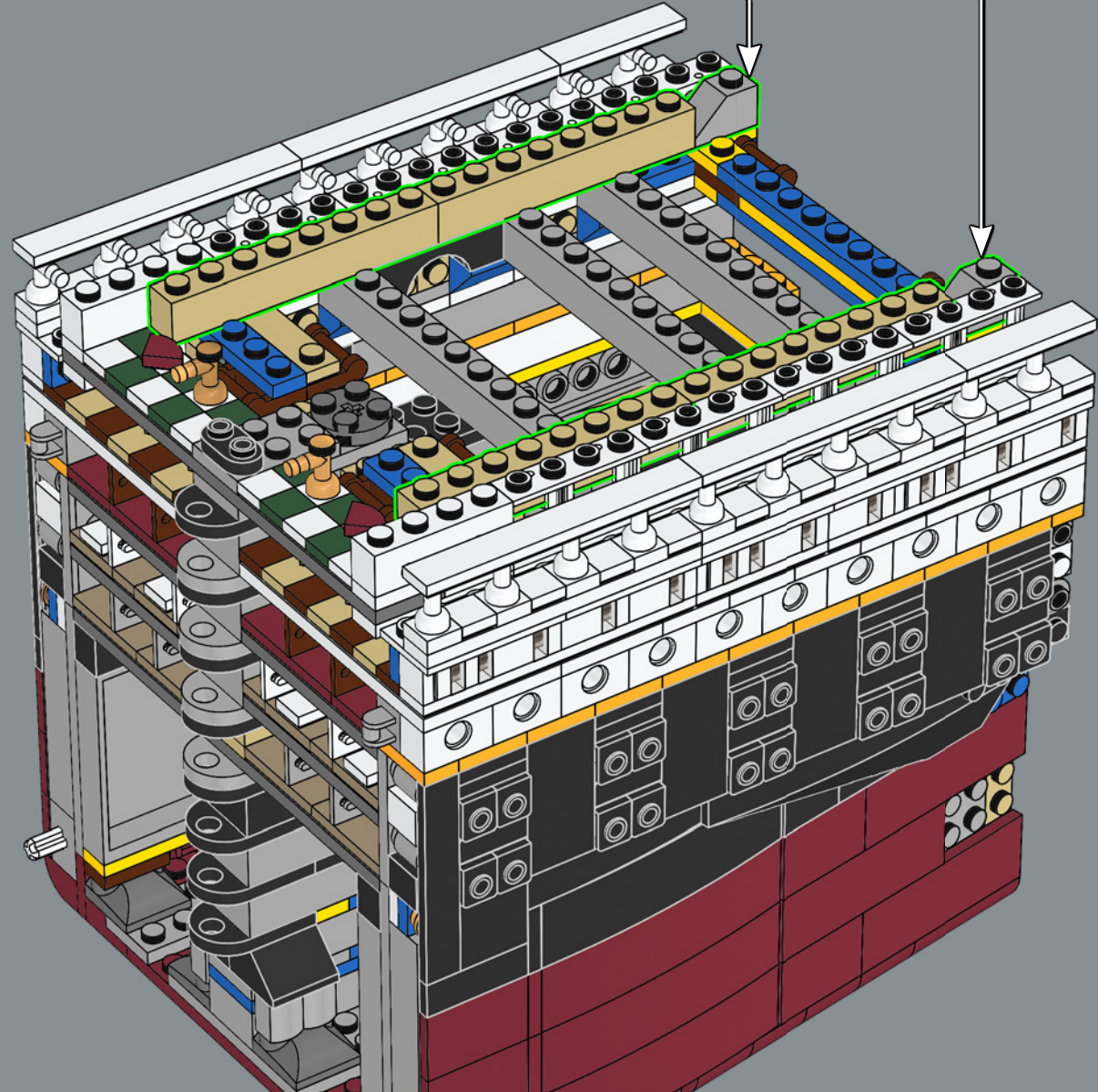



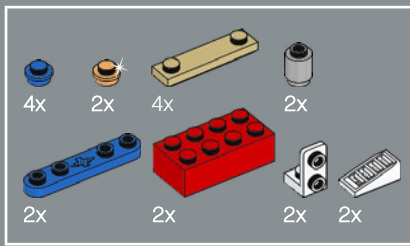

112

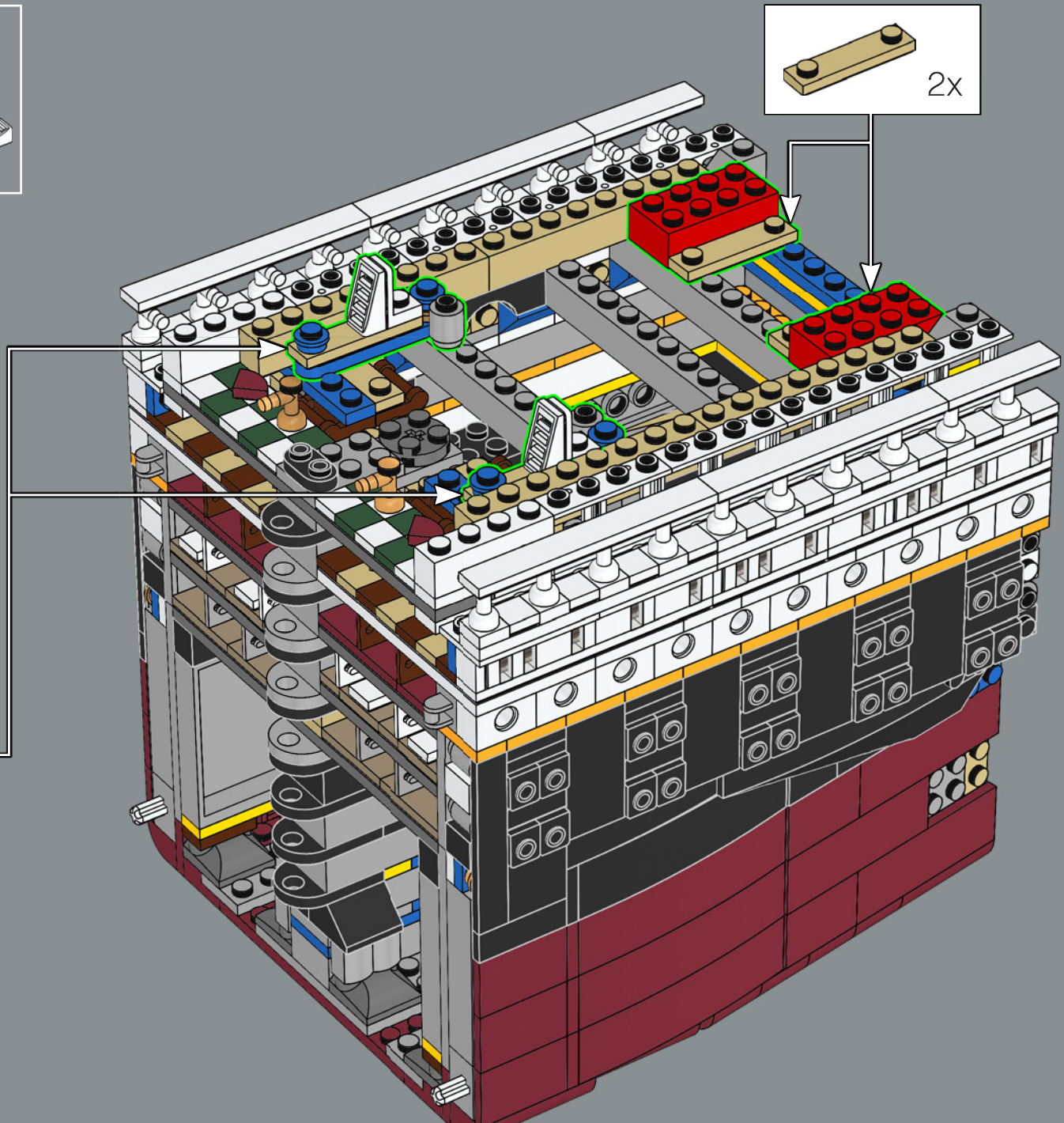
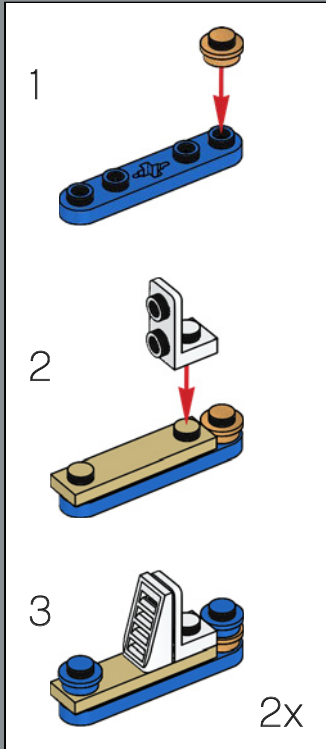

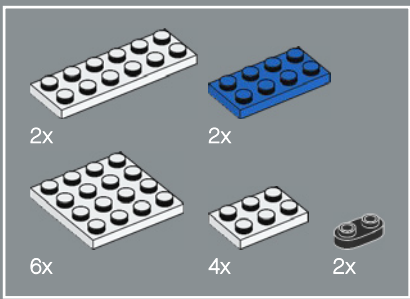

113

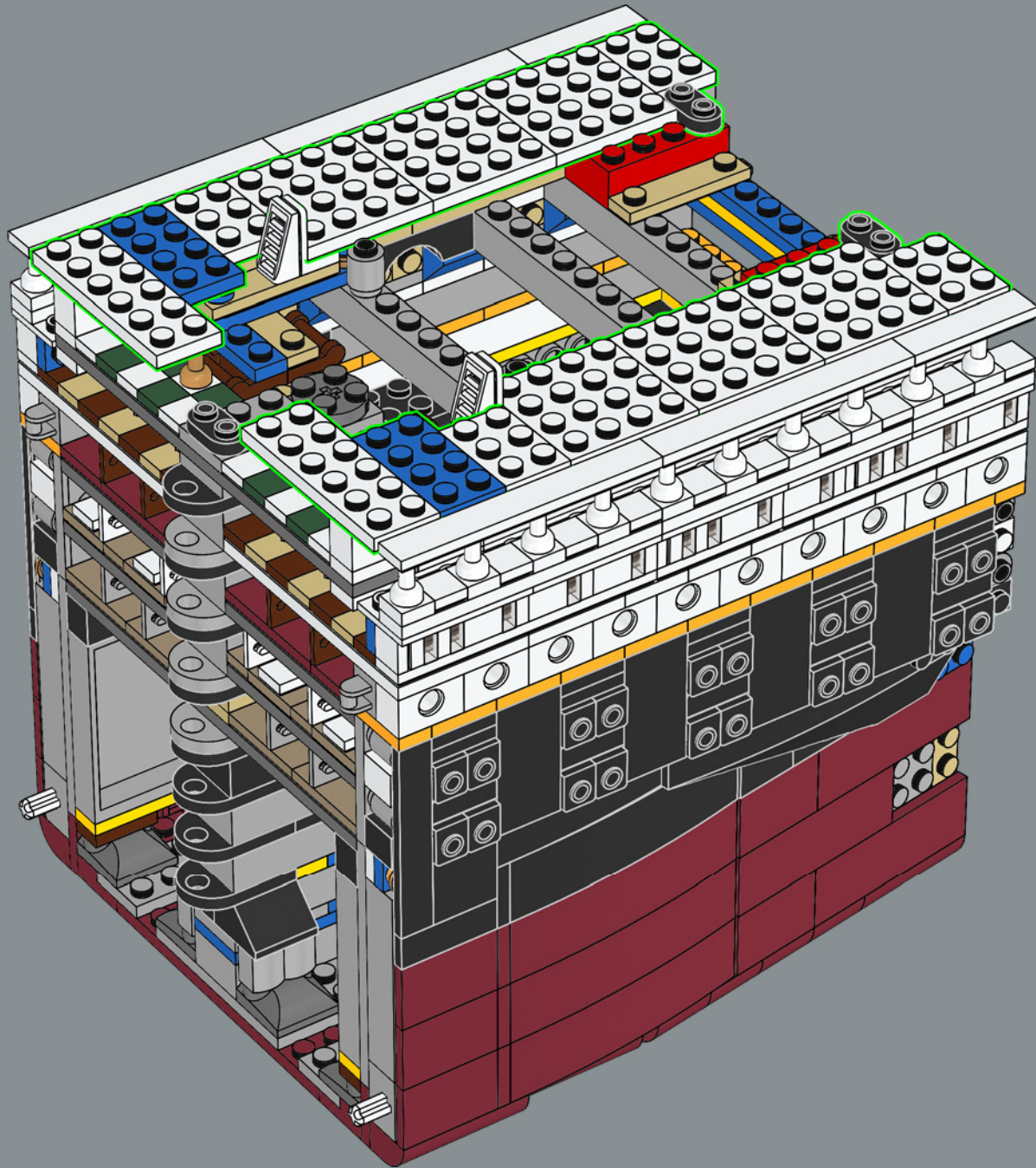

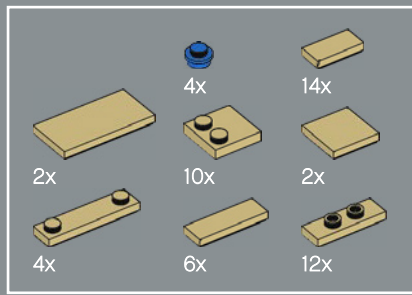

114

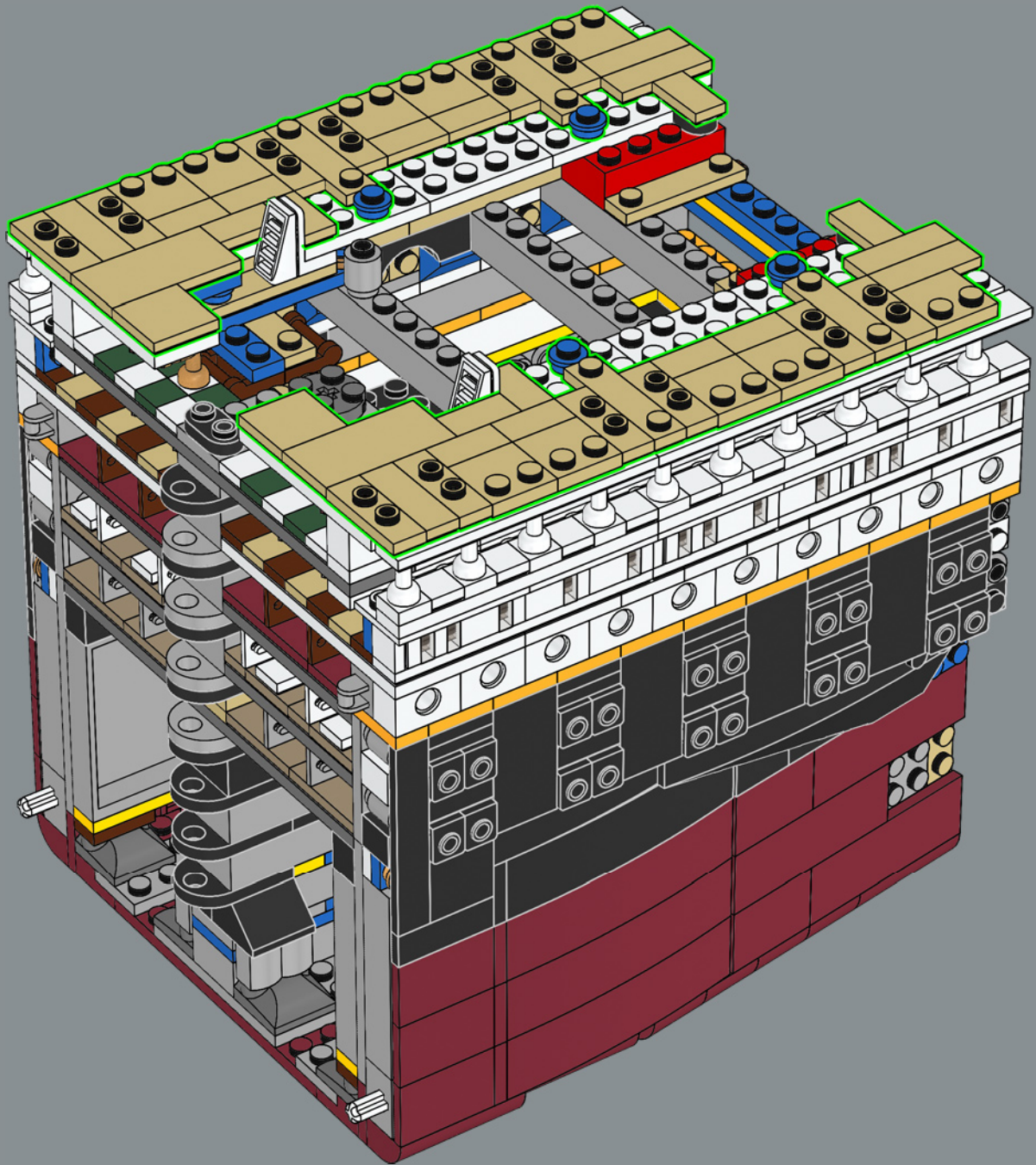

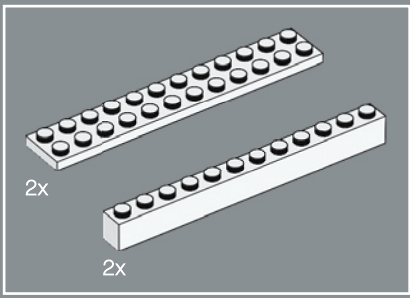

115

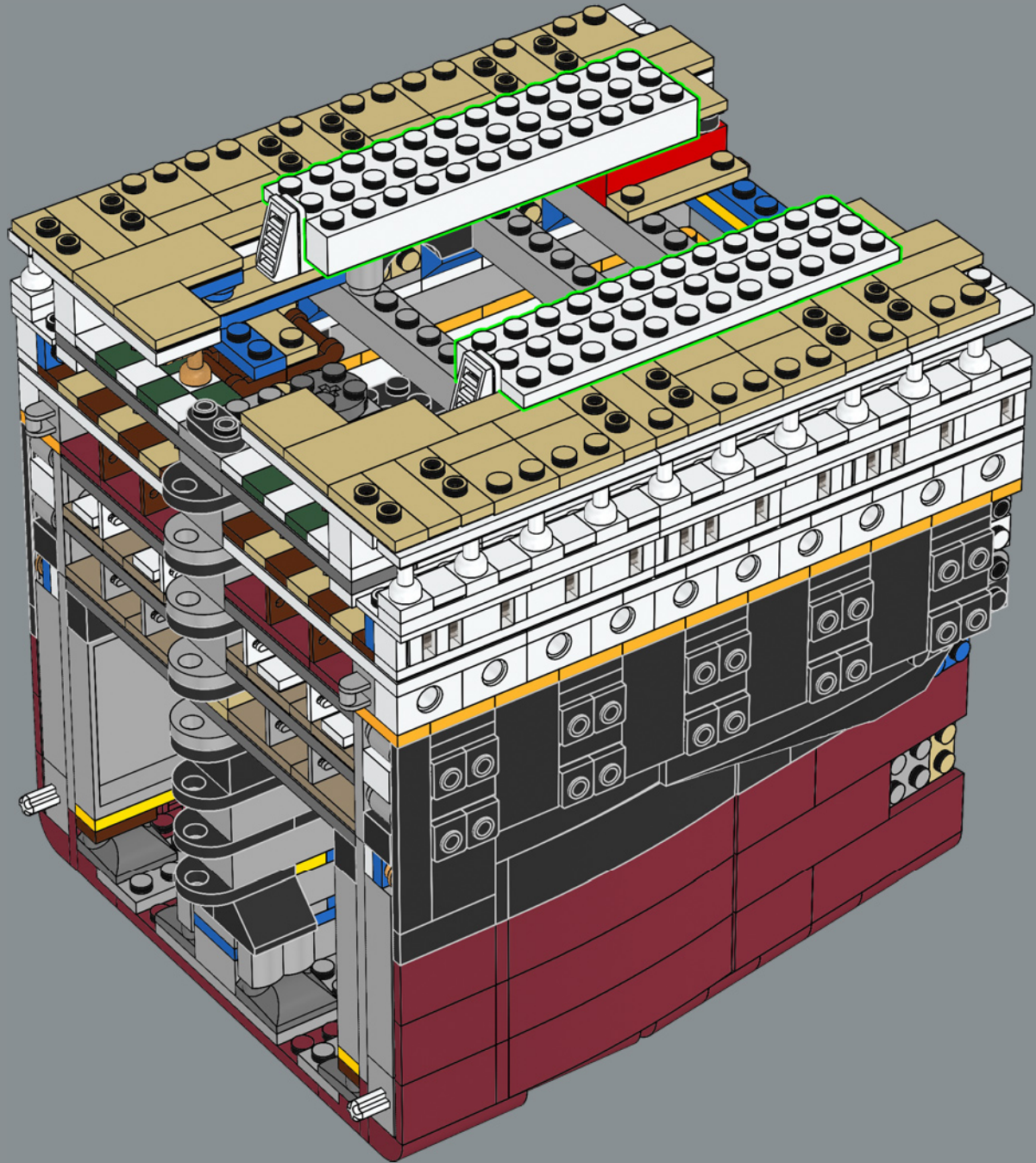

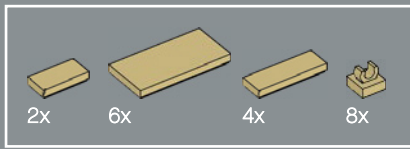

116

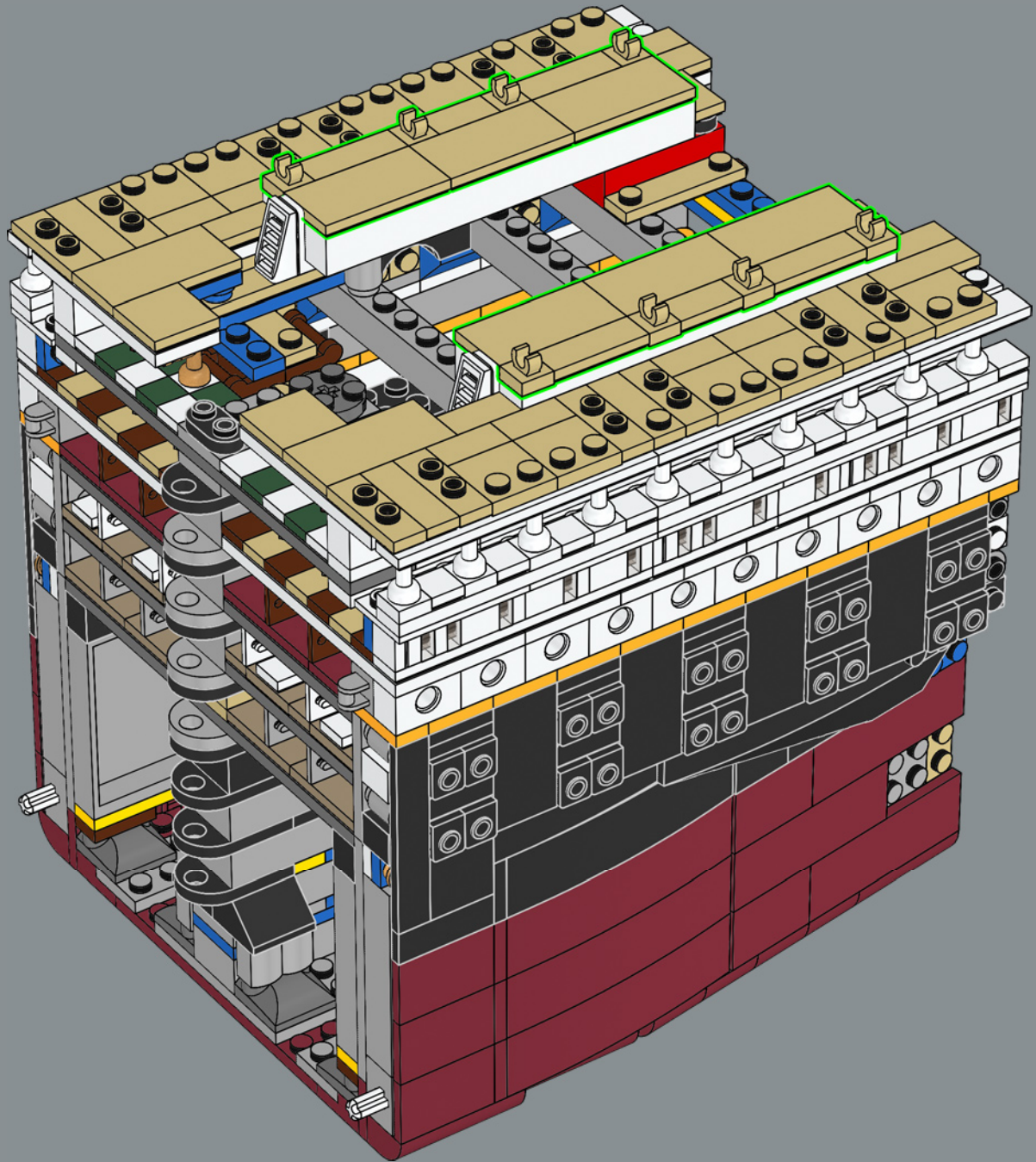

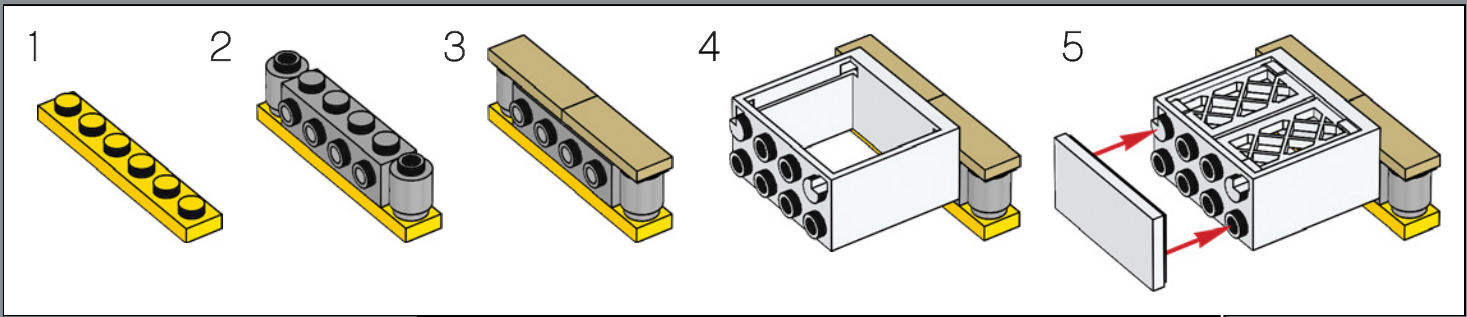
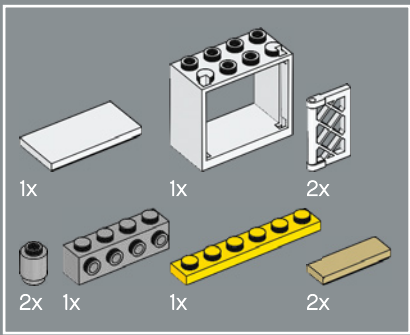

117

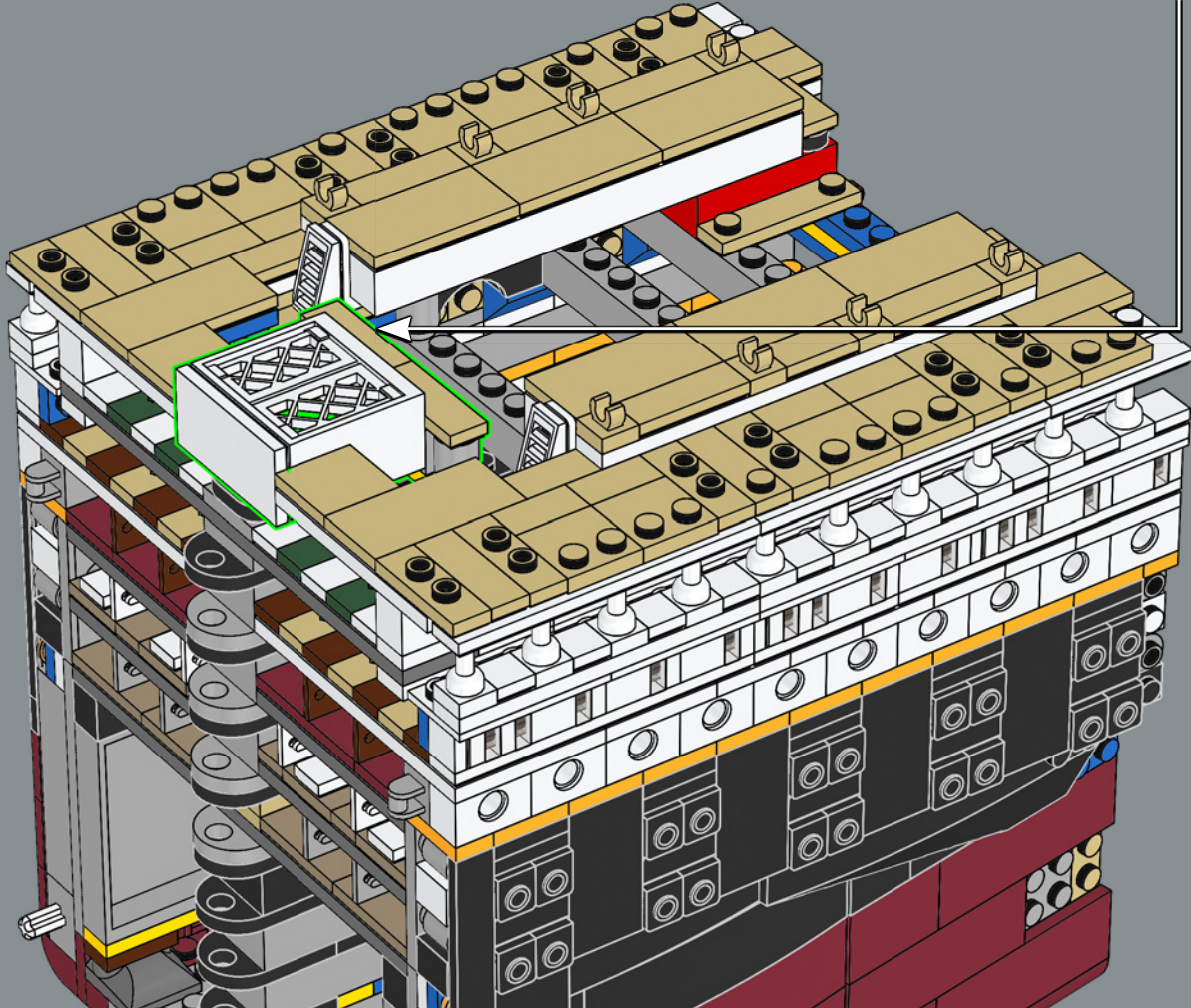

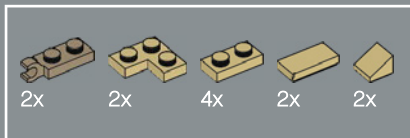

118

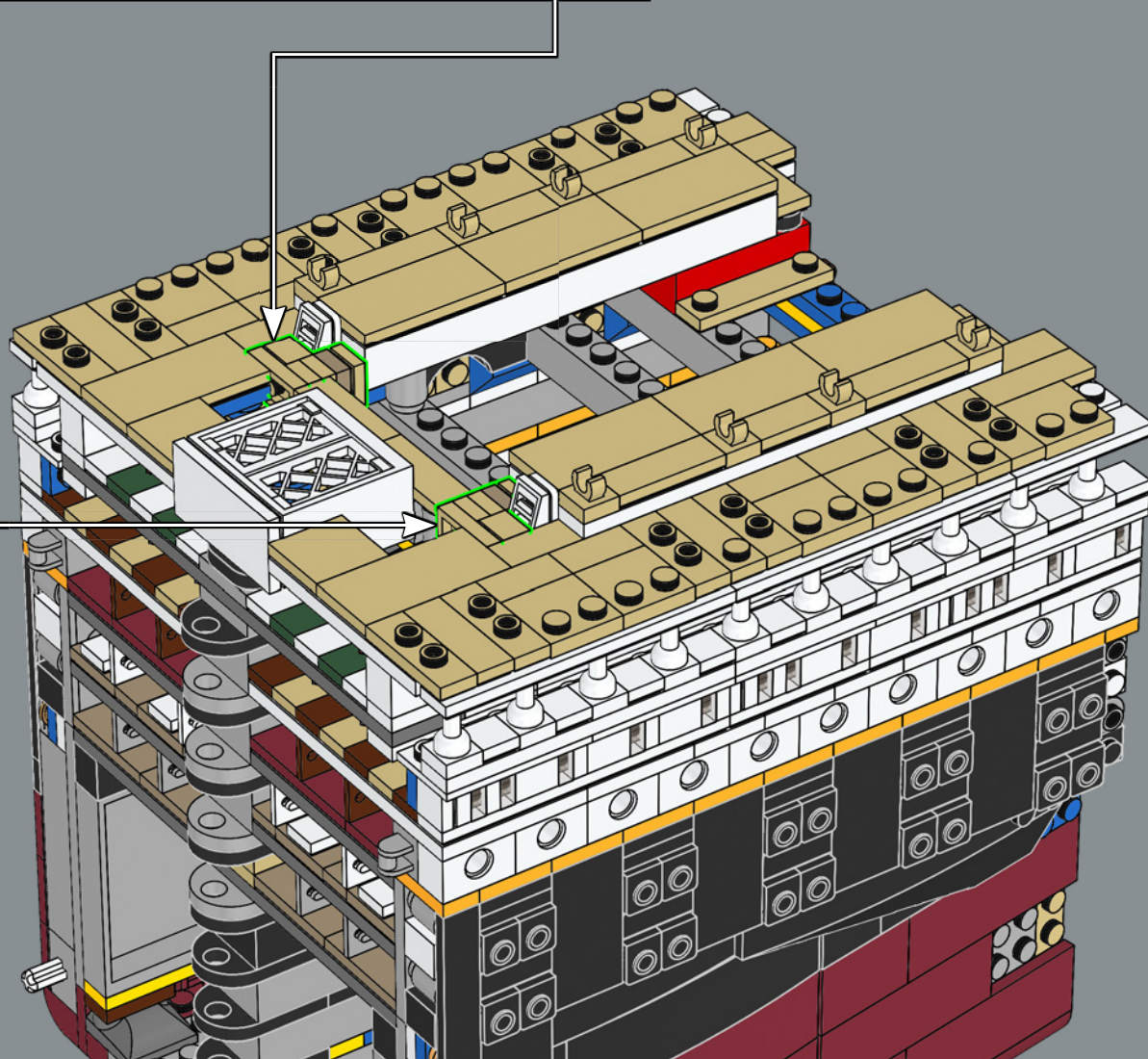
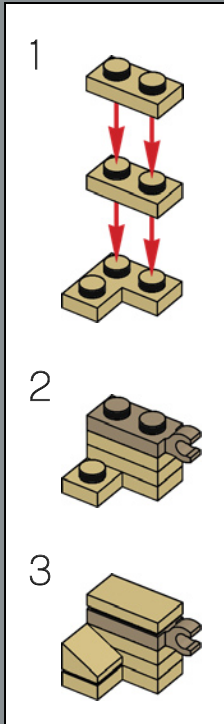
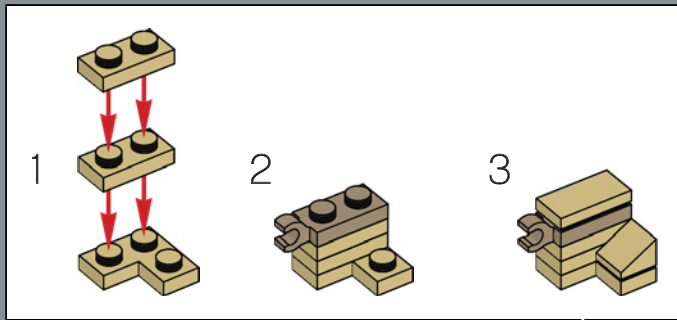

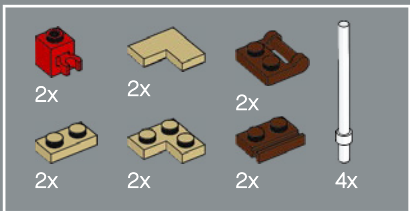

119

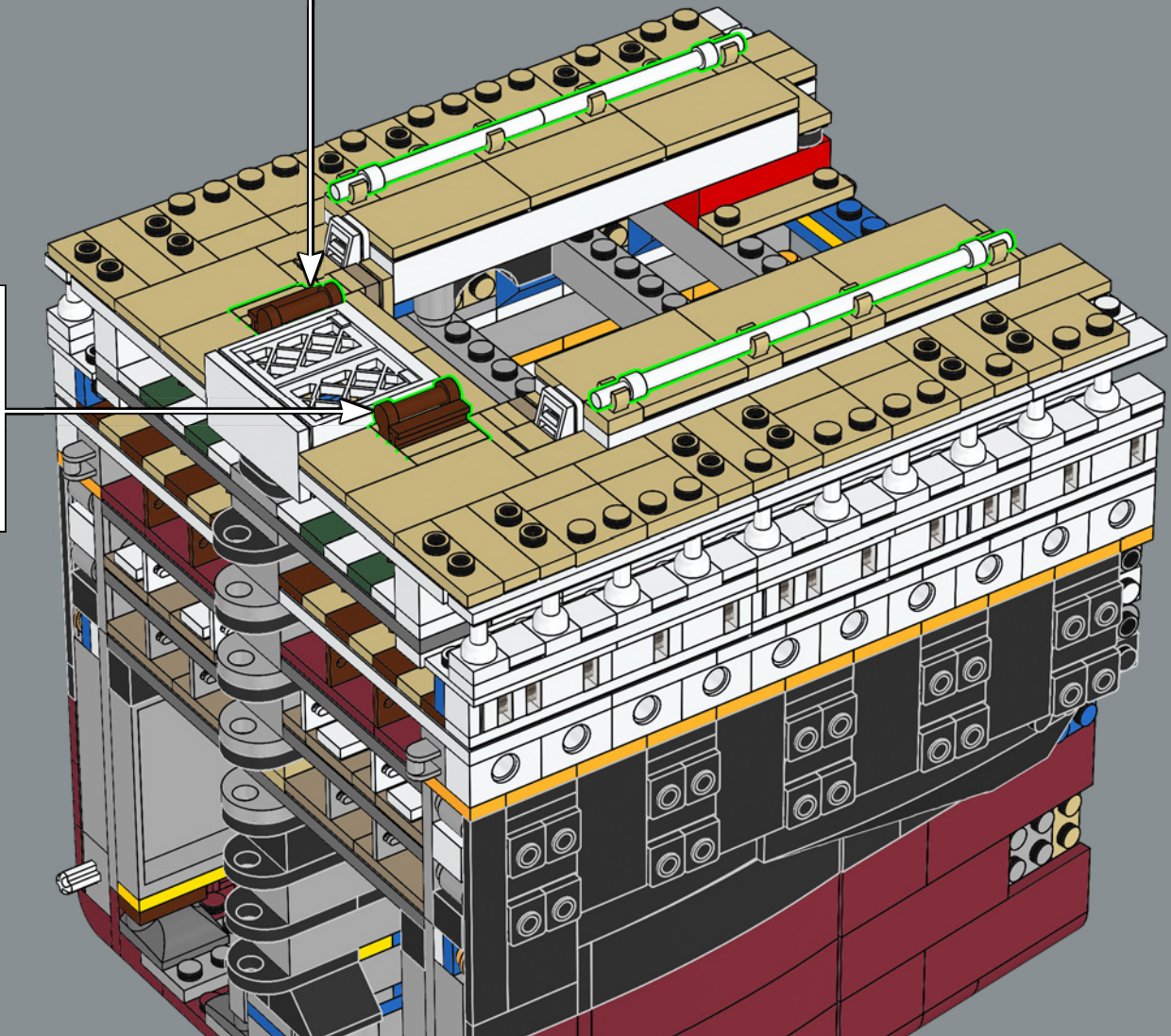
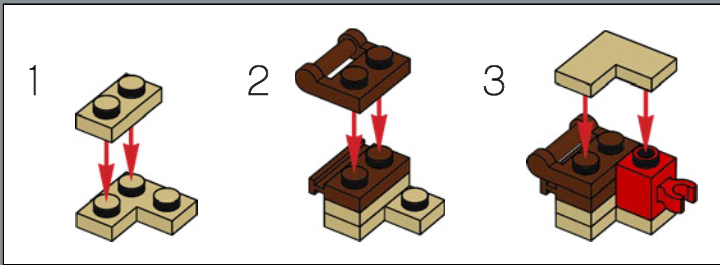
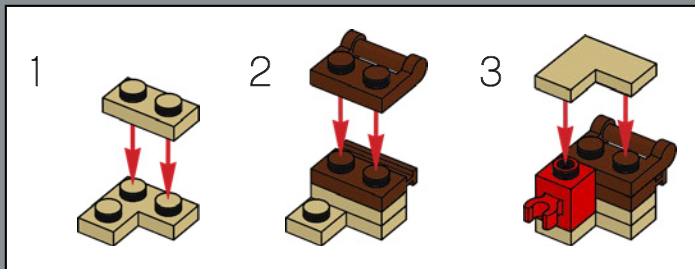



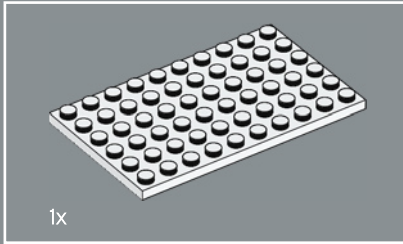
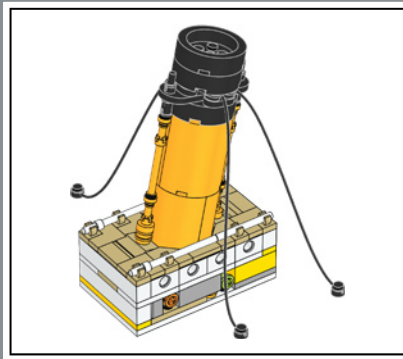
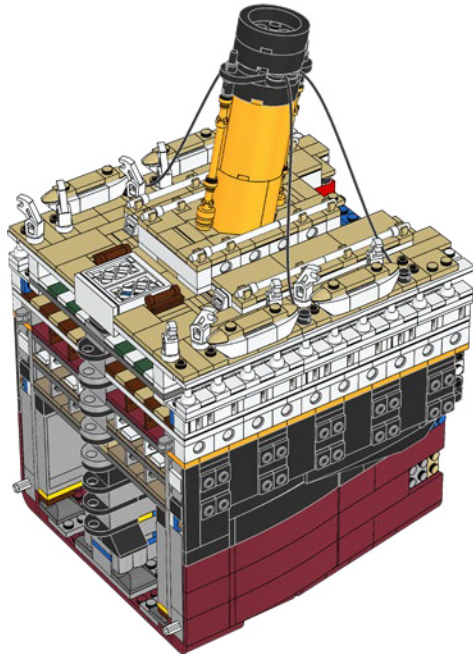
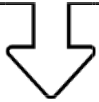

120

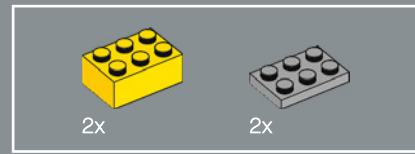
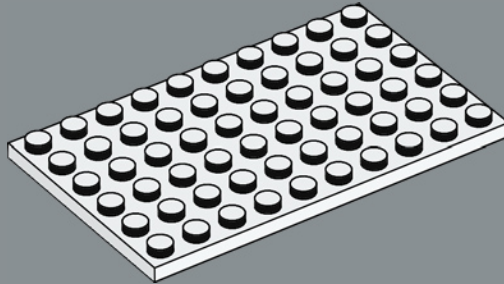

121

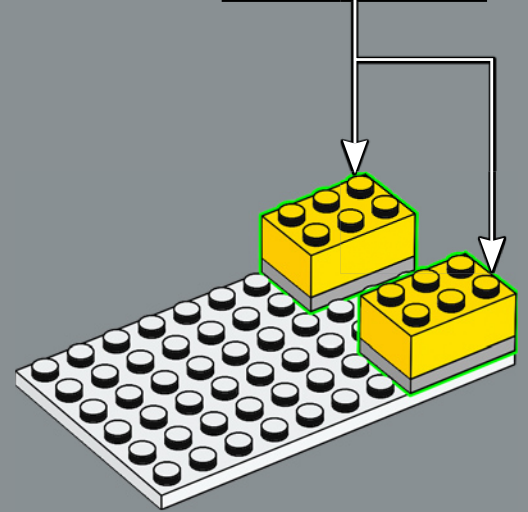
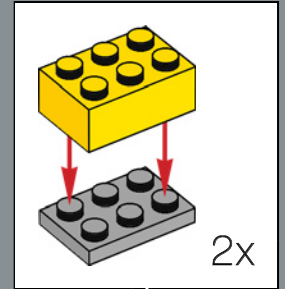

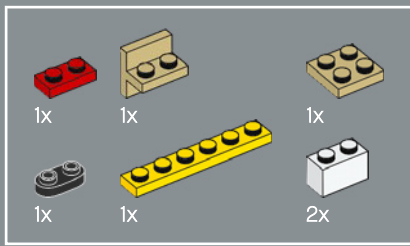

122

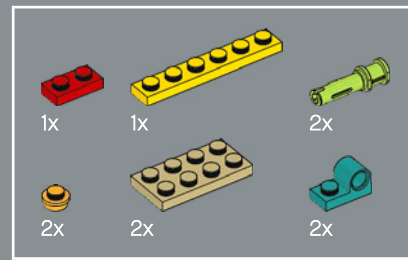
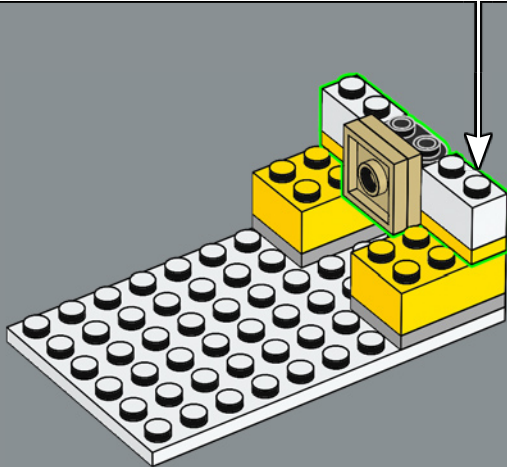
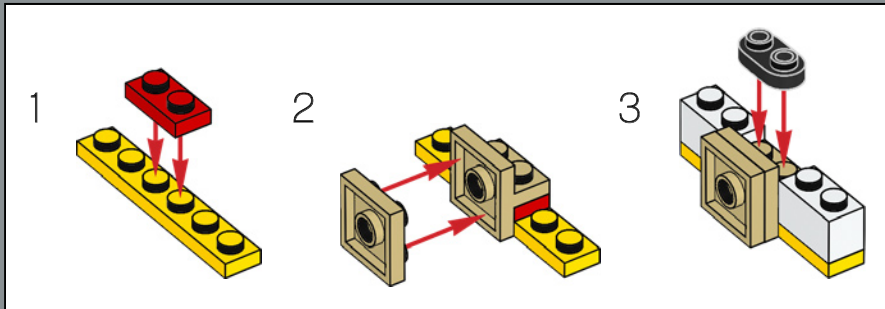

123

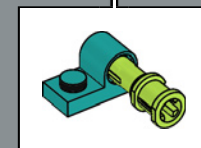
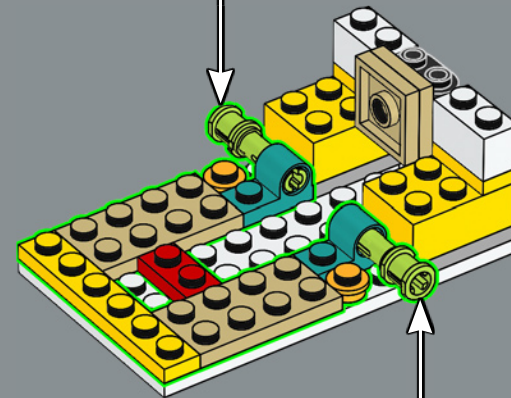
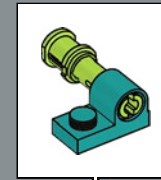

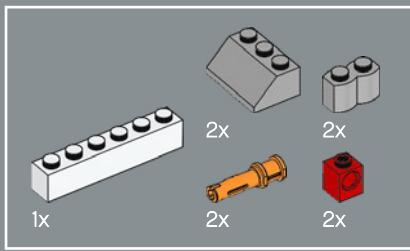

124

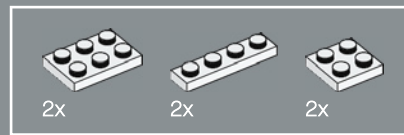
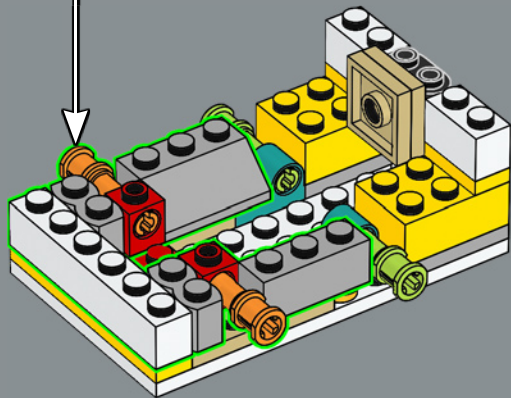
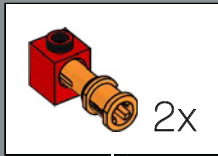

125

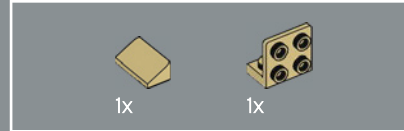
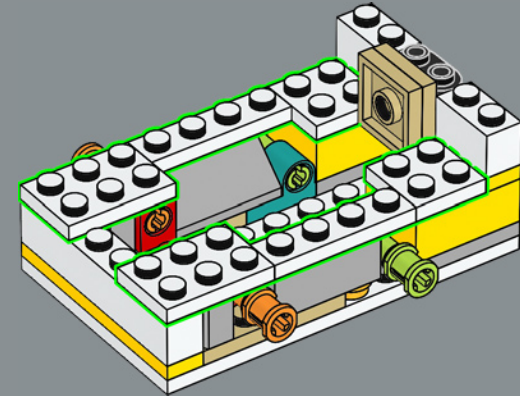

126

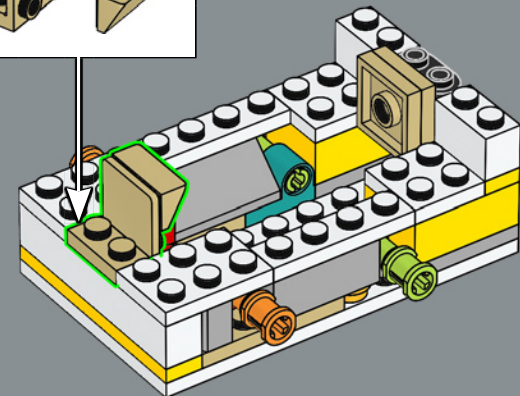
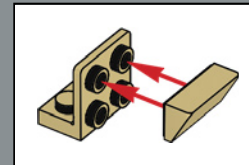

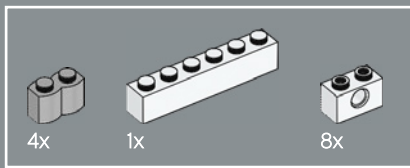

127

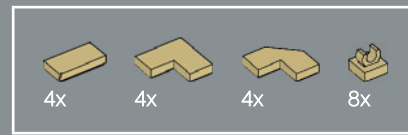
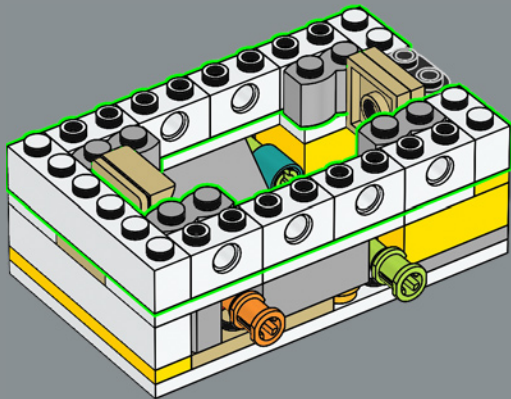

128

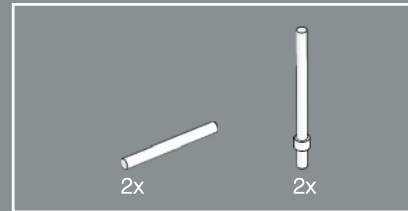
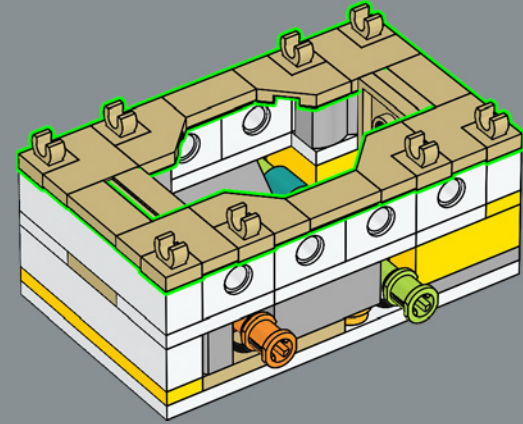

129

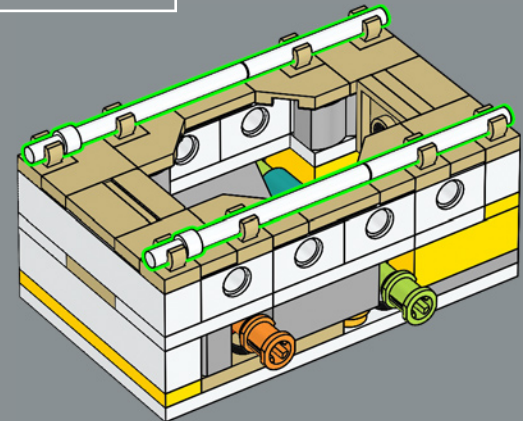

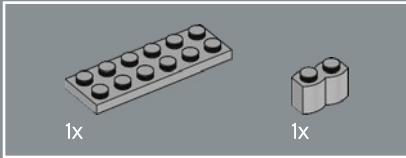
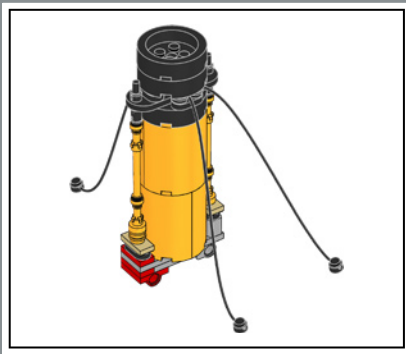

130

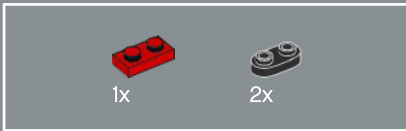
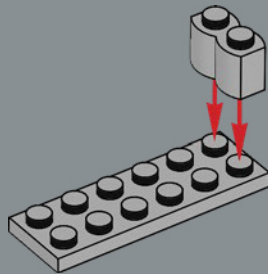

131

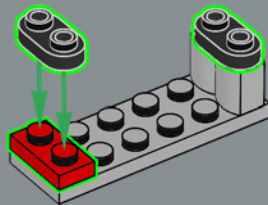

132

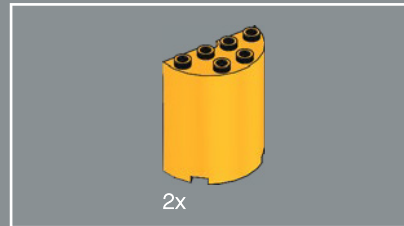
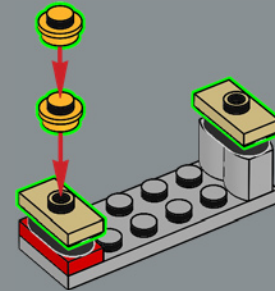

133

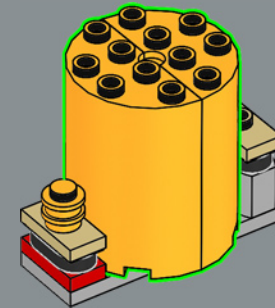

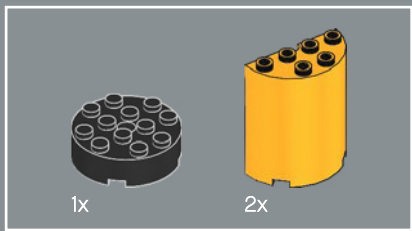

134

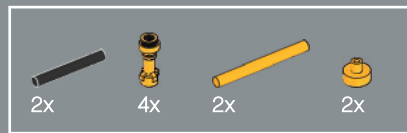
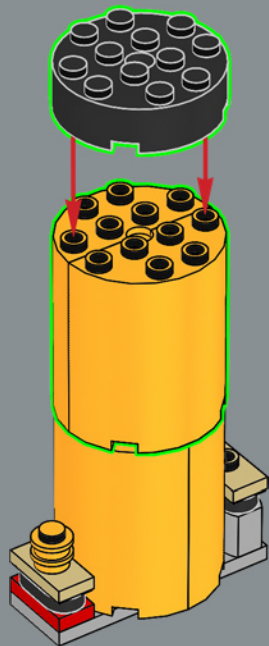

135

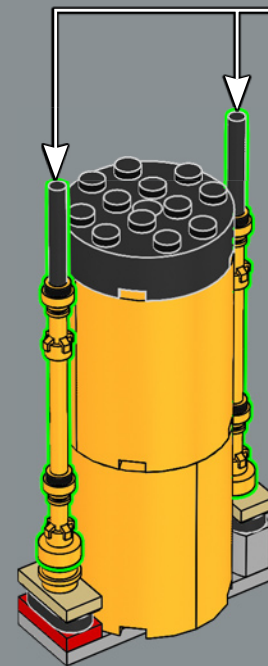
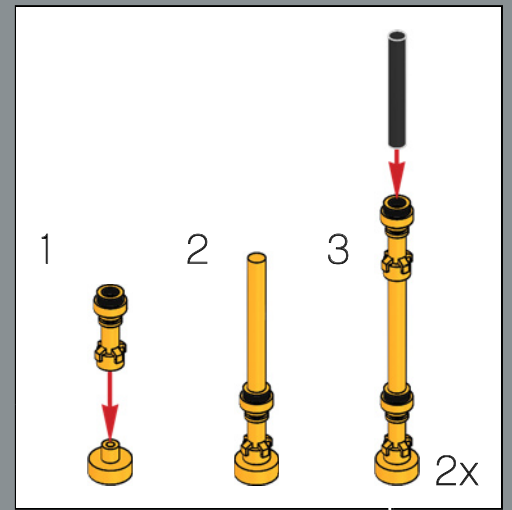

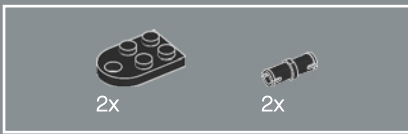

136

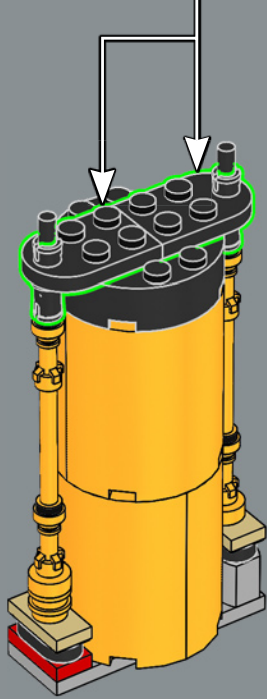
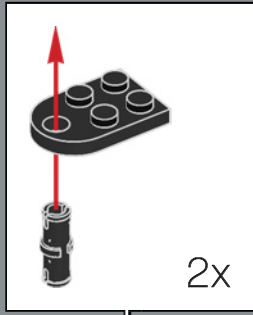

137

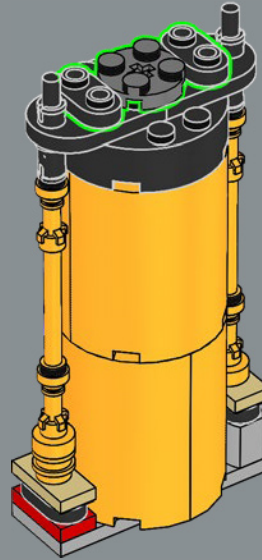

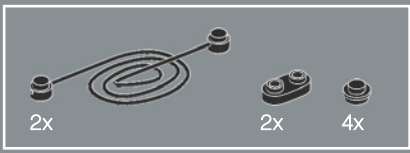

138

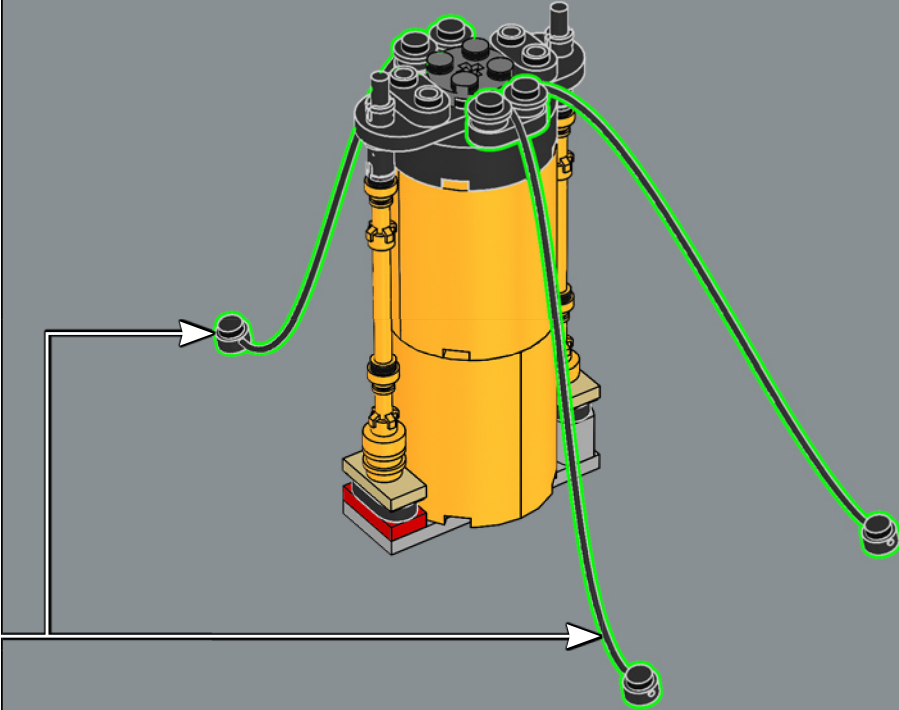
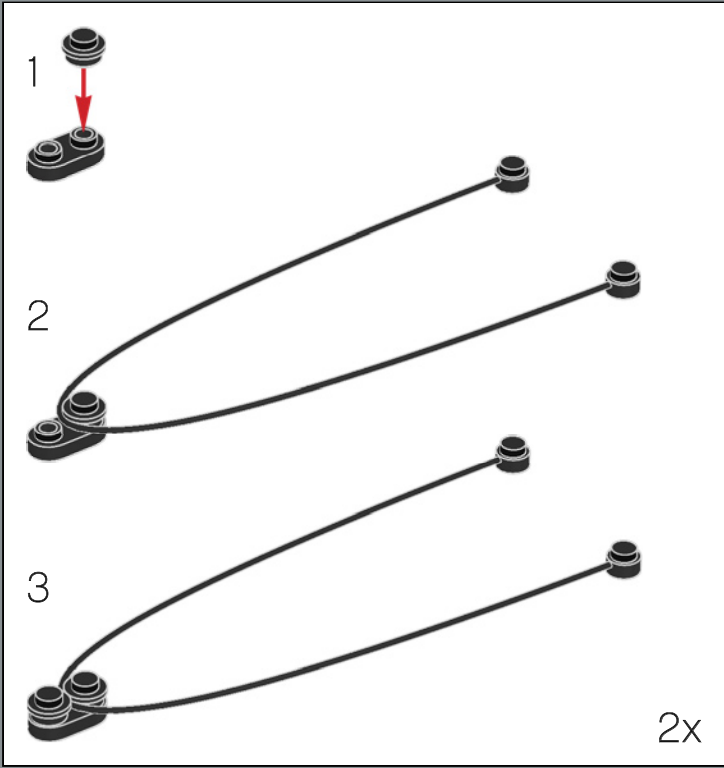



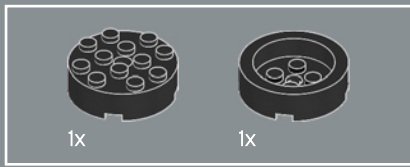

139

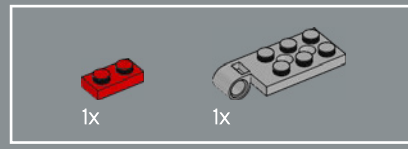
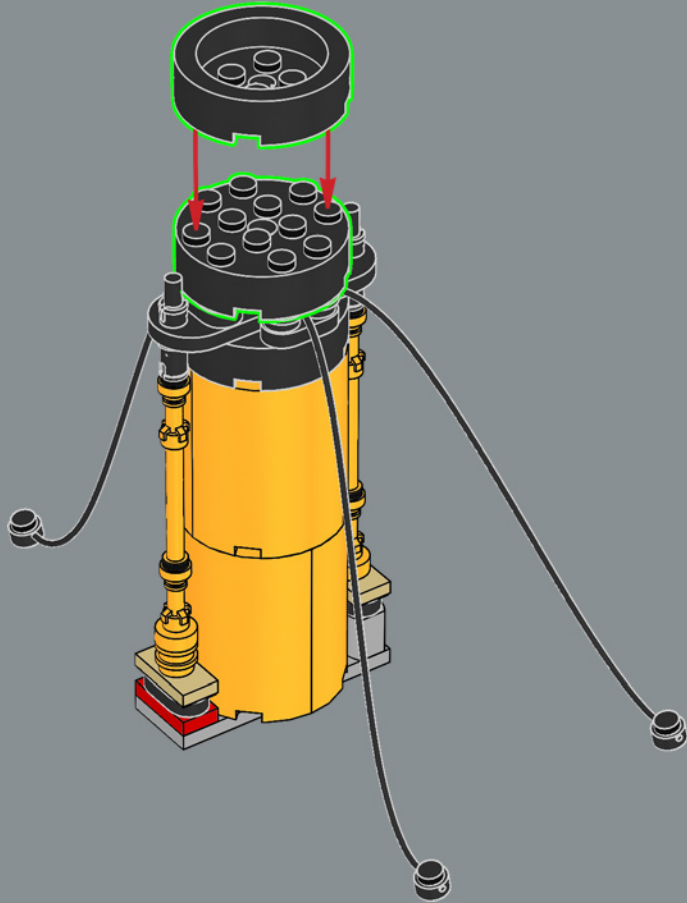

140

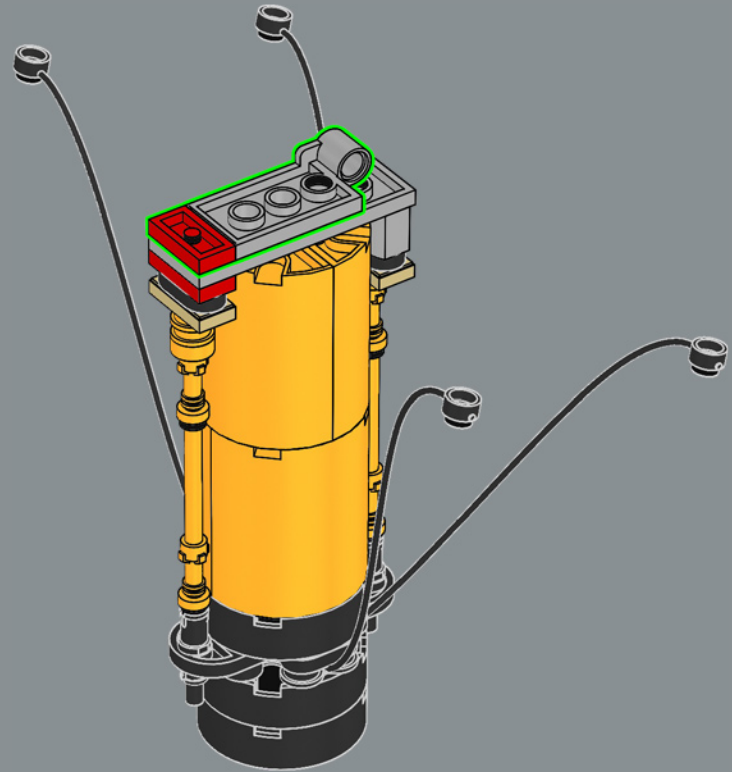

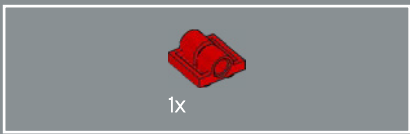

141

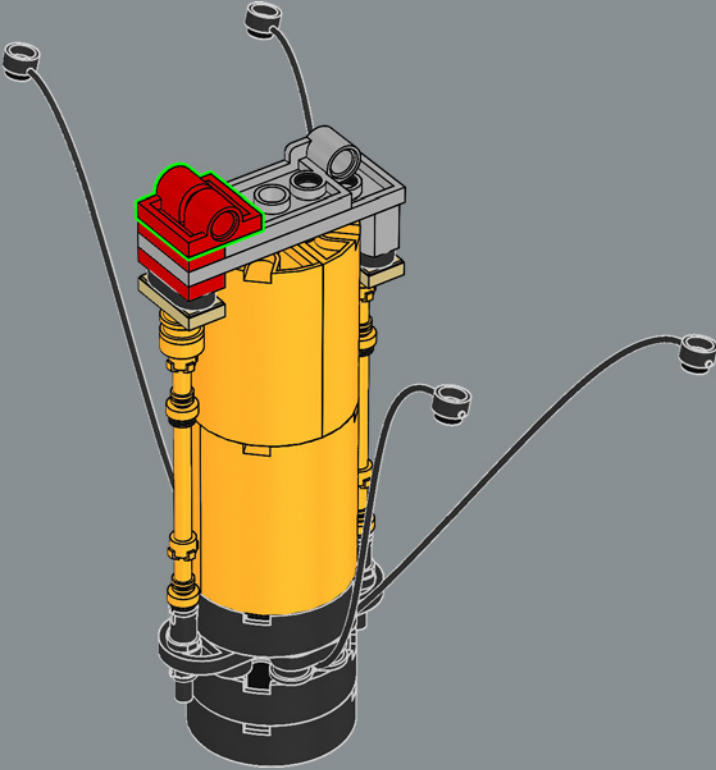

142

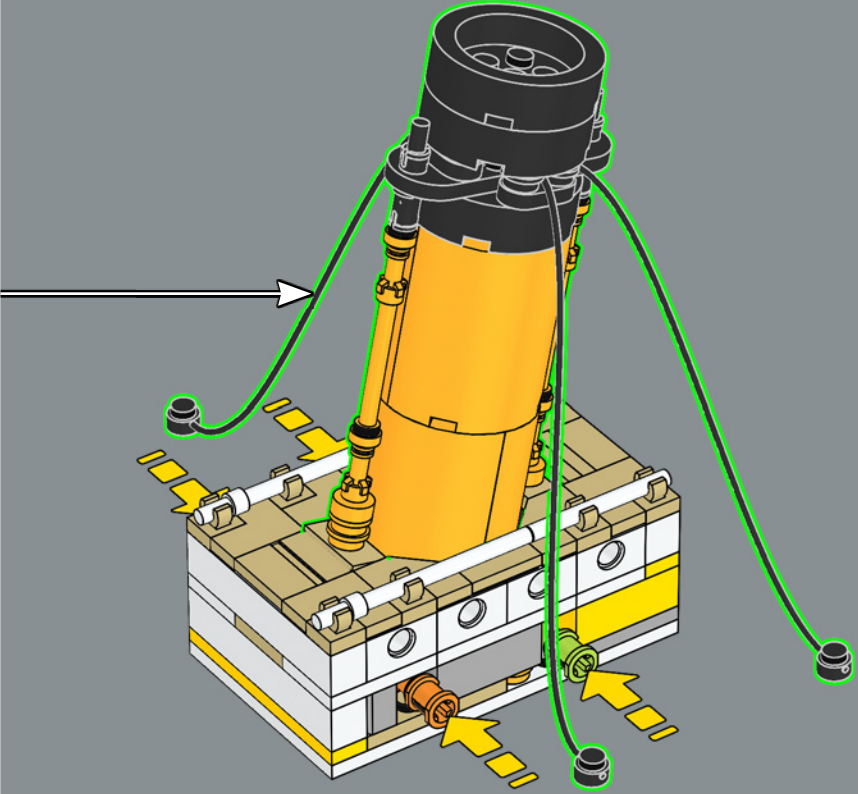

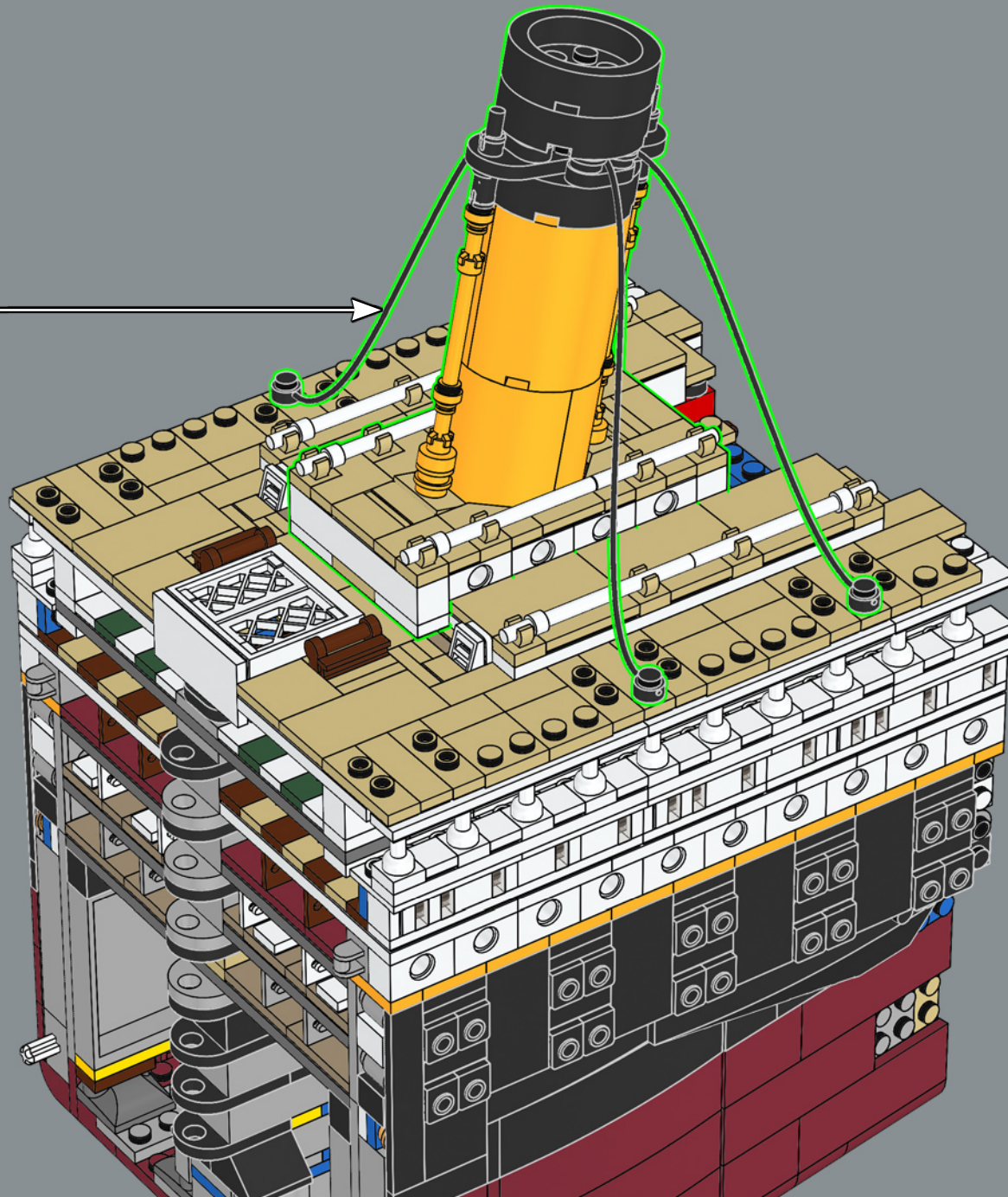

Die *Titanic* hatte vier Schornsteine, allerdings waren nur drei davon funktionstüchtig. Der hinterste war eine Attrappe, die ausschließlich ästhetischen Zwecken diente.

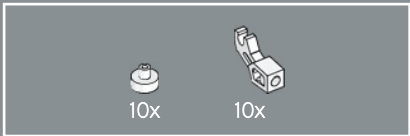

144

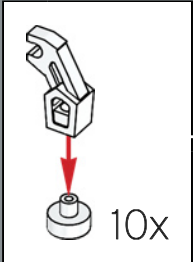
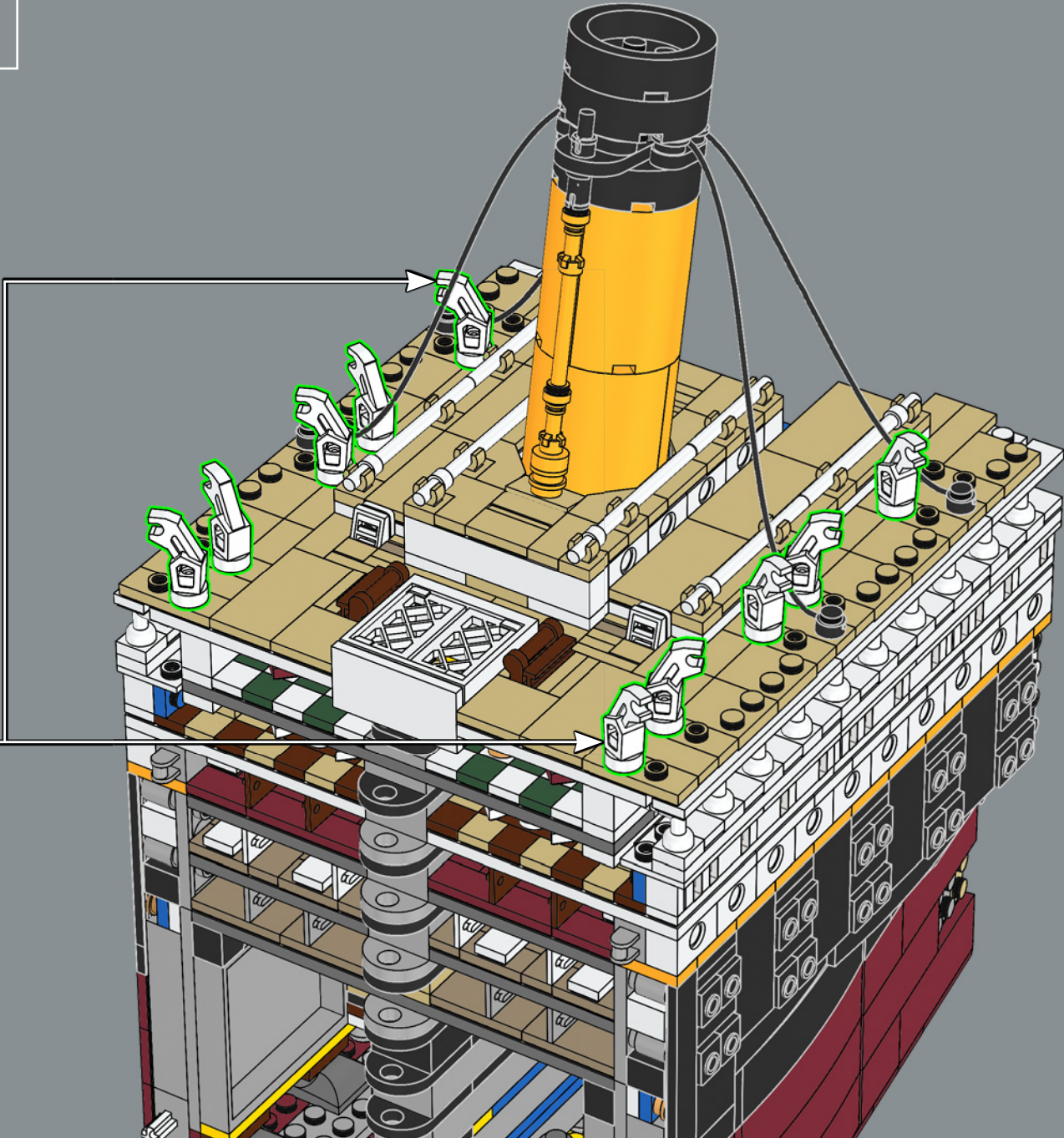

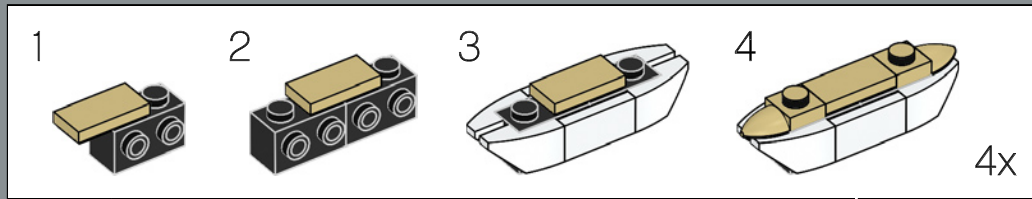
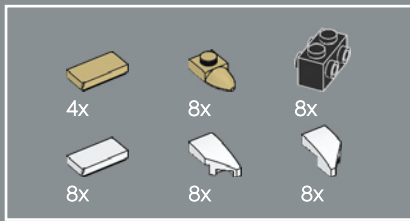

145

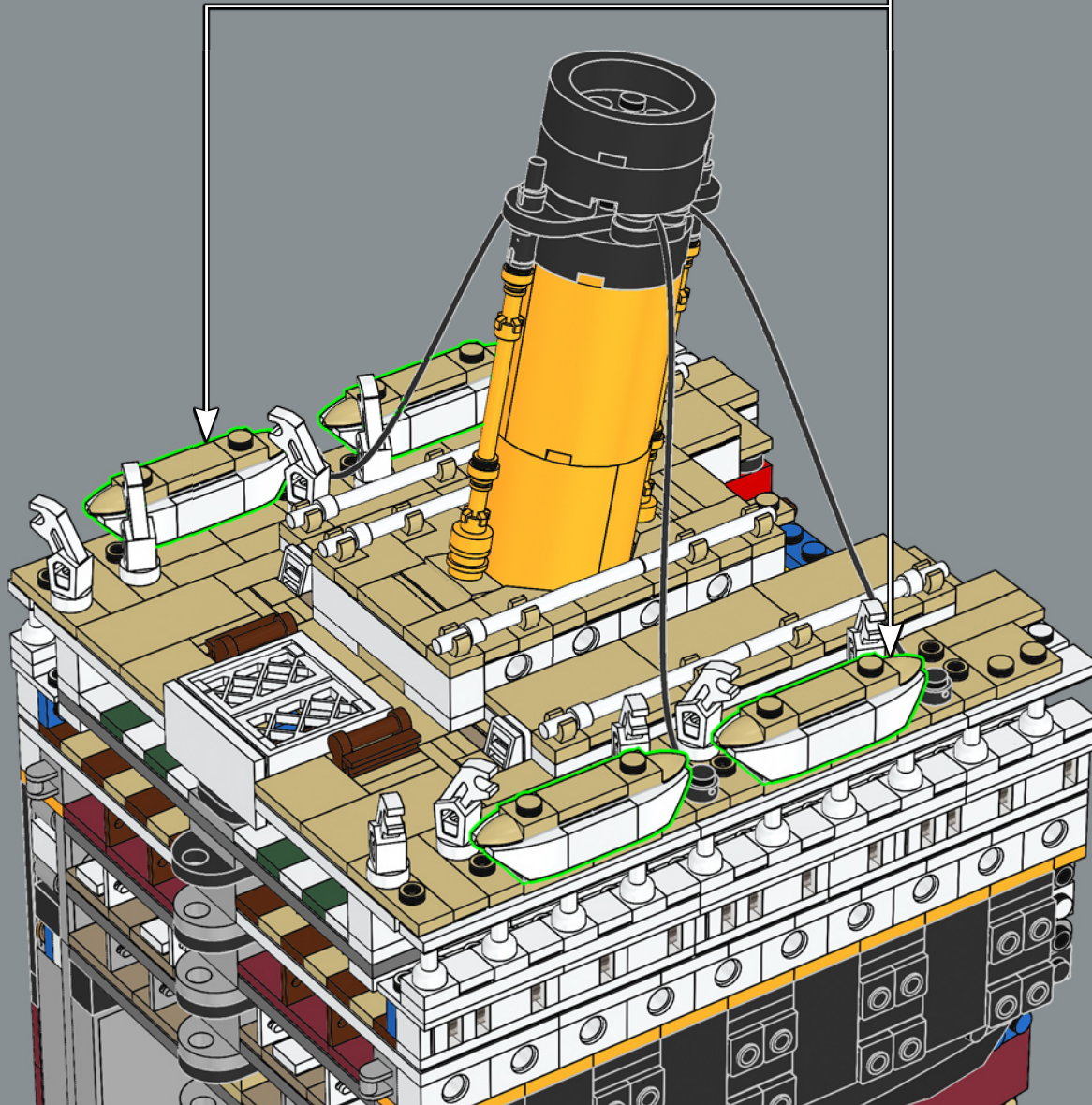

↓ Die äußeren Details in diesem Abschnitt beinhalten die Heckbrücke und die Bänke für die Passagiere der 3. Klasse.

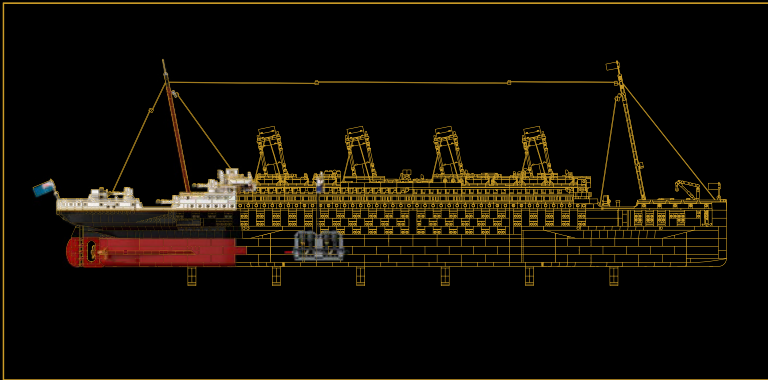

#### ABSCHNITT 6:

## HECK & WELLDECK

Dieser letzte Abschnitt ist das komplizierteste Segment des Rumpfes und beherbergt das Ruder und die drei Hauptantriebswellen, die die Schiffsschrauben mit den Maschinen verbinden. Du baust die beiden Kolbendampfmaschinen, die direkt mit den Backbord- und Steuerbordpropellern verbunden sind. Wenn du die Schiffsschrauben drehst, bewegen sich die Kurbelwellen und Kolben im Inneren des Modells.



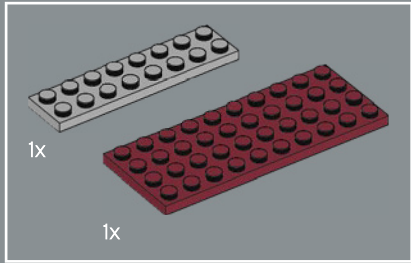
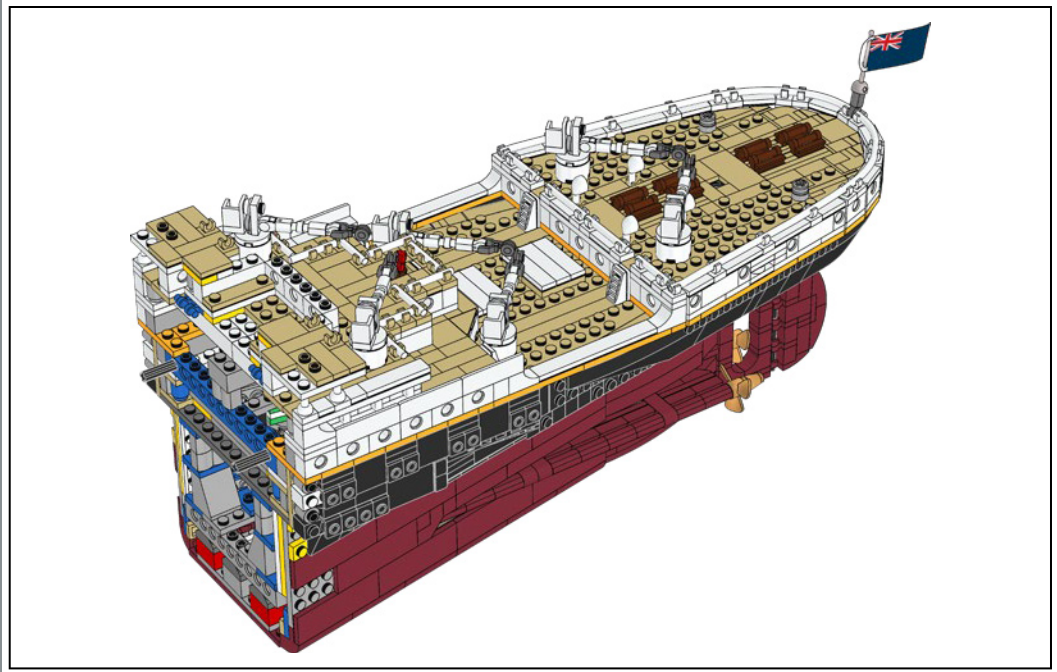
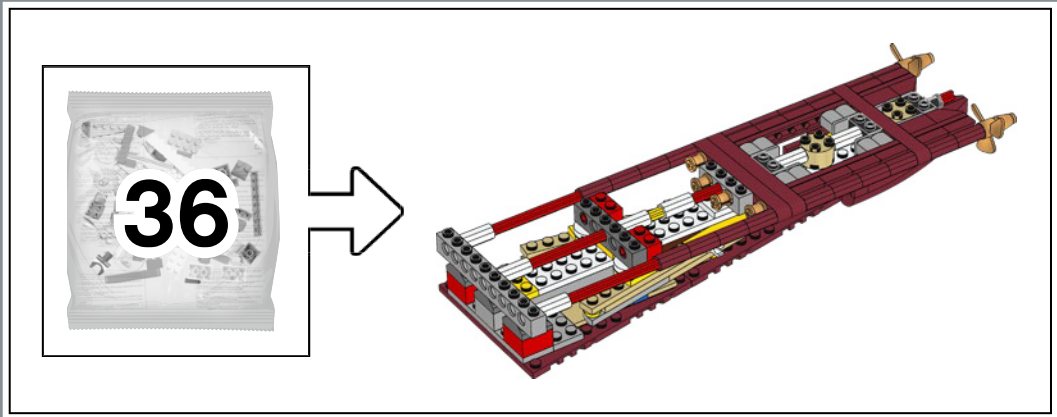

146

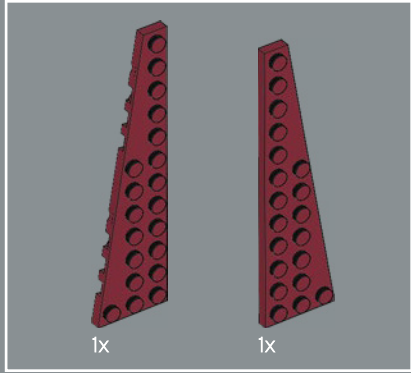
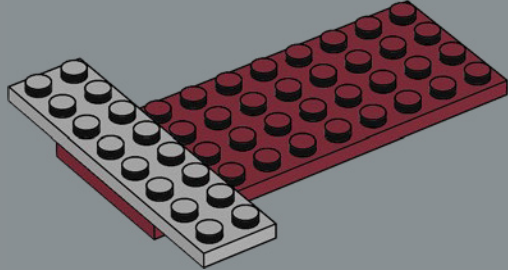

147

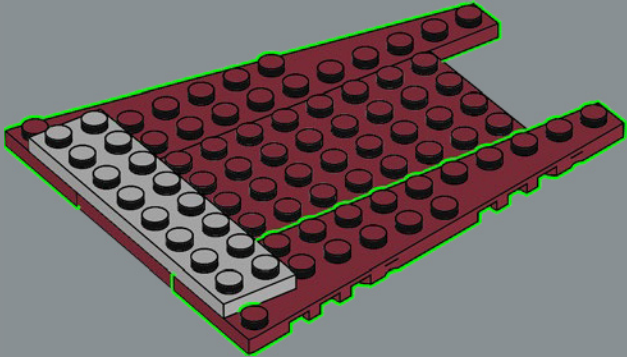

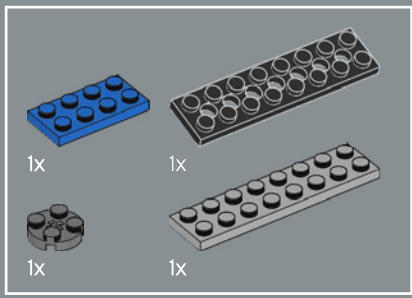

148

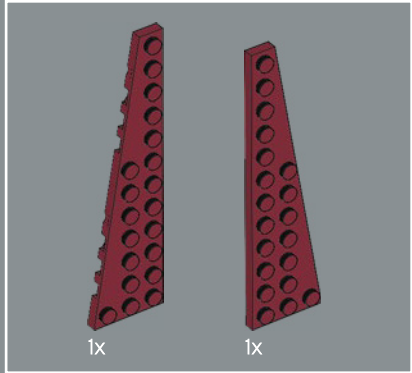
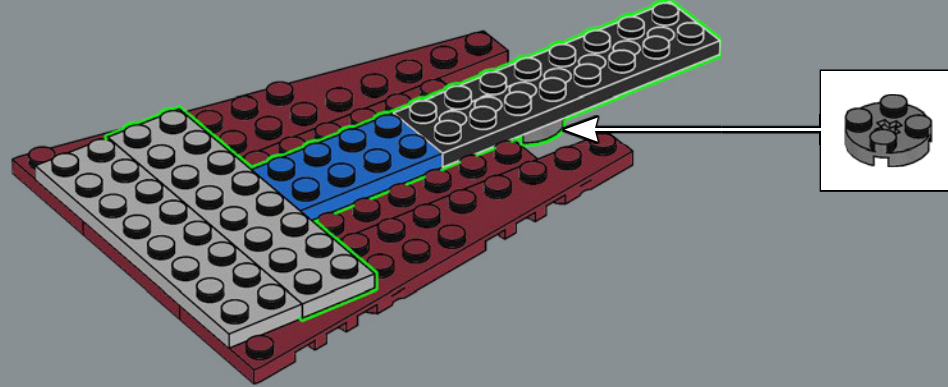

149

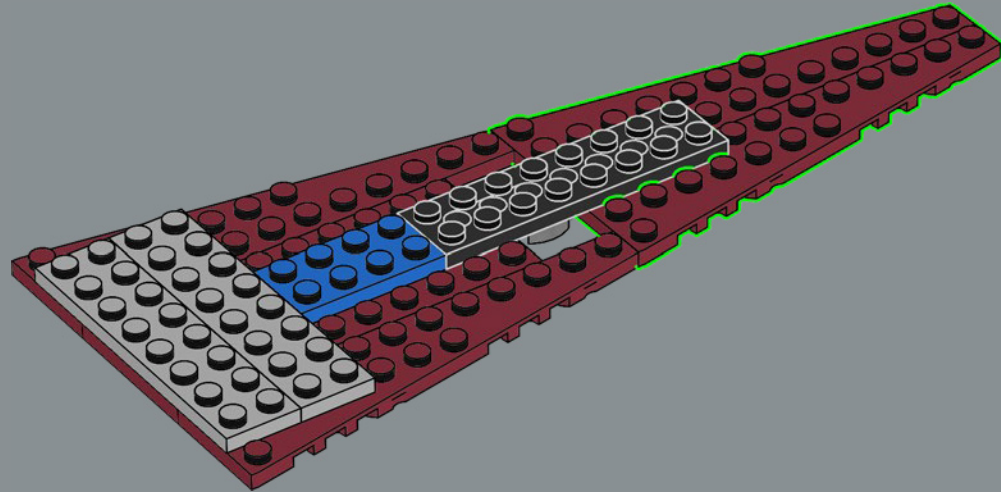



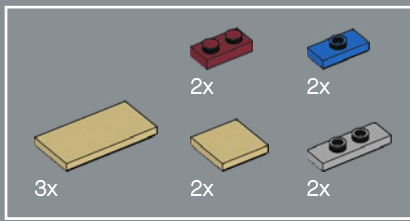

150

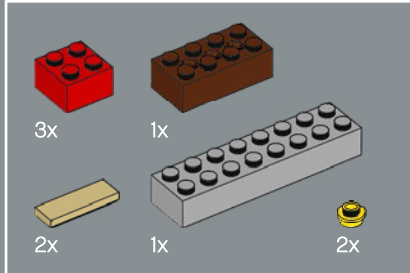
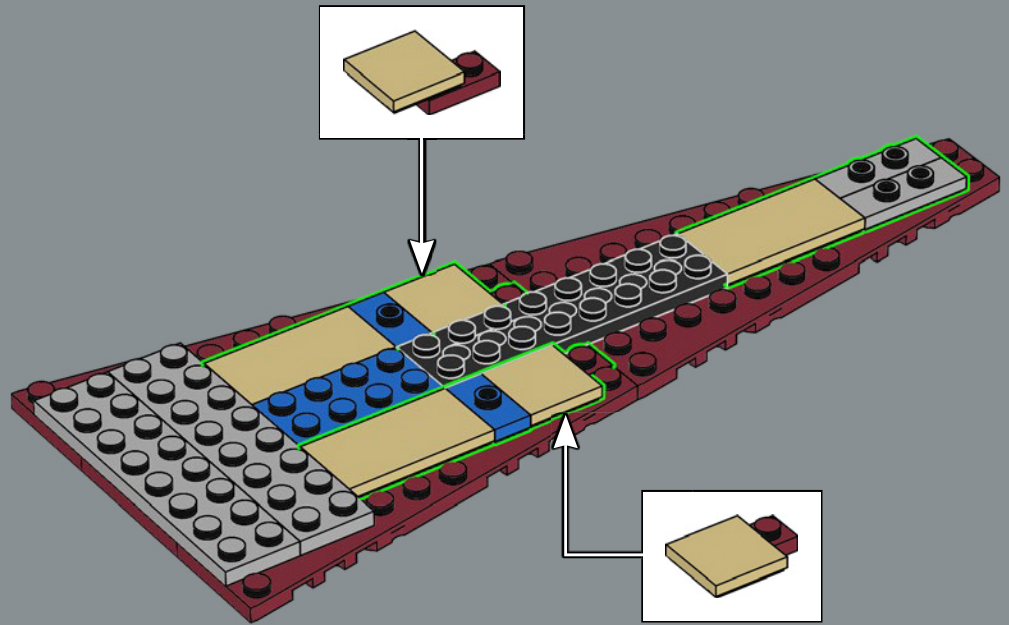

151

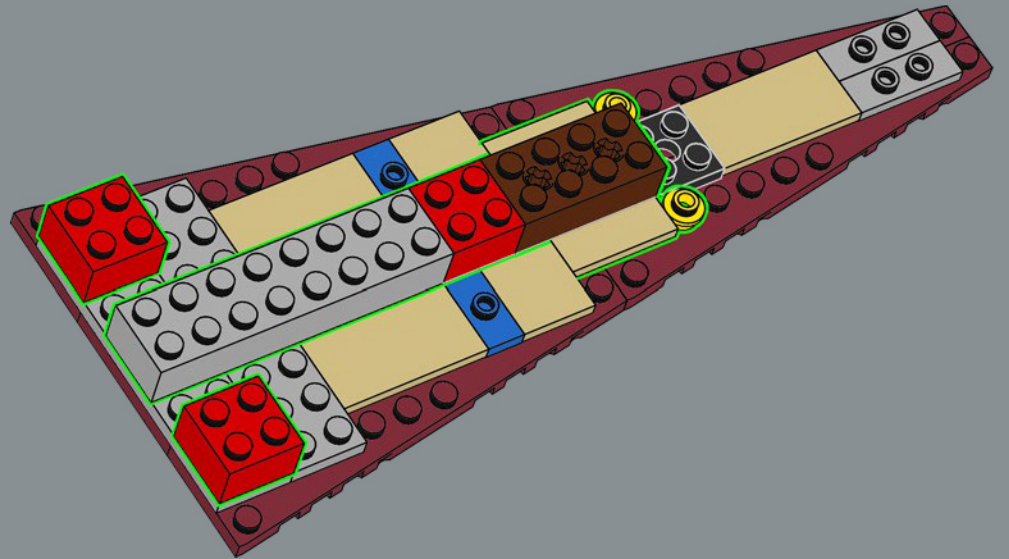

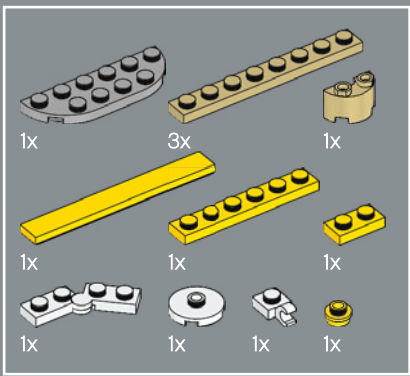

152

1

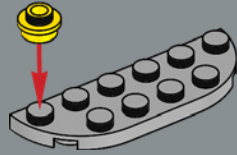

2

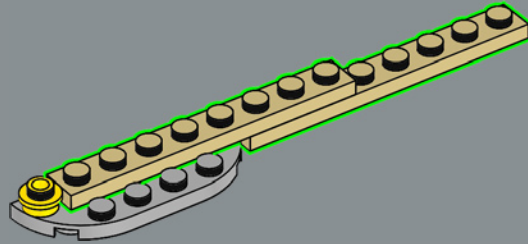

3

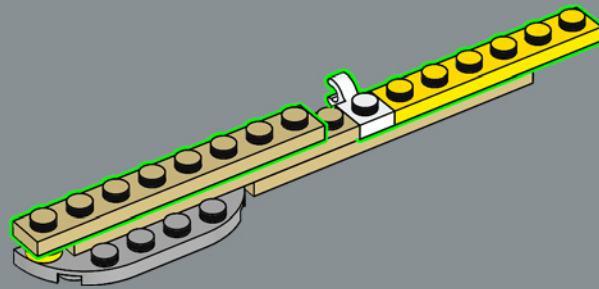

4

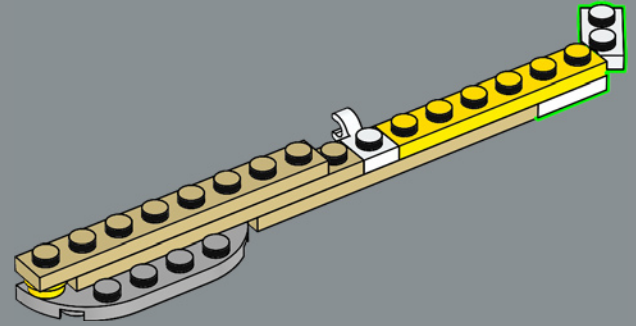

5

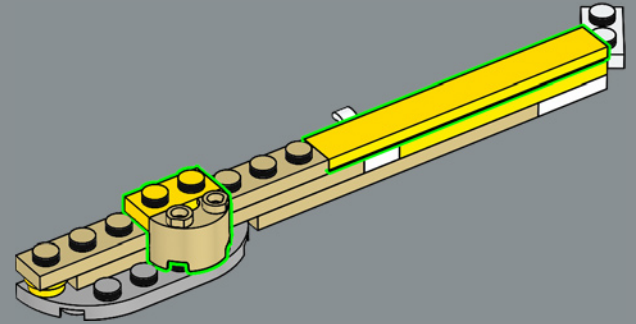

6

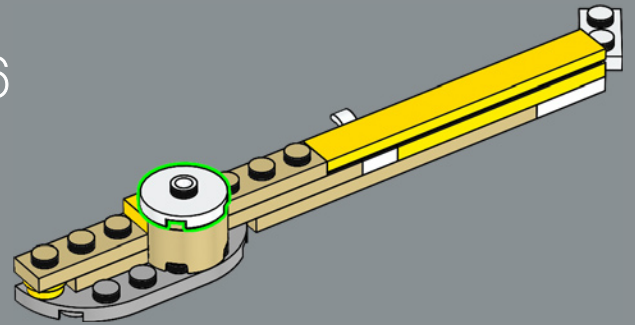

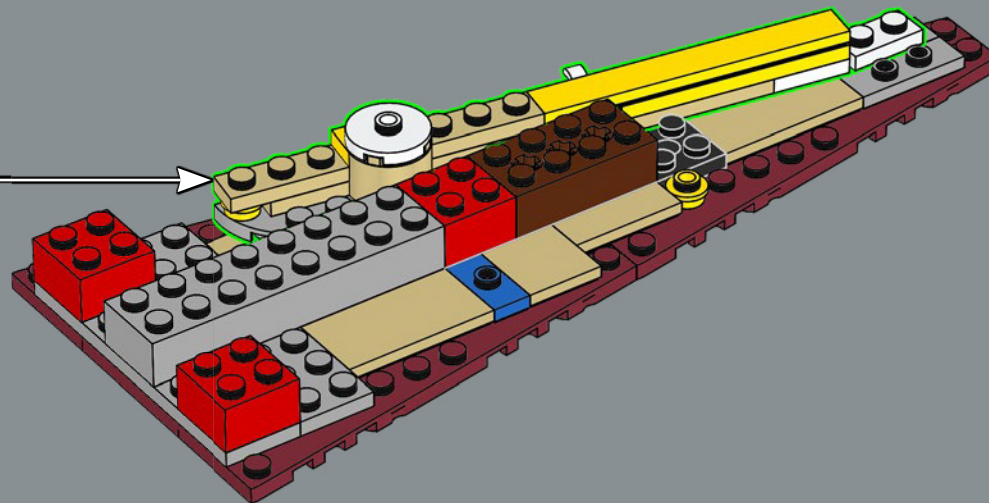

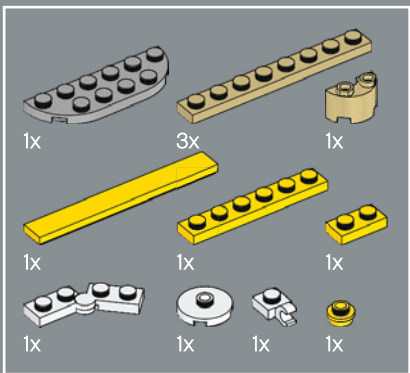

153

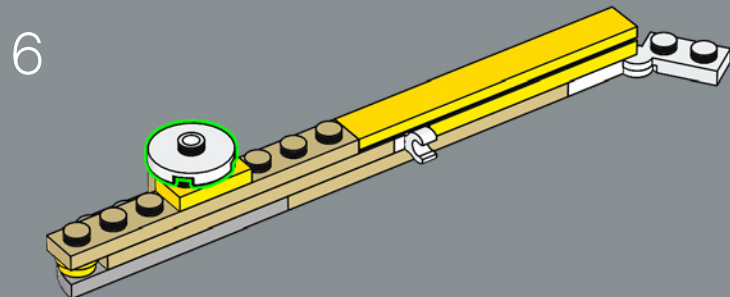
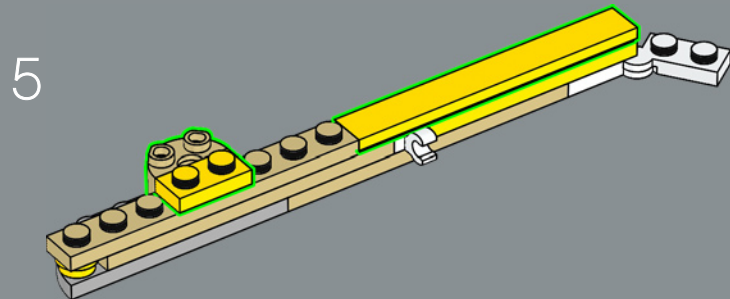
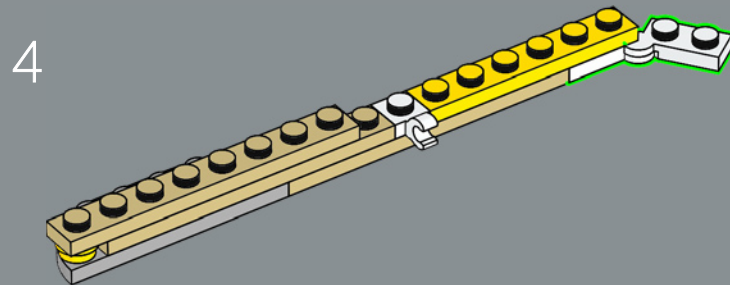
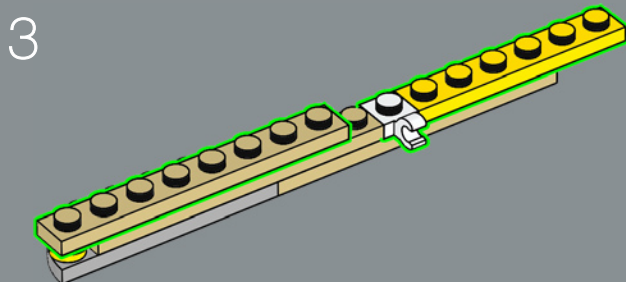
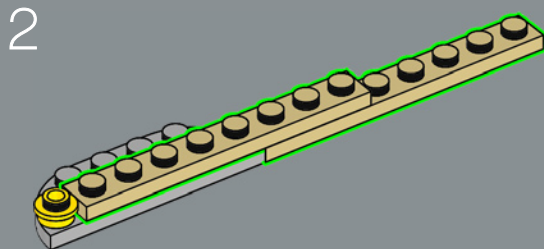
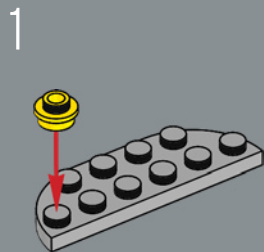

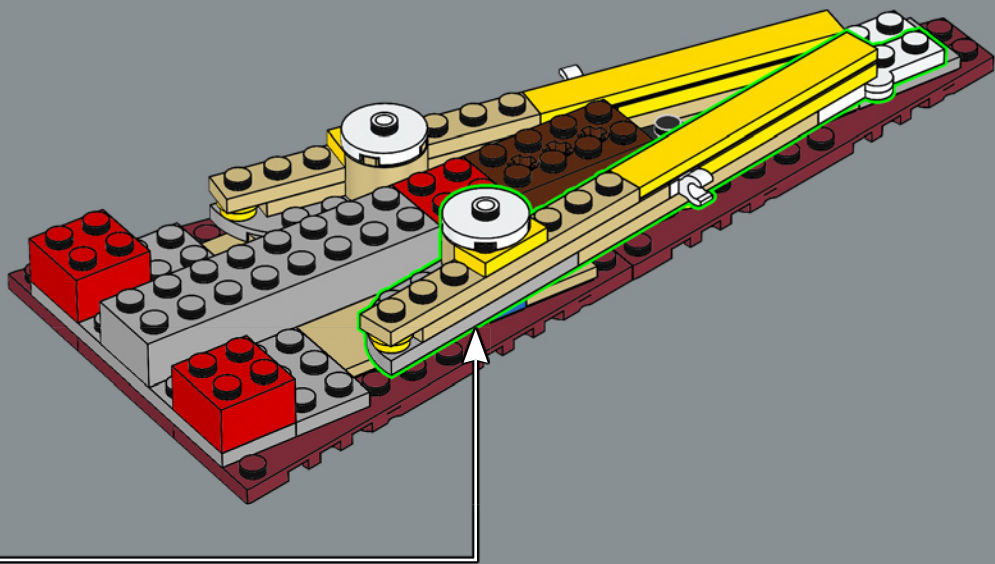

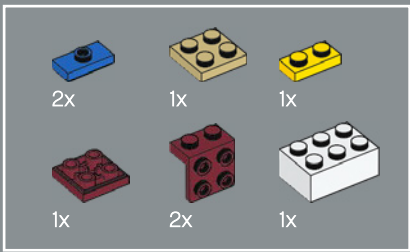

154

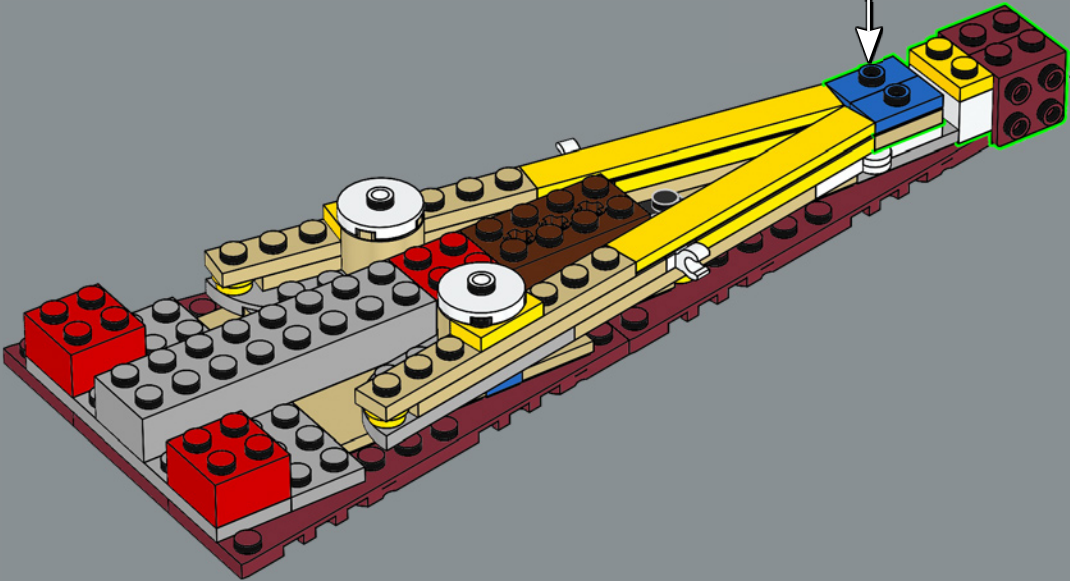
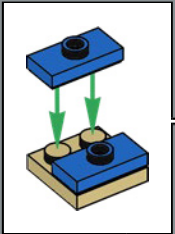
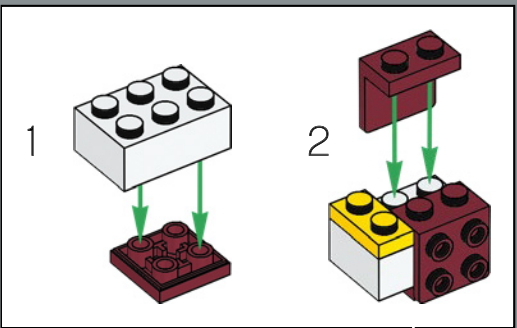

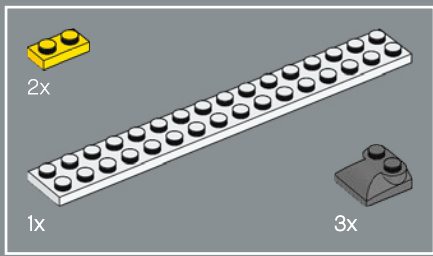

155

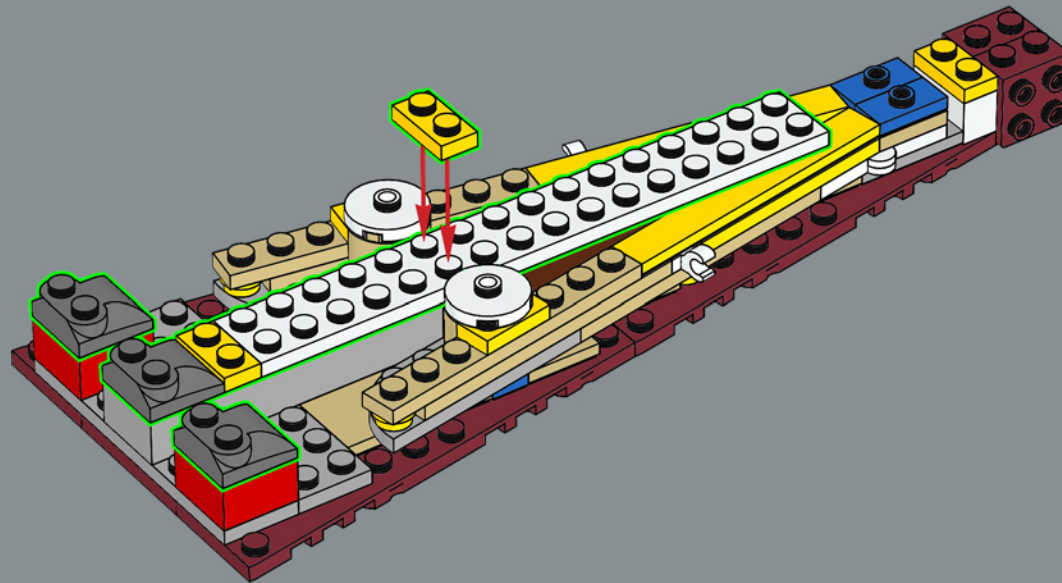

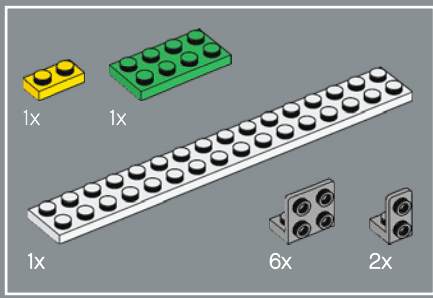

156

1

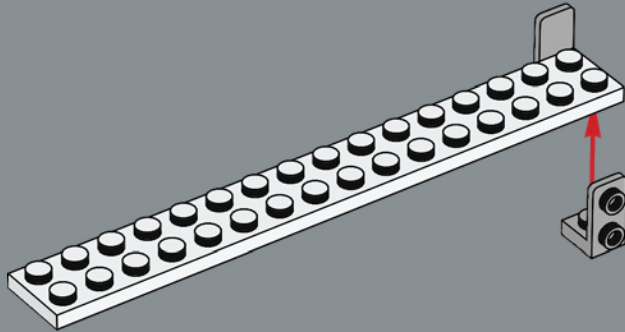

2

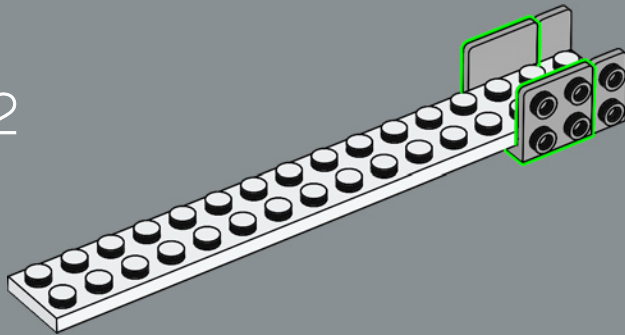

3

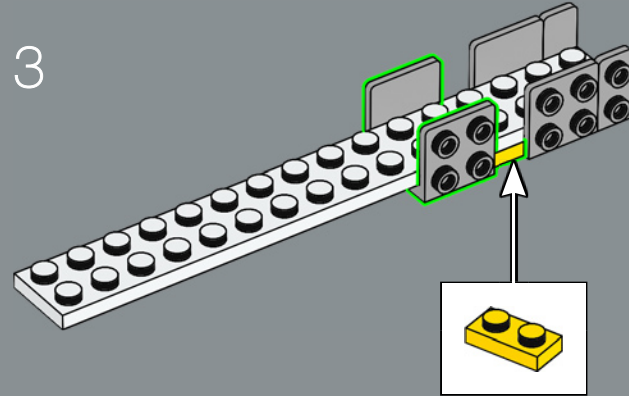

4

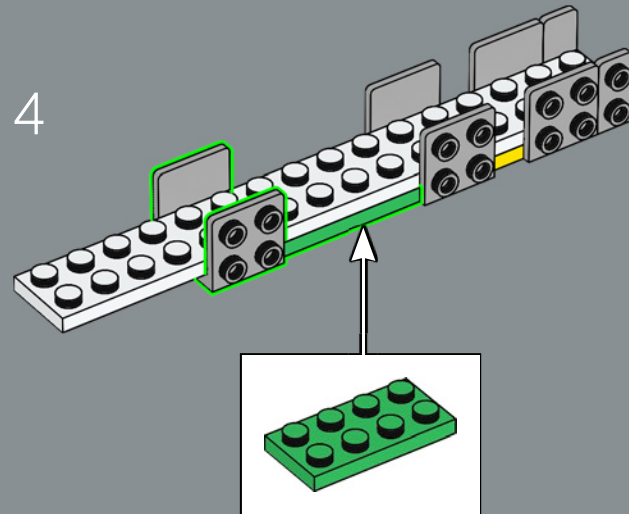



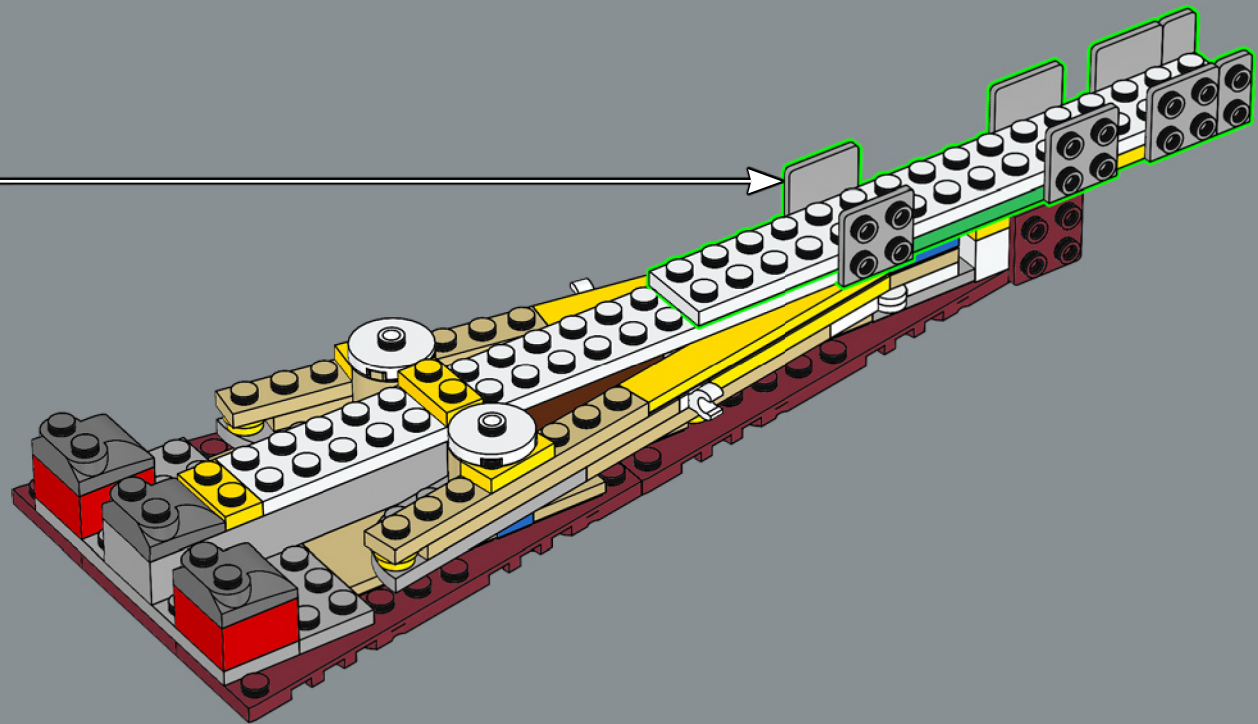

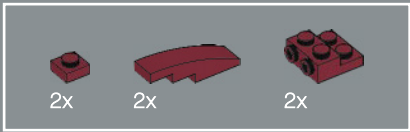

157

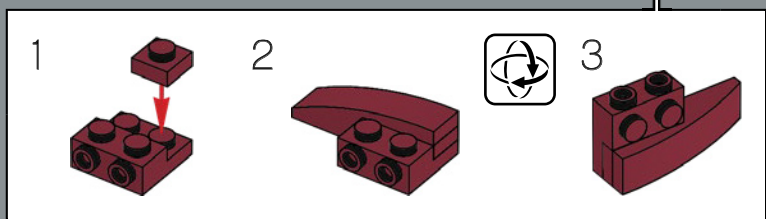
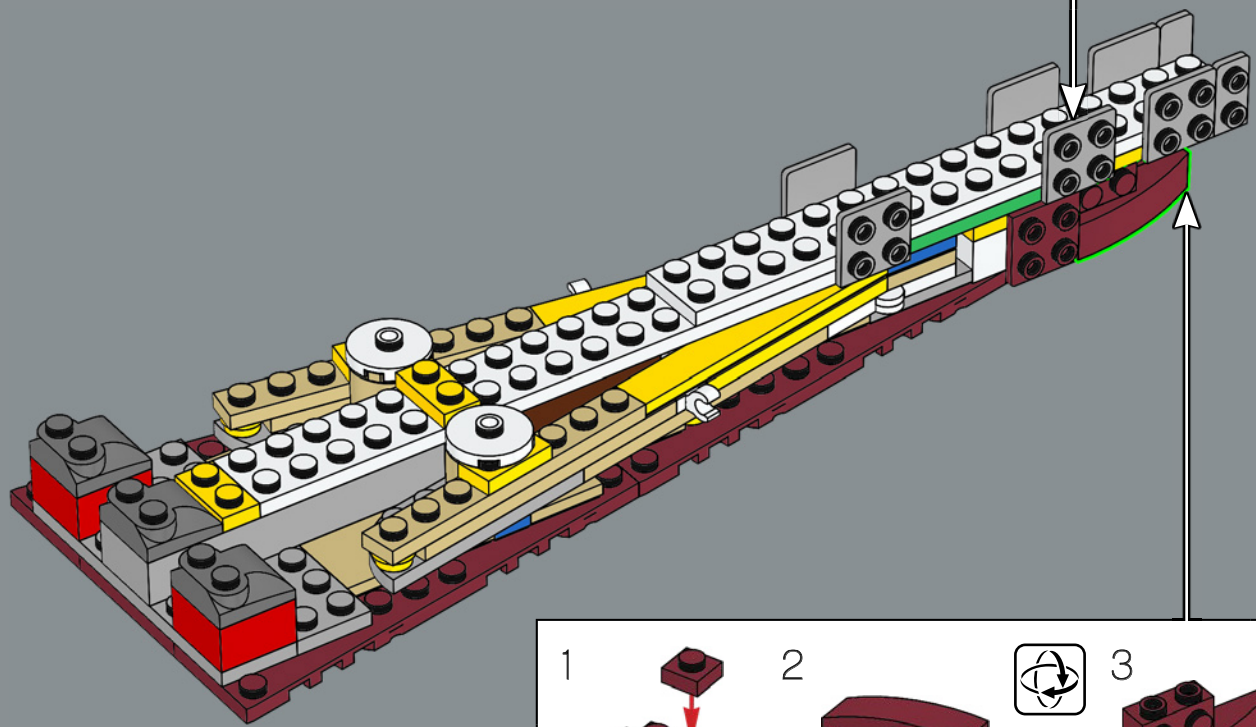
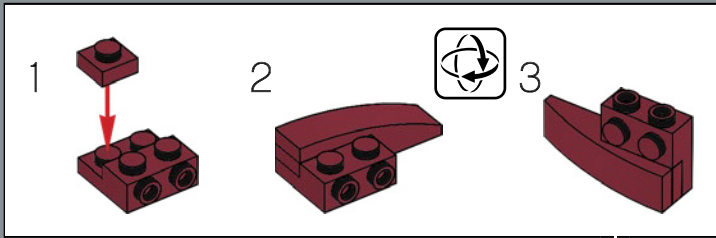

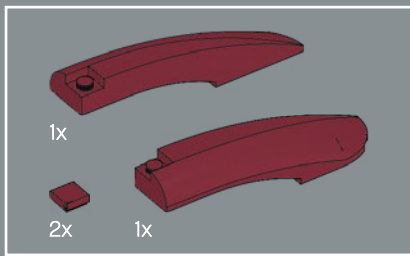

158

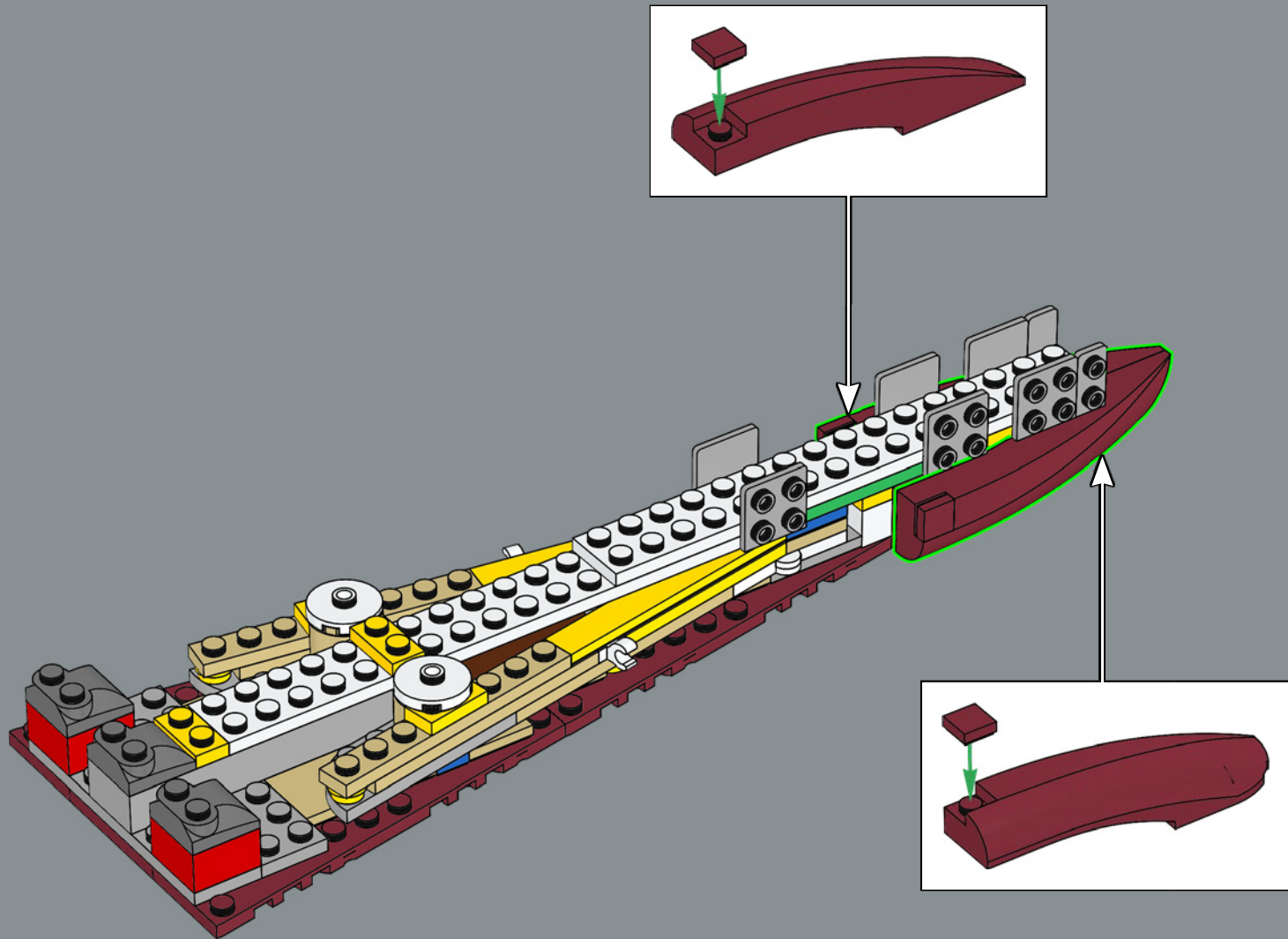

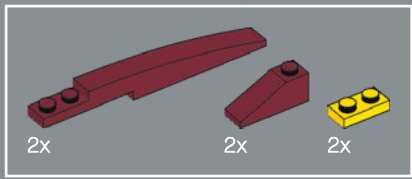

159

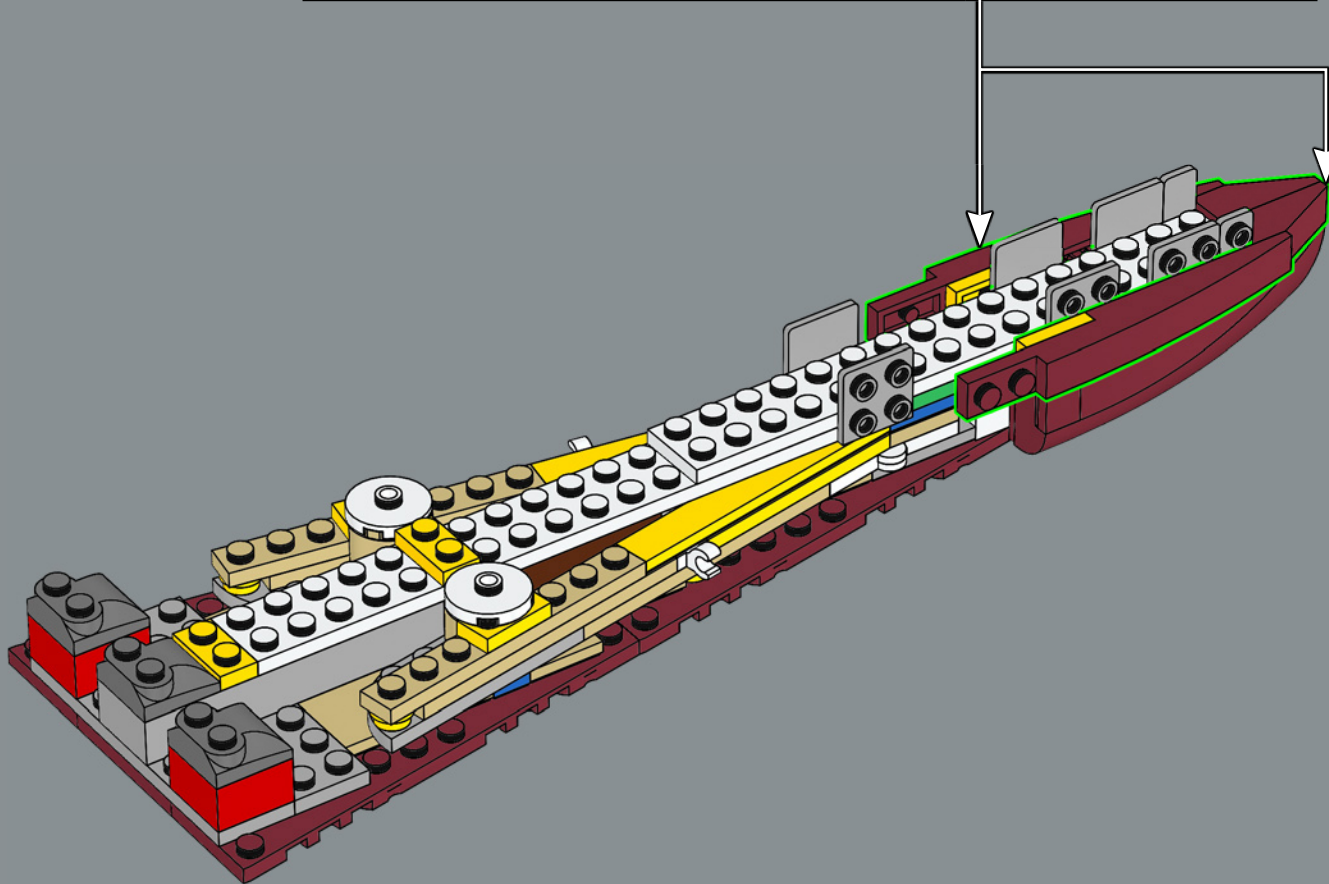
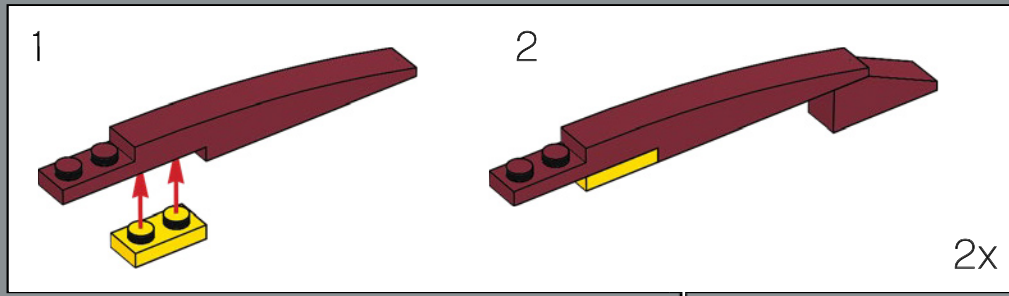

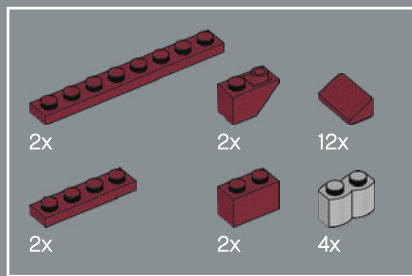

160

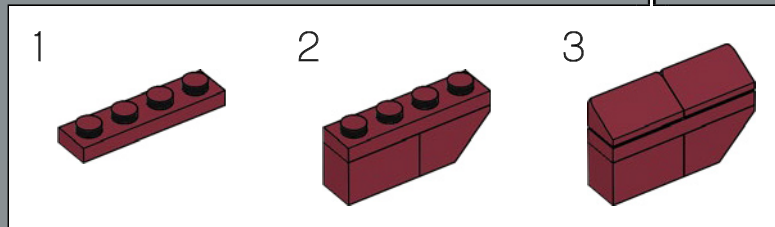
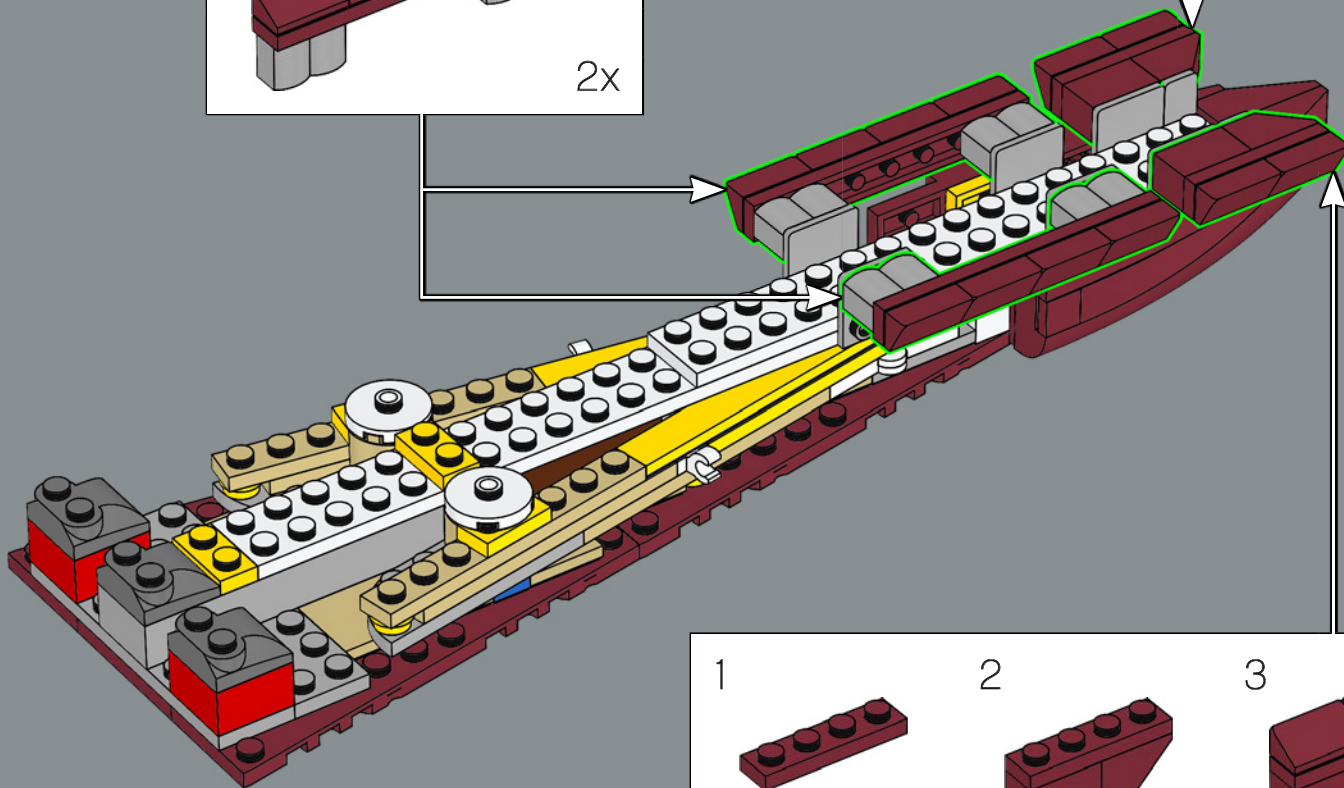
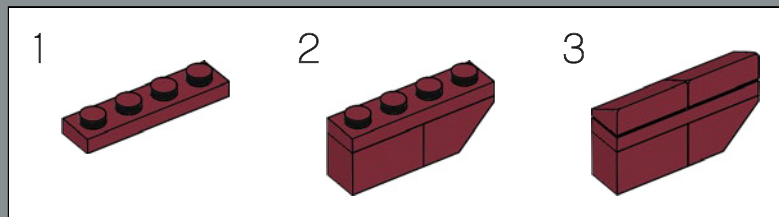
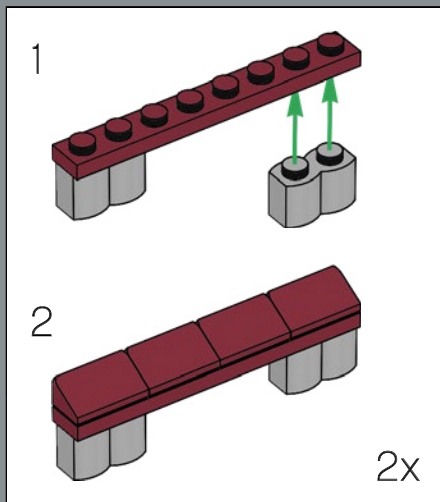

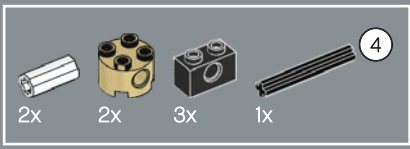

161

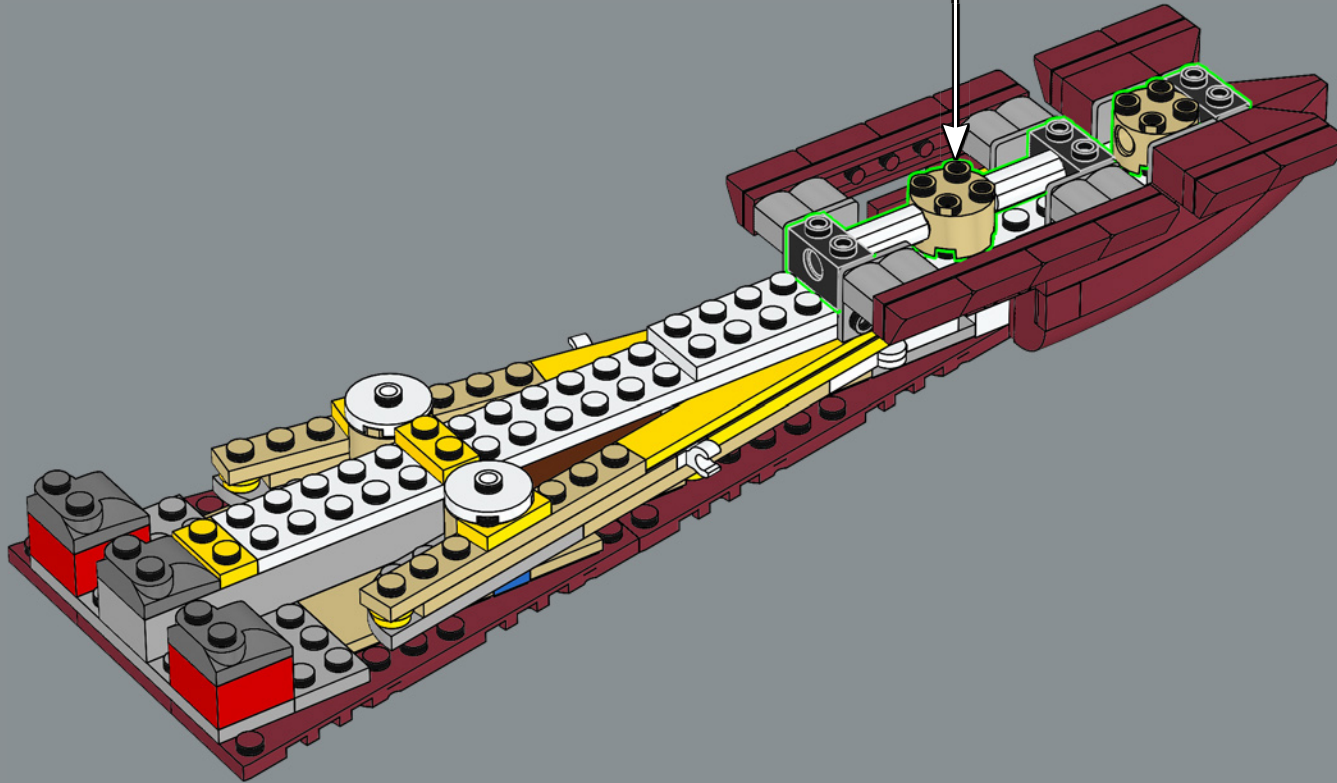
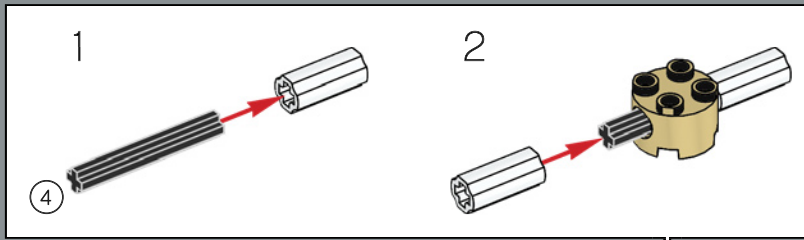

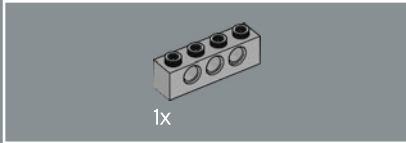
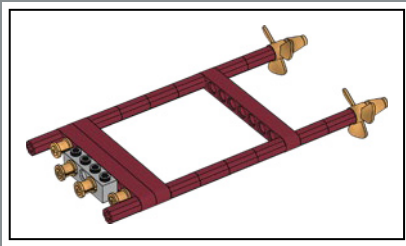

162

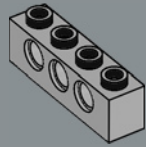

163

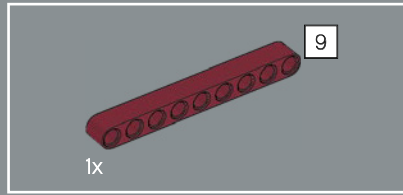
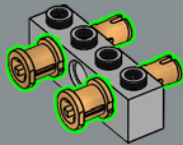

164

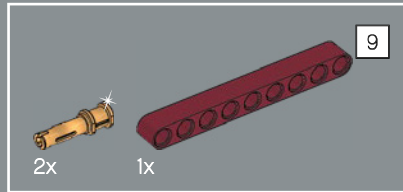

165

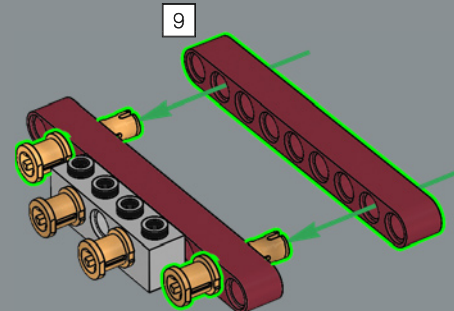
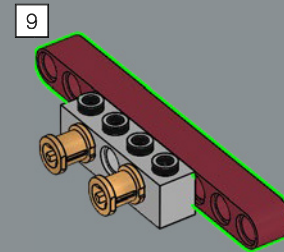

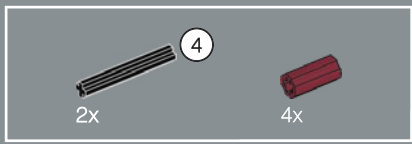

166

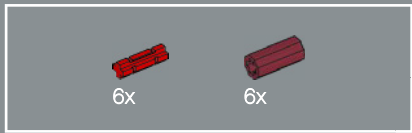
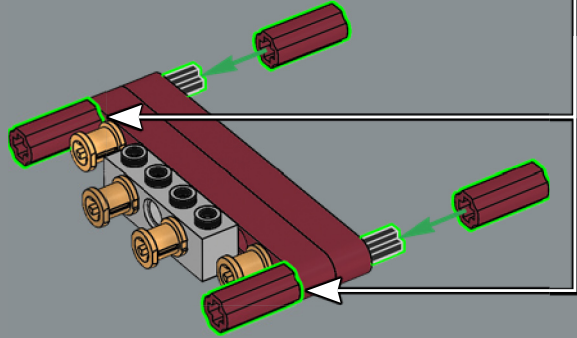
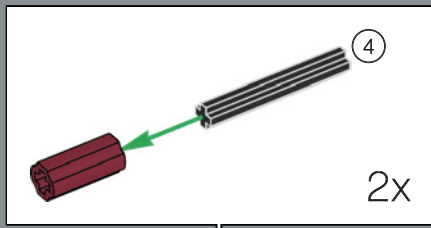

167

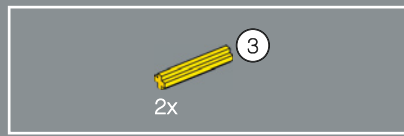
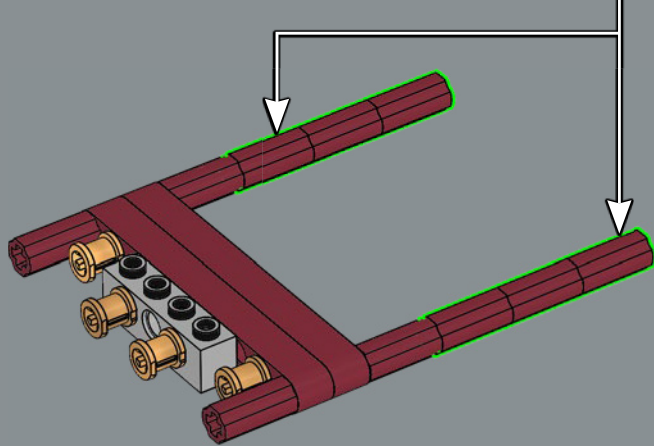
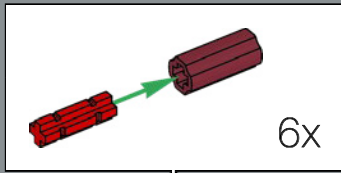

168

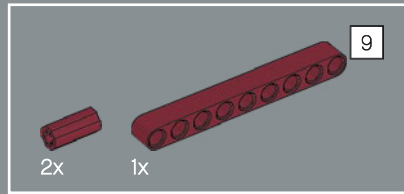
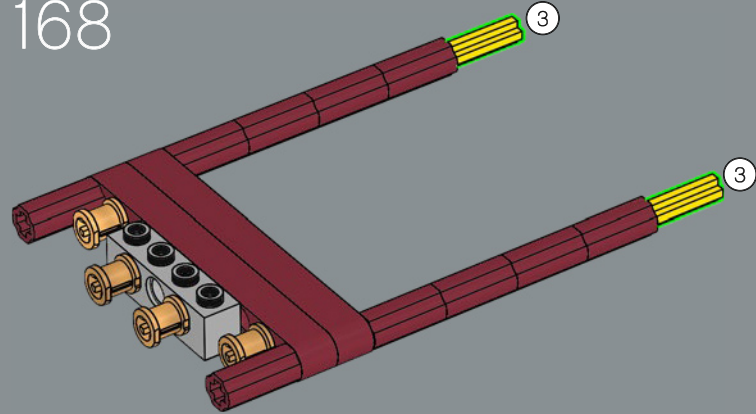

169

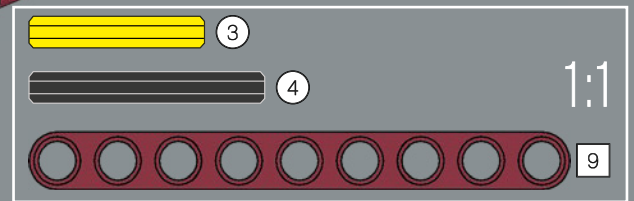
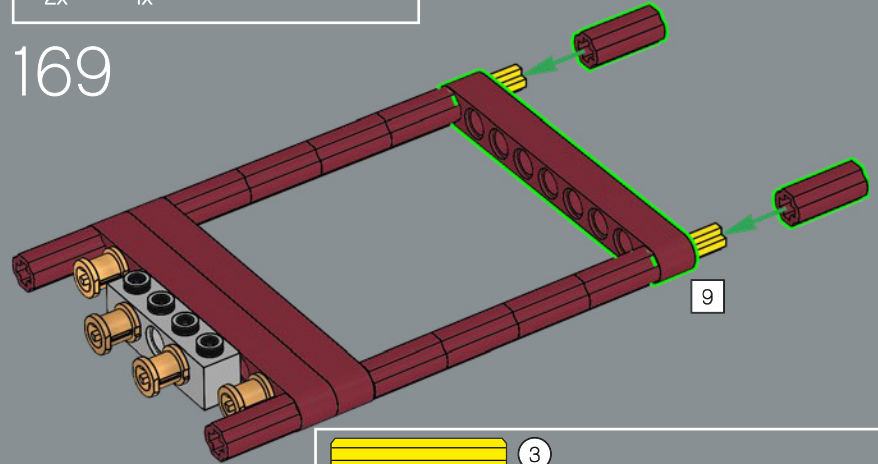



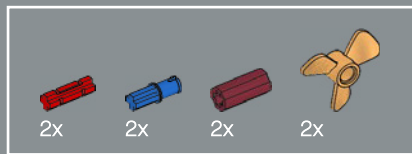

170

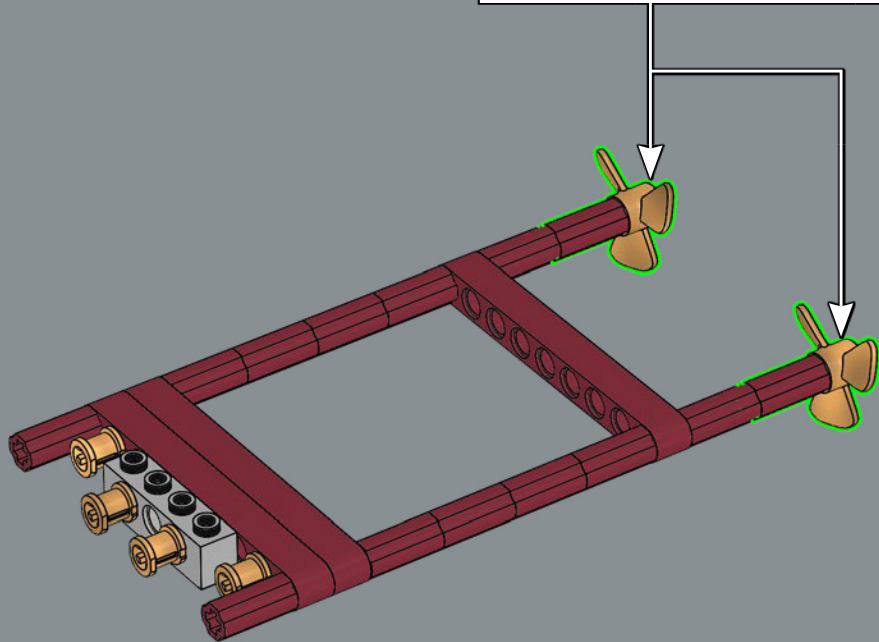
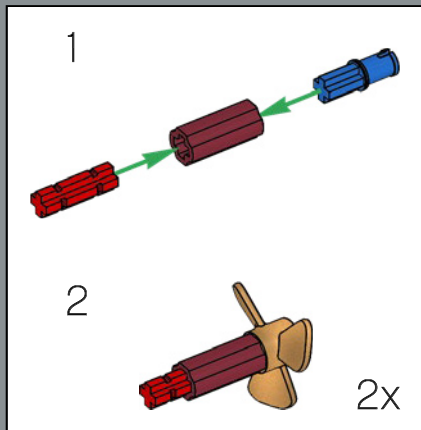

171

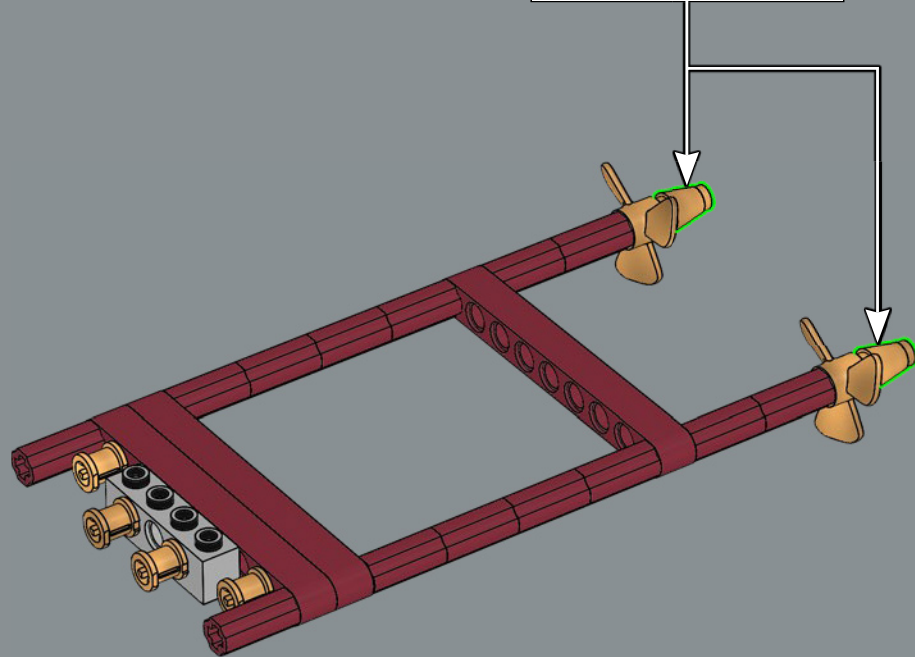
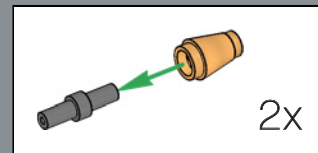

172

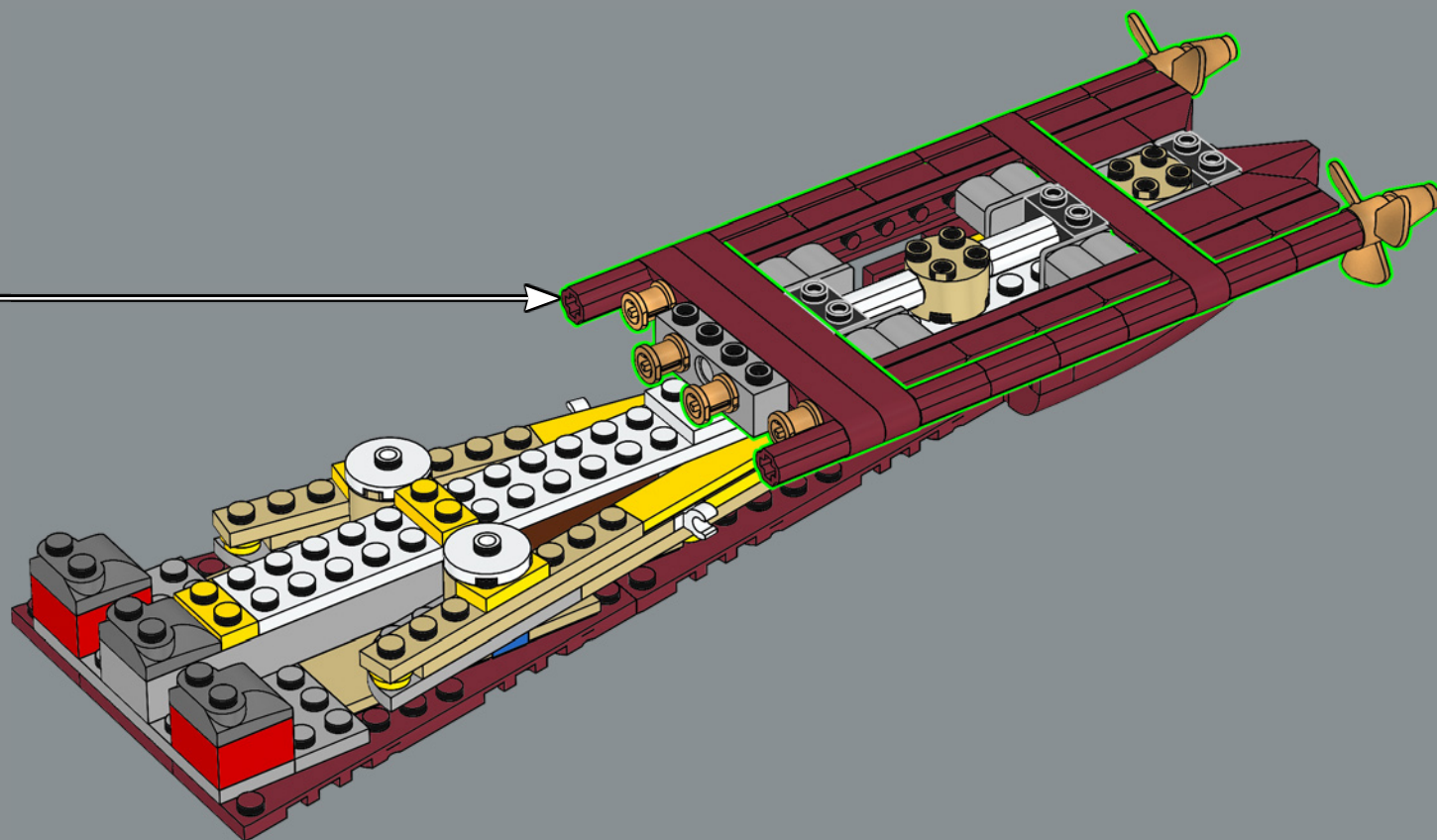

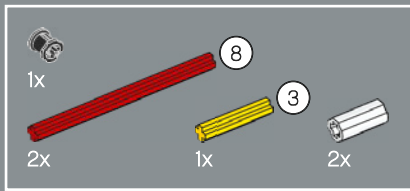

173

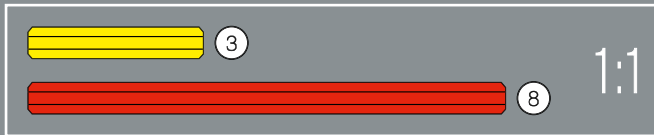
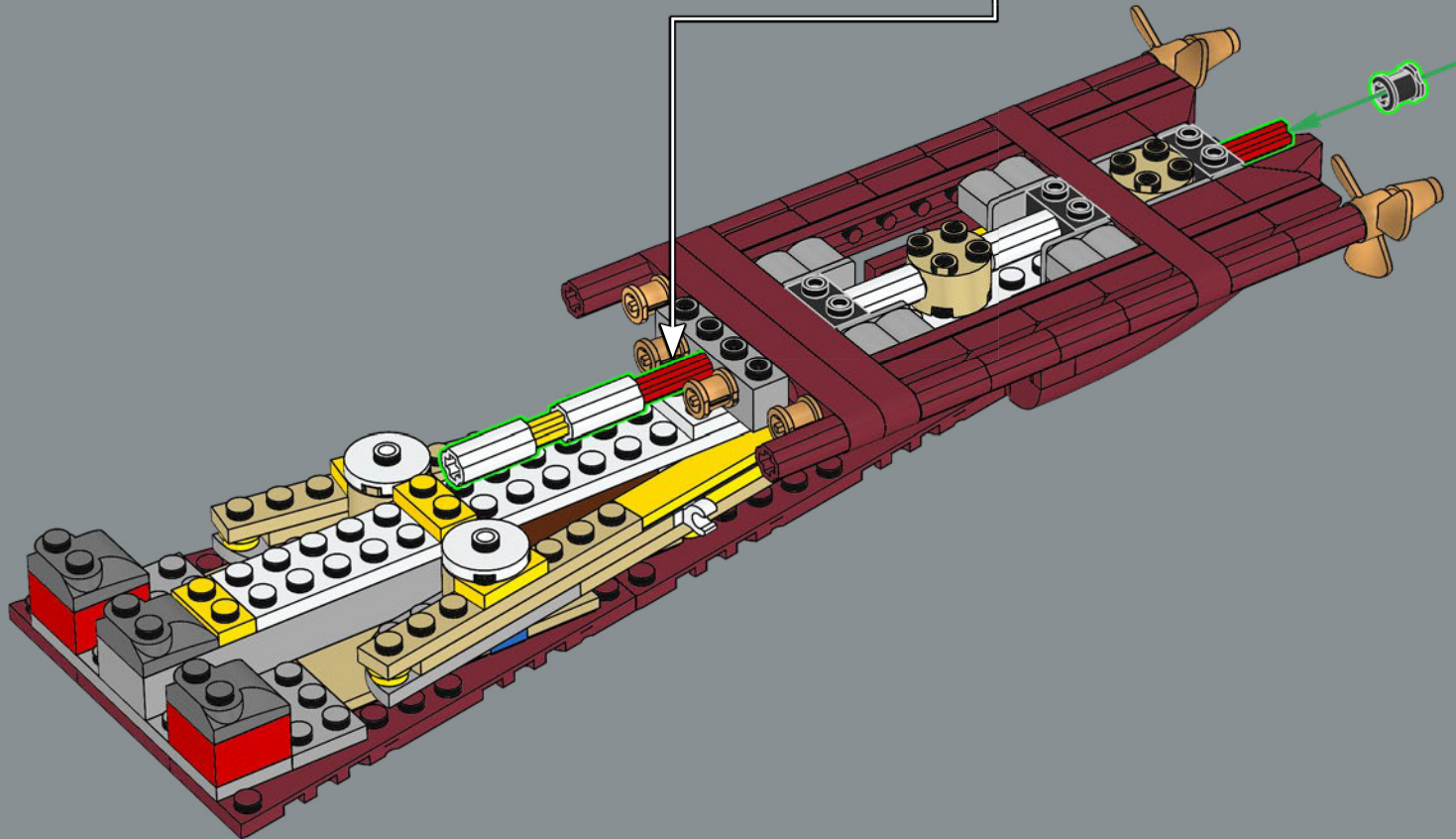
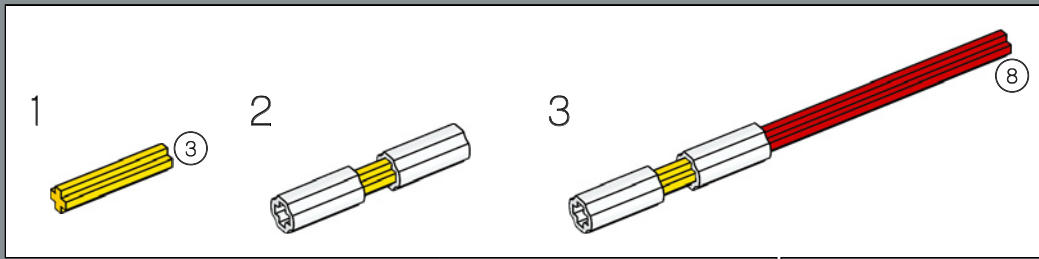

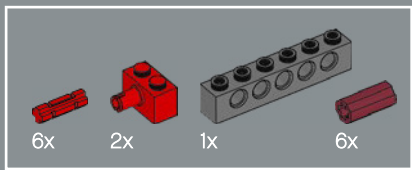

174

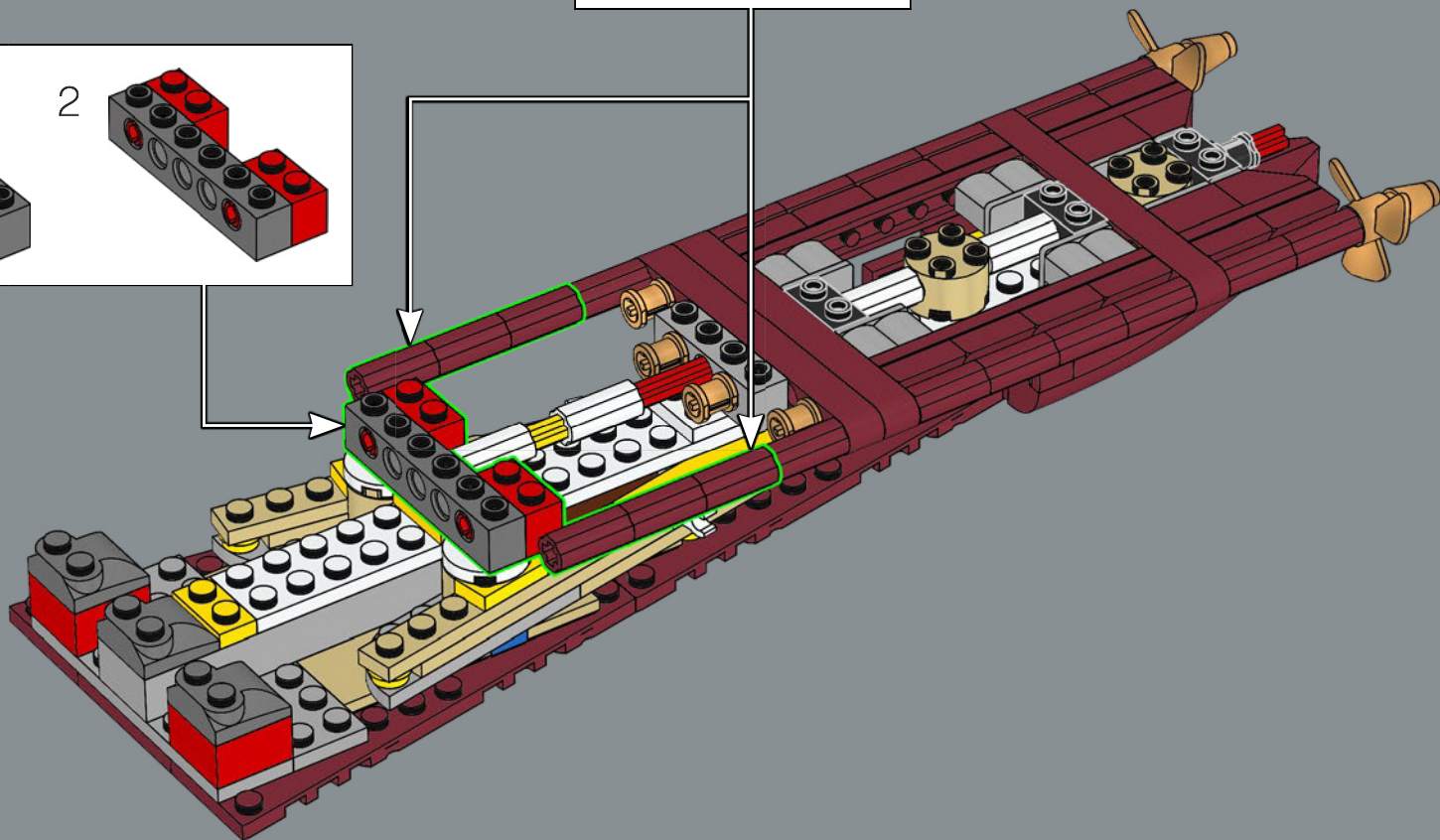
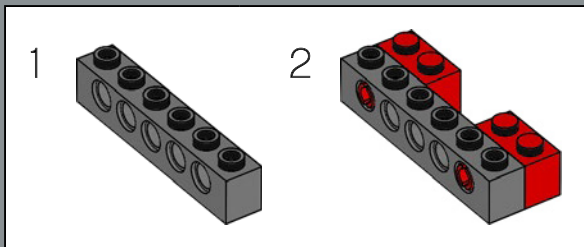
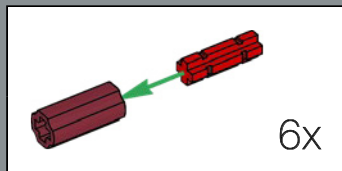

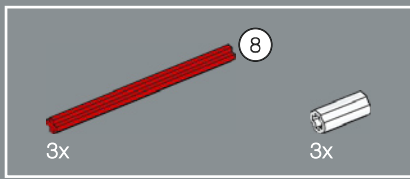

175

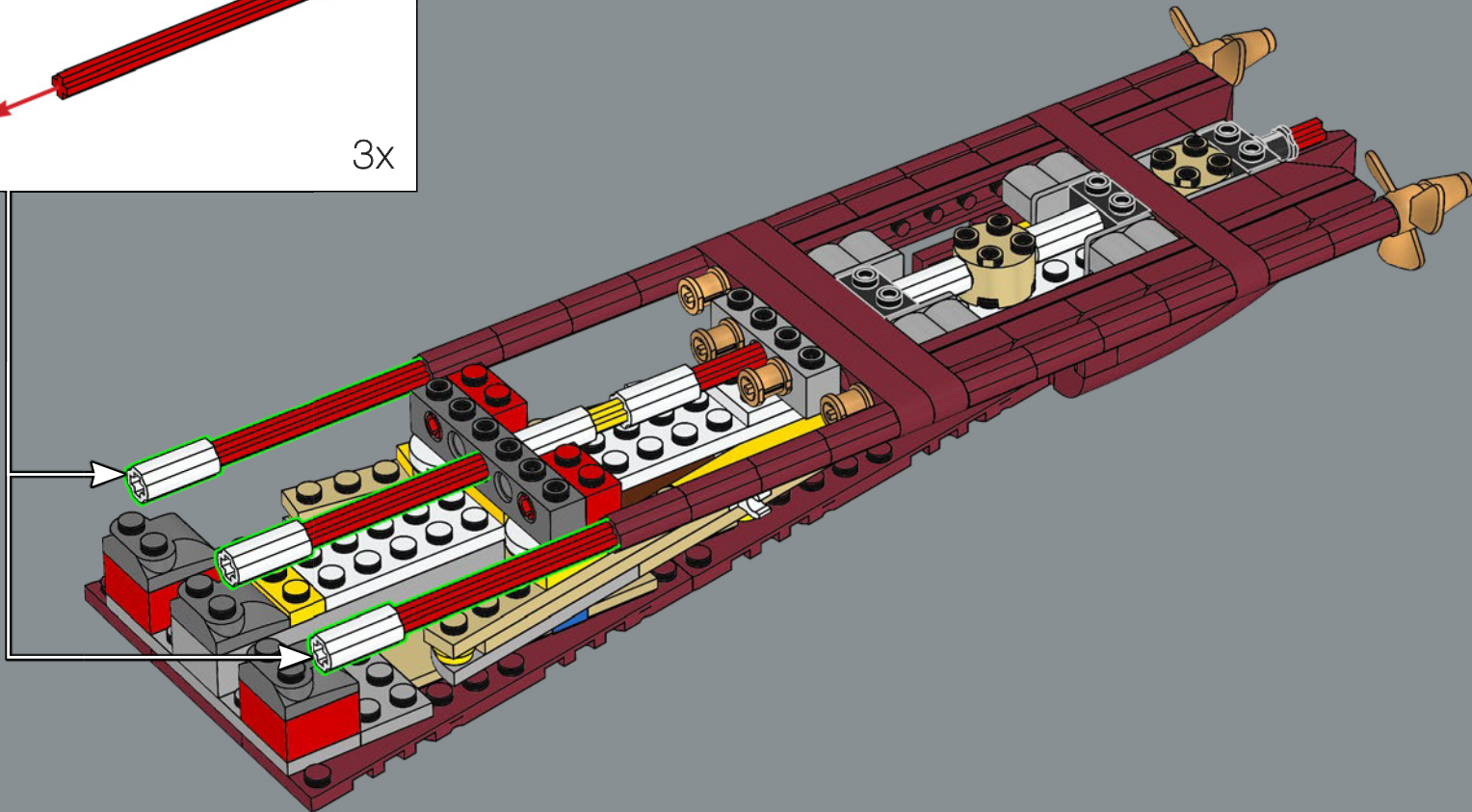
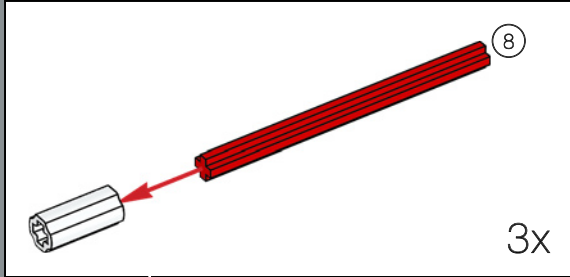

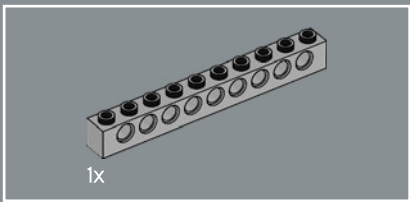

176

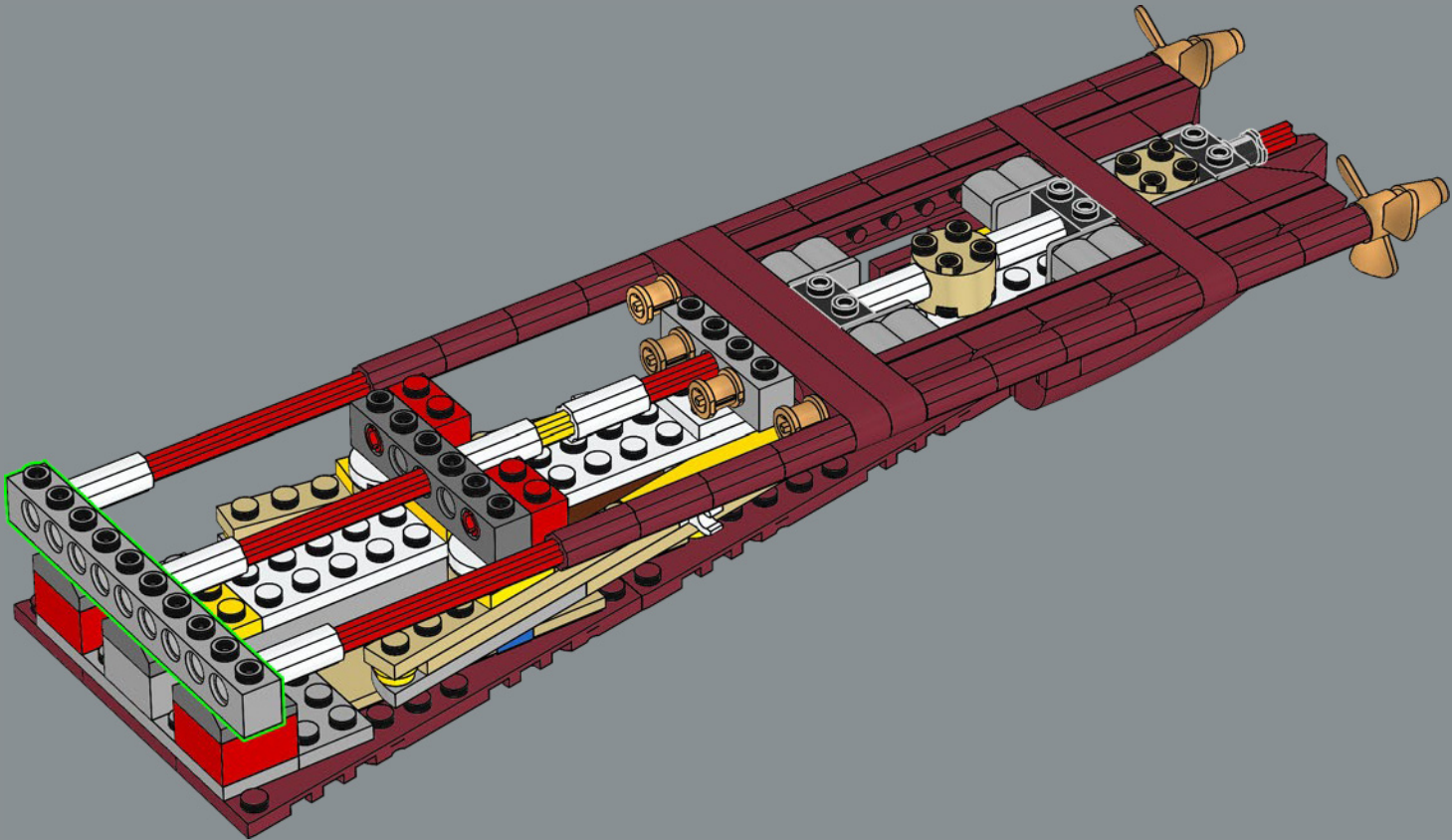

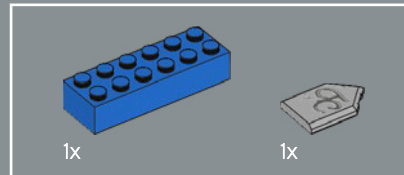
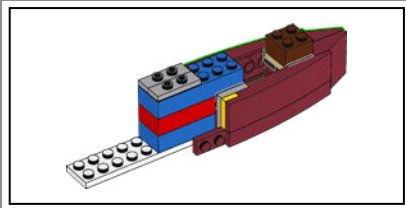
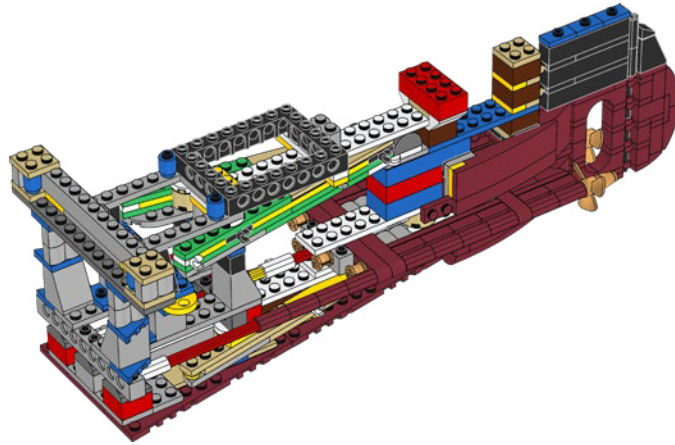
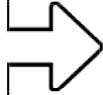

178

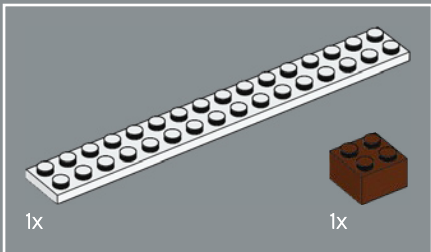

177

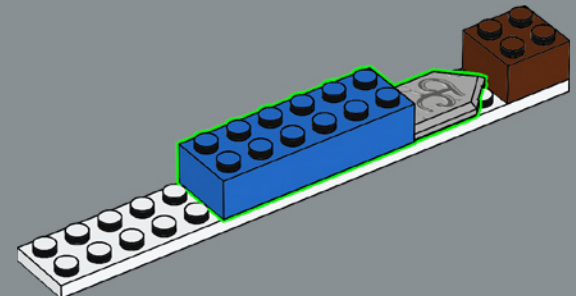
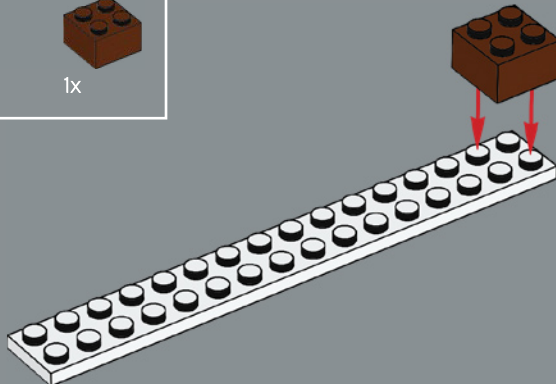



4x

179

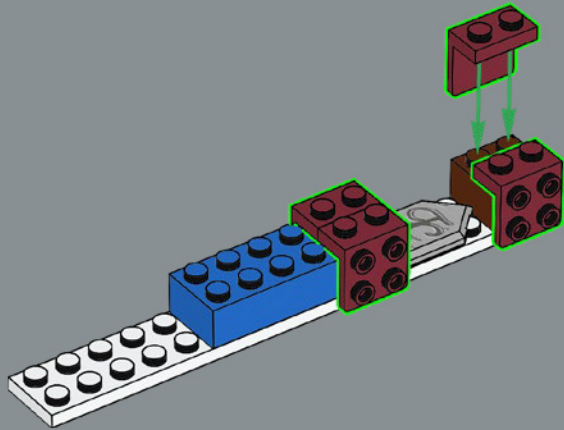

4x

180

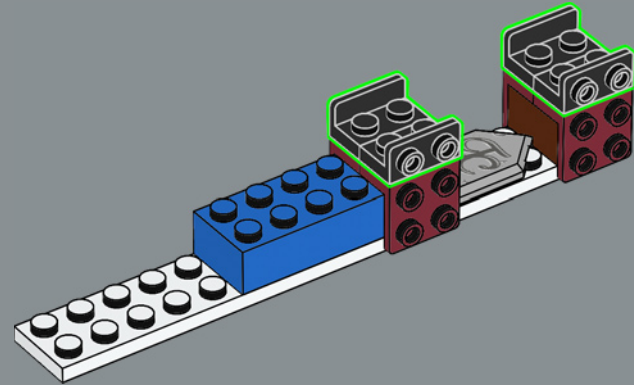



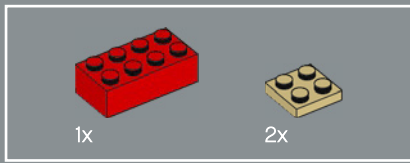

181

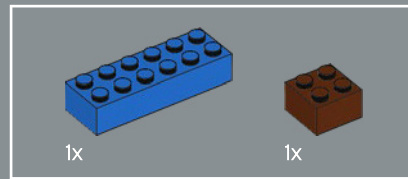
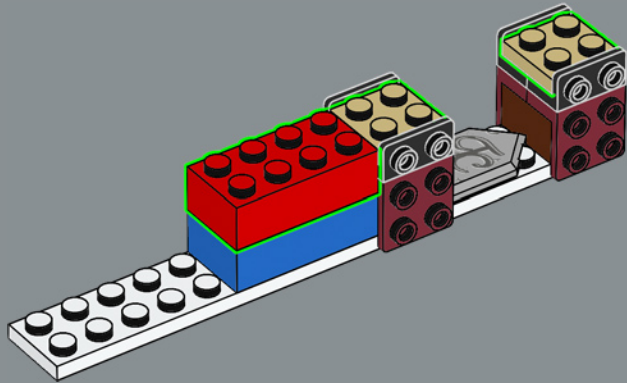

182

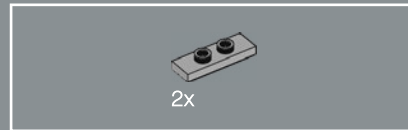
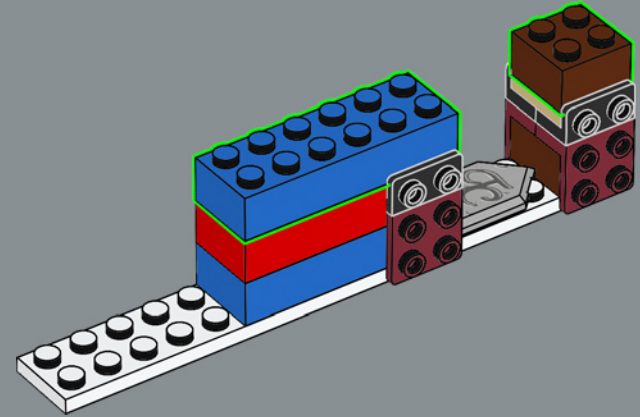

183

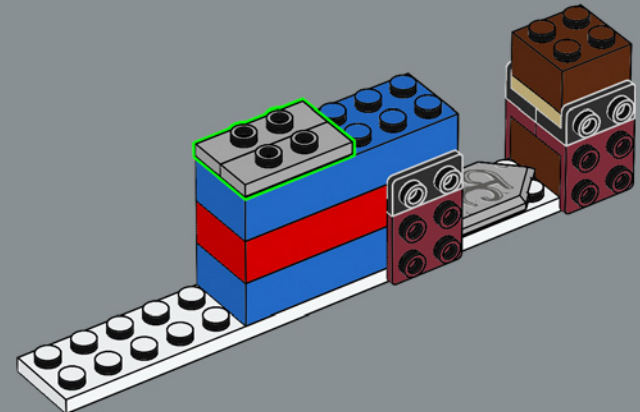

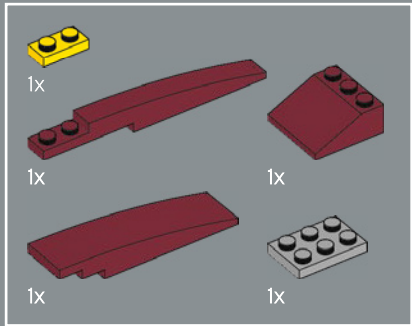

184

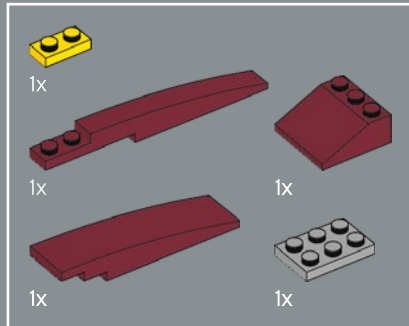
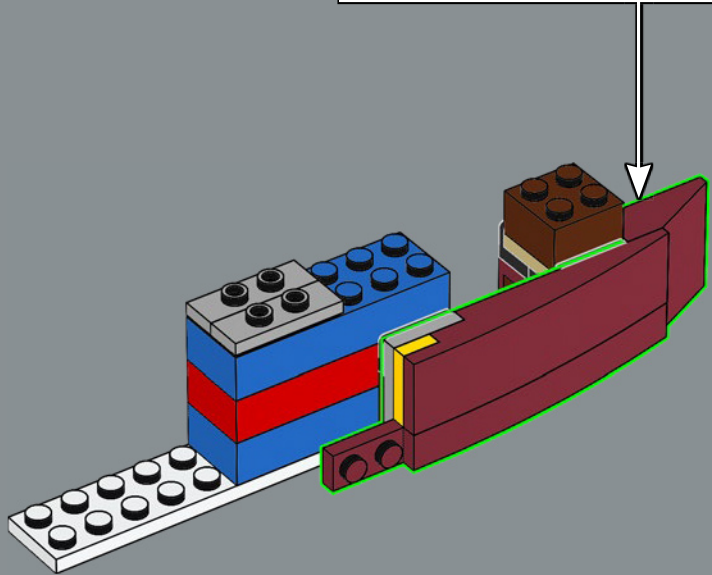
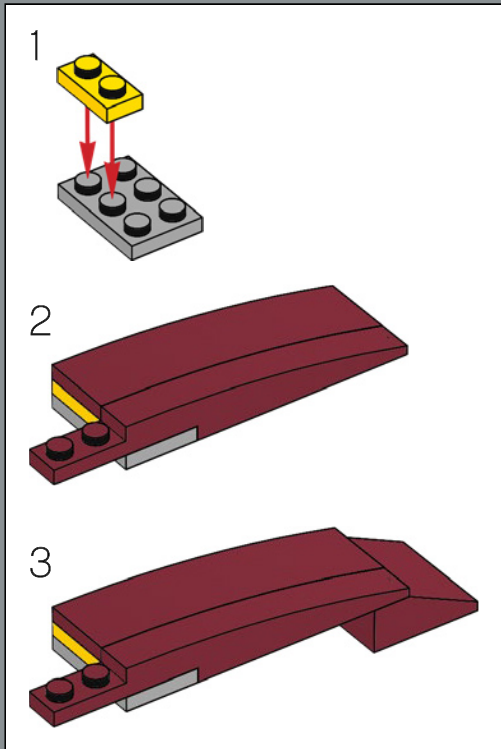

185

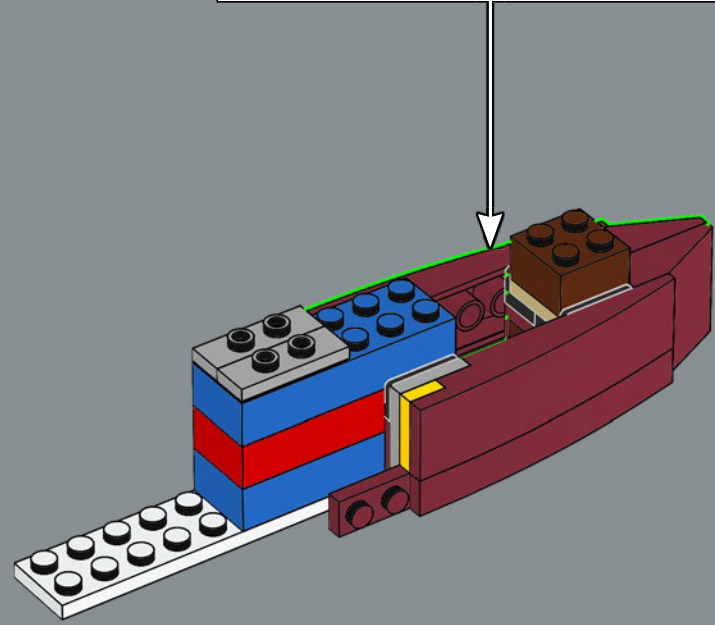
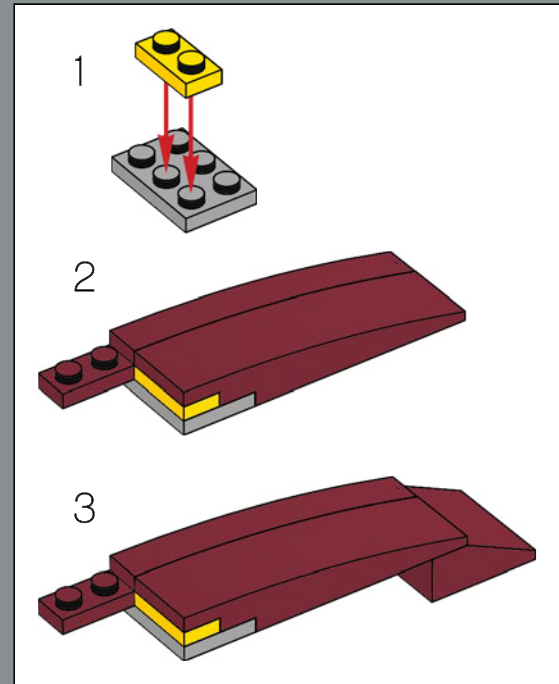

186

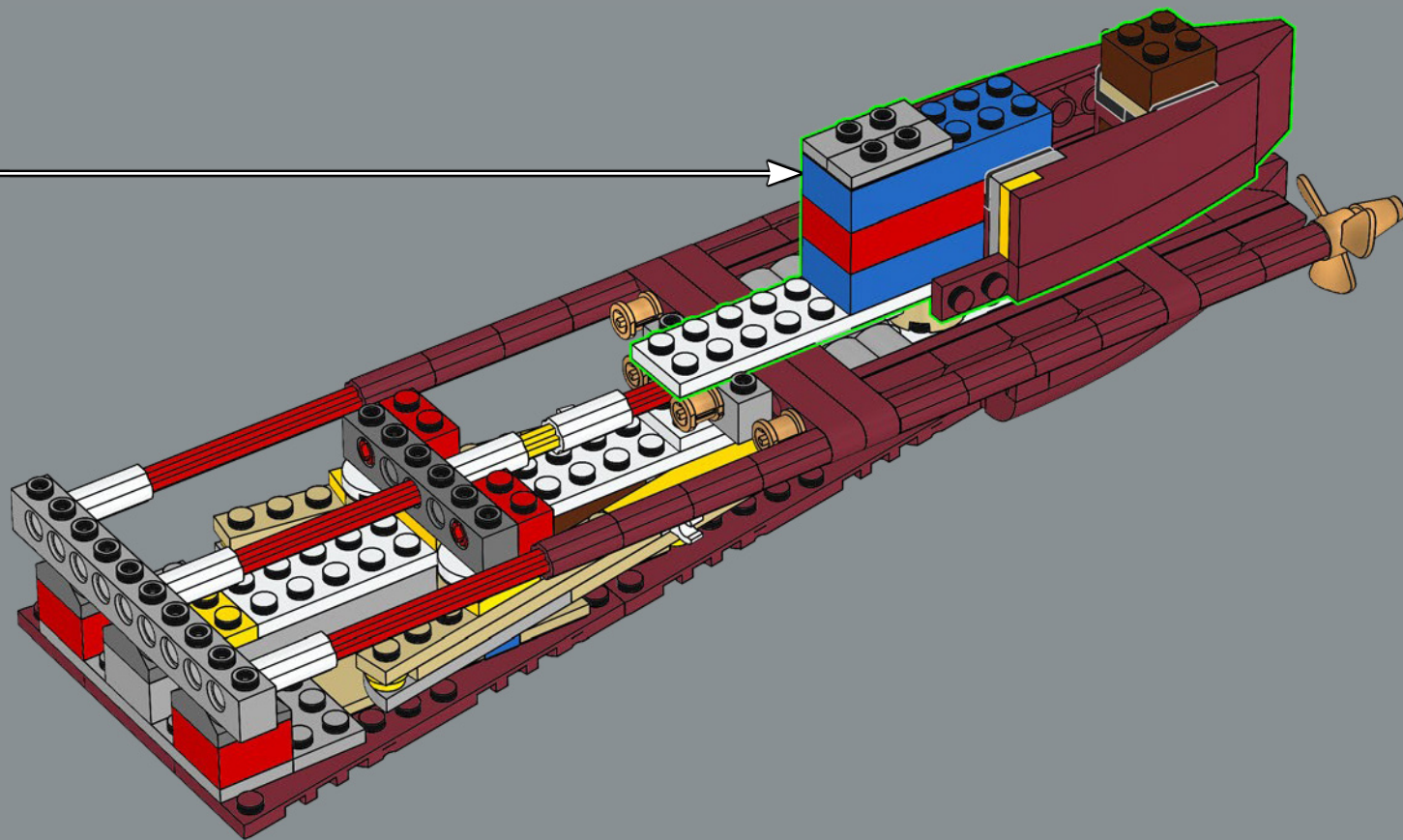

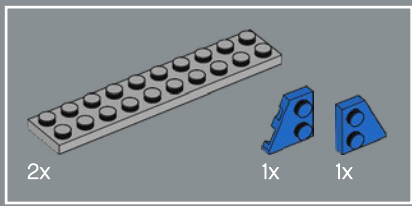

187

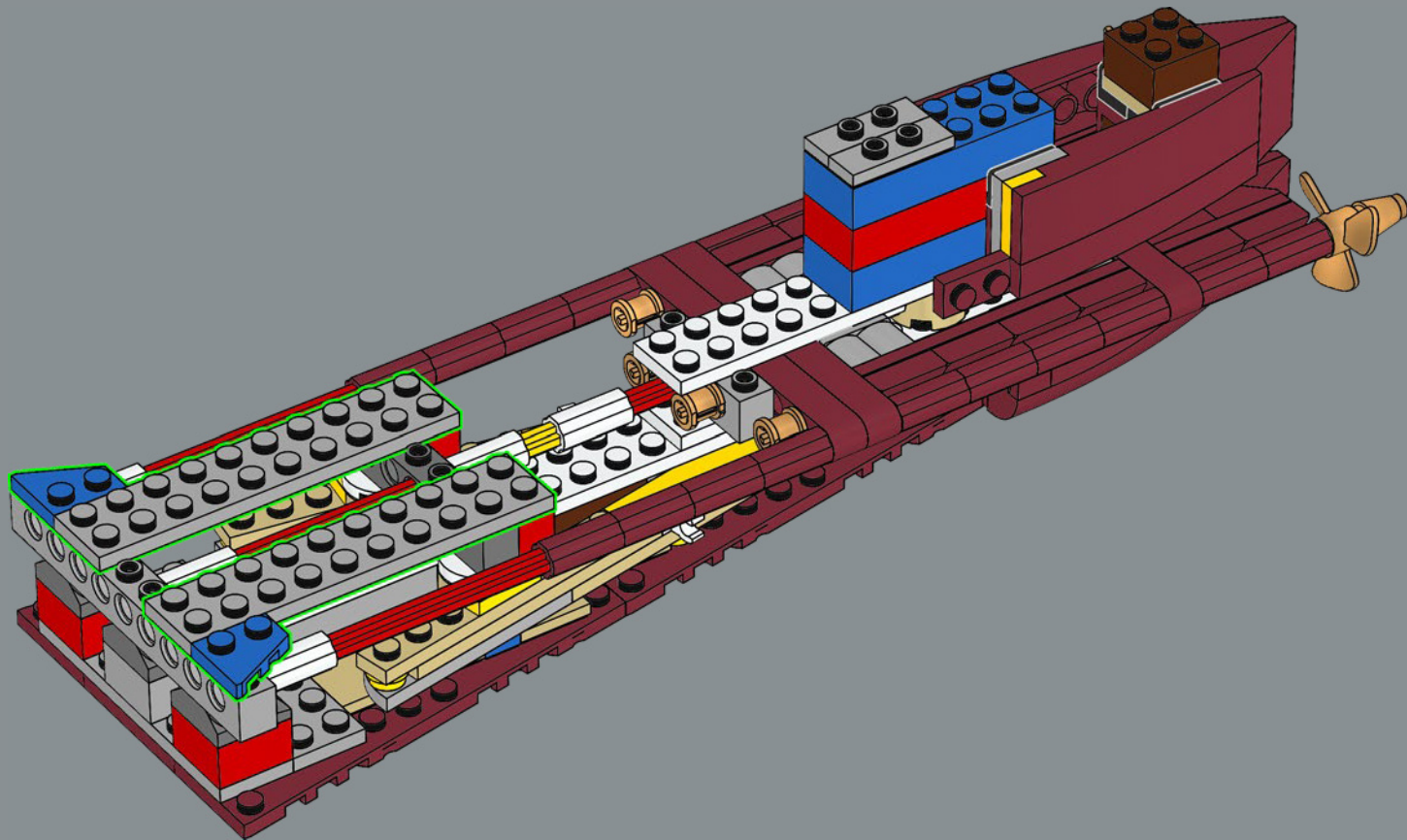

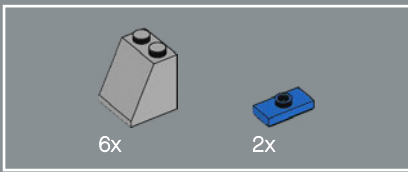

188

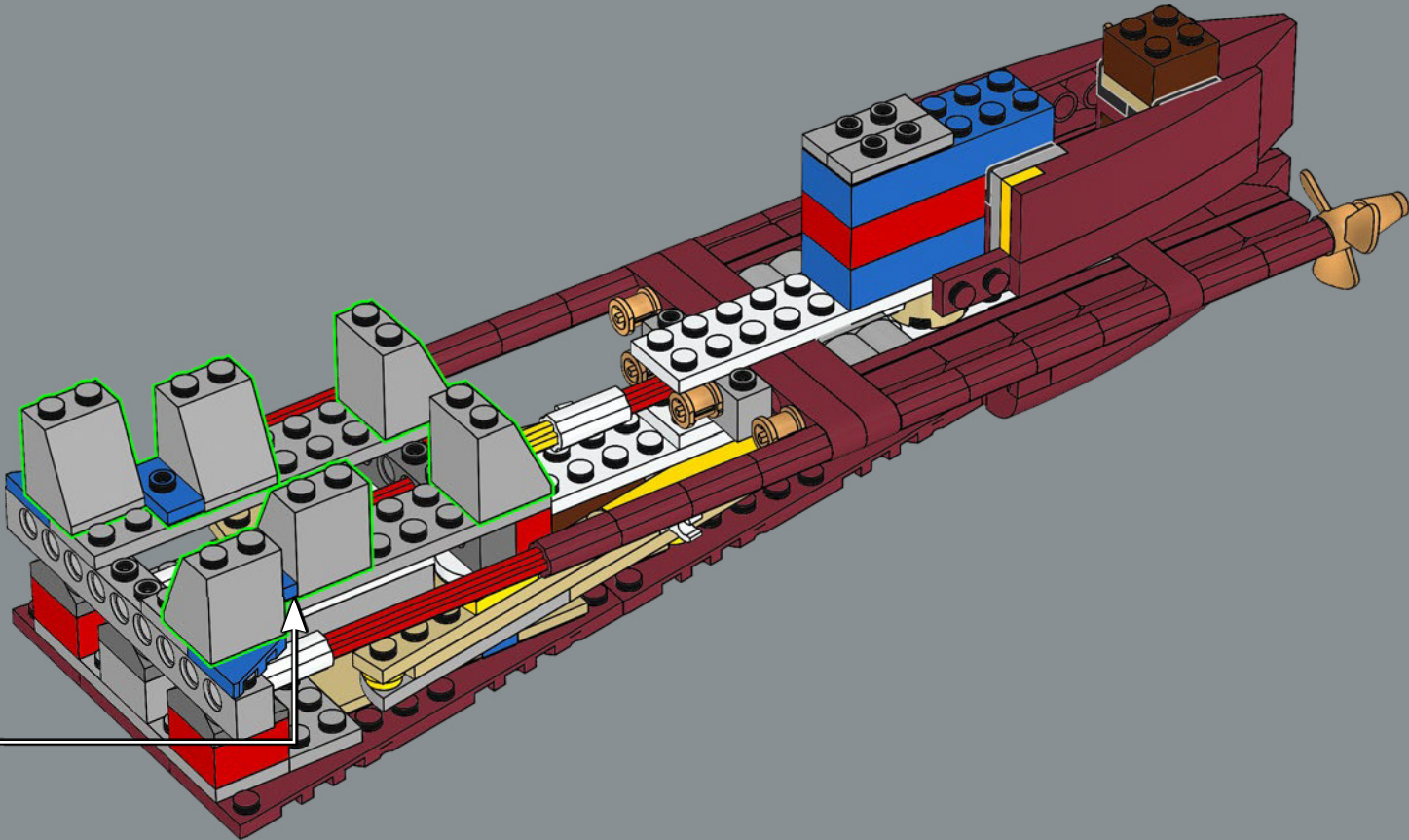

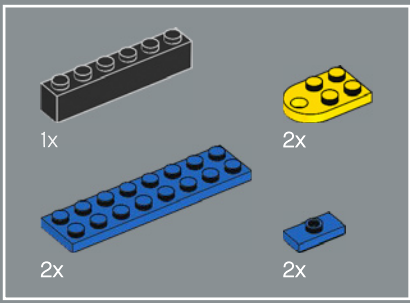

189

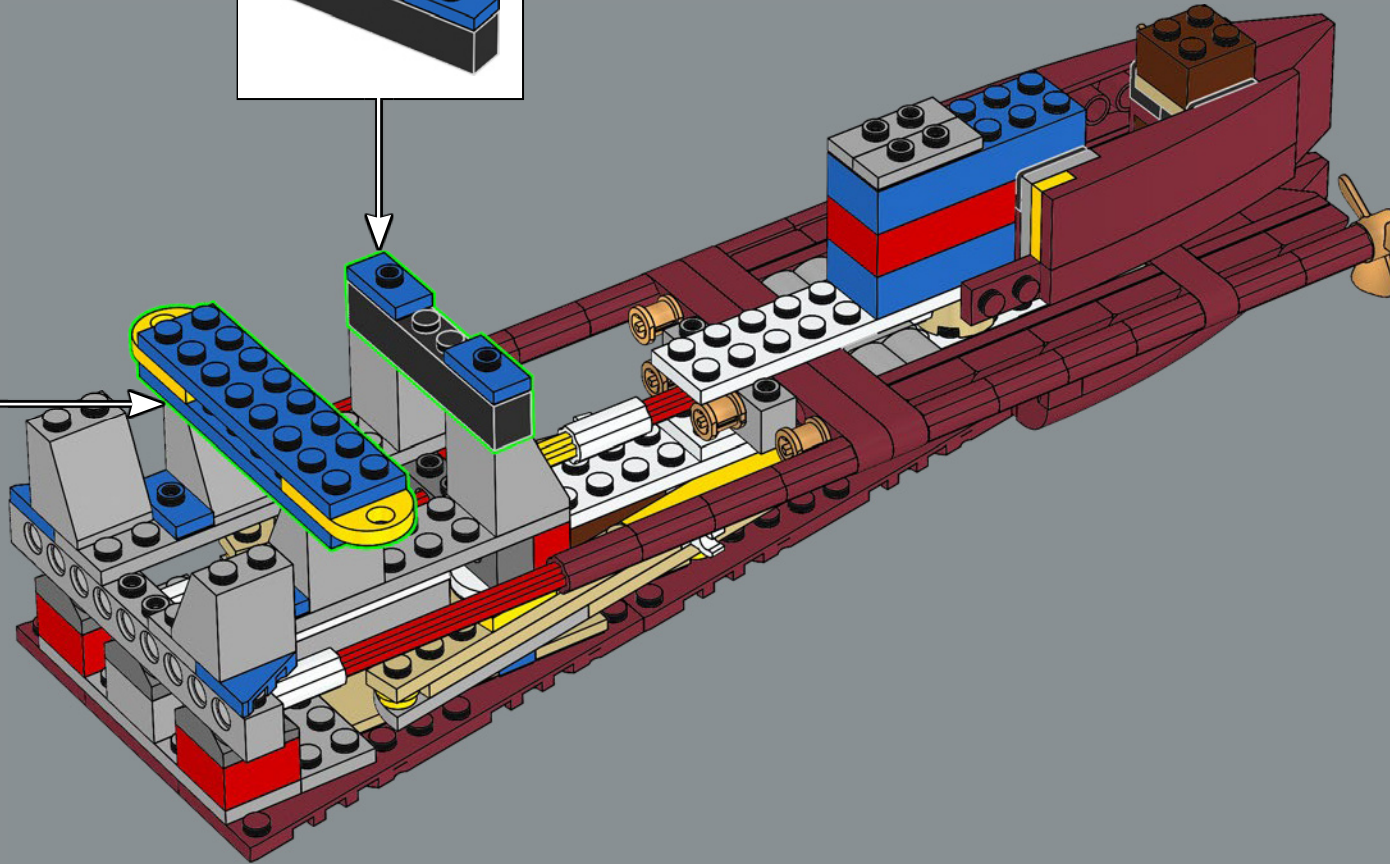
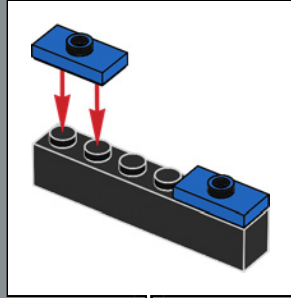
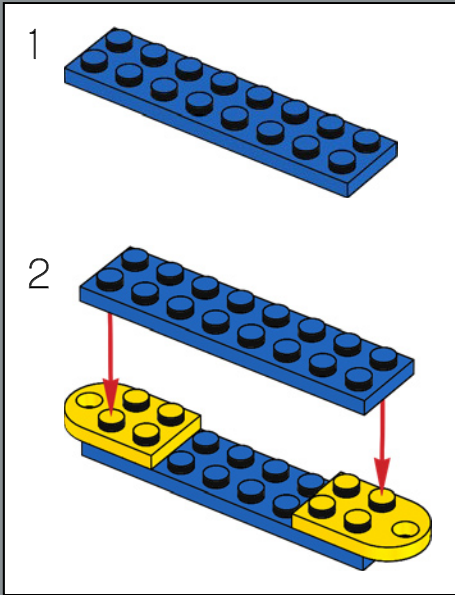



190

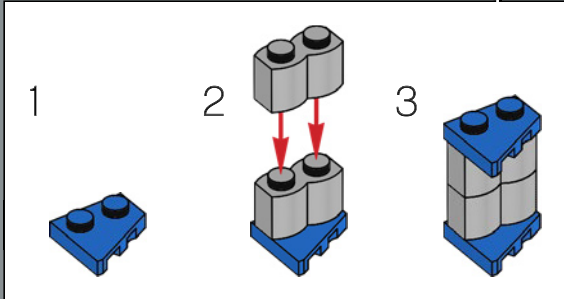
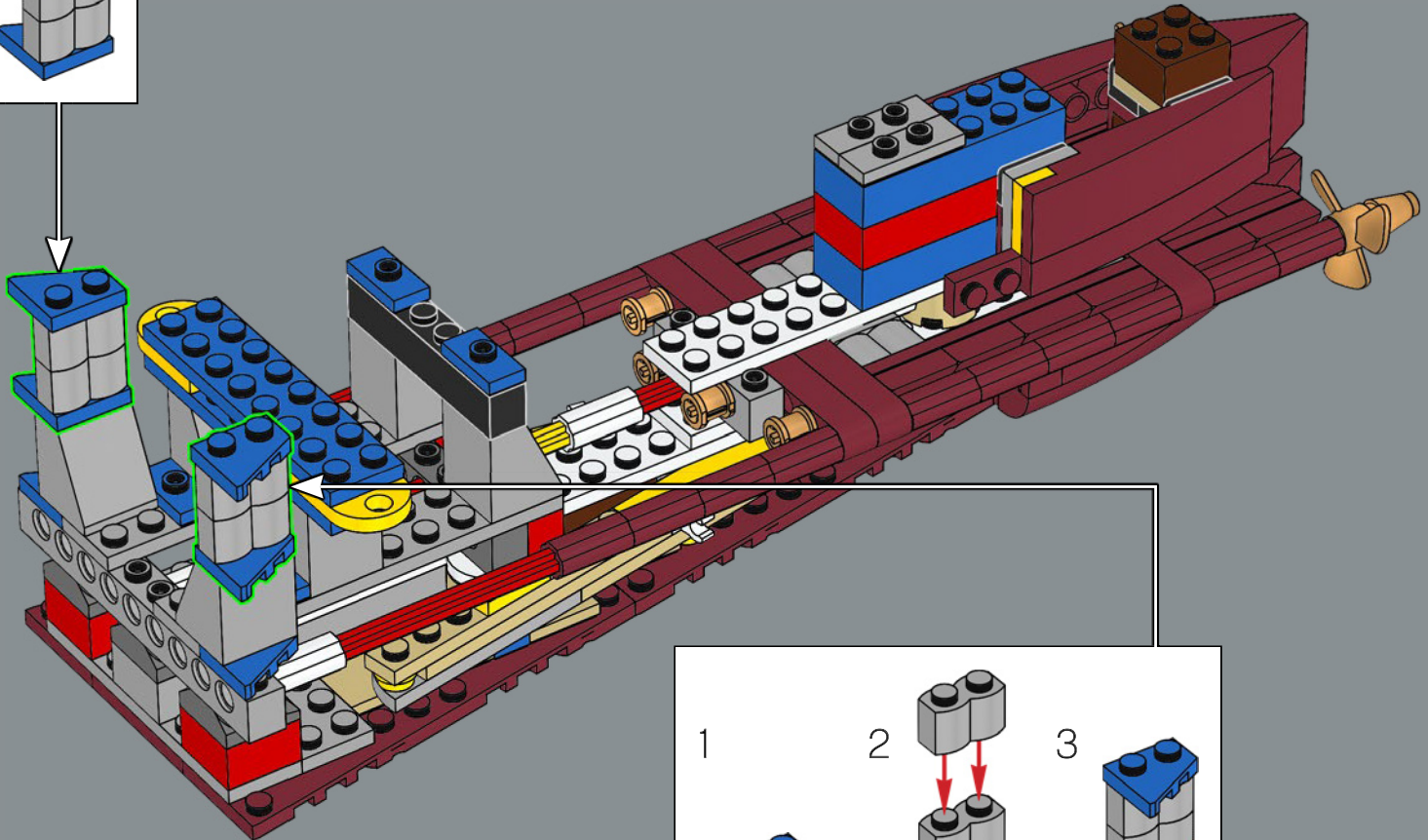
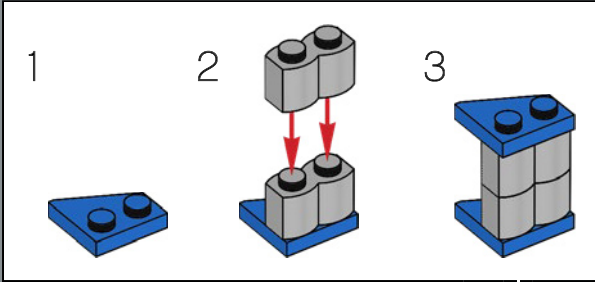

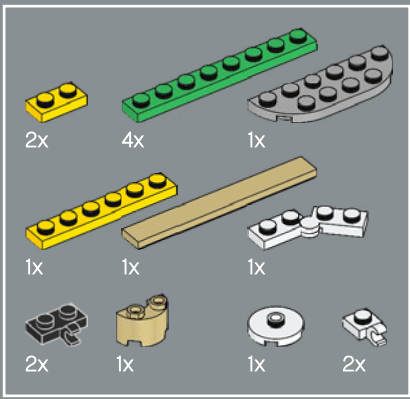

191

1



2

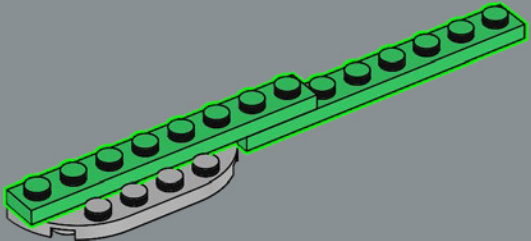

3

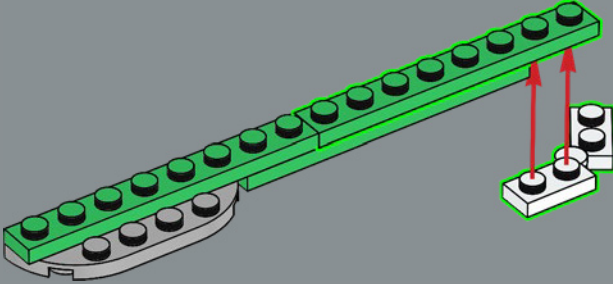

4

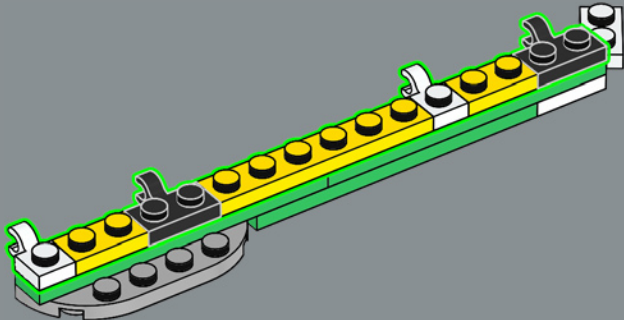

5

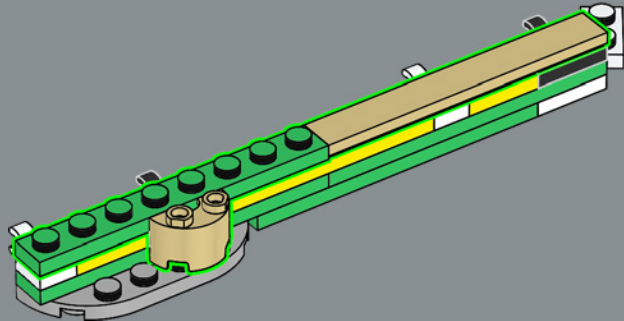

6

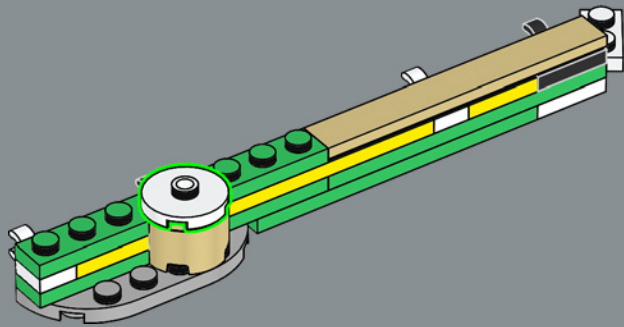



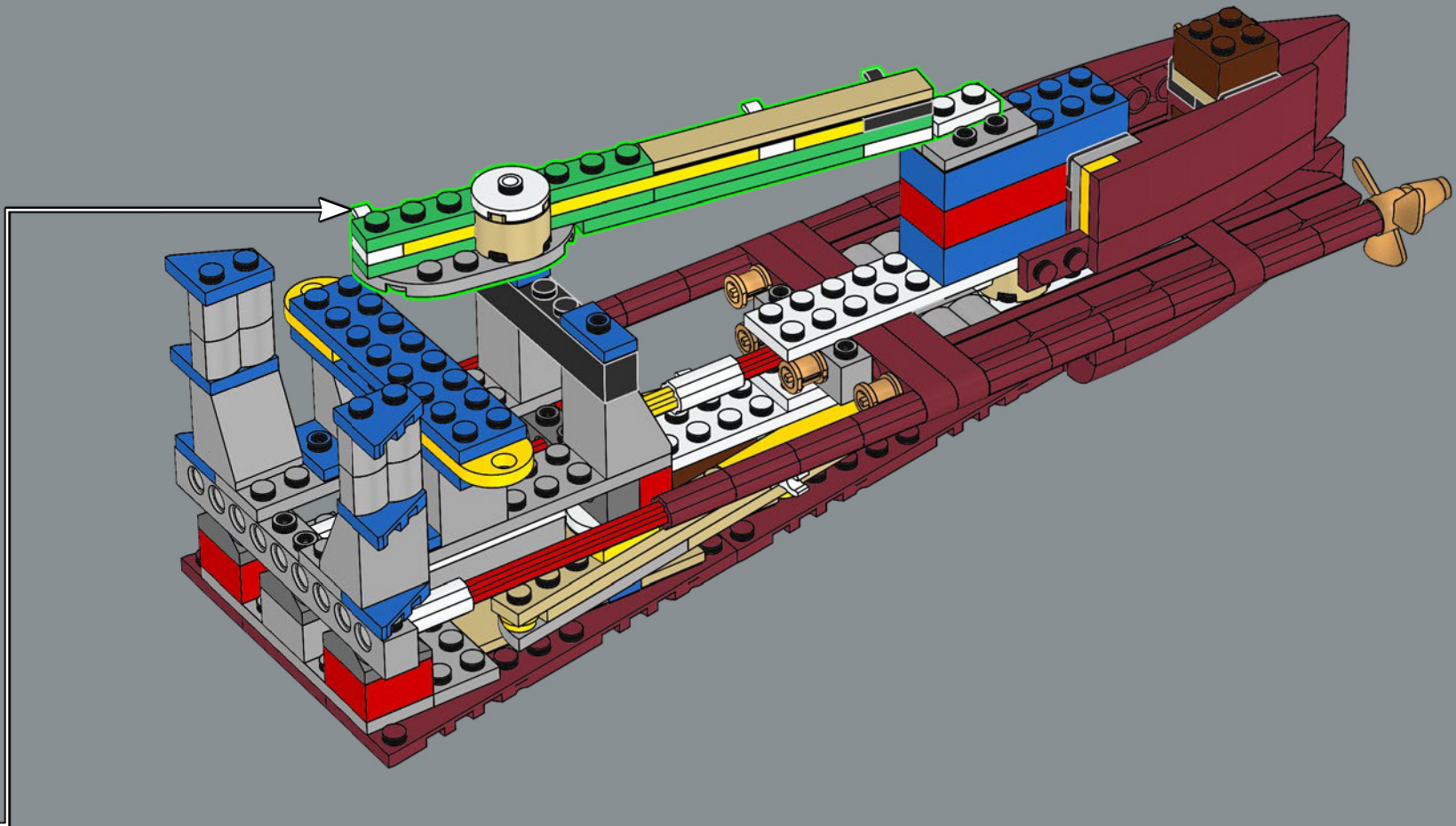

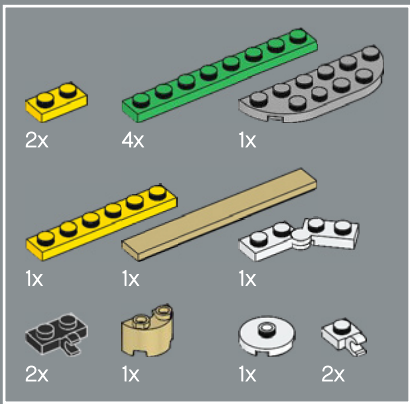

192

1

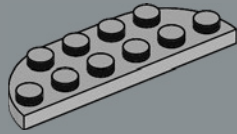

2

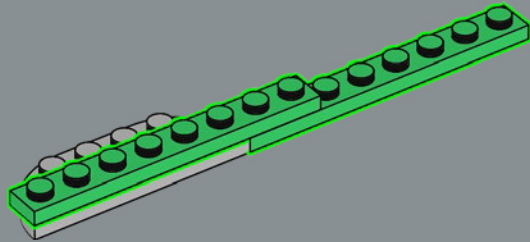

3

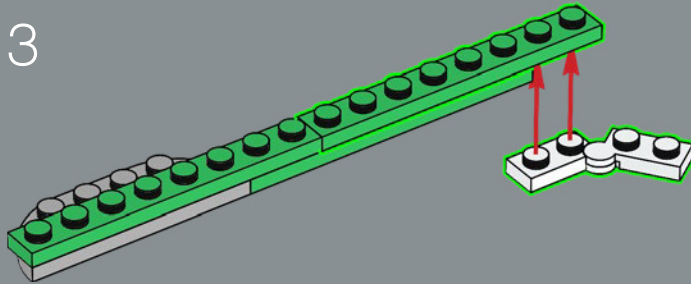

4

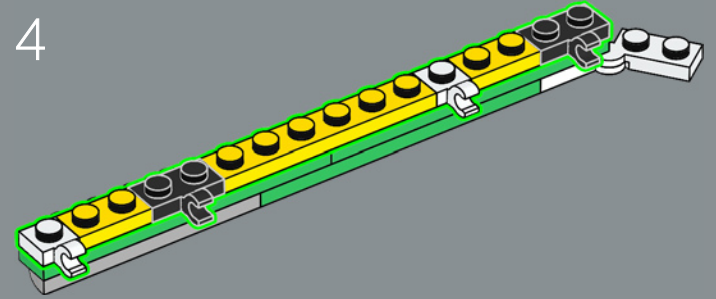

5

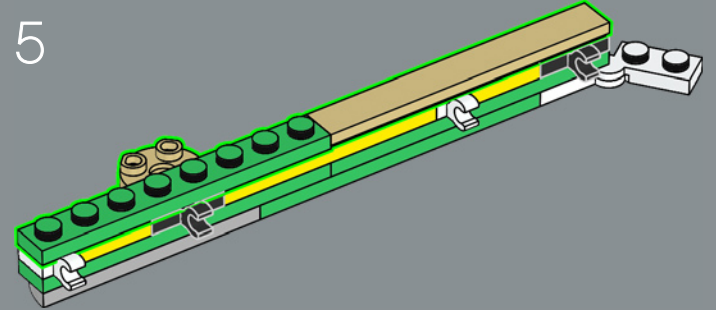

6

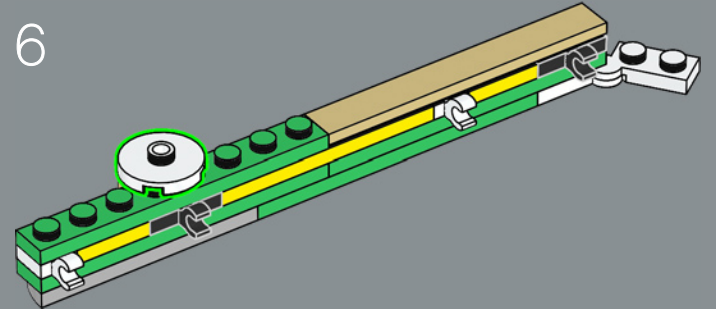

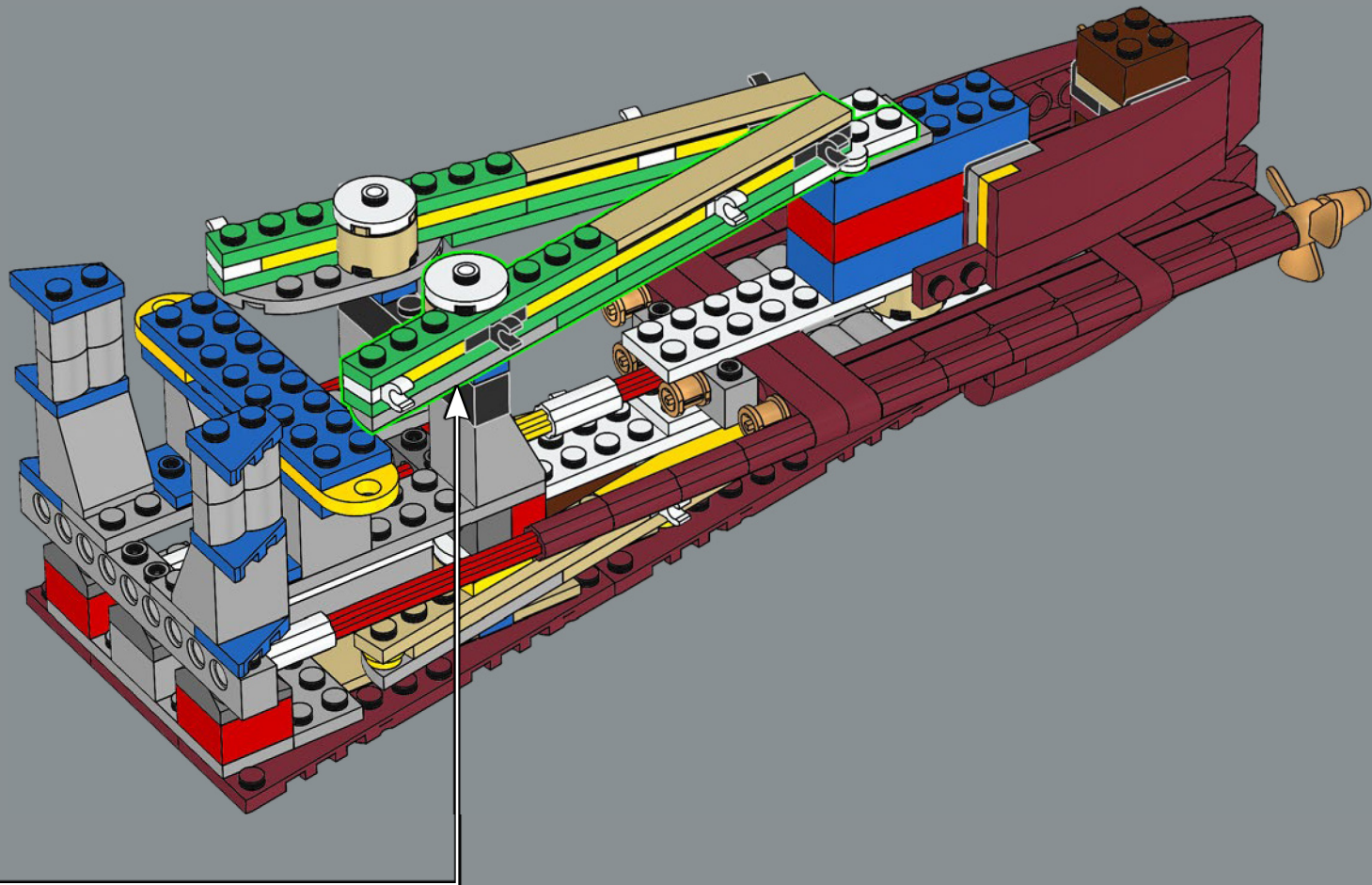

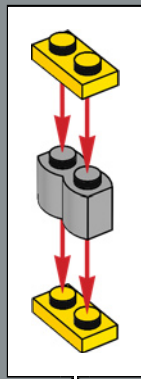
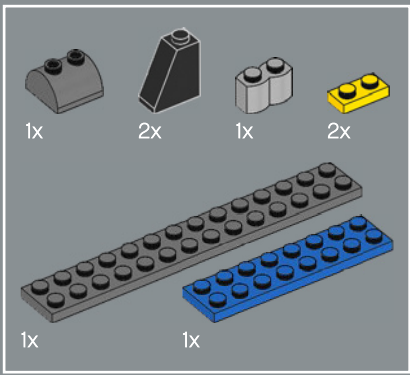

193

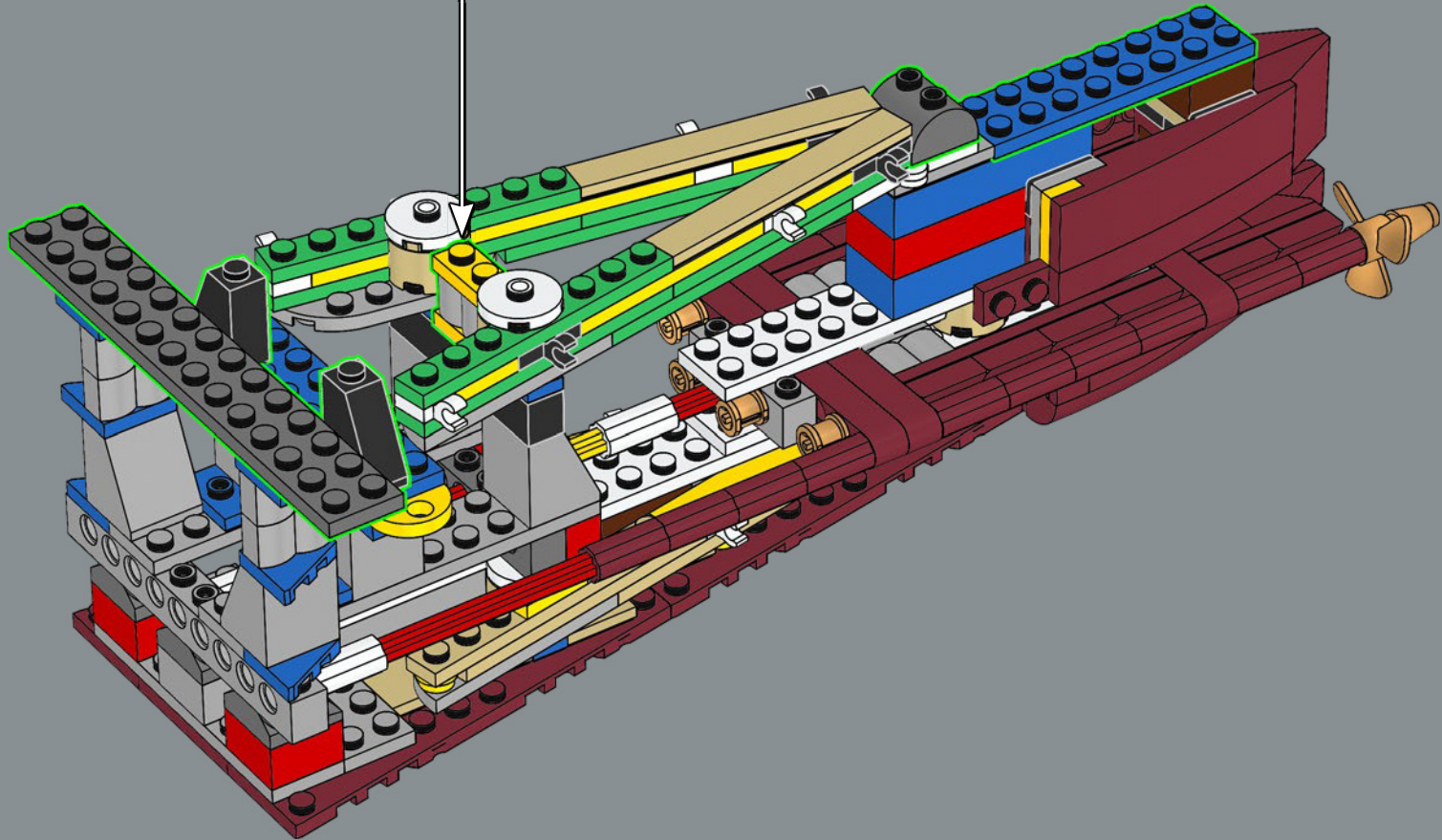

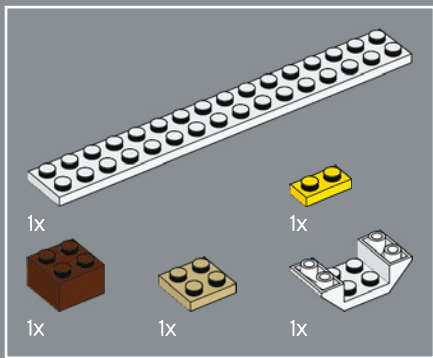

194

1

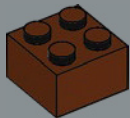

2

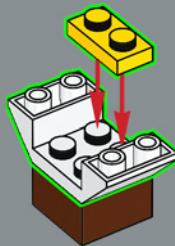

3

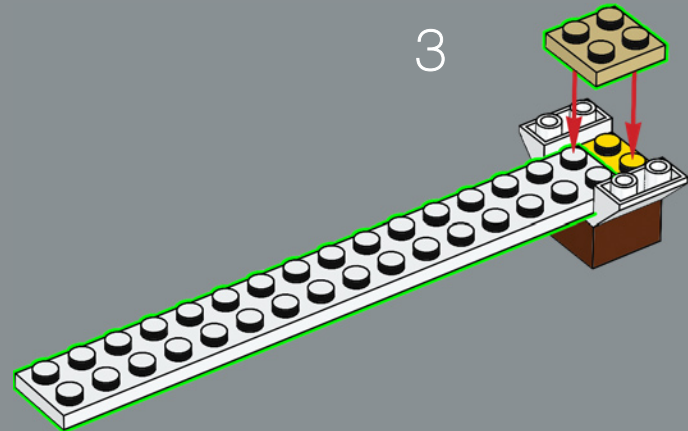

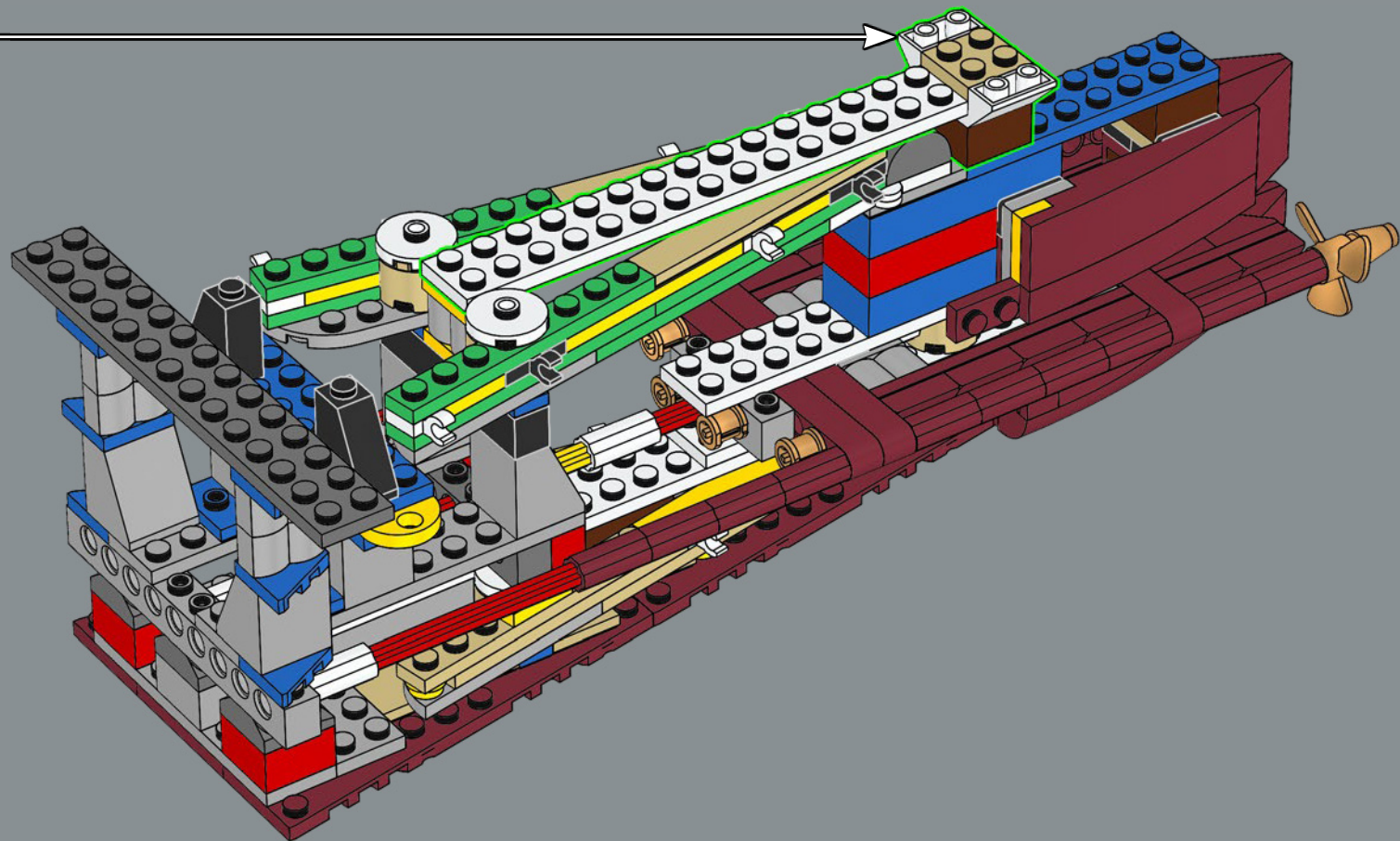

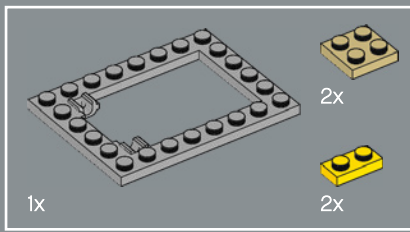

195

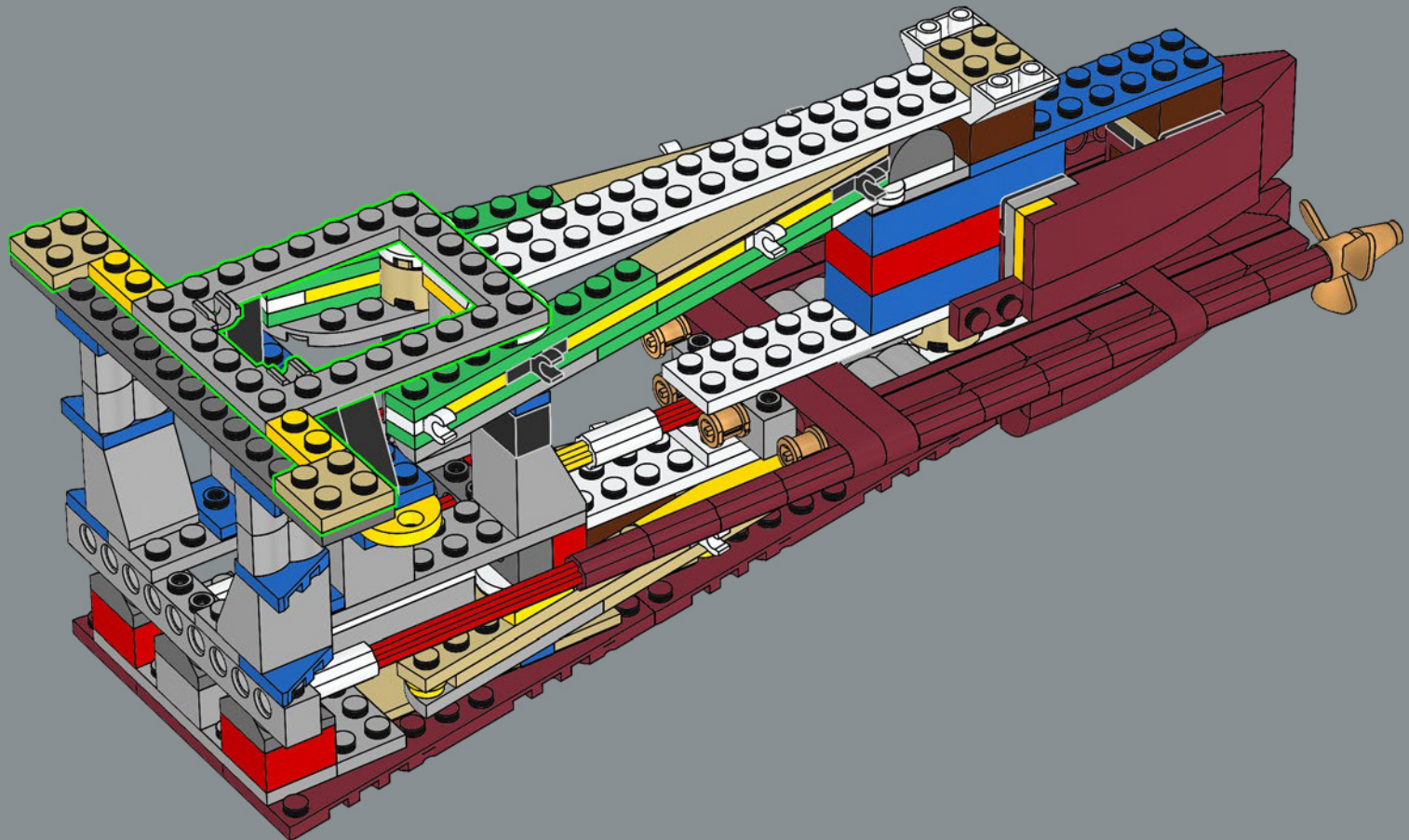

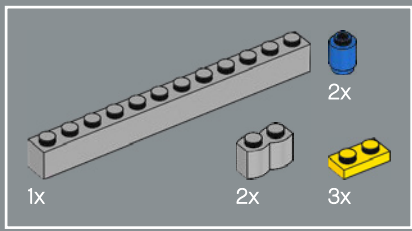

196

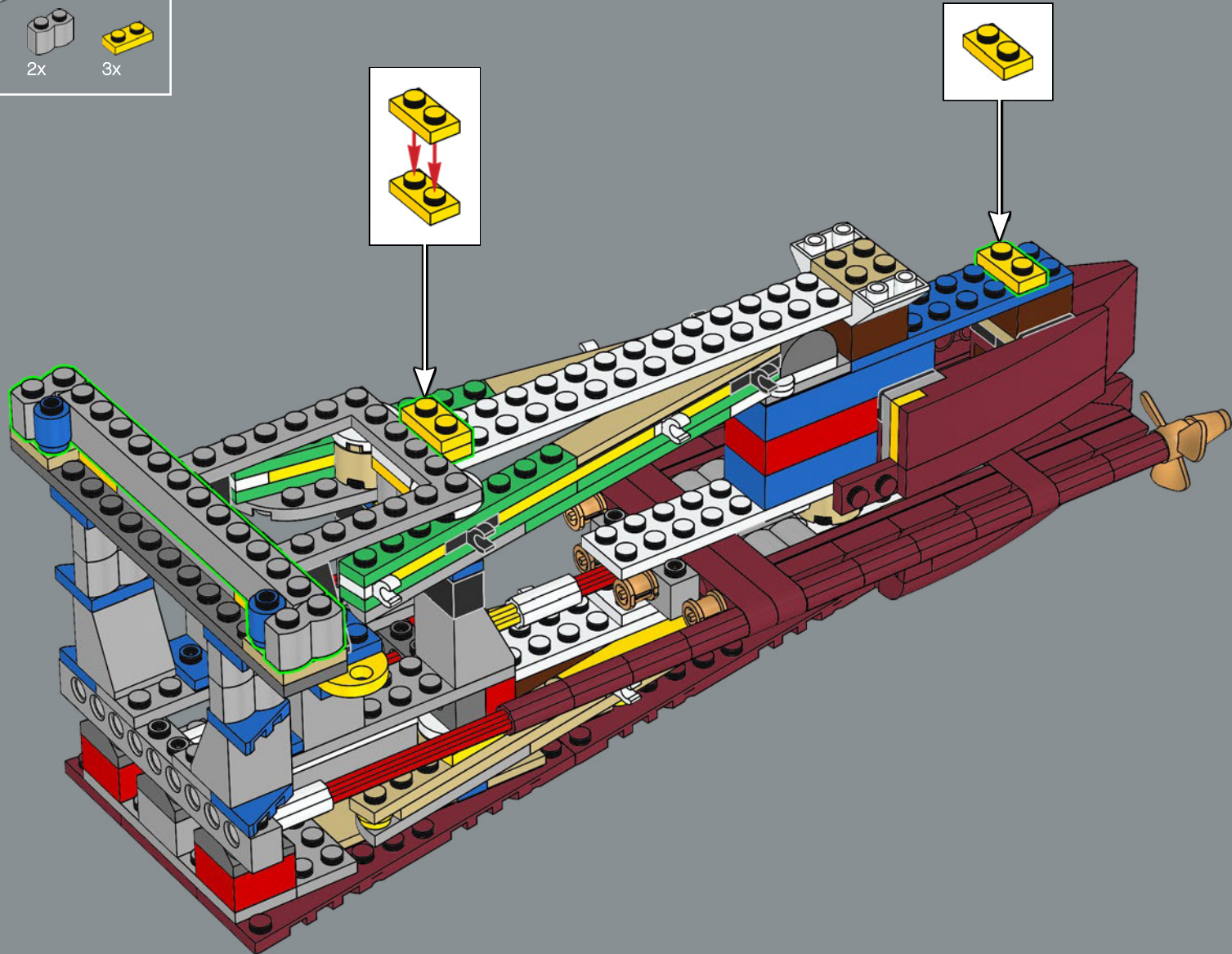



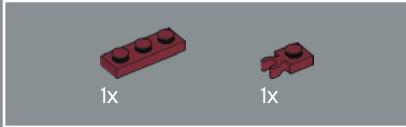
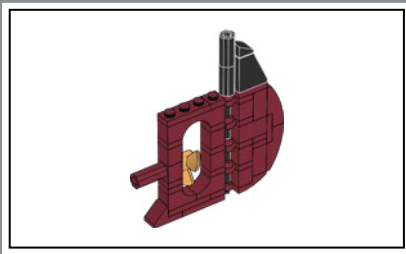

197

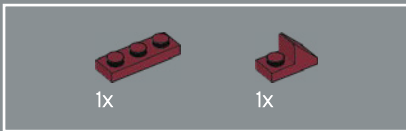
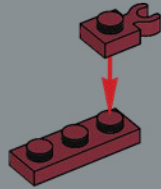

198

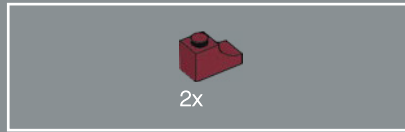
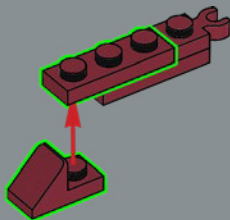

199

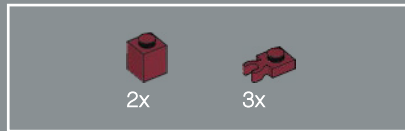
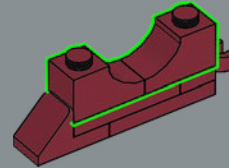

200

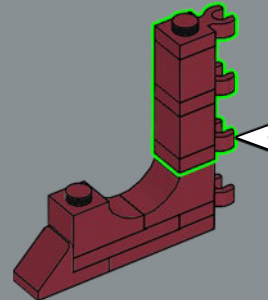
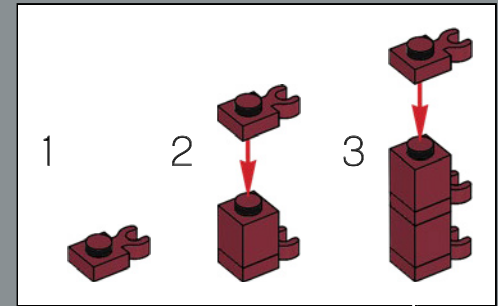

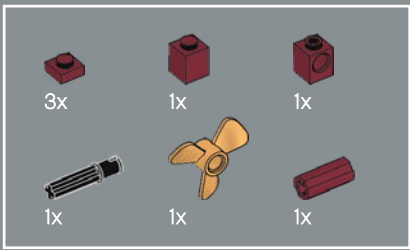

201

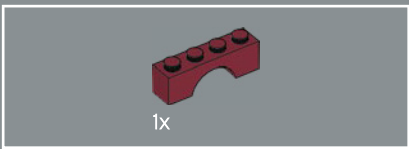
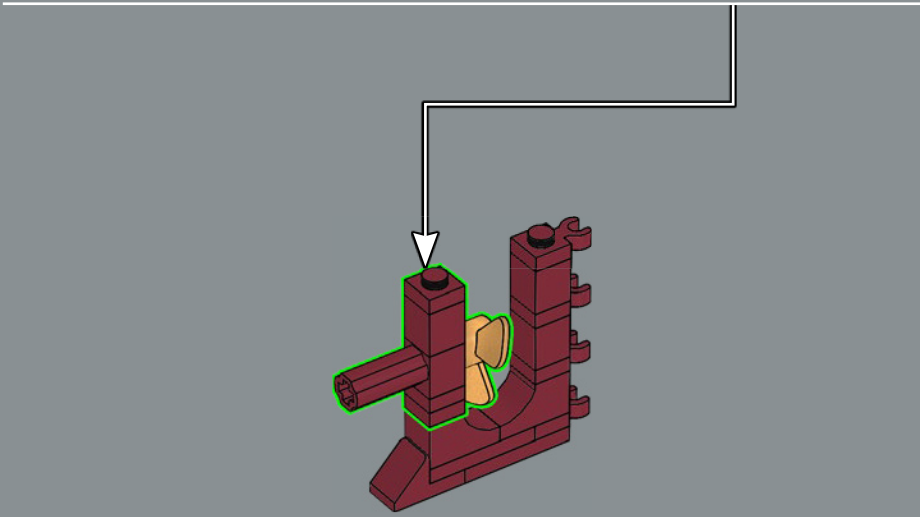
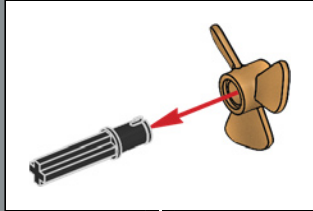
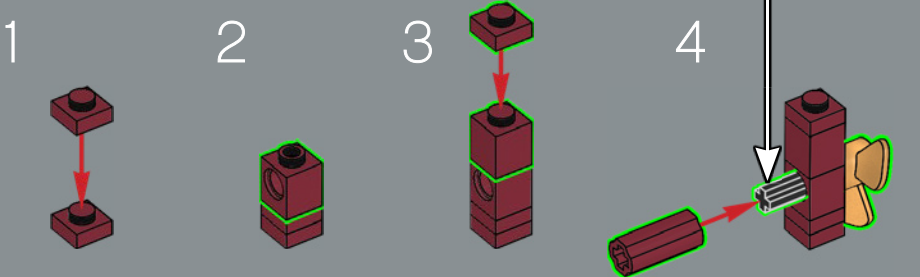

202

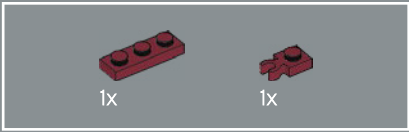
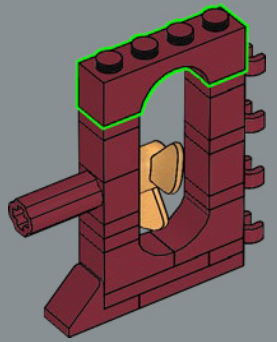

203

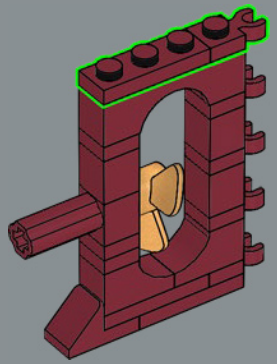

204

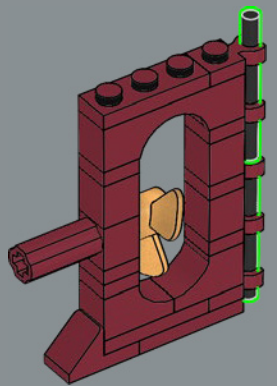

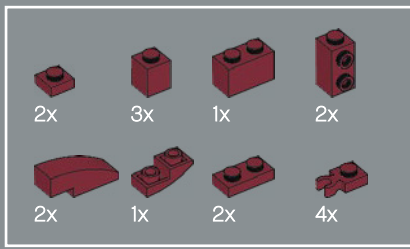

205

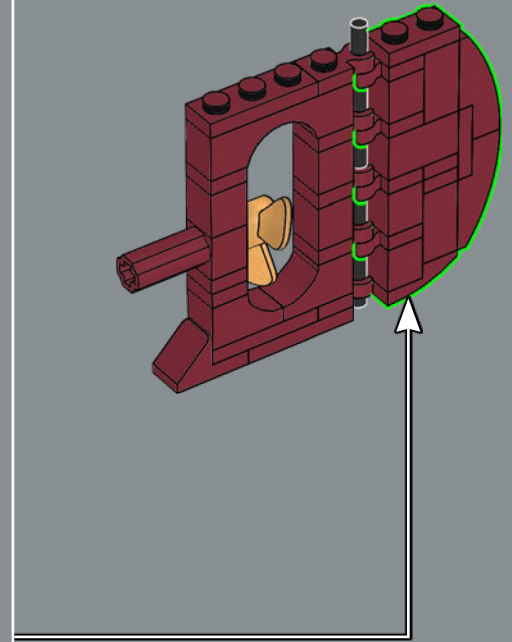
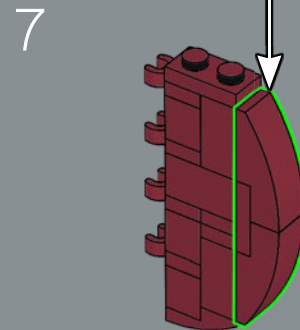
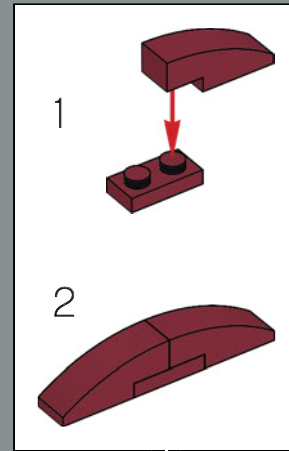
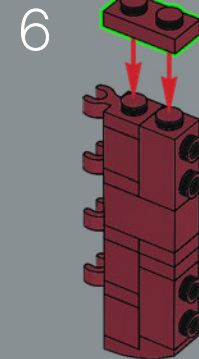
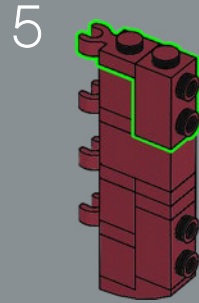
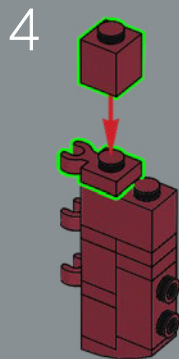
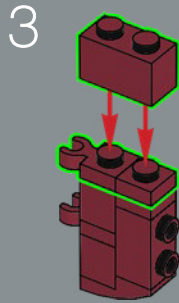
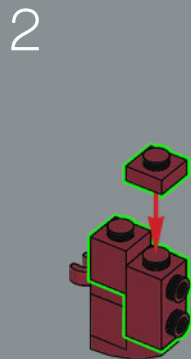
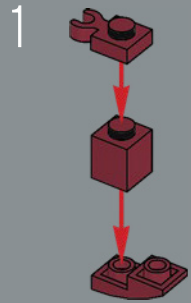

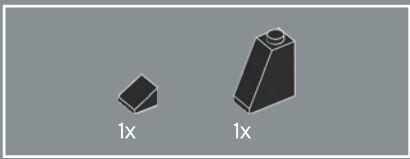

206

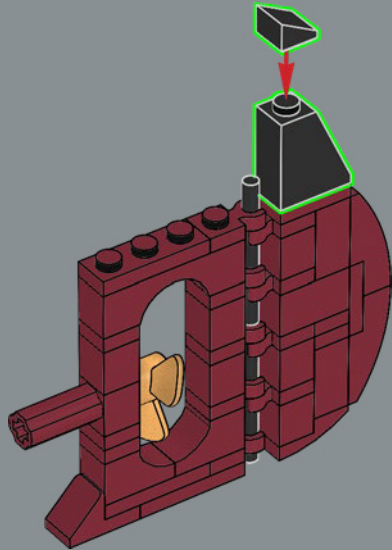

207

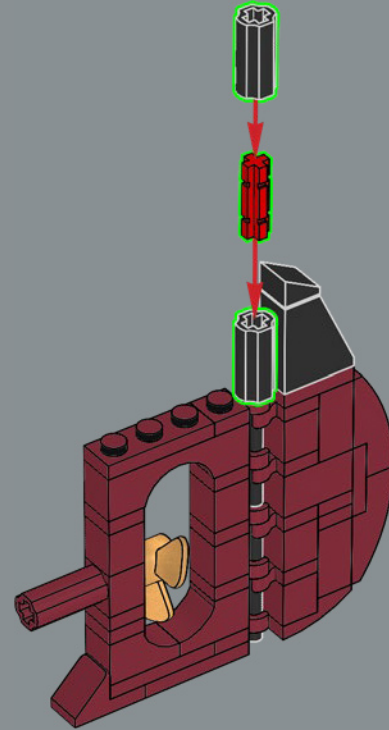

Wegen seiner Höhe von 24 Metern, seiner Länge von 4,65 Metern und seinem Gewicht von mehr als 100 Tonnen waren Lenkmotoren erforderlich, um das Ruder zu bewegen.

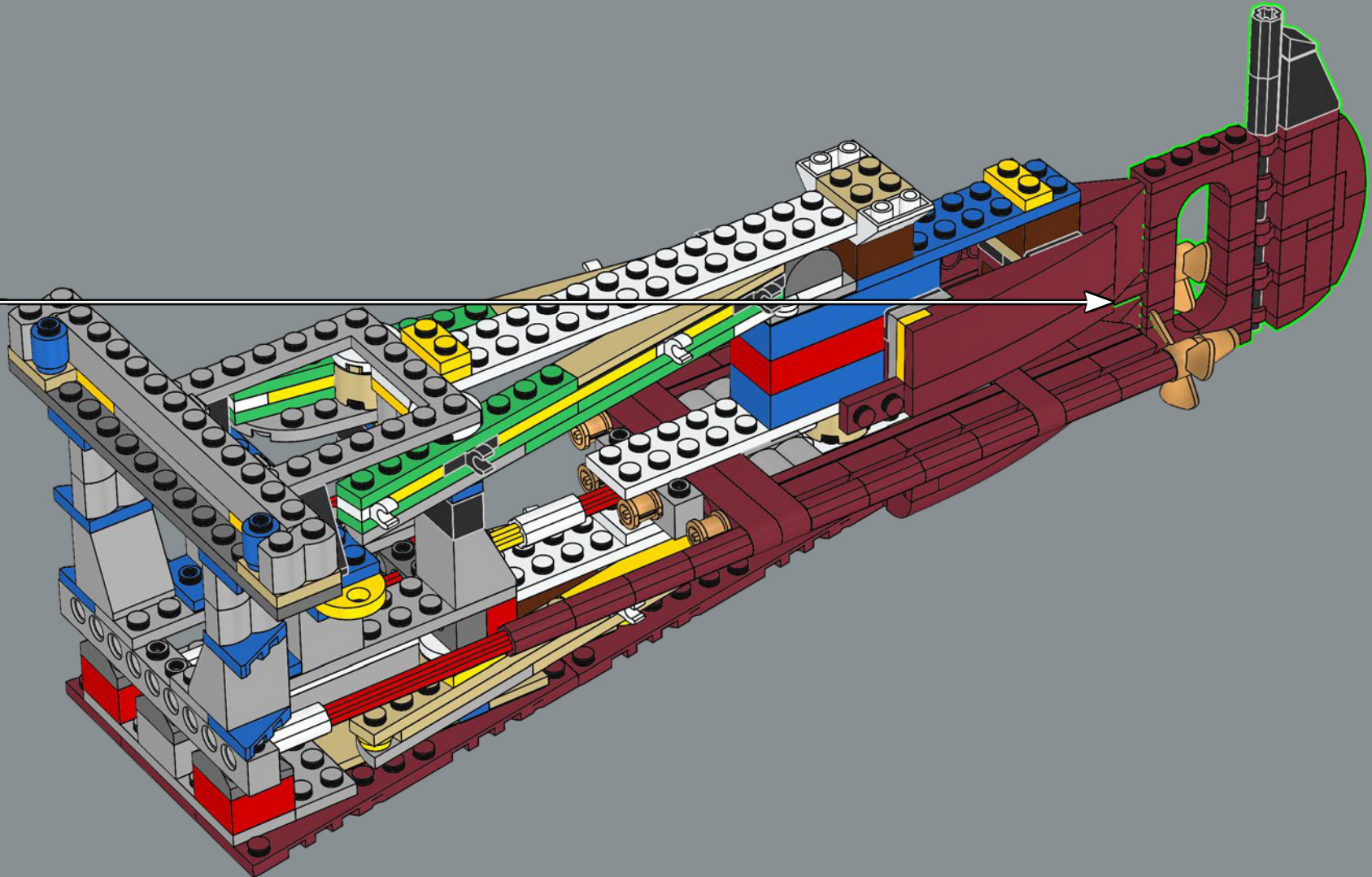

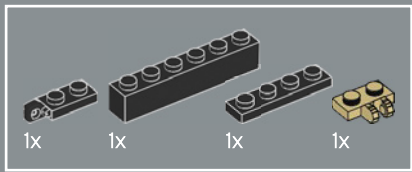

209

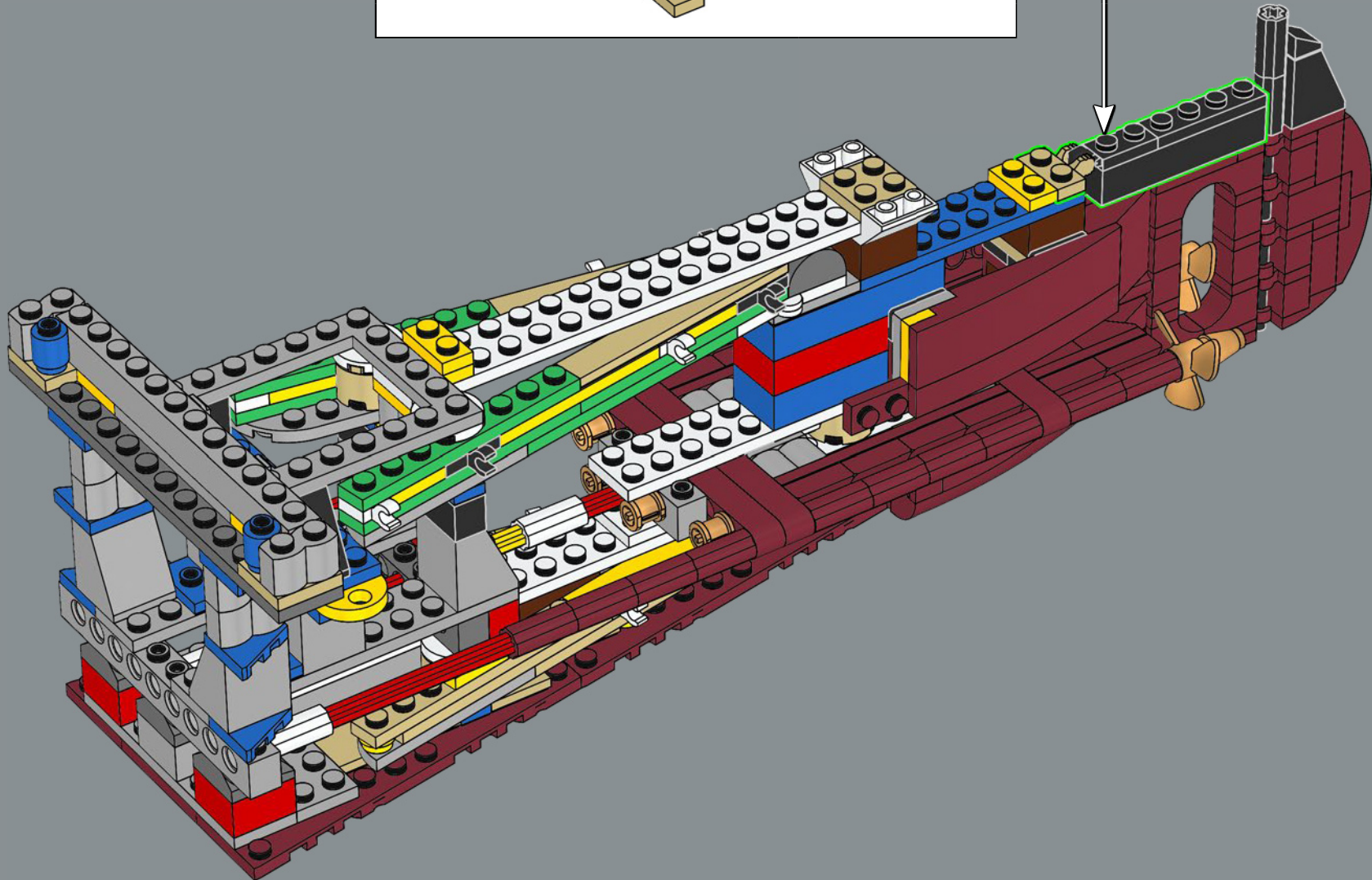
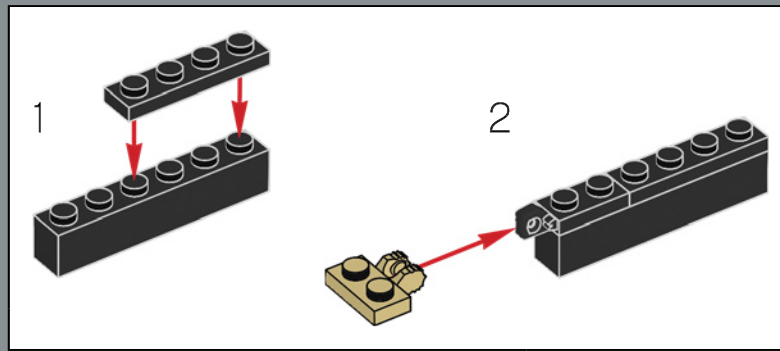

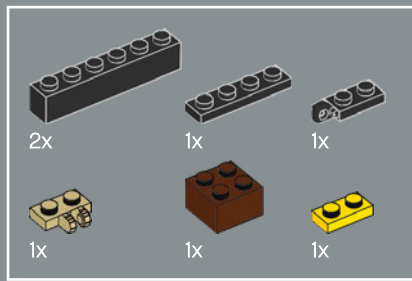

210

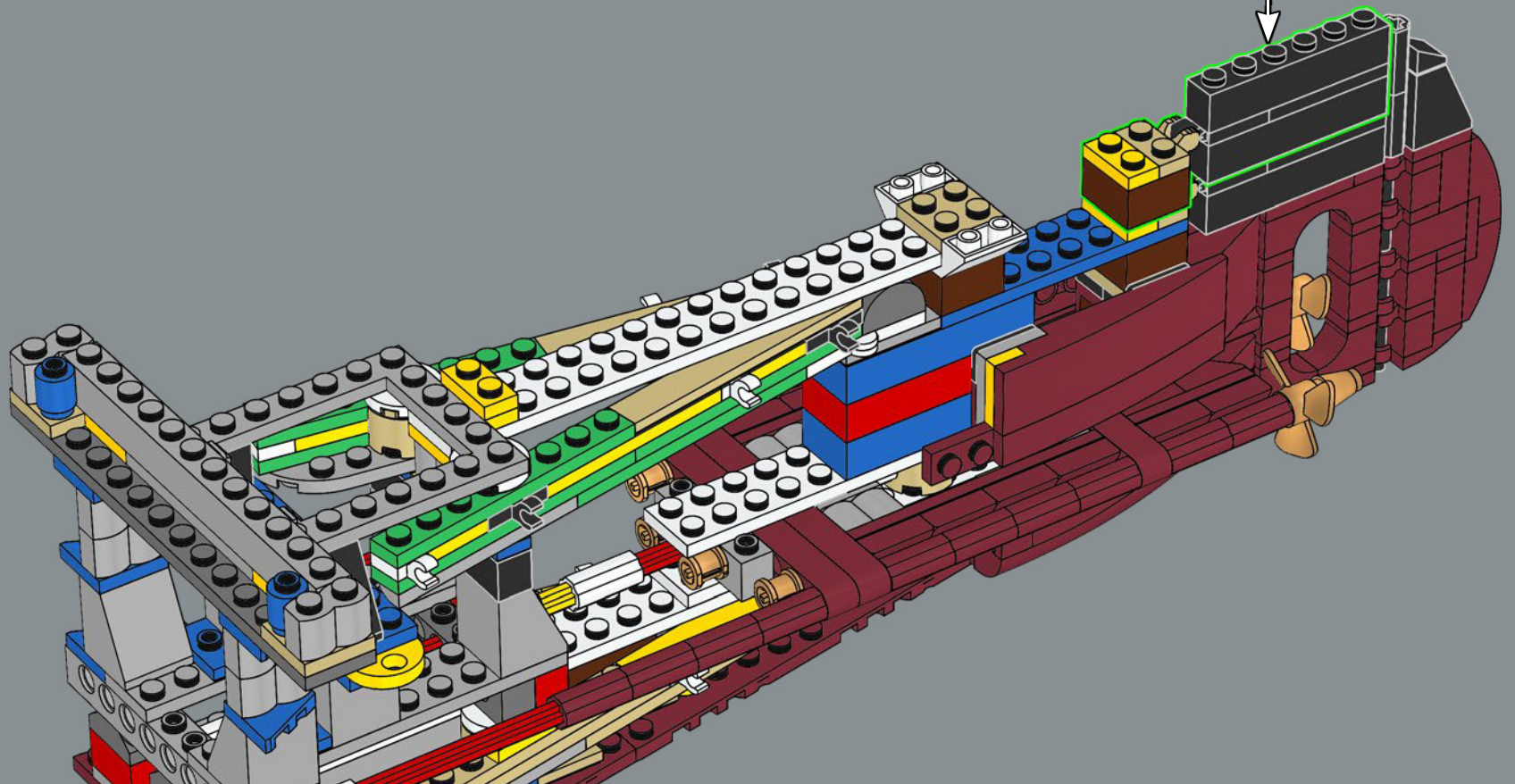
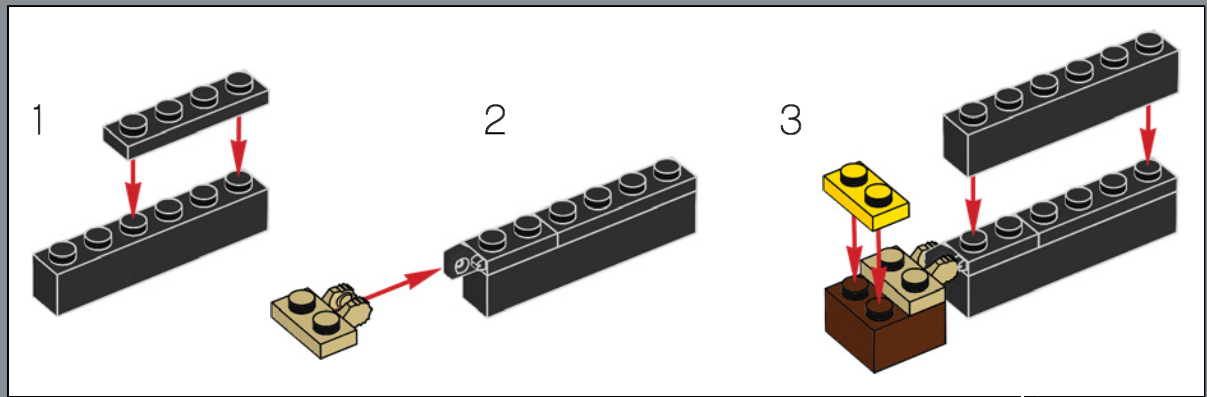

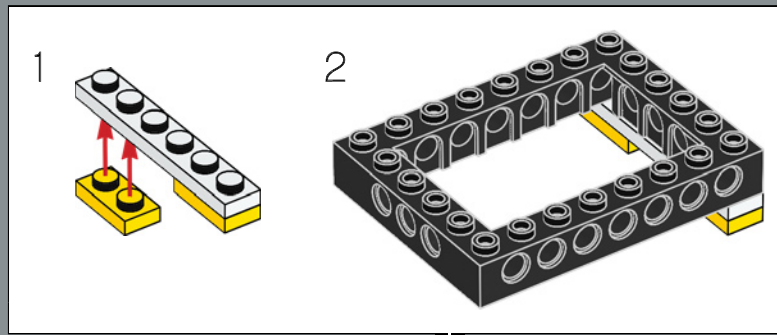
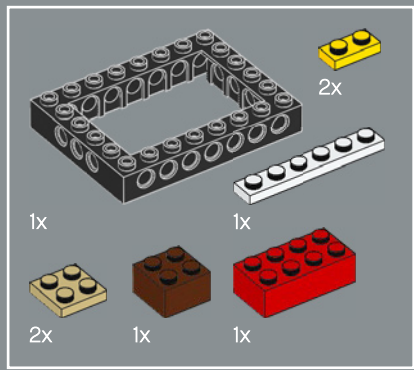

211

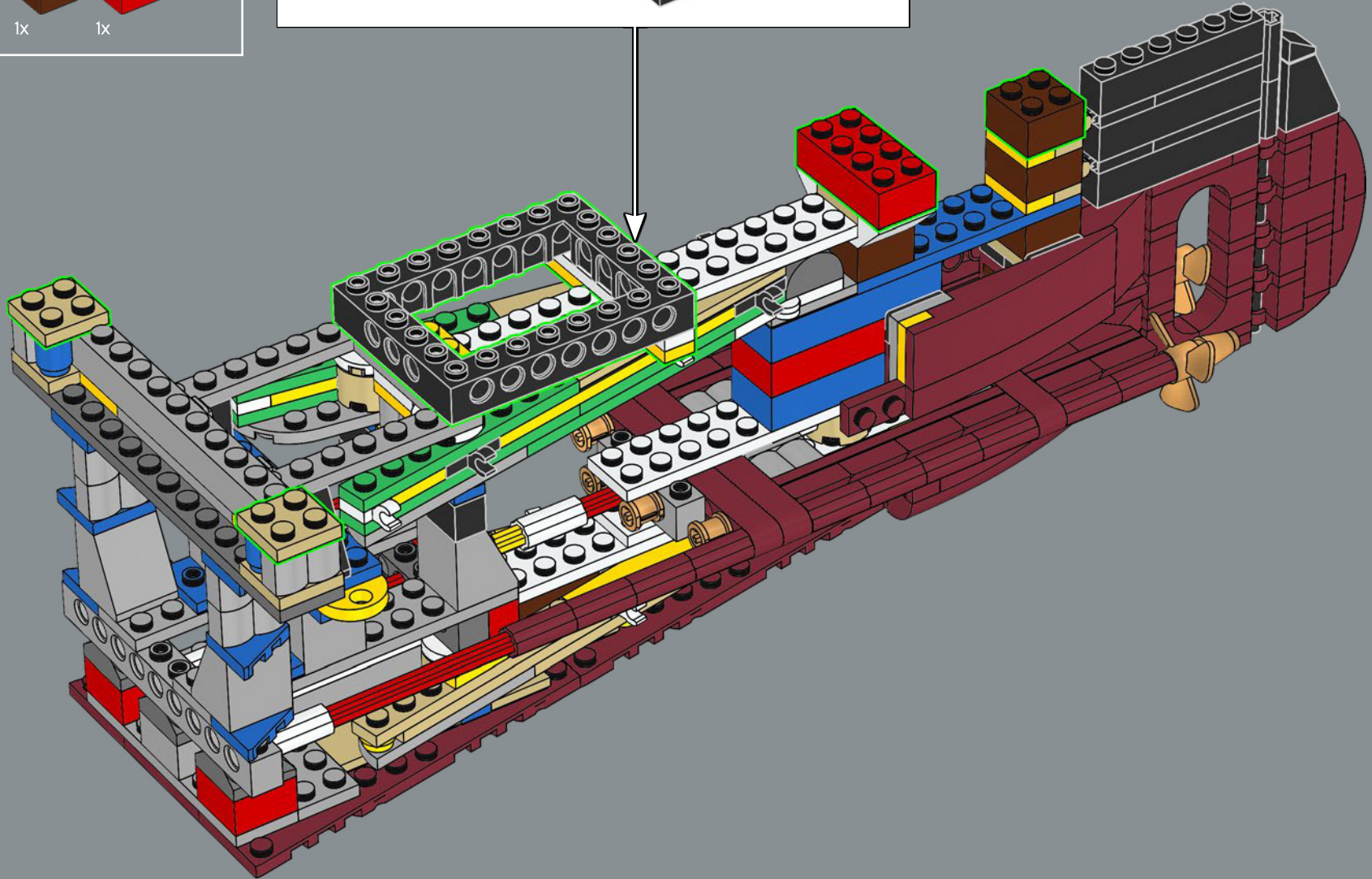



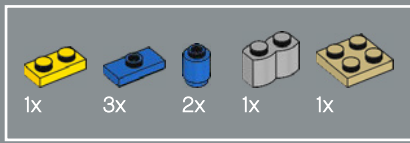

212

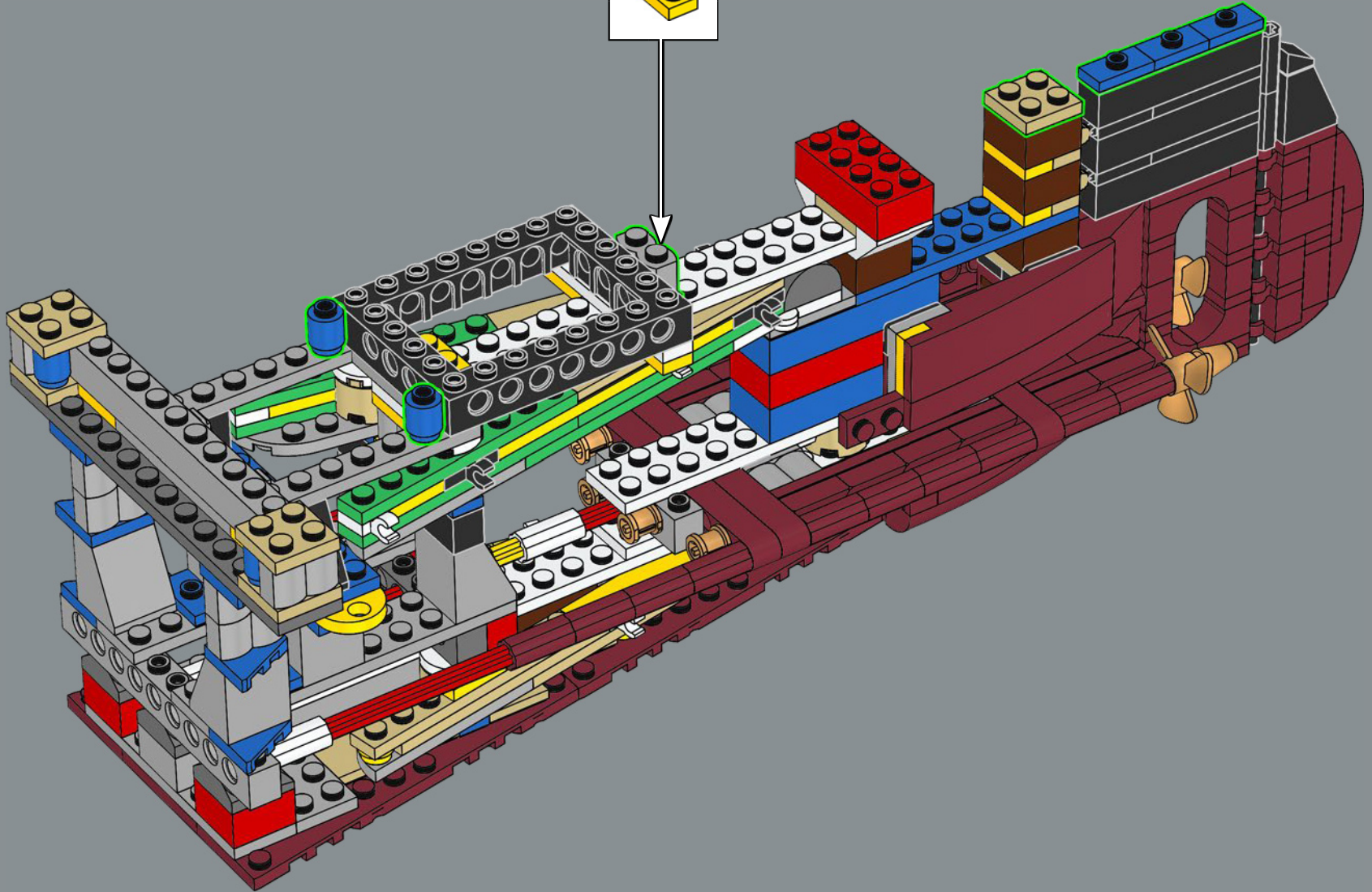
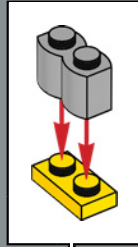

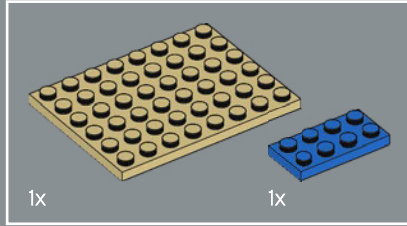
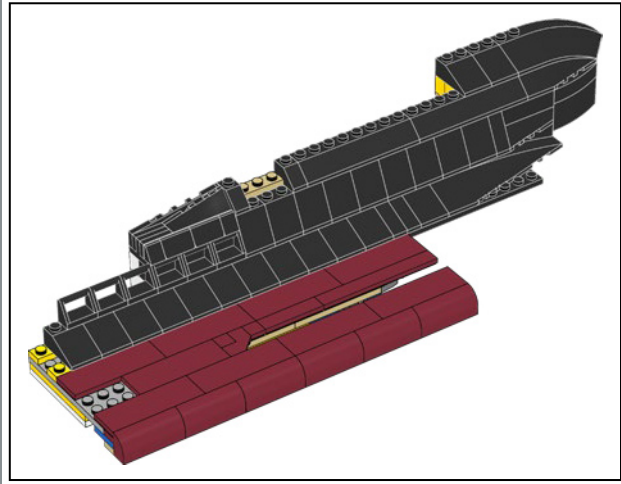
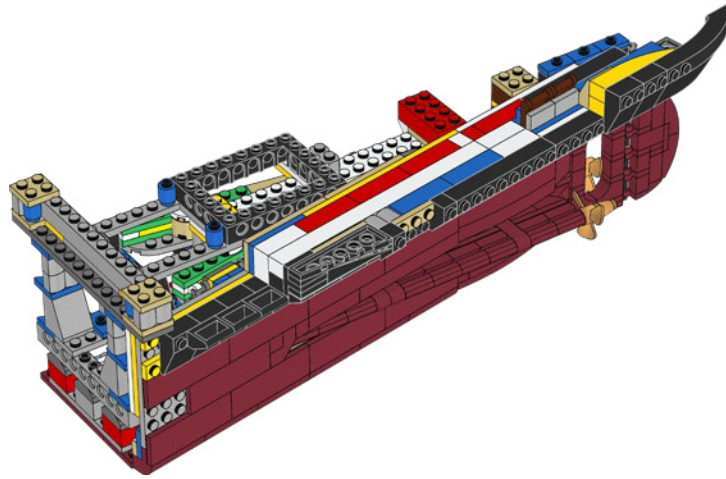
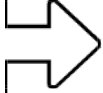

213

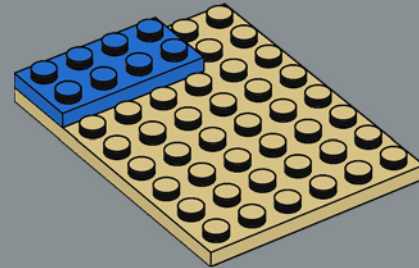

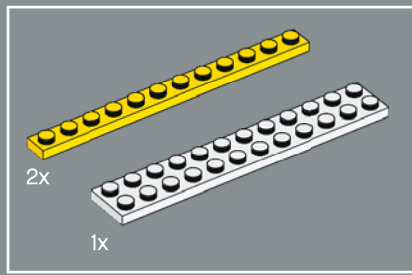

214

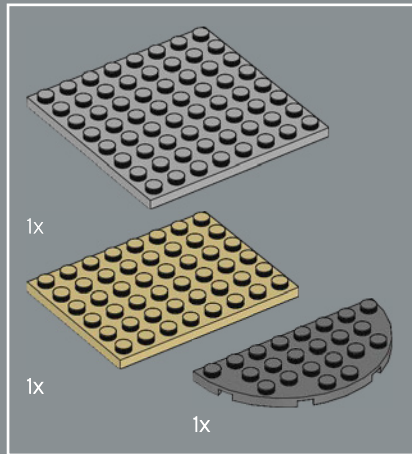
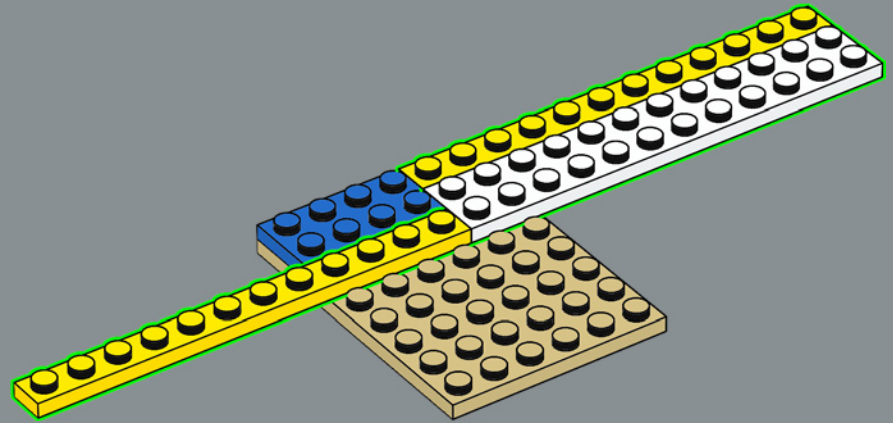

215

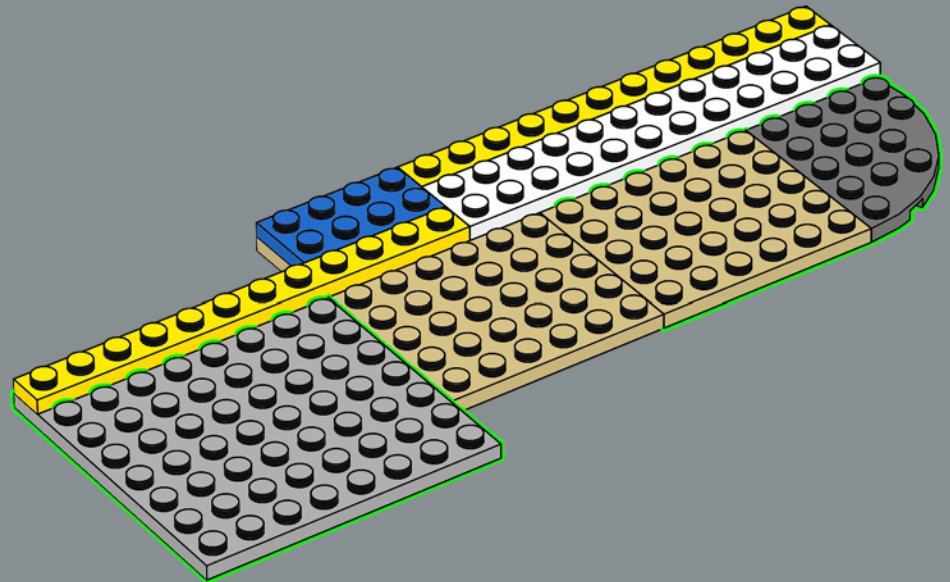

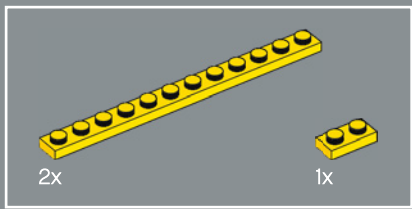

216

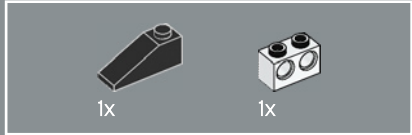
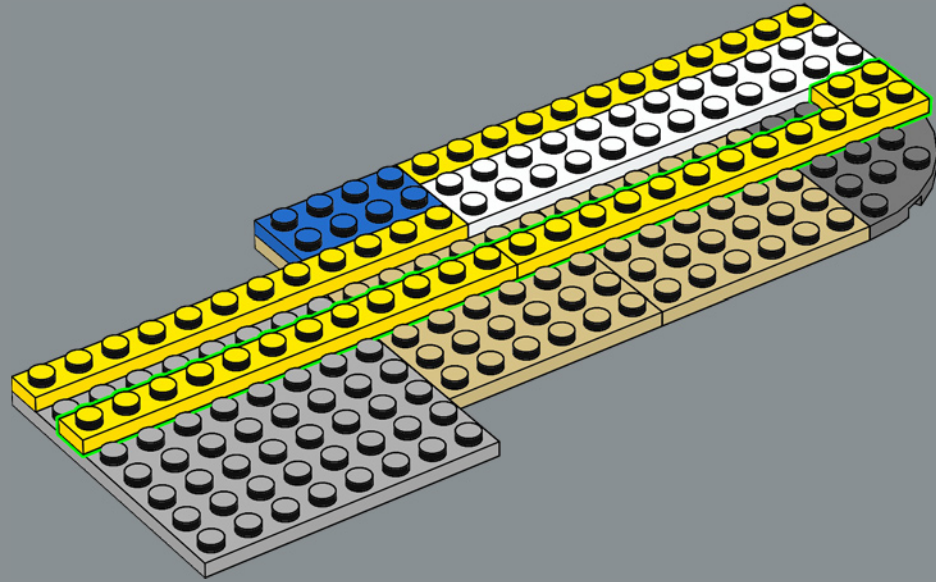

217

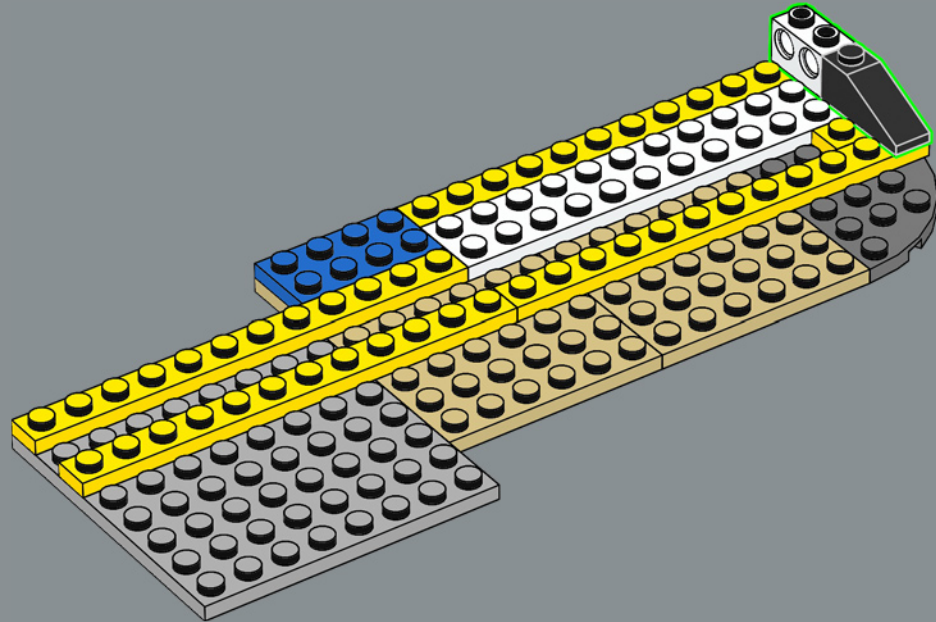

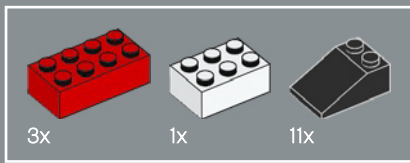

218

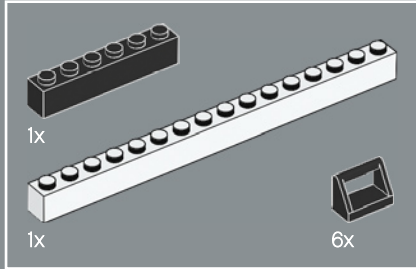
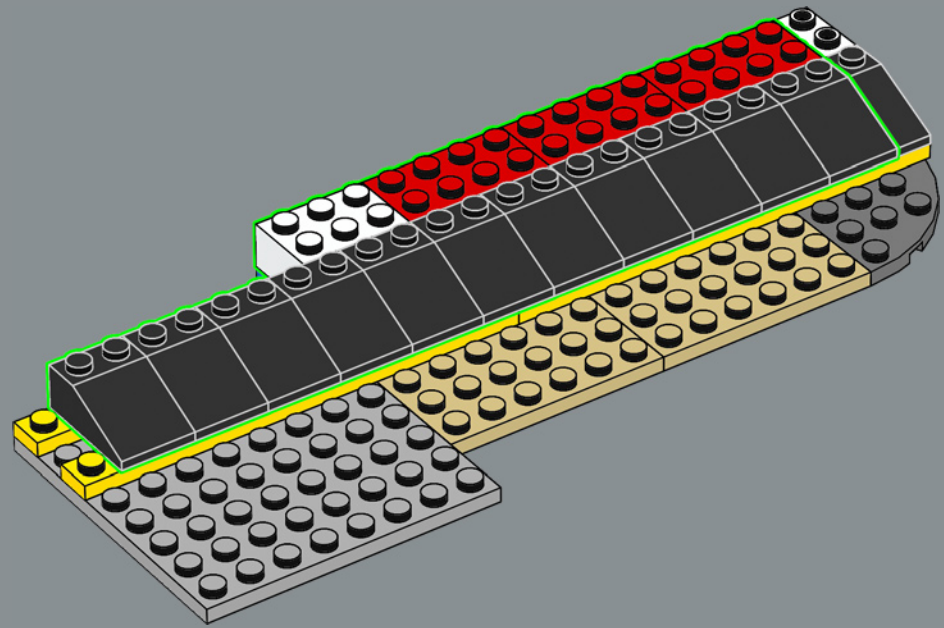

219

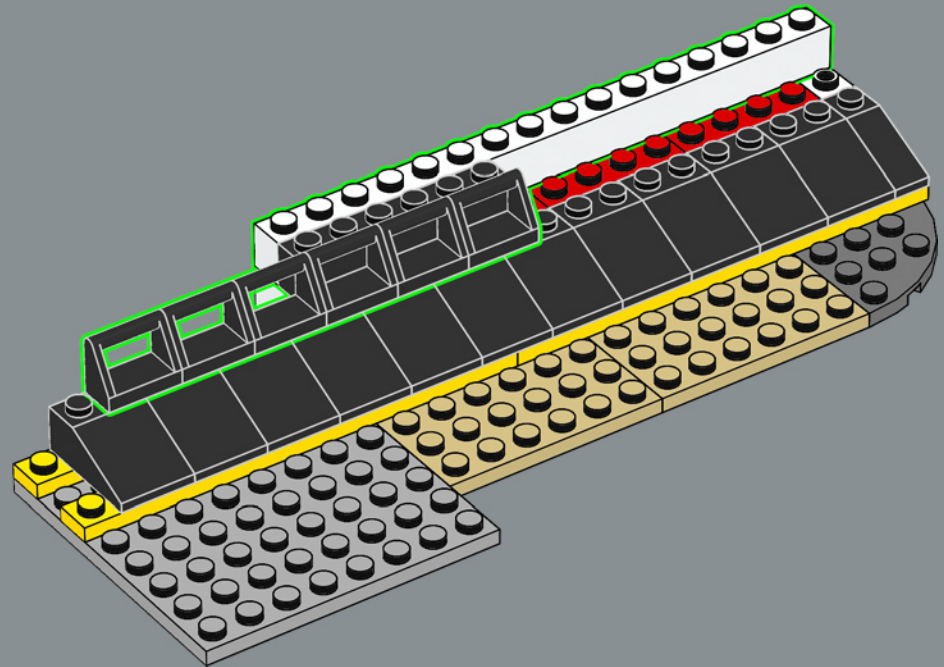

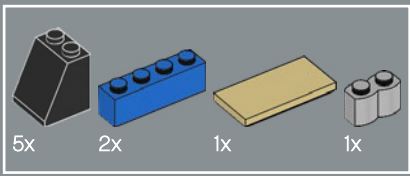

220

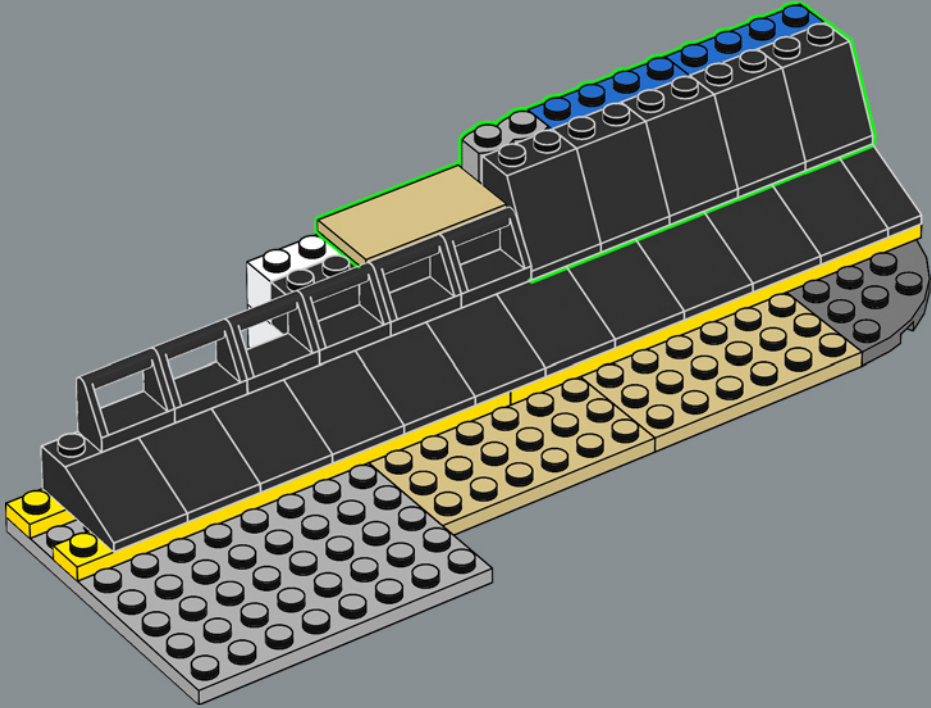

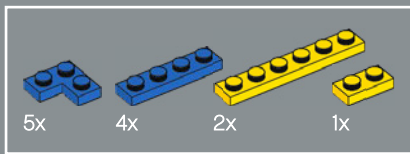

221

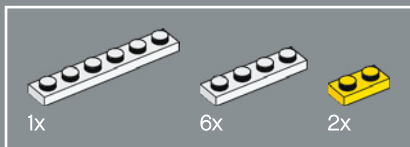
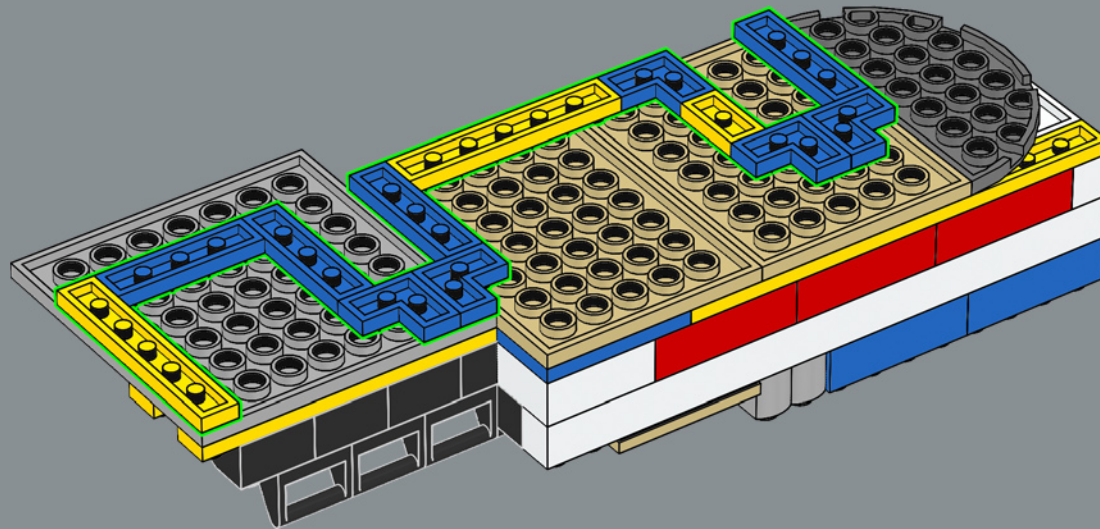

222

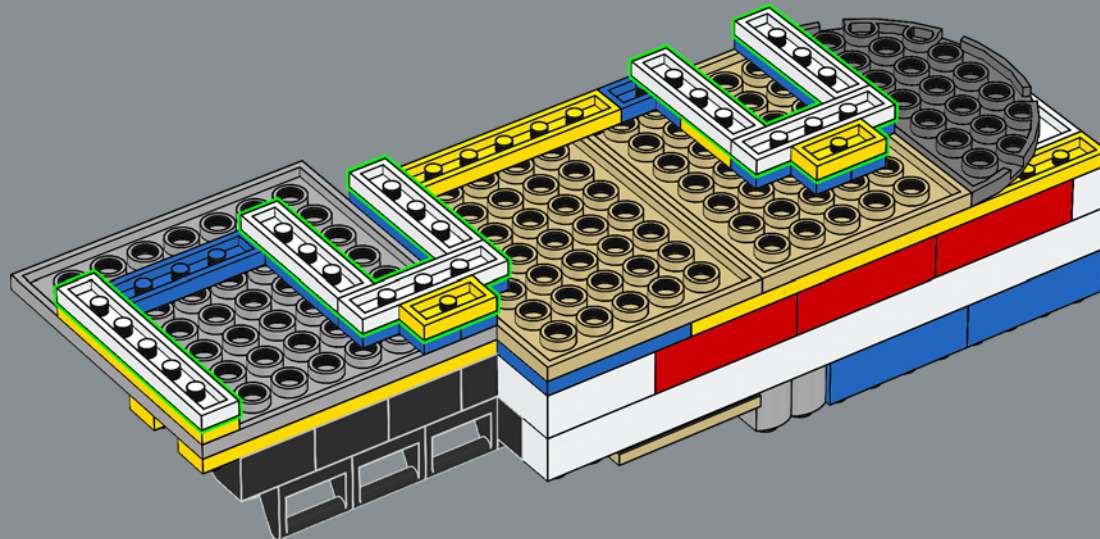

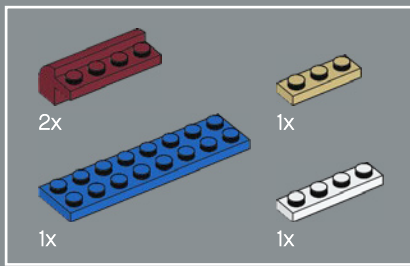

223

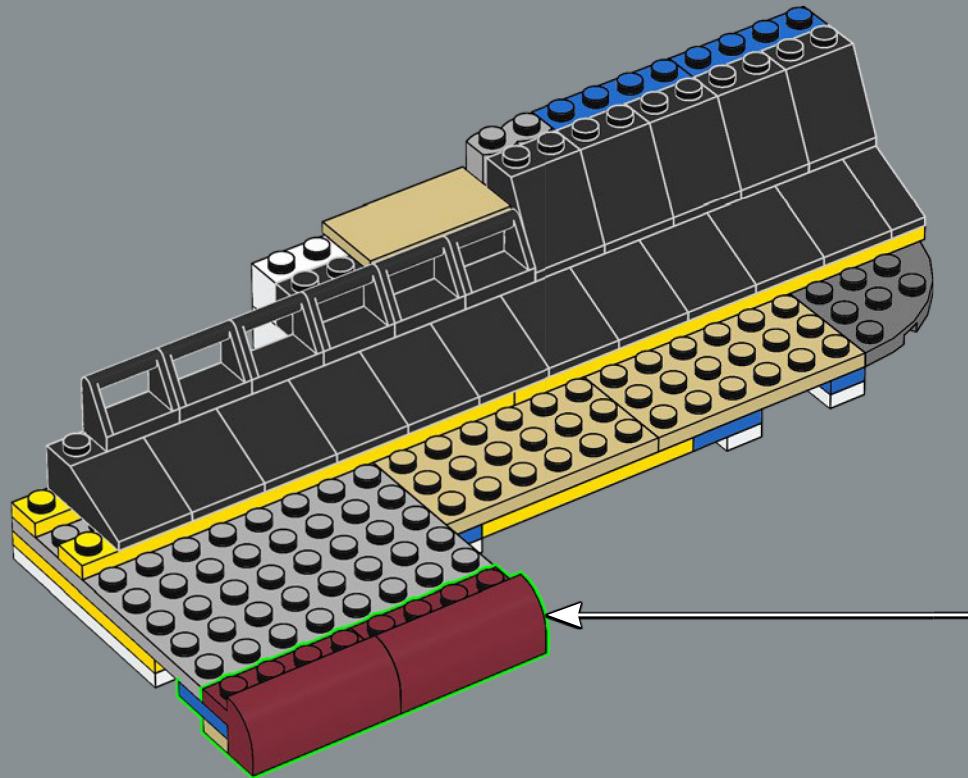
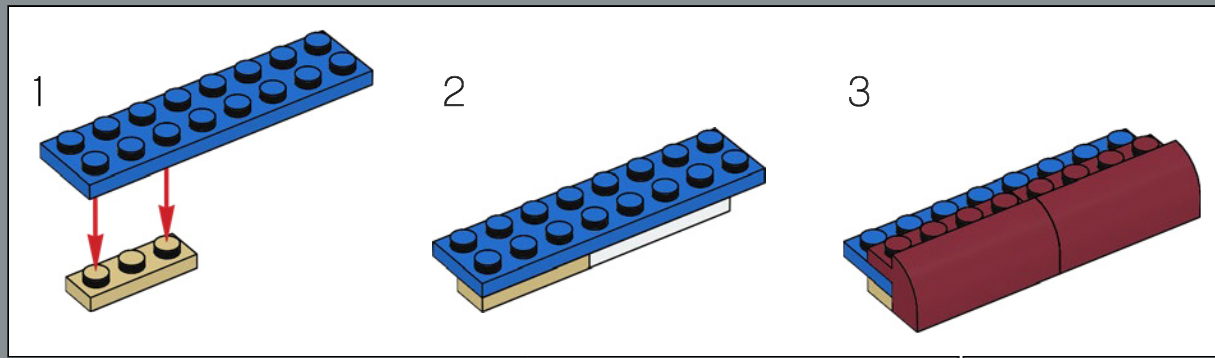



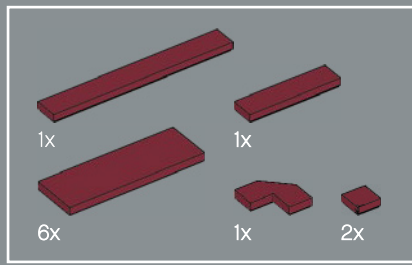

224

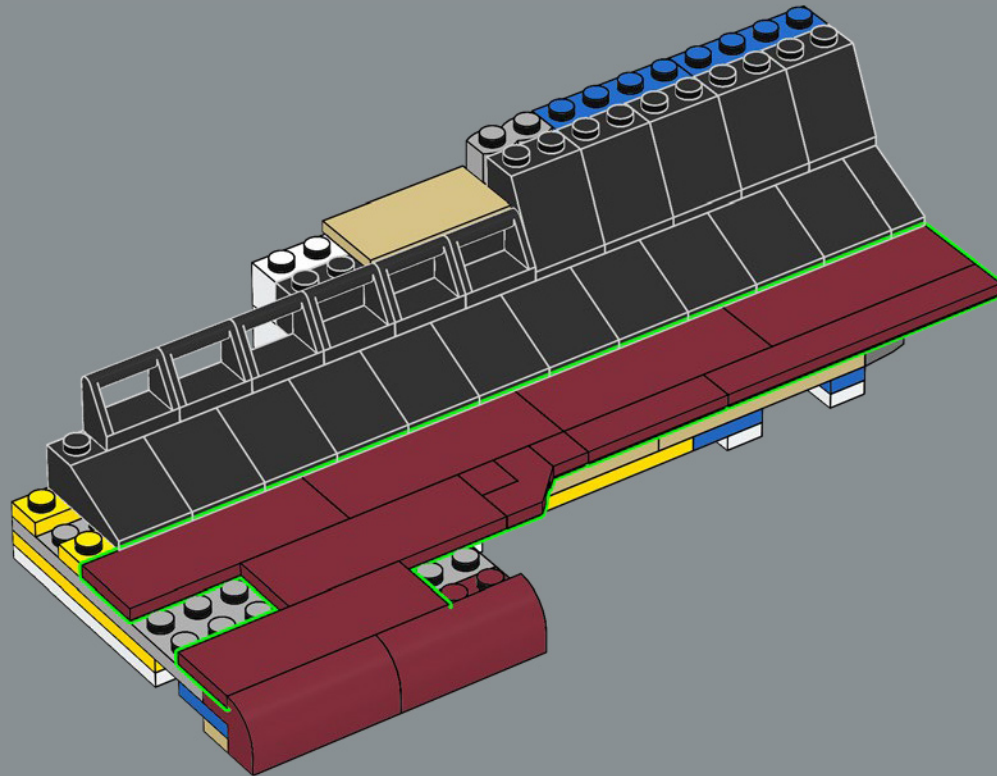

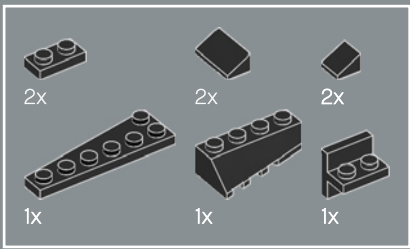

225

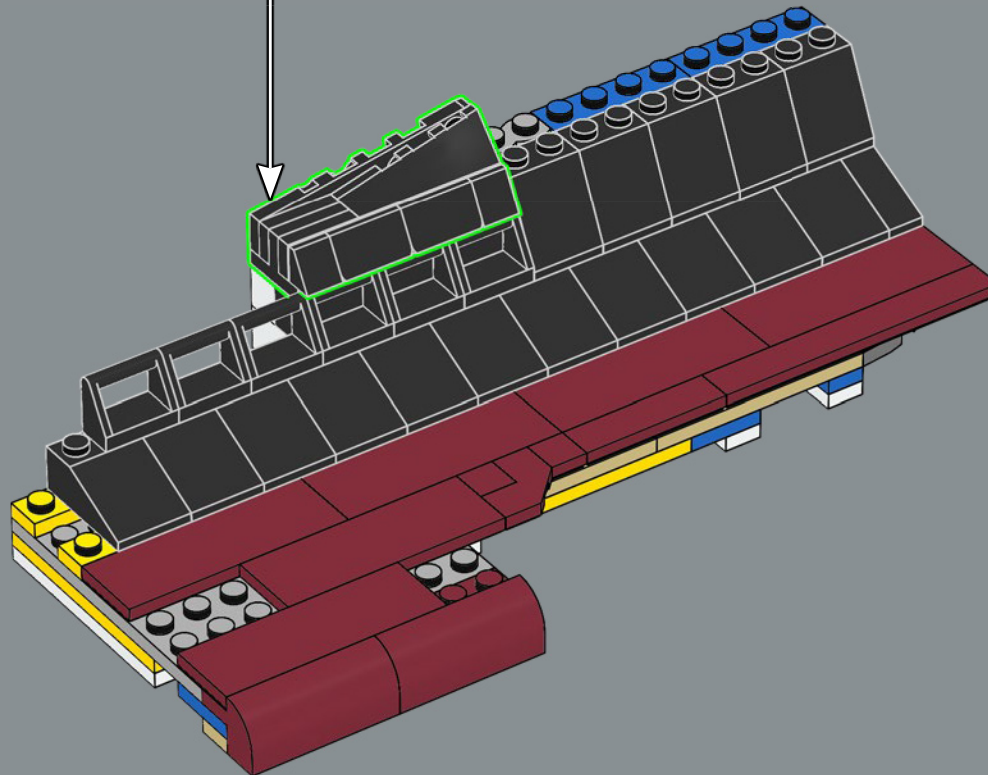
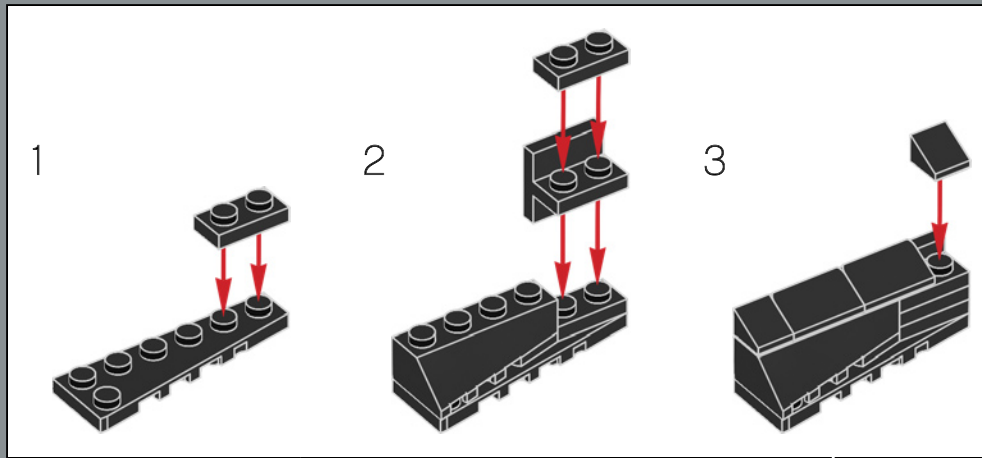

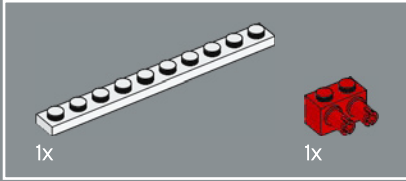
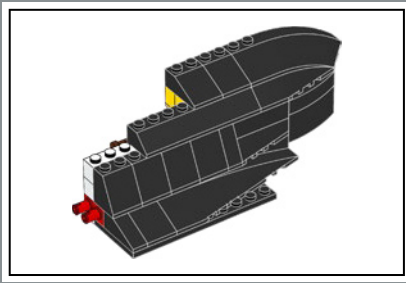

226

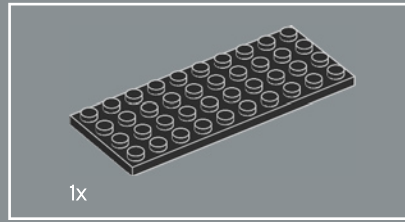
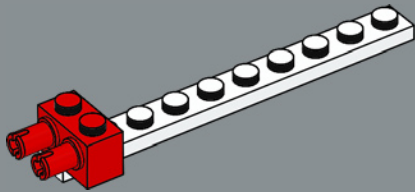

227

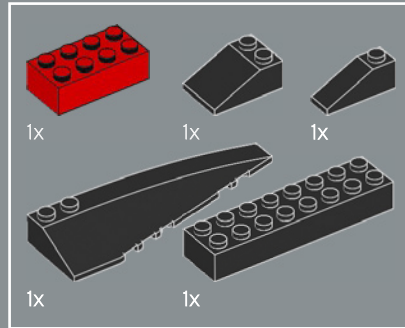
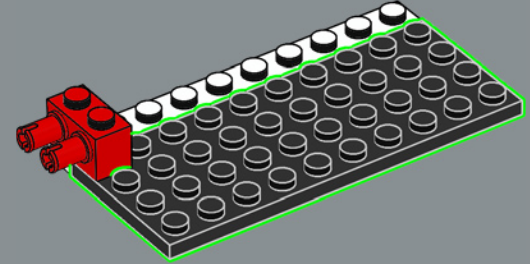

228

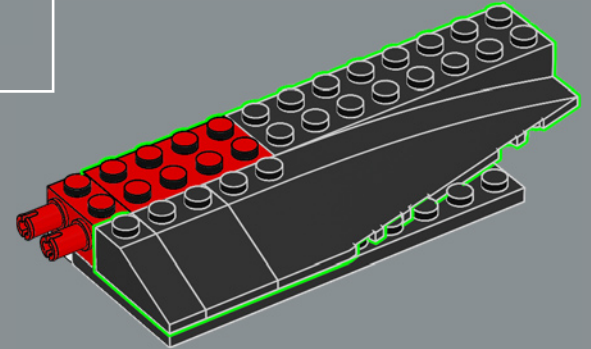

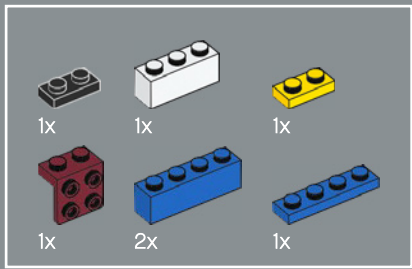

229

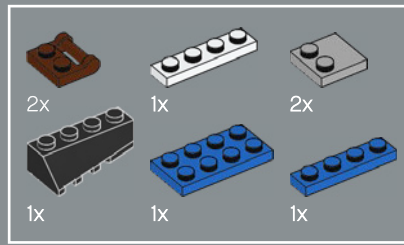
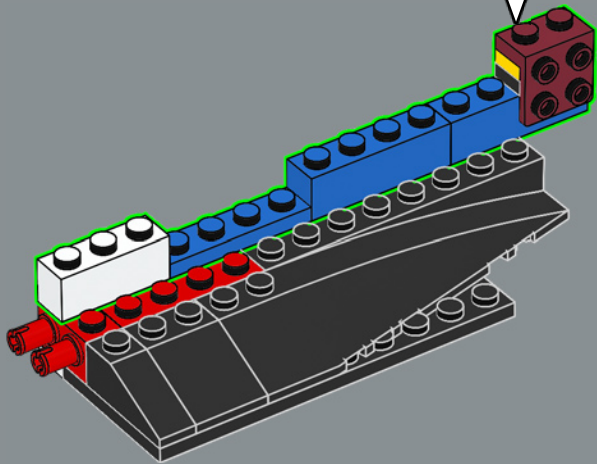
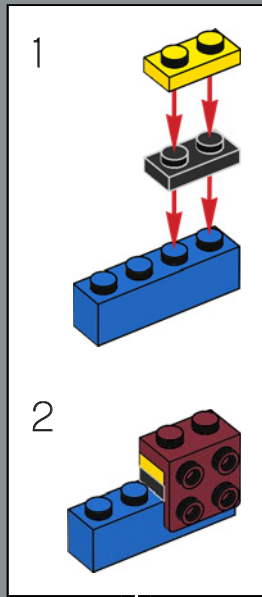

230

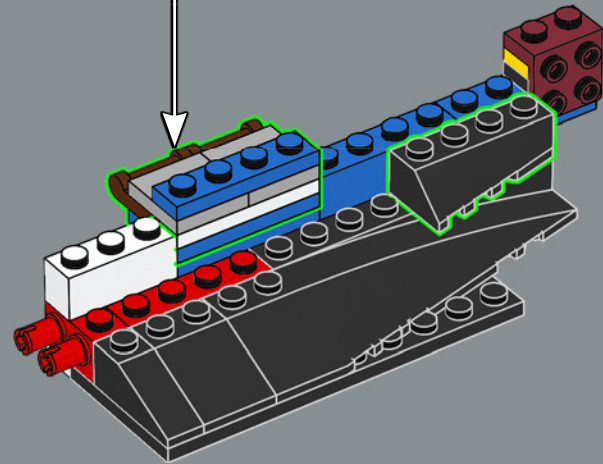
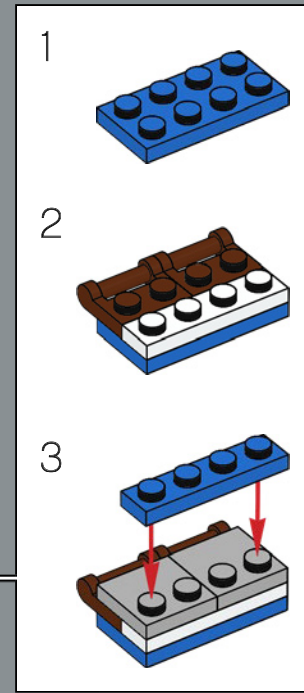

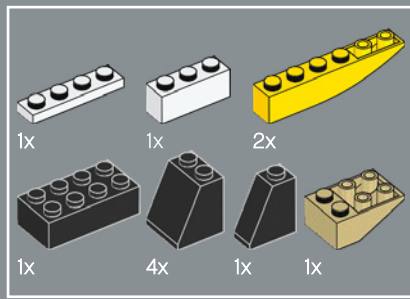

231

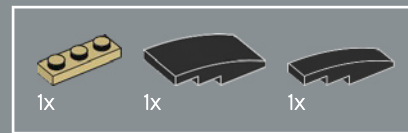
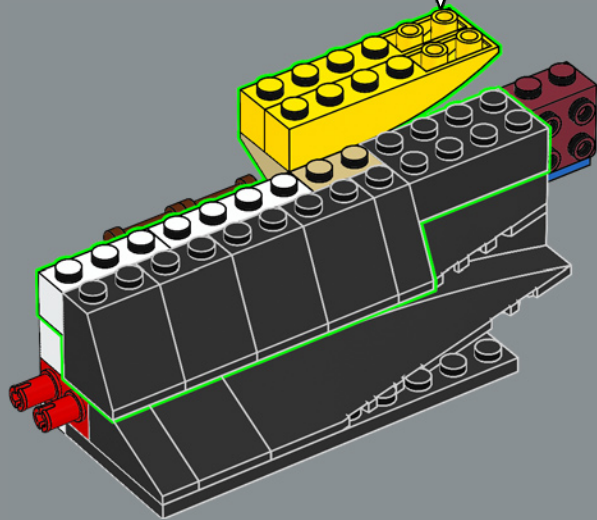
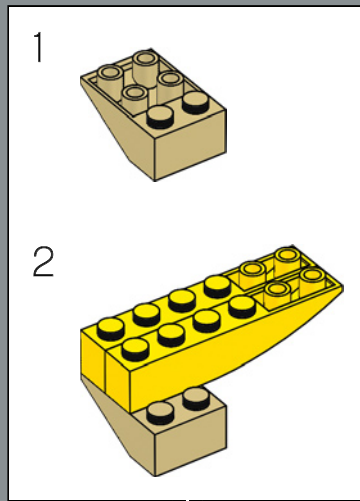

232

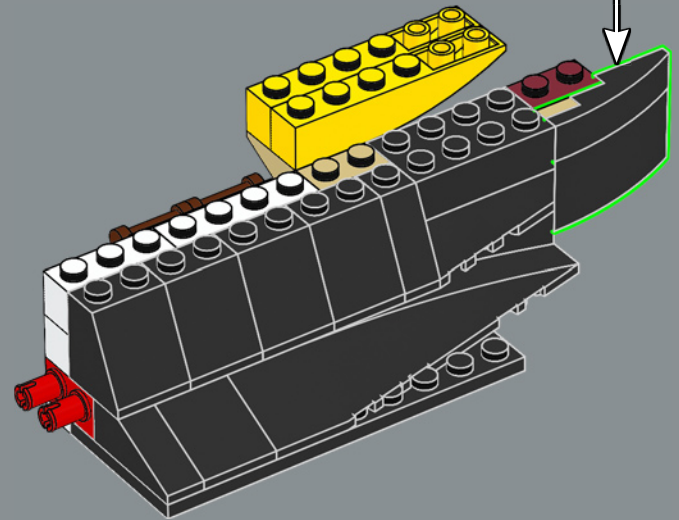
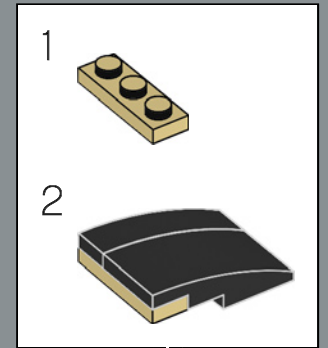

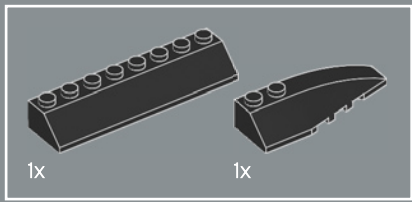

233

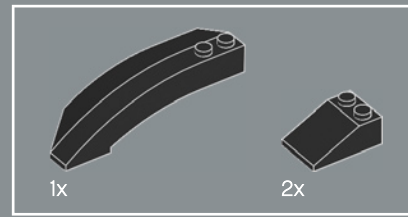
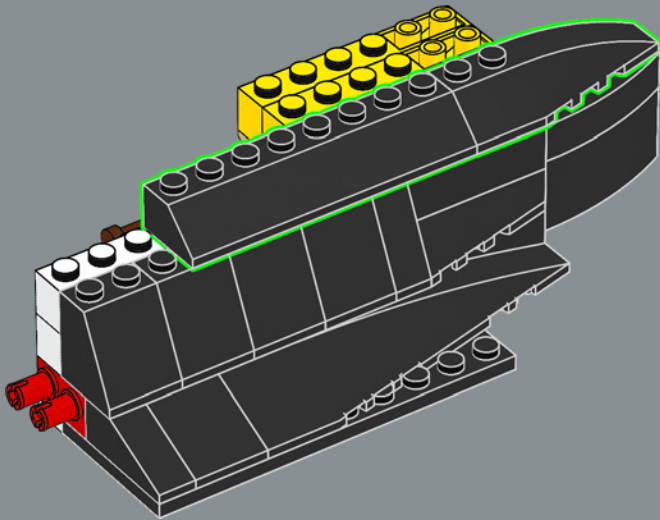

234

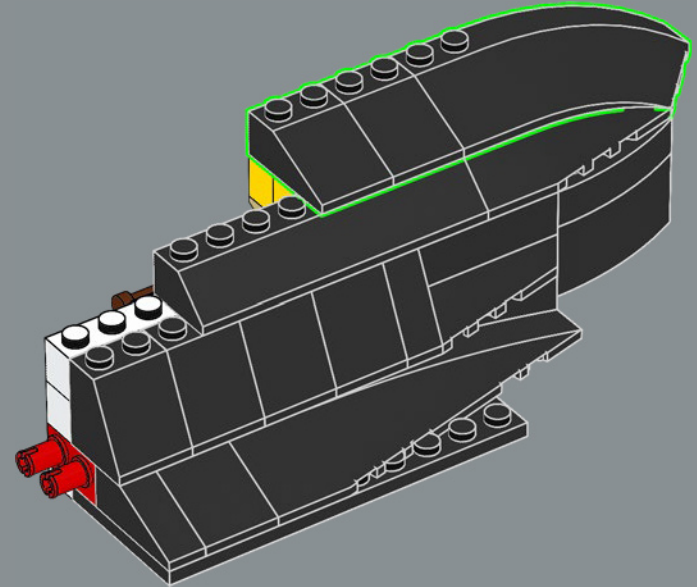

235

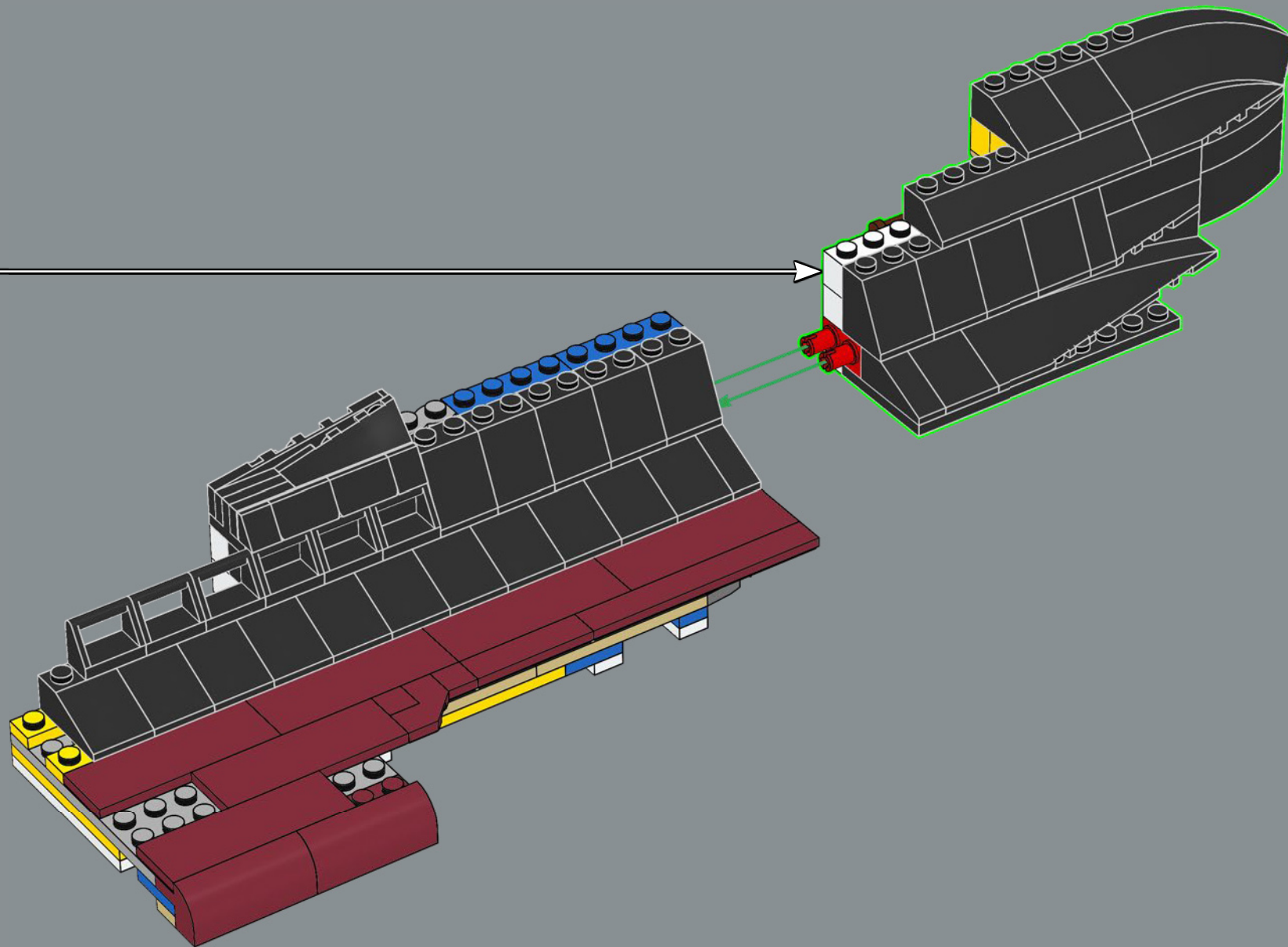

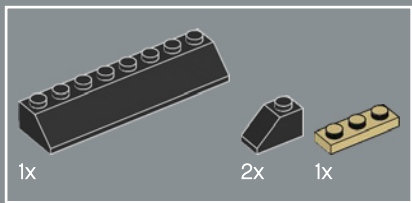

236

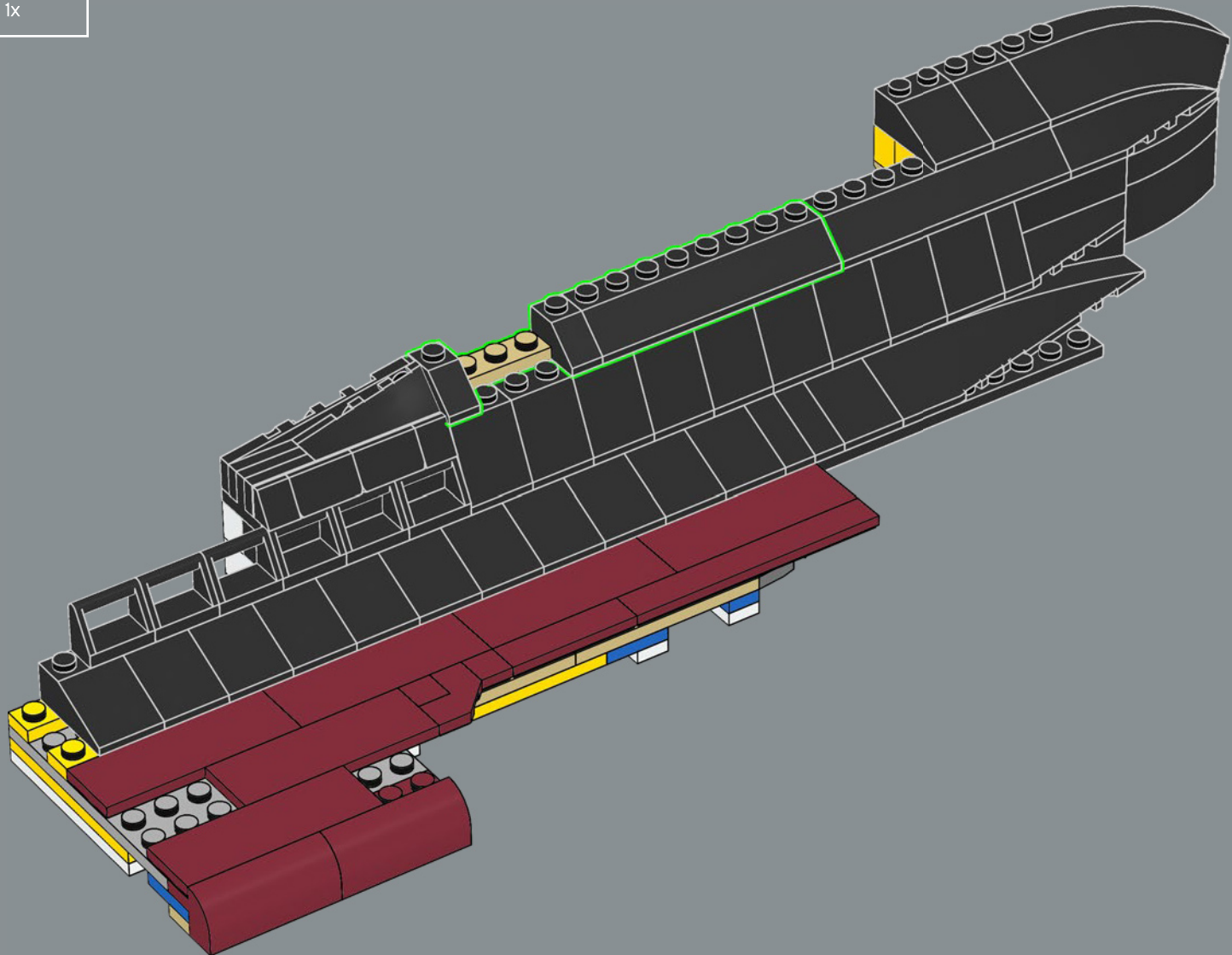



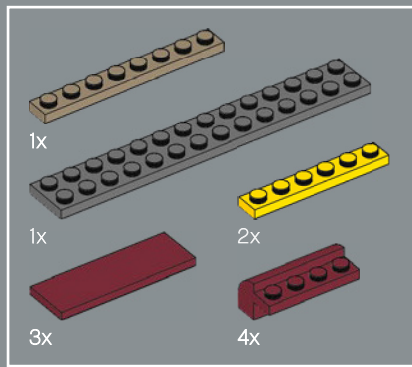

237

1

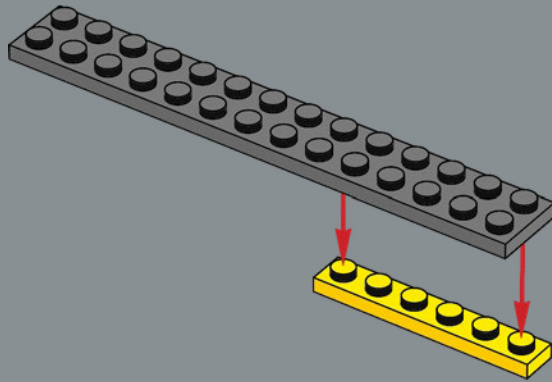

2

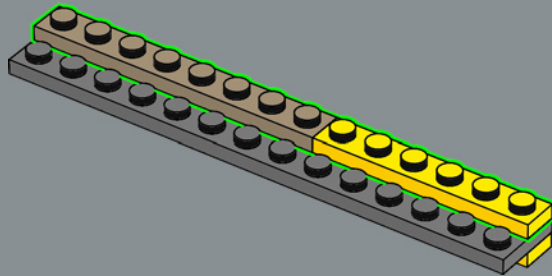

3

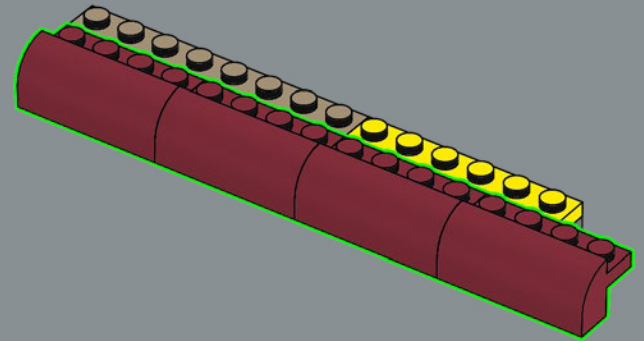

4

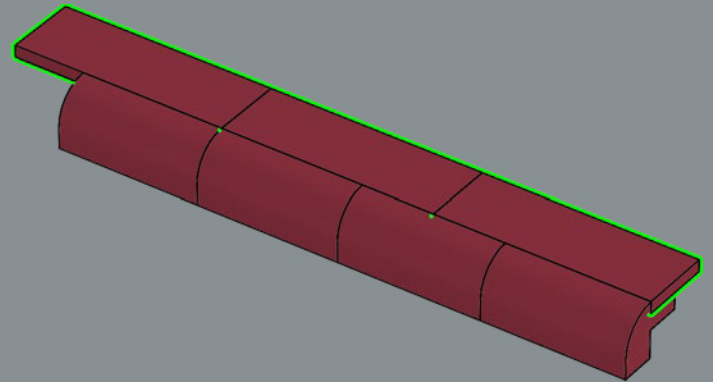

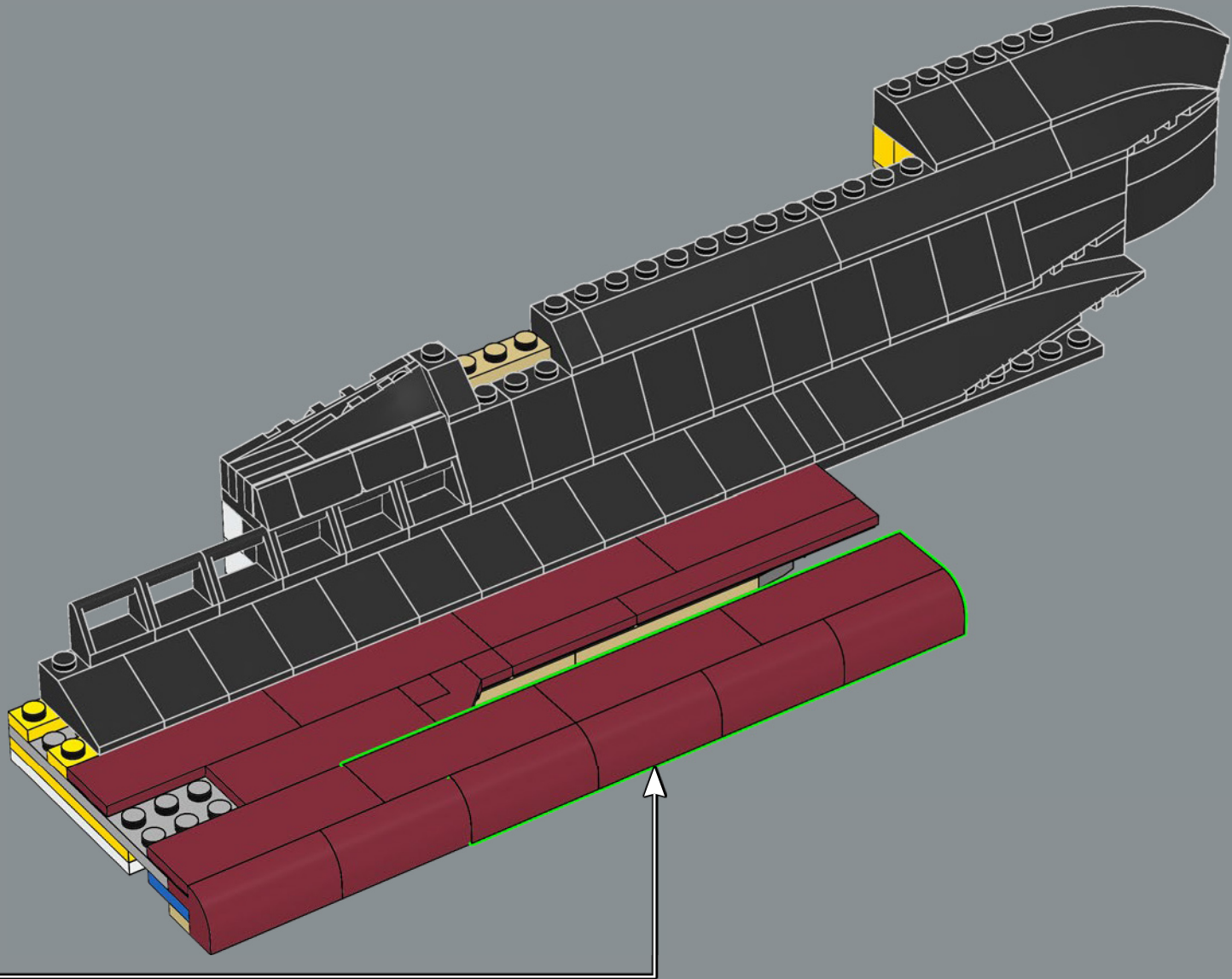

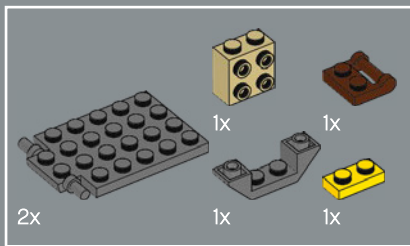

238

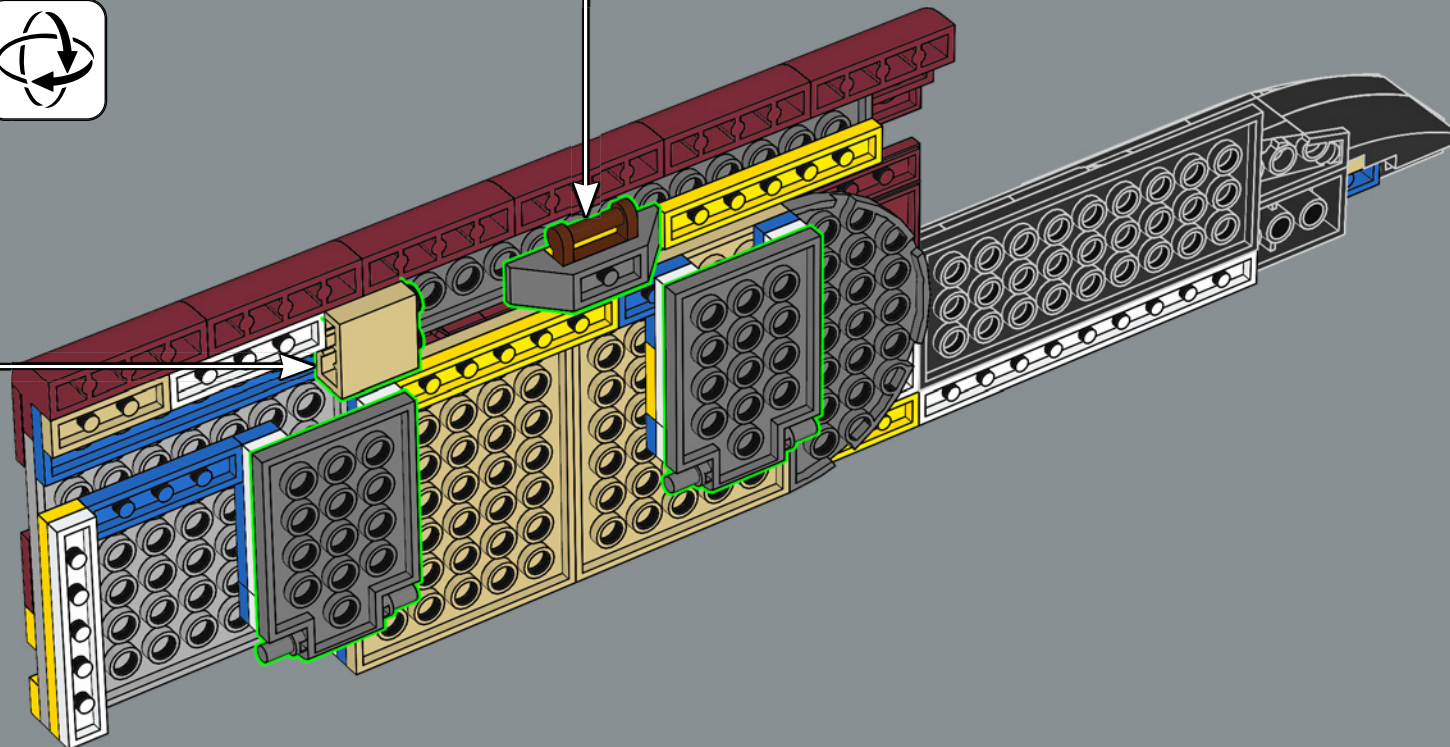
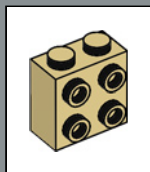
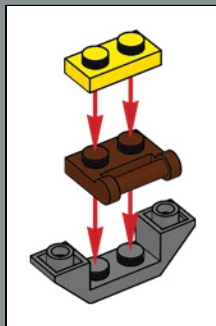

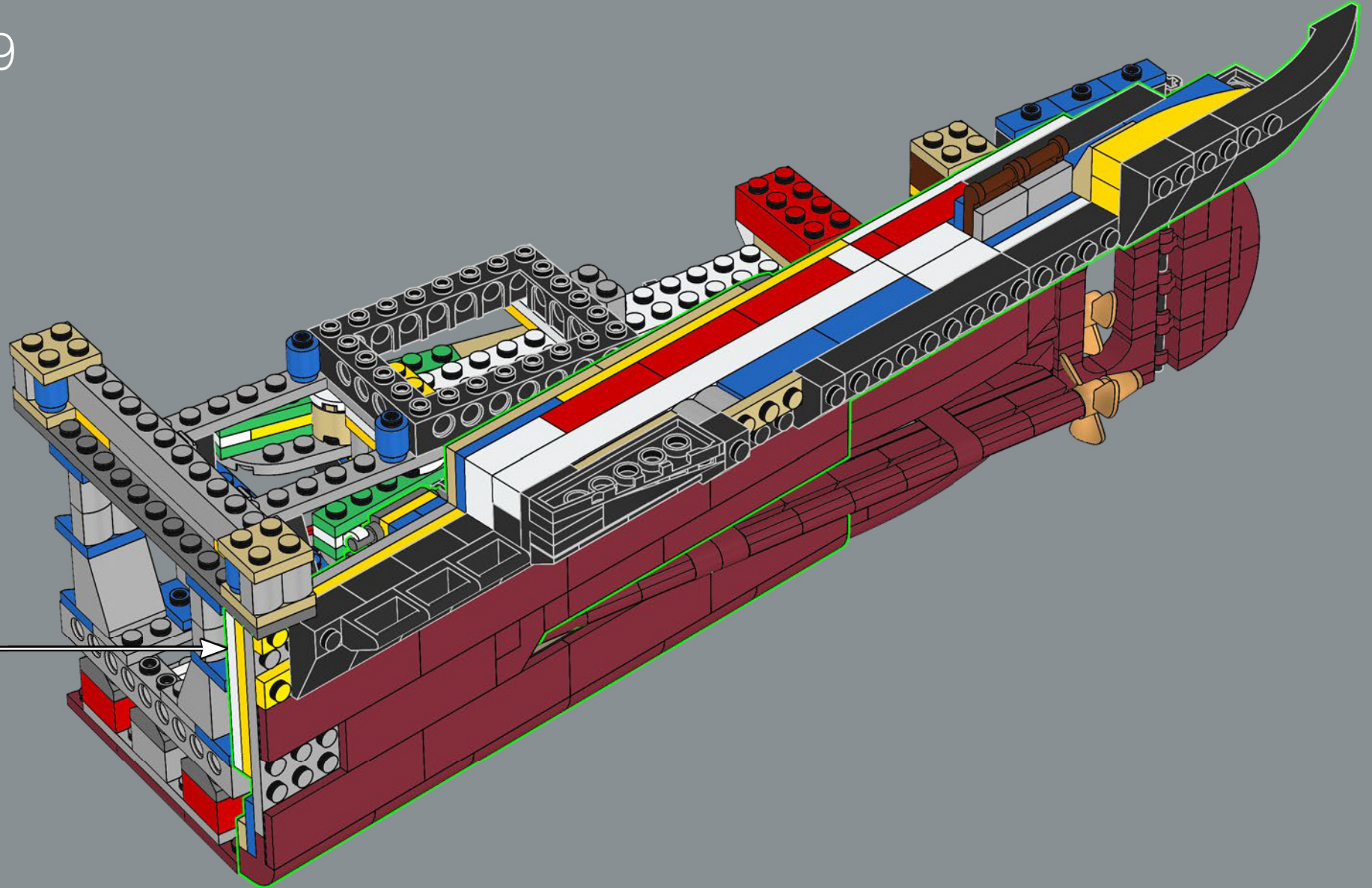

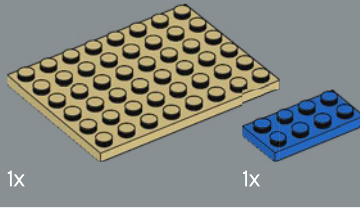
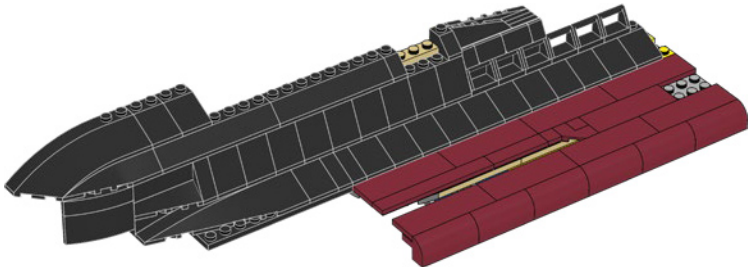
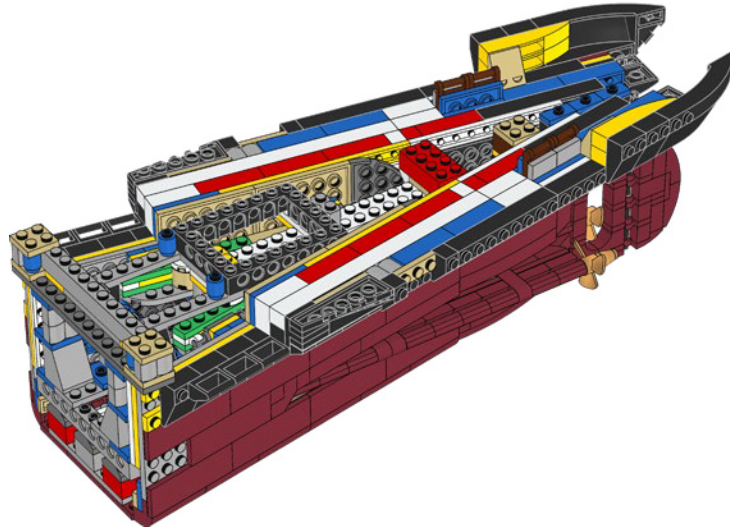
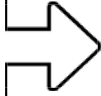

240

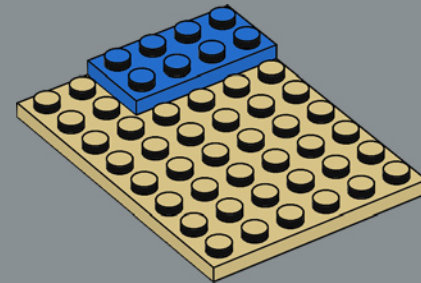

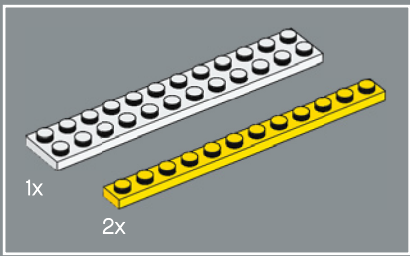

241

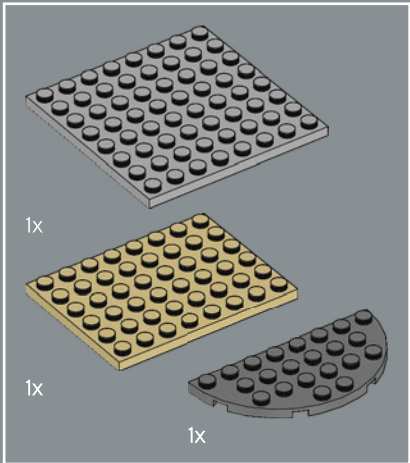
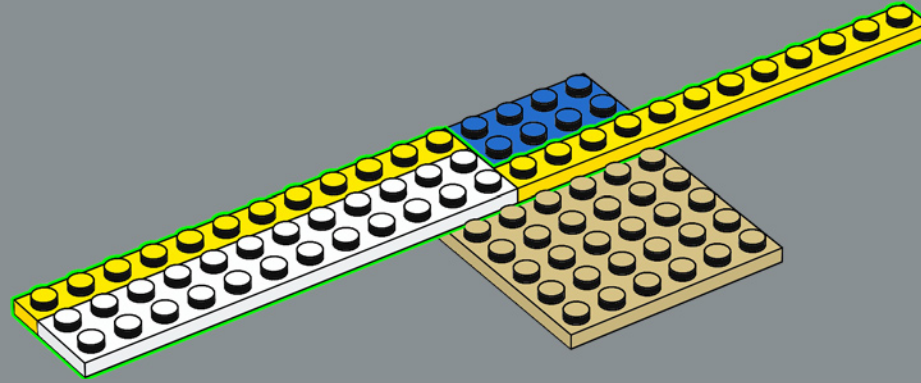

242

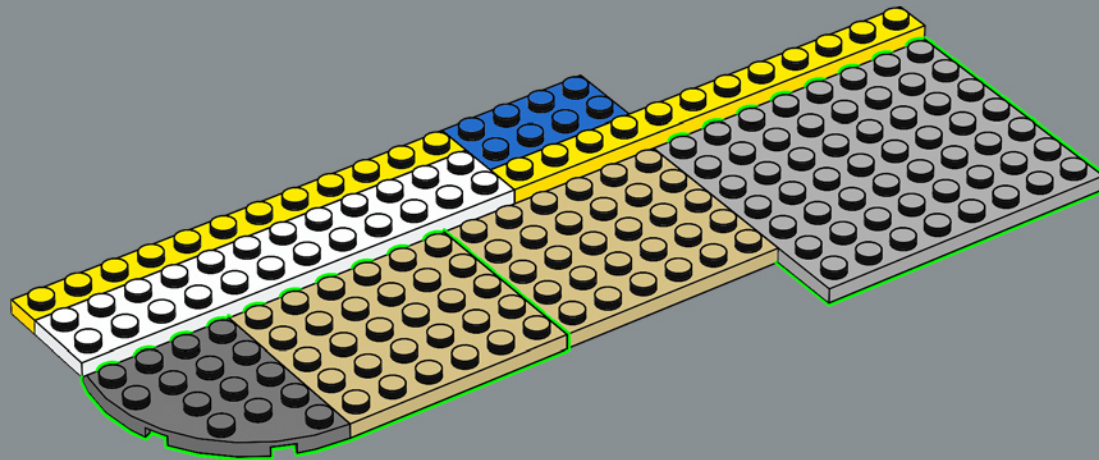

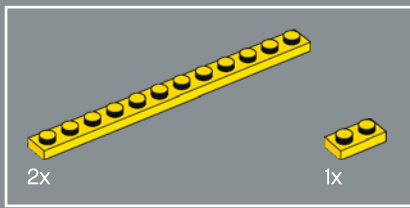

243

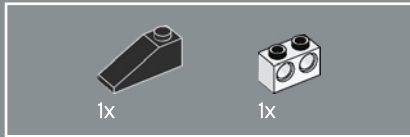
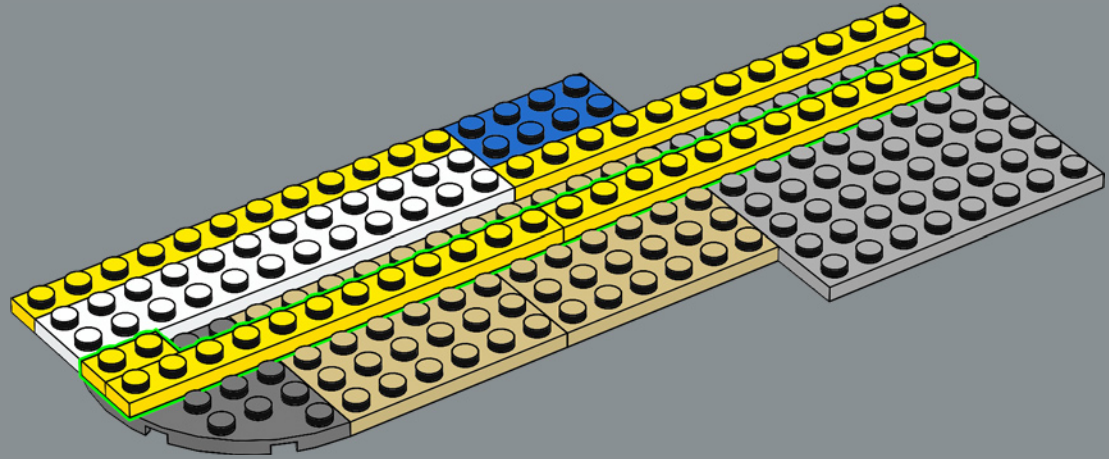

244

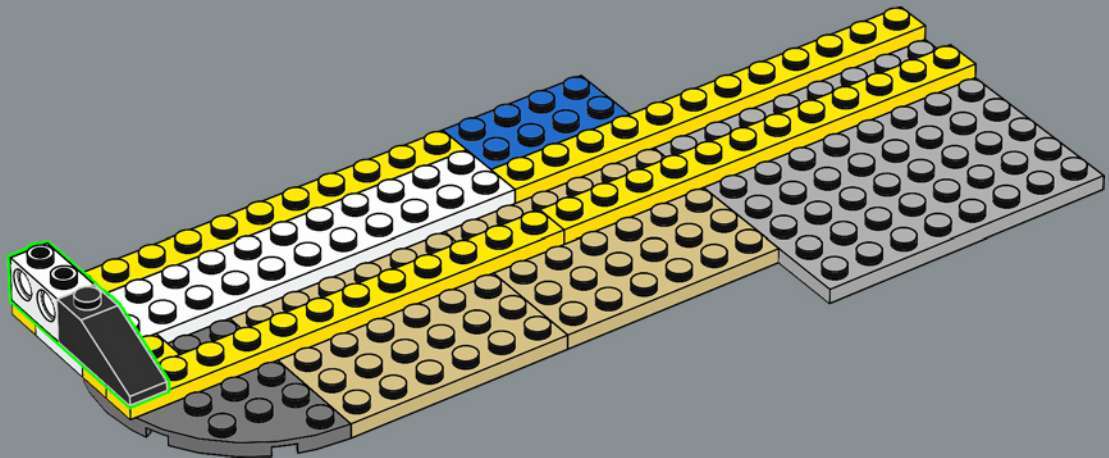

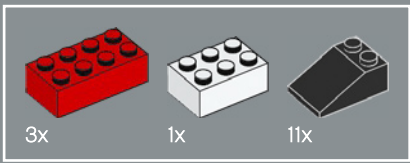

245

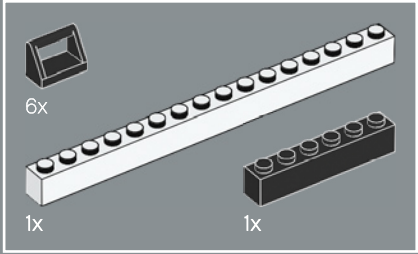
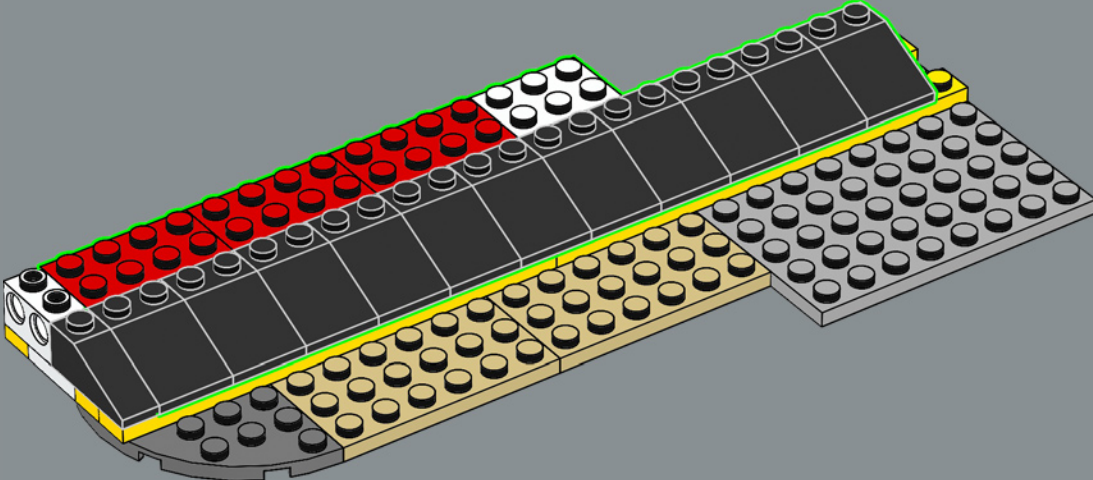

246

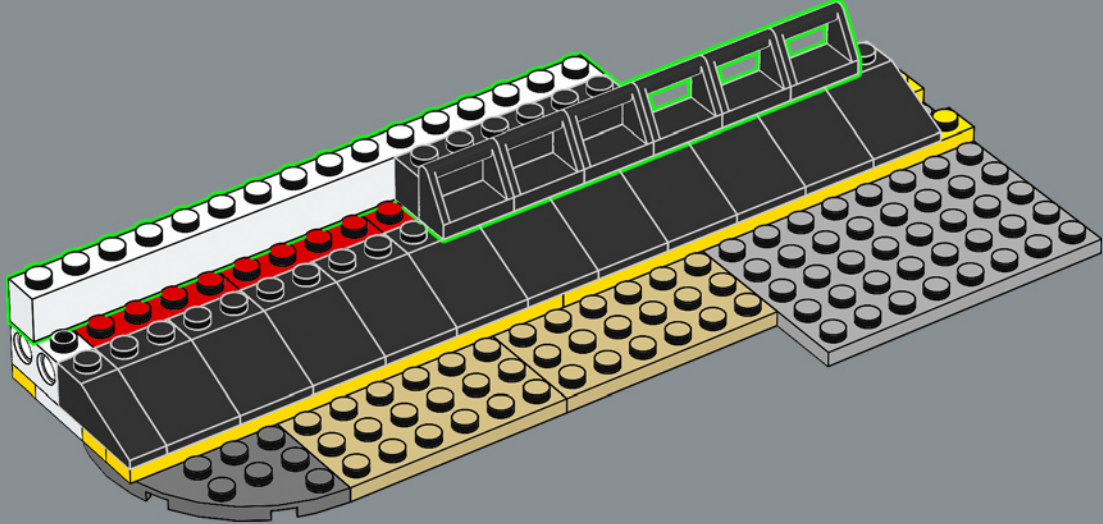



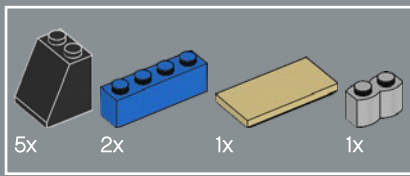

247

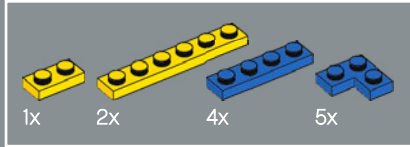
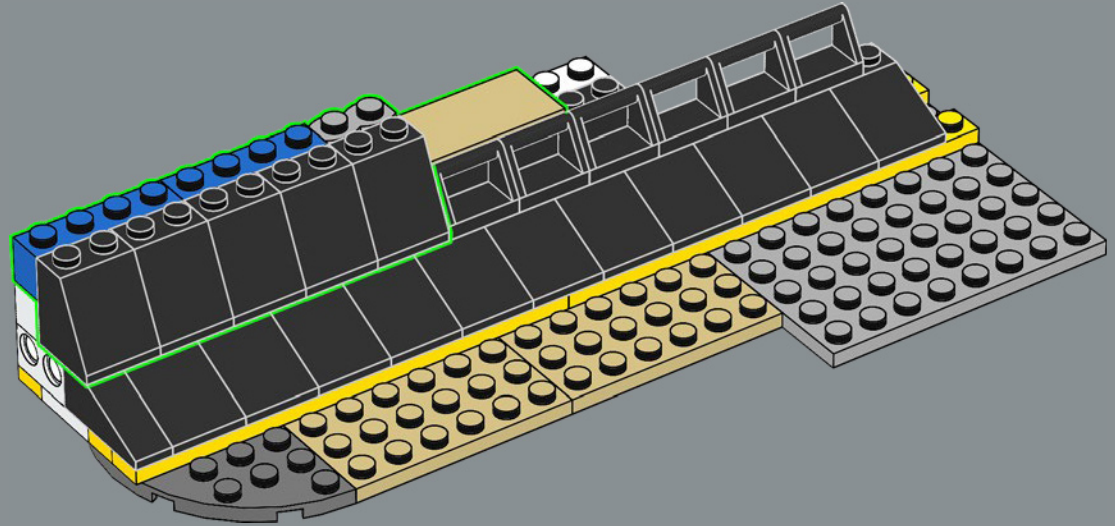

248

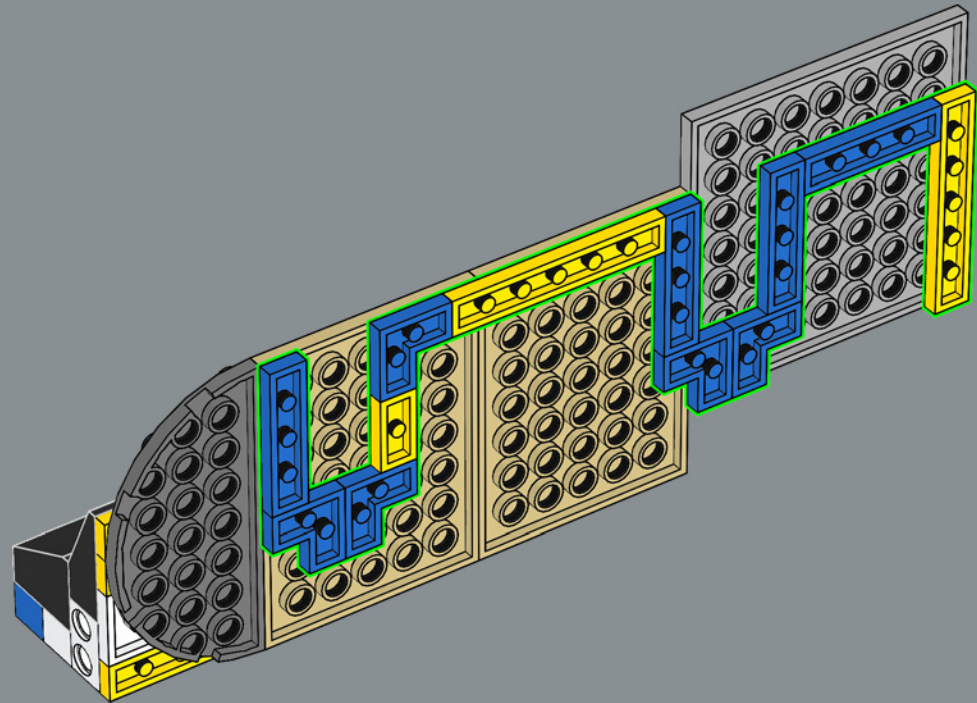

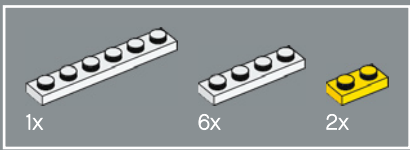

249

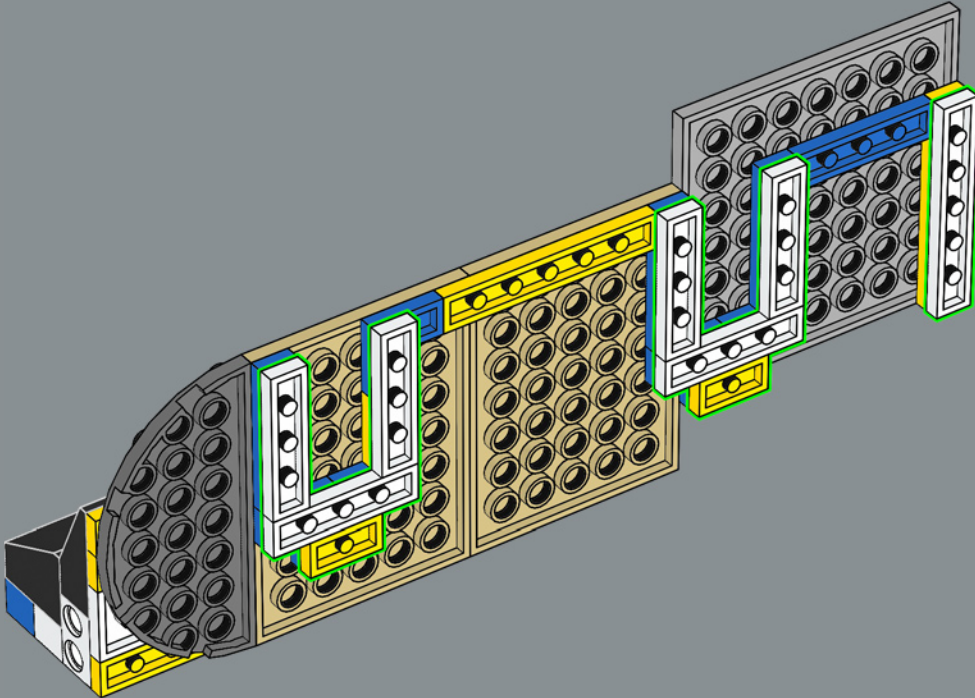

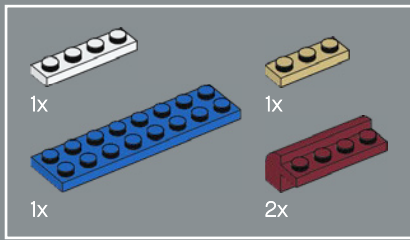

250

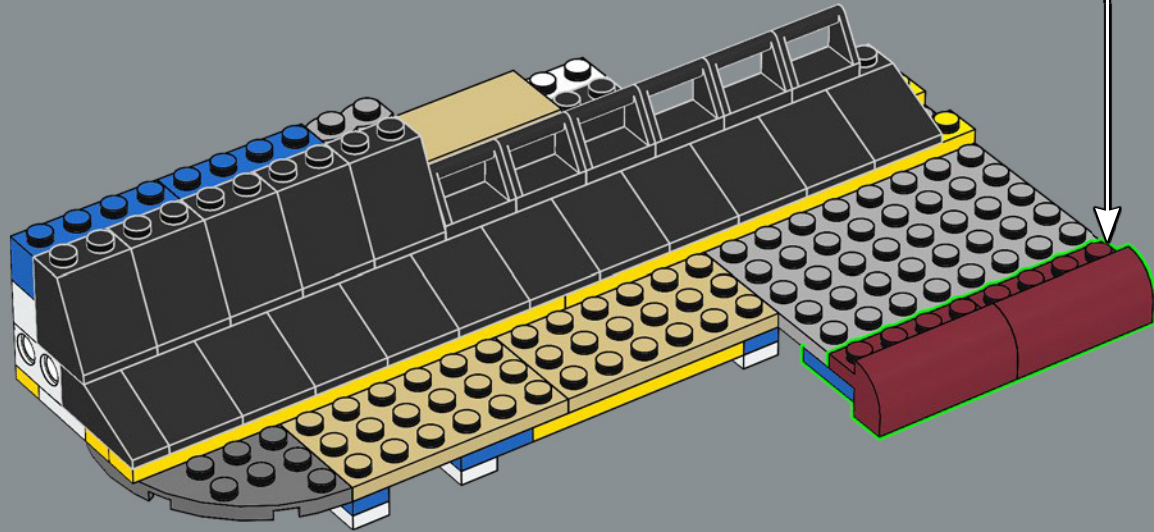
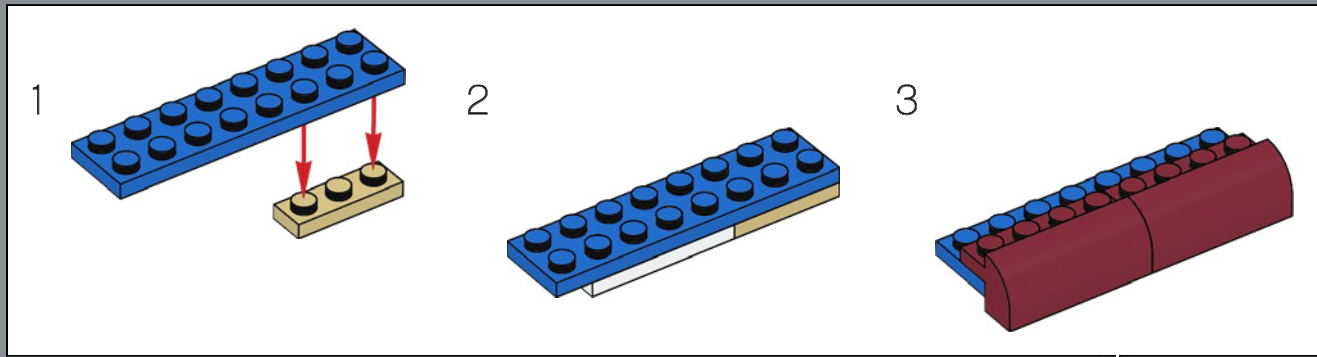

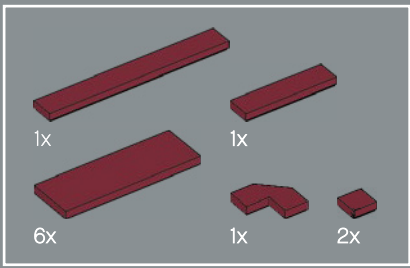

251

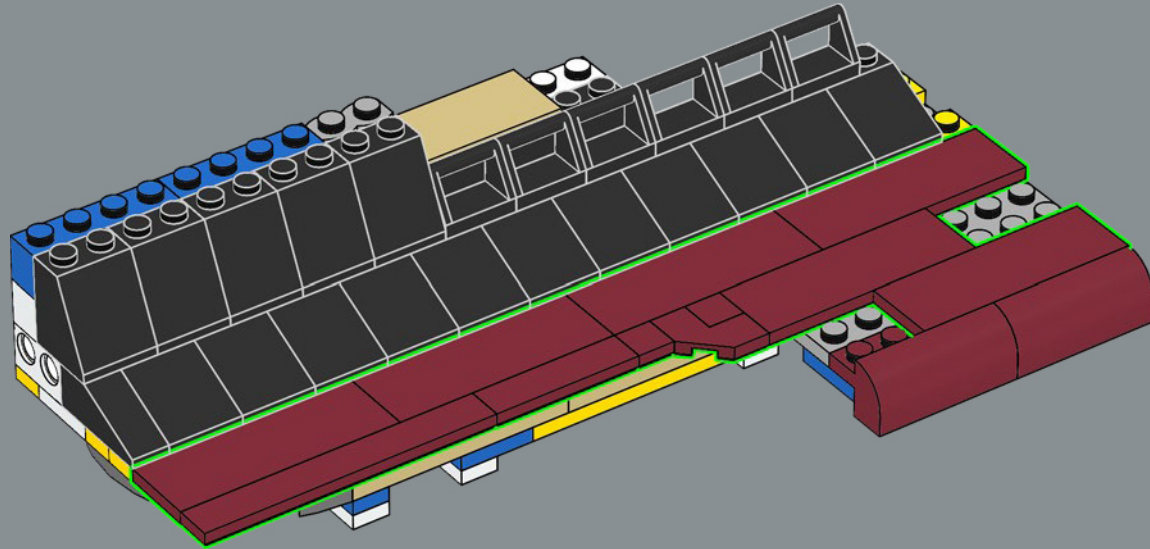

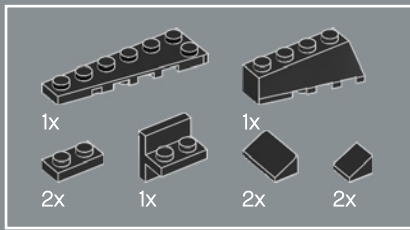

252

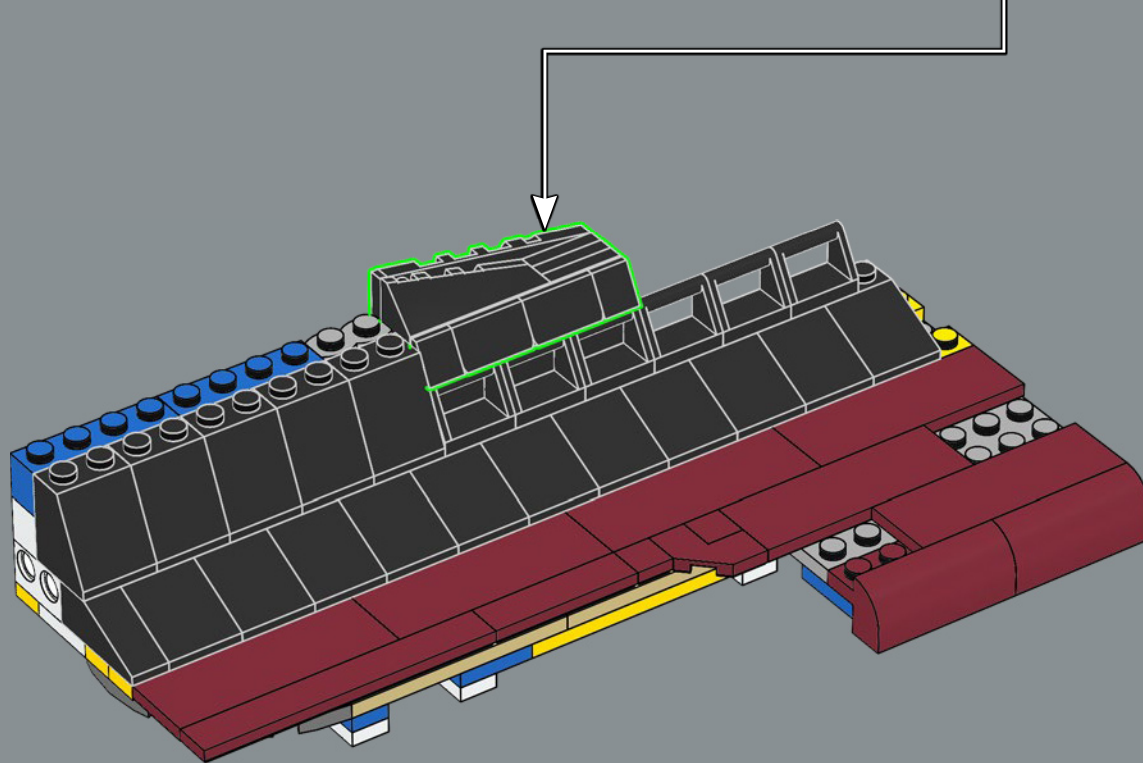
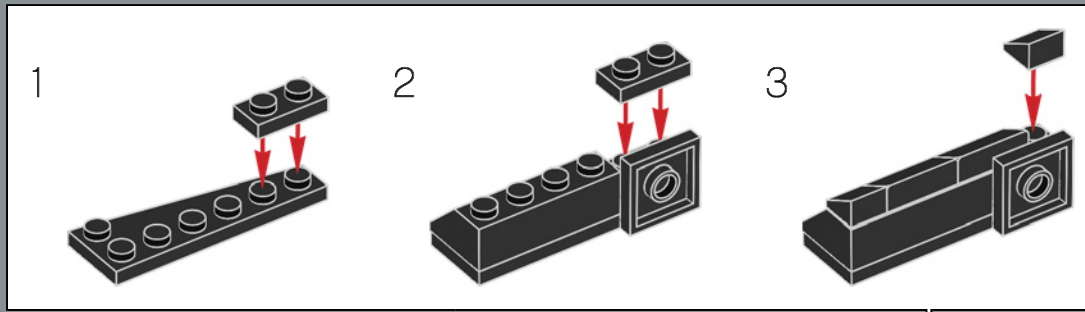

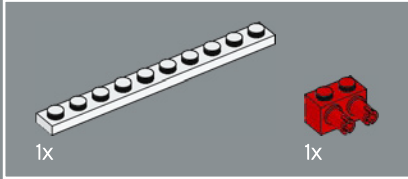
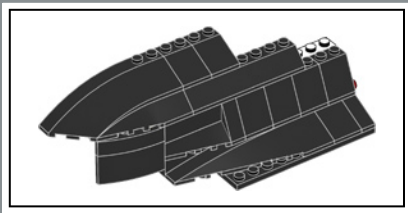

253

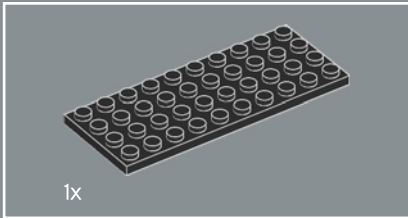
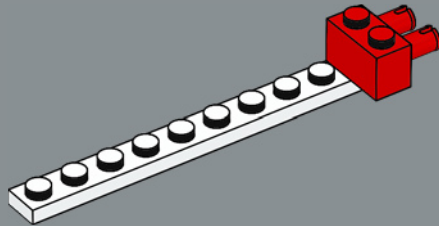

254

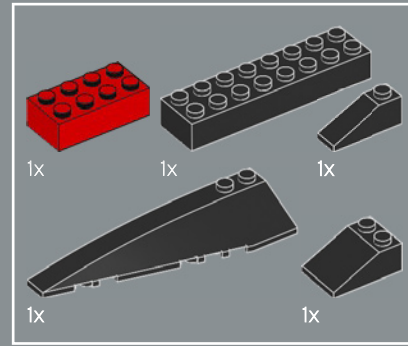
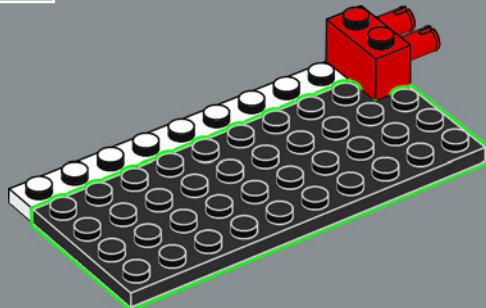

255

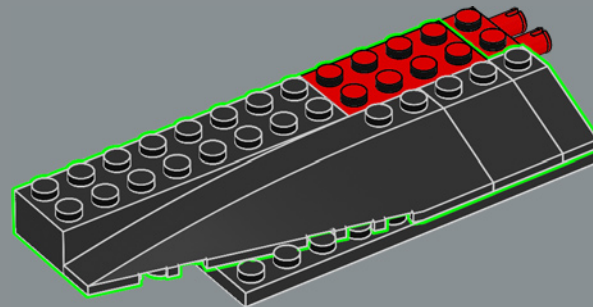

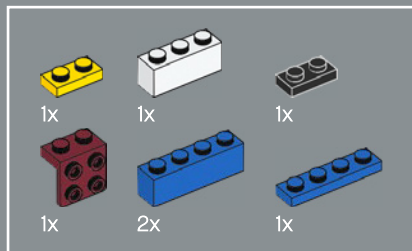

256

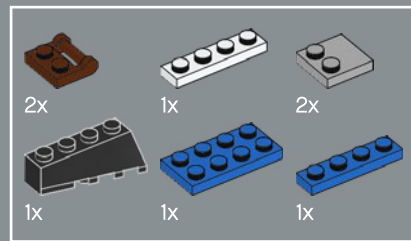
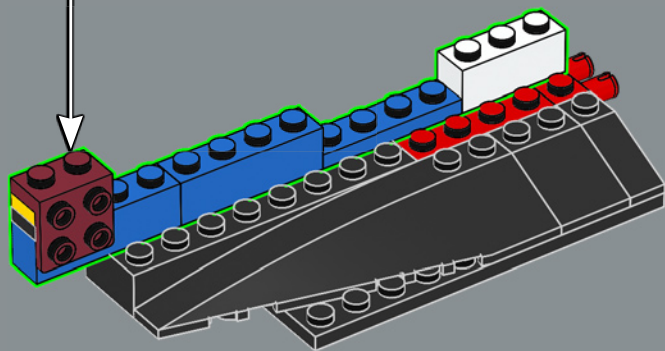
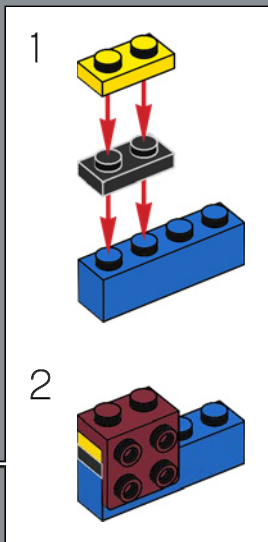

257

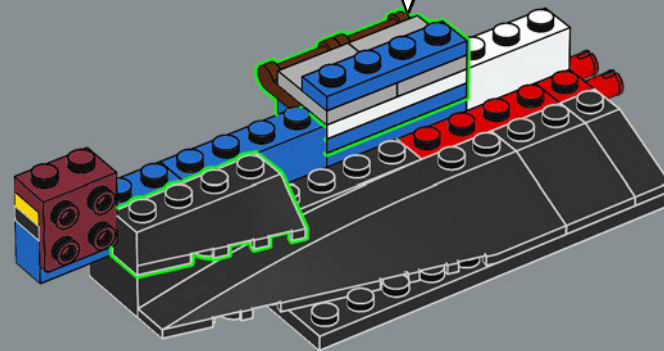
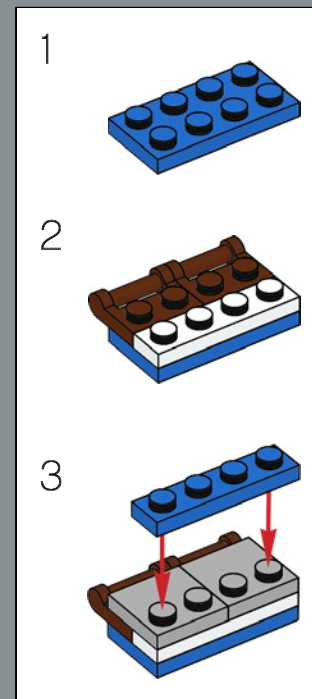

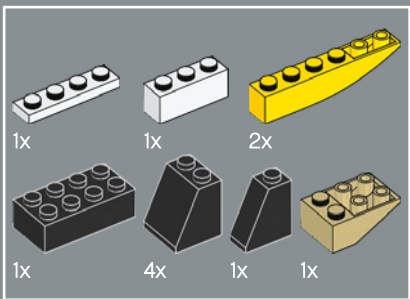

258

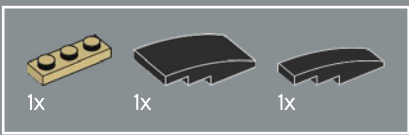
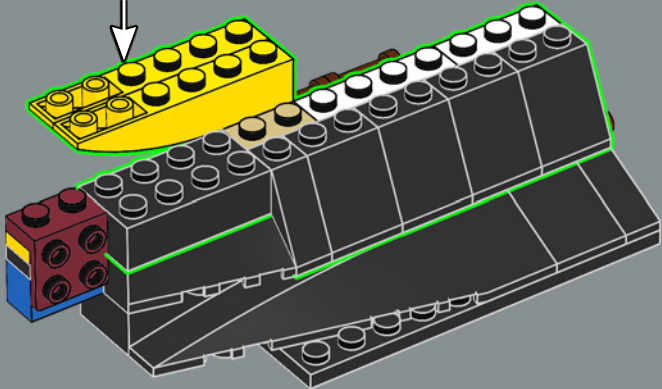
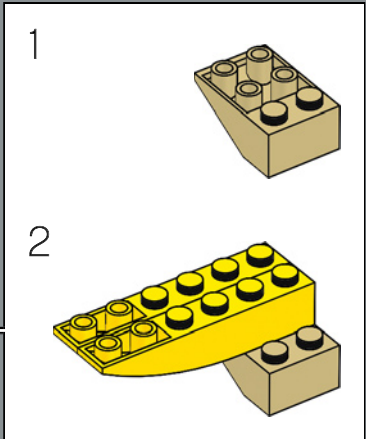

259

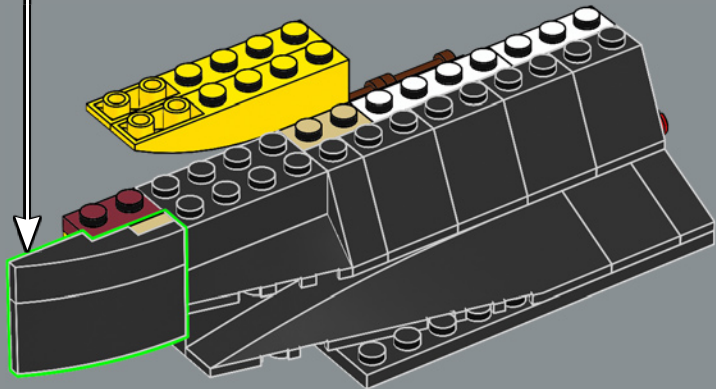
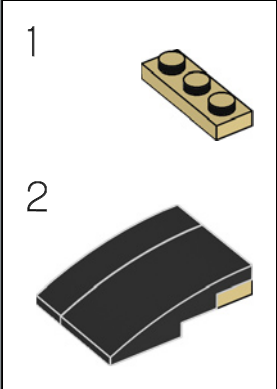



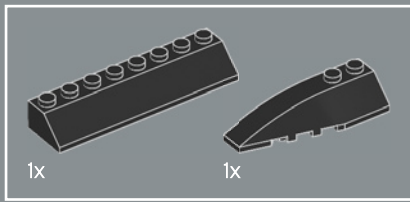

260

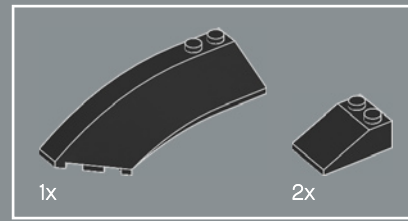
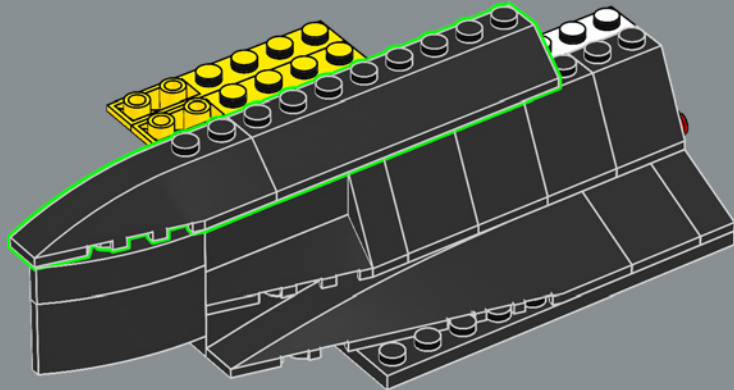

261

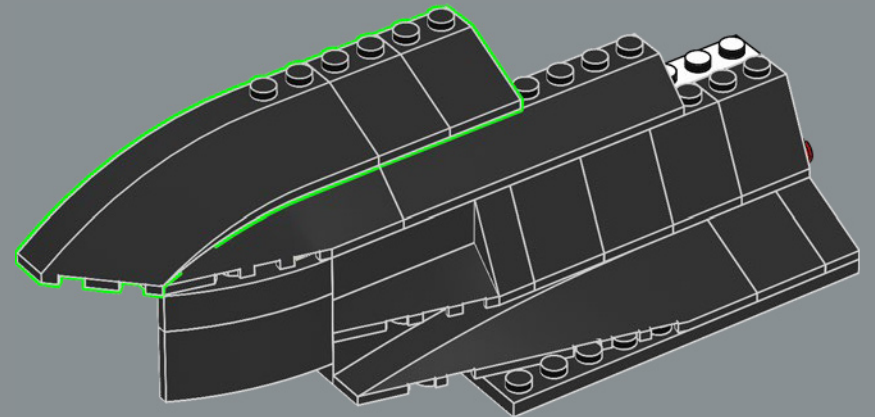

262

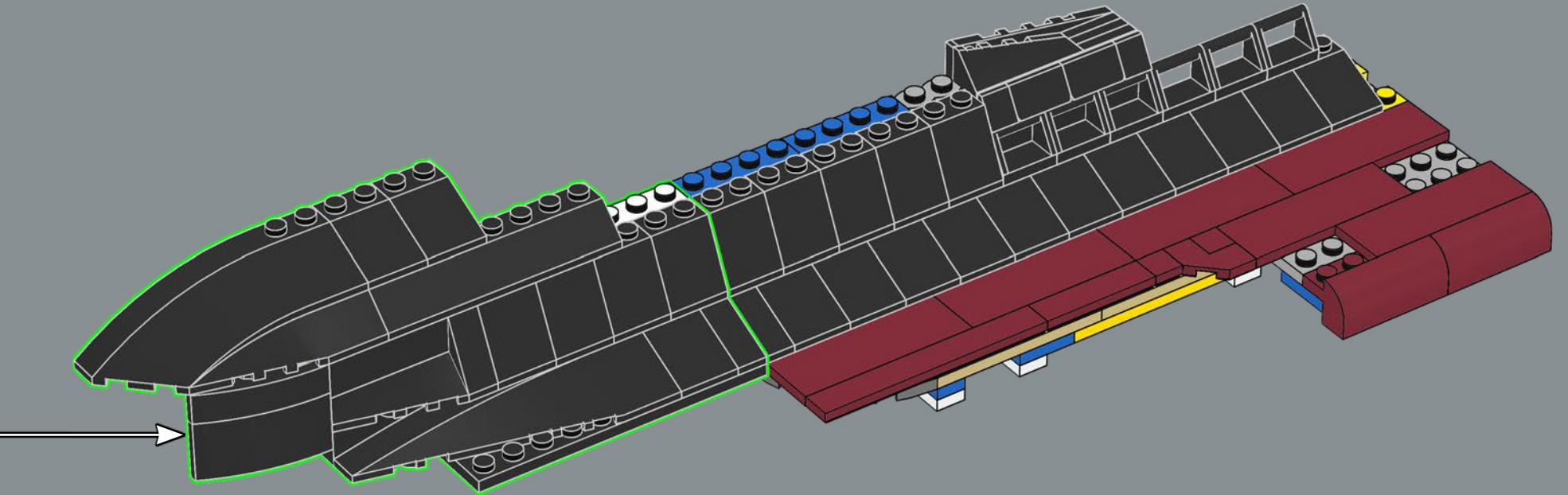

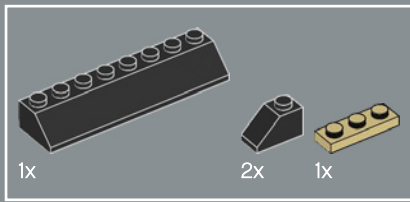

263

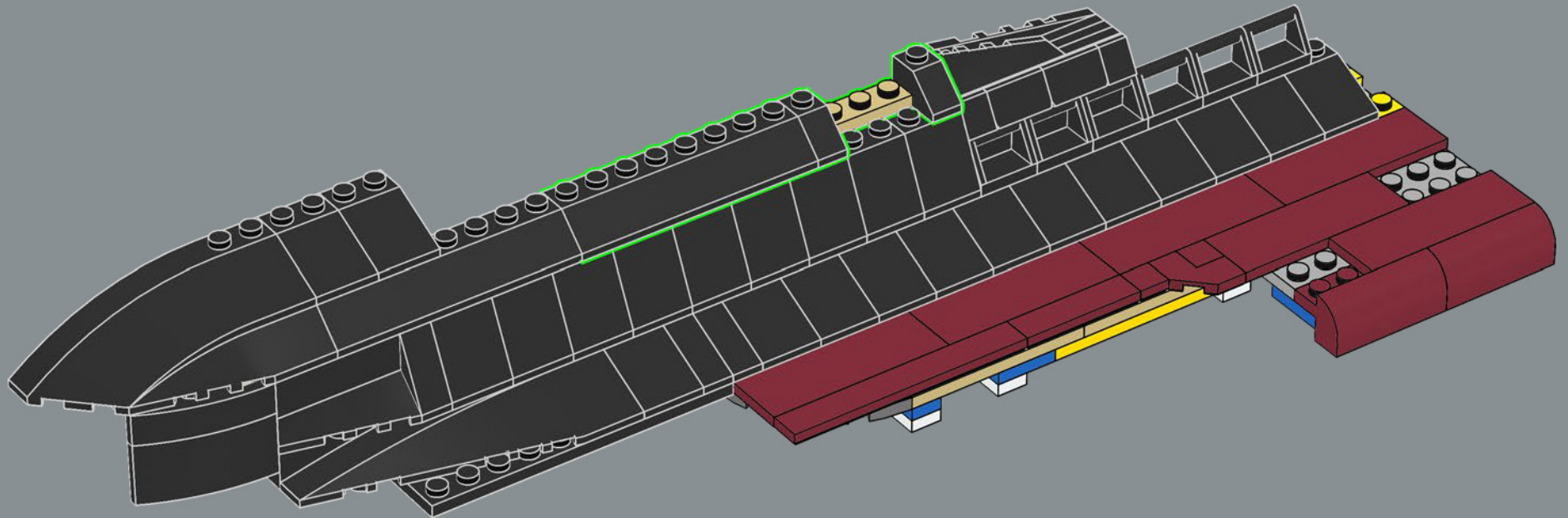

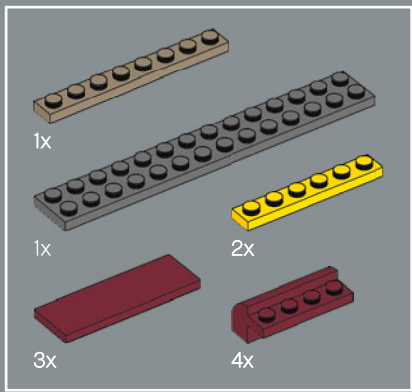

264

1

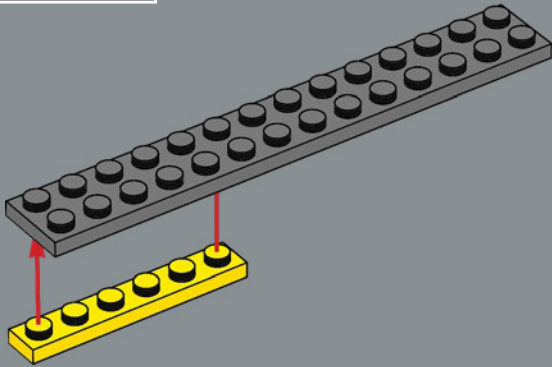

2

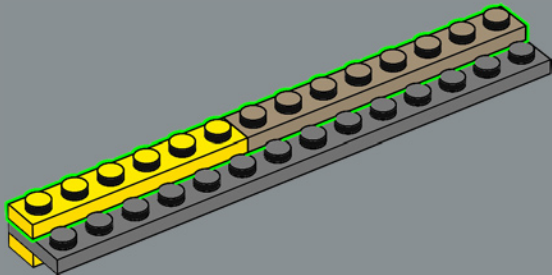

3

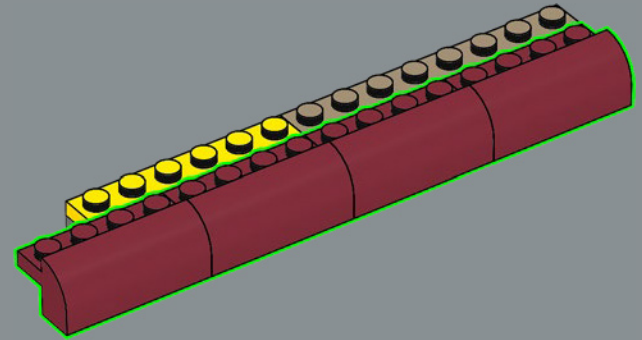

4

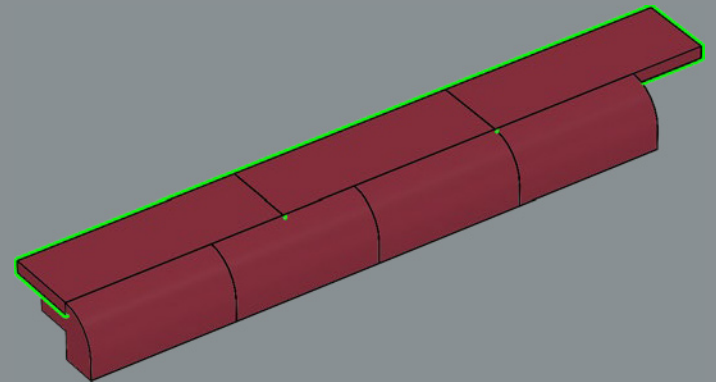

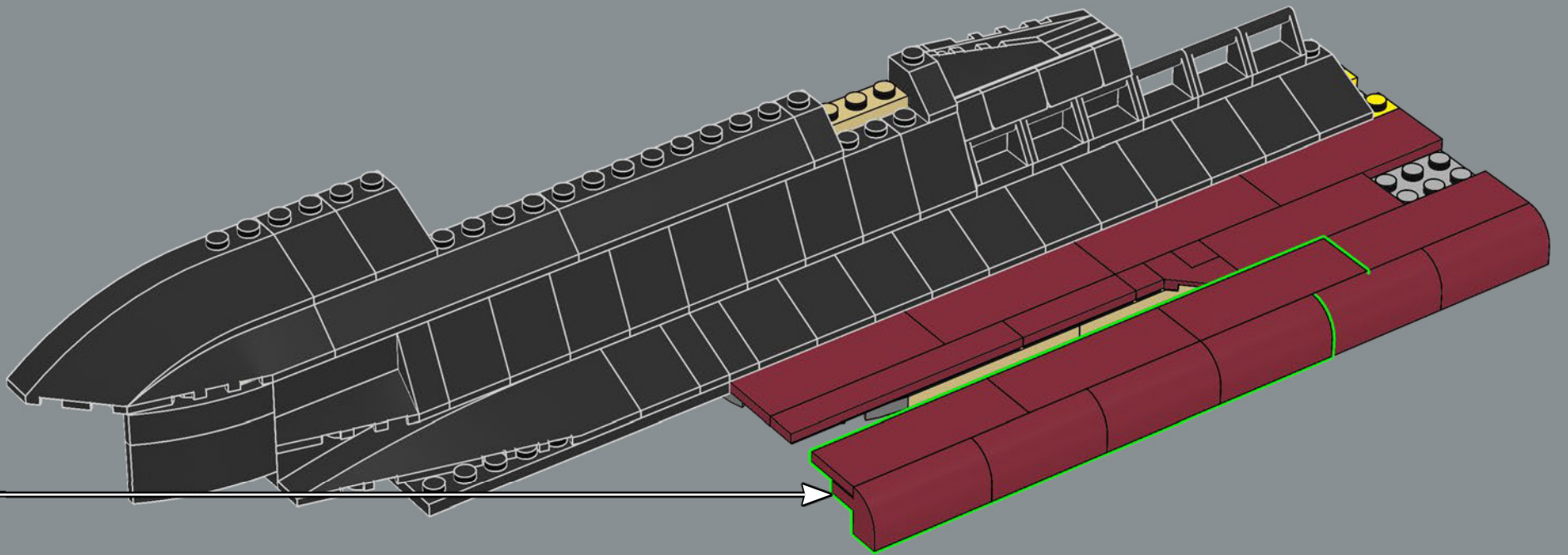

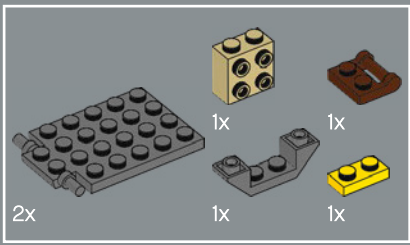

265

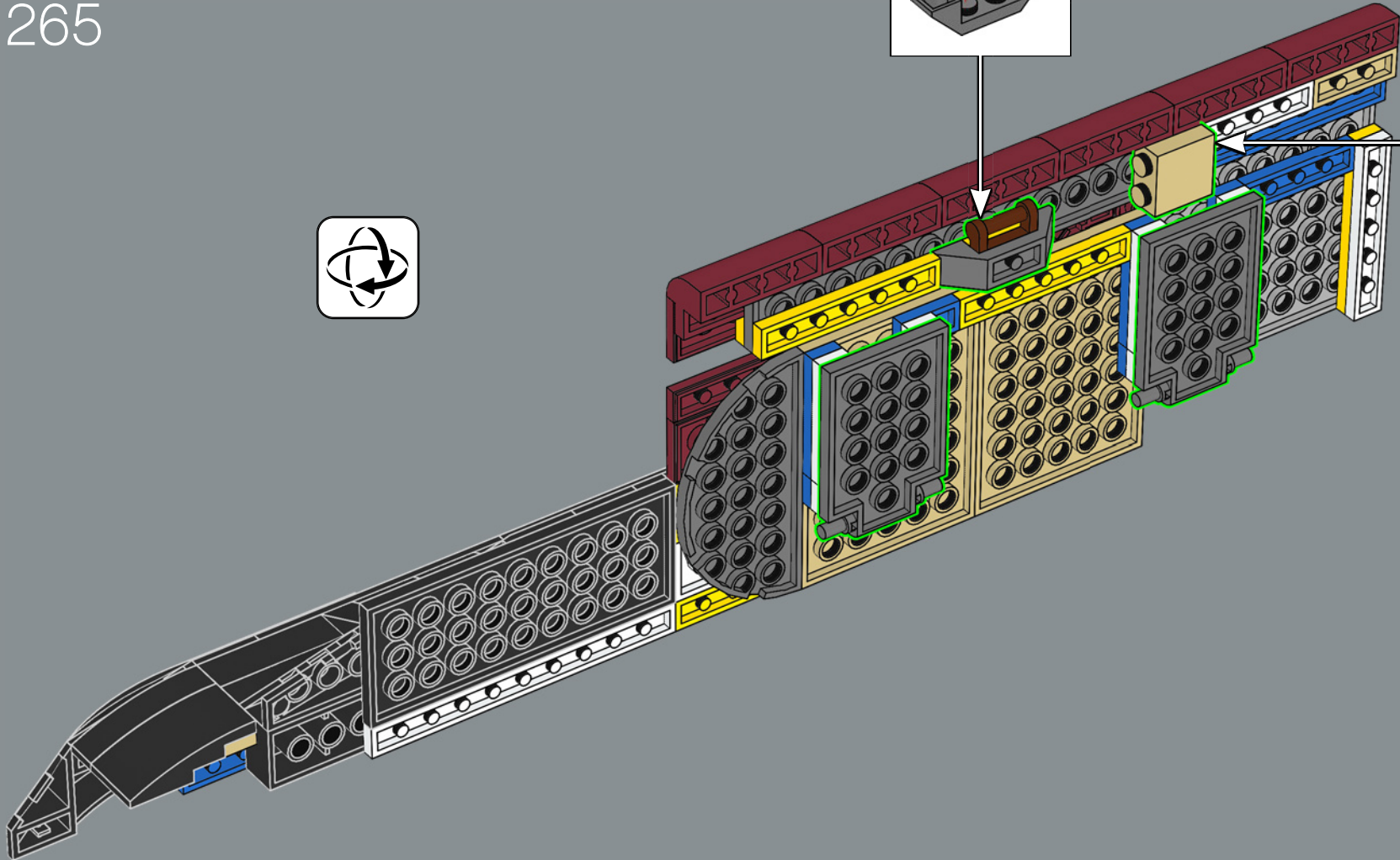
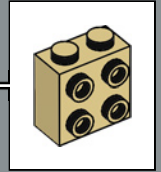
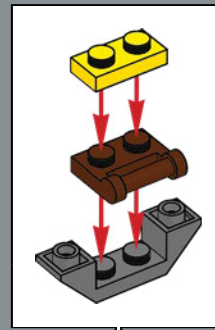

266

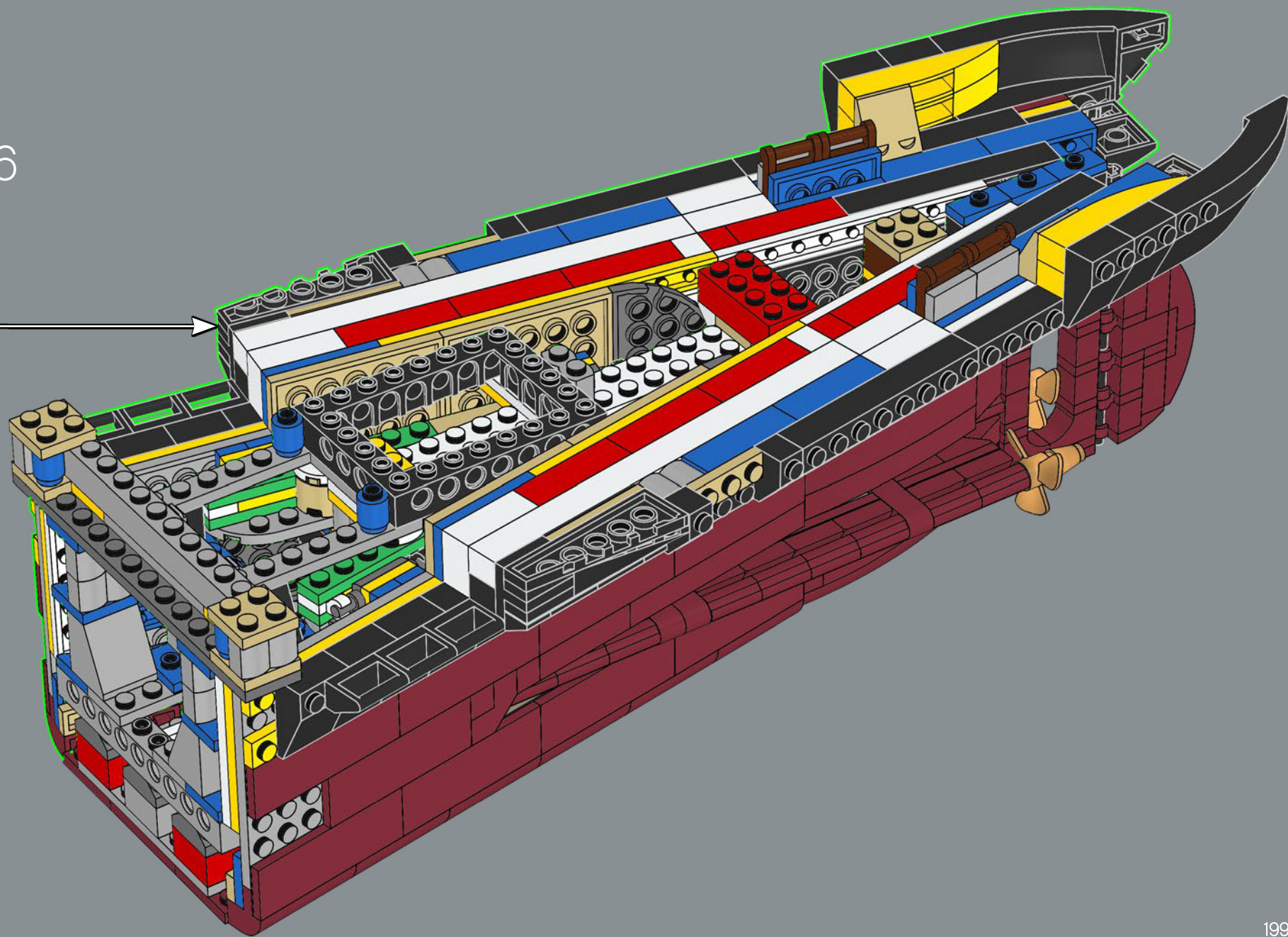

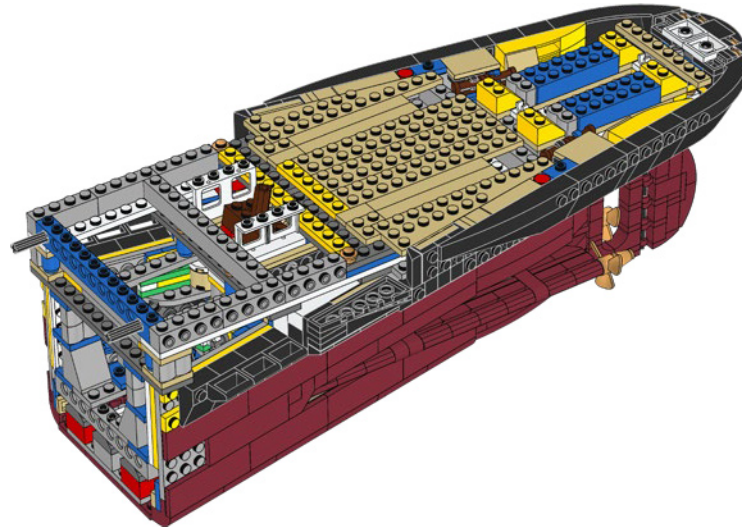
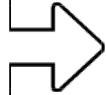



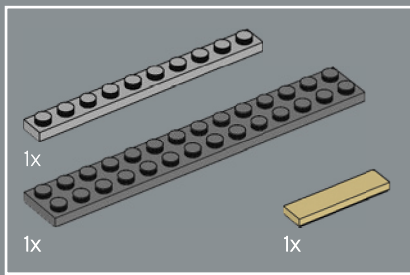

267

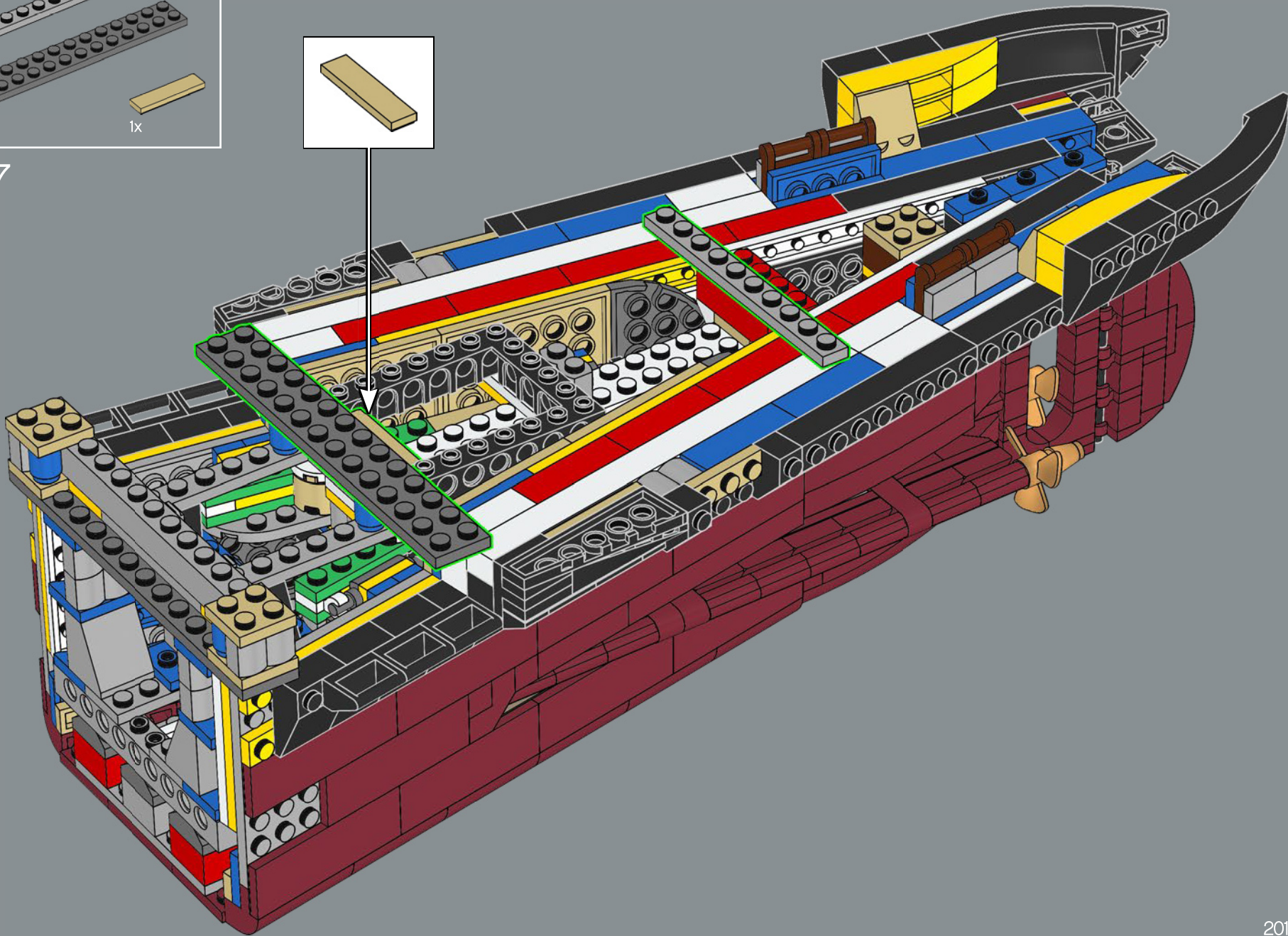
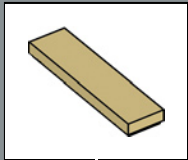

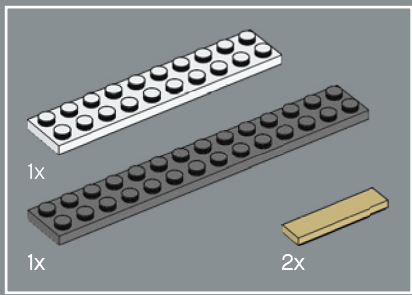

268

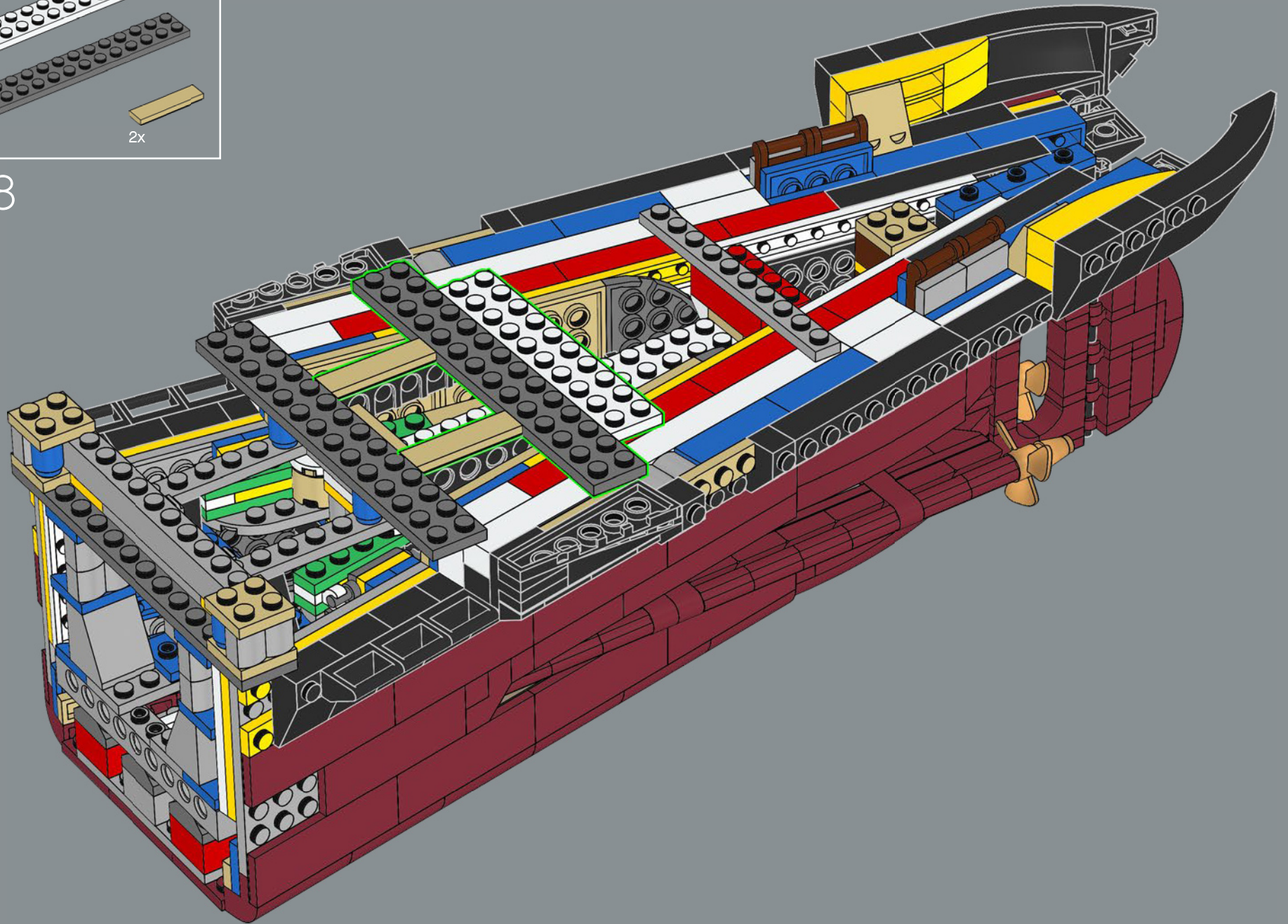

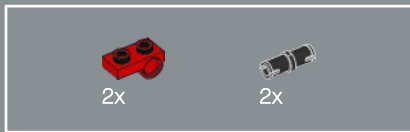

269

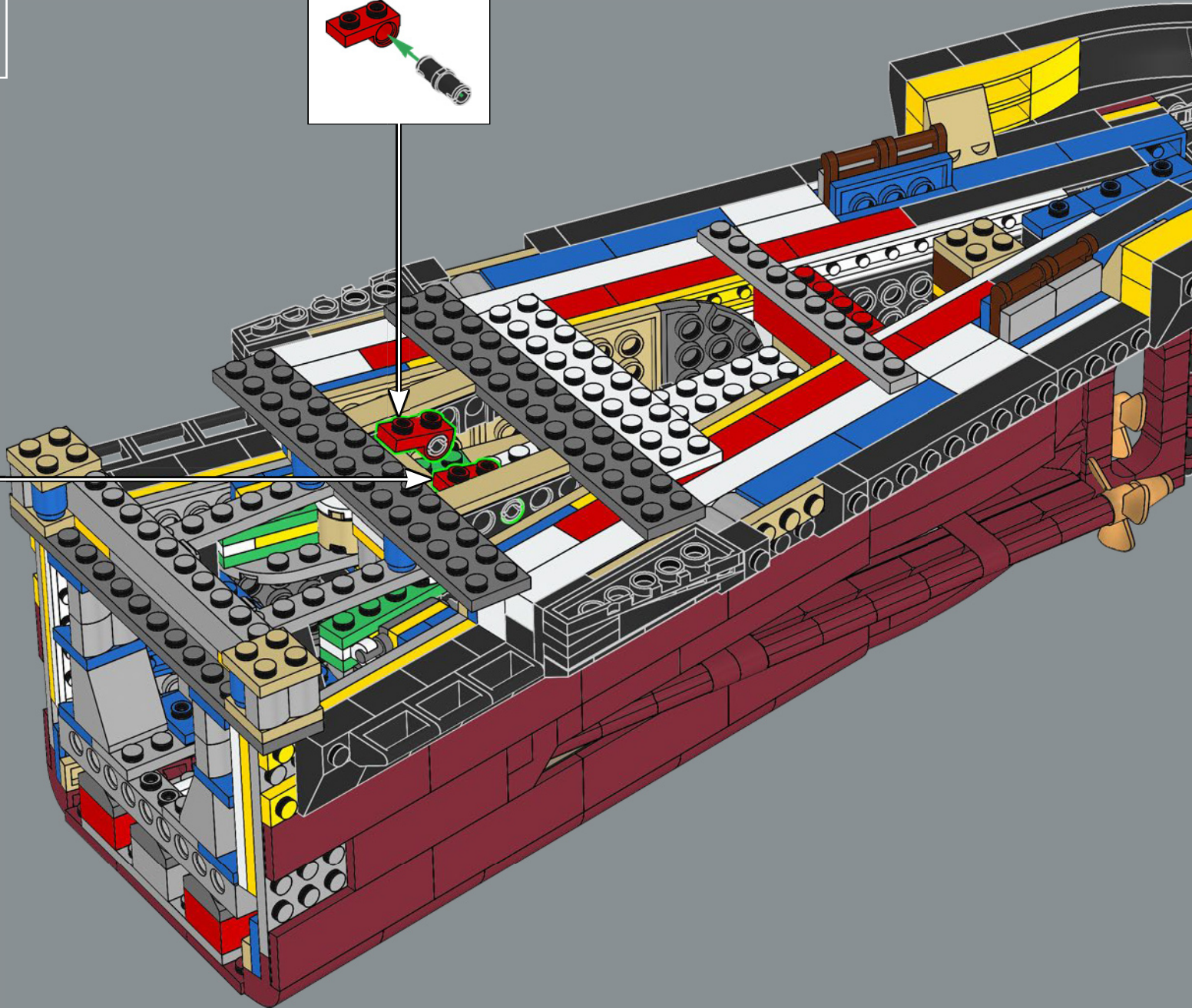
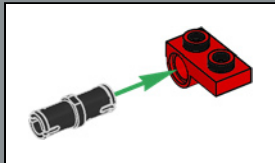
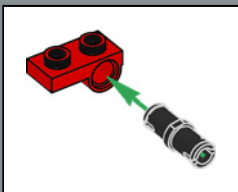

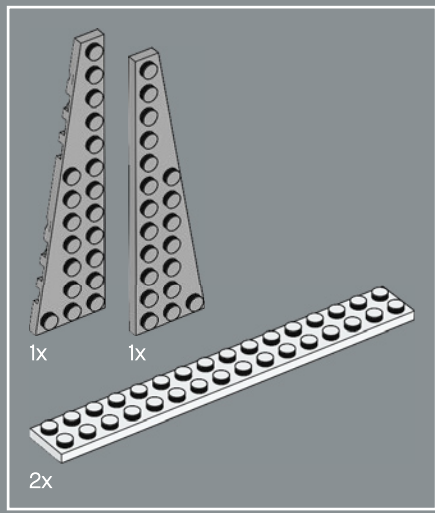

270

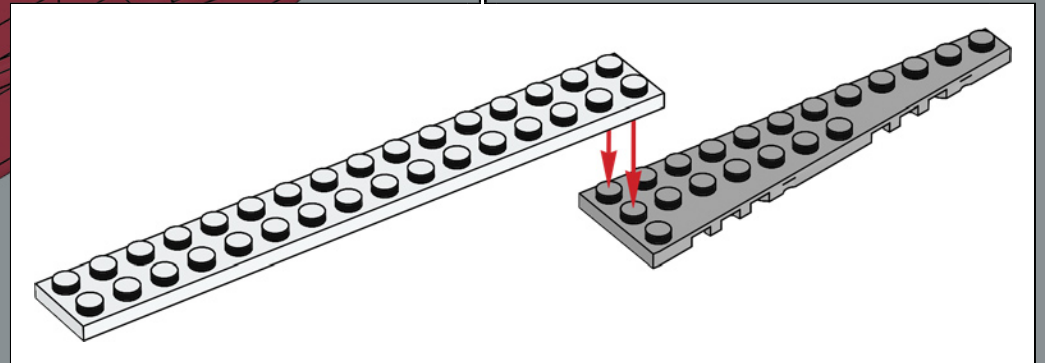
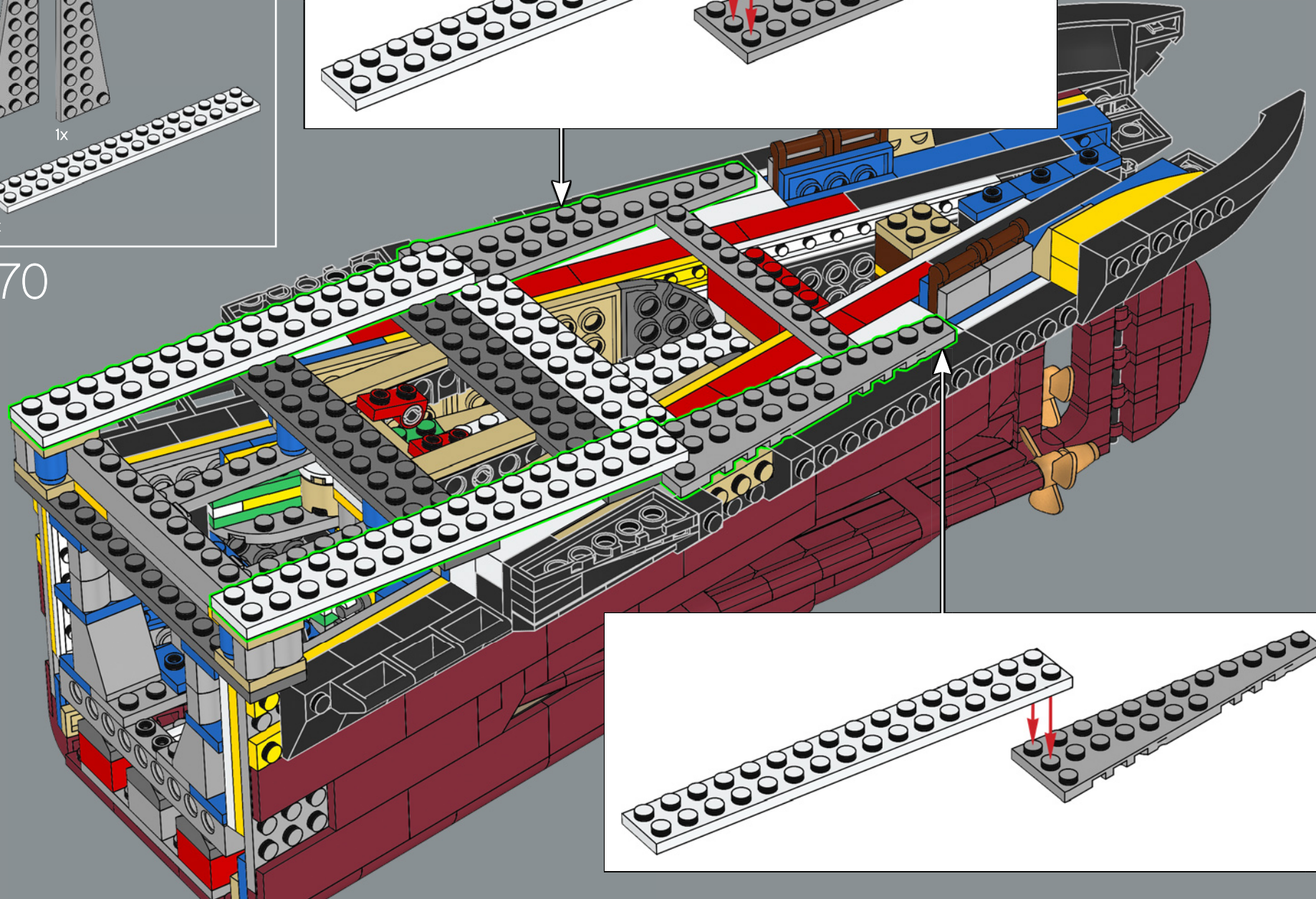
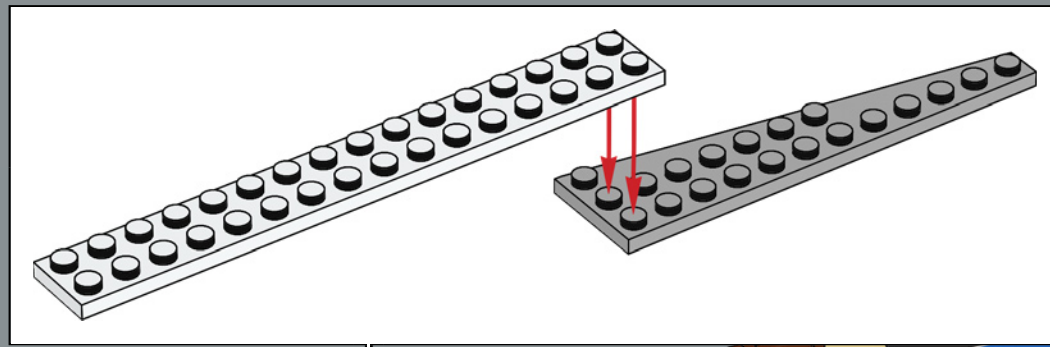

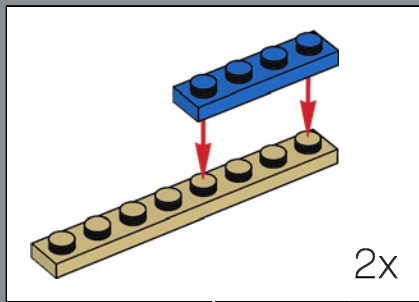
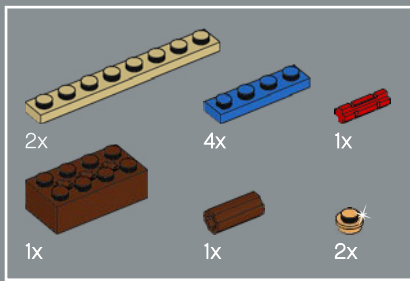

271

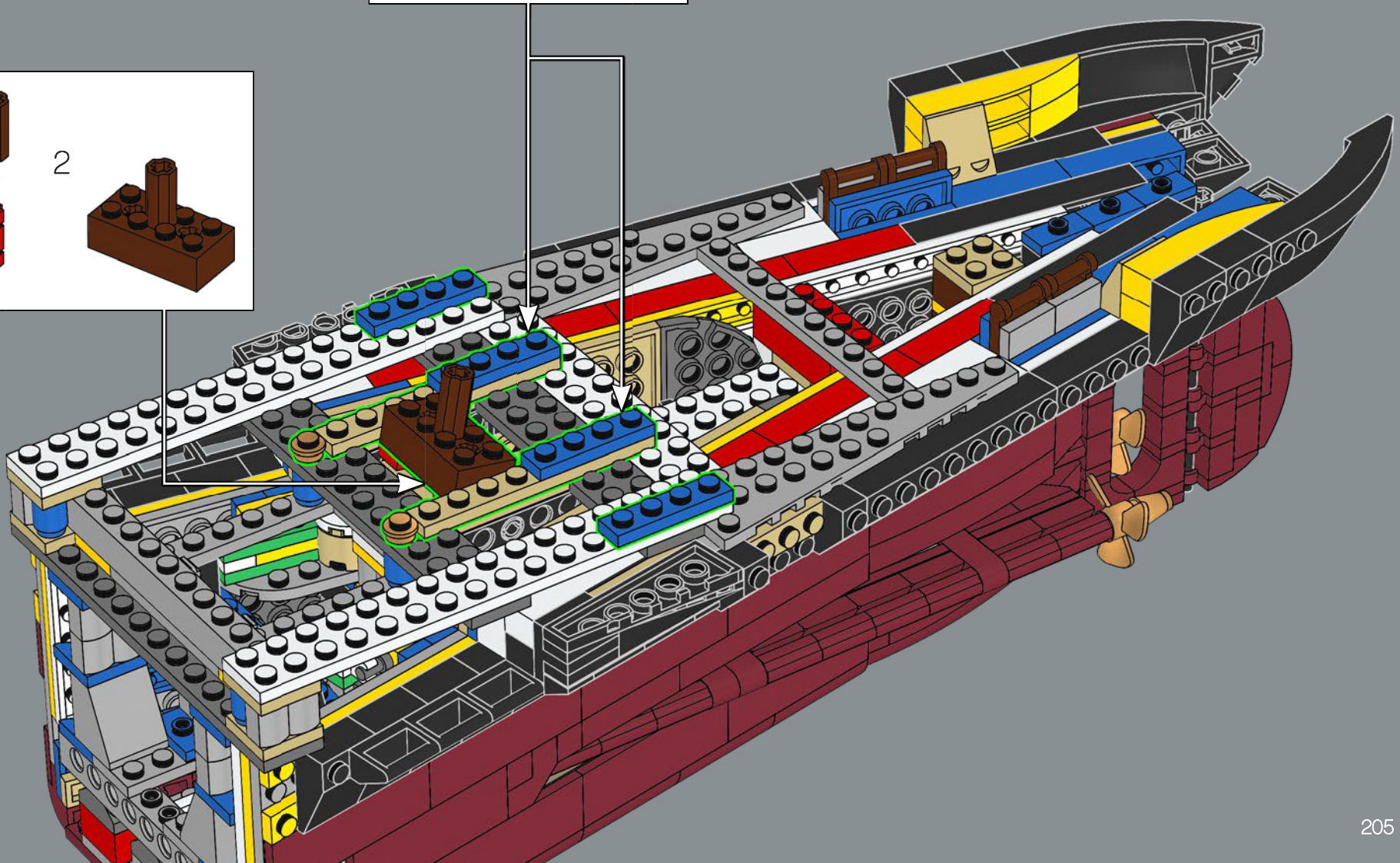
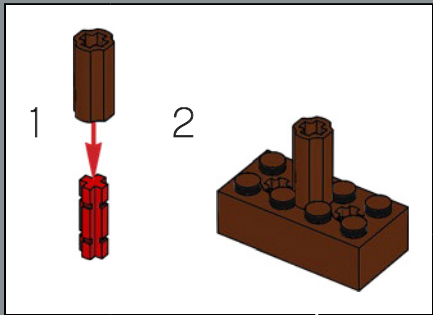

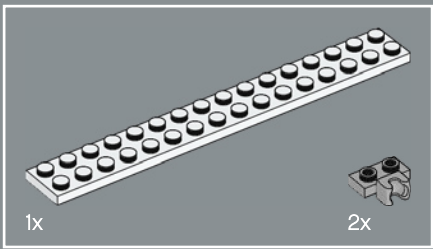

272

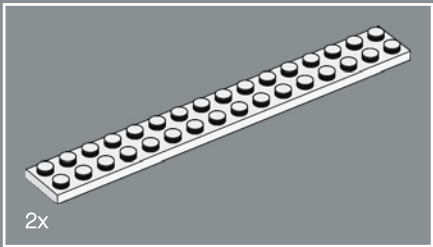
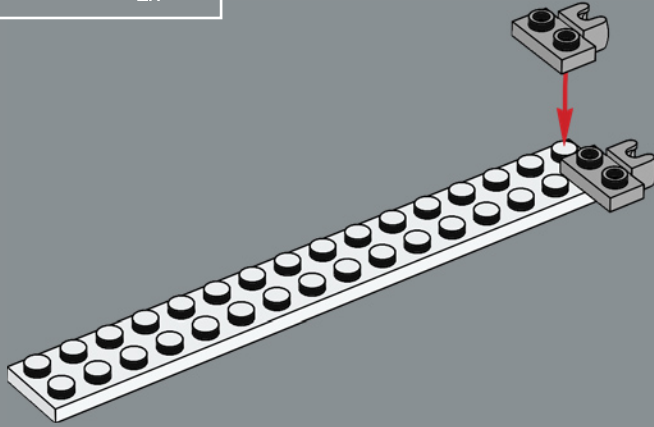

273

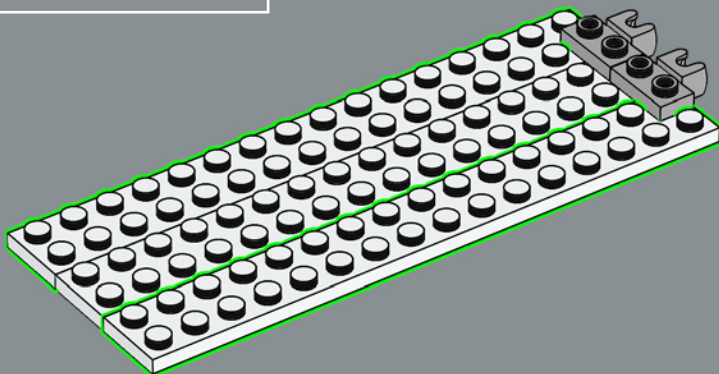

274

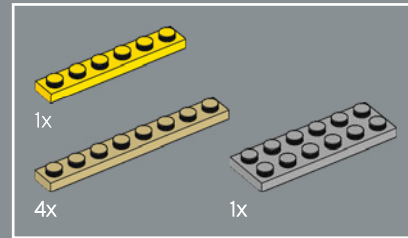
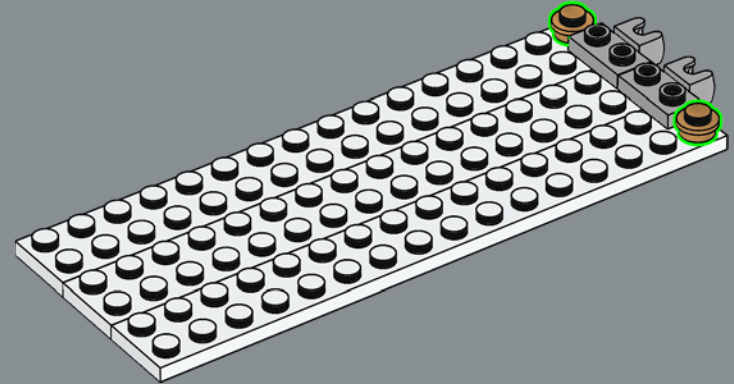

275

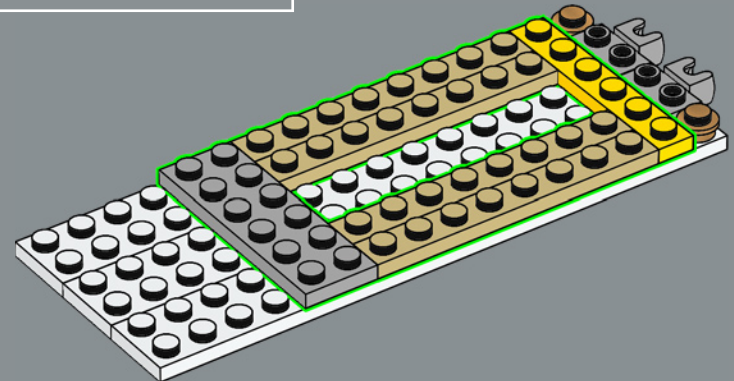

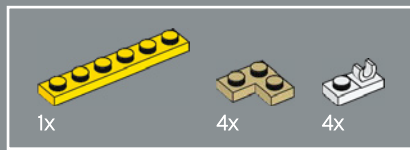

276

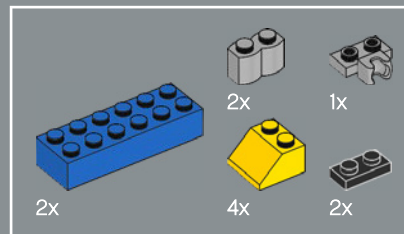
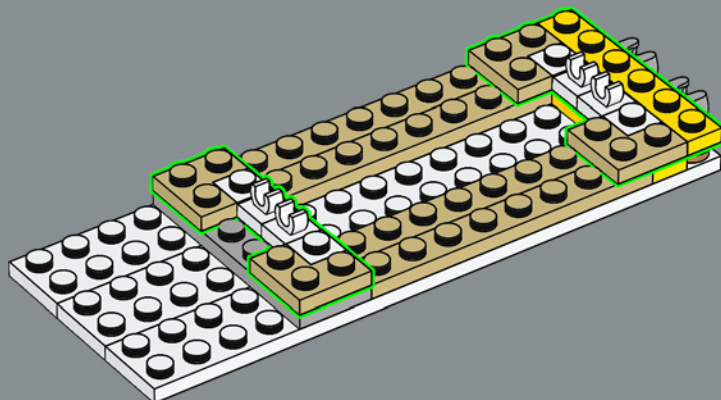

277

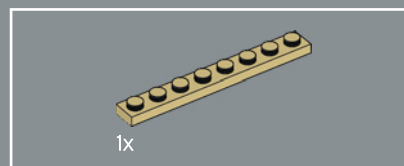
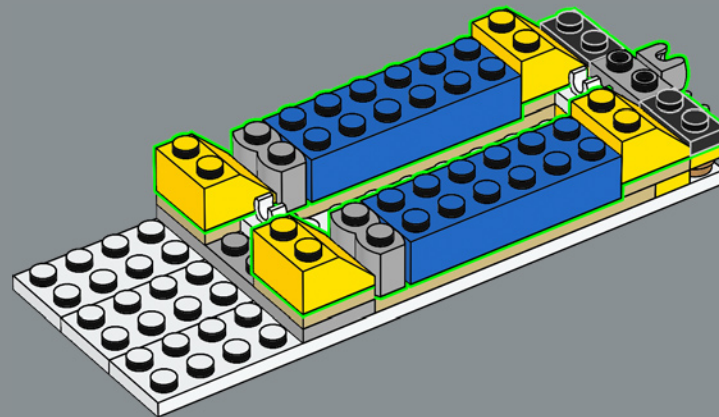

278

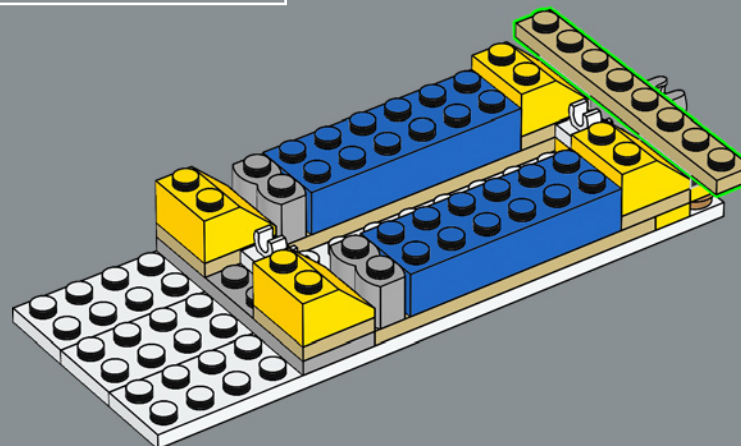

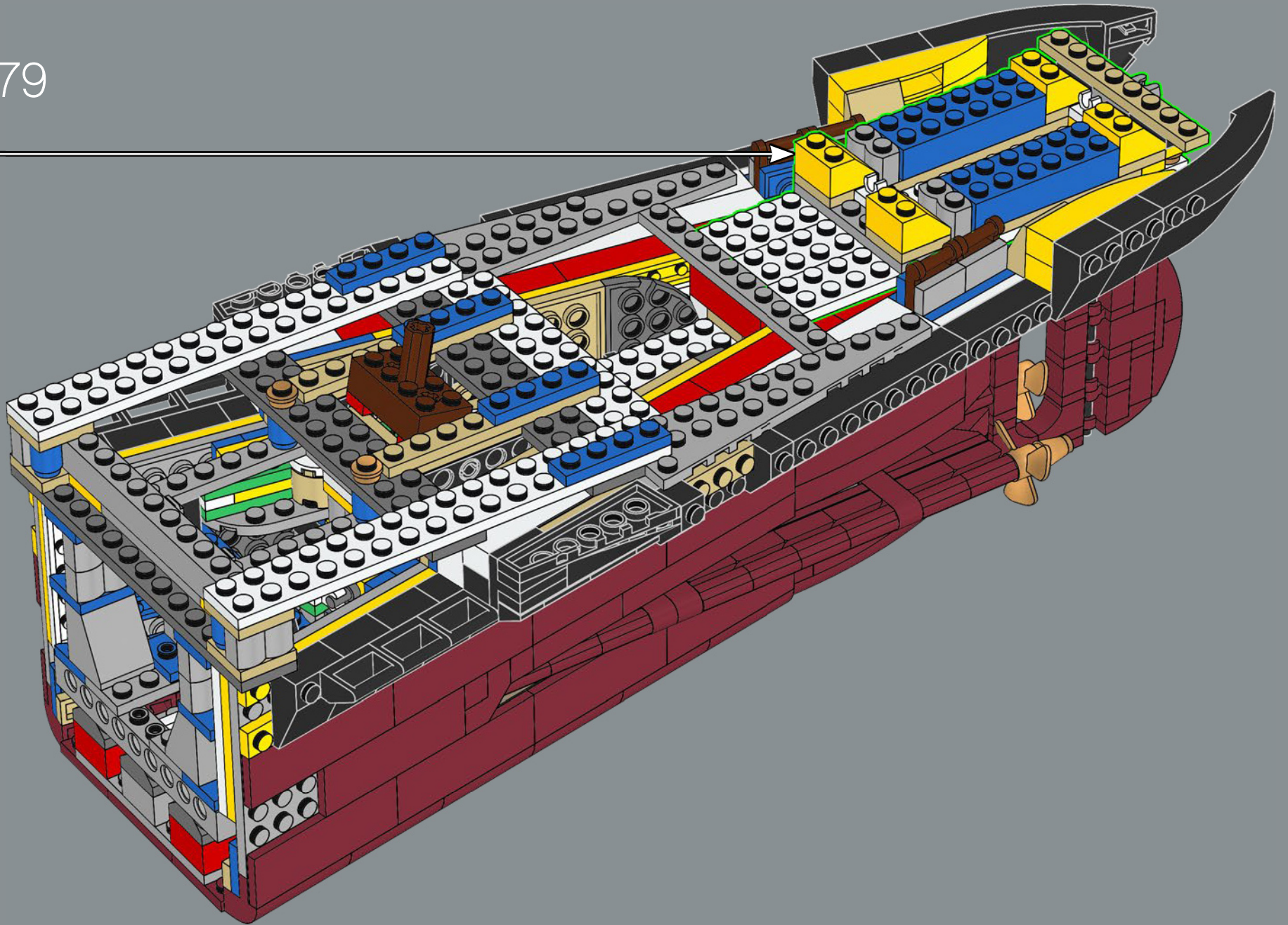



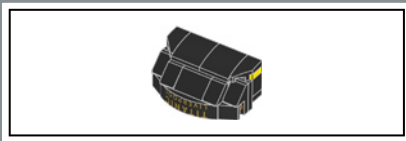

280

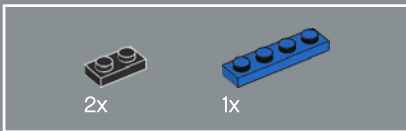
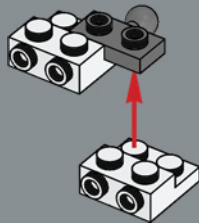

281

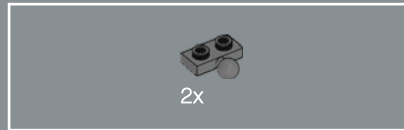
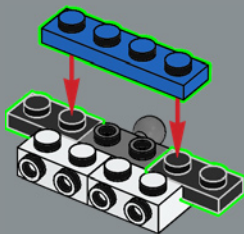

282

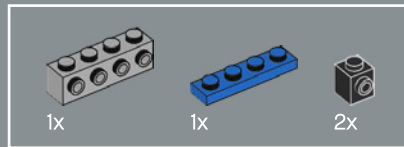
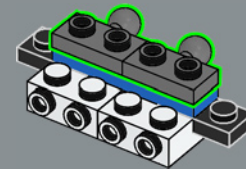

283

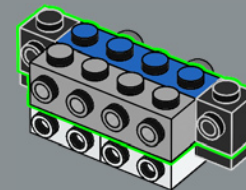

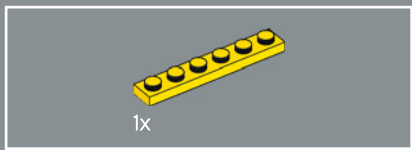

284

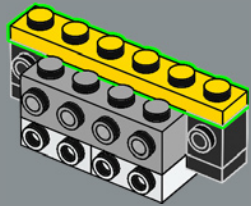

285

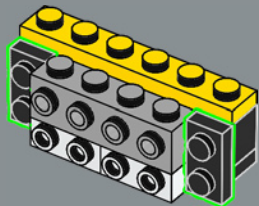

286

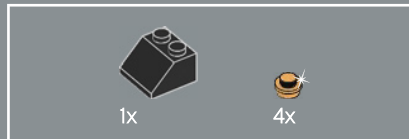
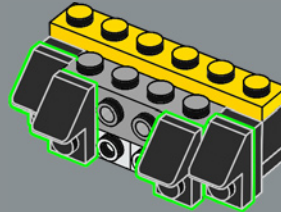

287

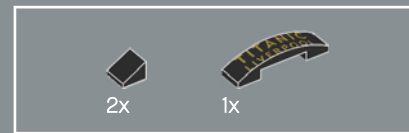
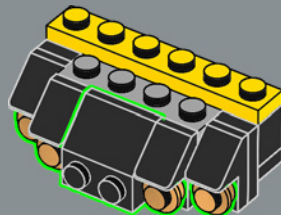

288

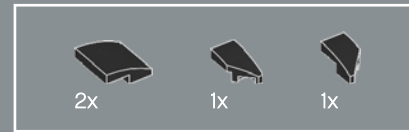
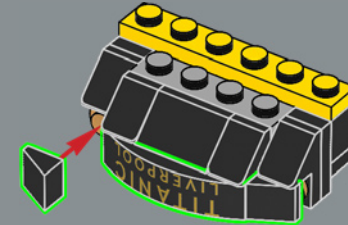

289

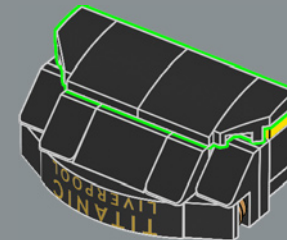

Die *Titanic* hatte weder Suchscheinwerfer  
noch eine Sprechanlage für Durchsagen.

290

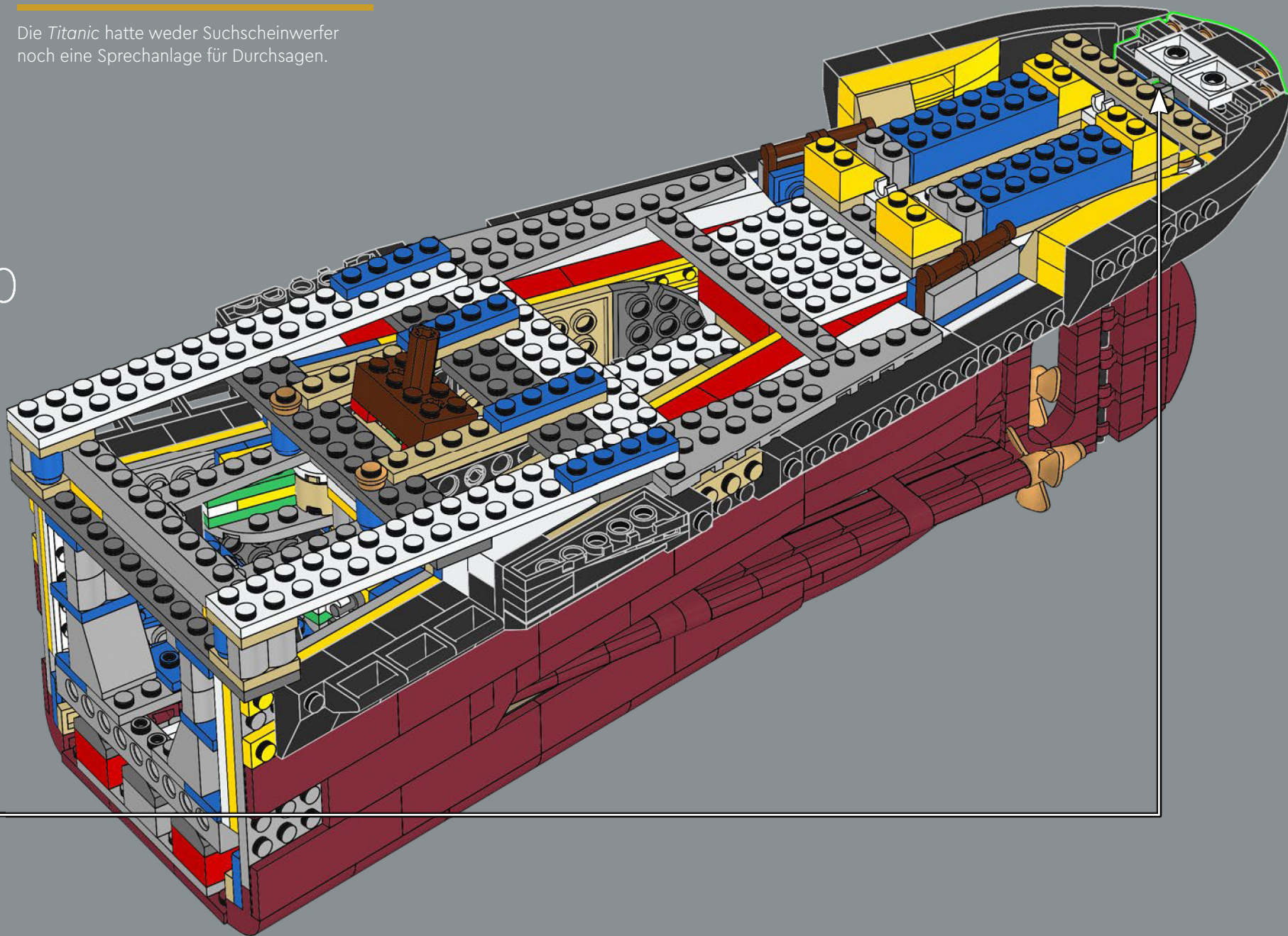

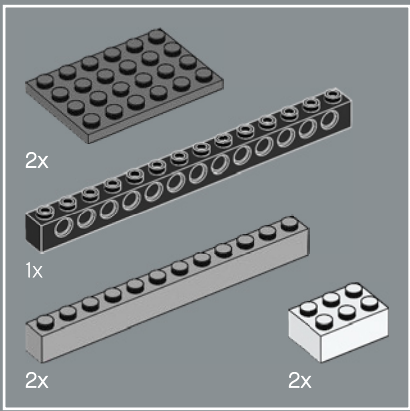

291

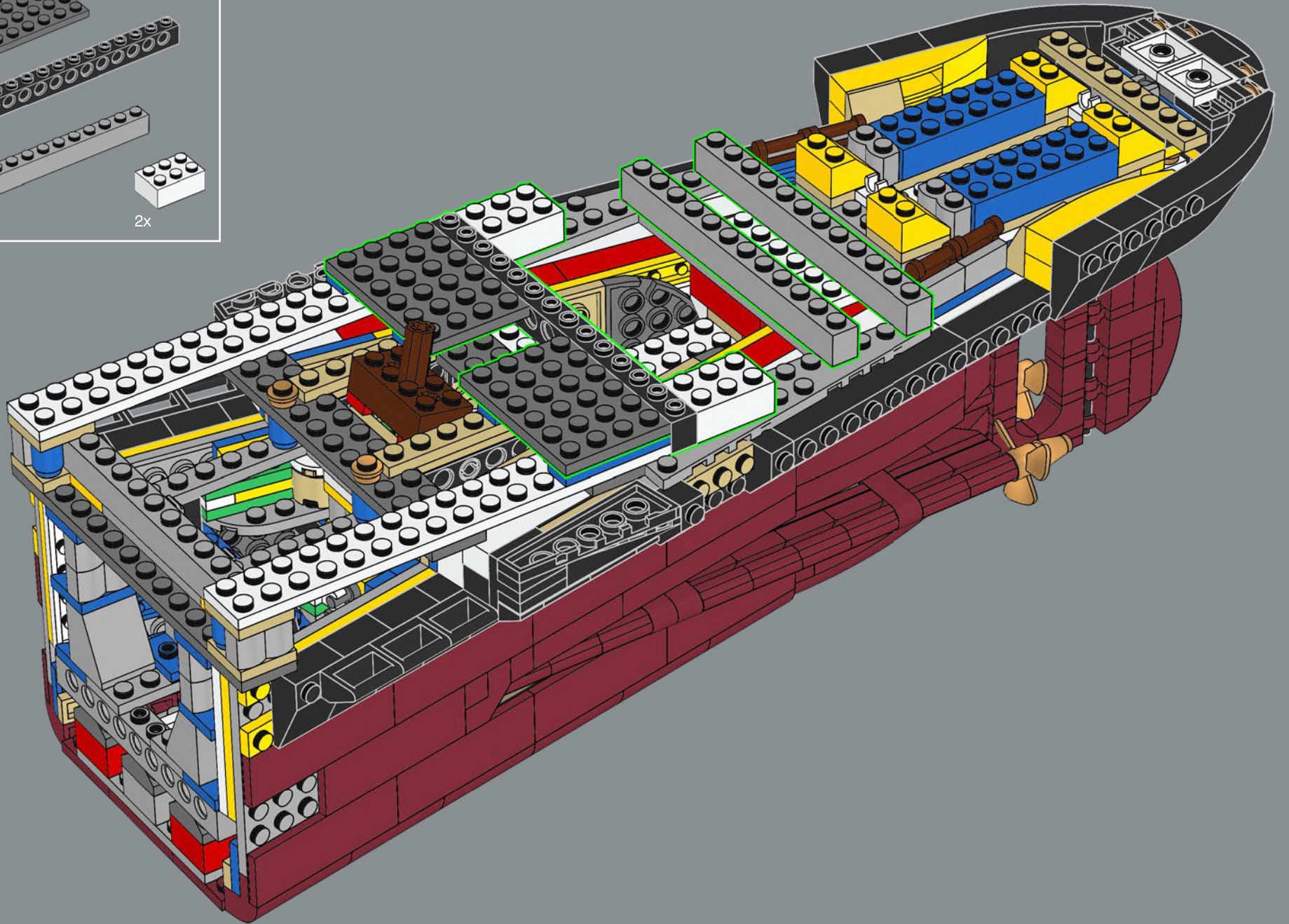

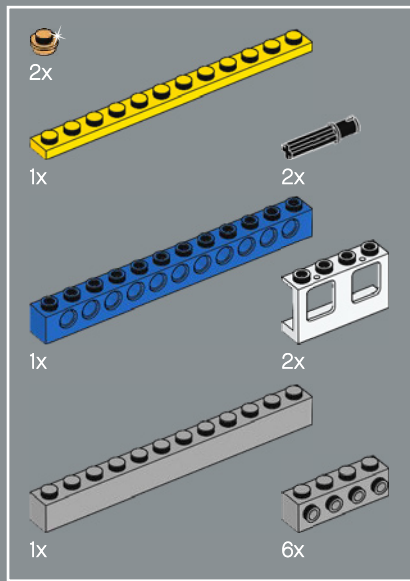

292

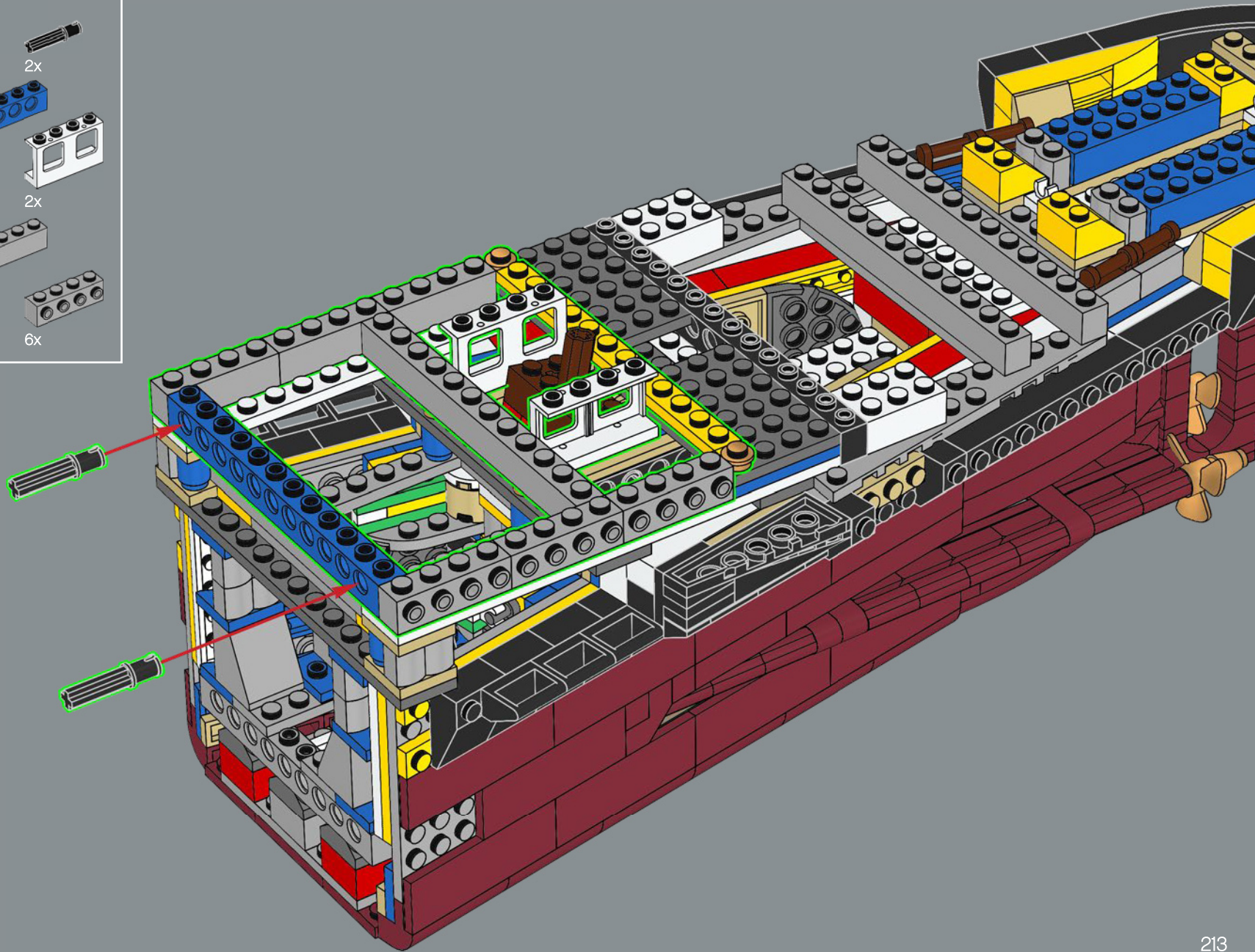

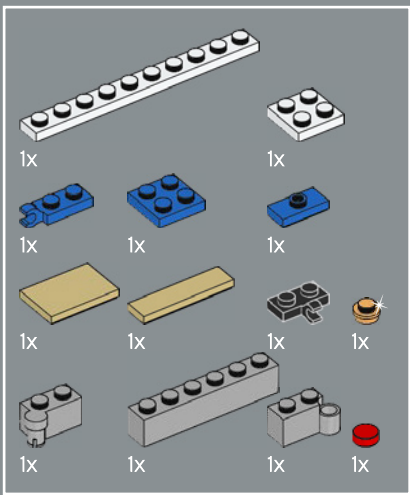

293

1

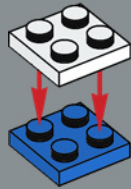

2

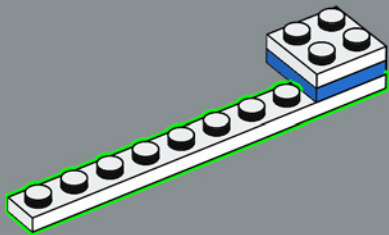

3

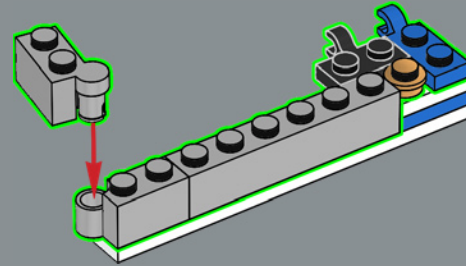

4

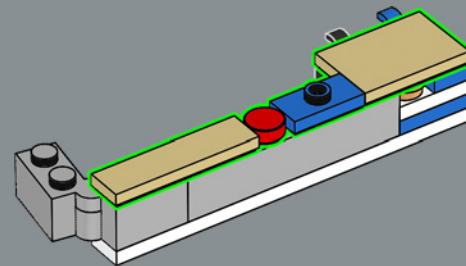

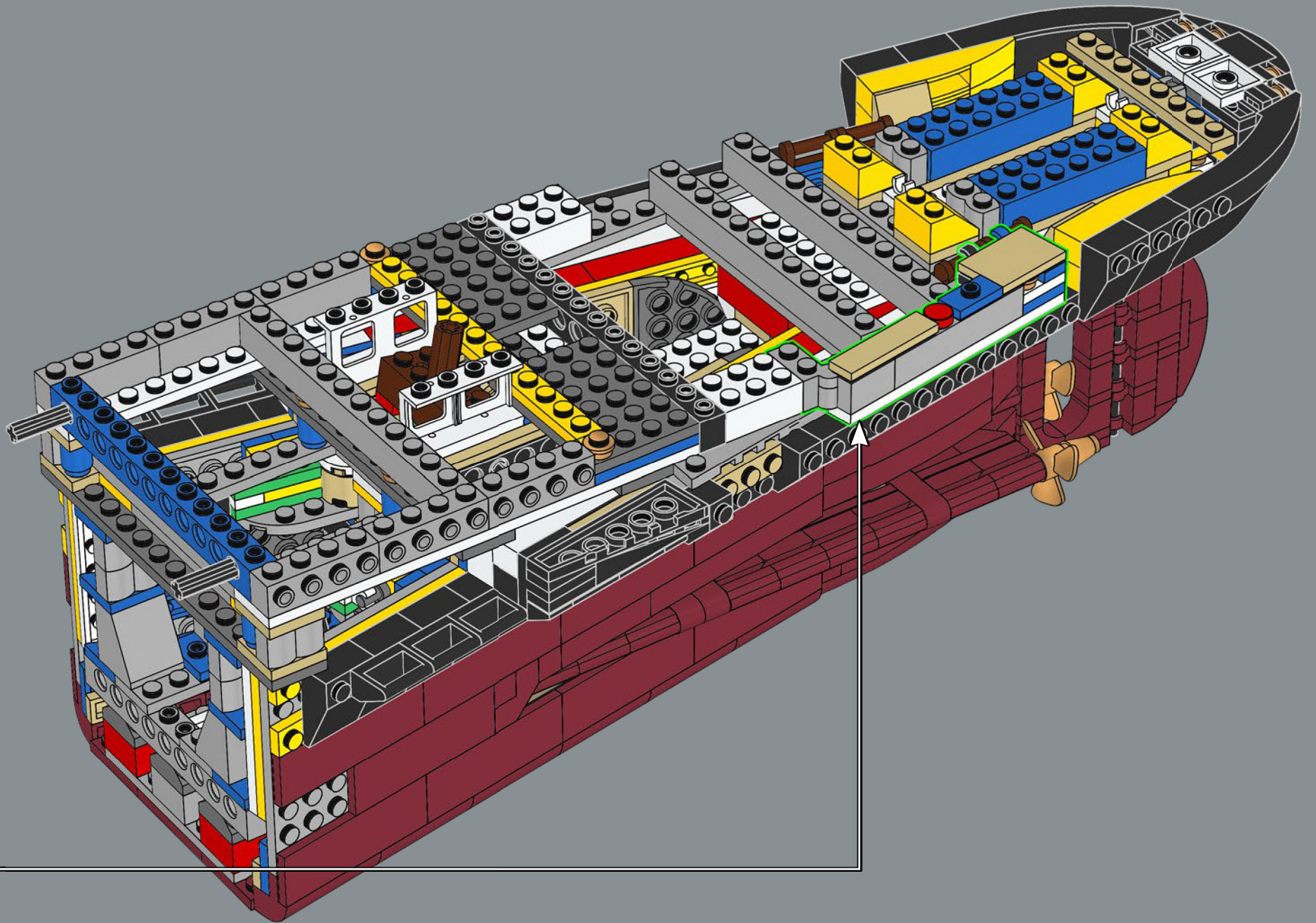

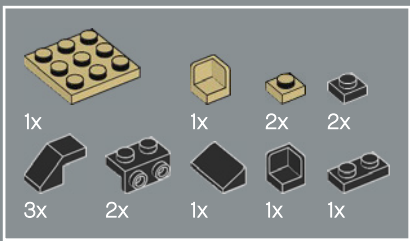

294

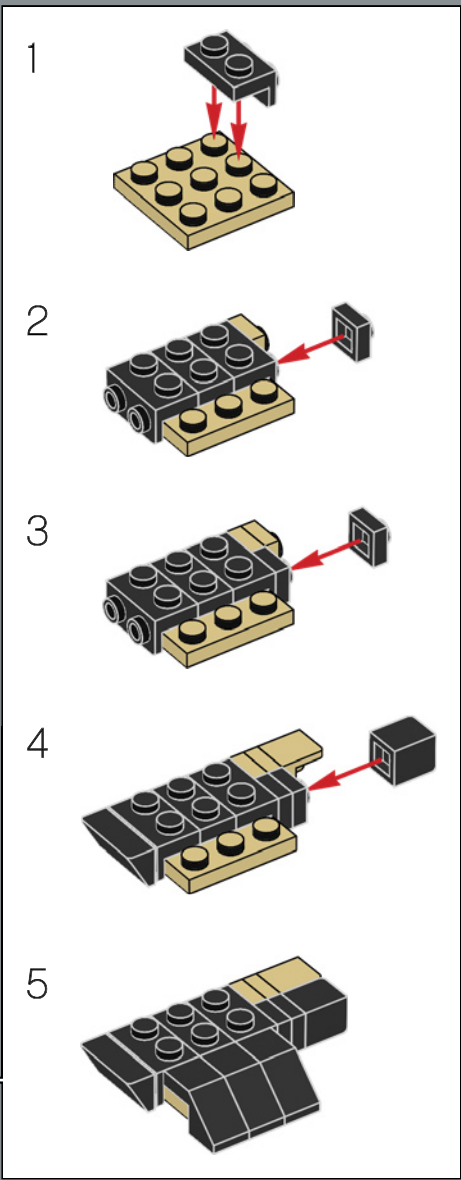
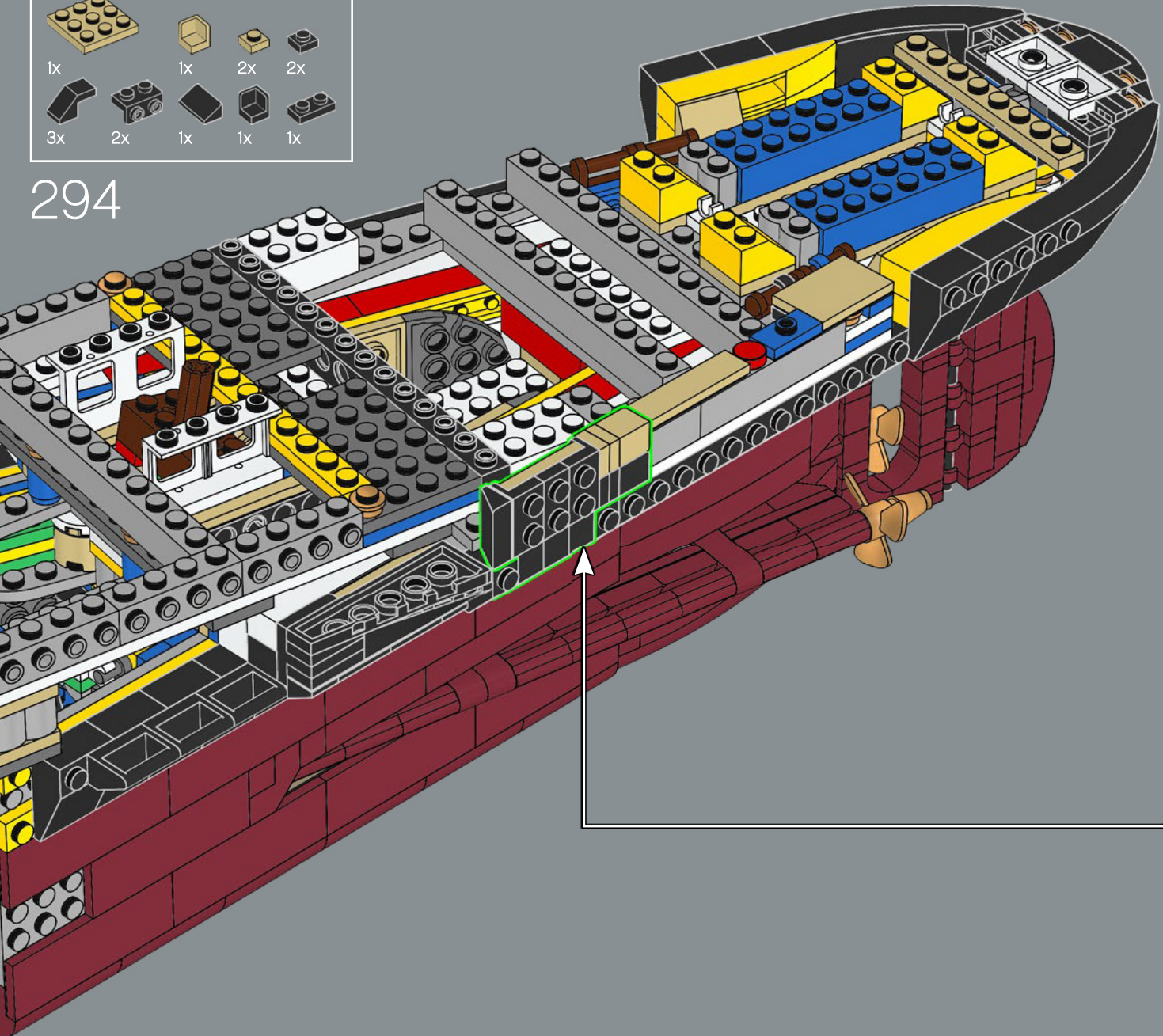



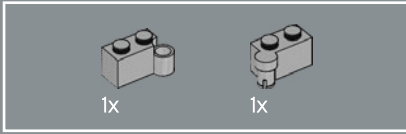
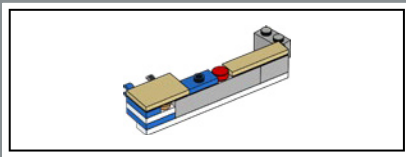

295

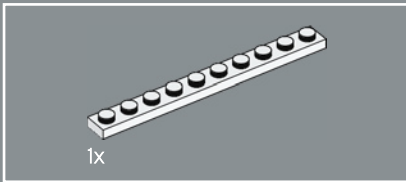
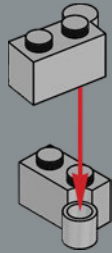

296

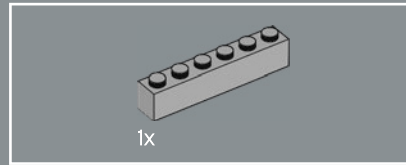
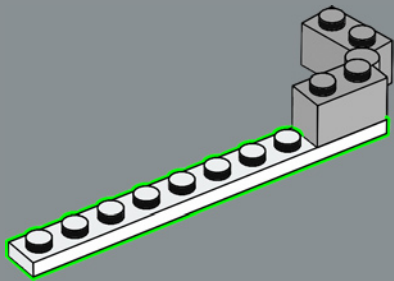

297

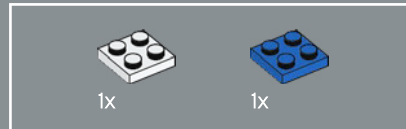
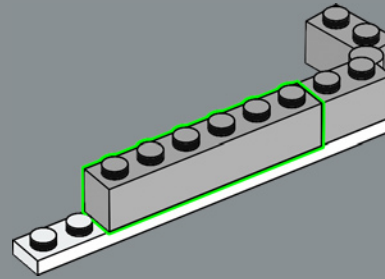

298

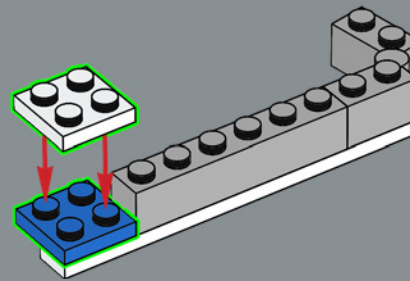

299

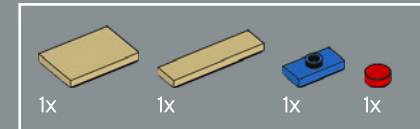
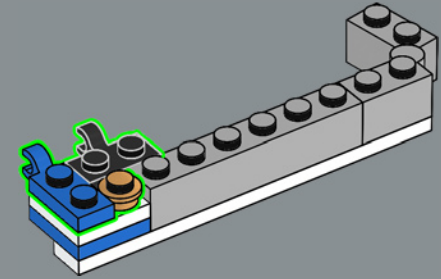

300

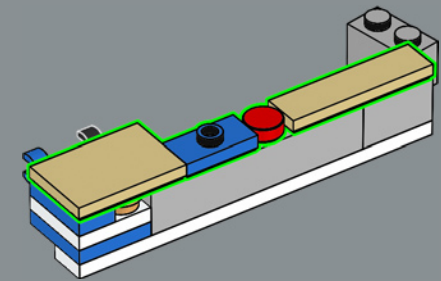

301

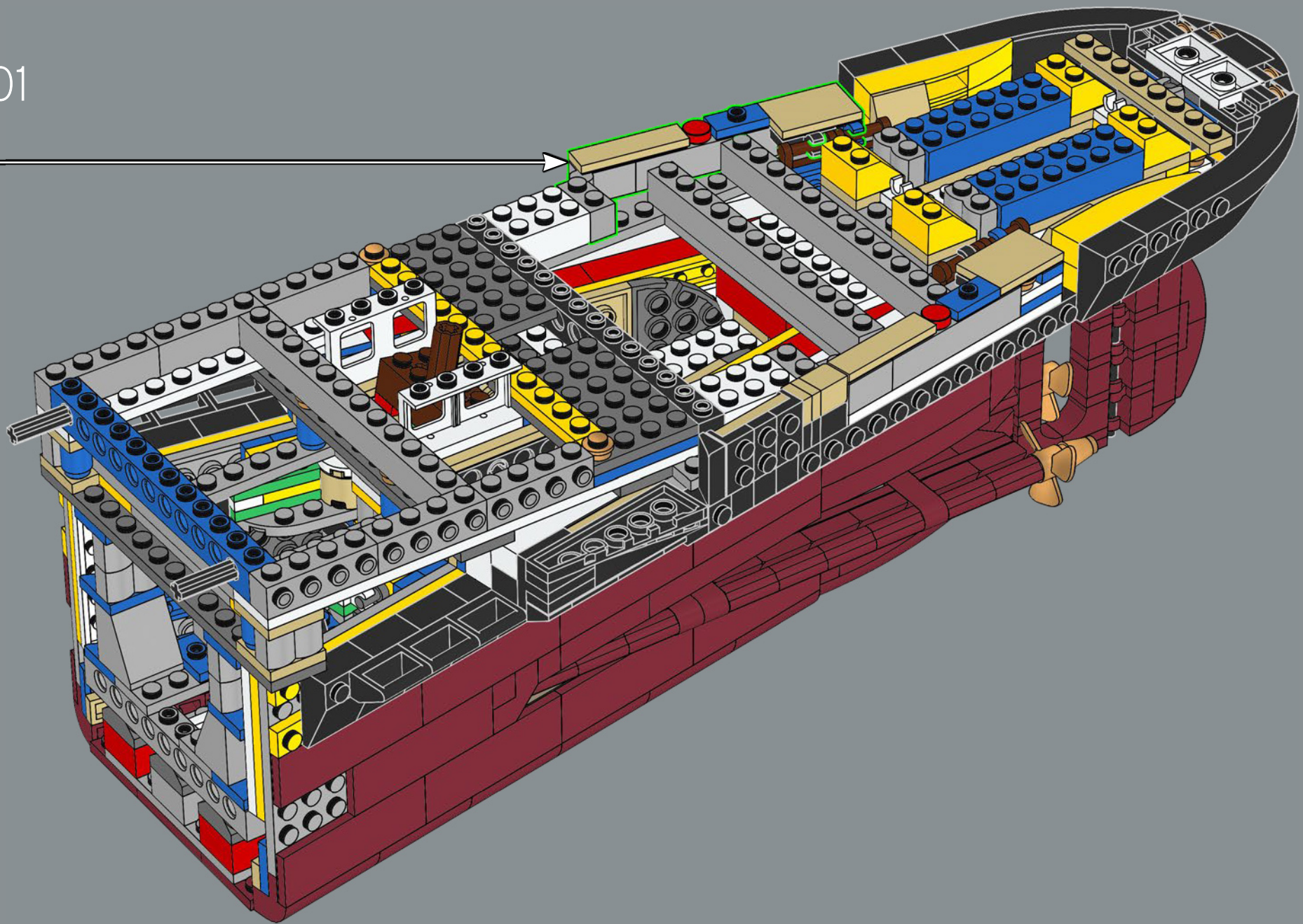

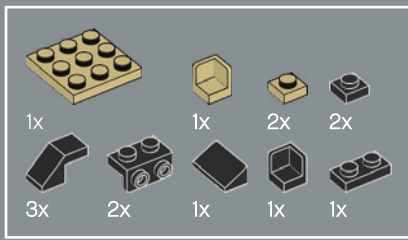

302

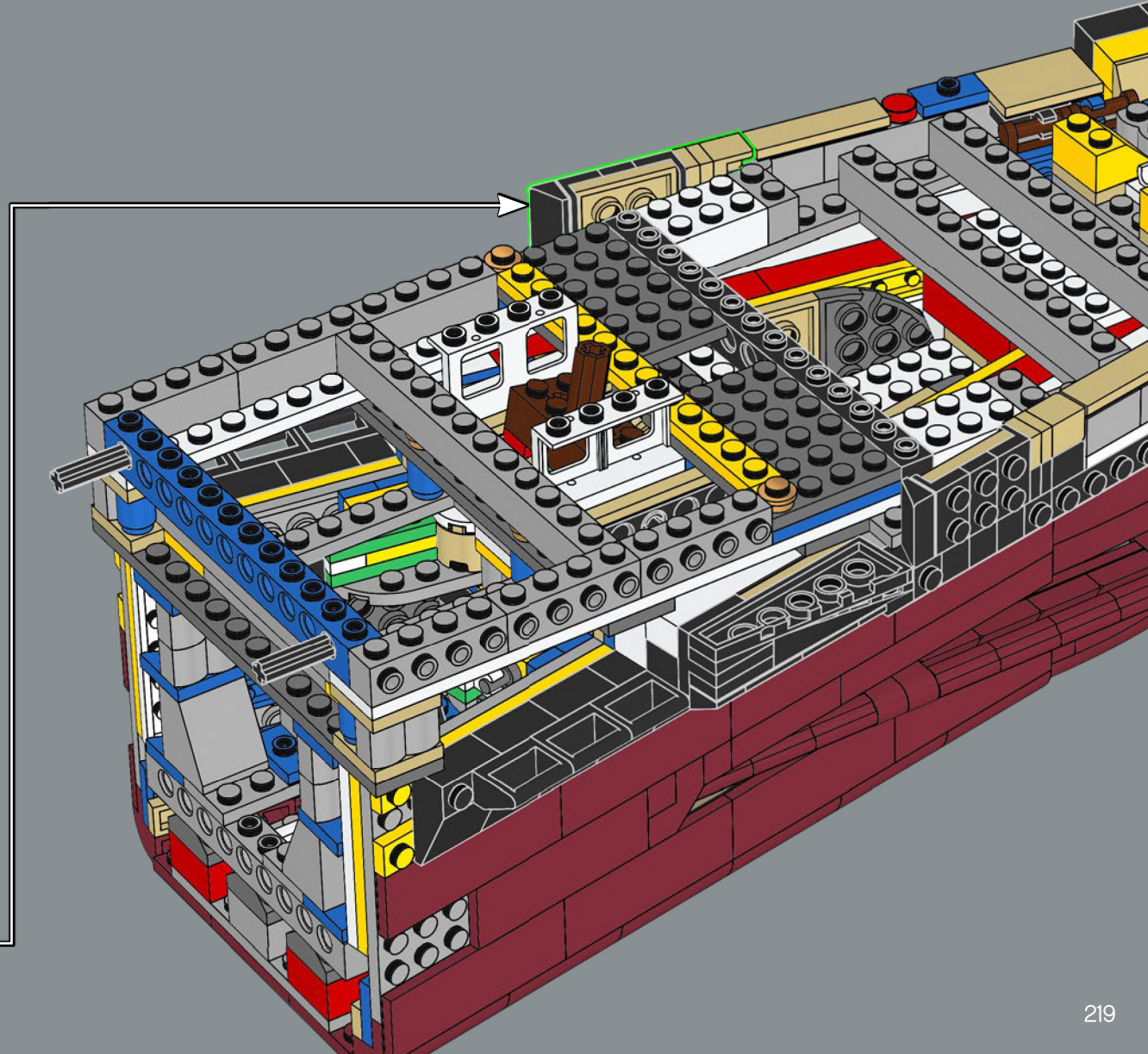
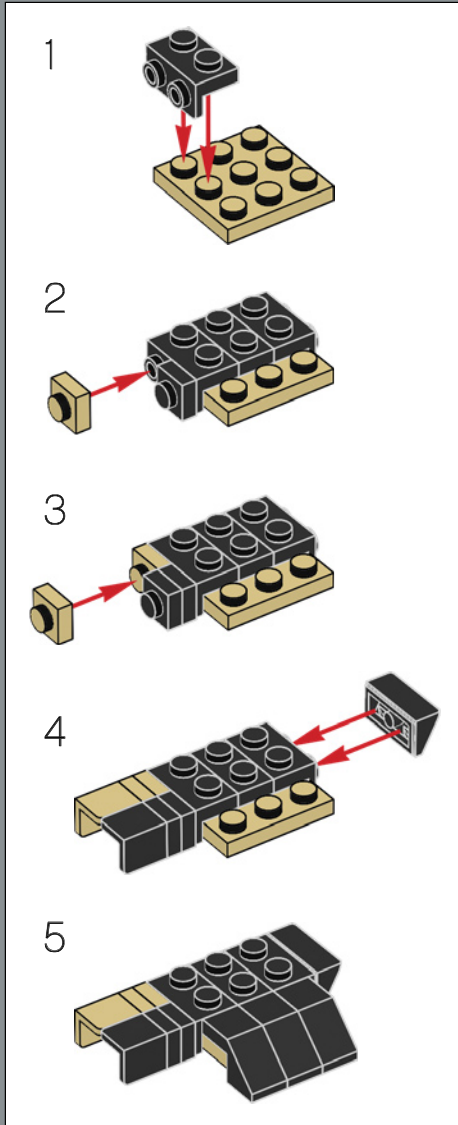

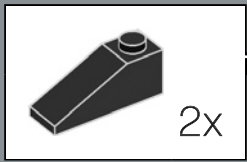
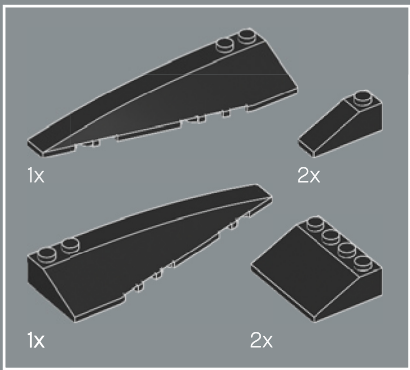

303

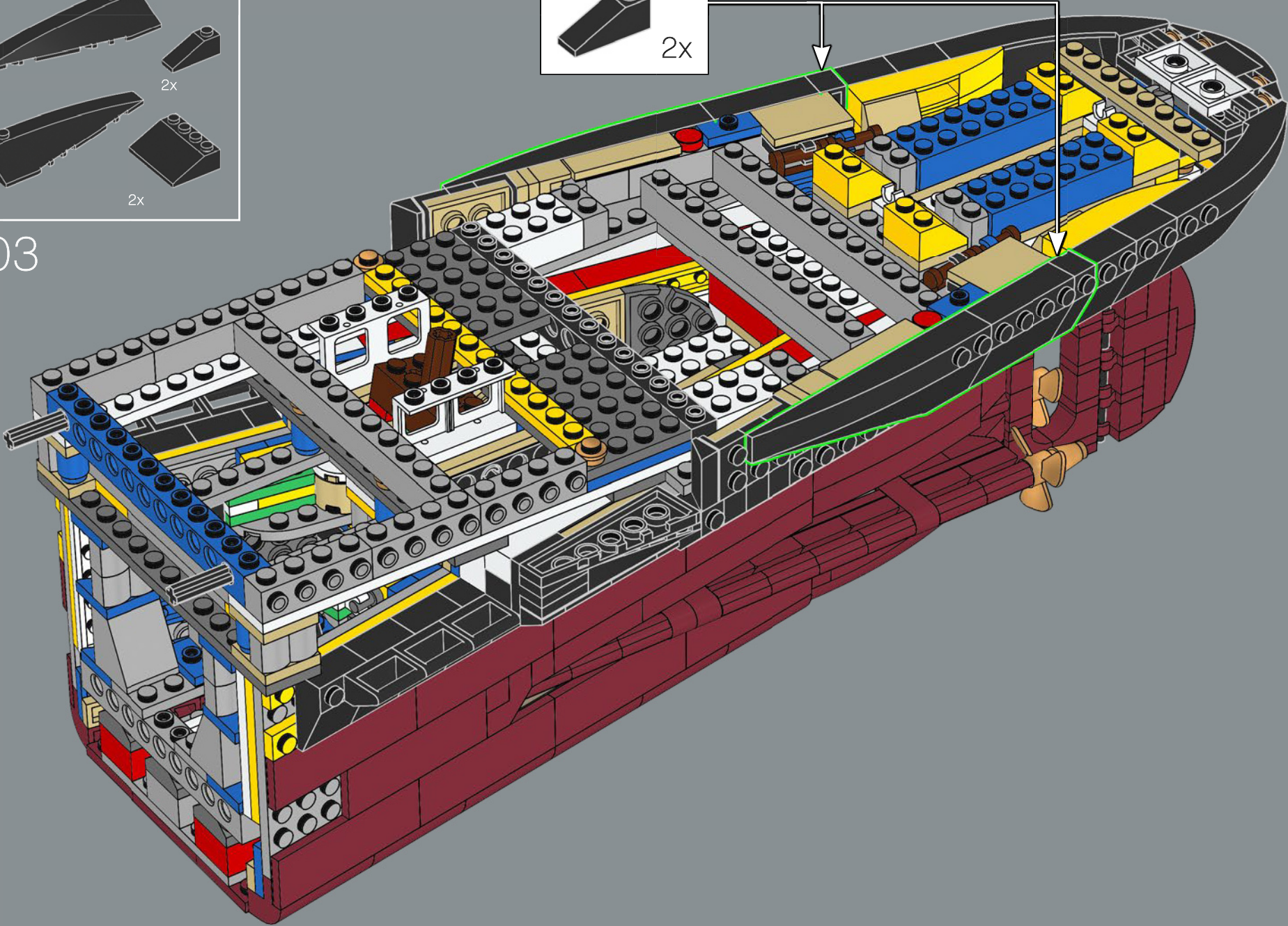

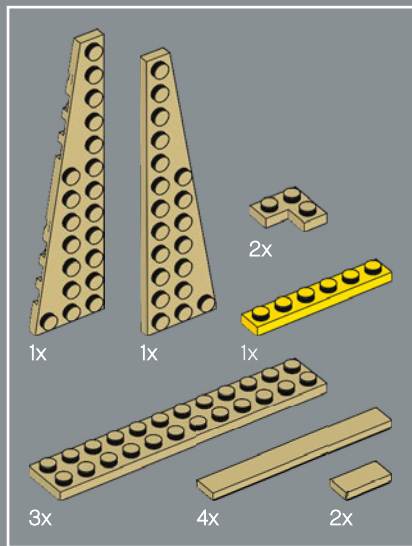

304

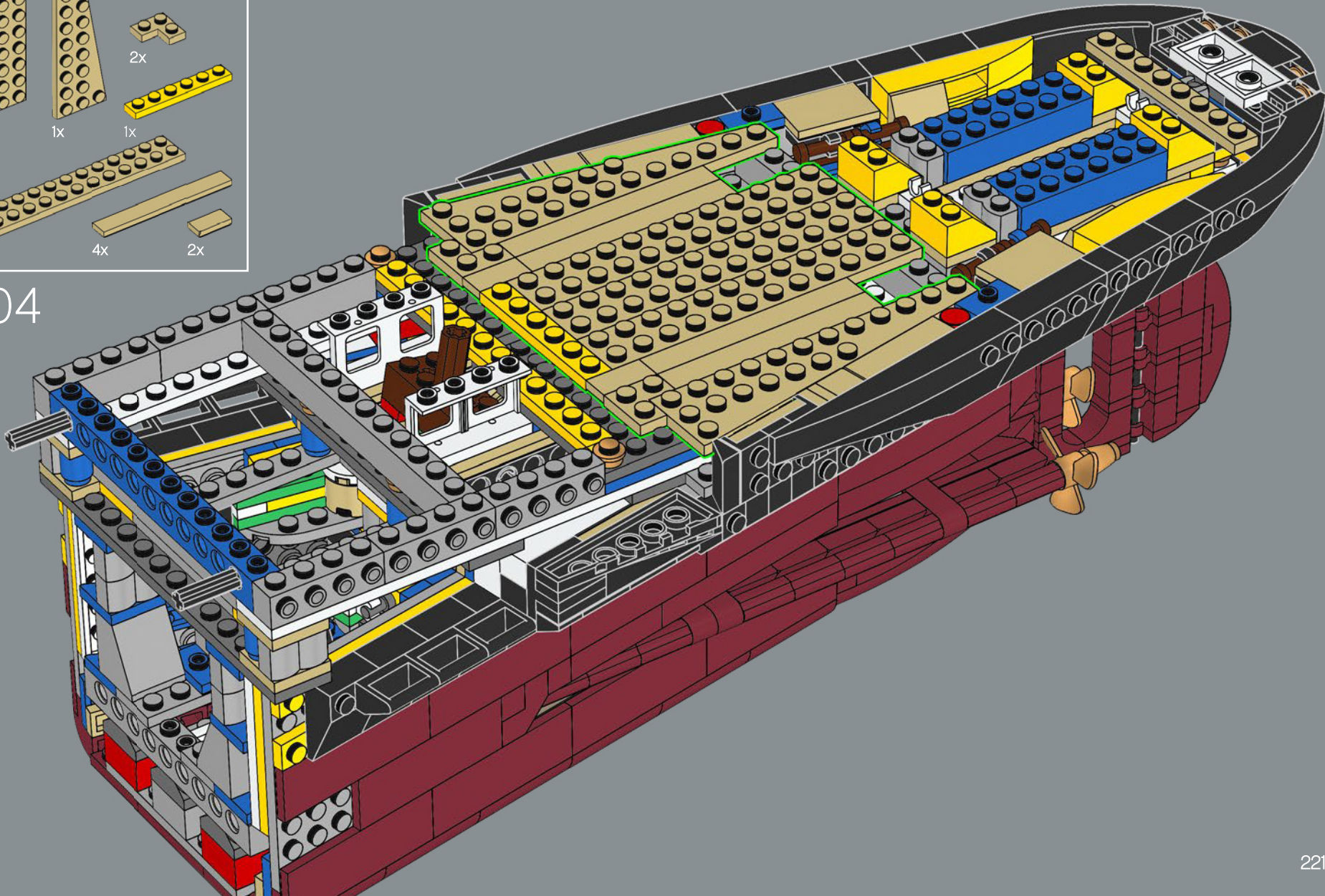

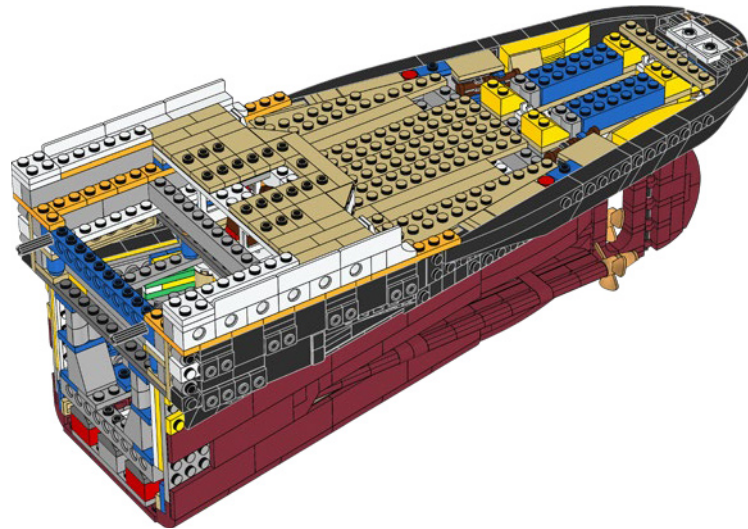
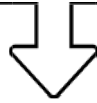

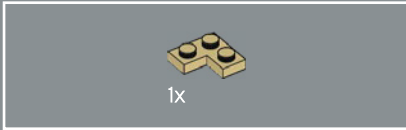
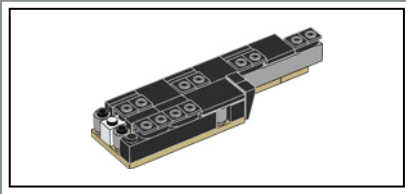

305

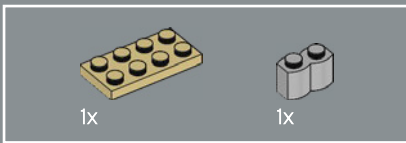
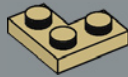

306

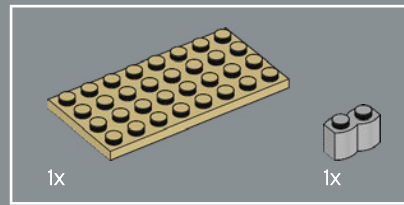
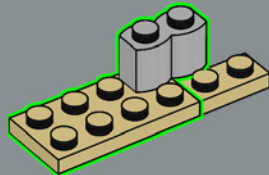

307

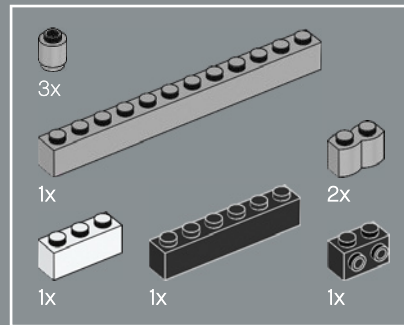
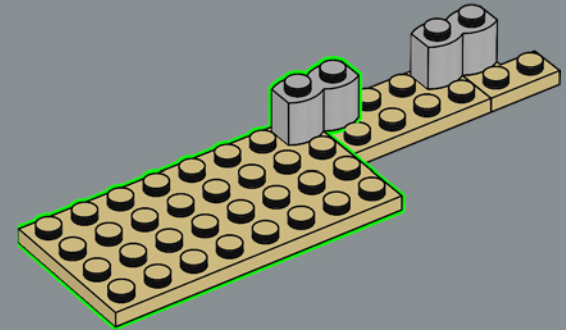

308

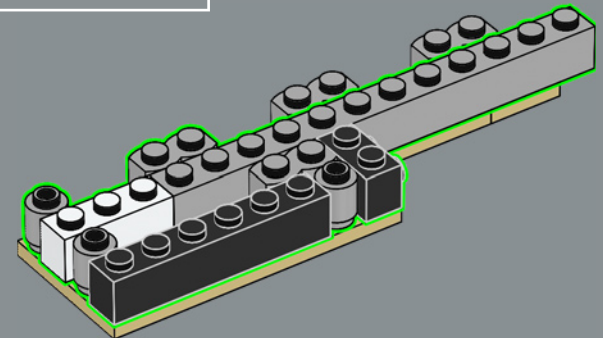

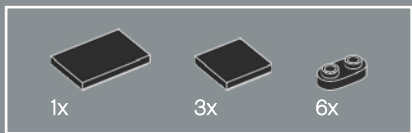

309

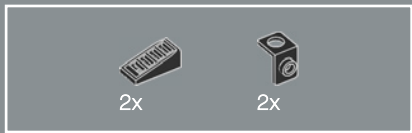
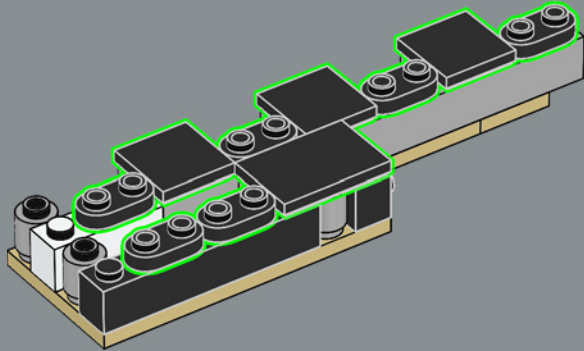

310

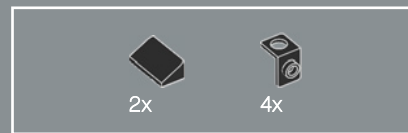
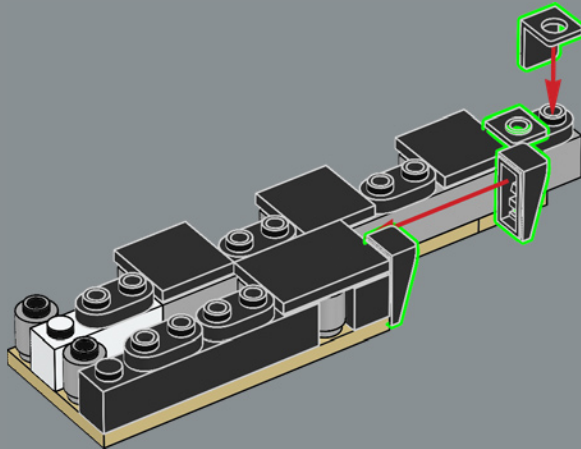

311

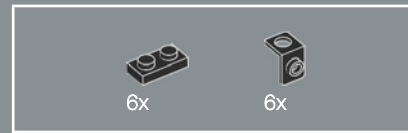
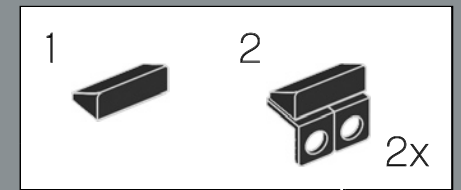
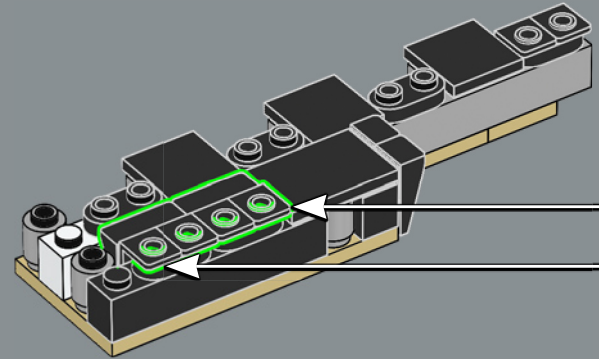

312

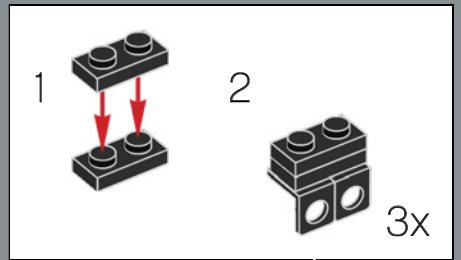
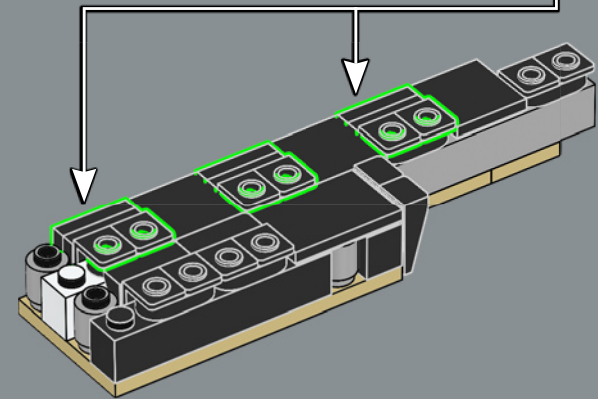



313

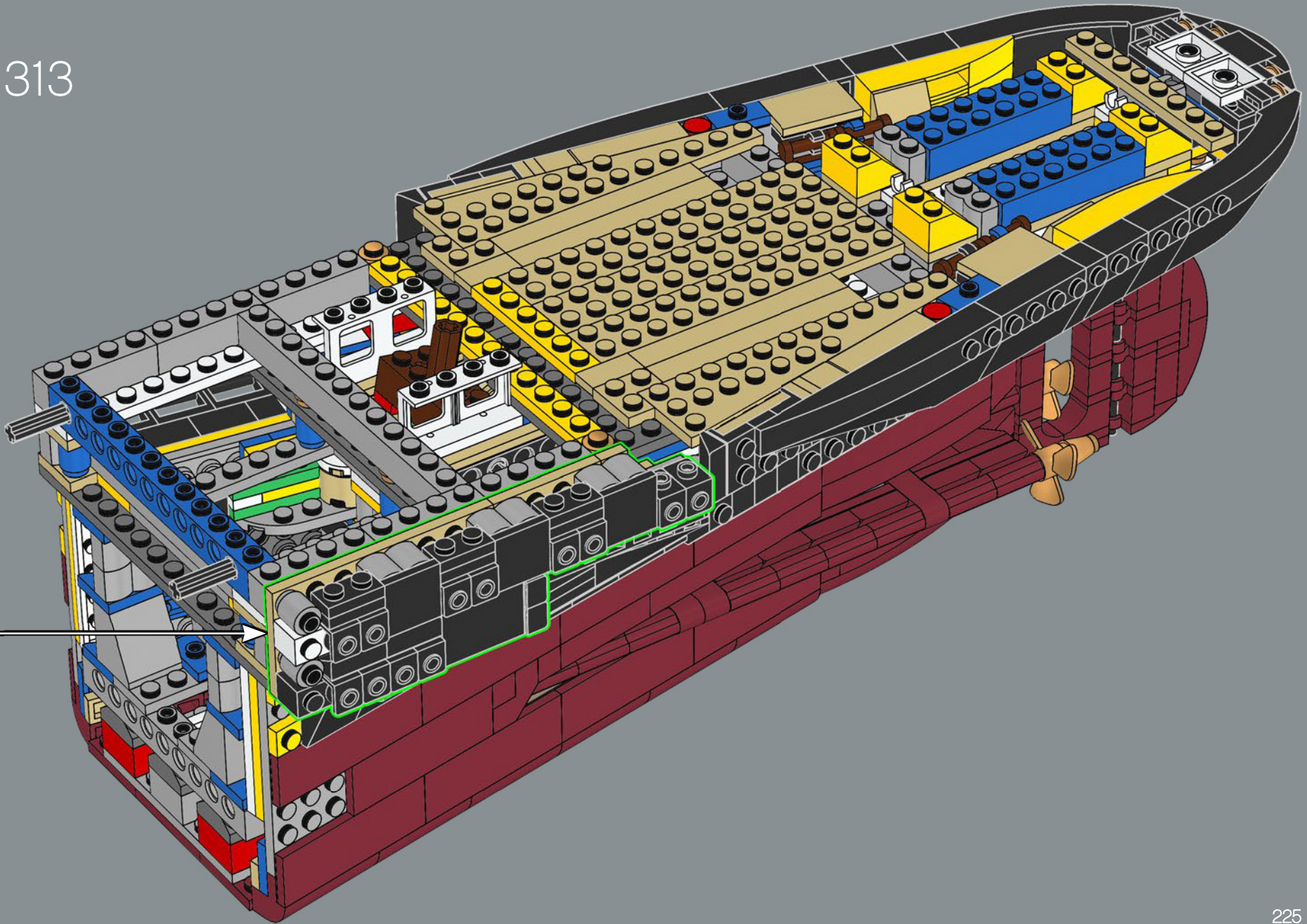

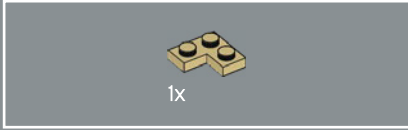
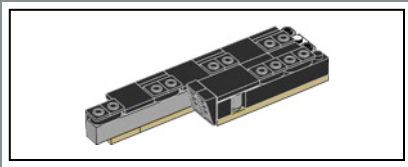

314

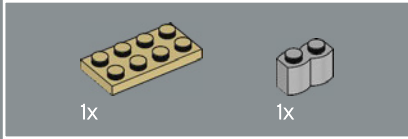

315

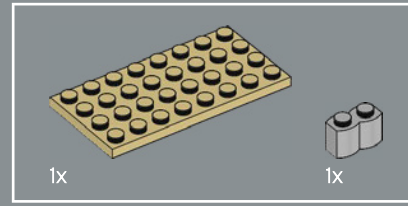
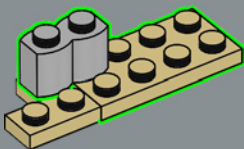

316

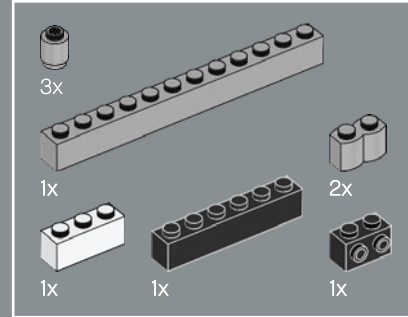
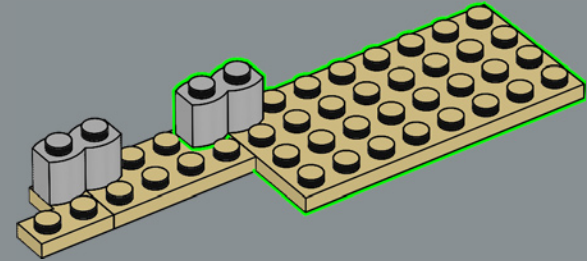

317

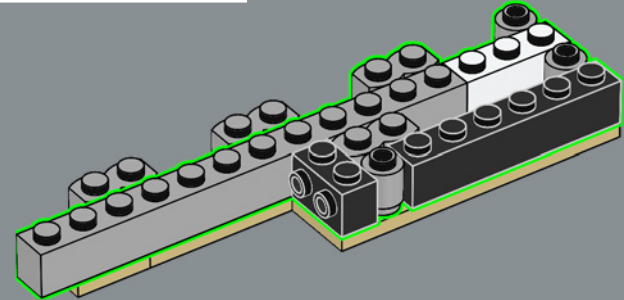

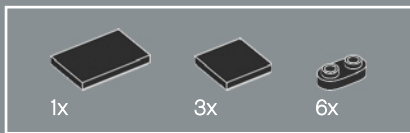

318

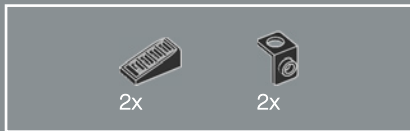
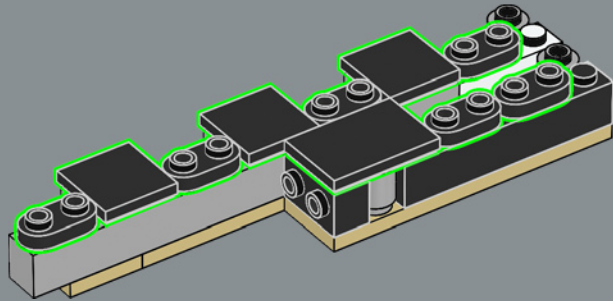

319

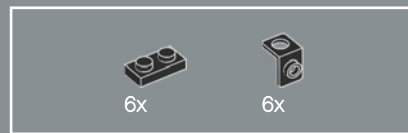
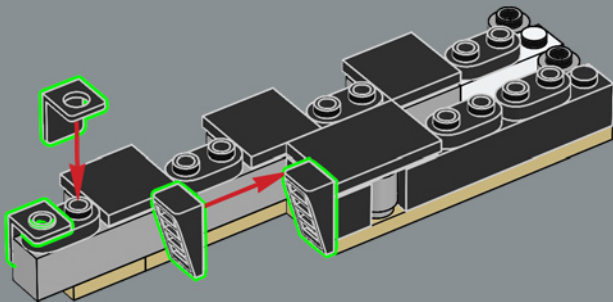

320

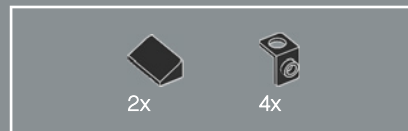
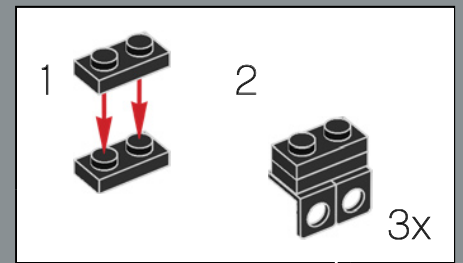
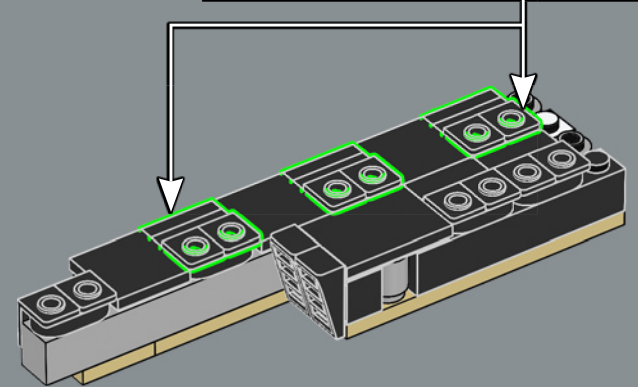

321

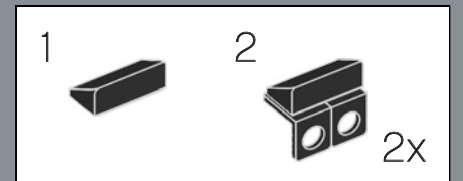
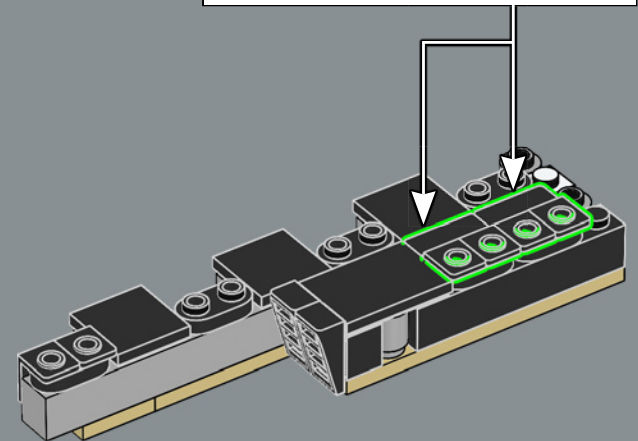

322

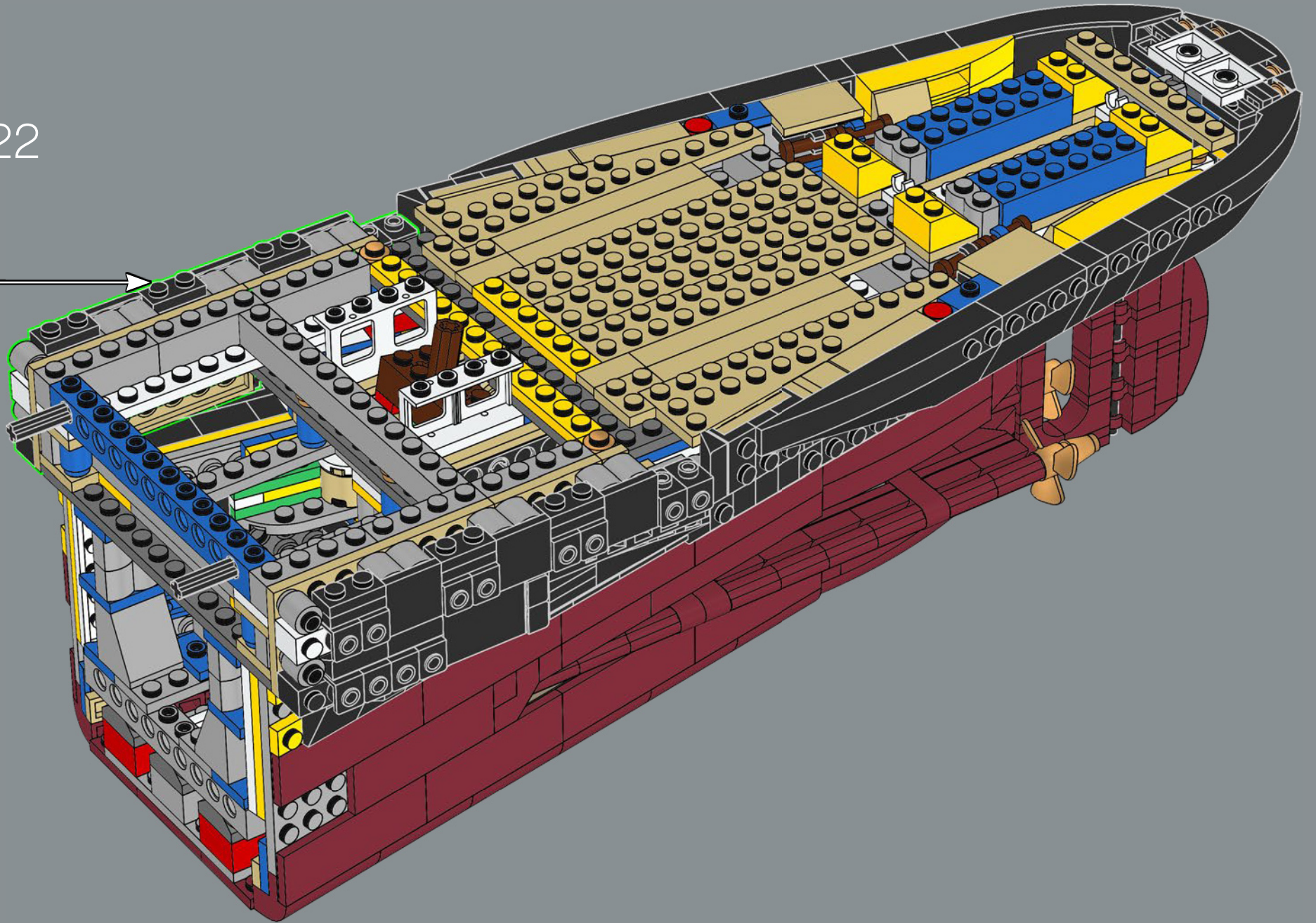

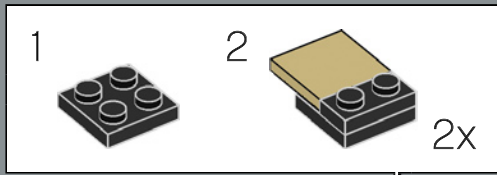
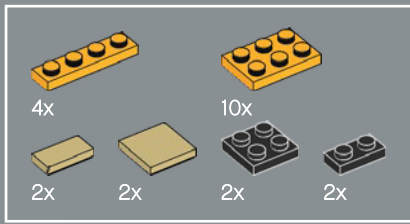

323

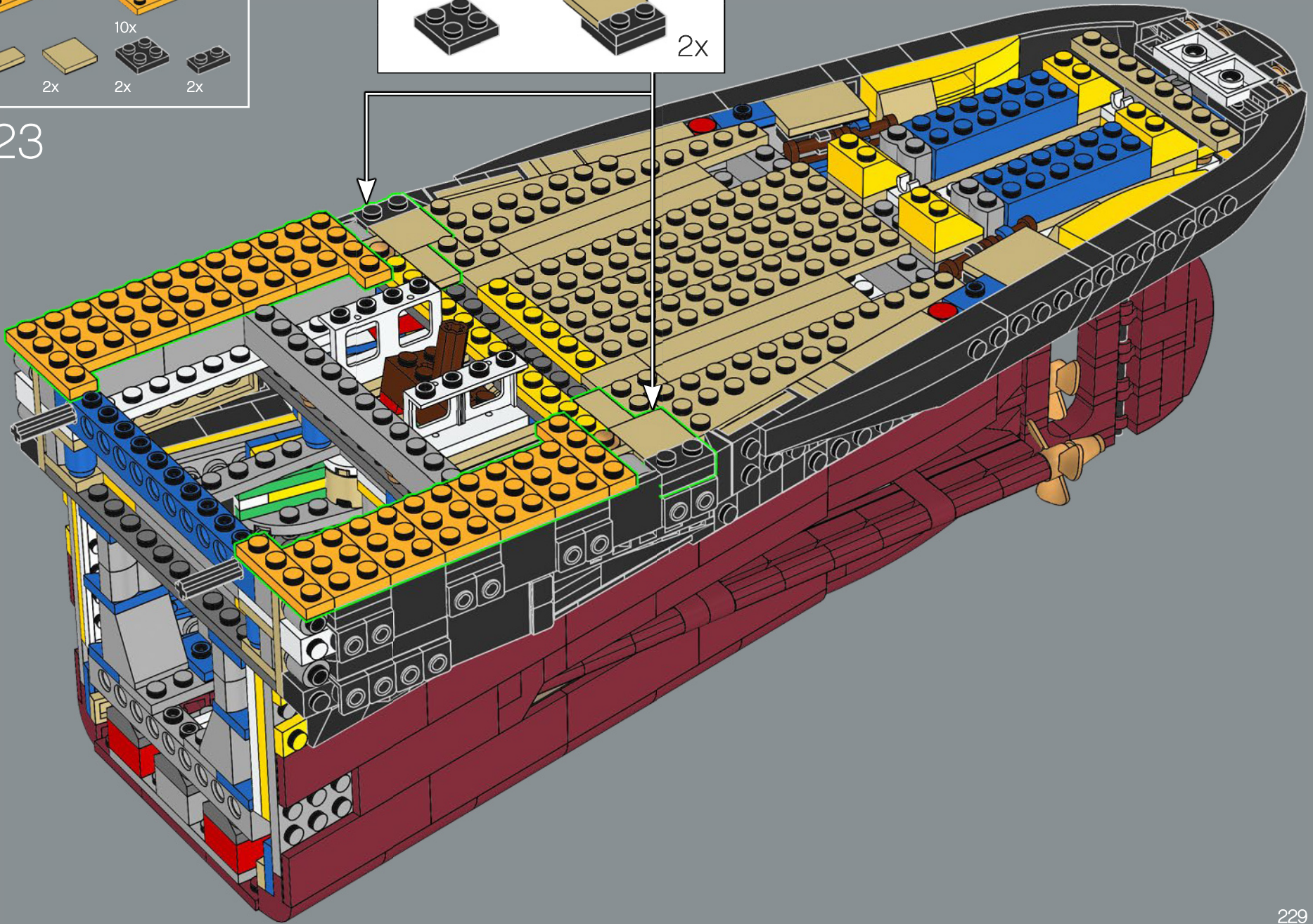

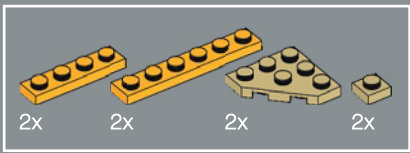

324

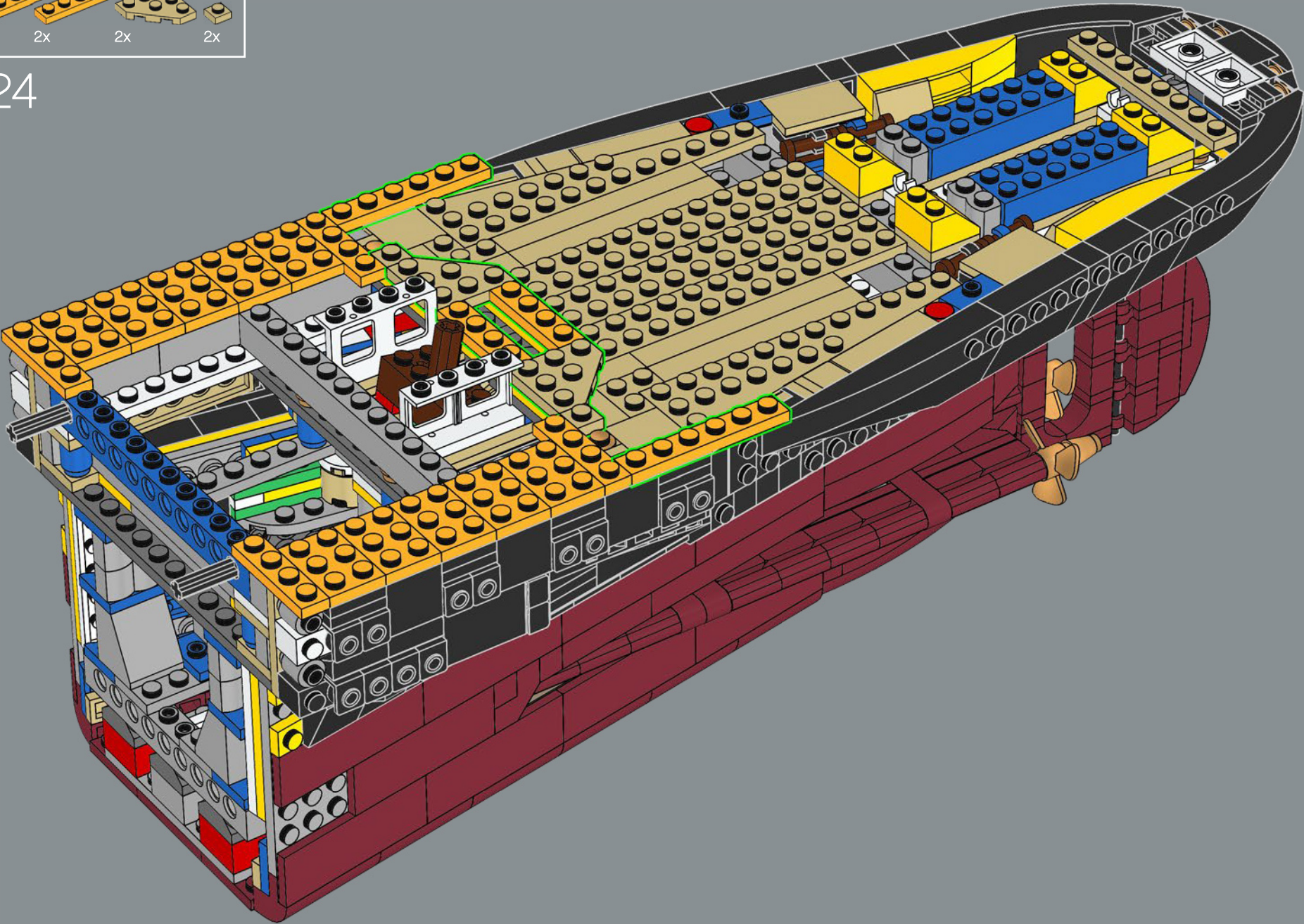

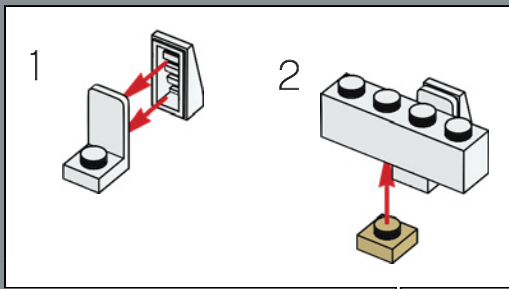
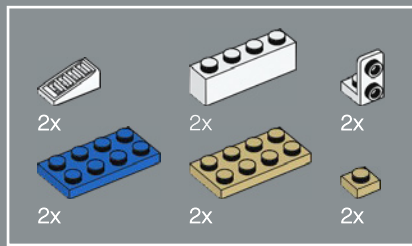

325

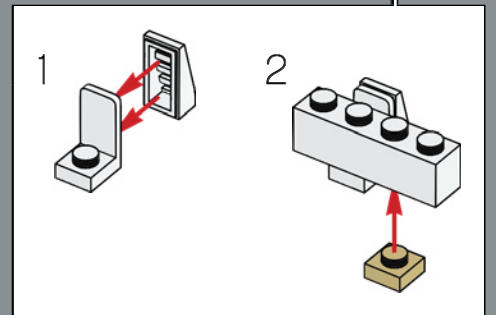
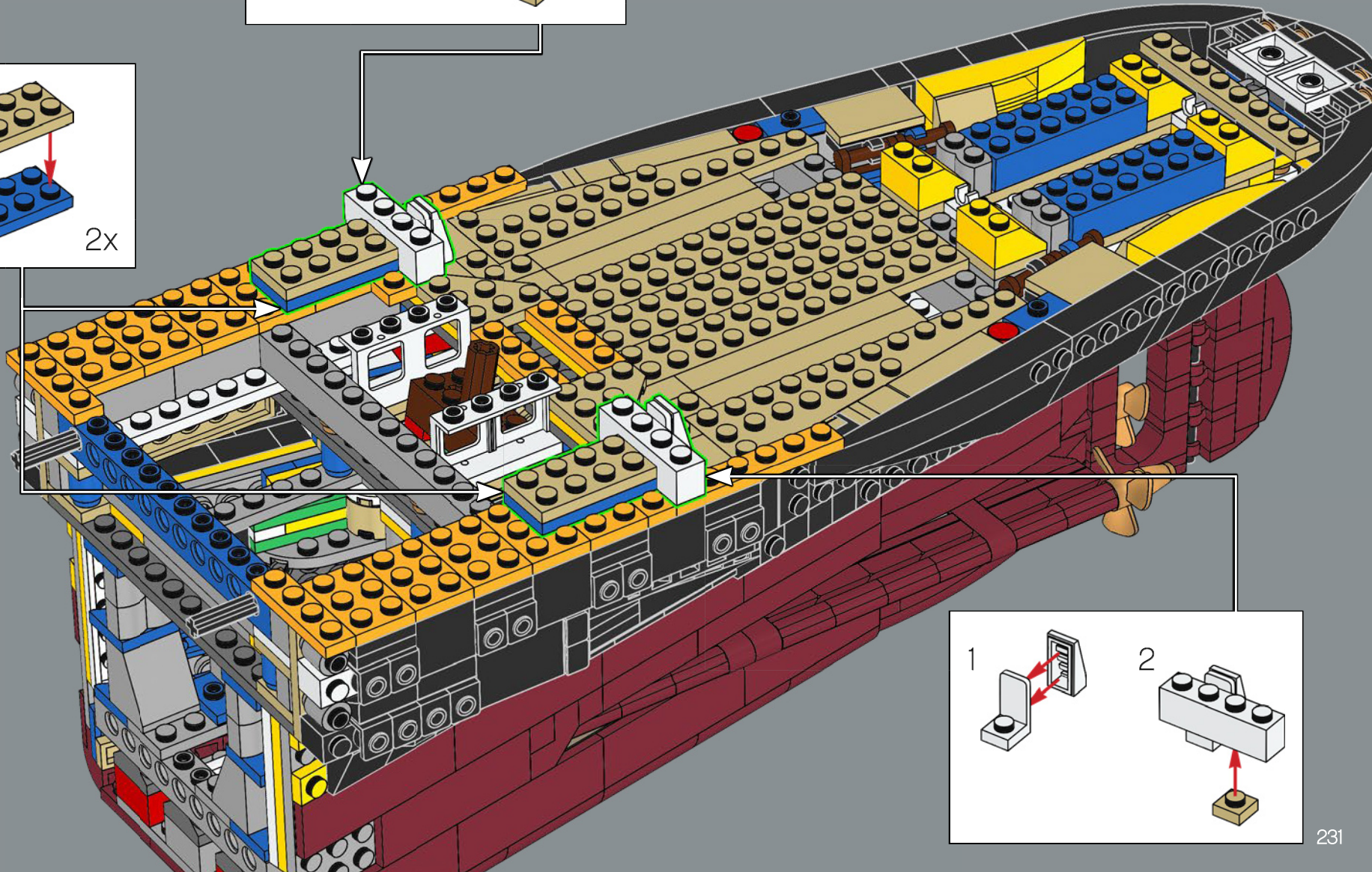
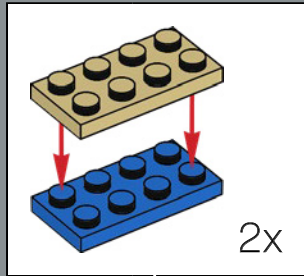

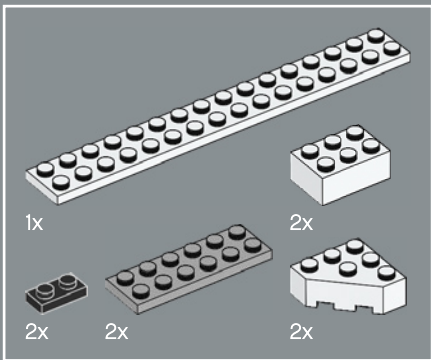

326

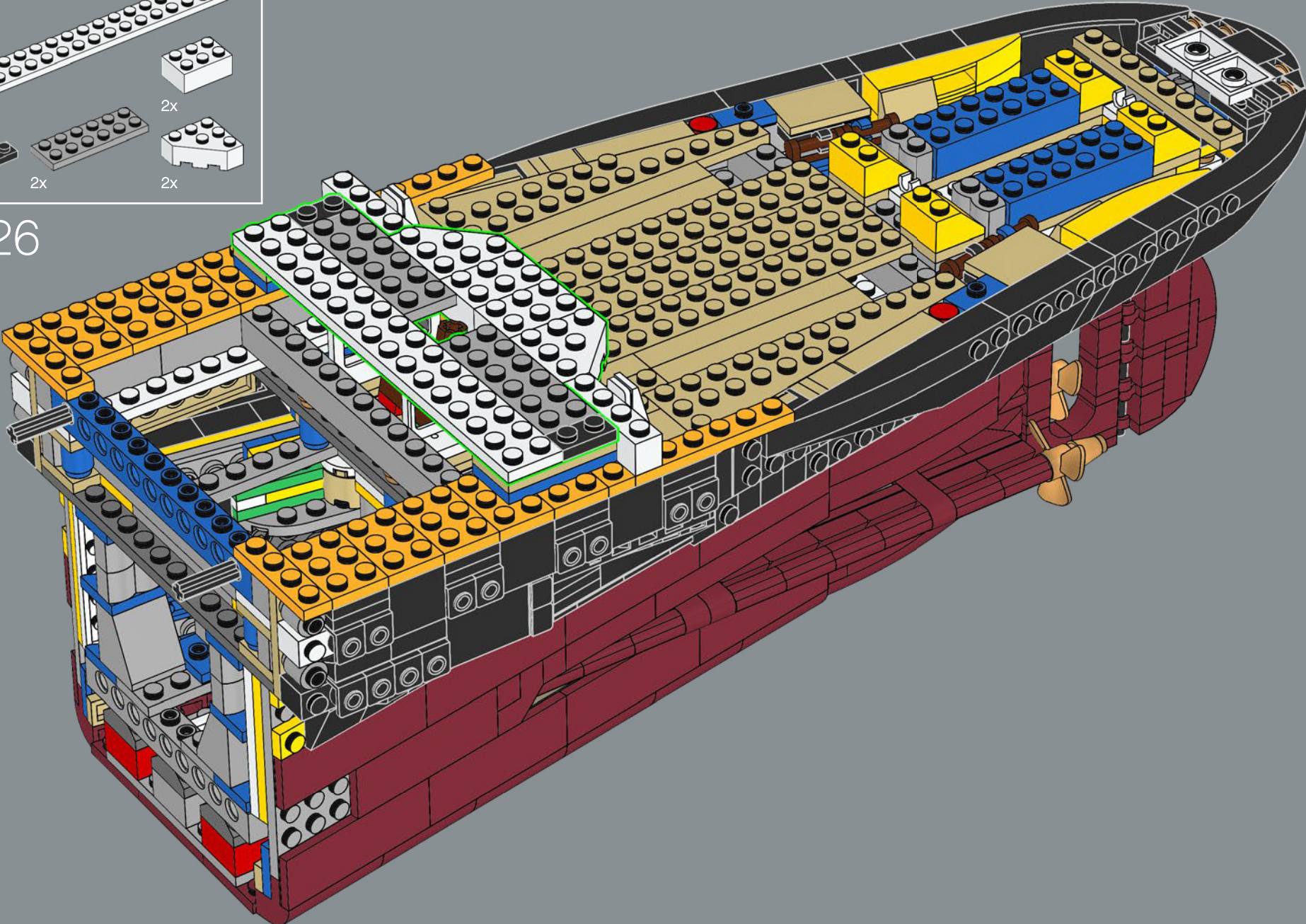



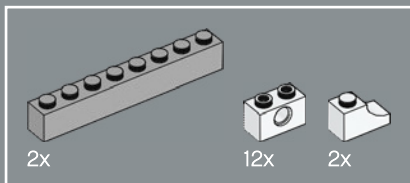

327

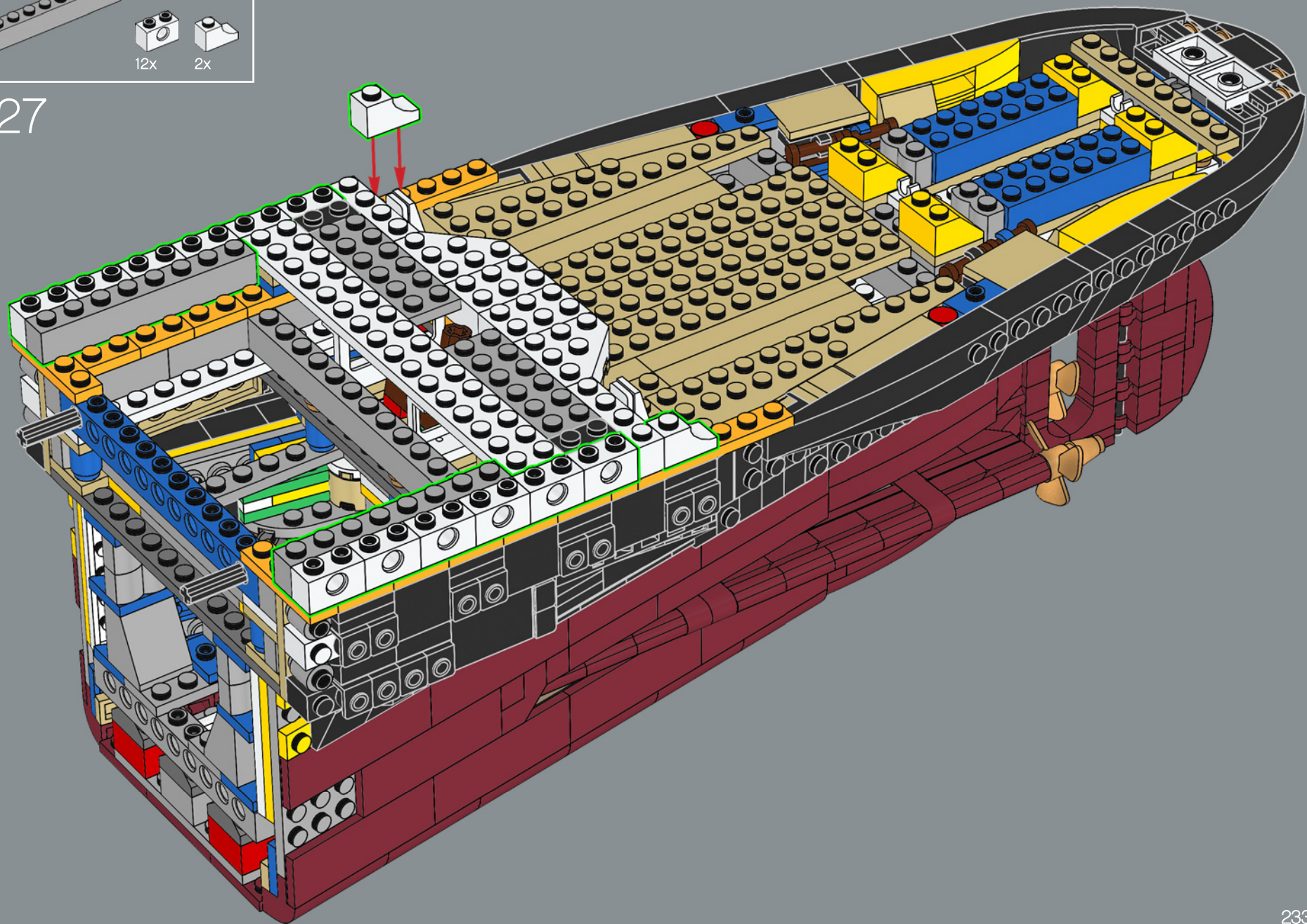

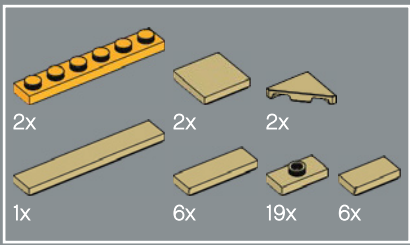

328

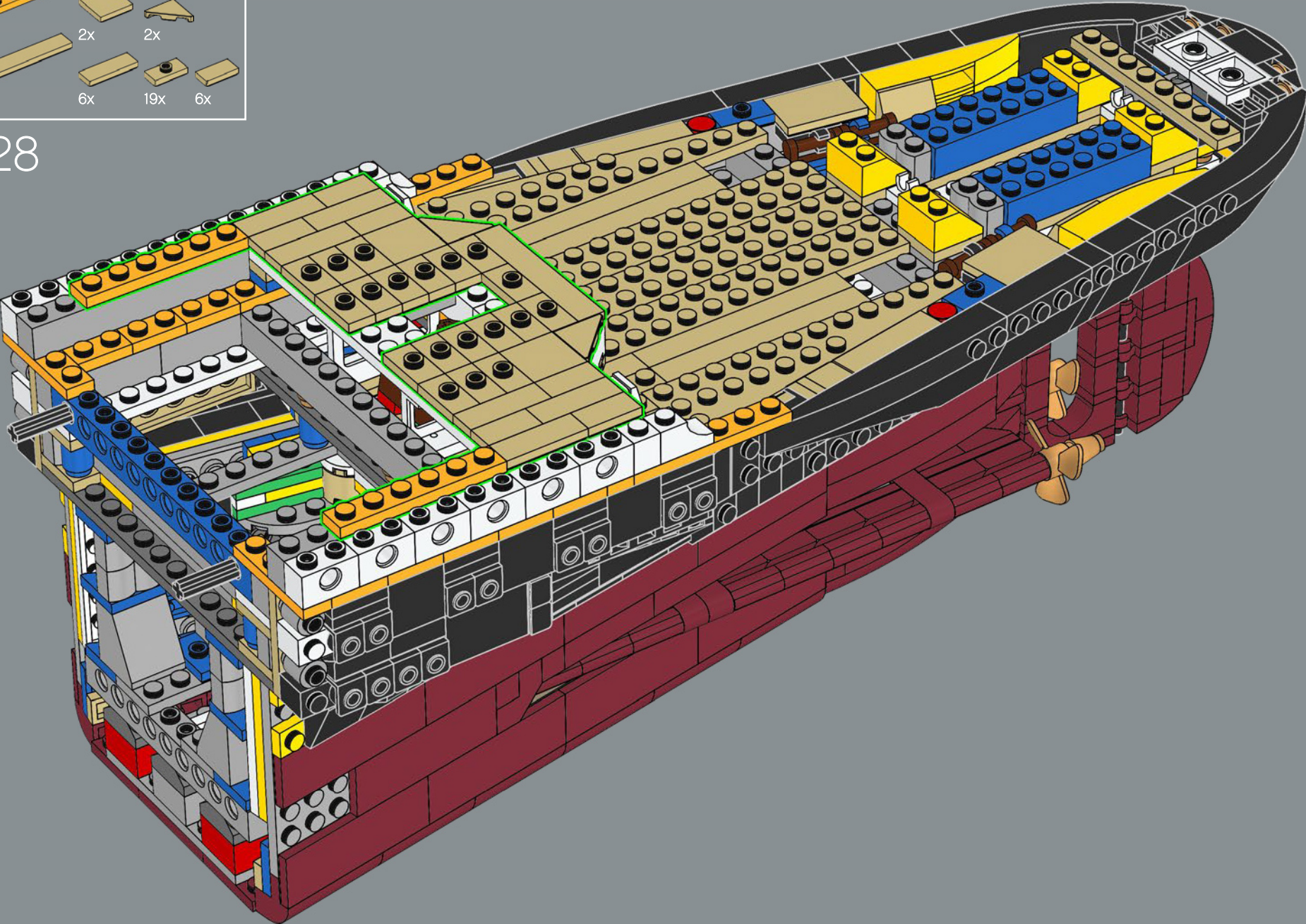

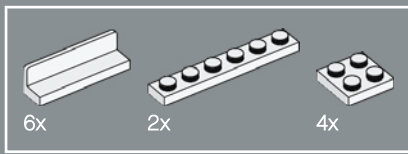

329

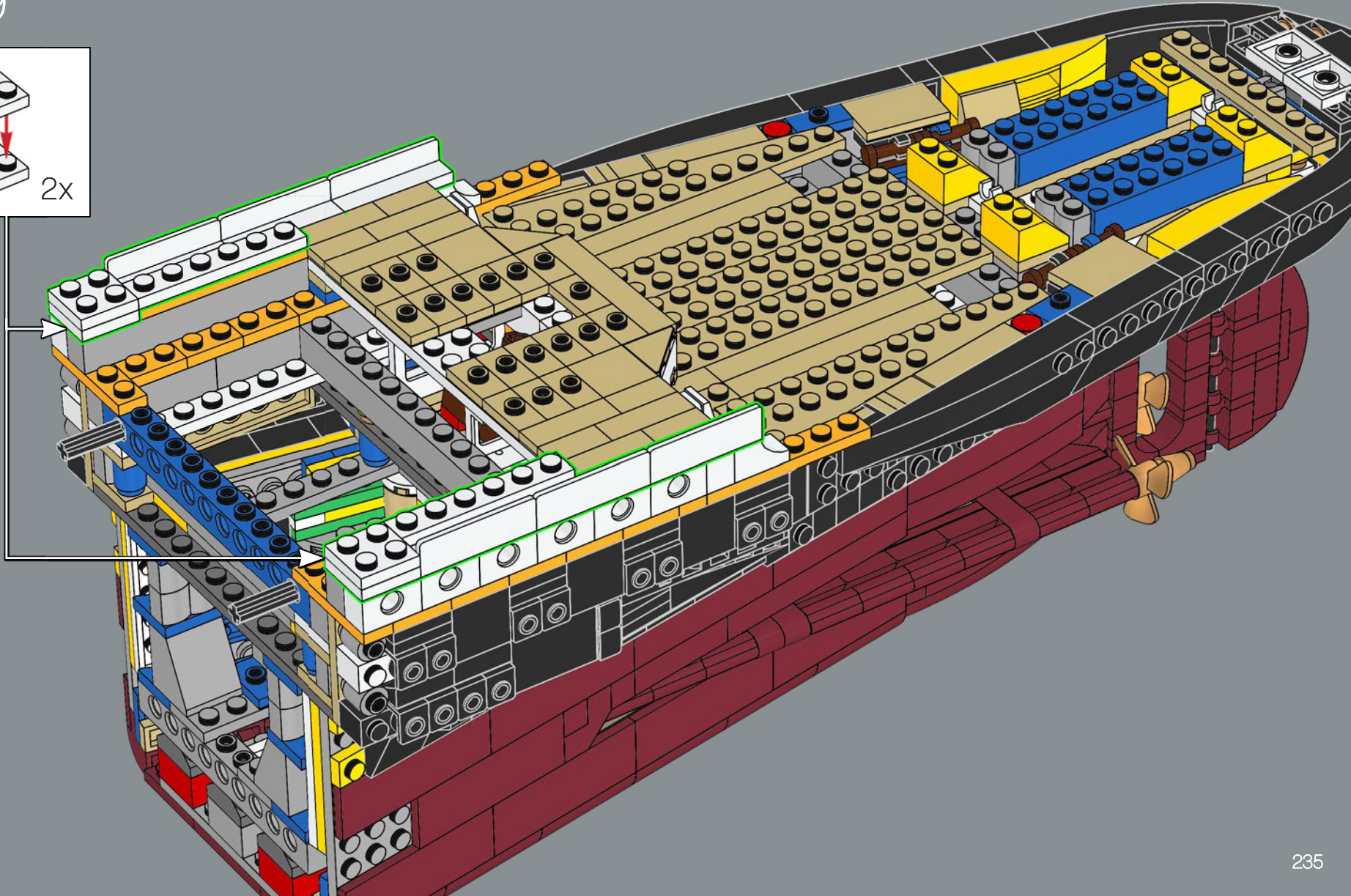
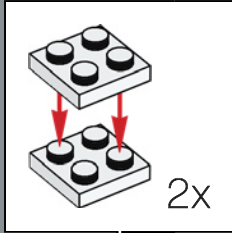

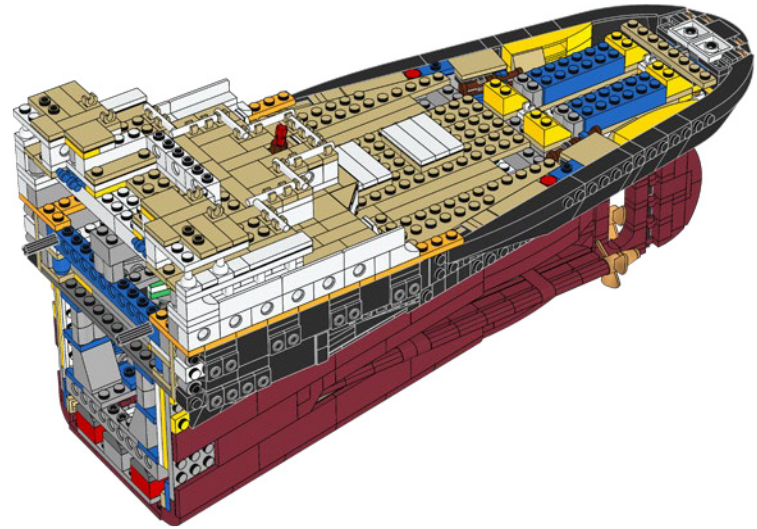
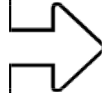

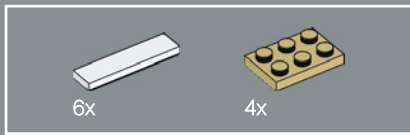

330

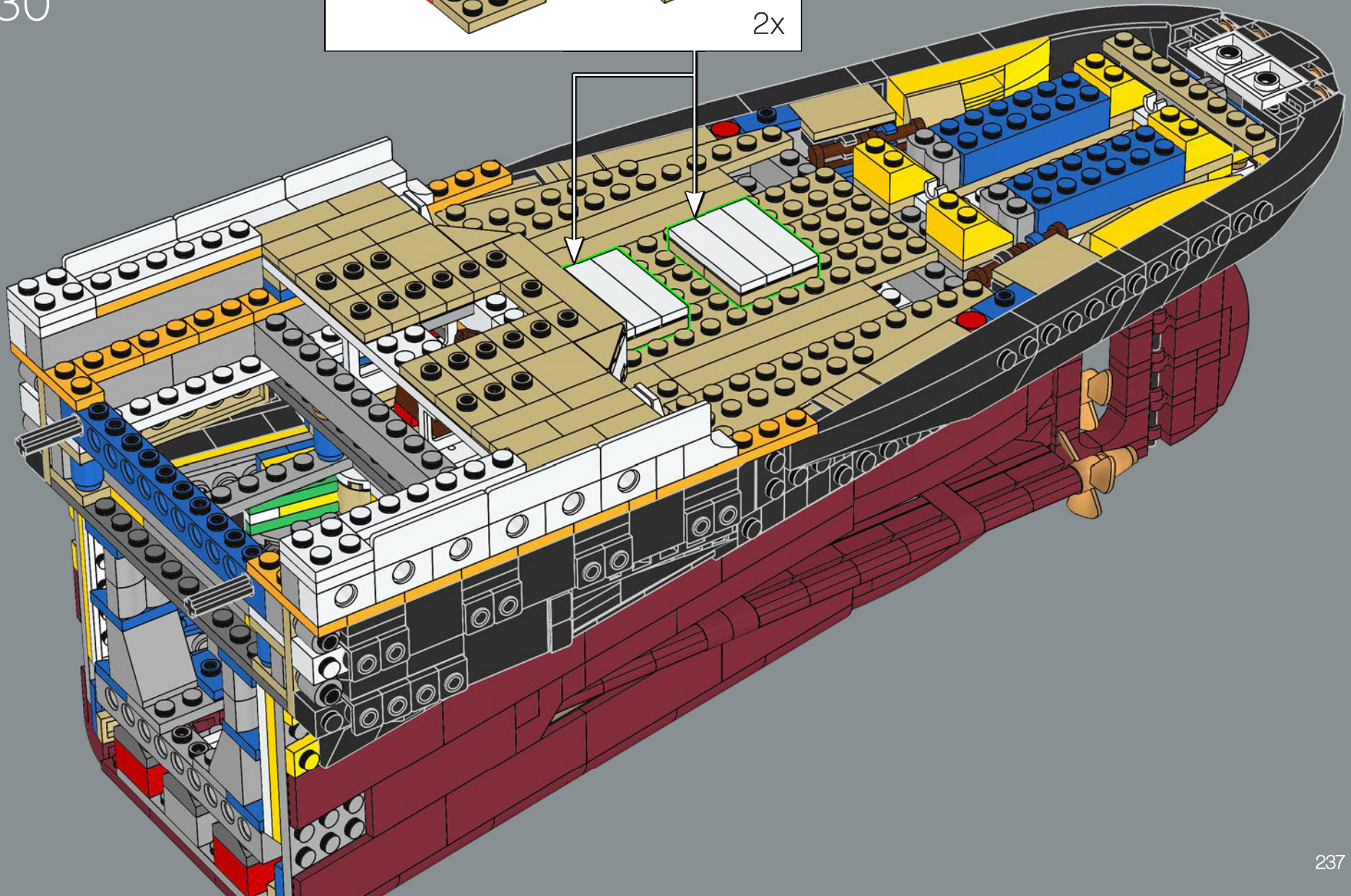
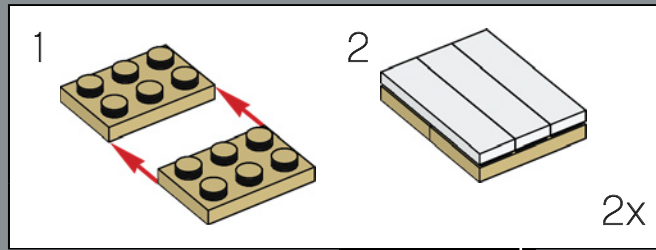

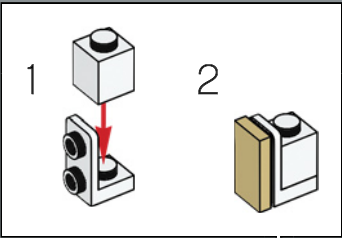
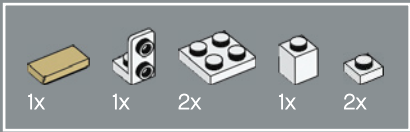

331

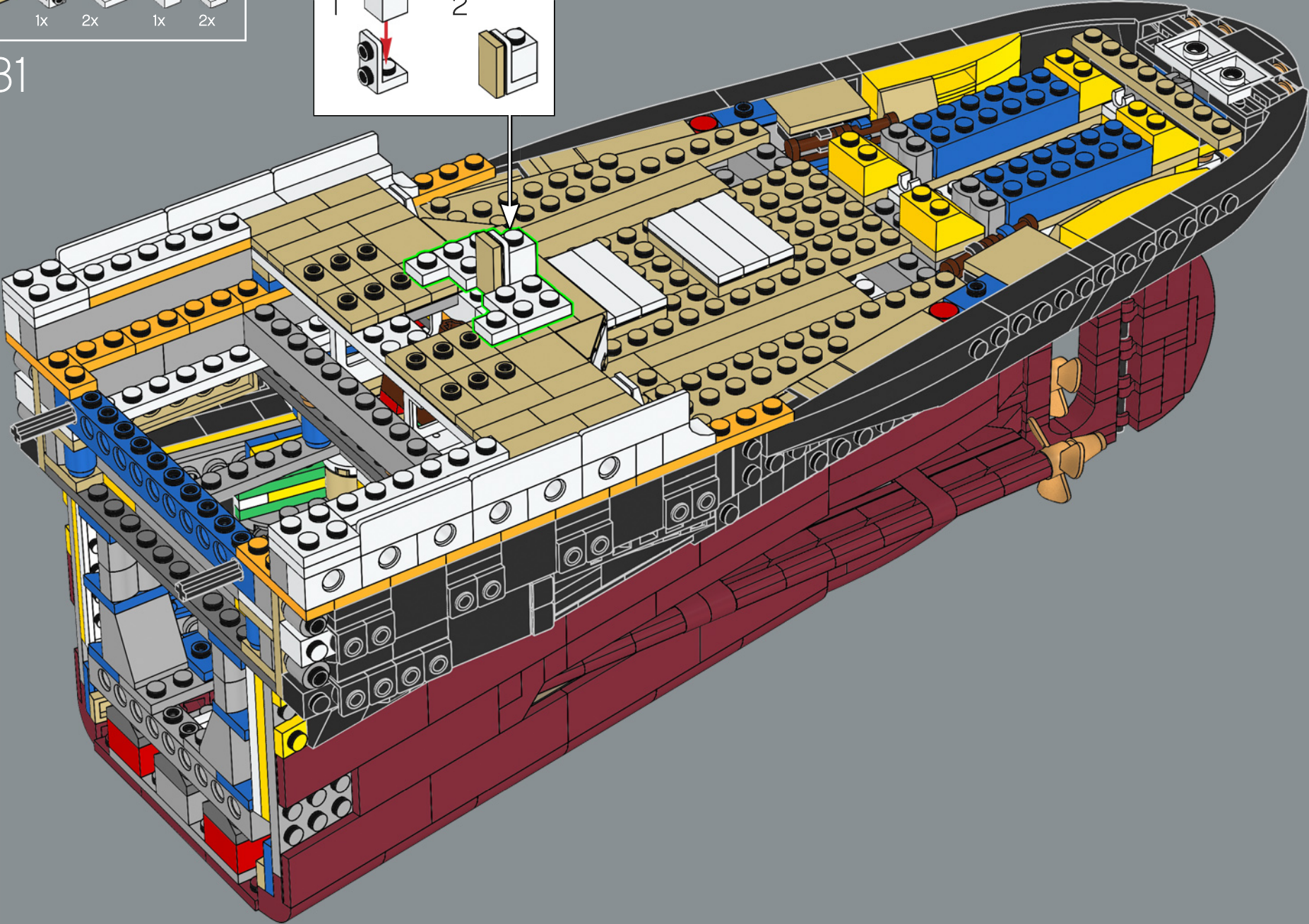

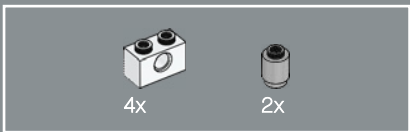

332

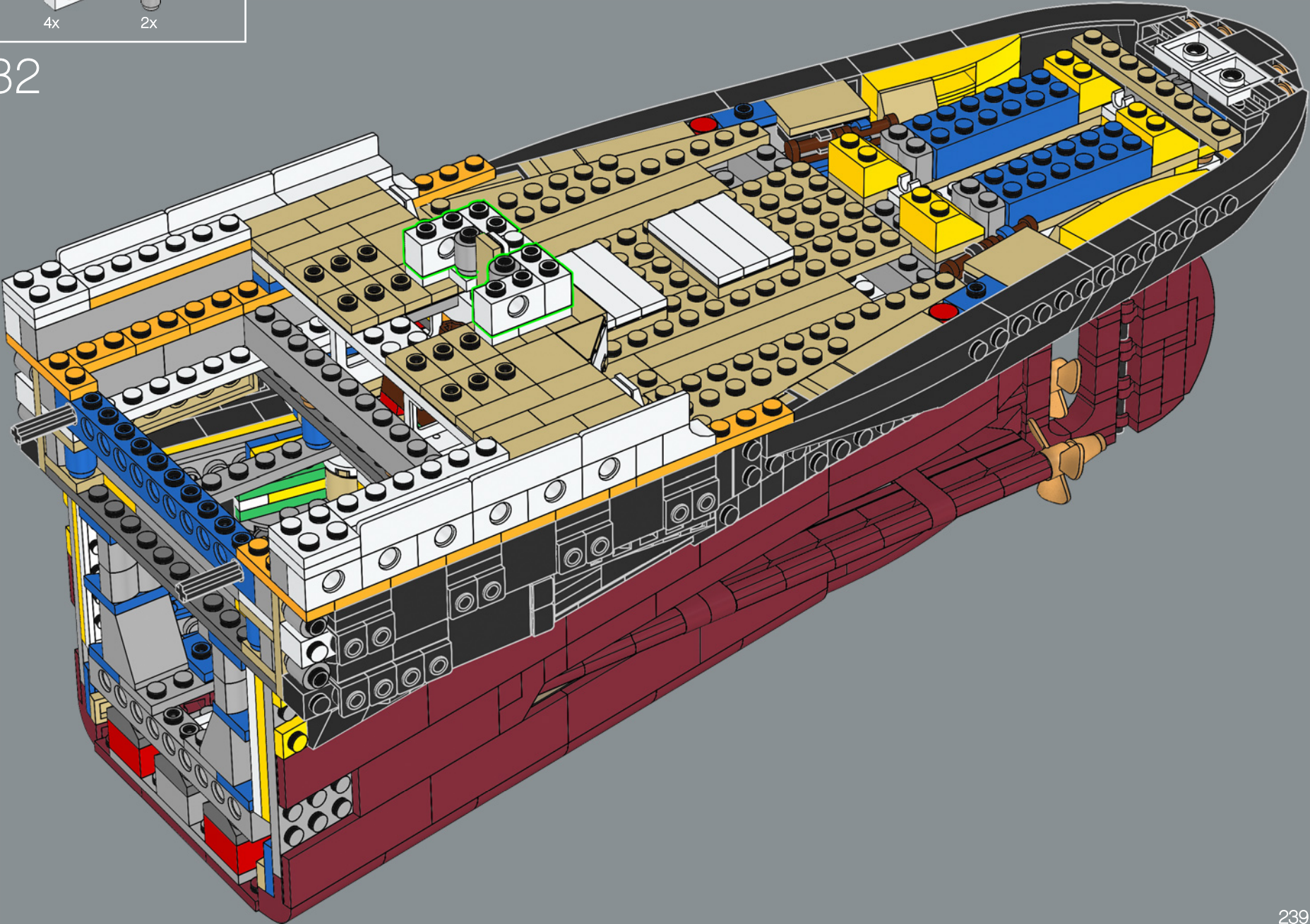

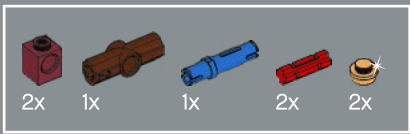

333

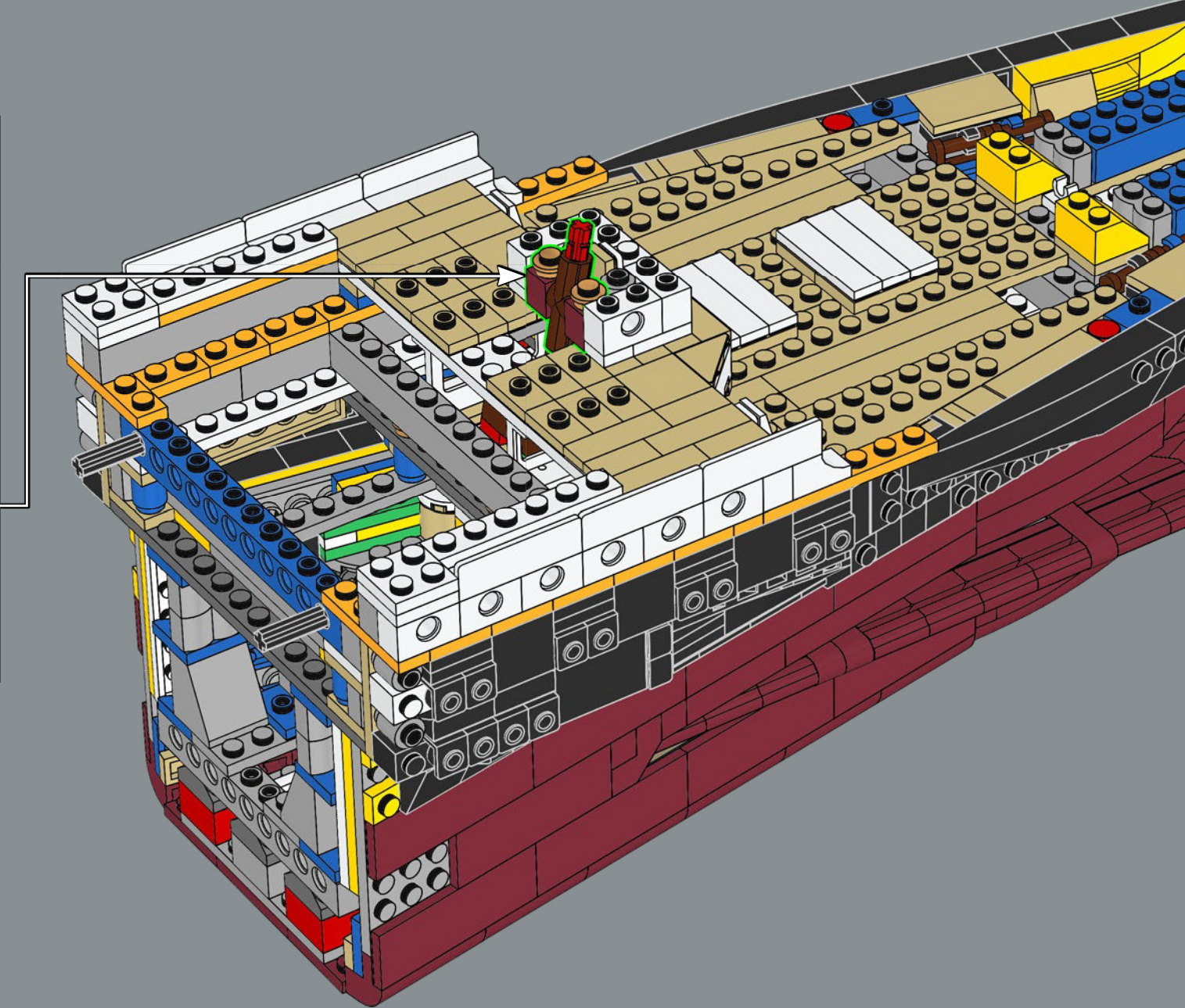
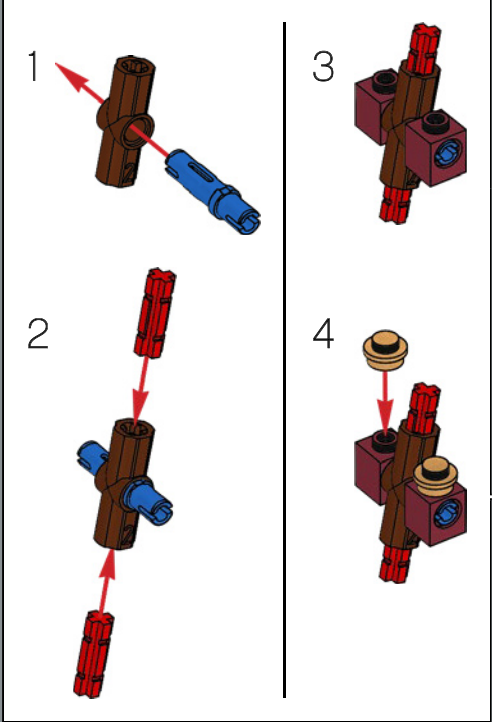



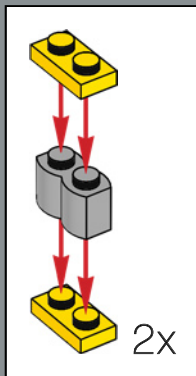
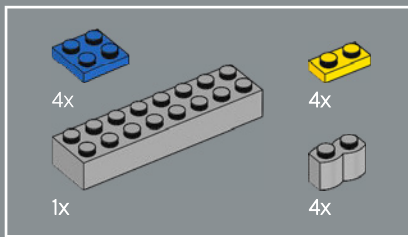

334

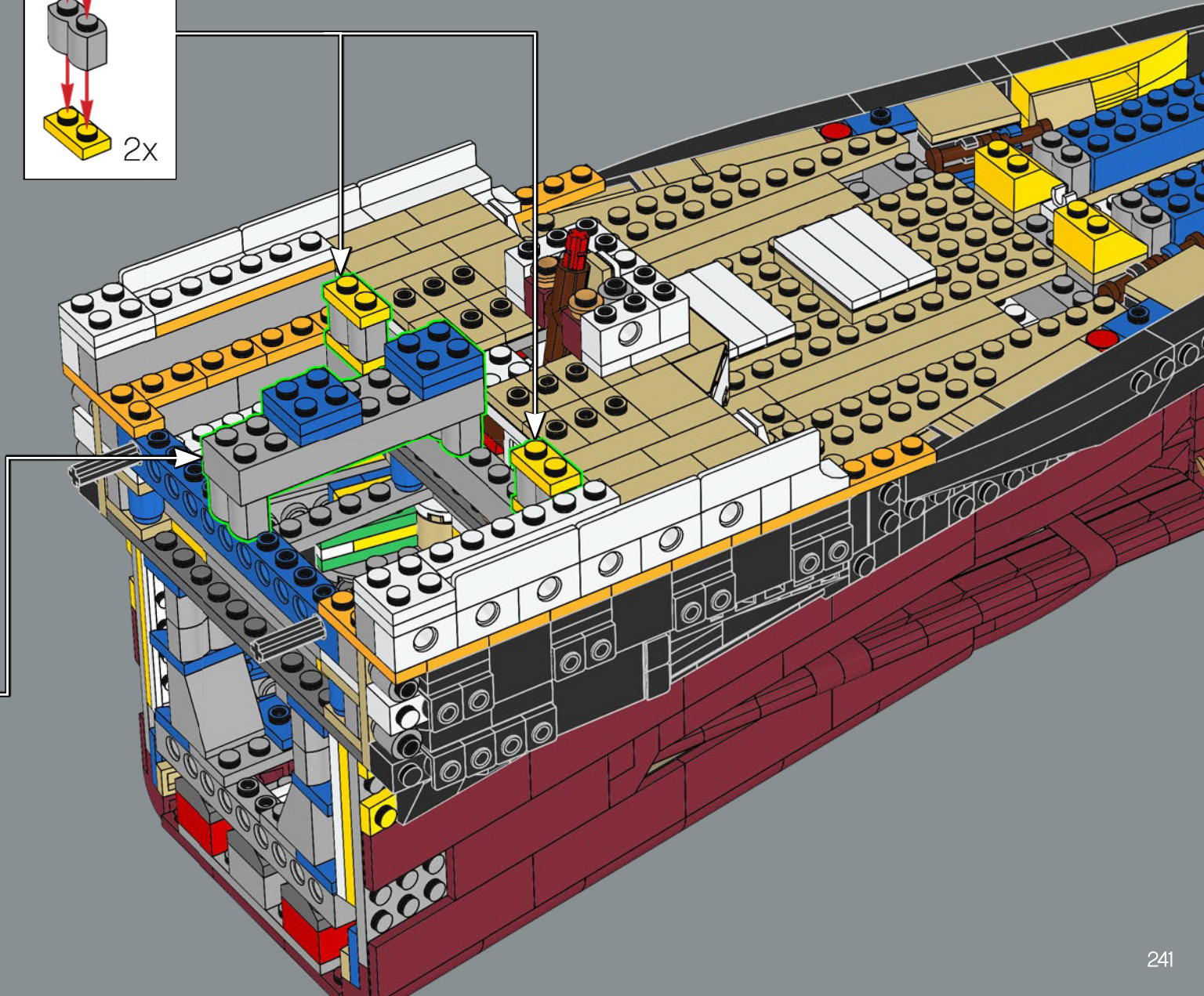
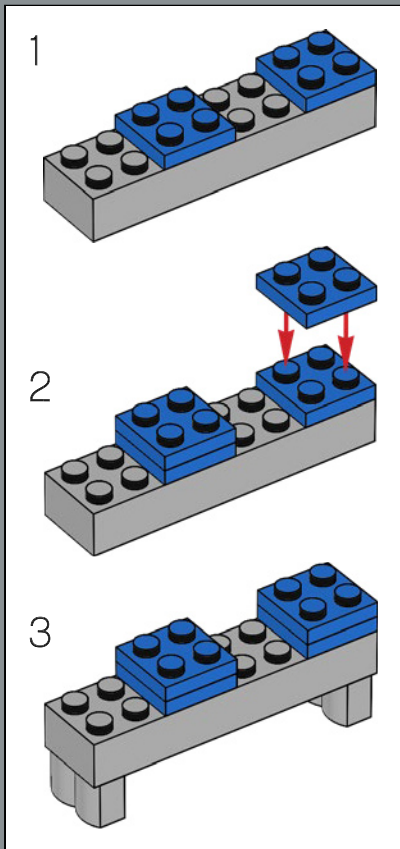

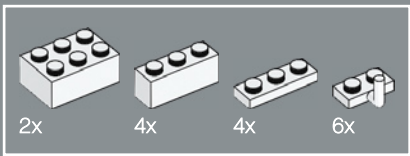

335

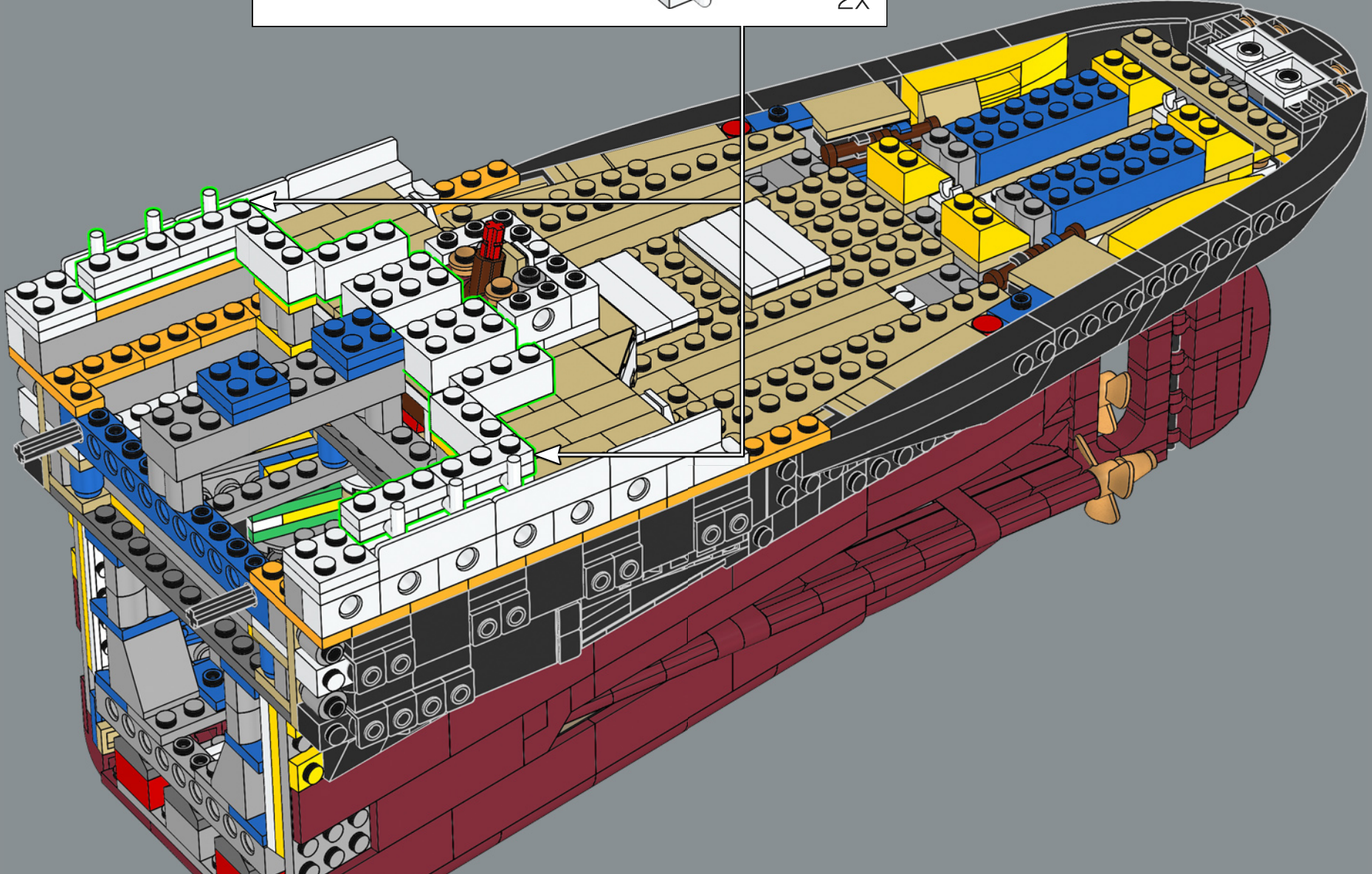
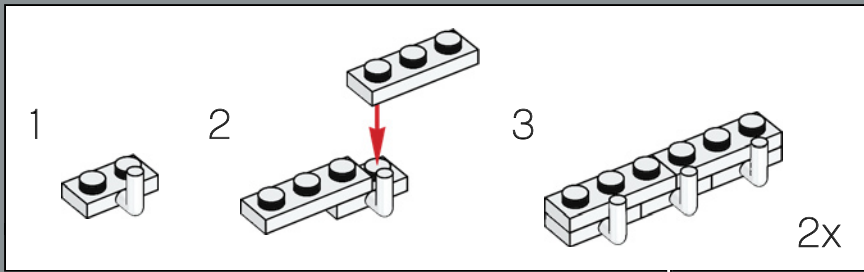

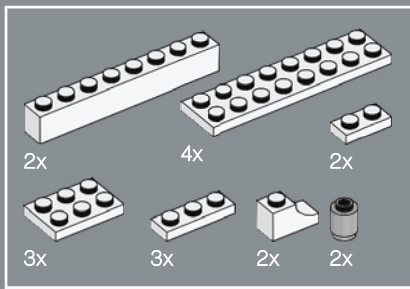

336

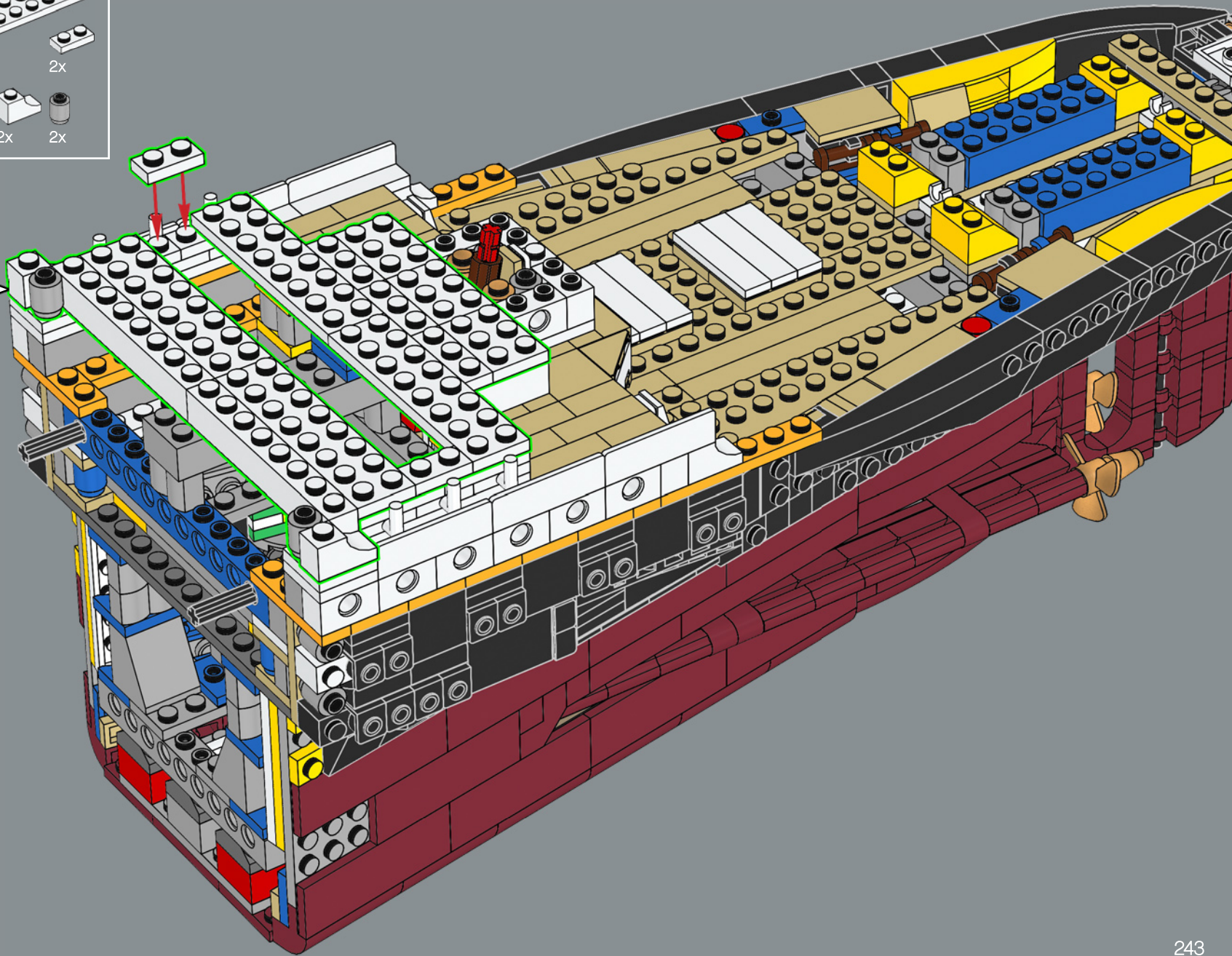
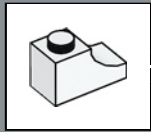

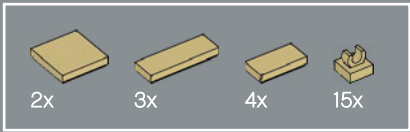

337

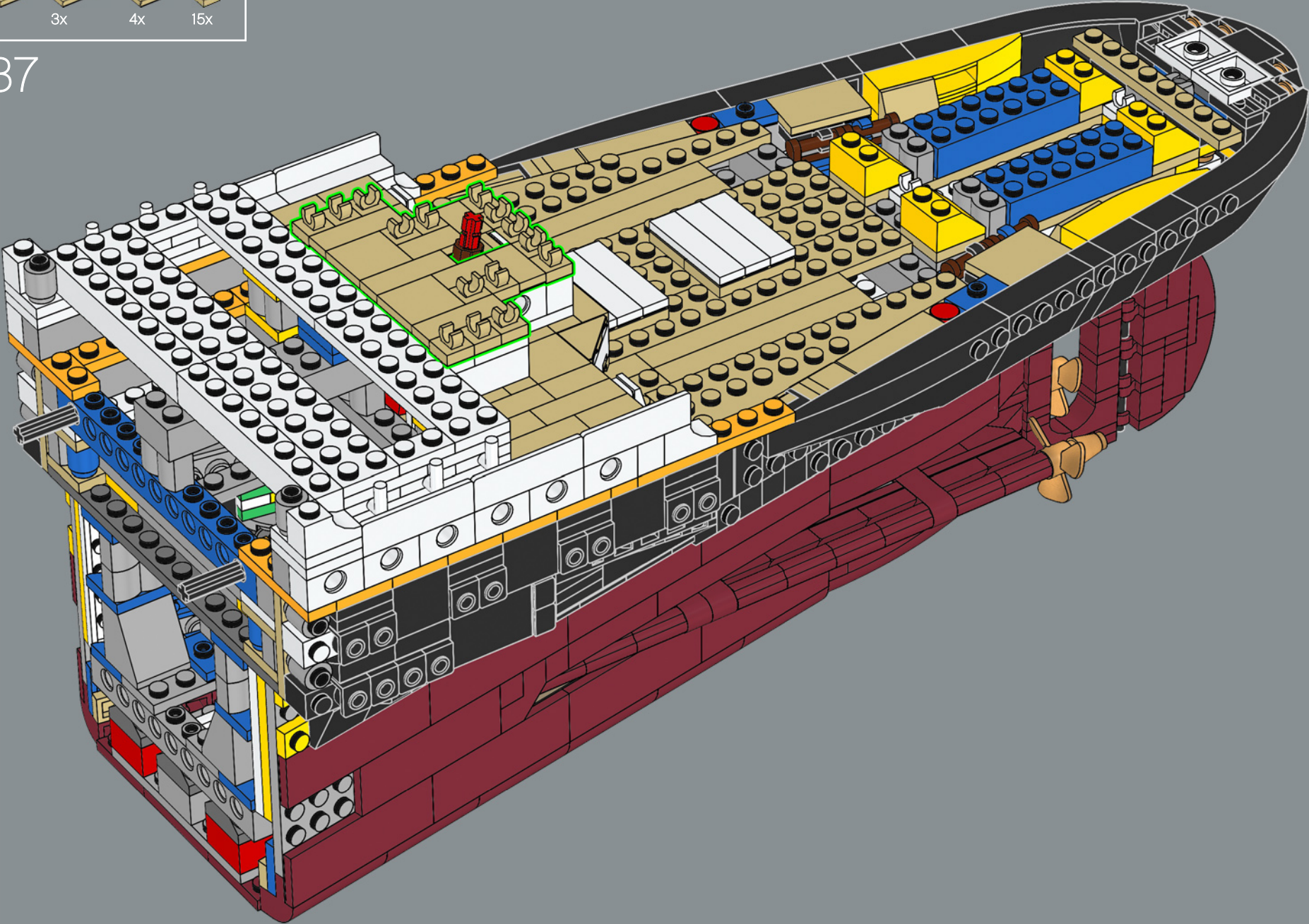

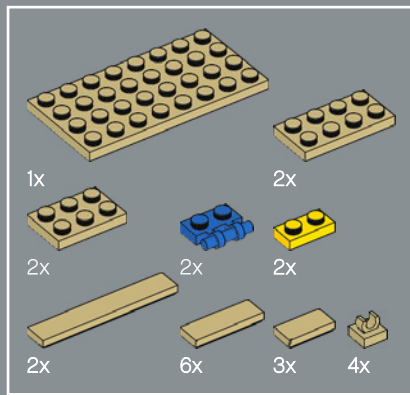

338

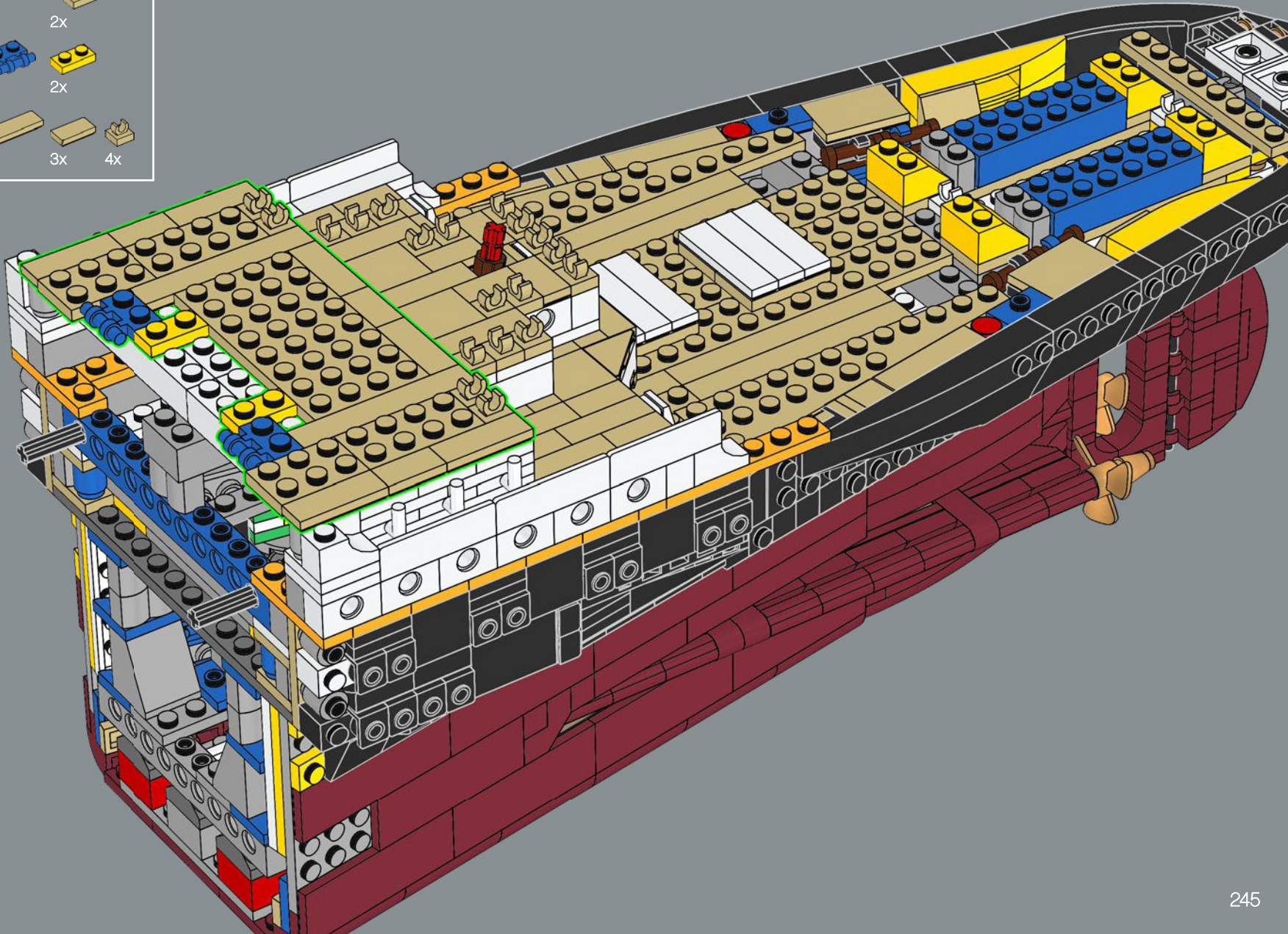

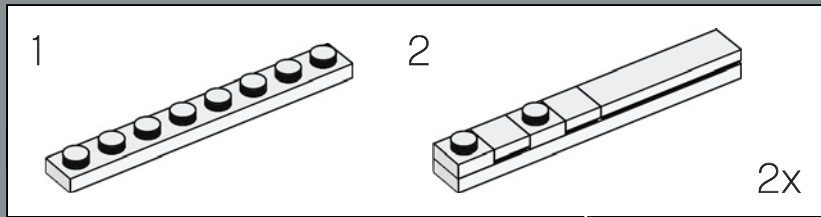
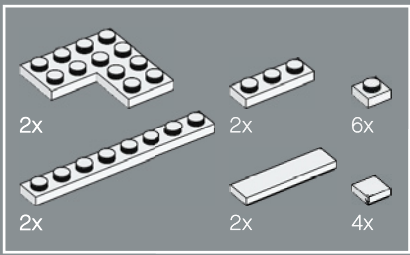

339

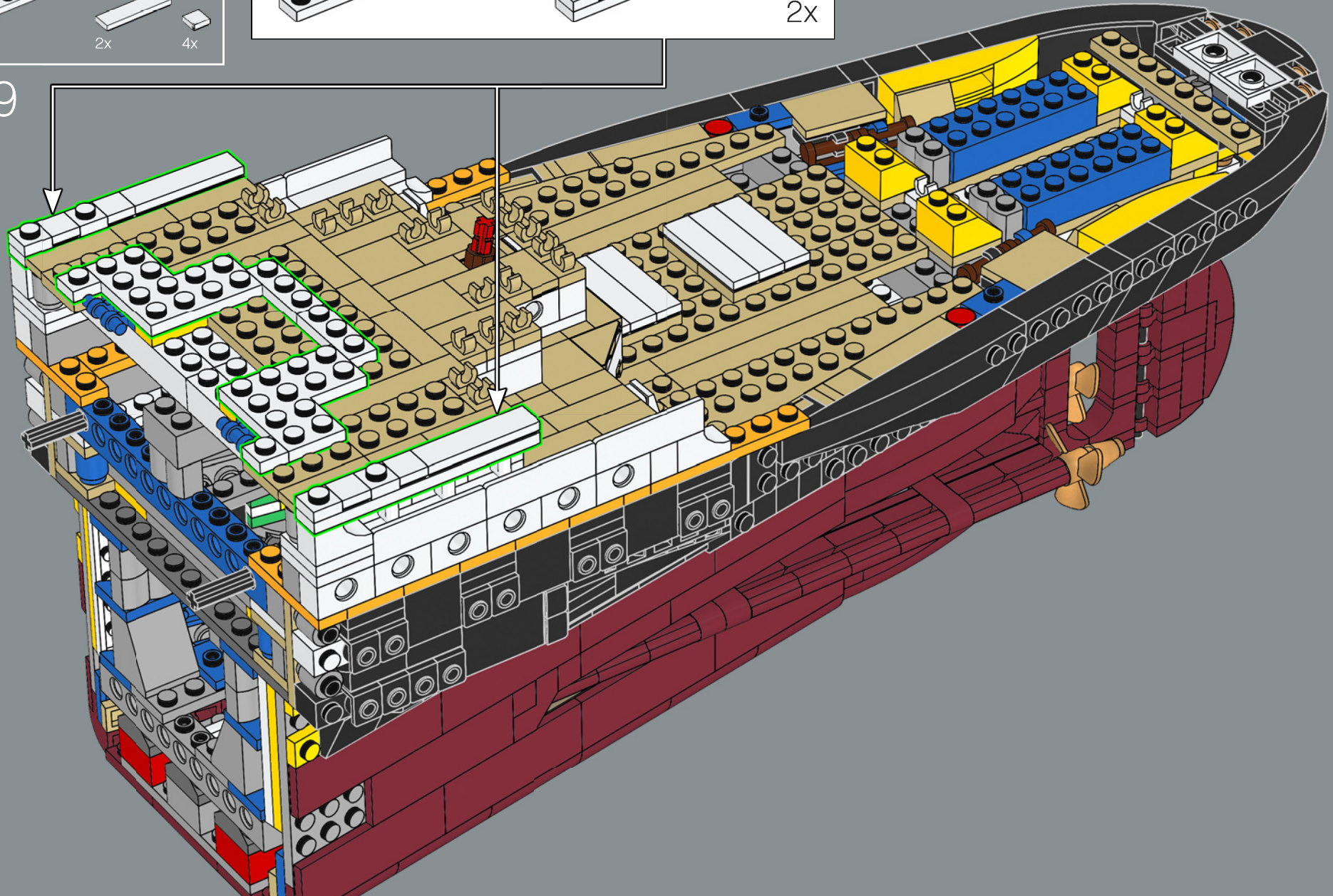

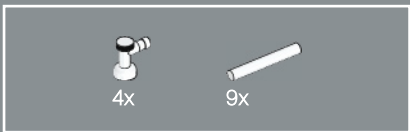

340

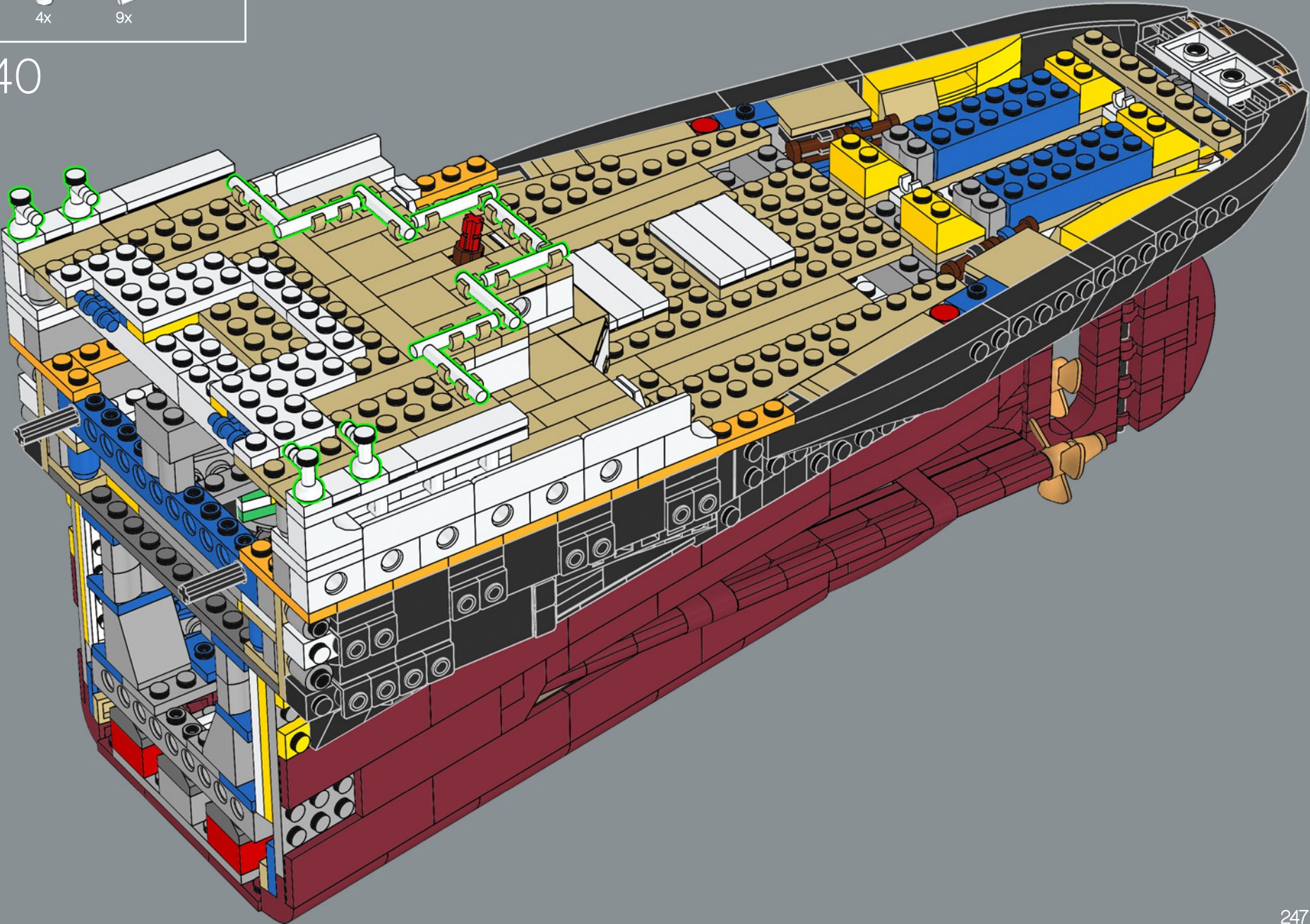

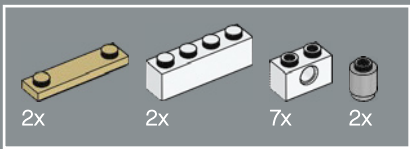

341

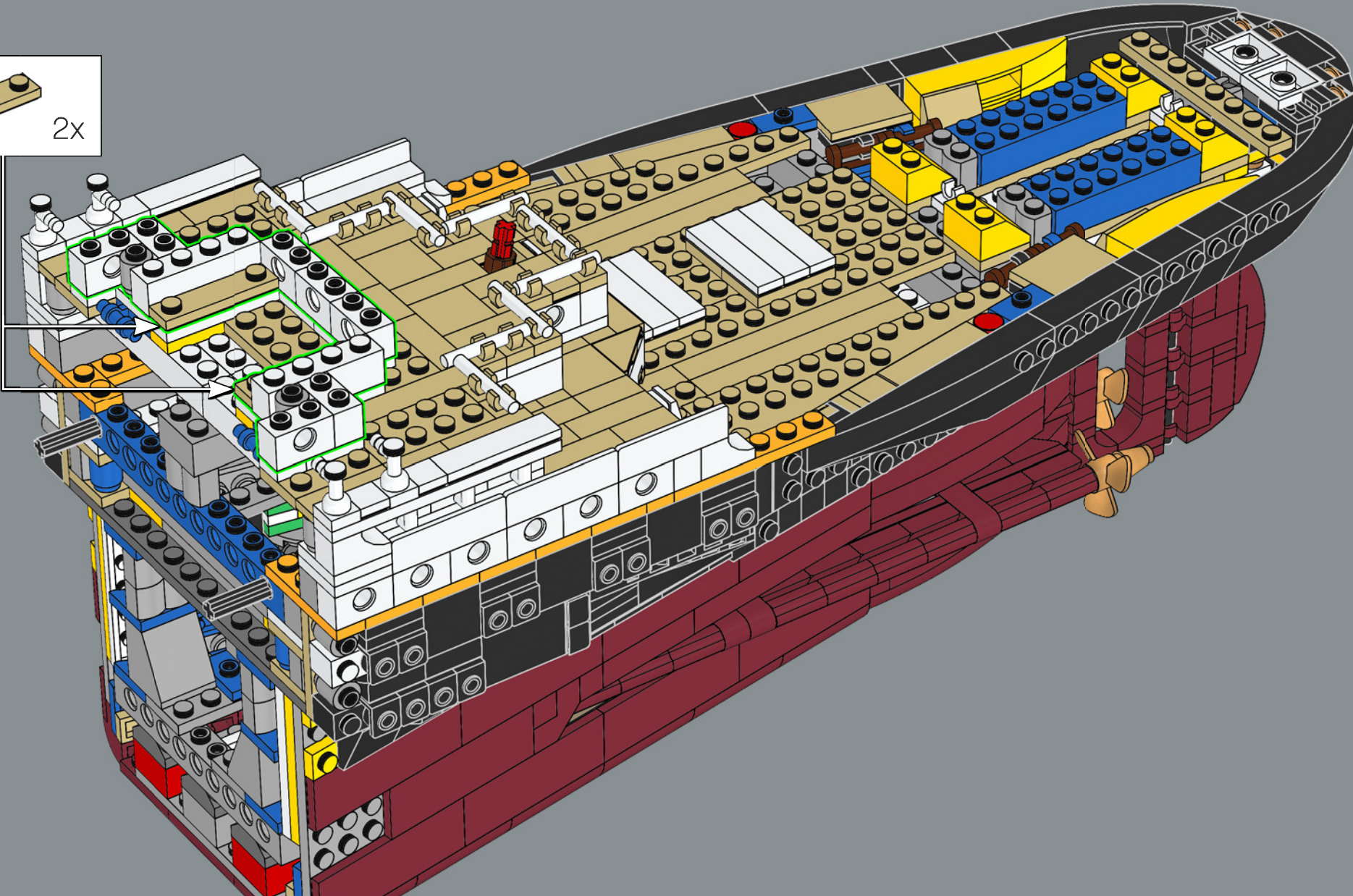
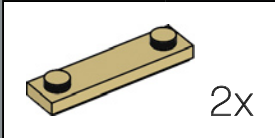



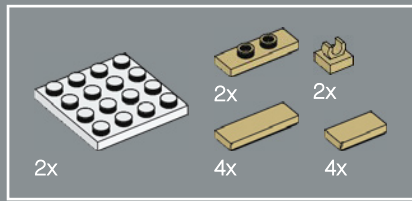

342

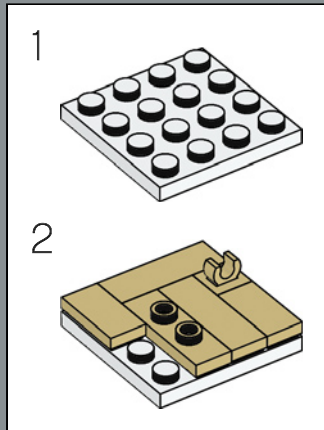
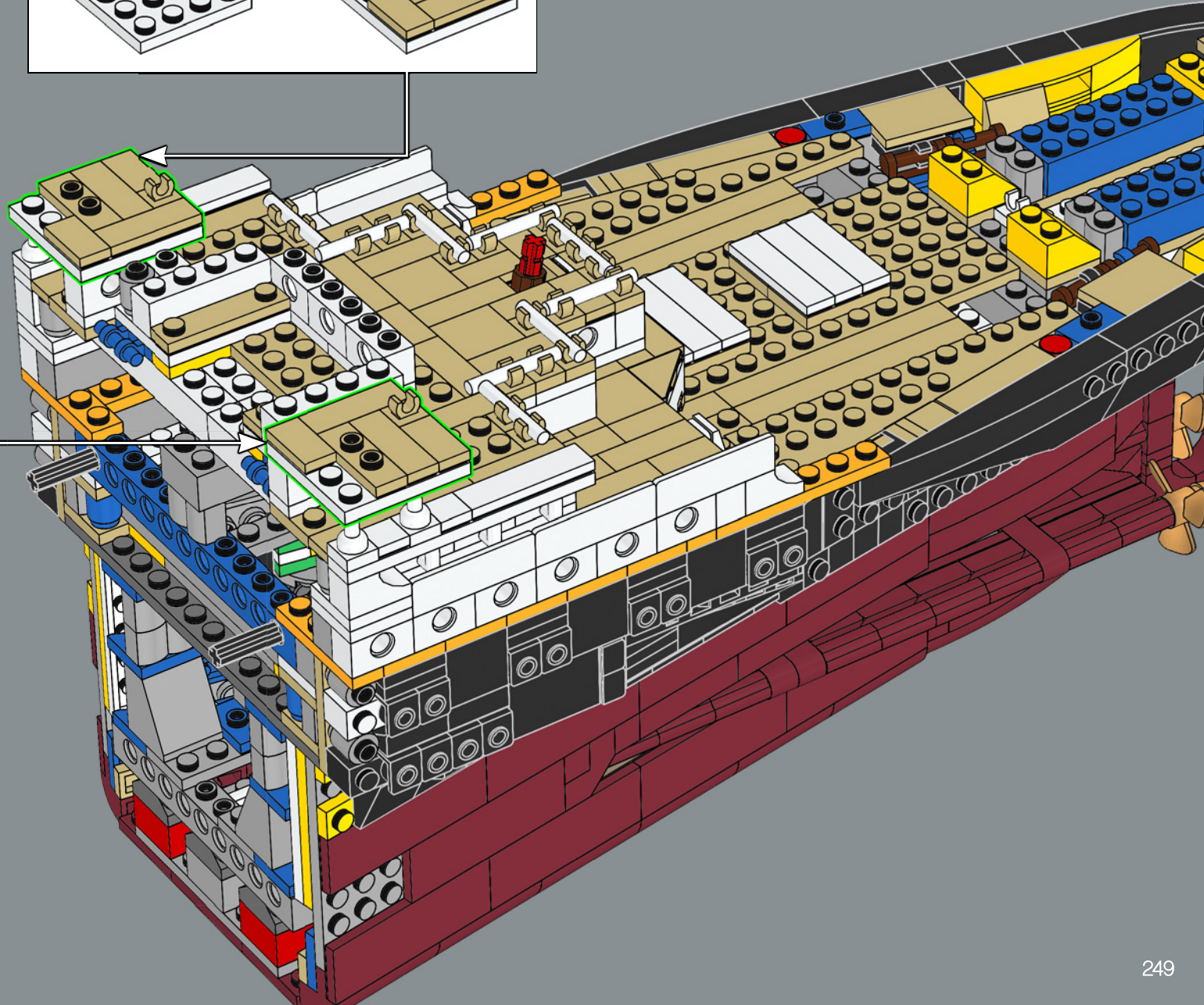
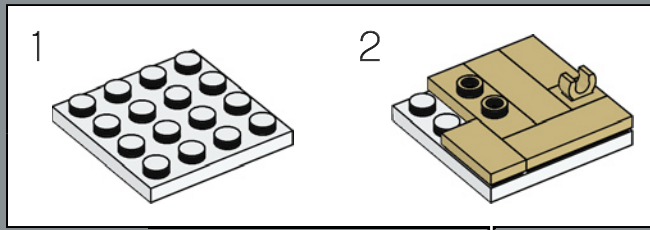

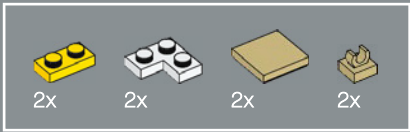

343

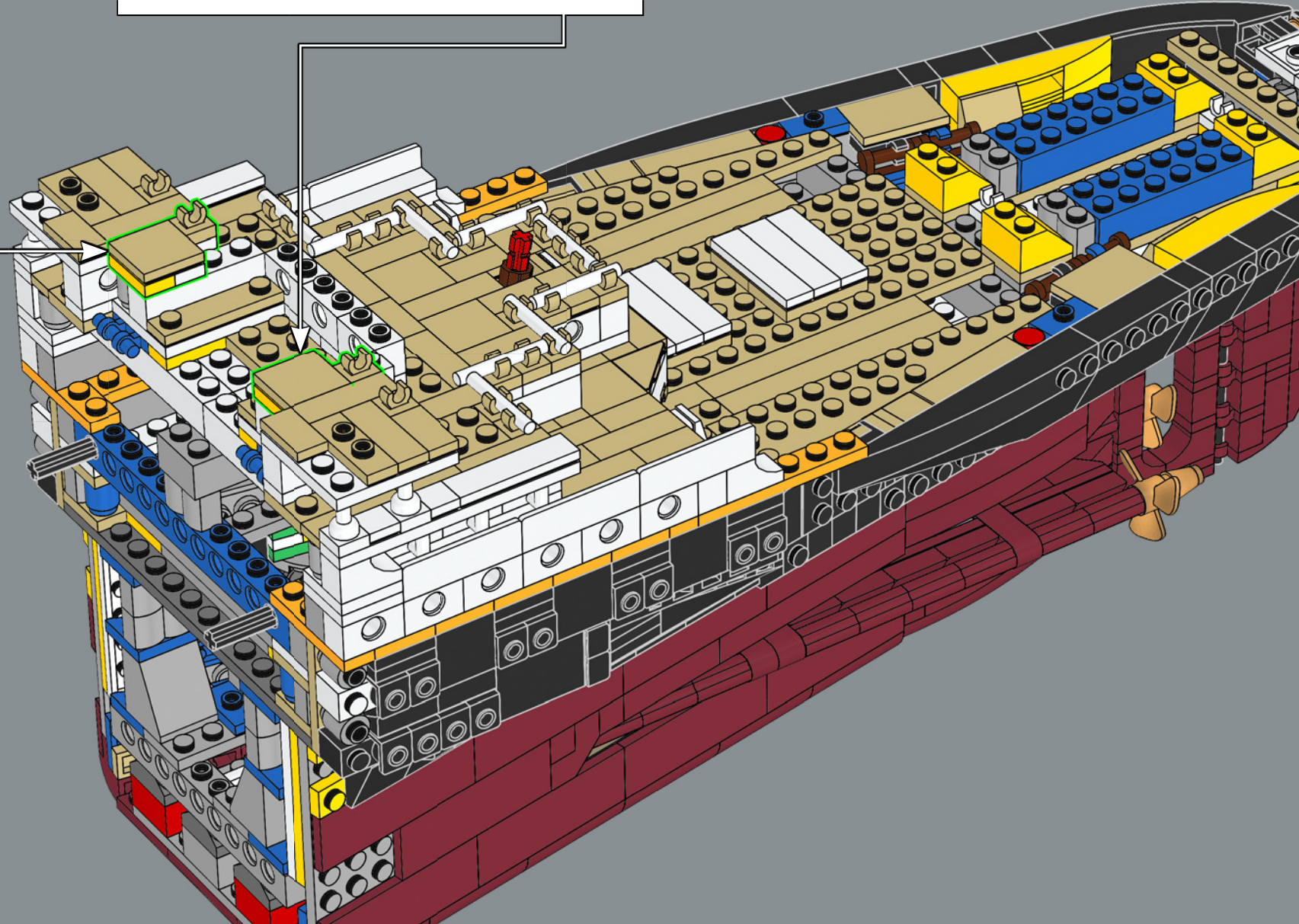
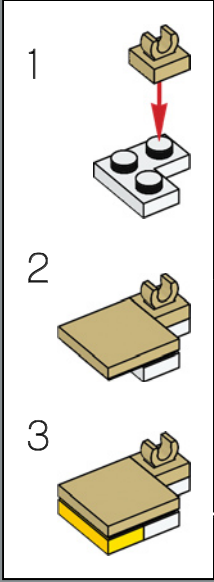
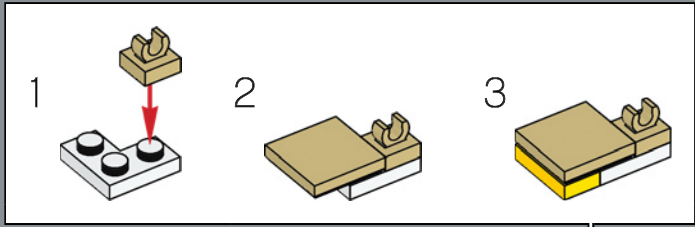

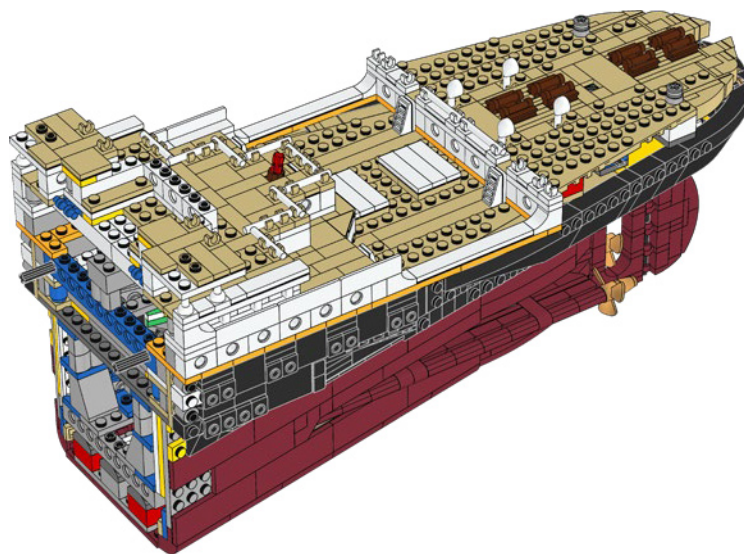

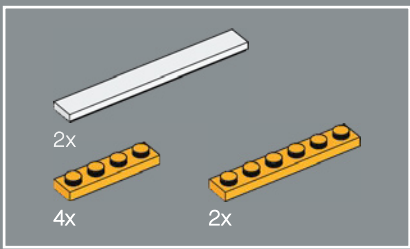

344

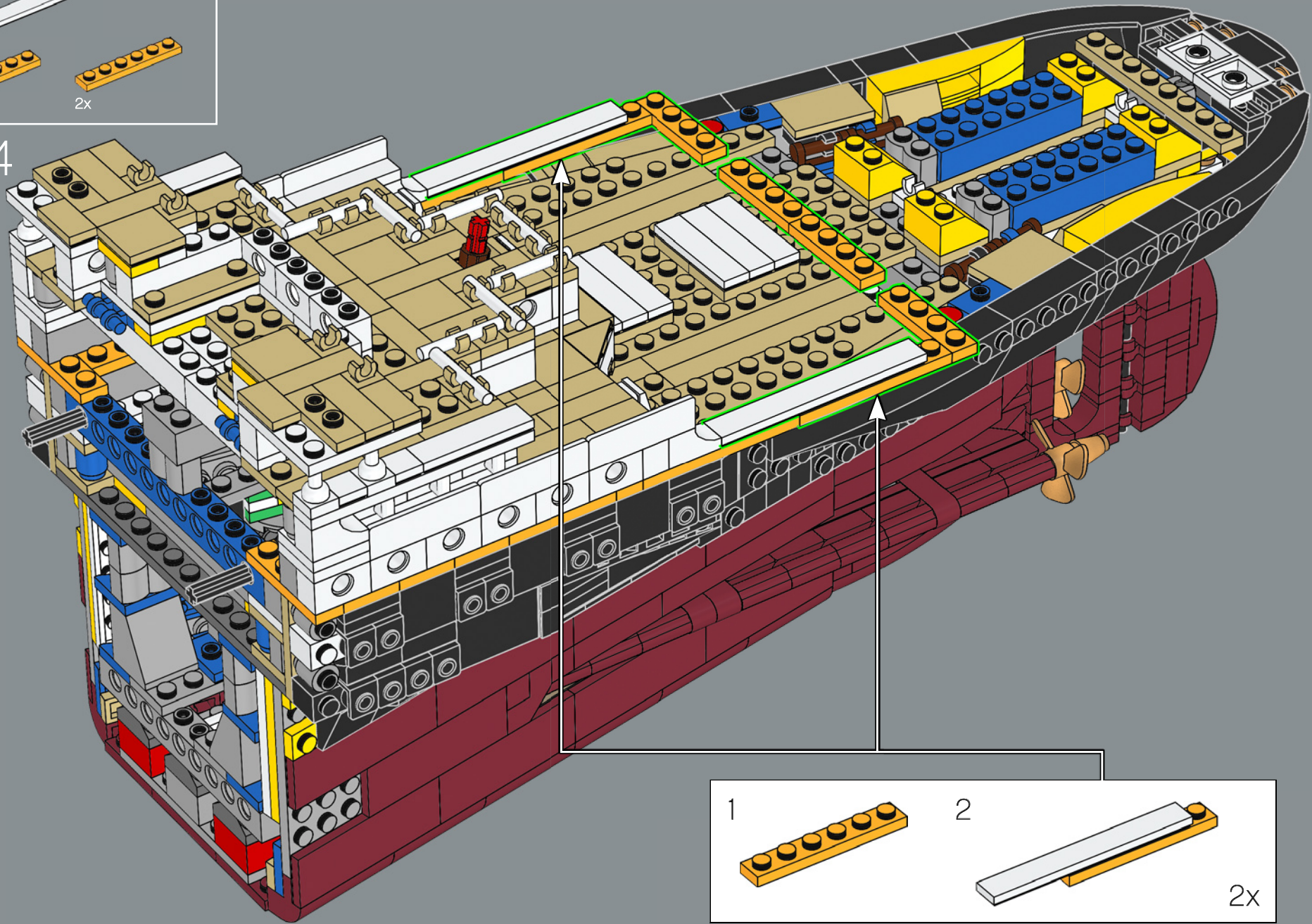

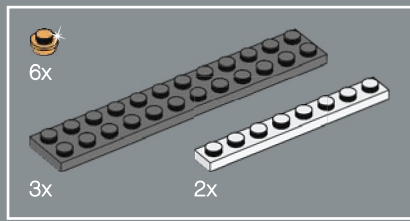

345

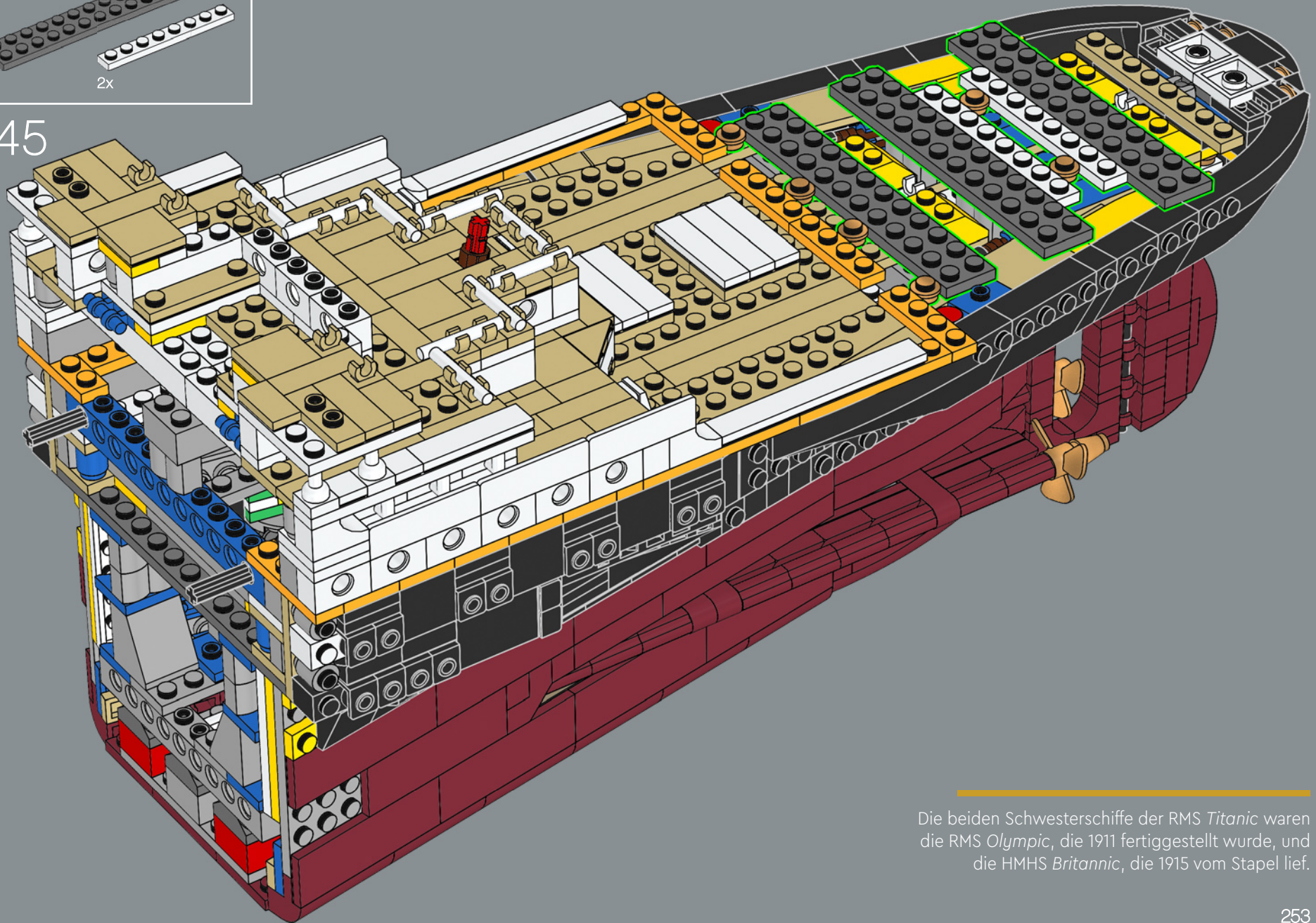

Die beiden Schwesterschiffe der RMS *Titanic* waren die RMS *Olympic*, die 1911 fertiggestellt wurde, und die HMHS *Britannic*, die 1915 vom Stapel lief.

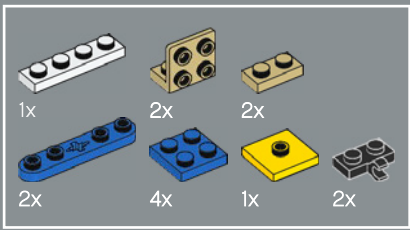

346

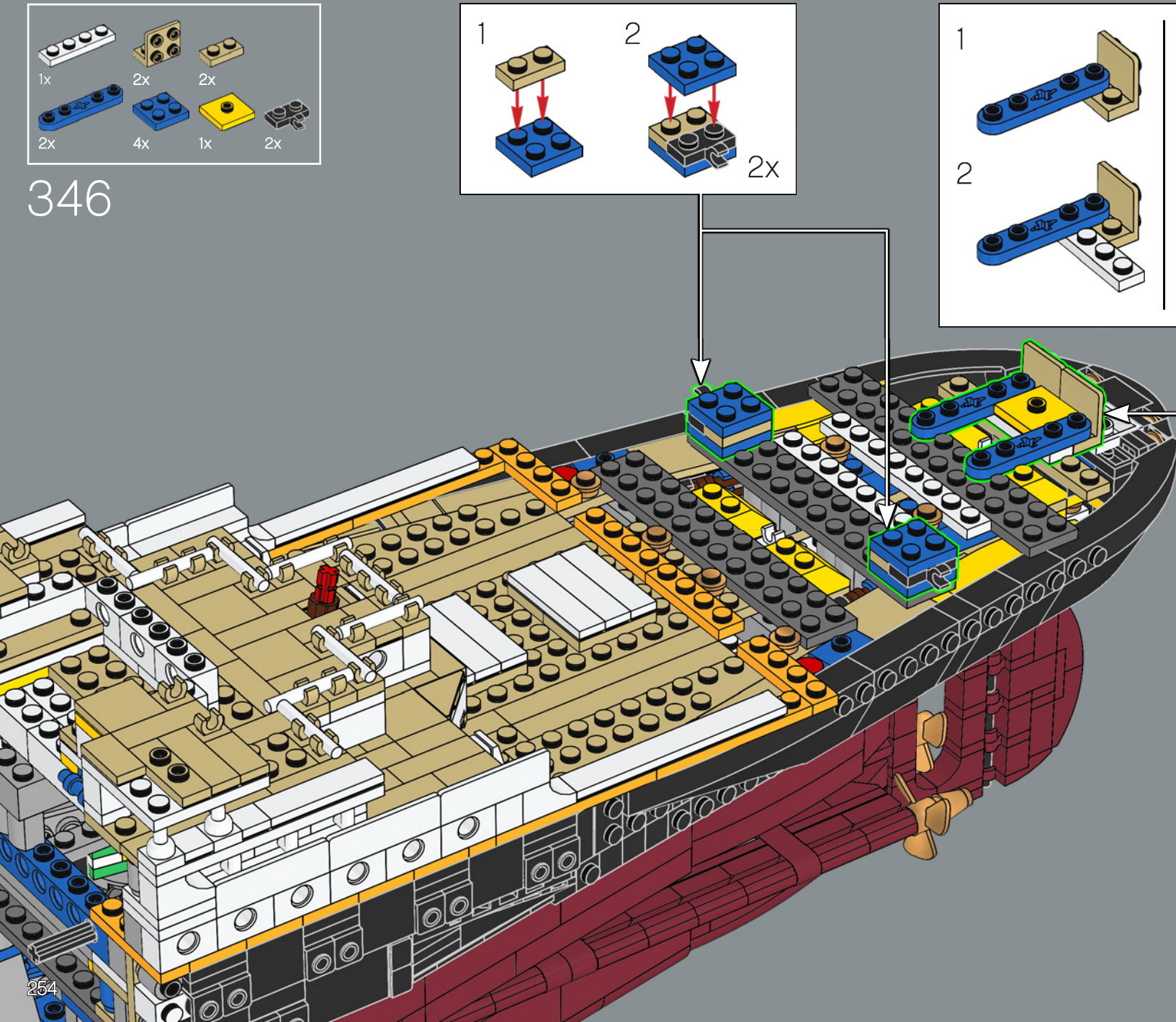
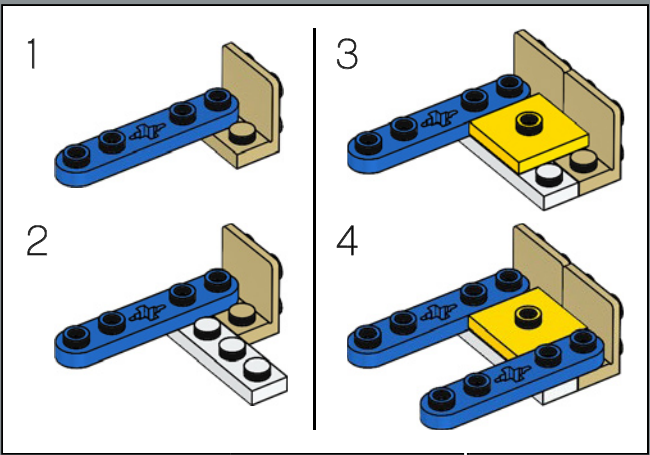
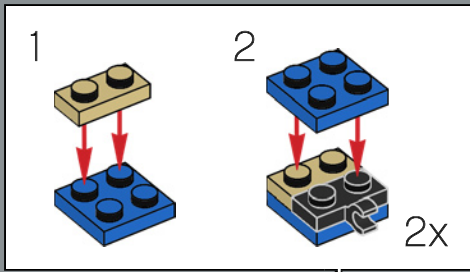

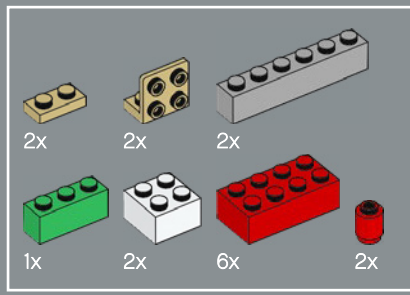

347

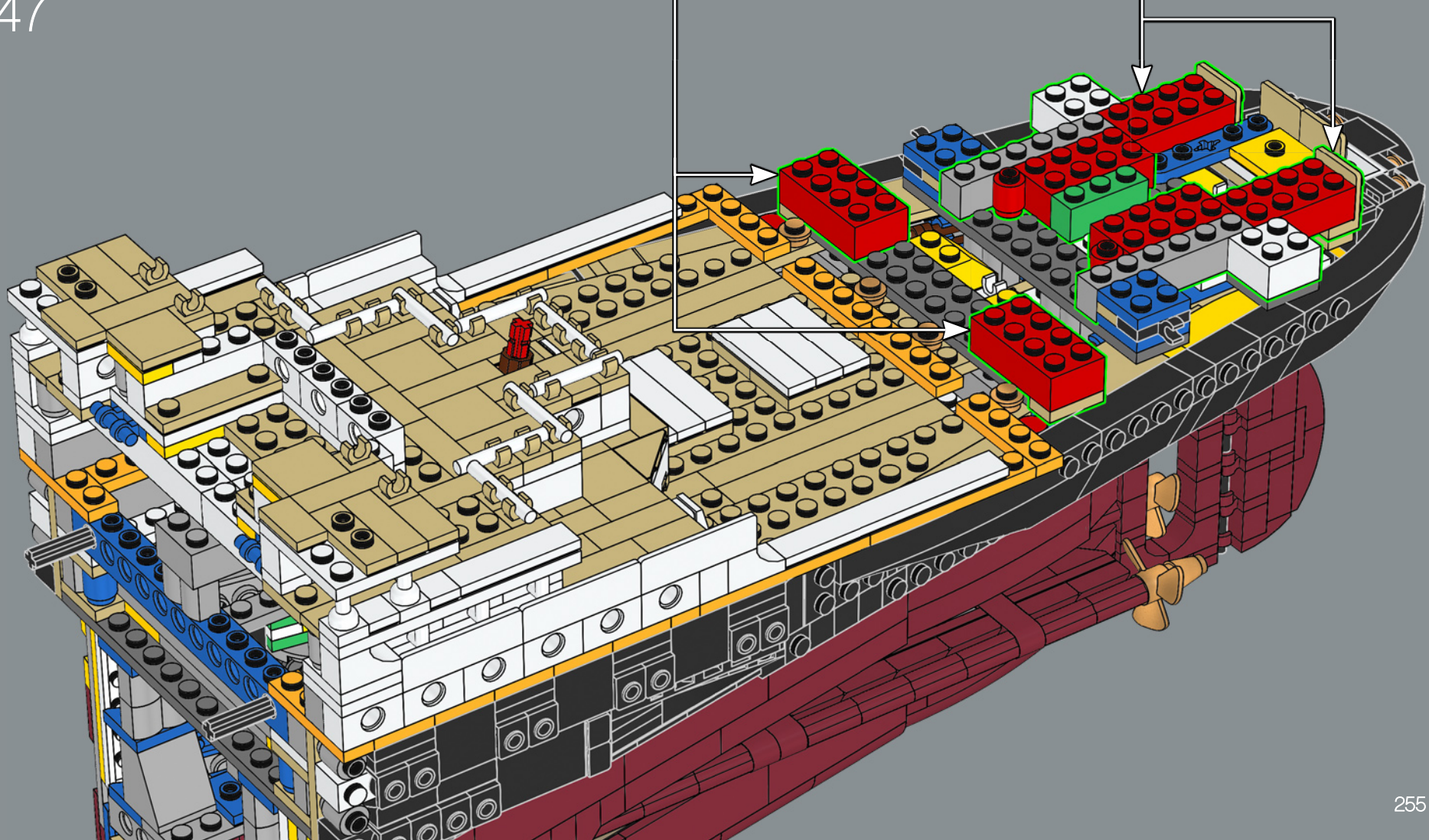
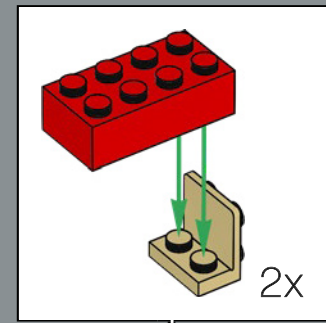
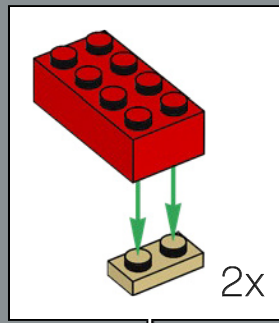

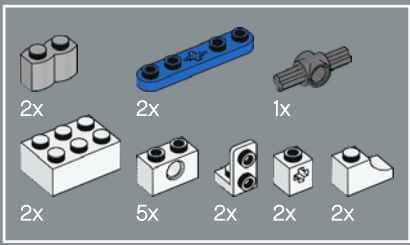

348

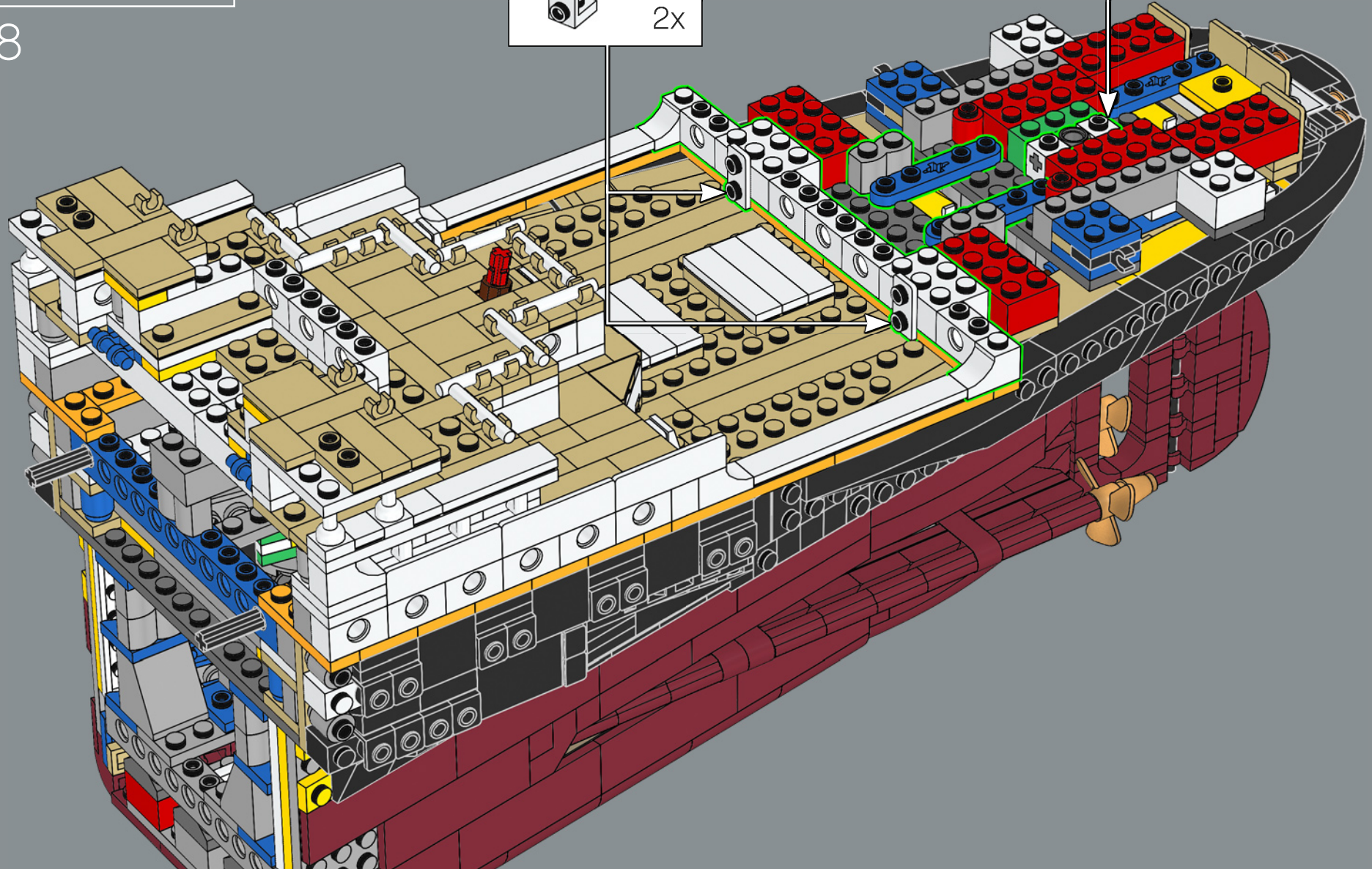
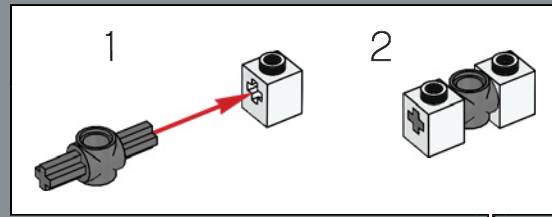
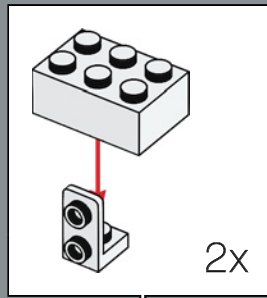



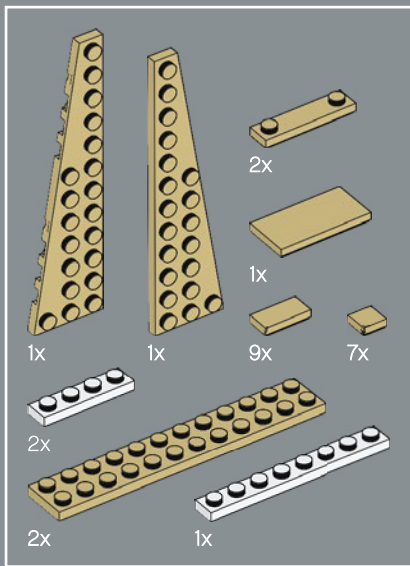

349

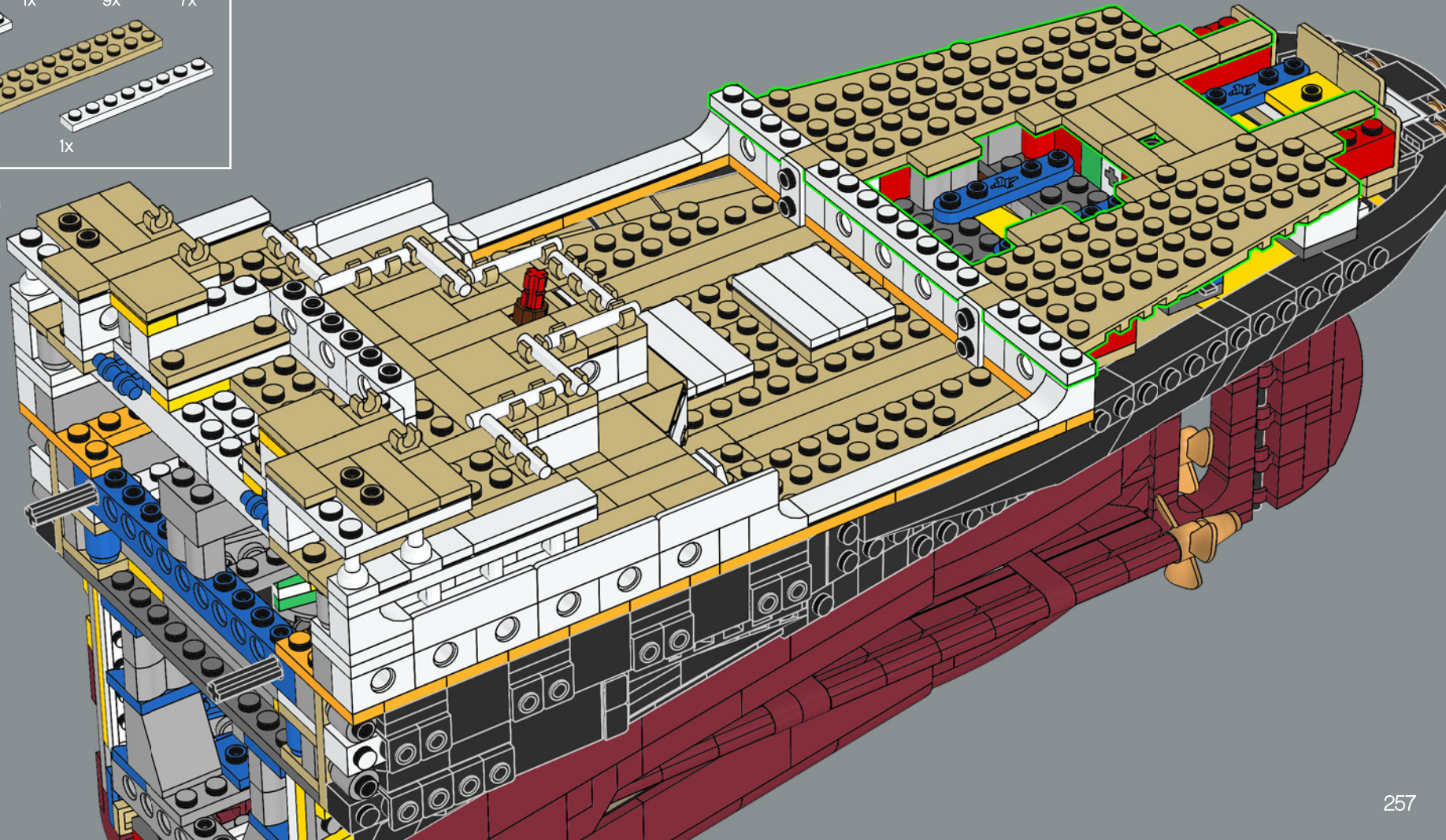

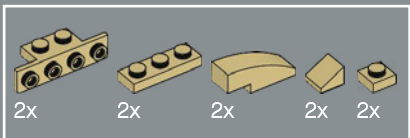

350

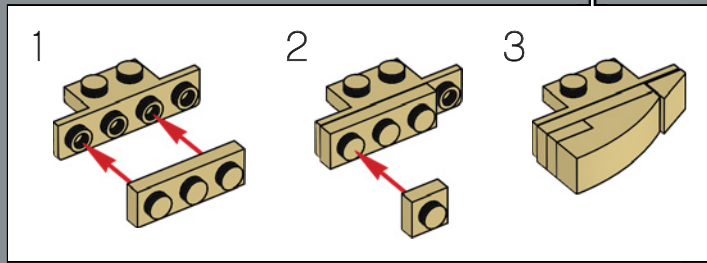
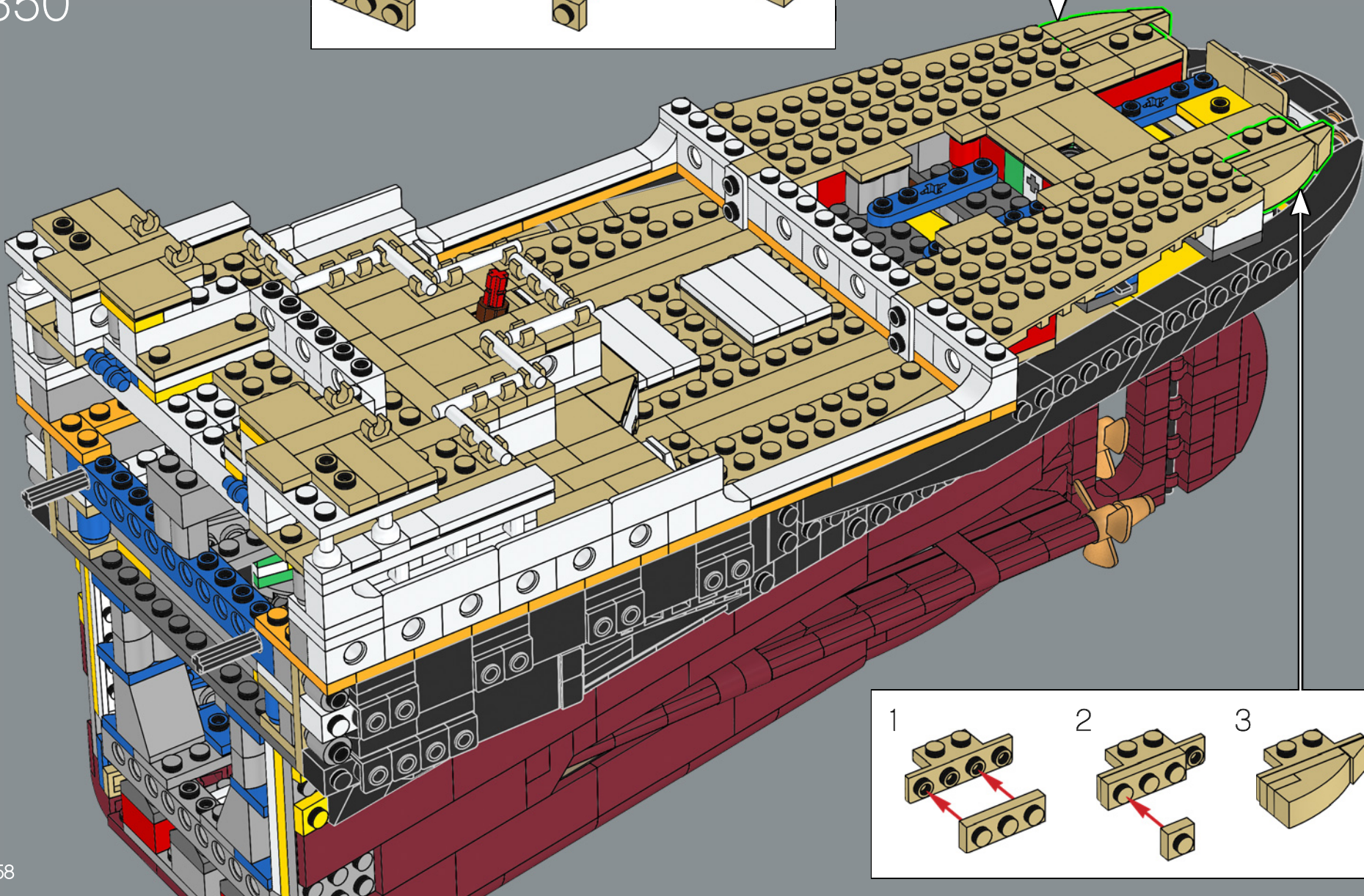
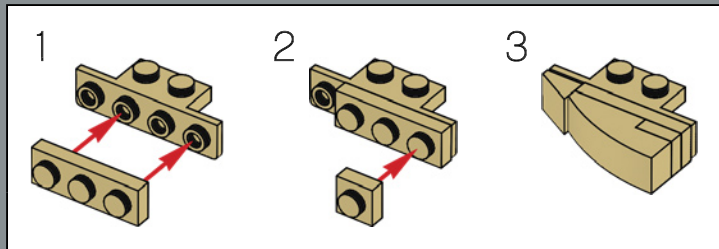

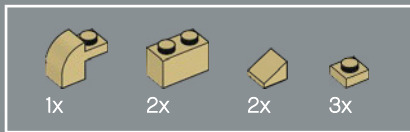

351

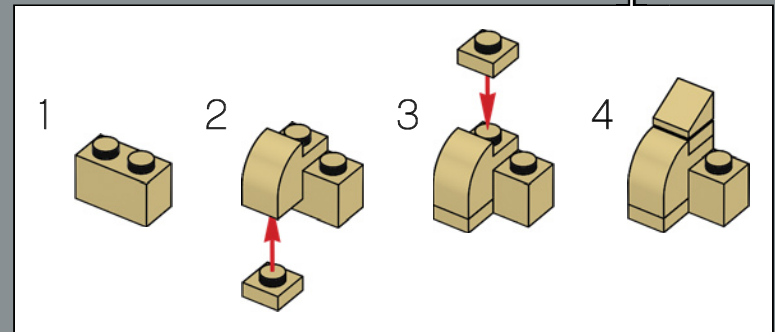
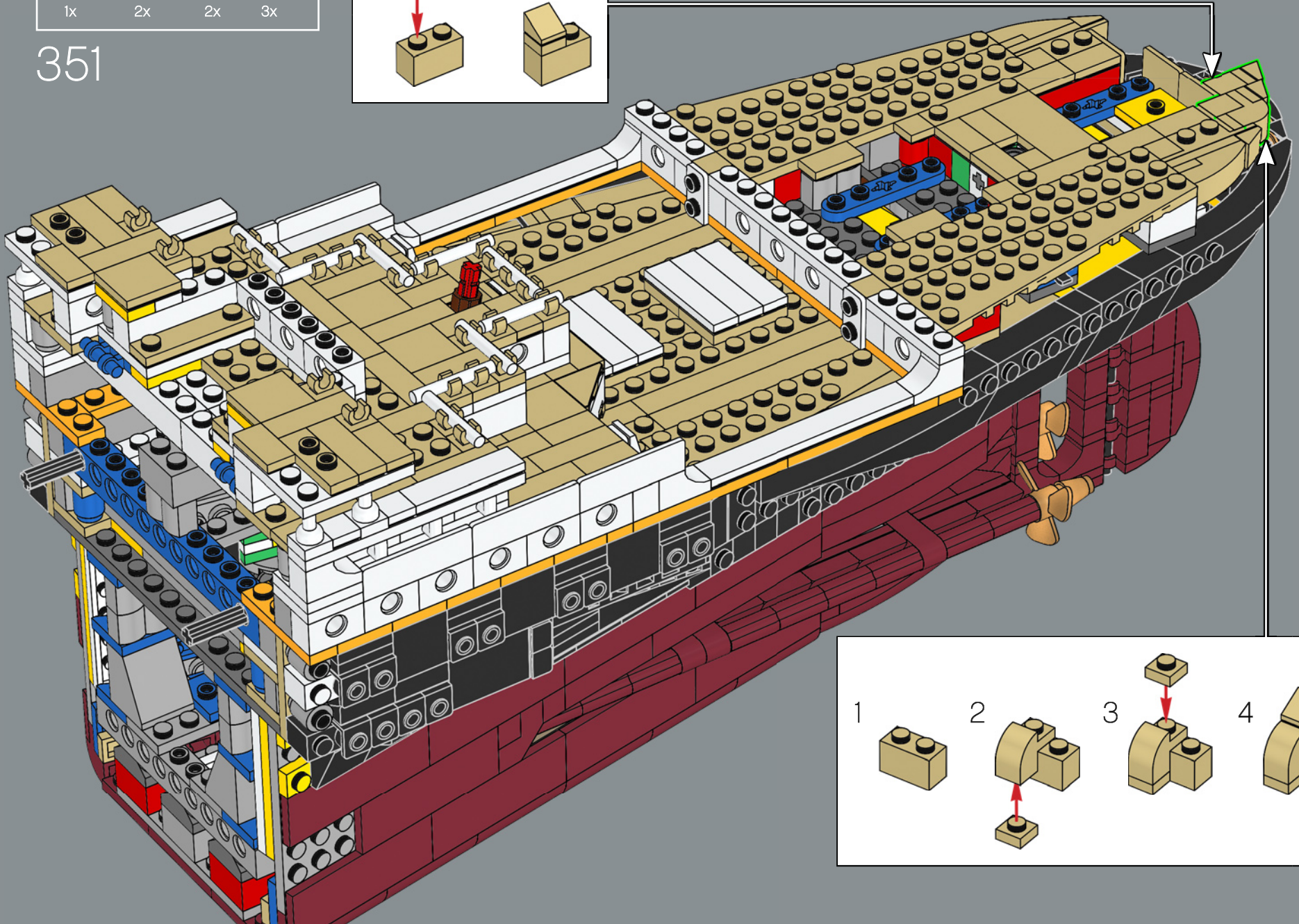
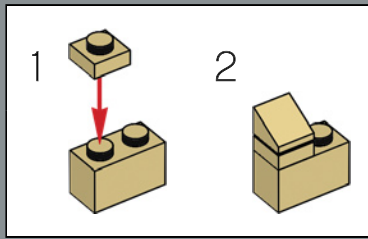

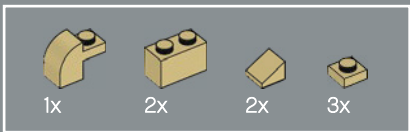

352

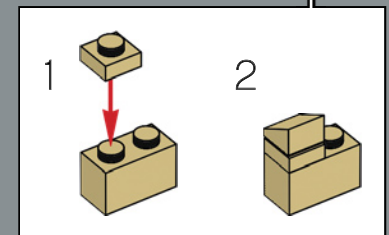
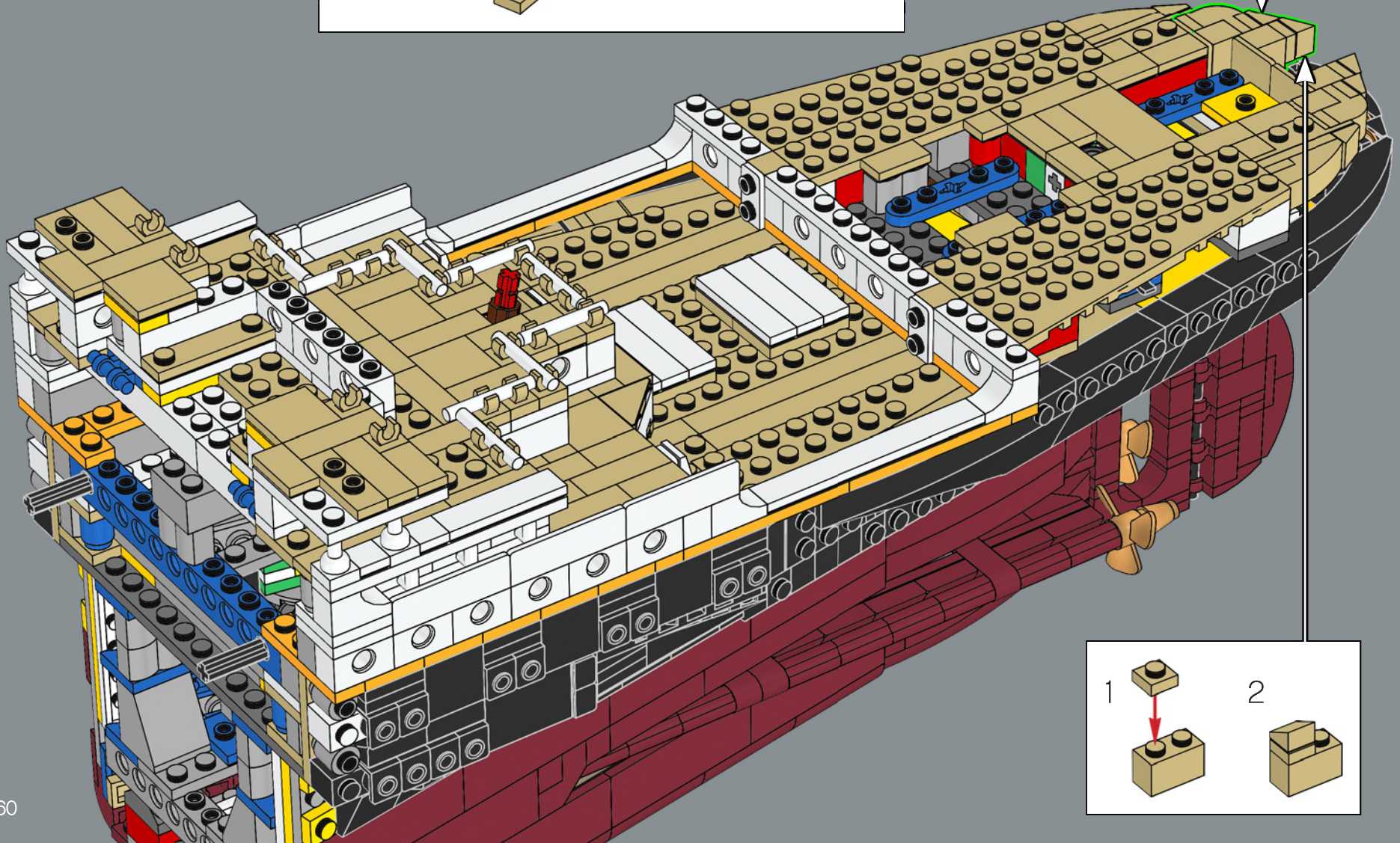
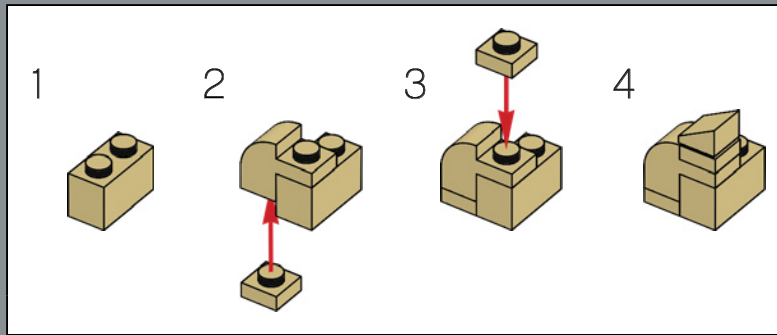

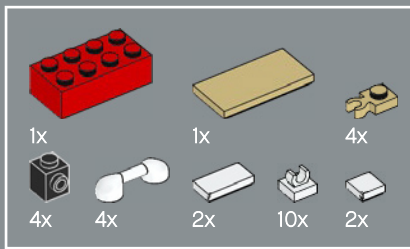

353

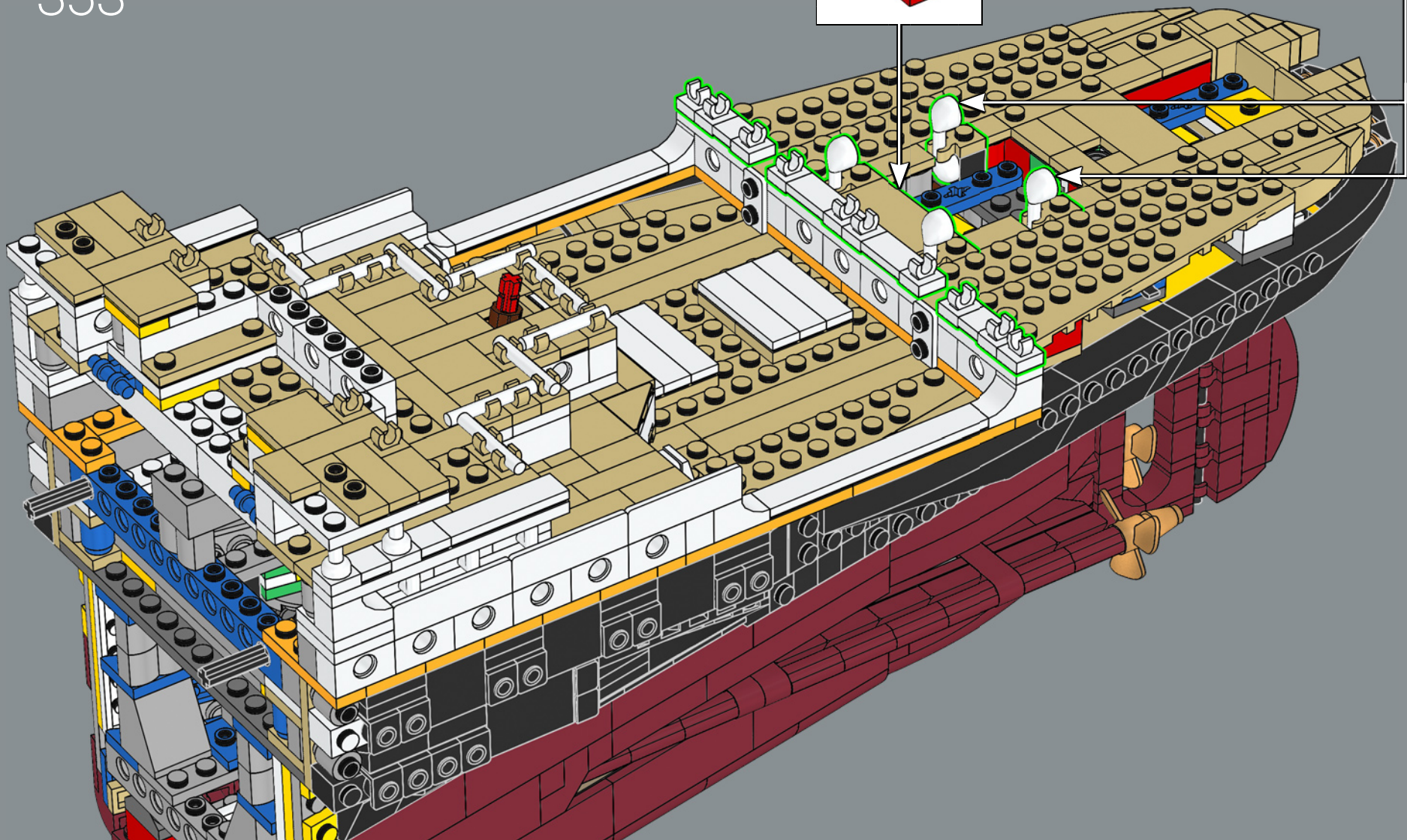
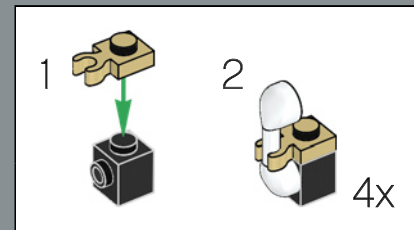
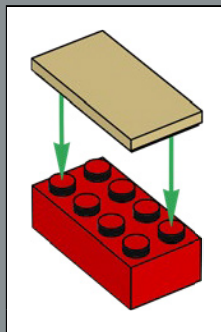



354

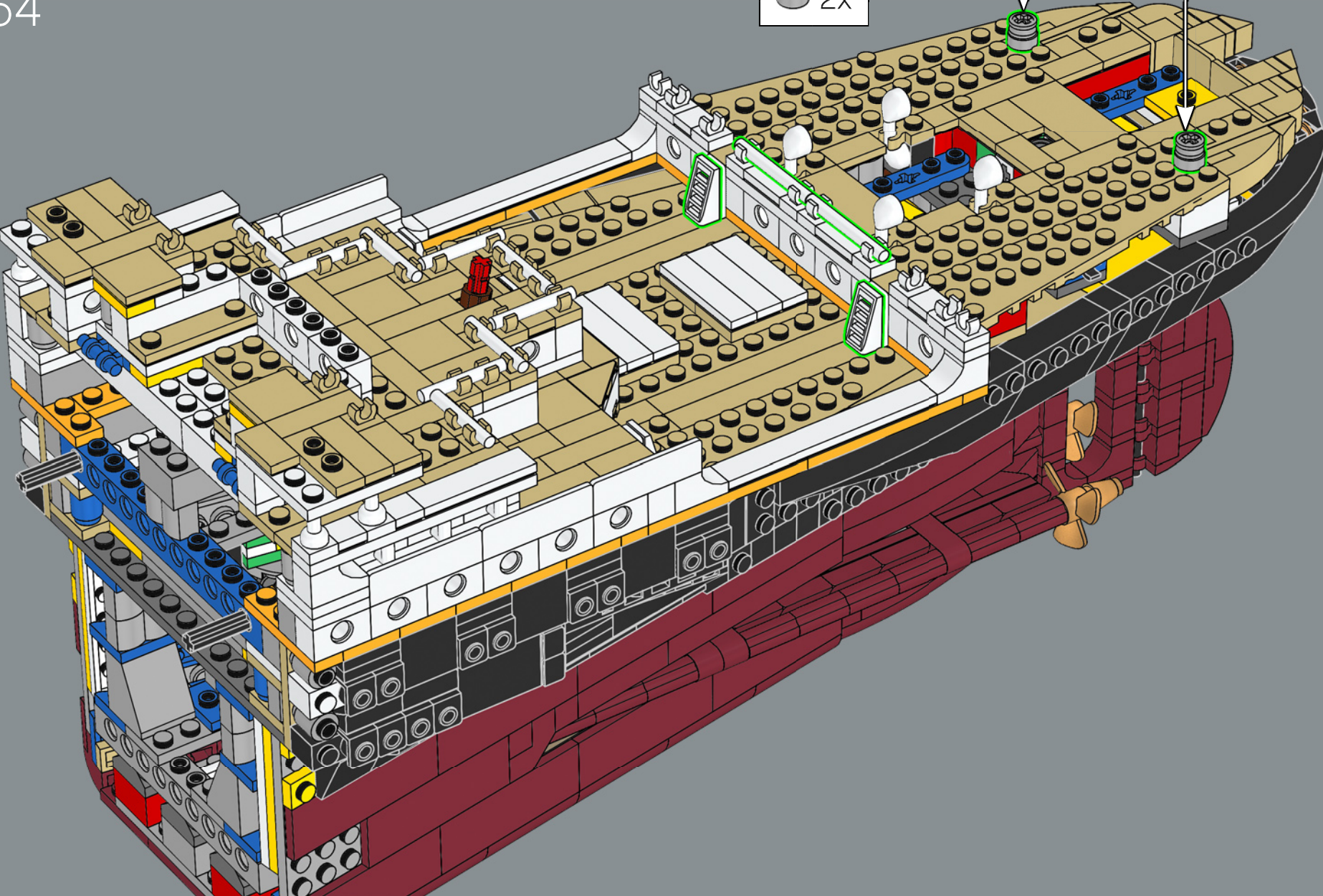
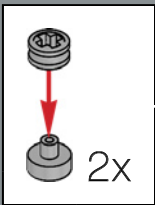

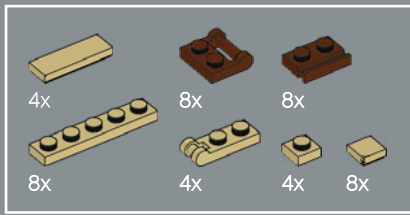

355

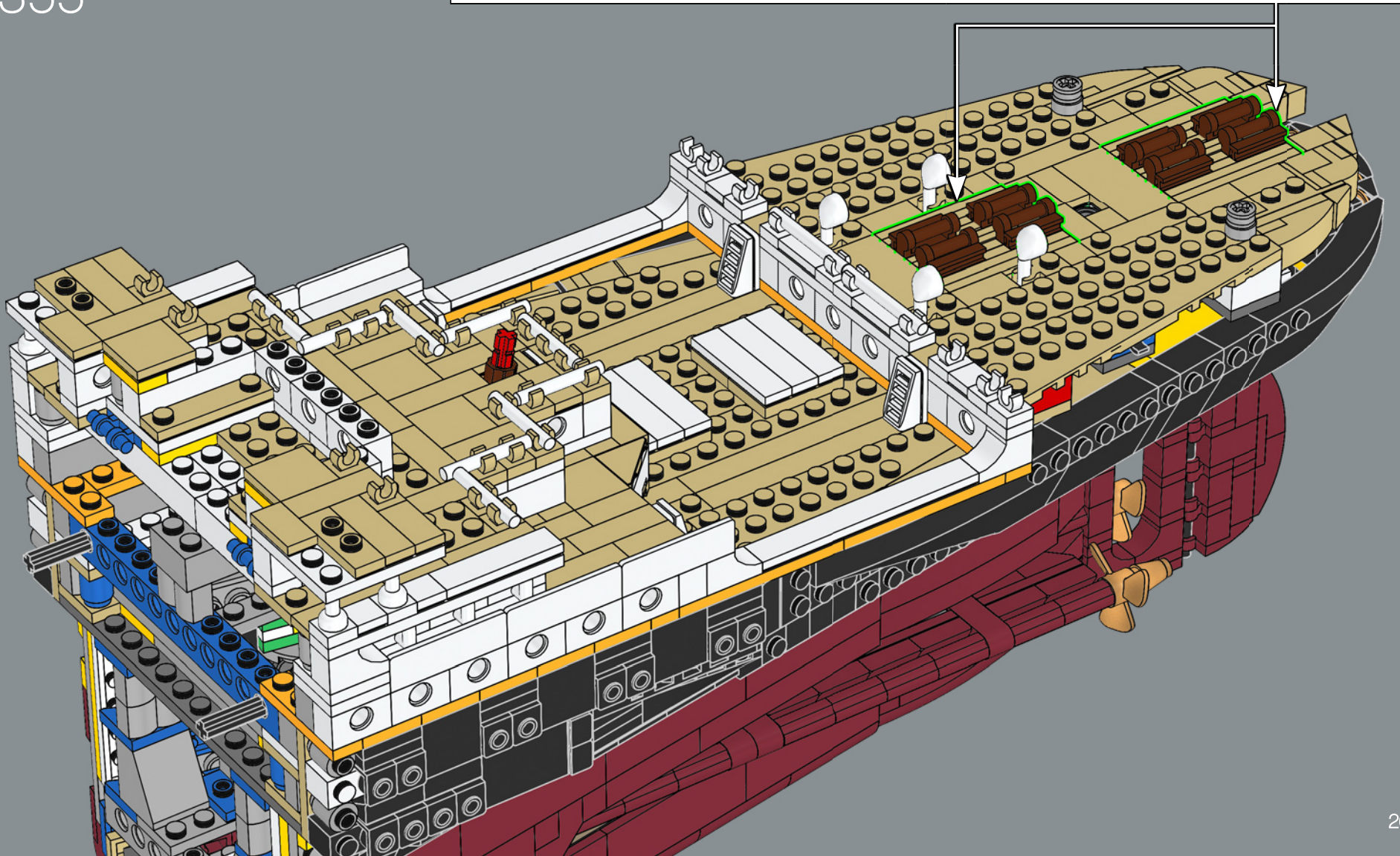
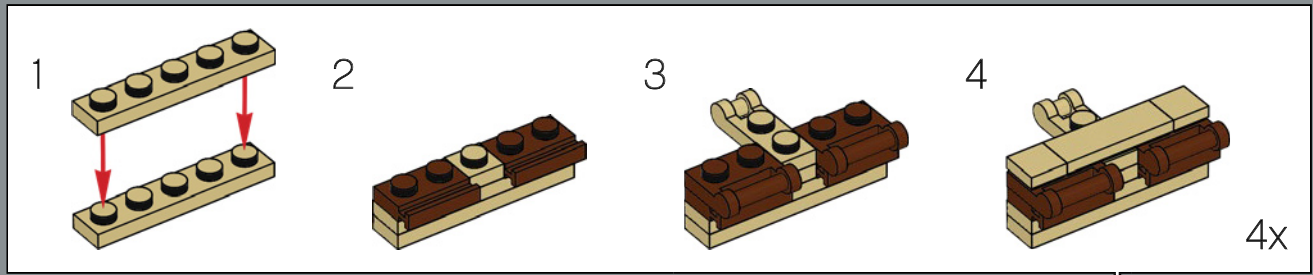

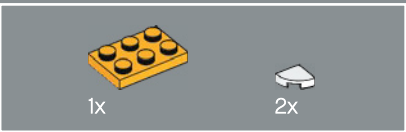
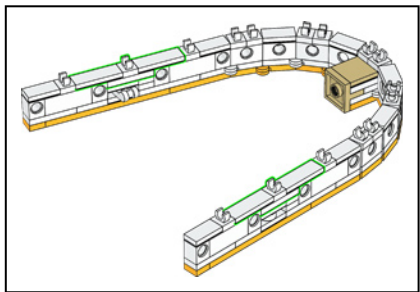
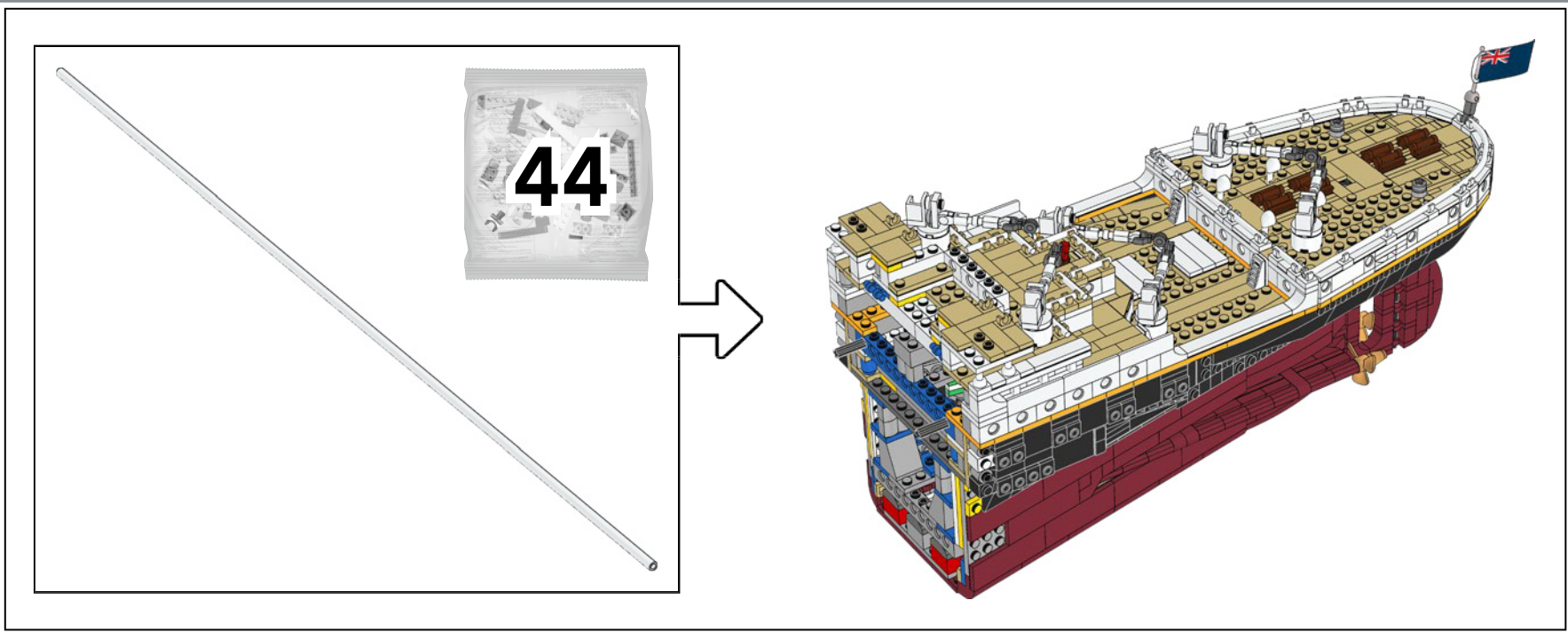

356

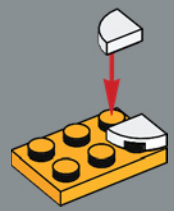

357

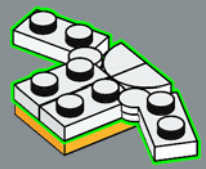



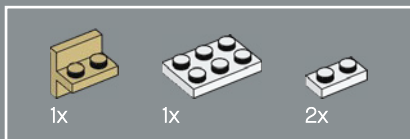

358

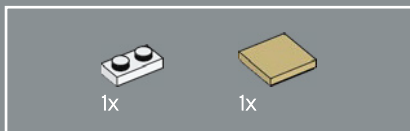
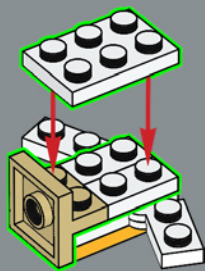

359

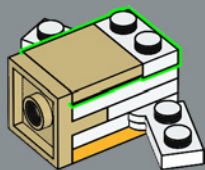

360

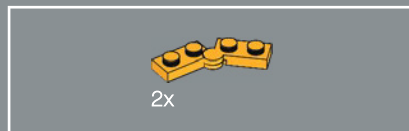
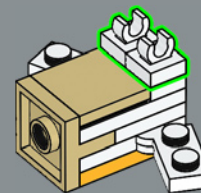

361

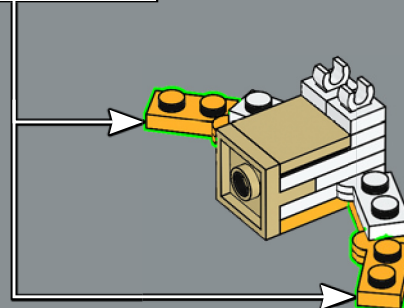
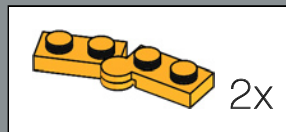



362

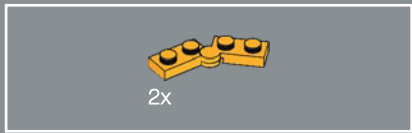
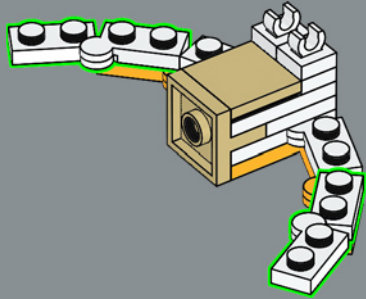

363

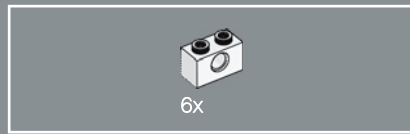
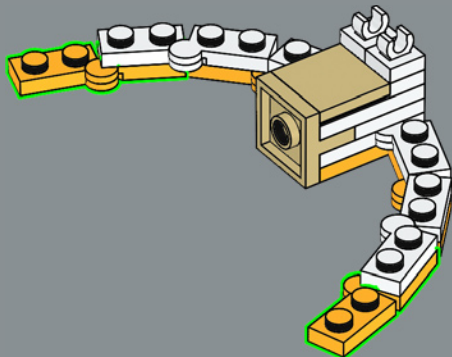

364

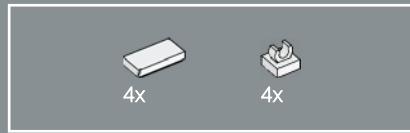
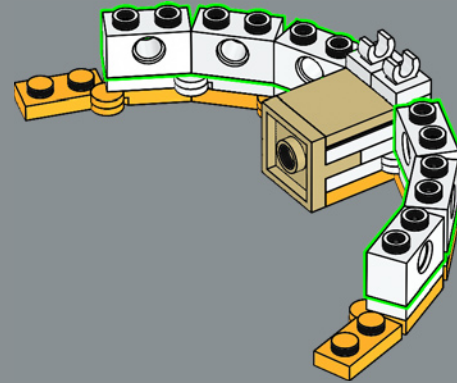

365

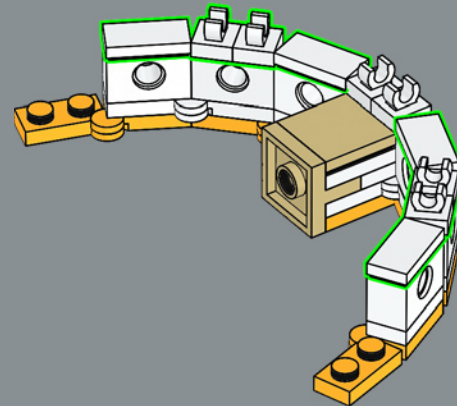



366

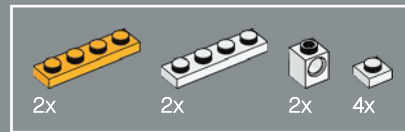
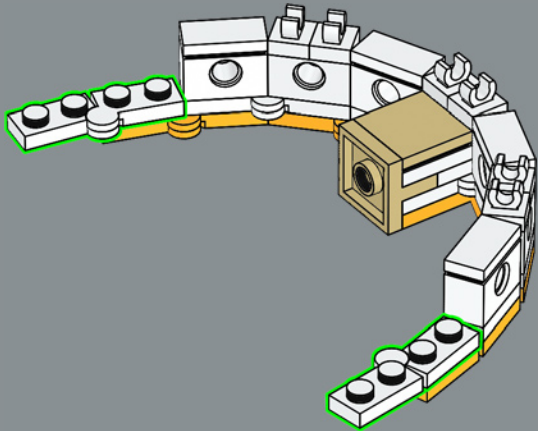

367

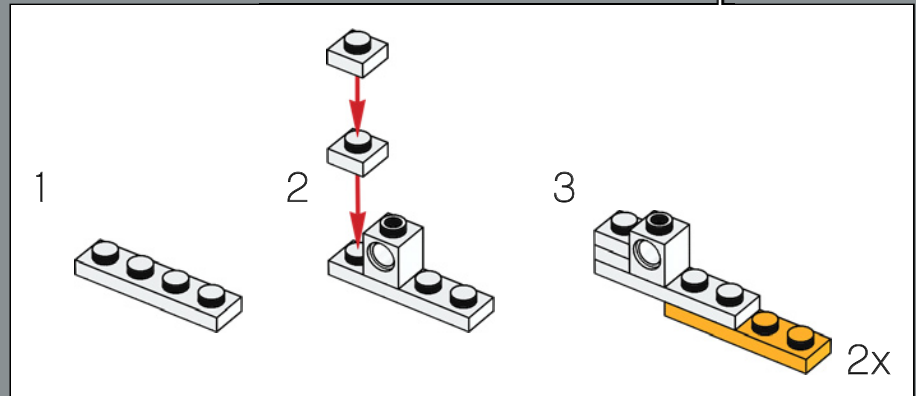
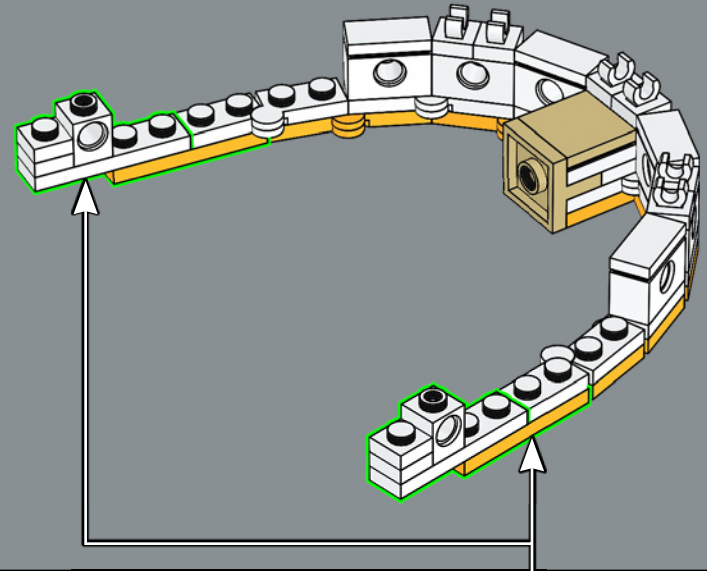

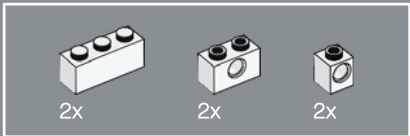

368

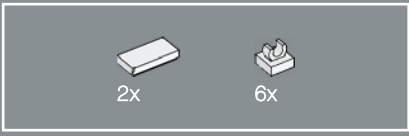
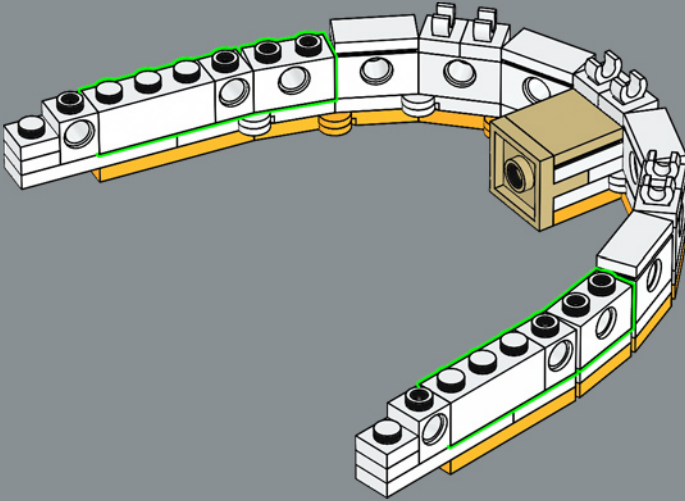

369

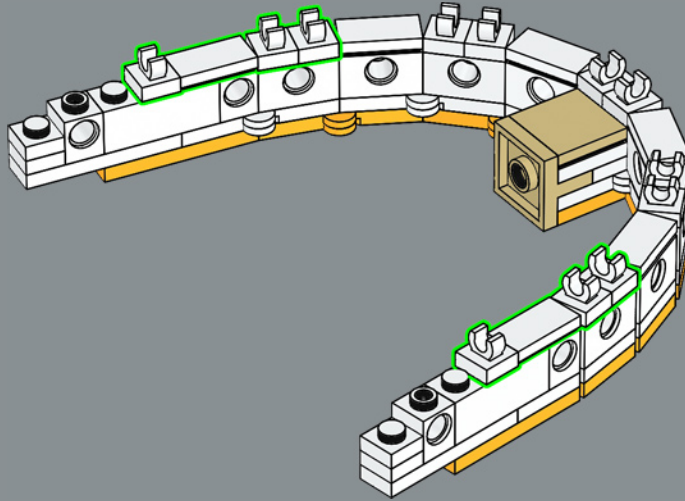

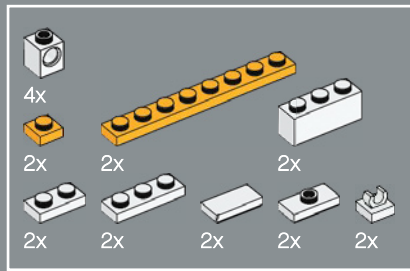

370

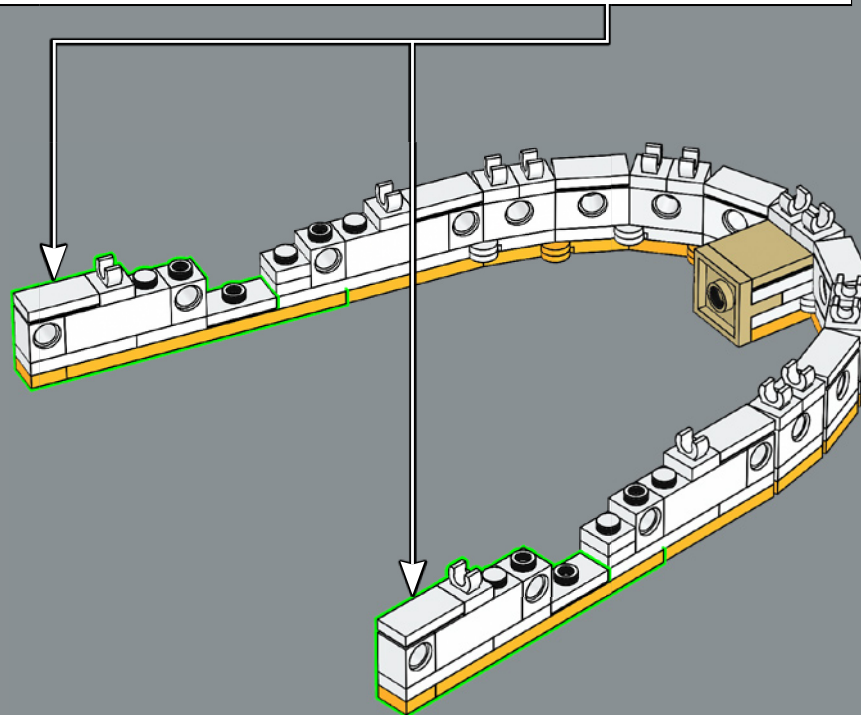
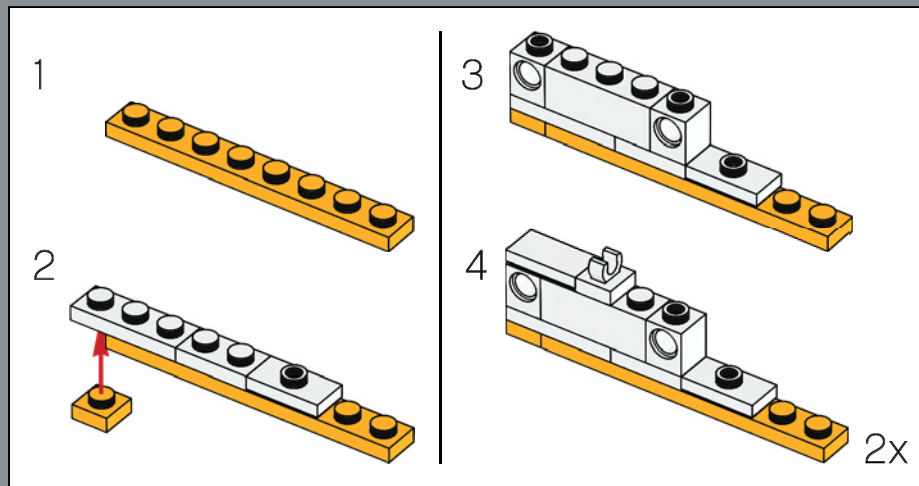



2x

371

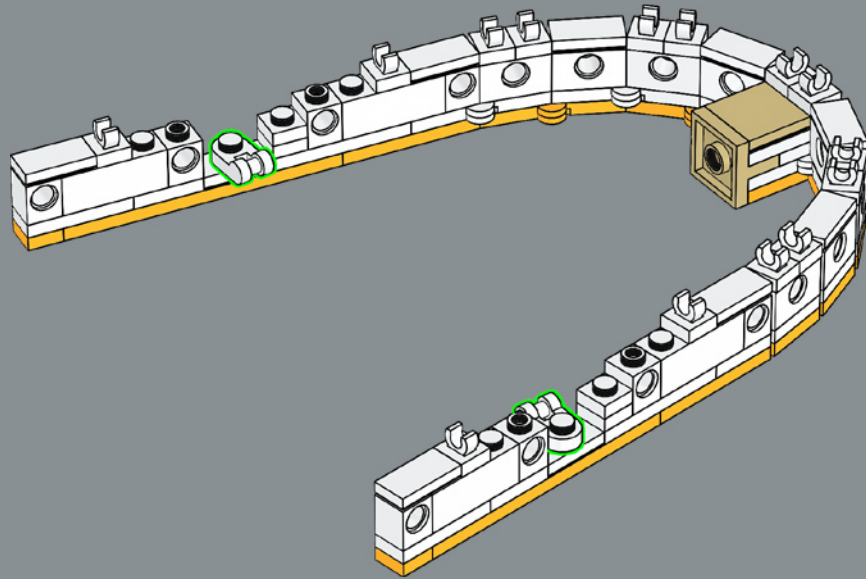

2x

372

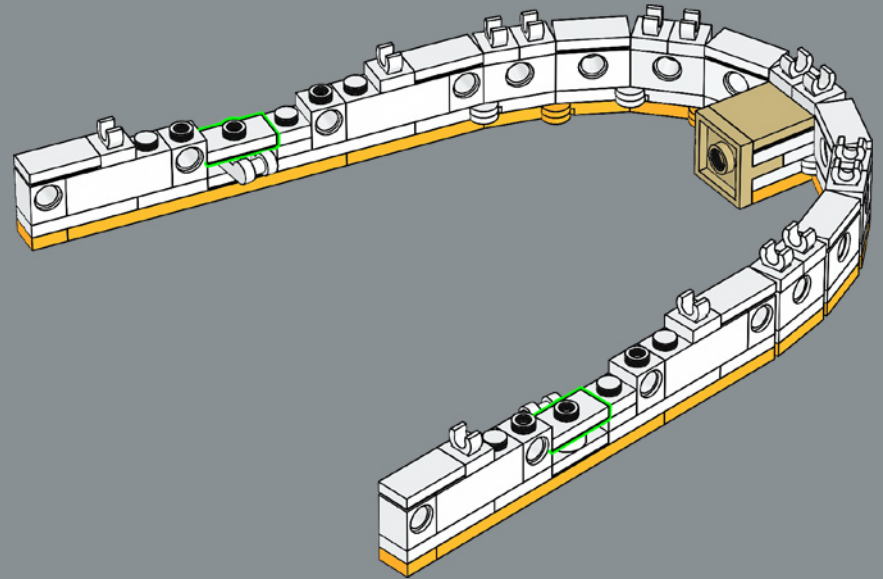

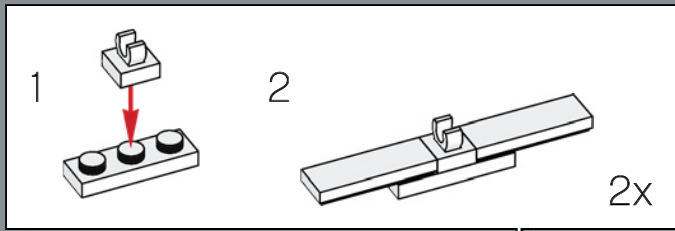
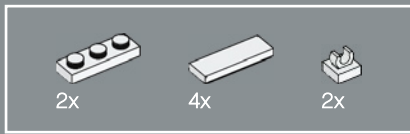

373

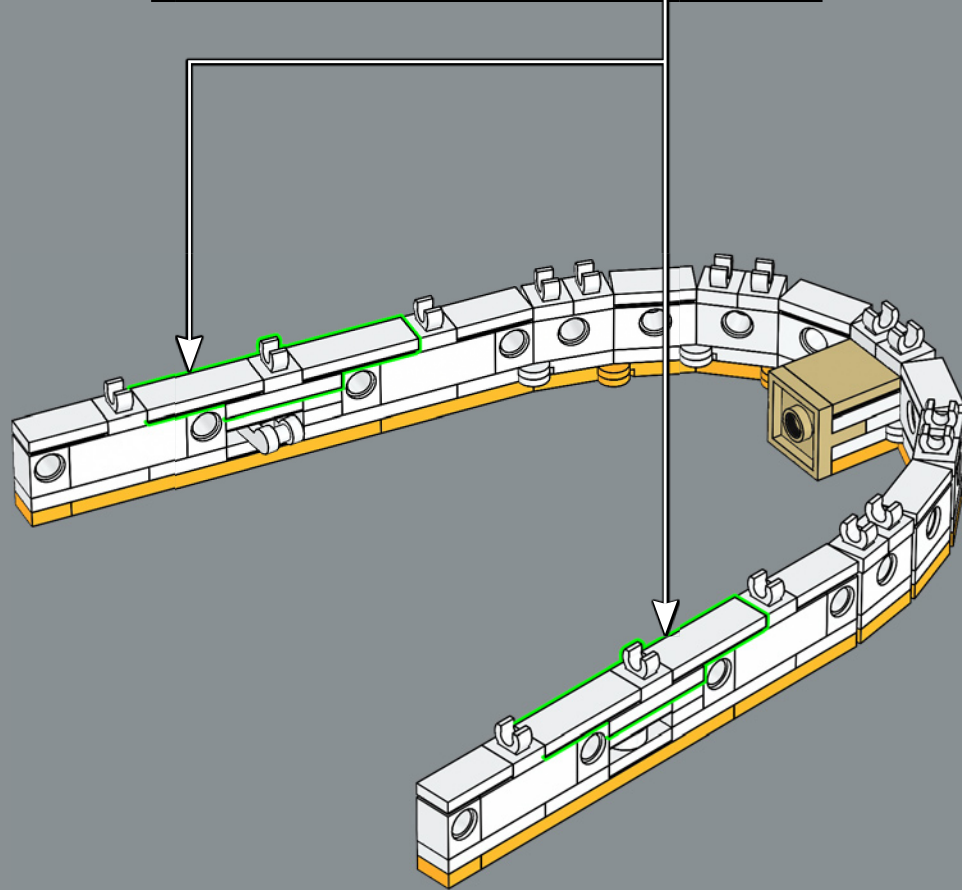

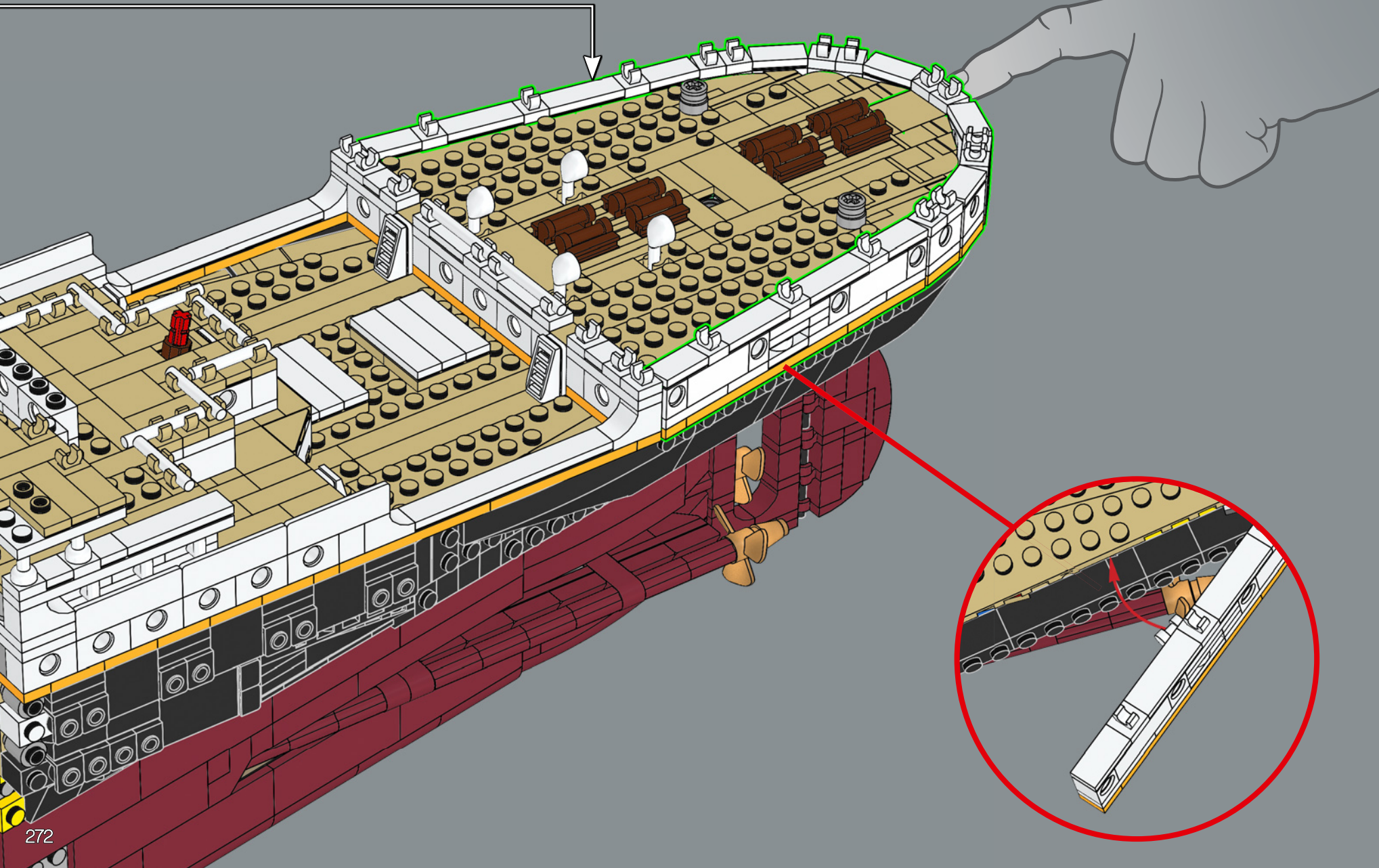



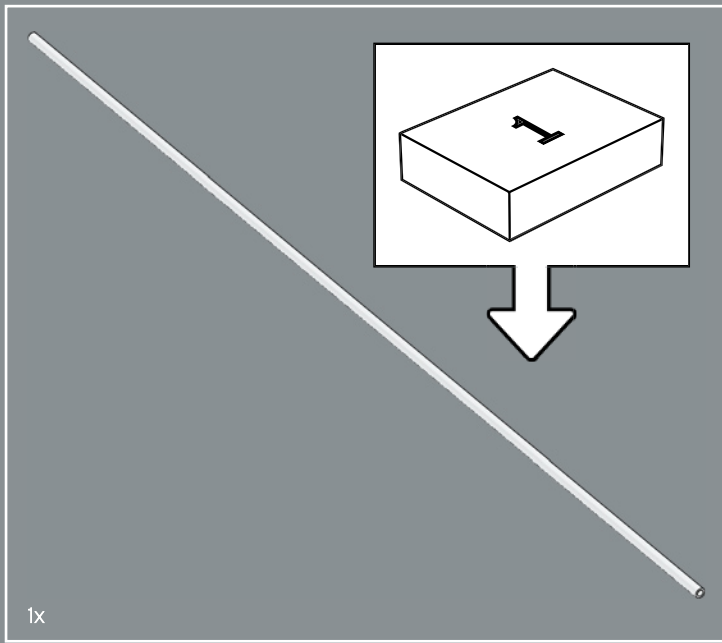

375

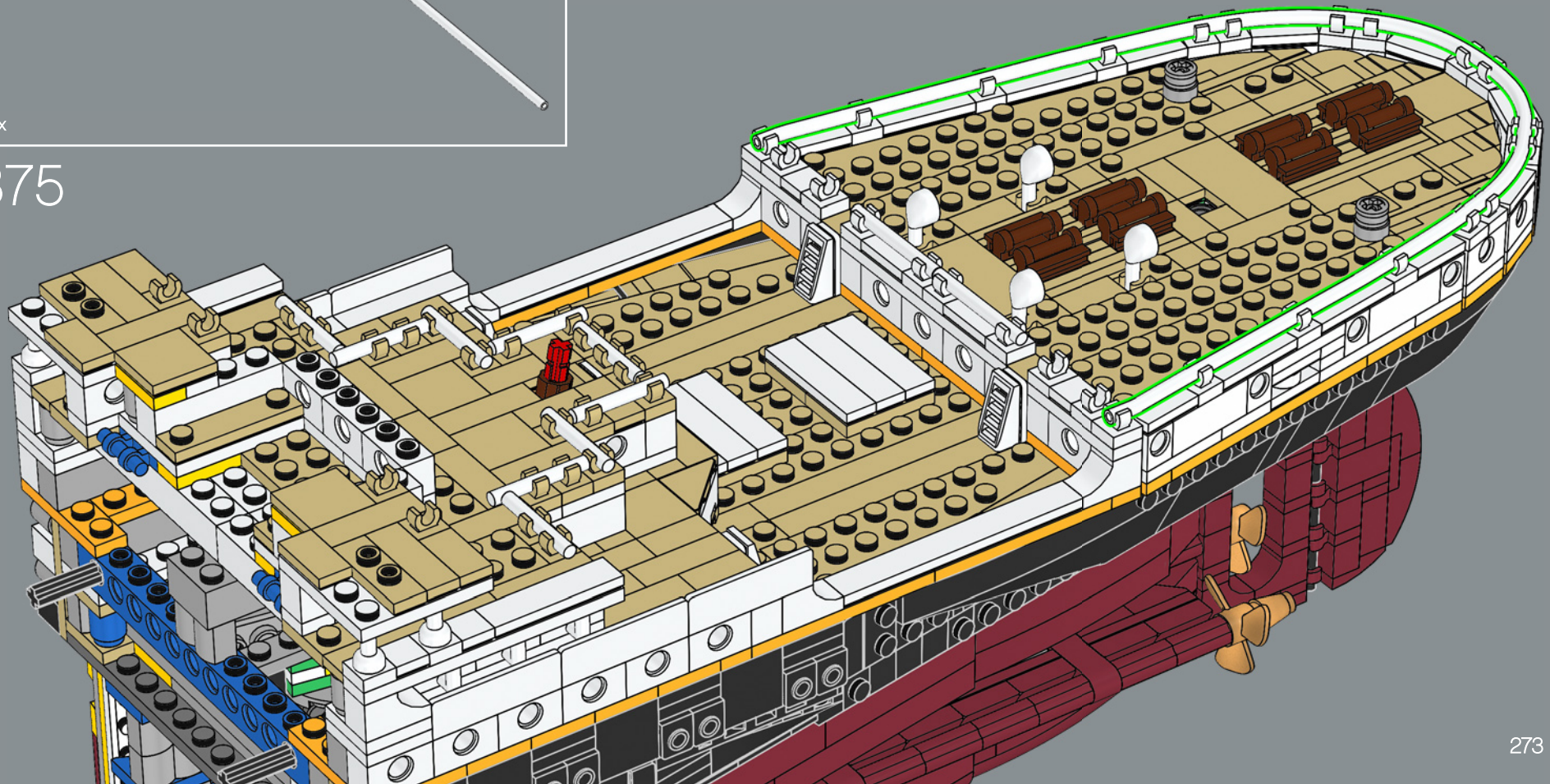



376

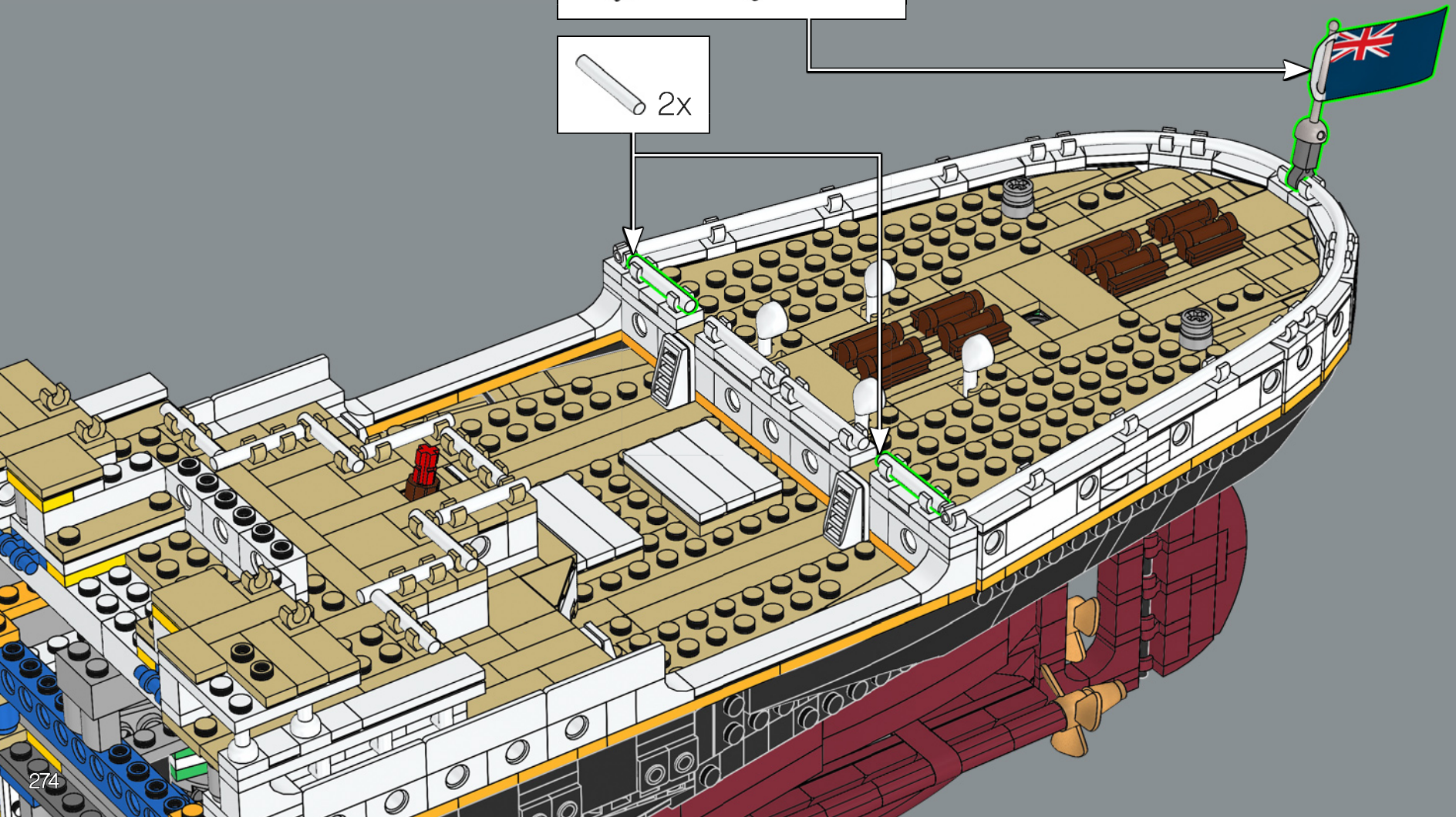
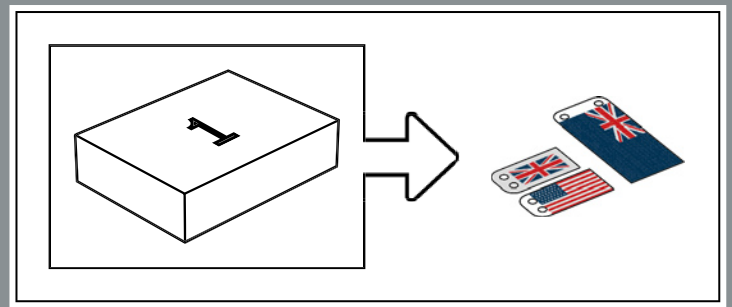
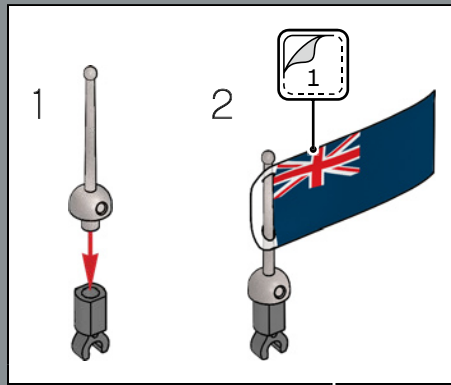

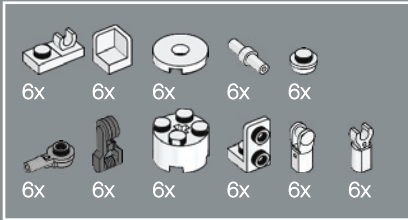
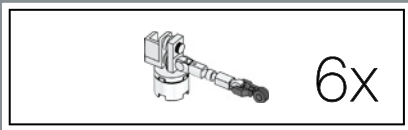

377

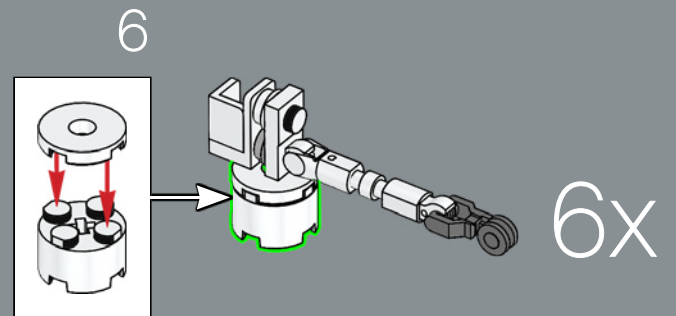
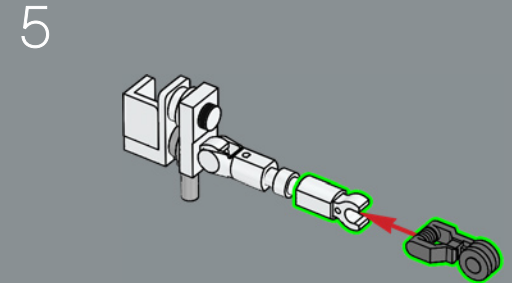
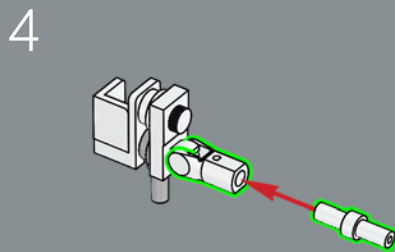
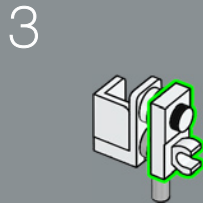
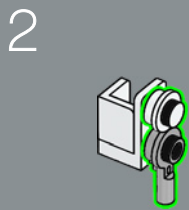
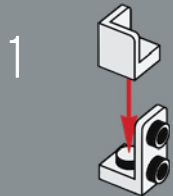

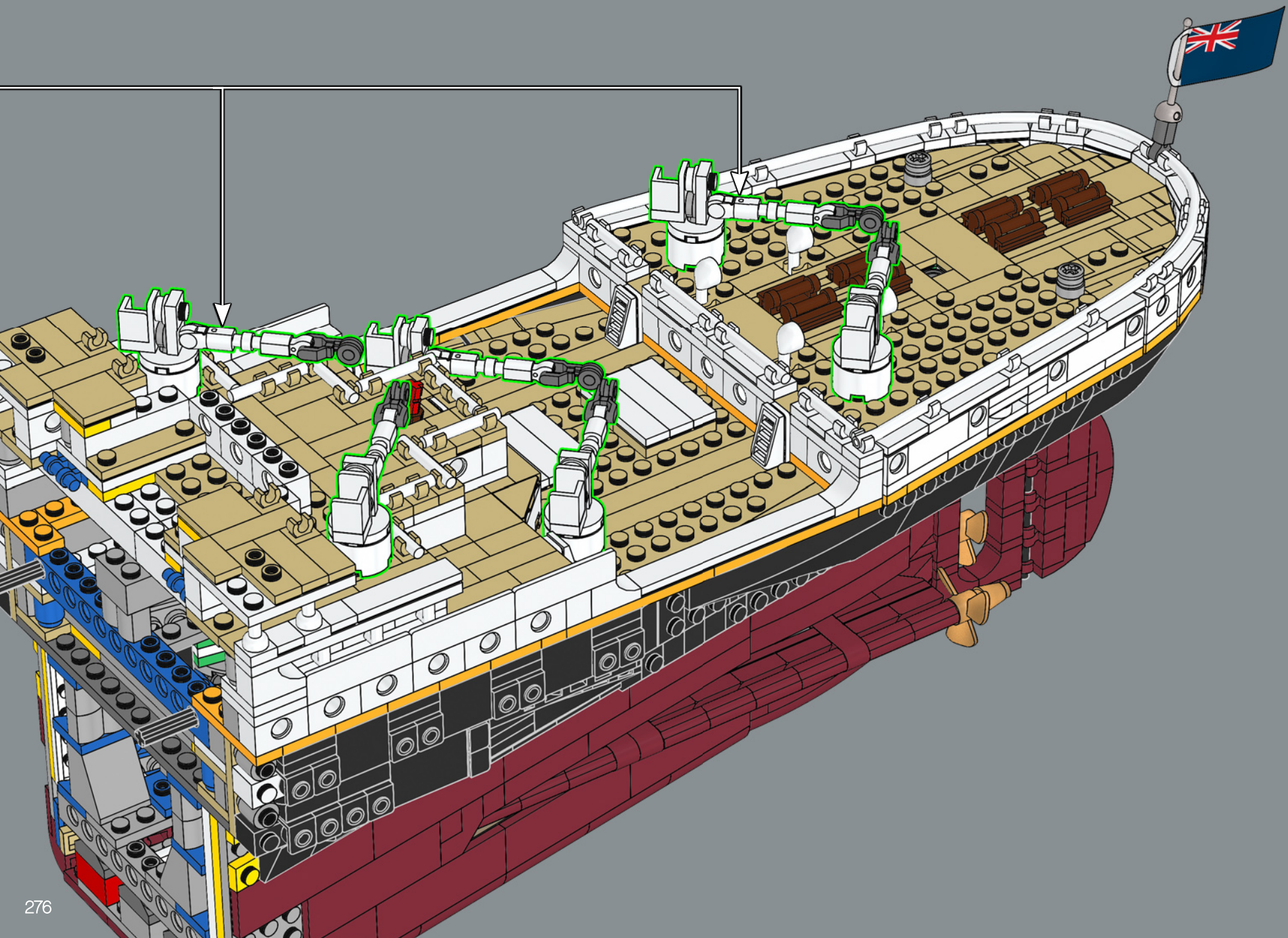

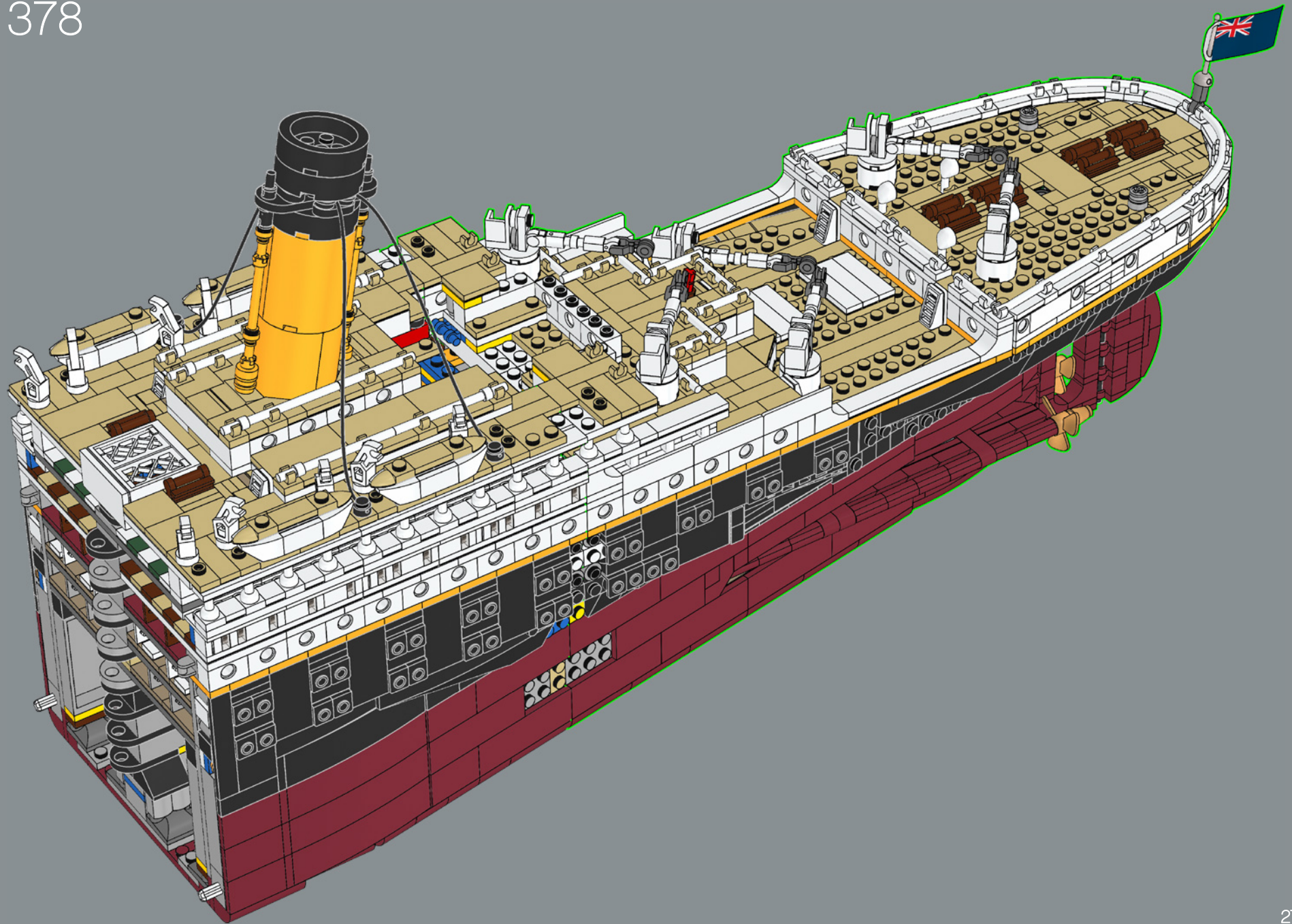

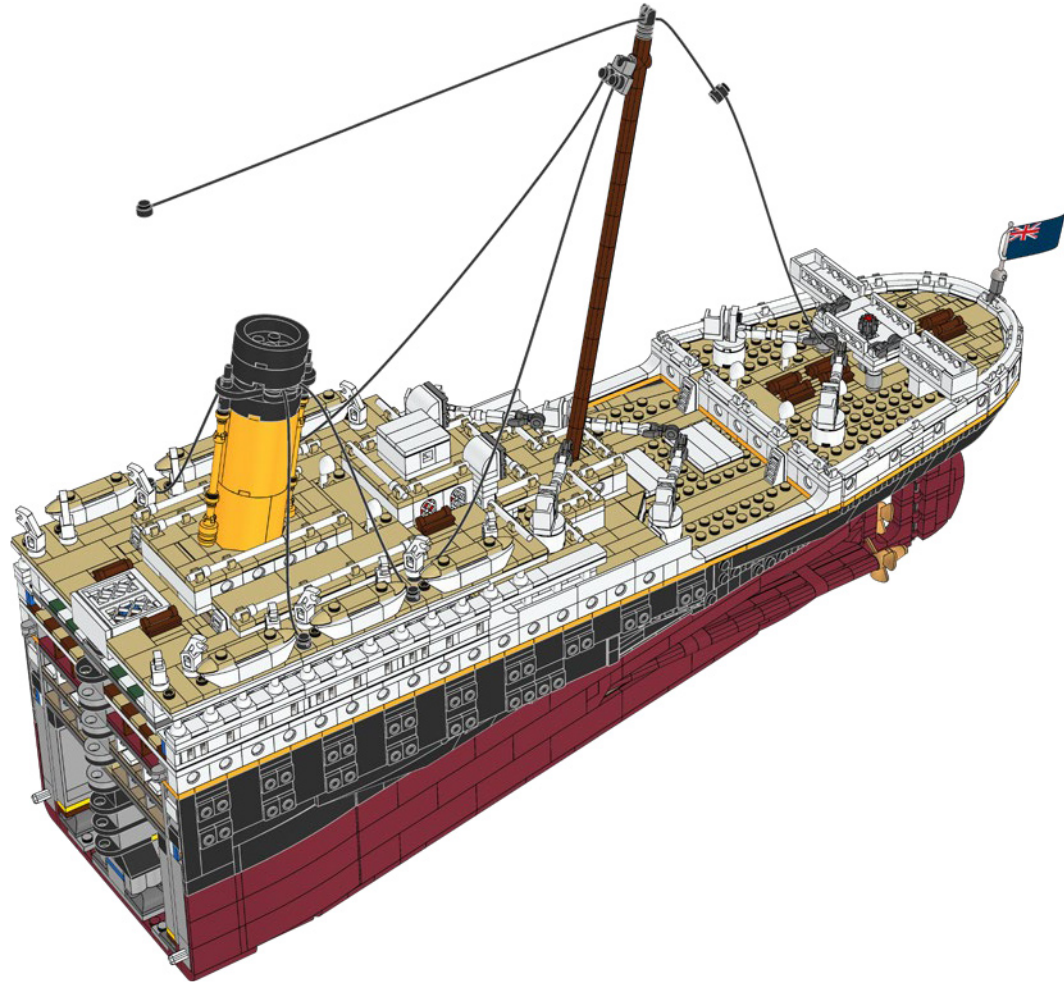
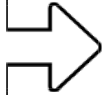

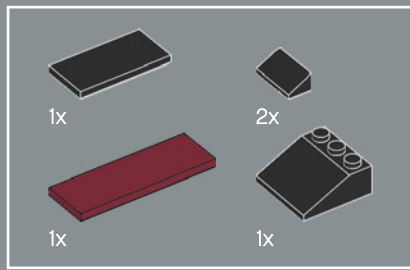

379

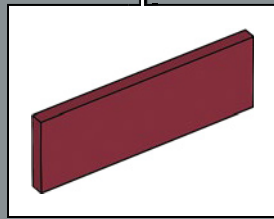
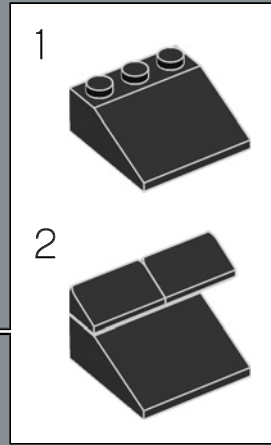
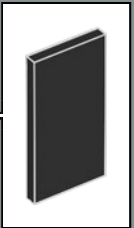
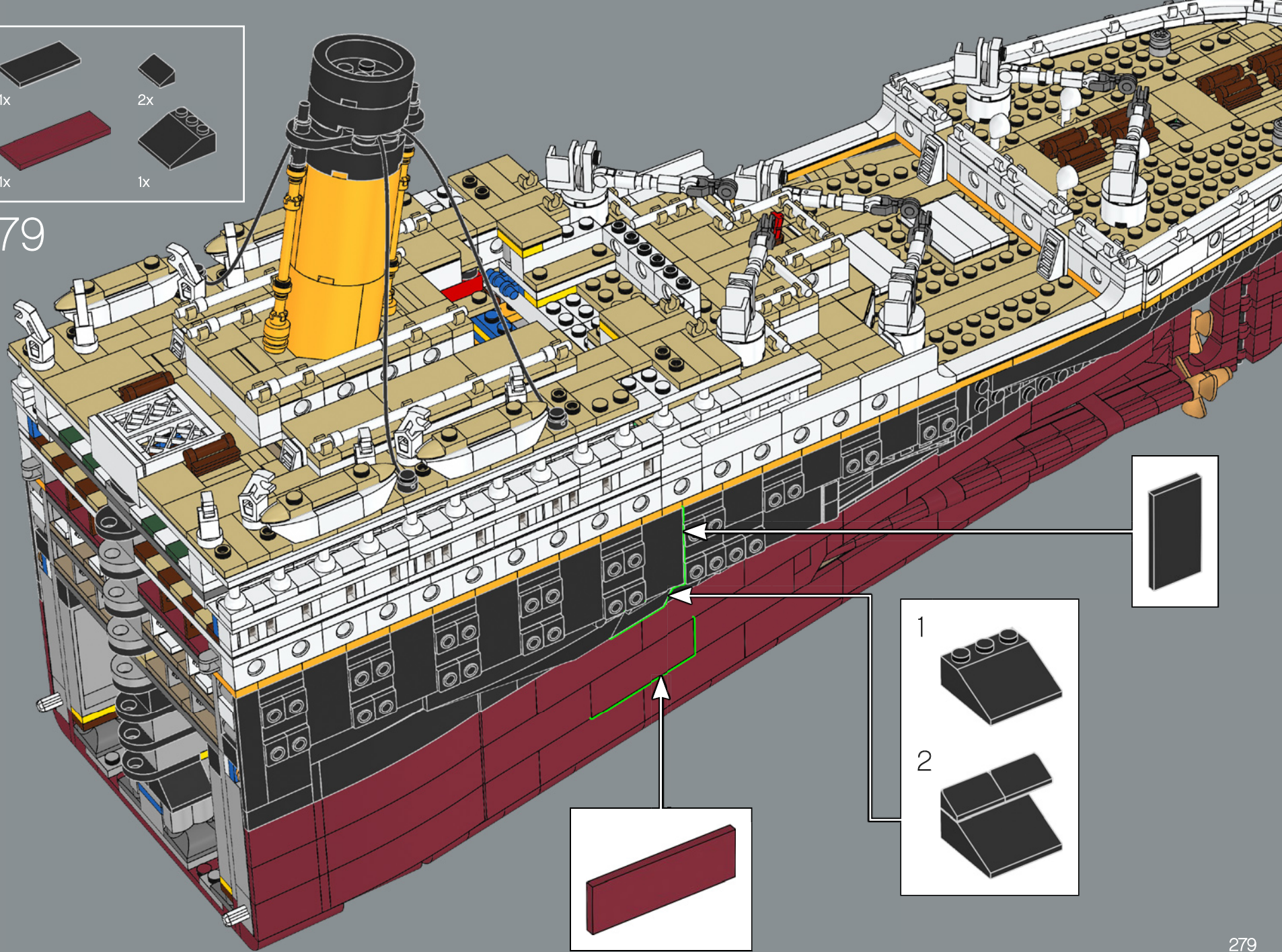

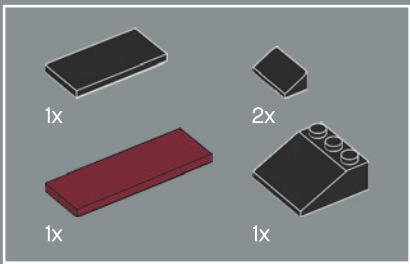

380

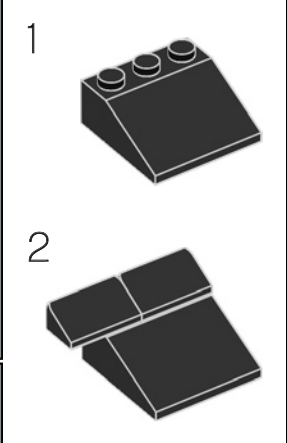
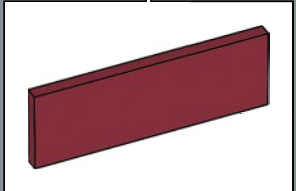
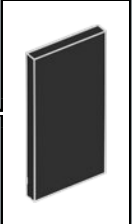
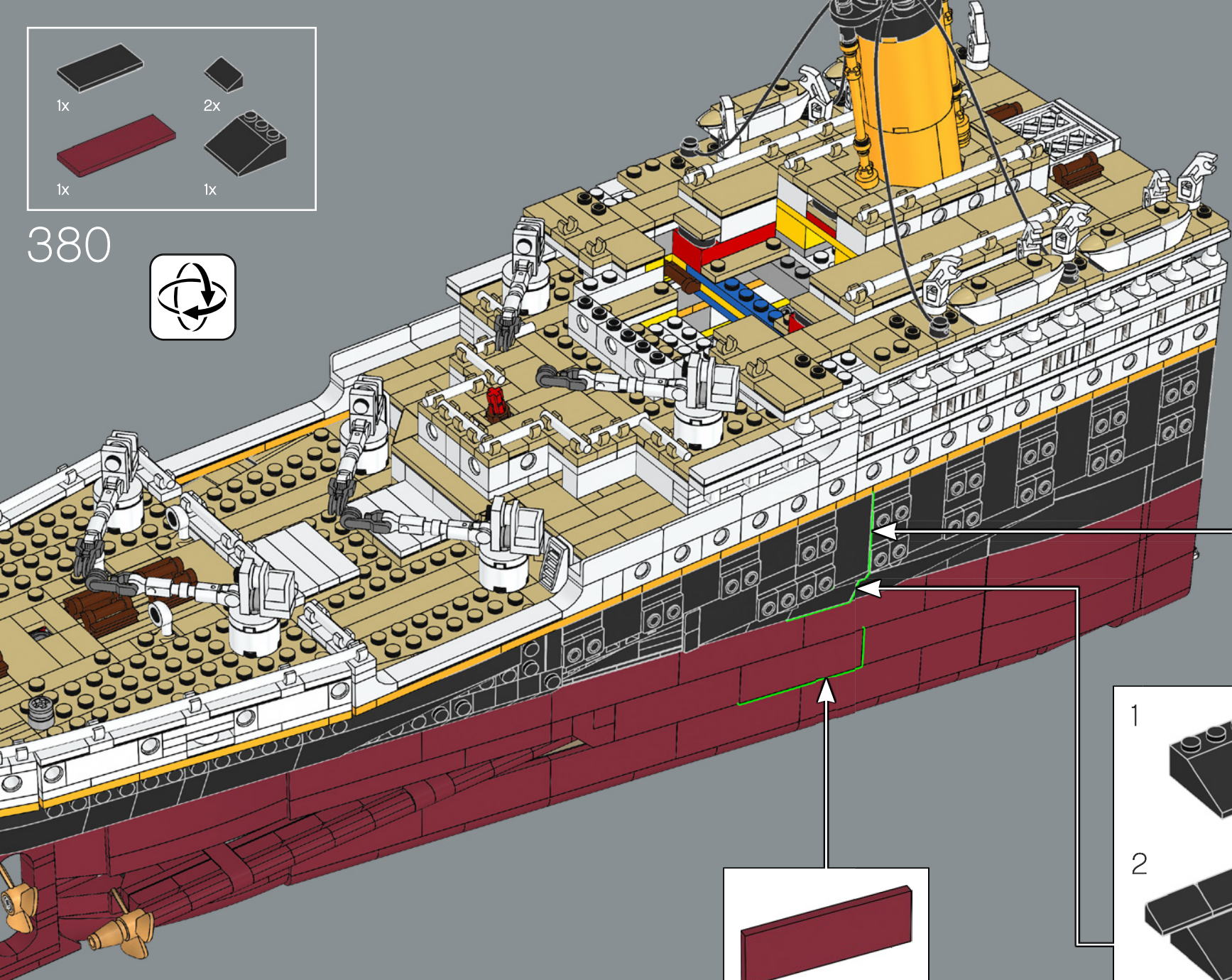



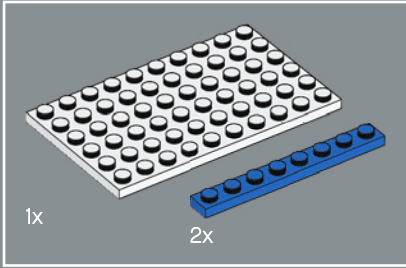
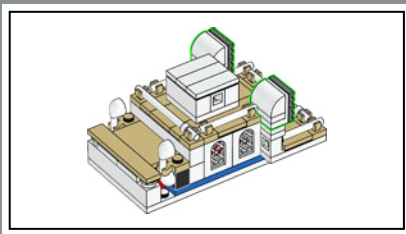

381

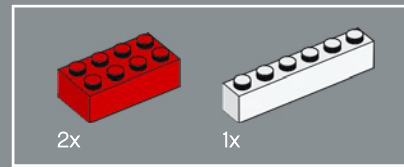
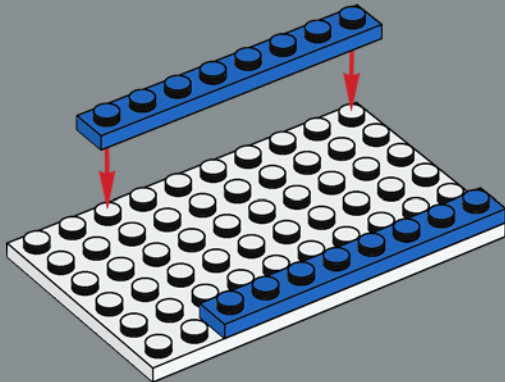

382

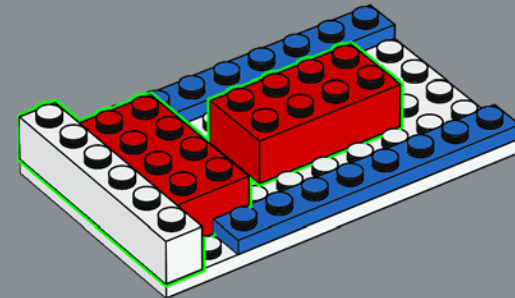

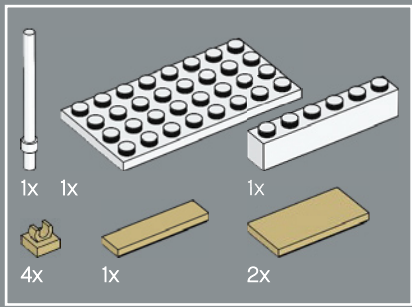

383

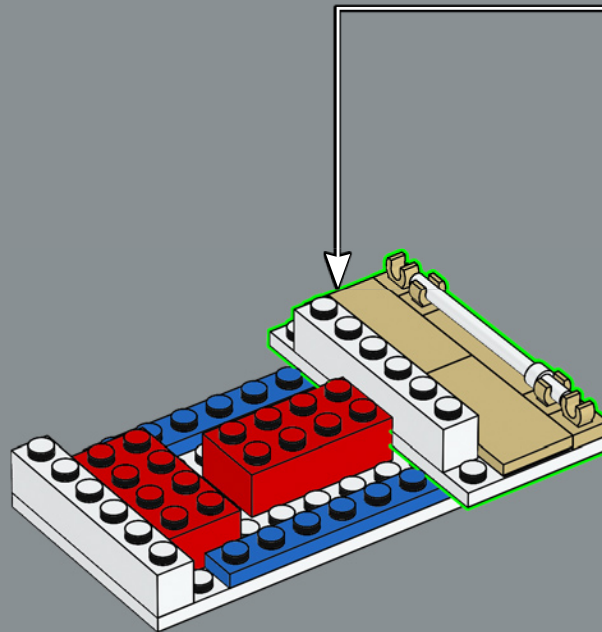
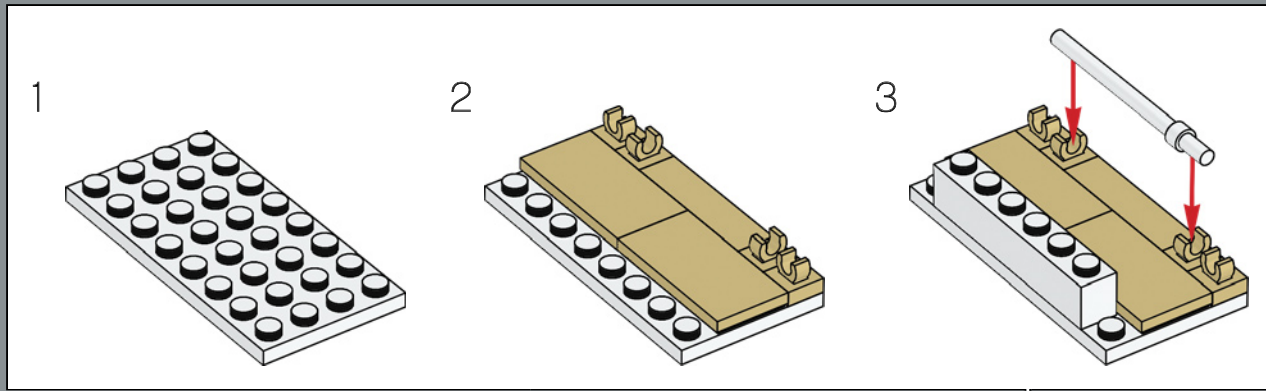

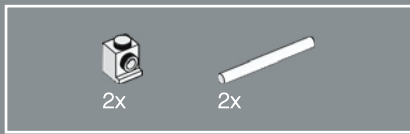

384

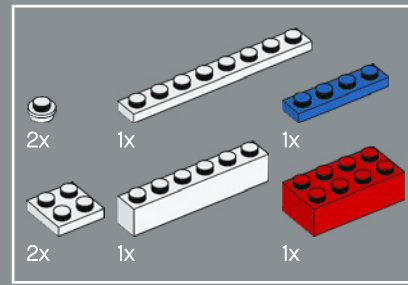
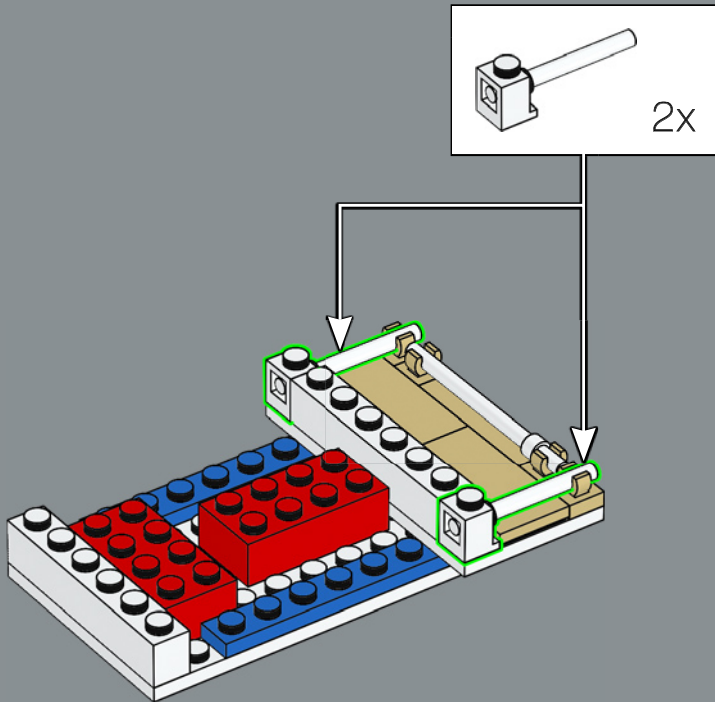

385

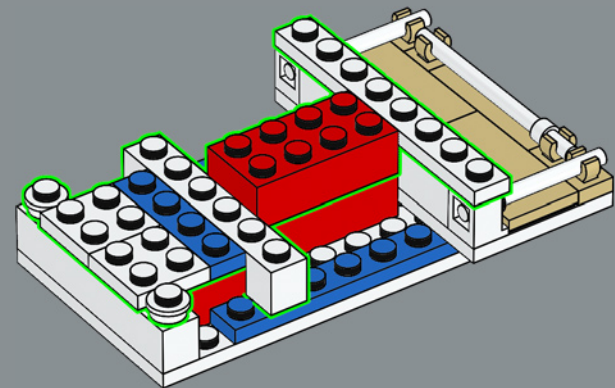

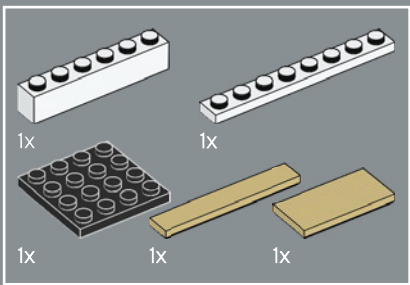

386

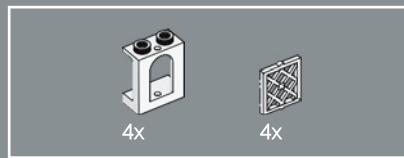
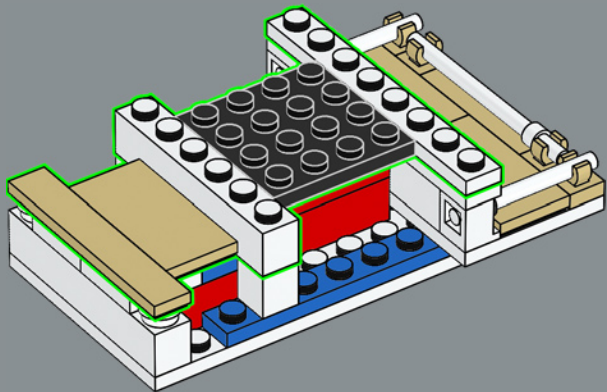

387

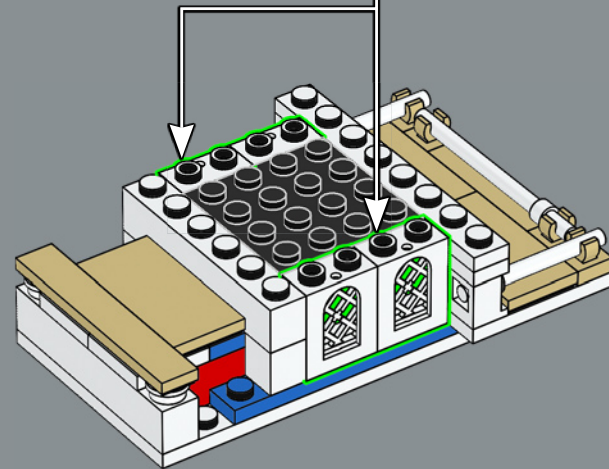
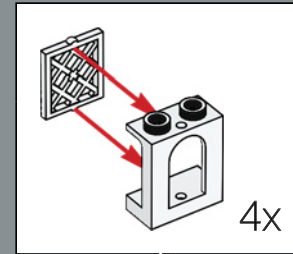

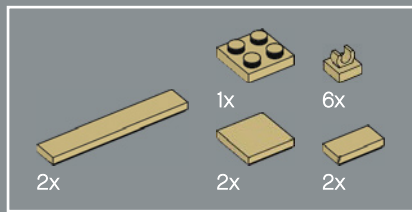

388

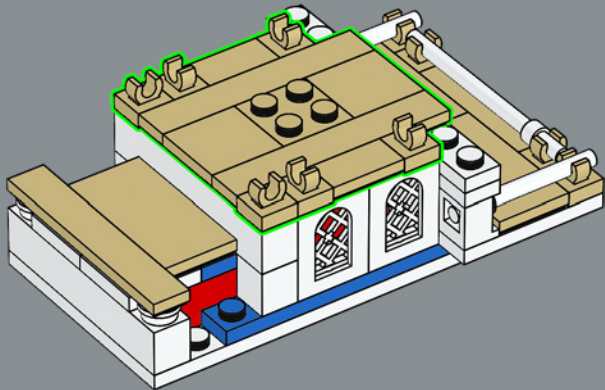

389

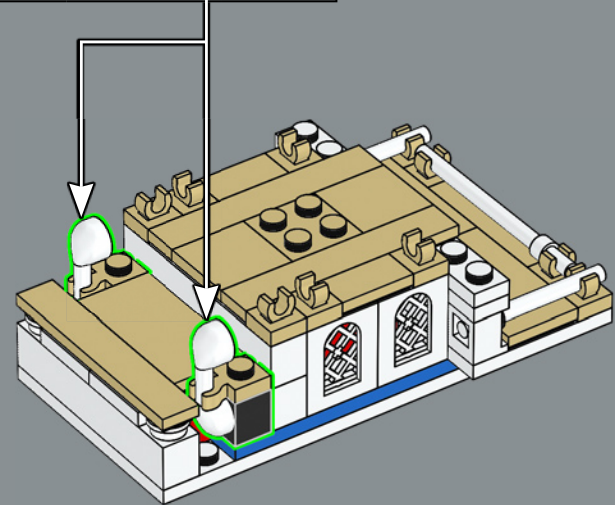
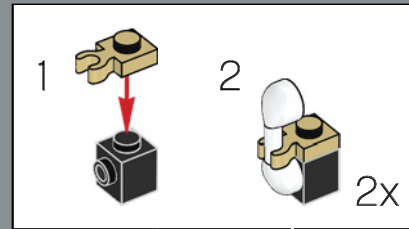

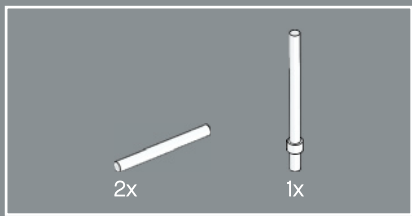

390

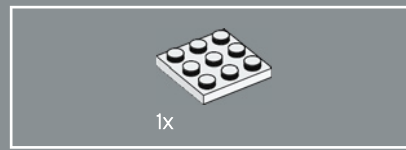
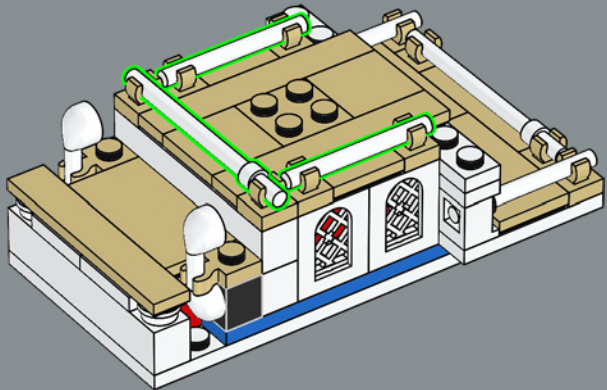

391

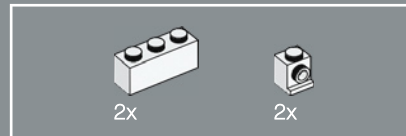
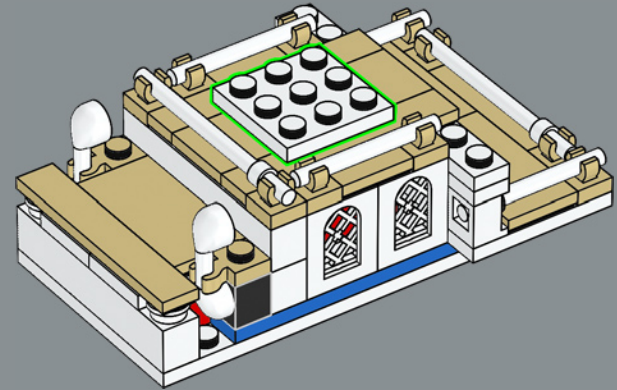

392

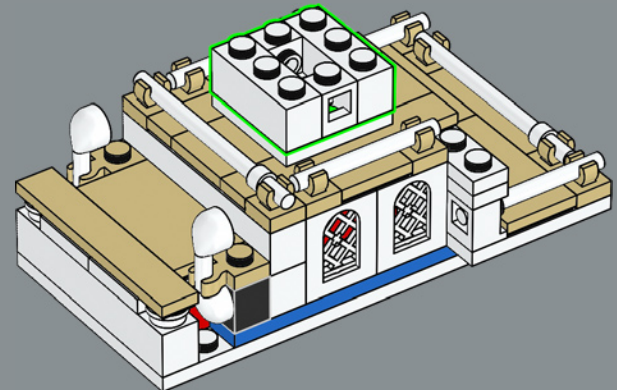

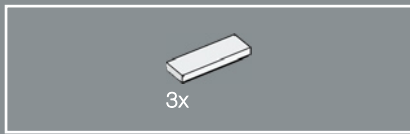

393

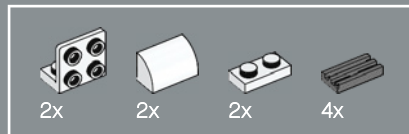
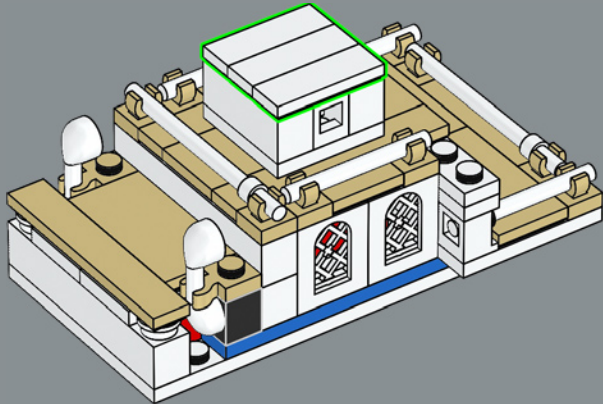

394

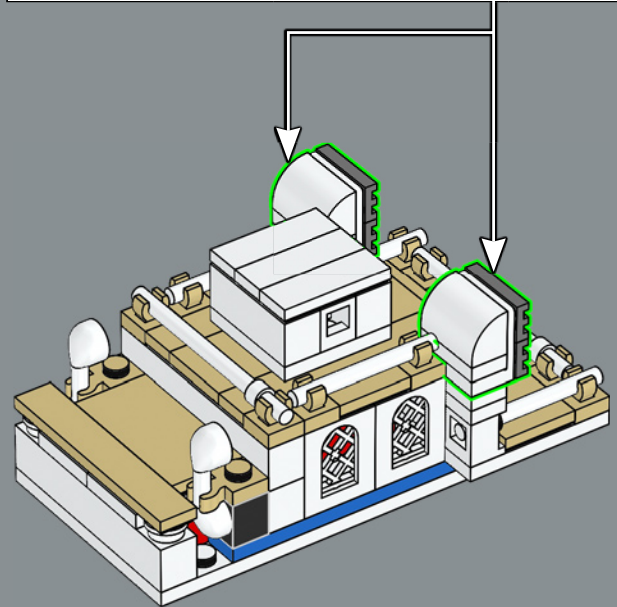
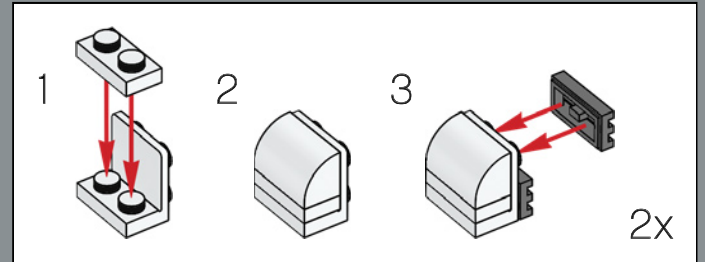

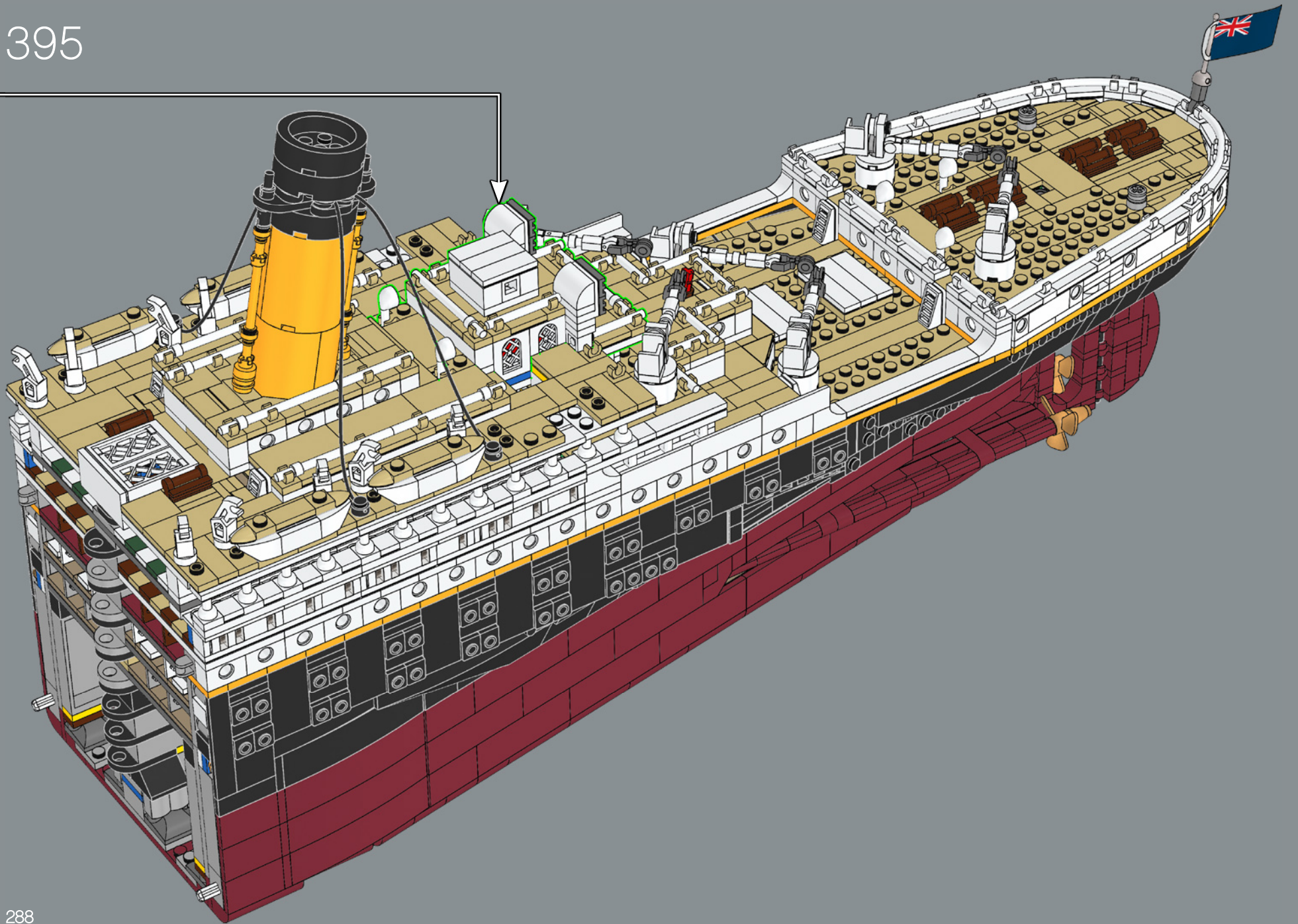



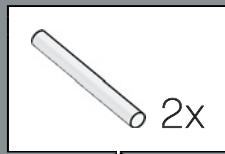
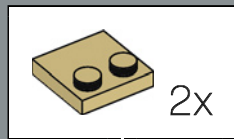
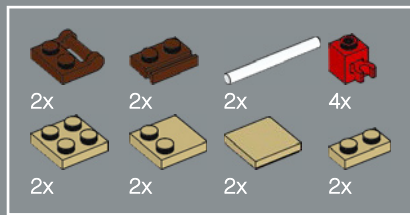

396

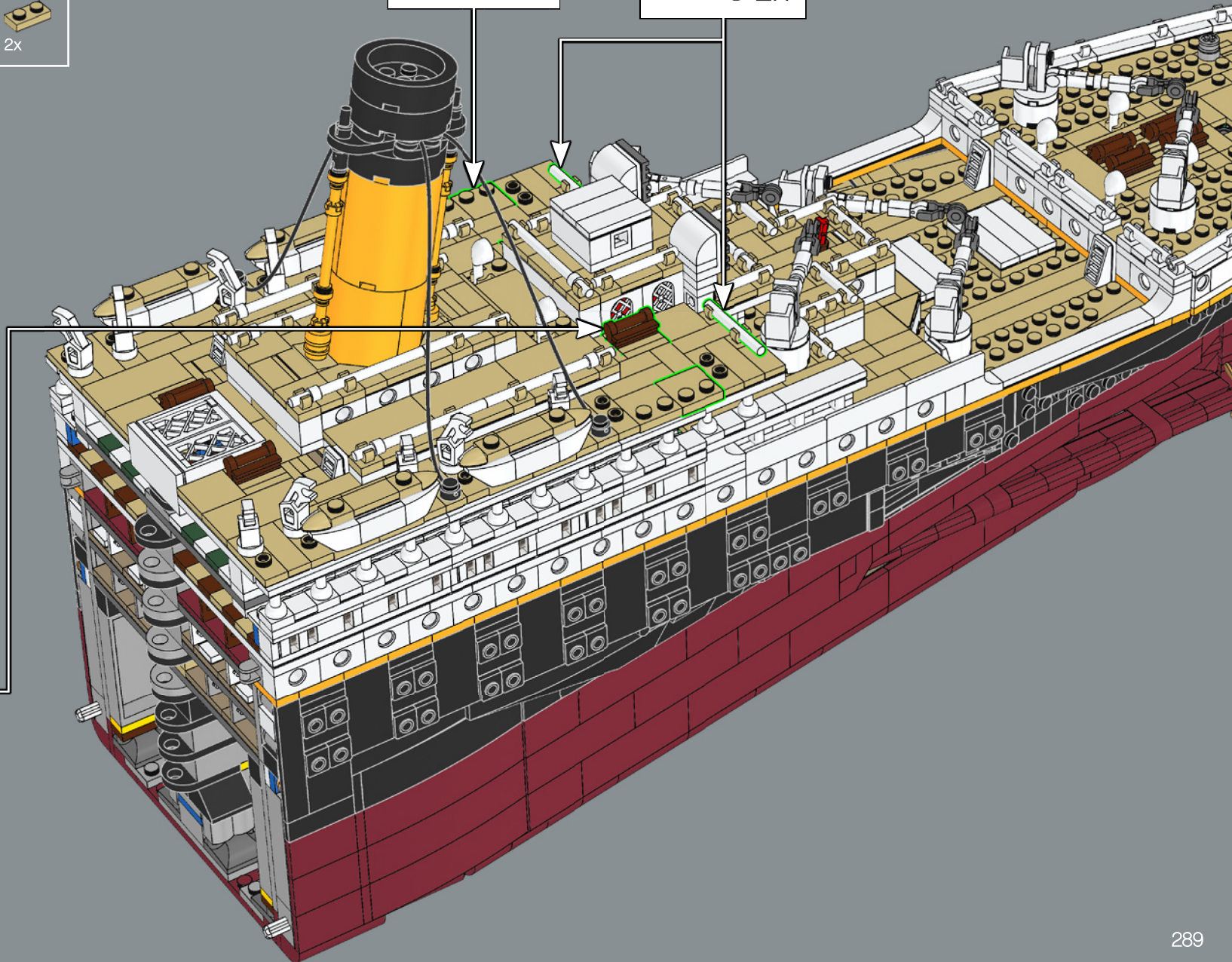
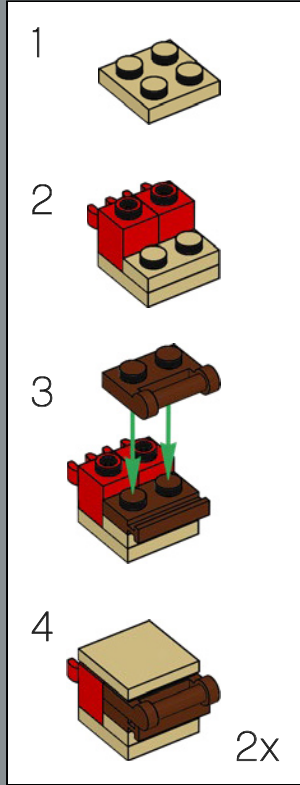

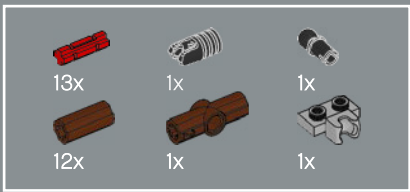

397

1

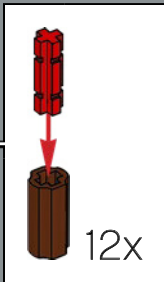
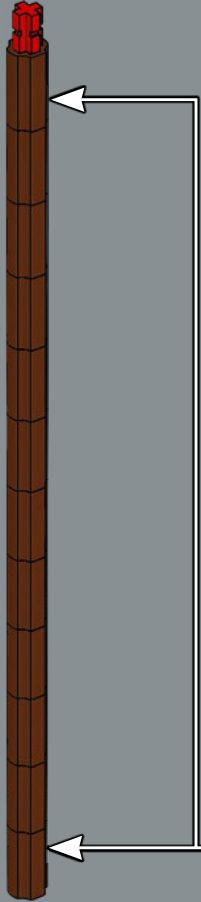

2



3

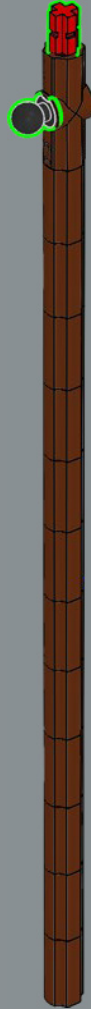

4

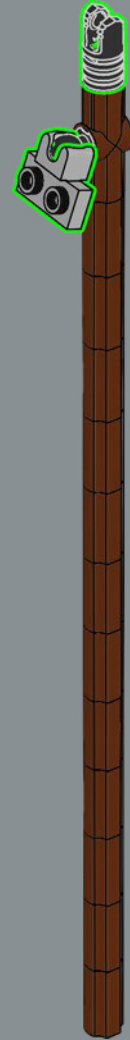

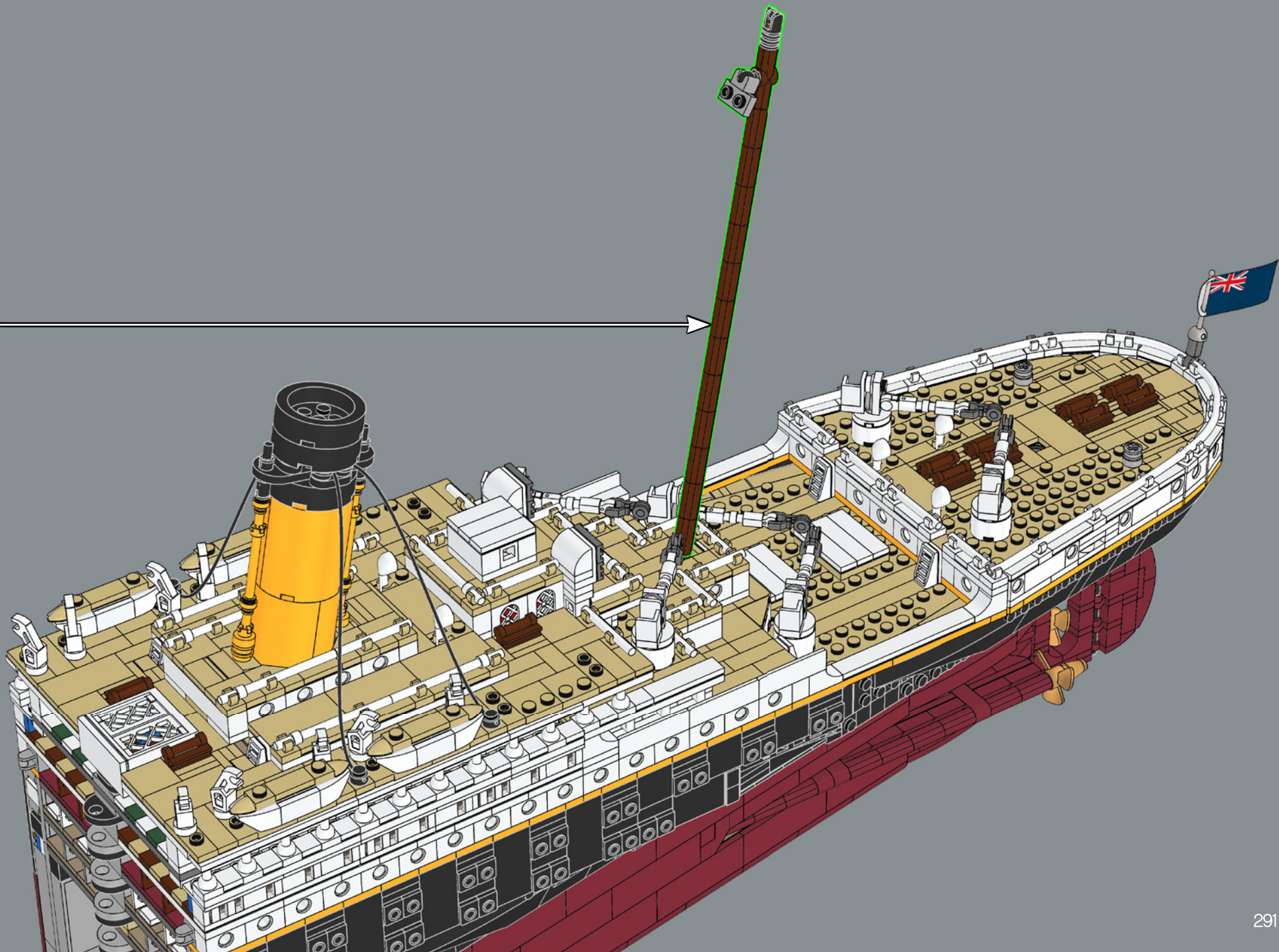

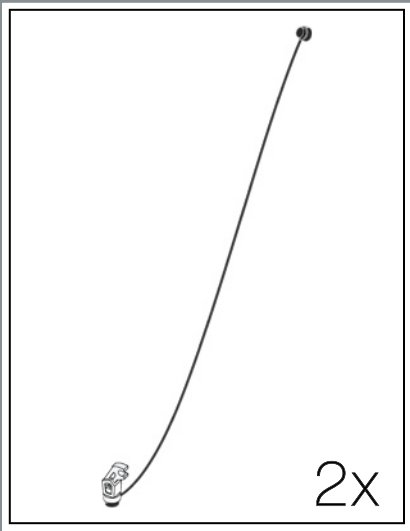

398

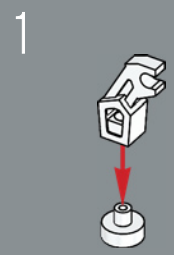

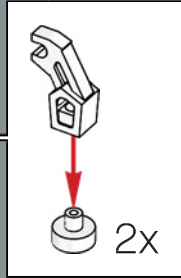
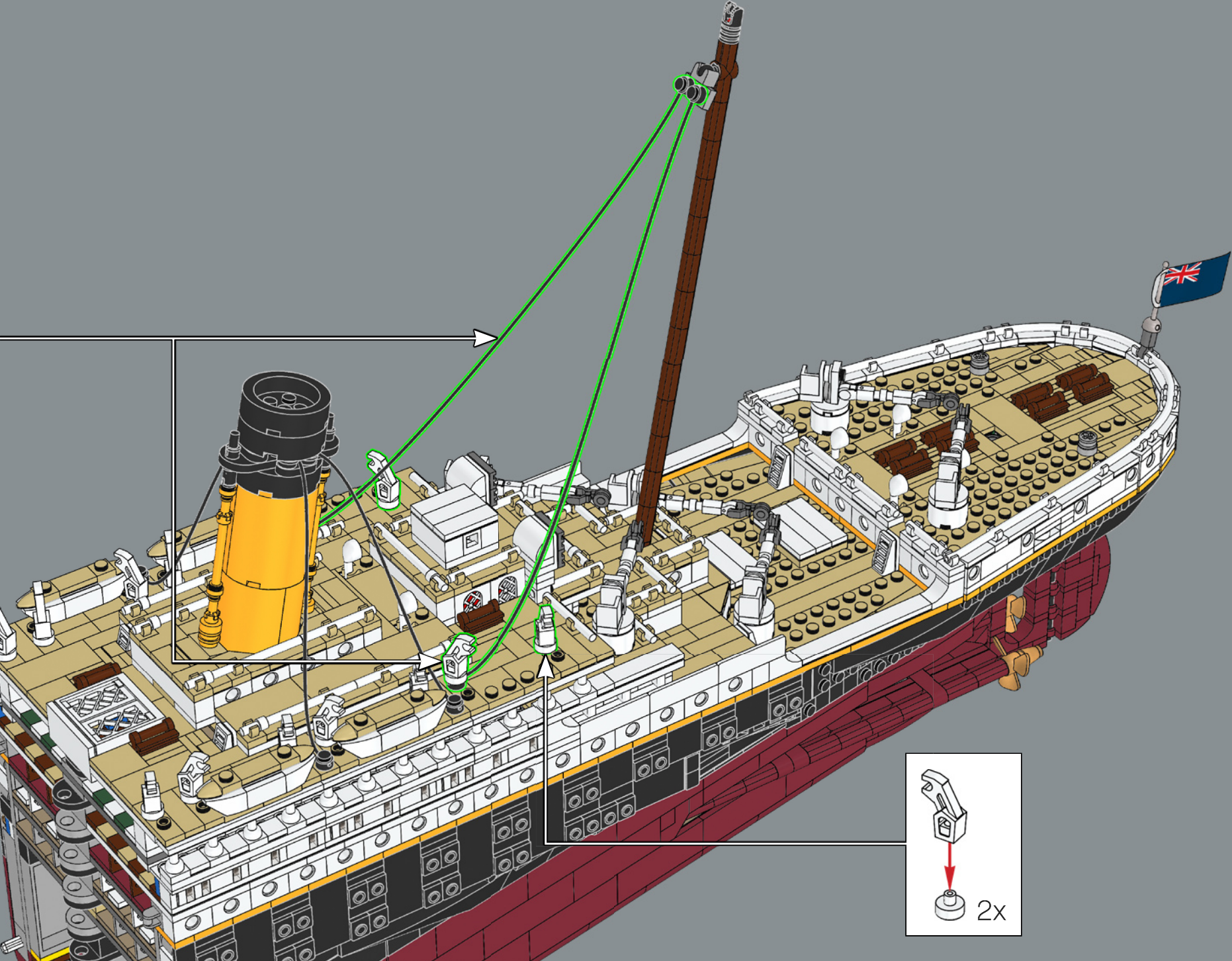

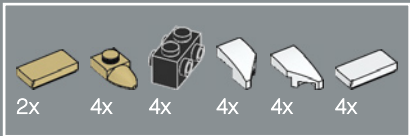

399

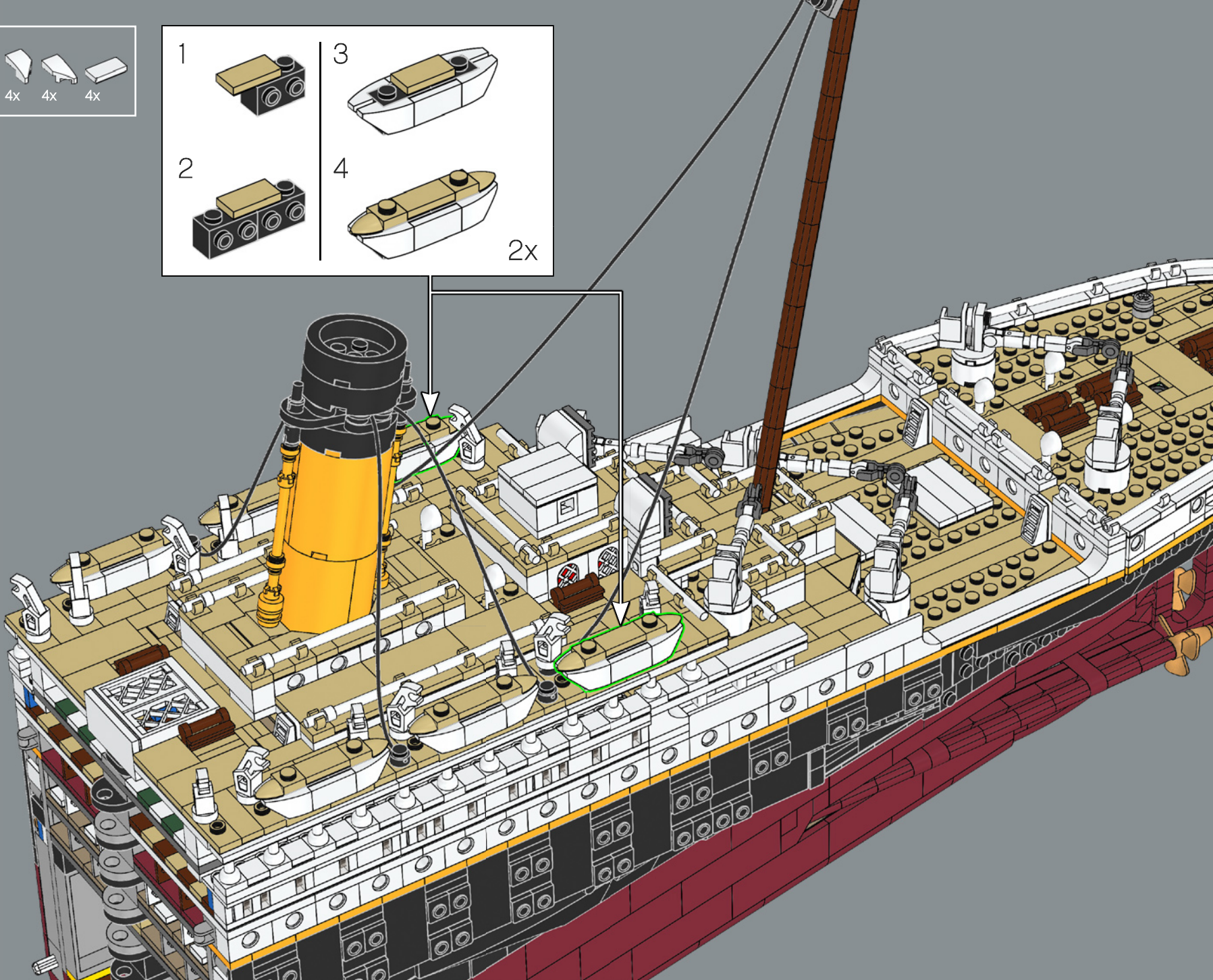
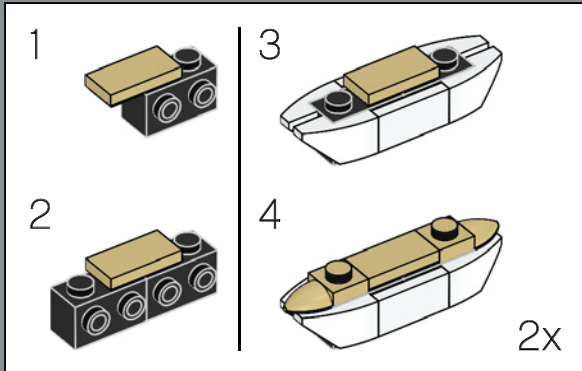

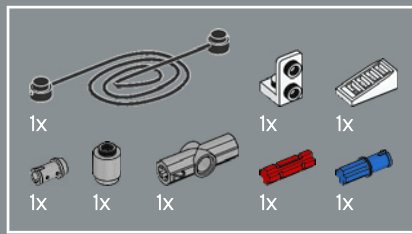

400

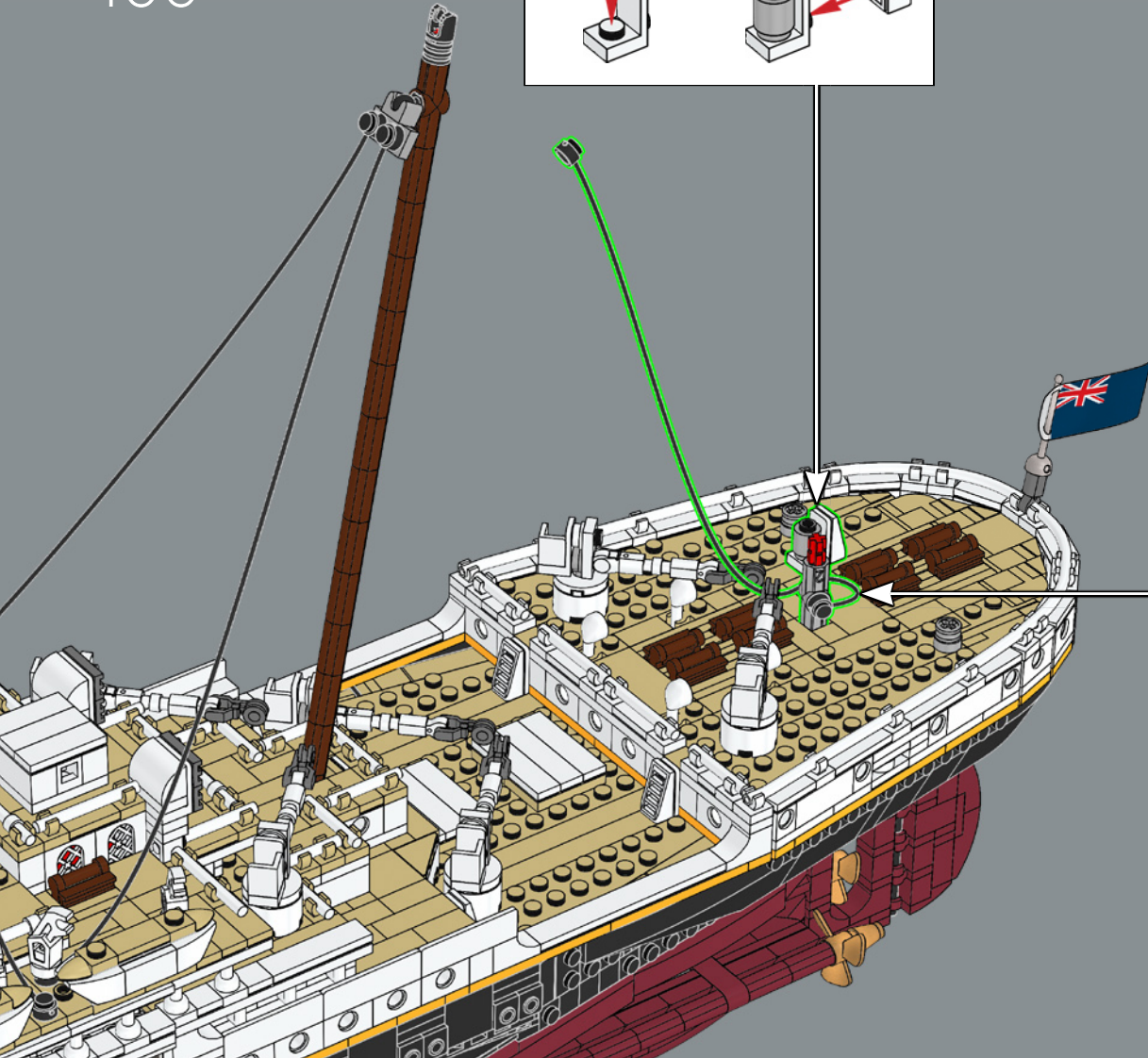
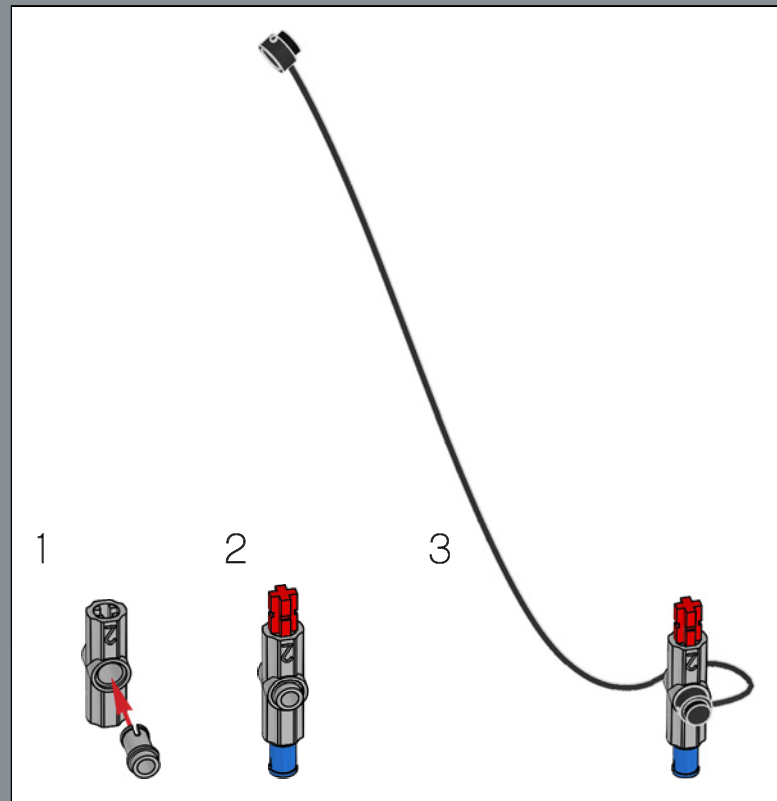
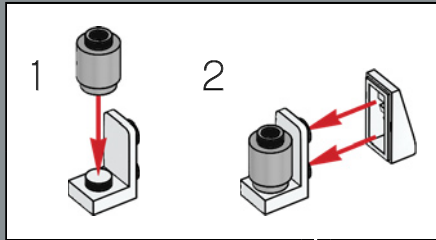

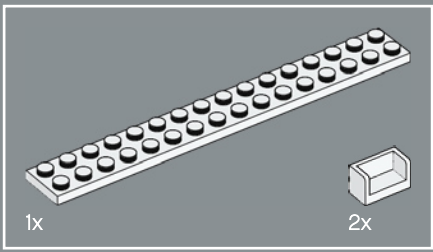

401

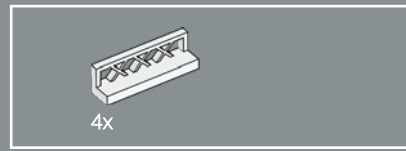
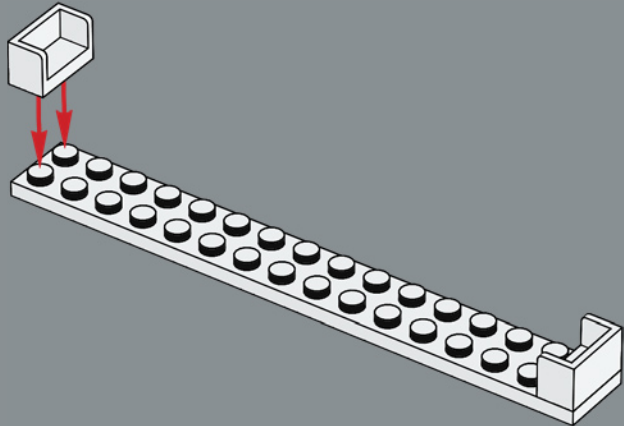

402

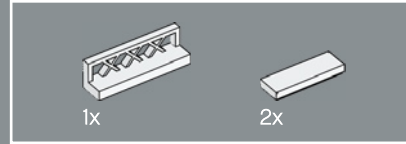
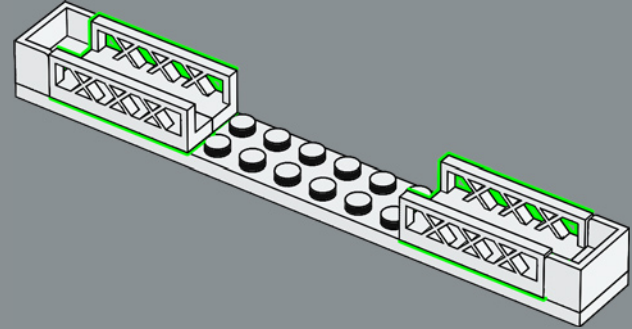

403

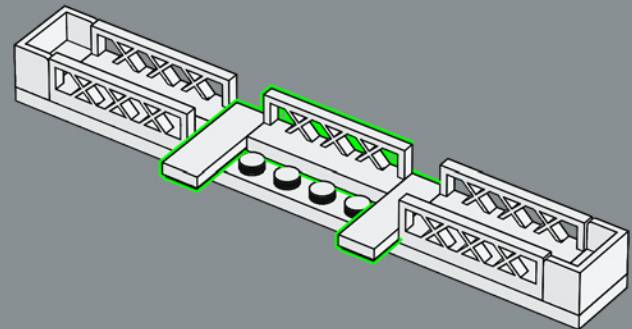



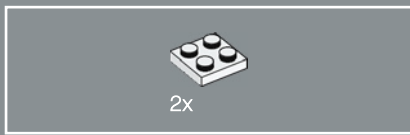

404

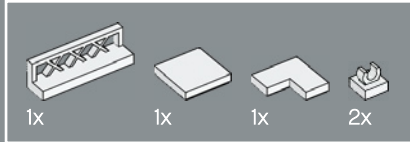
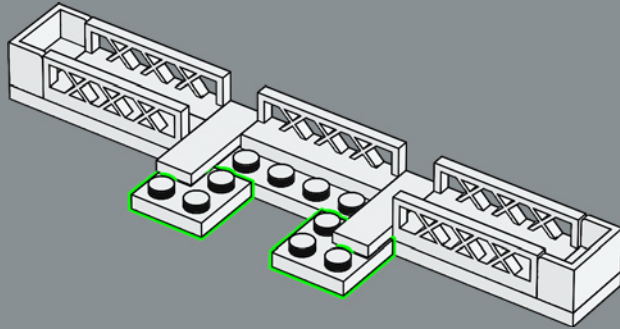

405

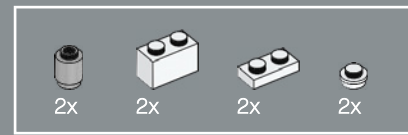
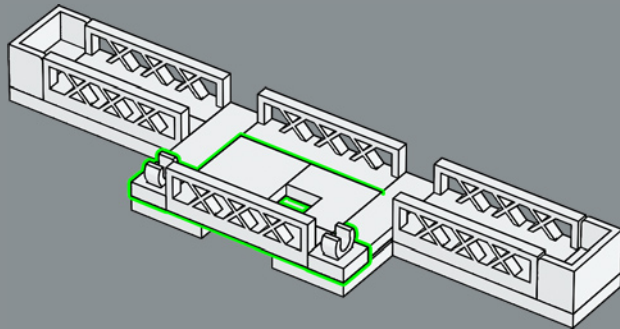

406

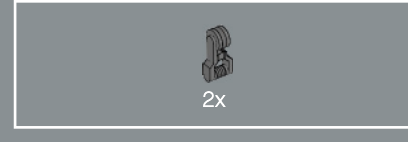
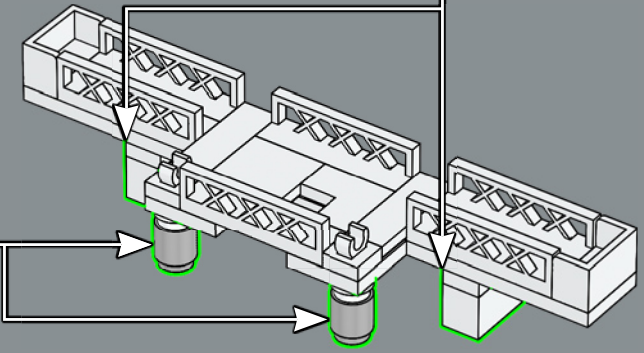
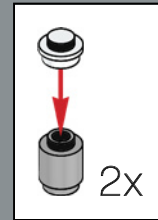
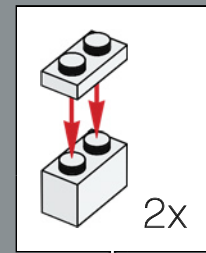

407

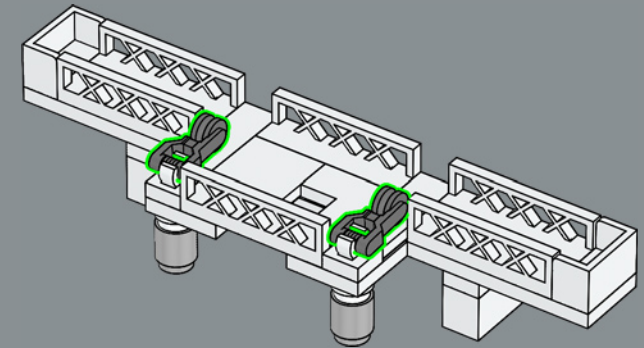



1x

408

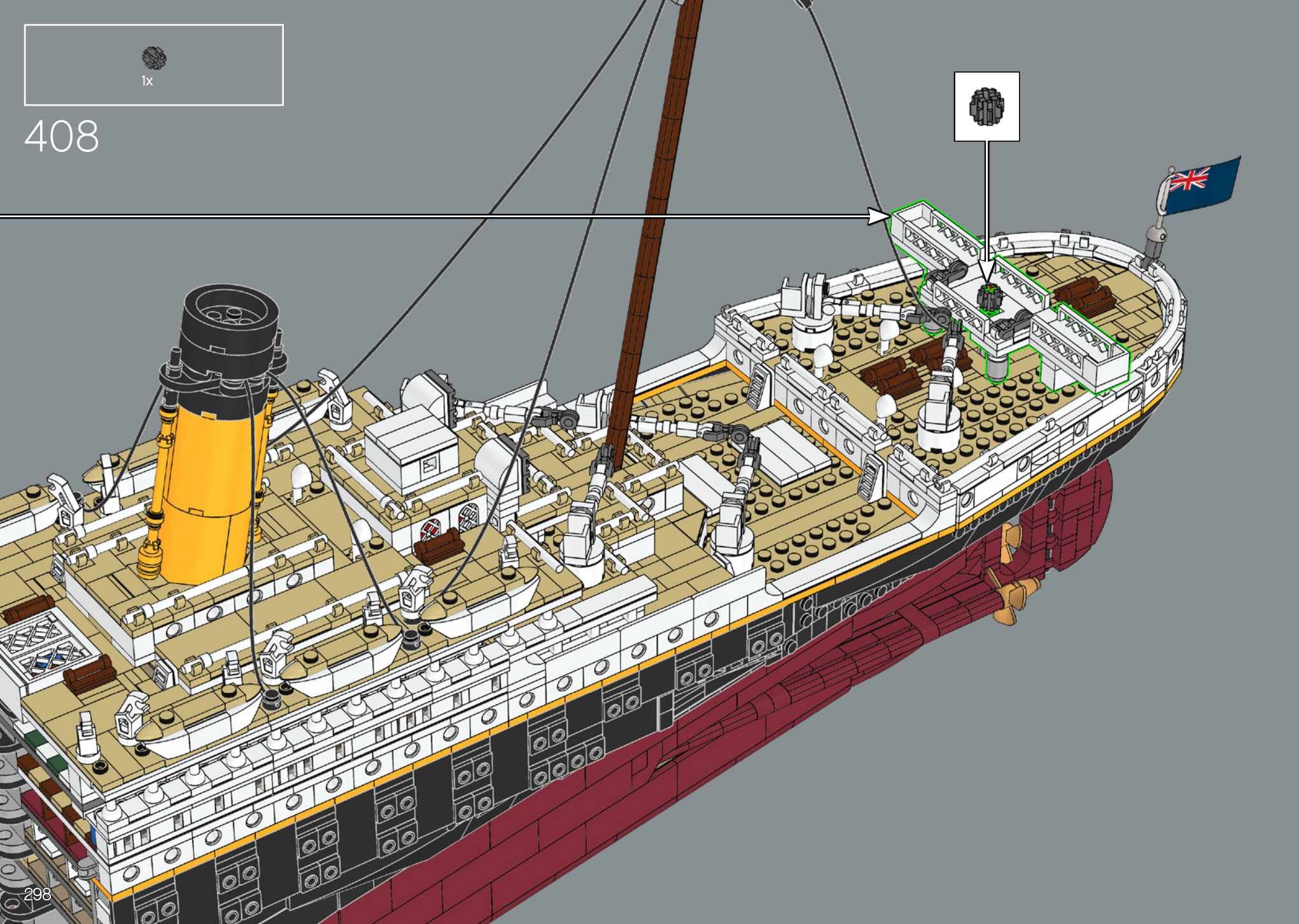

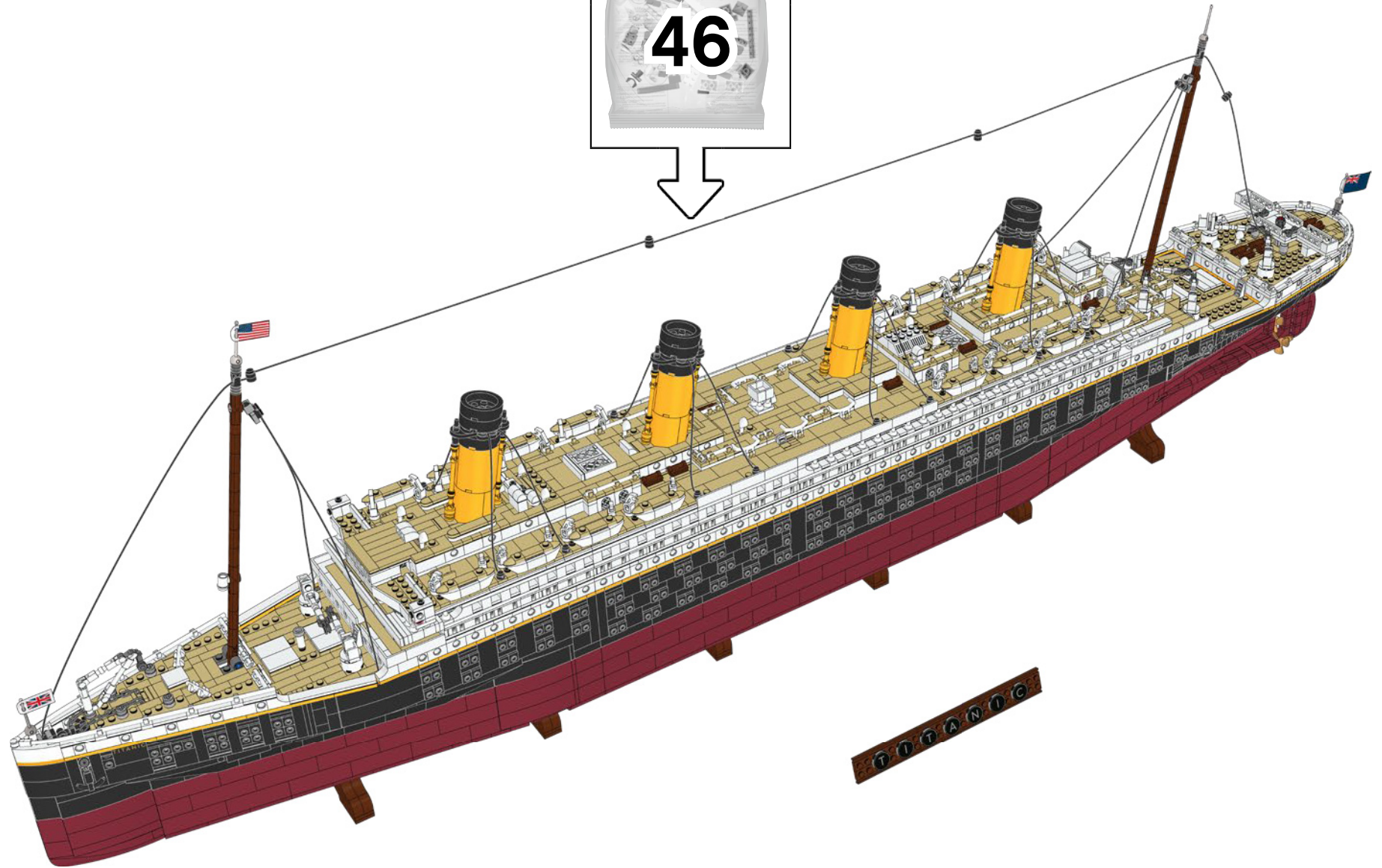

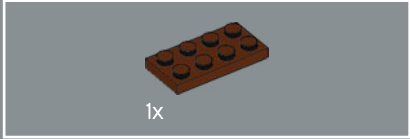
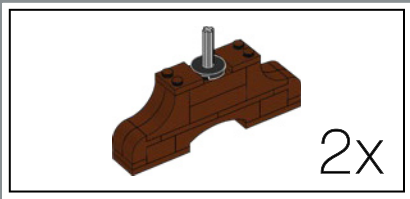

409

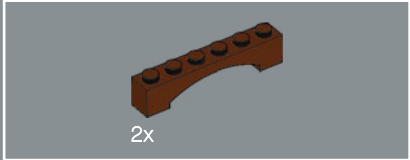
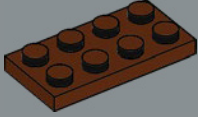

410

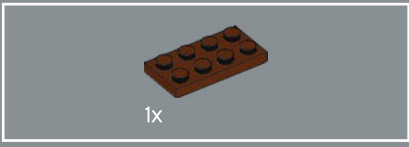
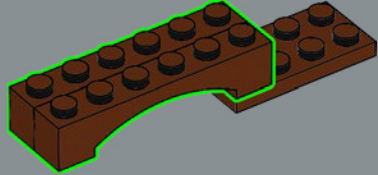

411

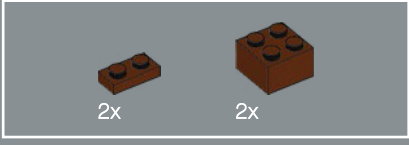
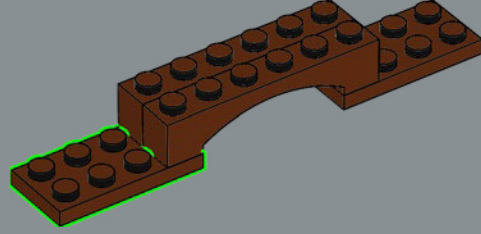

412

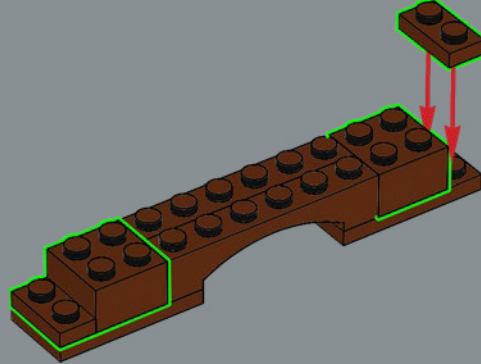

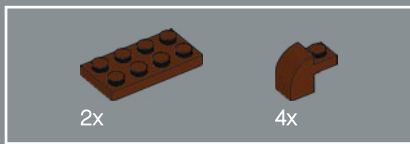

413

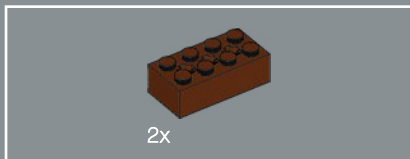
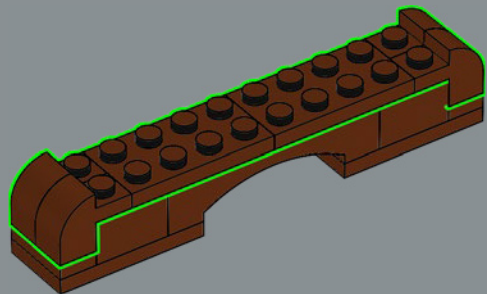

414

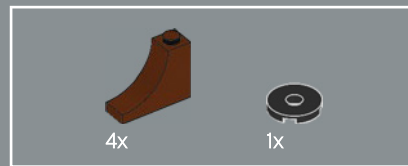
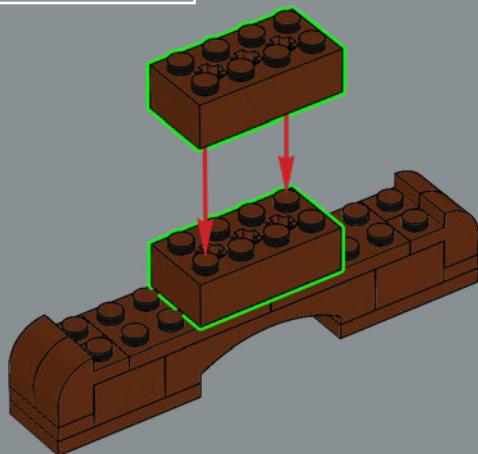

415

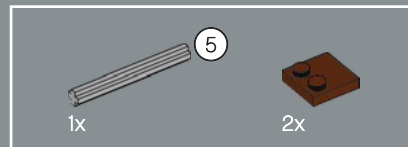
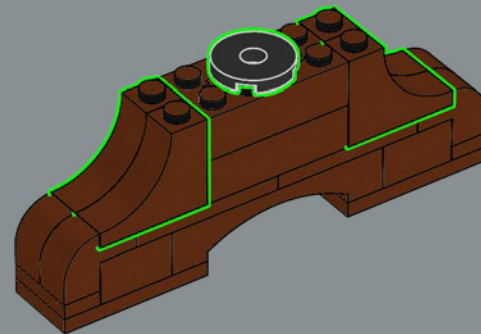

416

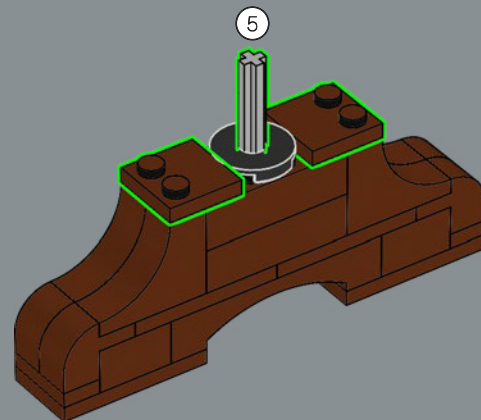

2x



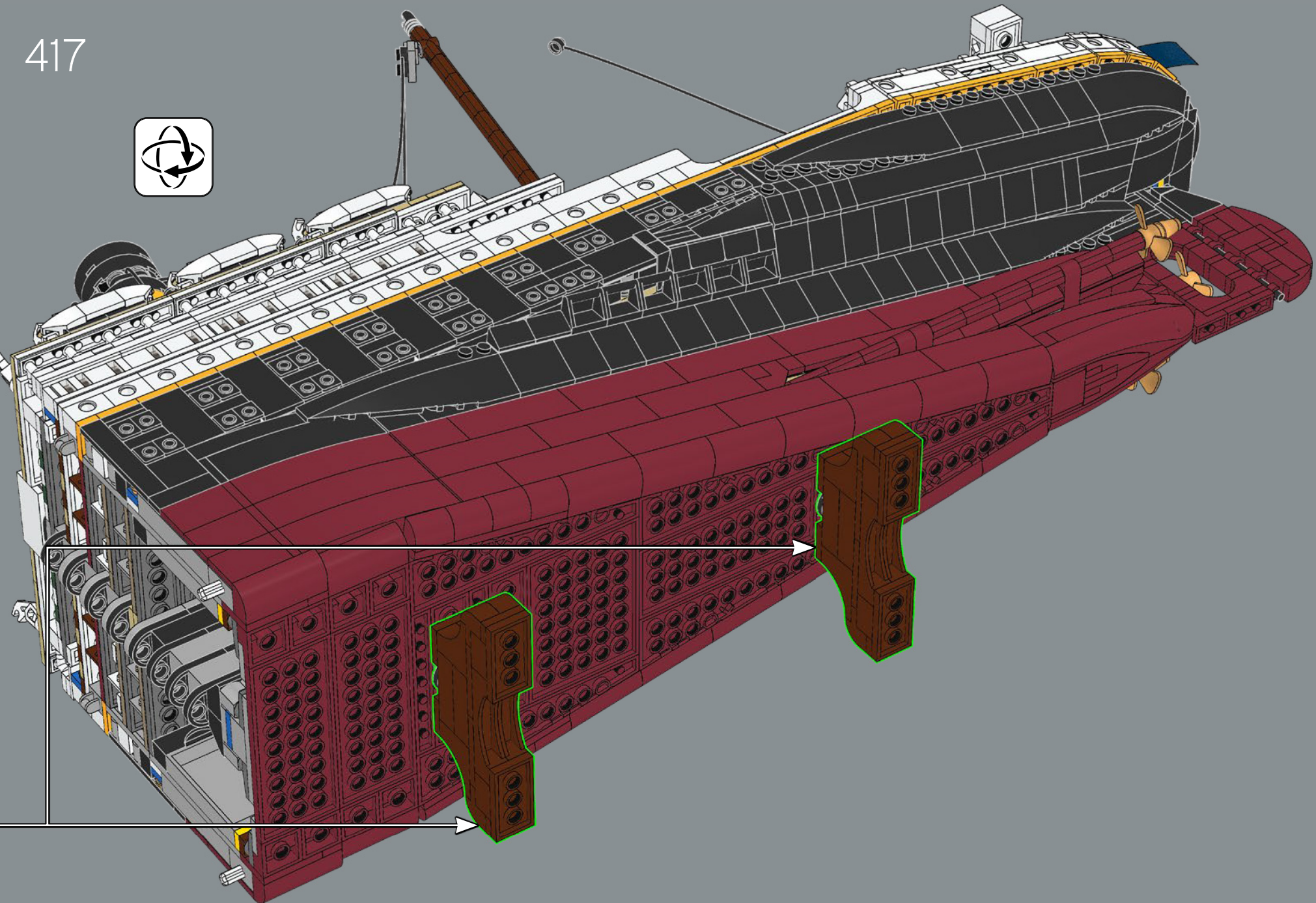

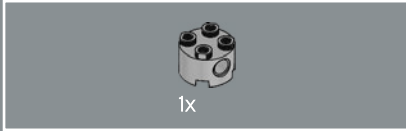
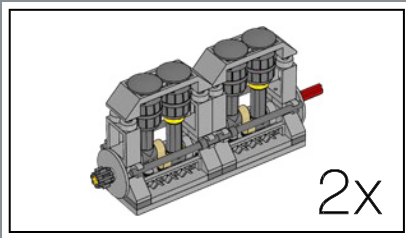

418

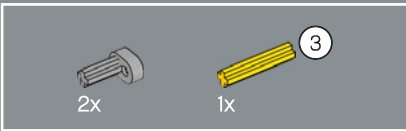
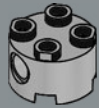

419

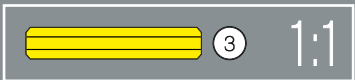
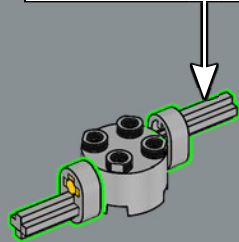
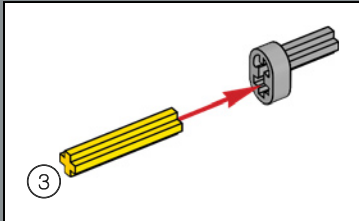

420

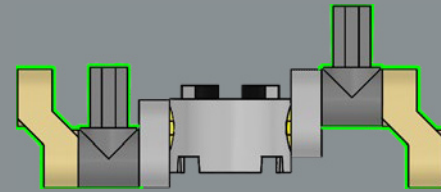

1:1

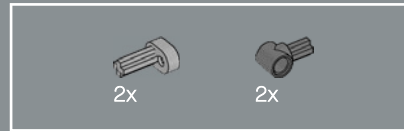

421

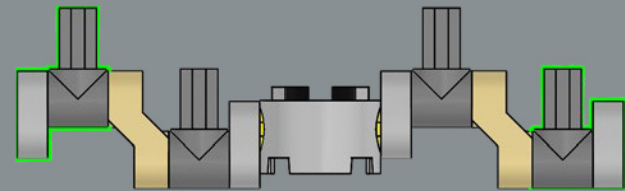

1:1

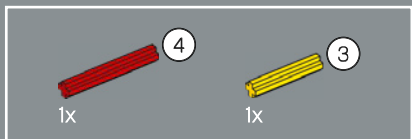

422

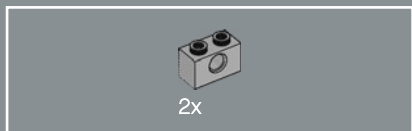
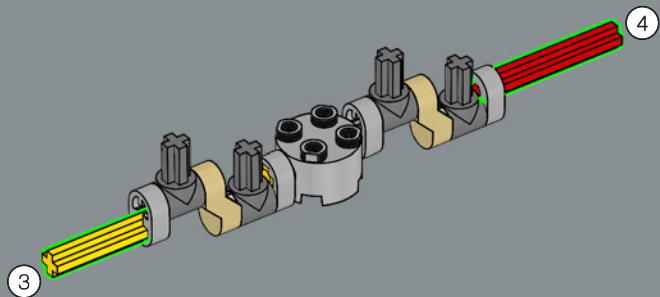

423

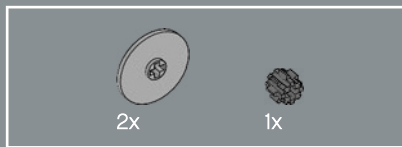
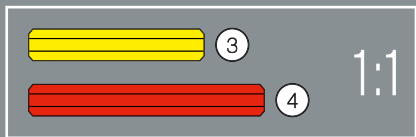
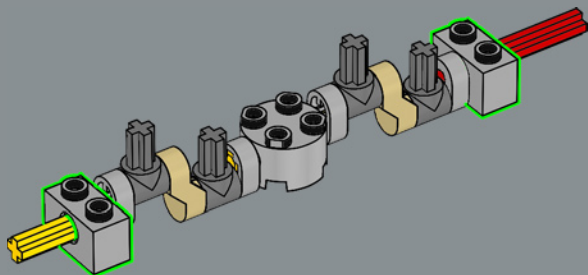

424

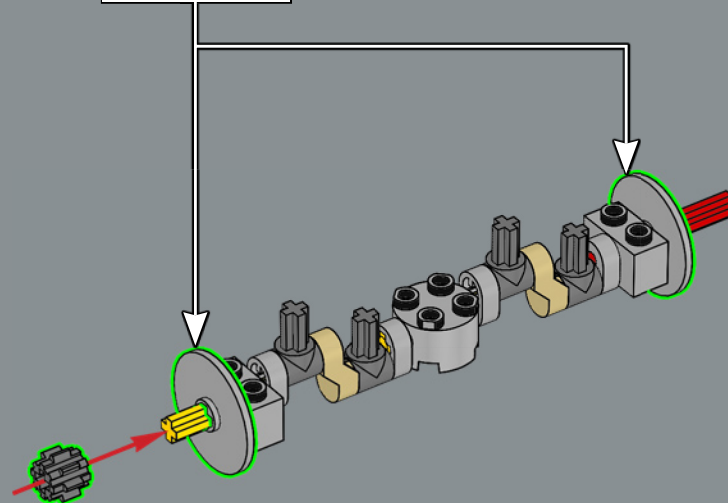
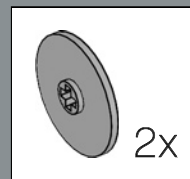



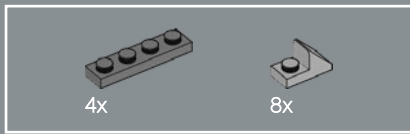

425

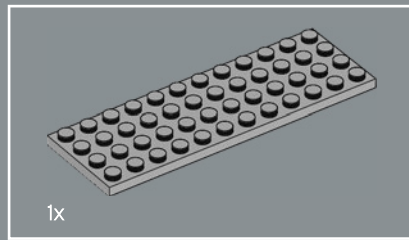
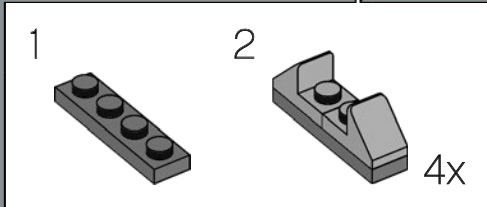
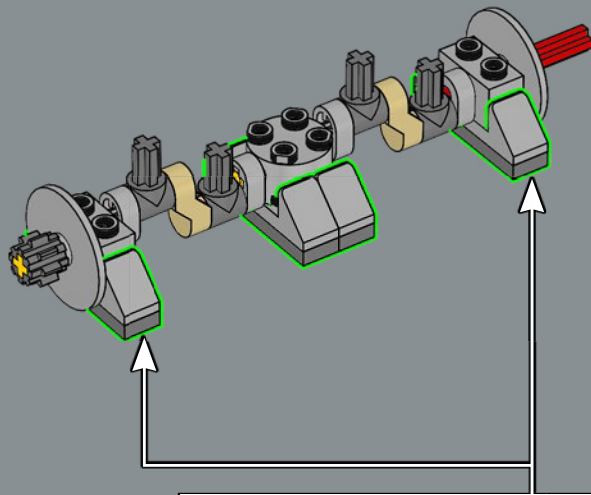

426

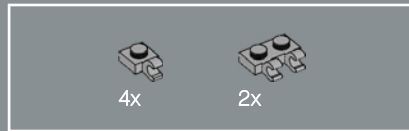
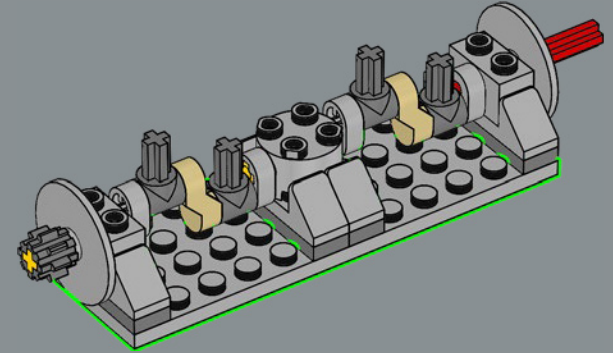

427

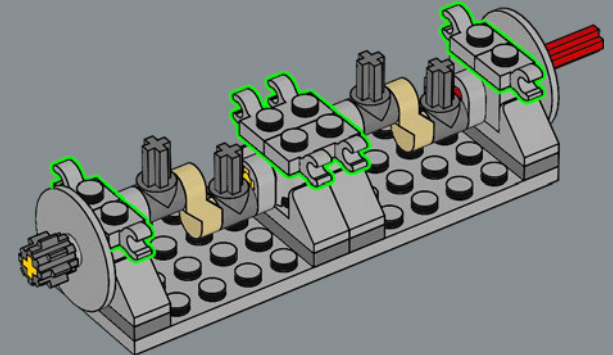



428

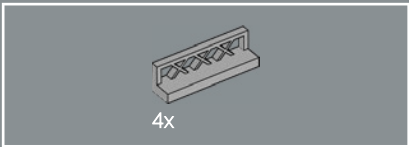
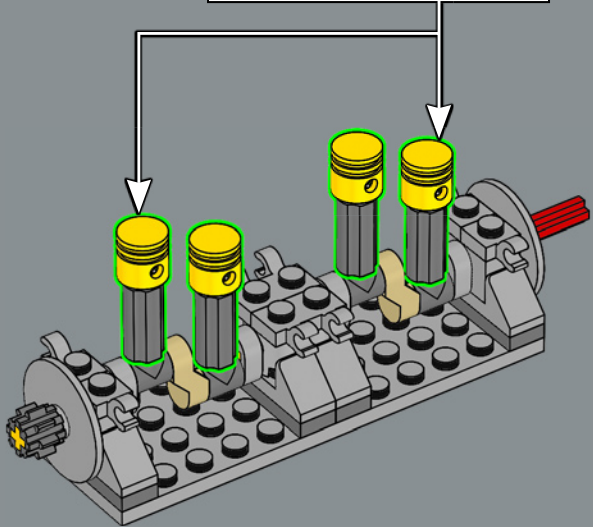
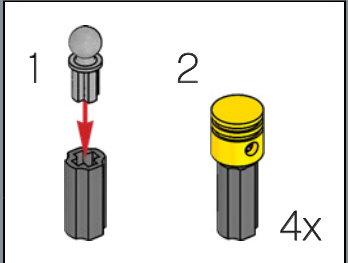

429

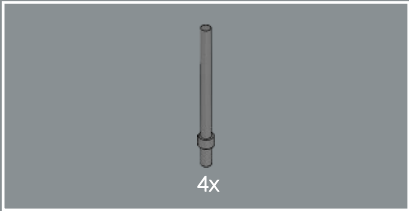
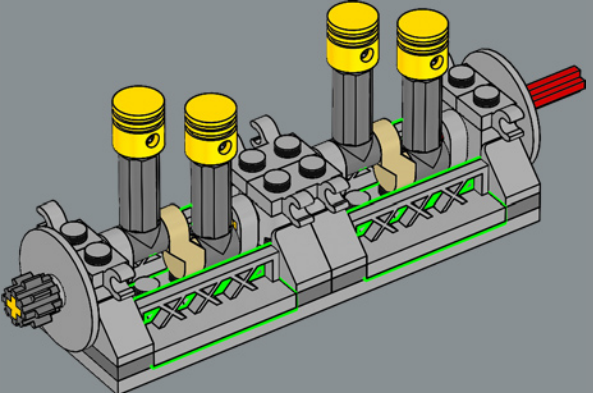

430

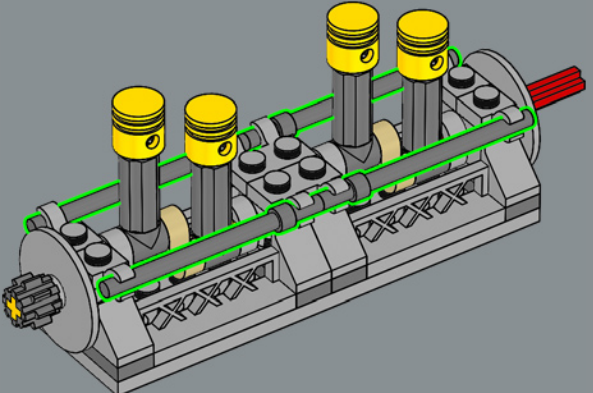

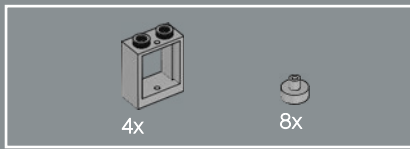

431

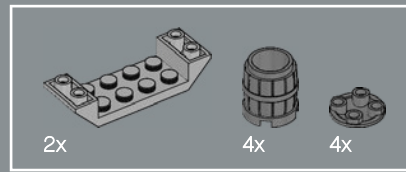
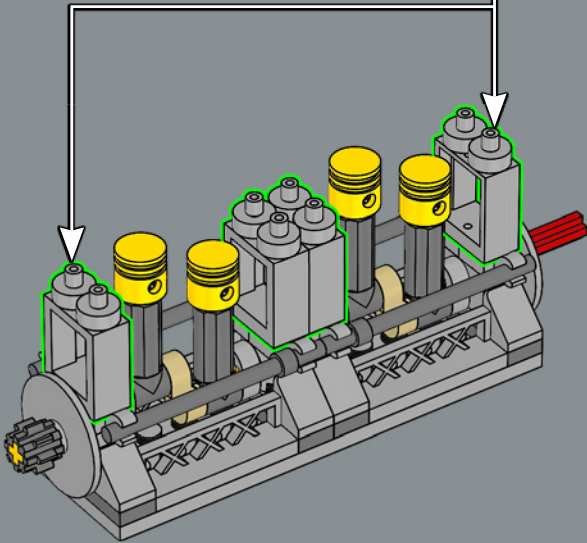
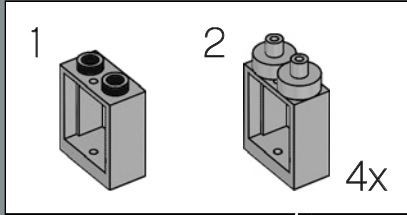

432

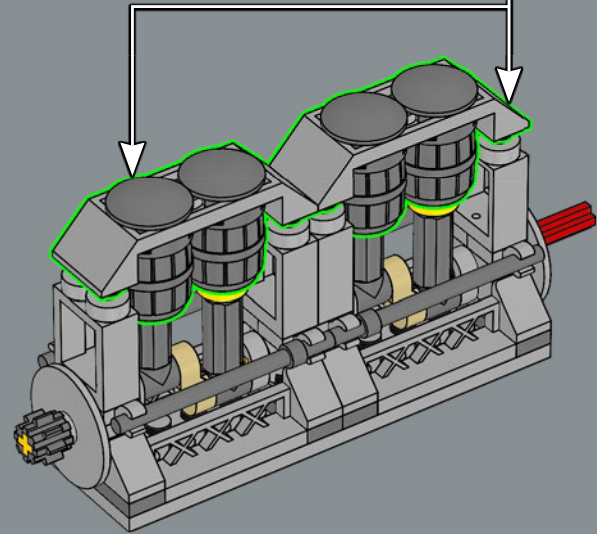
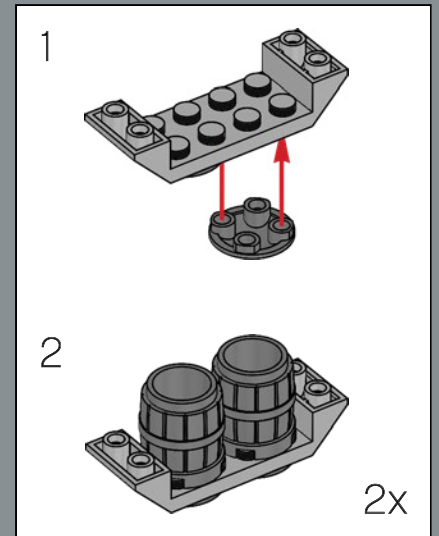

2x

433

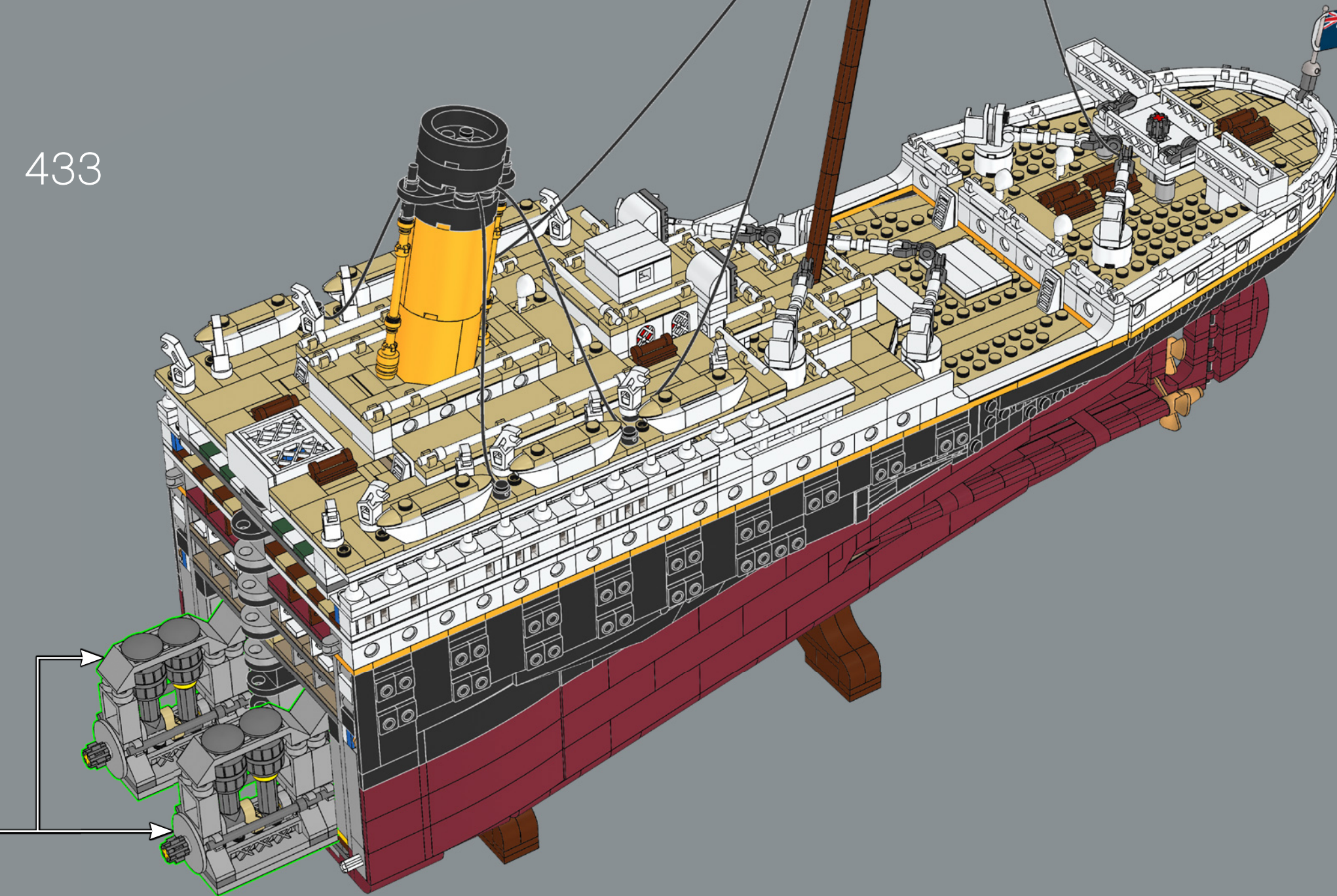

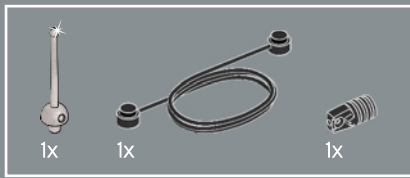

434

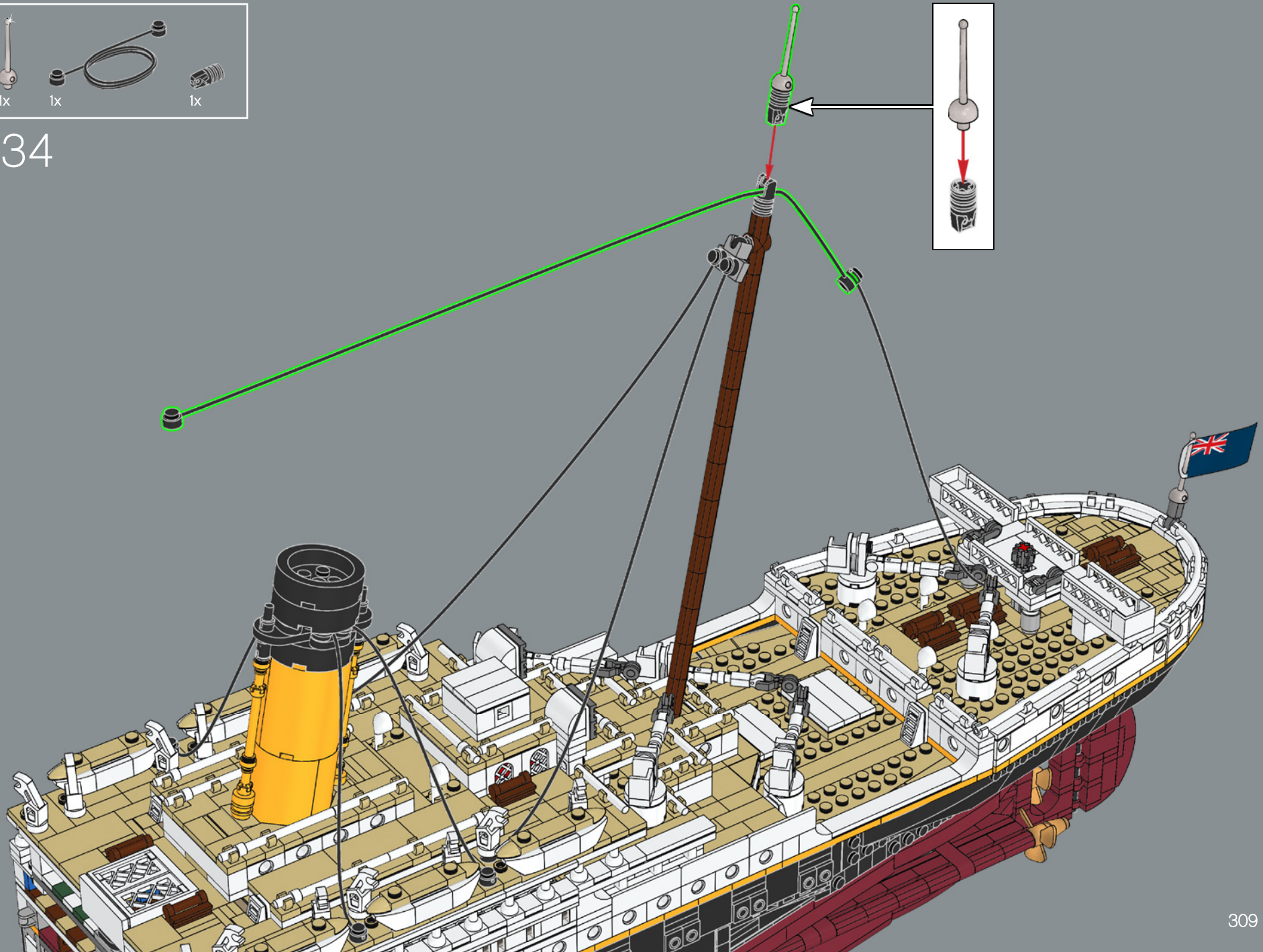

435

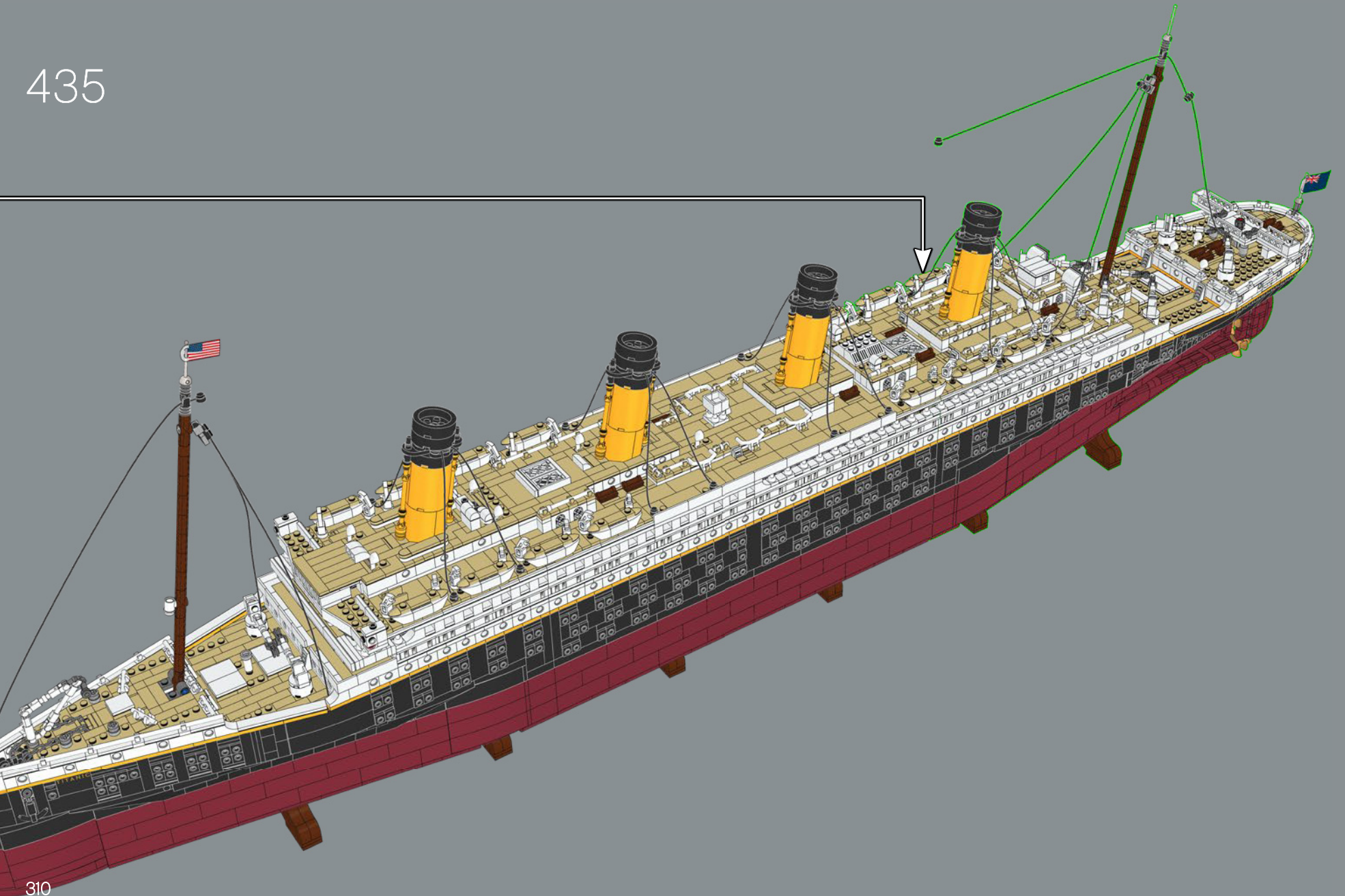

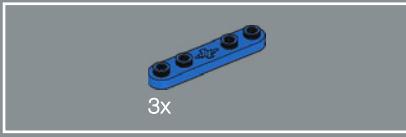
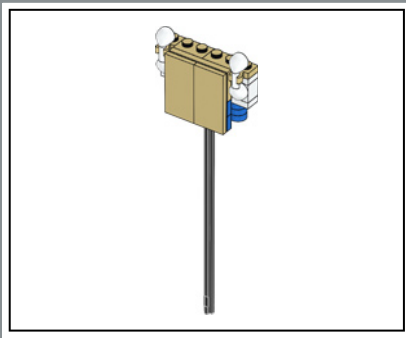

436

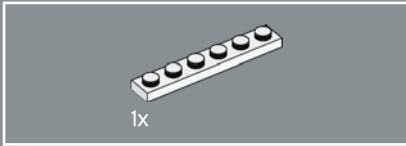
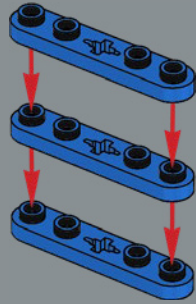

437

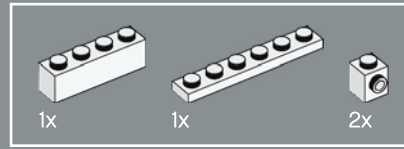
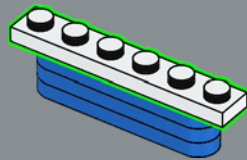

438

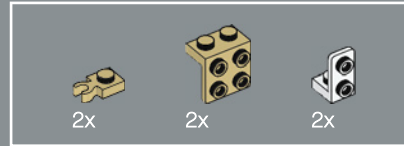
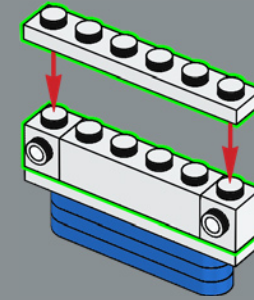

439

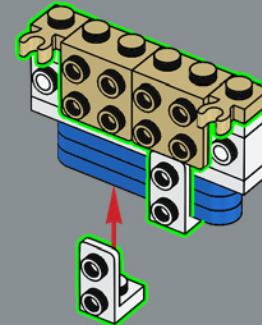

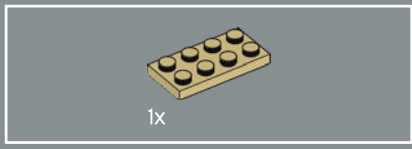

440

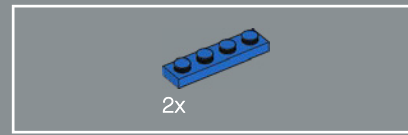
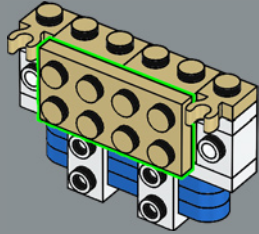

441

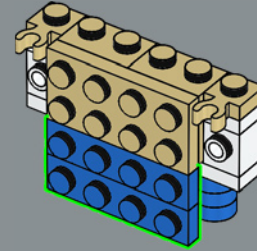



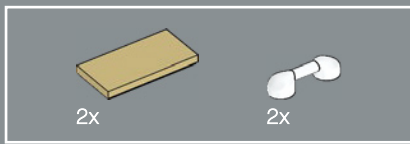

442

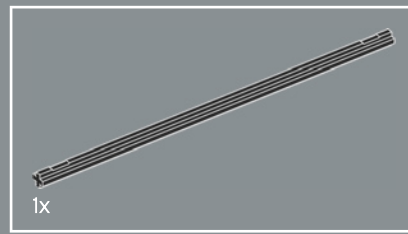
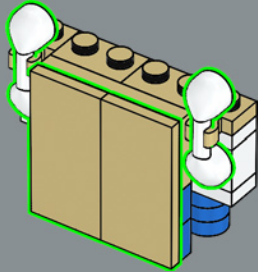

443

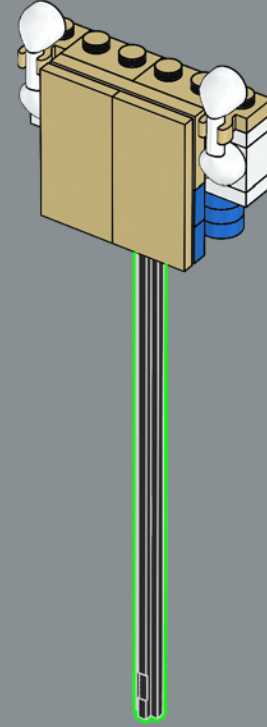

Der Stapellauf der *Titanic* am 31. Mai 1911  
jährte sich 2021 zum 110. Mal.

444

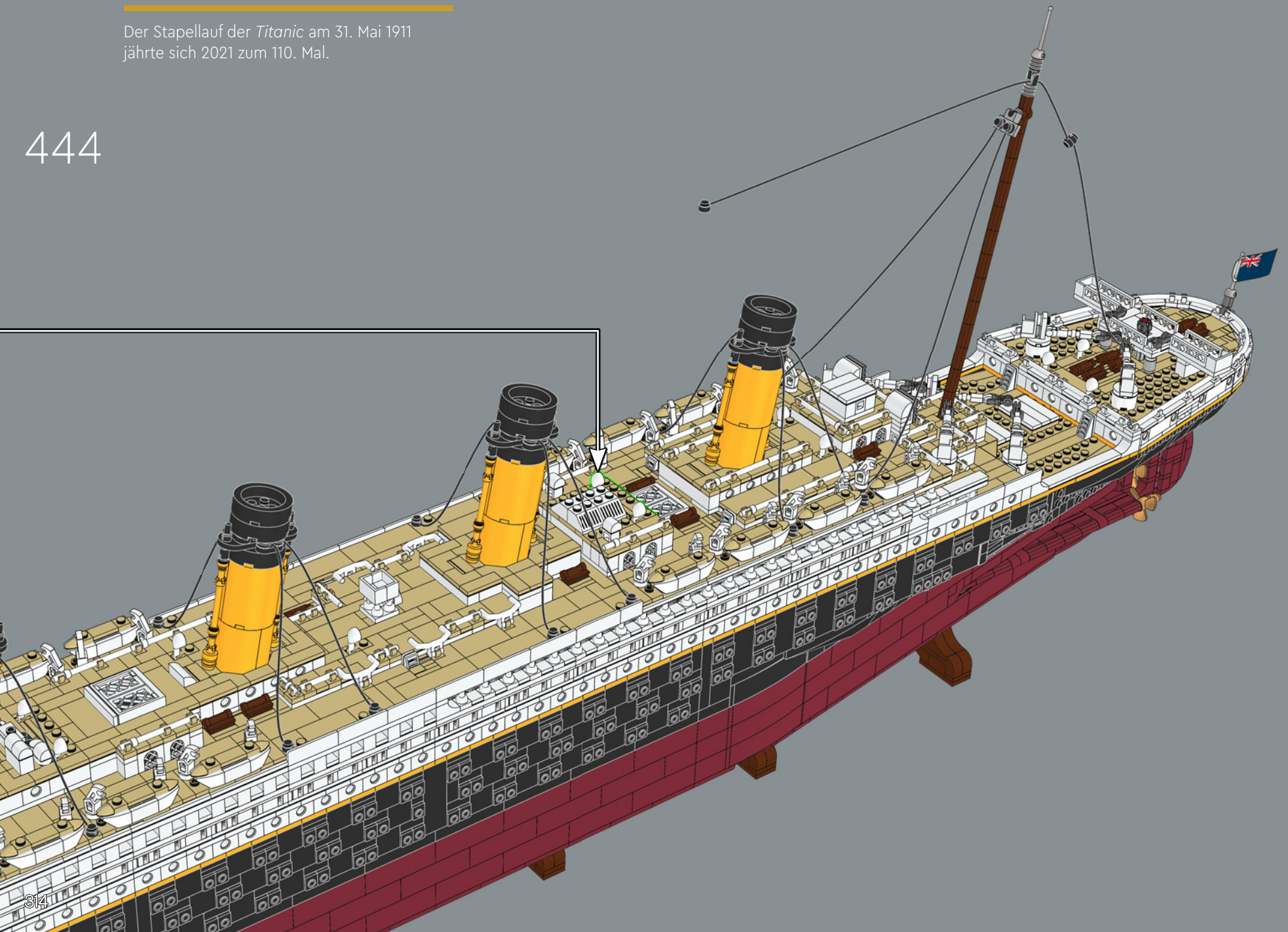

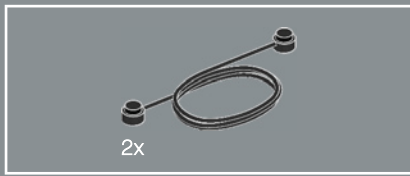

445

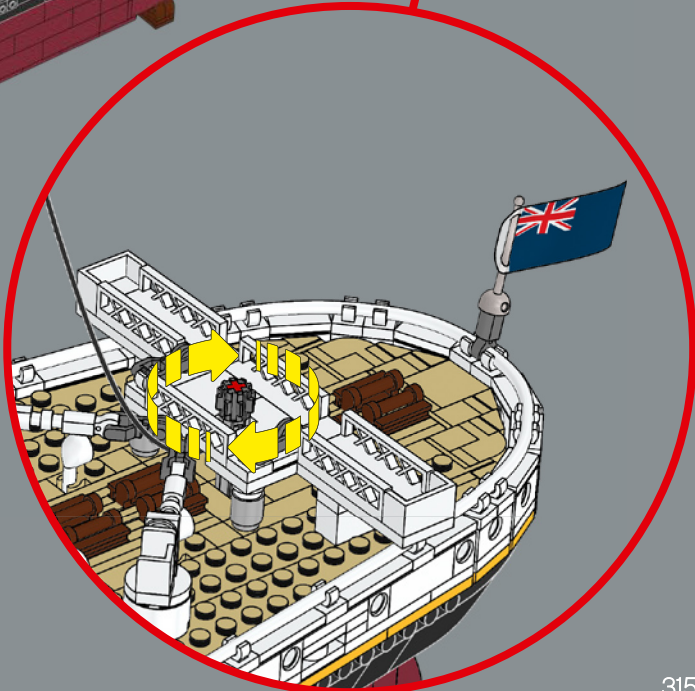
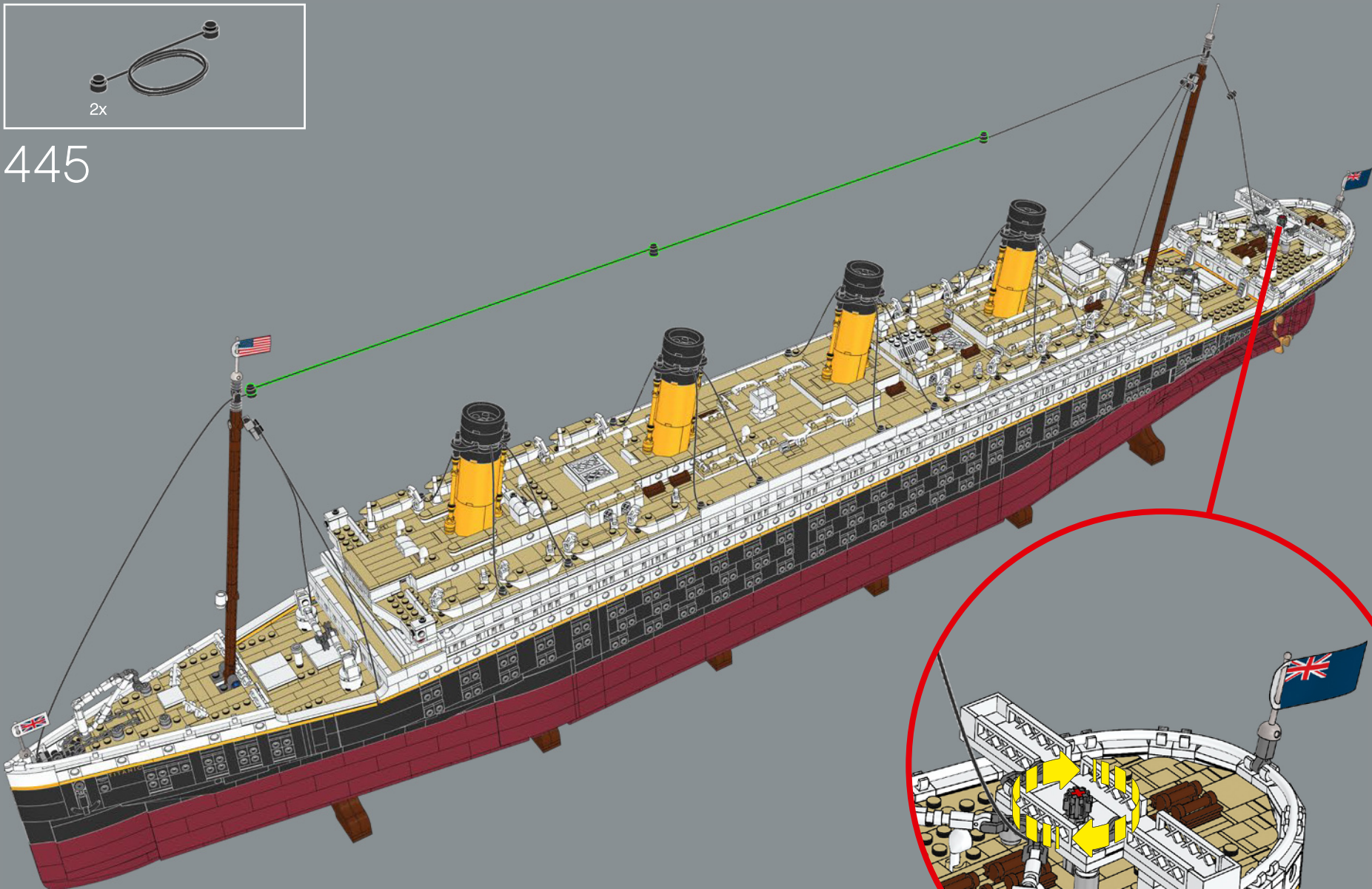

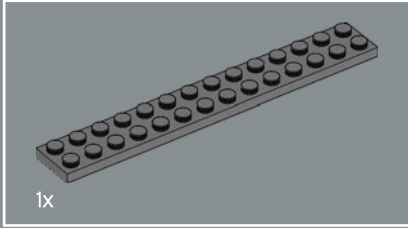
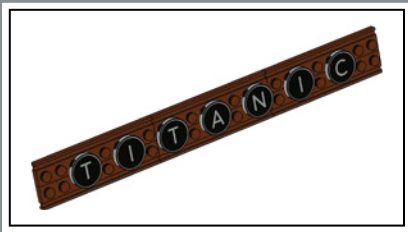

1x

446

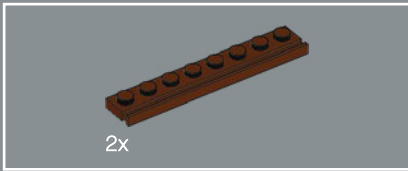
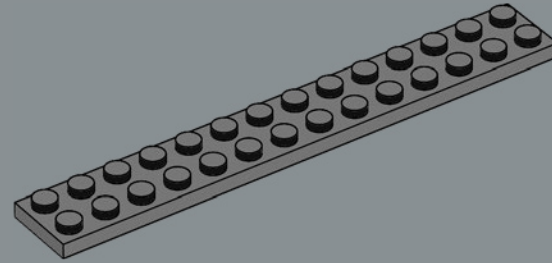

2x

447

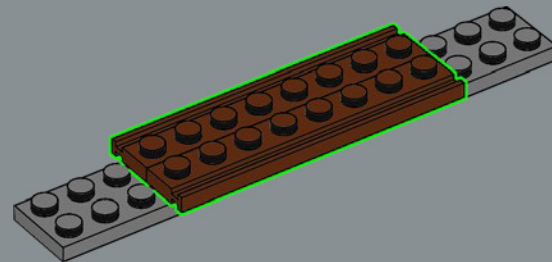



448

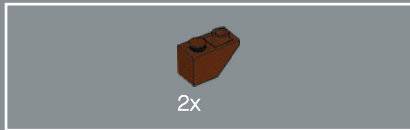
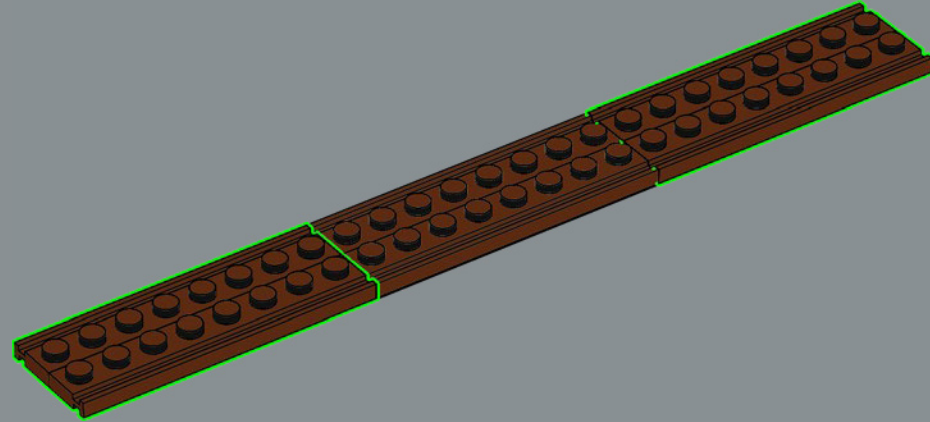

449

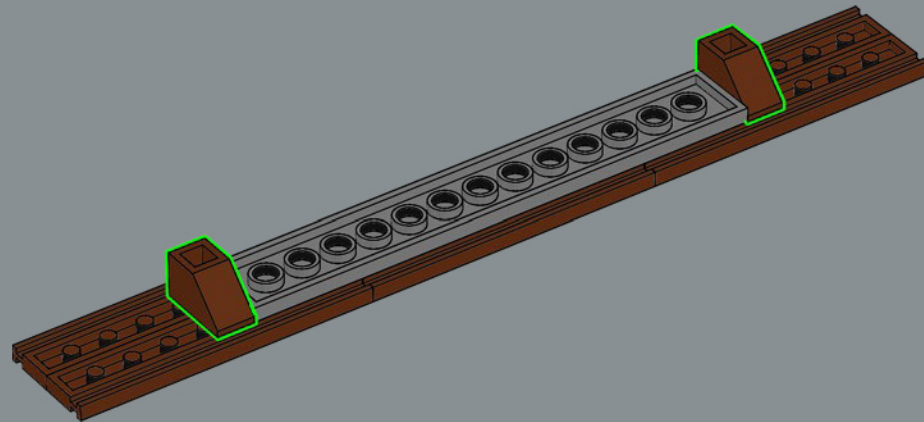



450

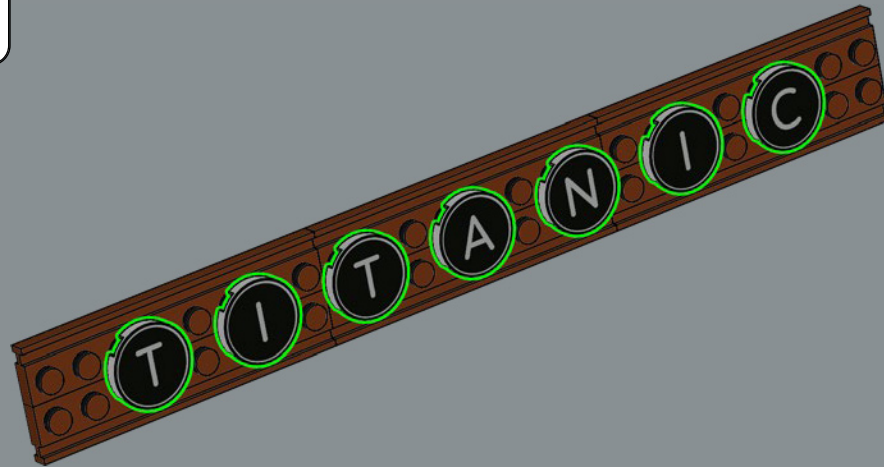

Der Name *Titanic* geht auf die Titanen aus der griechischen Mythologie zurück.

