

# TITANIC

LIBRO 3



# EL TRANSATLÁNTICO INSUMERGIBLE

Aunque el RMS *Titanic* estaba equipado con numerosos y extraordinarios avances en materia de seguridad, según los obsoletos reglamentos de seguridad marítima de entonces, el transatlántico no necesitaba más que 20 botes salvavidas a bordo: suficientes para tan solo un tercio de la tripulación y los pasajeros. Minutos antes de la medianoche del 14 de abril de 1912, el buque colisionó con un iceberg a gran velocidad y empezó a hundirse rápidamente. Debido a la falta de botes, perecieron más de 1500 personas y solo 710 lograron sobrevivir. Como consecuencia directa de esta tragedia, se aprobaron nuevos estándares internacionales de seguridad de amplio alcance, muchos de los cuales siguen vigentes hoy en día.

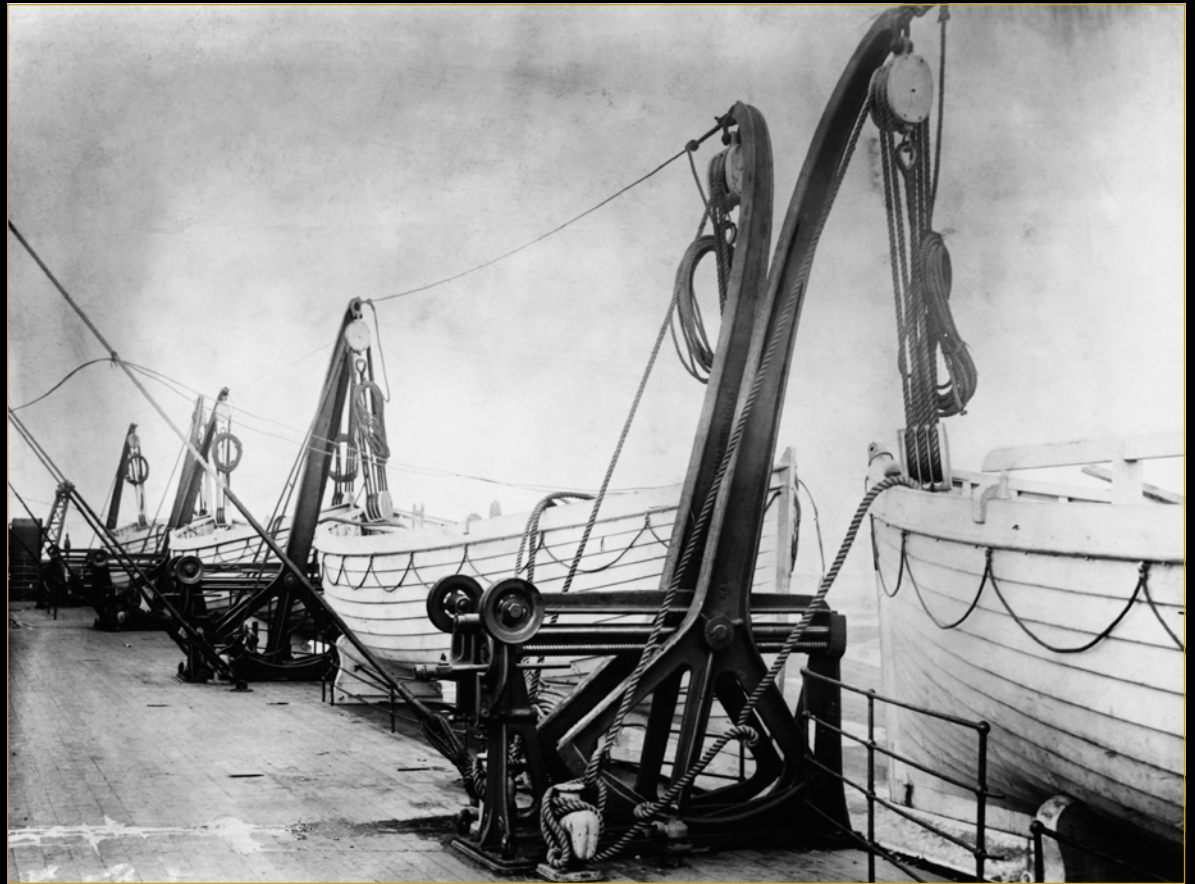

↑ Botes salvavidas en pescantes del *Titanic*.

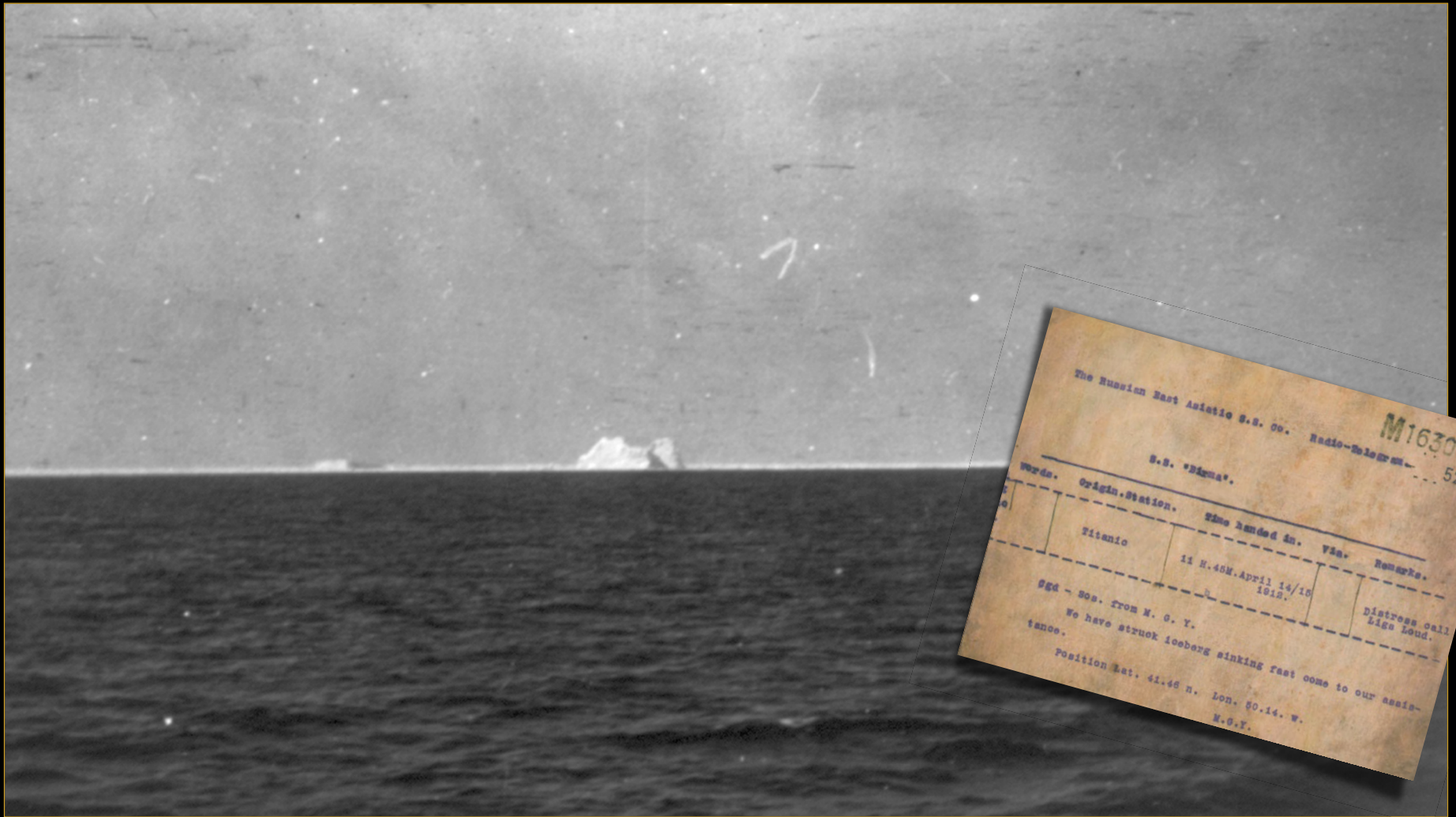

↑ Fotografía de la supuesta localización del desastre, tomada desde el SS Carpathia, que rescató a supervivientes del naufragio del Titanic.

↗ Telegrama de solicitud de ayuda transmitido por el RMS Titanic al SS Birma.

# IMPRESIONANTE ESCALA

En su botadura, el *Titanic* era la nave más grande jamás construida por el hombre. Tenía 269 m de eslora y medía 53,3 m desde la parte inferior del casco hasta la parte superior de sus chimeneas. De la misma manera, la versión LEGO® del RMS *Titanic* es el modelo LEGO de mayor longitud que hemos creado hasta ahora y uno de los más elaborados.

*La versión LEGO del Titanic está diseñada a escala 1:200, la misma utilizada para el set LEGO Architecture Estatua de la Libertad.*

*El Titanic era 11 veces más largo que la ballena azul, el animal conocido más grande que haya poblado la Tierra.*

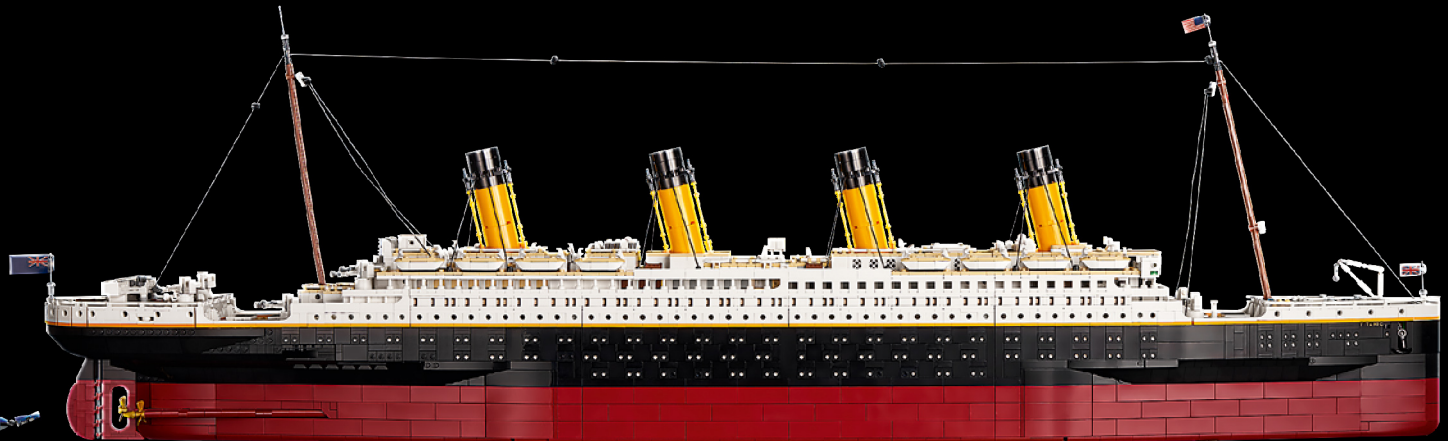



[LEGO.com/brickseparator](https://www.lego.com/brickseparator)



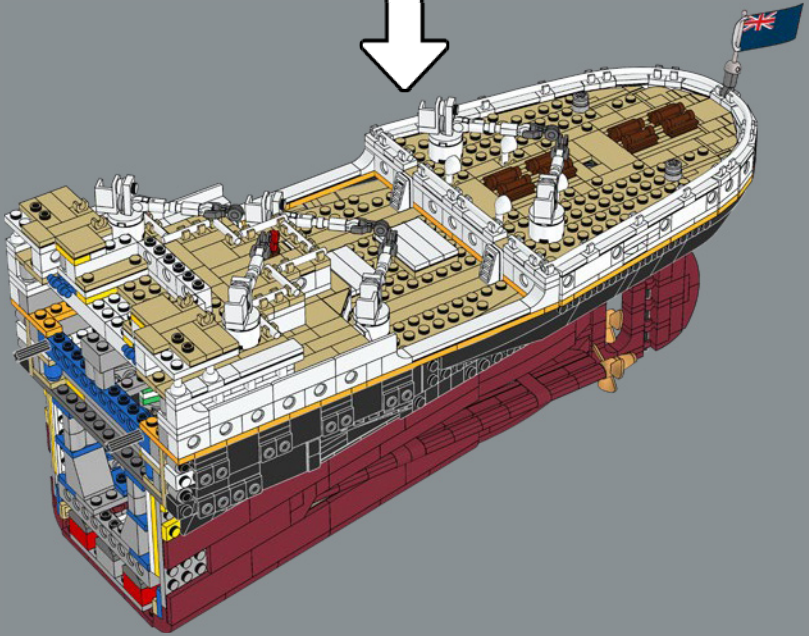
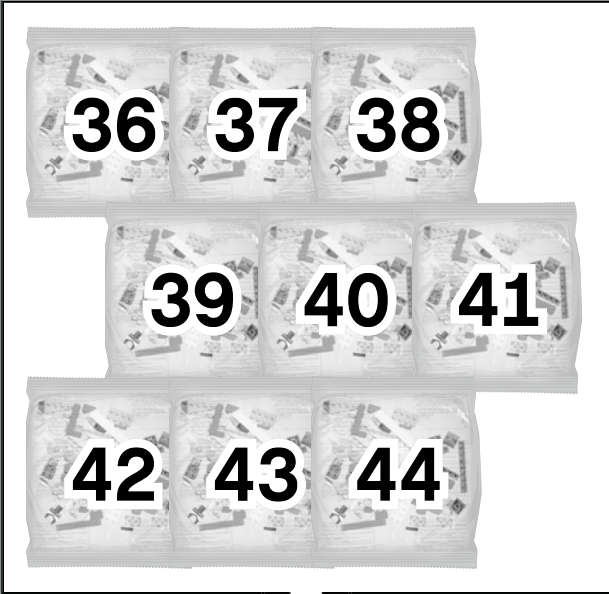
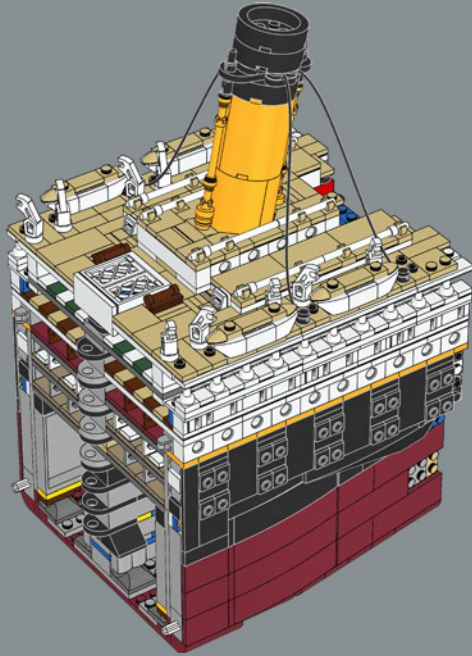
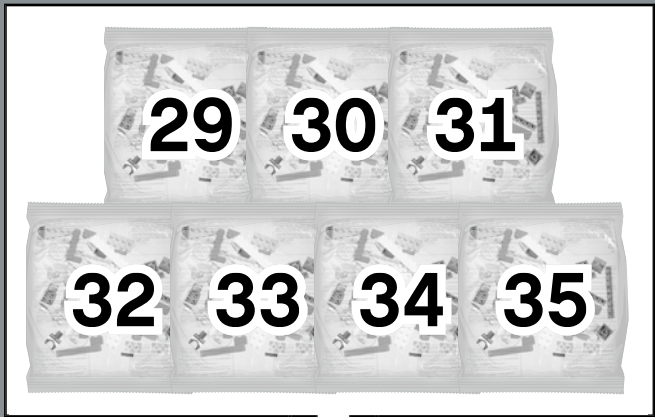

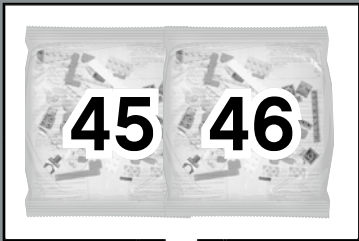

45 46

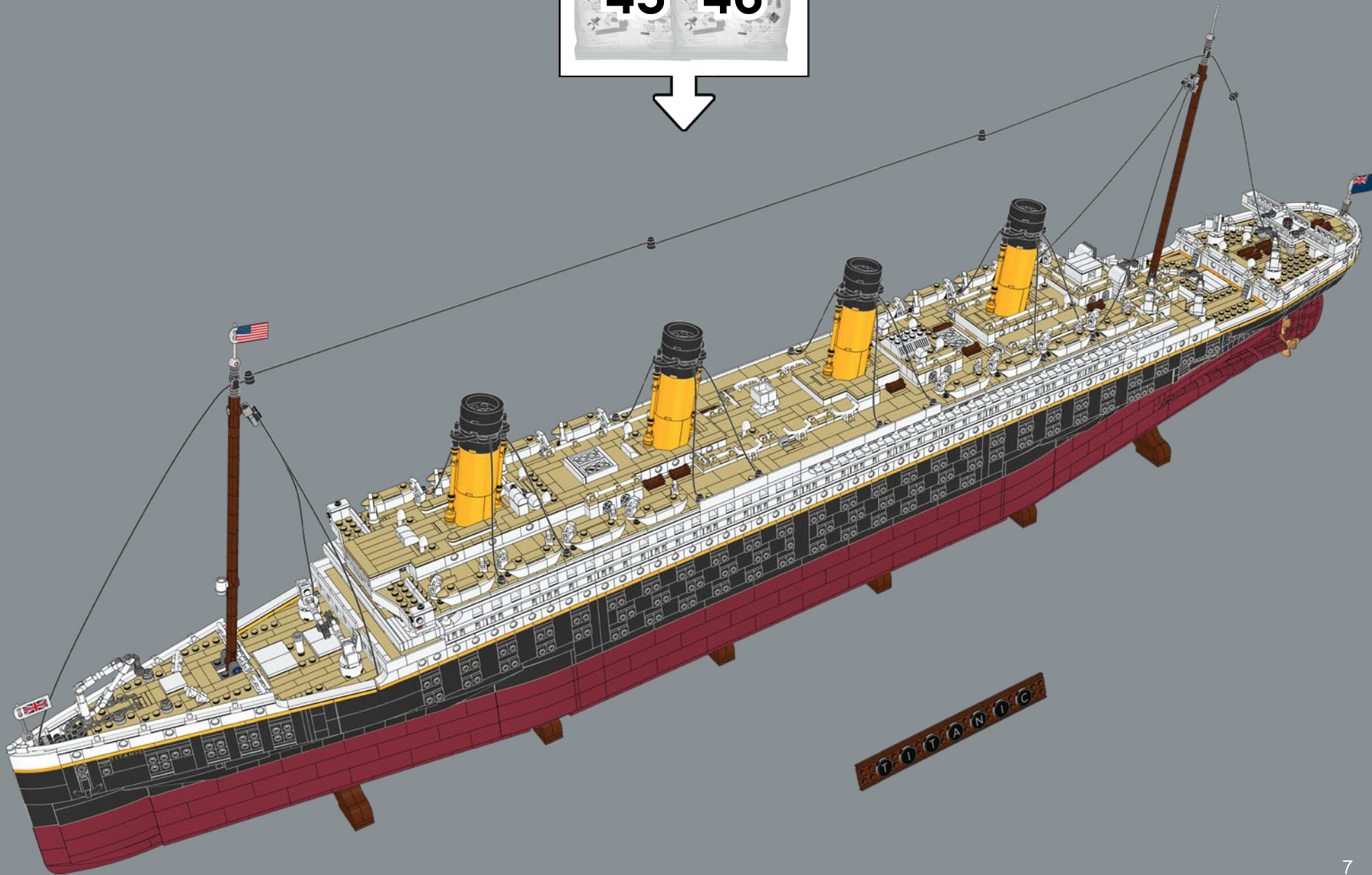

TITANIC

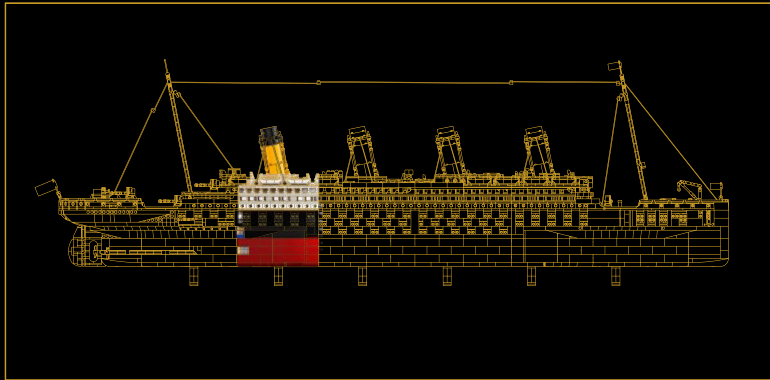

## SECCIÓN 5:

# CHIMENEA Y SALA DE MÁQUINAS

En esta sección, el modelo se estrecha conforme sus líneas se van afilando hacia las hélices y el timón en la popa del barco. También construirás la última chimenea. En el *Titanic* real, esta chimenea no estaba conectada a ninguna caldera; se incluyó en el diseño de la nave para realzar su belleza y sensación de equilibrio.

↓ En la parte superior de esta sección, incorporarás la sala de lectura y algunos camarotes de segunda clase.





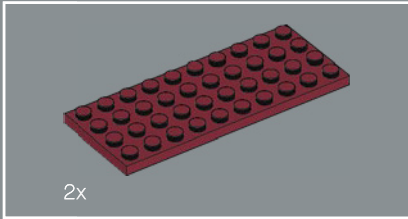
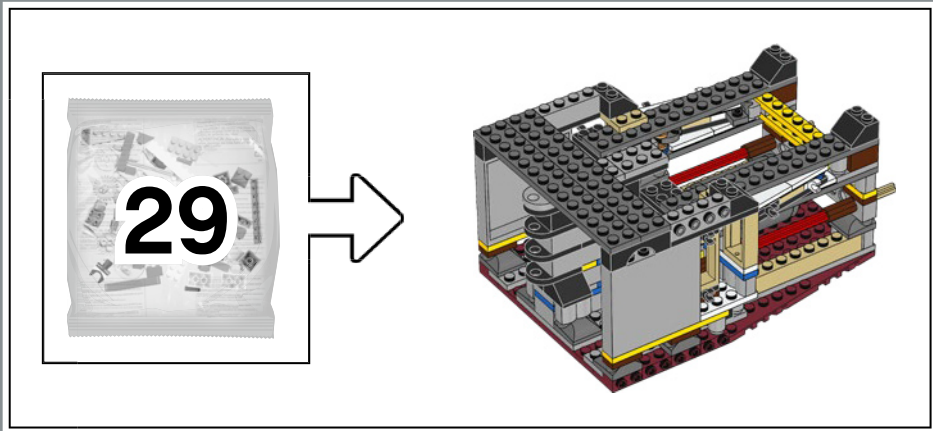

1

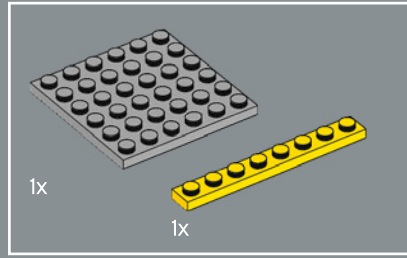
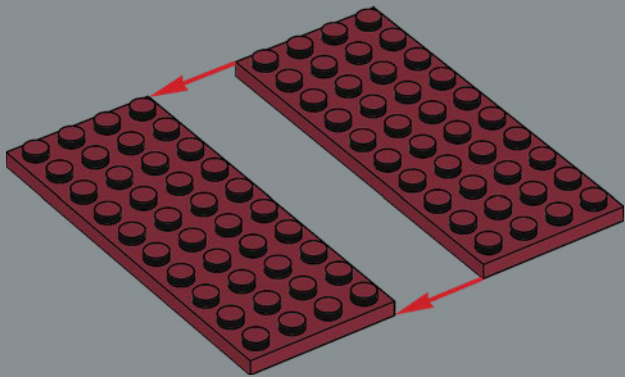

2

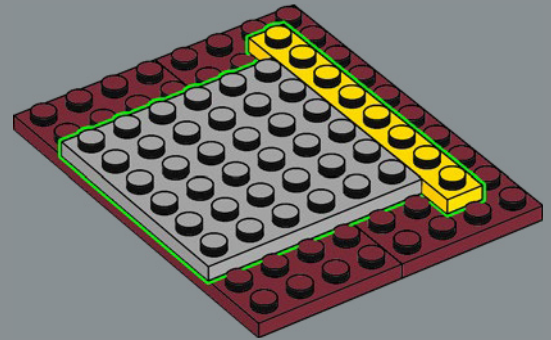



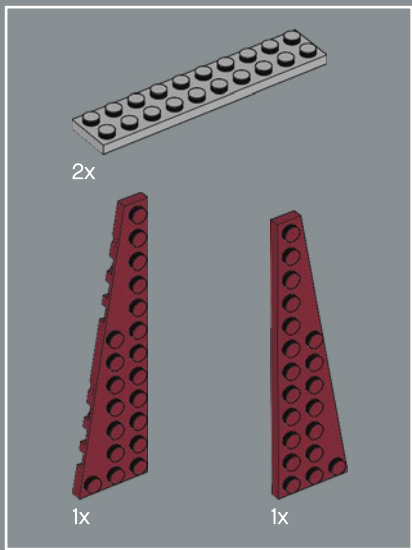

3

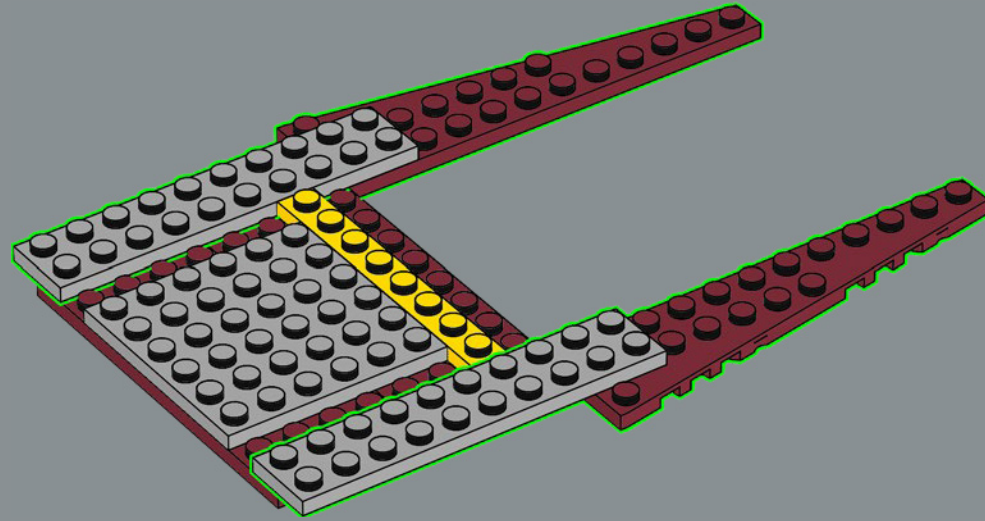

4

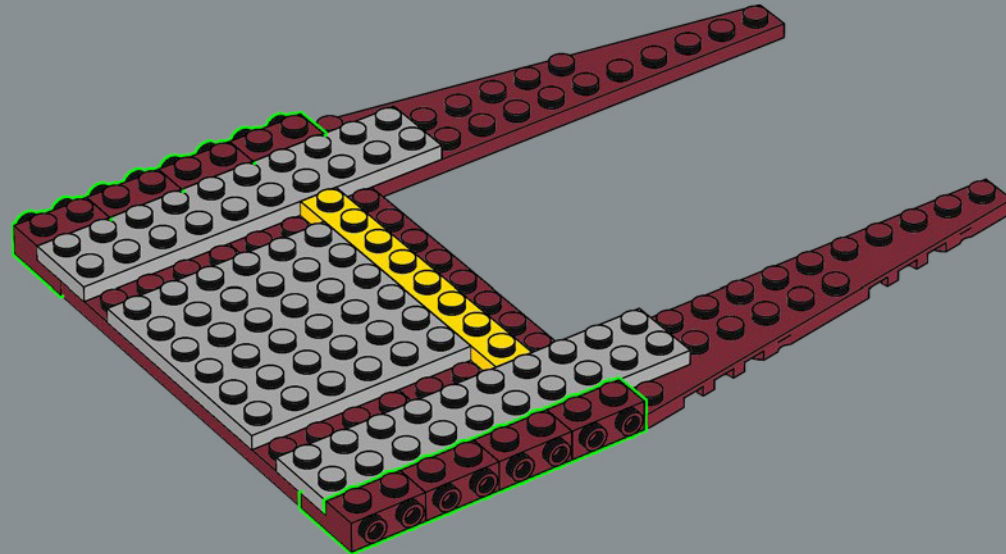

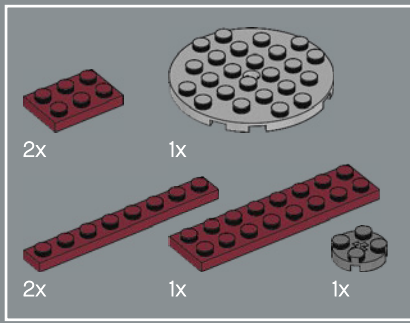

5

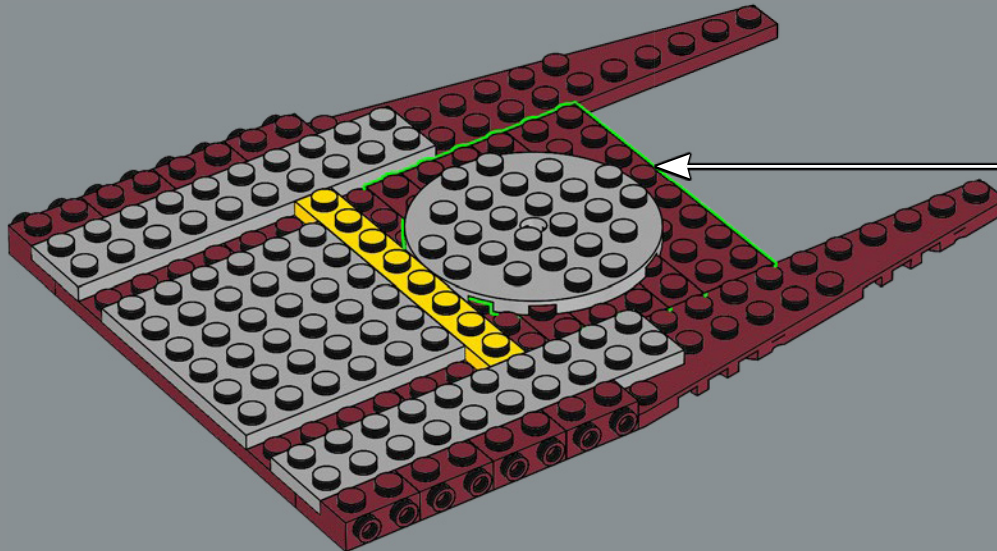
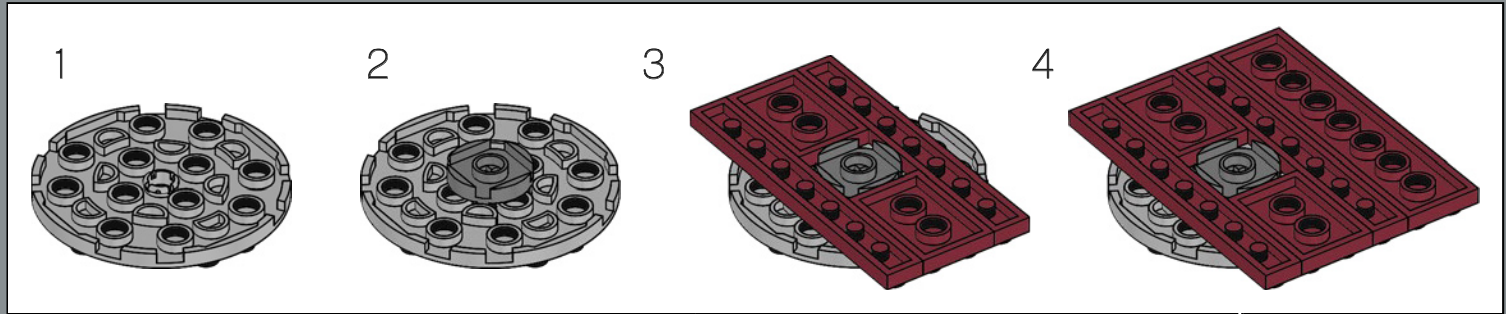

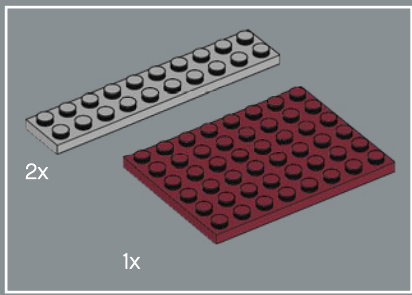

6

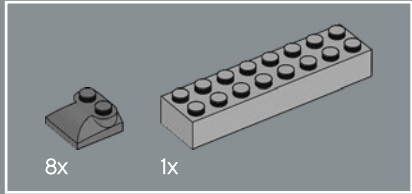
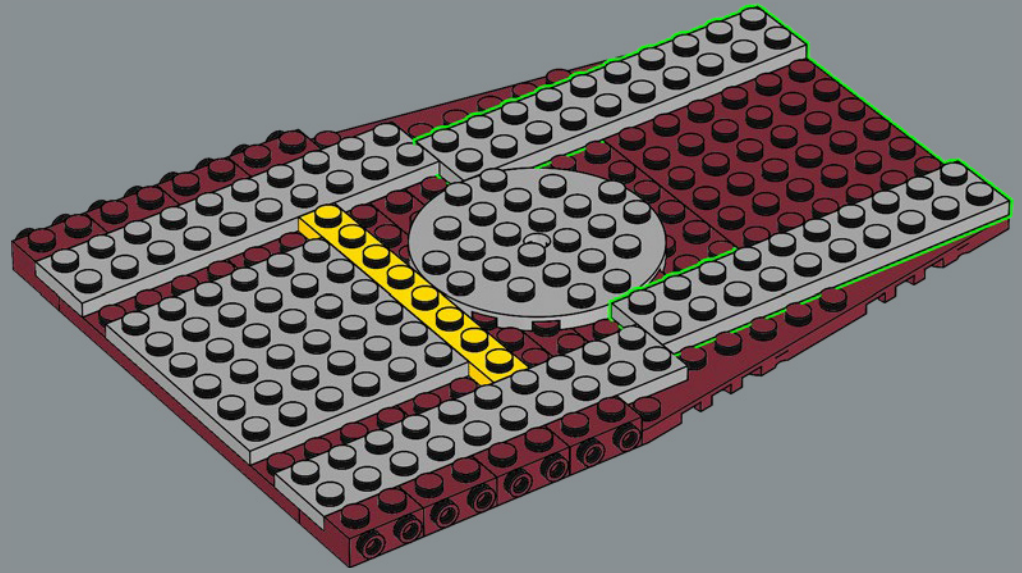

7

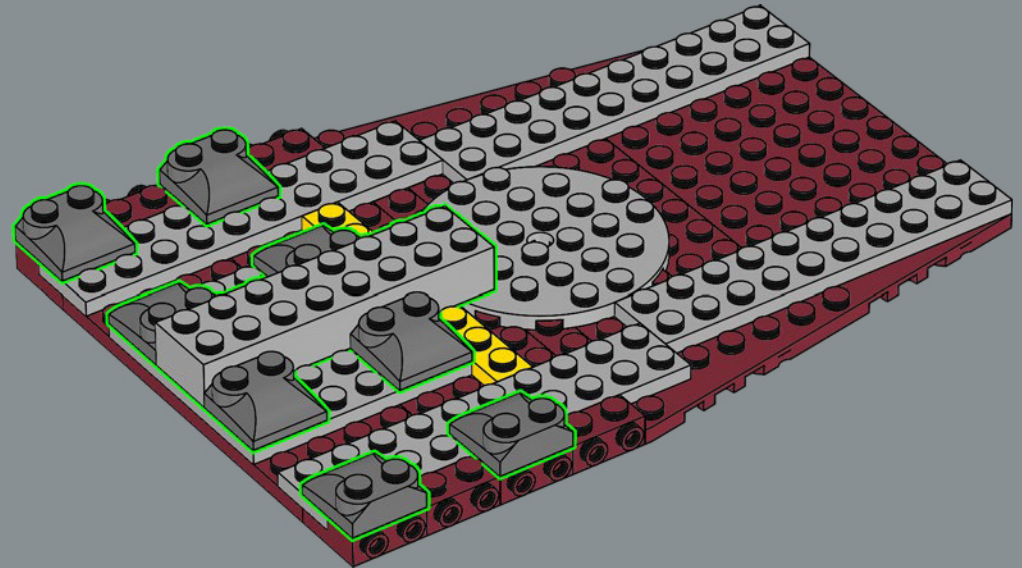





8

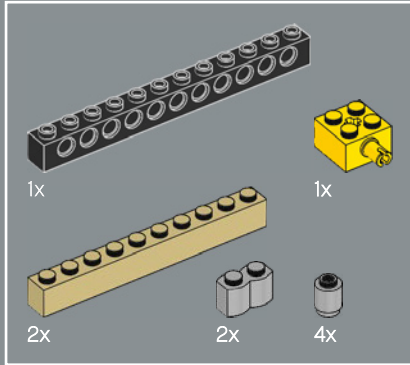
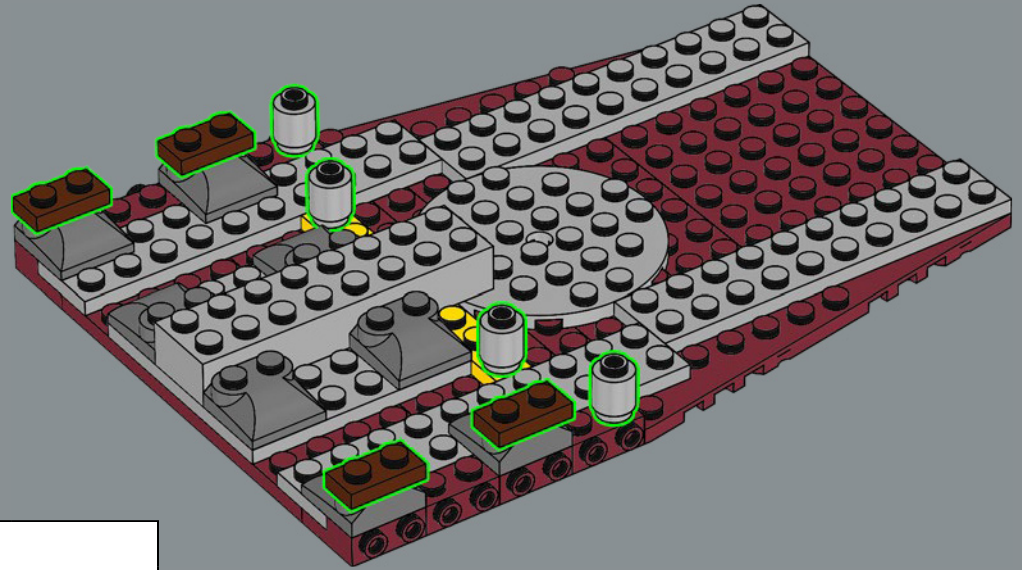

9

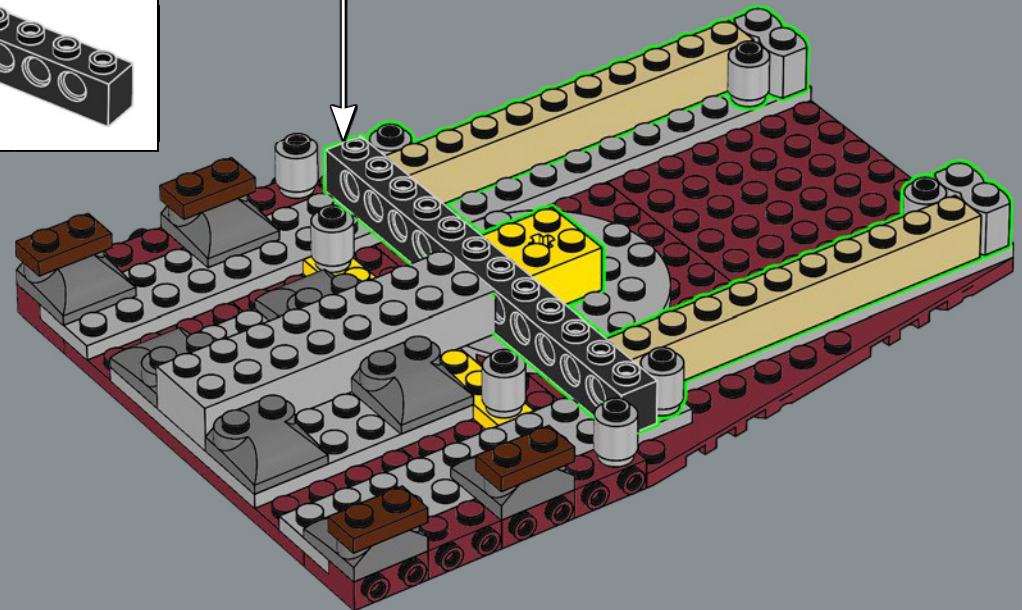
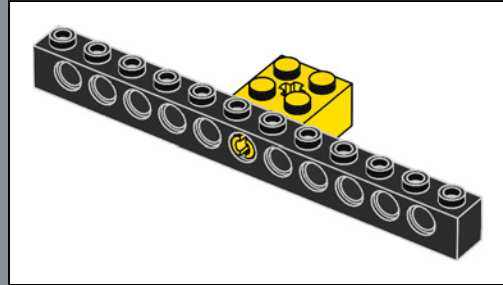

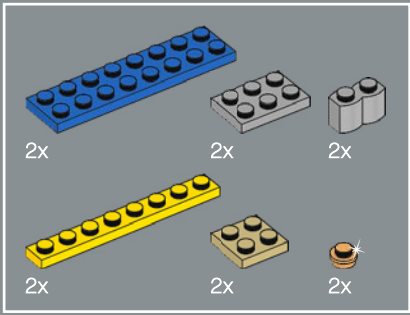

10

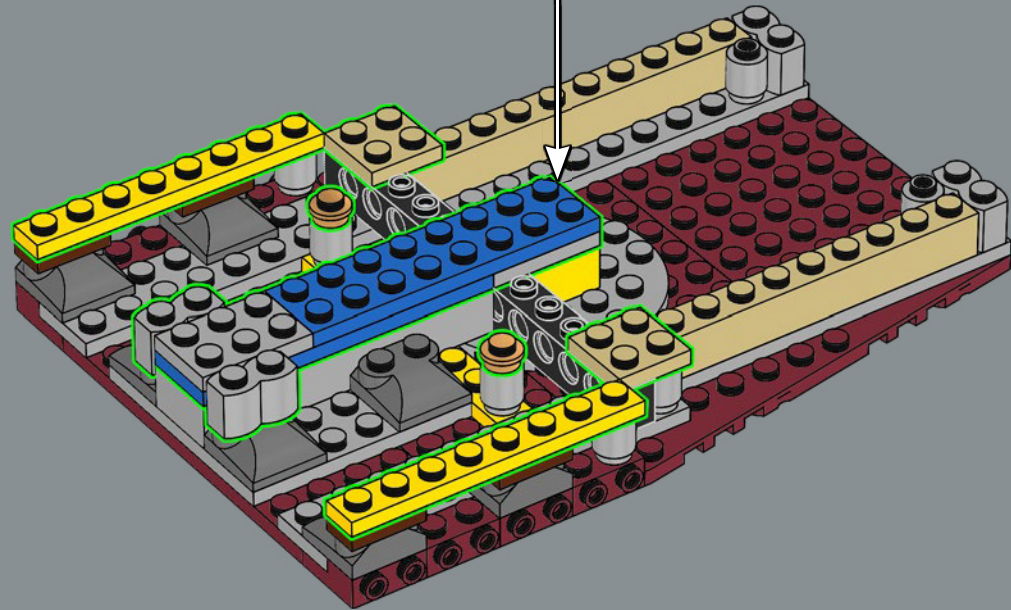
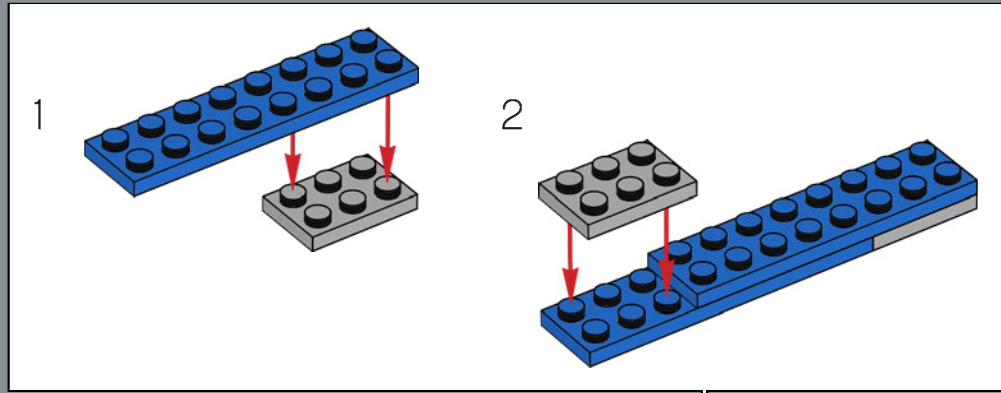

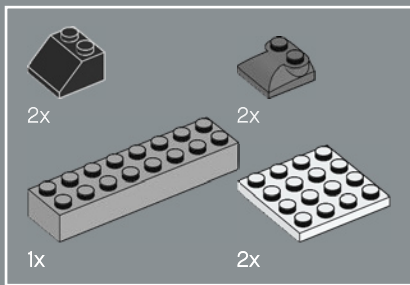

11

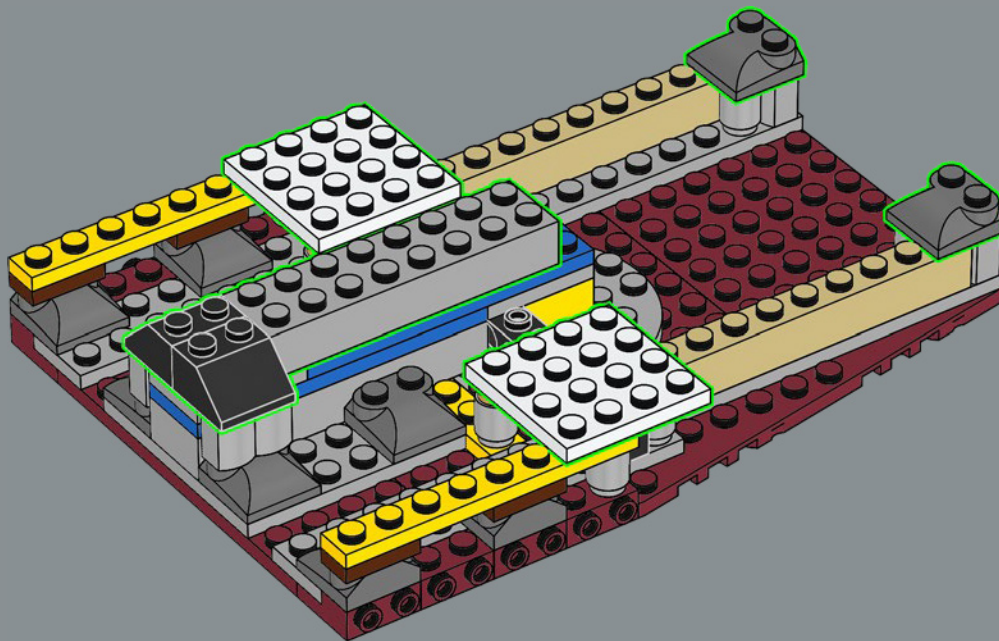

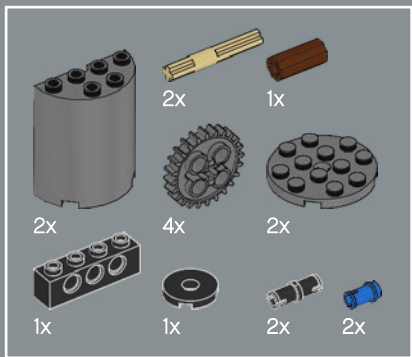

12

1

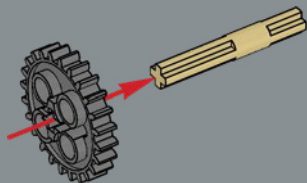

2

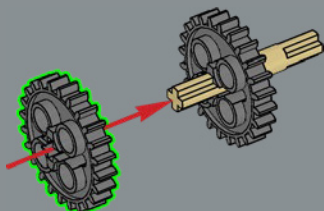

3

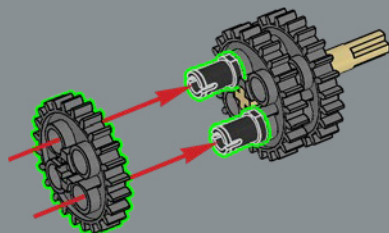

4

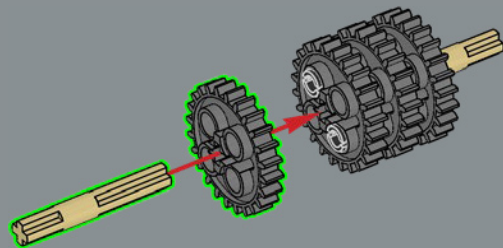

5

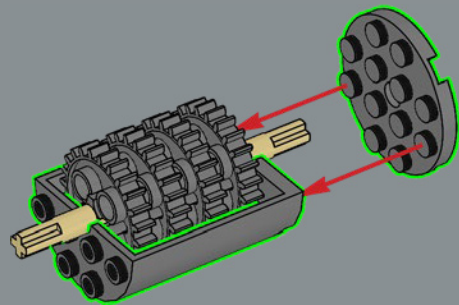

6

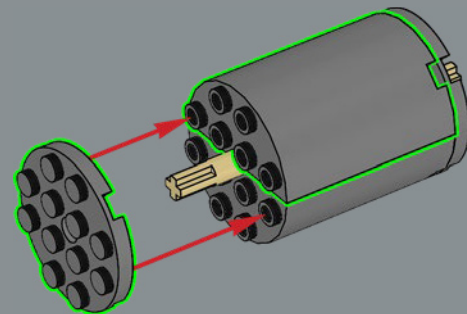

7

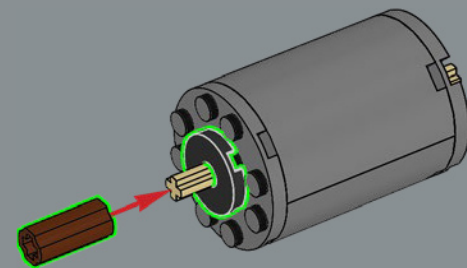

8

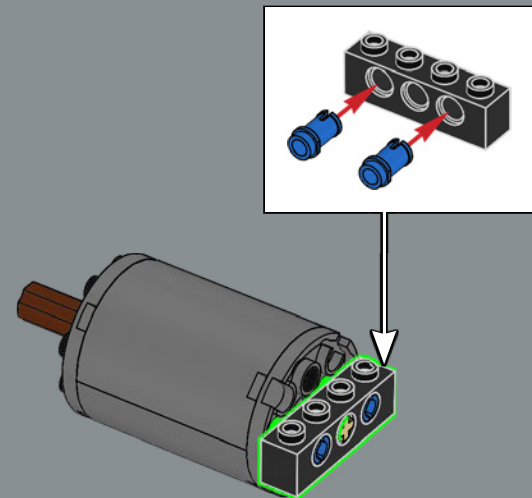



El sistema de suministro eléctrico del *Titanic* era capaz de producir más potencia que una central eléctrica de una ciudad de tamaño medio de la época.

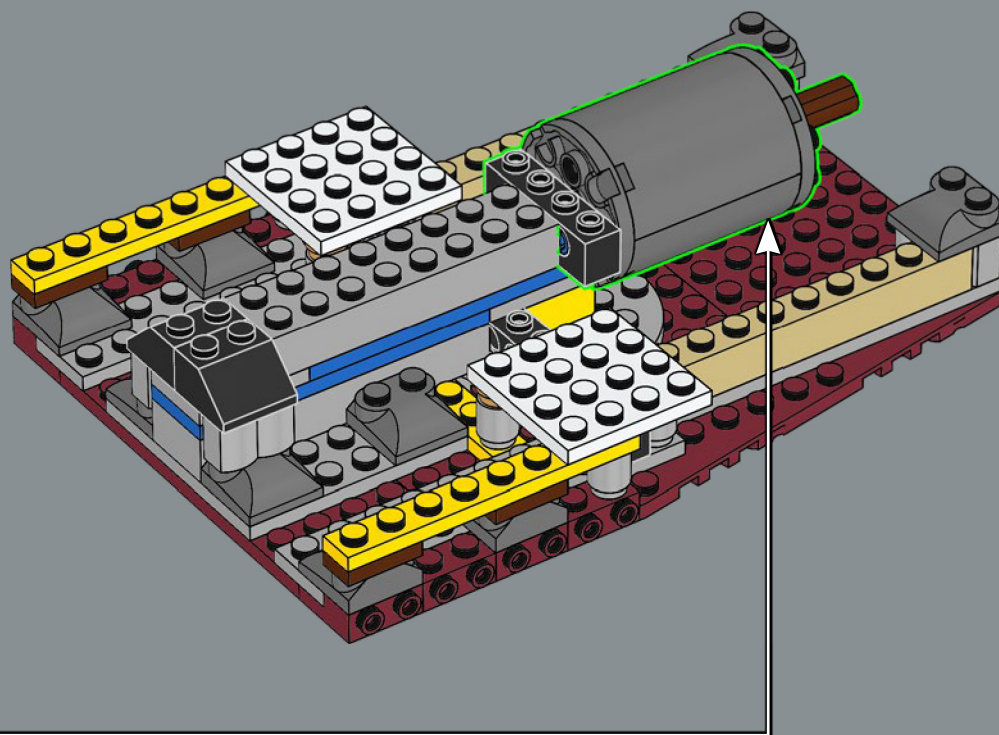



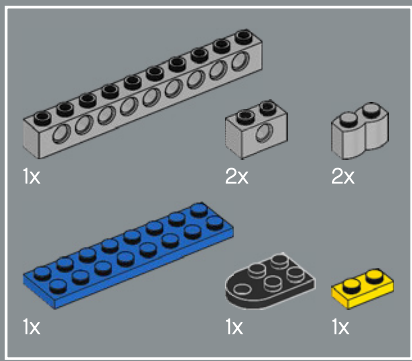

13

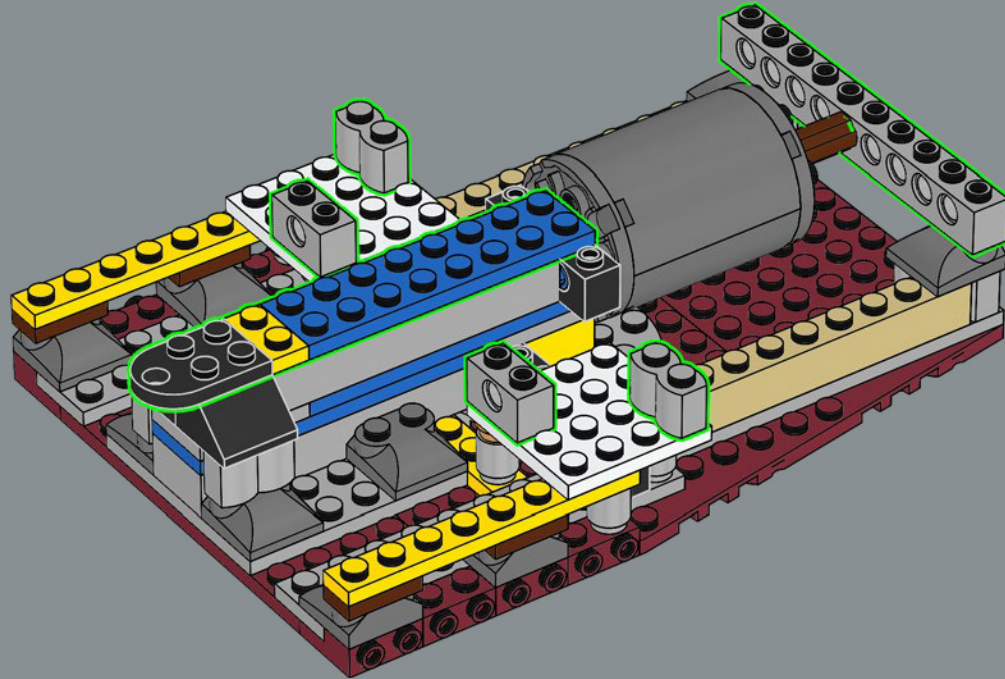

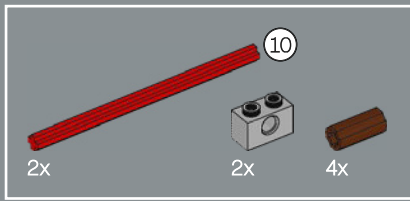

14

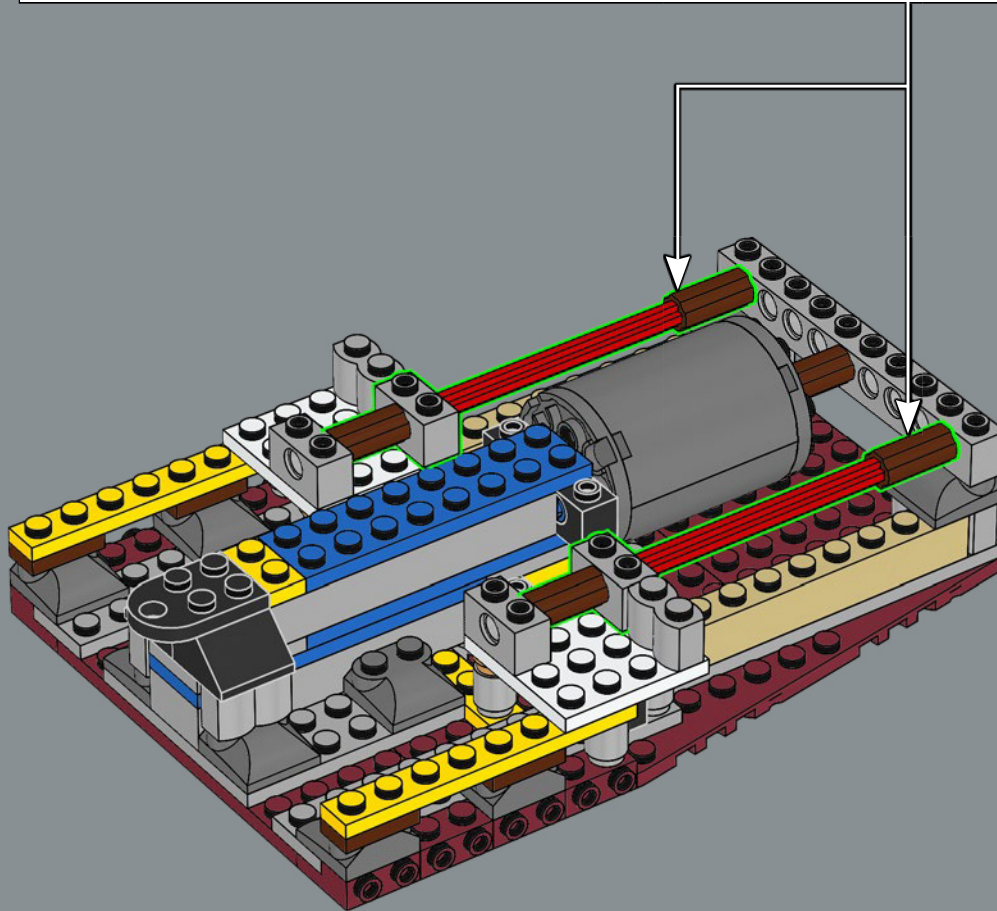
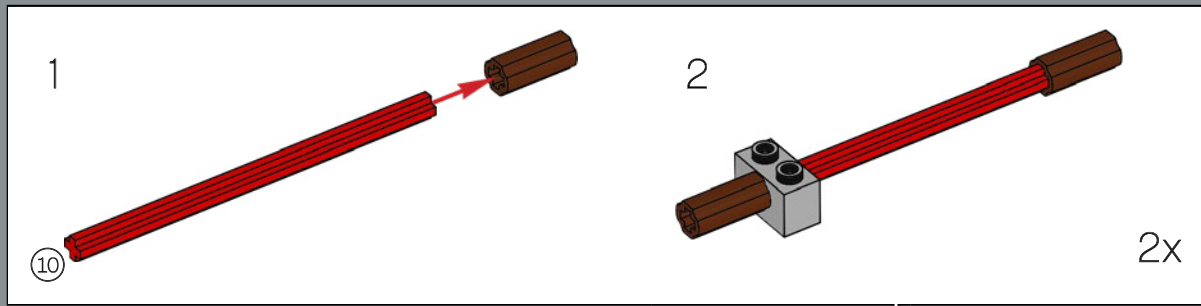

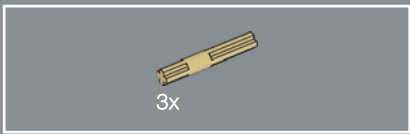

15

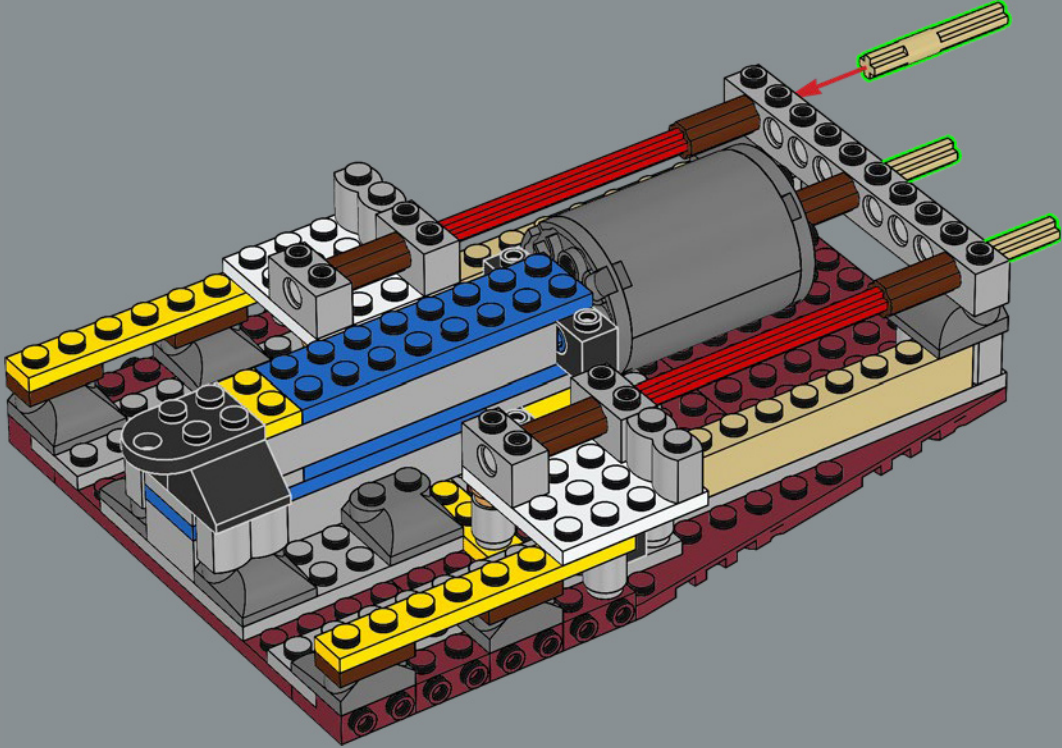

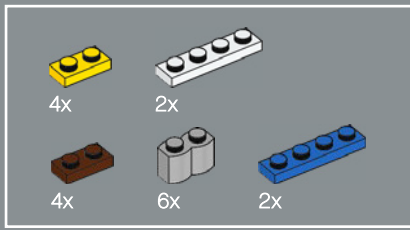

16

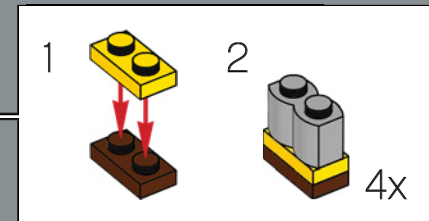
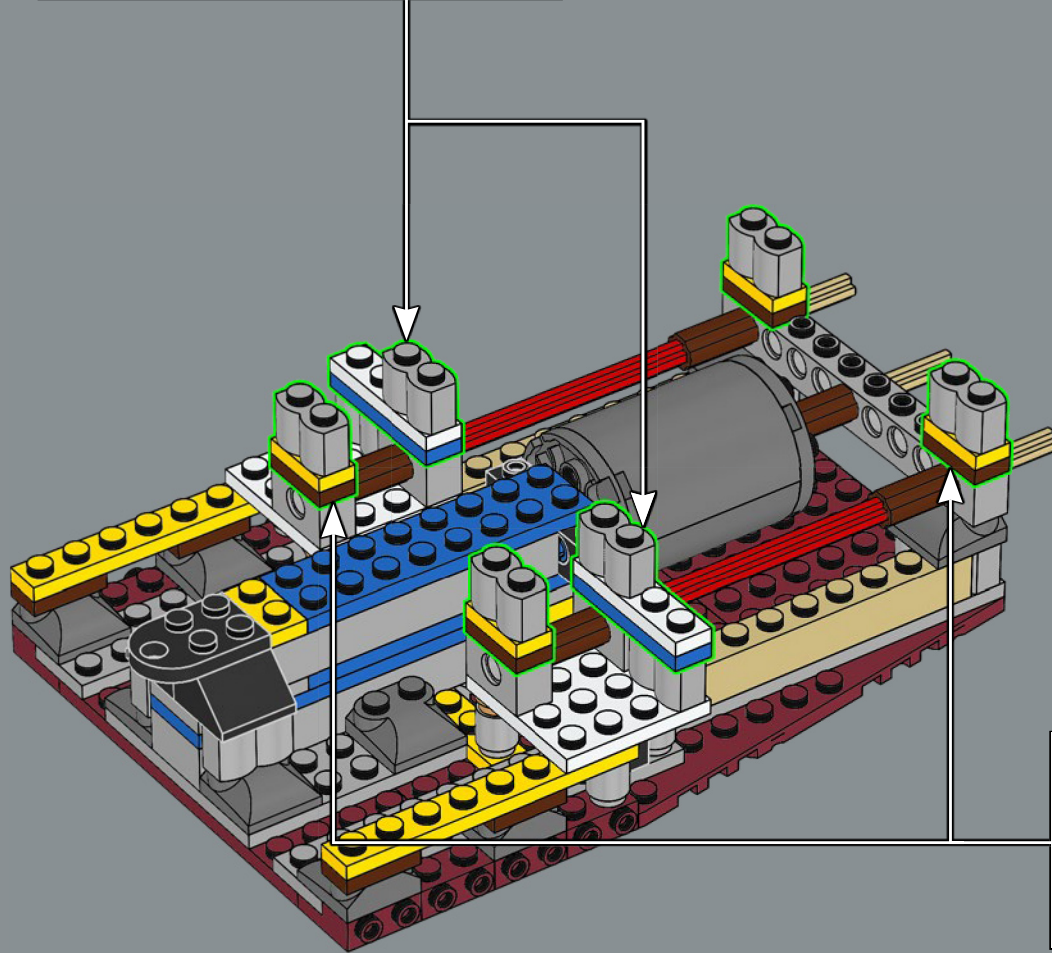
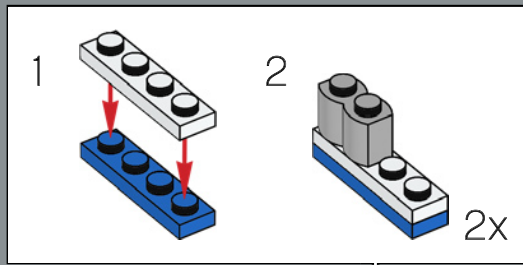



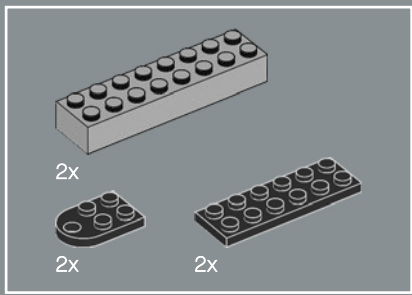

17

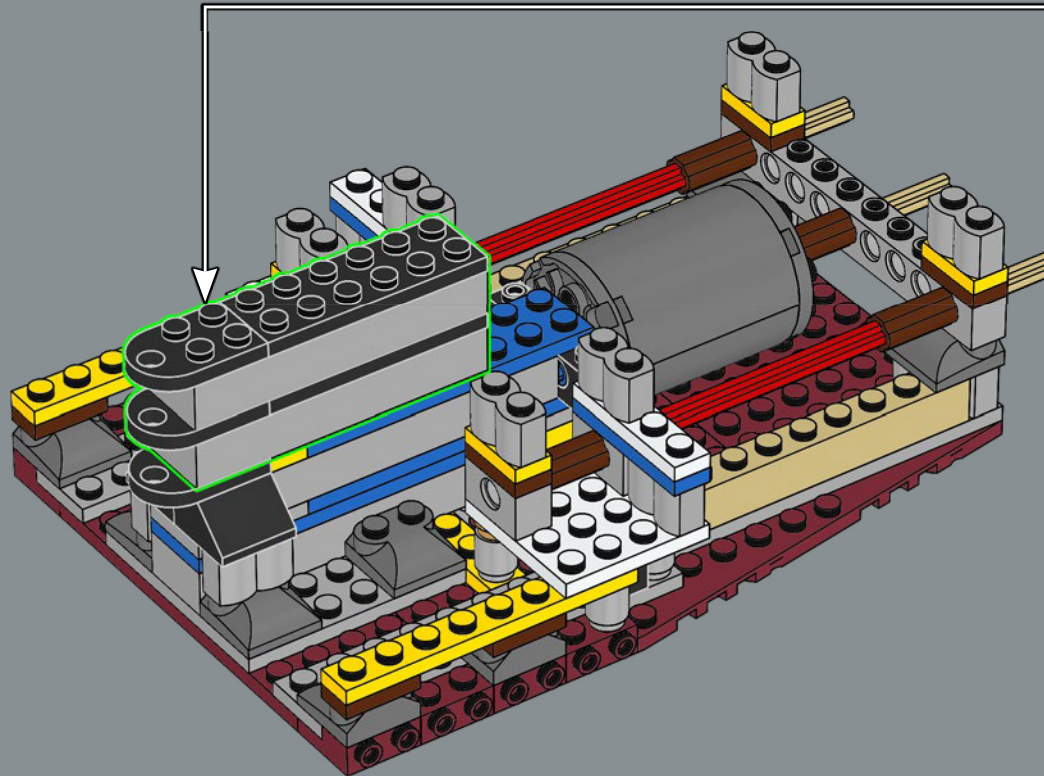
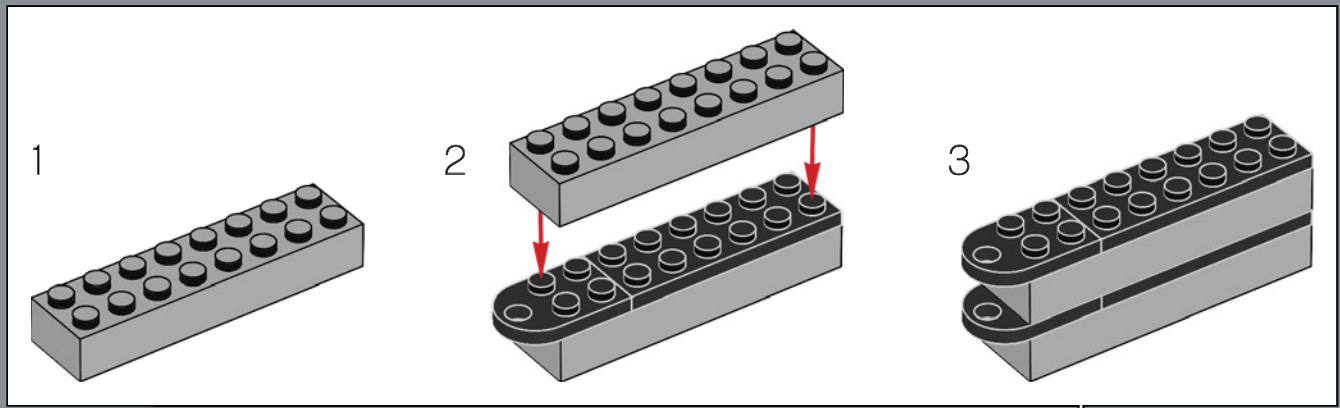

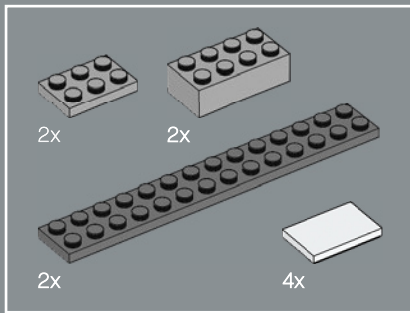

18

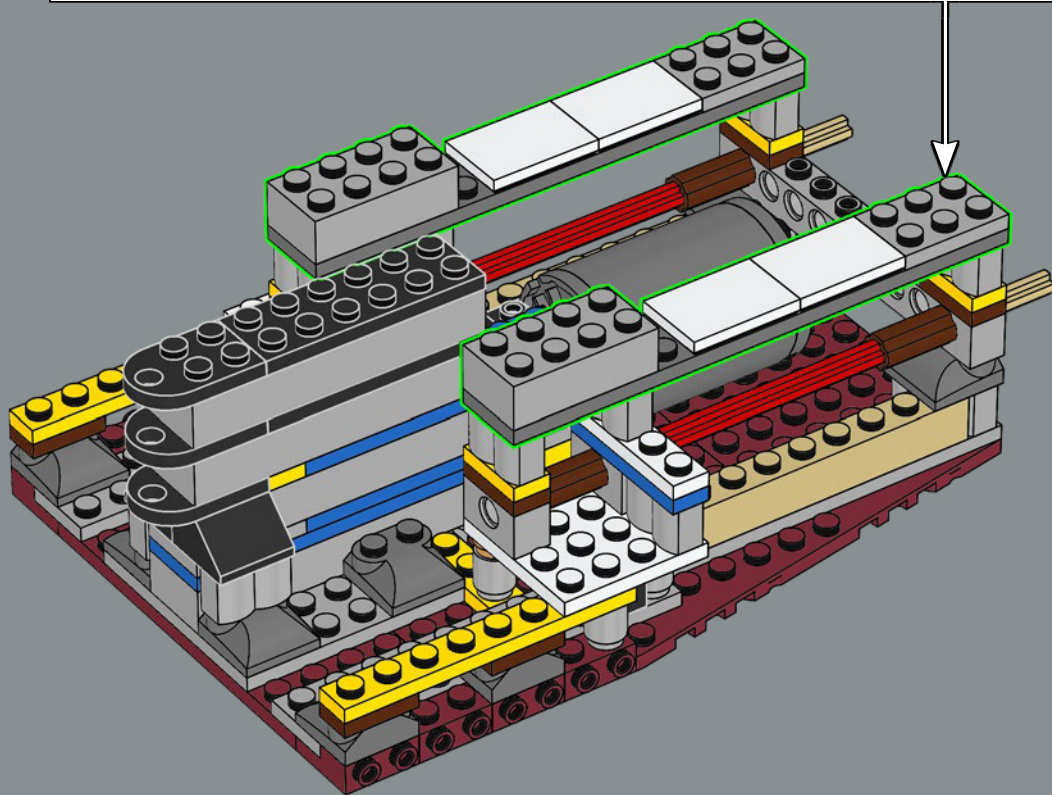
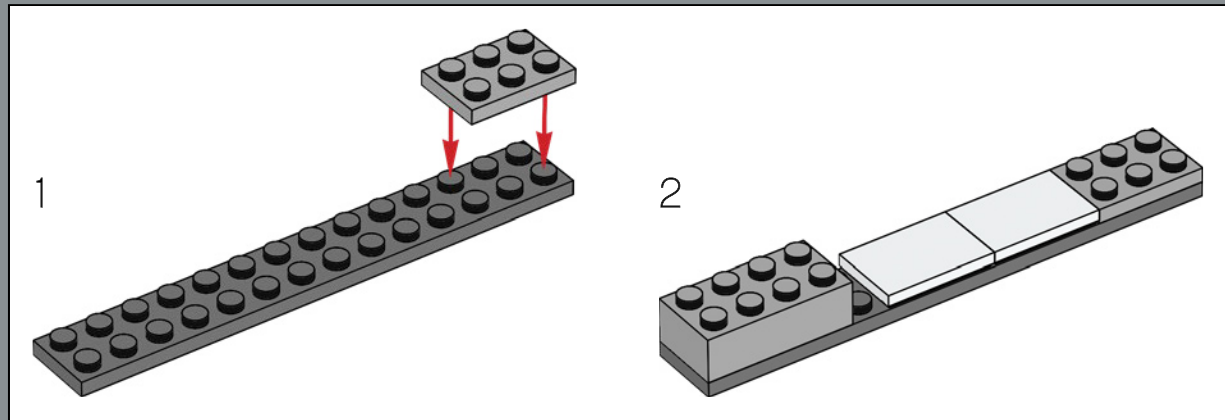

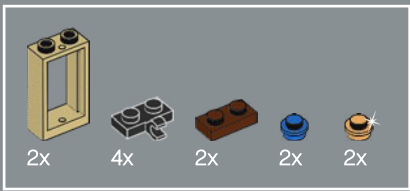

19

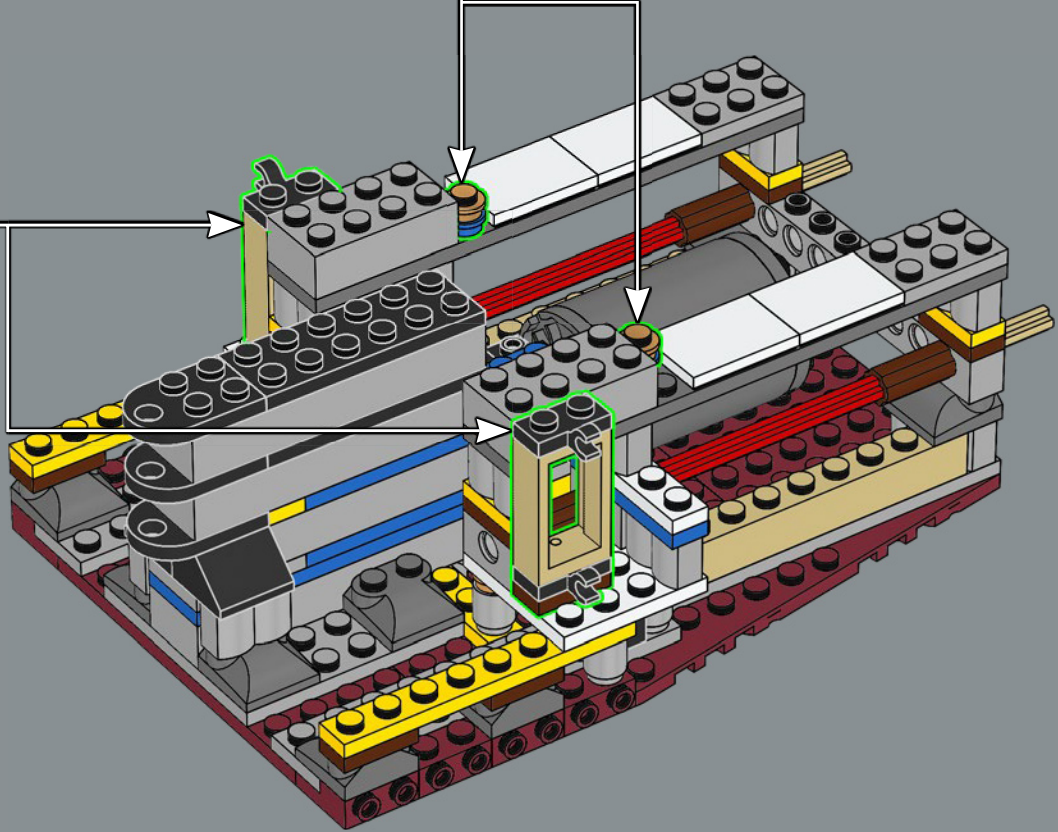
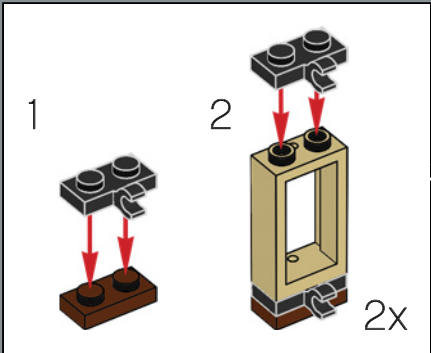
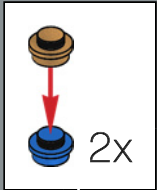

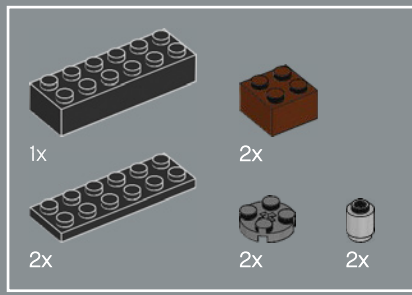

20

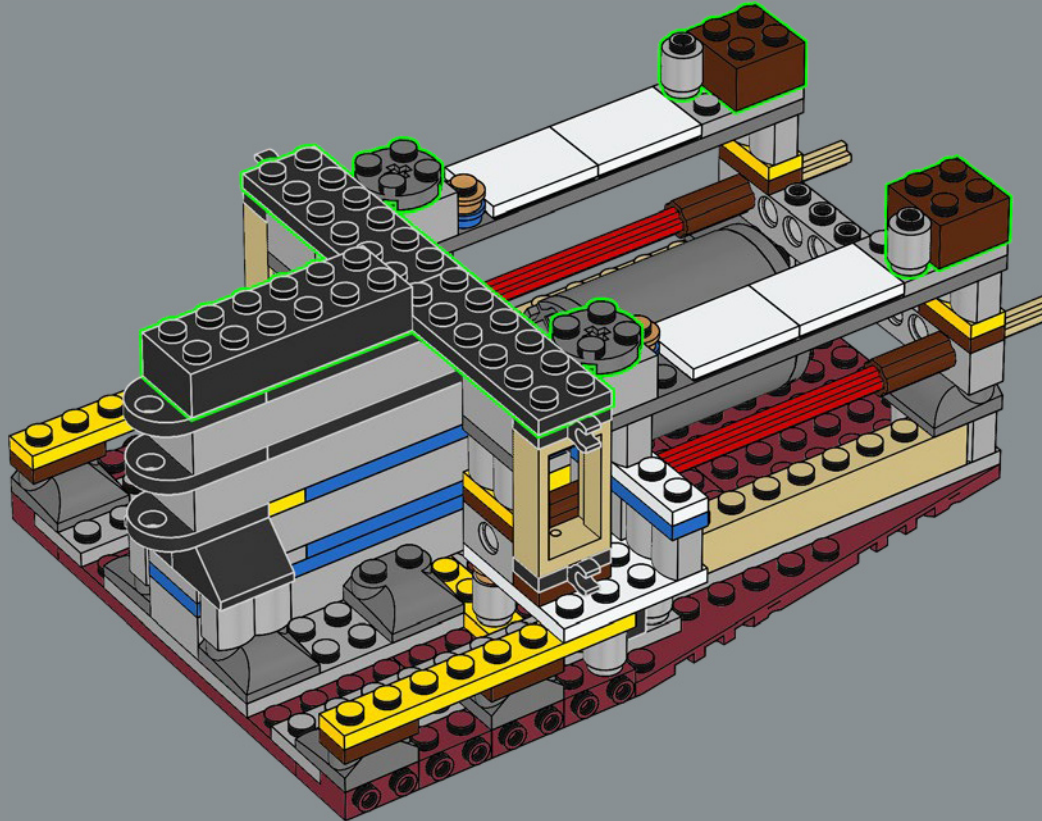





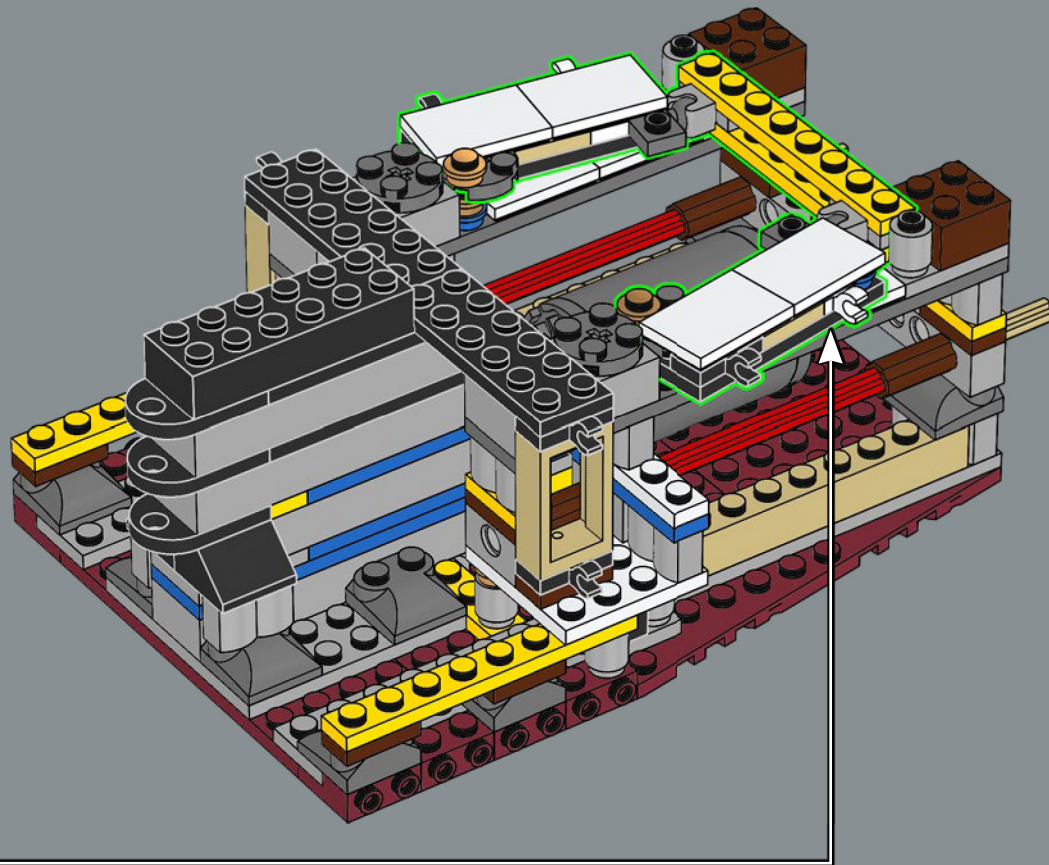

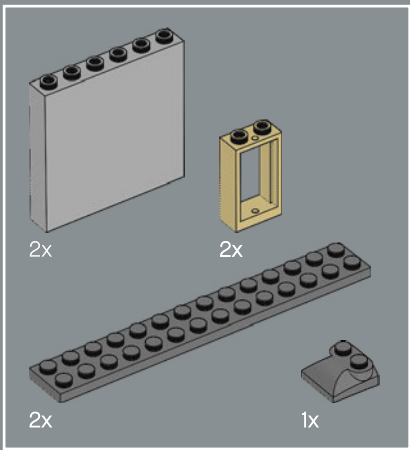

22

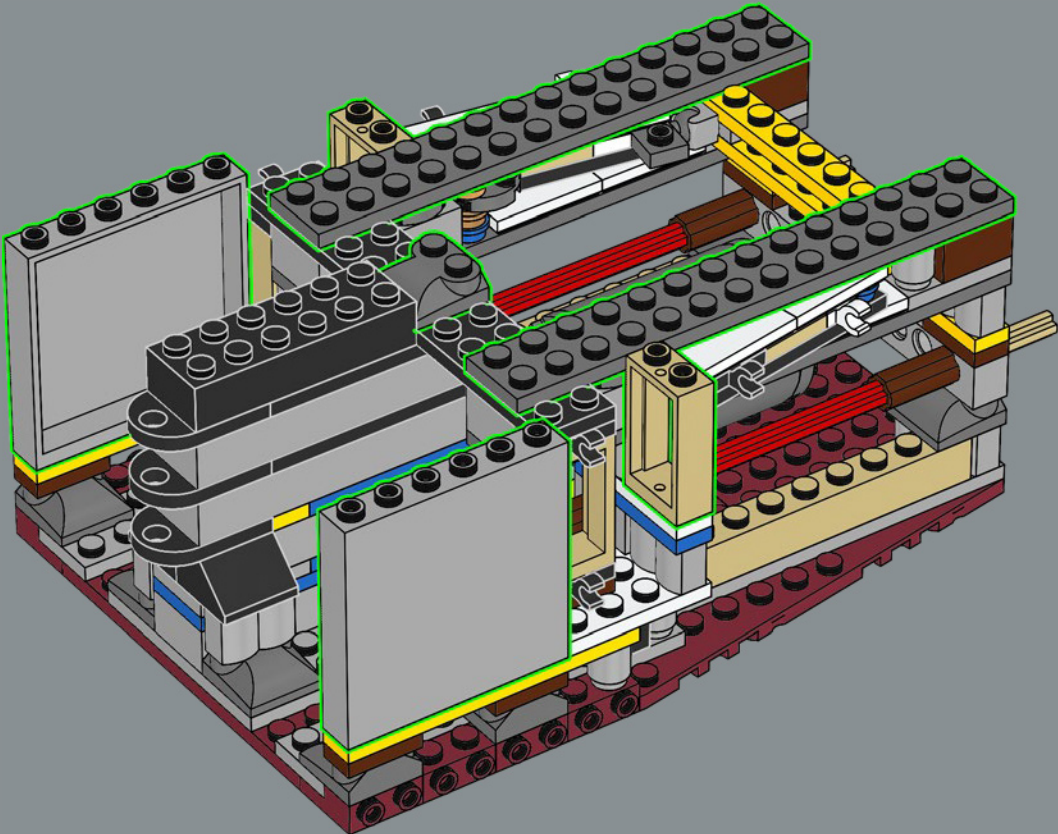

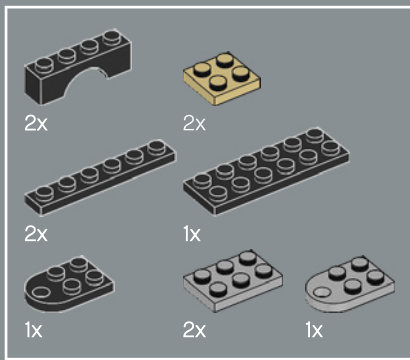

23

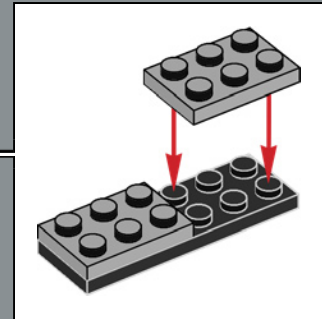
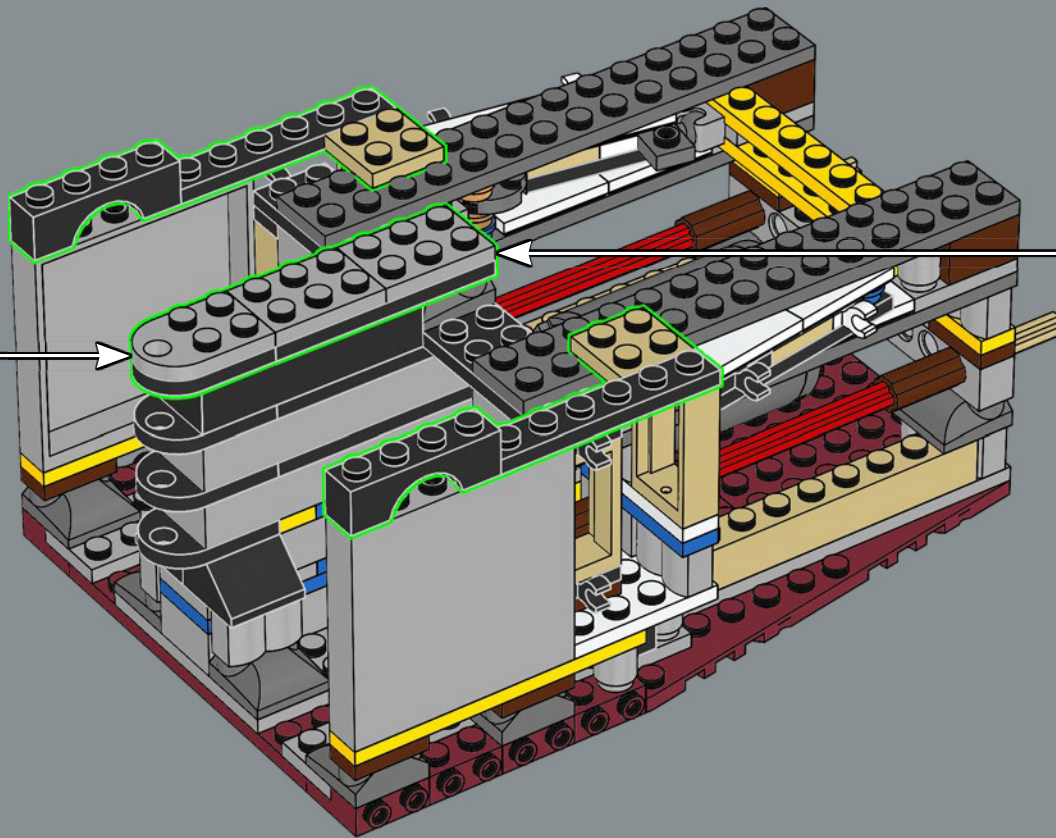
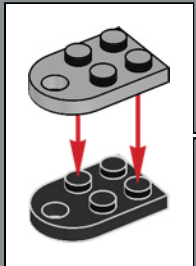



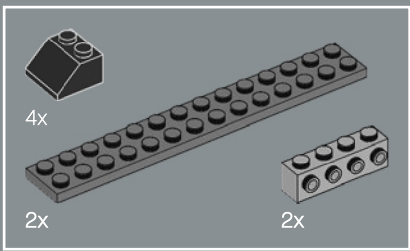

24

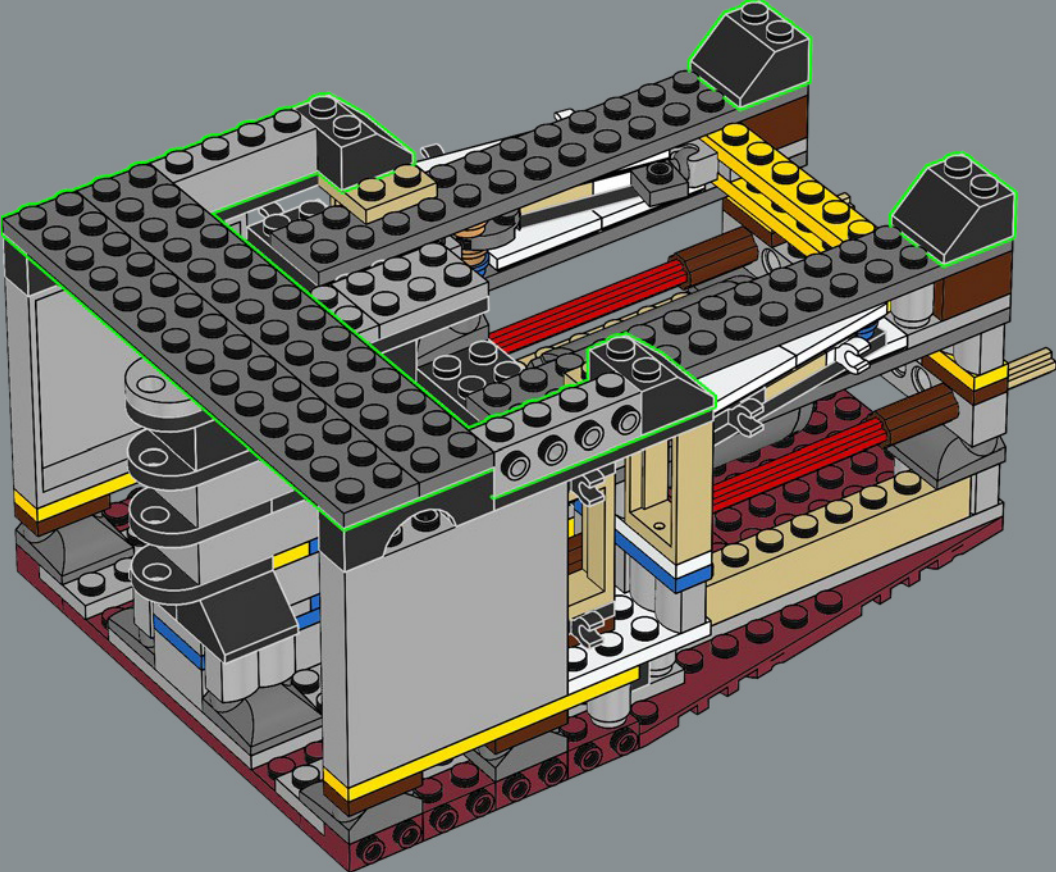

30

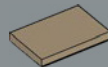
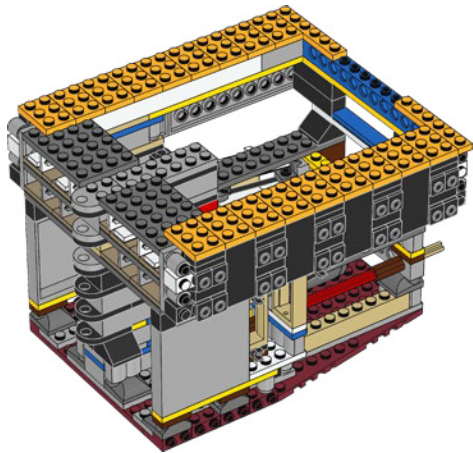
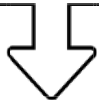

4x



1x



4x

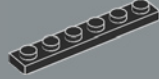

2x



2x

25

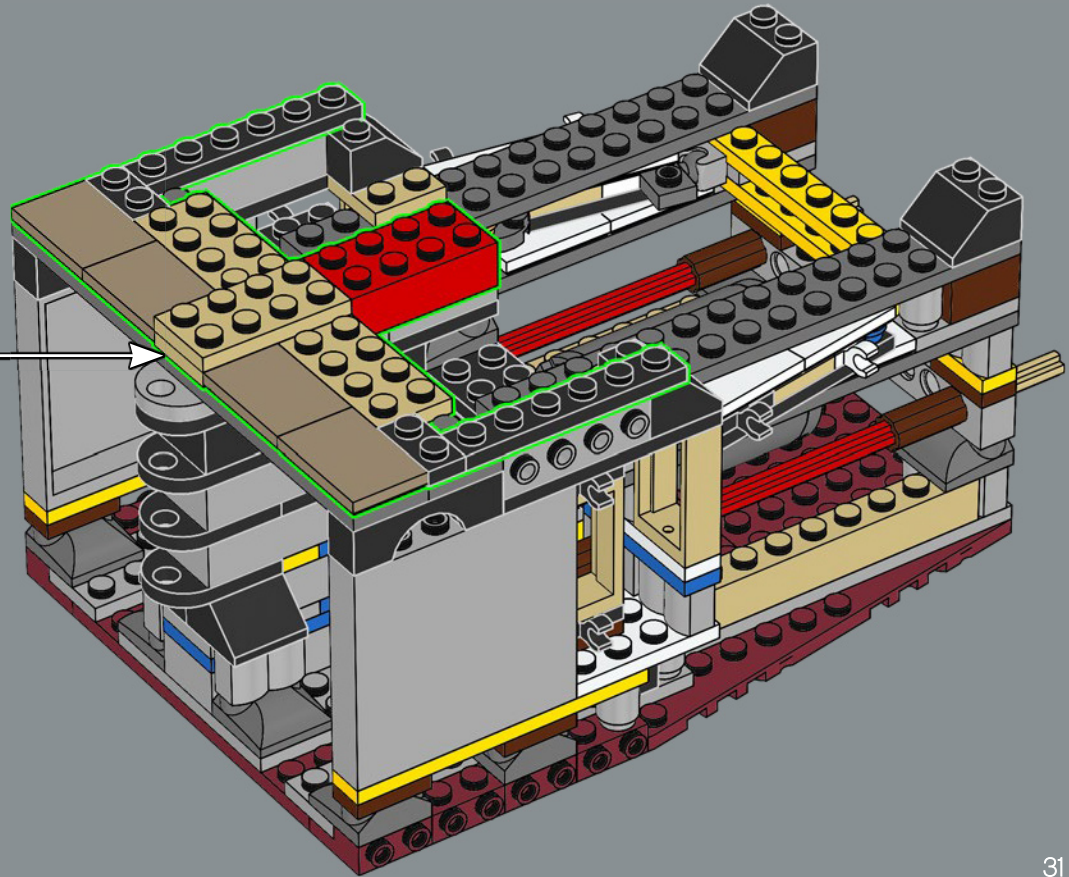
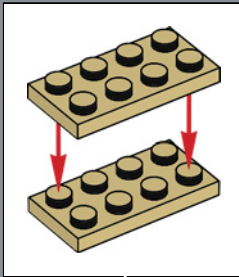

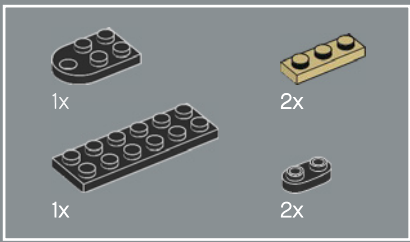

26

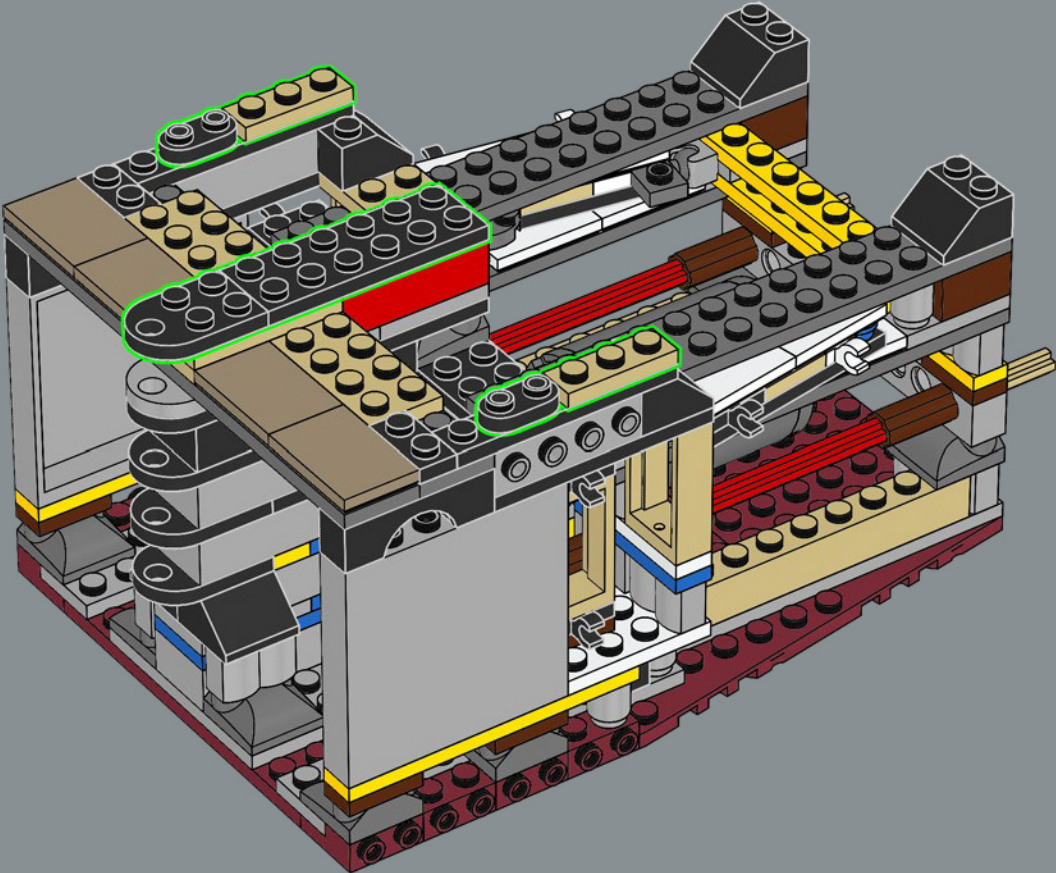



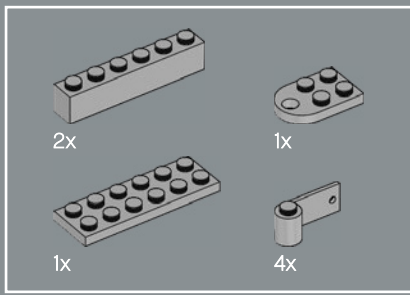

27

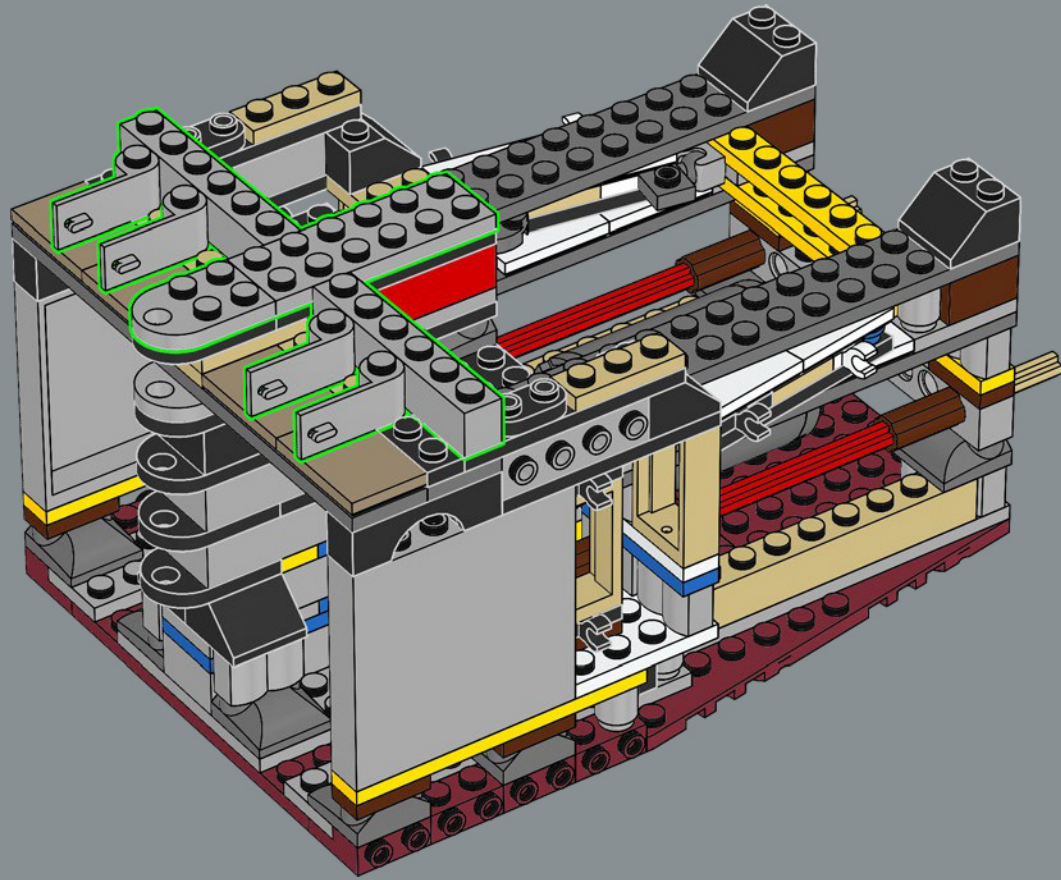



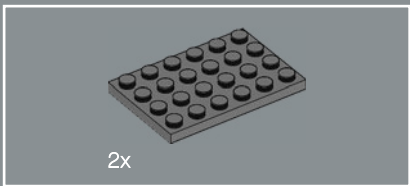

28

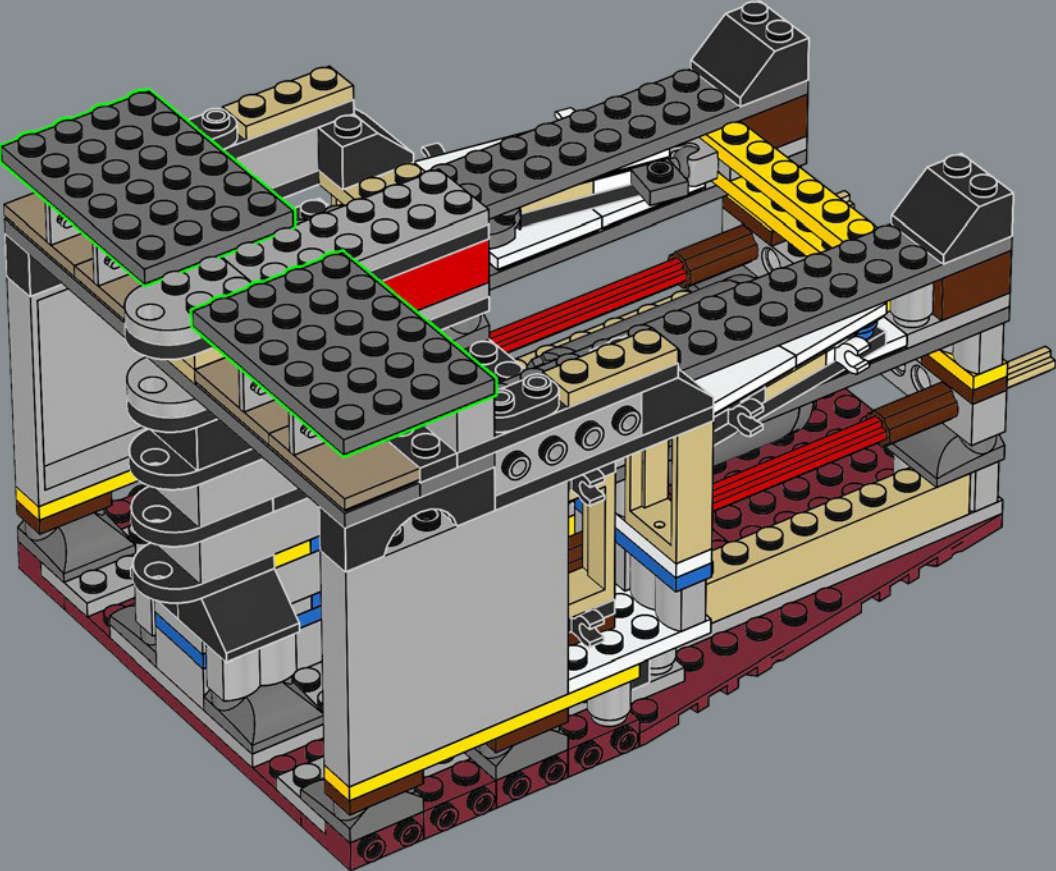

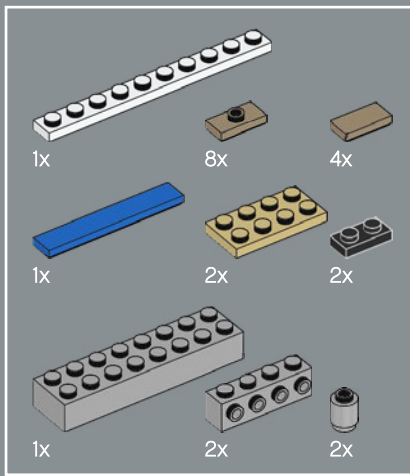

29

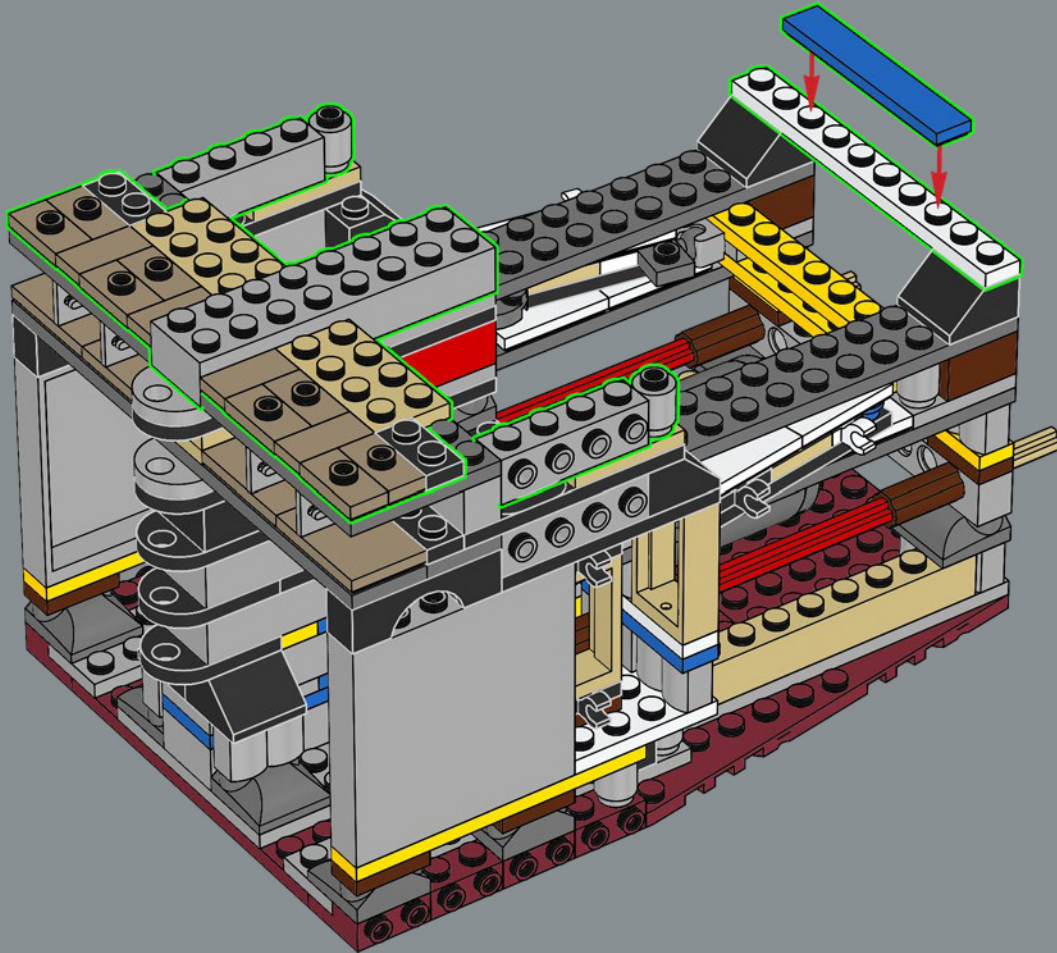

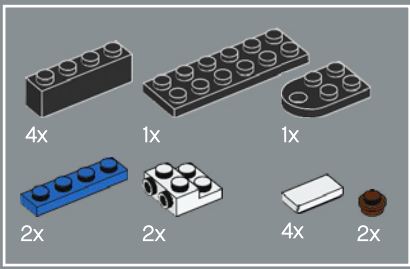

30

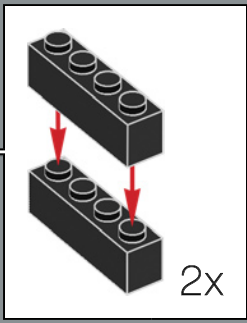
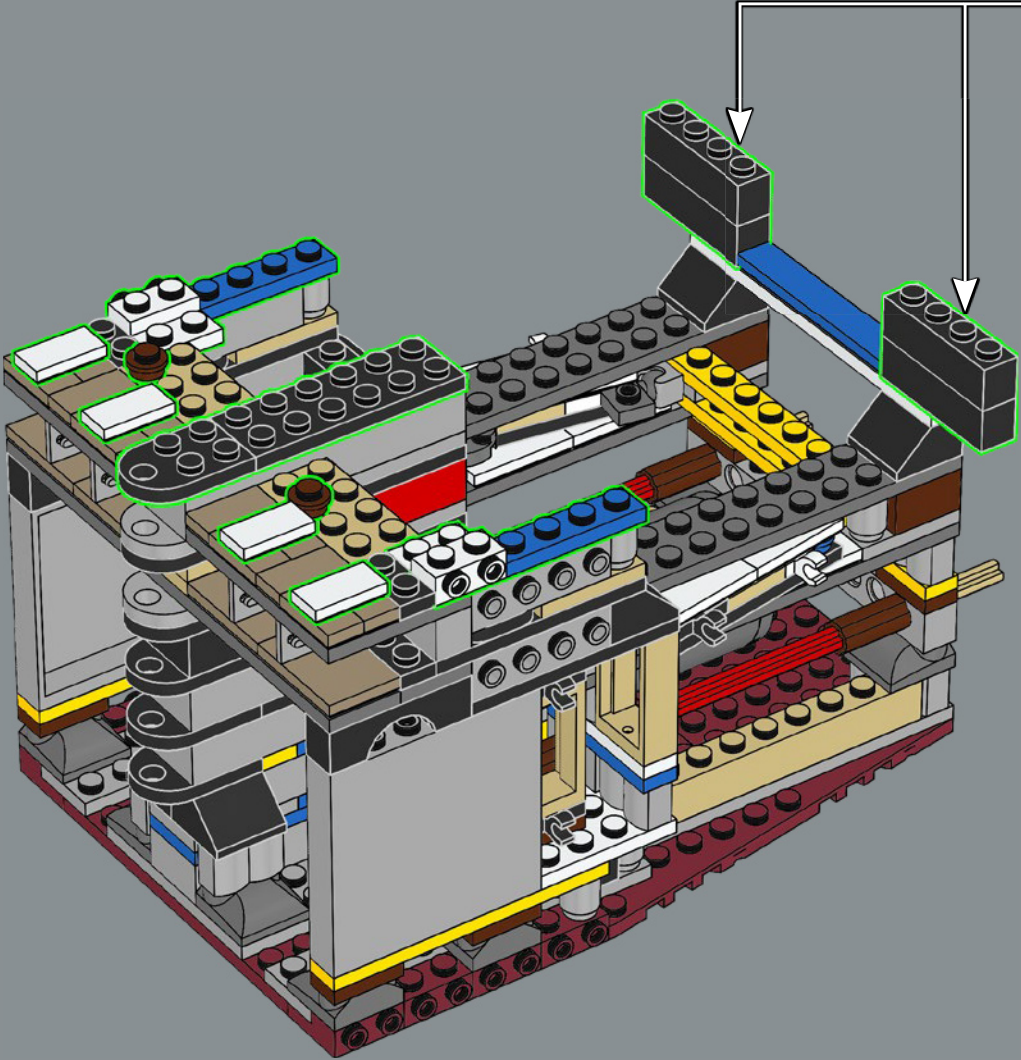



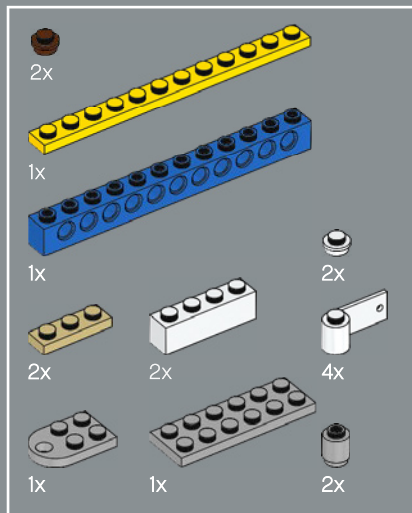

31

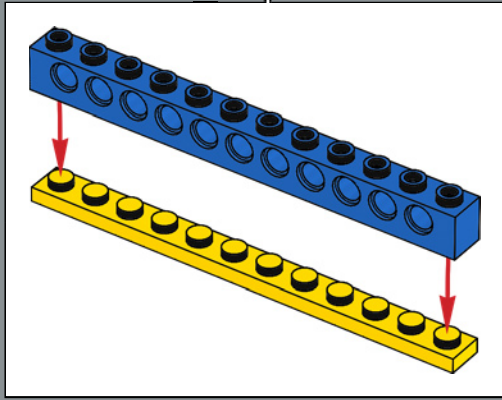
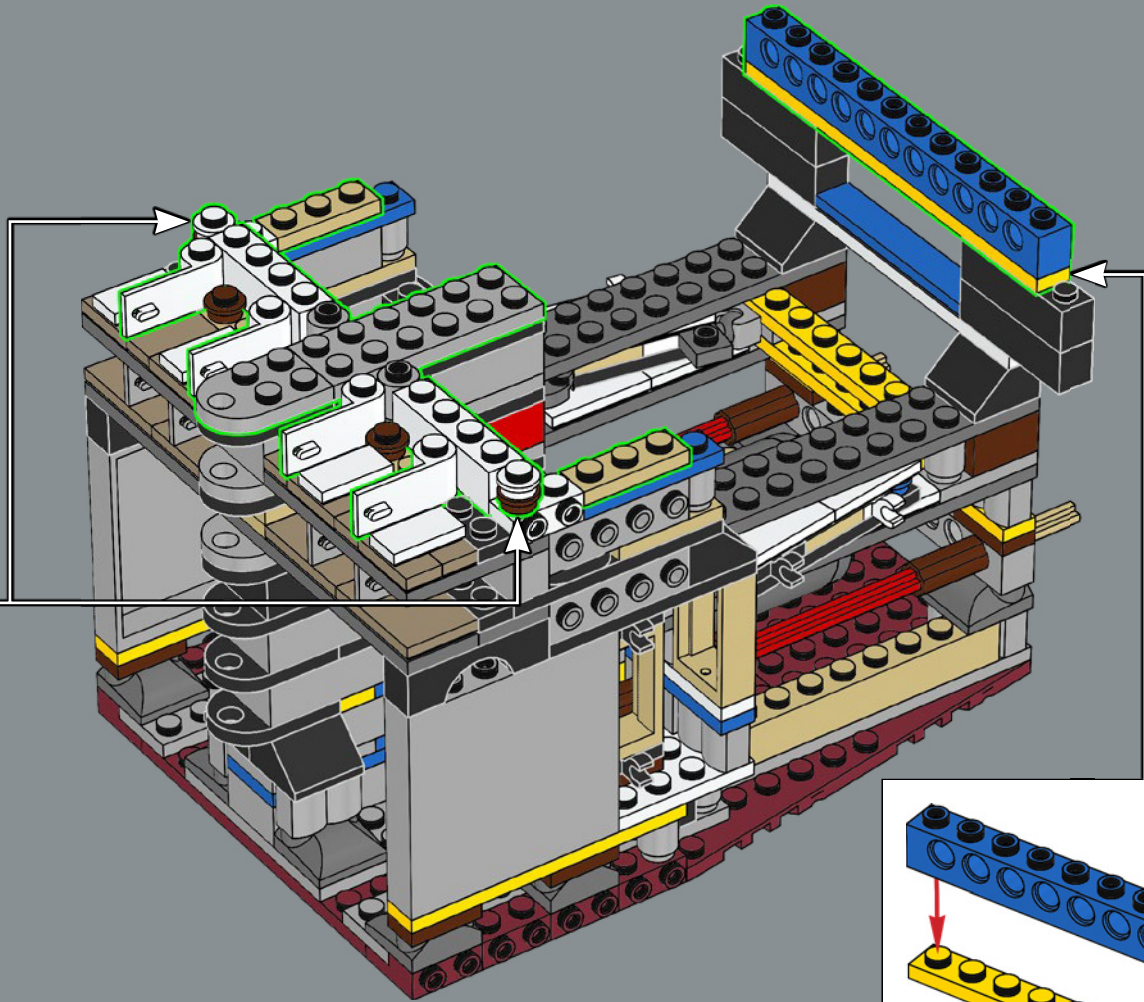
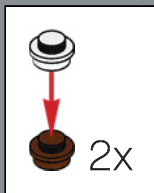



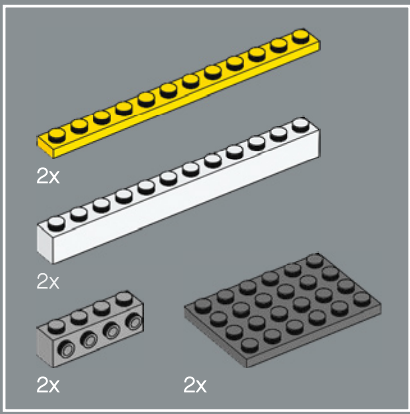

32

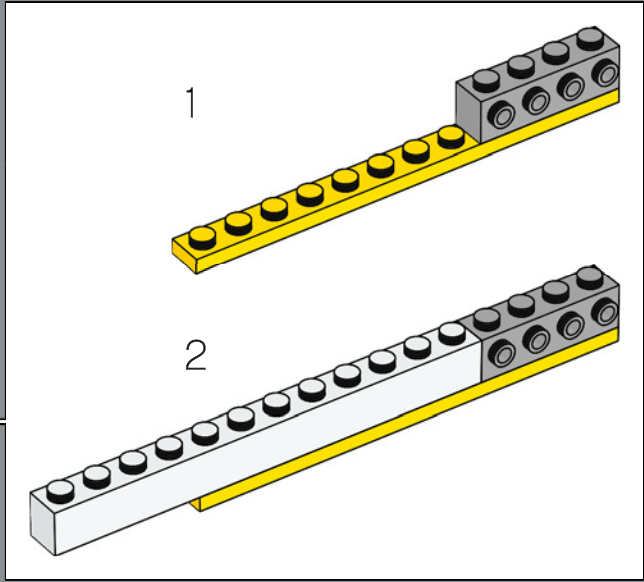
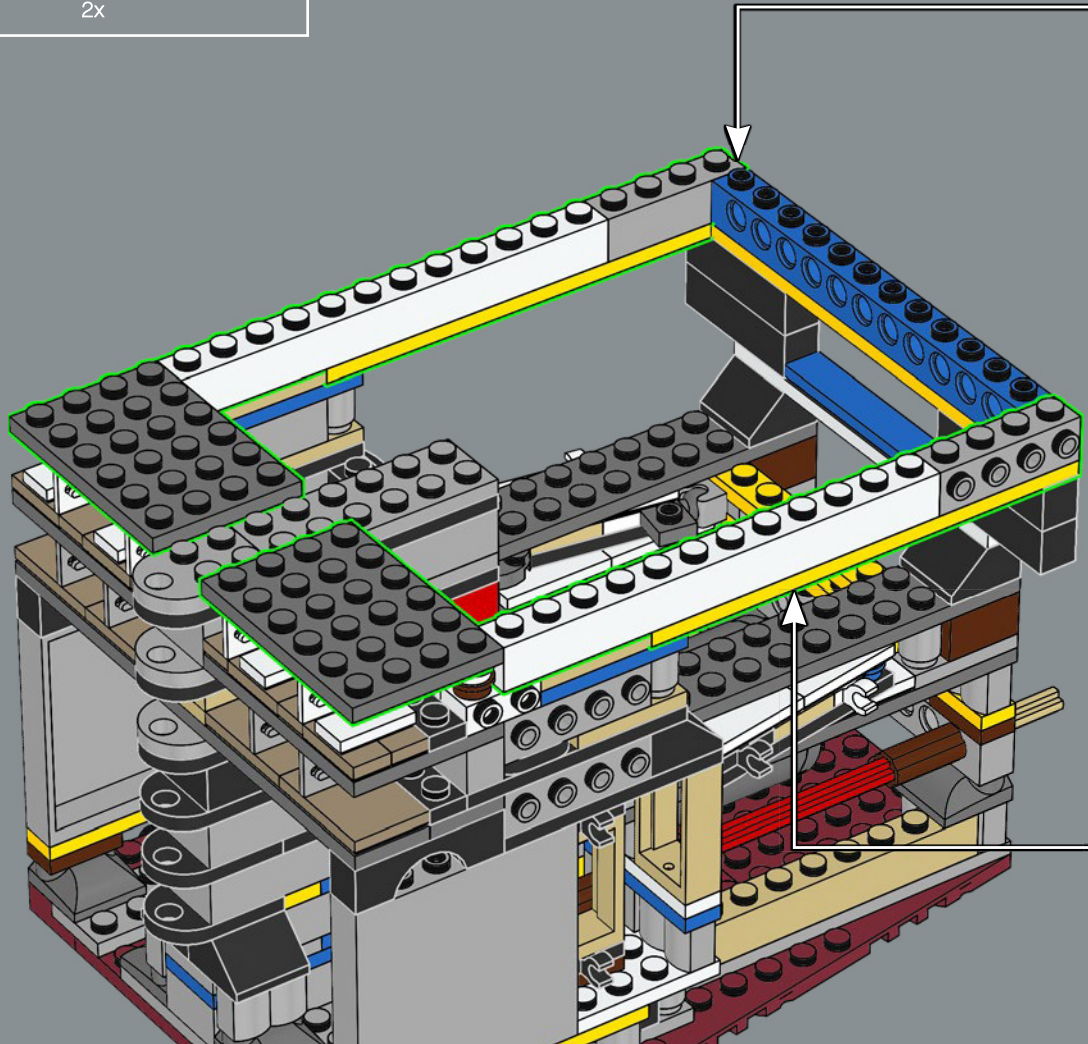
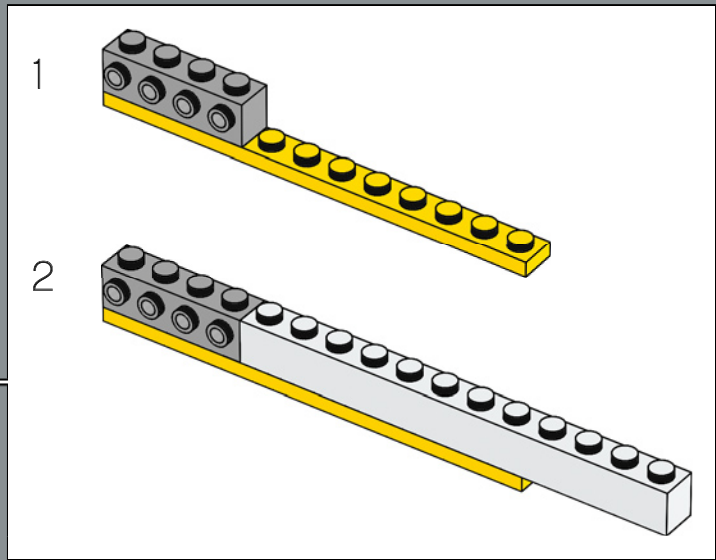

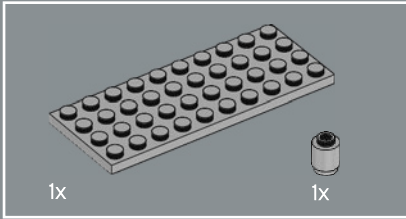
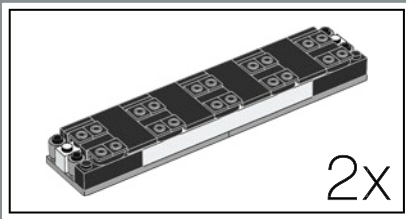

33

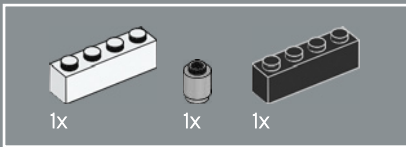
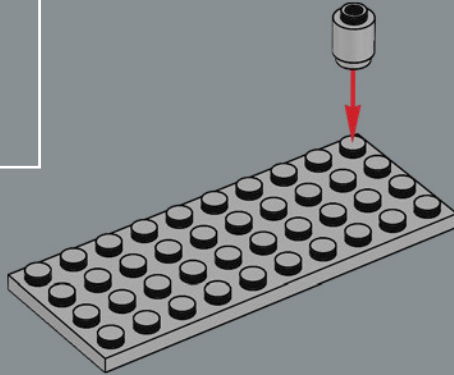

34

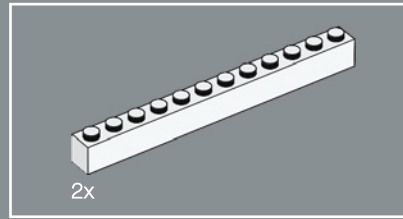
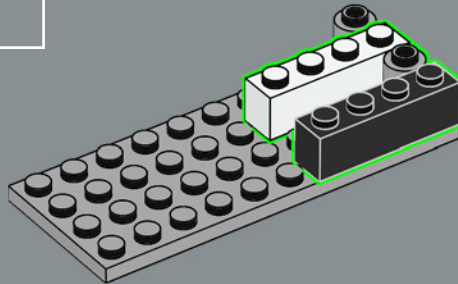

35

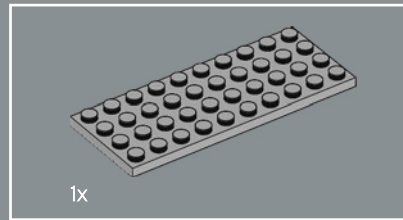
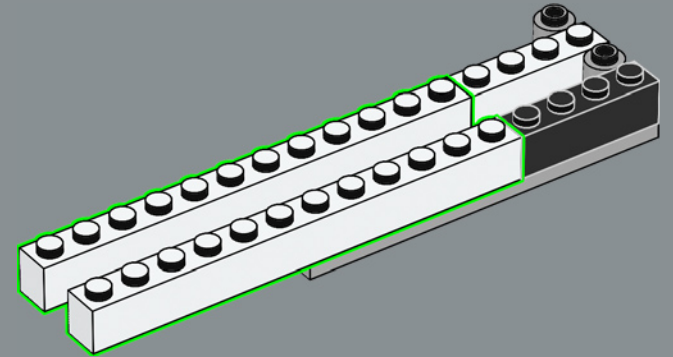

36

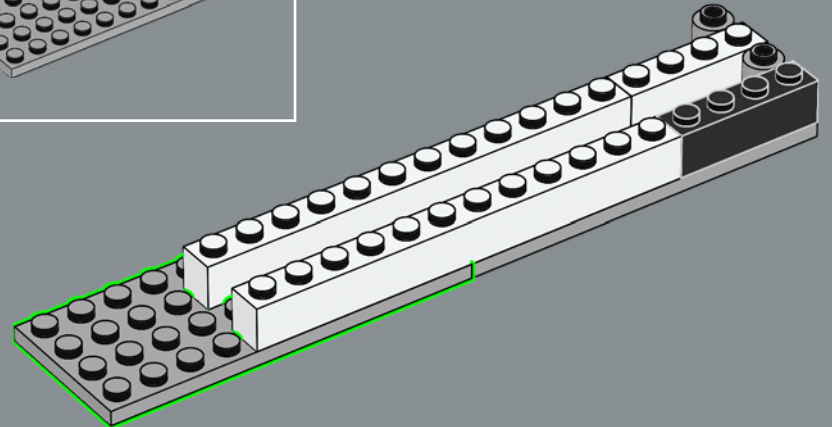

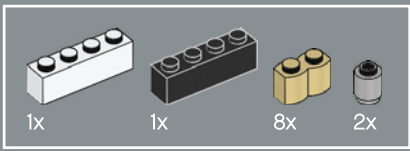

37

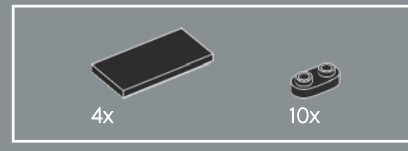
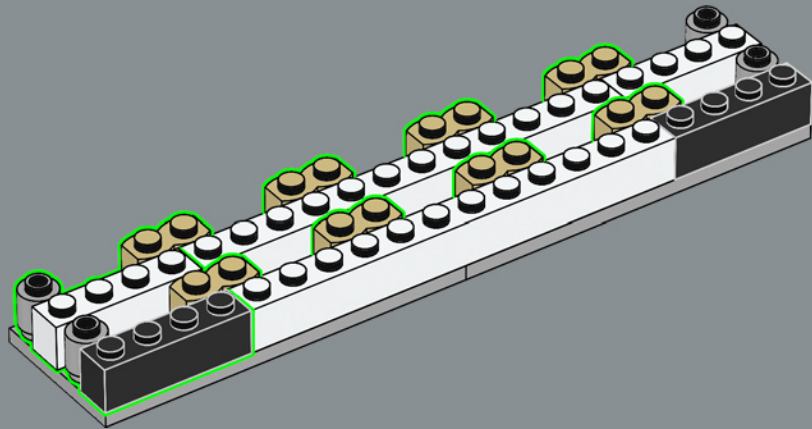

38

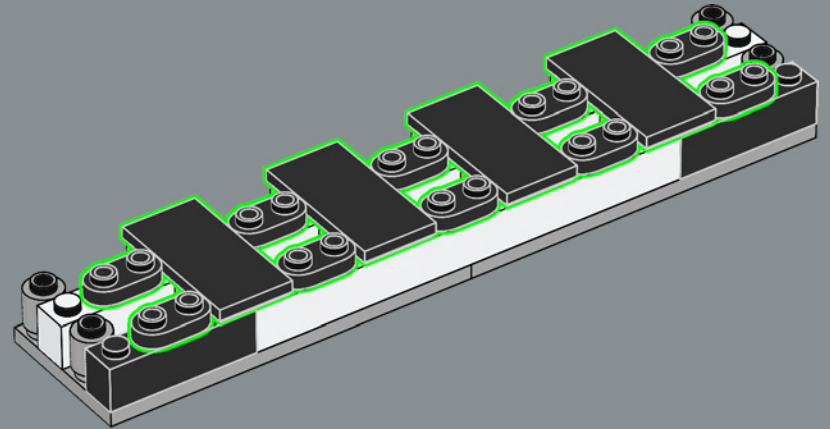



39

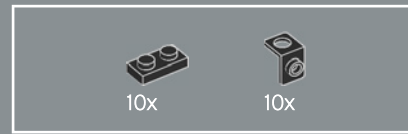
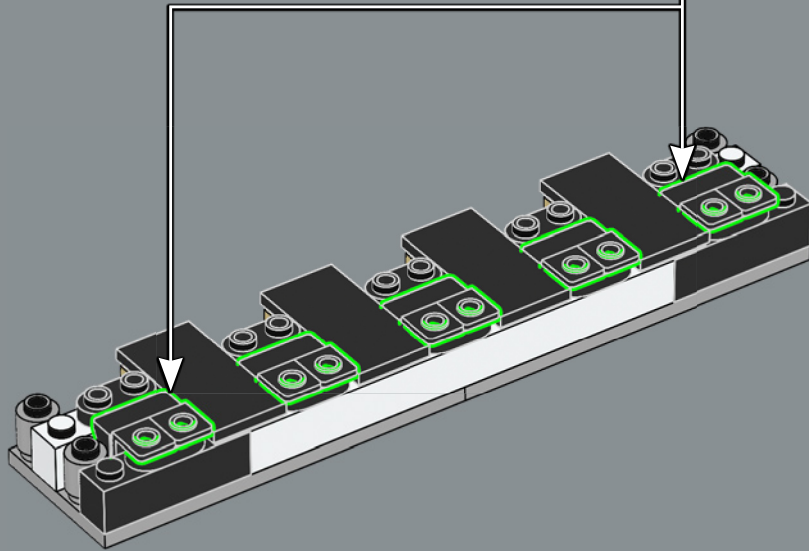
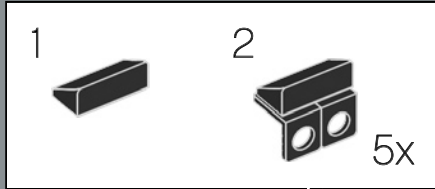

40

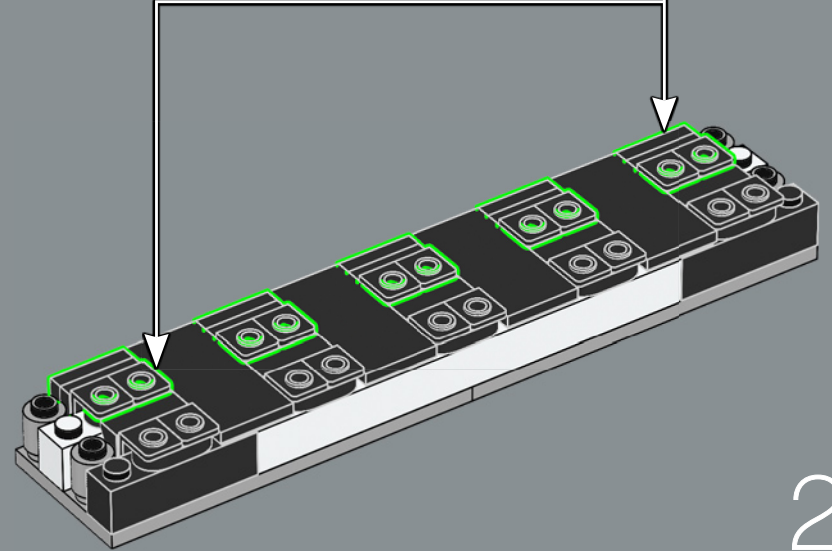
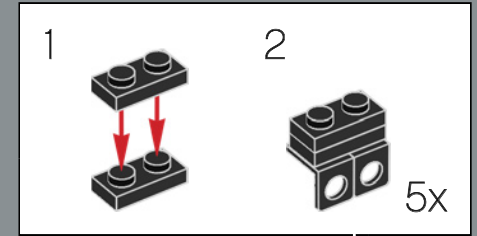

2x



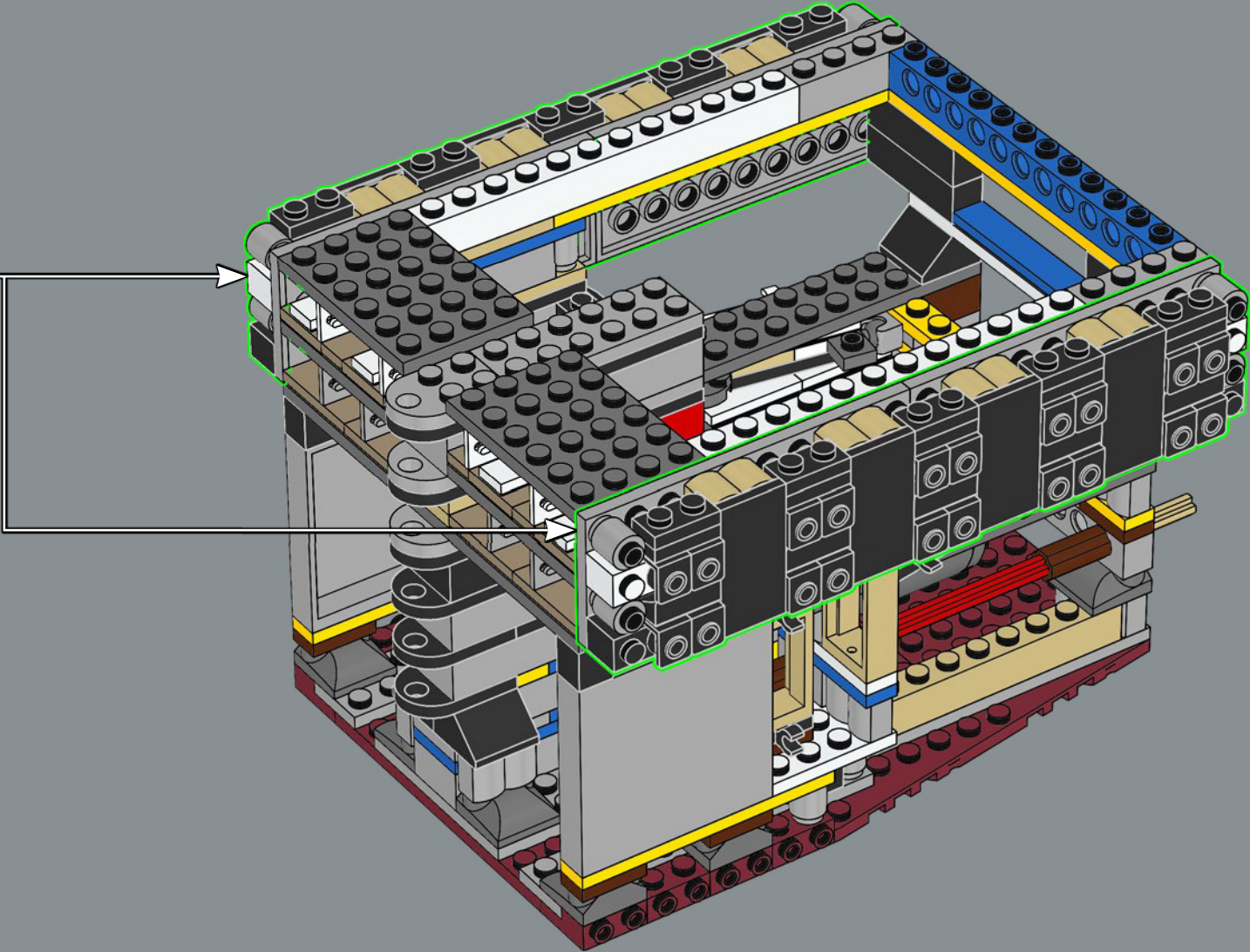

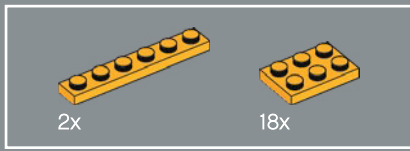

42

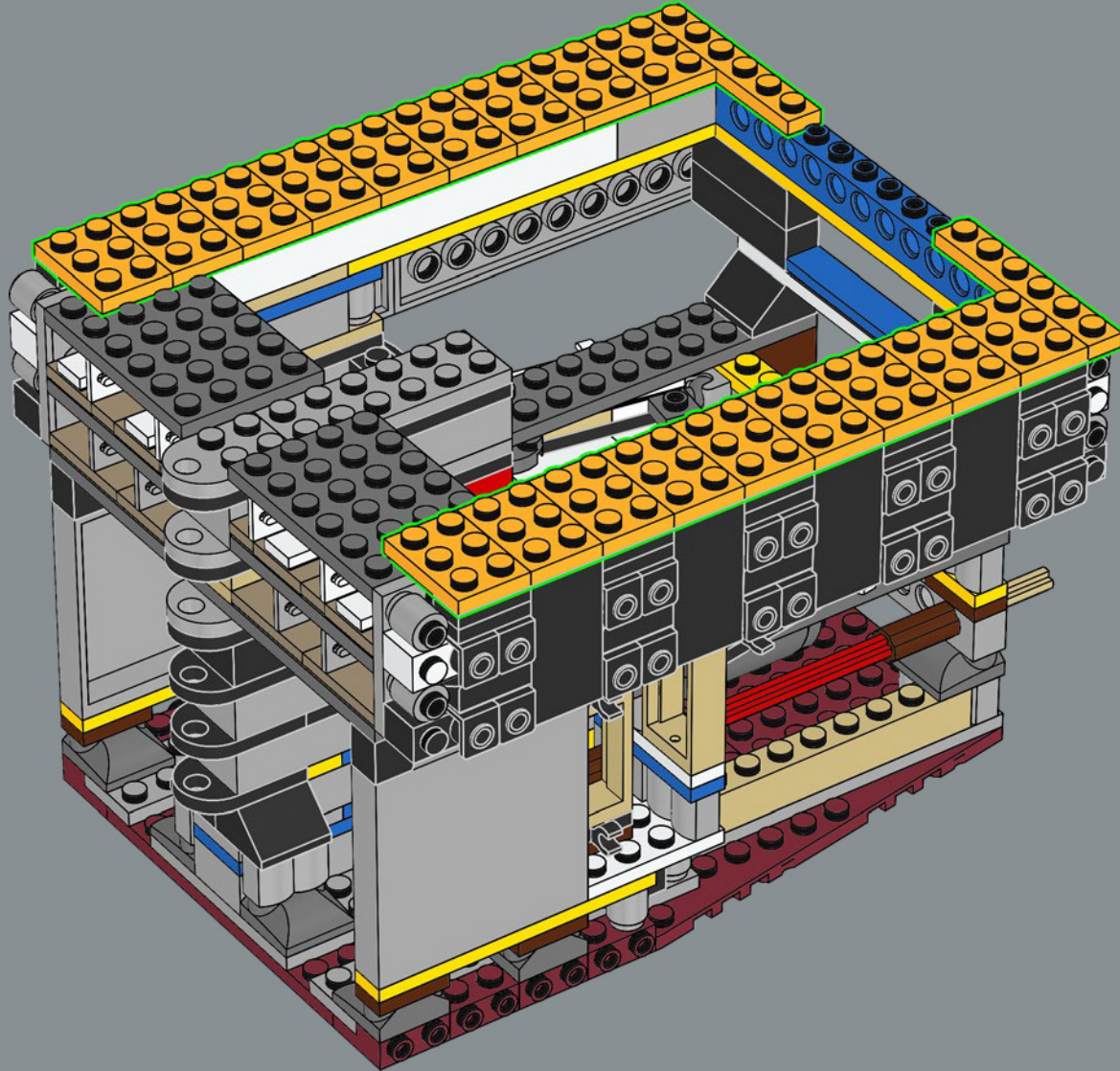

31

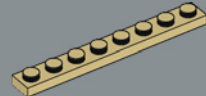
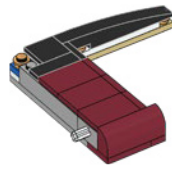
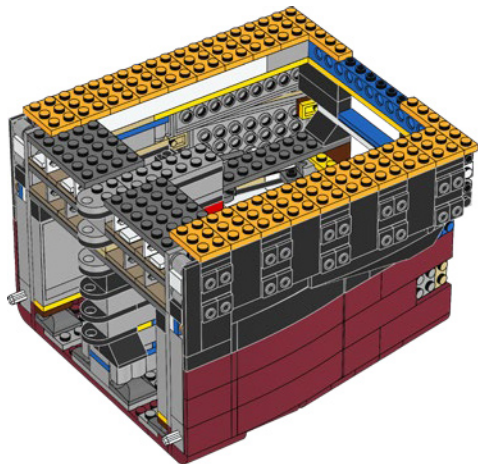
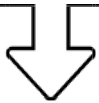

1x



1x

43

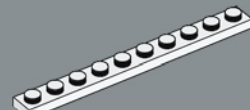
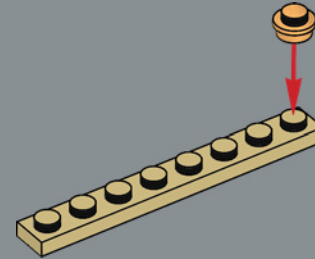

1x

44

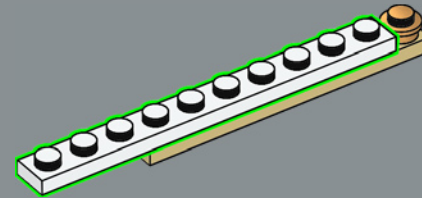



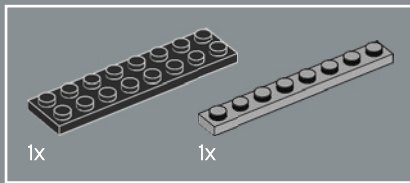

45

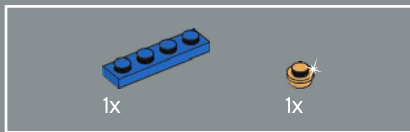
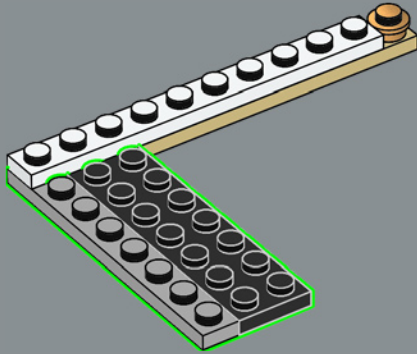

46

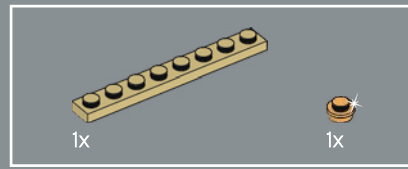
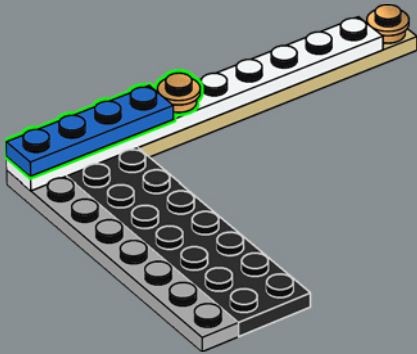

47

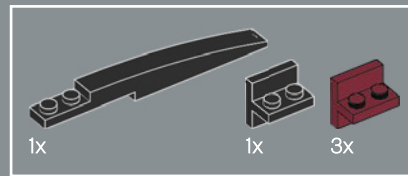
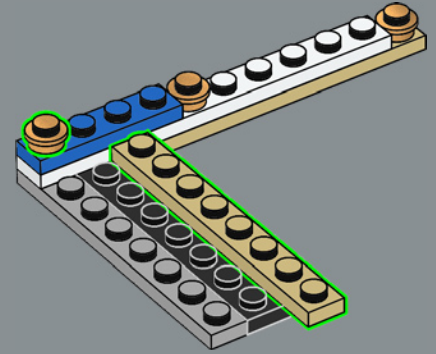

48

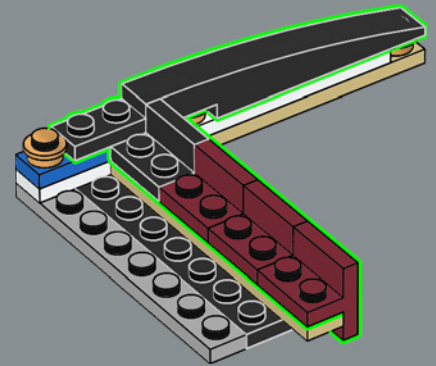



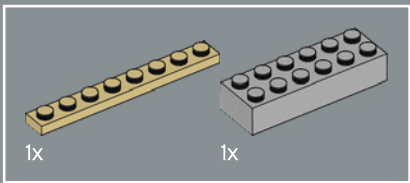

49

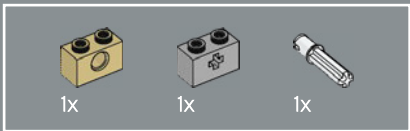
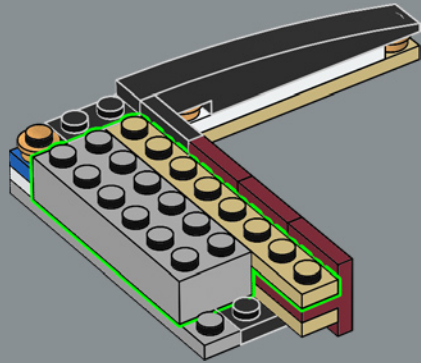

50

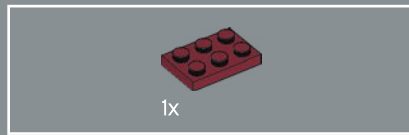
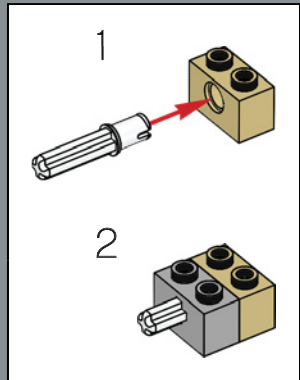
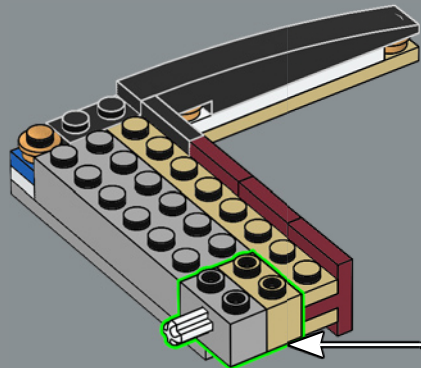

51

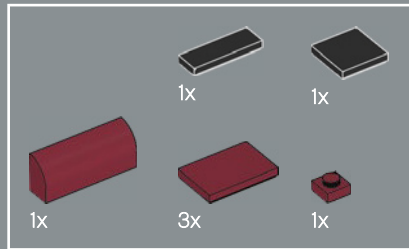
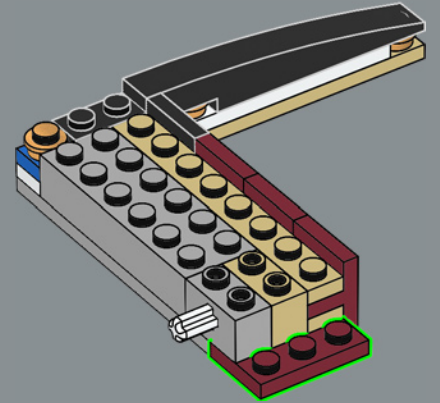

52

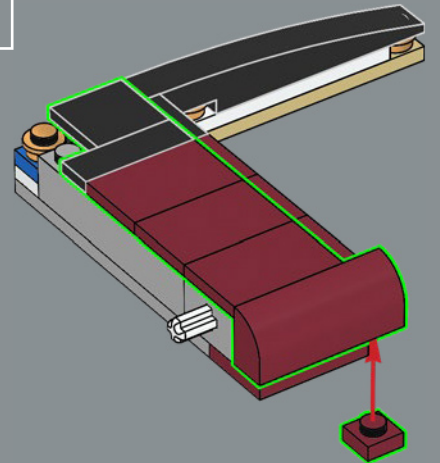

53

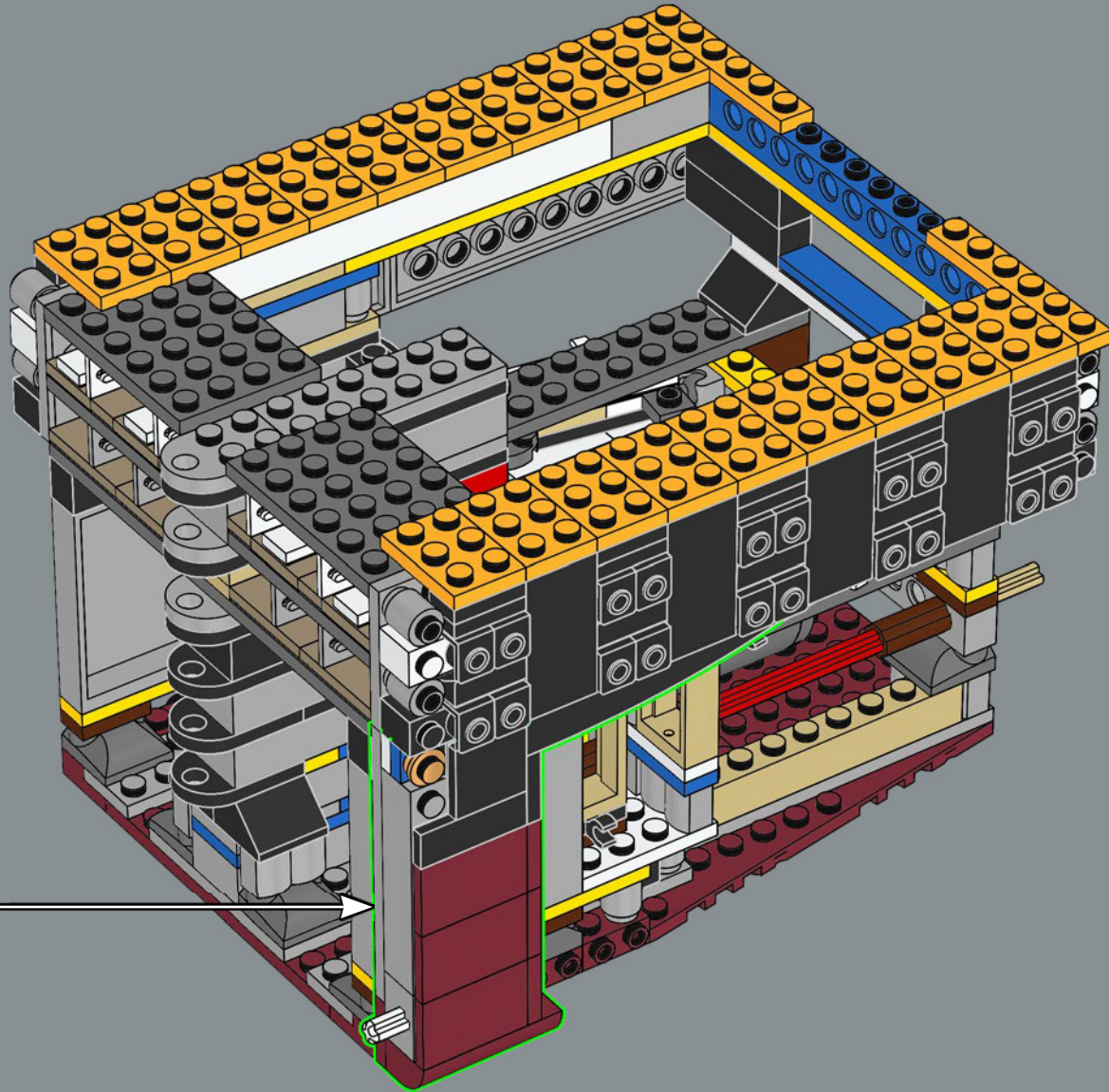

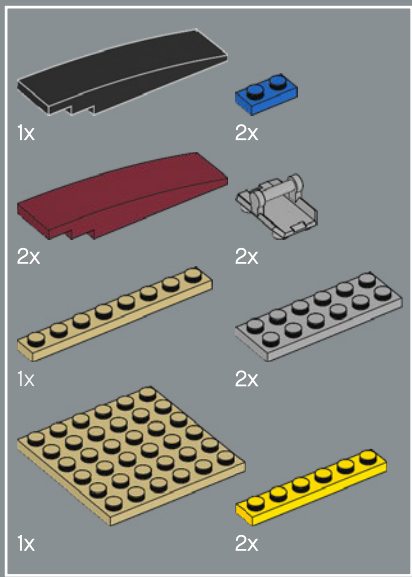

54

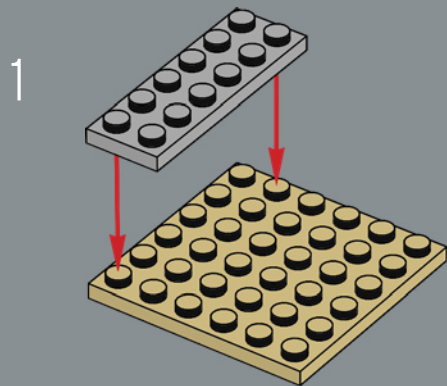

2

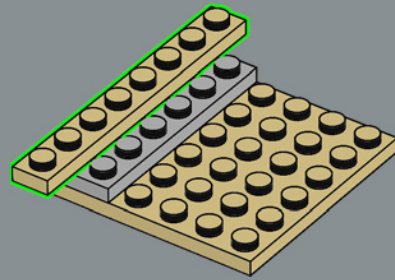

3

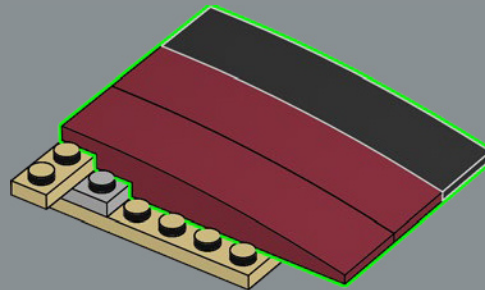

4

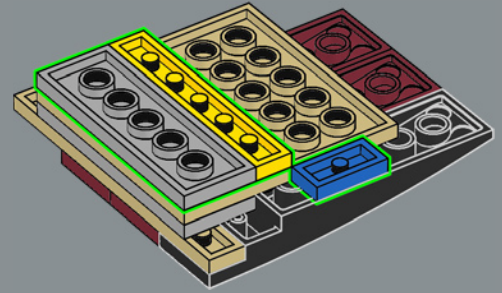

5

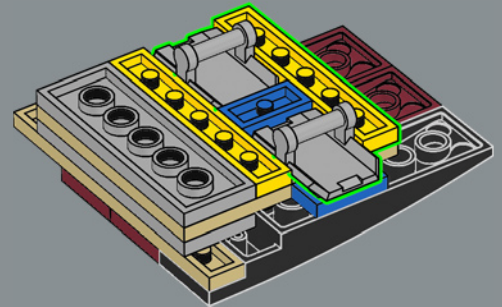



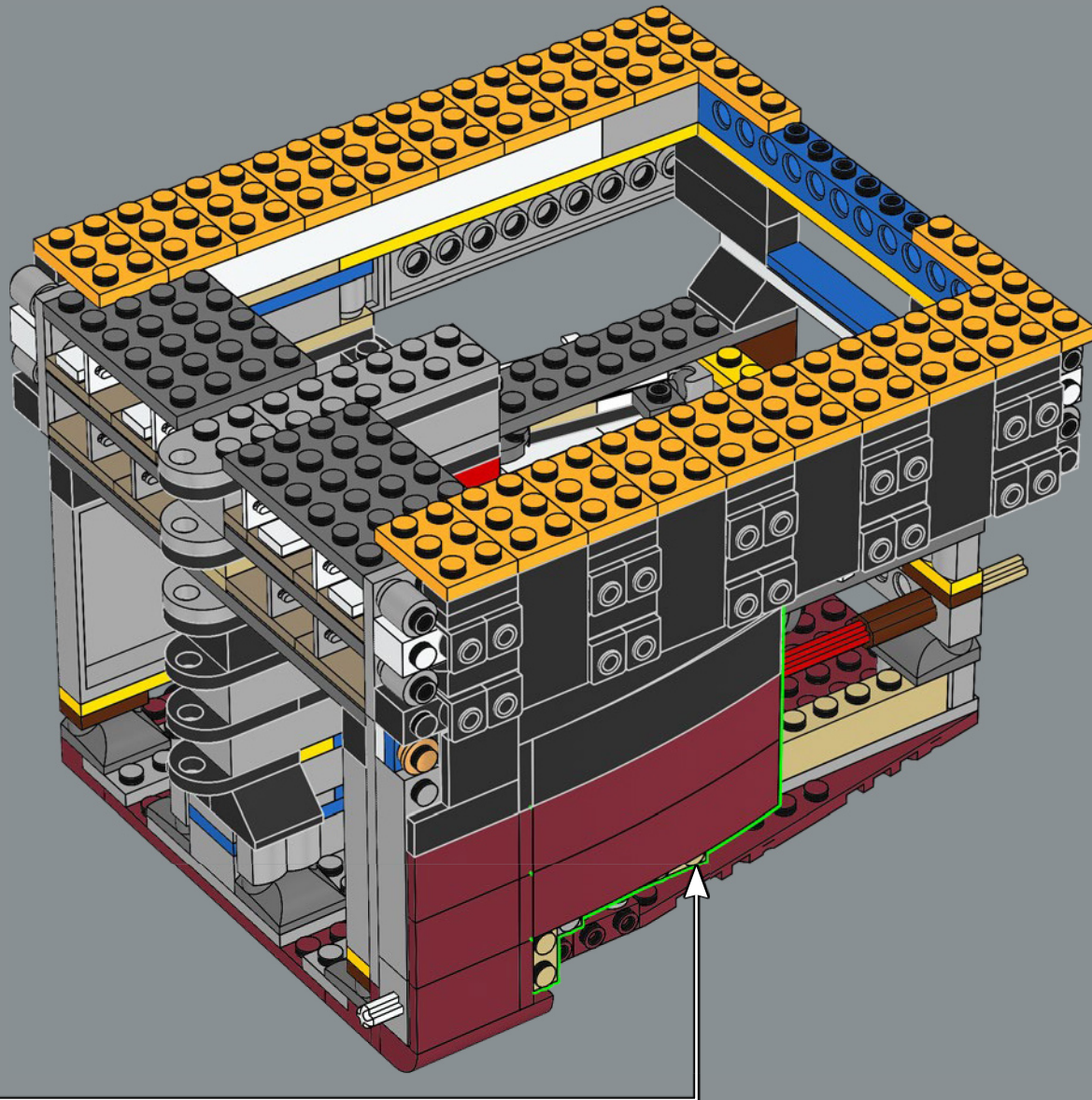





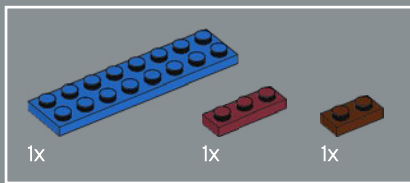

59

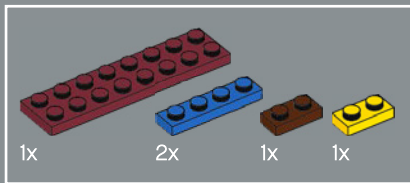
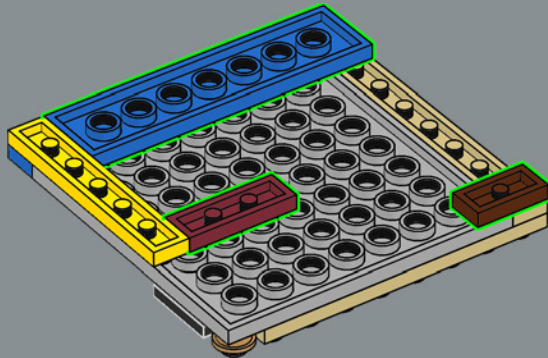

60

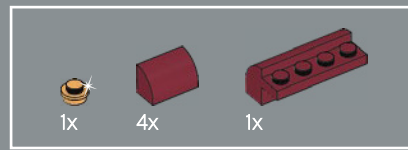
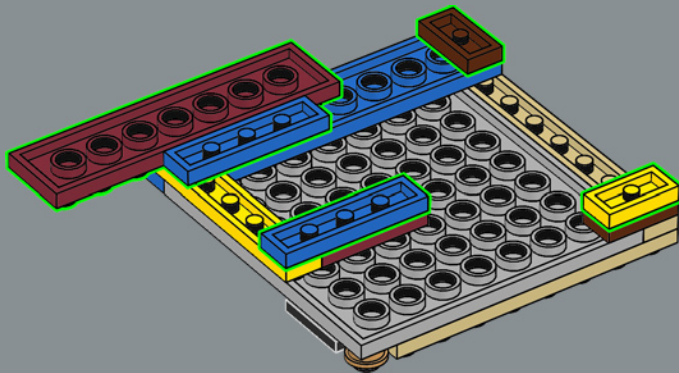

61

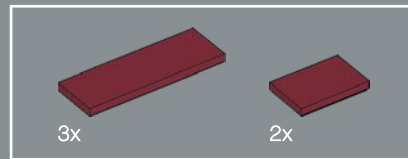
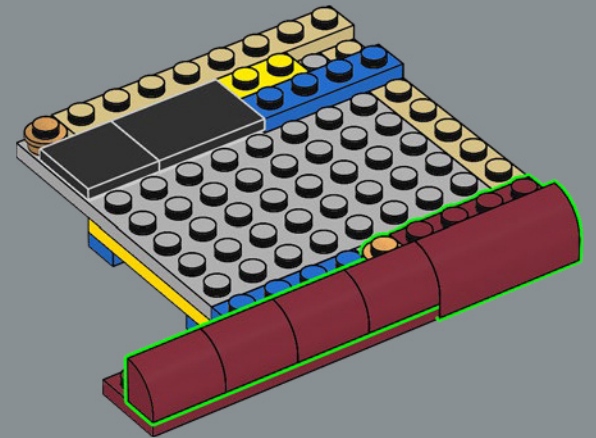

62

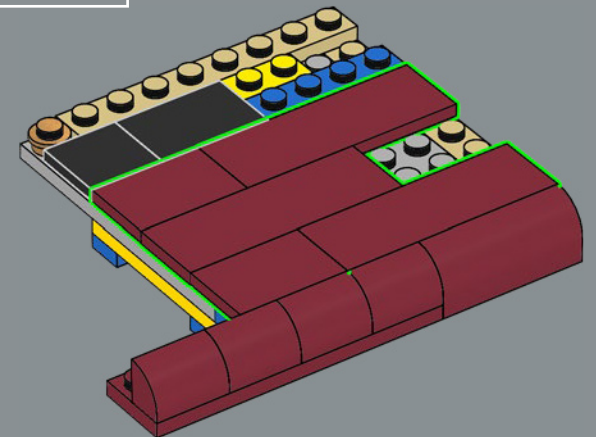

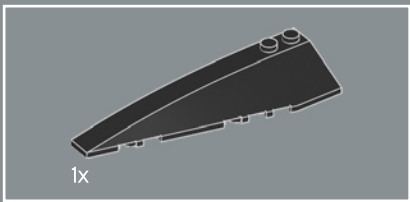

63

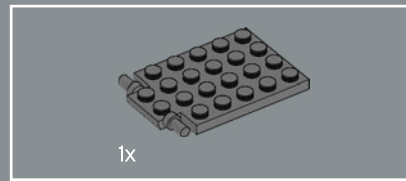
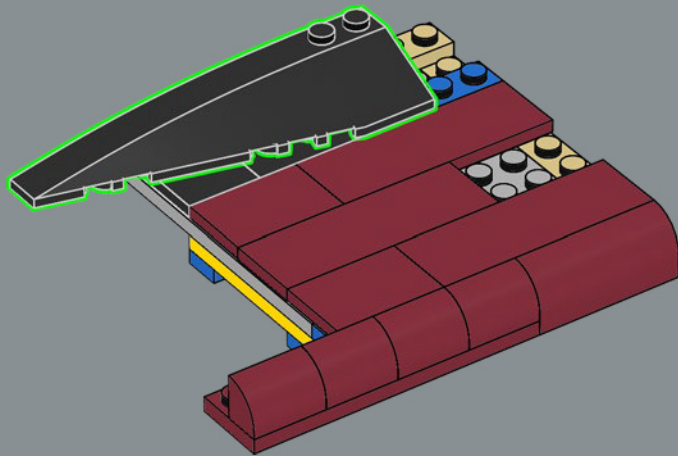

64

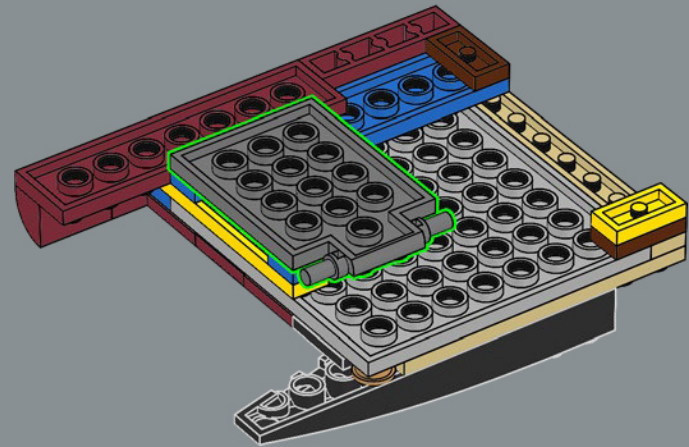



65

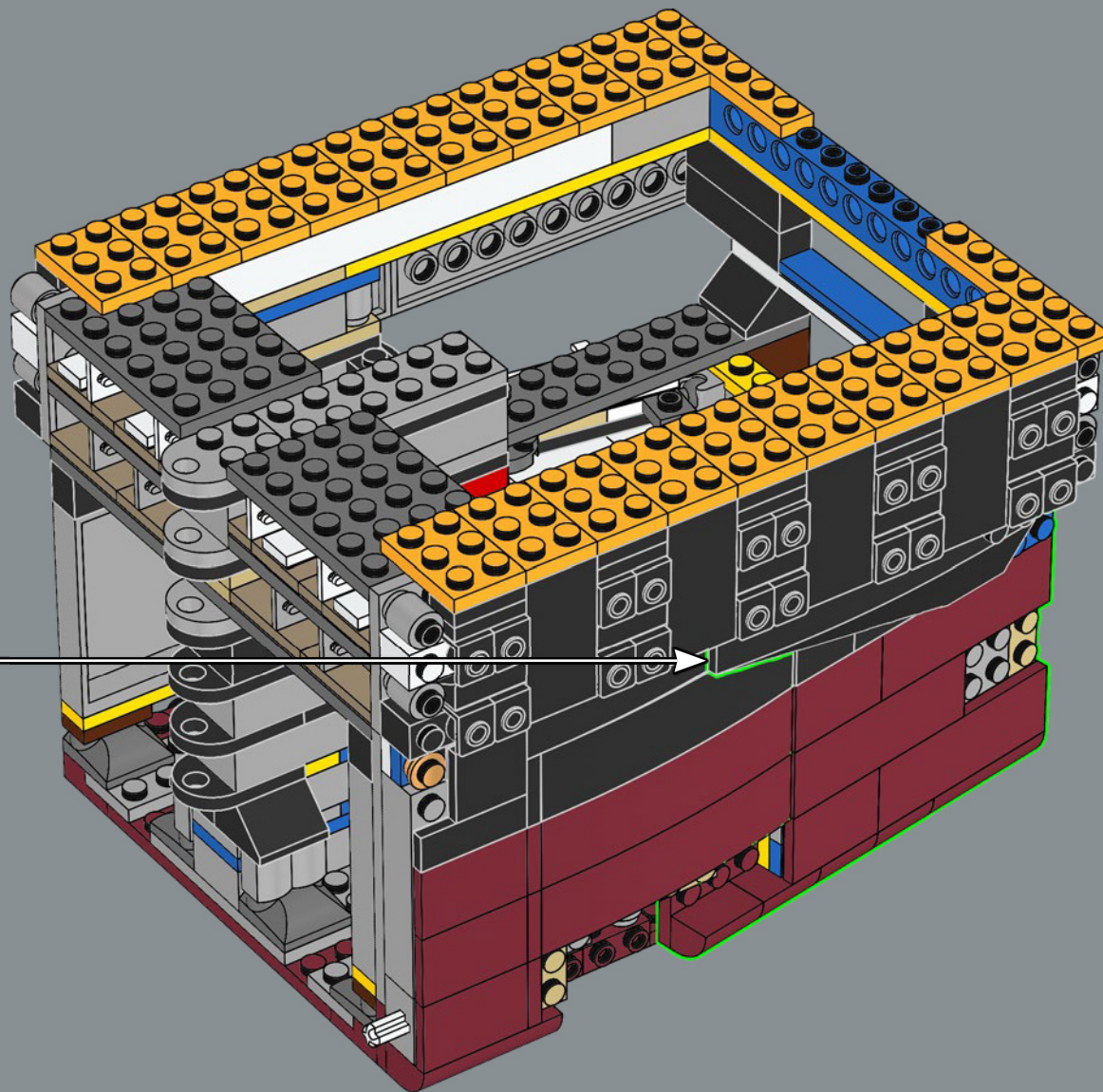



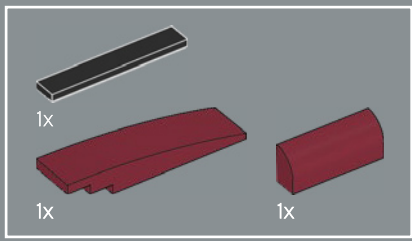

66

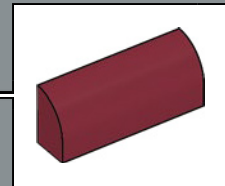
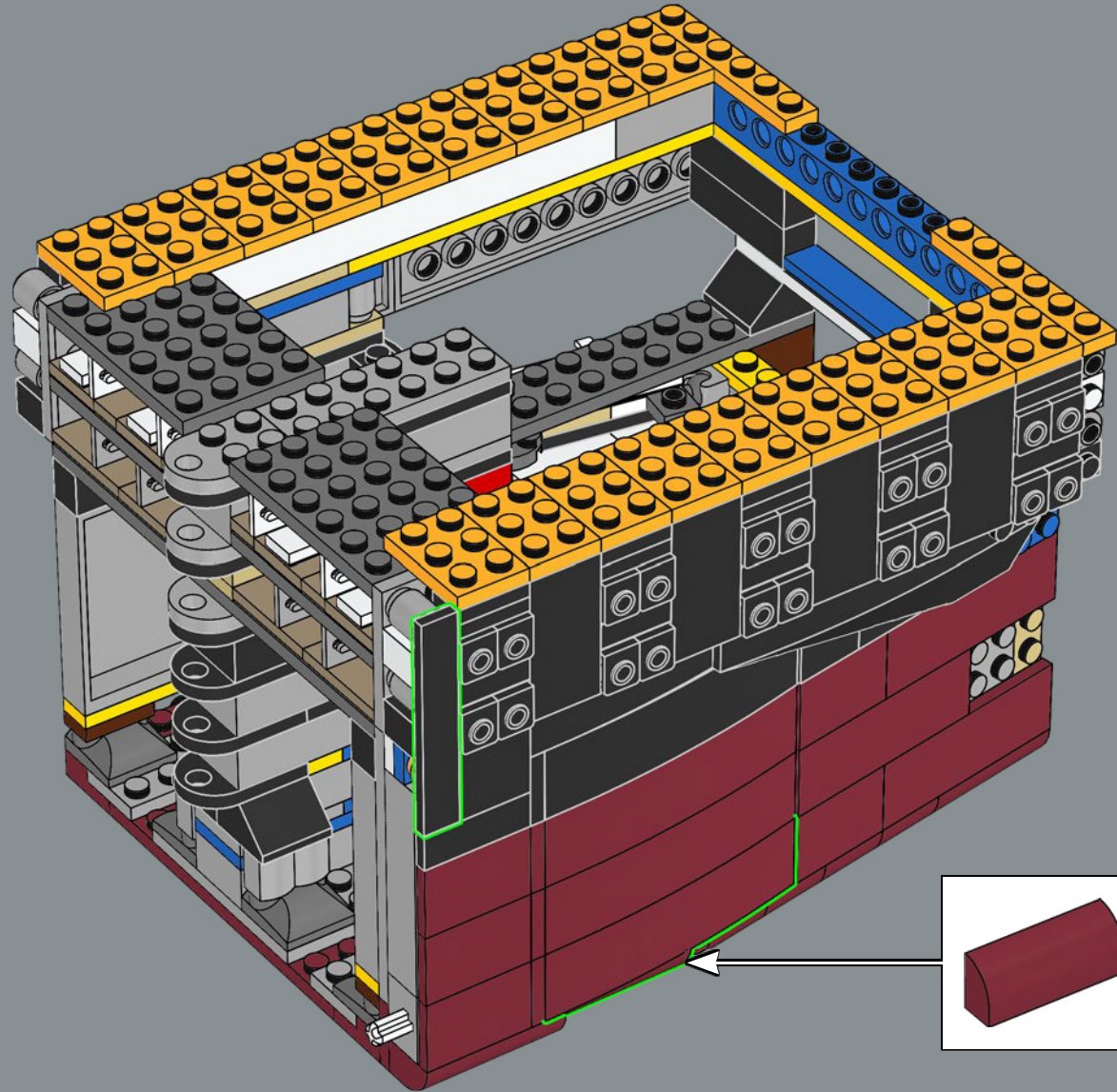

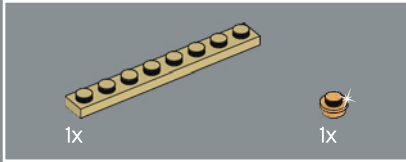
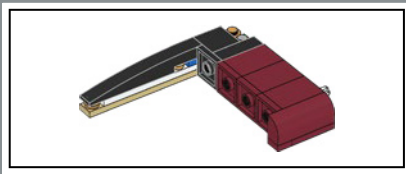

67

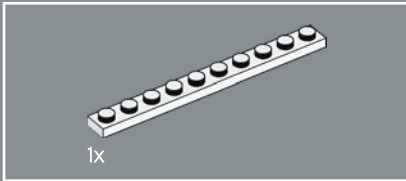
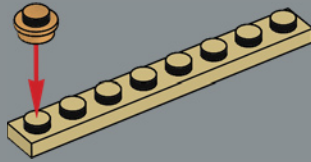

68

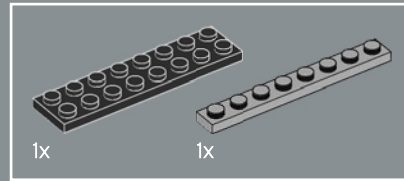
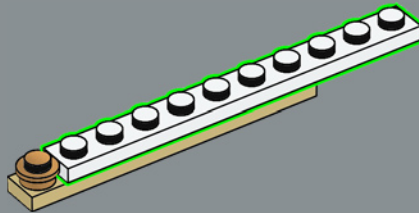

69

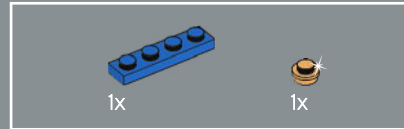
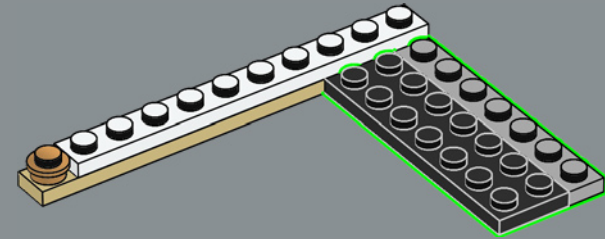

70

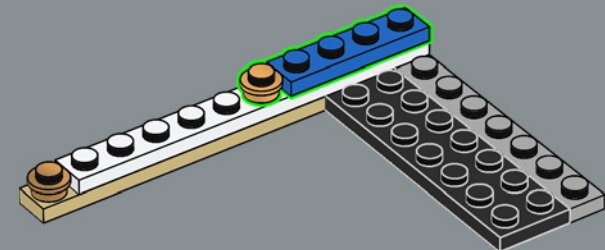

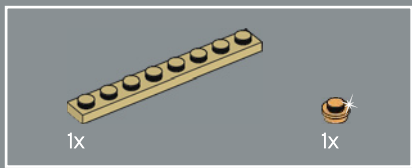

71

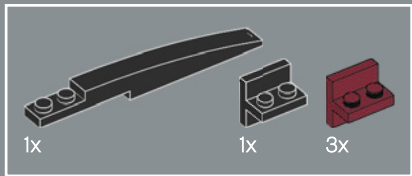
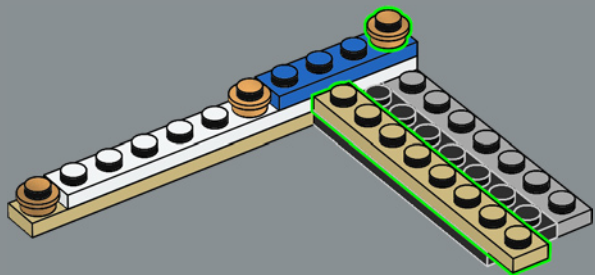

72

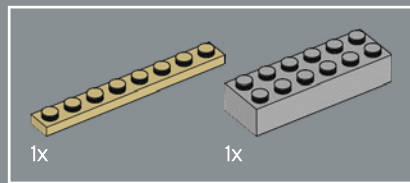
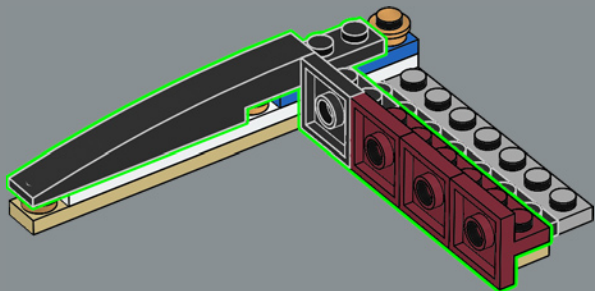

73

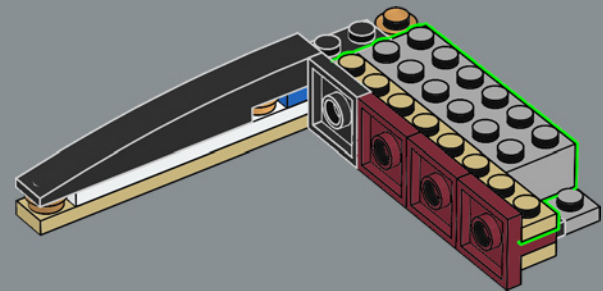

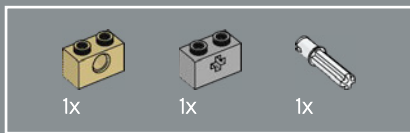

74

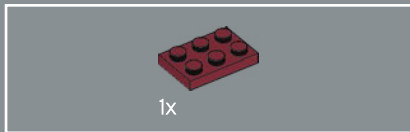
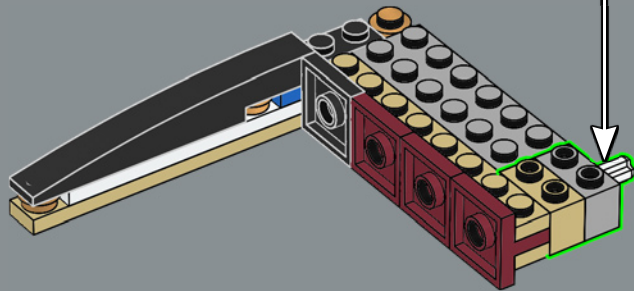
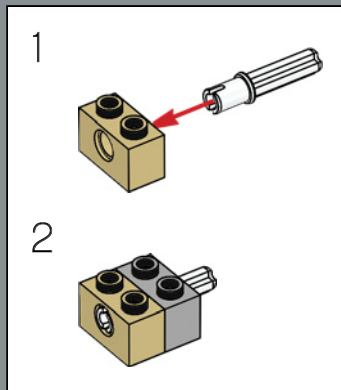

75

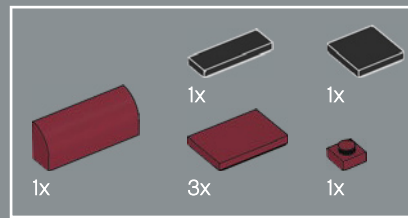
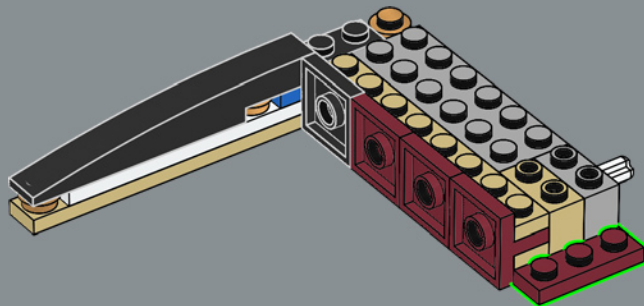

76

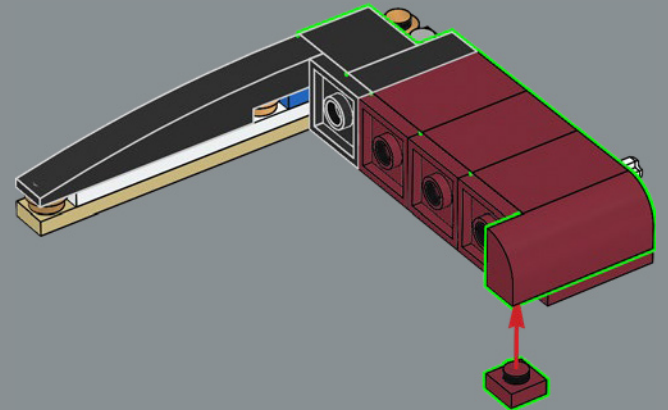



77

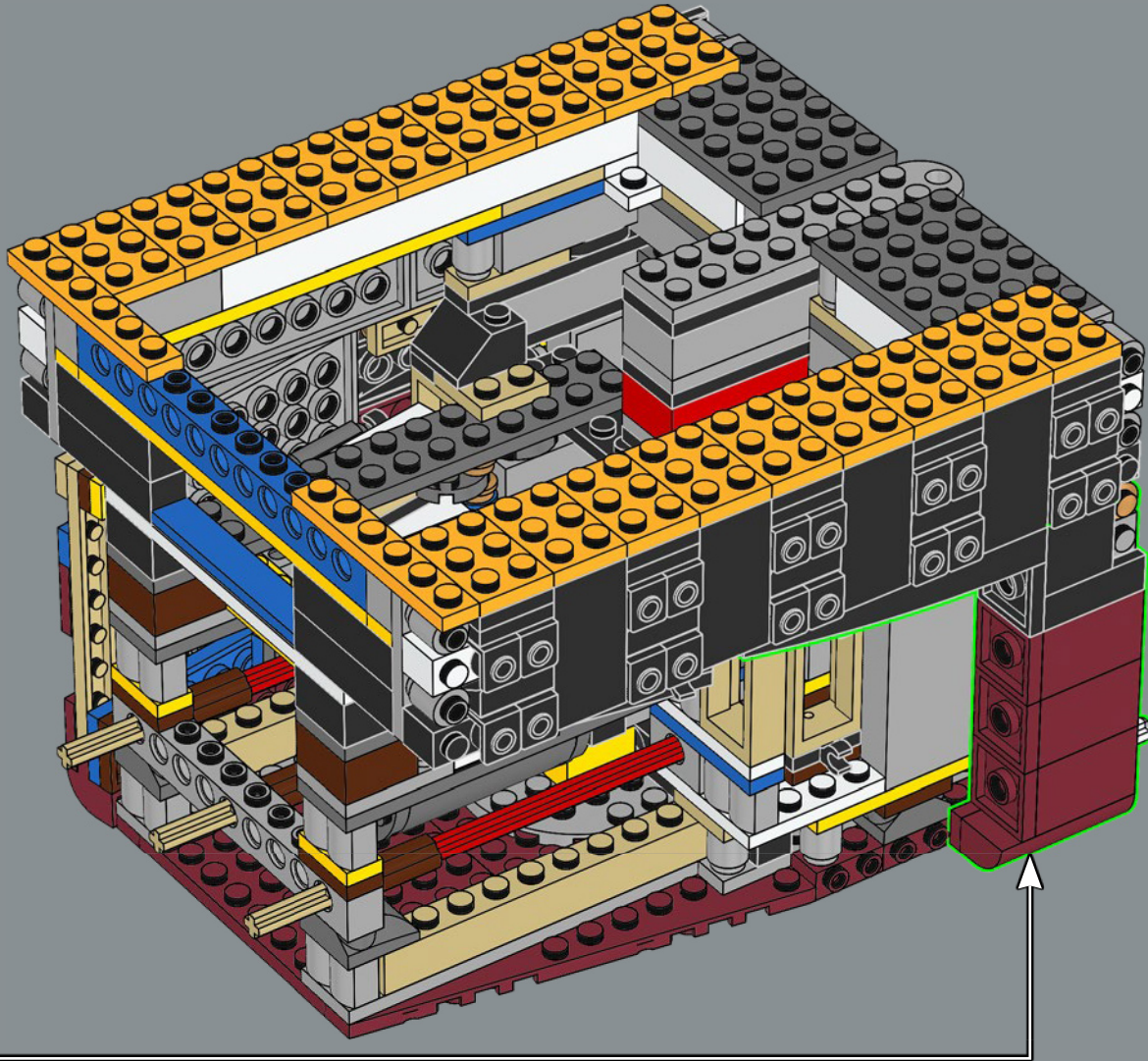

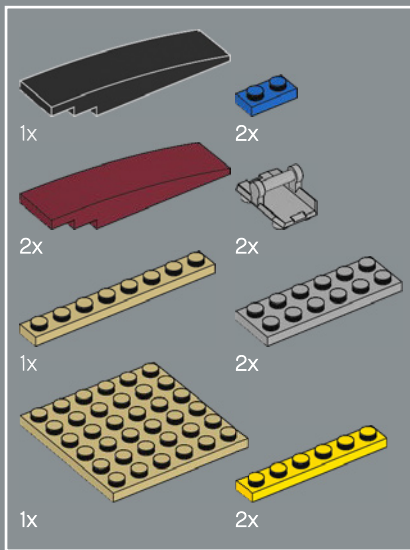

78

1

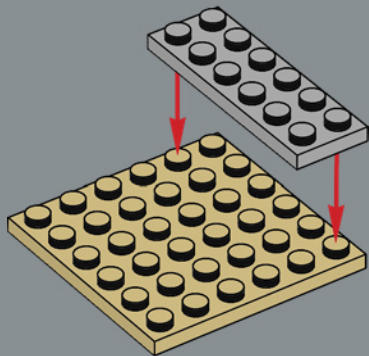

2

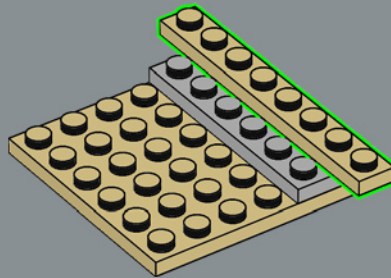

3

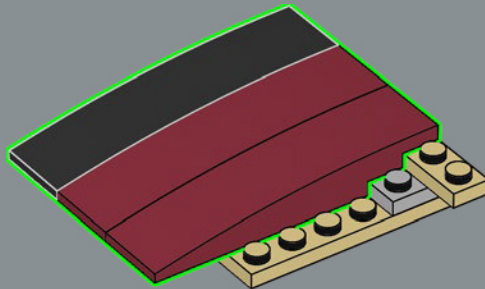

4

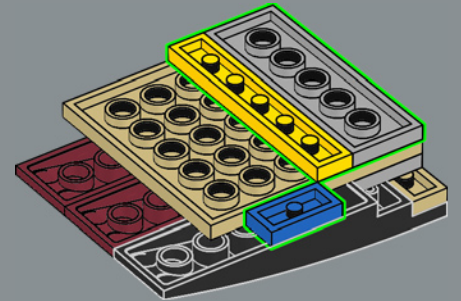

5

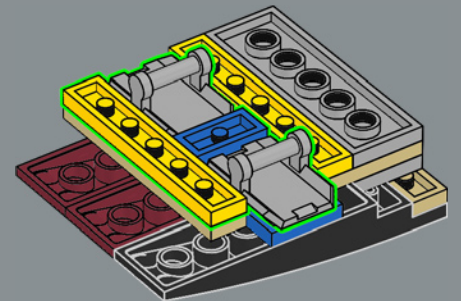



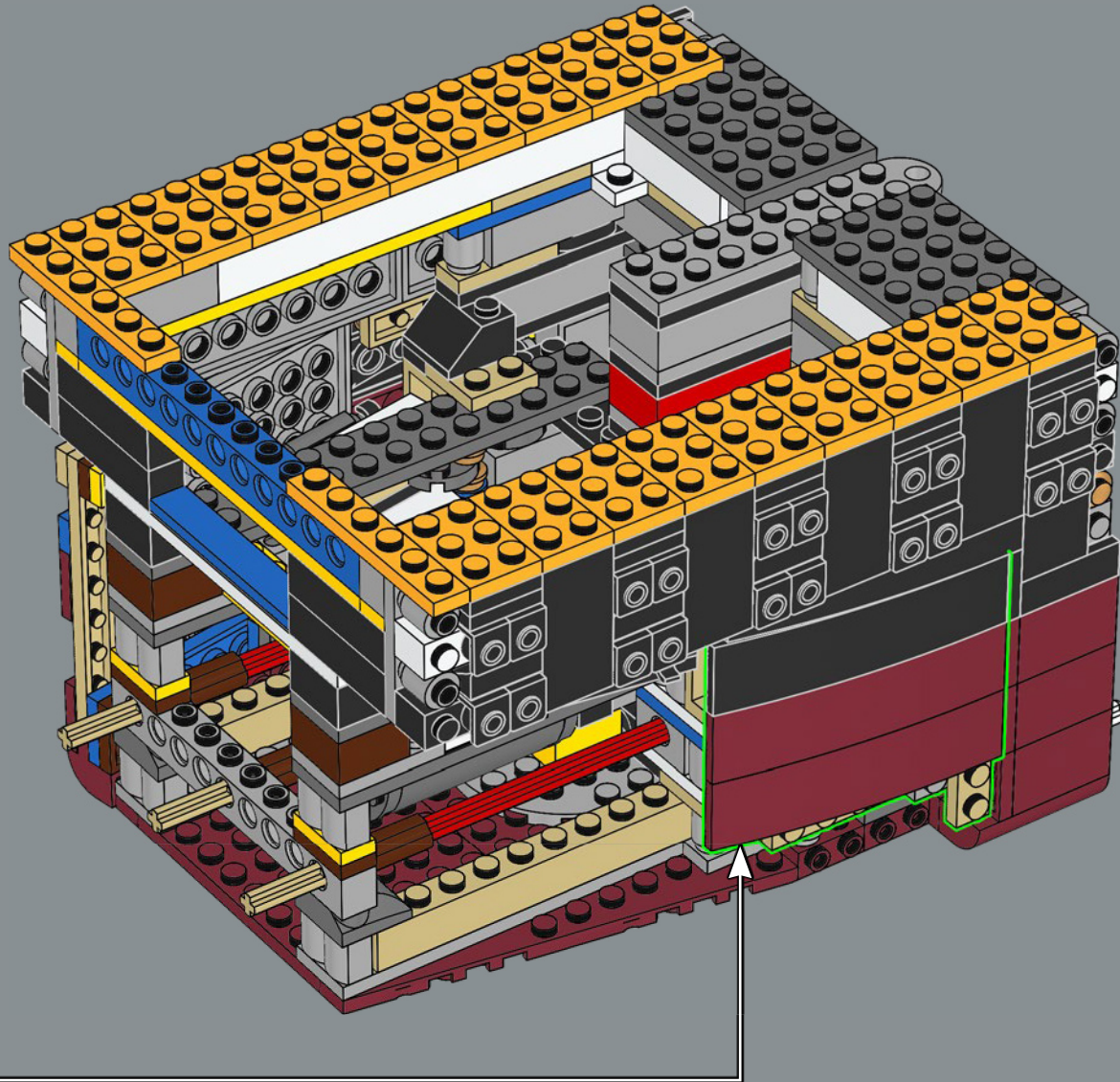

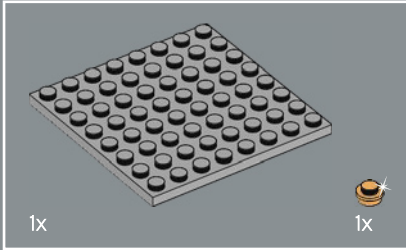
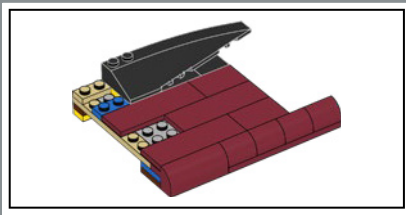

79

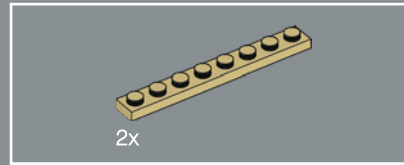
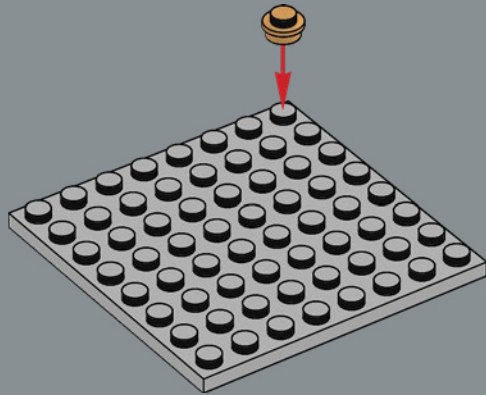

80

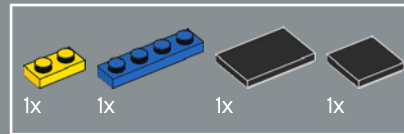
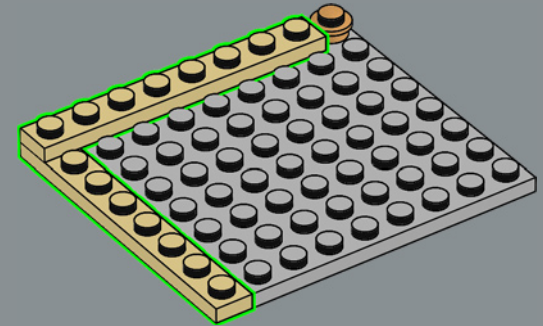

81

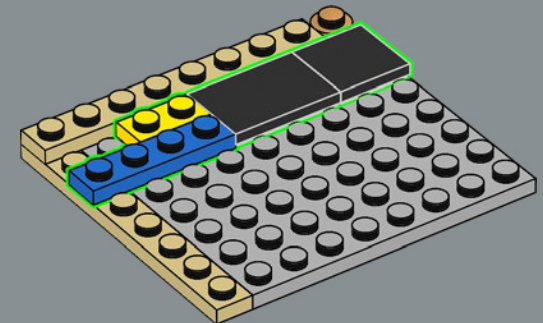



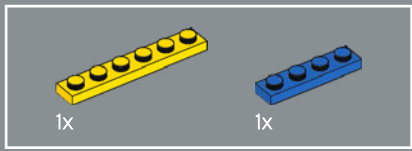

82

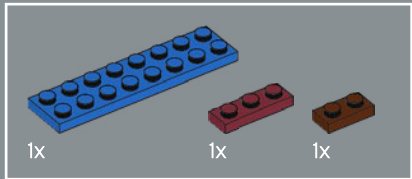
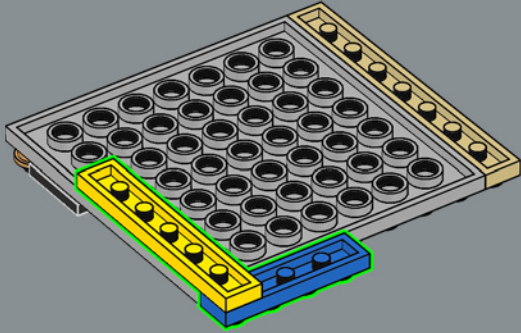

83

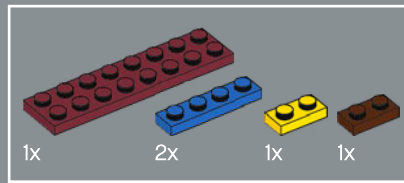
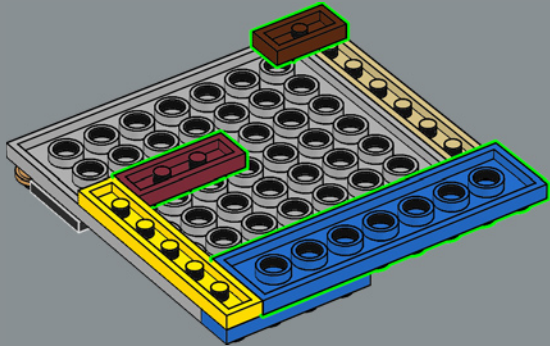

84

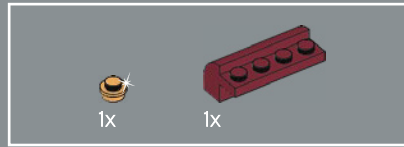
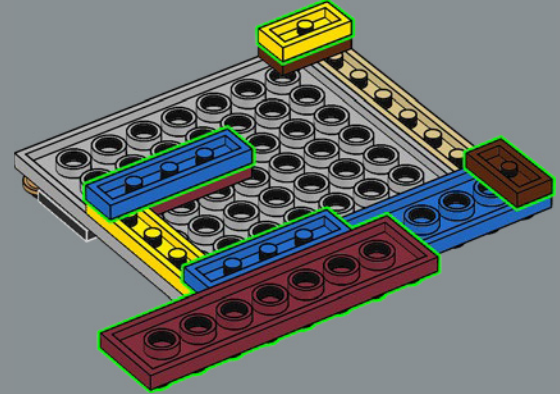

85

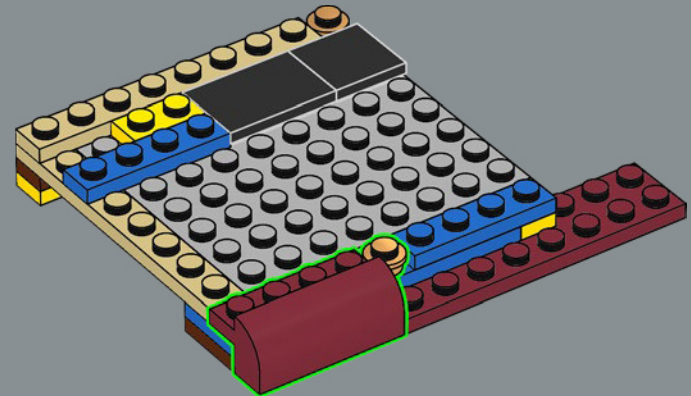

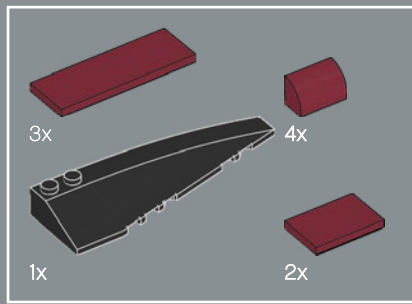

86

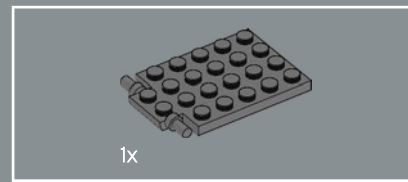
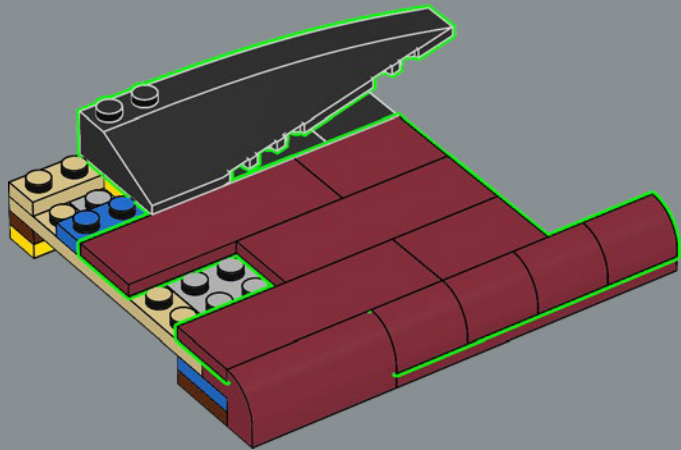

87

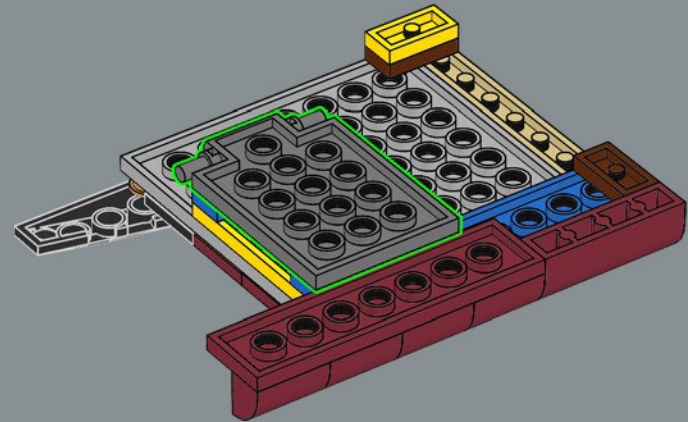

El *Titanic* se encontraba a 640 km de la costa cuando colisionó con el iceberg.

88

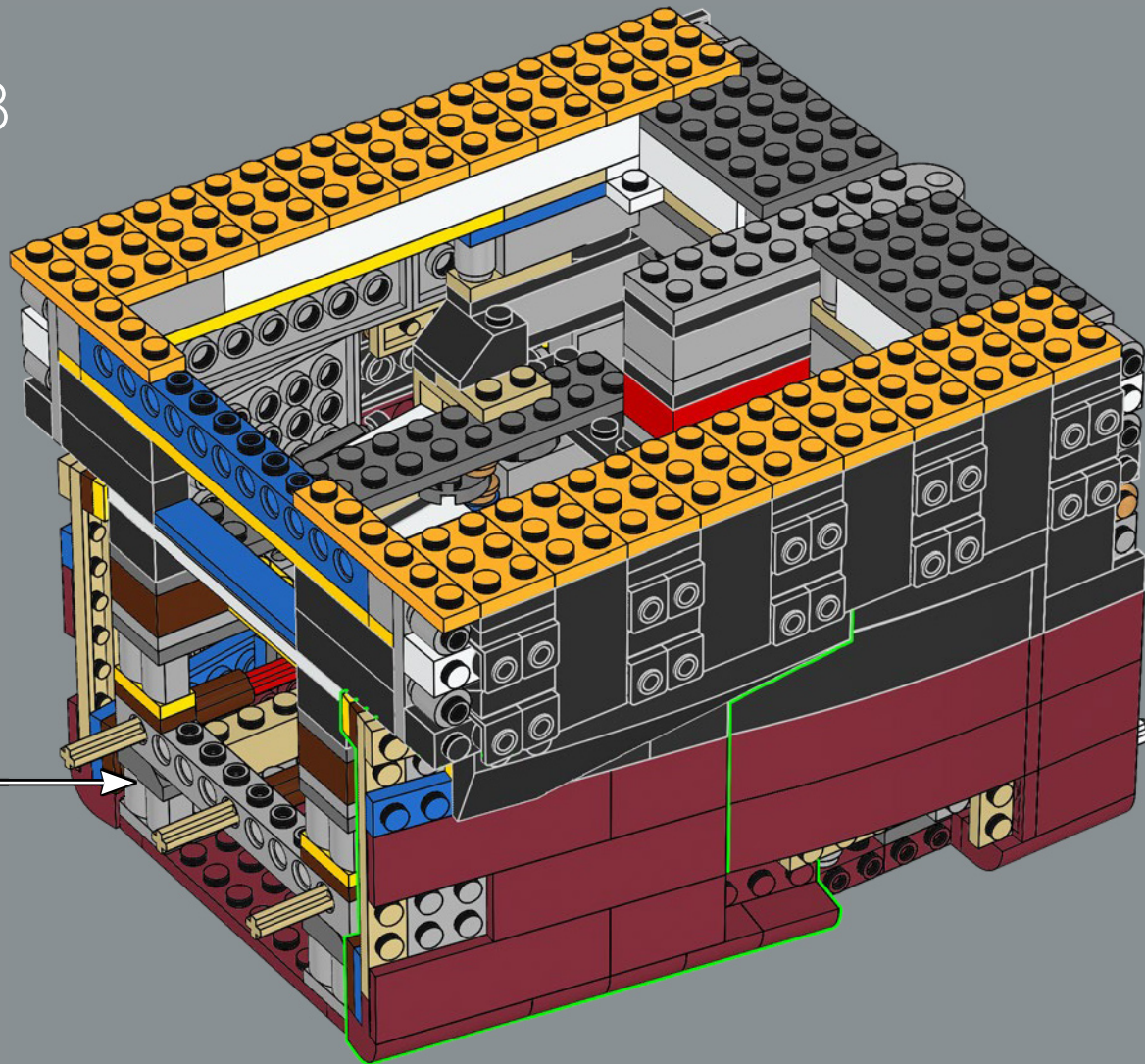



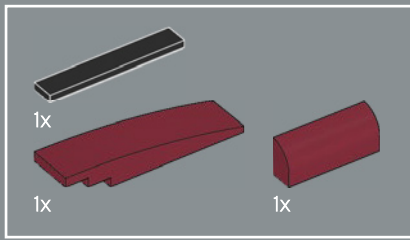

89

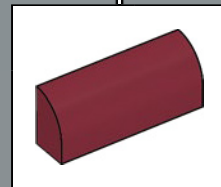
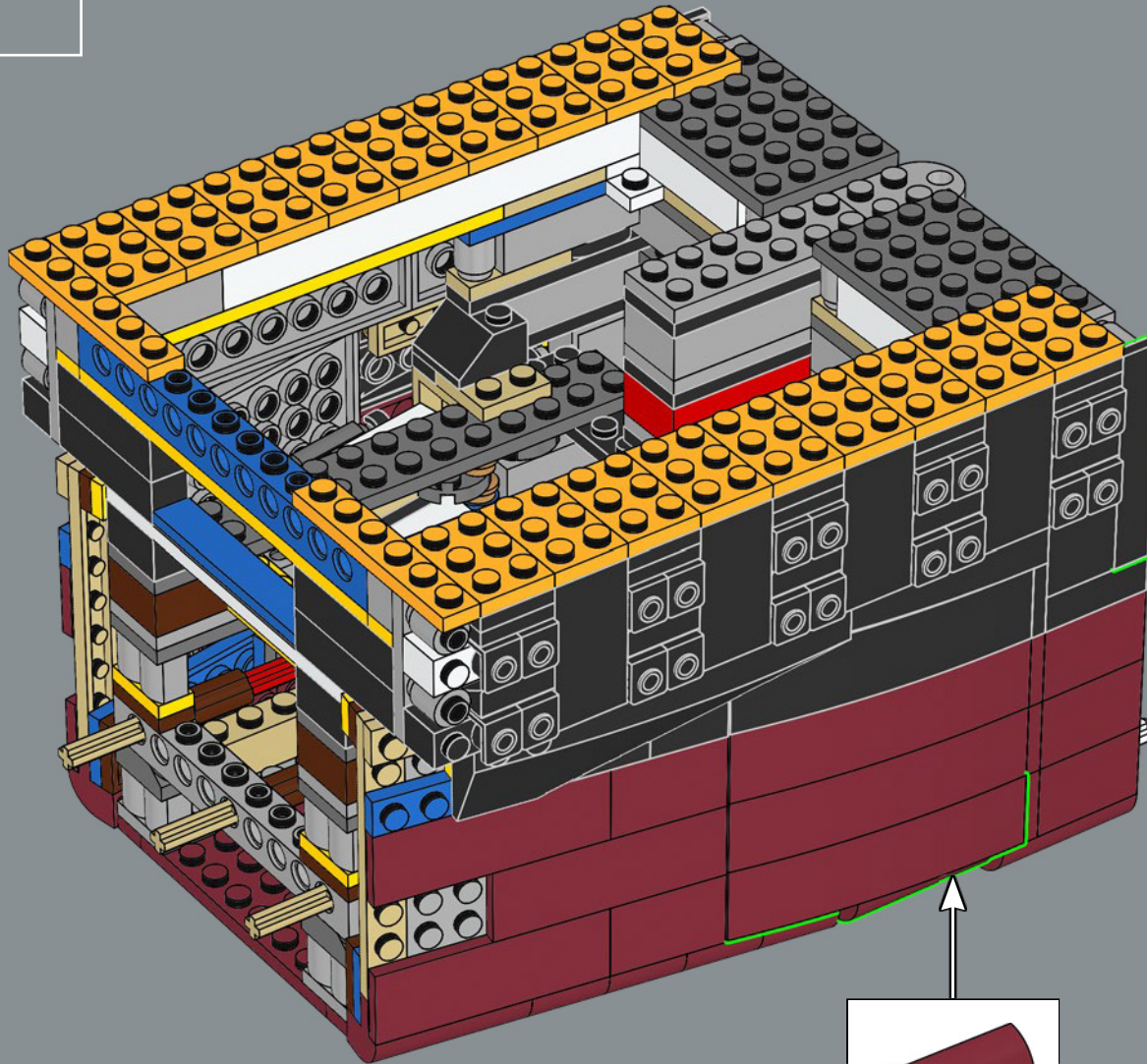



32

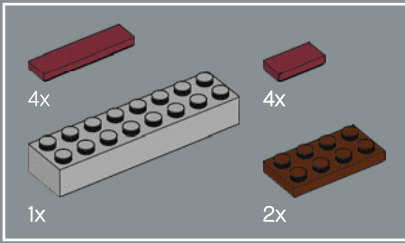
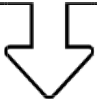

90

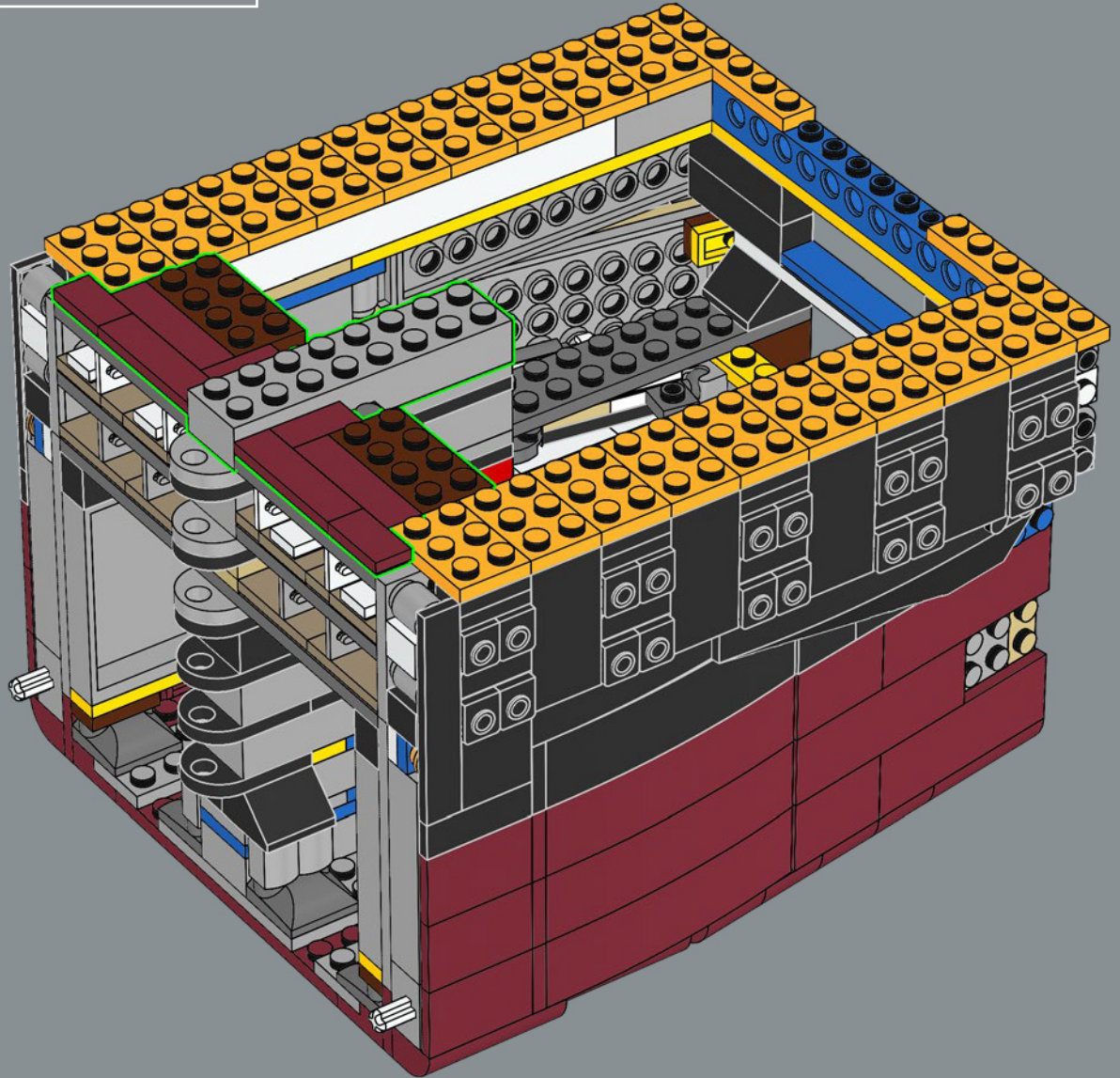

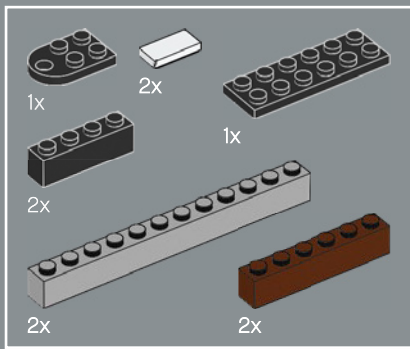

91

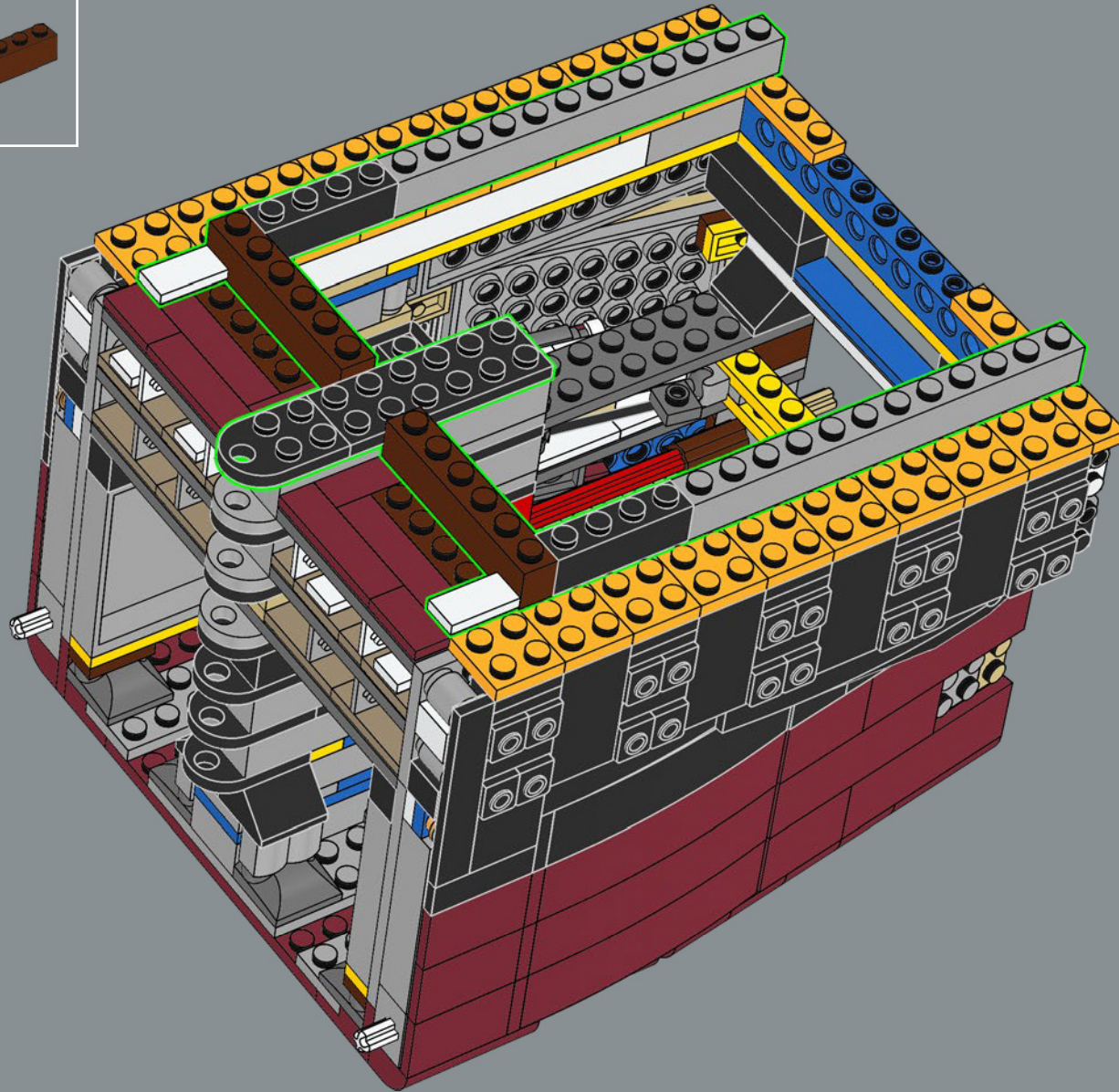



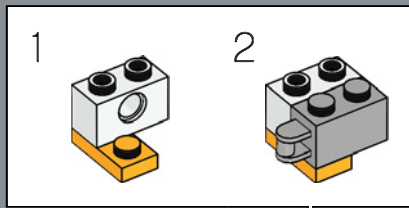
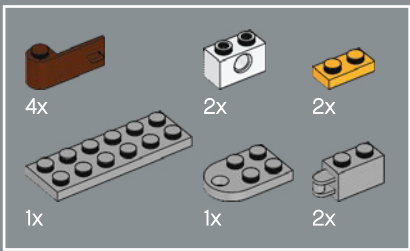

92

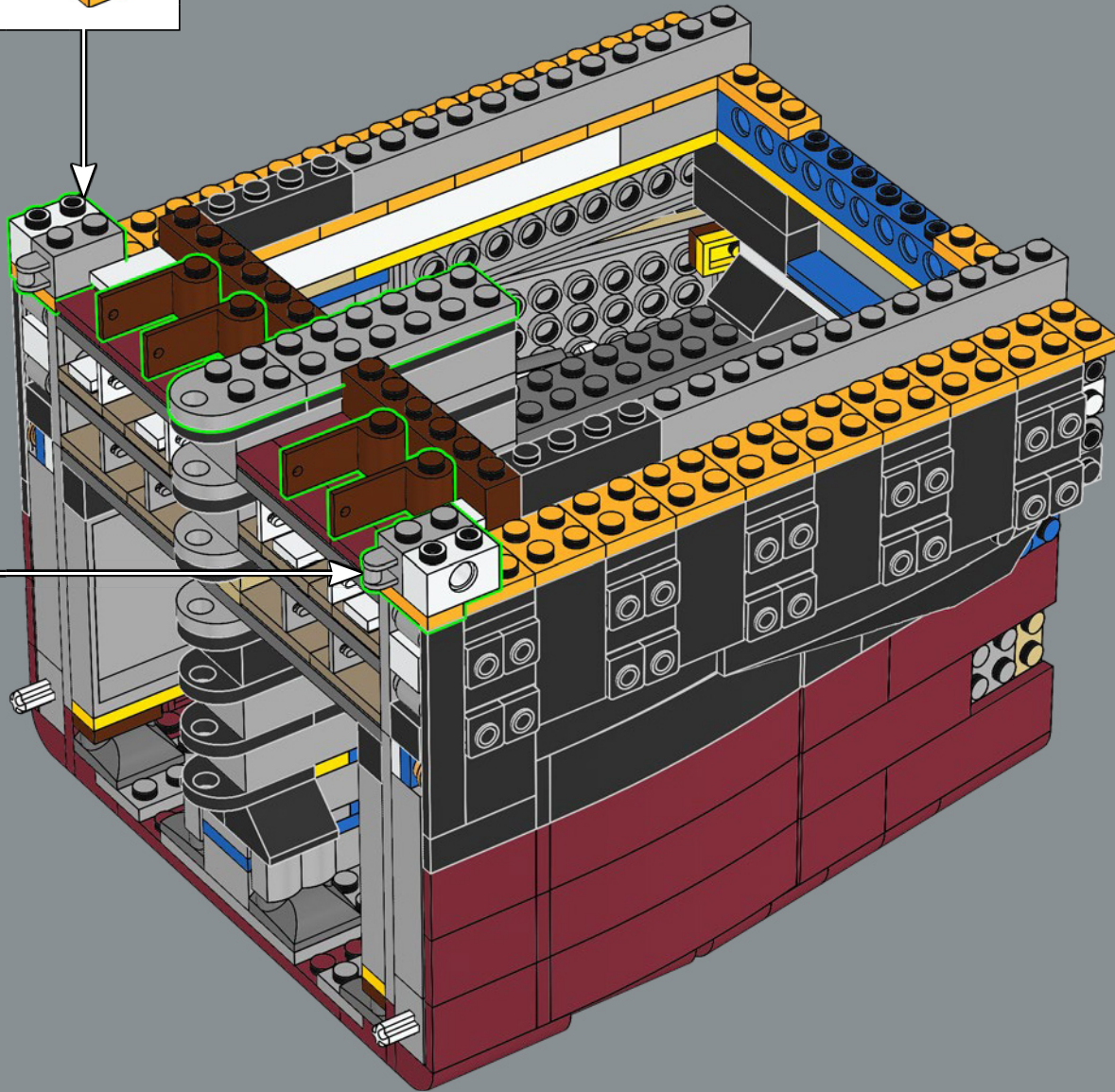
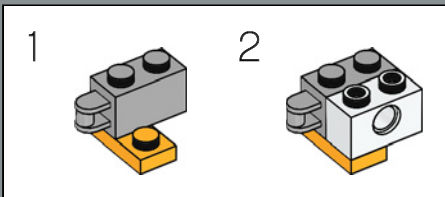





18x

93

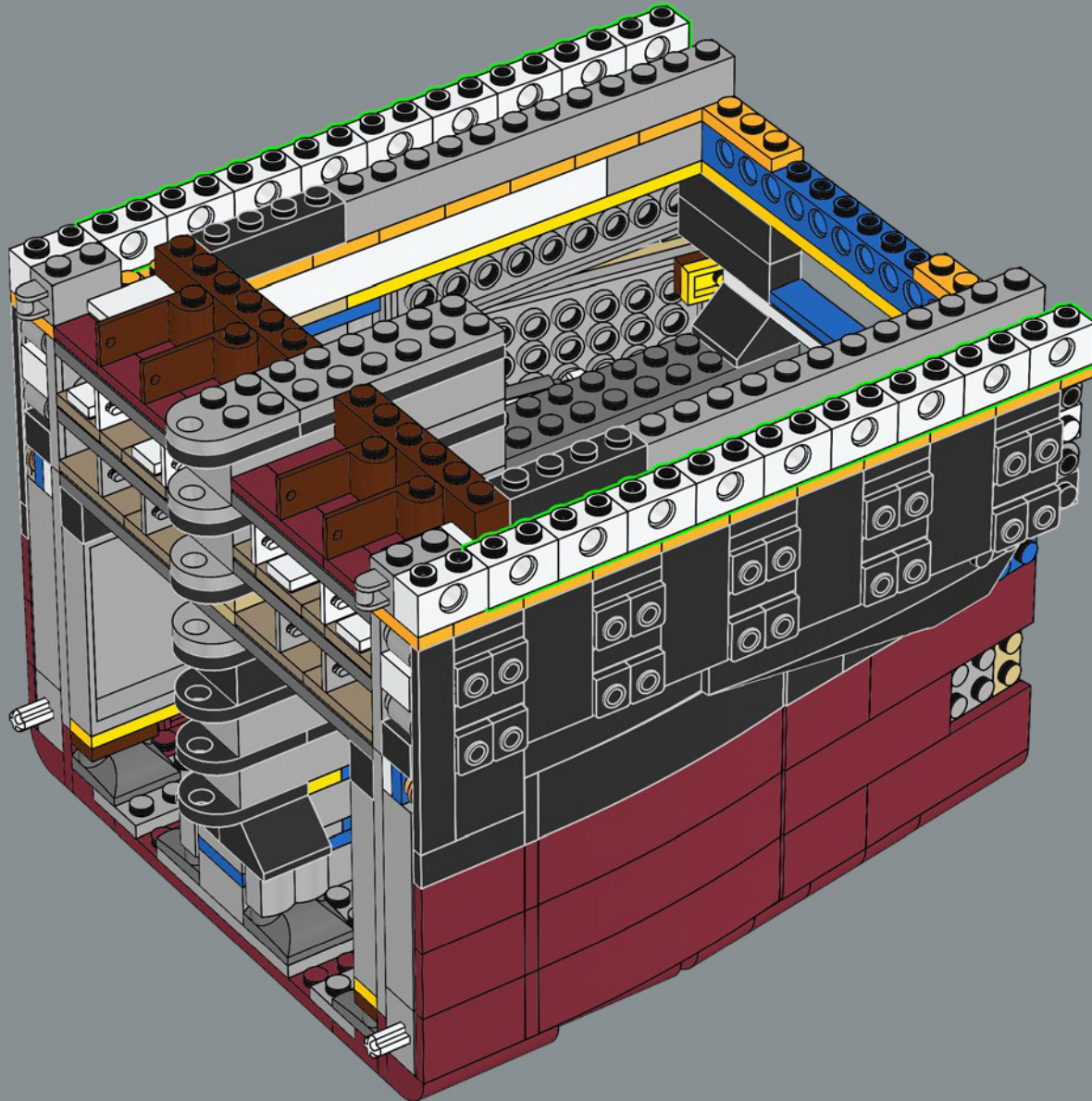

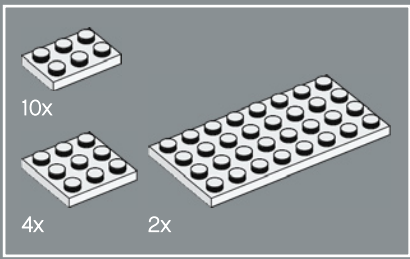

94

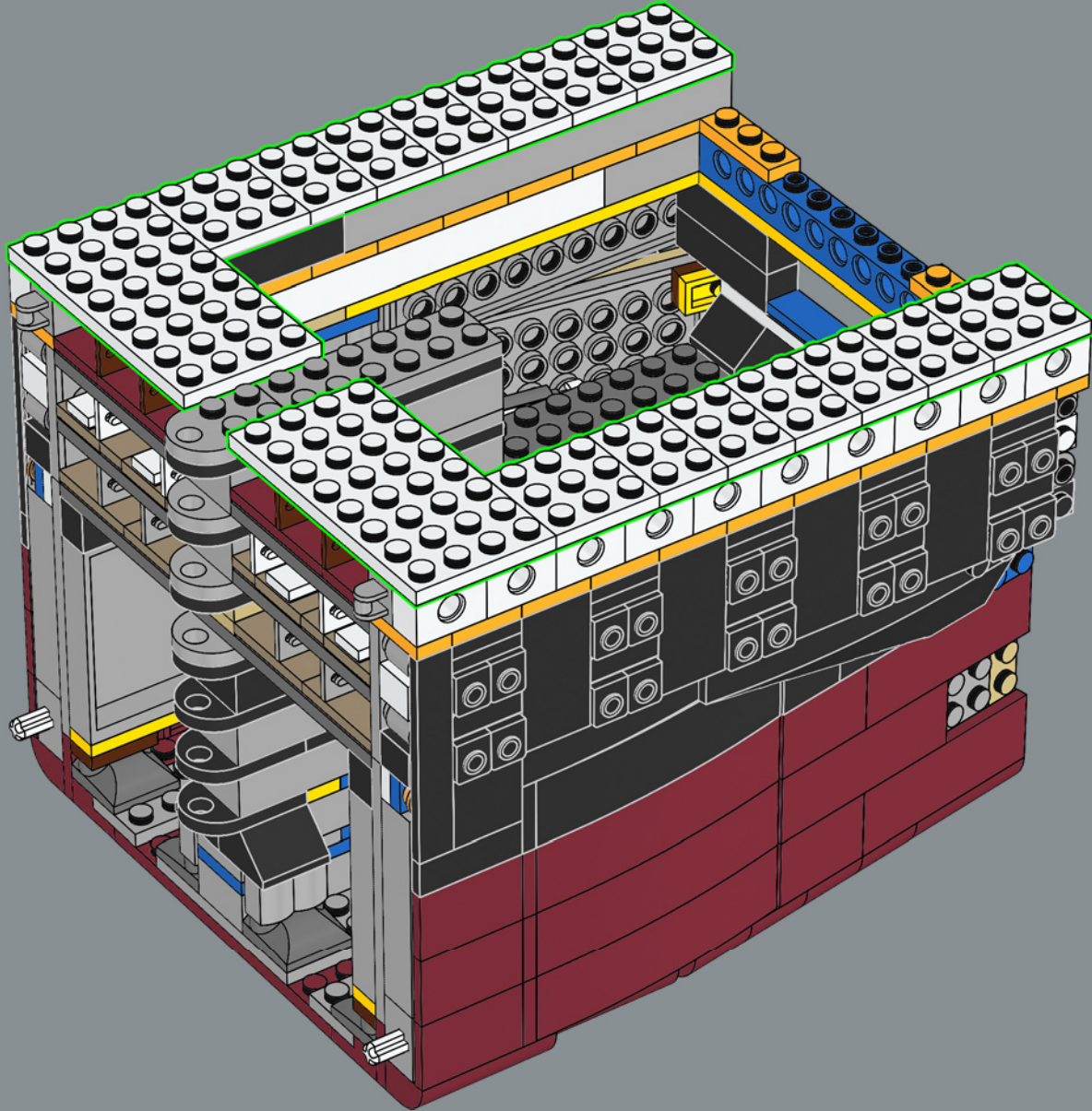



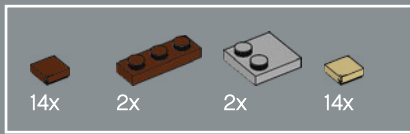

95

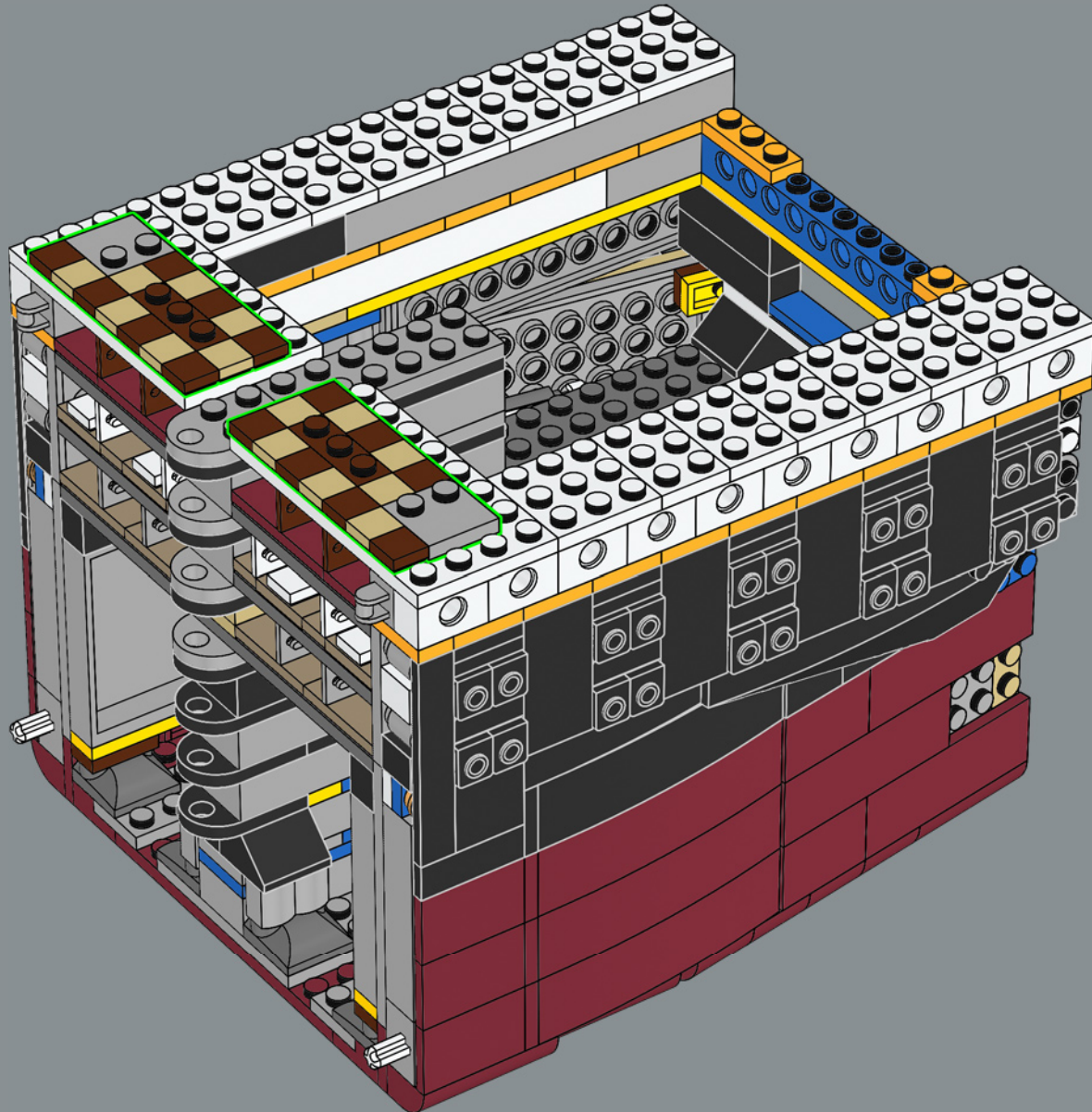





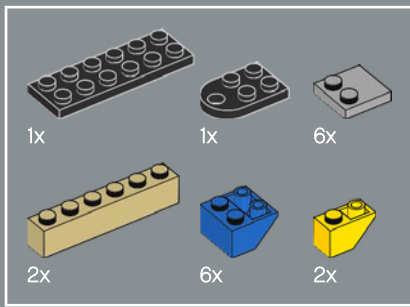

97

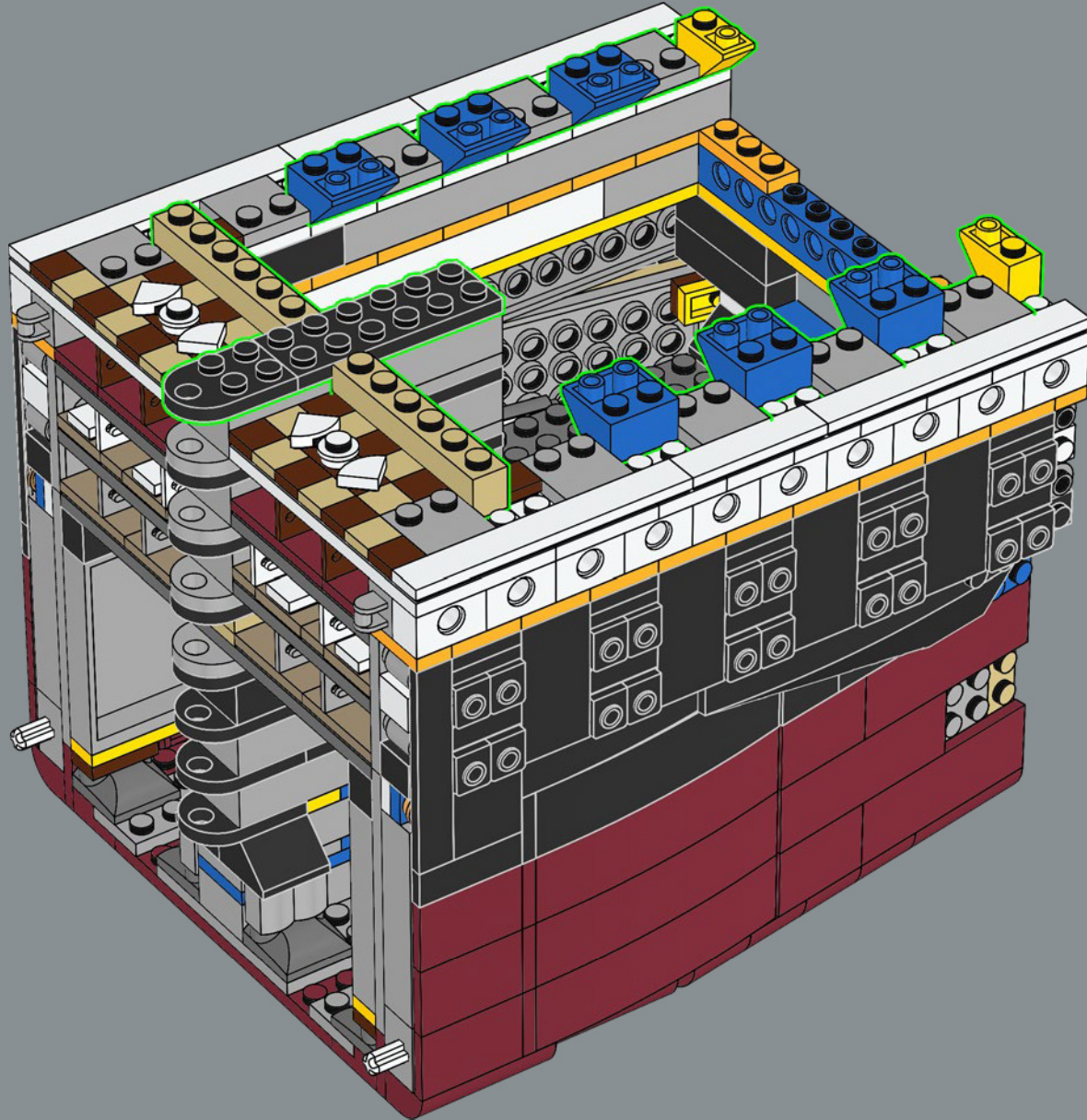



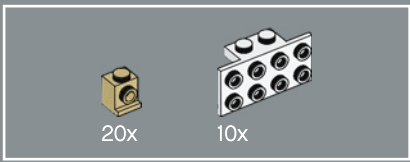

98

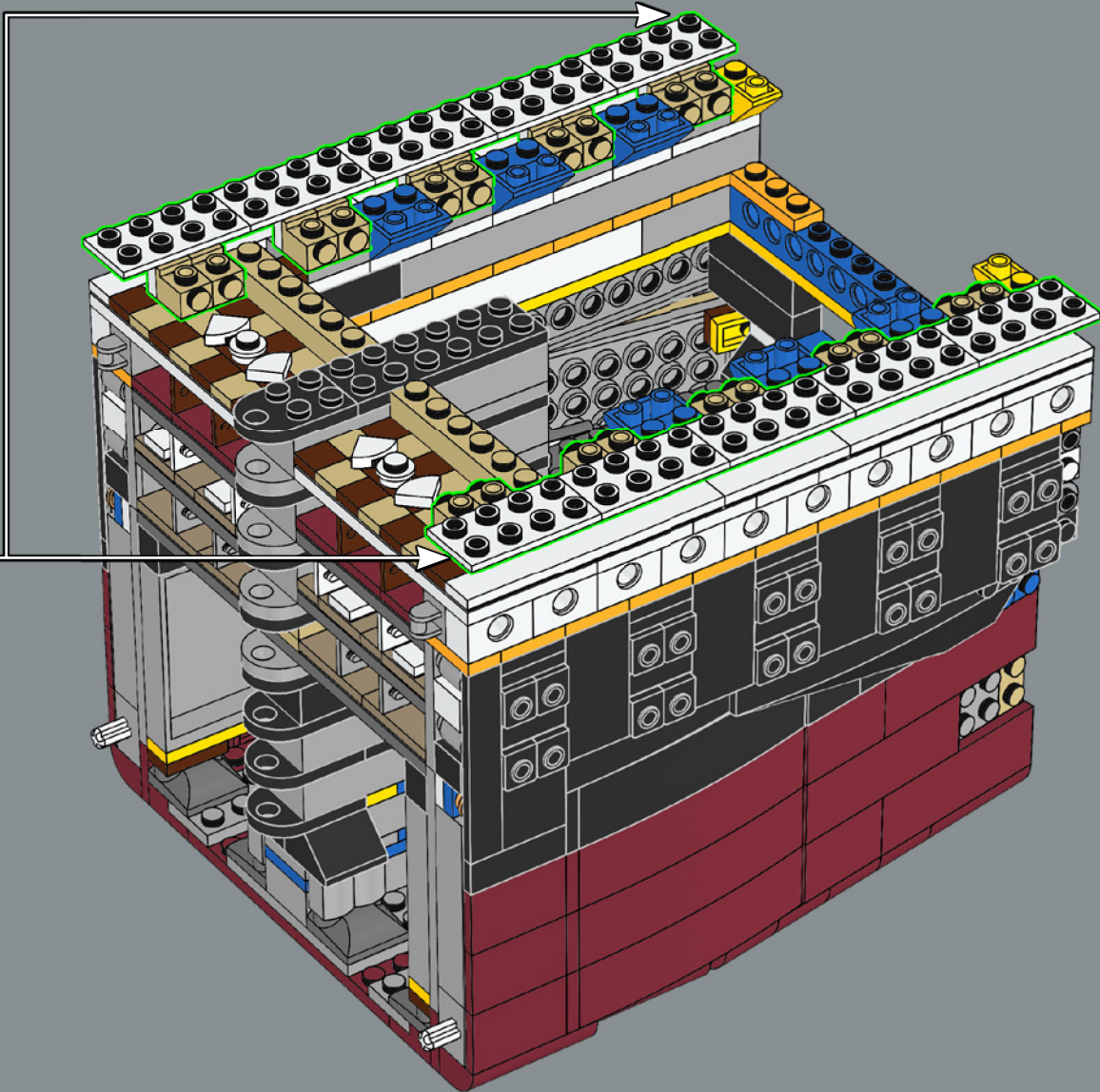
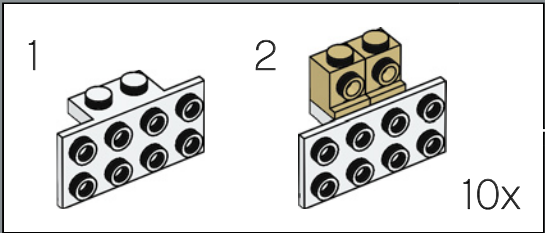



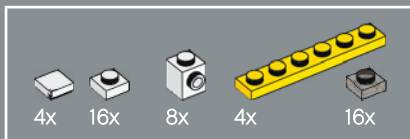

99

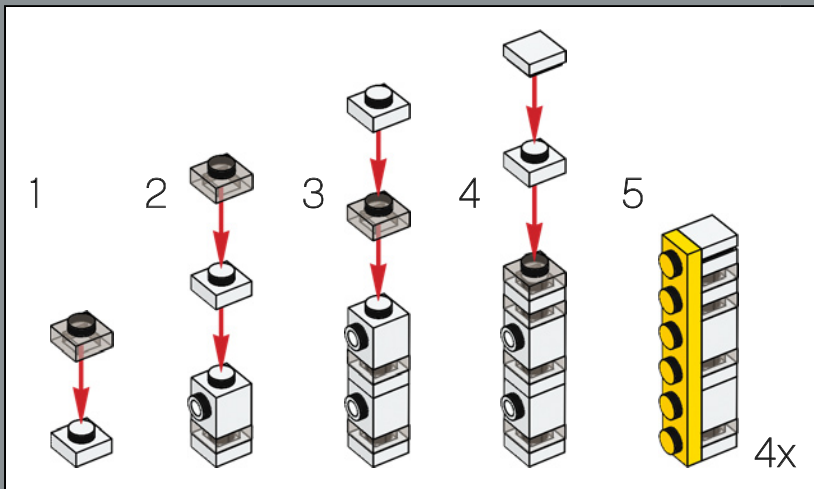
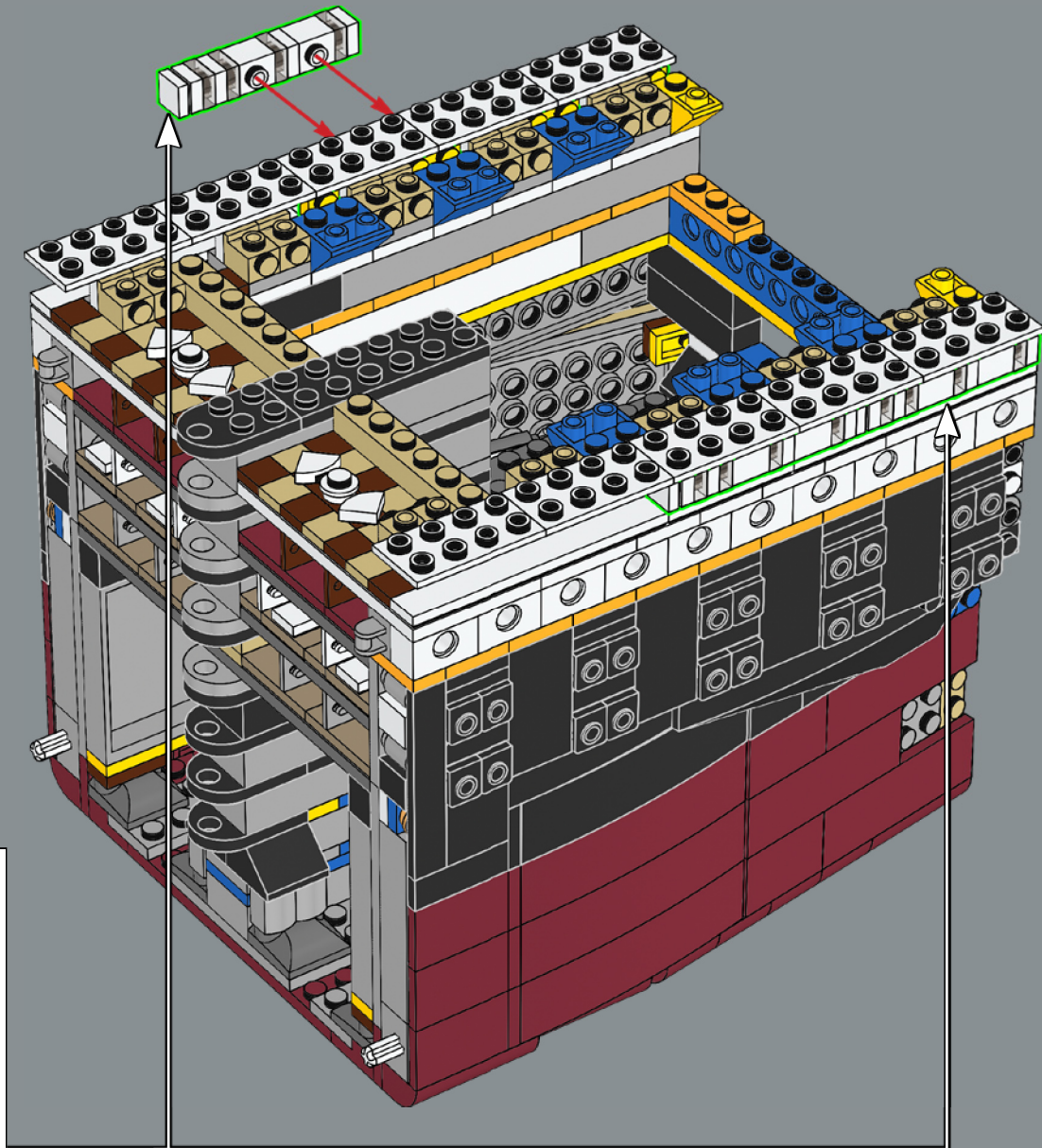

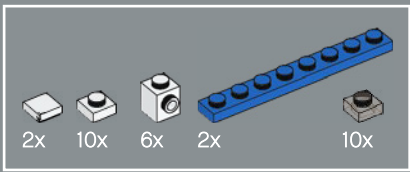

100

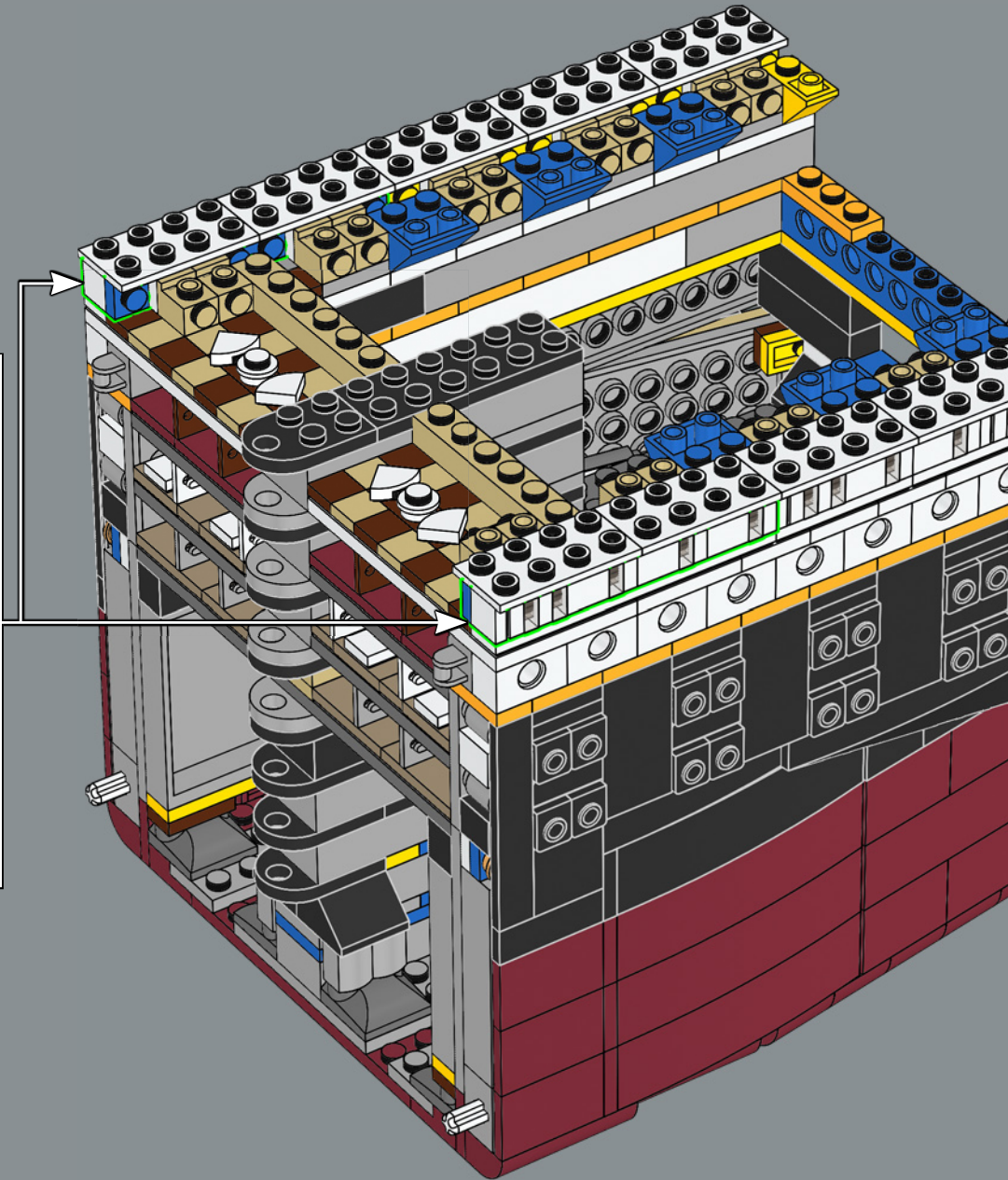
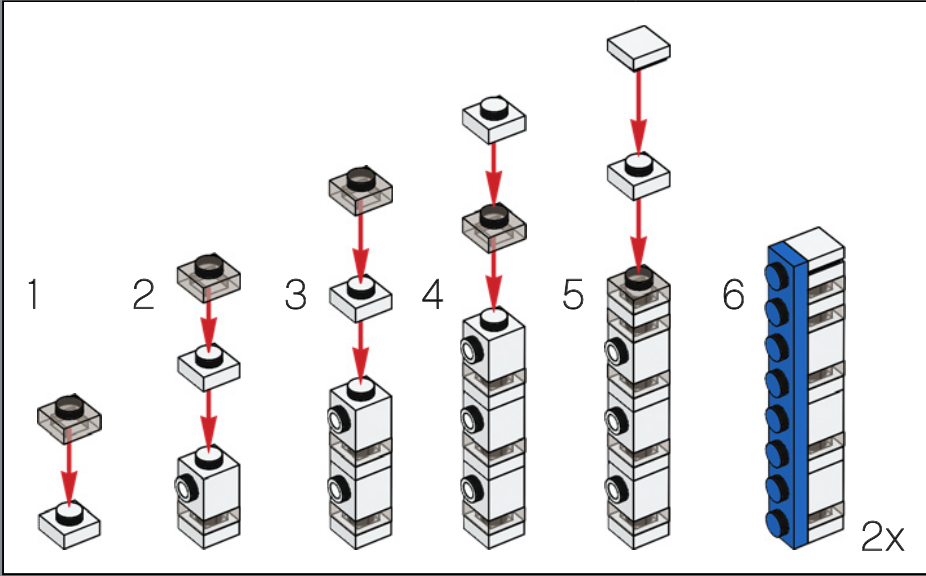



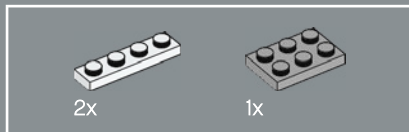
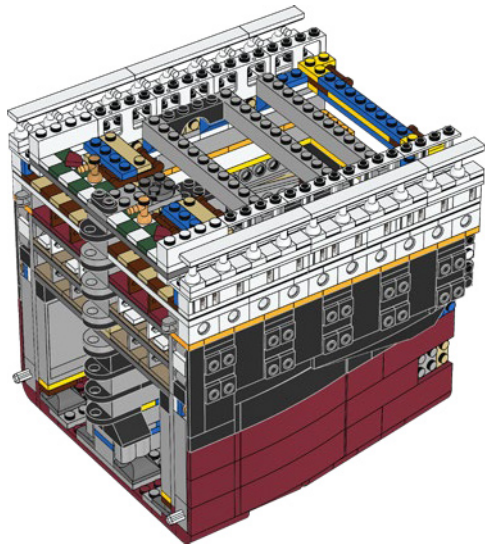
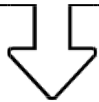

101

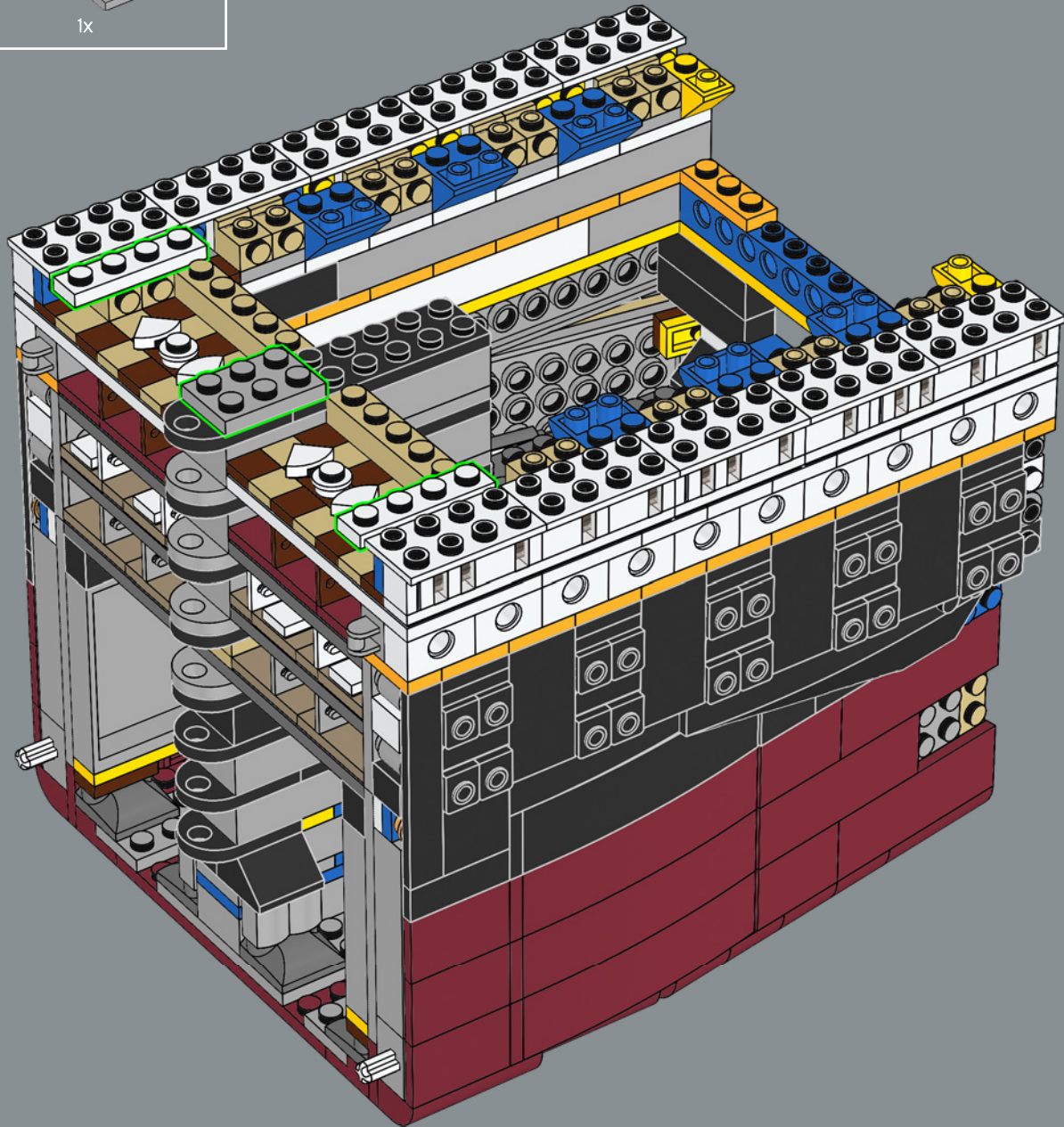



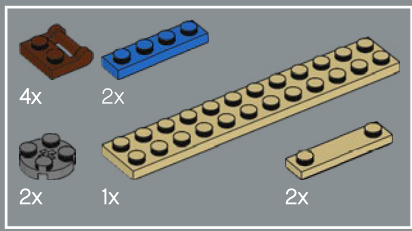

102

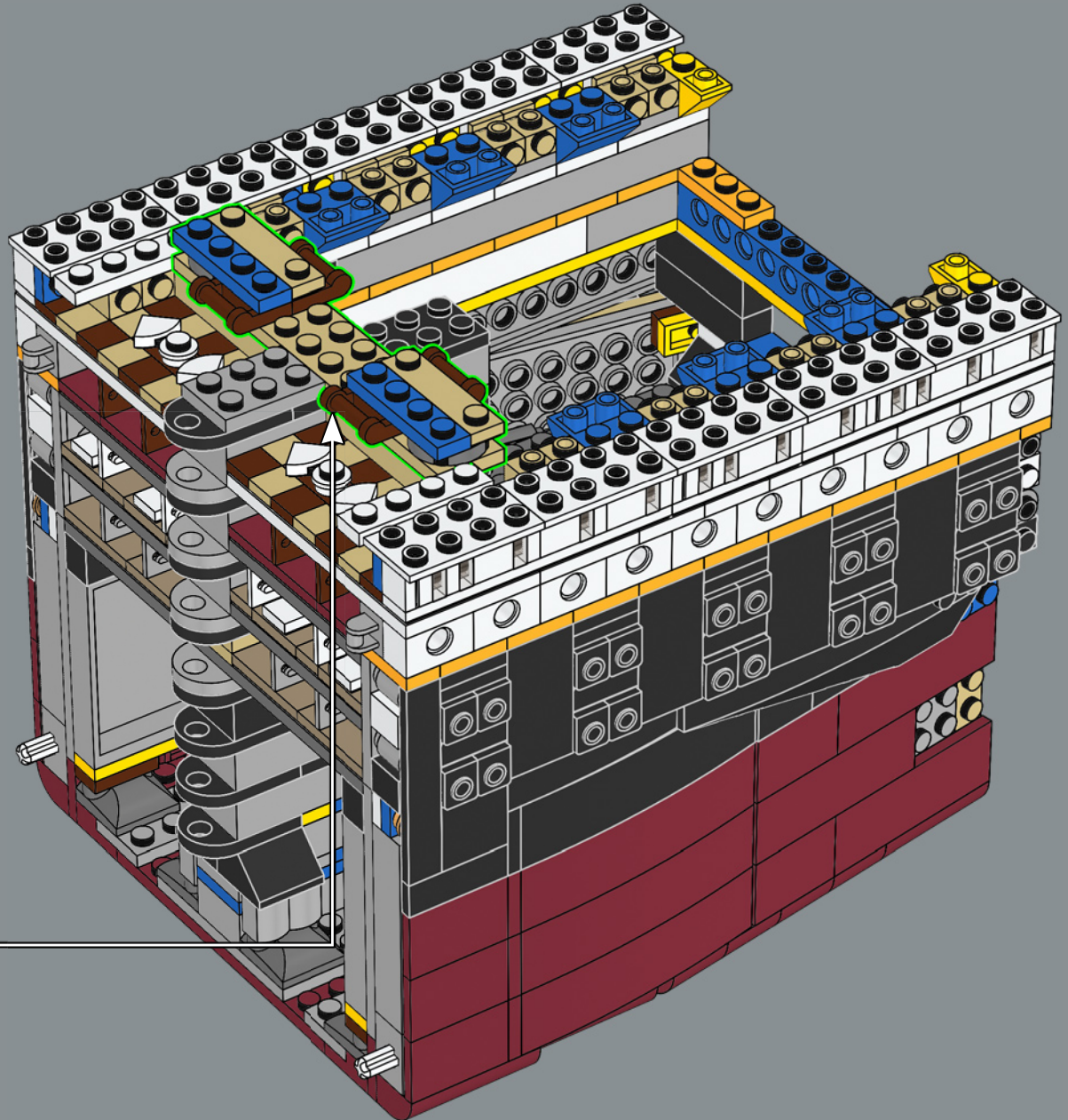
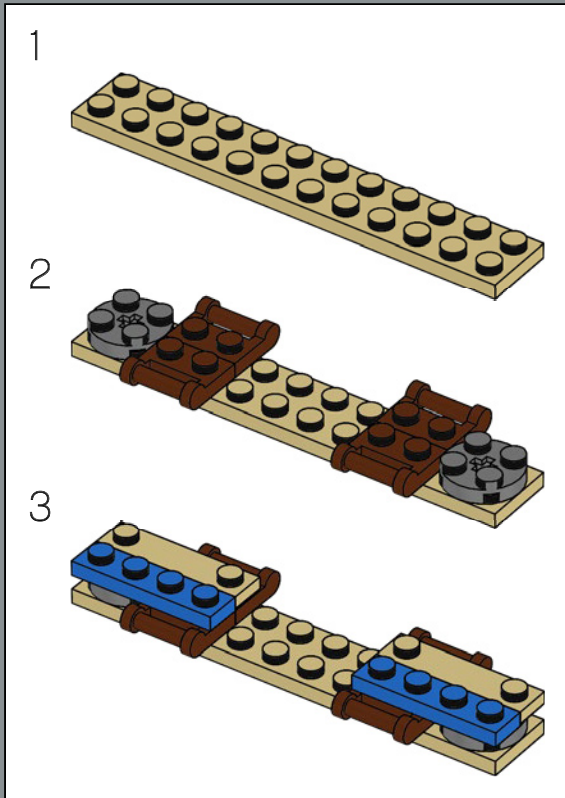

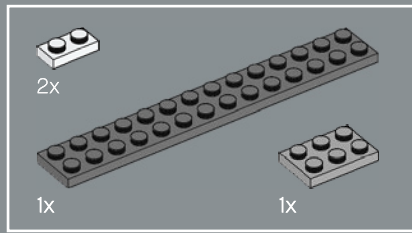

103

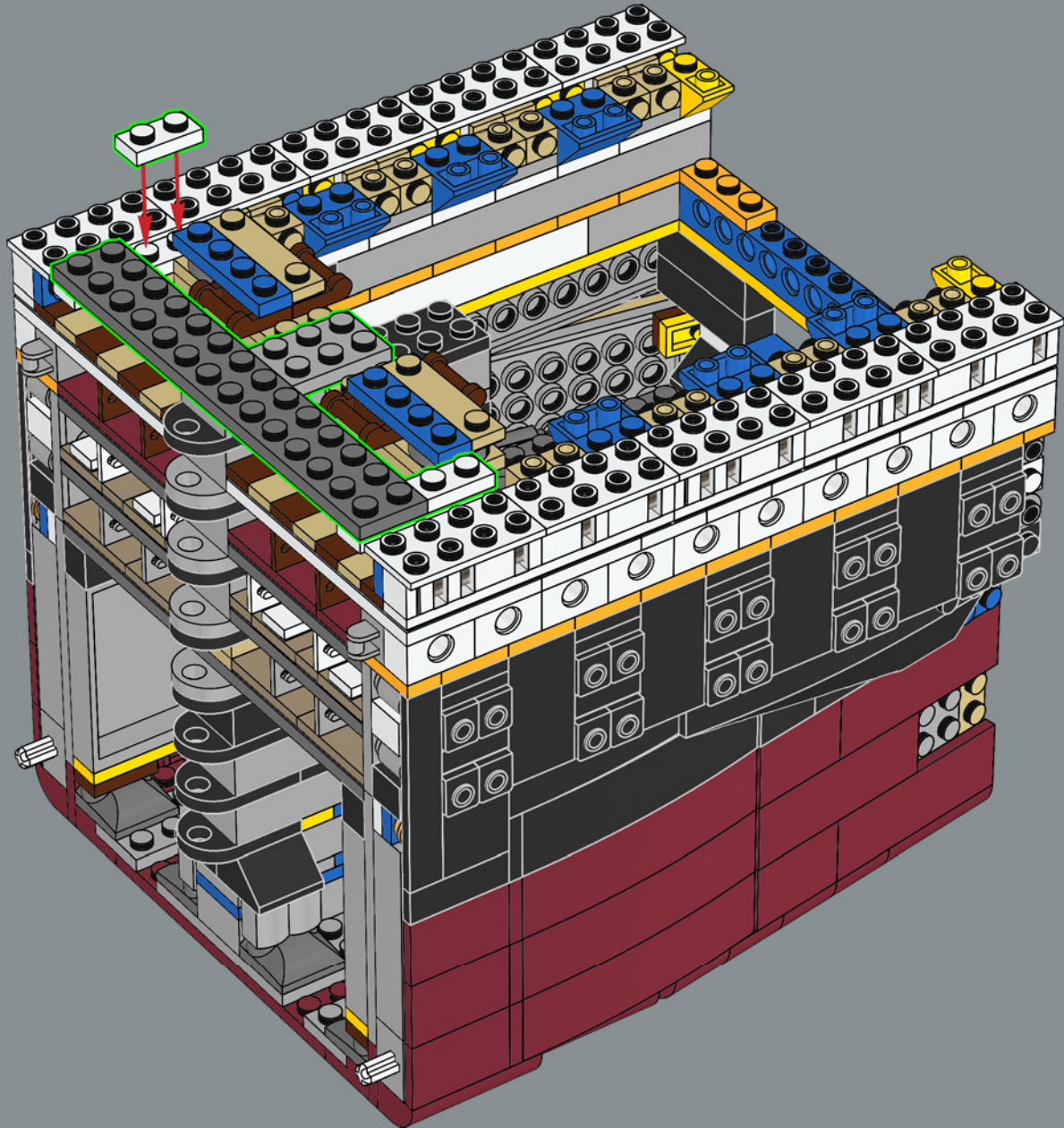



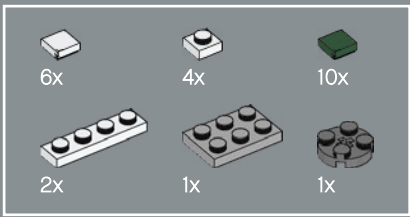

104

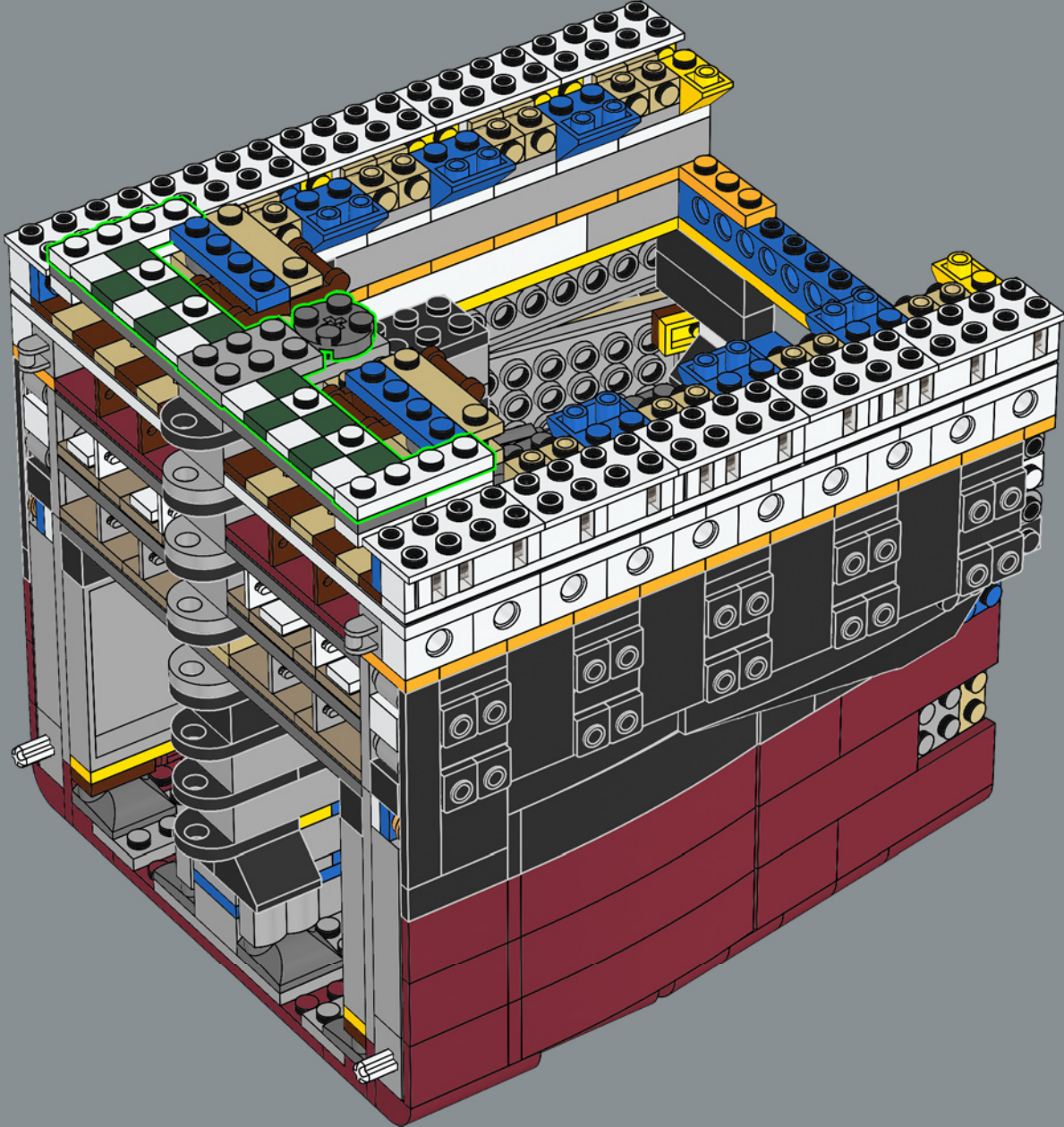



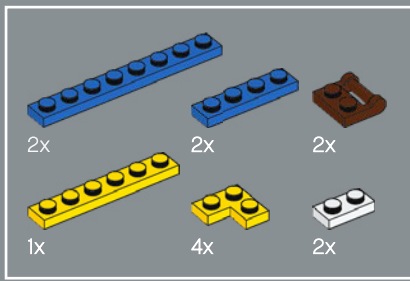

105

1

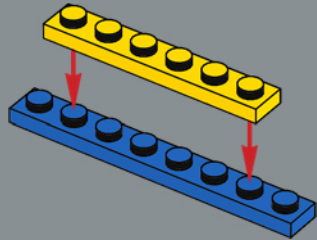

2

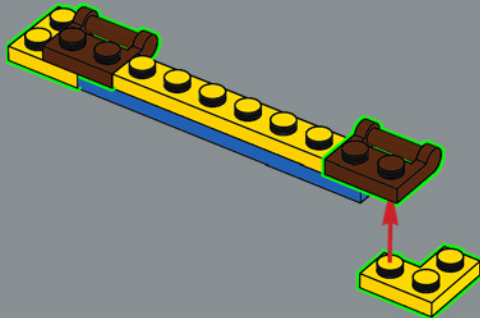

3

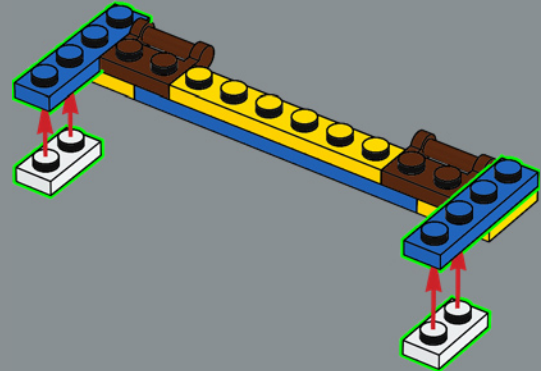

4

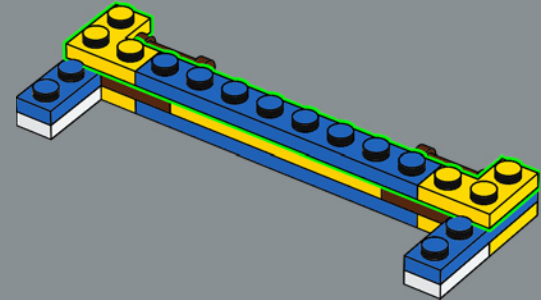

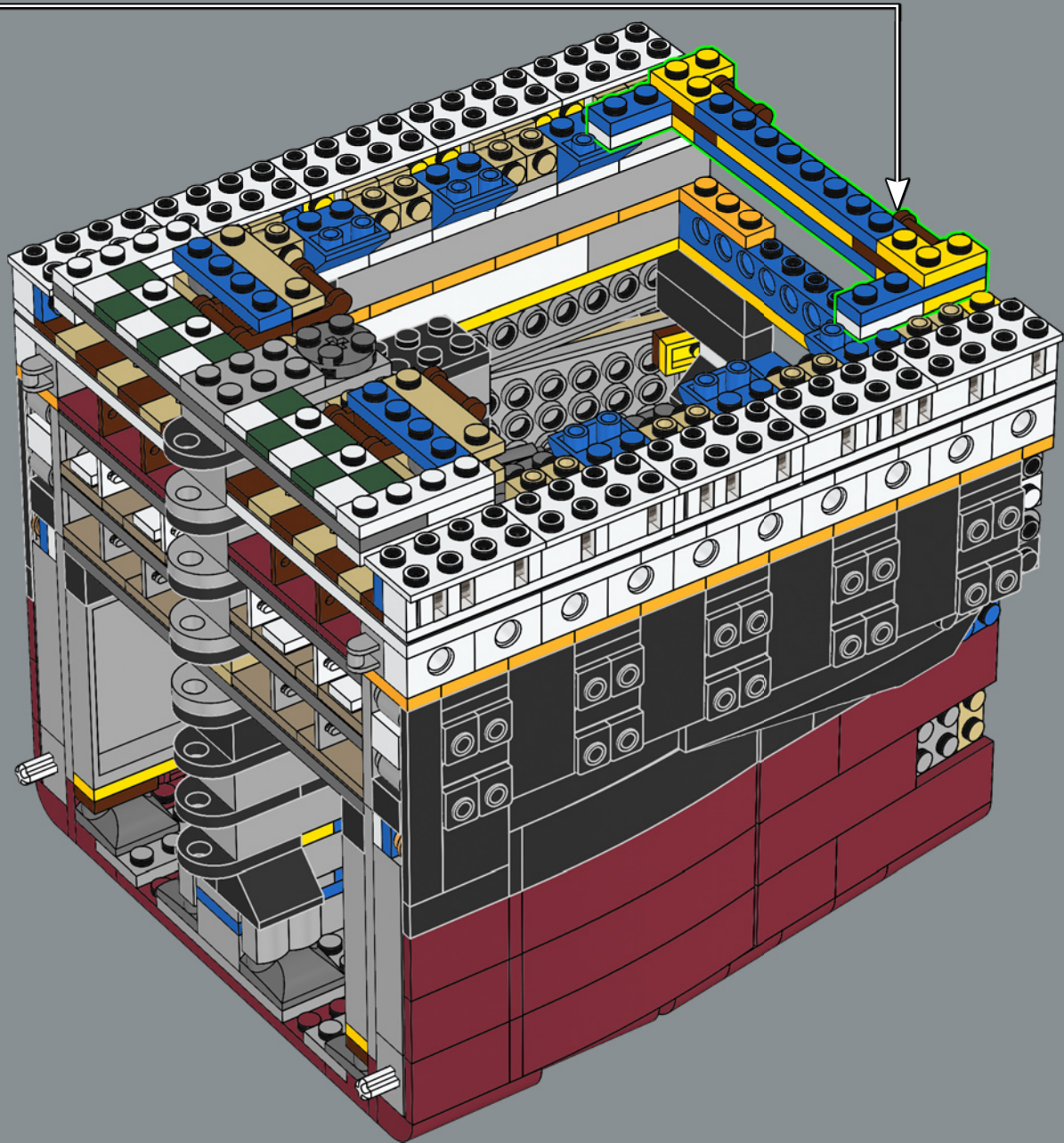

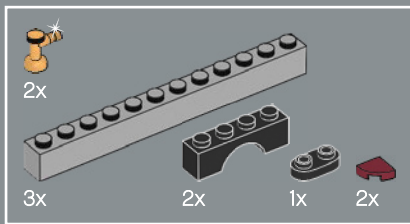

106

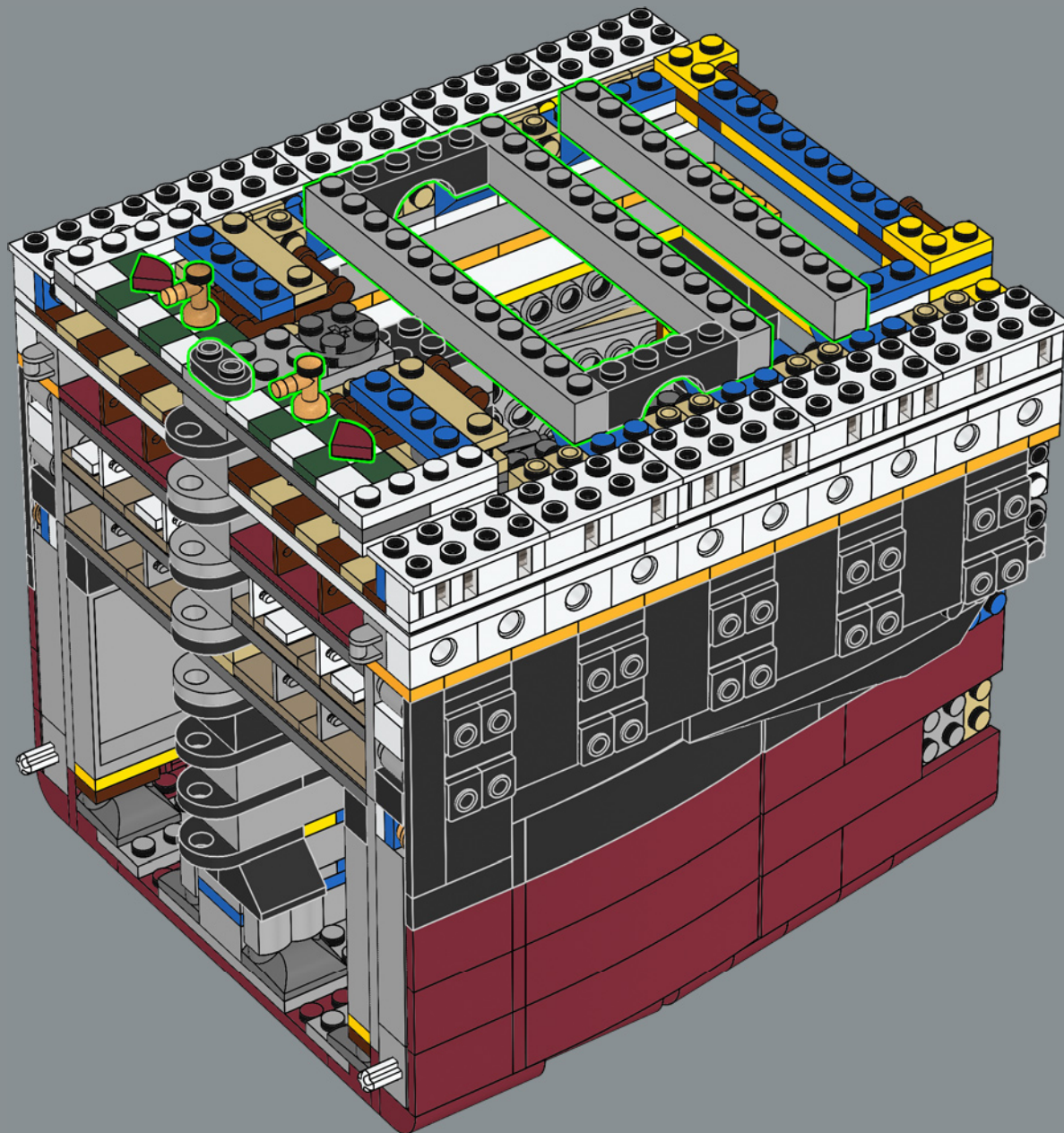



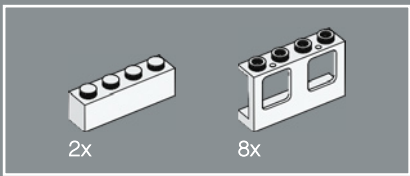

107

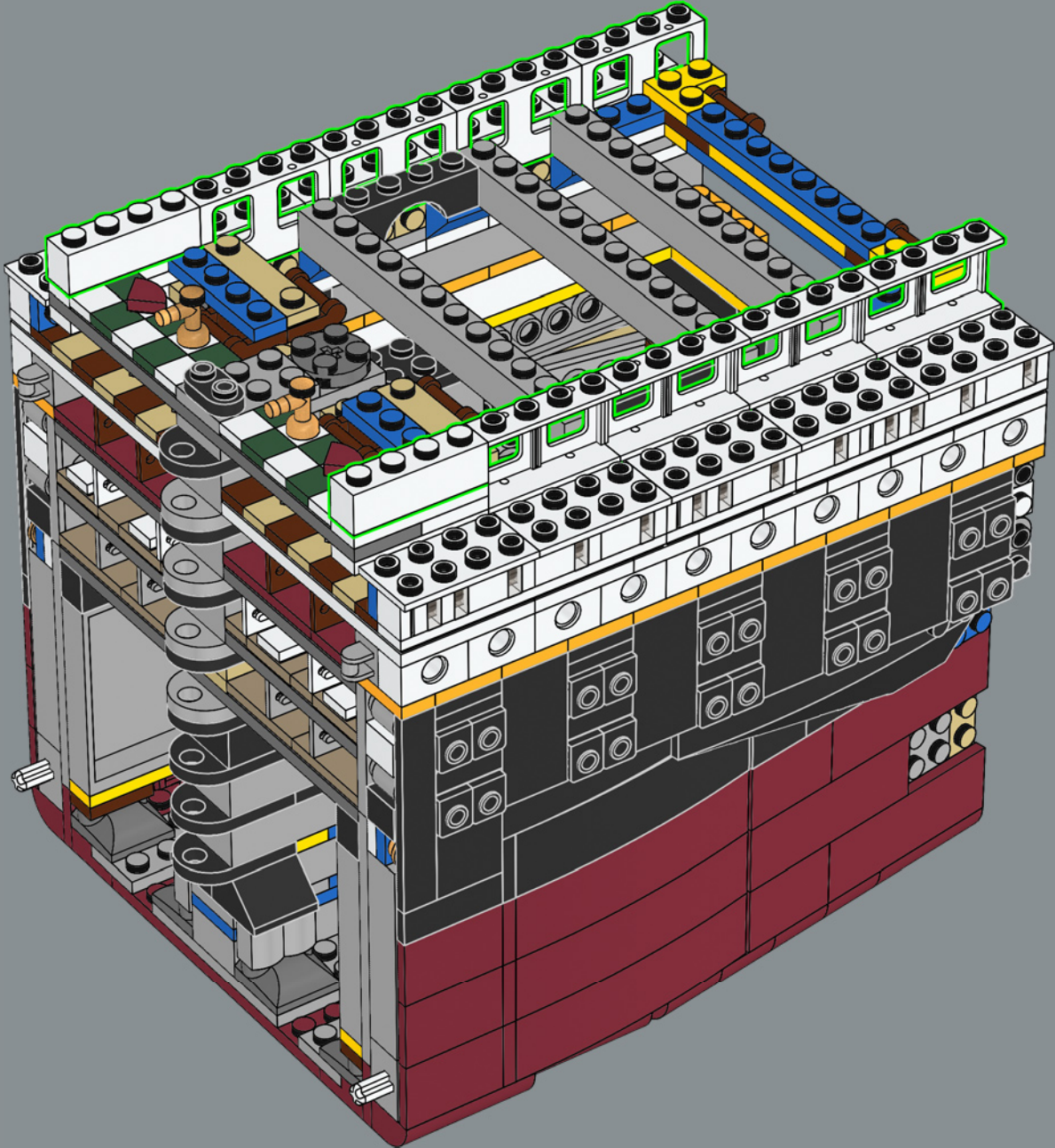

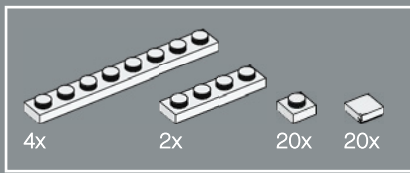

108

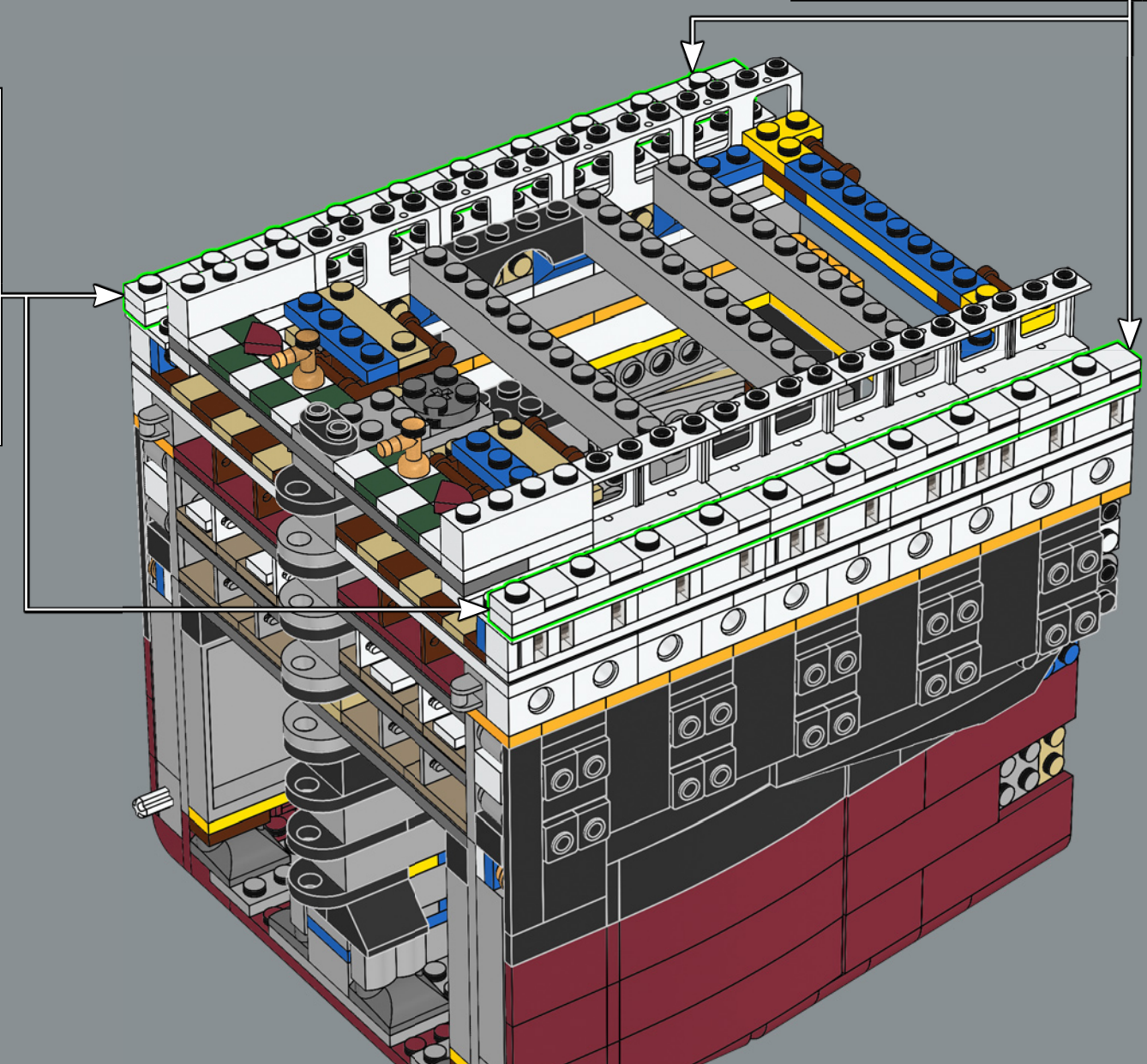
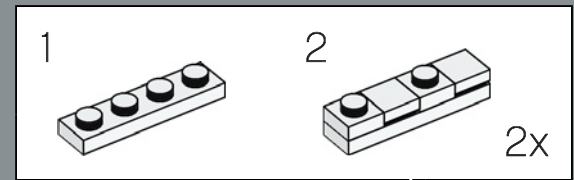
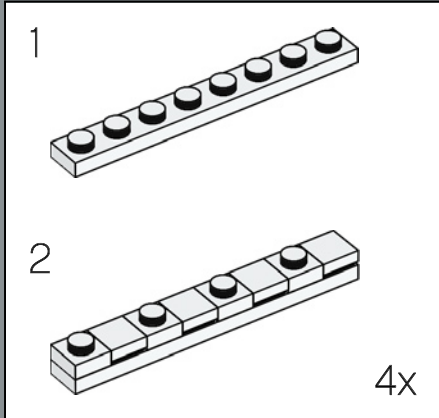





20x

109

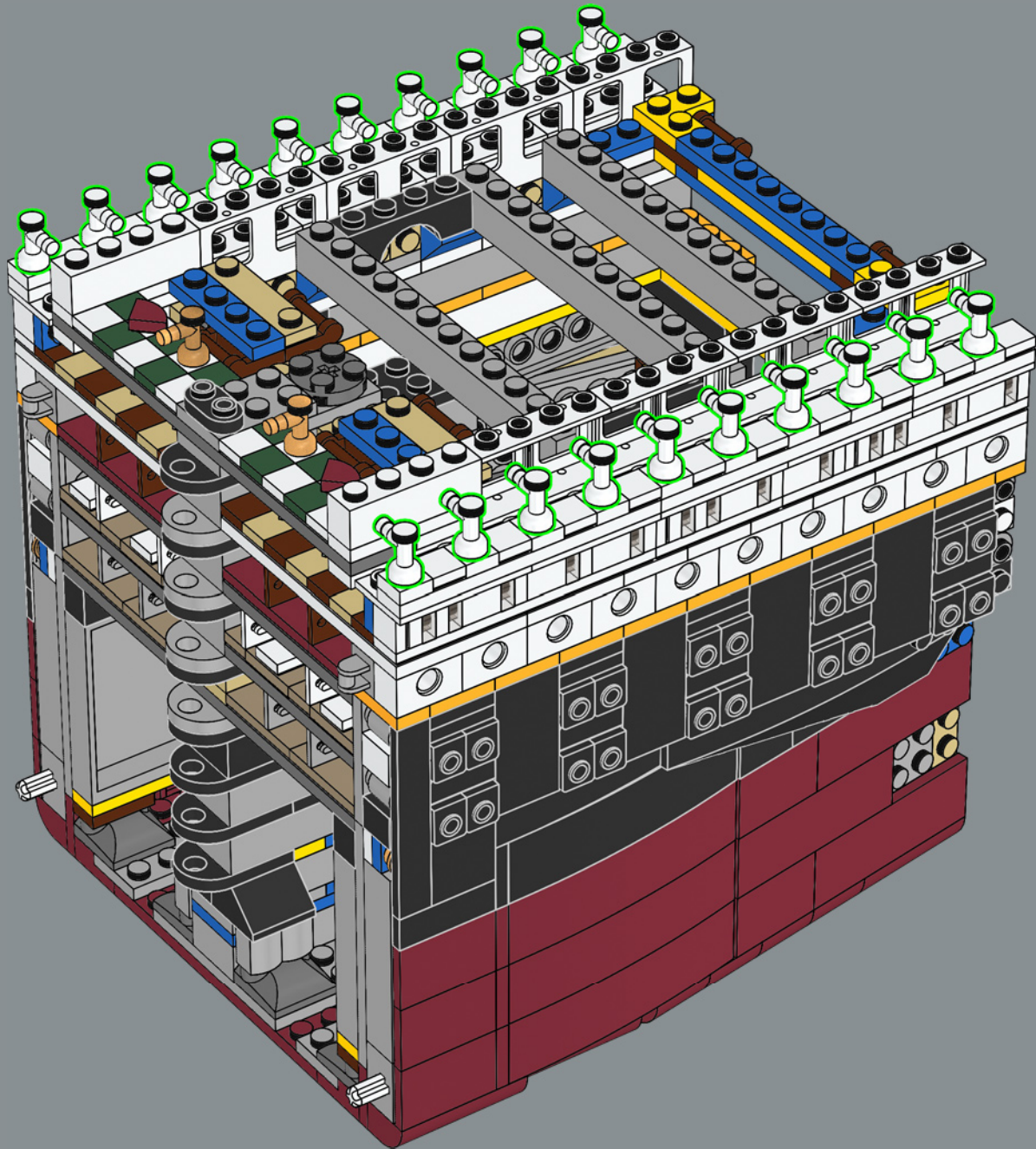



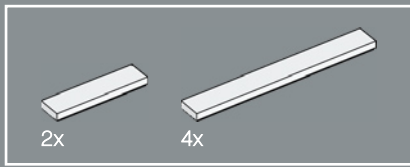

110

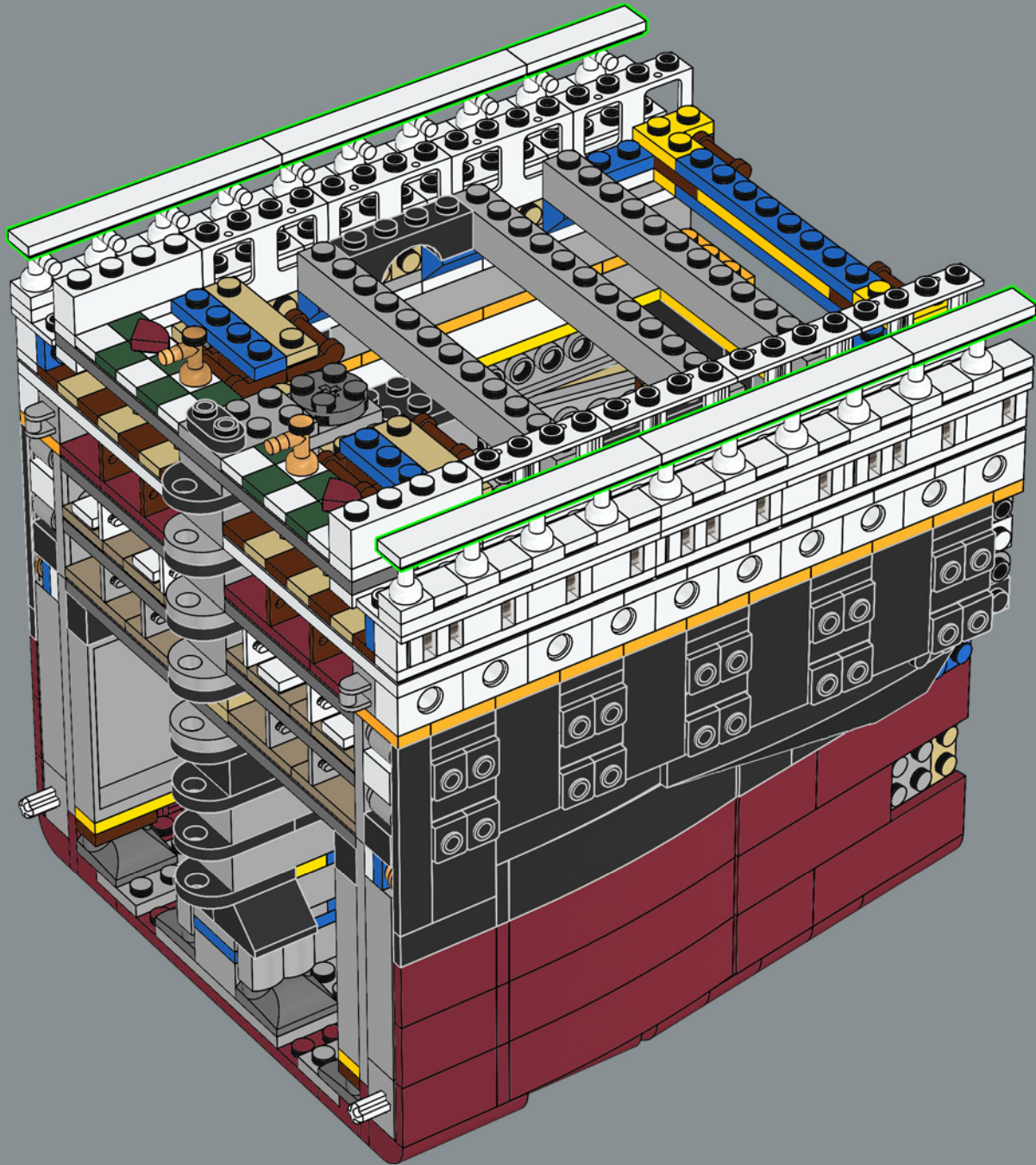

34

2x

4x

2x

111

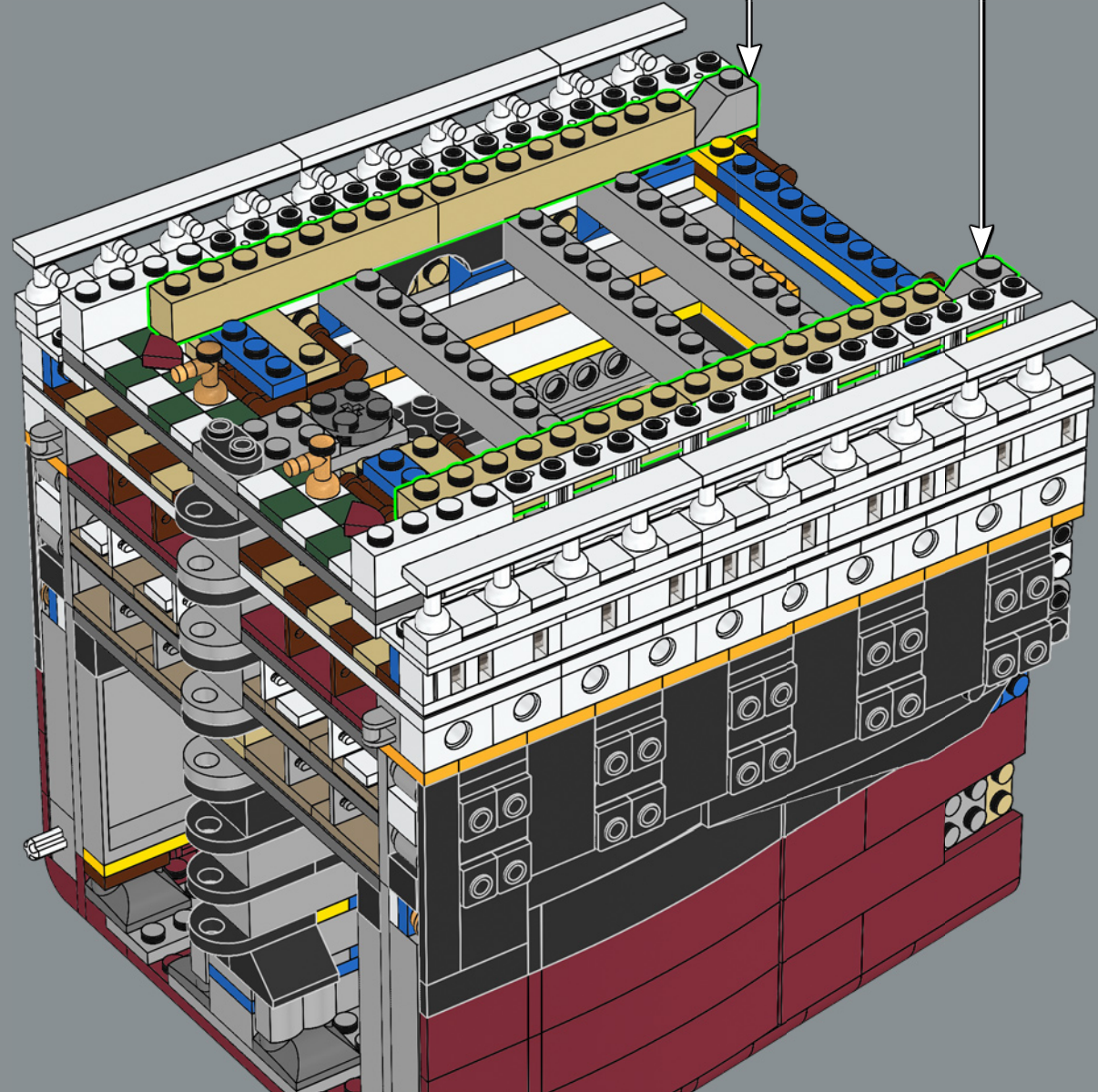



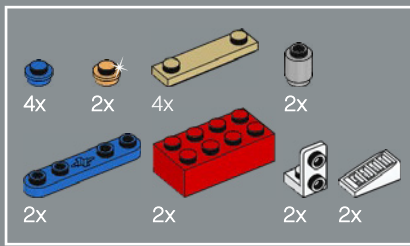

112

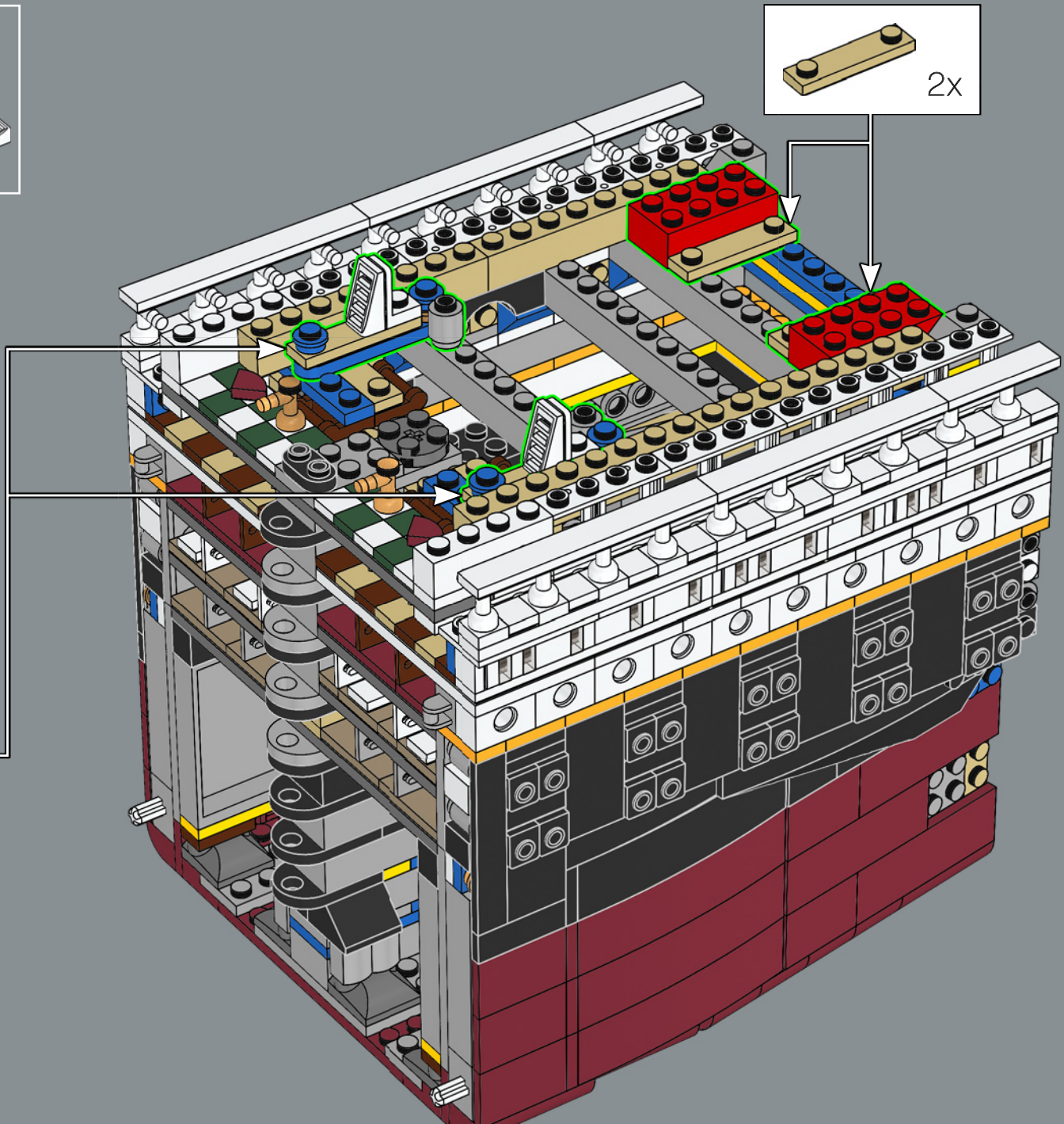
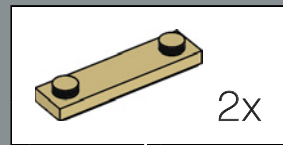
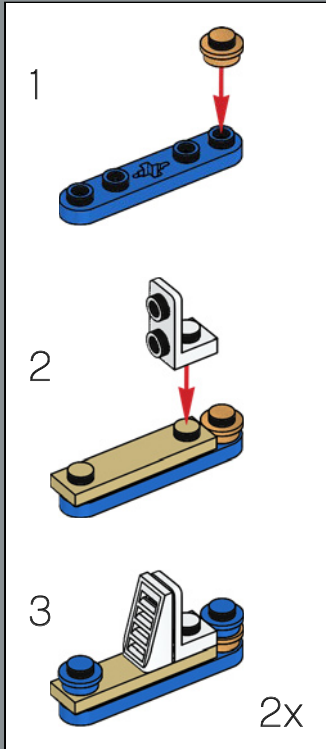



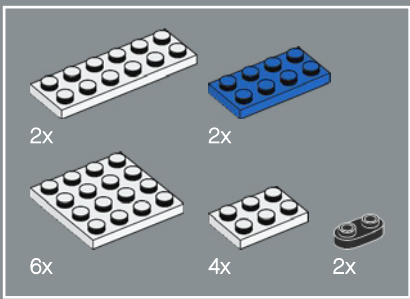

113

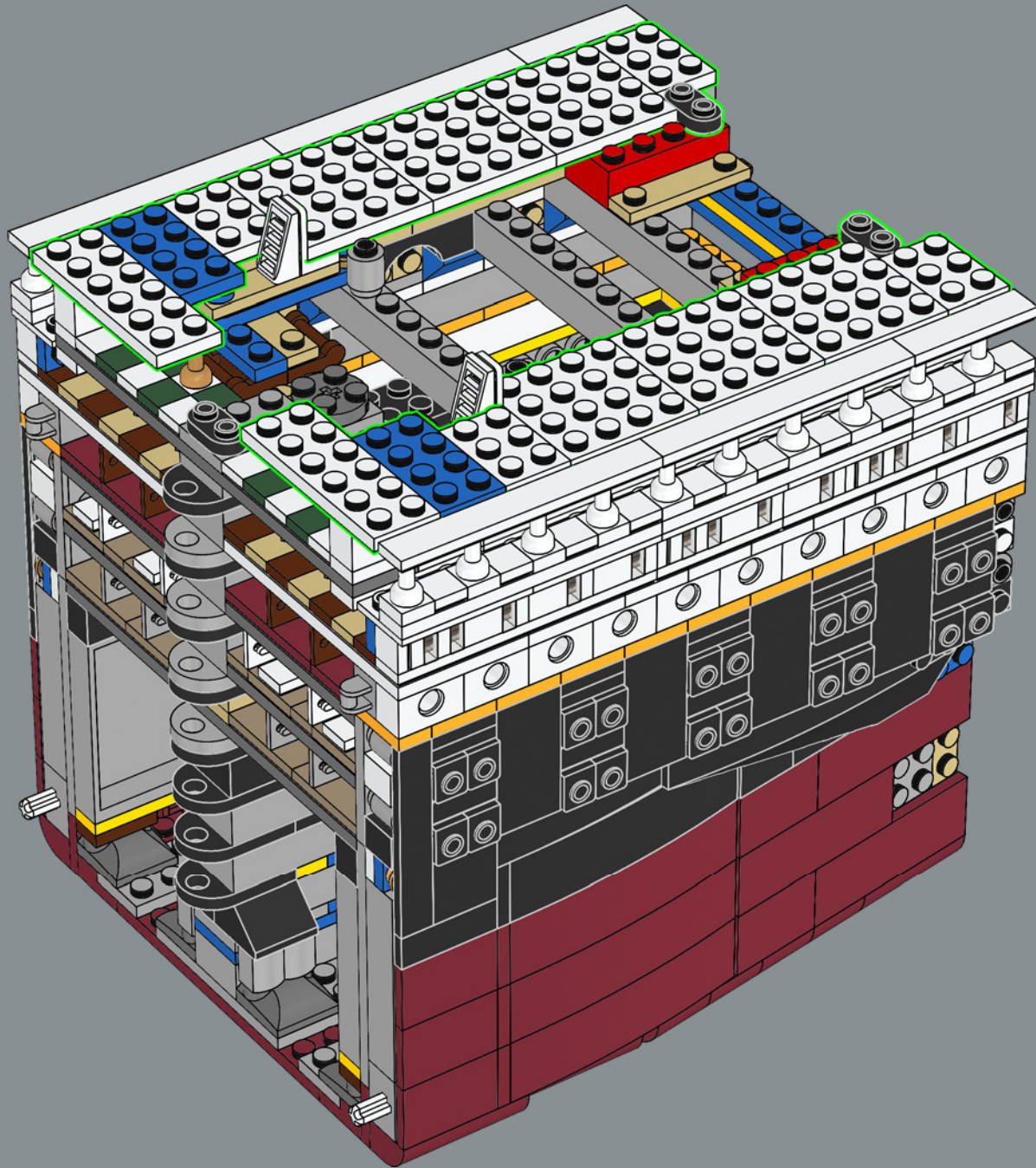

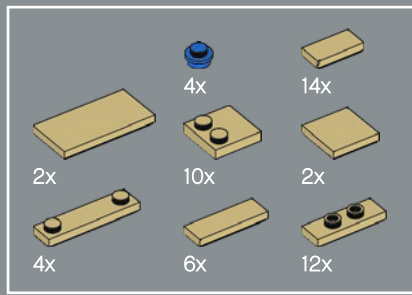

114

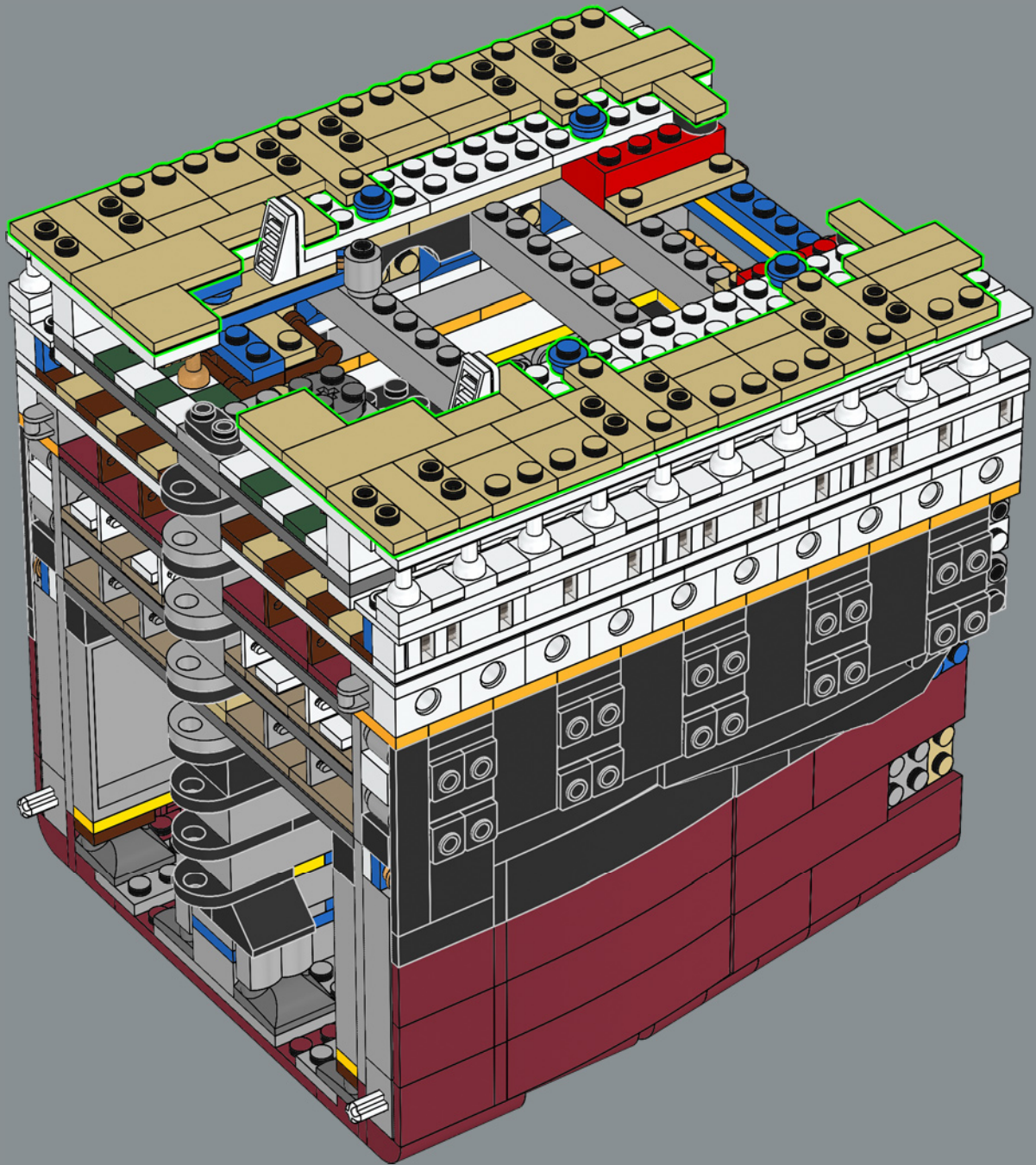



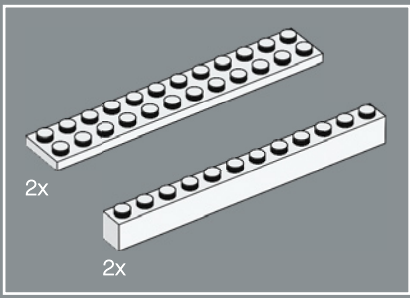

115

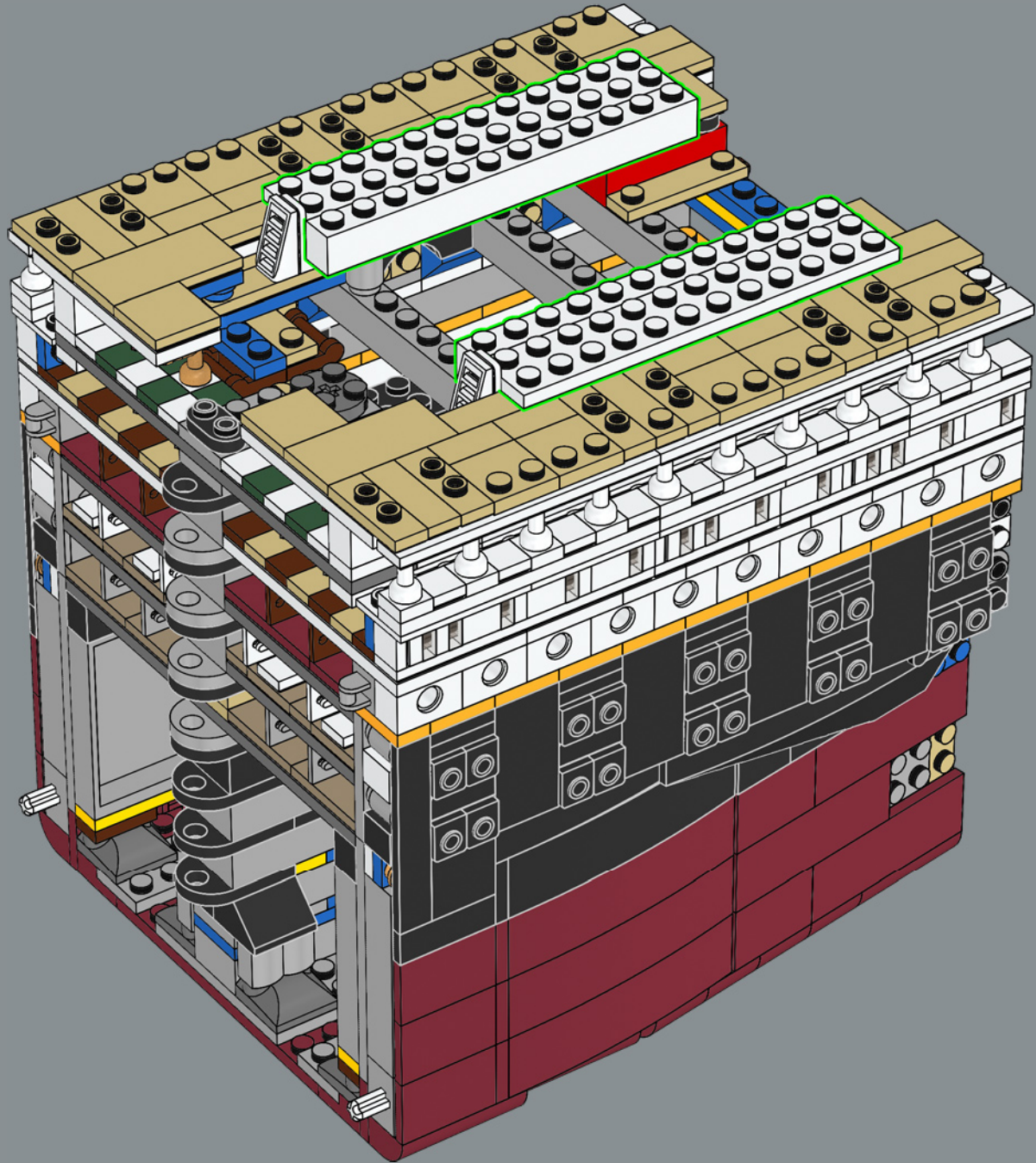



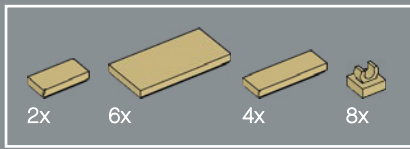

116

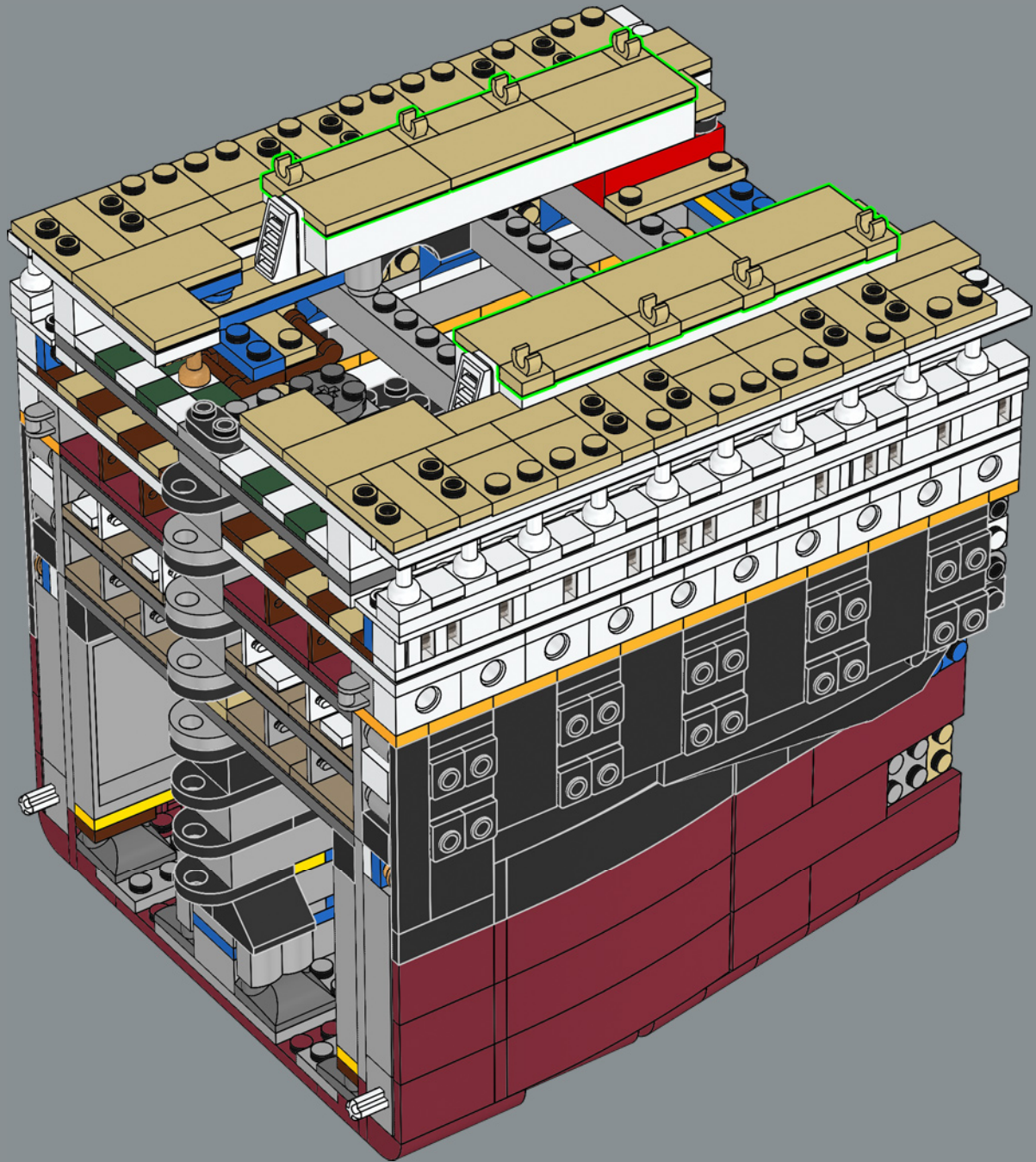

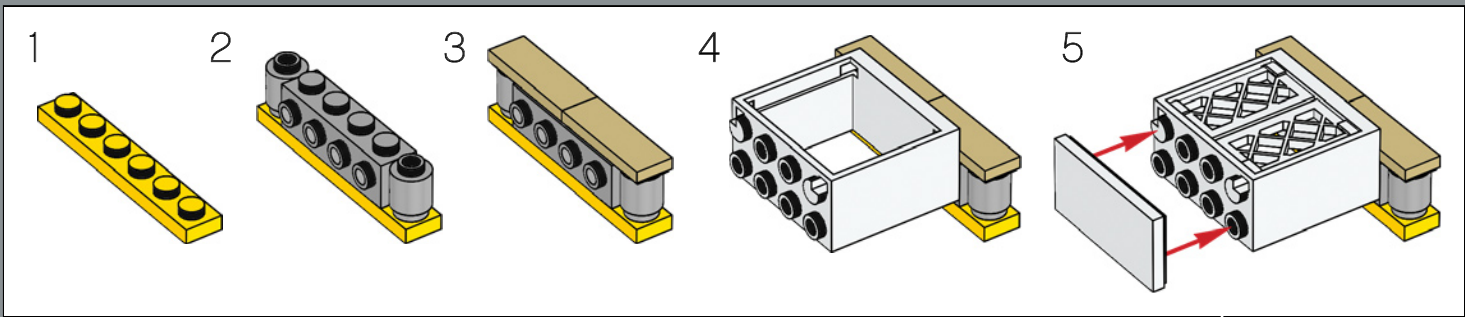
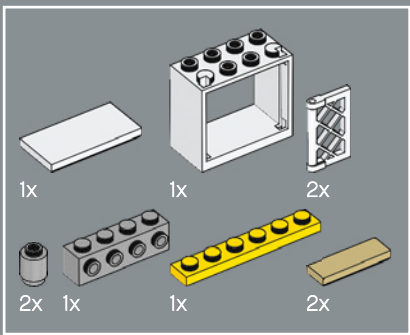

117

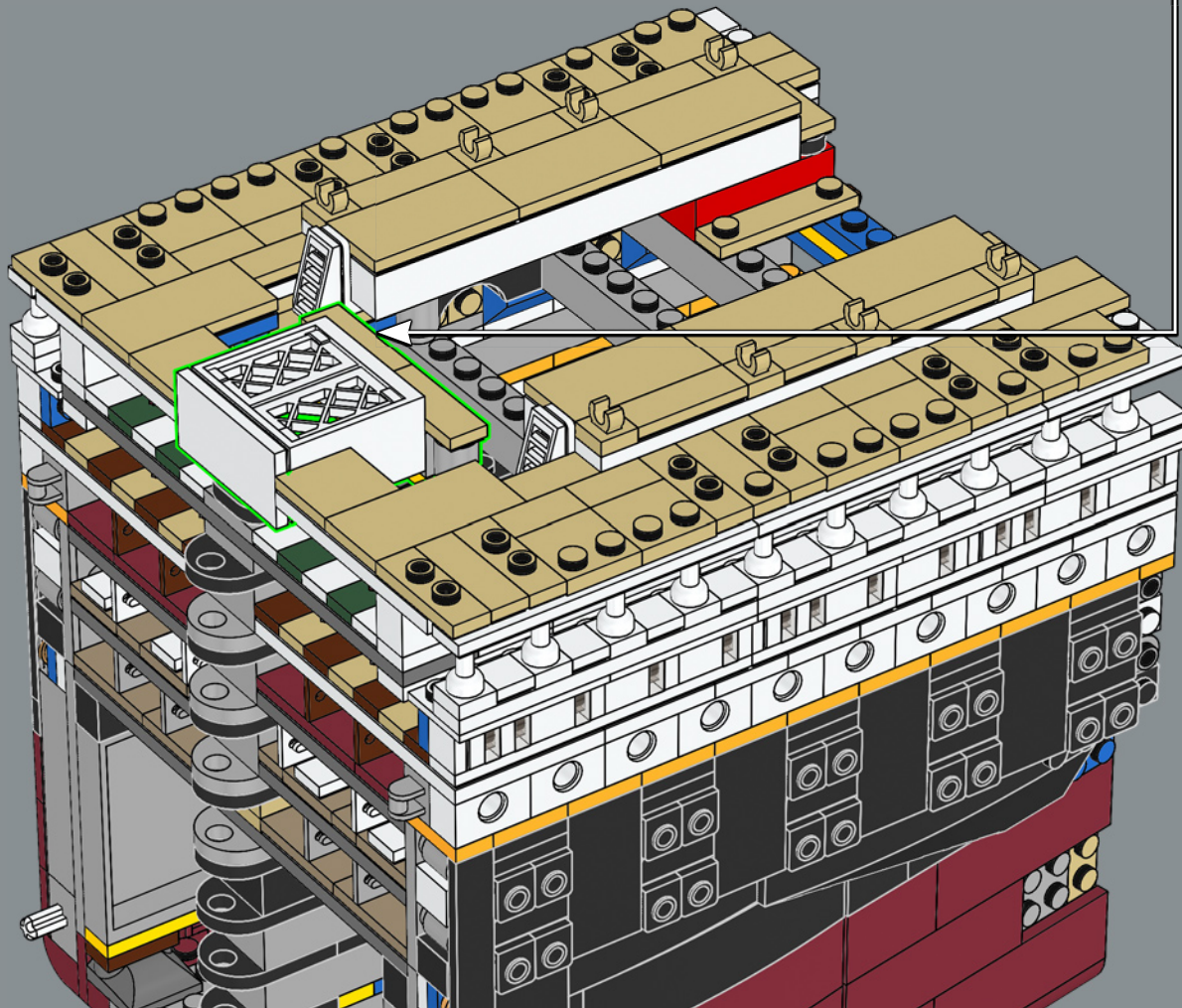



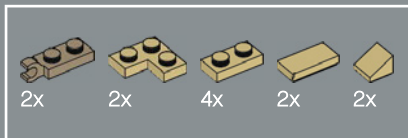

118

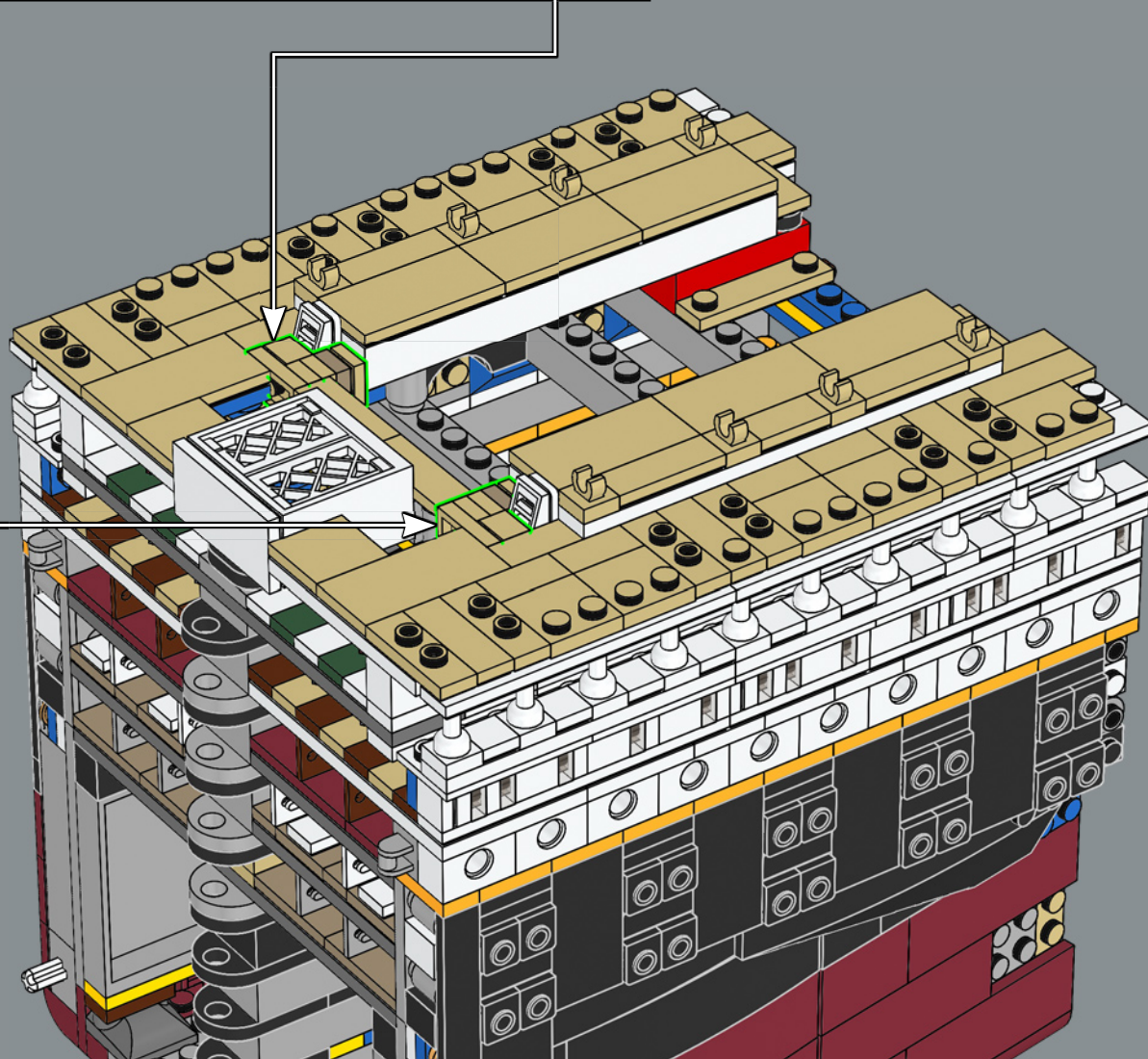
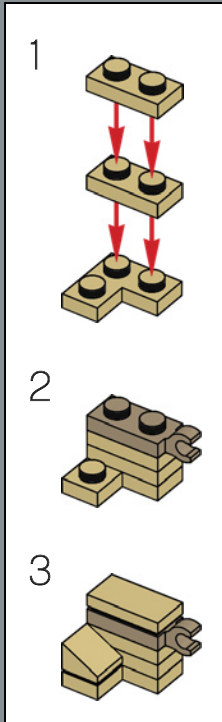
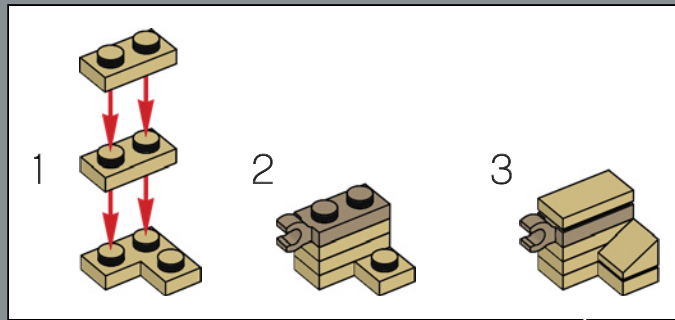



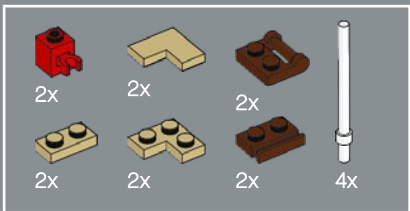

119

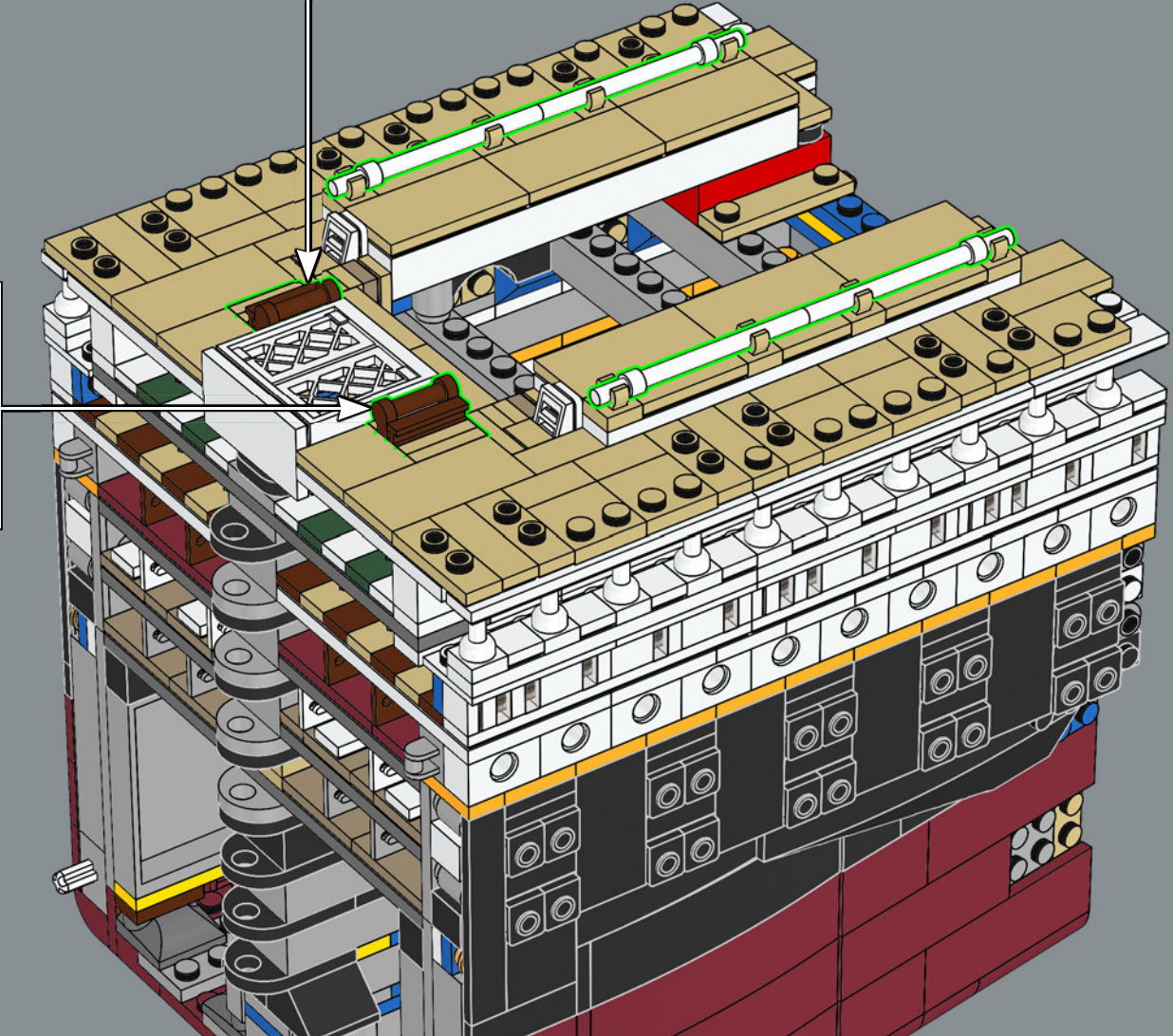
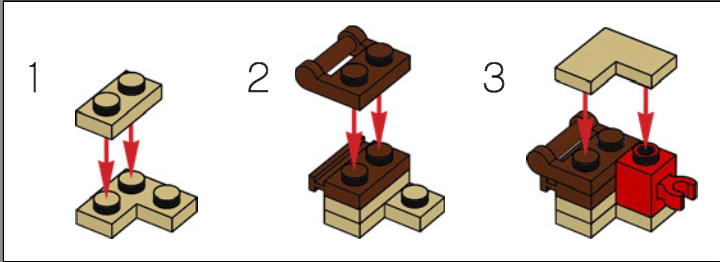
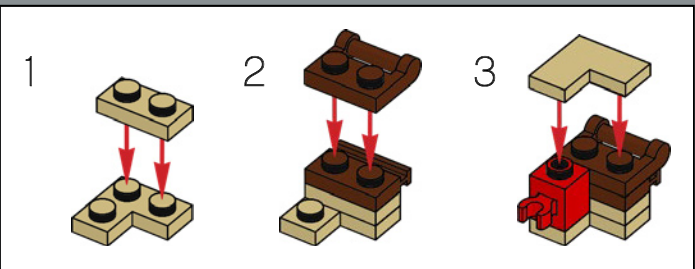

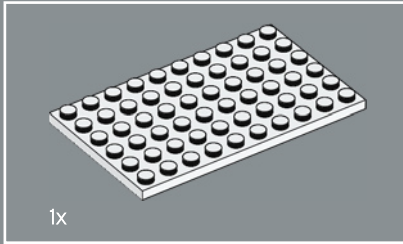
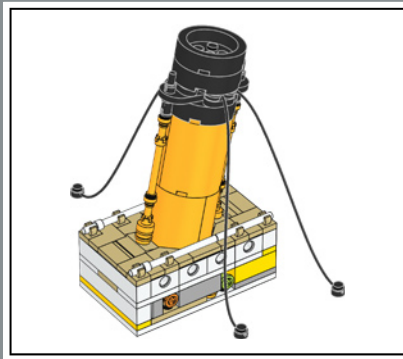
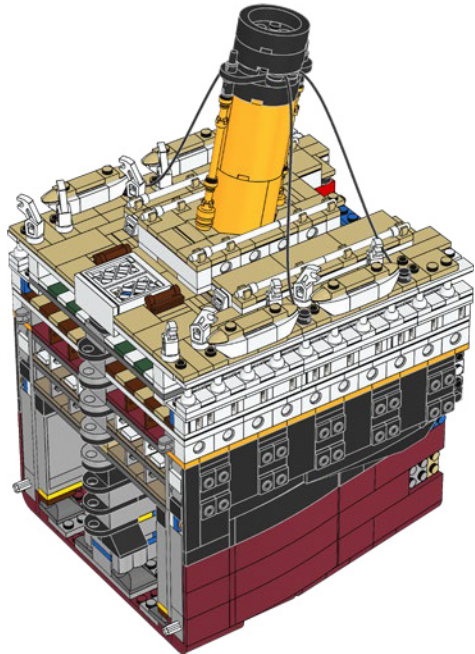

120

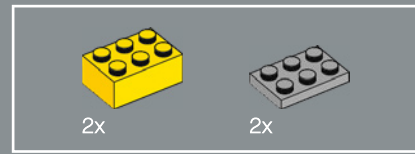
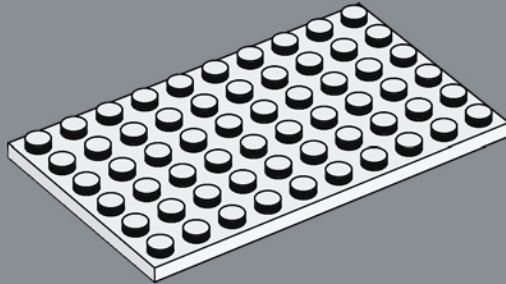

121

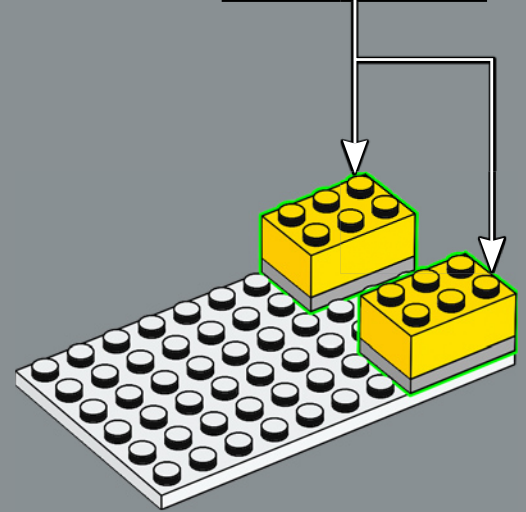
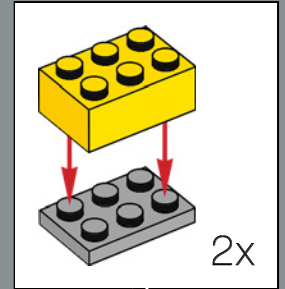

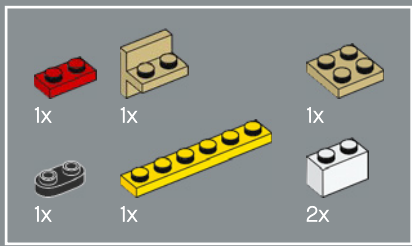

122

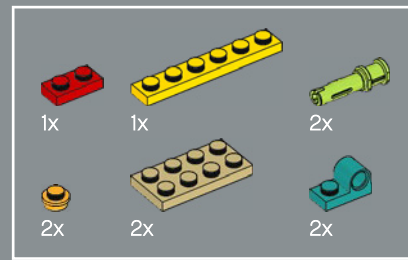
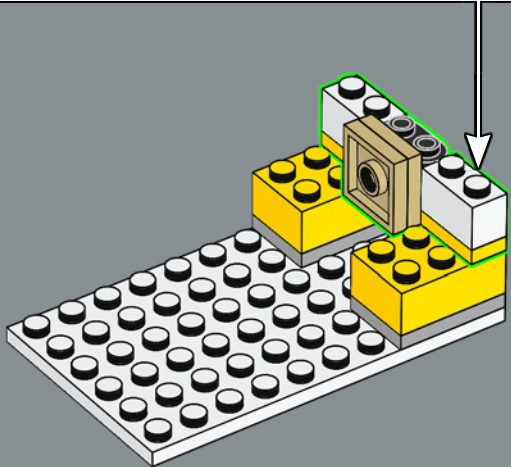
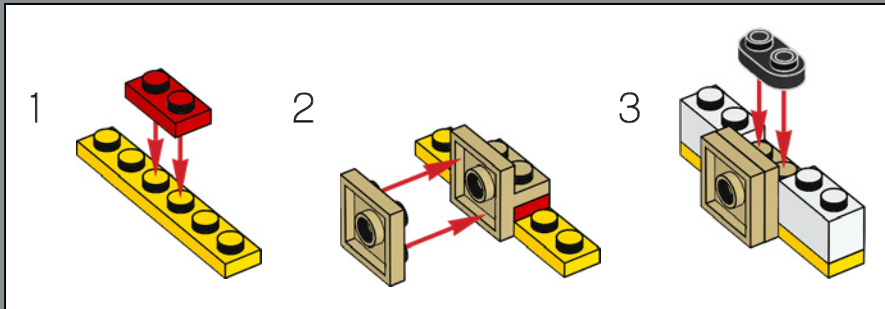

123

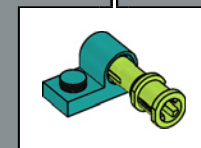
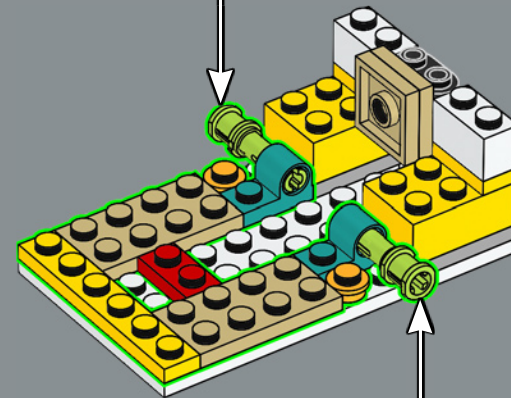
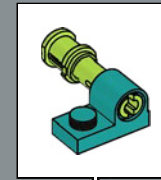



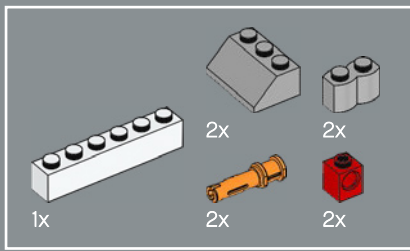

124

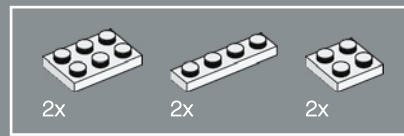
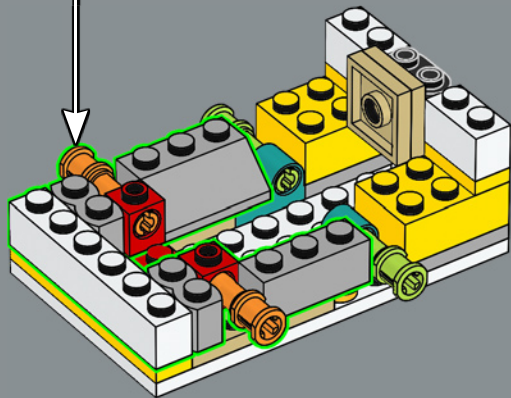
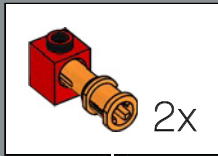

125

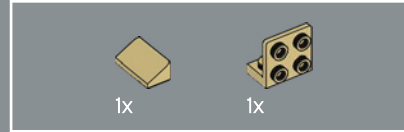
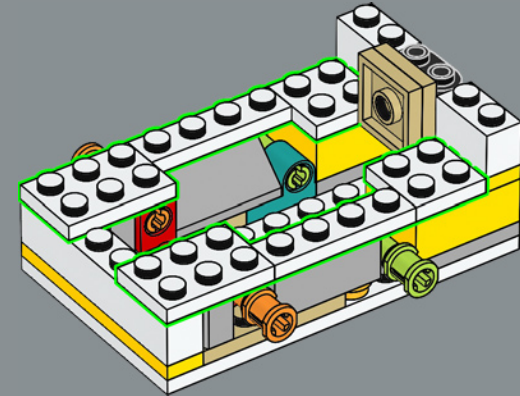

126

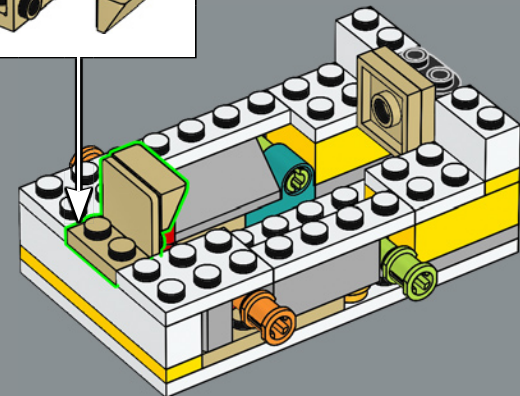
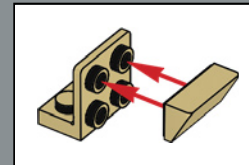

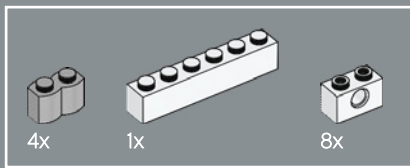

127

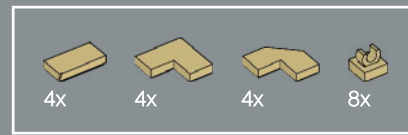
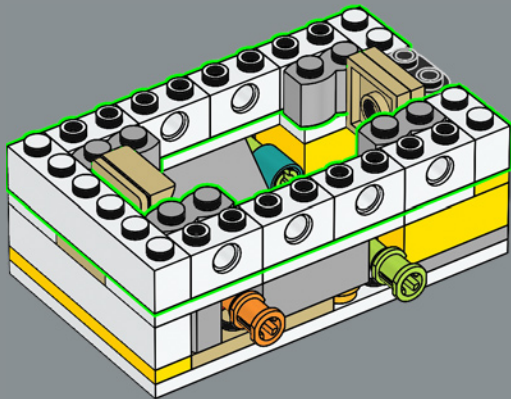

128

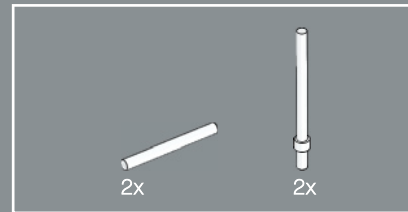
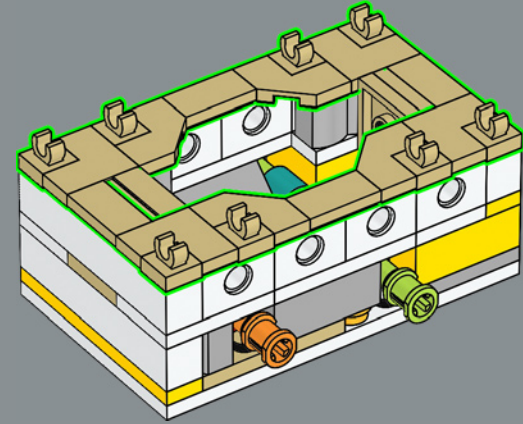

129

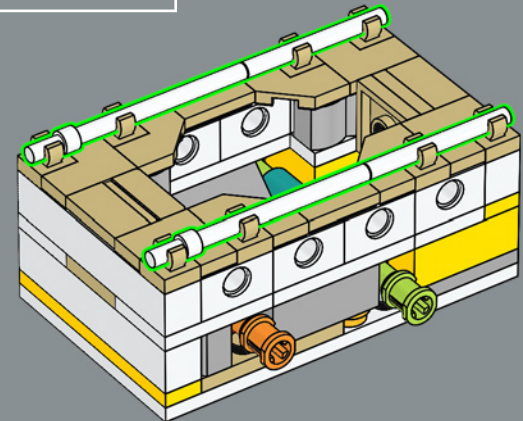

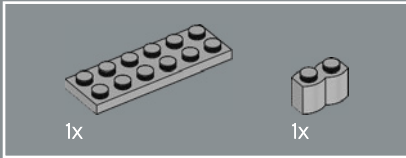
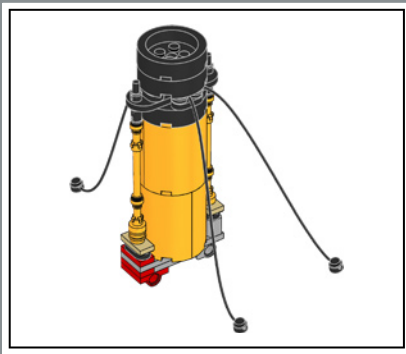

130

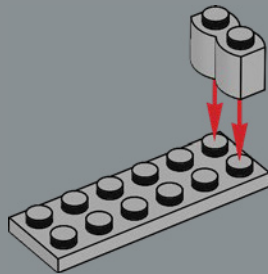

131

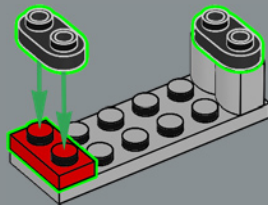

132

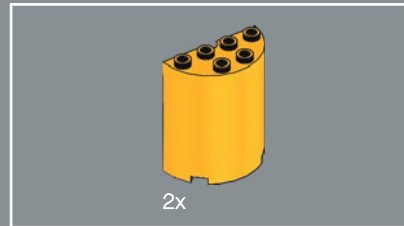
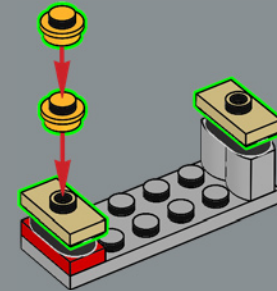

133

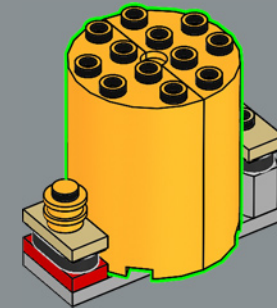



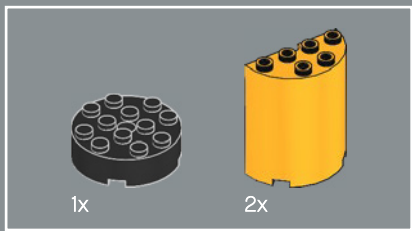

134

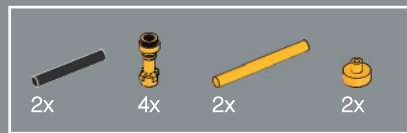
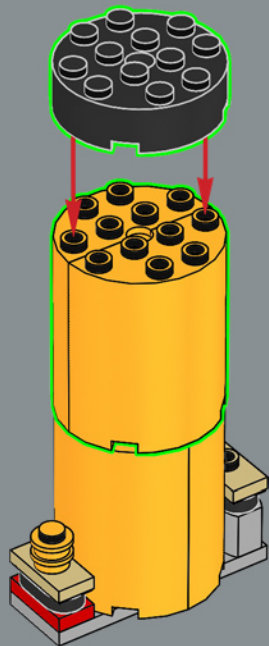

135

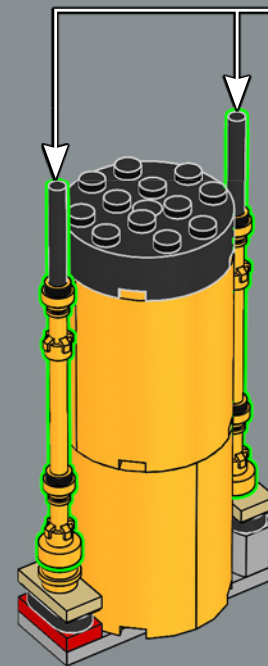
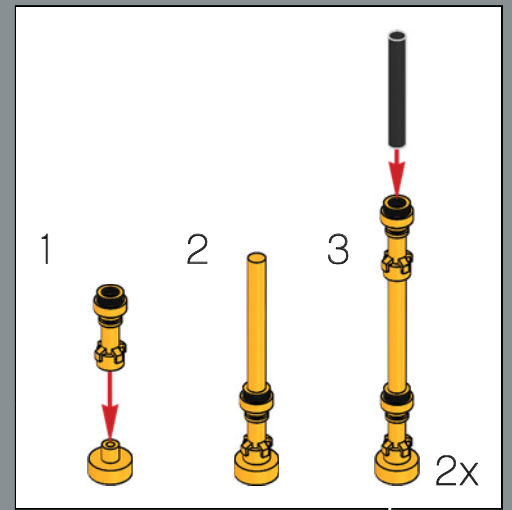

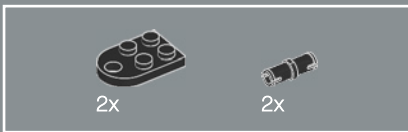

136

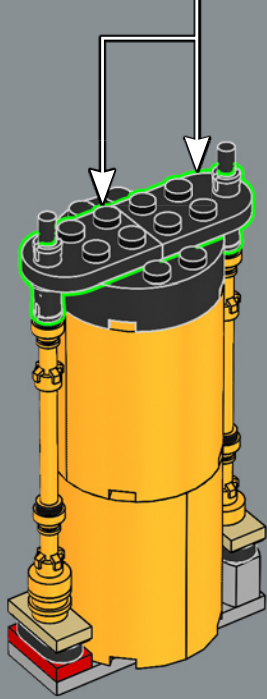
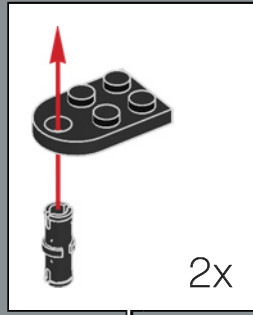

137

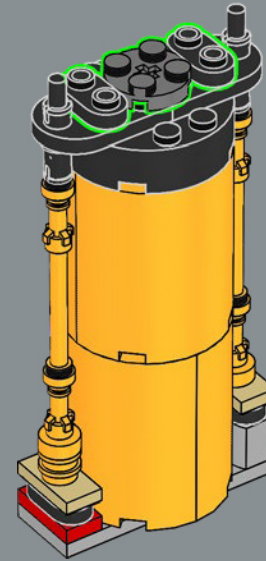

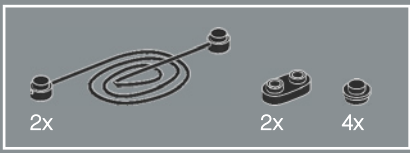

138

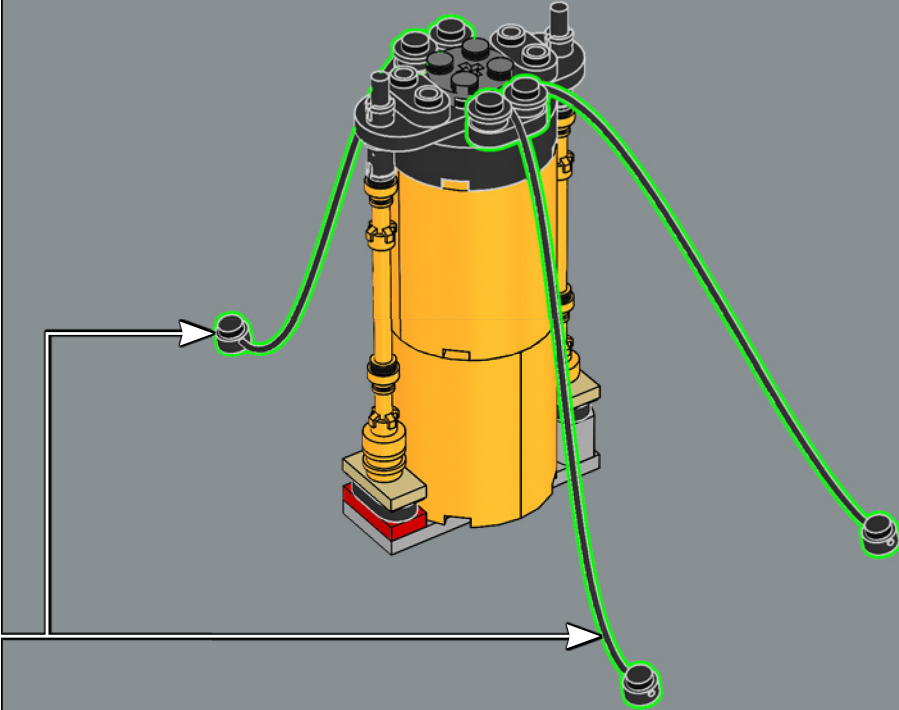
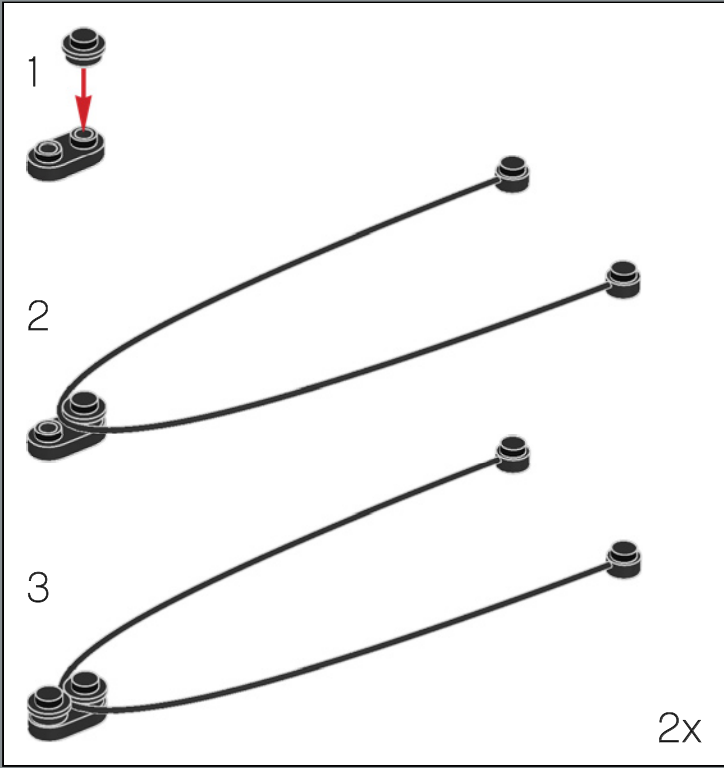



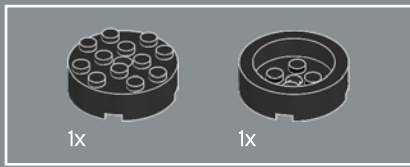

139

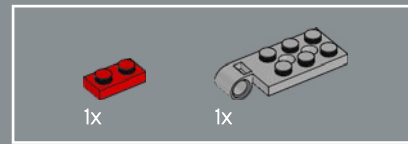
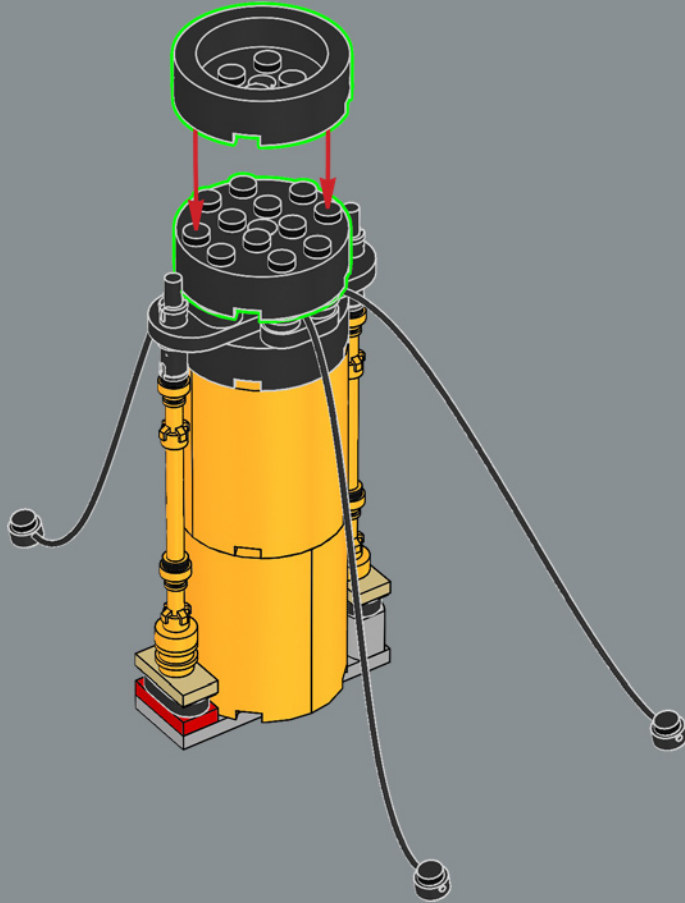

140

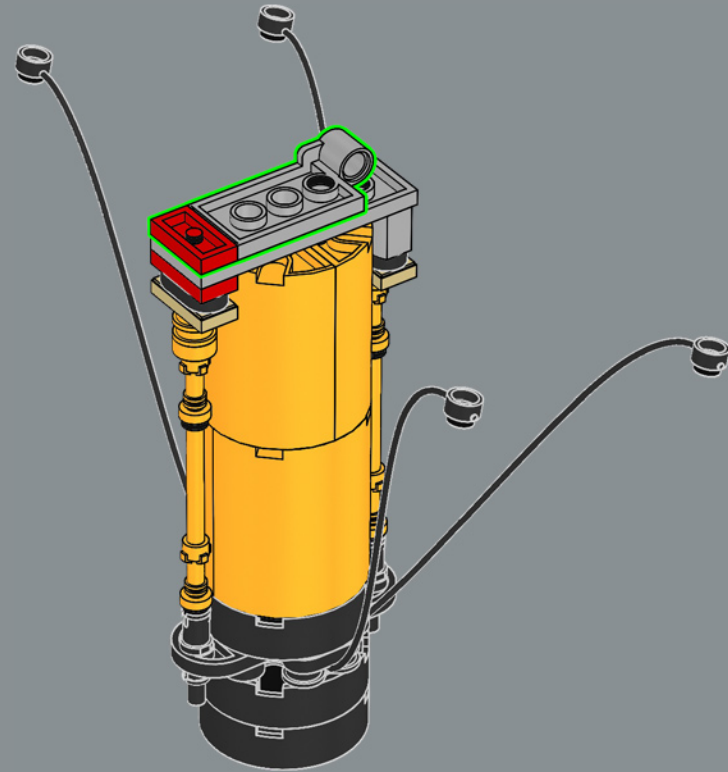

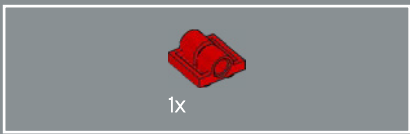

141

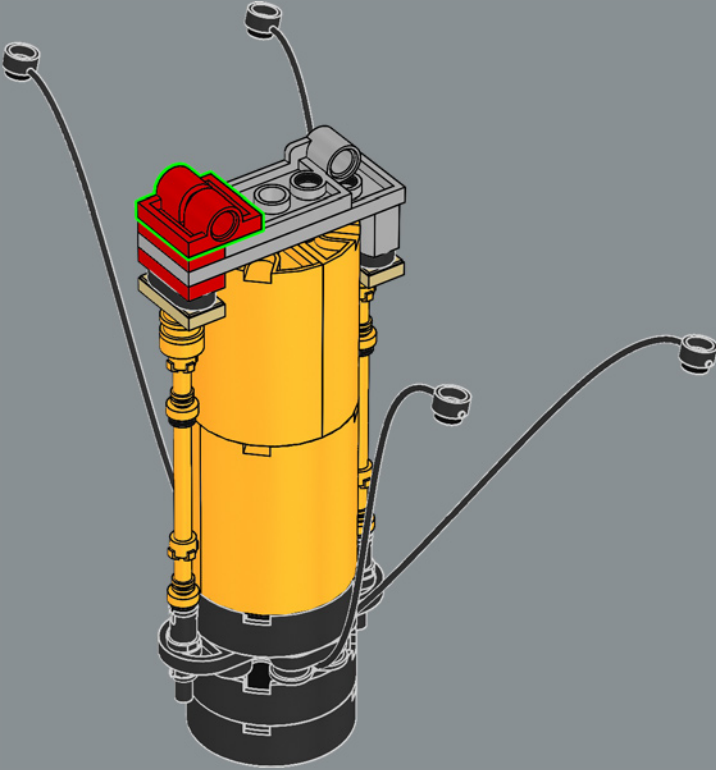

142

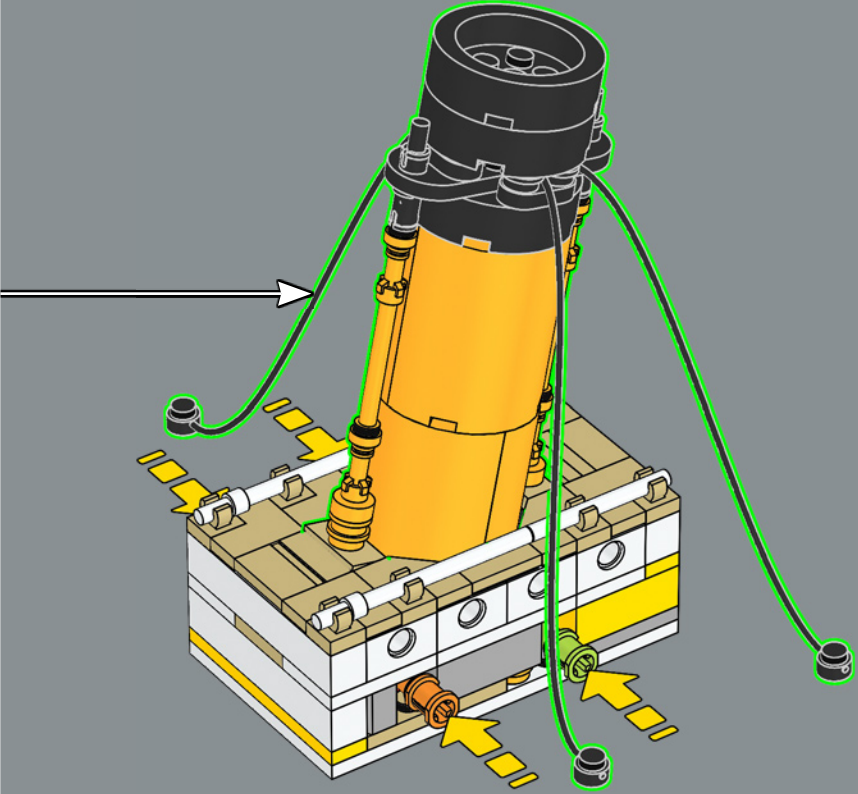

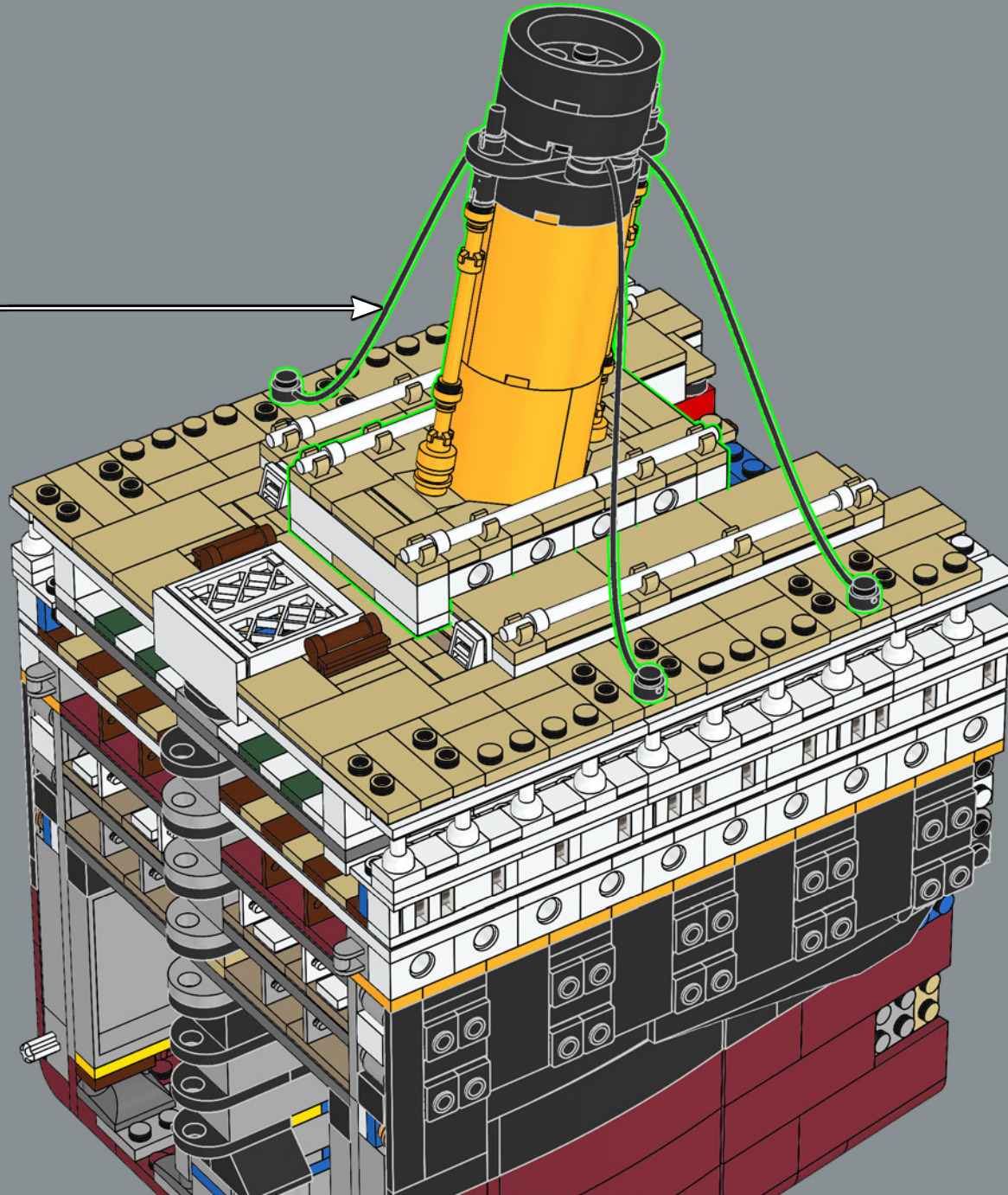

El *Titanic* contaba con cuatro chimeneas, aunque solo tres funcionaban como tales: la cuarta era ornamental, instalada con fines estéticos.



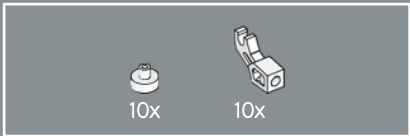

144

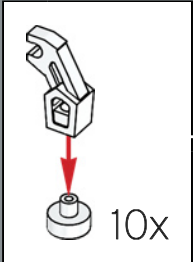
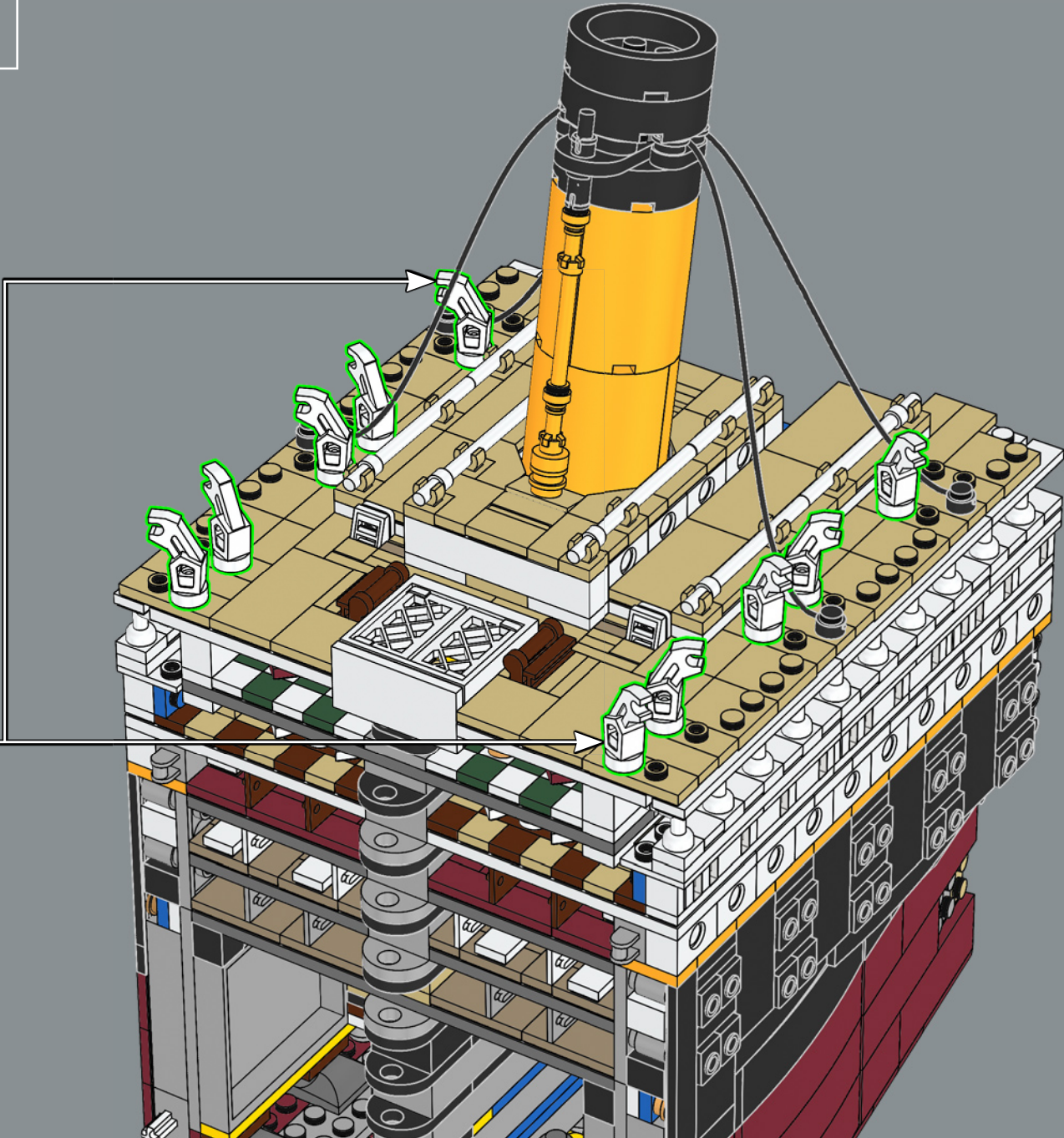

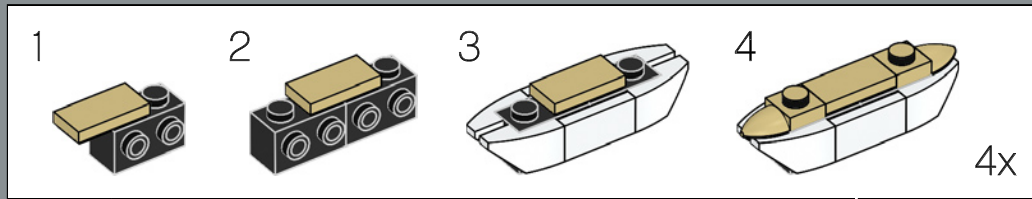
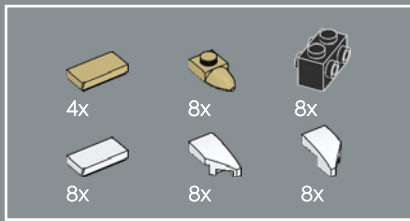

145

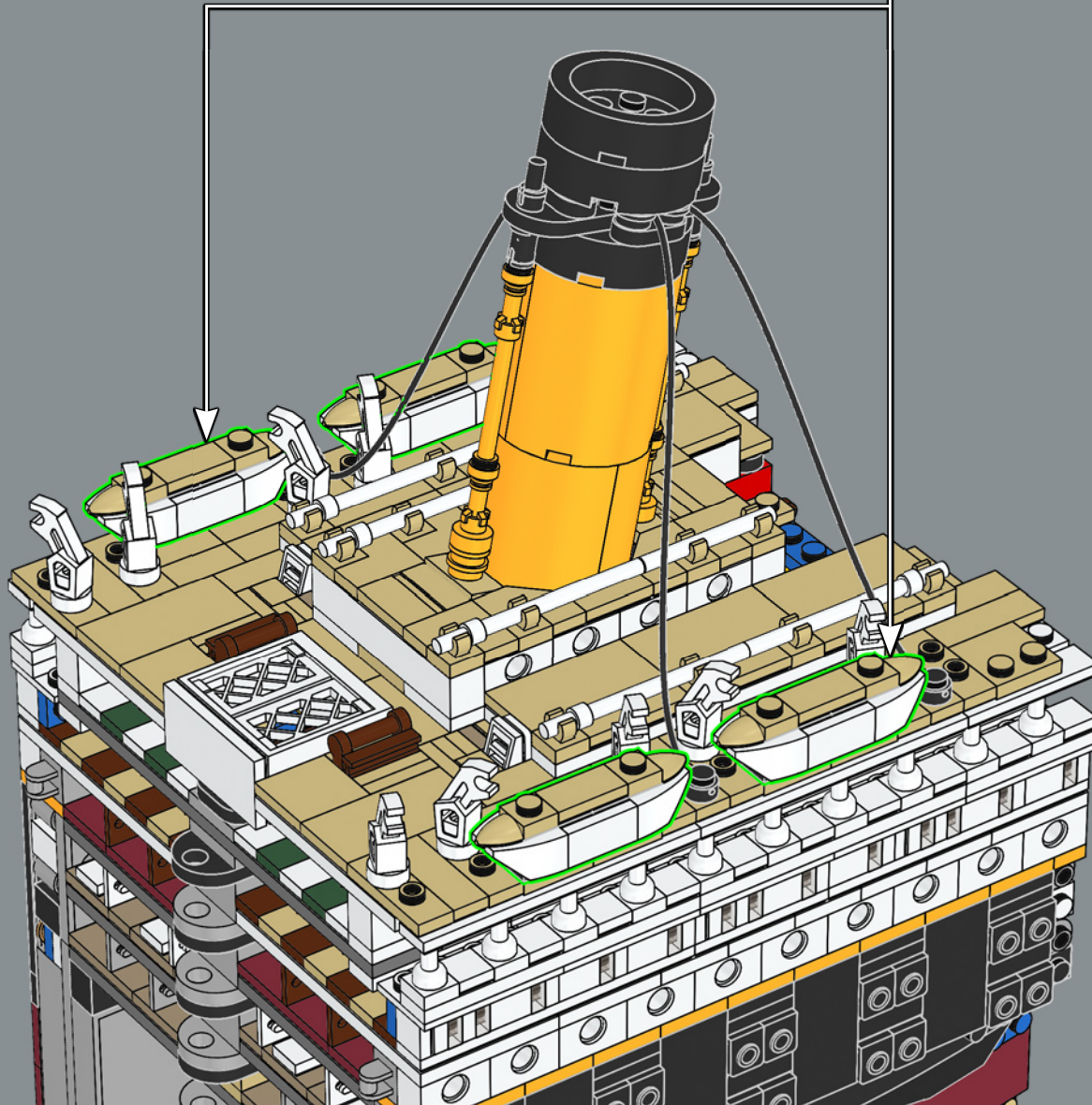



↓ Los detalles exteriores de esta sección incluyen el puente de popa y bancos para los pasajeros de tercera clase.

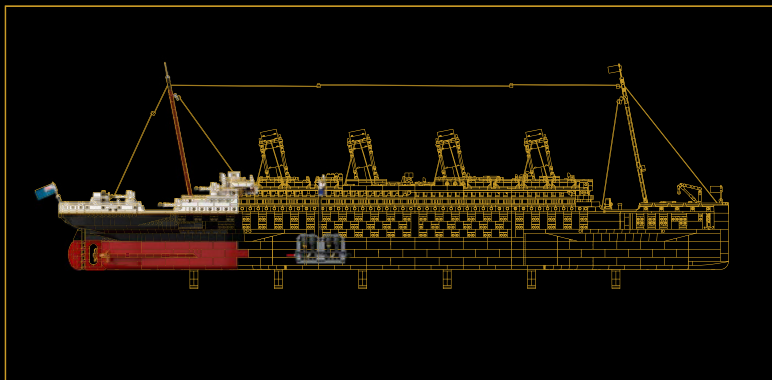

SECCIÓN 6:

## POPA Y CUBIERTA DE POZO

Esta sección final es la más complicada del casco e incluye el timón y tres árboles de transmisión principales que conectan las hélices a los motores. Vas a construir los dos motores de pistones principales vinculados directamente a las hélices de babor y estribor. Al girar las hélices, se mueven los cigüeñales y los pistones del motor en el interior del modelo.





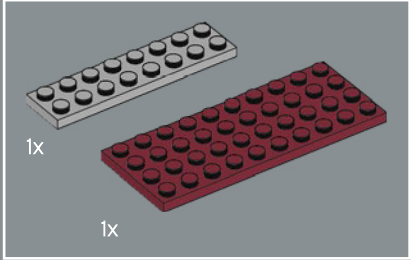
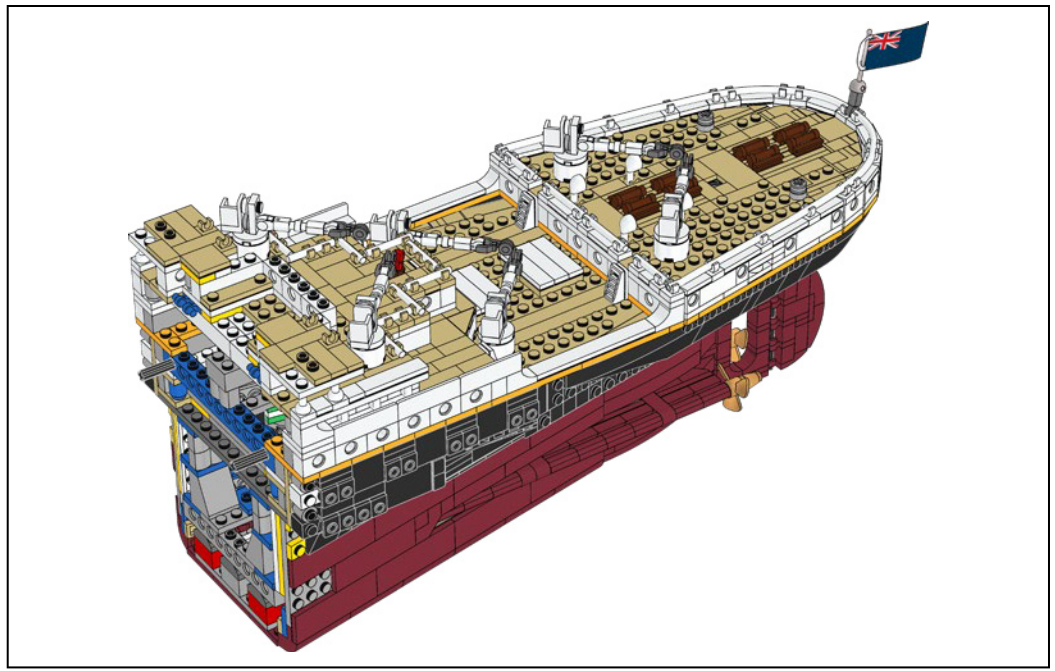
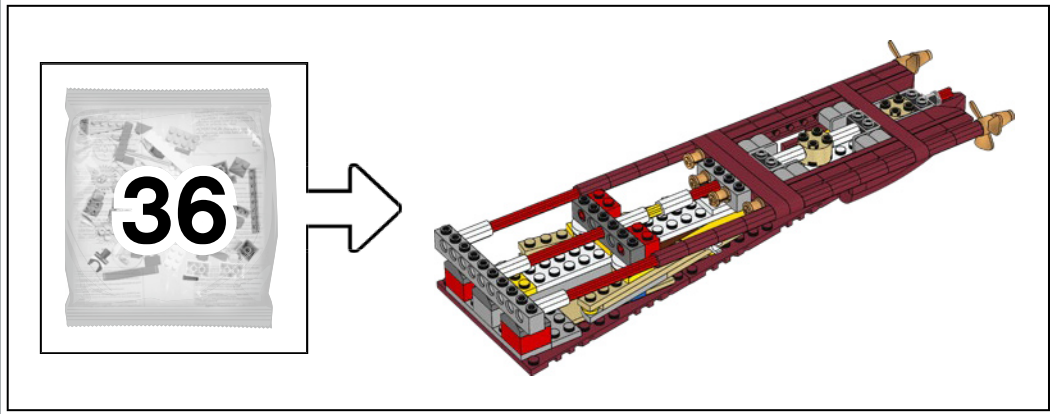

146

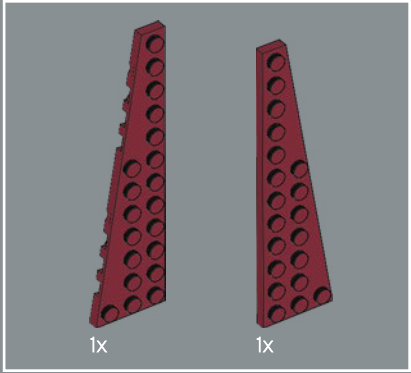
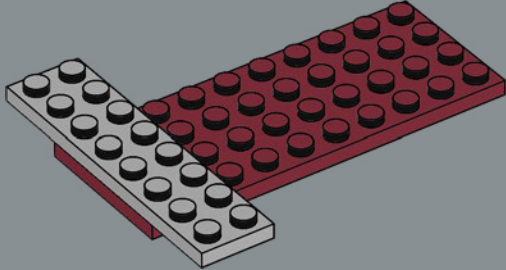

147

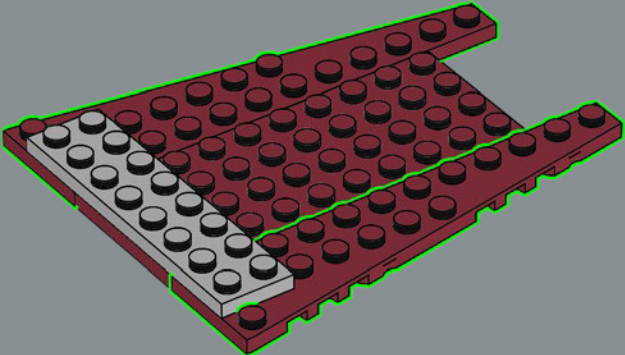

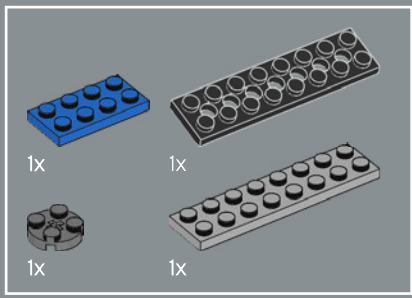

148

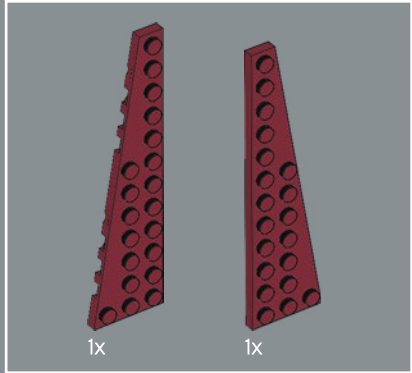
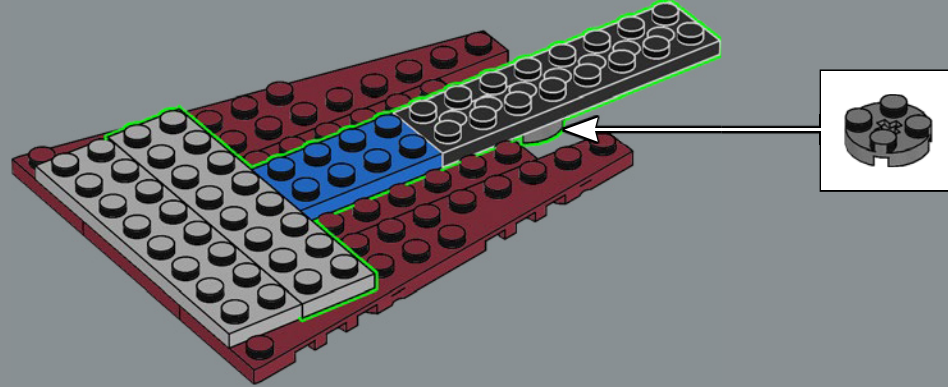

149

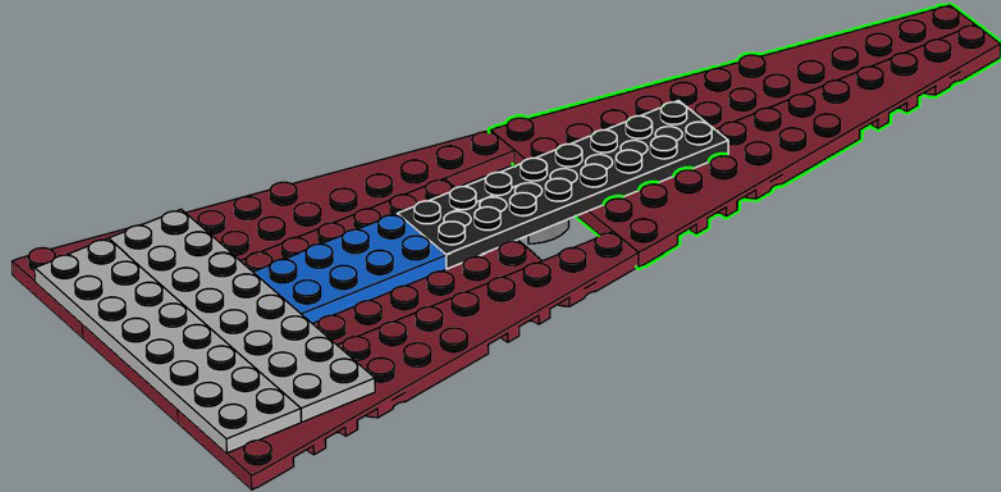

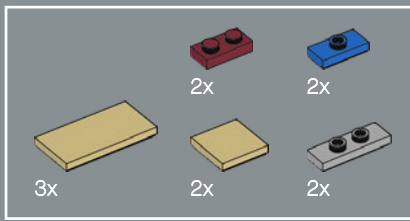

150

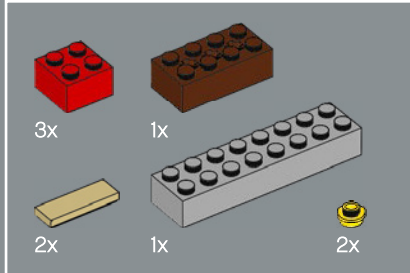
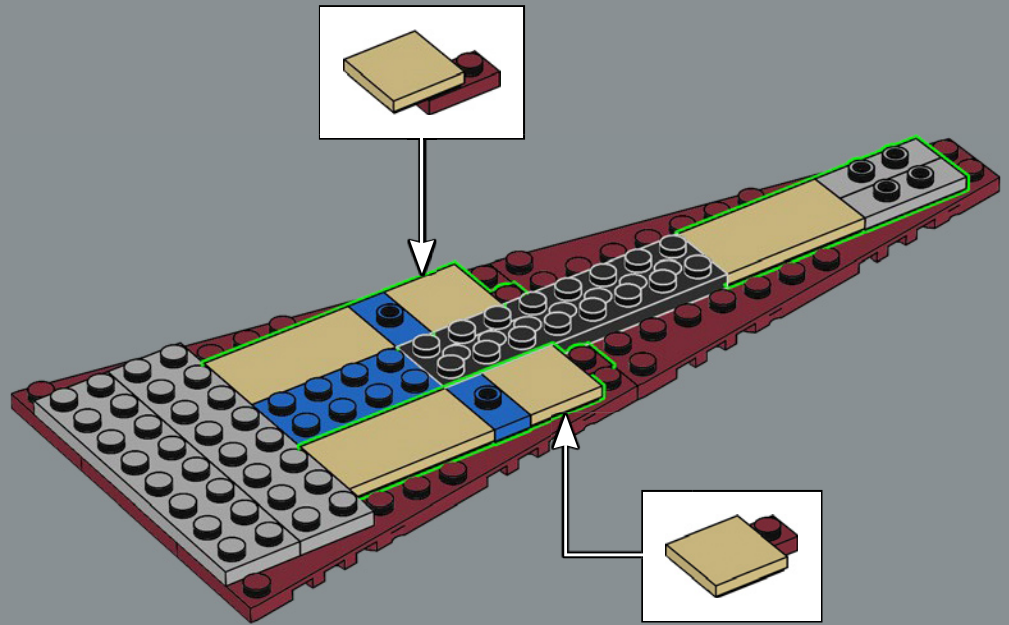

151

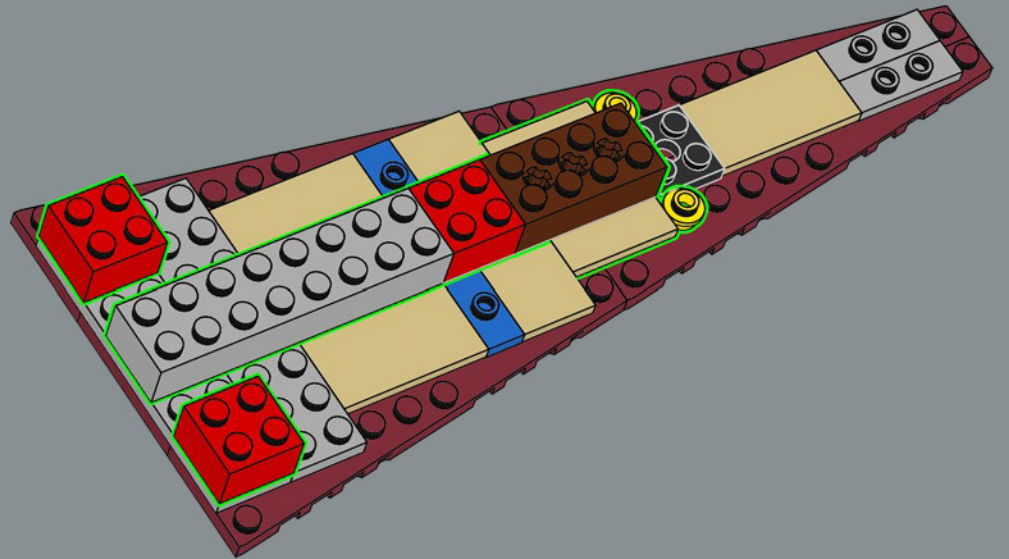





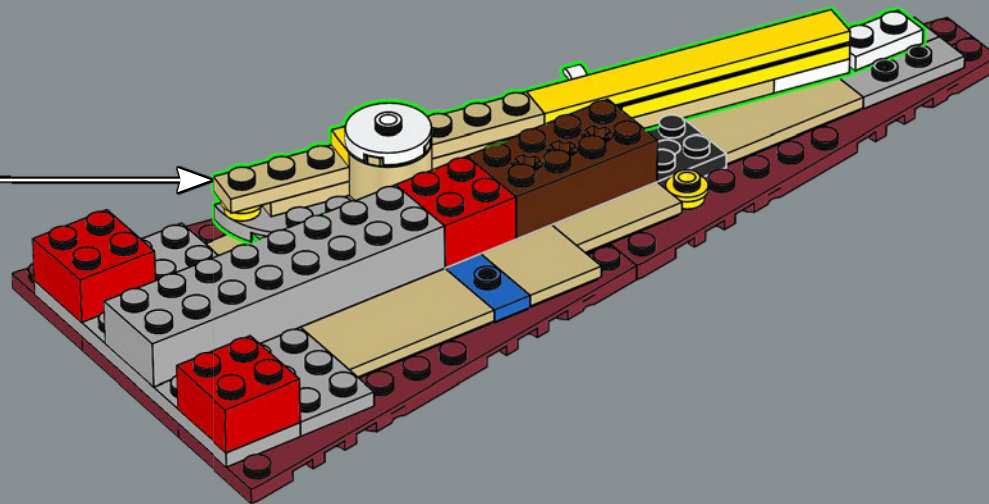





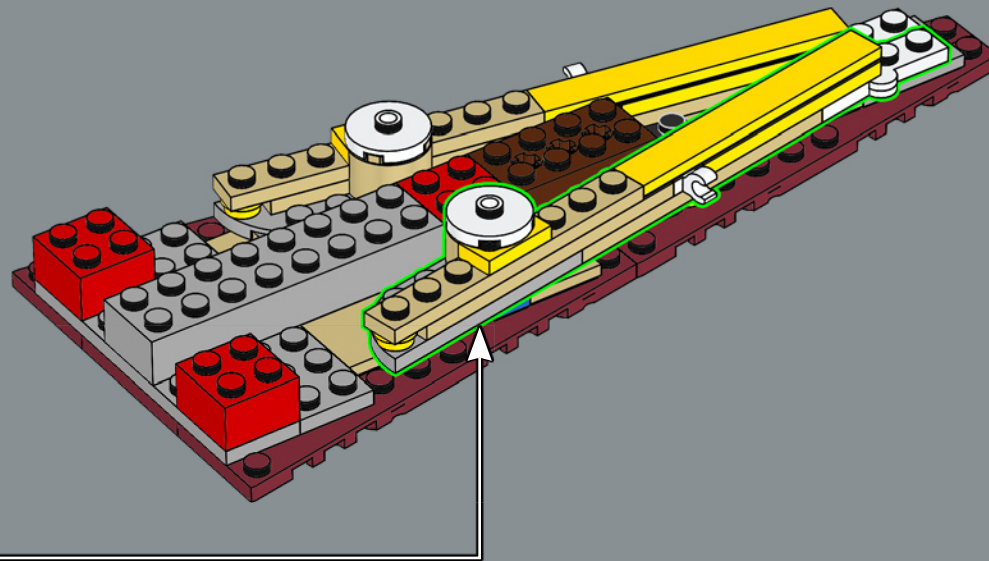

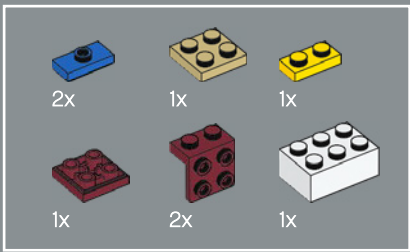

154

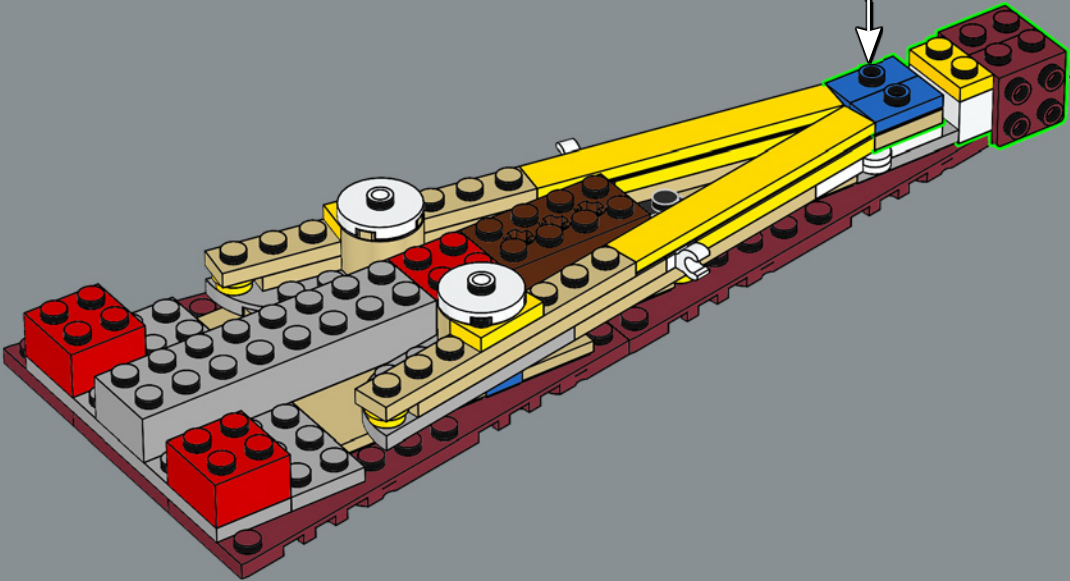
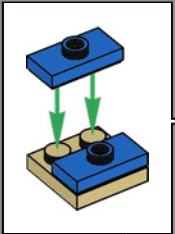
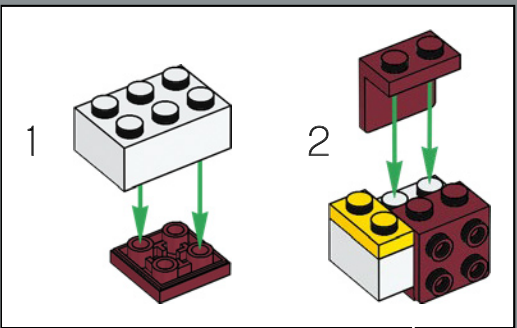

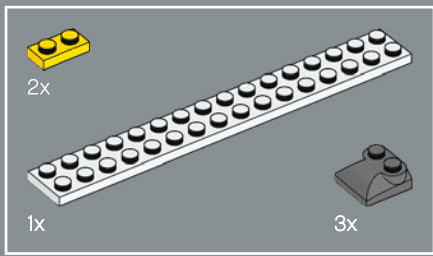

155

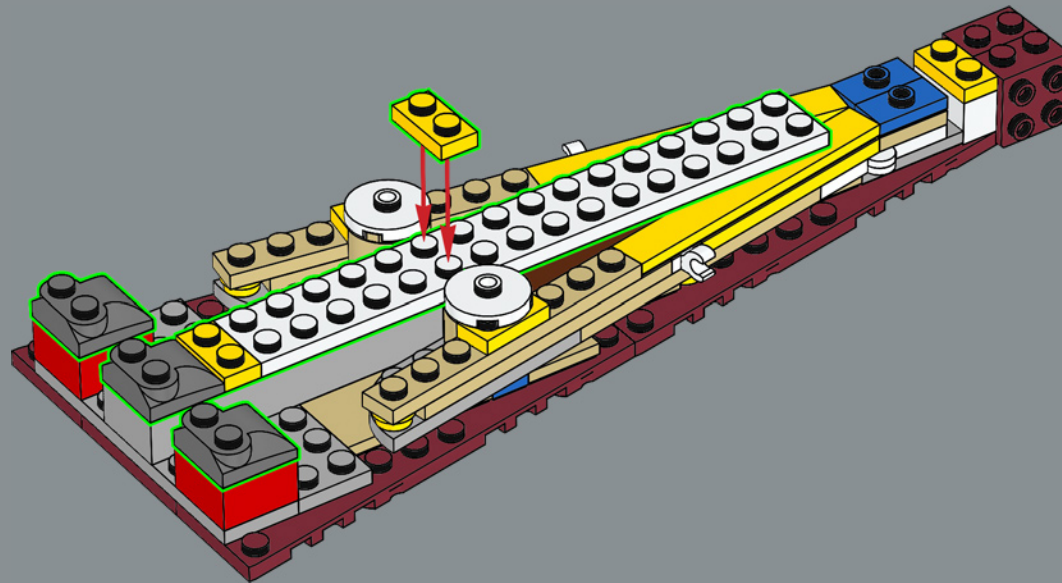



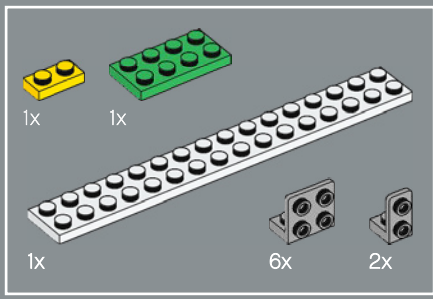

156

1

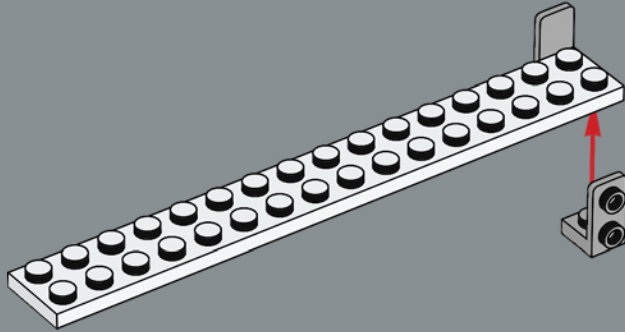

2

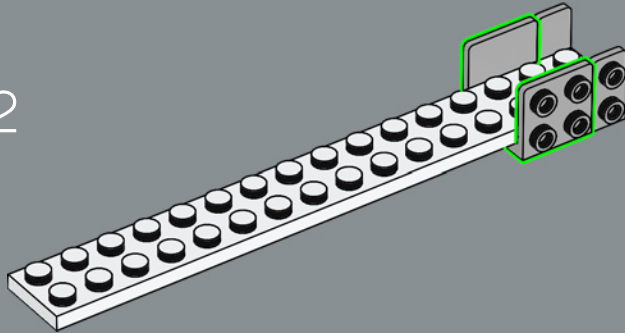

3

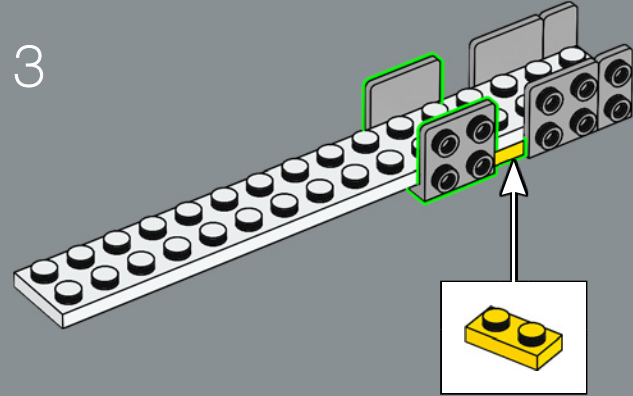

4

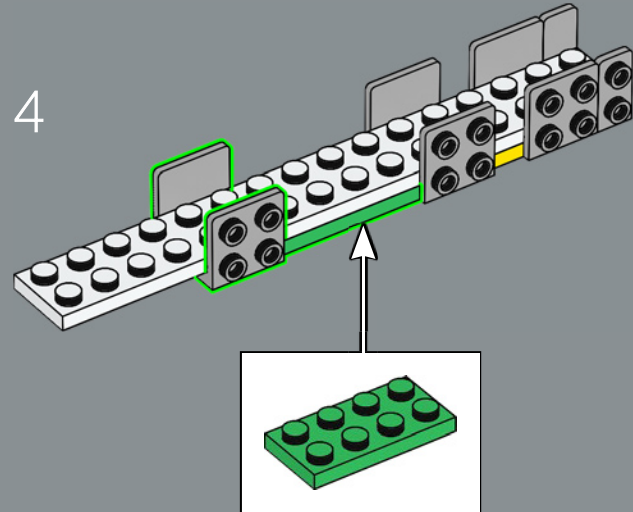

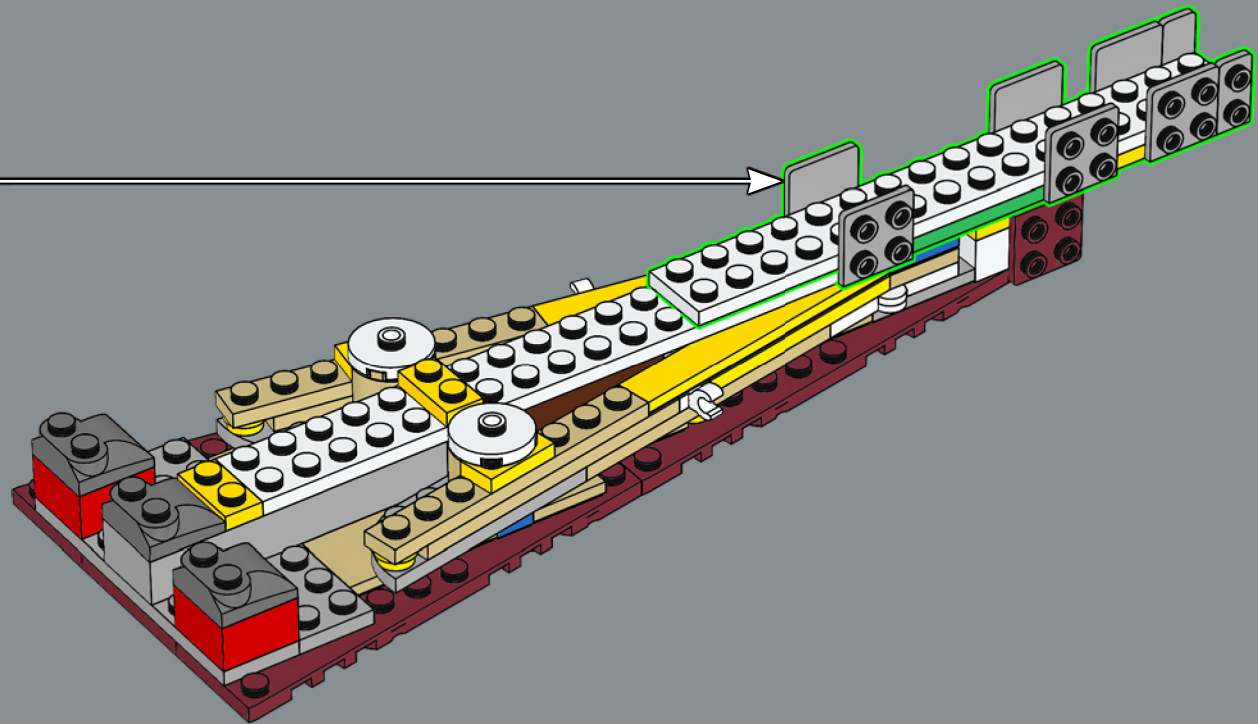

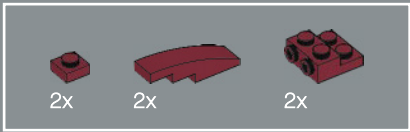

157

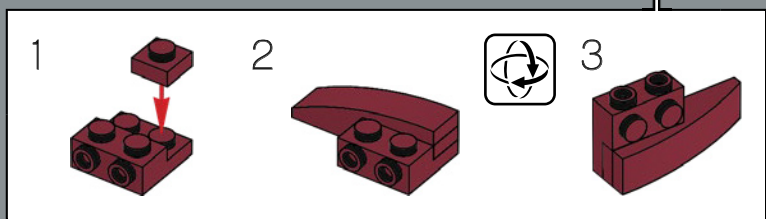
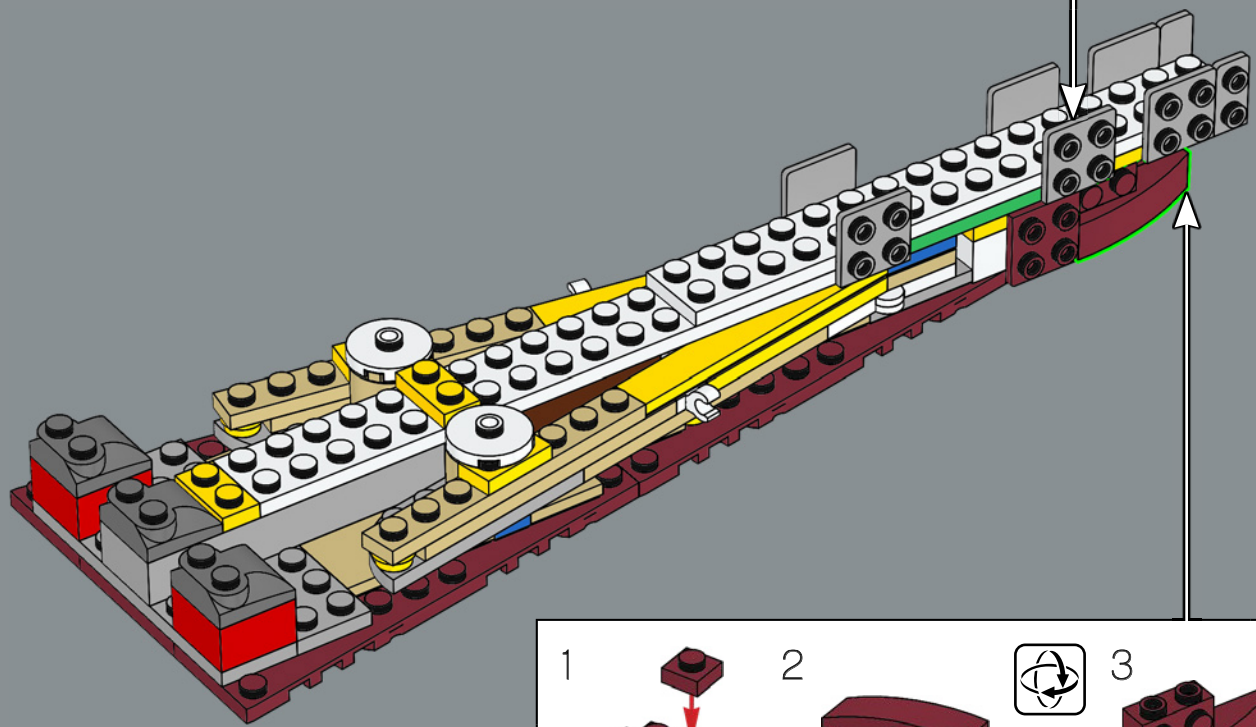
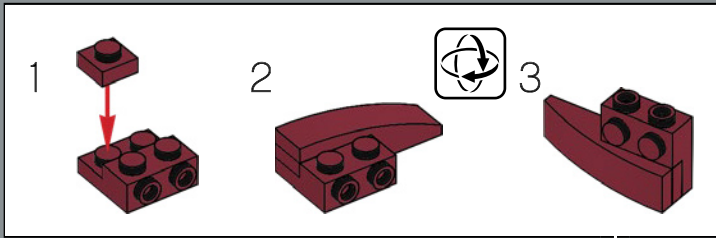



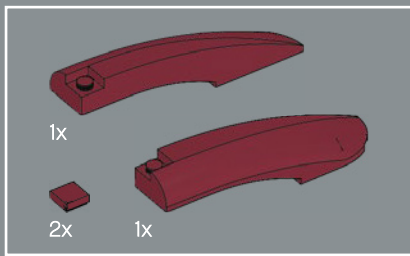

158

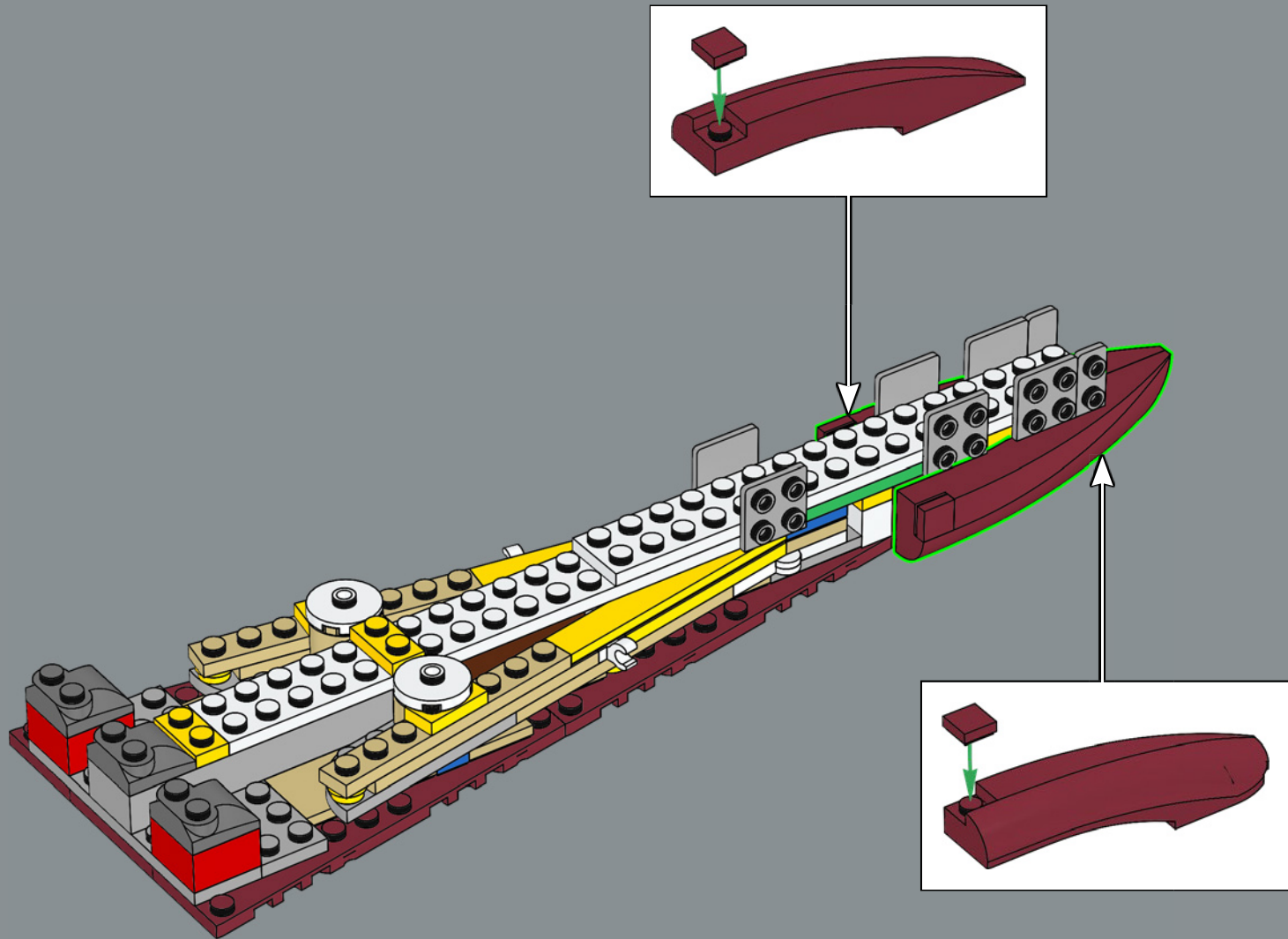

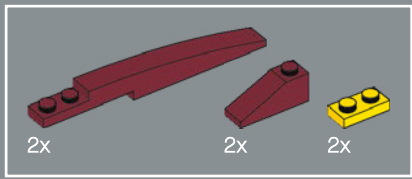

159

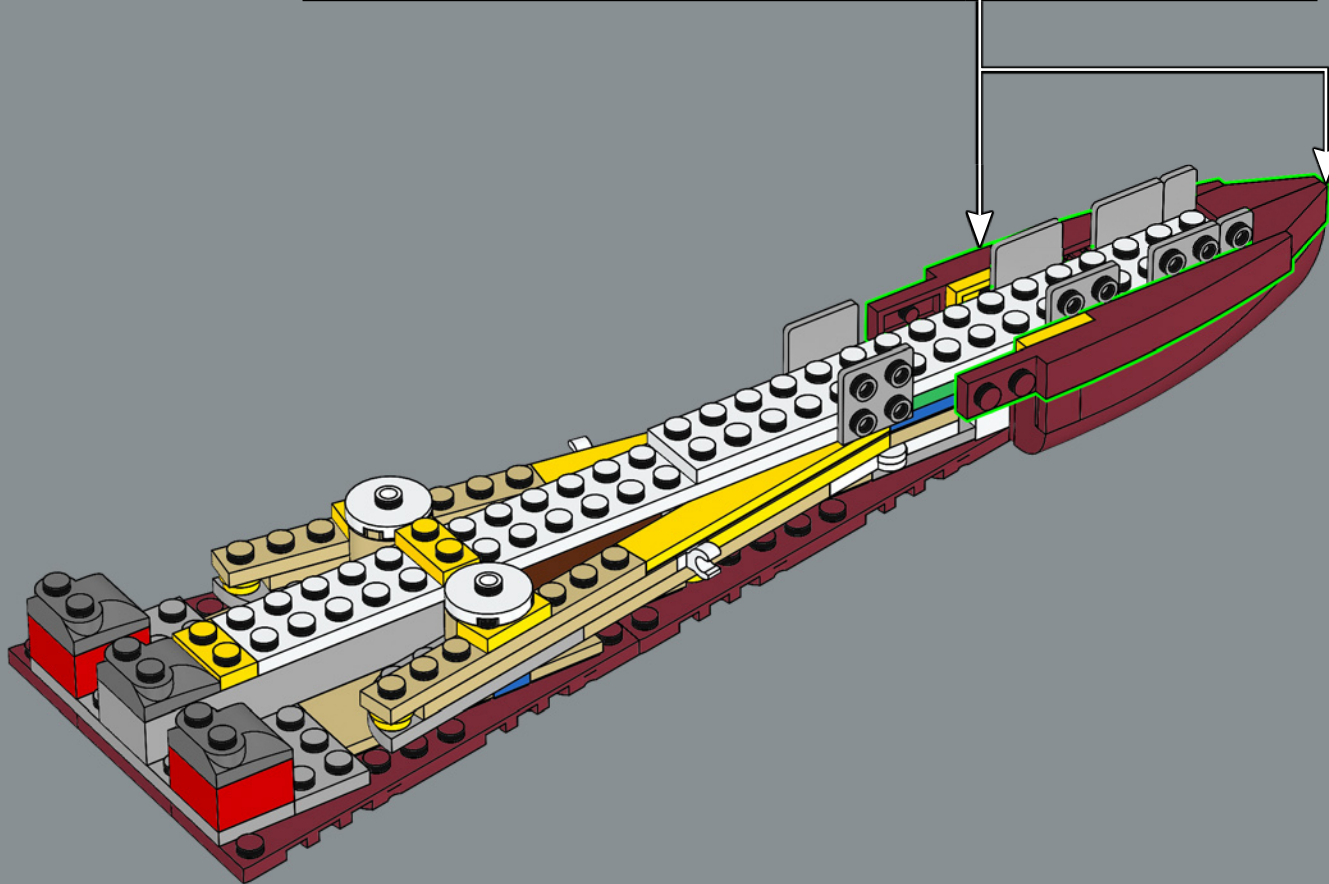
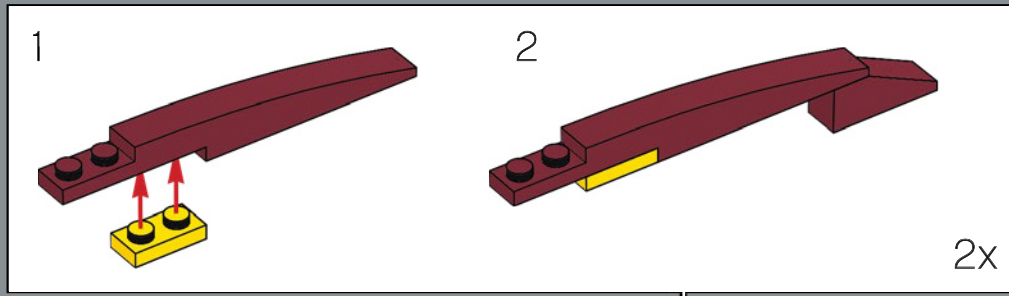

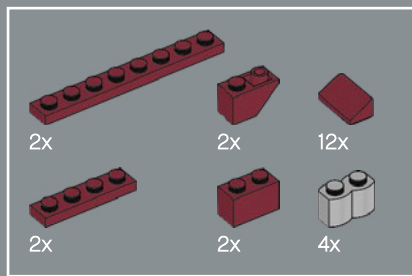

160

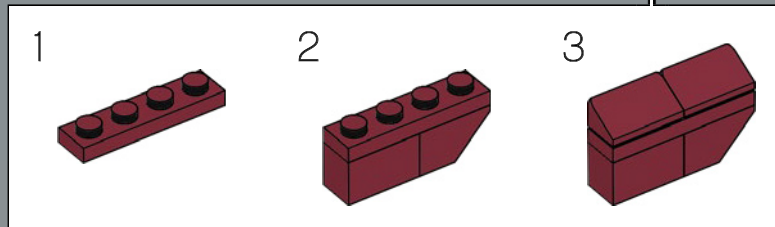
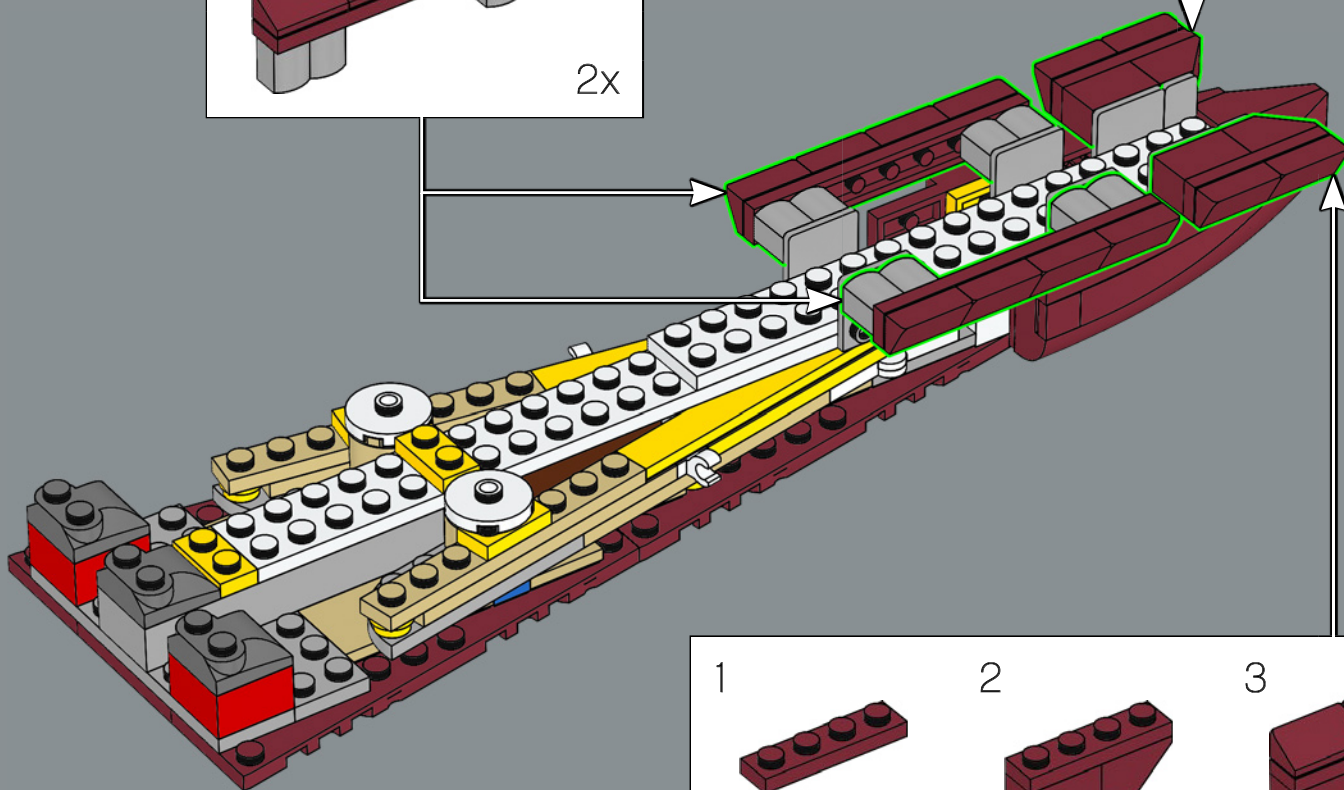
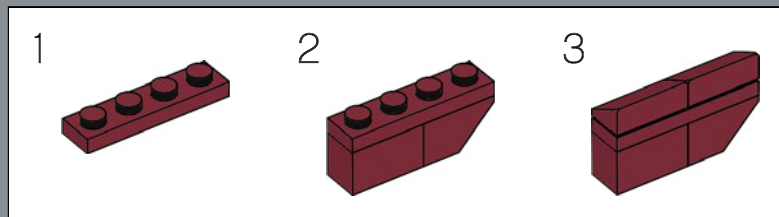
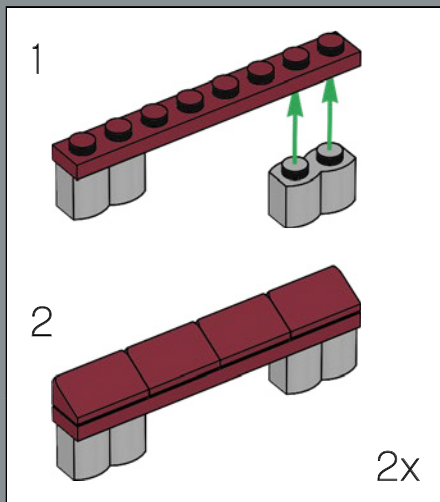



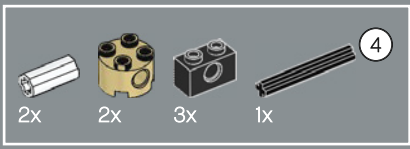

161

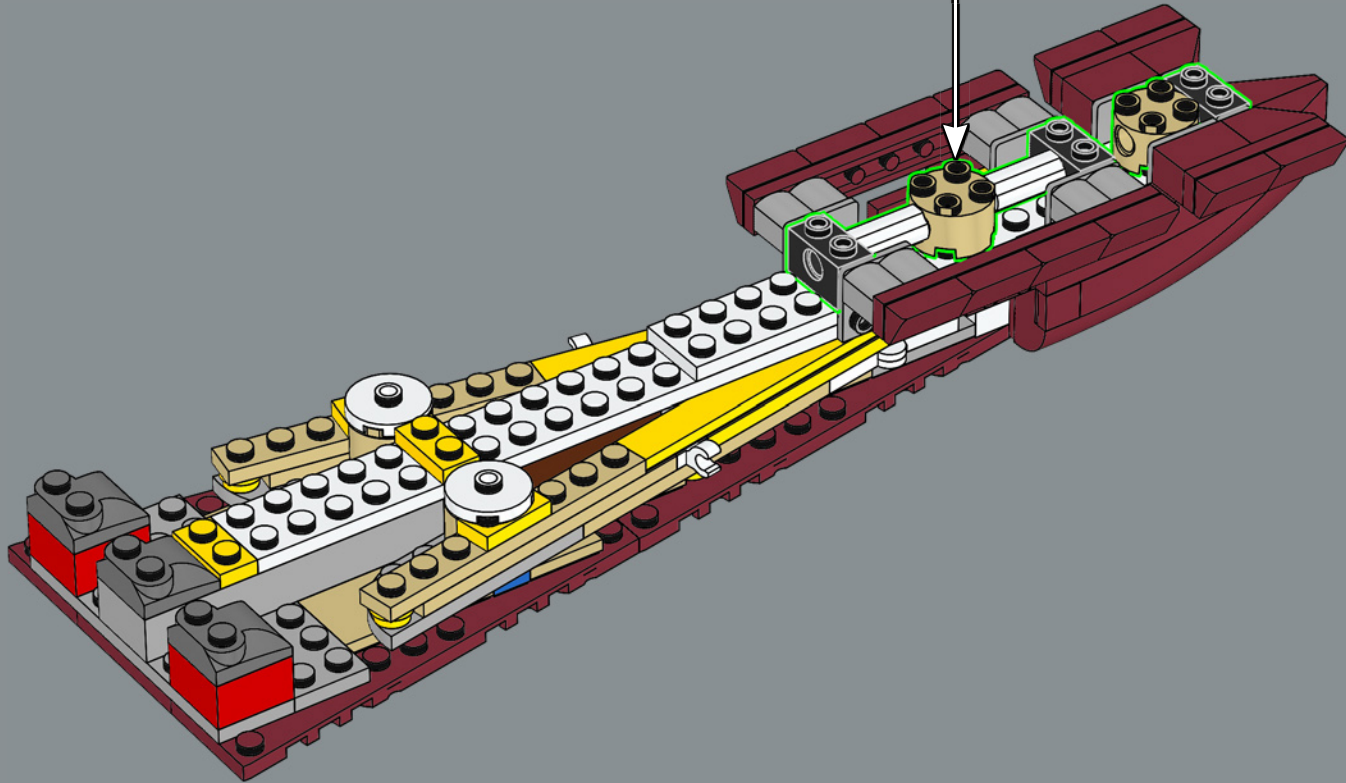
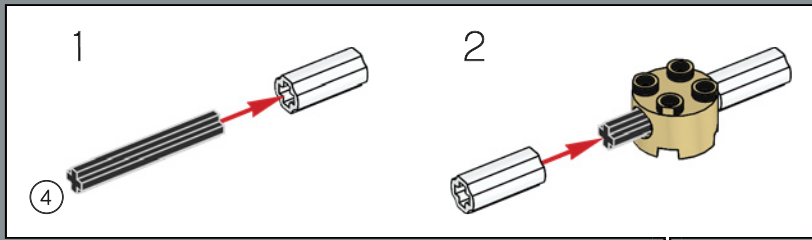

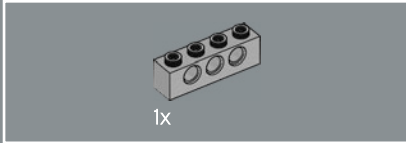
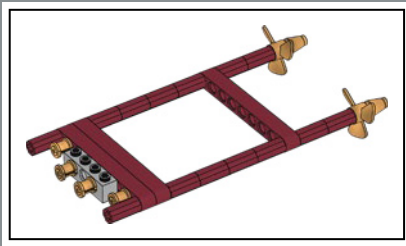

162

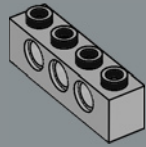

163

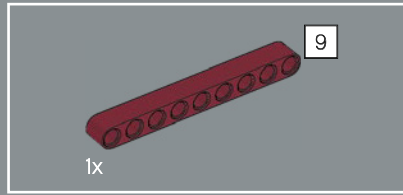
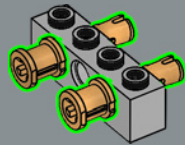

164

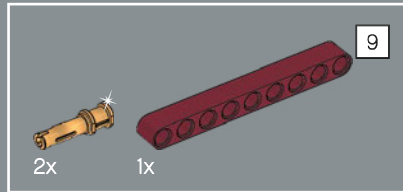

165

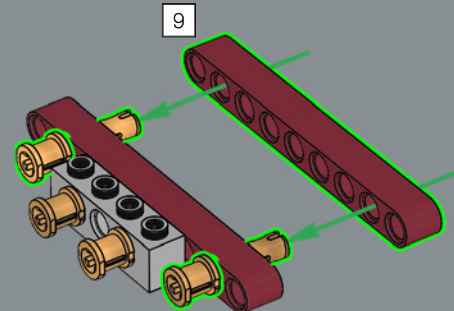
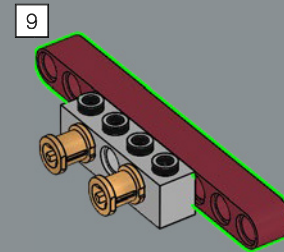

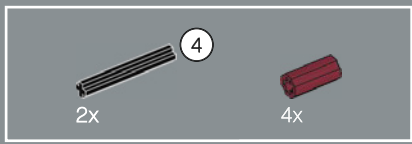

166

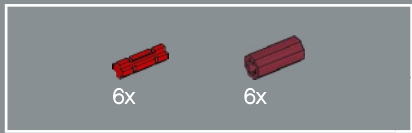
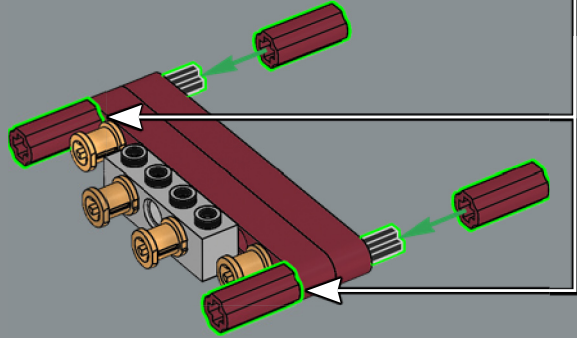
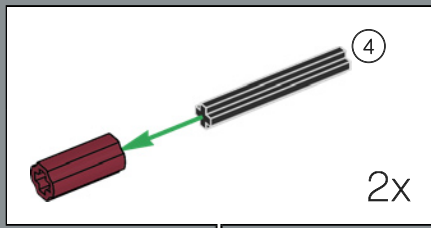

167

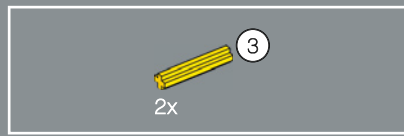
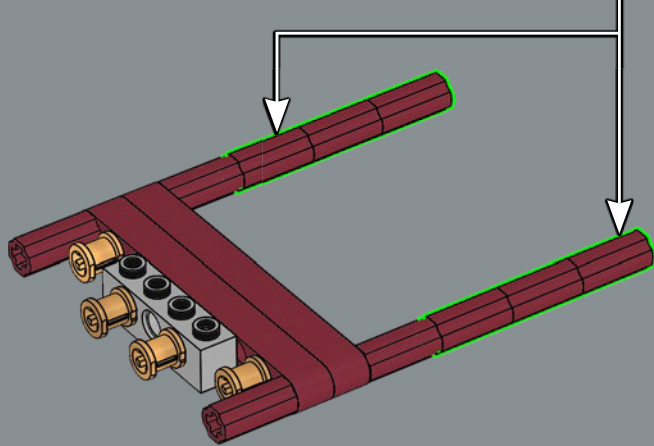
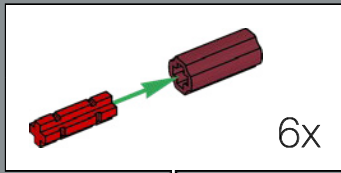

168

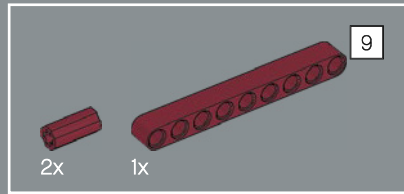
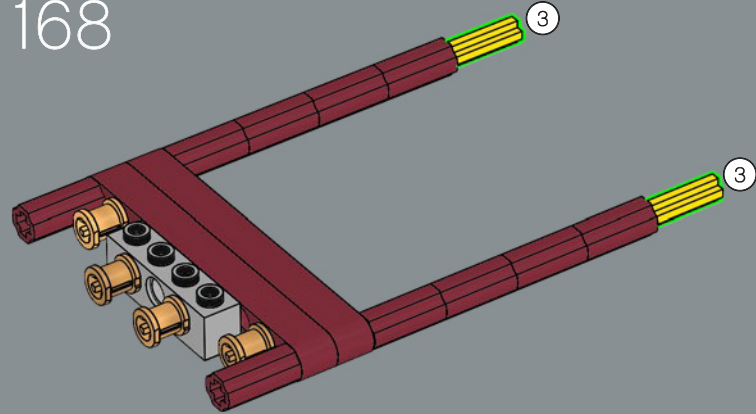

169

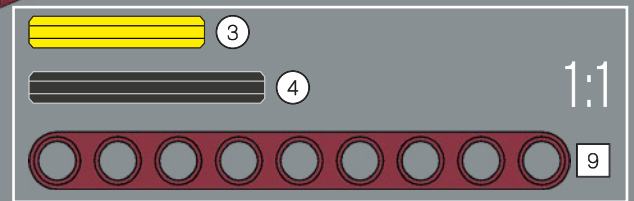
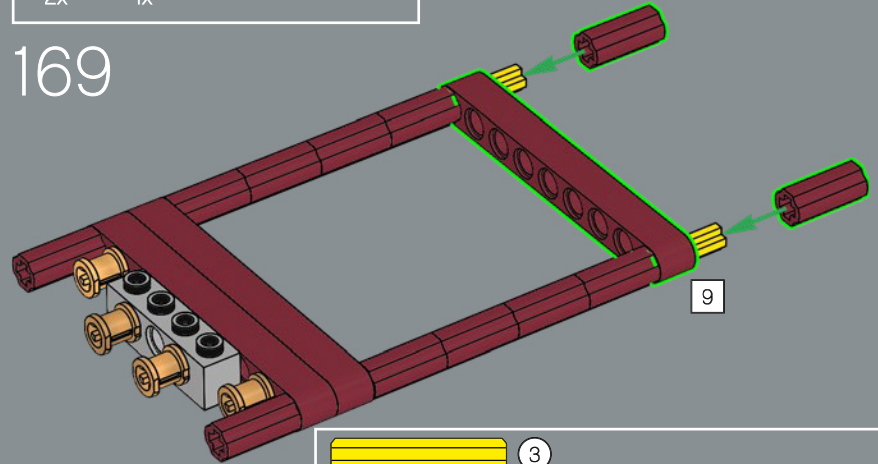

1:1



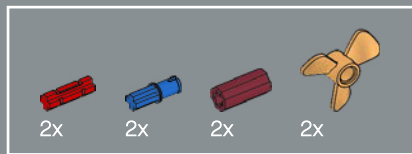

170

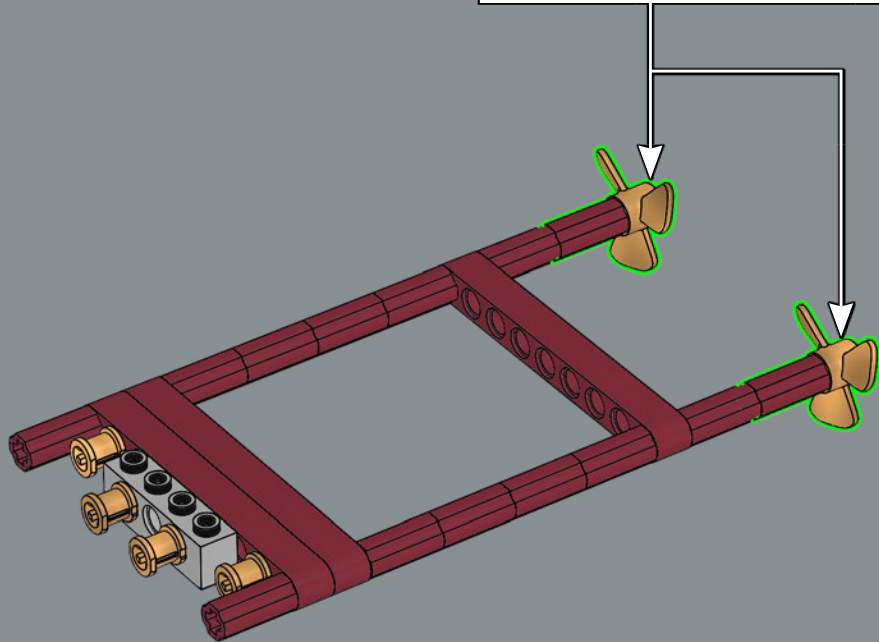
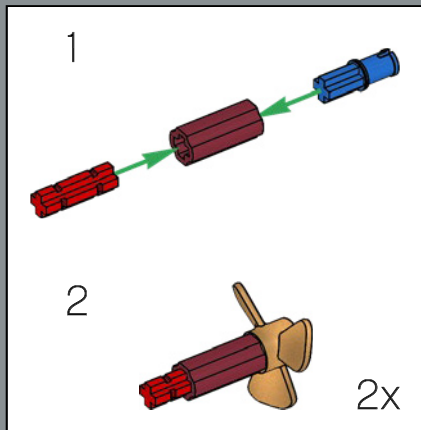

171

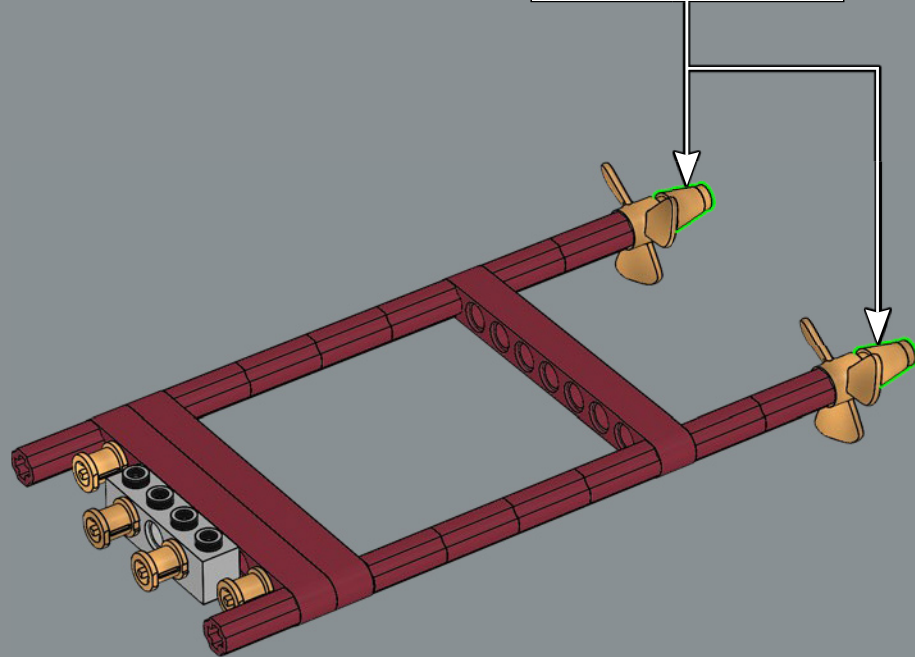
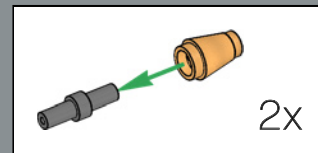

172

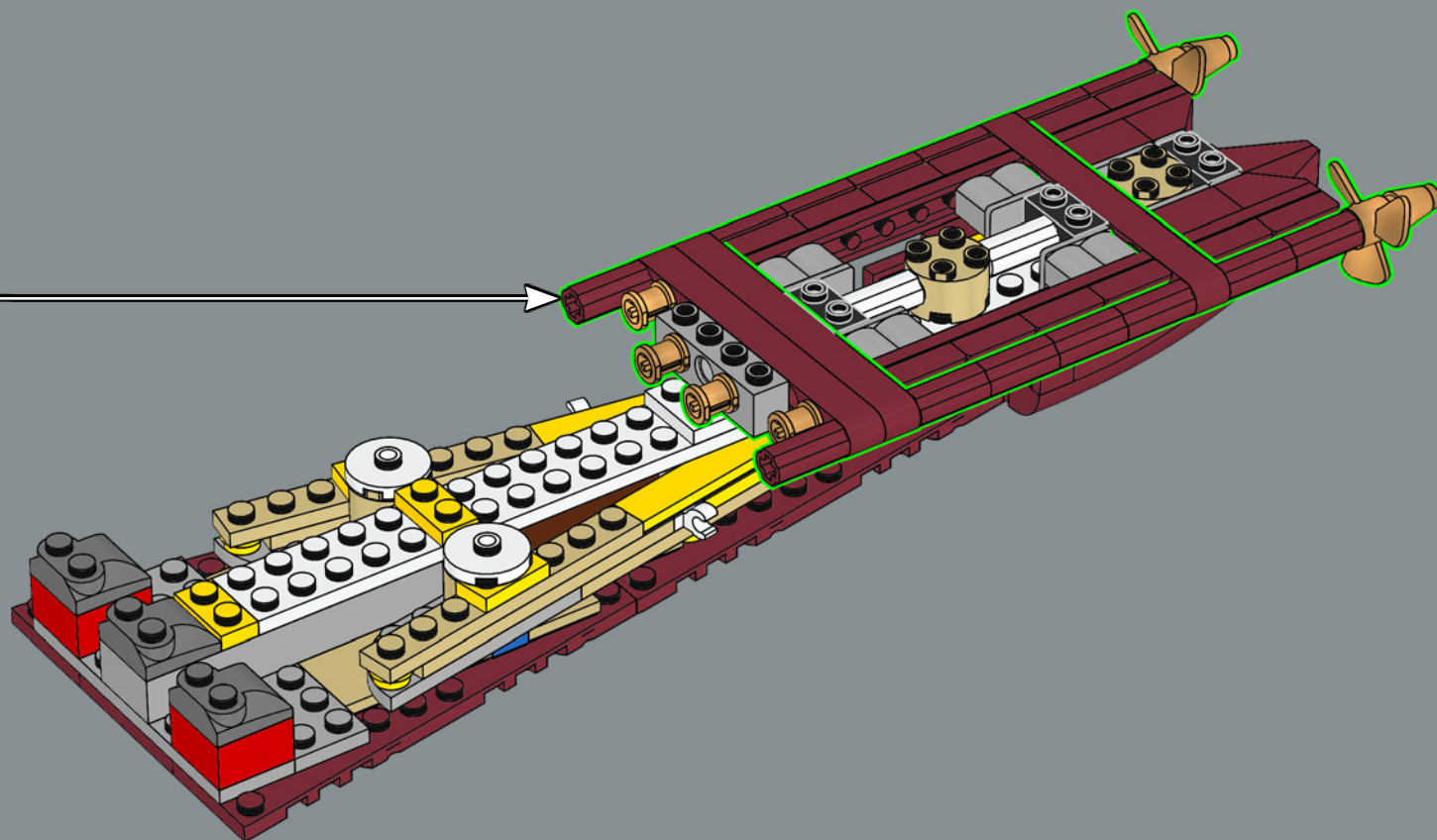

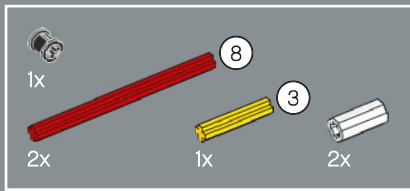

173

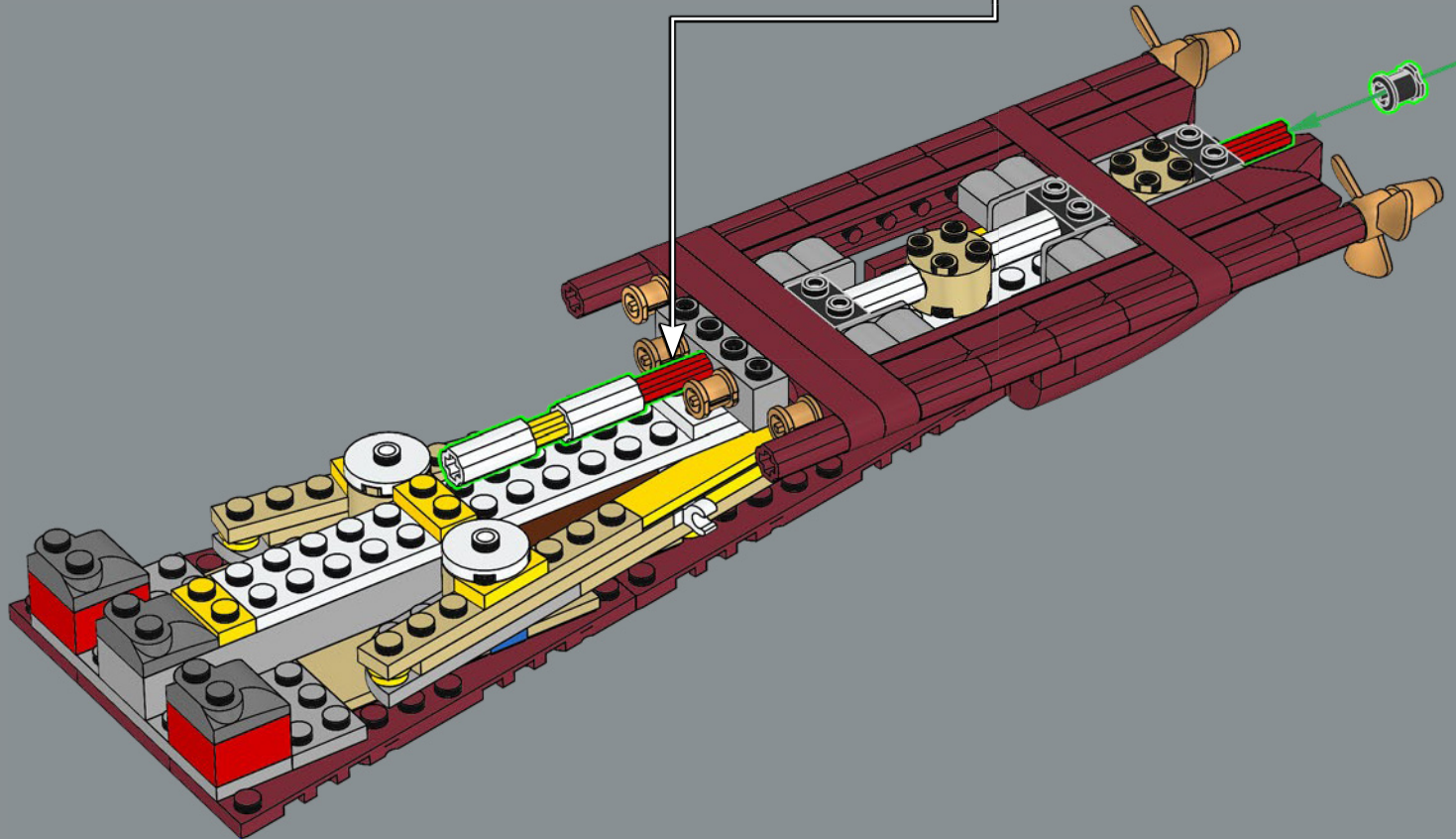
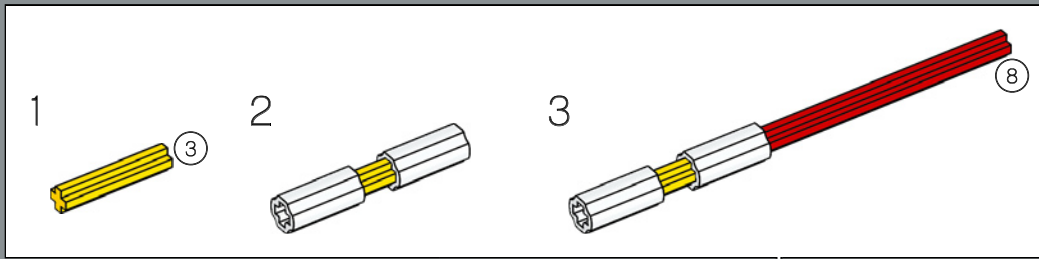



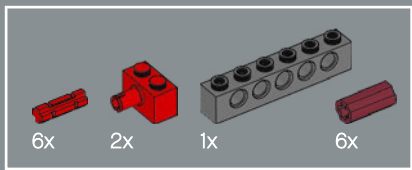

174

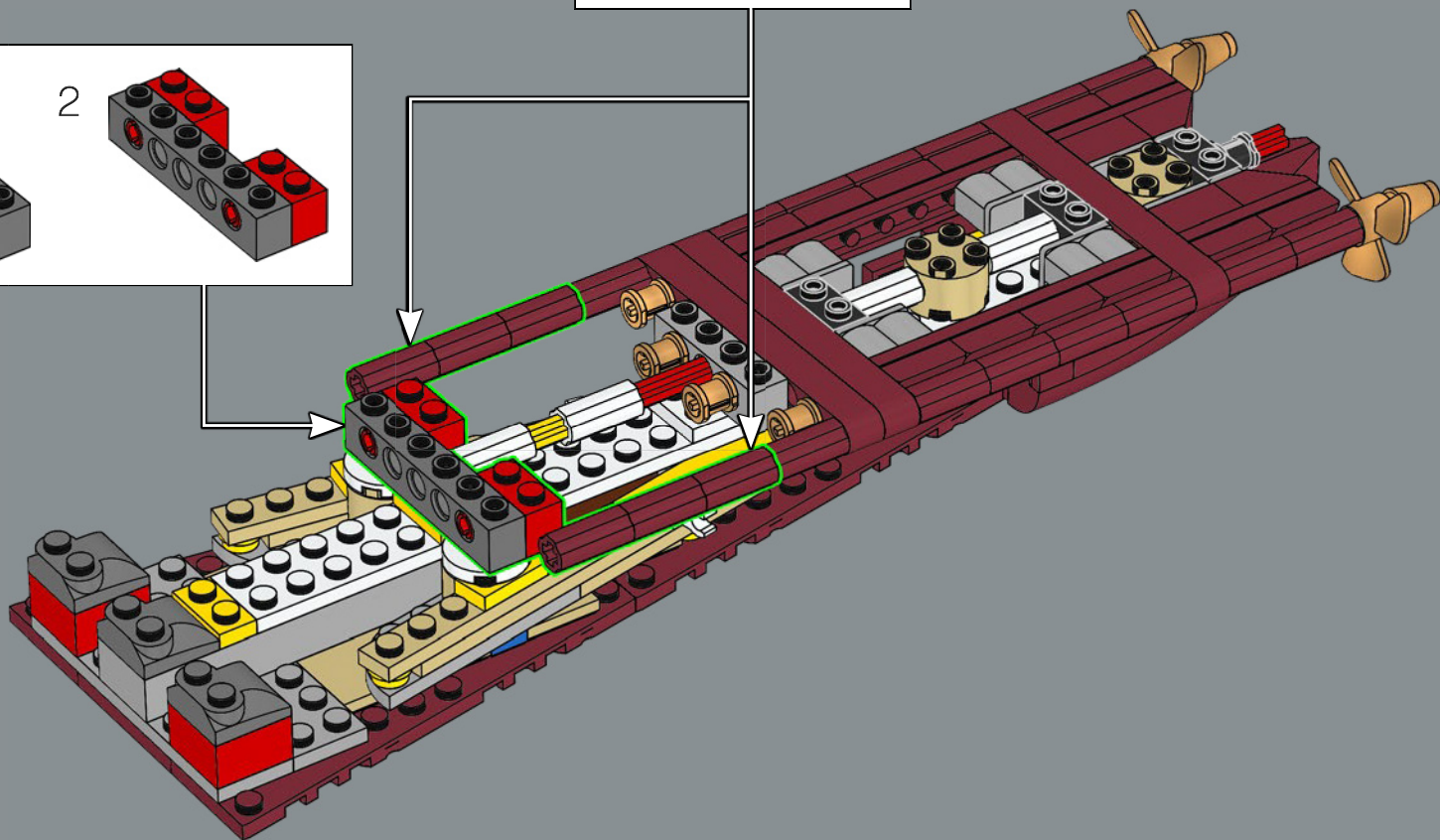
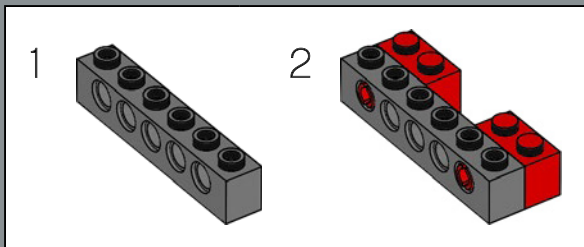
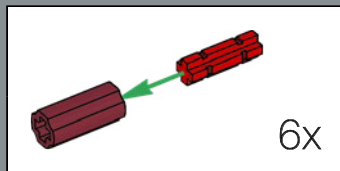

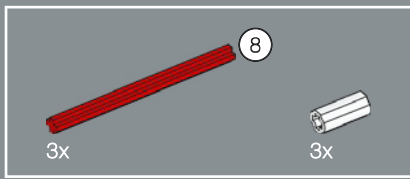

175

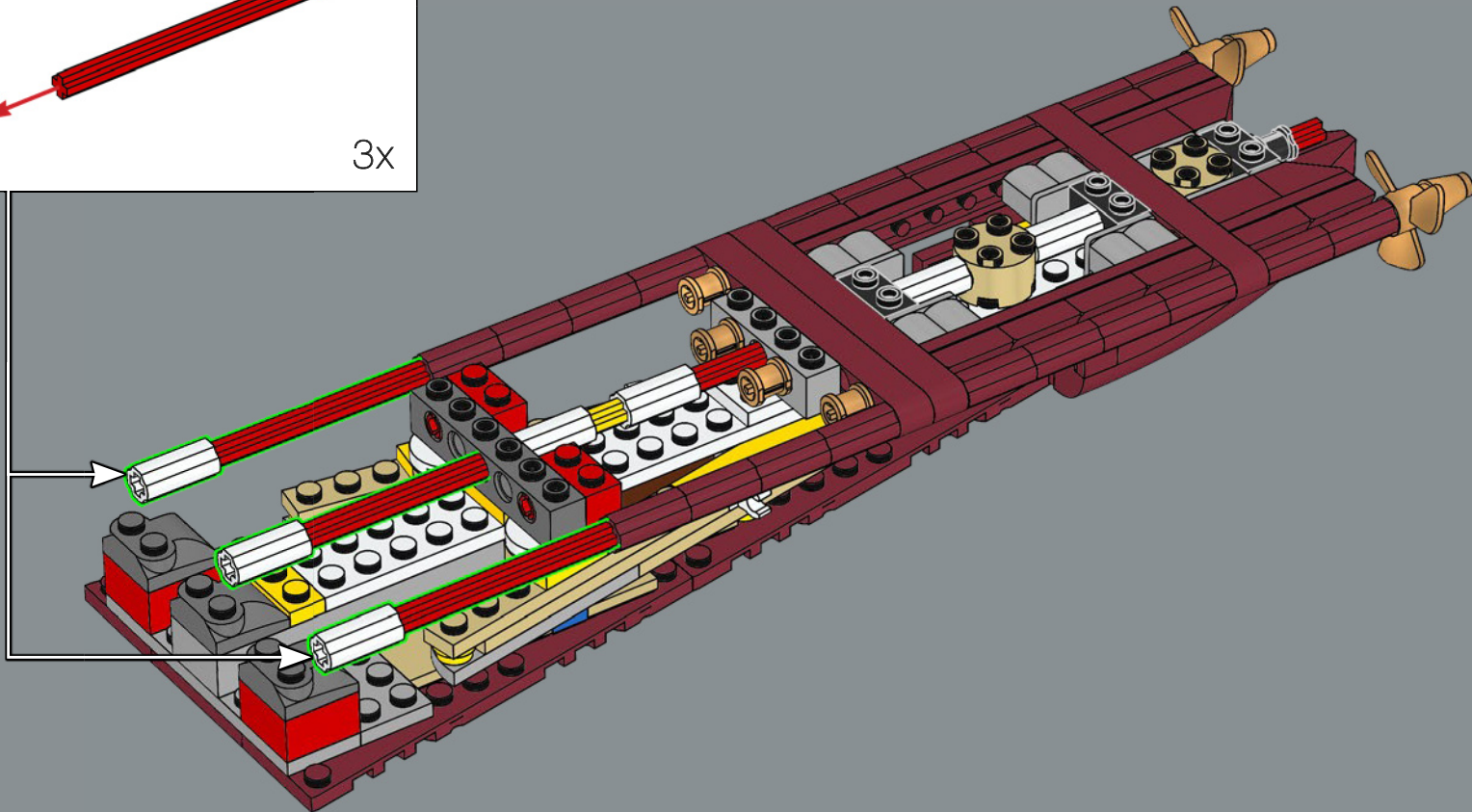
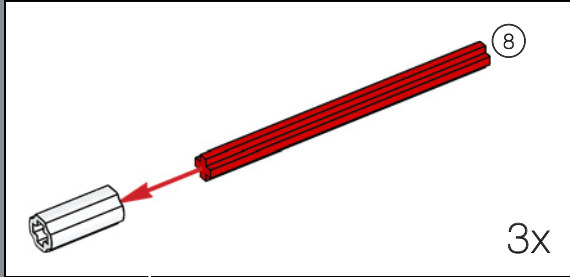

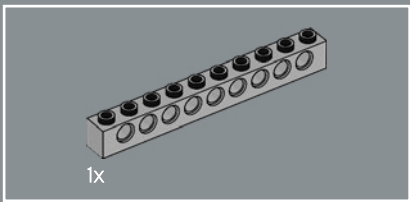

176

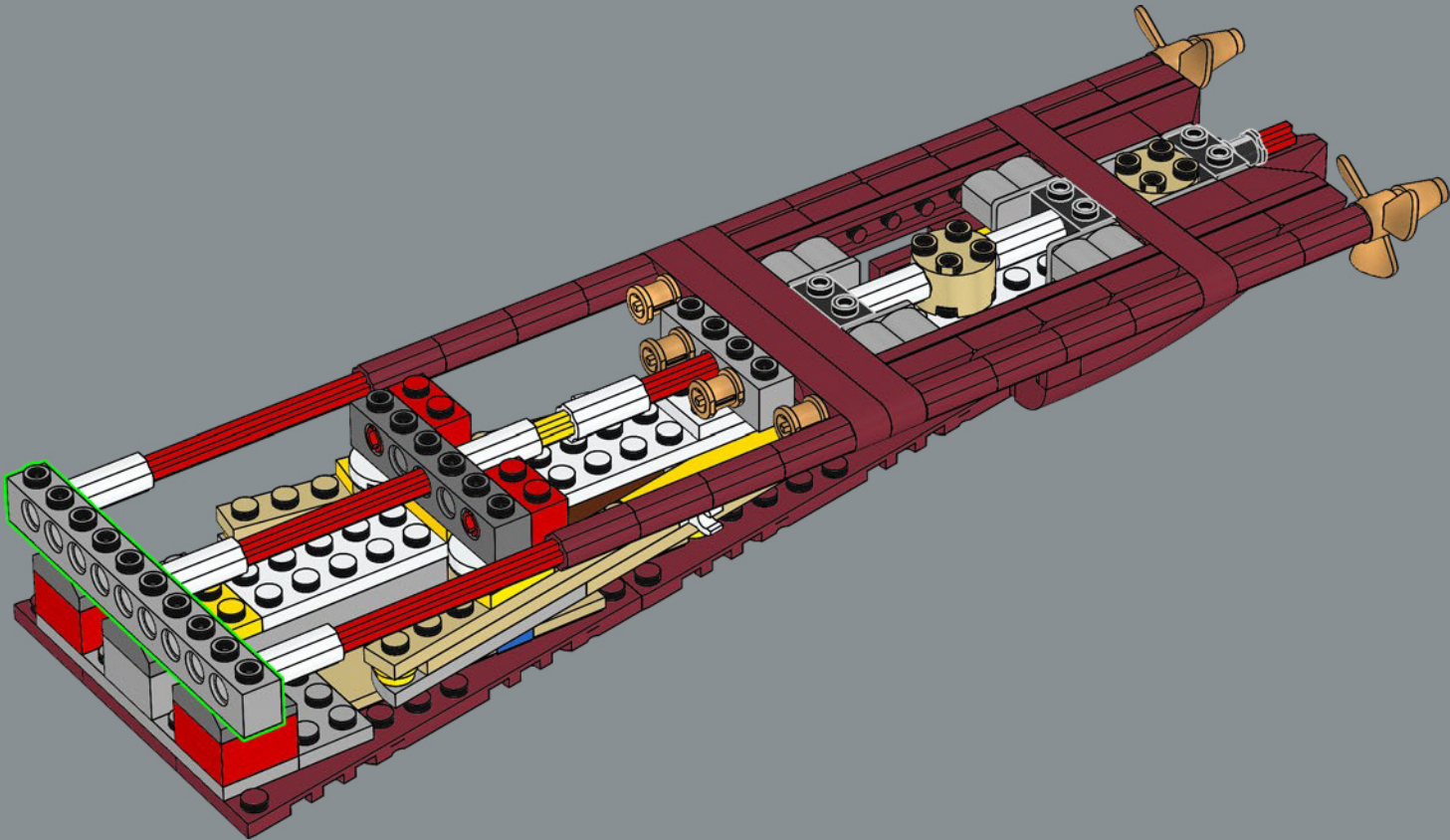



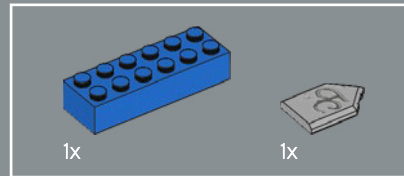
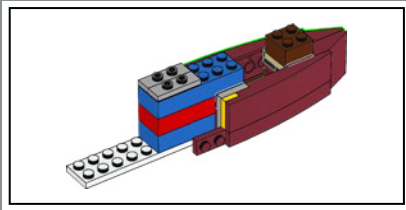
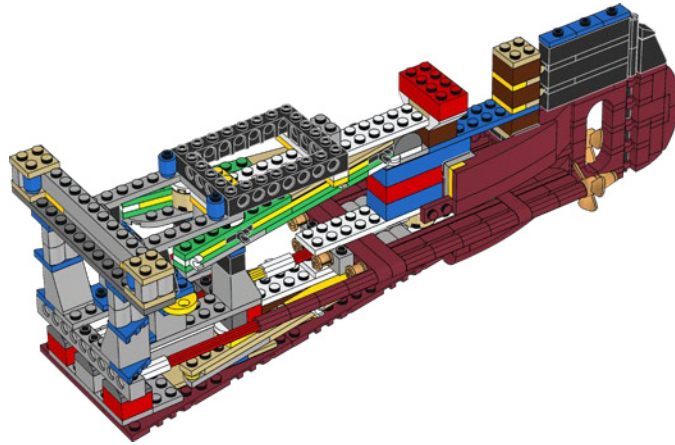
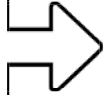

178

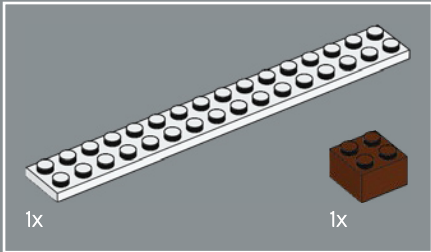

177

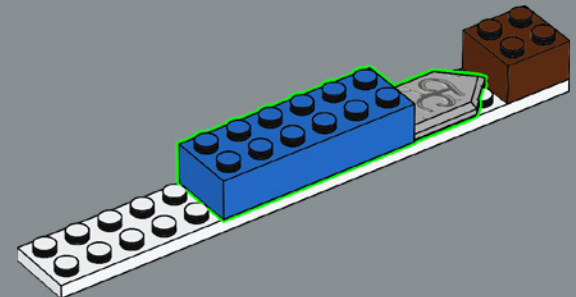
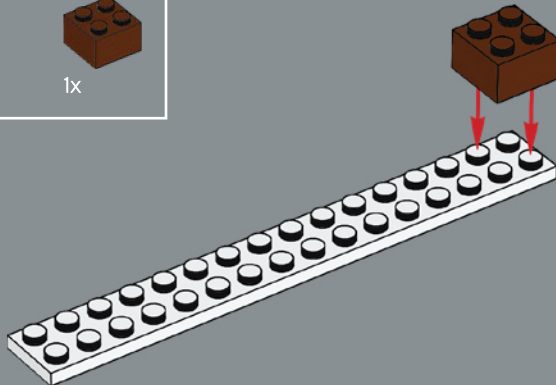



4x

179

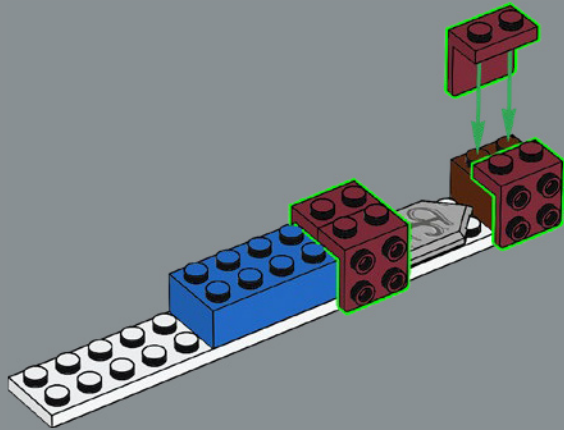

4x

180

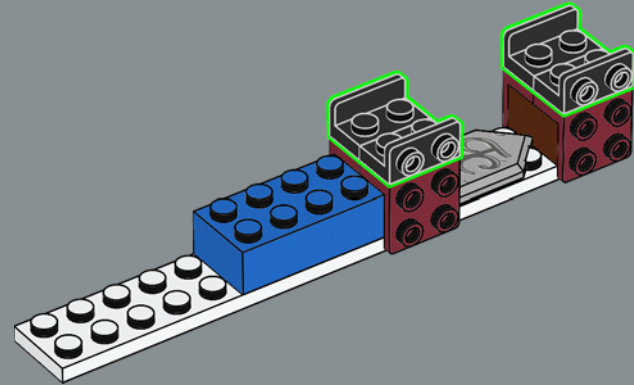

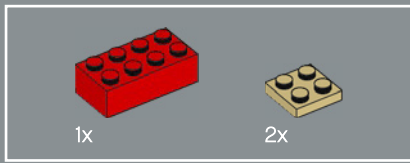

181

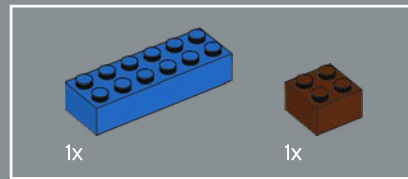
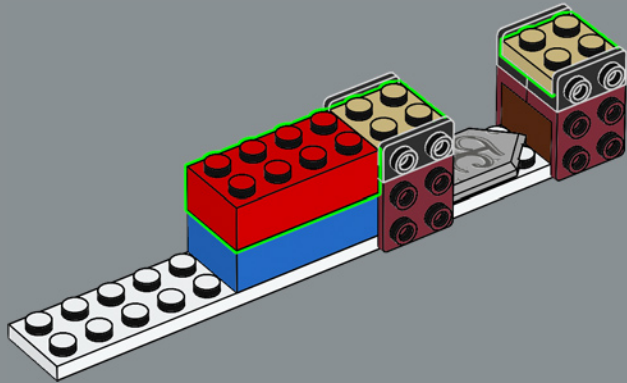

182

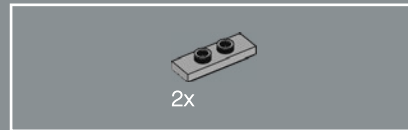
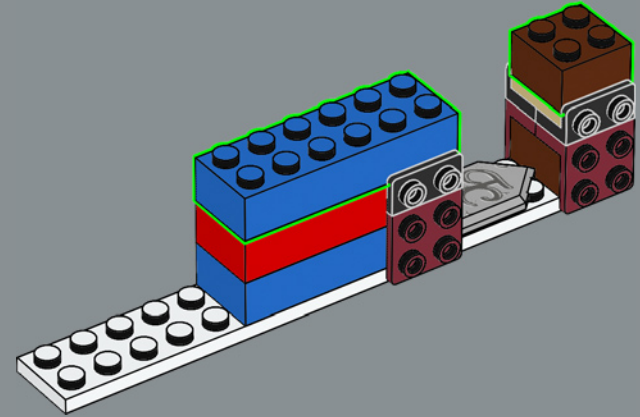

183

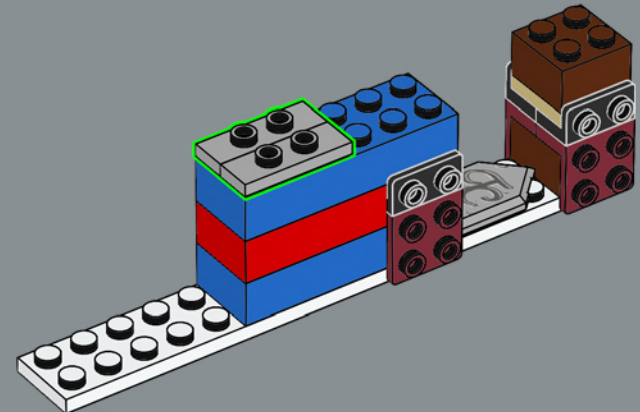



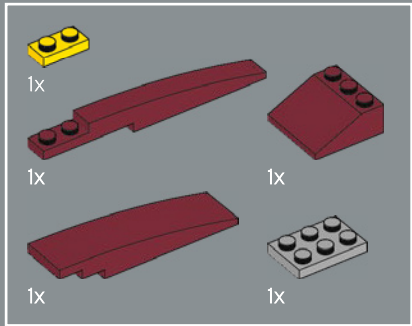

184

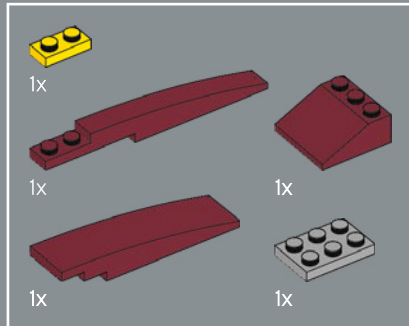
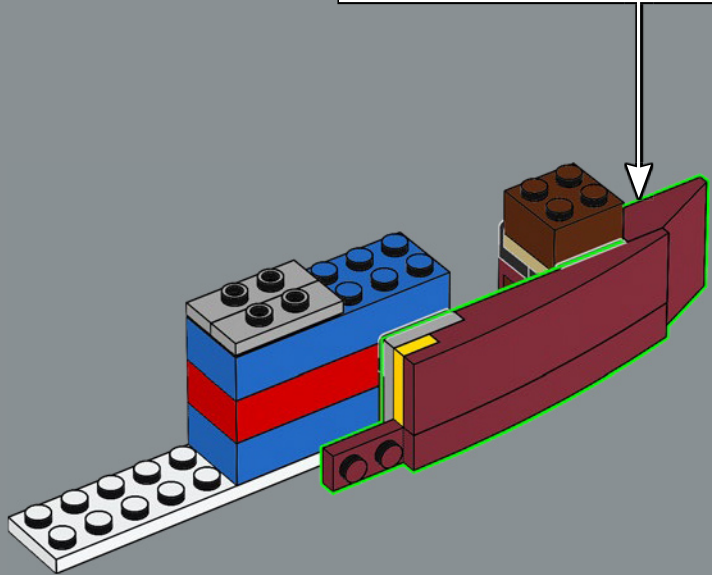
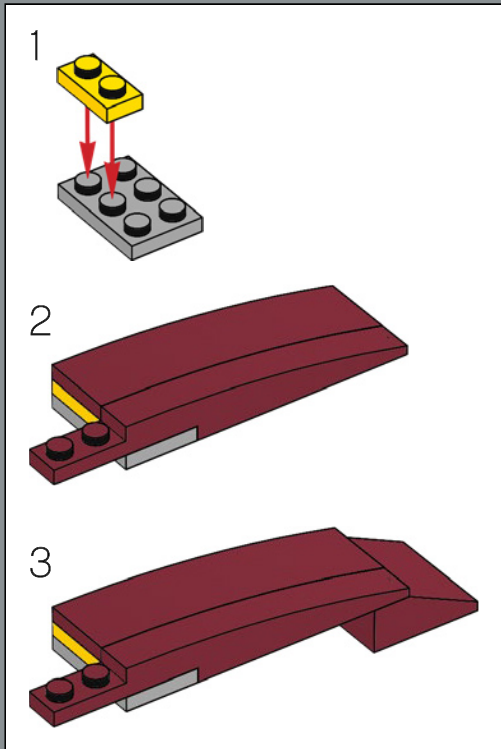

185

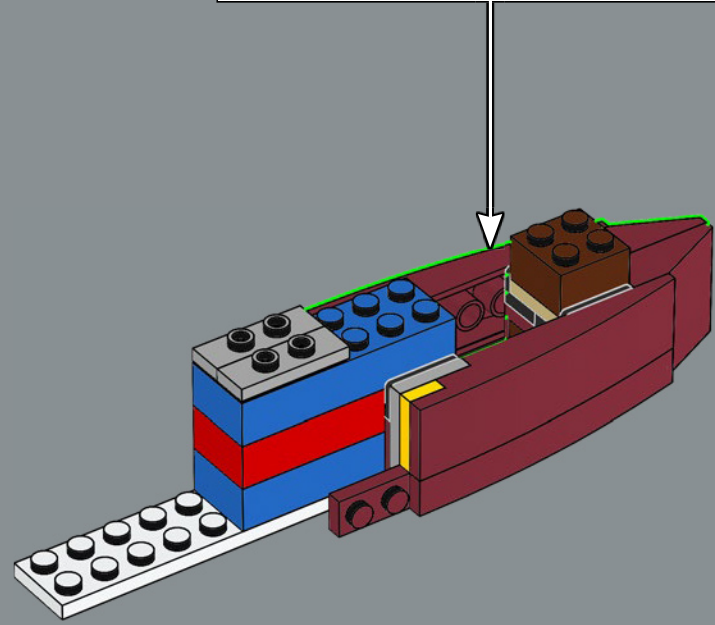
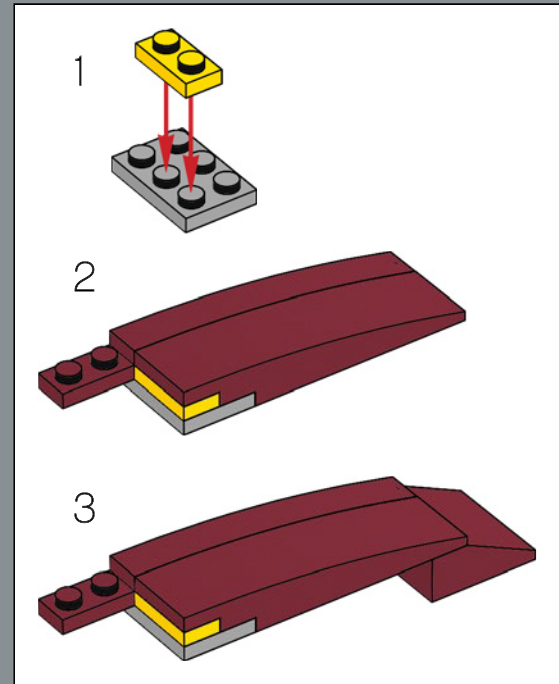

186

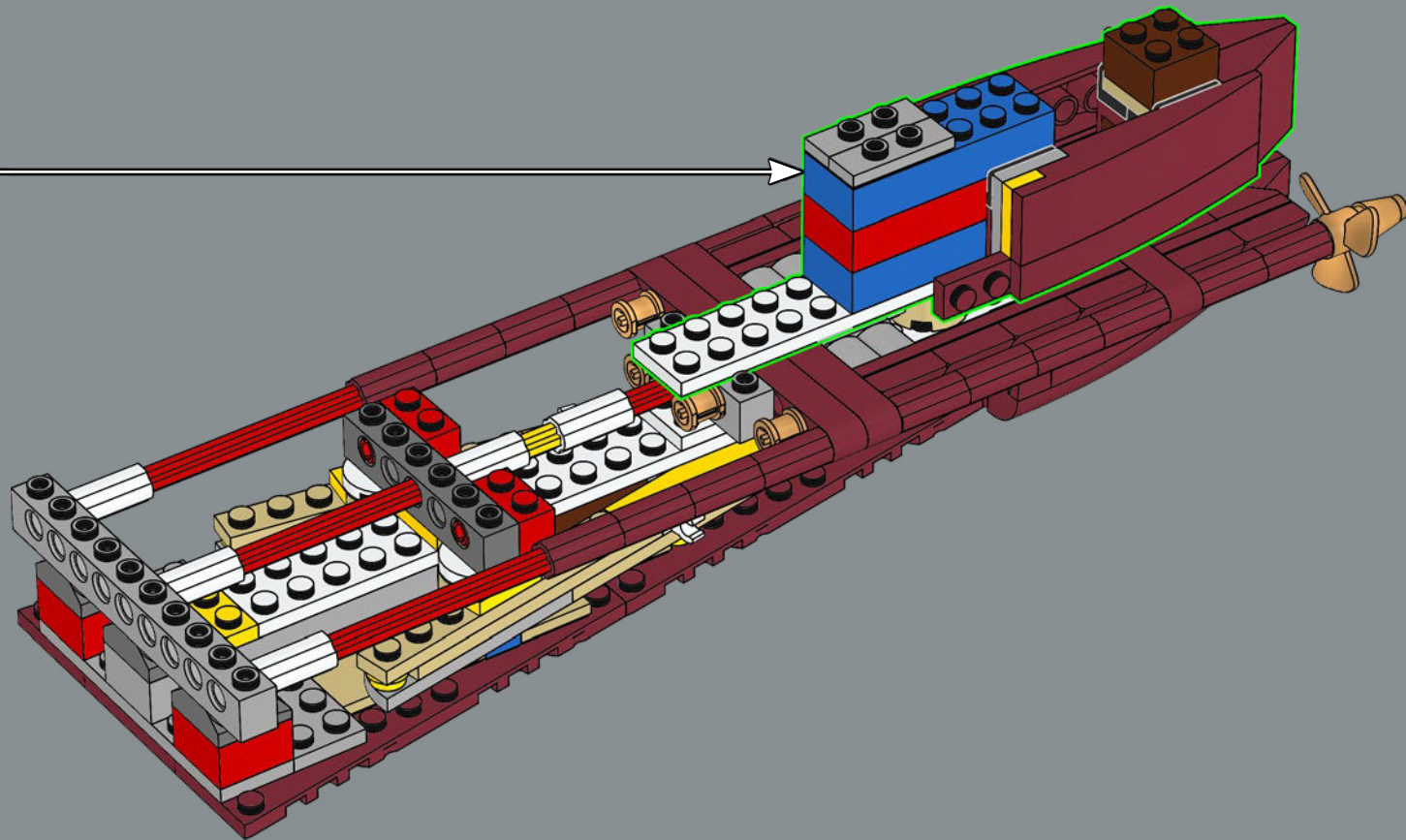

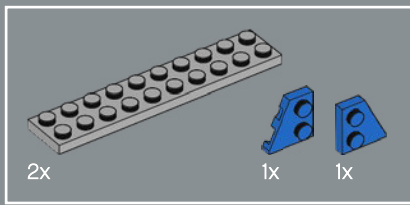

187

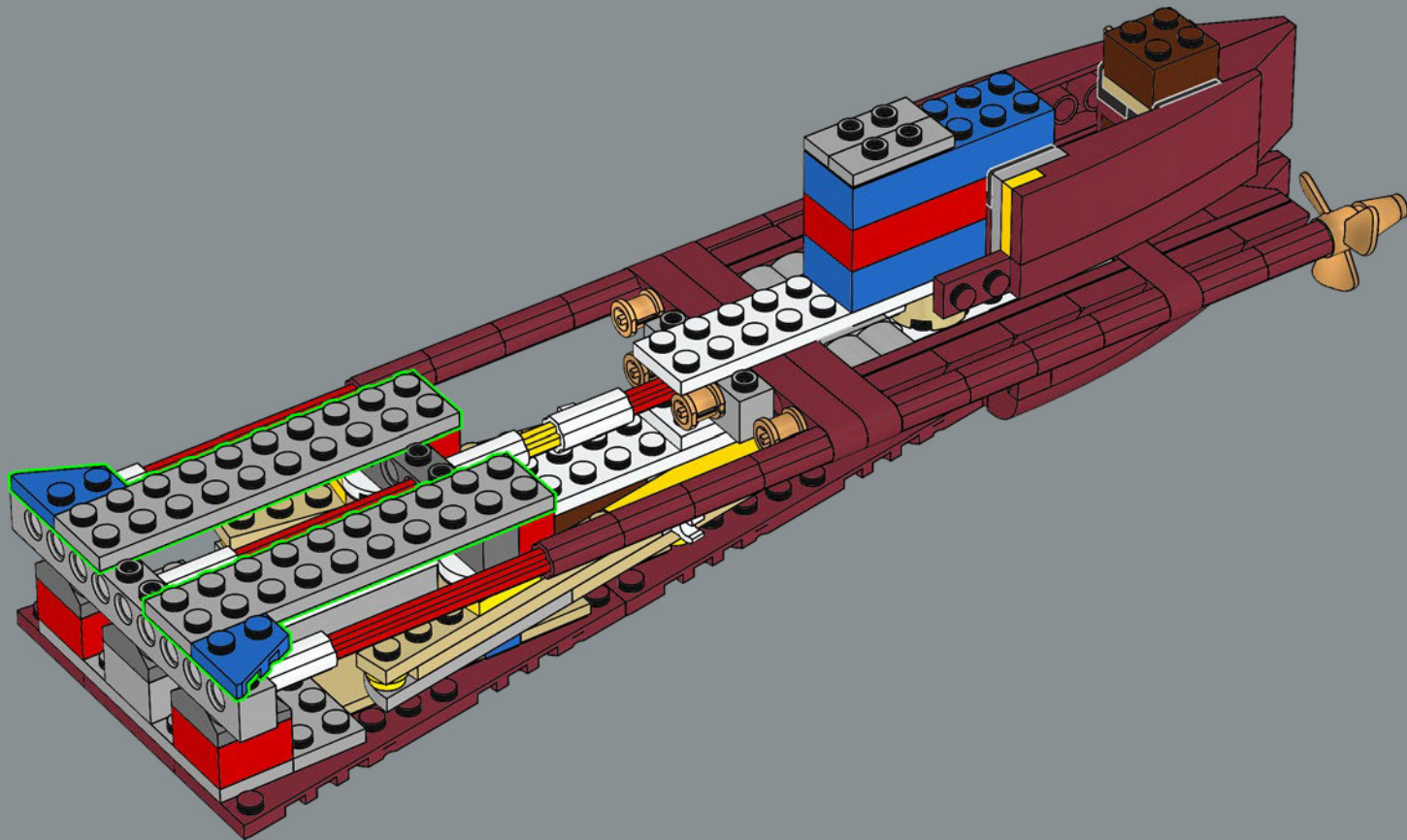



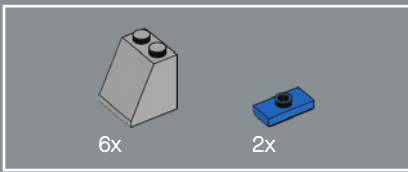

188

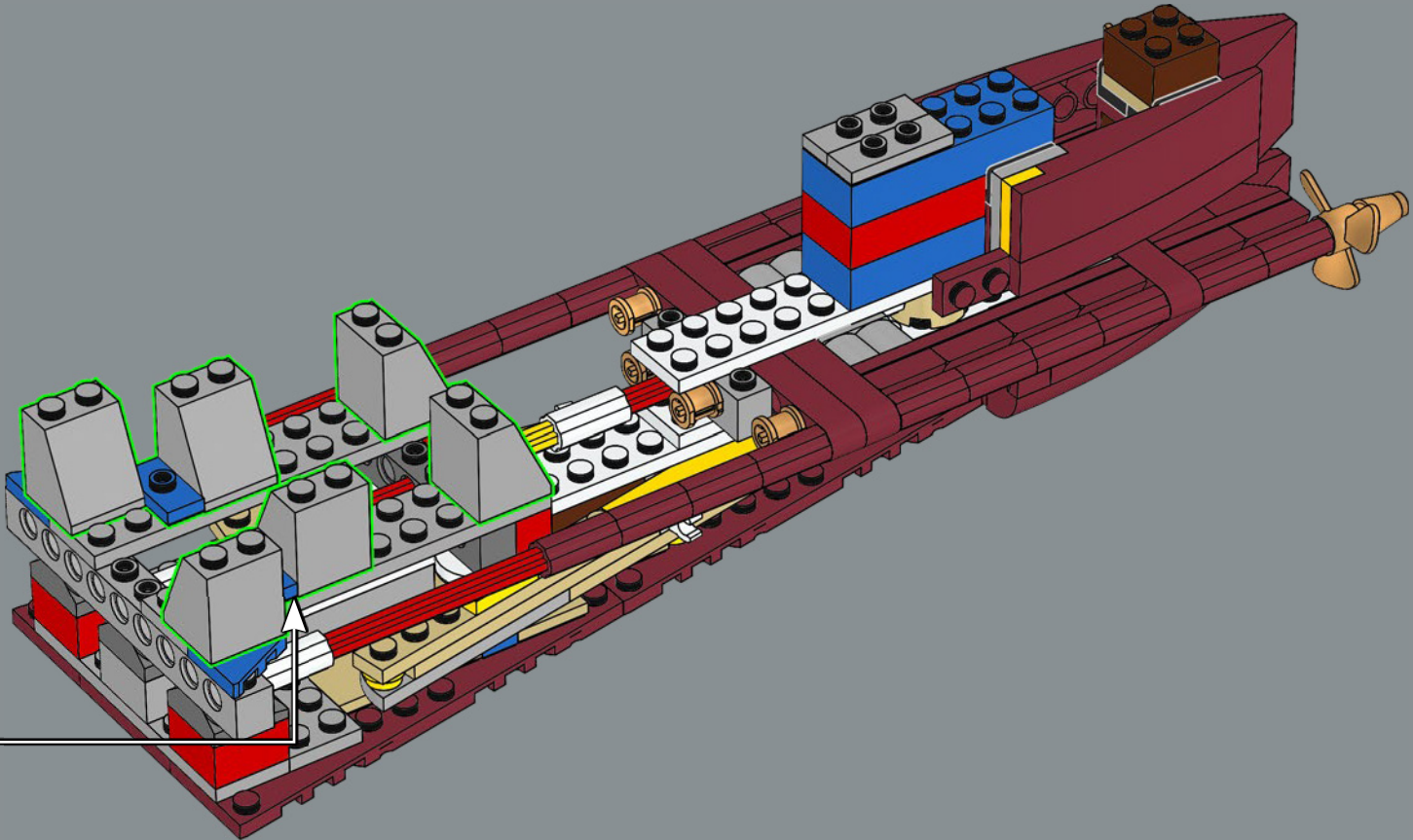

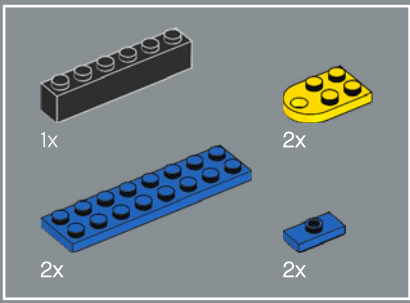

189

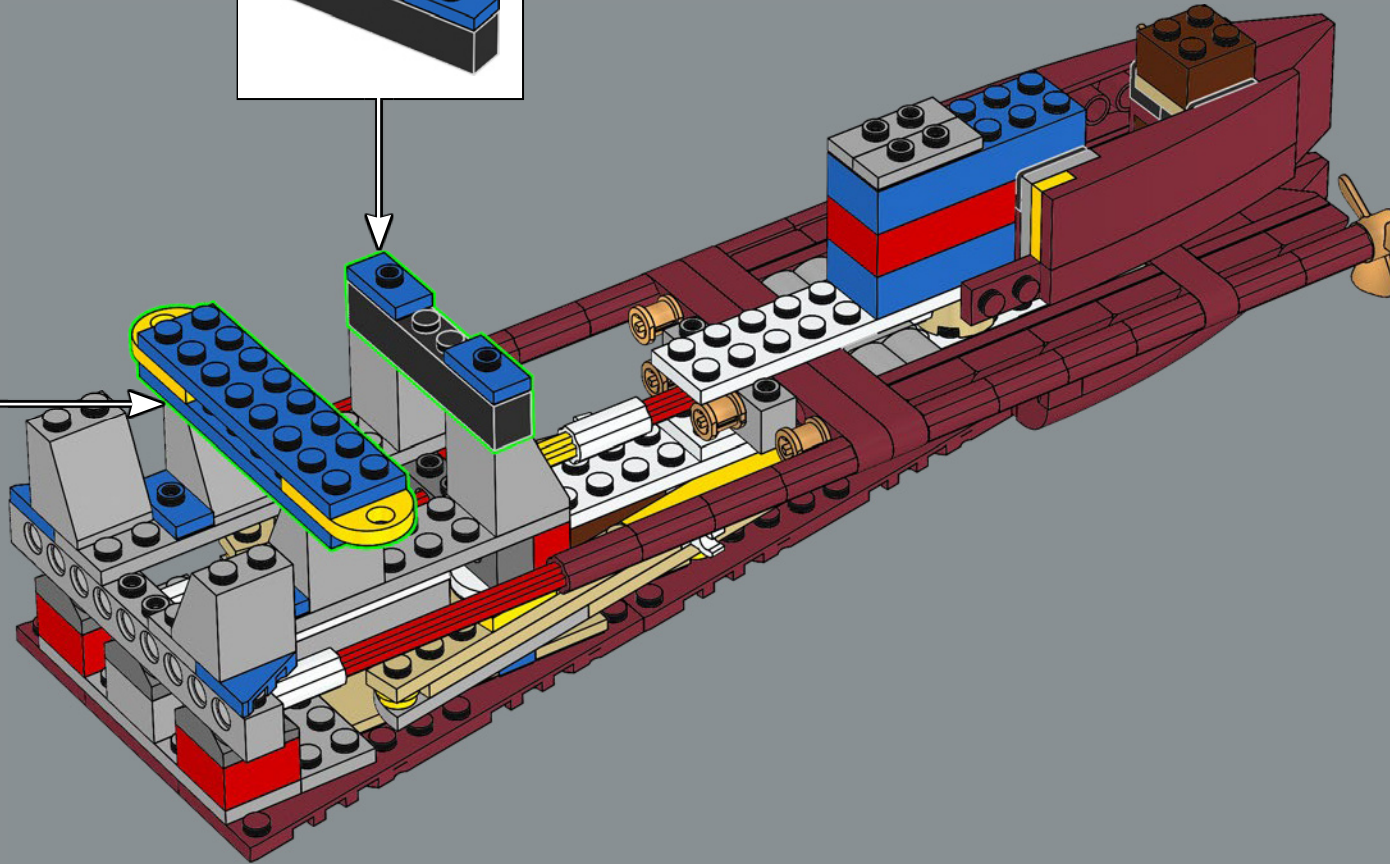
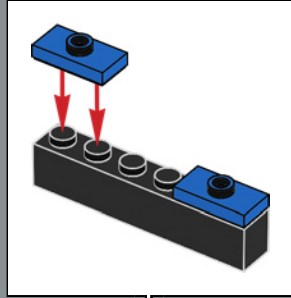
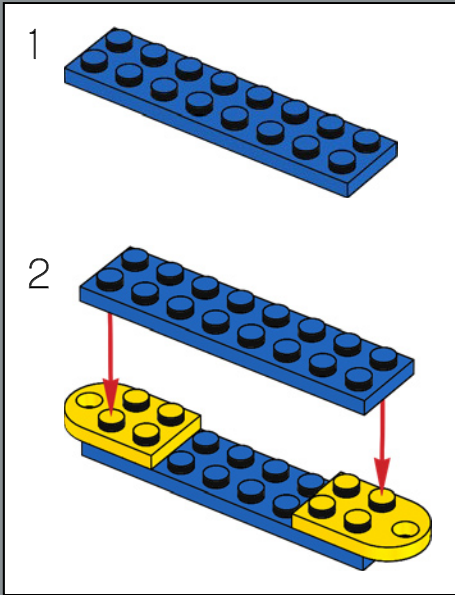

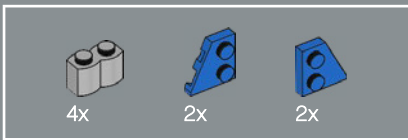

190

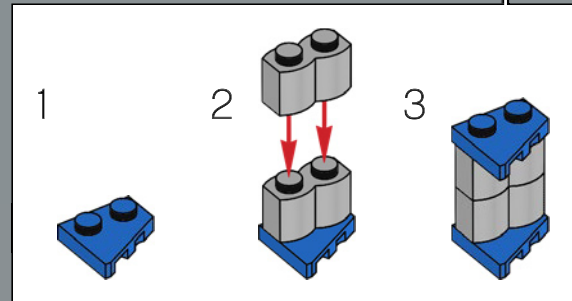
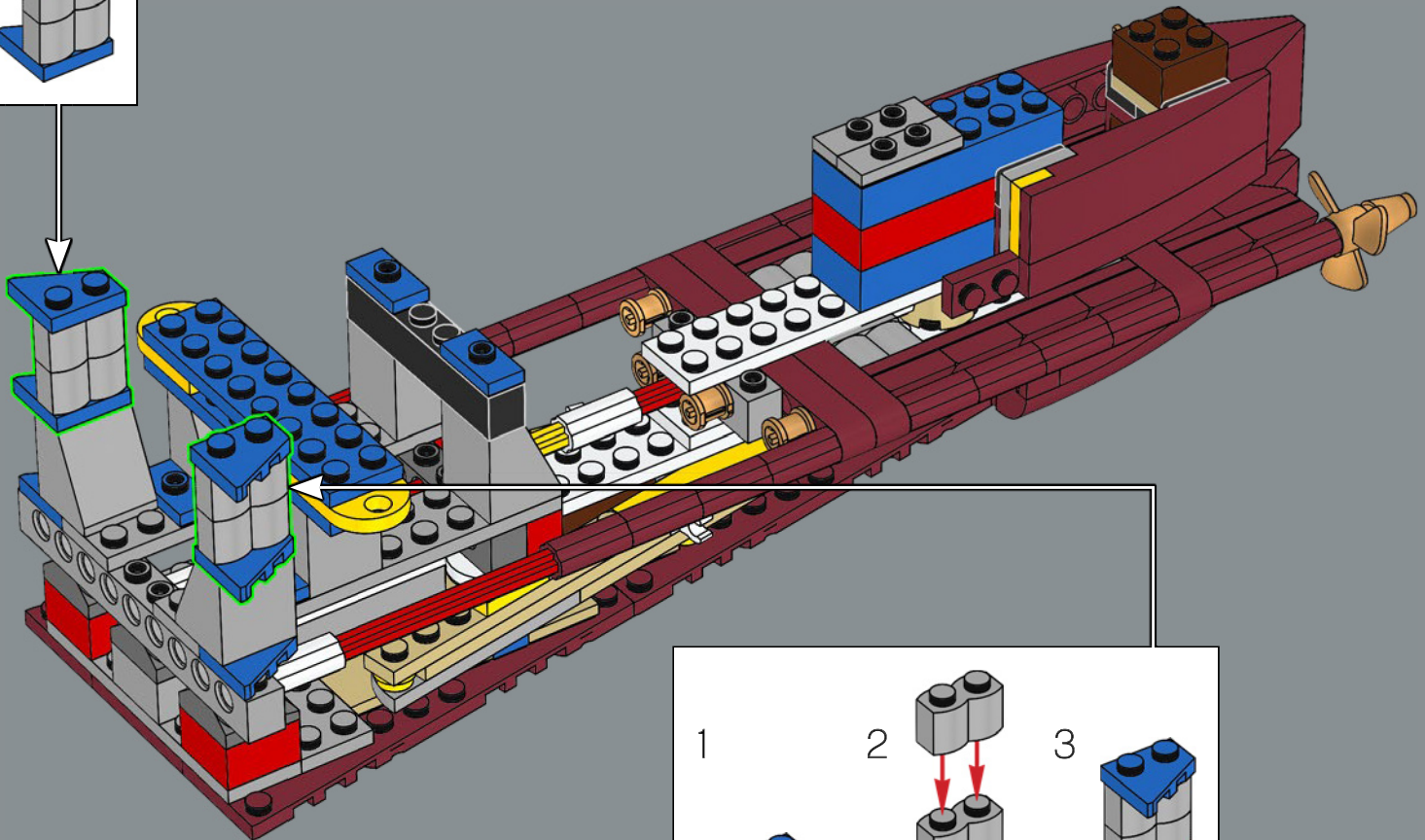
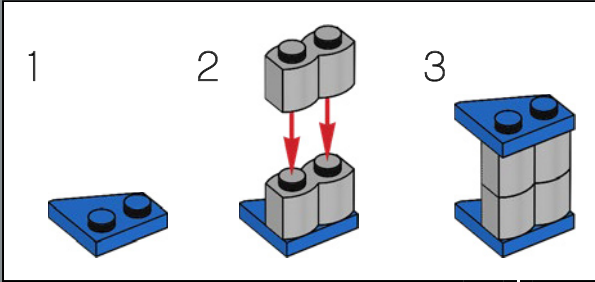





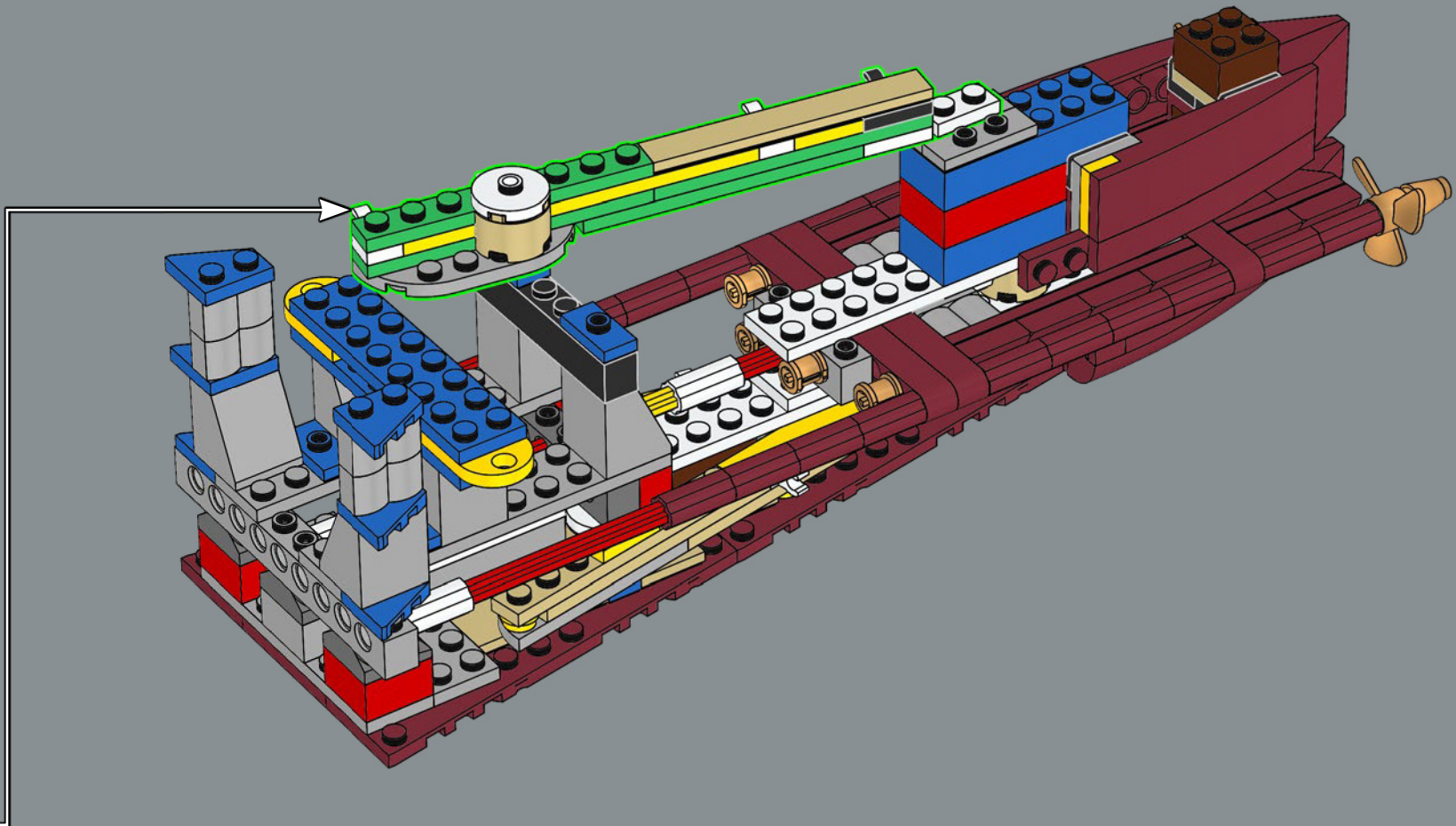

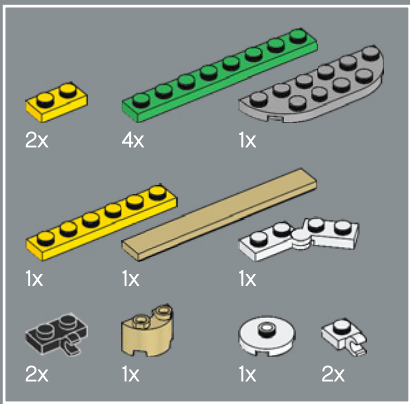

192

1

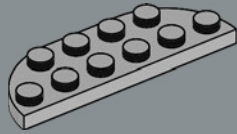

2

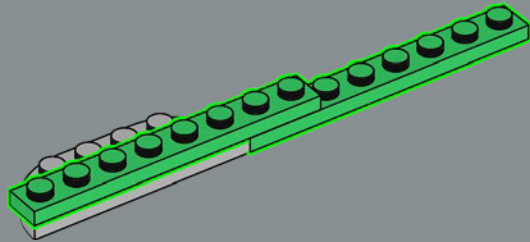

3

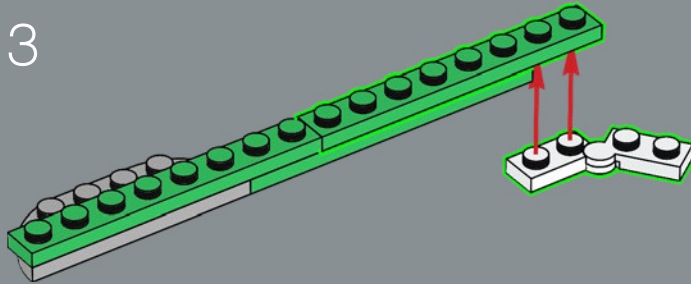

4

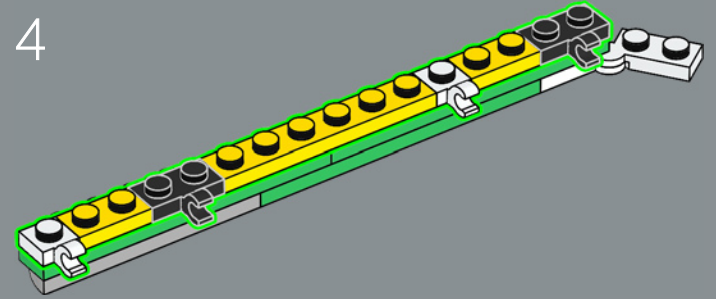

5

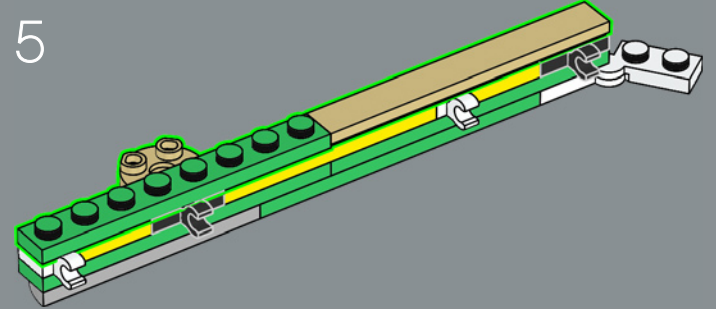

6

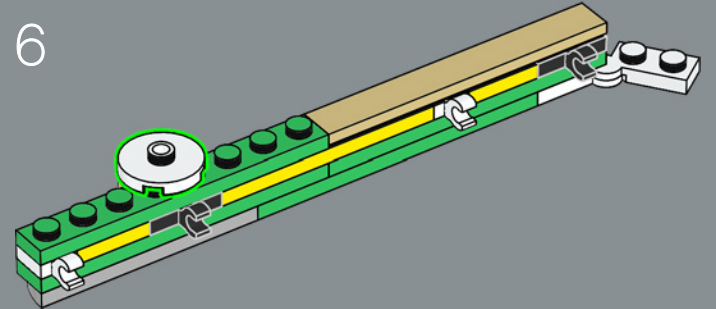



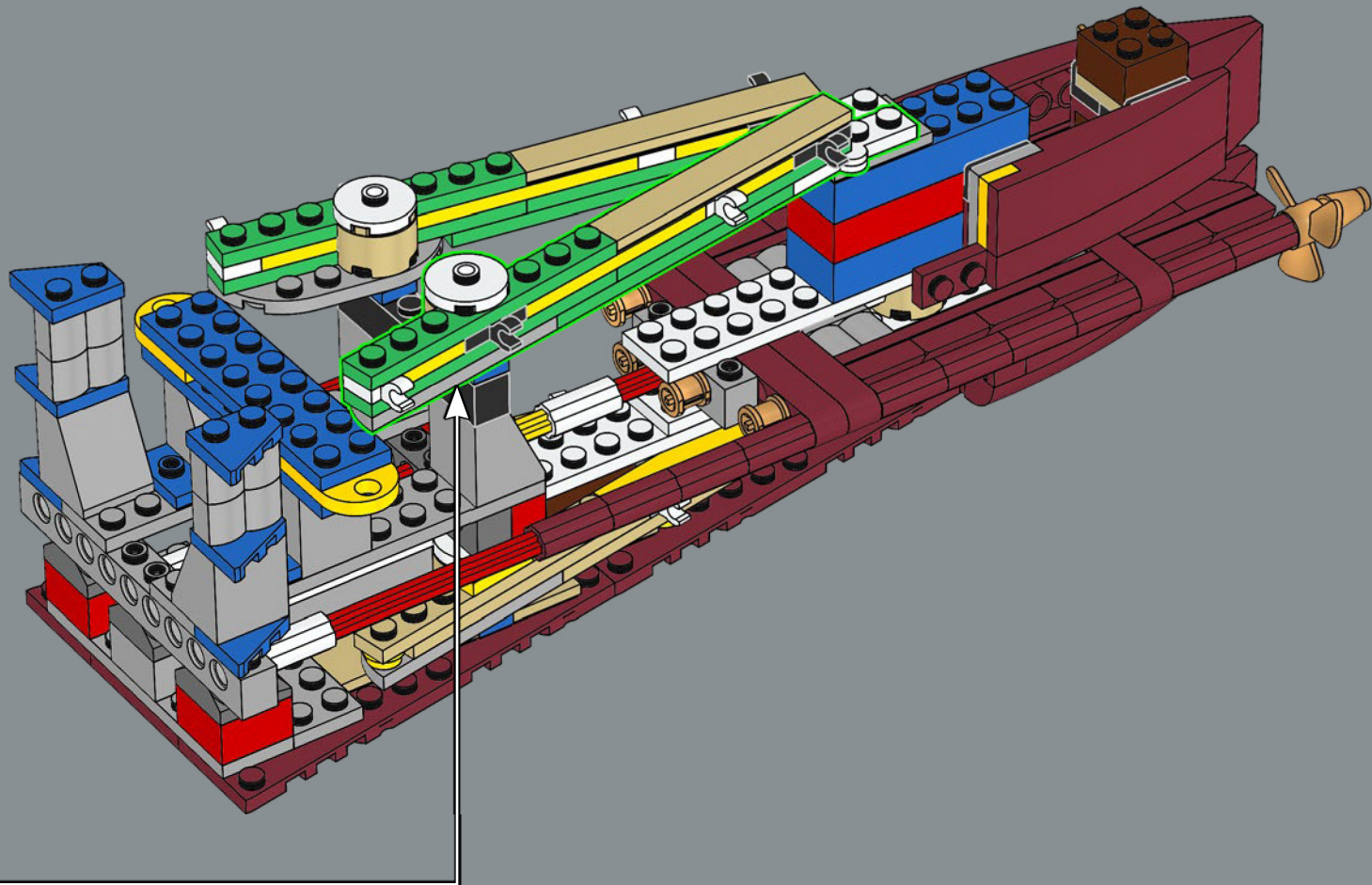

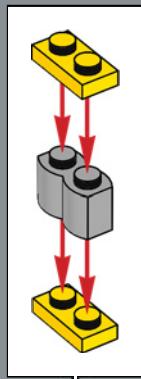
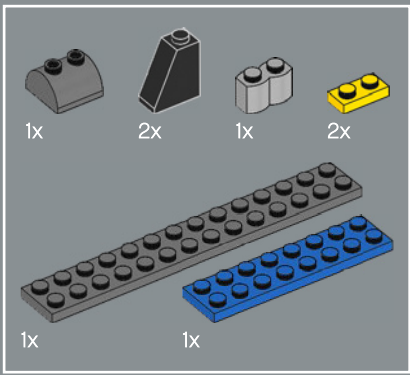

193

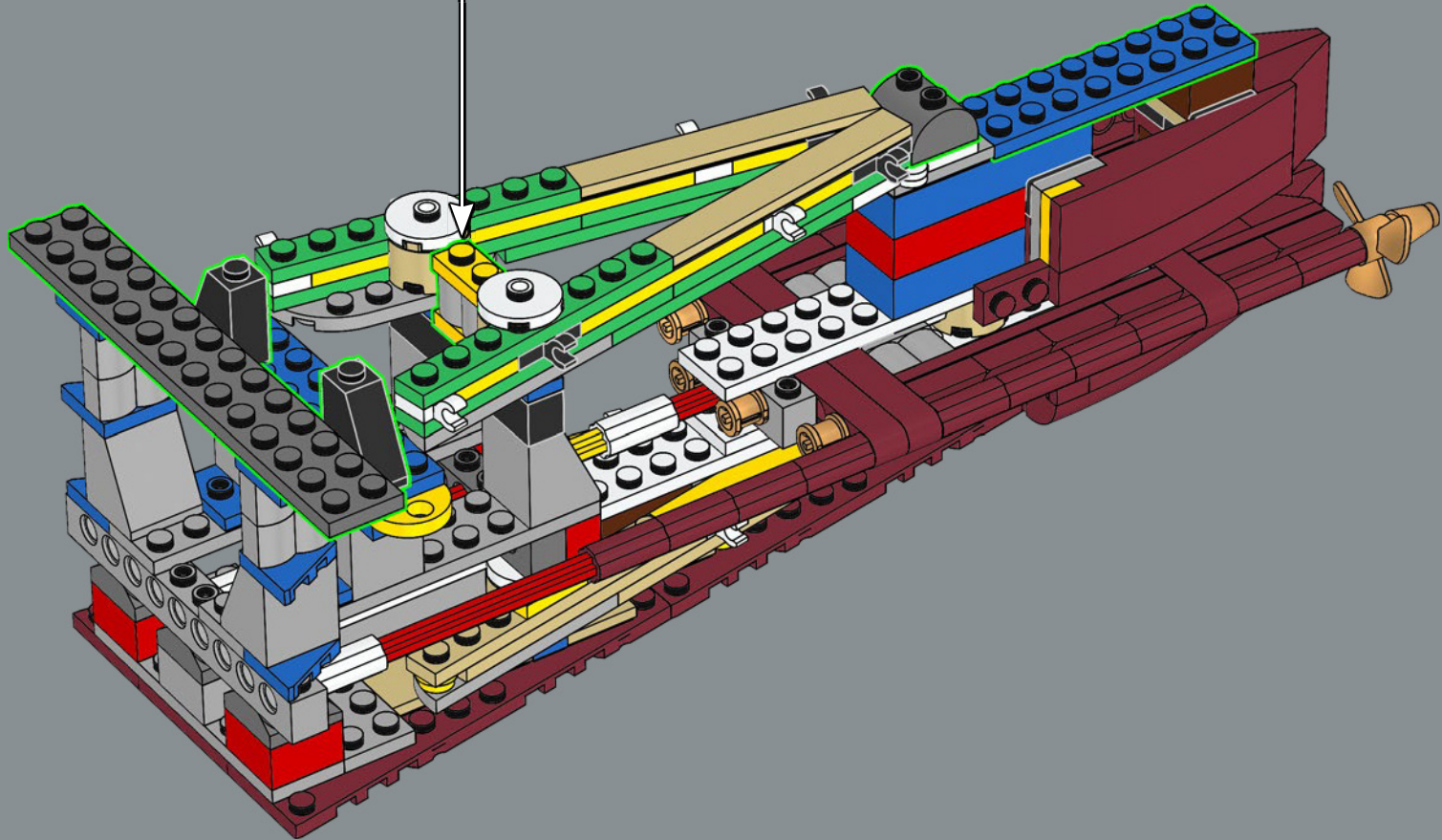

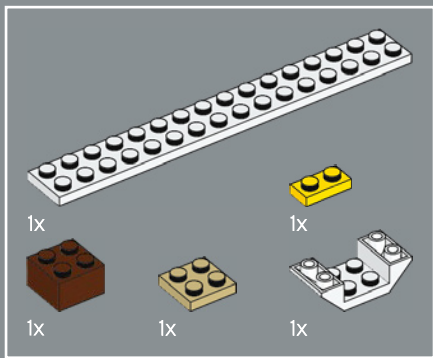

194

1

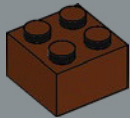

2

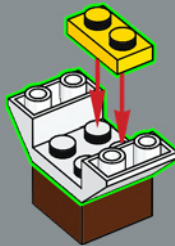

3

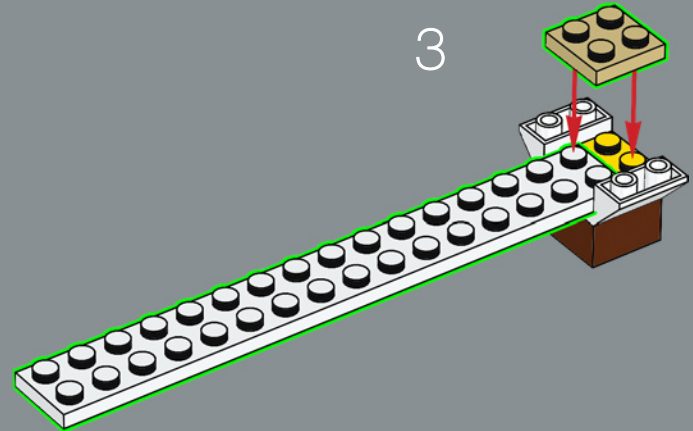



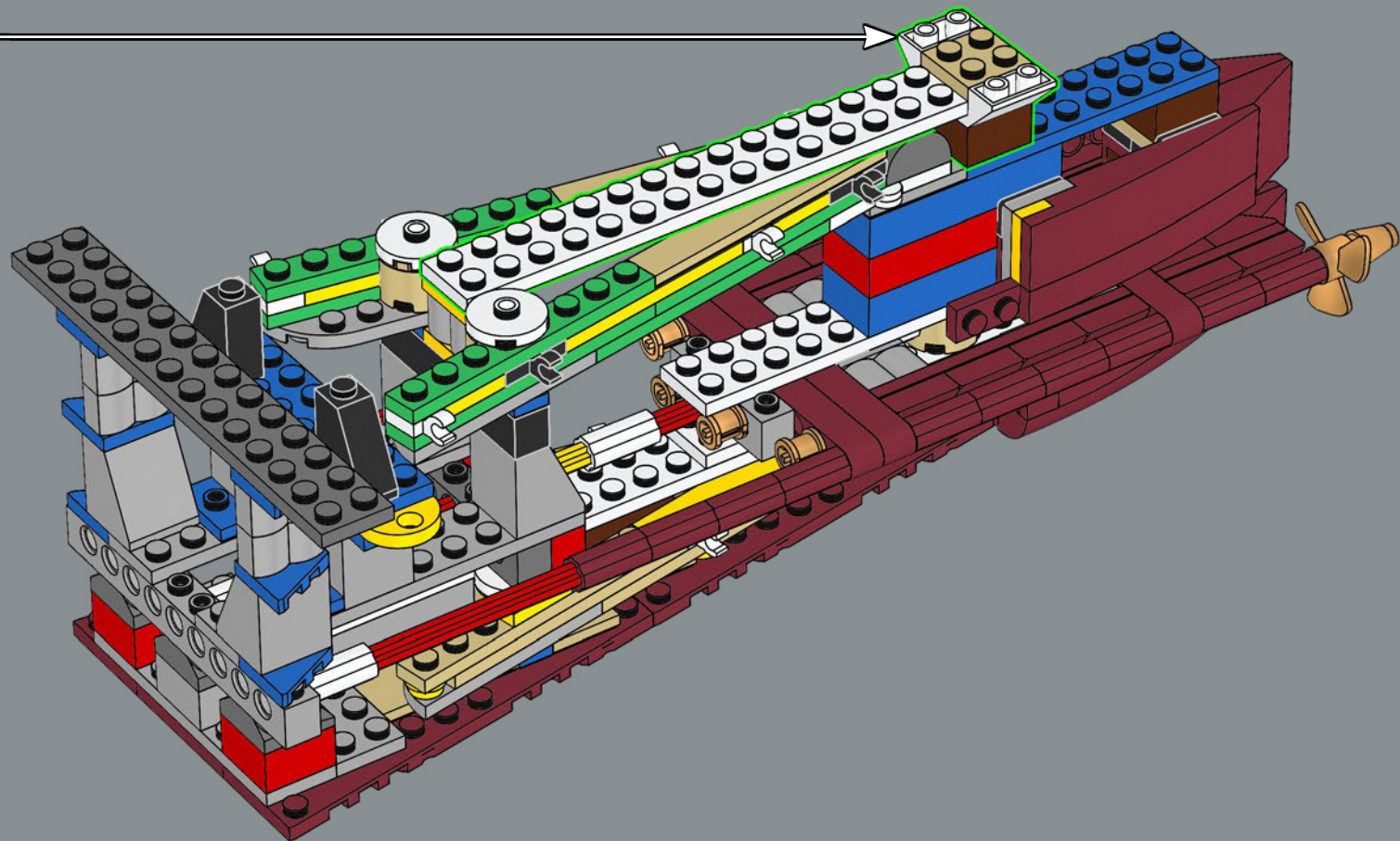

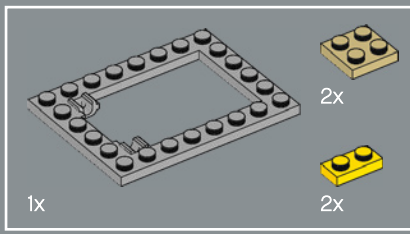

195

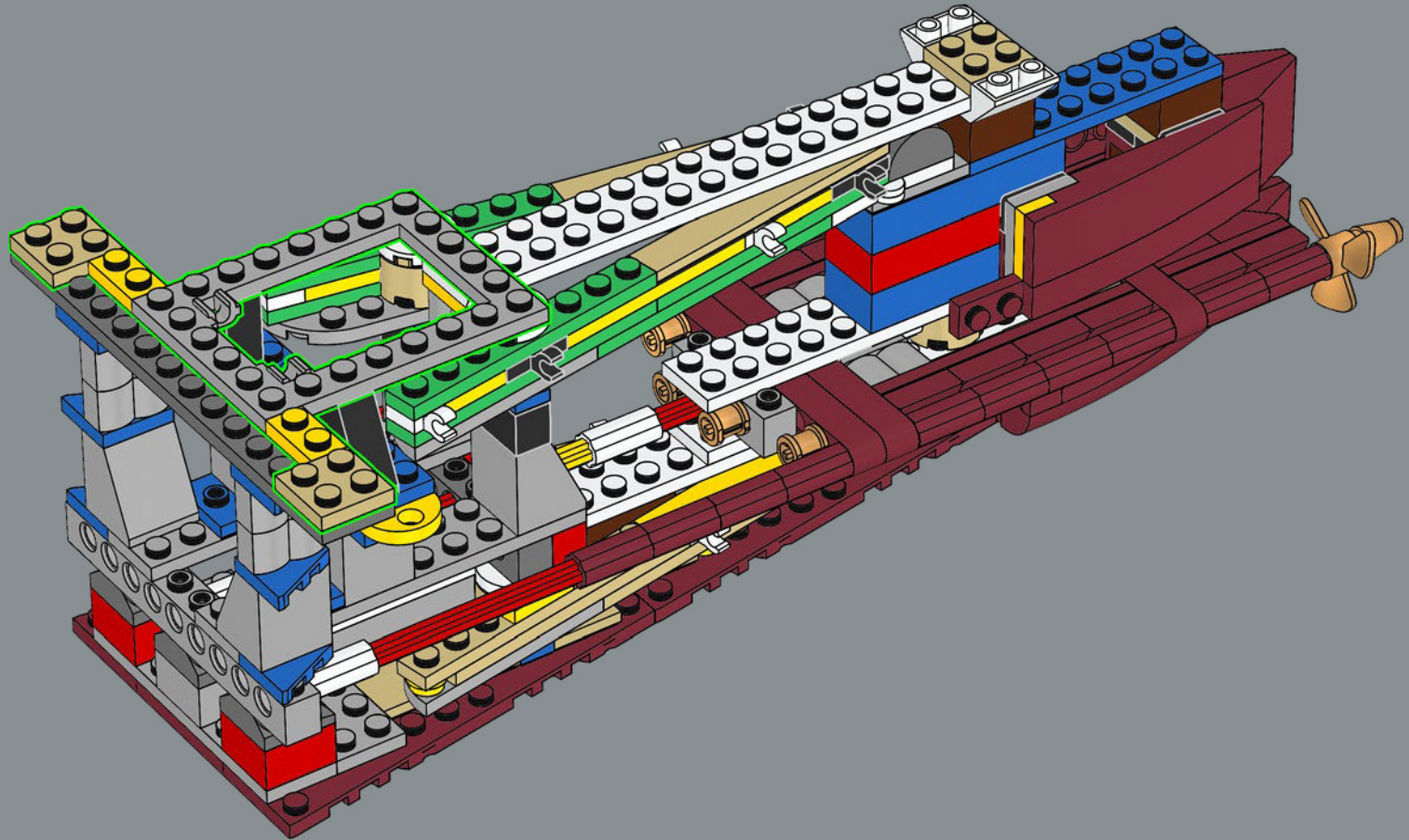

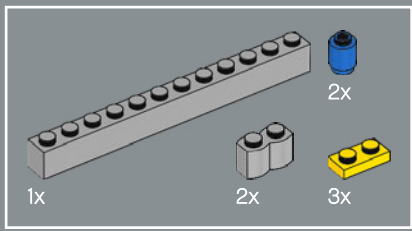

196

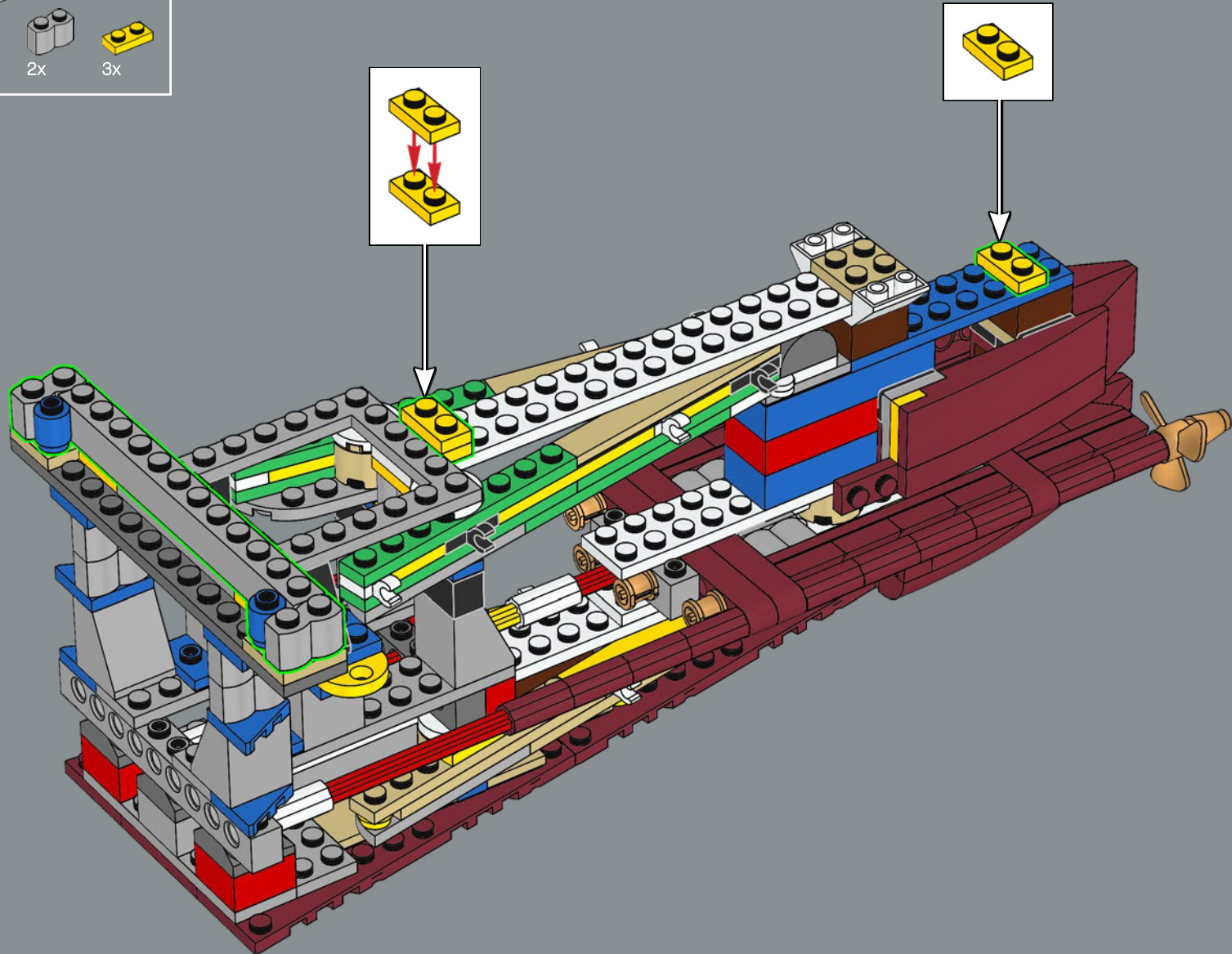



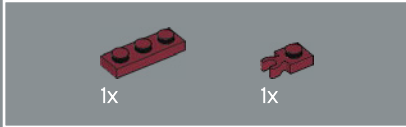
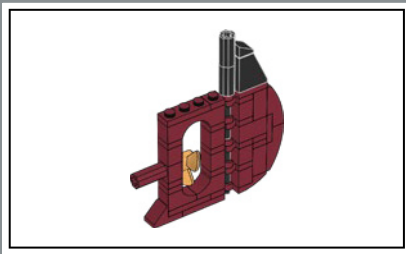

197

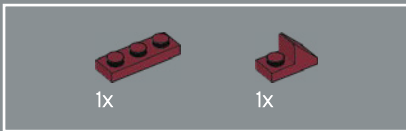
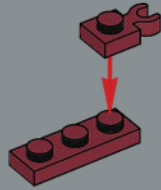

198

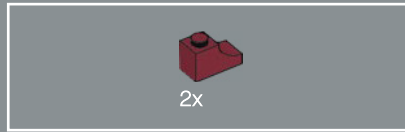
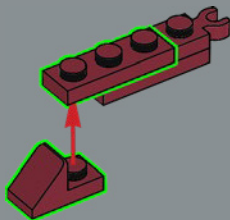

199

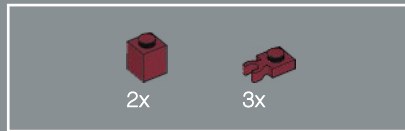
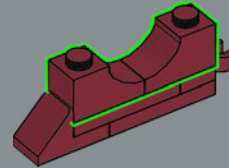

200

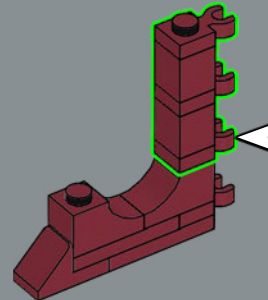
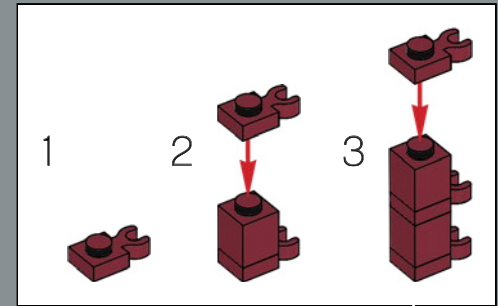

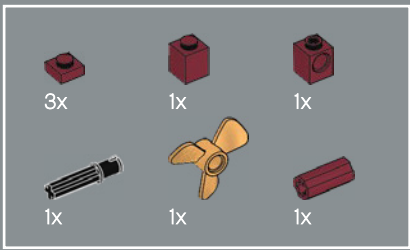

201

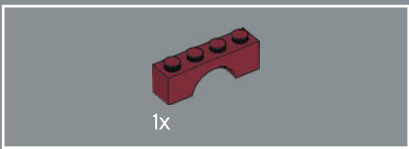
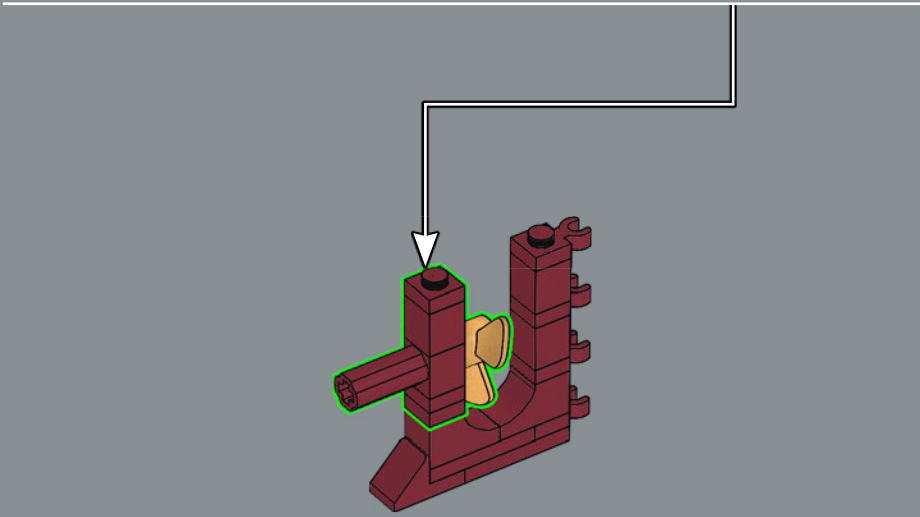
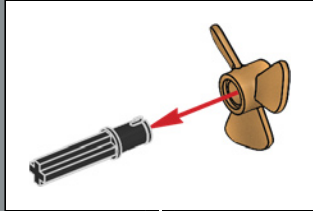
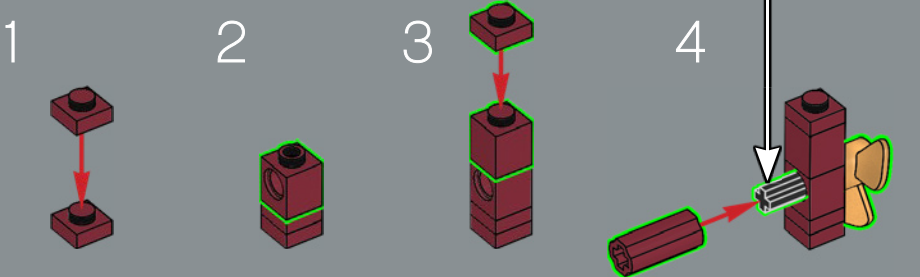

202

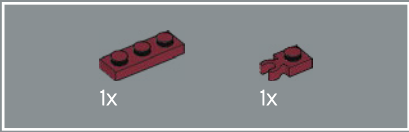
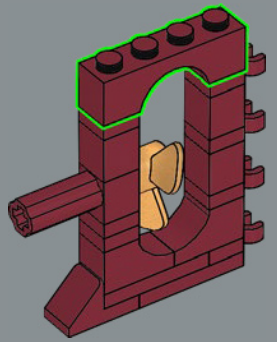

203

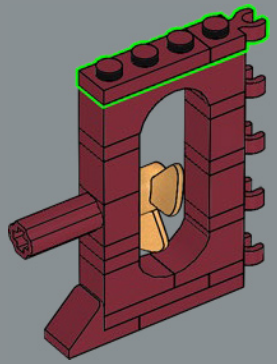

204

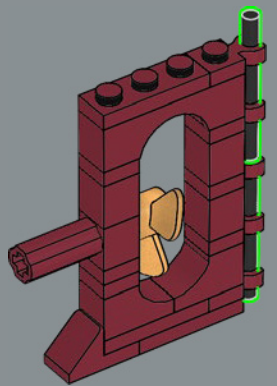

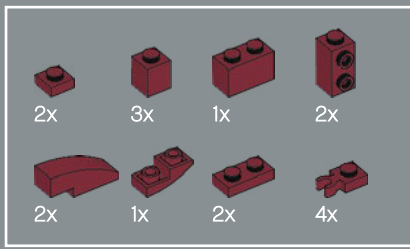

205

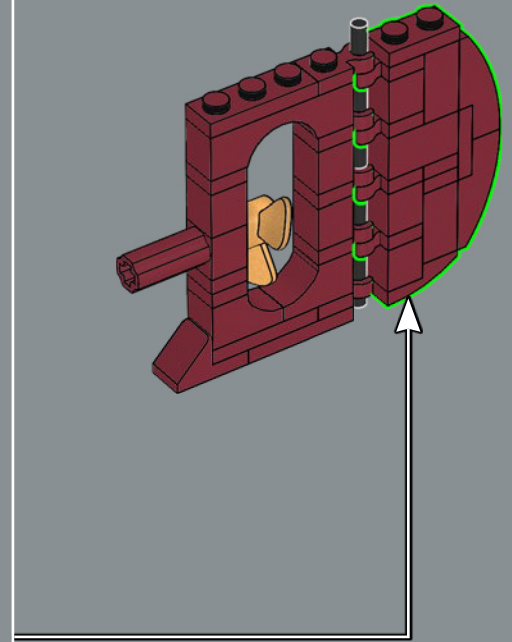
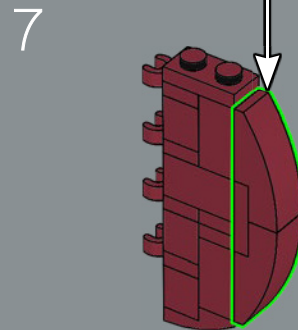
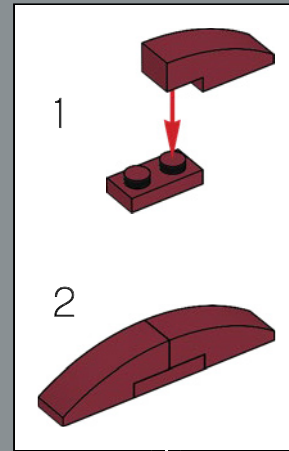
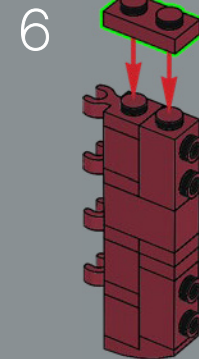
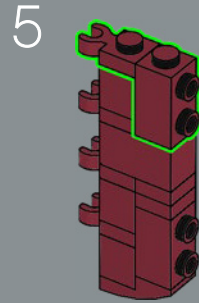
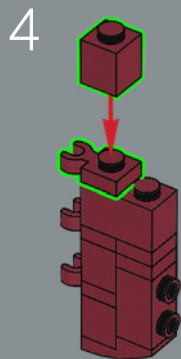
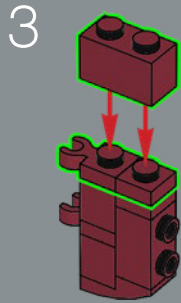
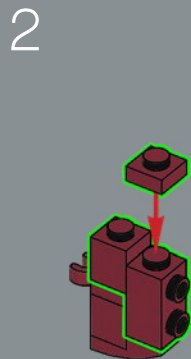
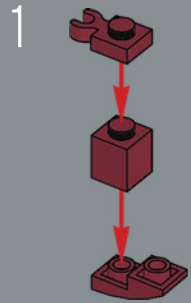



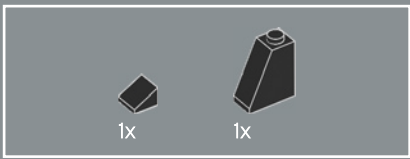

206

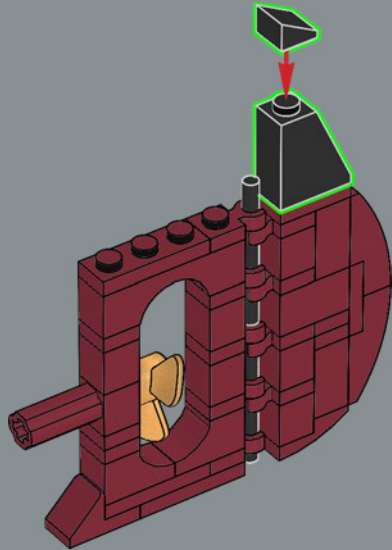

207

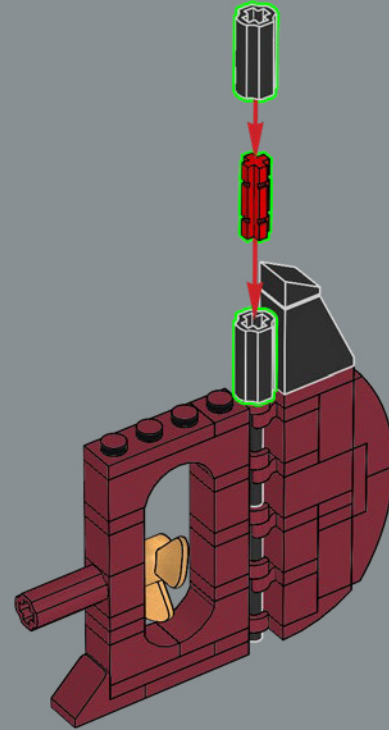

El timón del barco era tan grande (24 m de altura, 4,65 m de longitud y 100 t de peso) que se requerían motores auxiliares para moverlo.

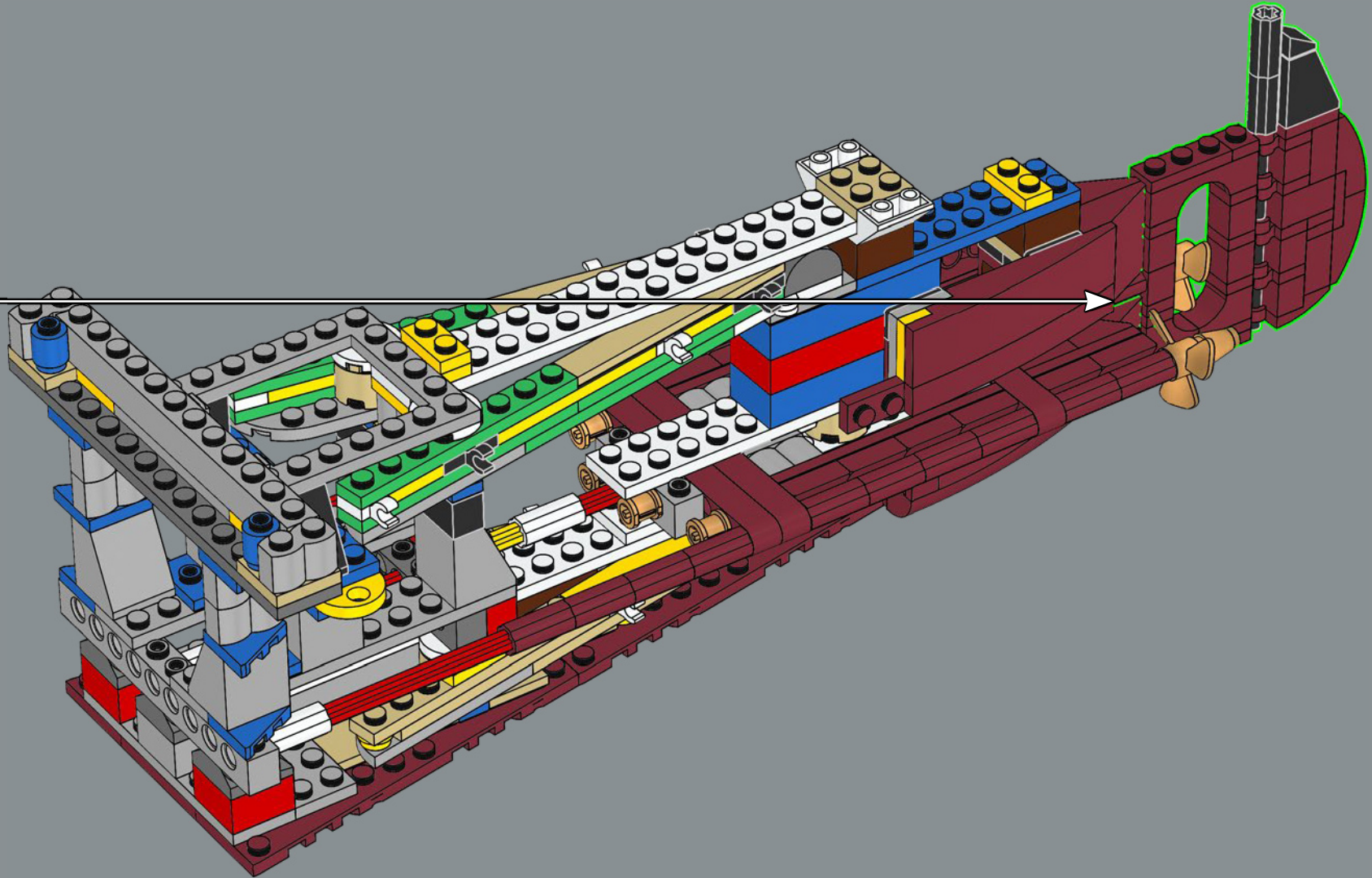

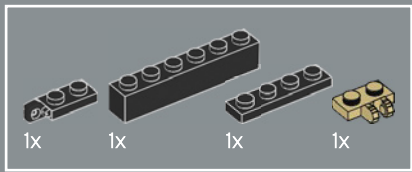

209

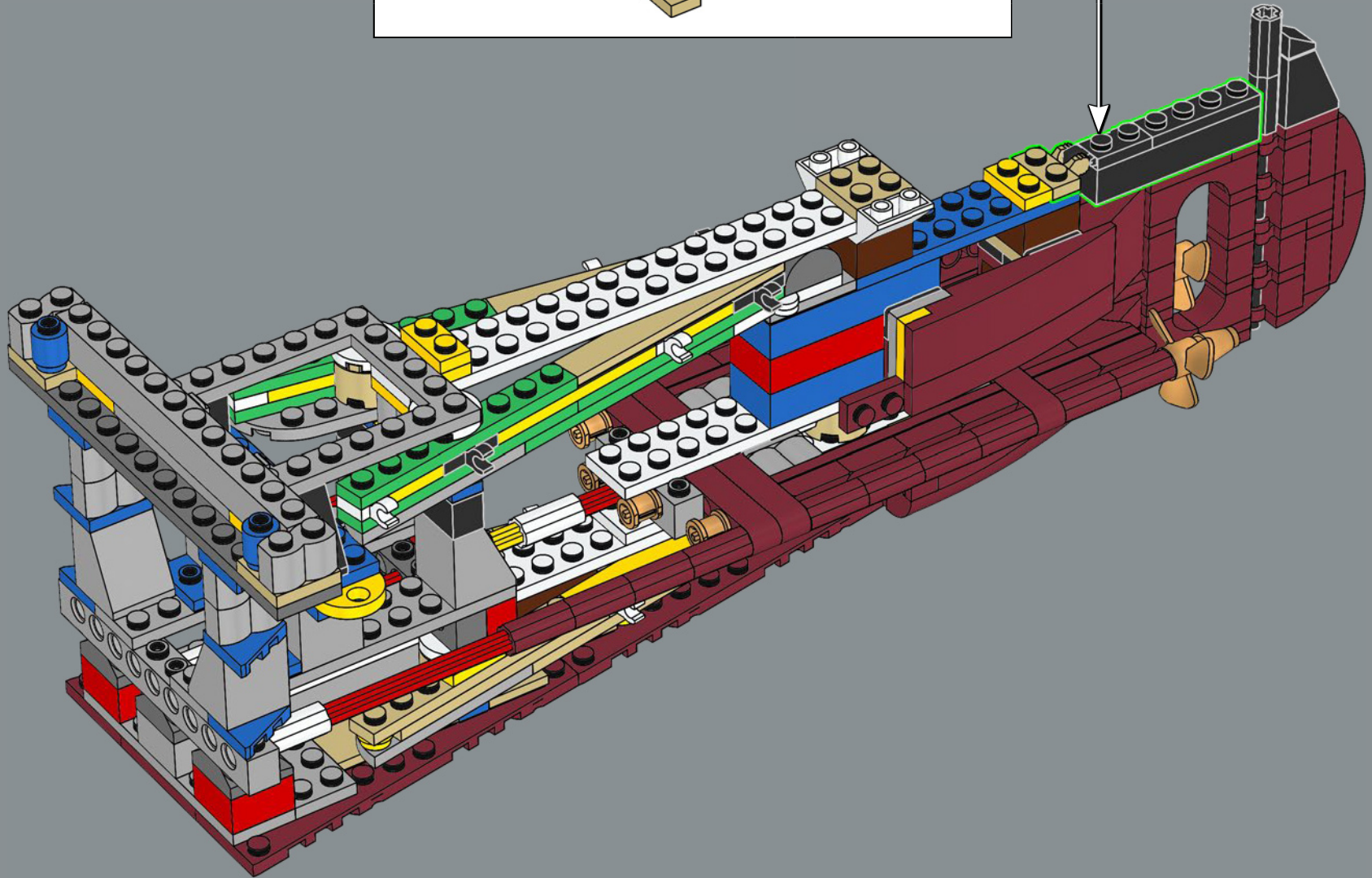
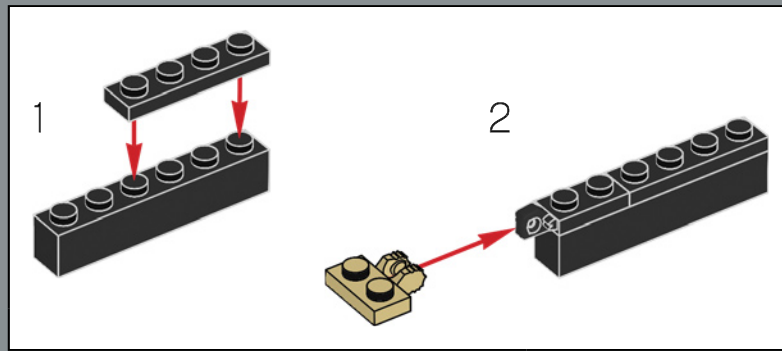



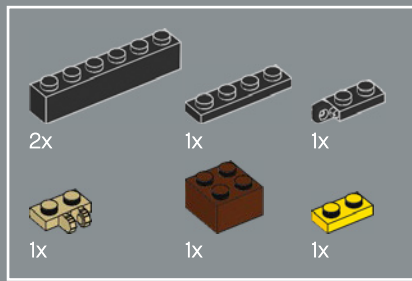

210

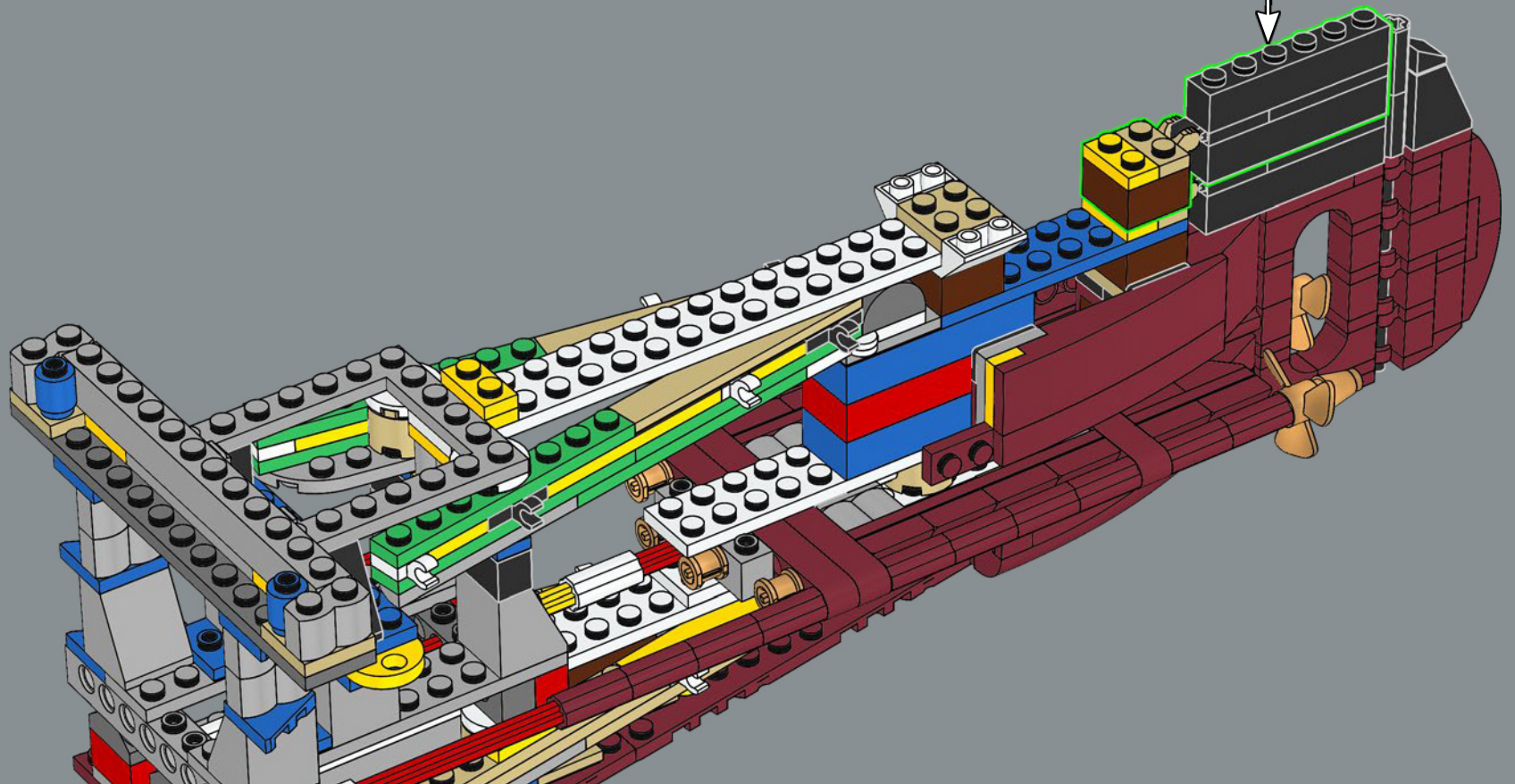
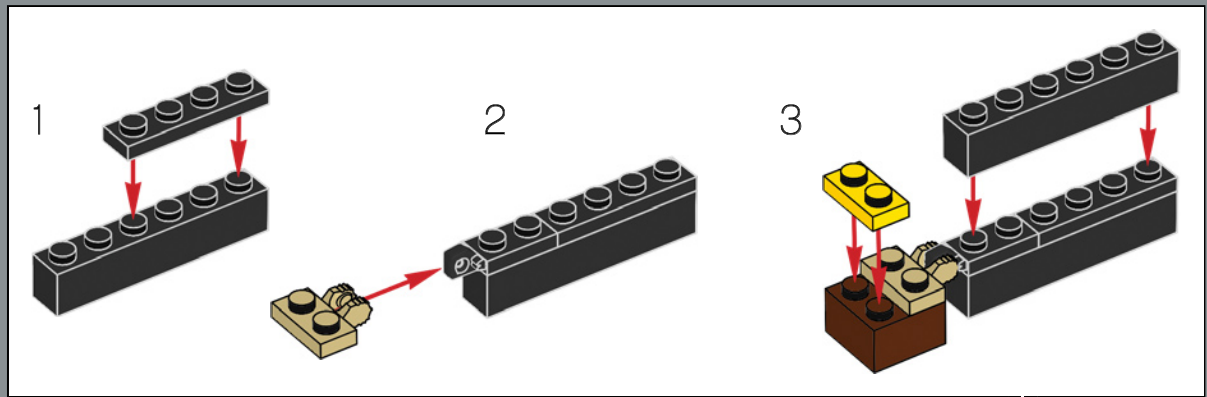

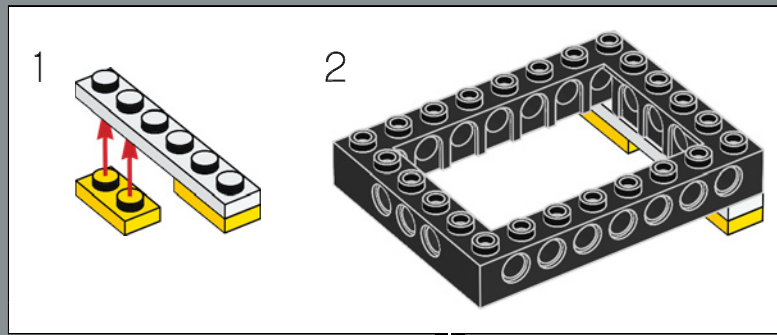
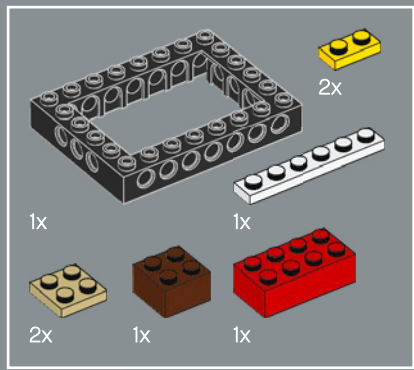

211

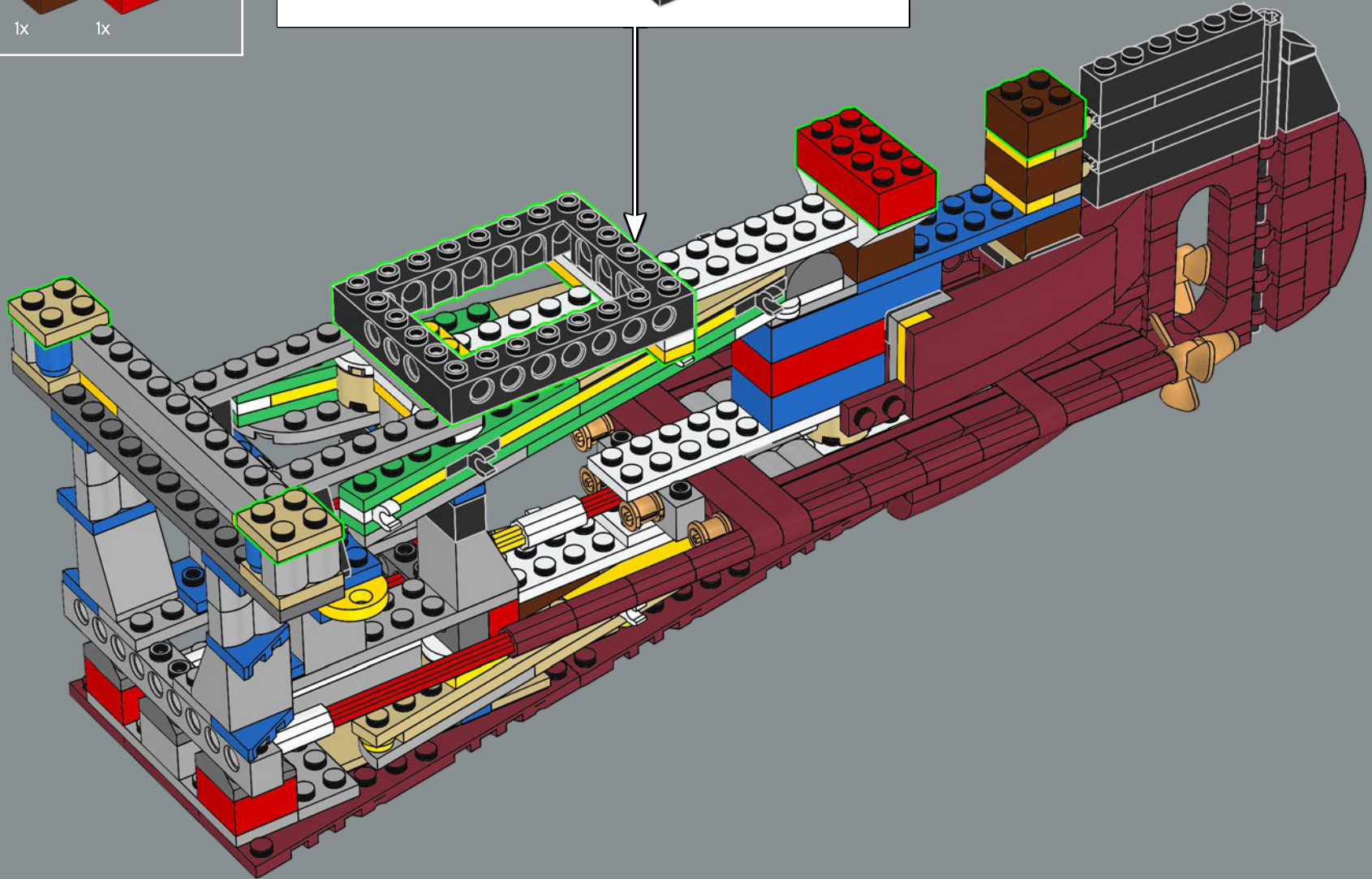



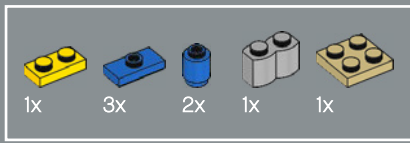

212

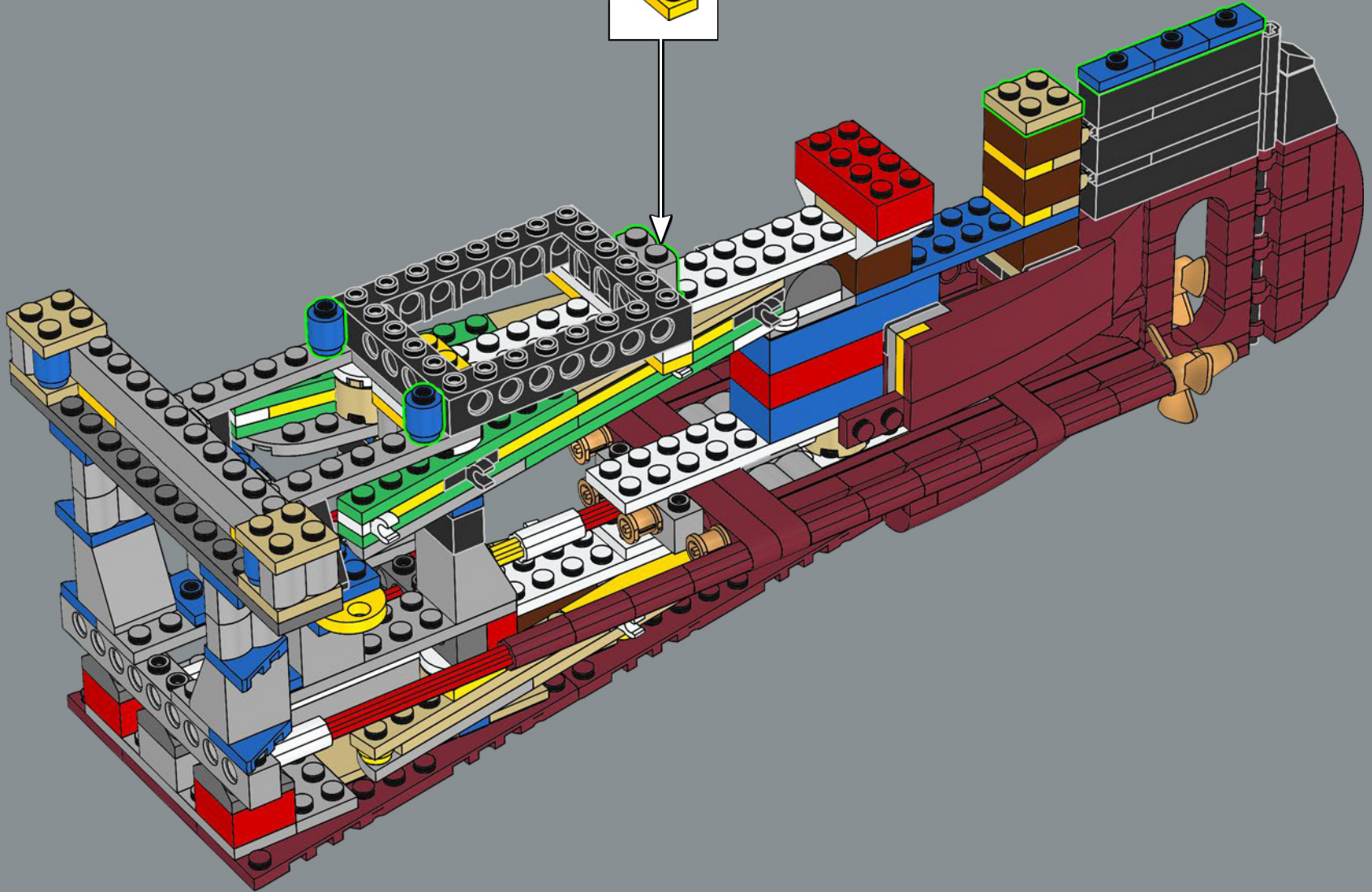
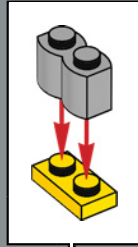



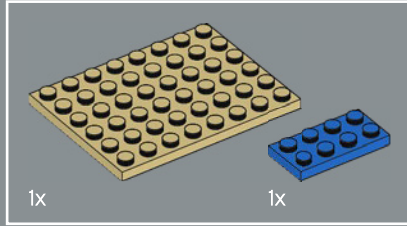
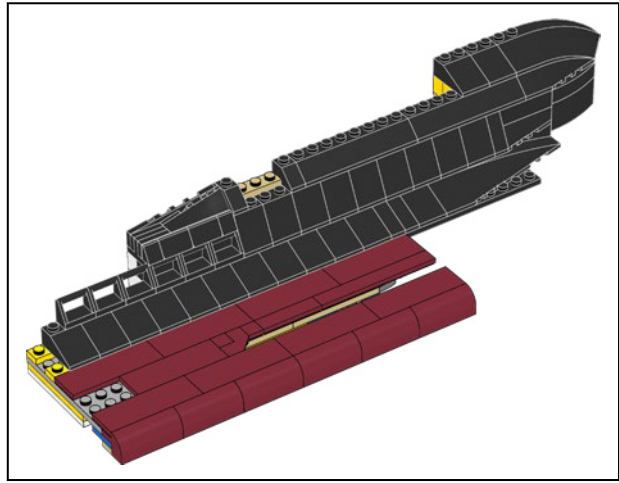
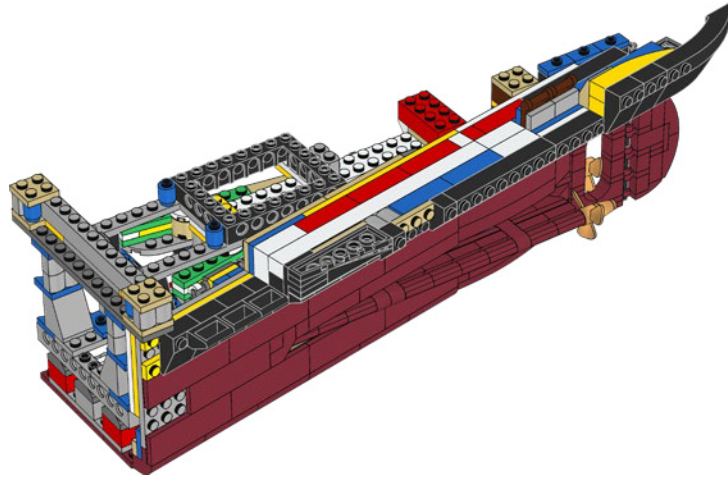
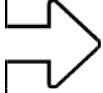

213

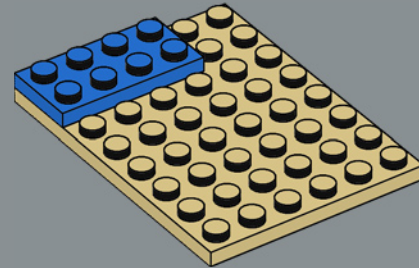

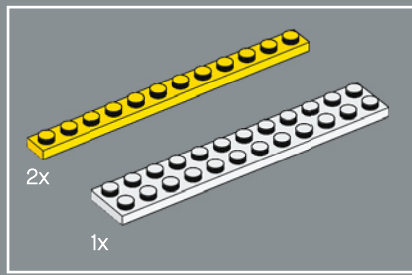

214

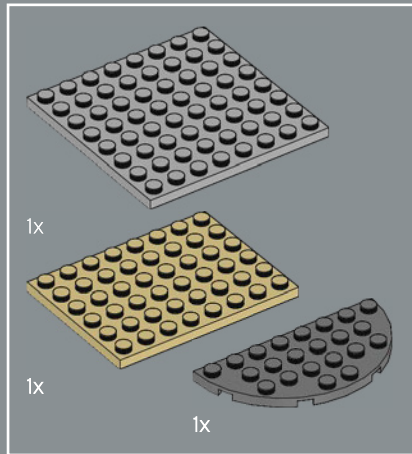
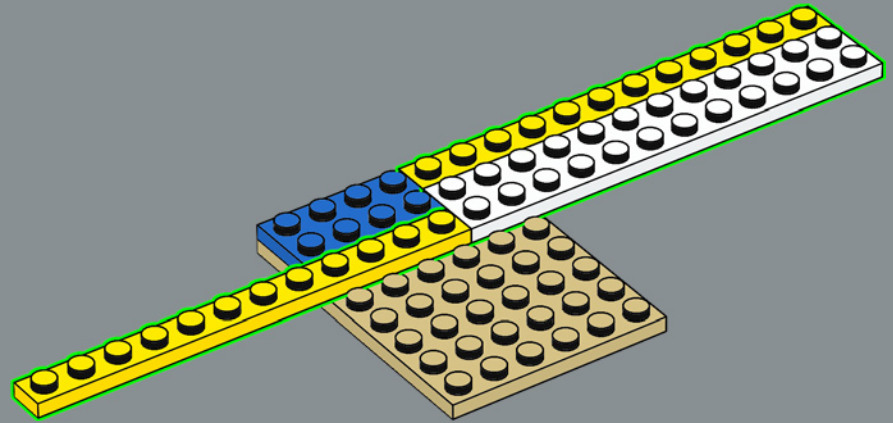

215

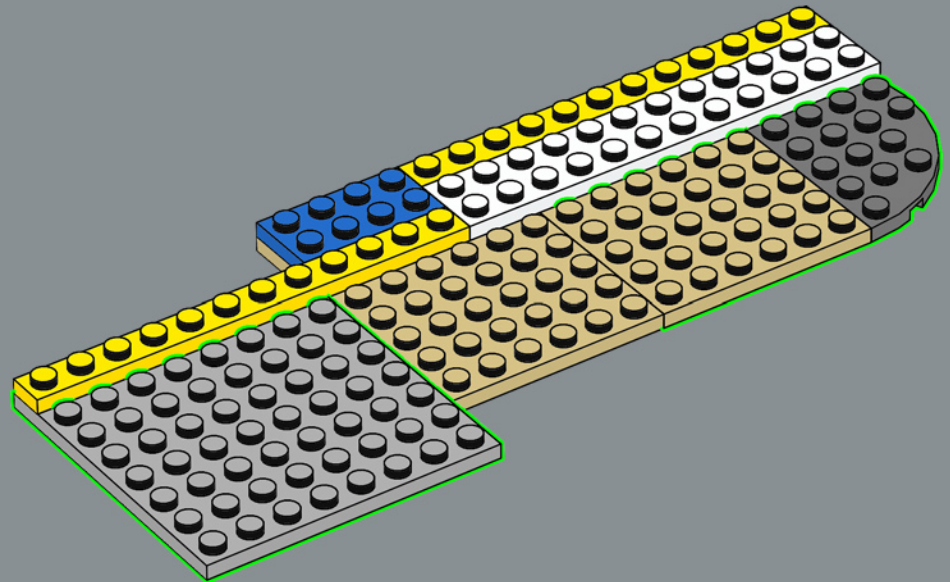

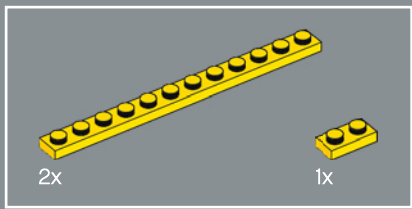

216

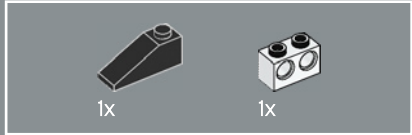
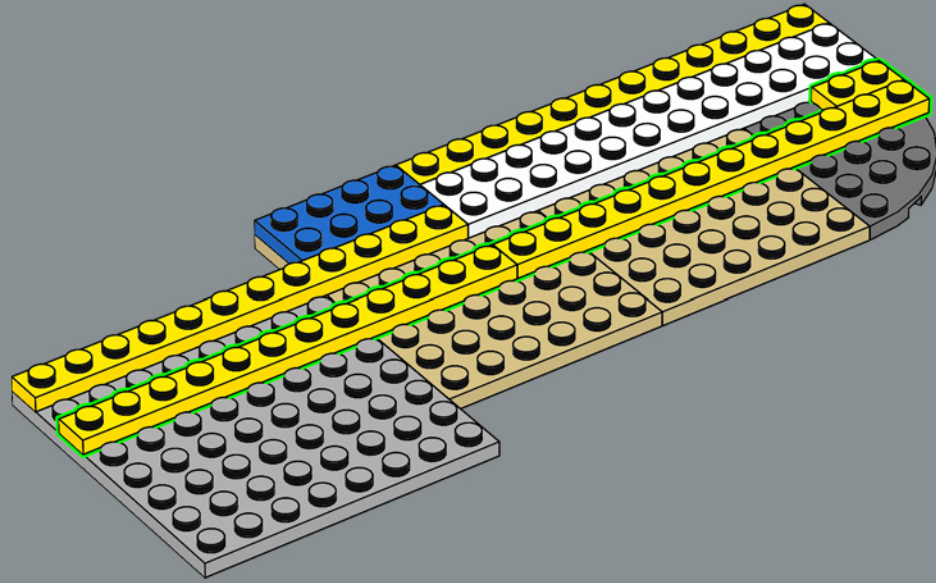

217

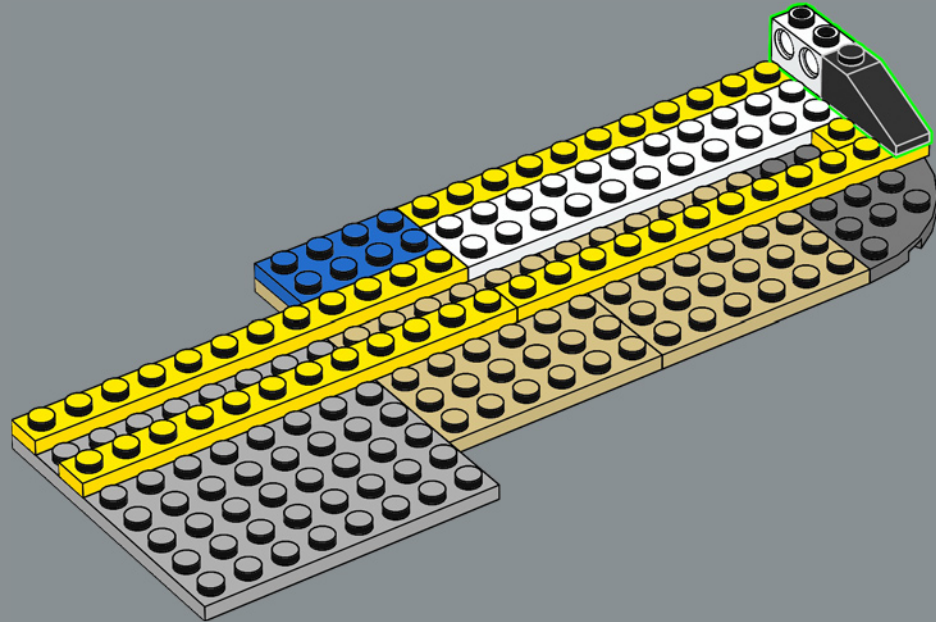



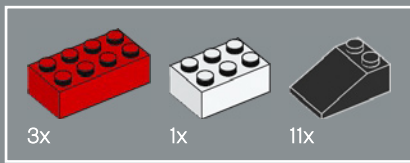

218

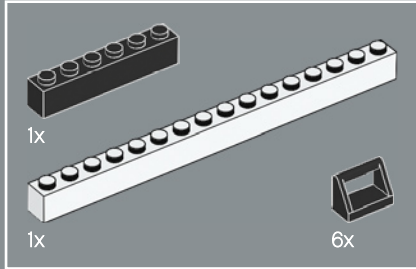
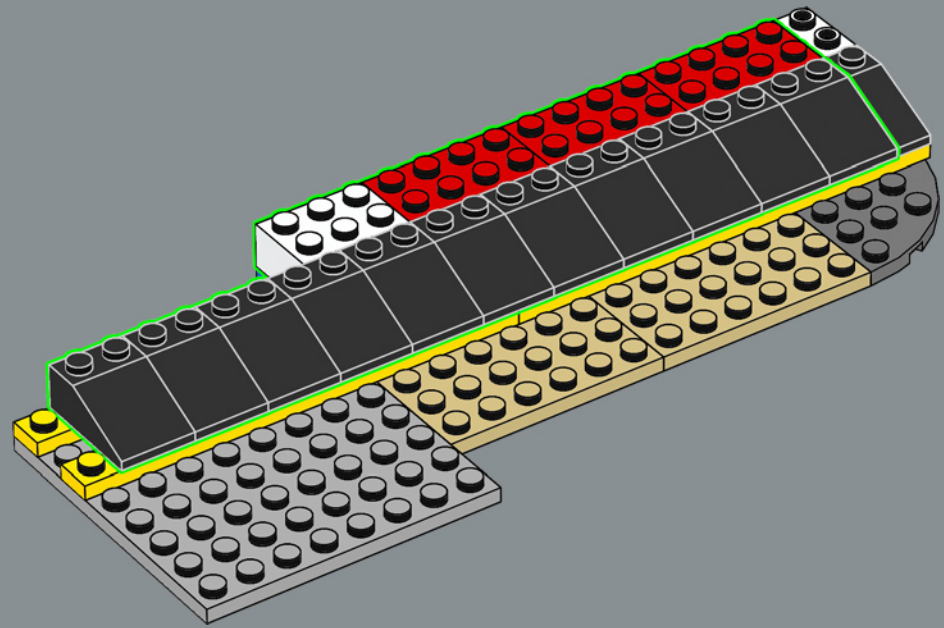

219

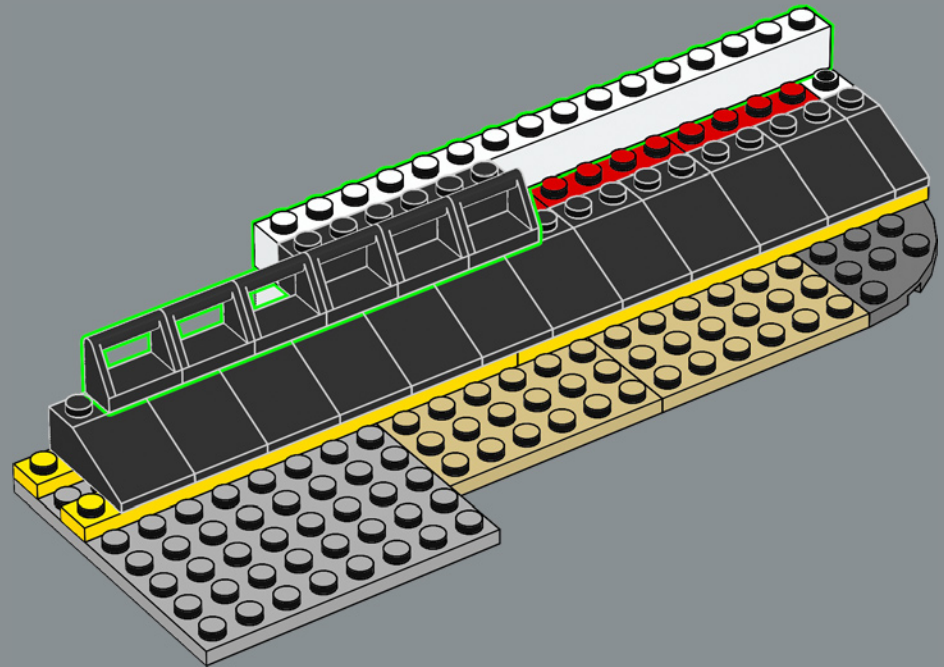

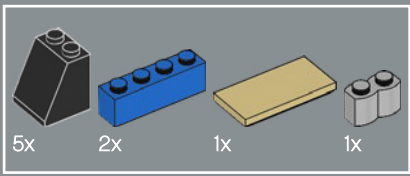

220

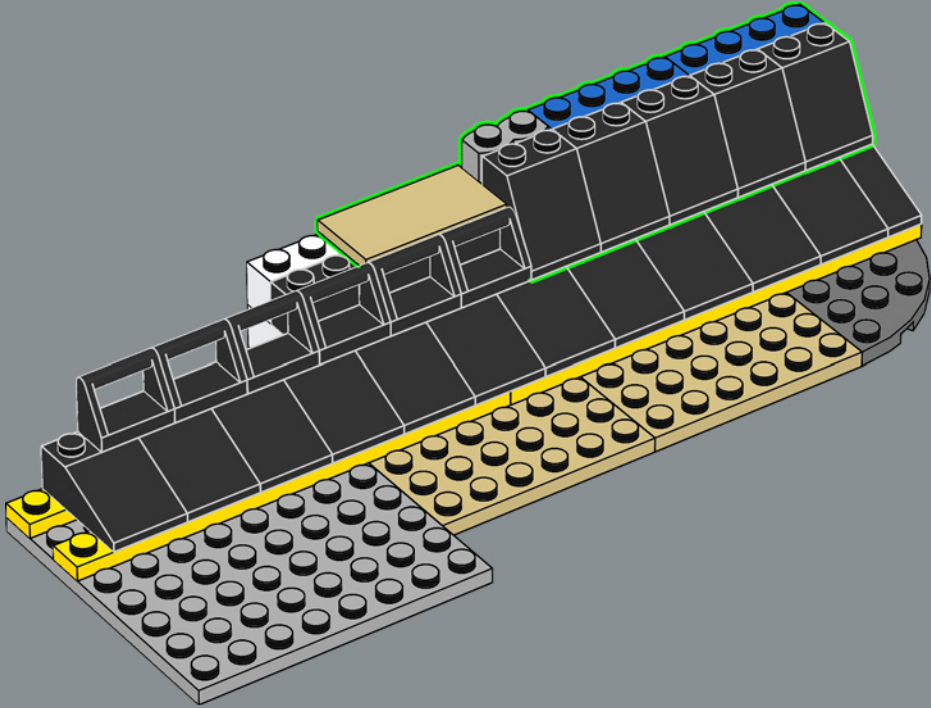

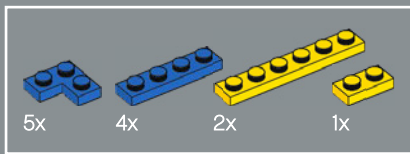

221

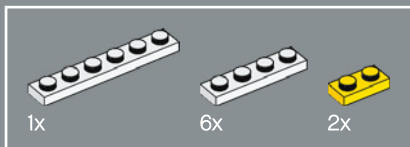
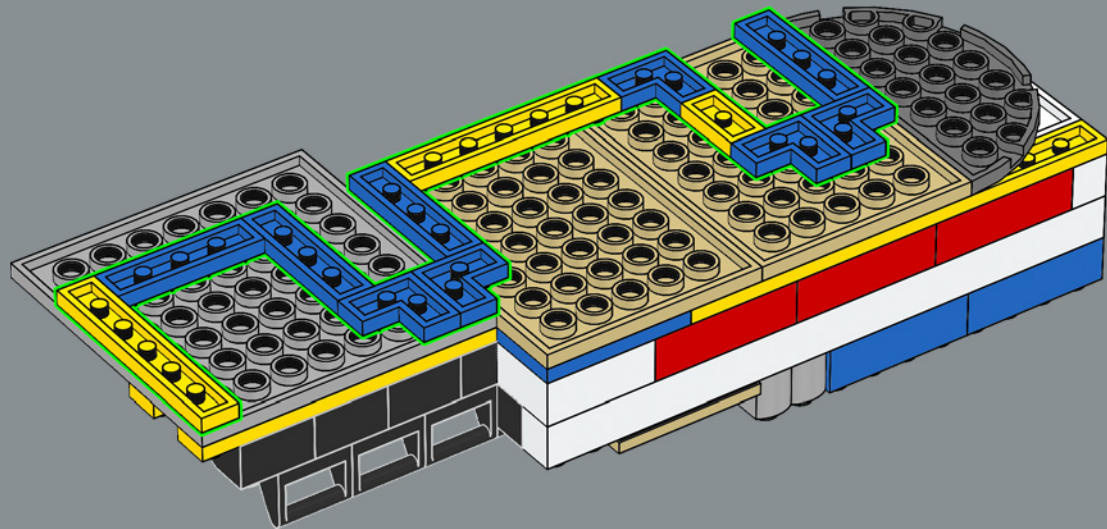

222

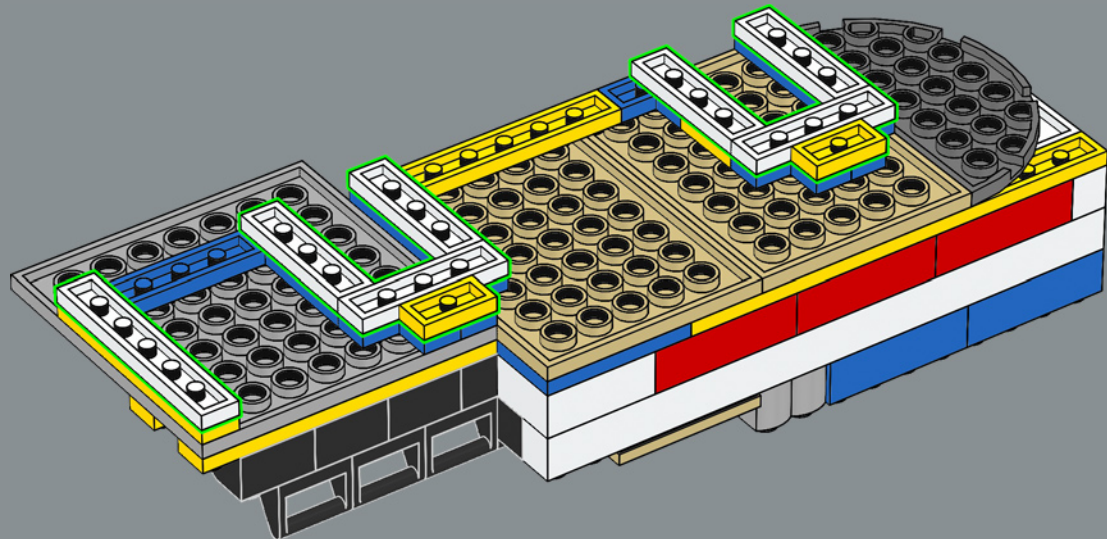



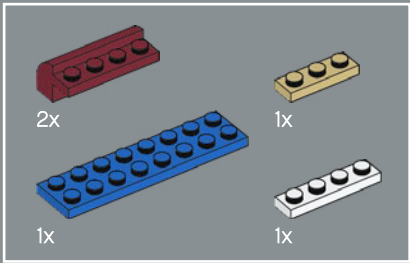

223

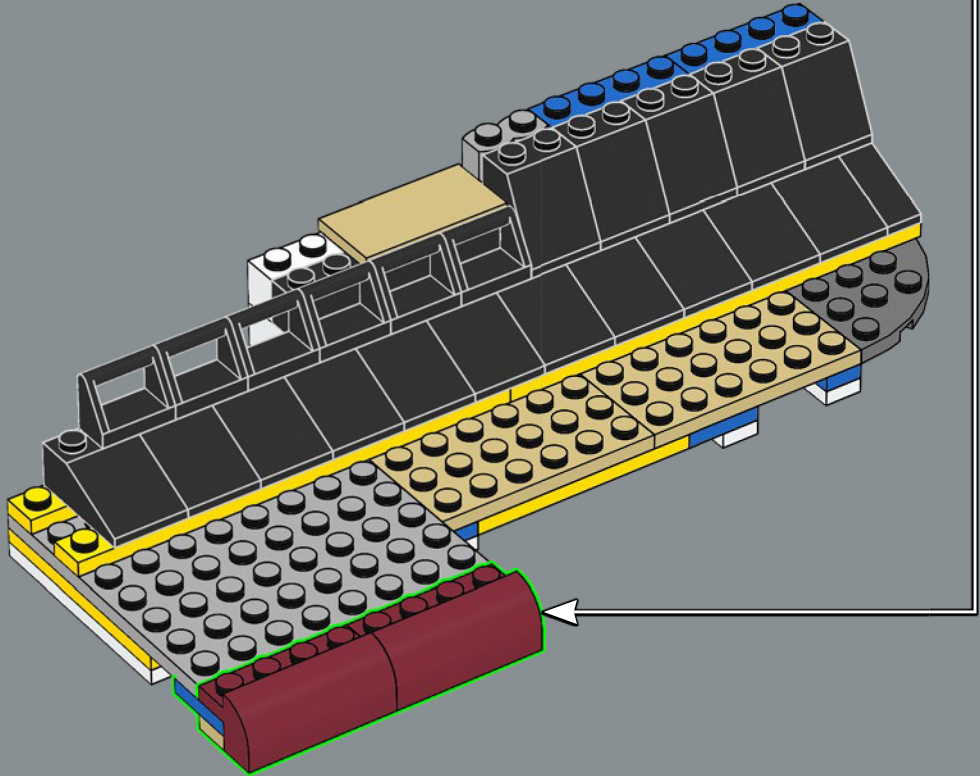
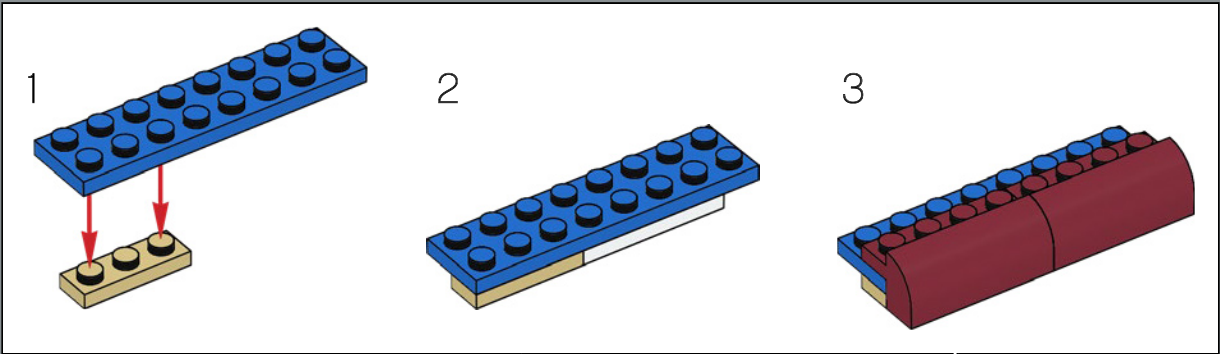

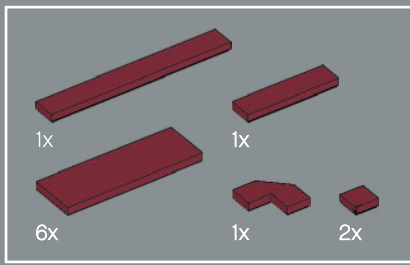

224

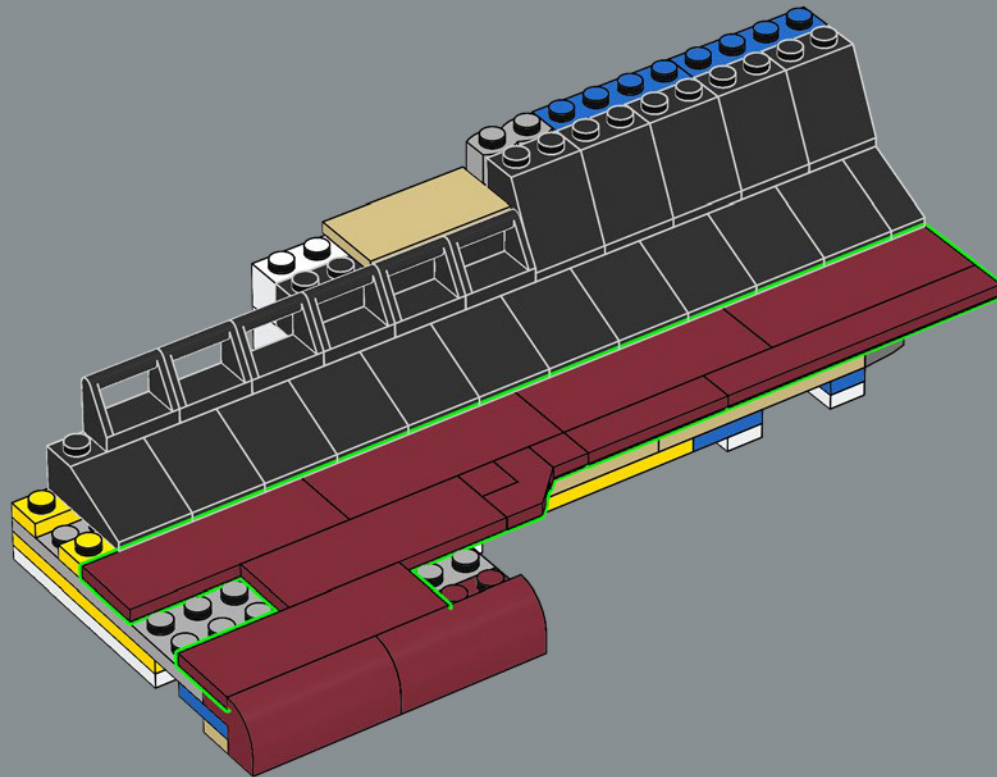





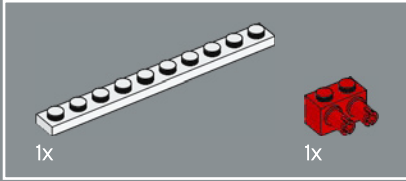
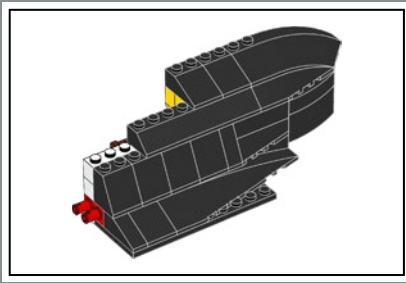

226

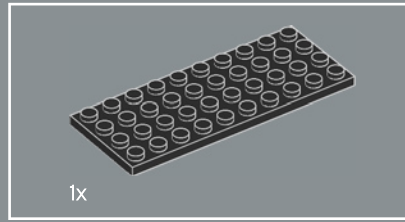
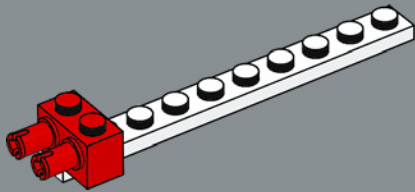

227

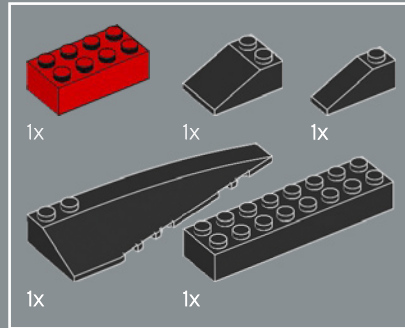
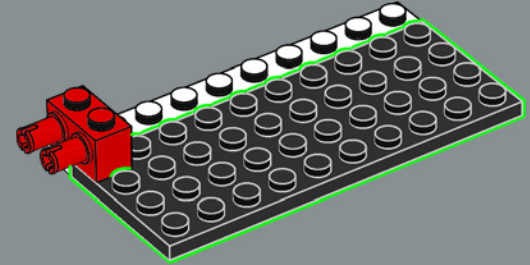

228

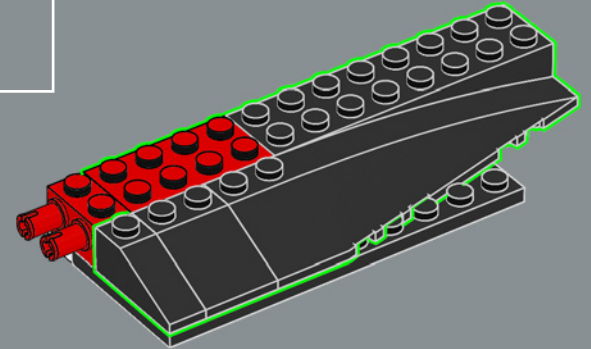

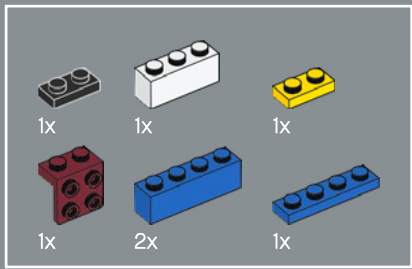

229

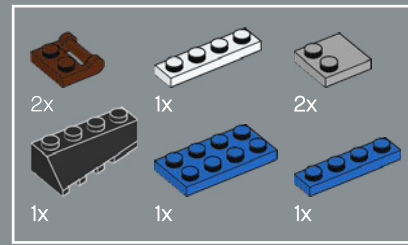
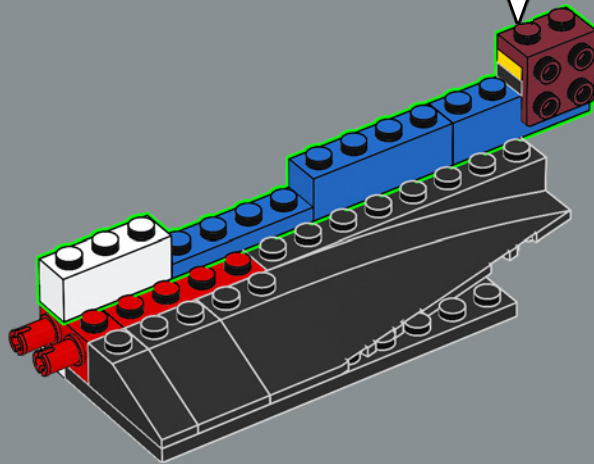
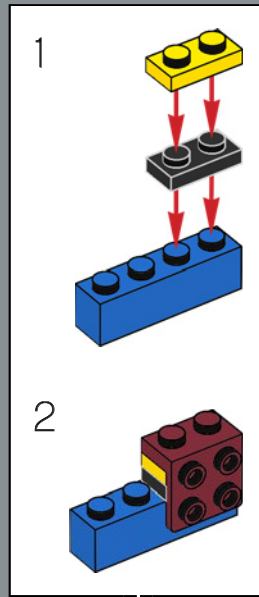

230

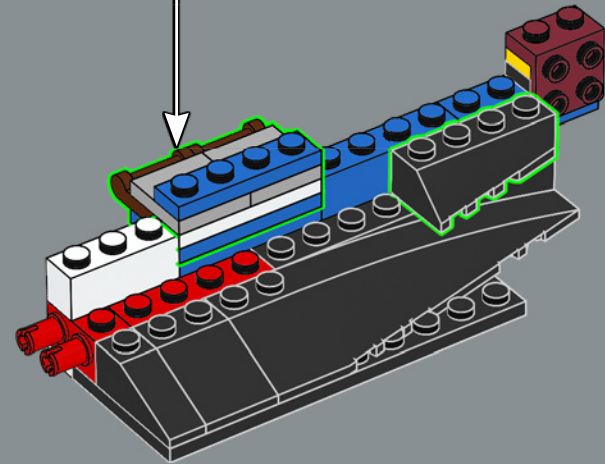
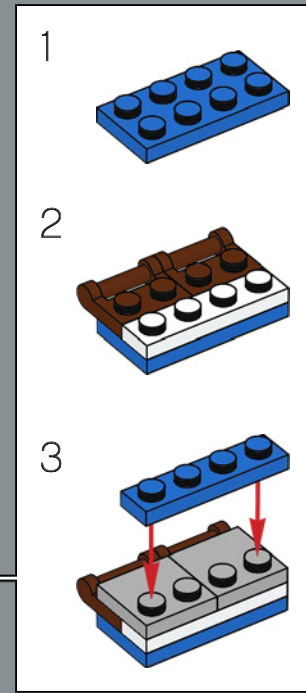

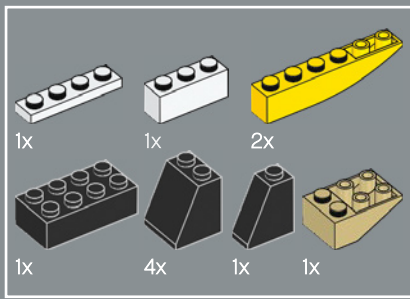

231

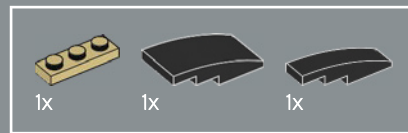
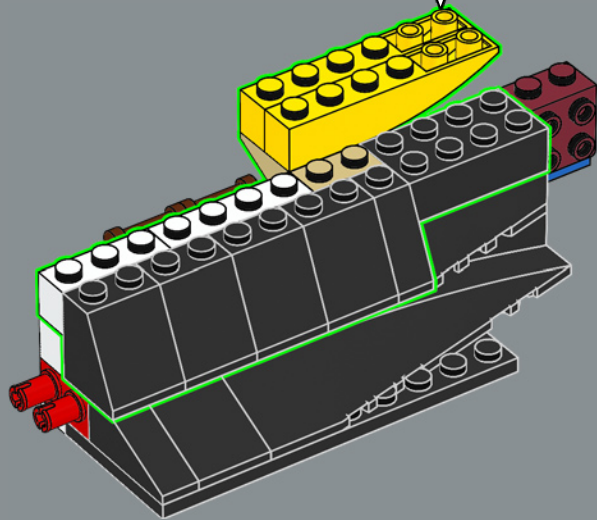
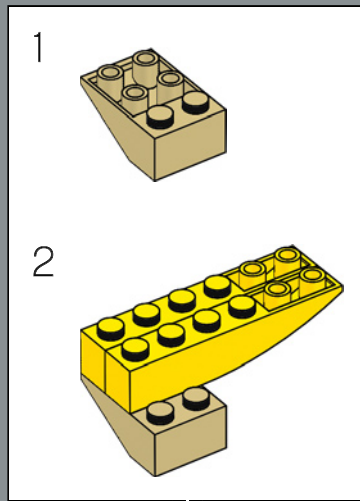

232

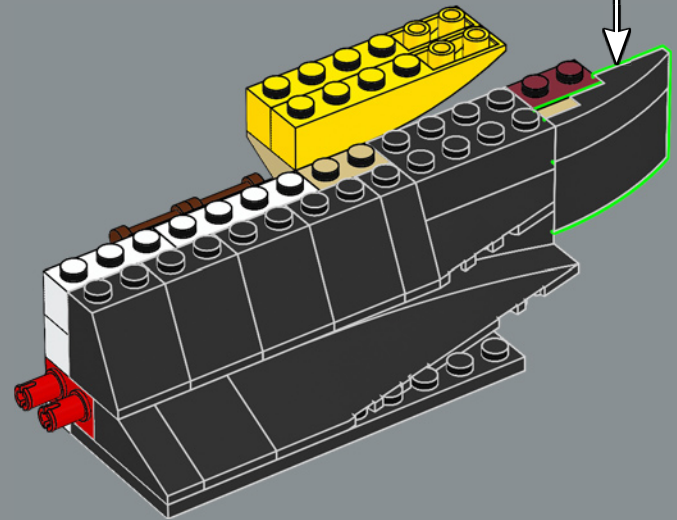
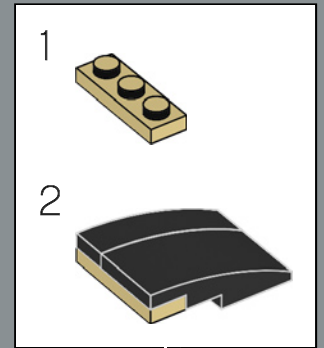



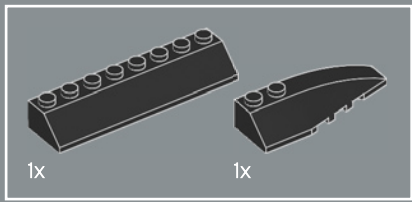

233

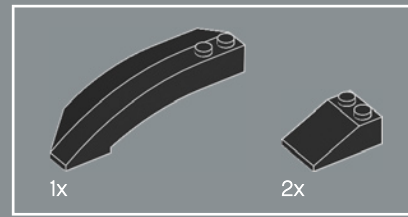
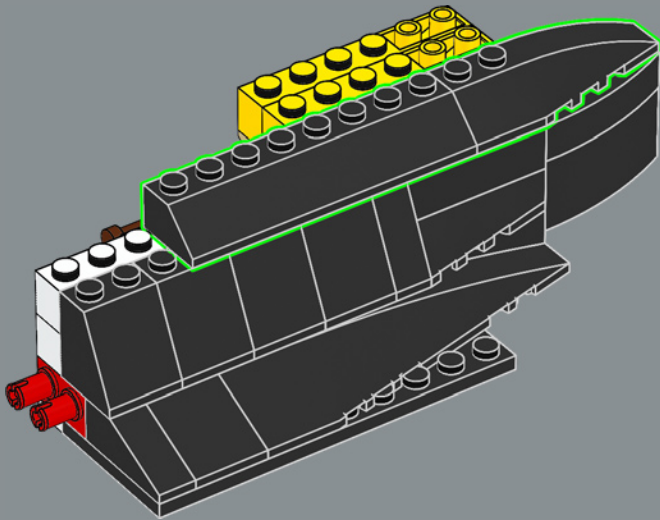

234

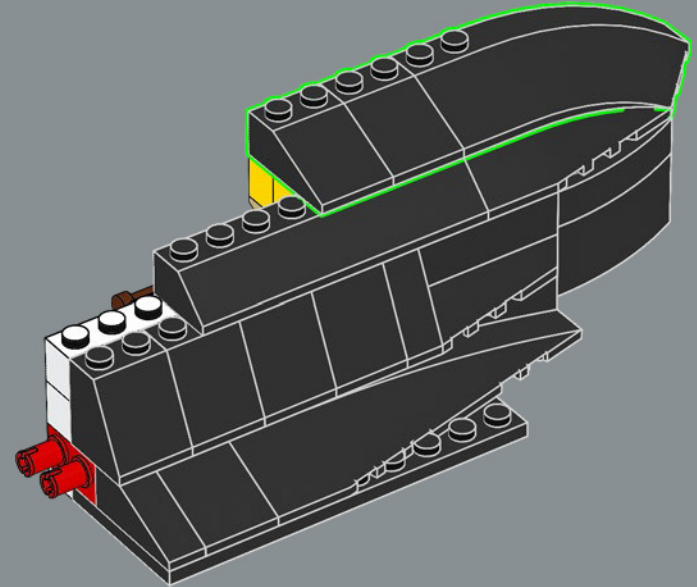

235

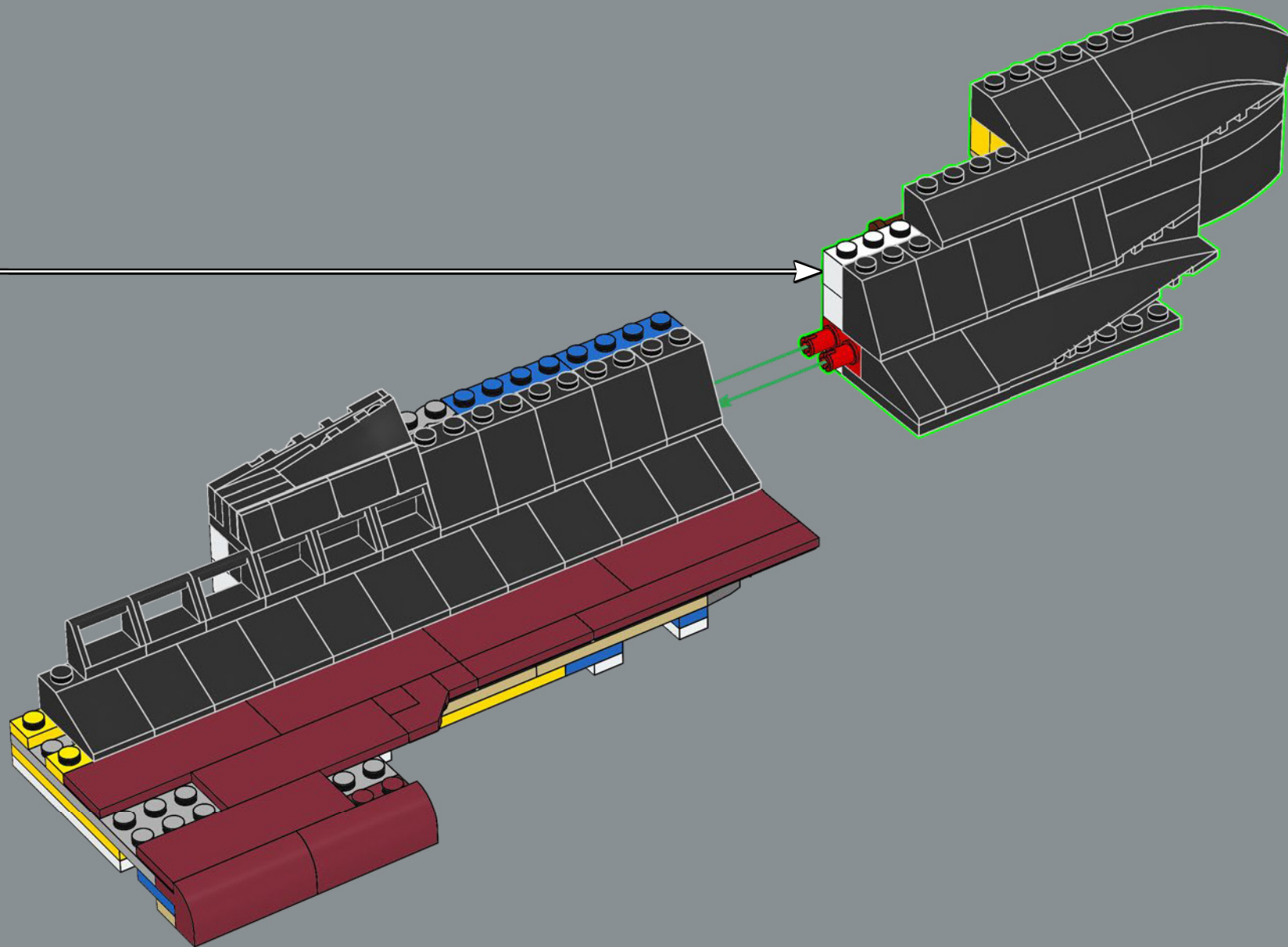

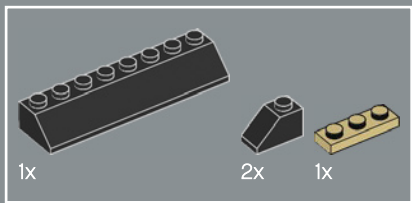

236

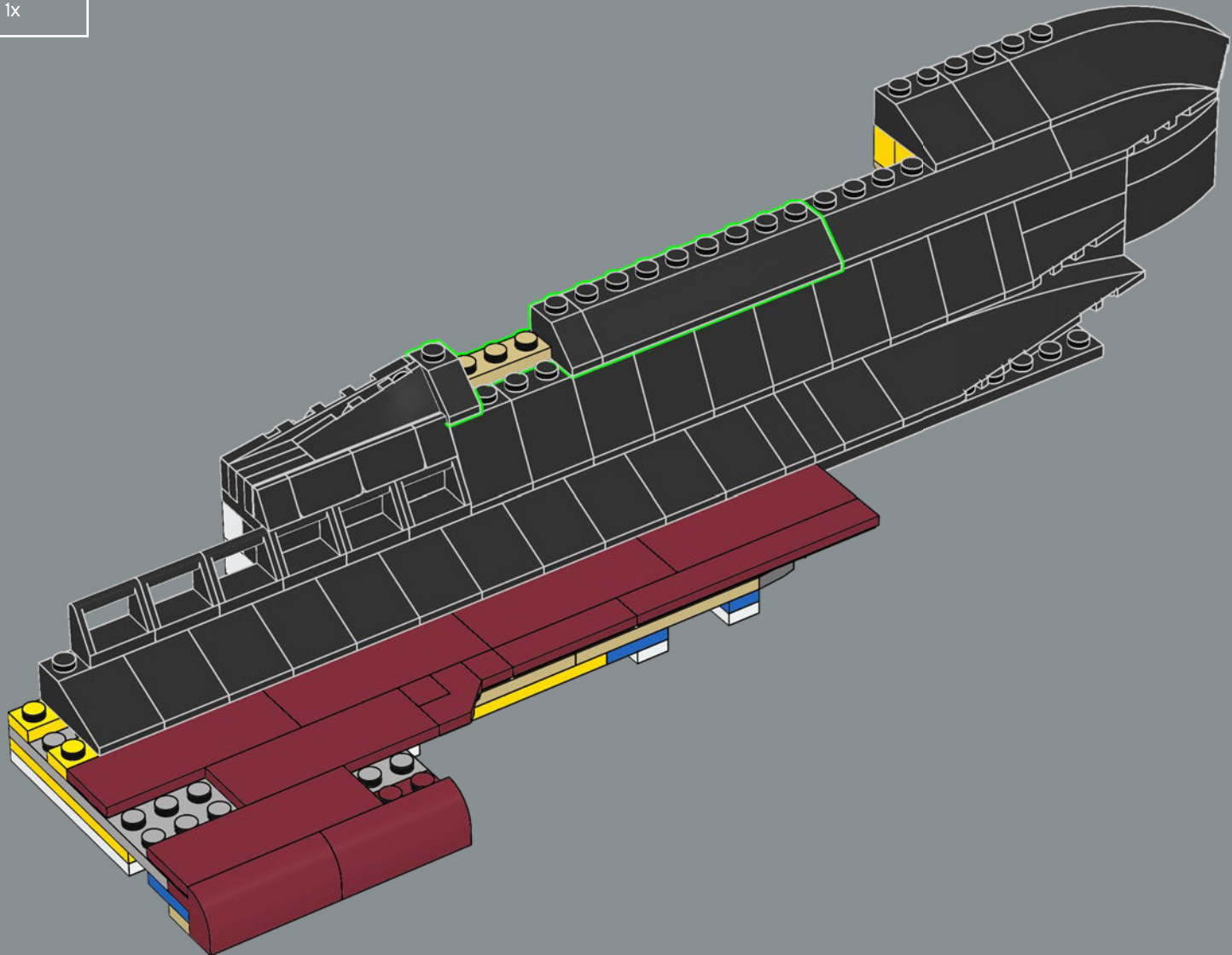



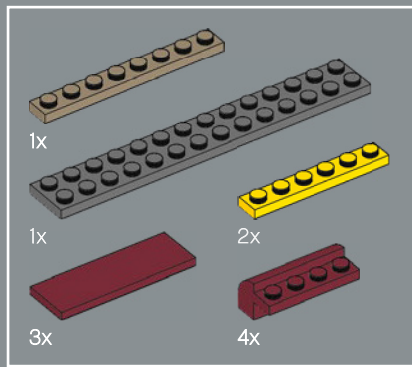

237

1

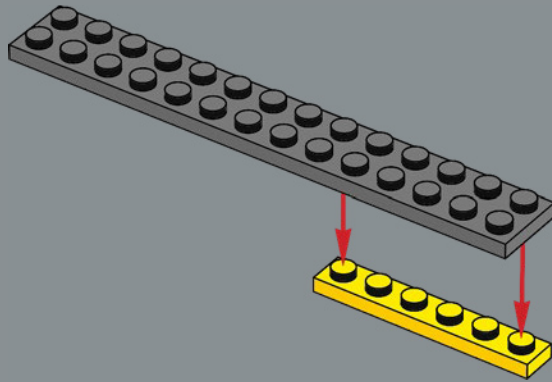

2

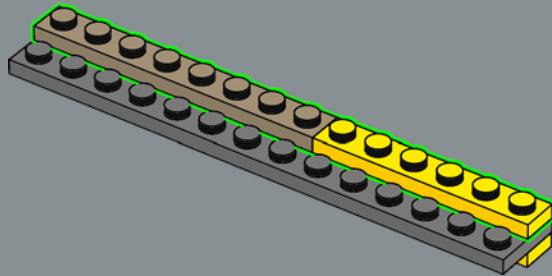

3

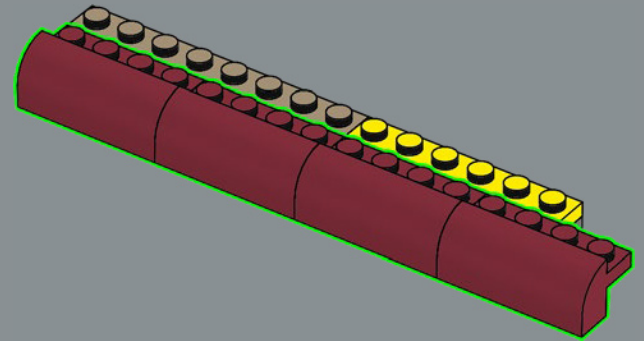

4

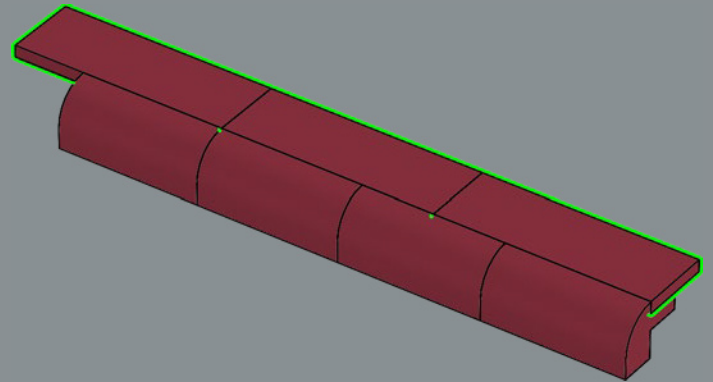

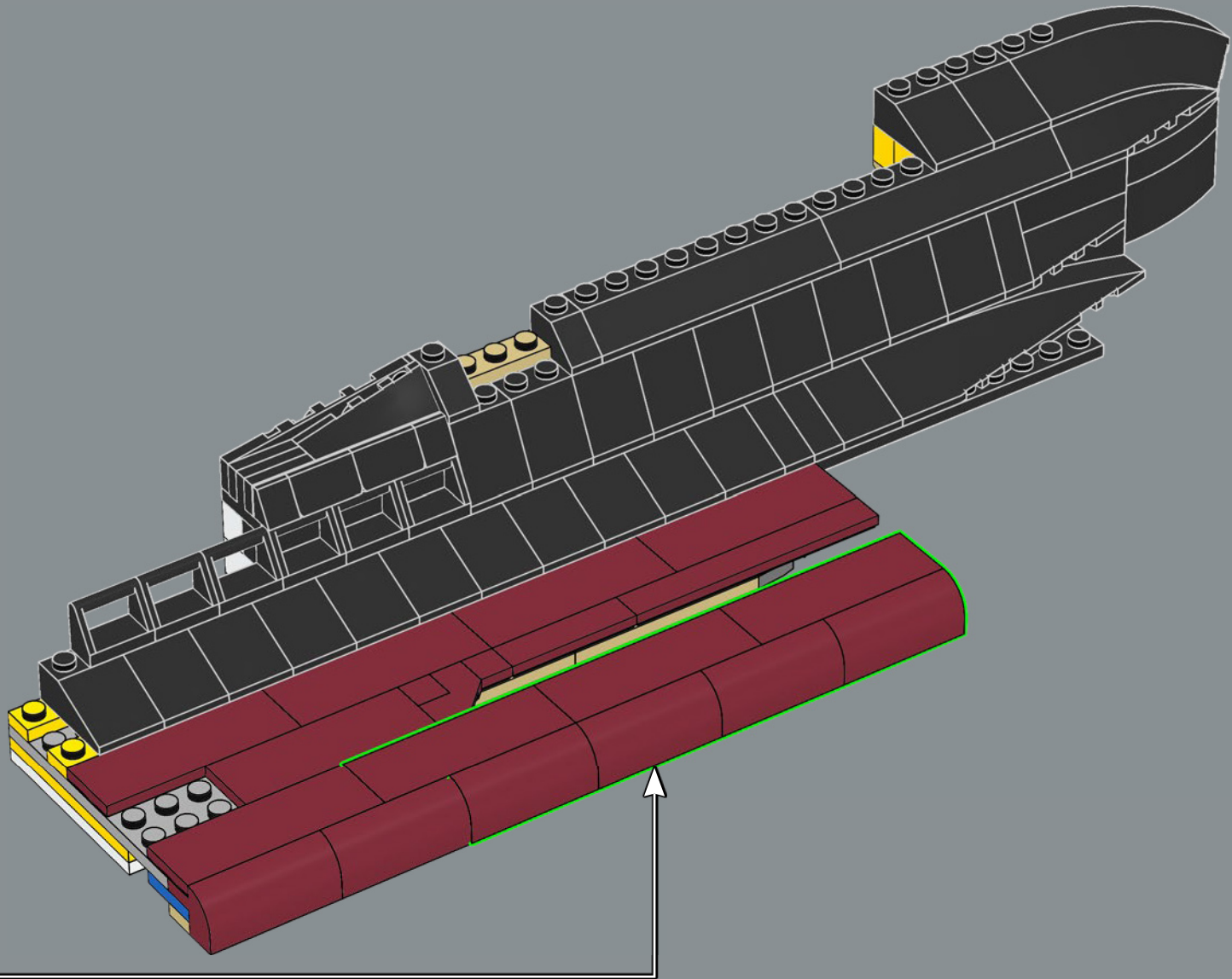

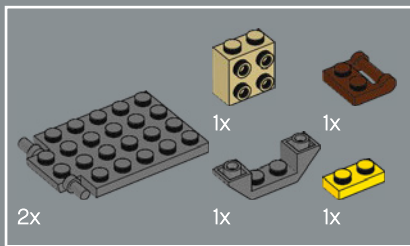

238

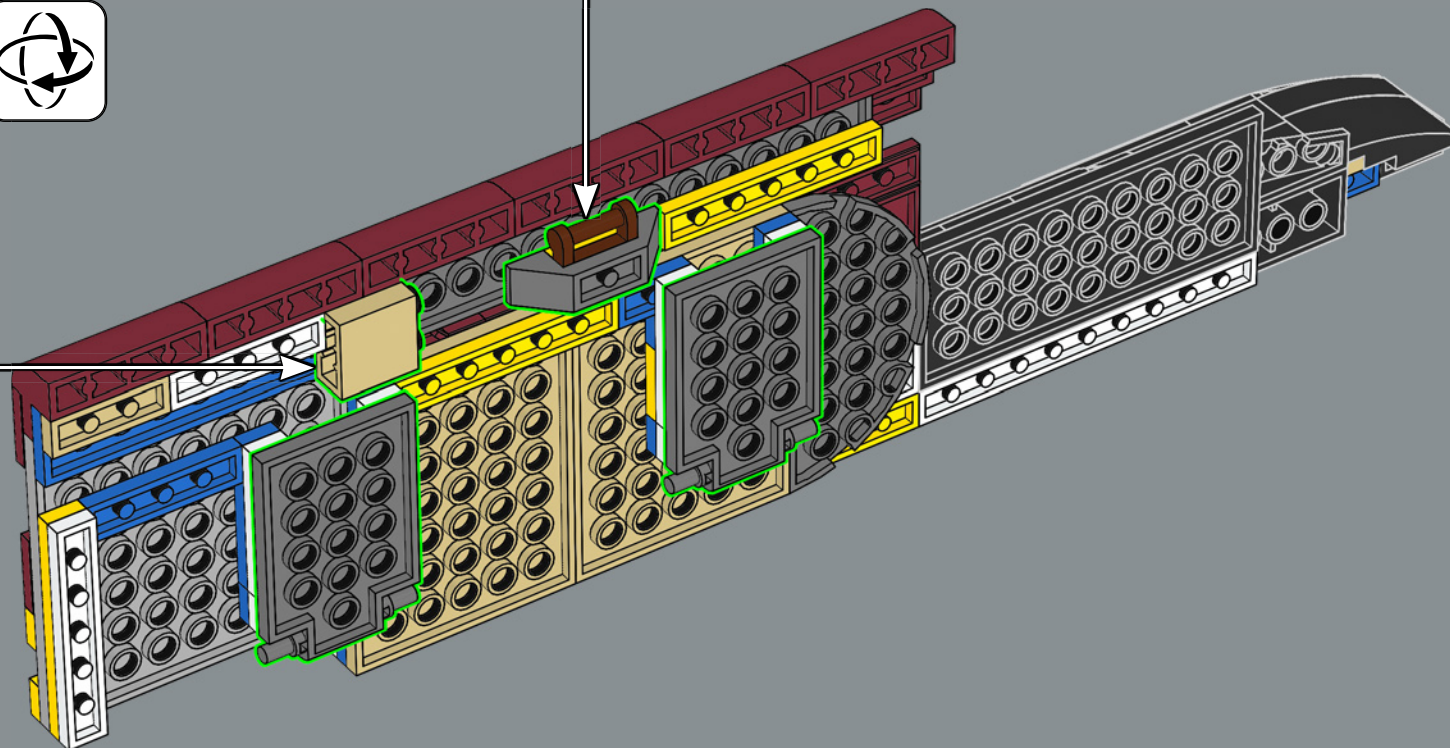
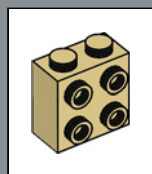
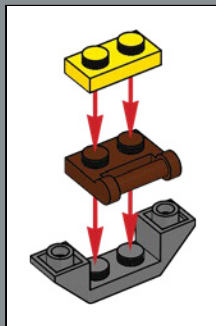



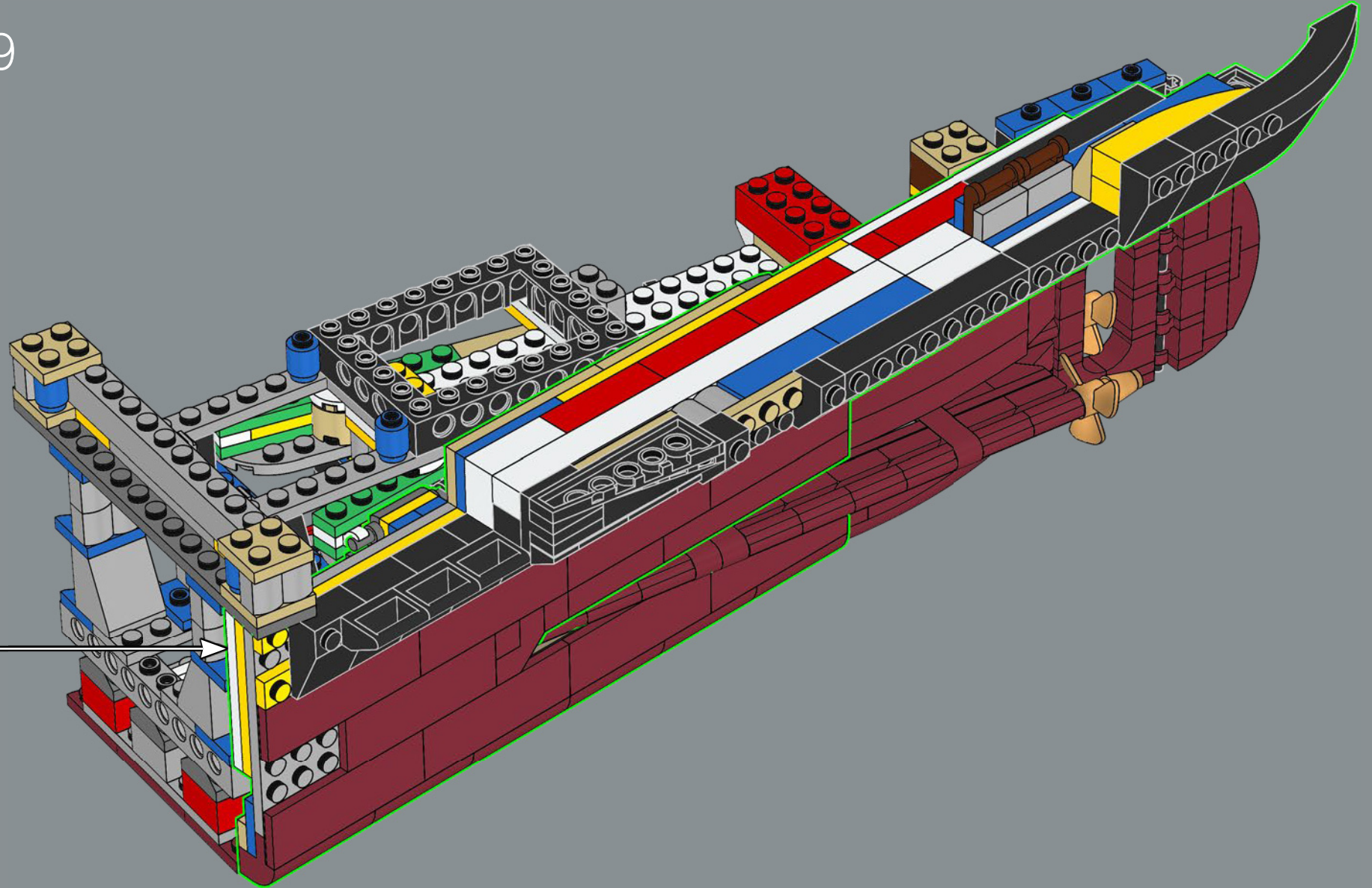

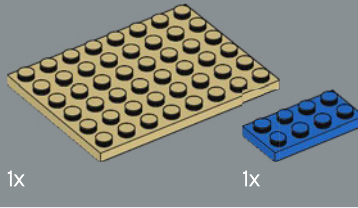
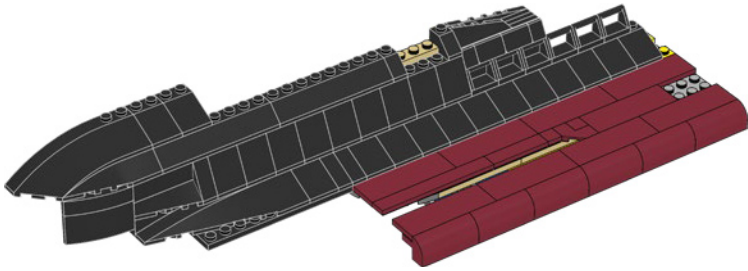
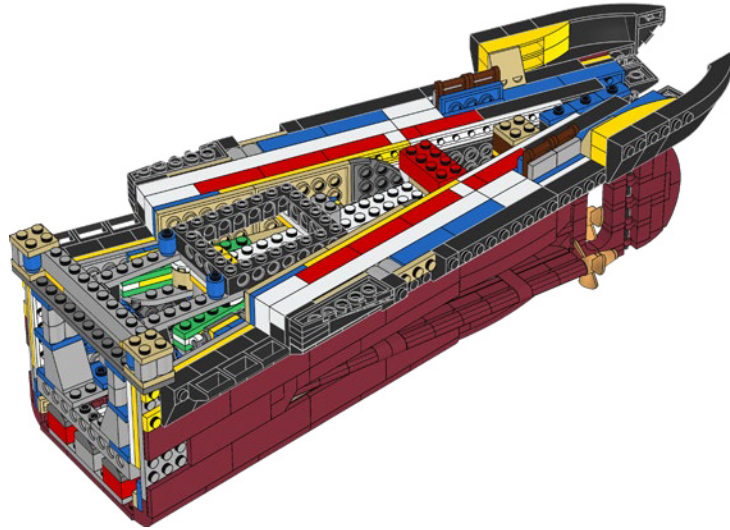
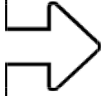

240

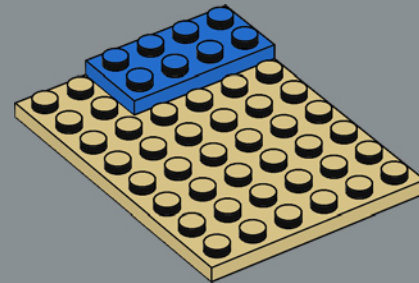

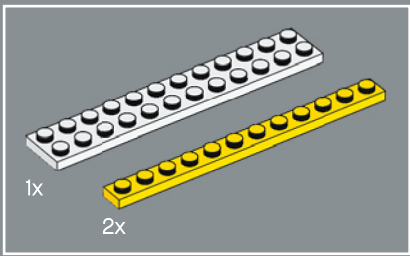

241

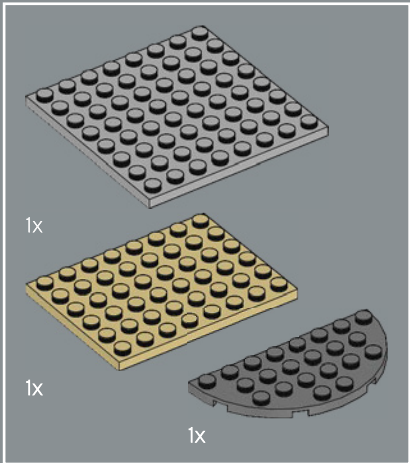
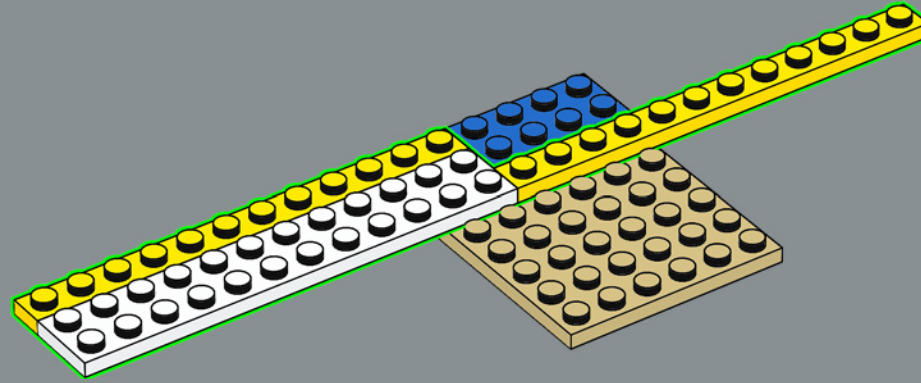

242

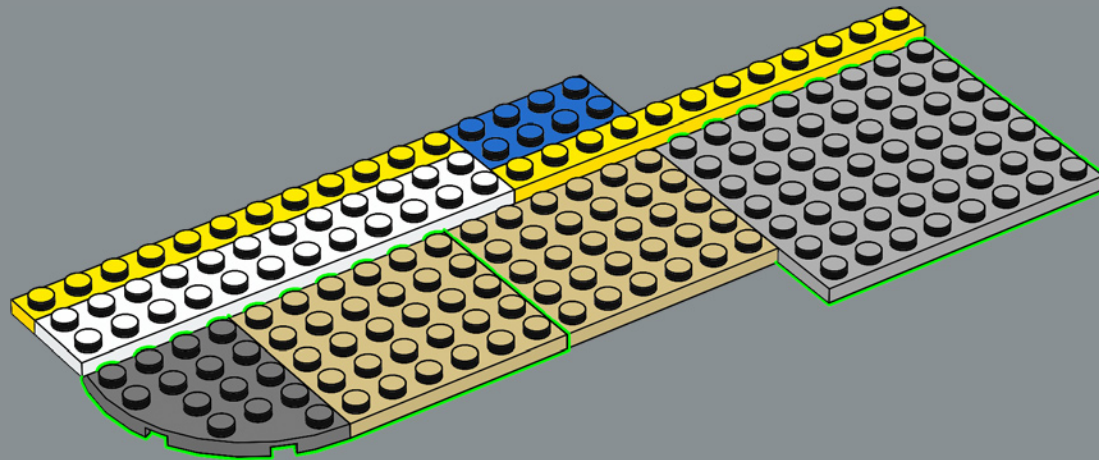



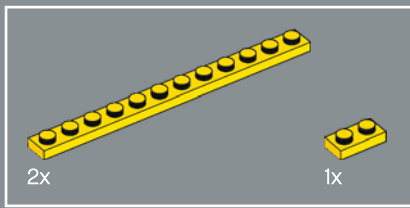

243

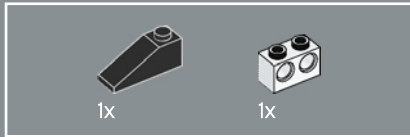
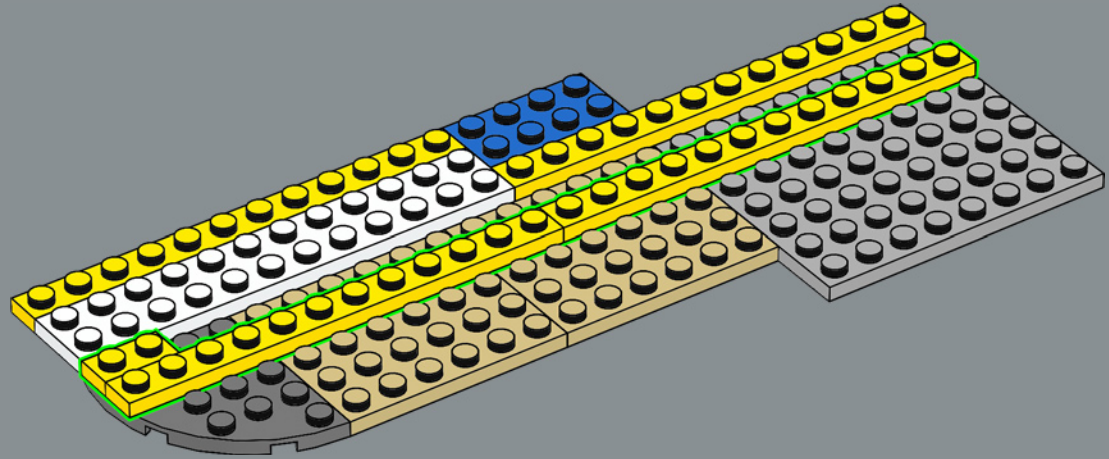

244

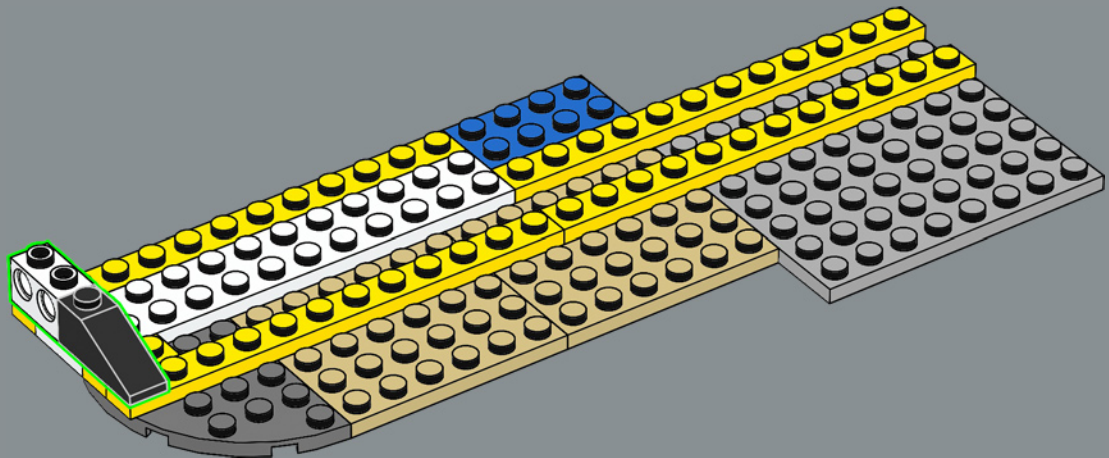

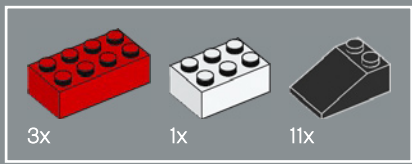

245

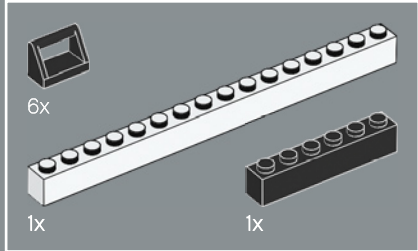
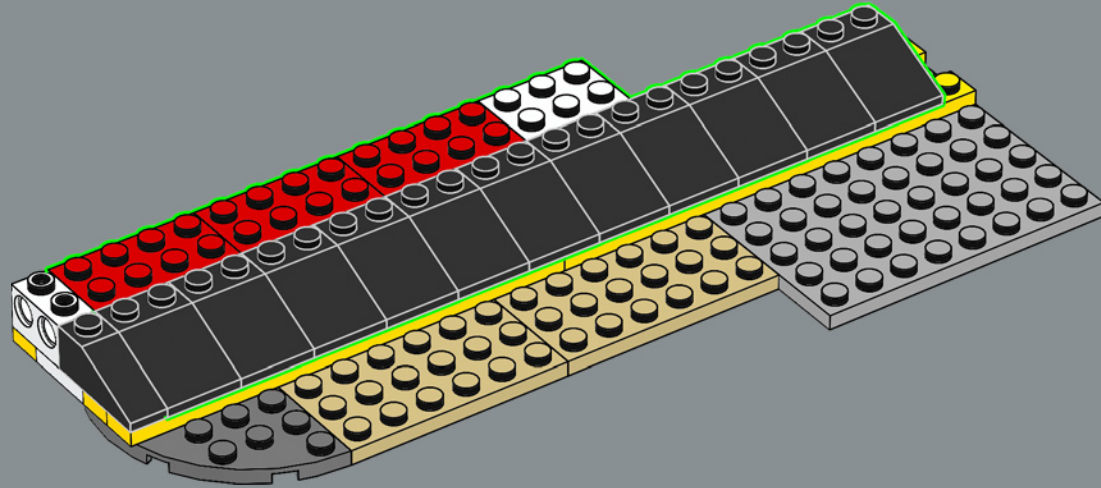

246

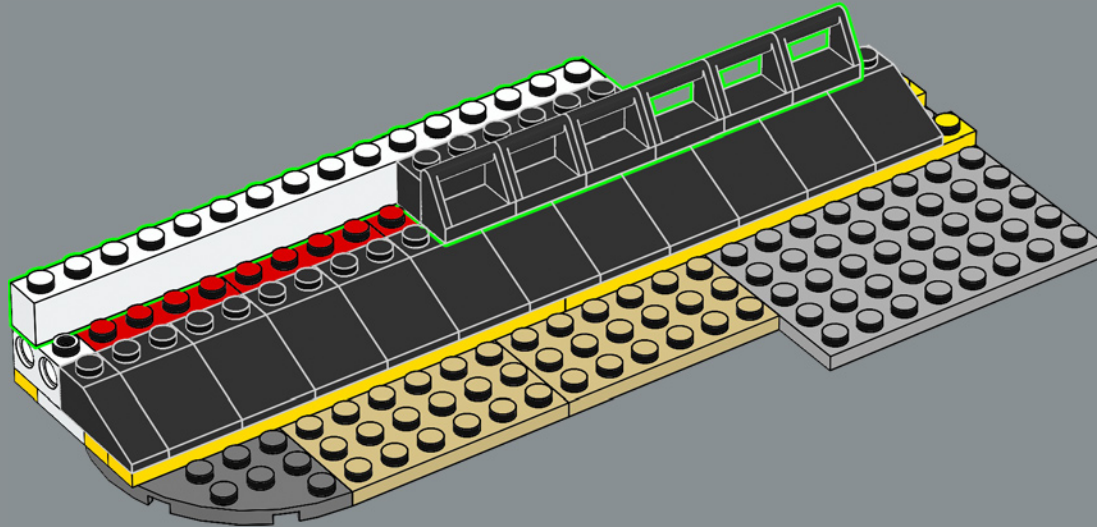

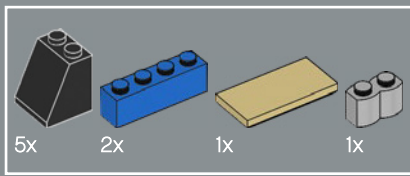

247

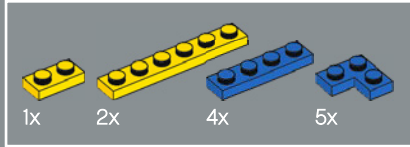
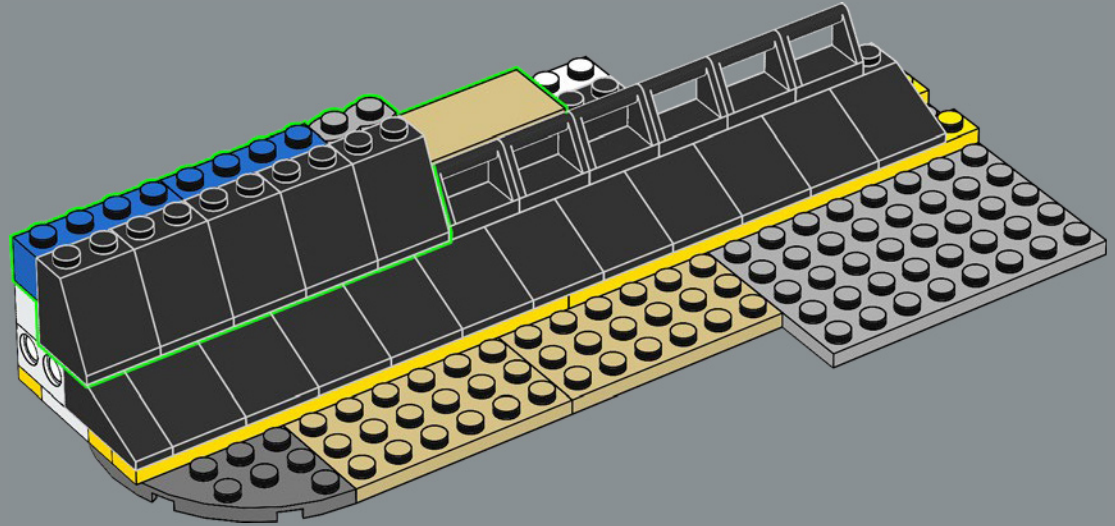

248

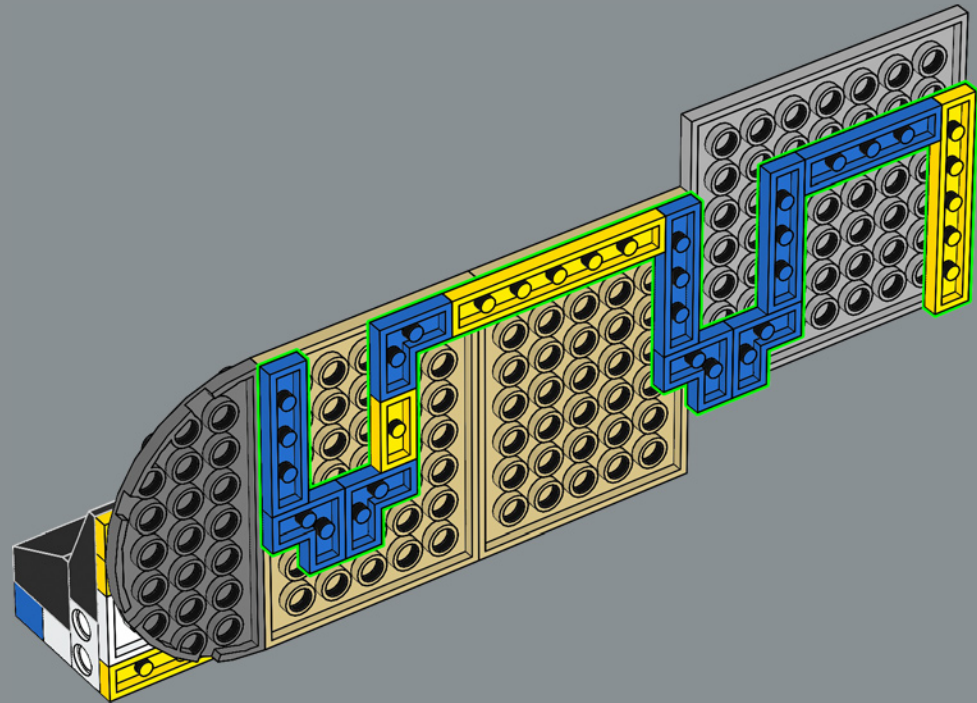



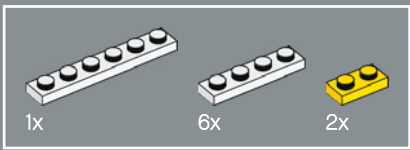

249

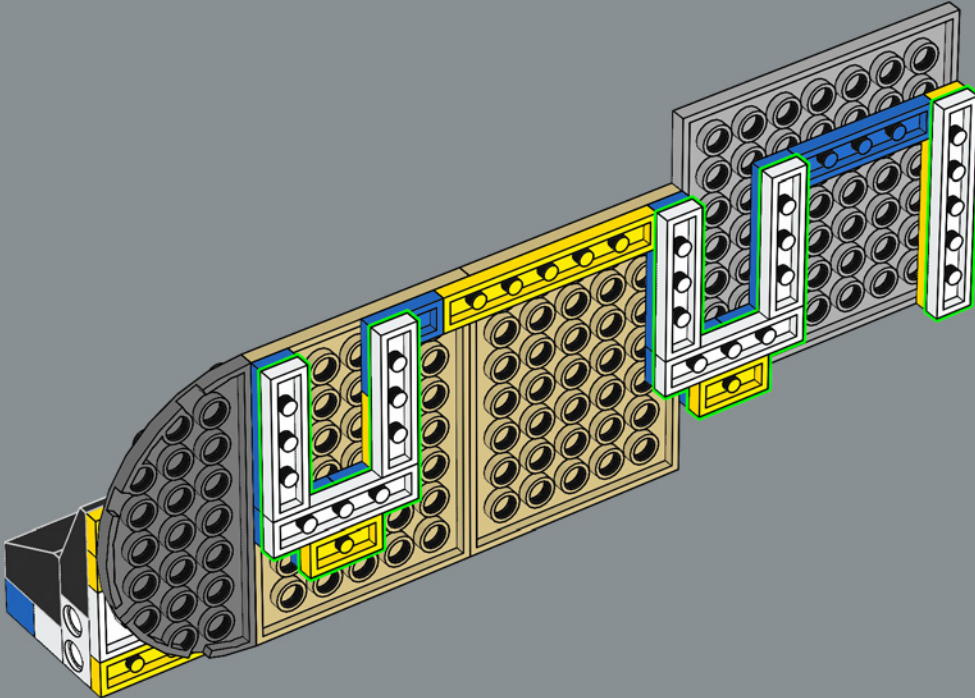

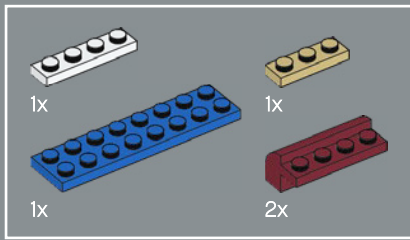

250

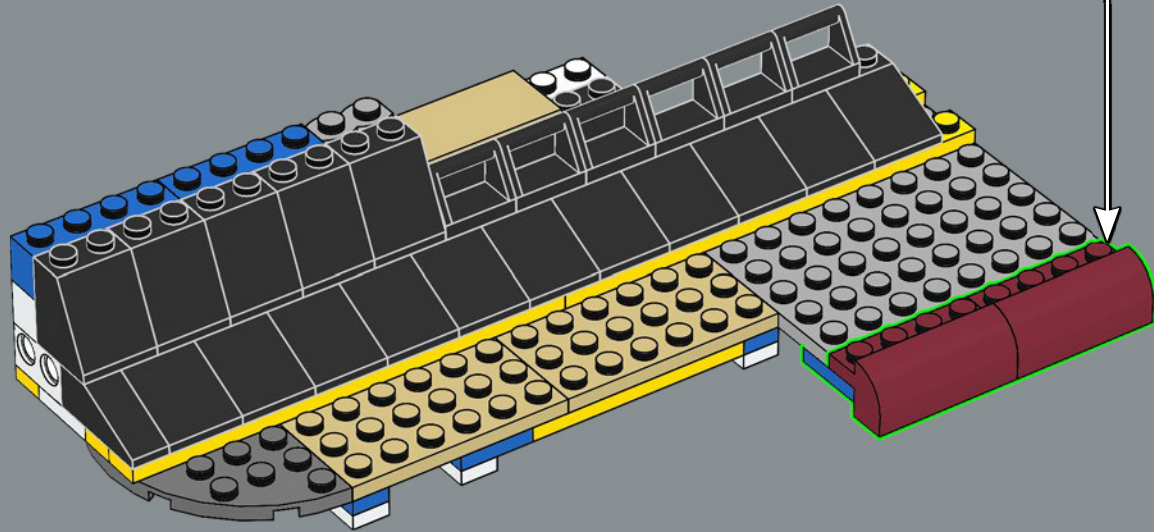
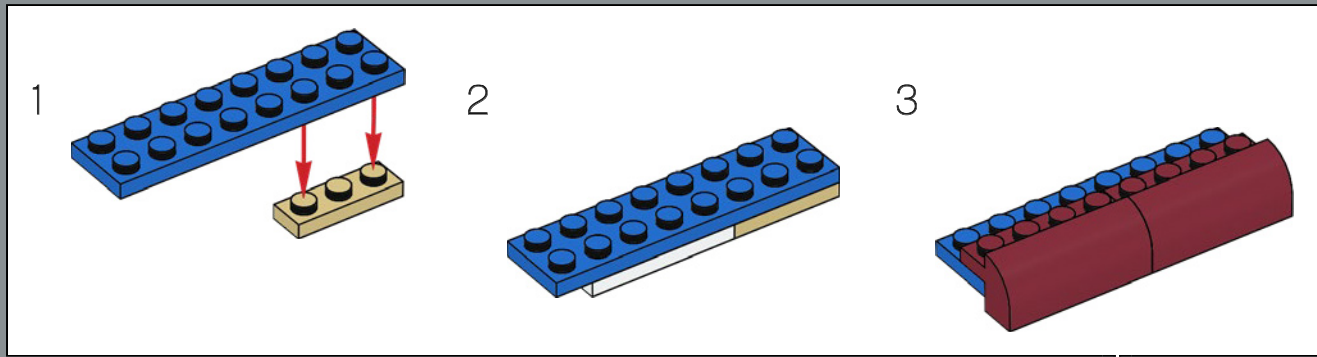

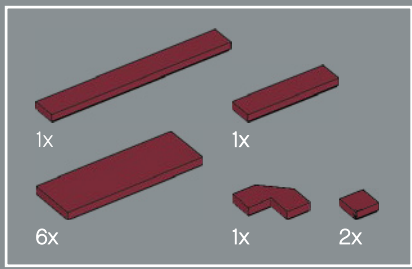

251

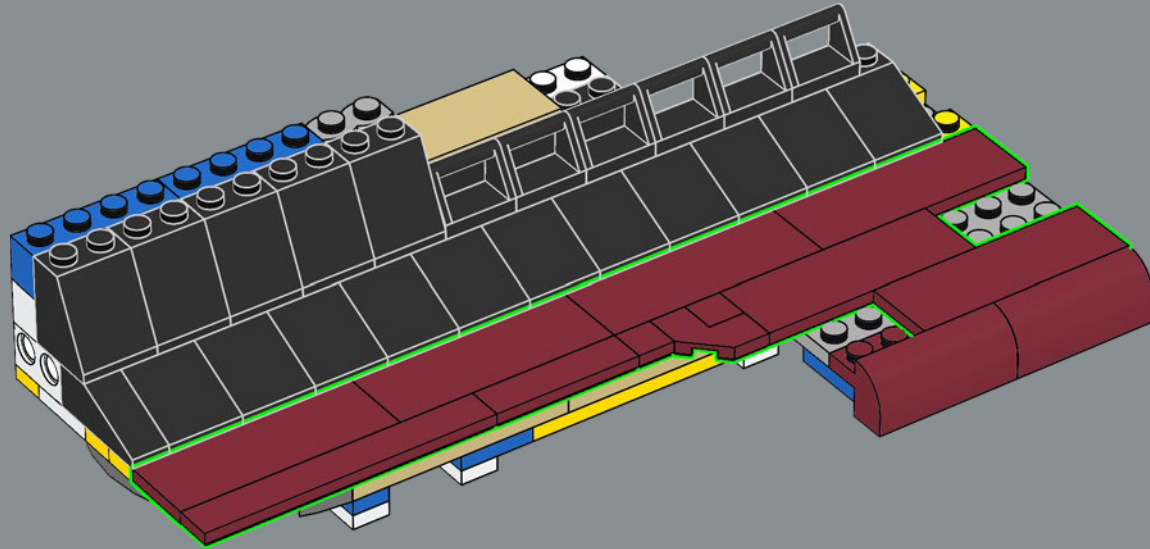



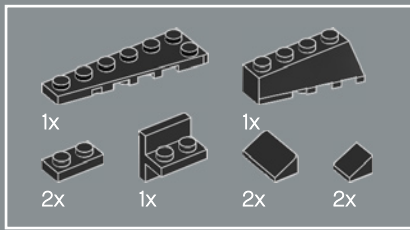

252

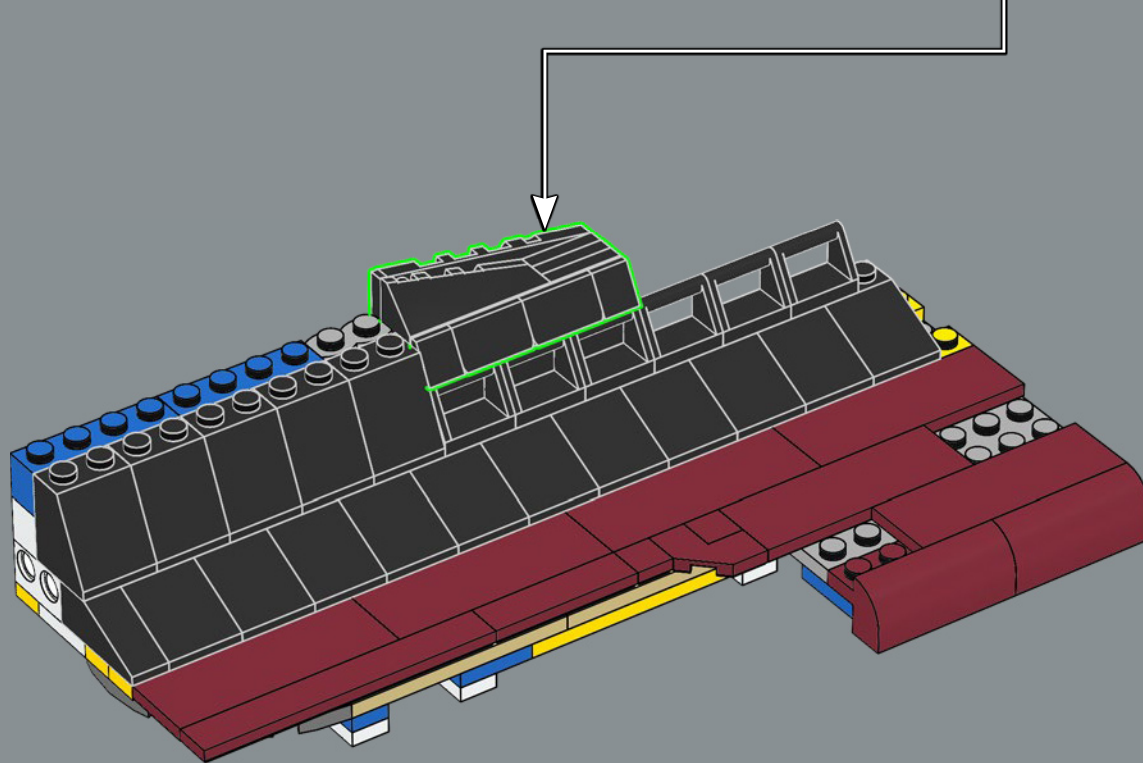
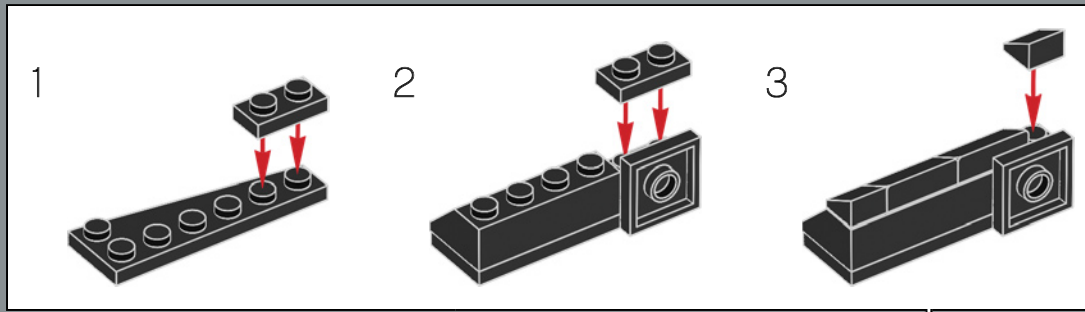

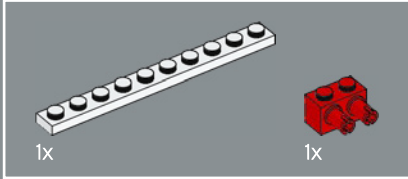
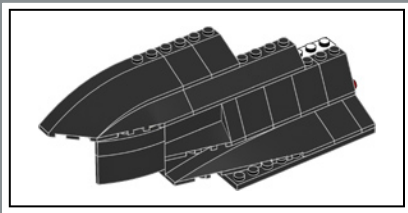

253

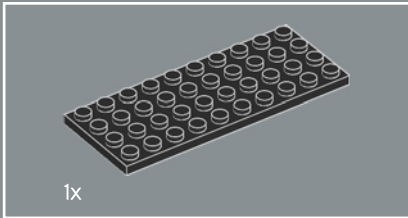
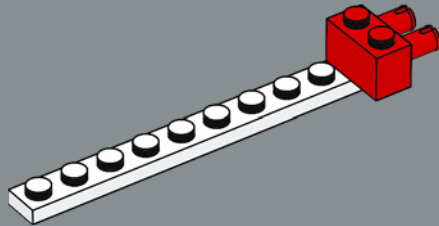

254

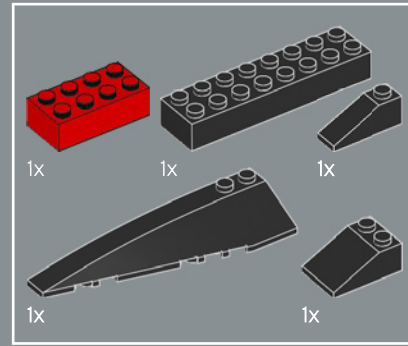
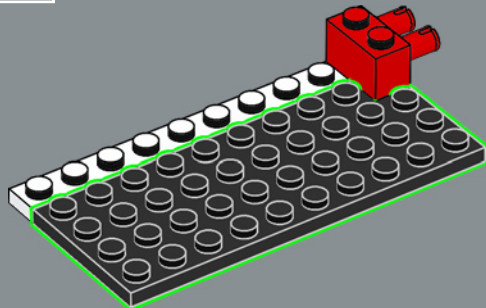

255

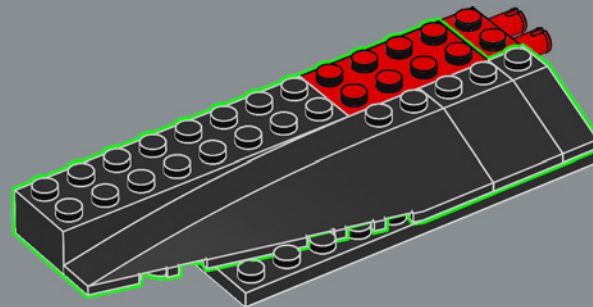

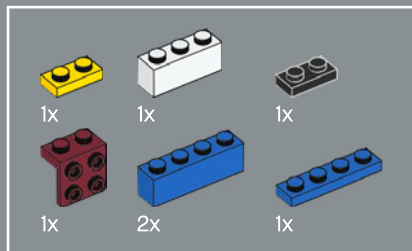

256

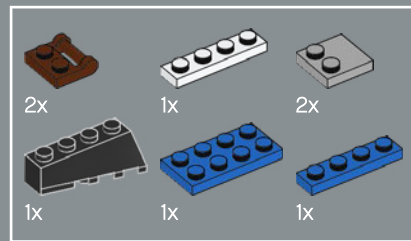
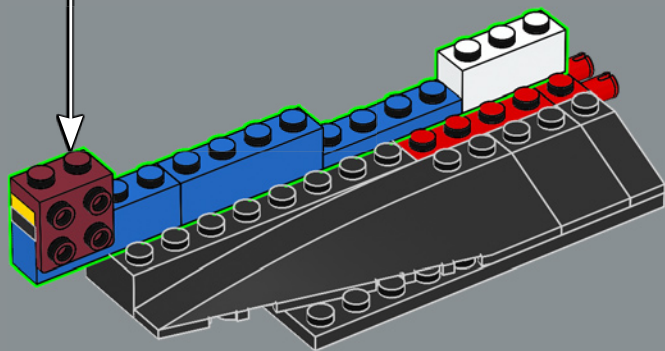
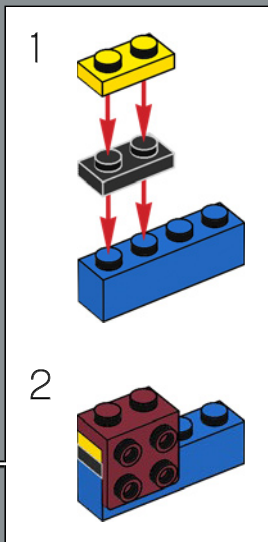

257

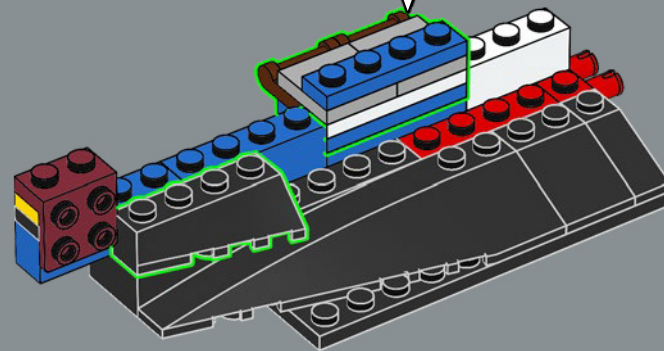
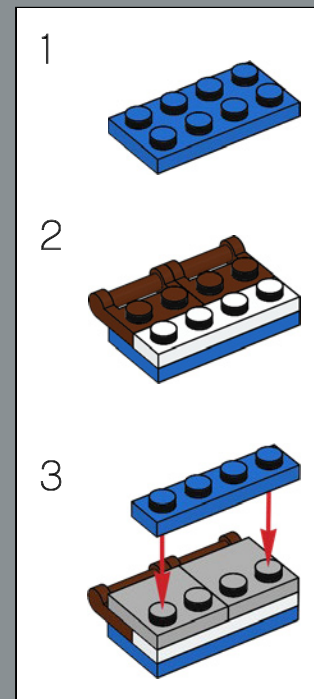



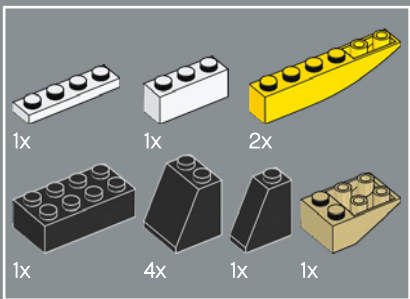

258

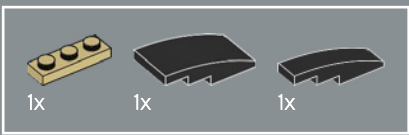
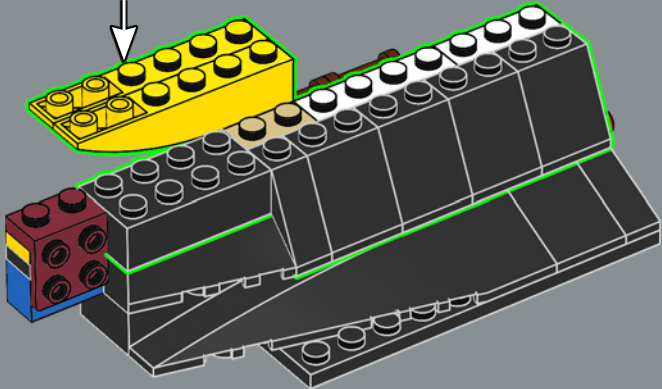
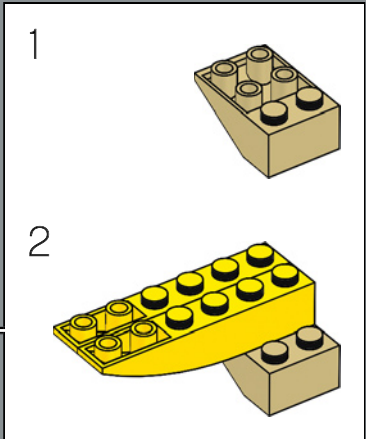

259

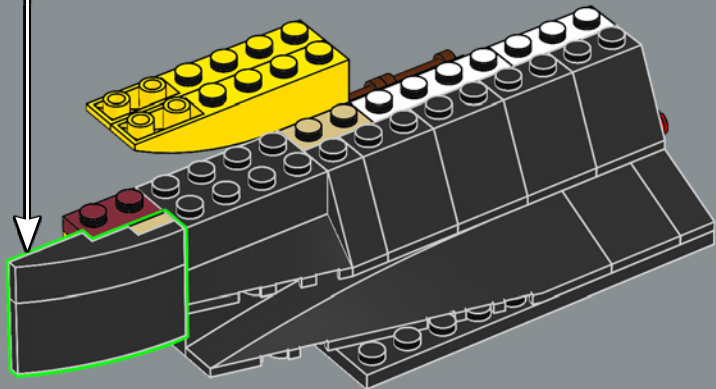
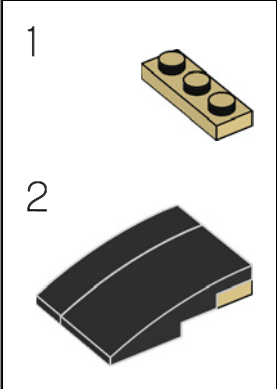

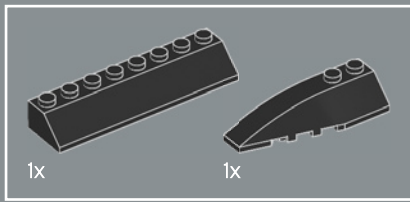

260

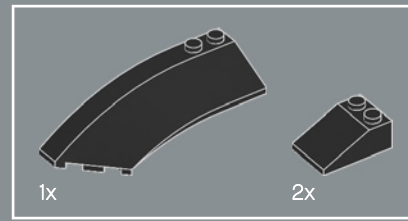
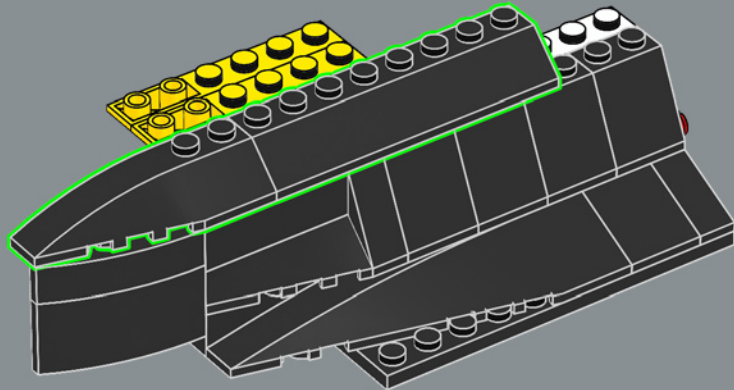

261

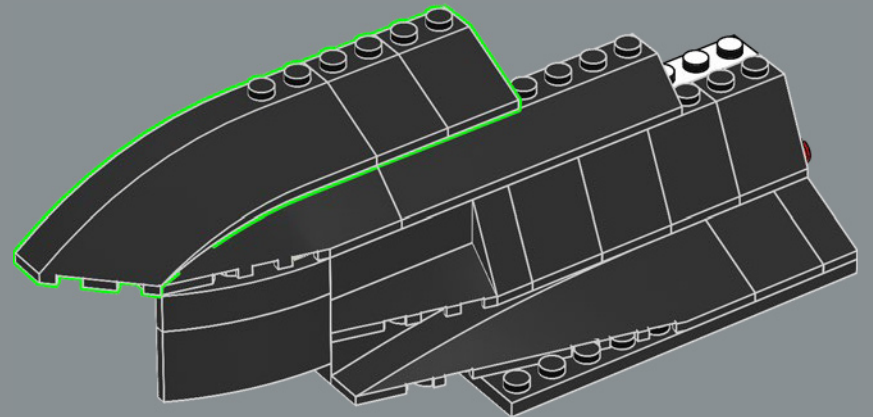

262

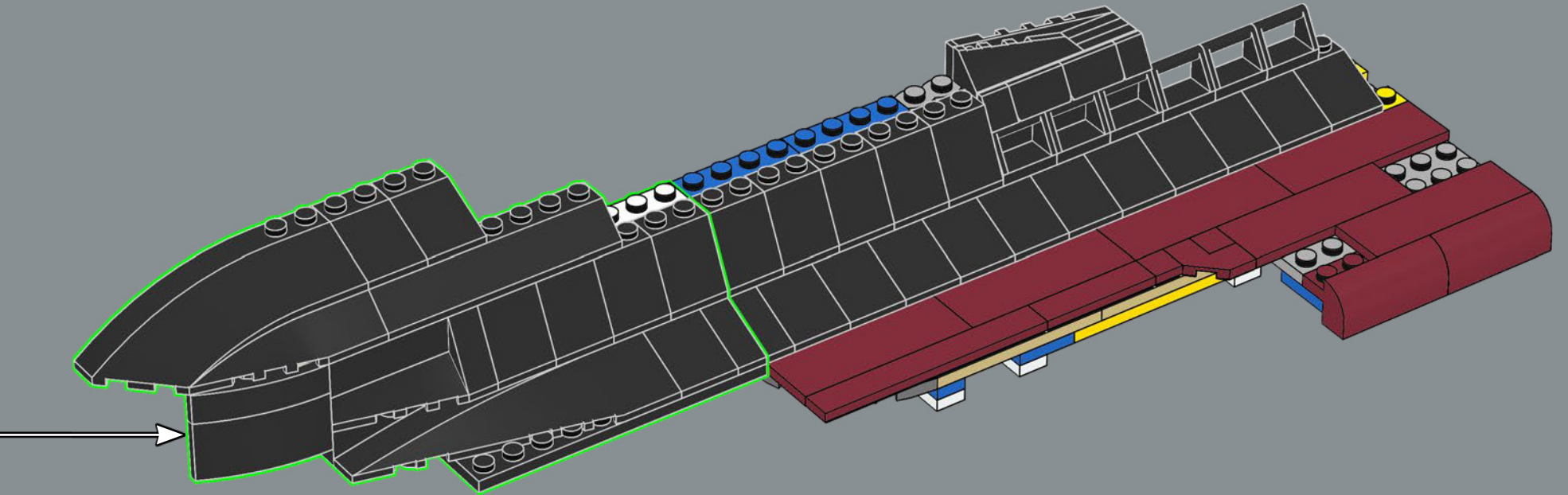



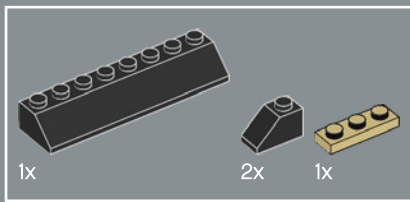

263

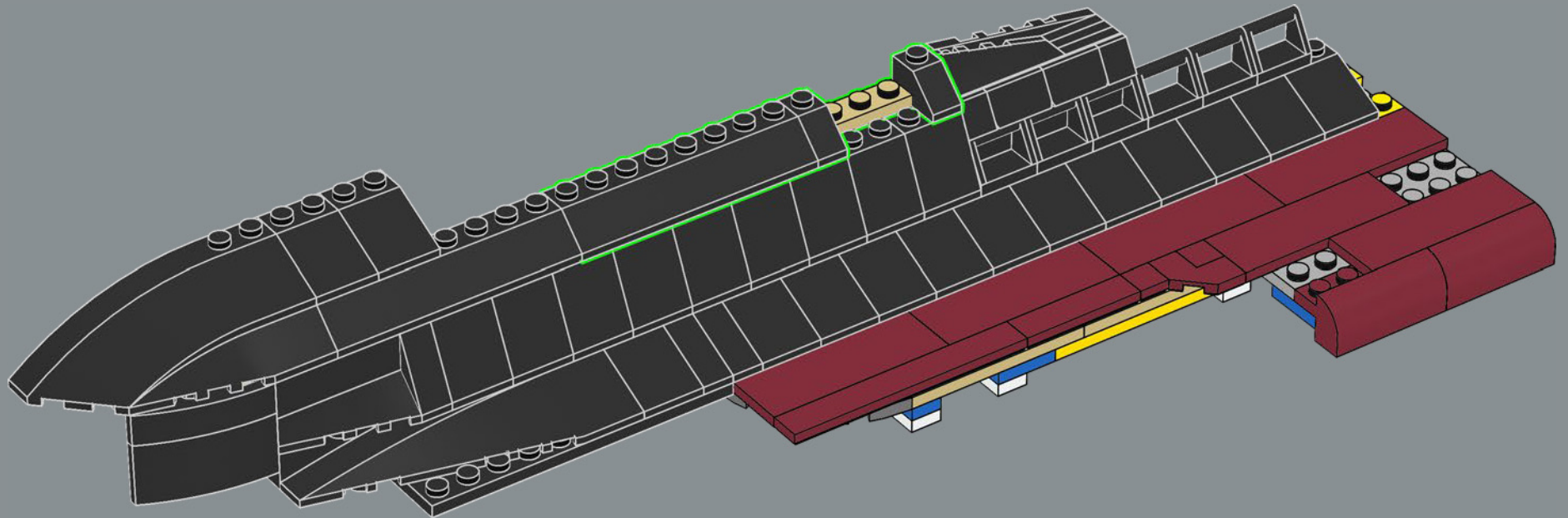

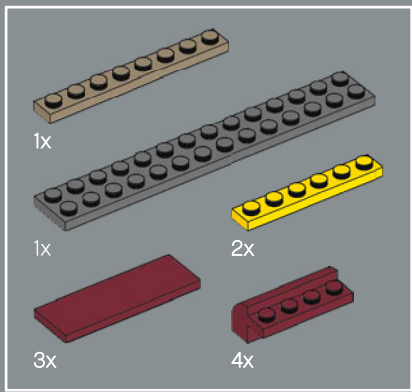

264

1

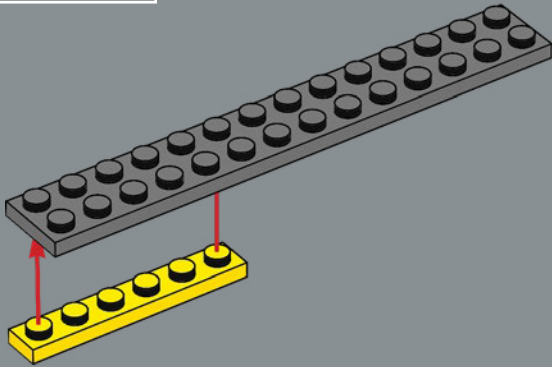

2

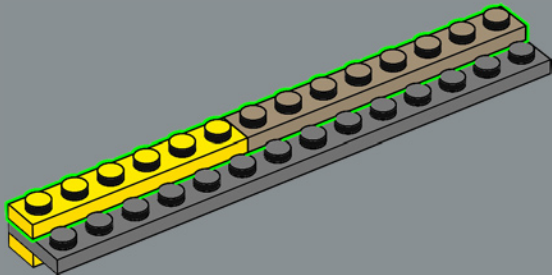

3

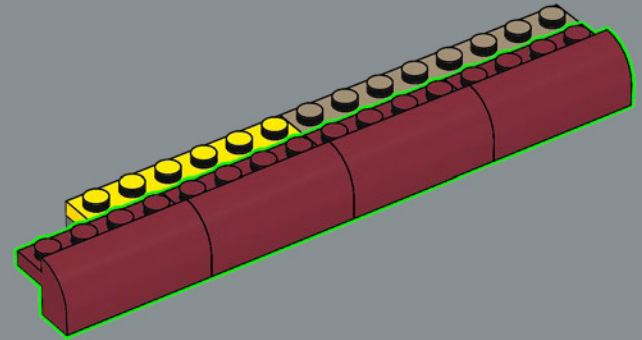

4

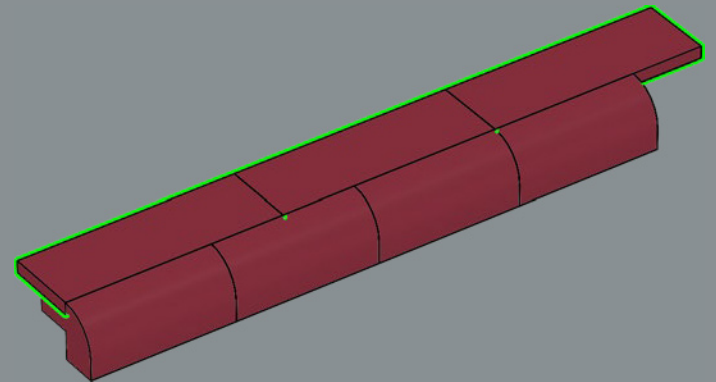

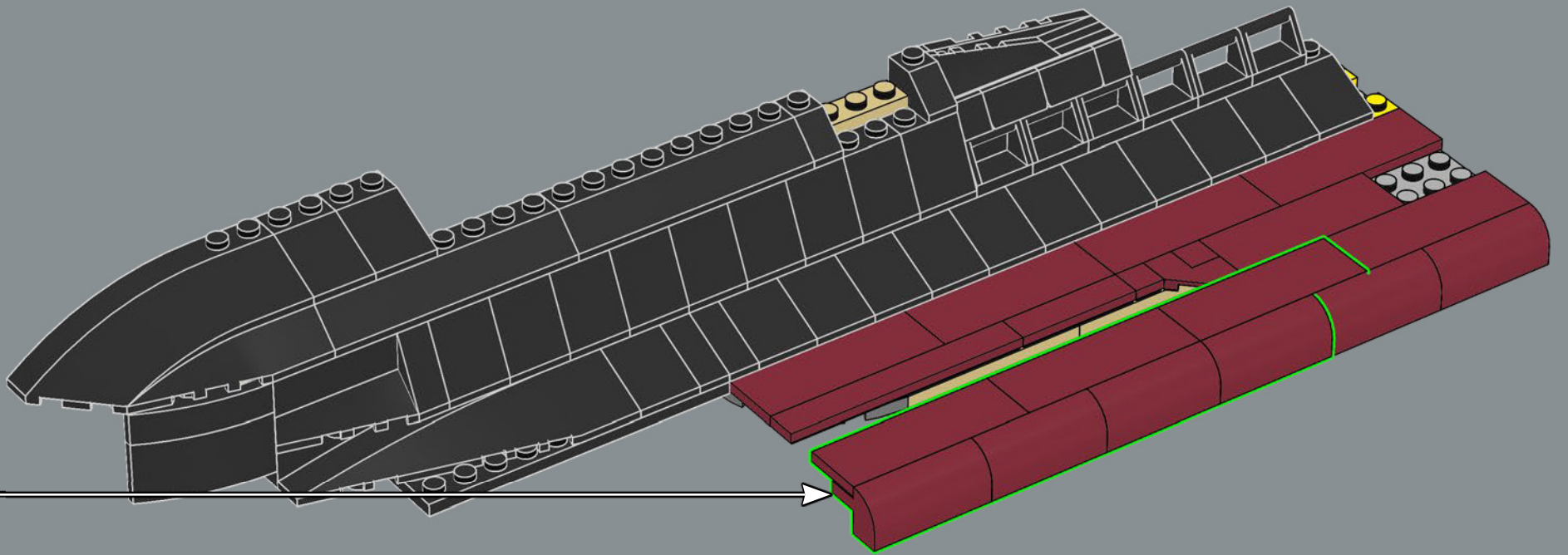



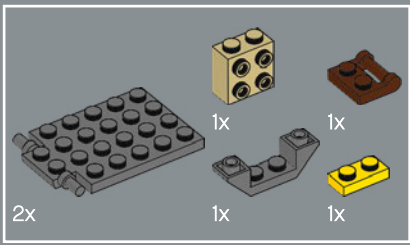

265

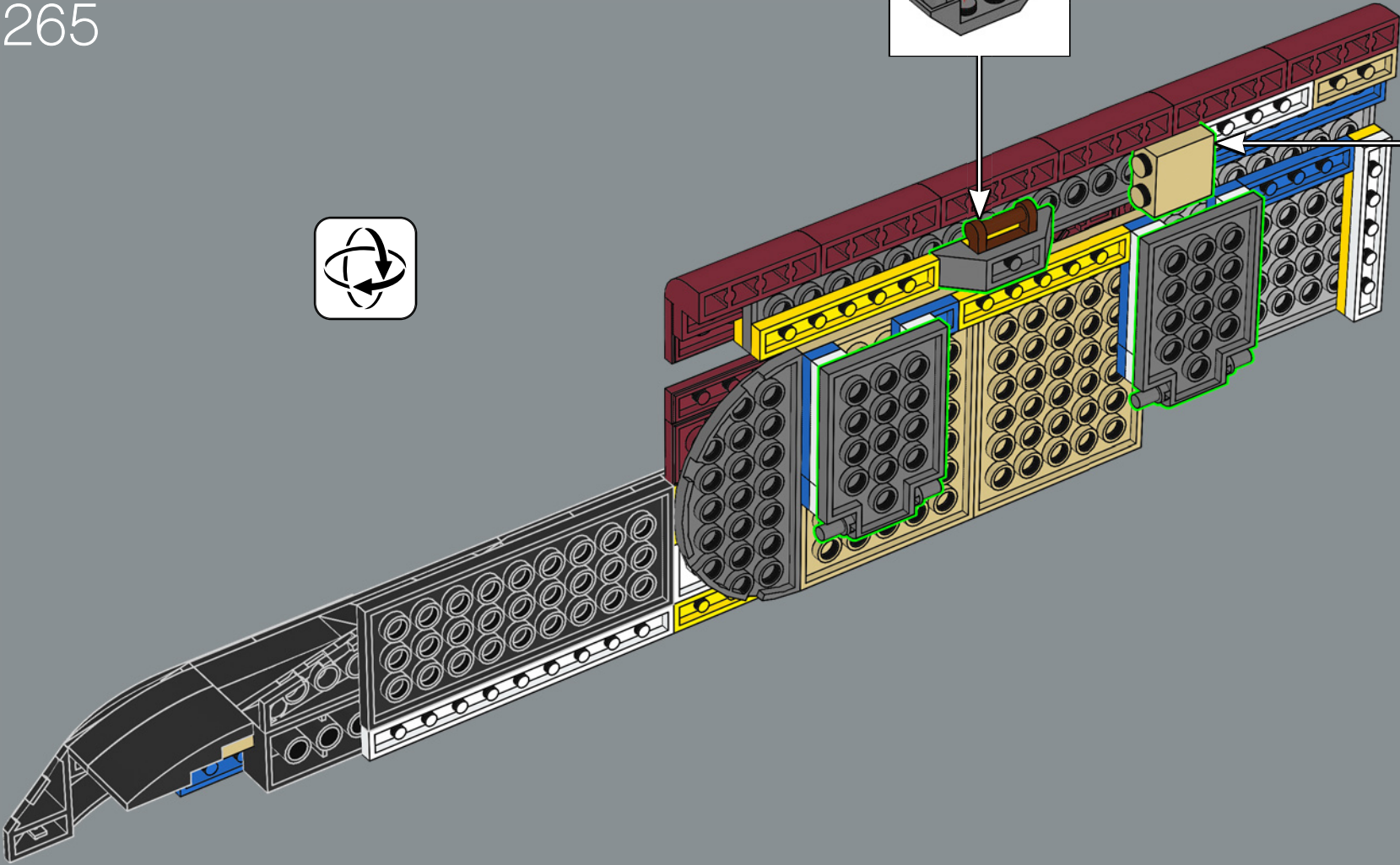
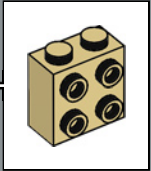
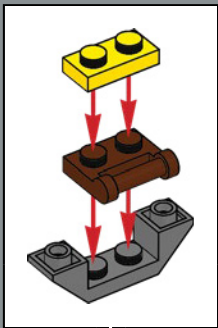

266

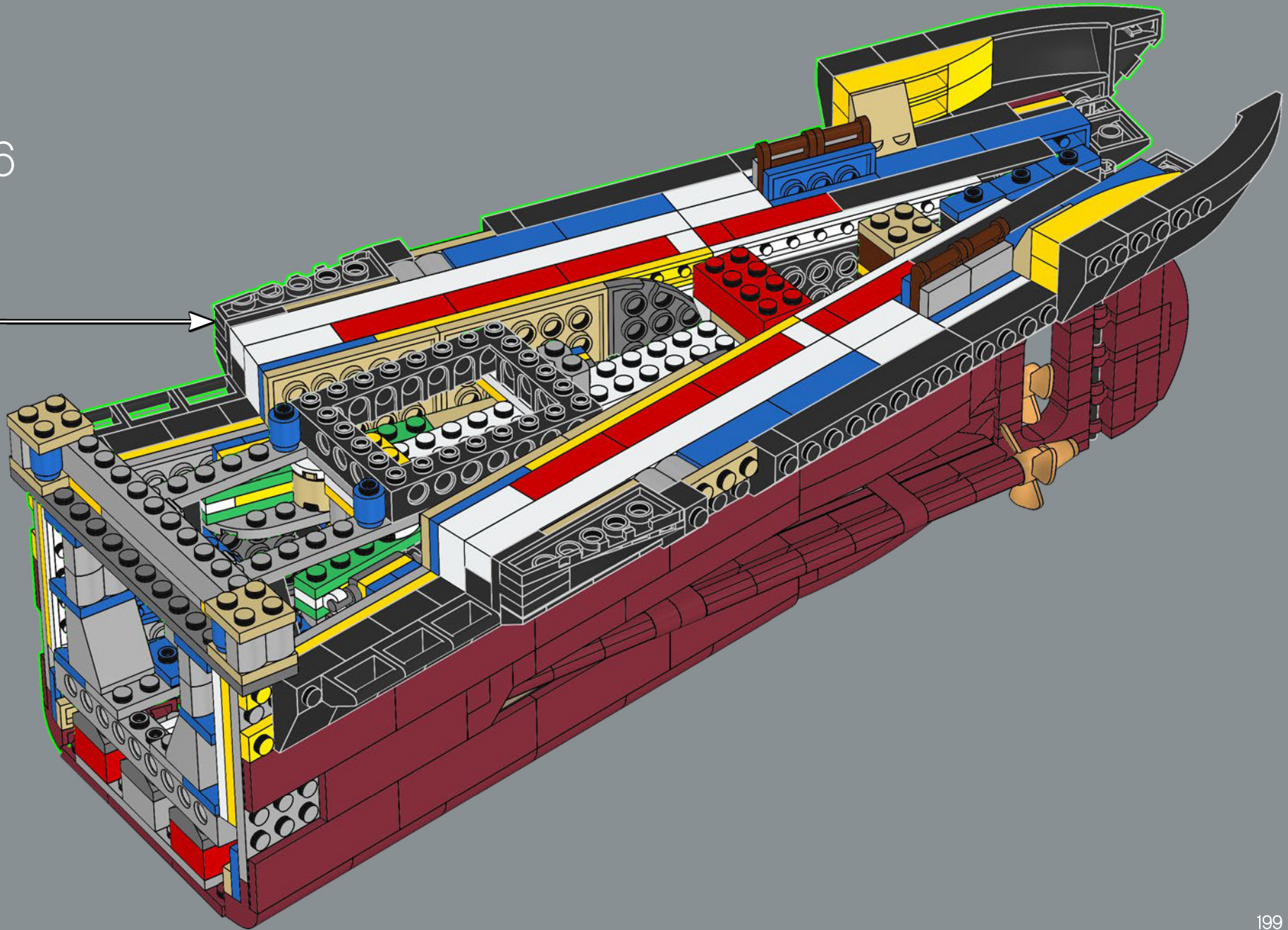

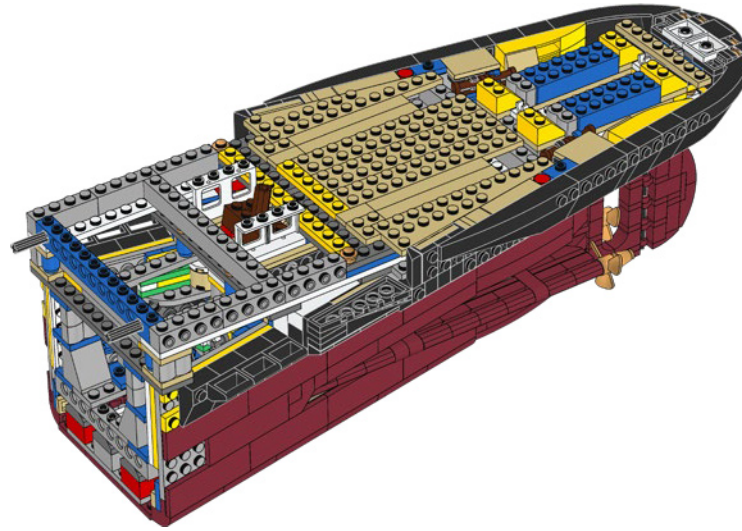
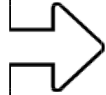



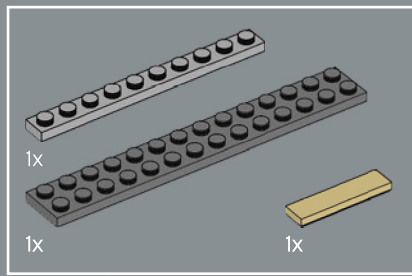

267

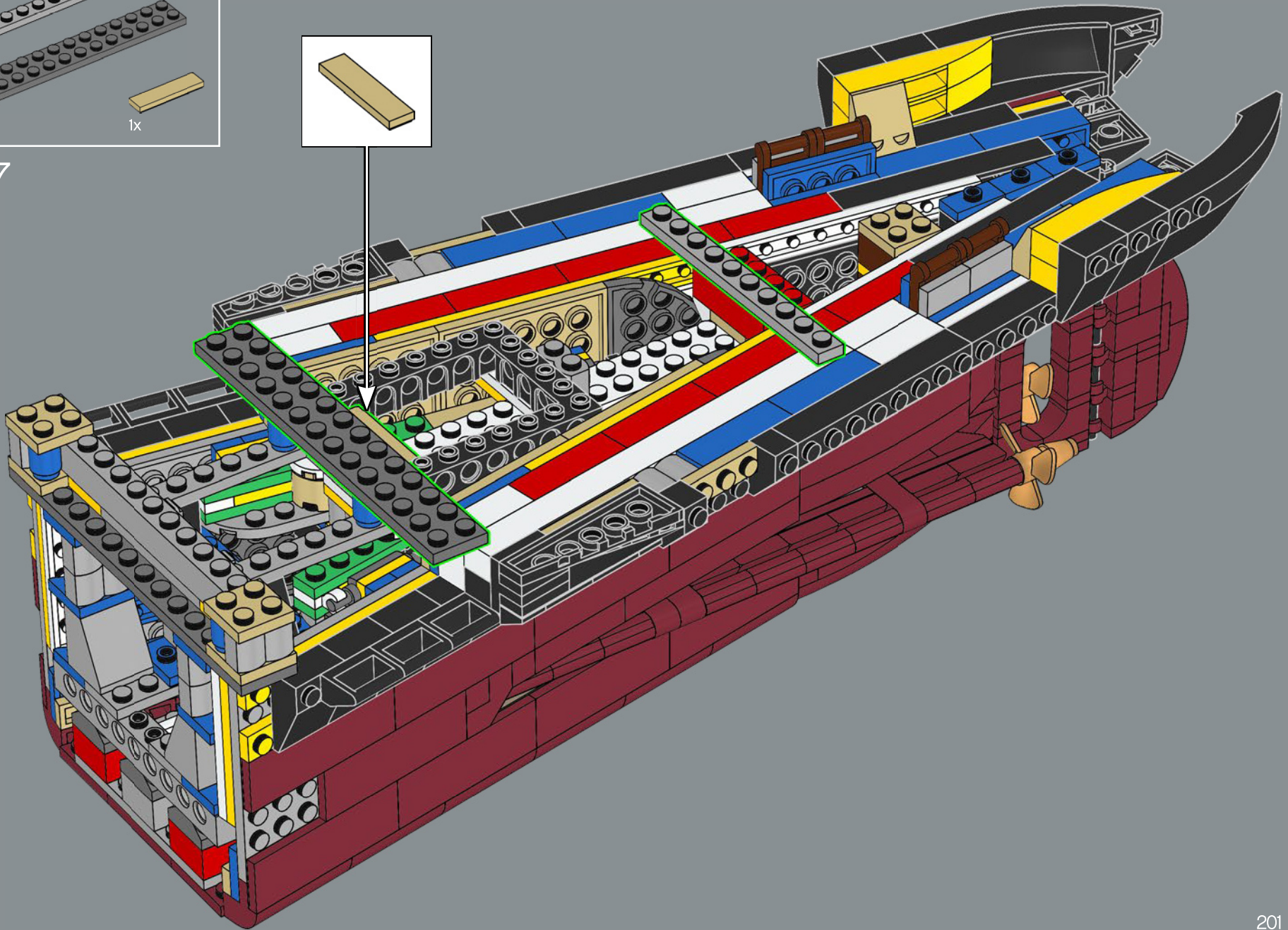
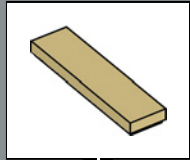



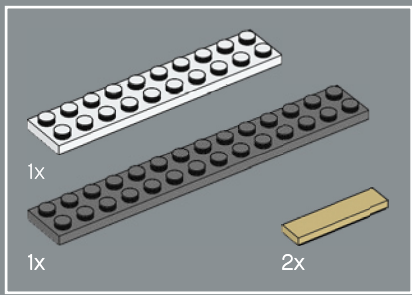

268

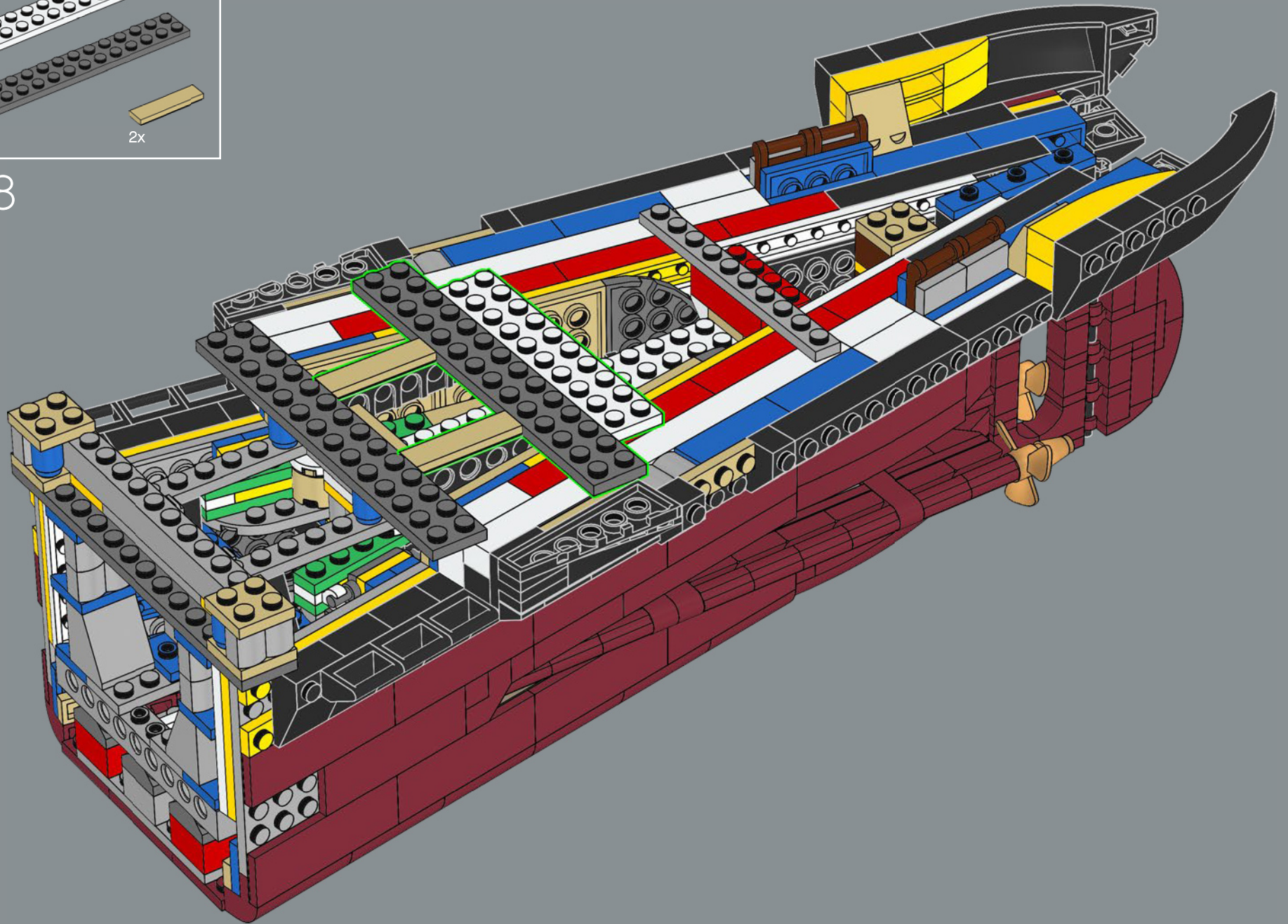



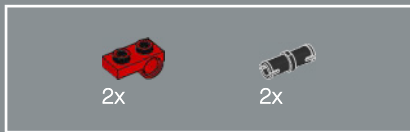

269

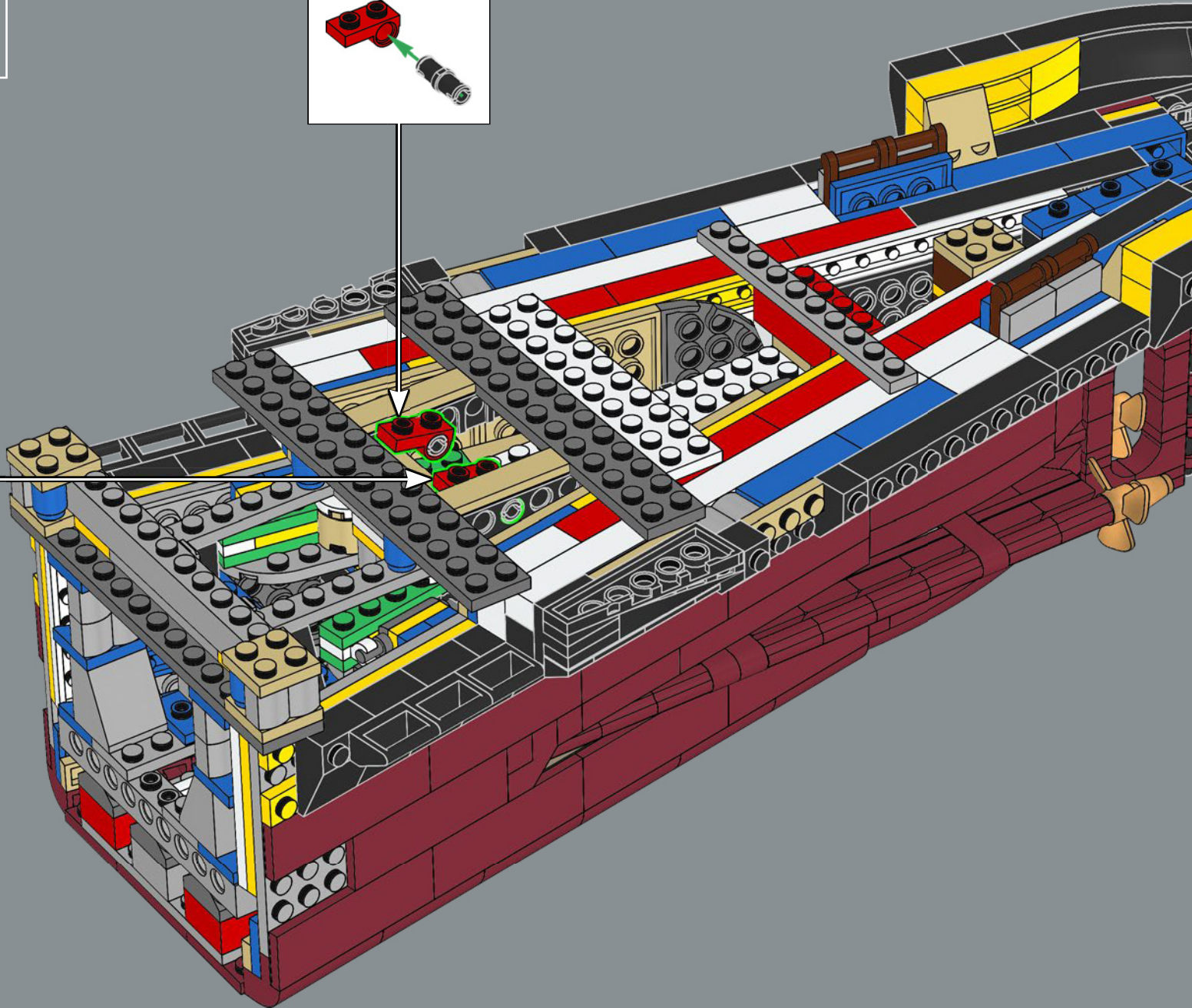
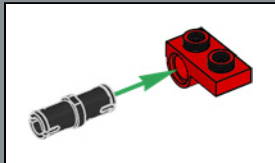
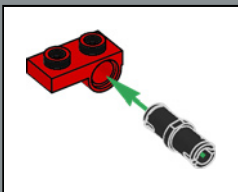



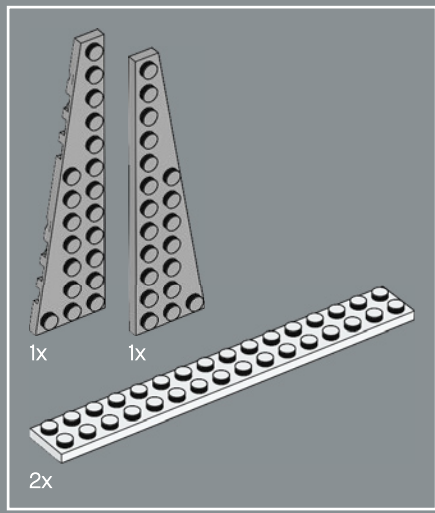

270

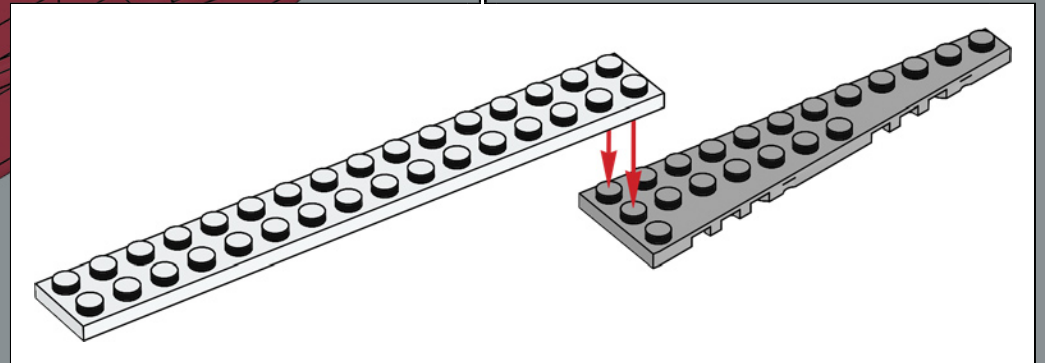
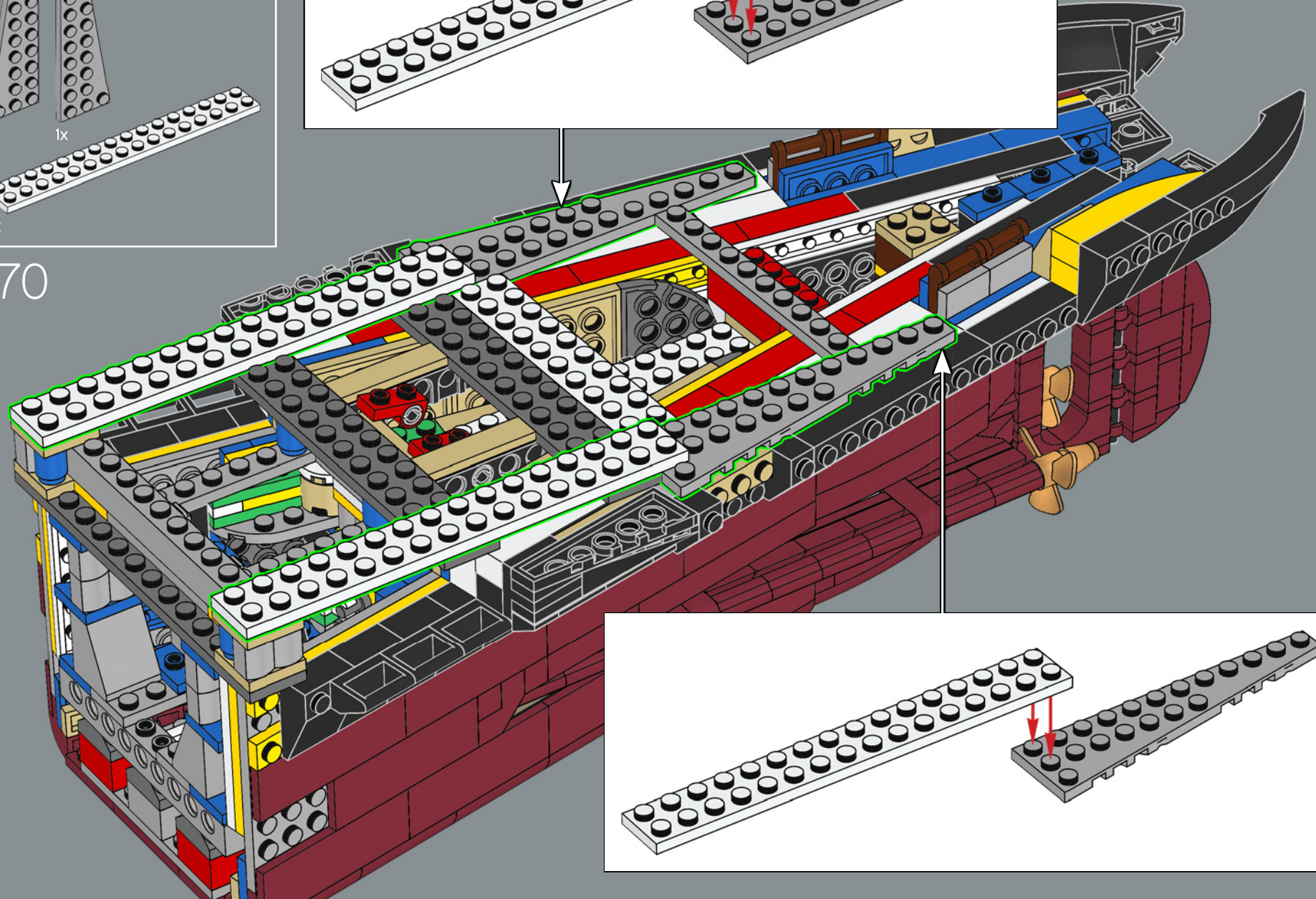
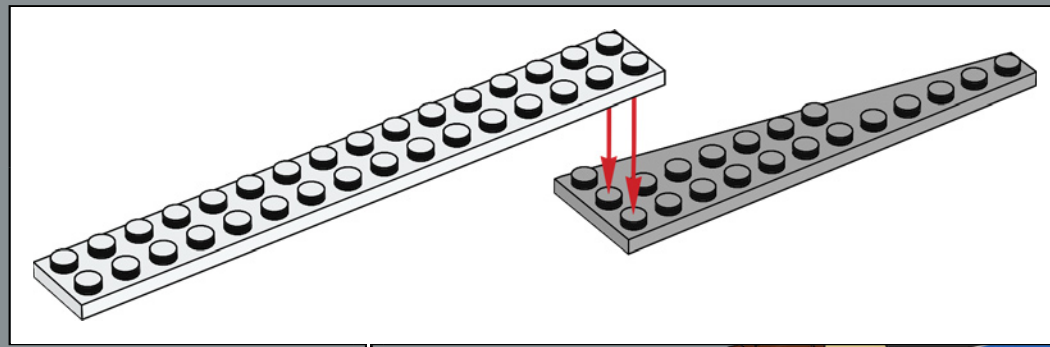



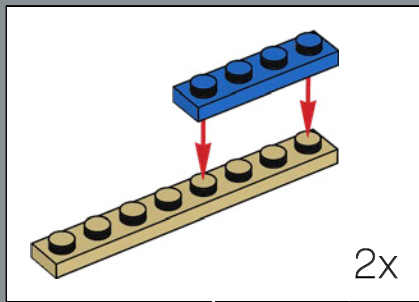
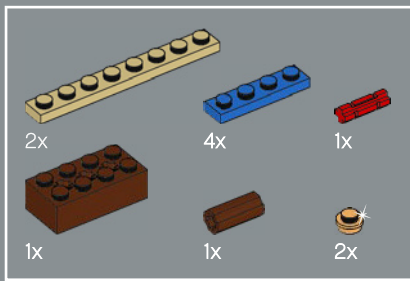

271

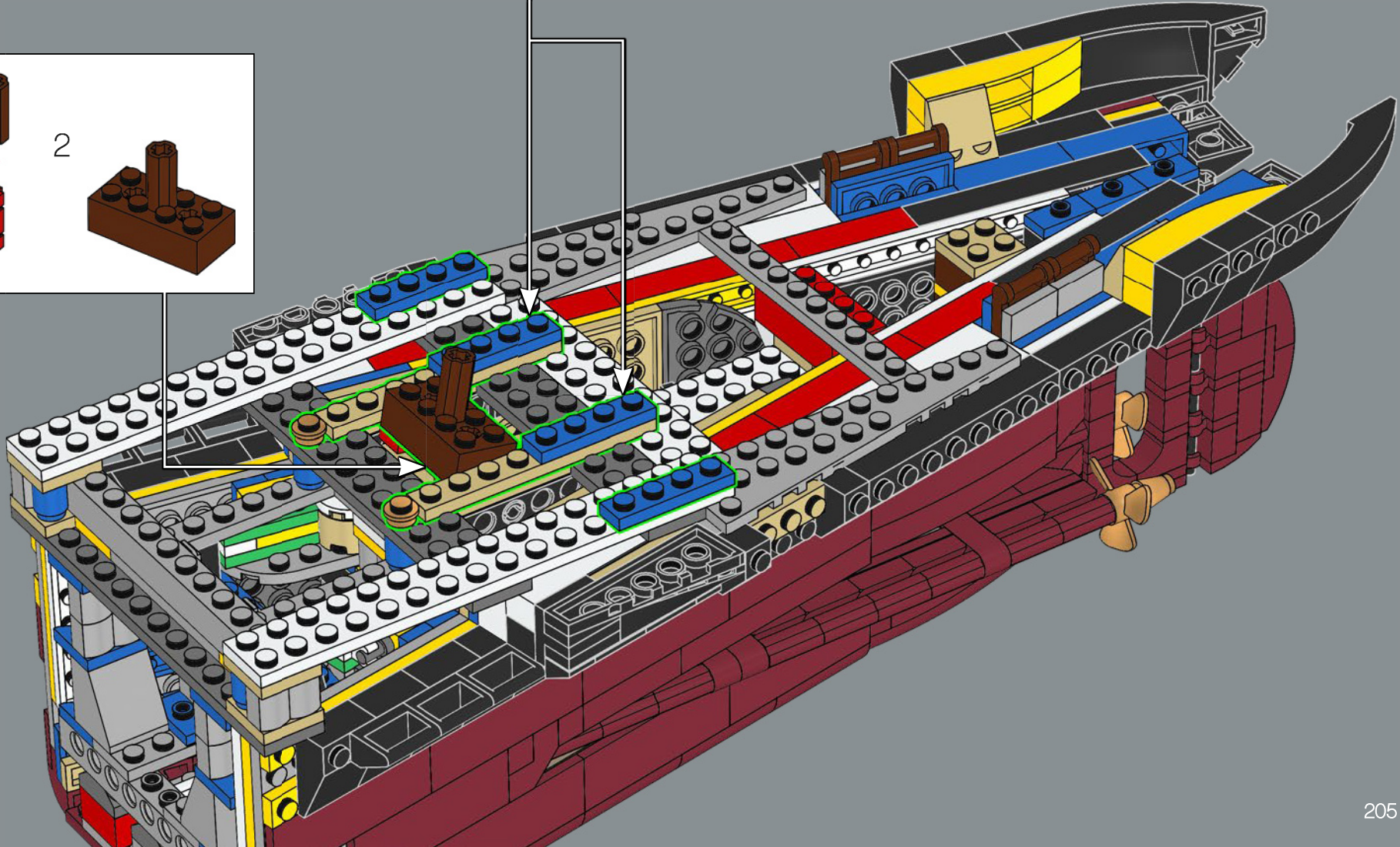
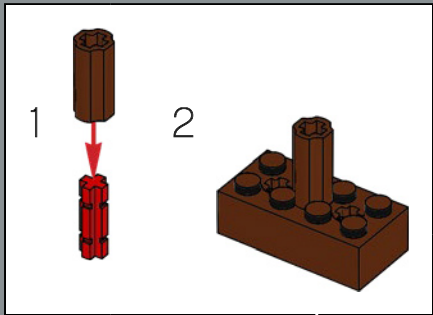

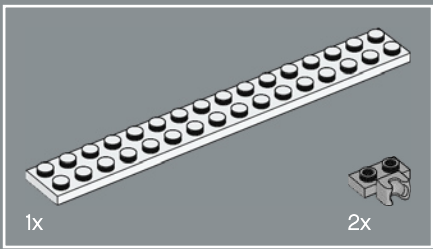

272

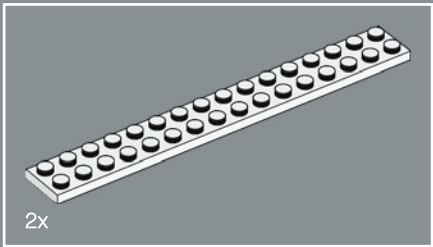
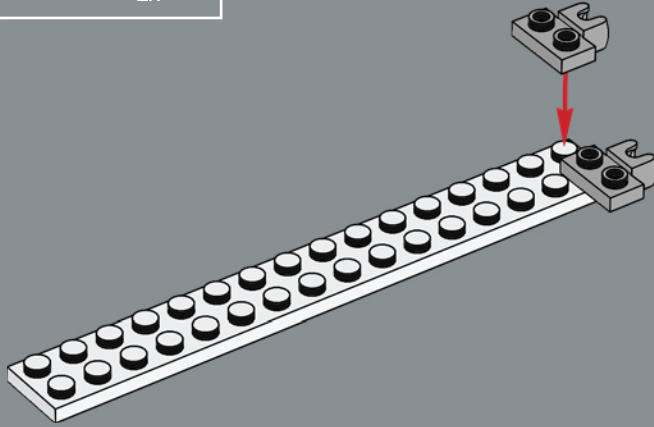

273

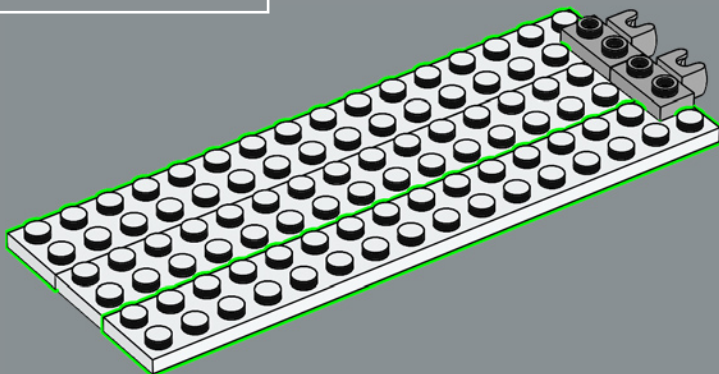

274

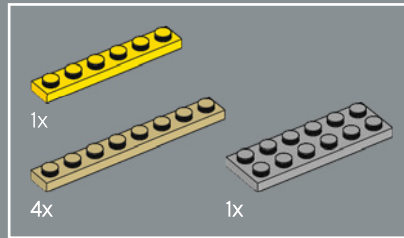
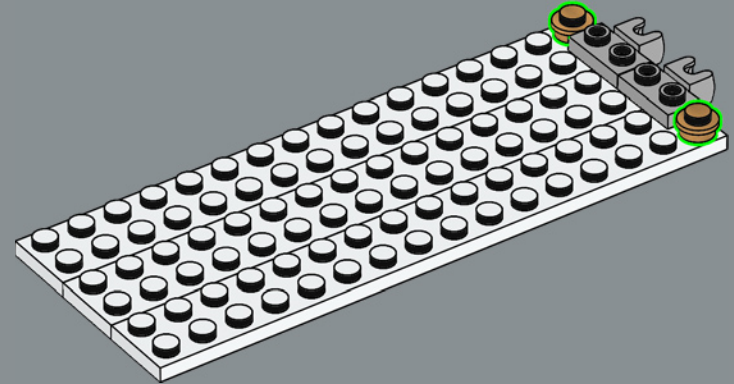

275

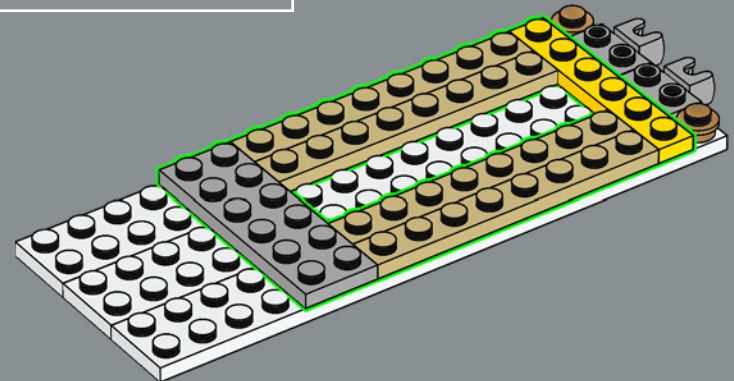



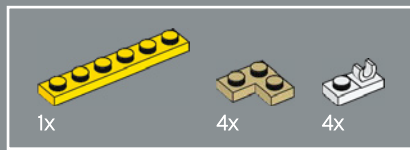

276

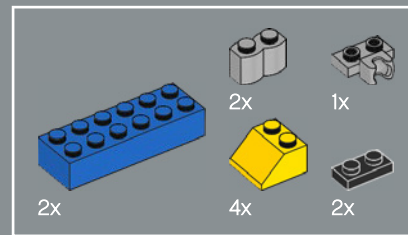
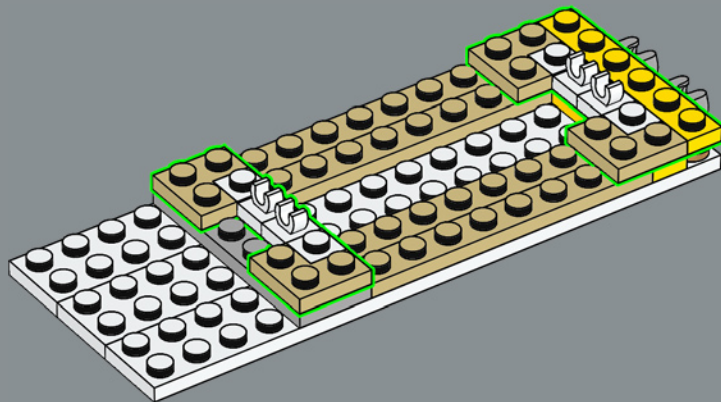

277

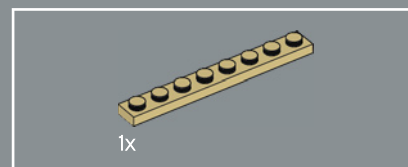
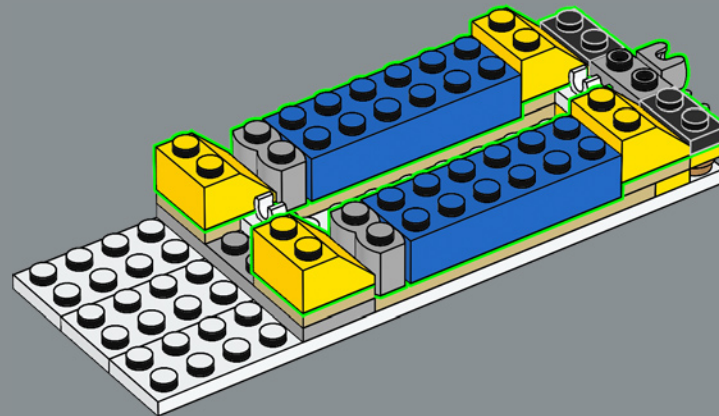

278

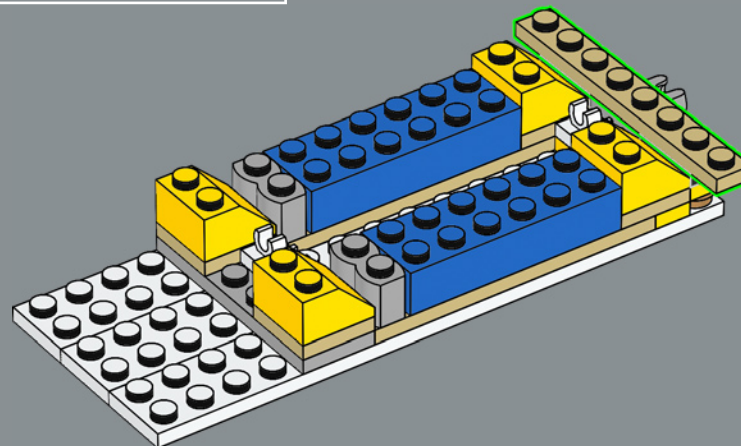



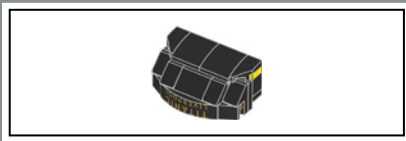

280

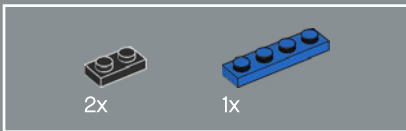
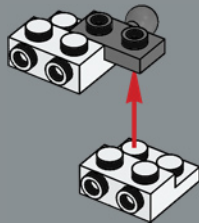

281

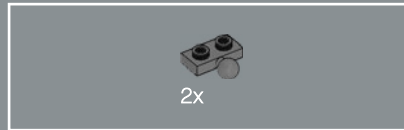
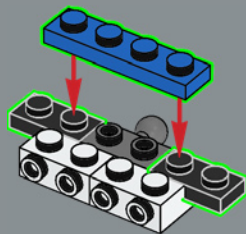

282

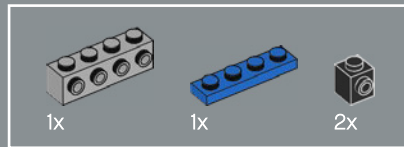
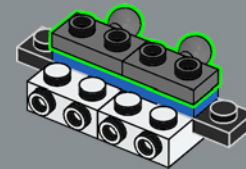

283

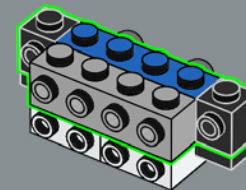



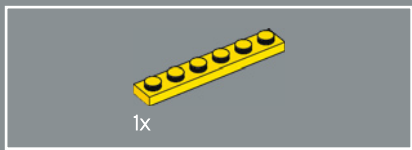

284

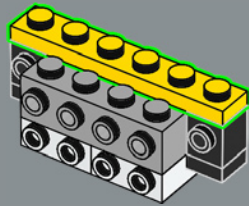

285

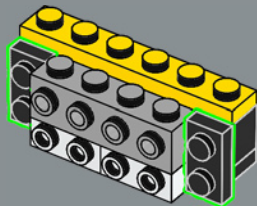

286

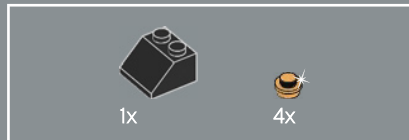
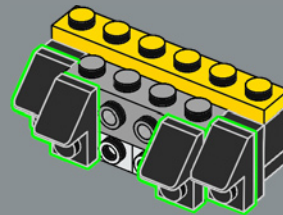

287

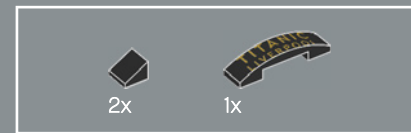
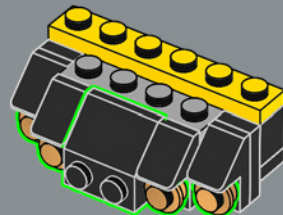

288

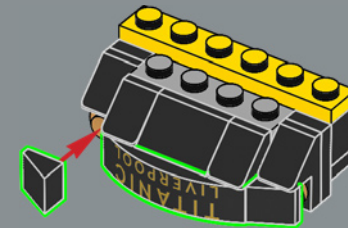

289

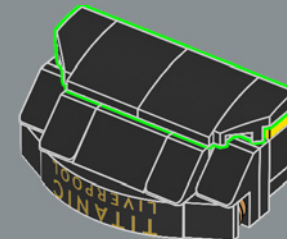

El *Titanic* carecía de reflector y no disponía de sistema de megafonía.

290

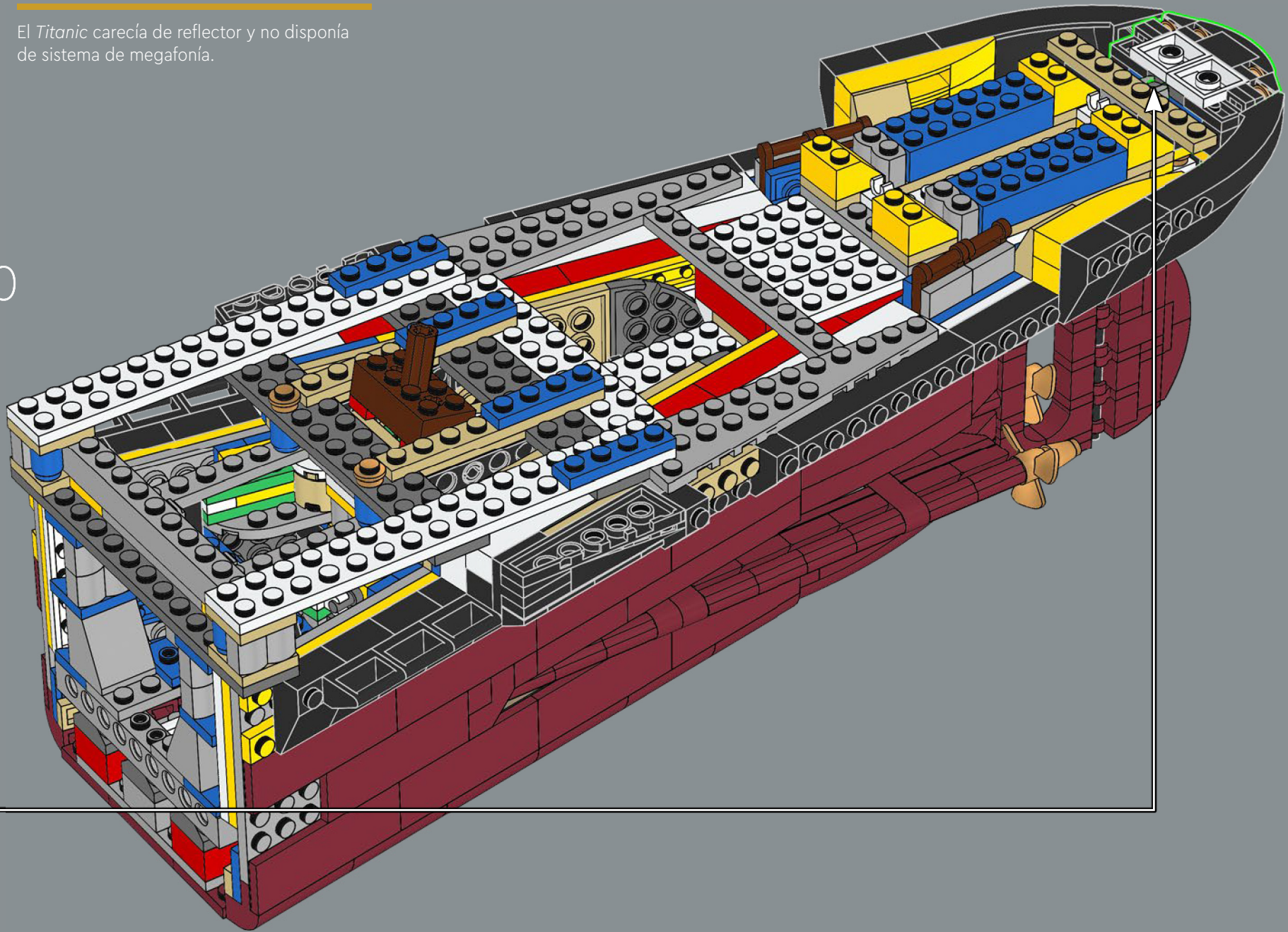



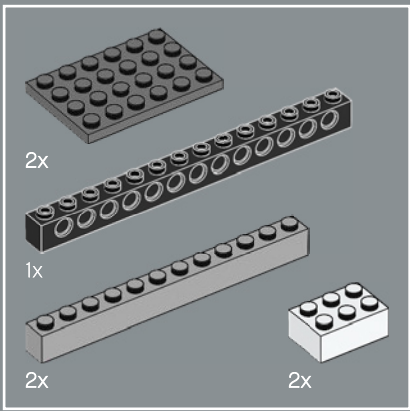

291

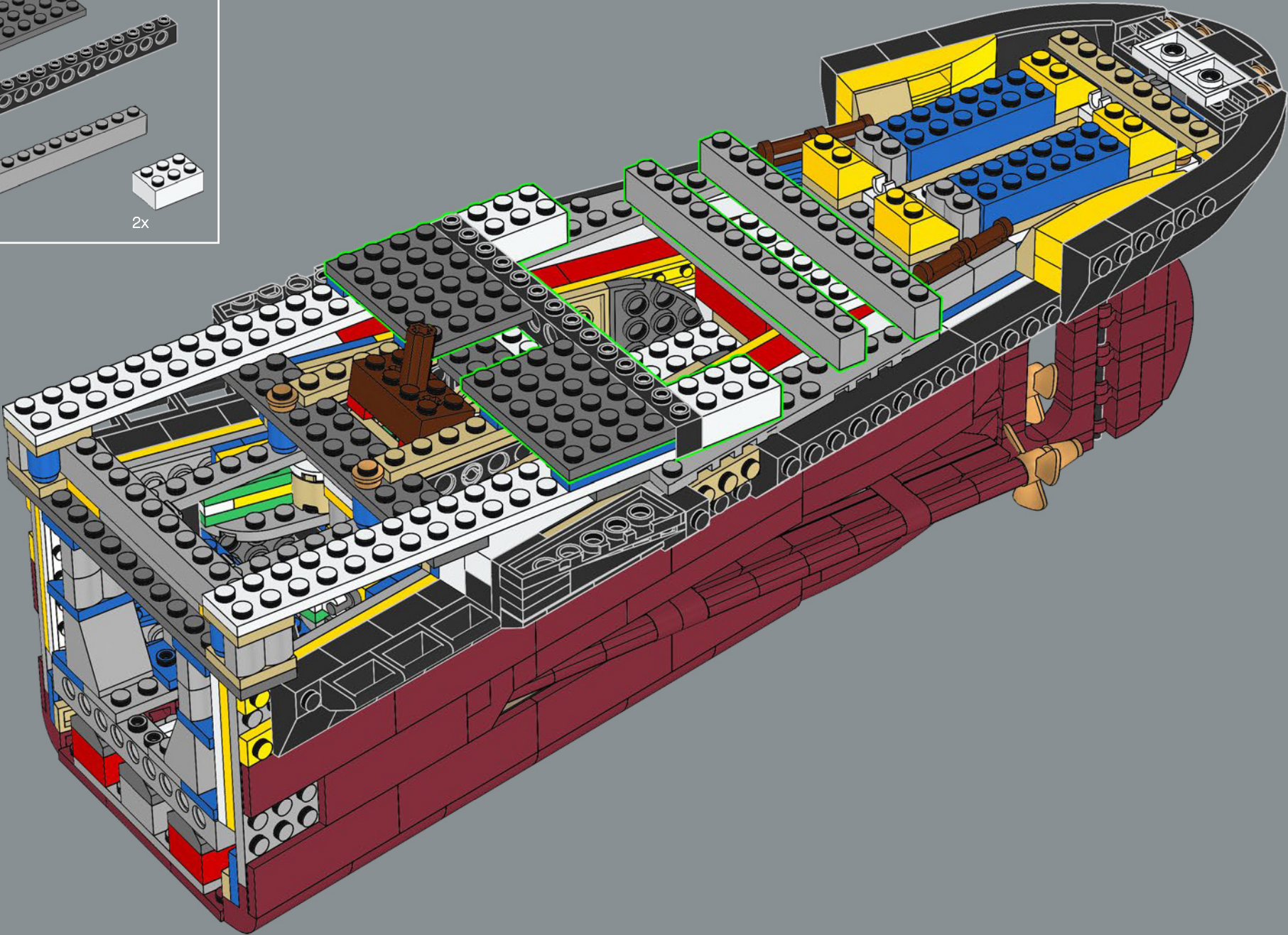



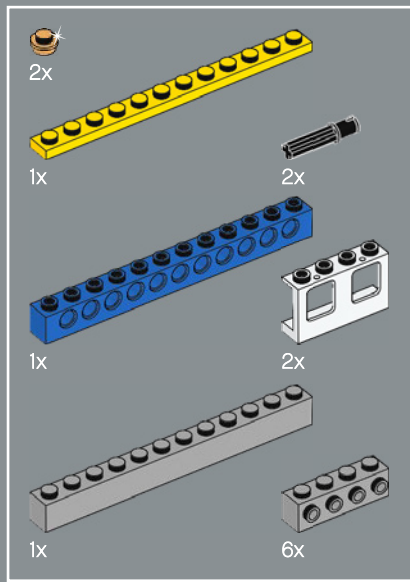

292

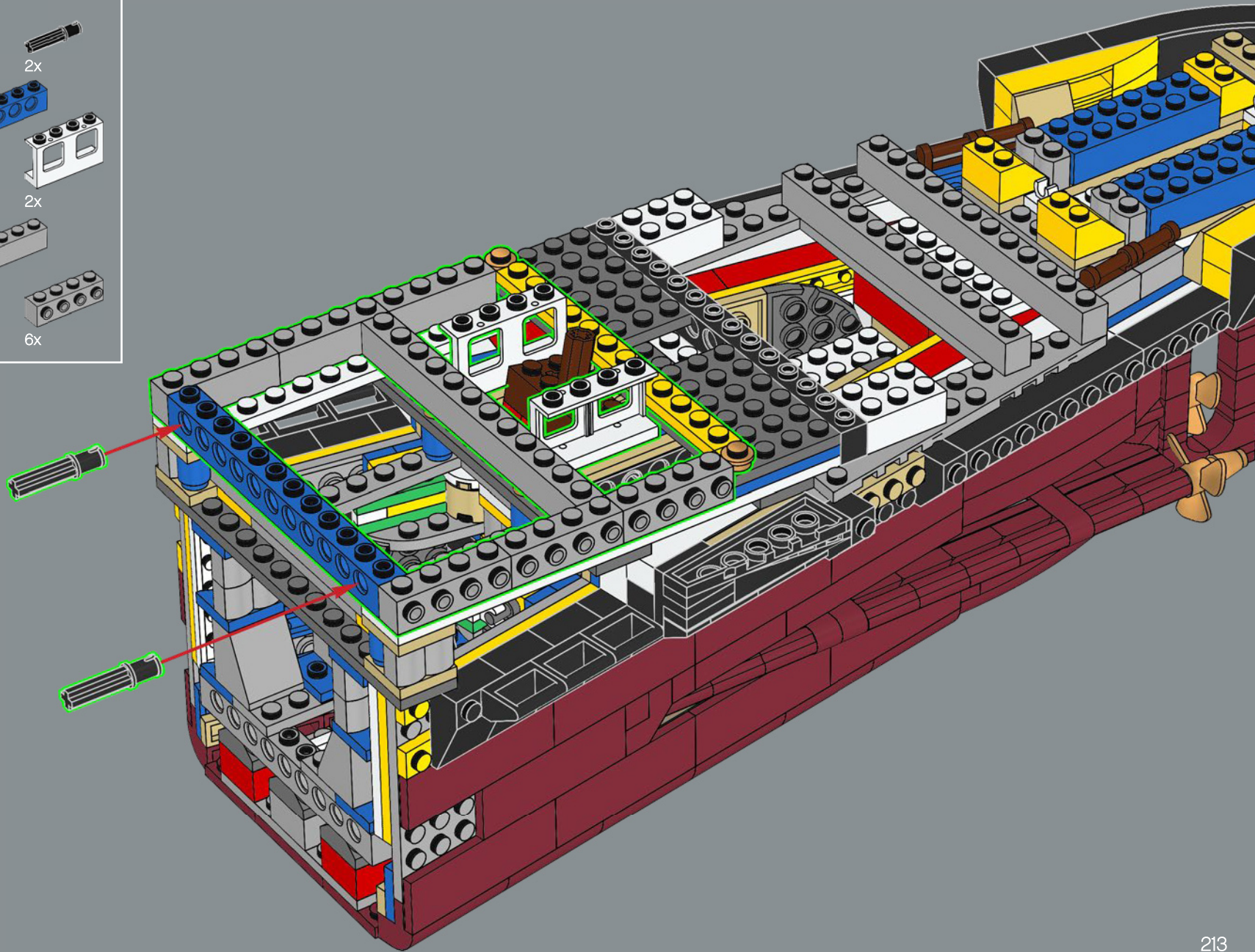

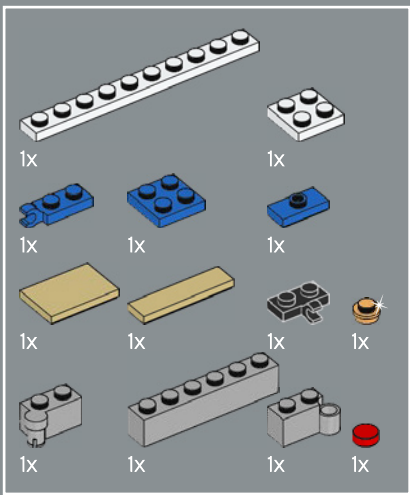

293

1

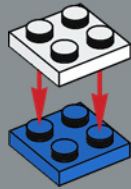

2

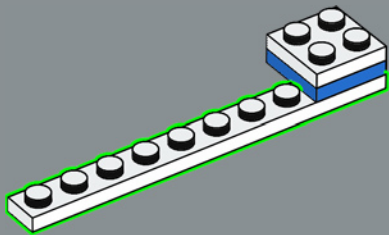

3

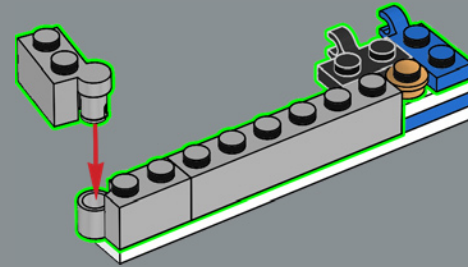

4

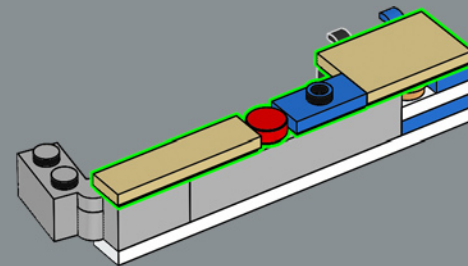



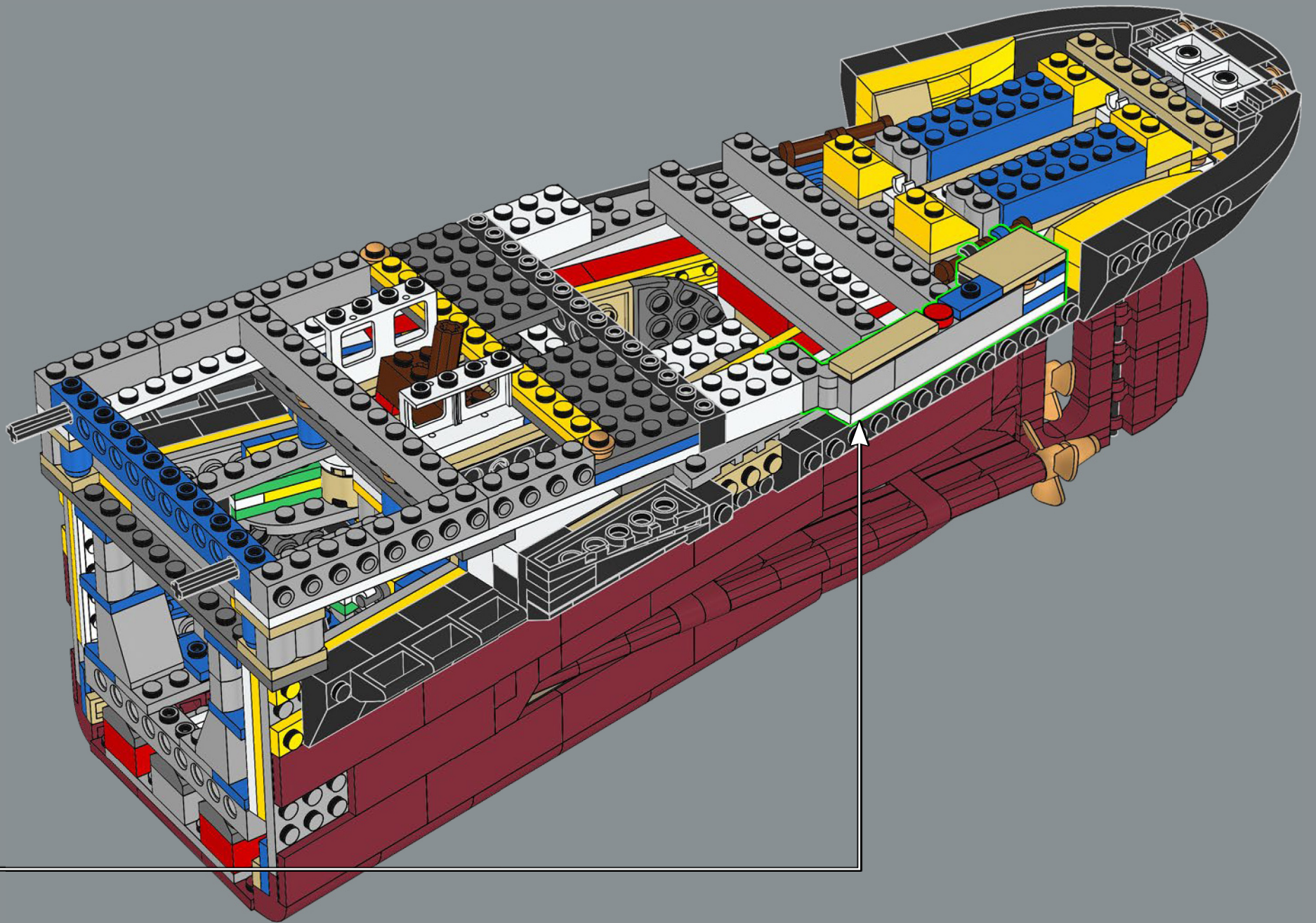



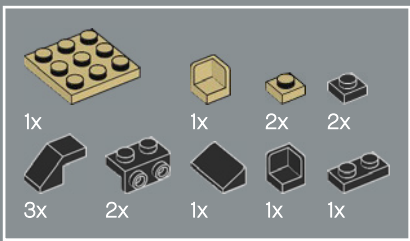

294

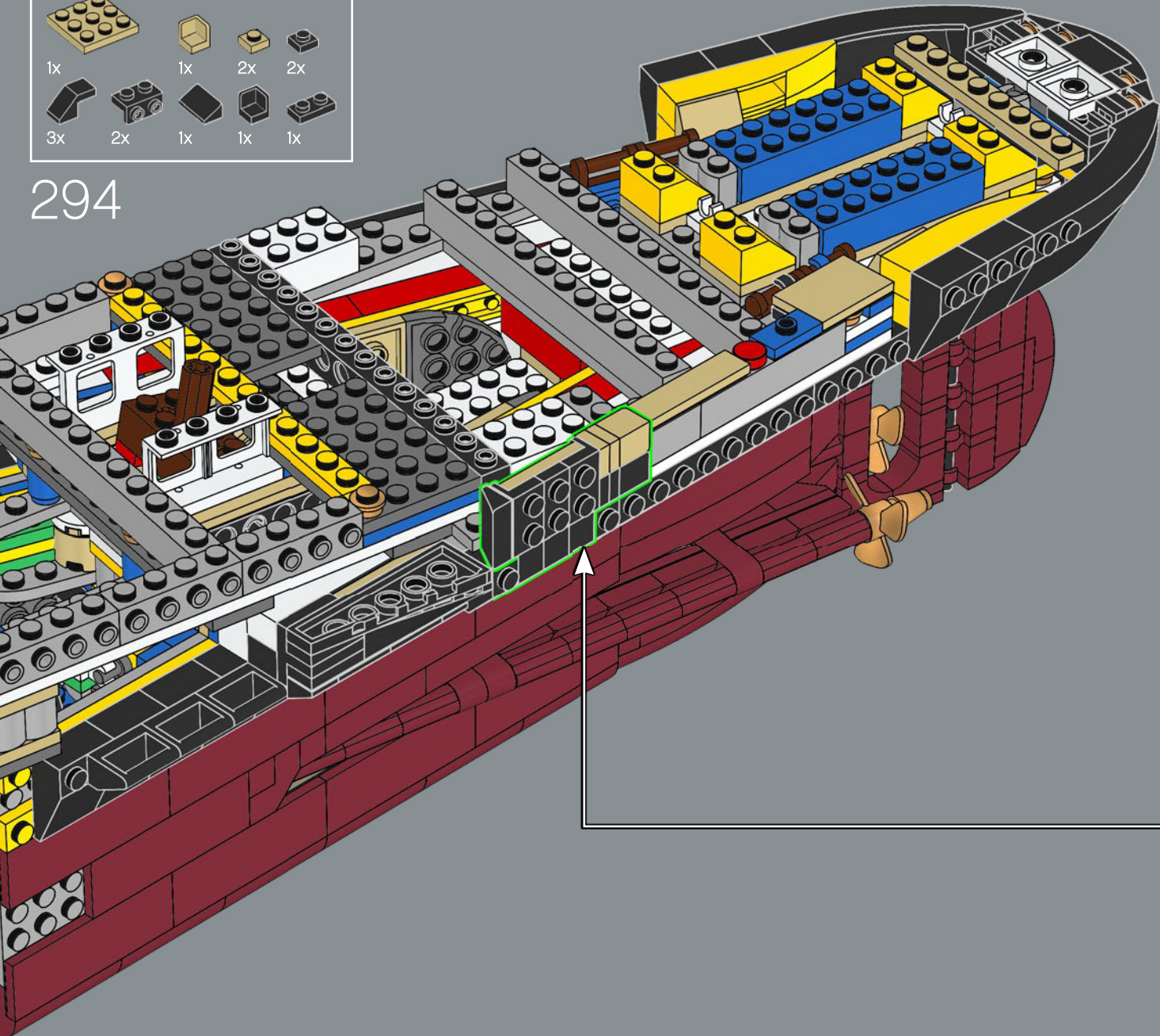

- 1
- 2
- 3
- 4
- 5

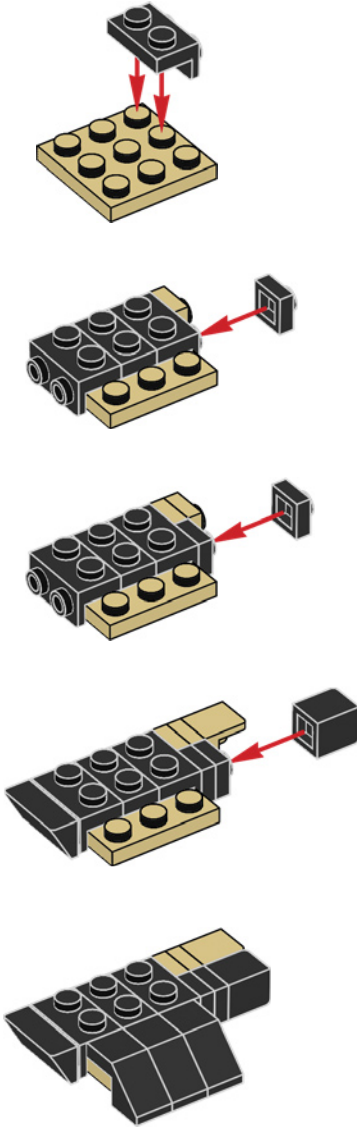

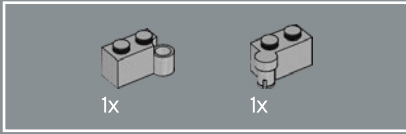
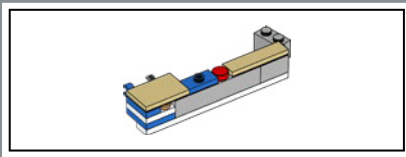

295

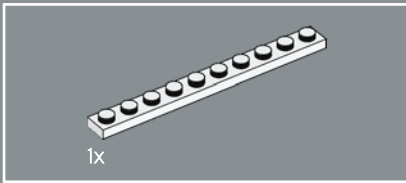
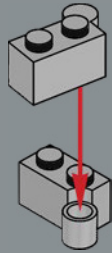

296

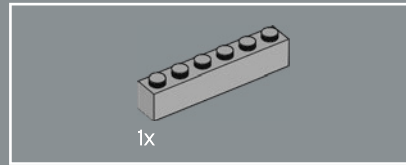
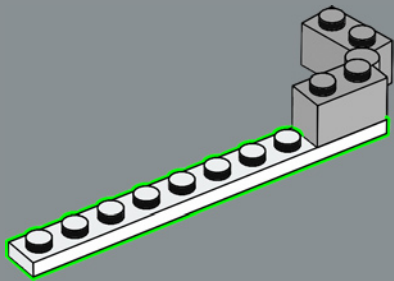

297

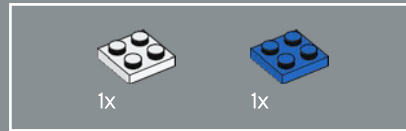
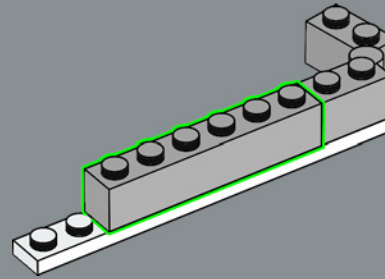

298

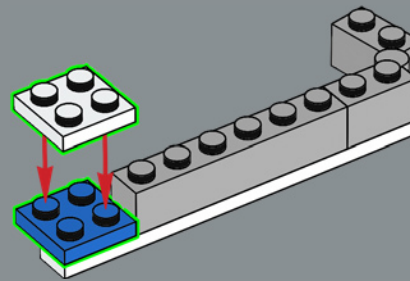

299

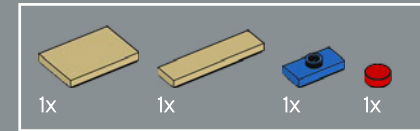
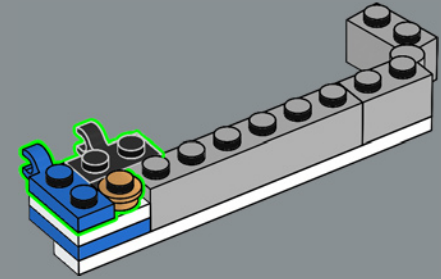

300

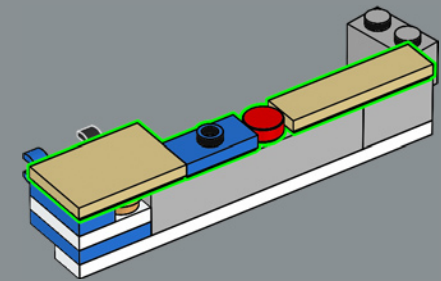



301

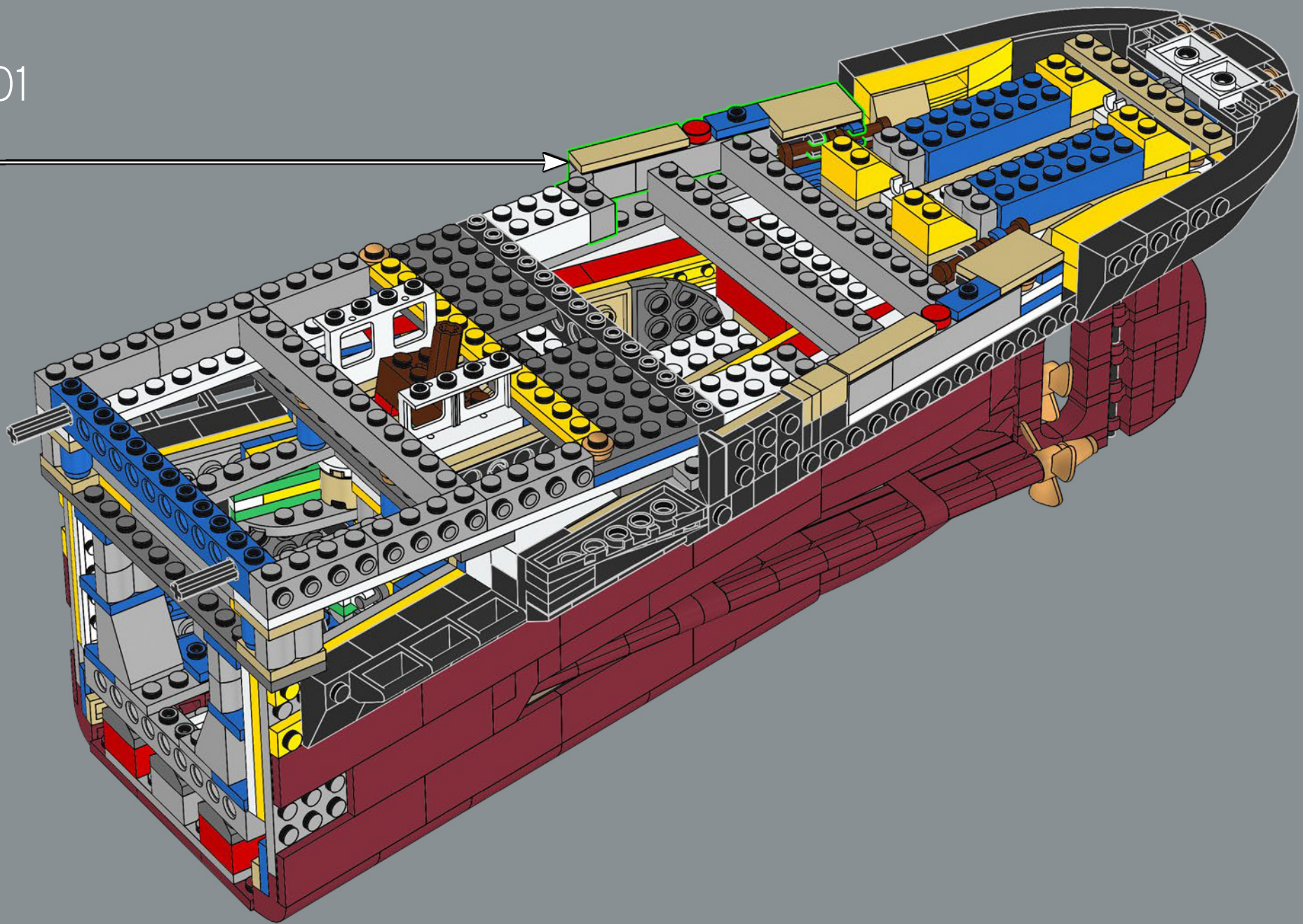



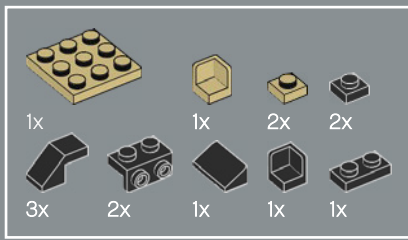

302

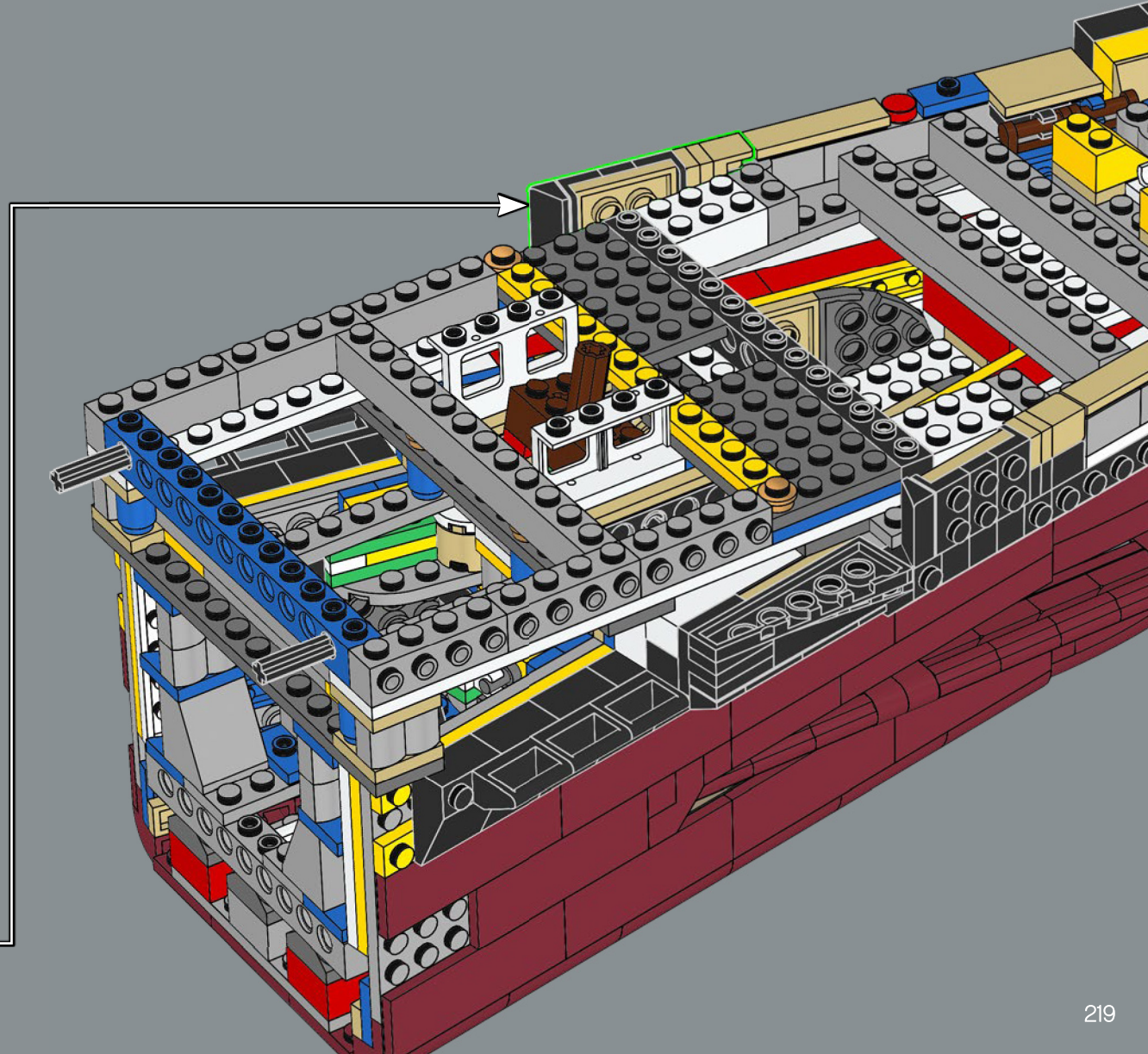
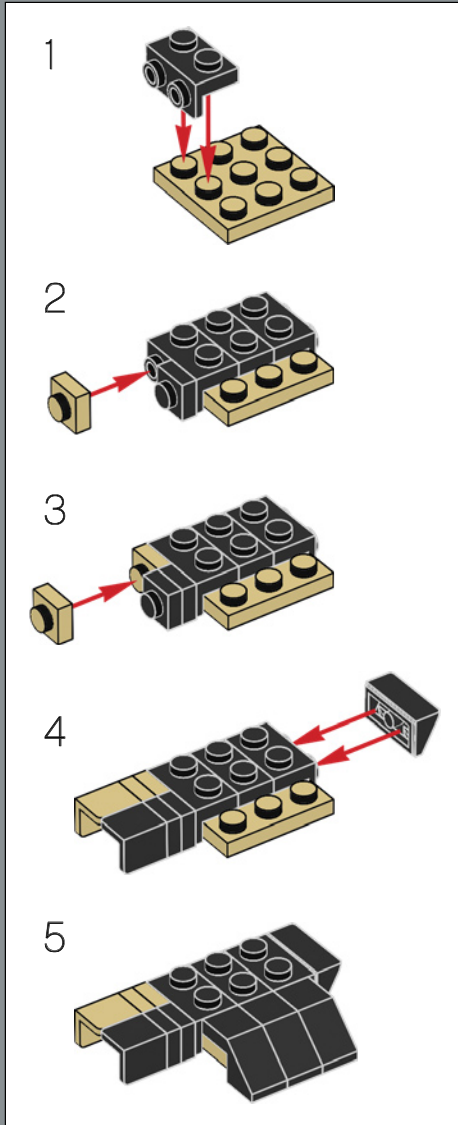



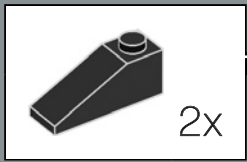
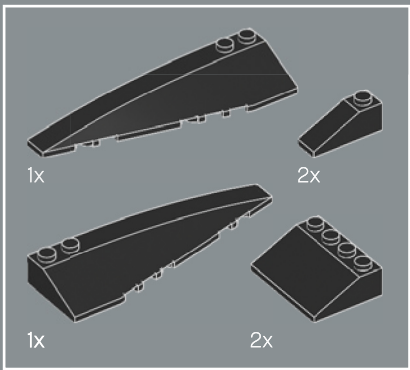

303

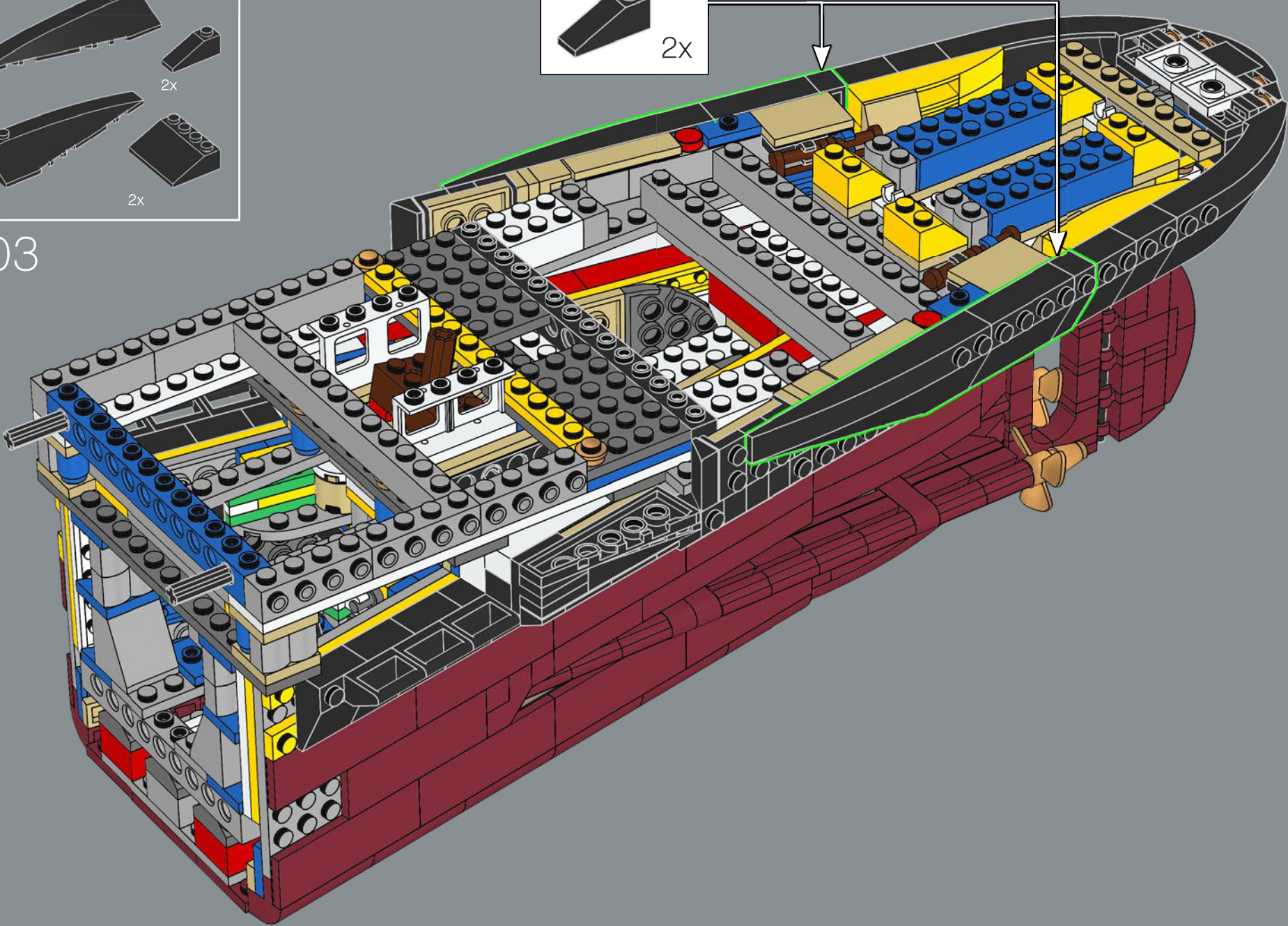



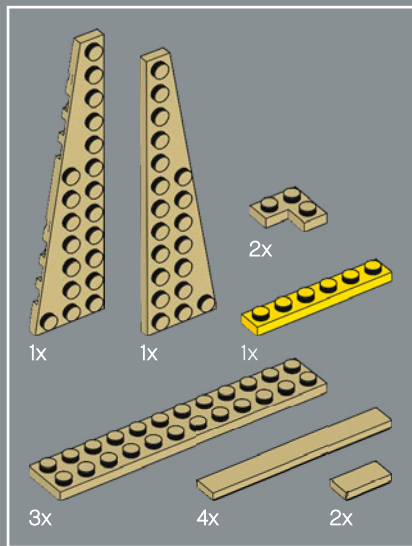

304

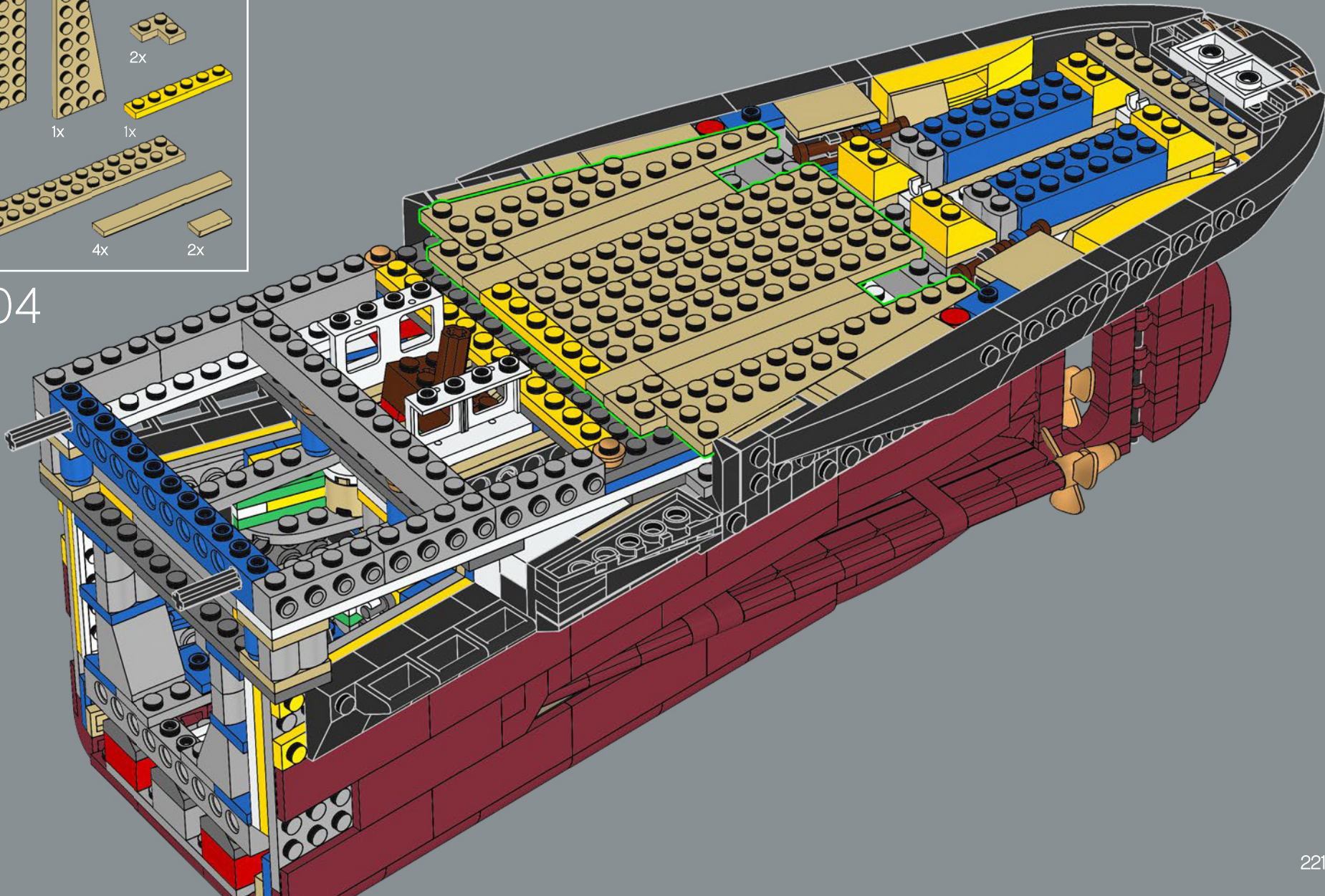



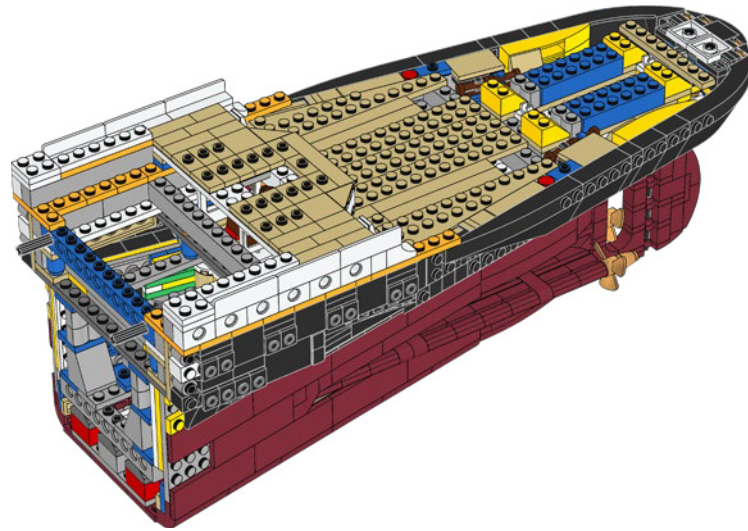
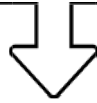

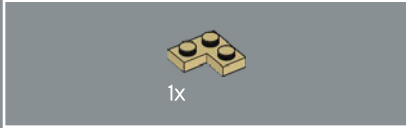
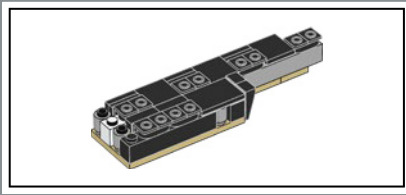

305

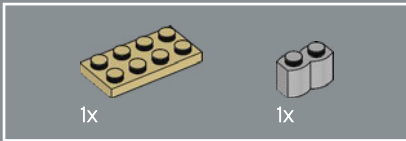

306

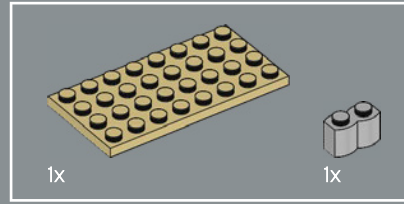
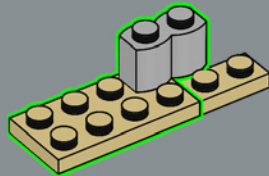

307

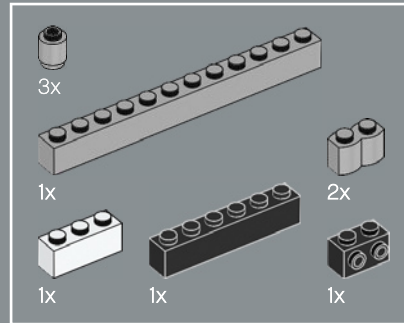
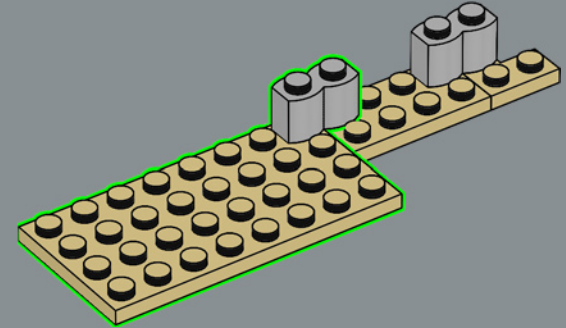

308

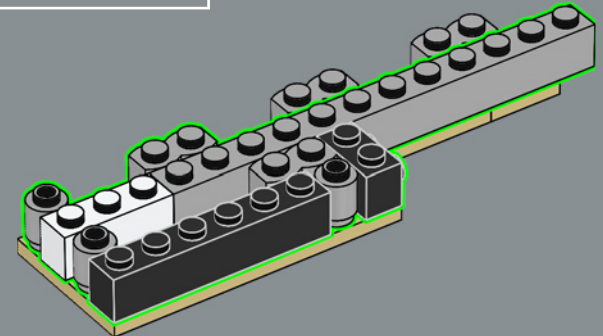

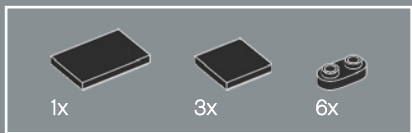

309

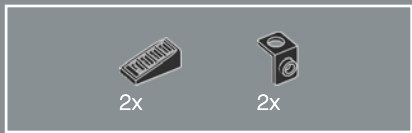
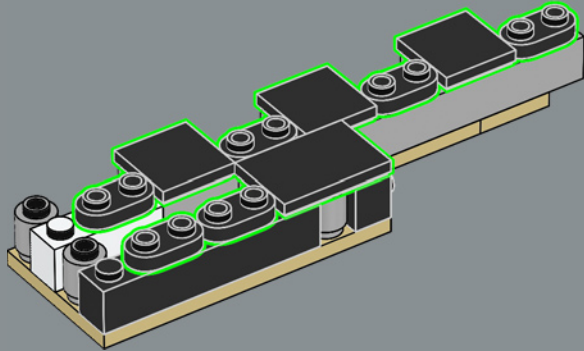

310

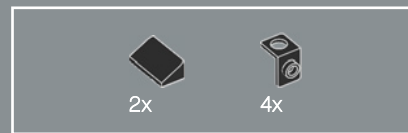
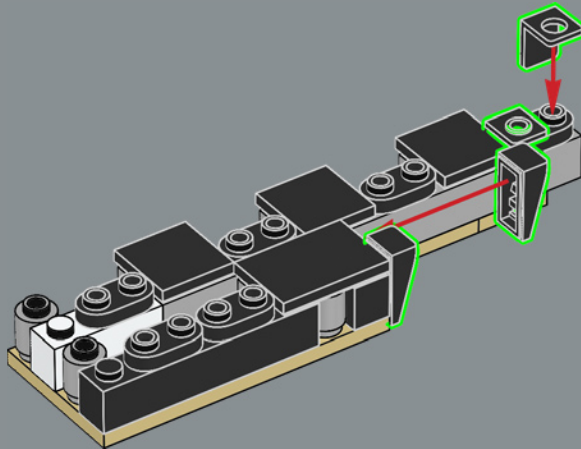

311

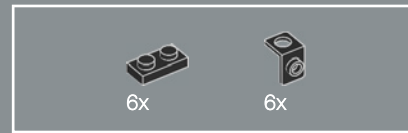
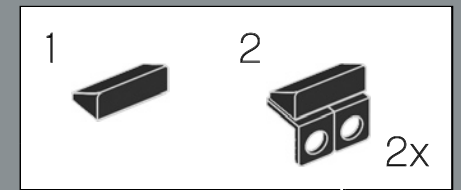
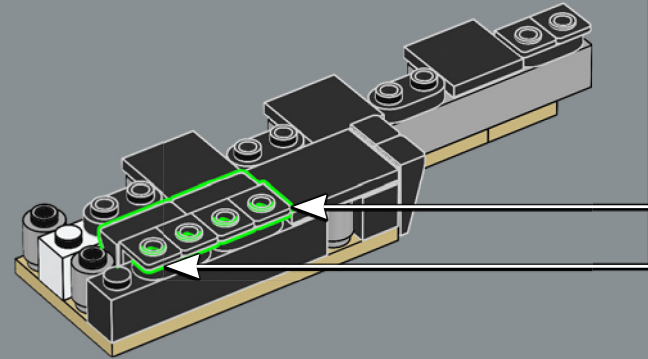

312

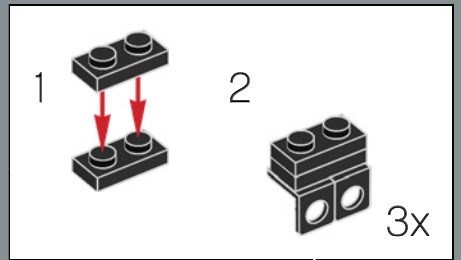
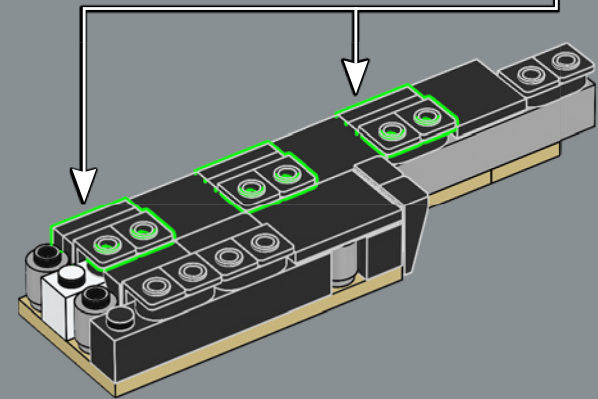



313

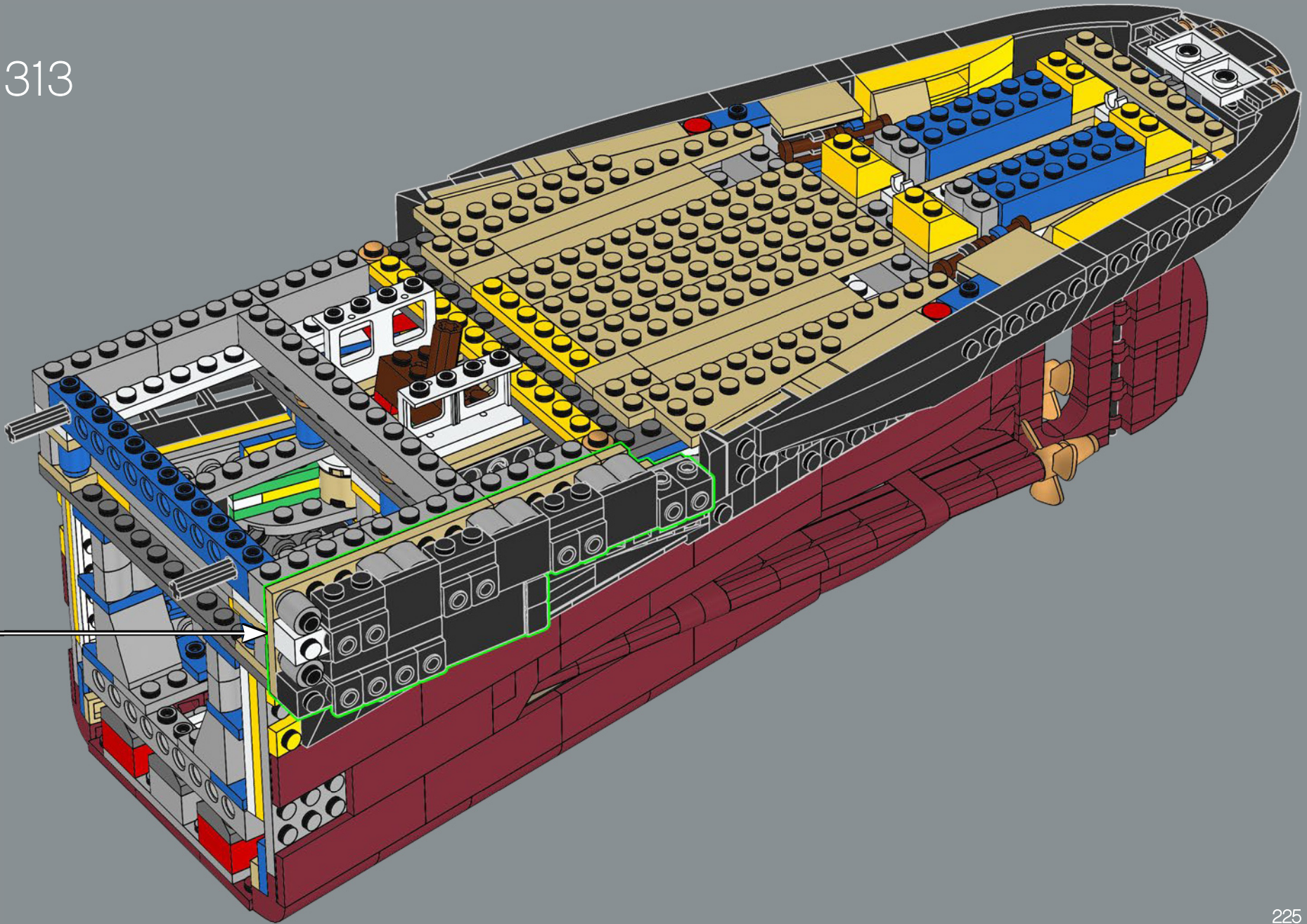

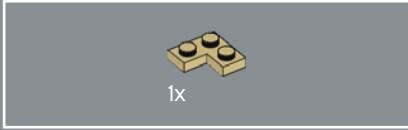
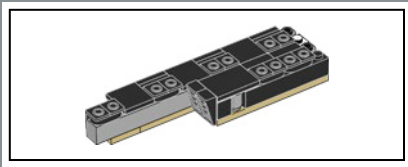

314

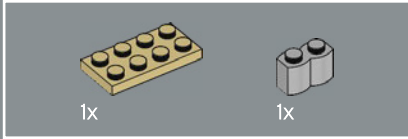

315

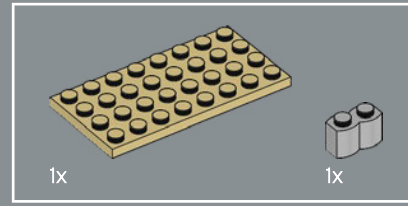
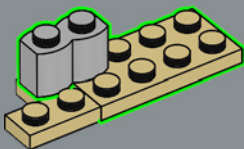

316

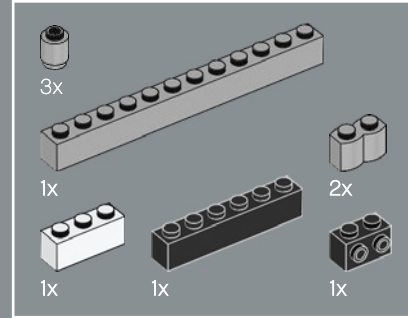
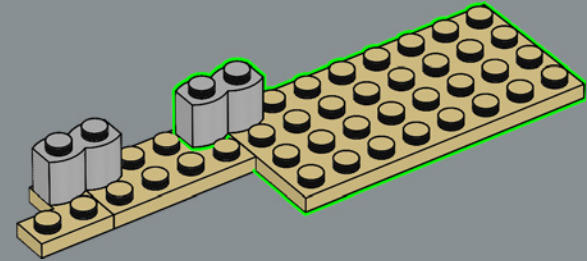

317

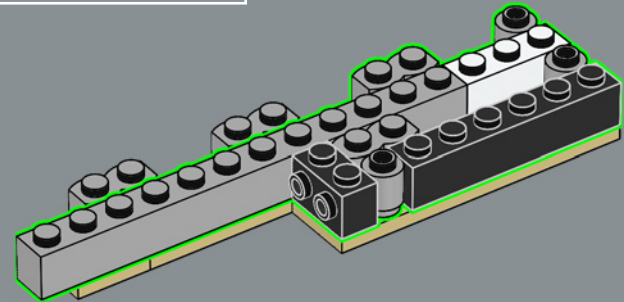

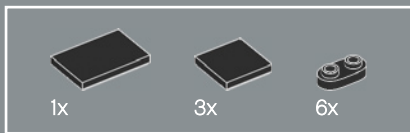

318

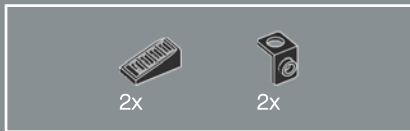
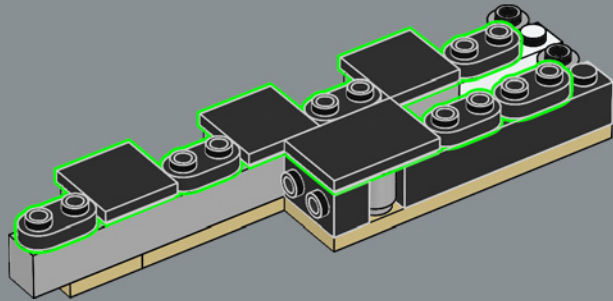

319

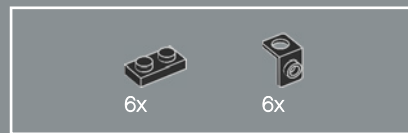
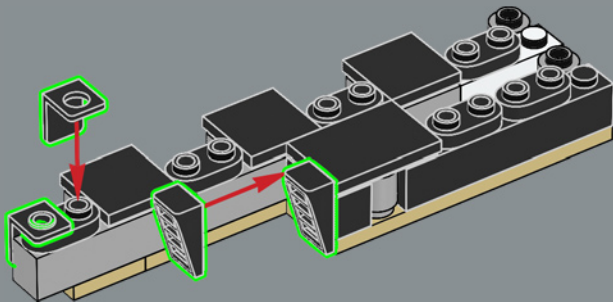

320

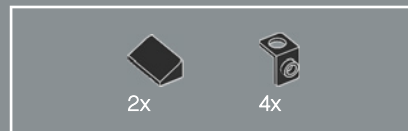
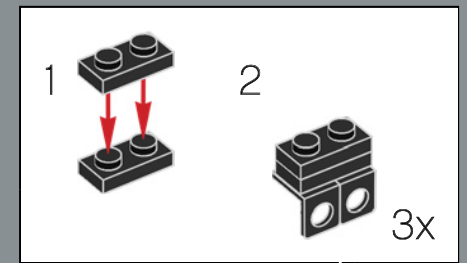
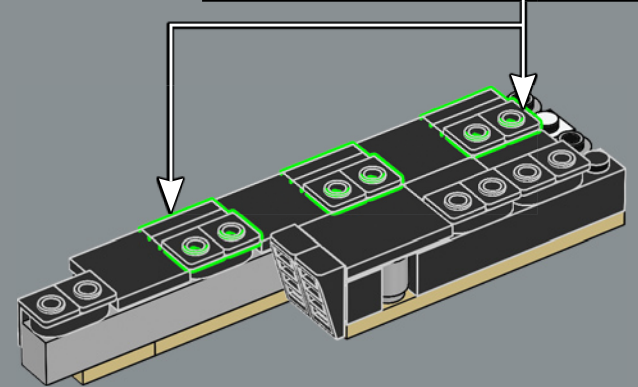

321

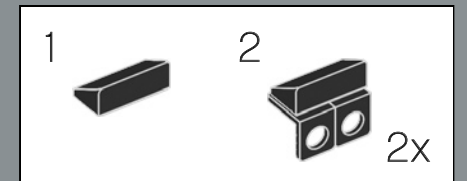
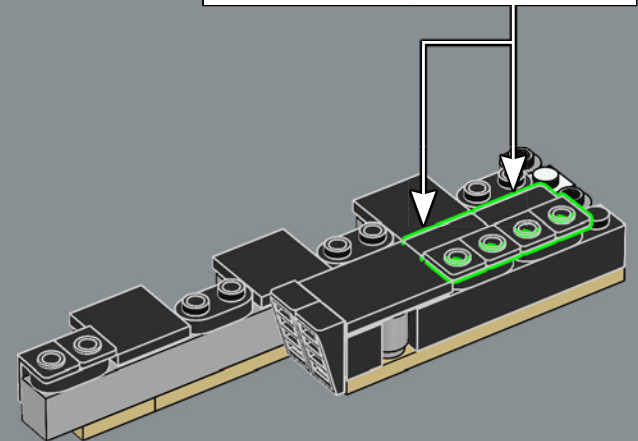



322

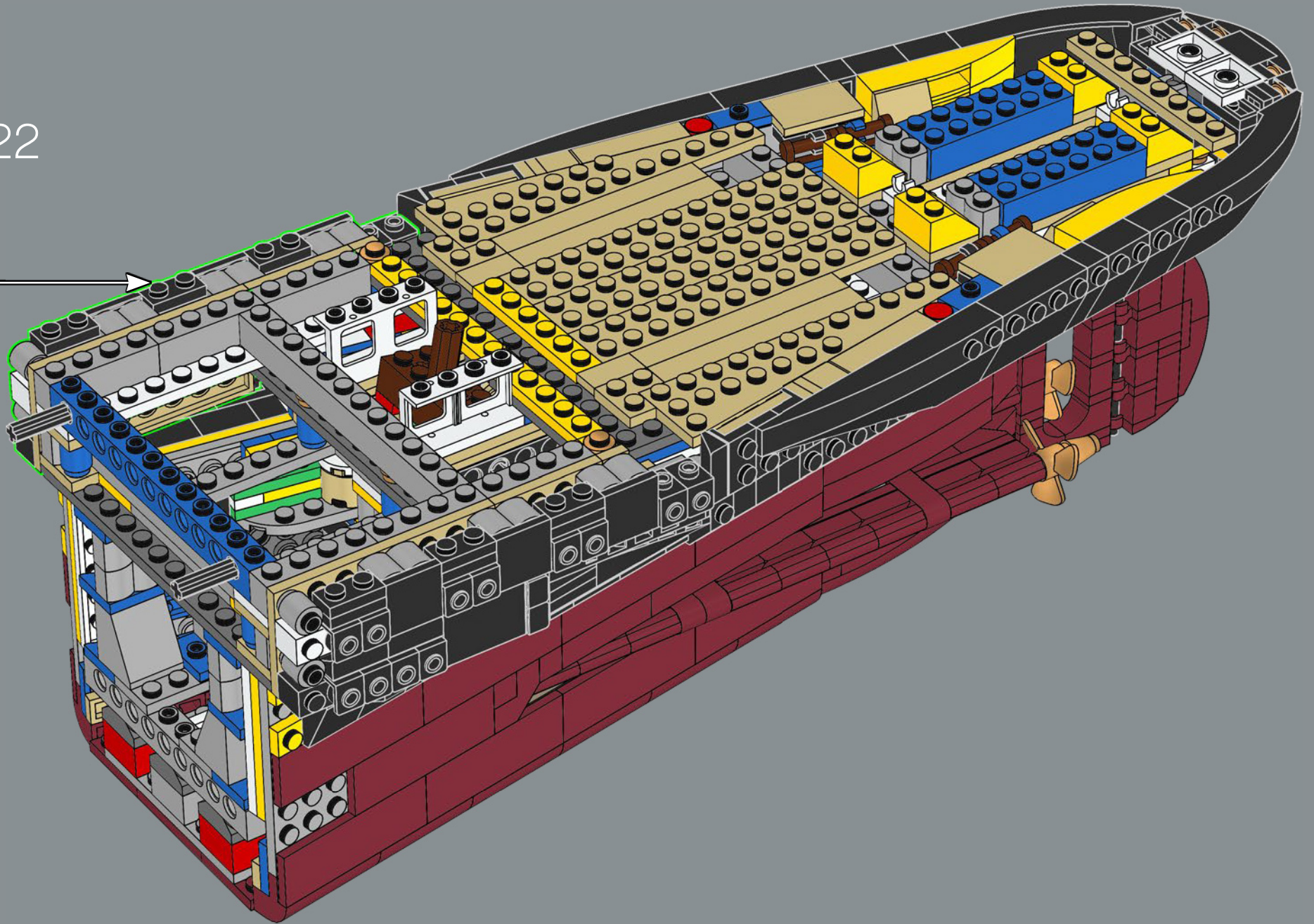



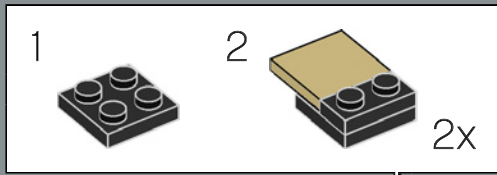
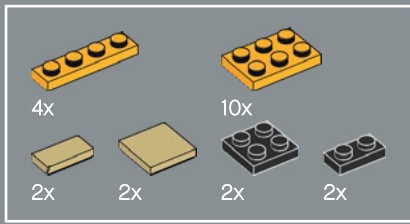

323

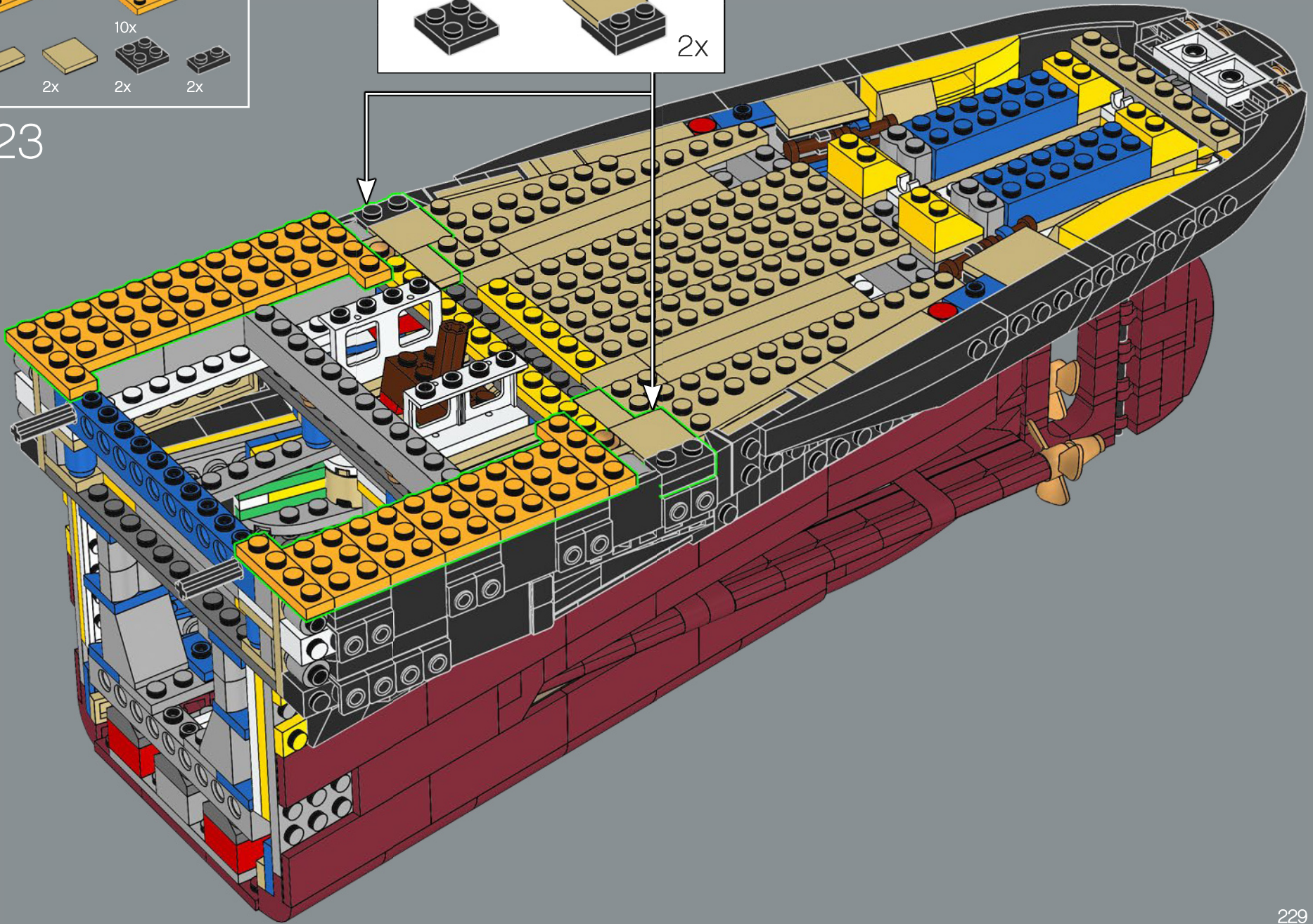



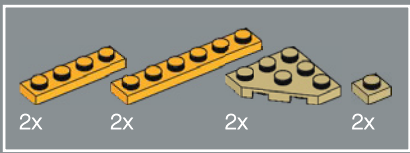

324

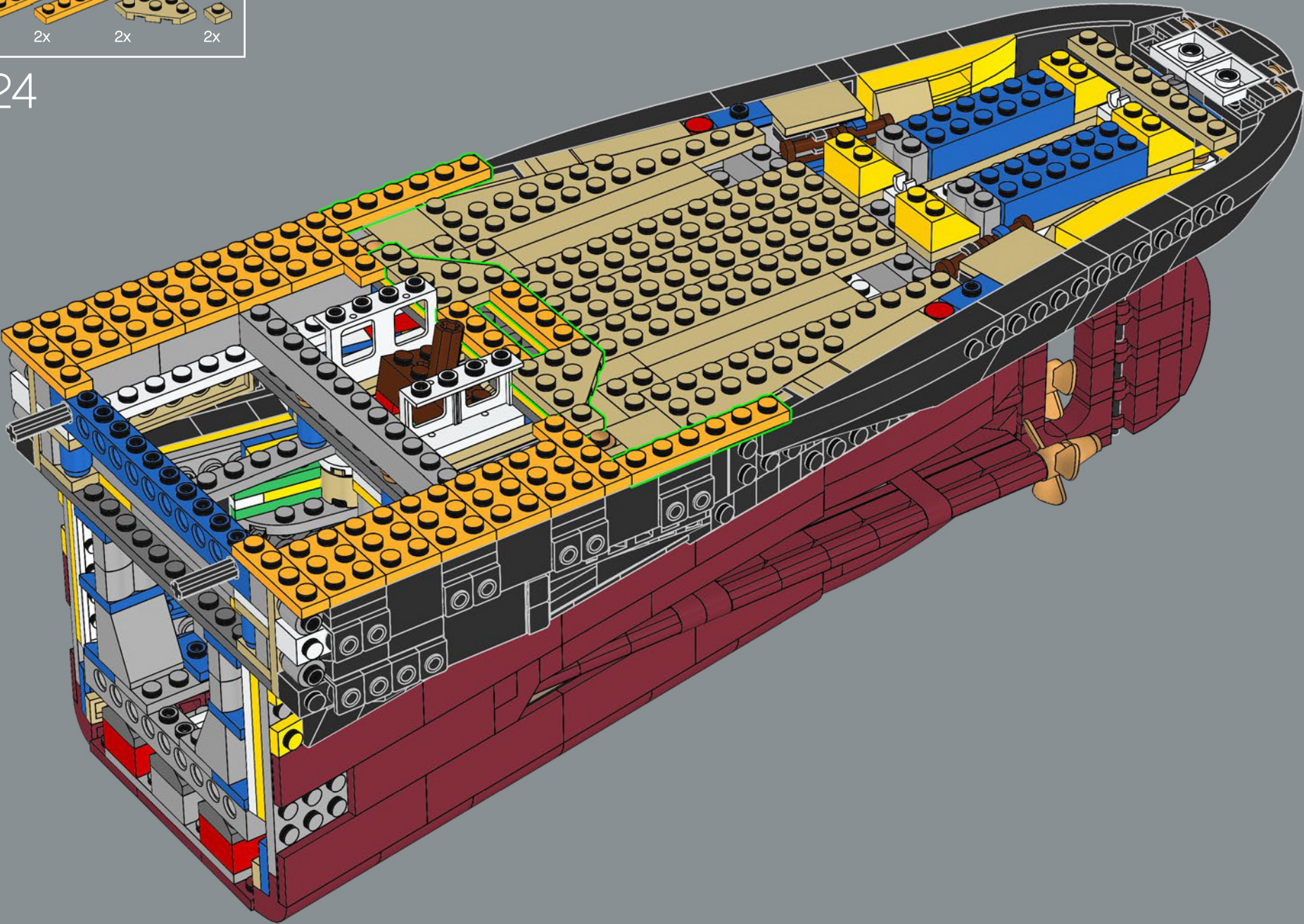



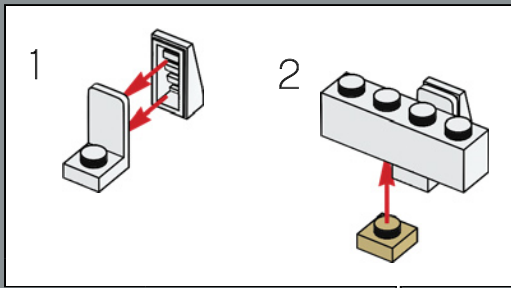
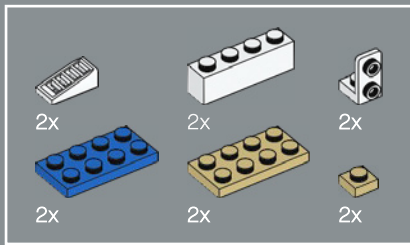

325

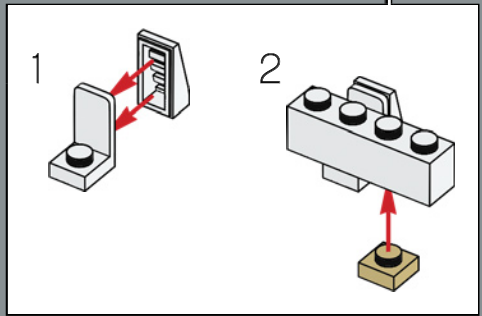
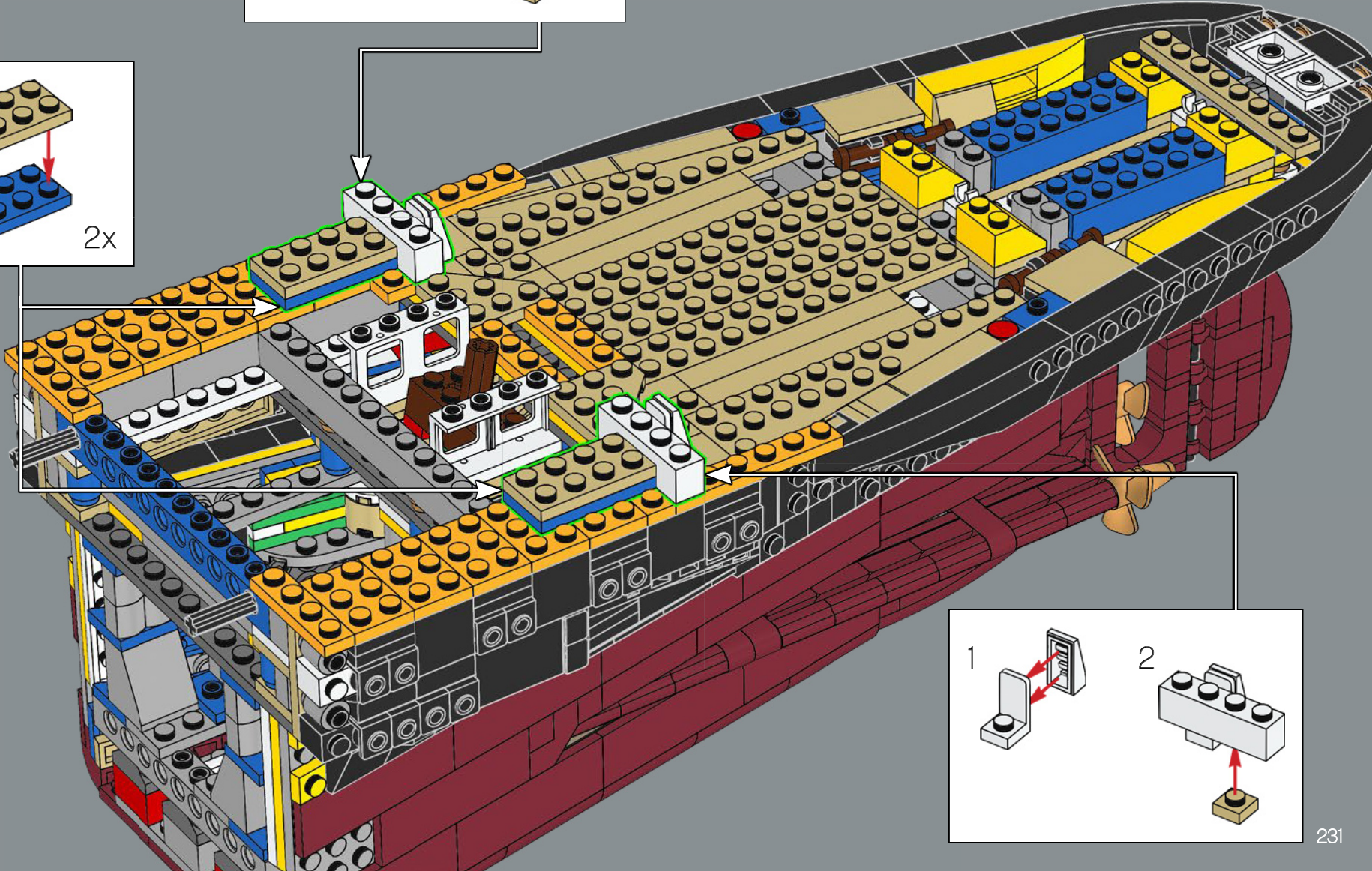
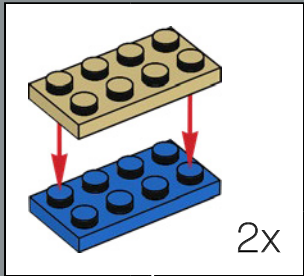



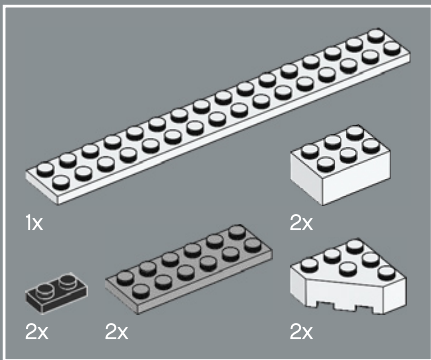

326

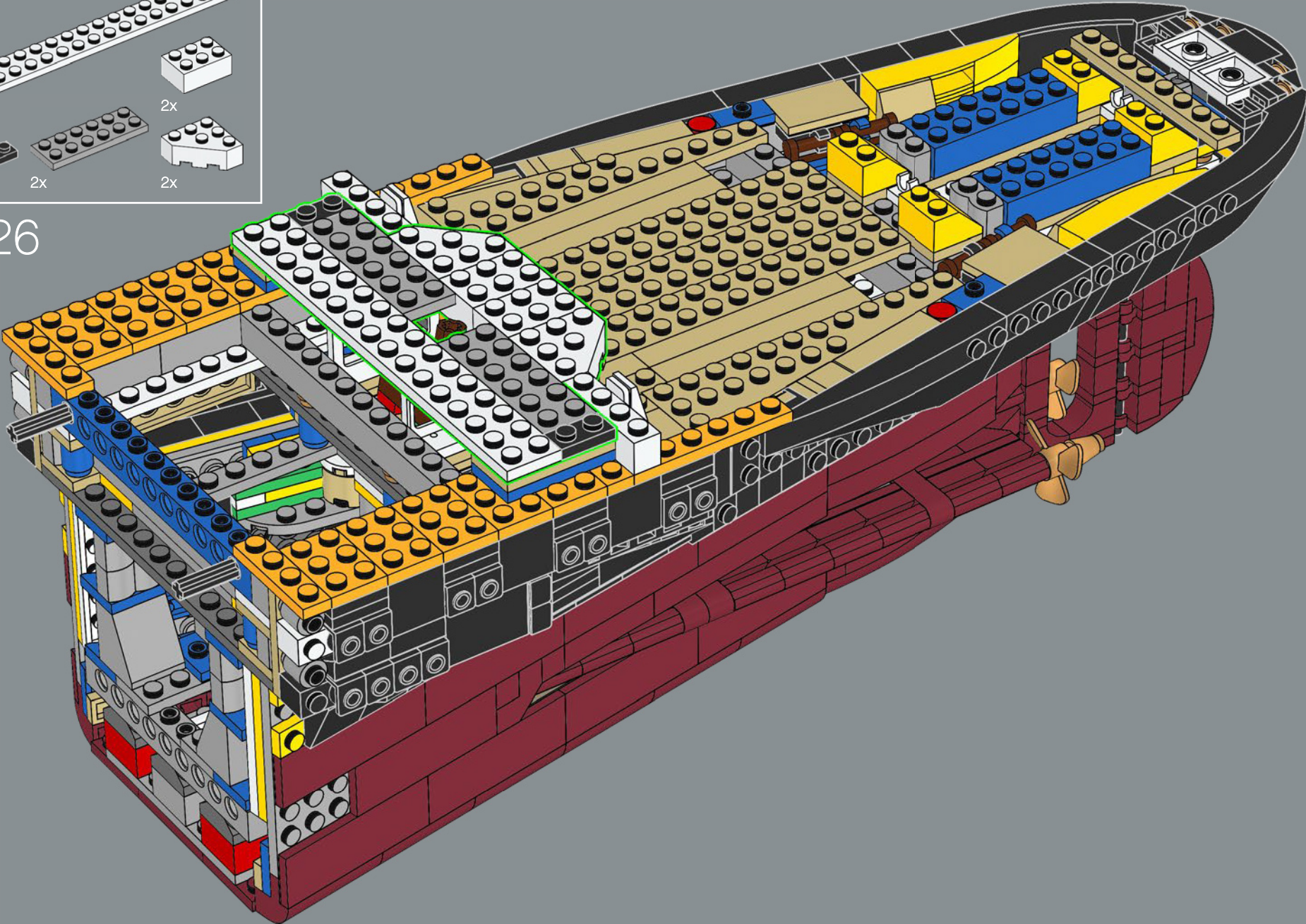



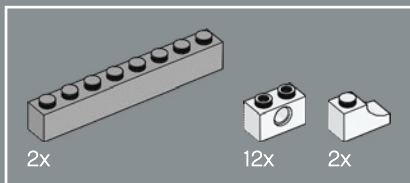

327

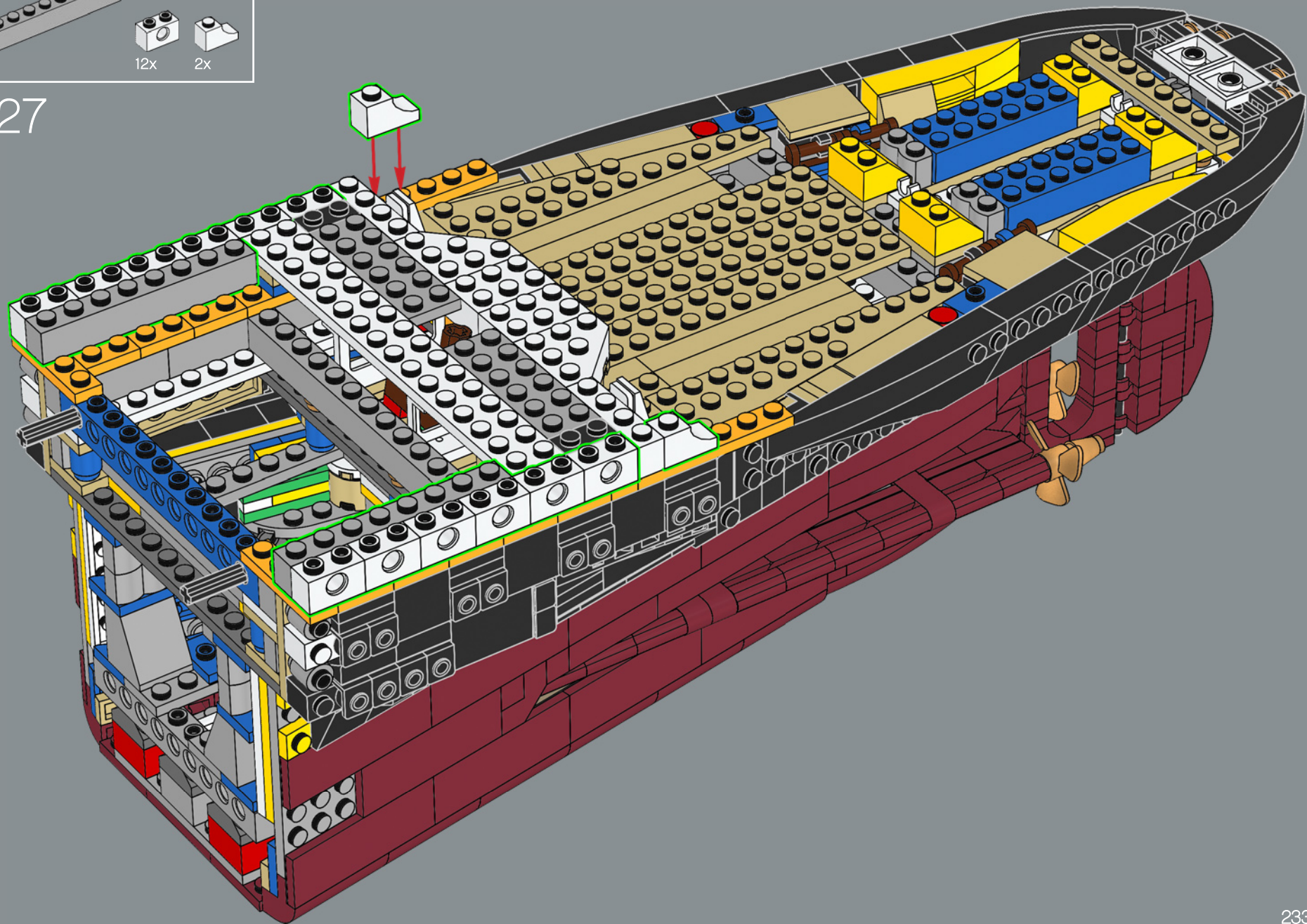



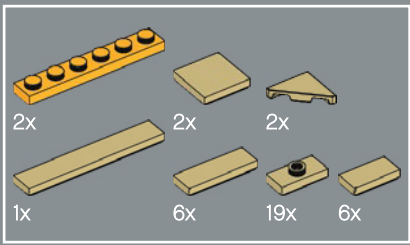

328

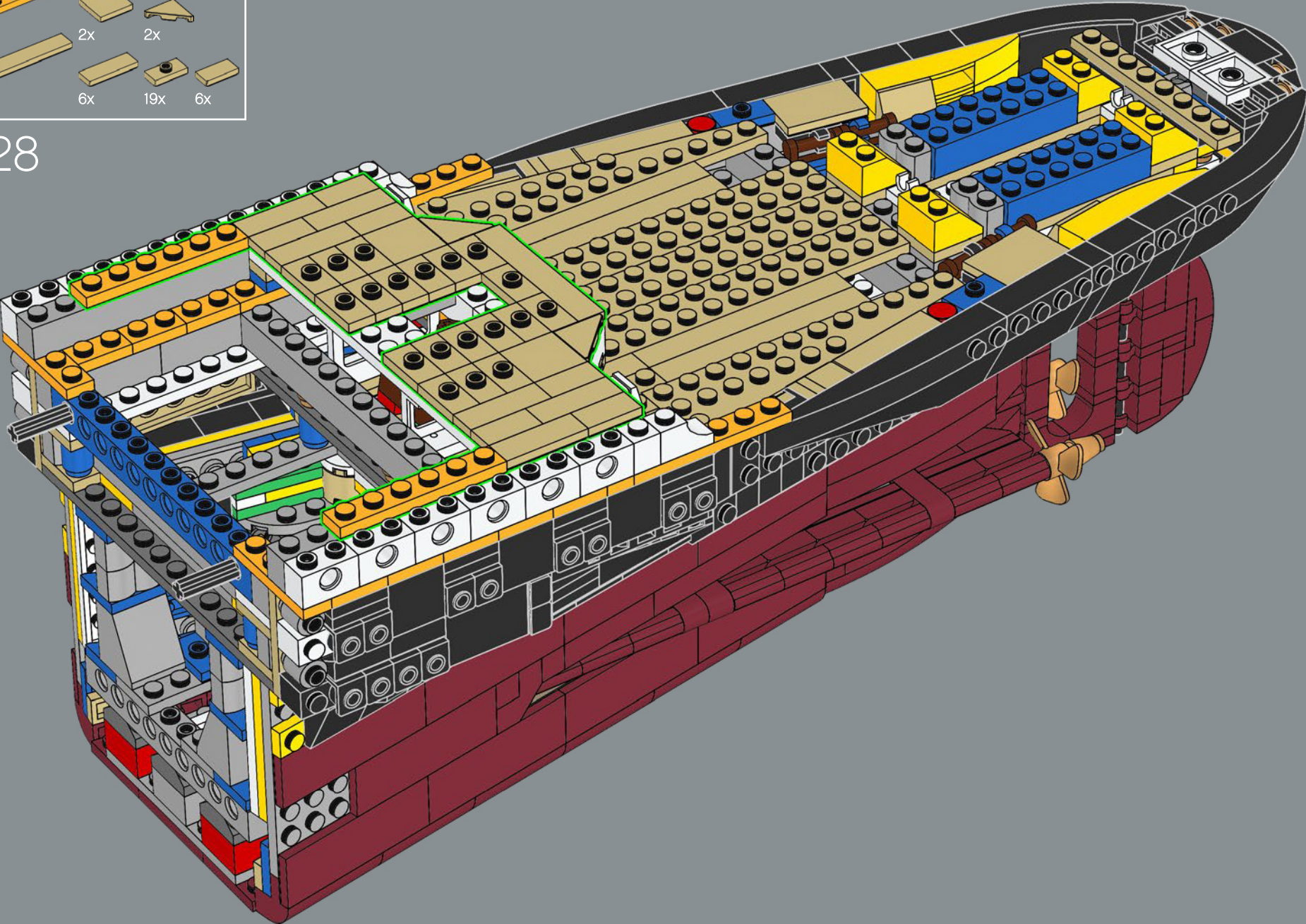



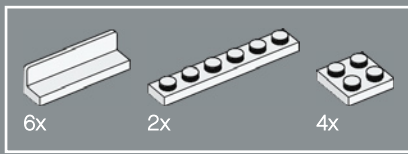

329

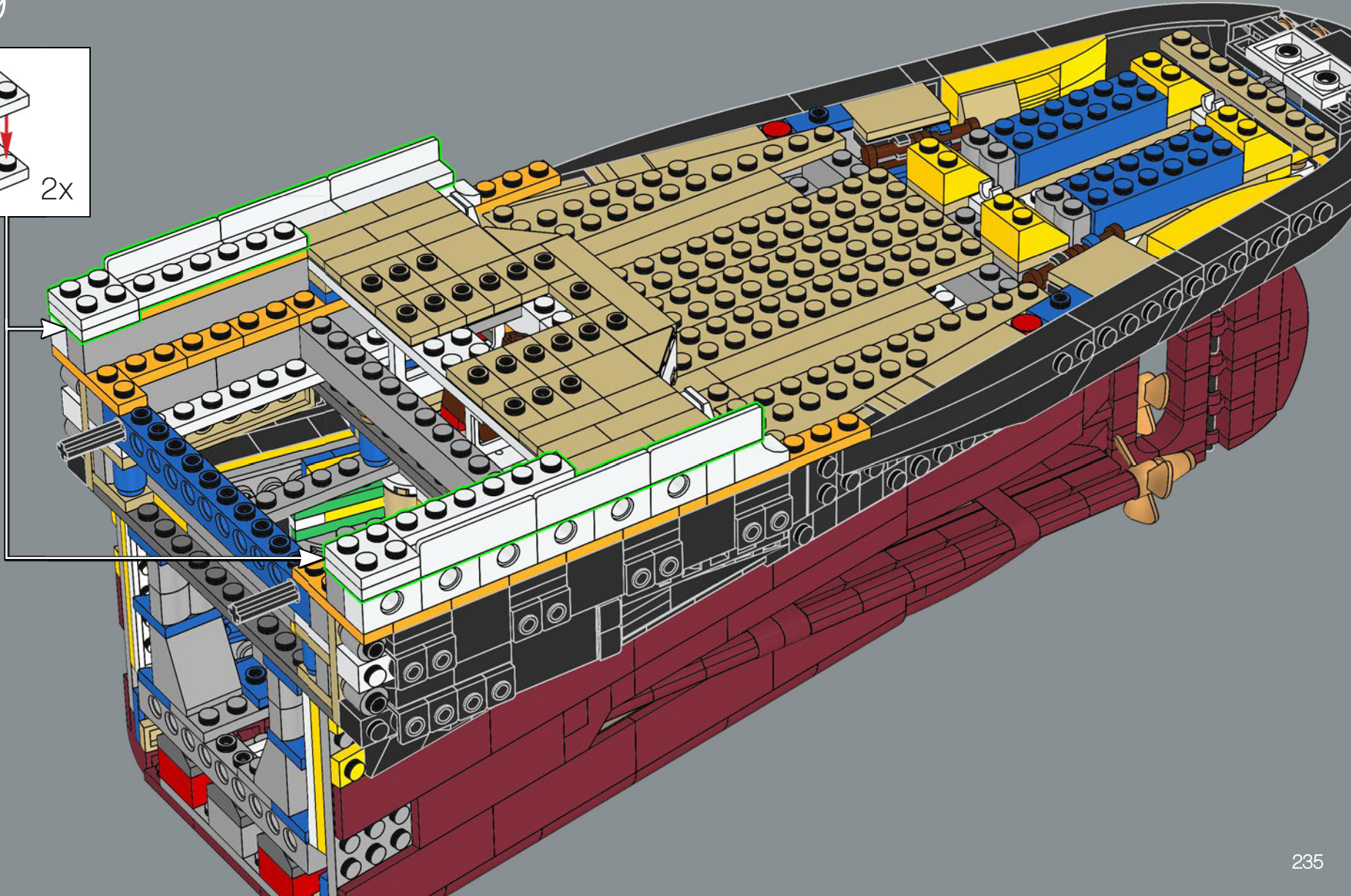
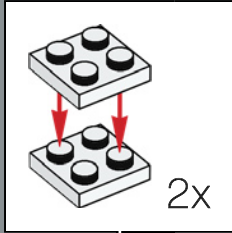

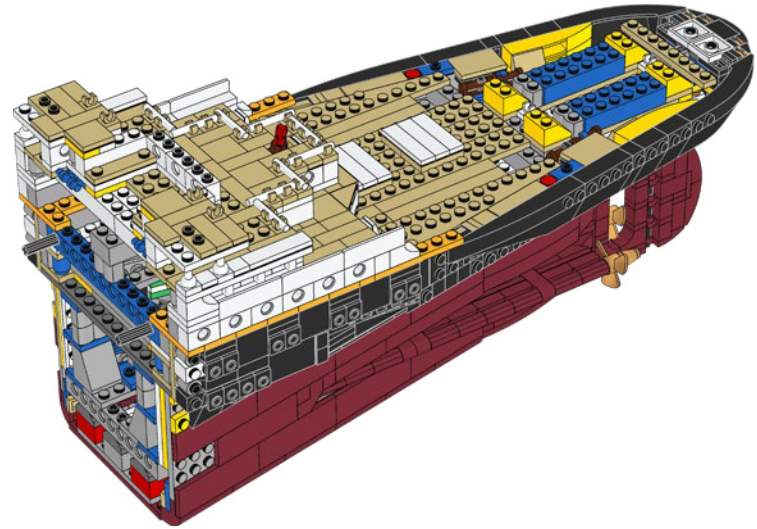
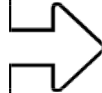



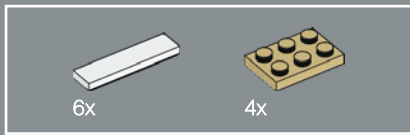

330

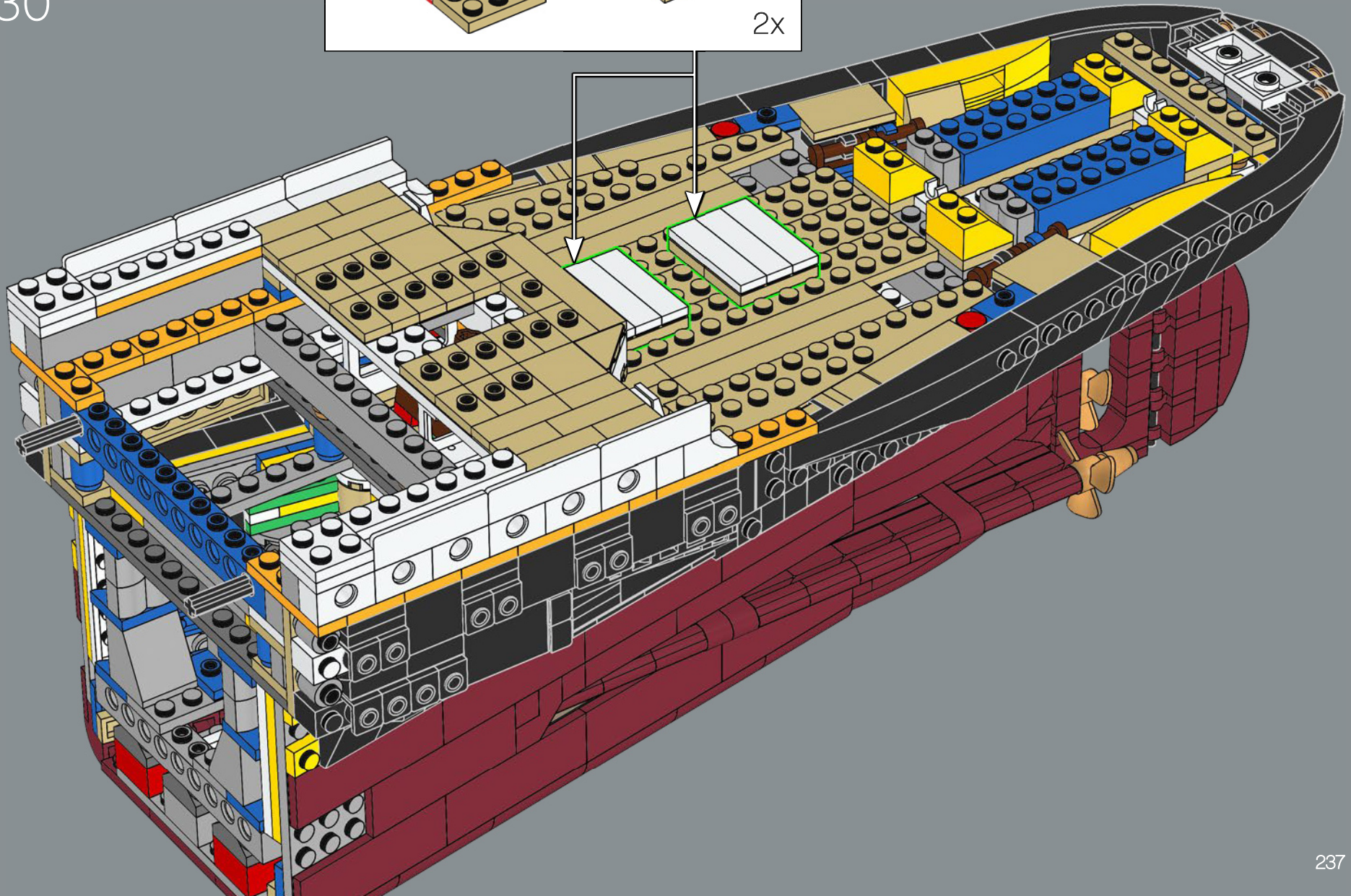
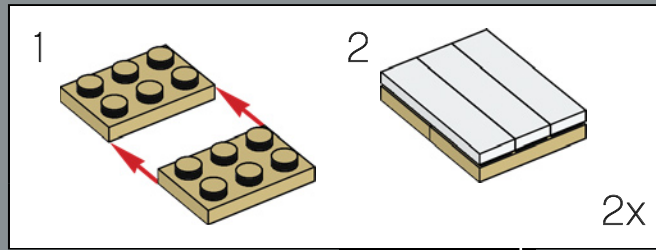



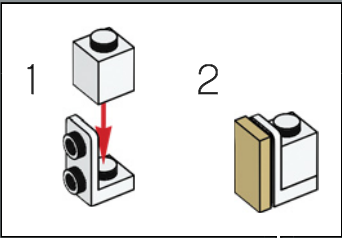
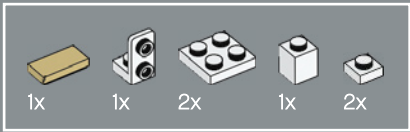

331

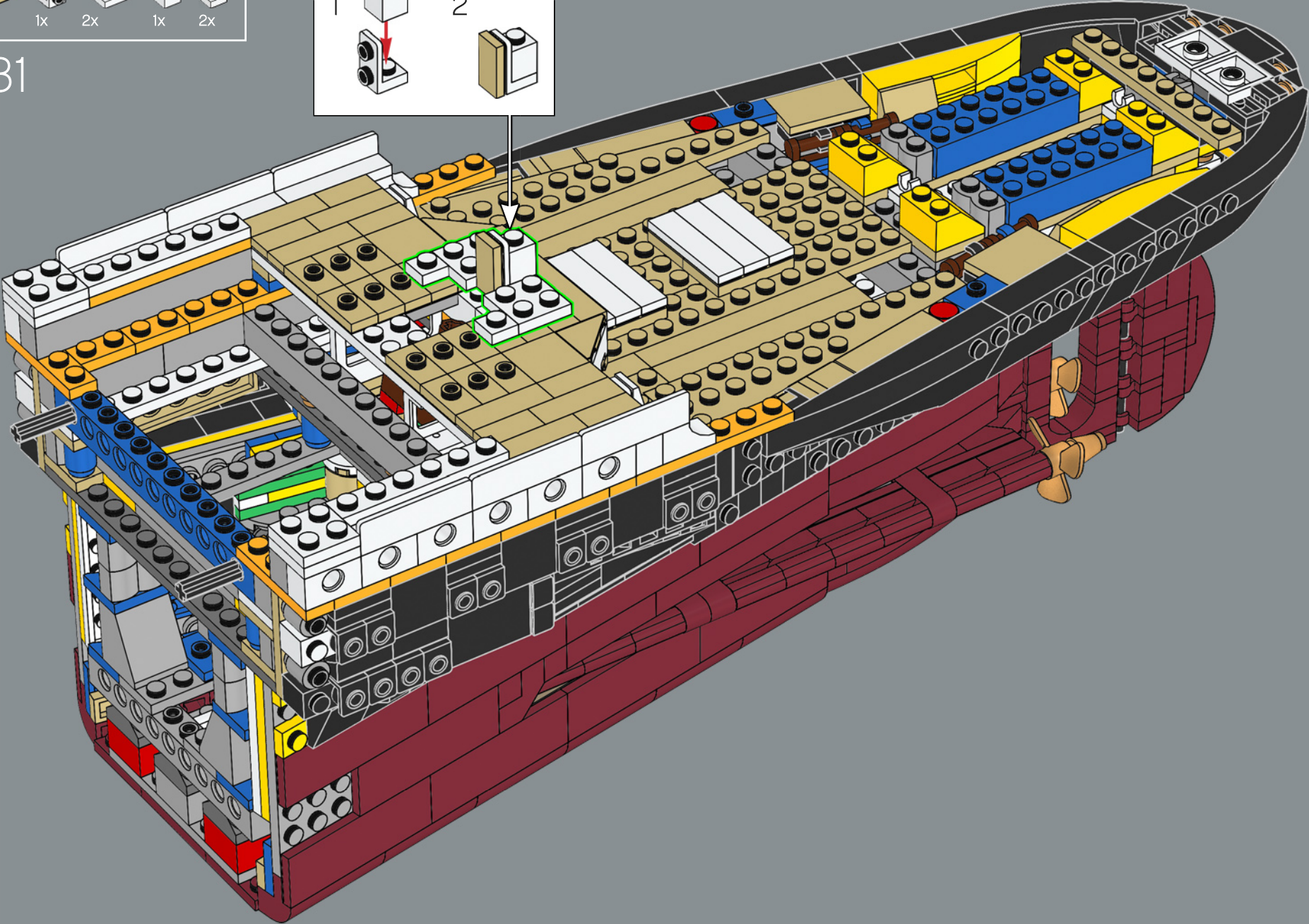



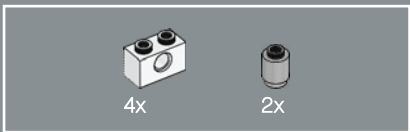

332

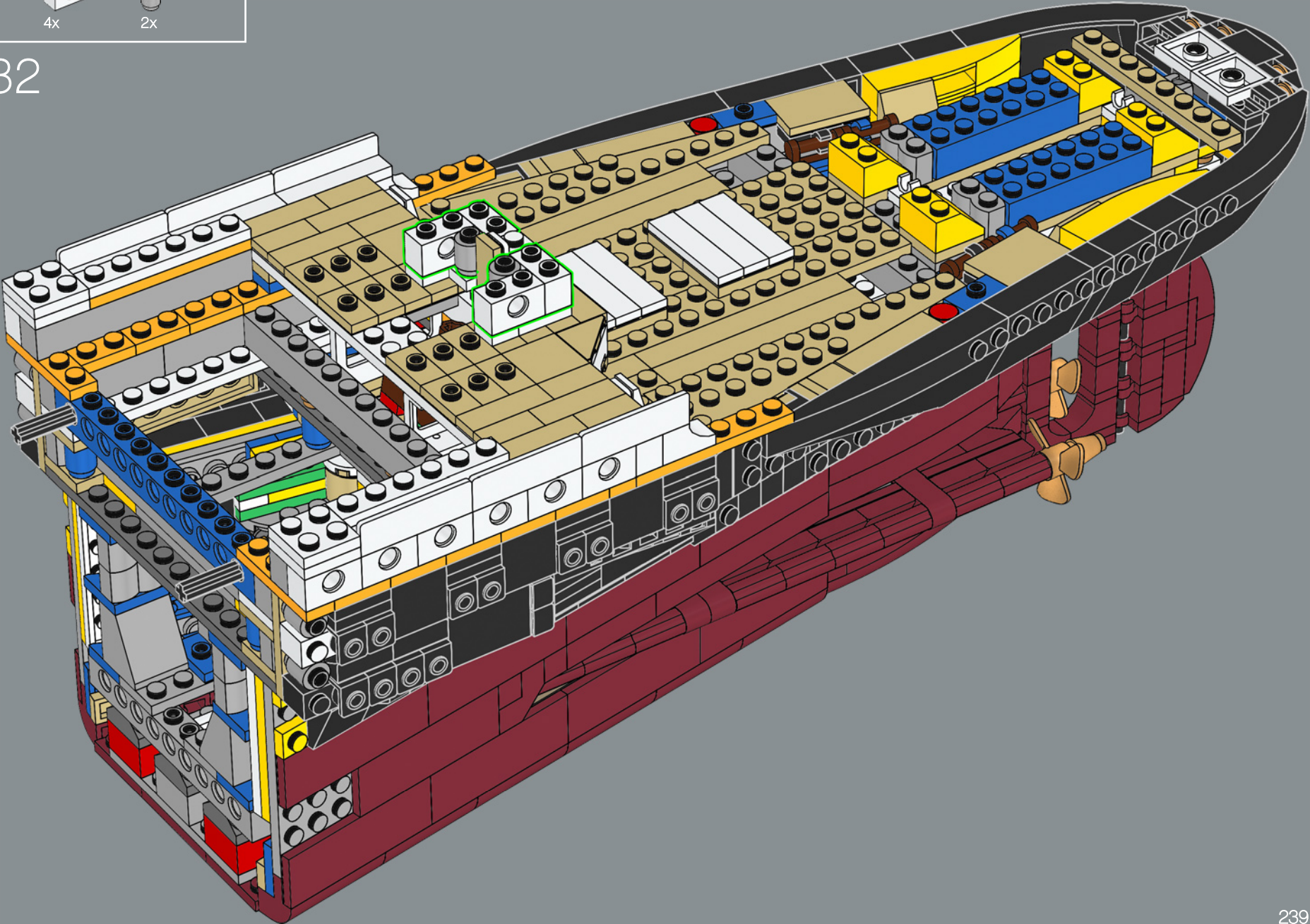



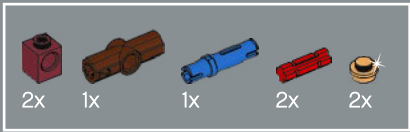

333

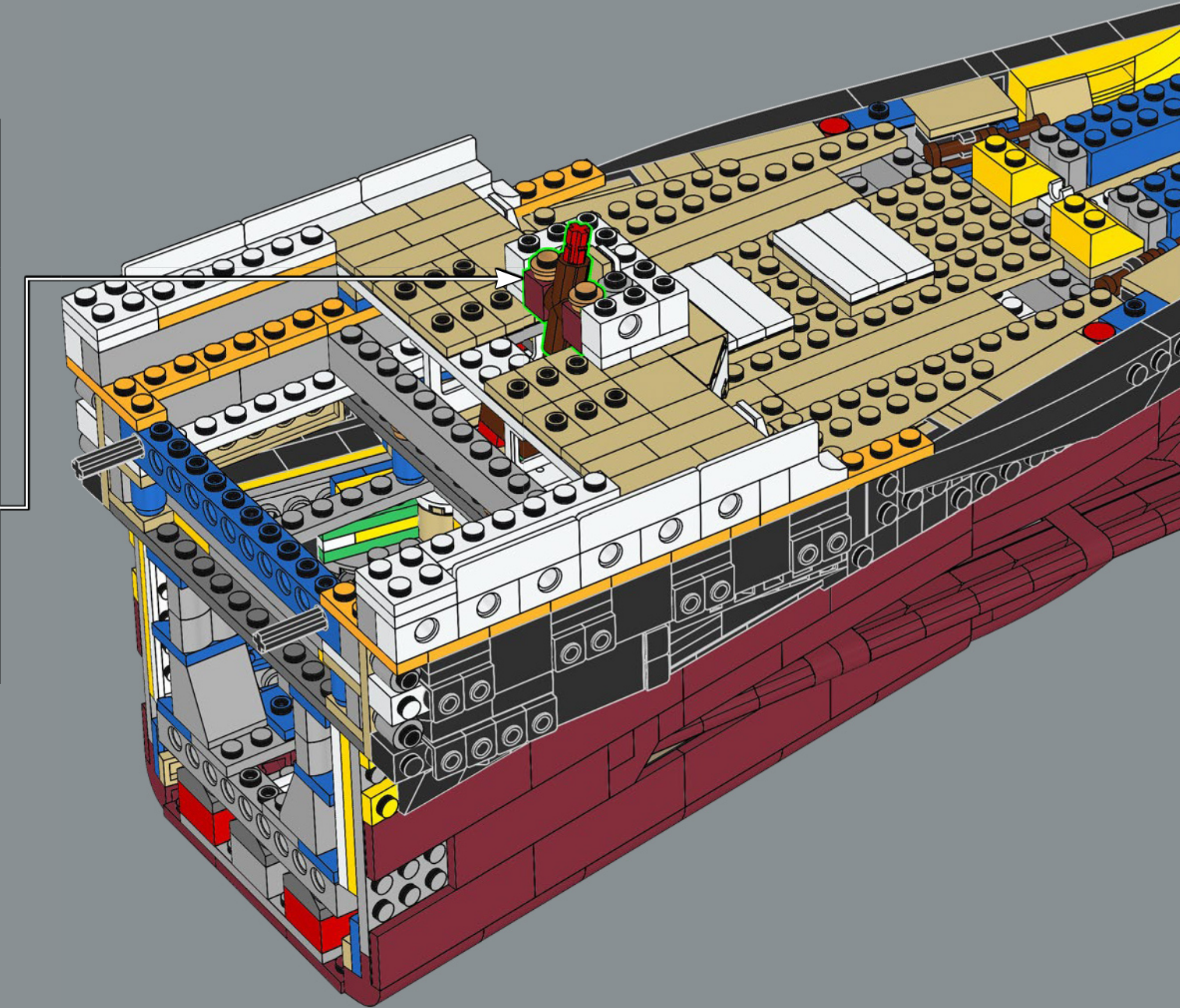
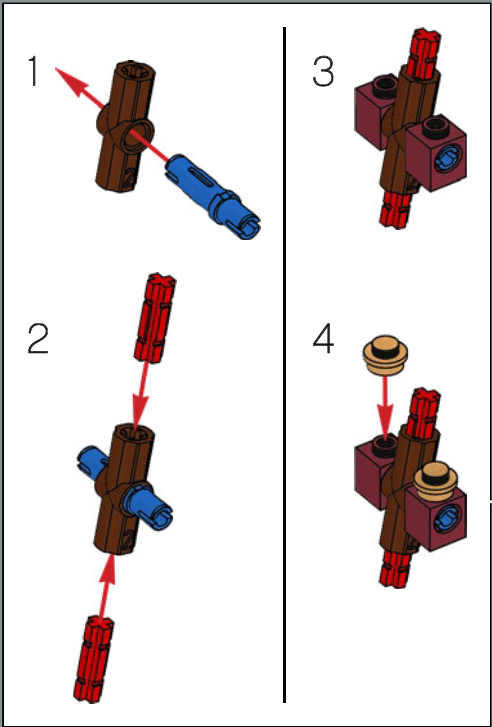



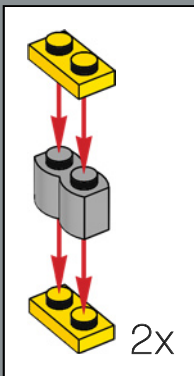
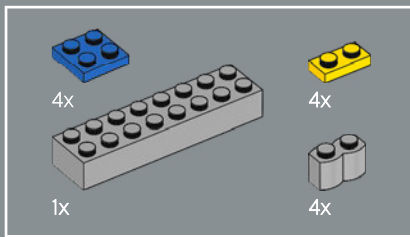

334

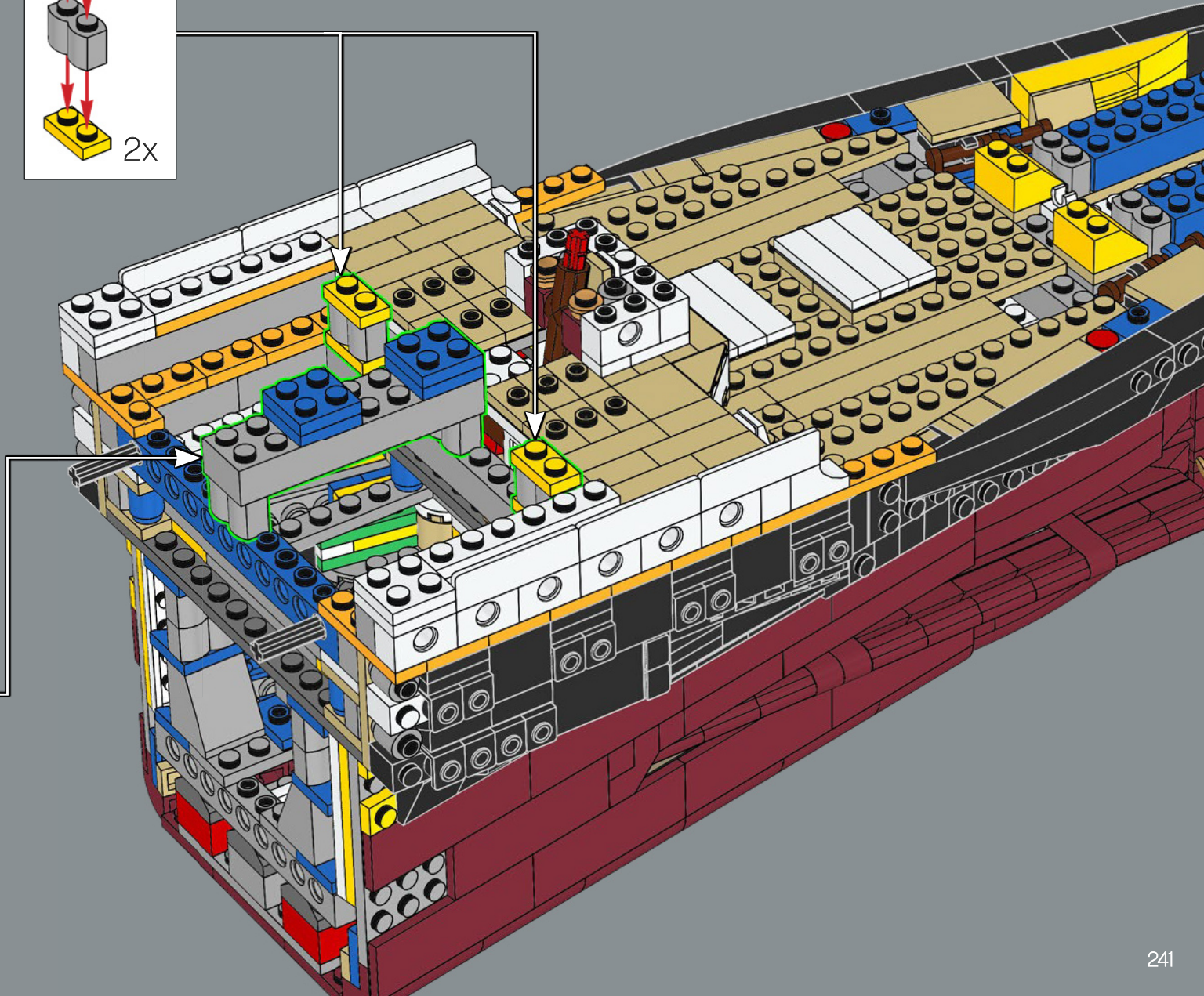
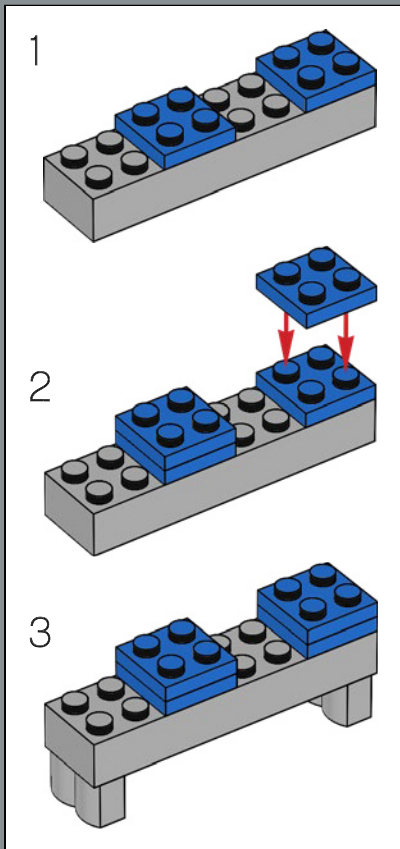



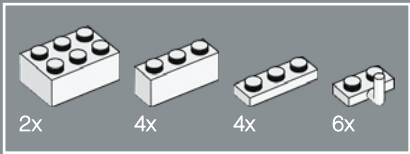

335

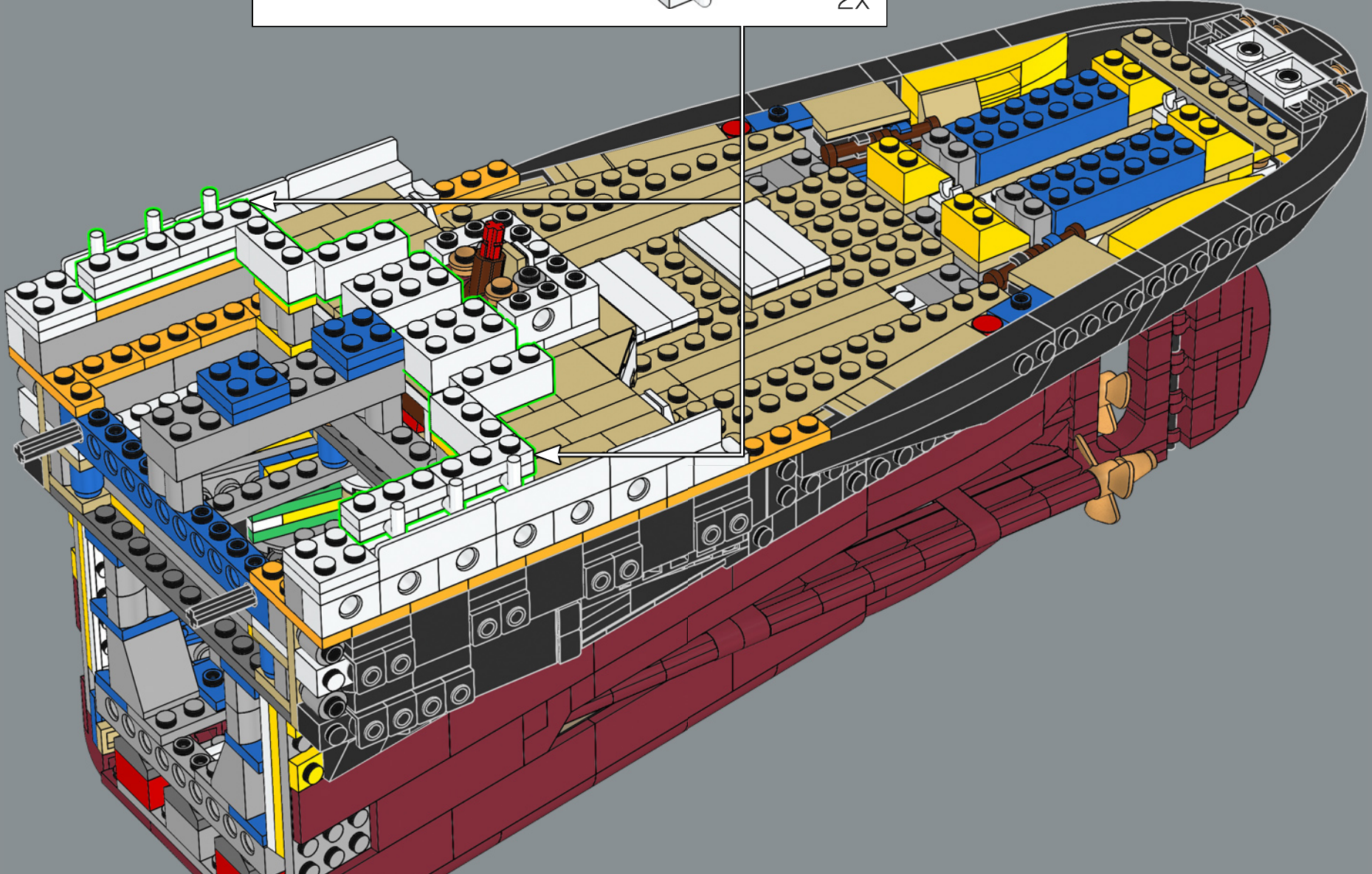
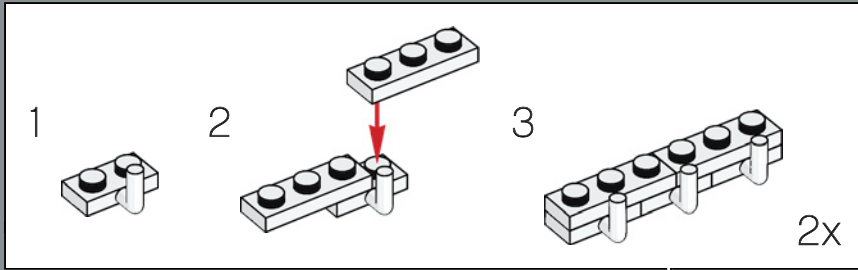



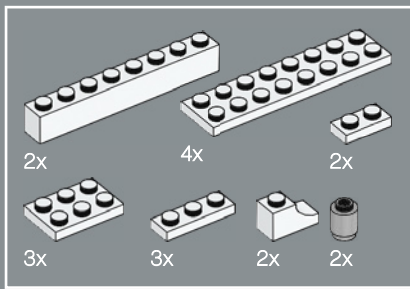

336

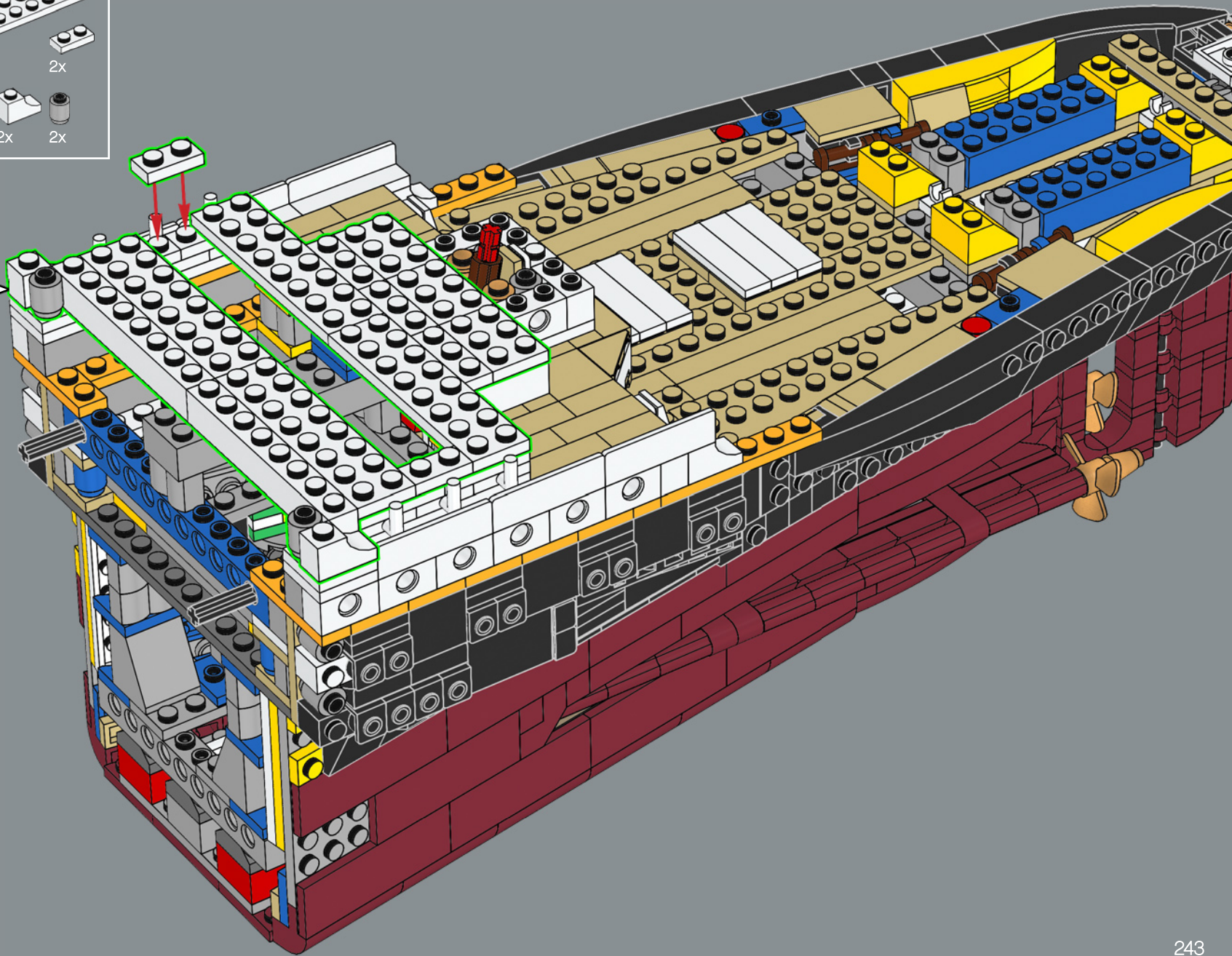
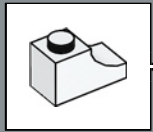



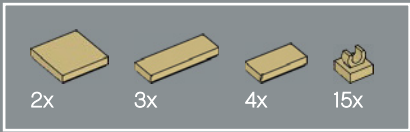

337

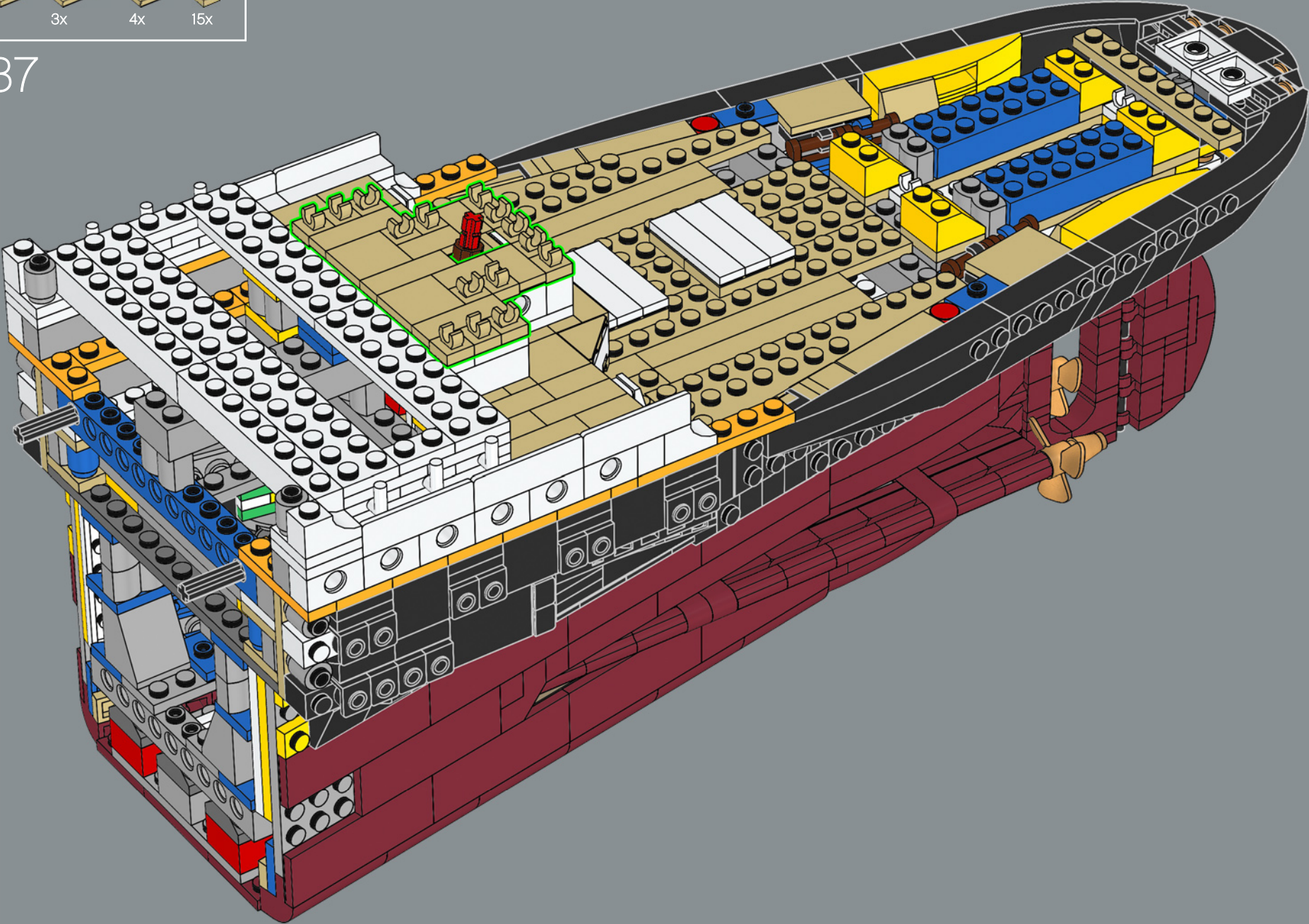



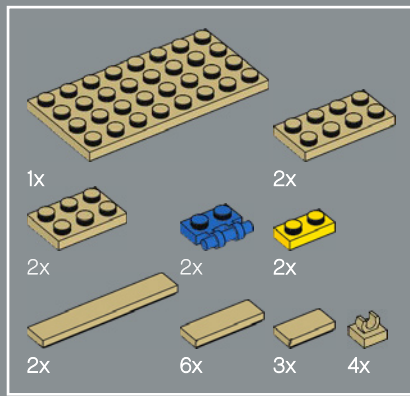

338

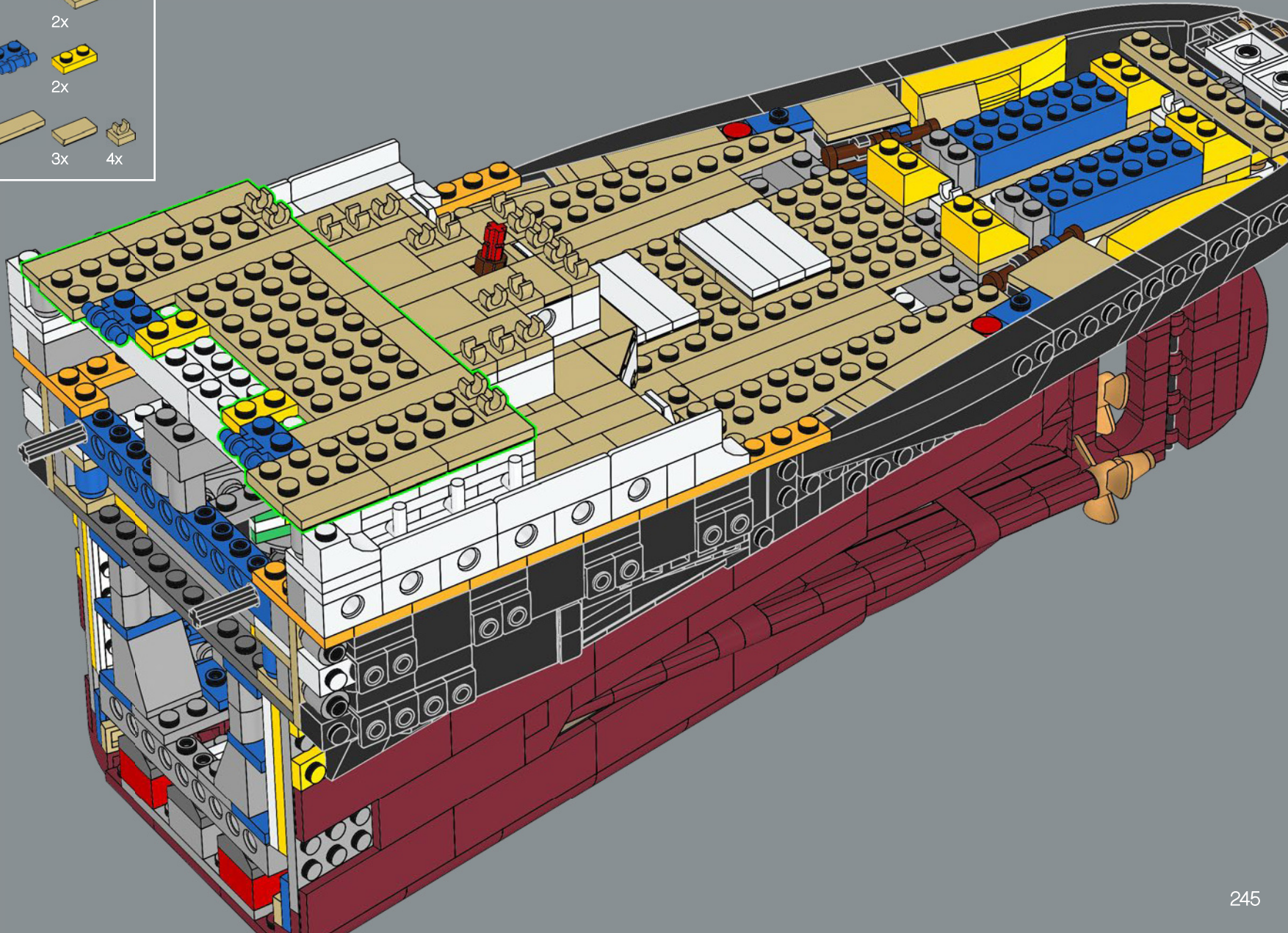



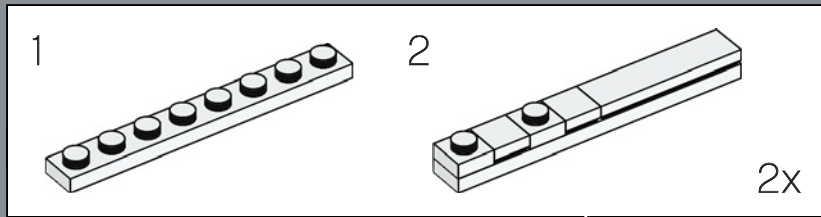
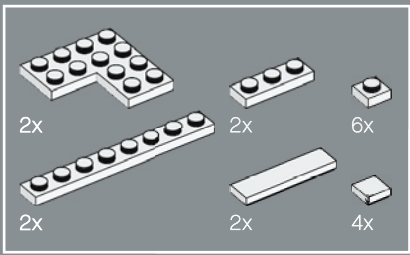

339

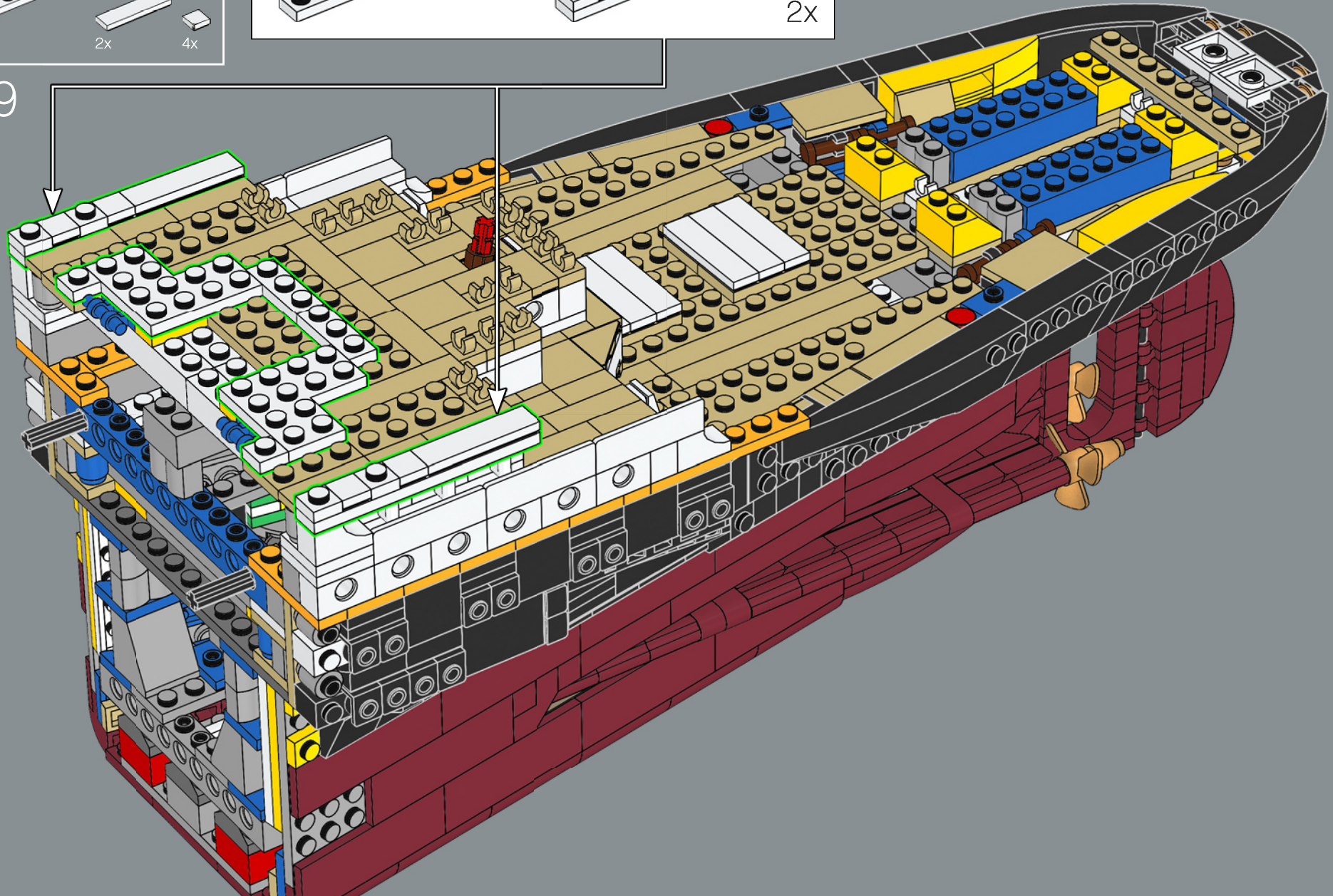



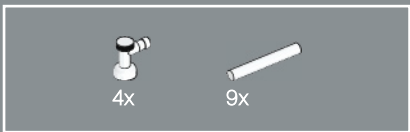

340

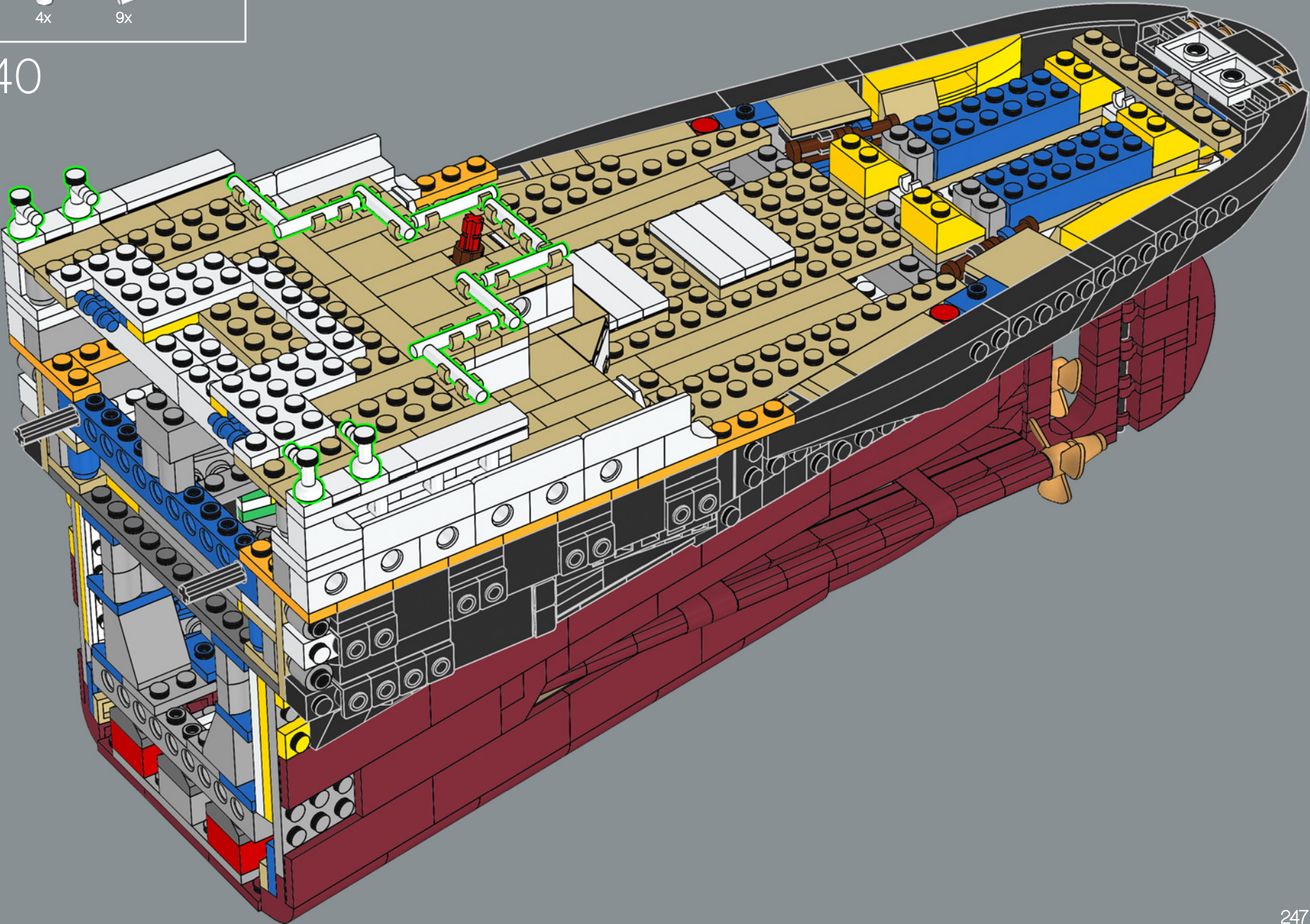



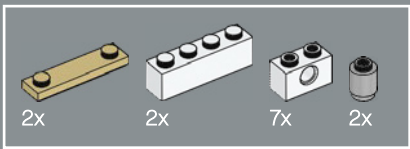

341

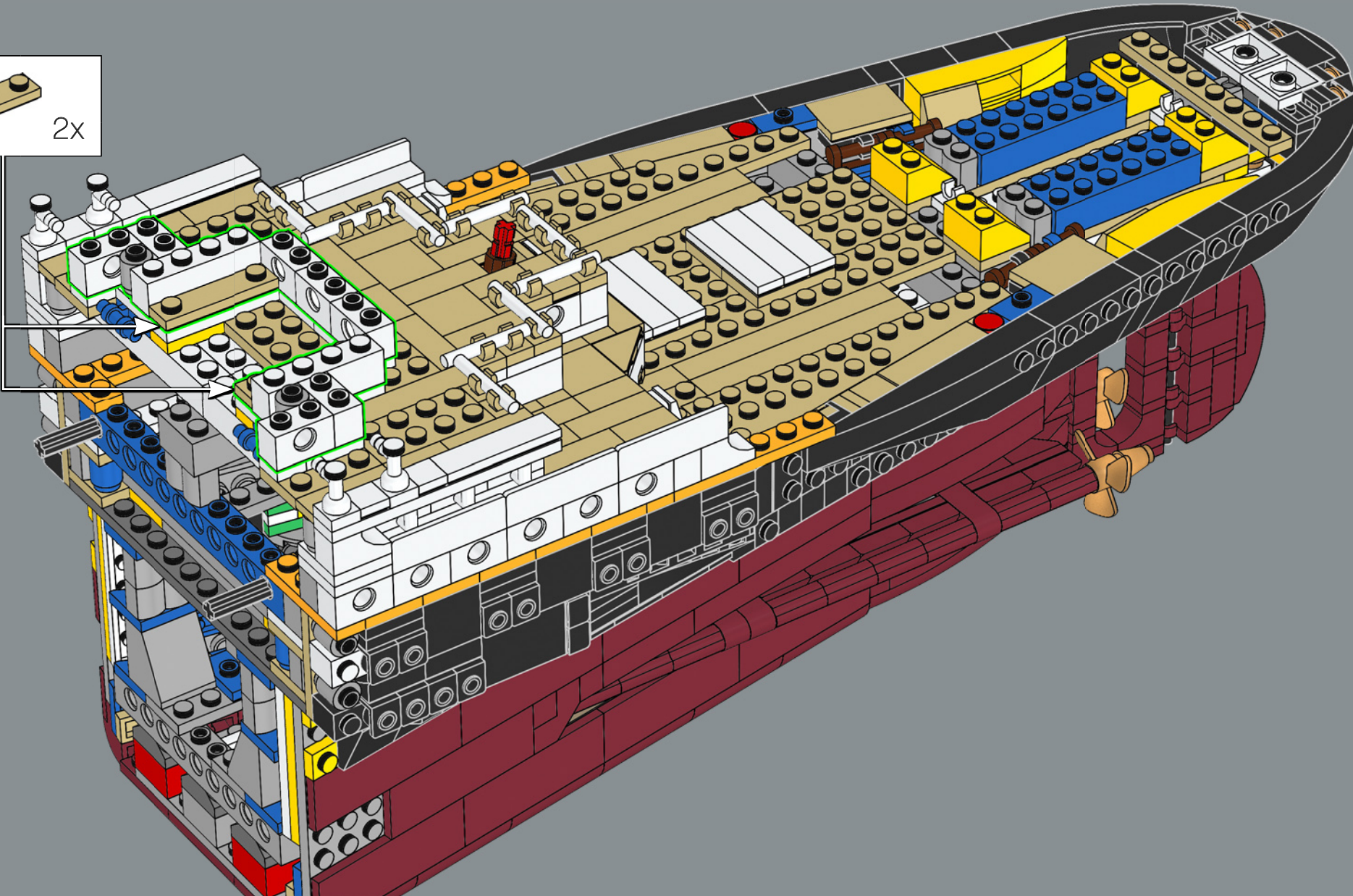
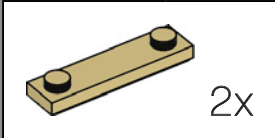



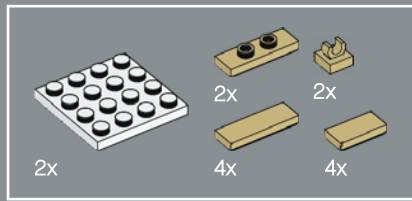

342

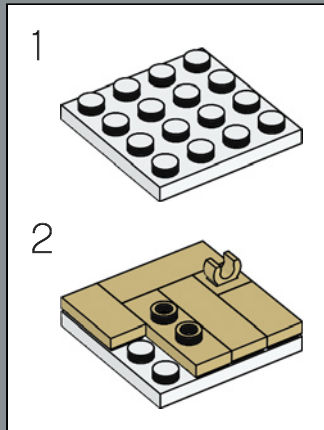
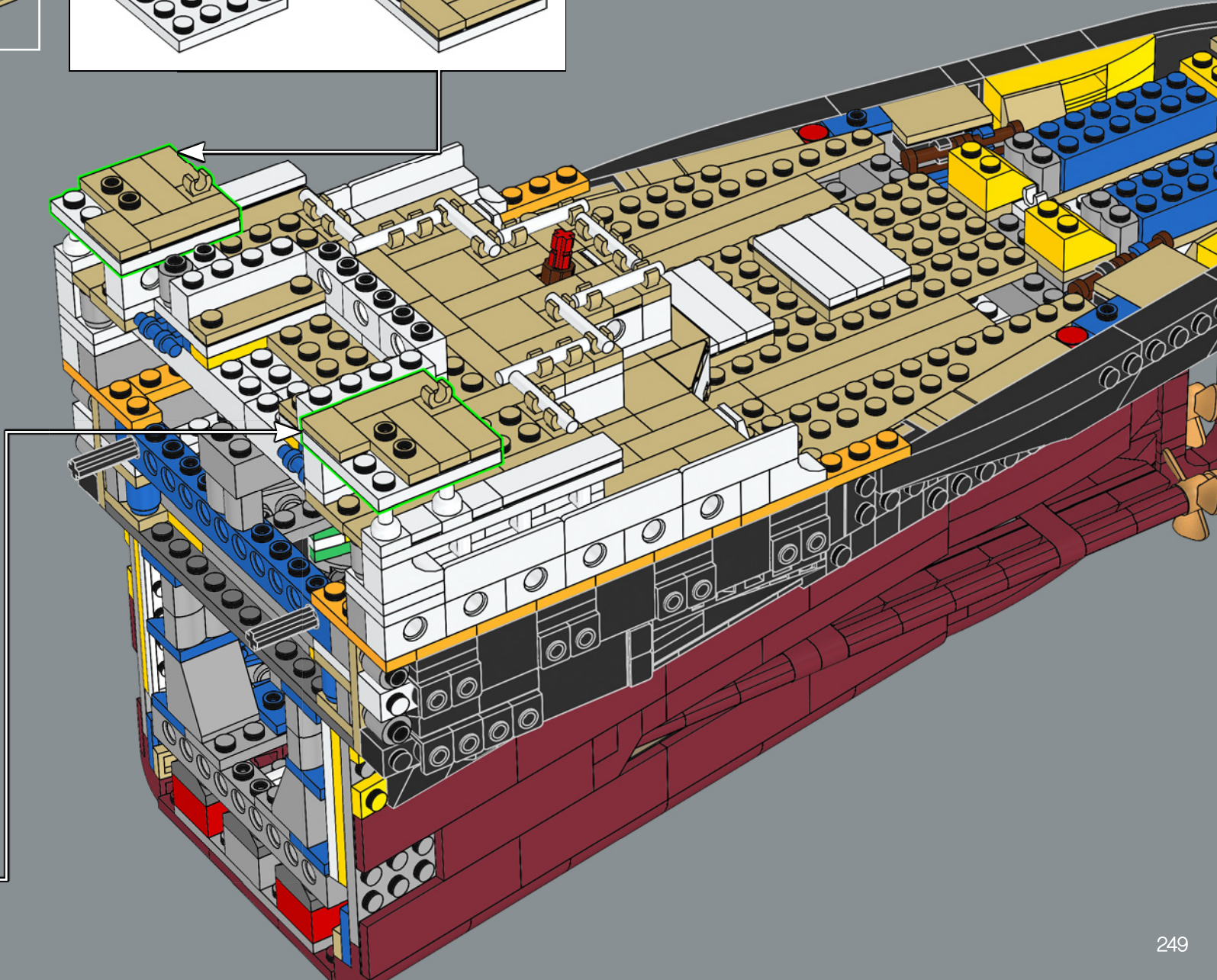
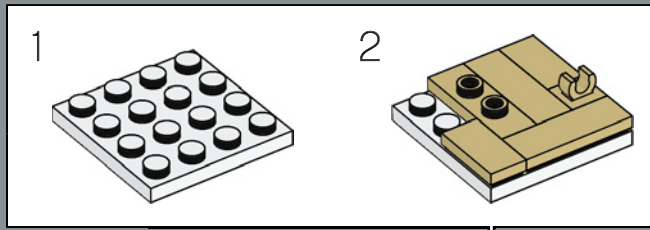



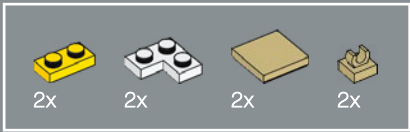

343

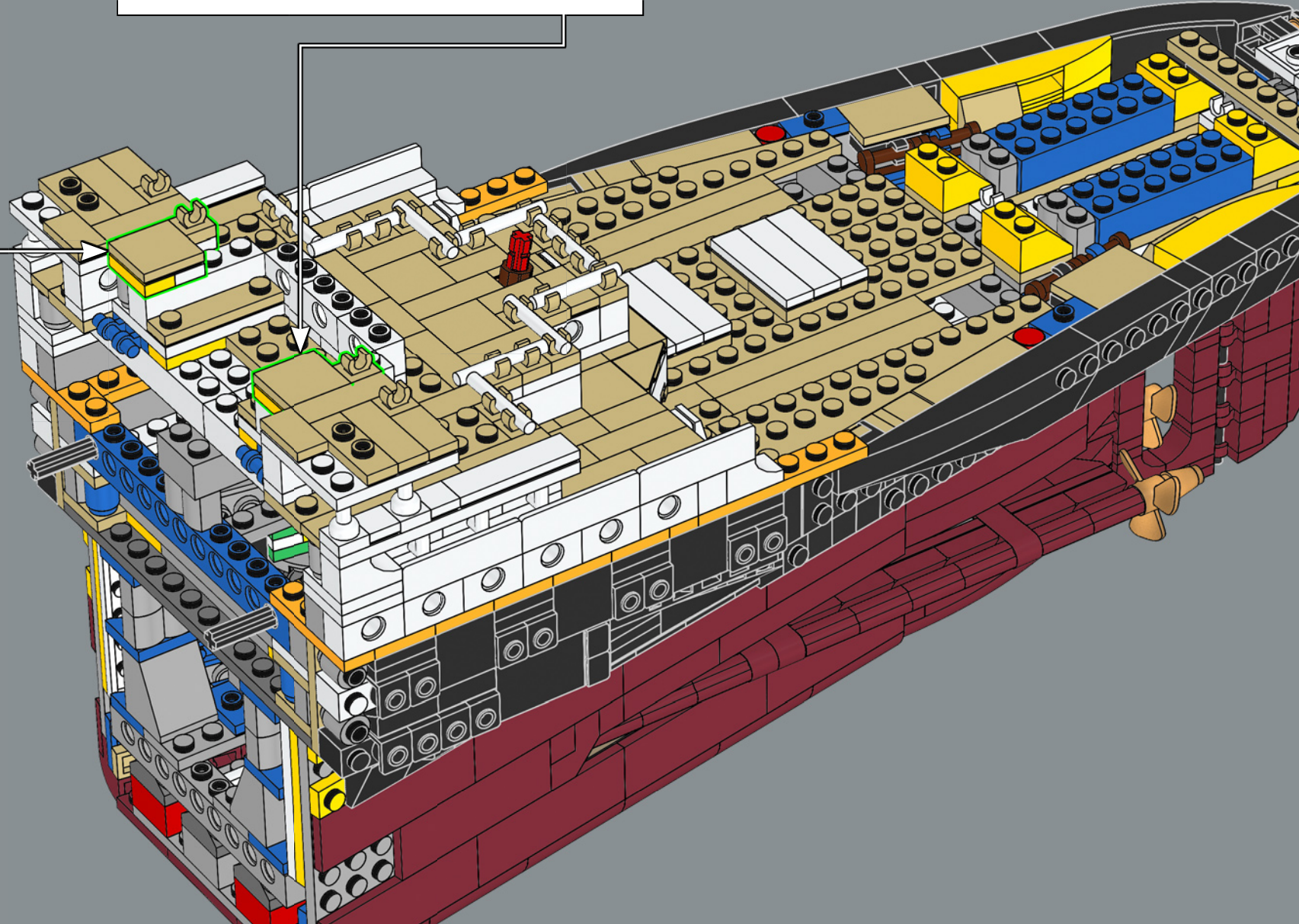
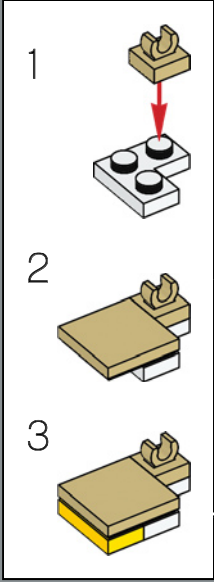
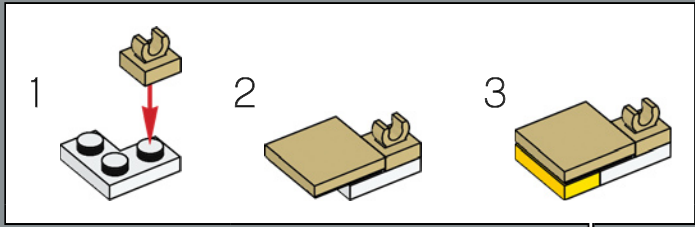

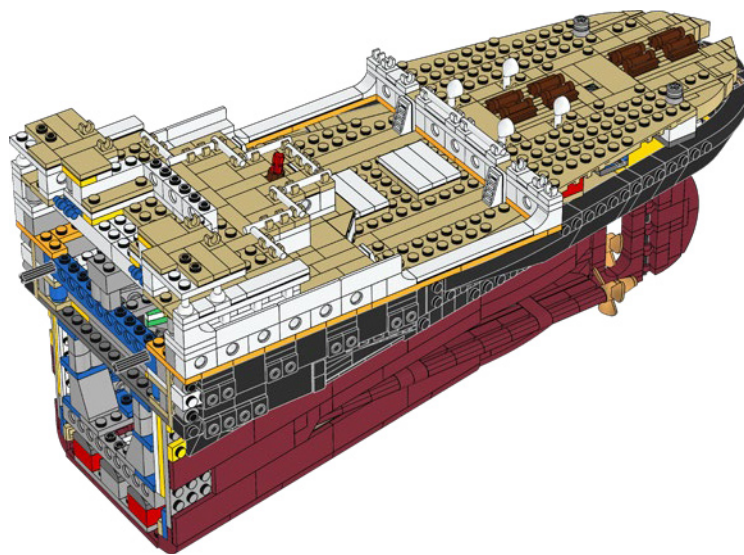



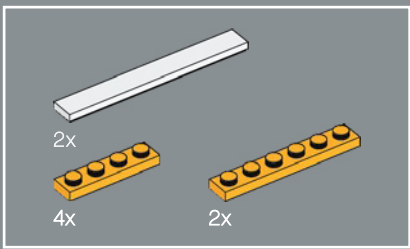

344

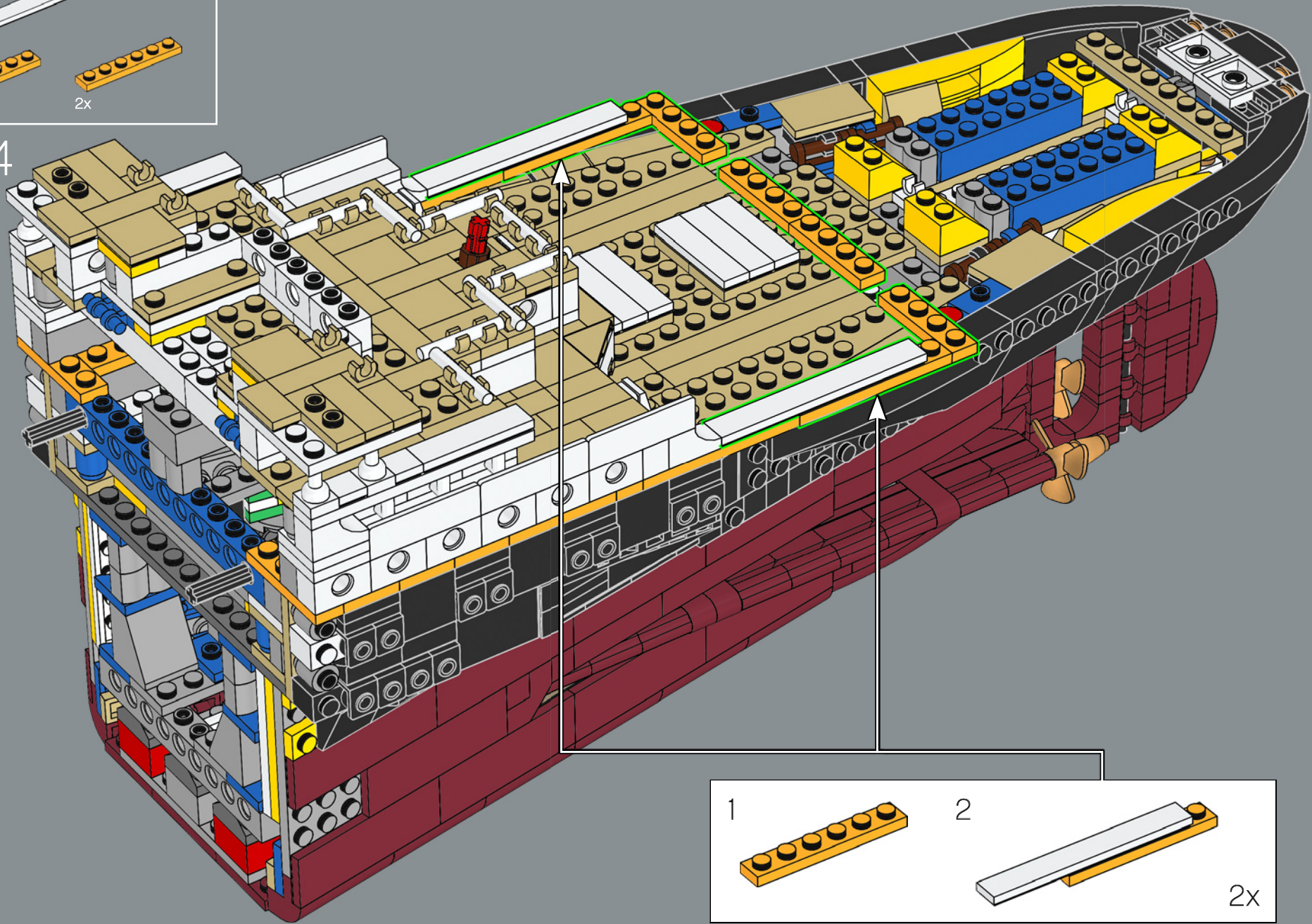



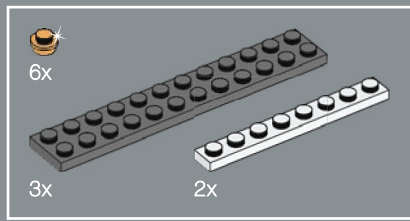

345

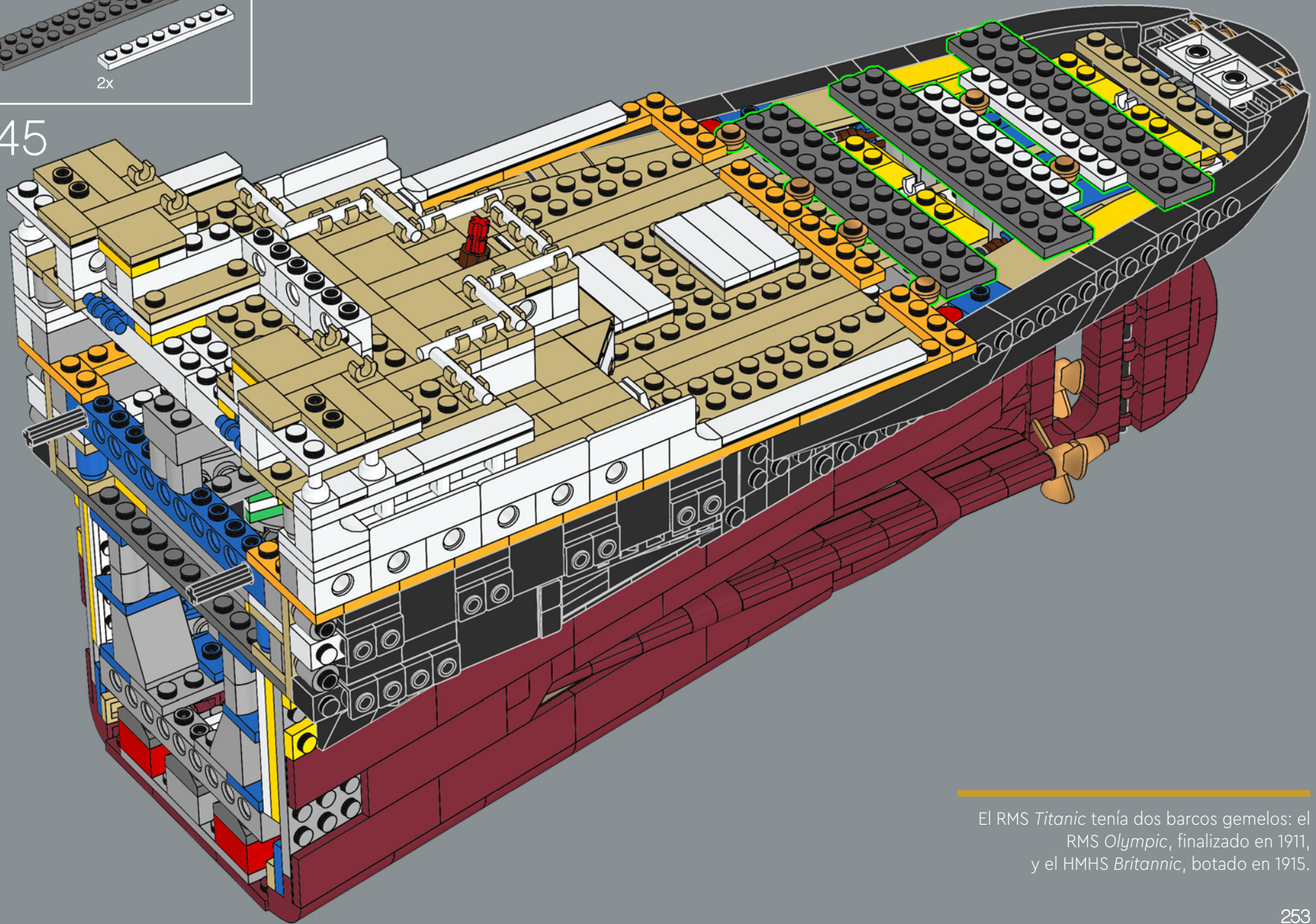

El RMS *Titanic* tenía dos barcos gemelos: el RMS *Olympic*, finalizado en 1911, y el HMHS *Britannic*, botado en 1915.



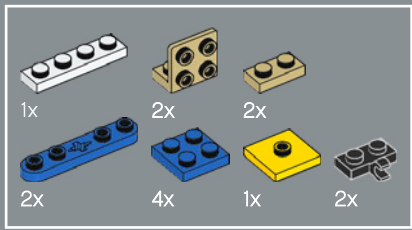

346

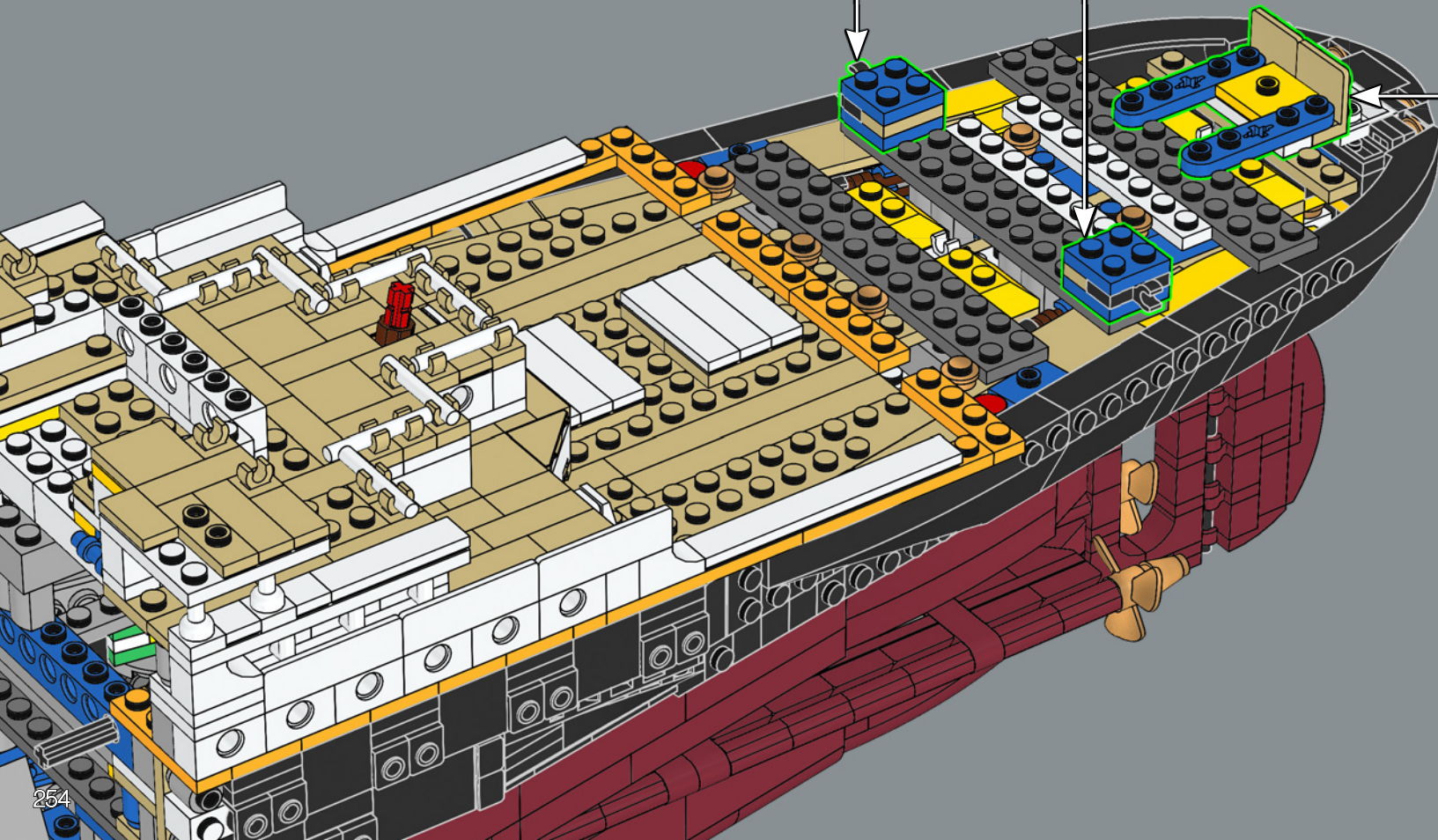
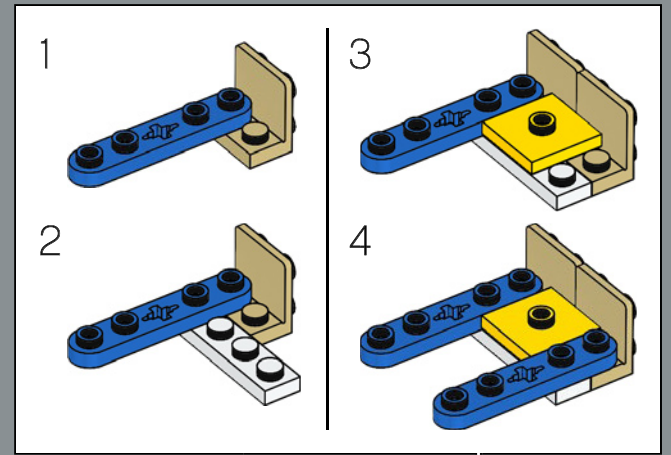
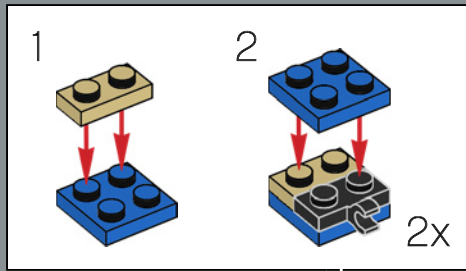







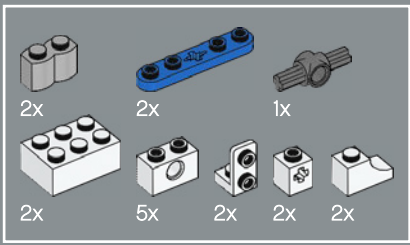

348

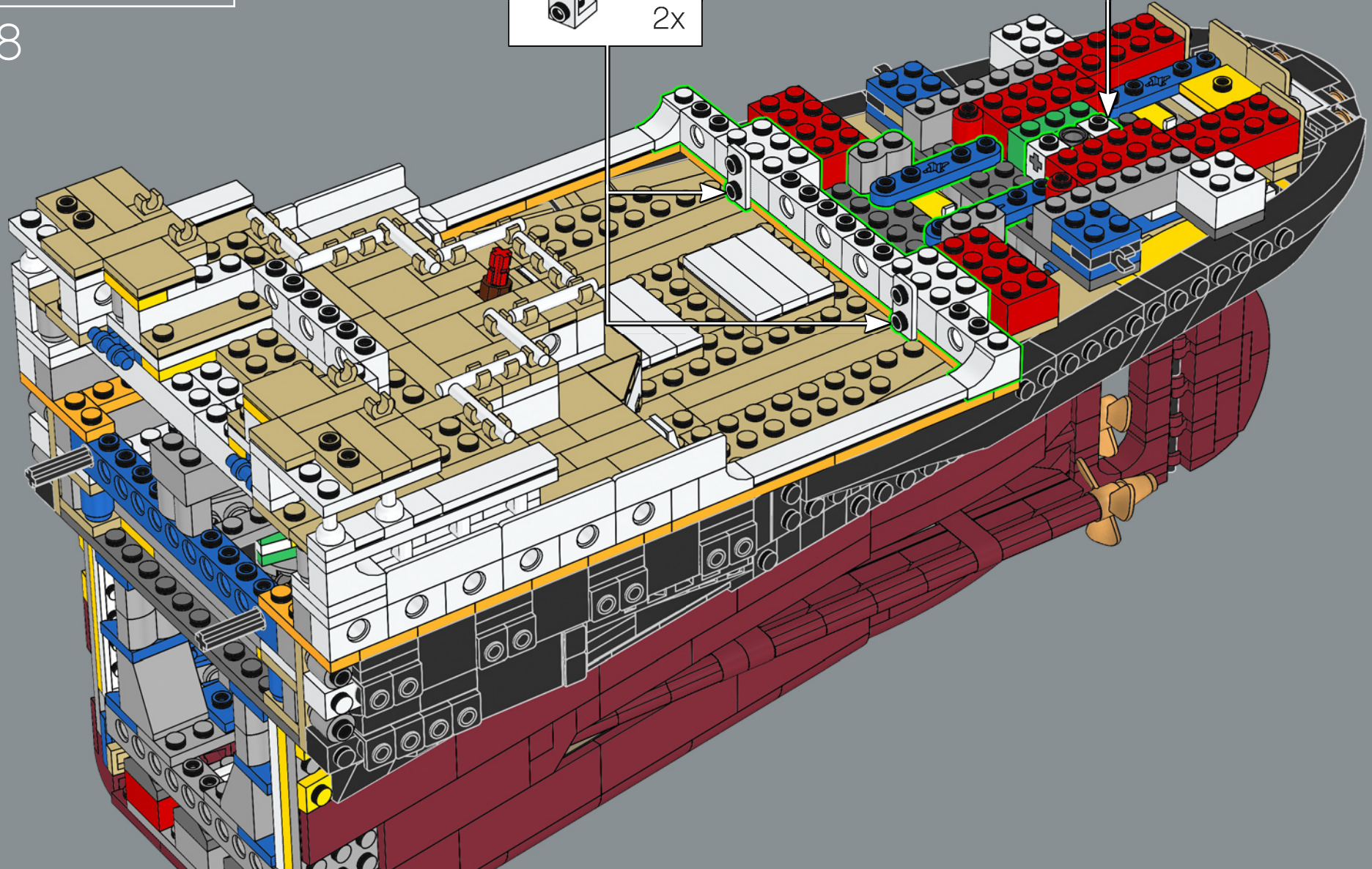
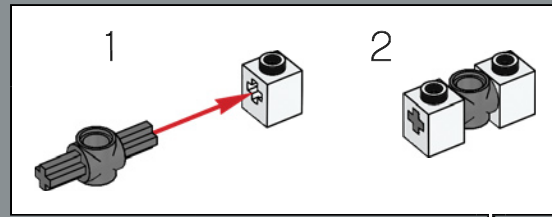
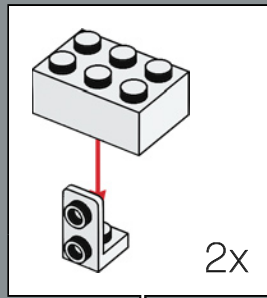



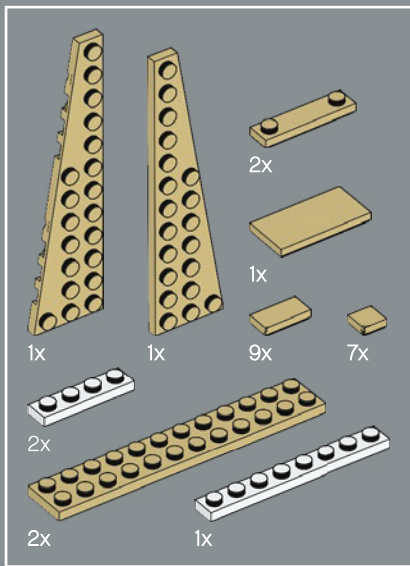

349

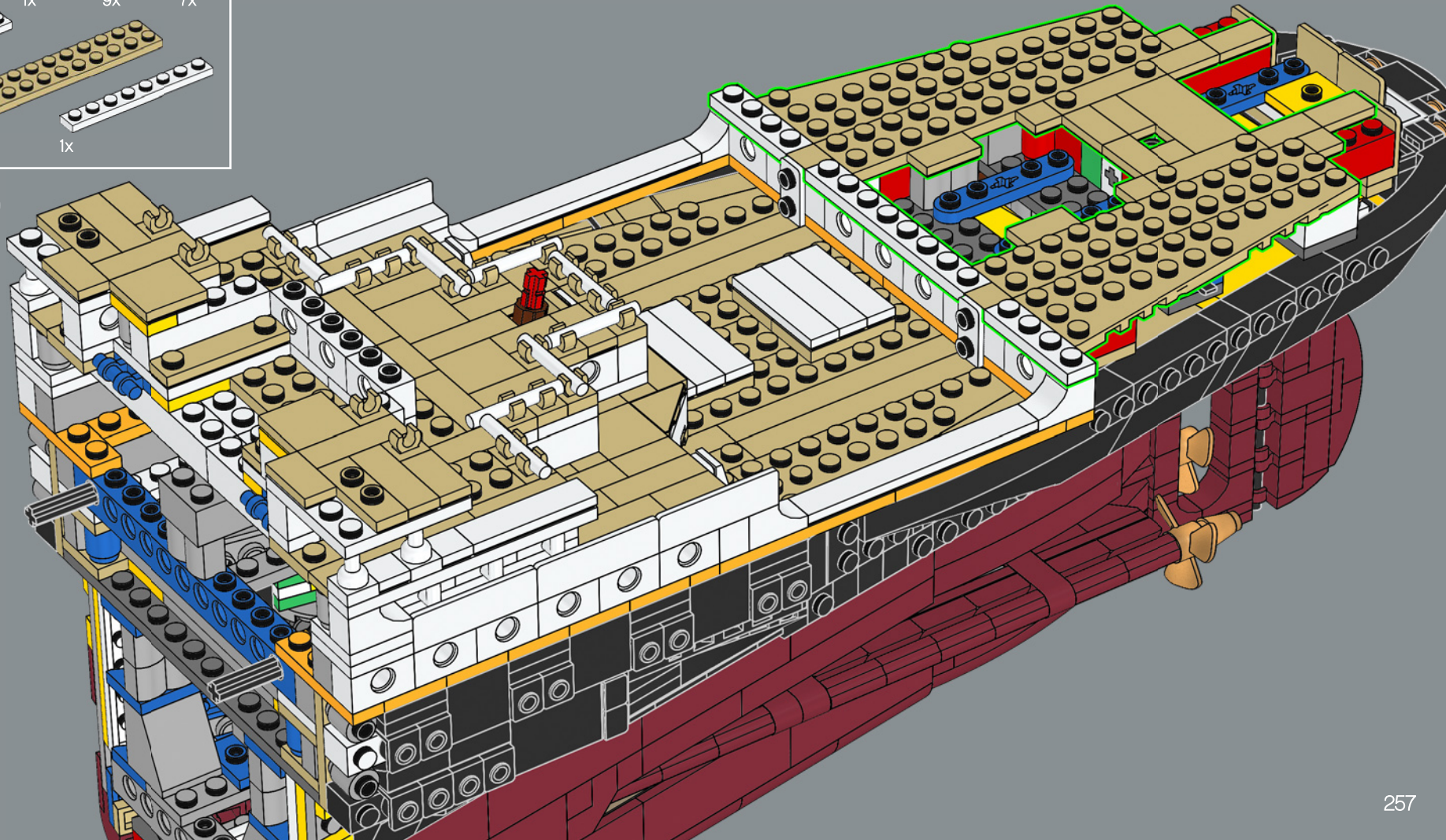



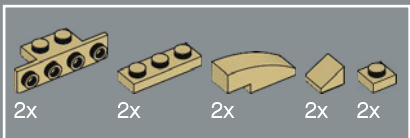

350

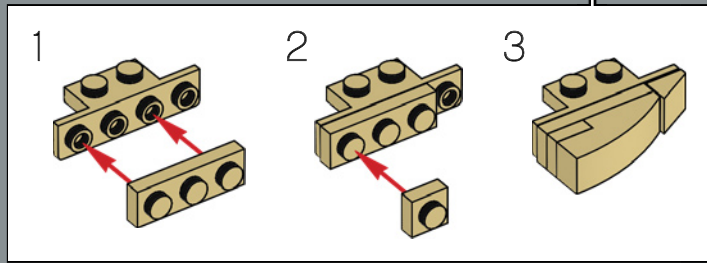
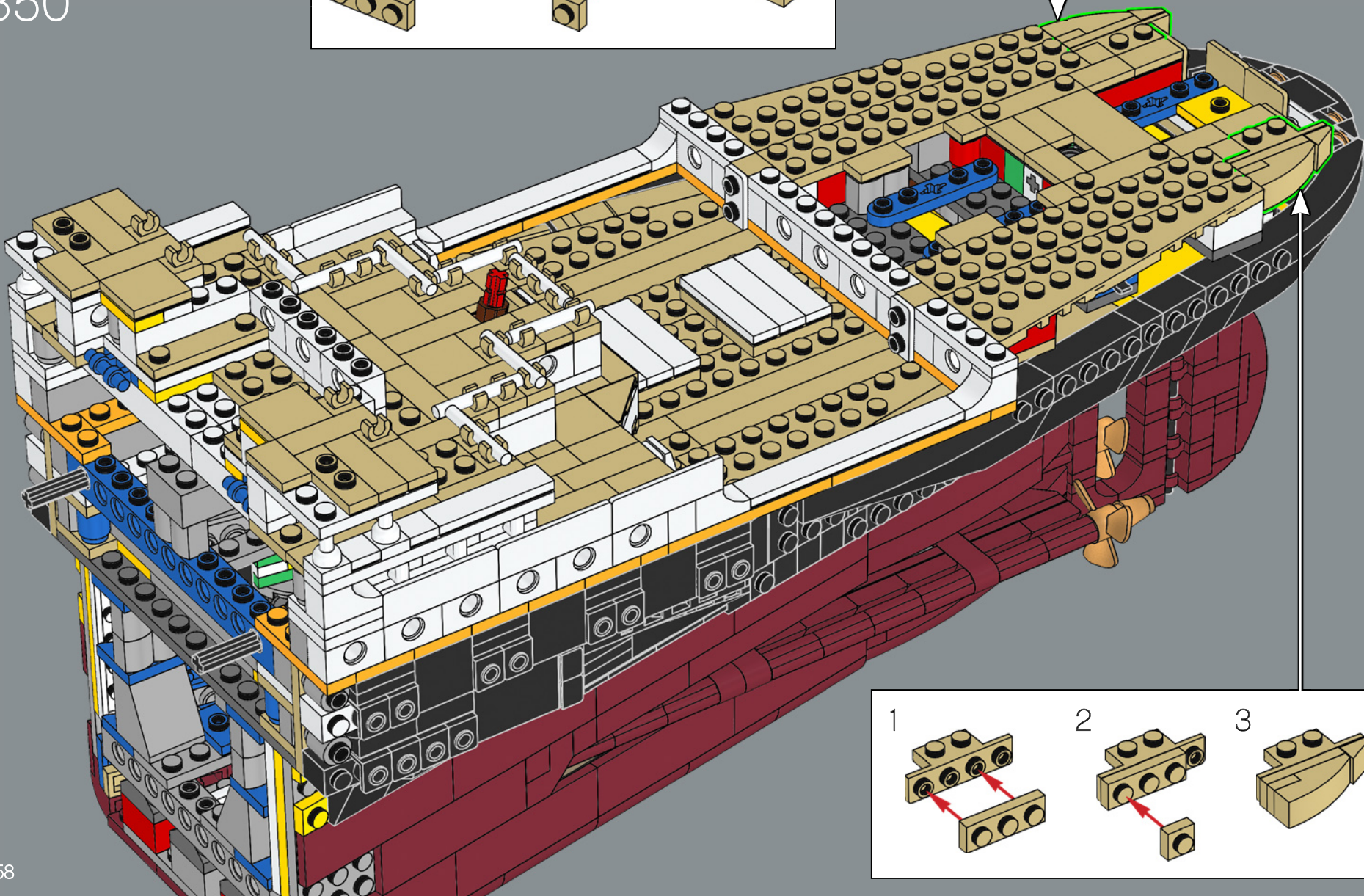
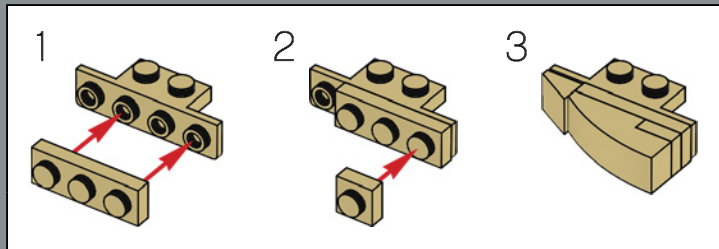



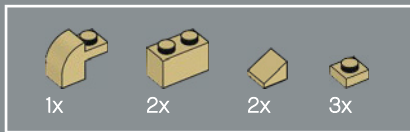

351

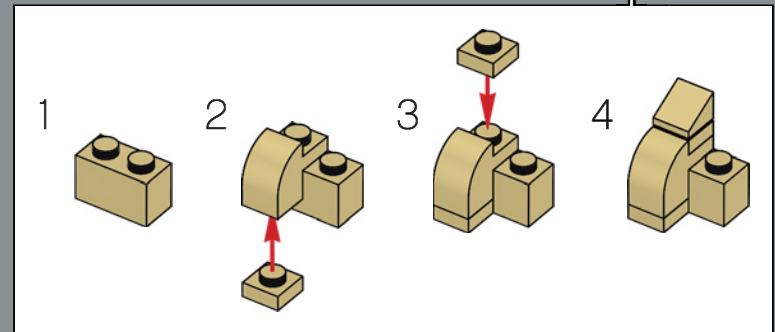
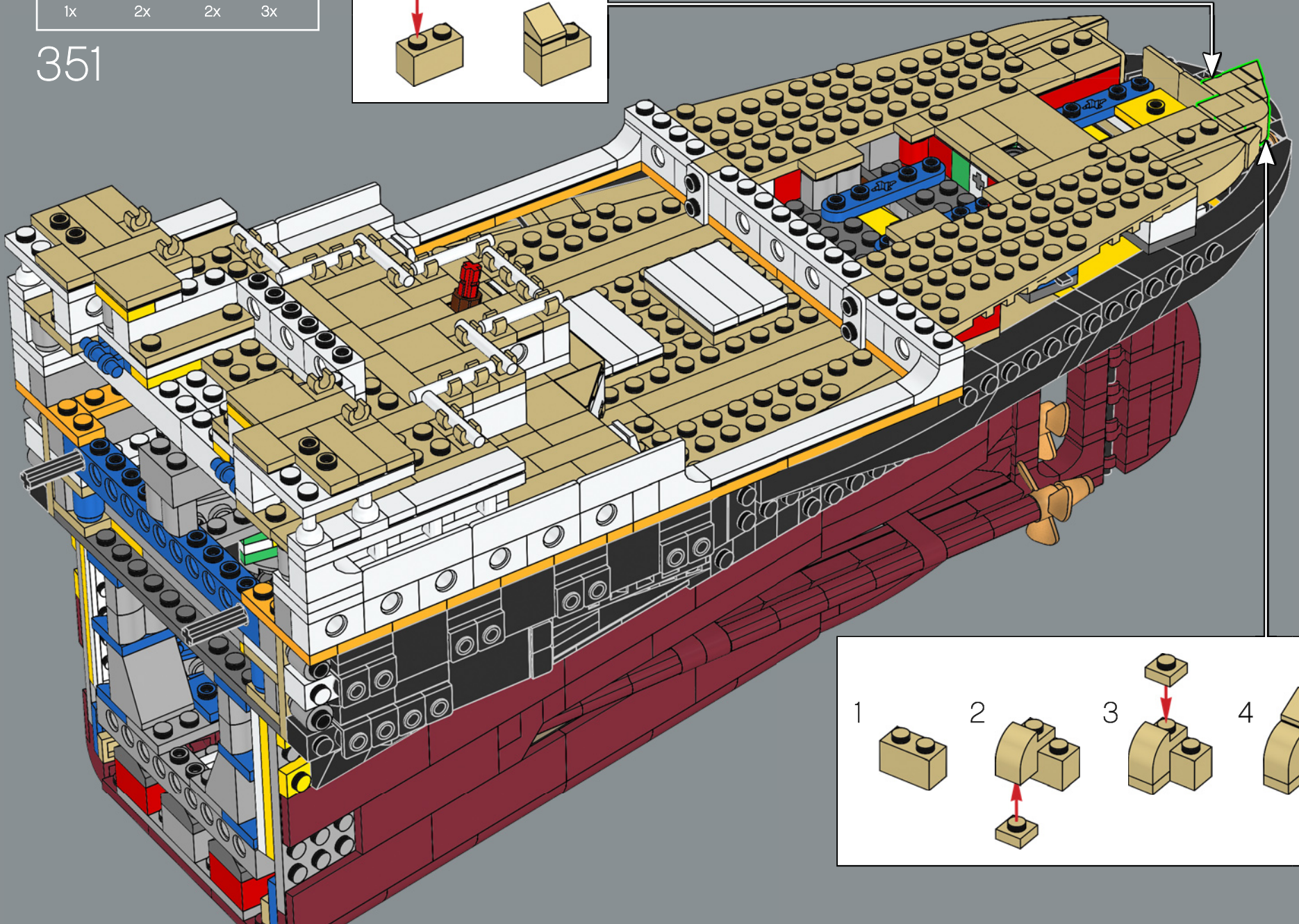
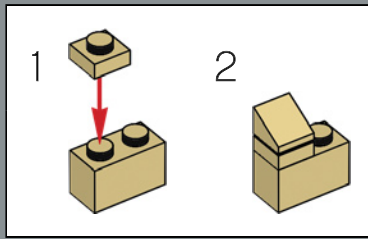



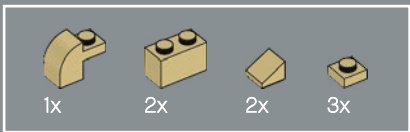

352

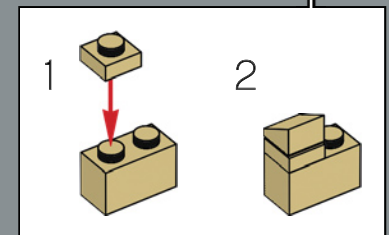
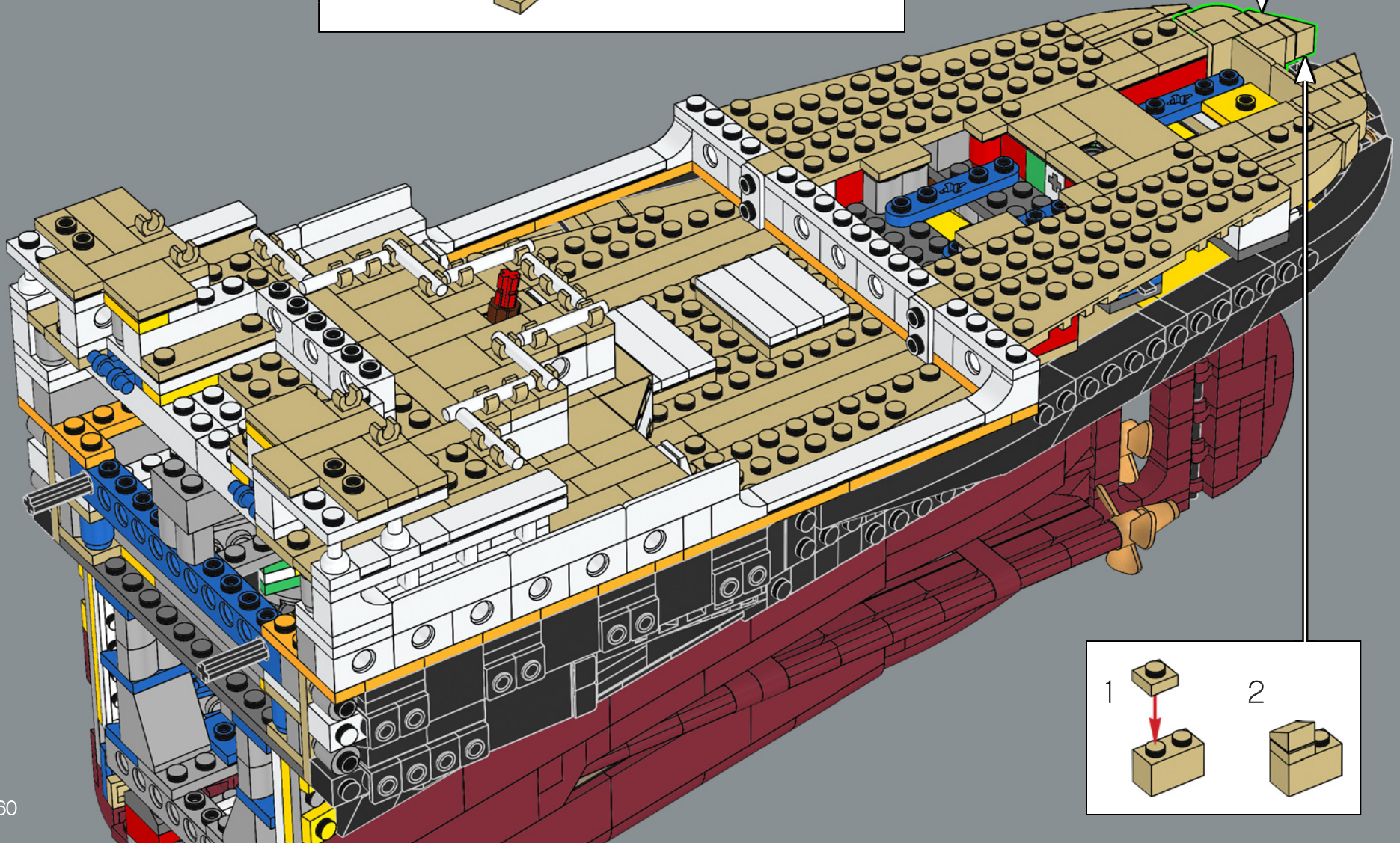
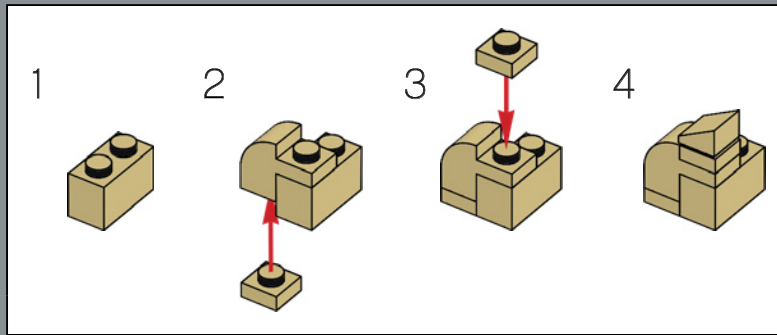



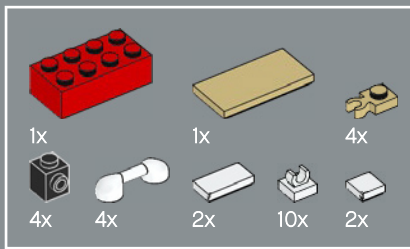

353

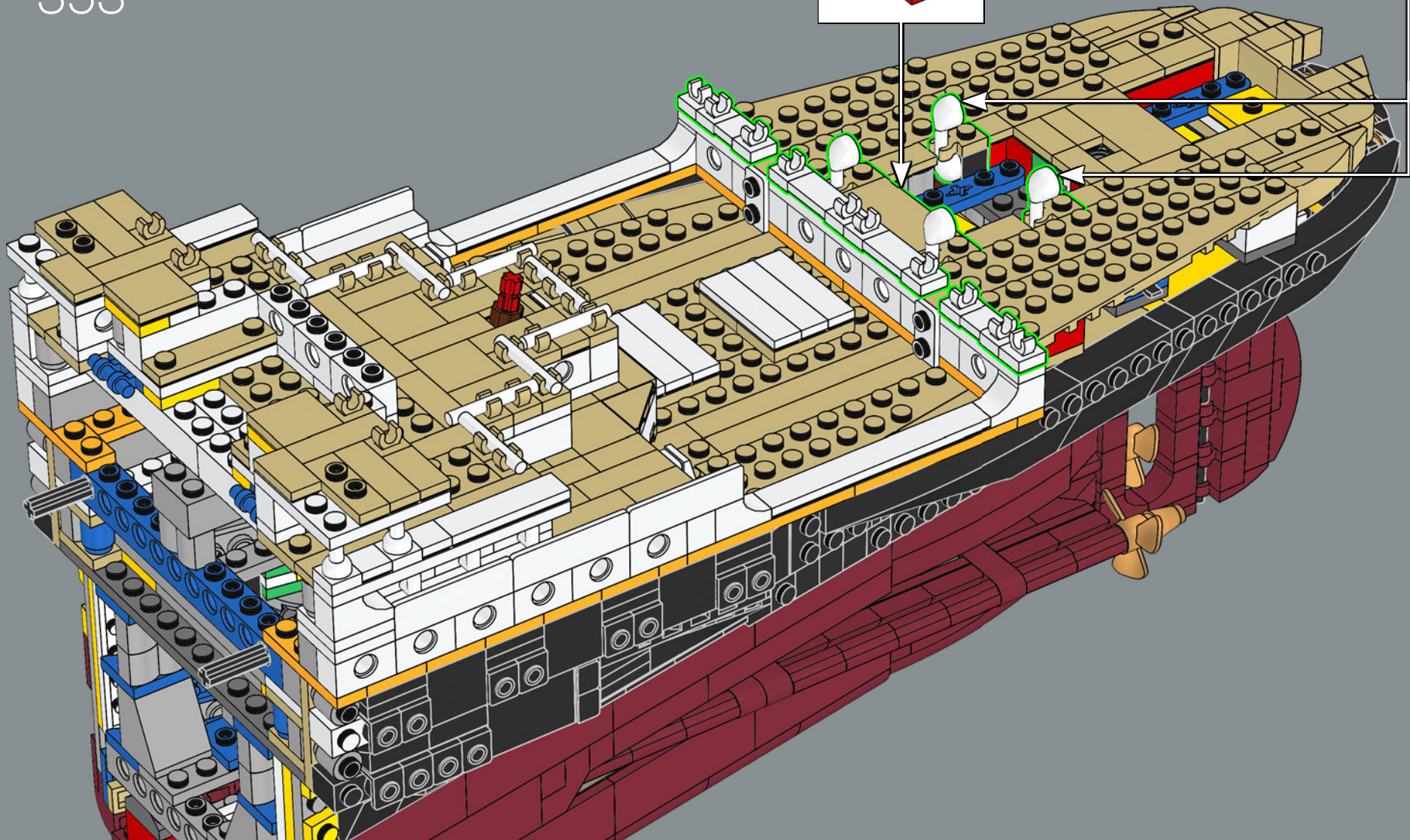
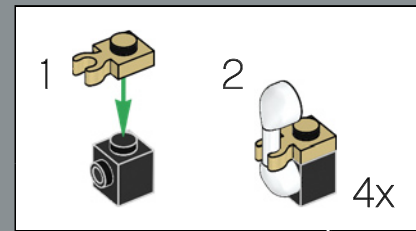
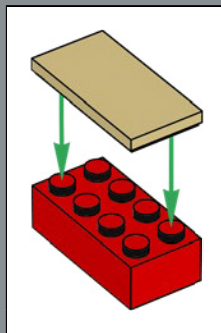





354

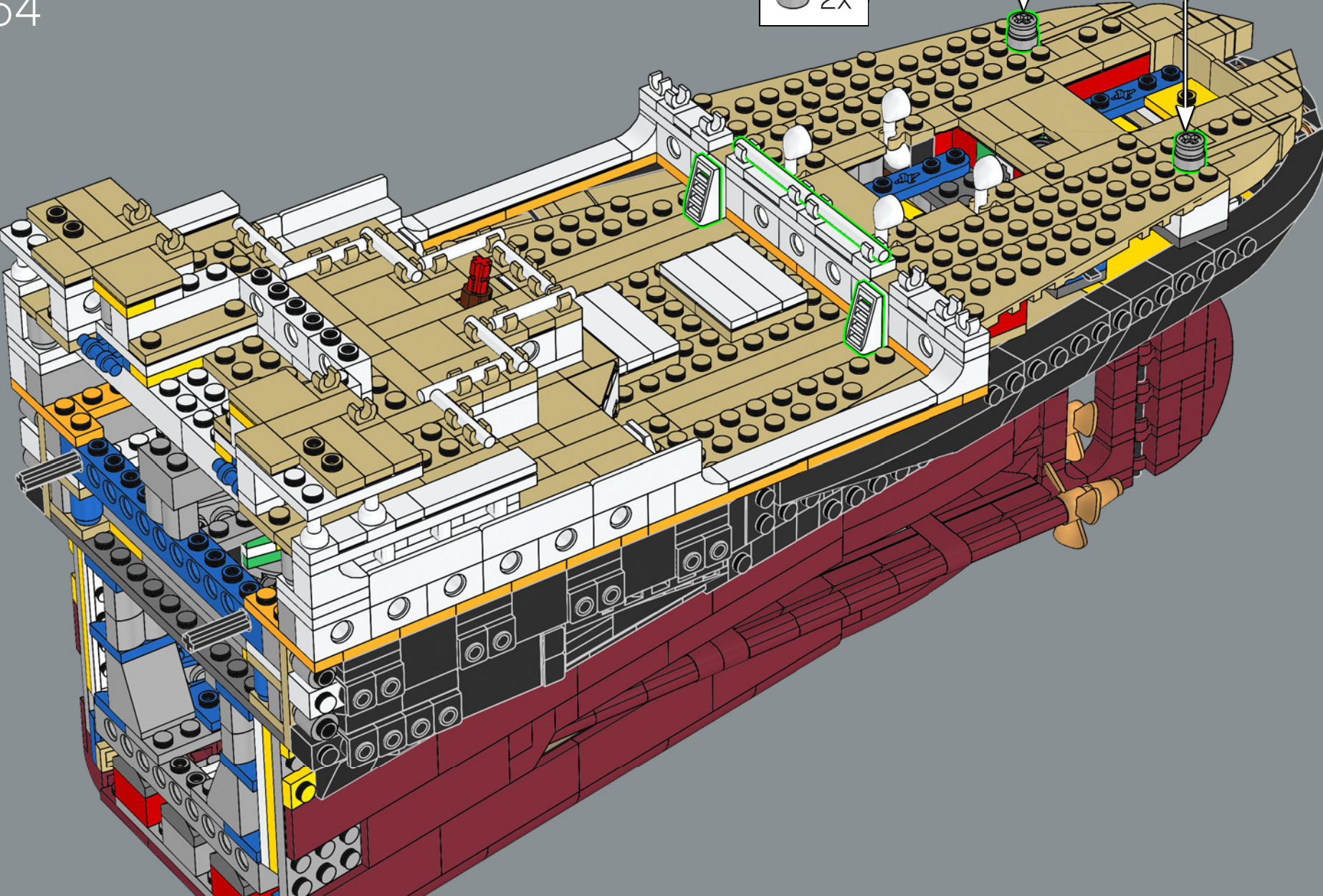
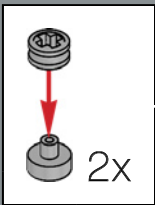



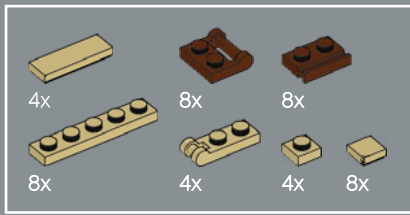

355

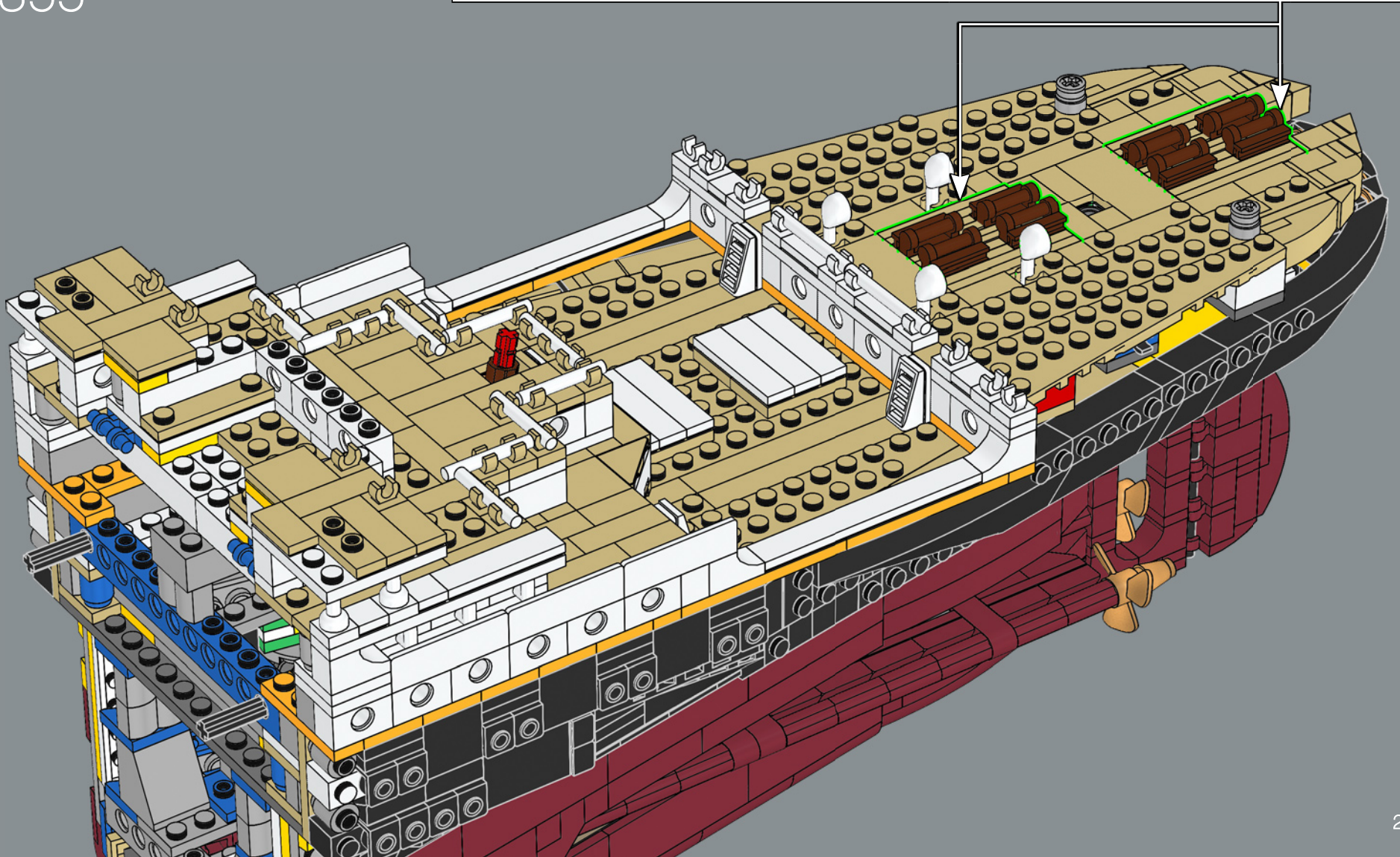
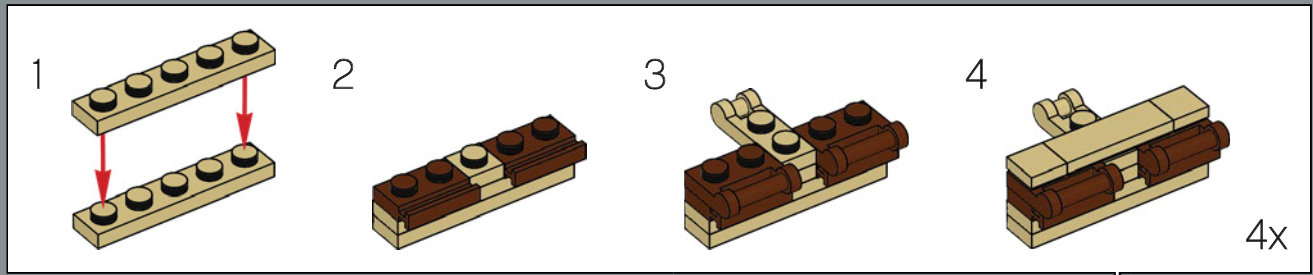



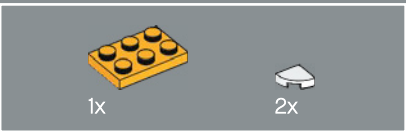
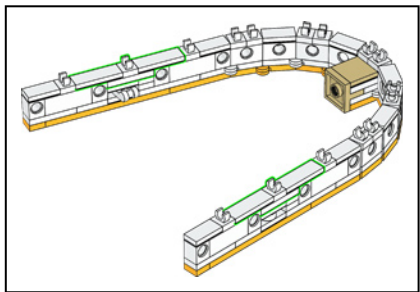
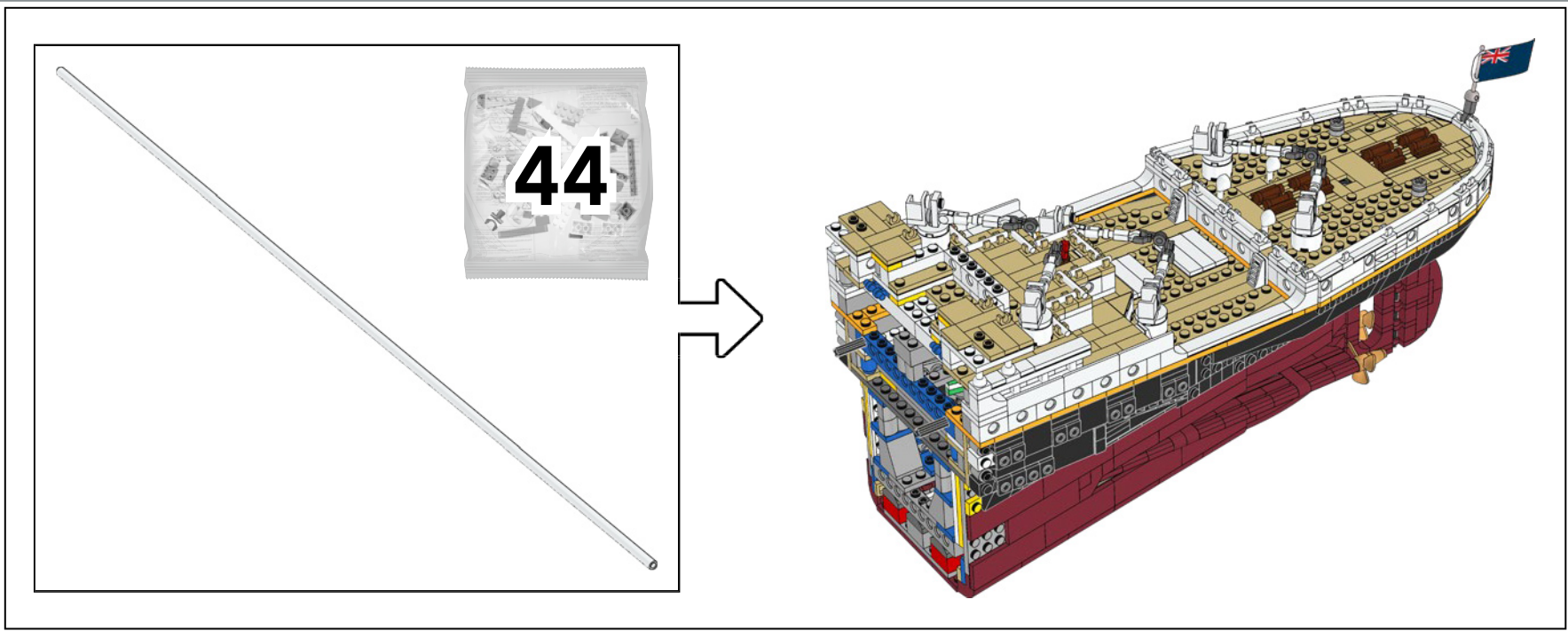

356

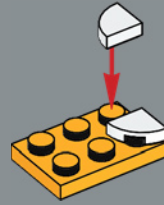

357

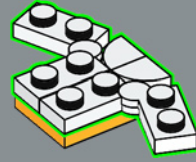

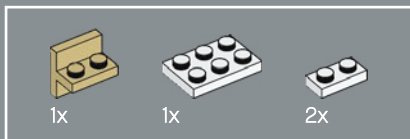

358

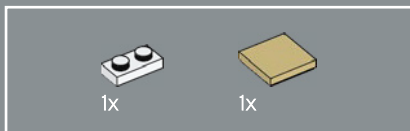
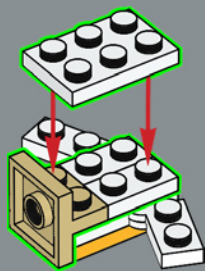

359

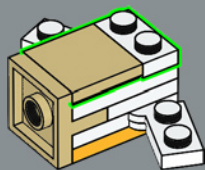

360

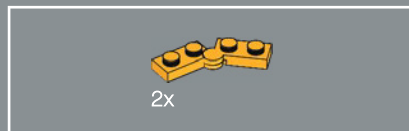
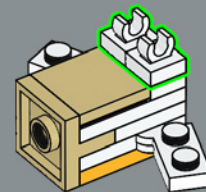

361

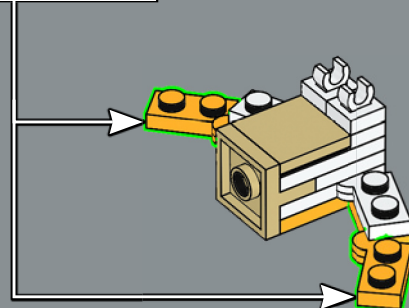
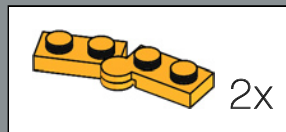



362

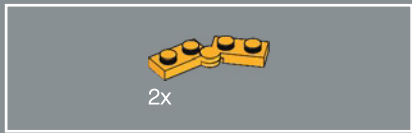
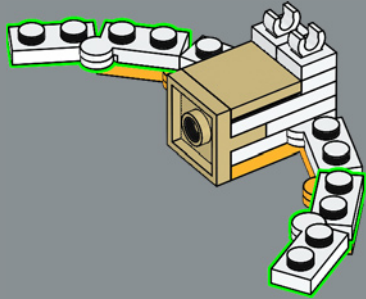

363

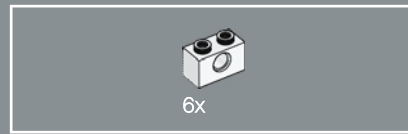
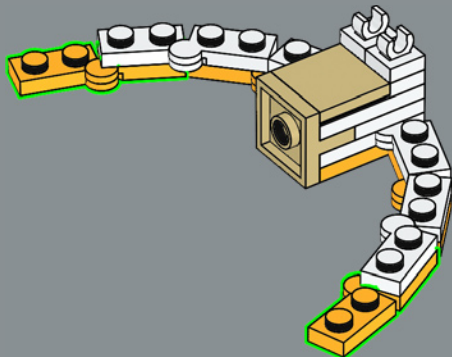

364

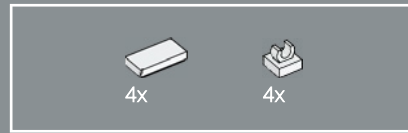
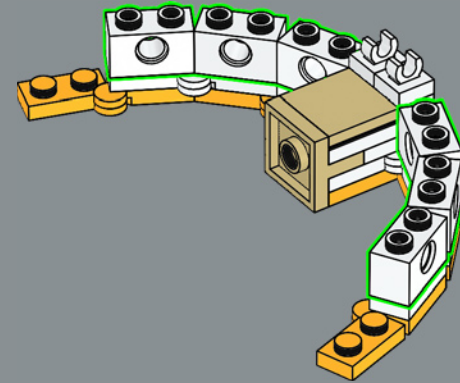

365

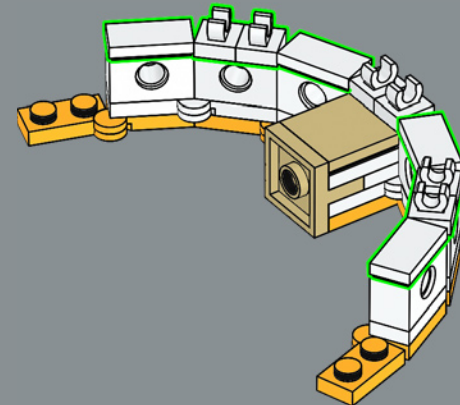





366

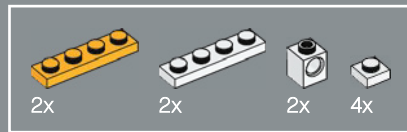
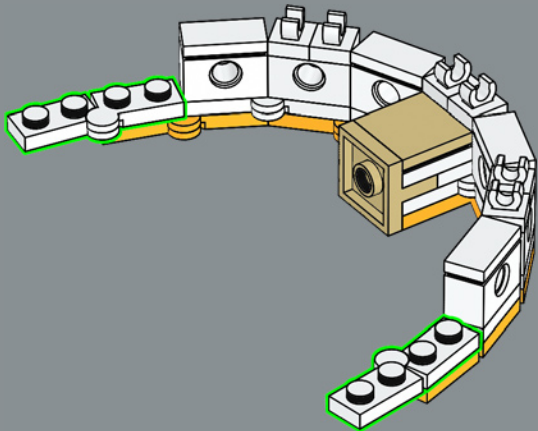

367

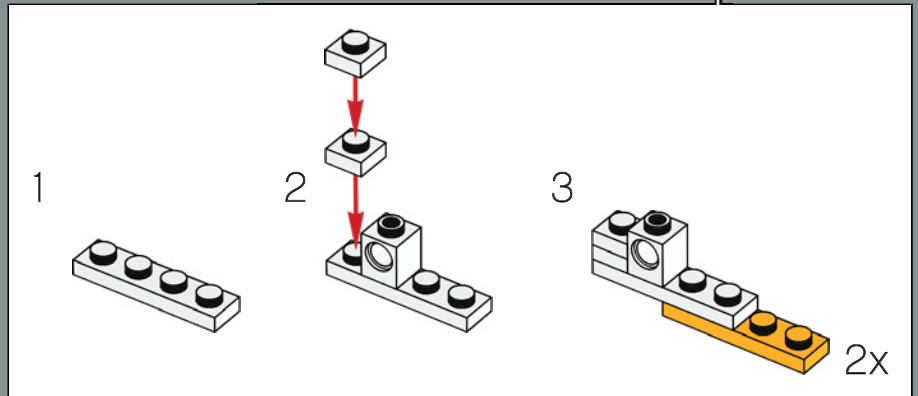
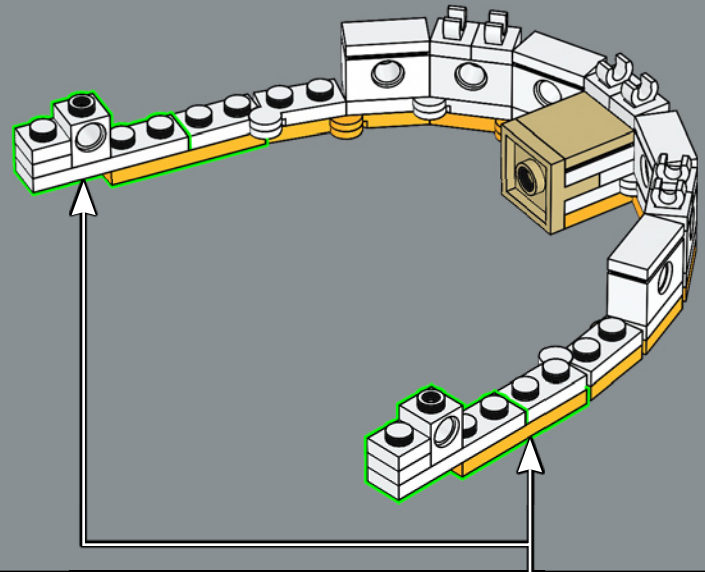

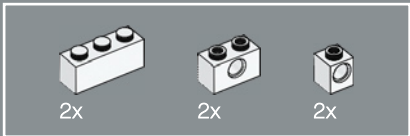

368

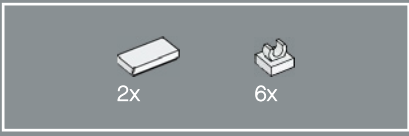
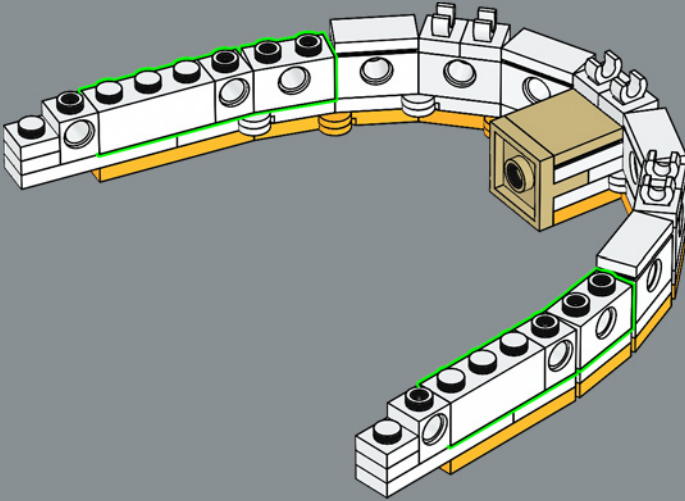

369

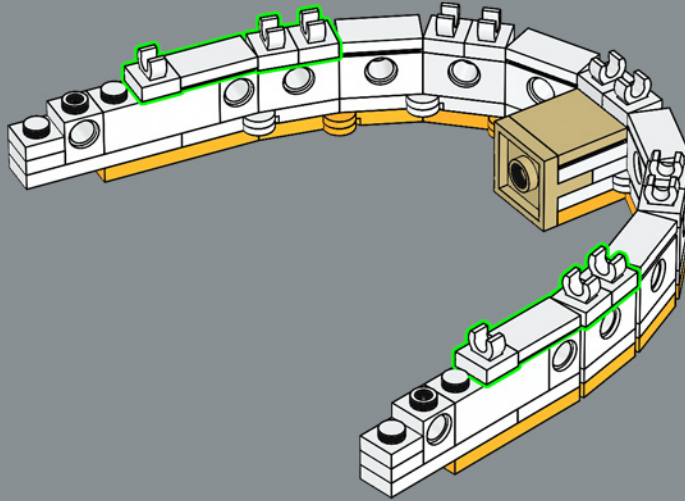

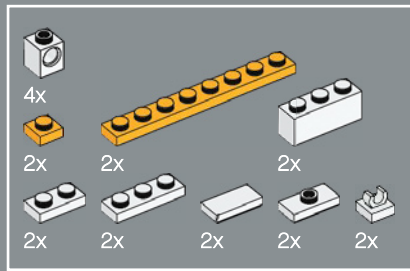

370

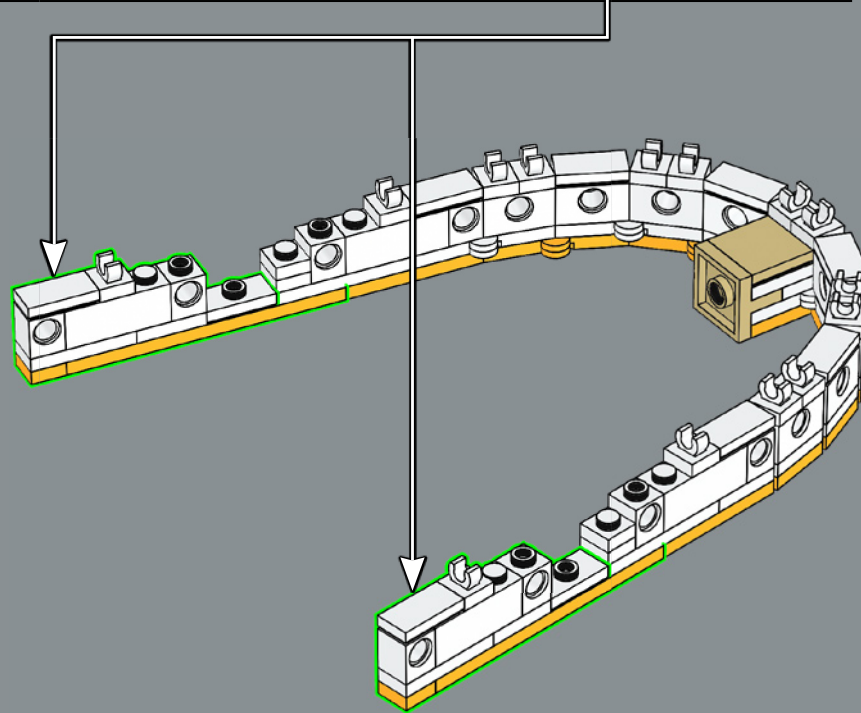
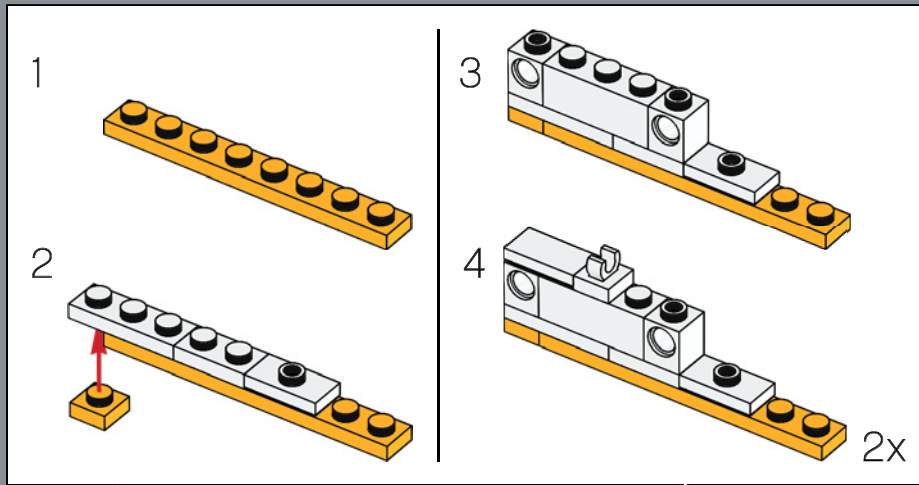





2x

371

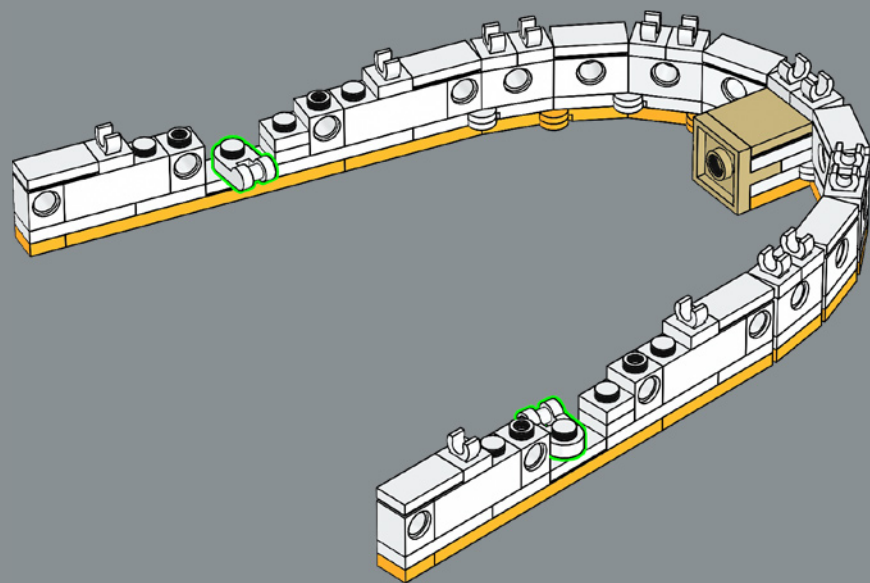

2x

372

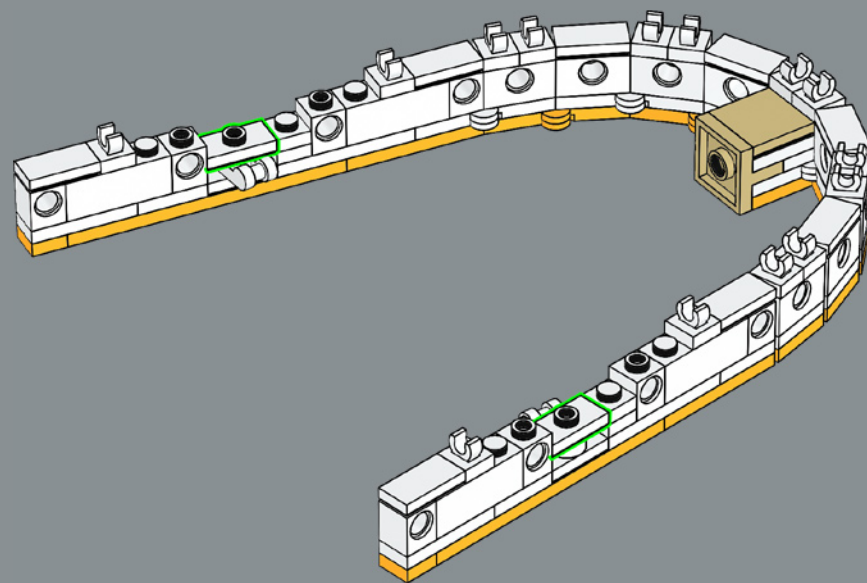

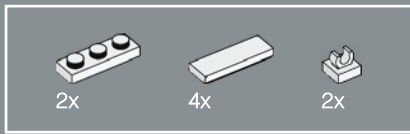

373

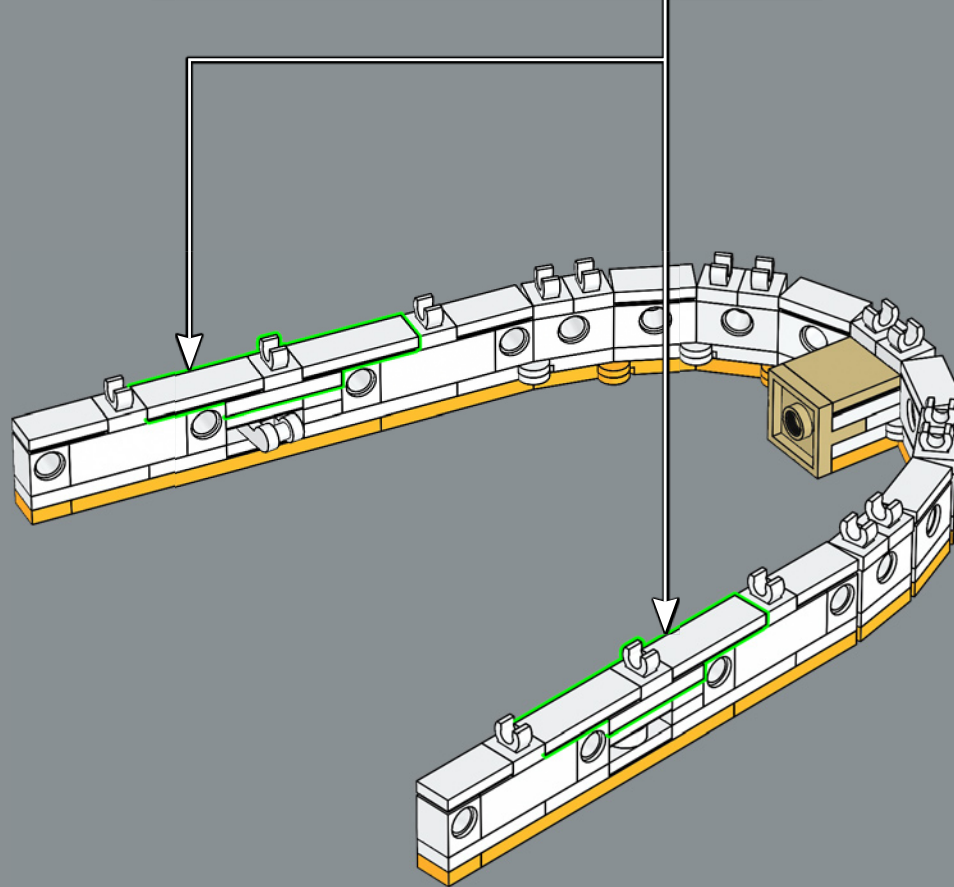
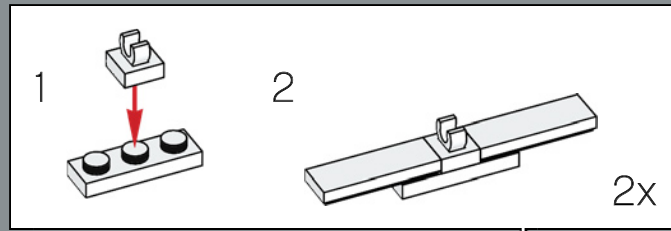

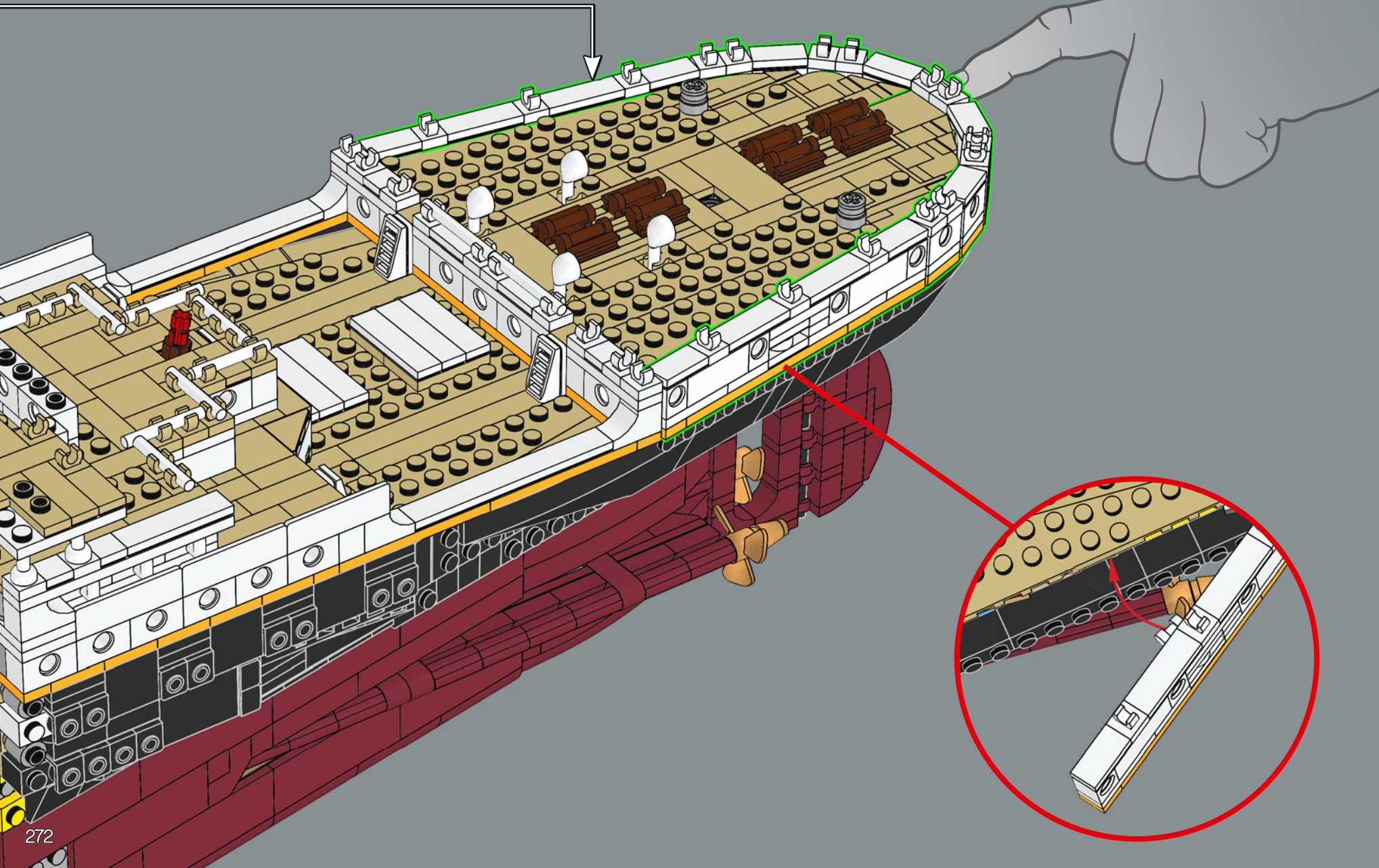



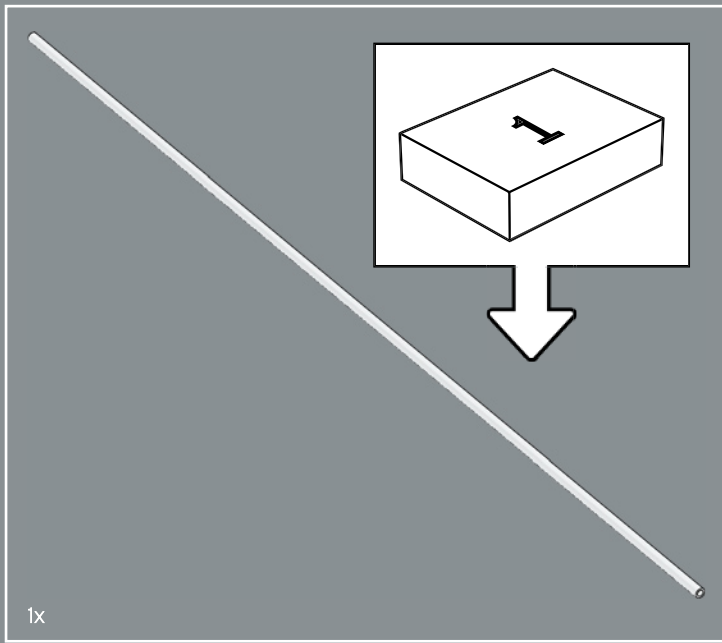

375

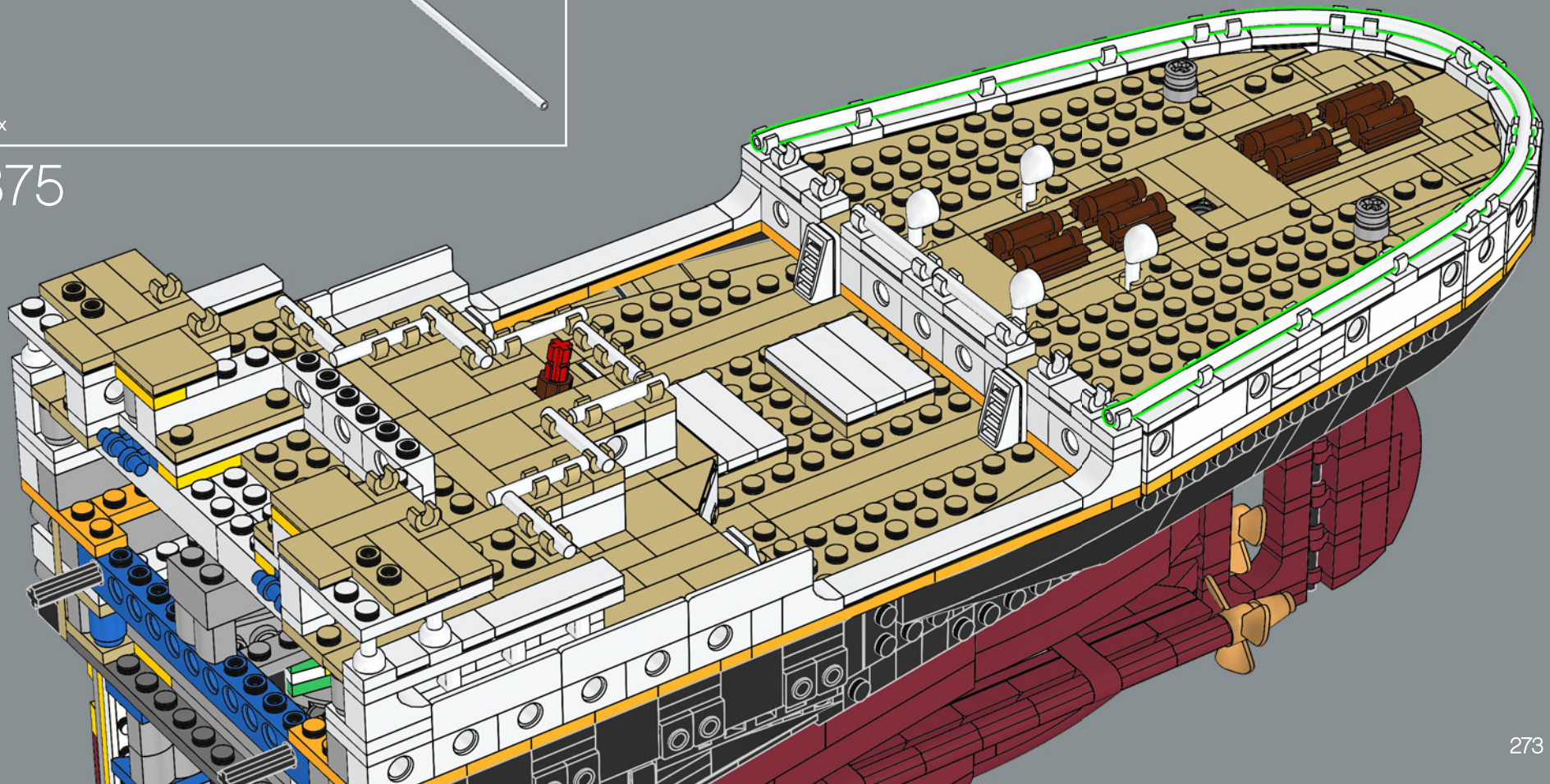





376

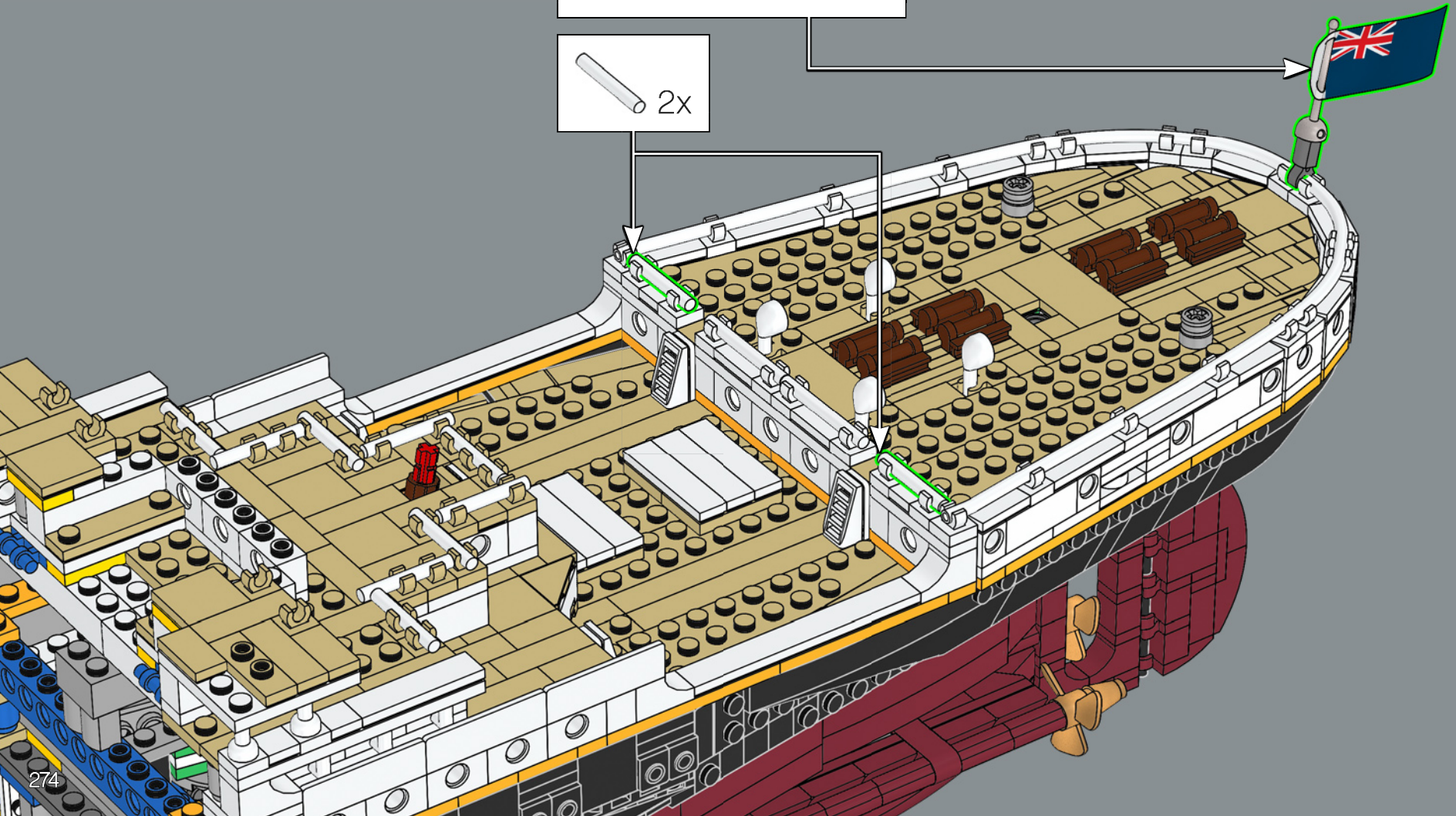
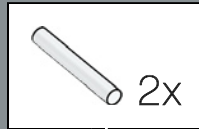
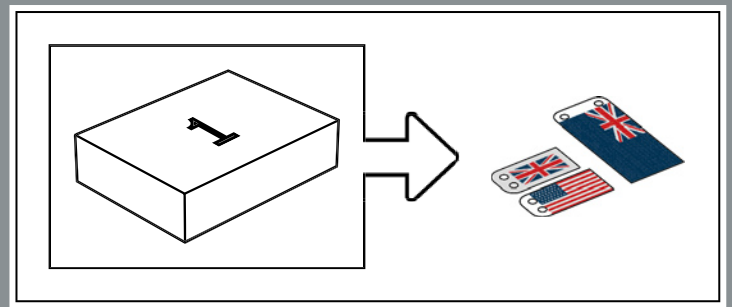
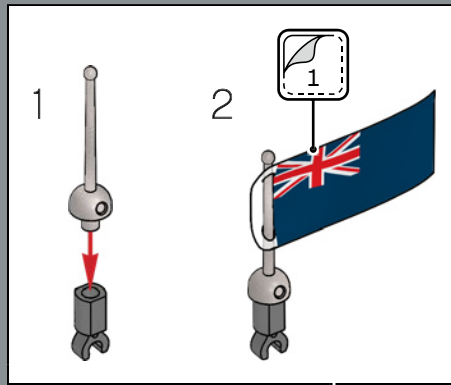

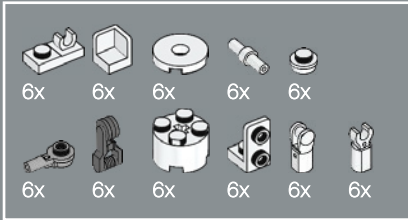
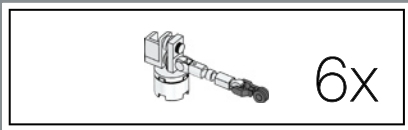

377

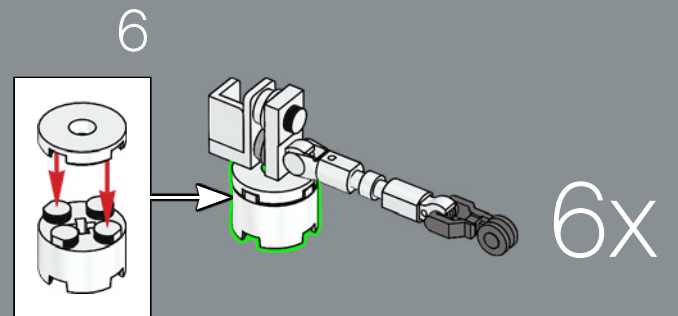
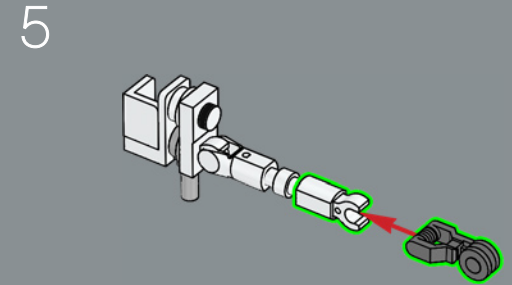
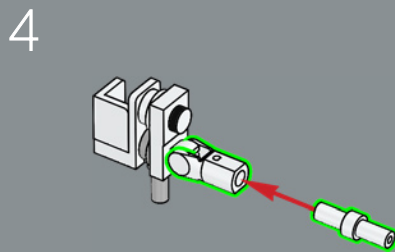
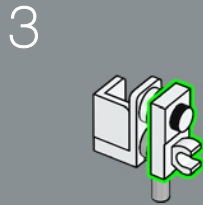
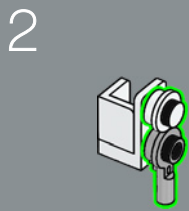
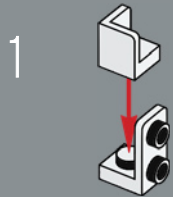



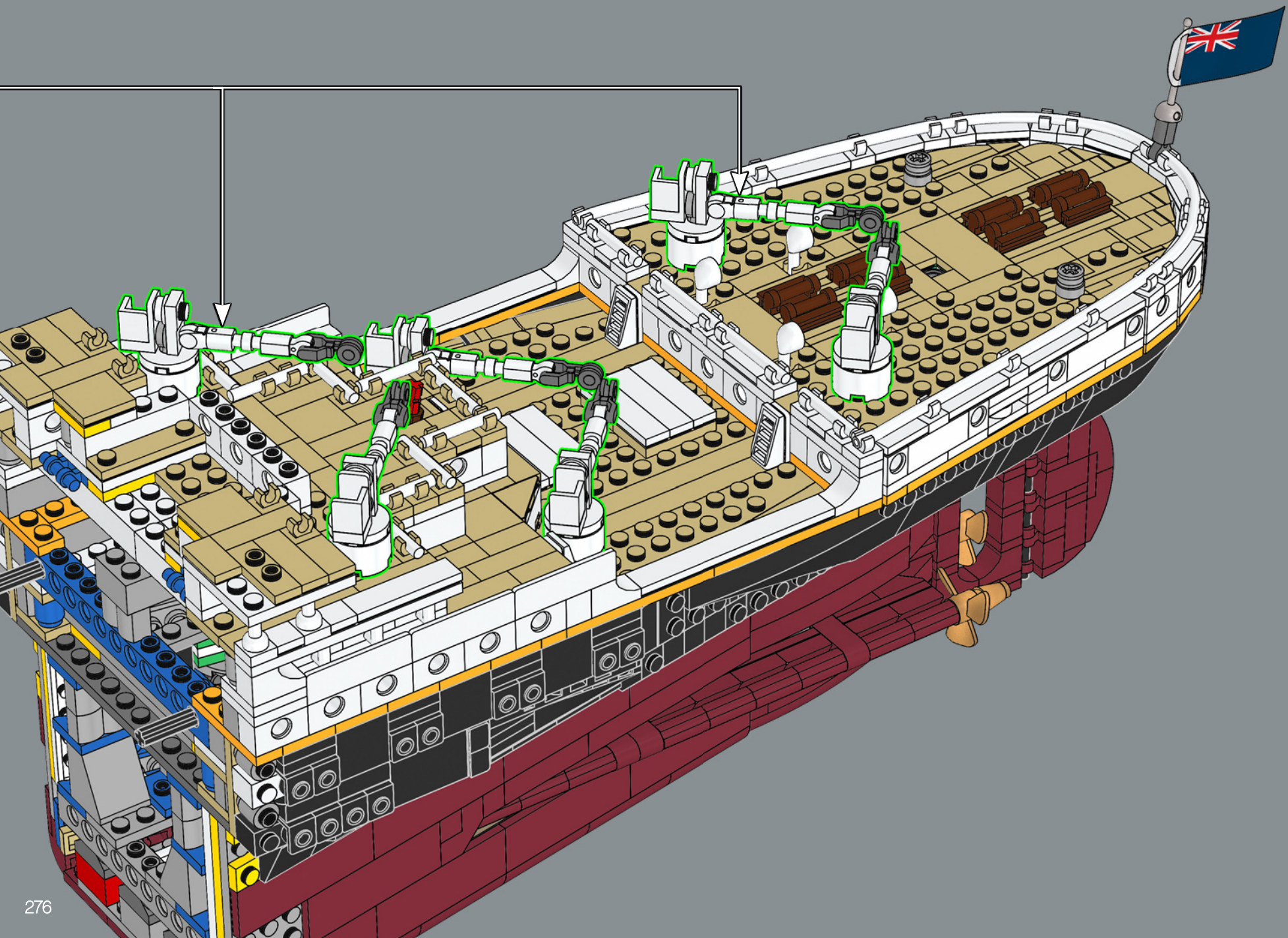



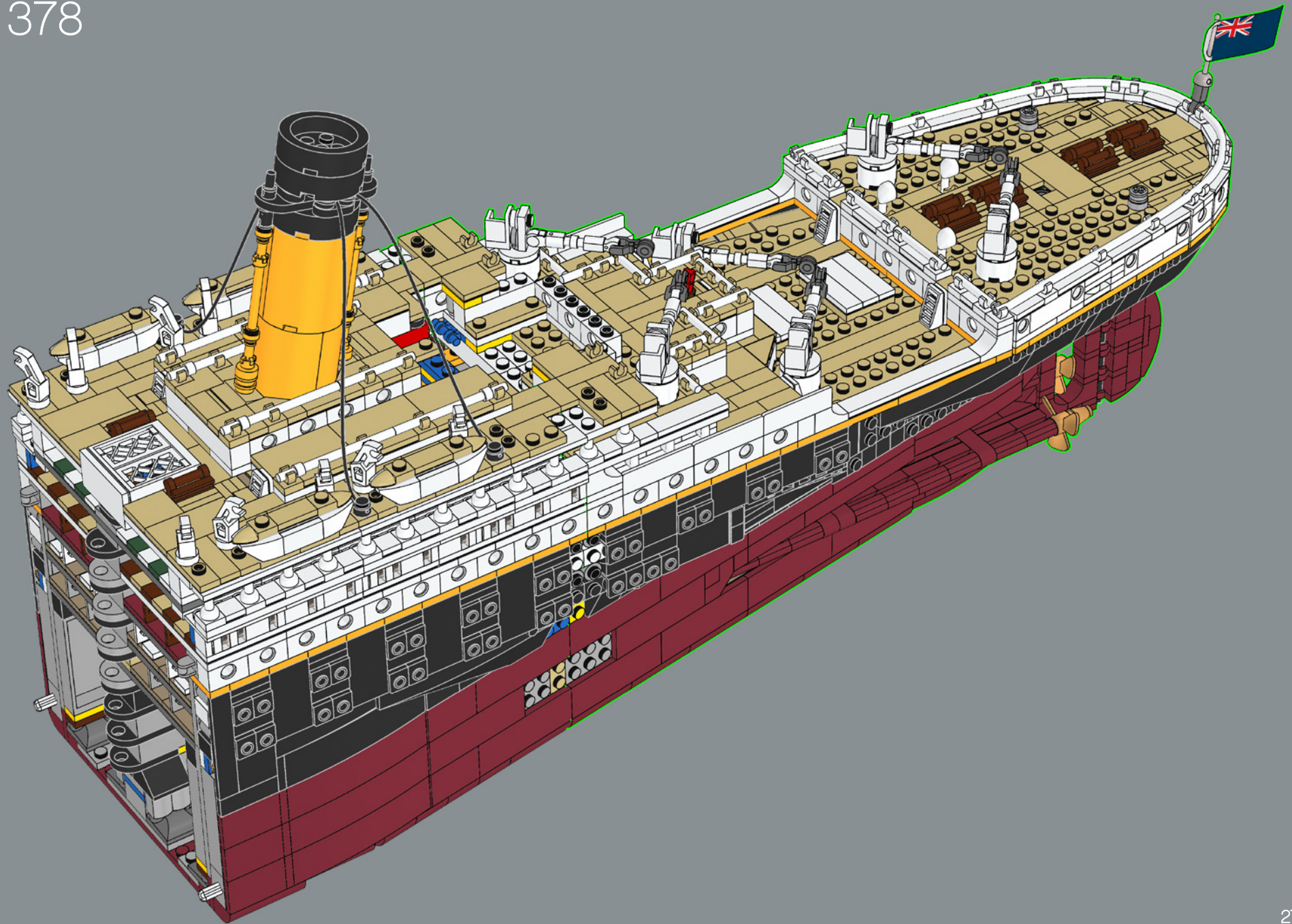

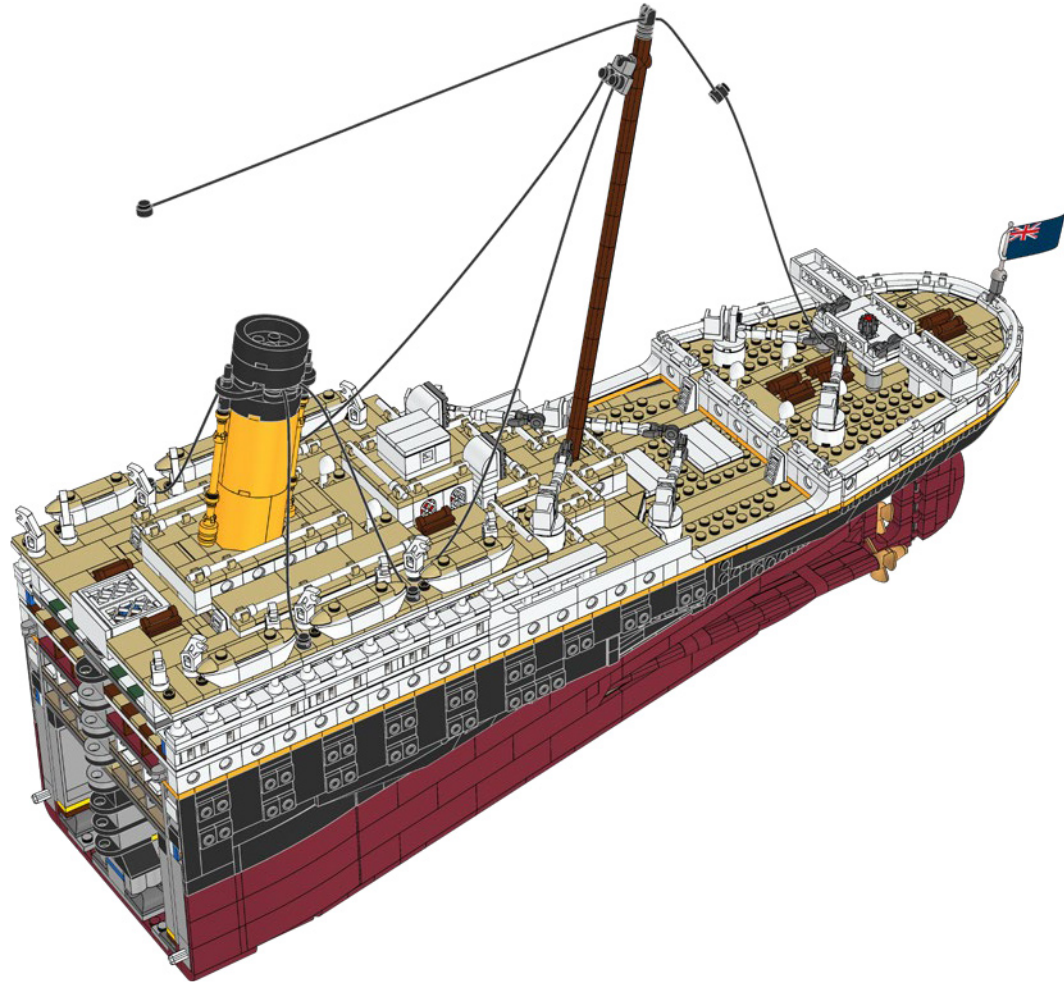
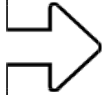



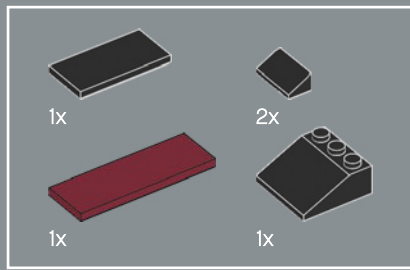

379

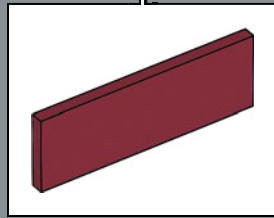
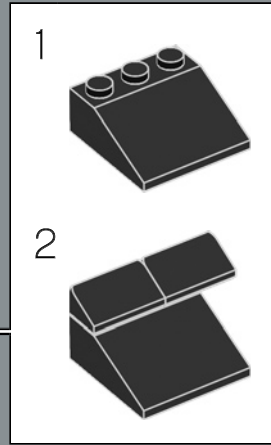
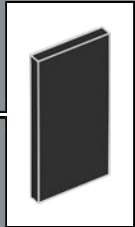
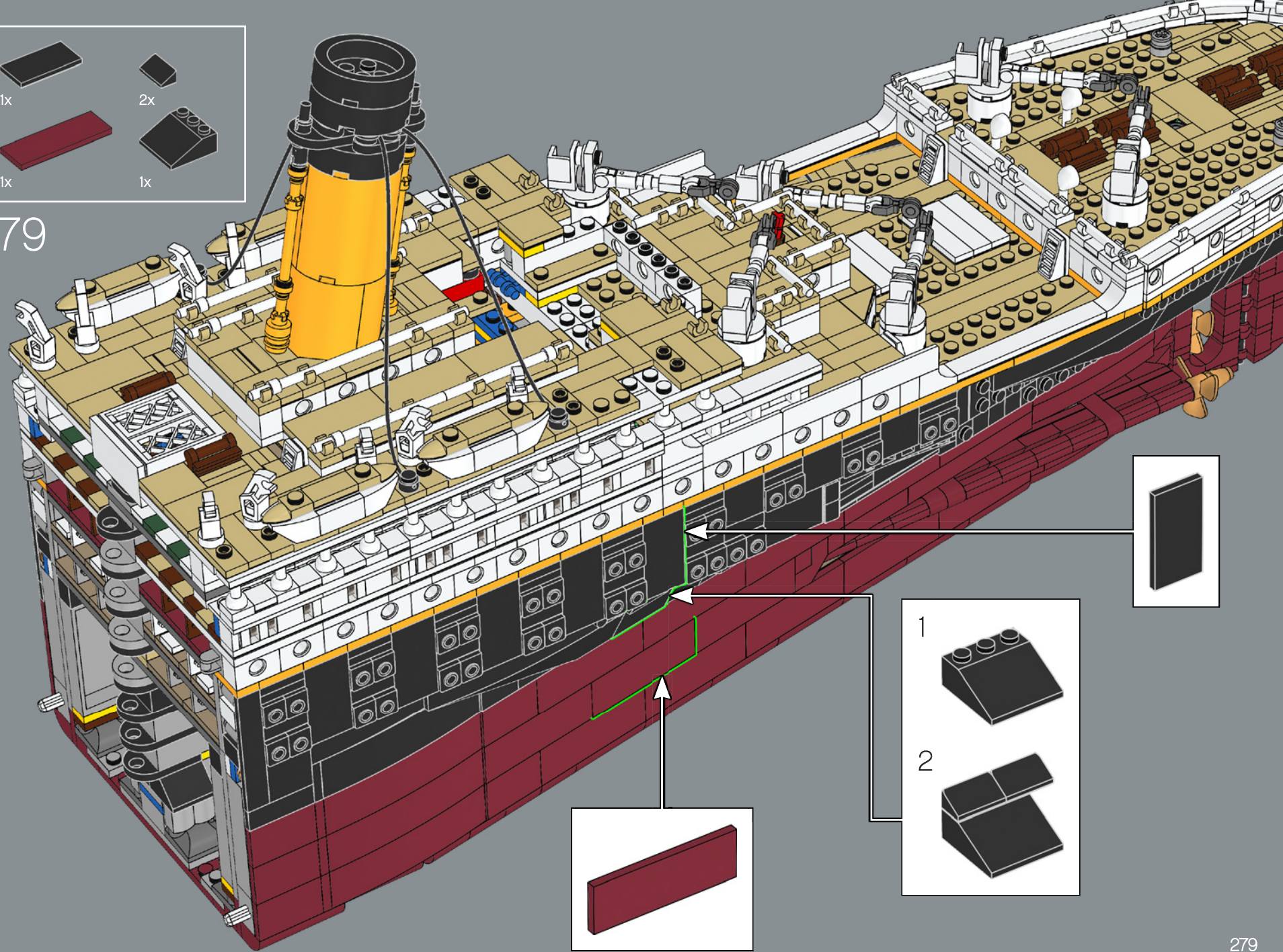



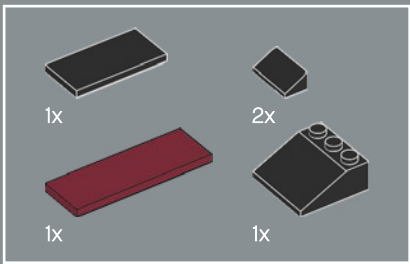

380

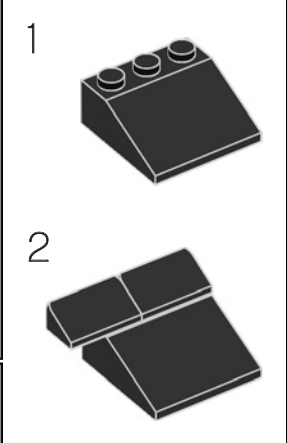
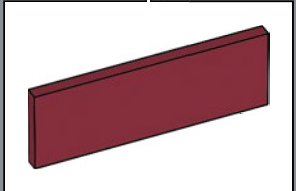
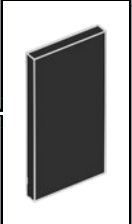
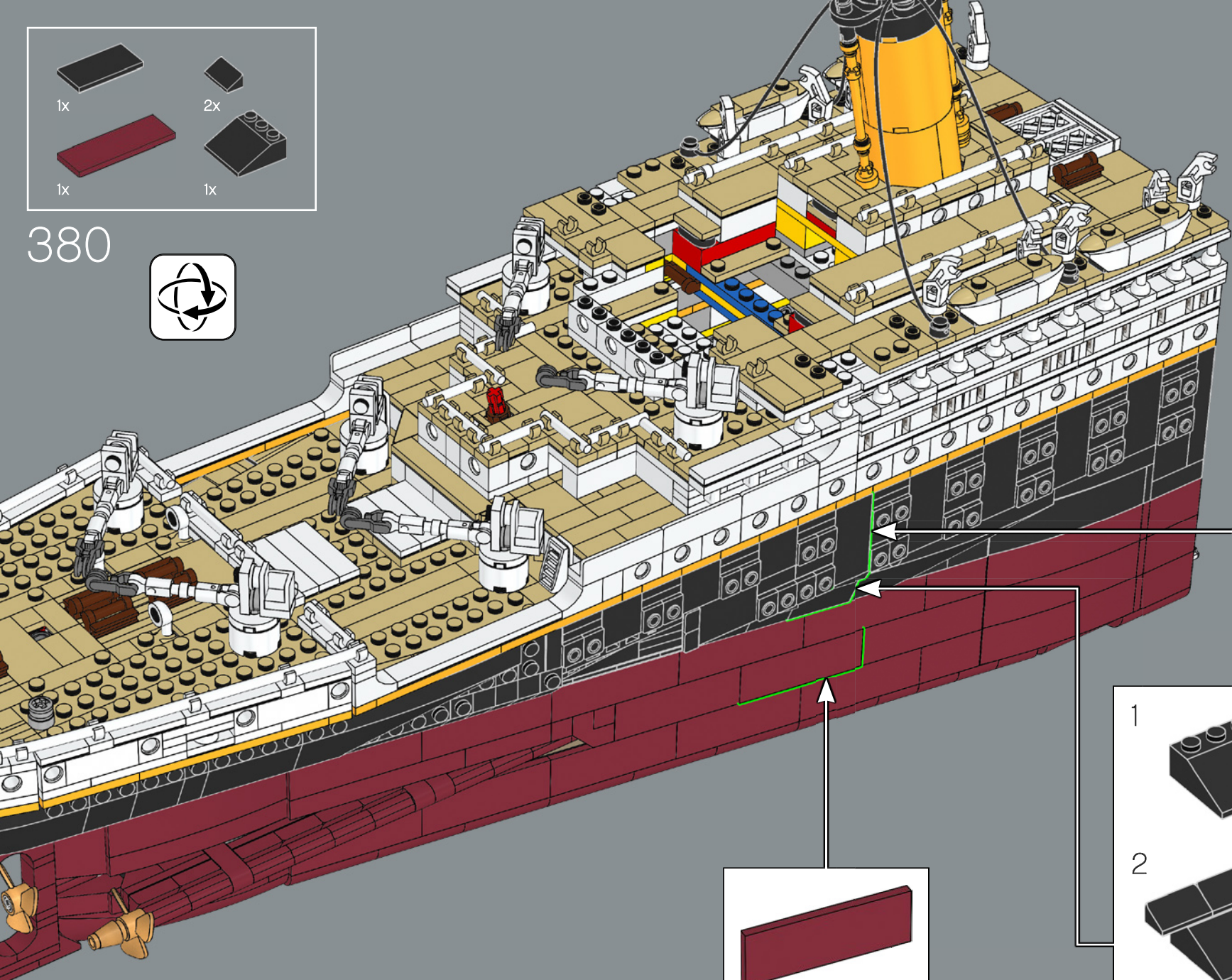

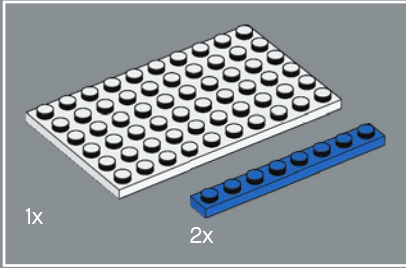
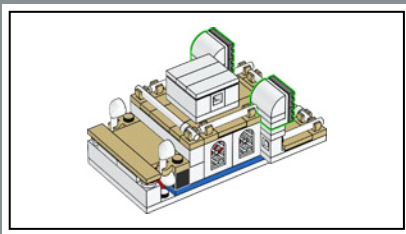

381

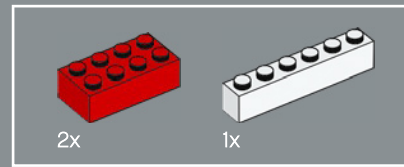
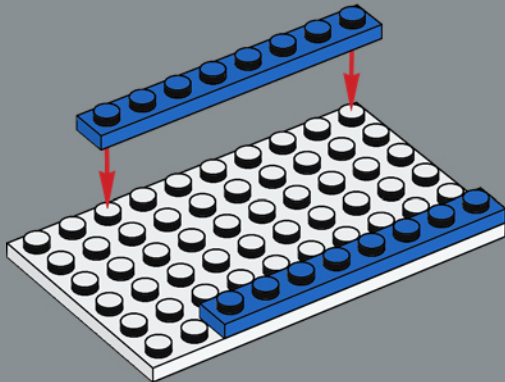

382

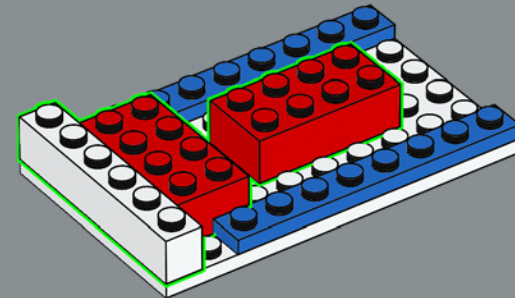



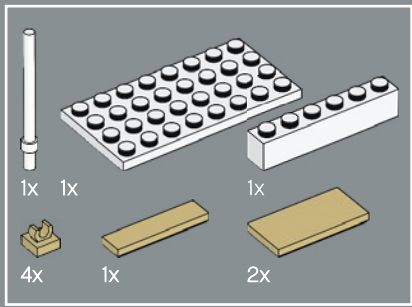

383

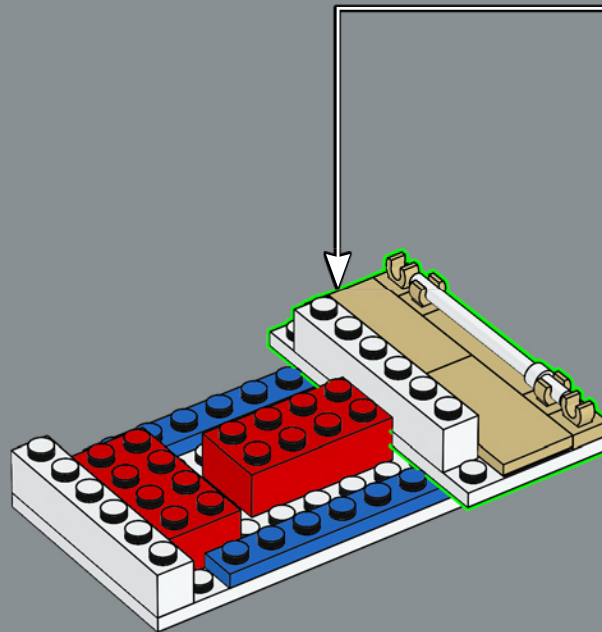
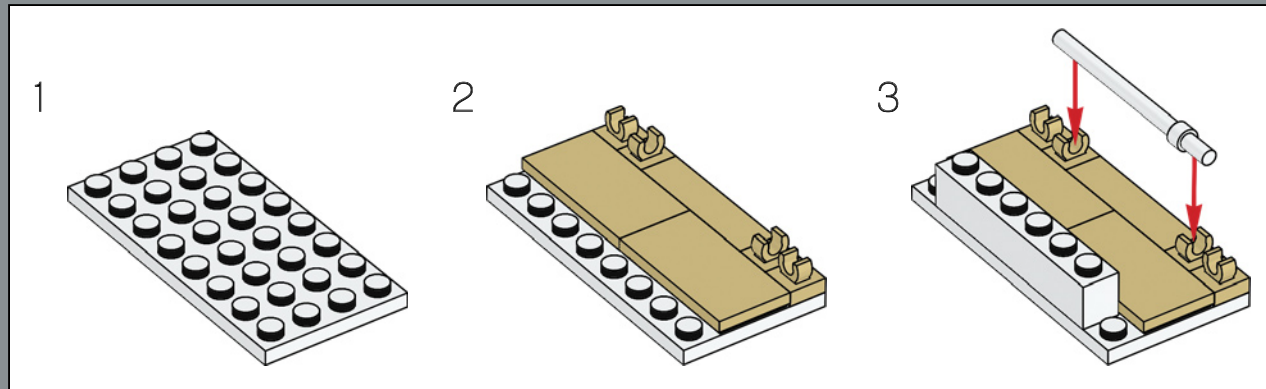

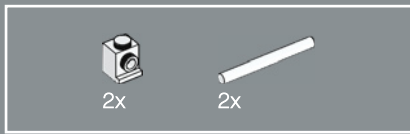

384

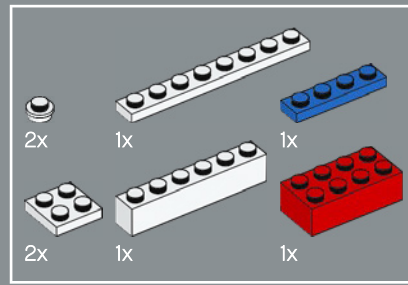
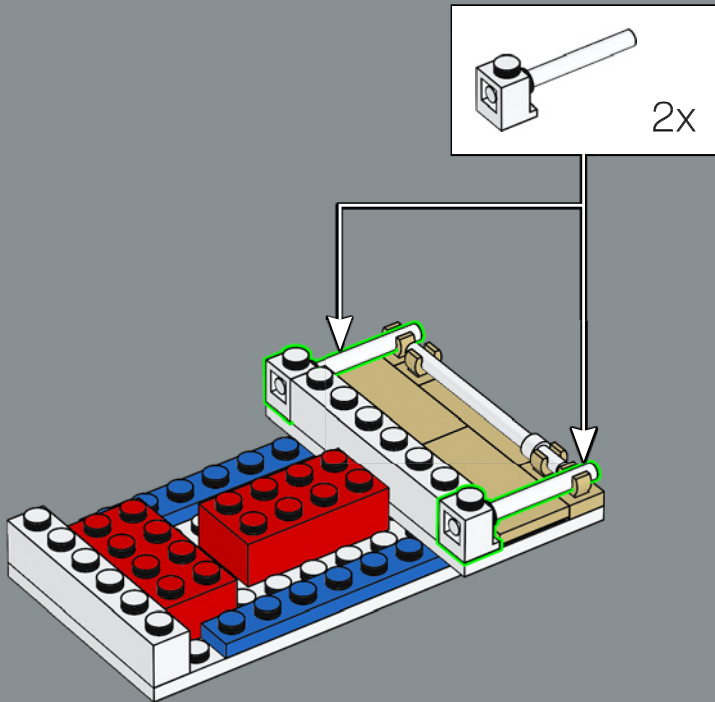

385

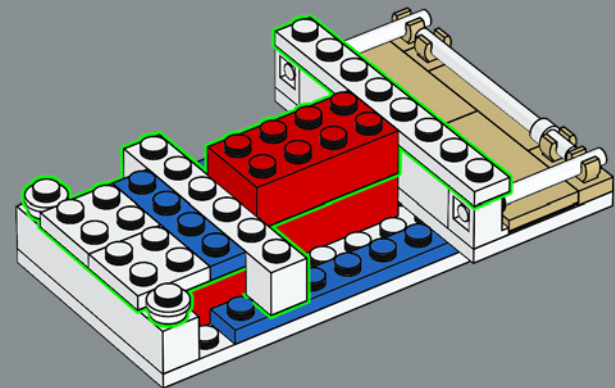

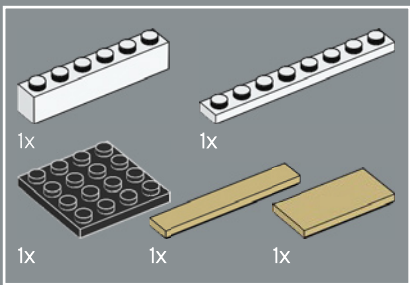

386

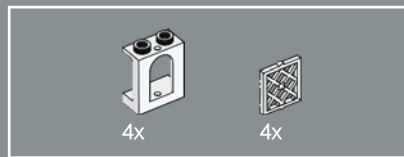
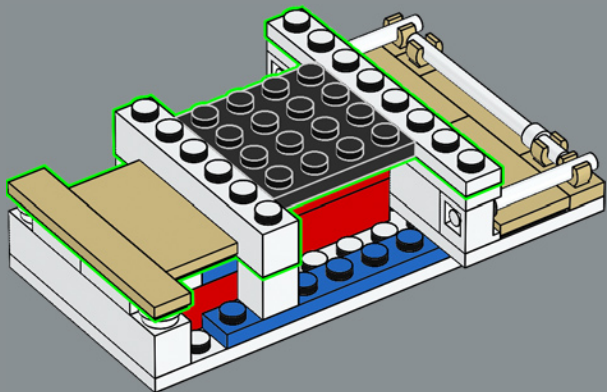

387

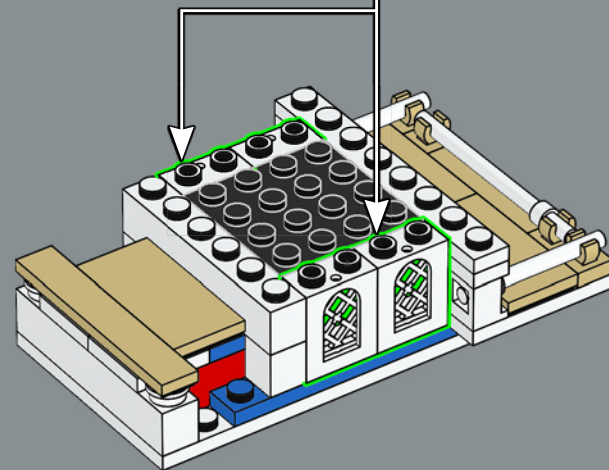
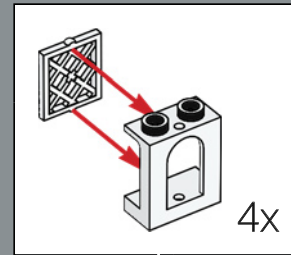



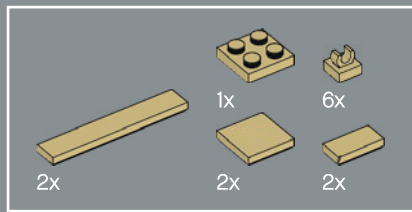

388

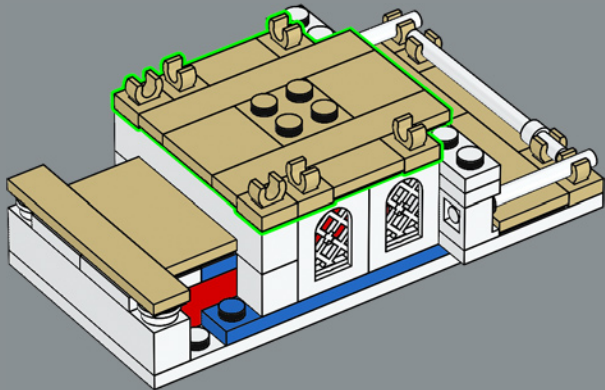

389

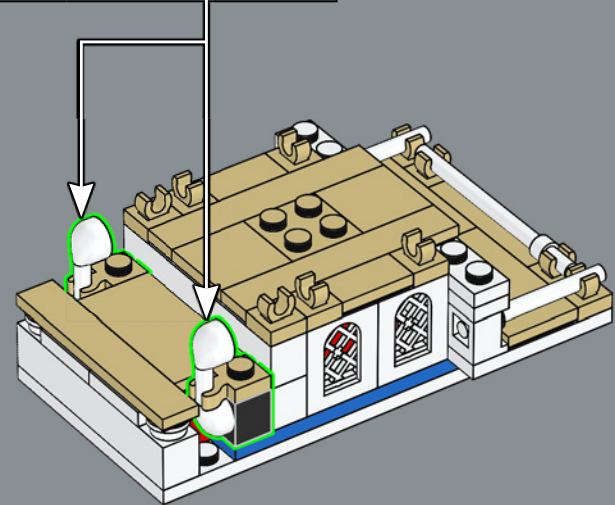
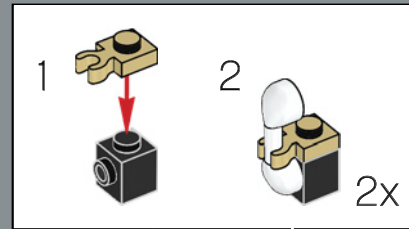

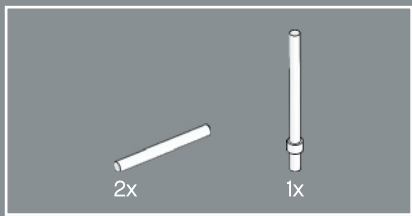

390

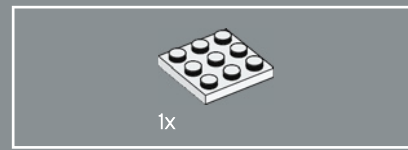
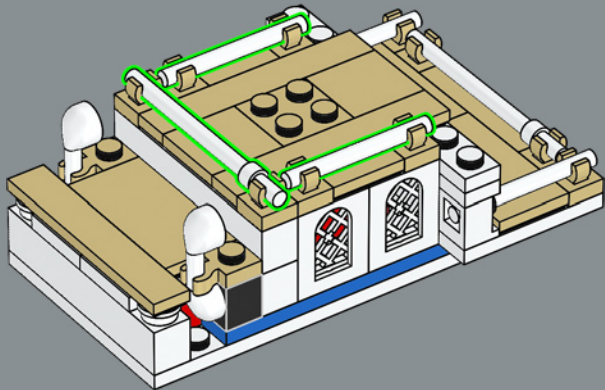

391

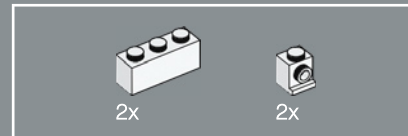
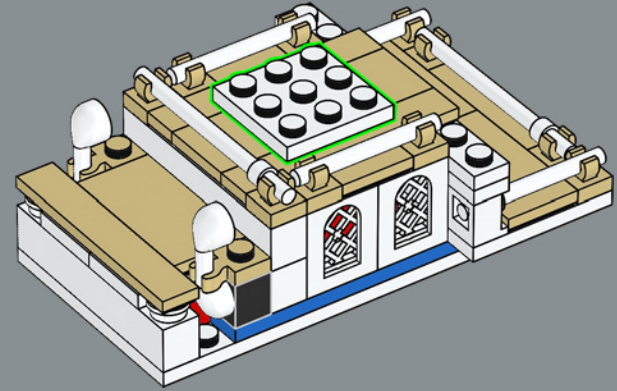

392

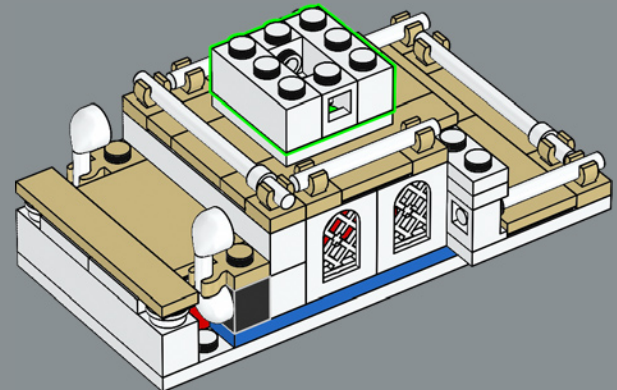

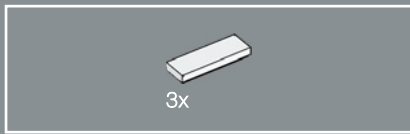

393

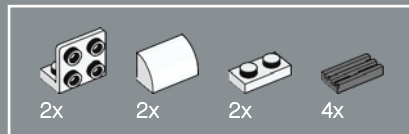
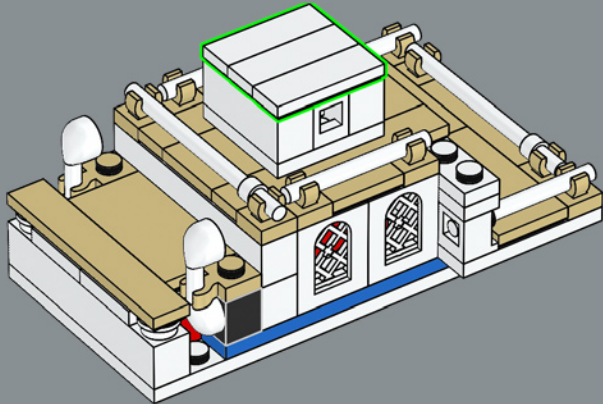

394

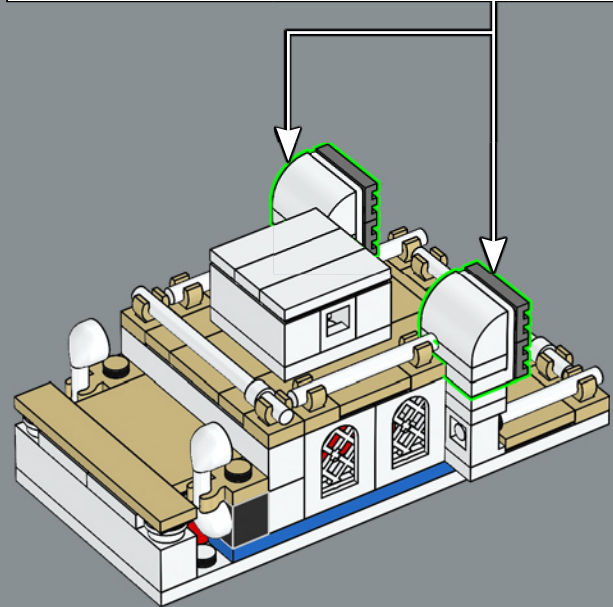
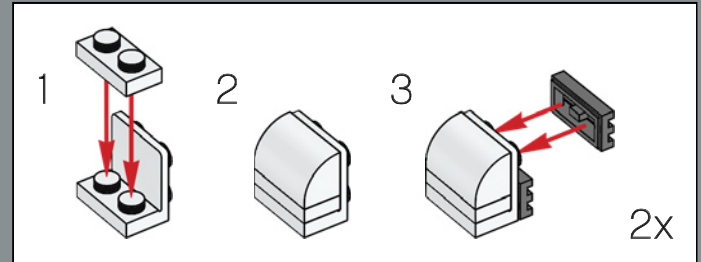



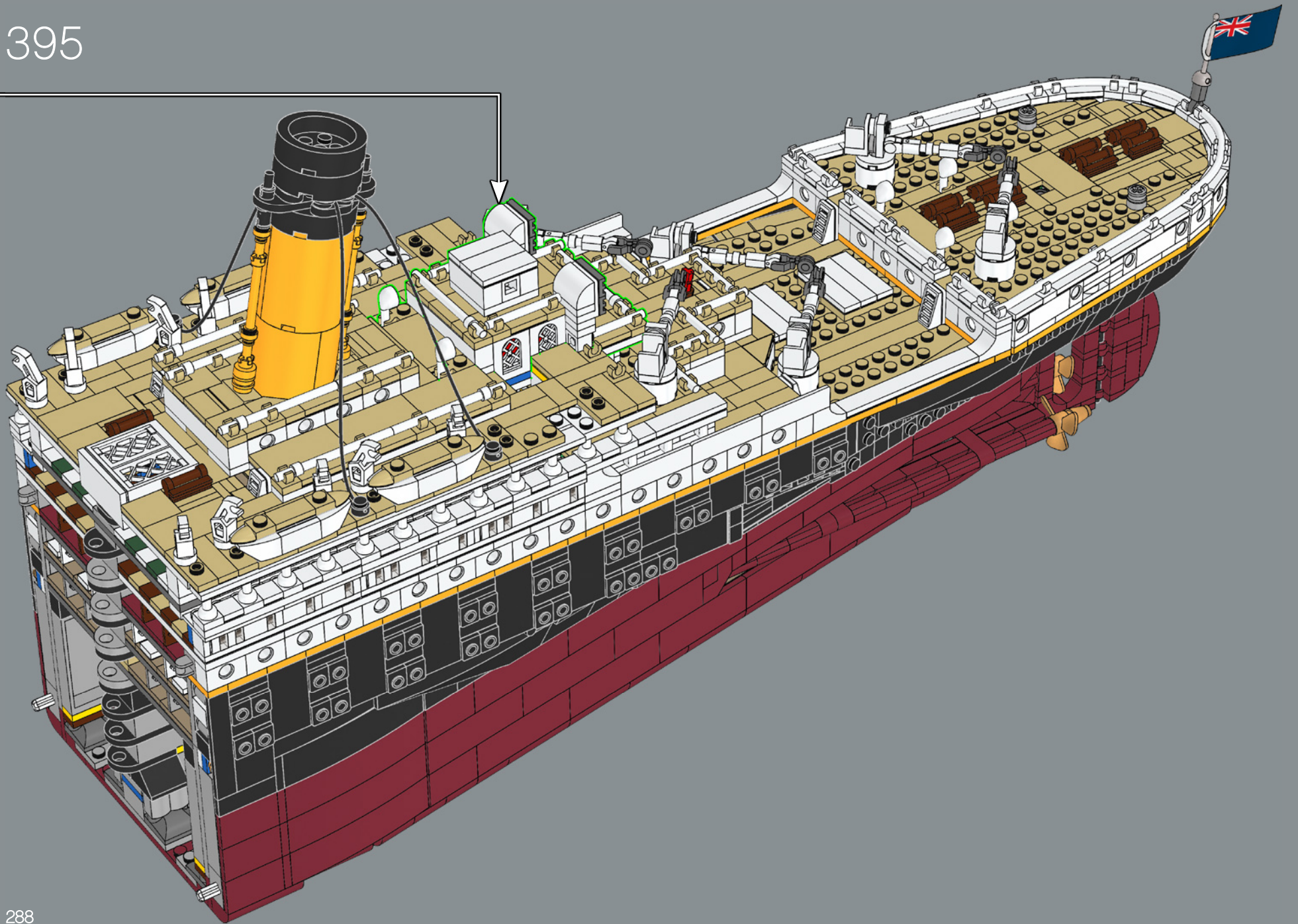



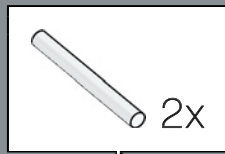
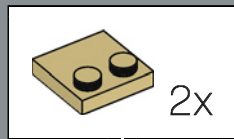
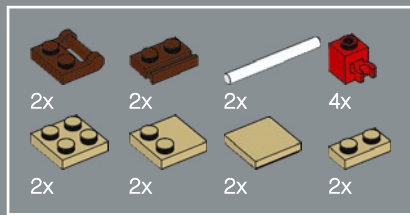

396

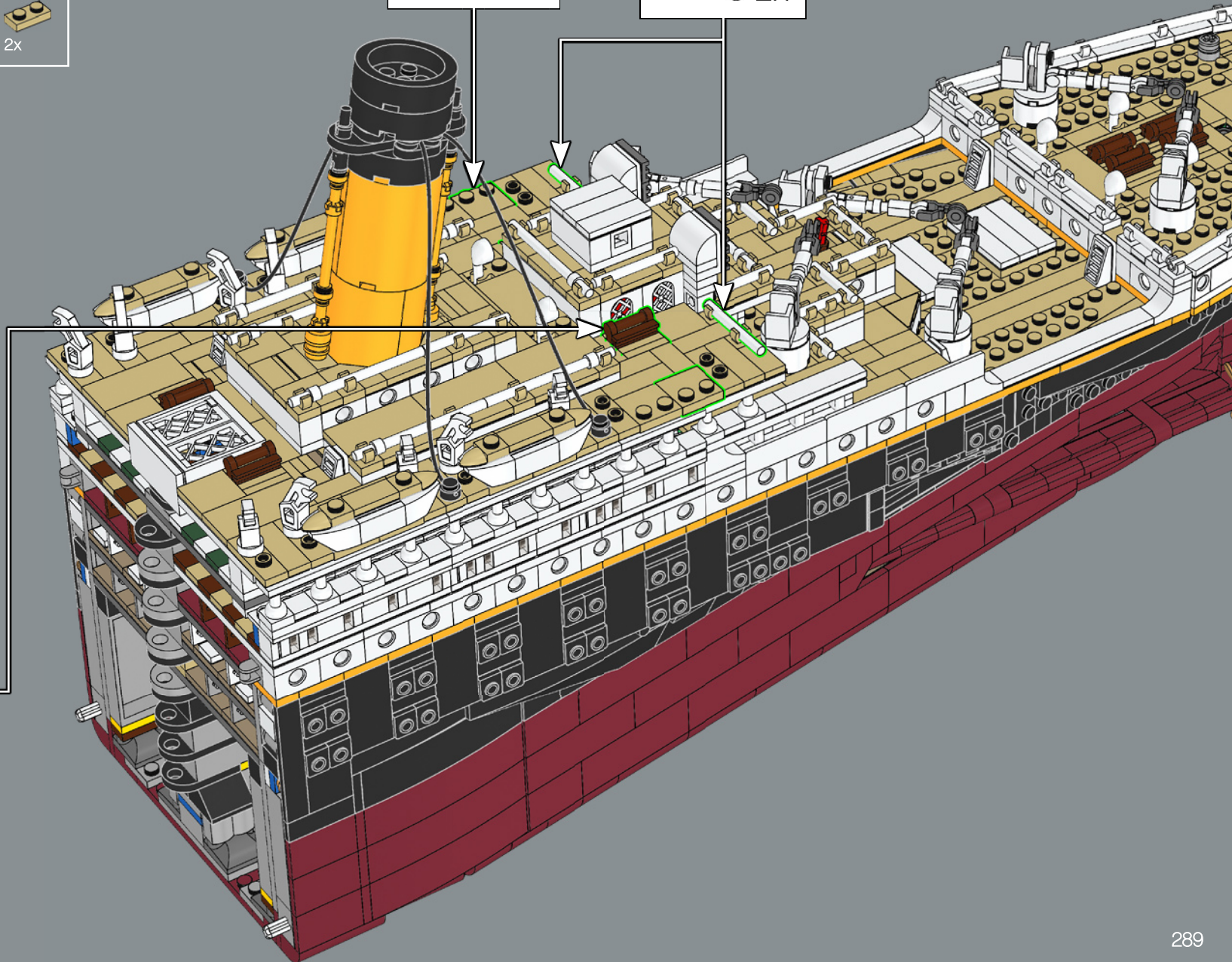
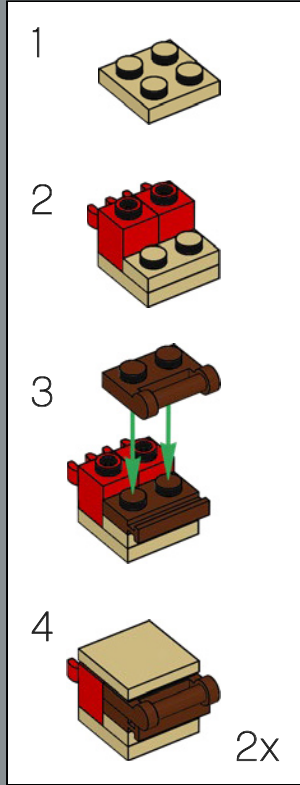

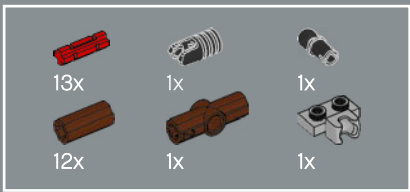

397

1

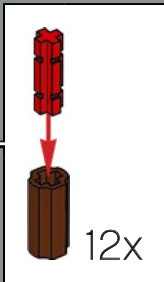
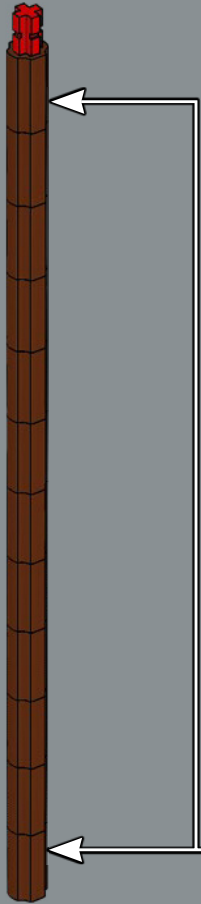

2



3

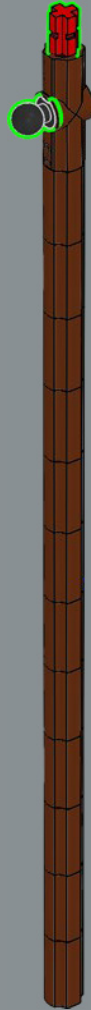

4

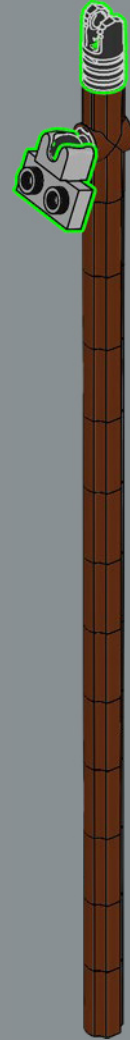



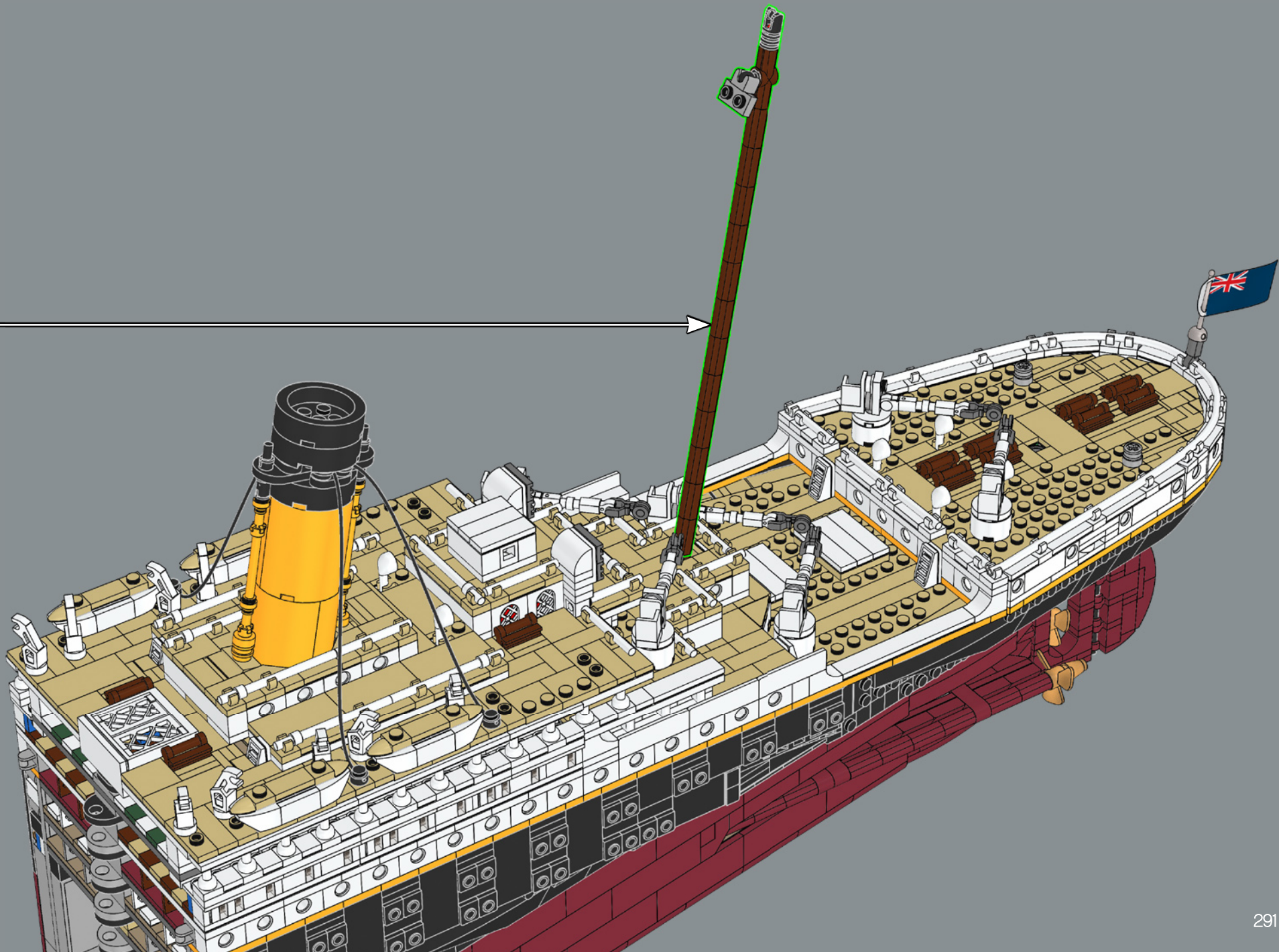

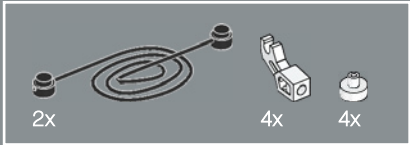
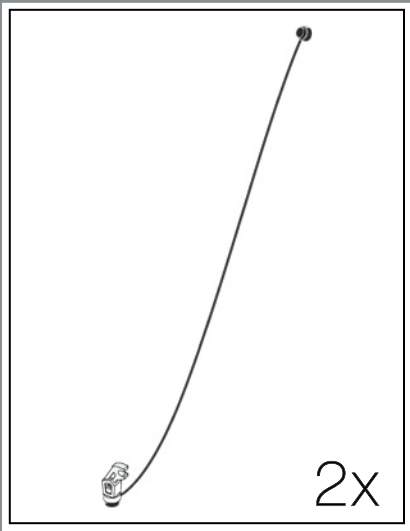

398

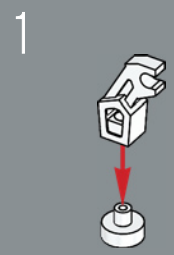



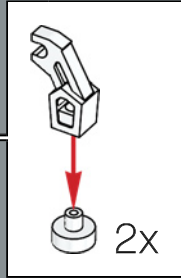
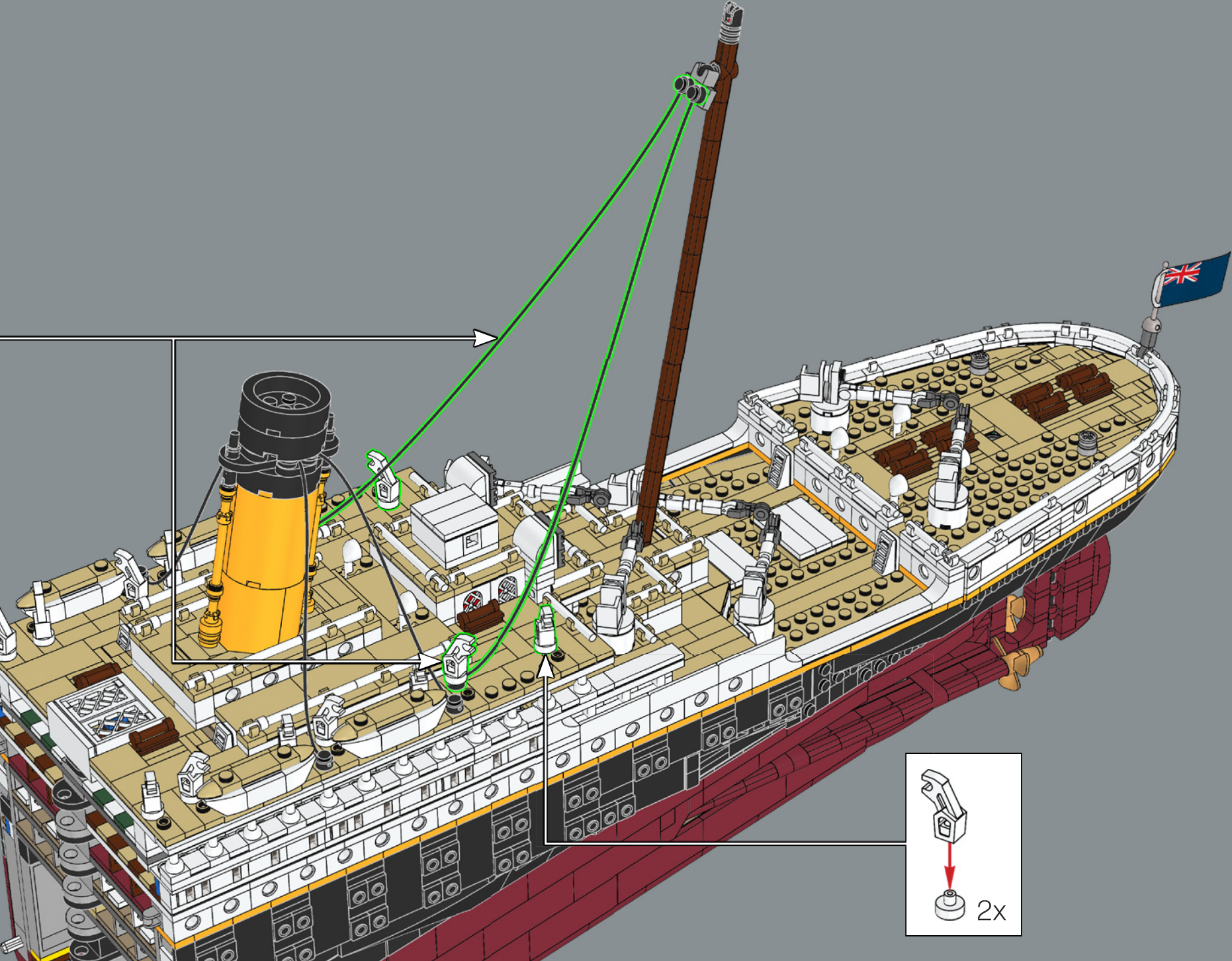



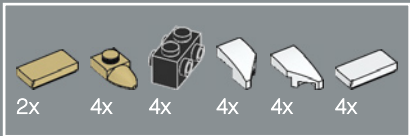

399

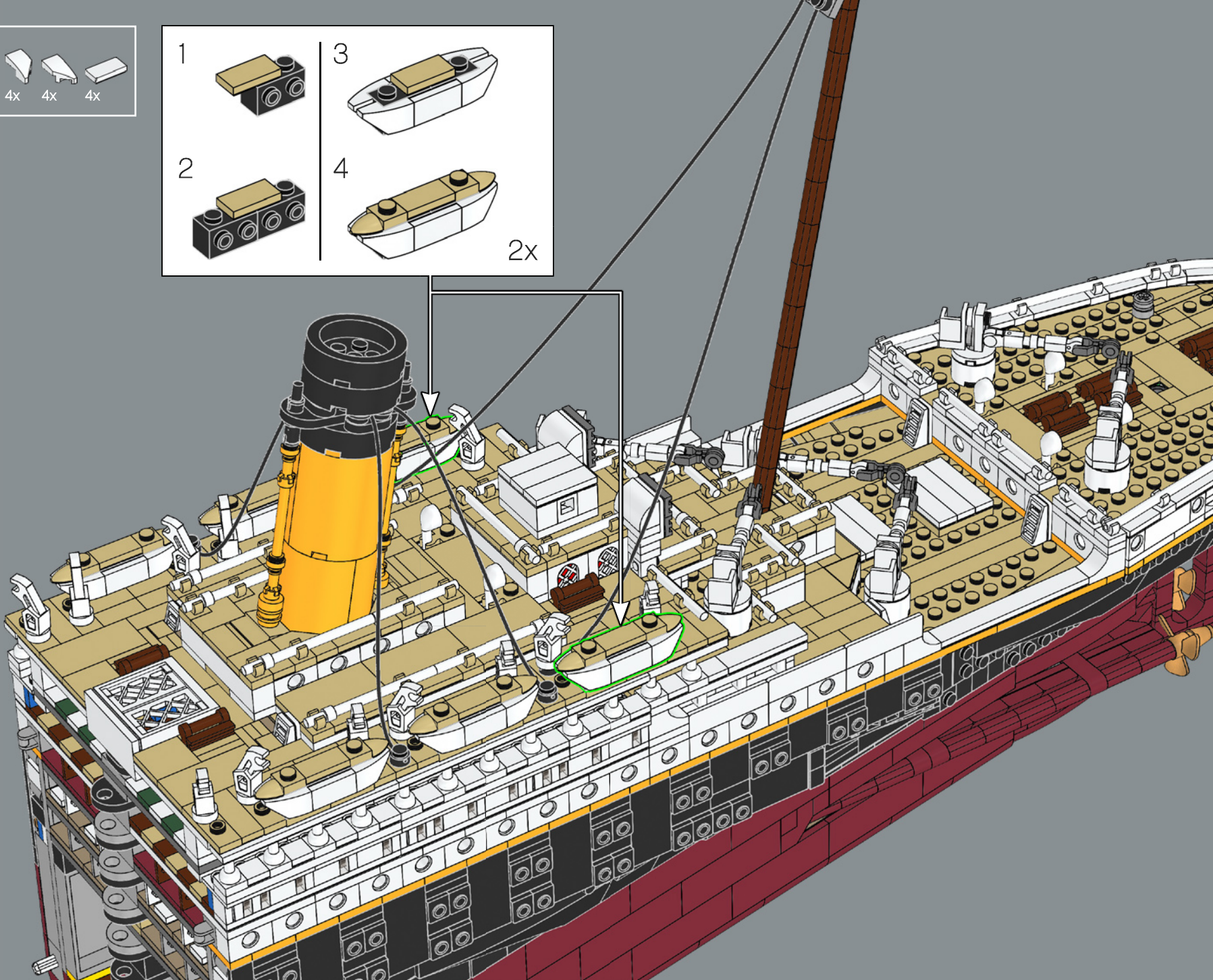
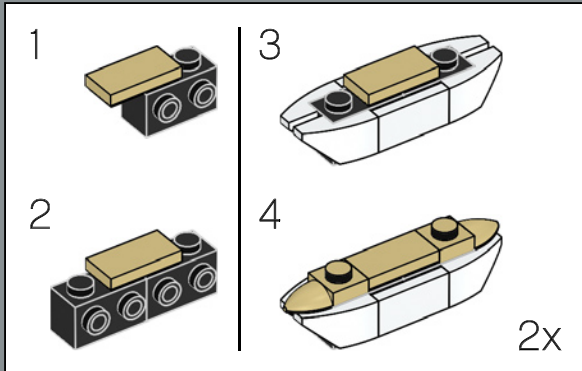





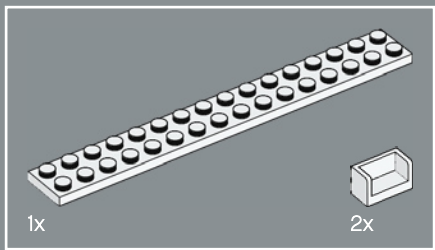

401

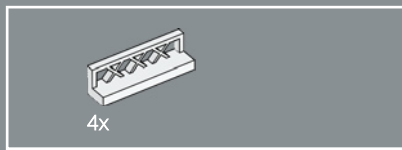
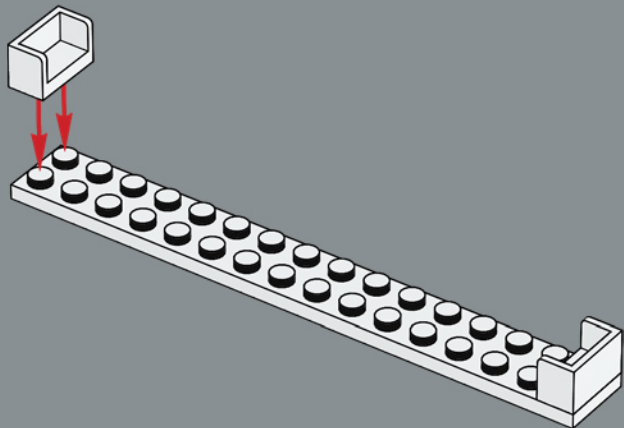

402

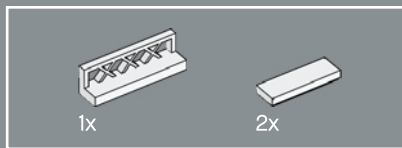
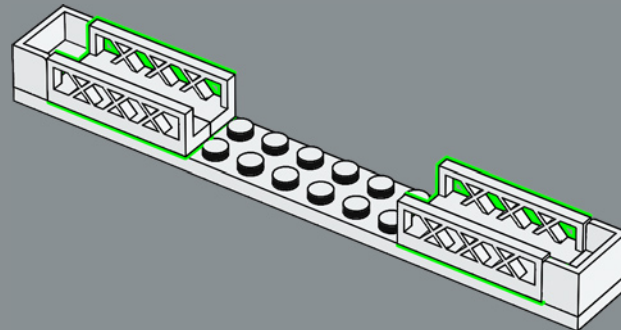

403

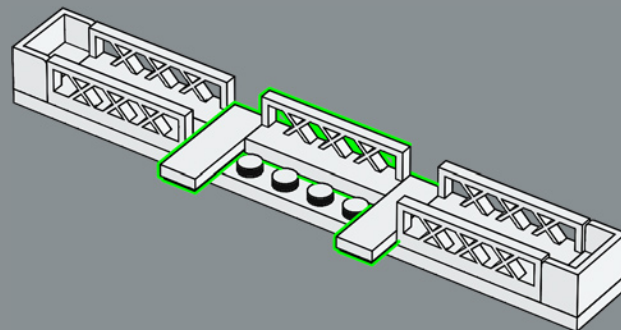



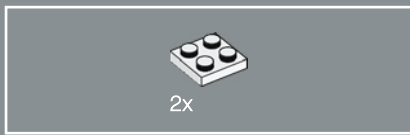

404

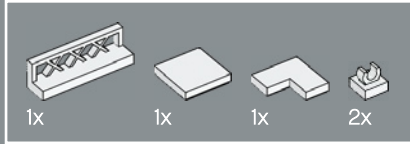
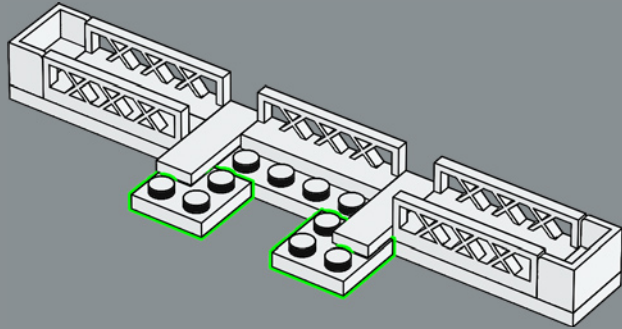

405

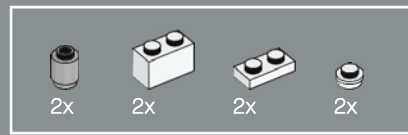
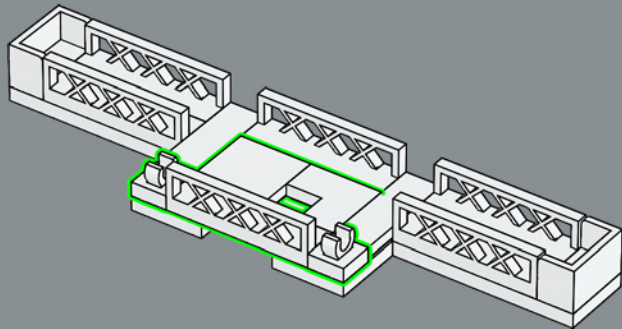

406

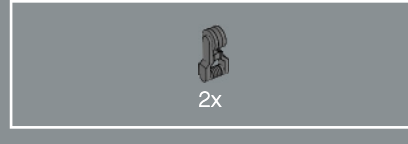
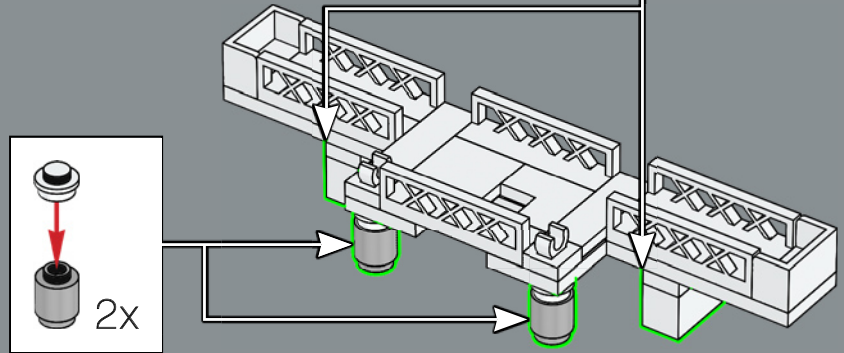

407

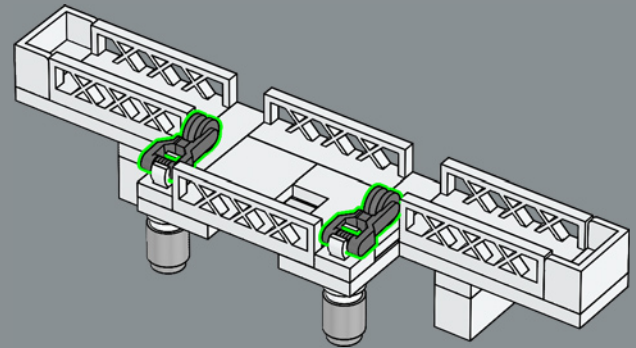



1x

408

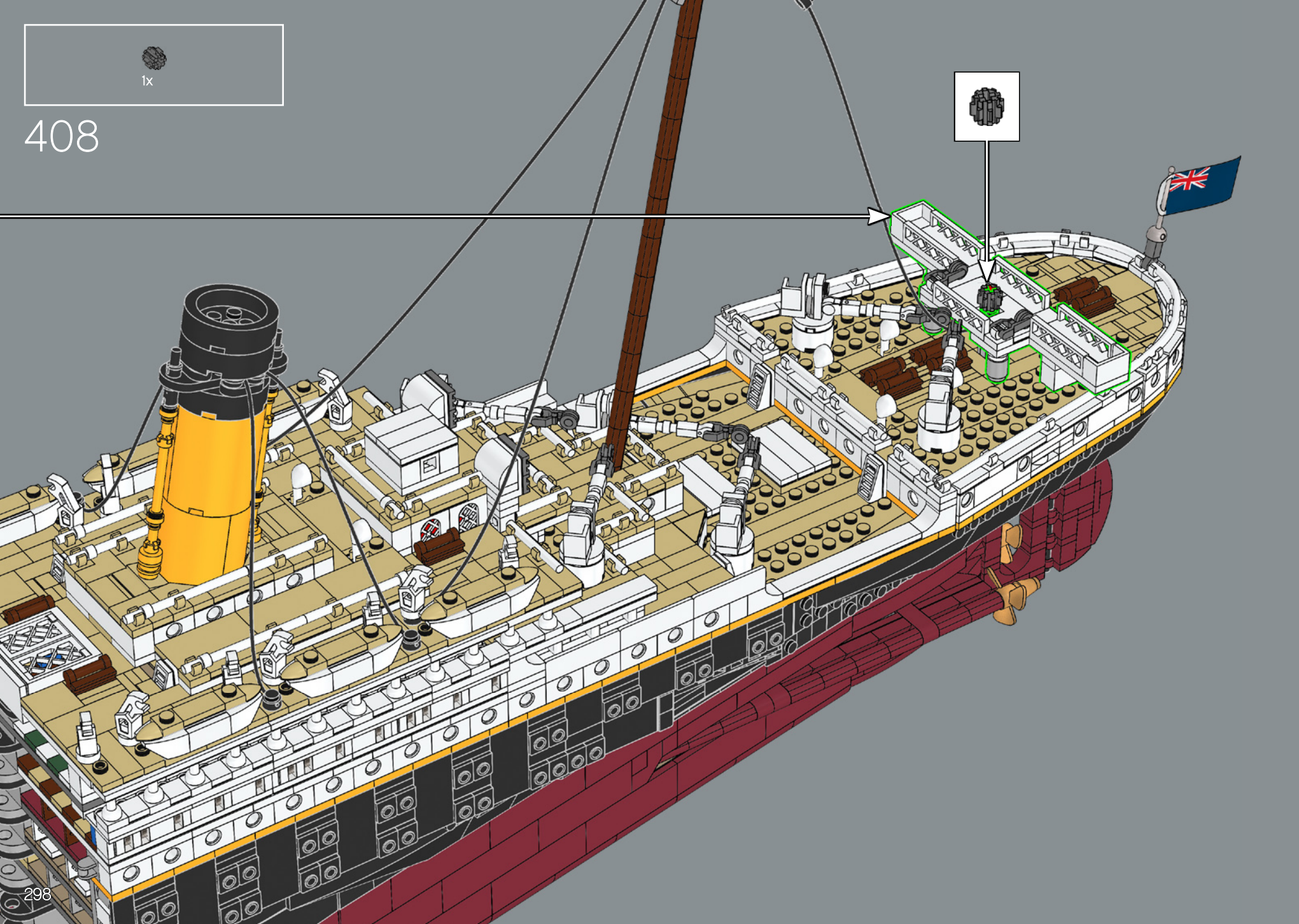



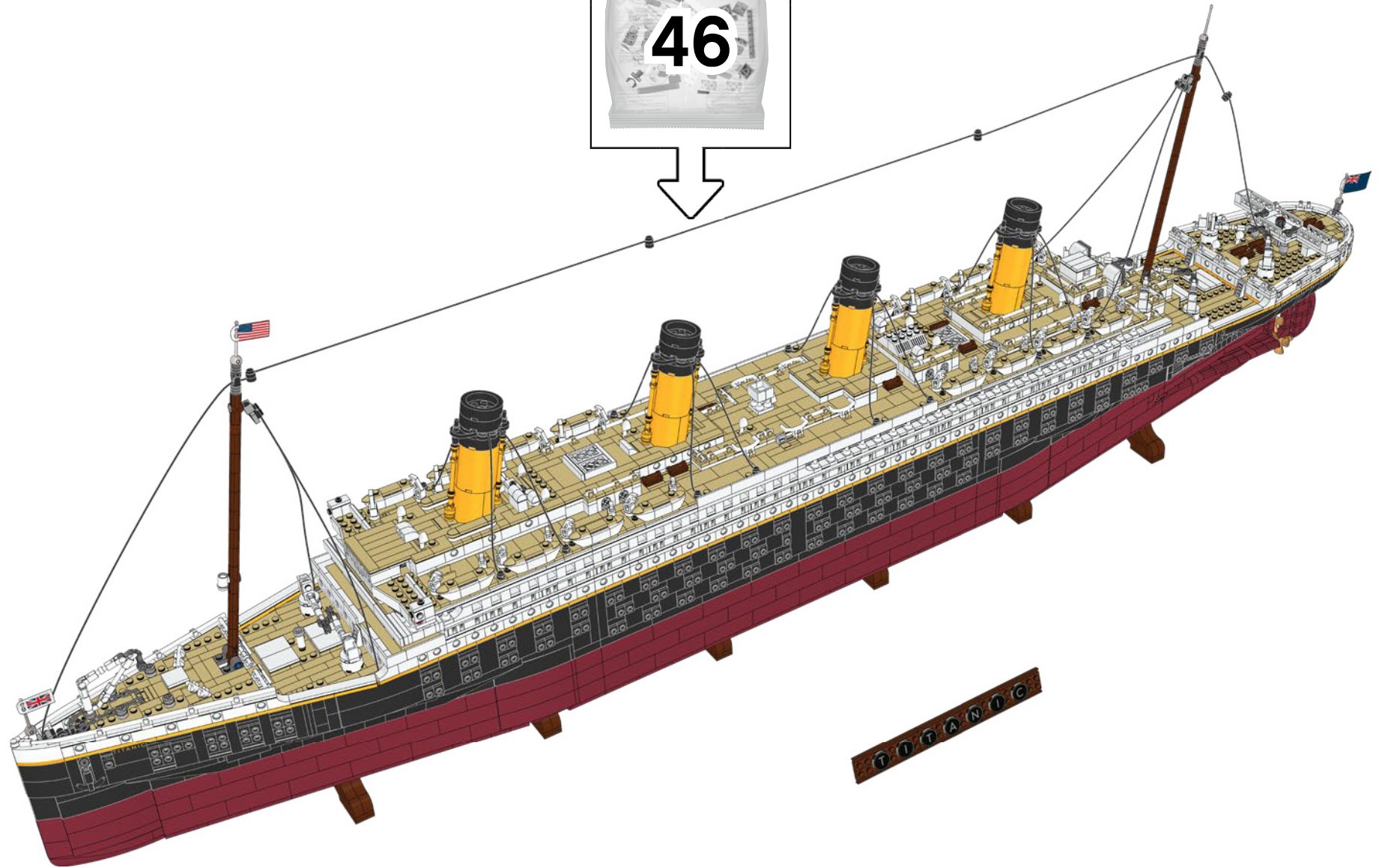



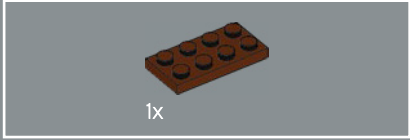
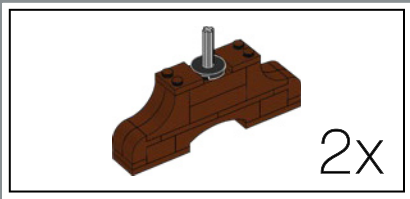

409

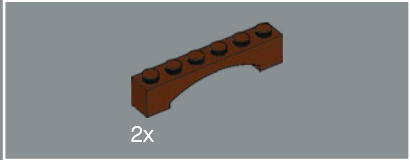
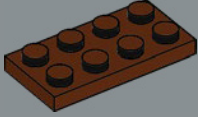

410

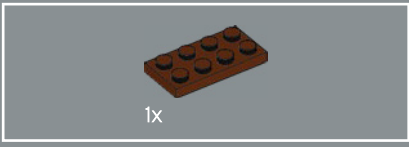
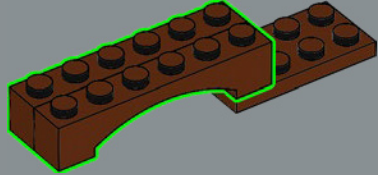

411

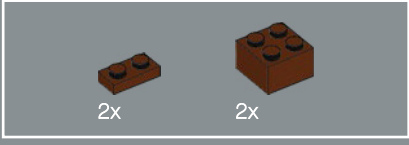
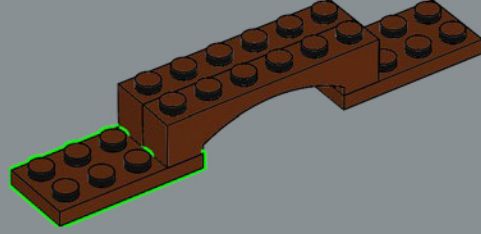

412

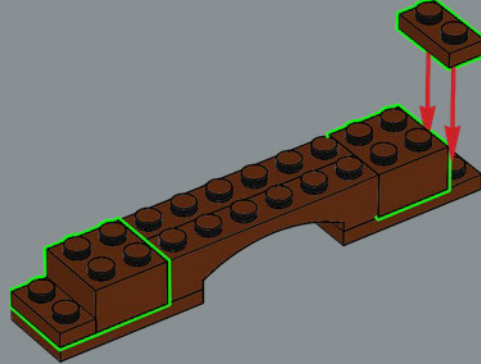

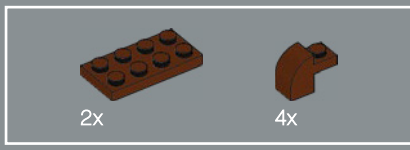

413

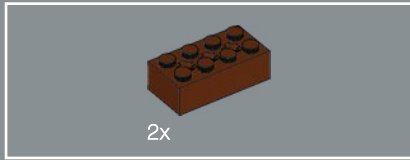
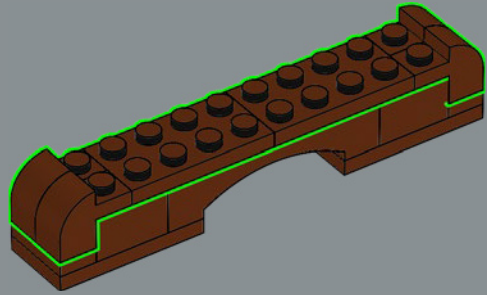

414

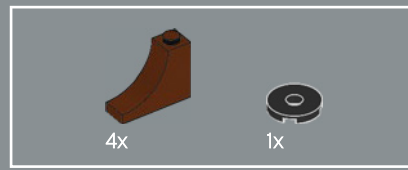
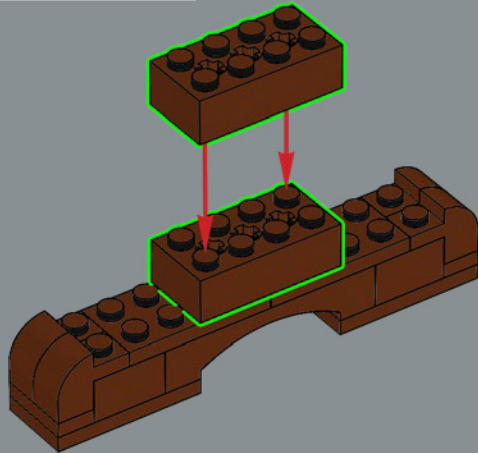

415

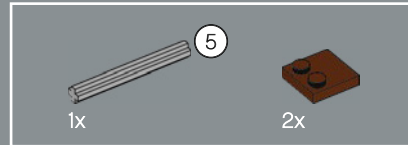
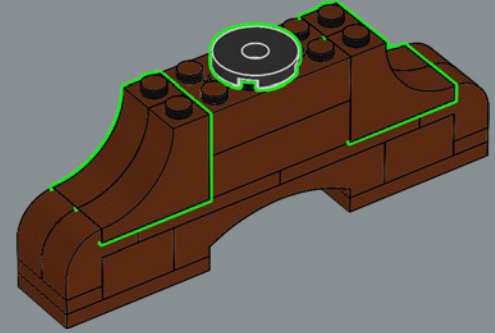

416

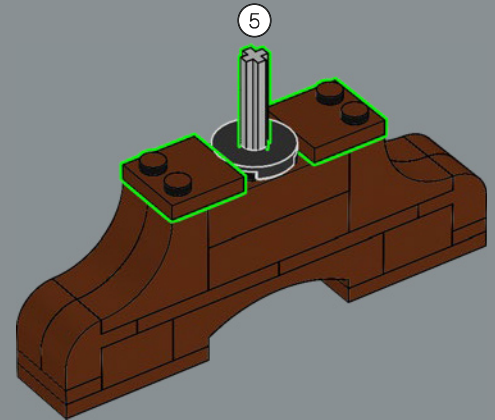

2x



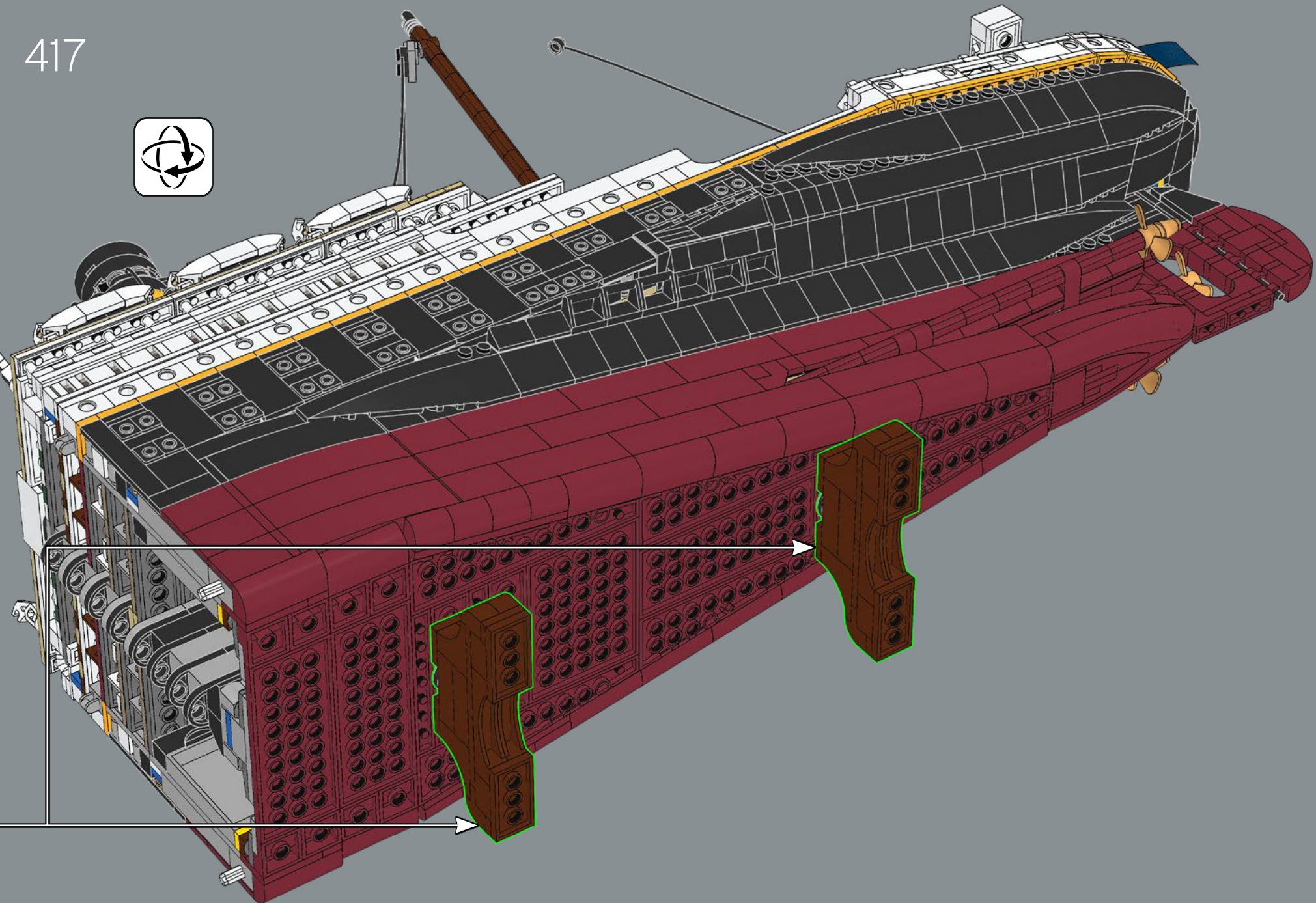



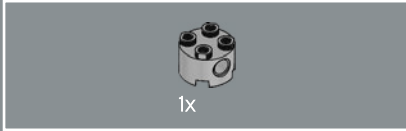
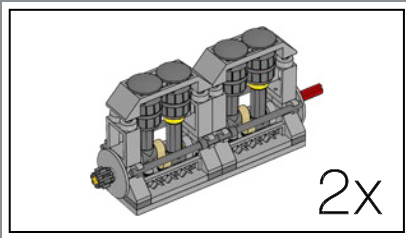

418

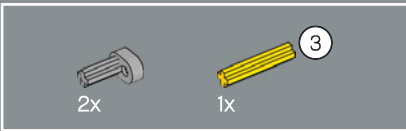
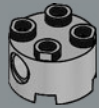

419

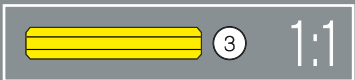
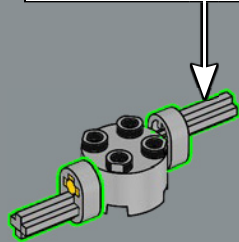
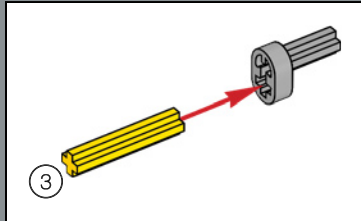

420

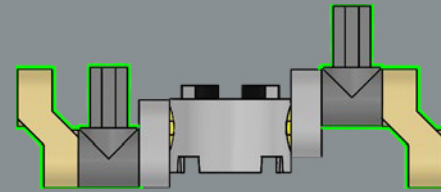

1:1

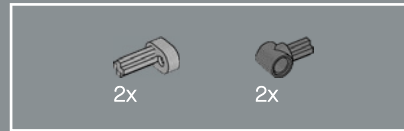

421

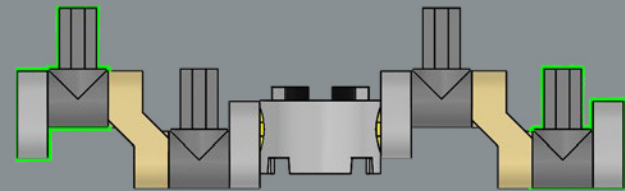

1:1

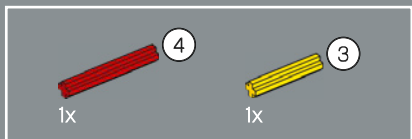

422

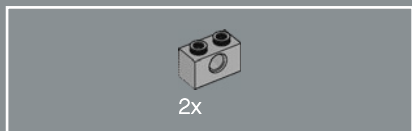
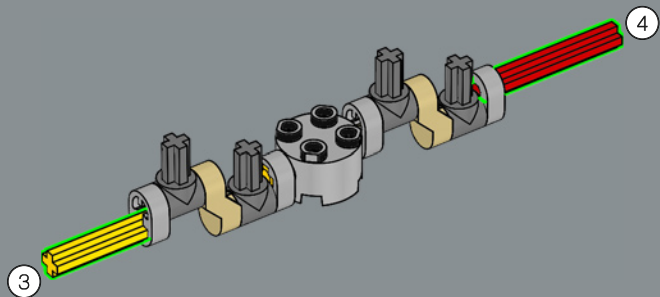

423

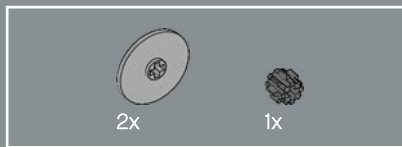
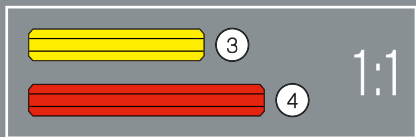
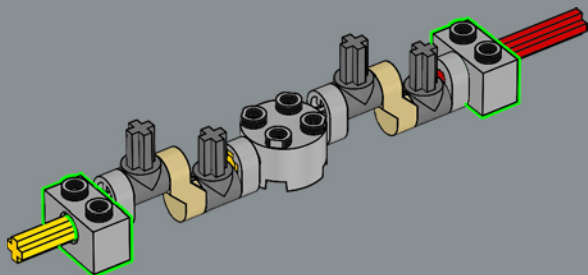

424

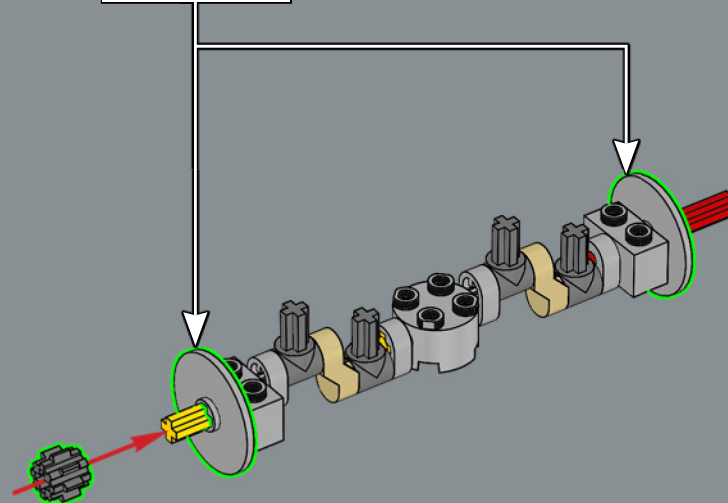
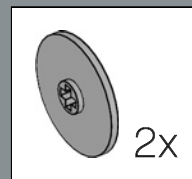

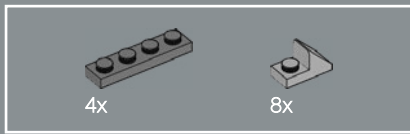

425

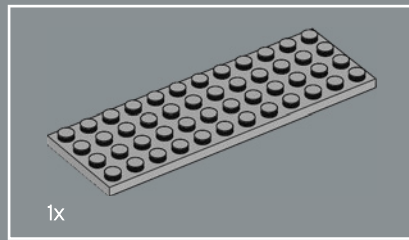
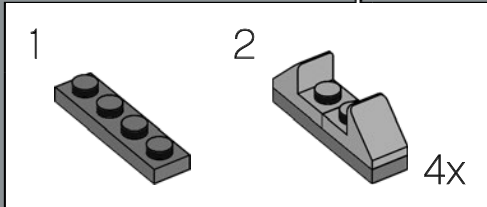
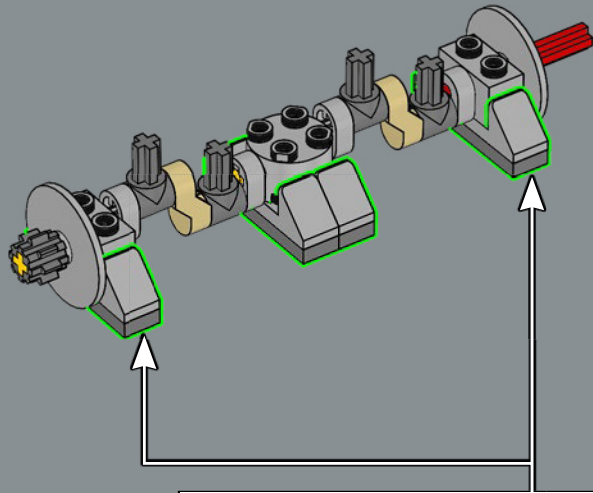

426

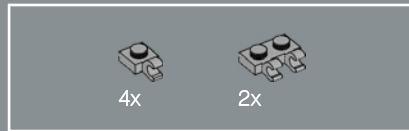
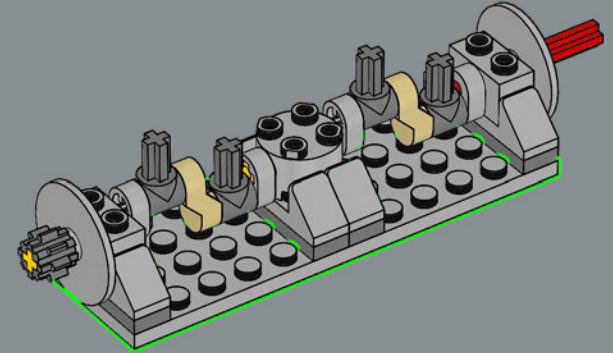

427

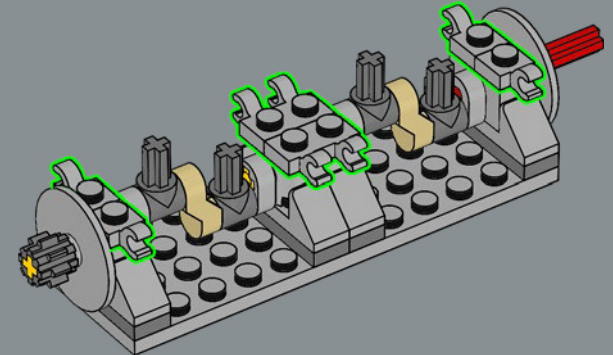





428

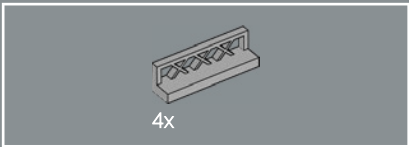
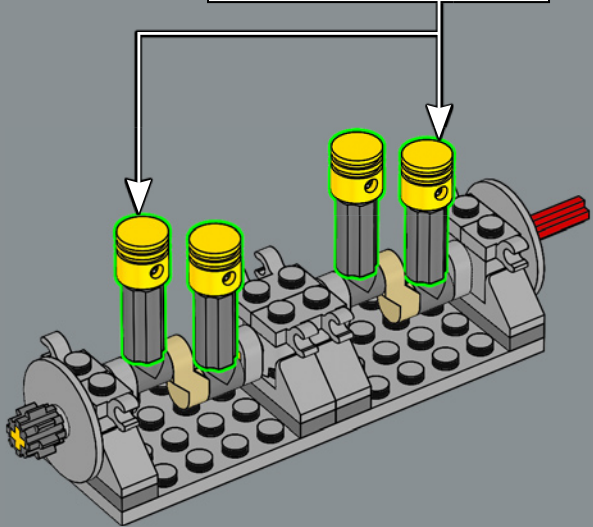
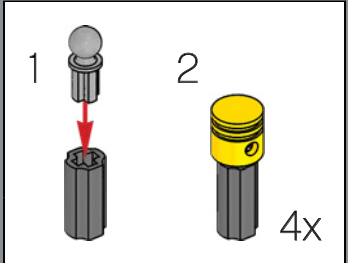

429

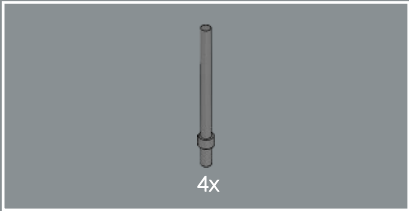
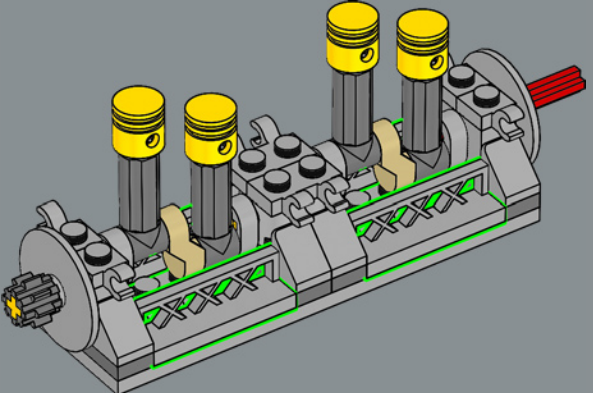

430

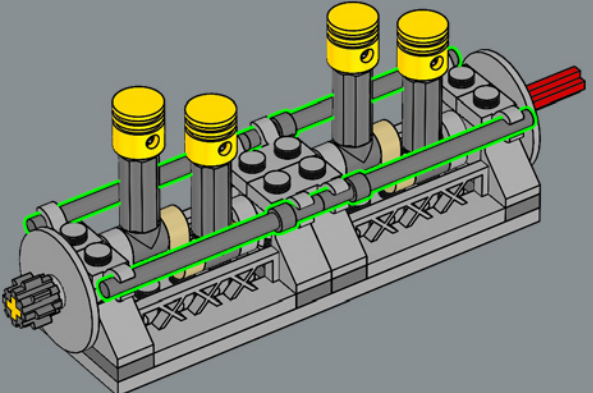

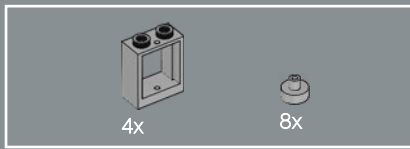

431

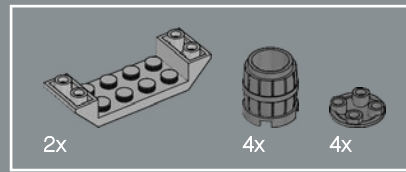
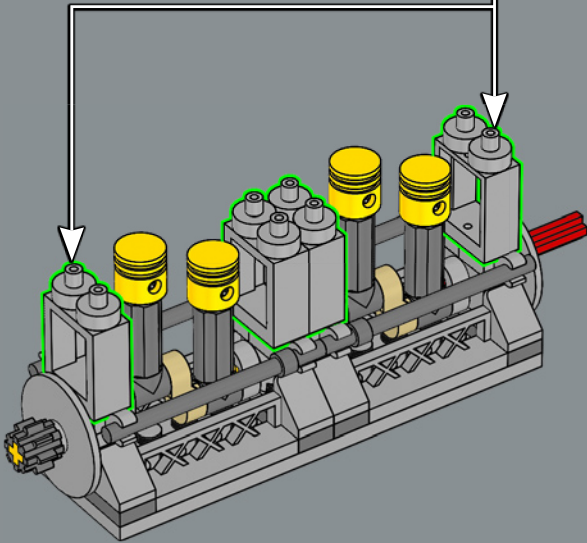
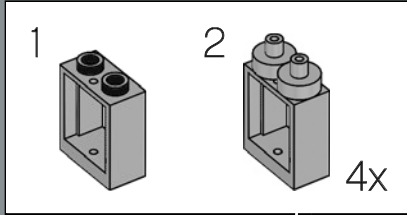

432

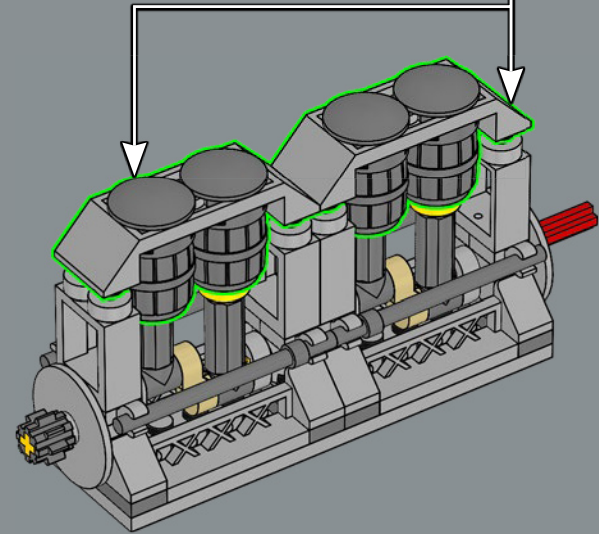
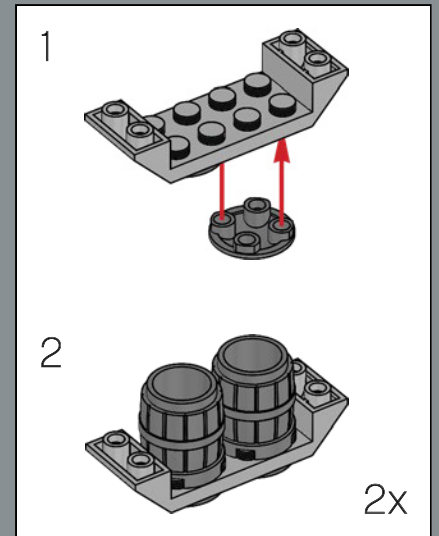

433

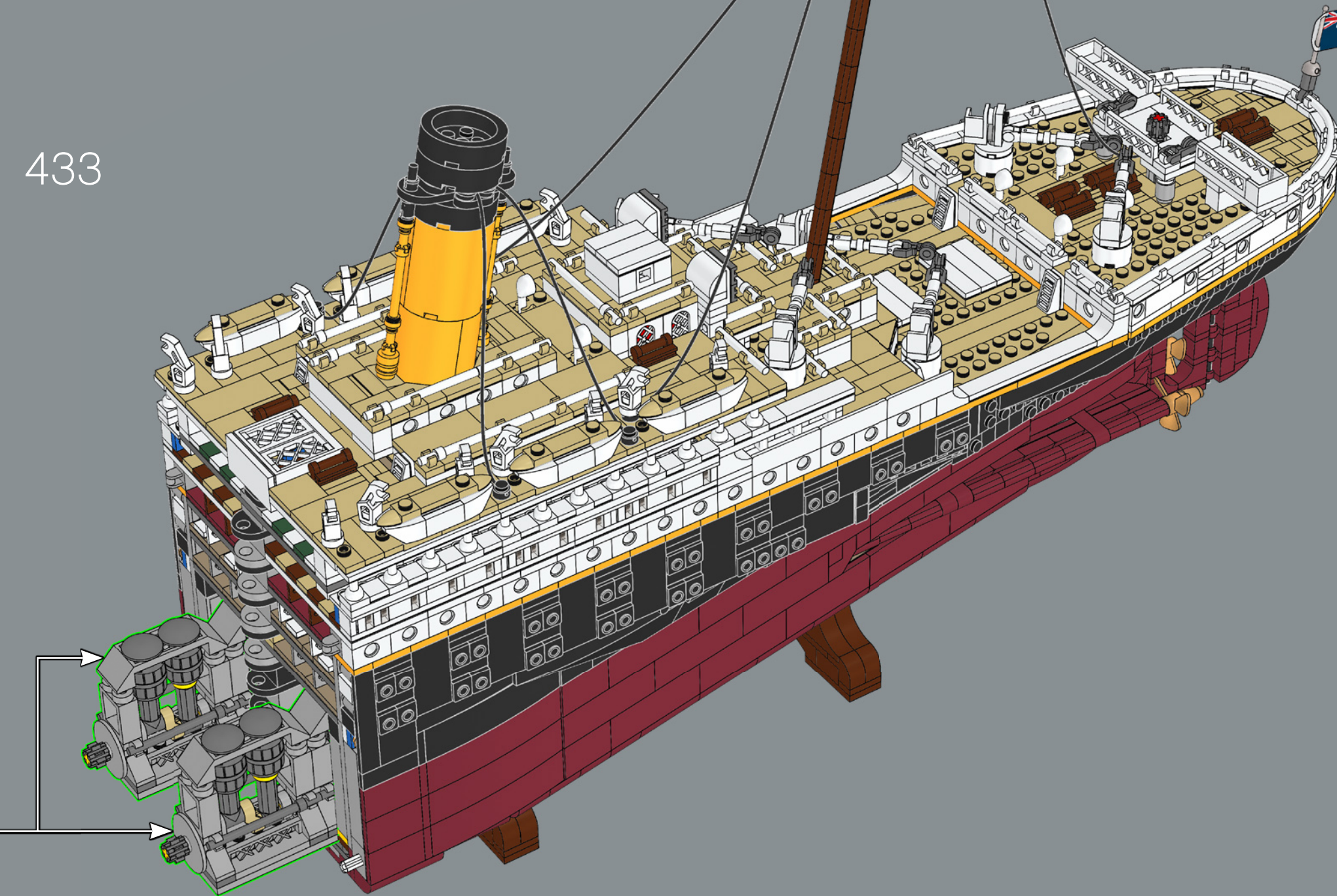



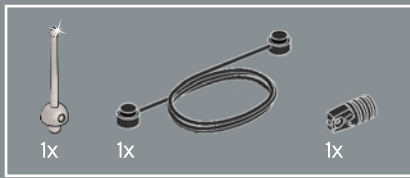

434

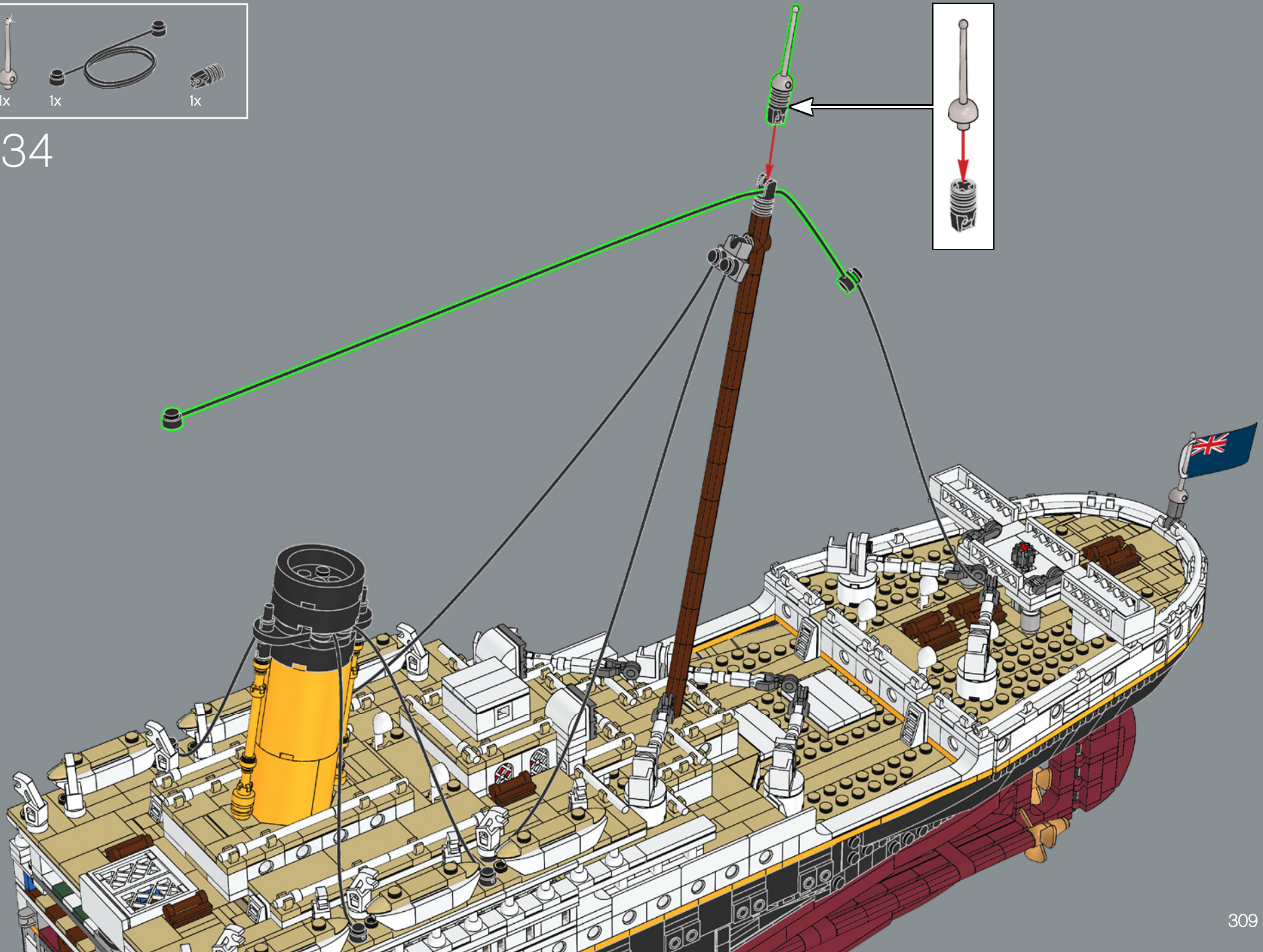

435

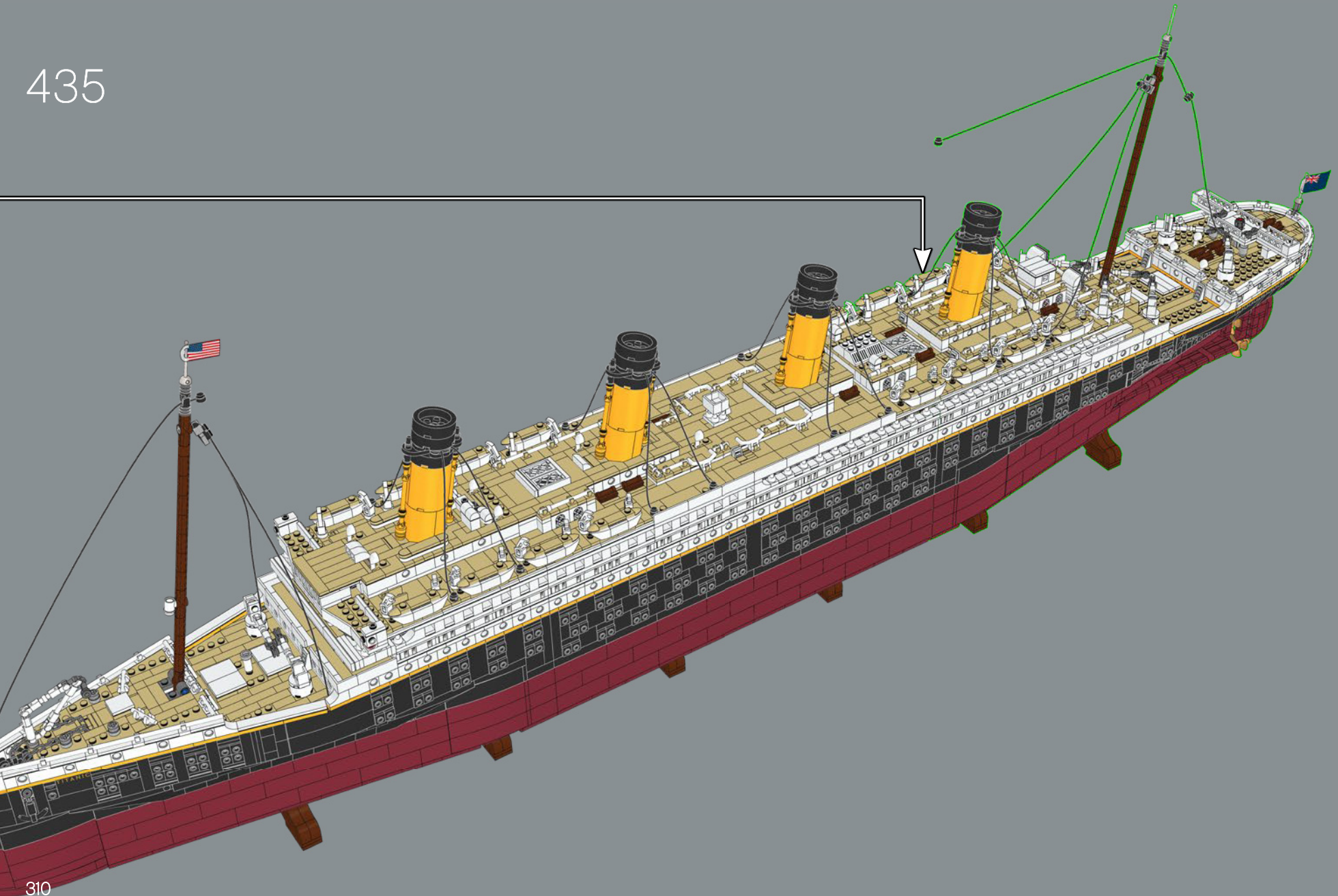

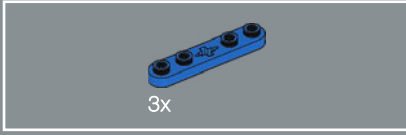
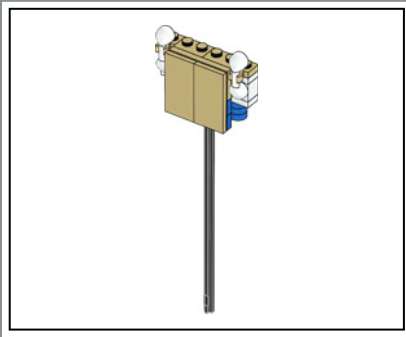

436

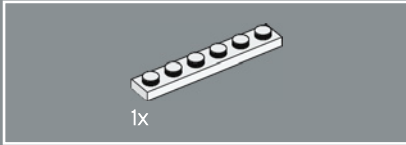
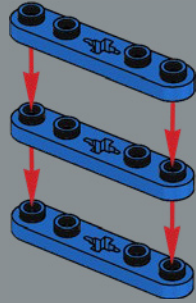

437

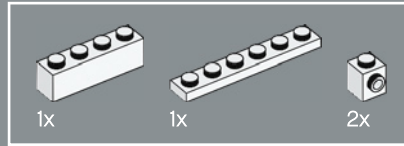
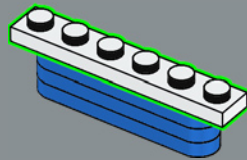

438

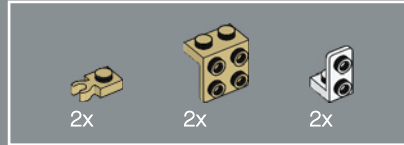
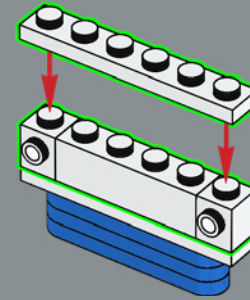

439

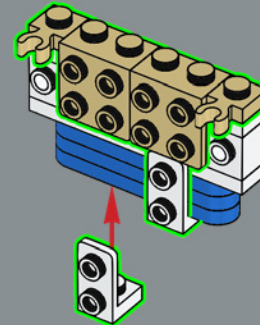



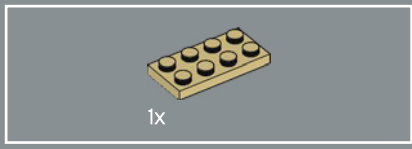

440

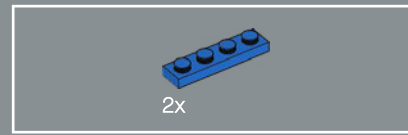
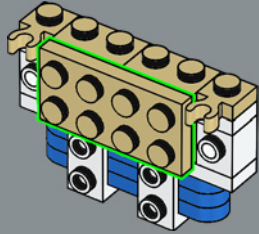

441

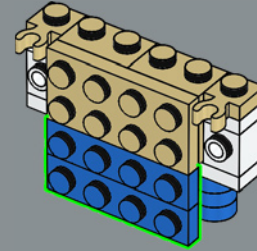

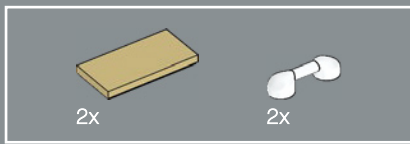

442

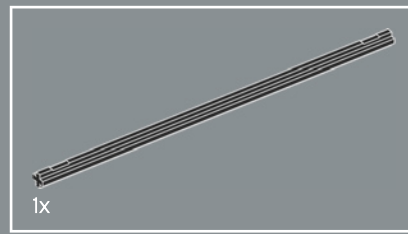
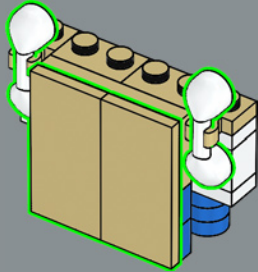

443

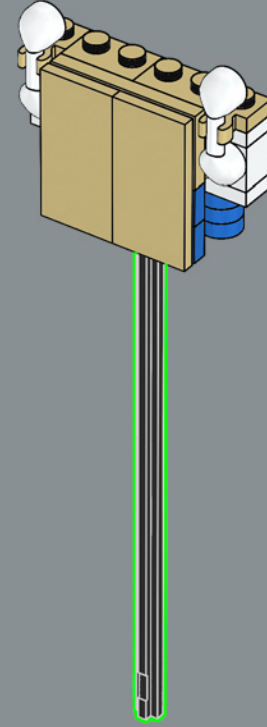

El *Titanic* se botó el 31 de mayo de 1911:  
en 2021 se cumplen 110 años.

444

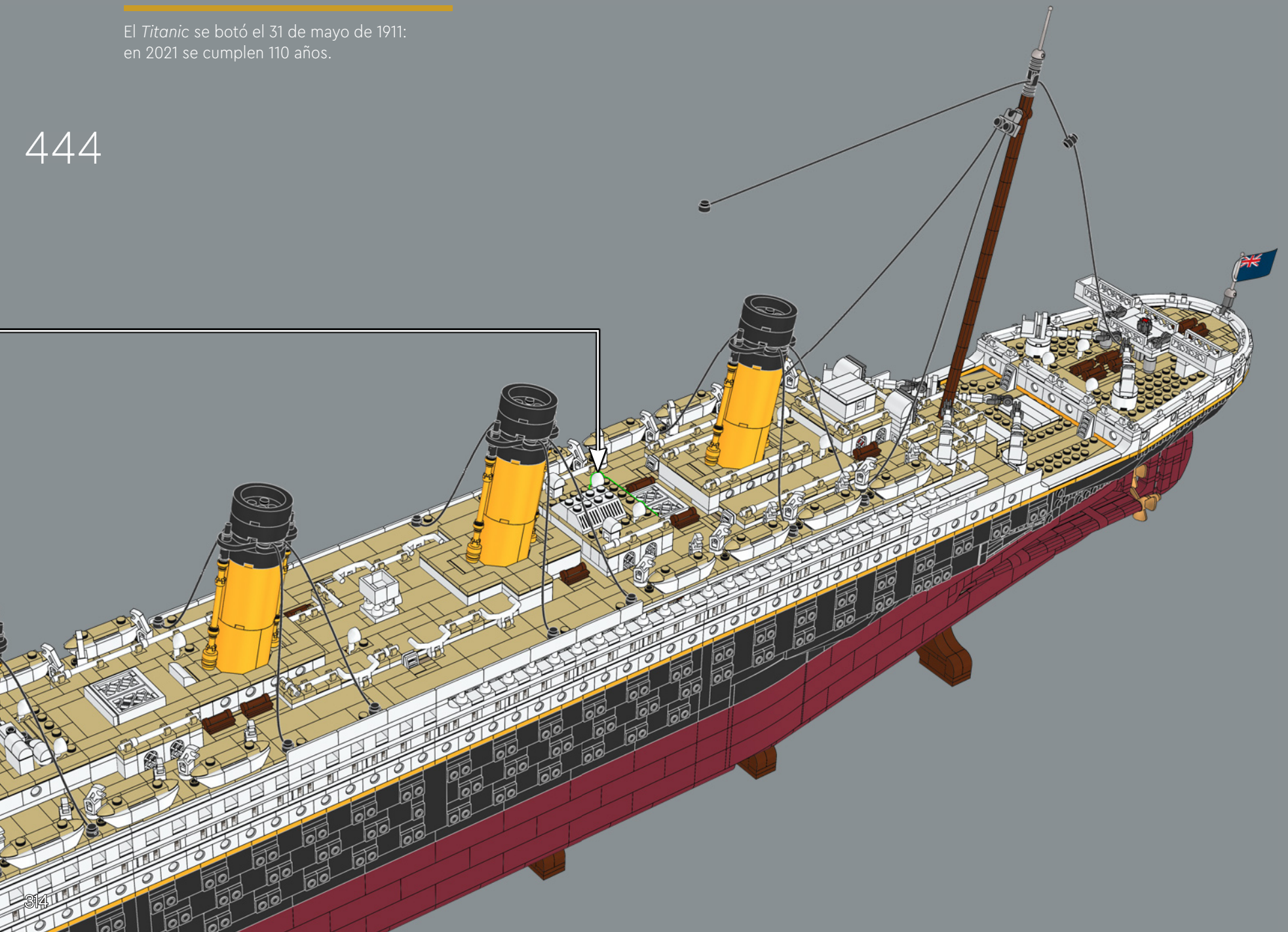



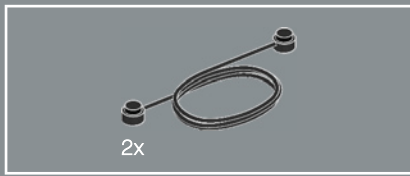

445

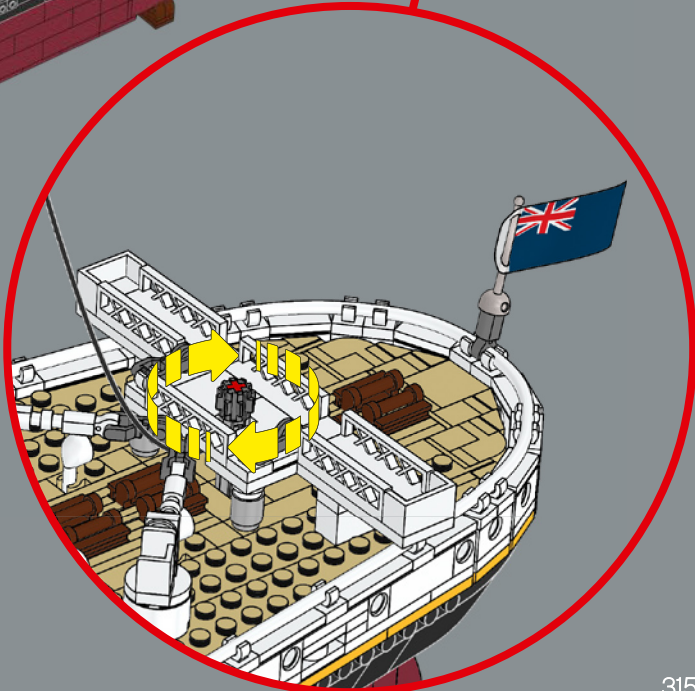
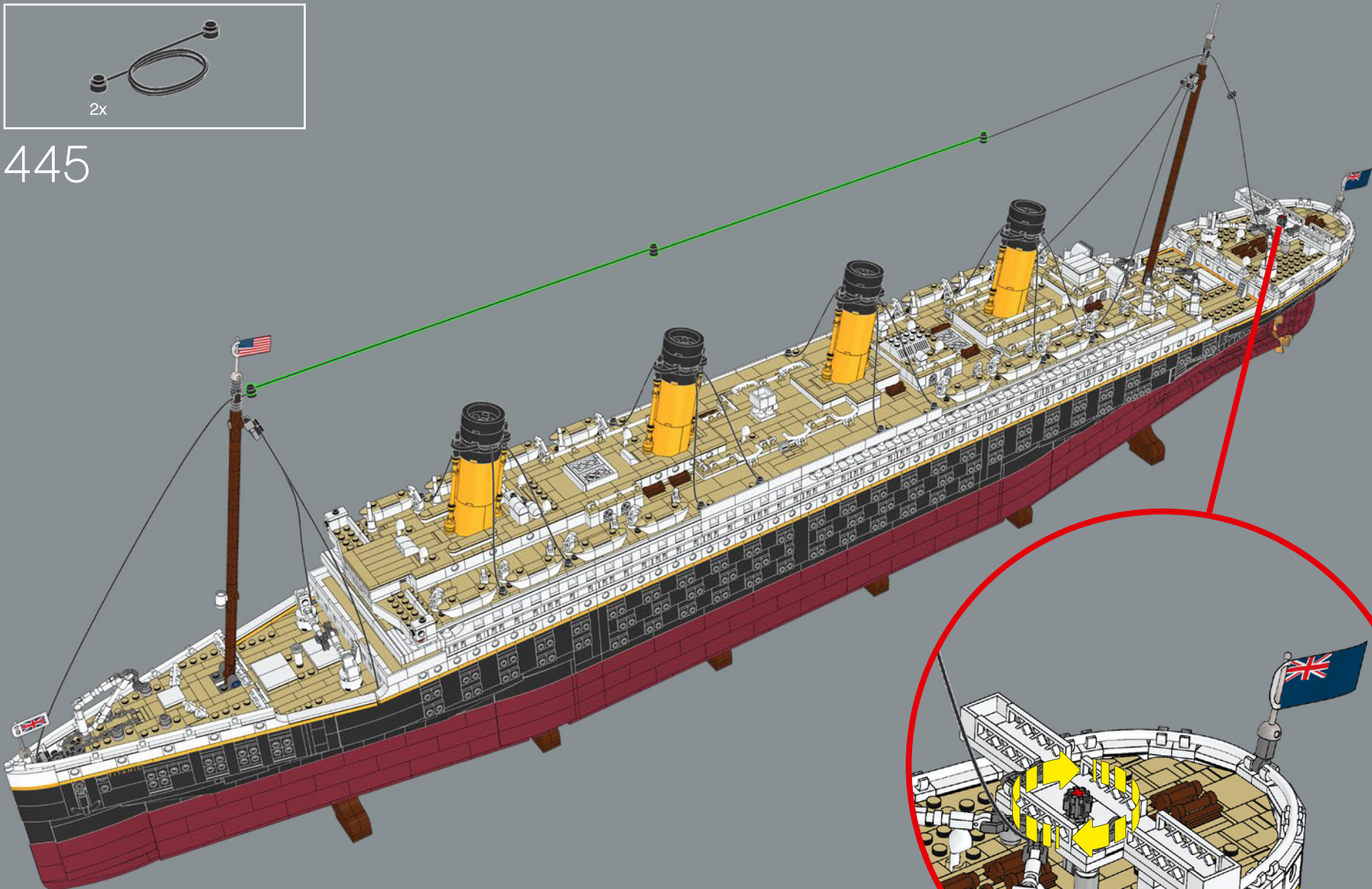

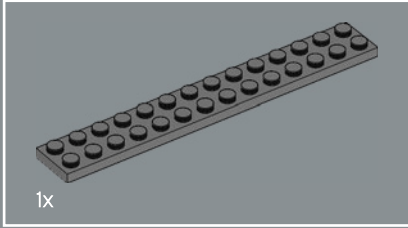
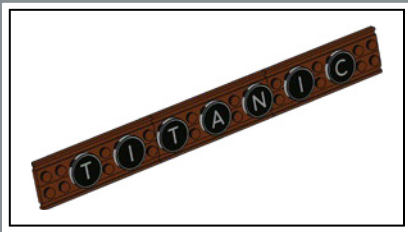

446

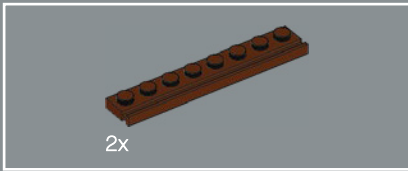
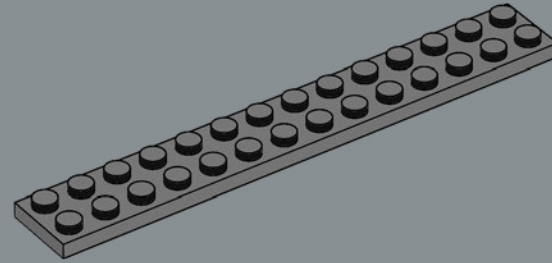

447

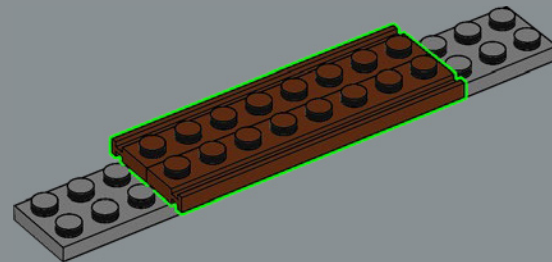

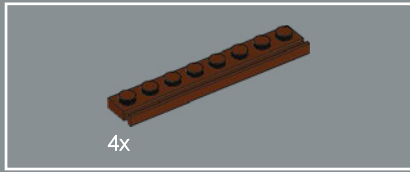

448

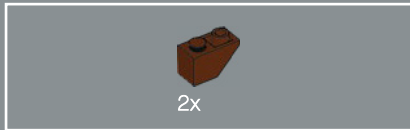
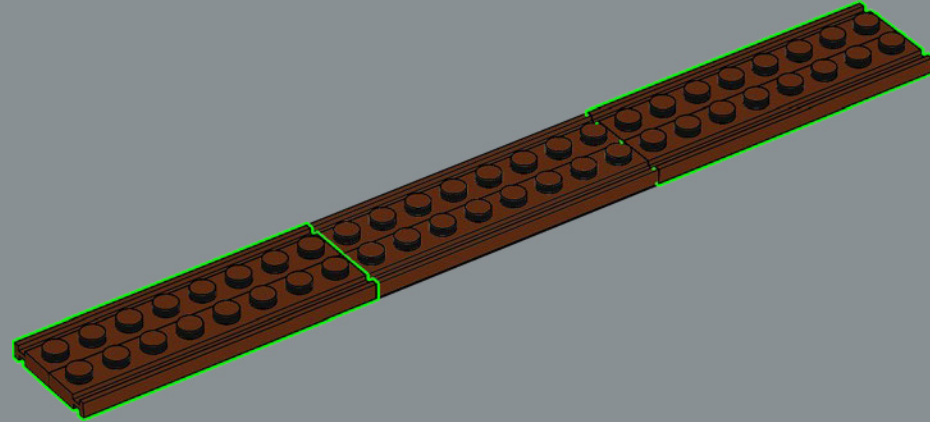

449

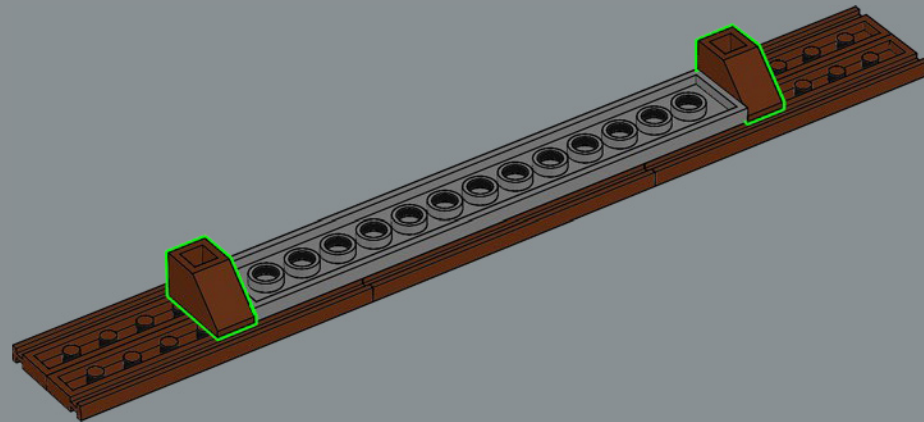





450

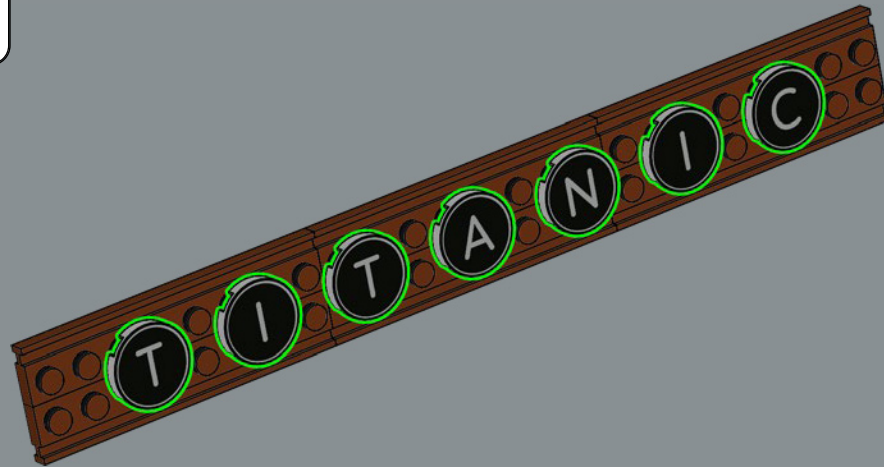

El nombre, *Titanic*, proviene de los titanes de la mitología griega.

