

TITANIC

LIBRO 3

IL TRANSATLANTICO INAFFONDABILE

Sebbene l'RMS *Titanic* vantasse molte caratteristiche di sicurezza avanzate, le obsolete normative sulla sicurezza marittima del tempo imponevano che il transatlantico fosse dotato di sole 20 scialuppe di salvataggio, sufficienti per appena un terzo del suo equipaggio e passeggeri. Quando entrò in collisione con un iceberg ad alta velocità poco prima della mezzanotte del 14 aprile 1912 iniziando rapidamente ad affondare, a causa del numero di lance di salvataggio insufficiente, solo 710 persone sopravvissero e oltre 1.500 perirono nell'incidente. Una diretta conseguenza della tragedia fu l'introduzione di nuovi standard internazionali di sicurezza, onnicomprensivi, molti dei quali sono ancora in vigore oggi.



↑ Le scialuppe di salvataggio nelle loro gruette sul *Titanic*.

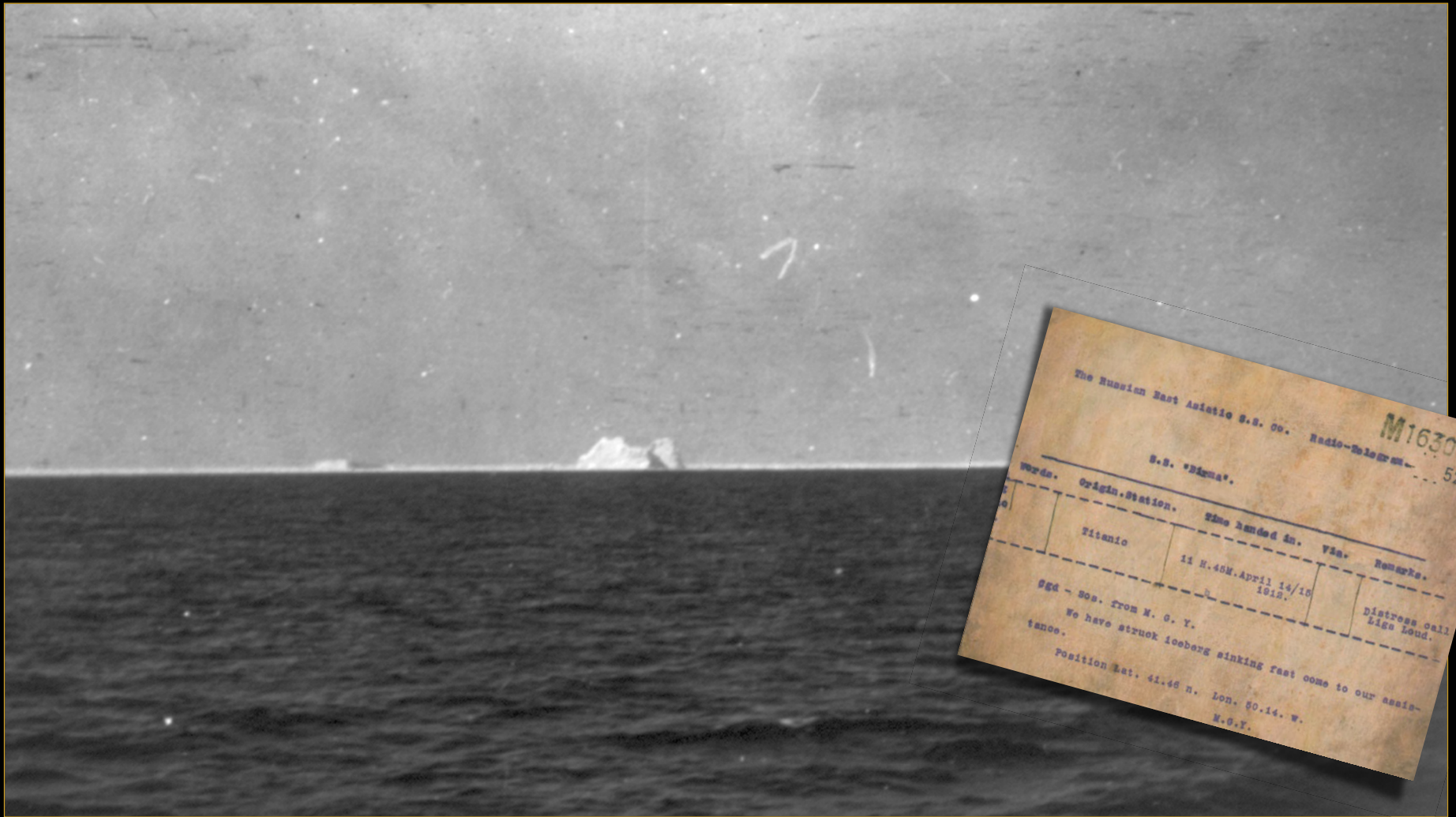

↑ Il luogo presunto del disastro rilevato dalla SS Carpathia intervenuta per soccorrere i sopravvissuti del Titanic.

↗ Un telegramma trasmesso dall'RMS Titanic alla SS Birma richiedendo assistenza.

UNA SCALA STRAORDINARIA

Al momento del varo, il *Titanic* era la più grande imbarcazione mai realizzata dall'uomo. Era lunga 269 metri e misurava 53,3 metri dal fondo dello scafo alla cima dei fumaioli. Allo stesso modo, la versione LEGO® dell'RMS *Titanic* è il modello più lungo mai creato per una collezione LEGO e uno dei più complicati.

La versione LEGO del Titanic è costruita in scala 1:200, la stessa scala del set Statua della Libertà LEGO Architecture.

Il Titanic era 11 volte più lungo della balenottera azzurra, il più grande animale mai vissuto sulla Terra.

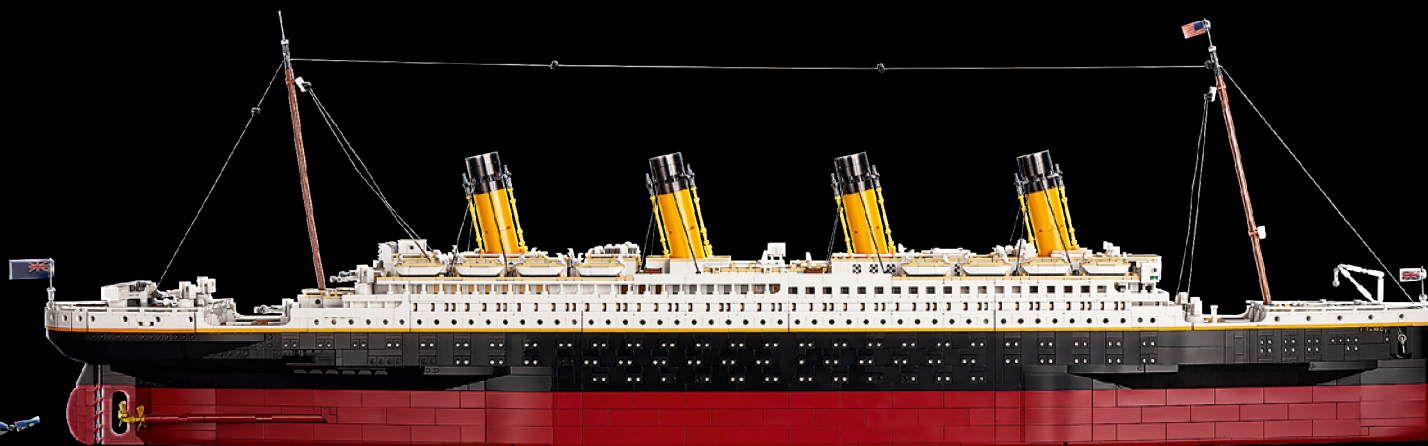

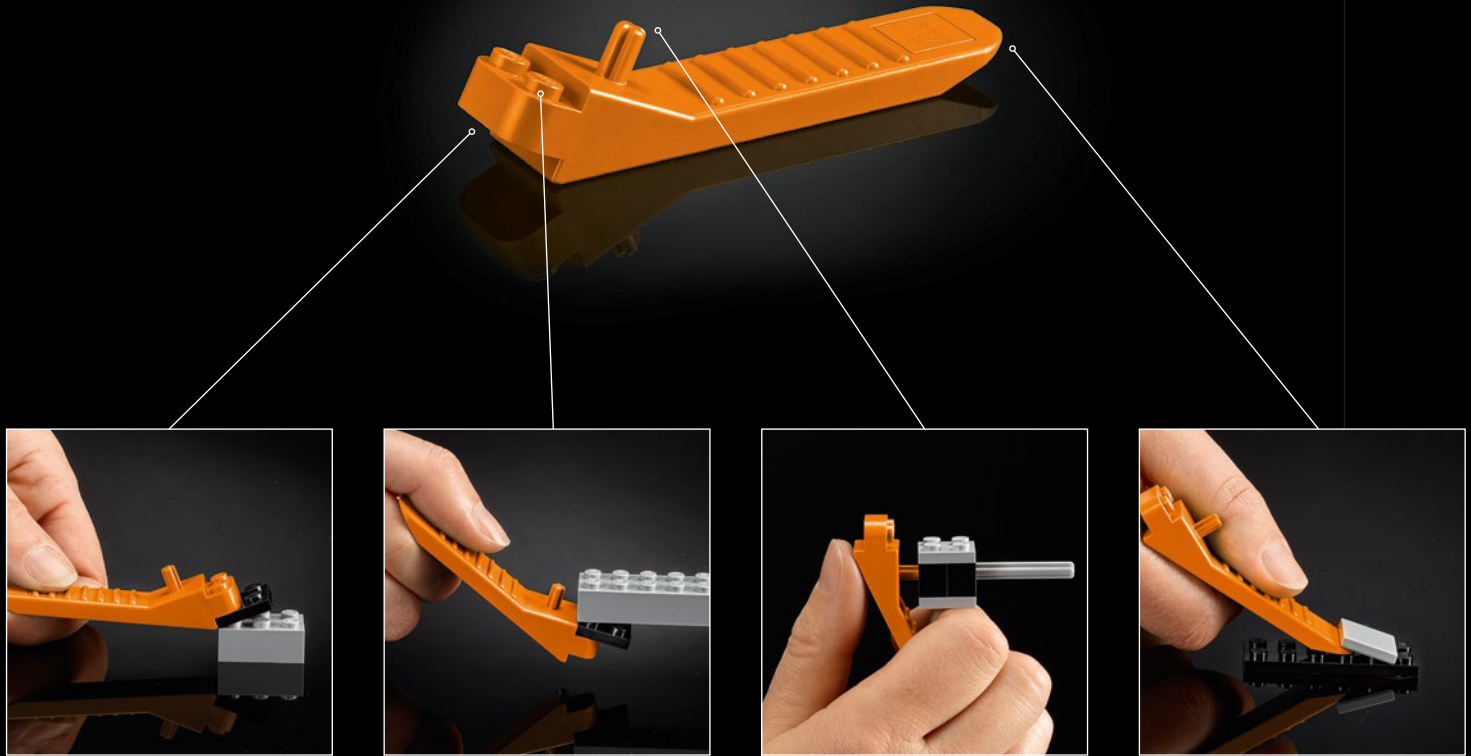

[LEGO.com/brickseparator](https://www.lego.com/brickseparator)

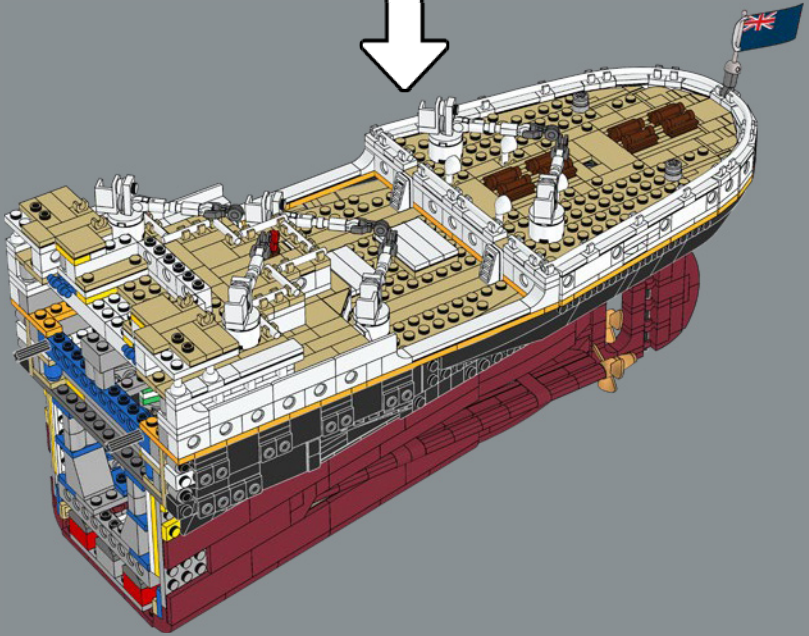
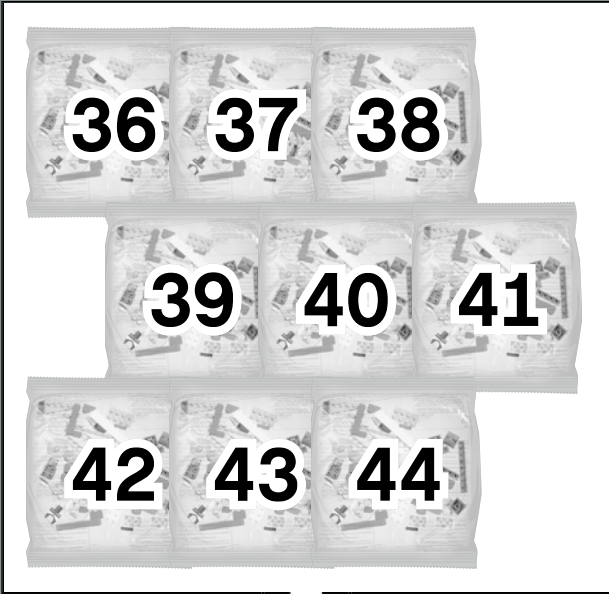
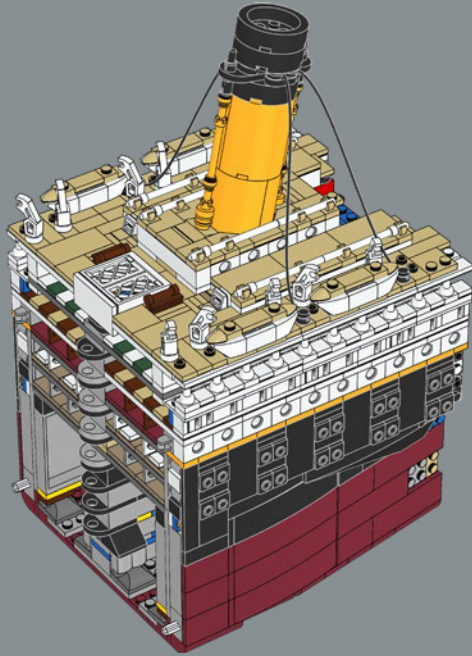
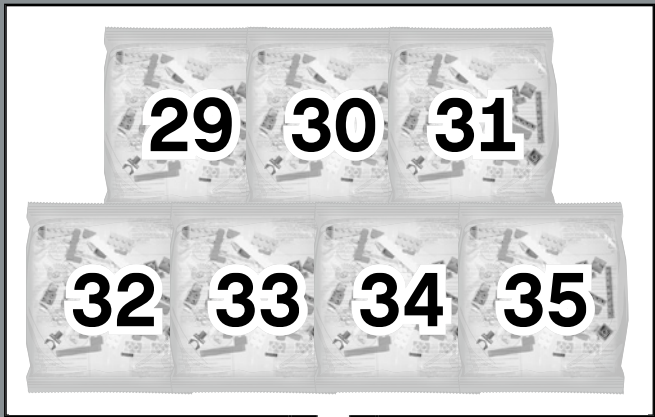

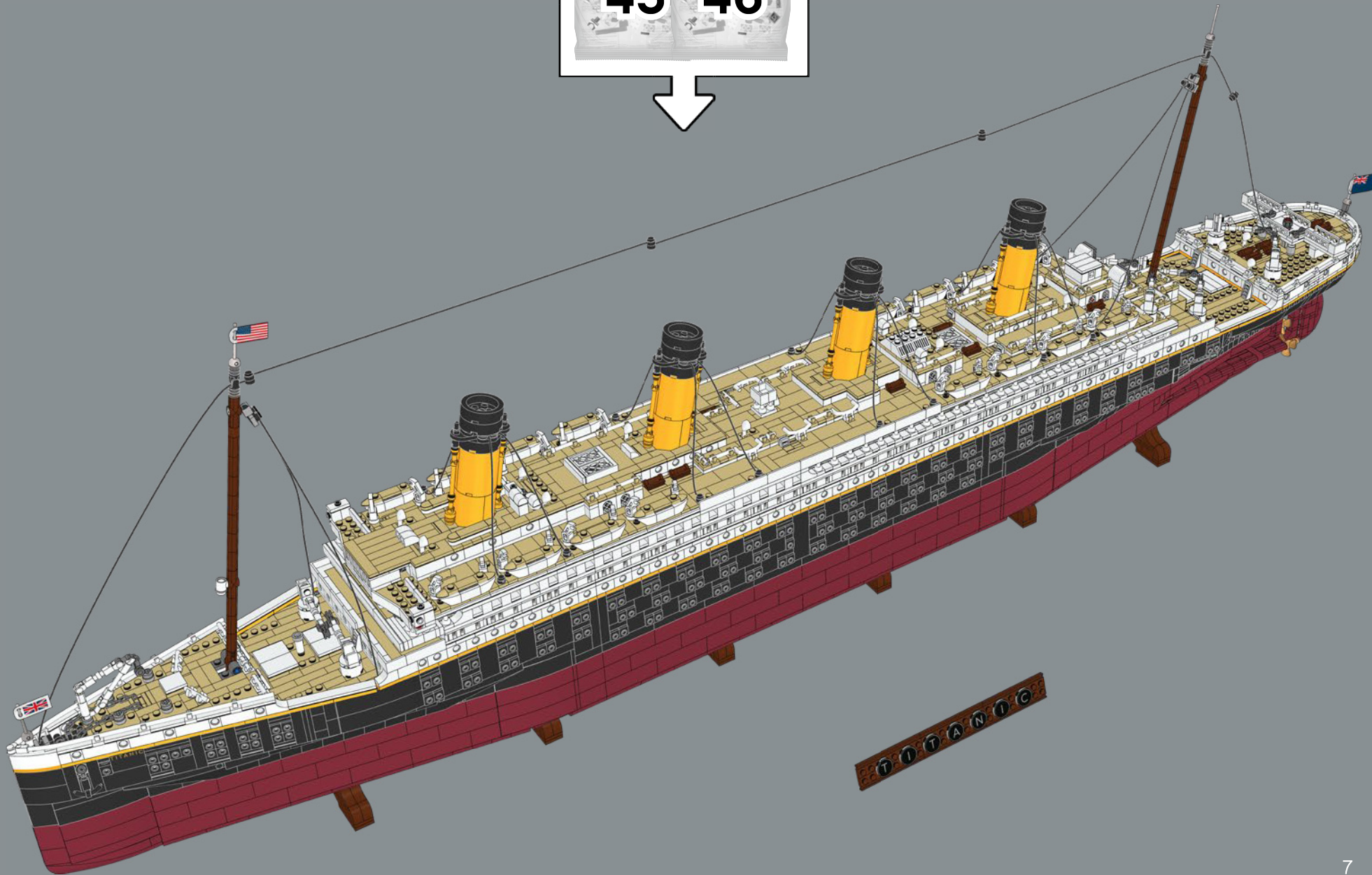
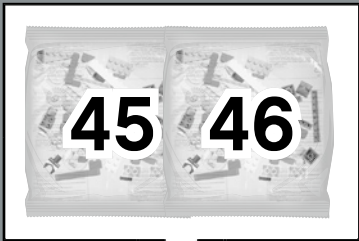

T I T A N I C

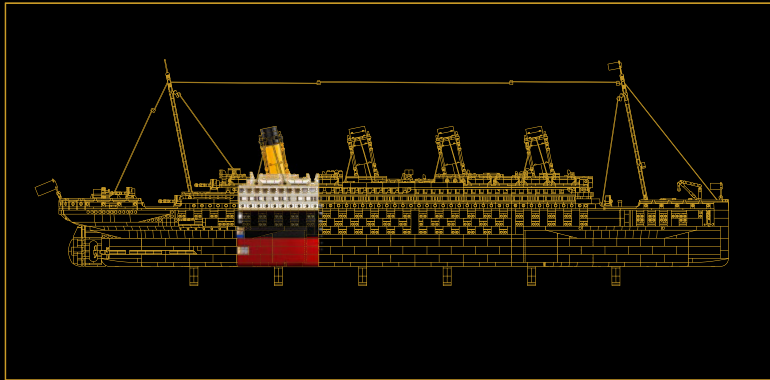

SEZIONE 5:

FUMAIOLO E SALA MACCHINE

In questa sezione, il modello si restringe man mano che si assottiglia verso le eliche e il timone a poppa della nave. Qui è possibile costruire l'ultimo fumaiolo del modello. Sul vero *Titanic*, questo fumaiolo era fittizio, in quanto non era collegato ad alcuna caldaia, ma fu incluso nel design della nave per renderla esteticamente ancora più attraente e completa.

↓ Nella parte superiore di questa sezione, è possibile aggiungere la sala lettura della nave e alcune delle sue cabine di 2° classe.



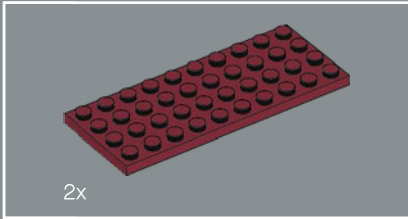
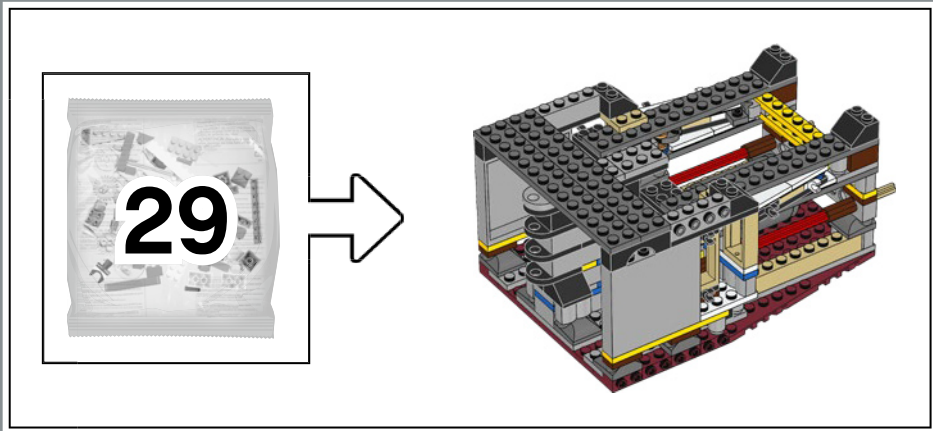

1

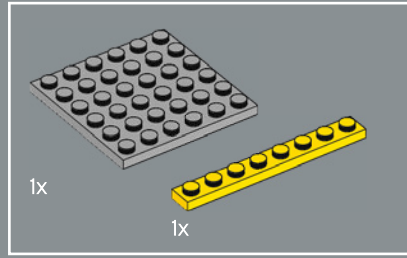
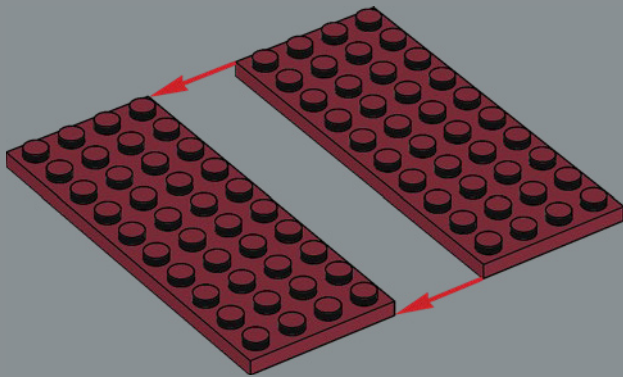

2

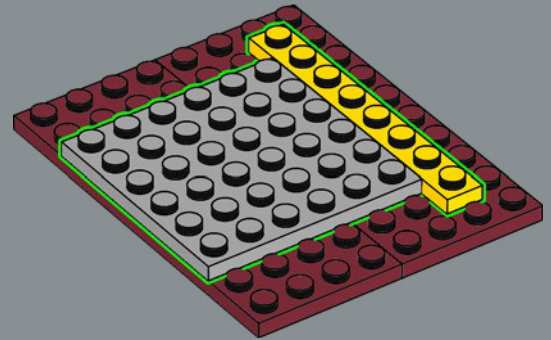

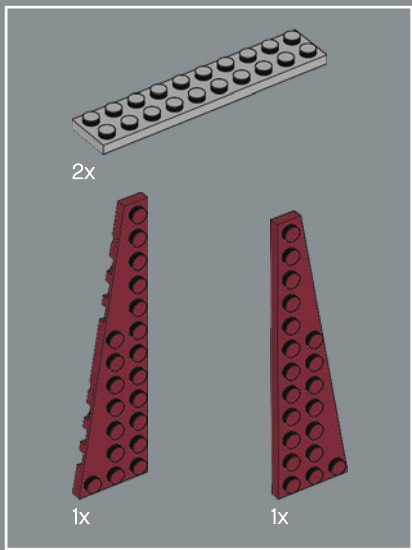

3

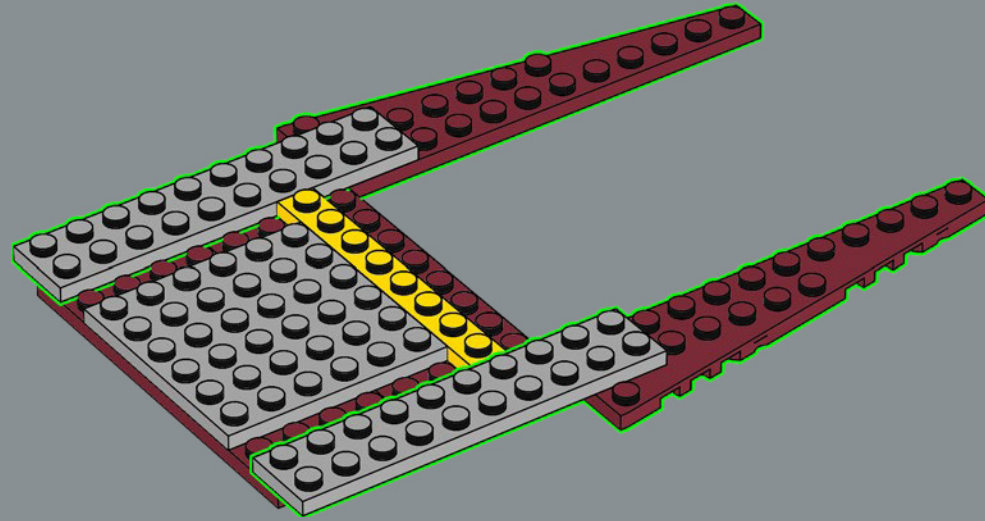

4

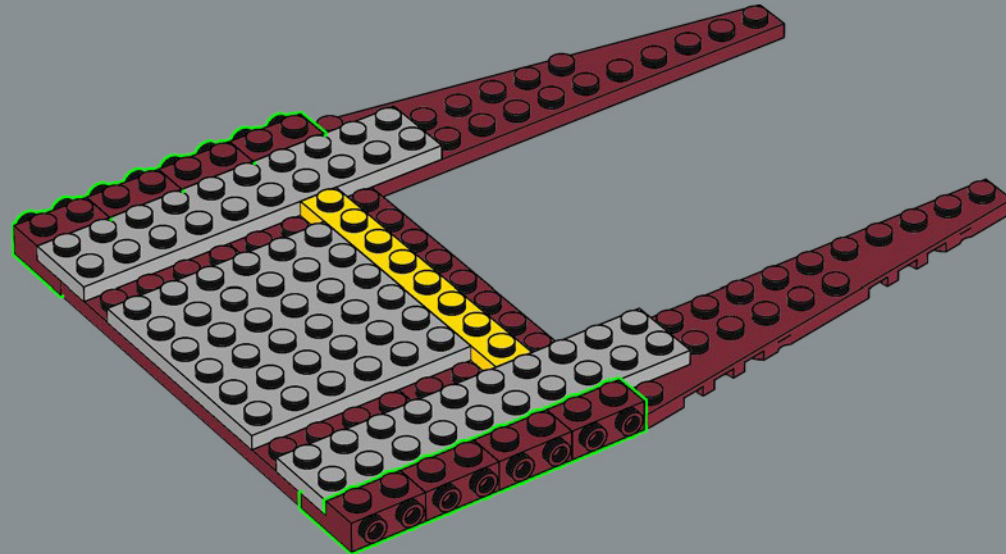

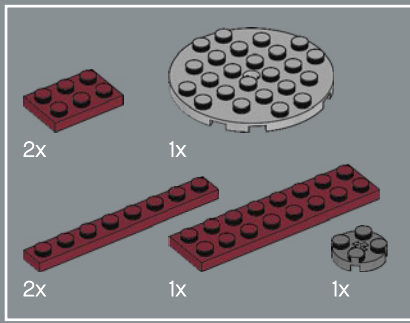

5

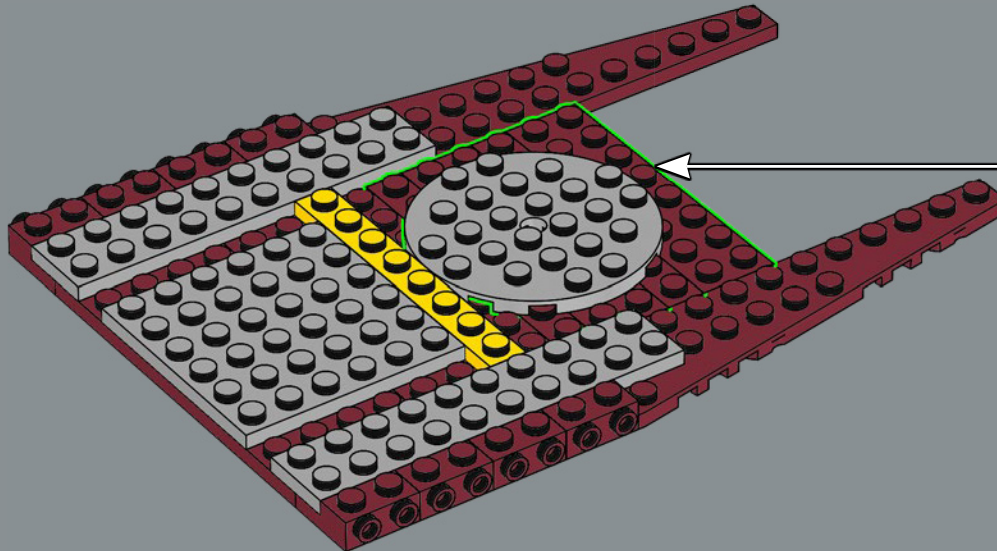
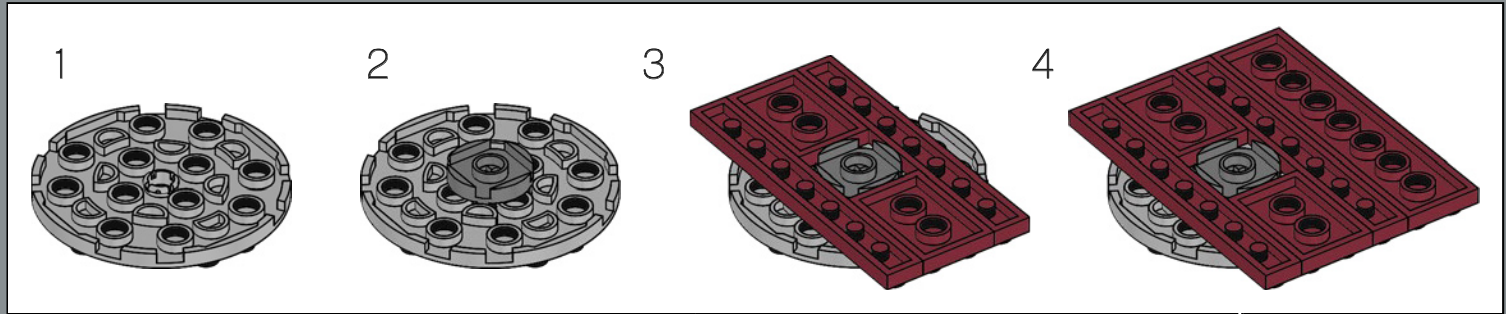

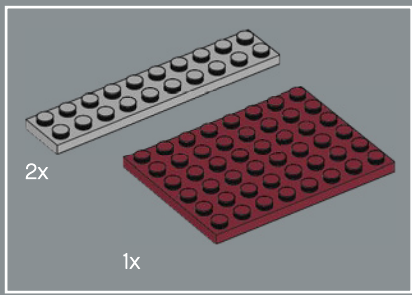

6

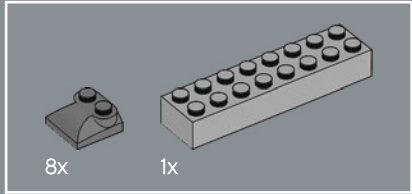
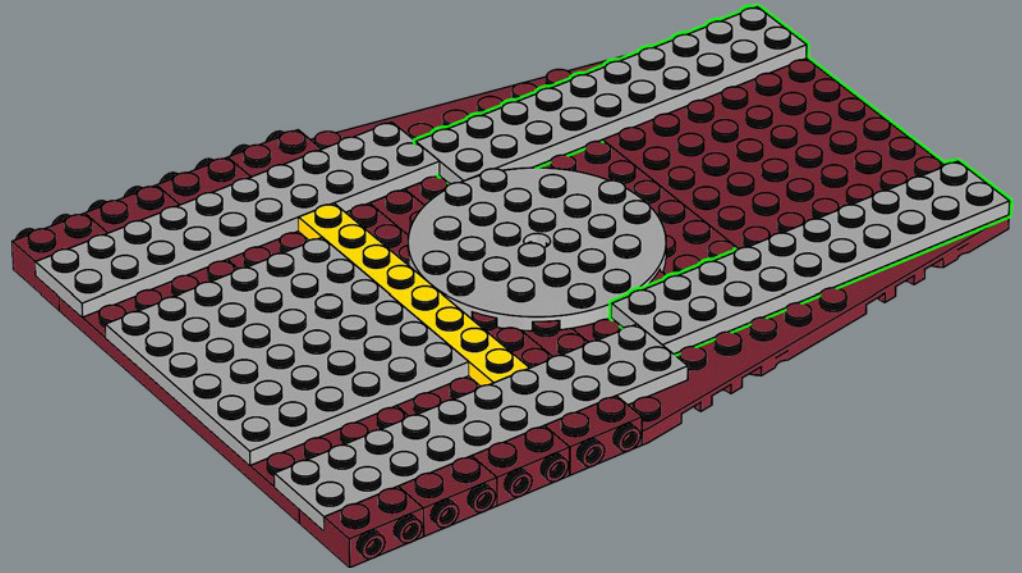

7

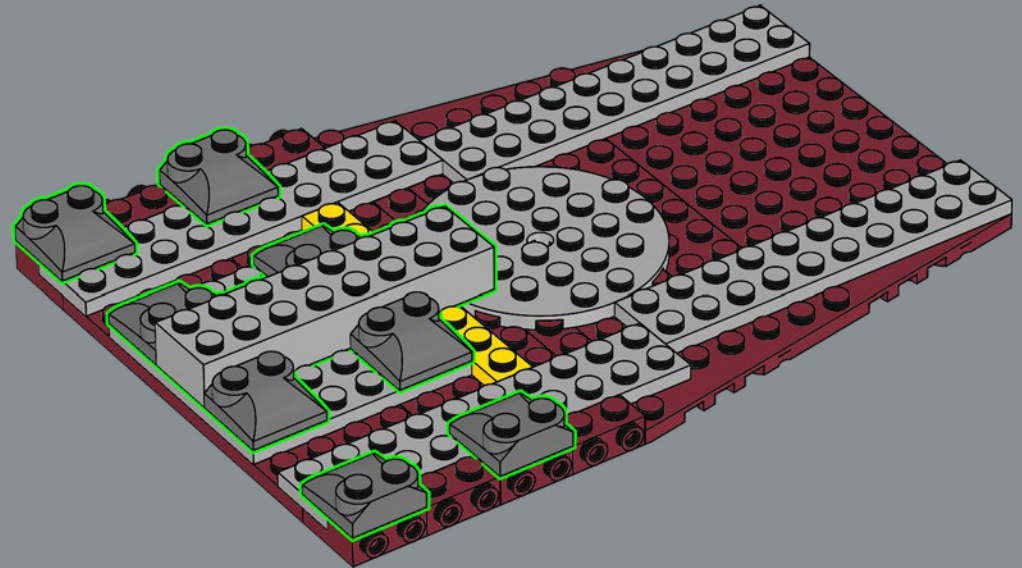



8

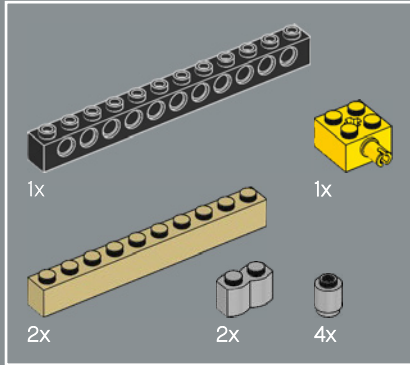
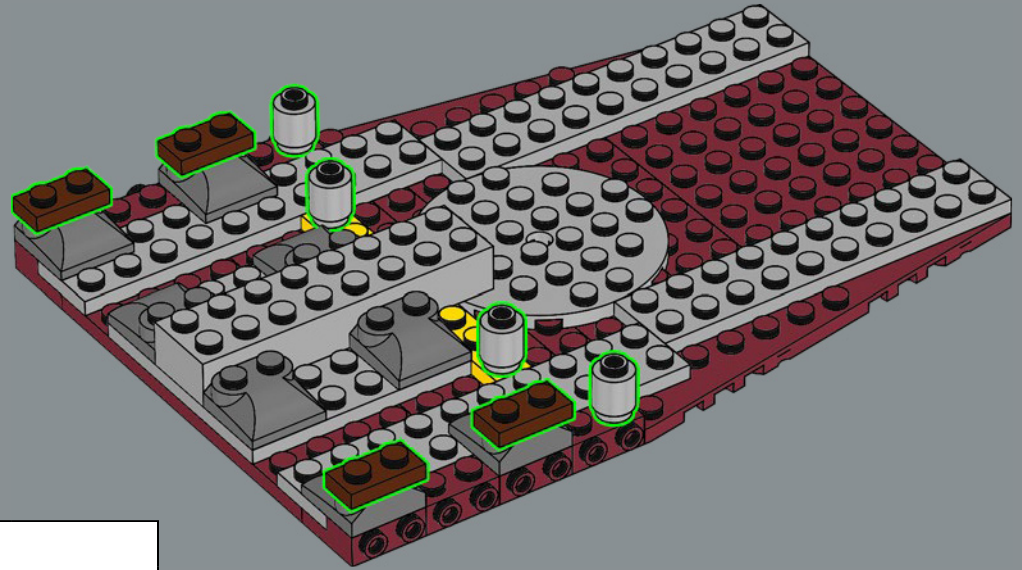

9

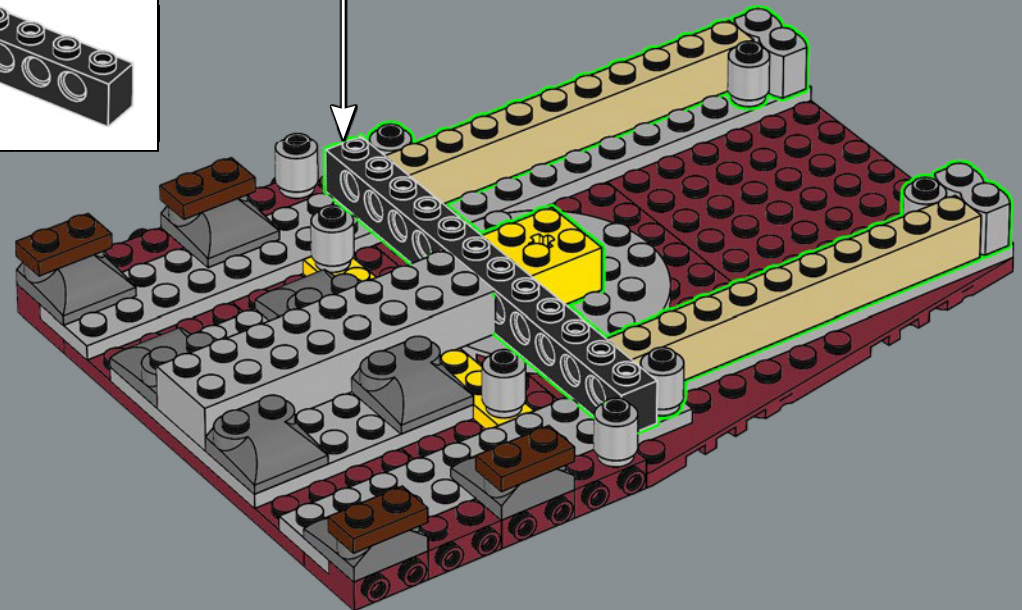
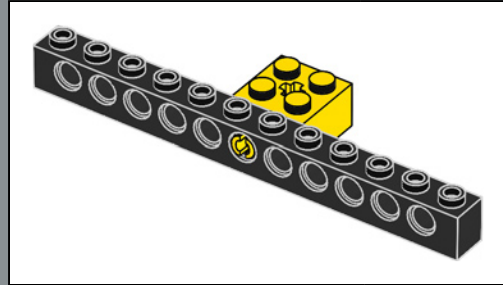

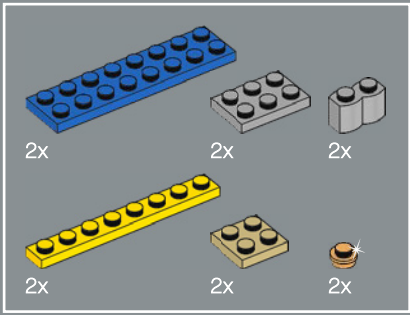

10

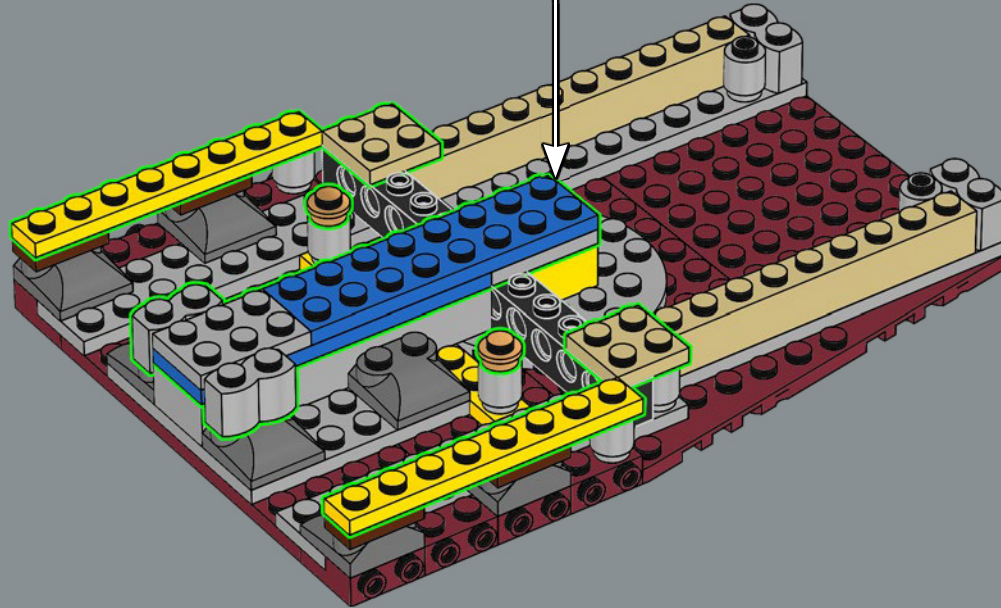
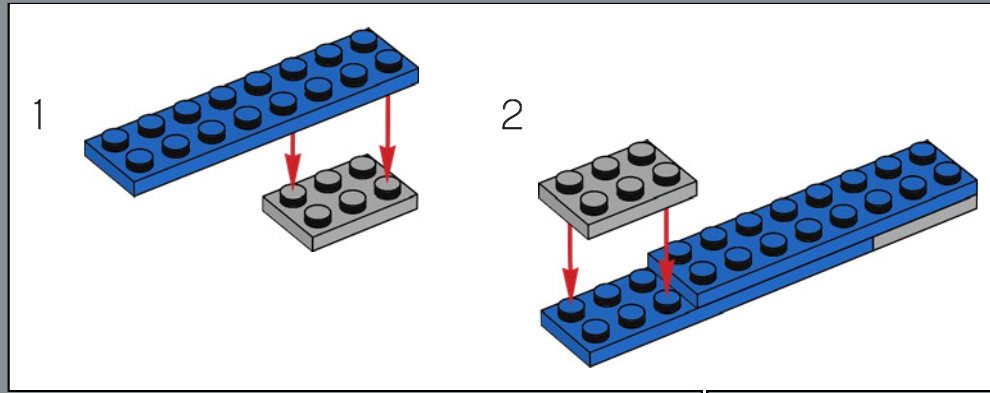

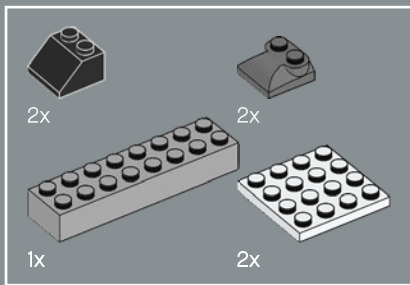

11

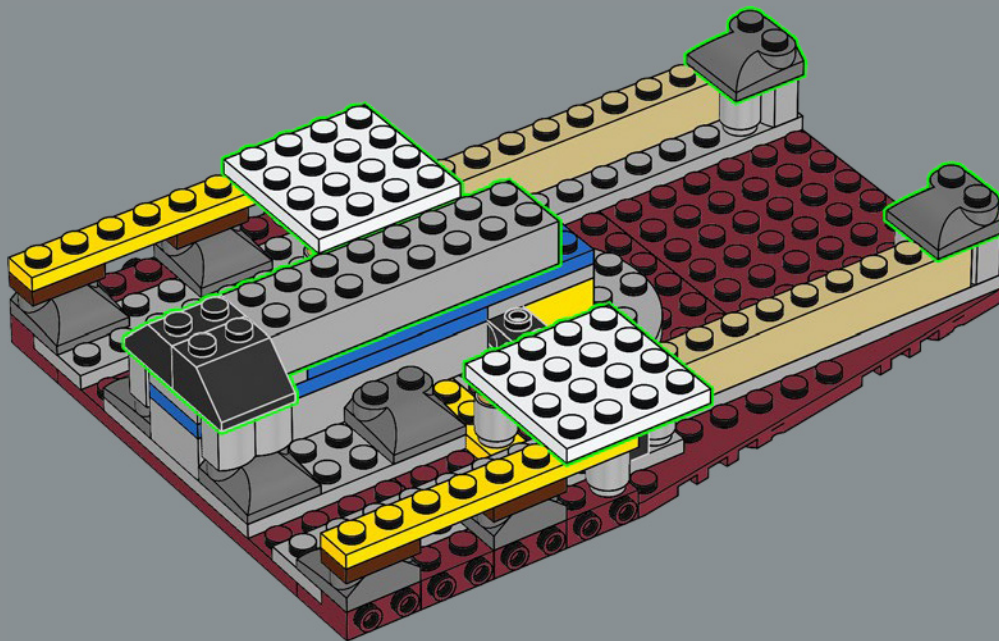

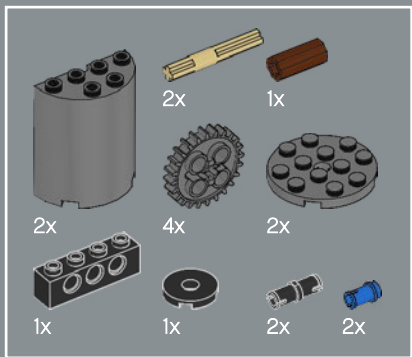

12

1

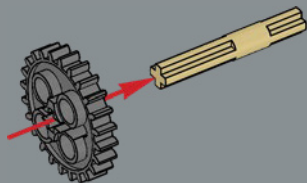

2

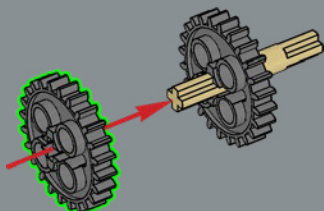

3

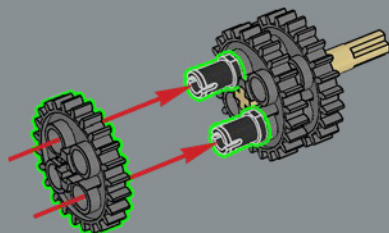

4

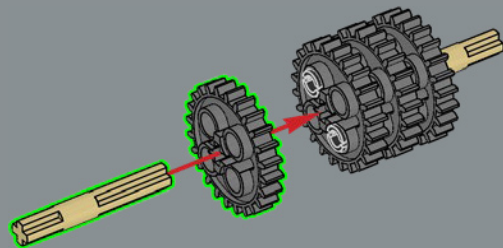

5

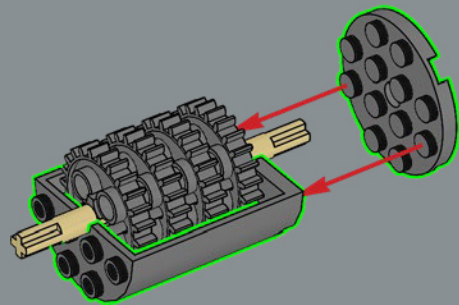

6

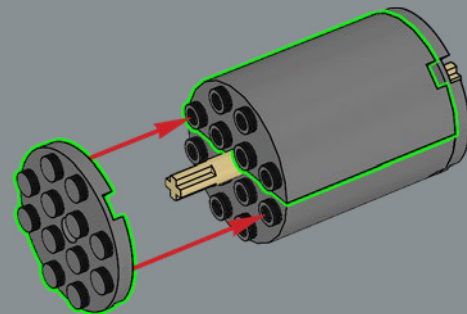

7

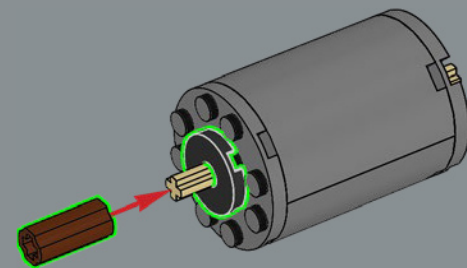

8

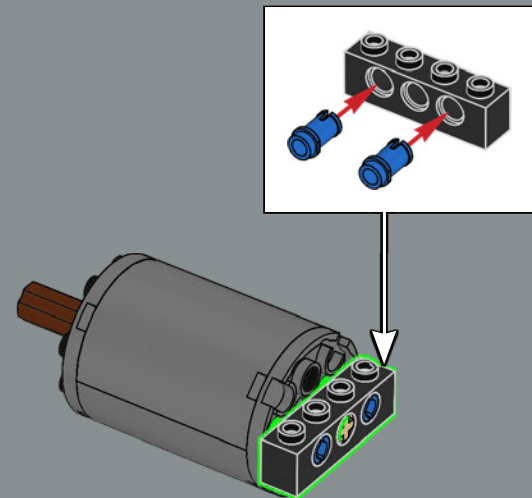

L'impianto elettrico del *Titanic* era in grado di produrre più energia di una centrale elettrica cittadina media dell'epoca.

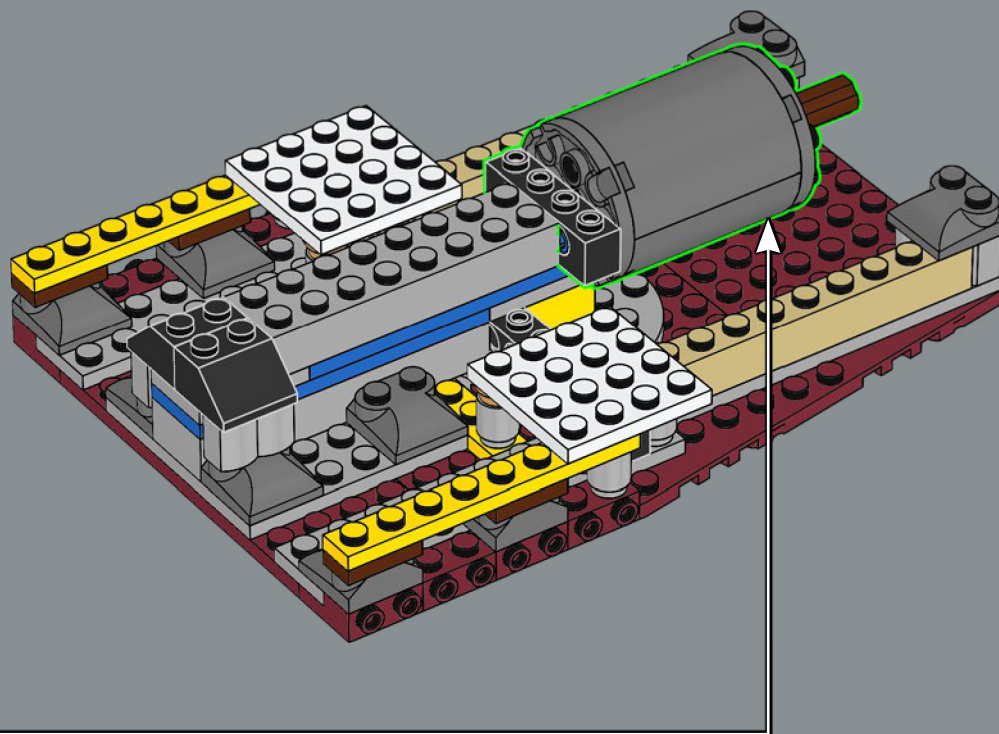

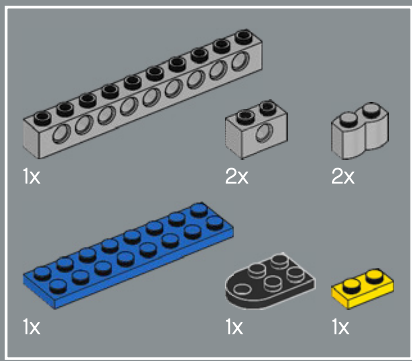

13

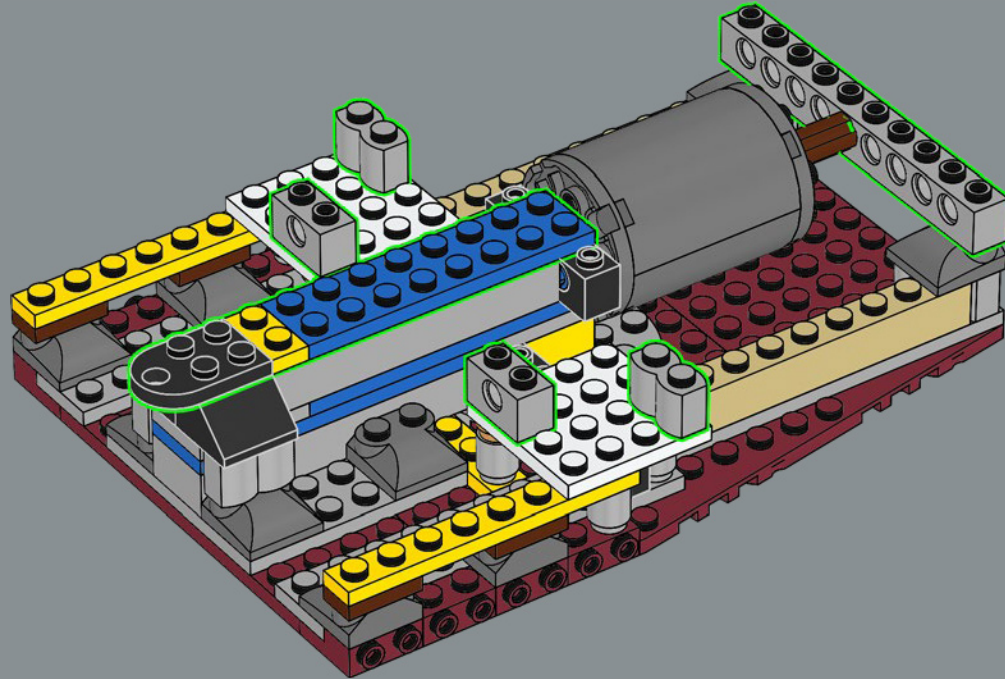

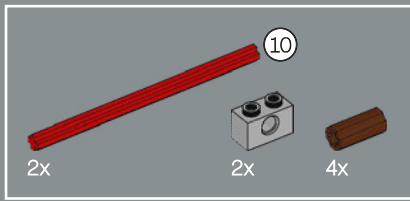

14

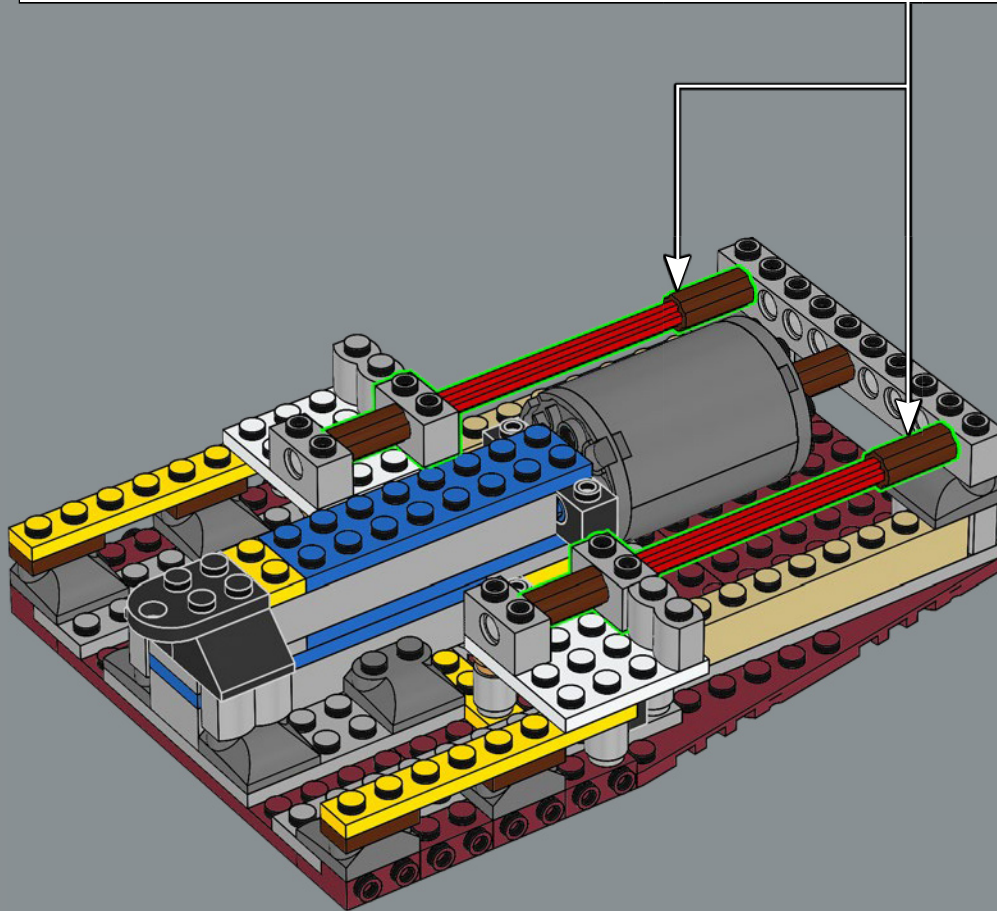
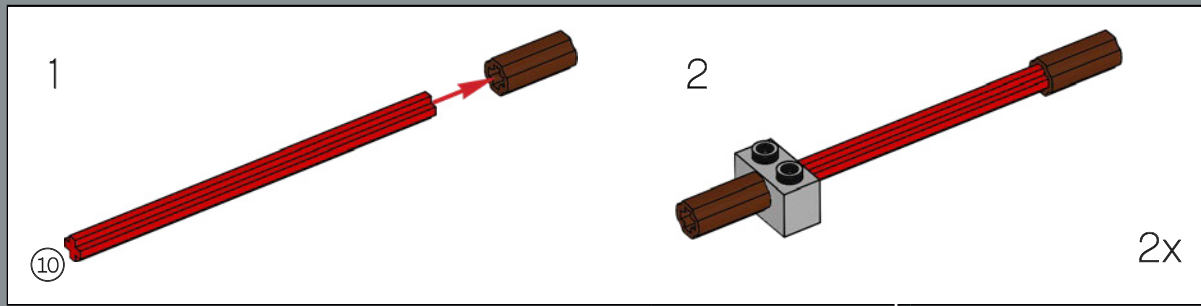



15

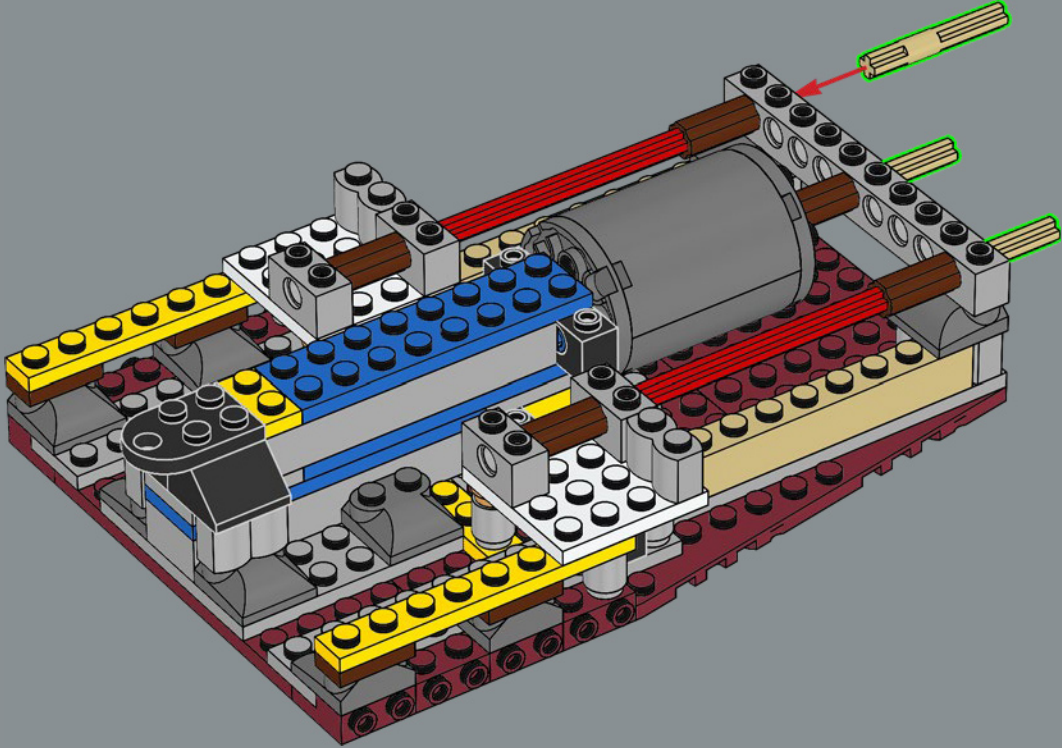

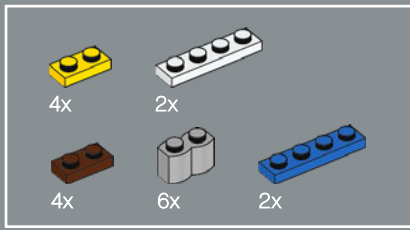

16

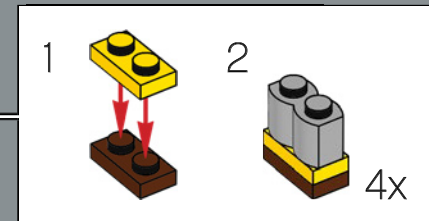
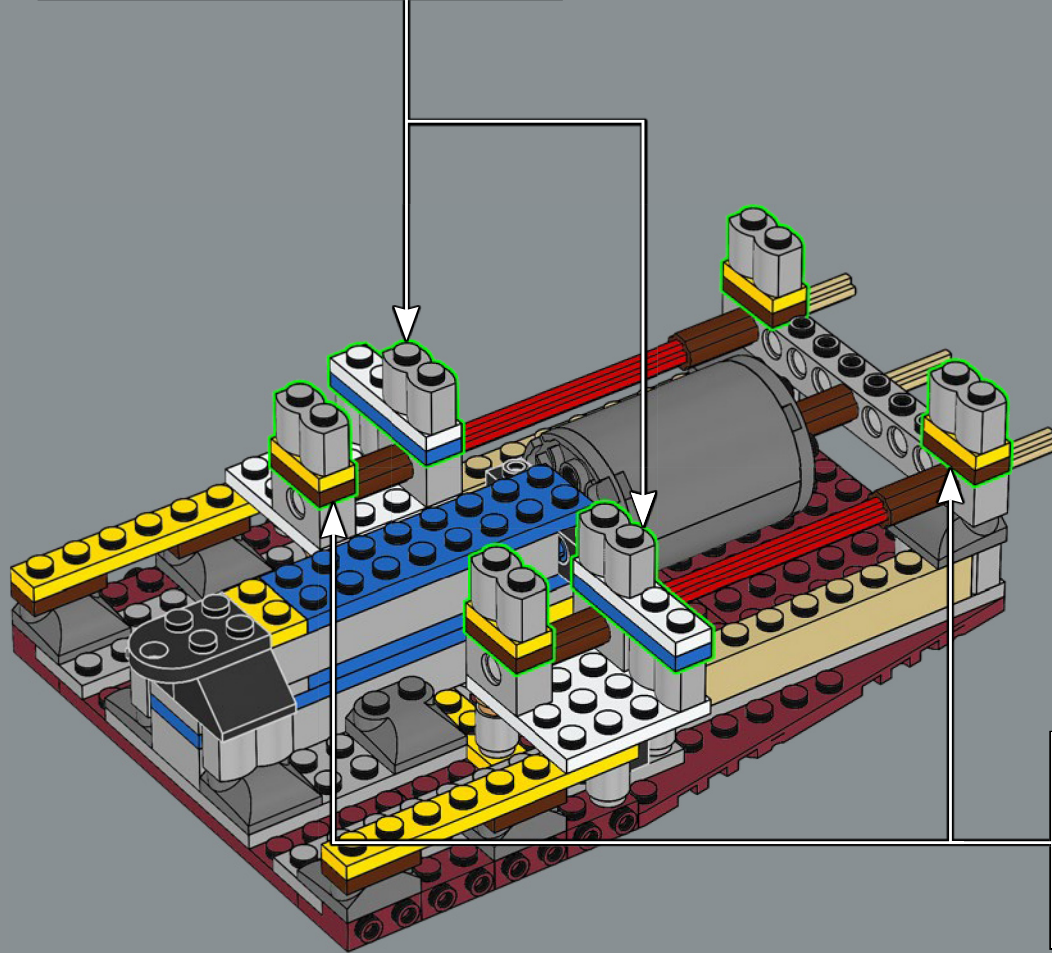
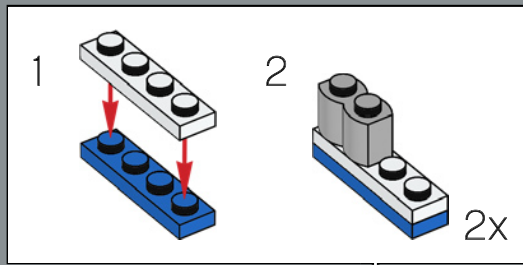

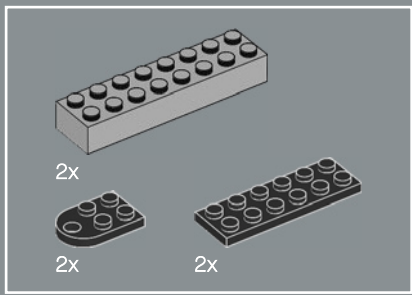

17

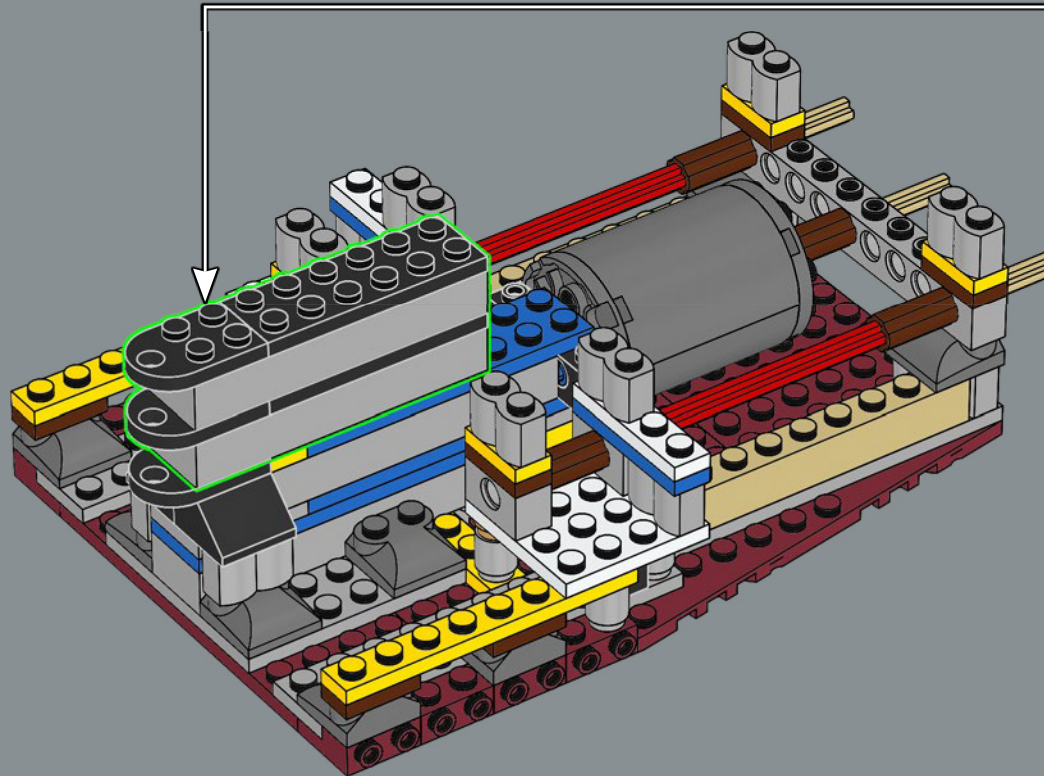
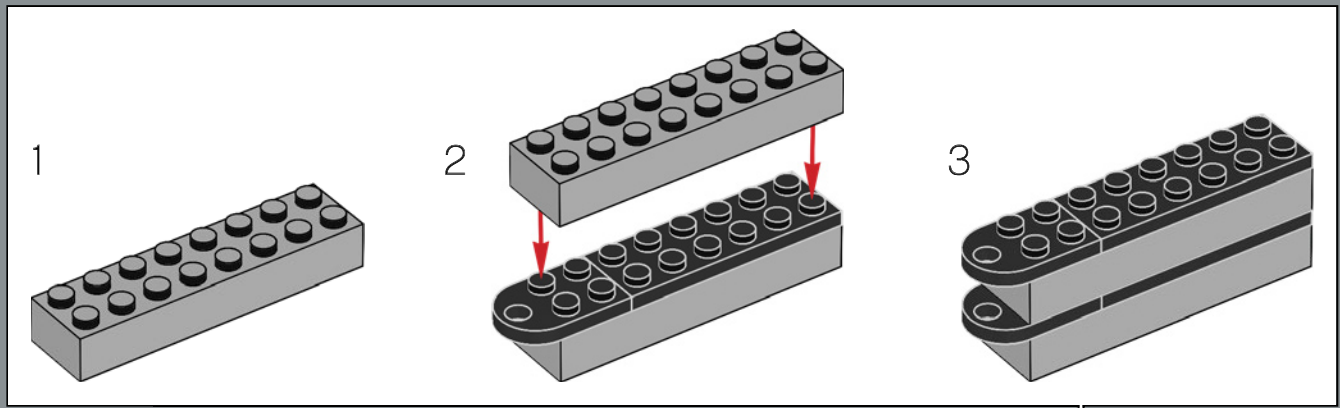

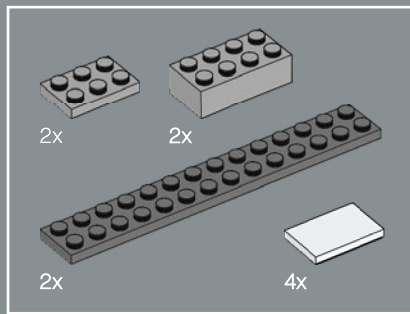

18

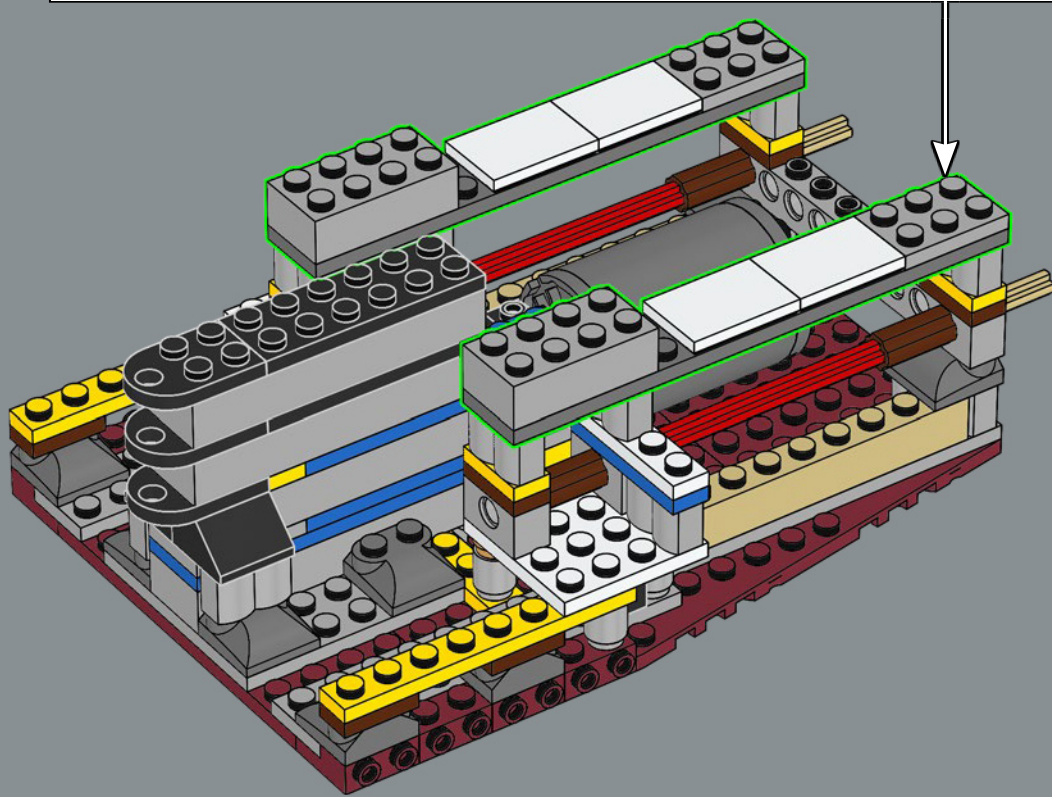
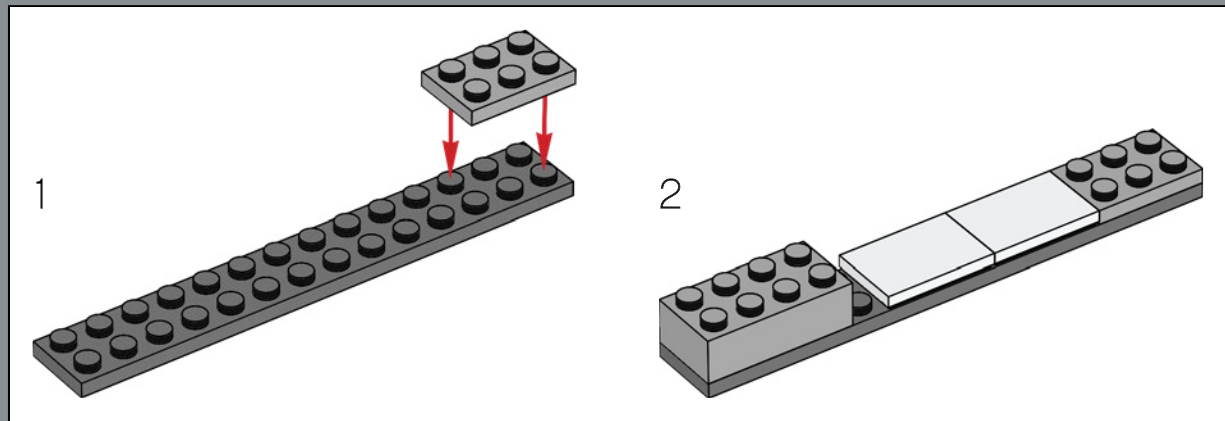



19

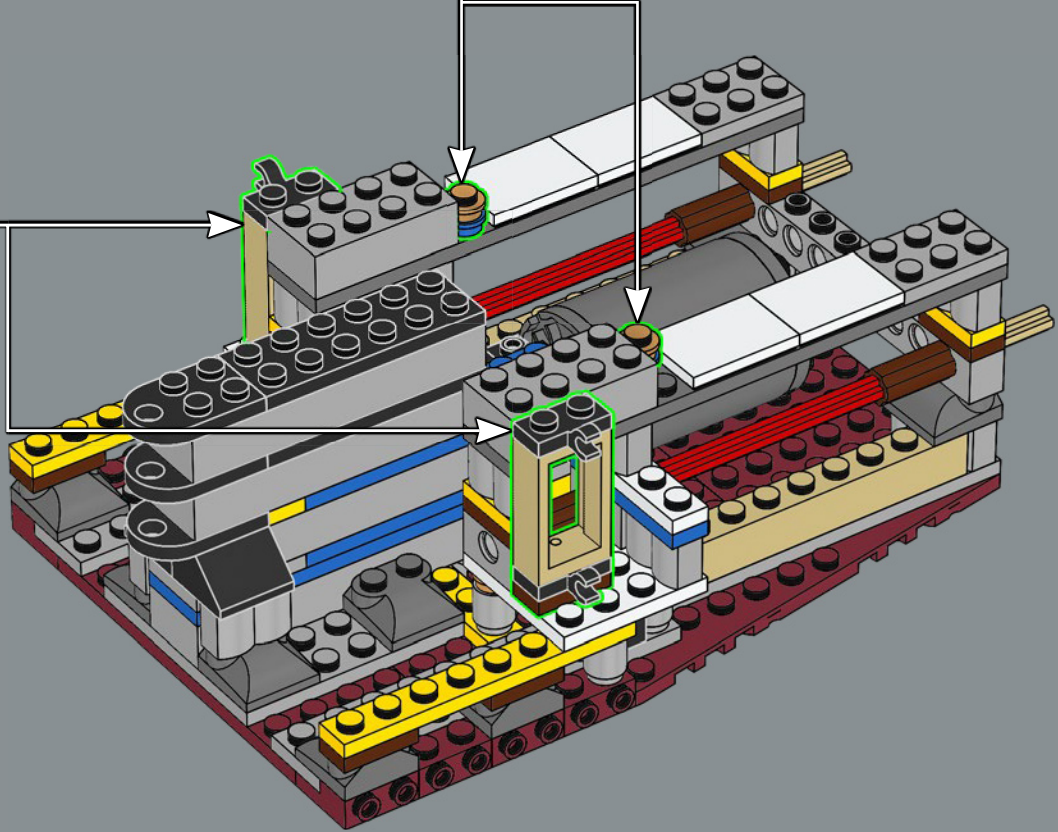
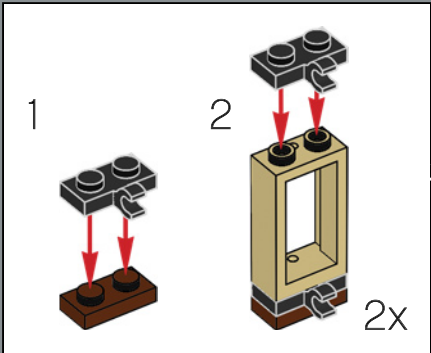
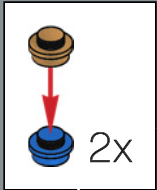

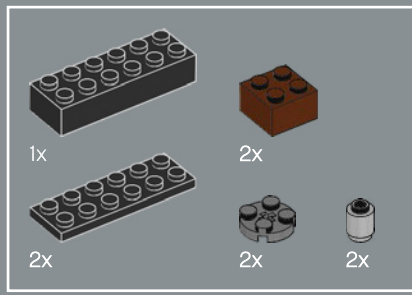

20

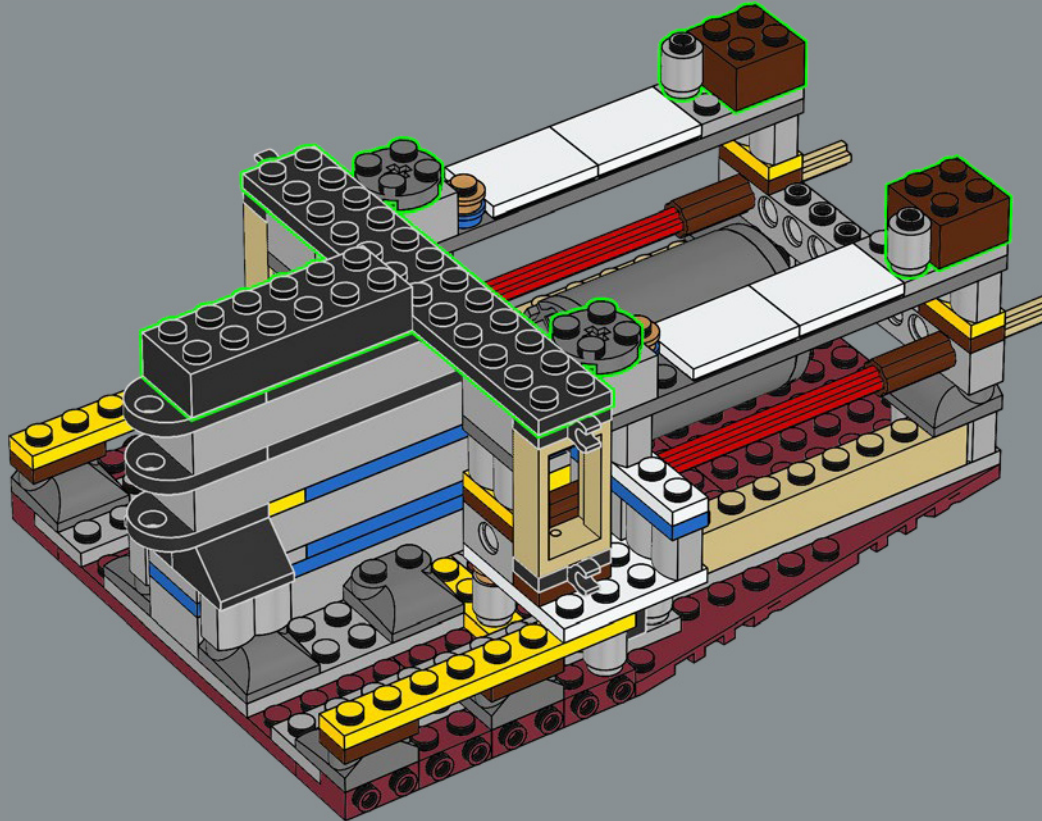

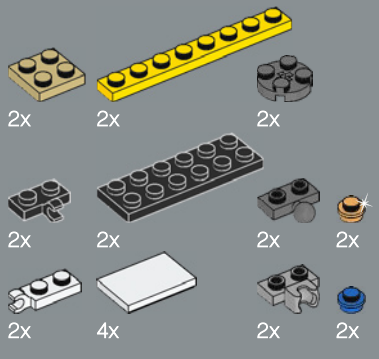

21

1

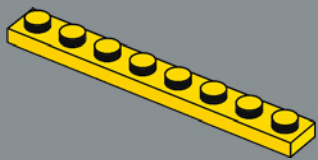

2

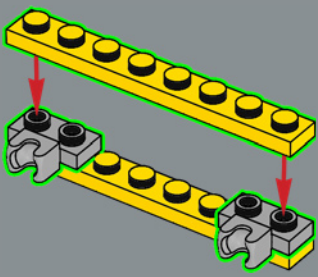

3

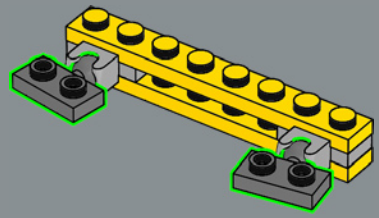

4

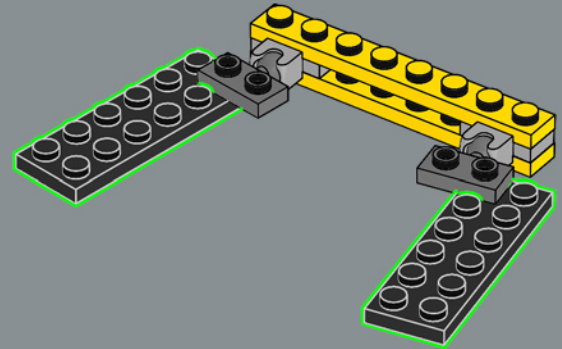

5

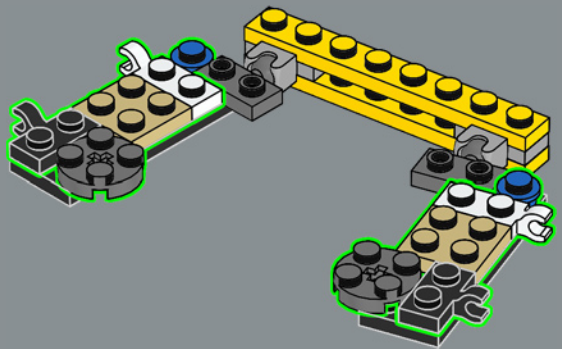

6

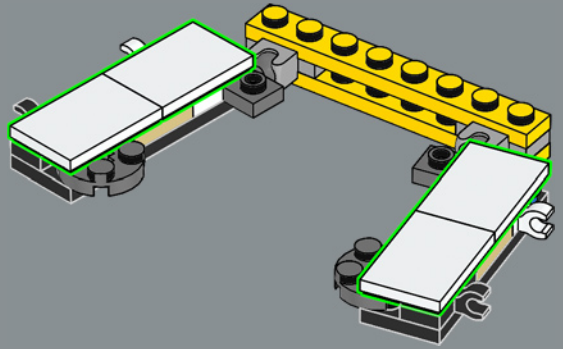

7

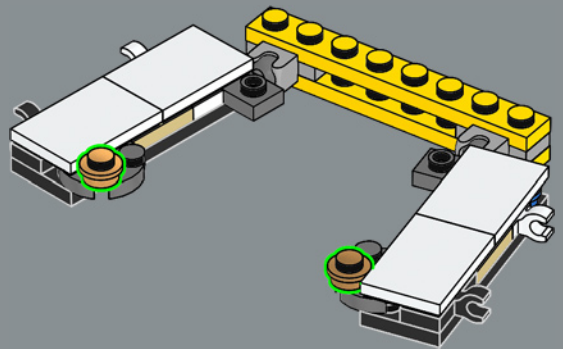

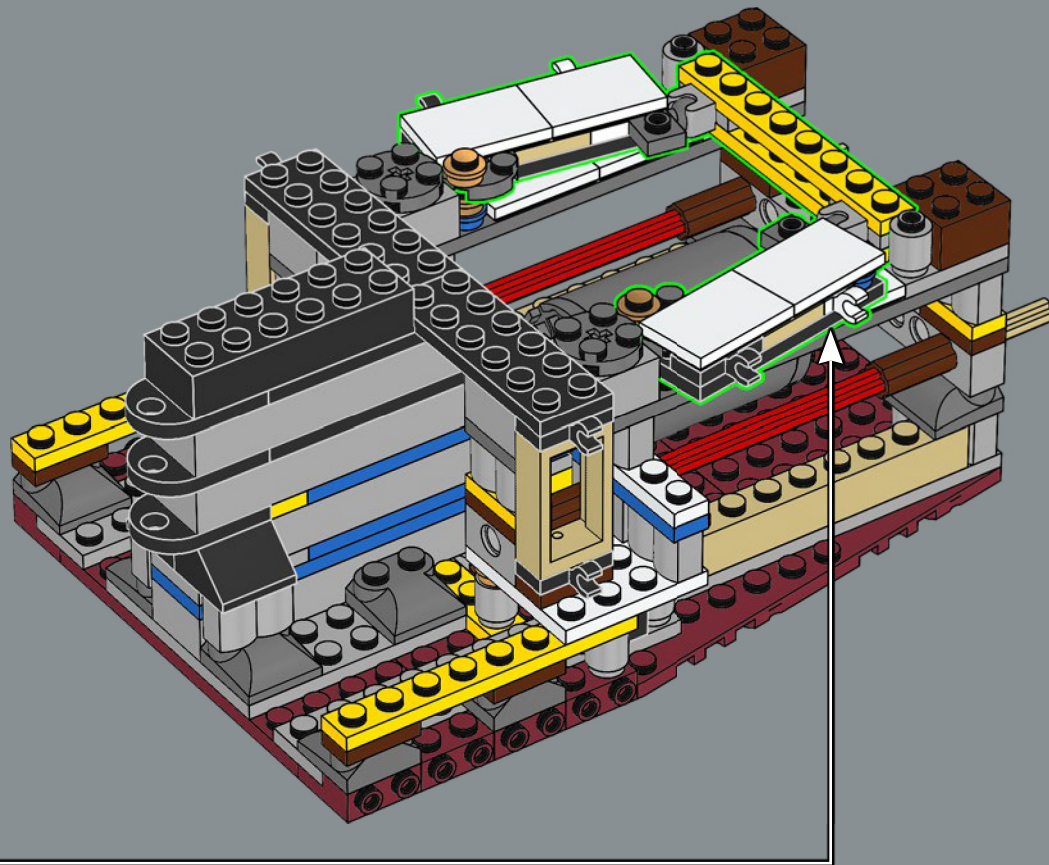

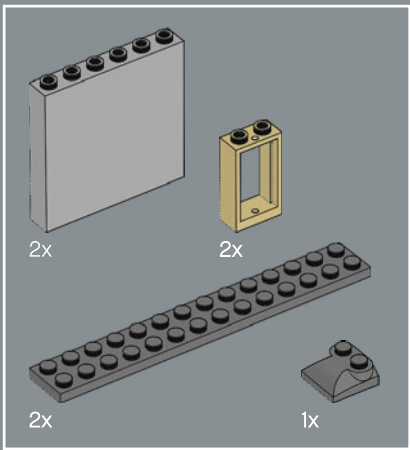

22

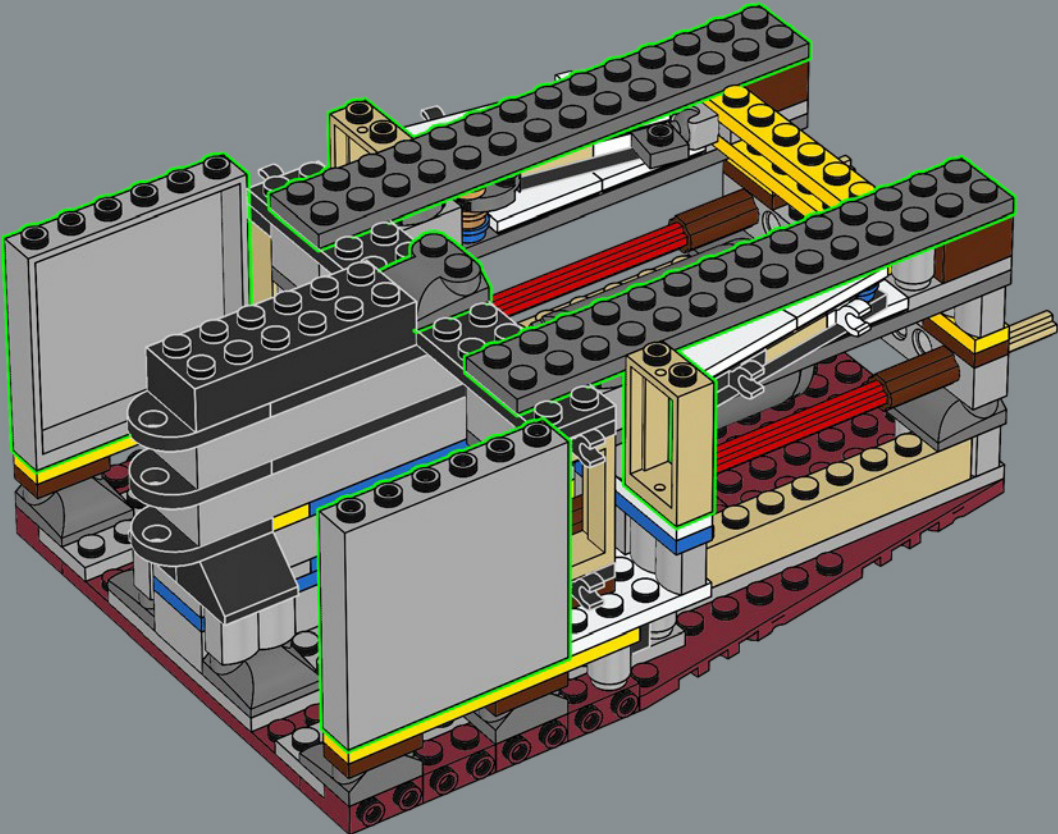

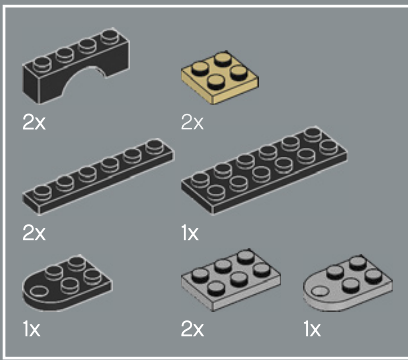

23

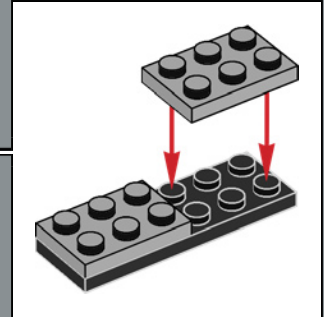
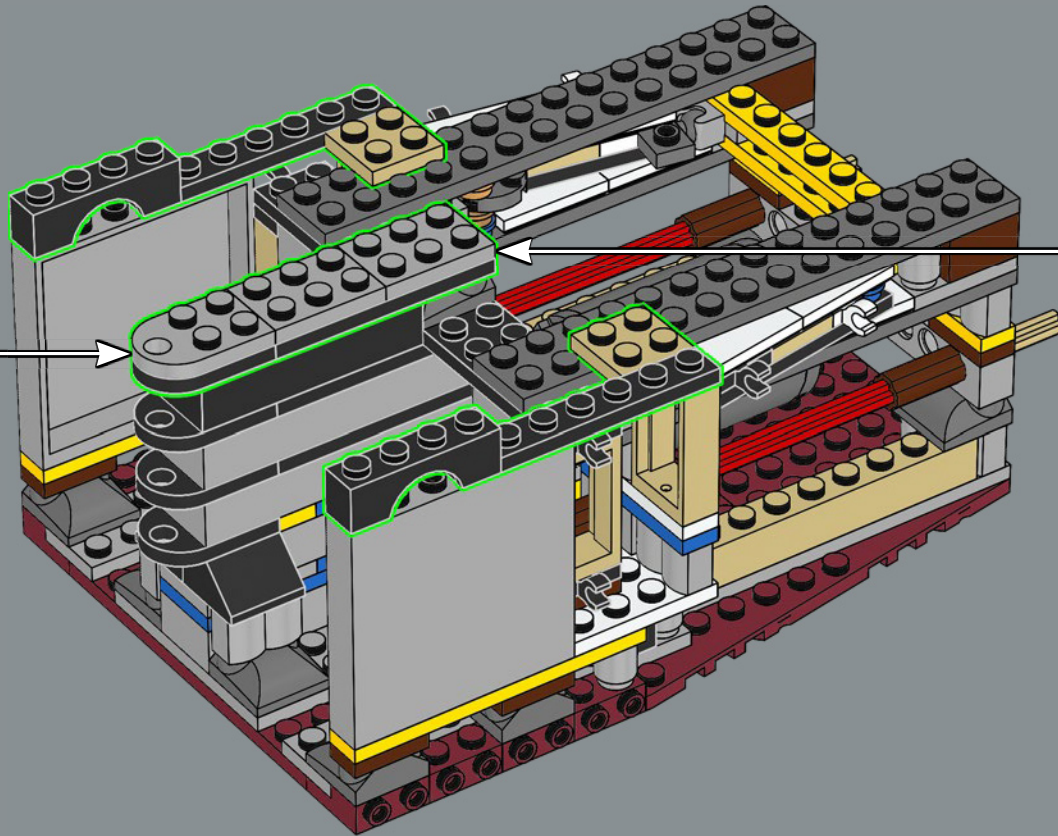
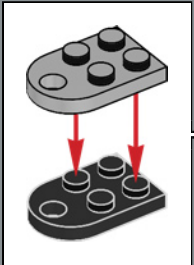

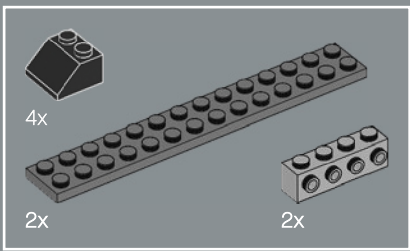

24

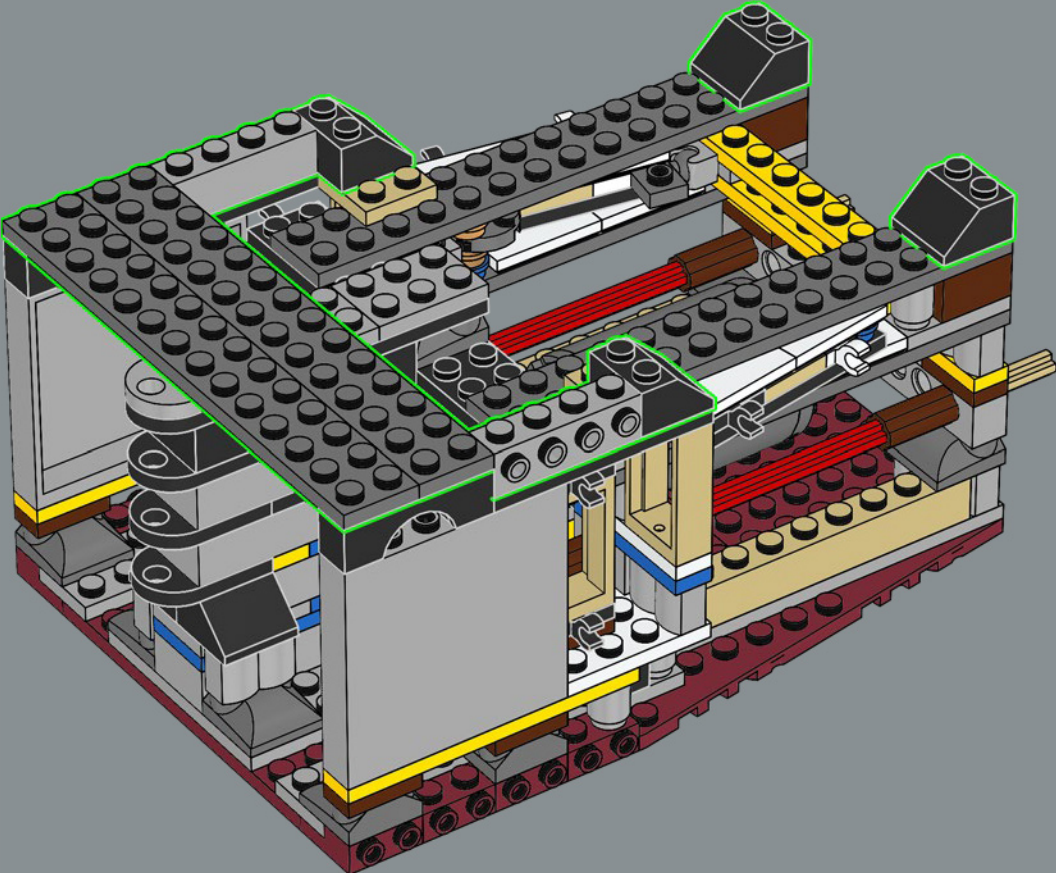

30

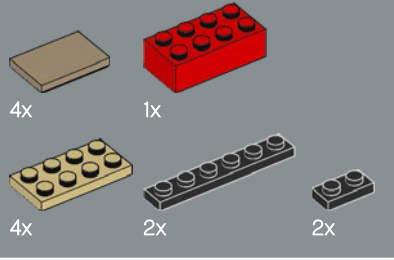
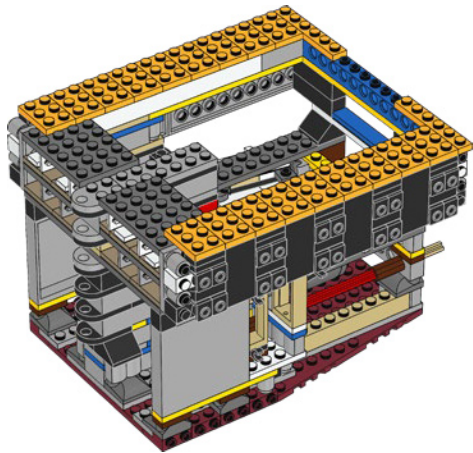
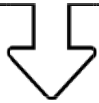

25

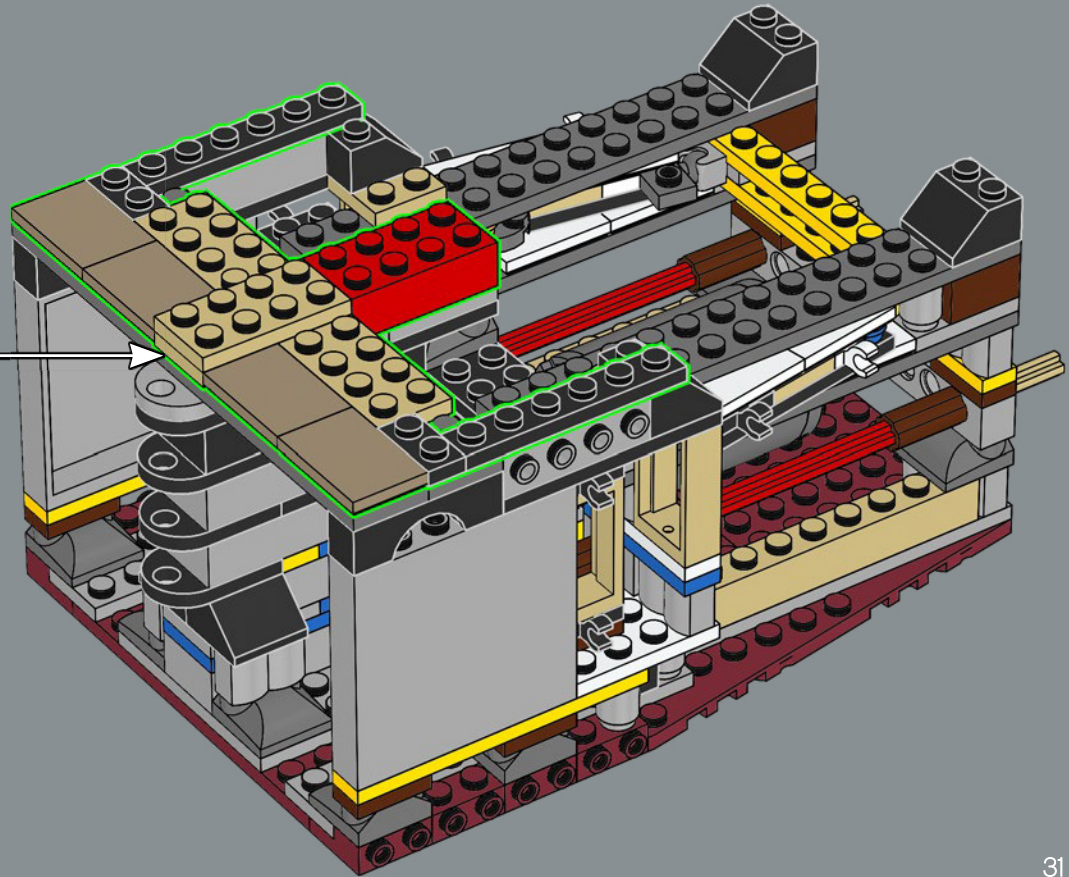
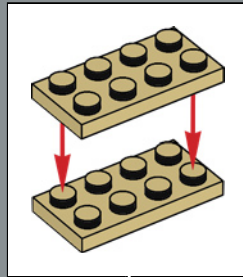

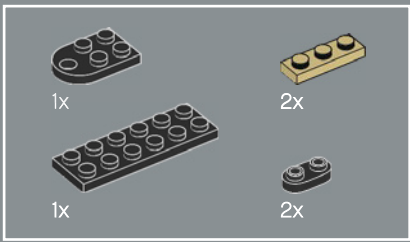

26

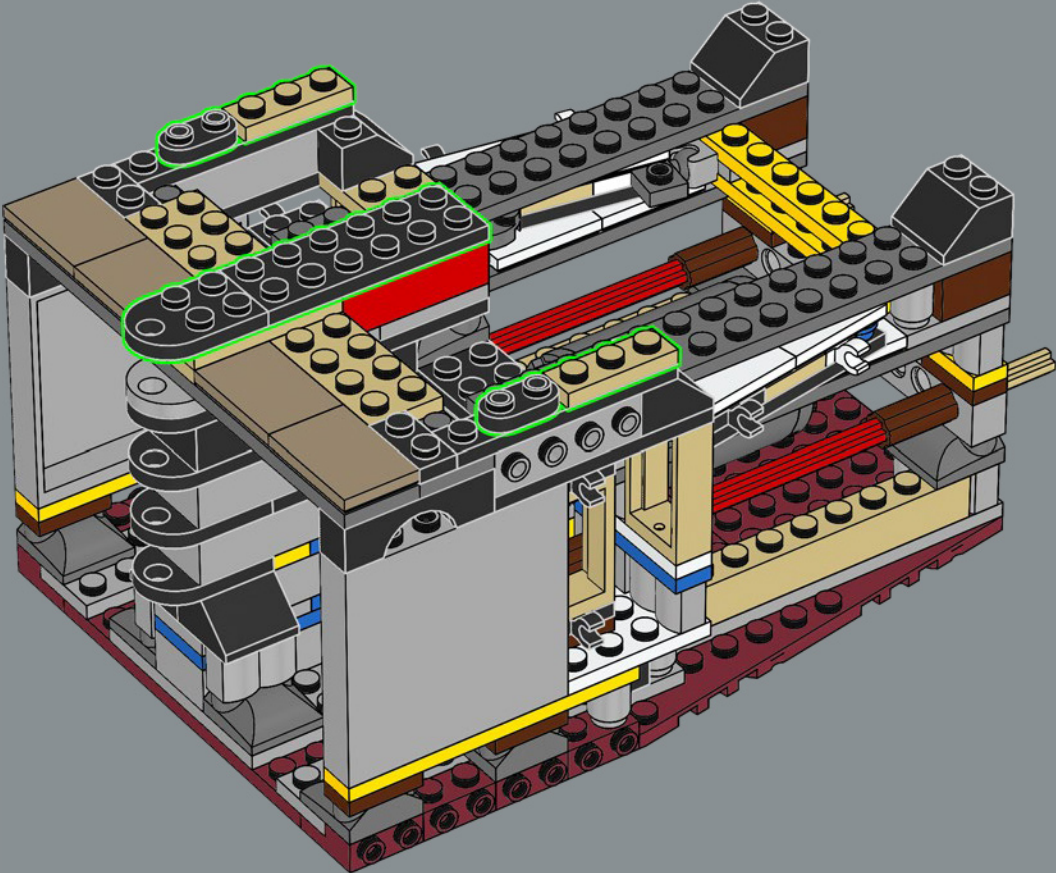

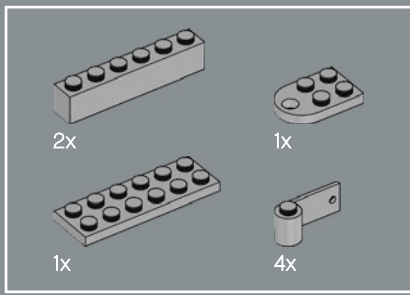

27

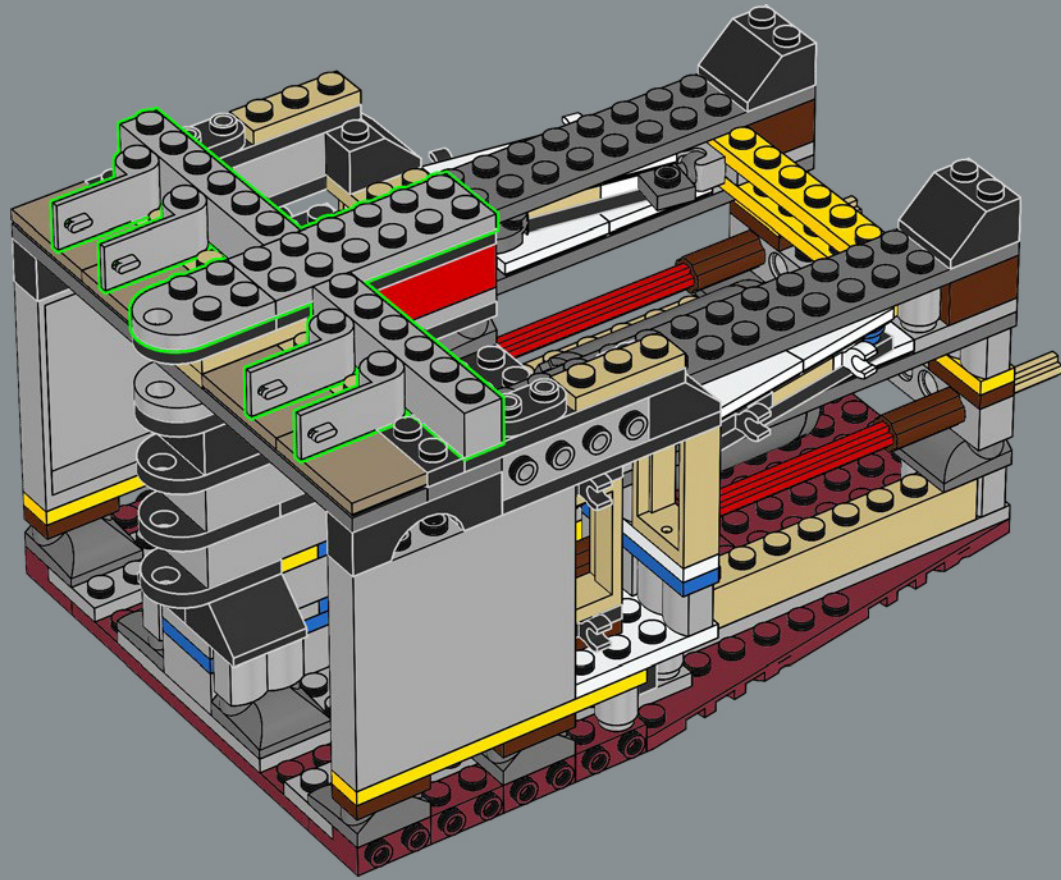

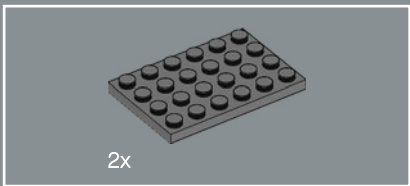

28

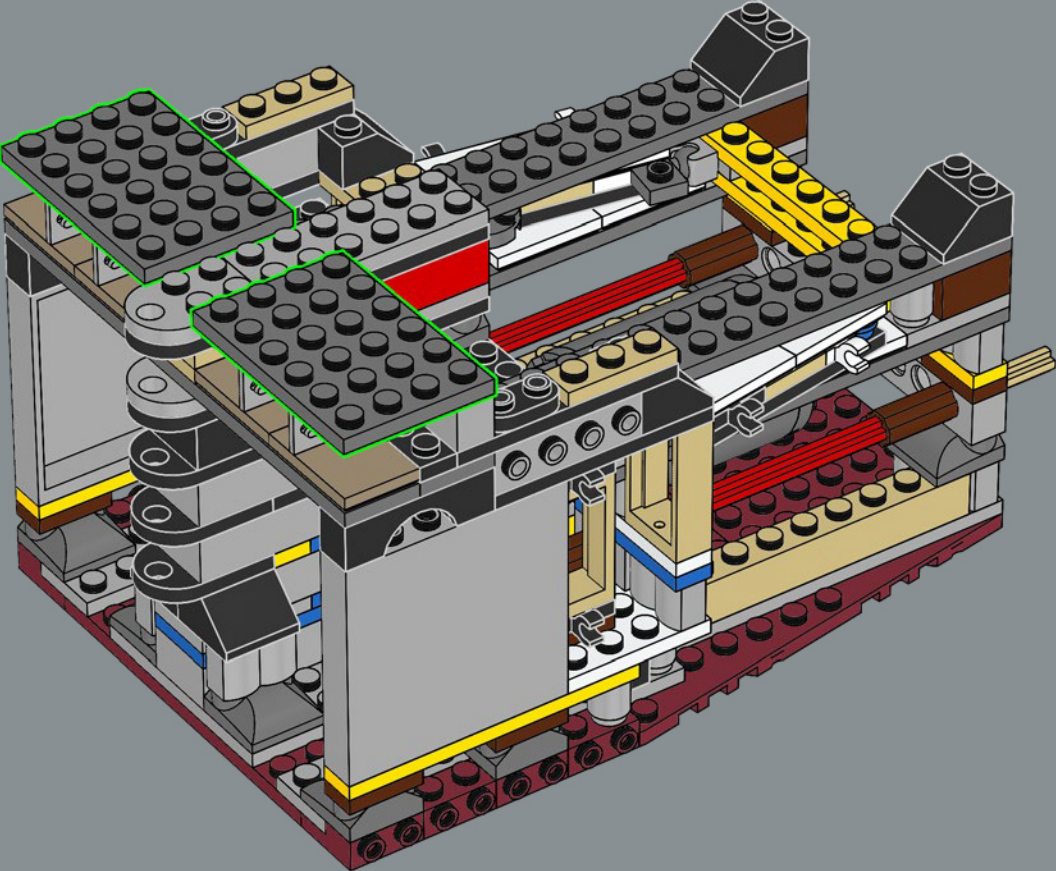

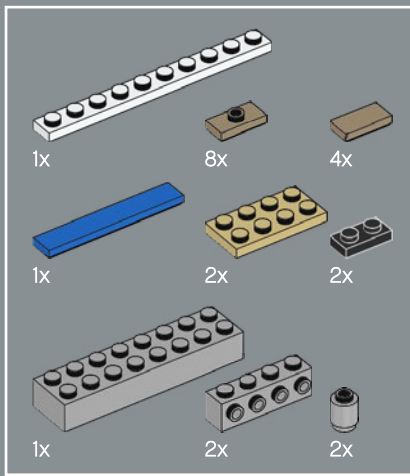

29

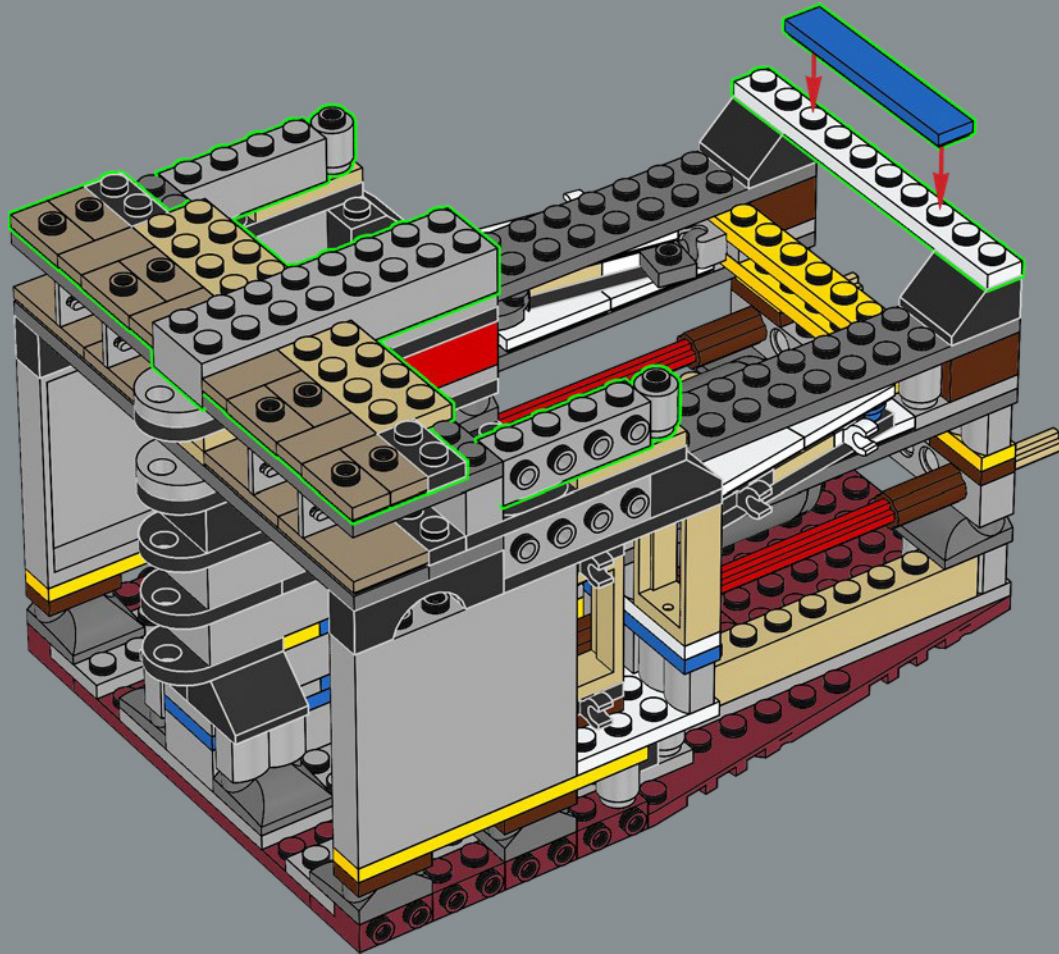

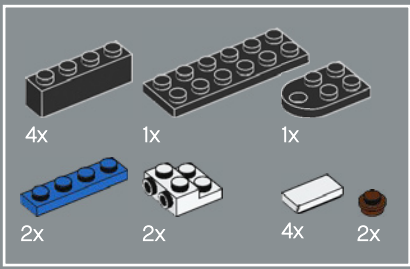

30

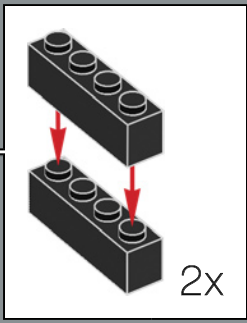
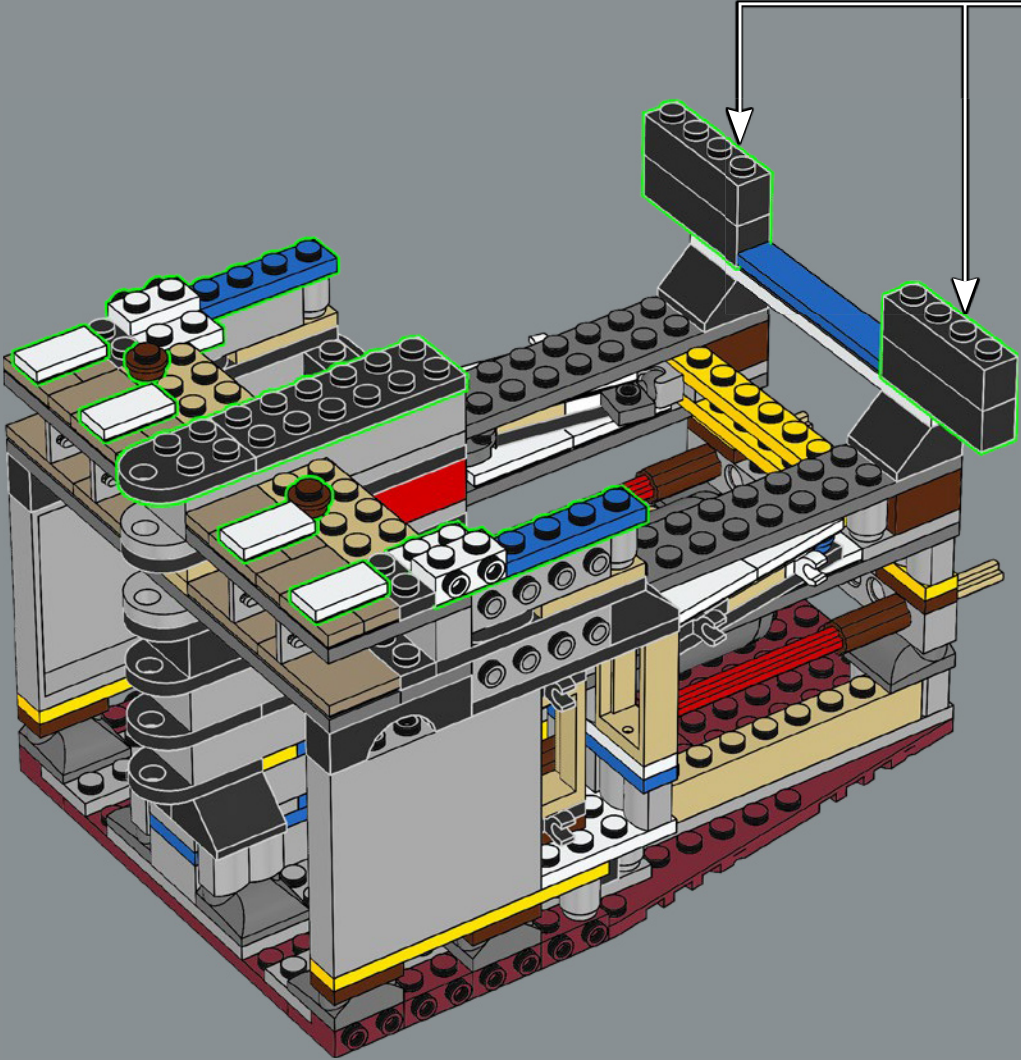

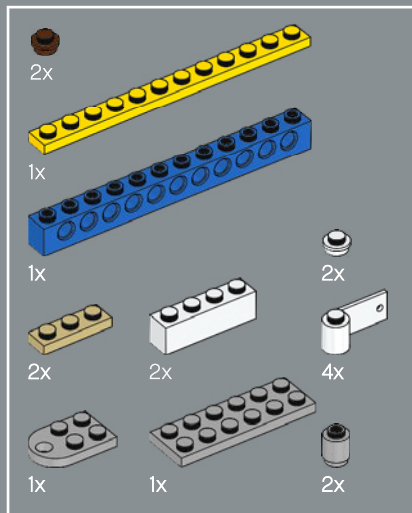

31

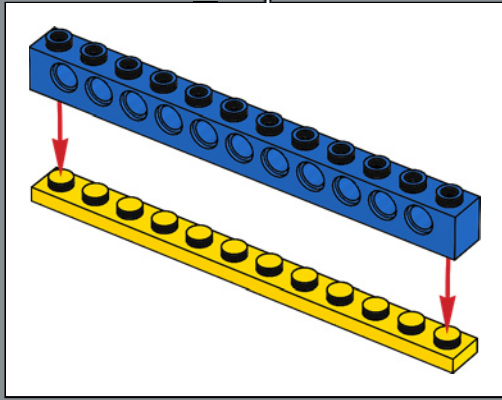
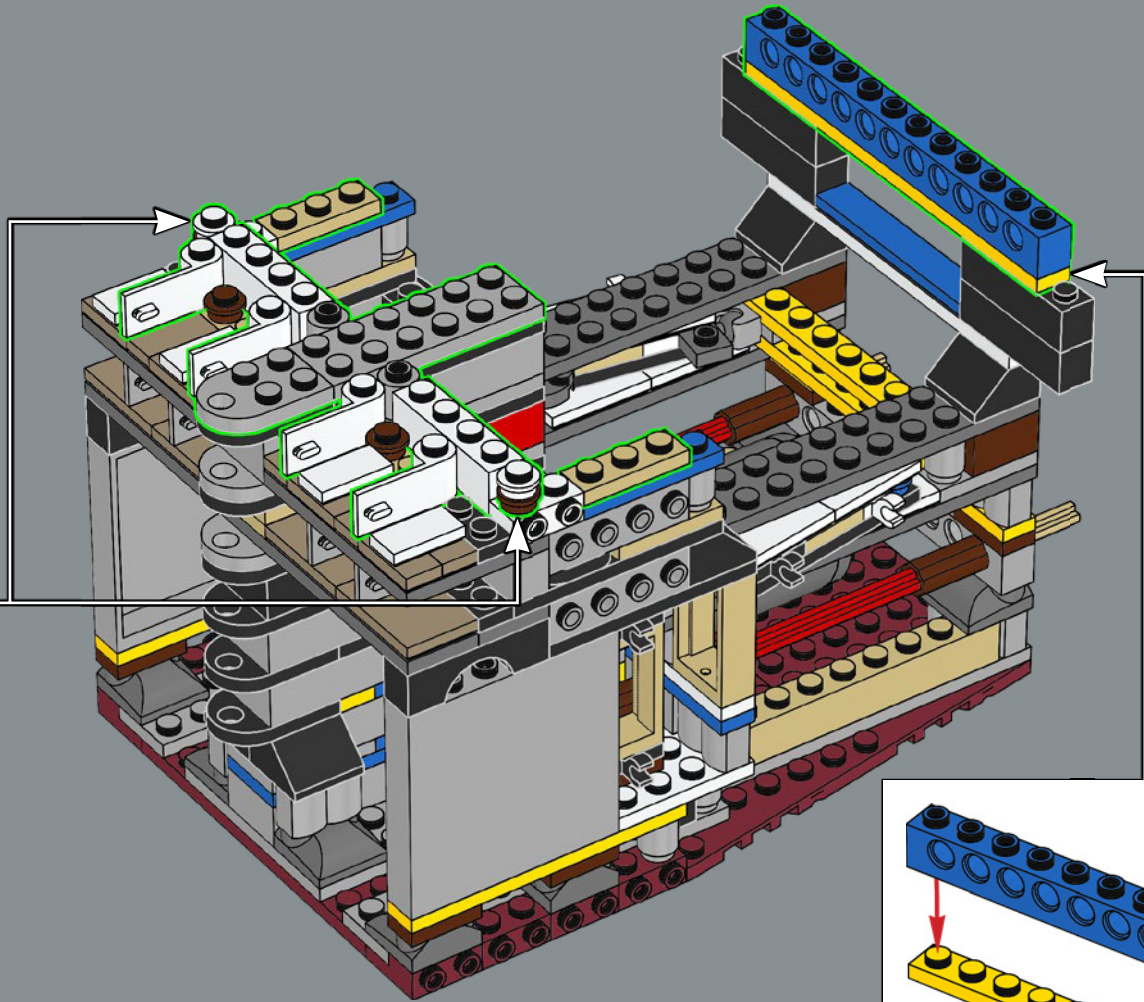
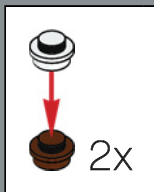

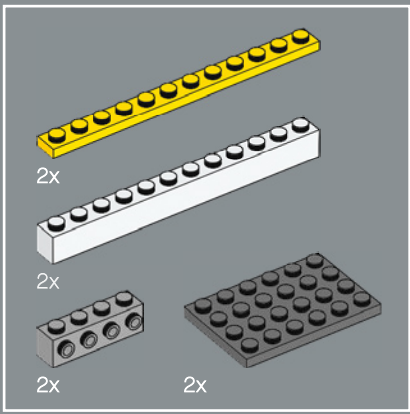

32

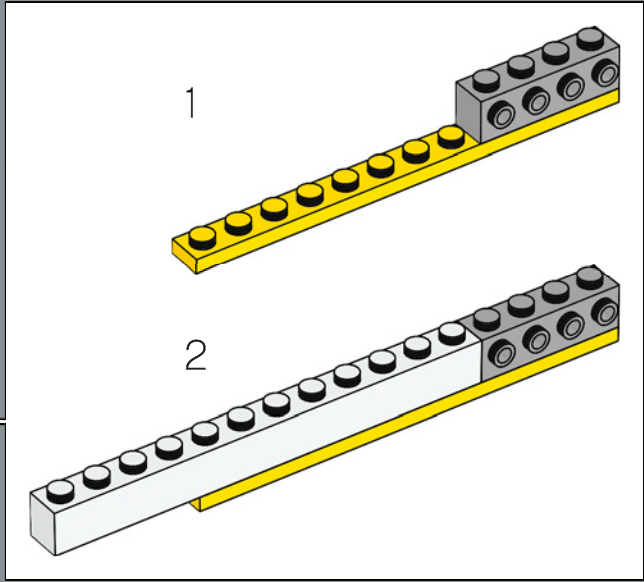
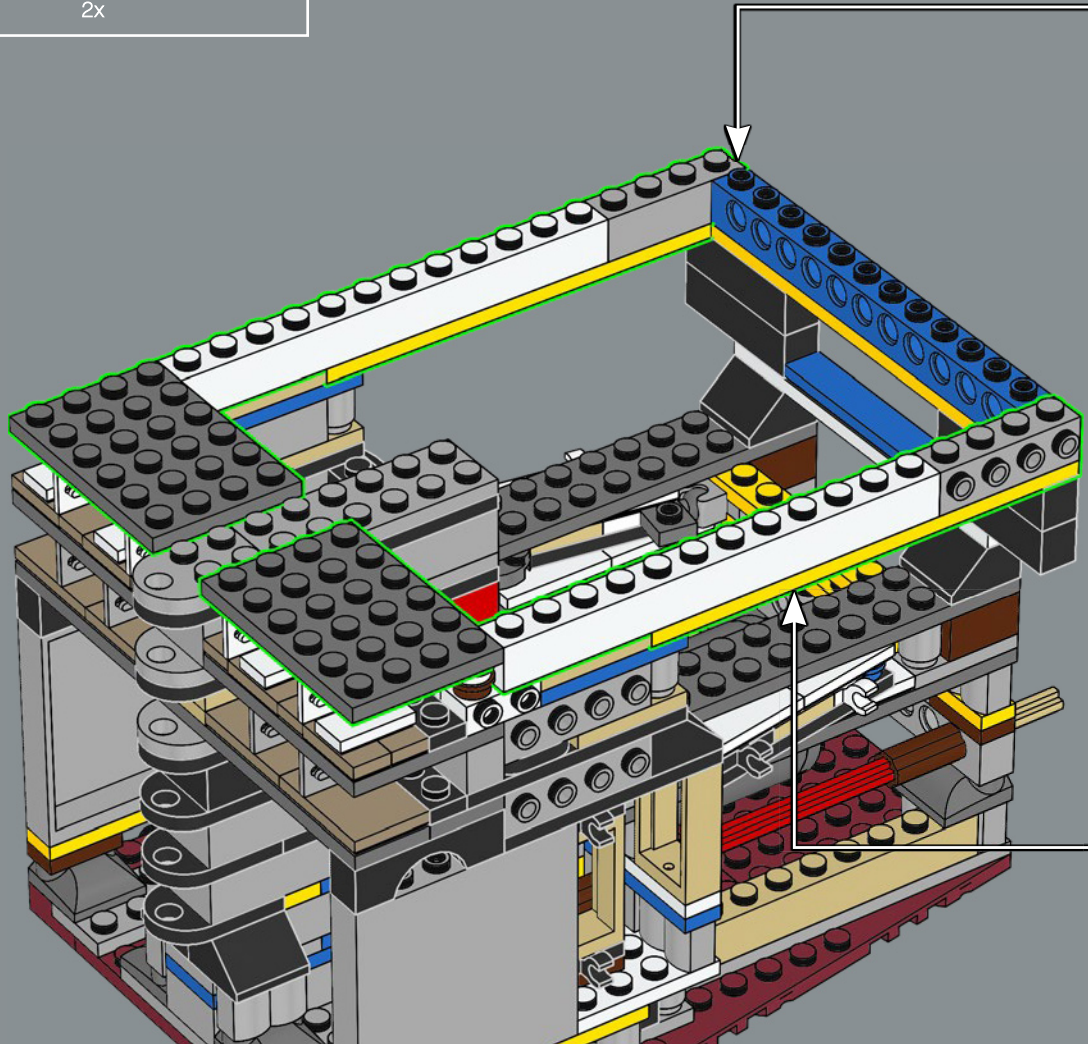
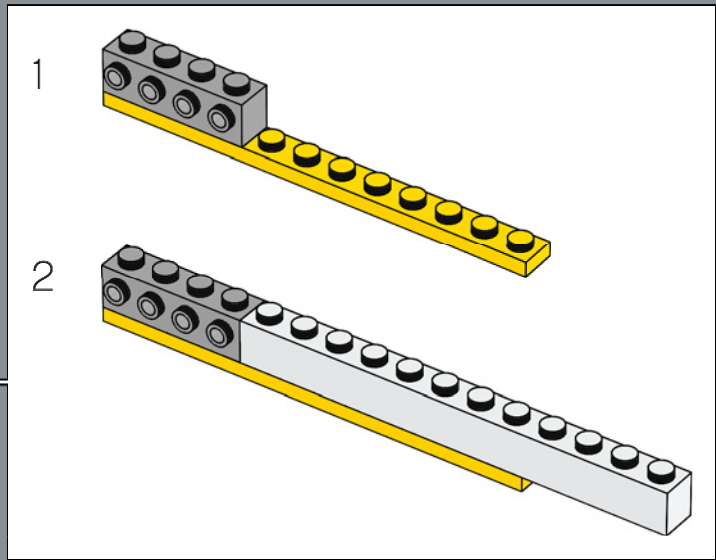

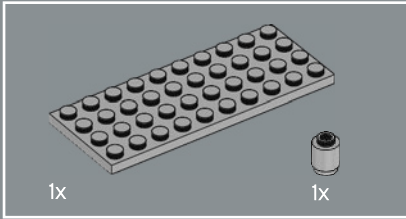
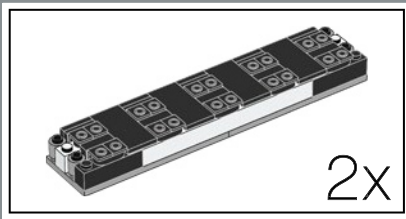

33

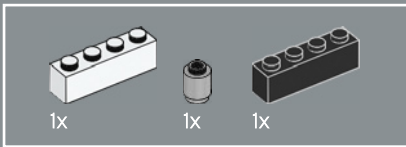
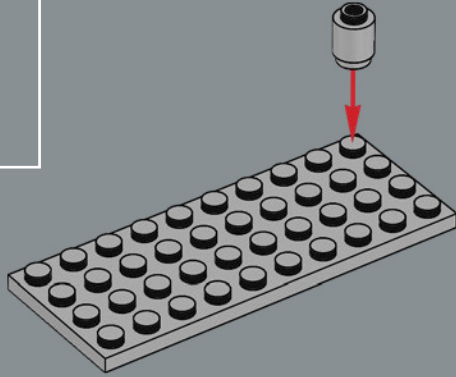

34

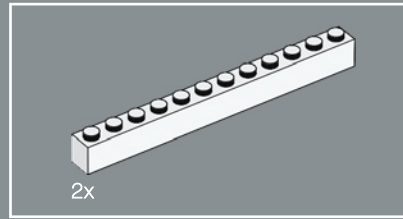
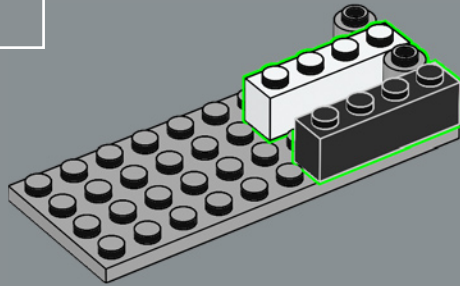

35

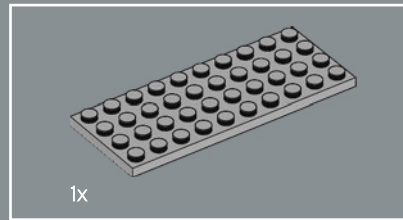
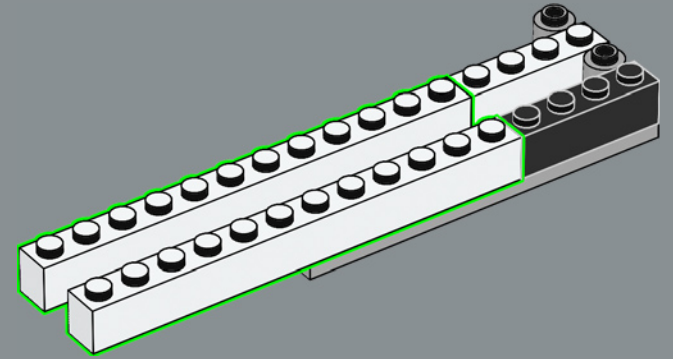

36

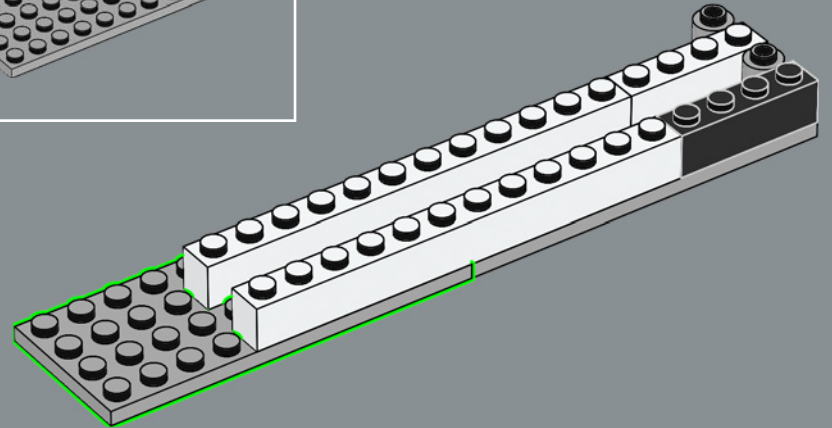

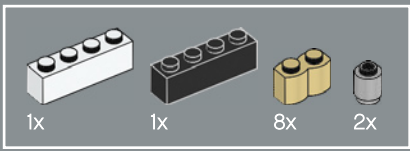

37

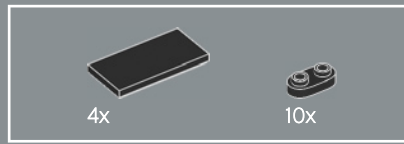
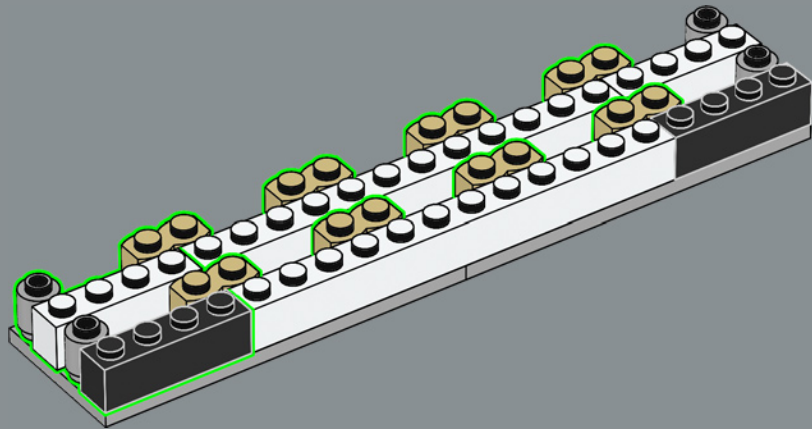

38

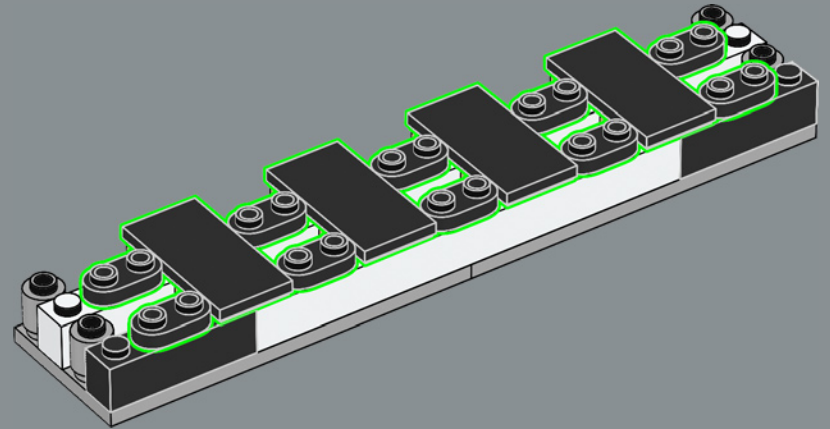



39

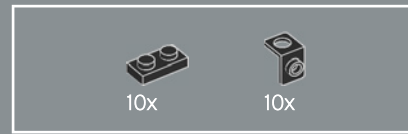
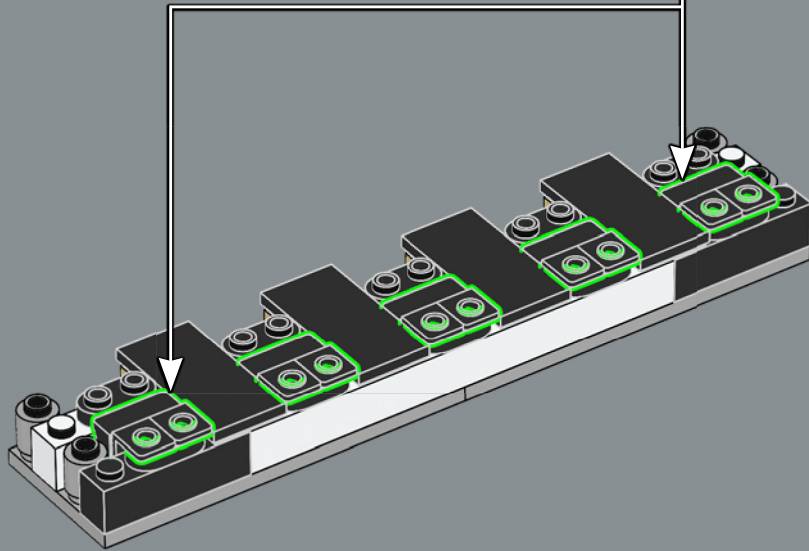
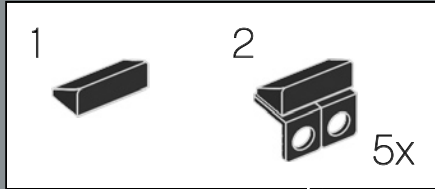

40

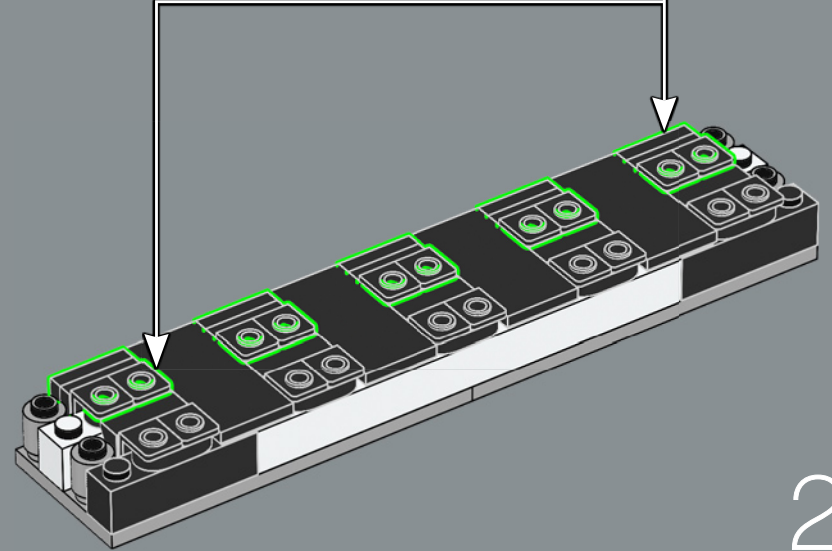
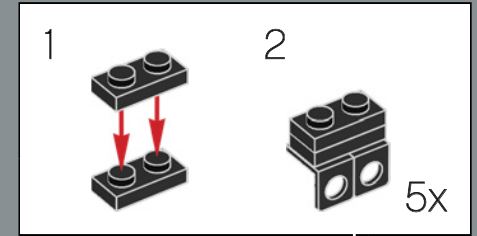

2x

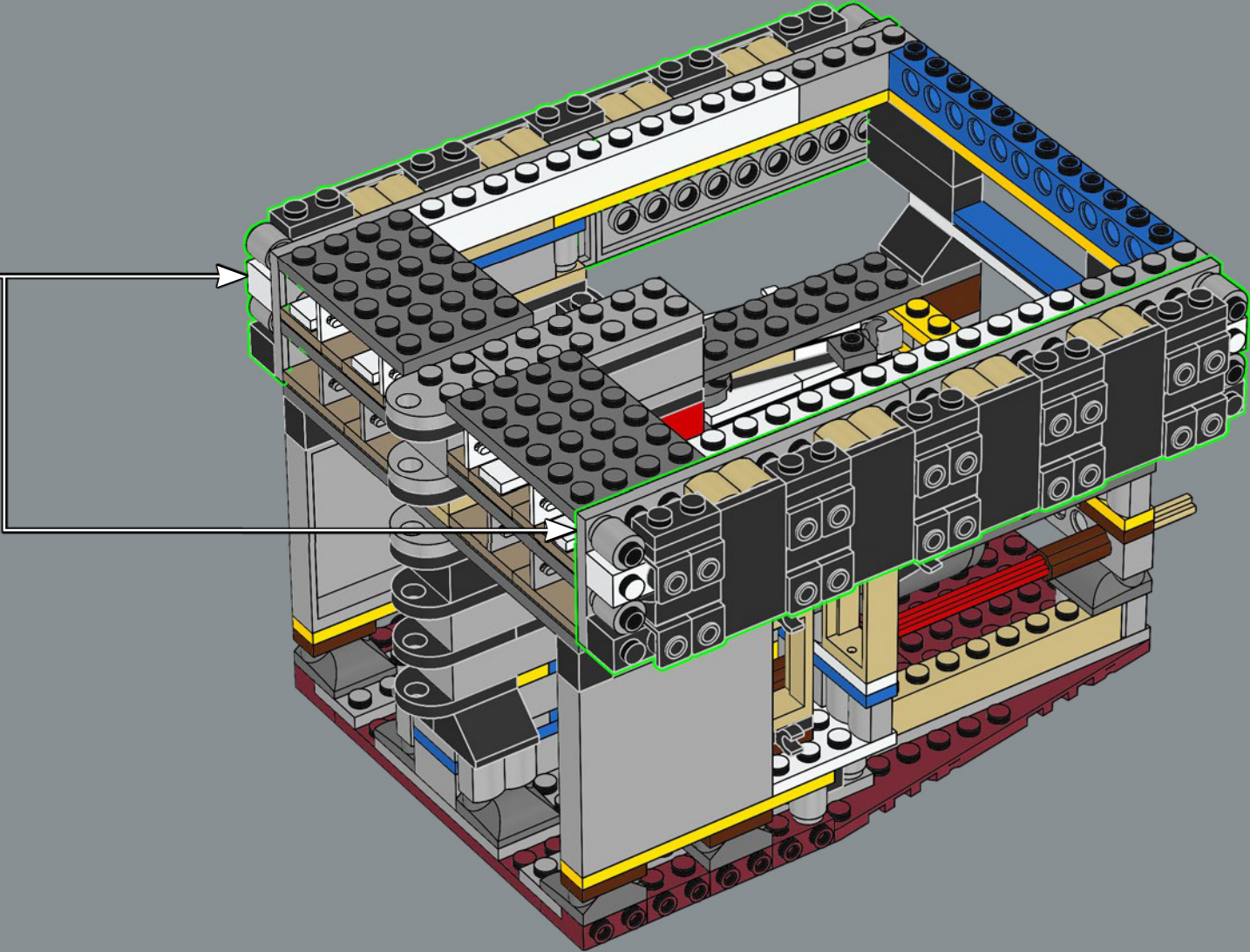

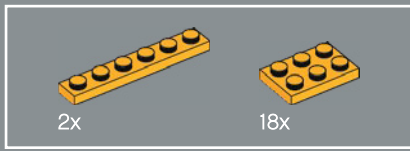

42

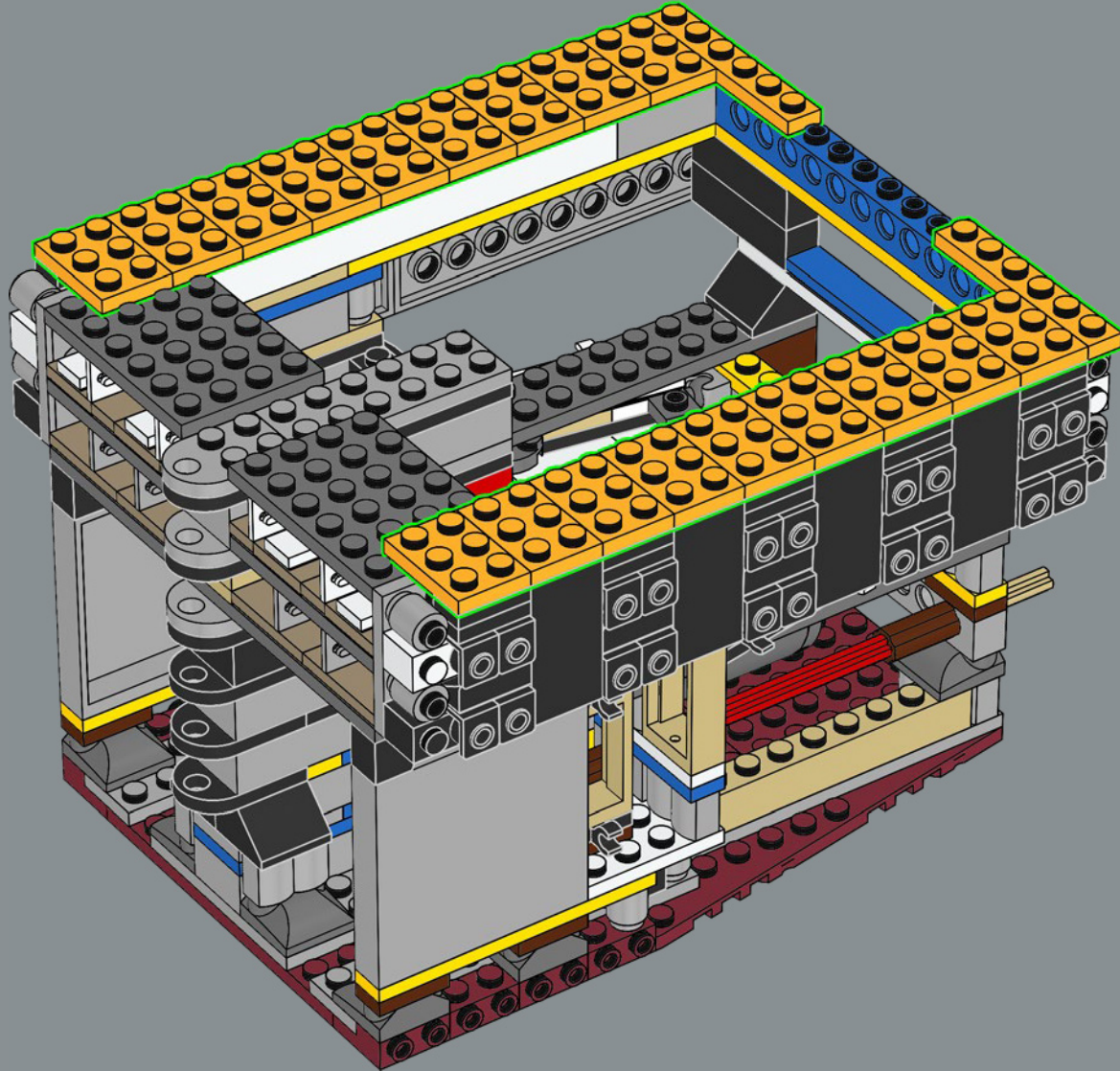

31

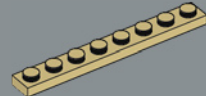
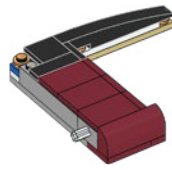
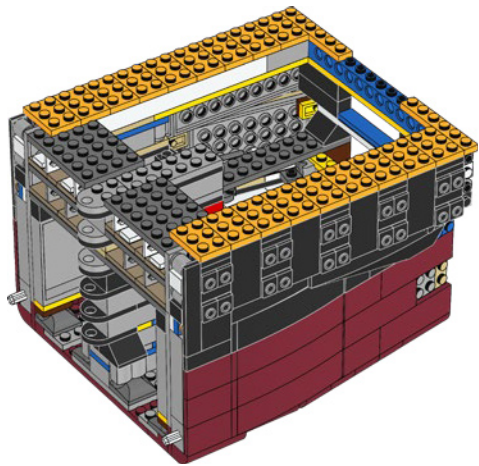
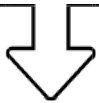

1x



1x

43

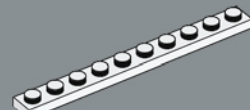
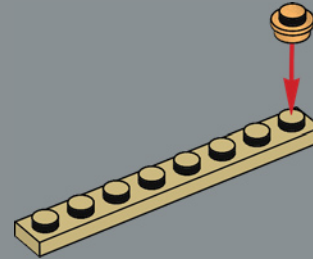

1x

44

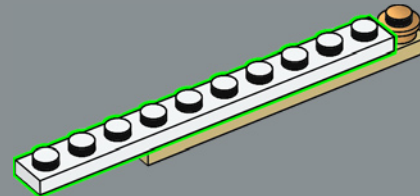

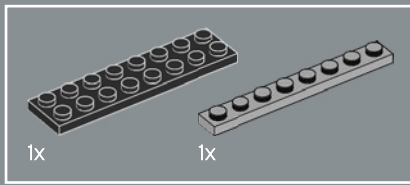

45

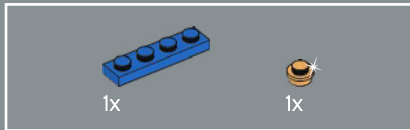
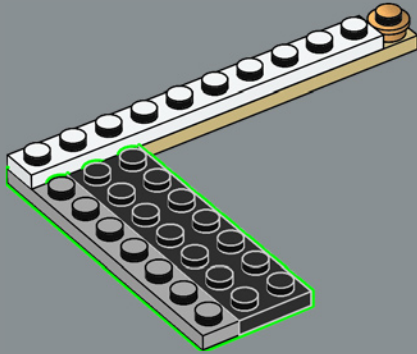

46

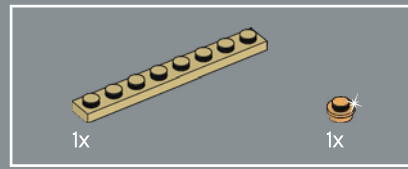
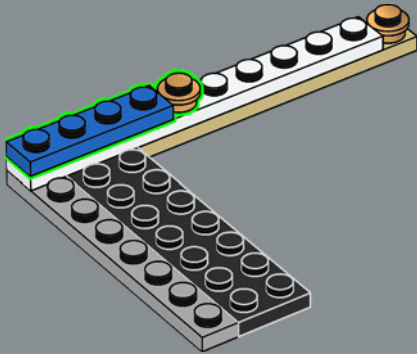

47

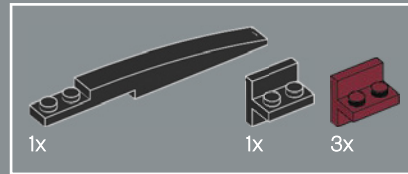
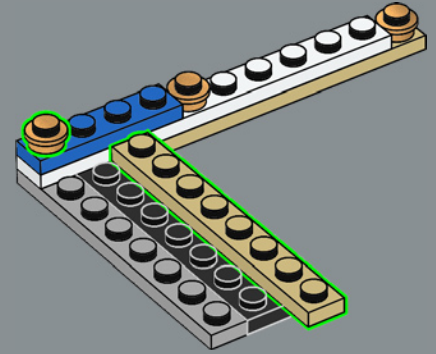

48

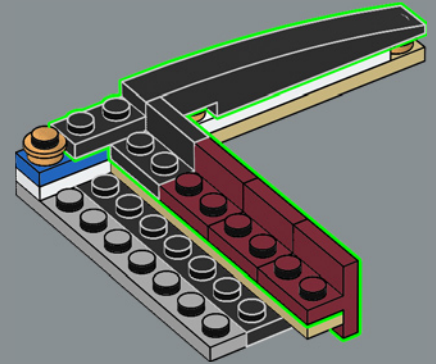

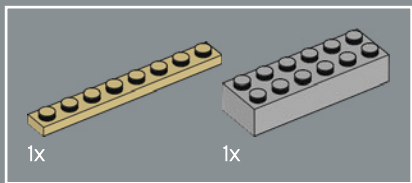

49

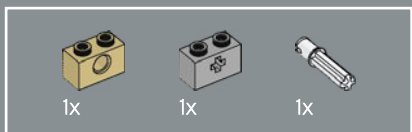
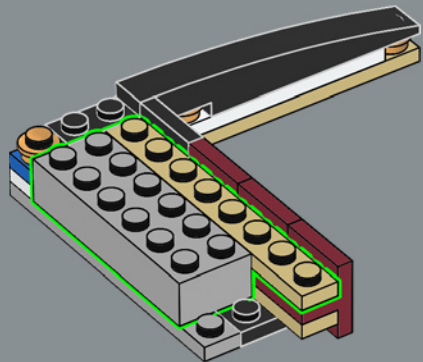

50

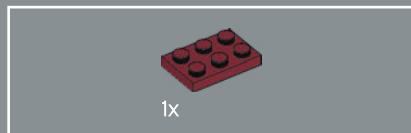
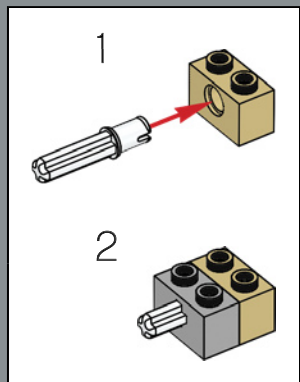
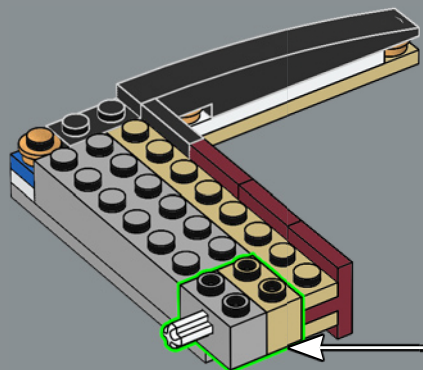

51

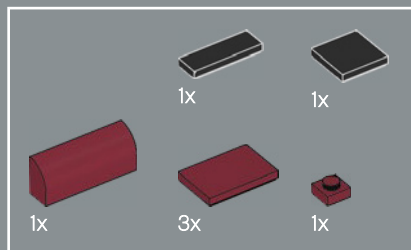
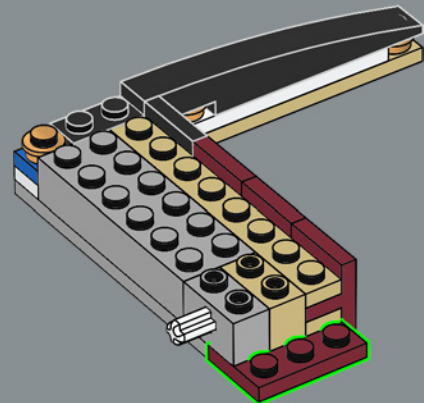

52

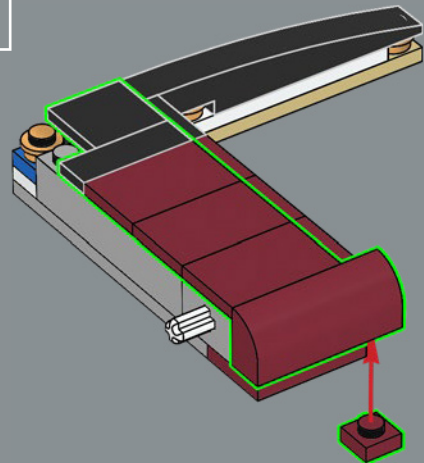

53

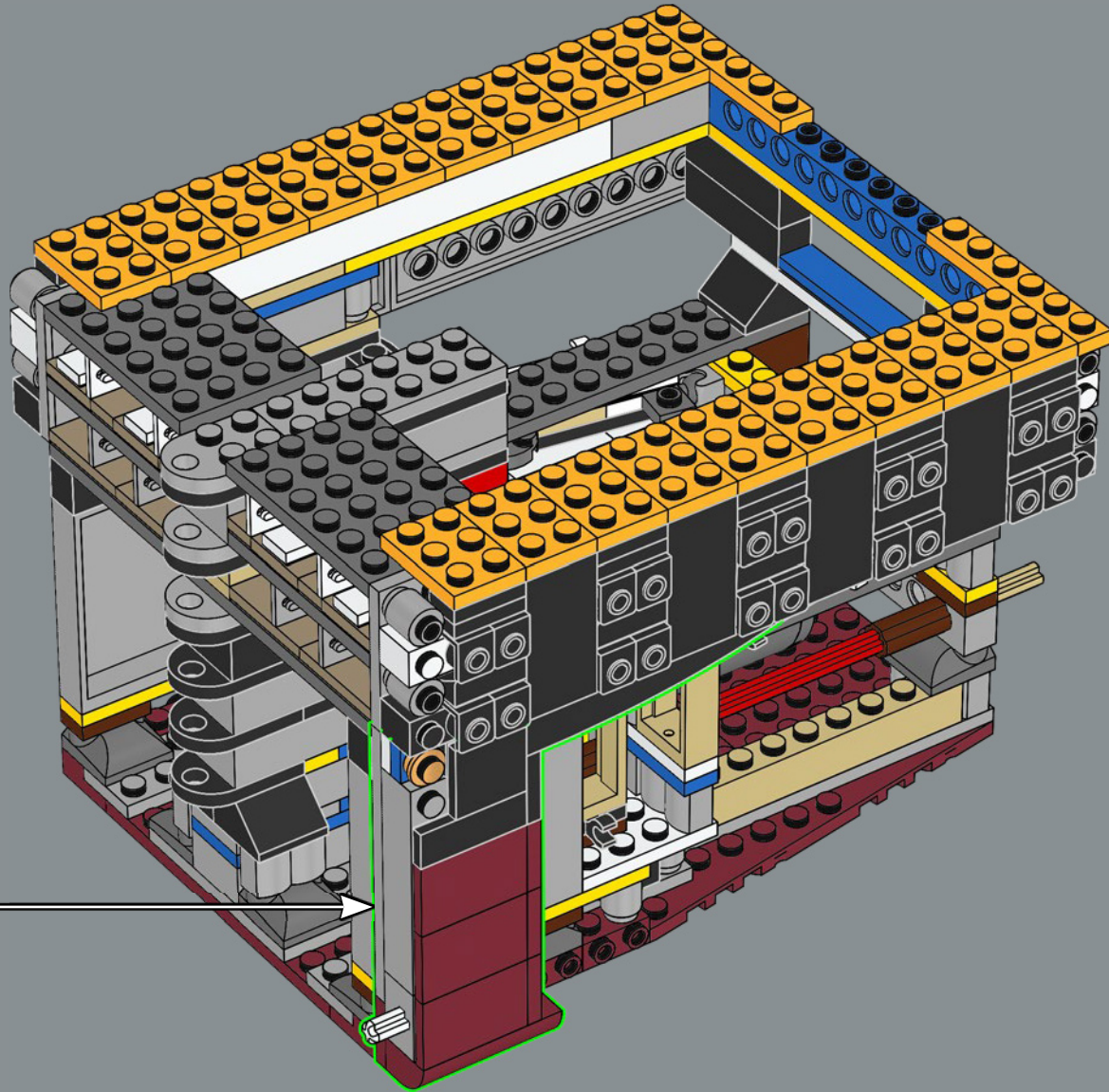

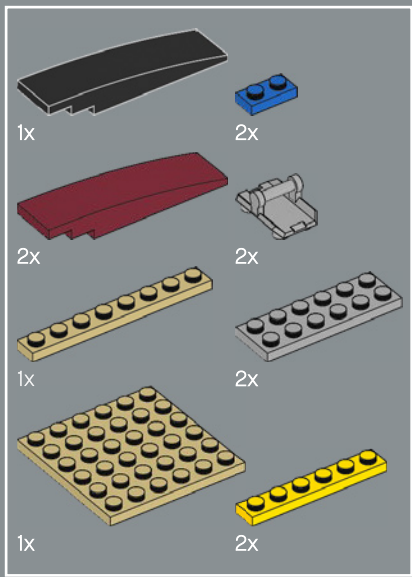

54

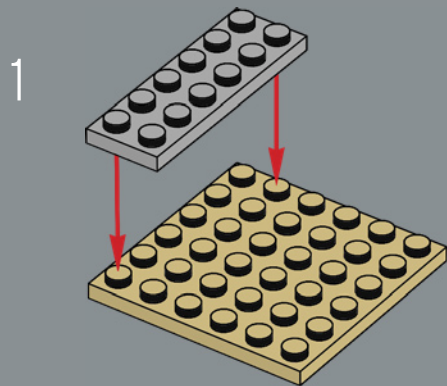

2

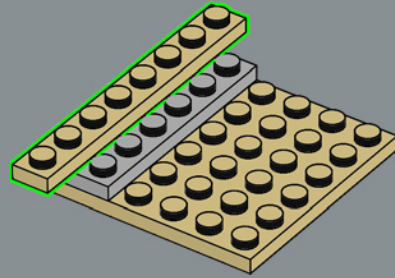

3

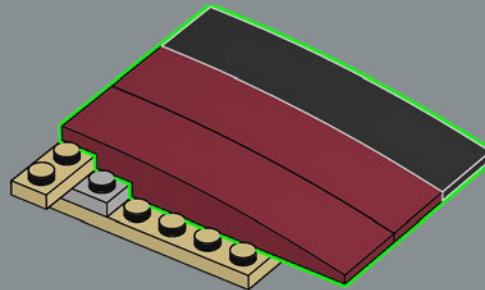

4

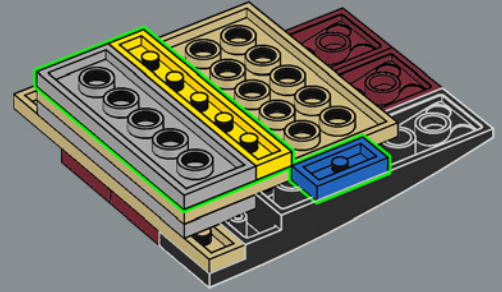

5

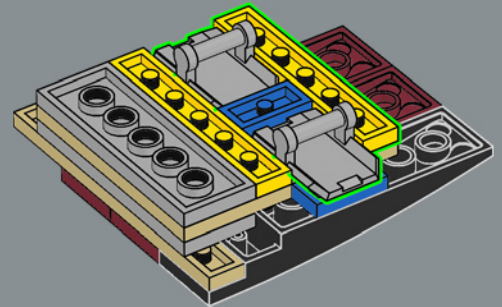

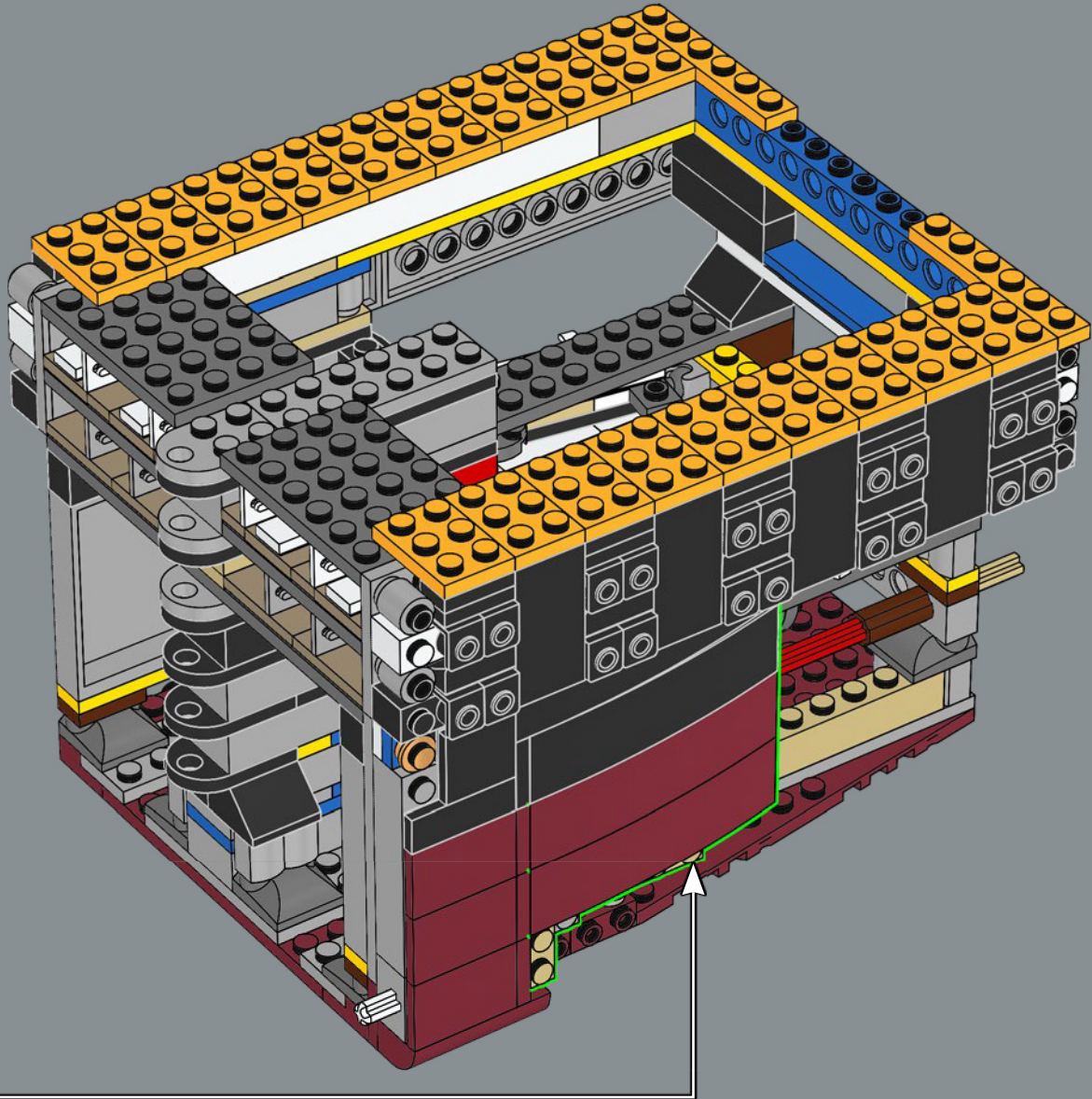

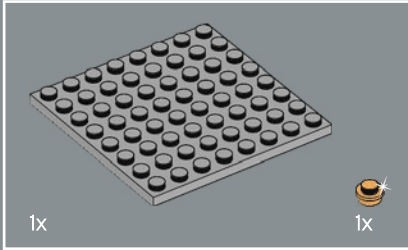
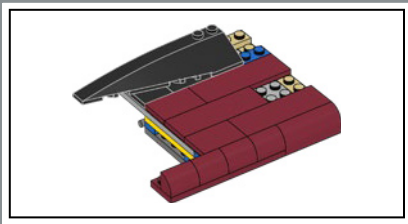

55

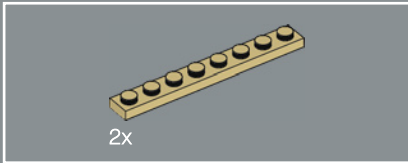
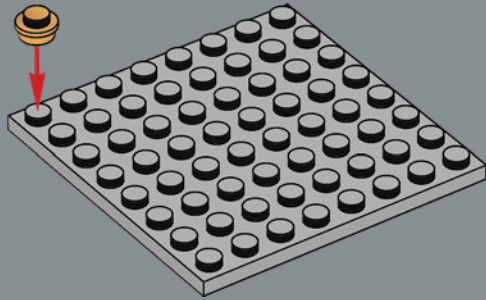

56

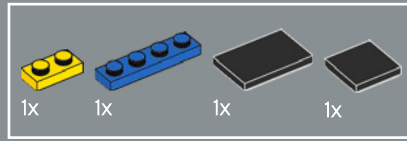
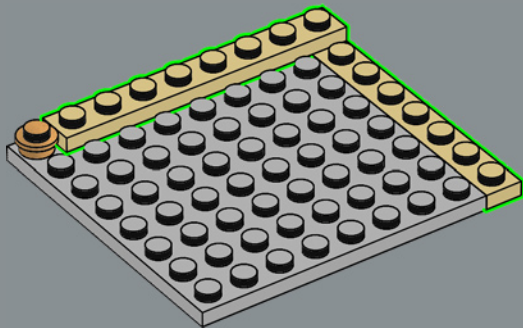

57

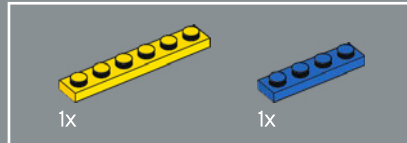
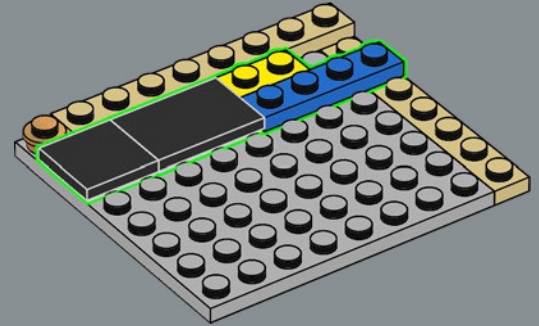

58

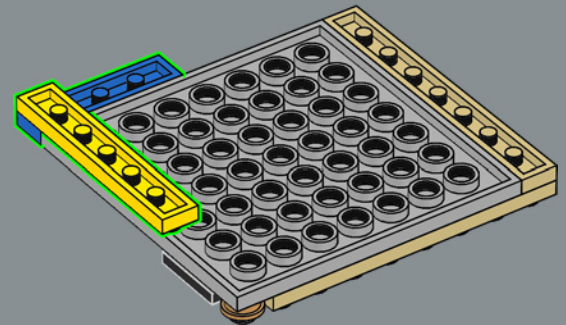

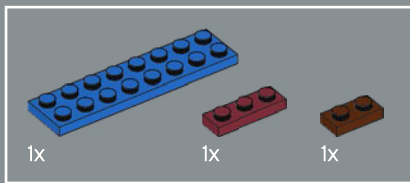

59

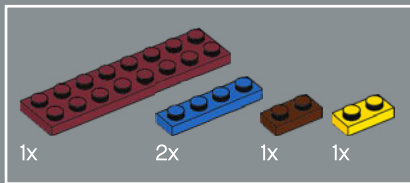
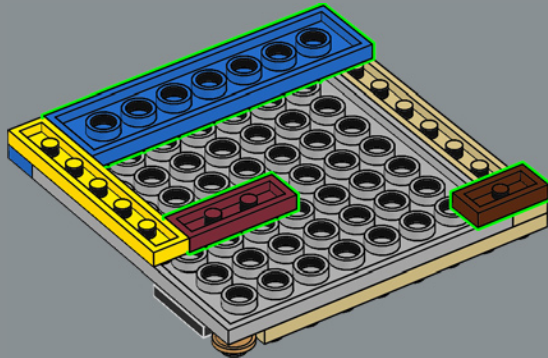

60

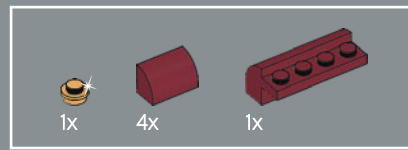
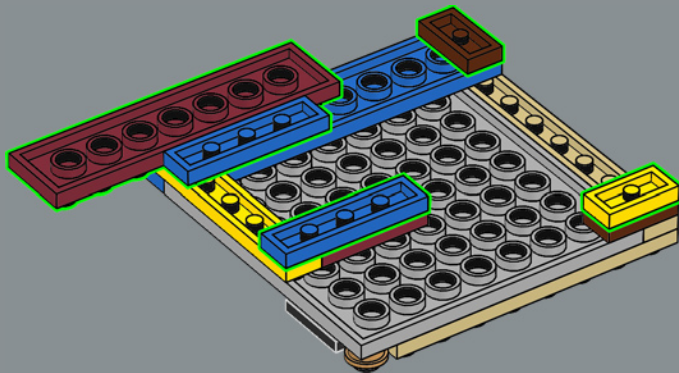

61

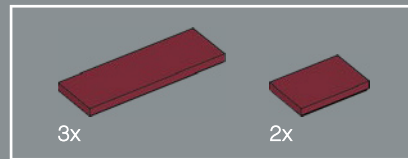
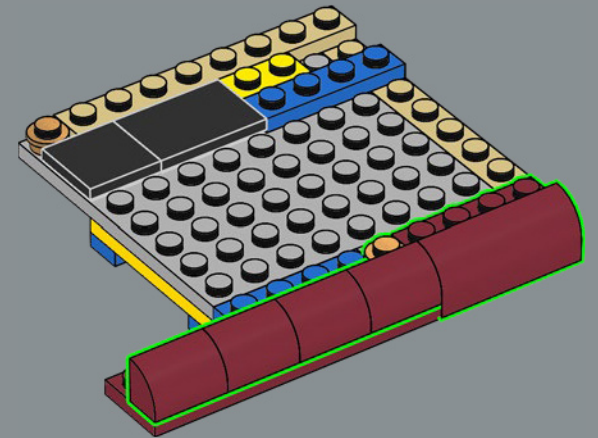

62

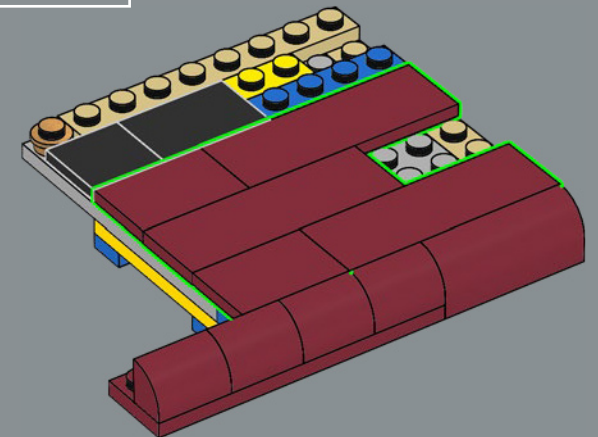

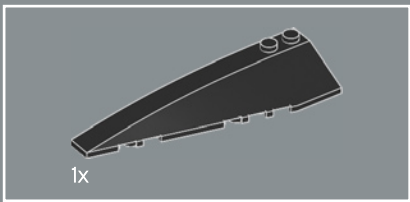

63

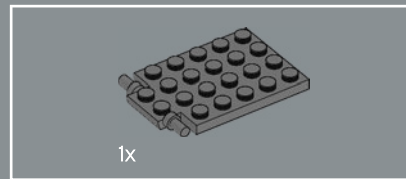
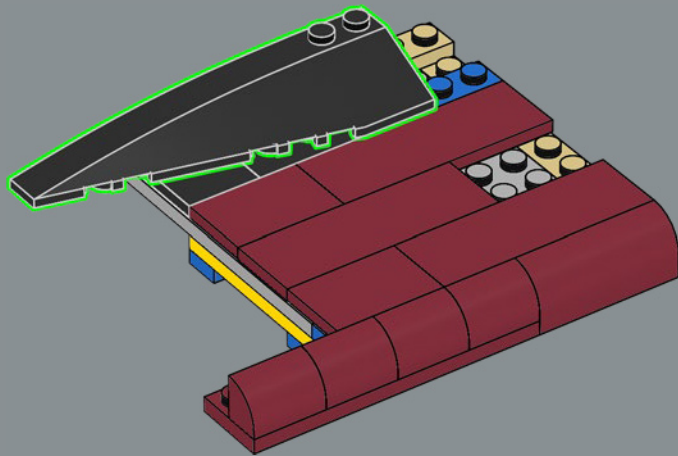

64

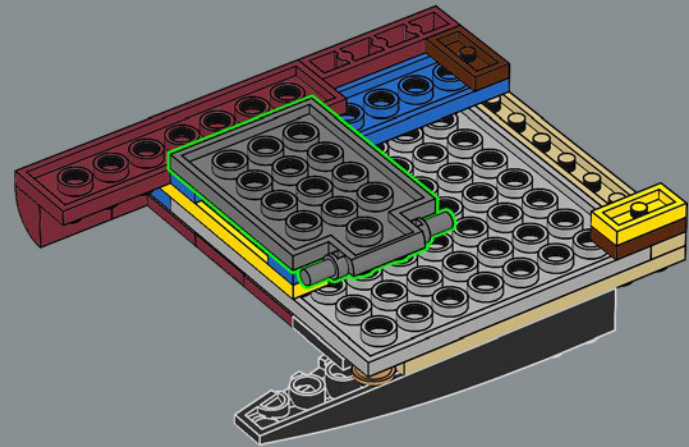

65

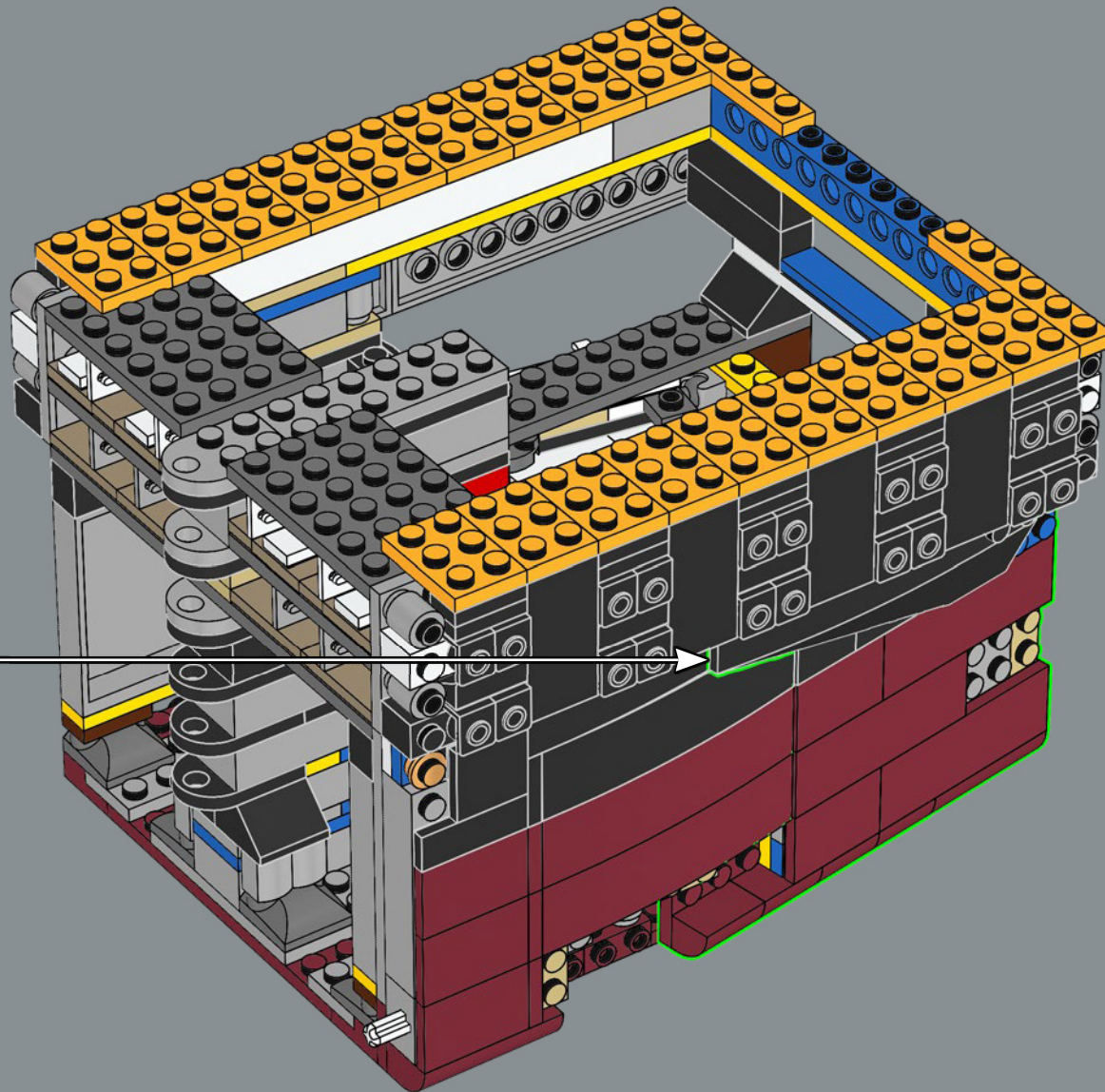

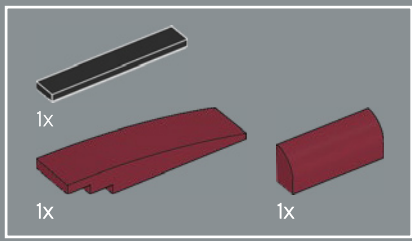

66

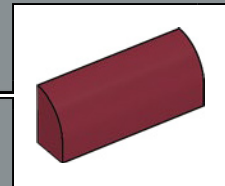
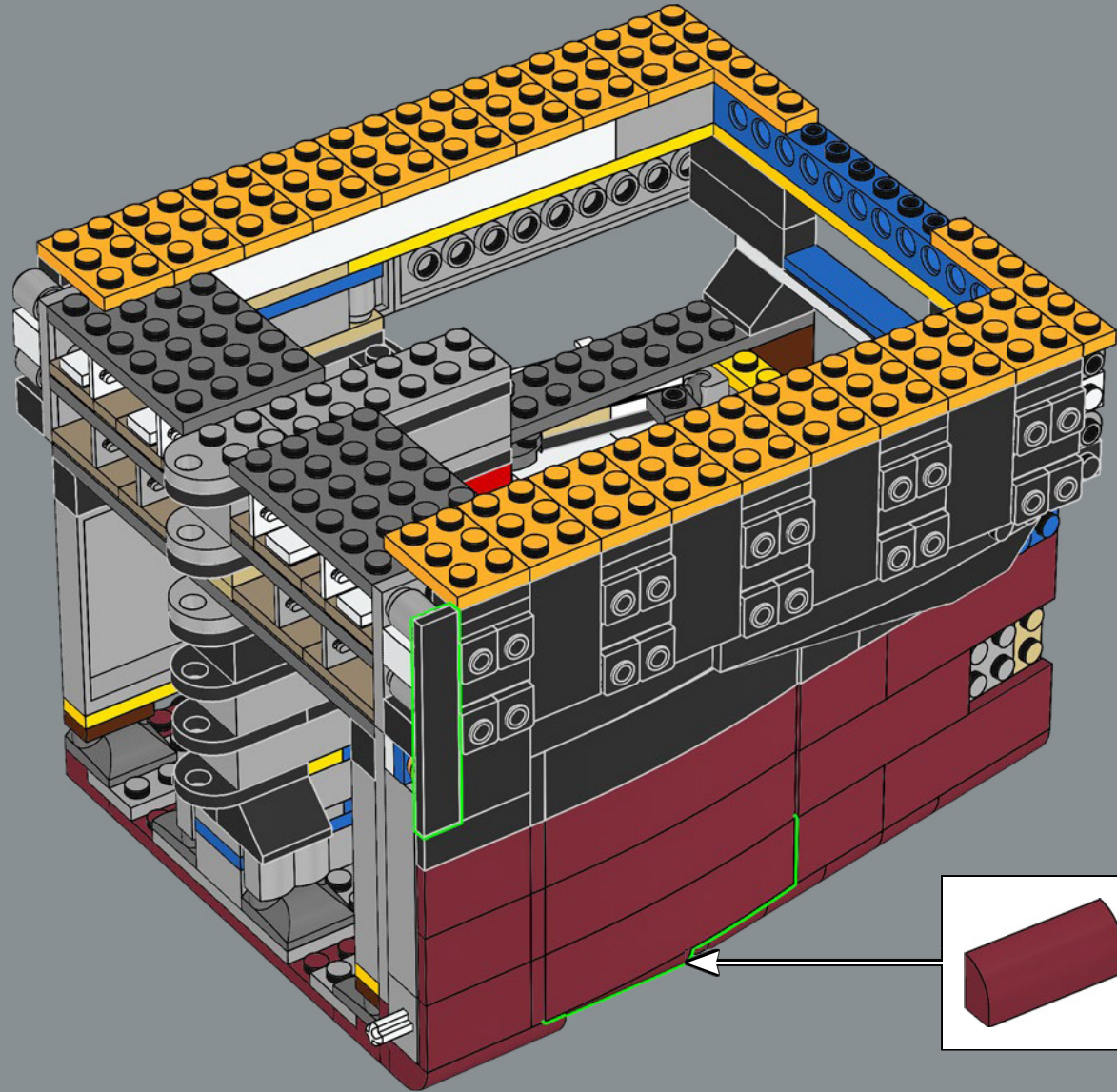

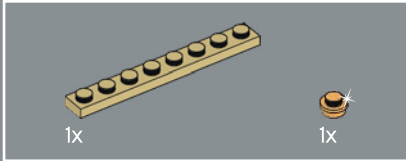
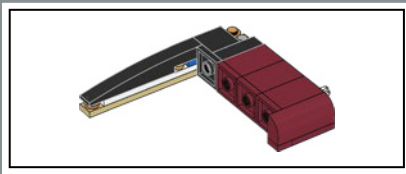

67

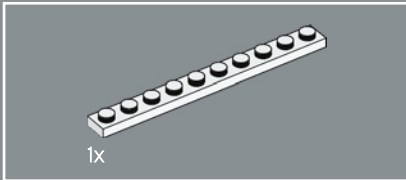
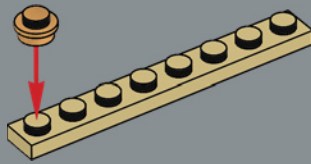

68

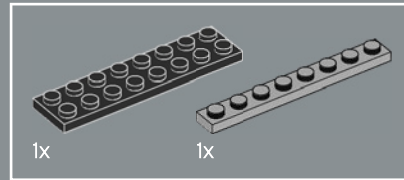
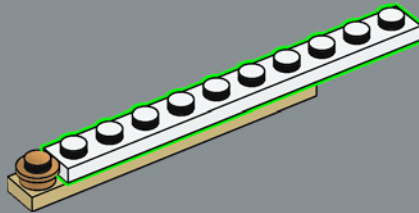

69

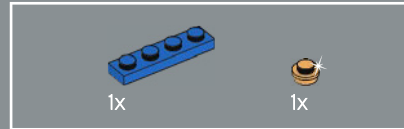
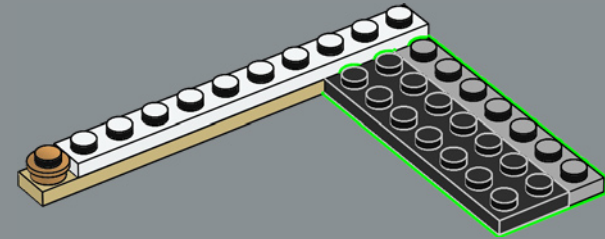

70

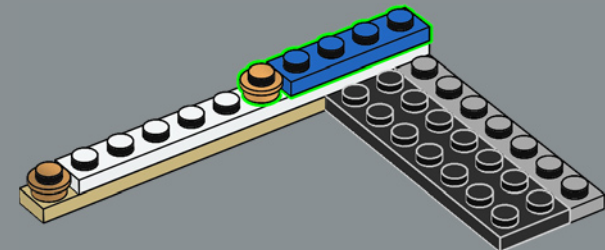

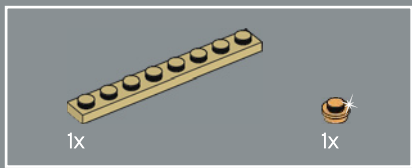

71

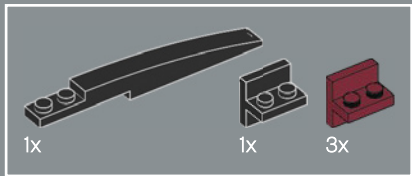
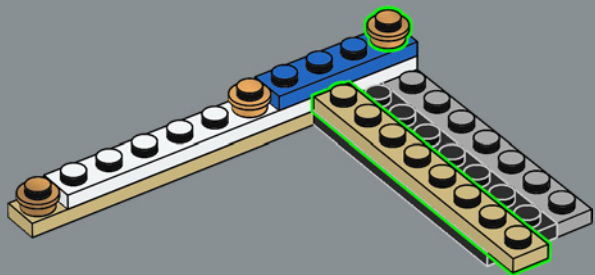

72

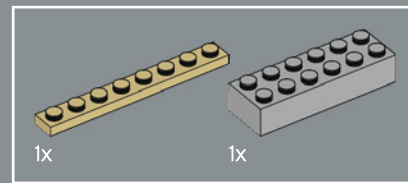
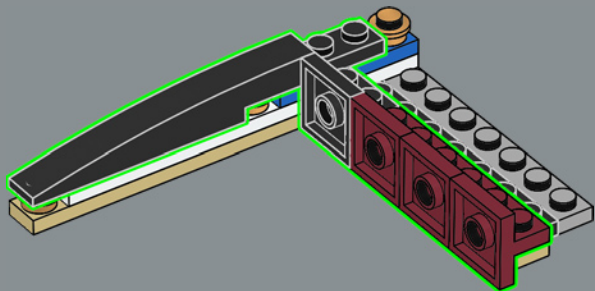

73

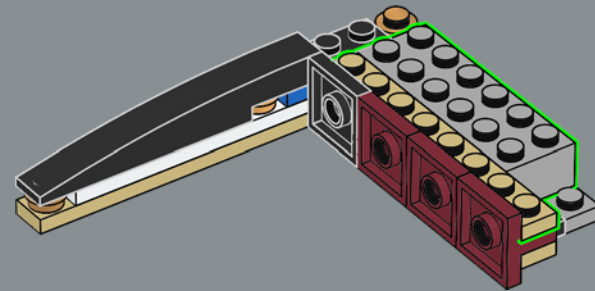

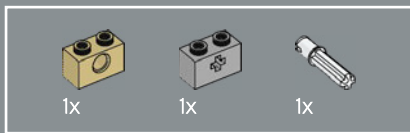

74

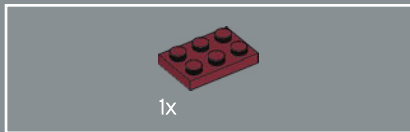
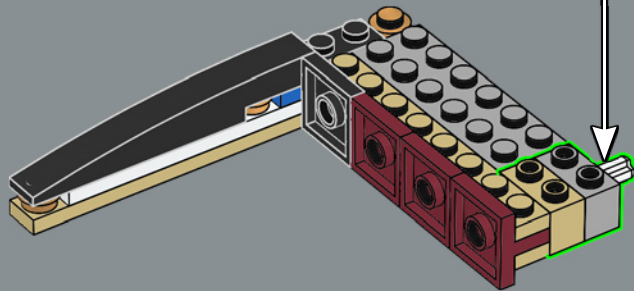
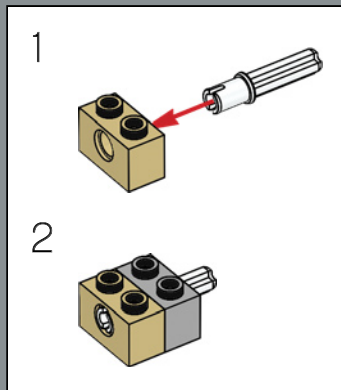

75

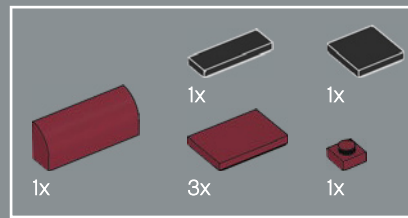
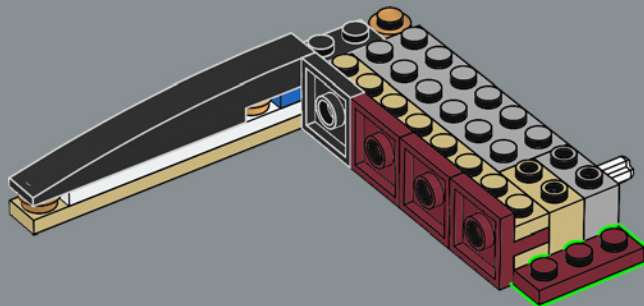

76

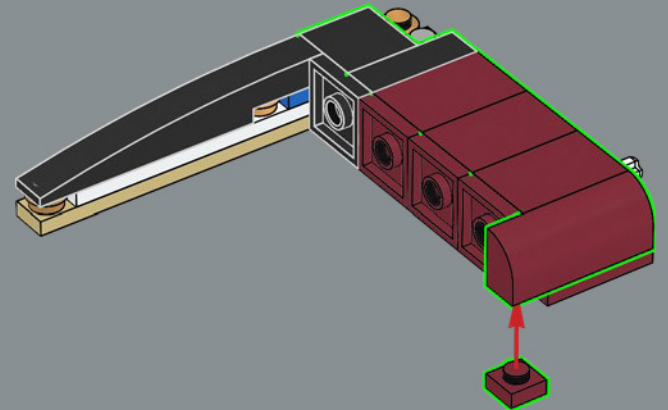

77

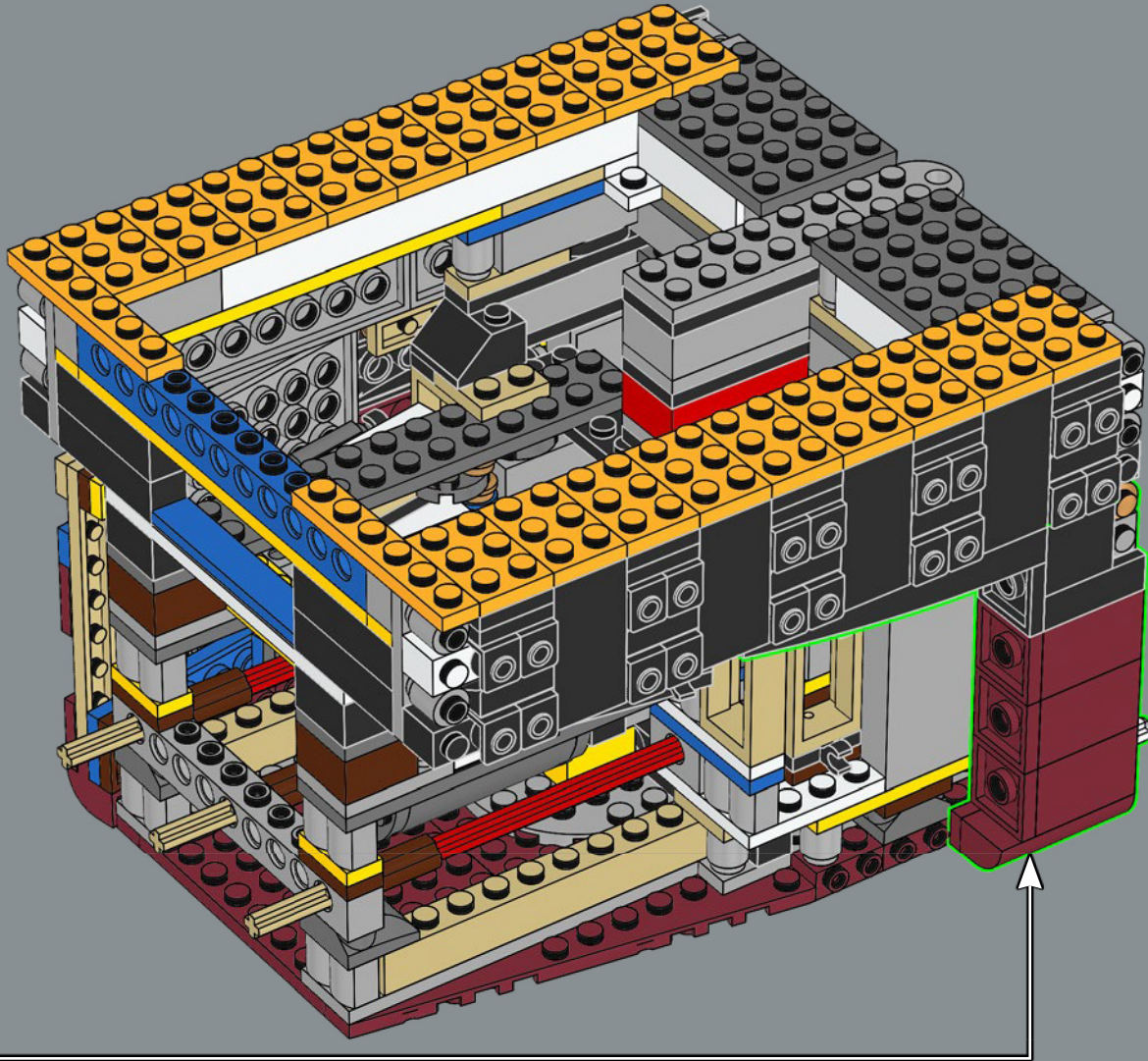

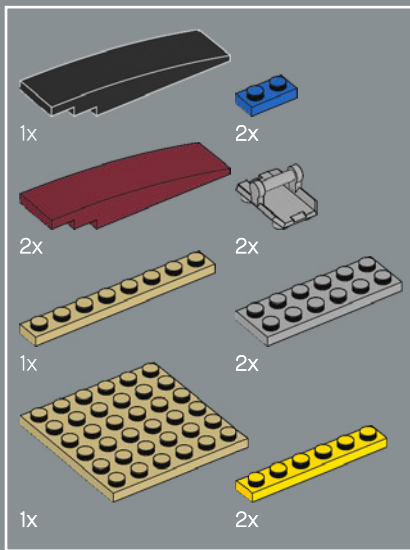

78

1

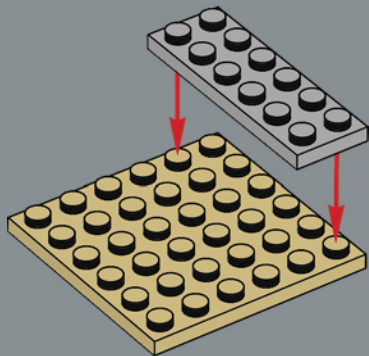

2

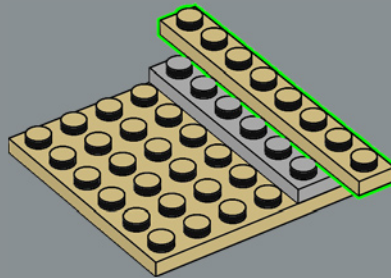

3

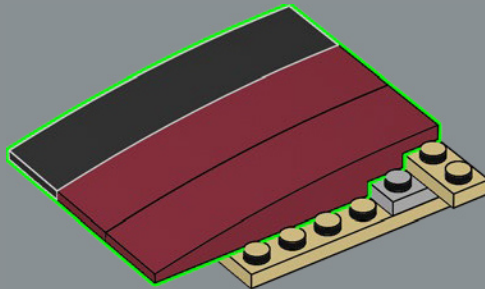

4

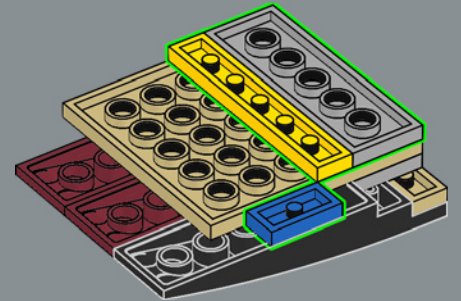

5

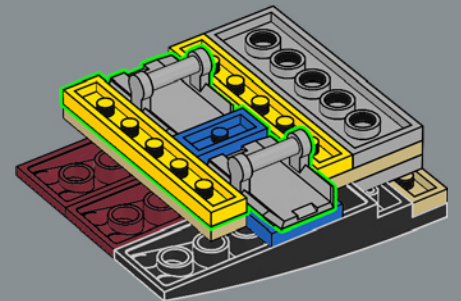

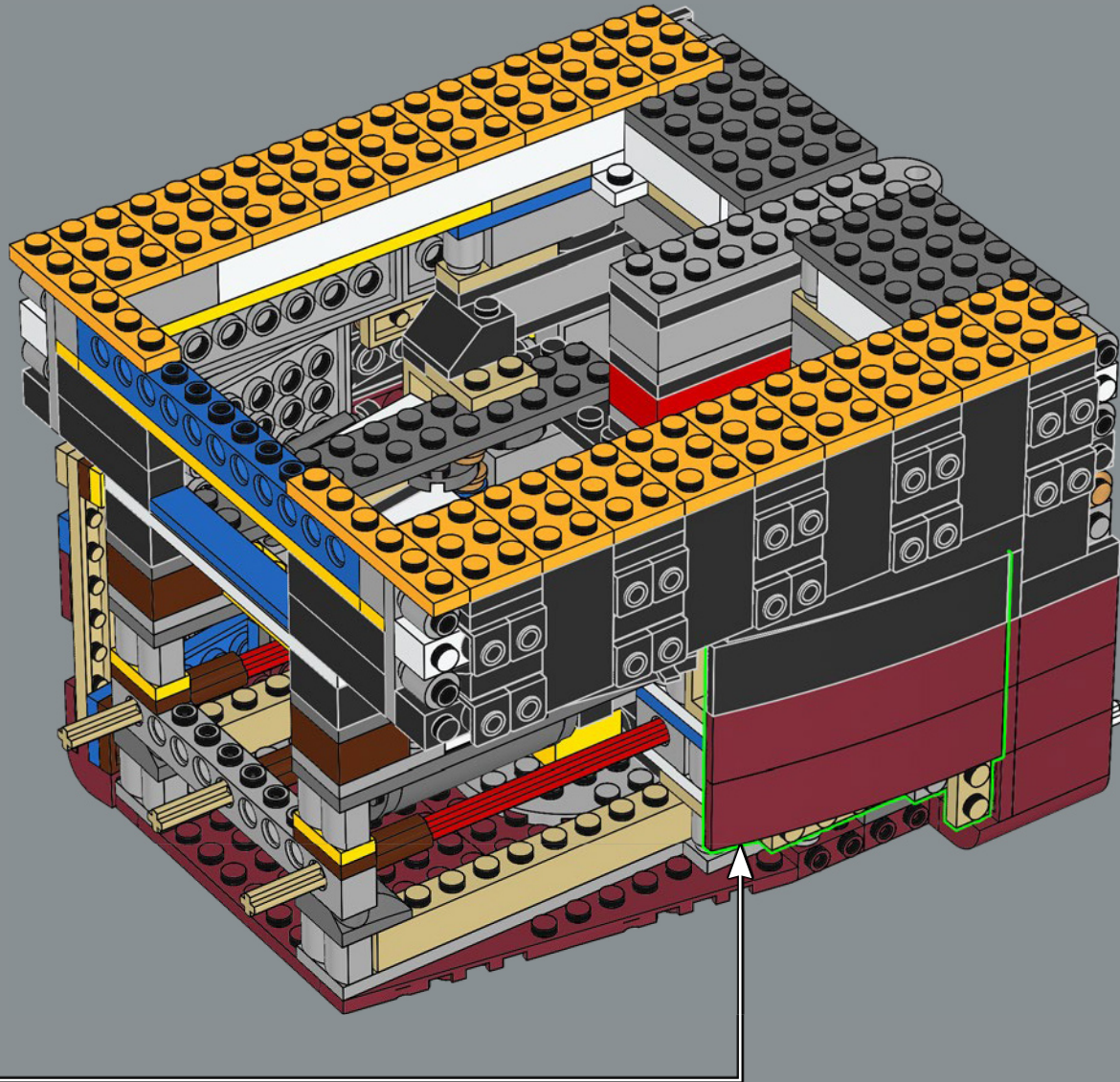

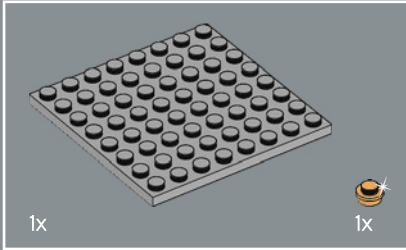
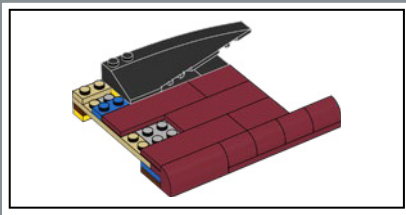

79

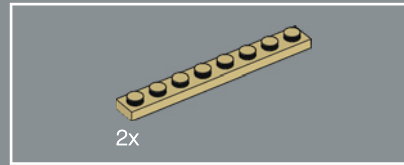
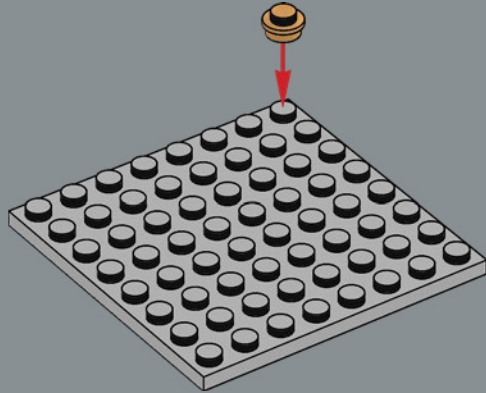

80

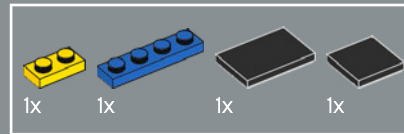
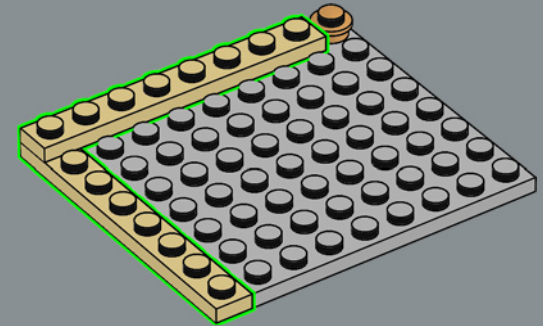

81

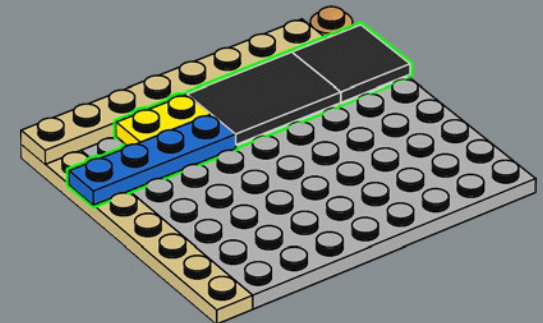

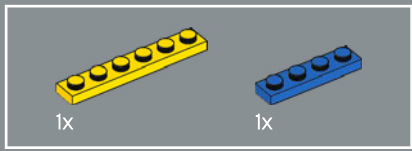

82

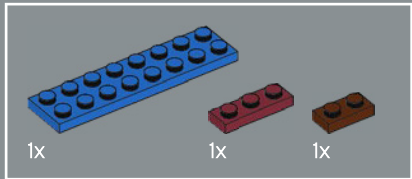
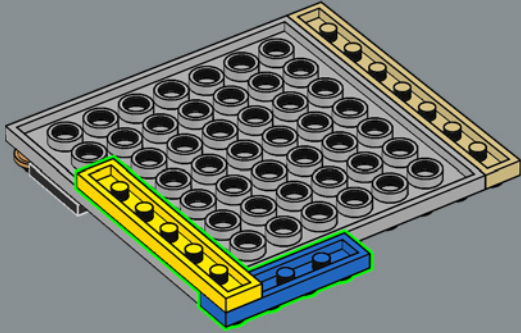

83

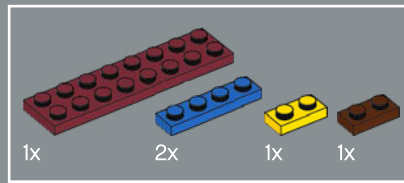
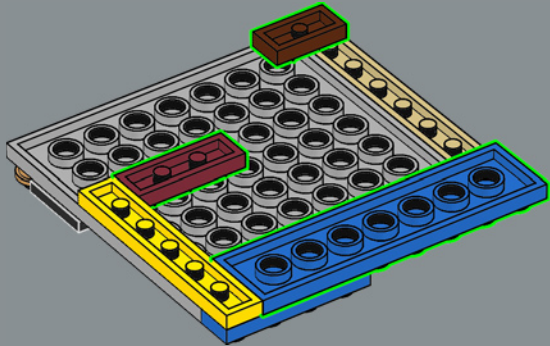

84

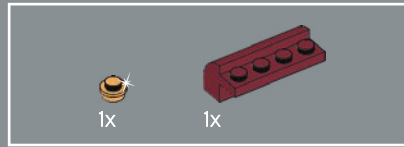
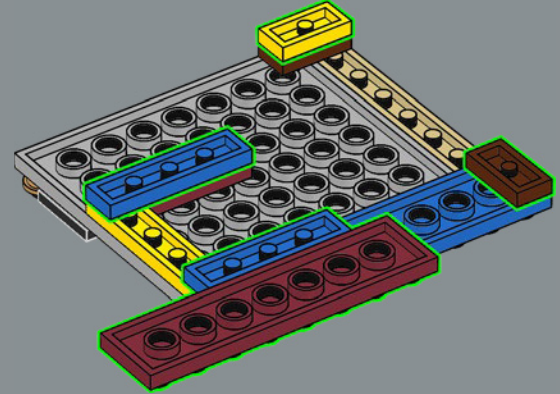

85

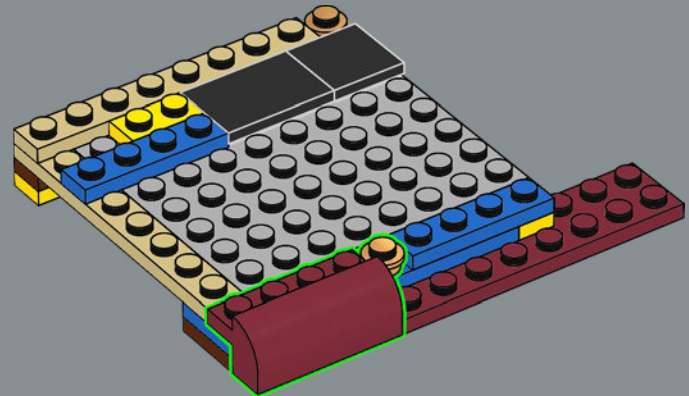

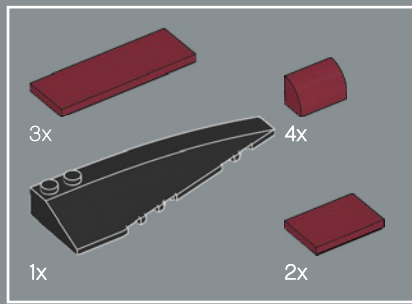

86

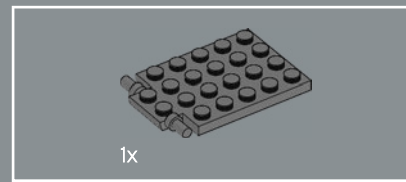
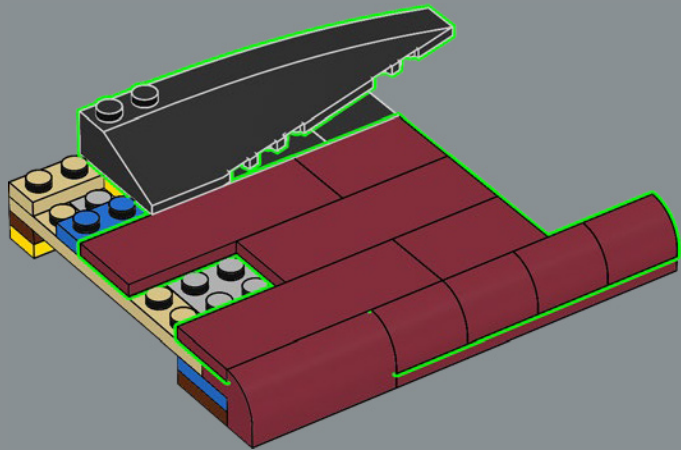

87

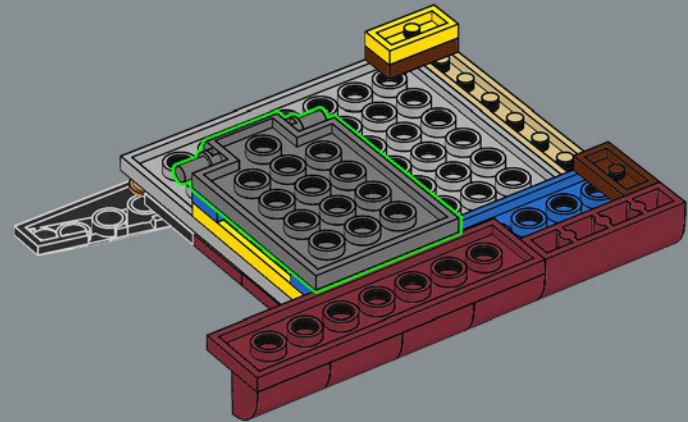

Il *Titanic* si trovava a 640 km dalla
terraferma quando entrò in collisione
con l'iceberg.

88

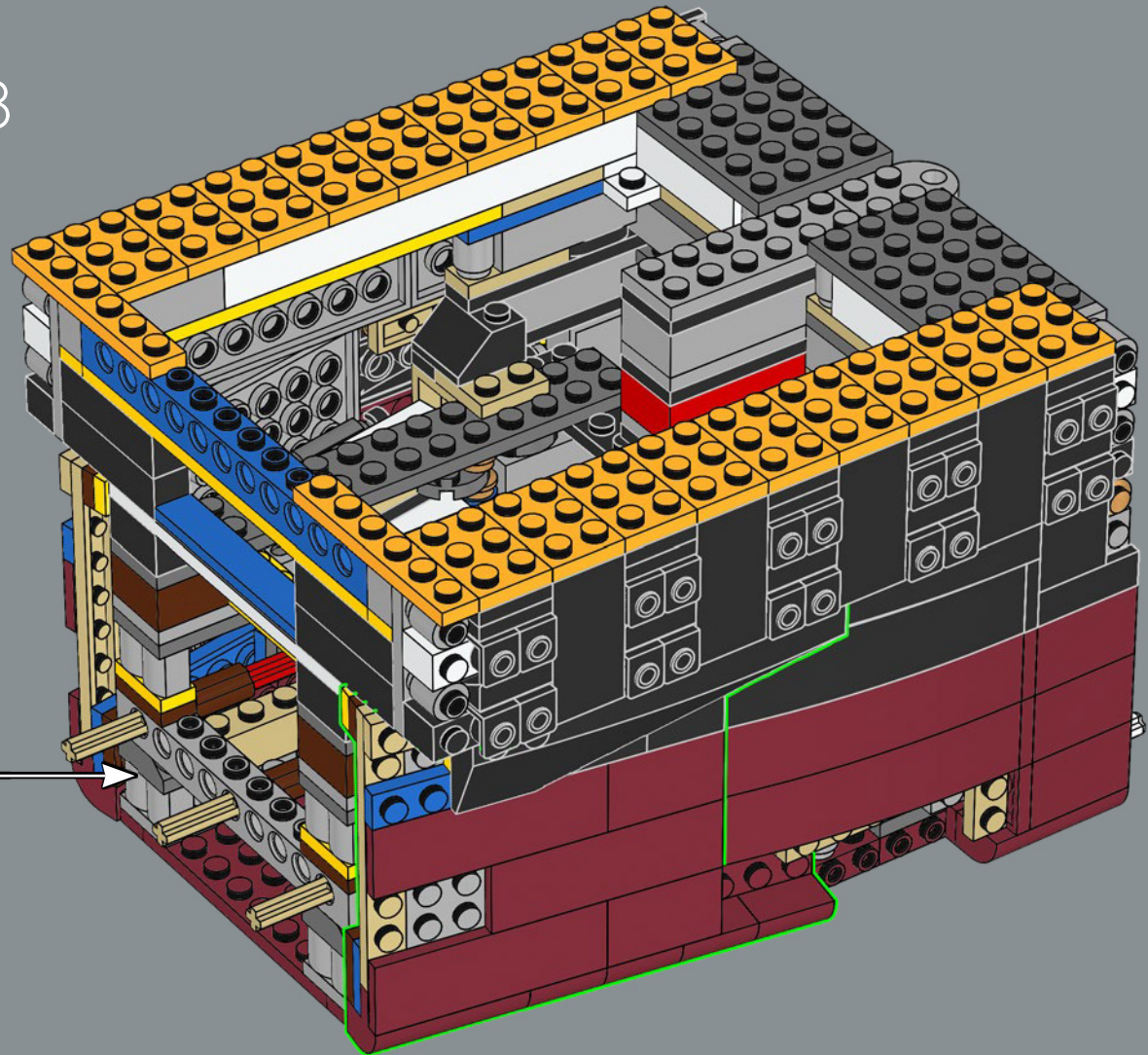

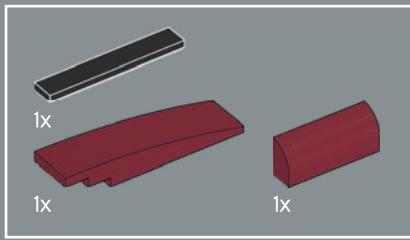

89

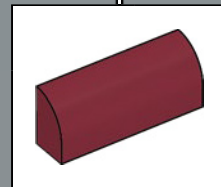
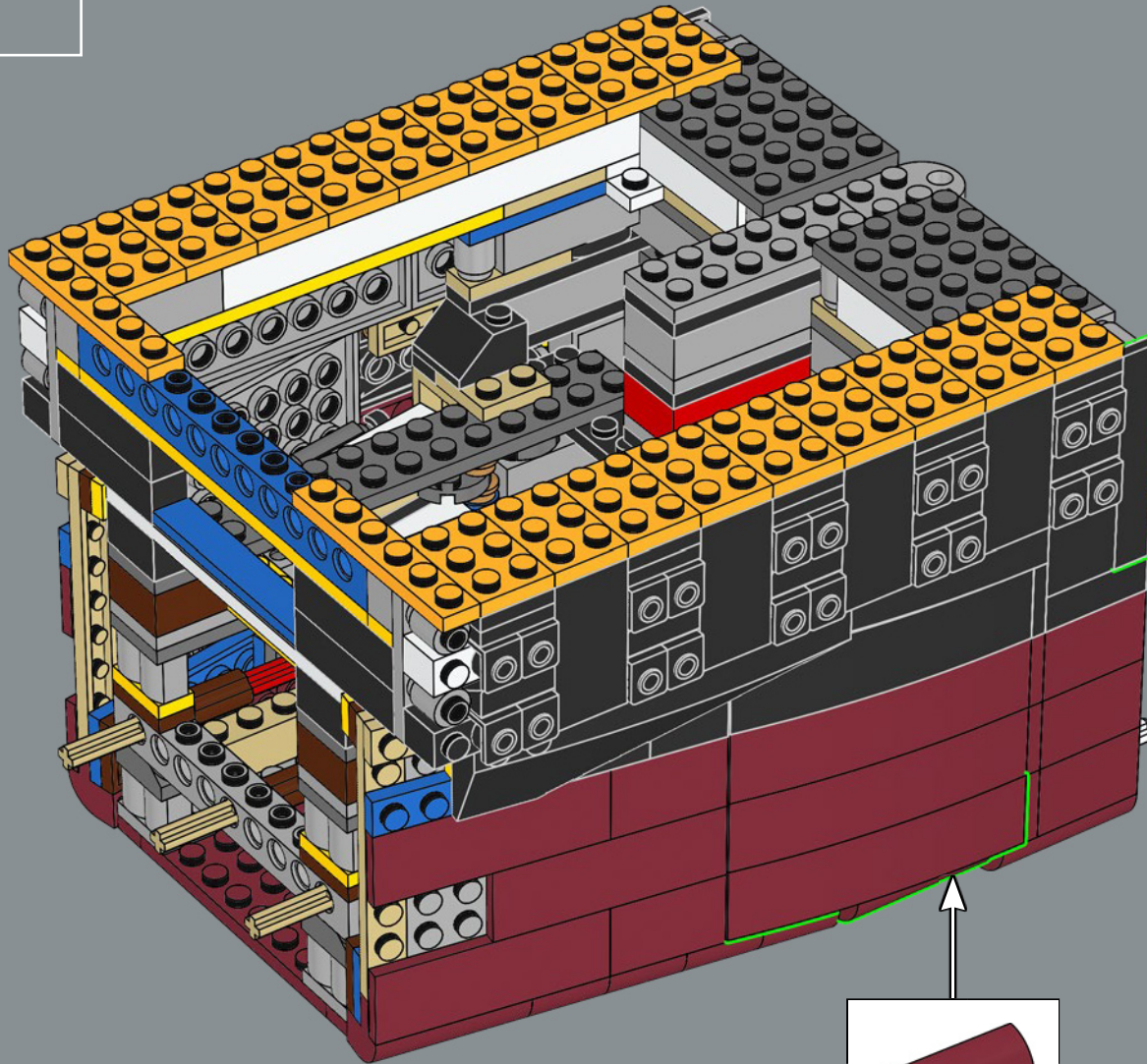

32

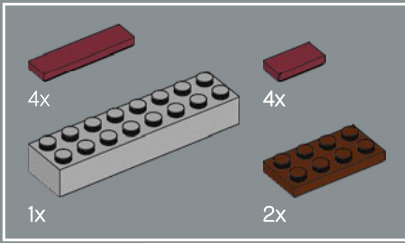
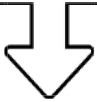

90

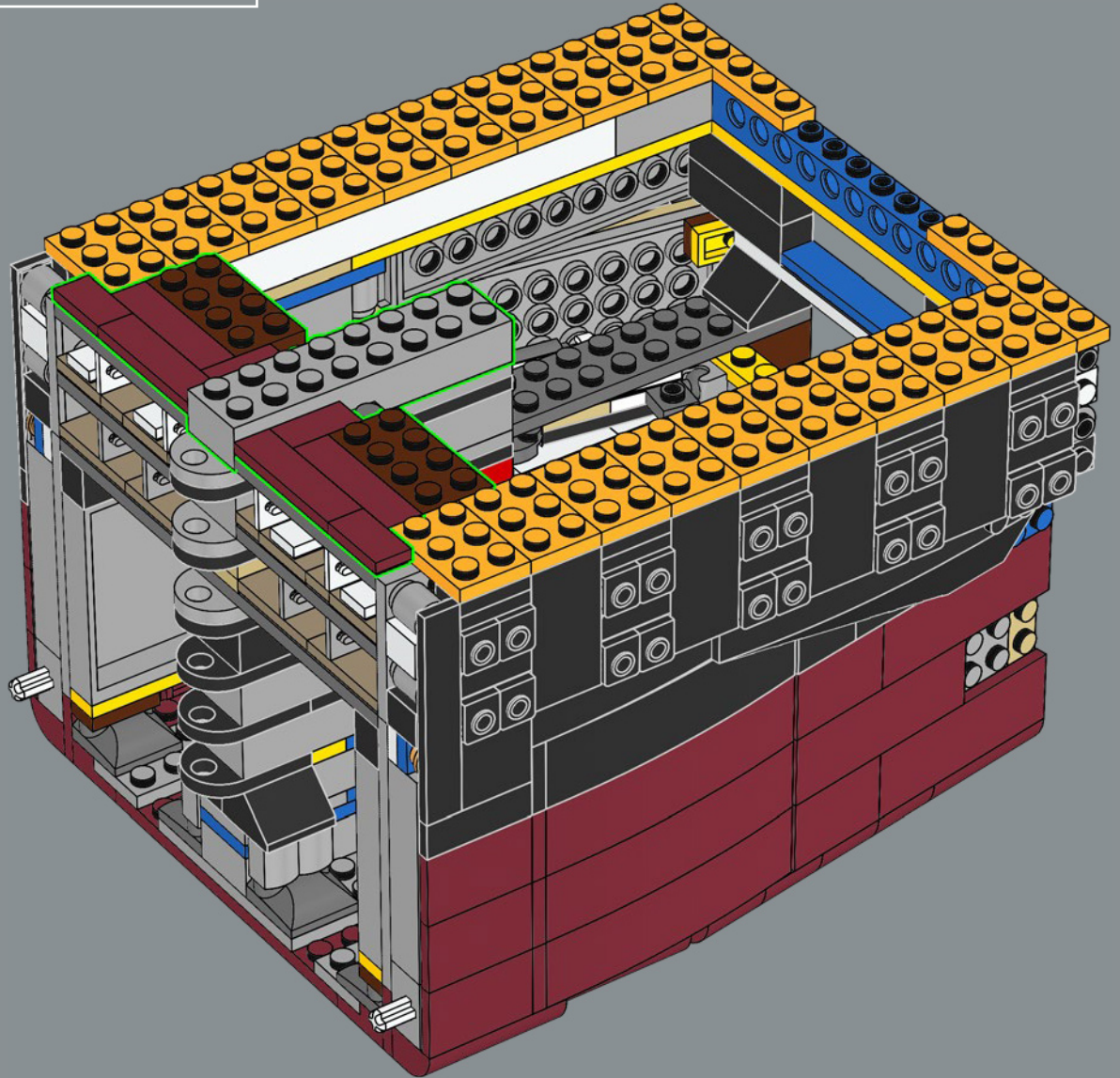

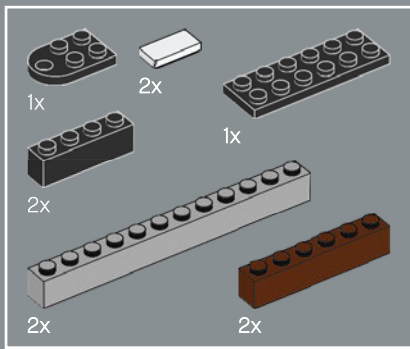

91

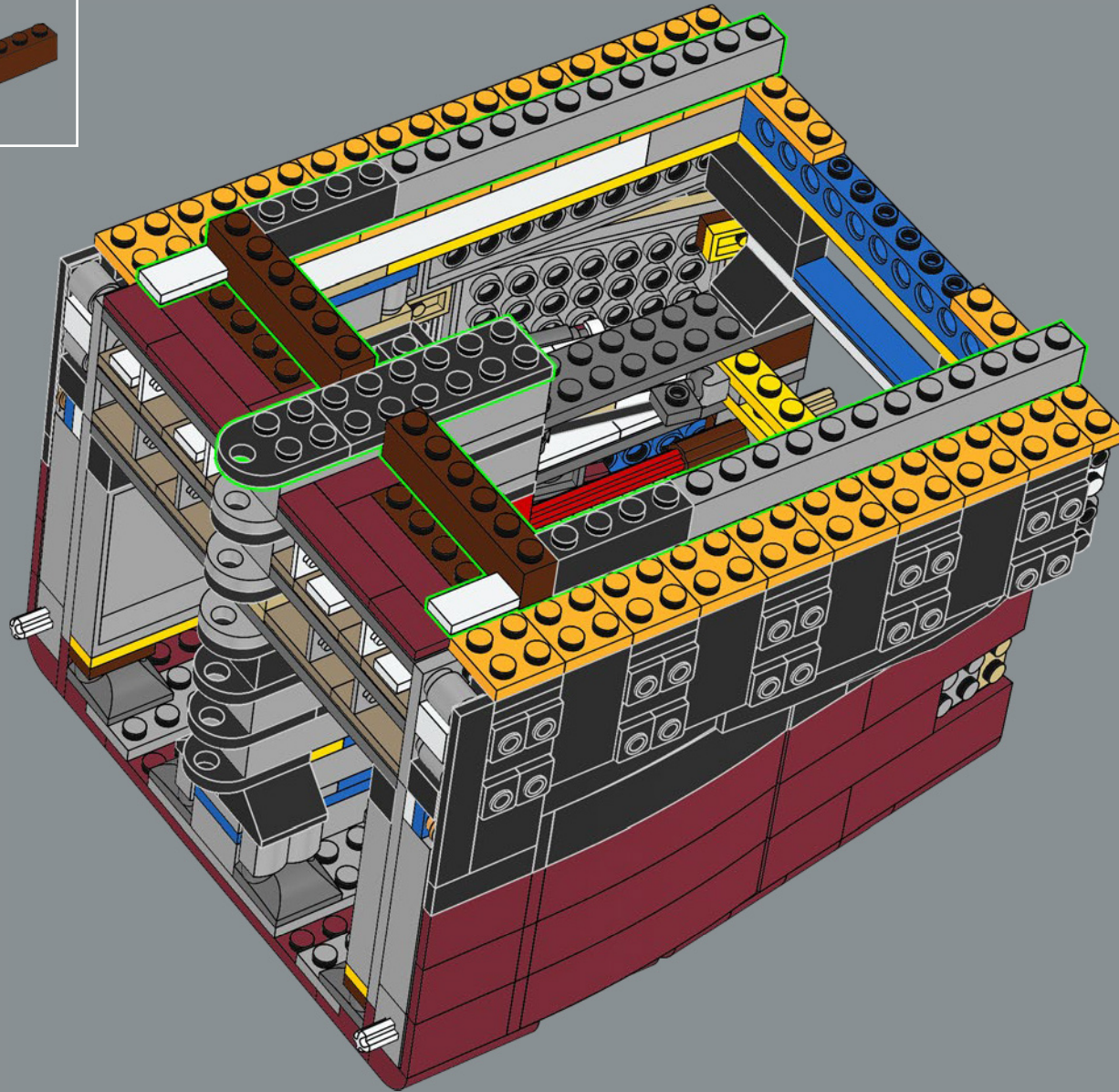

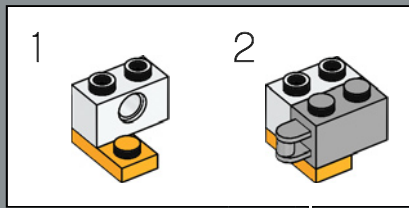
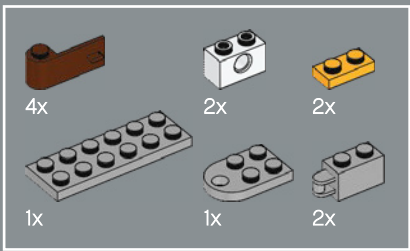

92

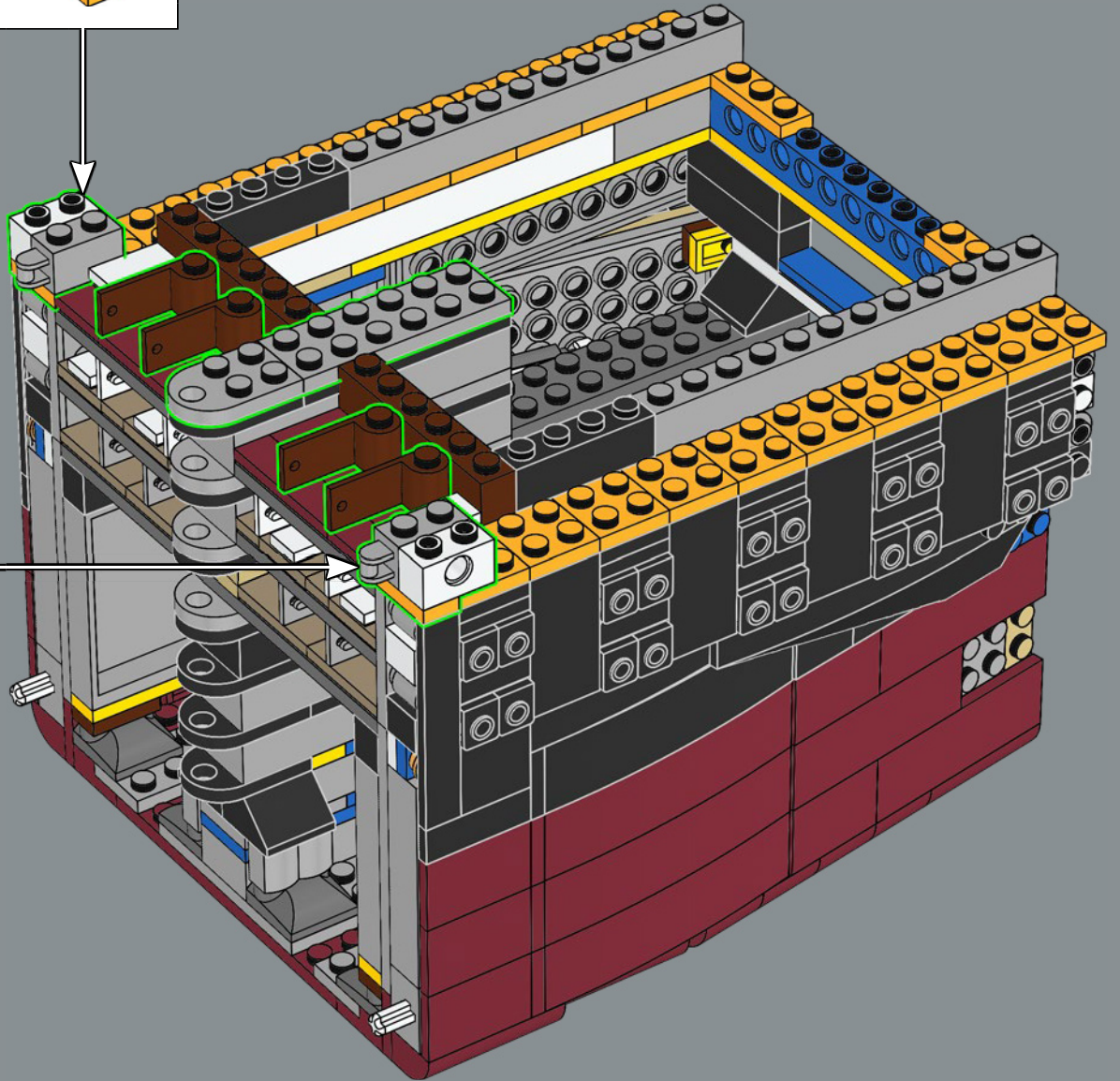
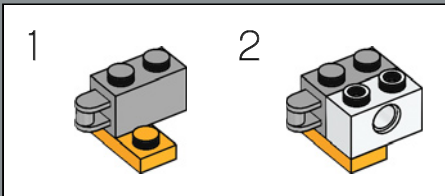



18x

93

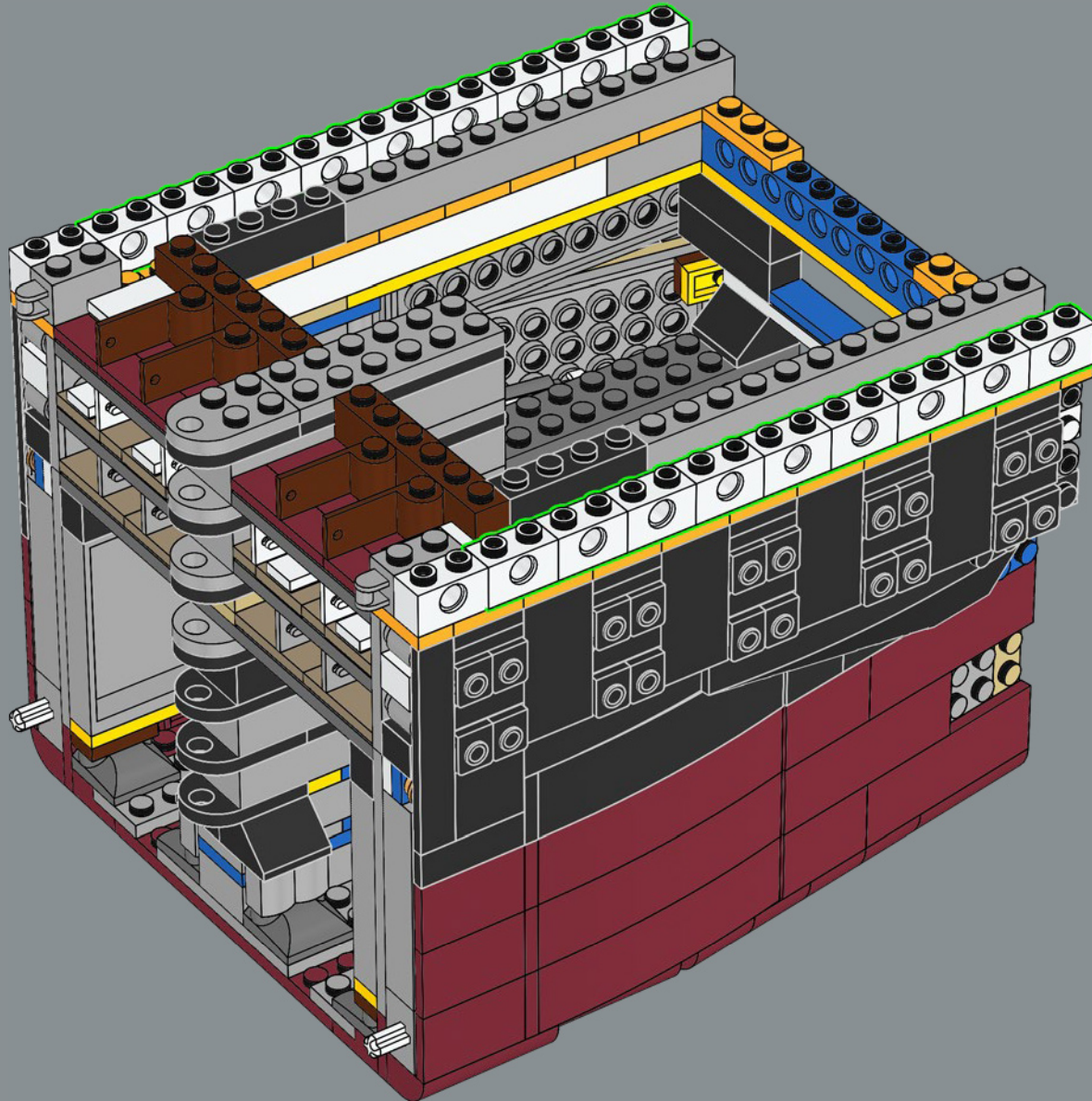

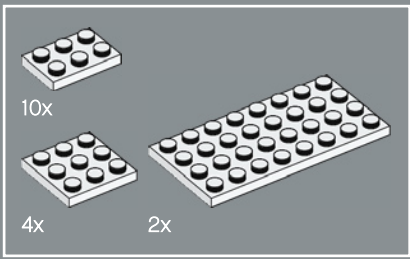

94

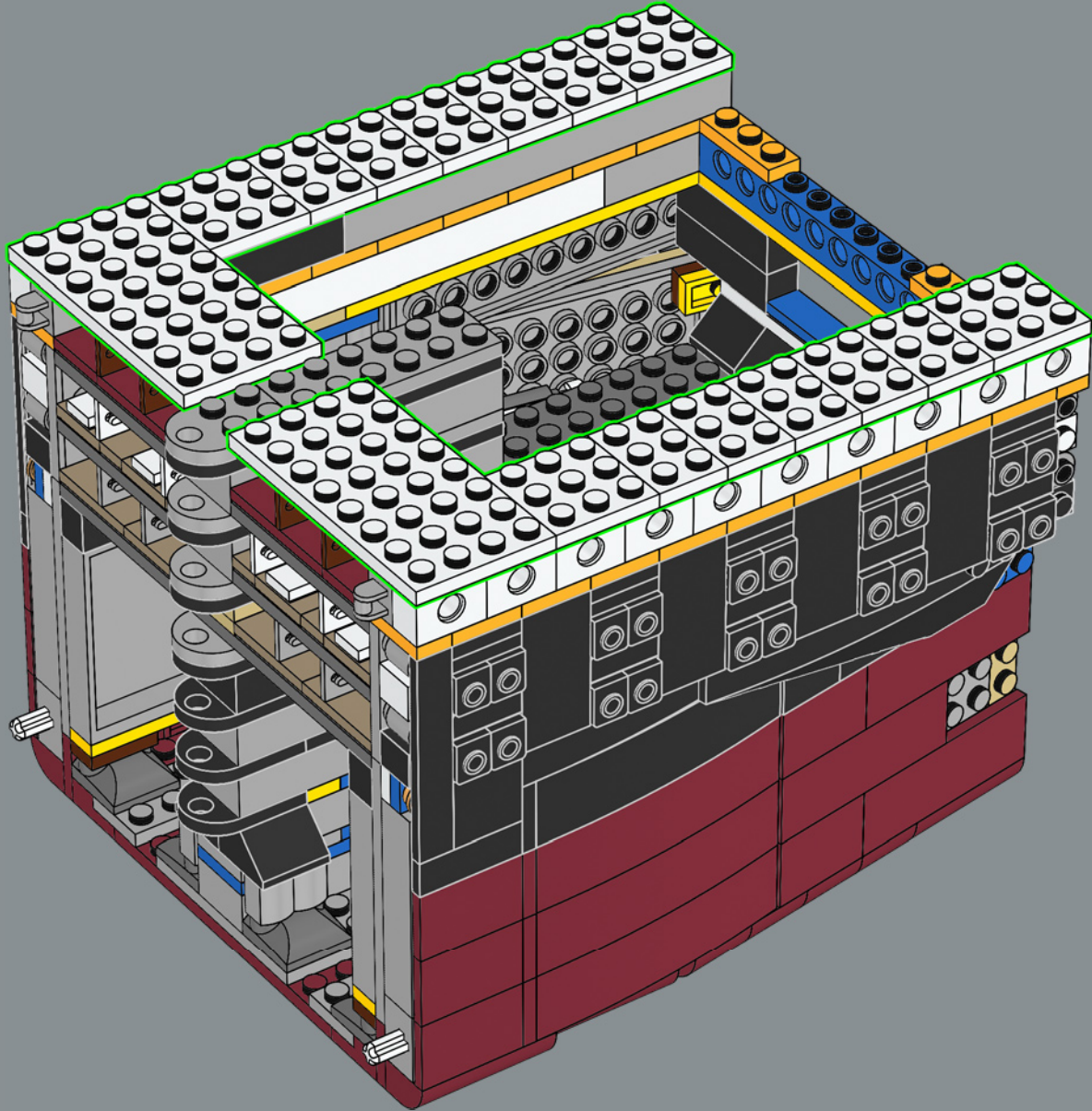

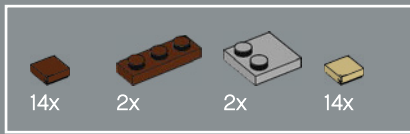

95

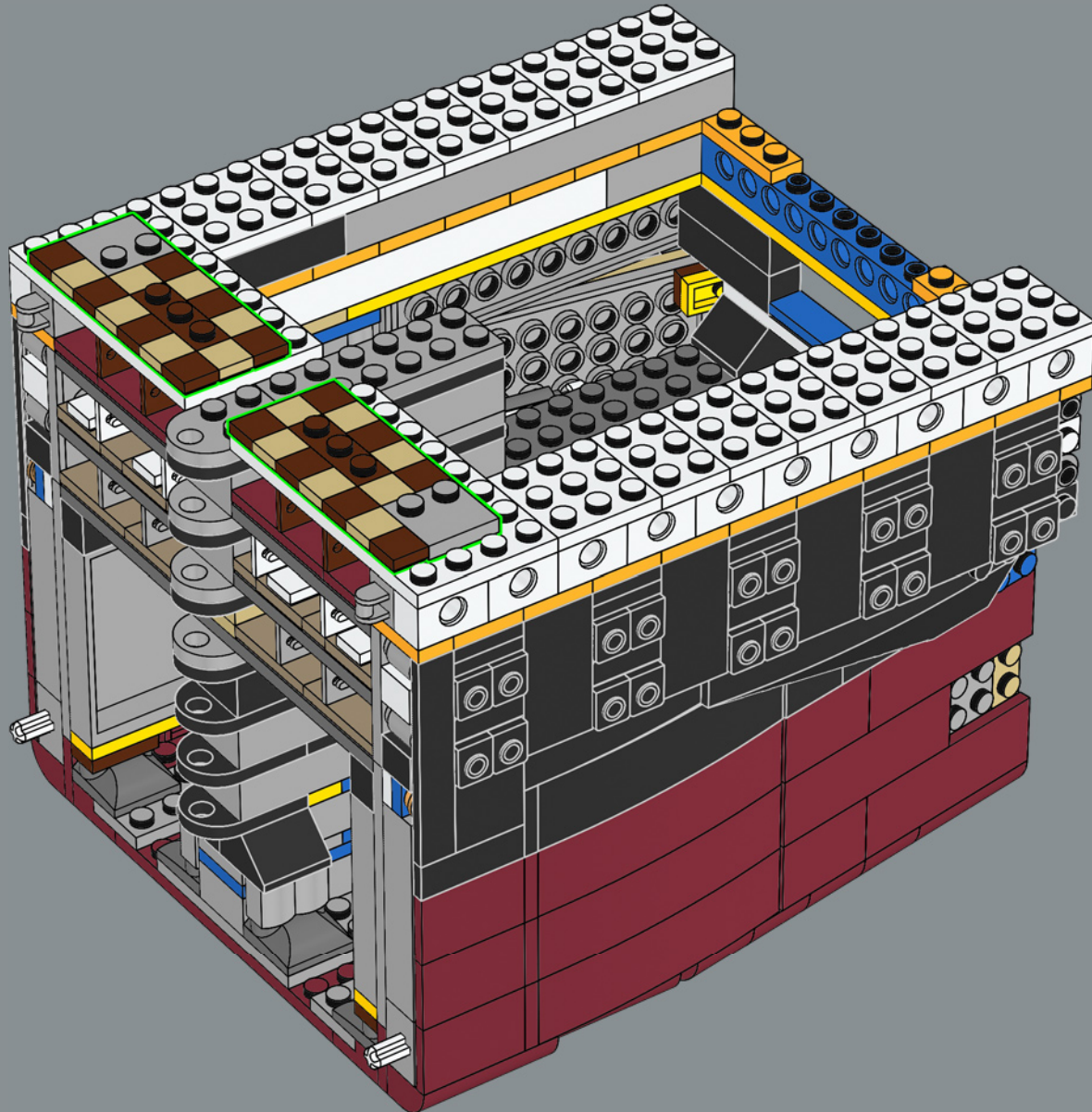

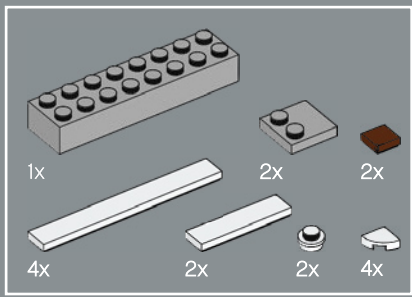

96

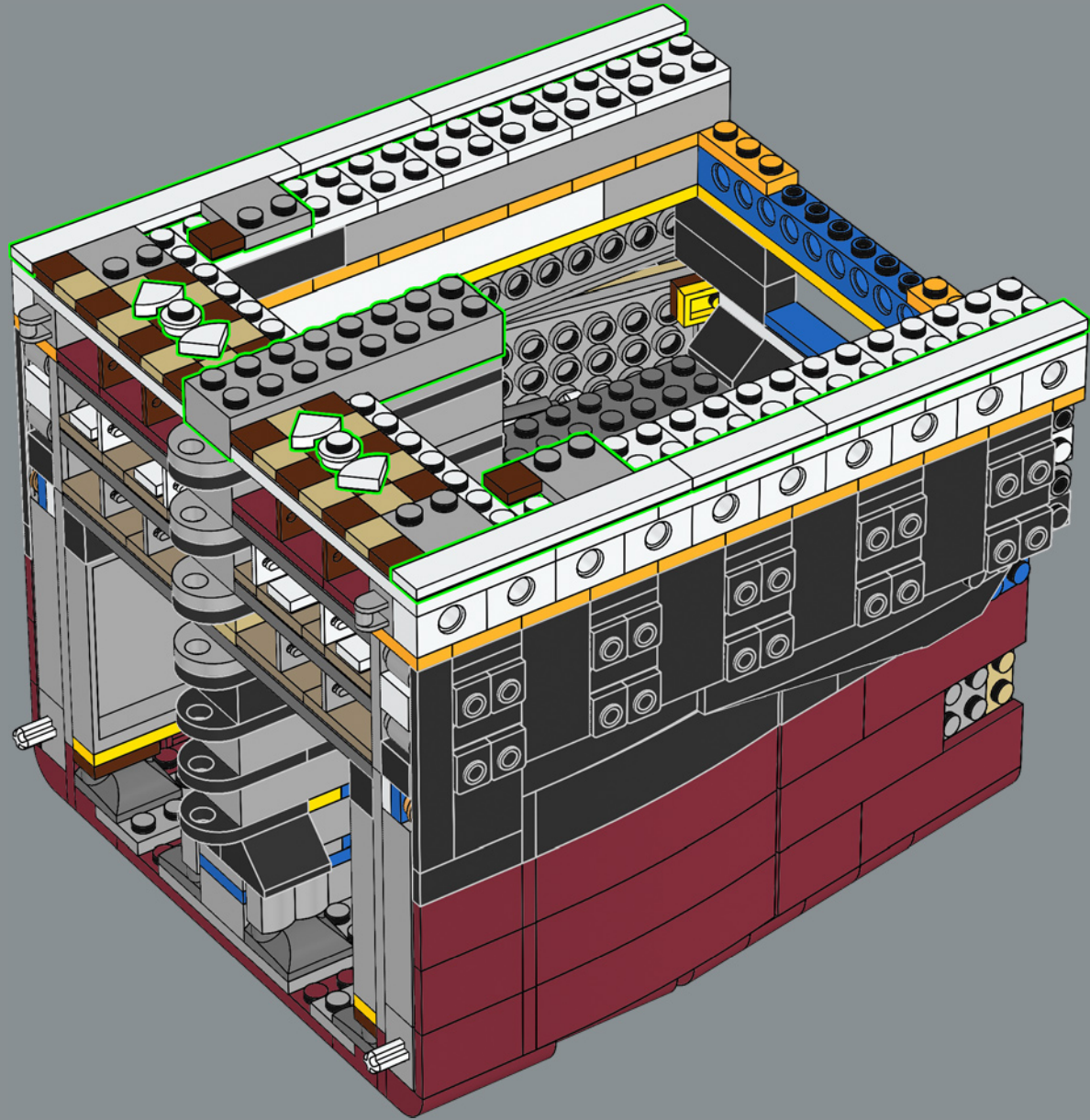

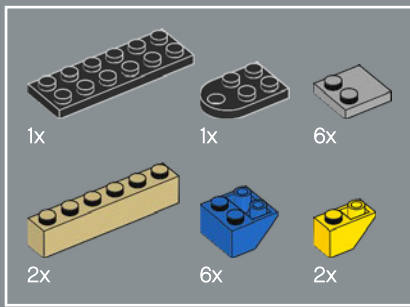

97

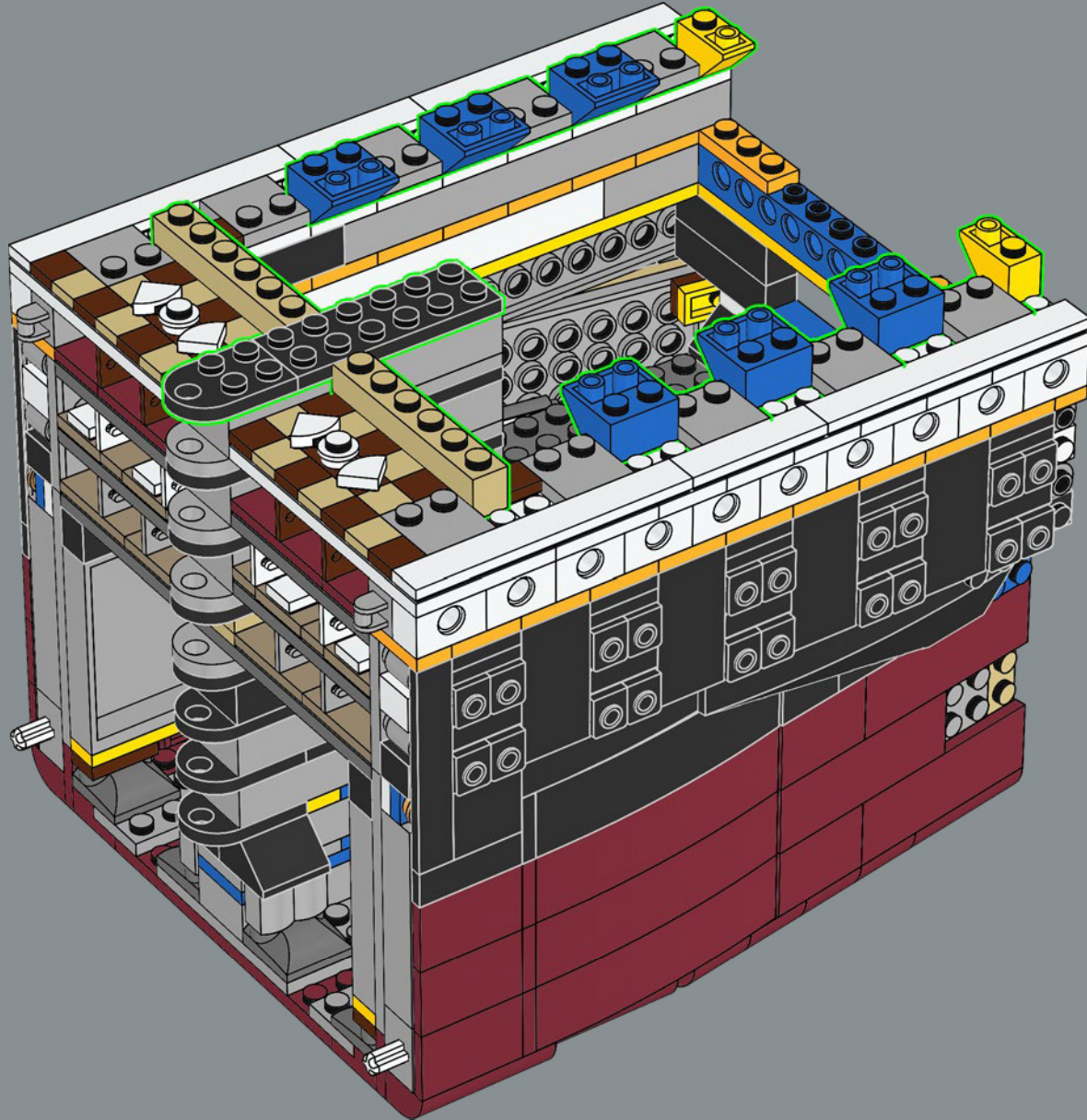

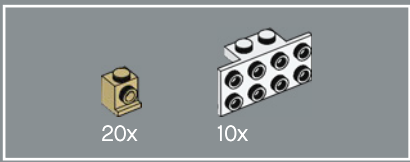

98

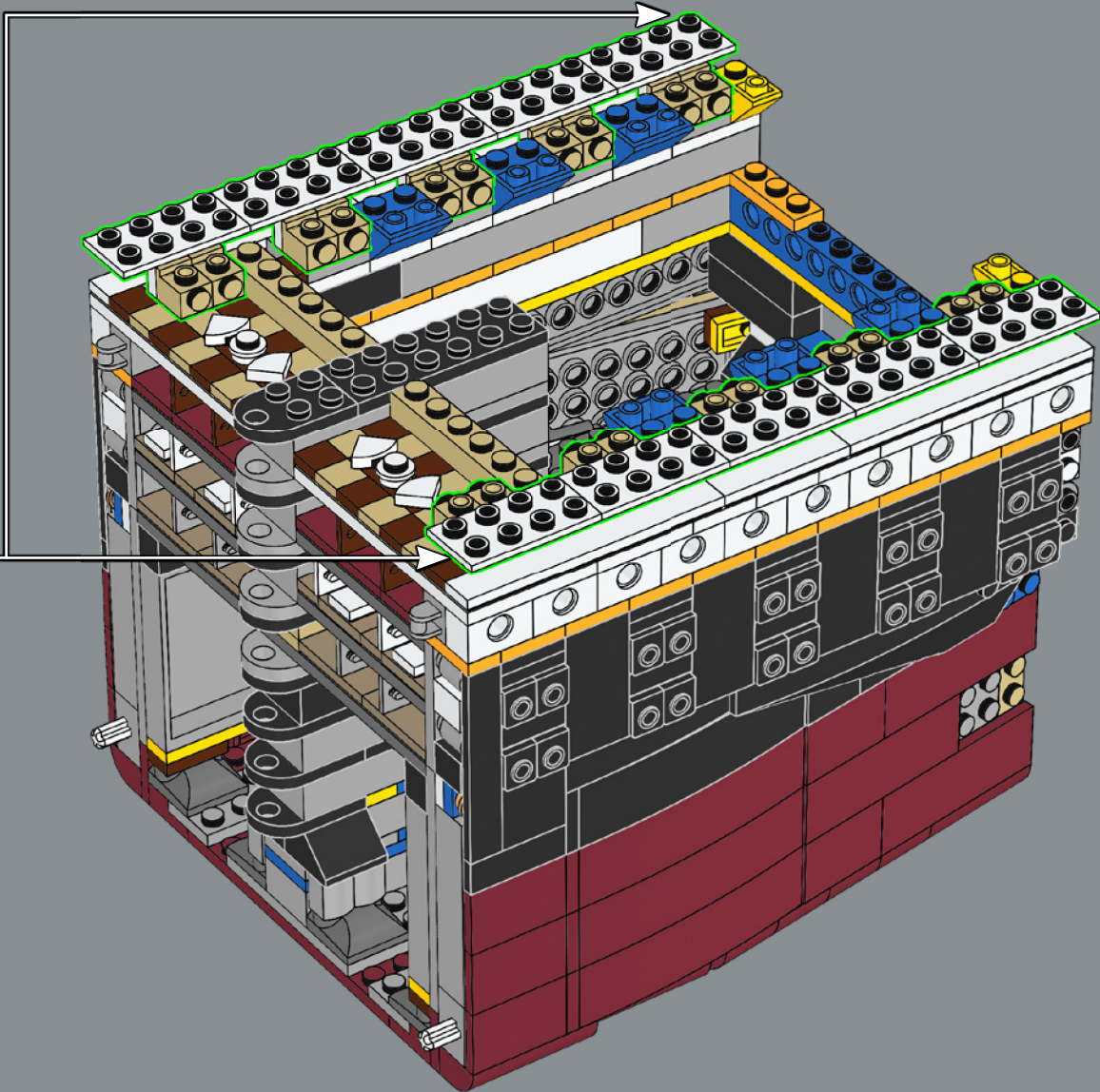
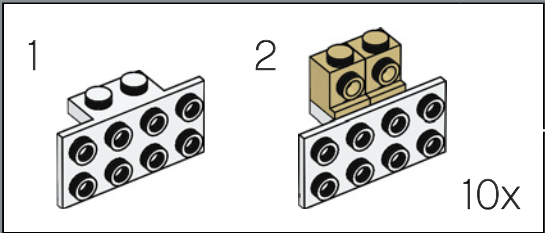

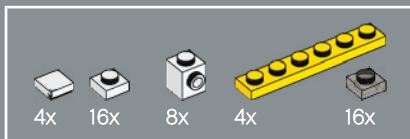

99

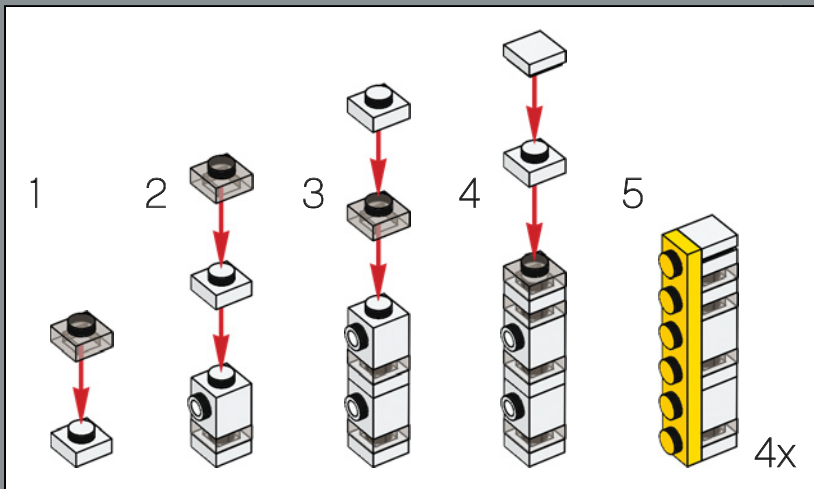
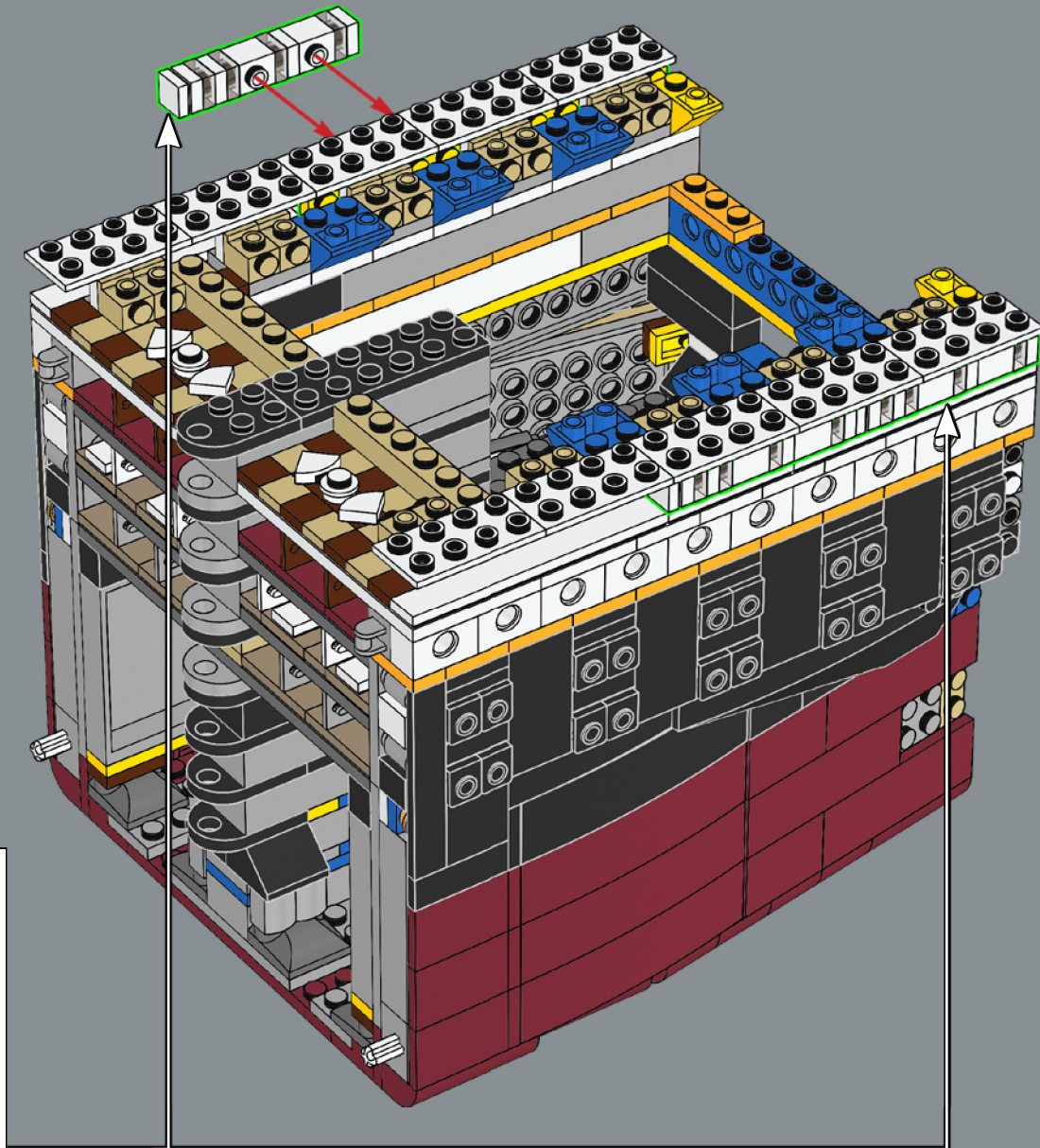

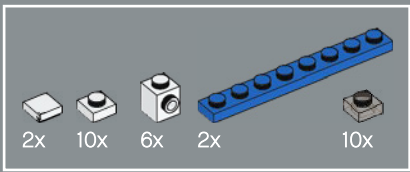

100

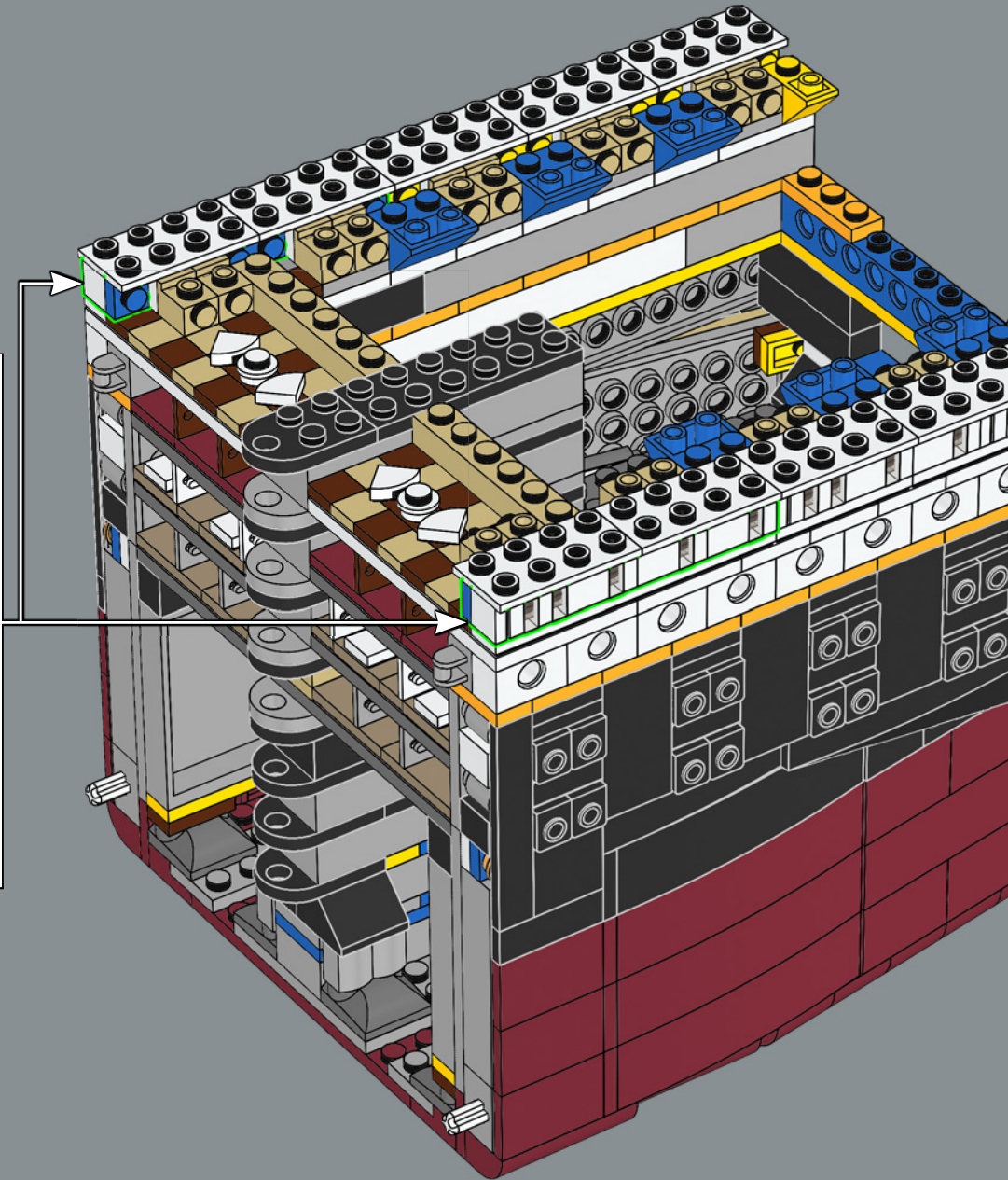
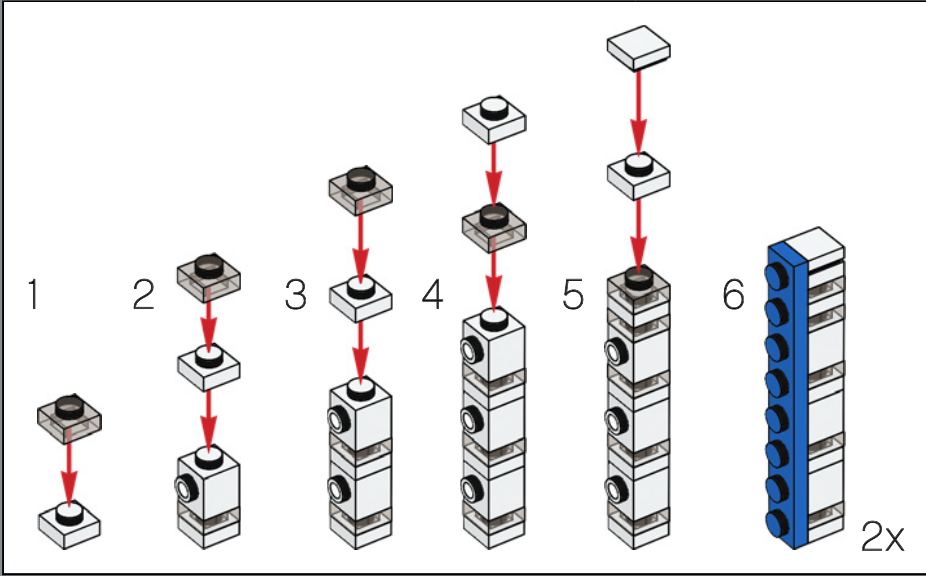

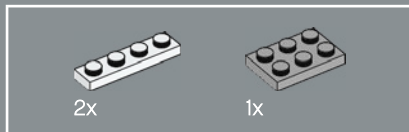
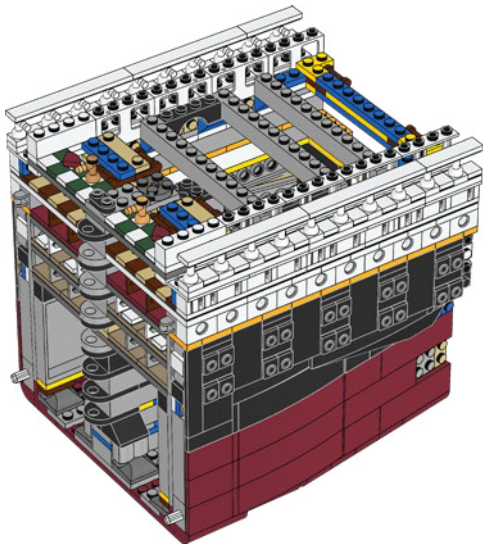
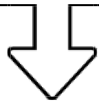

101

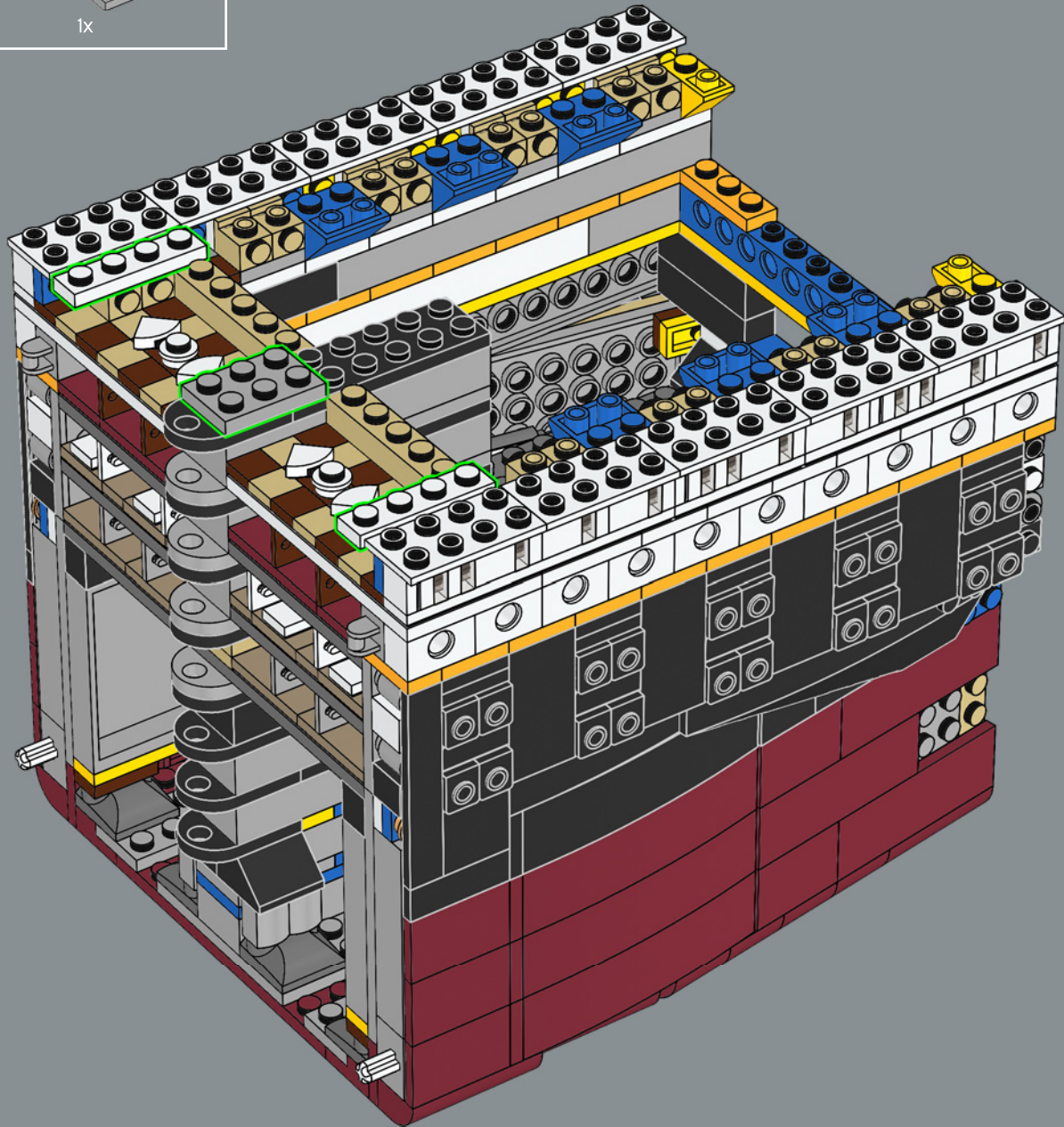

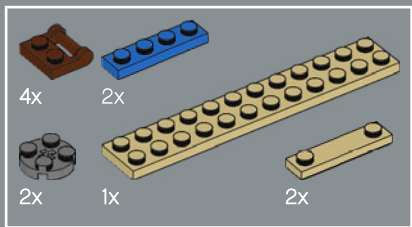

102

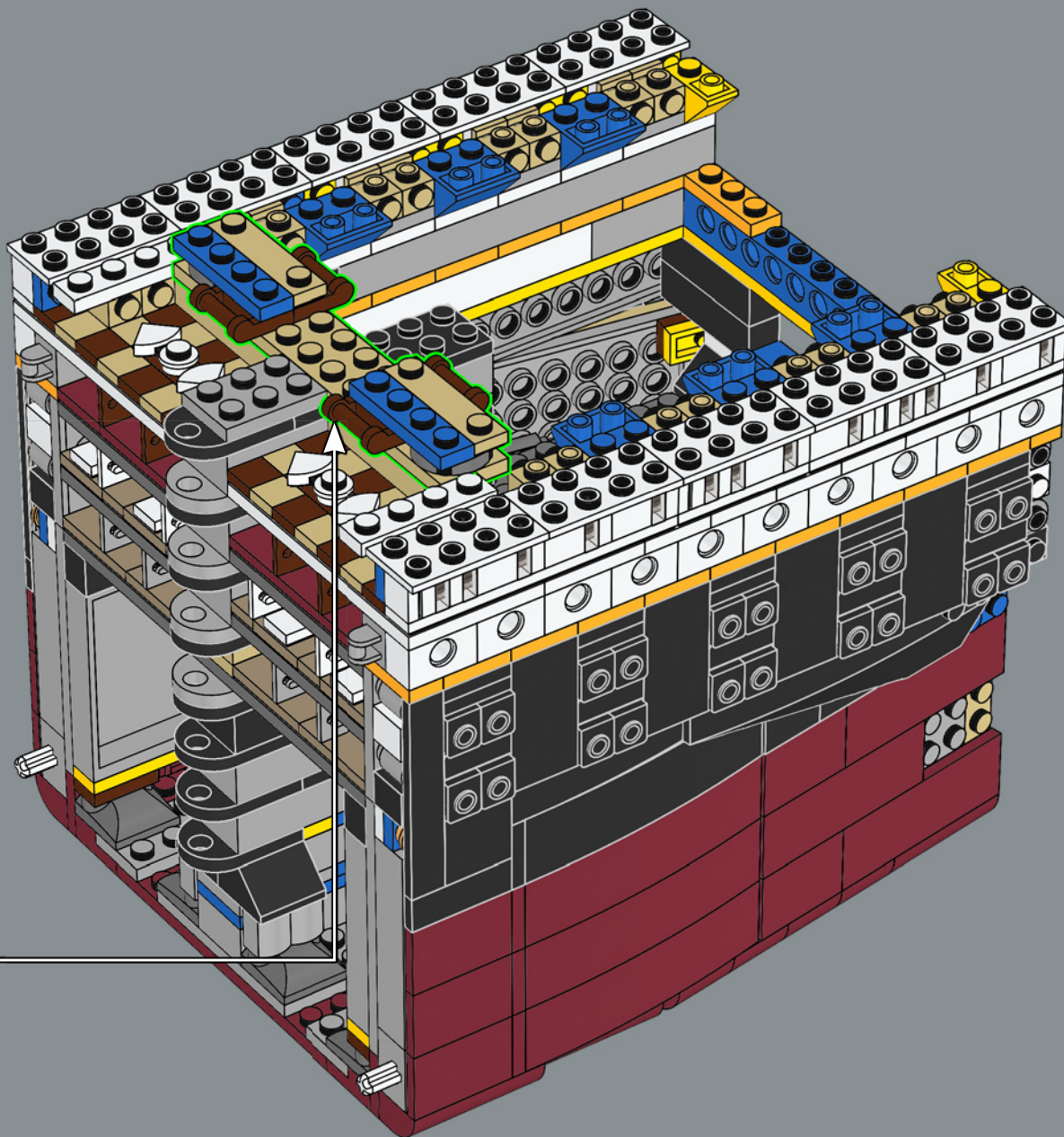
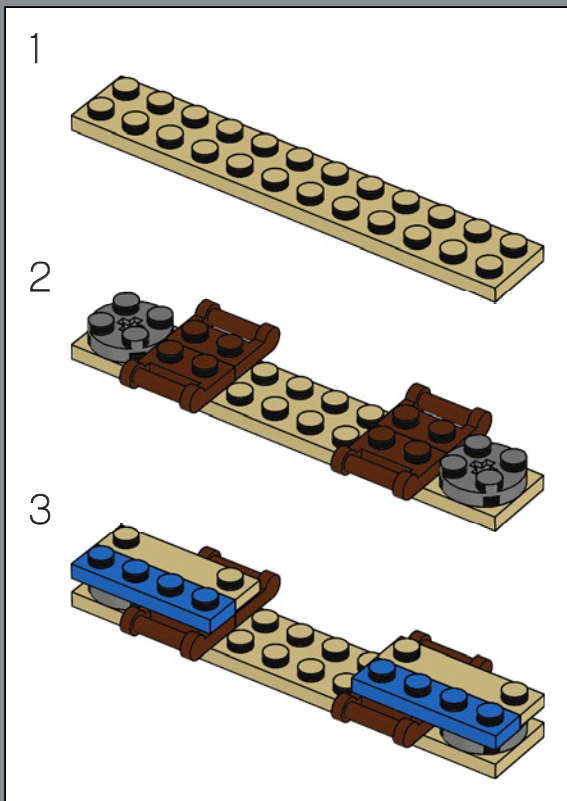

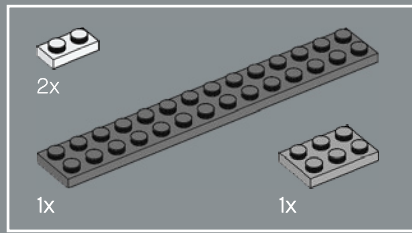

103

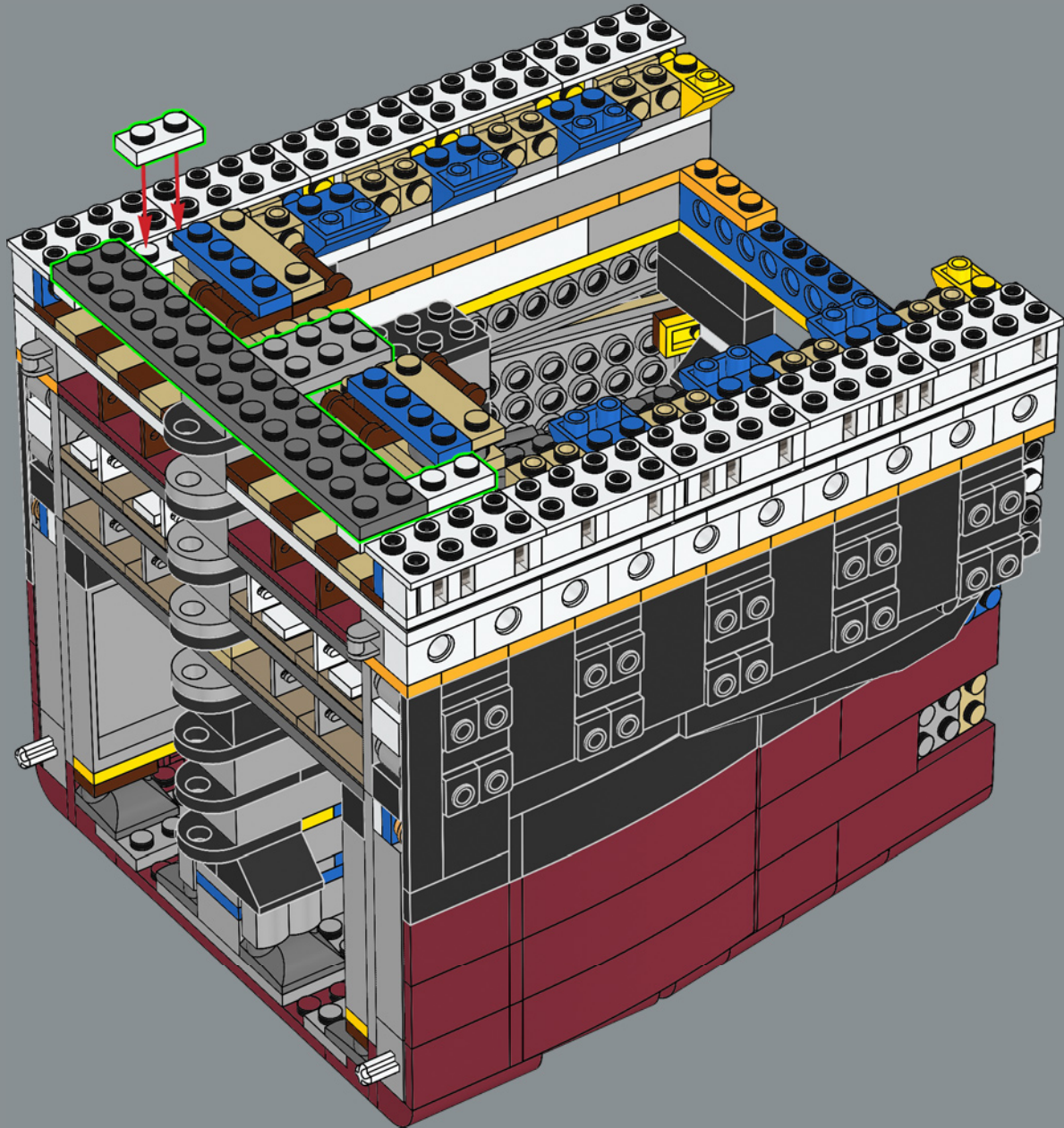

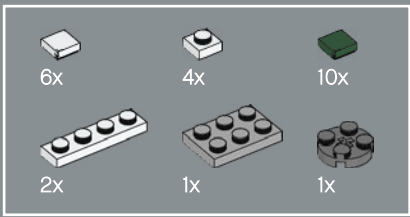

104

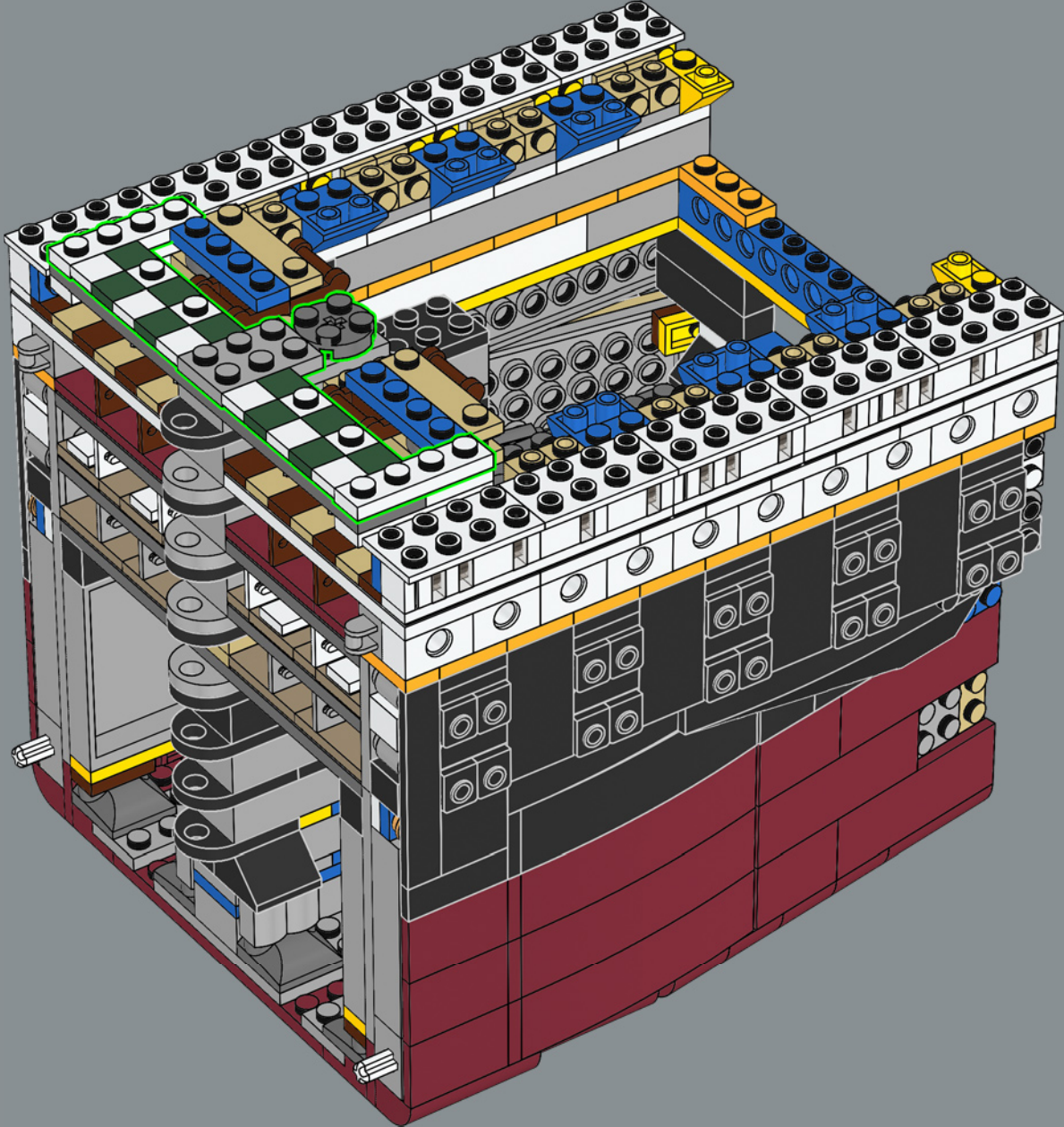

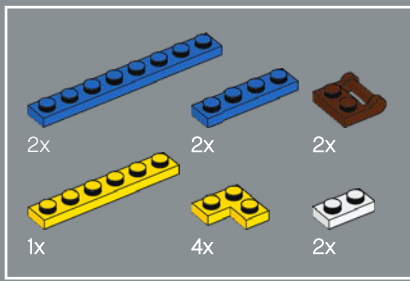

105

1

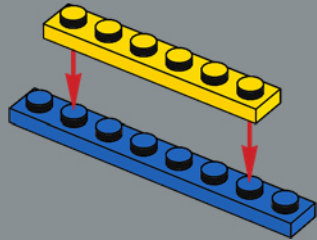

2

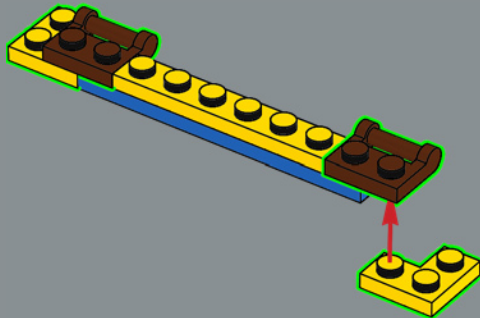

3

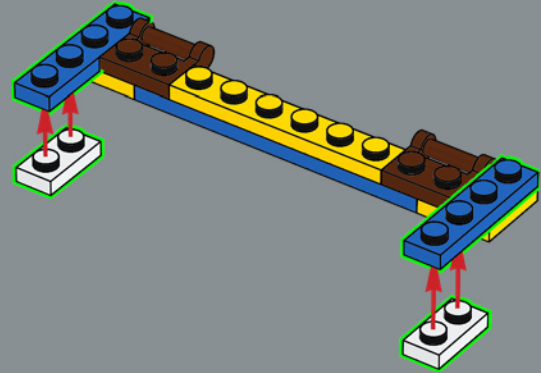

4

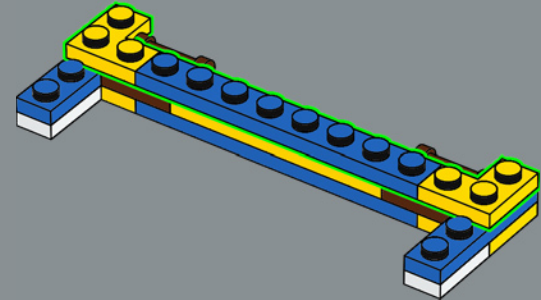

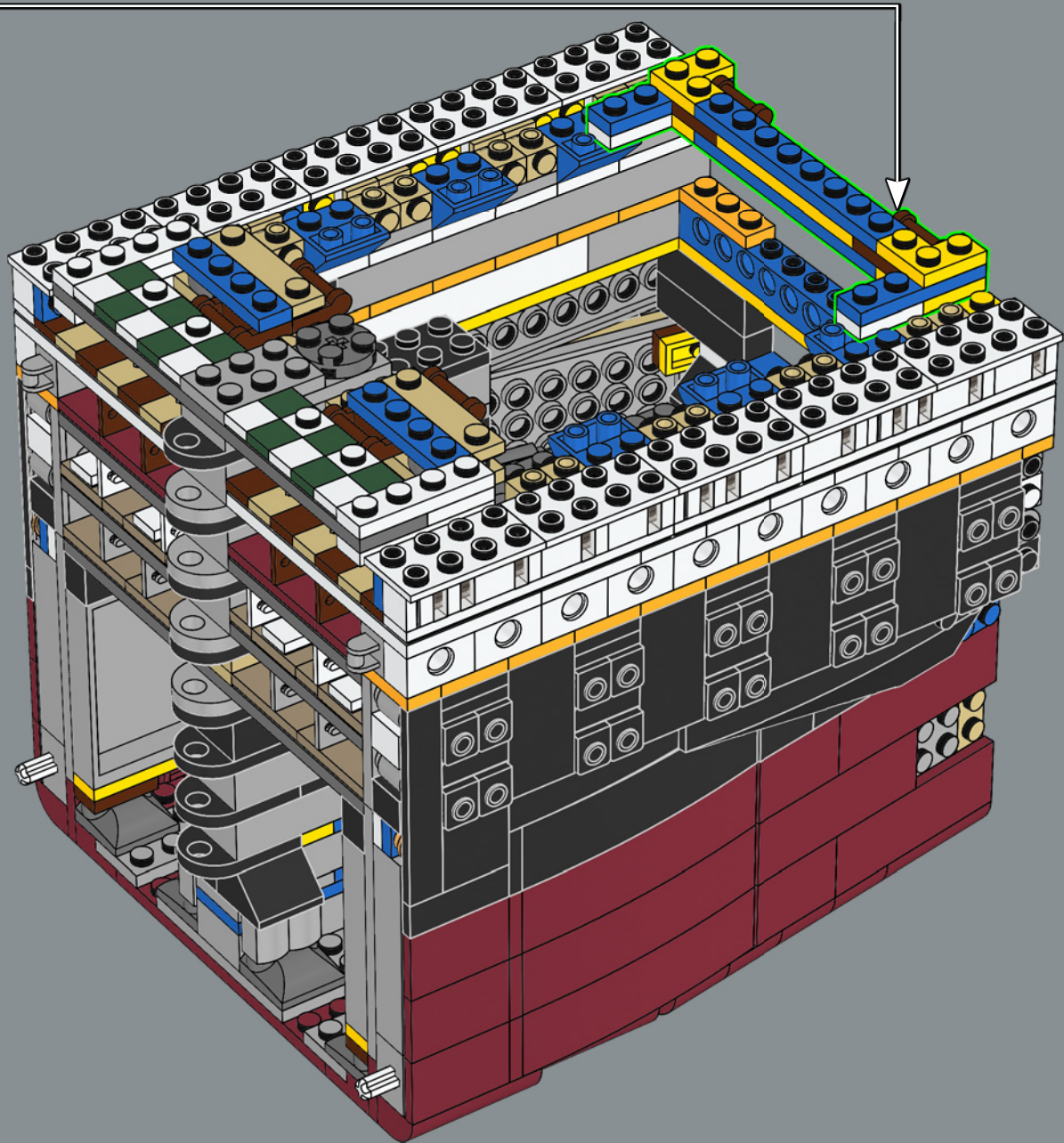

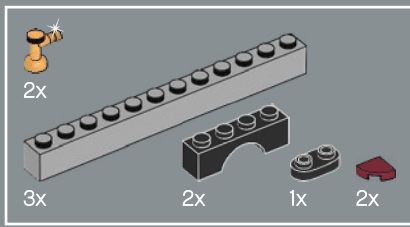

106

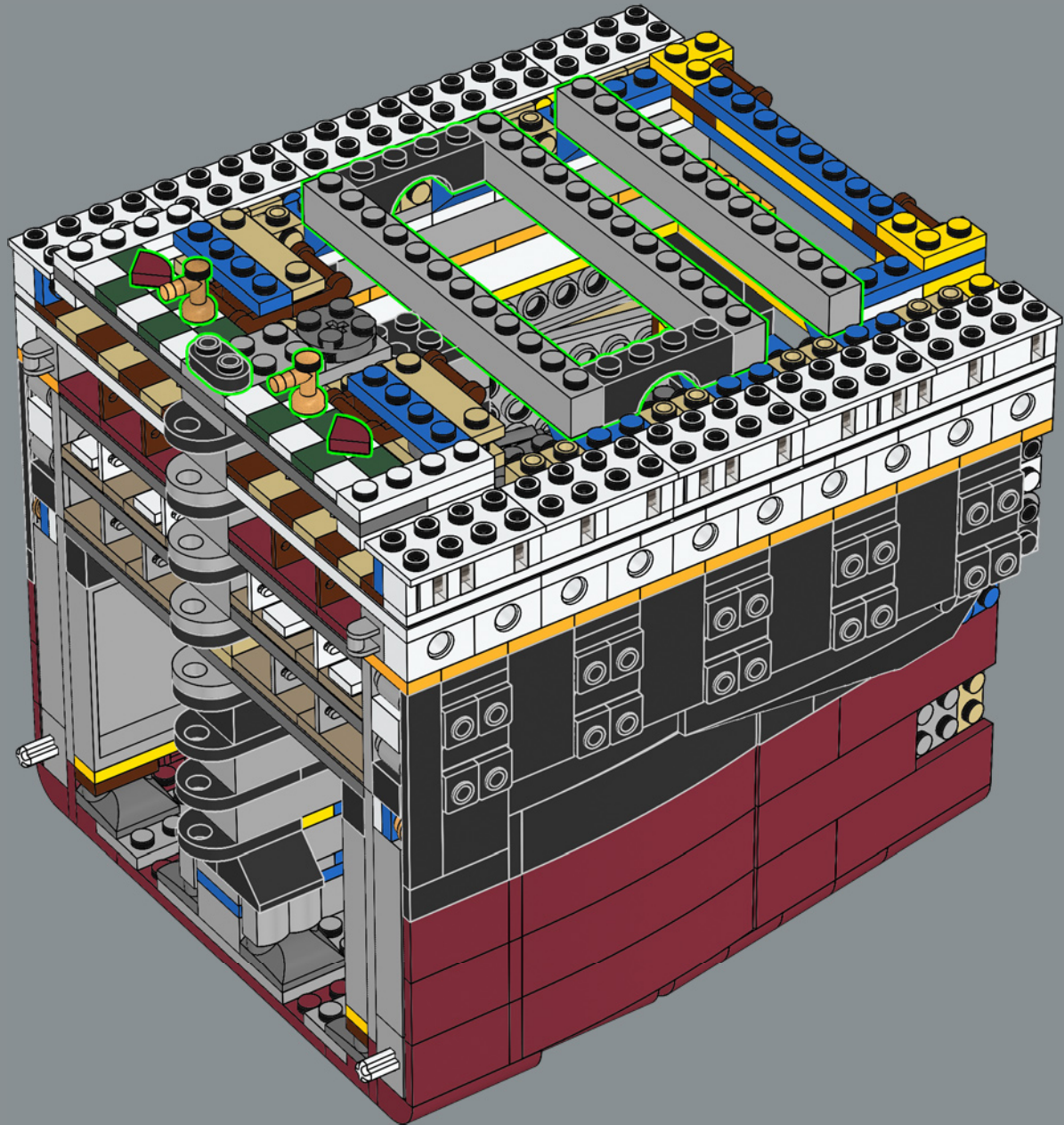

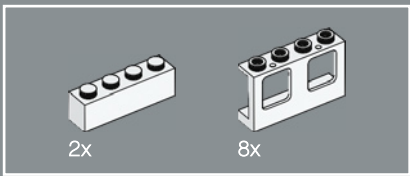

107

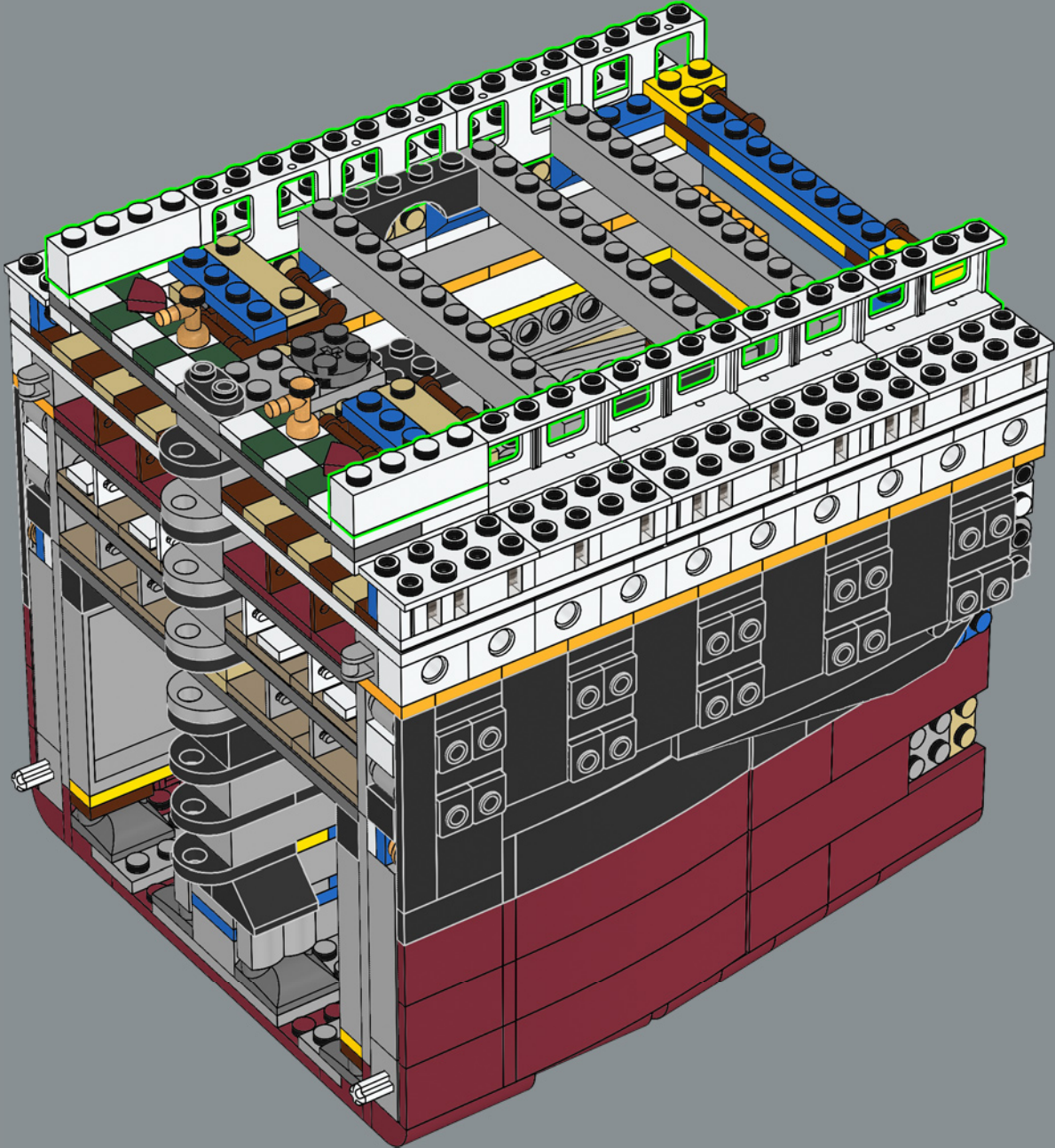

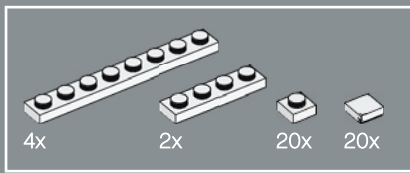

108

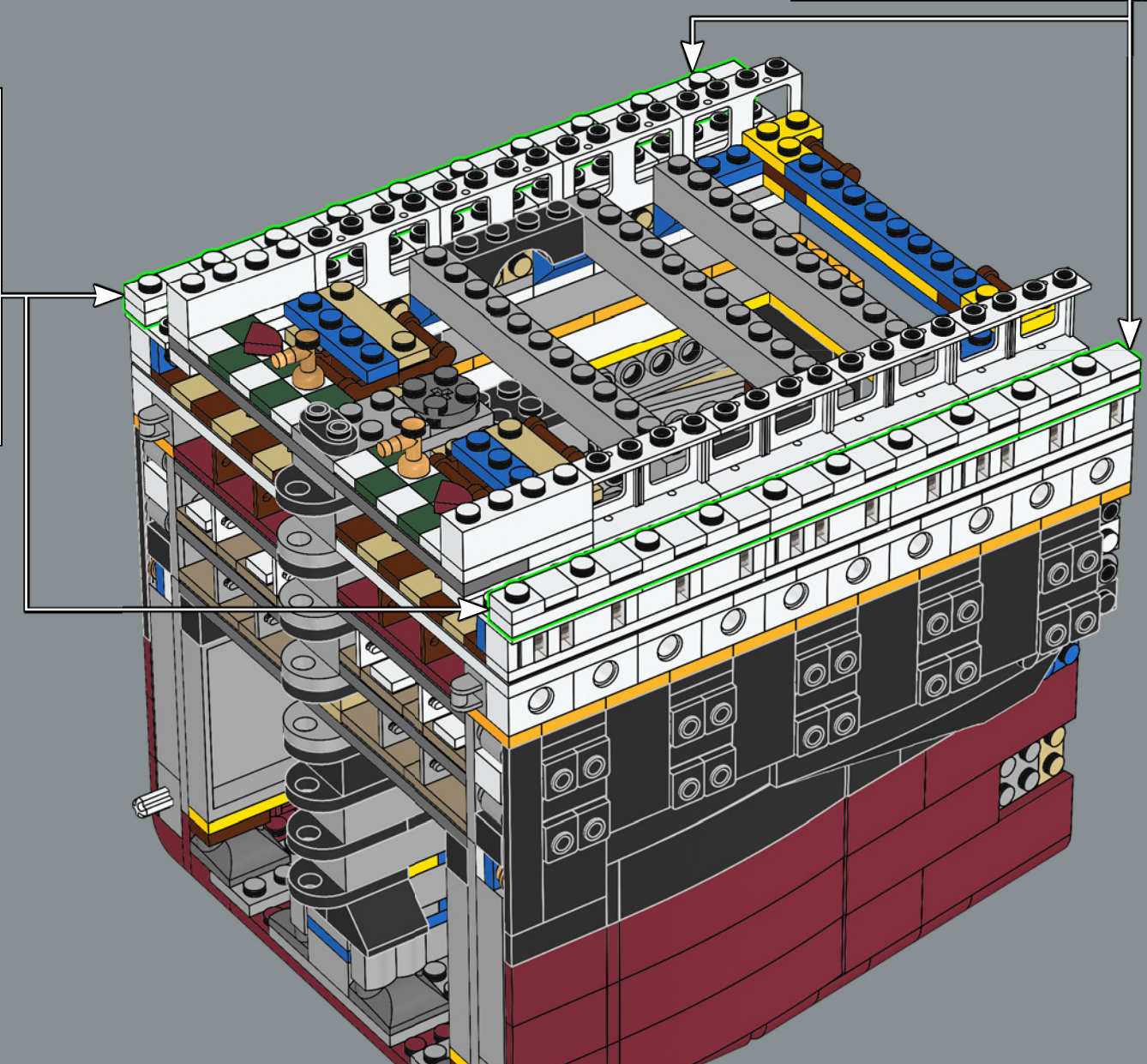
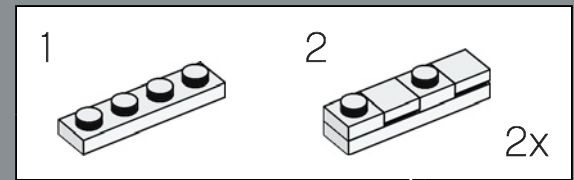
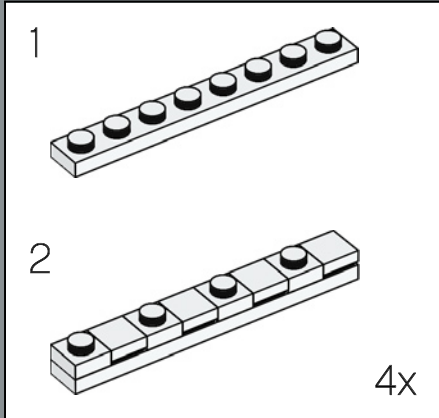



20x

109

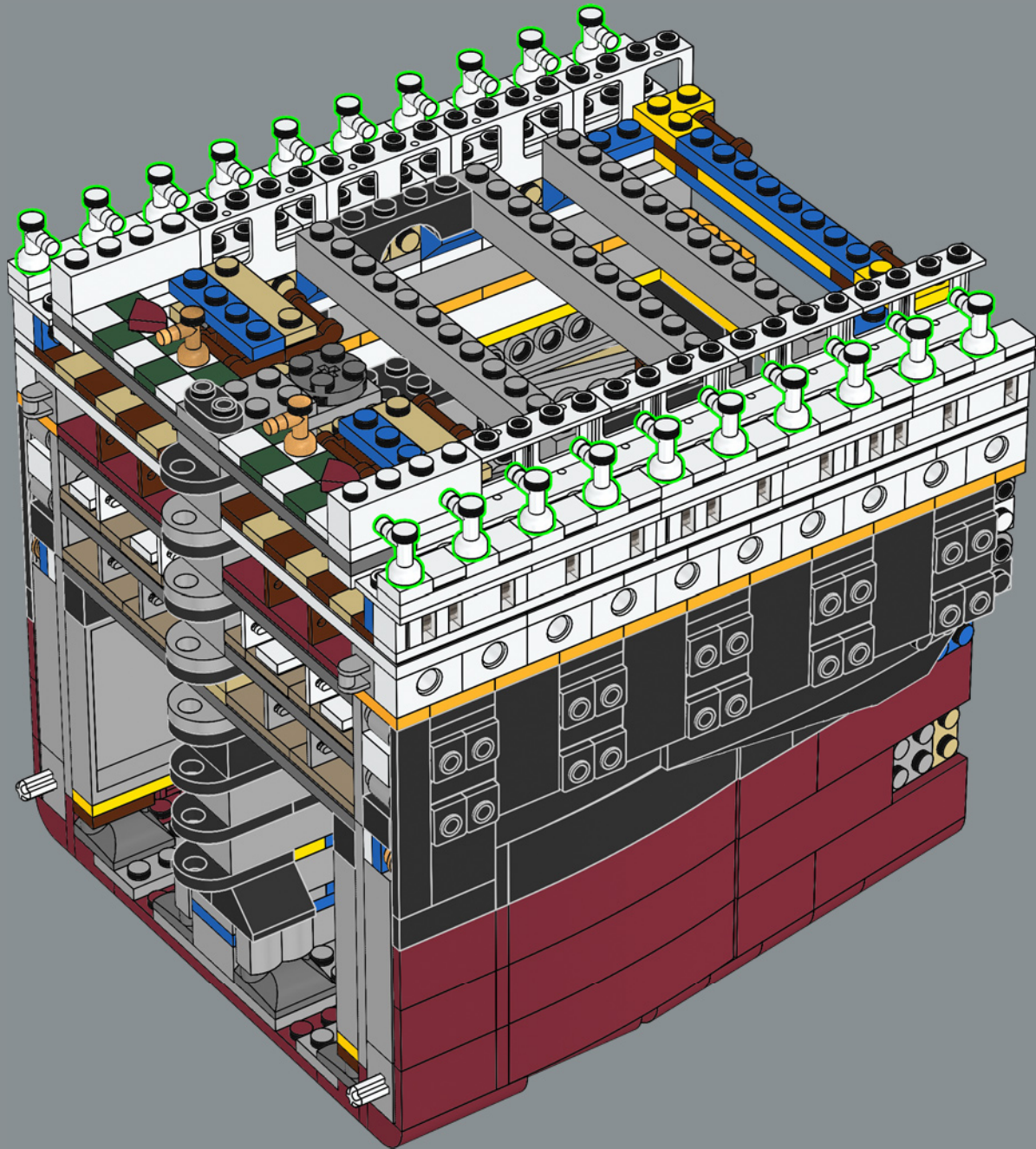

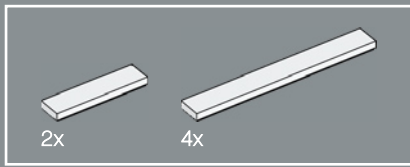

110

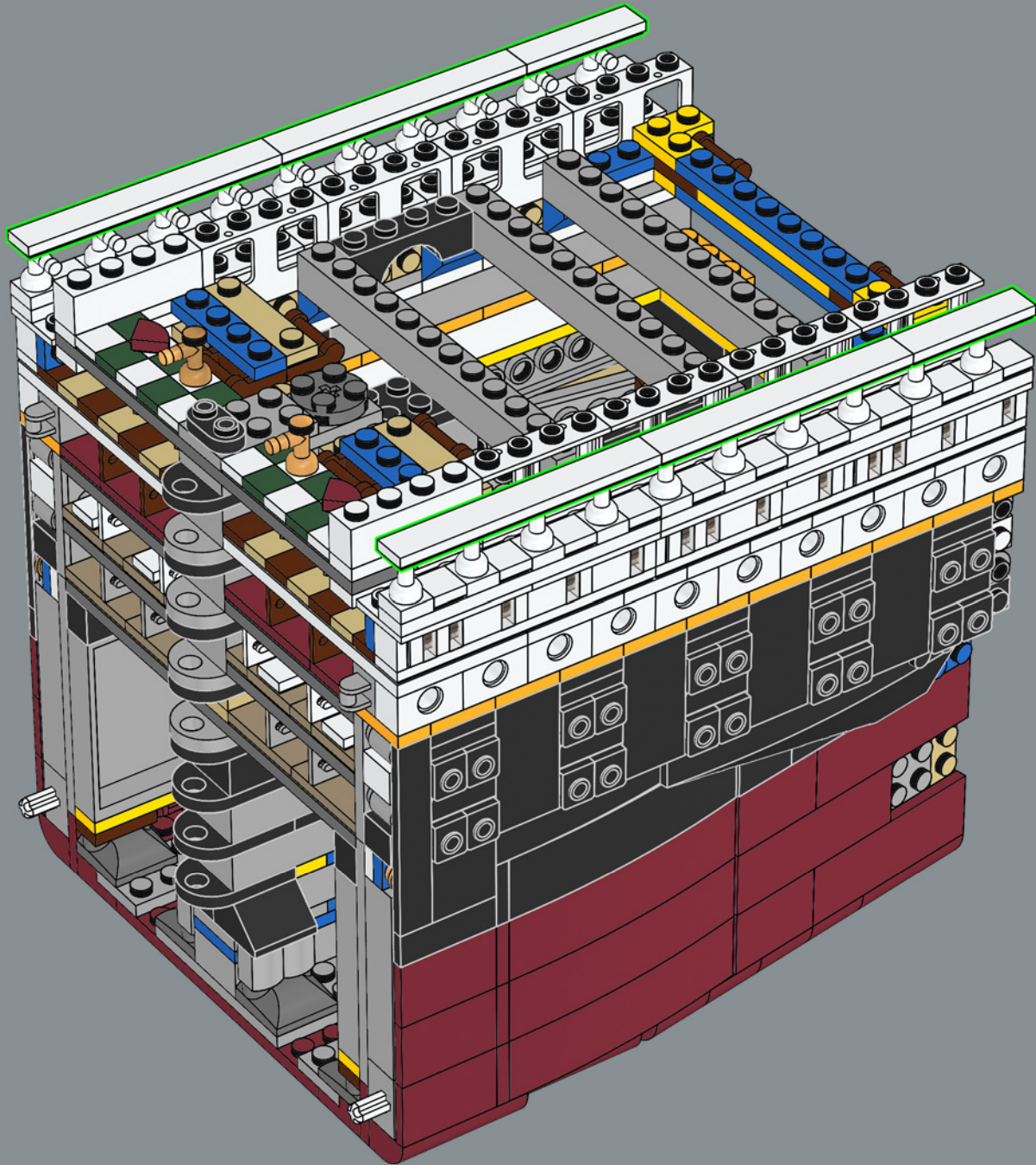

34

2x

4x

2x

111

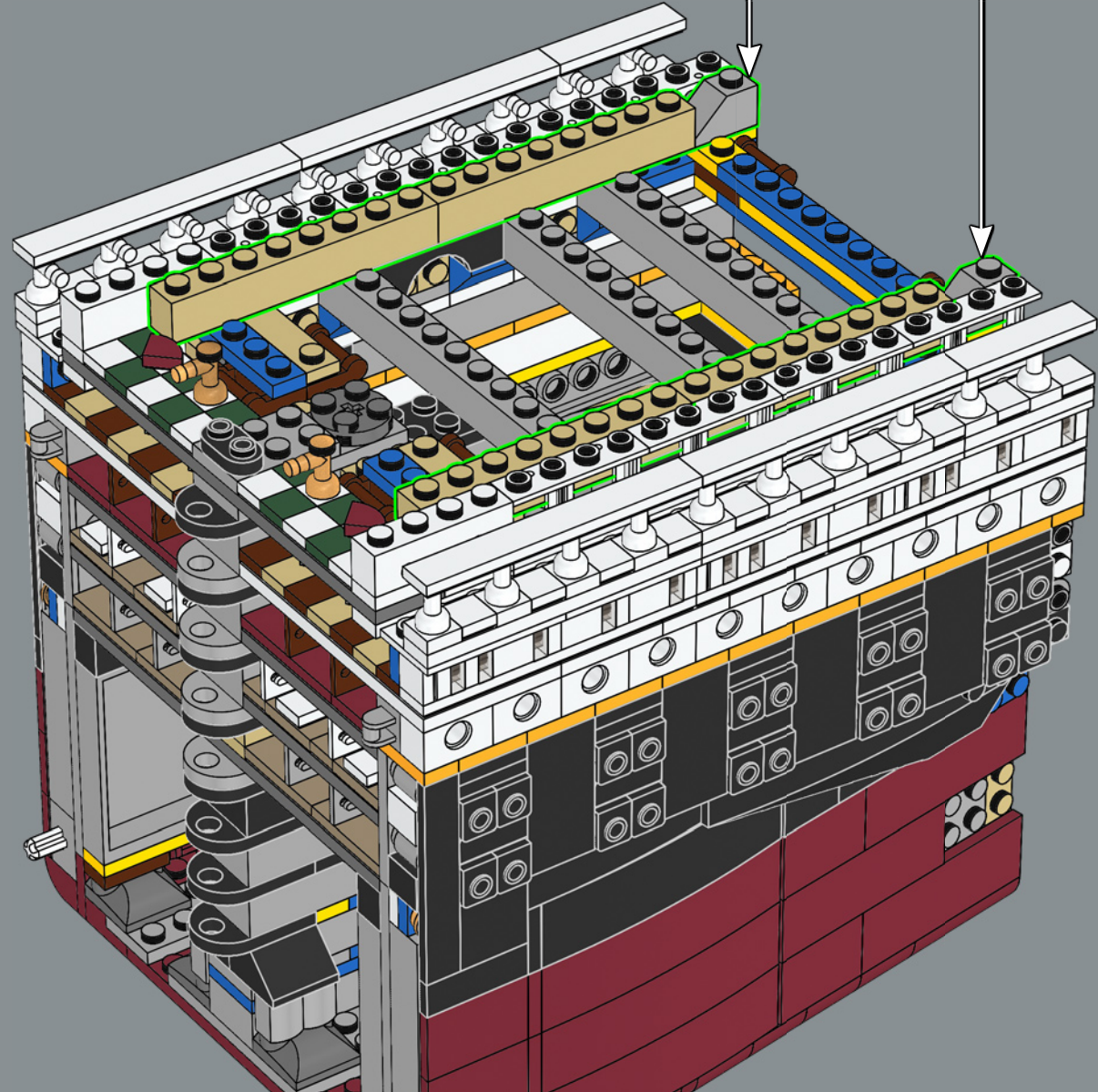

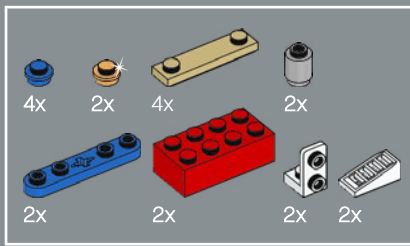

112

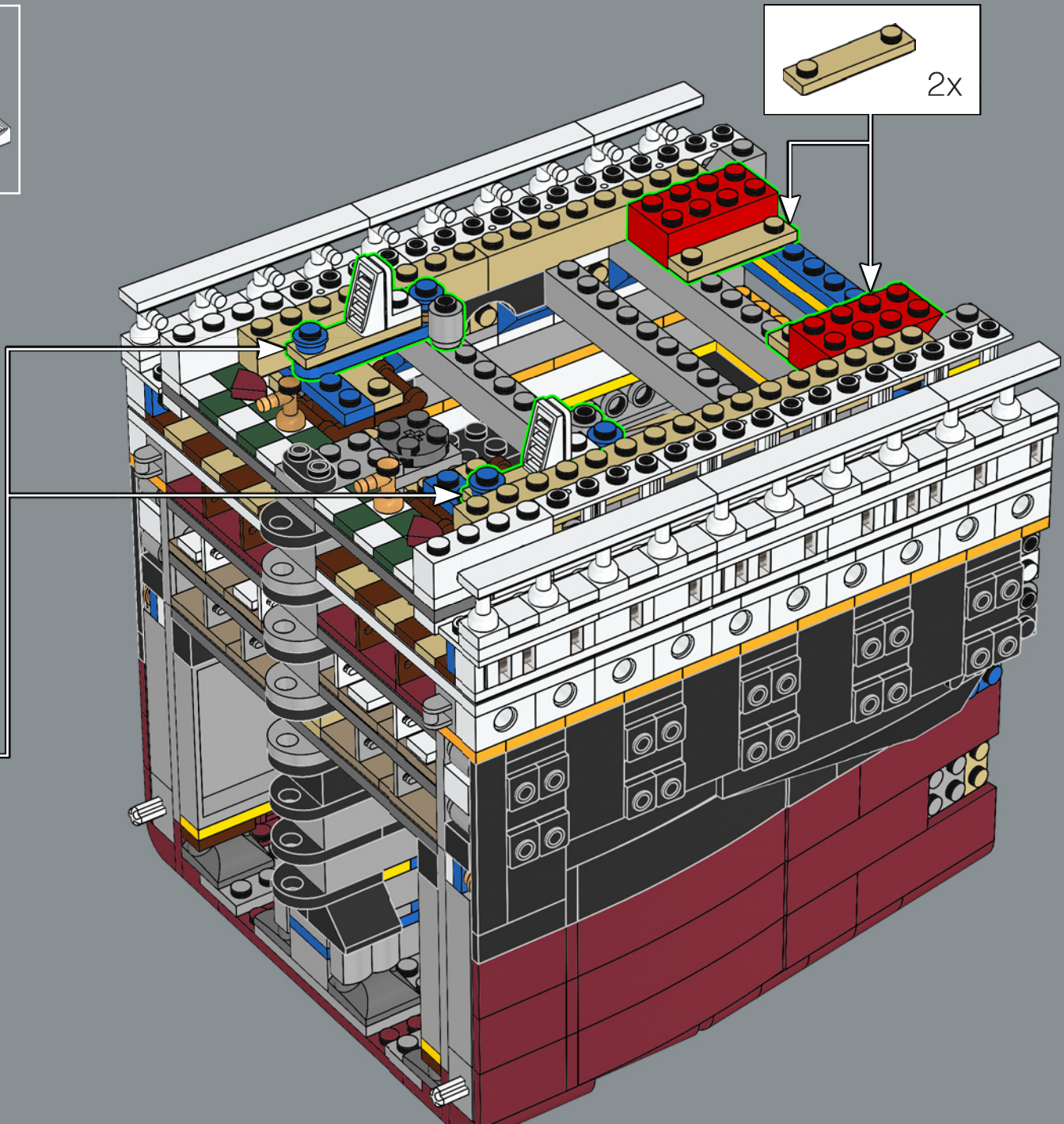
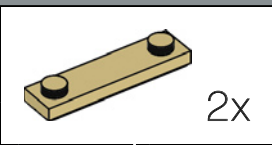
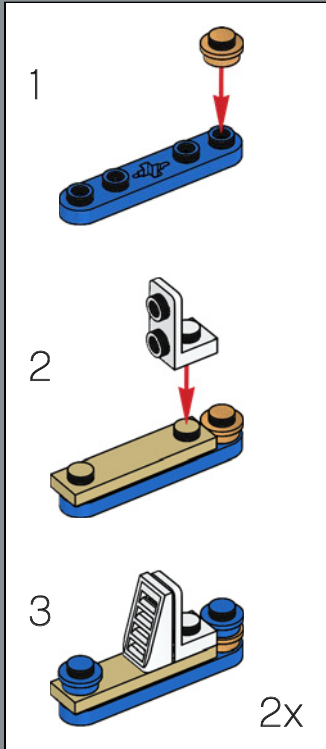

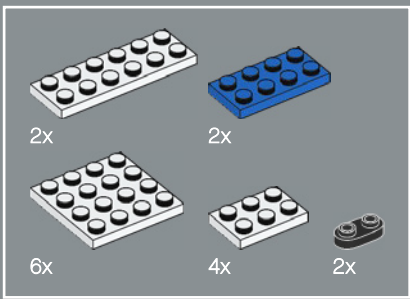

113

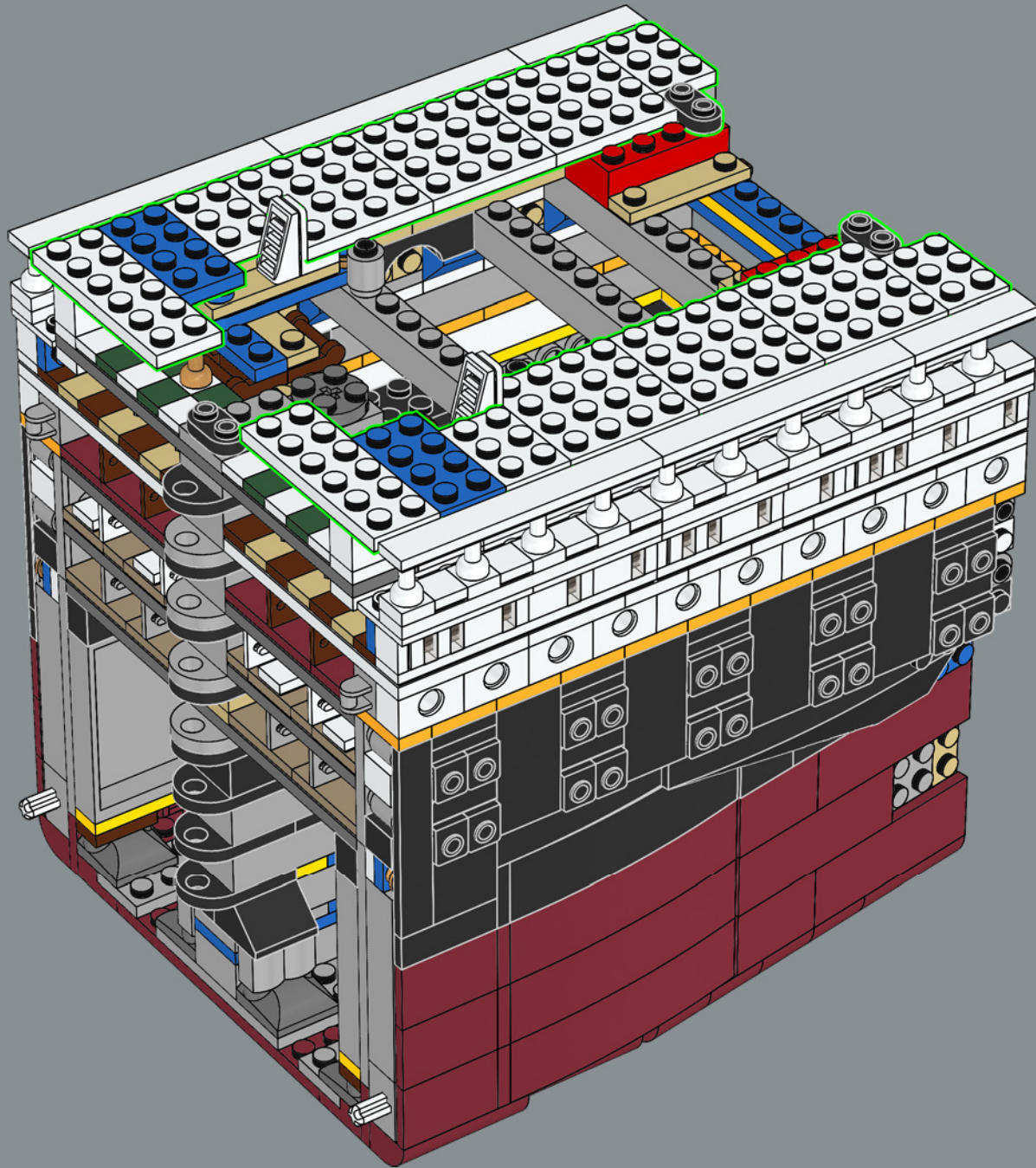

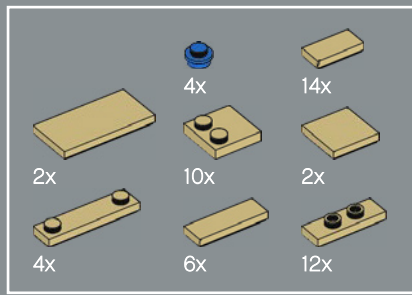

114

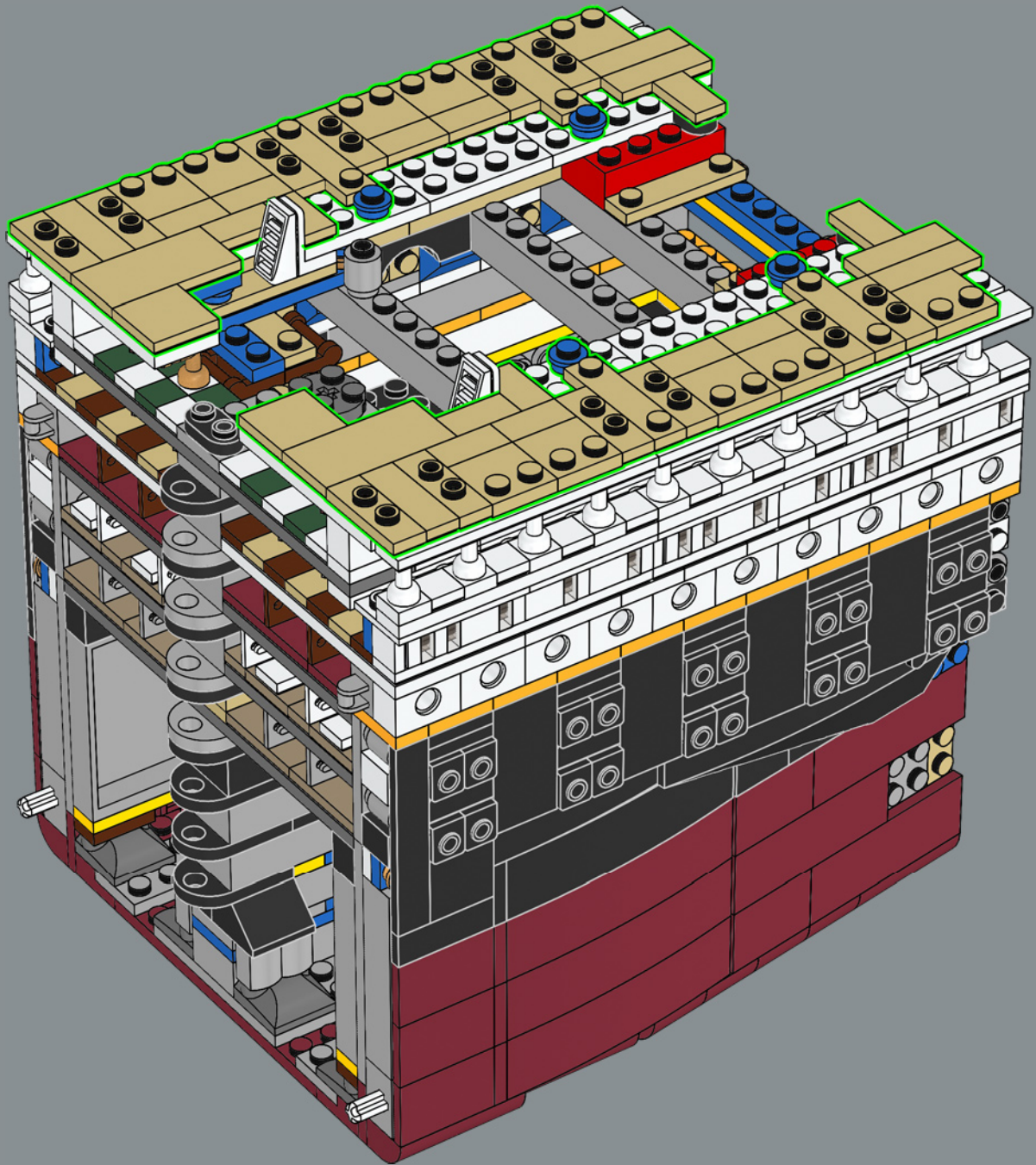

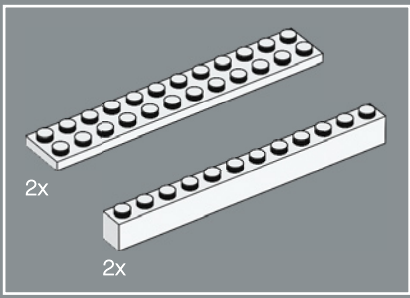

115

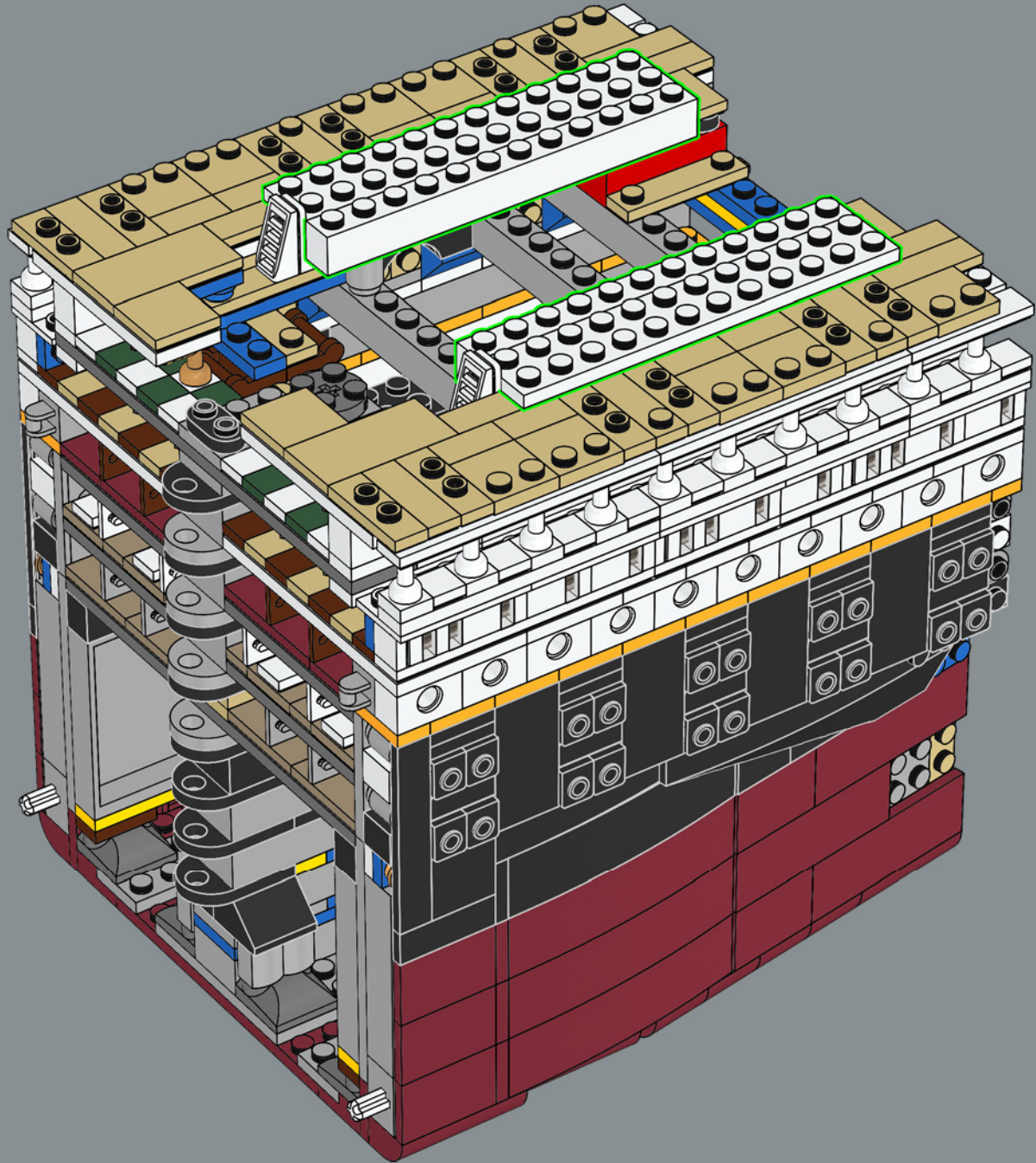

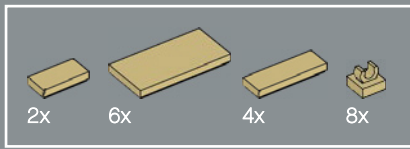

116

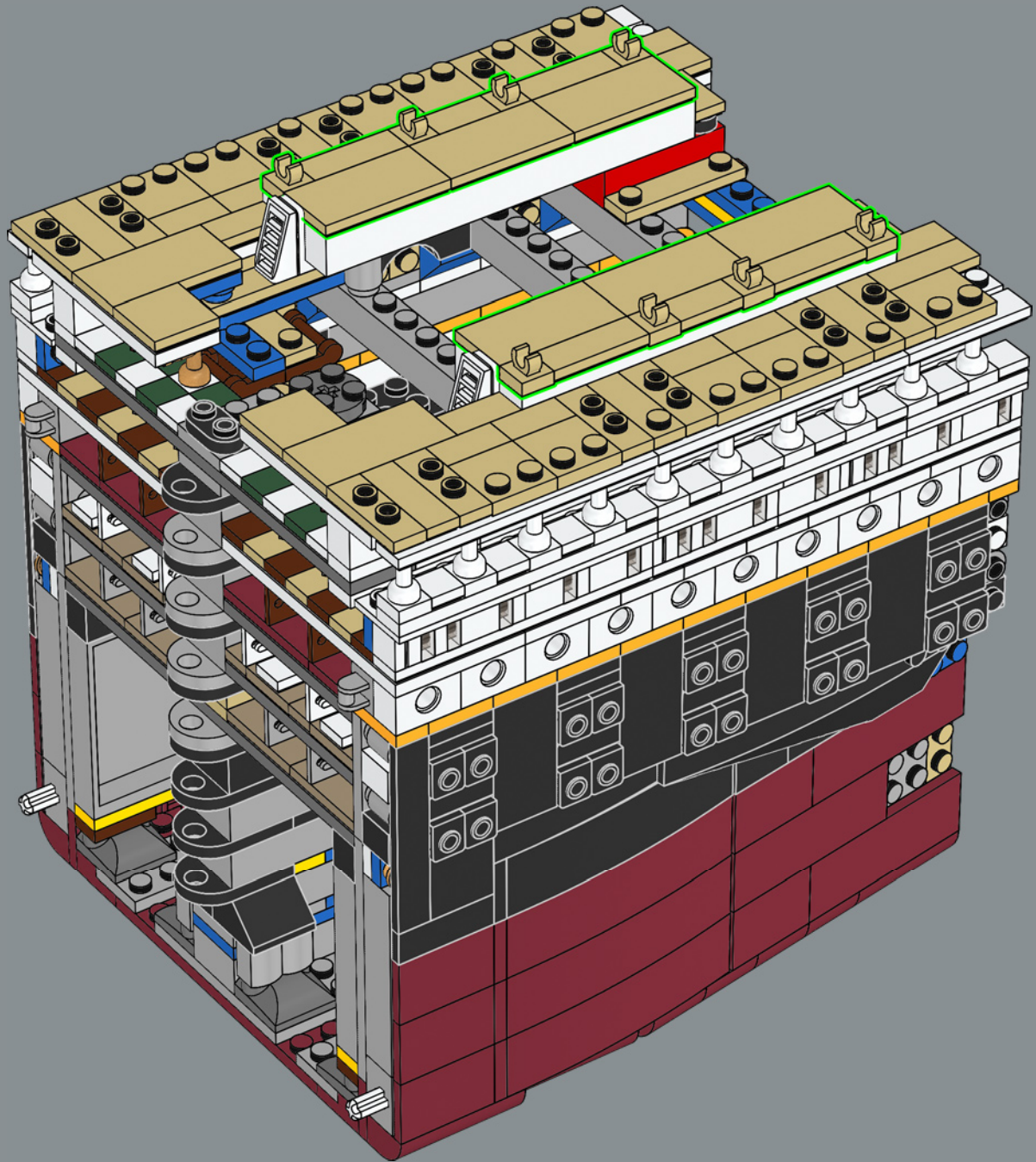

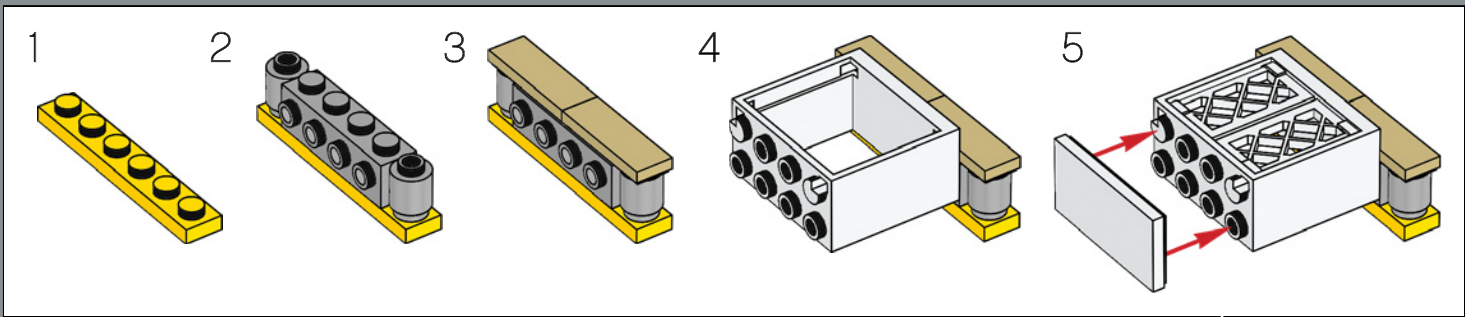
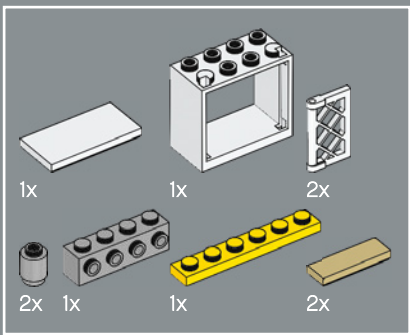

117

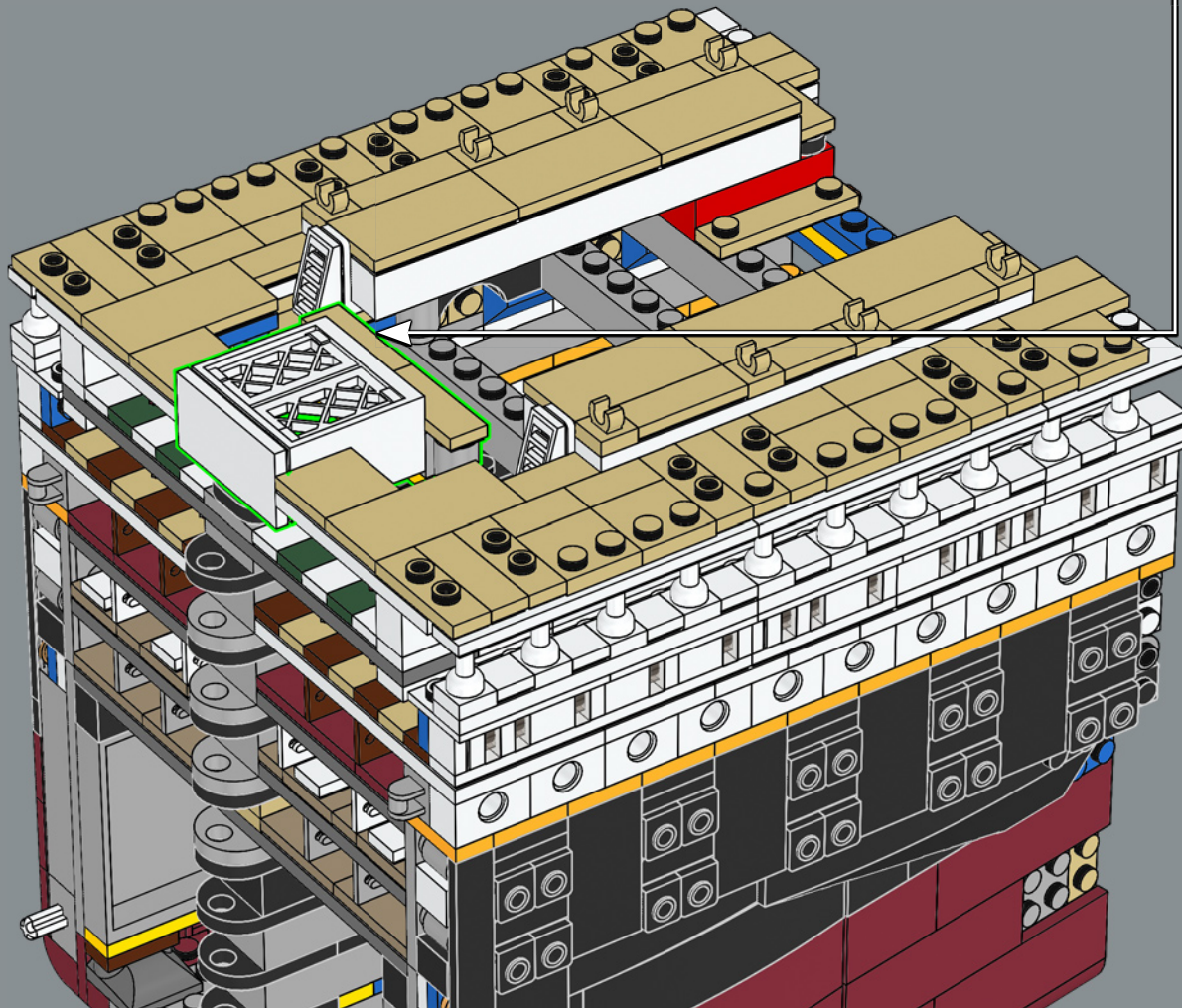

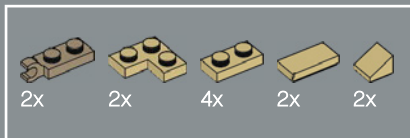

118

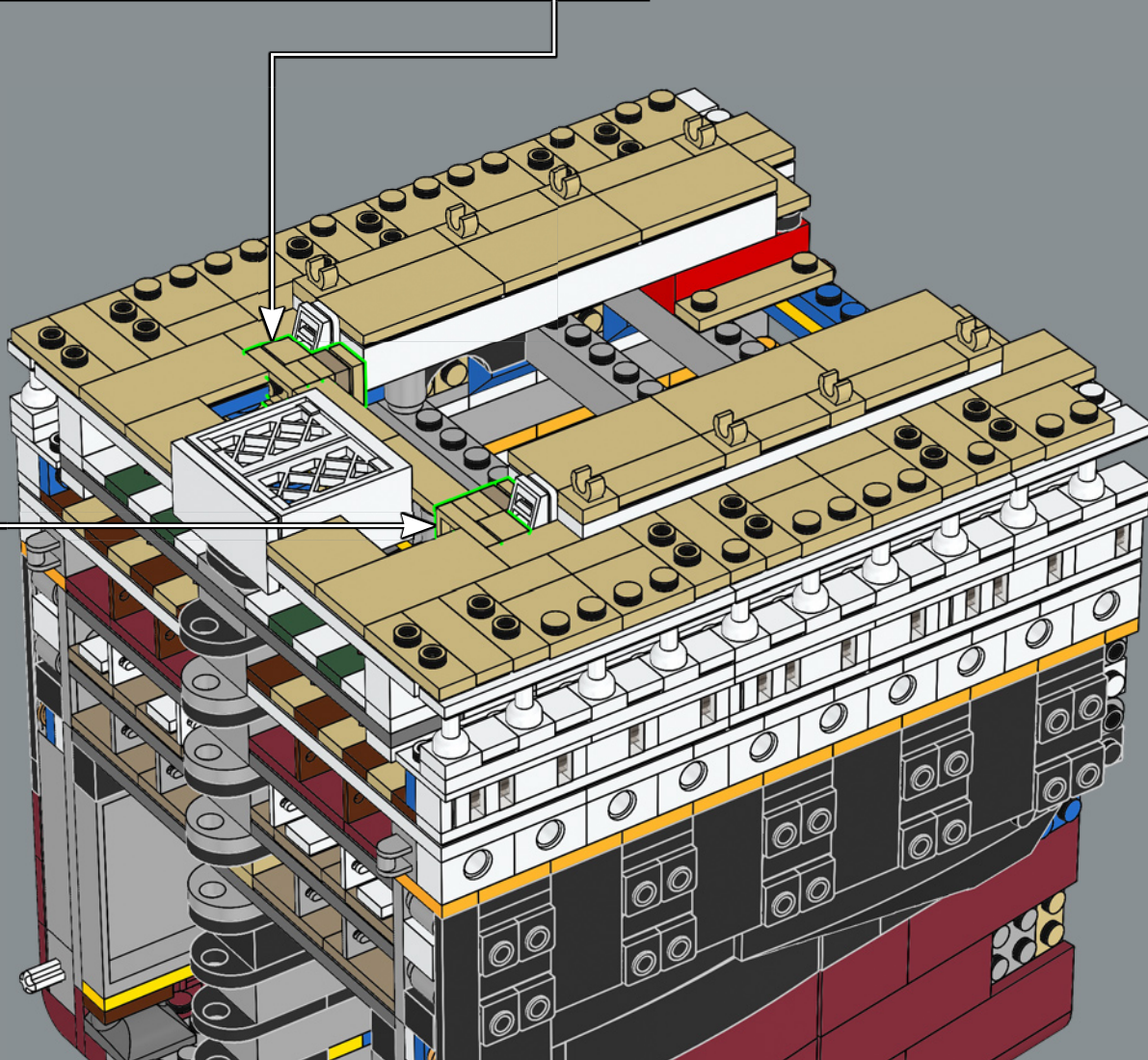
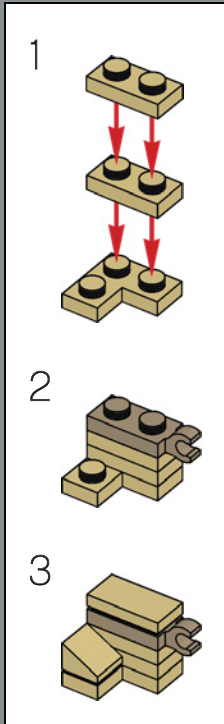
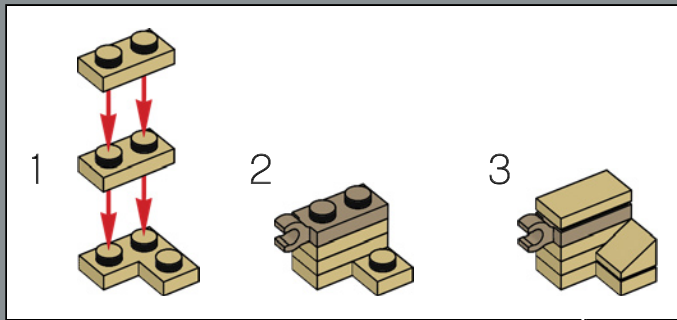

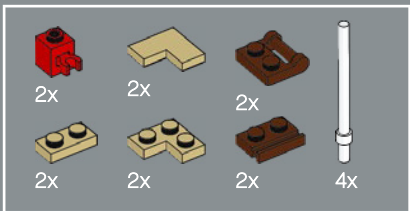

119

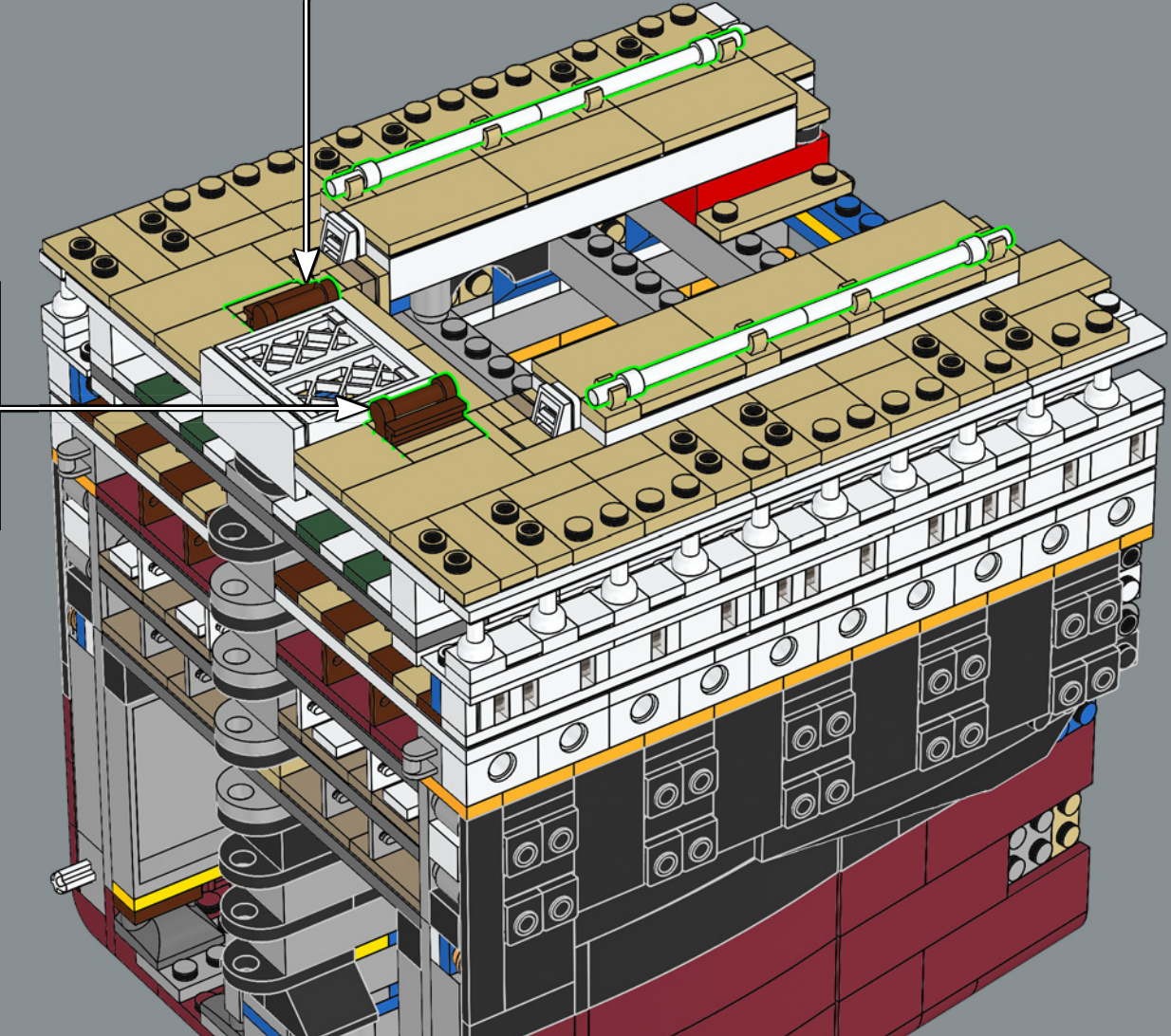
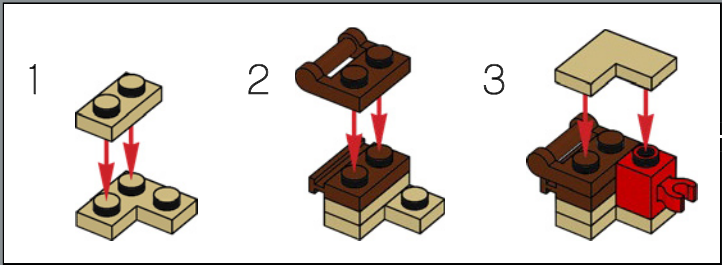
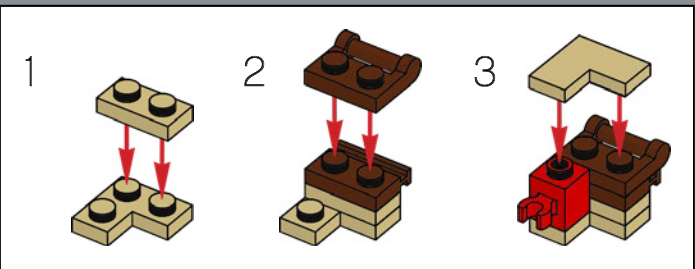

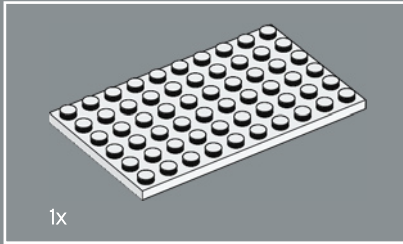
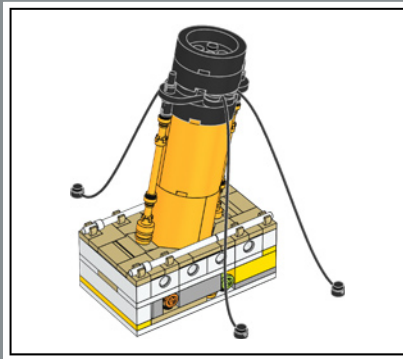
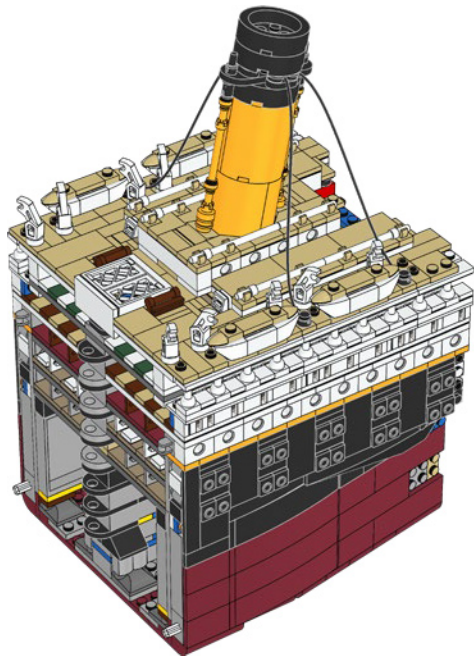
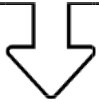

120

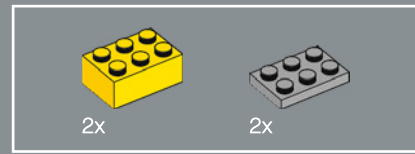
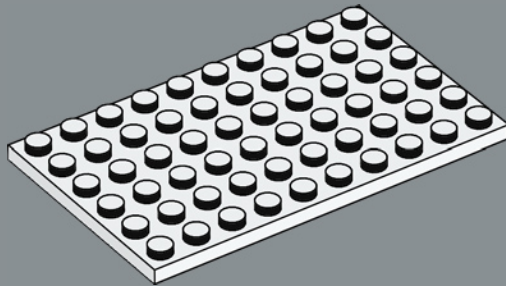

121

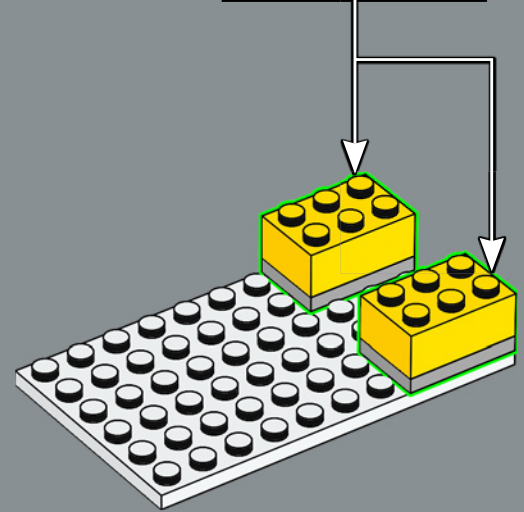
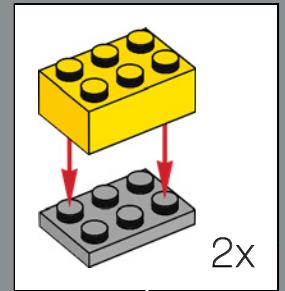

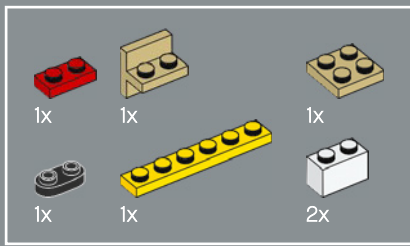

122

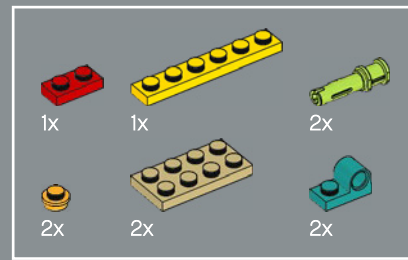
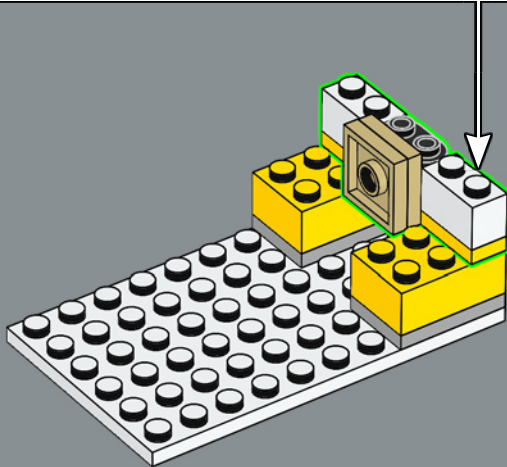
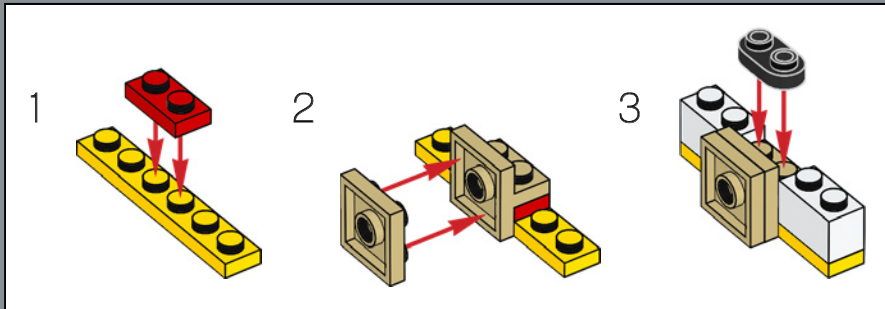

123

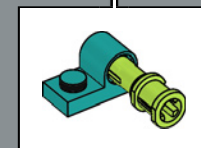
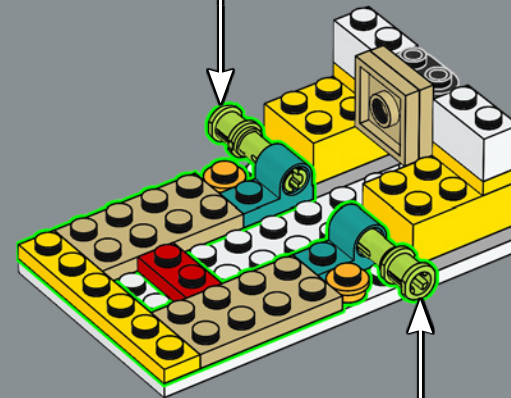
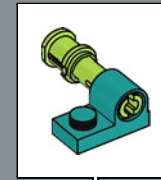

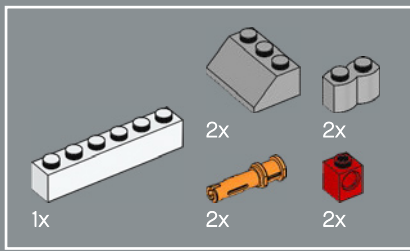

124

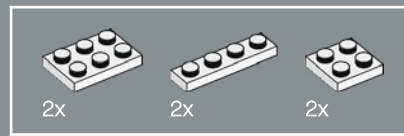
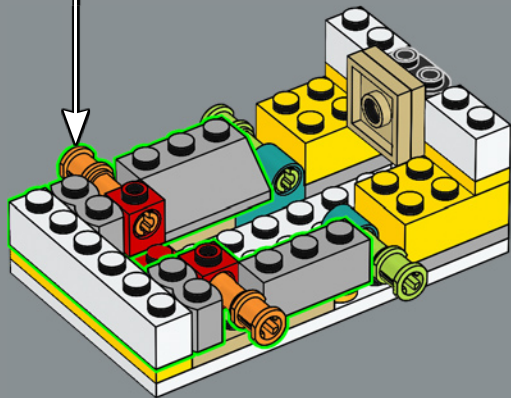
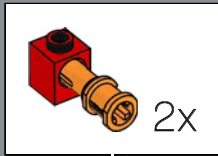

125

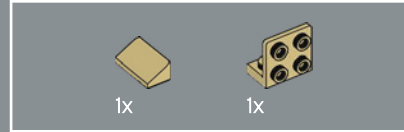
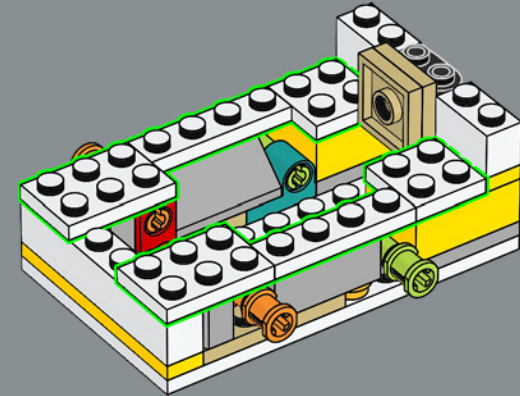

126

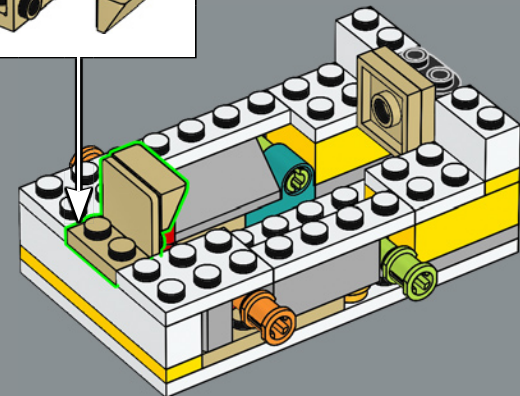
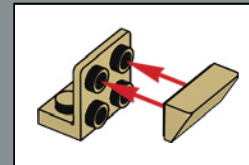

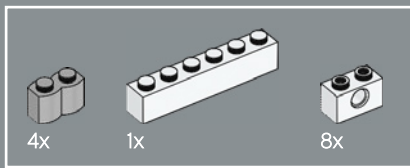

127

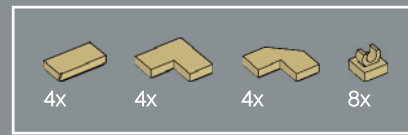
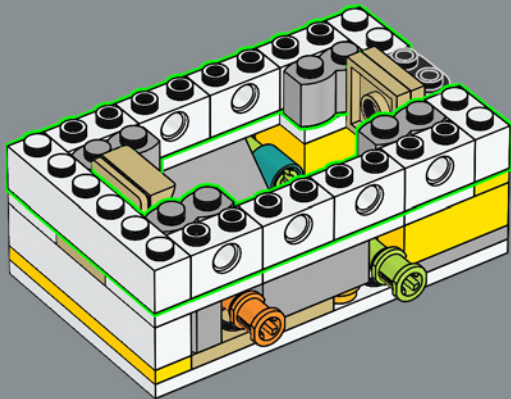

128

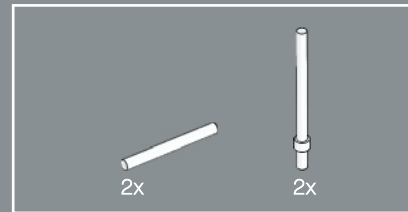
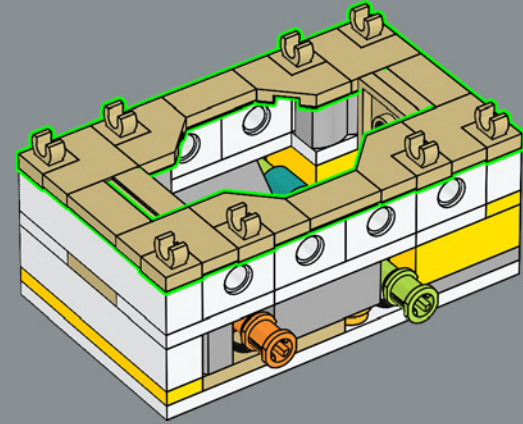

129

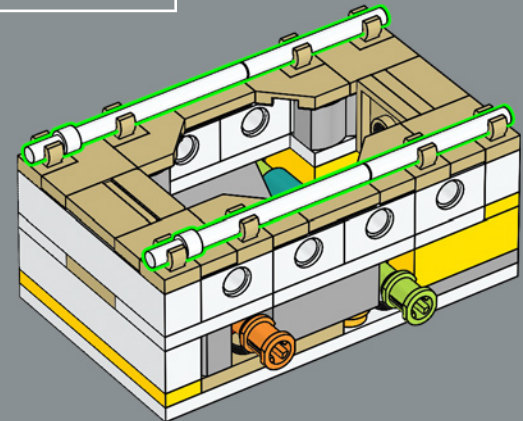

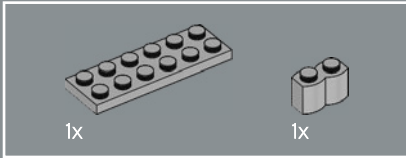
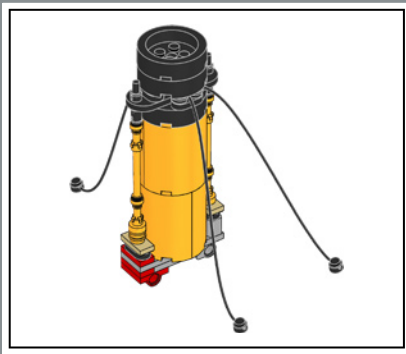

130

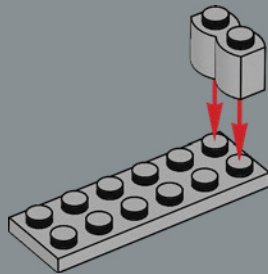

131

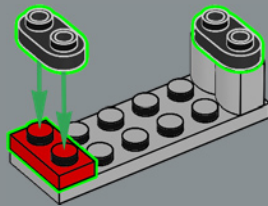

132

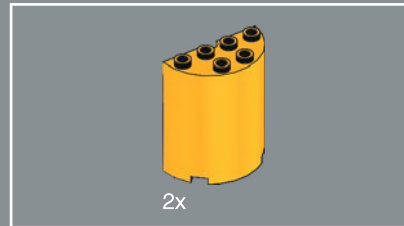
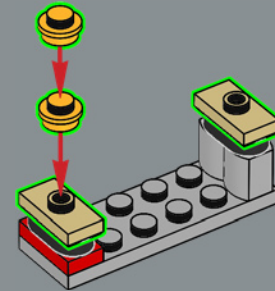

133

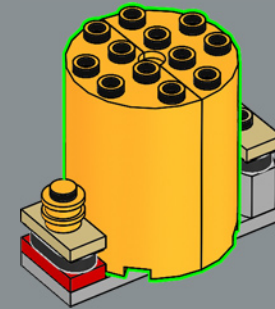

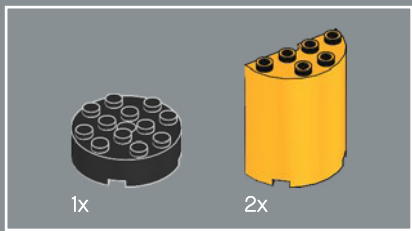

134

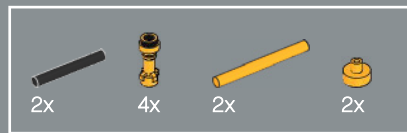
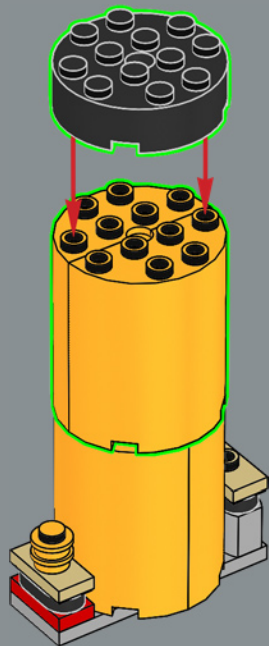

135

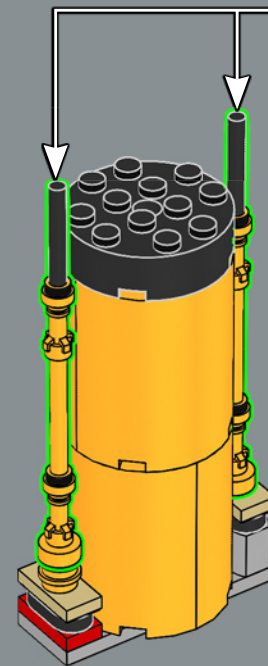
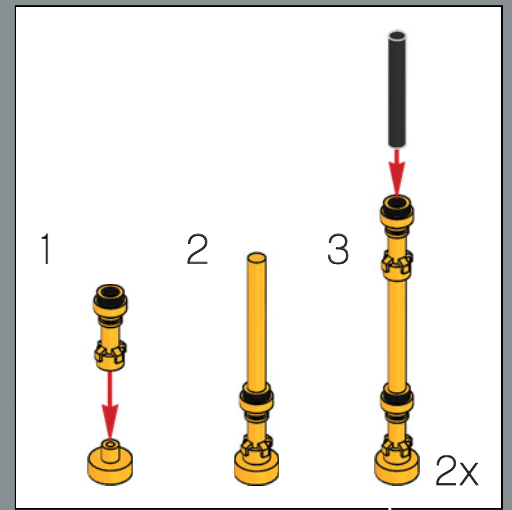

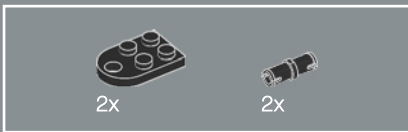

136

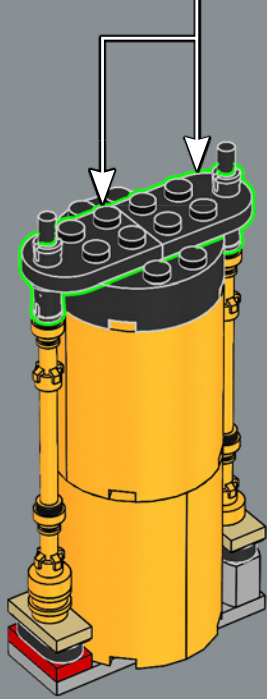
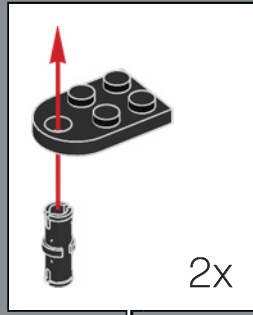

137

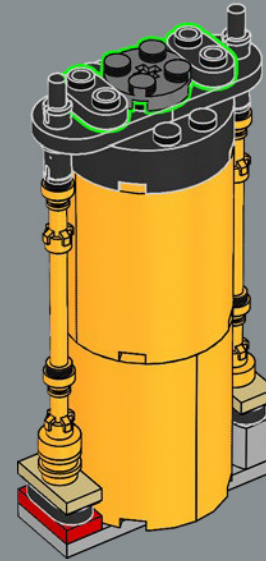

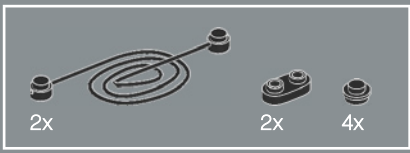

138

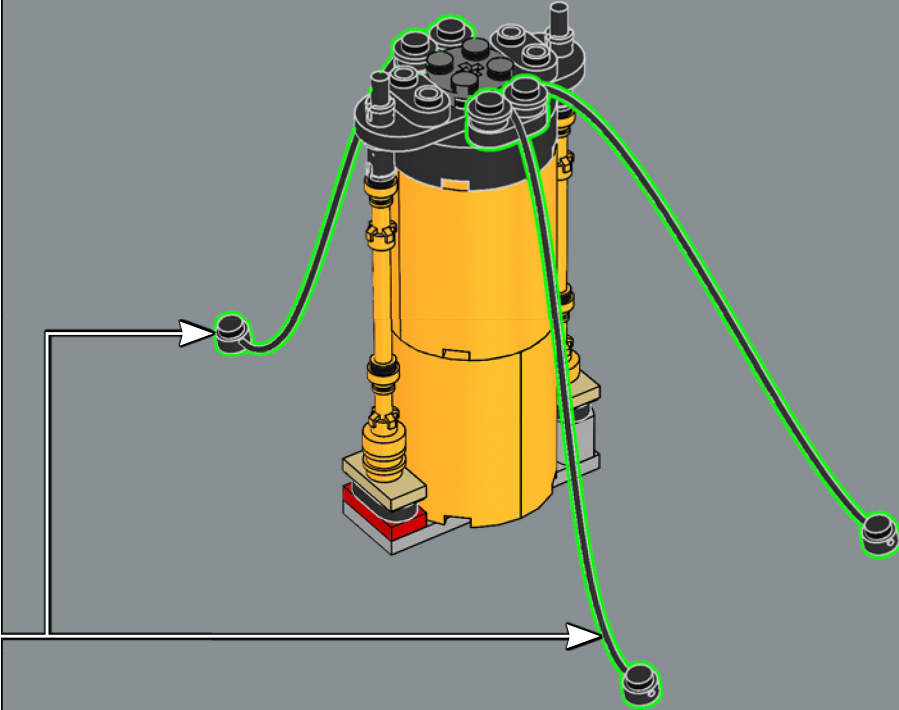
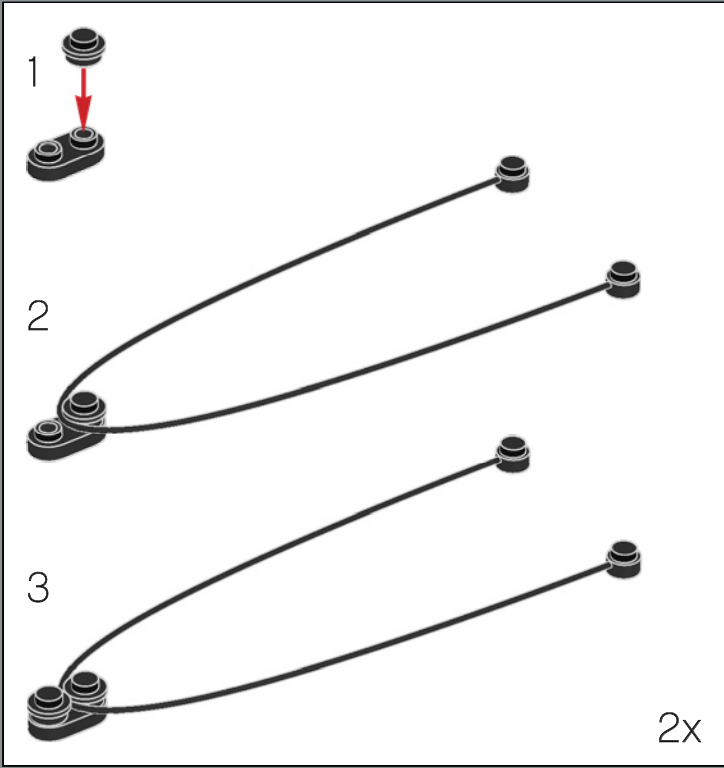

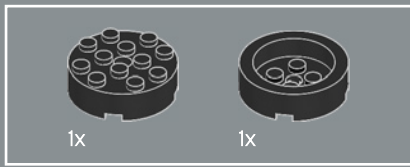

139

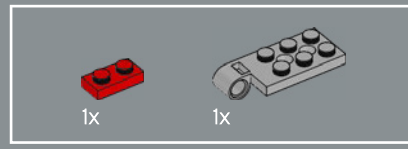
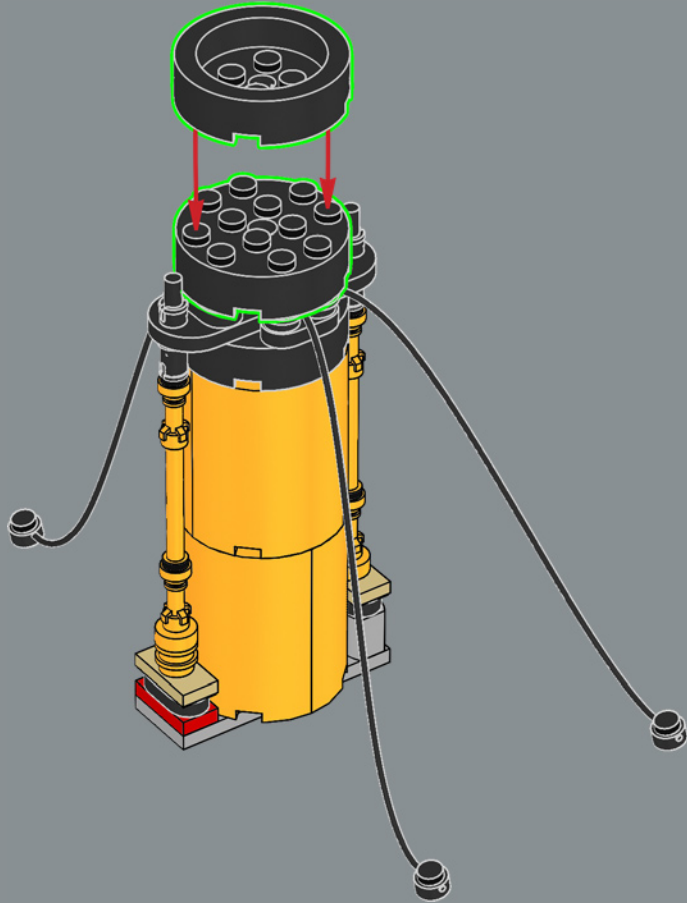

140

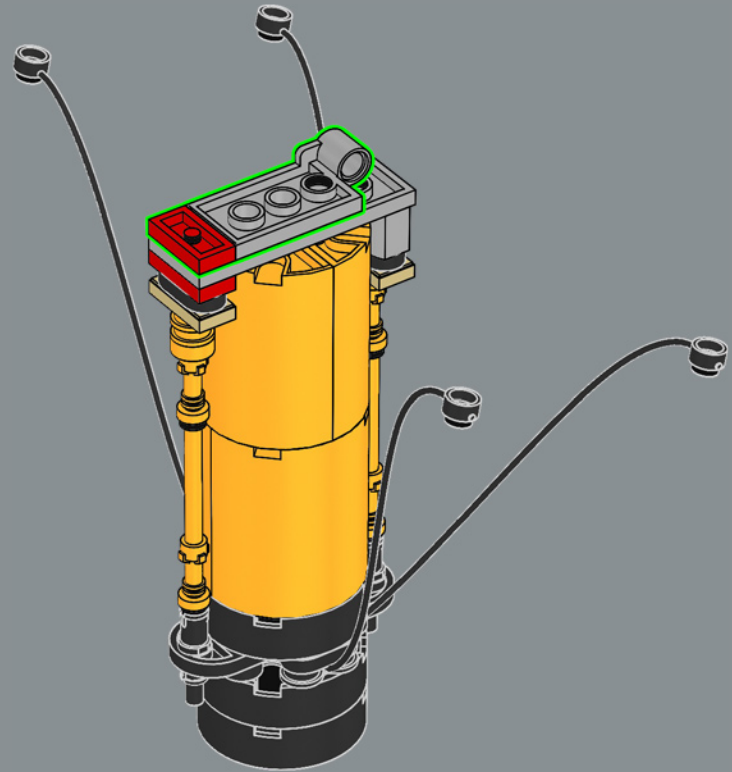

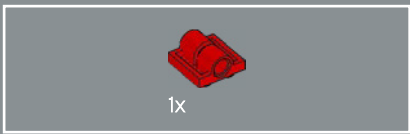

141

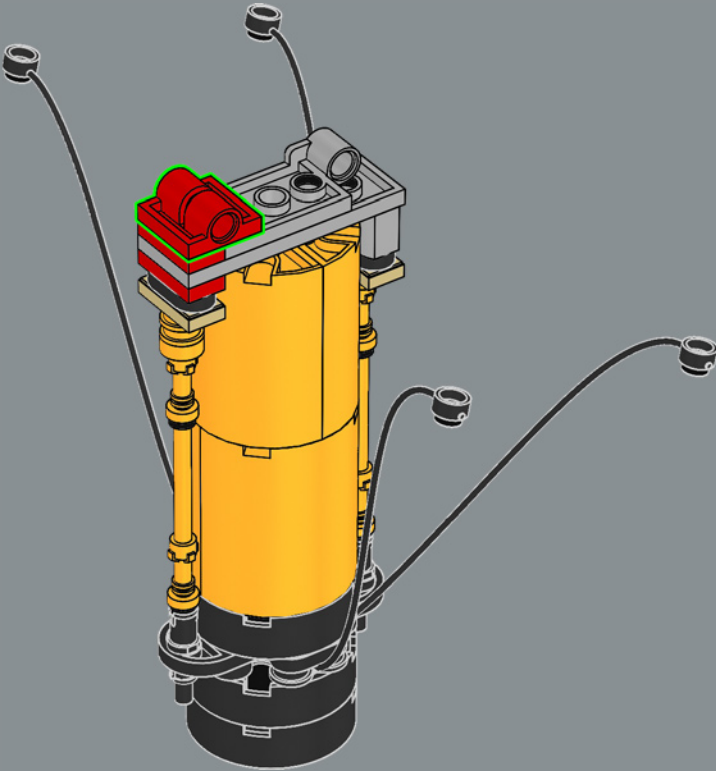

142

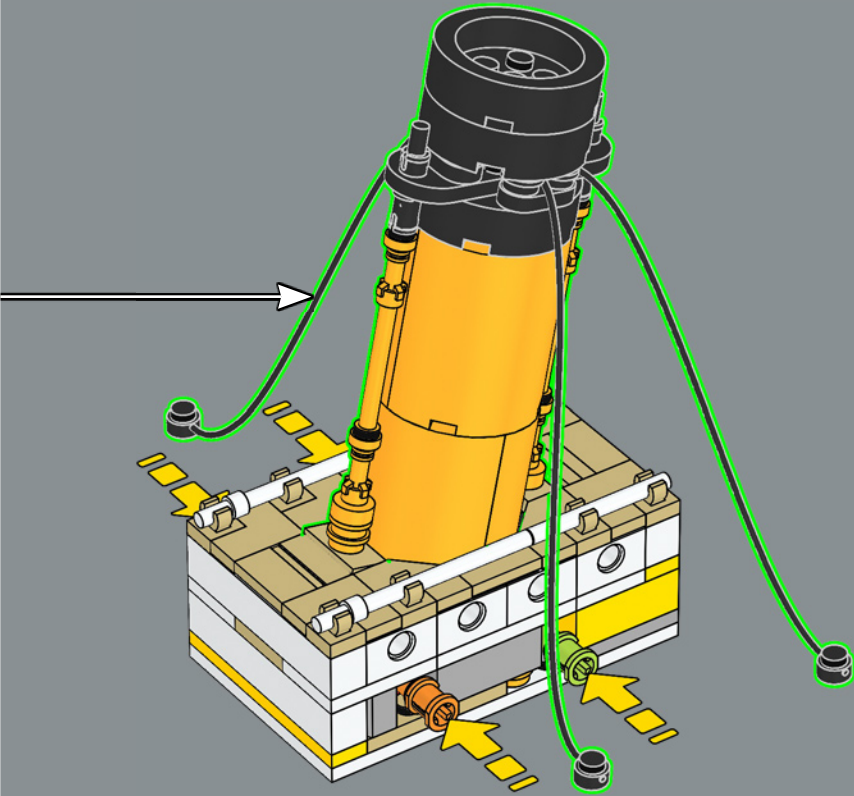

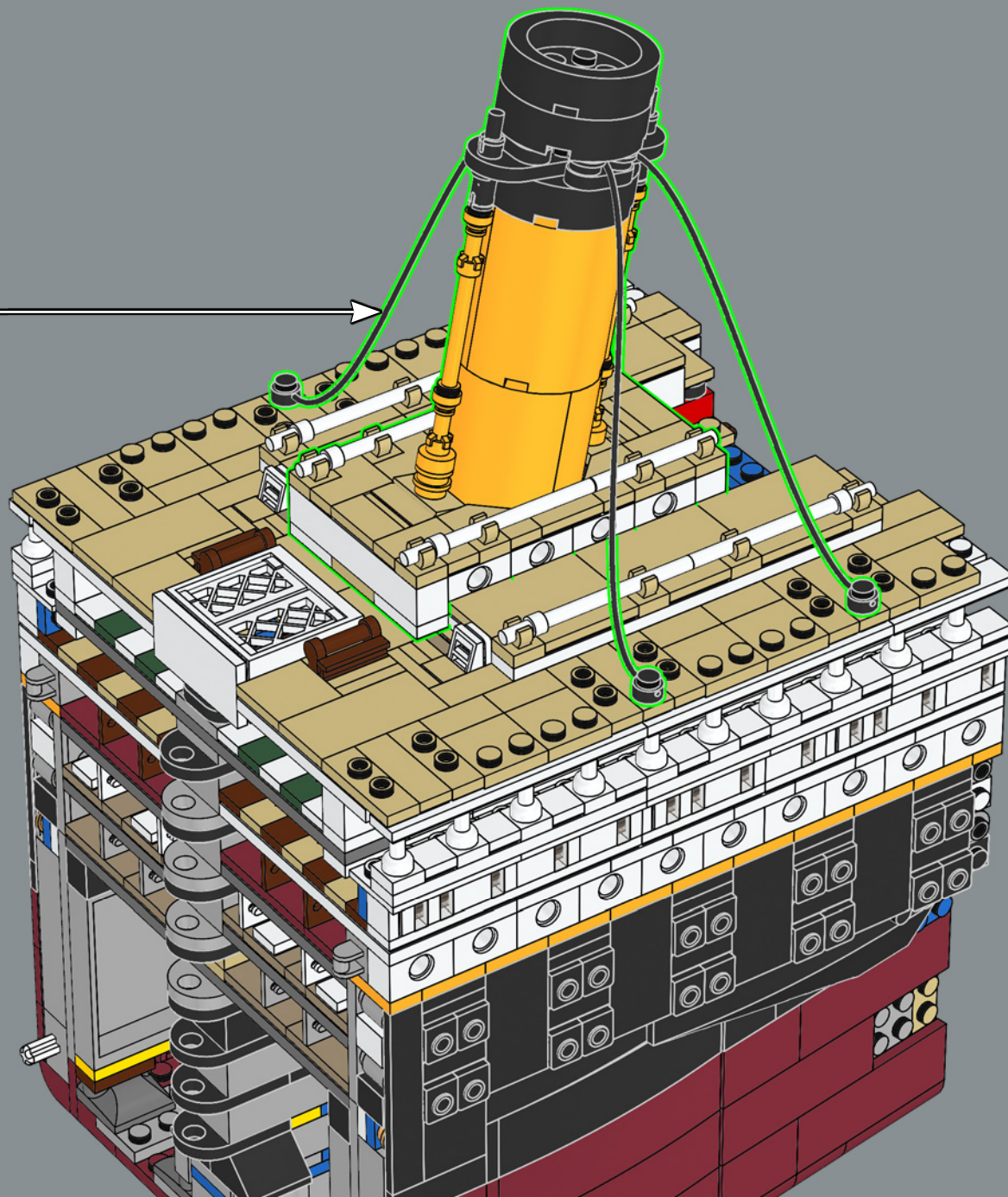

Il *Titanic* era dotato di quattro fumaioli, anche se solo tre erano funzionanti: l'ultimo era una ciminiera installata per motivi estetici.

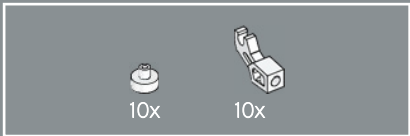

144

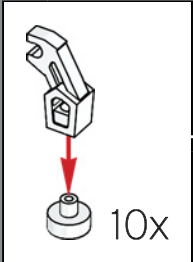
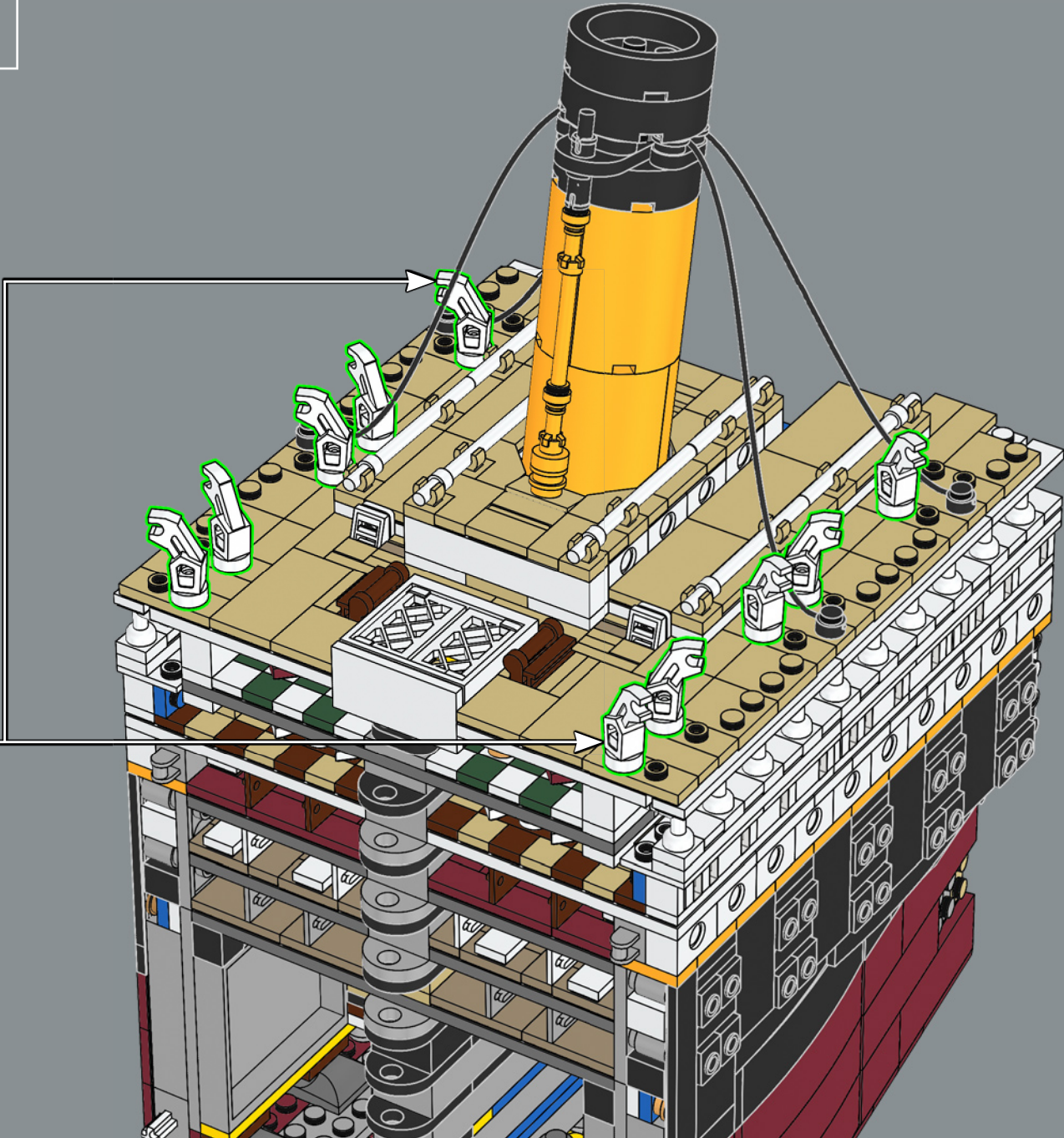

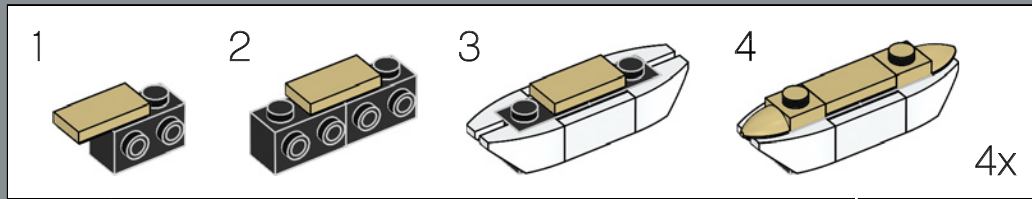
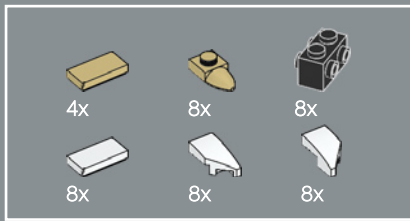

145

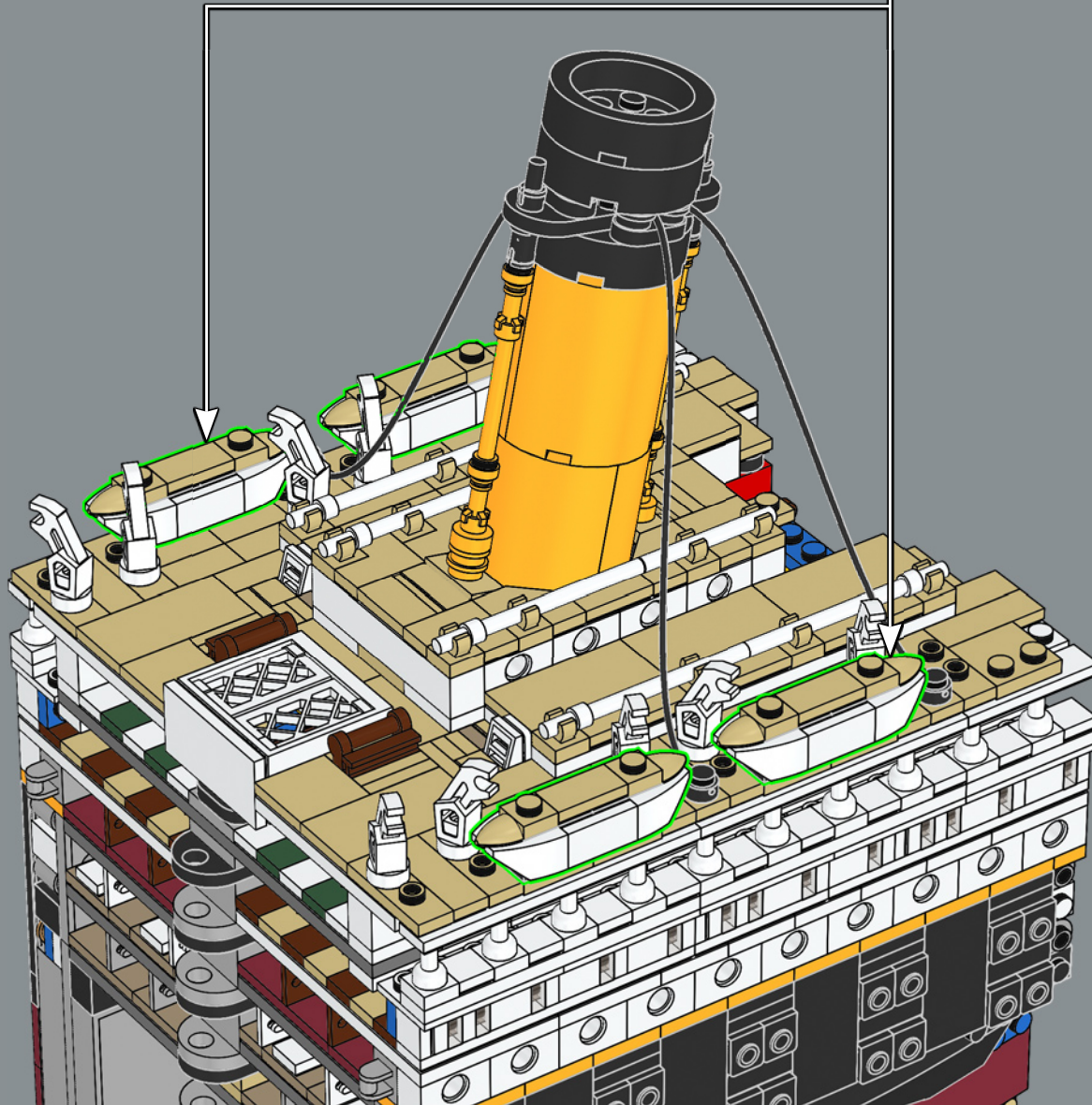

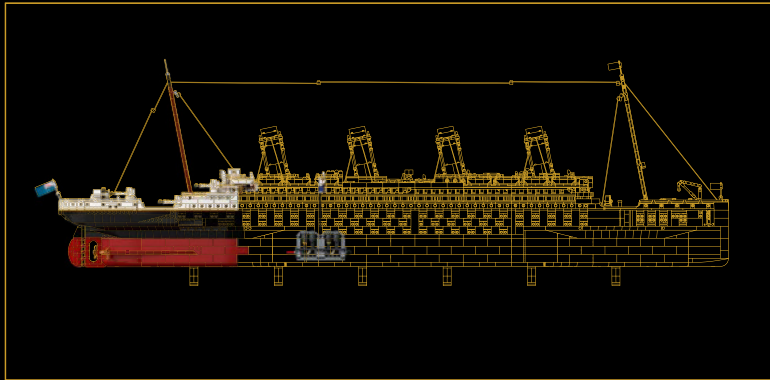

SEZIONE 6:

POPPA E COPERTA A POZZO

Questa sezione finale è la più complicata dello scafo e comprende il timone e tre alberi di trasmissione principali che collegano le eliche ai motori. Qui si costruiscono i due motori principali a pistoni, collegati direttamente alle eliche di babordo e tribordo. Girando le eliche si muovono gli alberi motore e i pistoni del motore all'interno del modello.

↓ I dettagli esterni di questa sezione includono il ponte di poppa e le panche per i passeggeri di 3° classe.



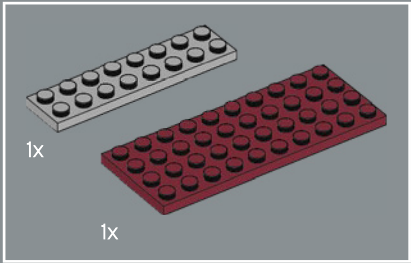
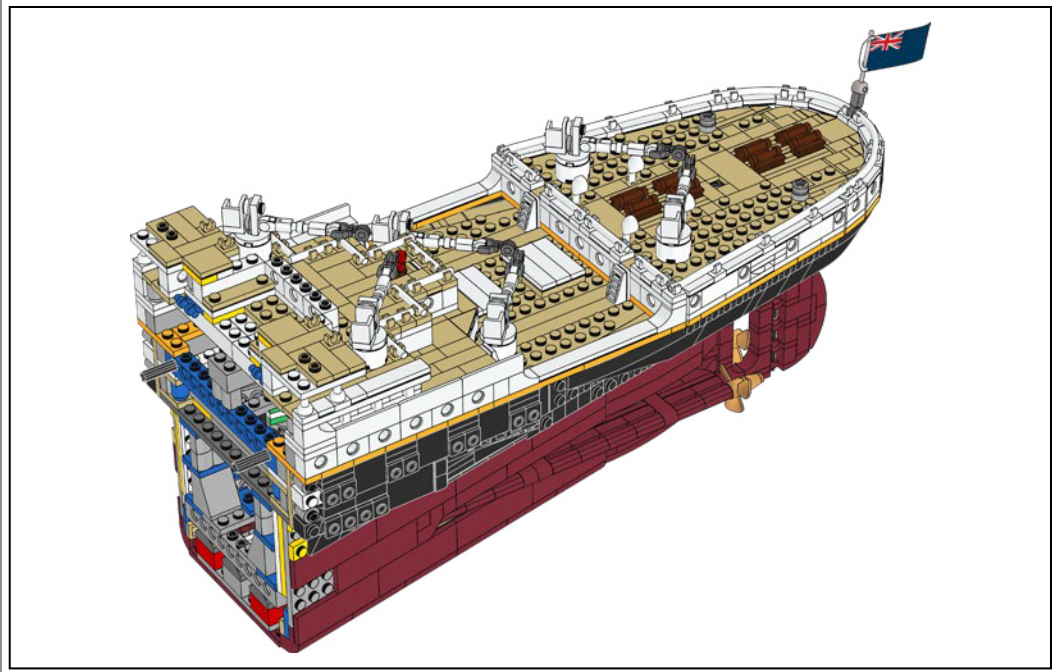
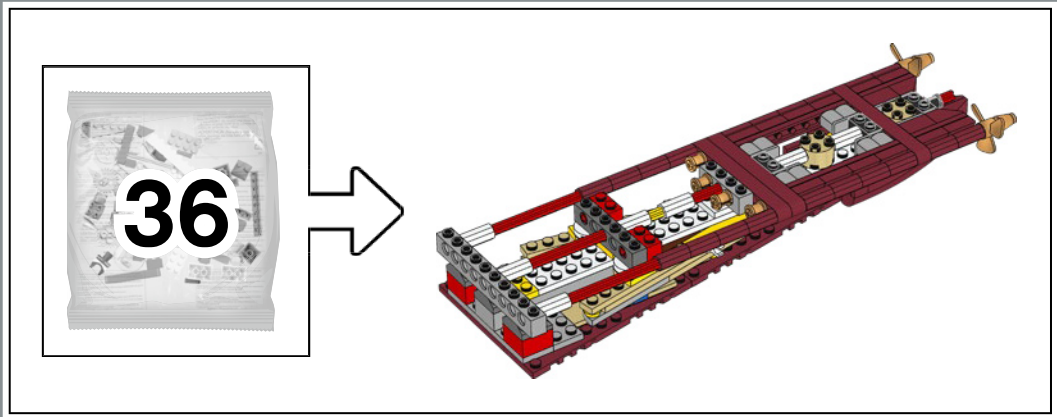

146

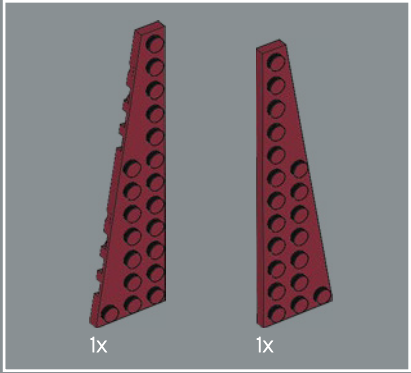
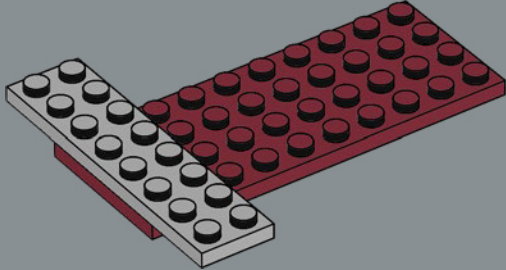

147

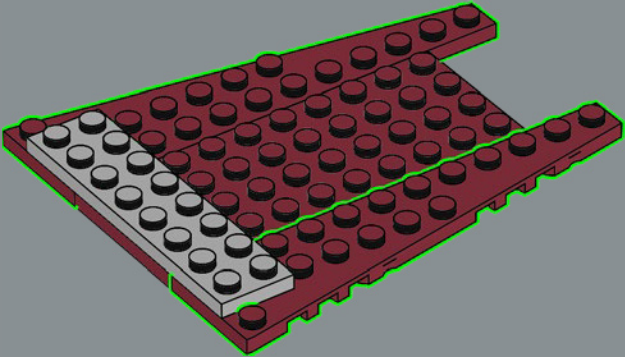

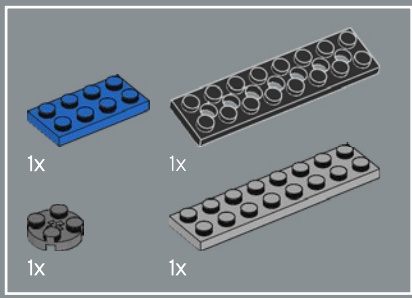

148

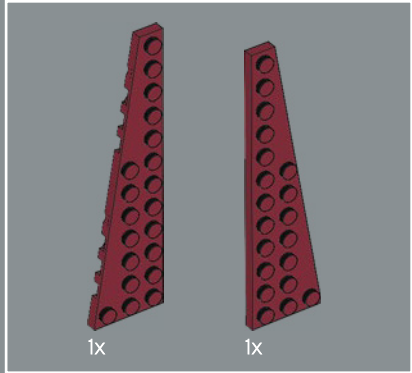
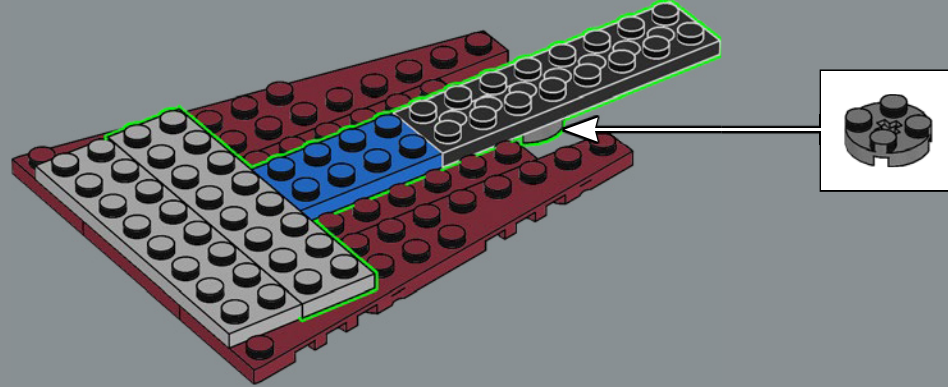

149

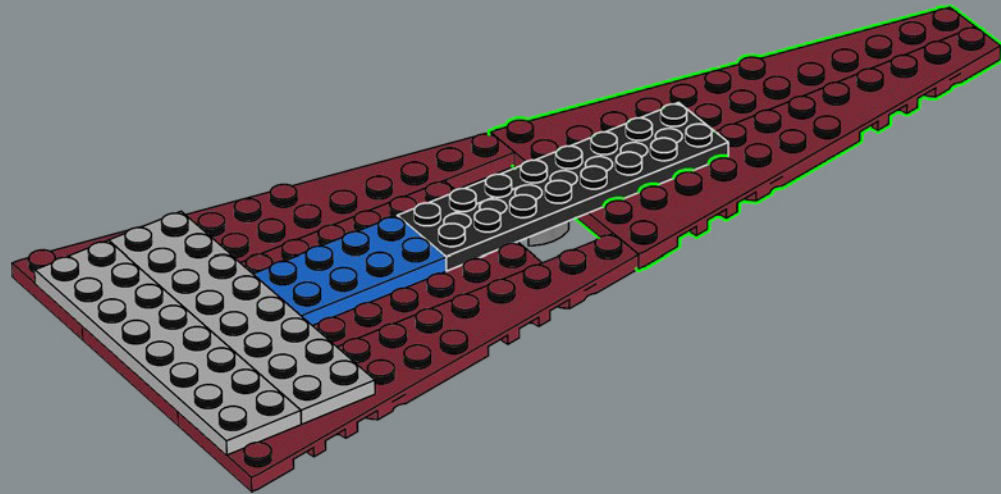

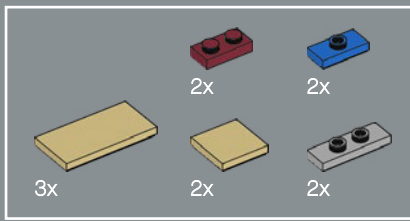

150

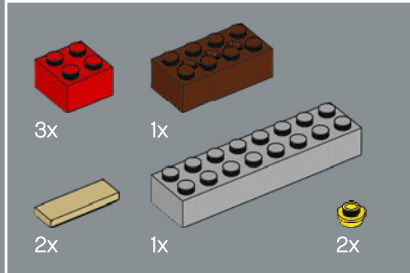
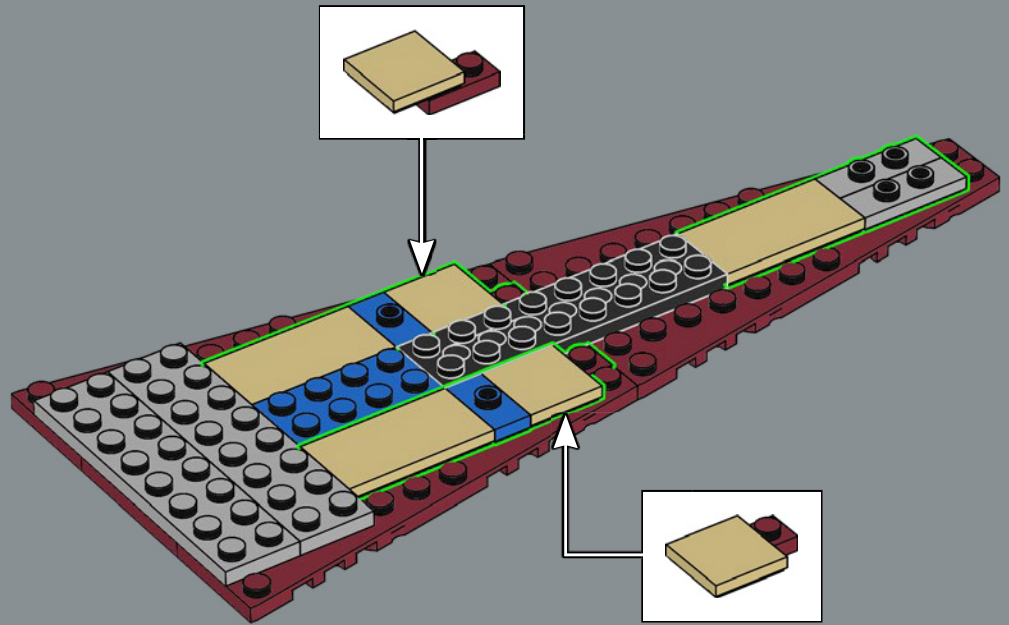

151

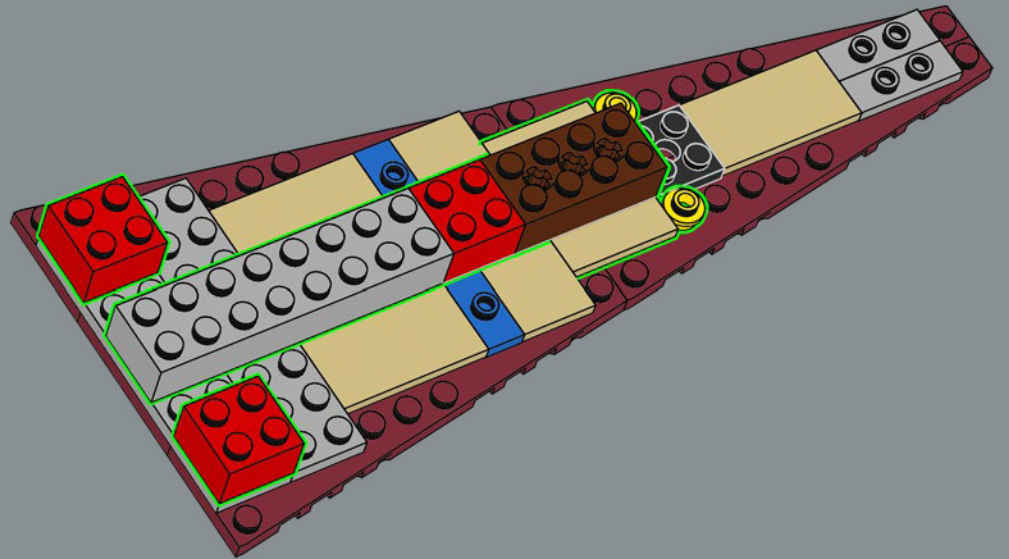

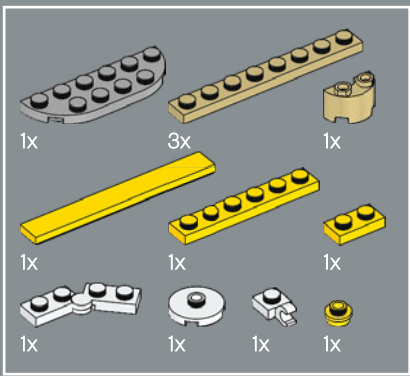

152

1

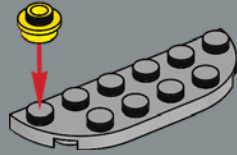

2

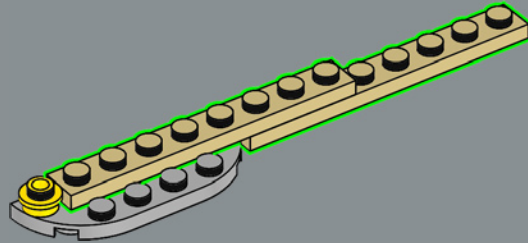

3

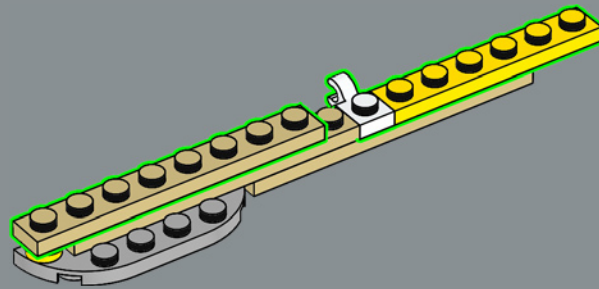

4

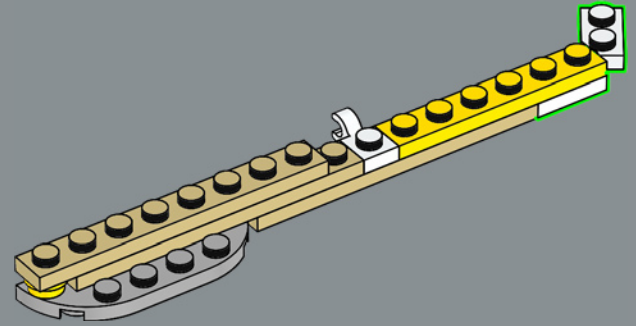

5

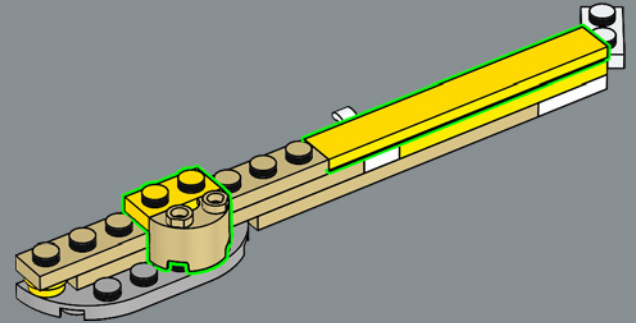

6

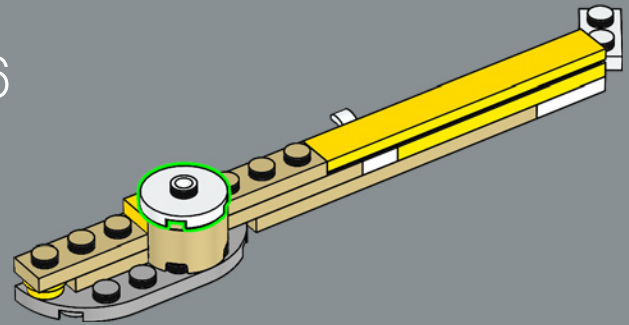

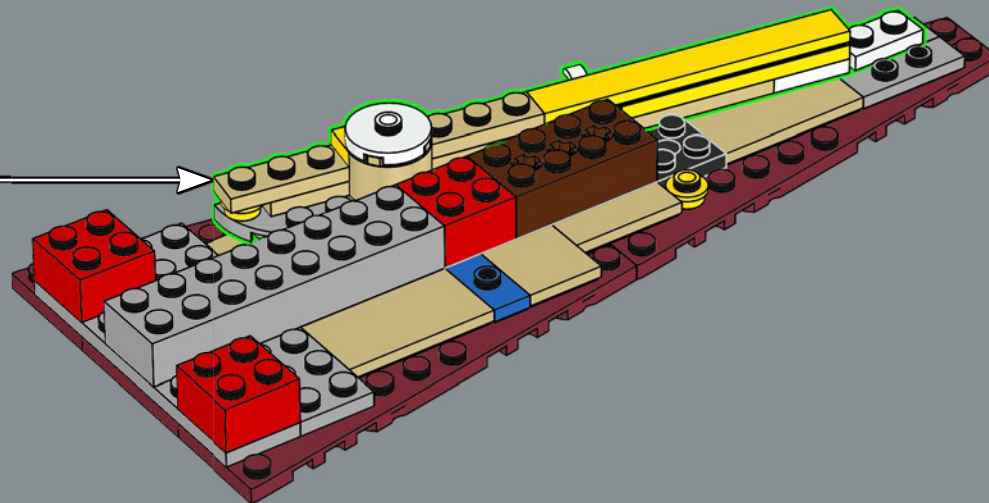

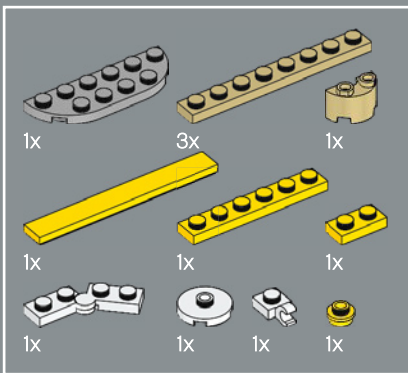

153

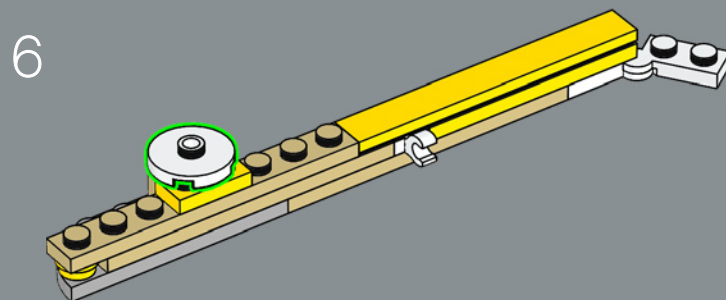
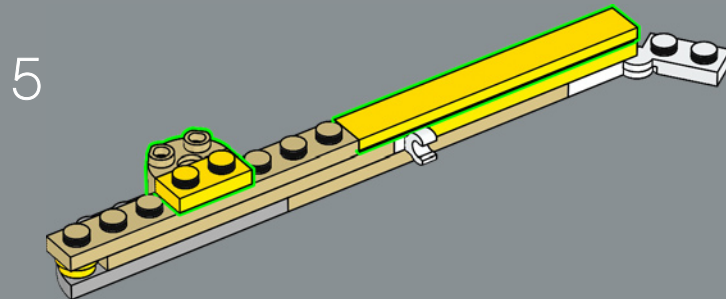
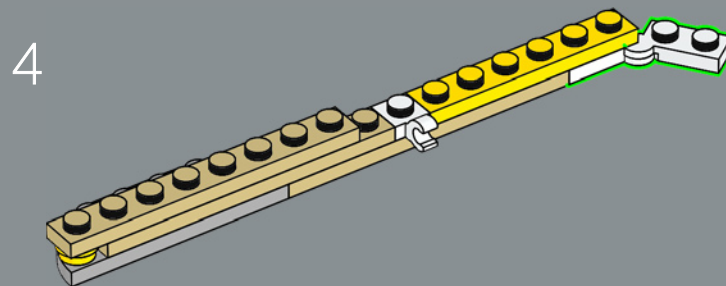
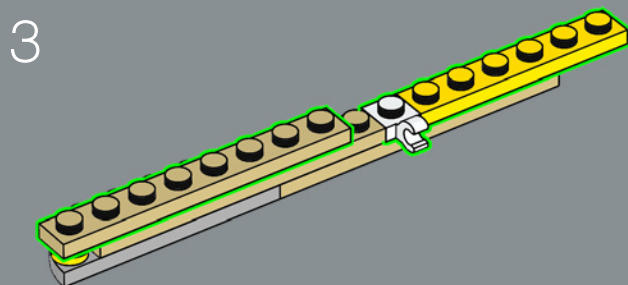
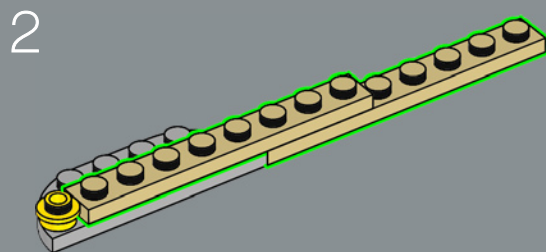
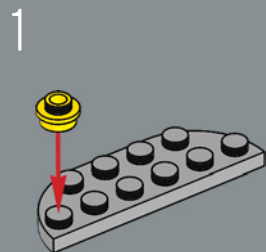

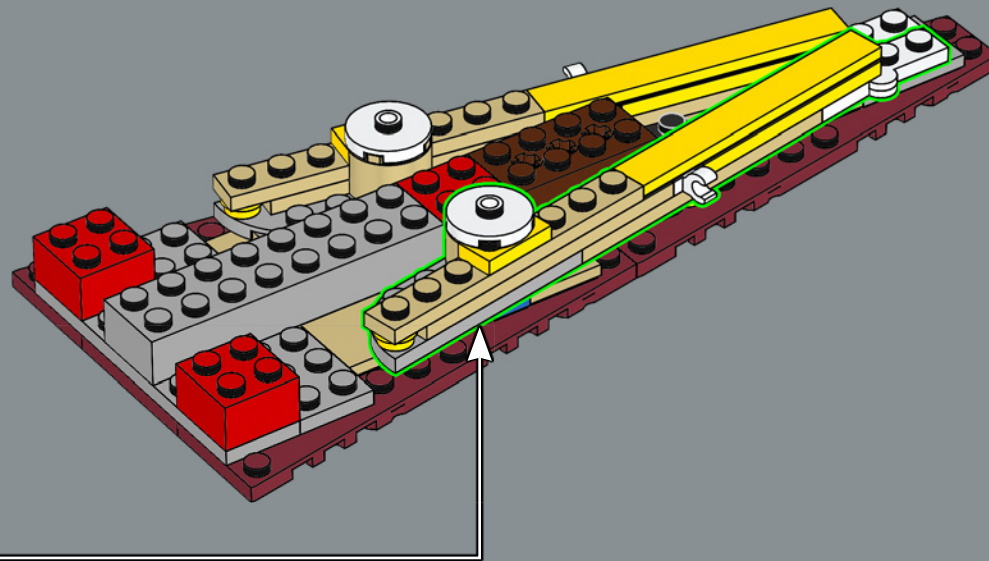

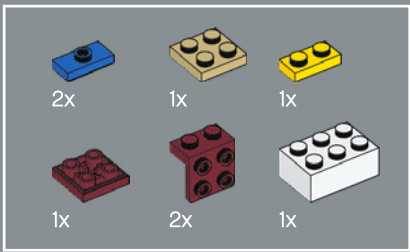

154

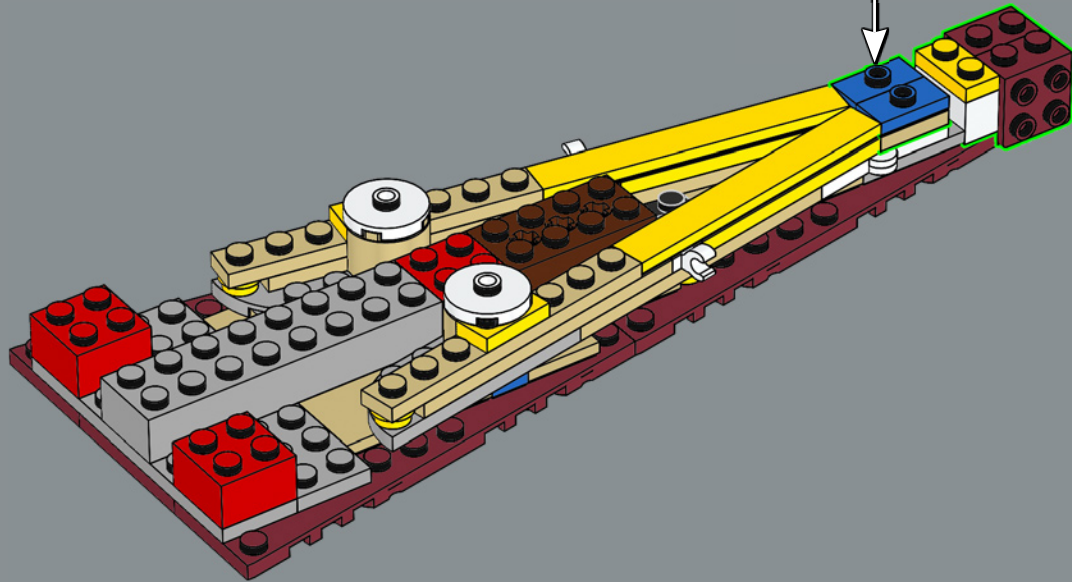
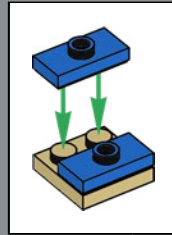
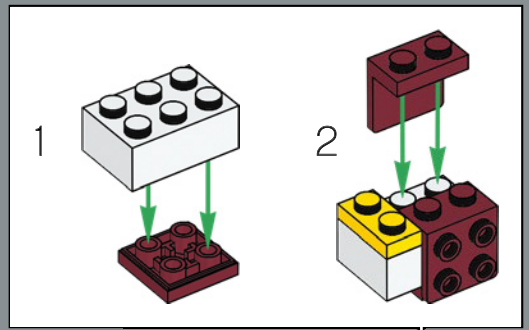

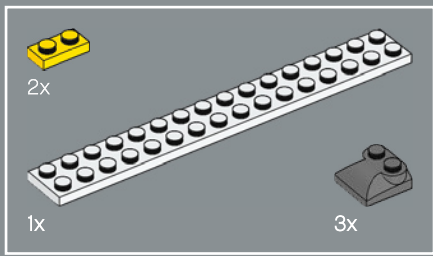

155

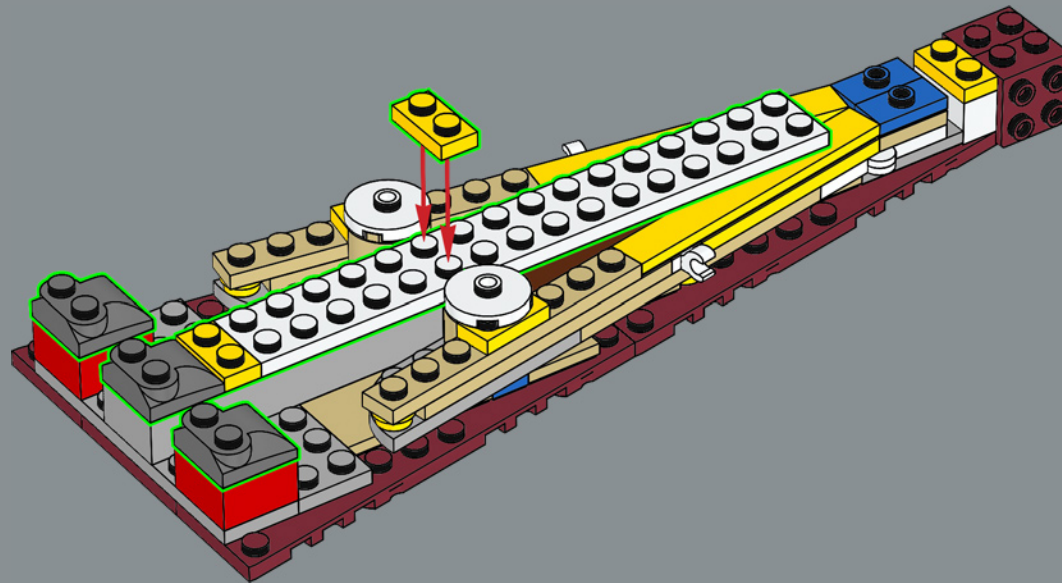

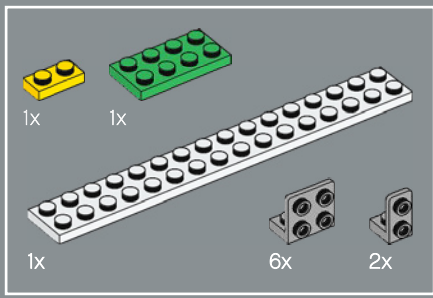

156

1

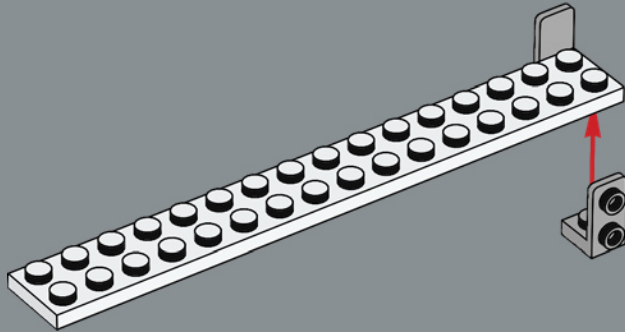

2

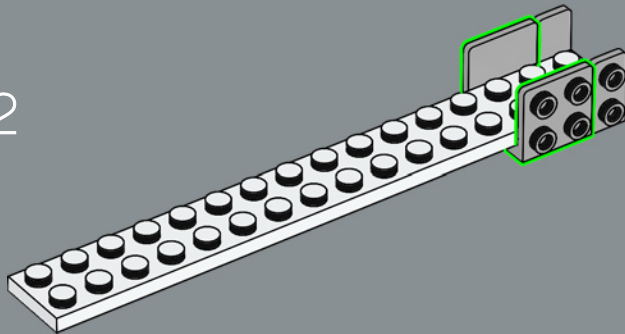

3

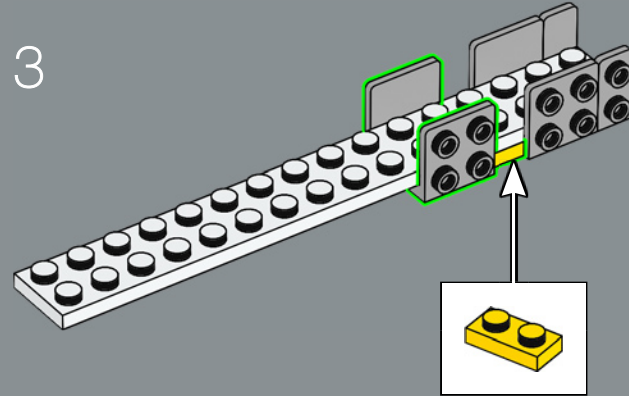

4

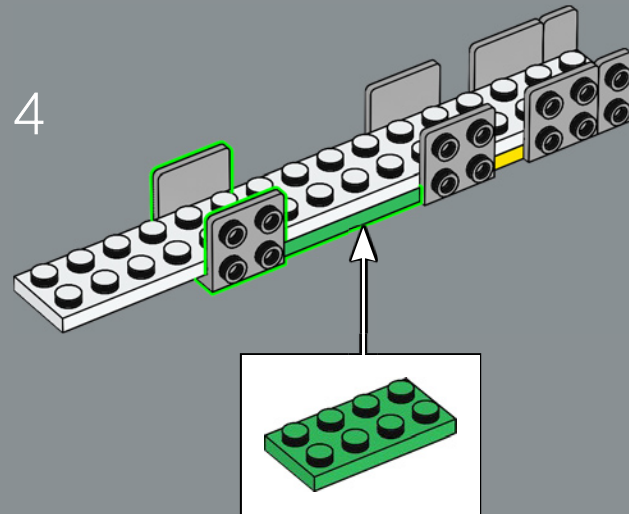

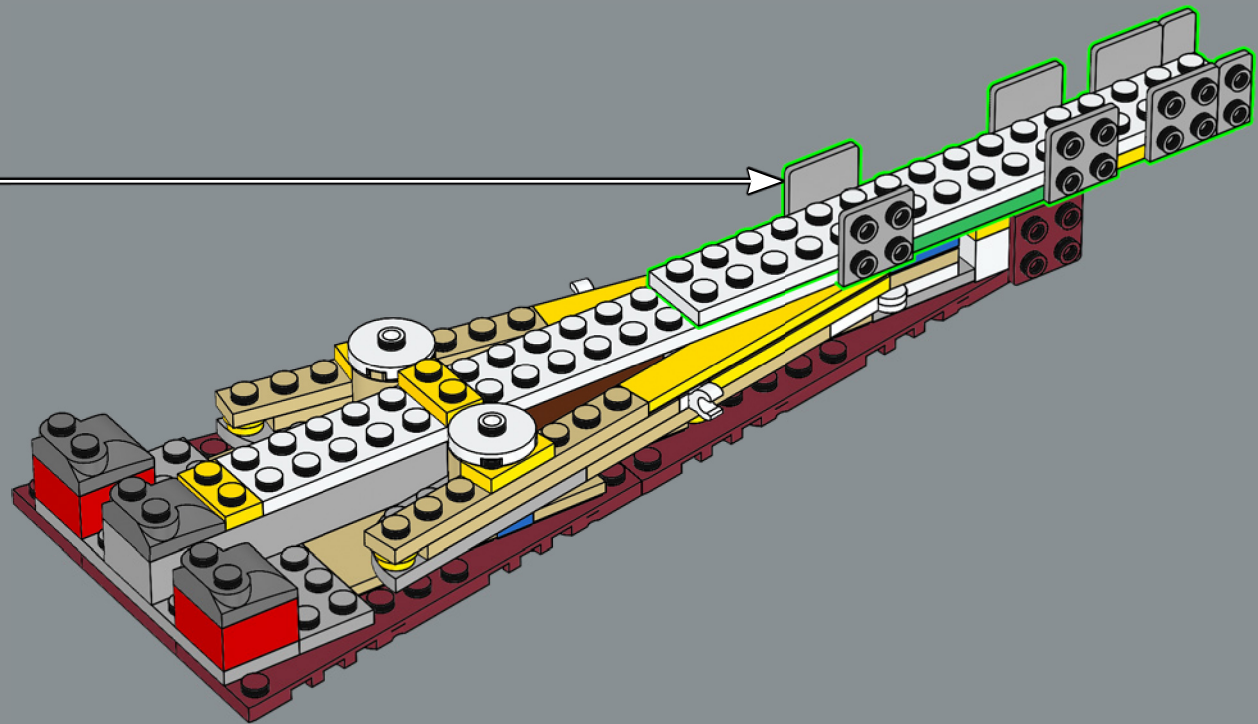

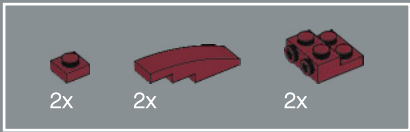

157

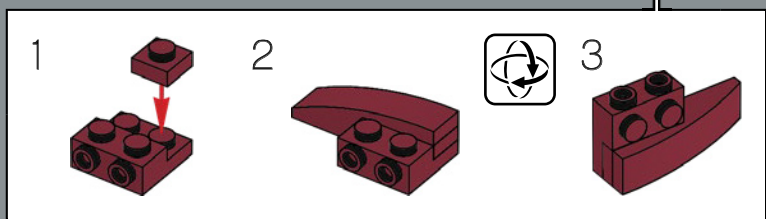
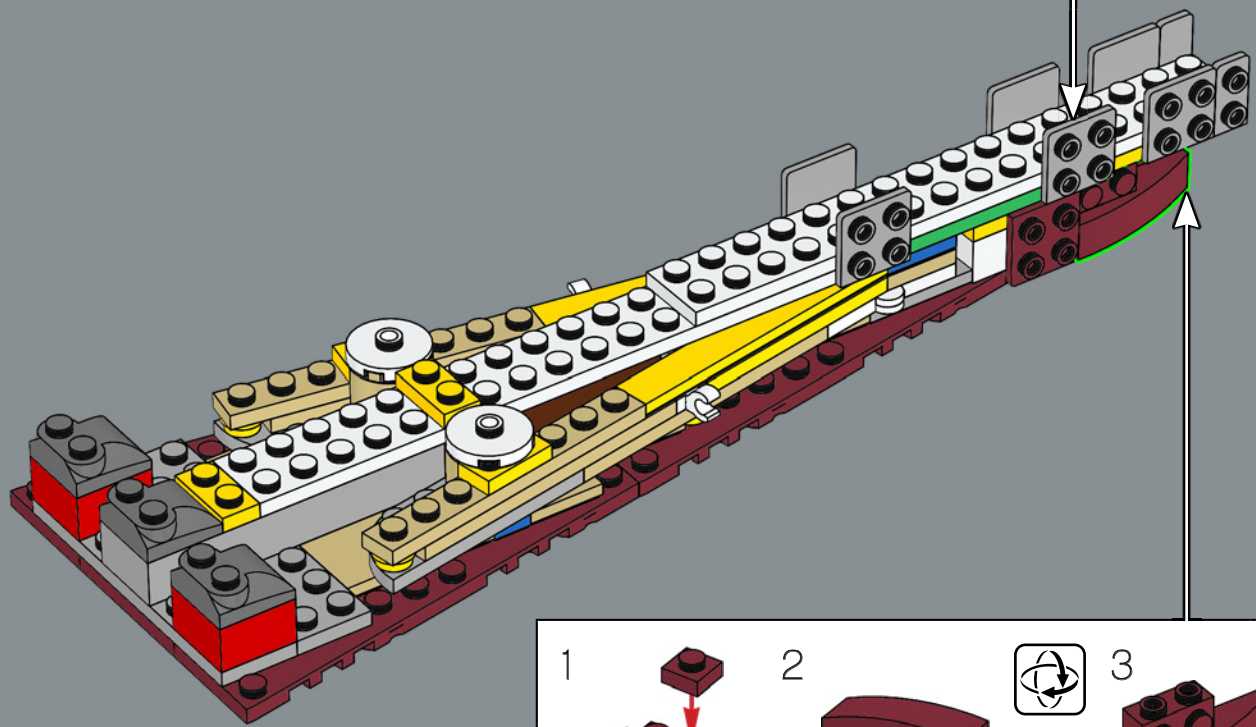
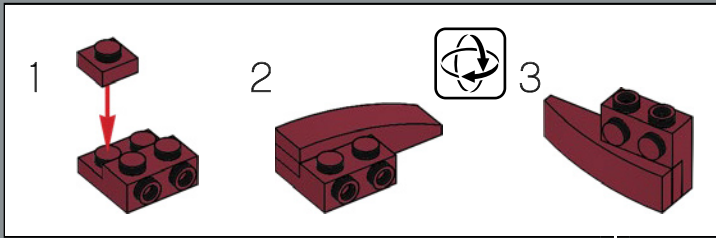

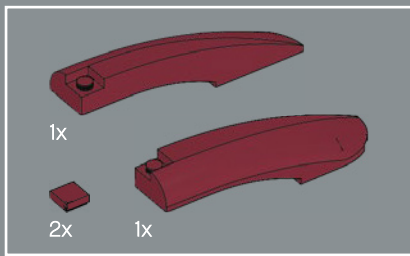

158

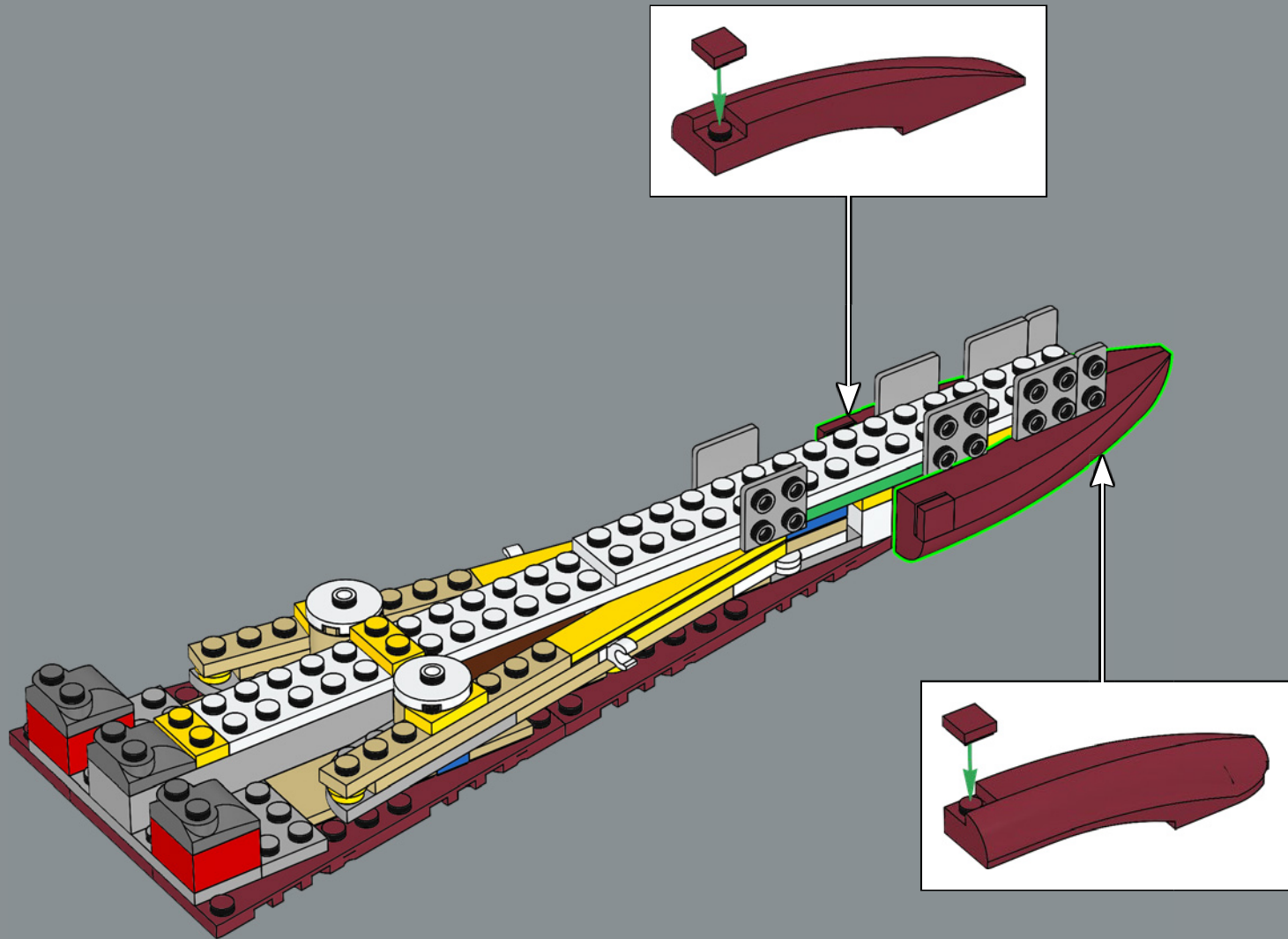

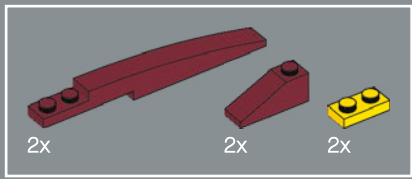

159

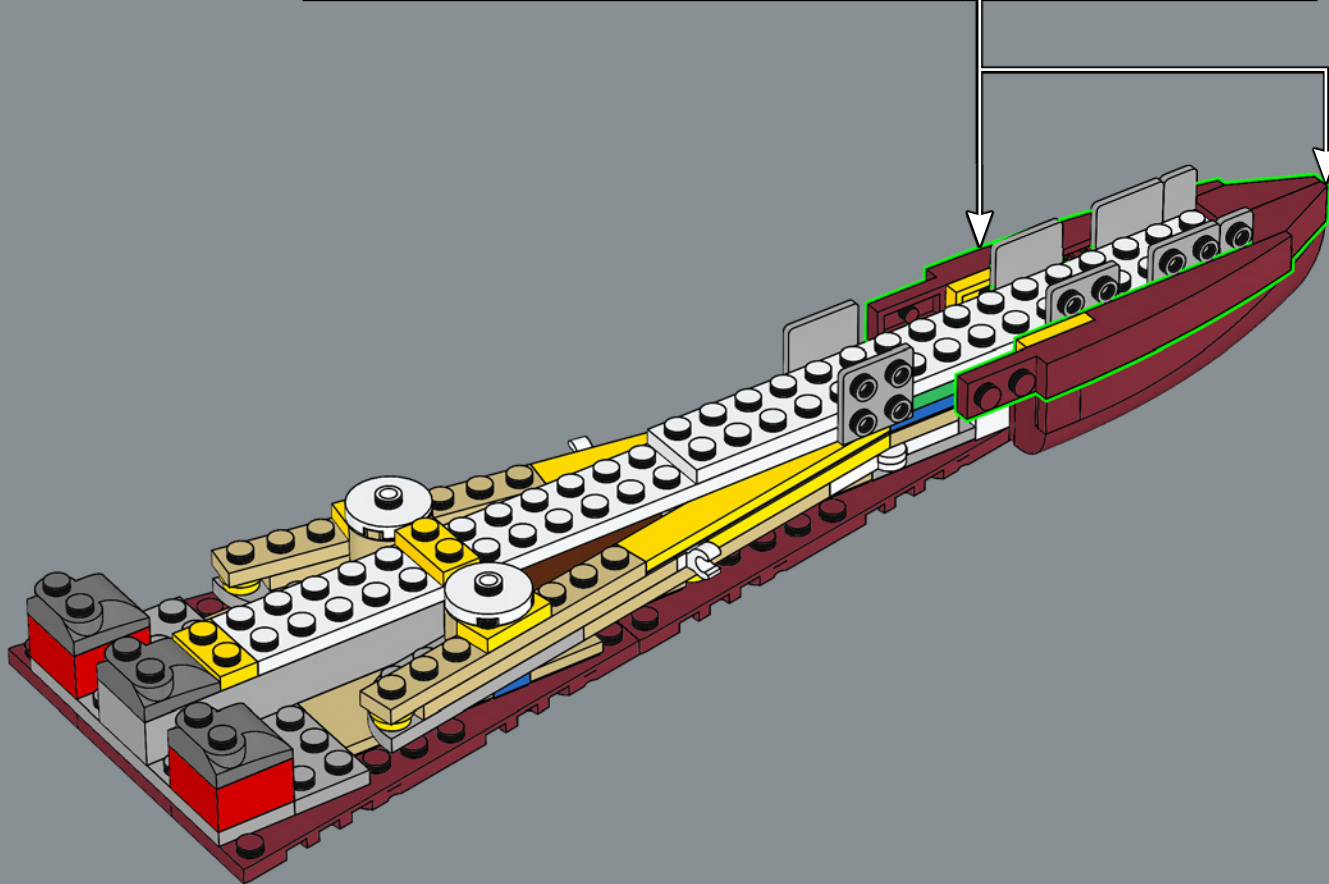
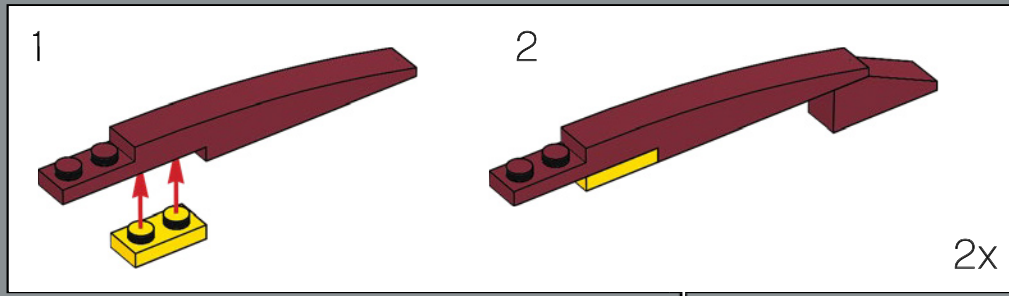

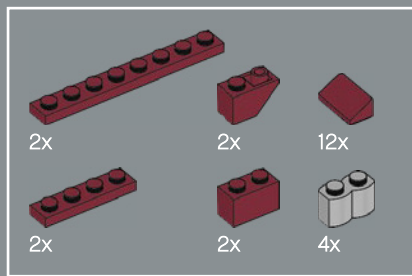

160

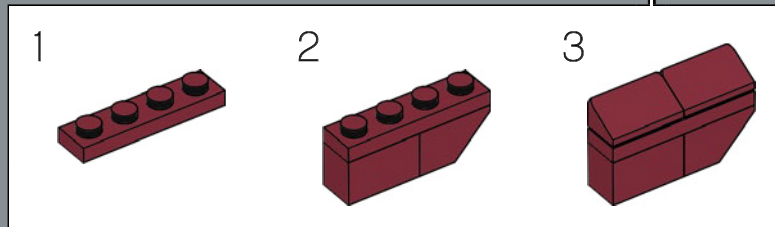
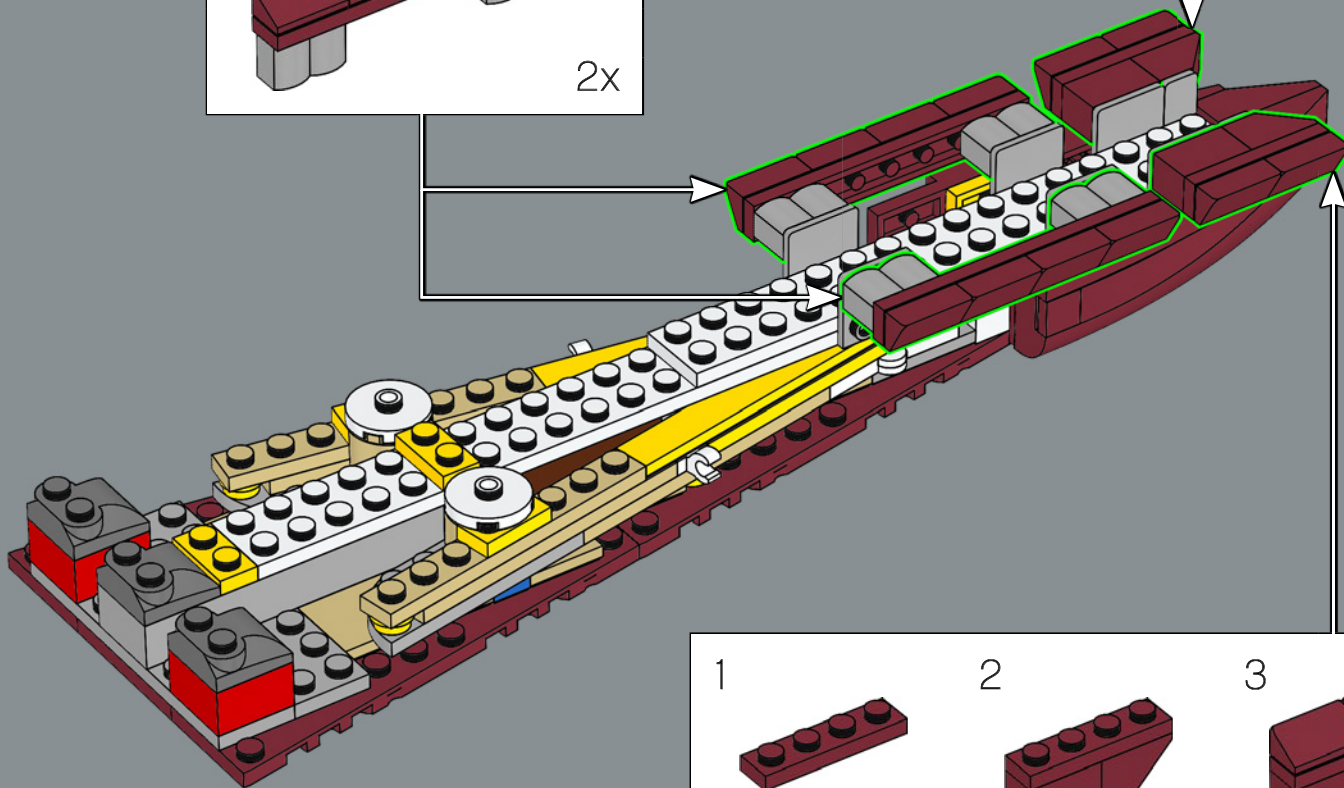
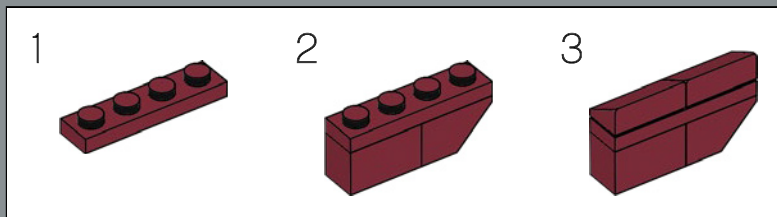
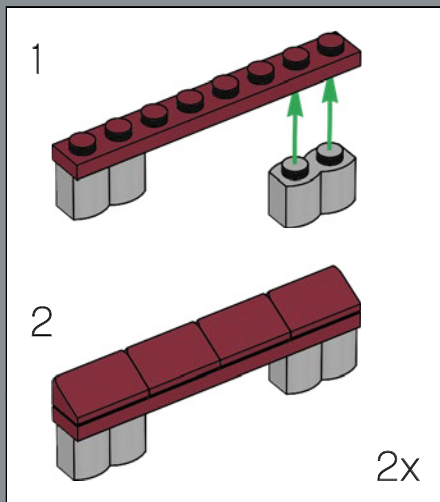

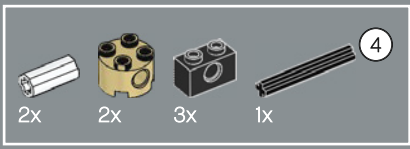

161

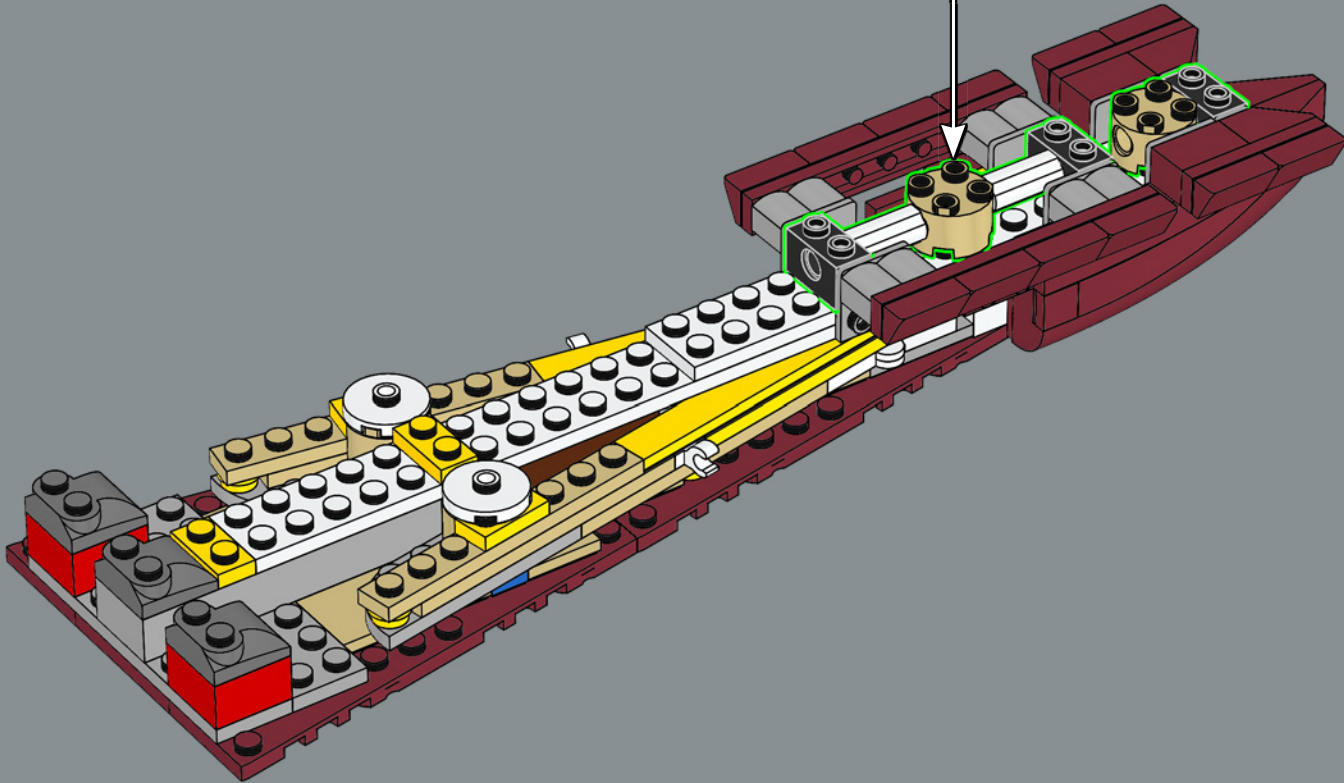
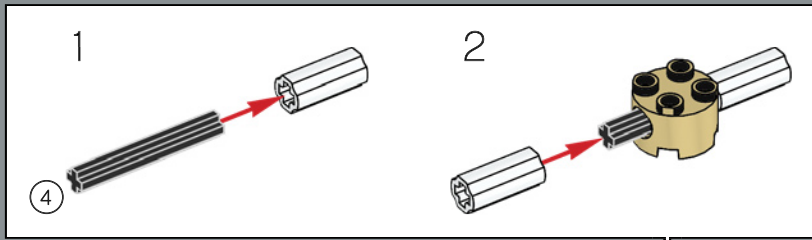

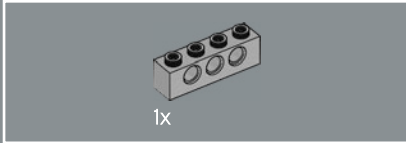
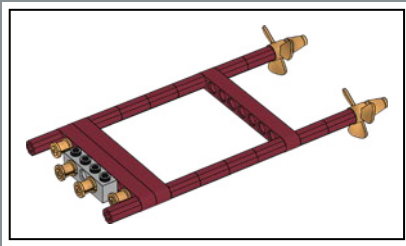

162

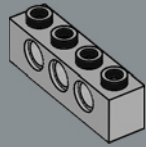

163

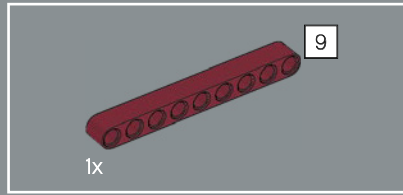
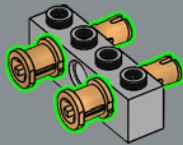

164

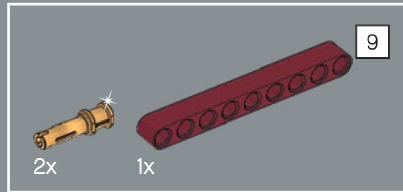
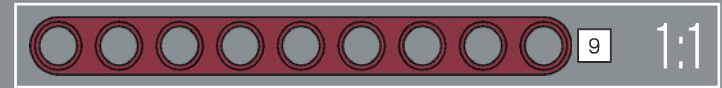

165

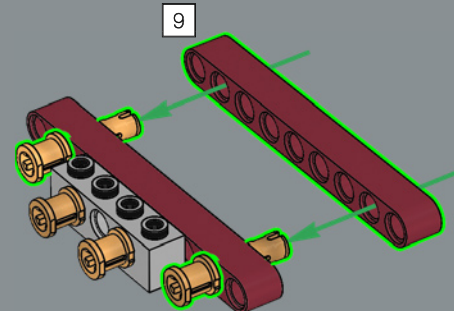
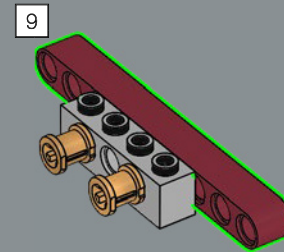

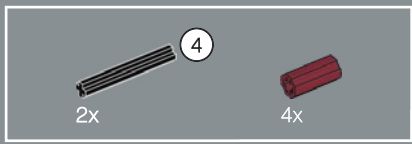

166

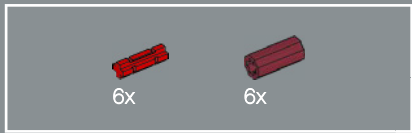
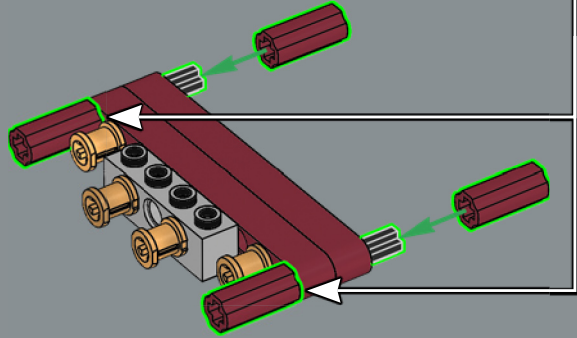
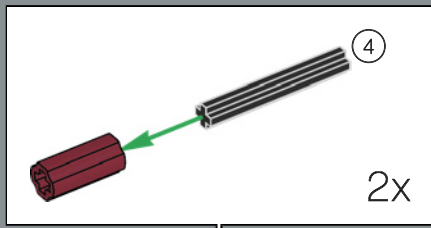

167

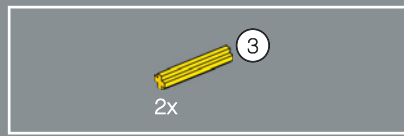
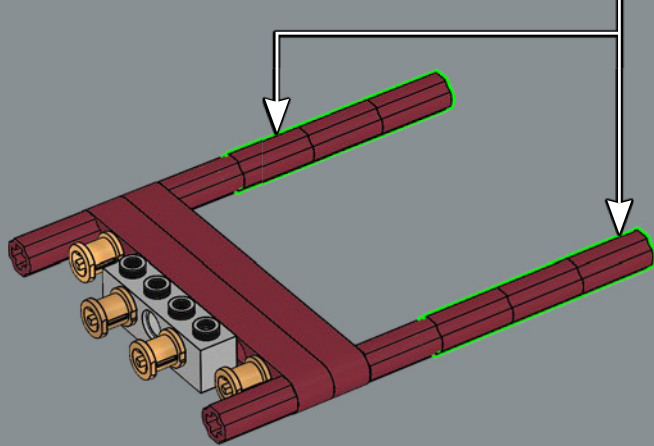
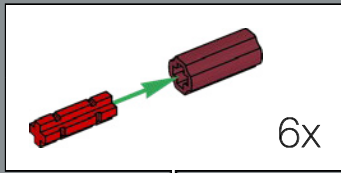

168

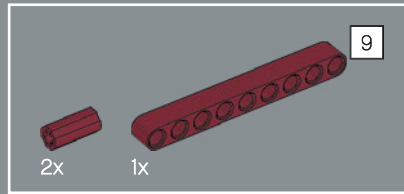
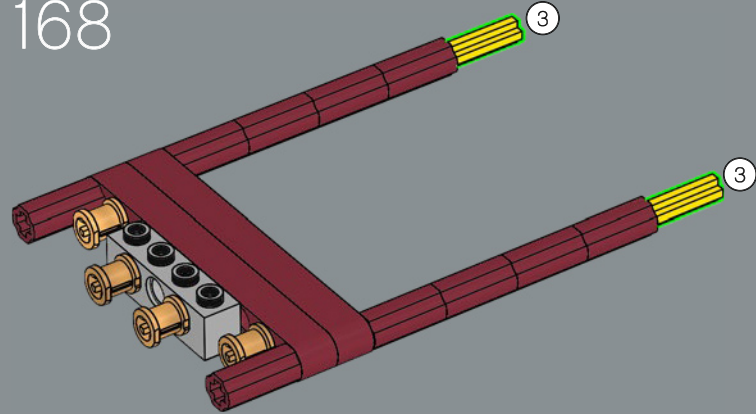

169

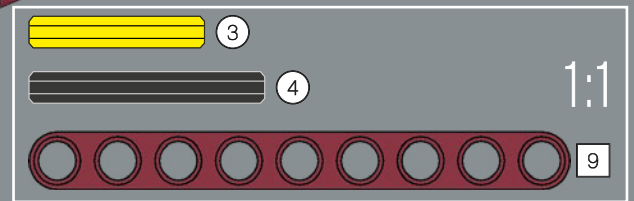
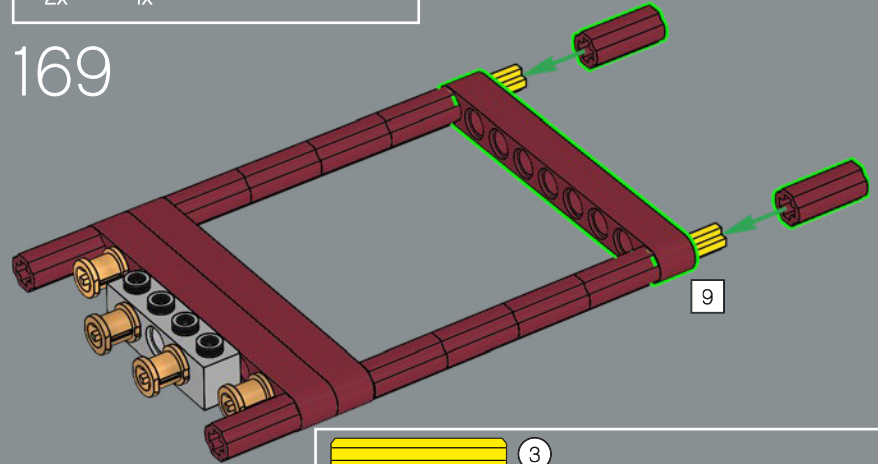

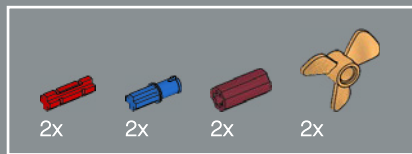

170

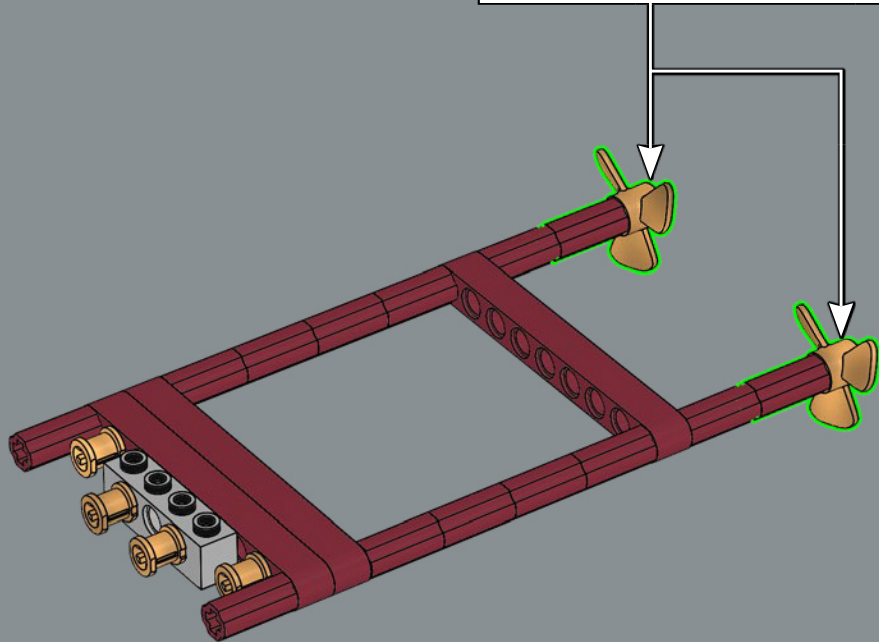
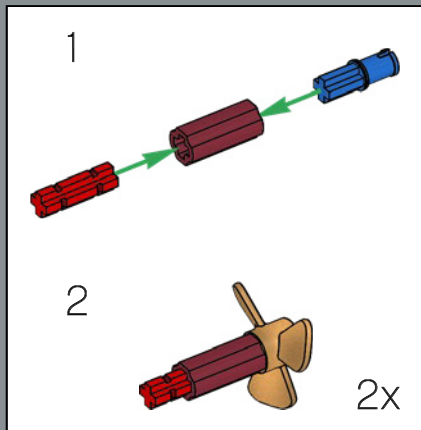

171

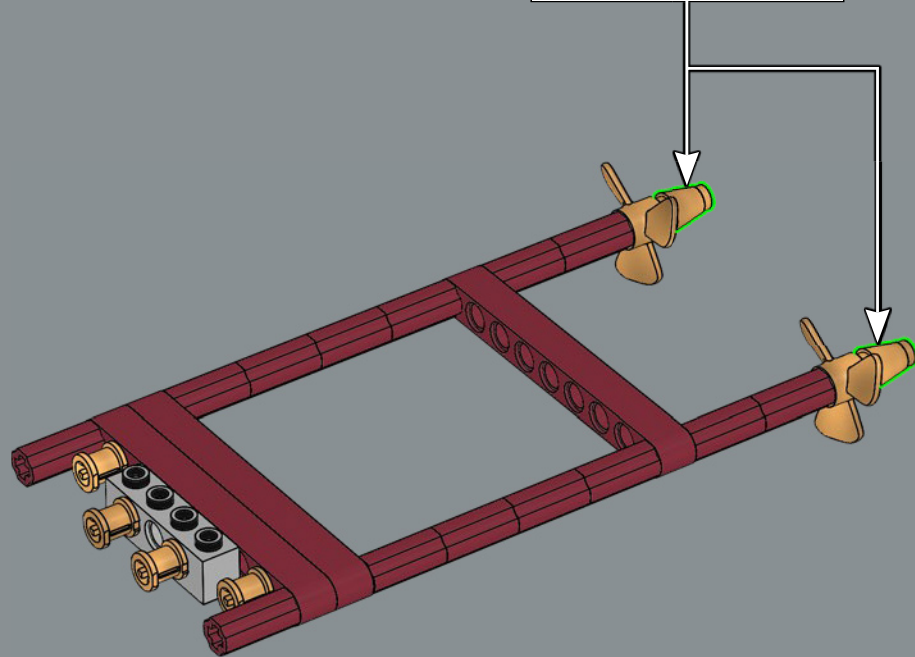
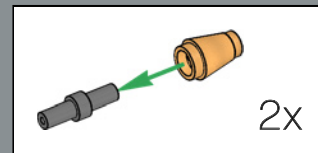

172

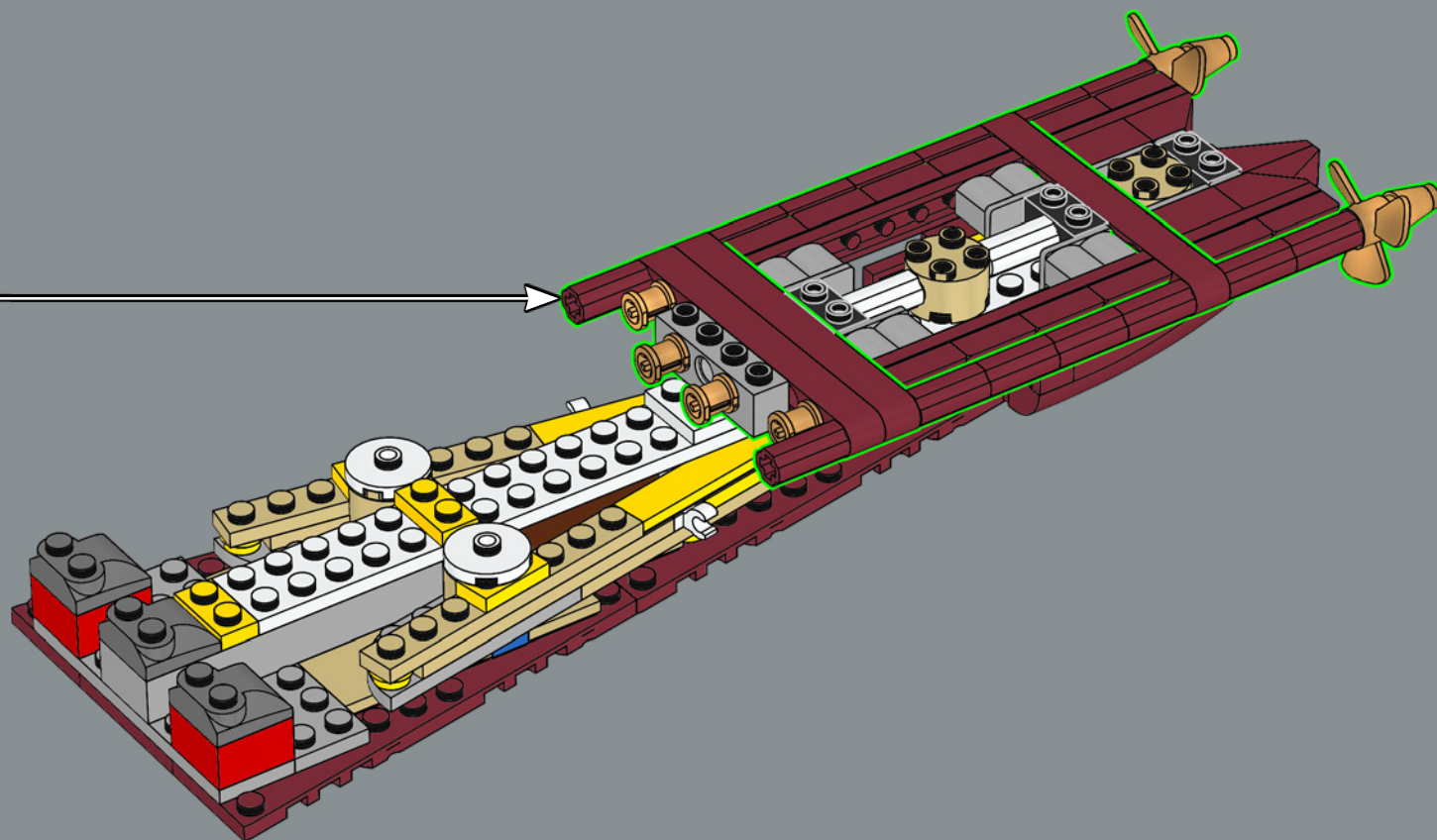

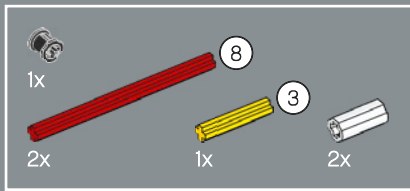

173

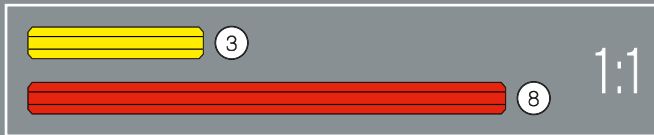
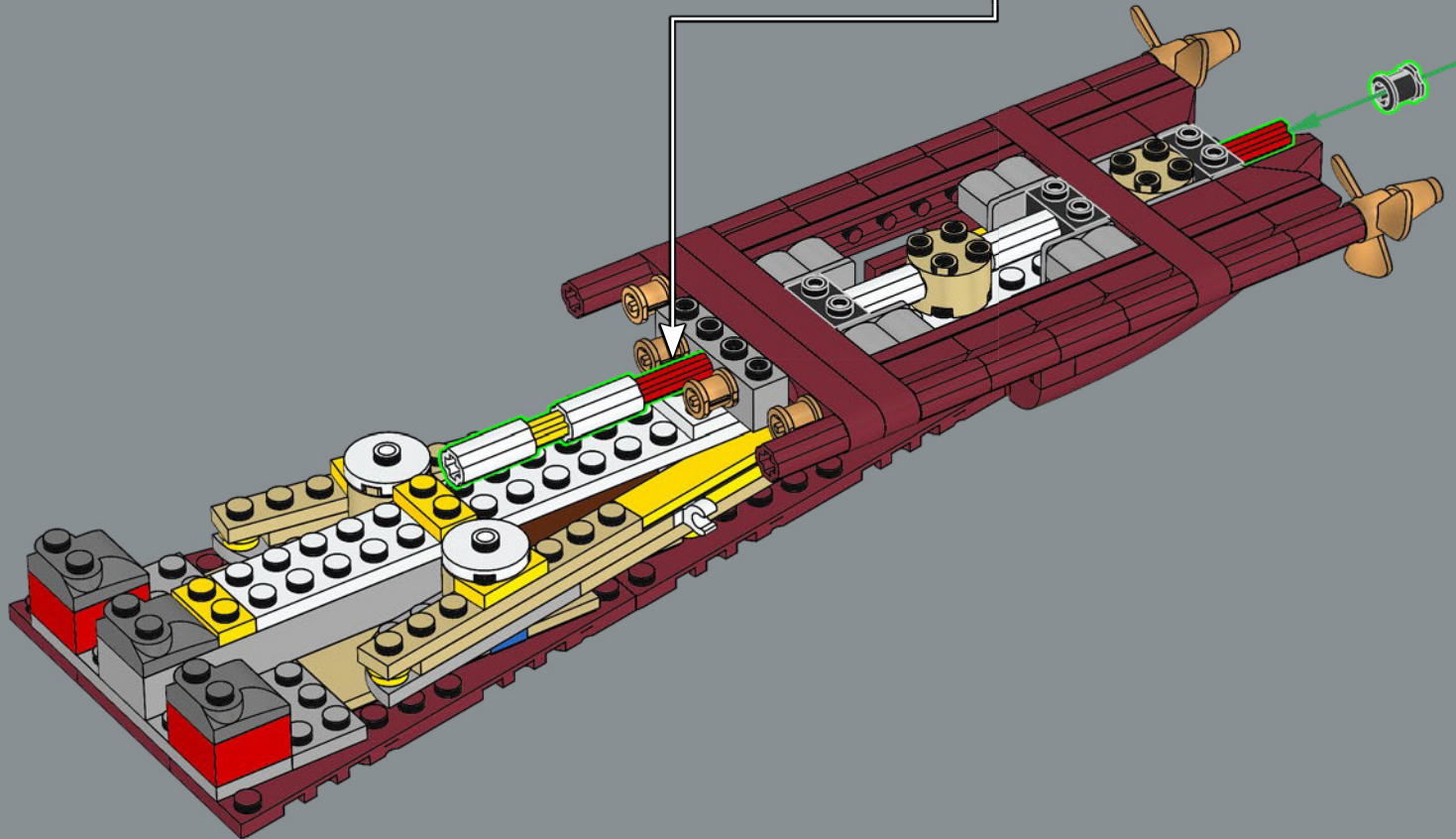
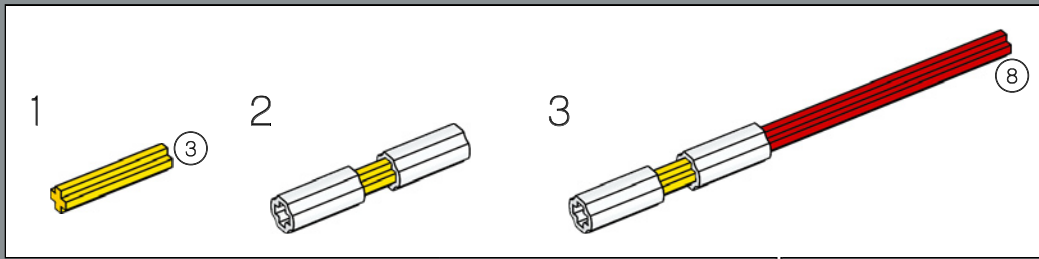

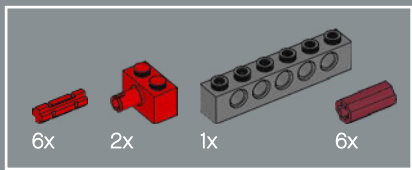

174

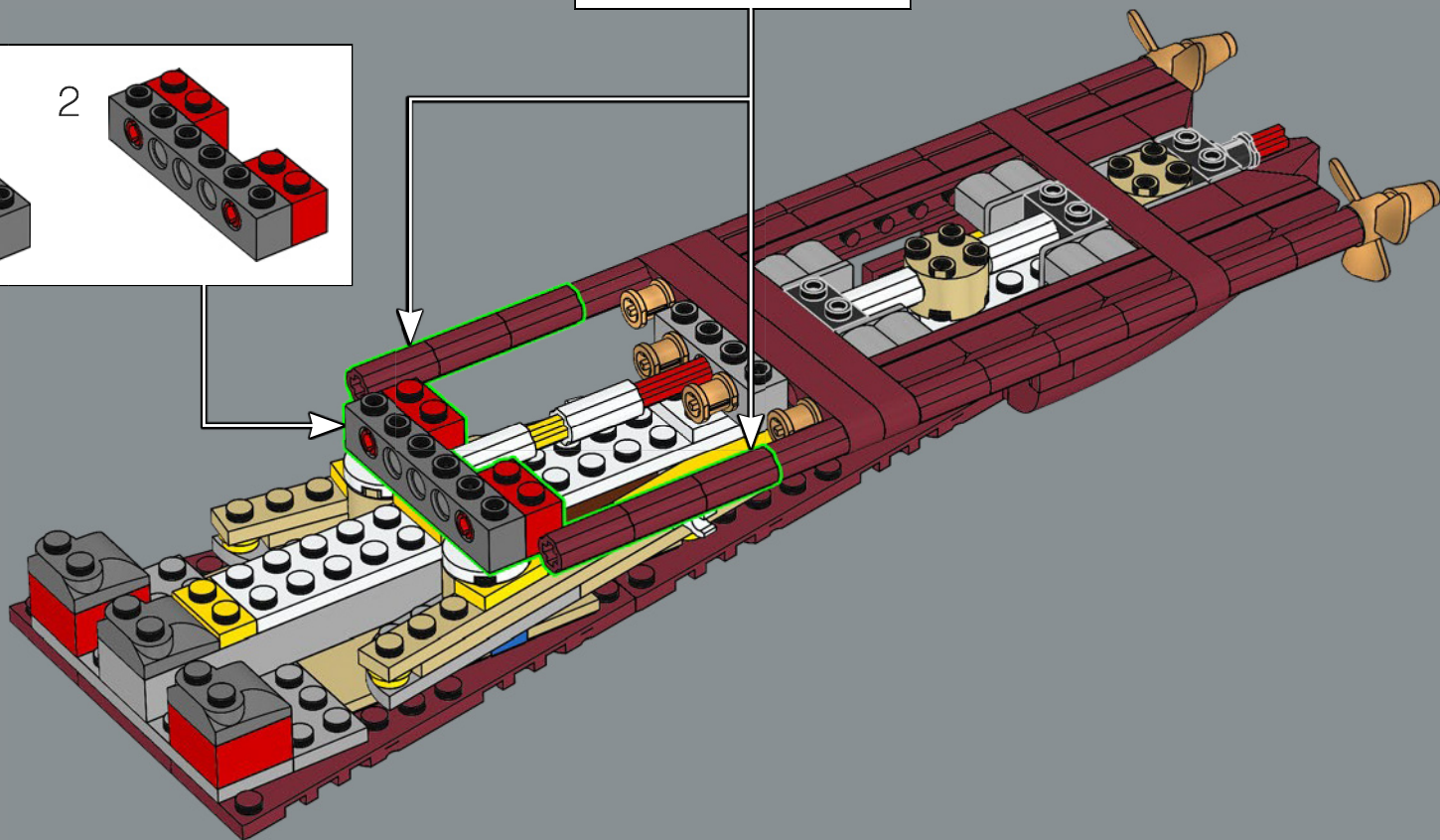
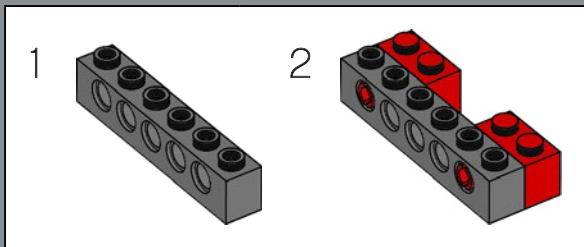
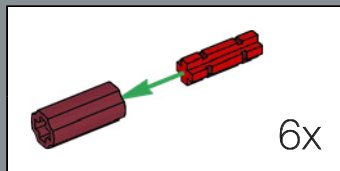

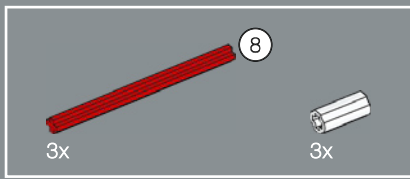

175

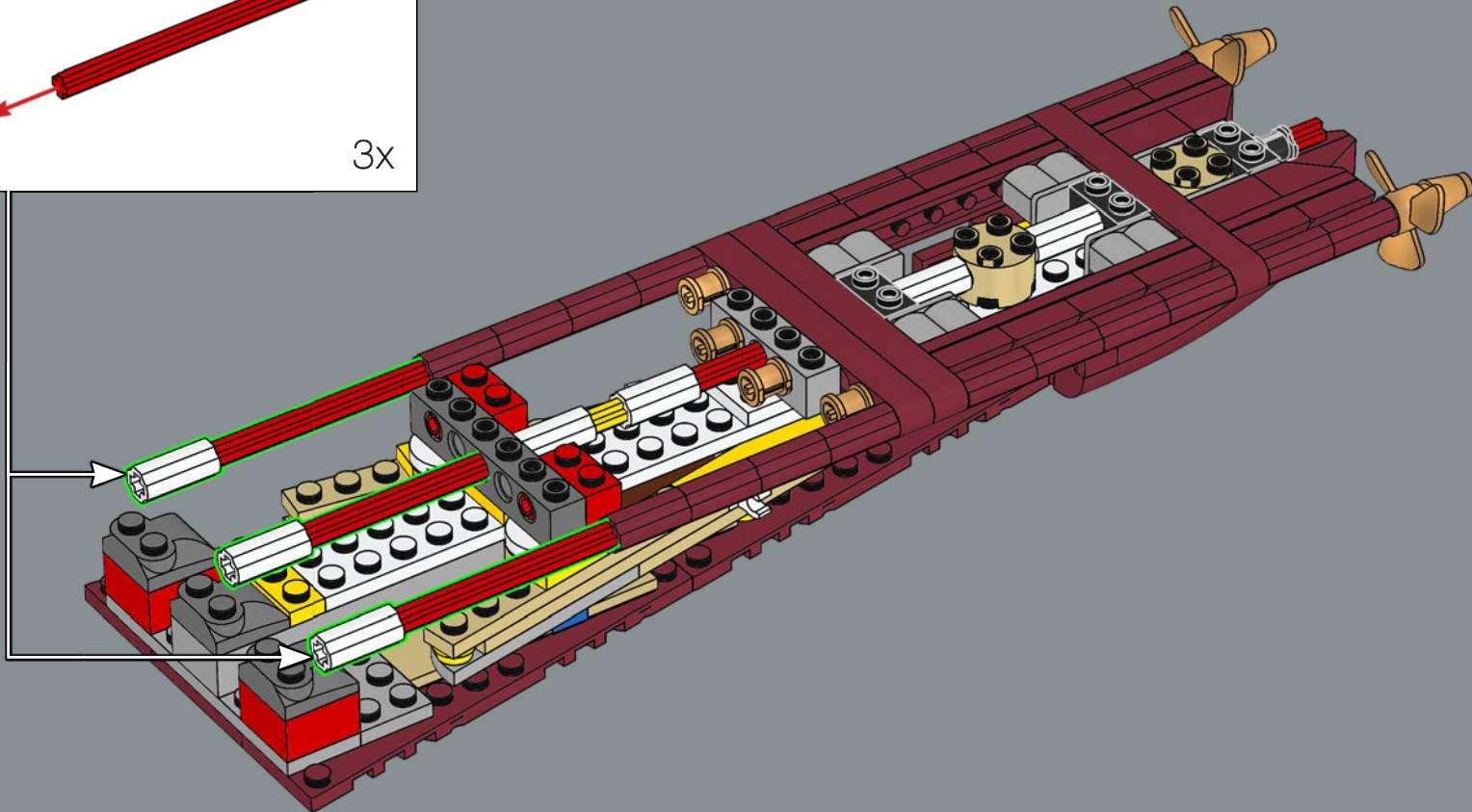
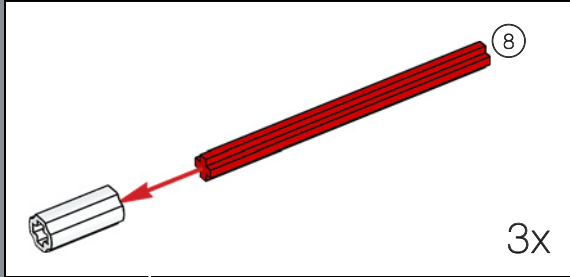

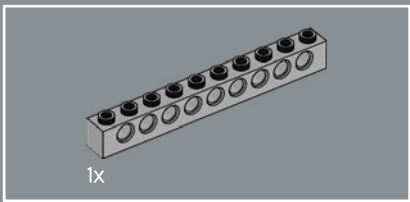

176

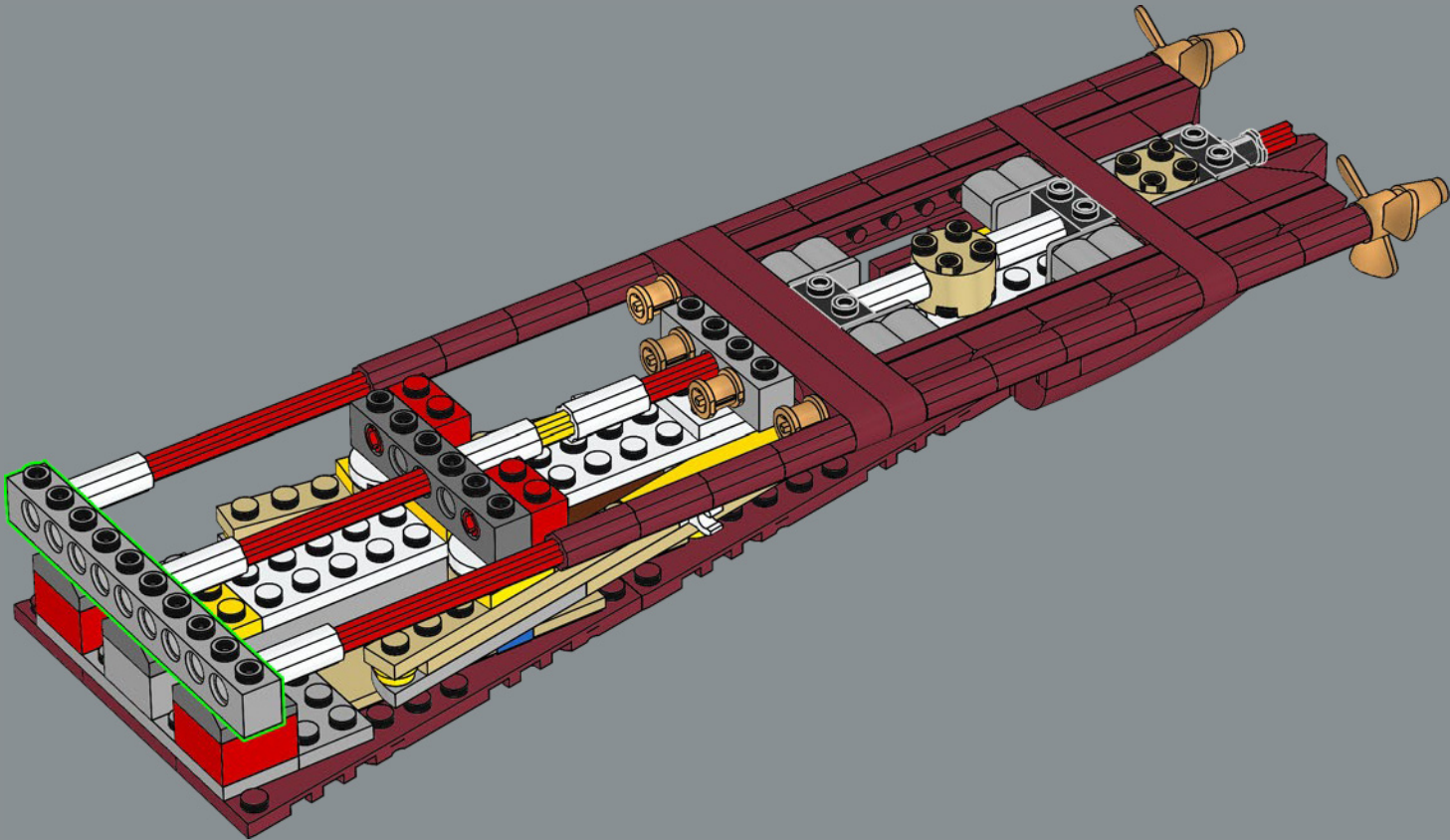

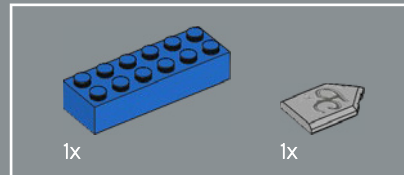
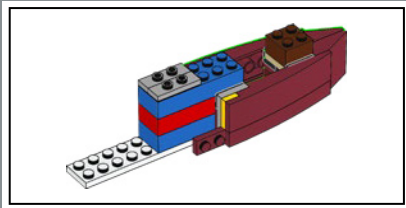
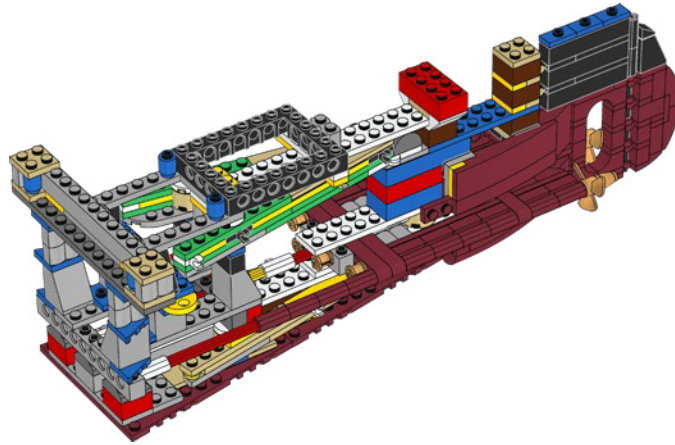
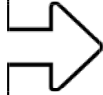

178

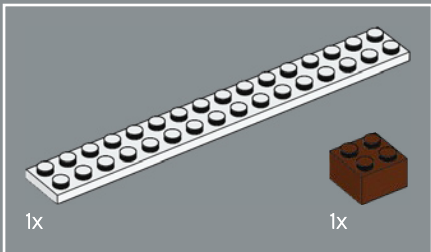

177

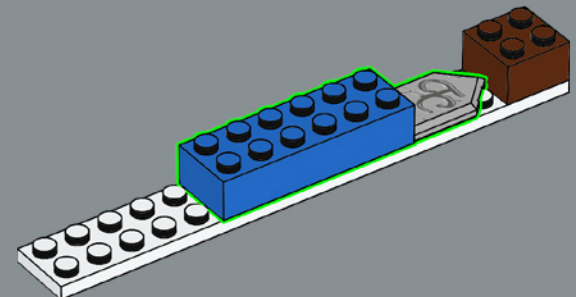
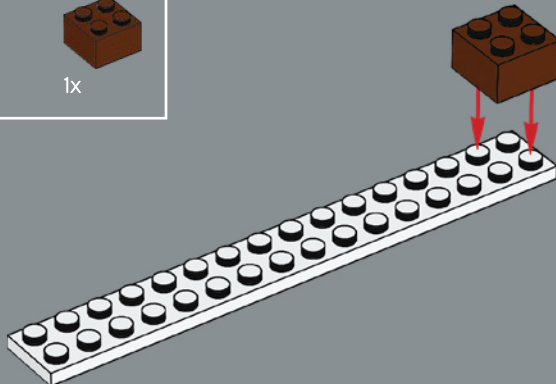



4x

179

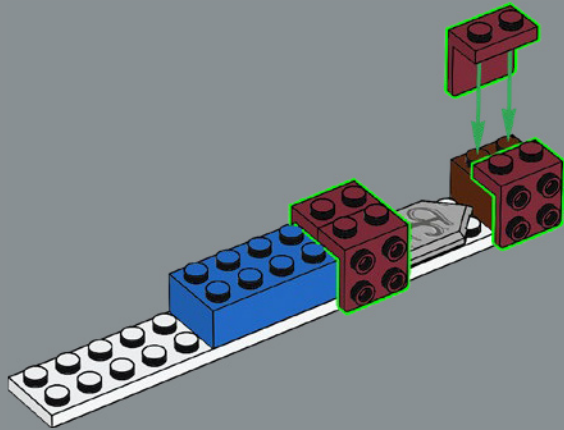

4x

180

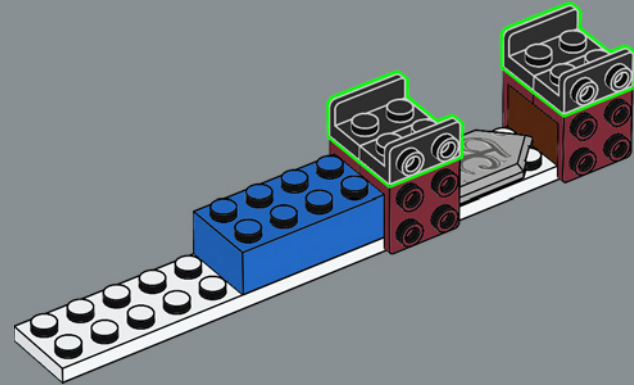

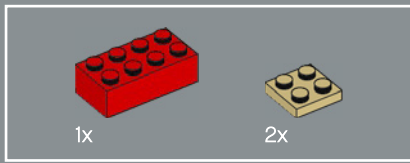

181

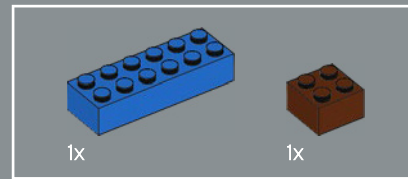
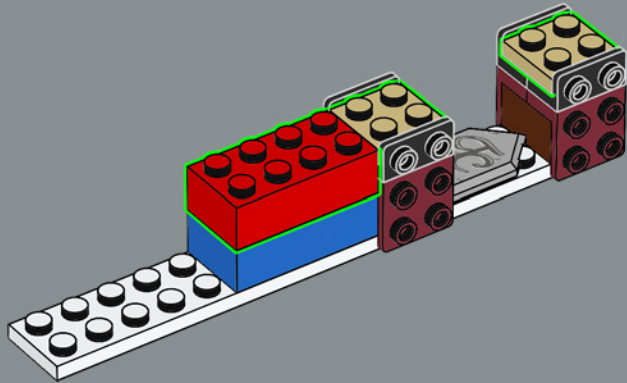

182

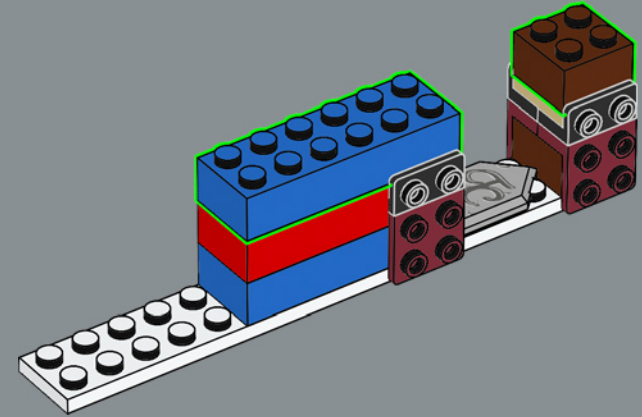

183

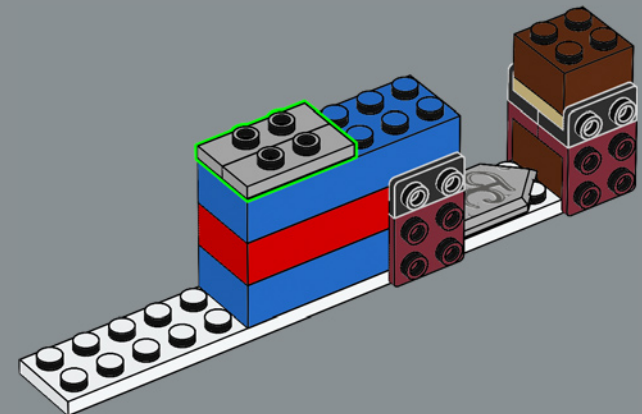

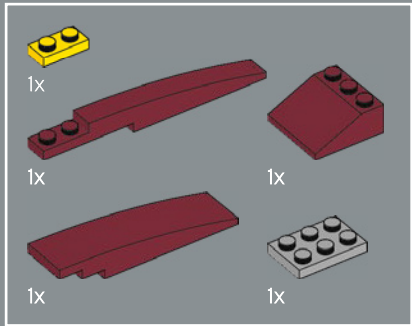

184

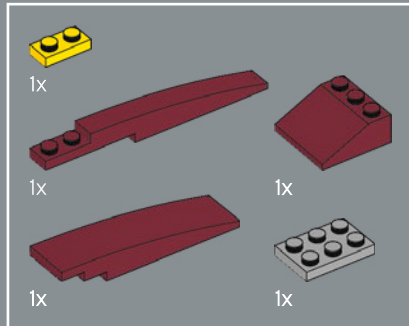
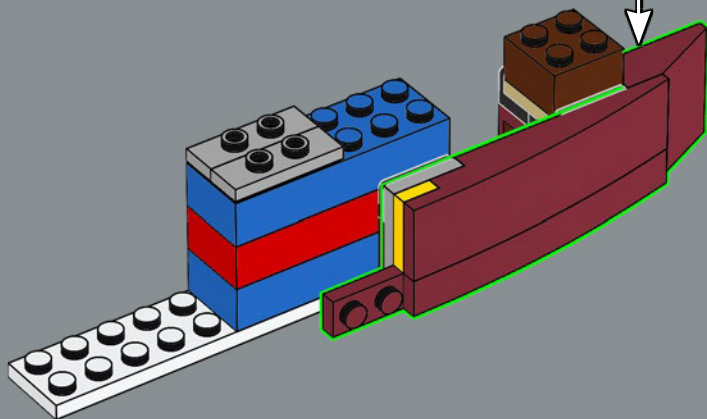
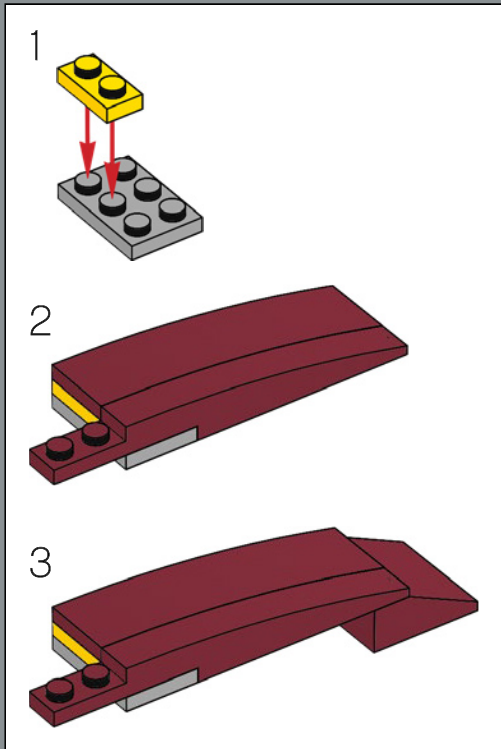

185

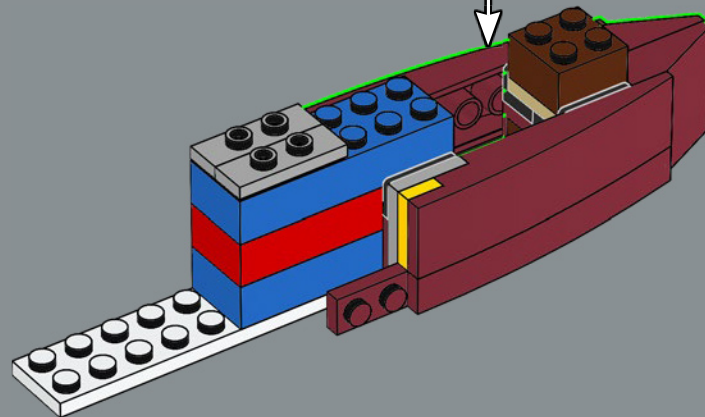
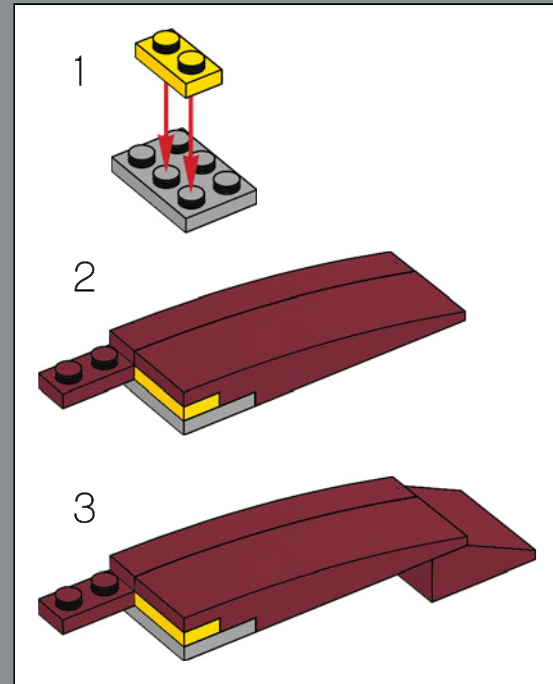

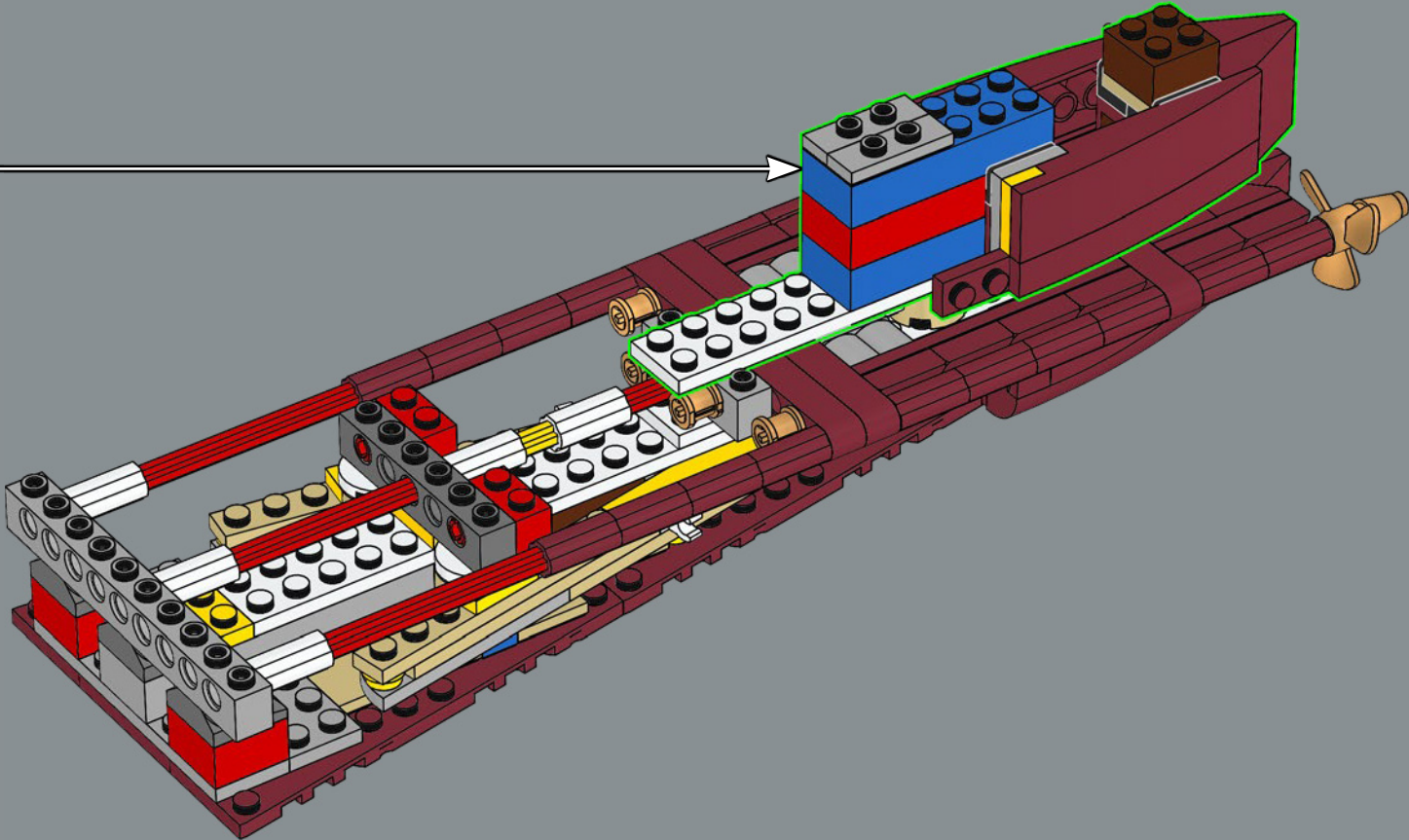

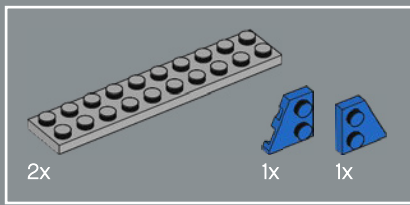

187

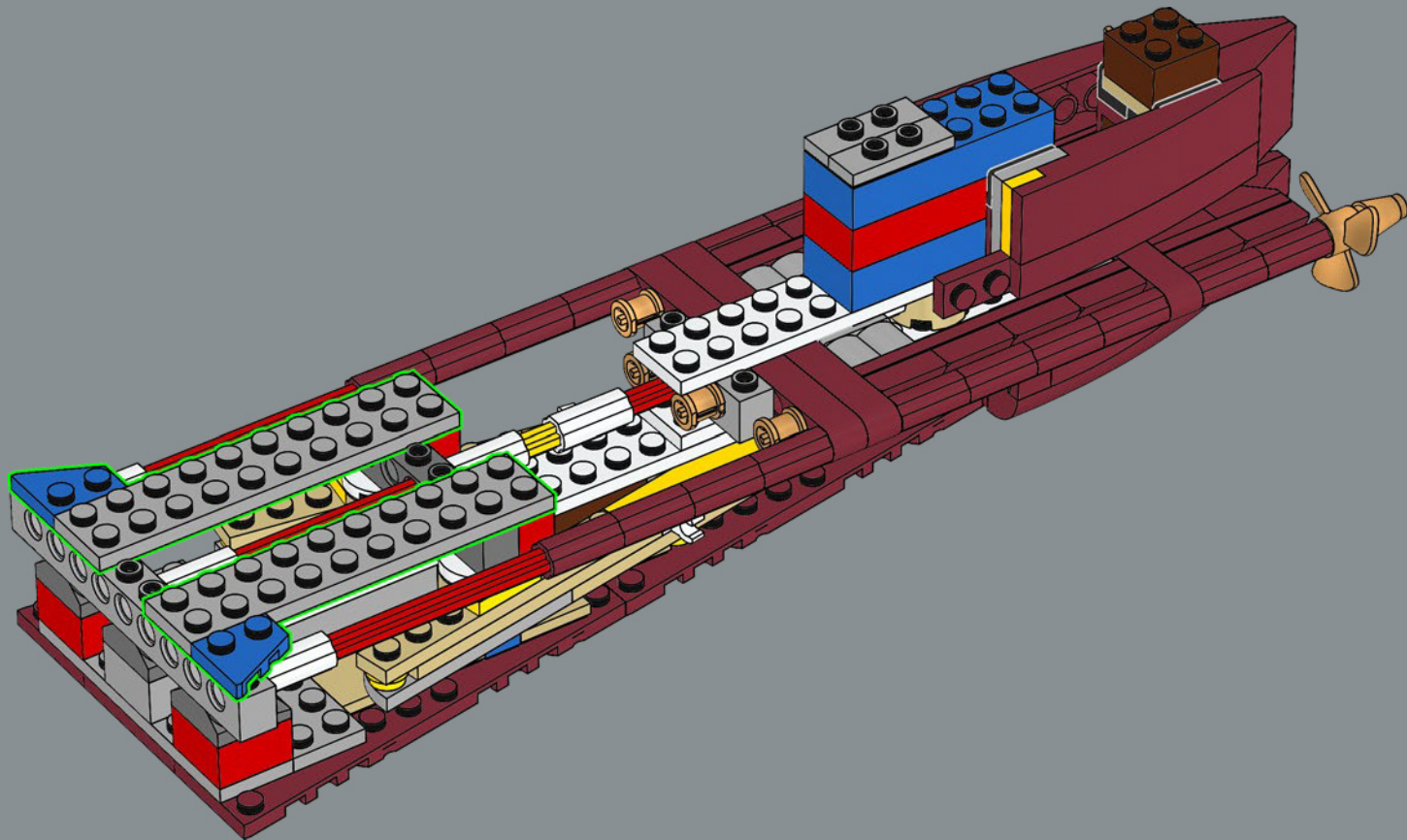

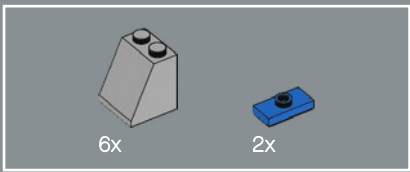

188

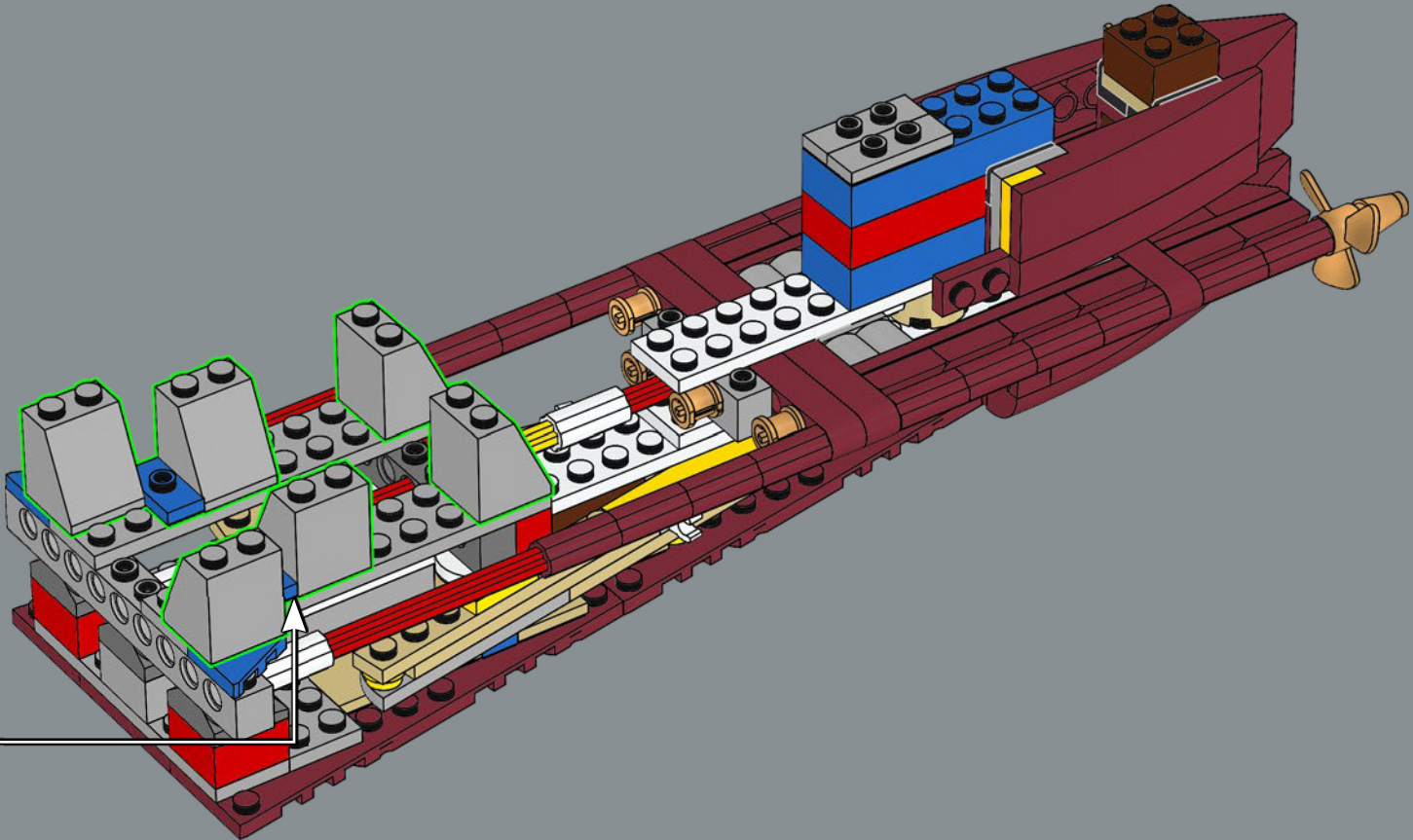

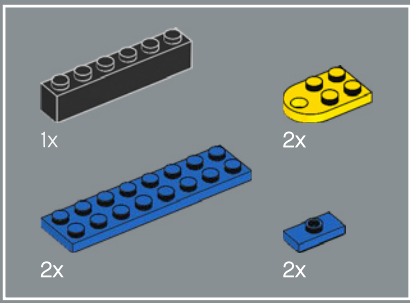

189

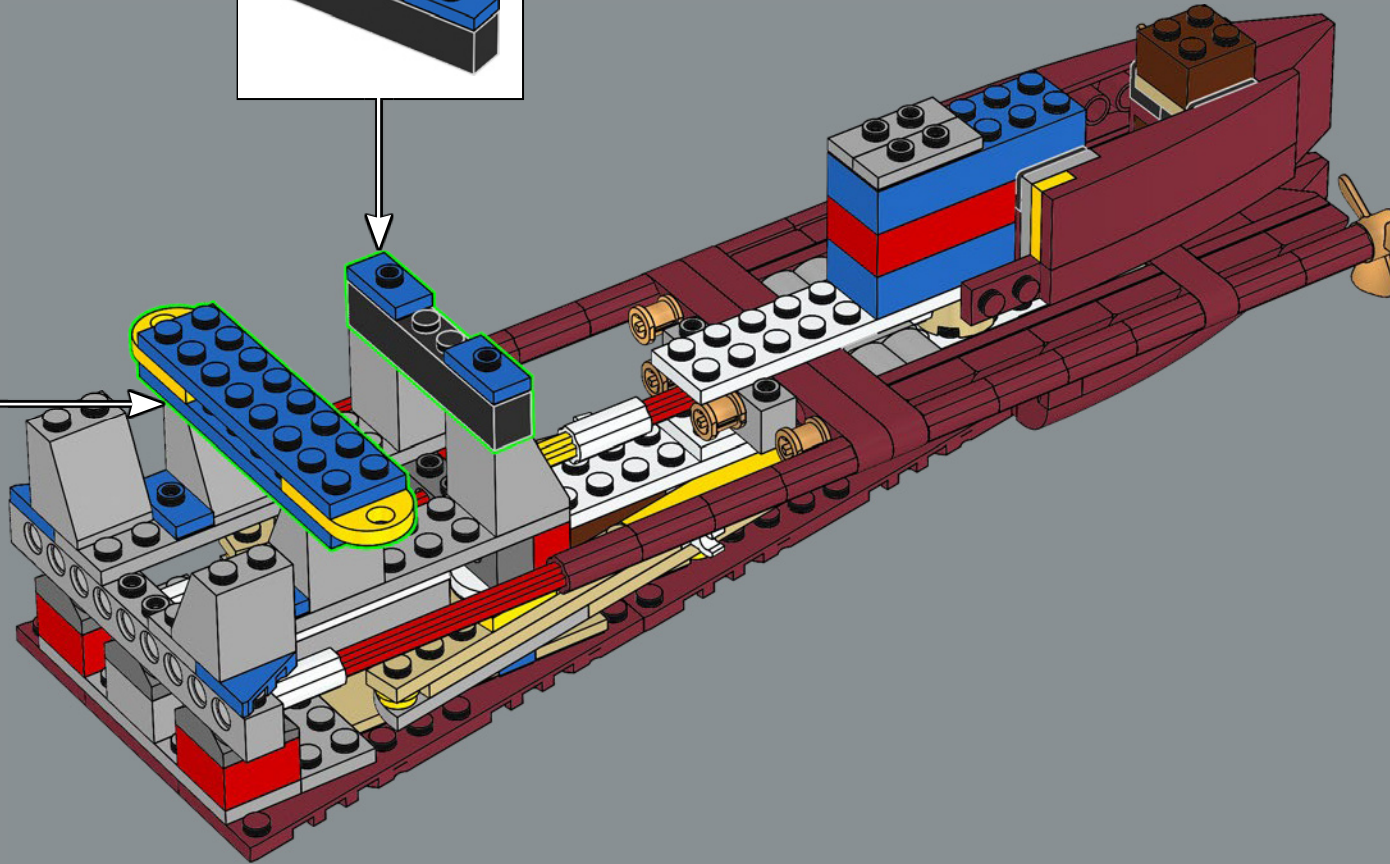
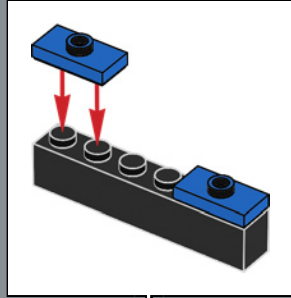
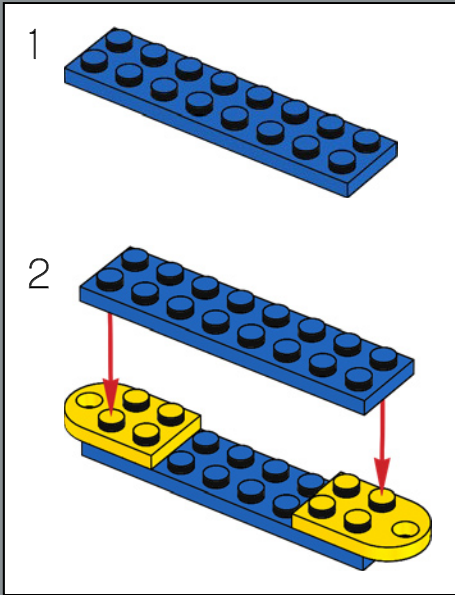

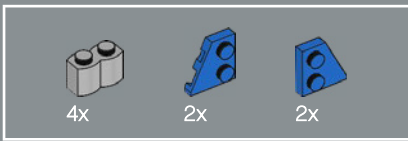

190

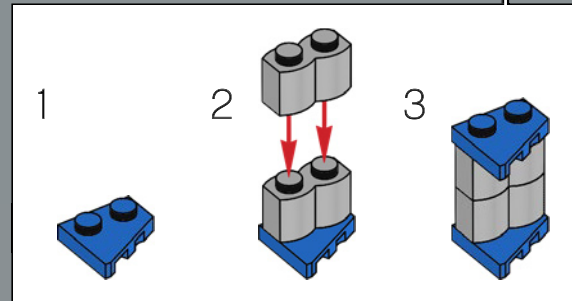
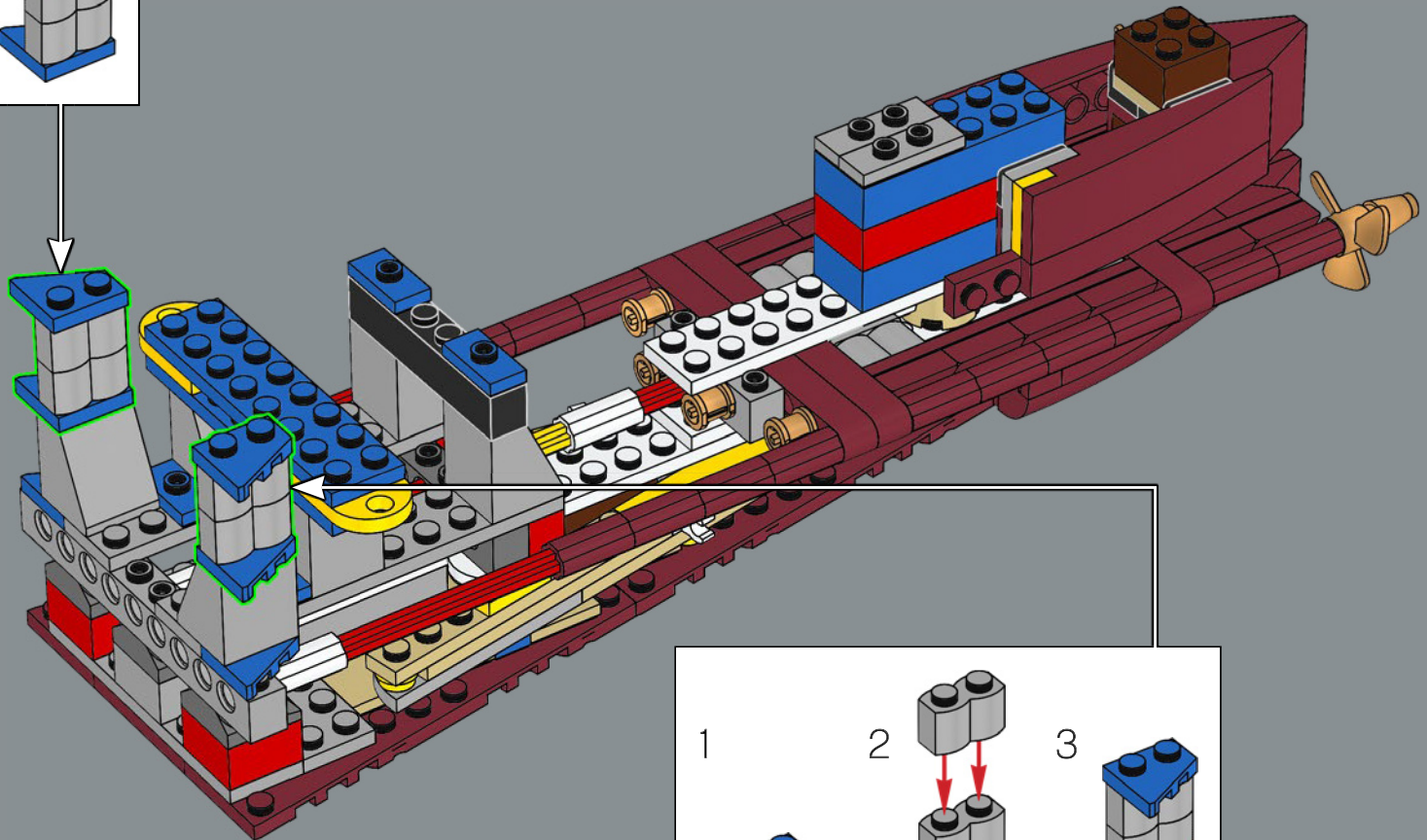
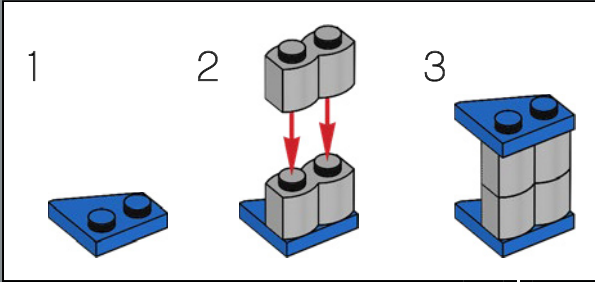

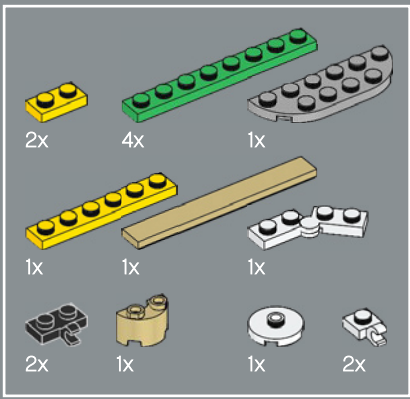

191

1



2

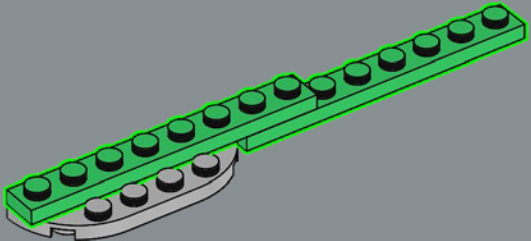

3

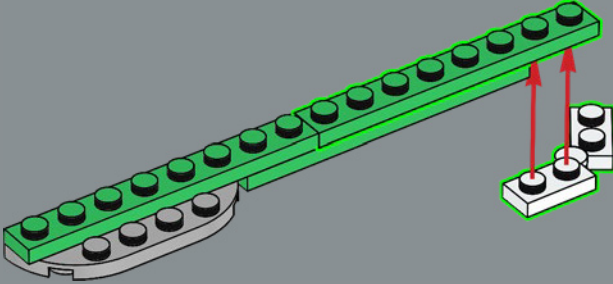

4

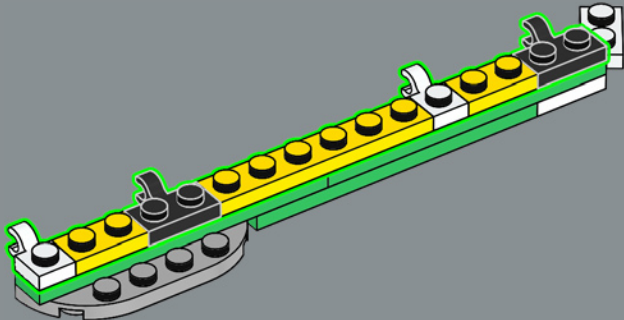

5

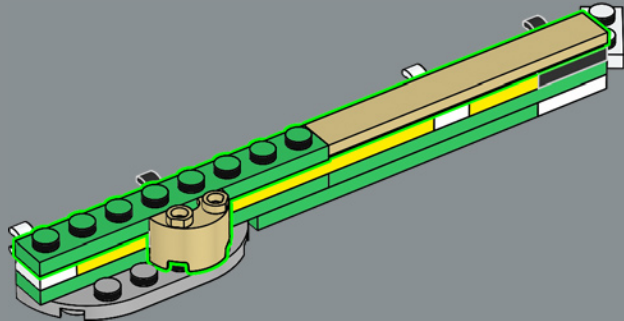

6

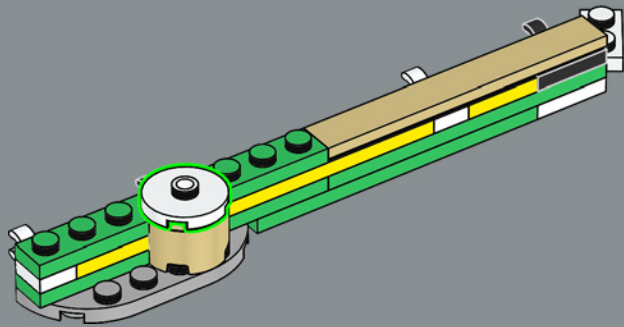

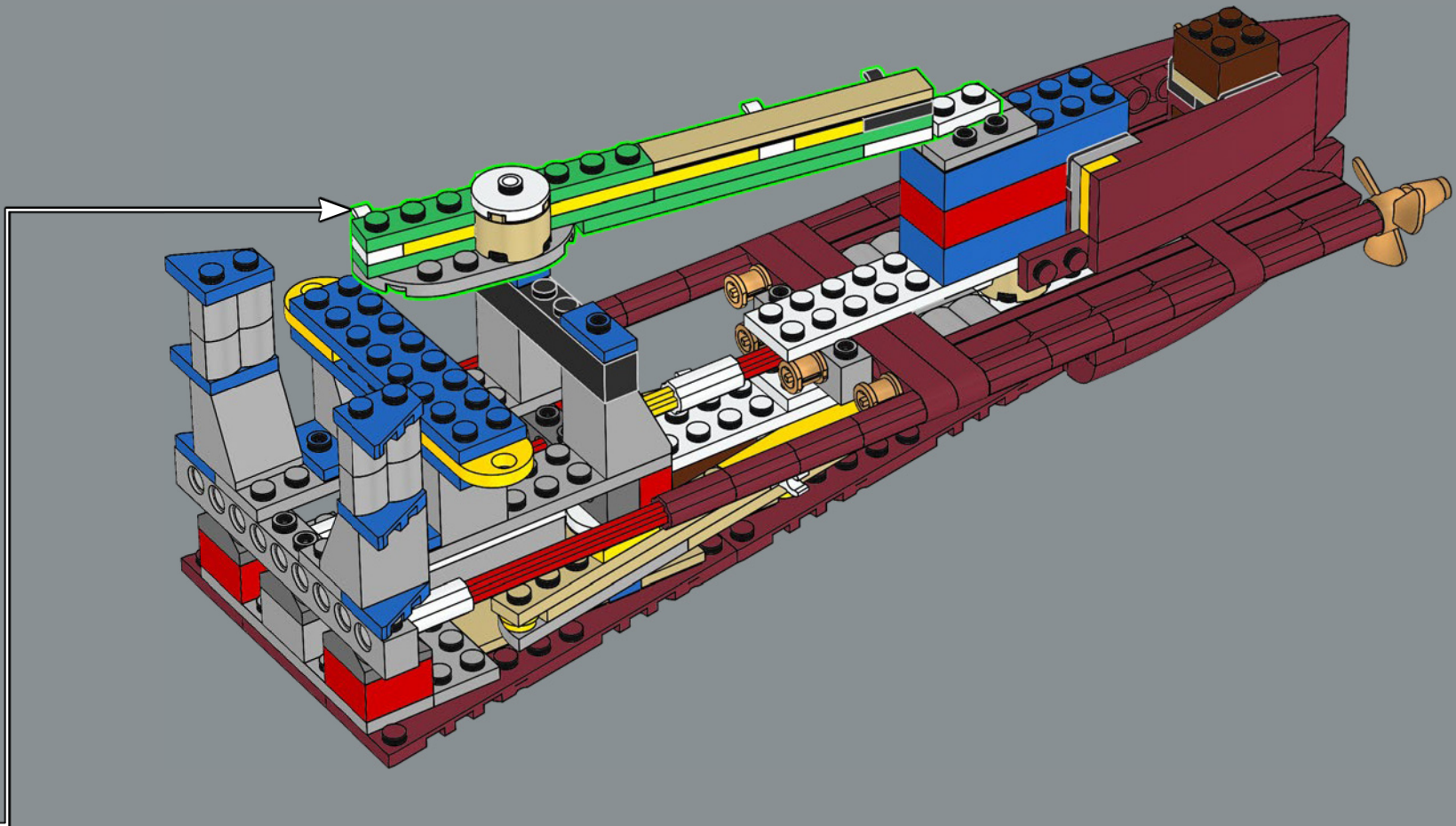

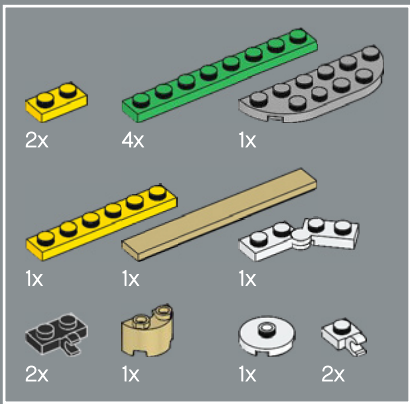

192

1

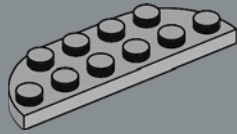

2

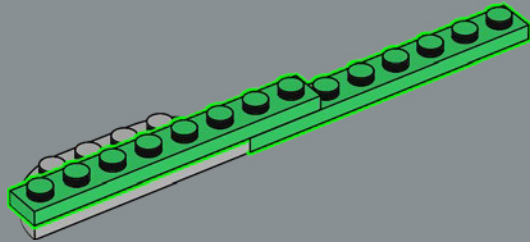

3

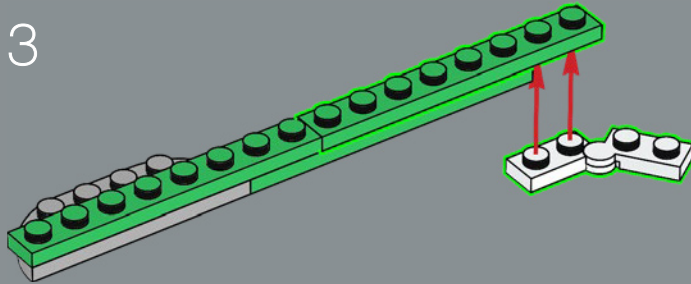

4

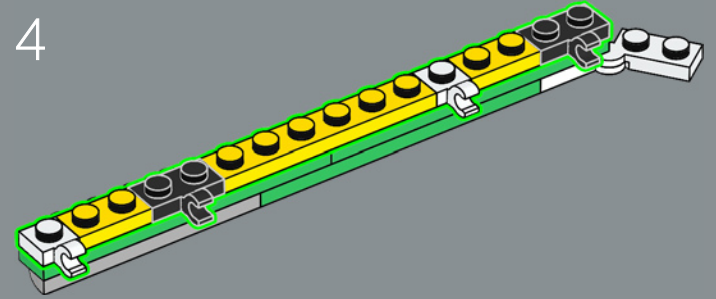

5

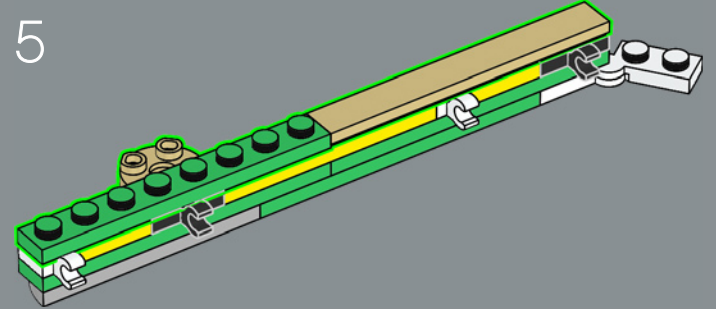

6

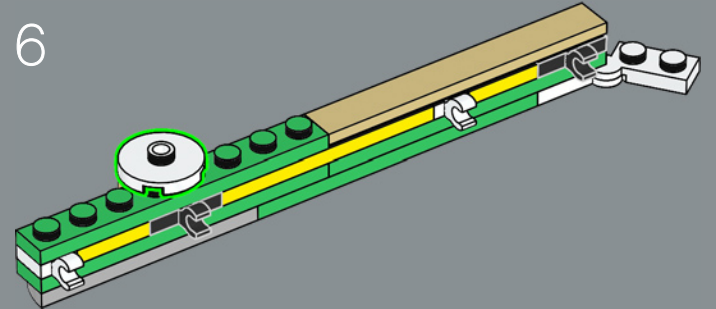

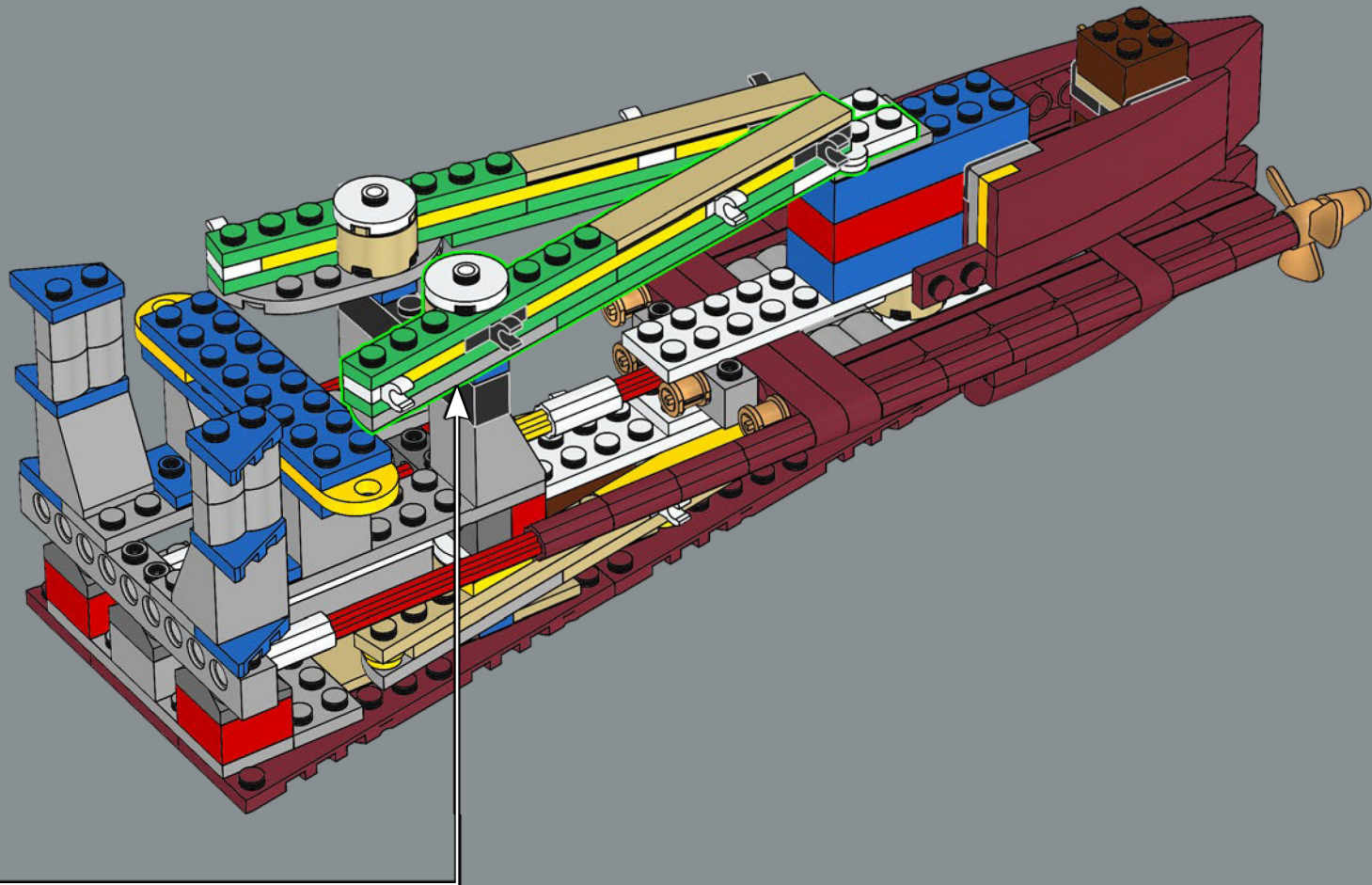

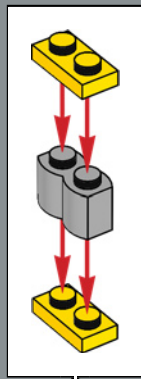
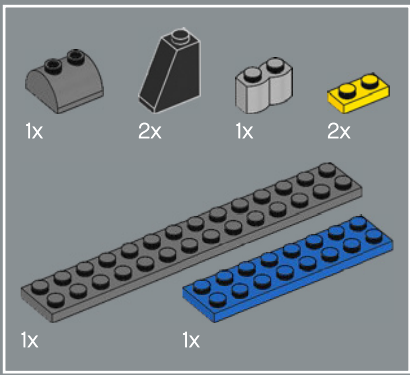

193

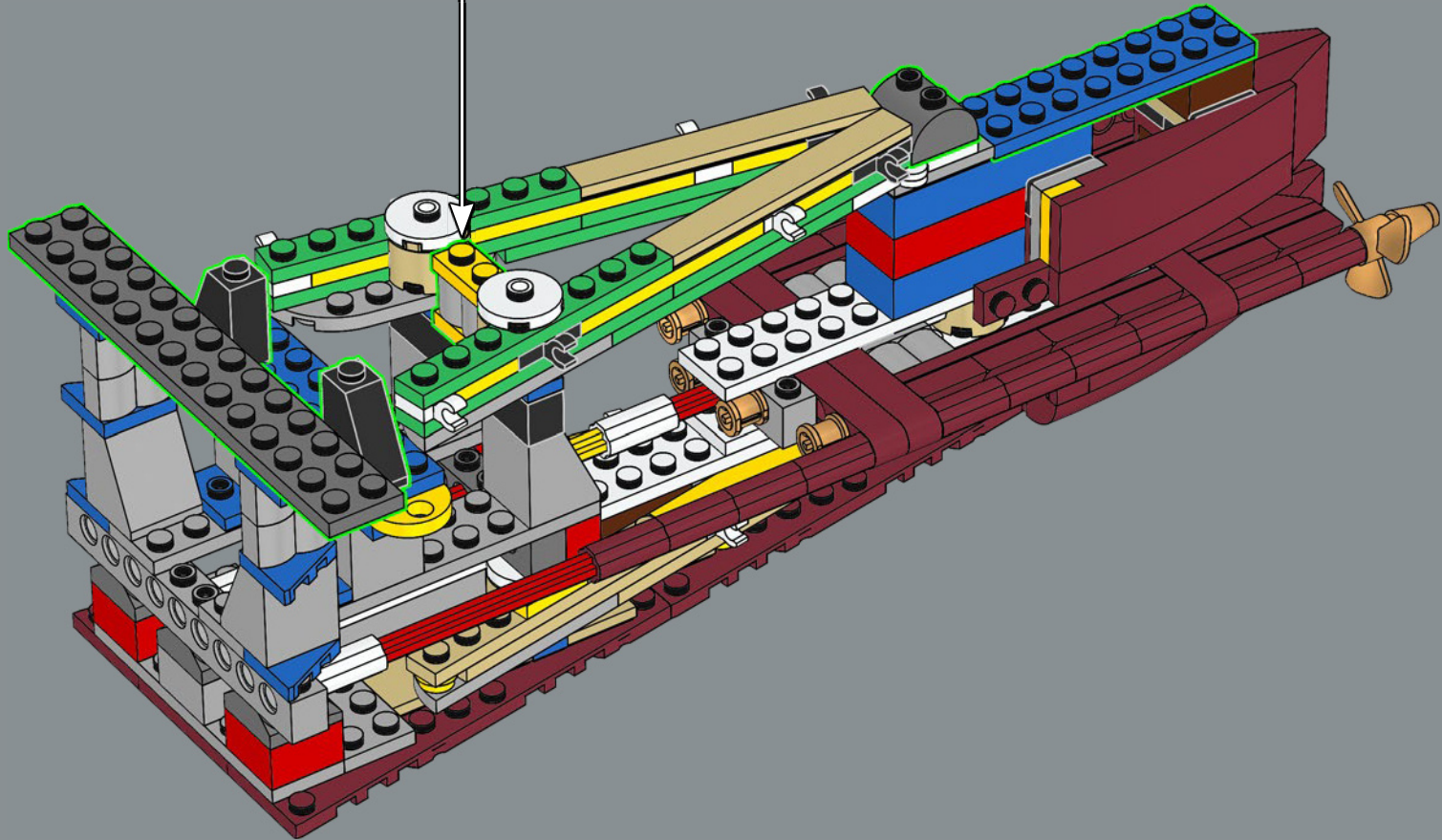

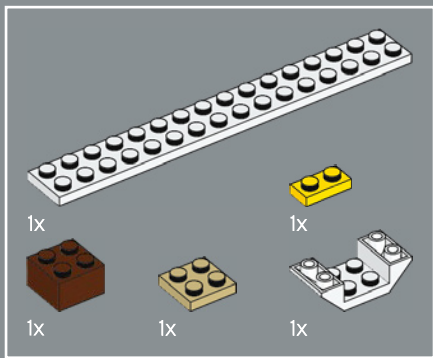

194

1

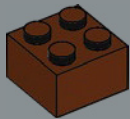

2

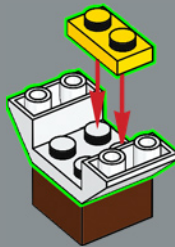

3

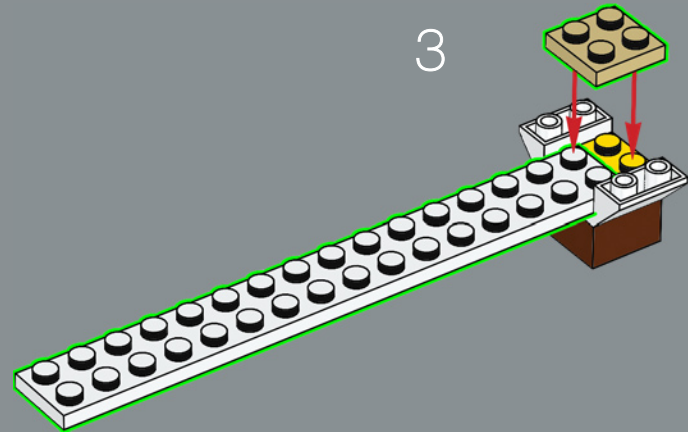

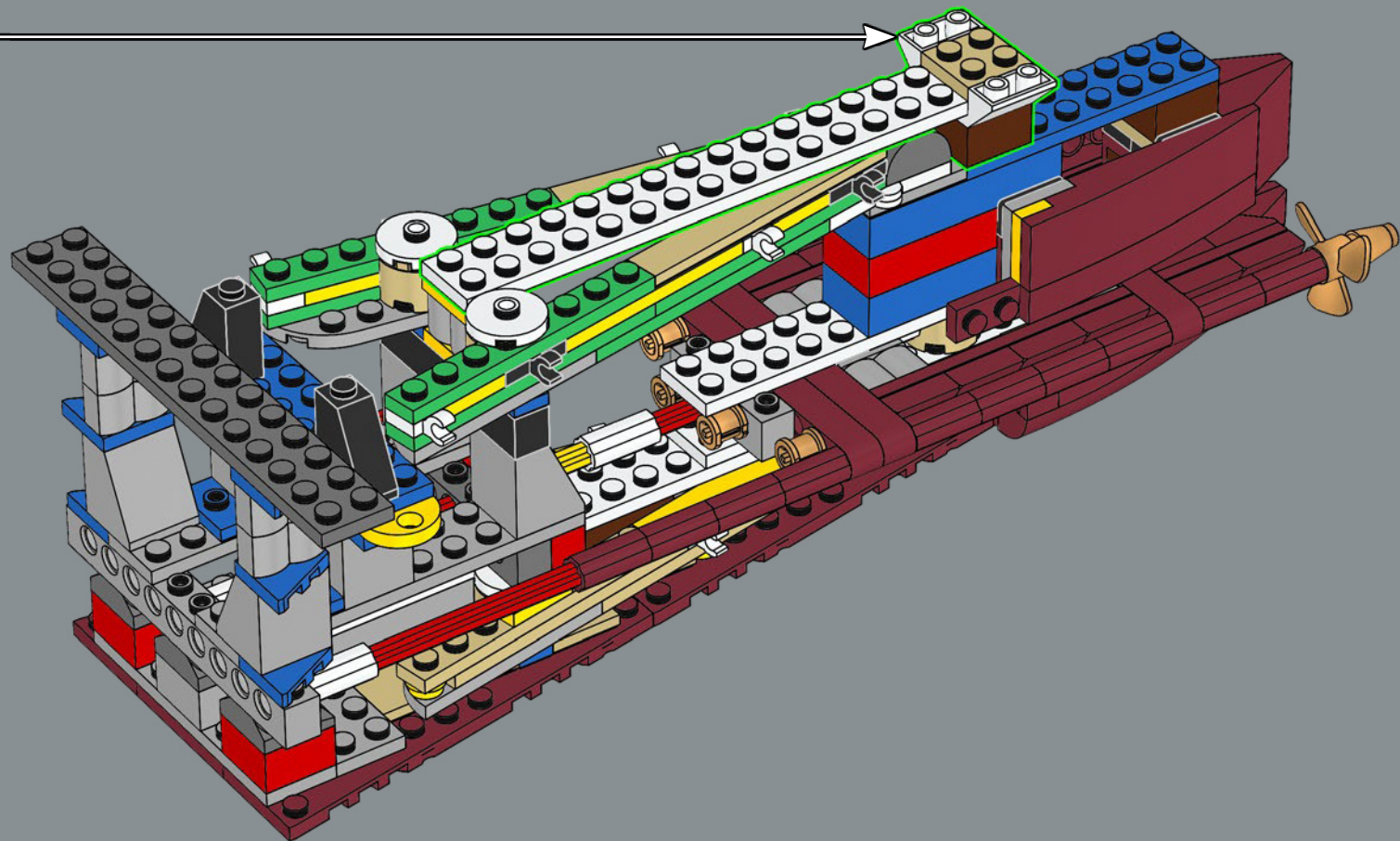

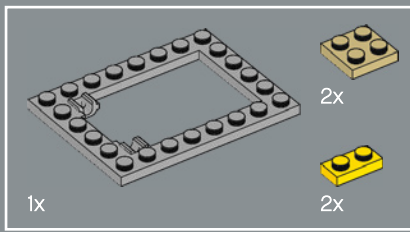

195

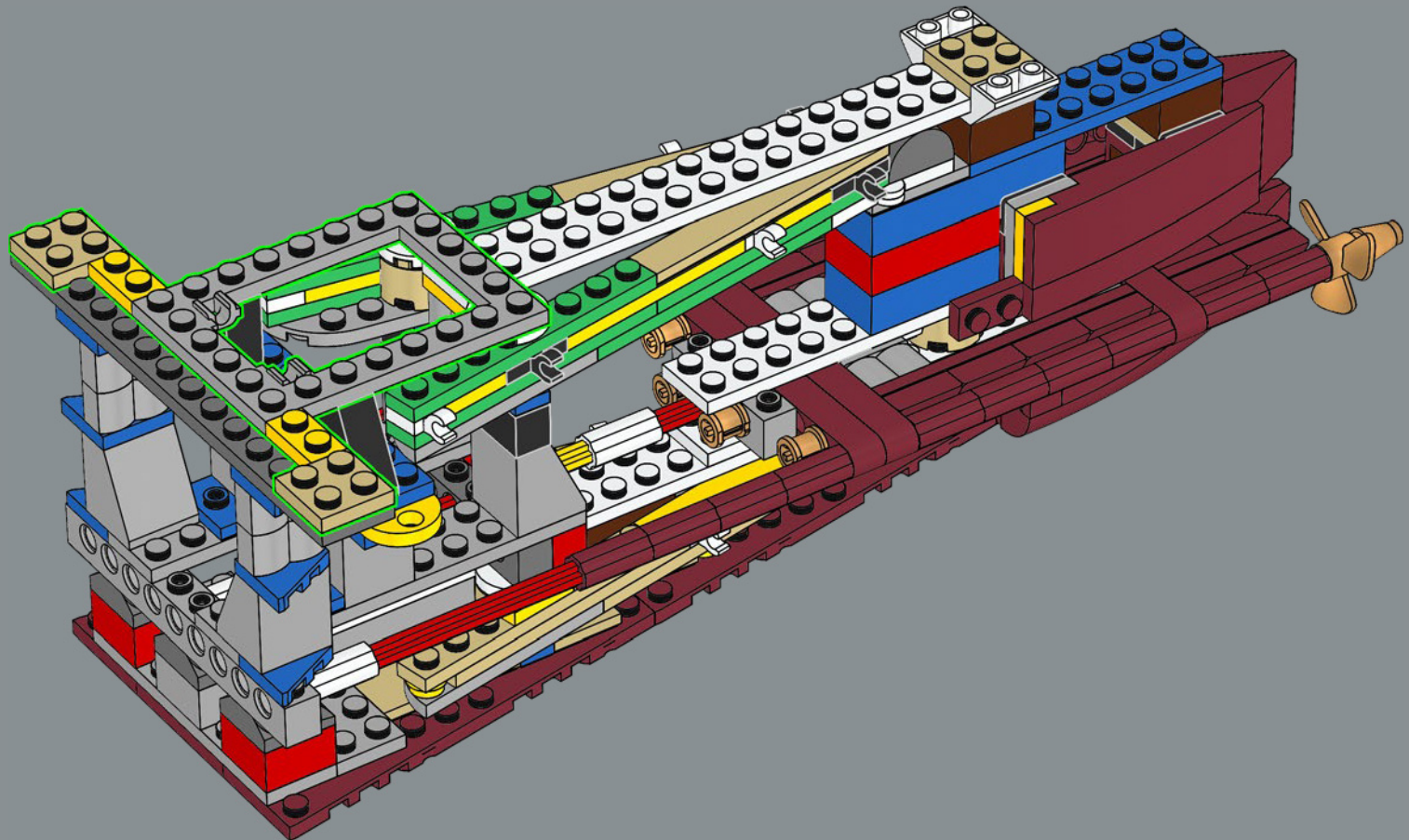

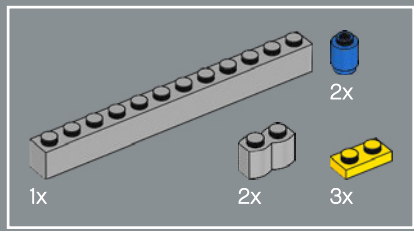

196

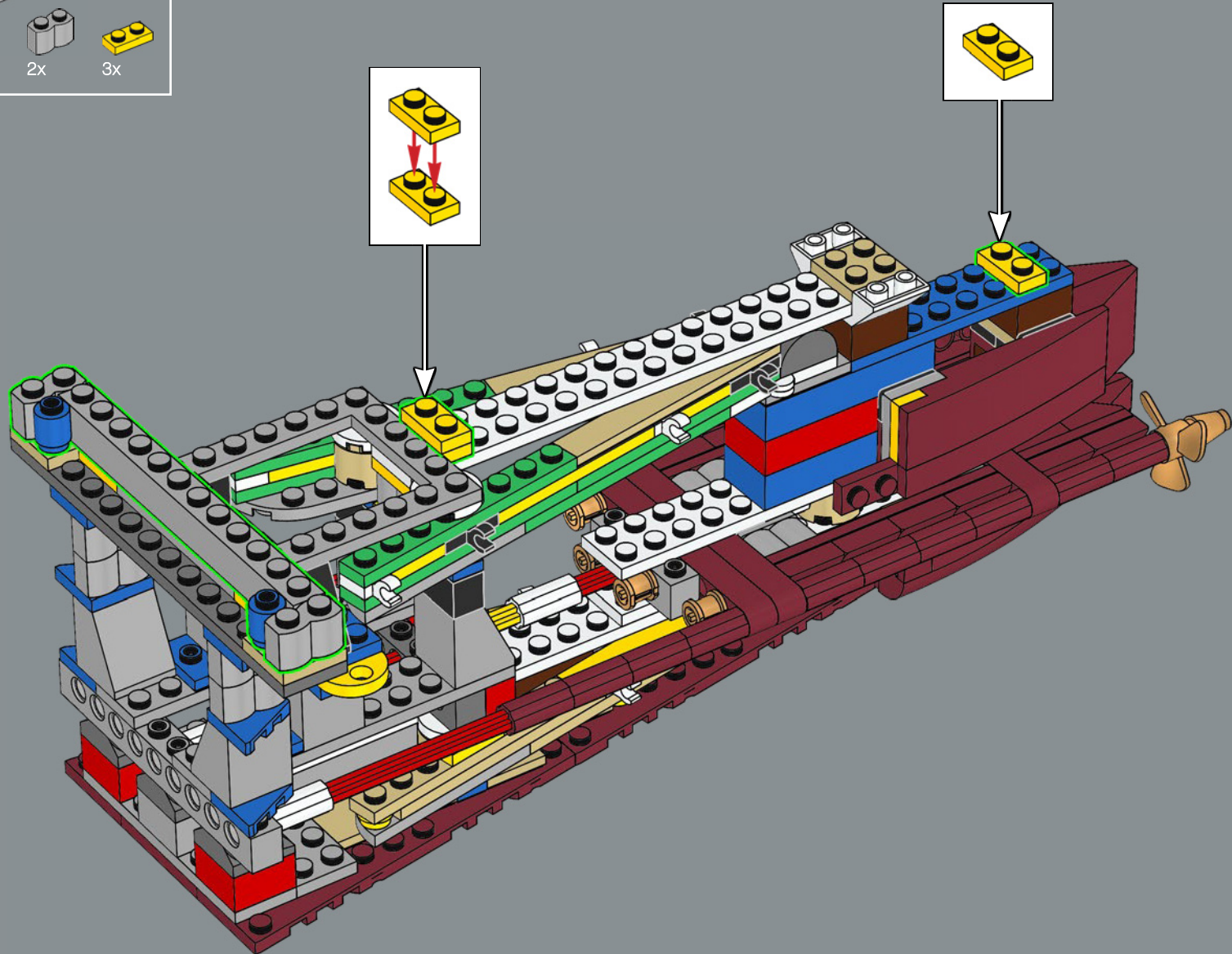

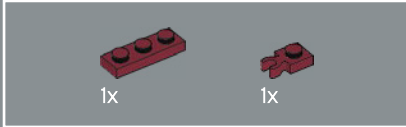
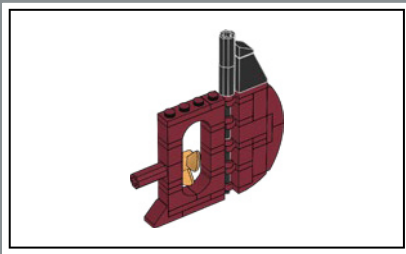

197

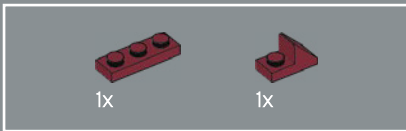
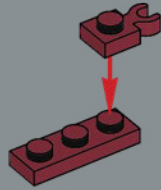

198

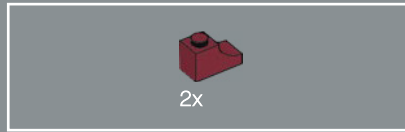
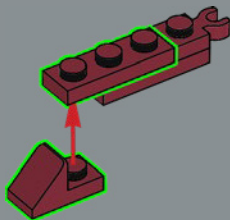

199

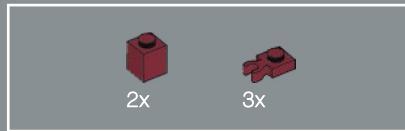
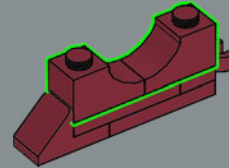

200

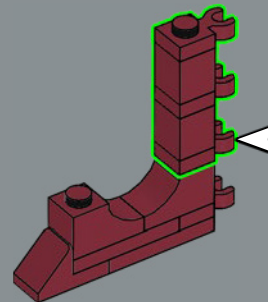
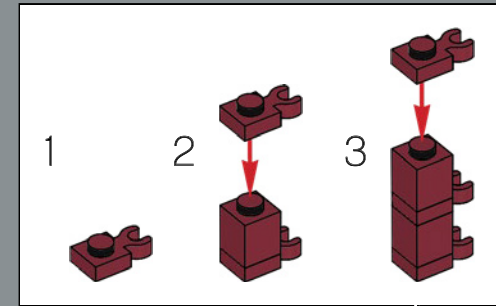

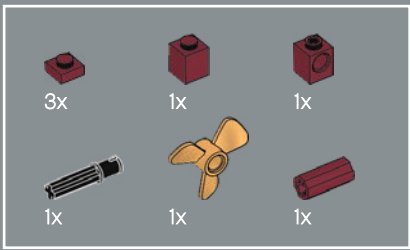

201

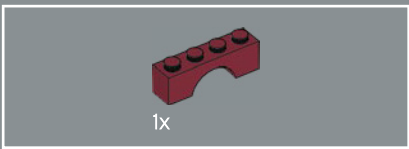
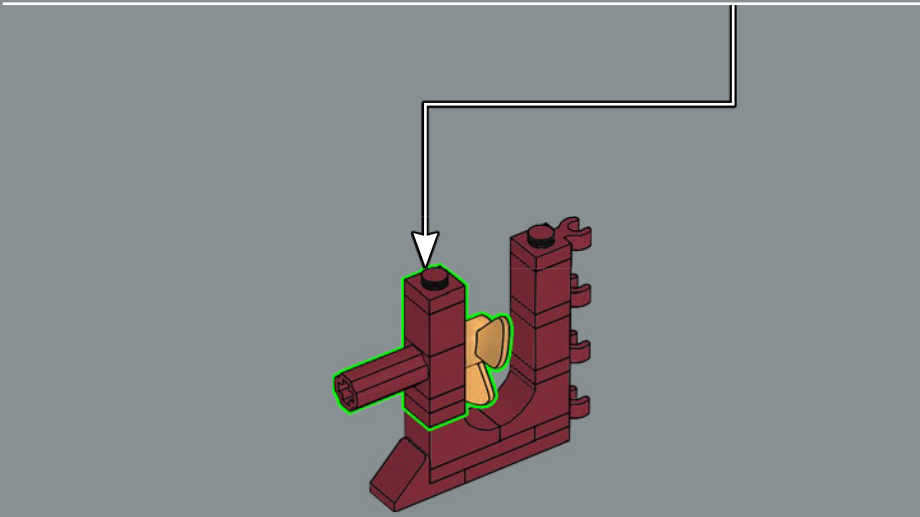
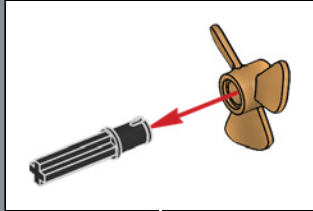
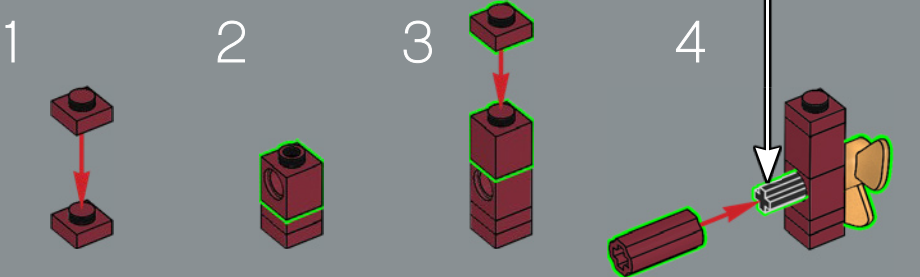

202

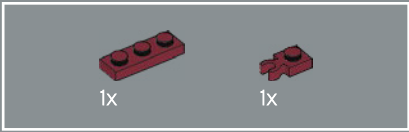
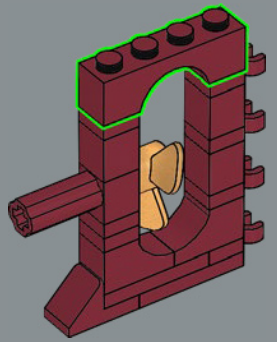

203

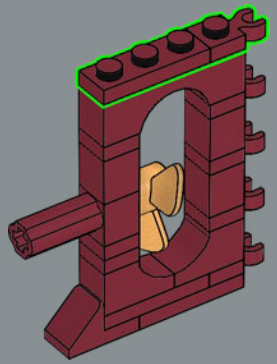

204

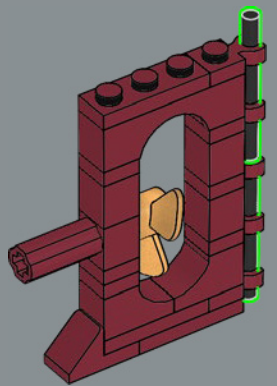

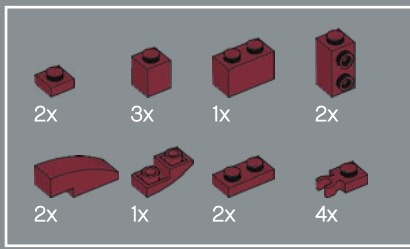

205

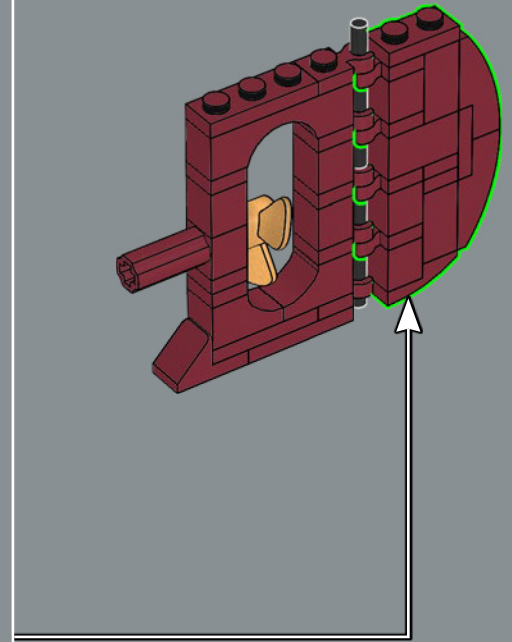
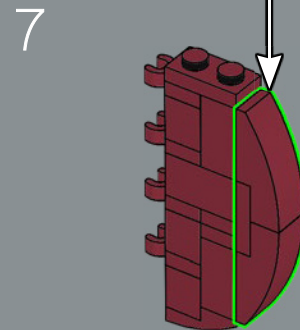
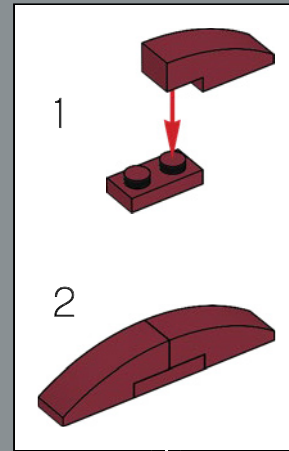
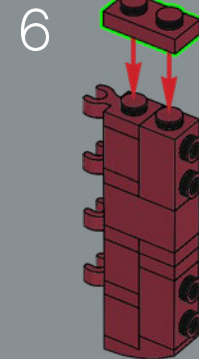
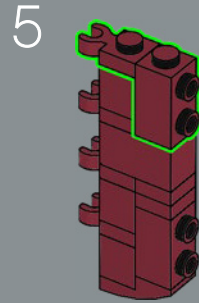
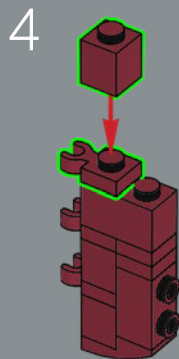
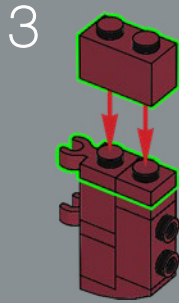
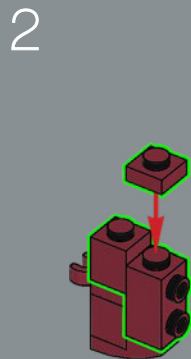
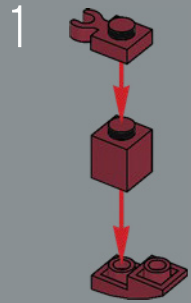

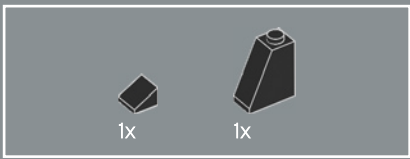

206

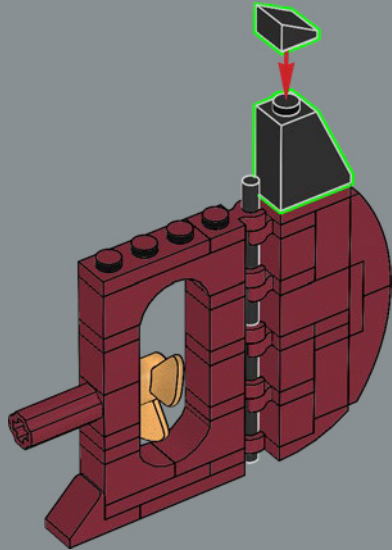

207

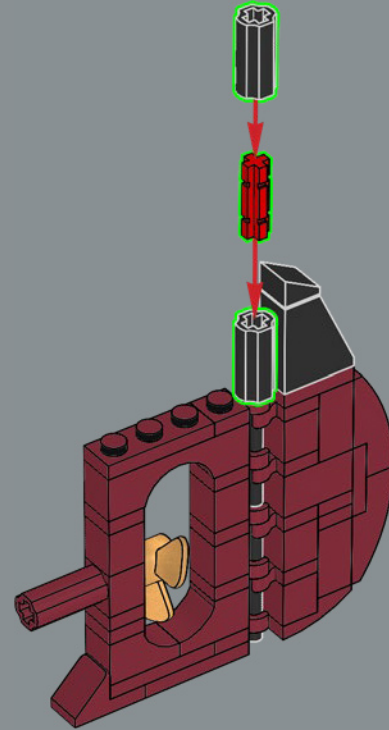

Con i suoi 24 metri di altezza, 4,65 metri di lunghezza e un peso di oltre 100 tonnellate, il timone era così grande che per spostarlo erano necessari appositi motori.

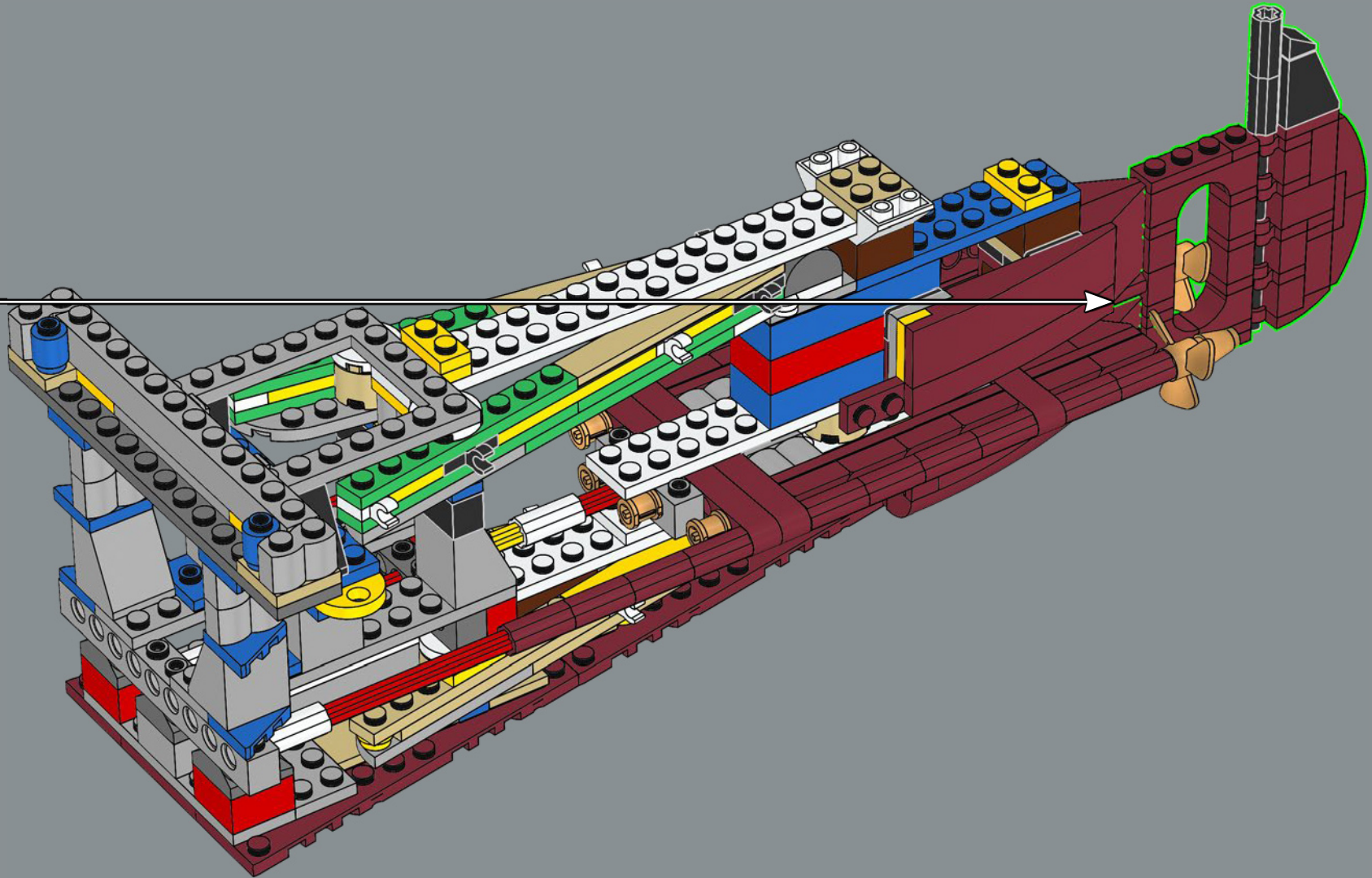

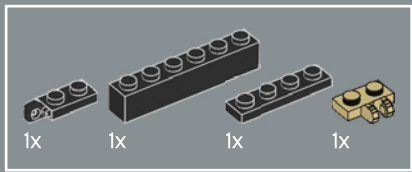

209

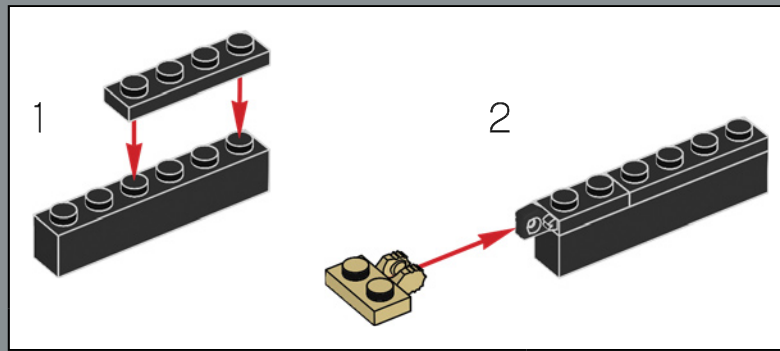

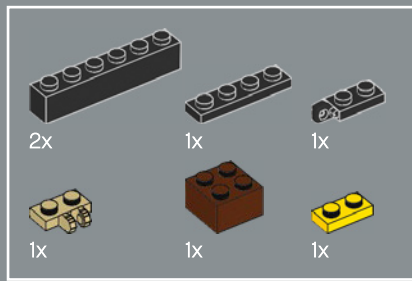

210

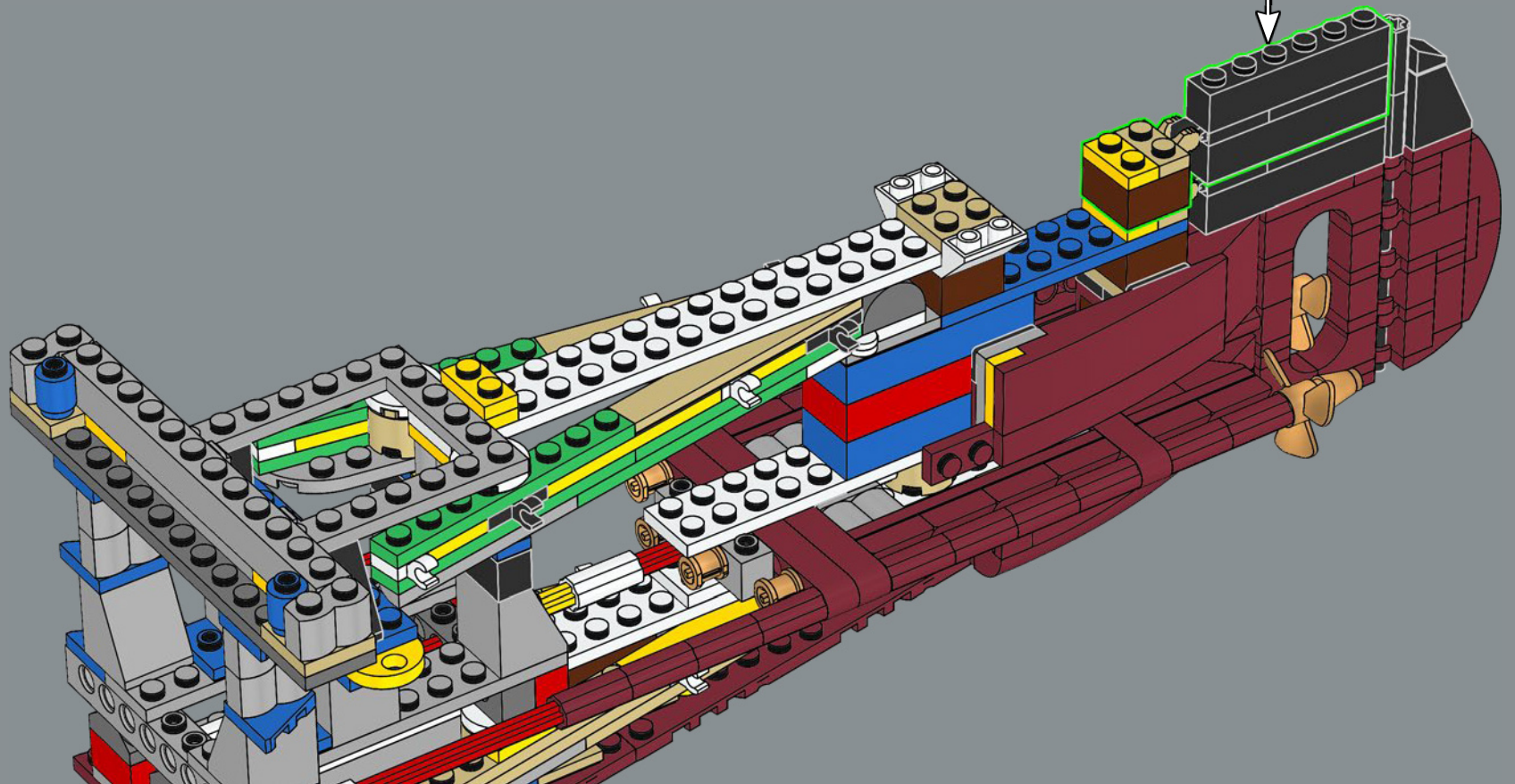
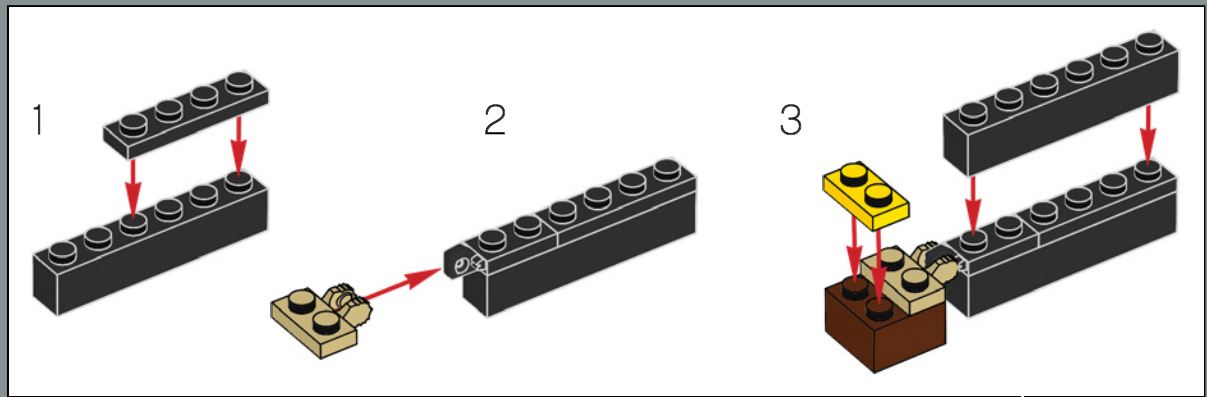

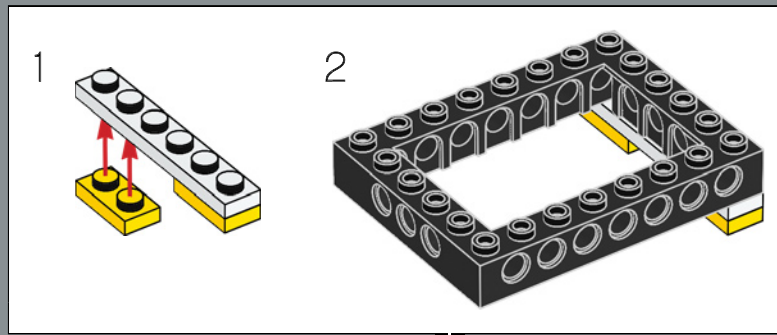
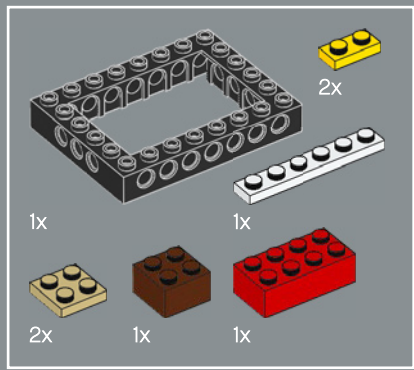

211

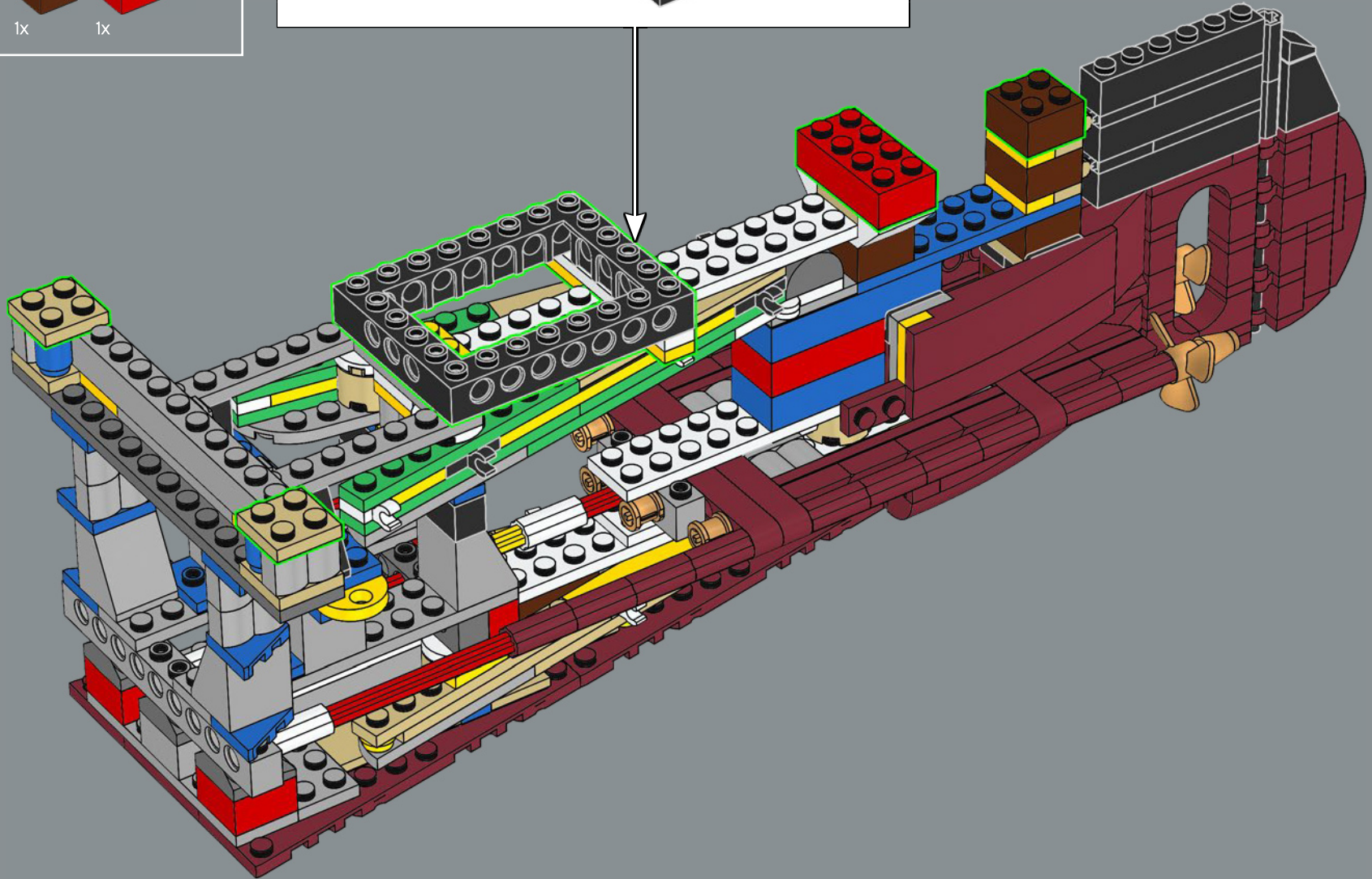

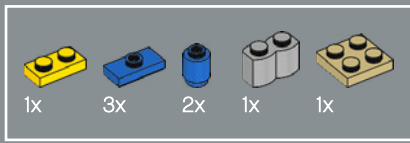

212

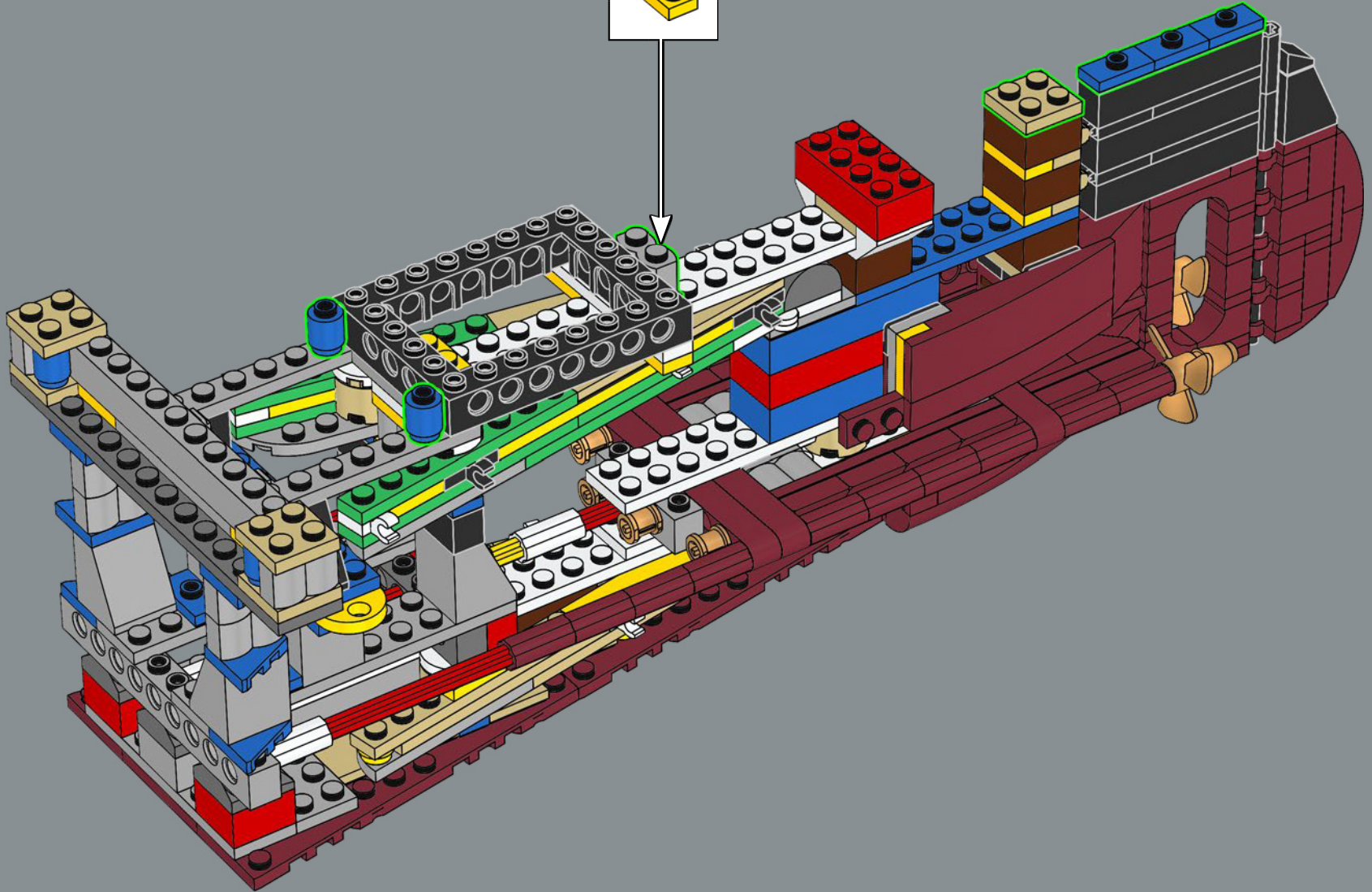
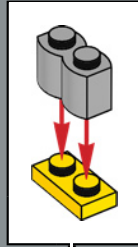

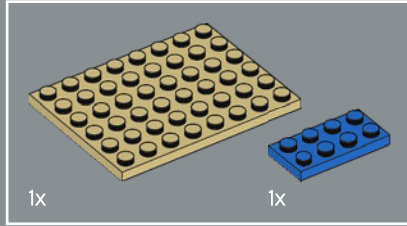
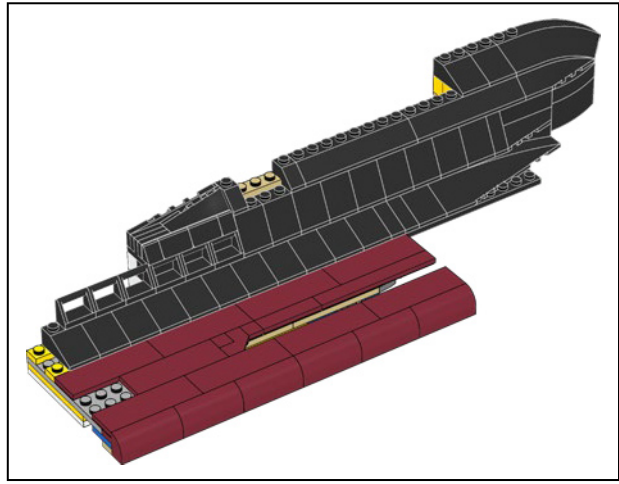
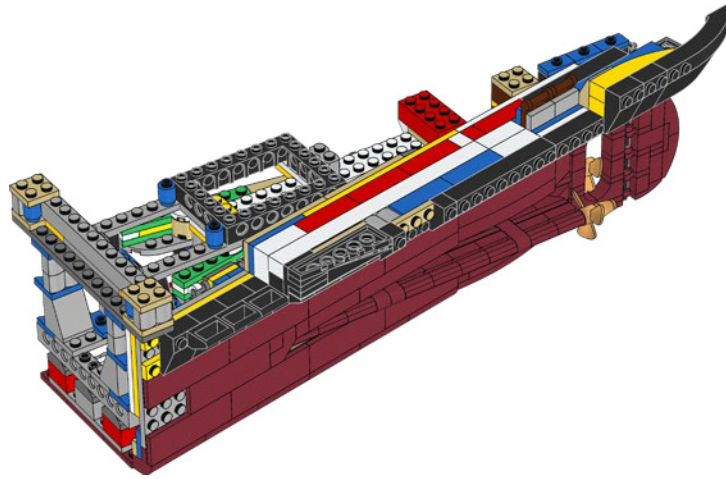
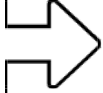

213

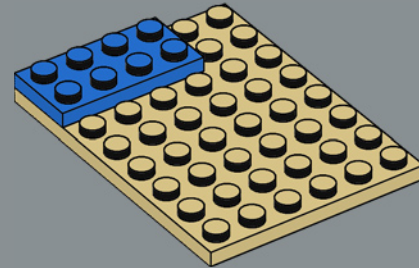

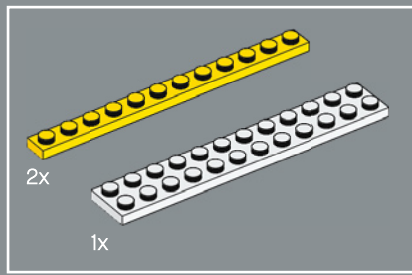

214

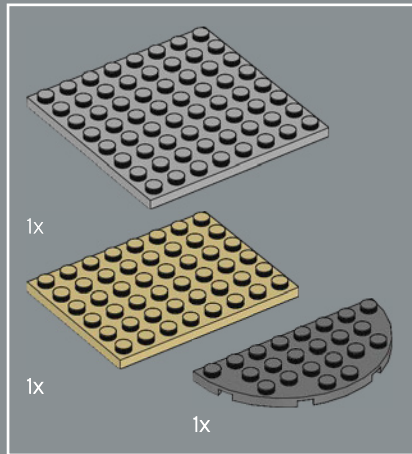
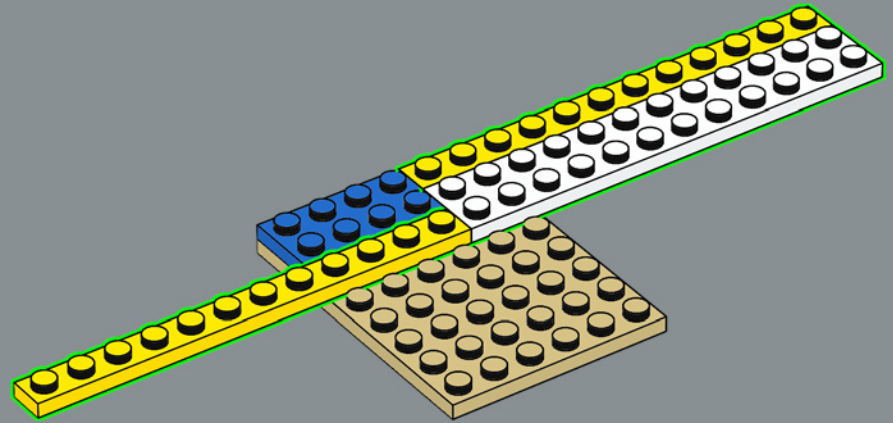

215

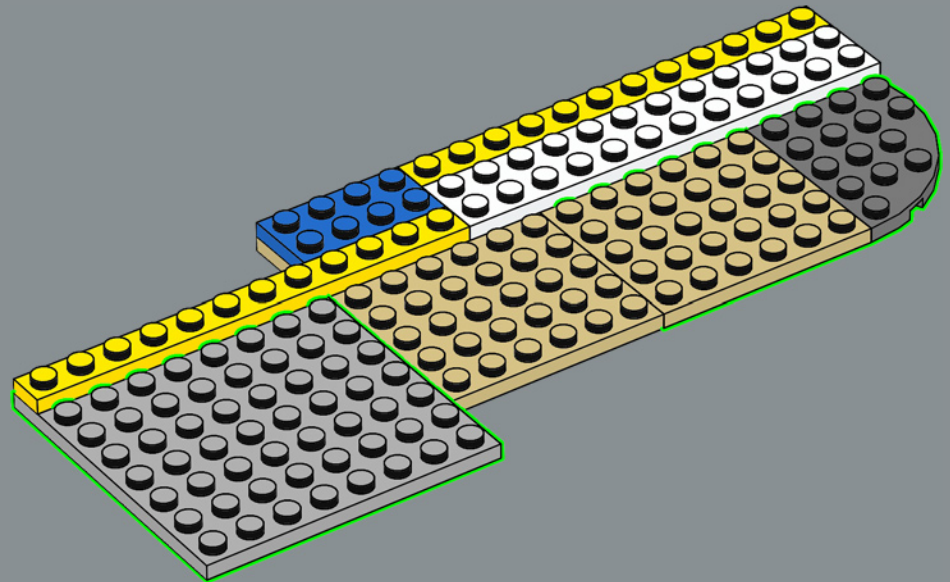

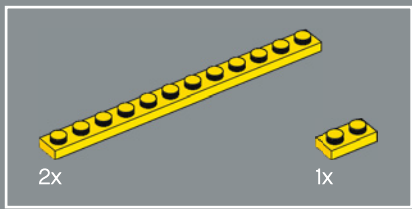

216

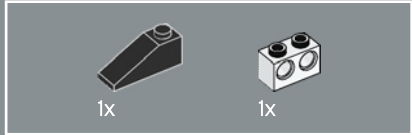
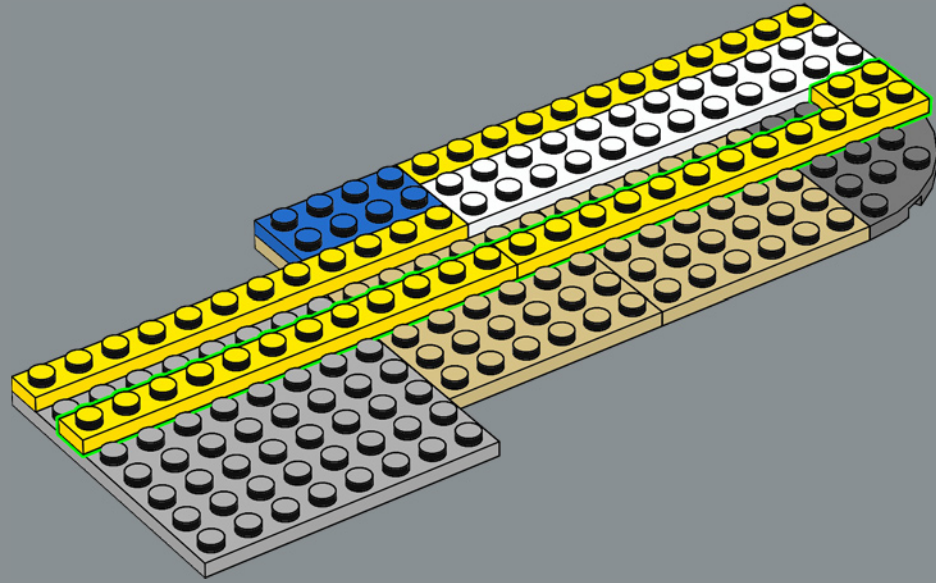

217

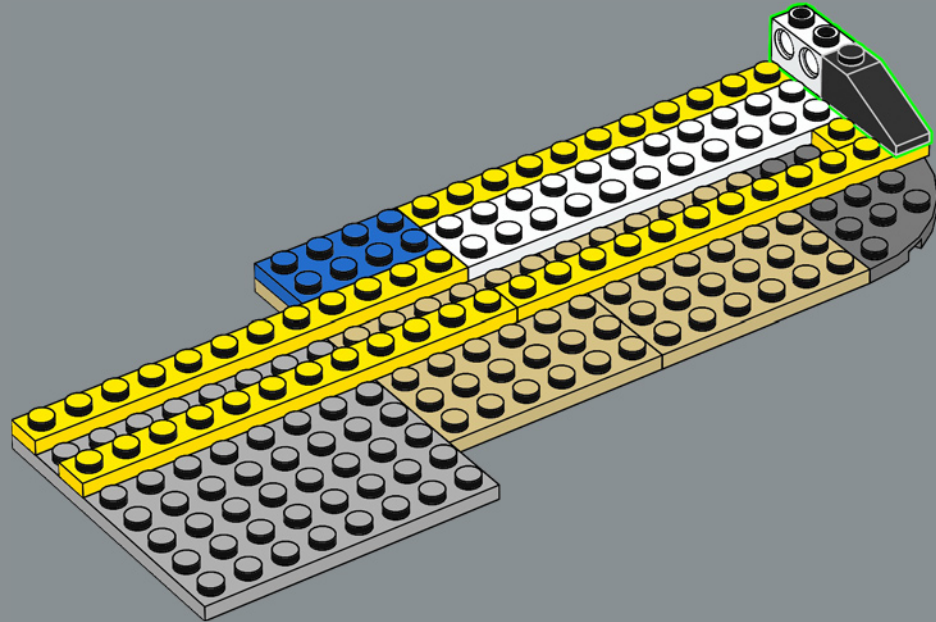

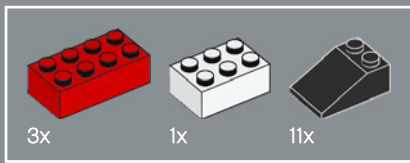

218

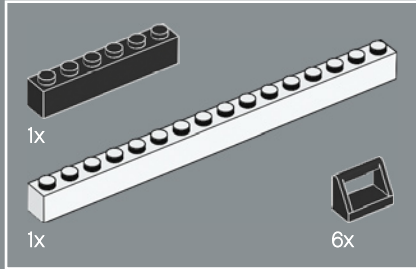
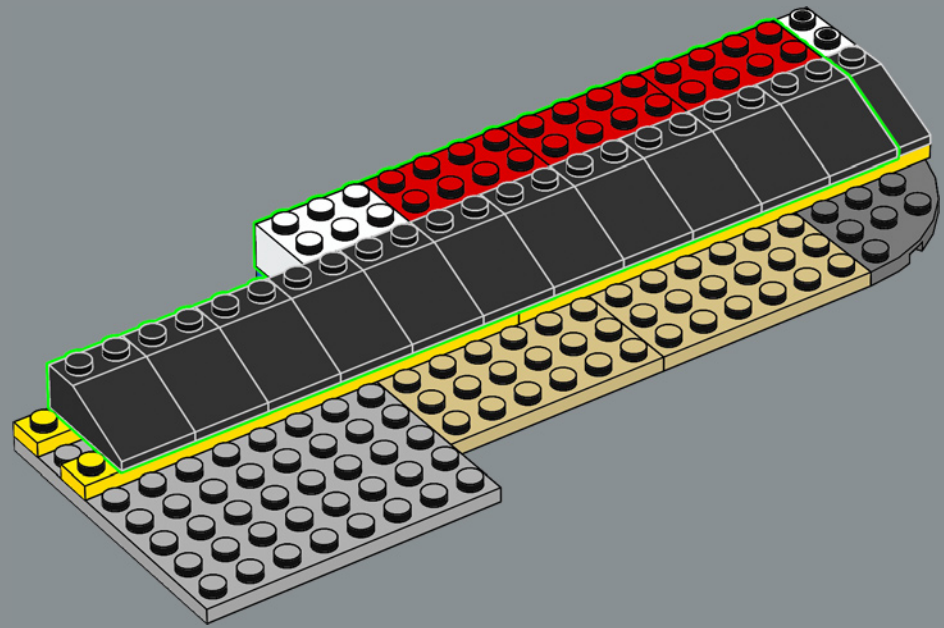

219

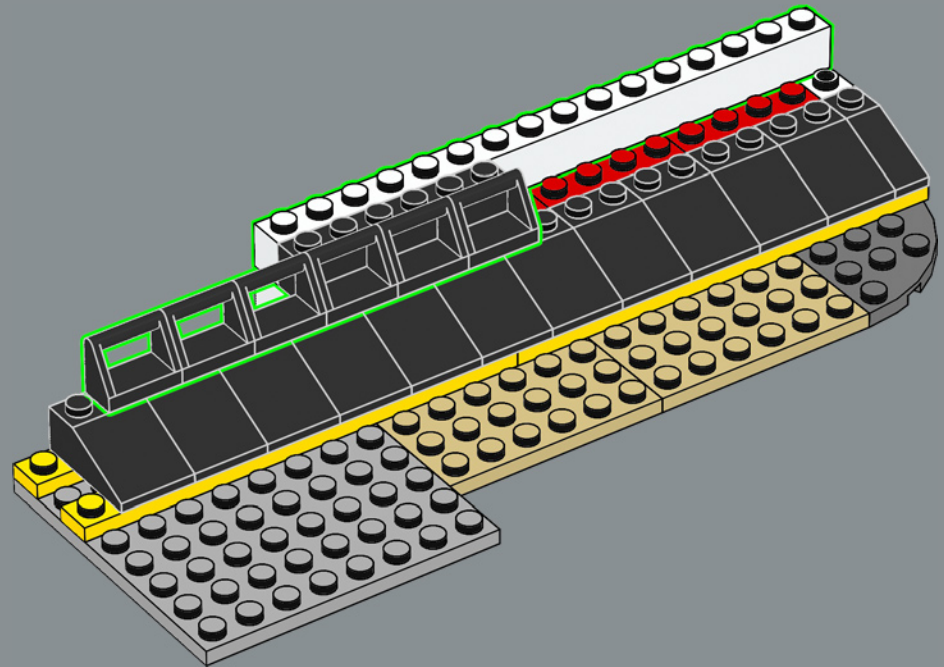

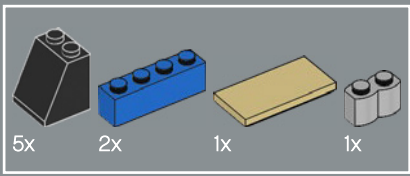

220

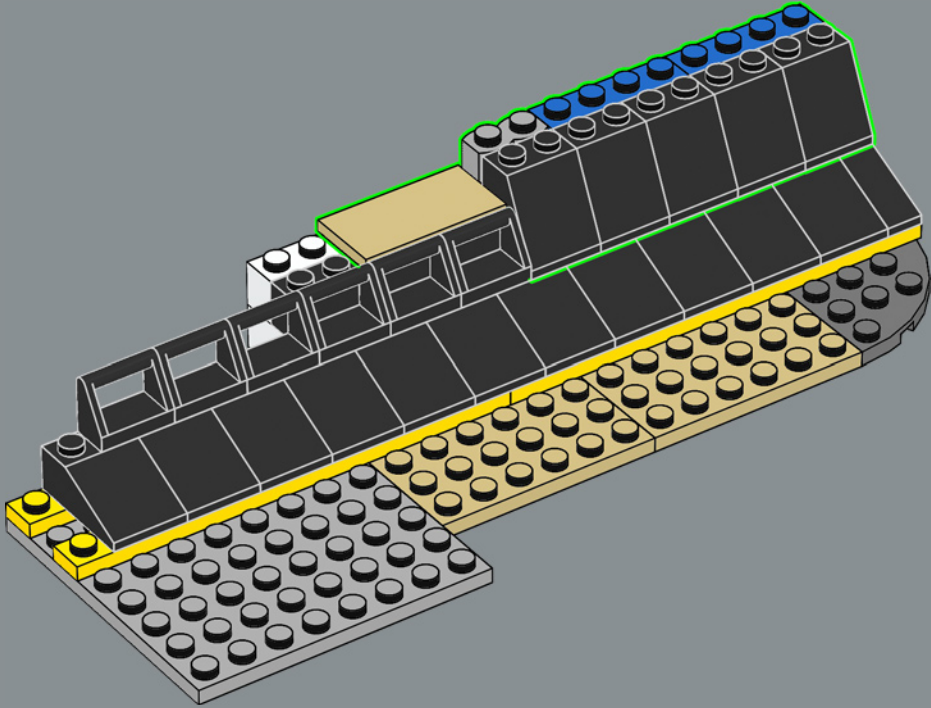

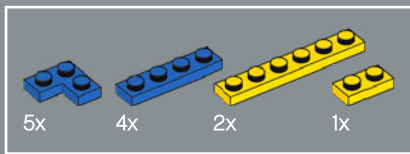

221

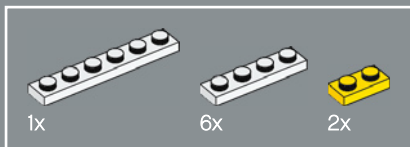
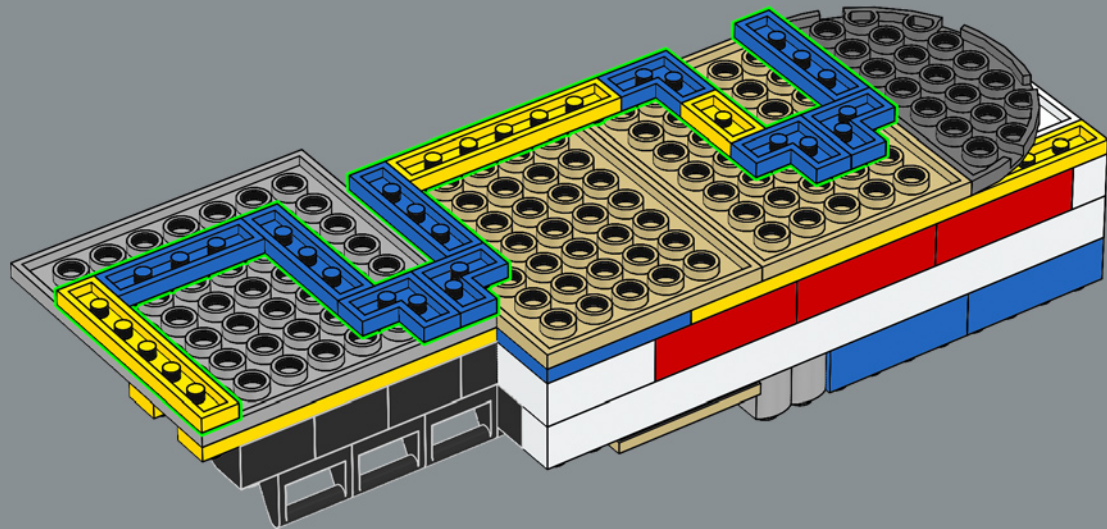

222

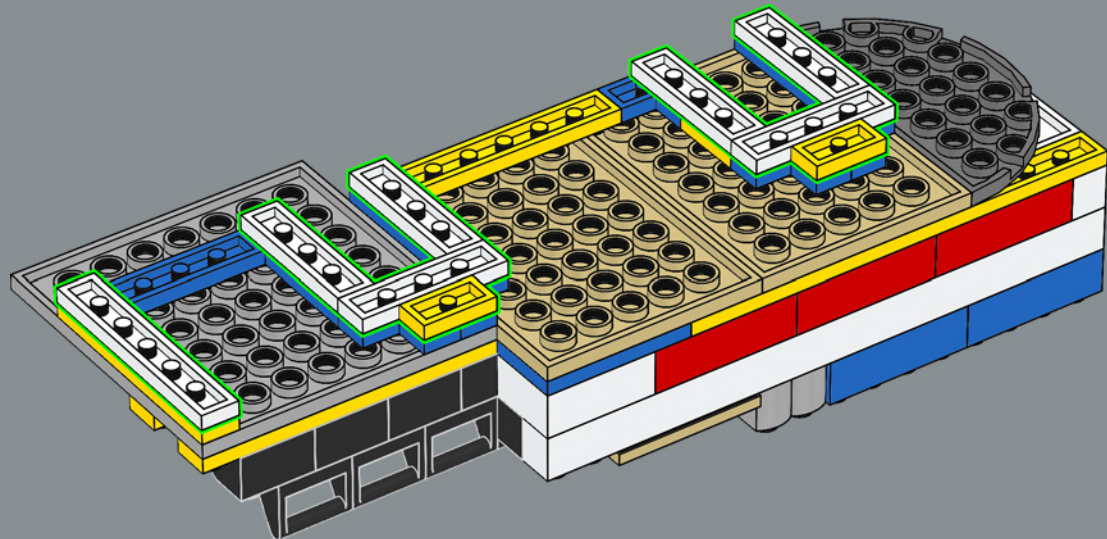

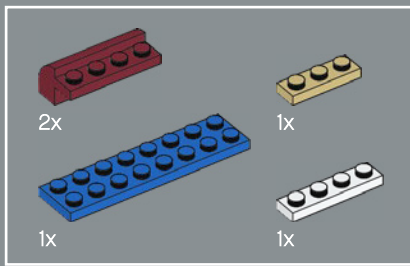

223

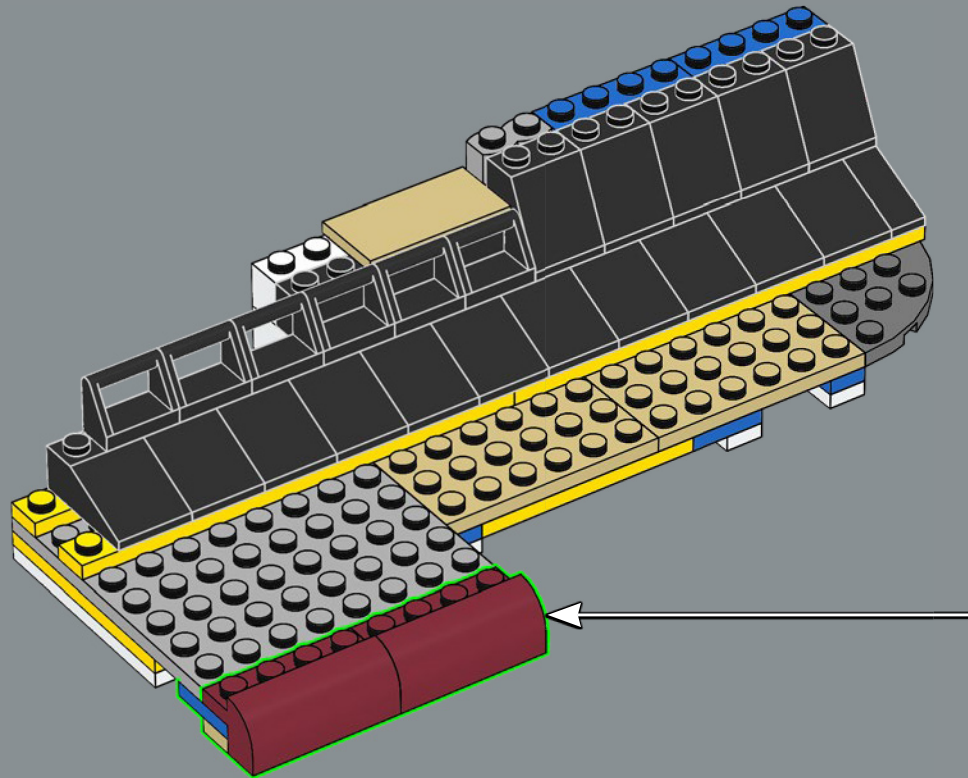
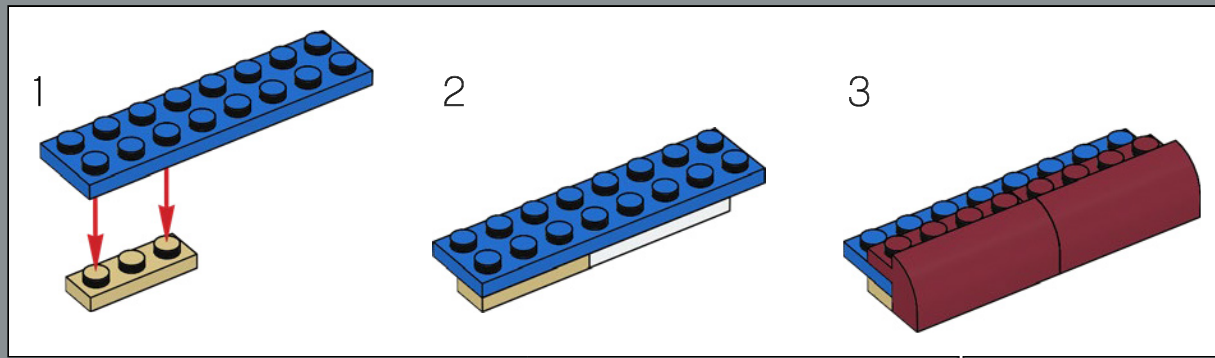

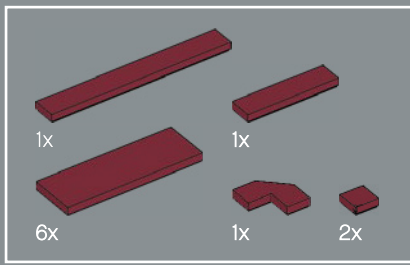

224

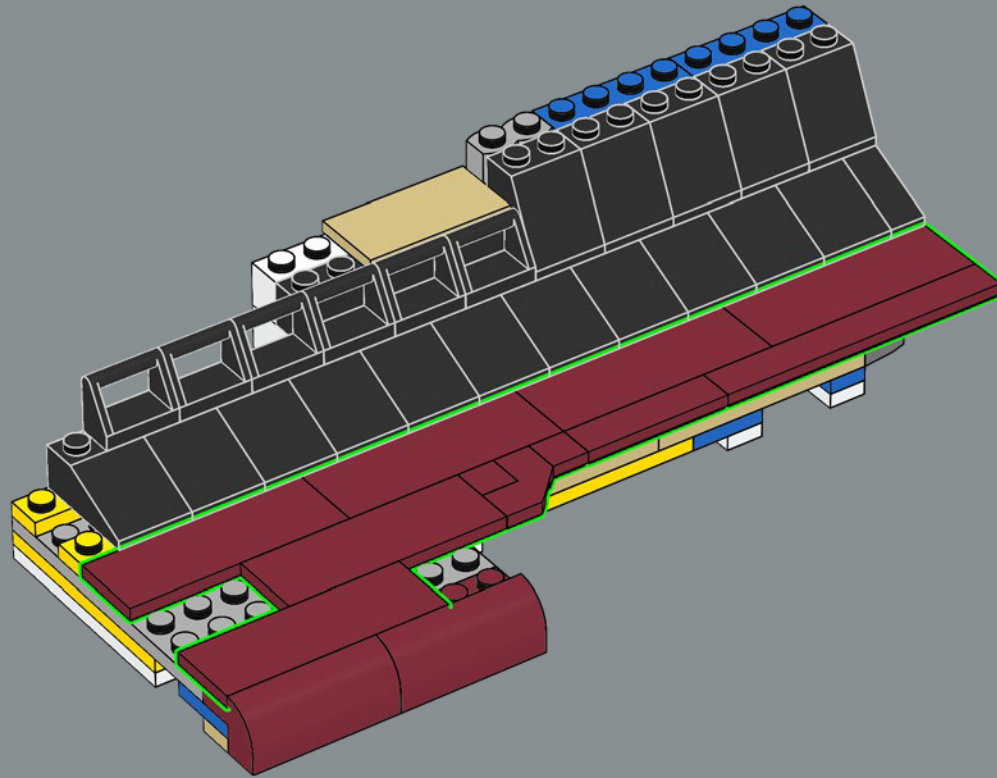

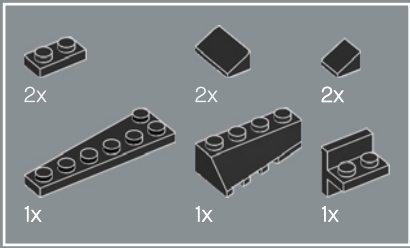

225

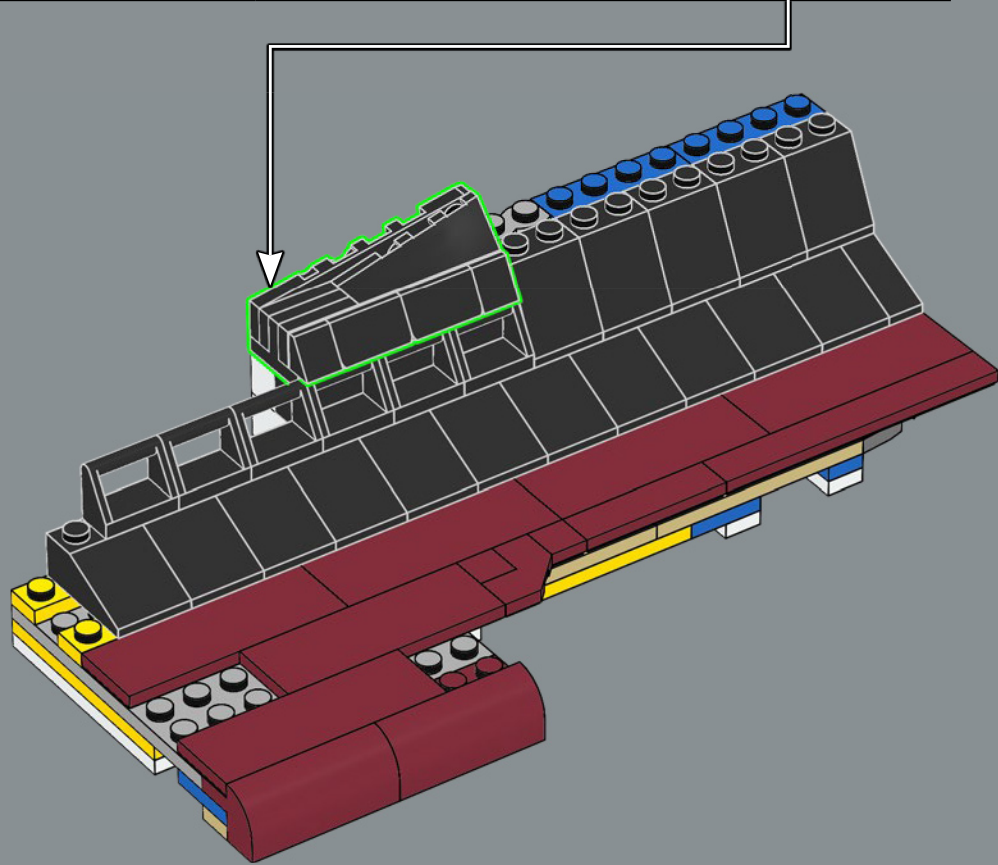
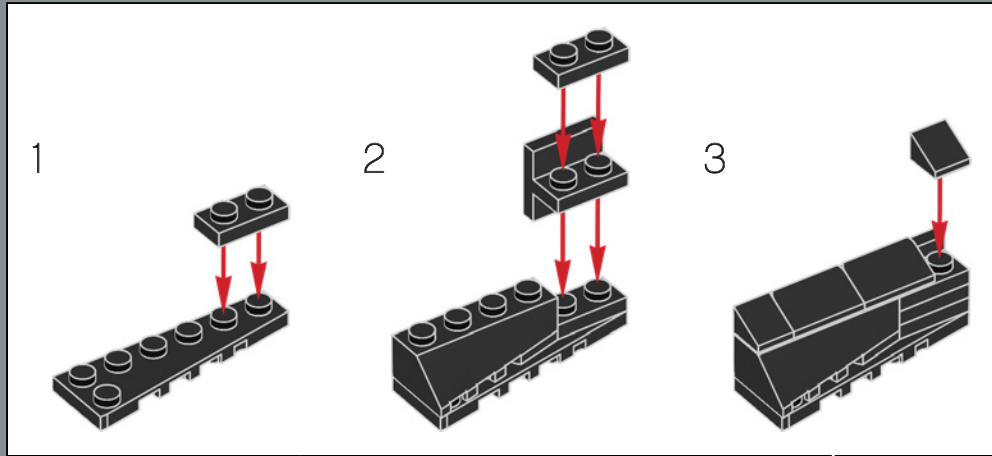

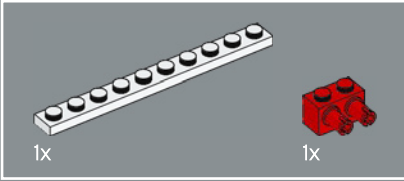
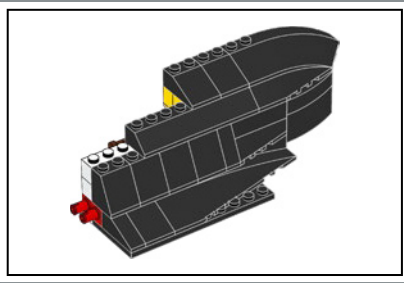

226

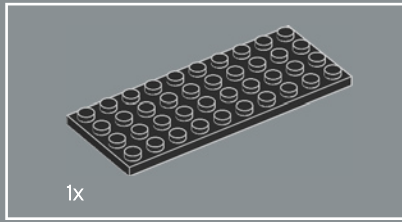
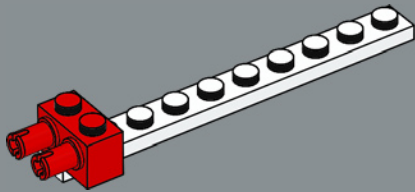

227

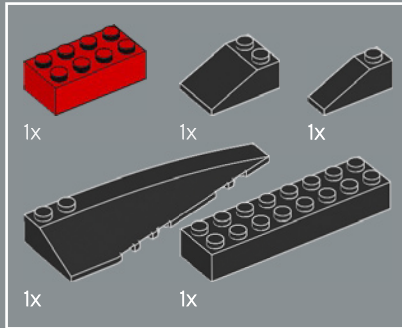
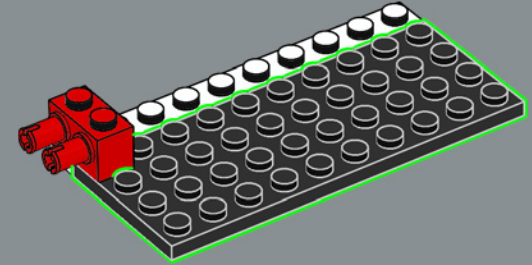

228

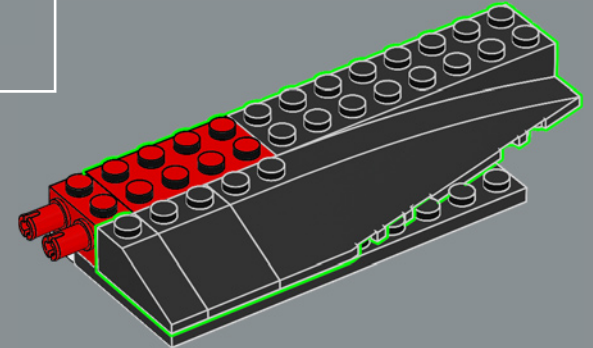

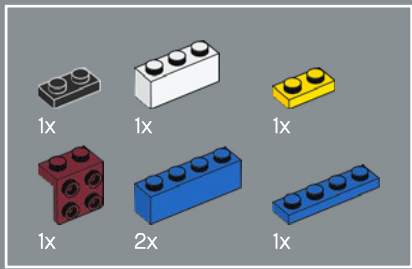

229

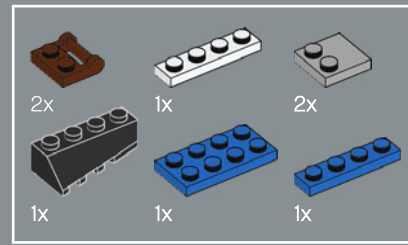
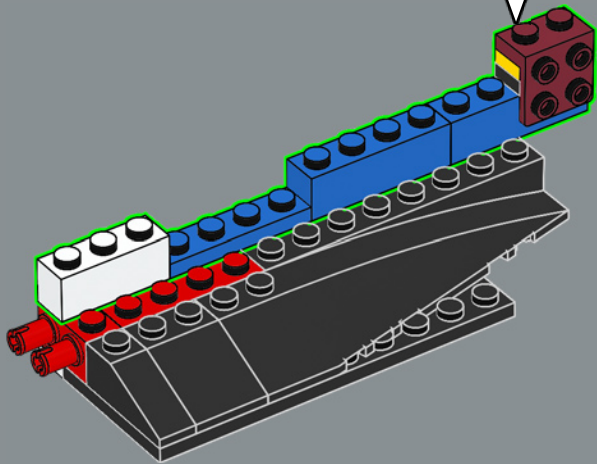
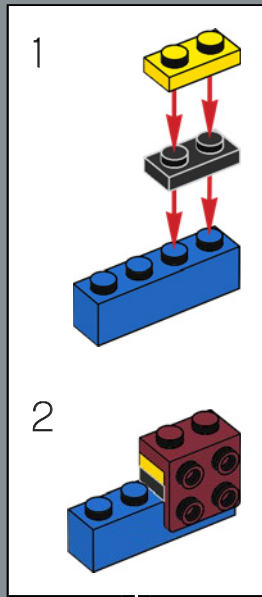

230

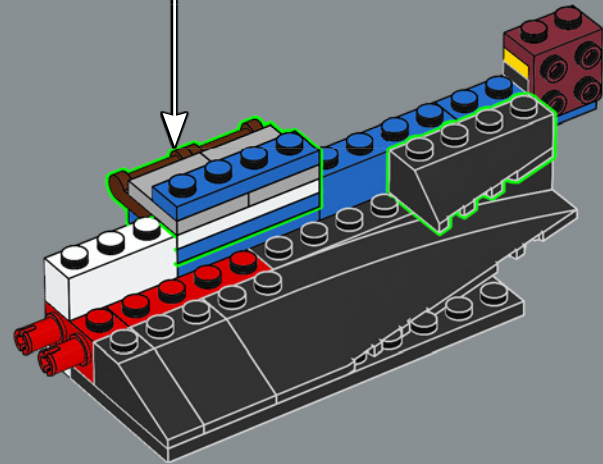
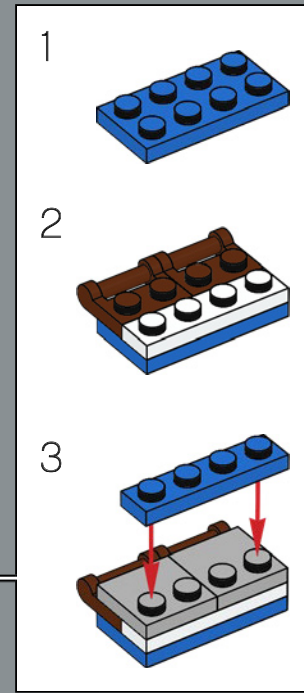

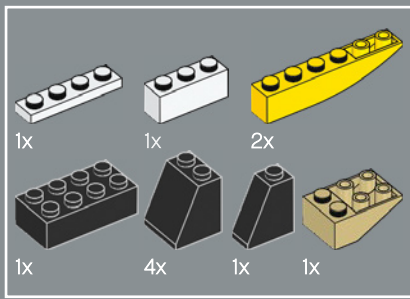

231

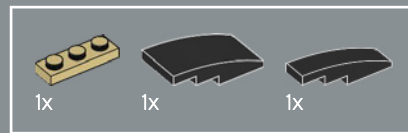
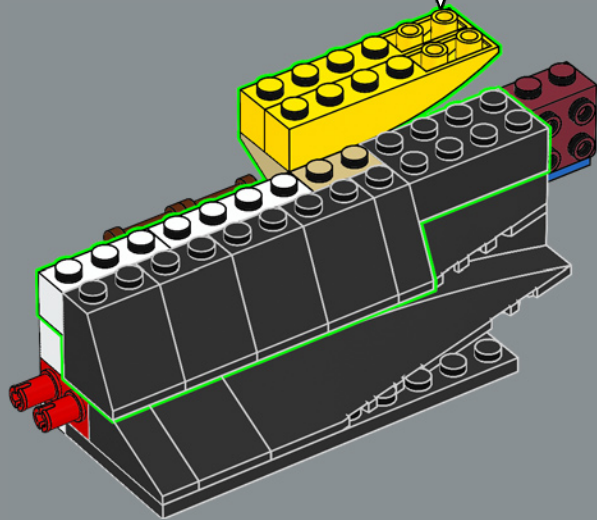
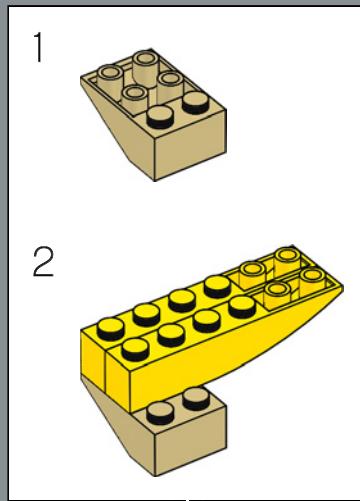

232

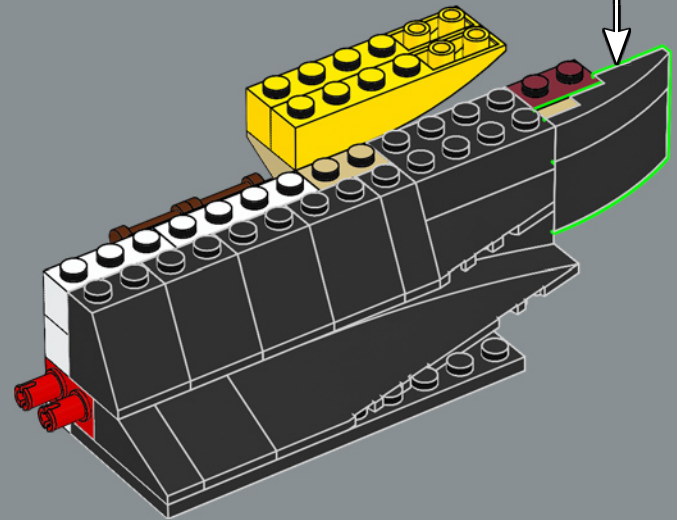
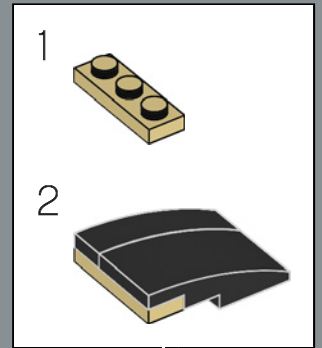

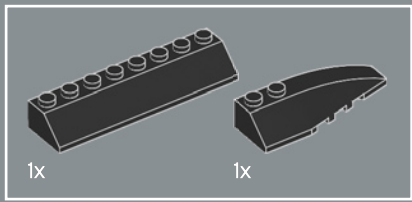

233

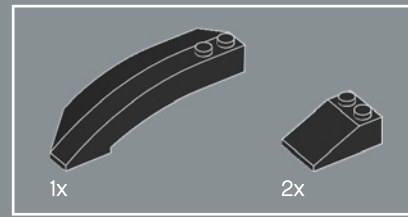
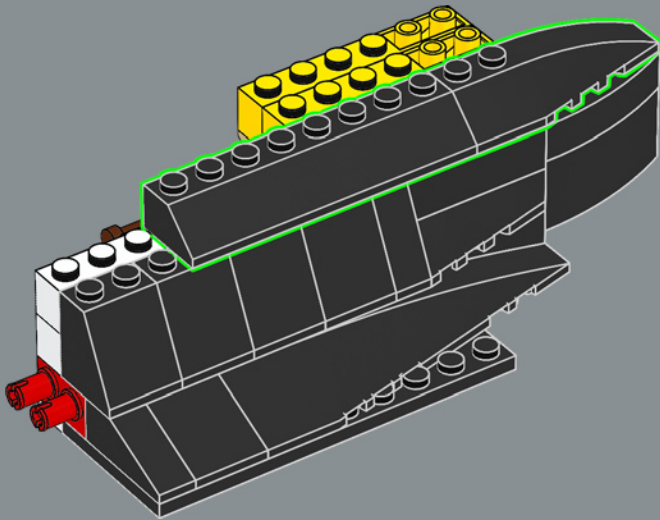

234

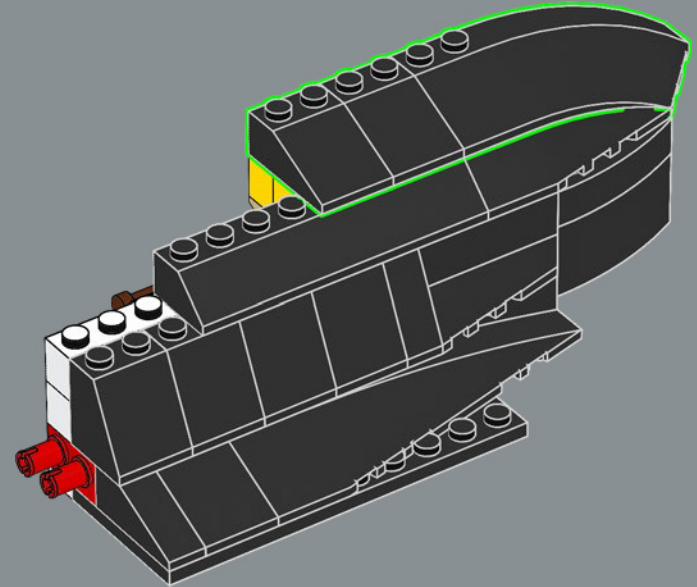

235

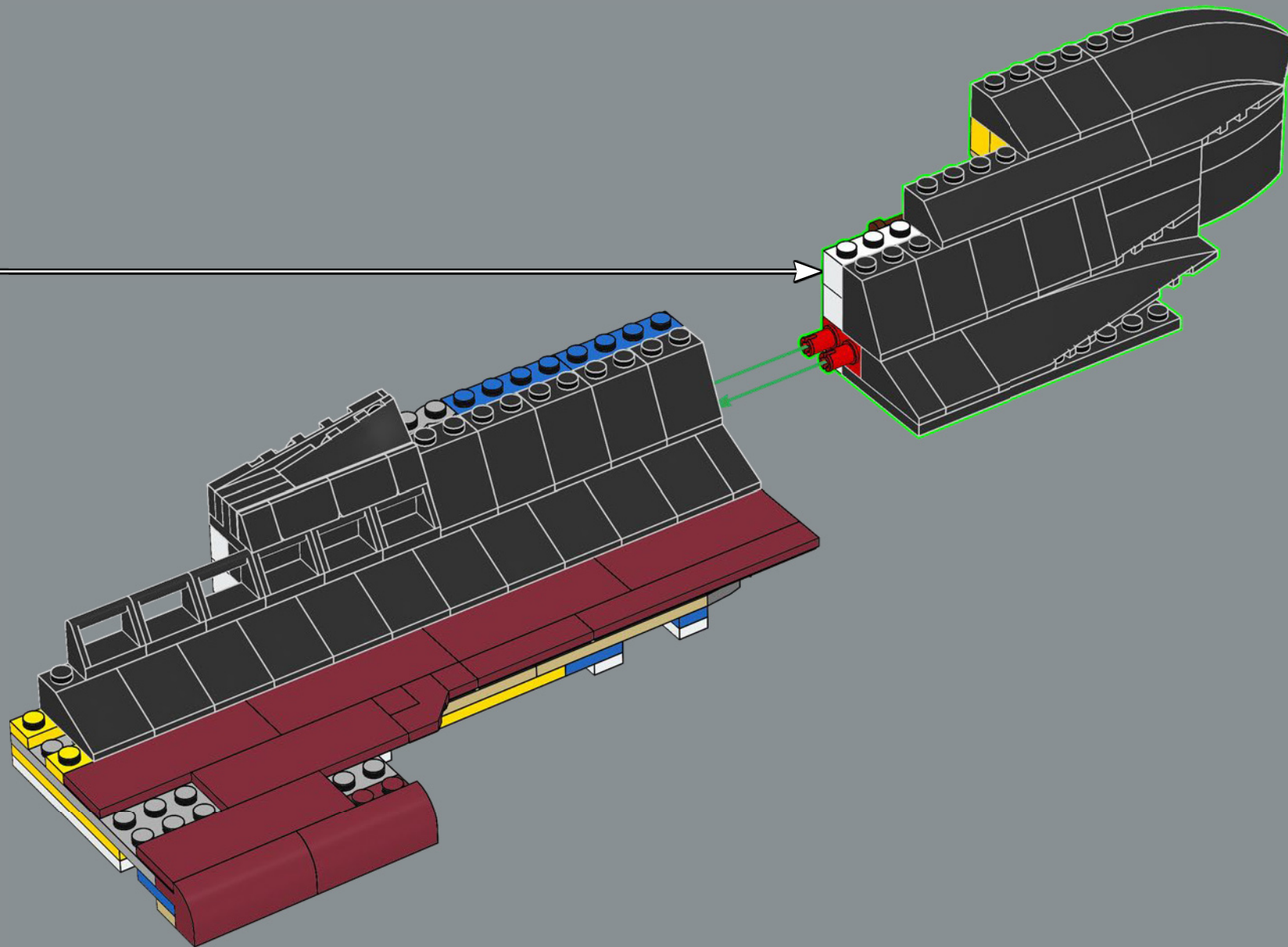

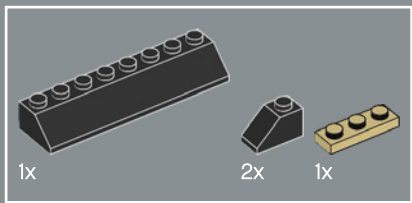

236

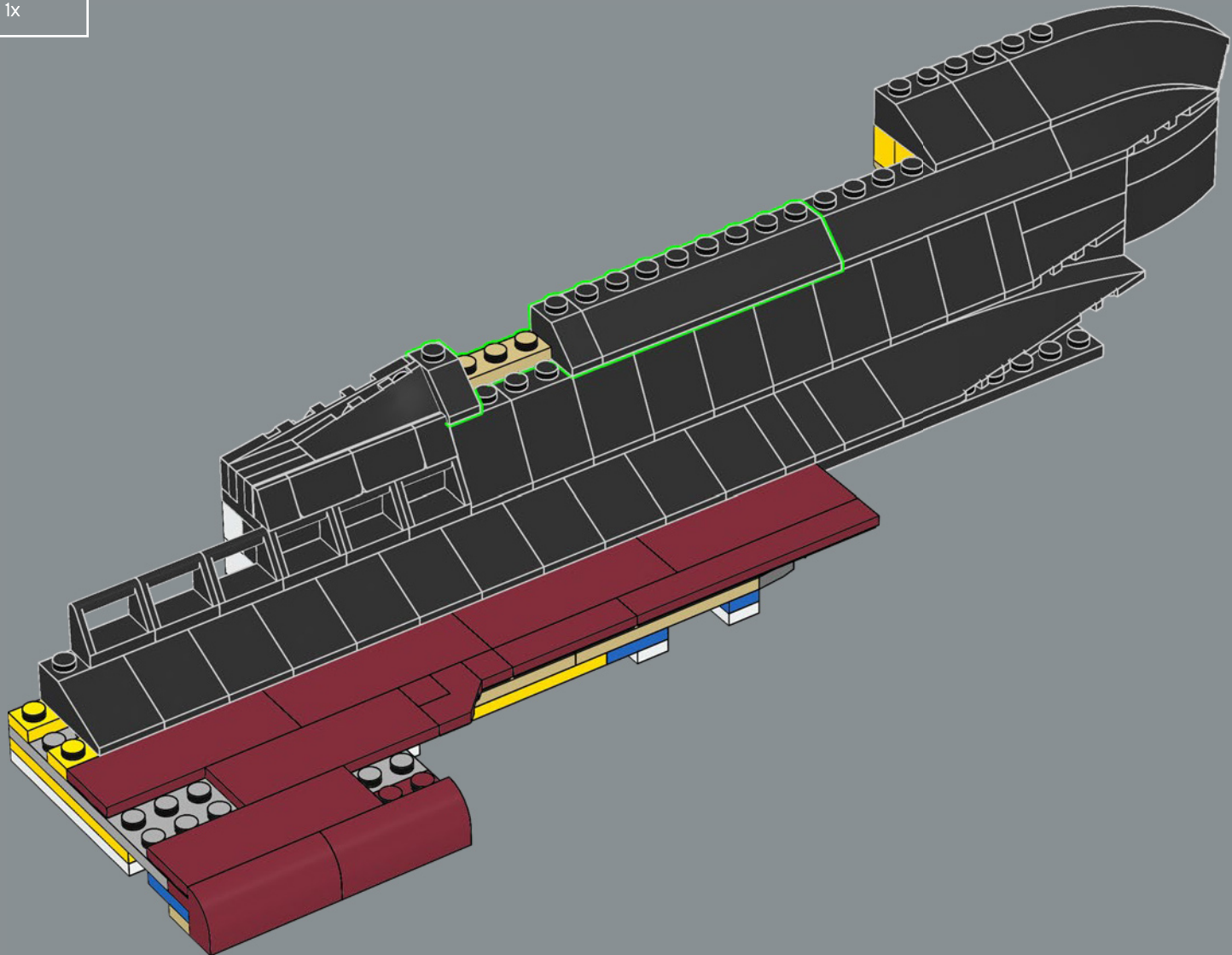

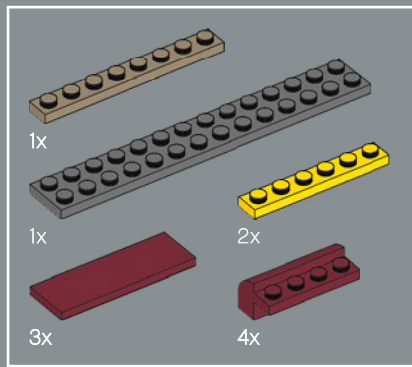

237

1

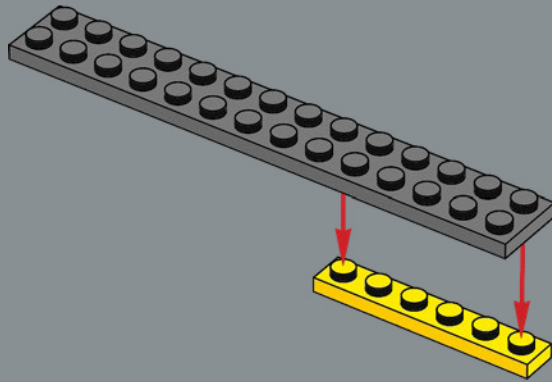

2

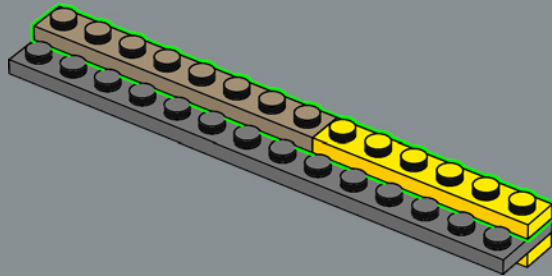

3

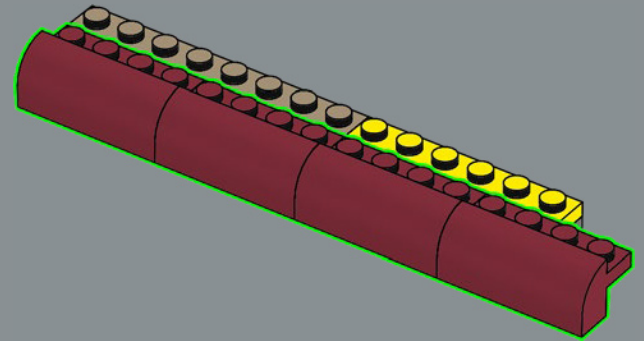

4

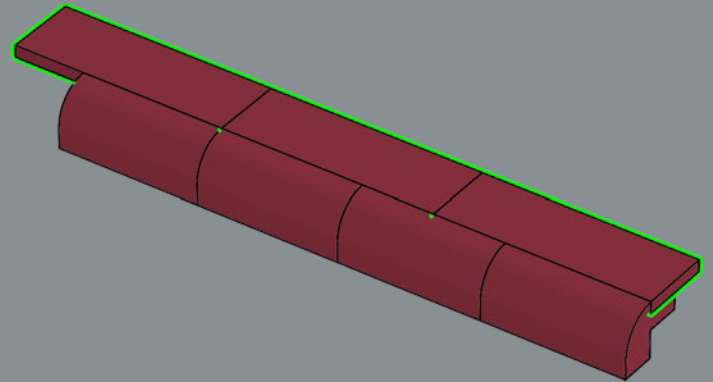

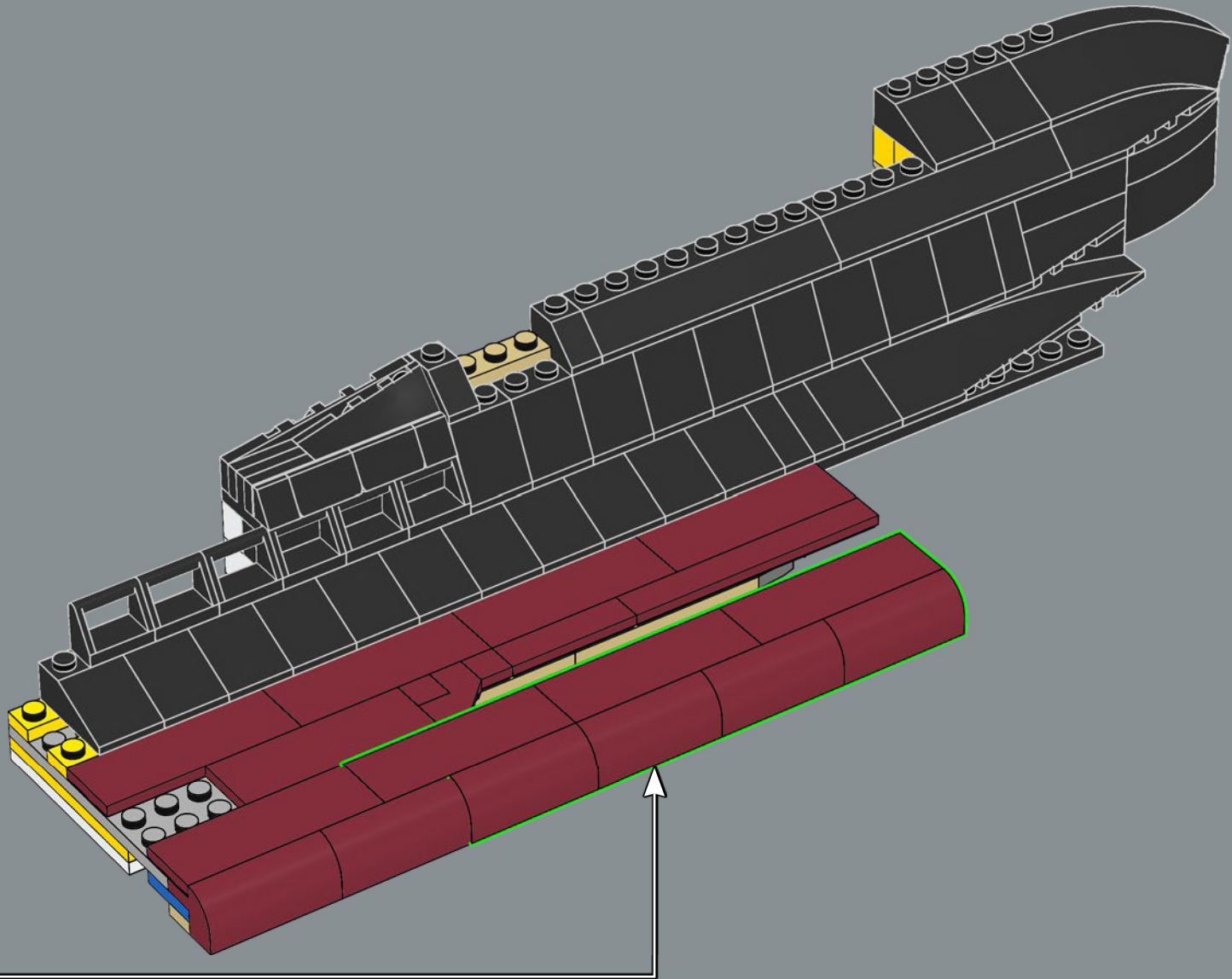

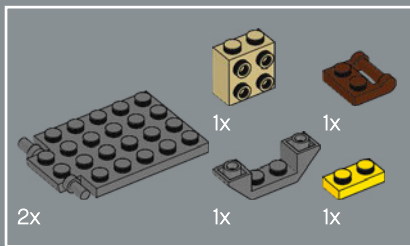

238

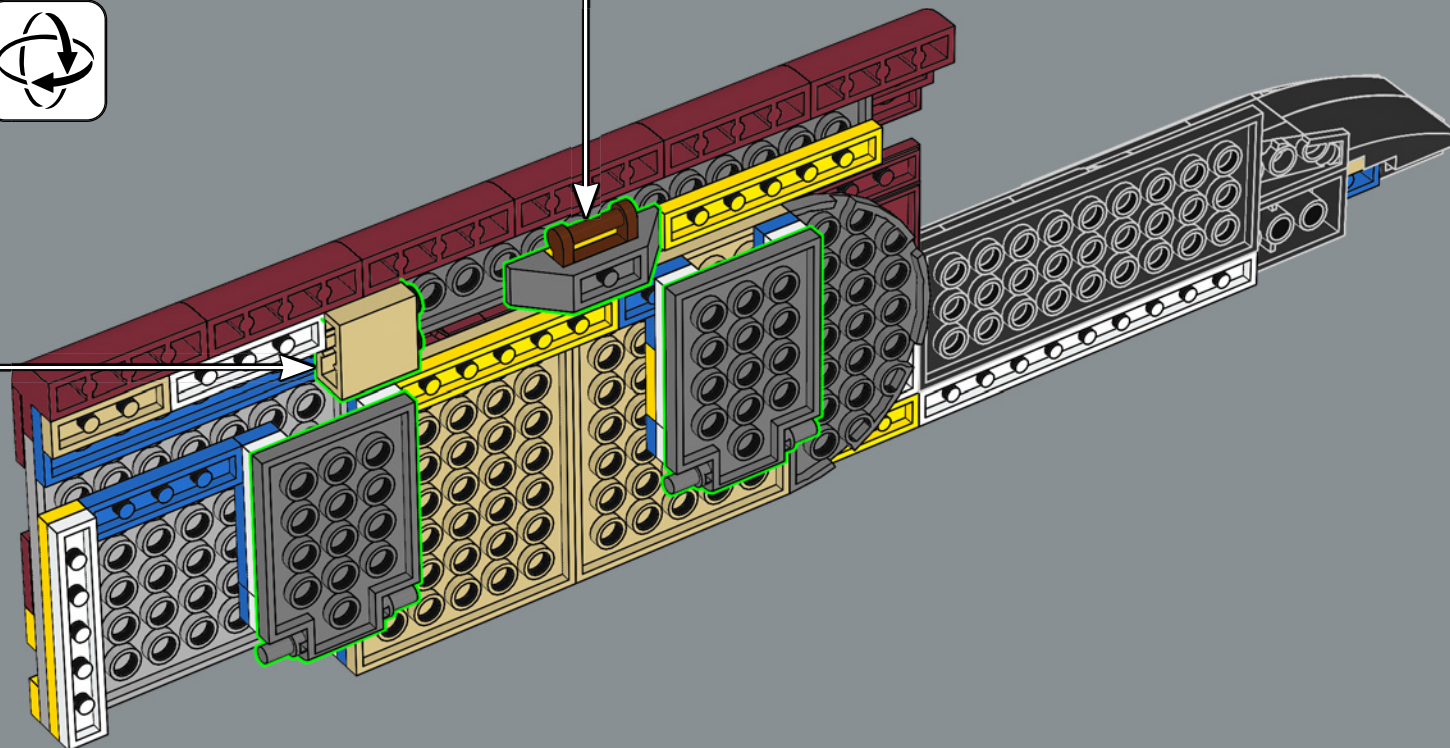
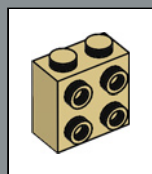
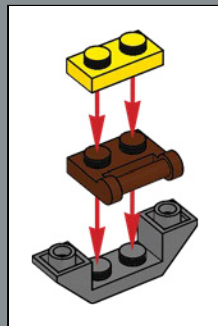

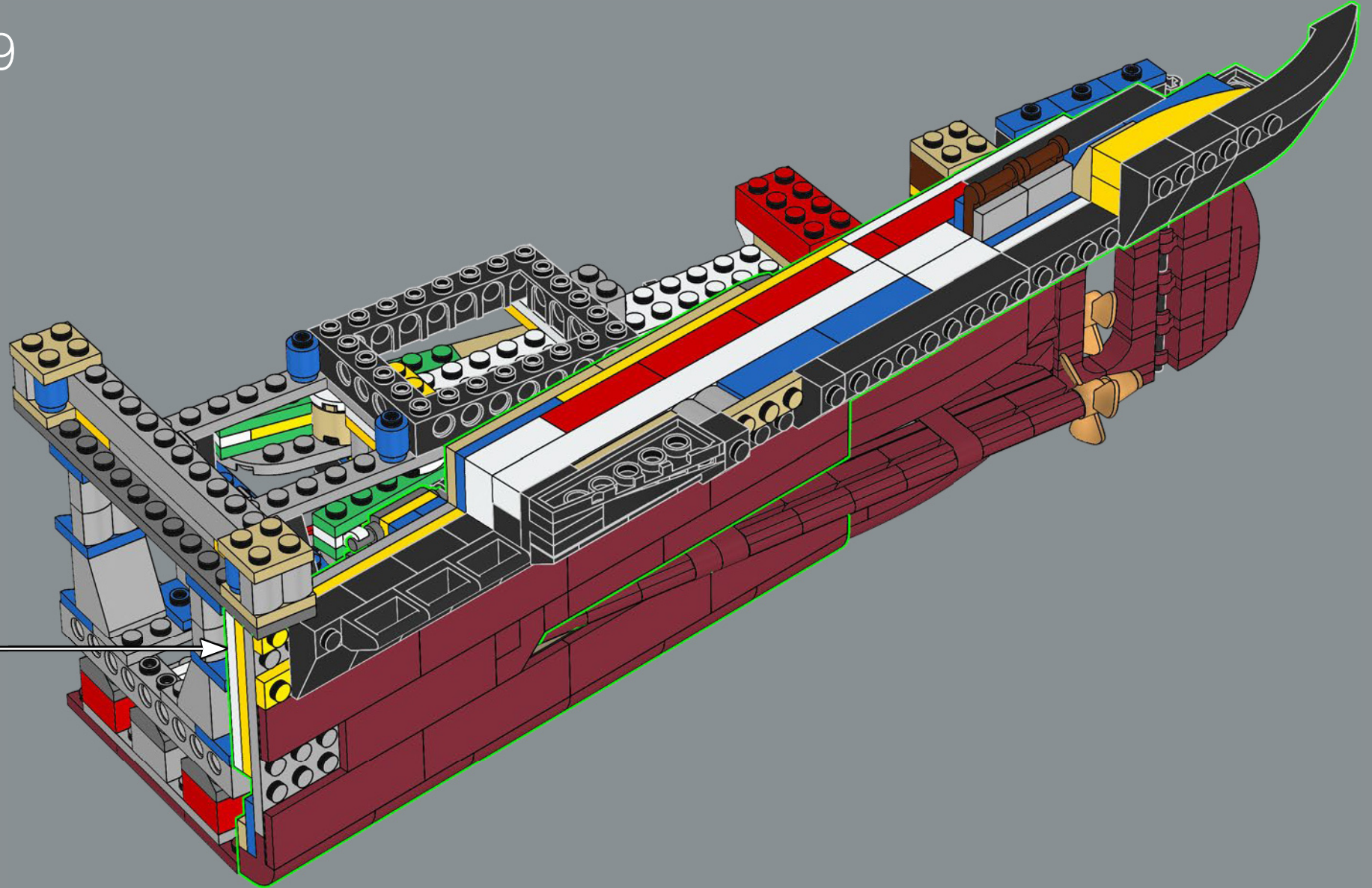

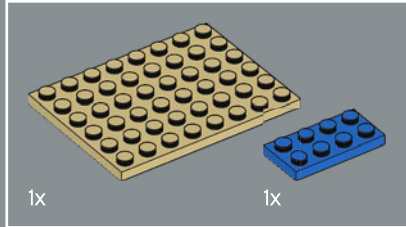
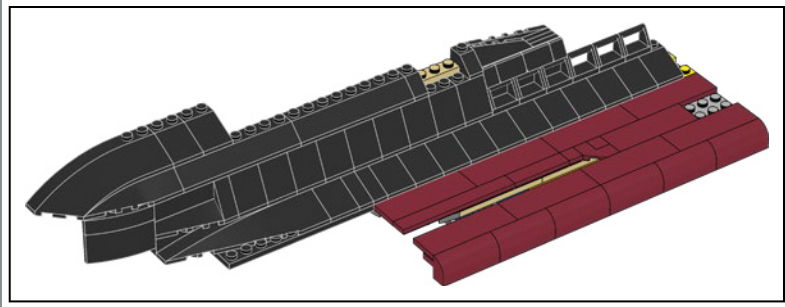
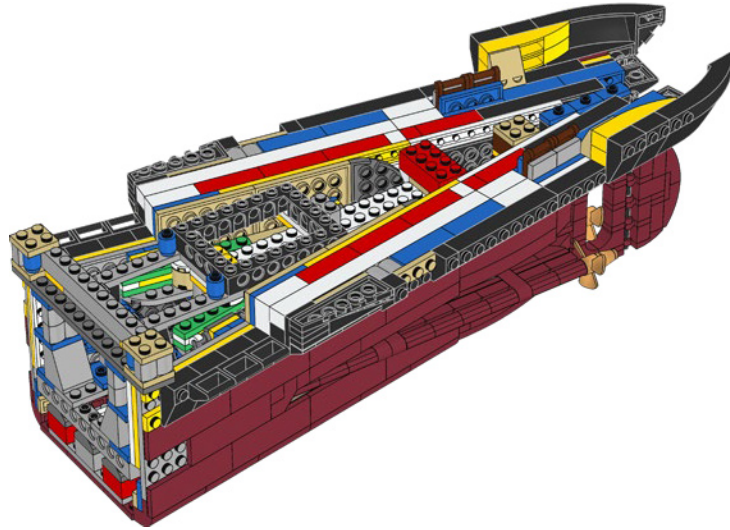
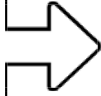

240

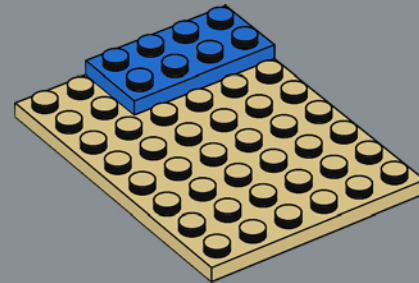

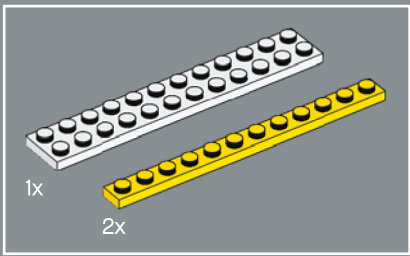

241

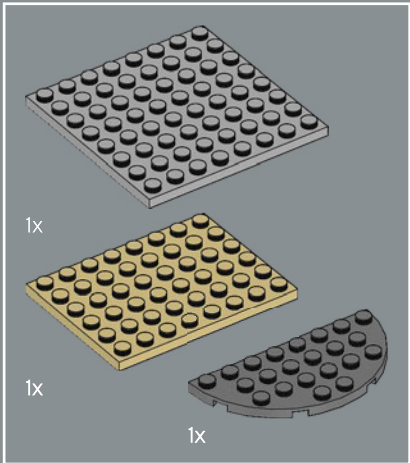
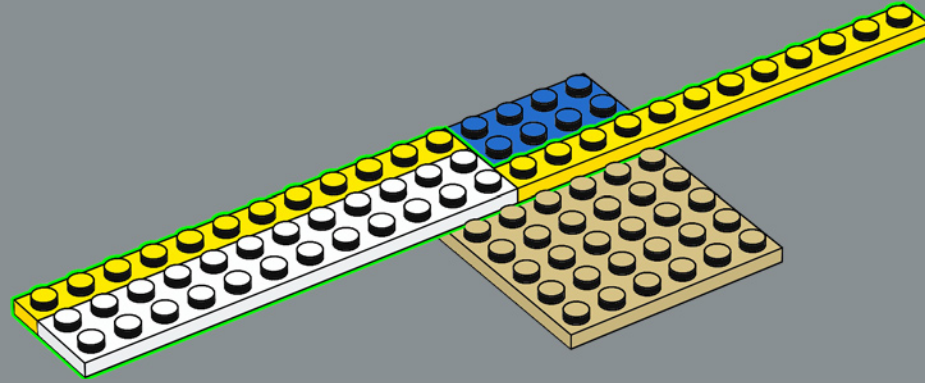

242

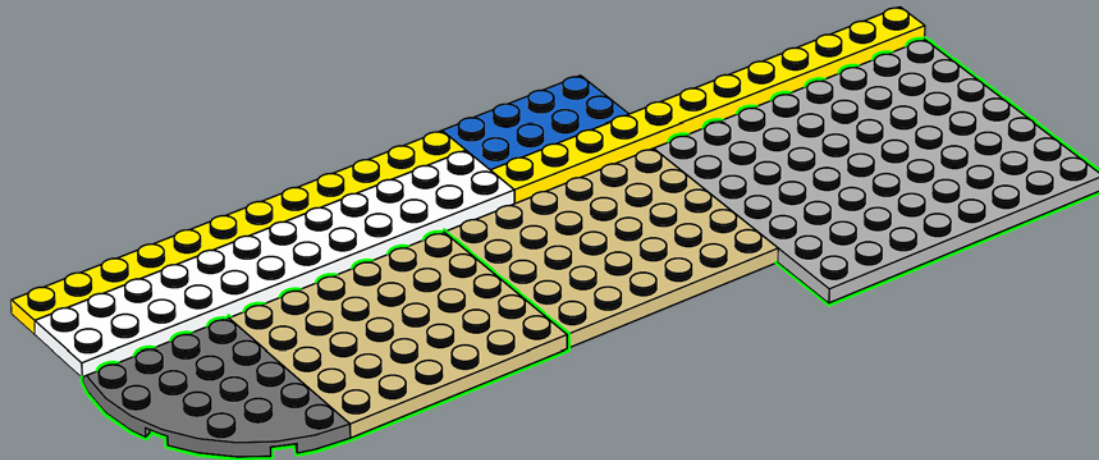

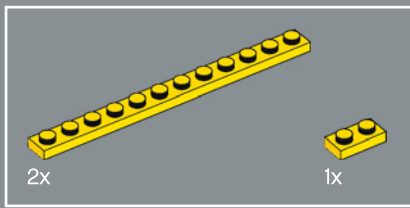

243

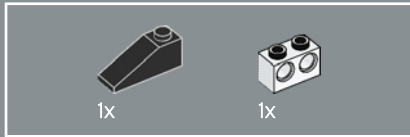
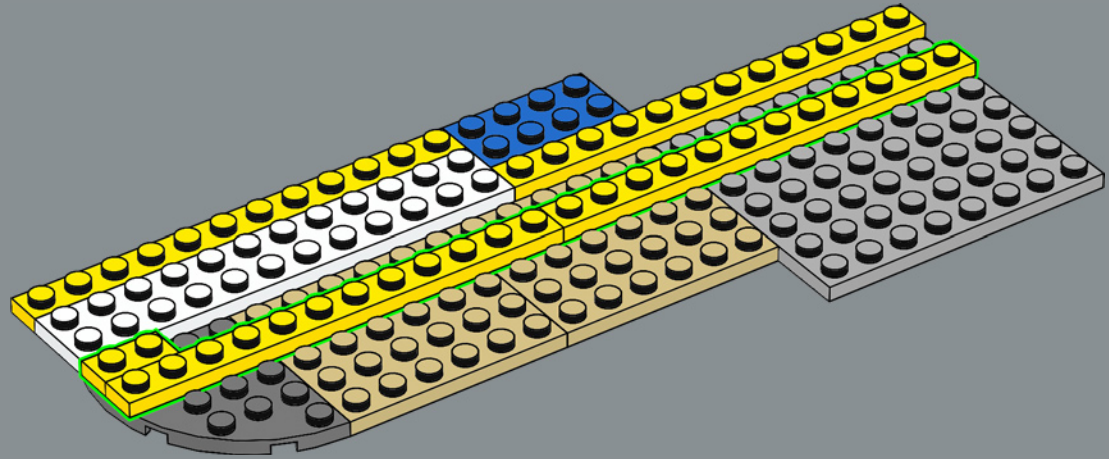

244

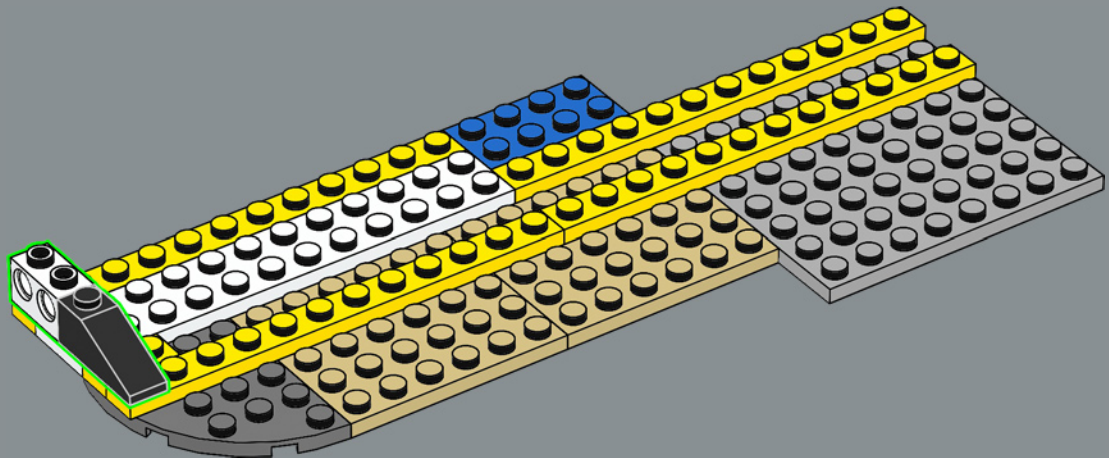

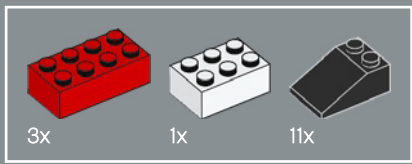

245

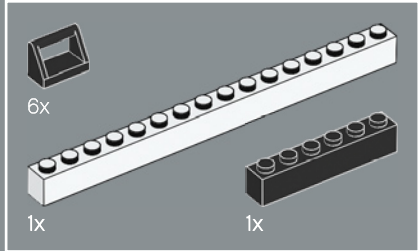
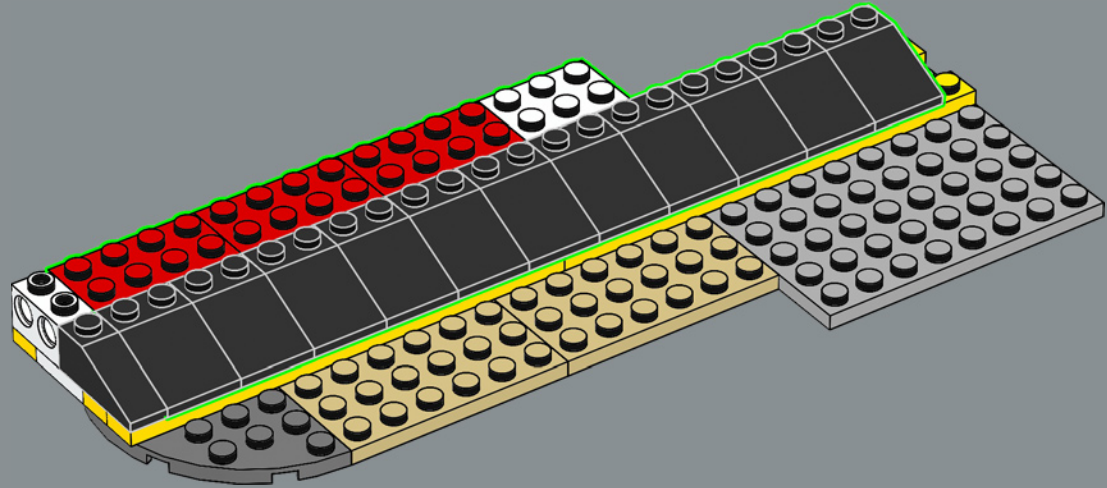

246

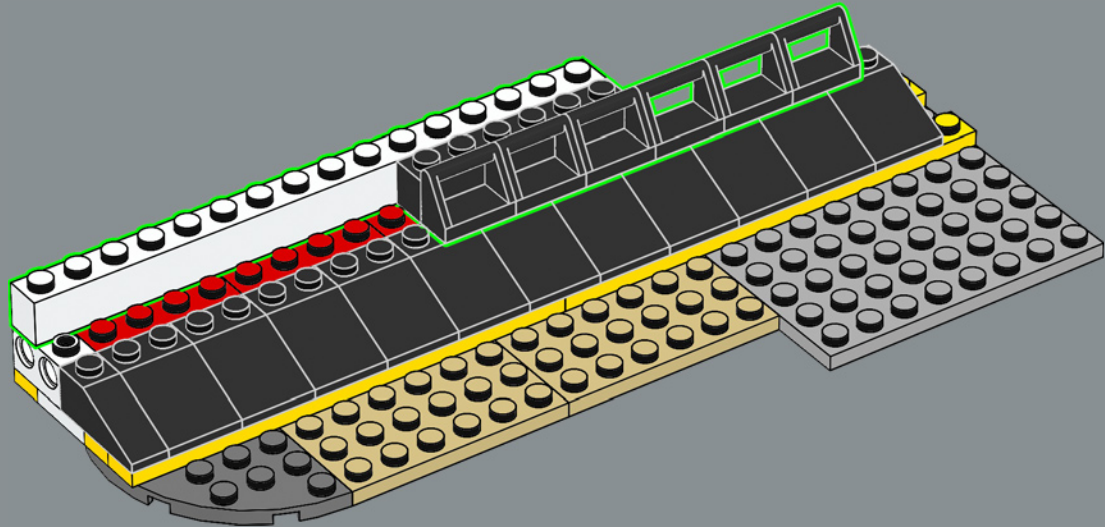

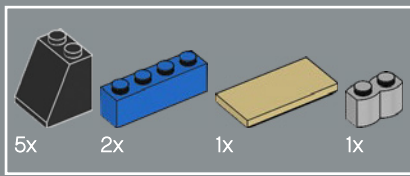

247

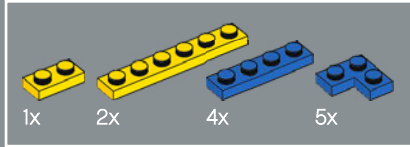
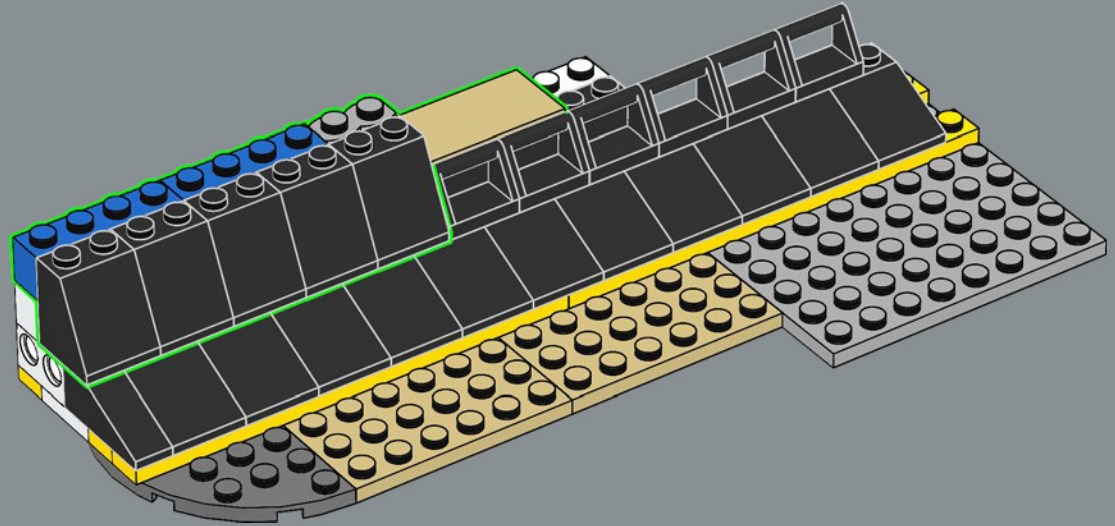

248

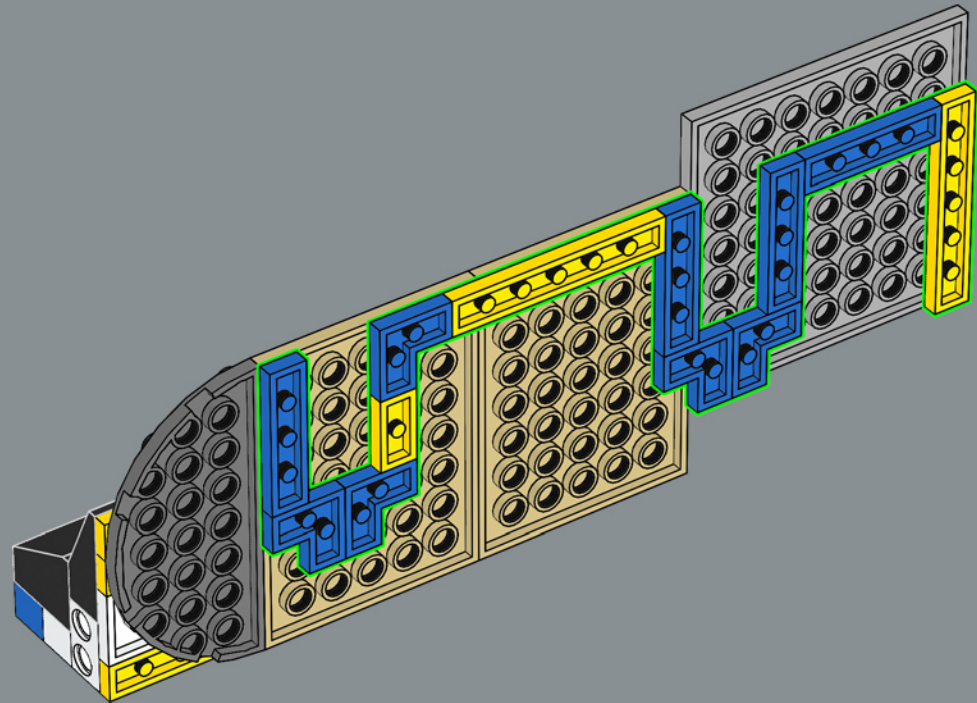

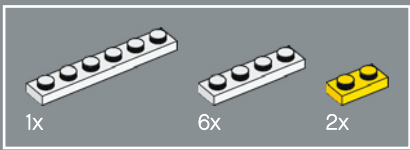

249

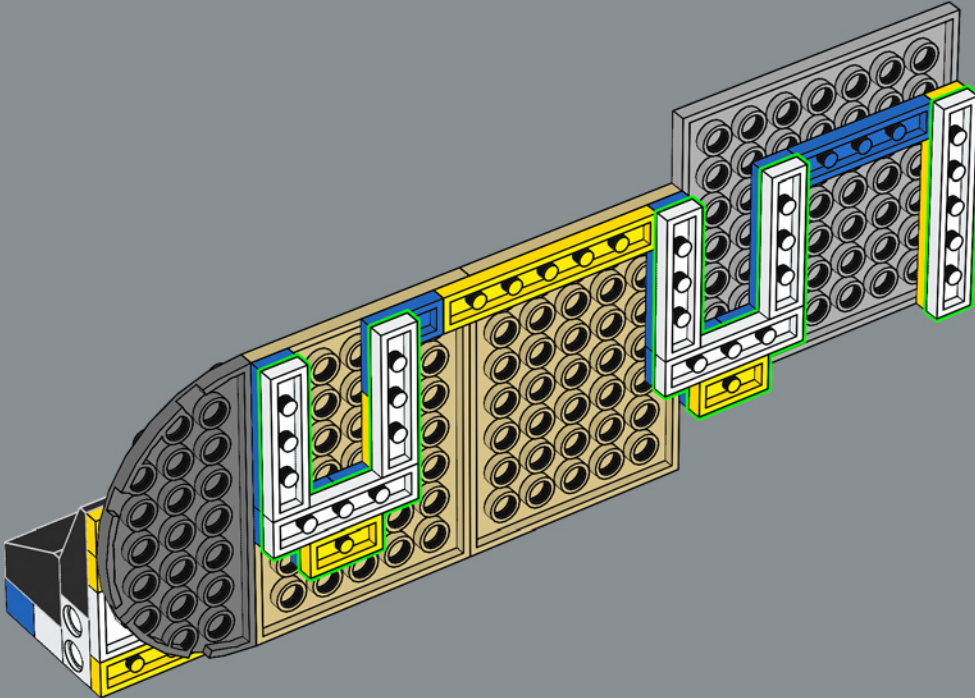

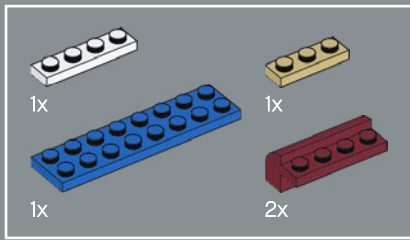

250

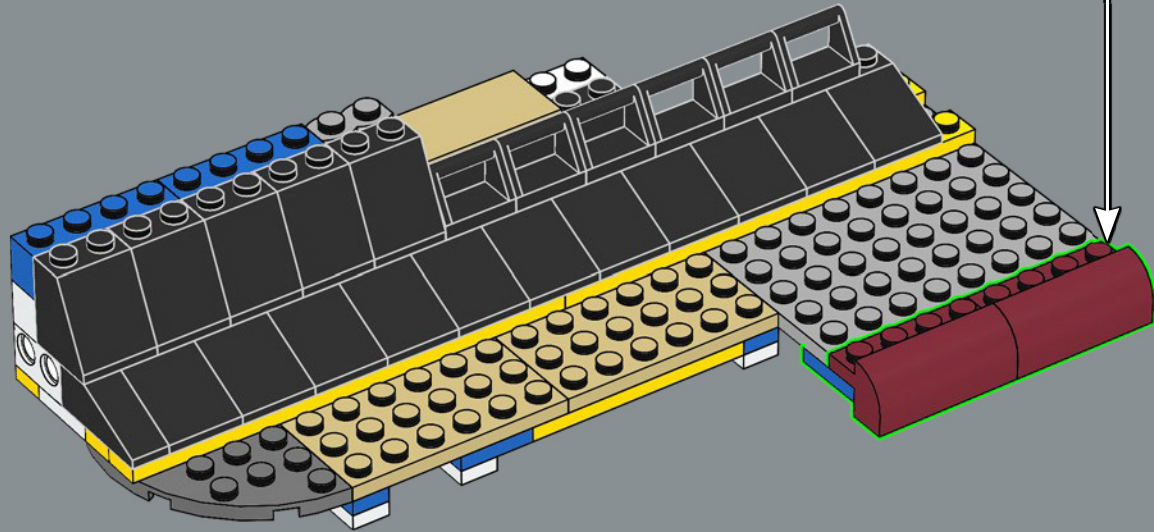
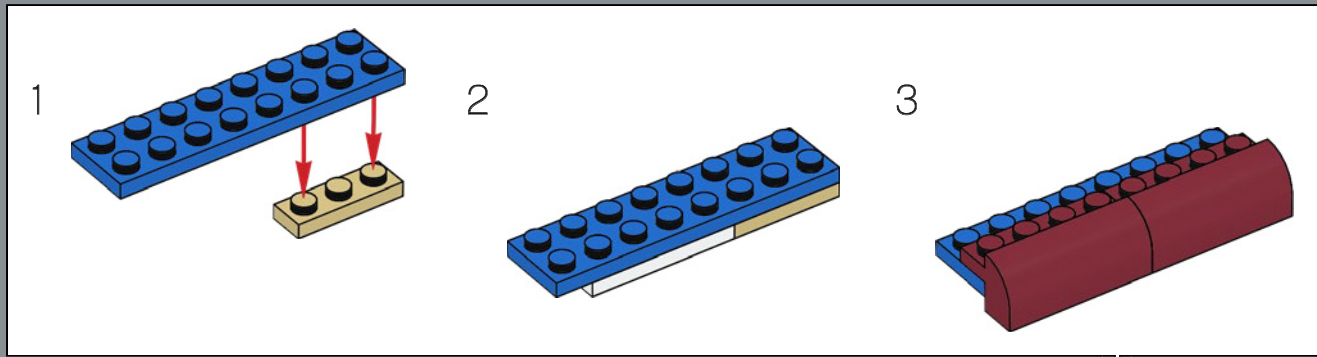

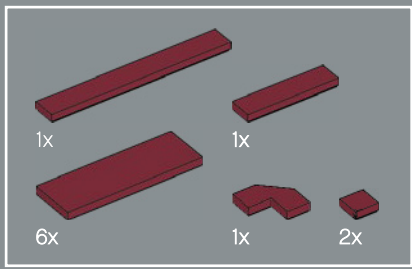

251

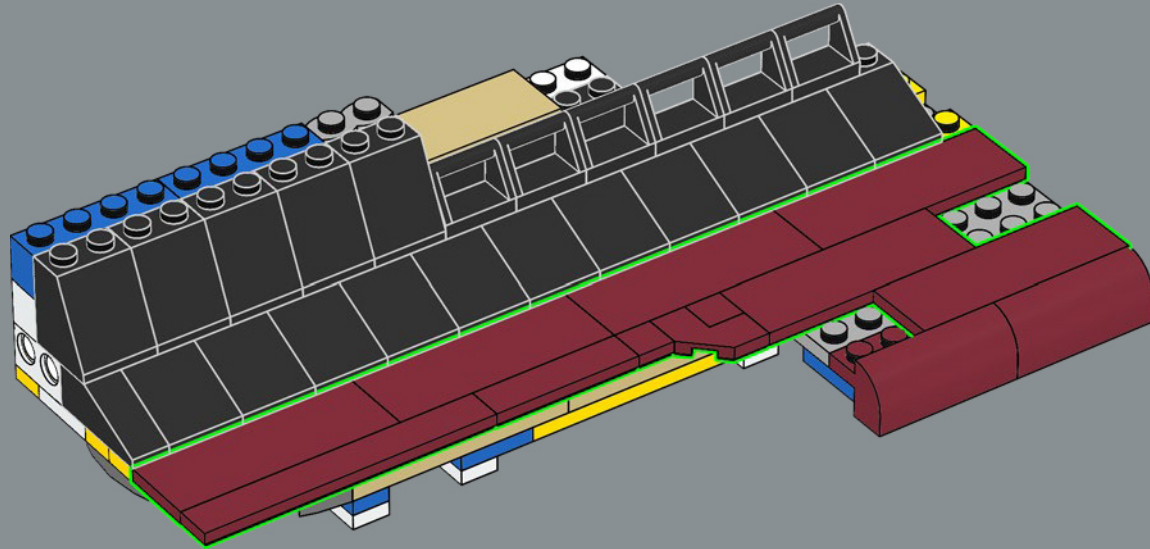

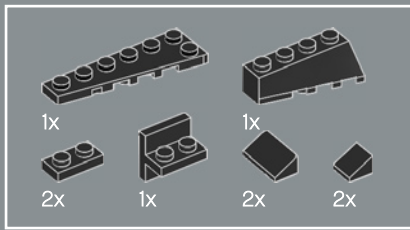

252

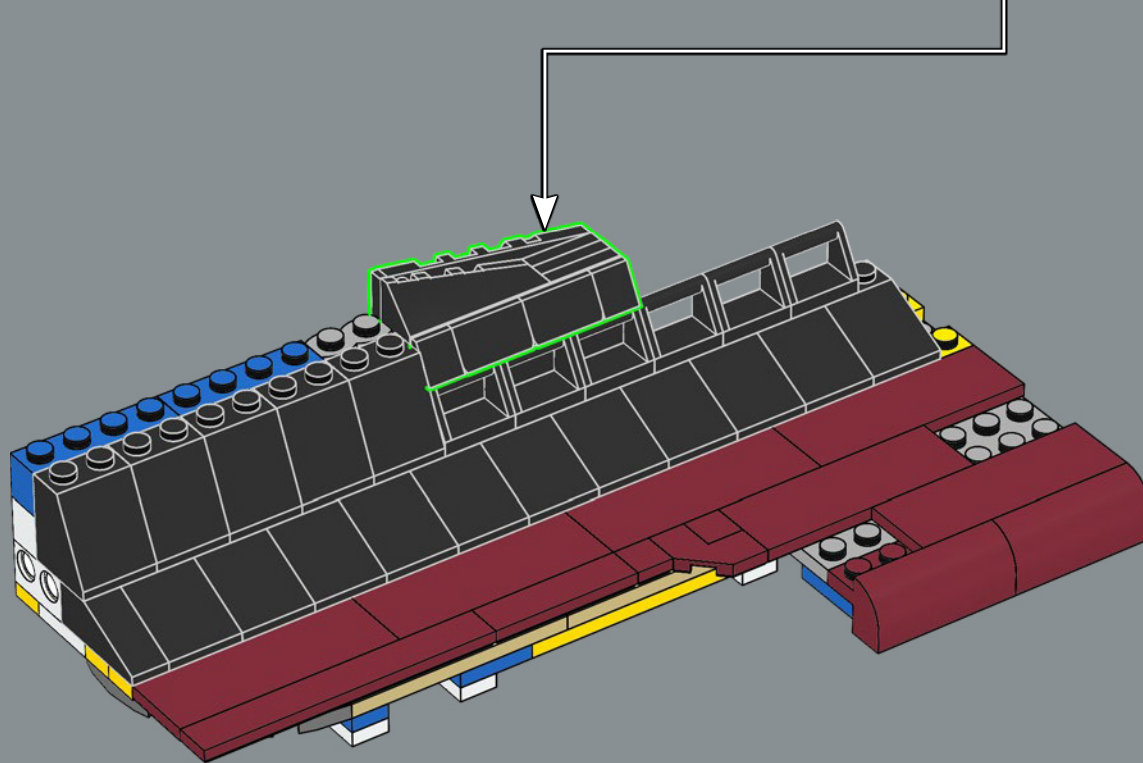
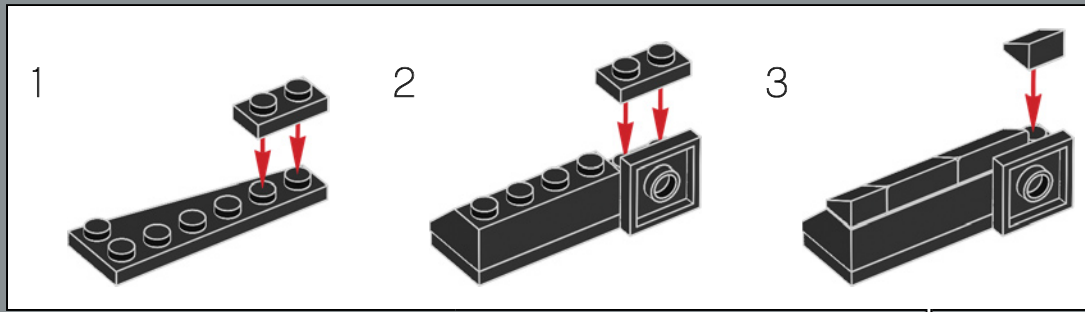

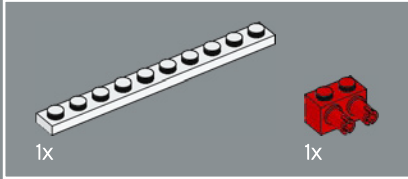
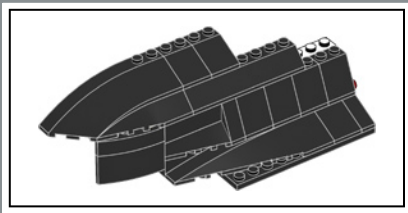

253

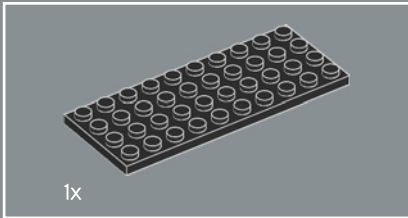
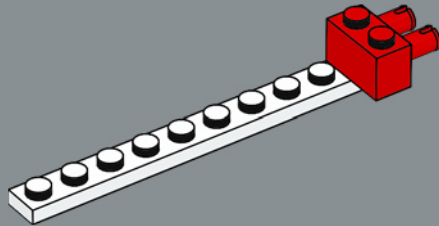

254

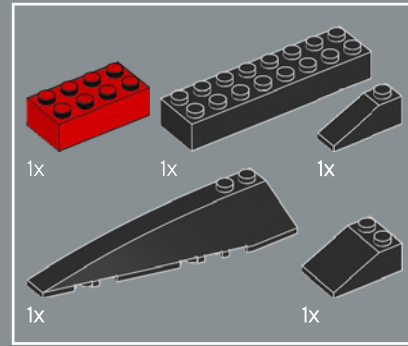
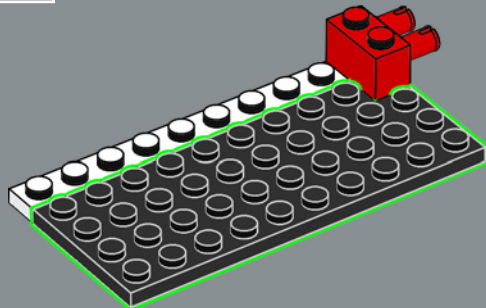

255

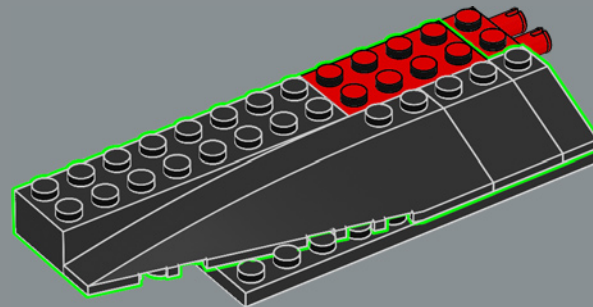

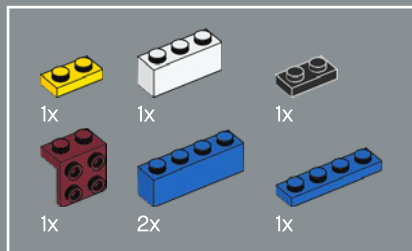

256

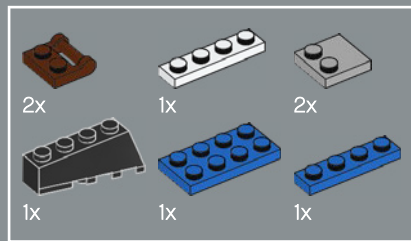
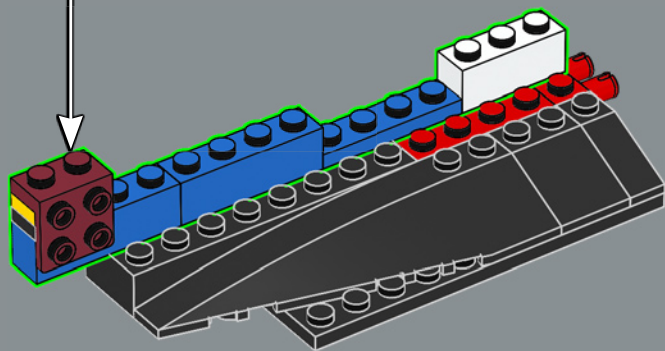
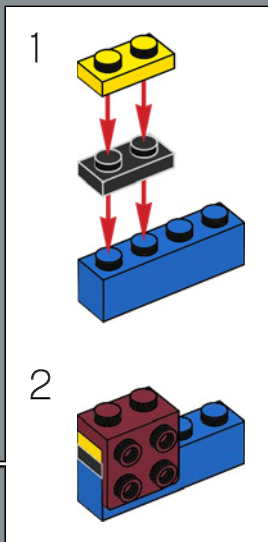

257

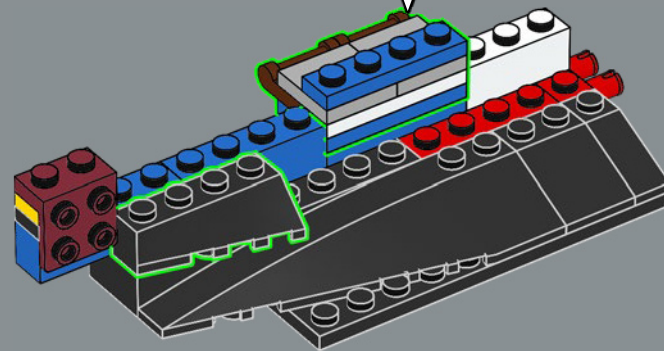
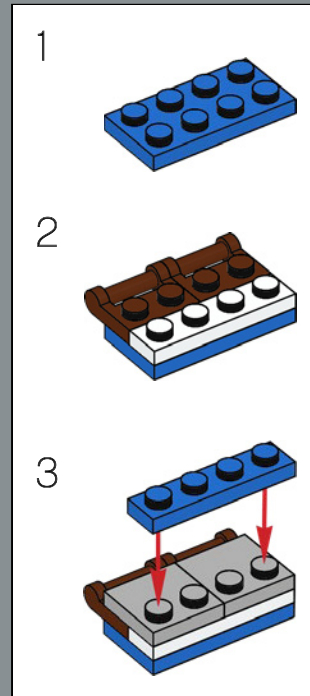

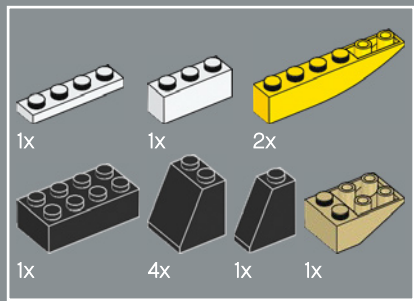

258

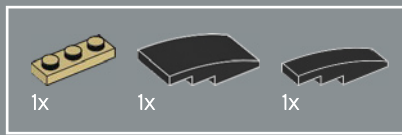
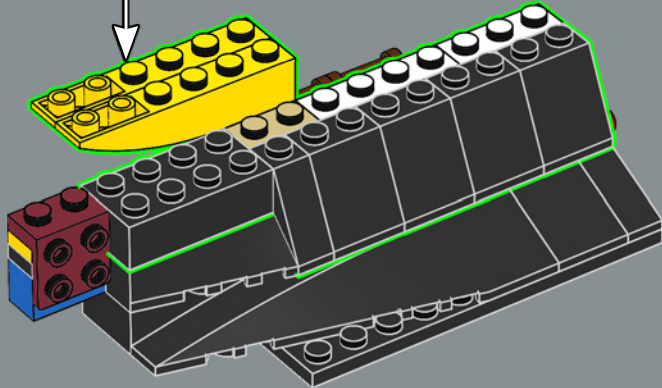
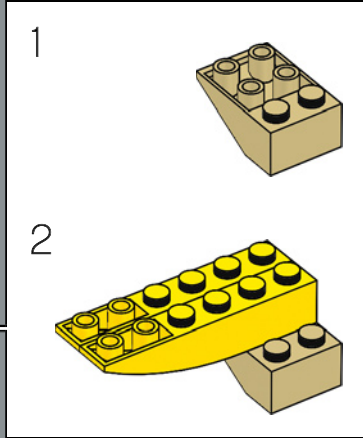

259

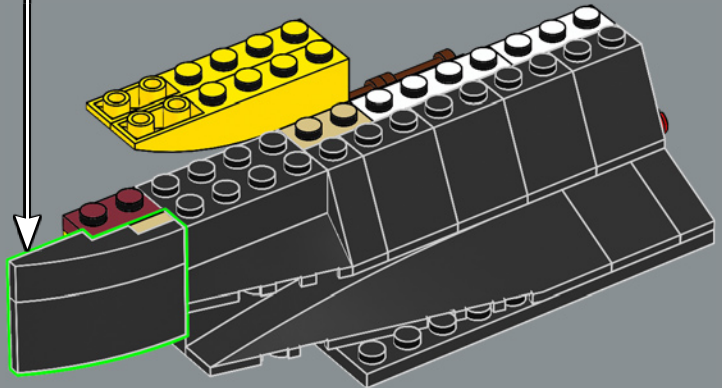
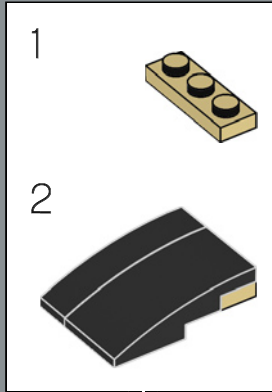

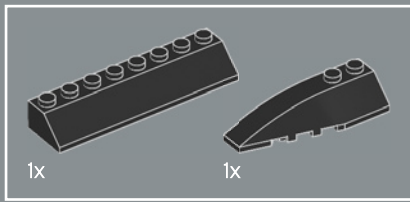

260

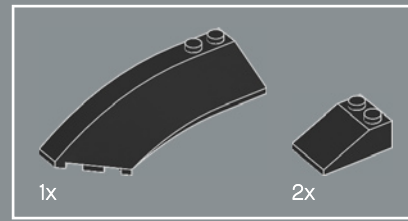
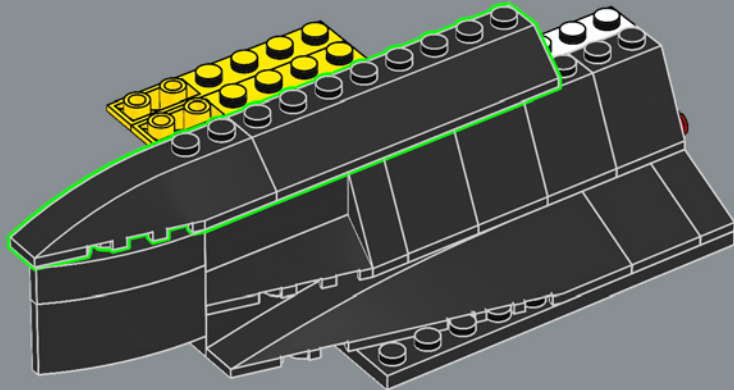

261

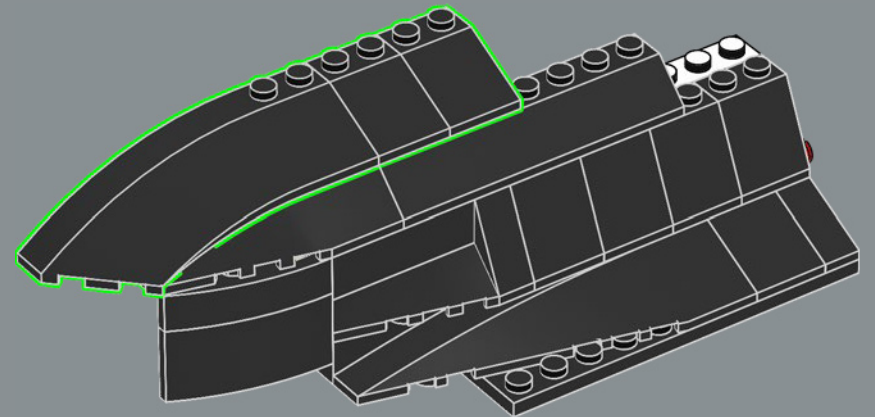

262

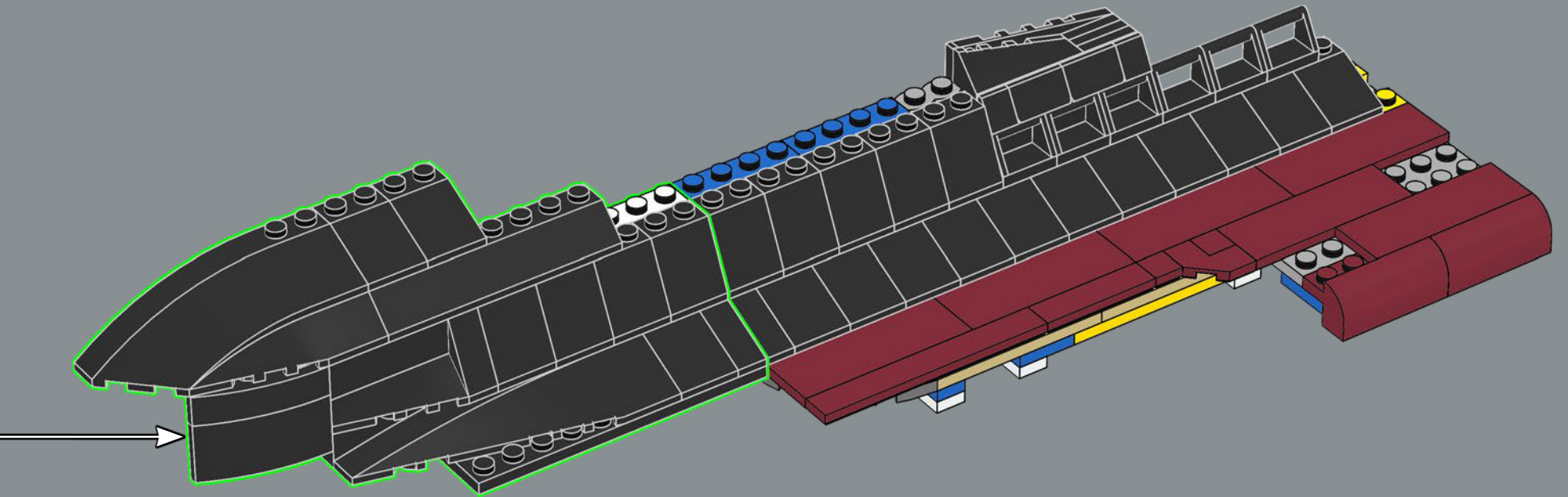

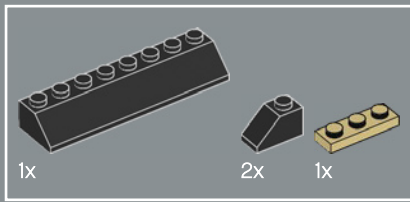

263

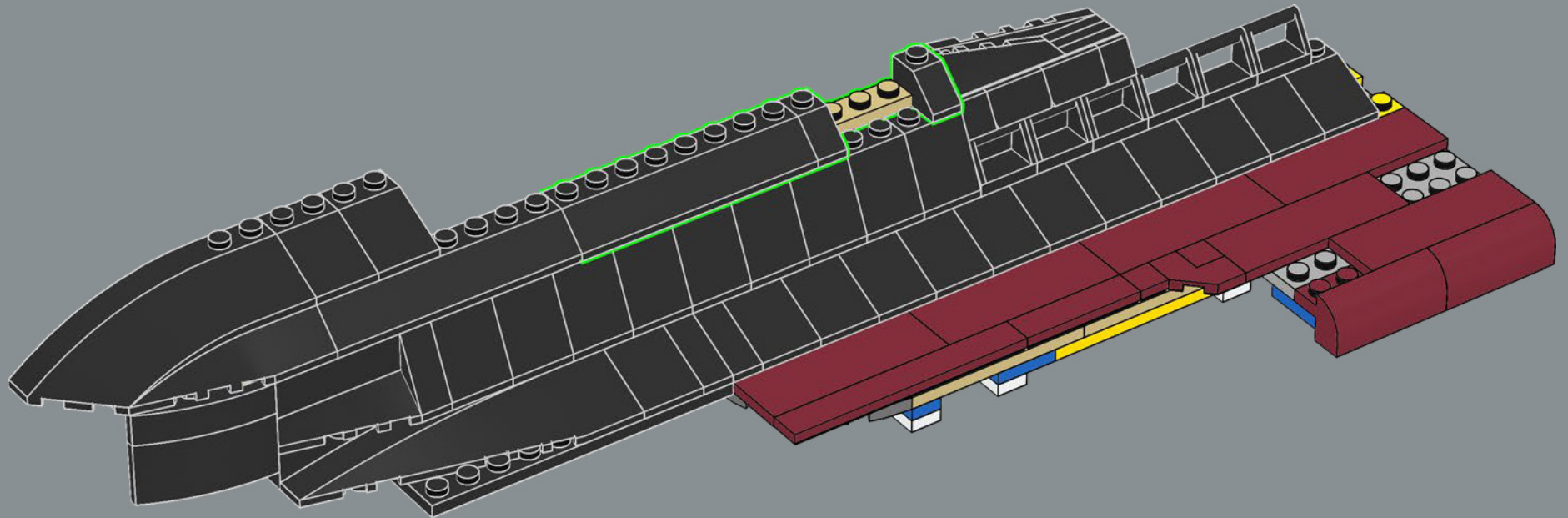

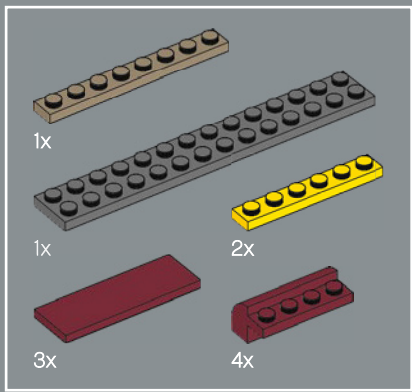

264

1

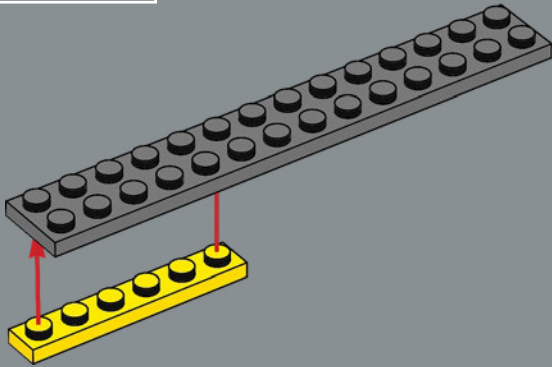

2

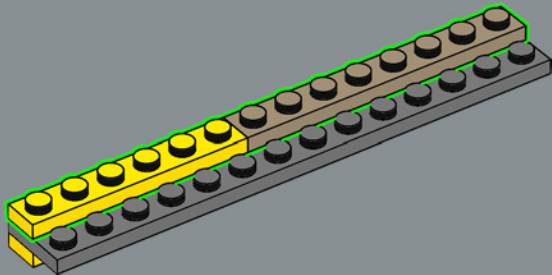

3

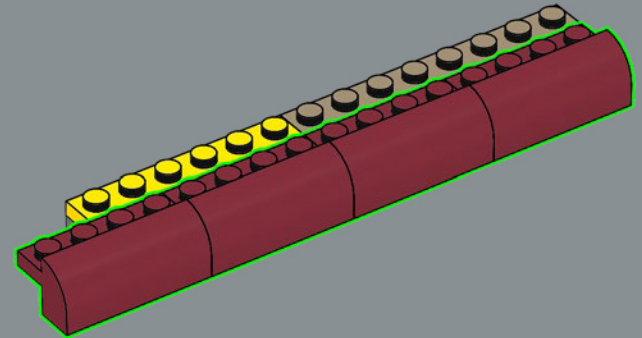

4

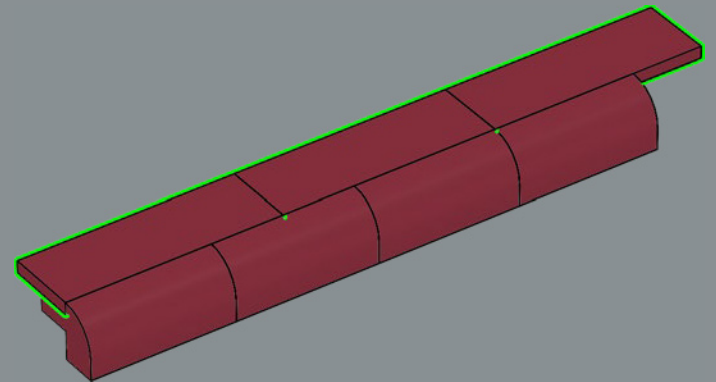

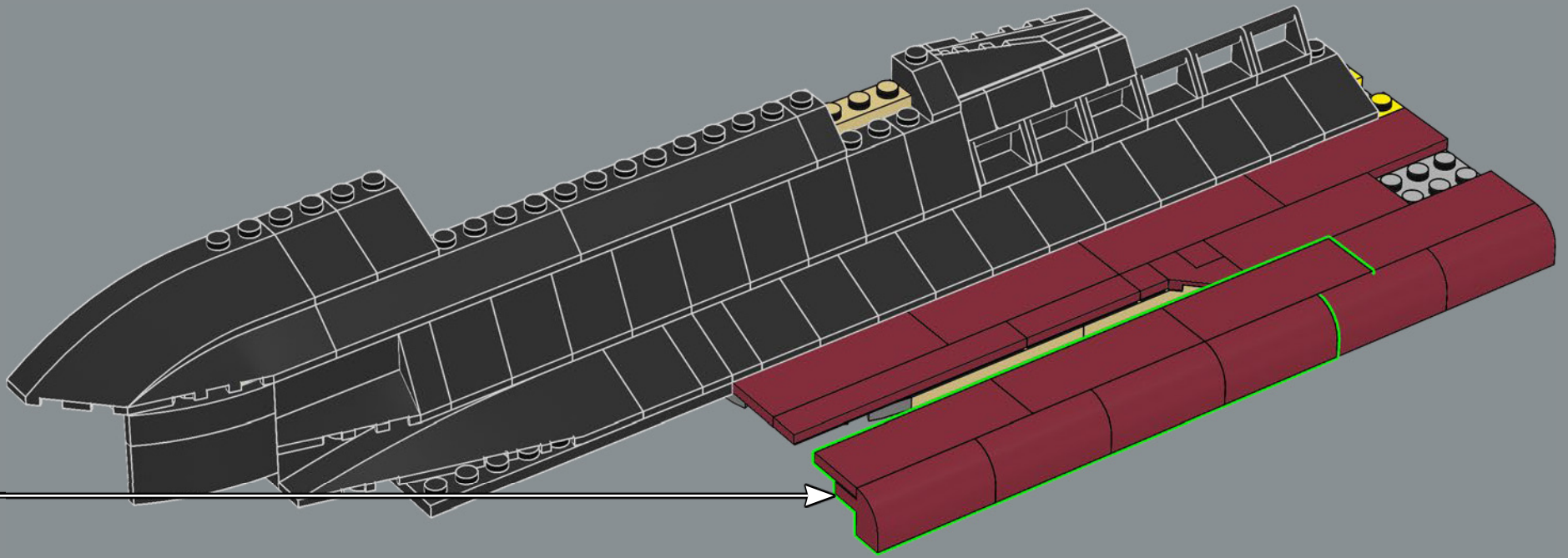

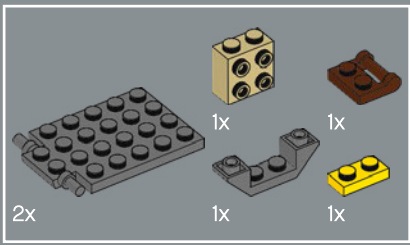

265

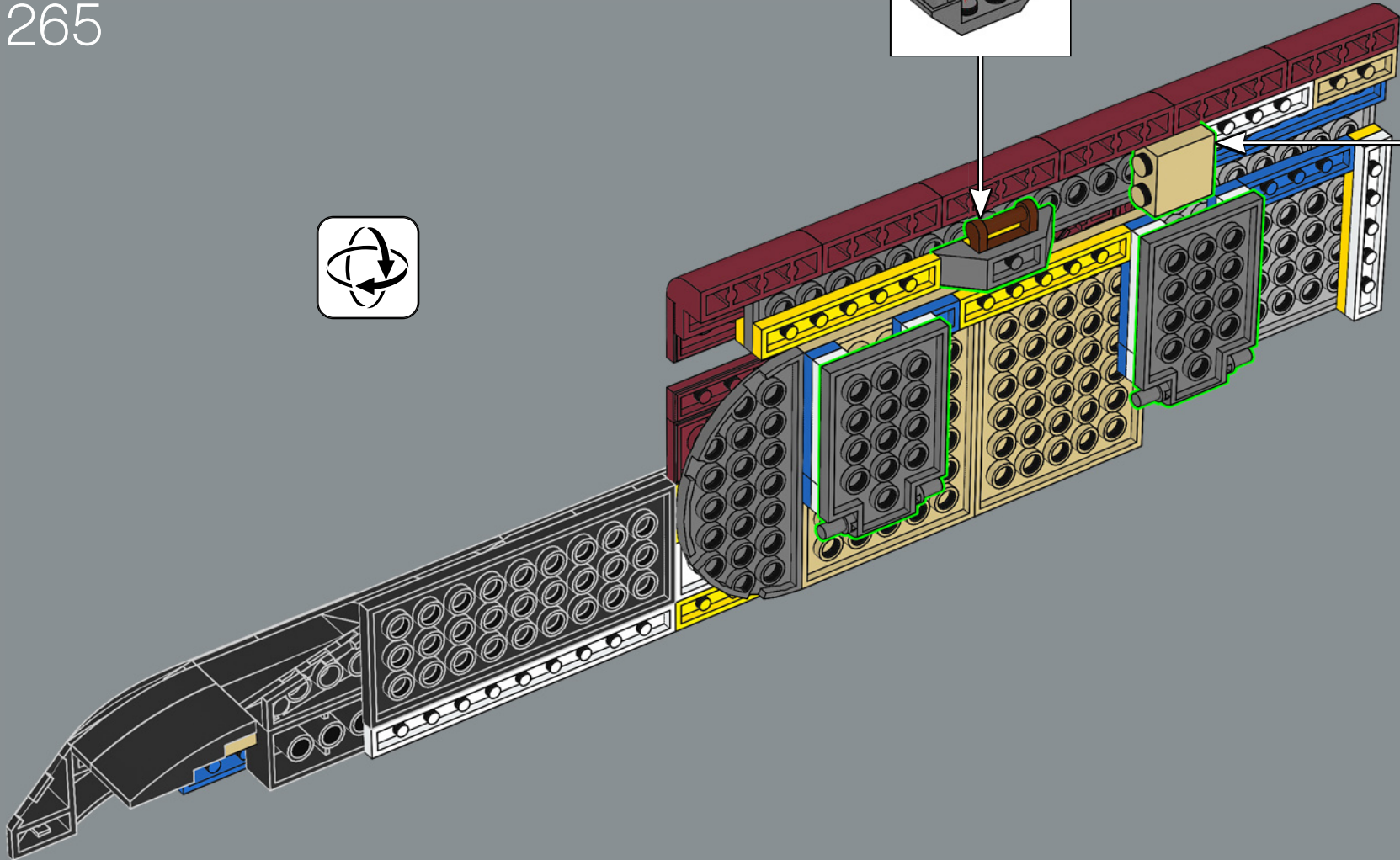
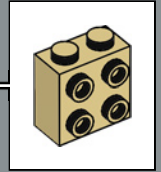
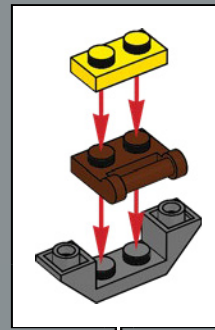

266

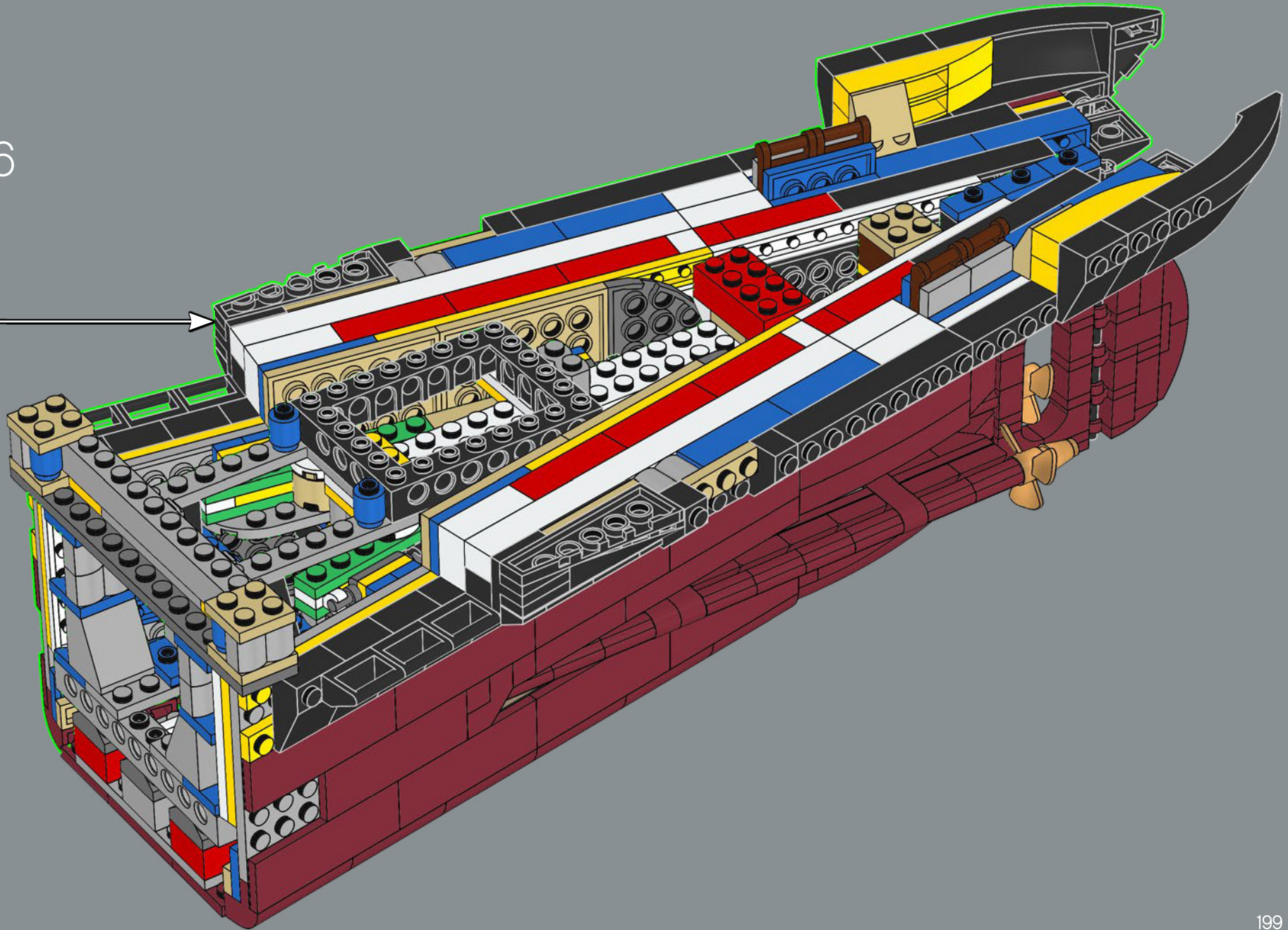

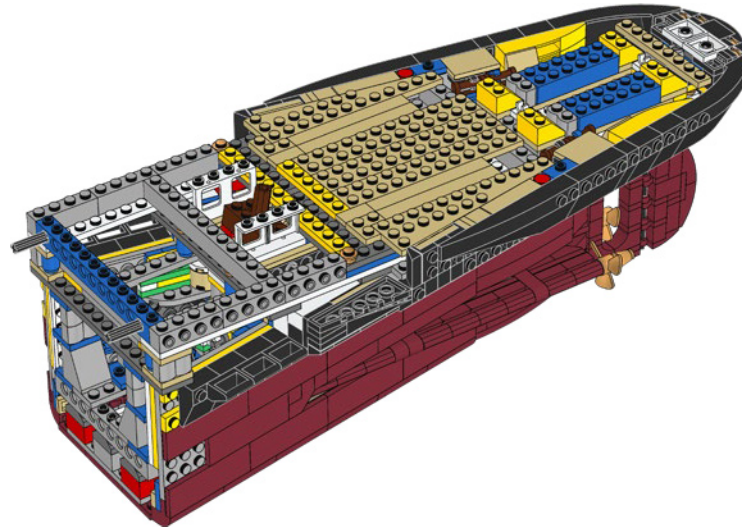
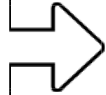

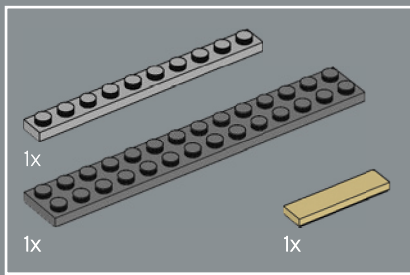

267

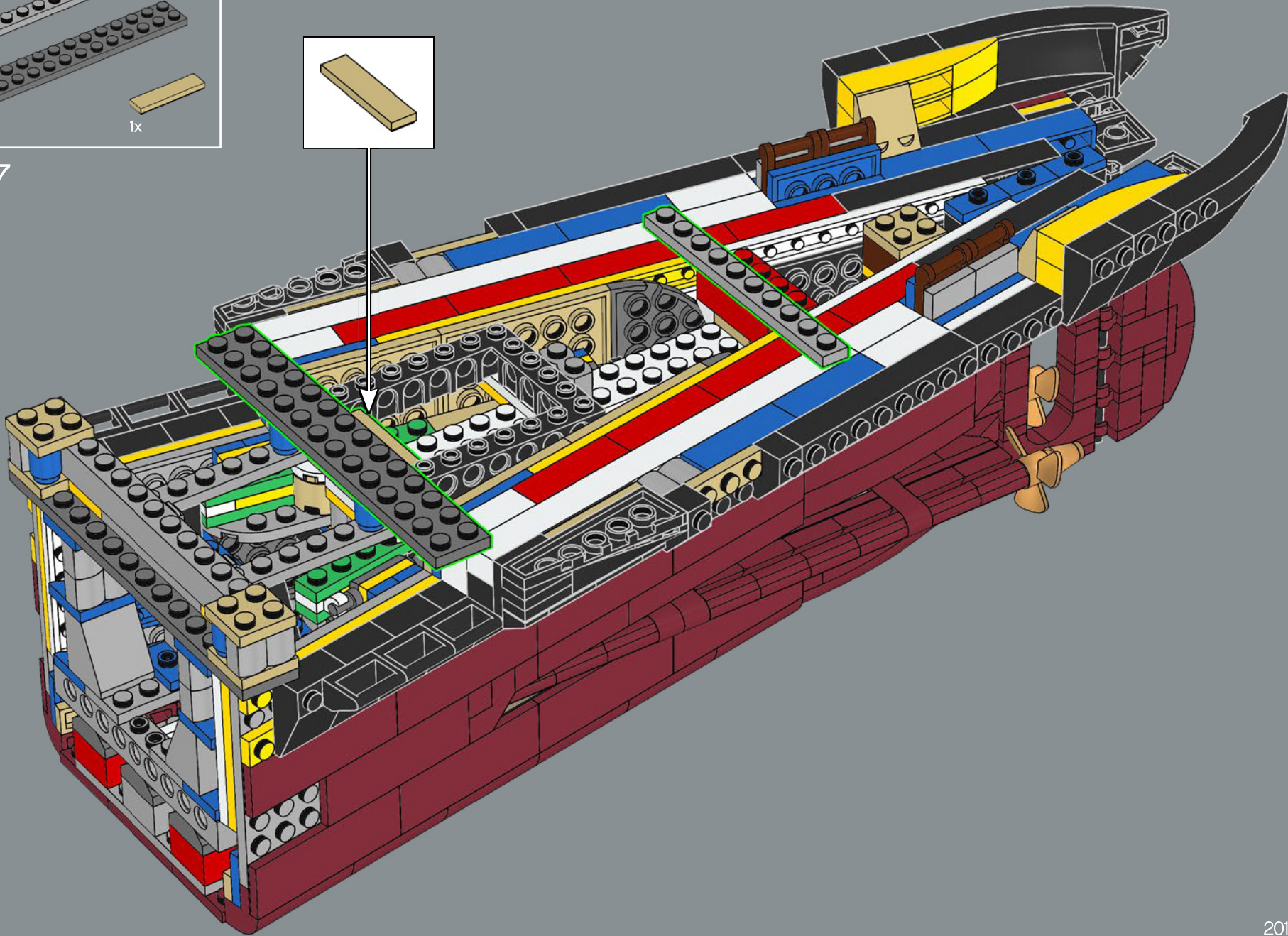
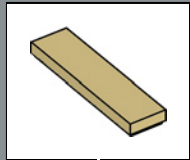

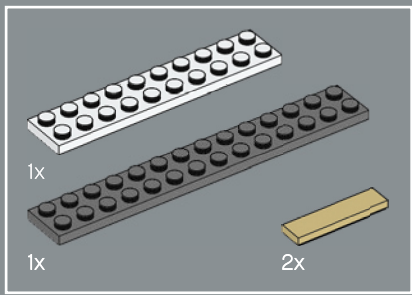

268

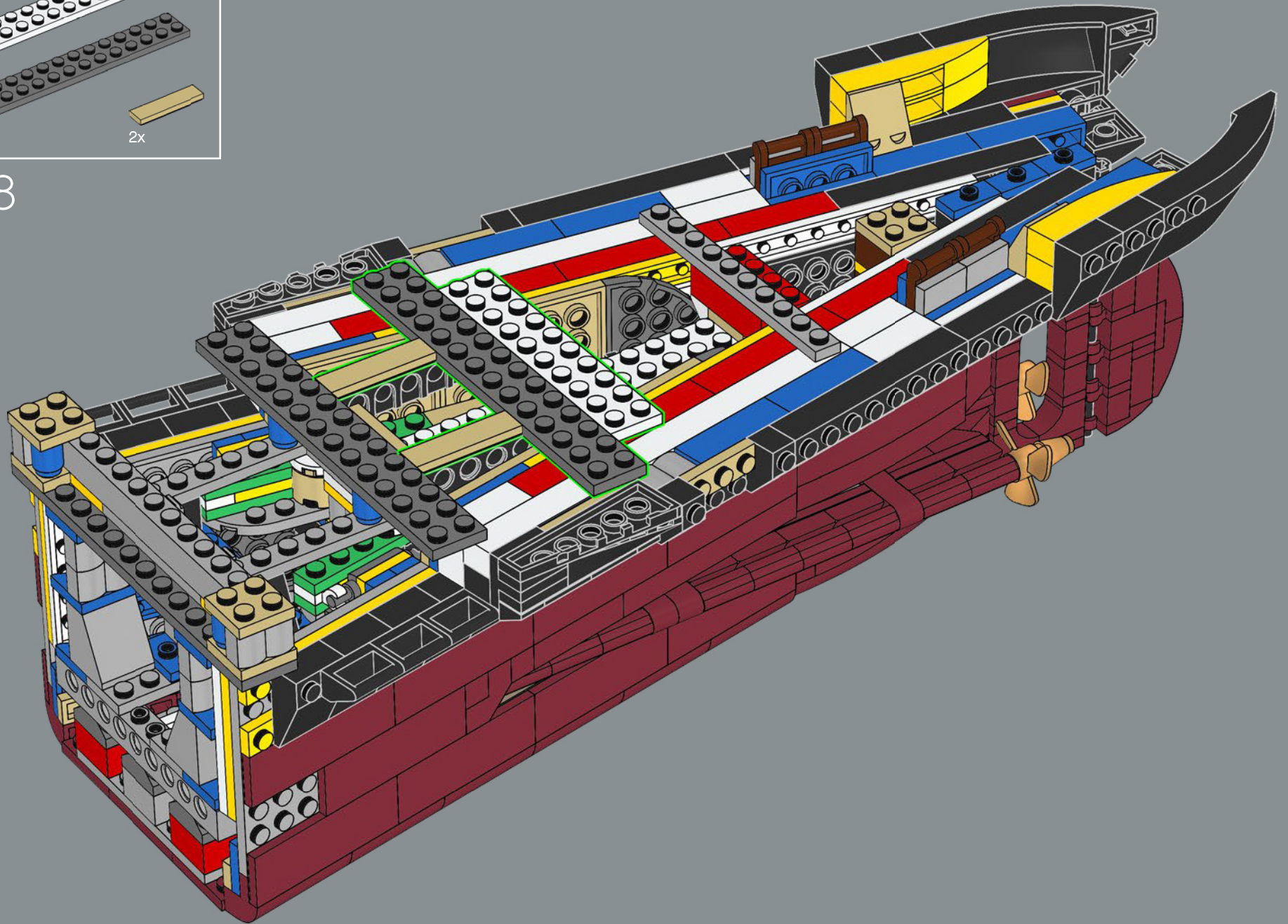

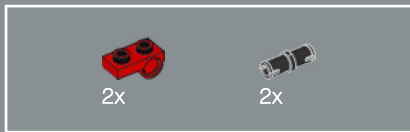

269

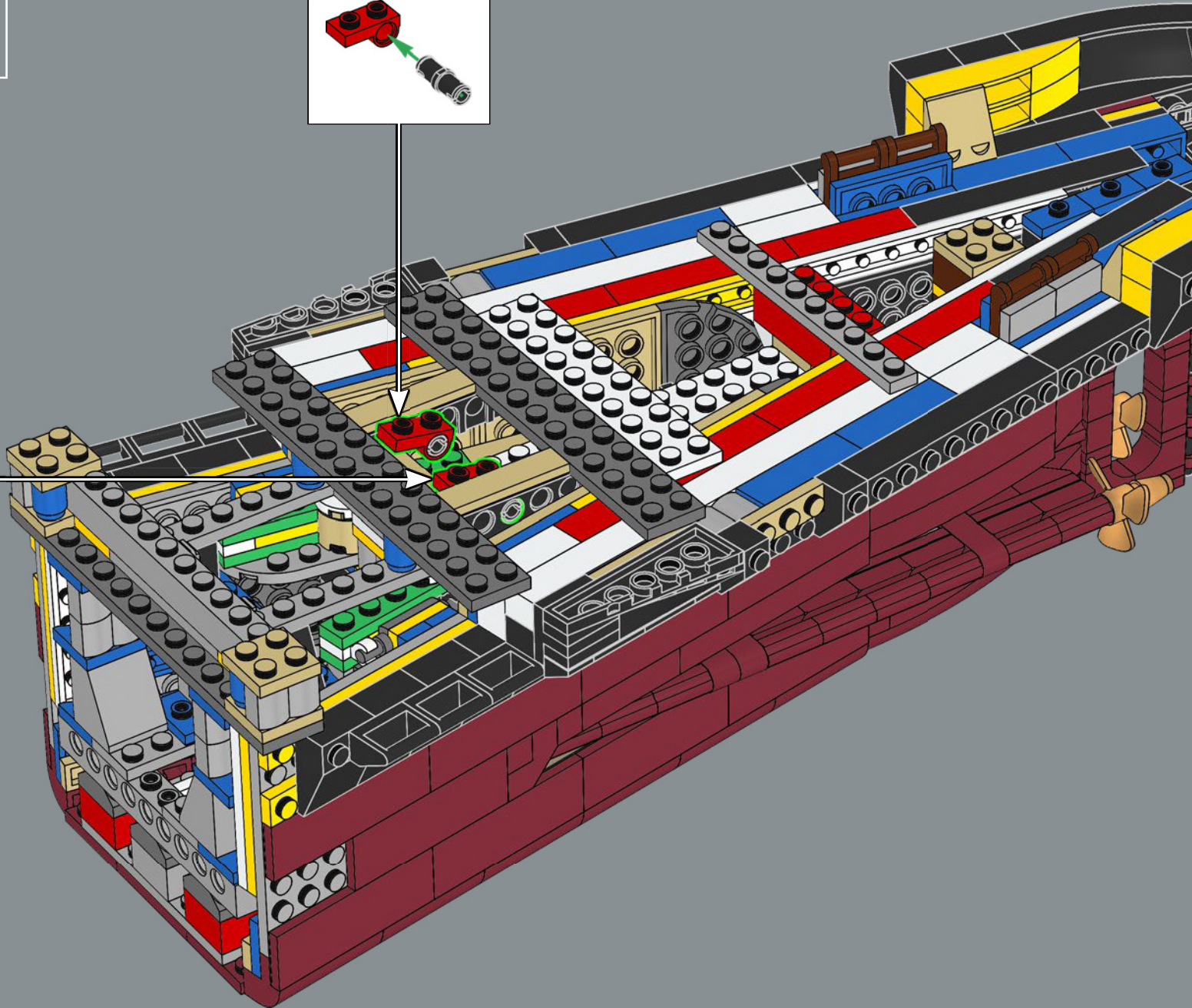
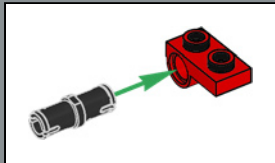
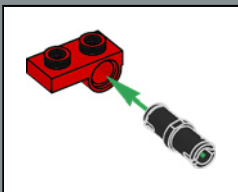

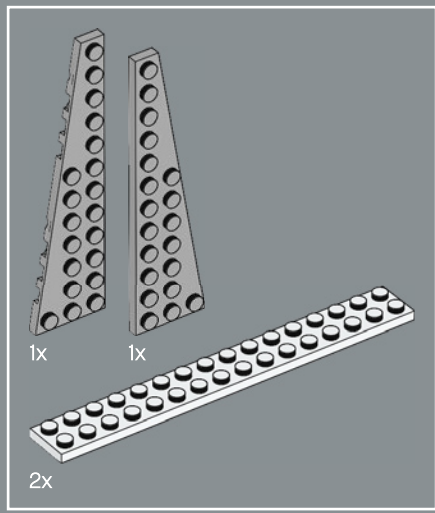

270

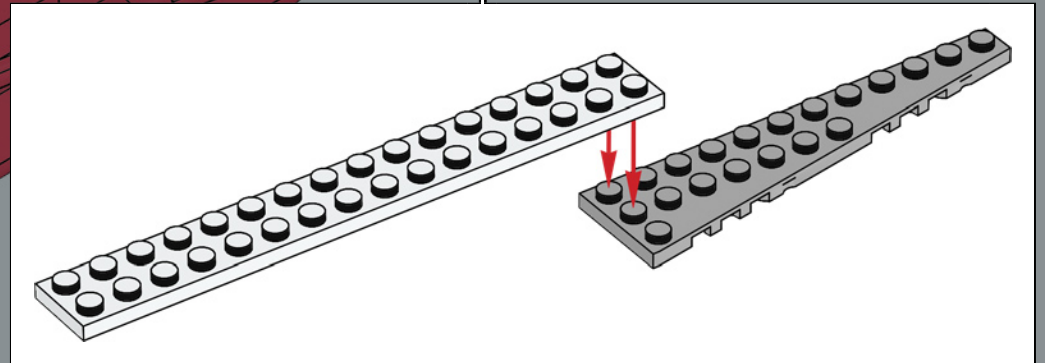
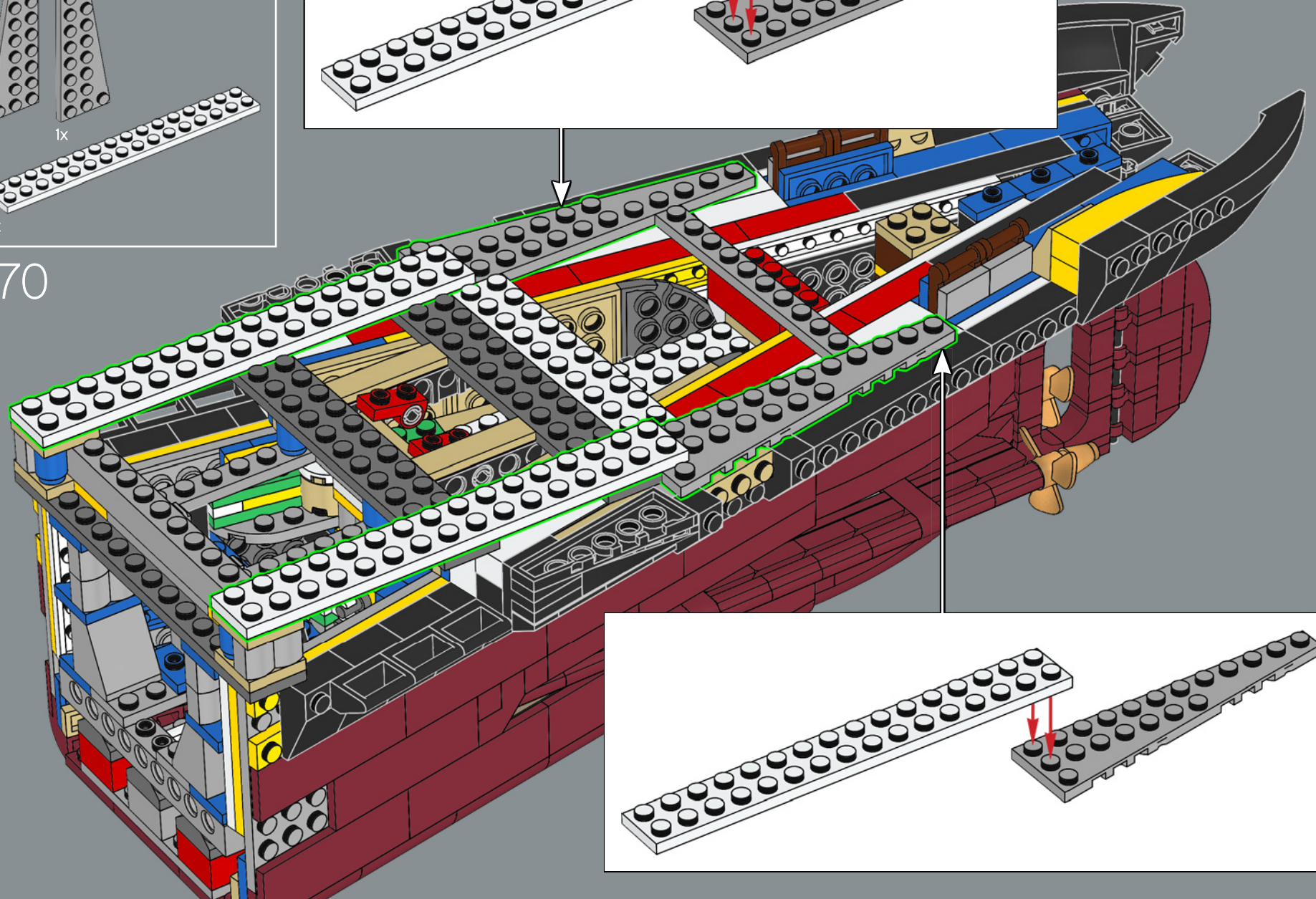
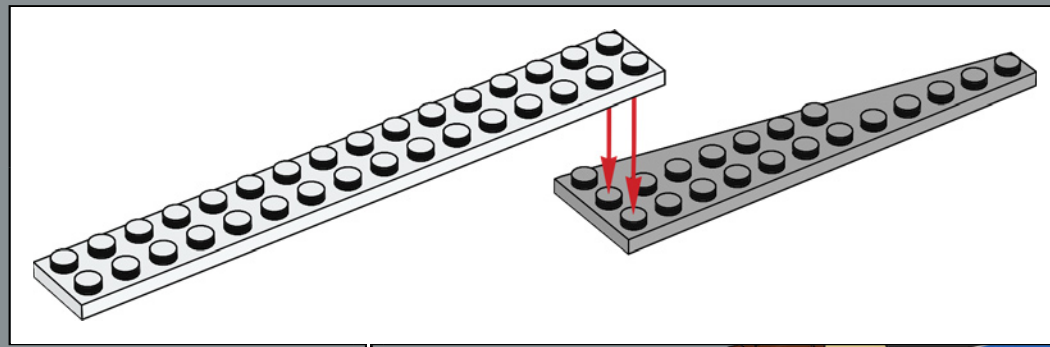

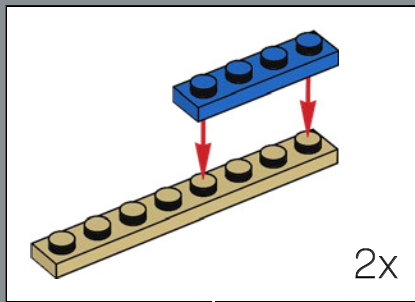
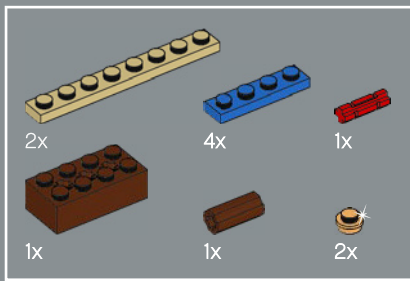

271

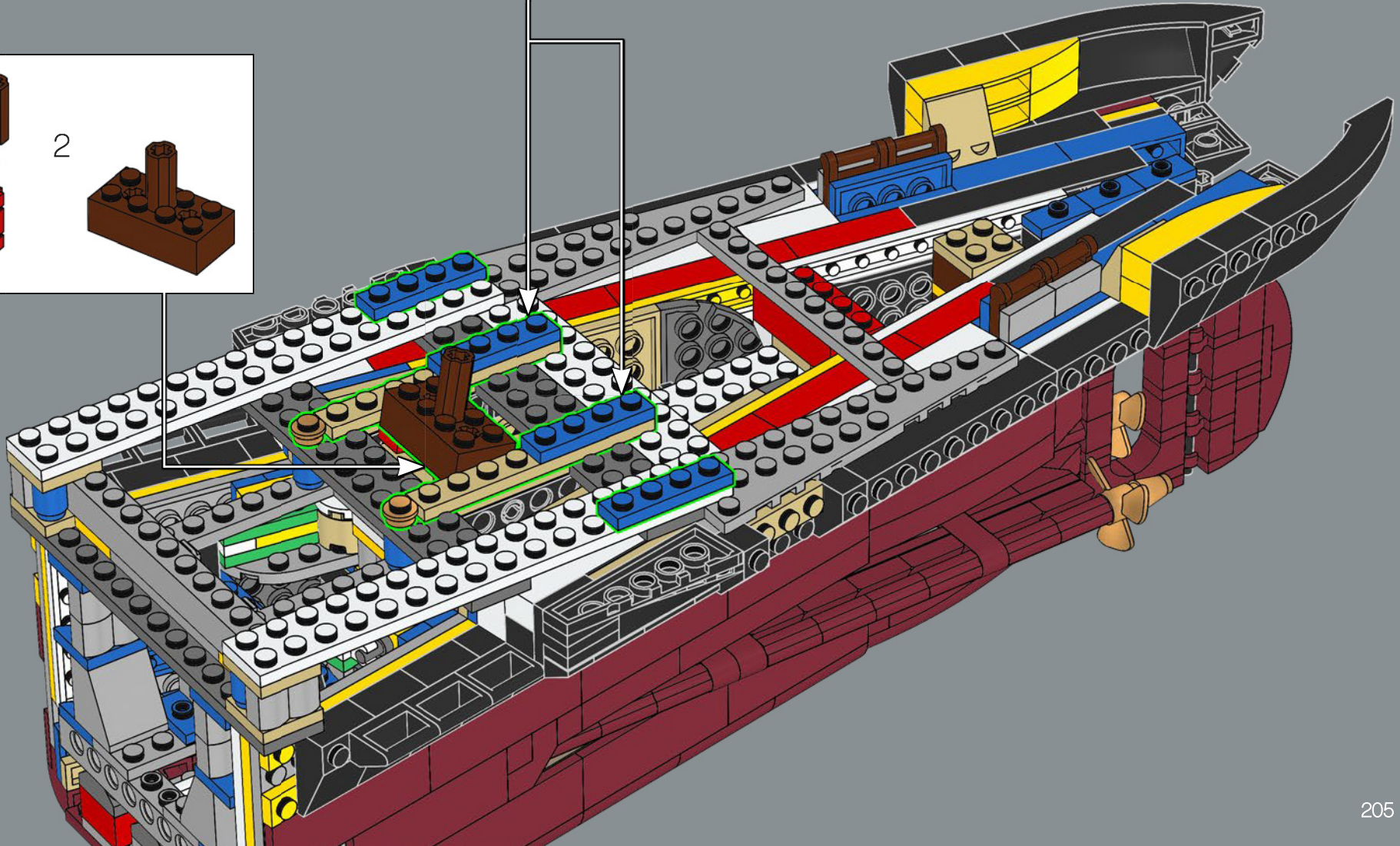
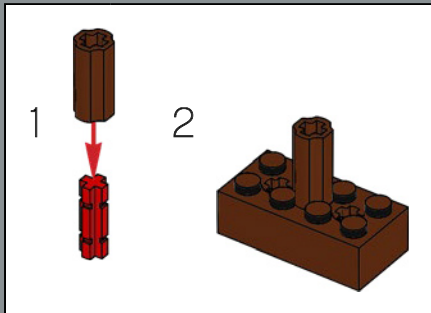

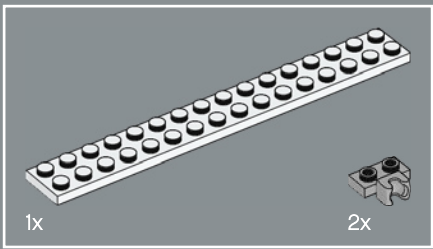

272

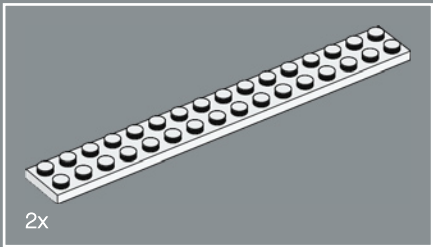
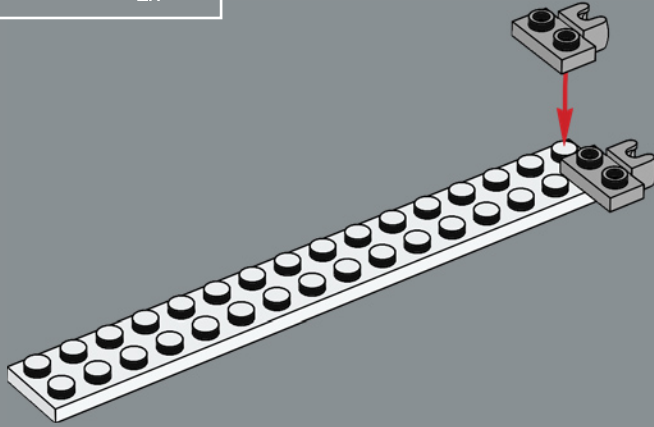

273

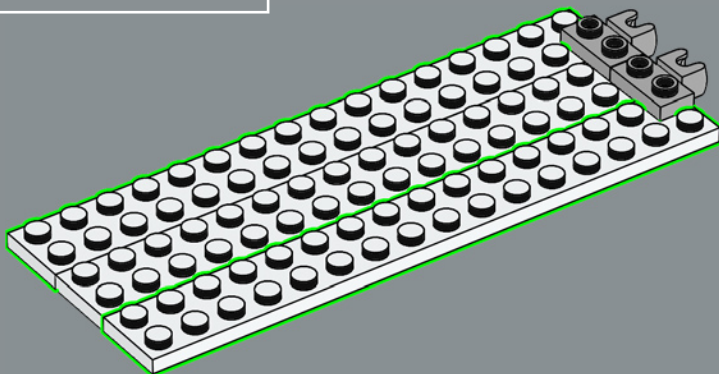

274

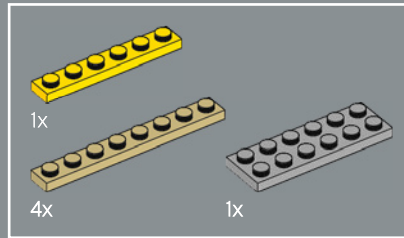
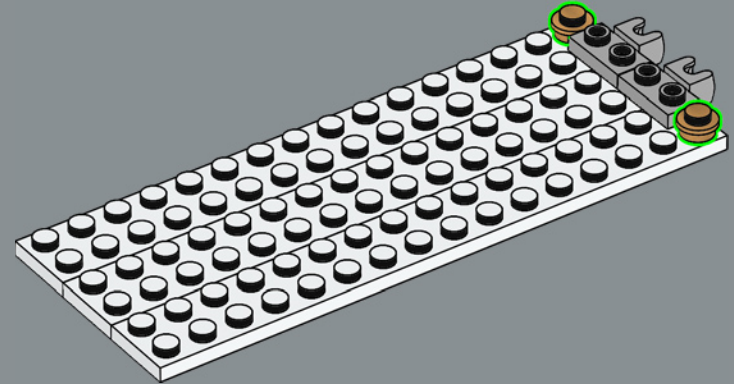

275

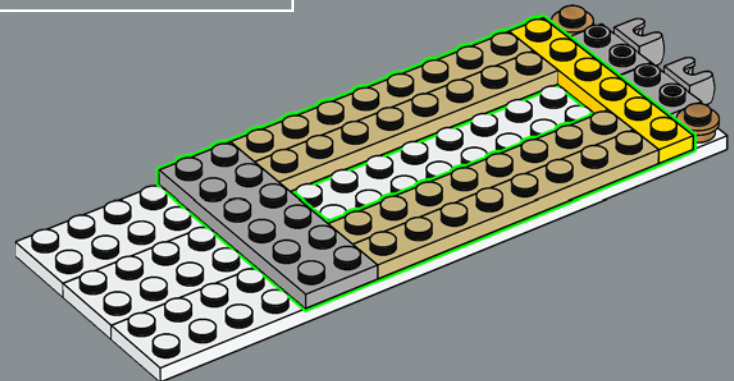

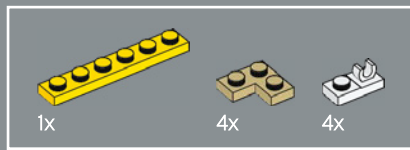

276

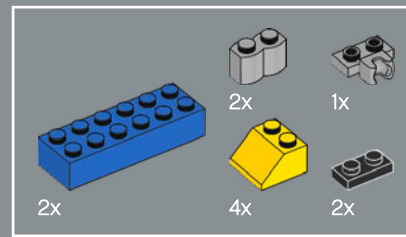
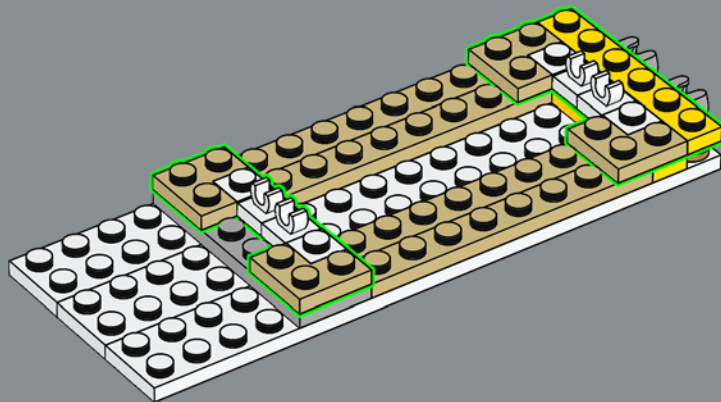

277

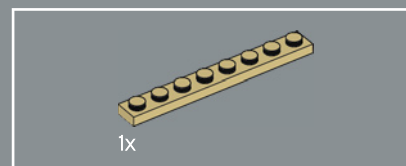
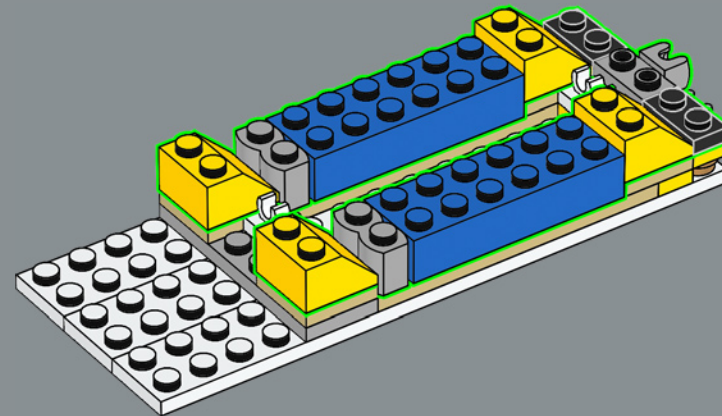

278

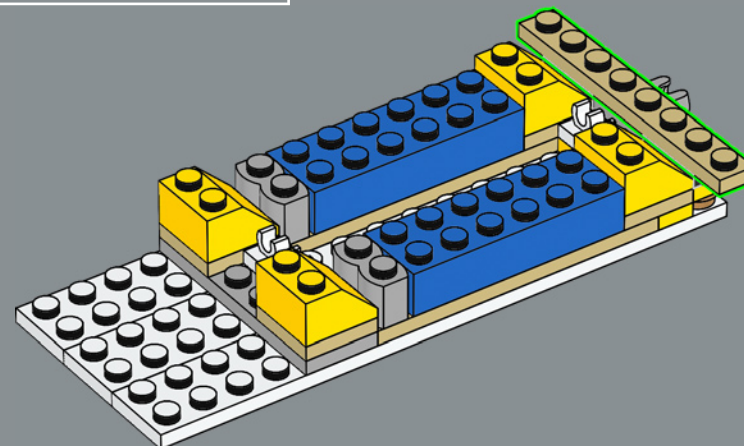

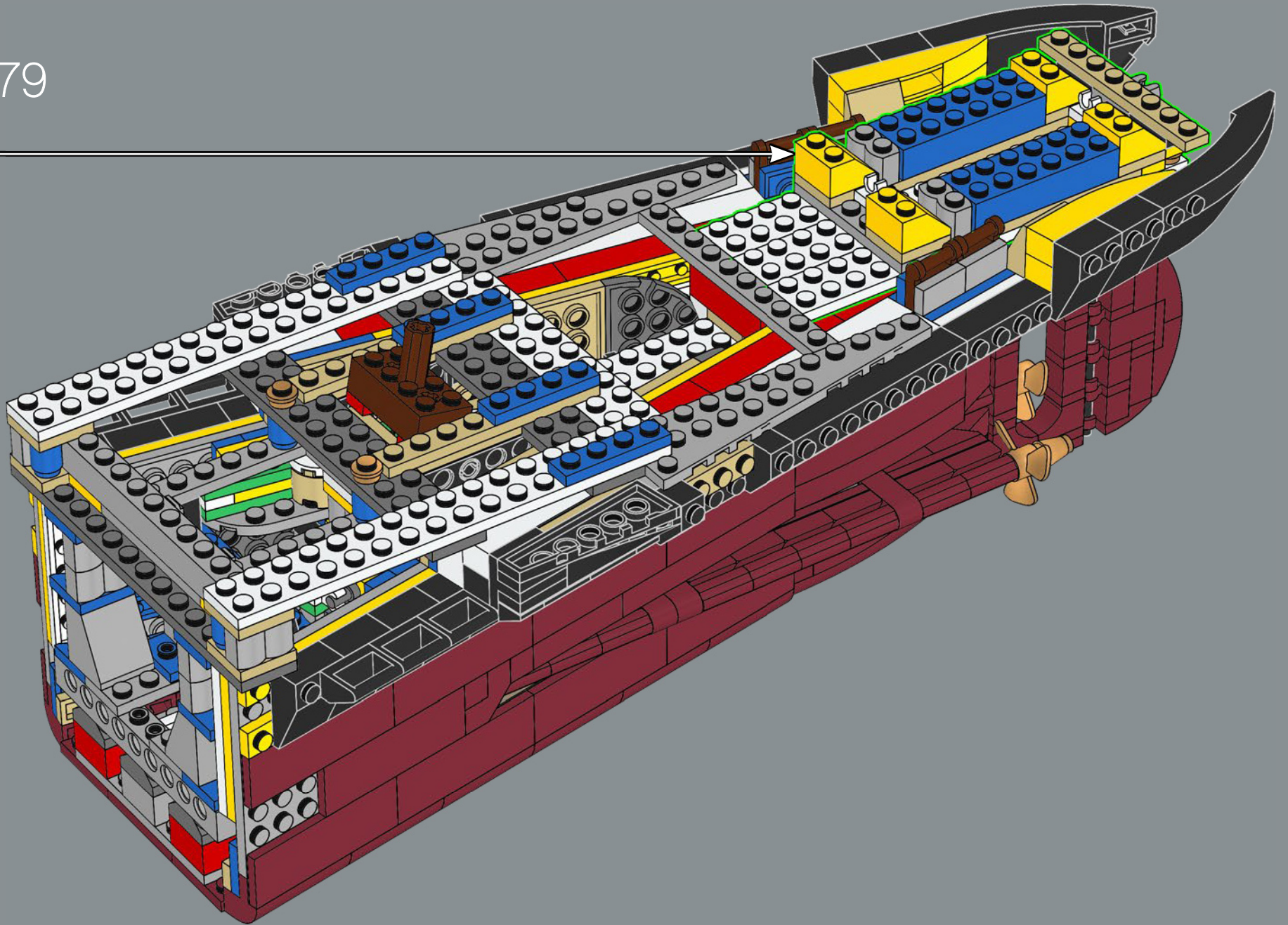

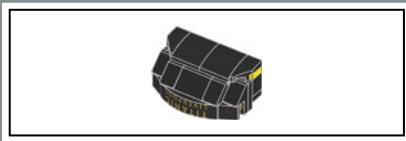

280

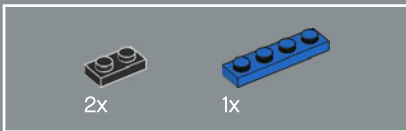
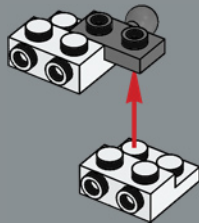

281

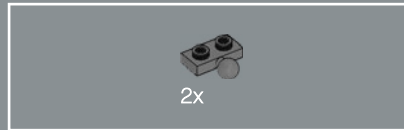
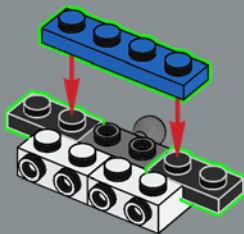

282

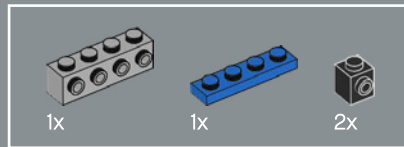
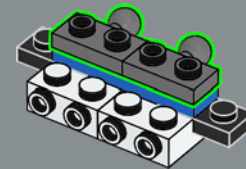

283

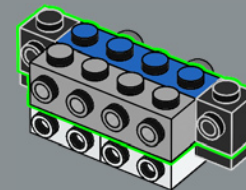

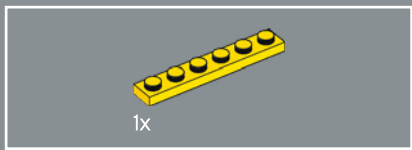

284

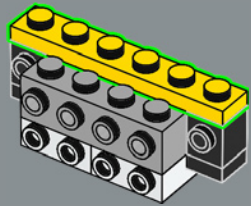

285

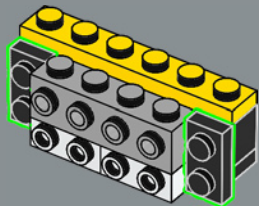

286

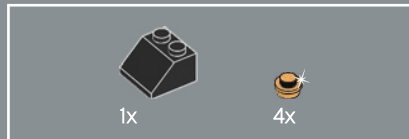
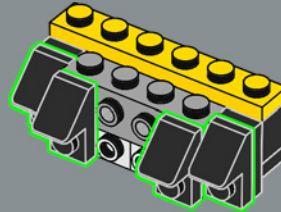

287

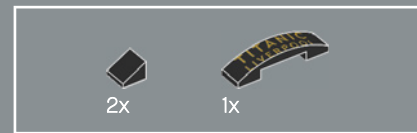
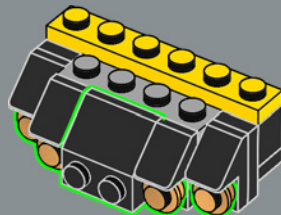

288

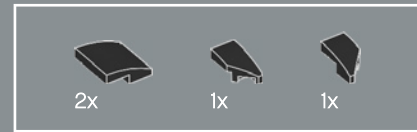
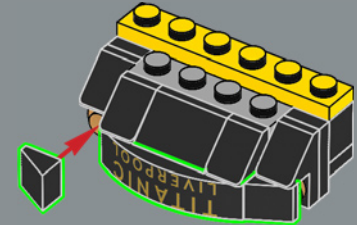

289

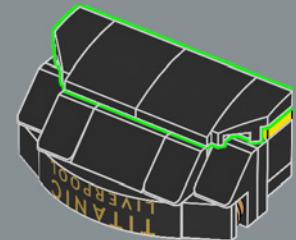

Il *Titanic* non era dotato di proiettori e non aveva un impianto di diffusione sonora.

290

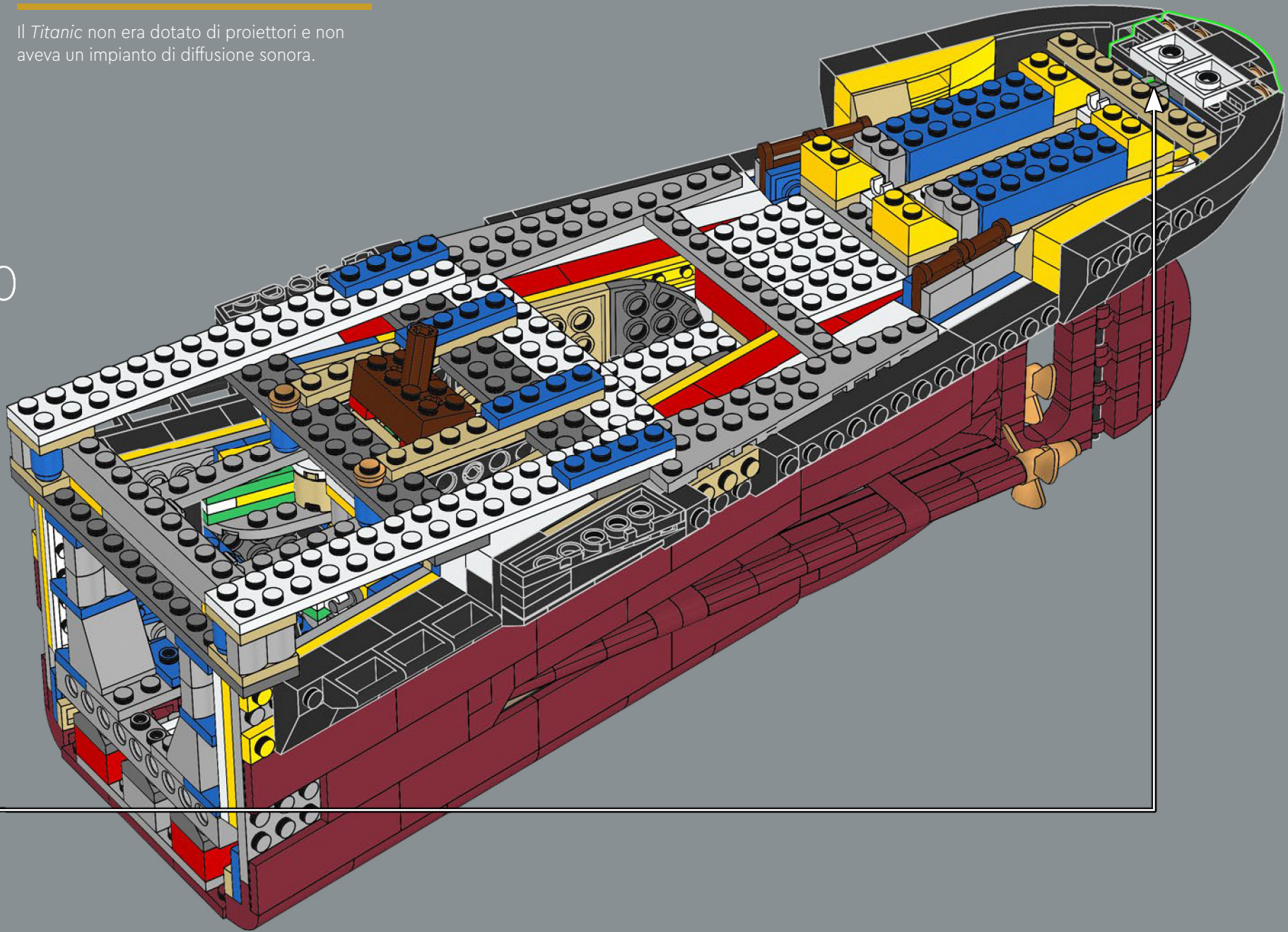

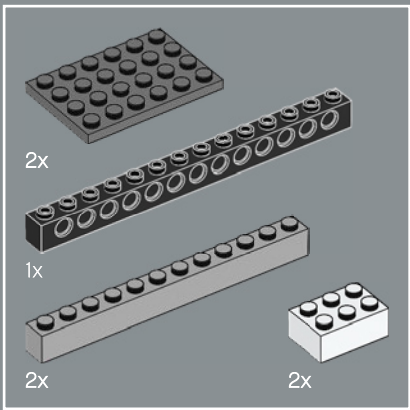

291

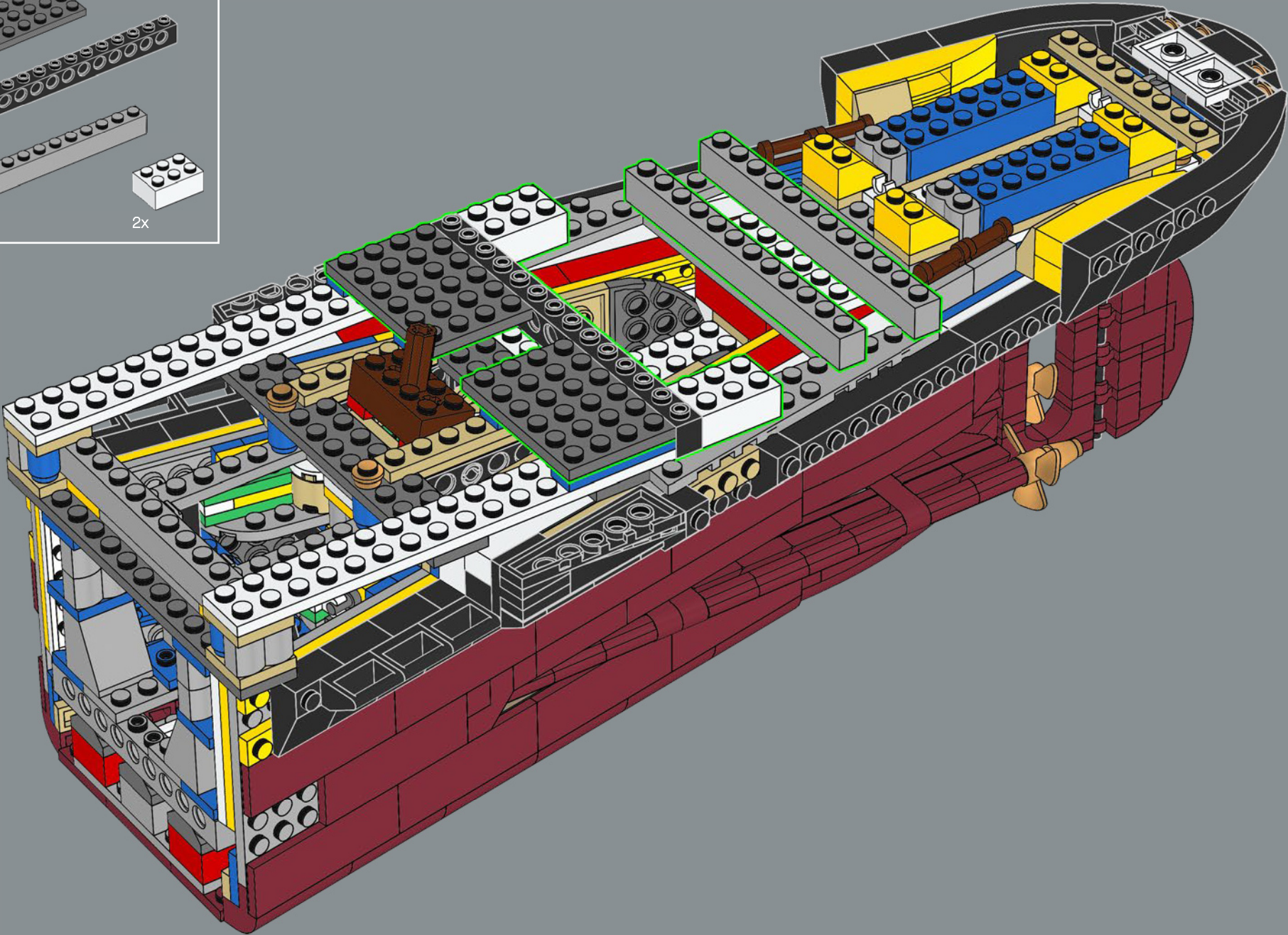

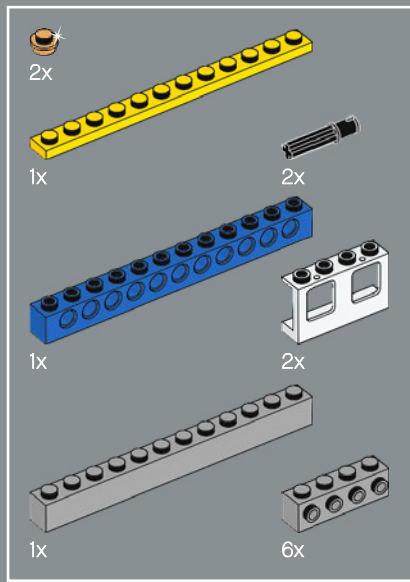

292

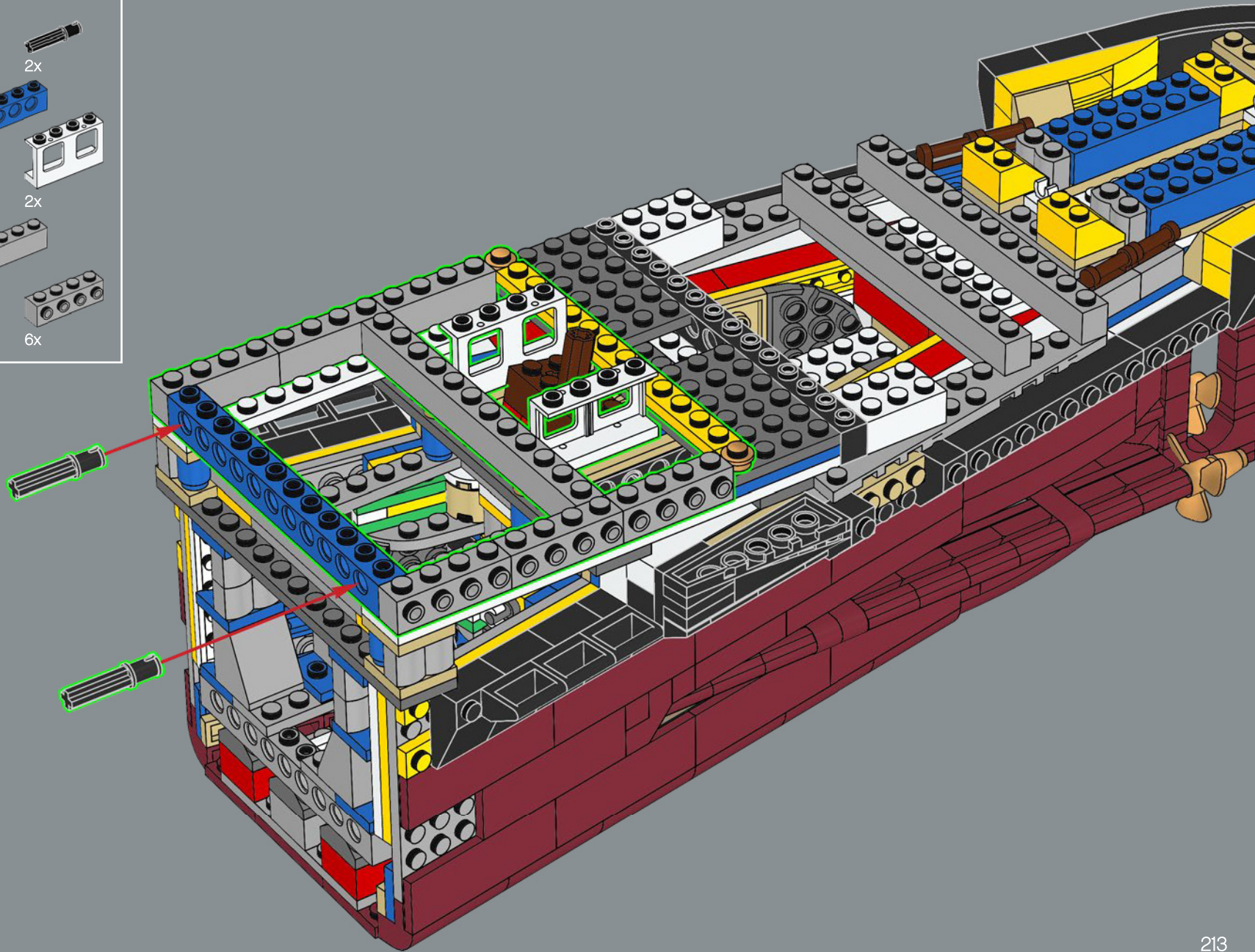

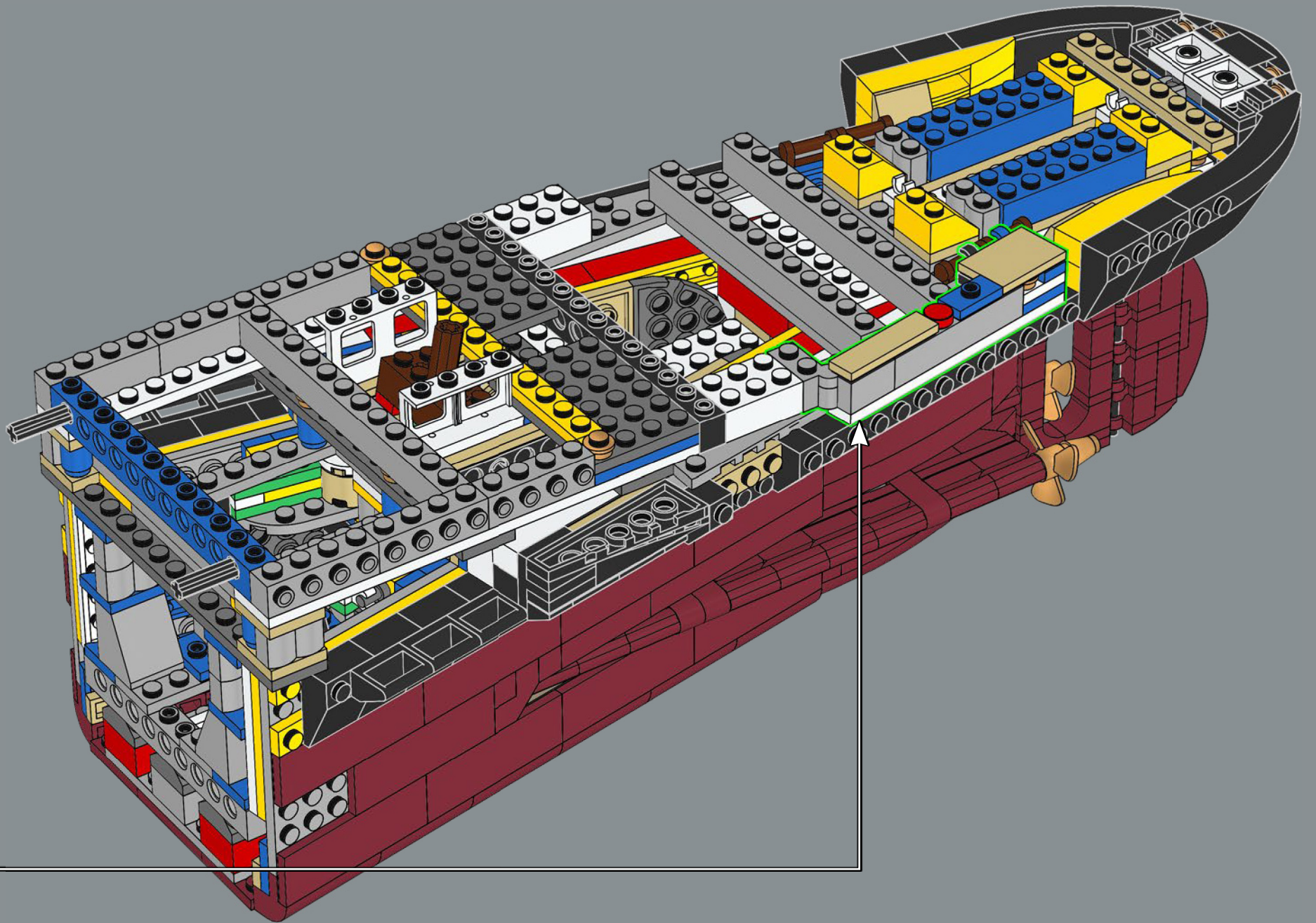

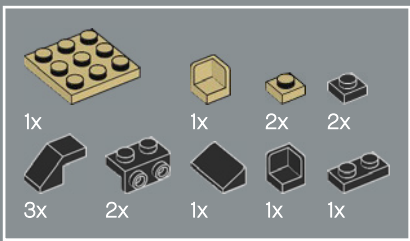

294

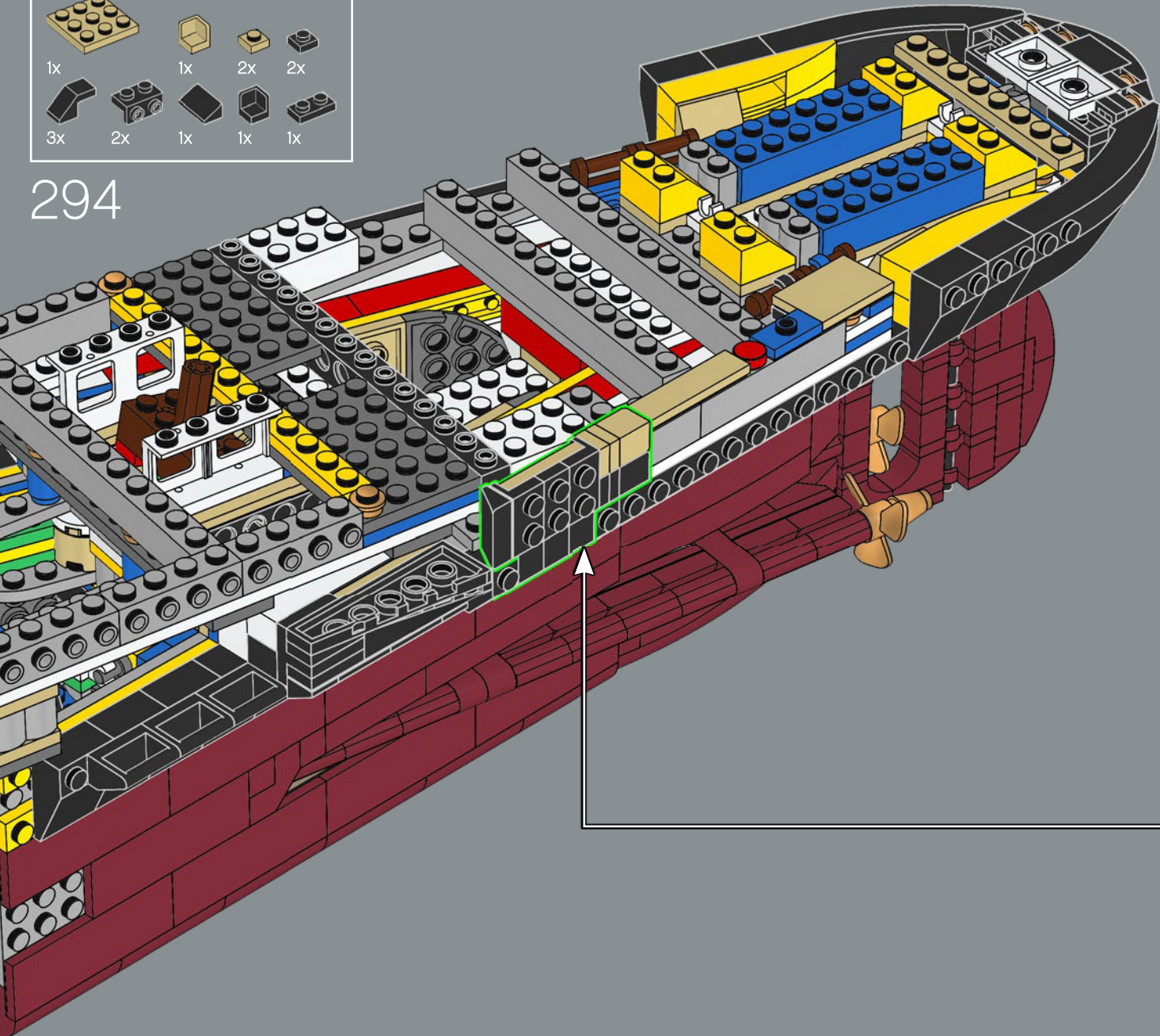

- 1
- 2
- 3
- 4
- 5

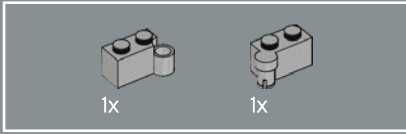
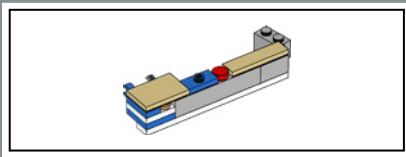

295

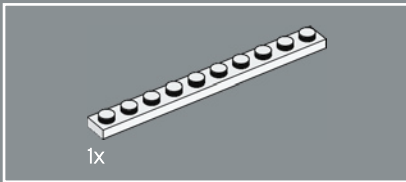
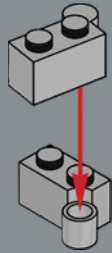

296

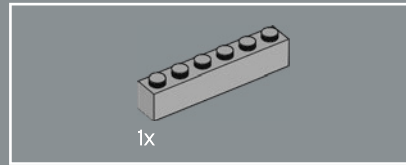
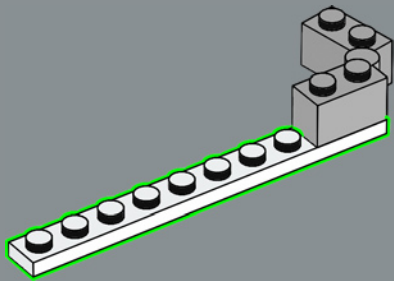

297

1x

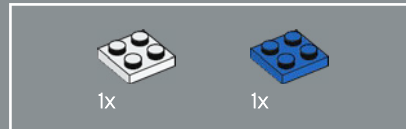
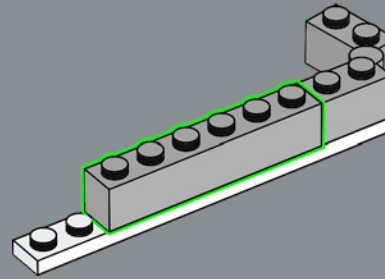

298

1x

1x

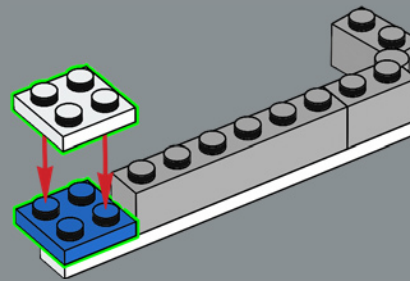

299

1x

1x

1x

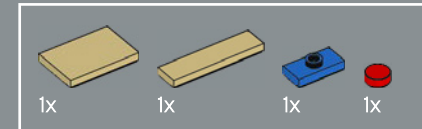
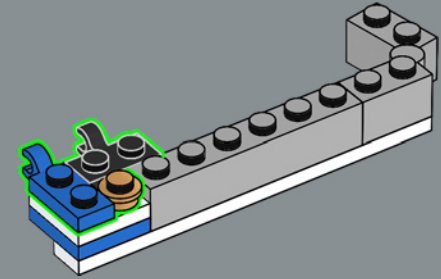

300

1x

1x

1x

1x

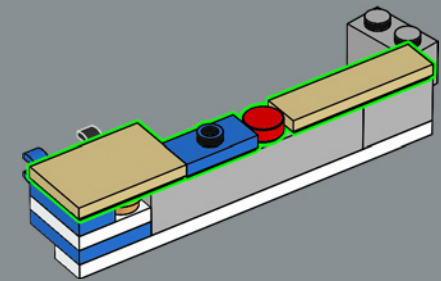

301

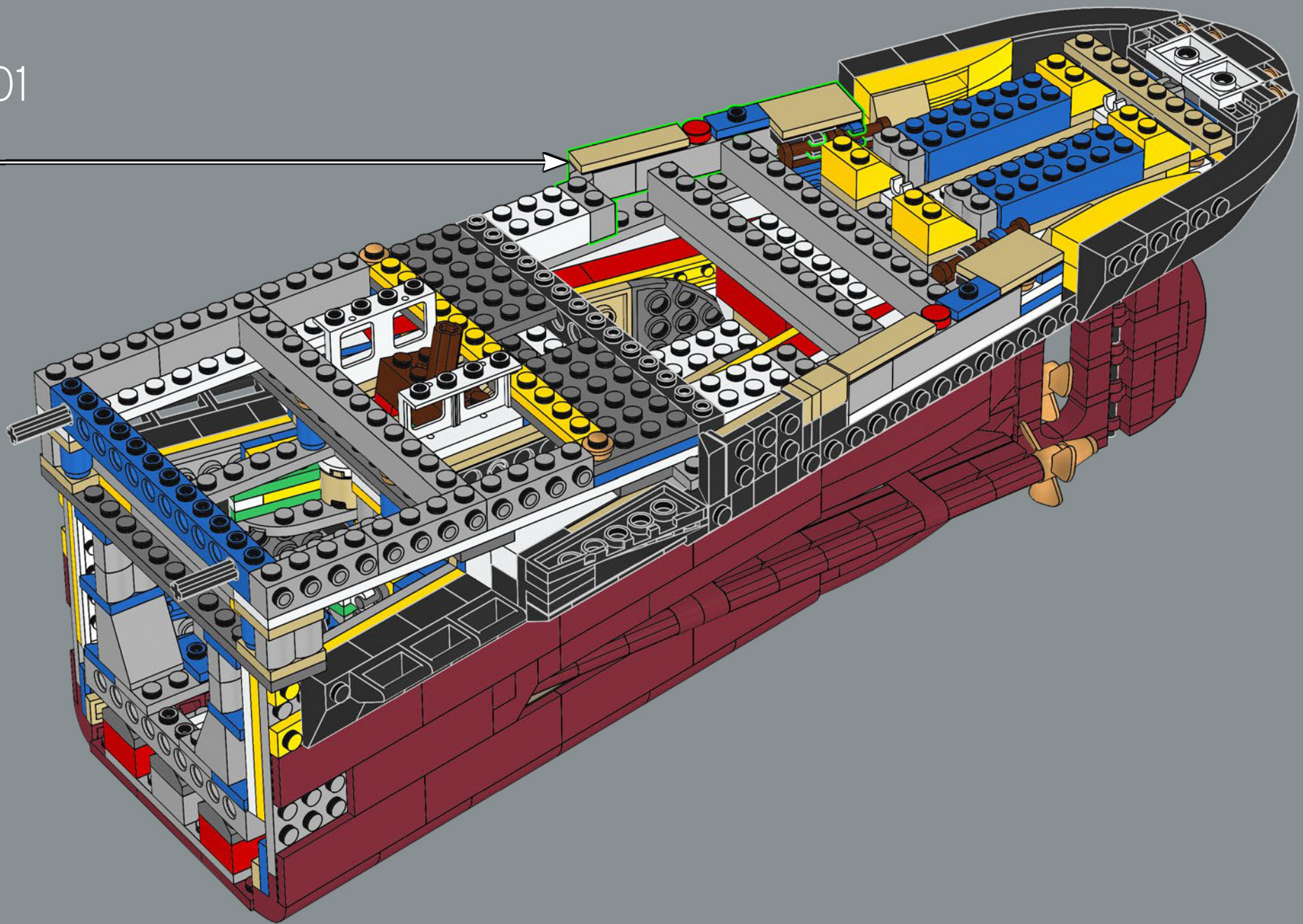

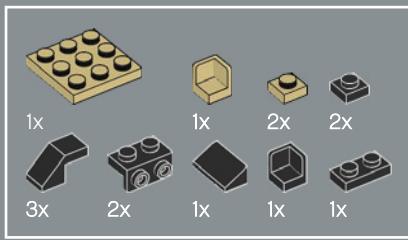

302

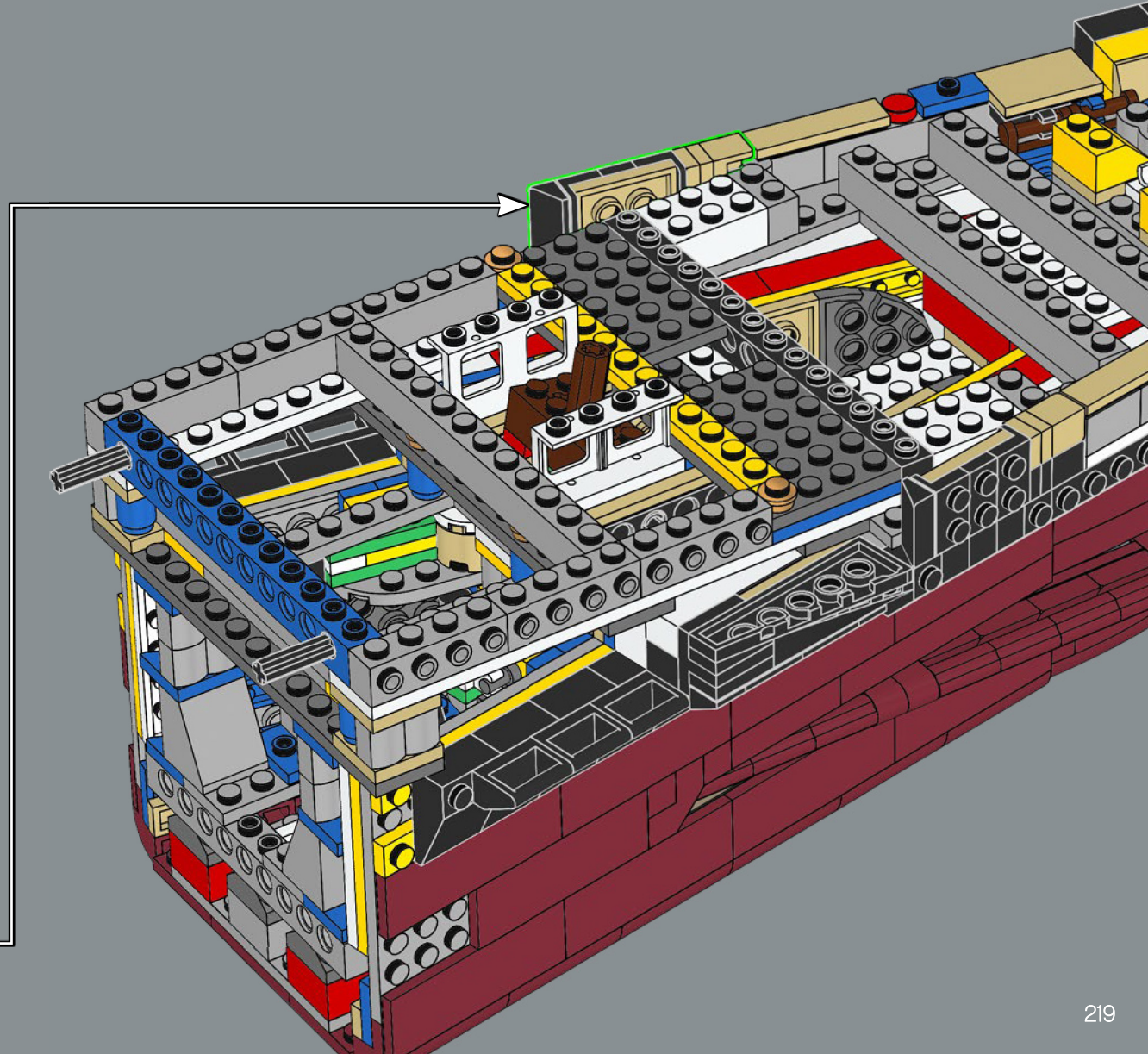
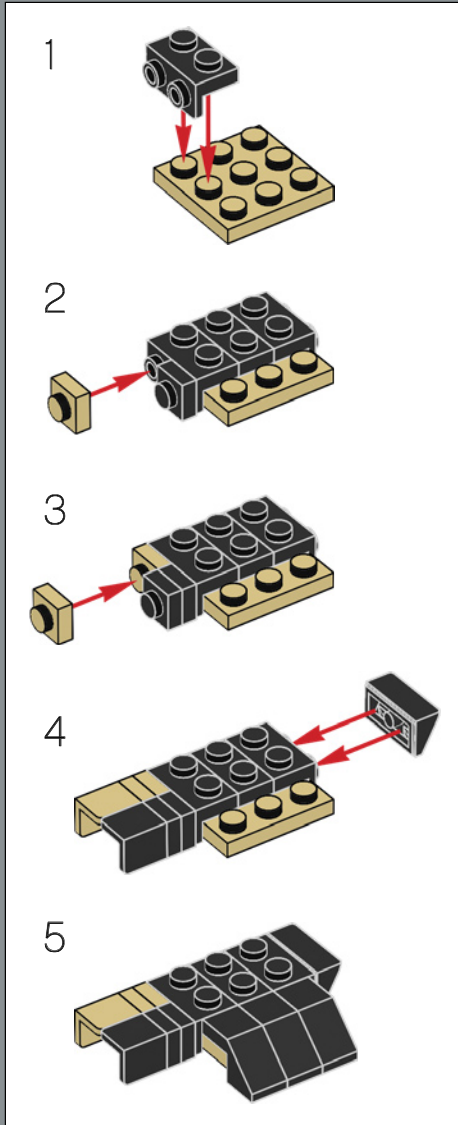

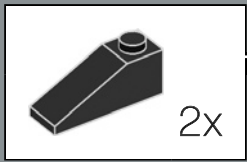
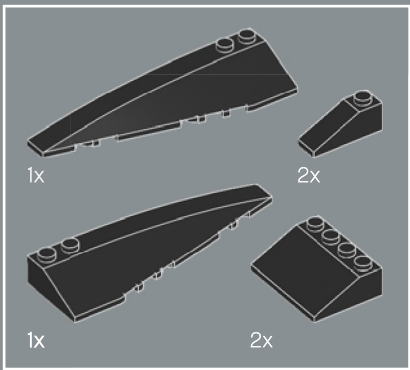

303

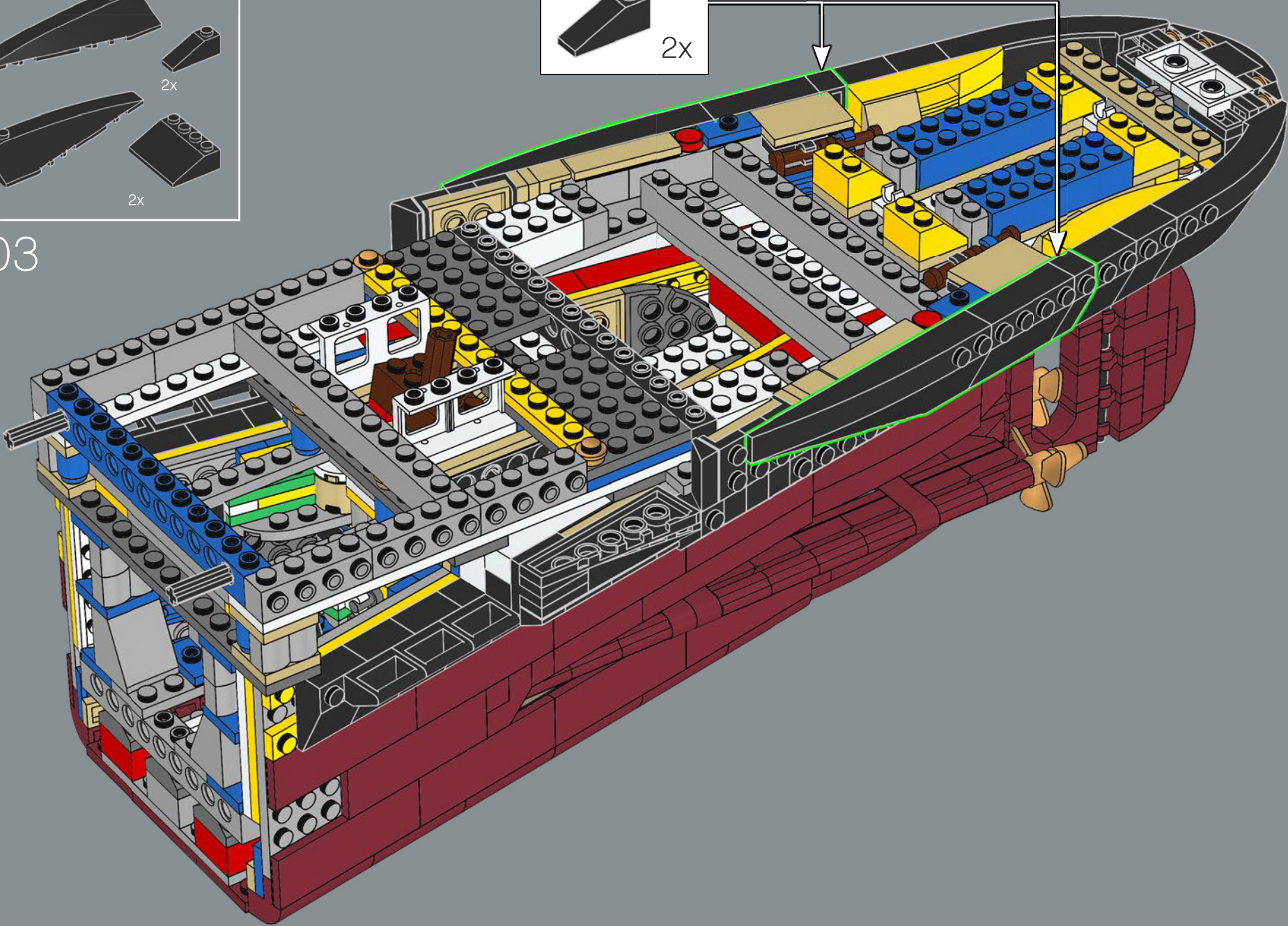

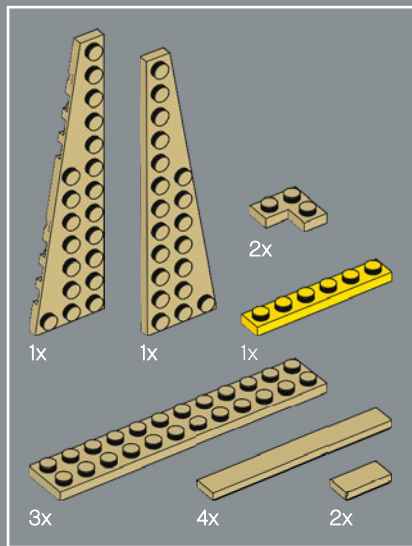

304

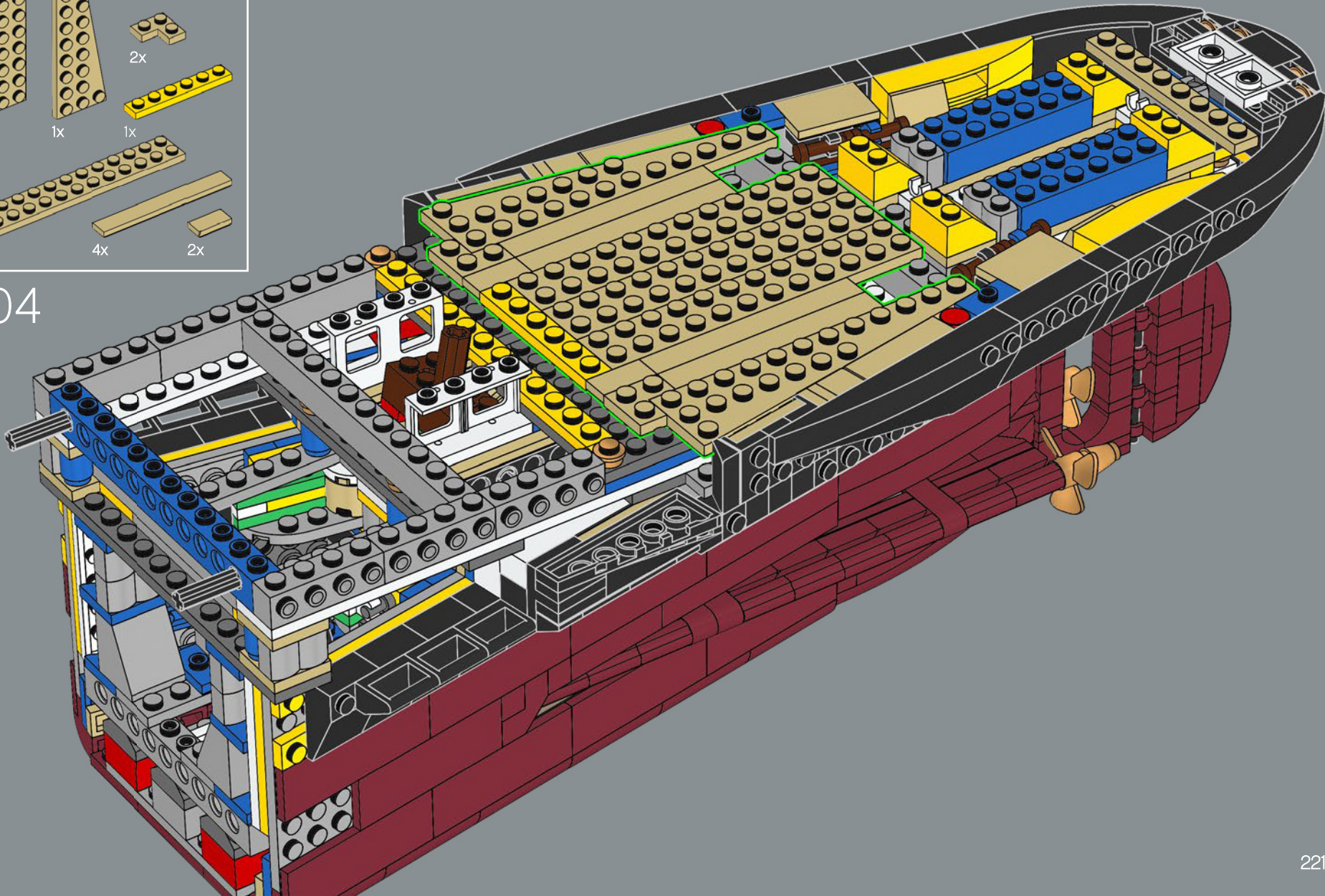

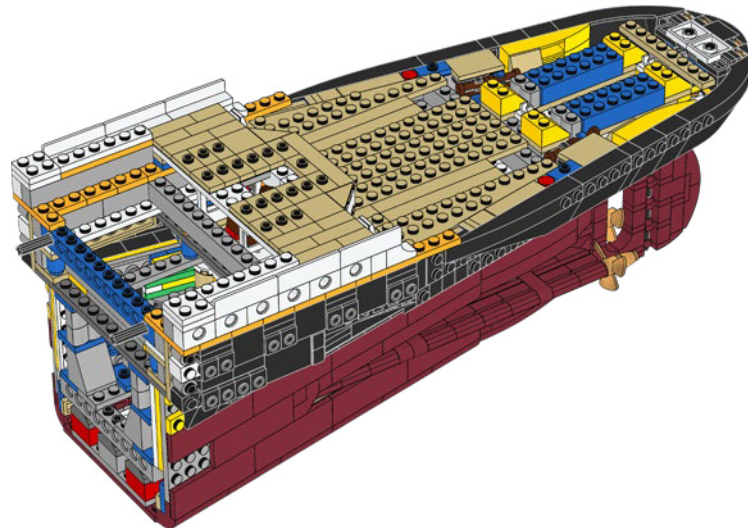
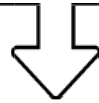

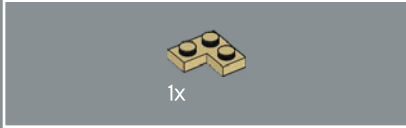
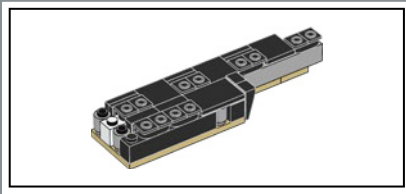

305

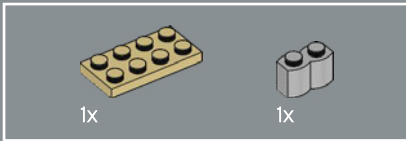

306

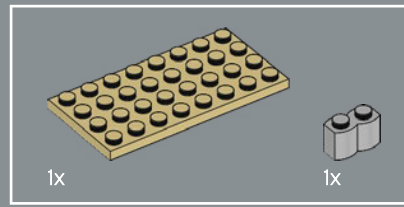
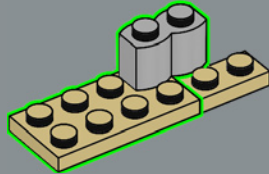

307

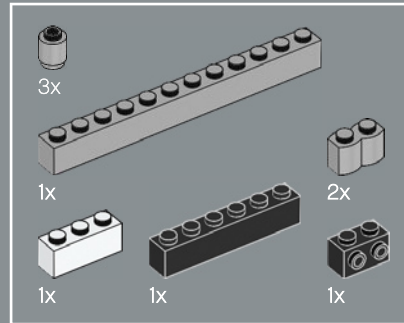
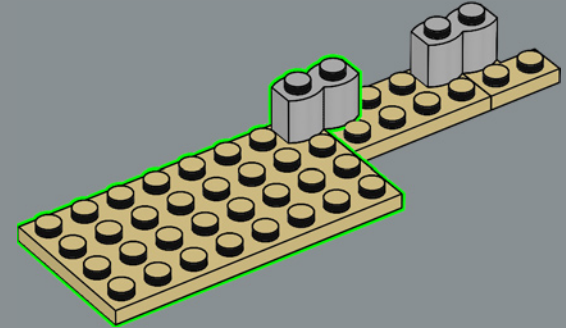

308

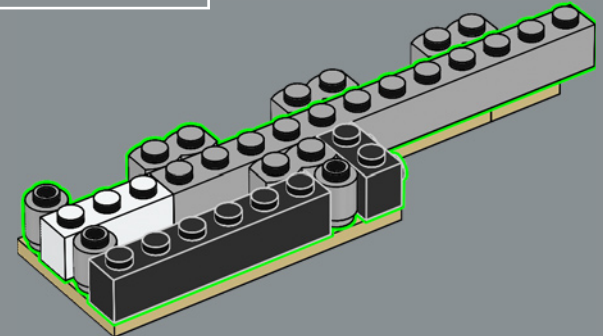

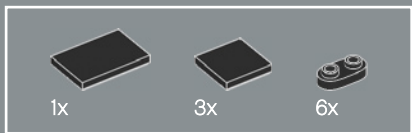

309

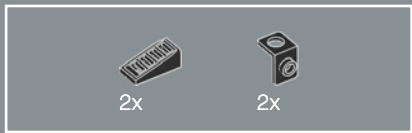
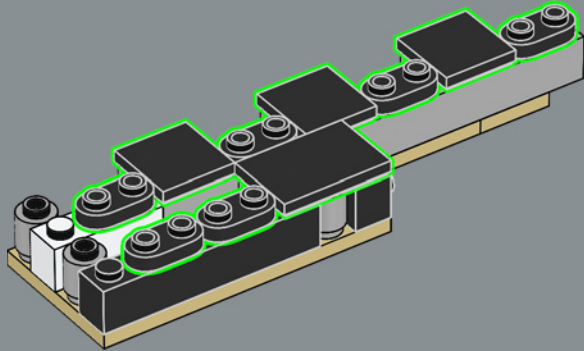

310

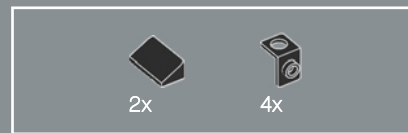
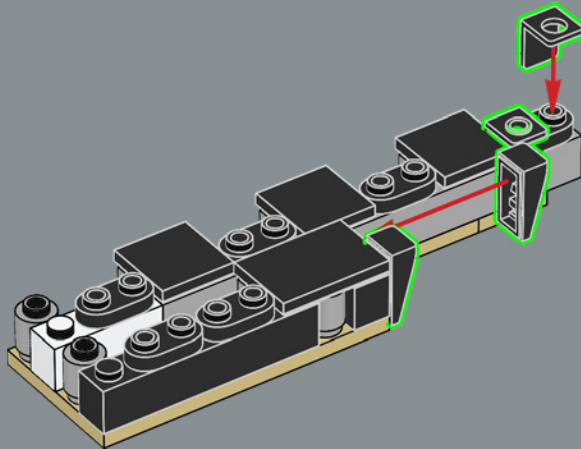

311

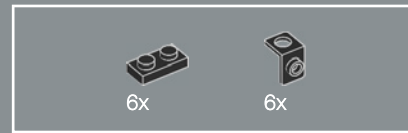
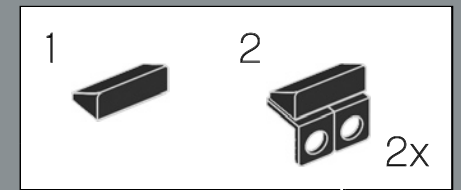
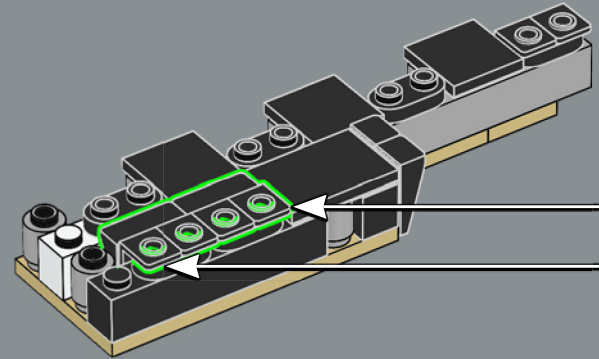

312

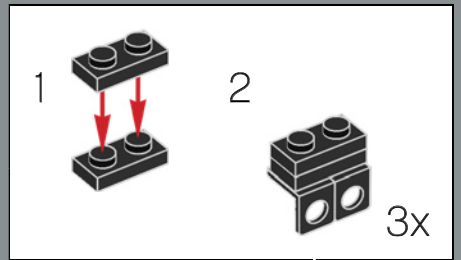
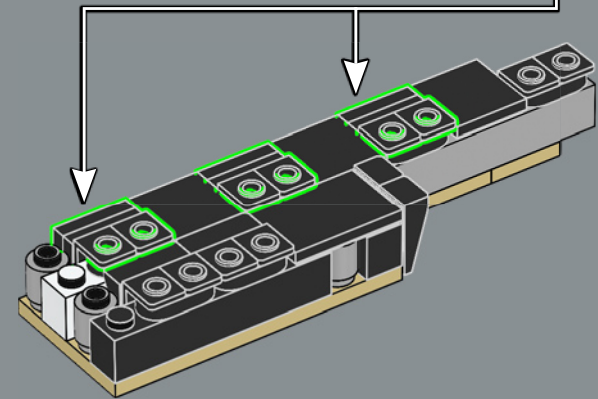

313

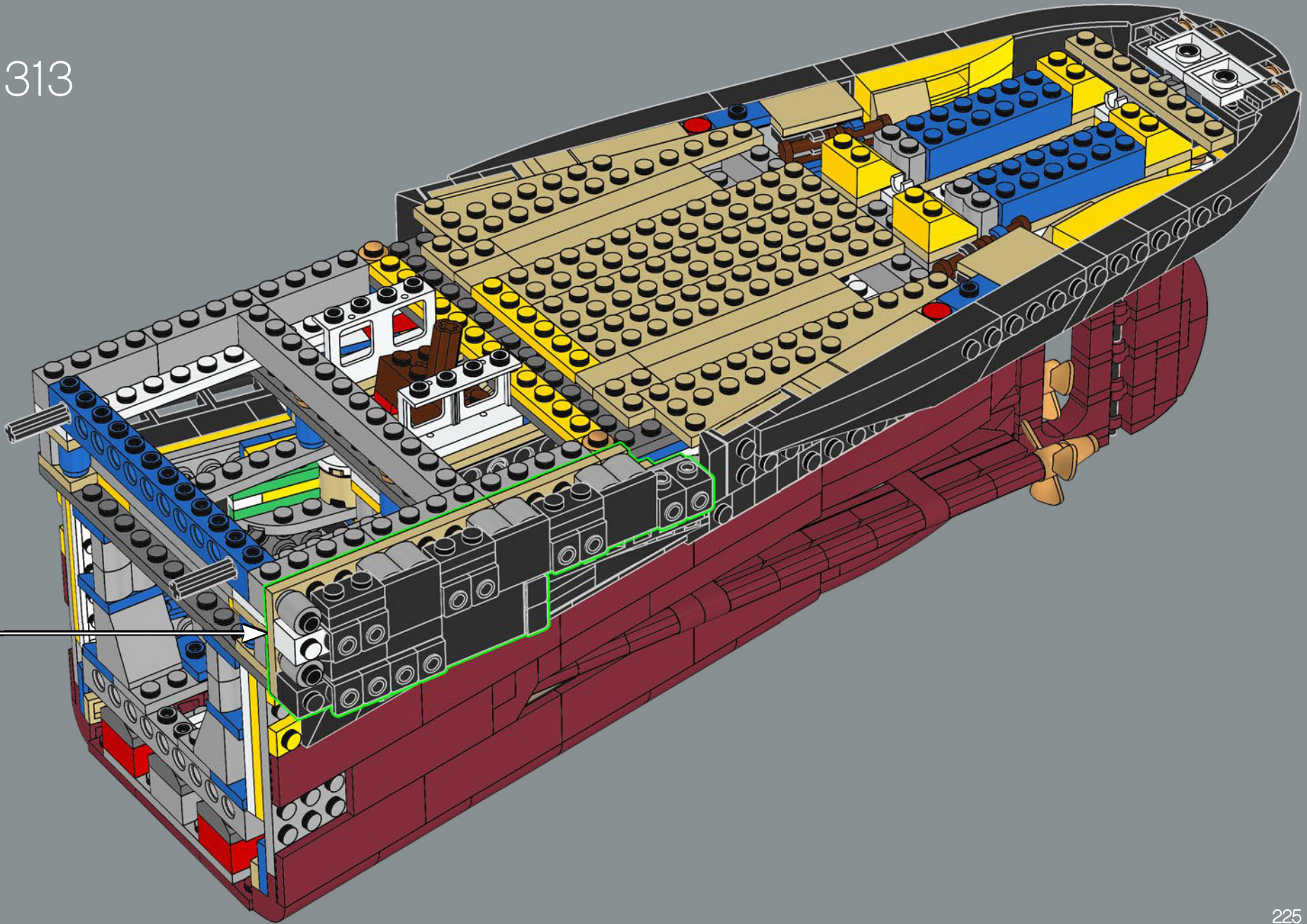

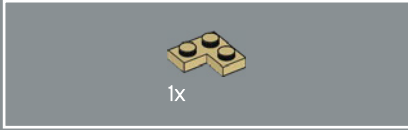
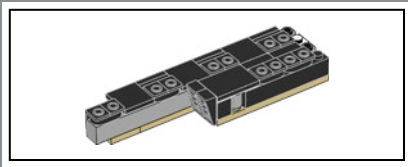

314

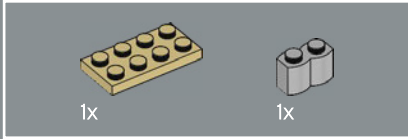

315

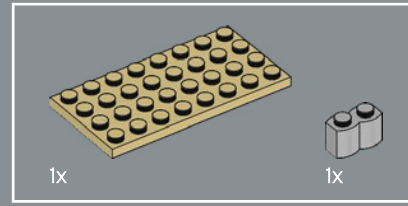
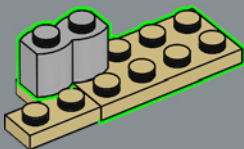

316

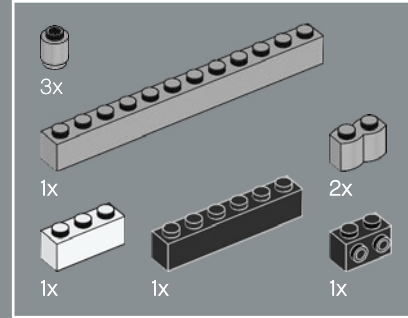
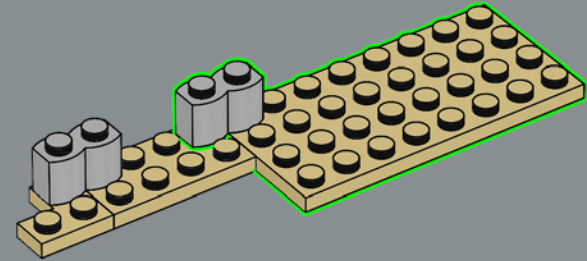

317

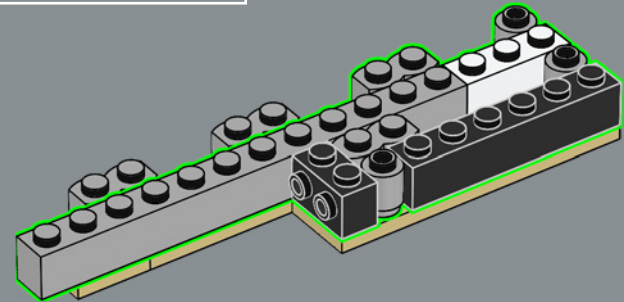

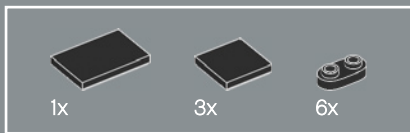

318

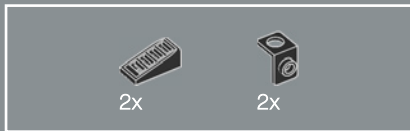
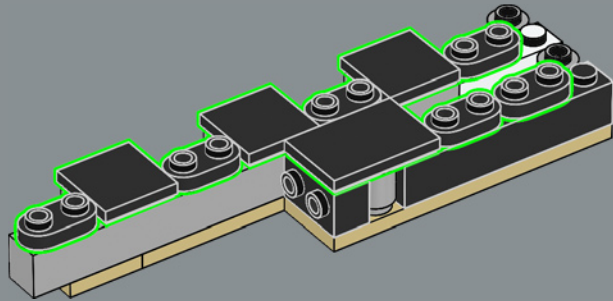

319

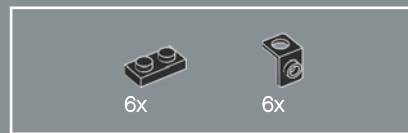
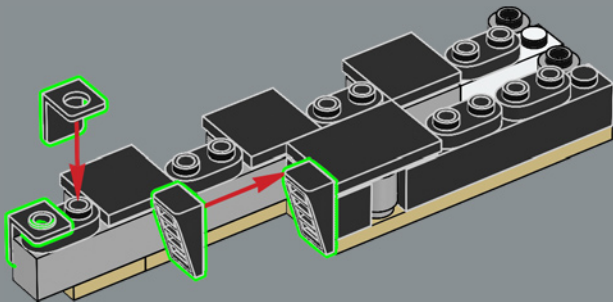

320

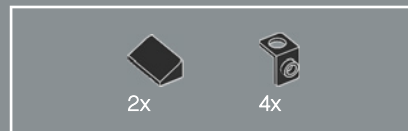
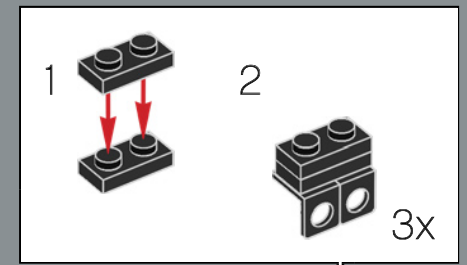
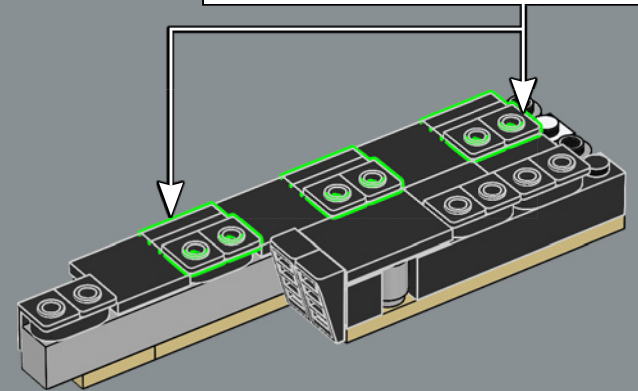

321

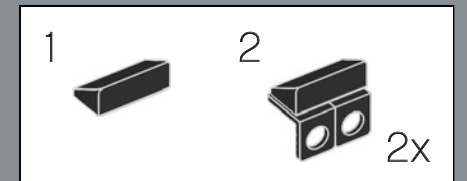
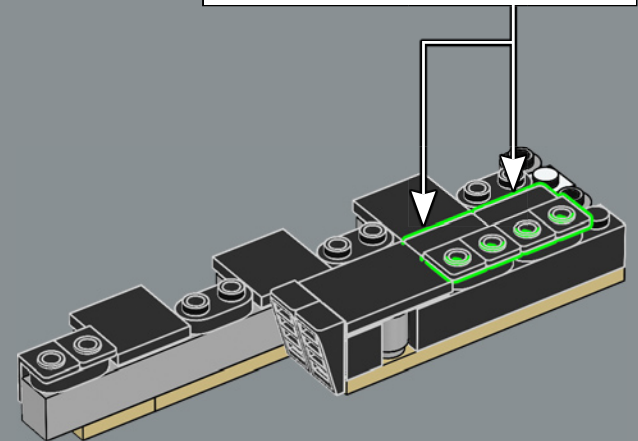

322

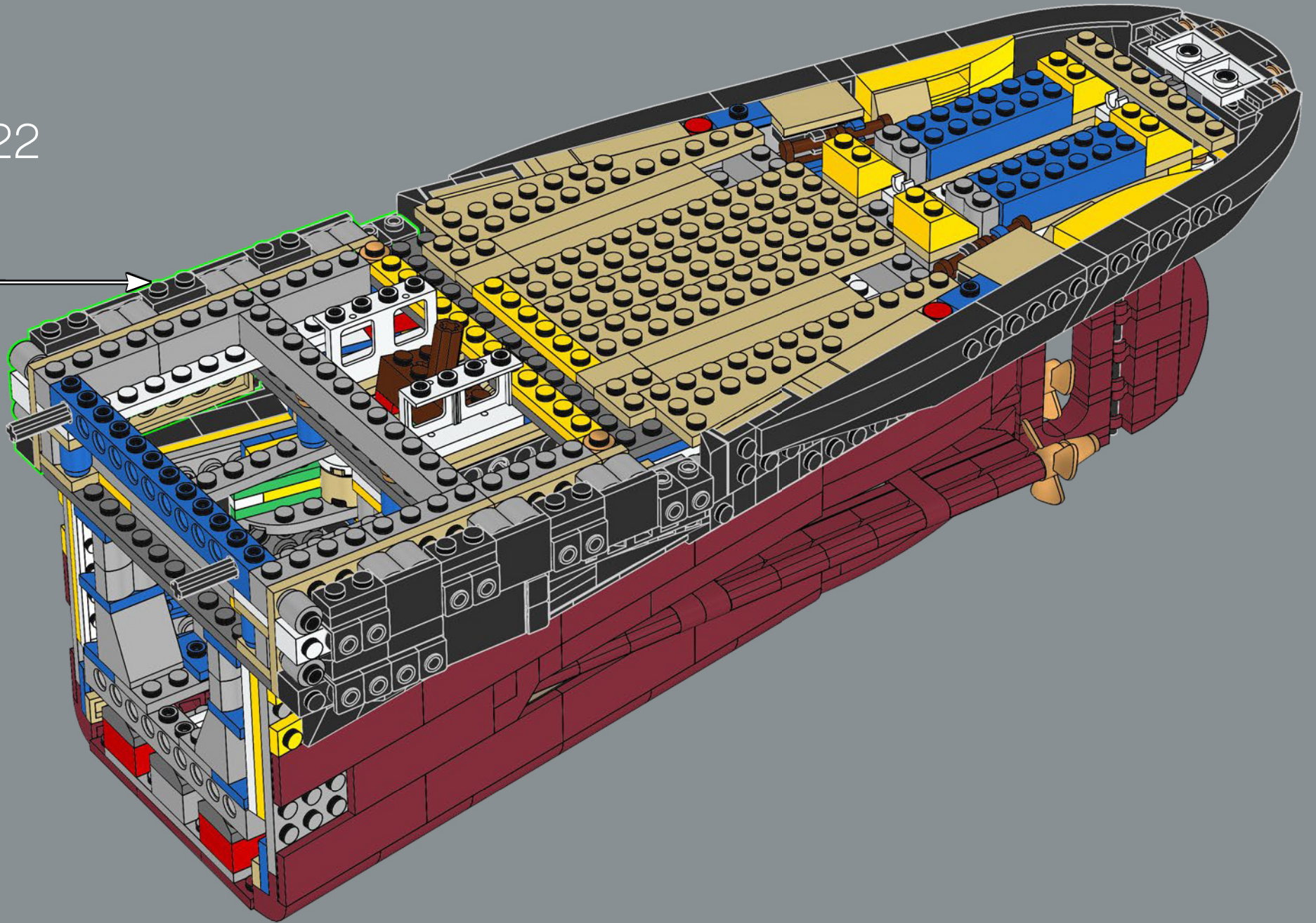

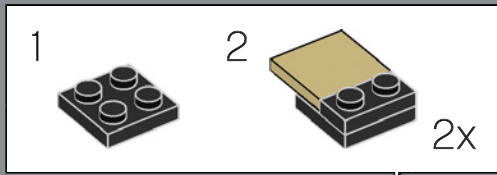
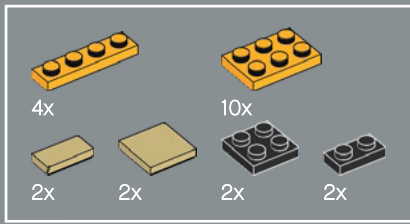

323

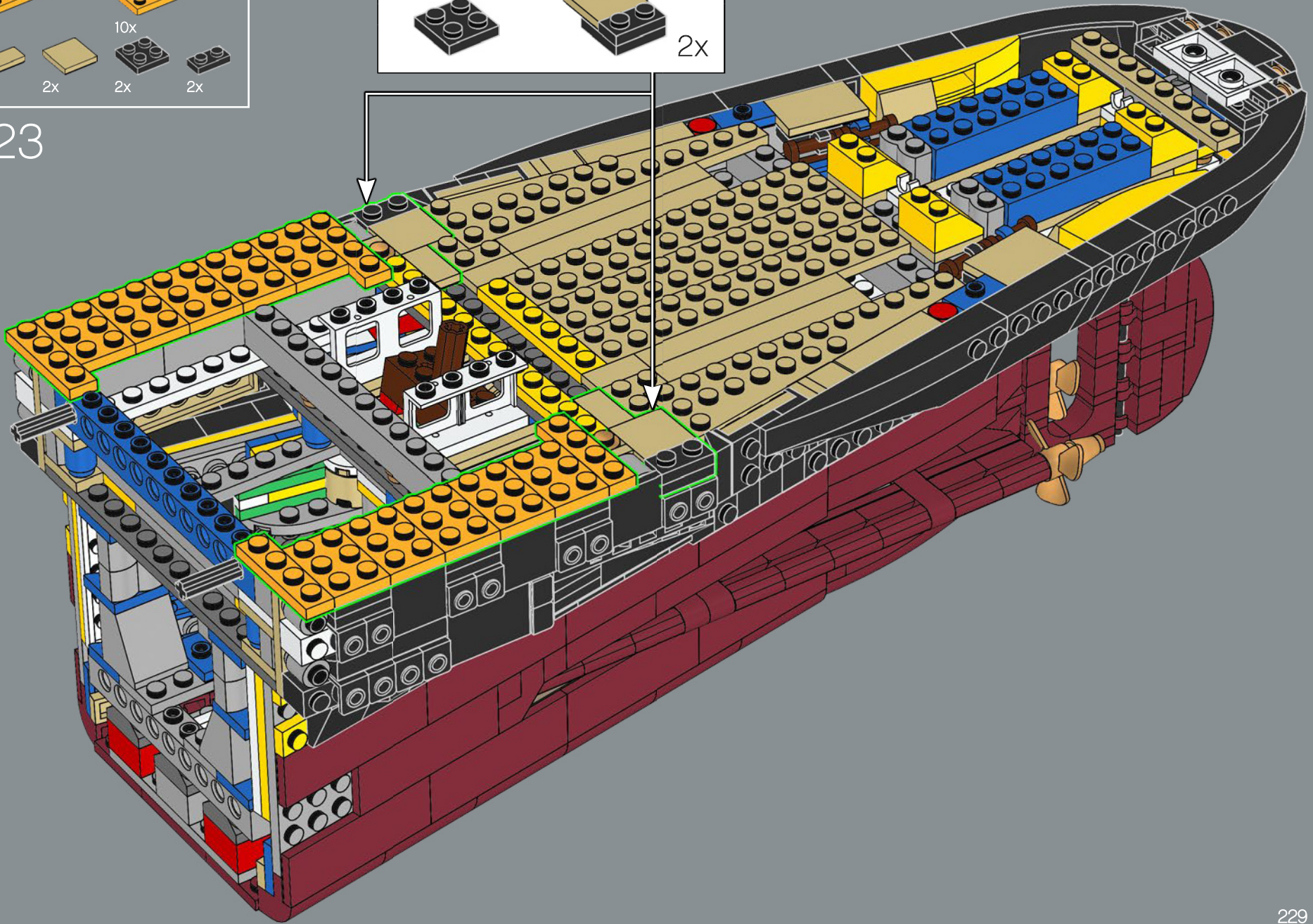

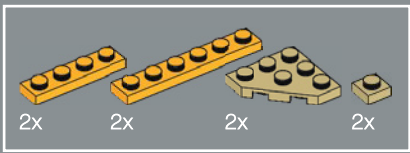

324

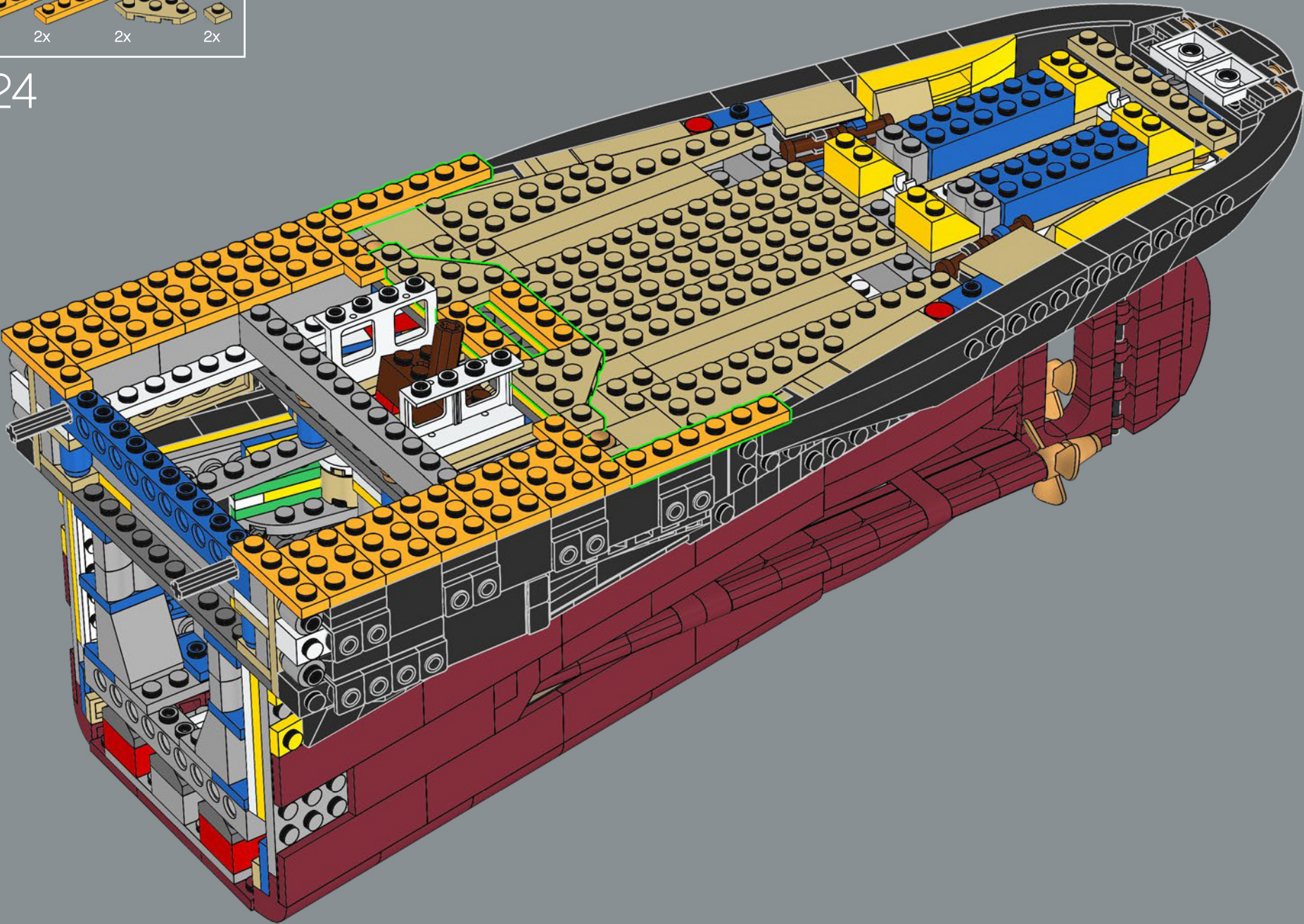

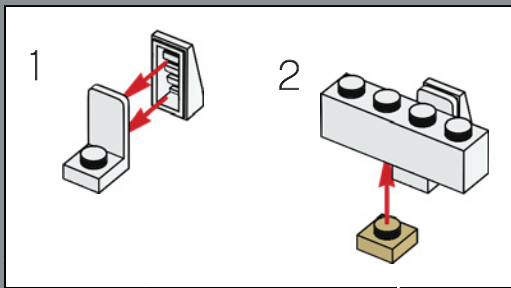
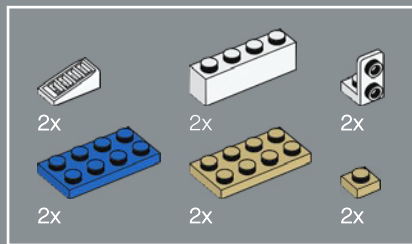

325

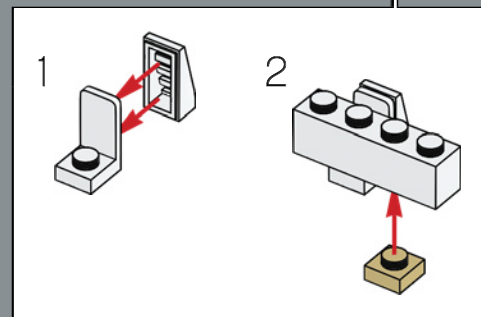
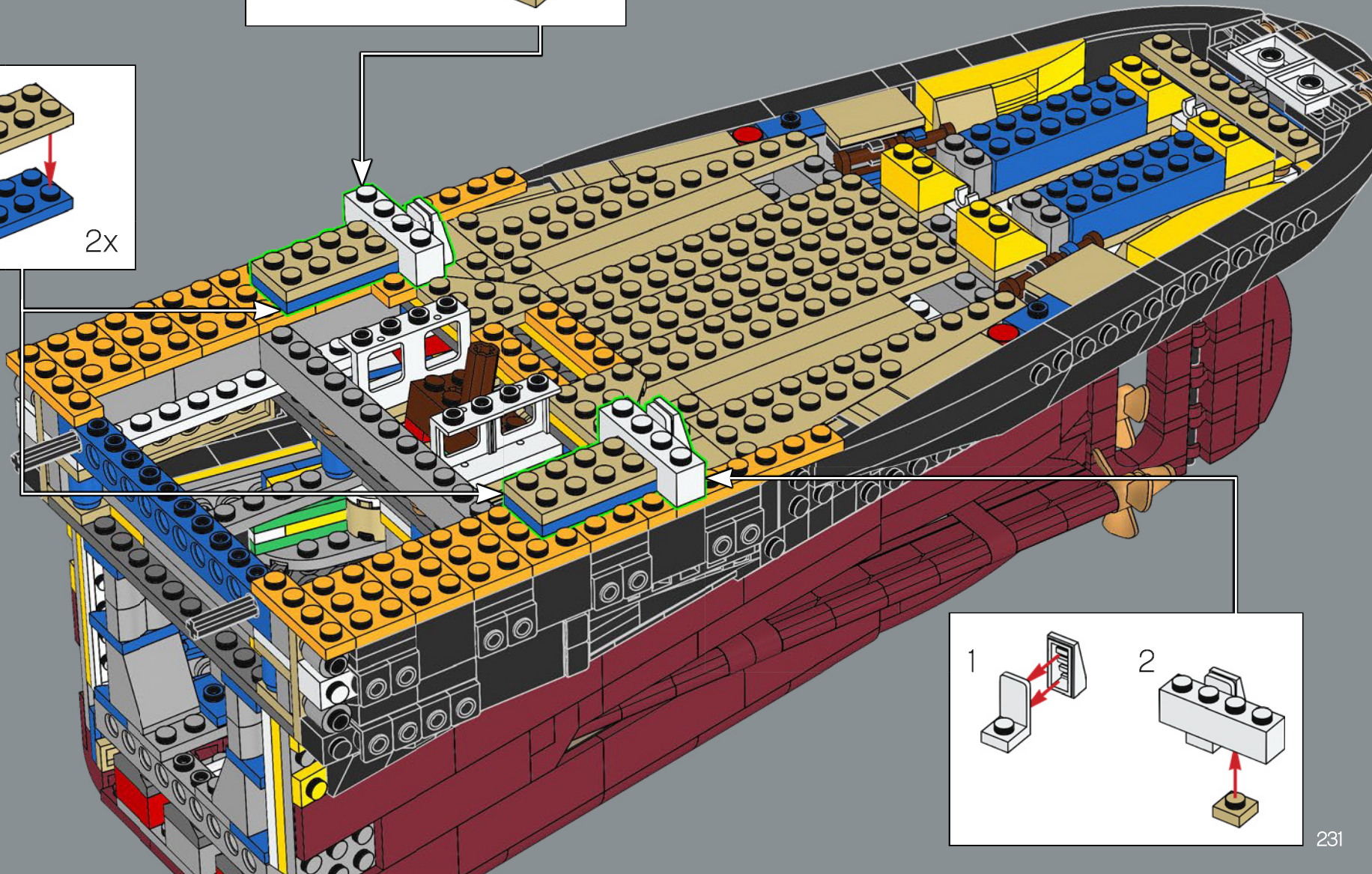
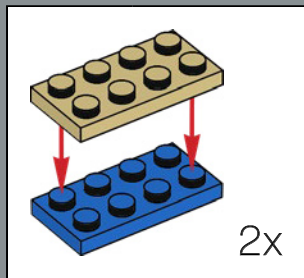

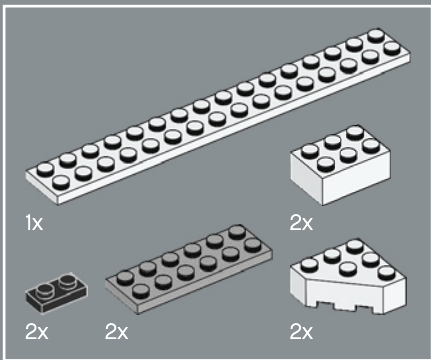

326

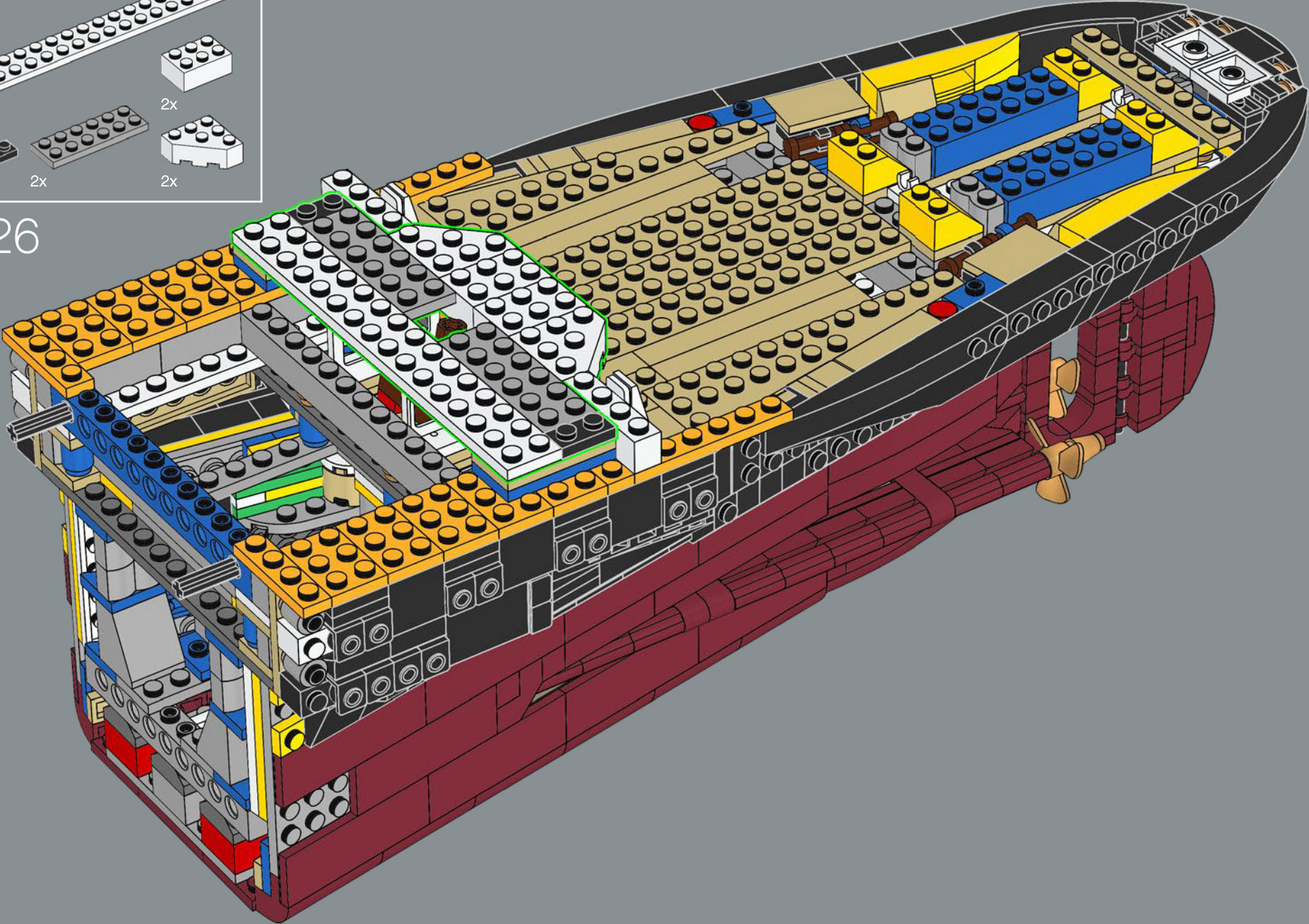

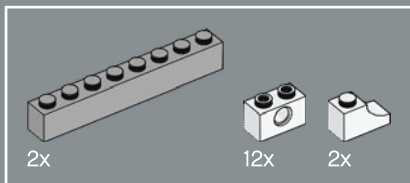

327

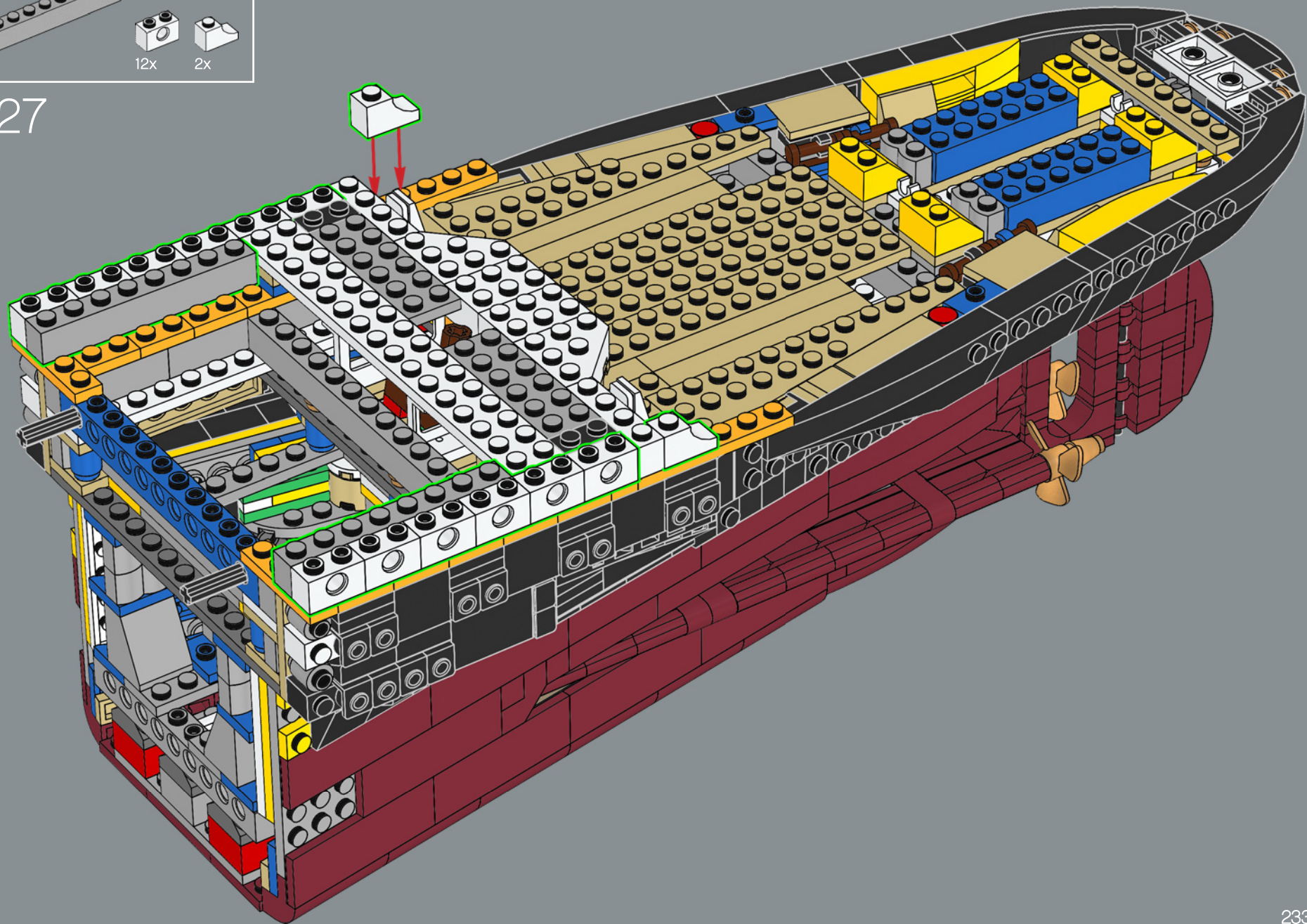

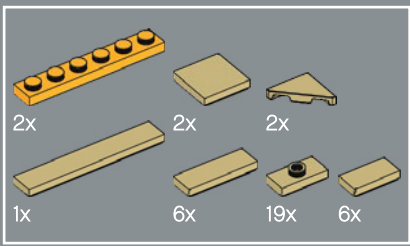

328

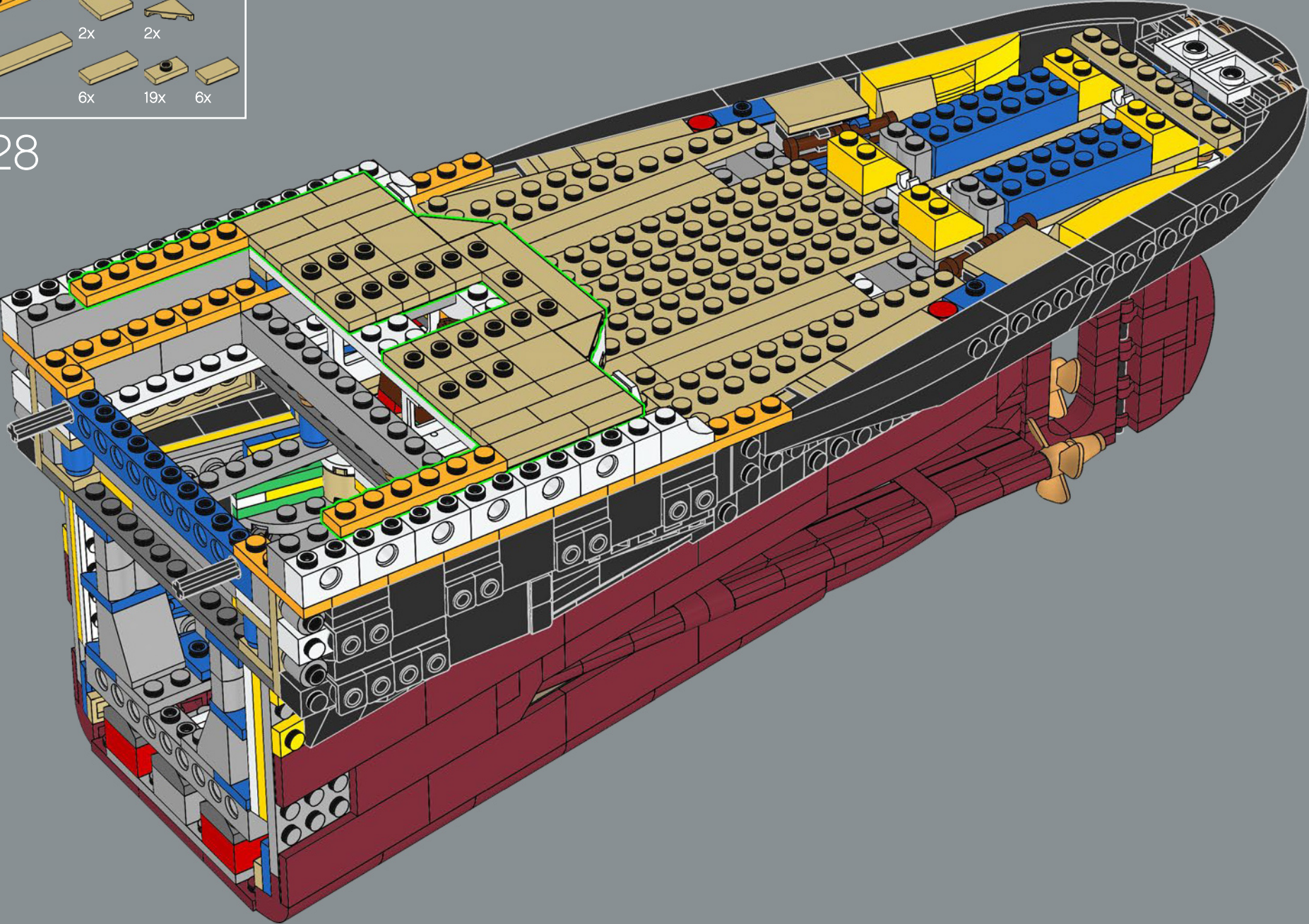

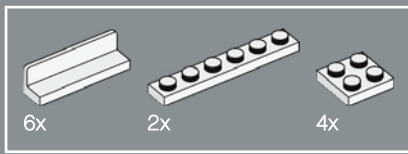

329

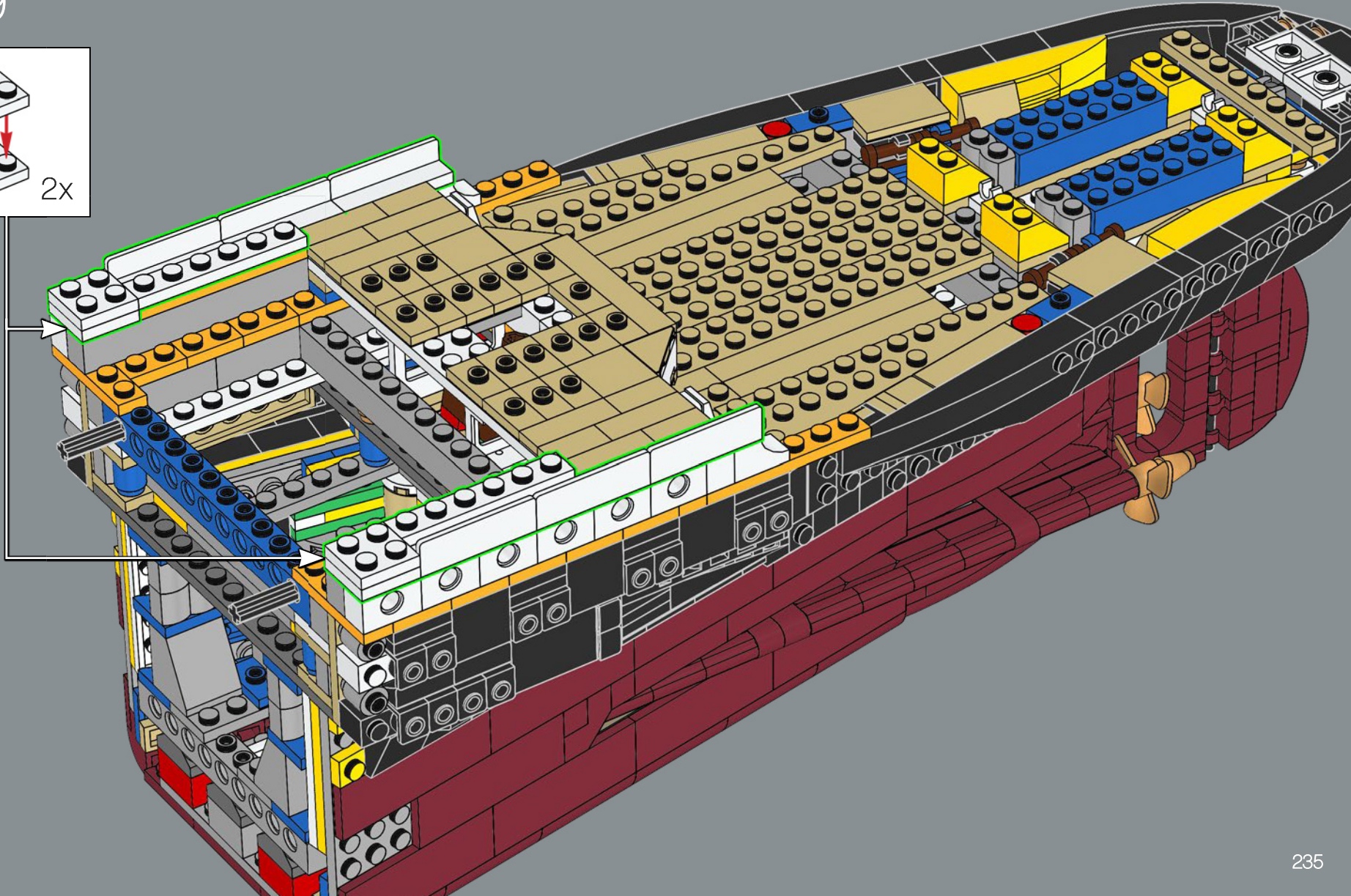
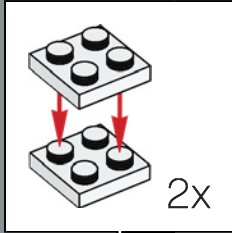

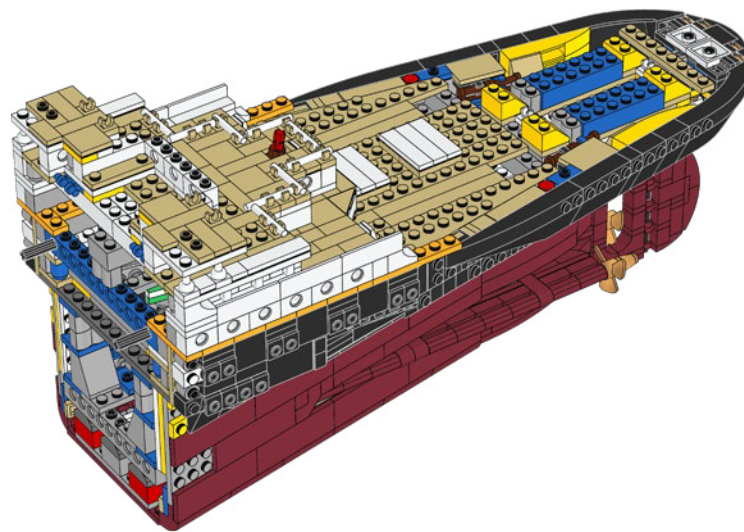
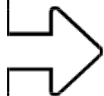

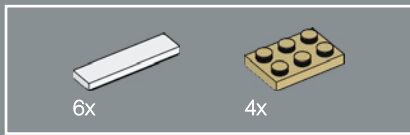

330

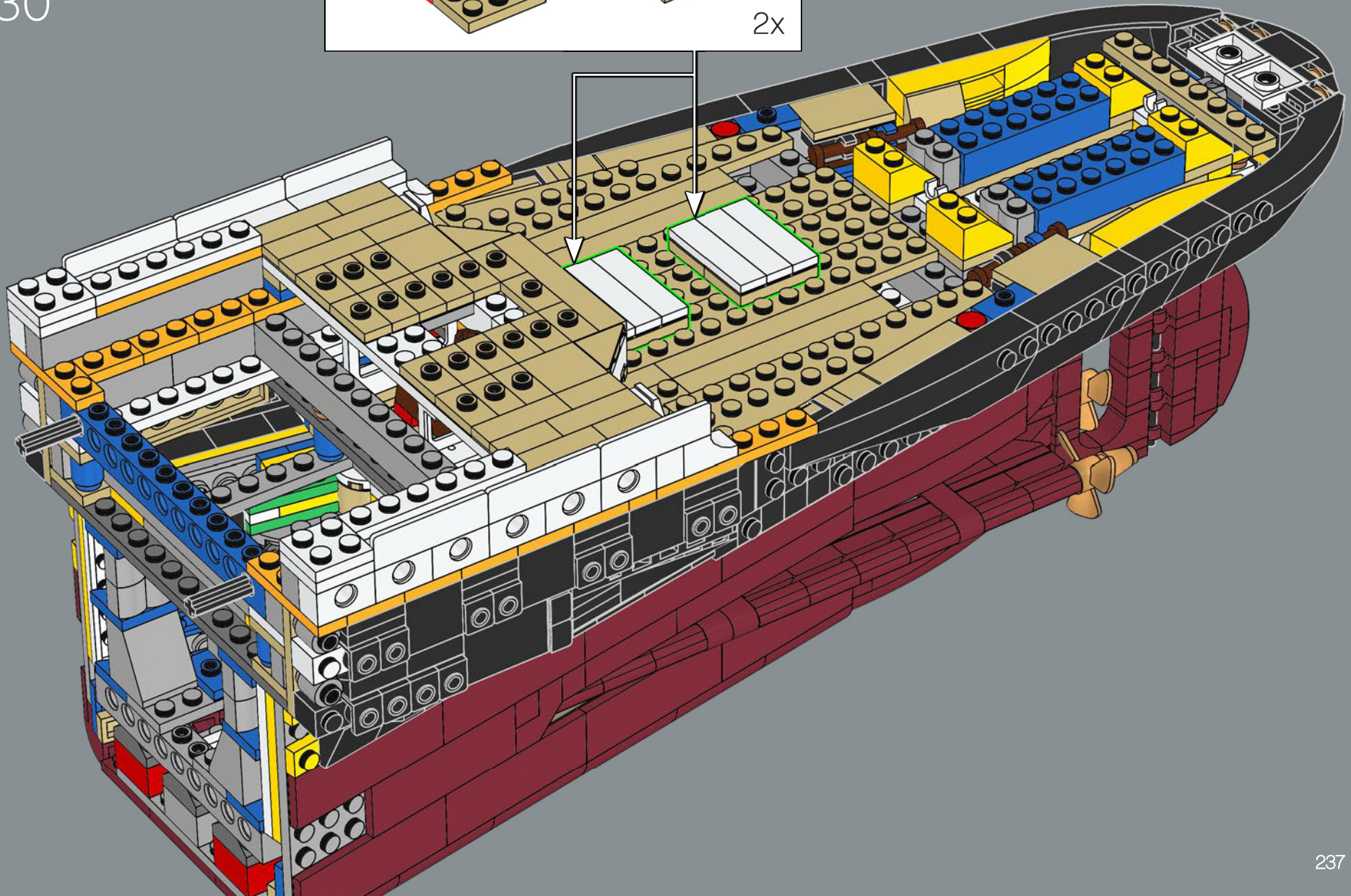
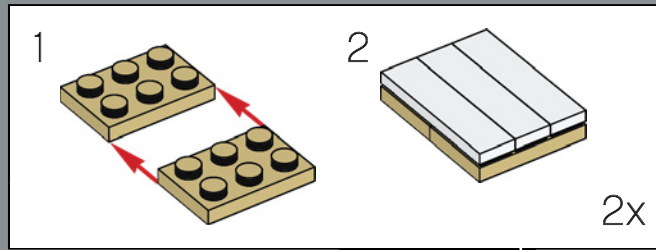

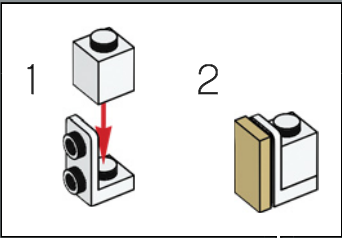
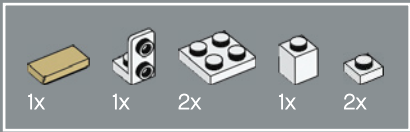

331

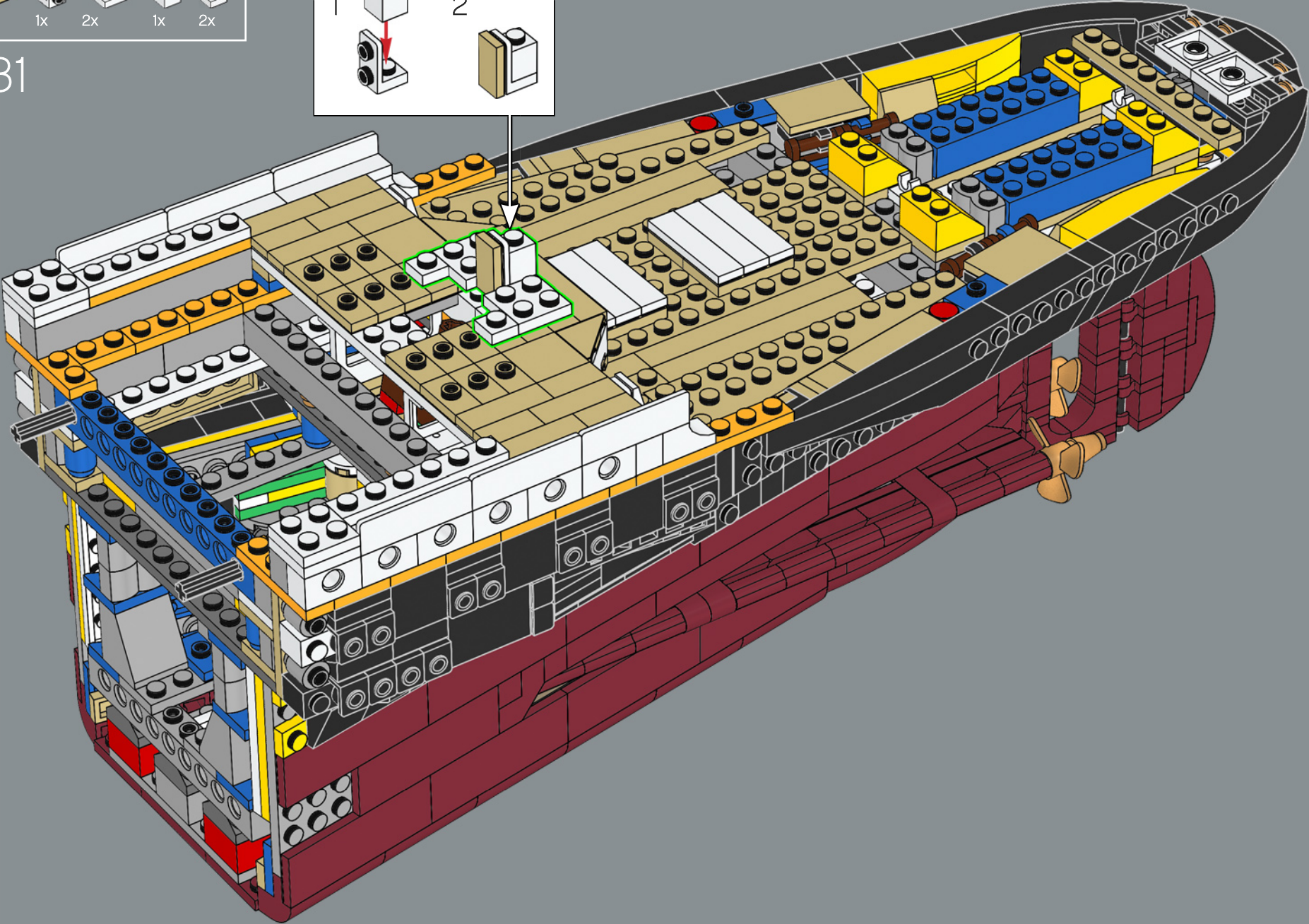

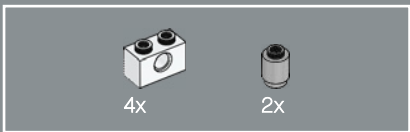

332

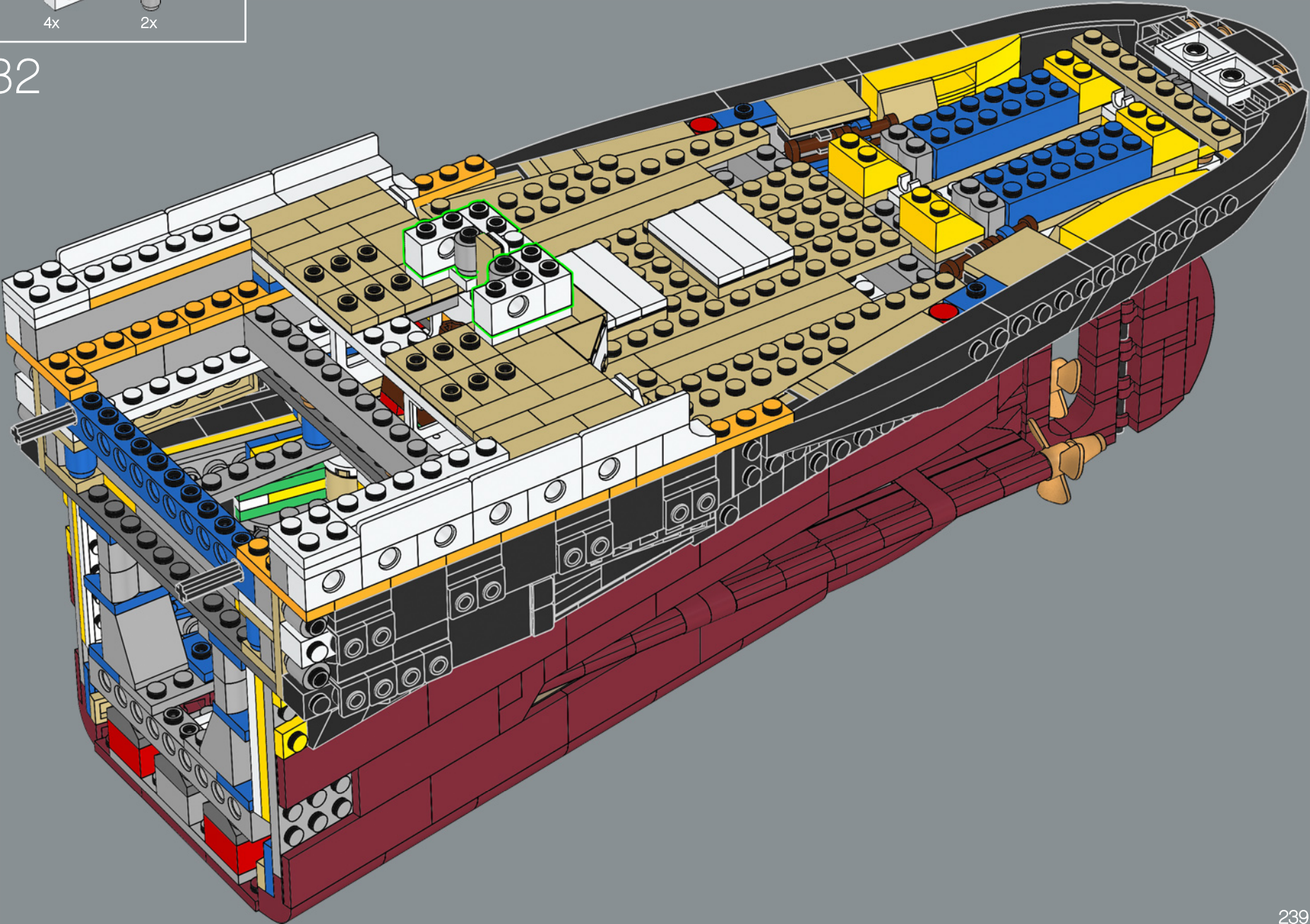

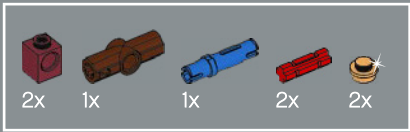

333

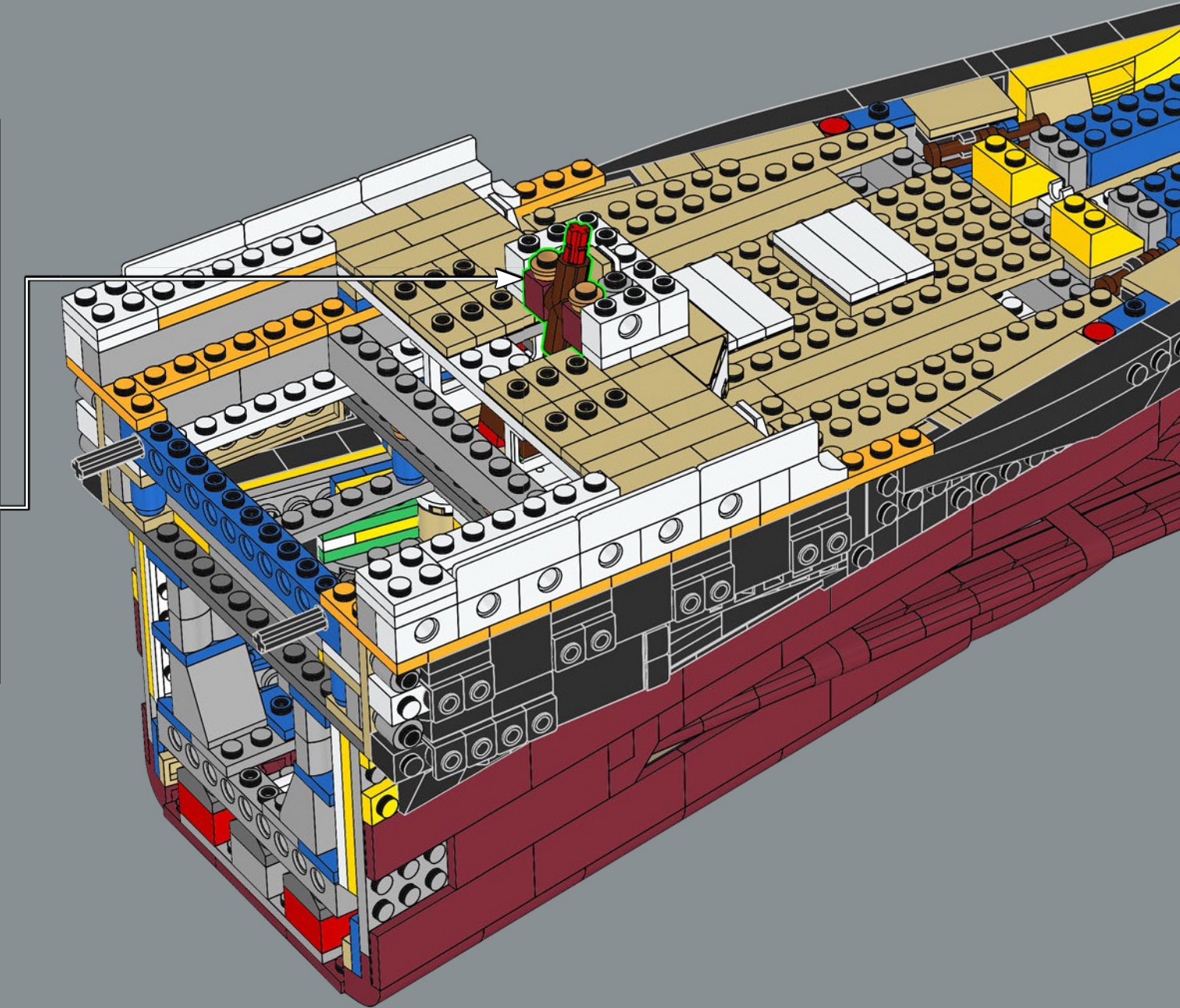
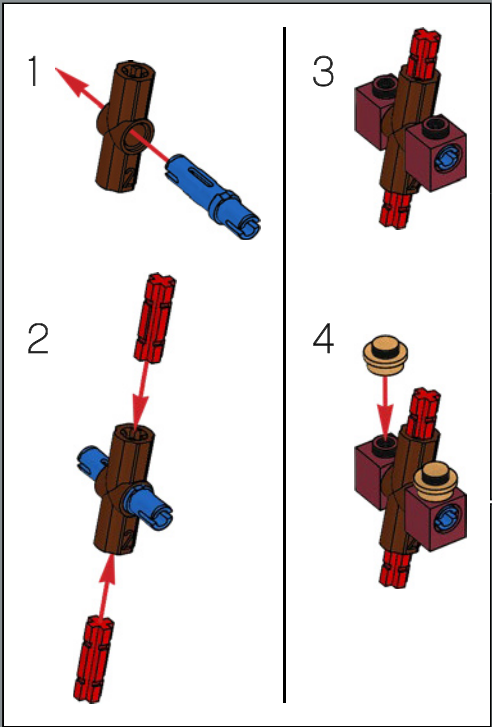

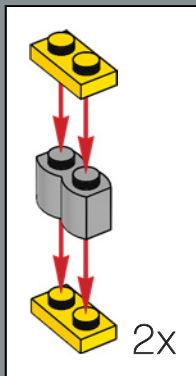
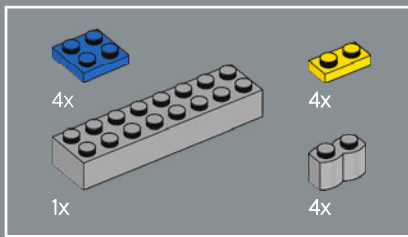

334

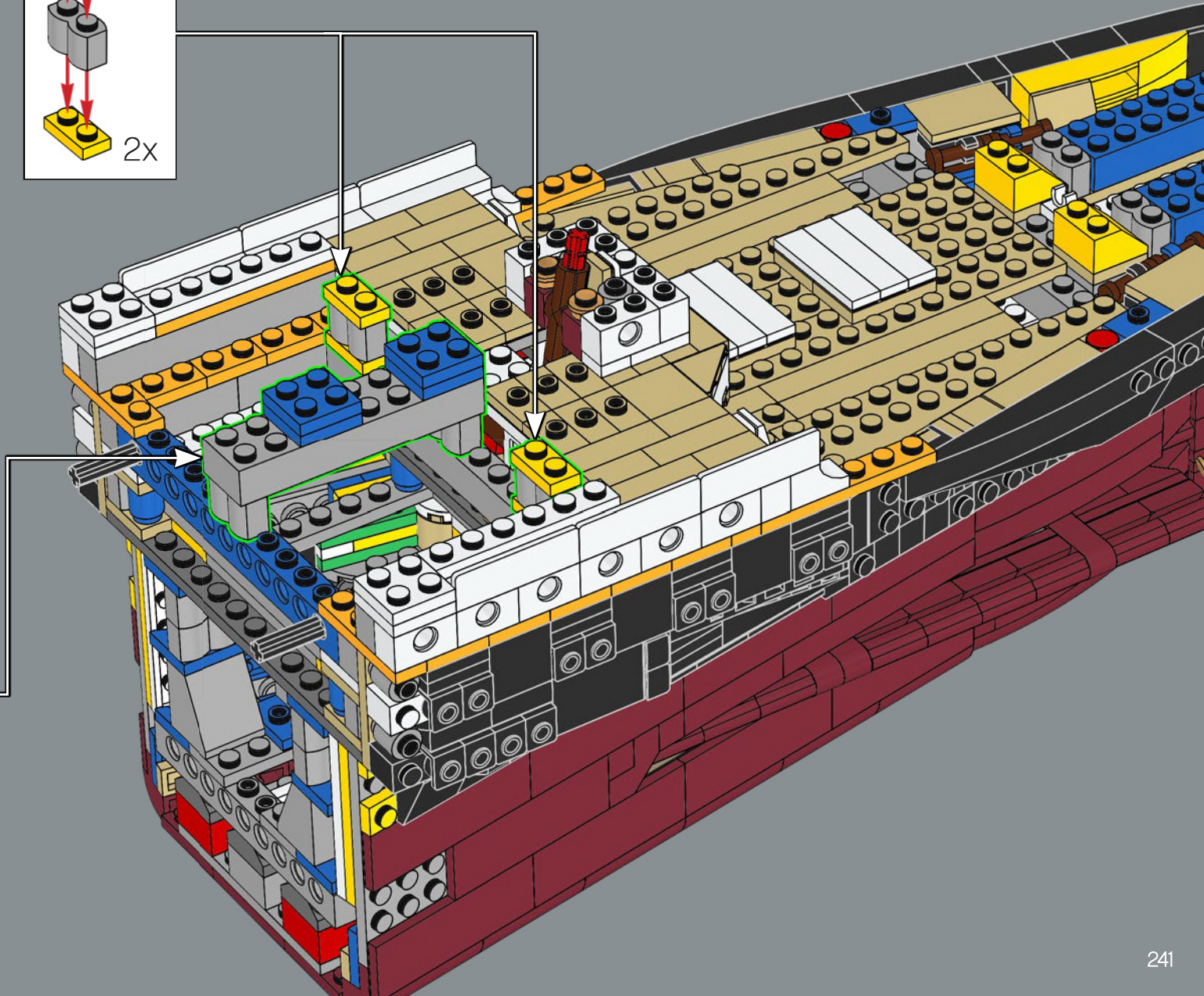
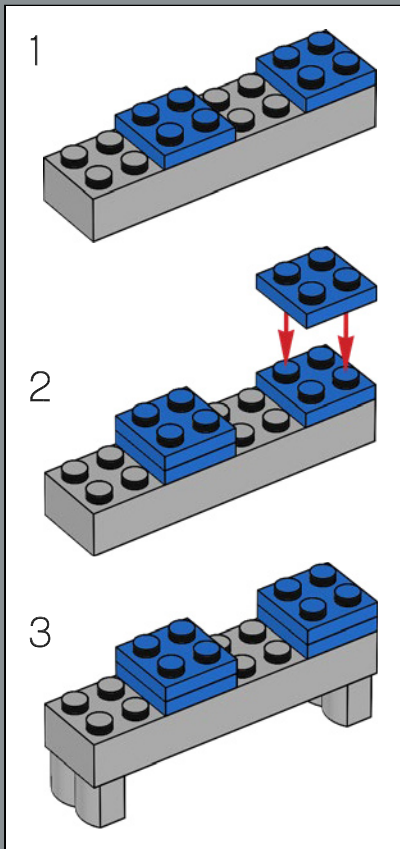

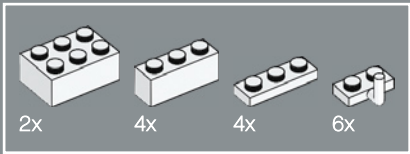

335

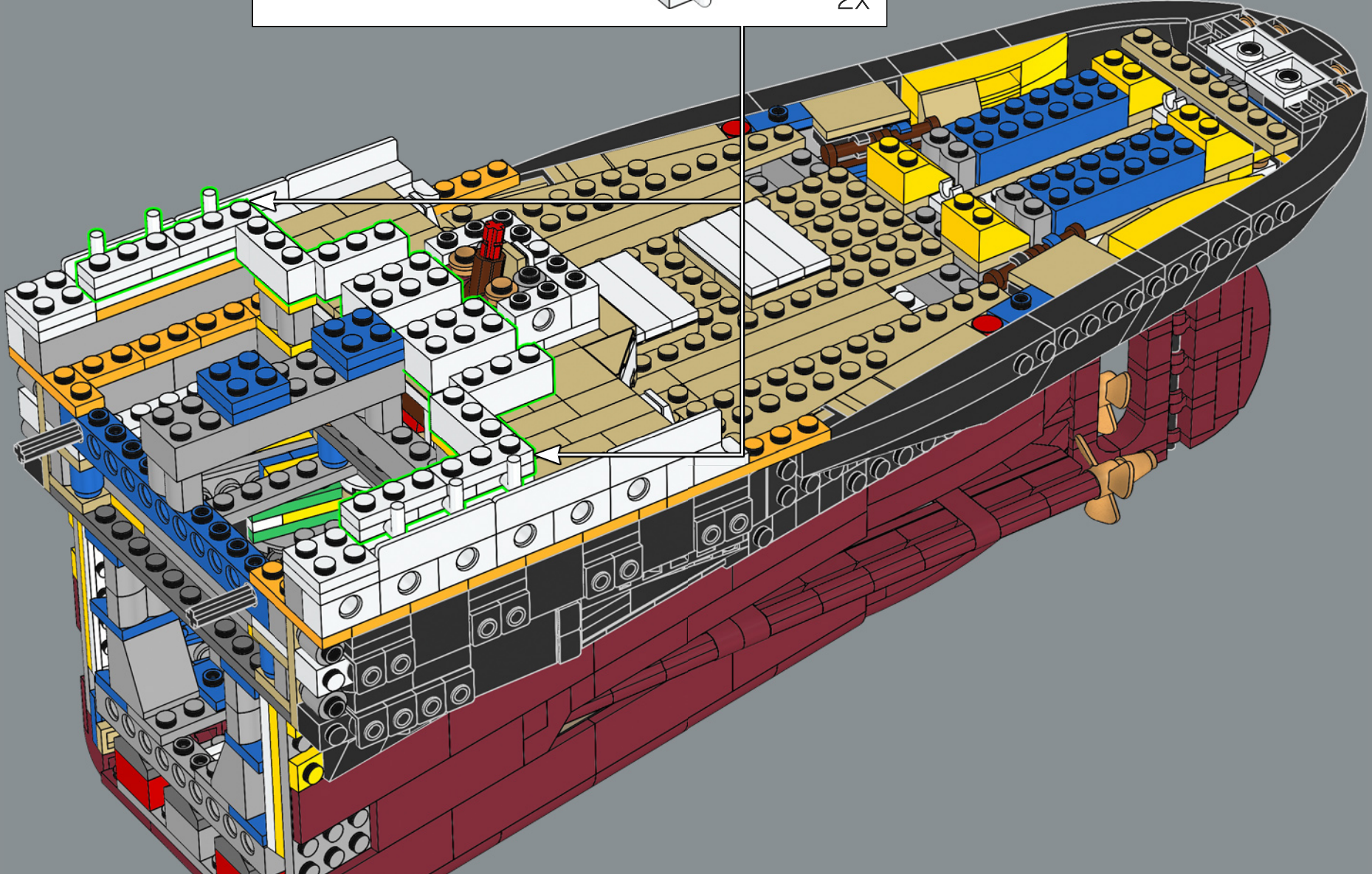
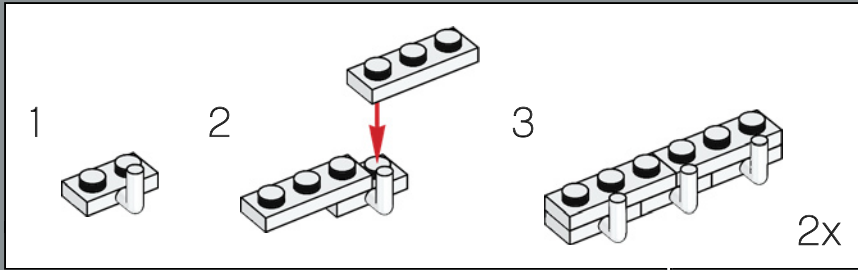

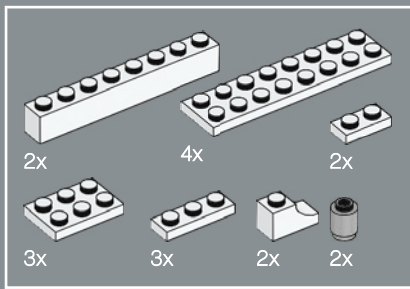

336

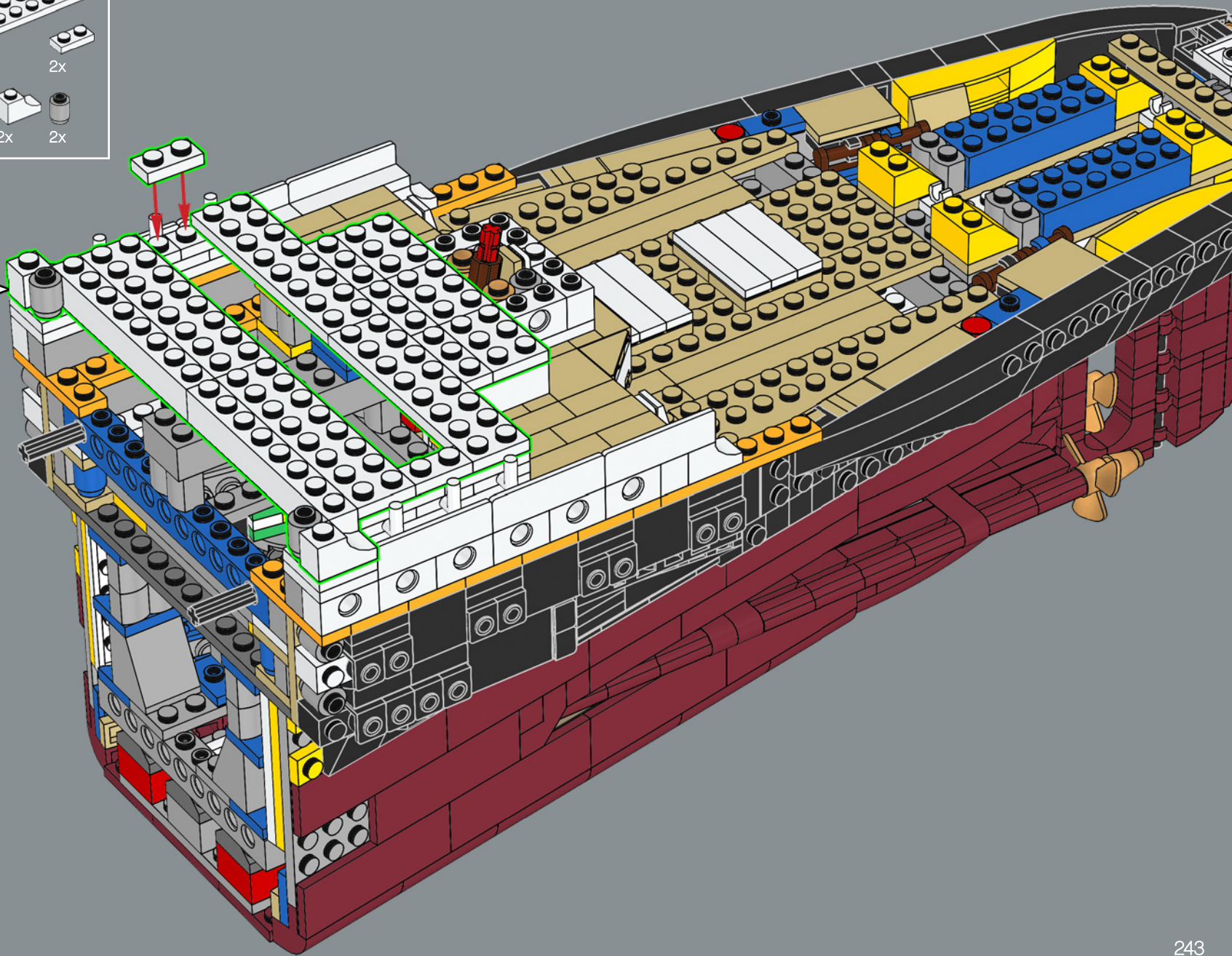
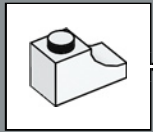

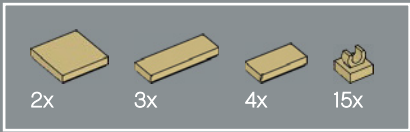

337

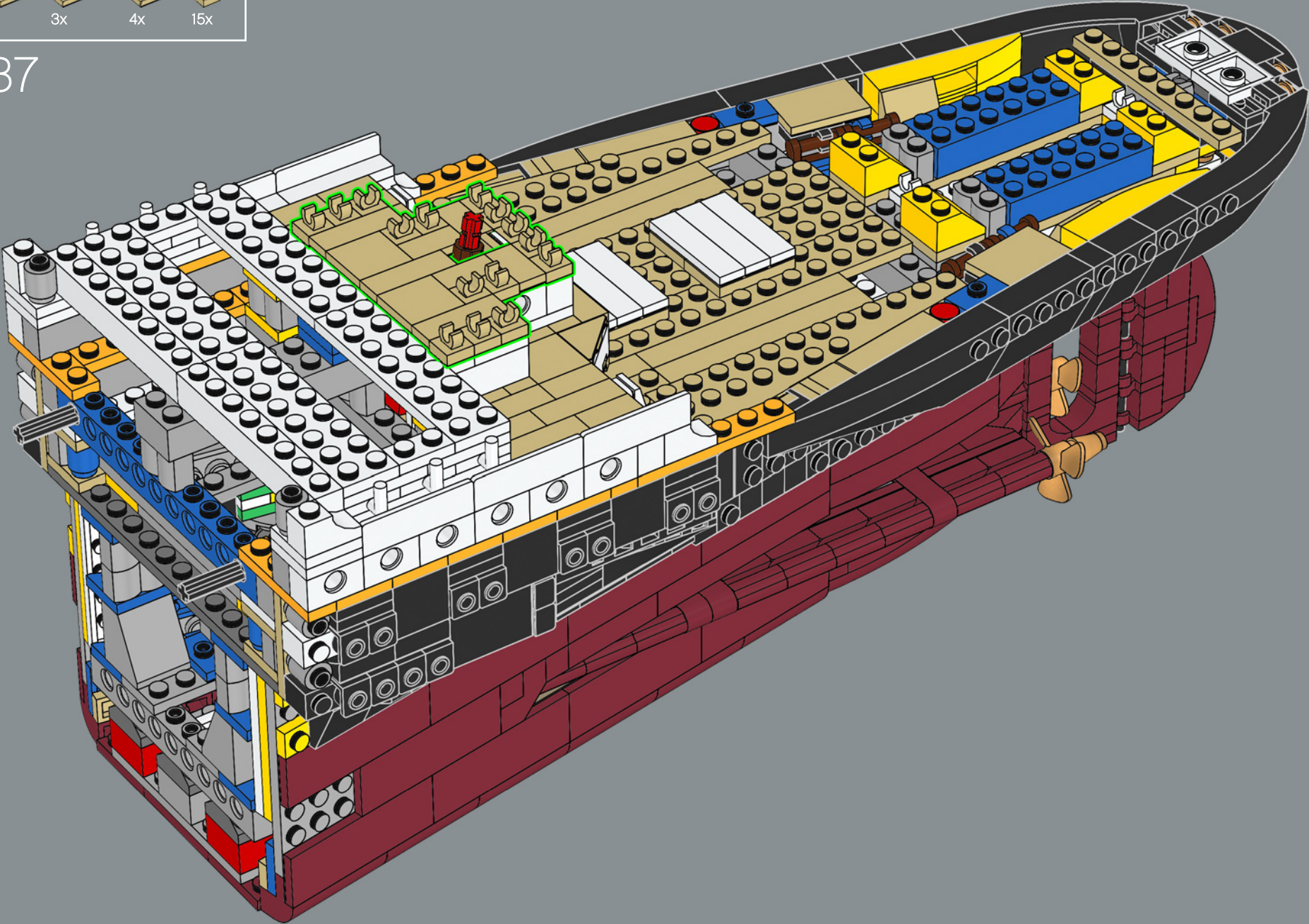

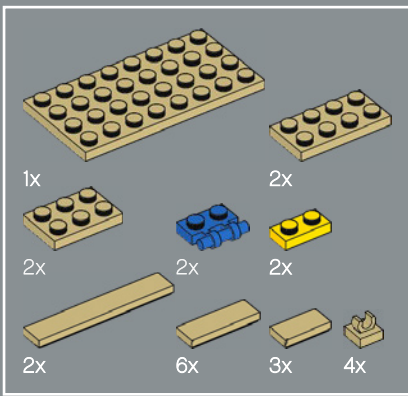

338

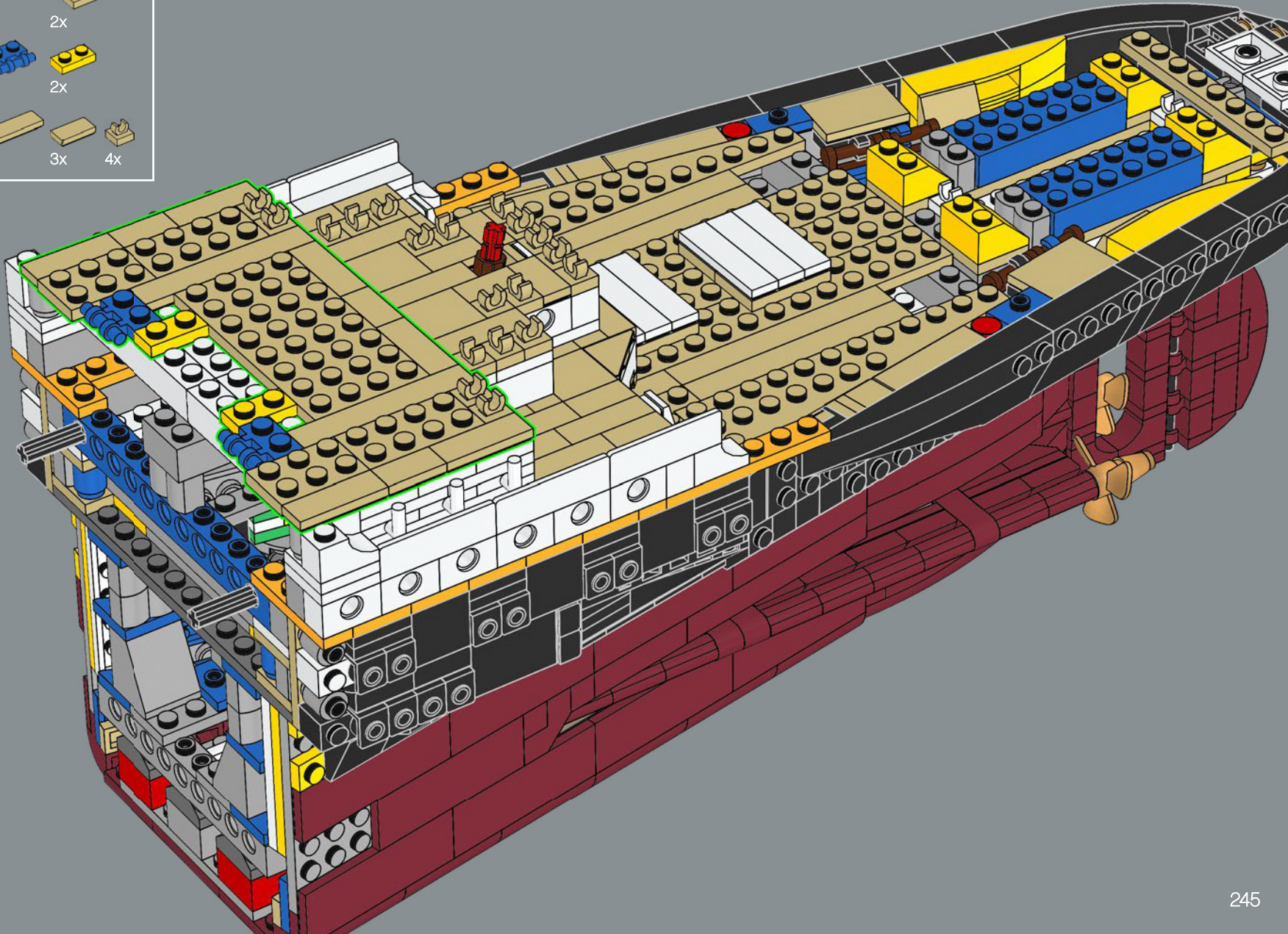

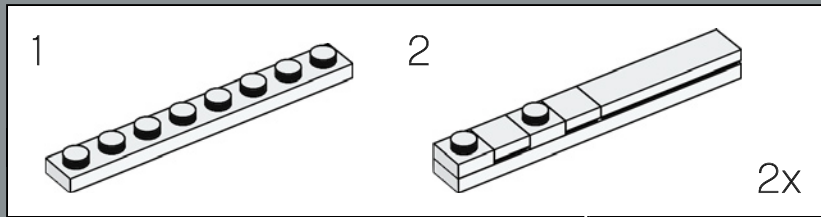
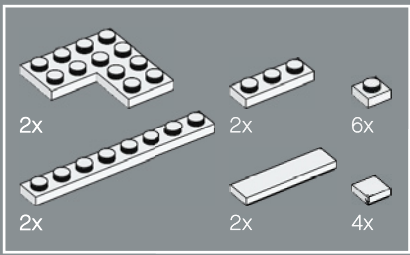

339

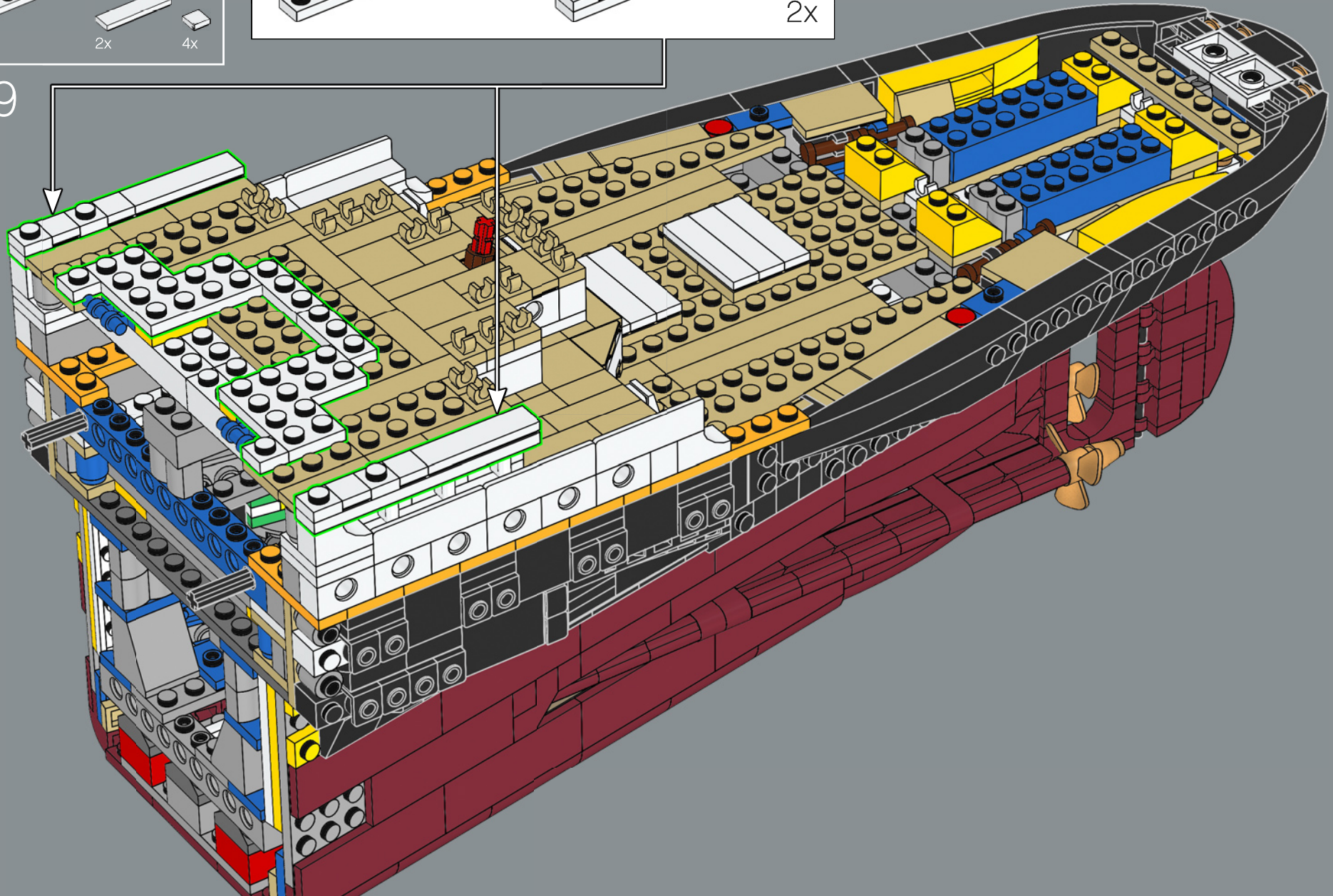

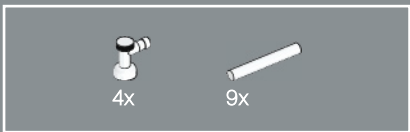

340

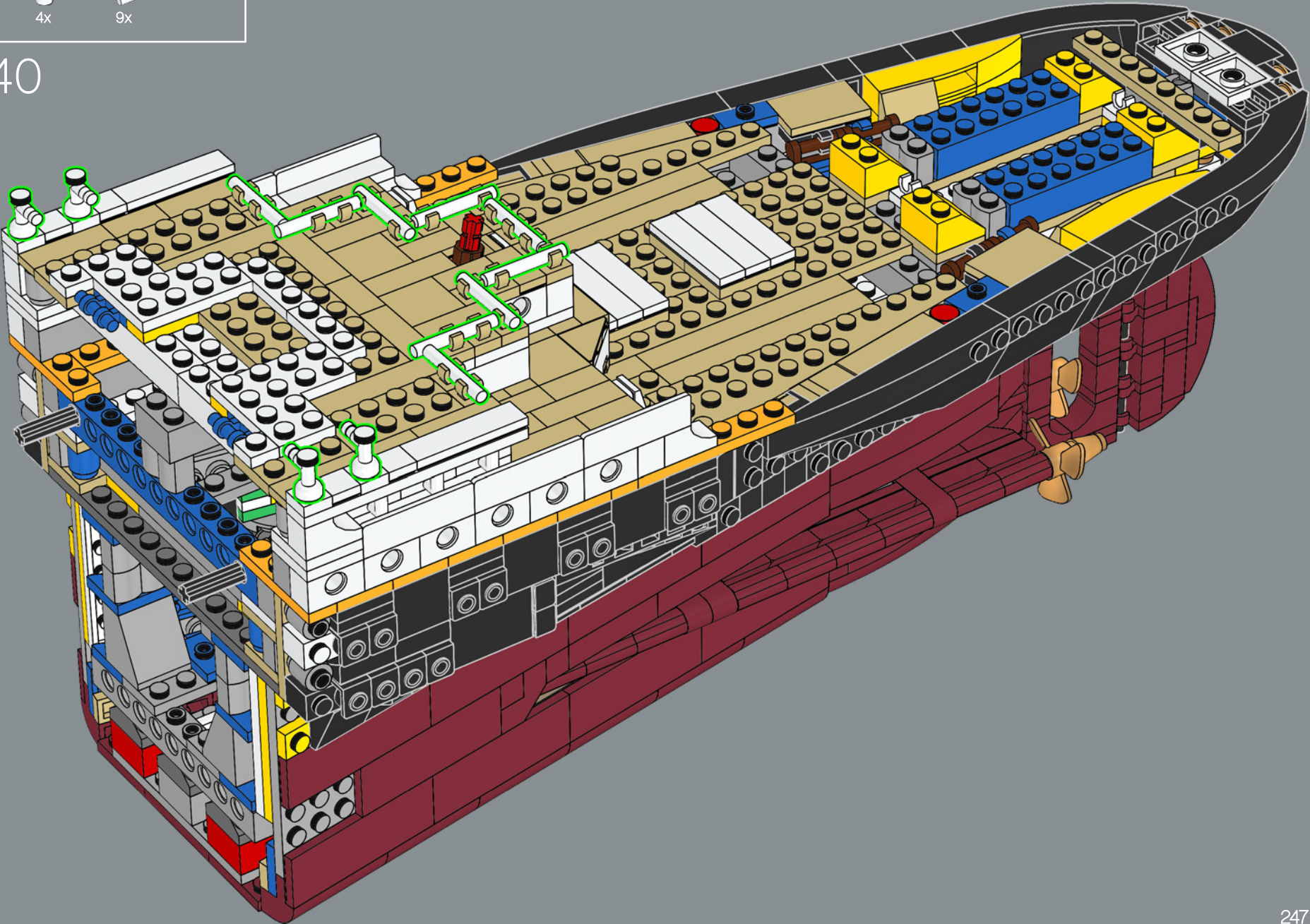

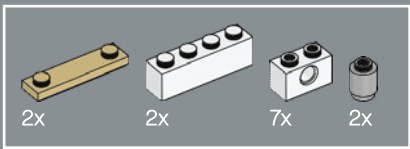

341

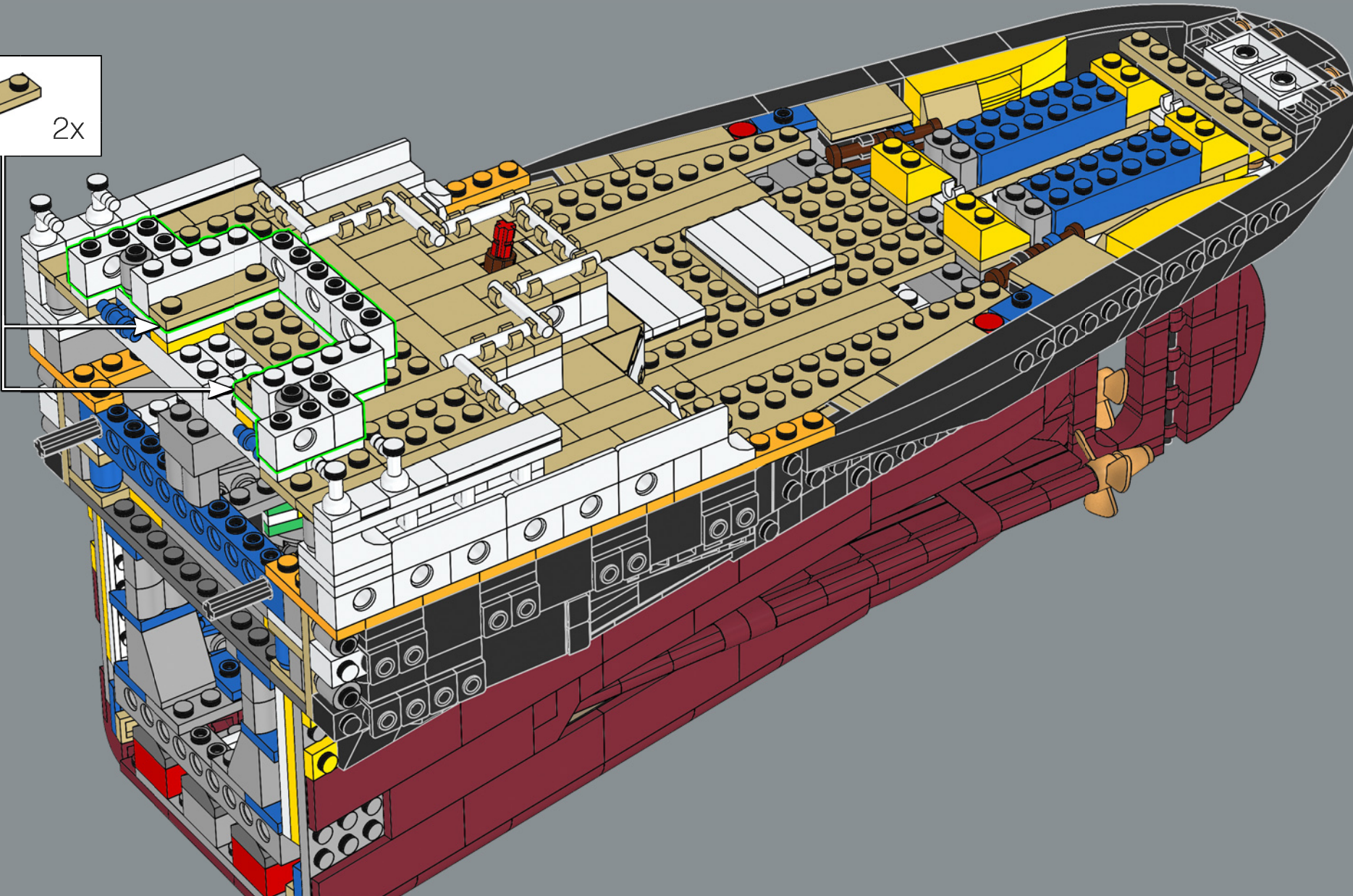
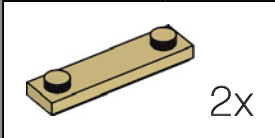

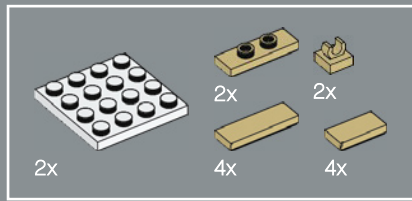

342

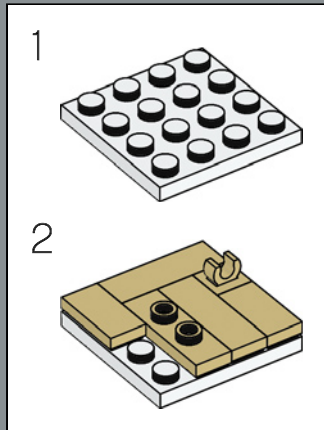
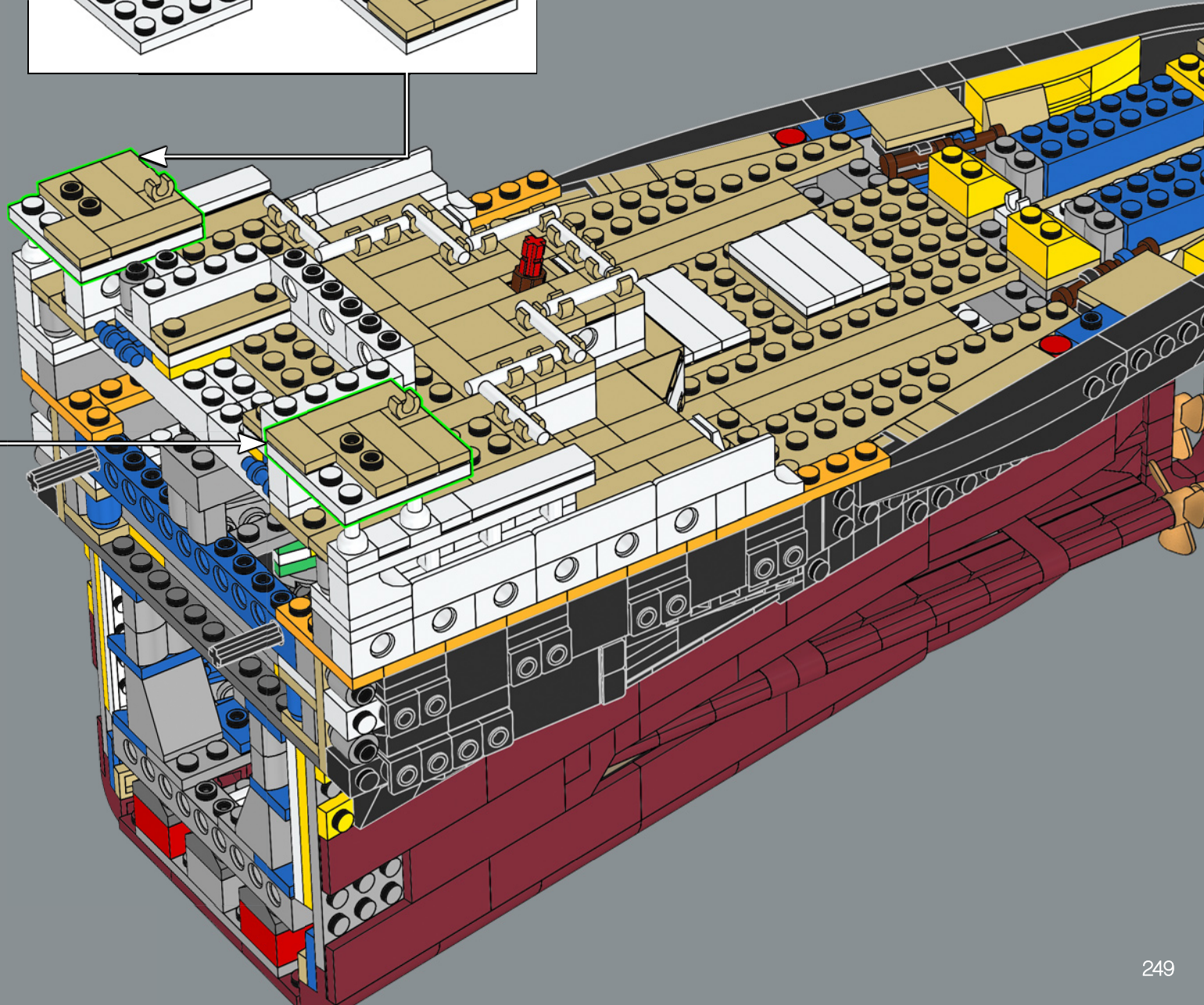
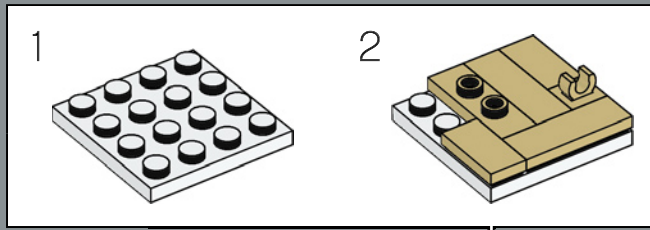

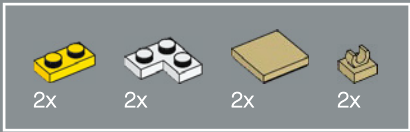

343

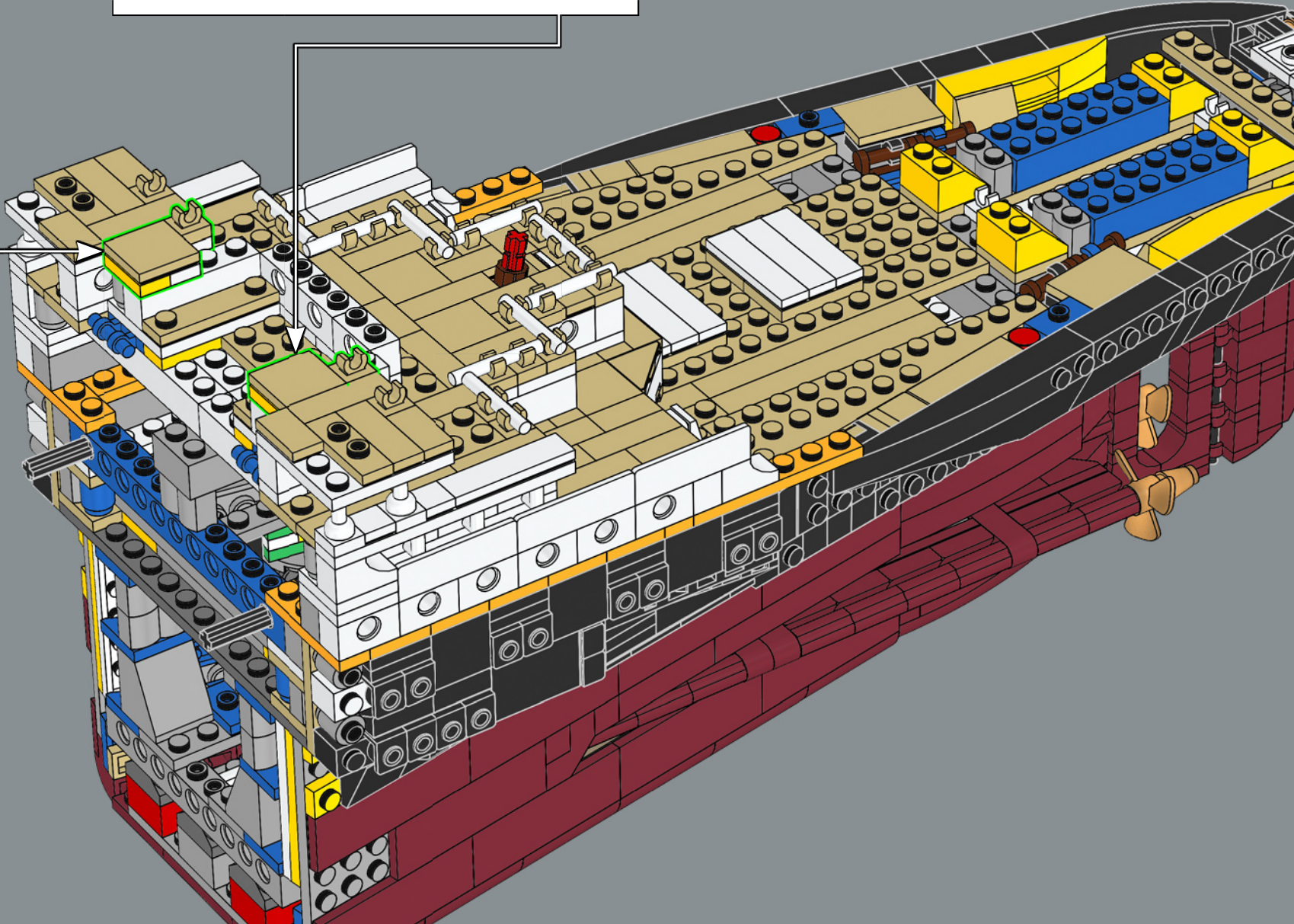
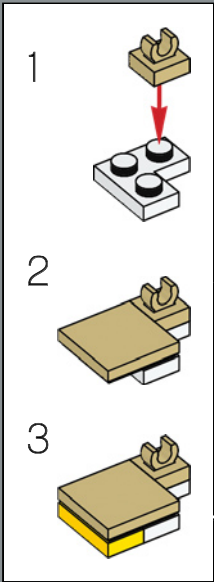
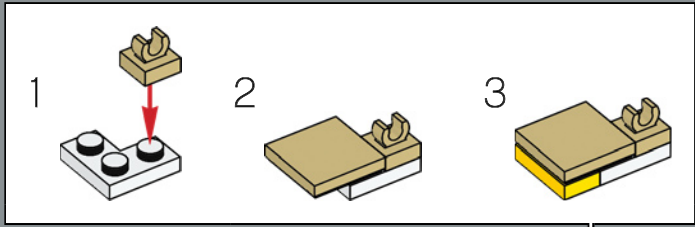

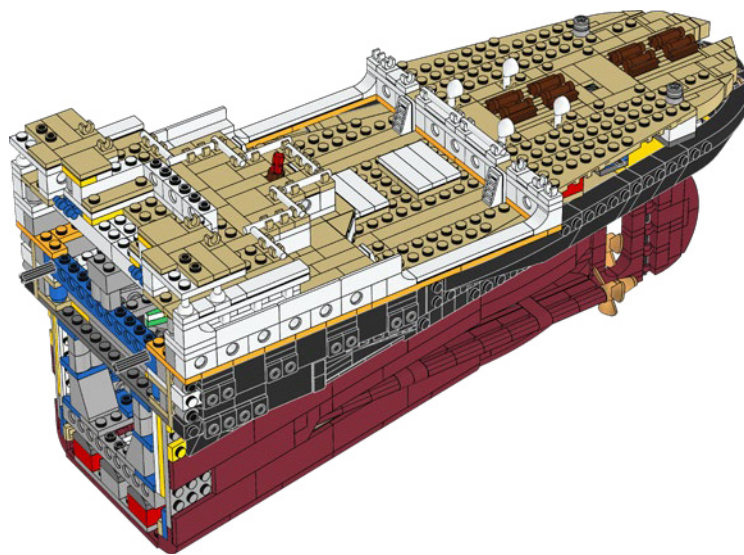

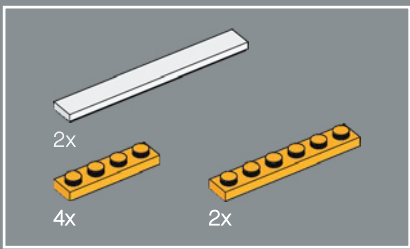

344

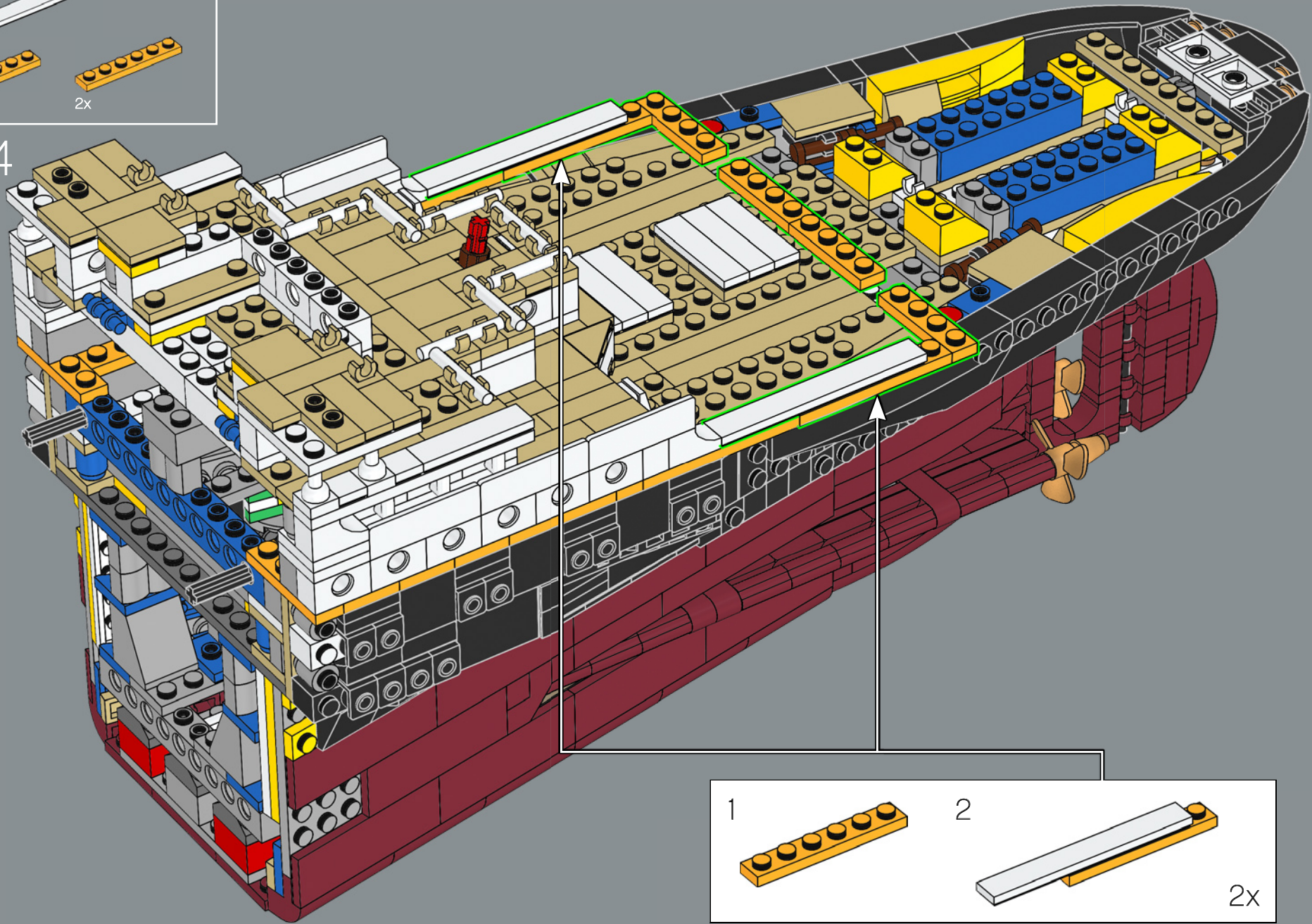

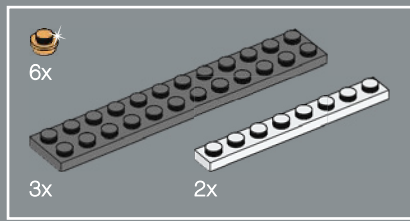

345

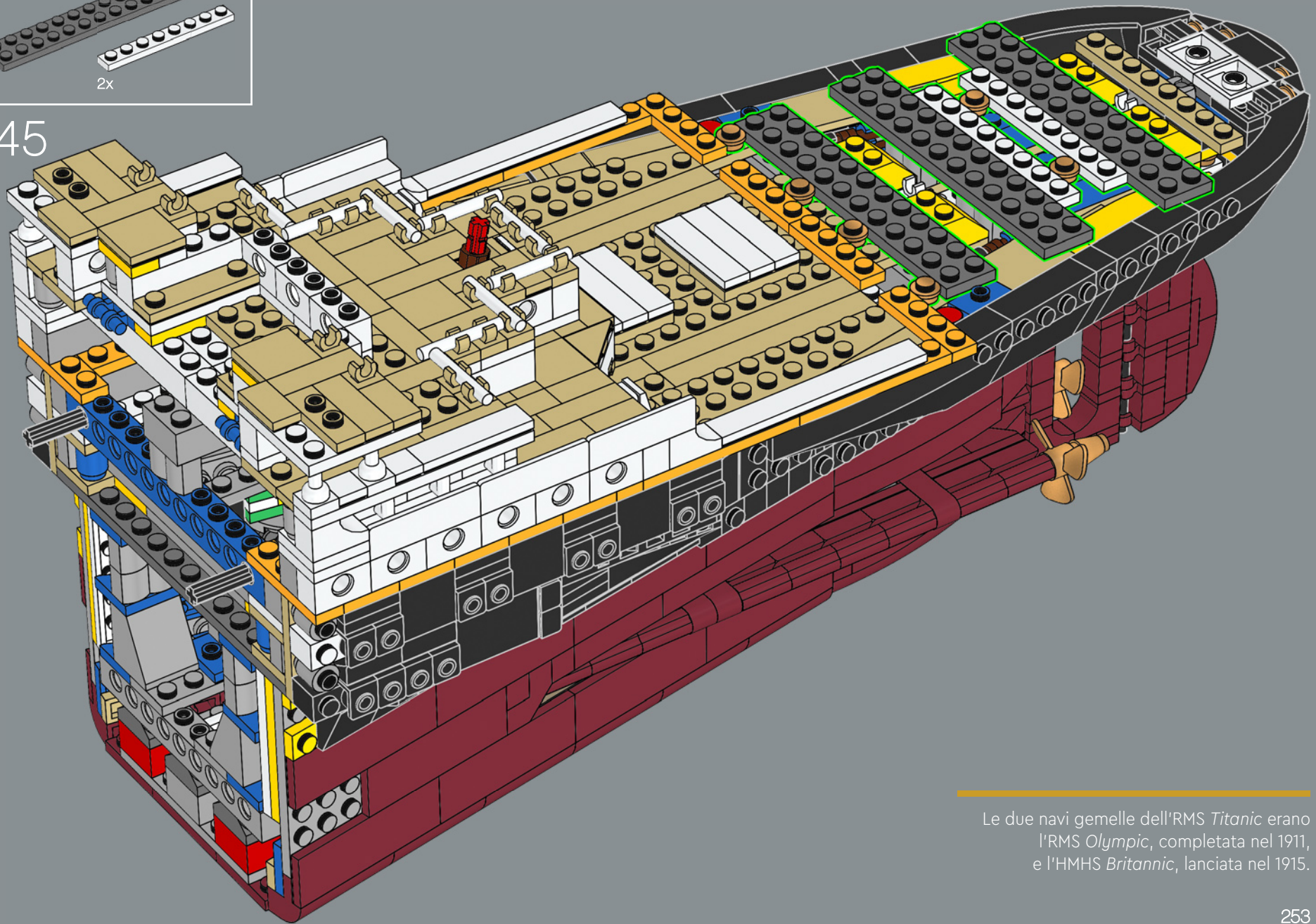

Le due navi gemelle dell'RMS *Titanic* erano l'RMS *Olympic*, completata nel 1911, e l'HMHS *Britannic*, lanciata nel 1915.

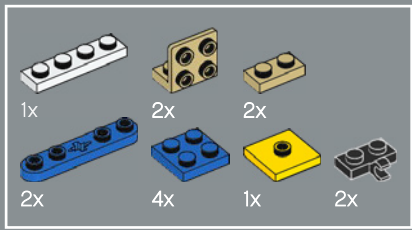

346

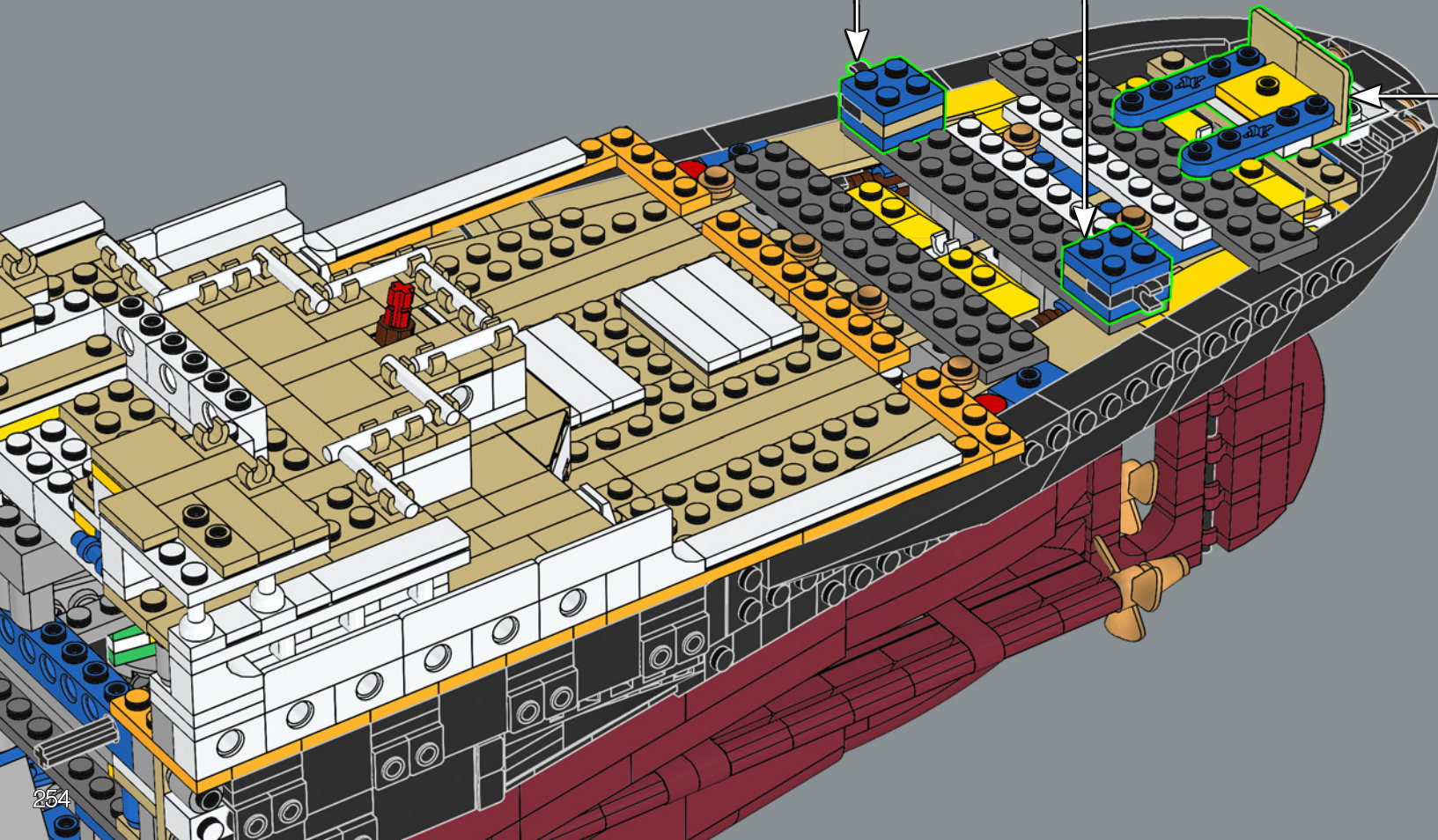
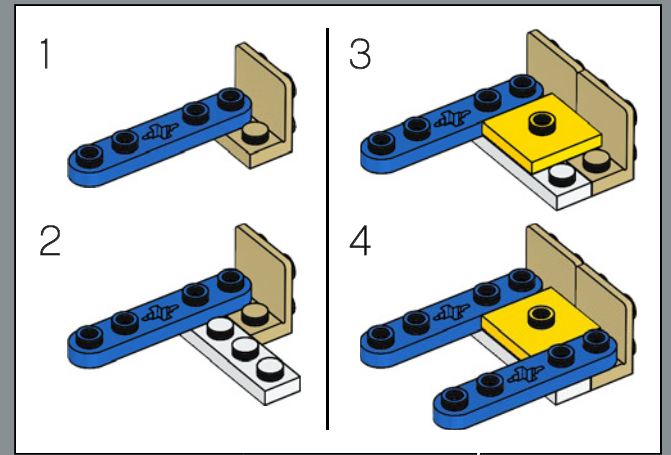
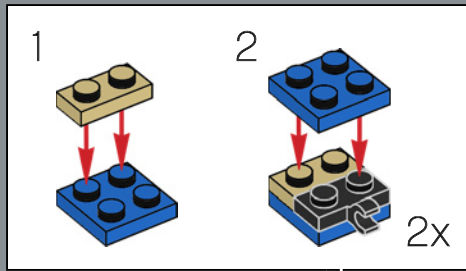

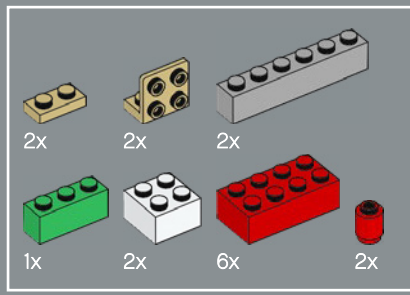

347

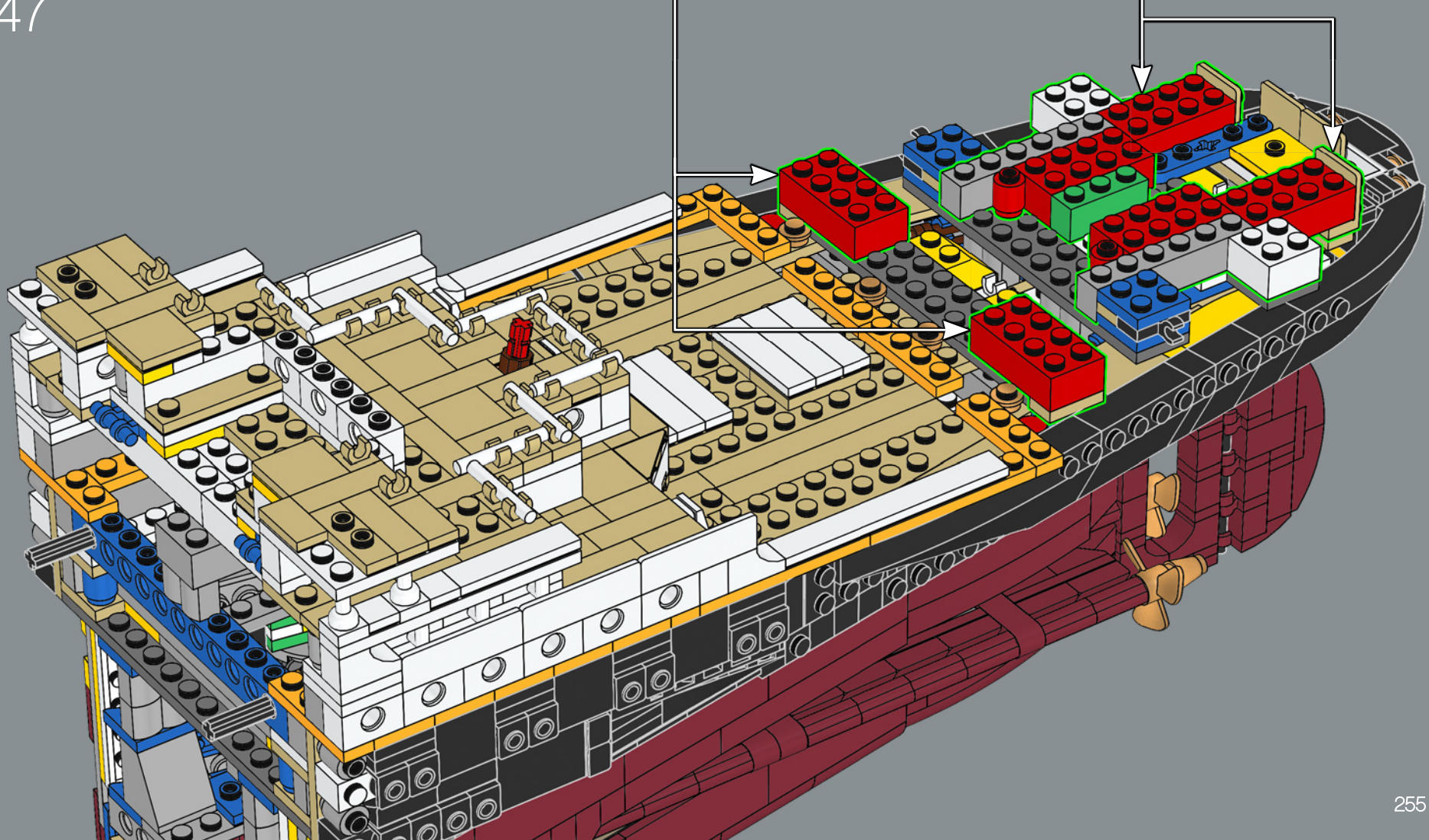
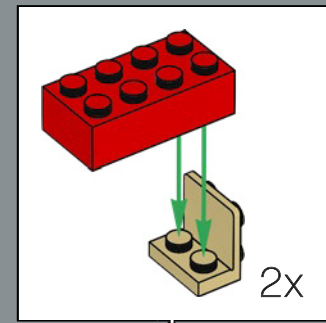
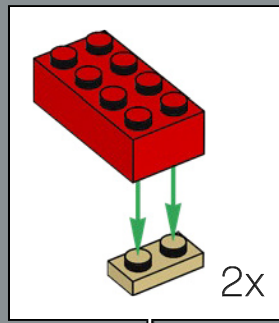

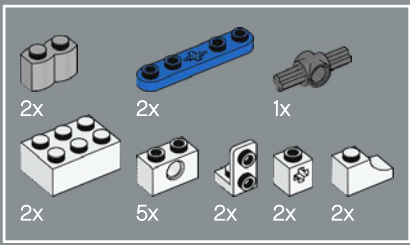

348

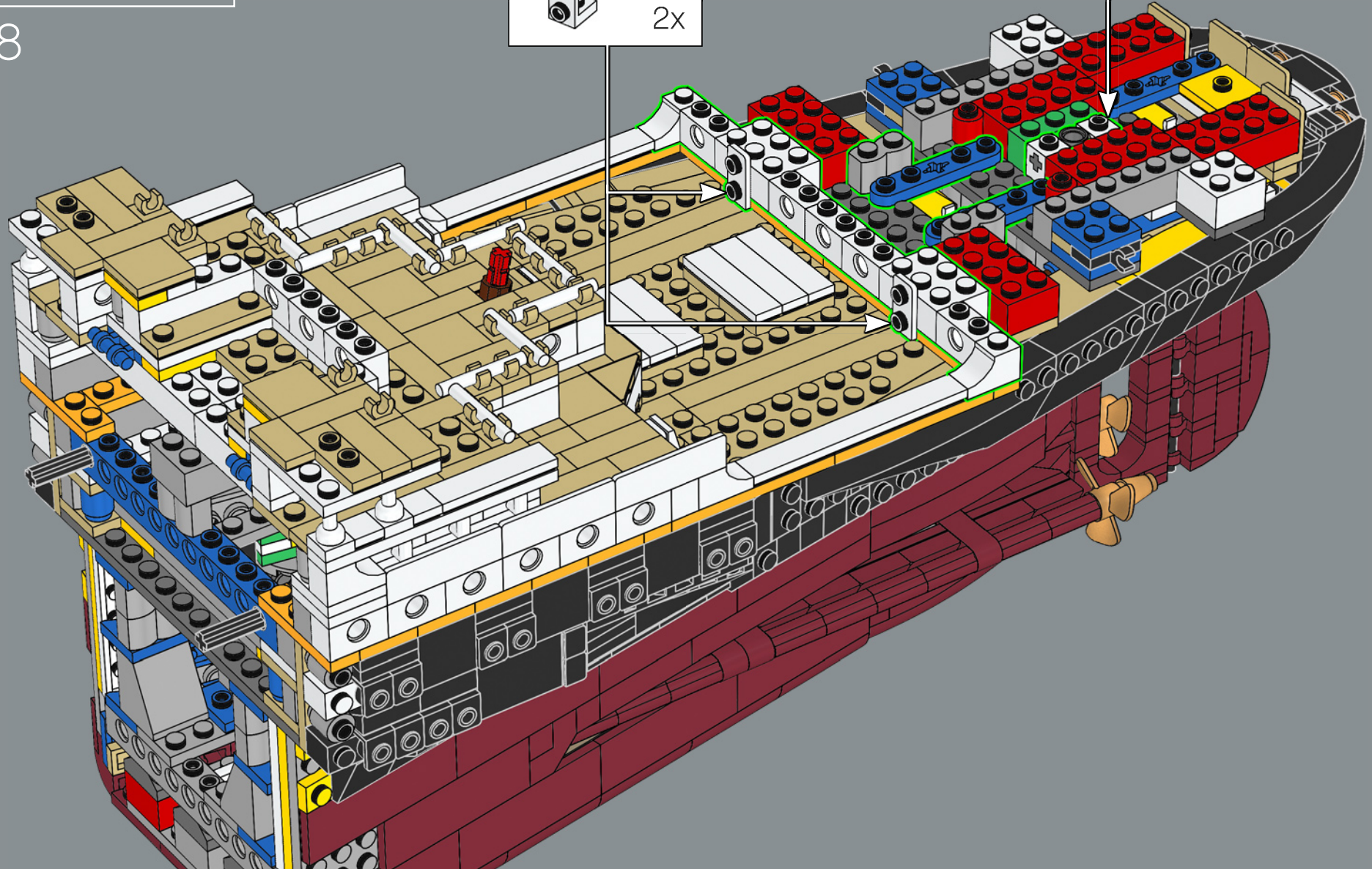
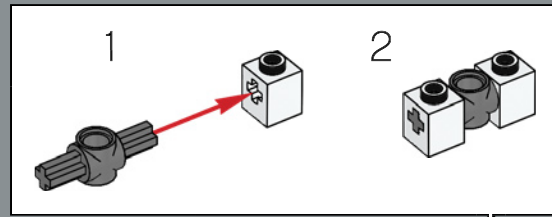
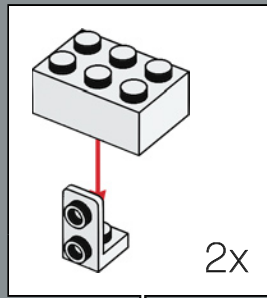

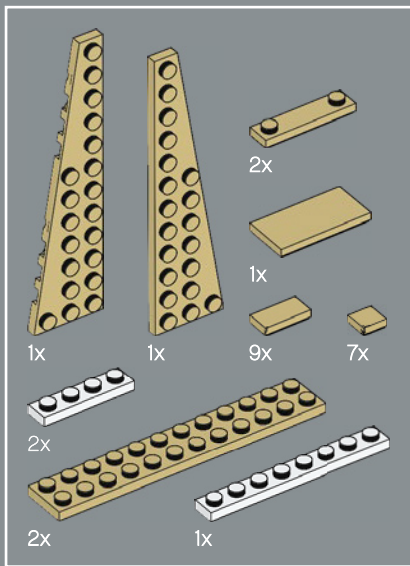

349

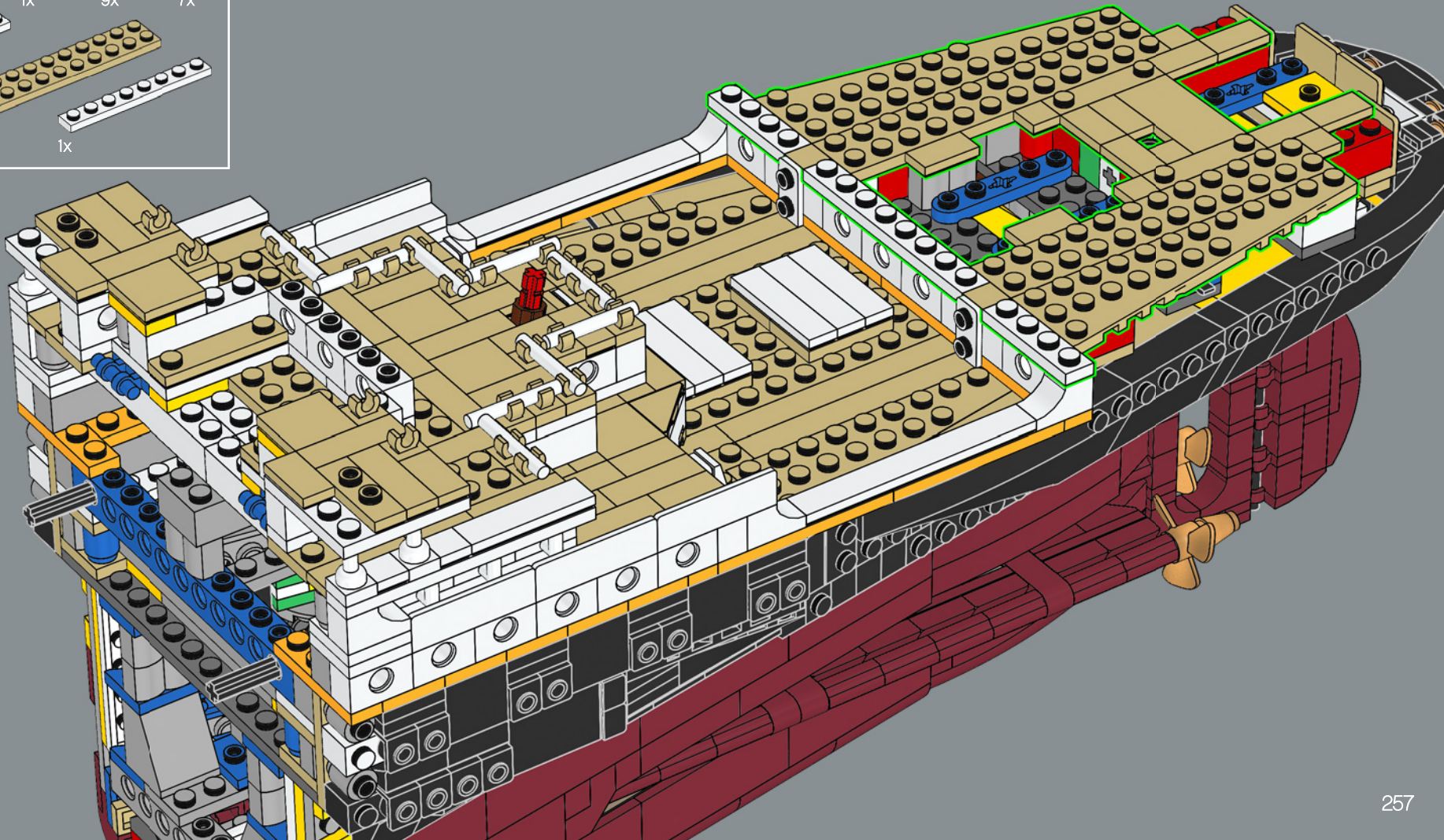

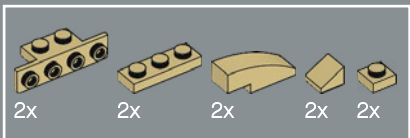

350

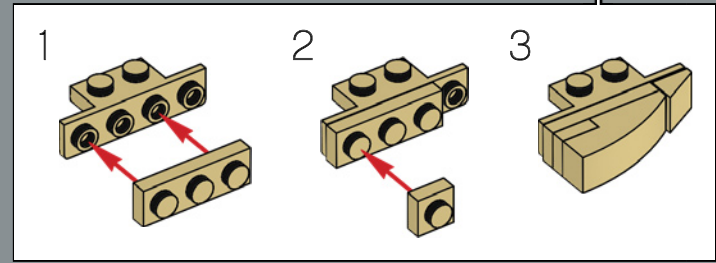
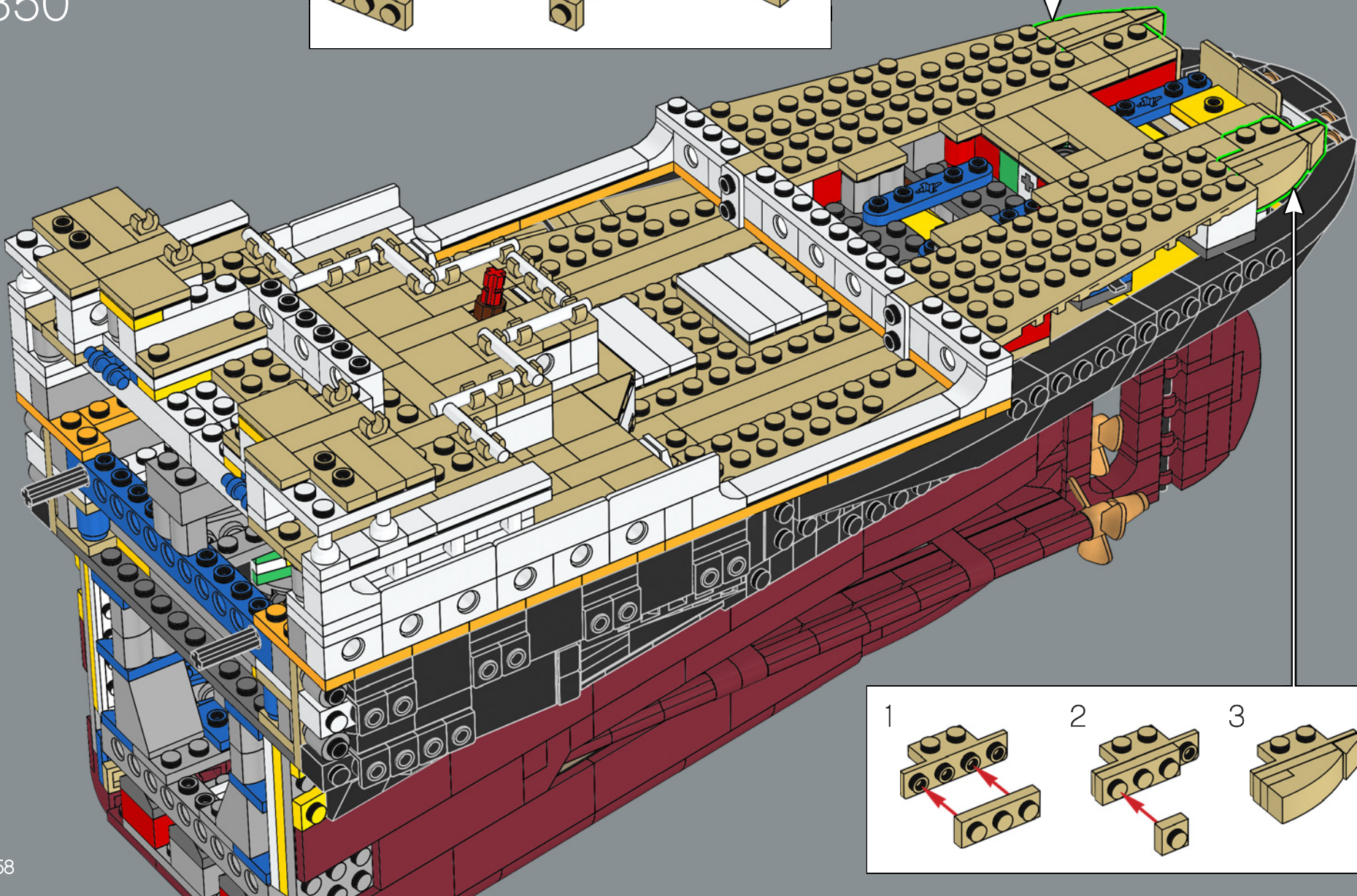
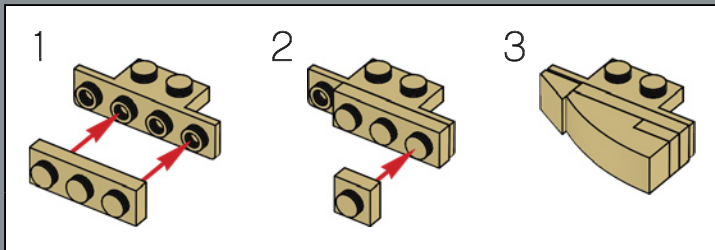

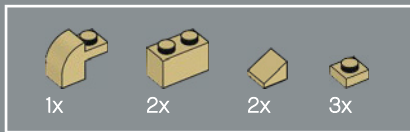

351

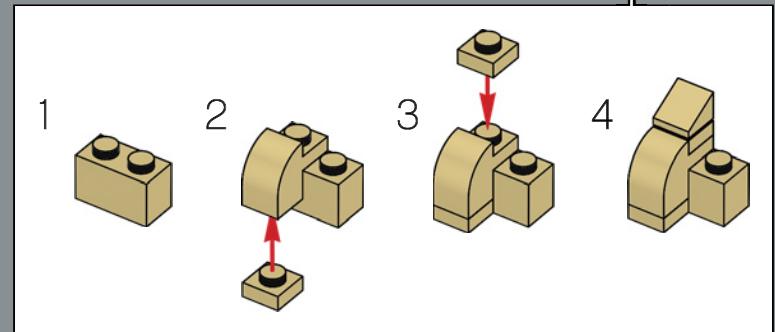
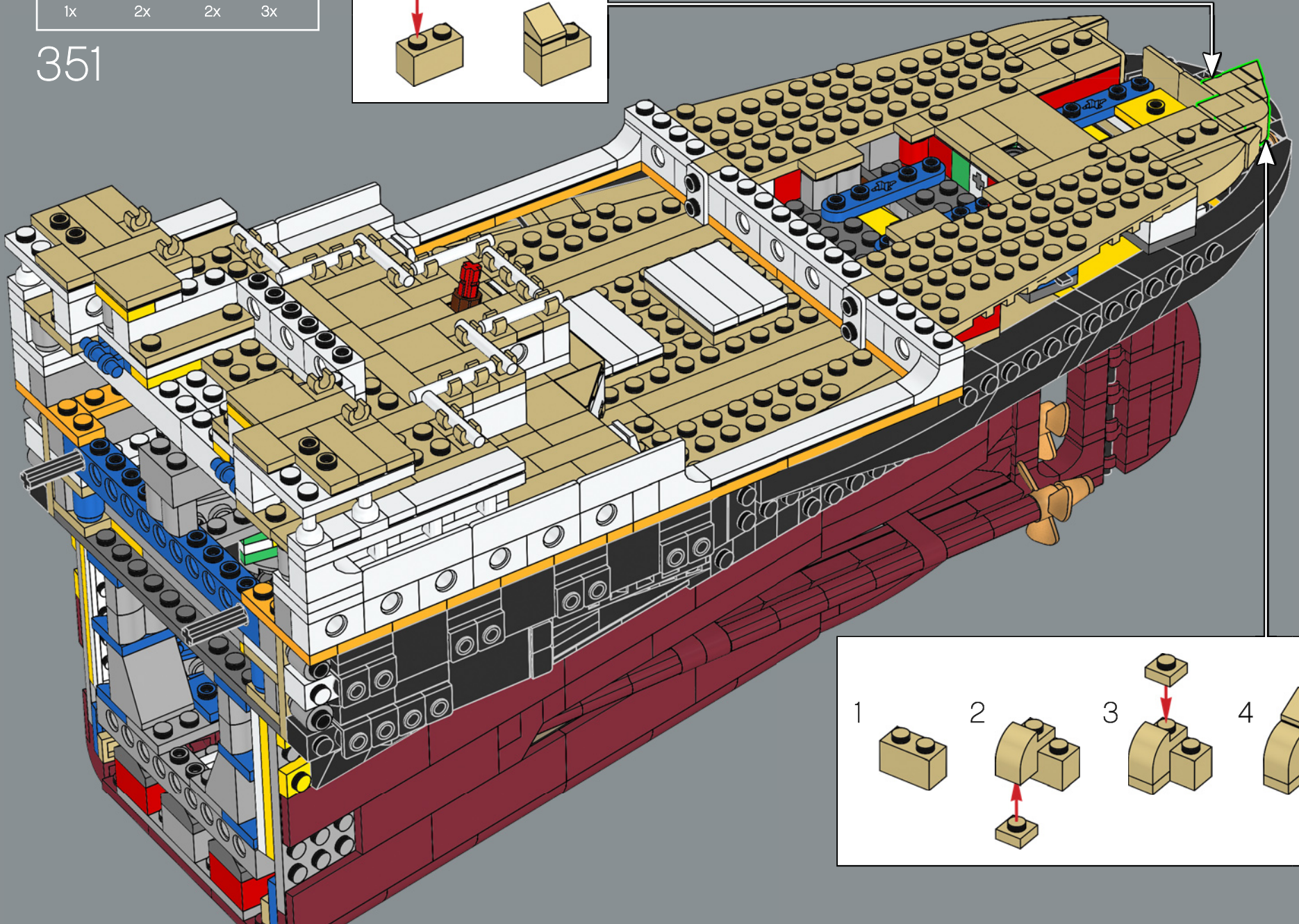
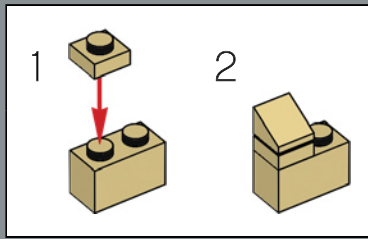

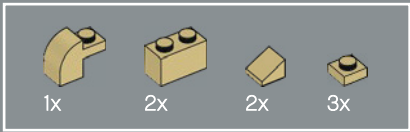

352

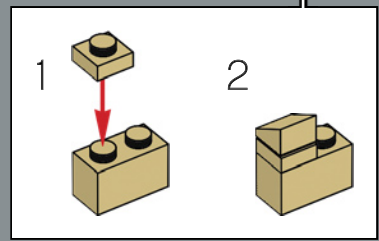
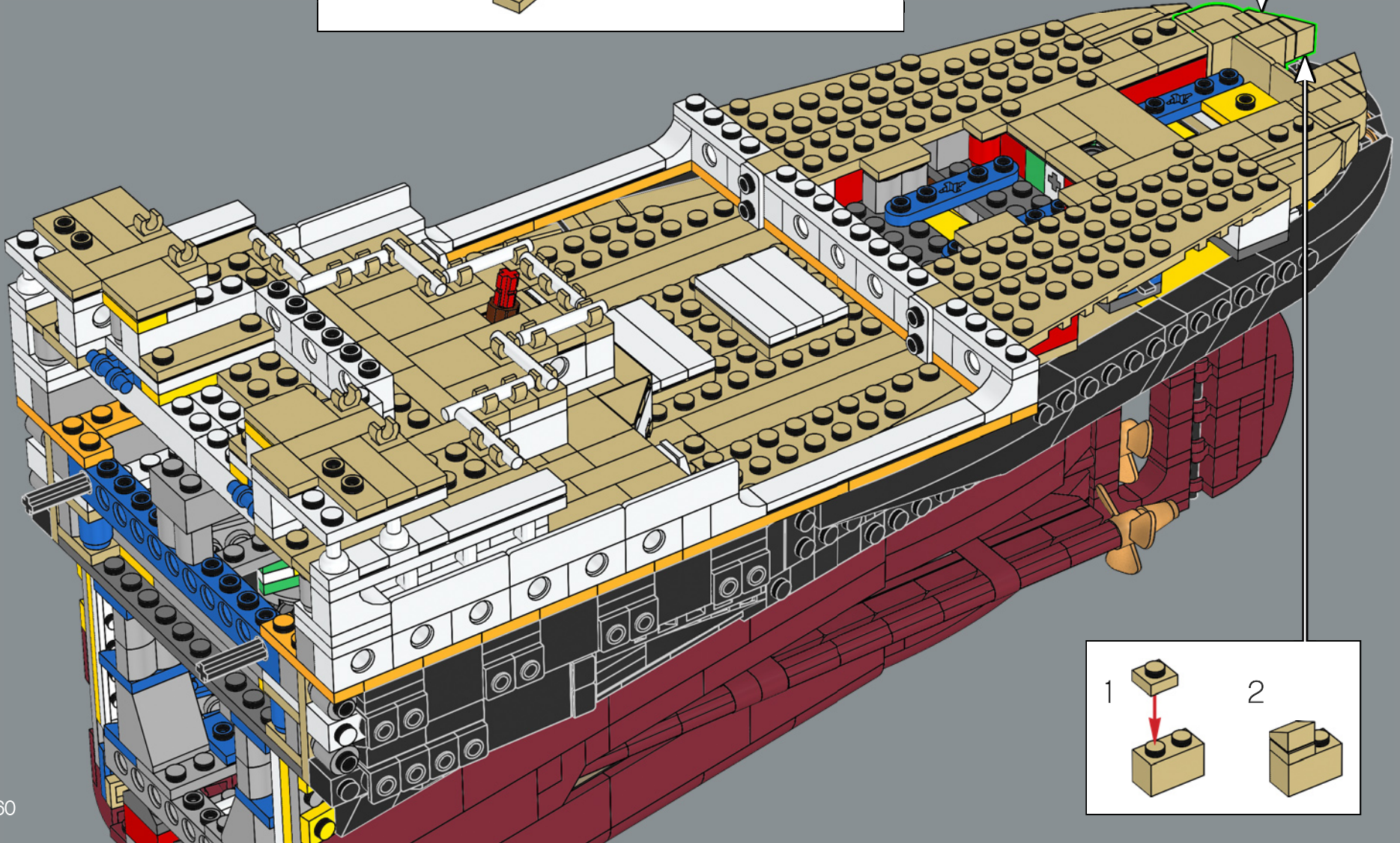
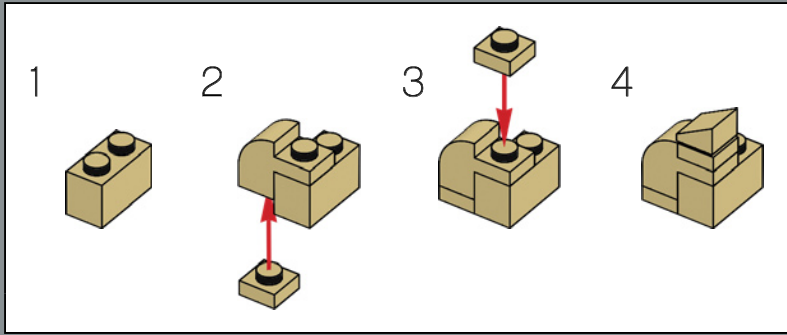

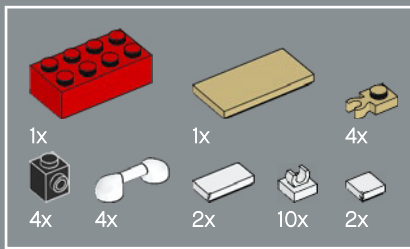

353

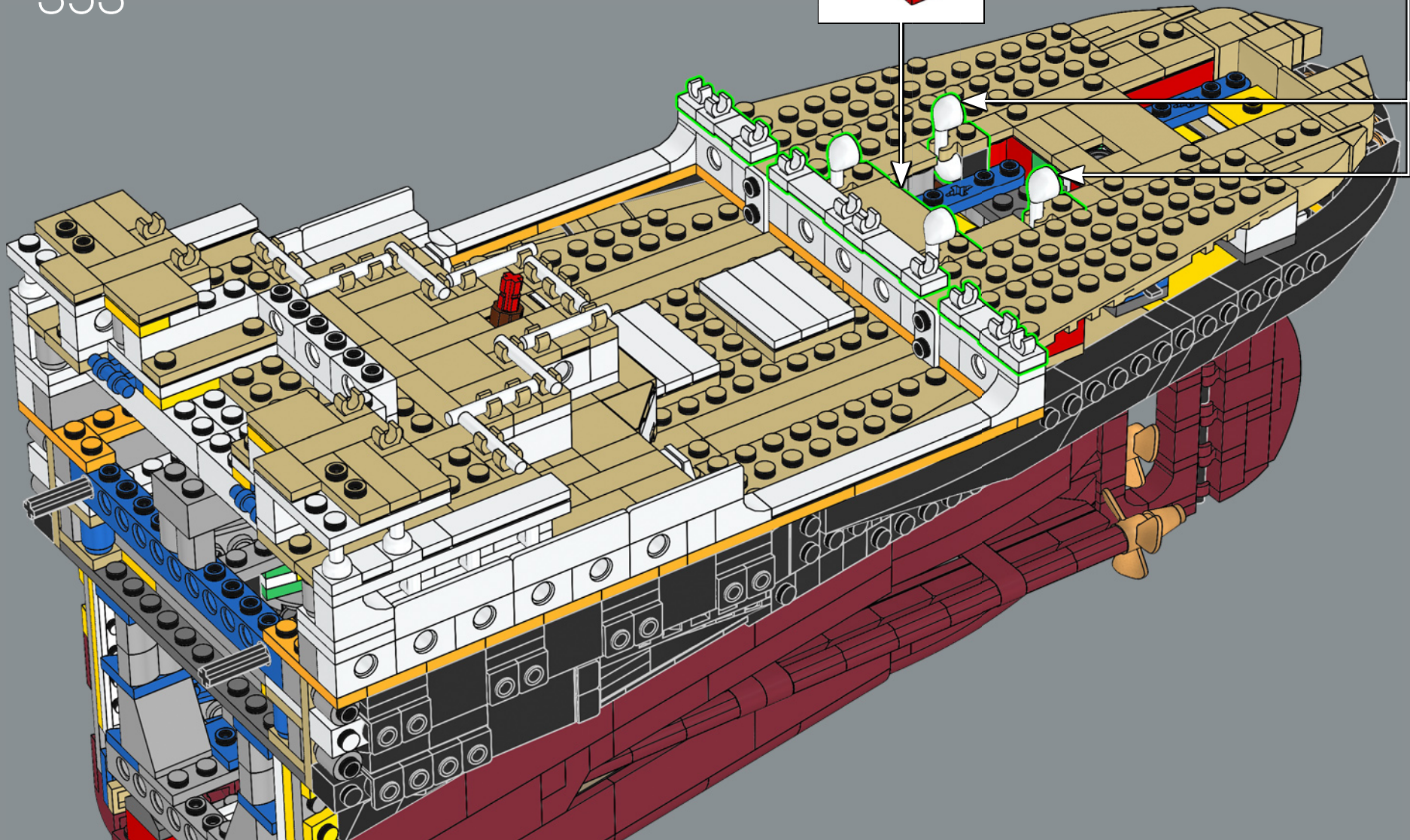
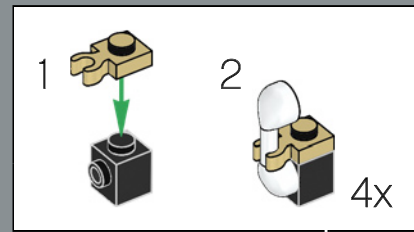
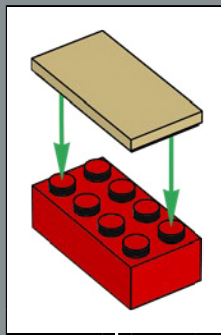



354

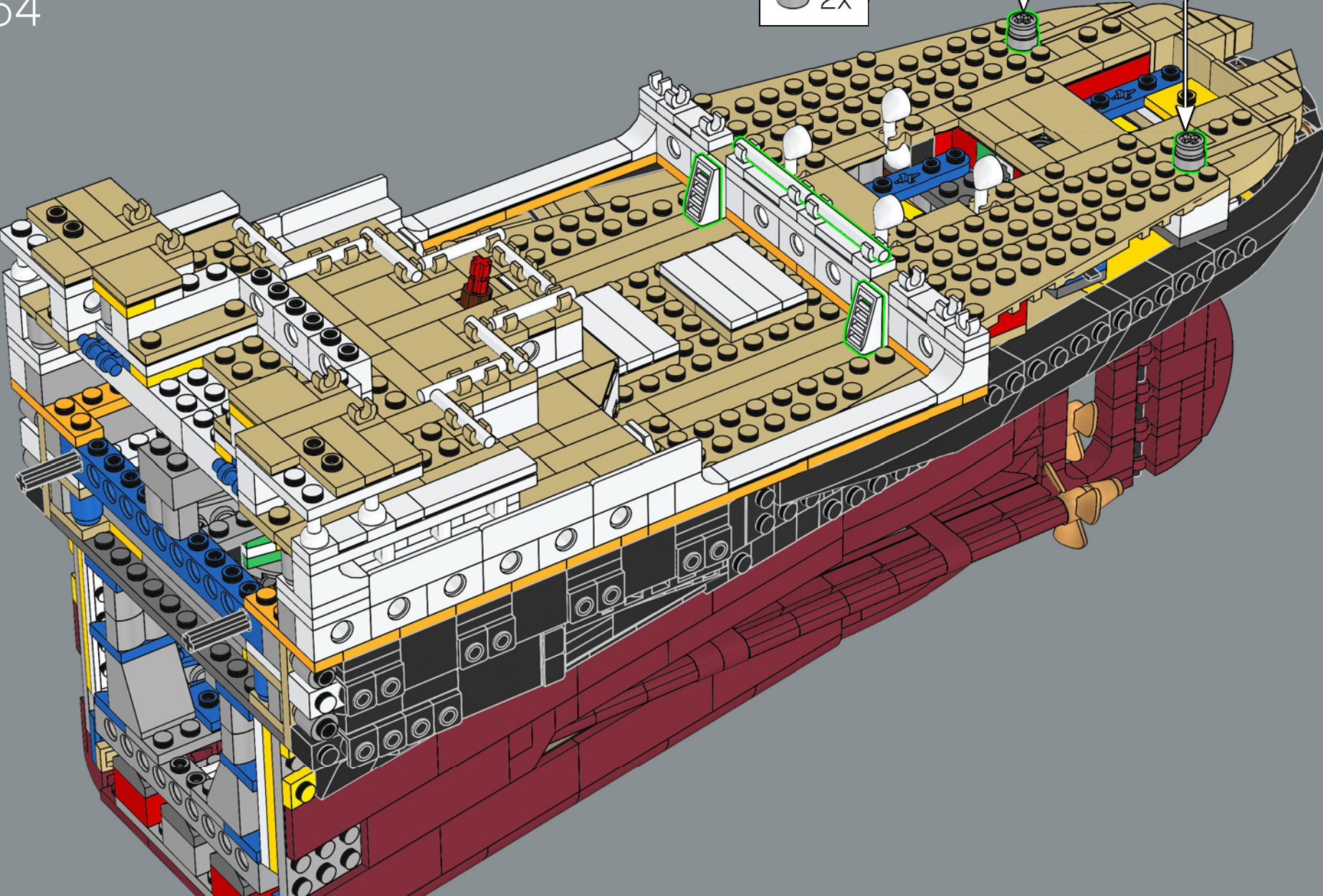
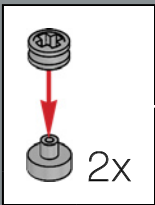

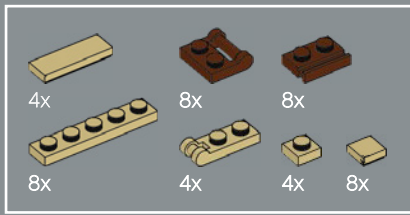

355

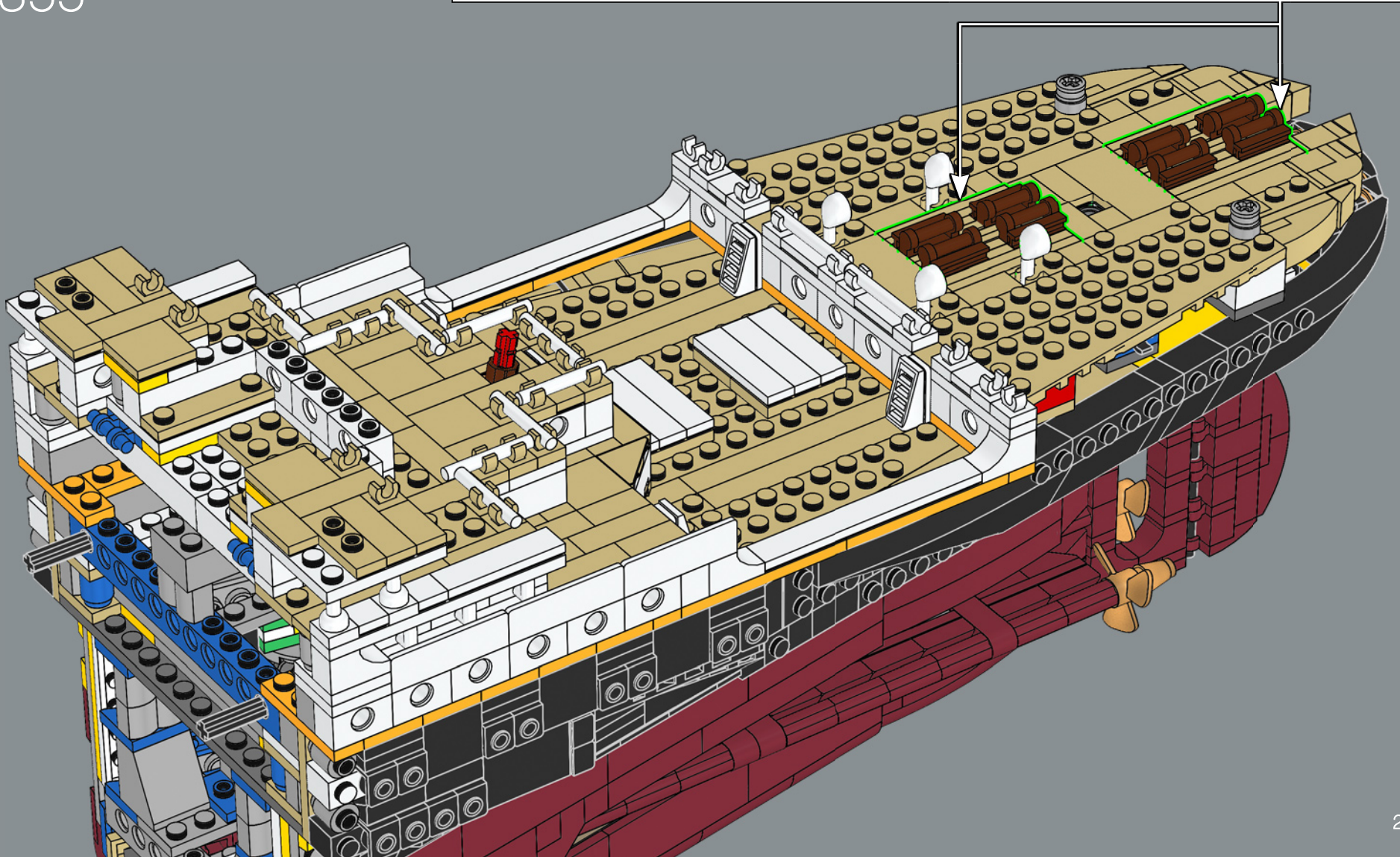
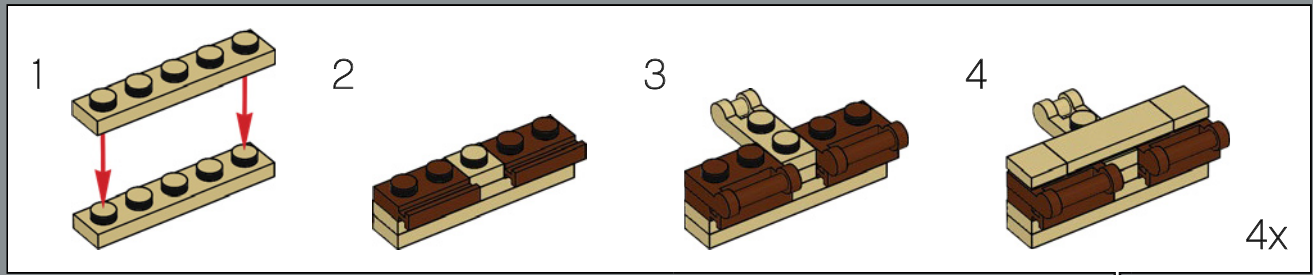

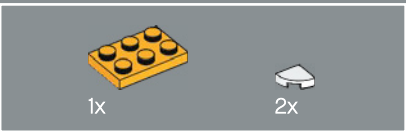
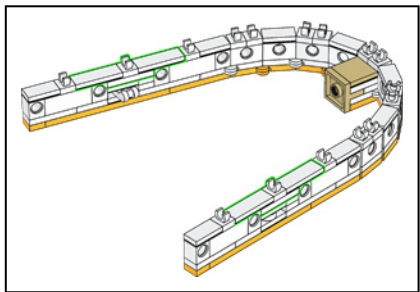
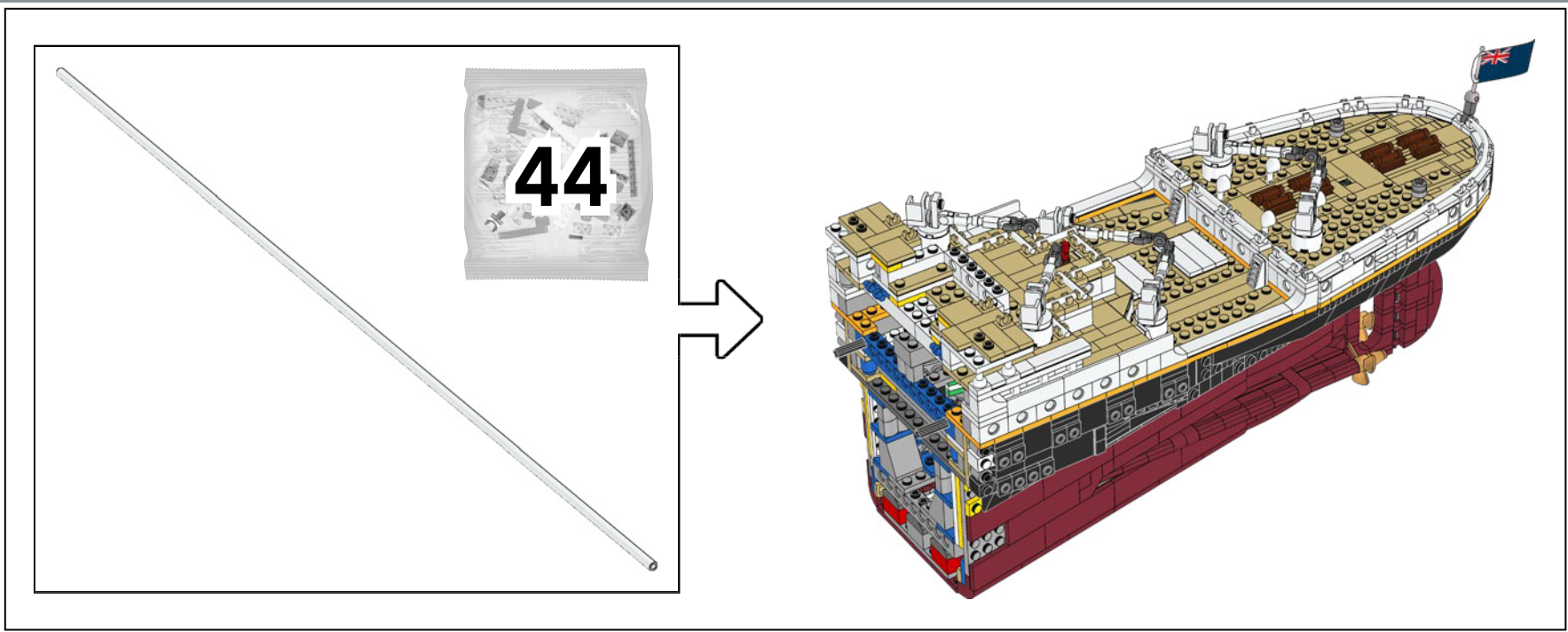

356

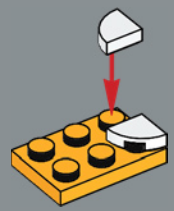

357

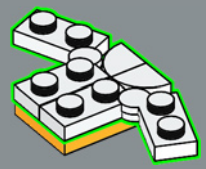

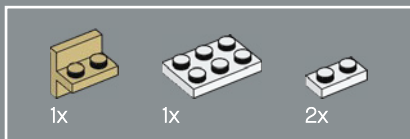

358

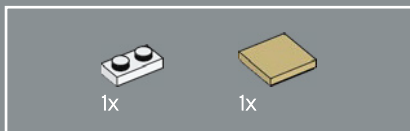
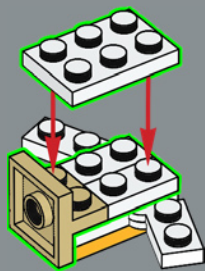

359

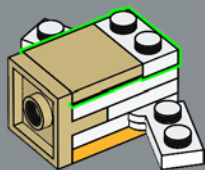

360

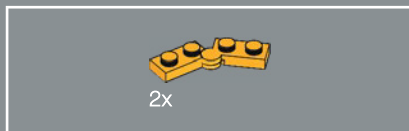
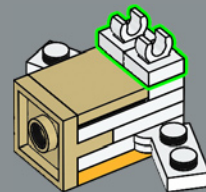

361

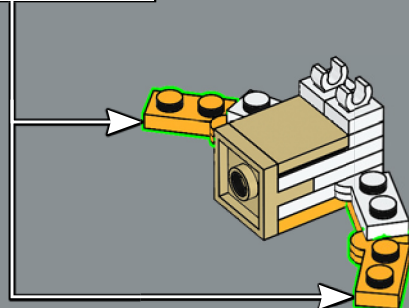
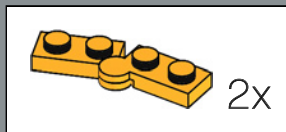



362

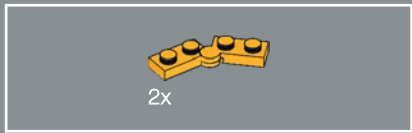
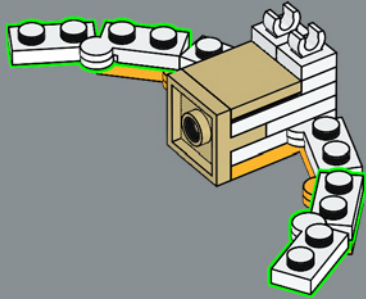

363

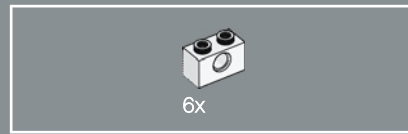
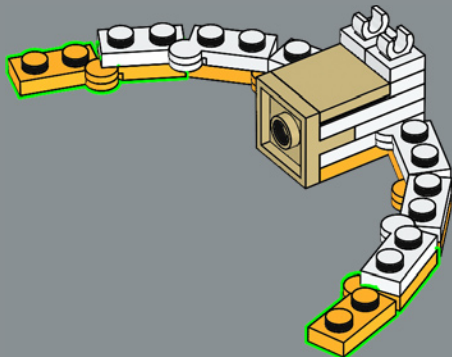

364

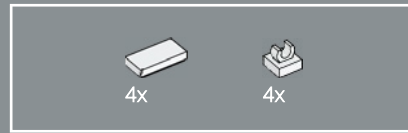
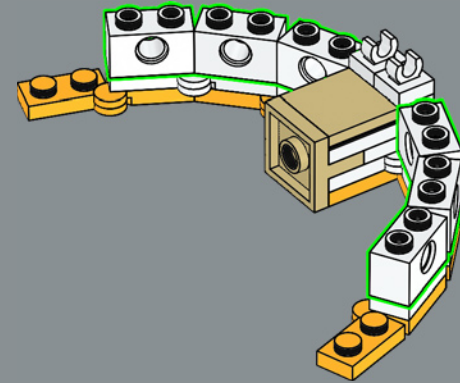

365

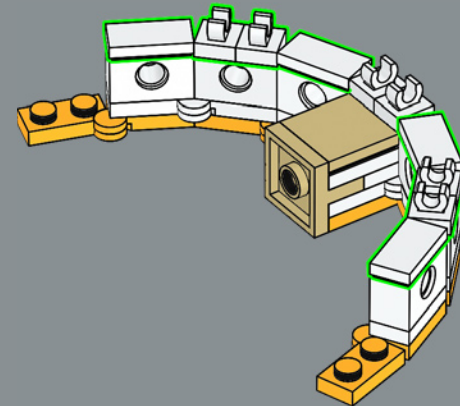



366

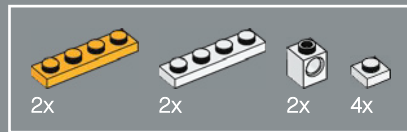
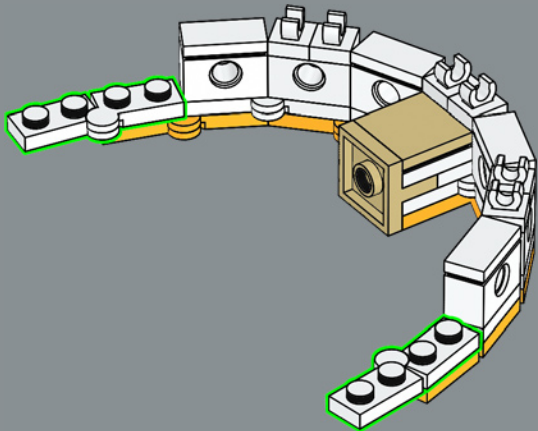

367

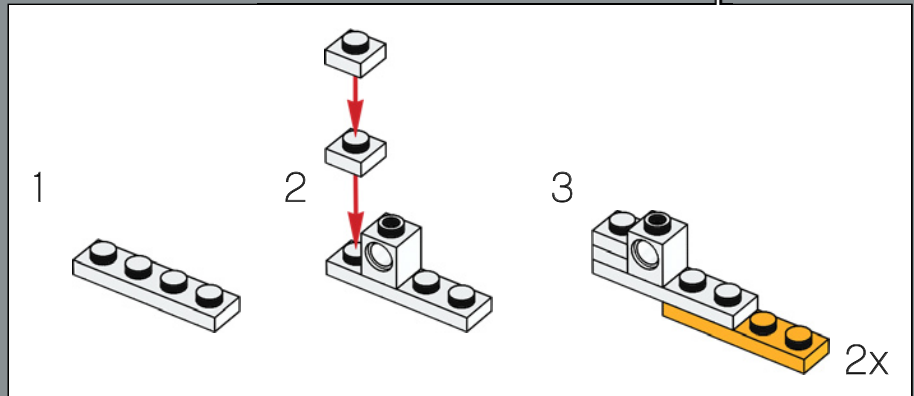
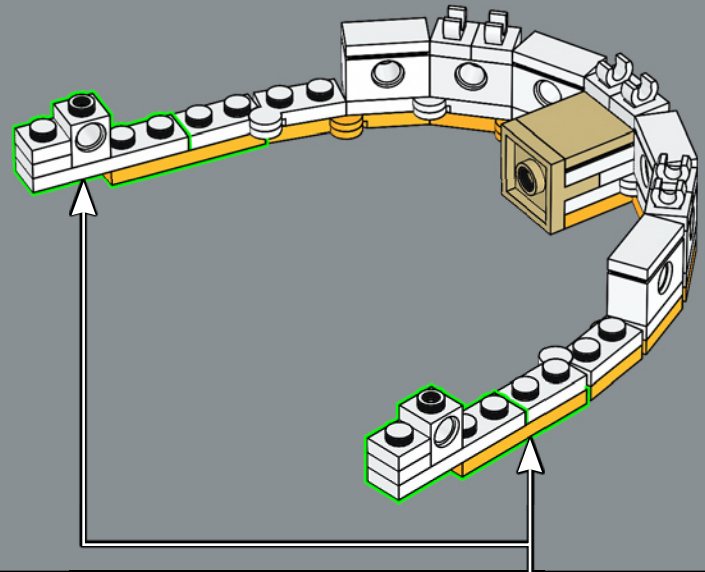

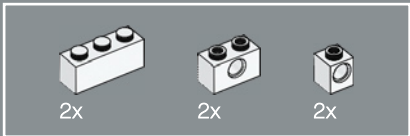

368

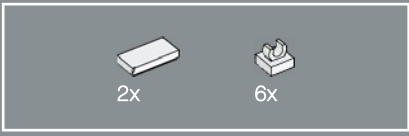
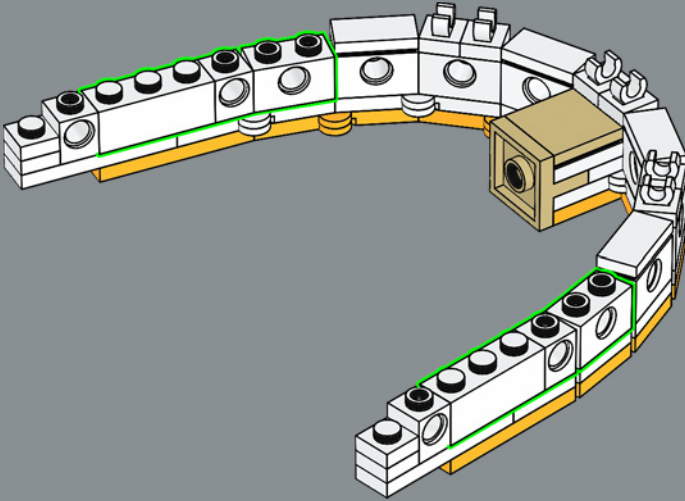

369

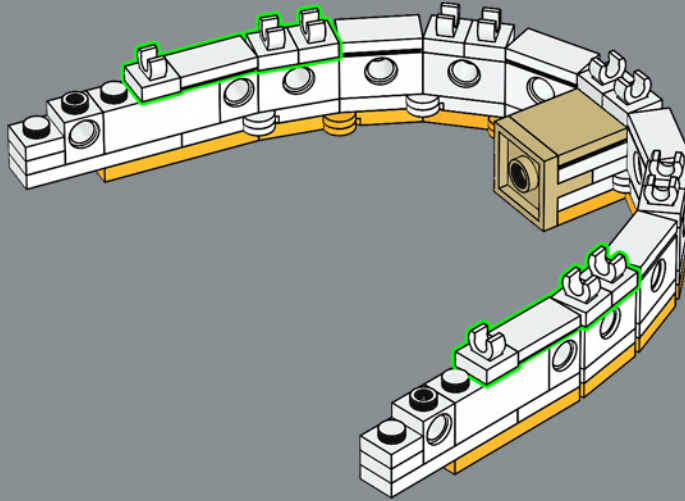

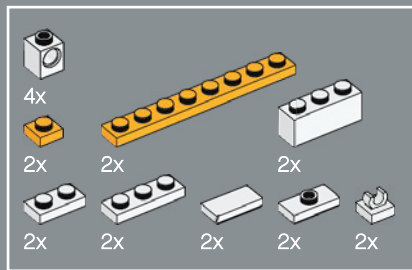

370

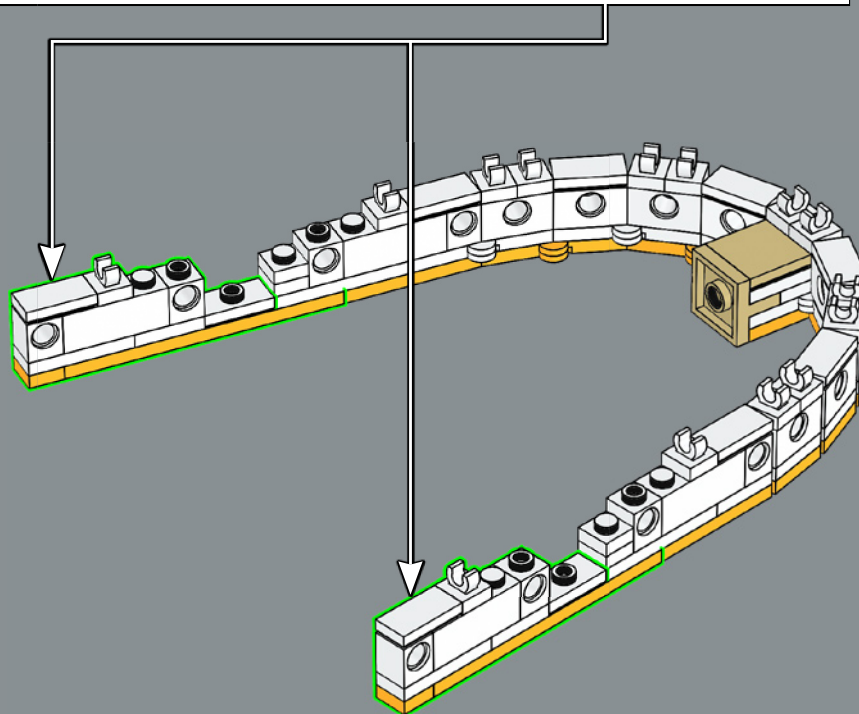
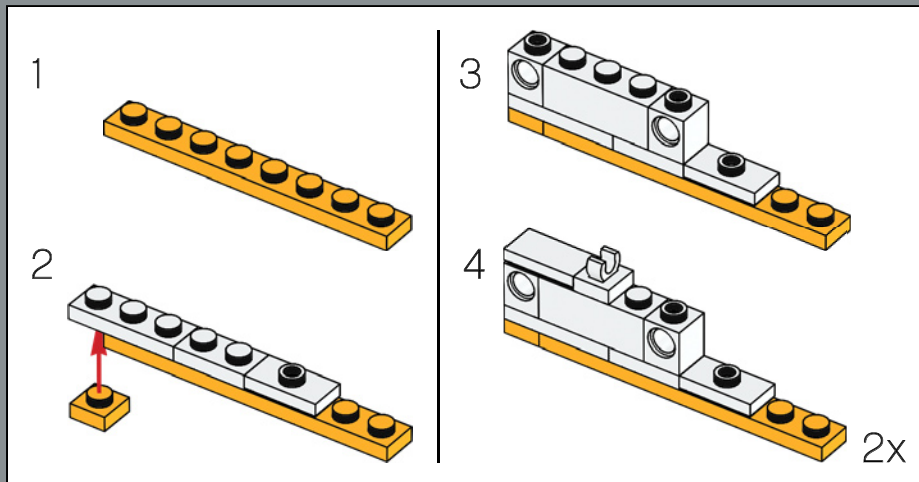



2x

371

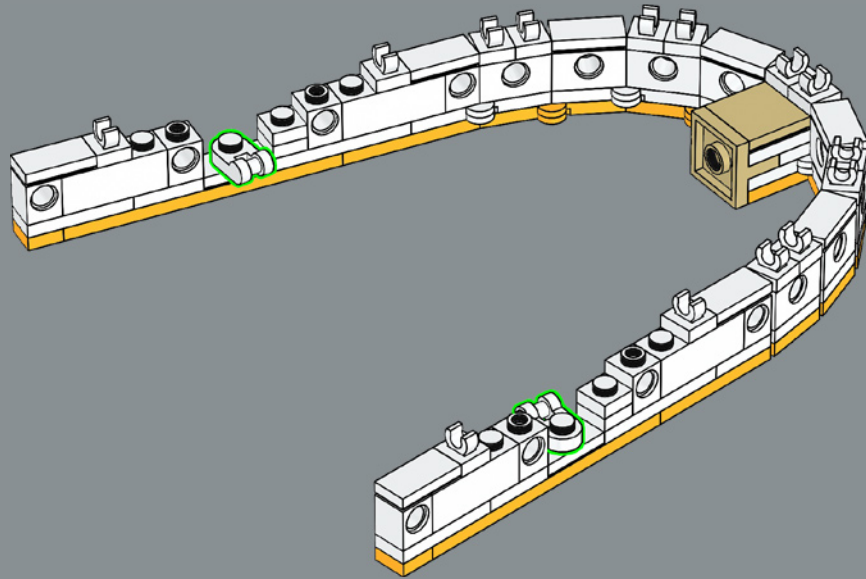

2x

372

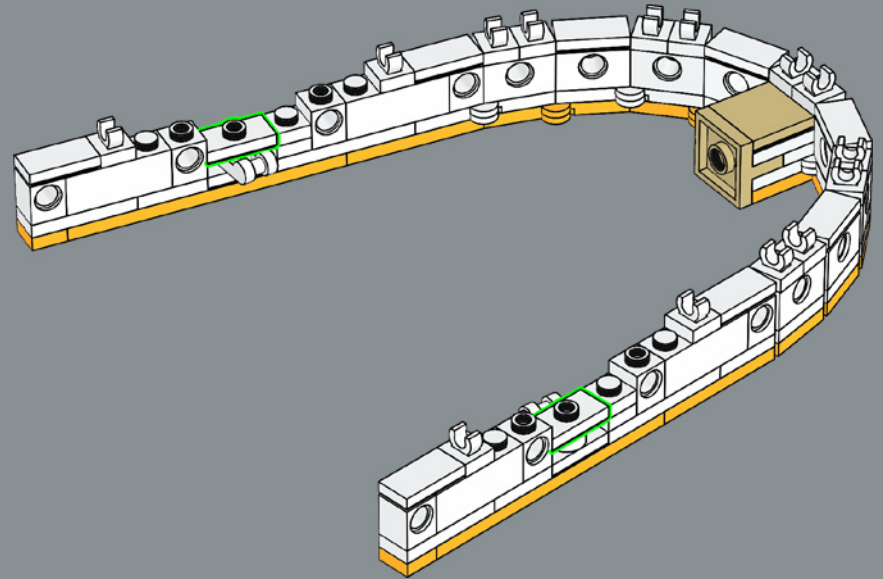

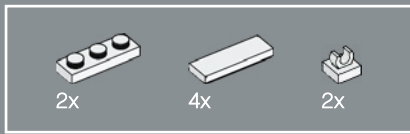

373

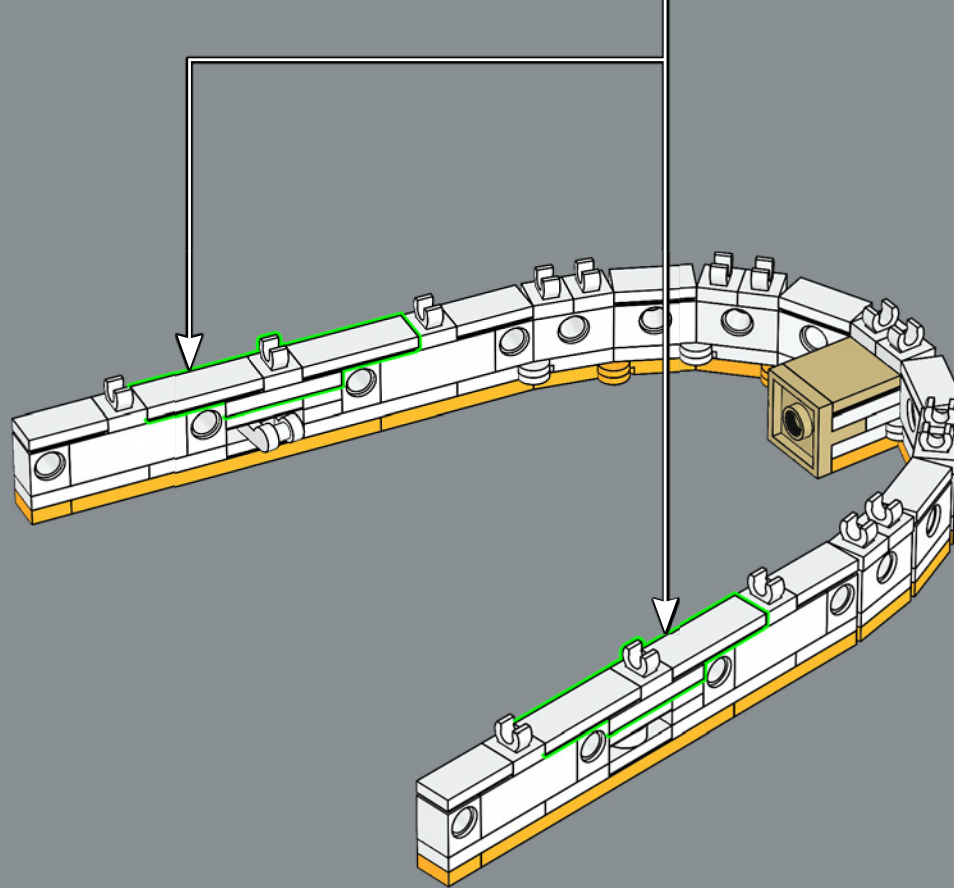
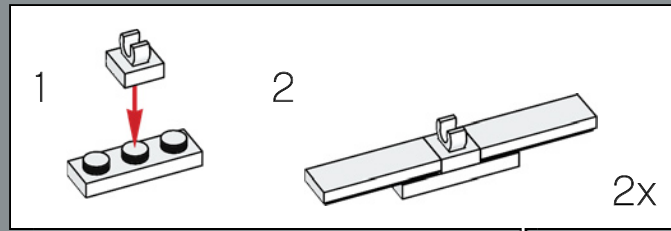

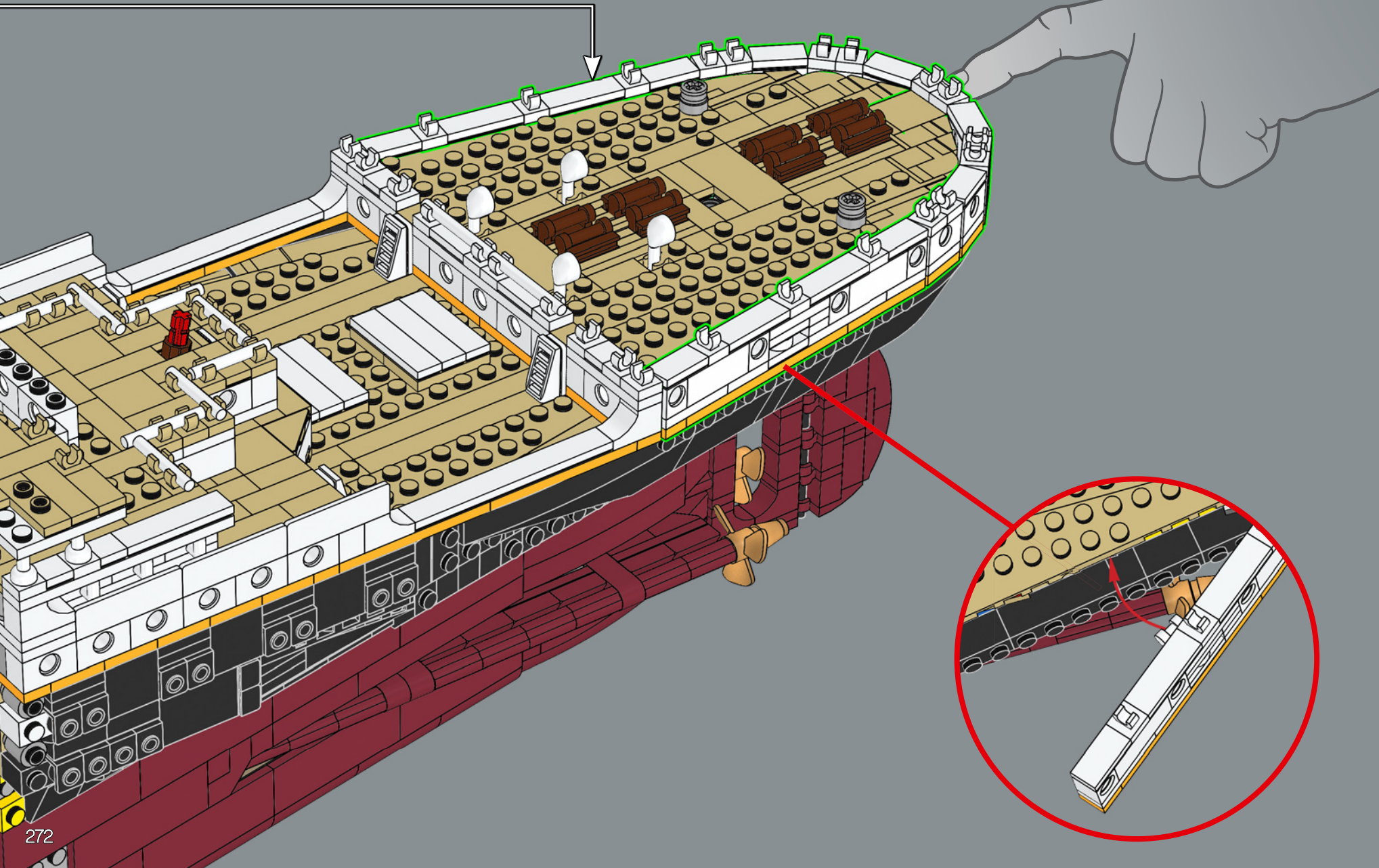

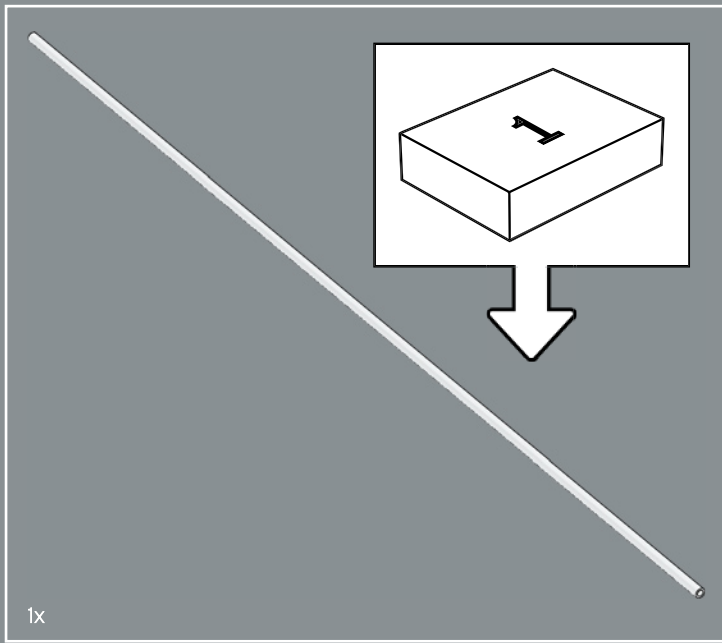

375

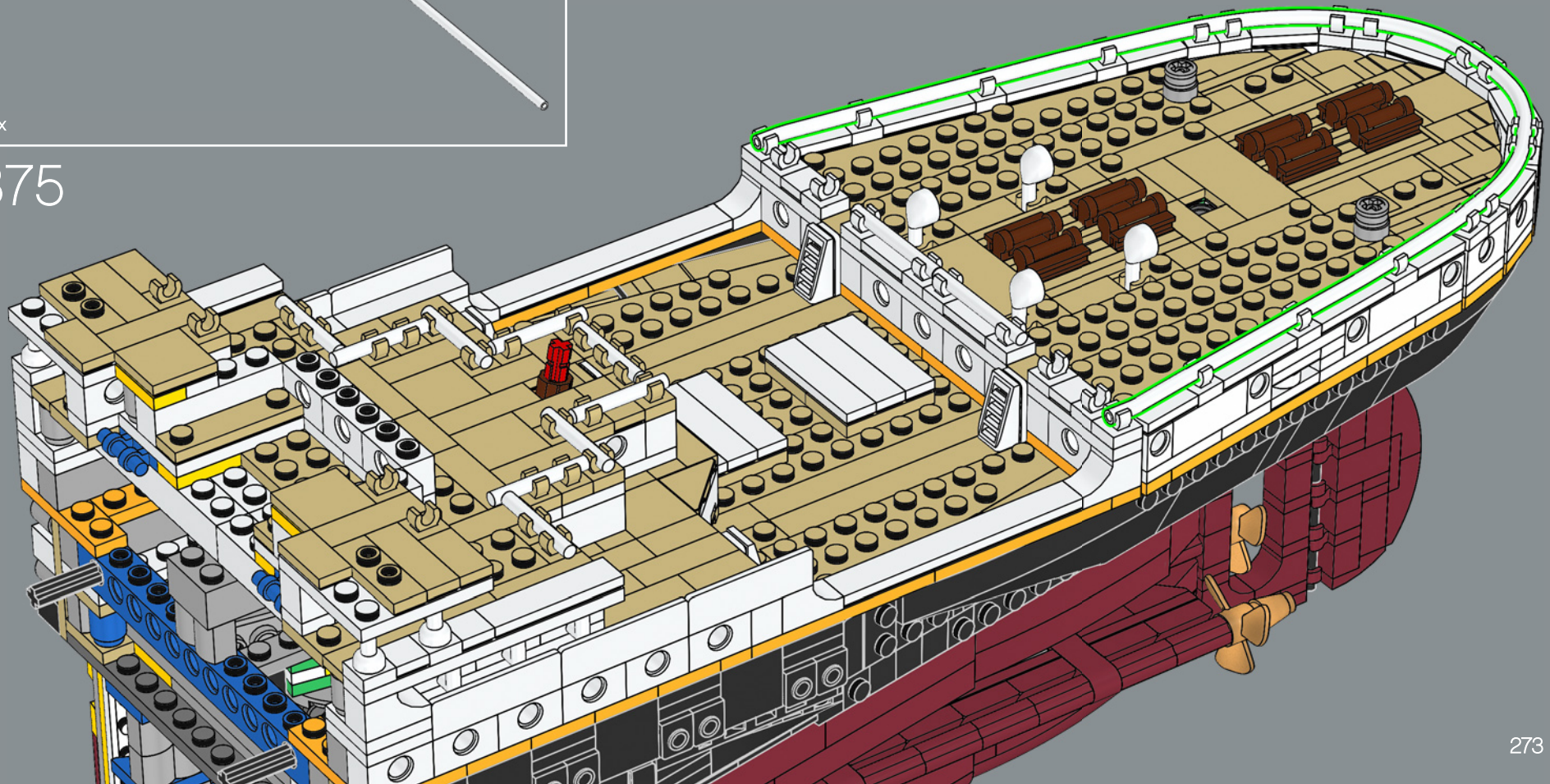



376

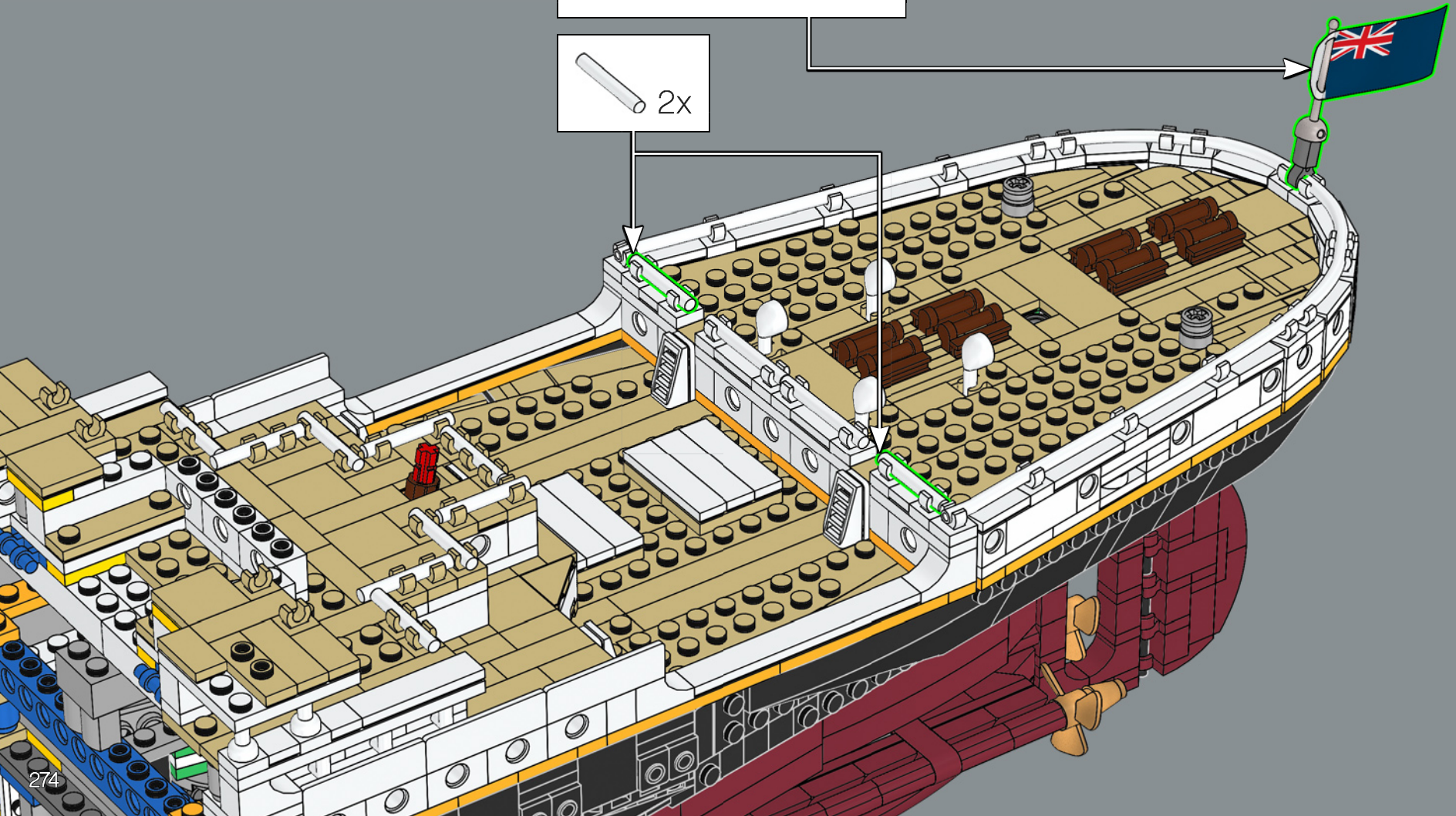
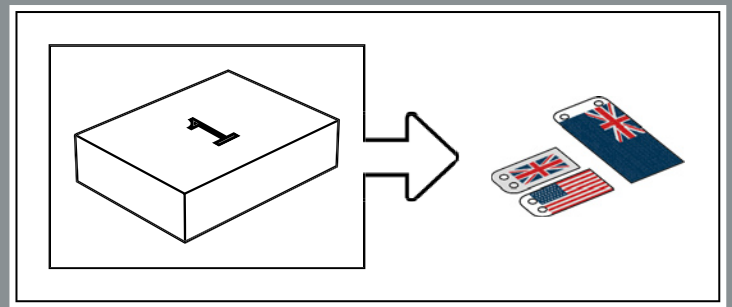
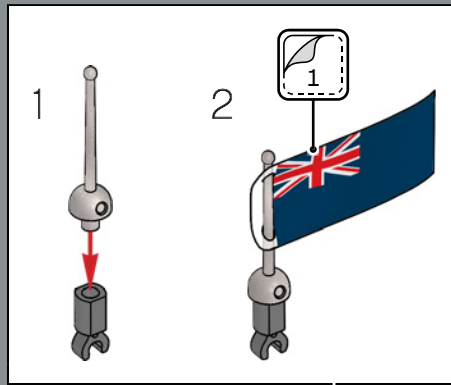

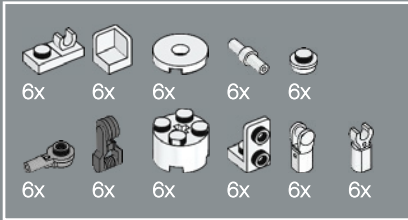
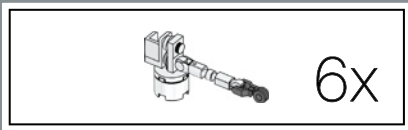

377

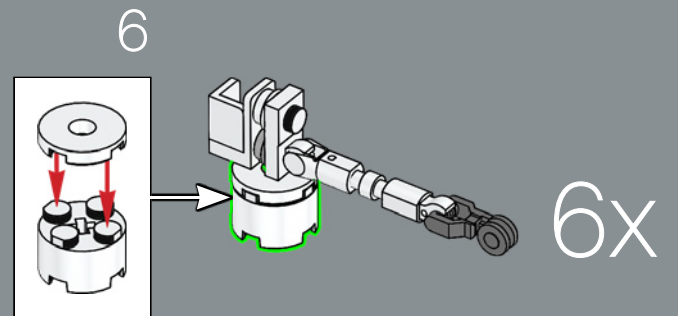
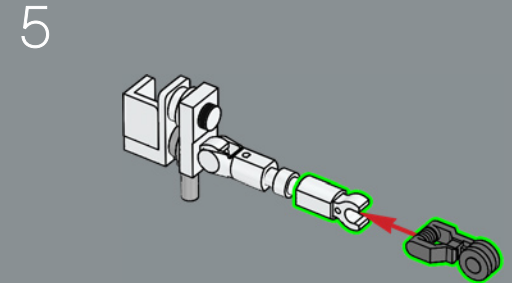
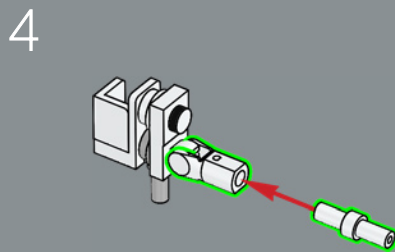
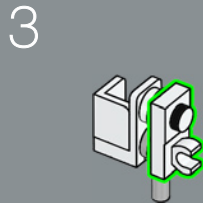
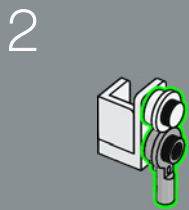
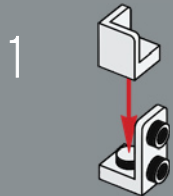

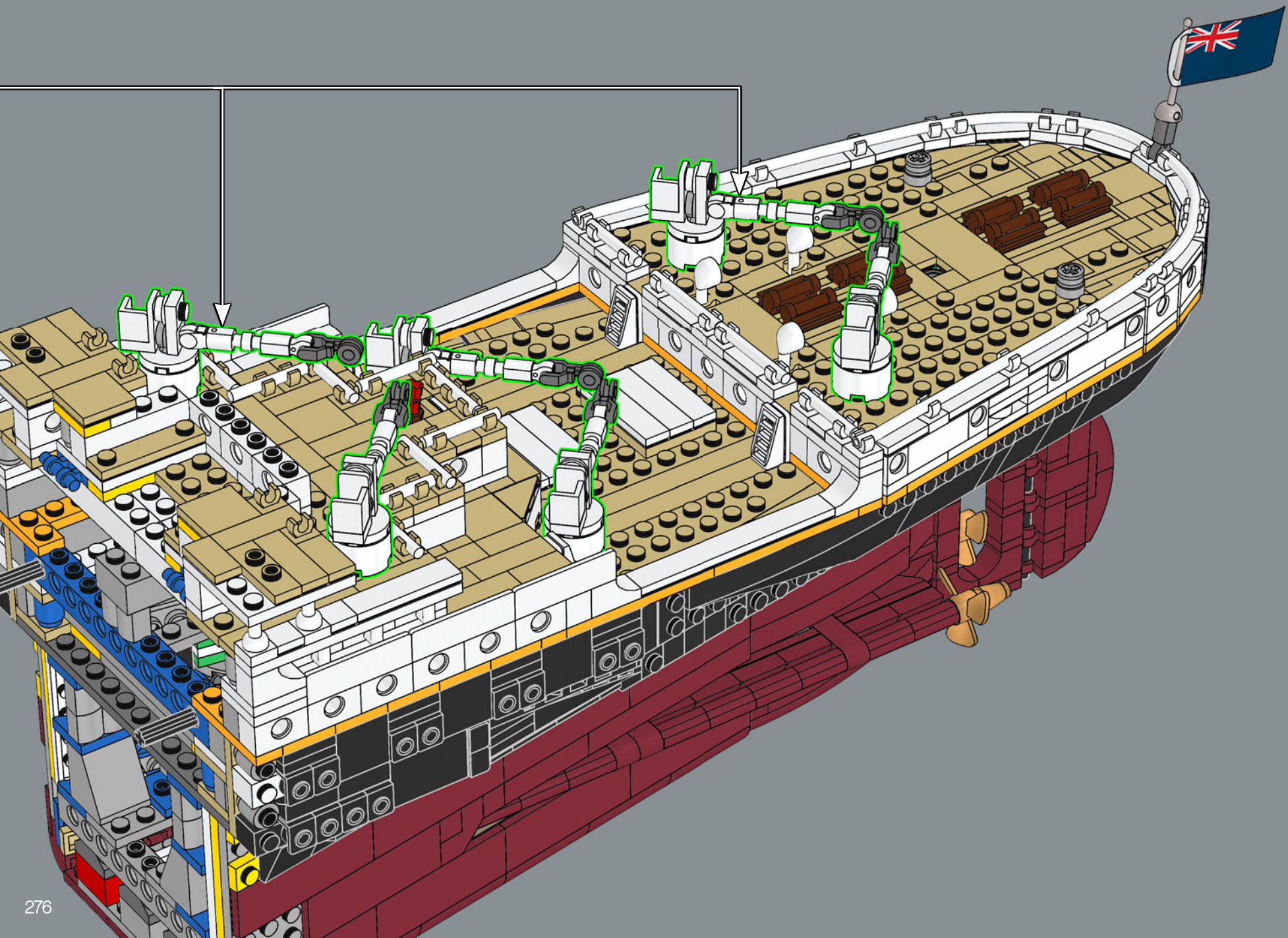

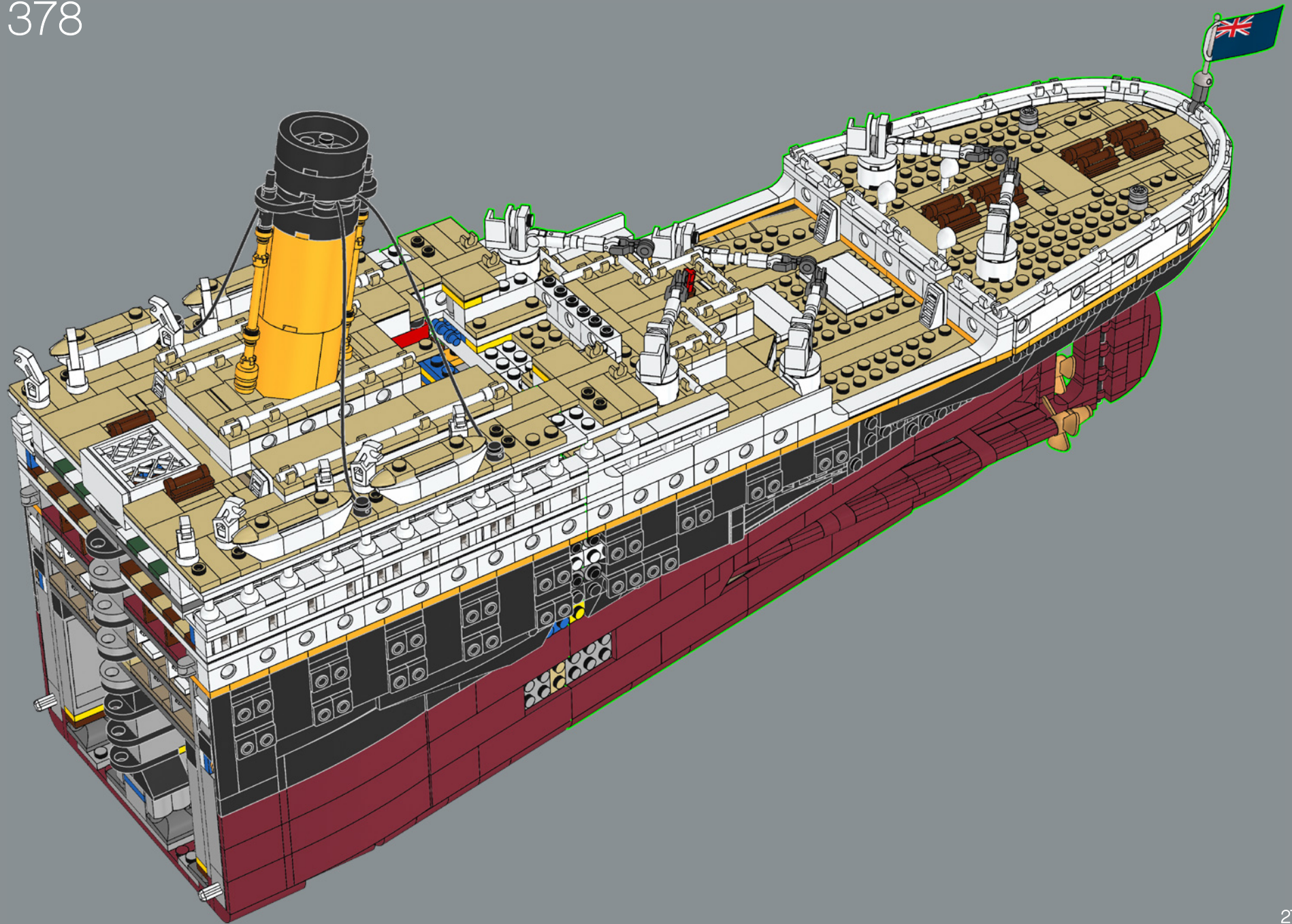

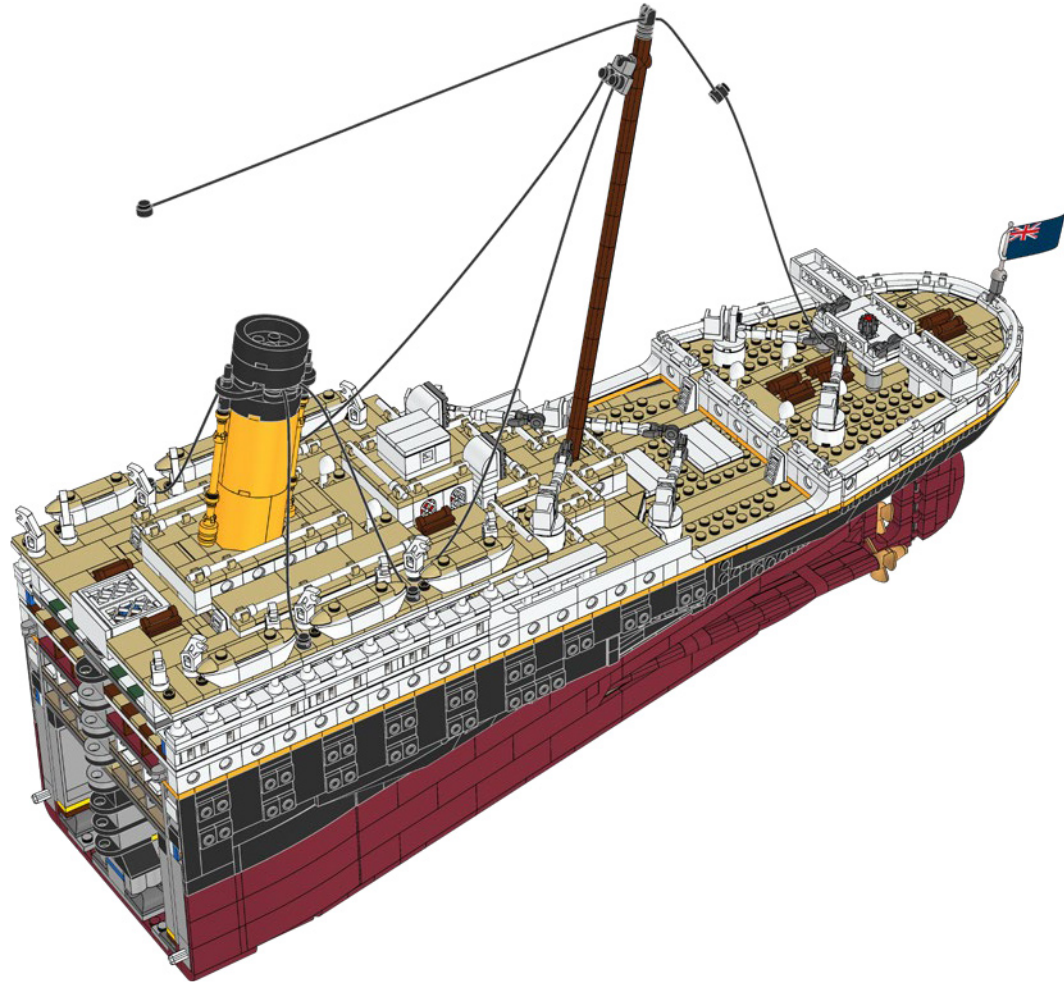
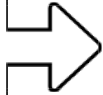

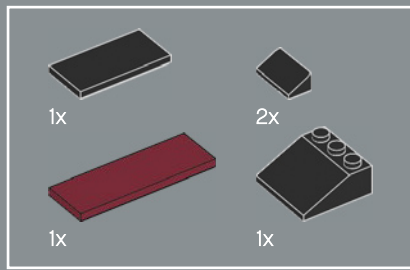

379

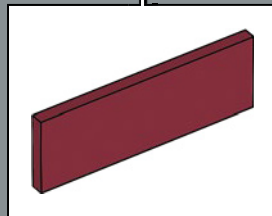
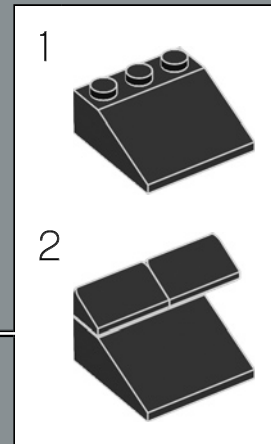
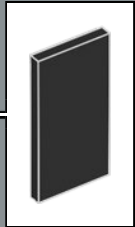
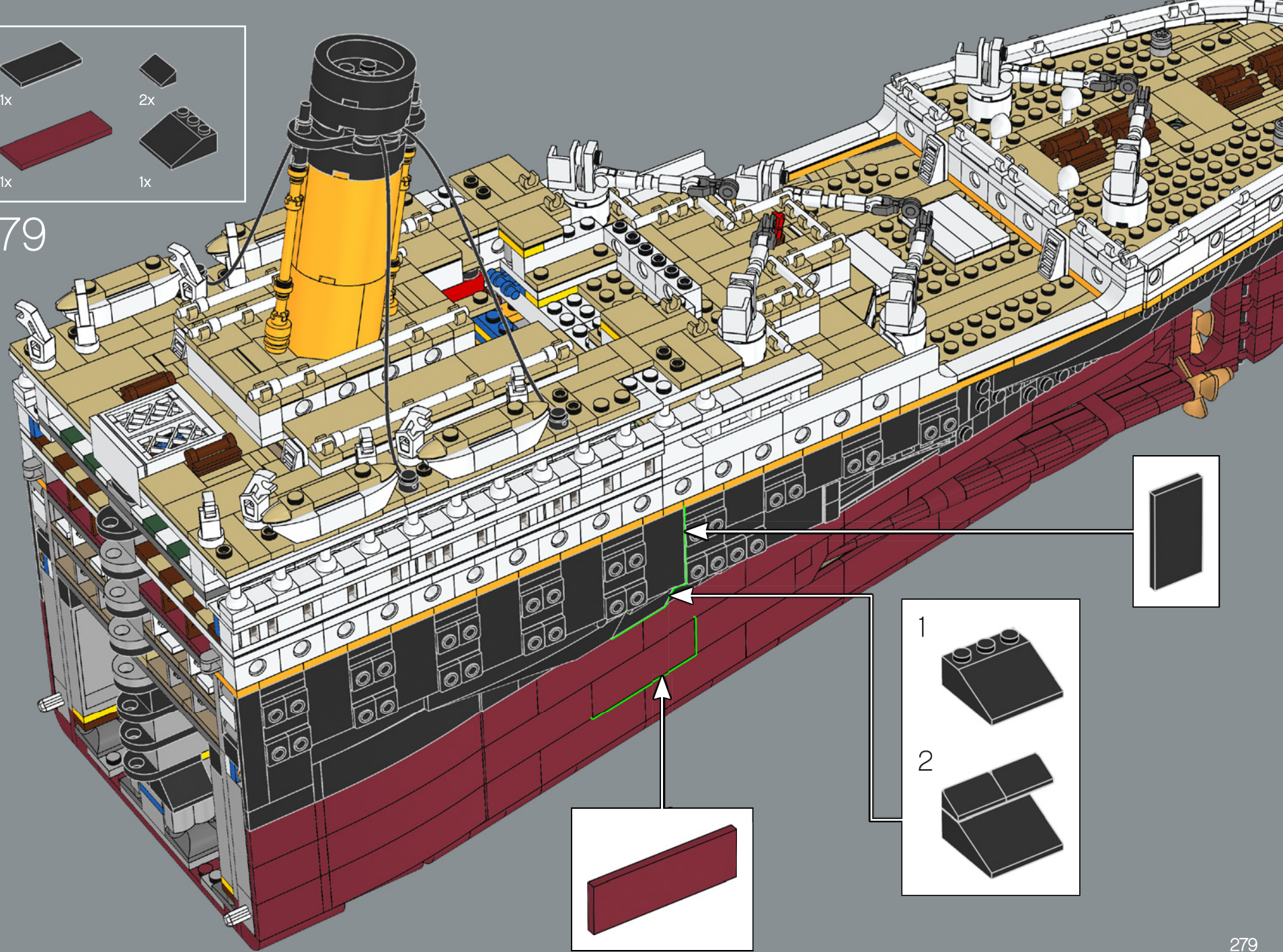

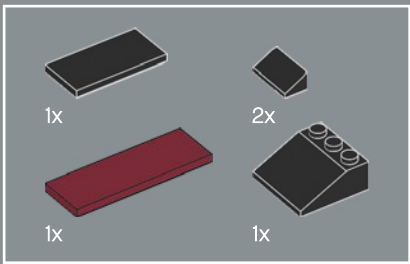

380

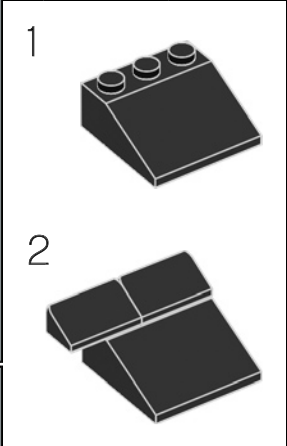
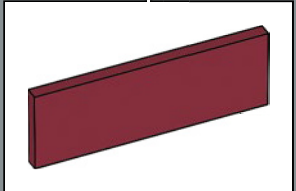
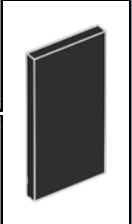
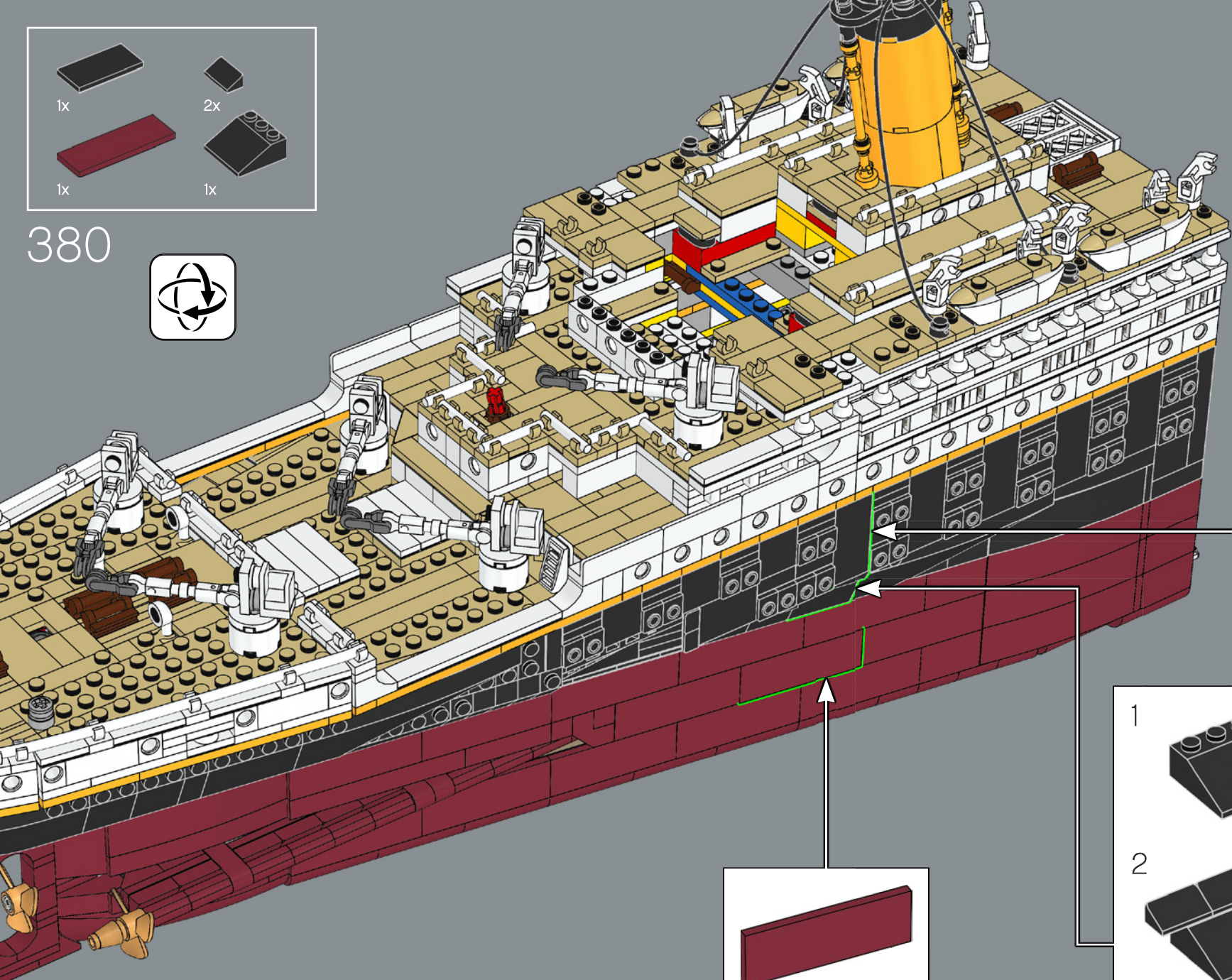

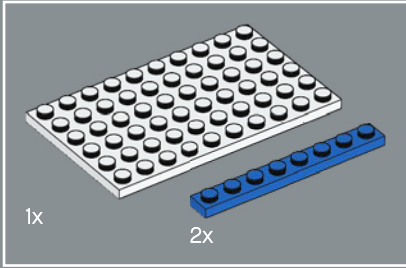
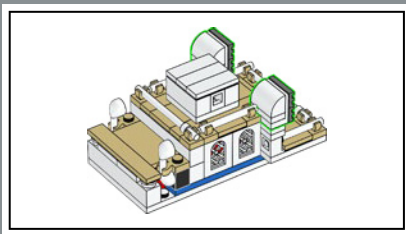

381

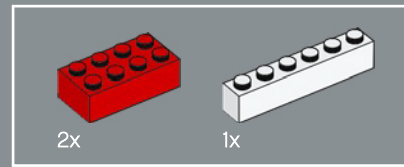
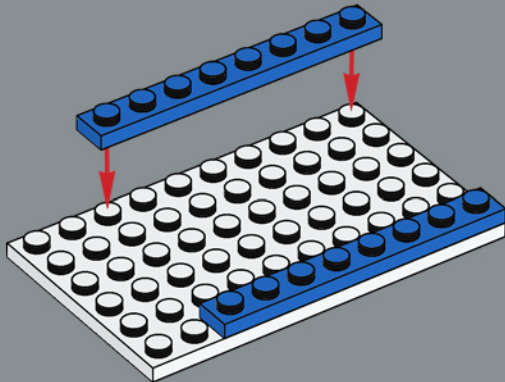

382

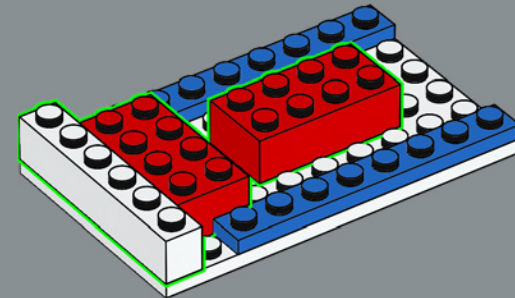

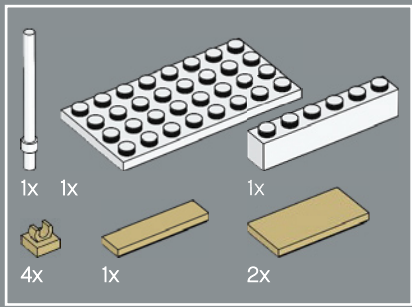

383

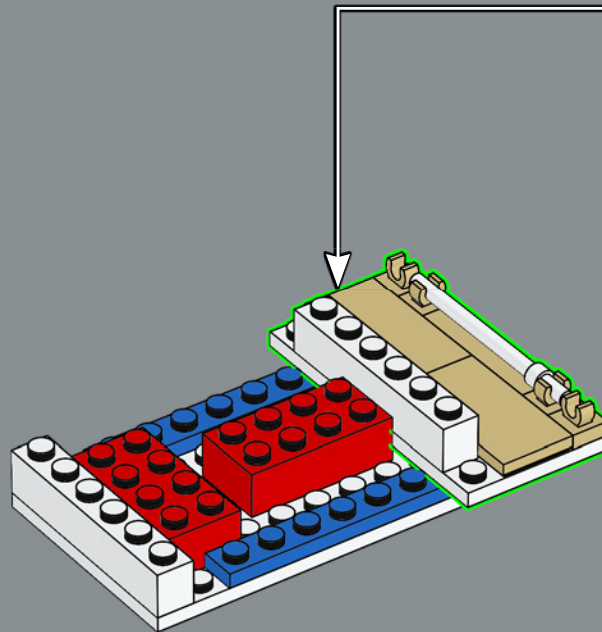
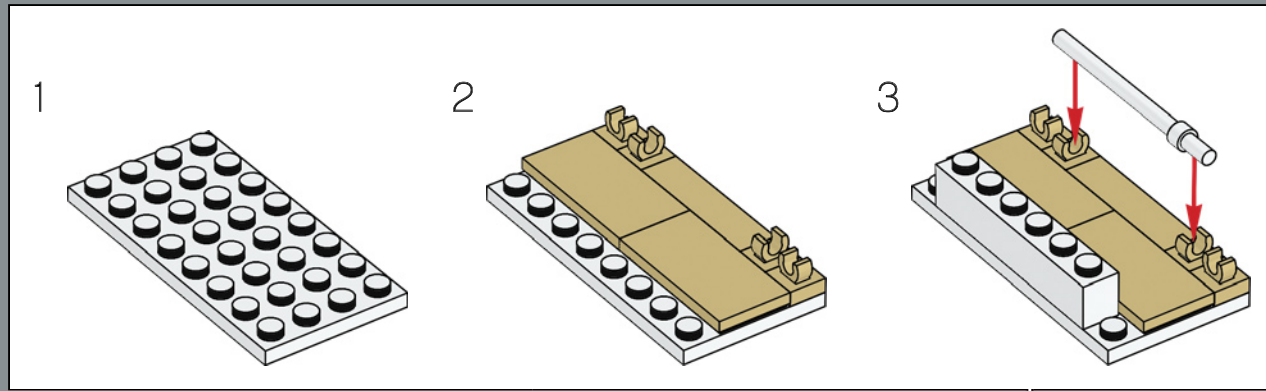

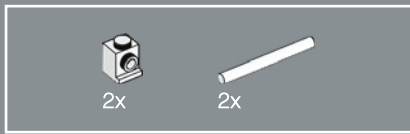

384

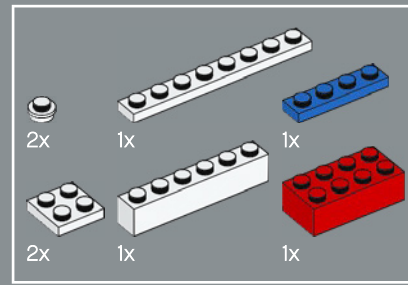
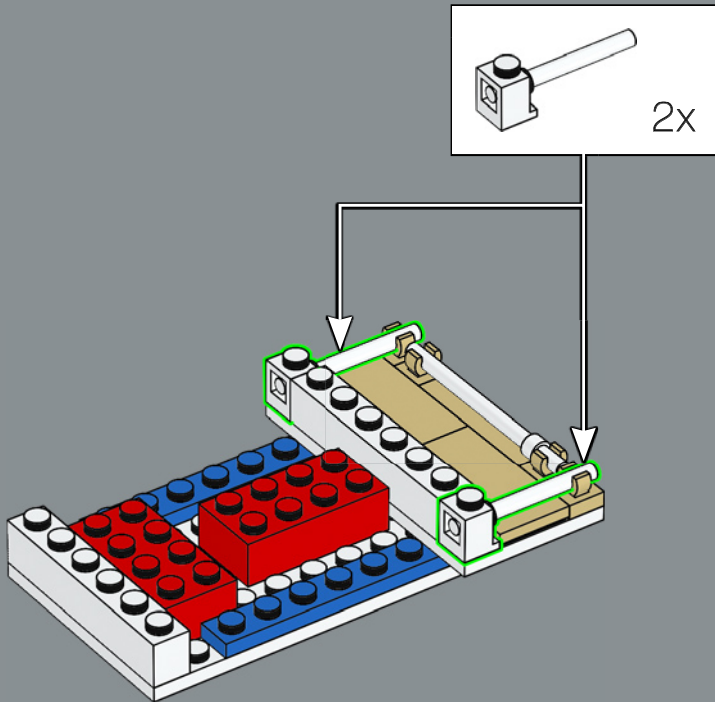

385

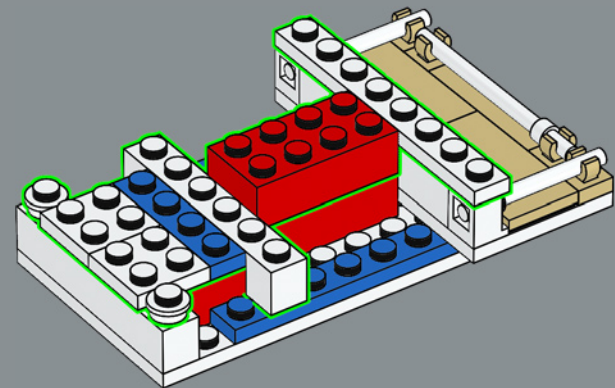

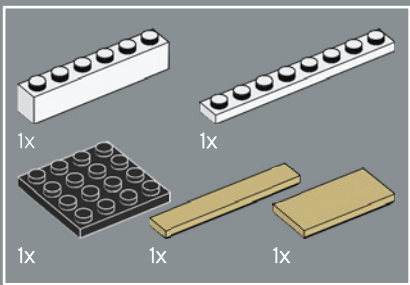

386

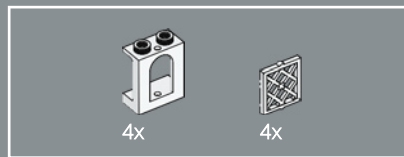
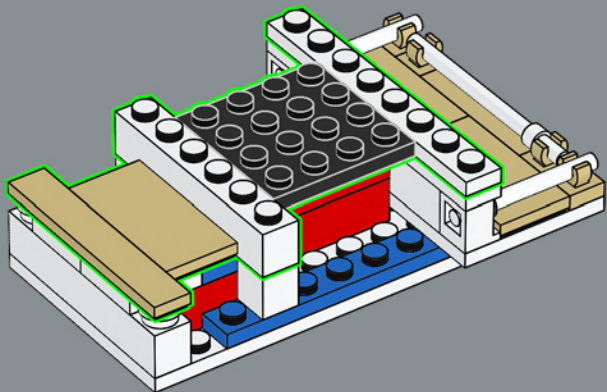

387

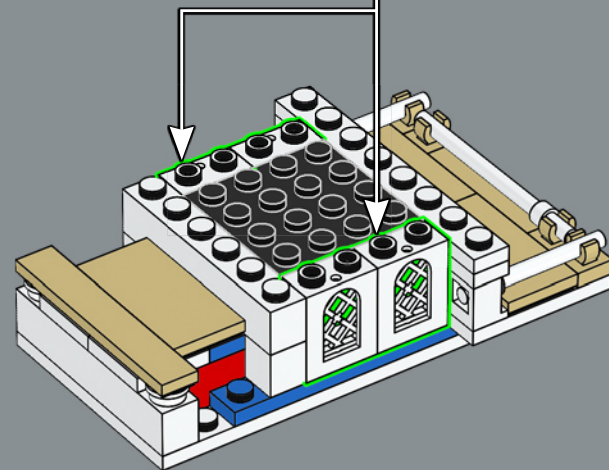
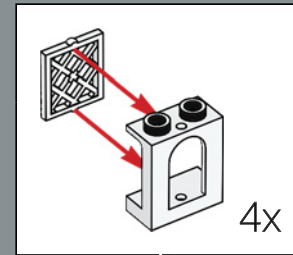

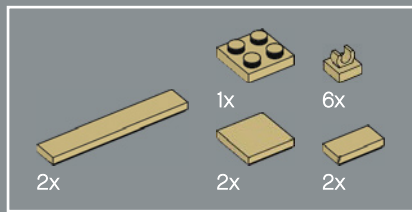

388

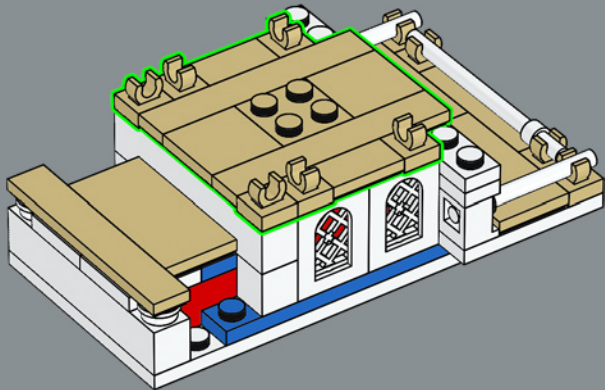

389

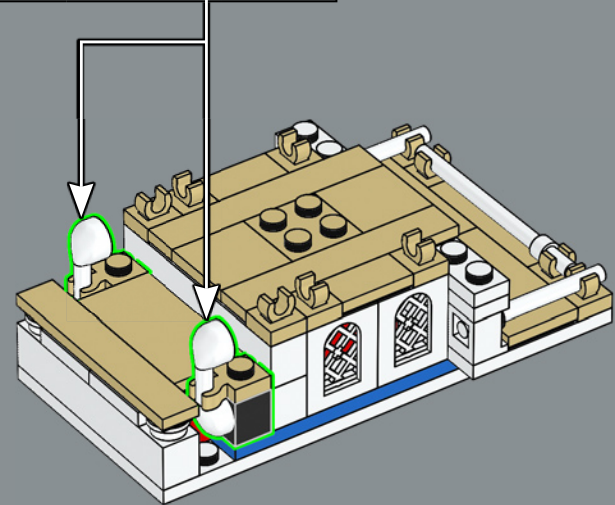
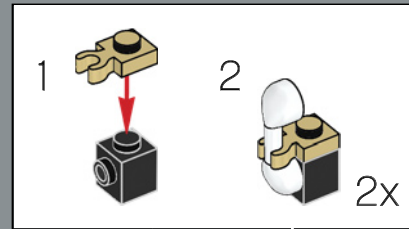

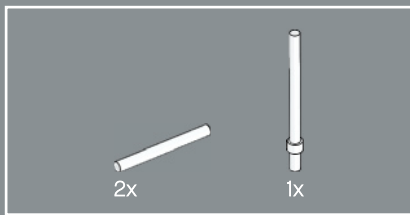

390

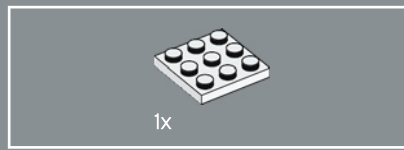
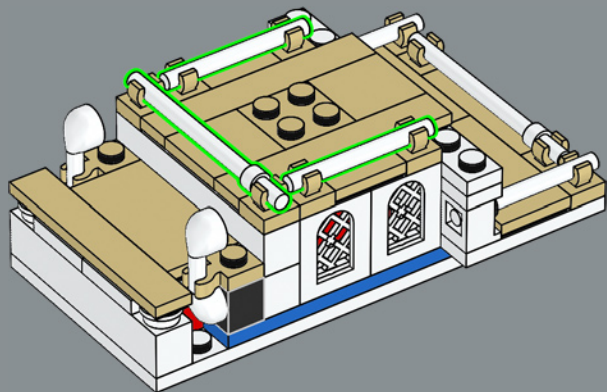

391

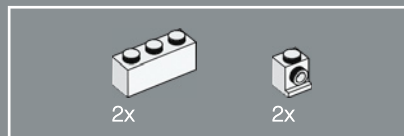
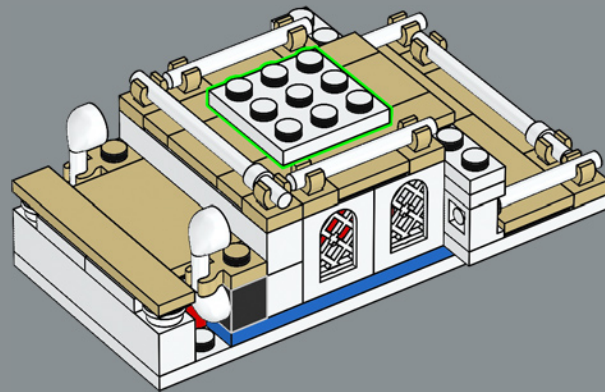

392

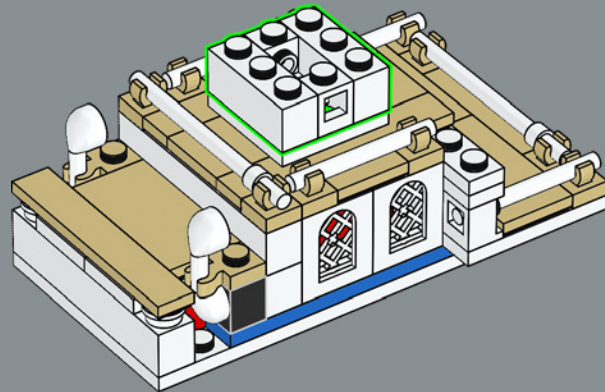

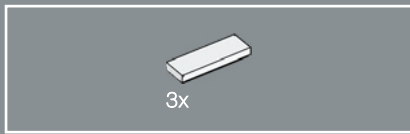

393

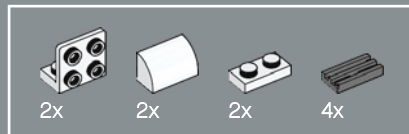
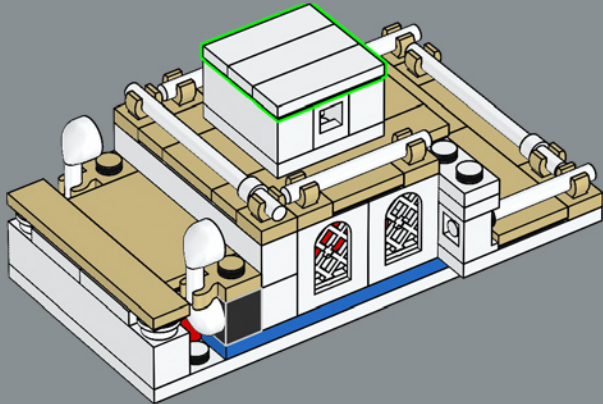

394

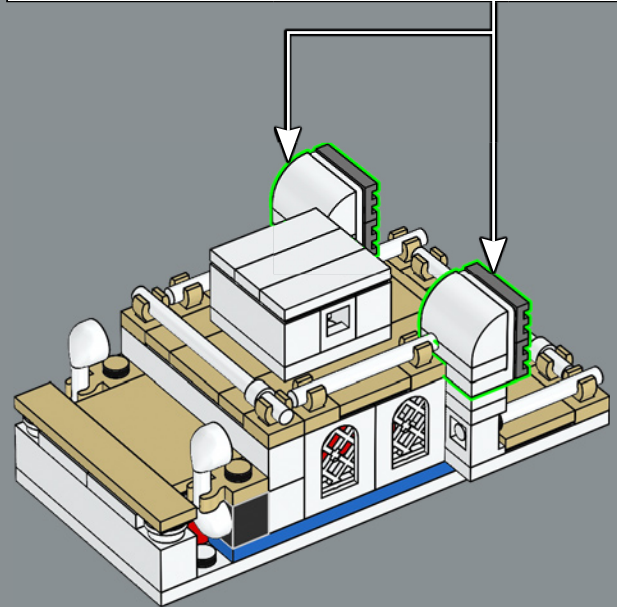
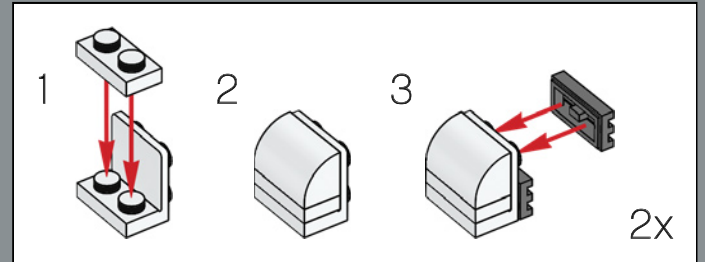

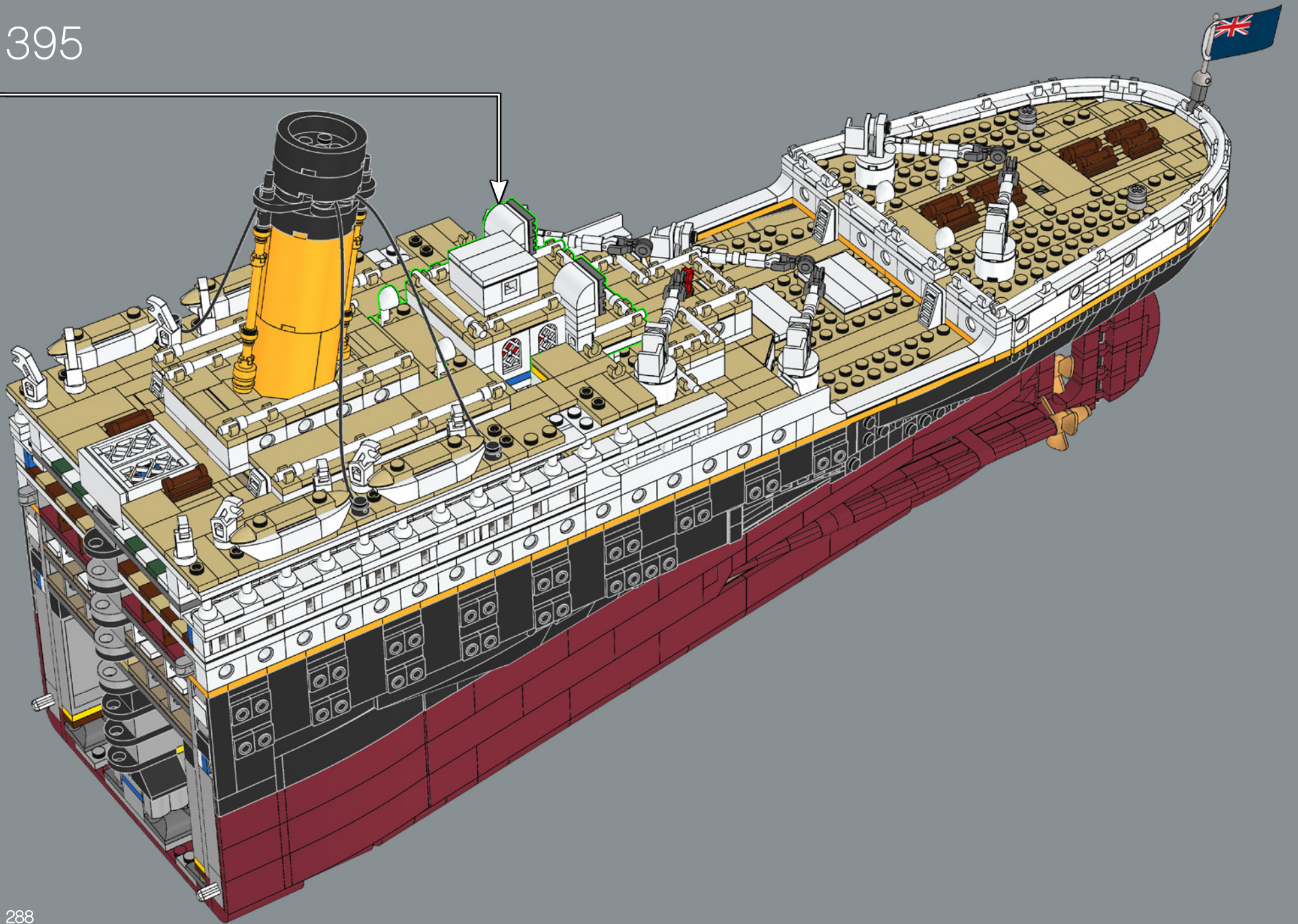

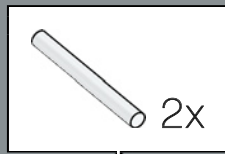
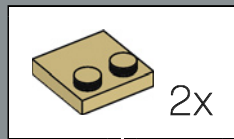
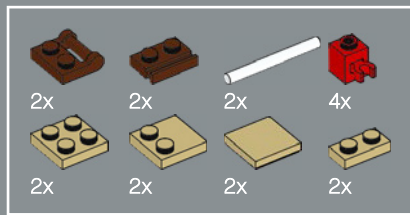

396

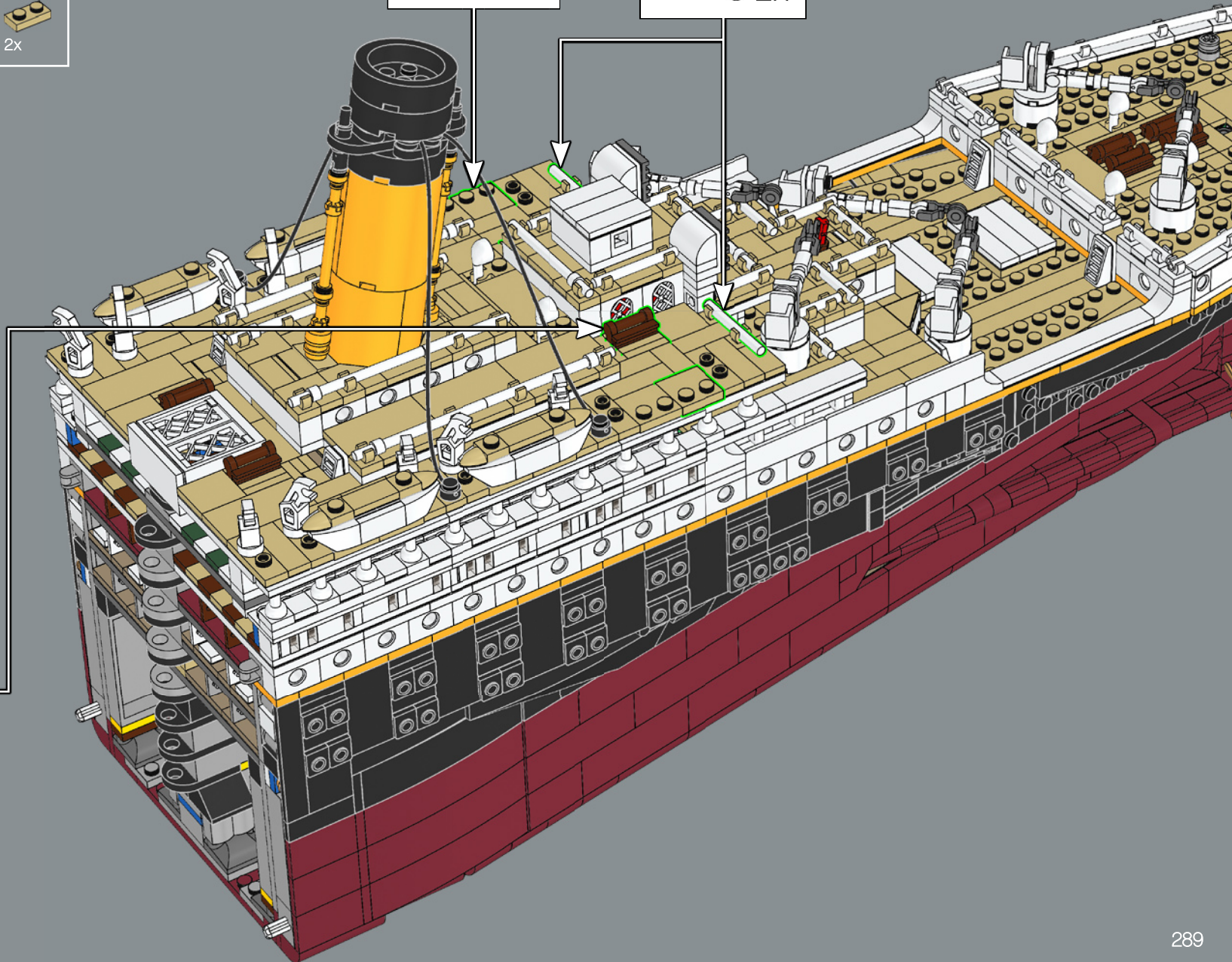
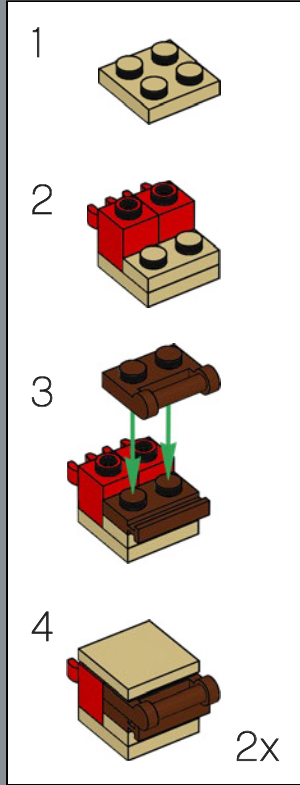

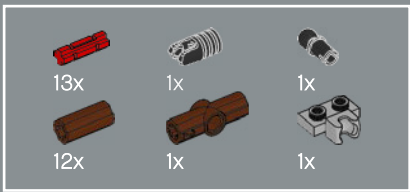

397

1

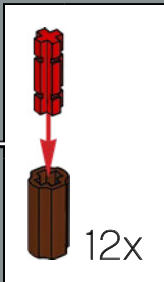
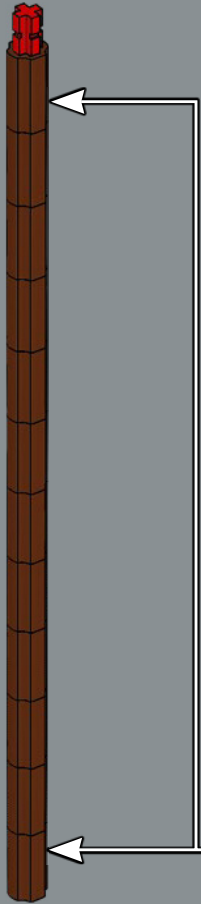

2



3

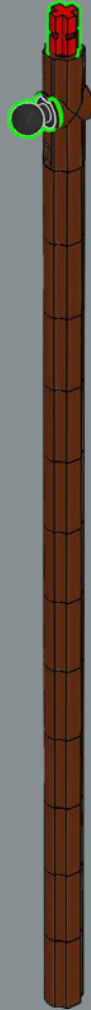

4

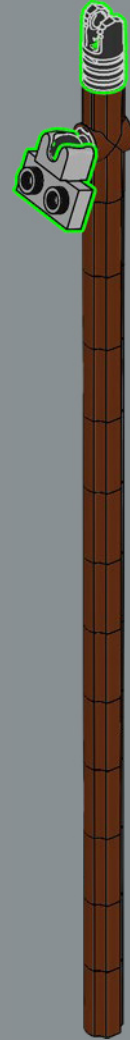

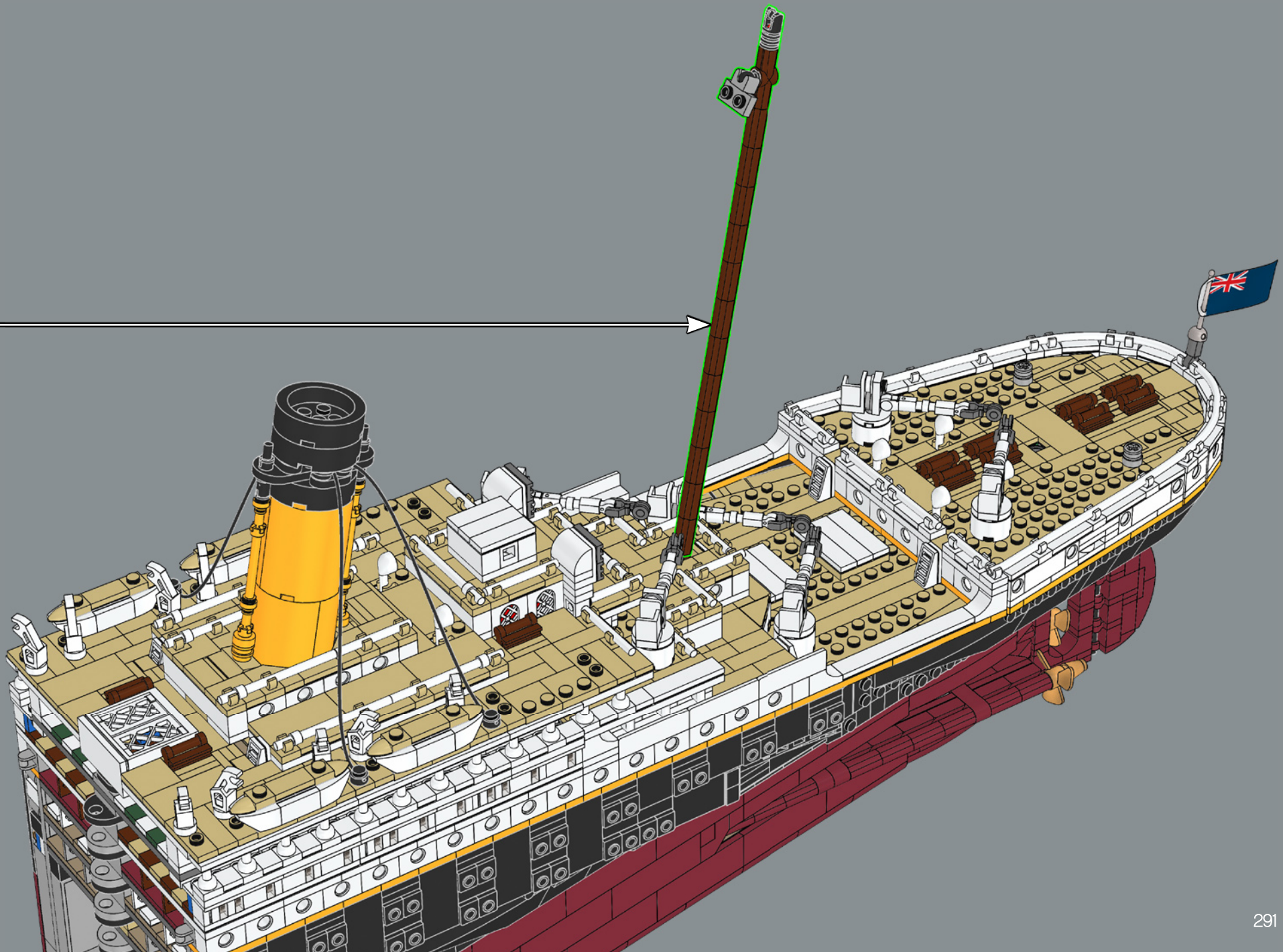

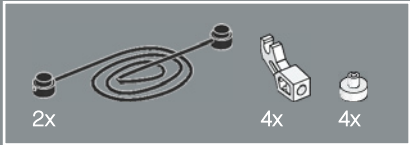
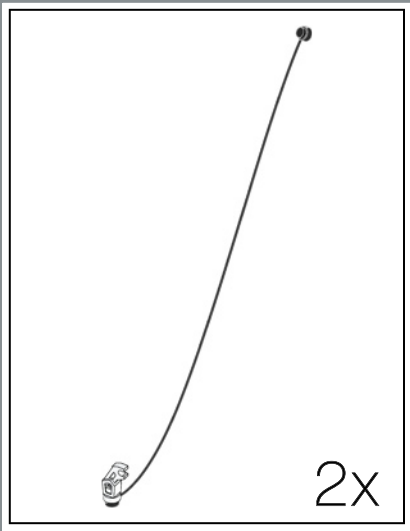

398

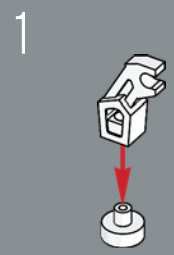

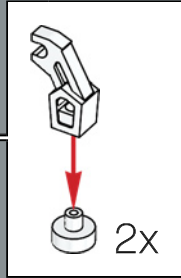
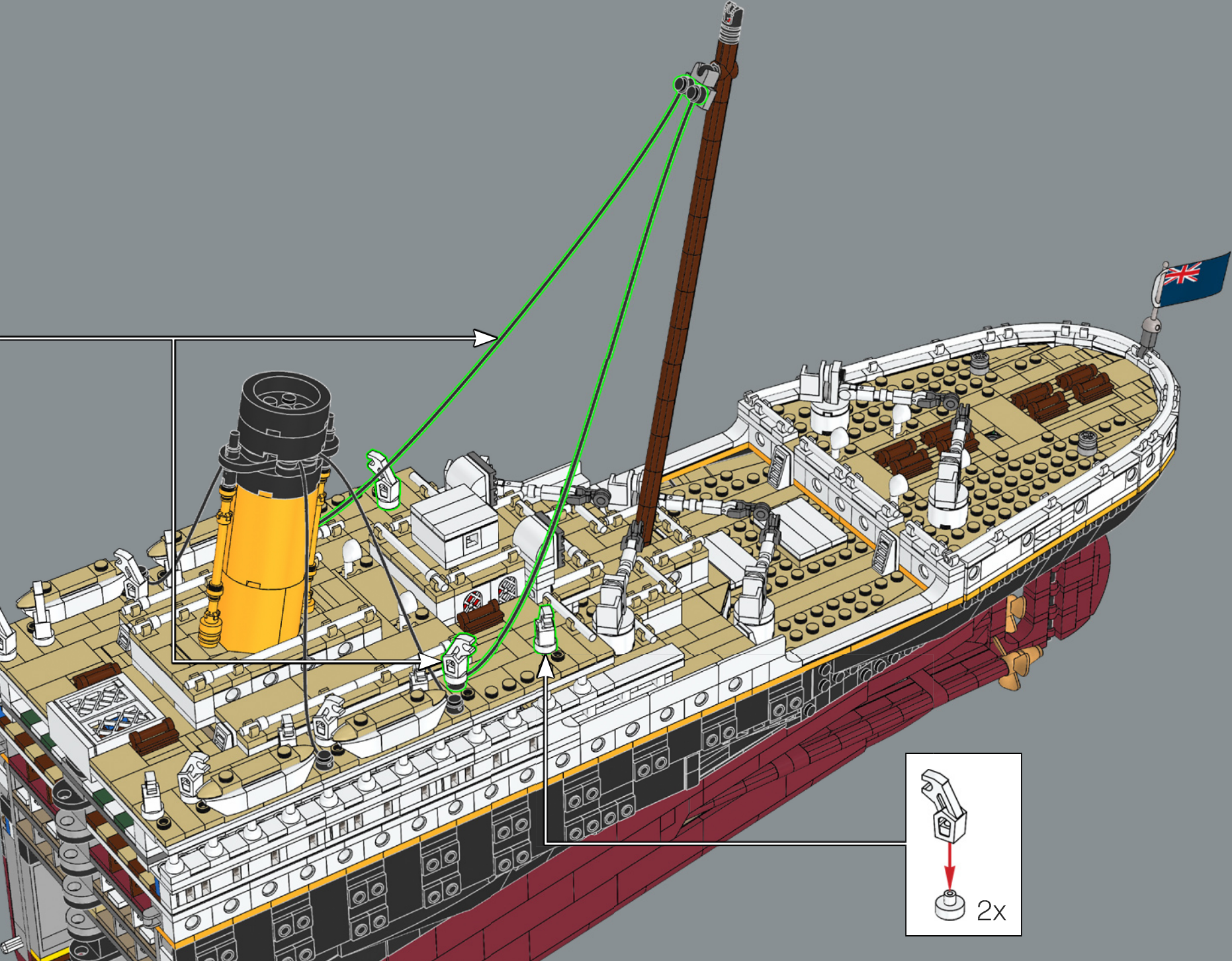

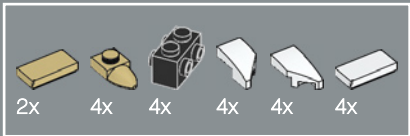

399

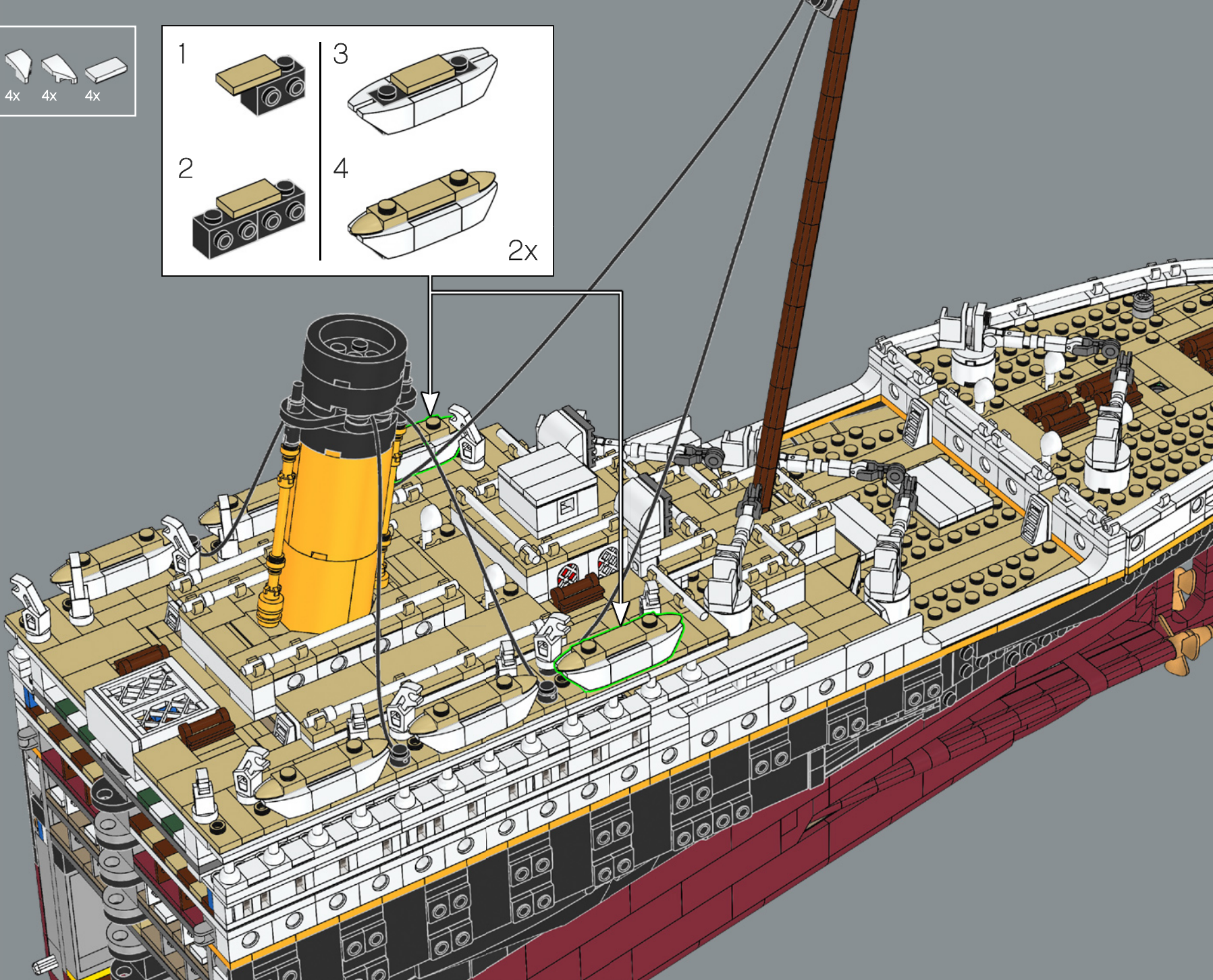
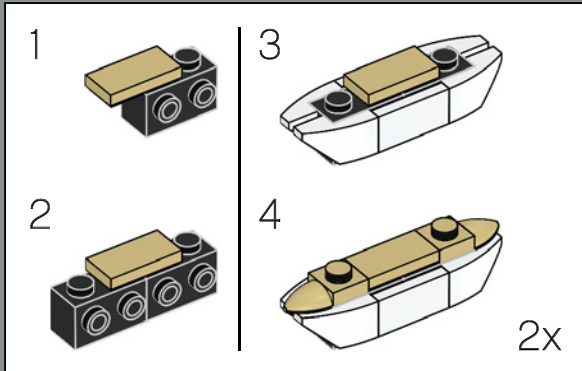

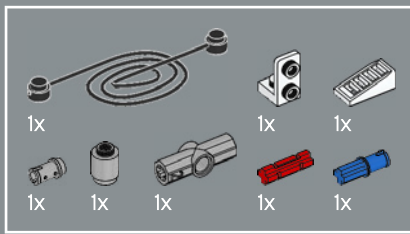

400

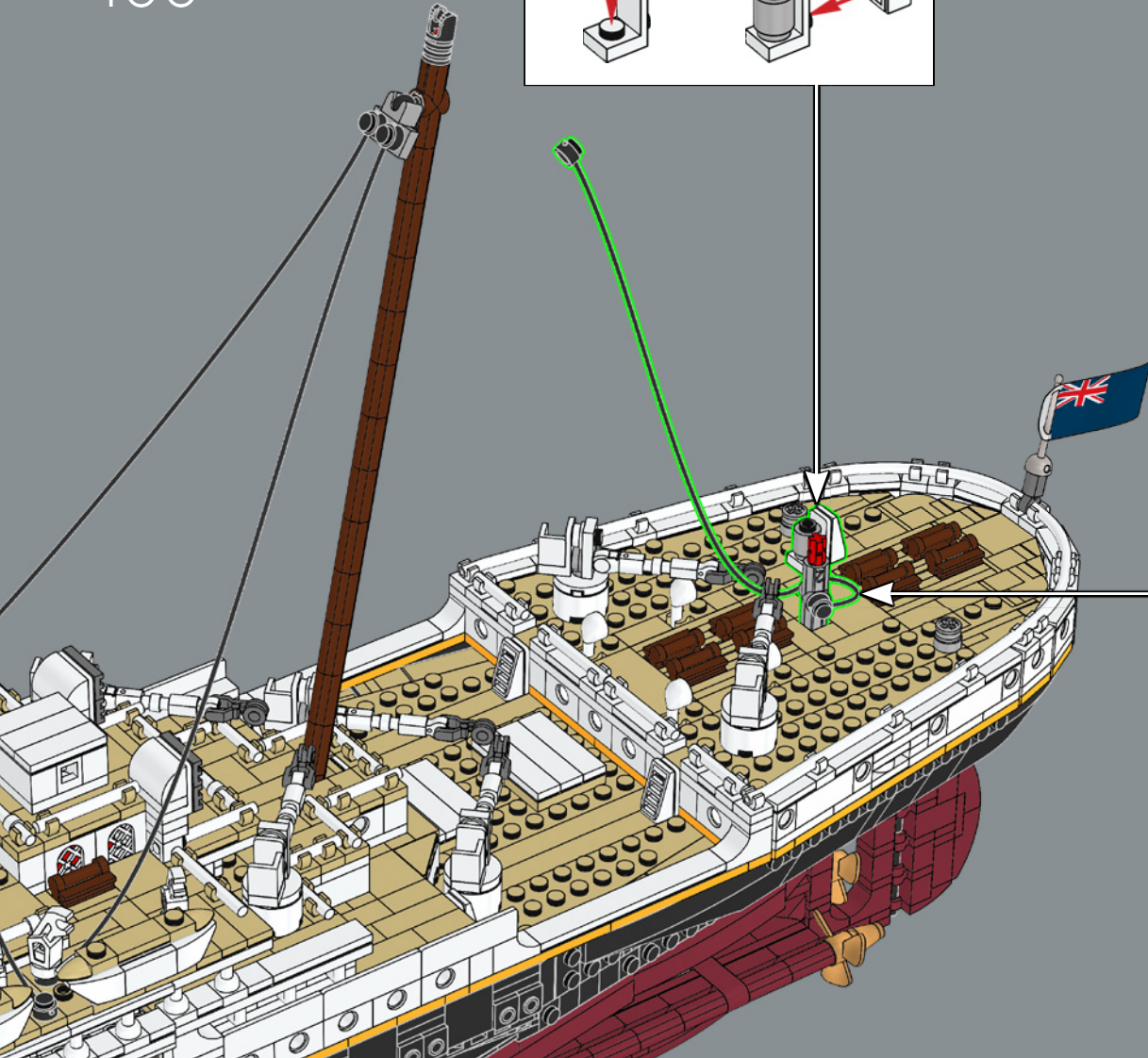
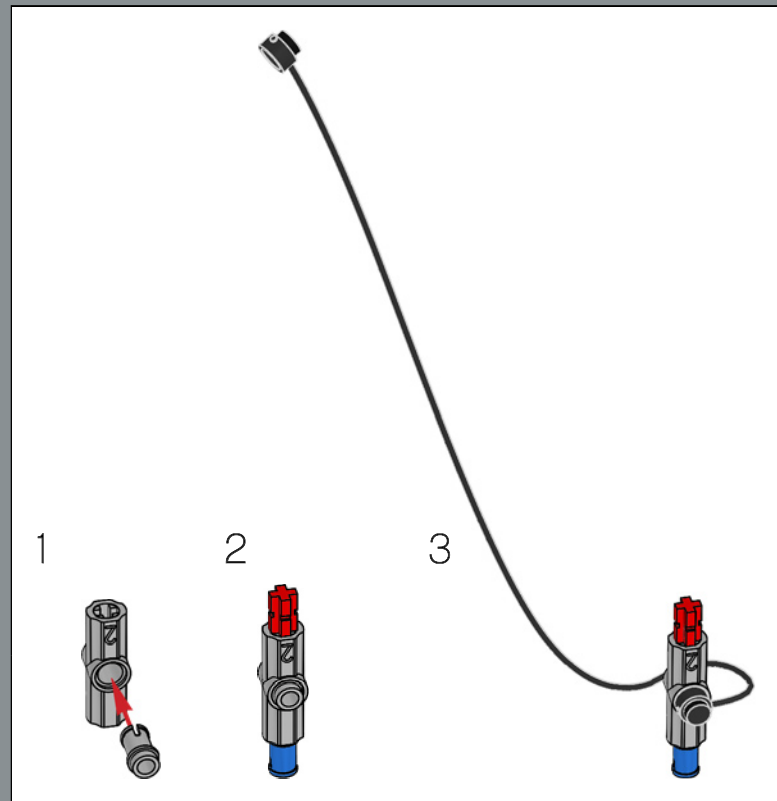
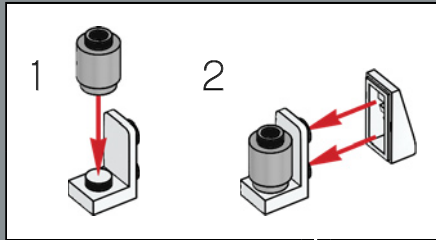

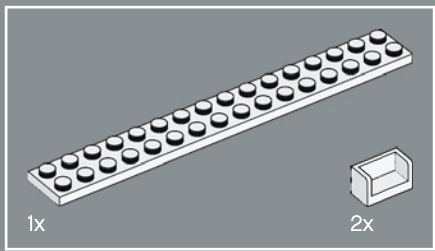

401

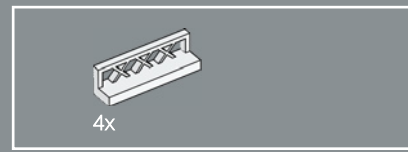
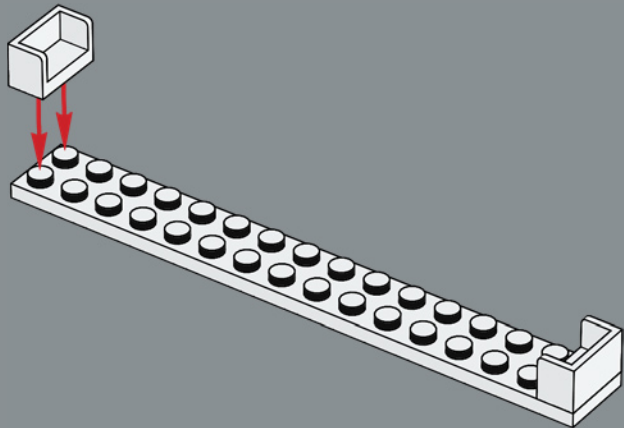

402

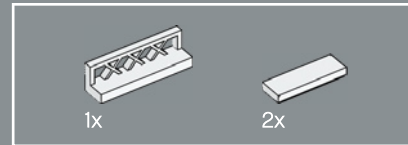
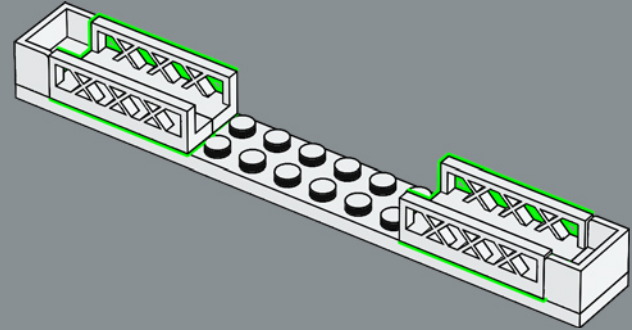

403

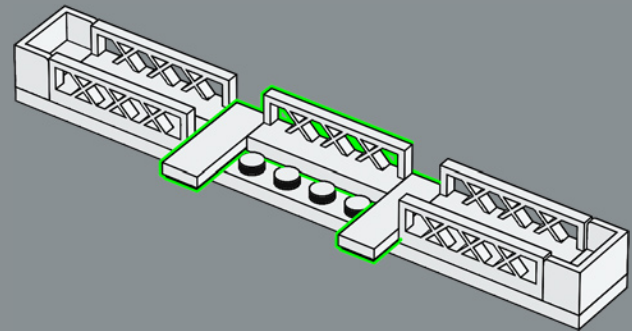

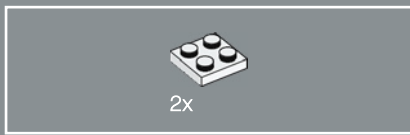

404

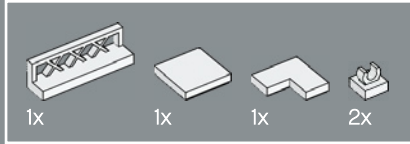
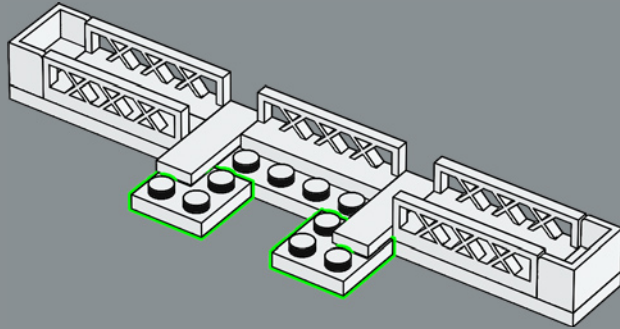

405

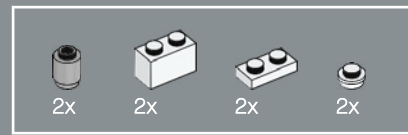
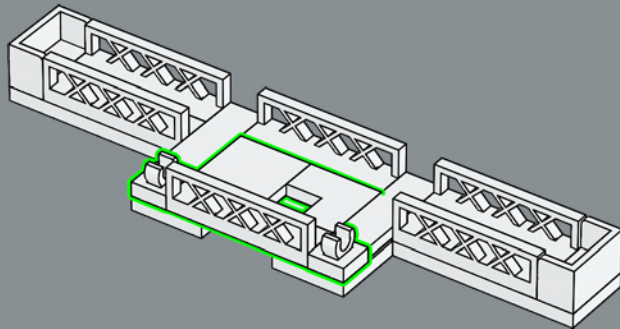

406

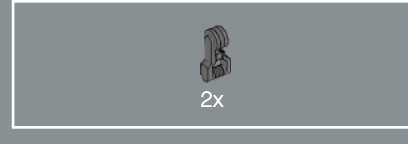
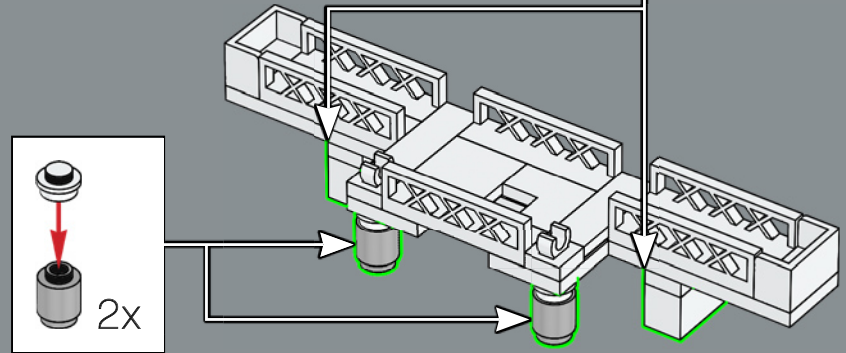

407

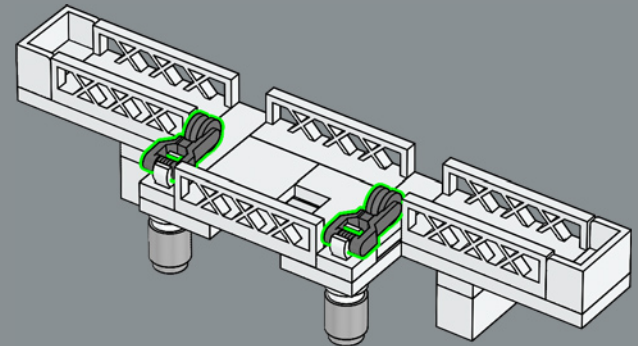



1x

408

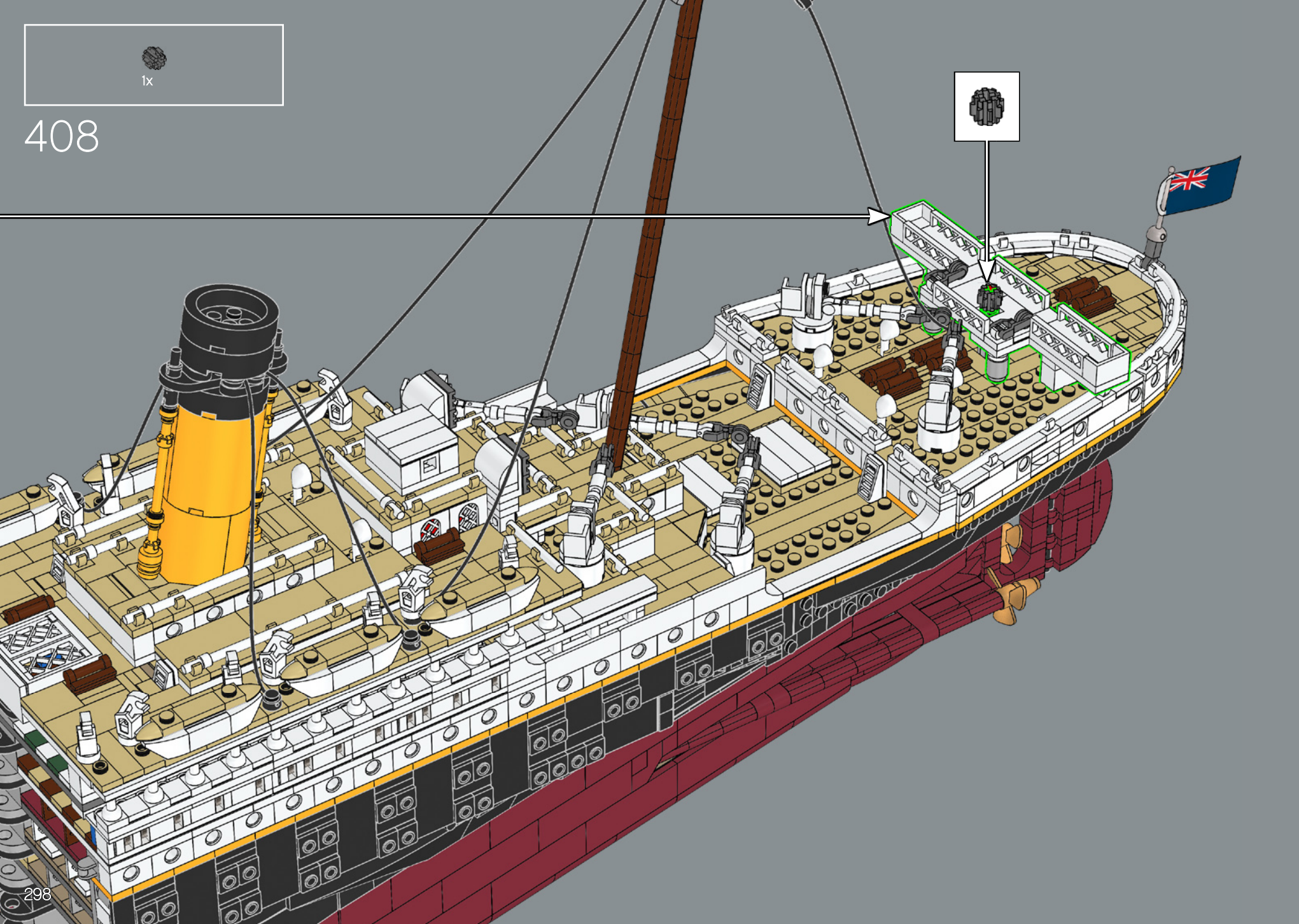

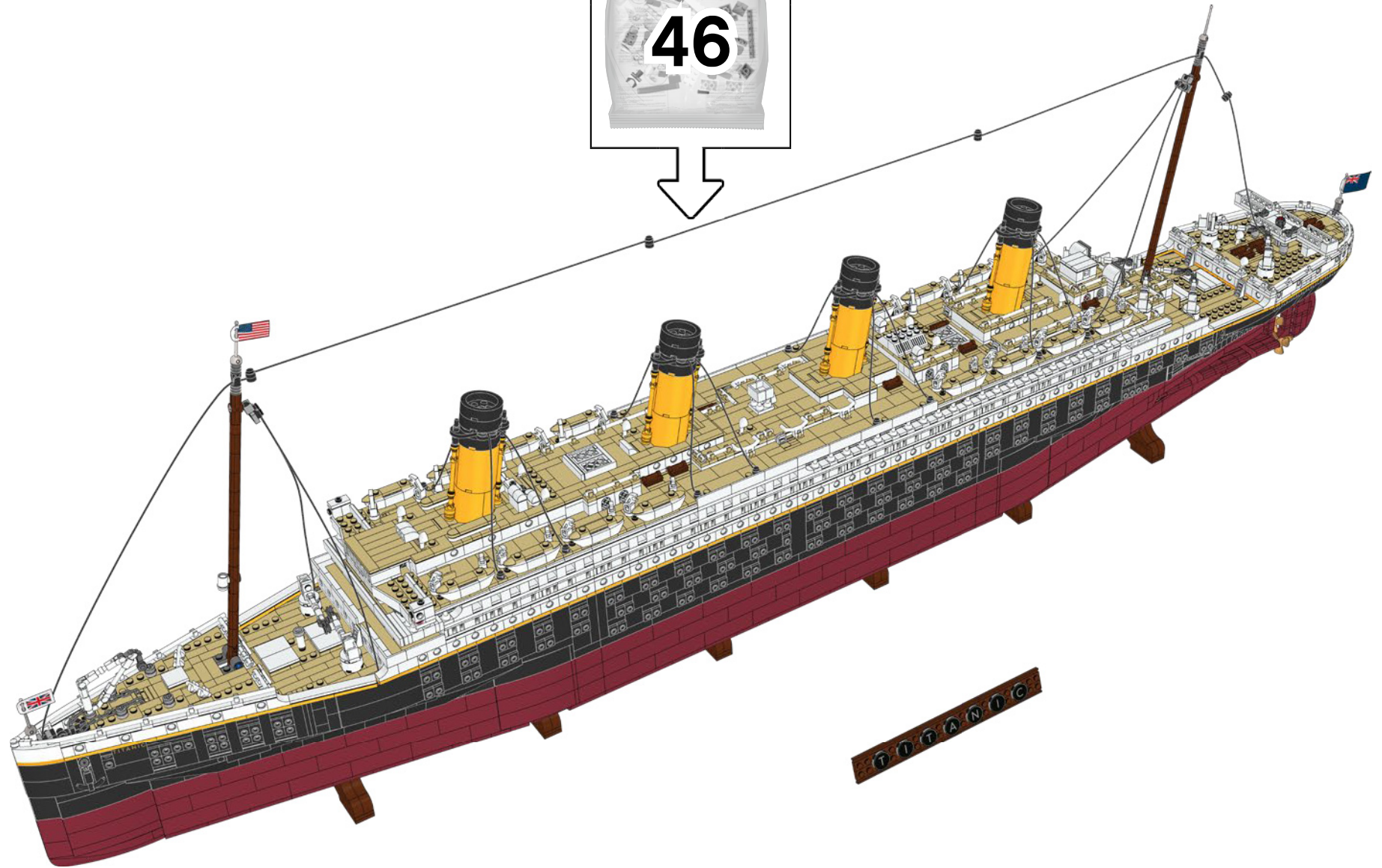

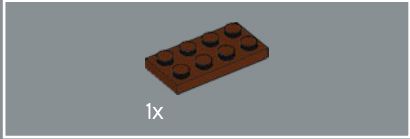
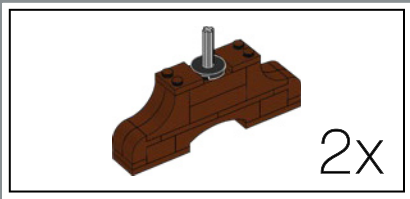

409

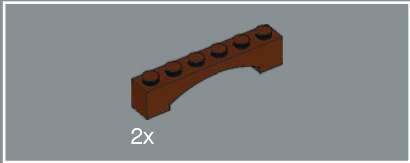
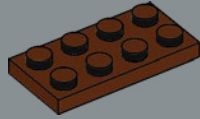

410

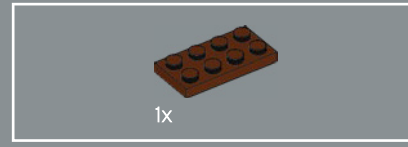
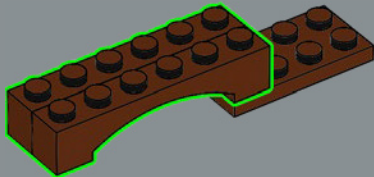

411

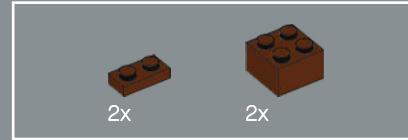
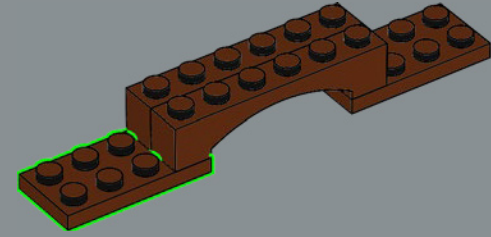

412

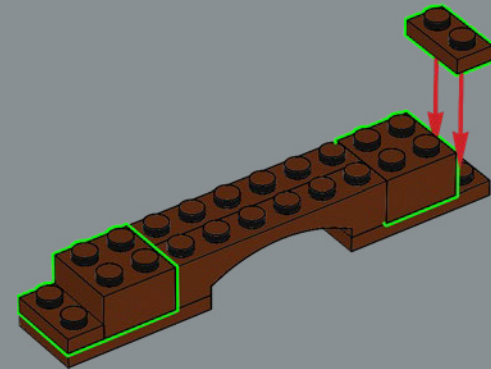

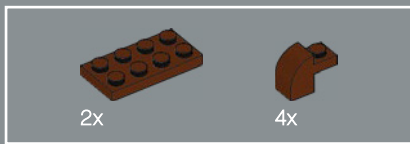

413

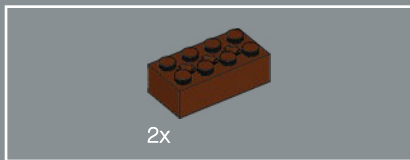
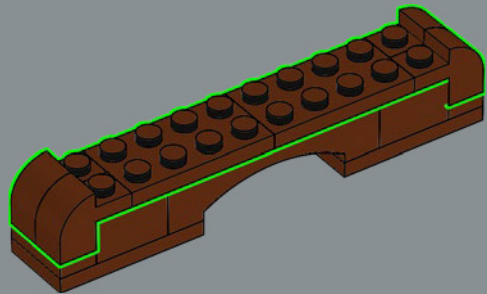

414

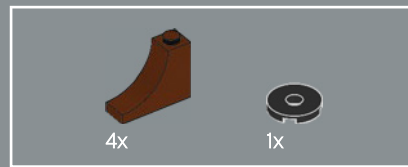
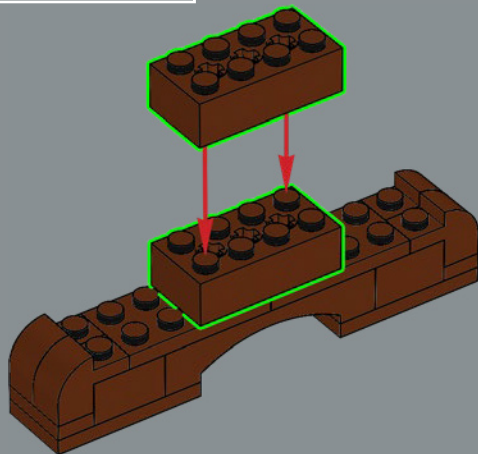

415

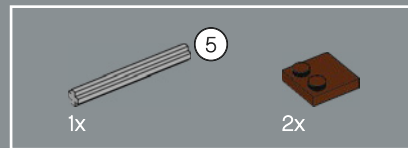
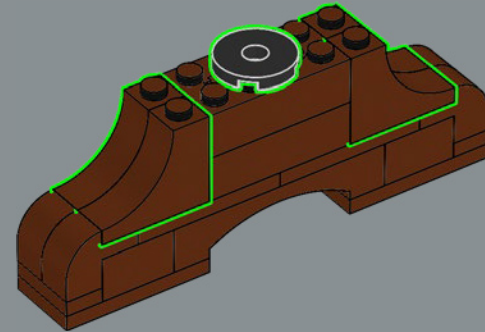

416

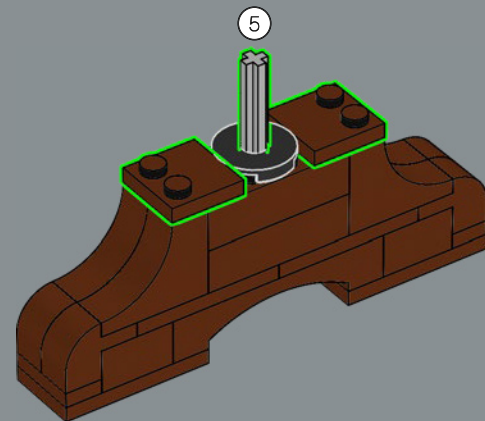

2x



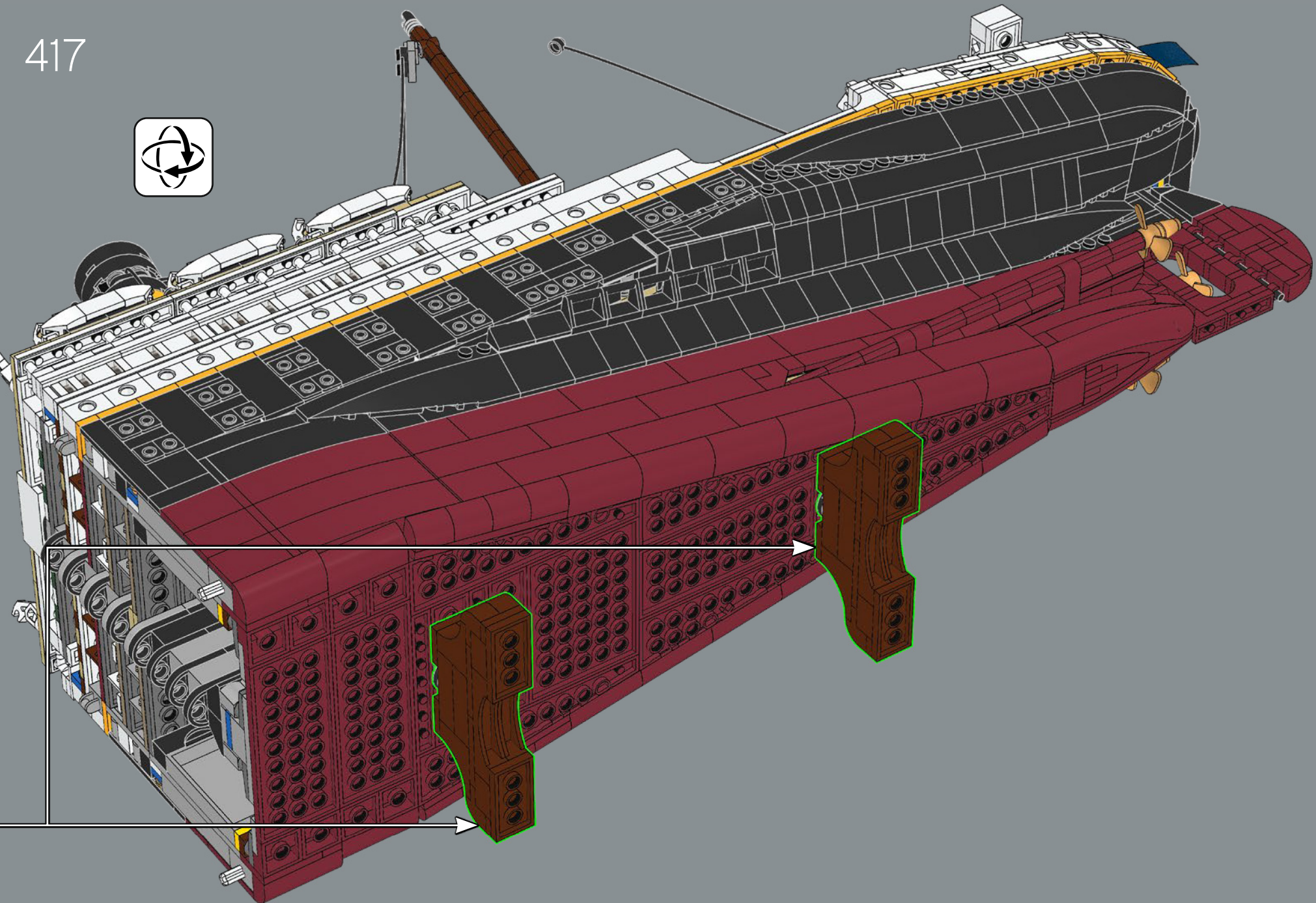

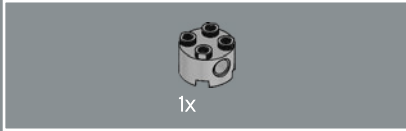
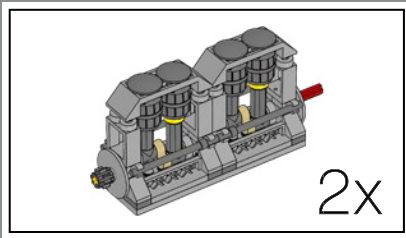

418

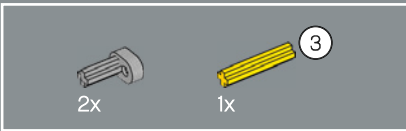
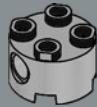

419

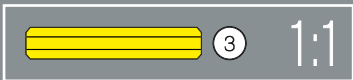
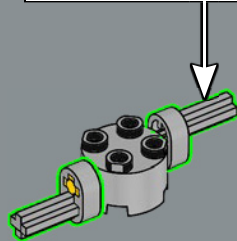
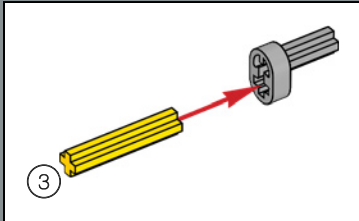

420

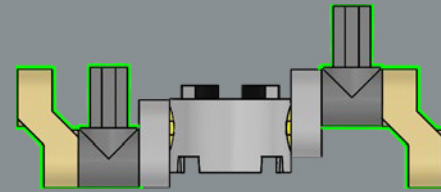

1:1

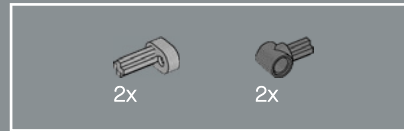

421

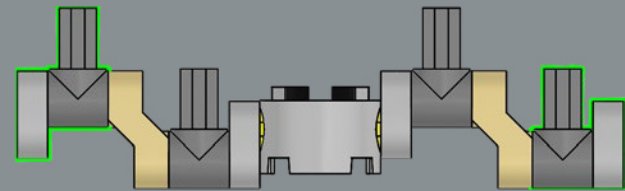

1:1

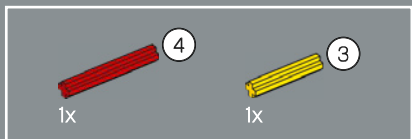

422

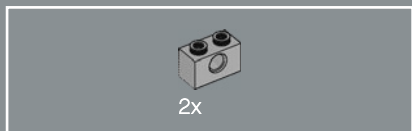
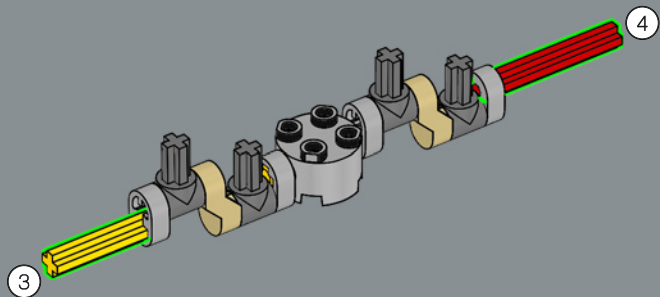

423

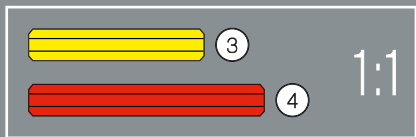
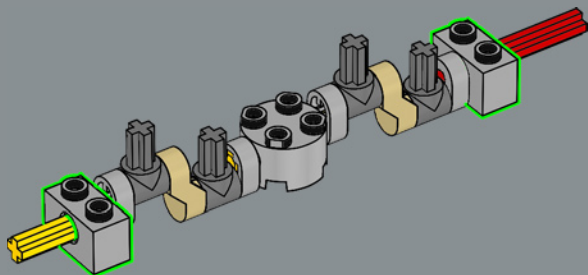

304

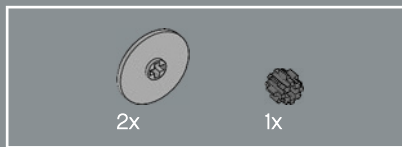

424

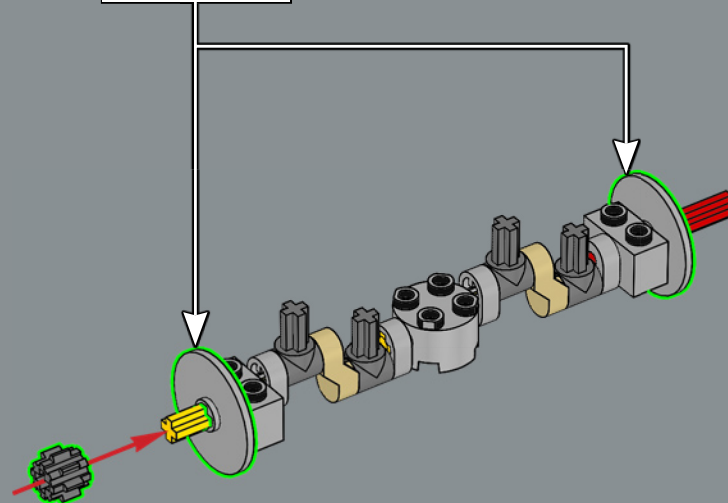
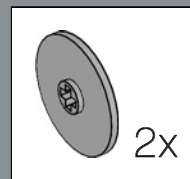

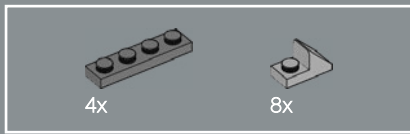

425

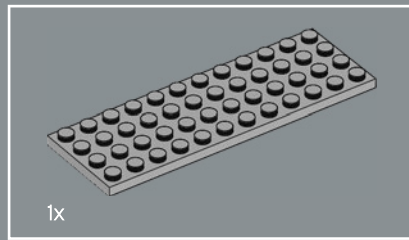
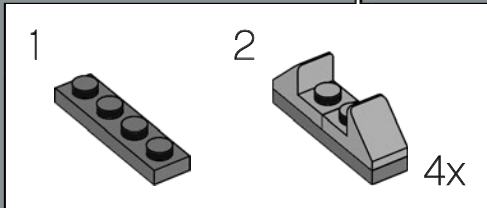
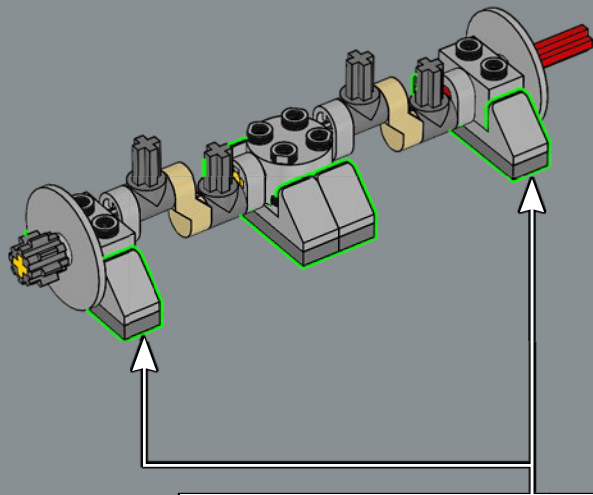

426

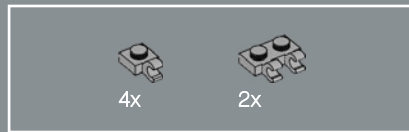
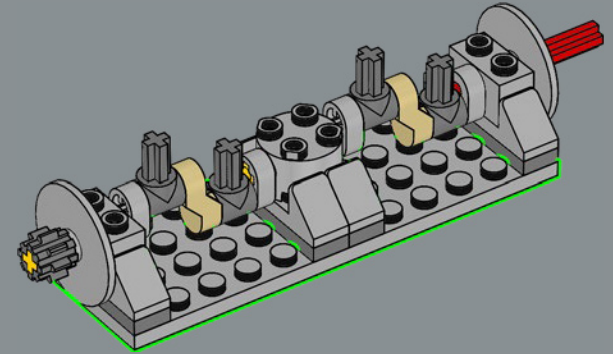

427

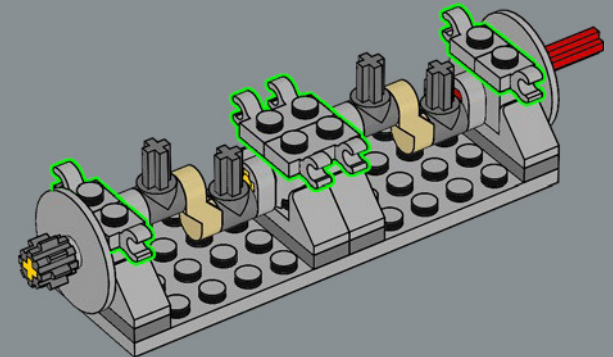



428

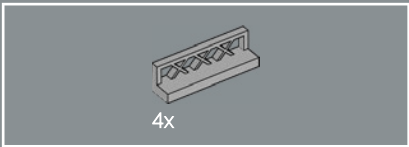
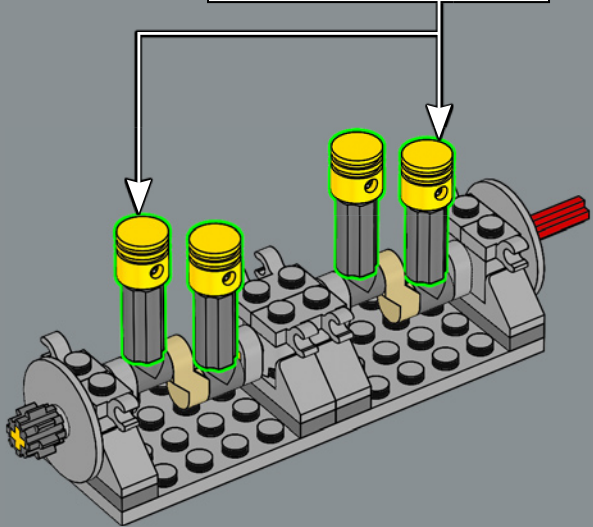
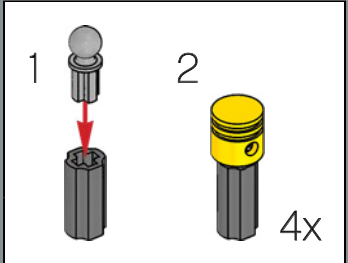

429

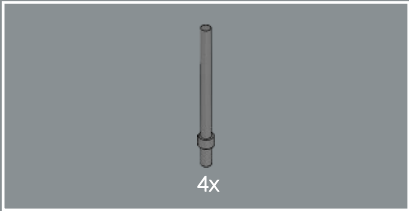
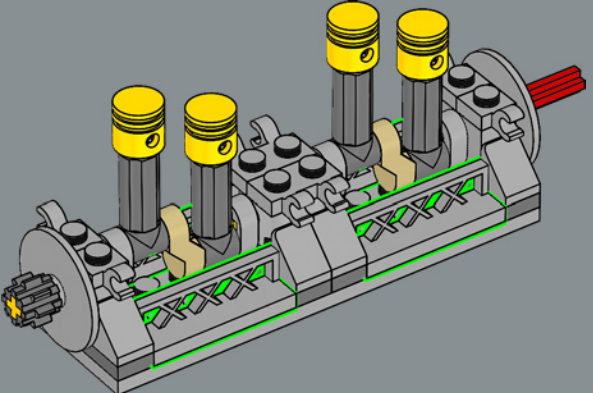

430

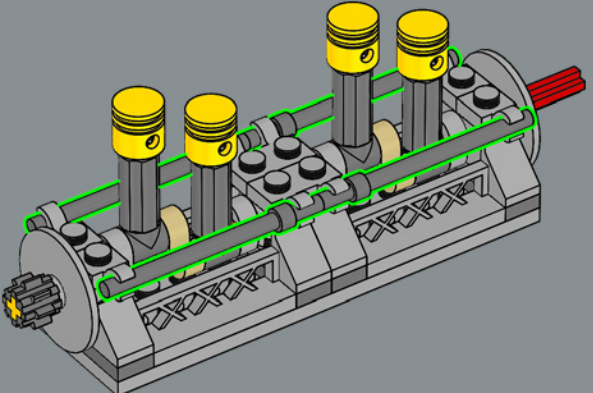

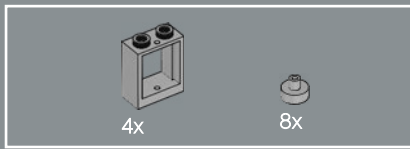

431

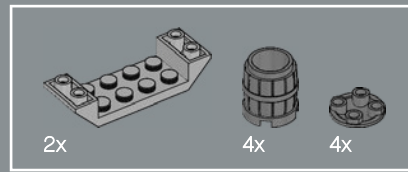
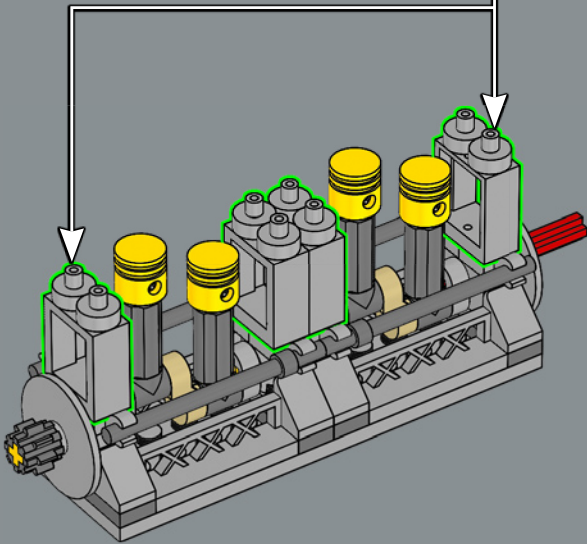
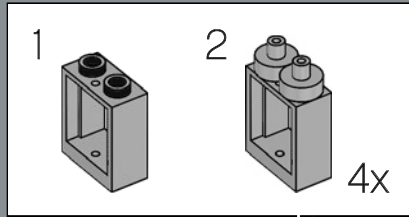

432

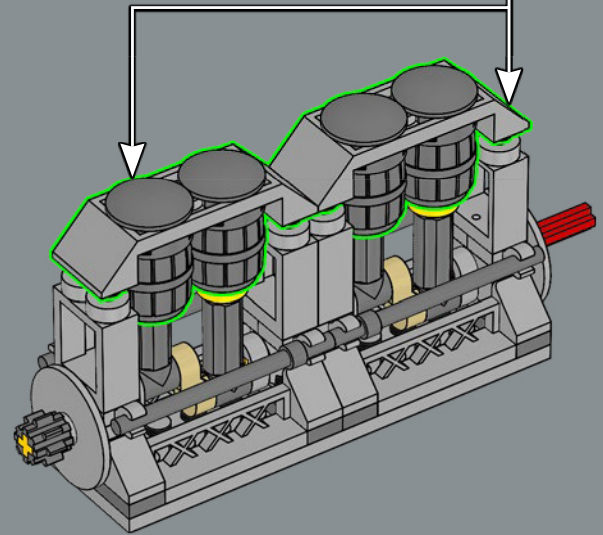
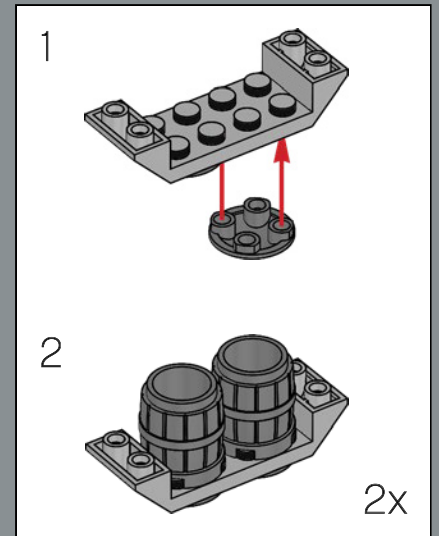

2x

433

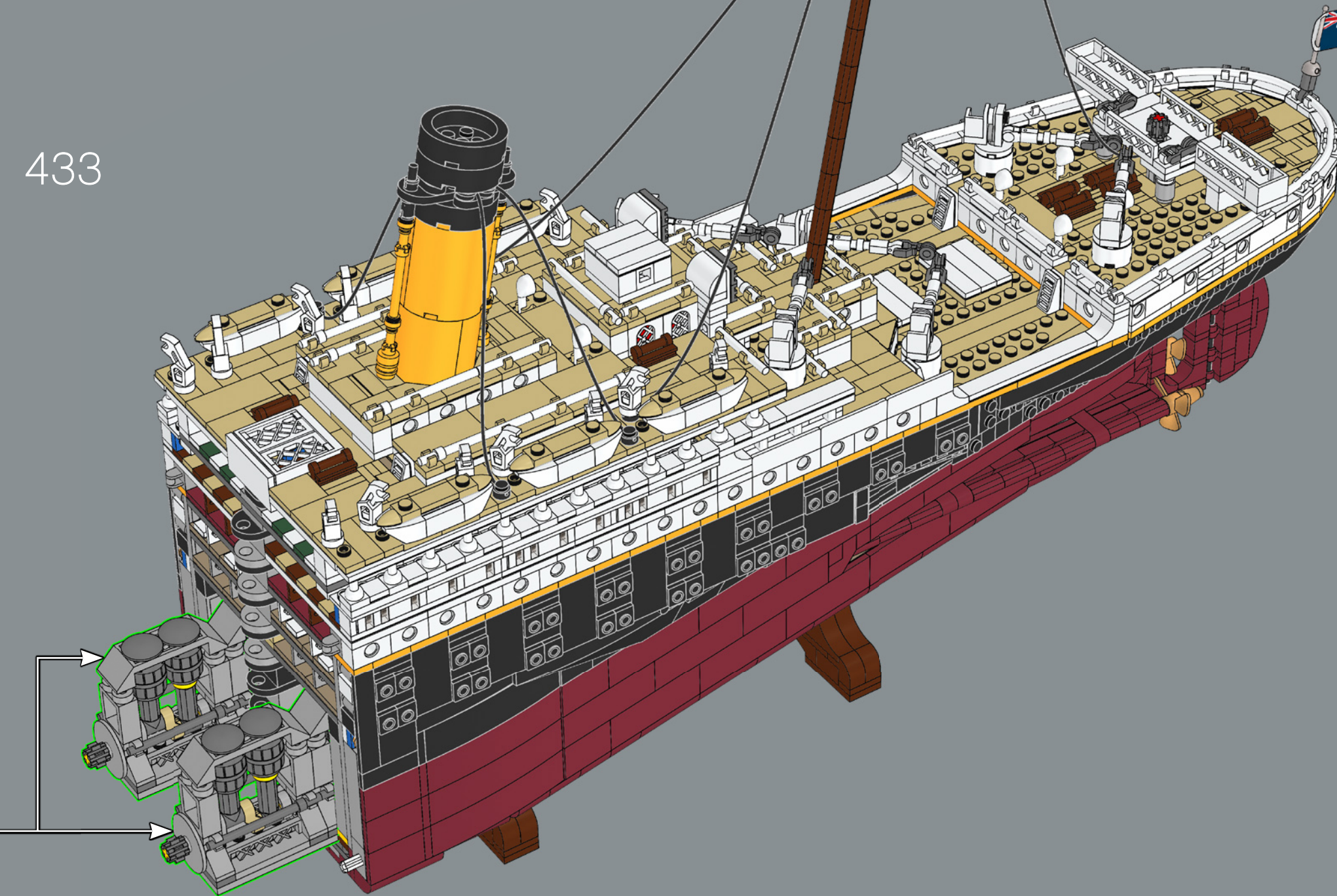

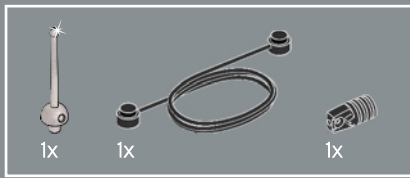

434

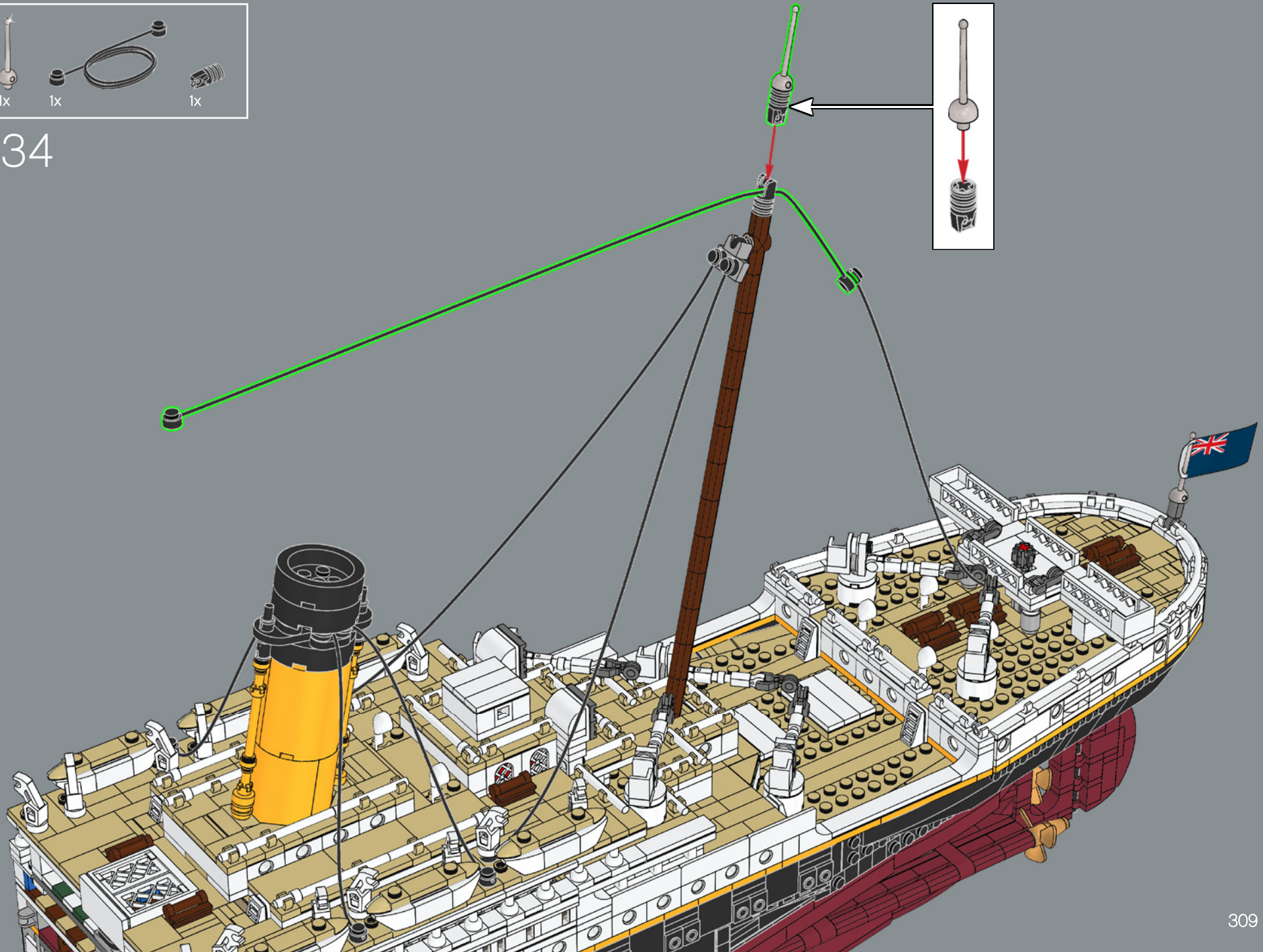

435

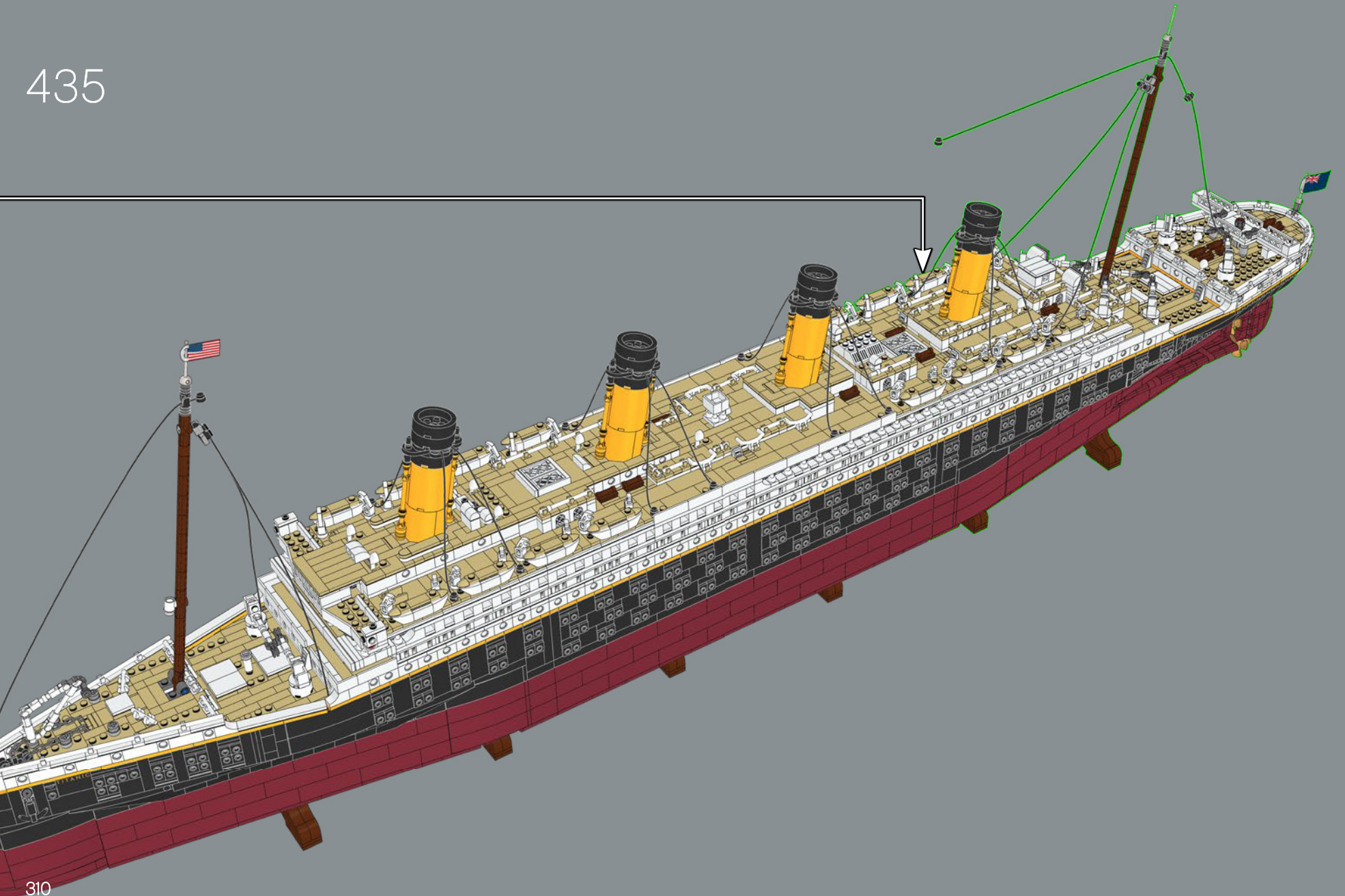

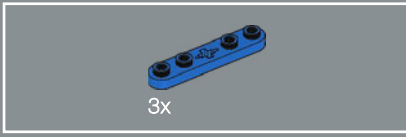
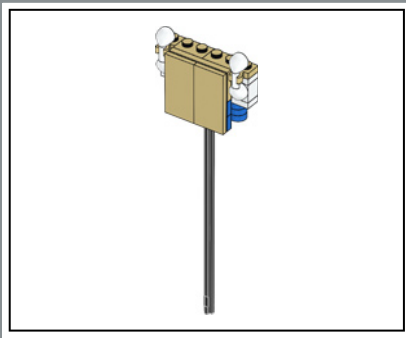

436

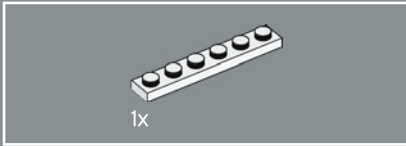
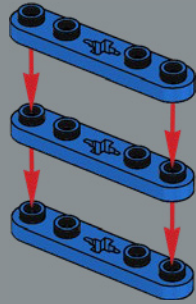

437

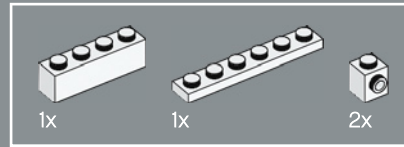
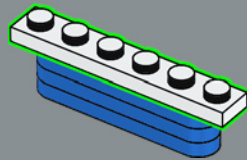

438

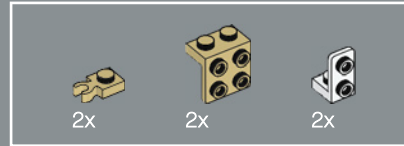
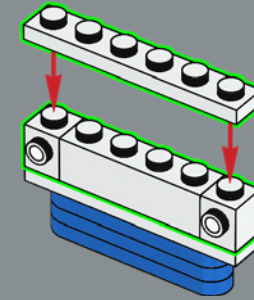

439

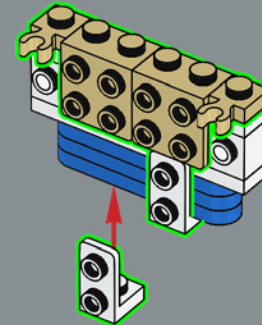

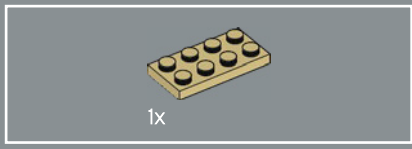

440

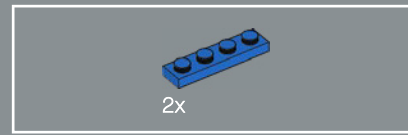
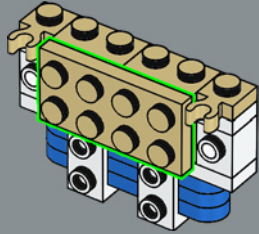

441

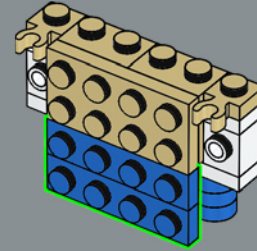

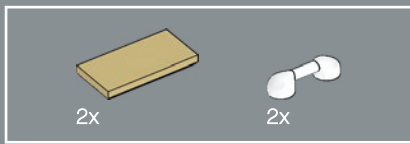

442

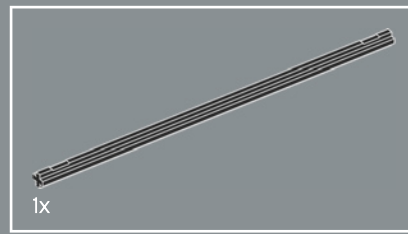
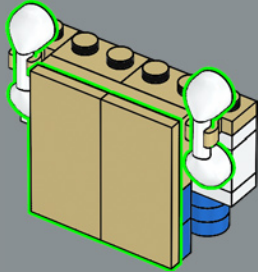

443

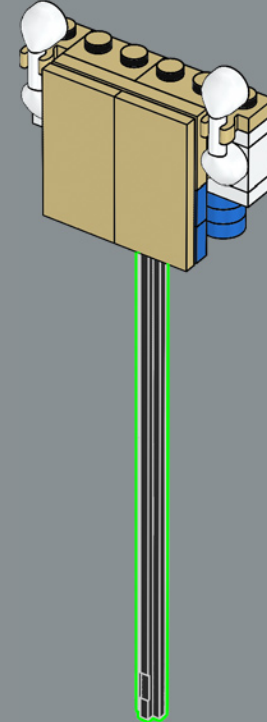

Il *Titanic* fu varato il 31 maggio 1911, 110 anni fa (nel 2021).

444

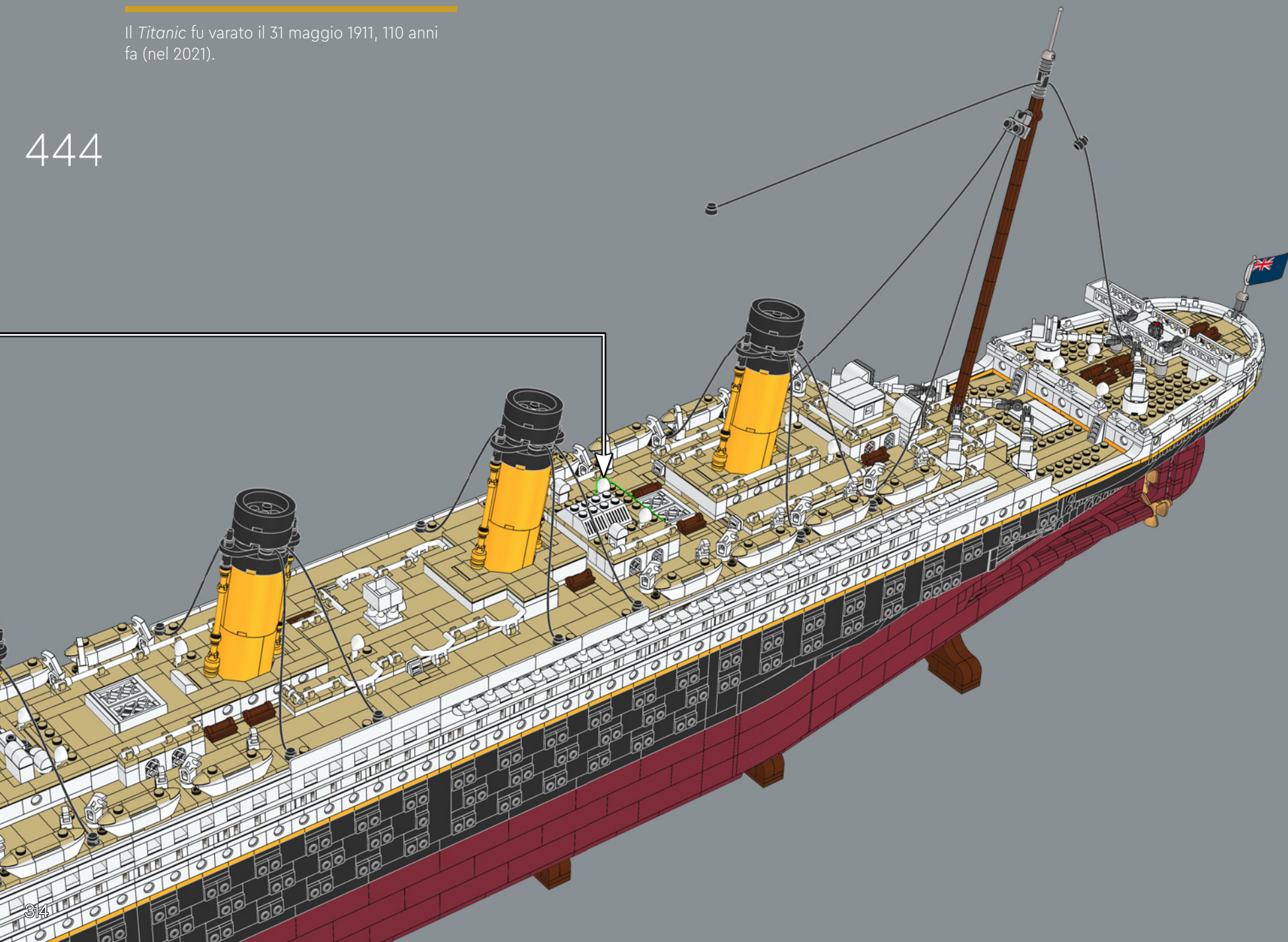

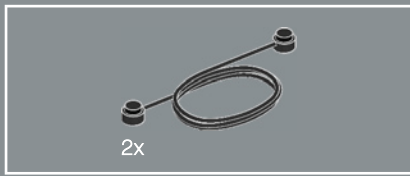

445

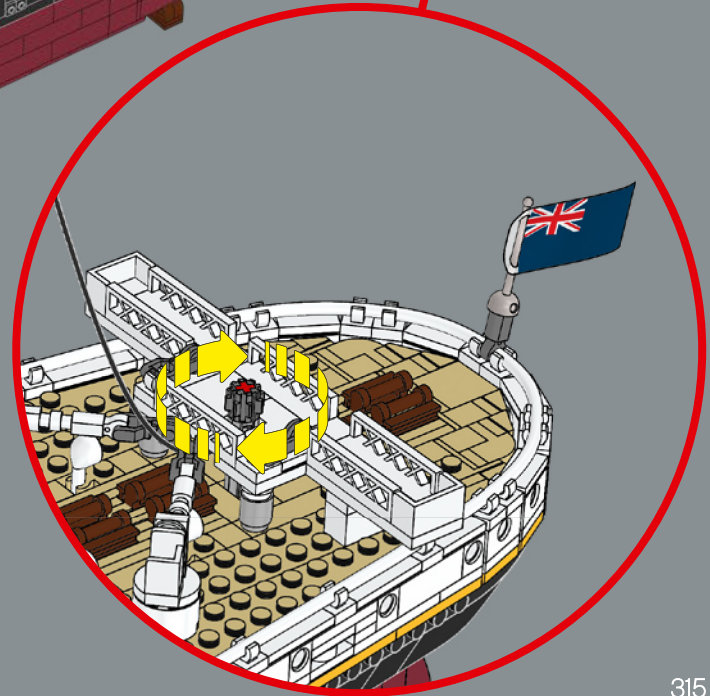
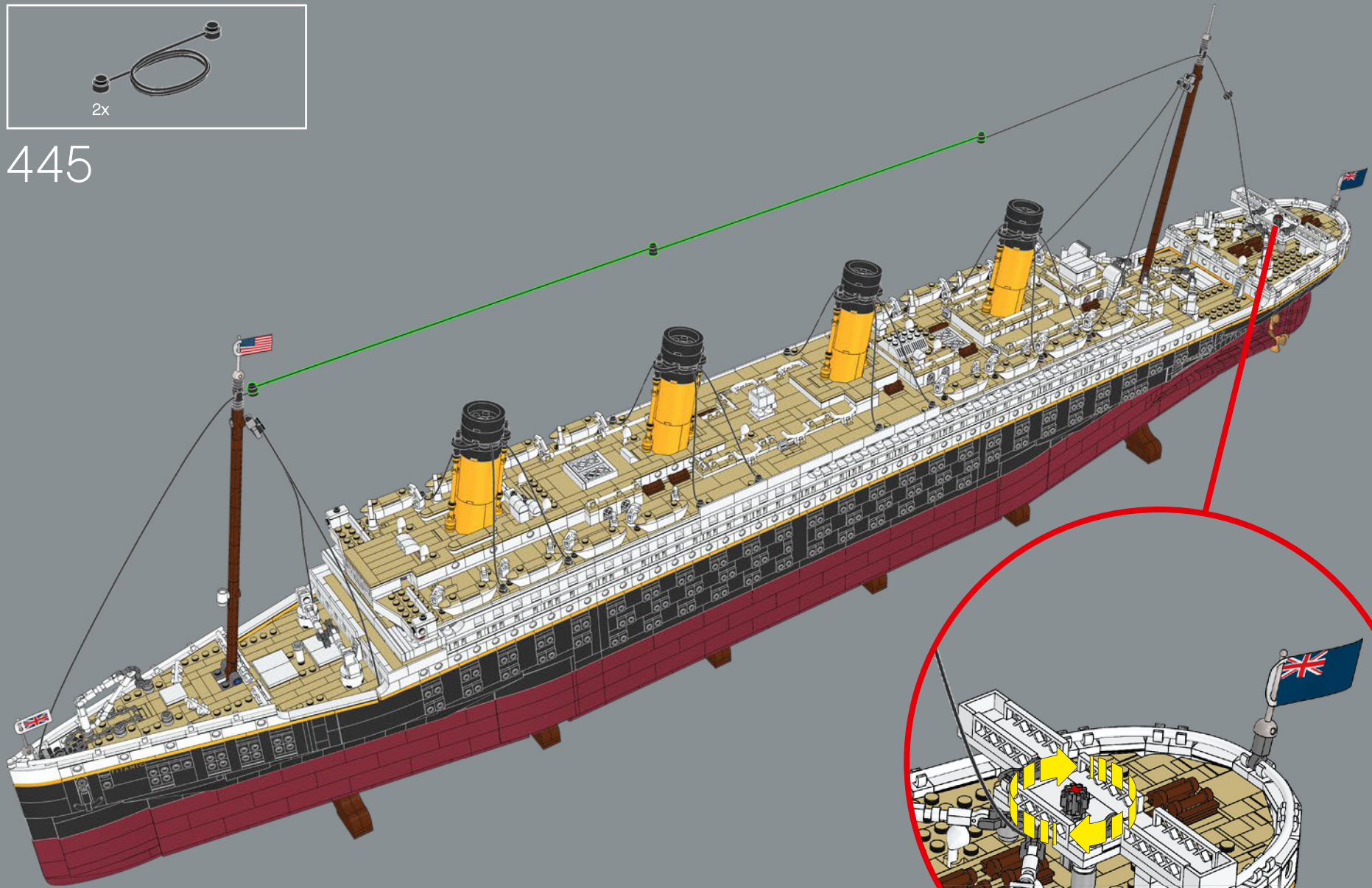

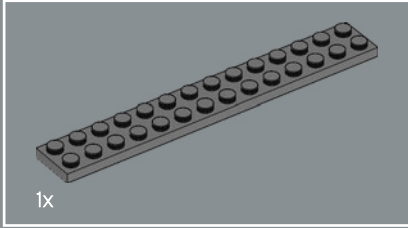
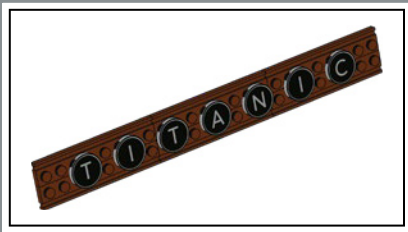

1x

446

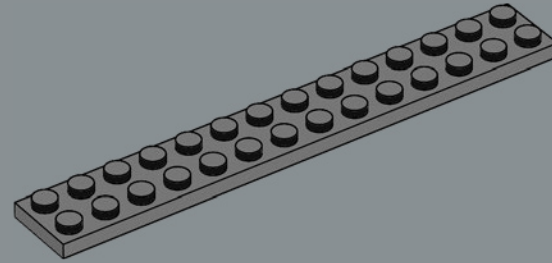

2x

447

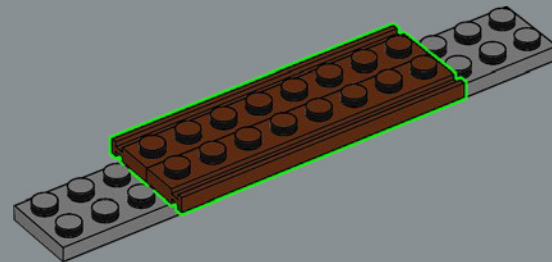



448

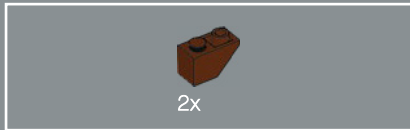
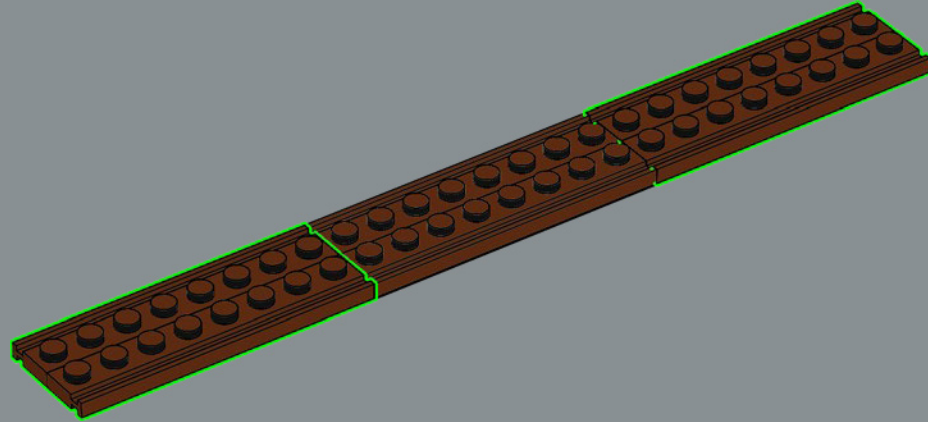

449

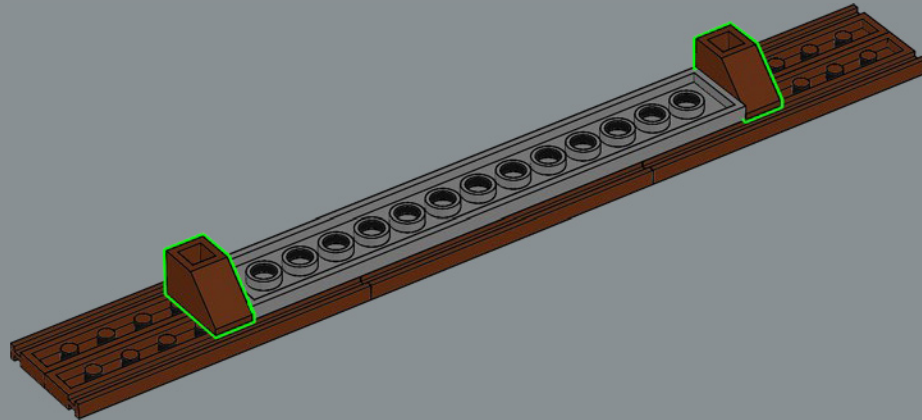



450

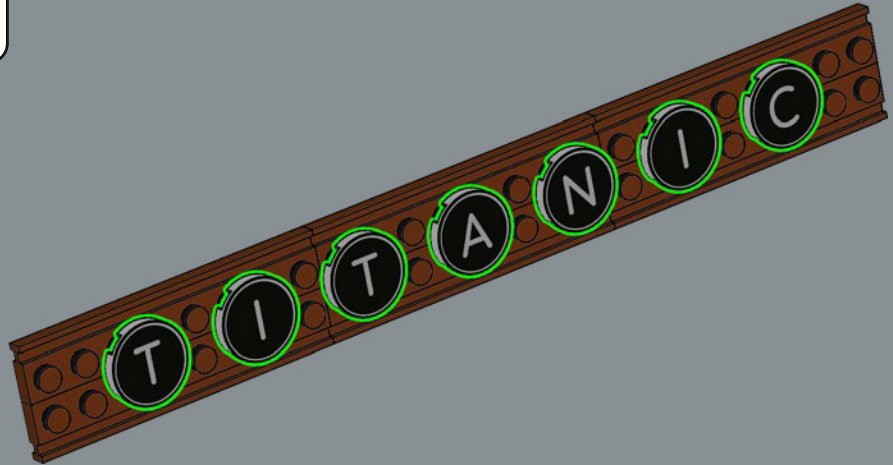

Il nome *Titanic* deriva dai Titani della mitologia greca.

