

泰坦尼克号

手册 2

世界上最豪华的客轮

泰坦尼克号设计经典、时尚、舒适、奢华，旨在为乘客带来水上酒店般的体验，而不仅仅是乘船旅行体验。她为 833 名头等舱乘客提供了各式各样的设施，包括船上健身房、壁球场、游泳池、图书馆以及精致的餐厅和客舱。这艘船最独特的结构是大楼梯，其采用橡木建造，以优美的曲线向下穿过客轮的七层甲板。



↑ 这道头等舱楼梯通向餐厅。

→ 1912年4月14日二等舱晚餐菜单，泰坦尼克号在当天撞上冰山而下沉。

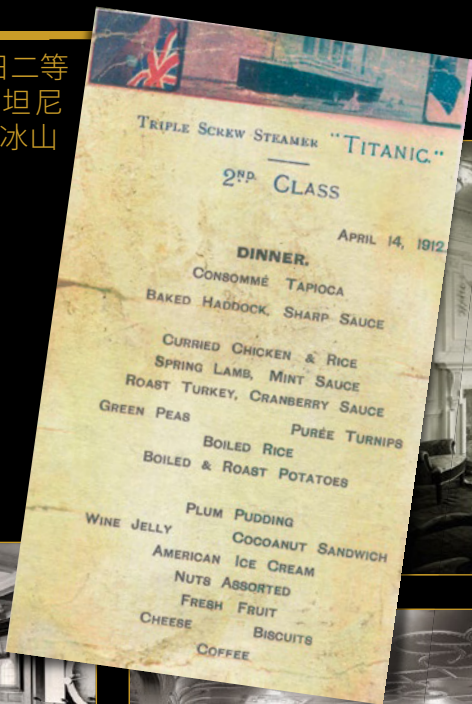

↓ 上部长廊上的阅览室



↓ 头等舱休息室



↓ 头等舱健身房

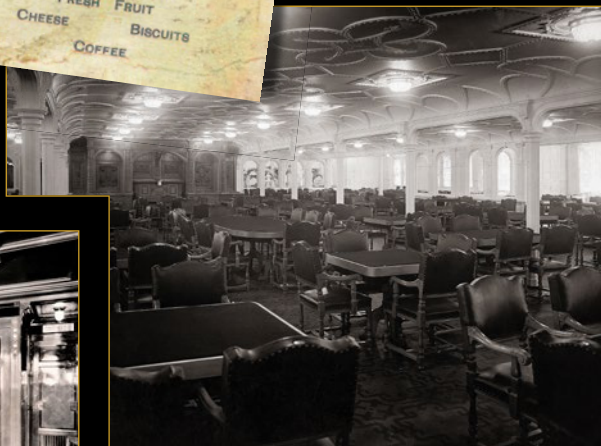

↑ 主餐厅



↑ 咖啡馆, 头等舱餐厅的拓展部分



↑ 优雅辉煌的头等舱 B57 套房

拼搭泰坦尼克号

这款套装最初始于乐高®设计师自由拼搭的概念模型，随后迅速演变成为有史以来最大的乐高套装之一。然而，此套装令人惊叹的外形尺寸绝不是其设计目标，而是在设计过程中，设计团队不断提出他们觉得必须纳入模型的复杂细节，使得模型的规模越来越大。对于资深乐高设计师 Mike Psiaki 来说，这包括使用乐高机械组元件创建带有移动式活塞的蒸汽机的复刻版模型。初始设计完成后，设计团队整整坐了一周，拼搭不同版本的模型，决定需要增强或简化的内容。

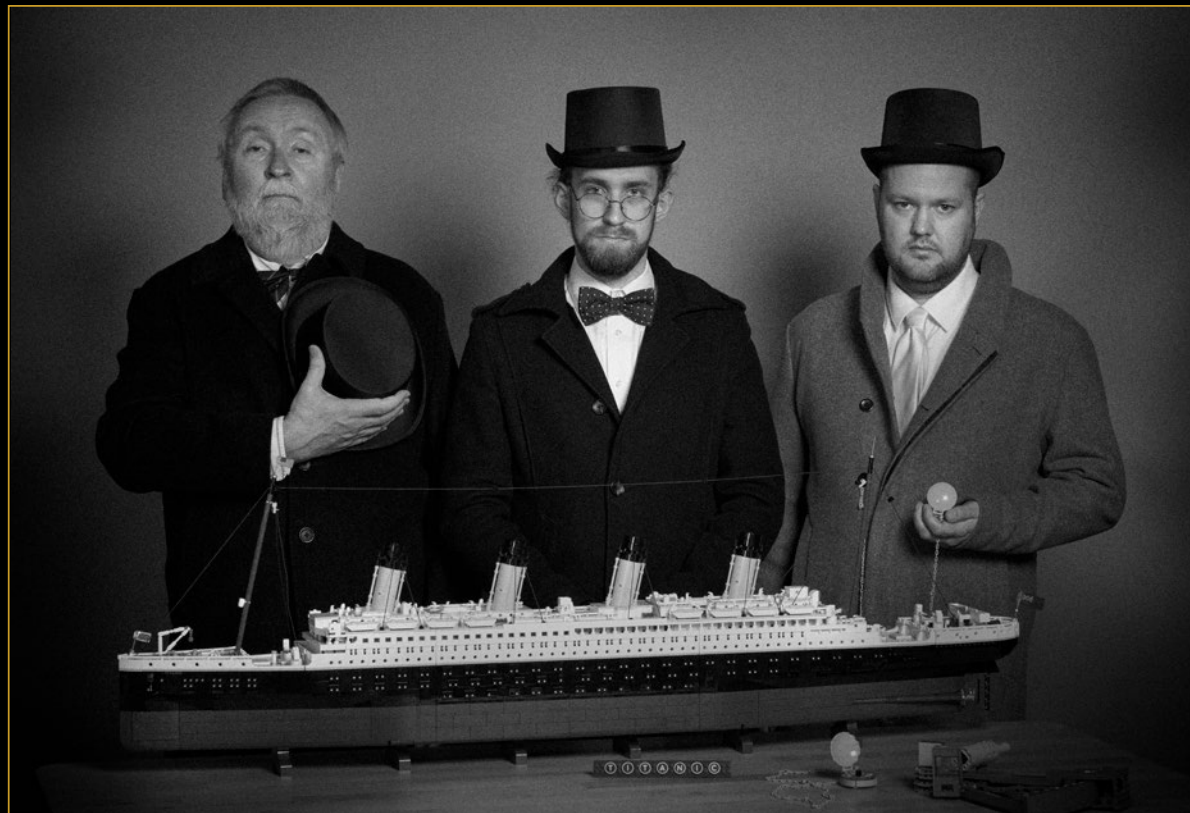

↑ 设计此模型的部分乐高®团队成员(从左至右):高级模型指导 Torben Kidde Skov, 资深设计师 Mike Psiaki, 高级拼搭说明专员 Martin Højen Holm Buk

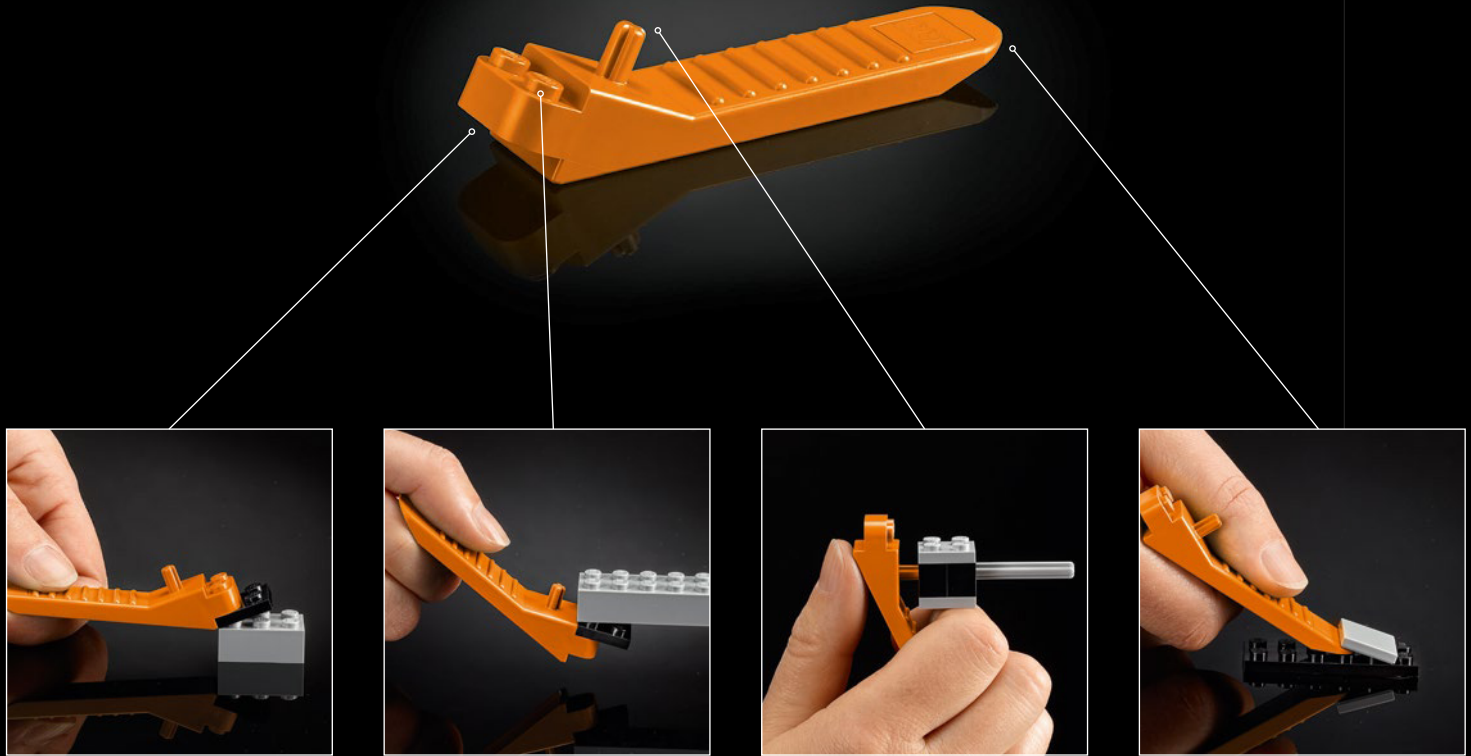

[LEGO.com/brickseparator](https://www.lego.com/brickseparator)

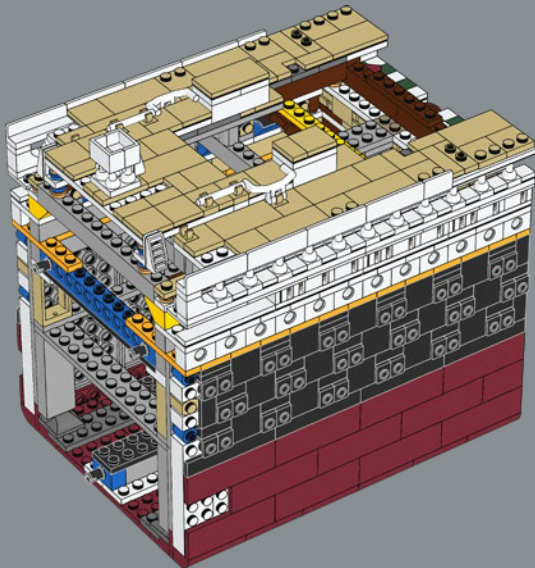
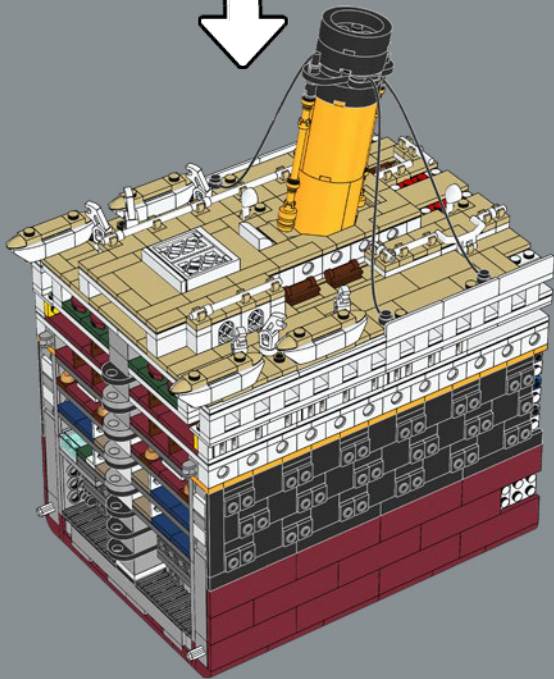

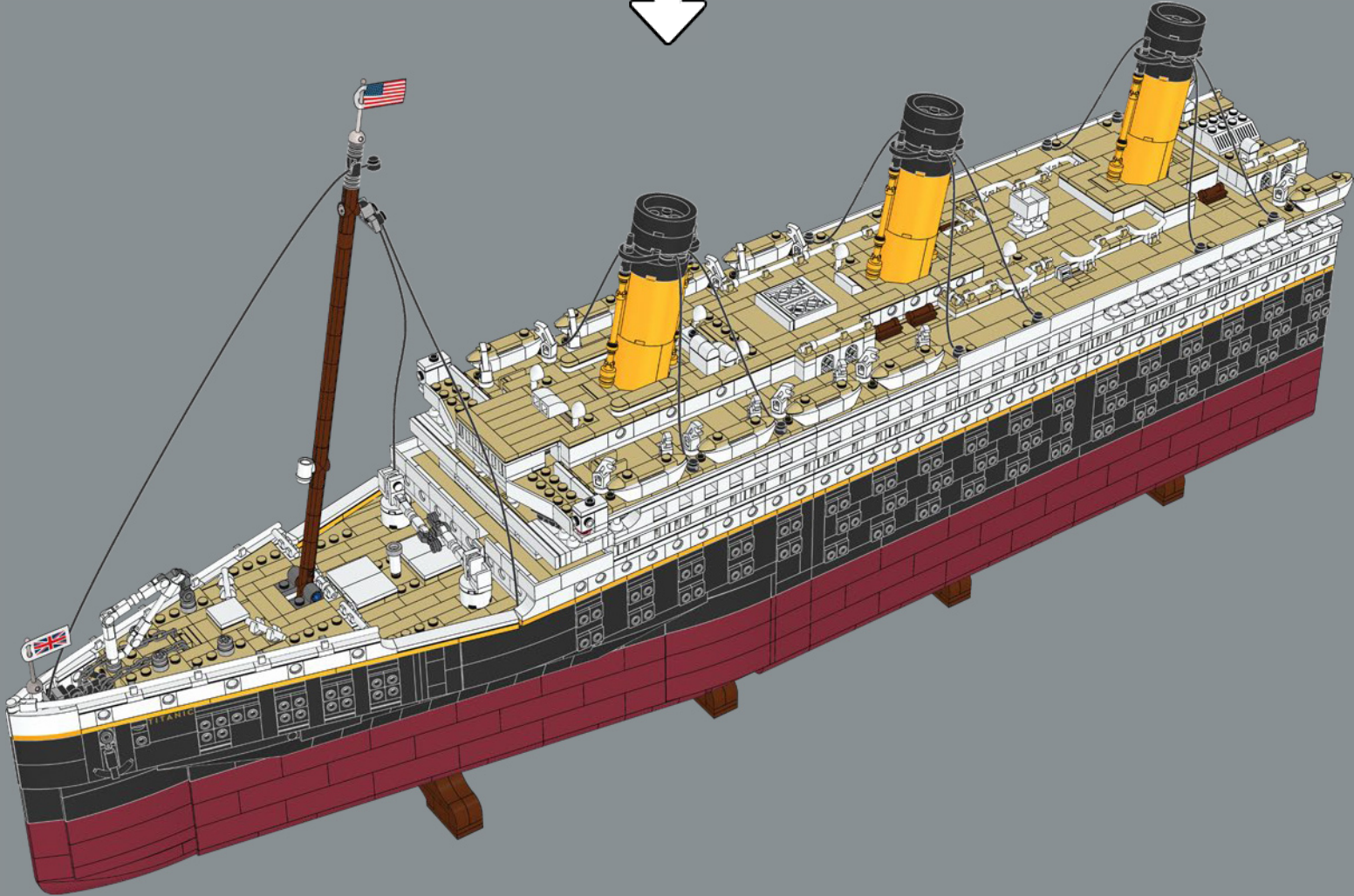
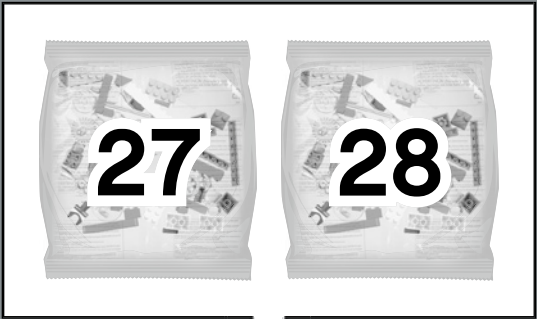

↓ 此处拼搭这艘船的后半部分锁定装置，
其将船的3个主要部分拼接在一起。

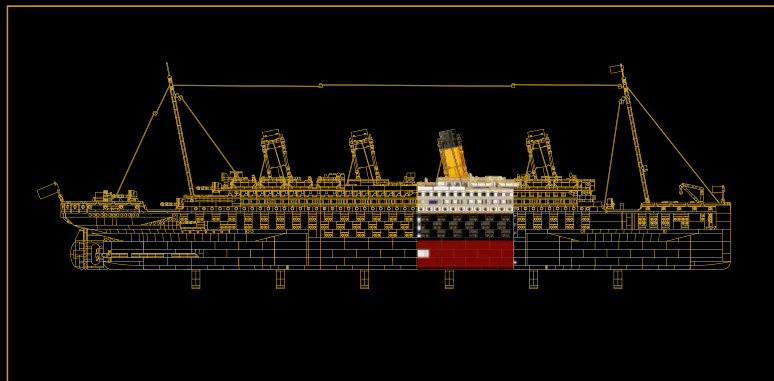

第3部分：

烟囱和主舱室

在这一部分，你将拼搭这艘船的另一个横截面，其中包括一些位于最低层甲板上的煤仓，以及众多不同等级的客舱。此部分的上层结构包含这艘船长廊甲板的开头部分，以及大楼梯和第二根烟囱的天窗。

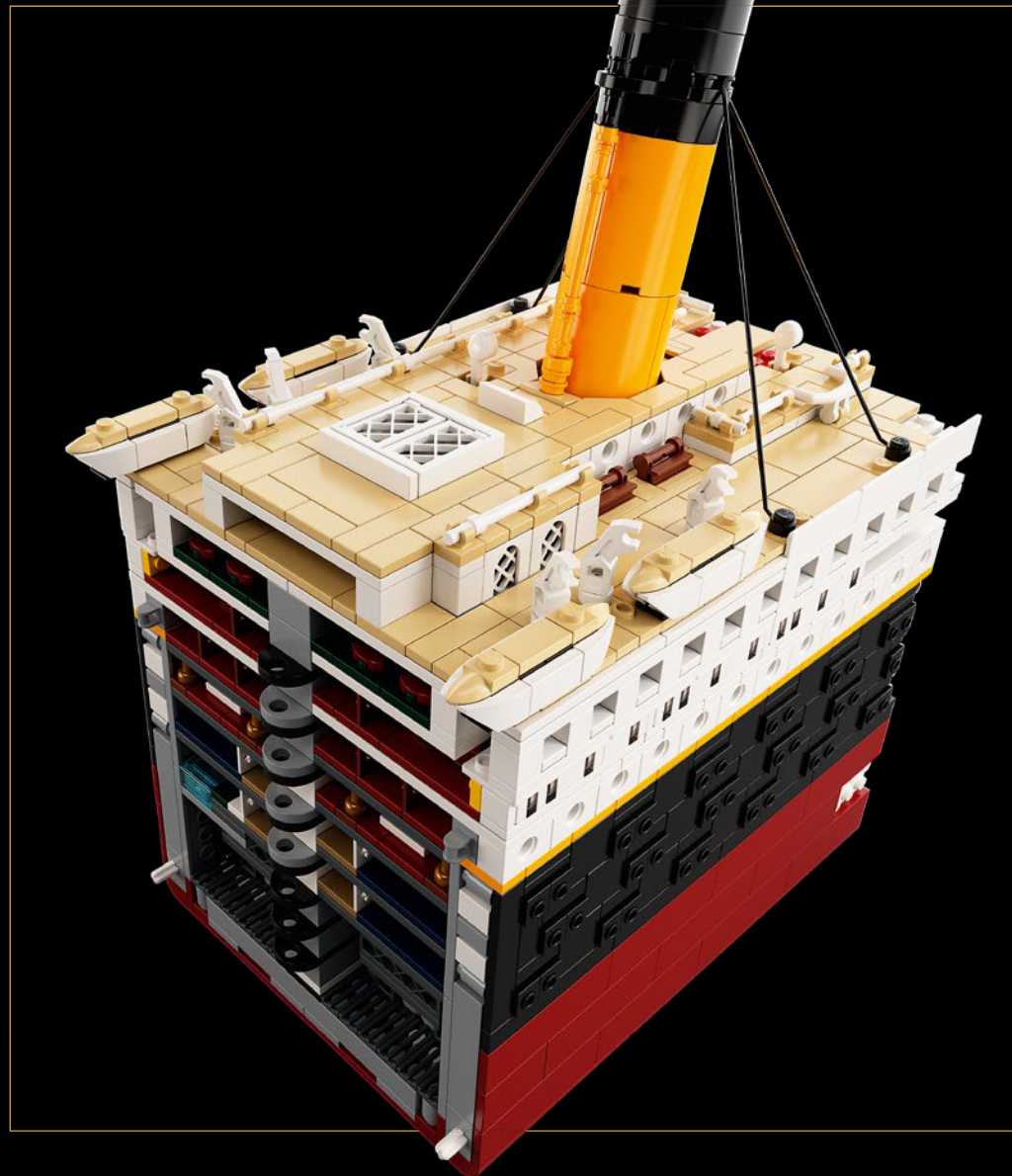

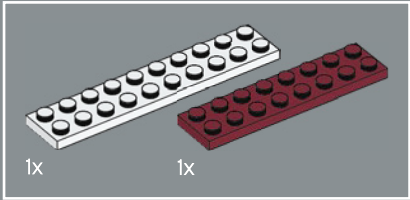
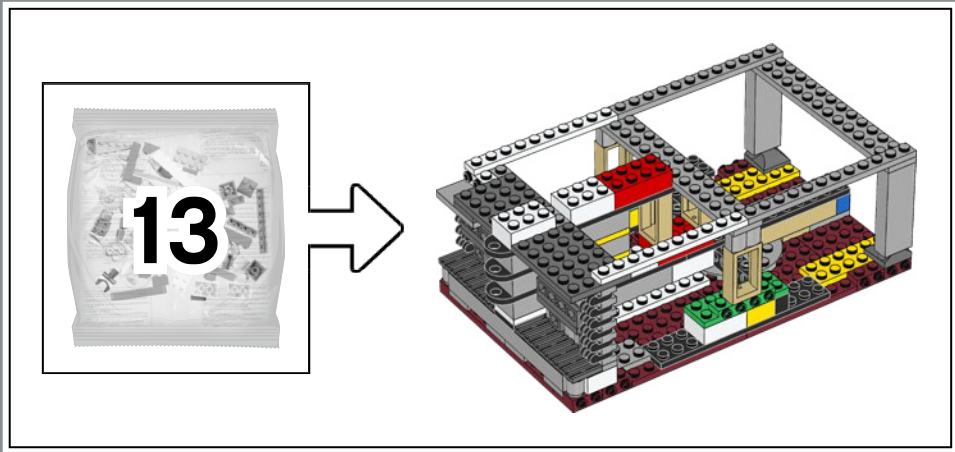

1

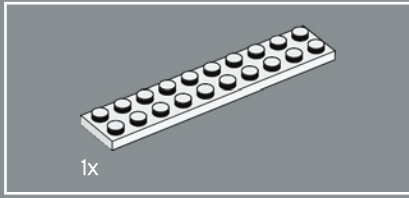
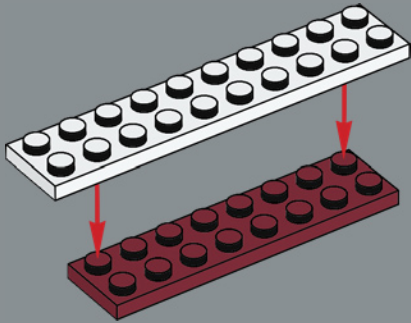

2

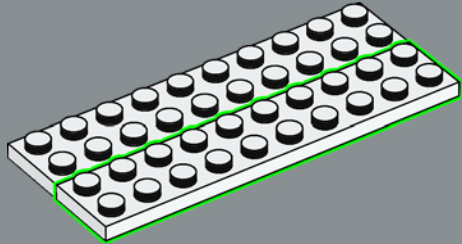

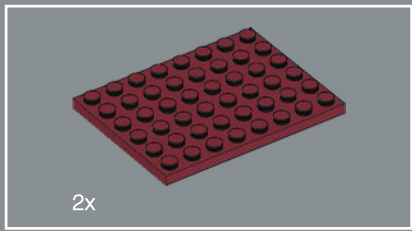

3

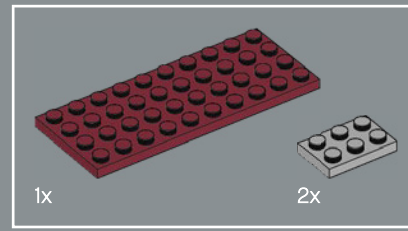
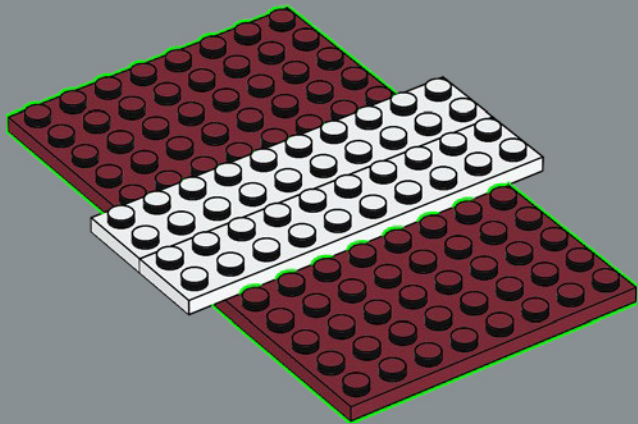

4

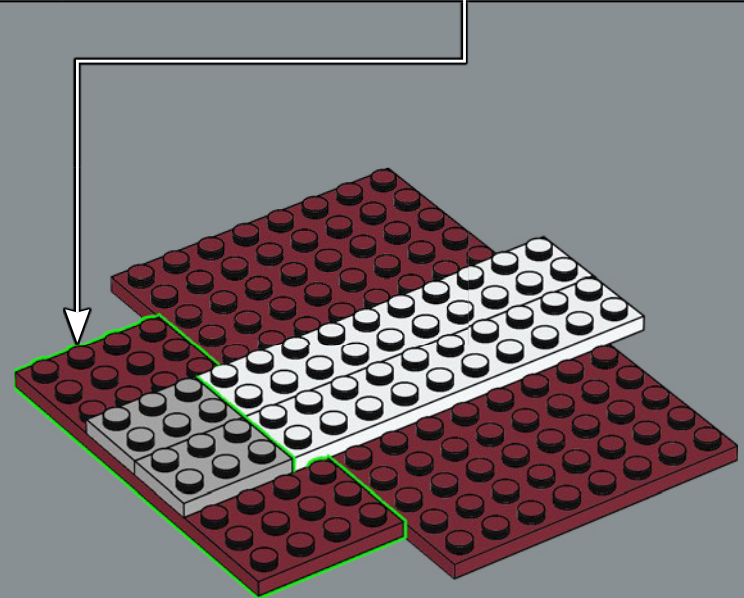
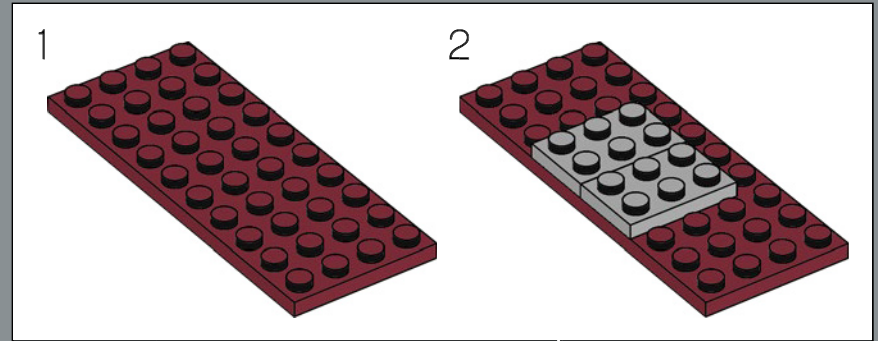

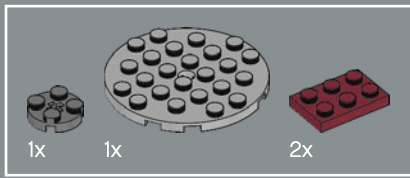

5

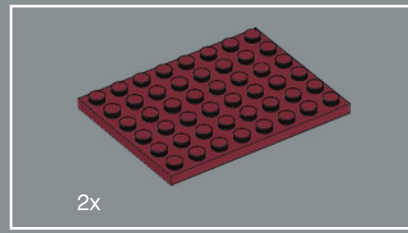
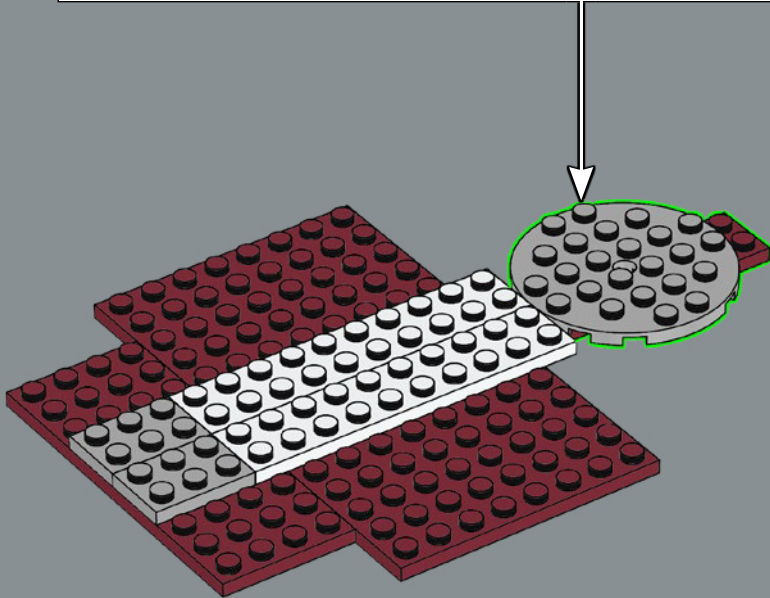
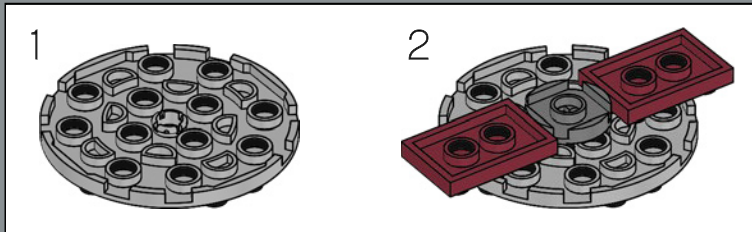

6

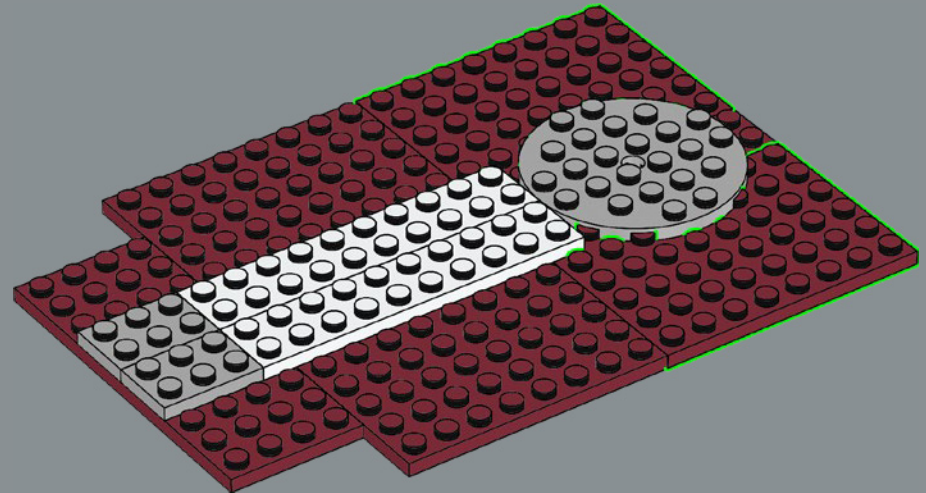

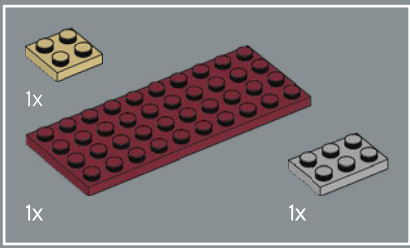

7

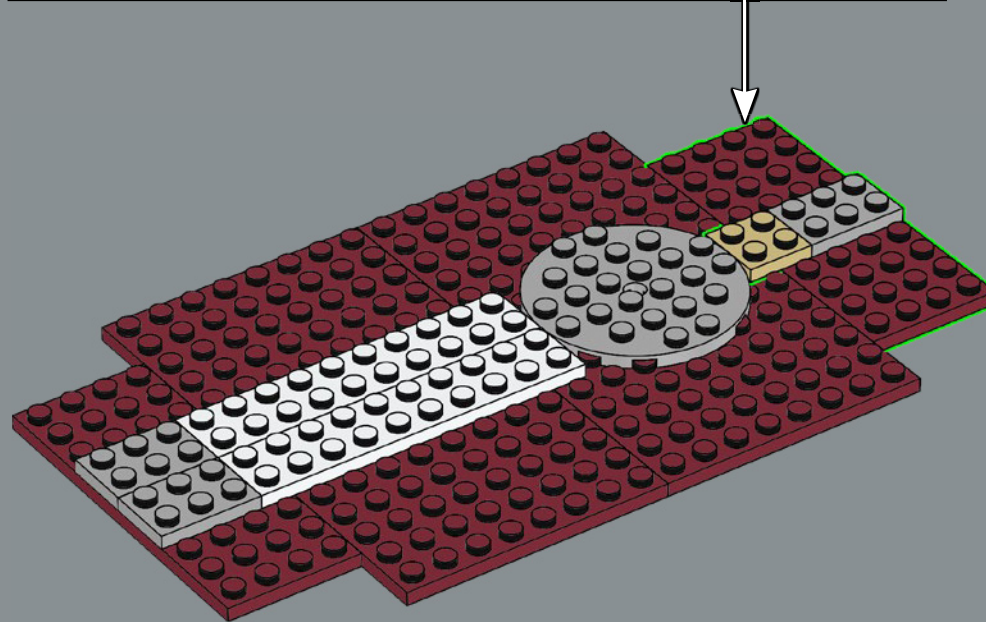
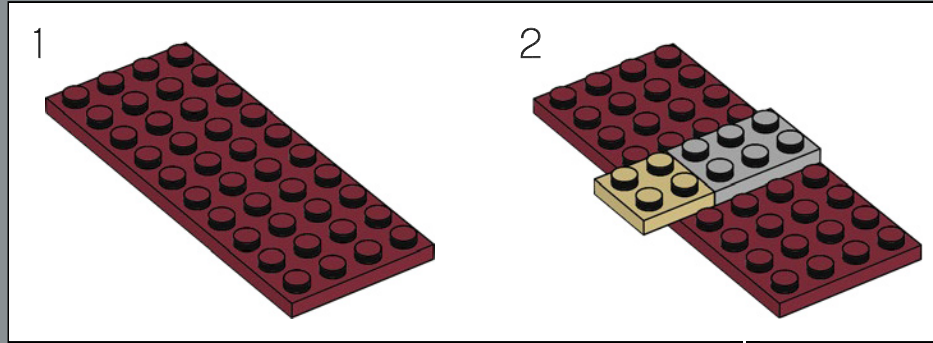

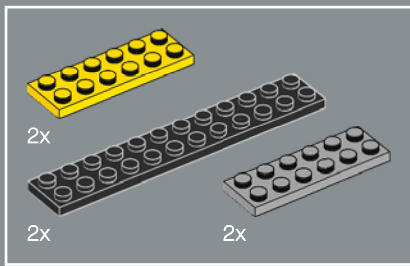

8

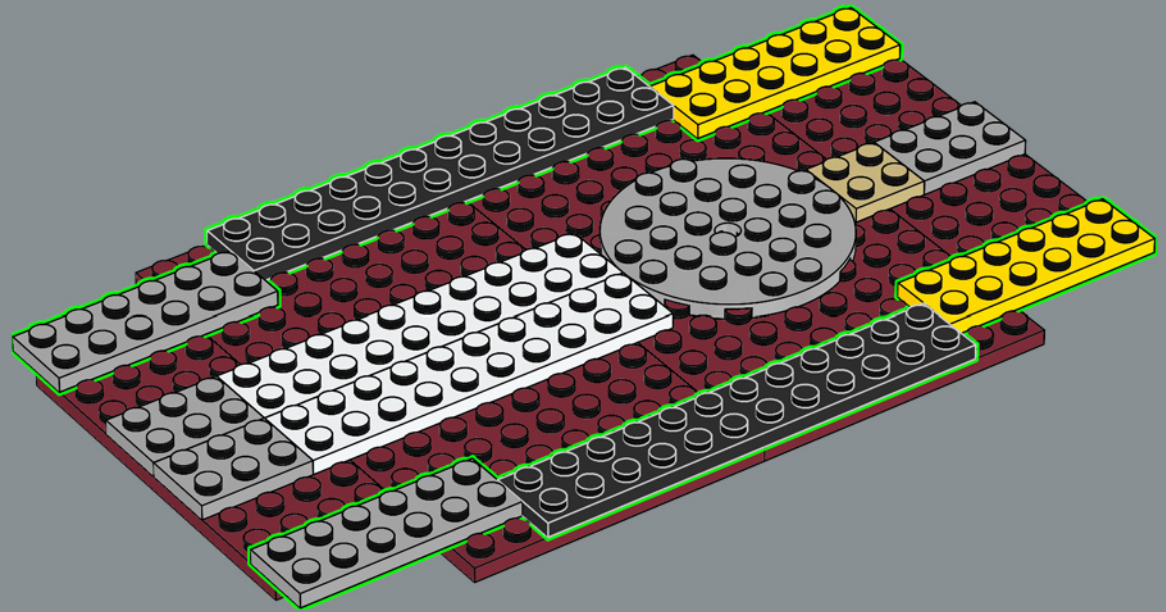

9

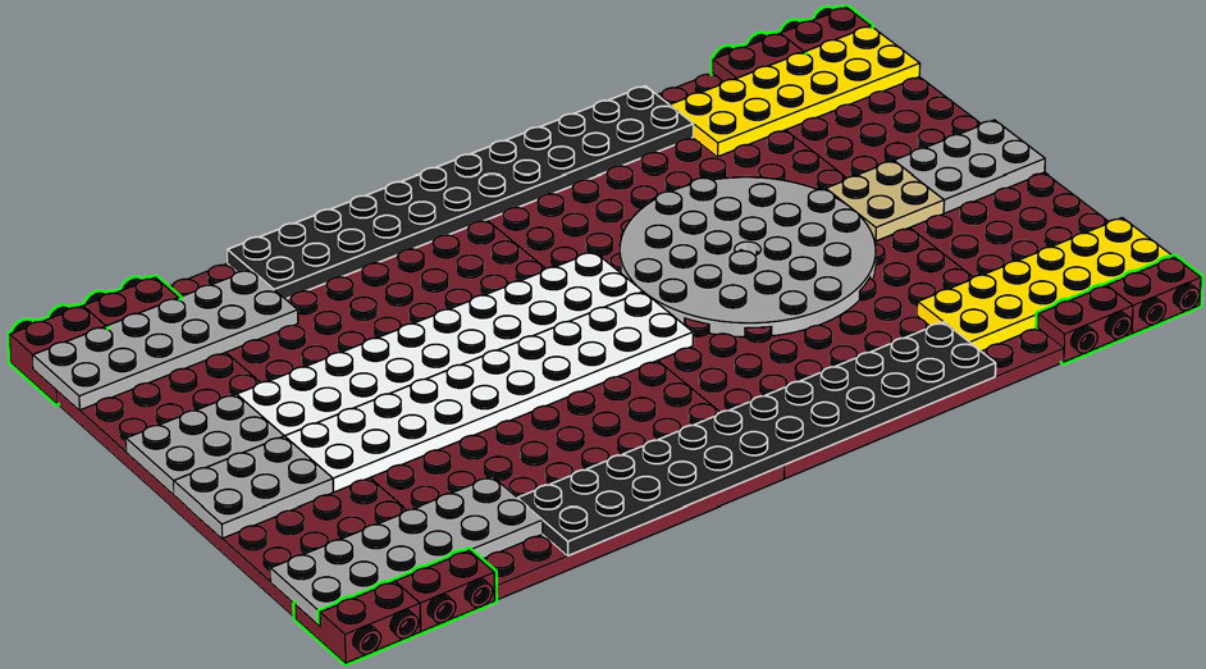

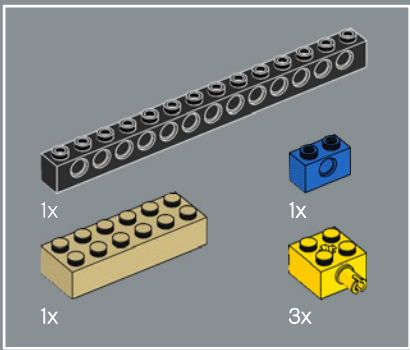

10

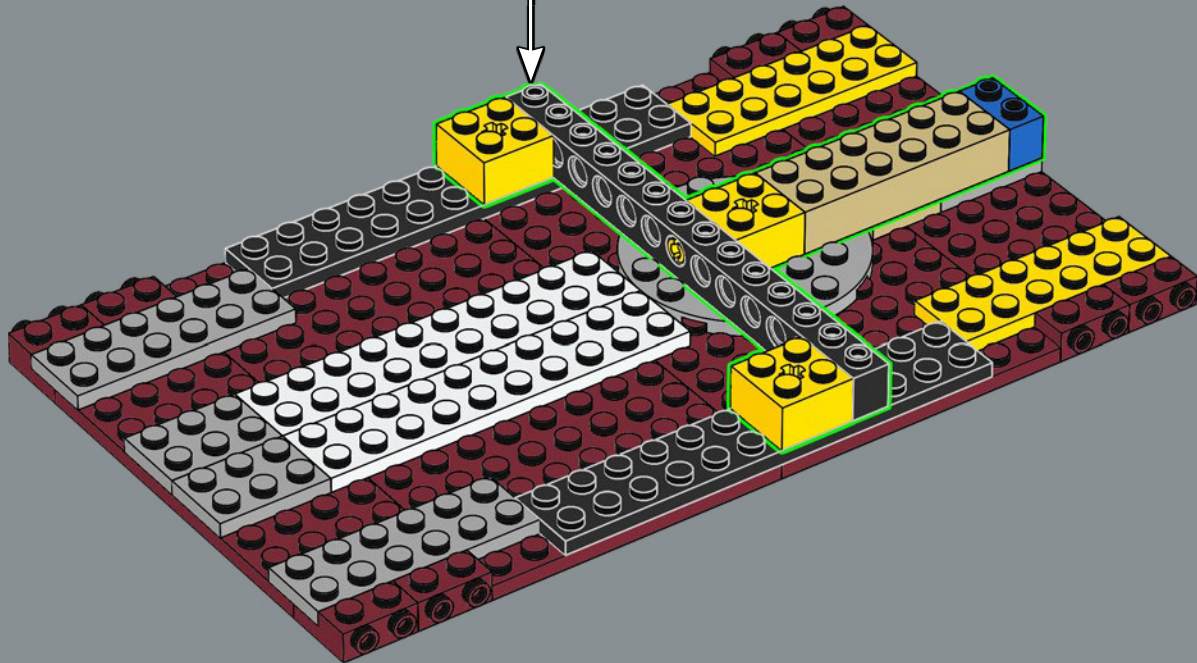
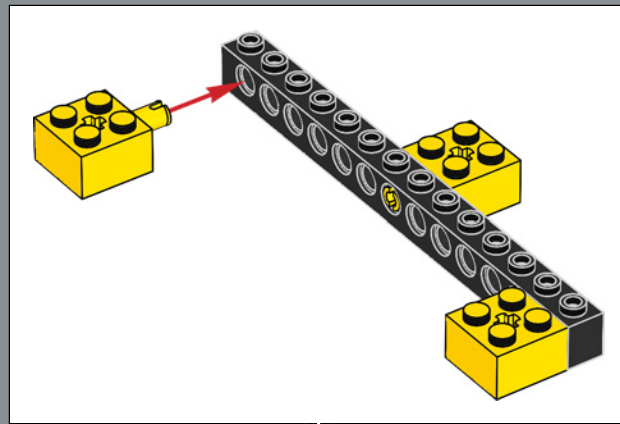

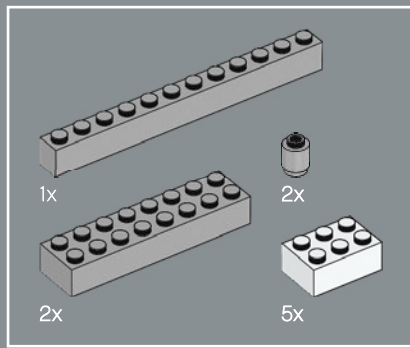

11

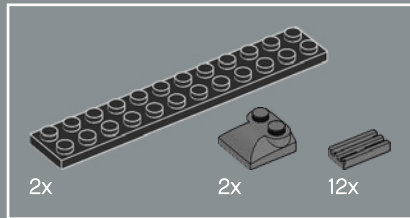
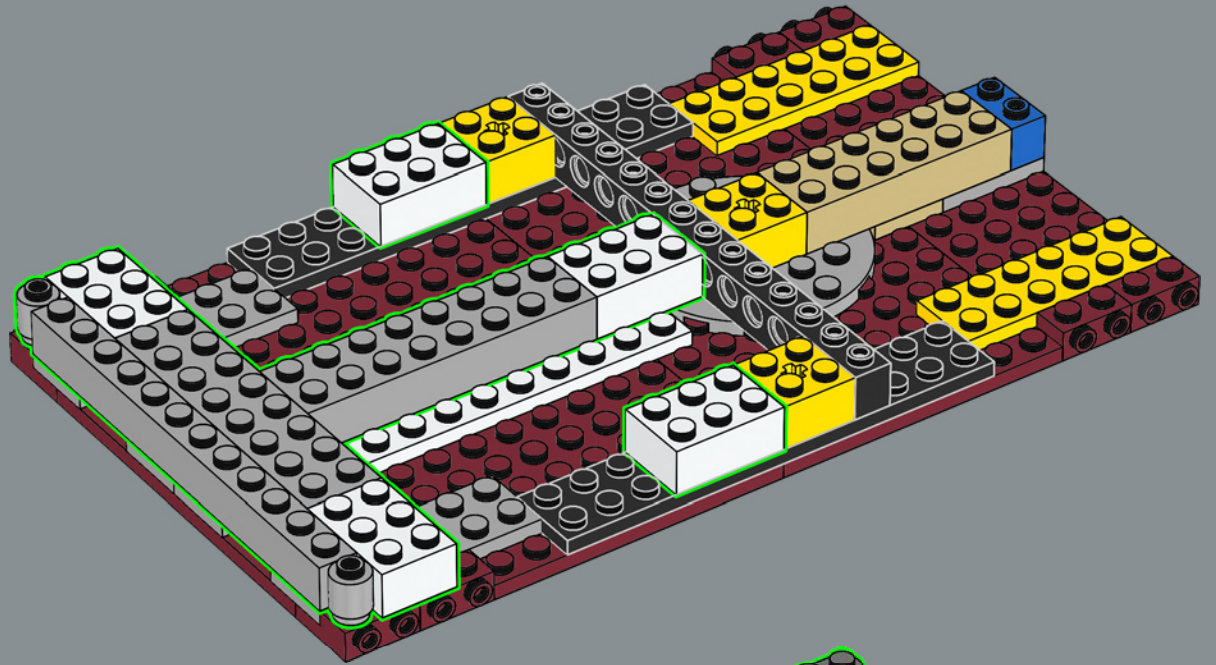

12

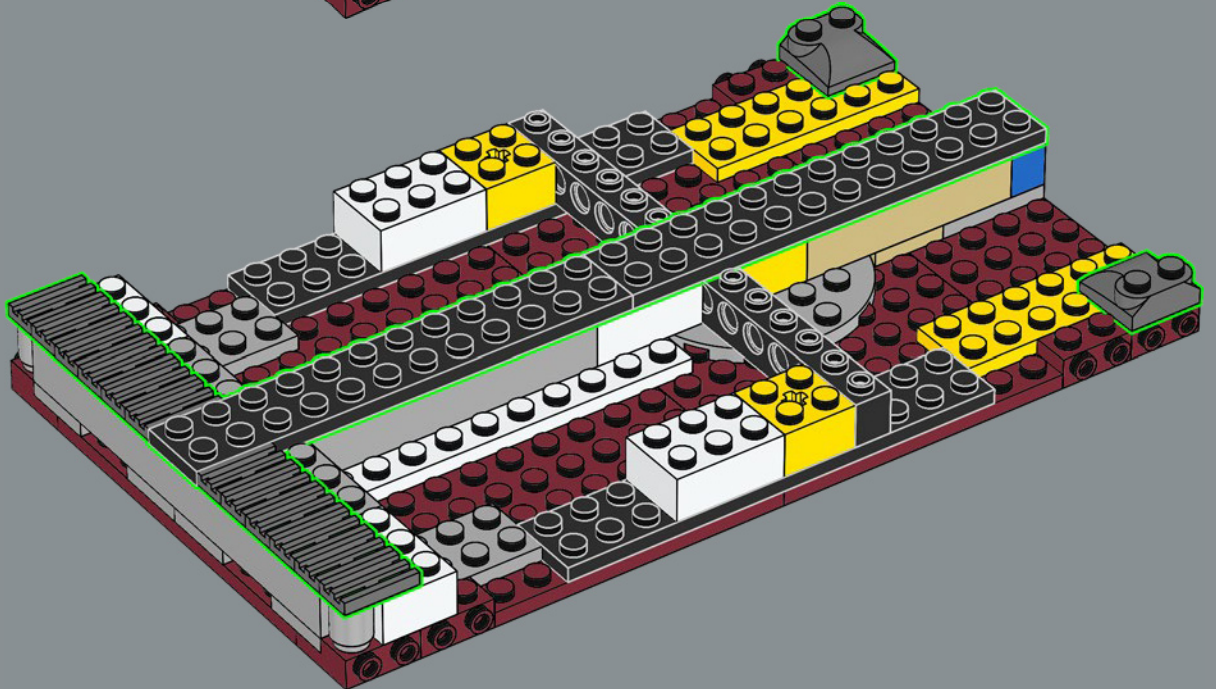

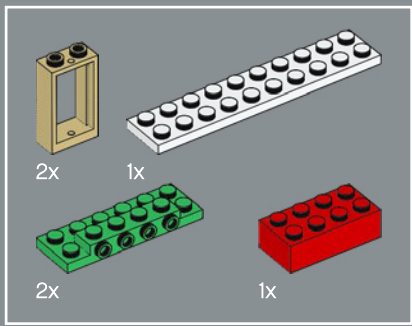

13

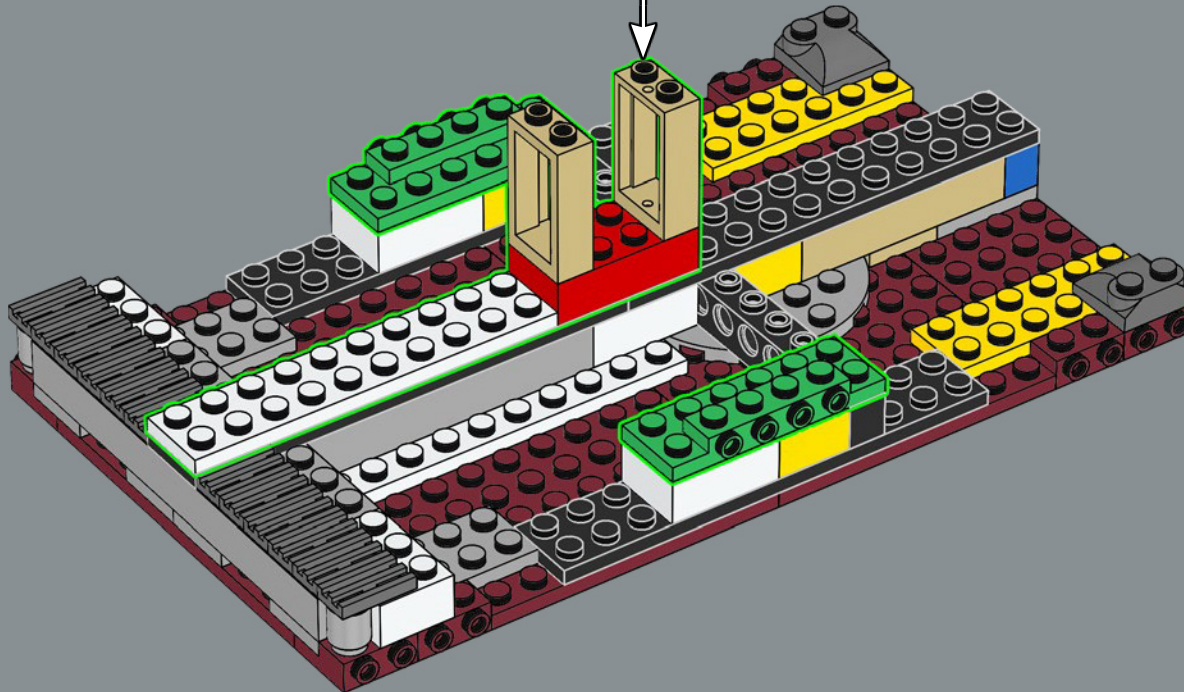
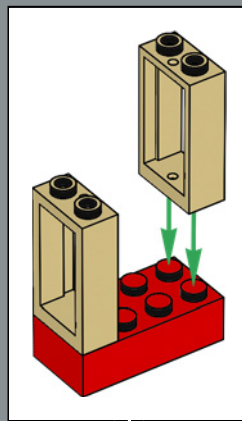

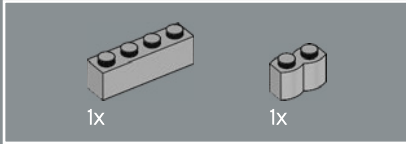
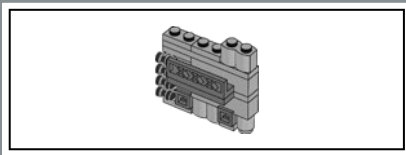

14

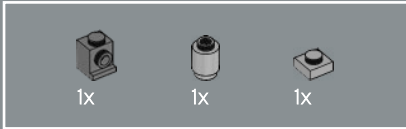
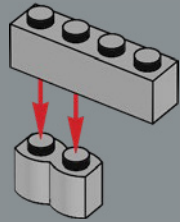

15

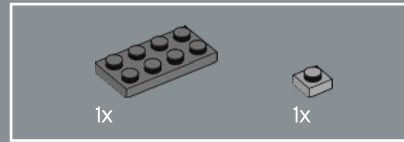
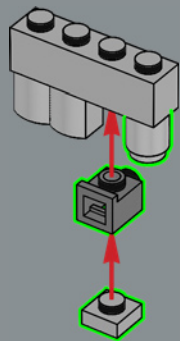

16

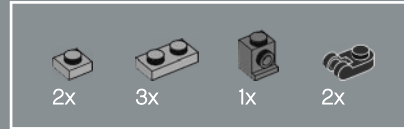
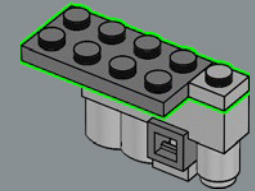

17

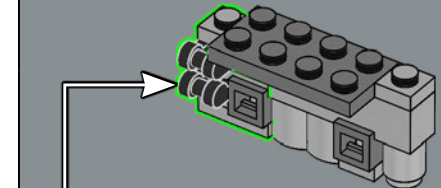
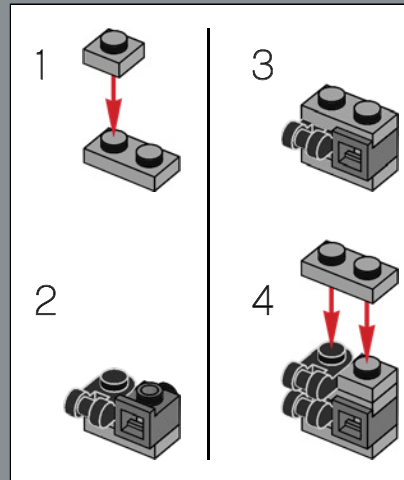



18

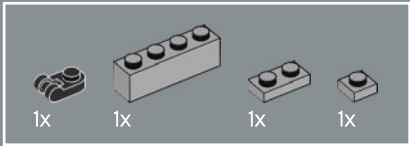
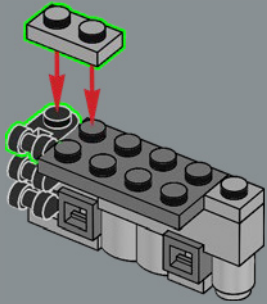

19

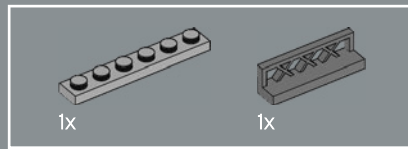
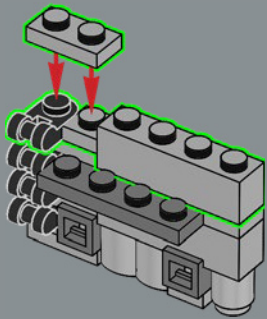

20

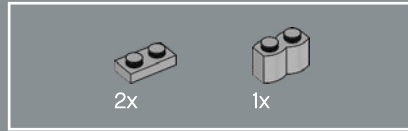
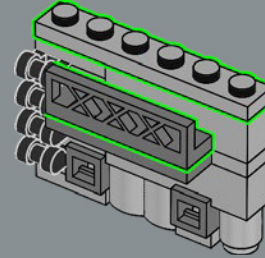

21

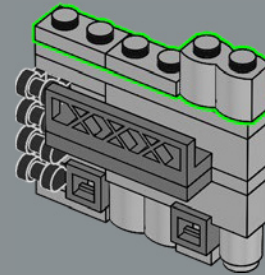

22

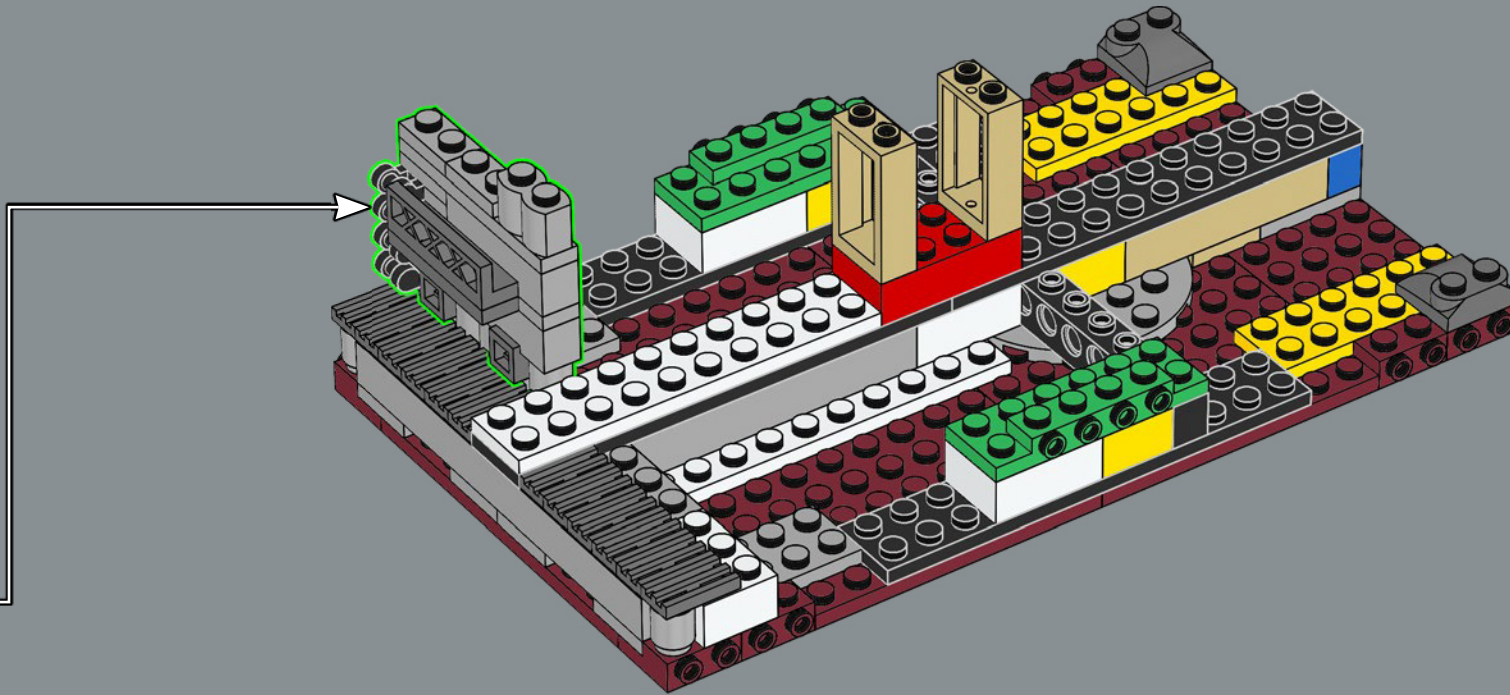

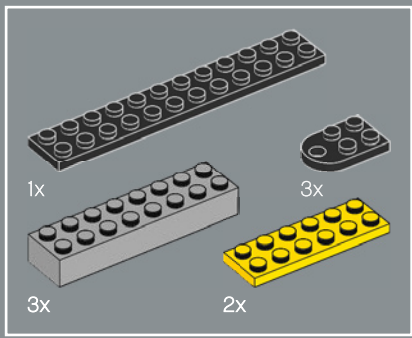

23

1

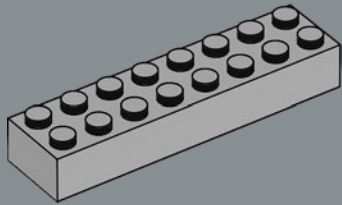

2

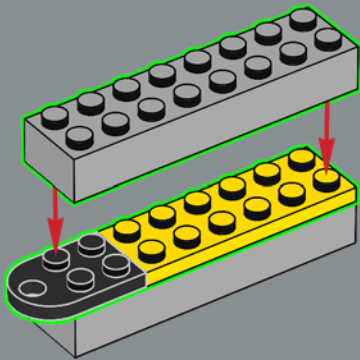

3

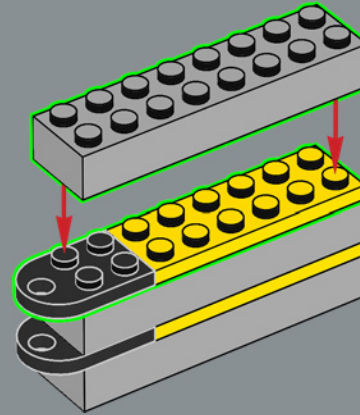

4

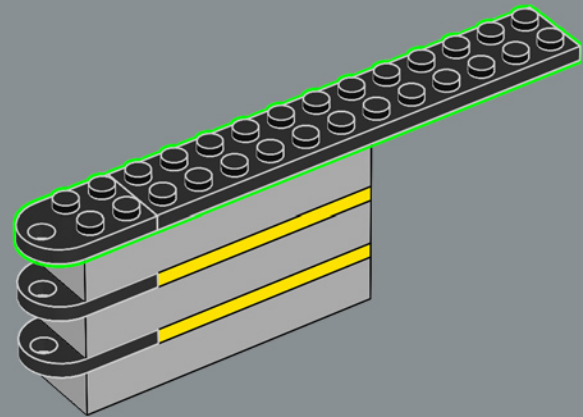

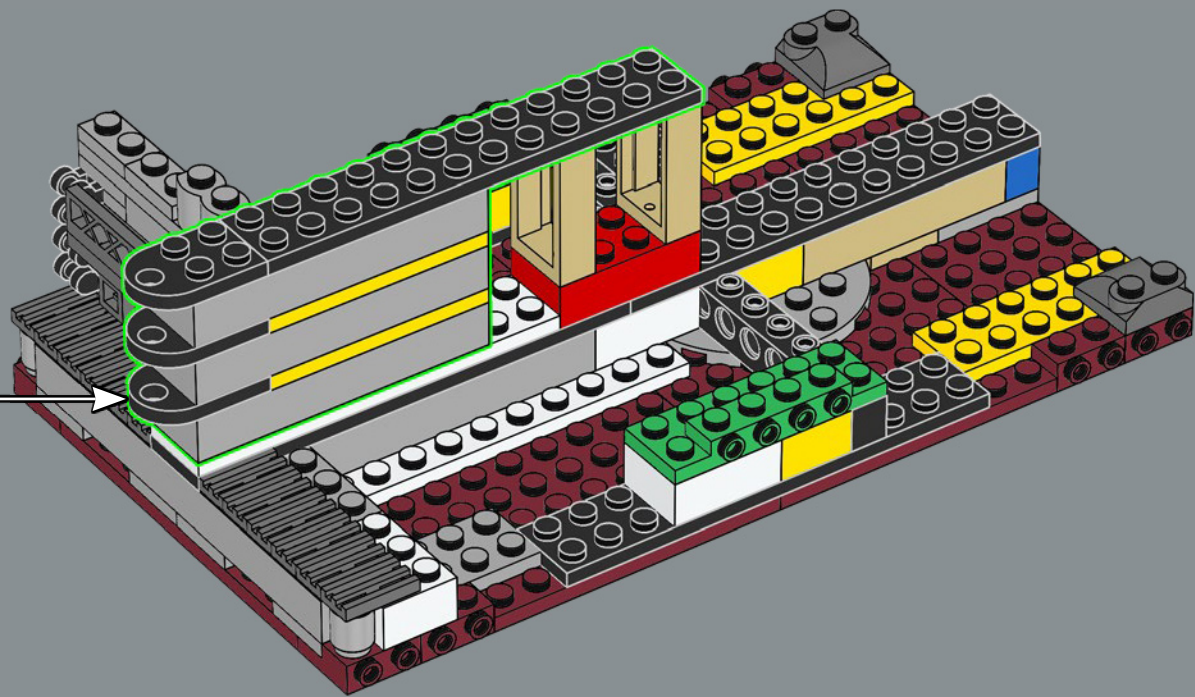

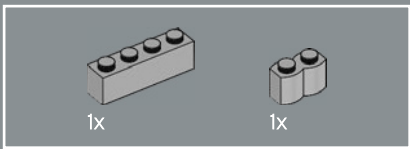

24

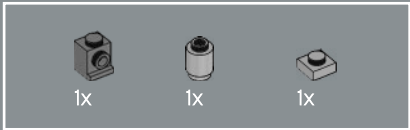
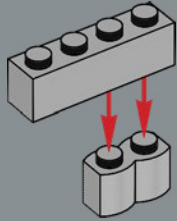

25

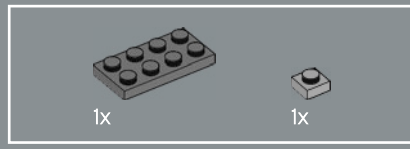
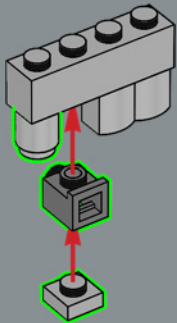

26

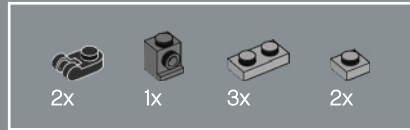
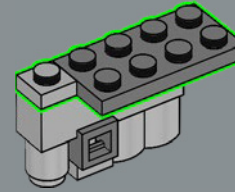

27

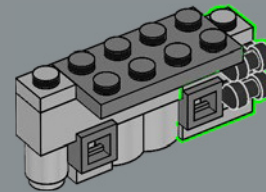
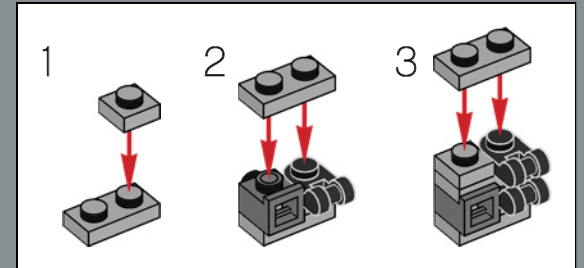

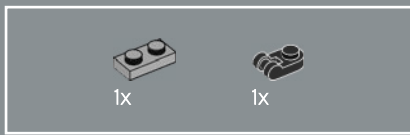

28

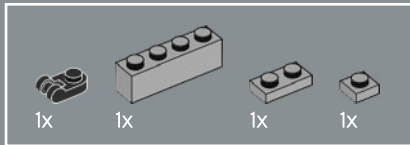
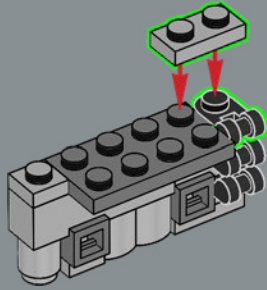

29

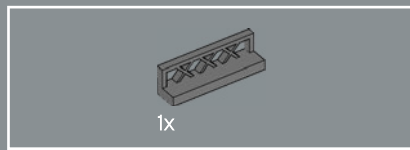
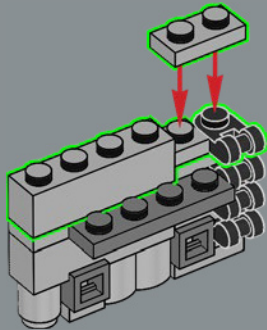

30

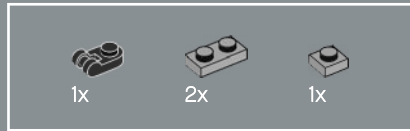
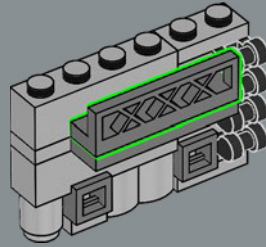

31

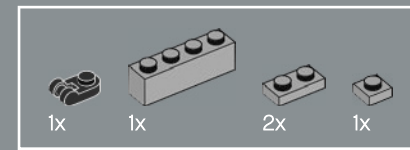
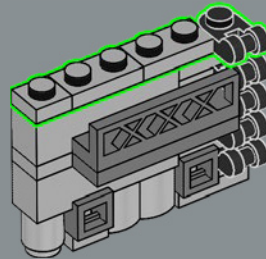

32

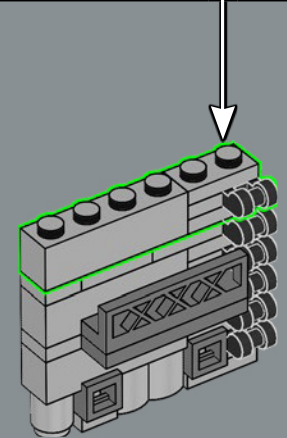
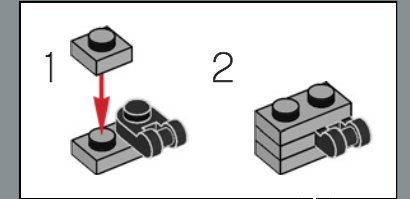

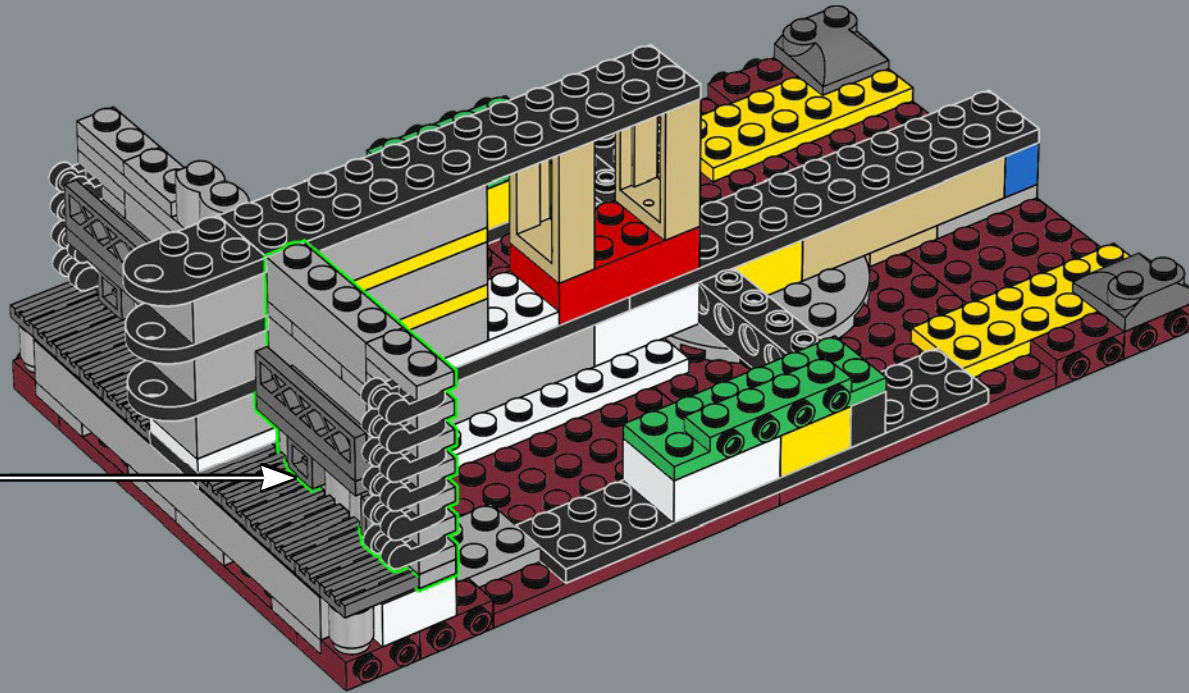

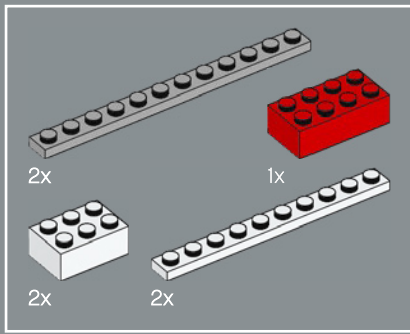

36

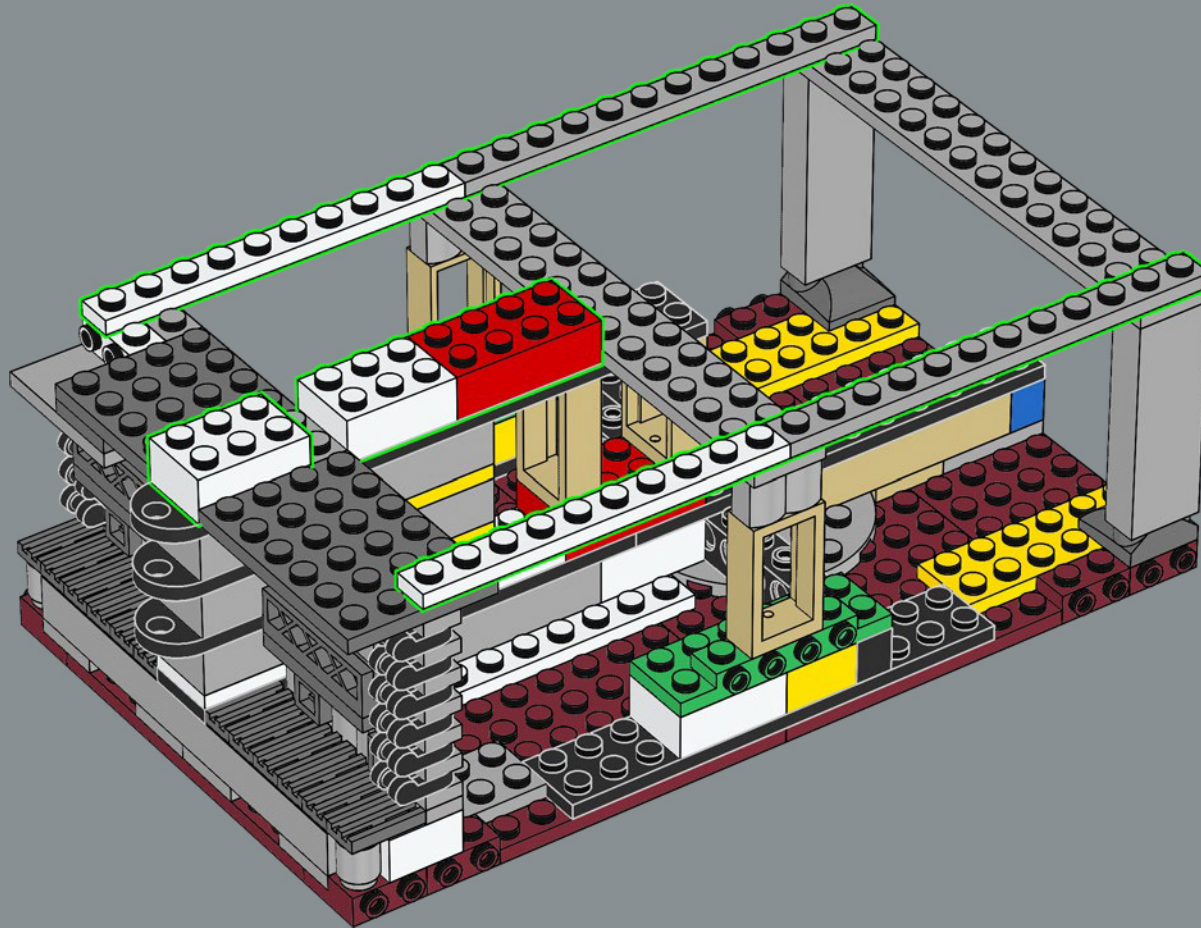

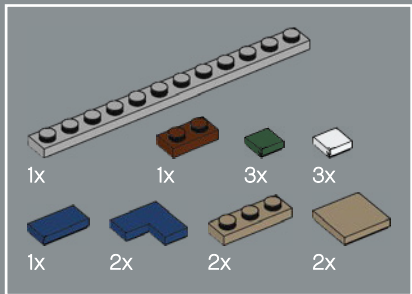
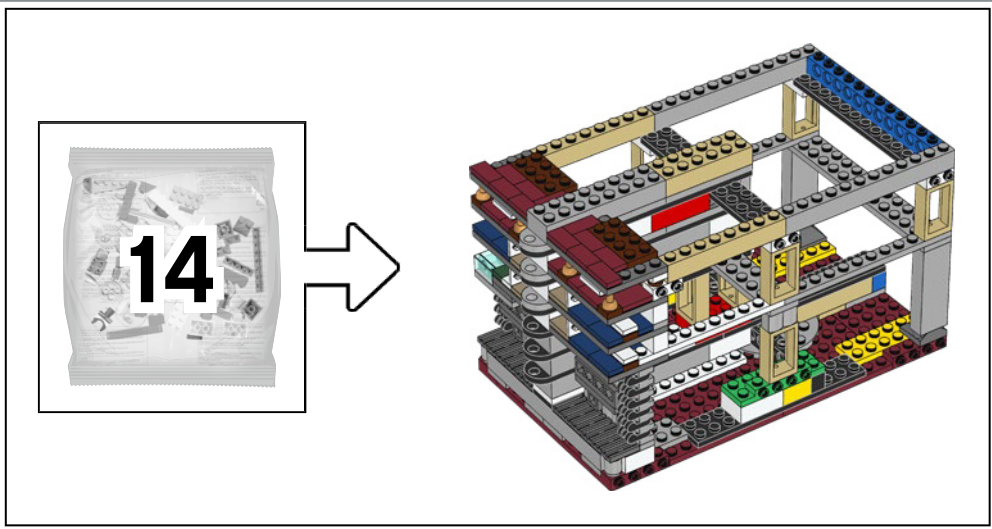

37

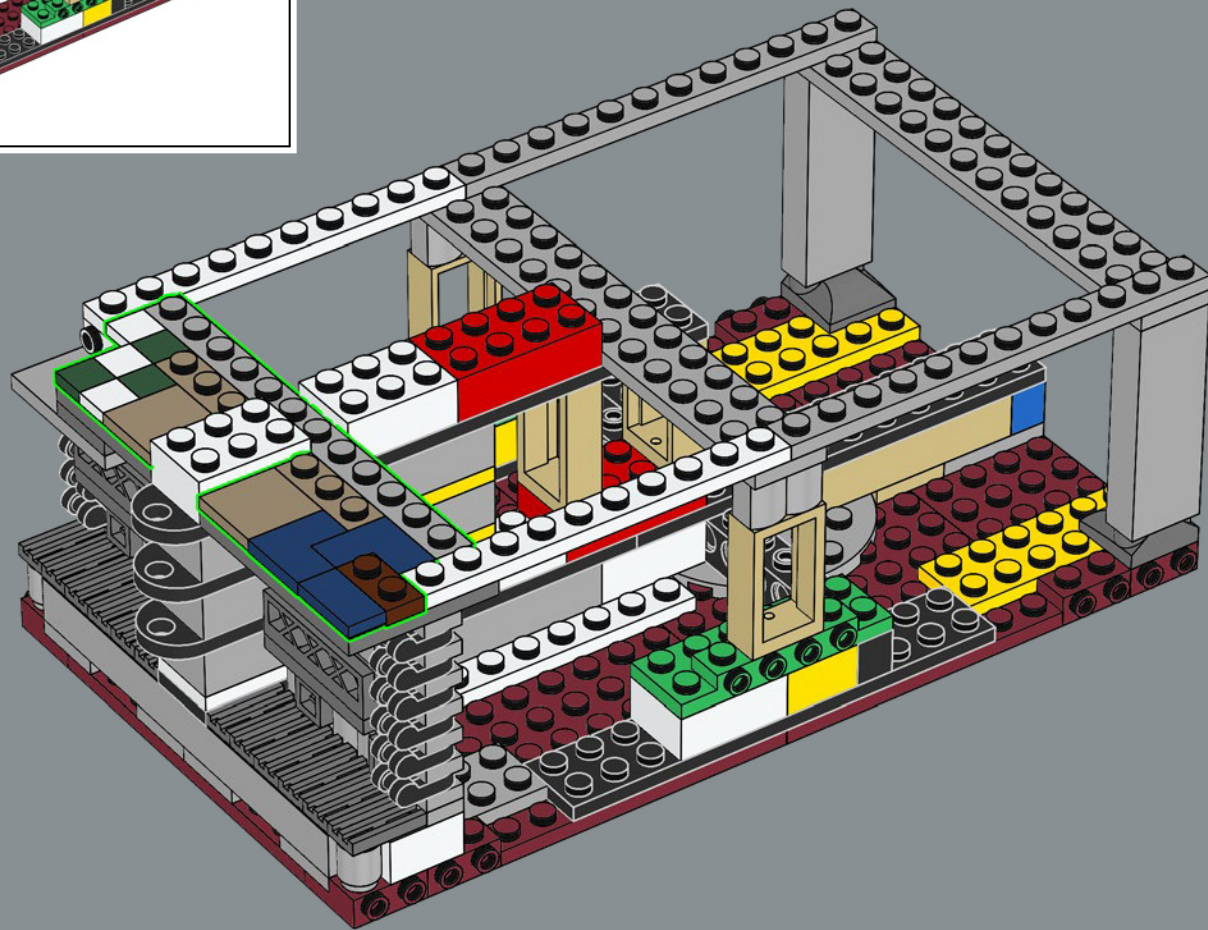

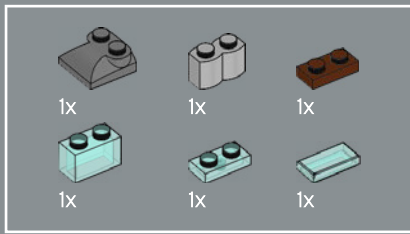

38

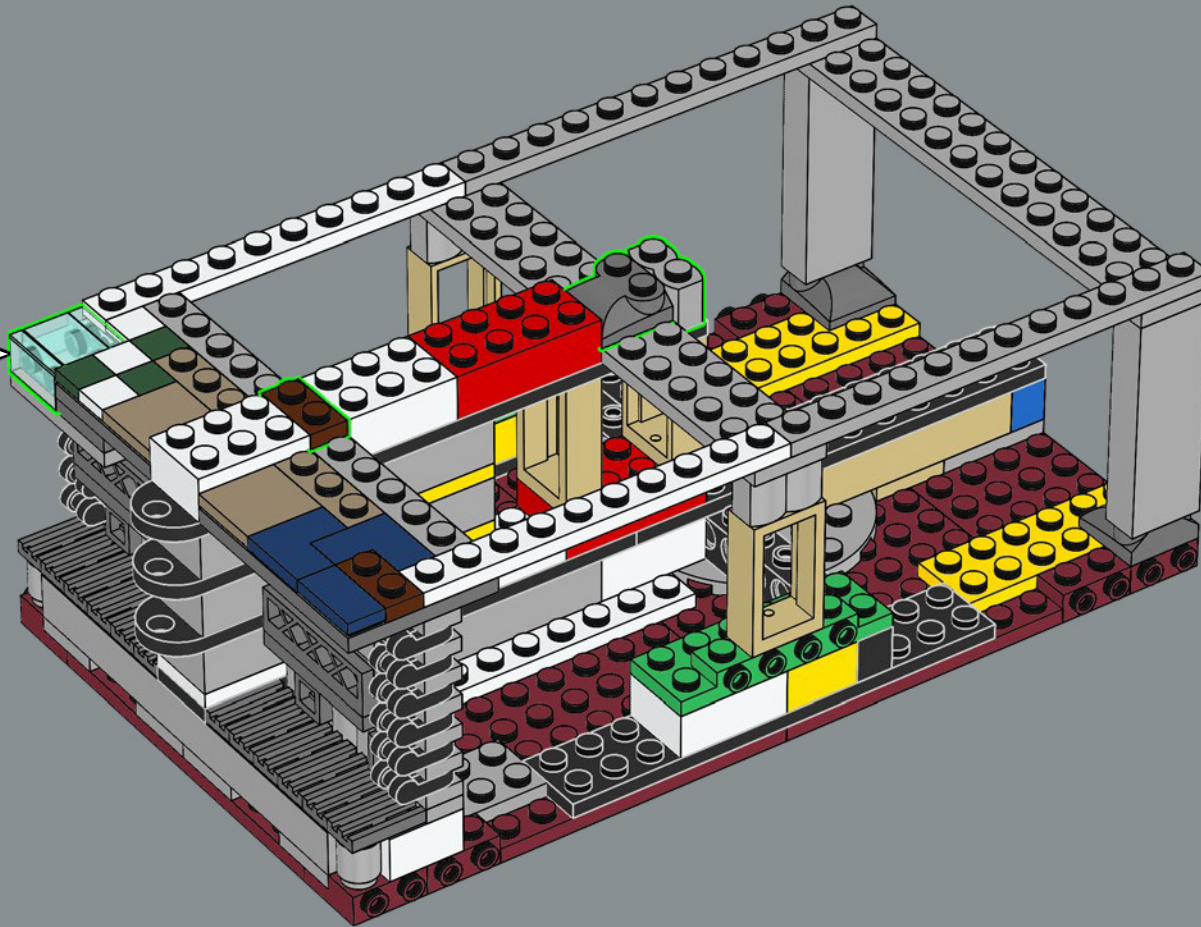
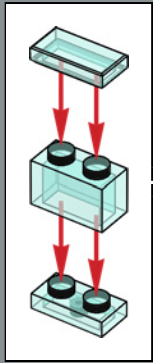

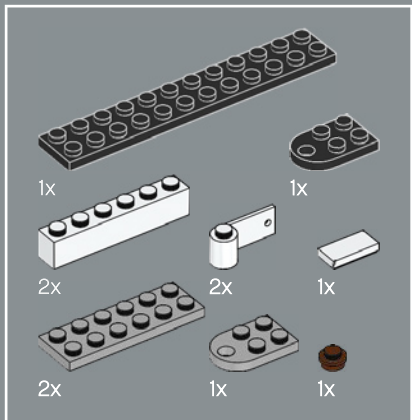

39

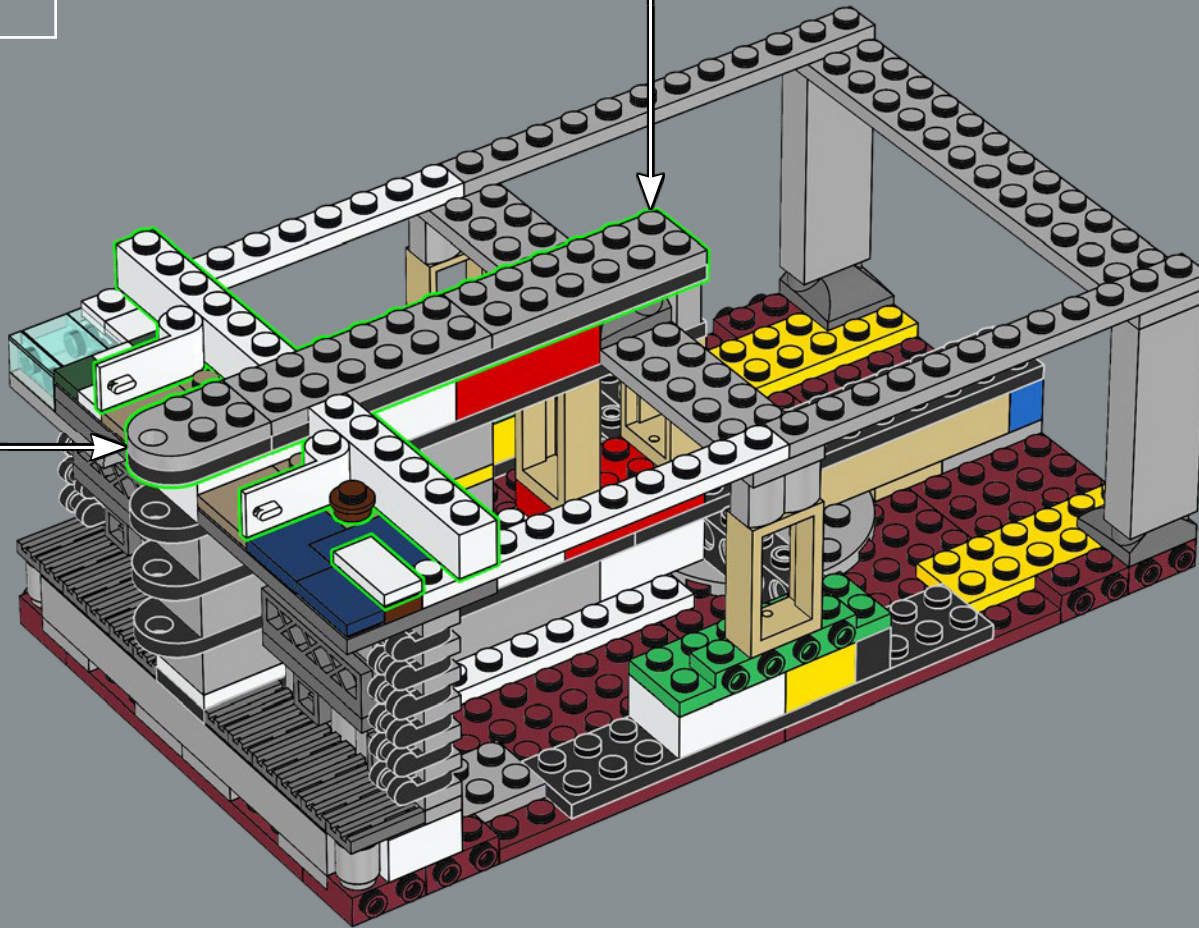
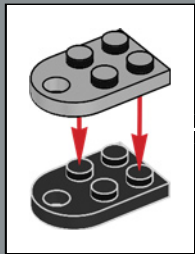
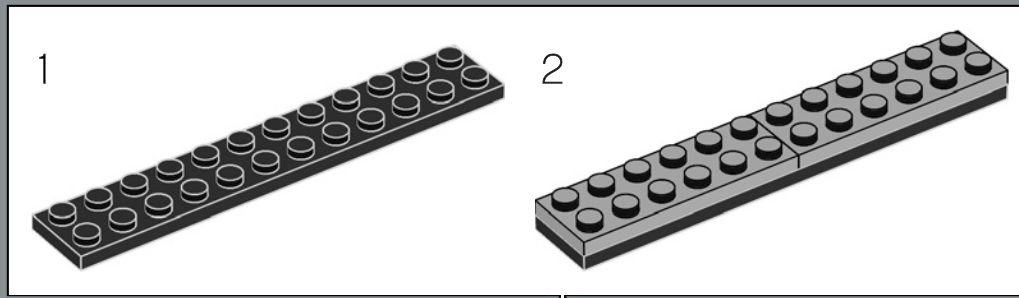

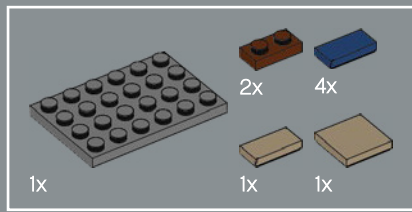

40

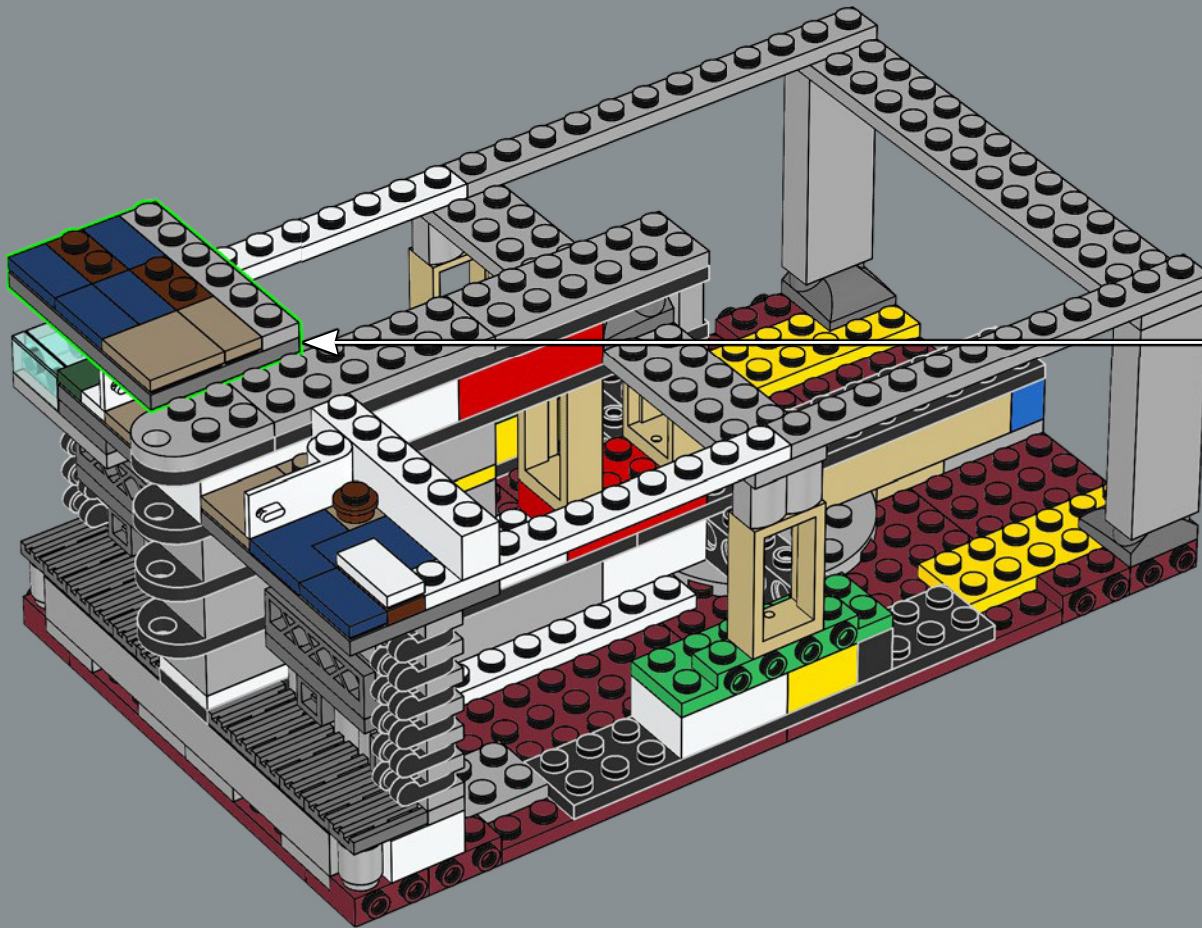
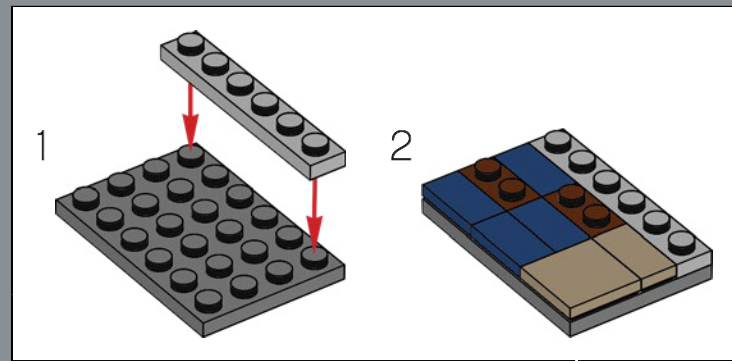

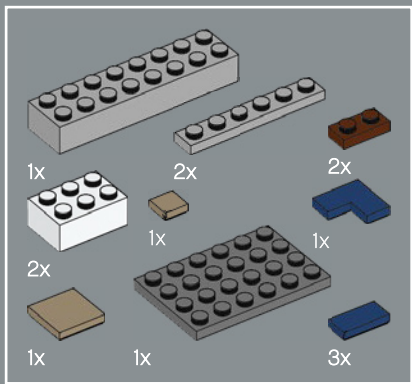

41

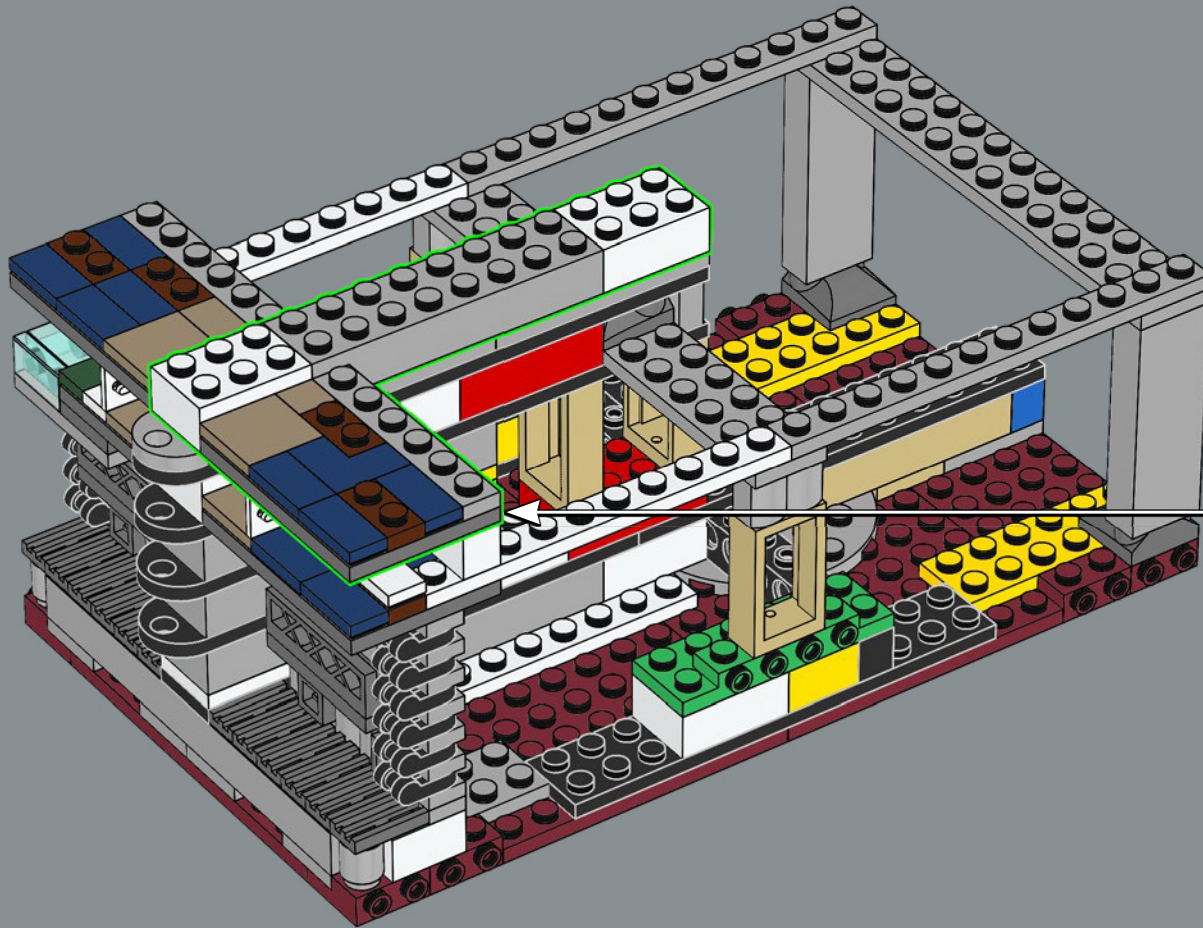
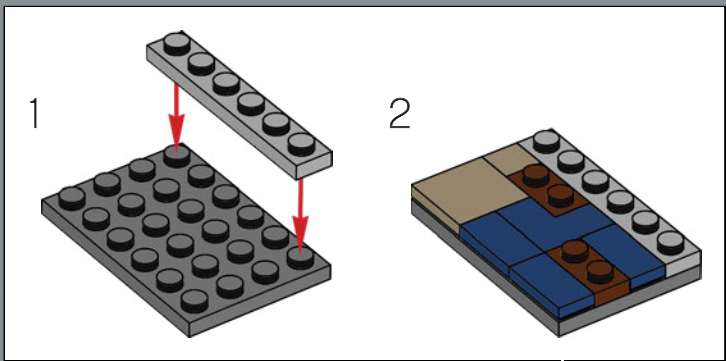

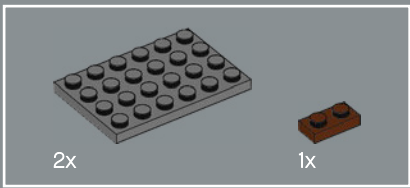

43

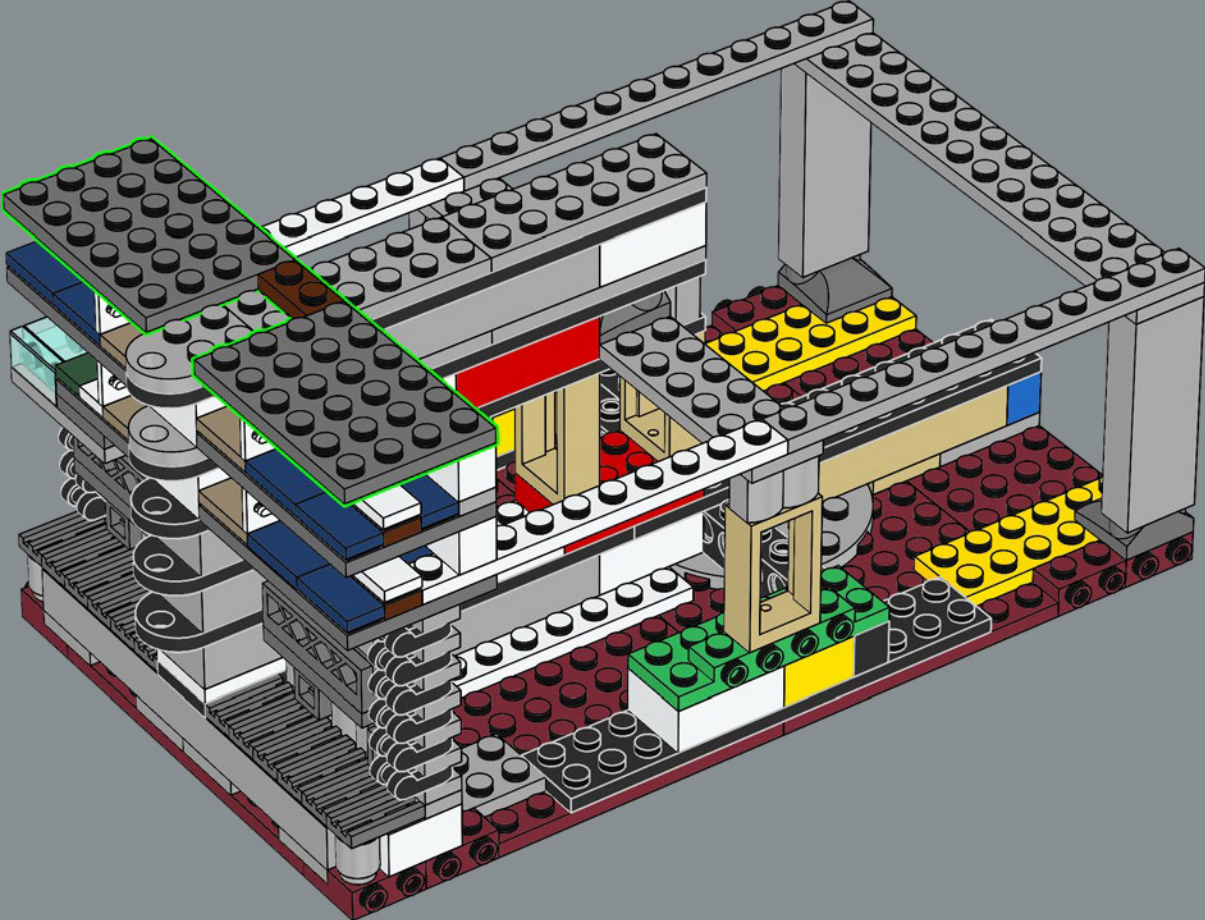

这艘船自带供水系统，能够对水加热并将其抽到船的各个部分。

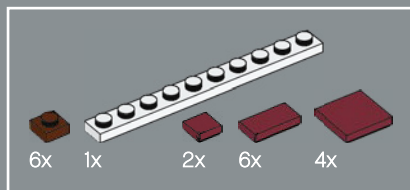

44

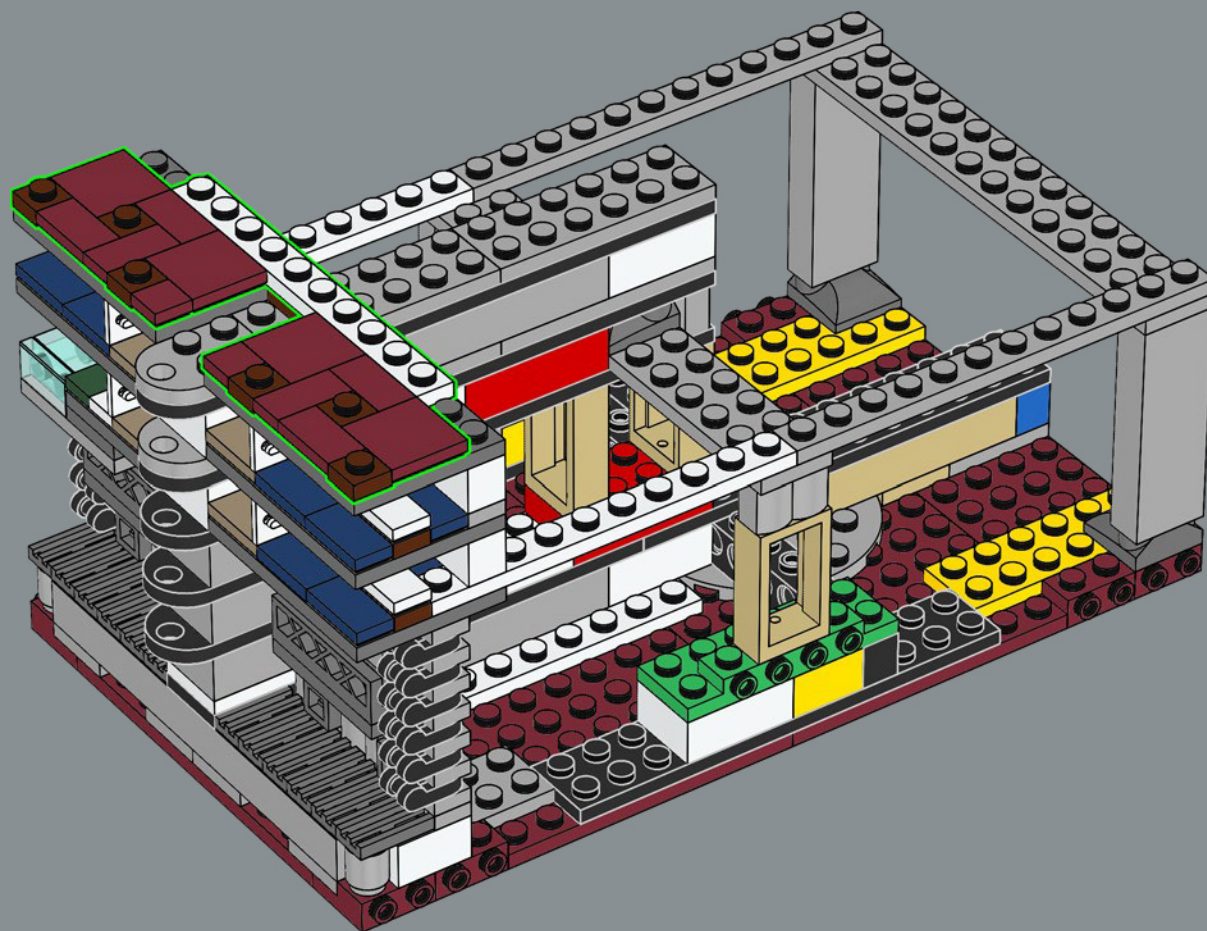

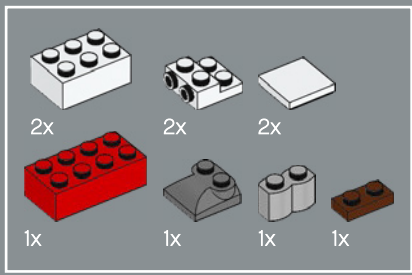

45

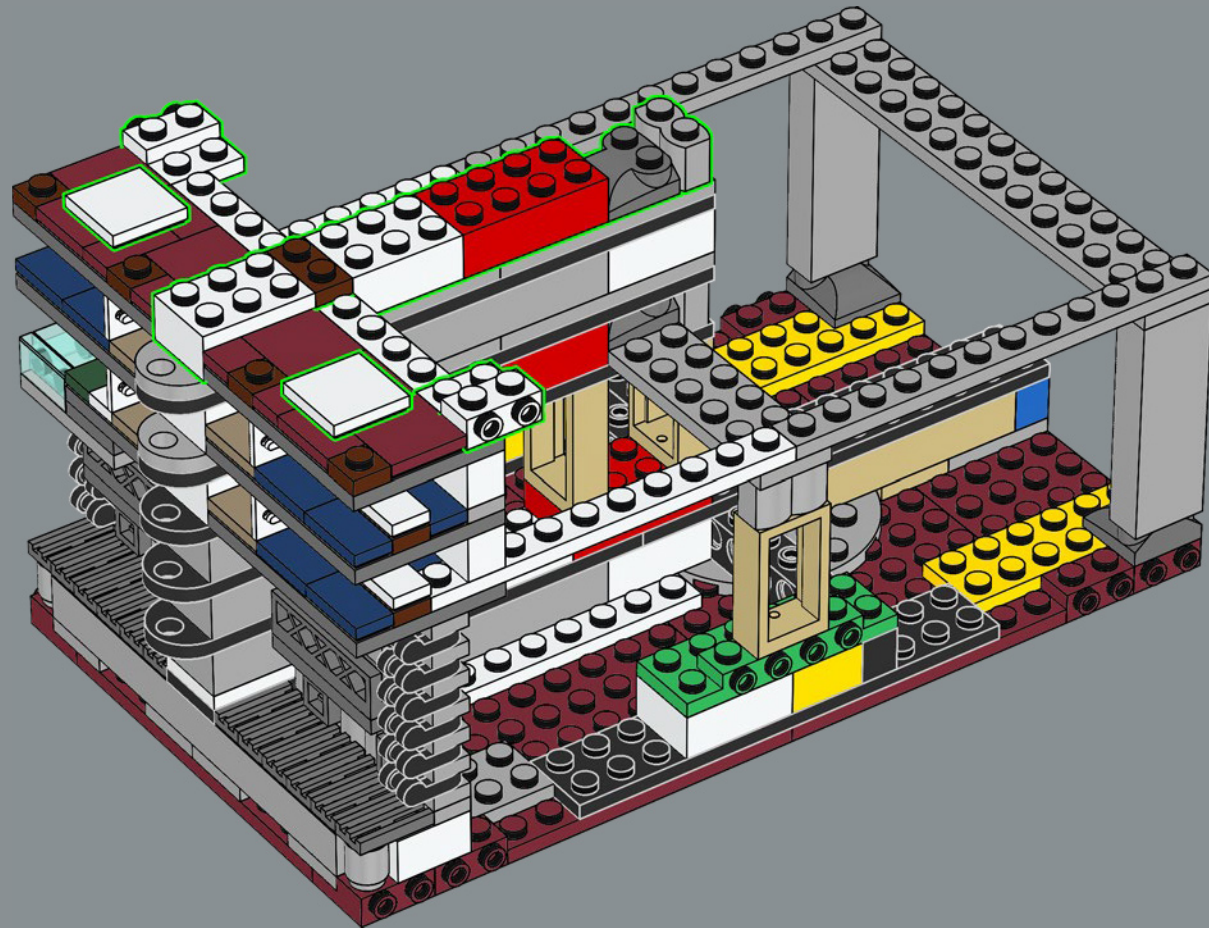

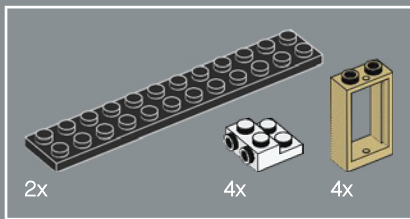

46

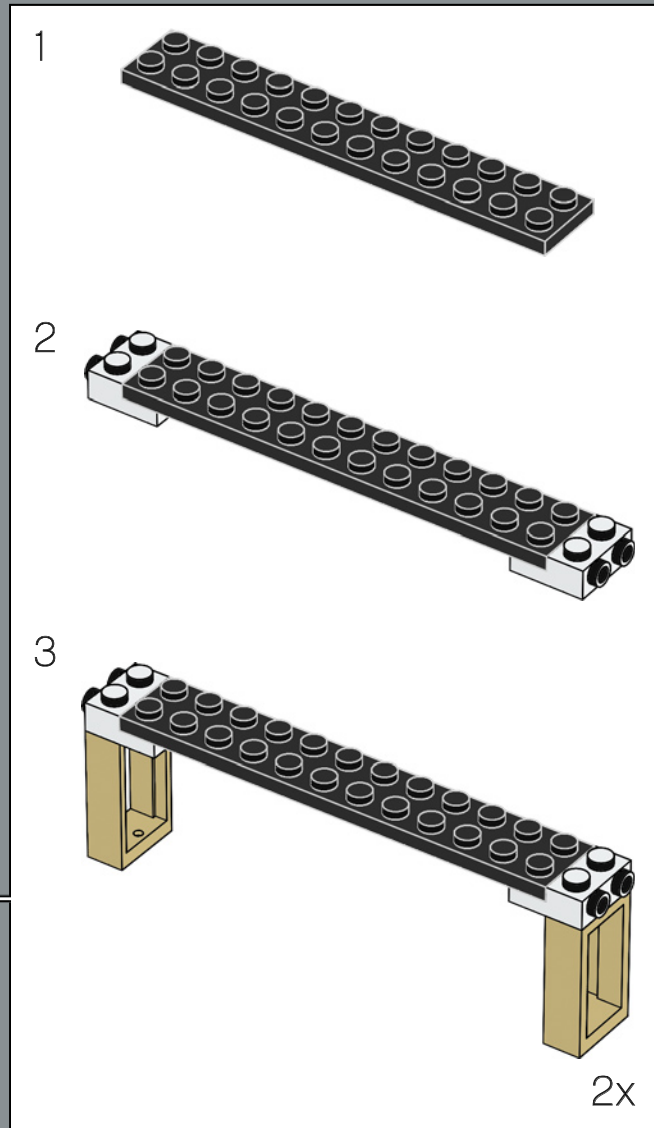
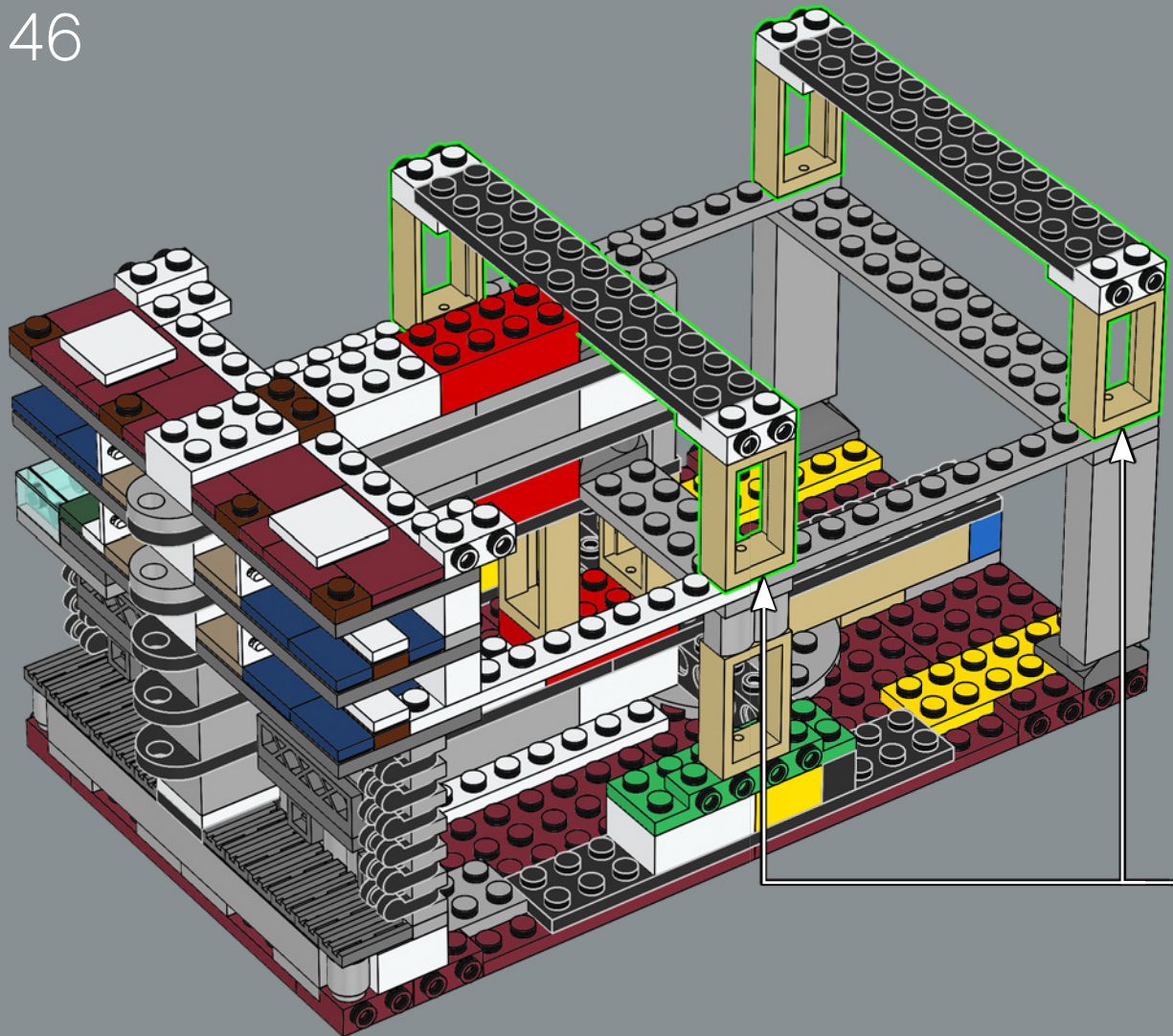

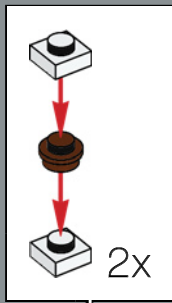
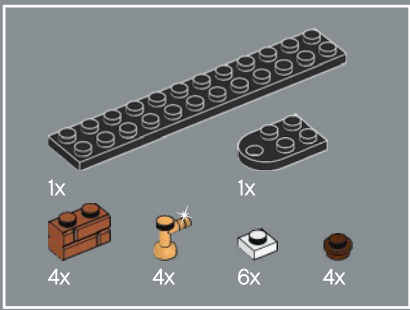

47

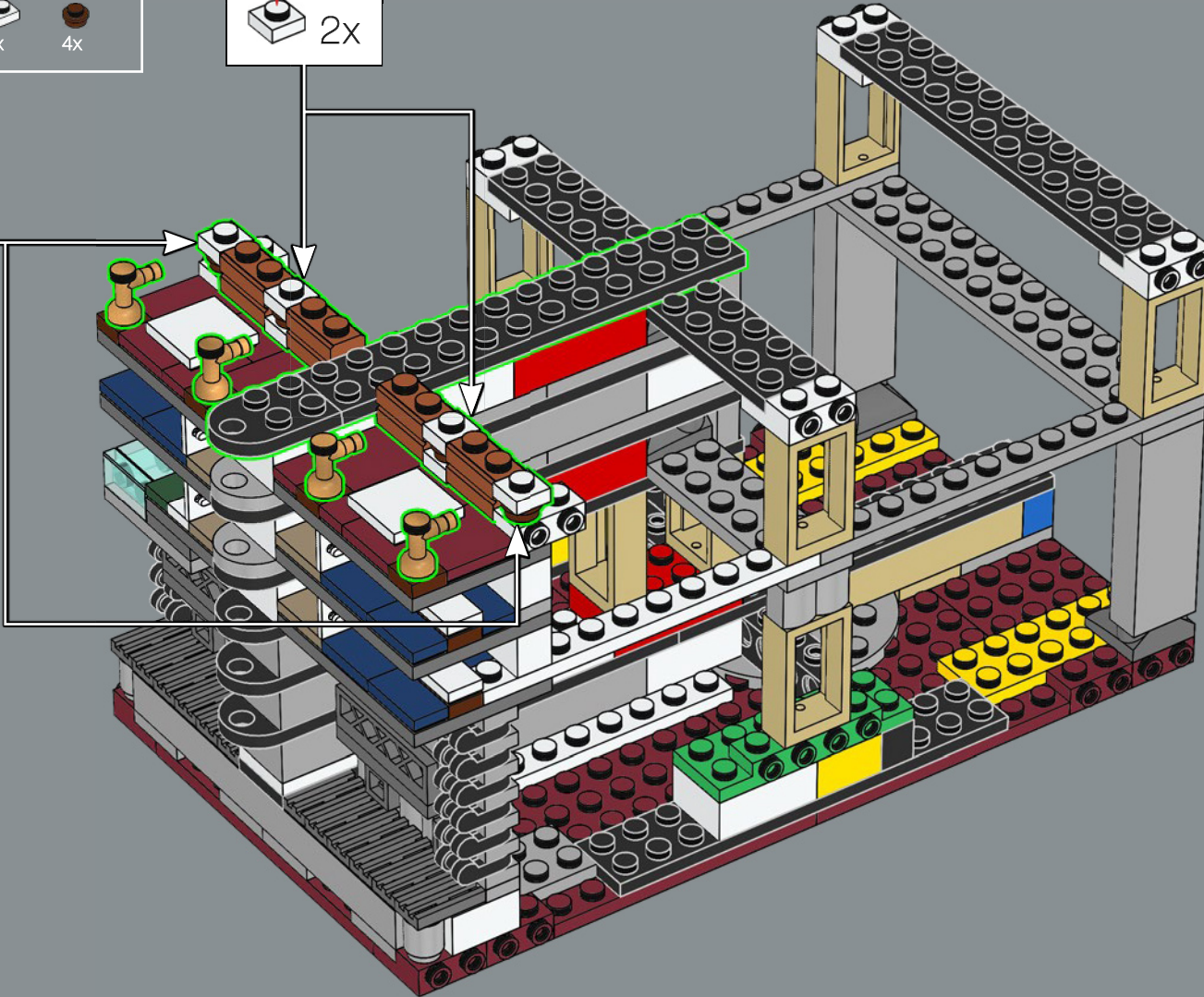
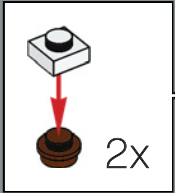

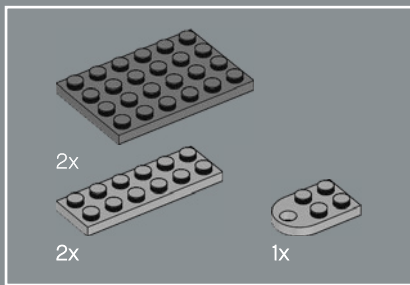

48

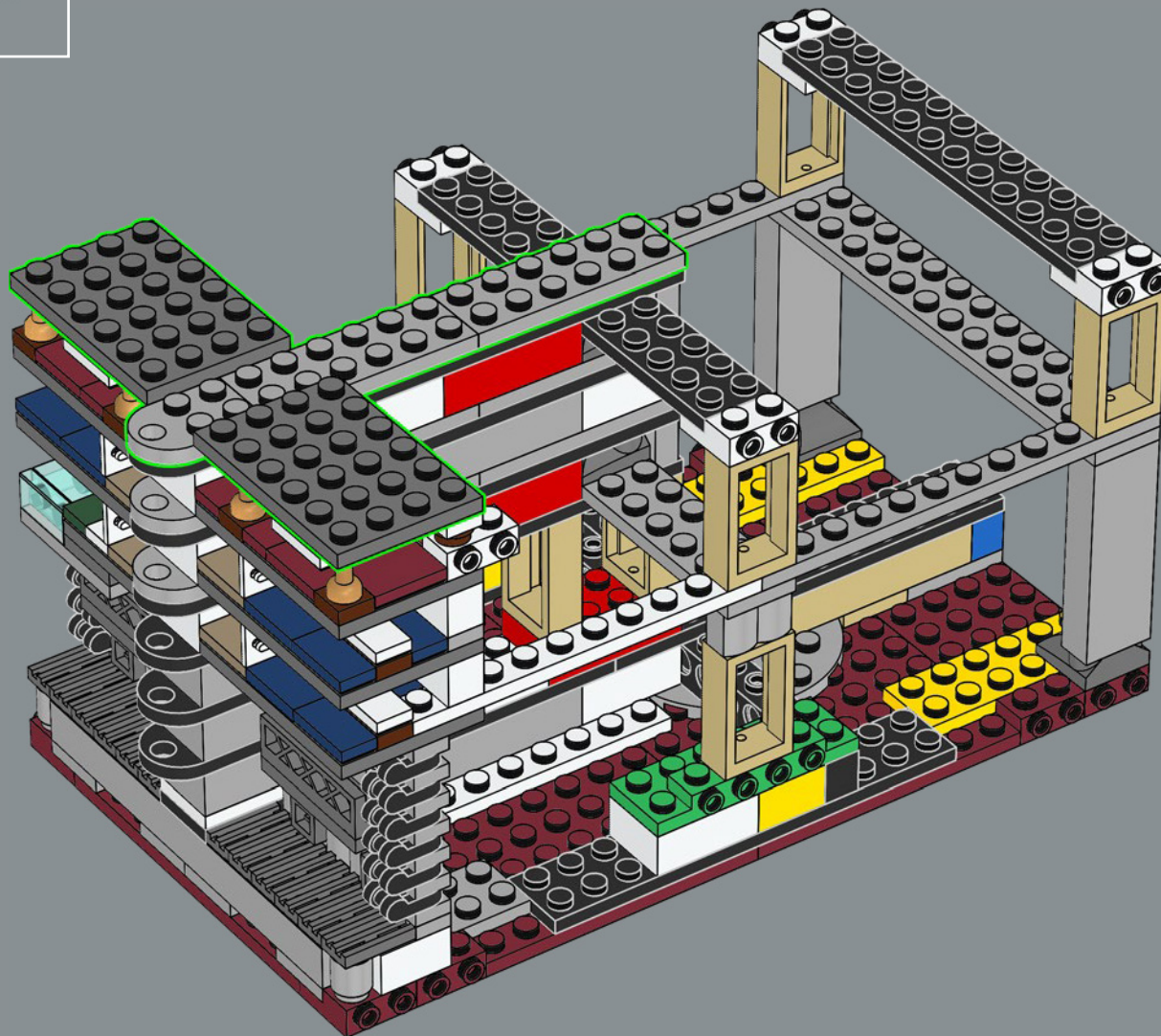



49

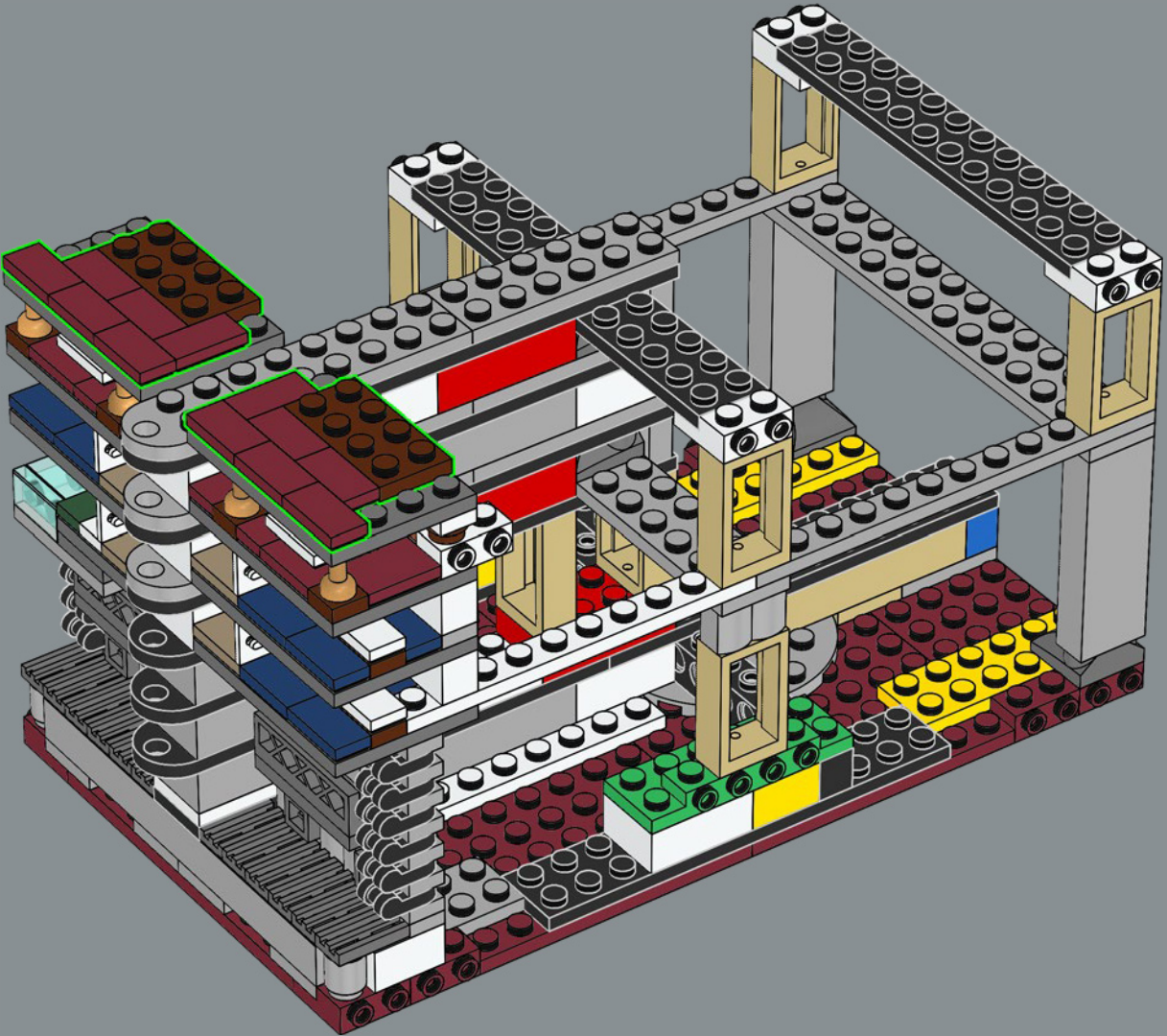

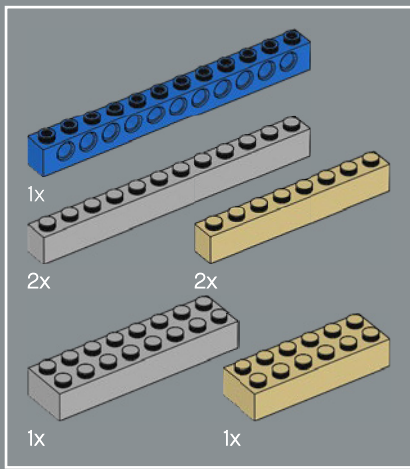

50

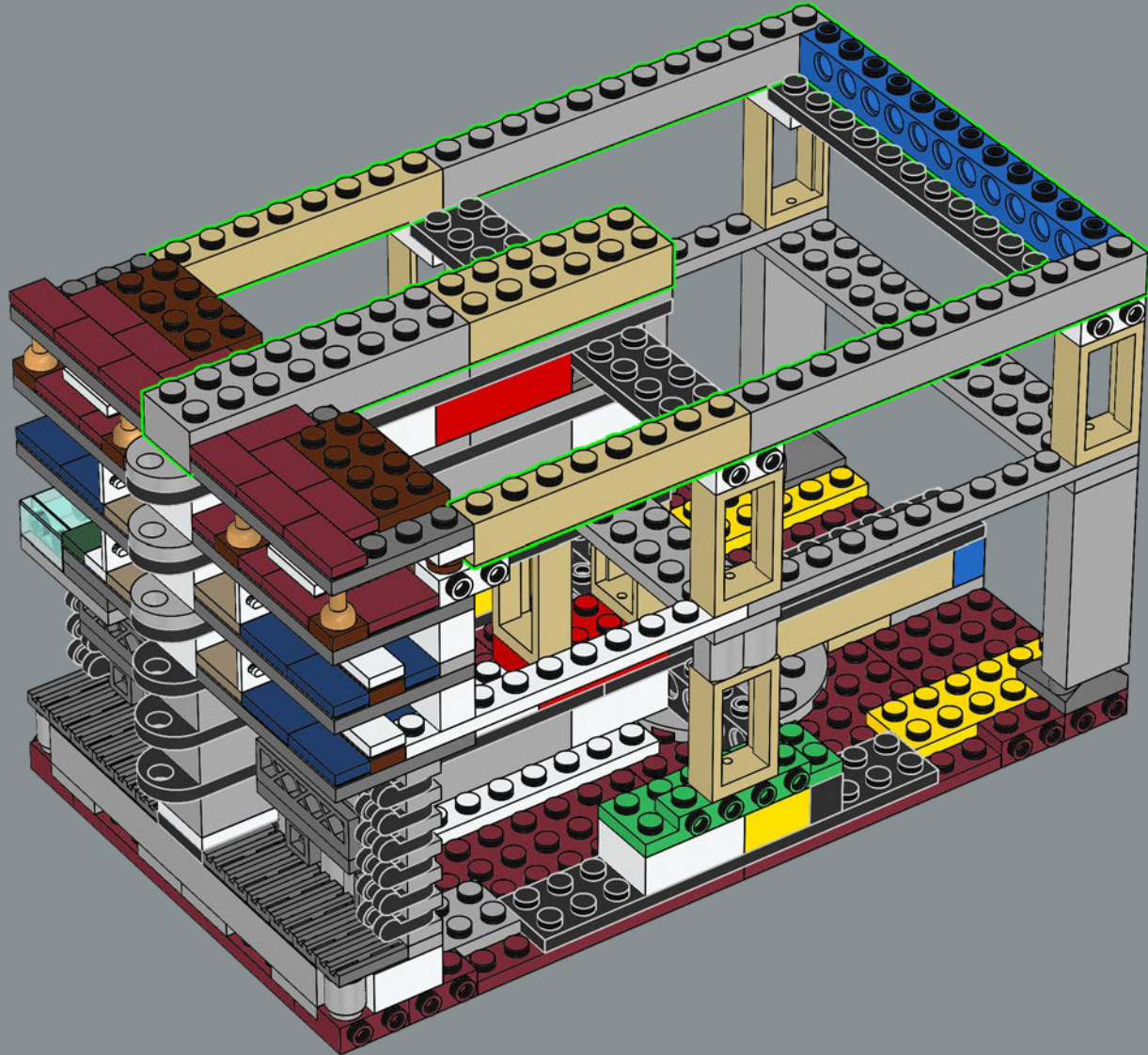

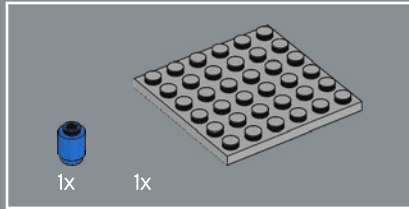
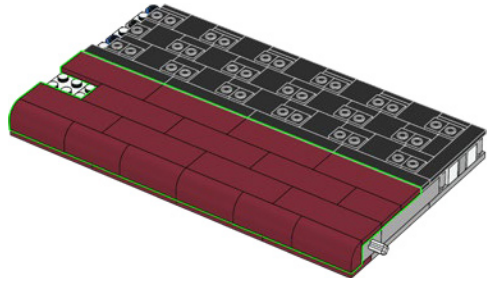
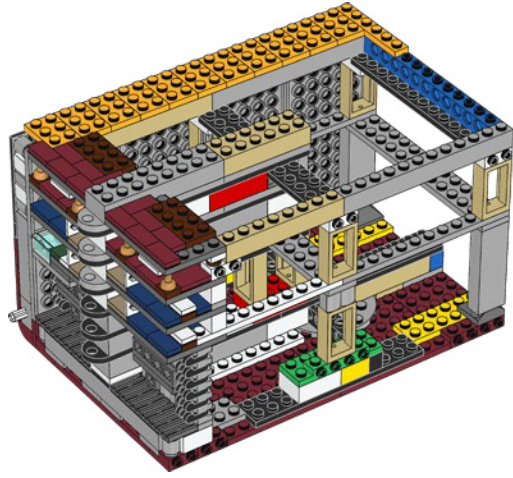
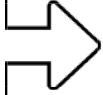

51

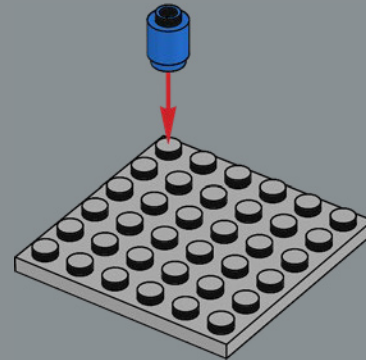

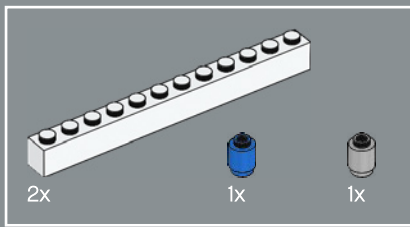

52

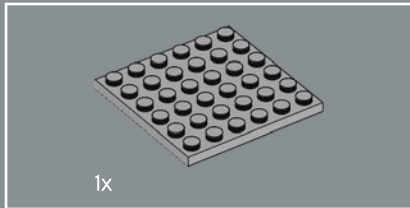
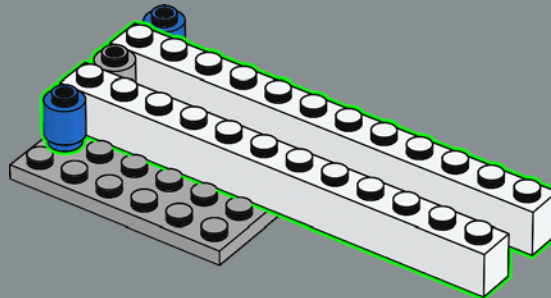

53

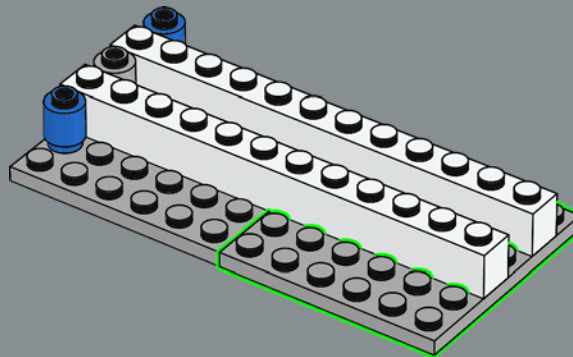

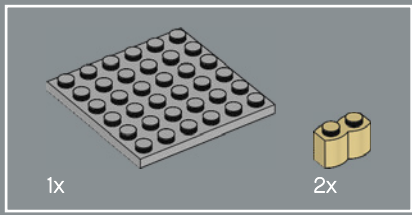

54

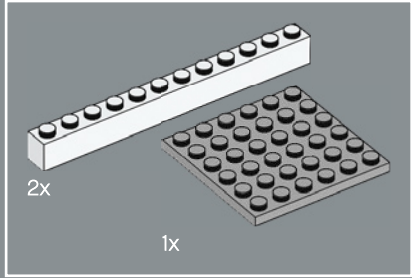
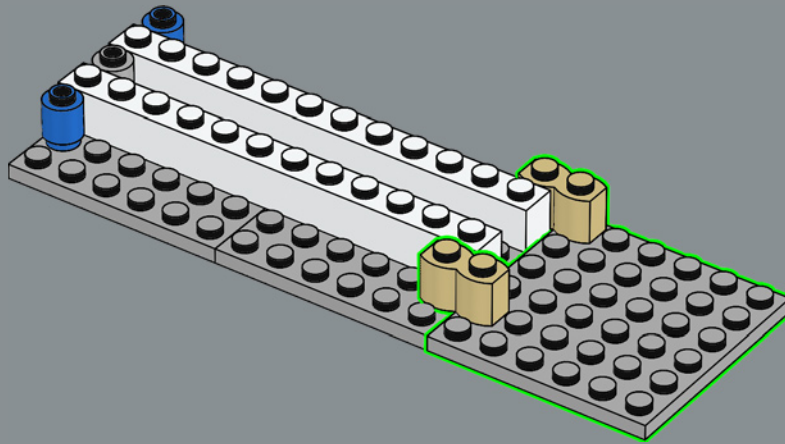

55

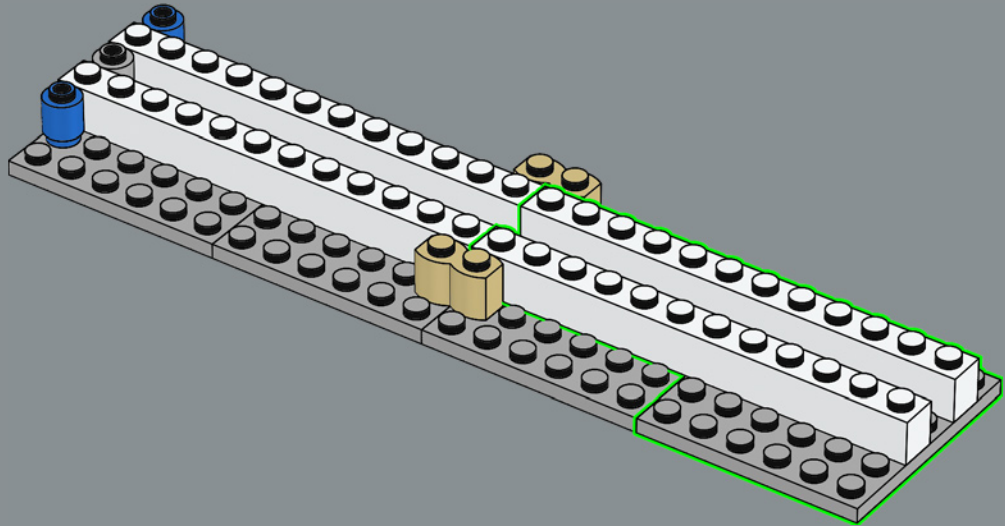

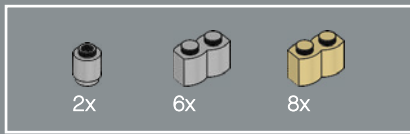

56

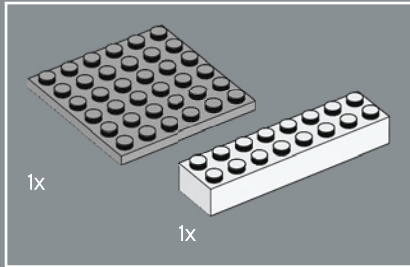
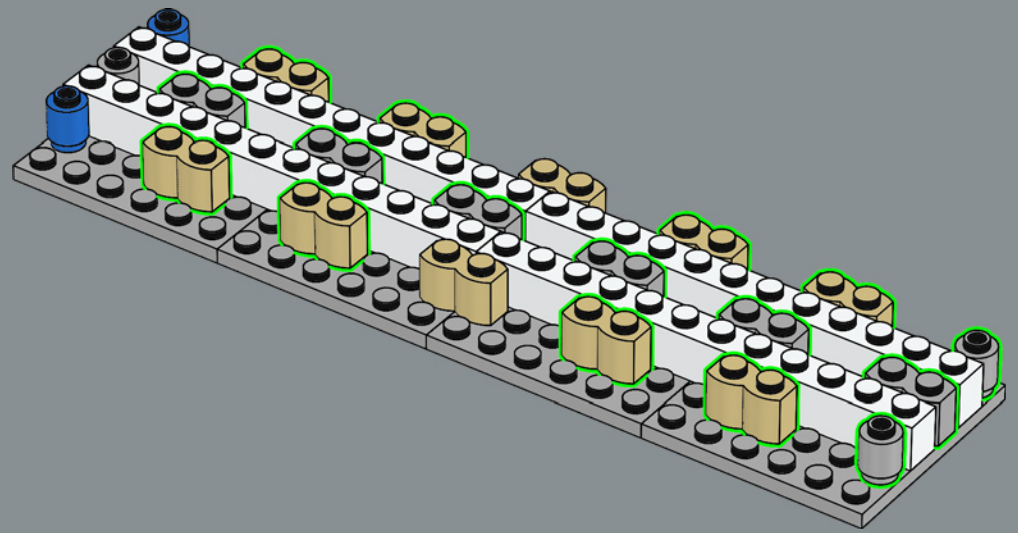

57

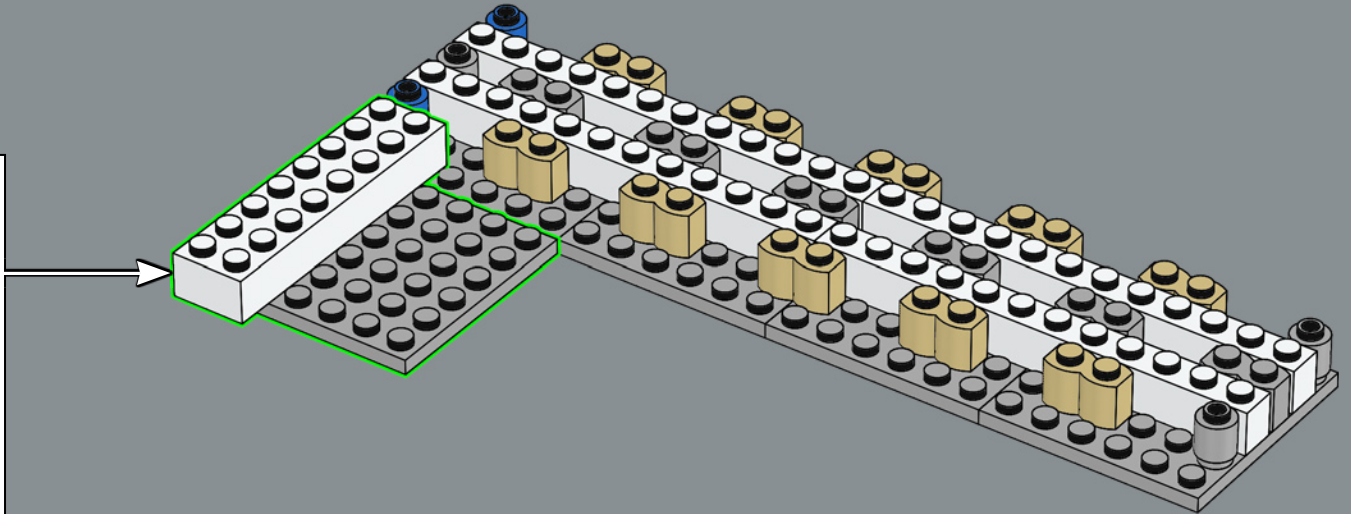
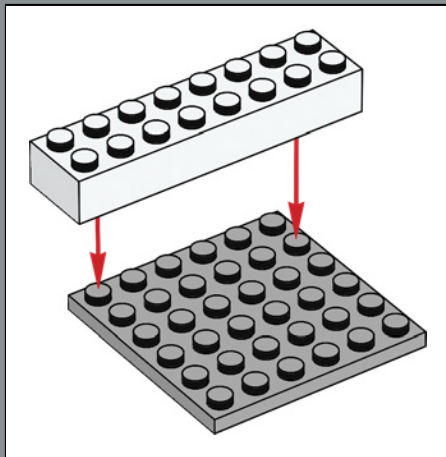

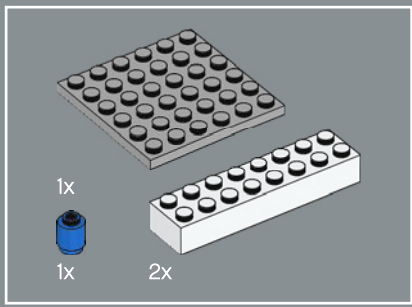

58

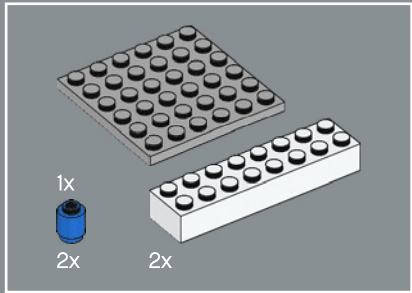
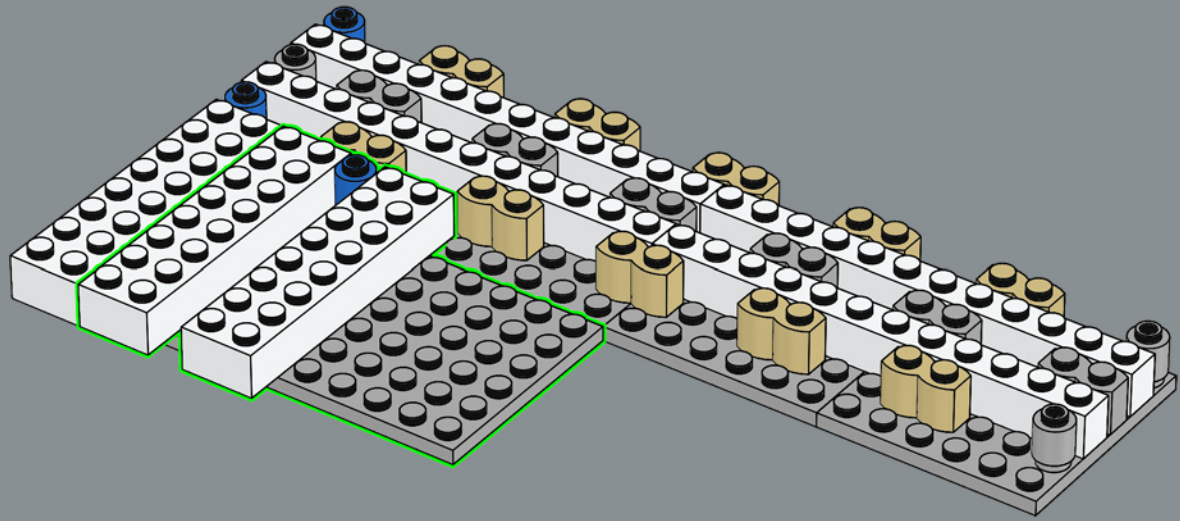

59

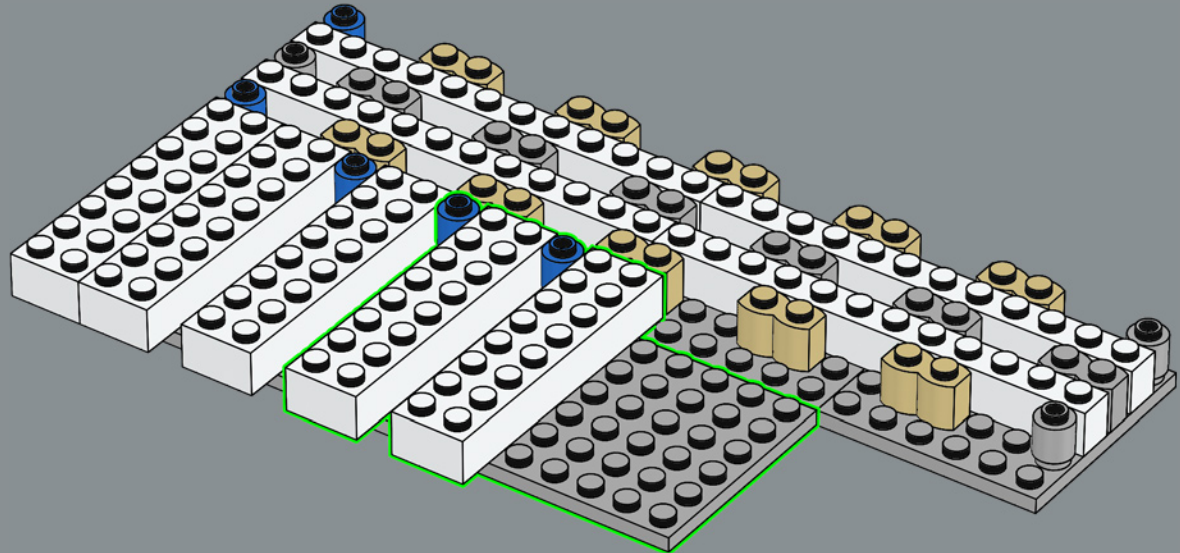

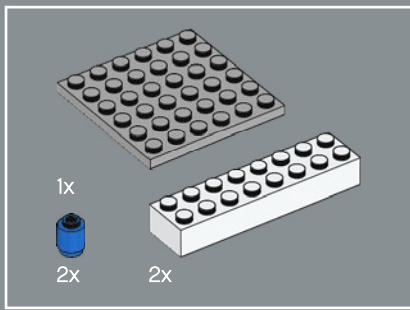

60

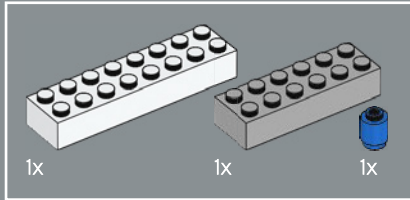
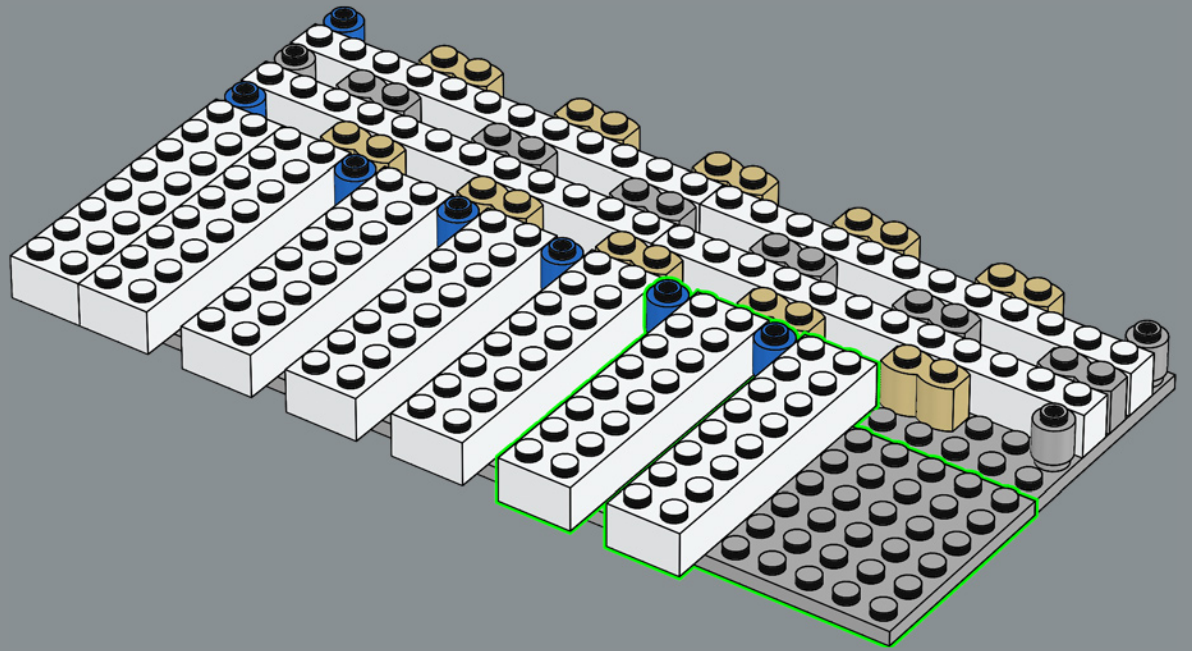

61

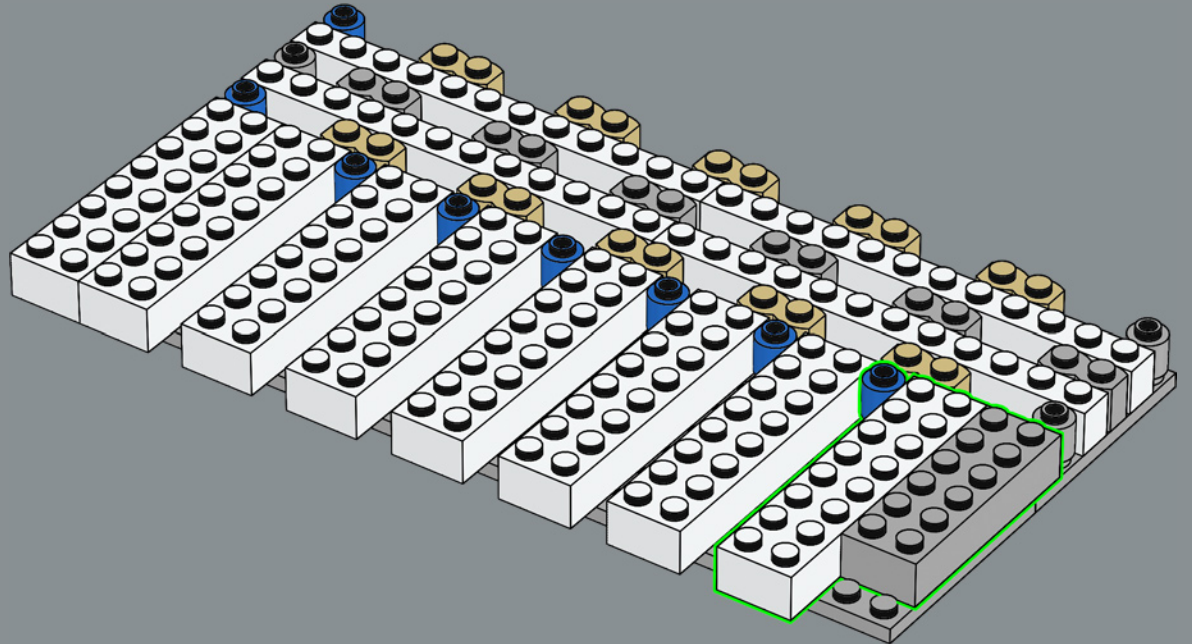

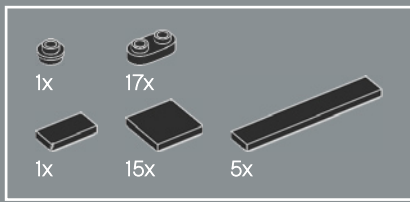

62

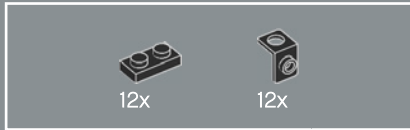
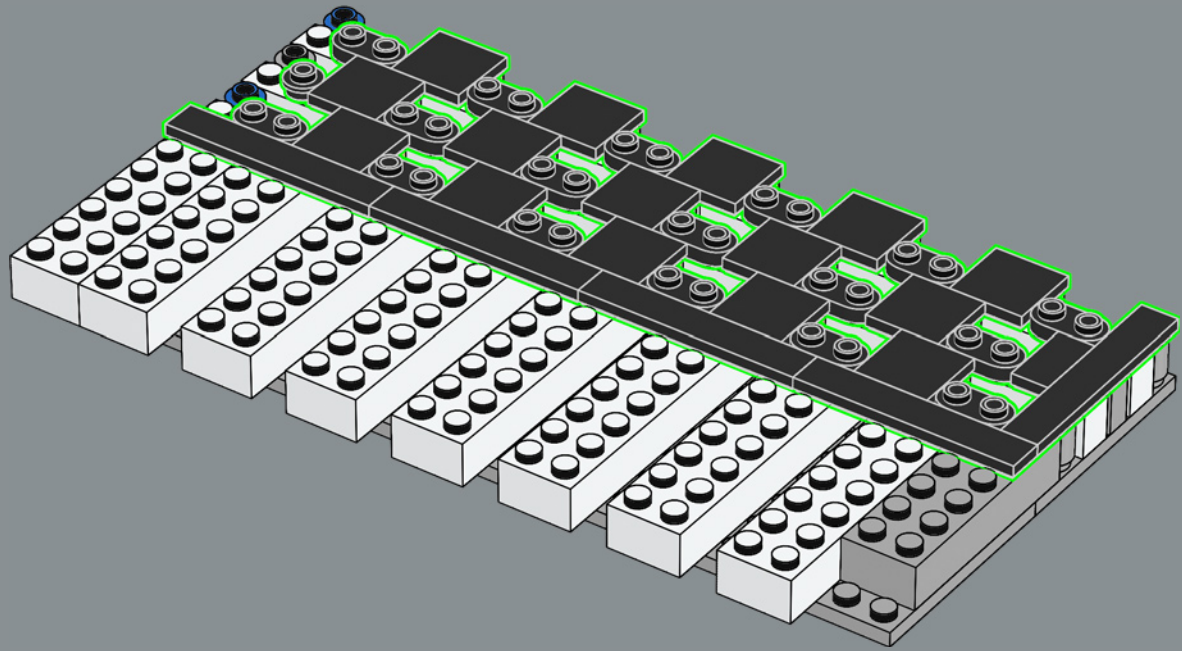

63

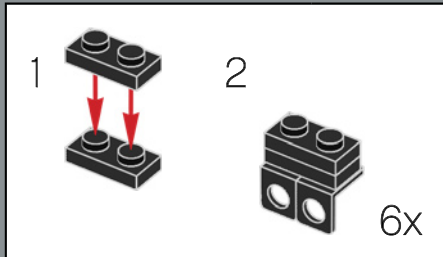
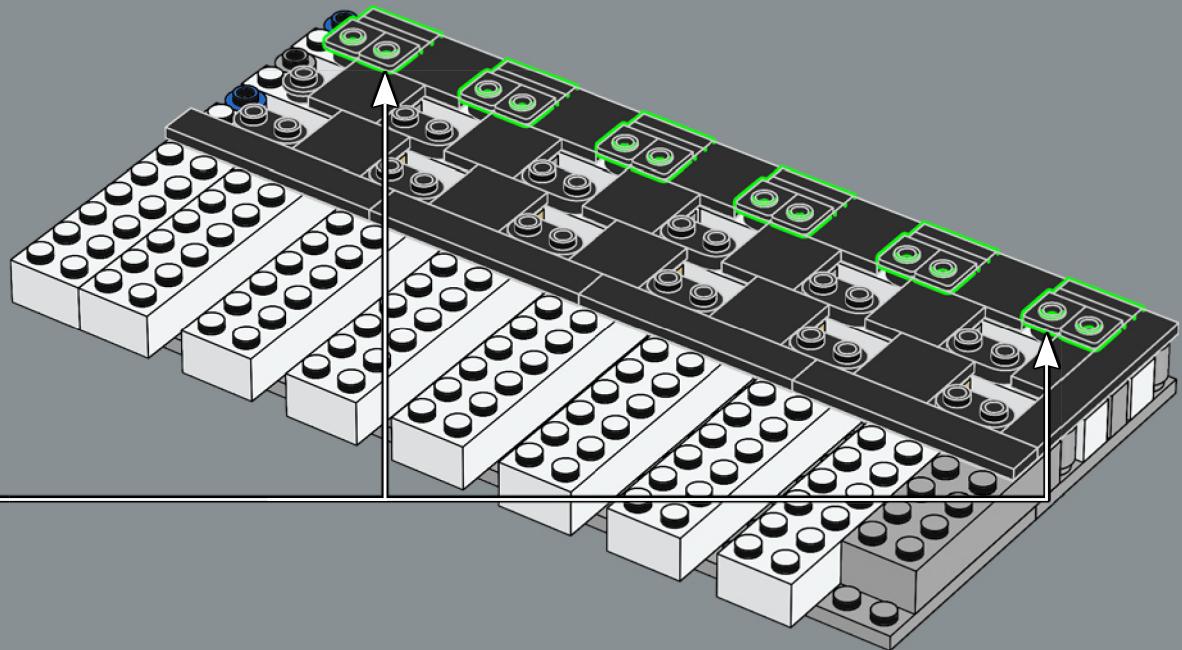

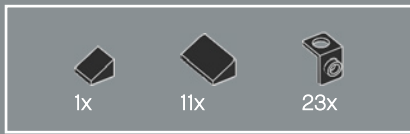

64

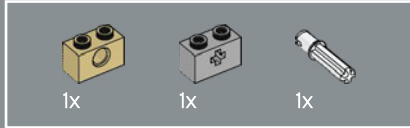
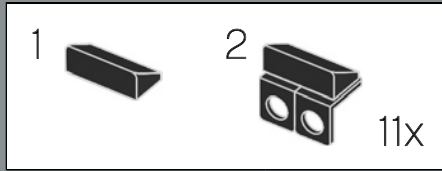
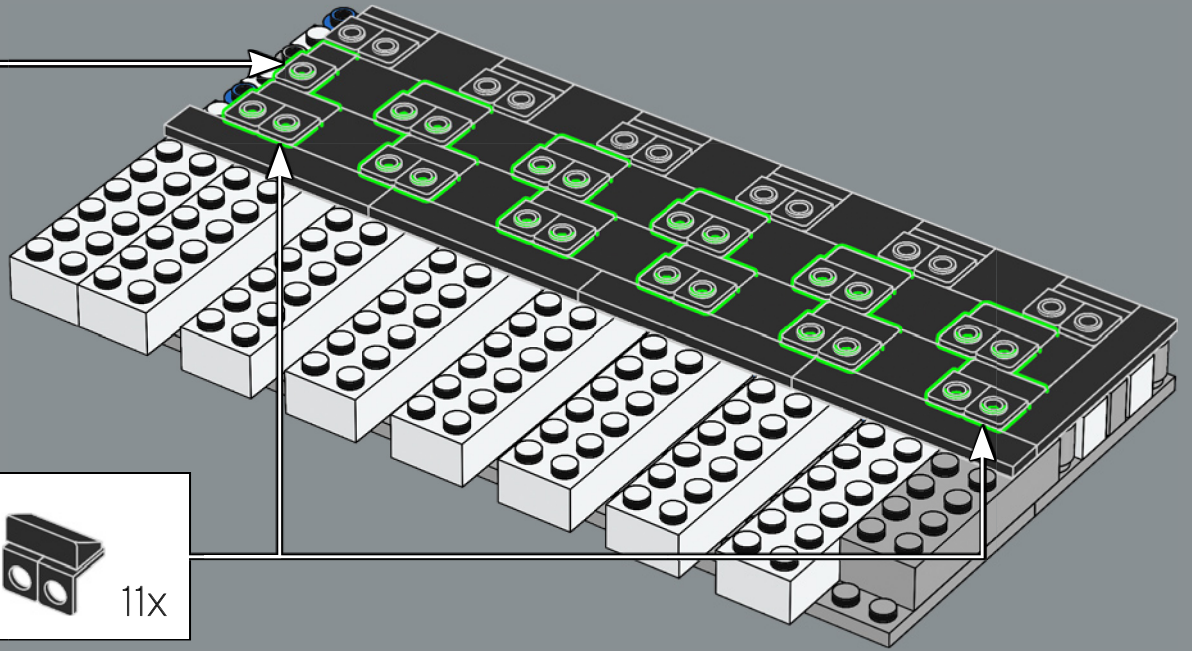
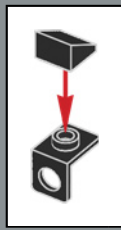

65

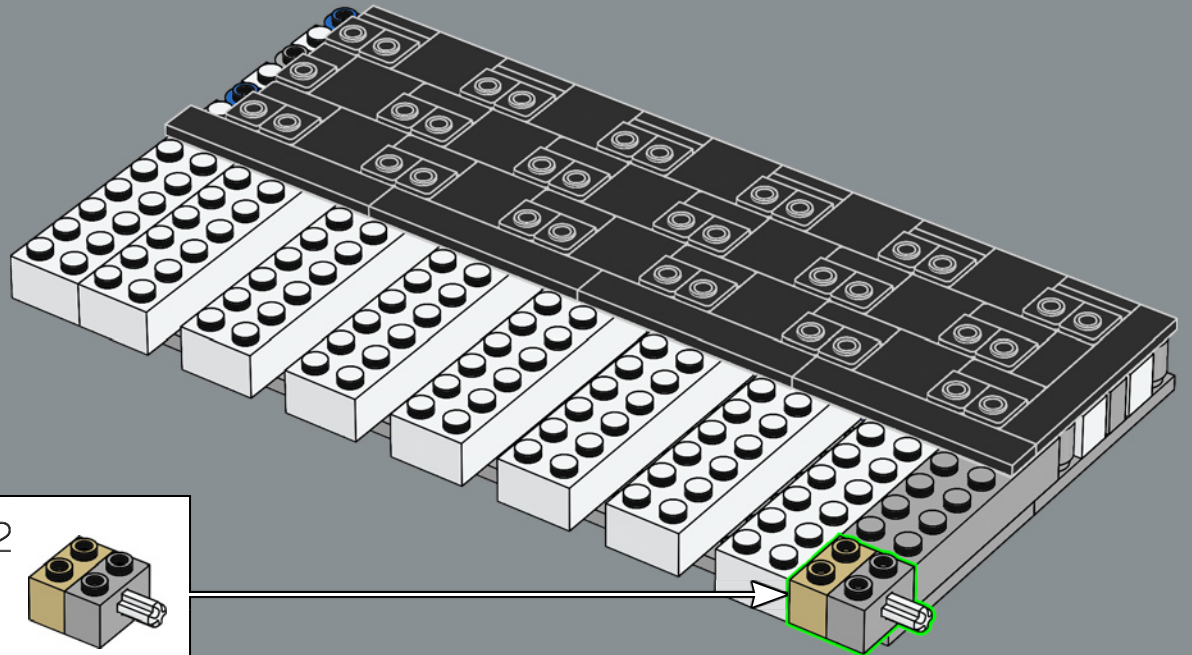
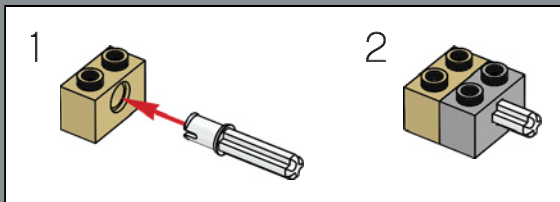

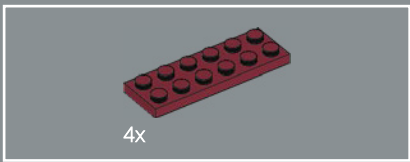

66

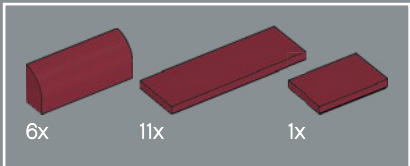
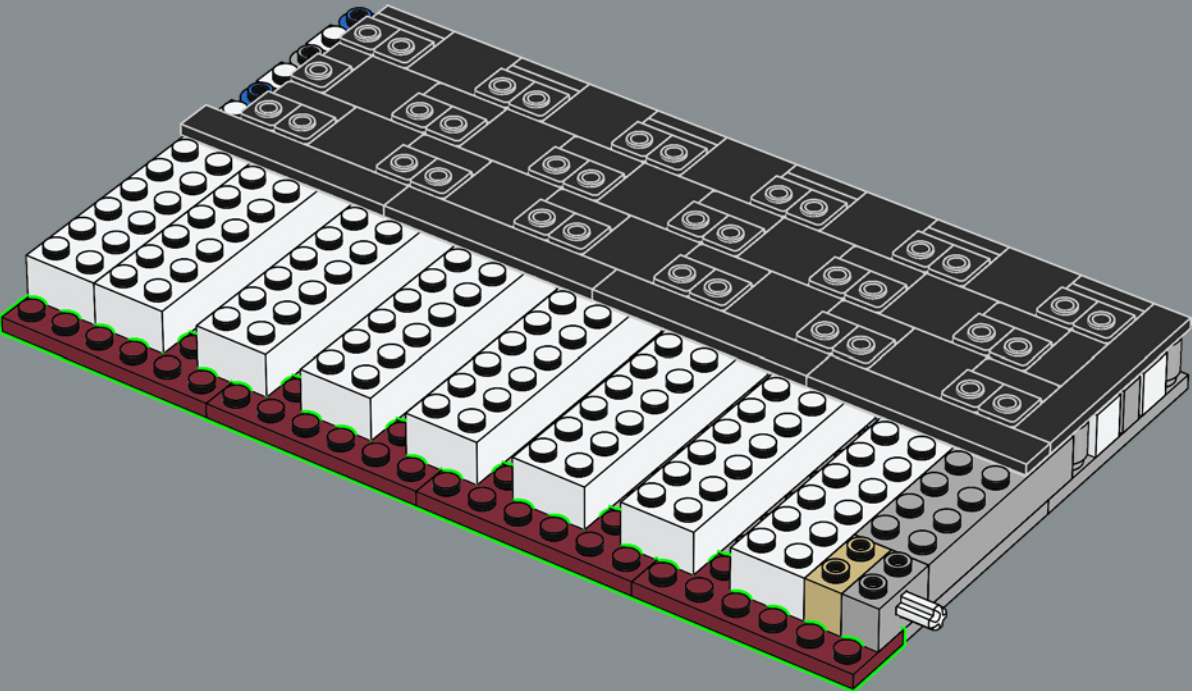

67

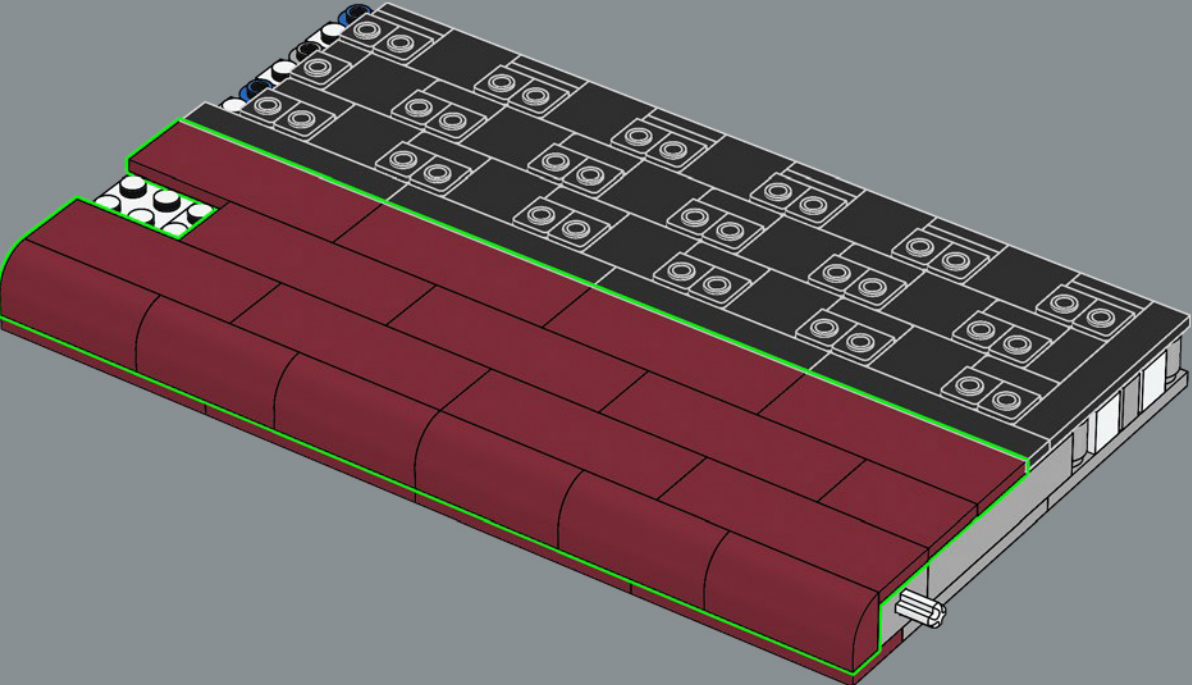

68

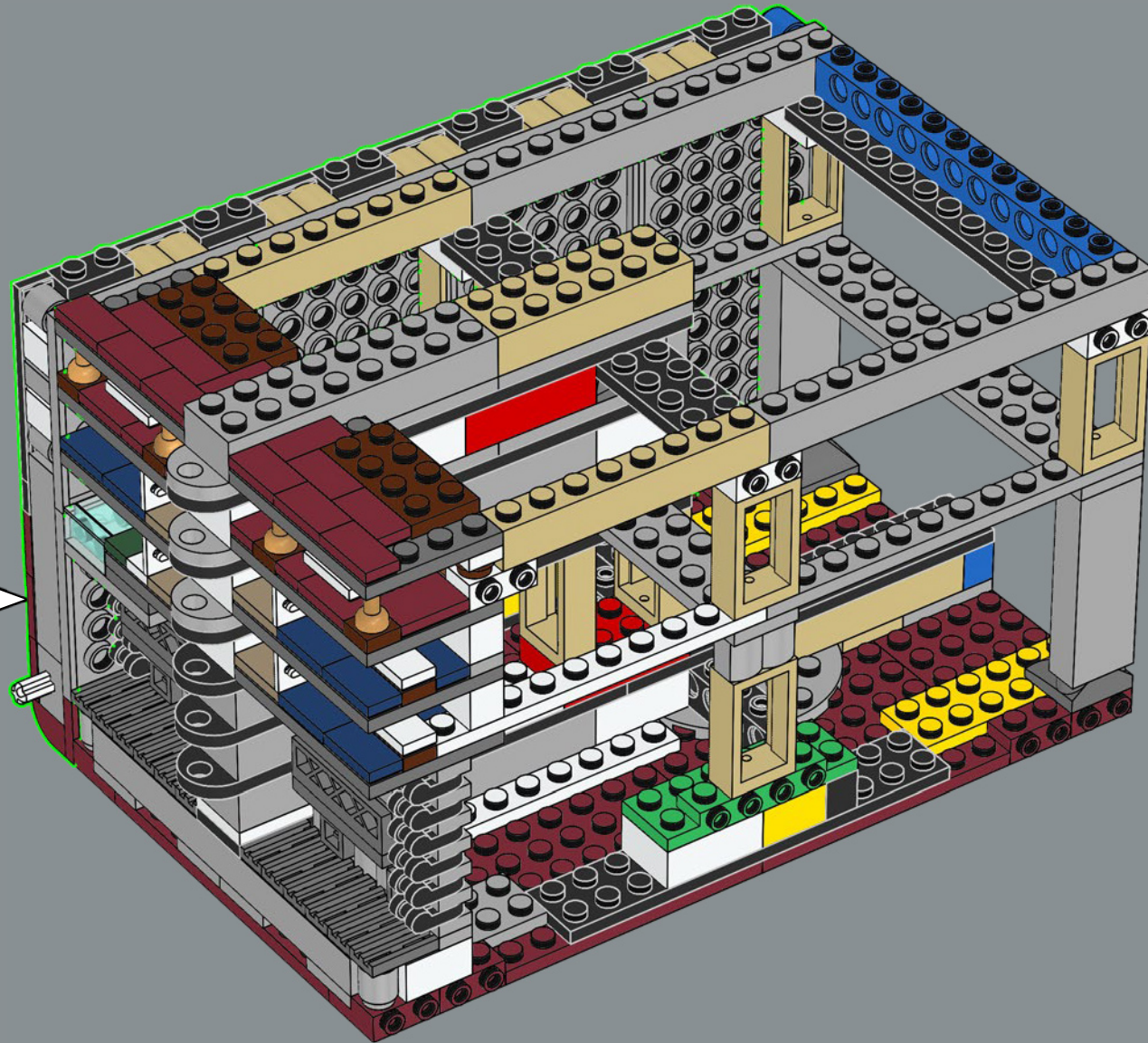

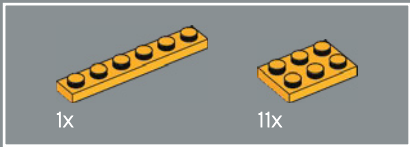

69

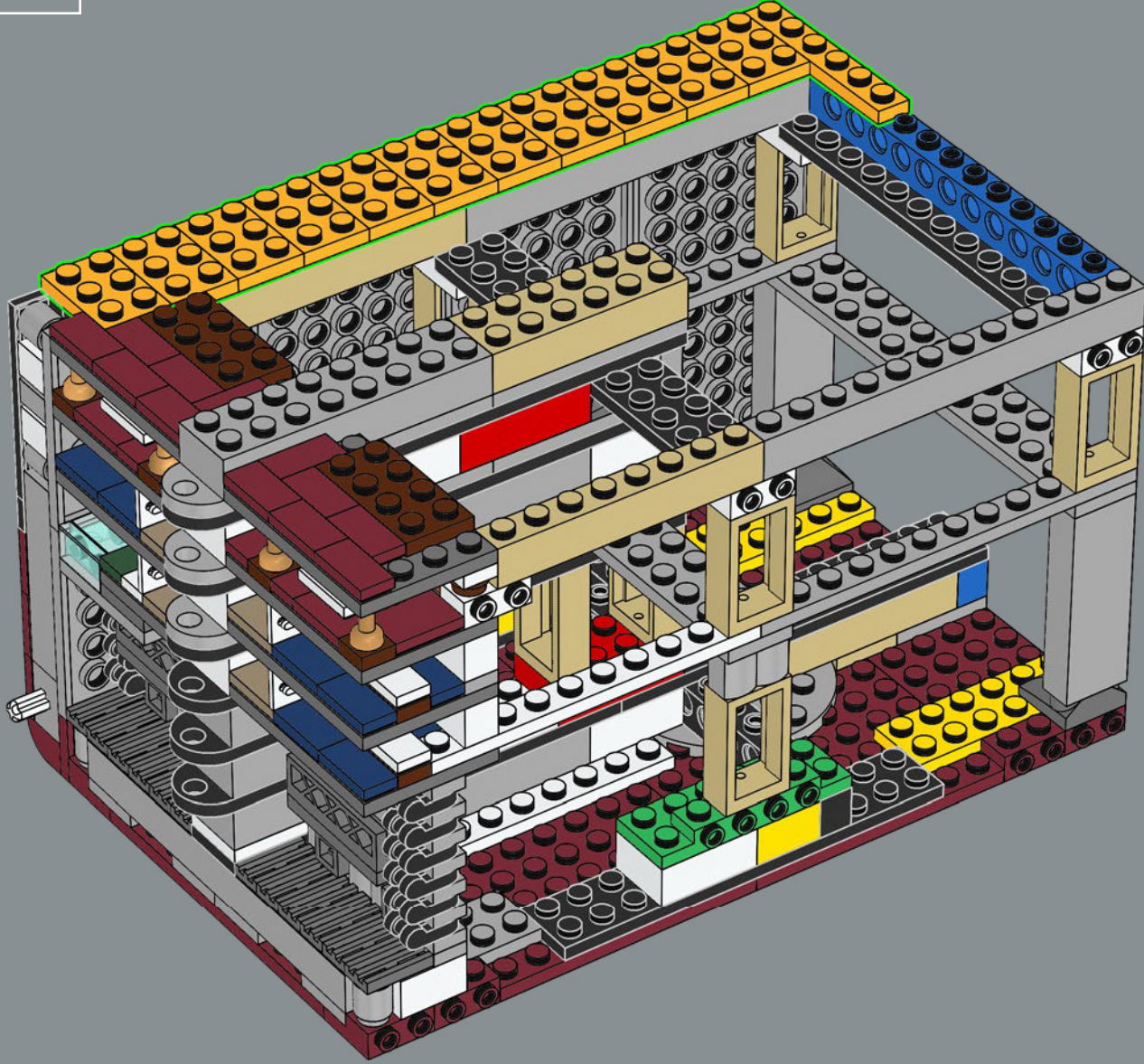

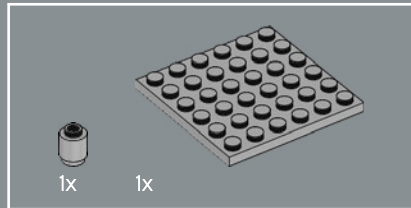
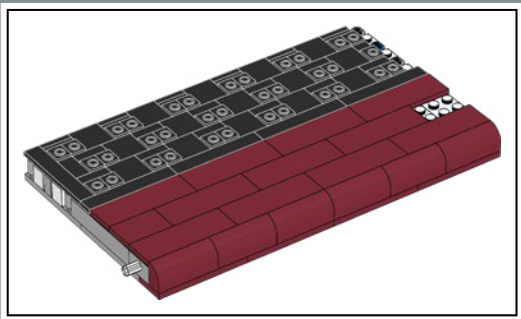
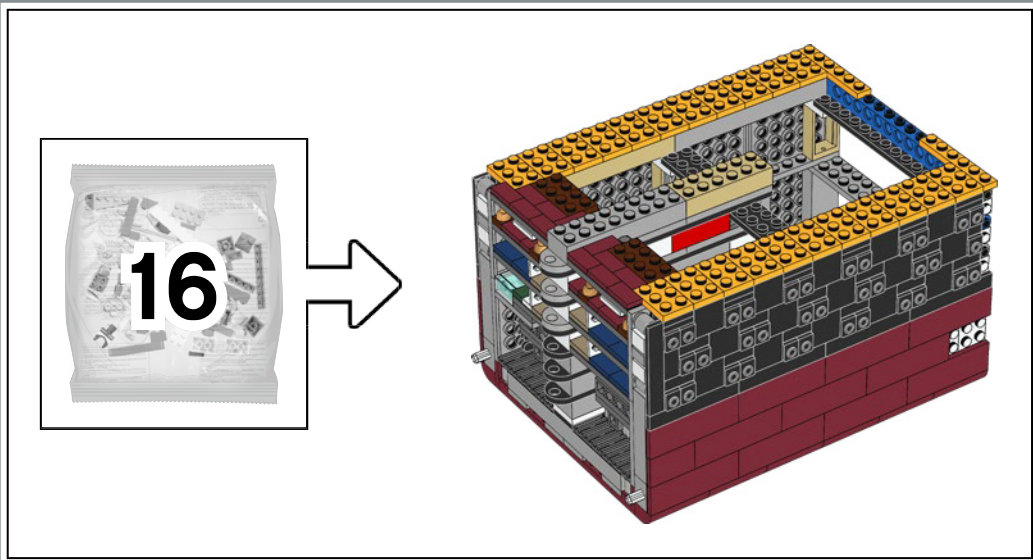

70

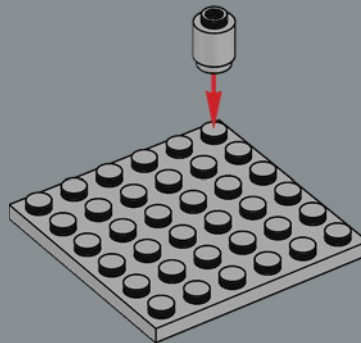

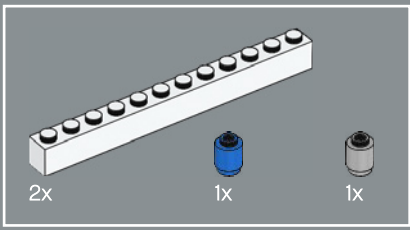

71

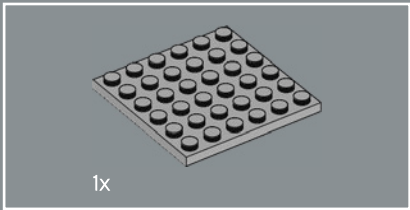
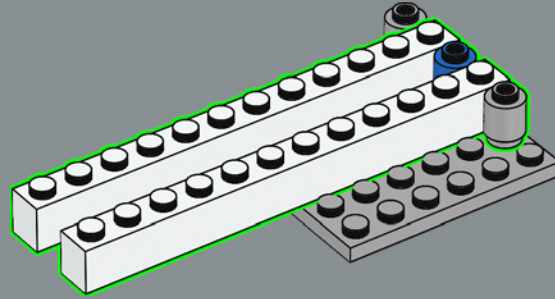

72

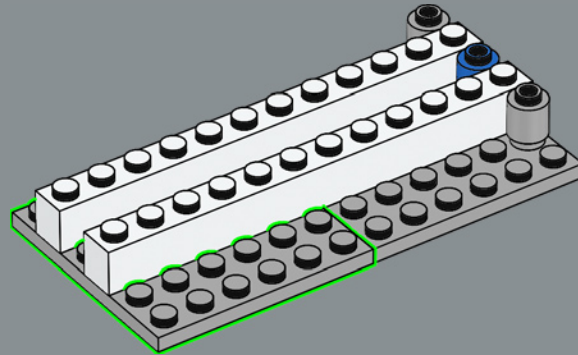

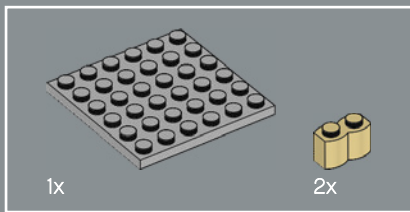

73

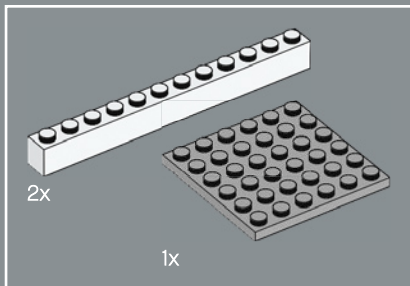
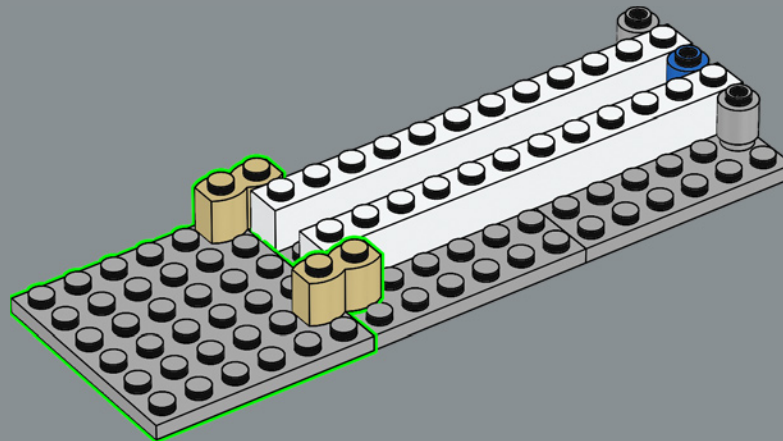

74

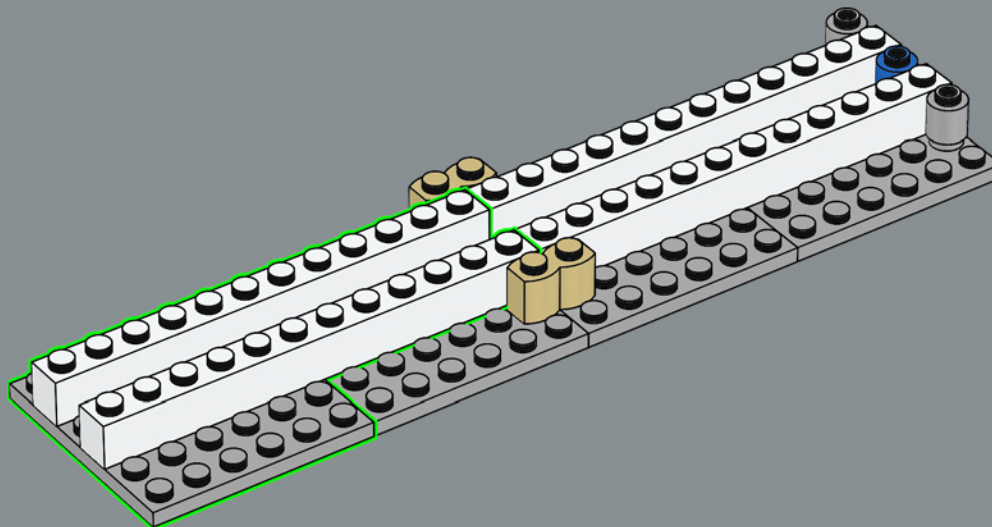

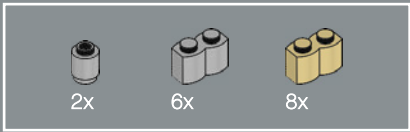

75

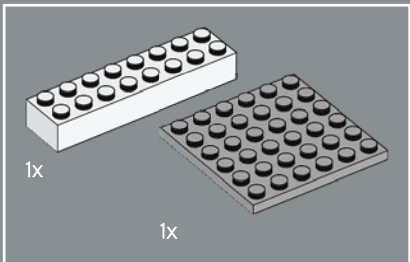
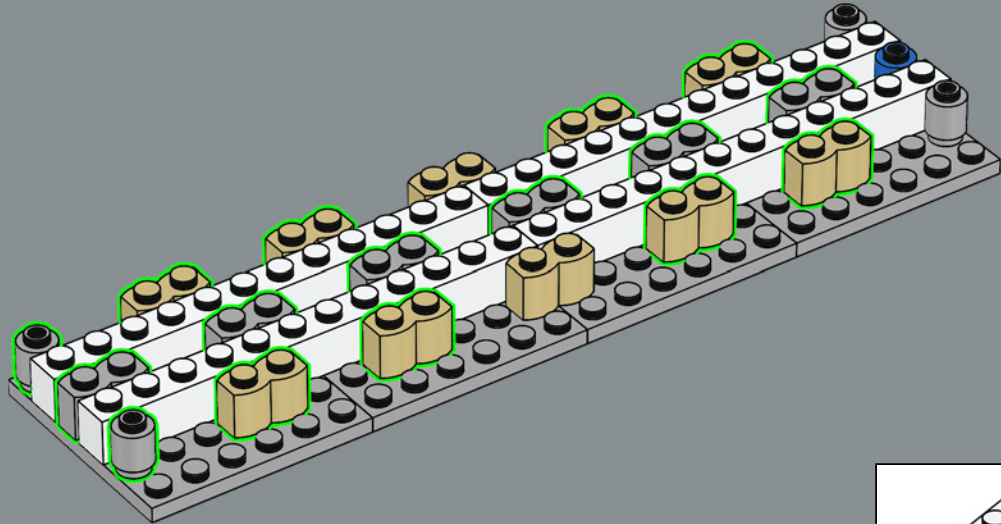

76

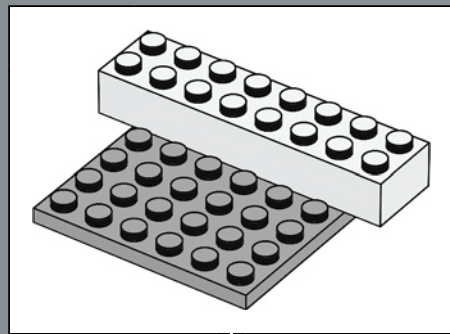
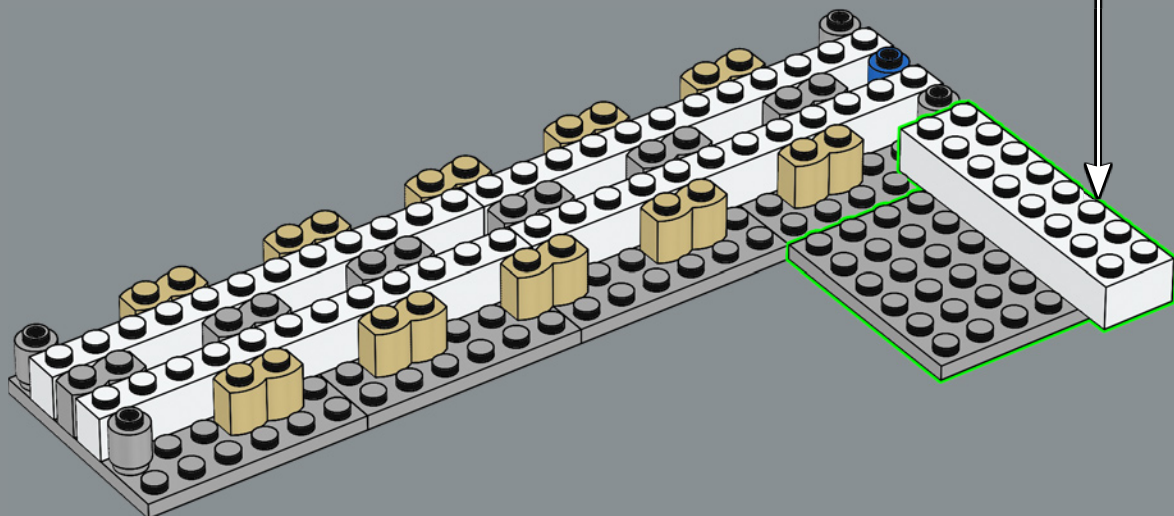

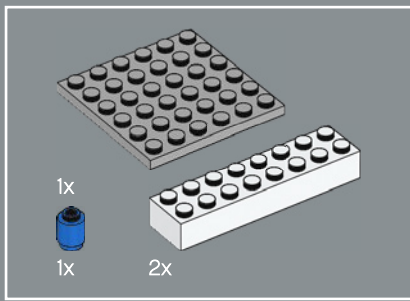

77

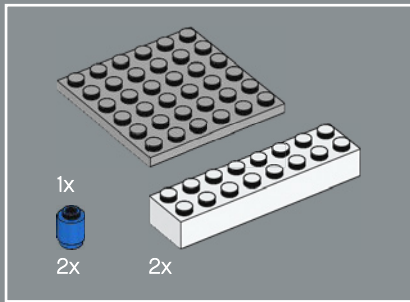
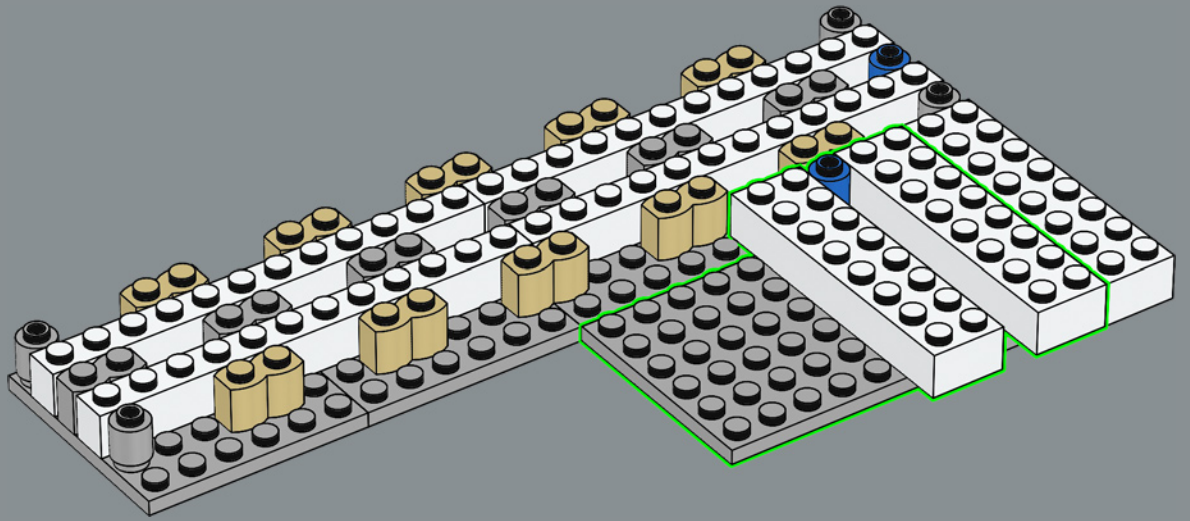

78

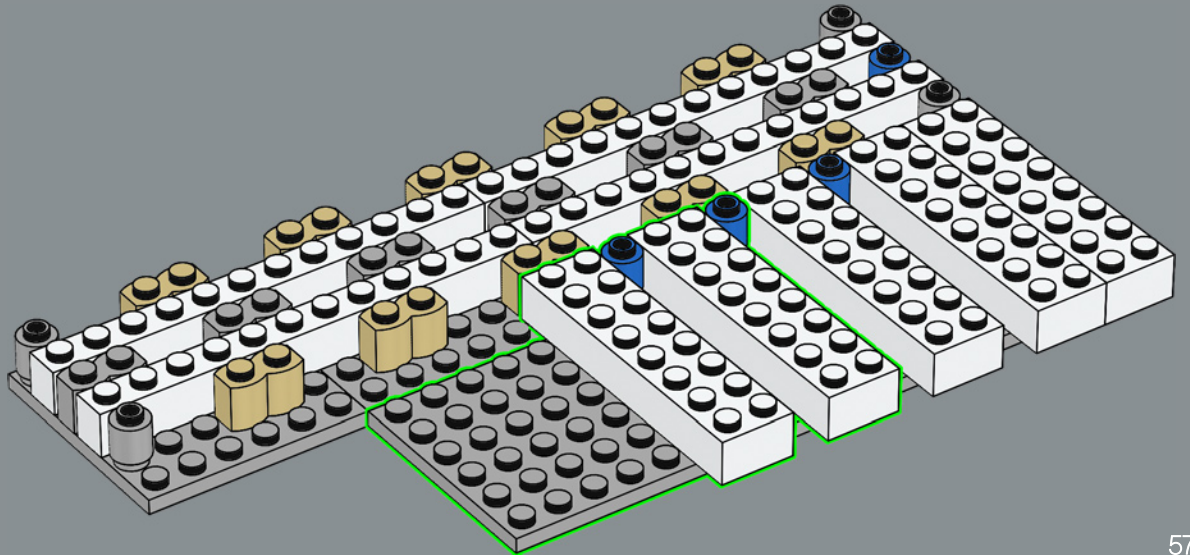

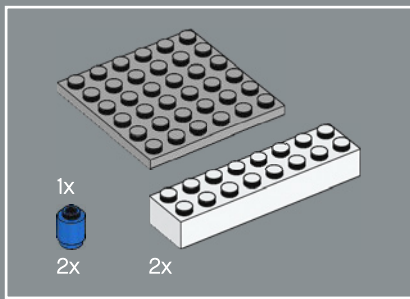

79

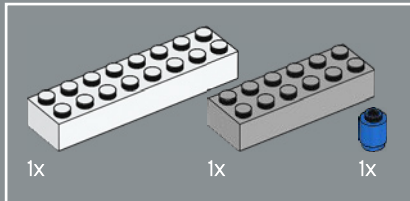
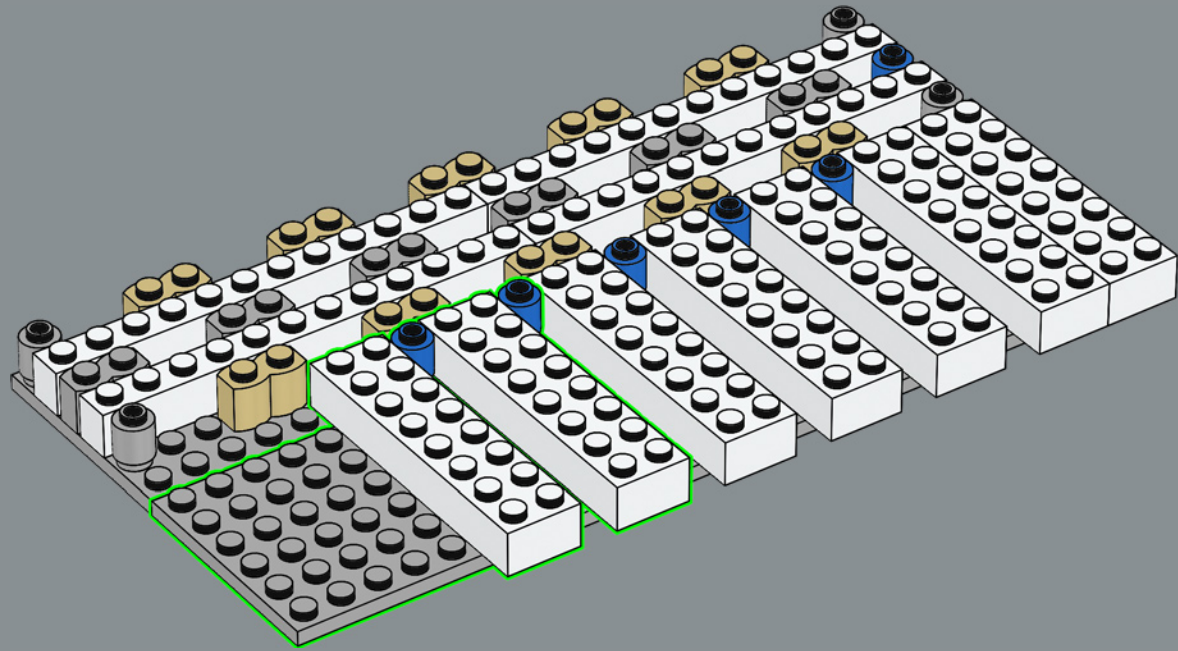

80

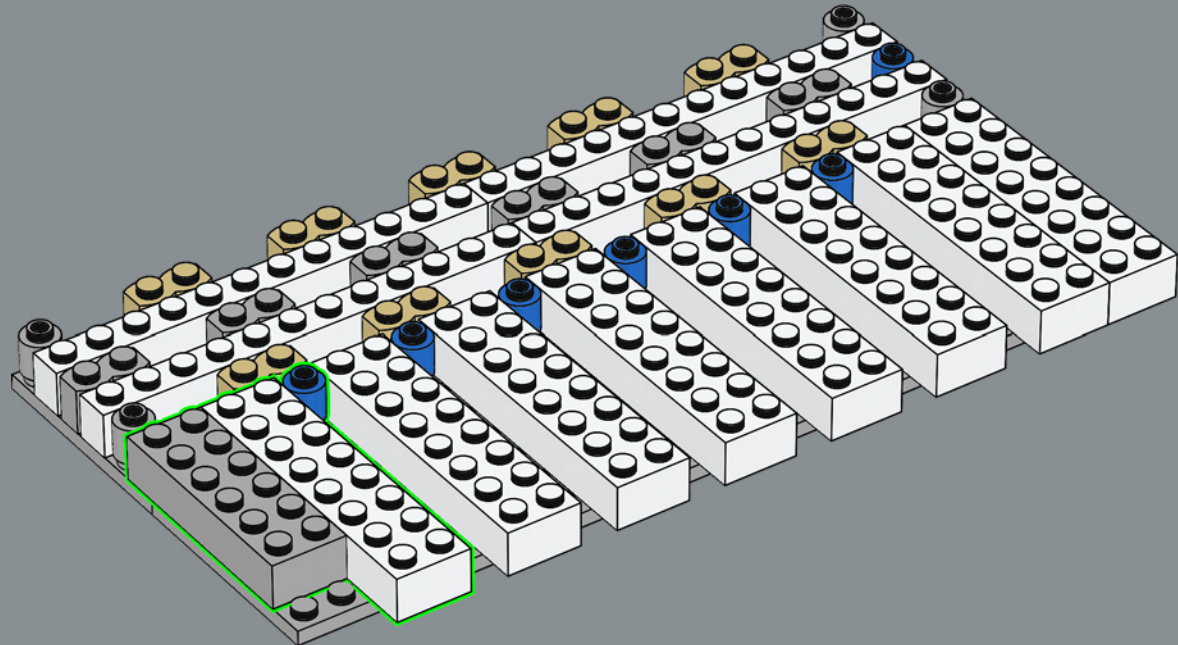

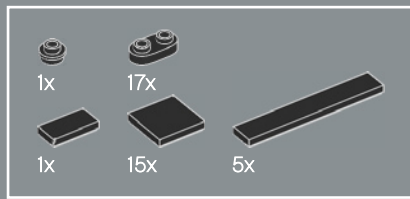

81

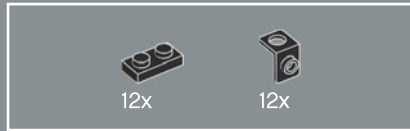
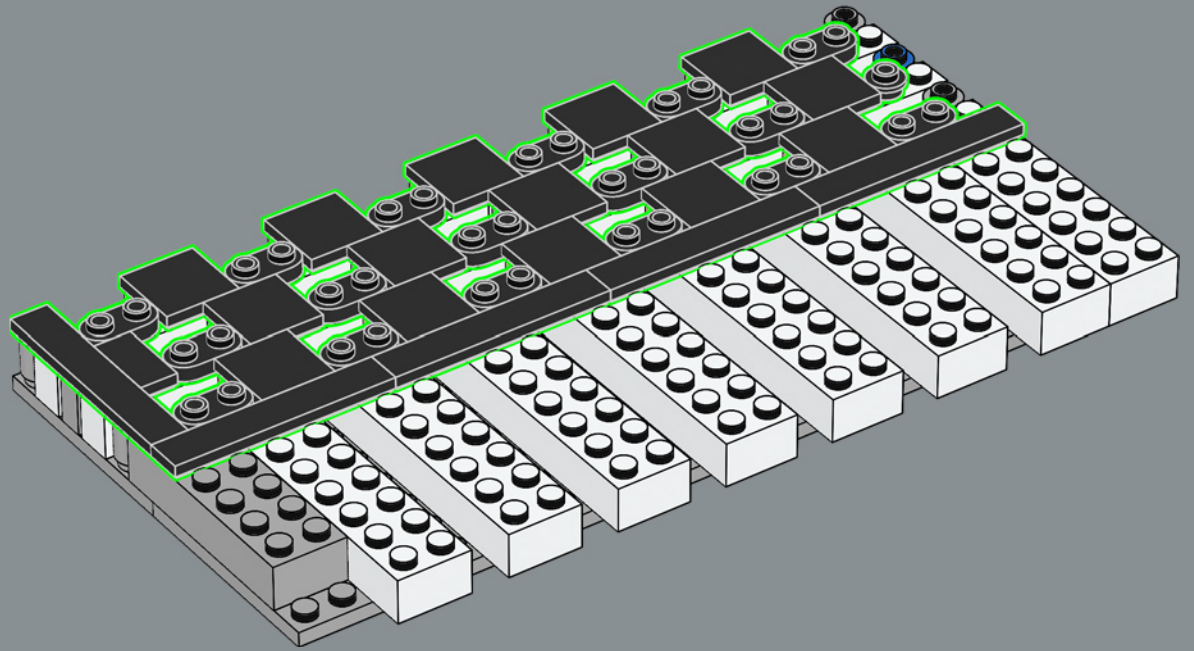

82

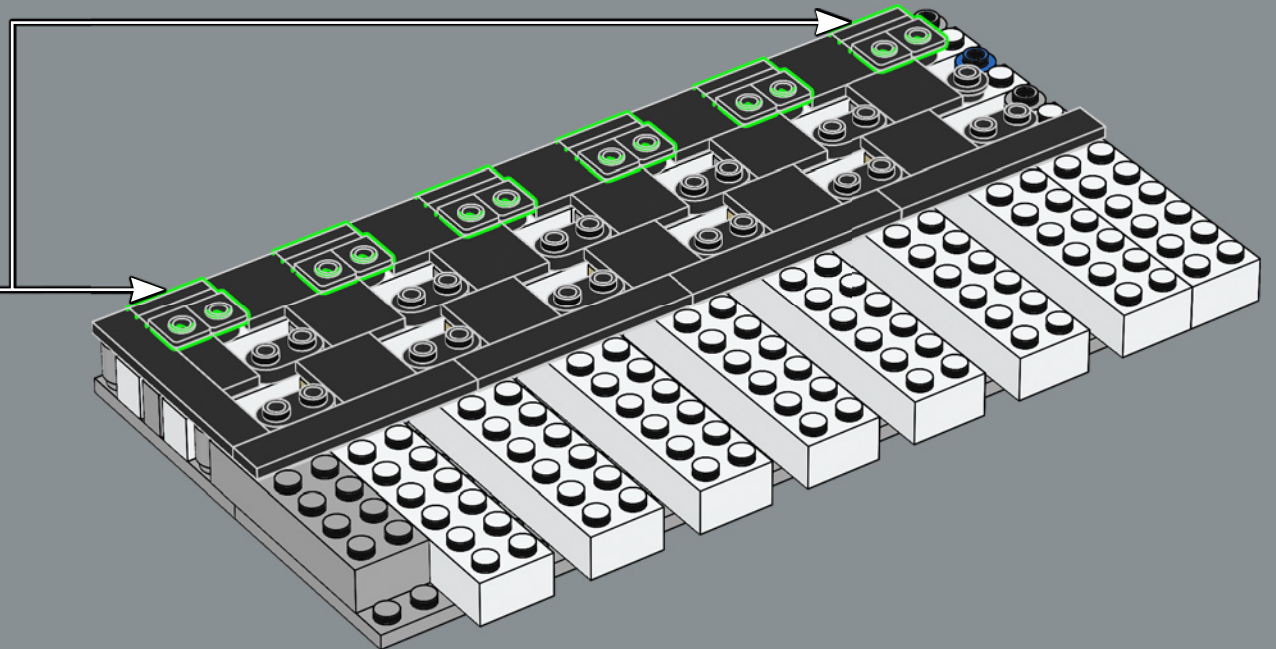
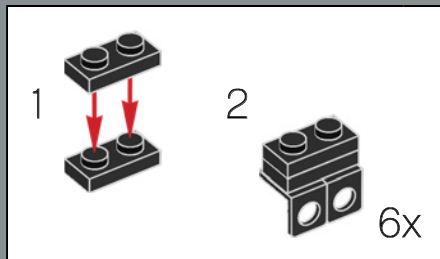



83

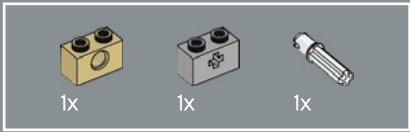
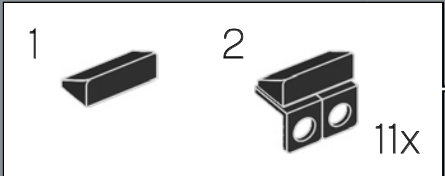
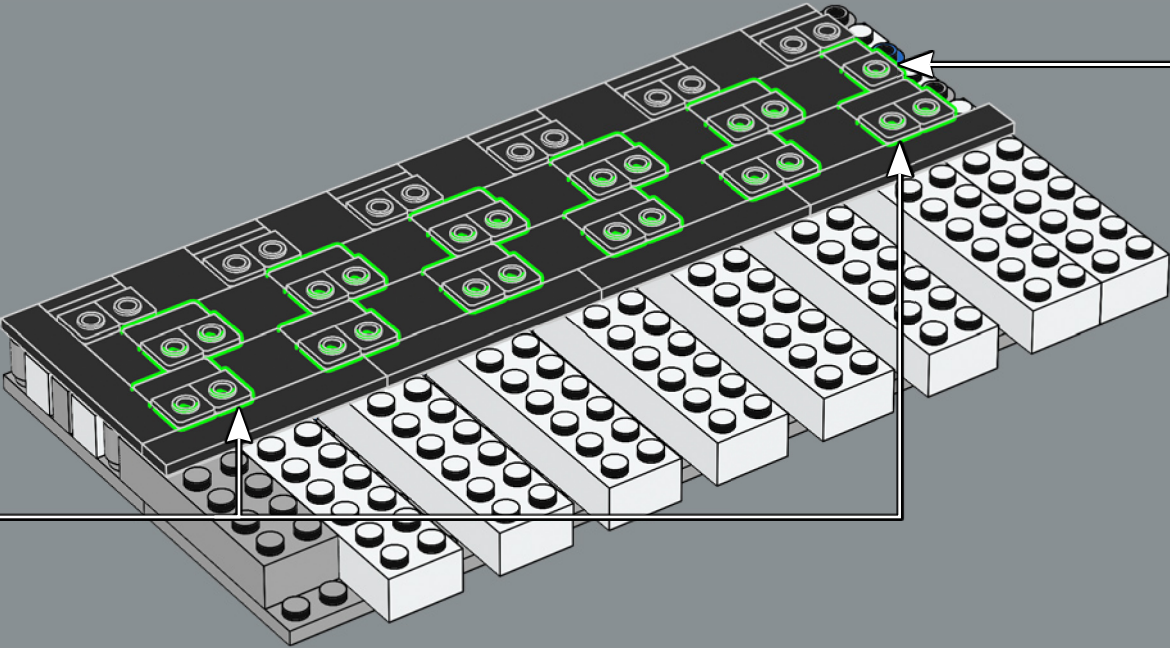
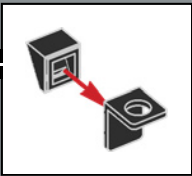

84

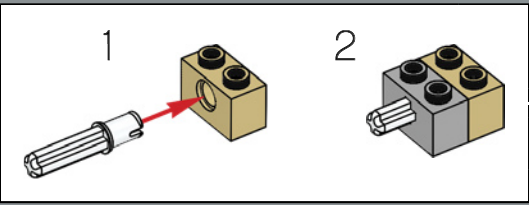
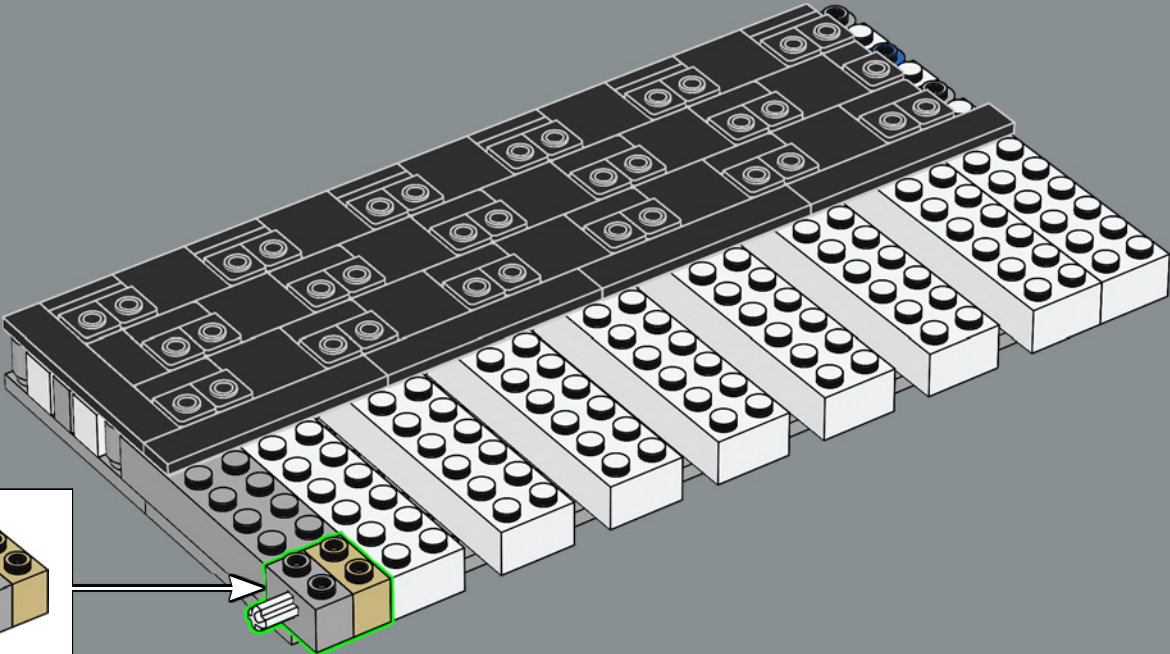

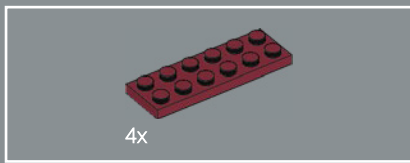

85

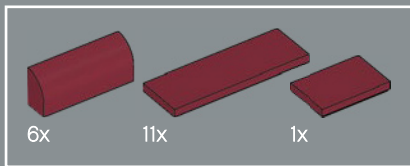
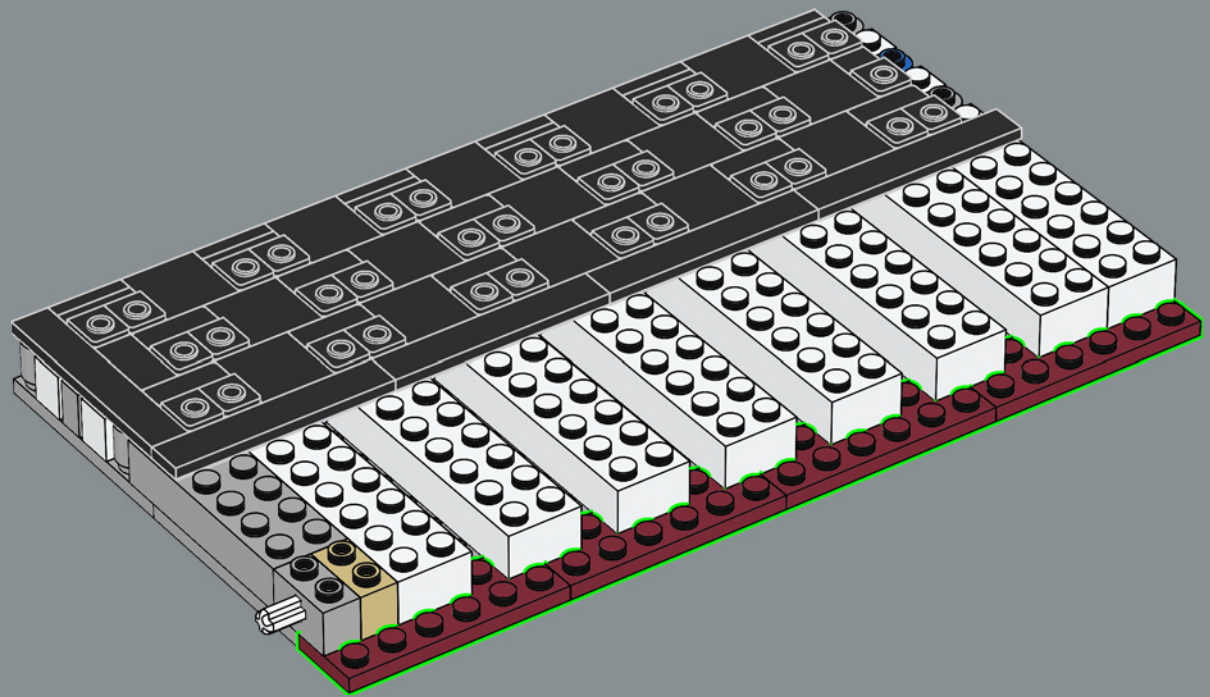

86

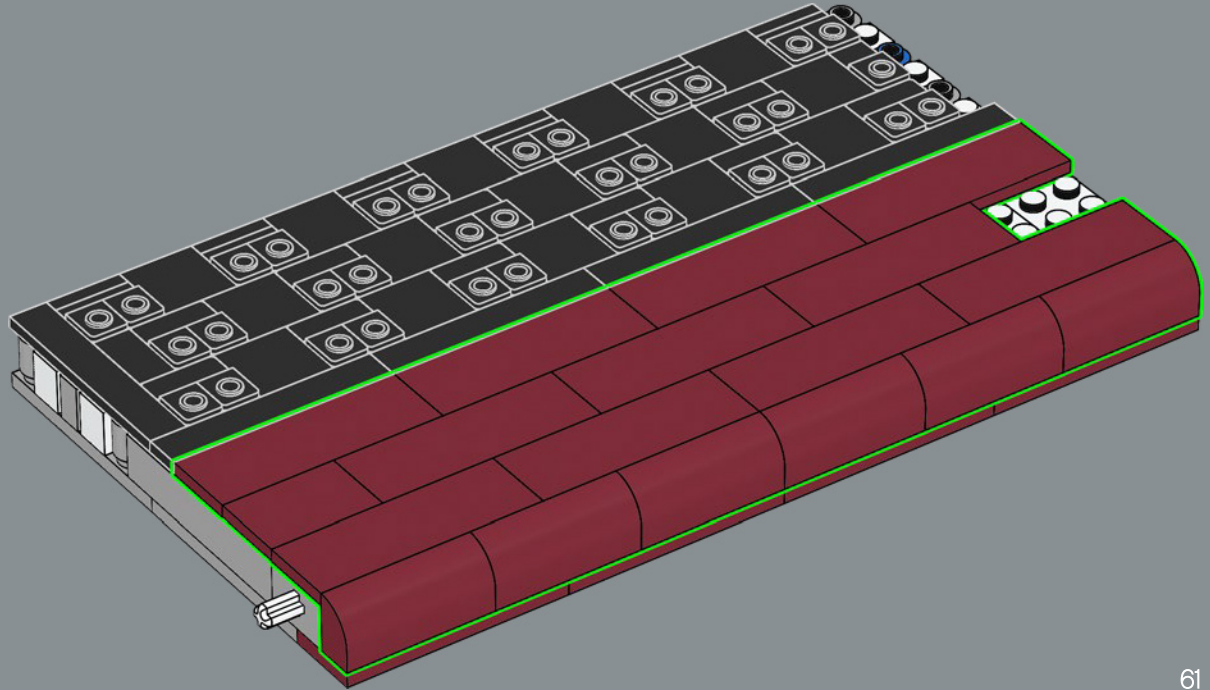

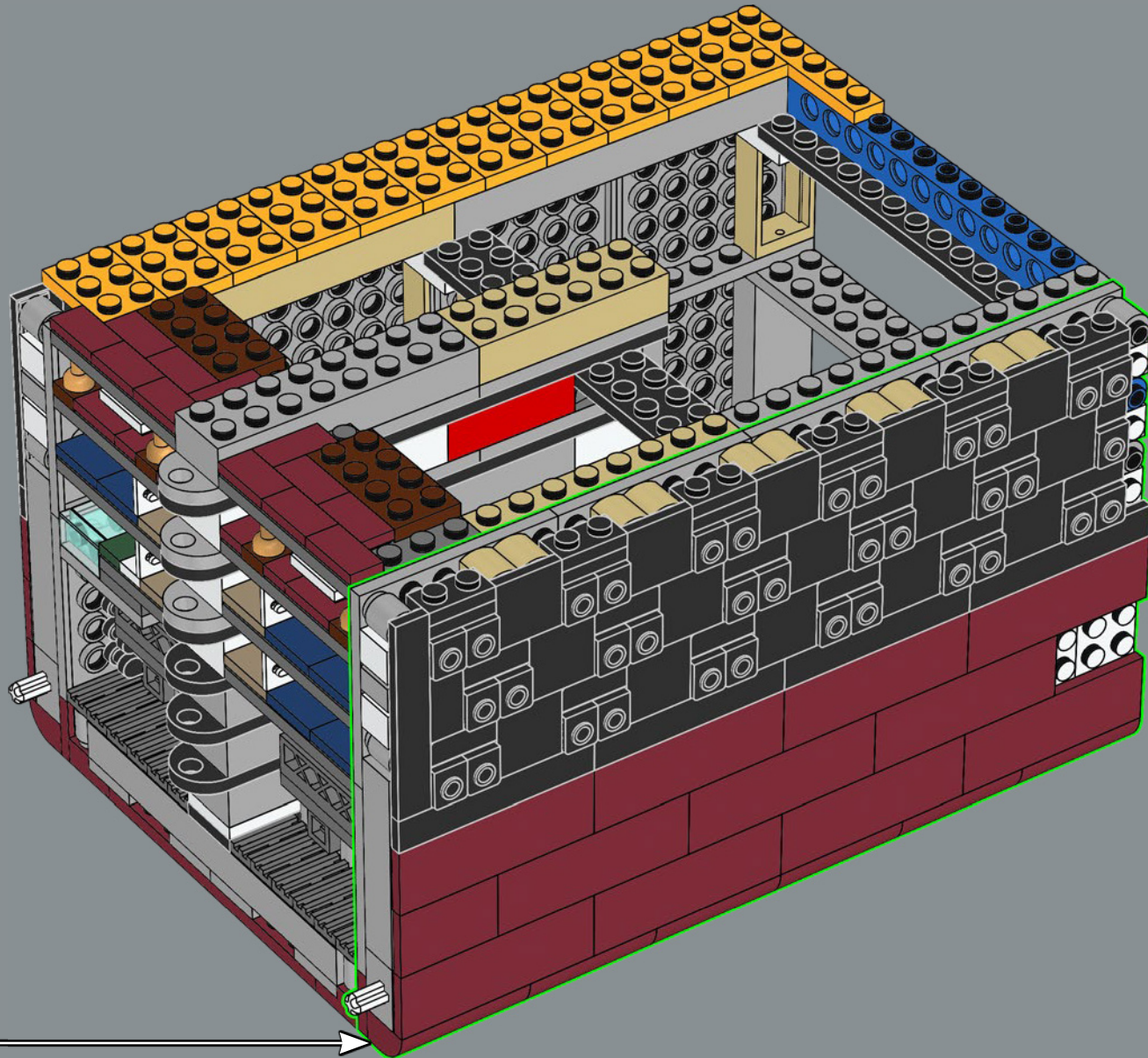

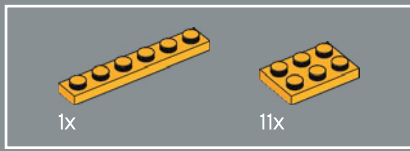

88

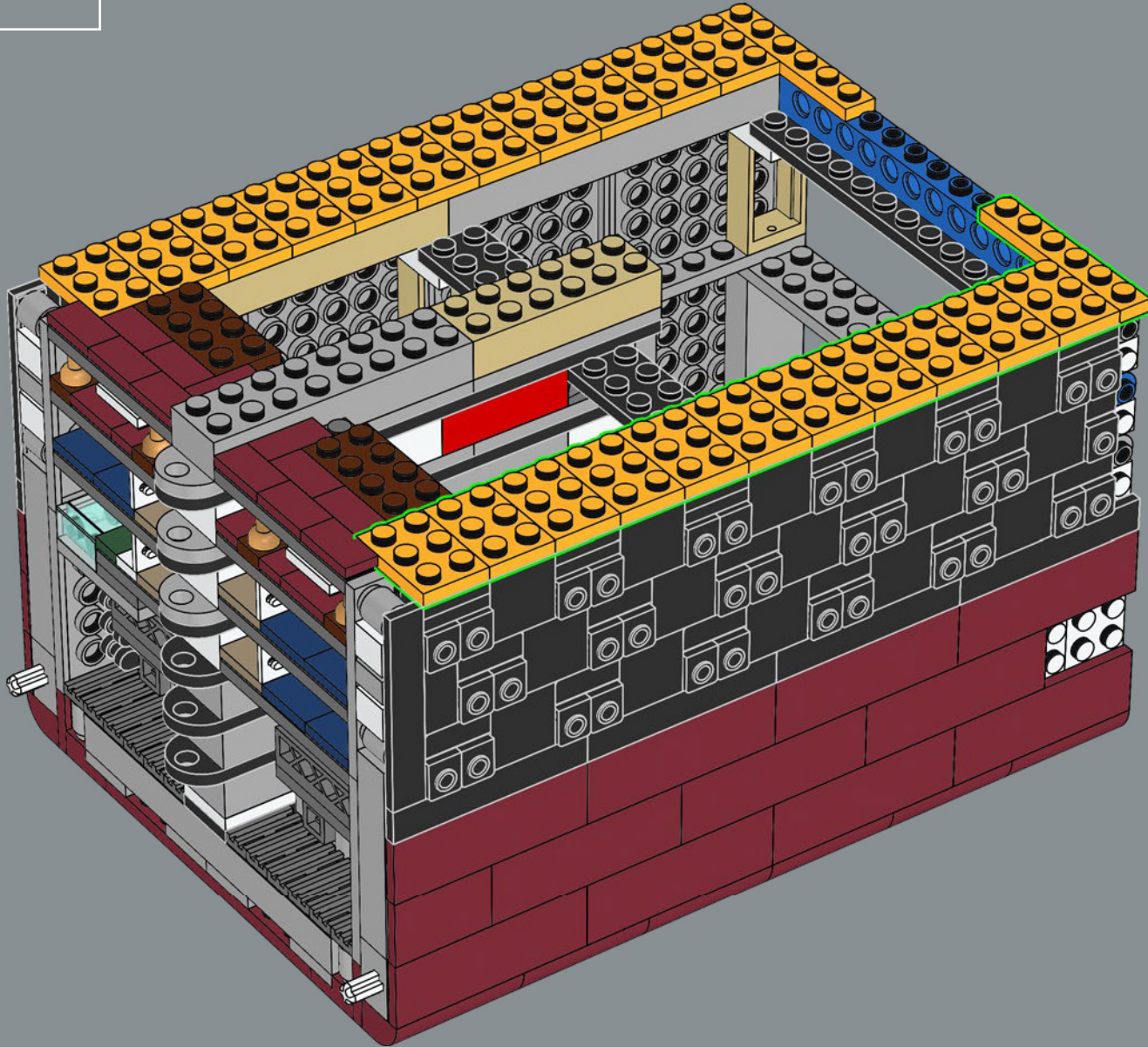

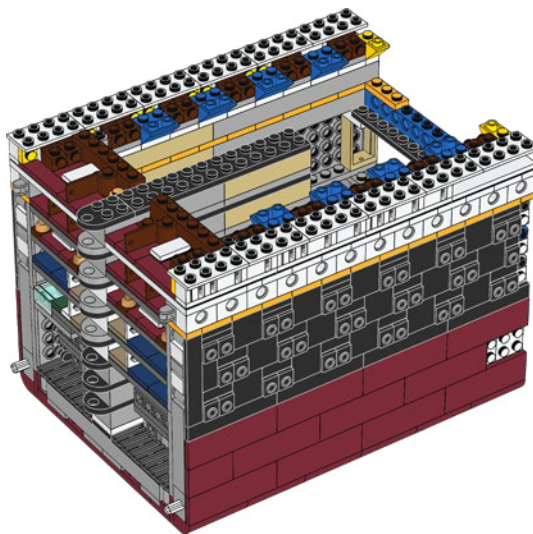
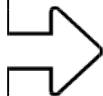

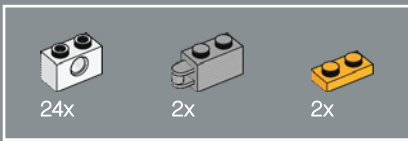

89

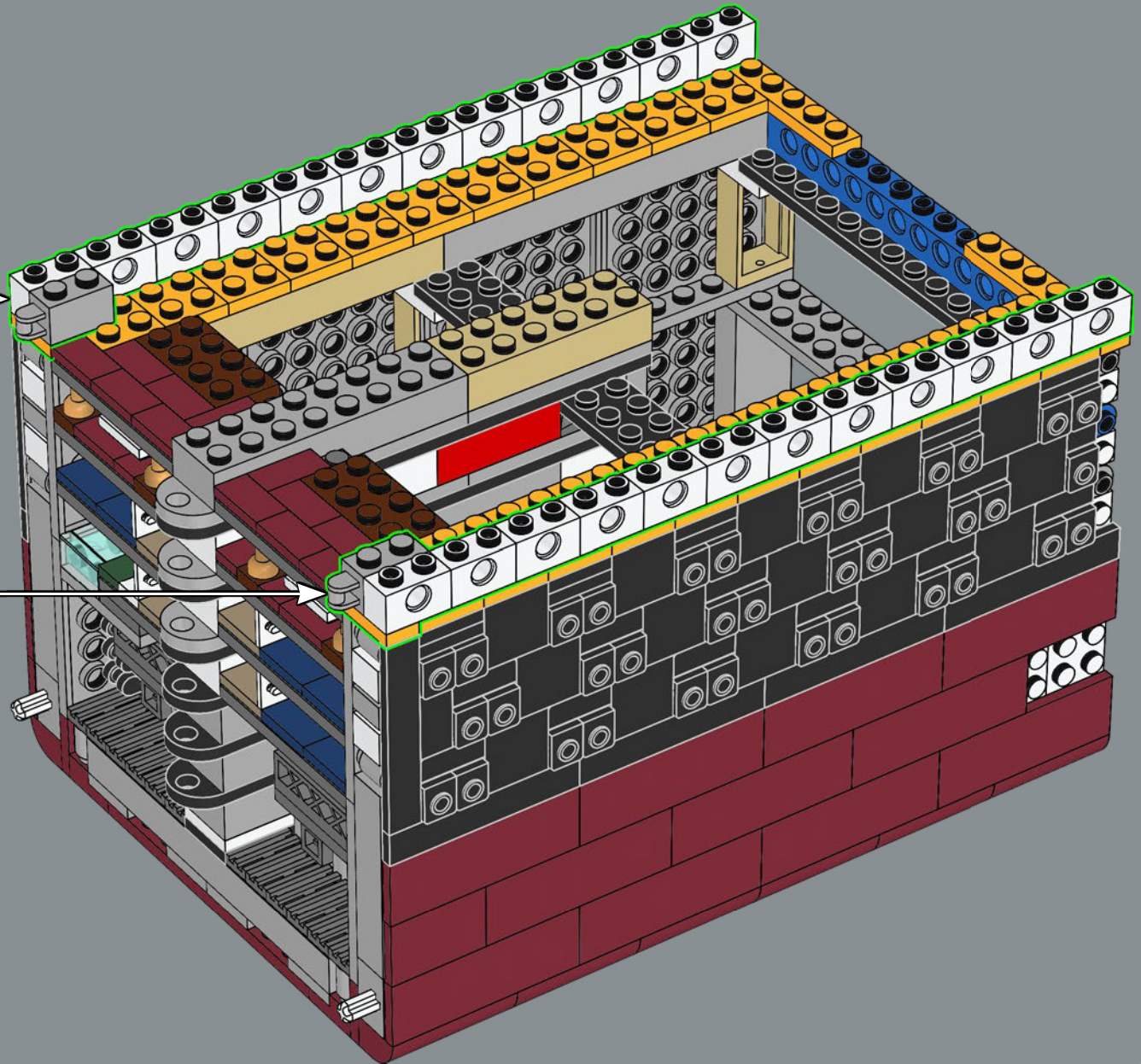
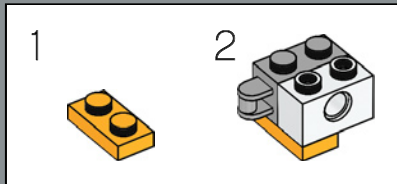
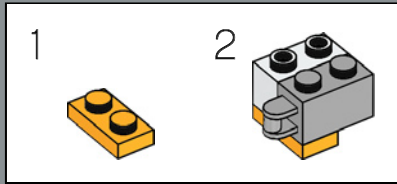

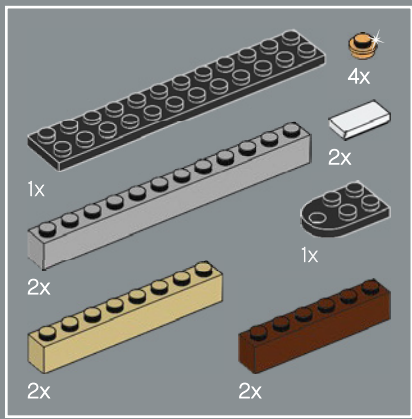

90

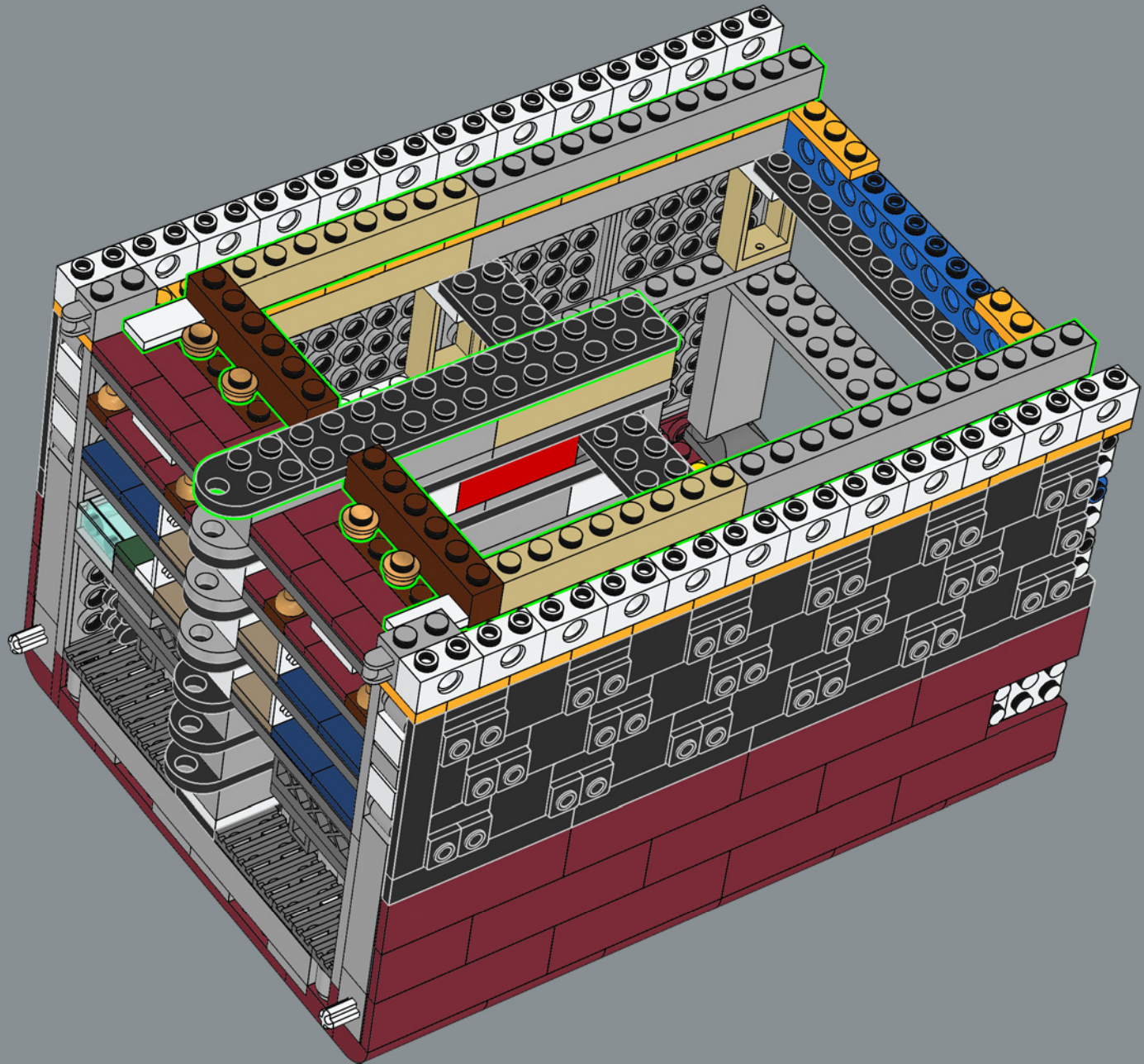

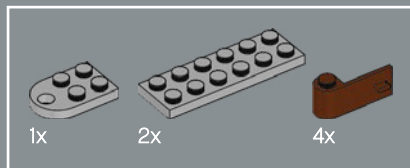

91

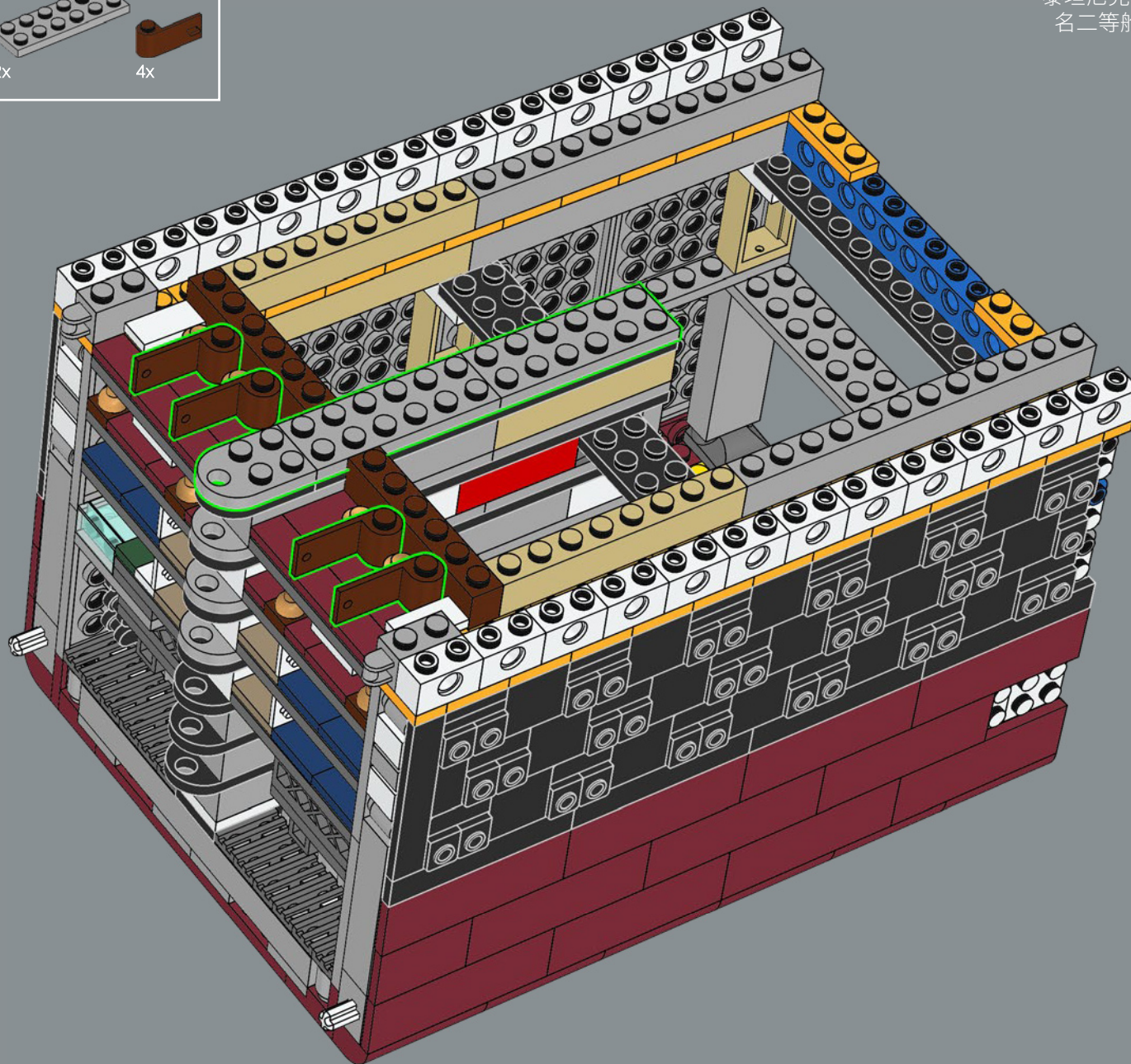

泰坦尼克号可容纳 833 名头等舱乘客、614 名二等舱乘客、1006 名三等舱乘客，总载客量为 2453 人。

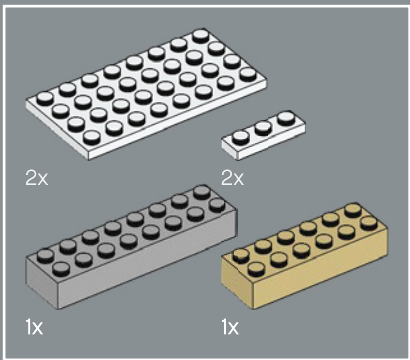

92

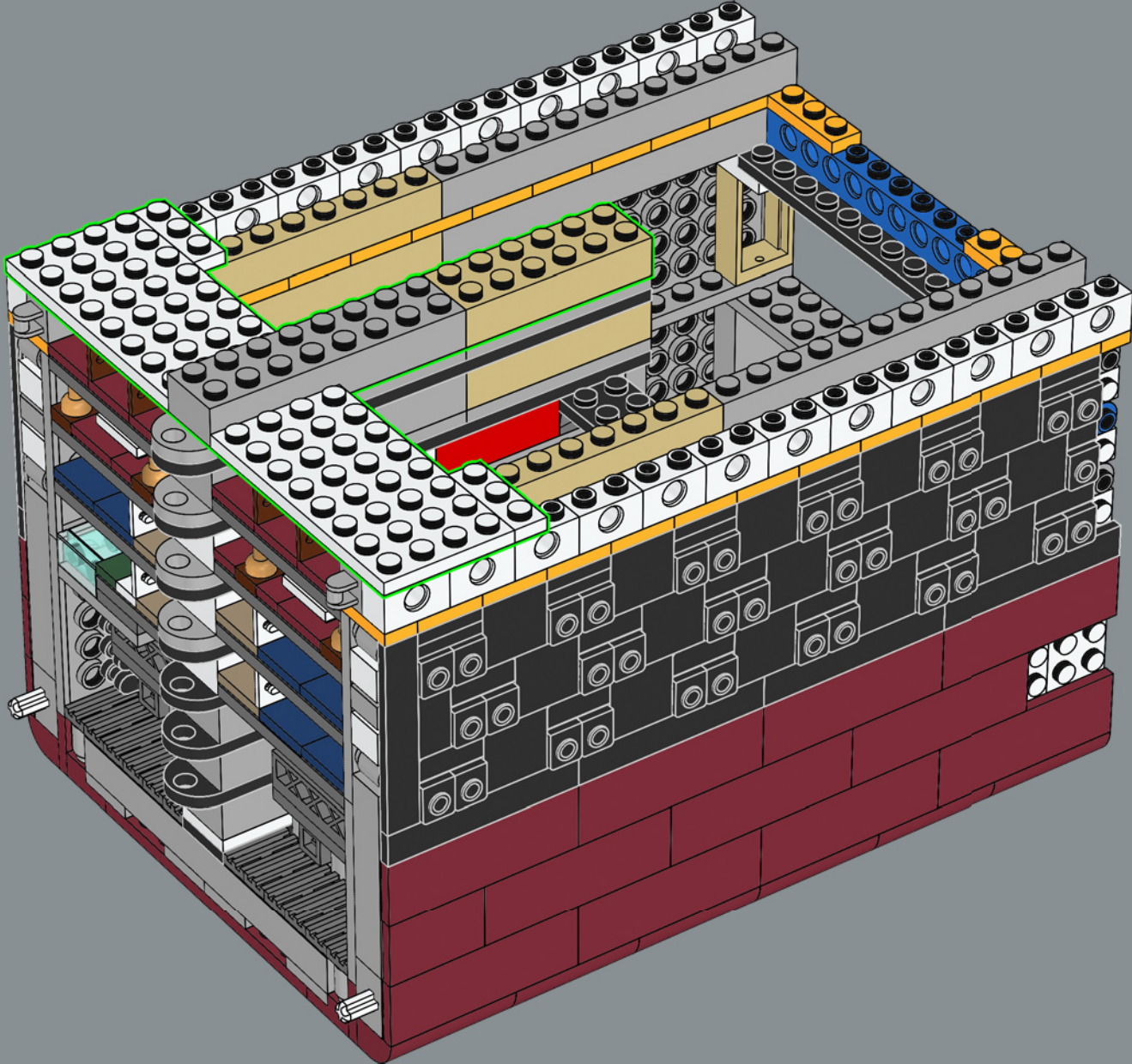

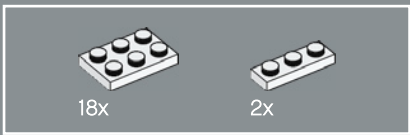

93

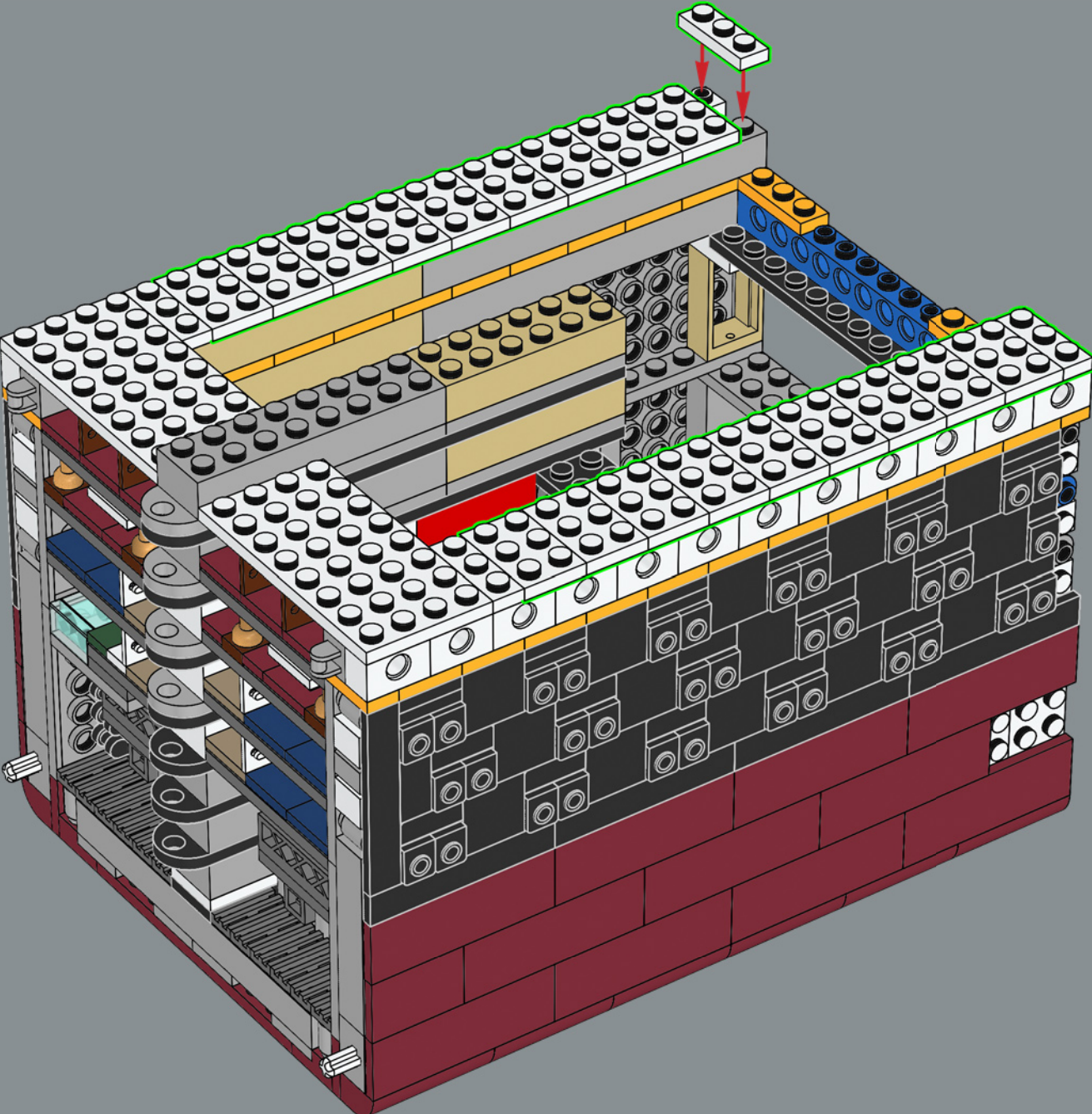

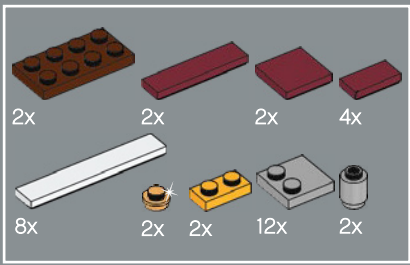

94

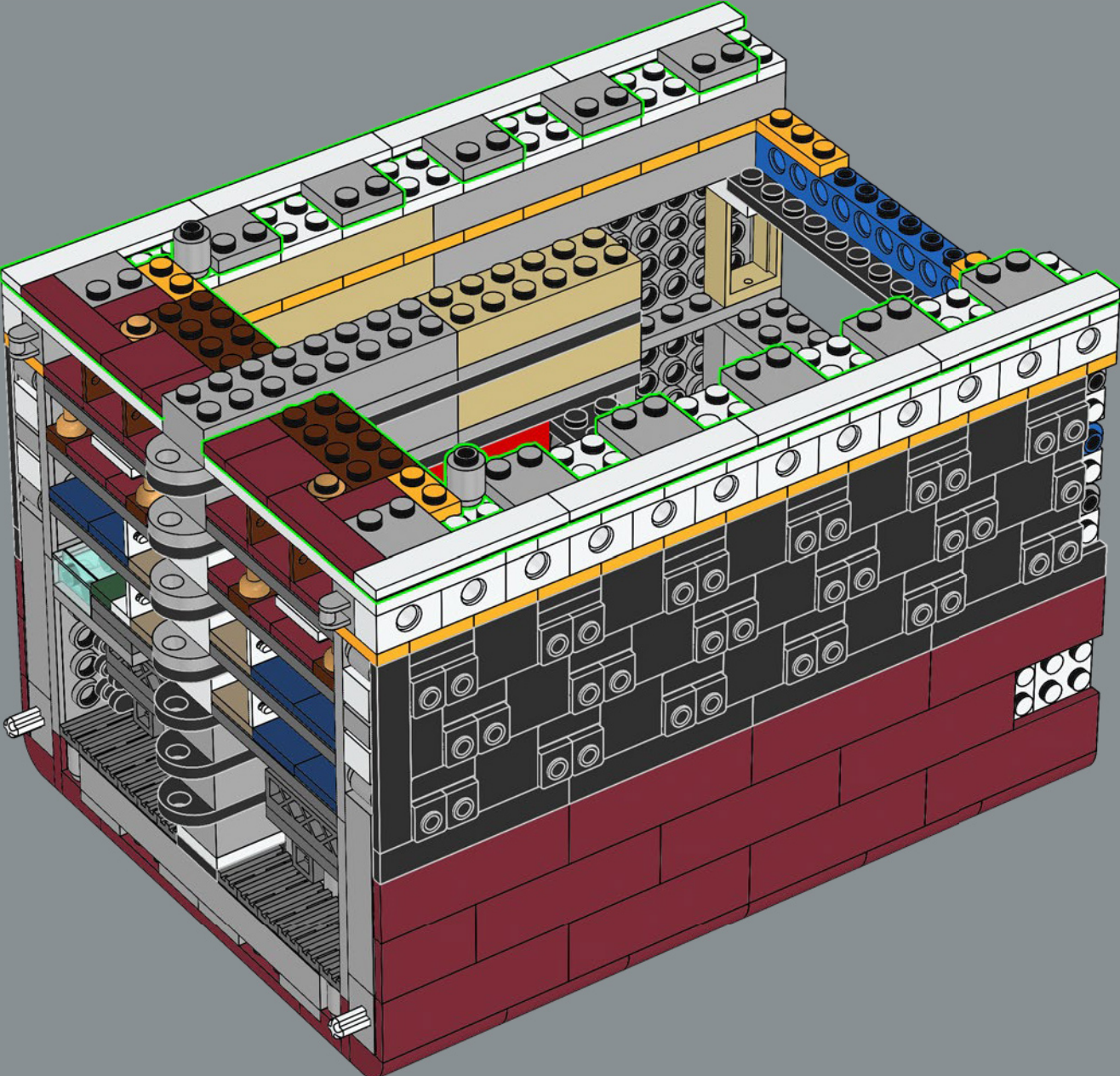

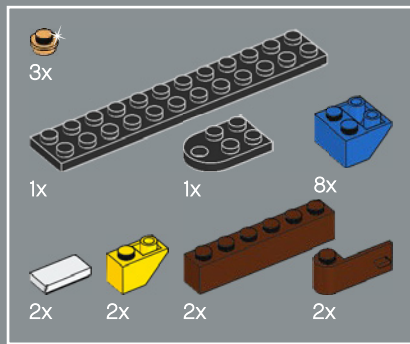

95

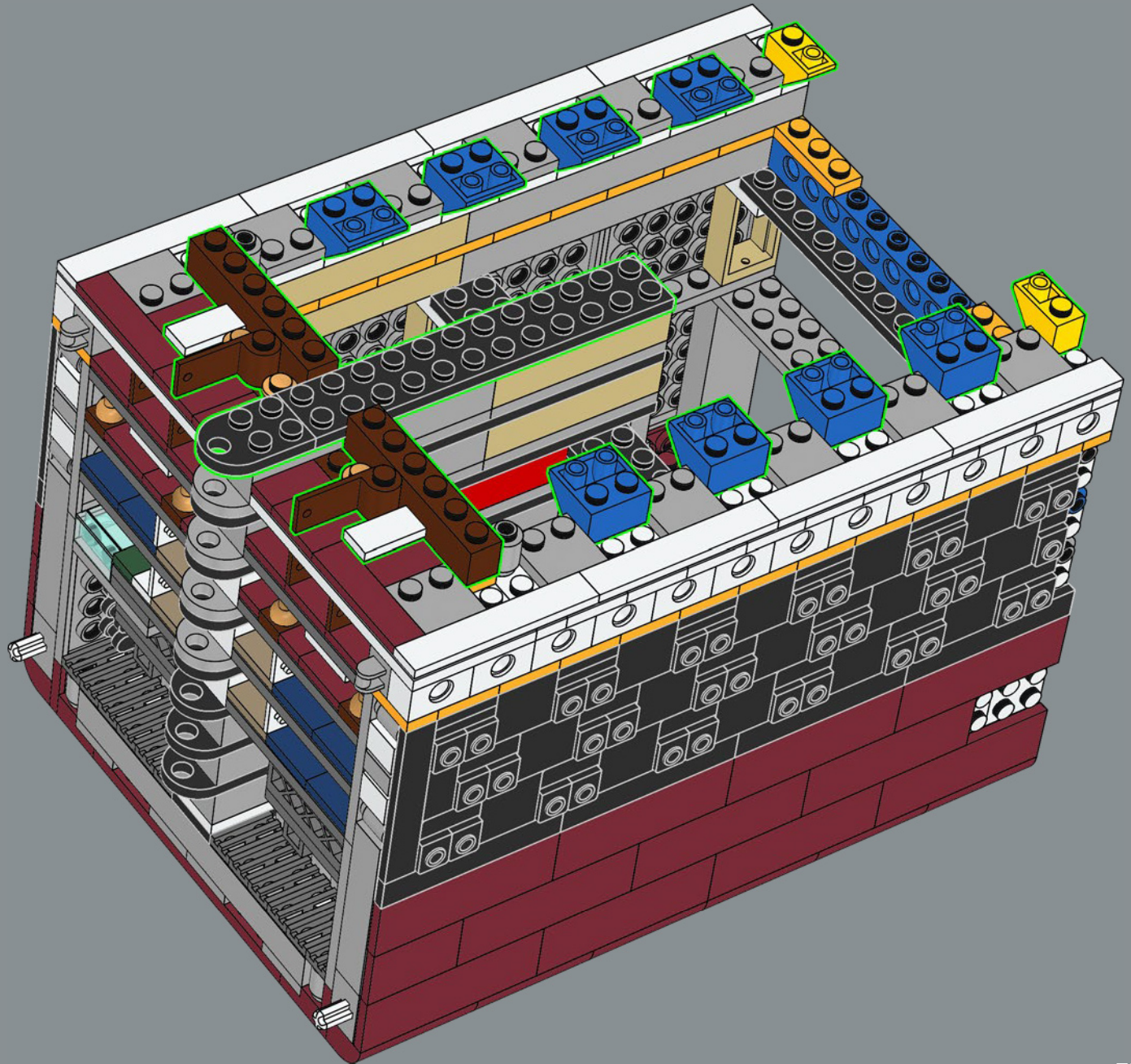

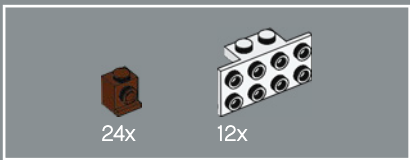

96

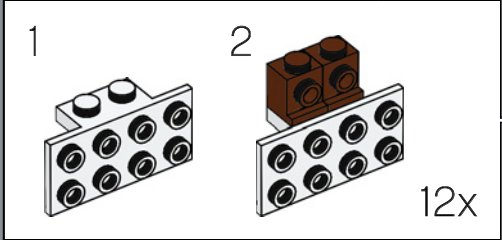
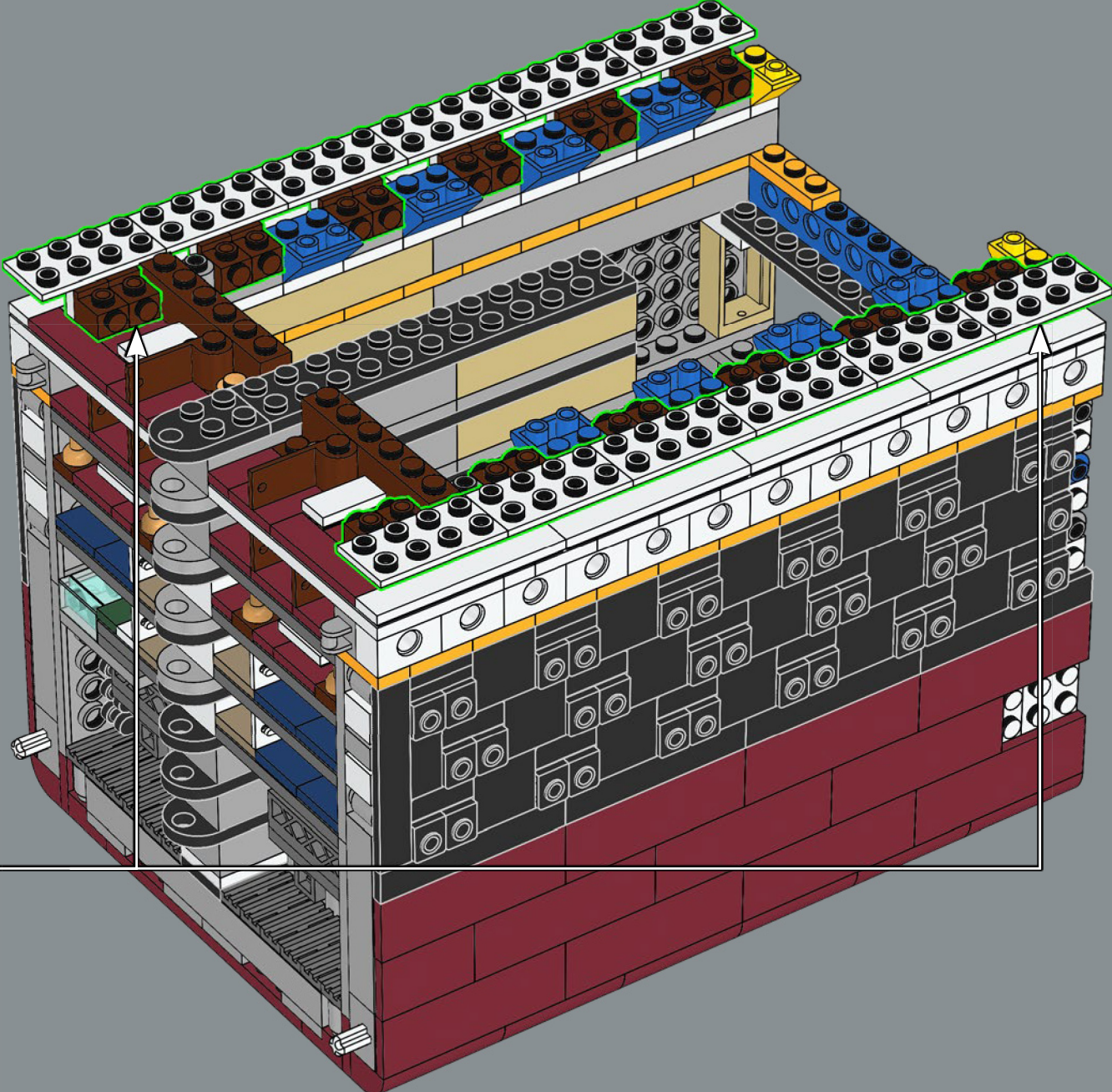

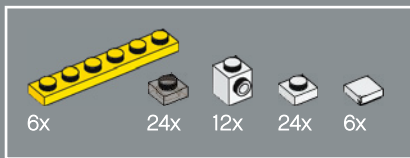

97

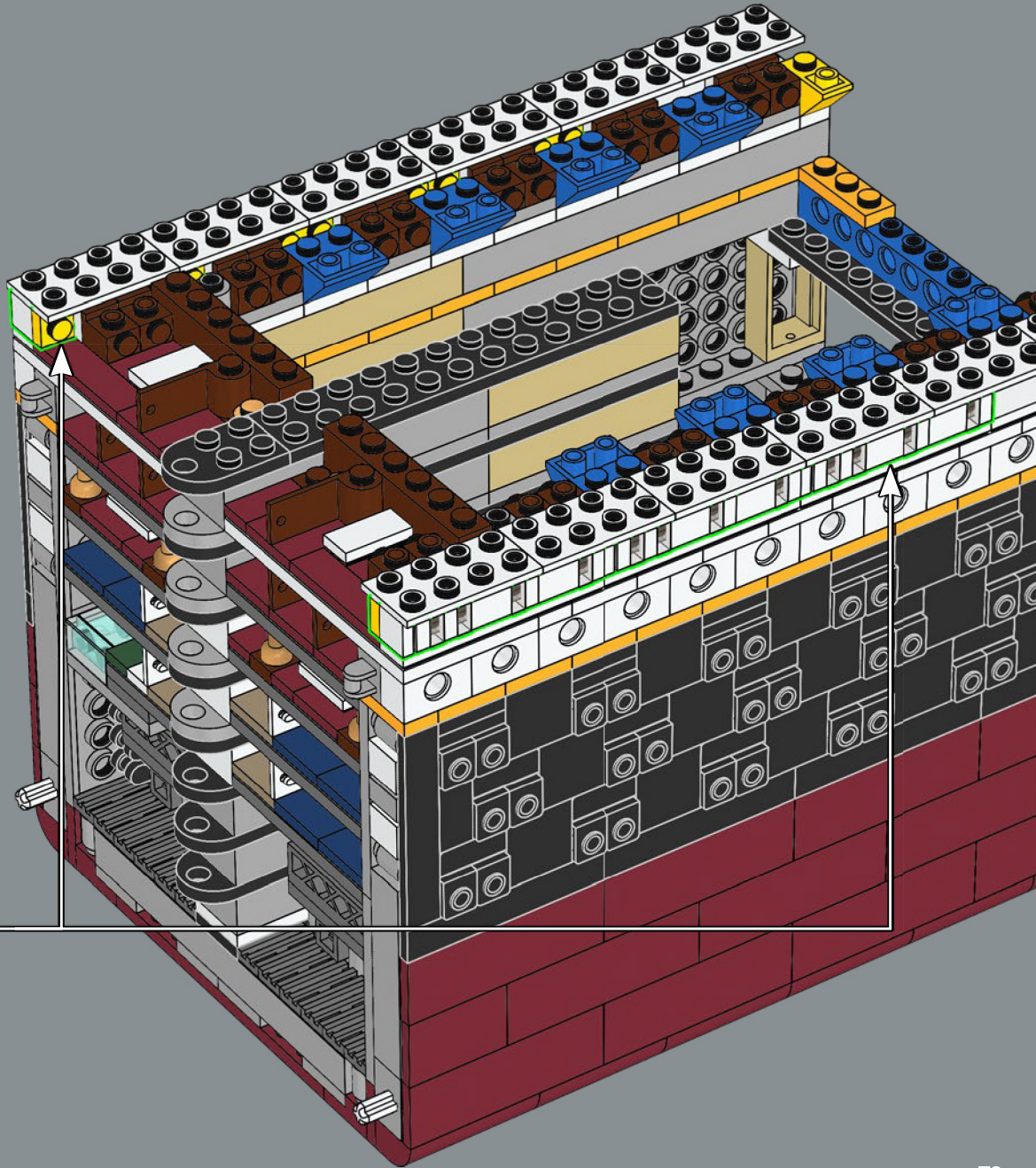
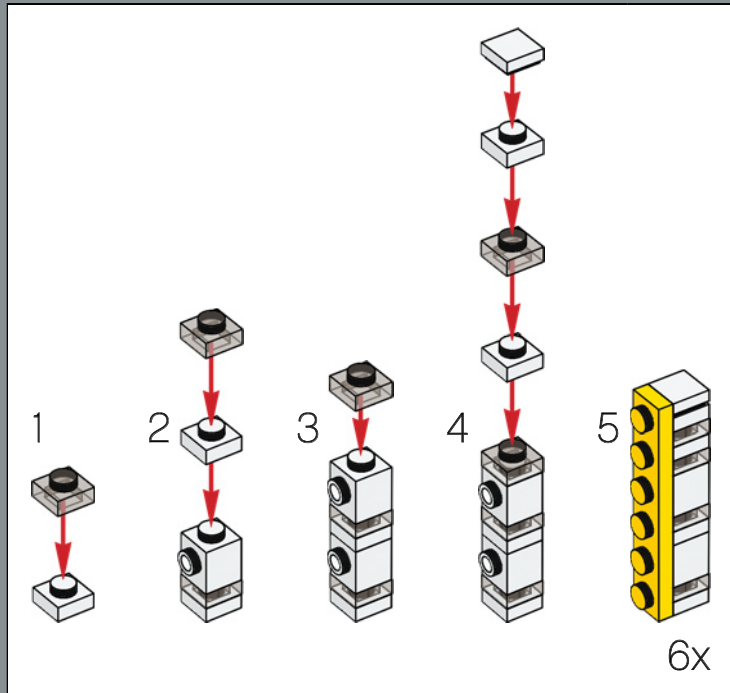

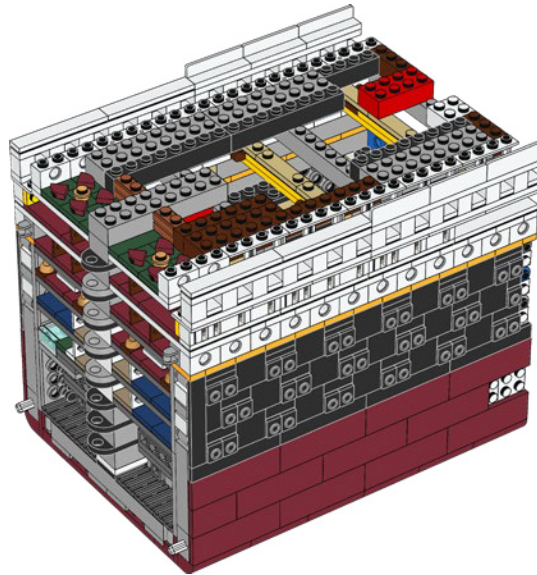
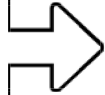

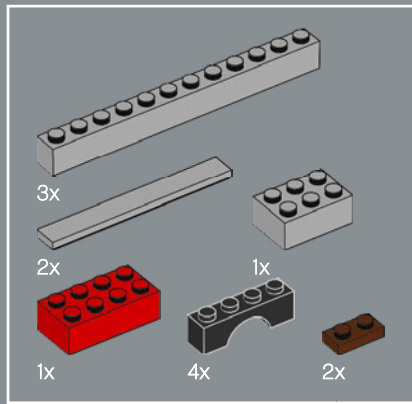

98

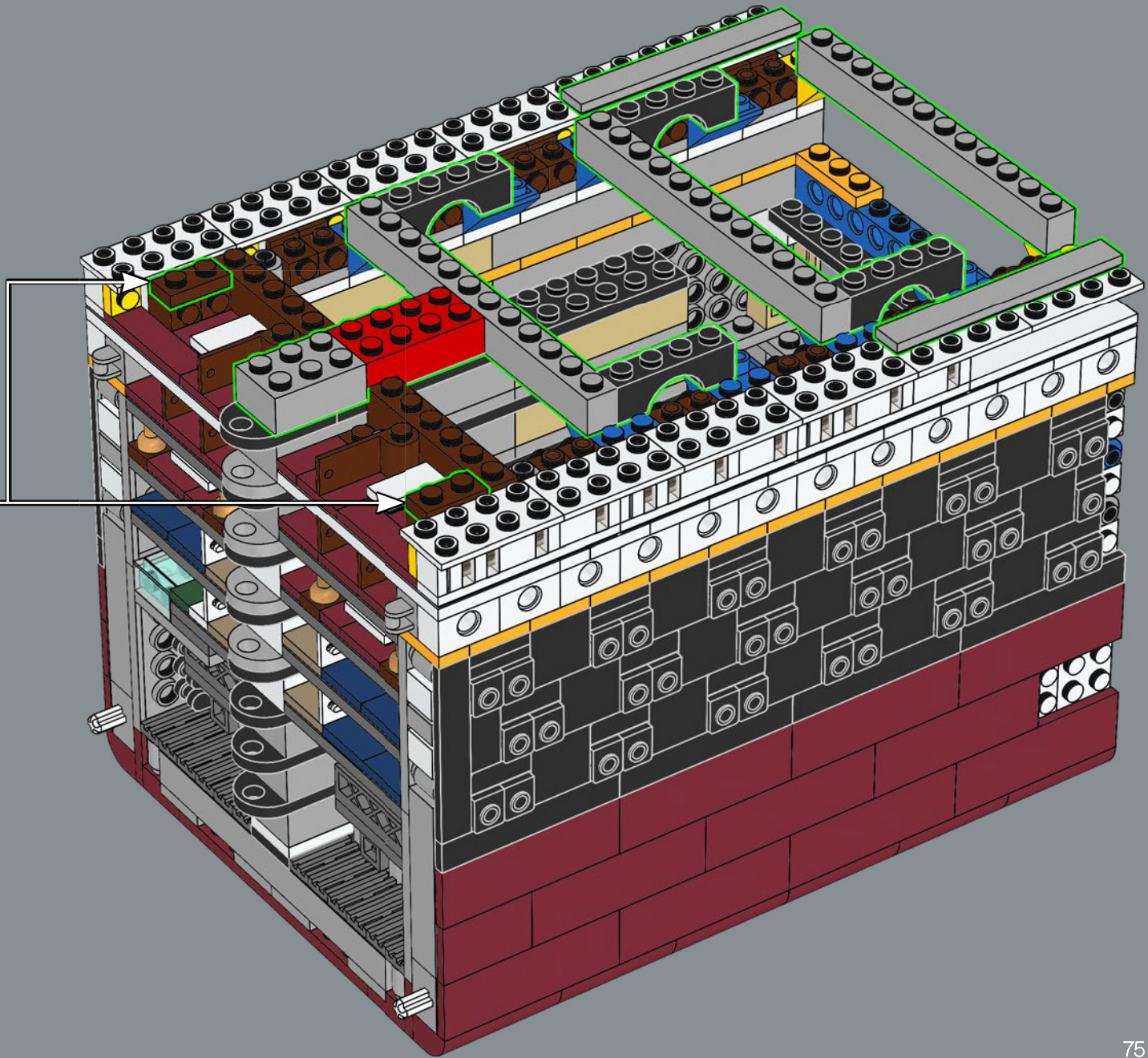
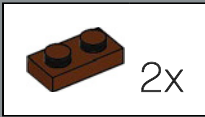

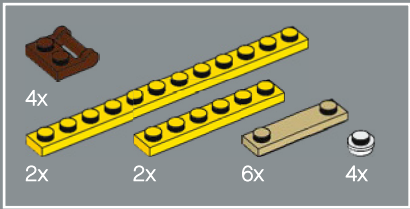

99

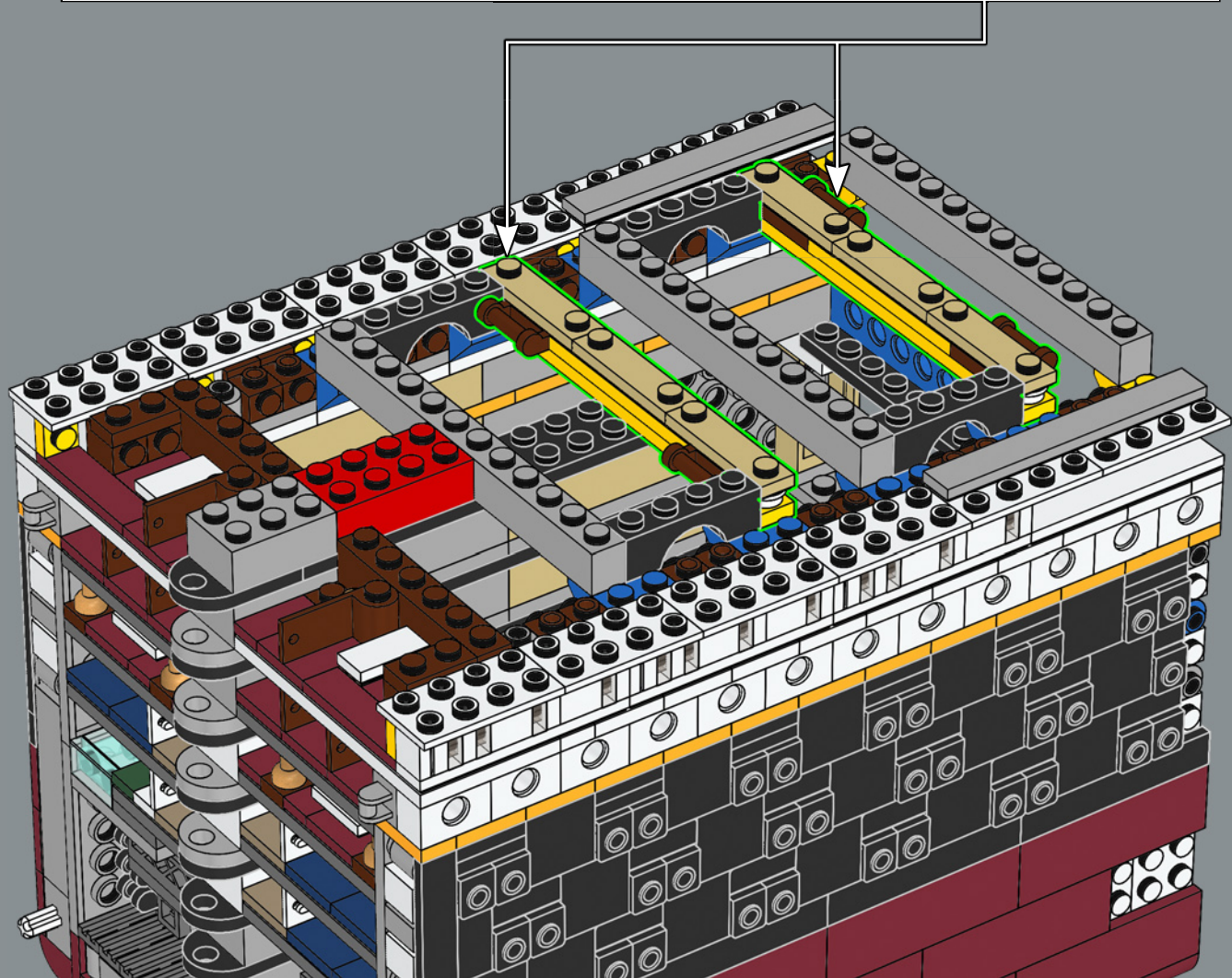
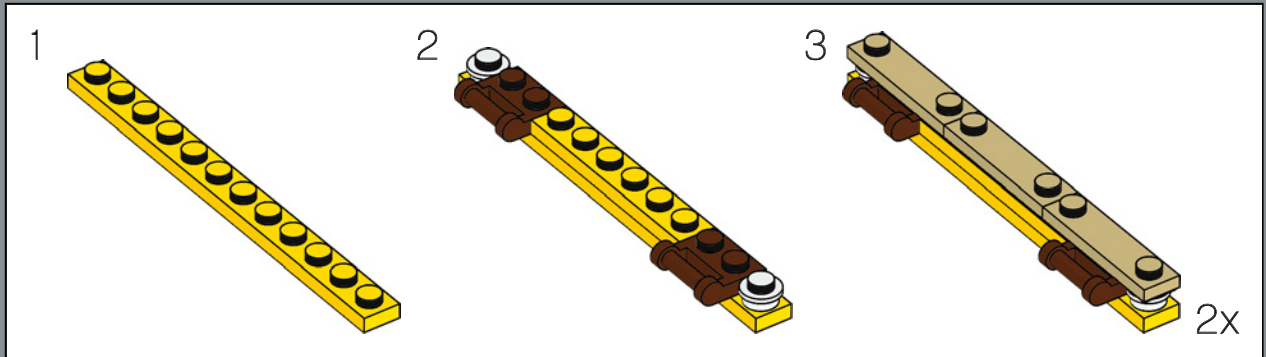

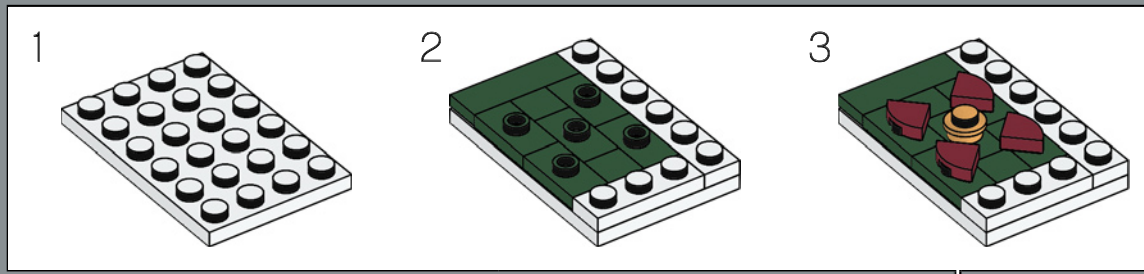
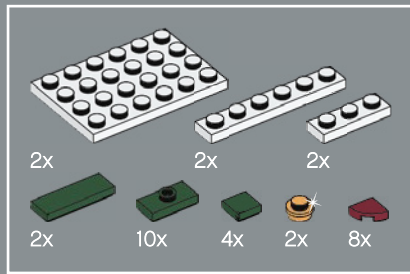

100

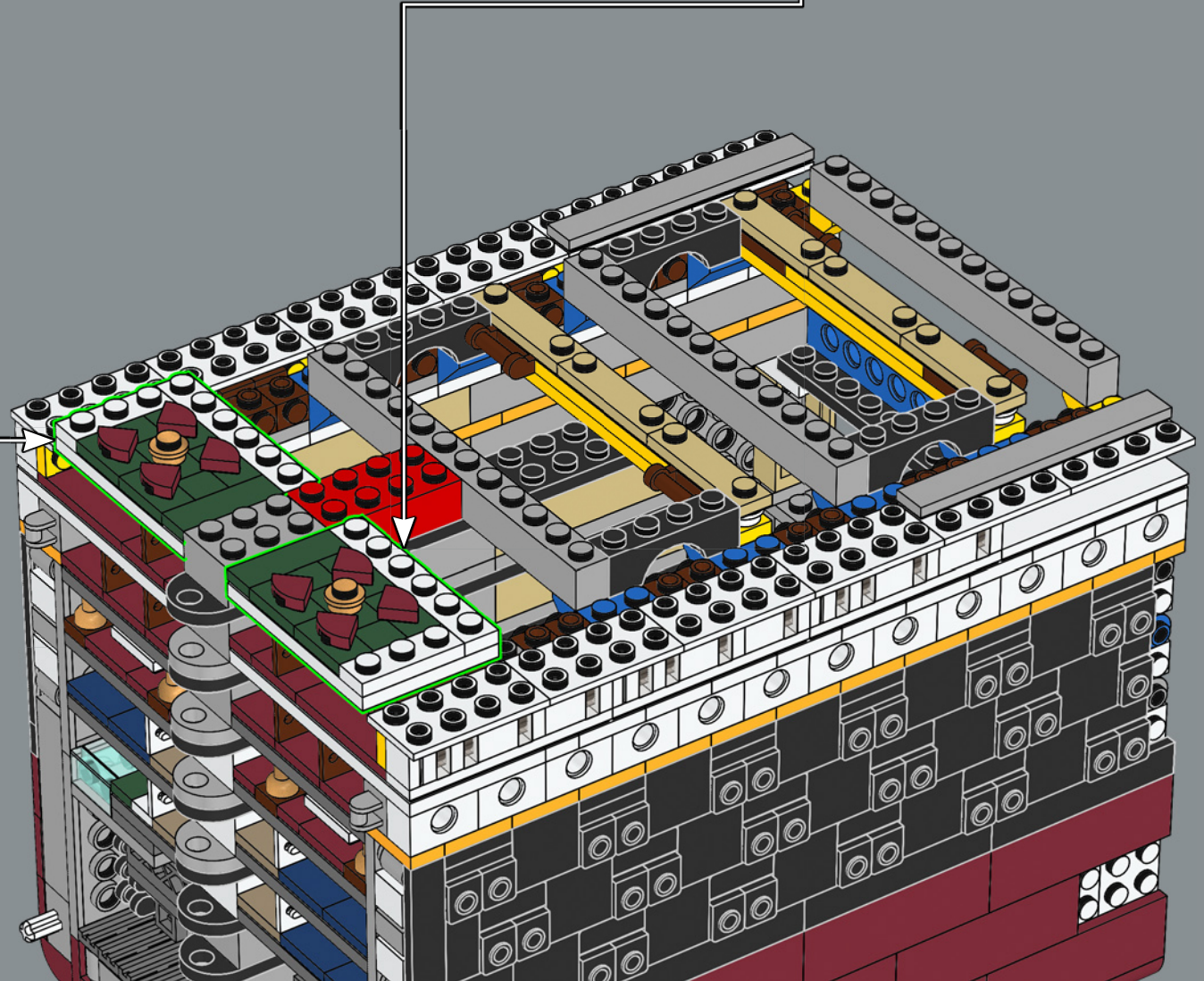
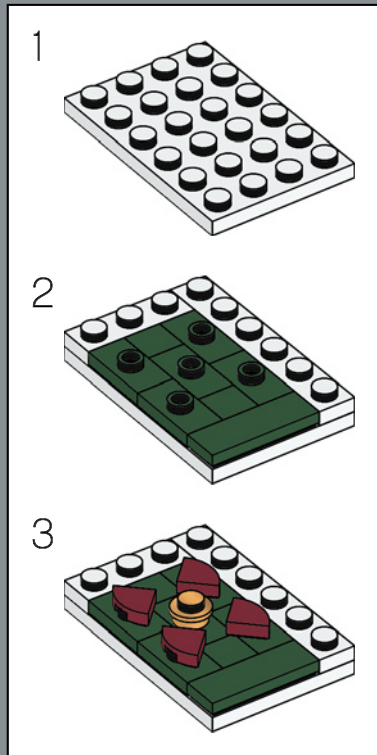

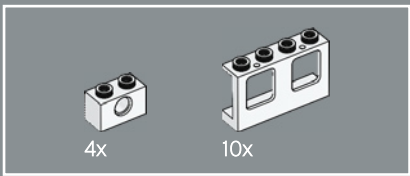

102

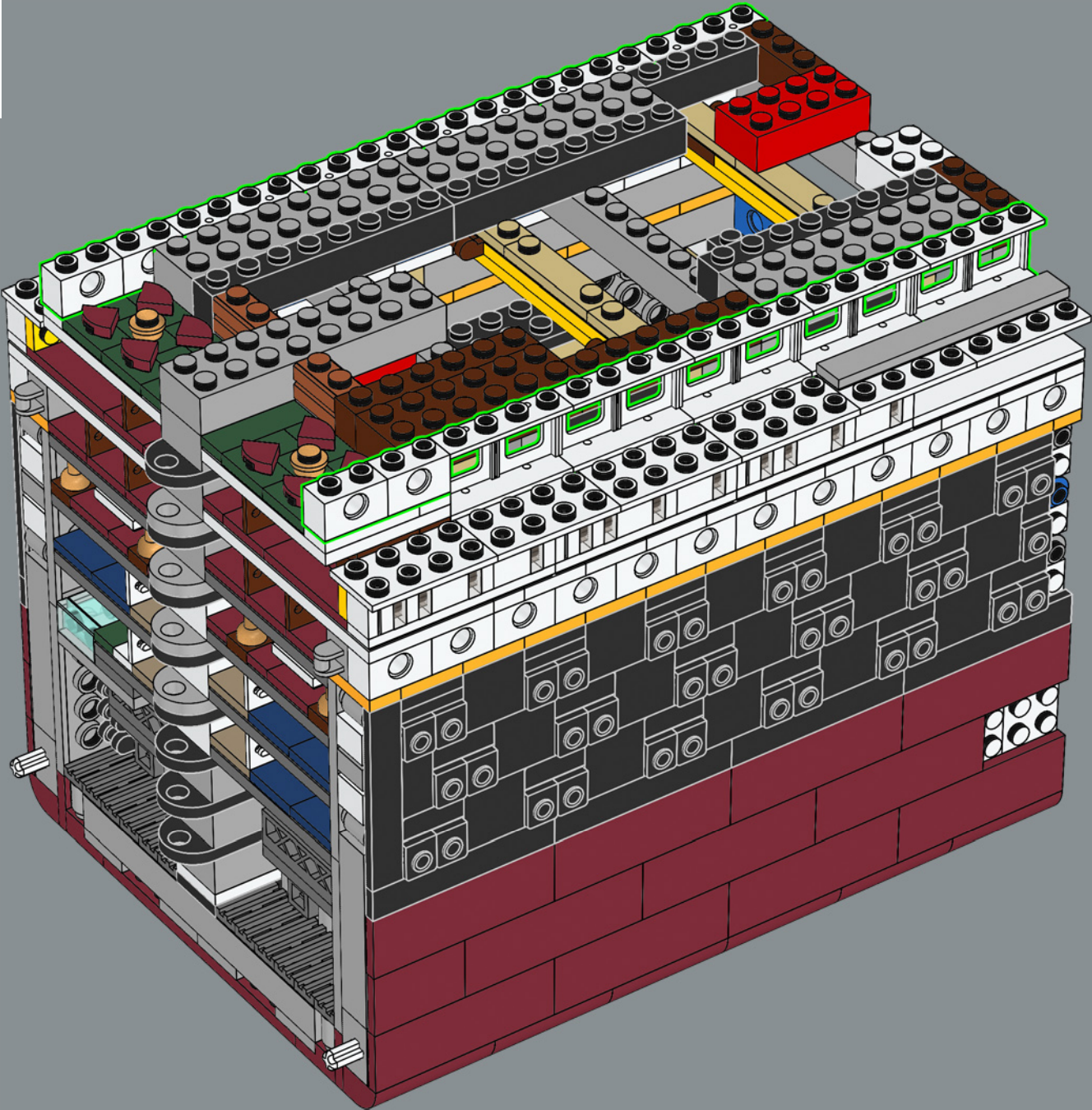

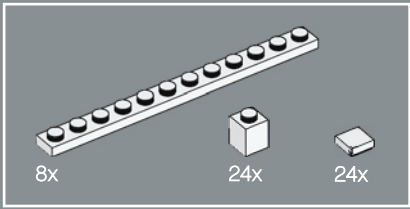

103

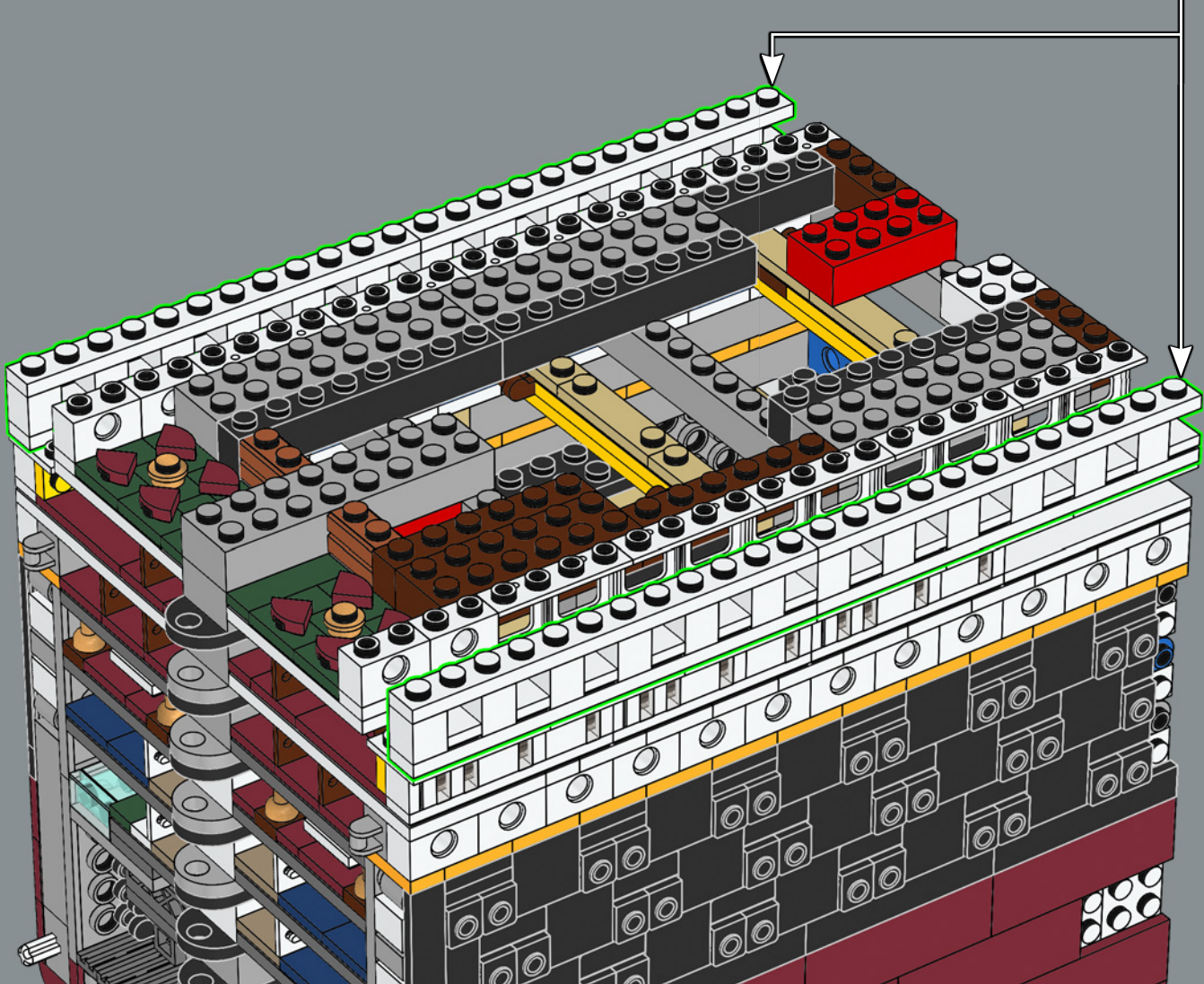
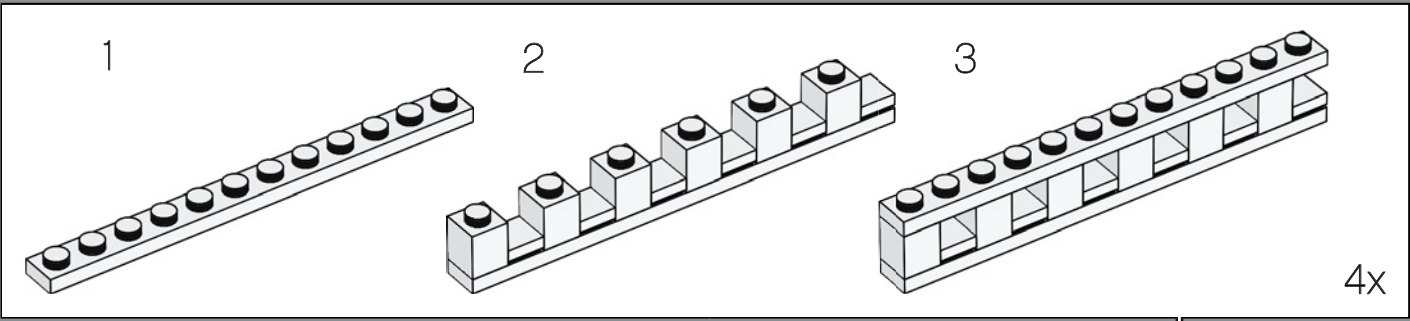

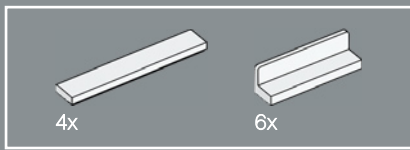

104

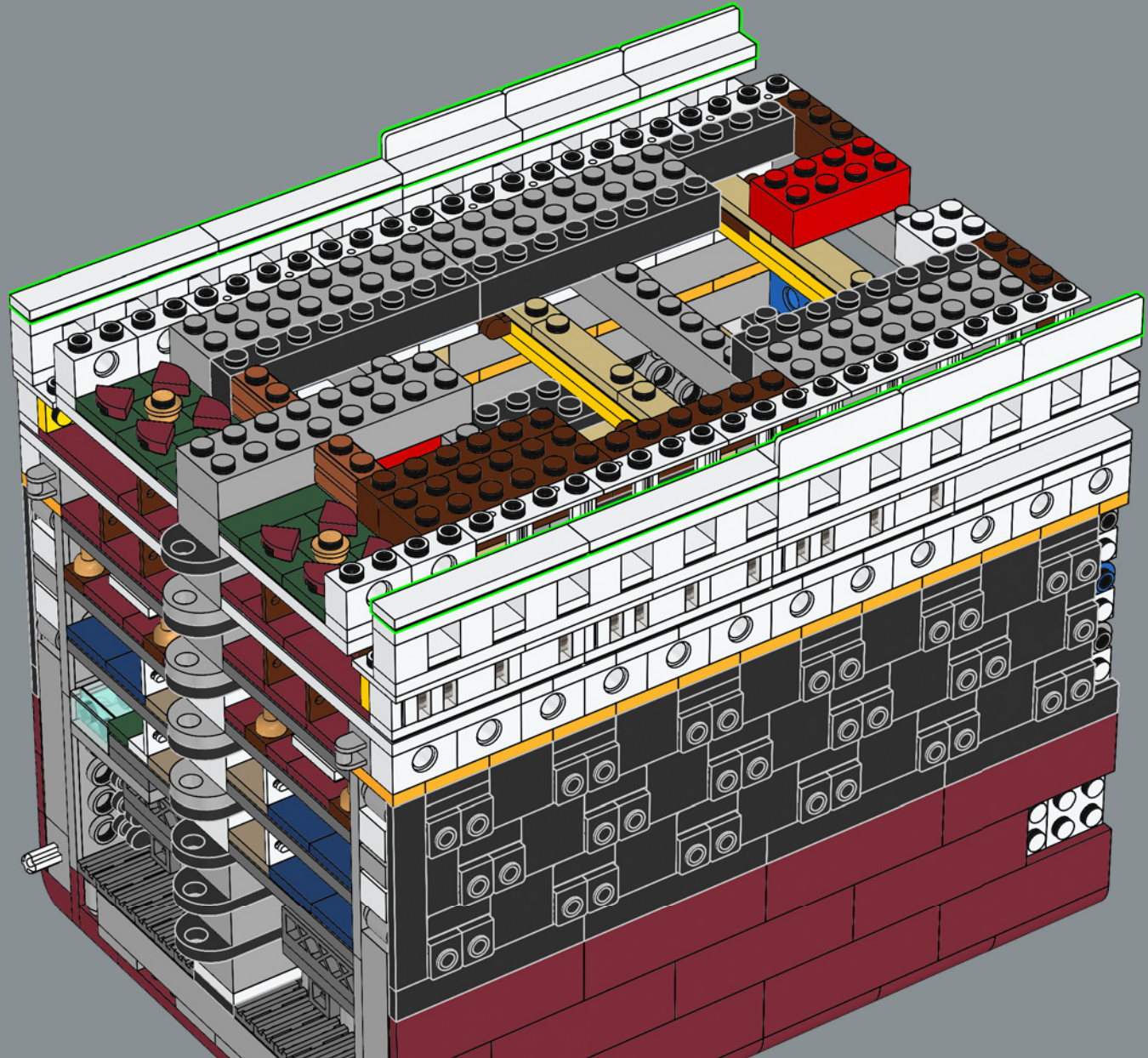

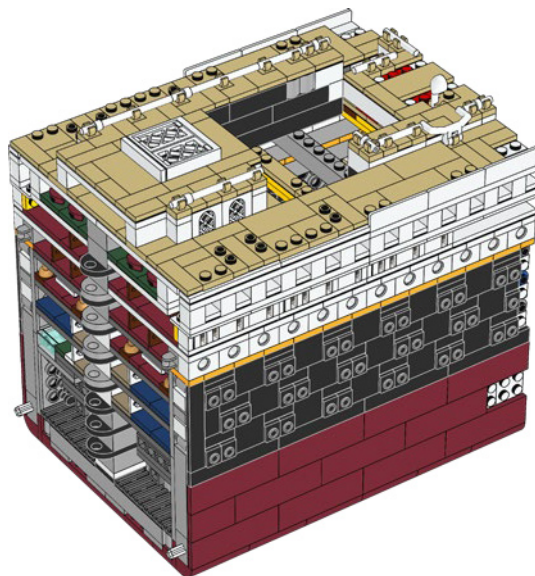
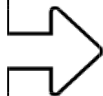

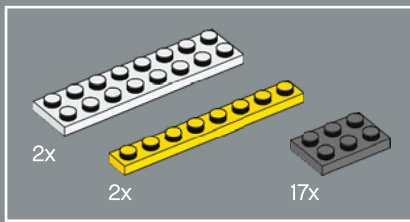

105

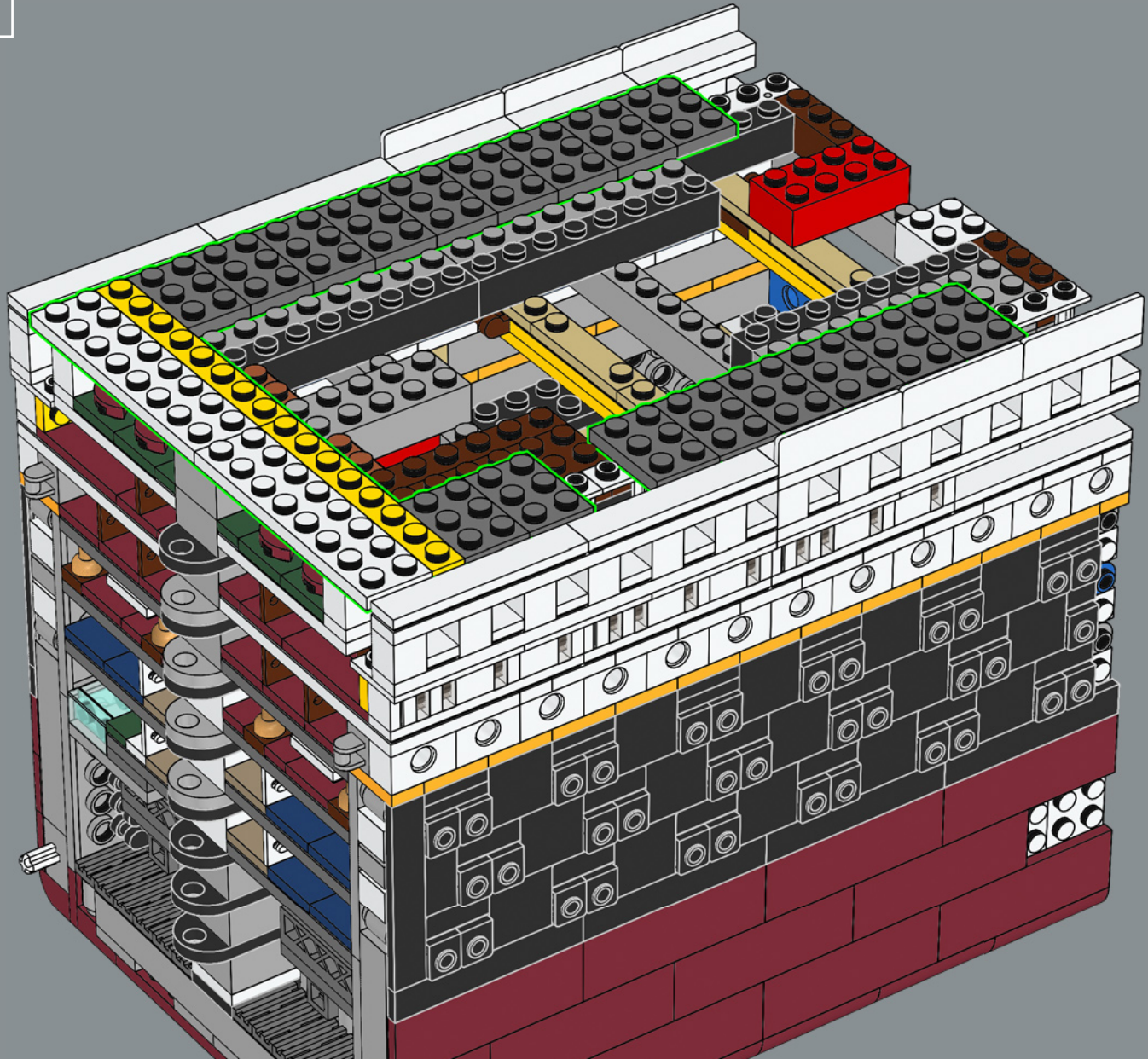

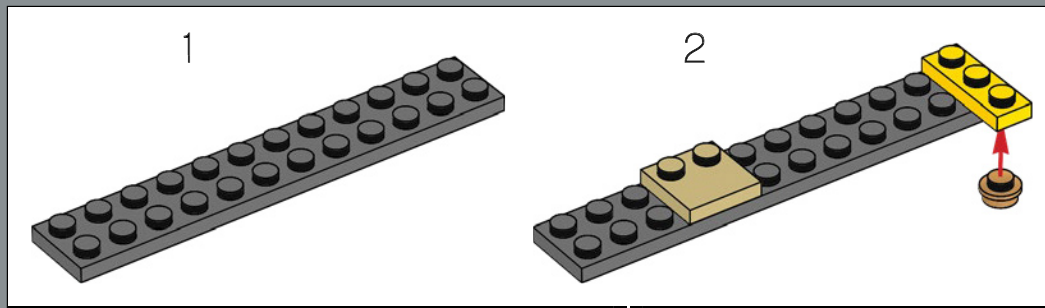
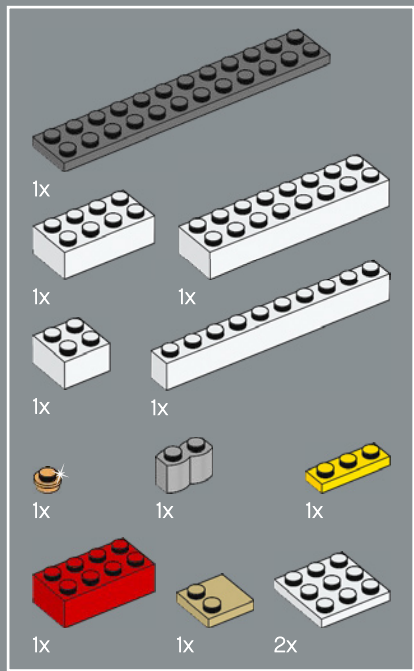

106

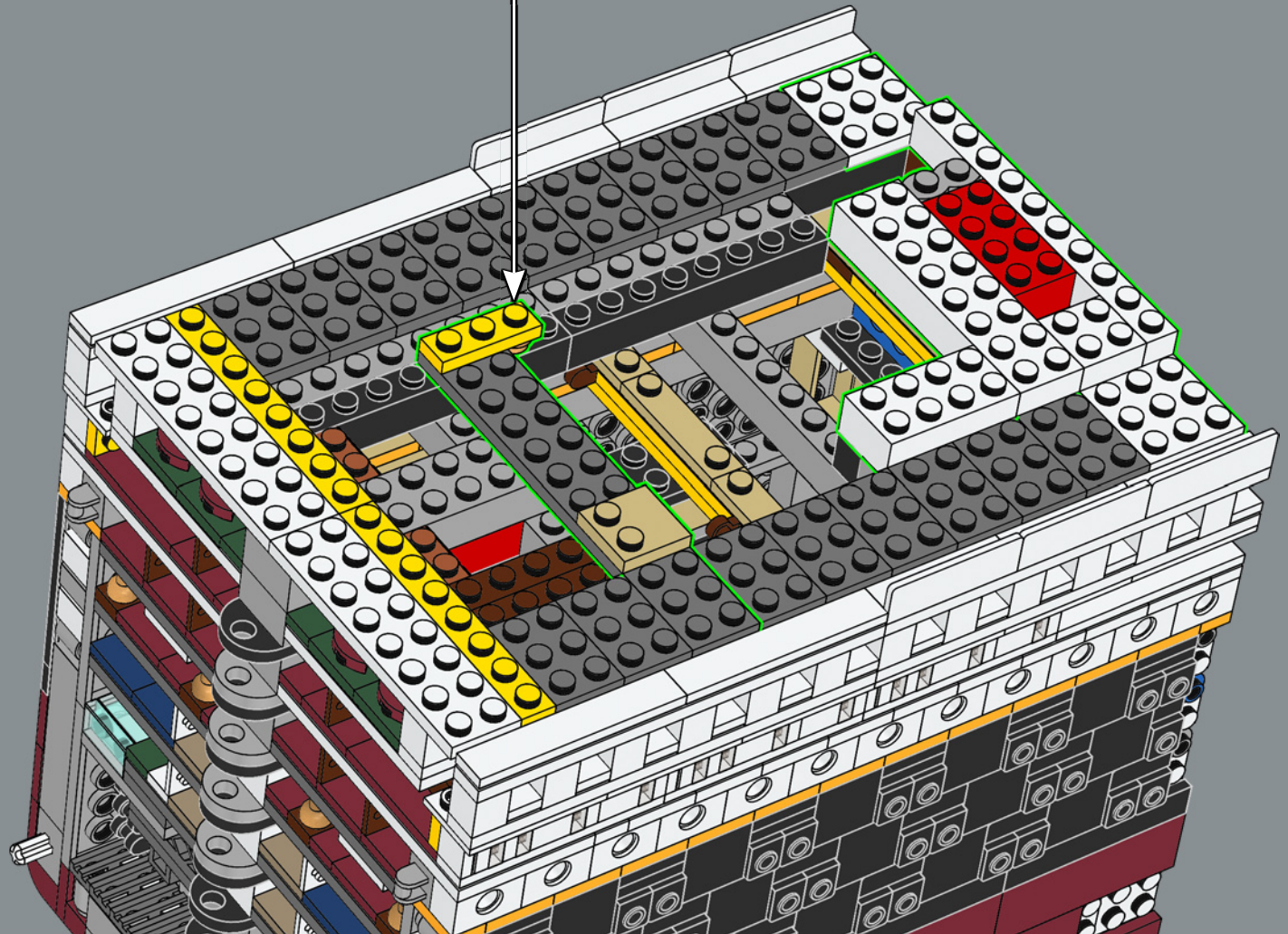

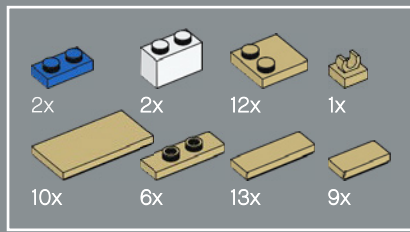

107

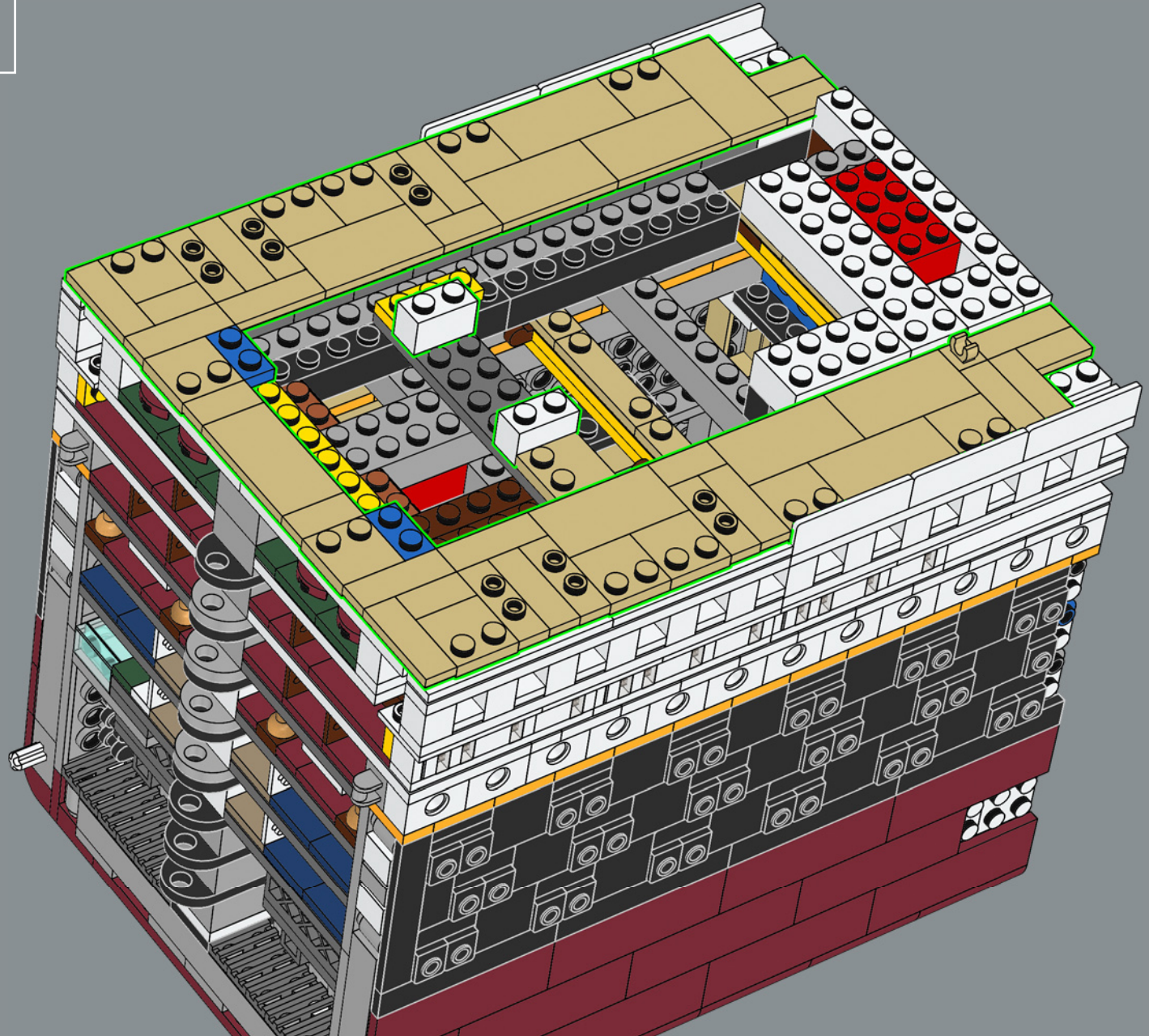

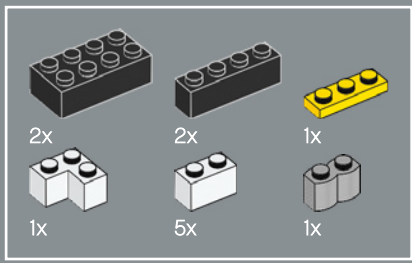

108

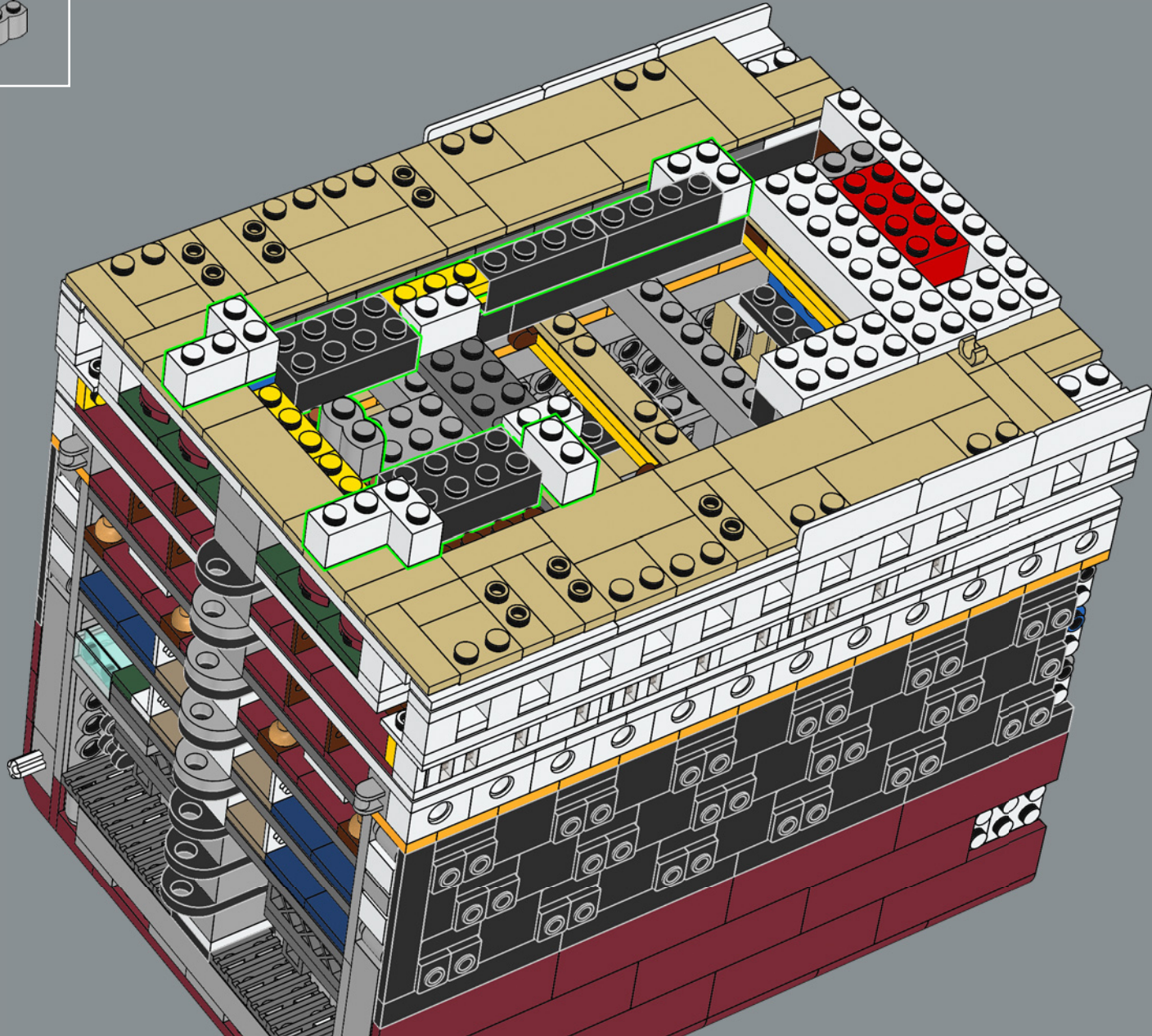

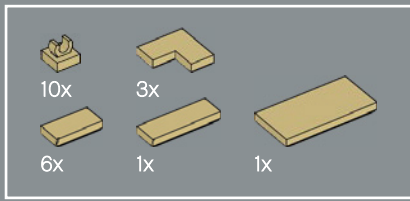

109

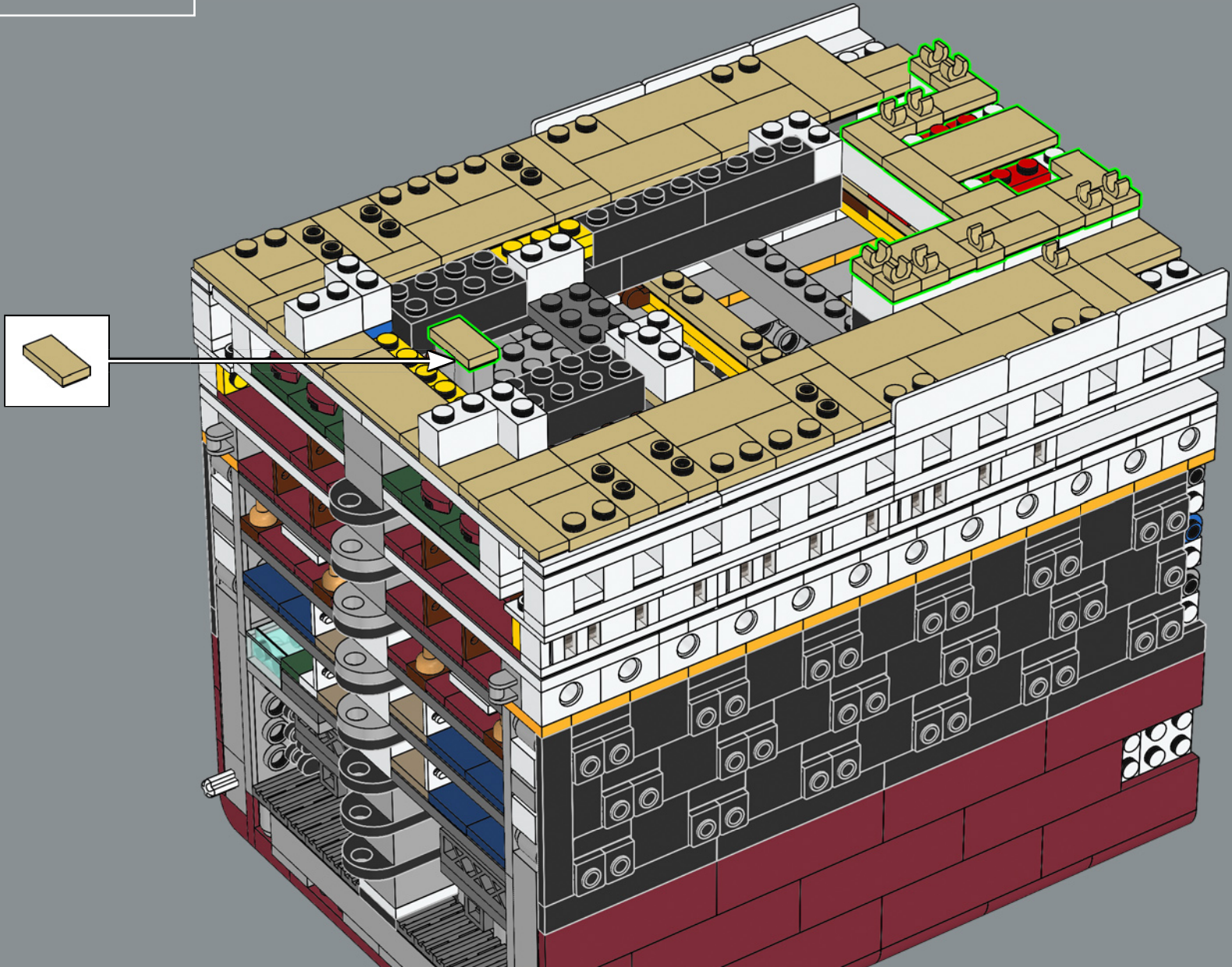

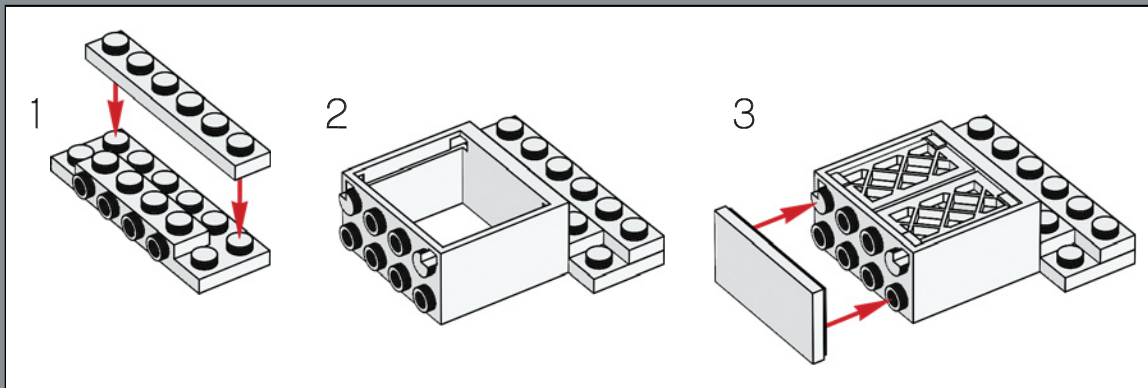
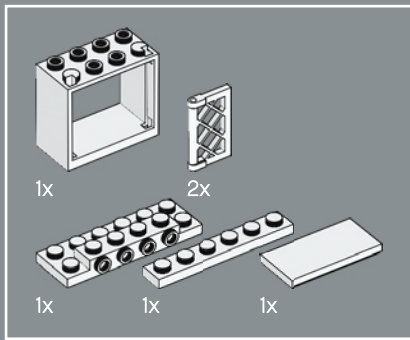

111

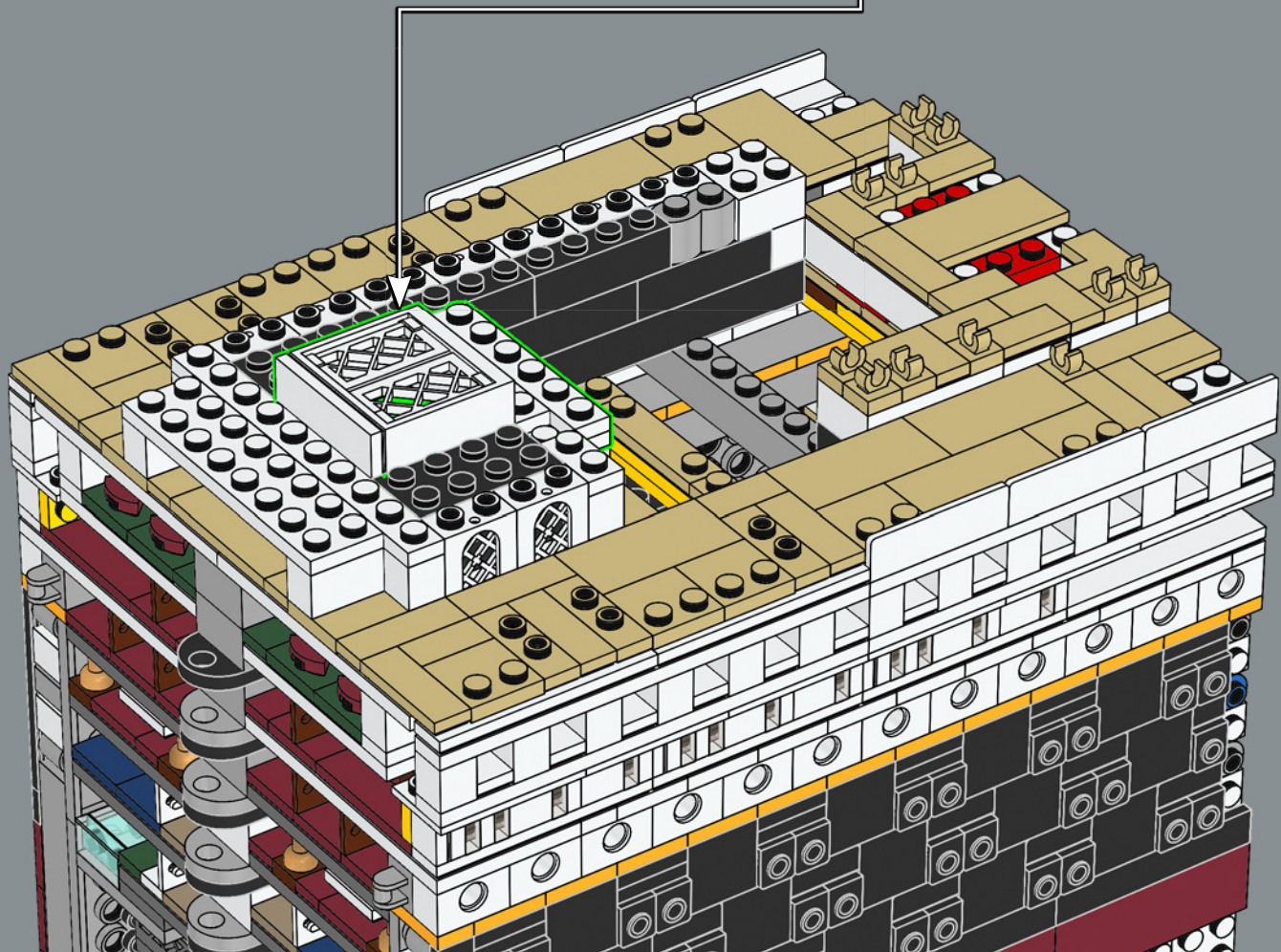

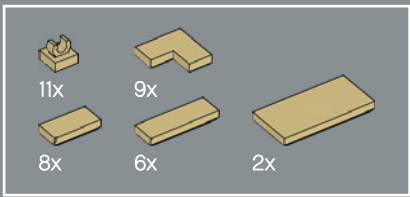

112

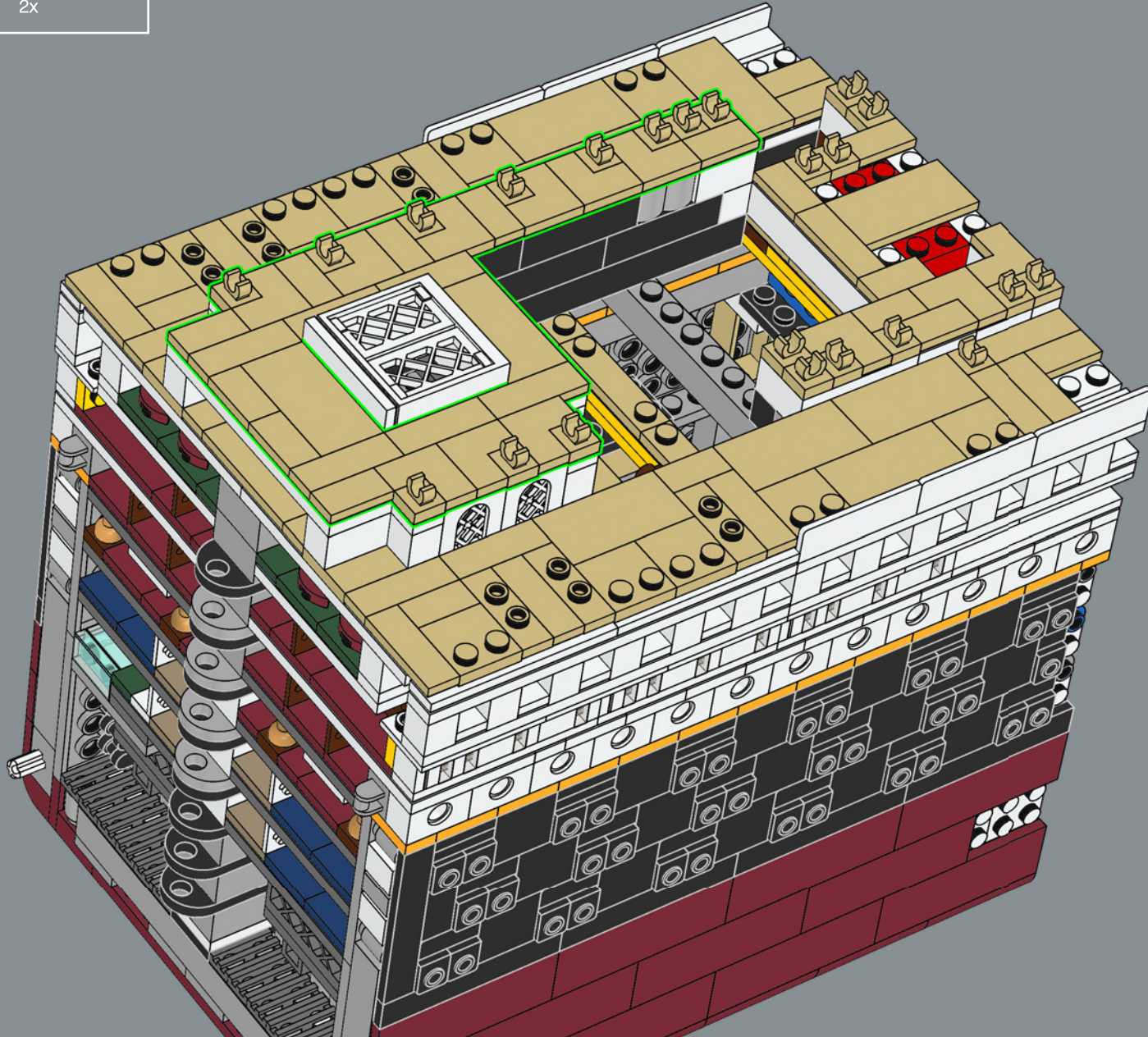

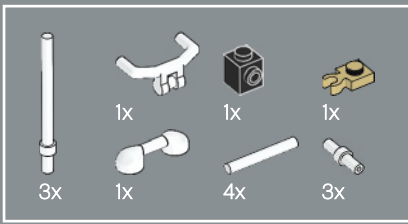

113

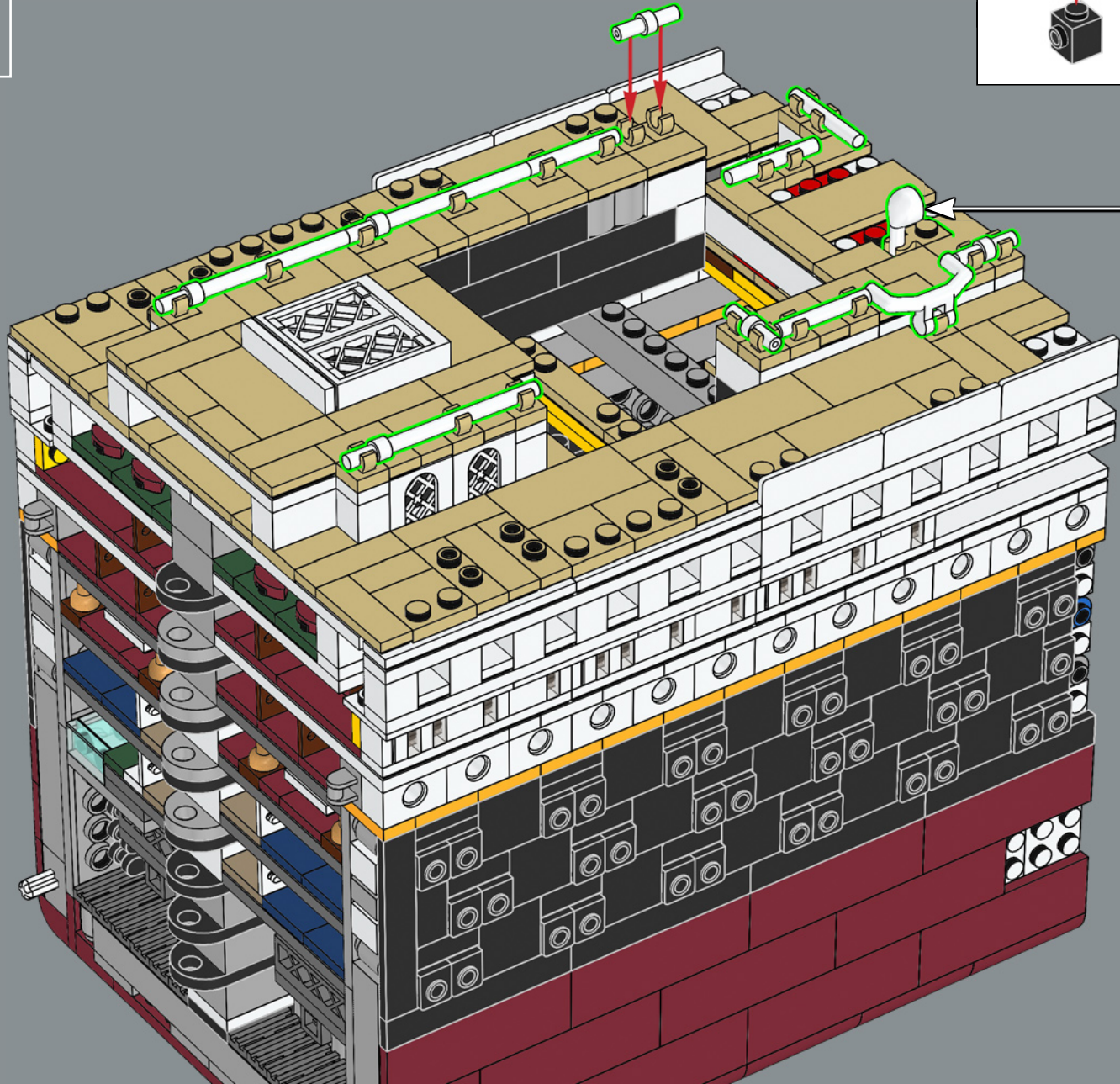
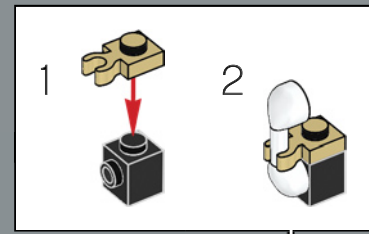

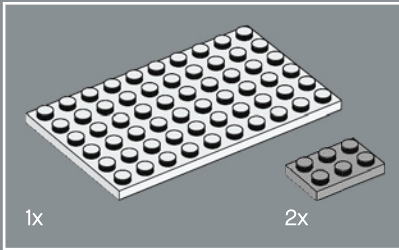
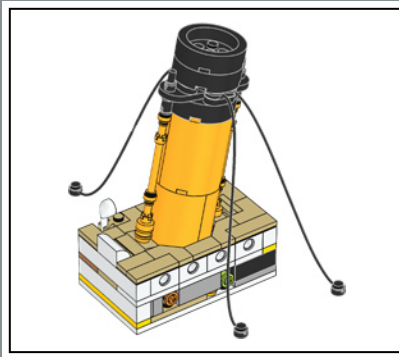
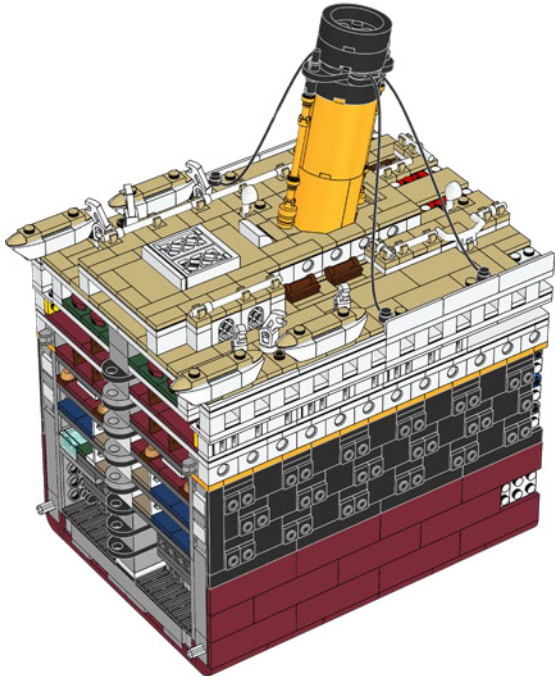
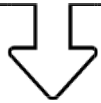

114

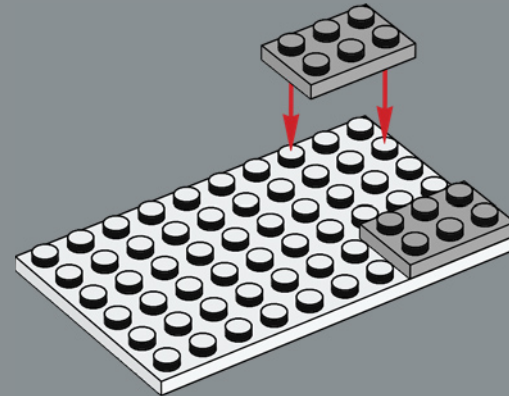

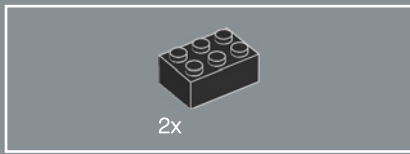

115

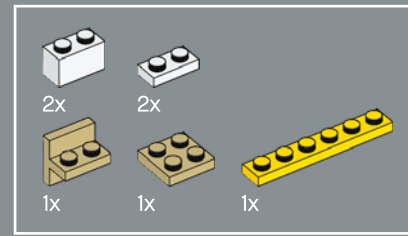
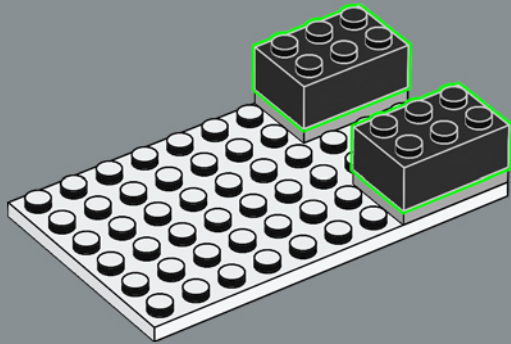

116

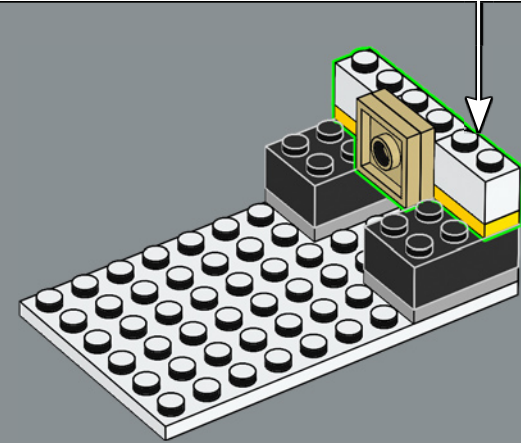
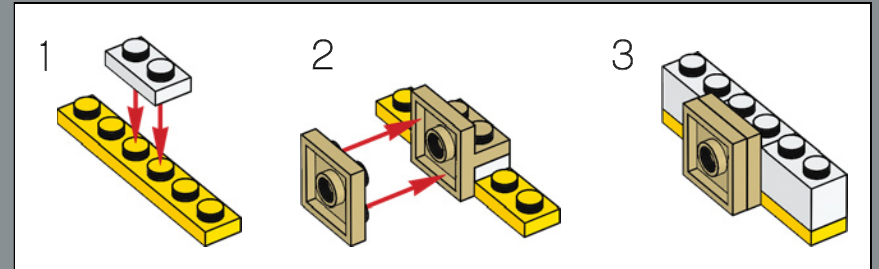

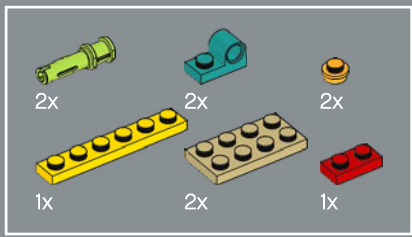

117

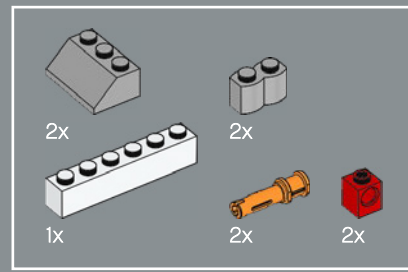
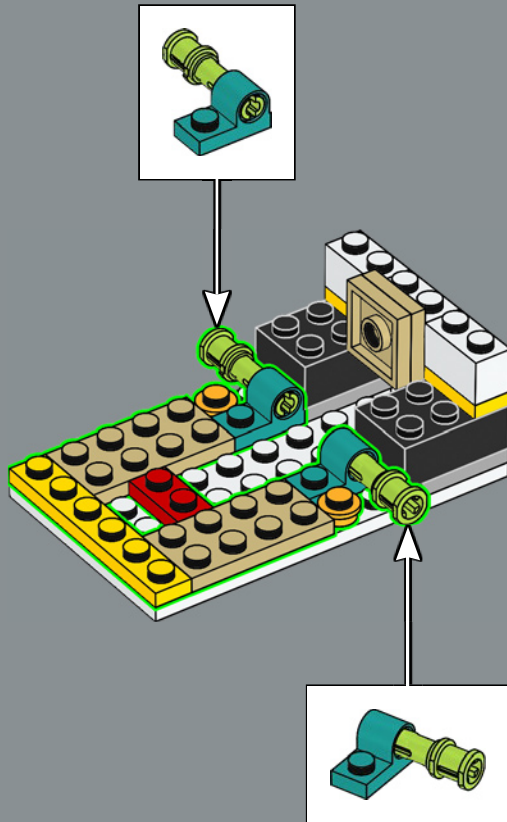

118

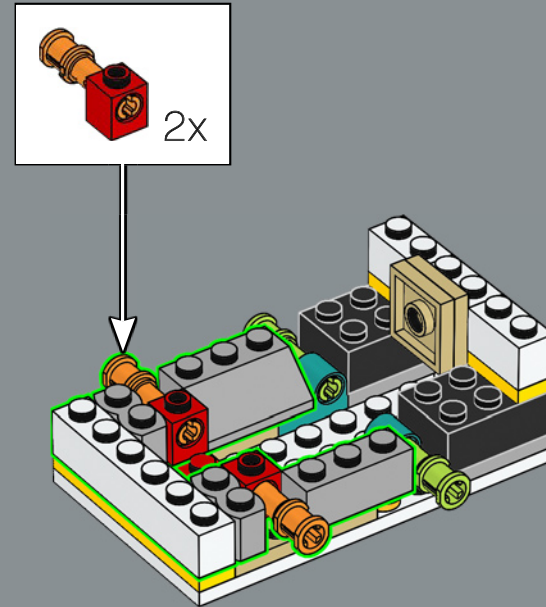

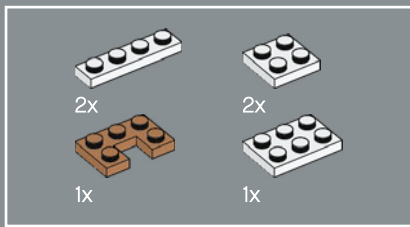

119

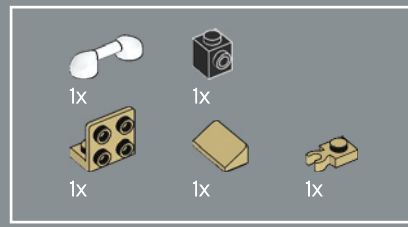
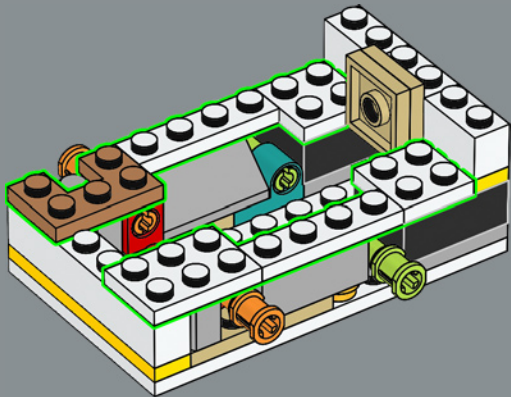

120

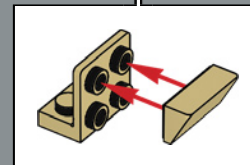
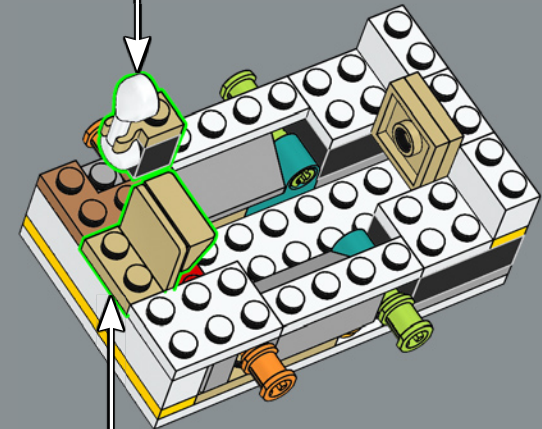
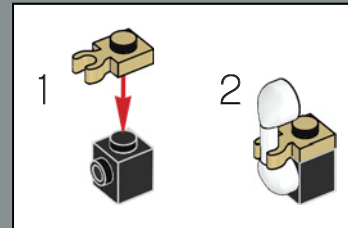

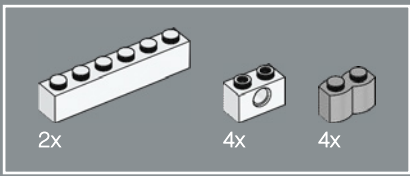

121

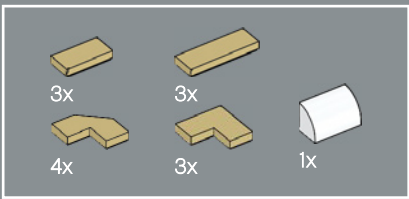
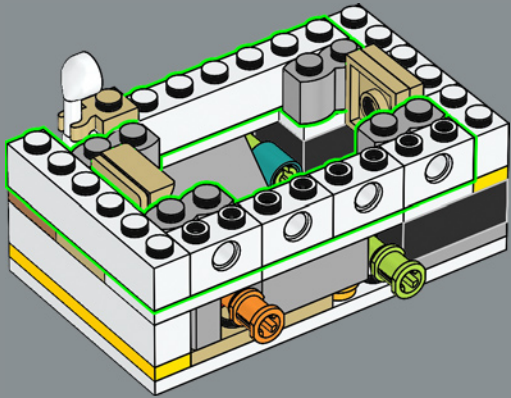

122

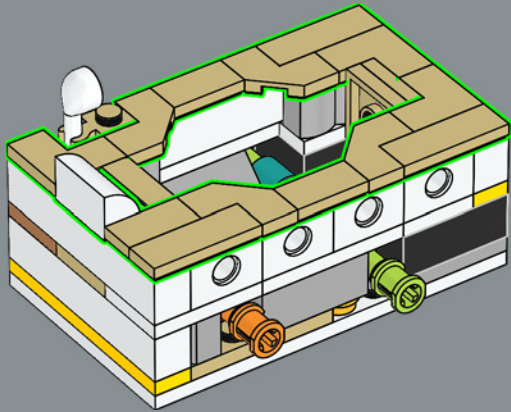

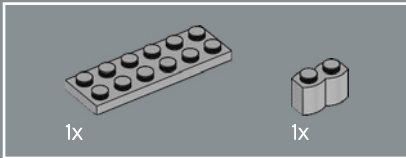
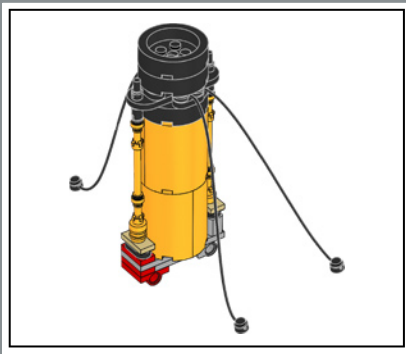

123

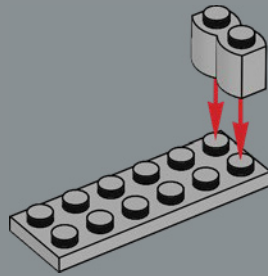

124

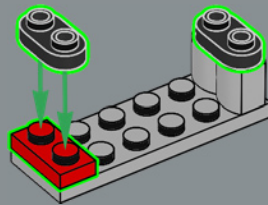

125

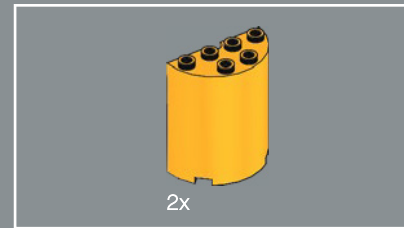
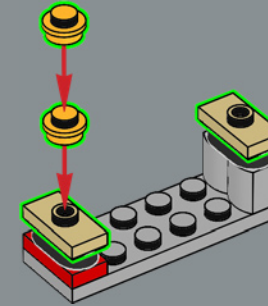

126

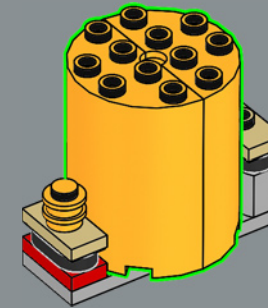

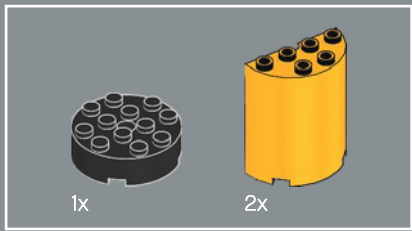

127

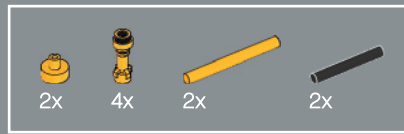
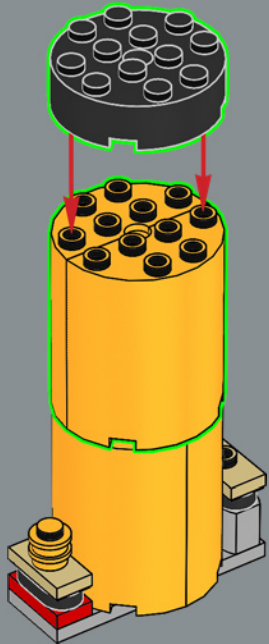

128

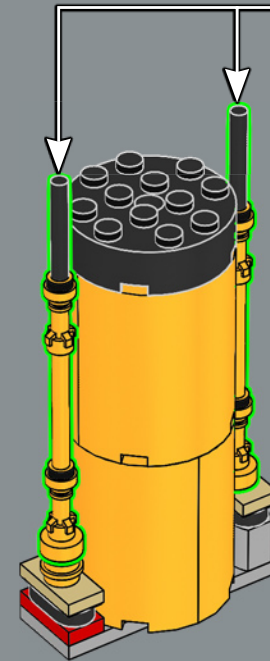
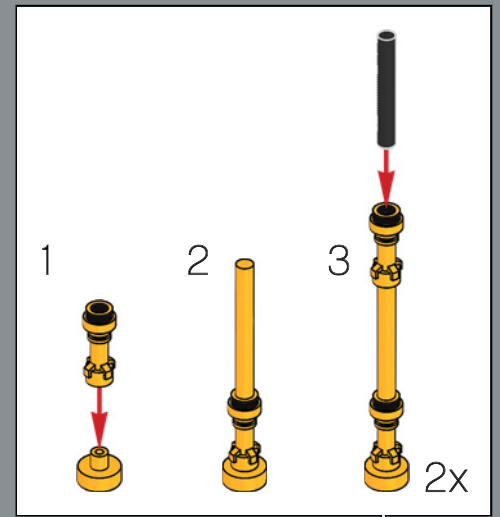

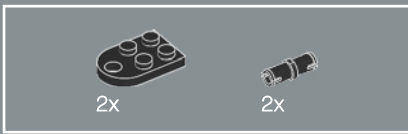

129

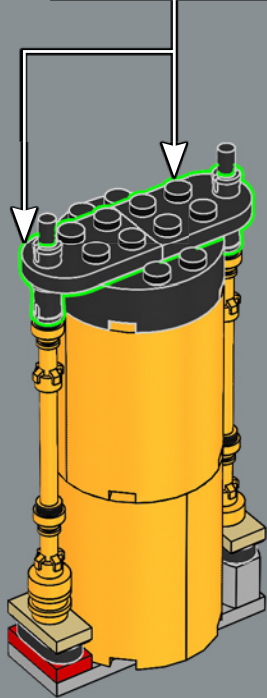
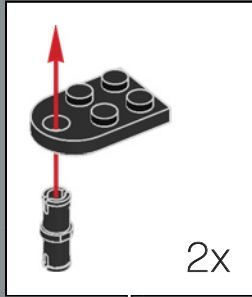

130

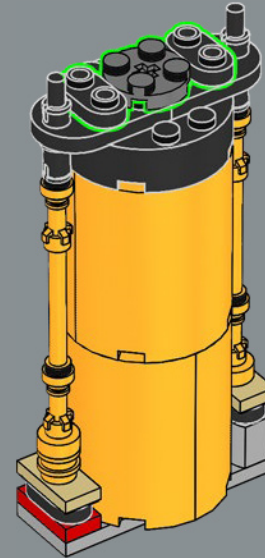



131

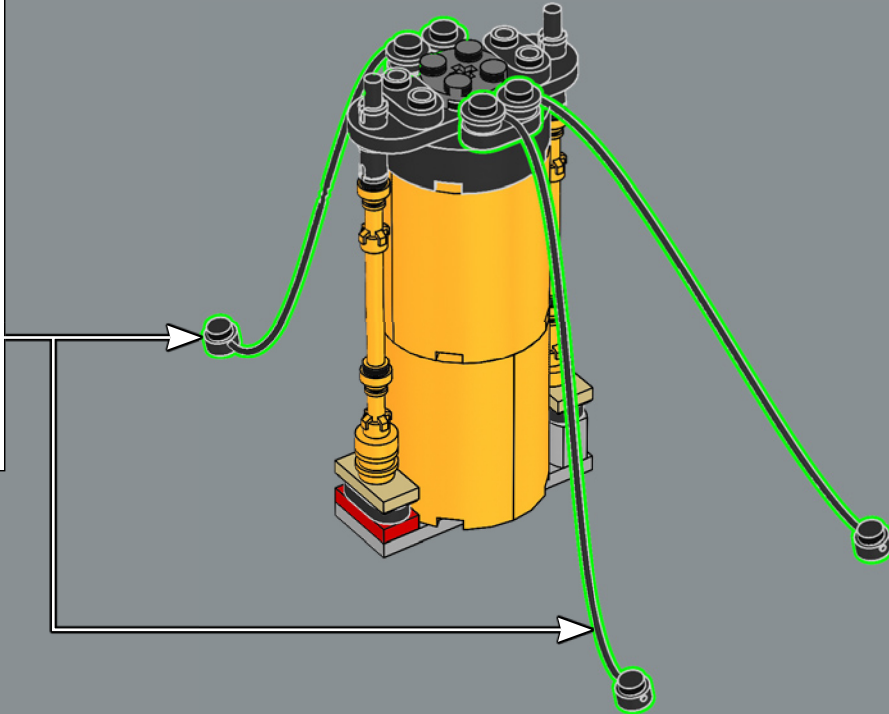
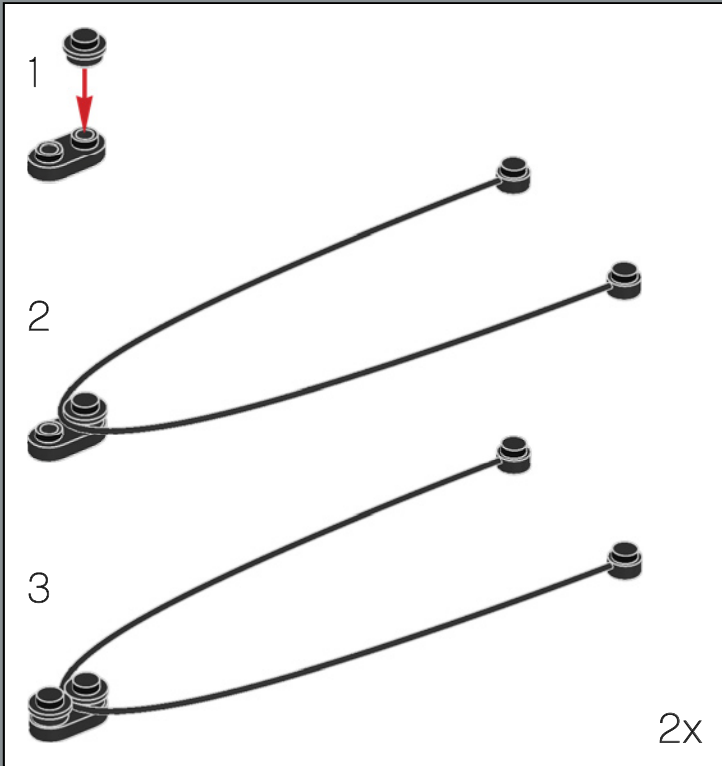

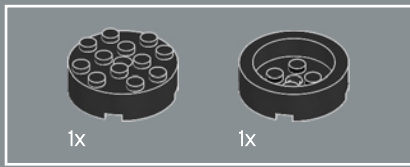

132

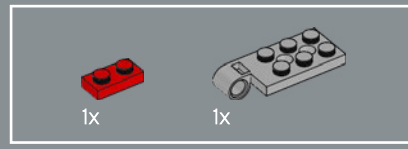
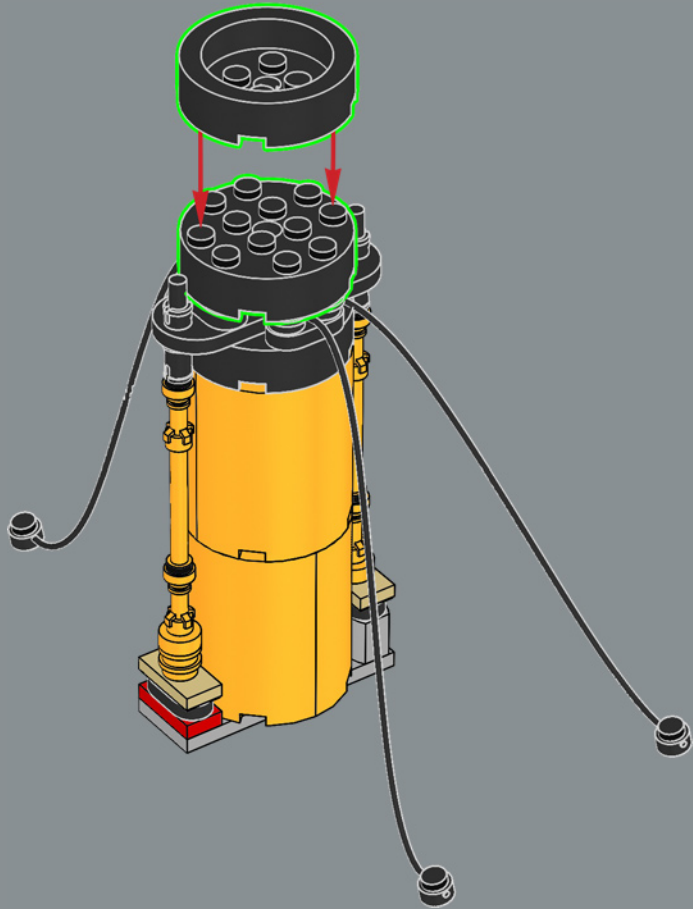

133

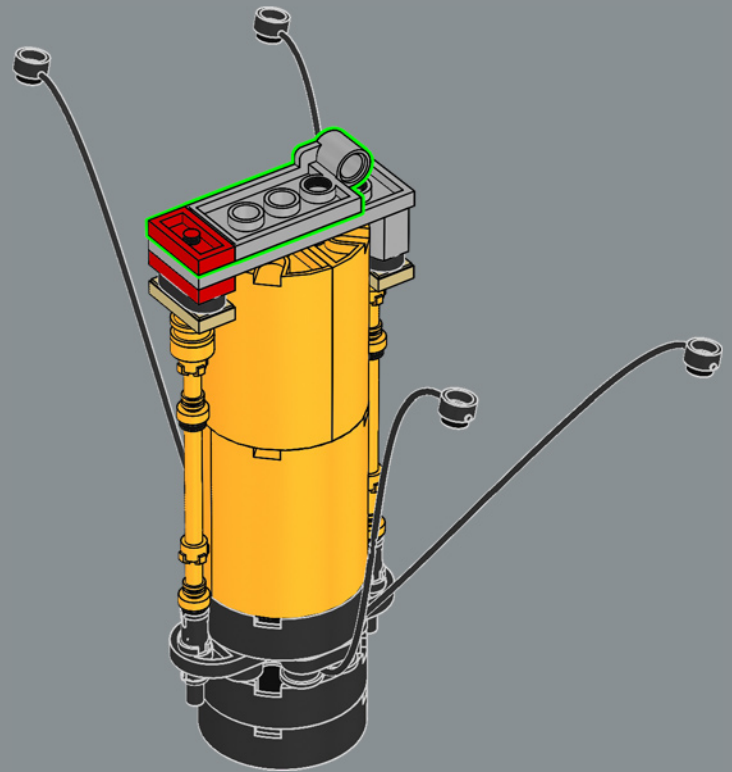

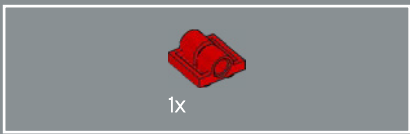

134

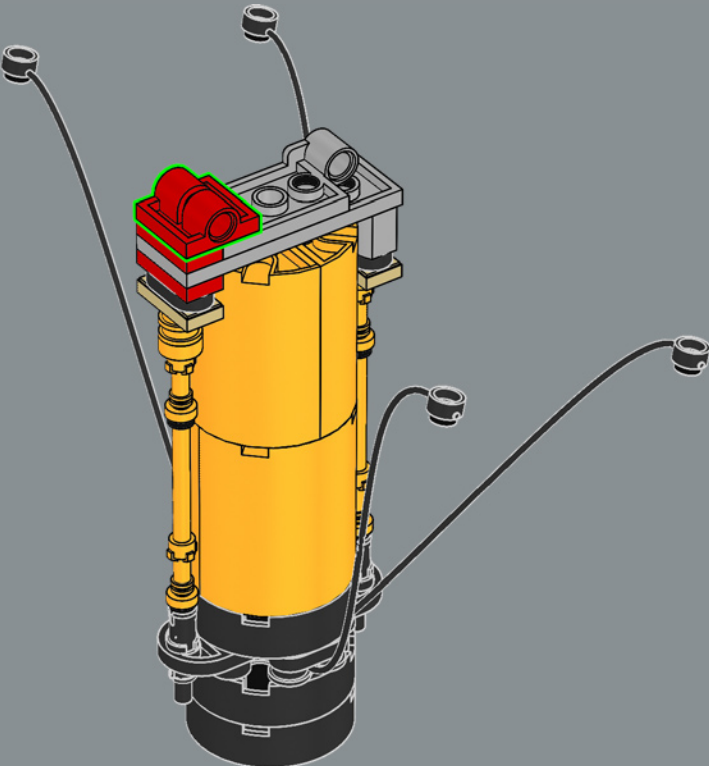

135

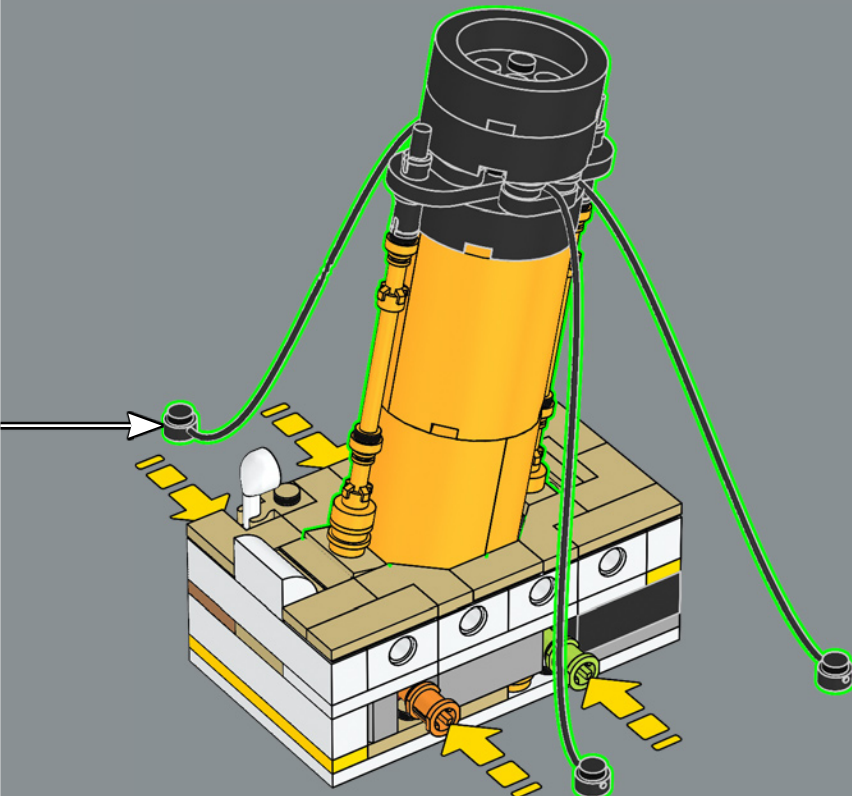

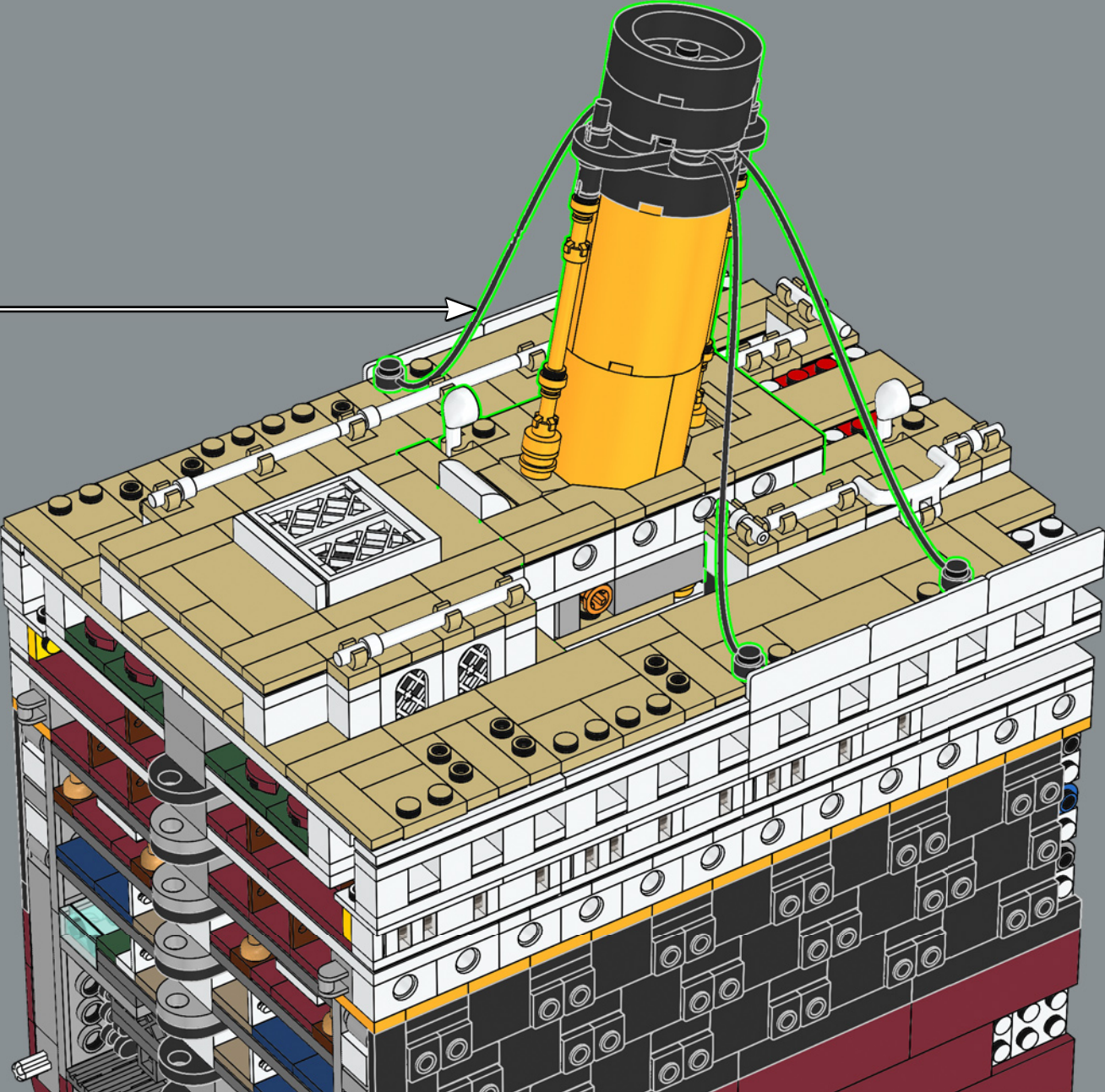

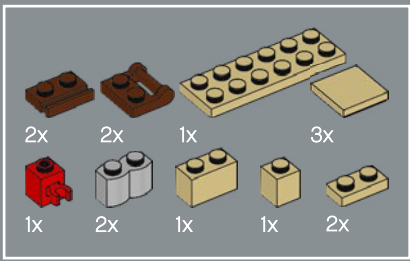

137

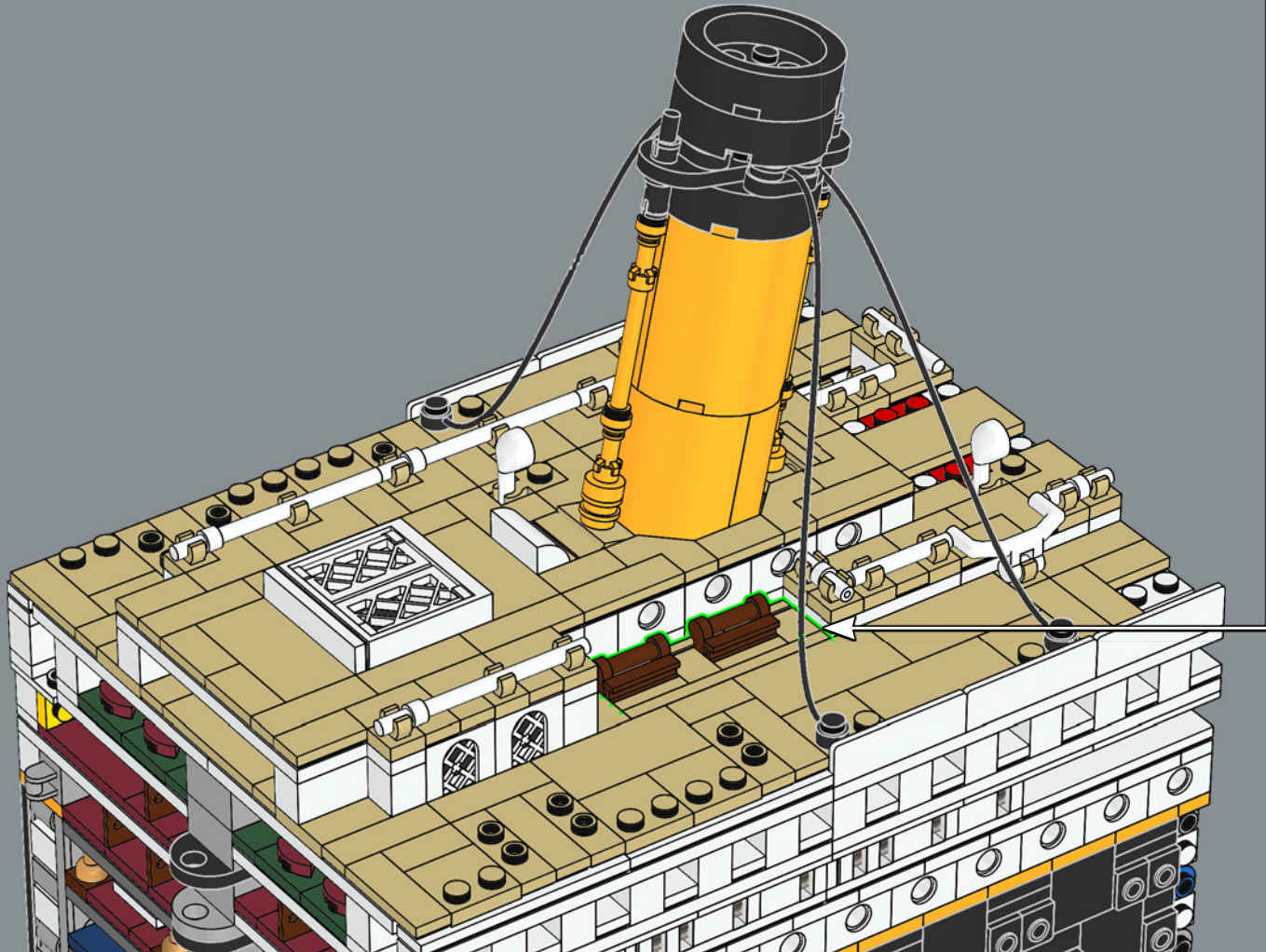
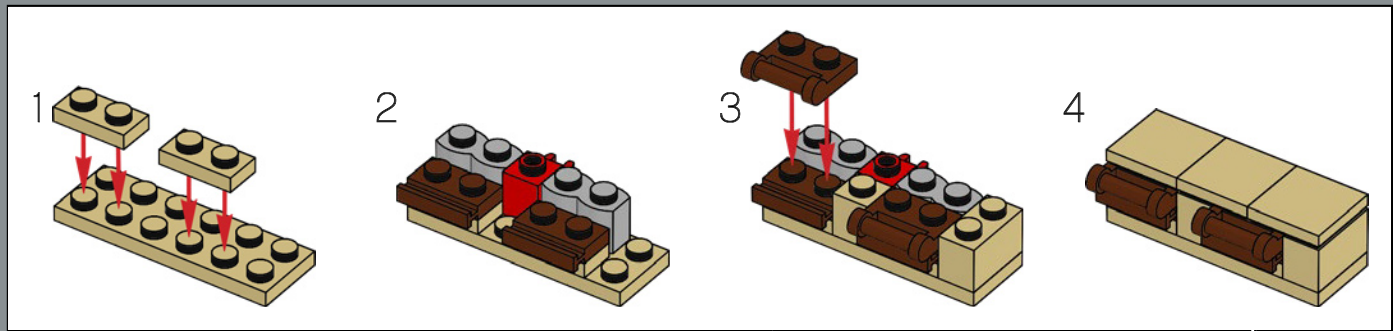

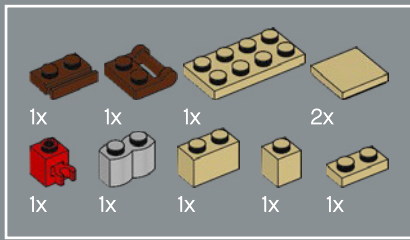

138

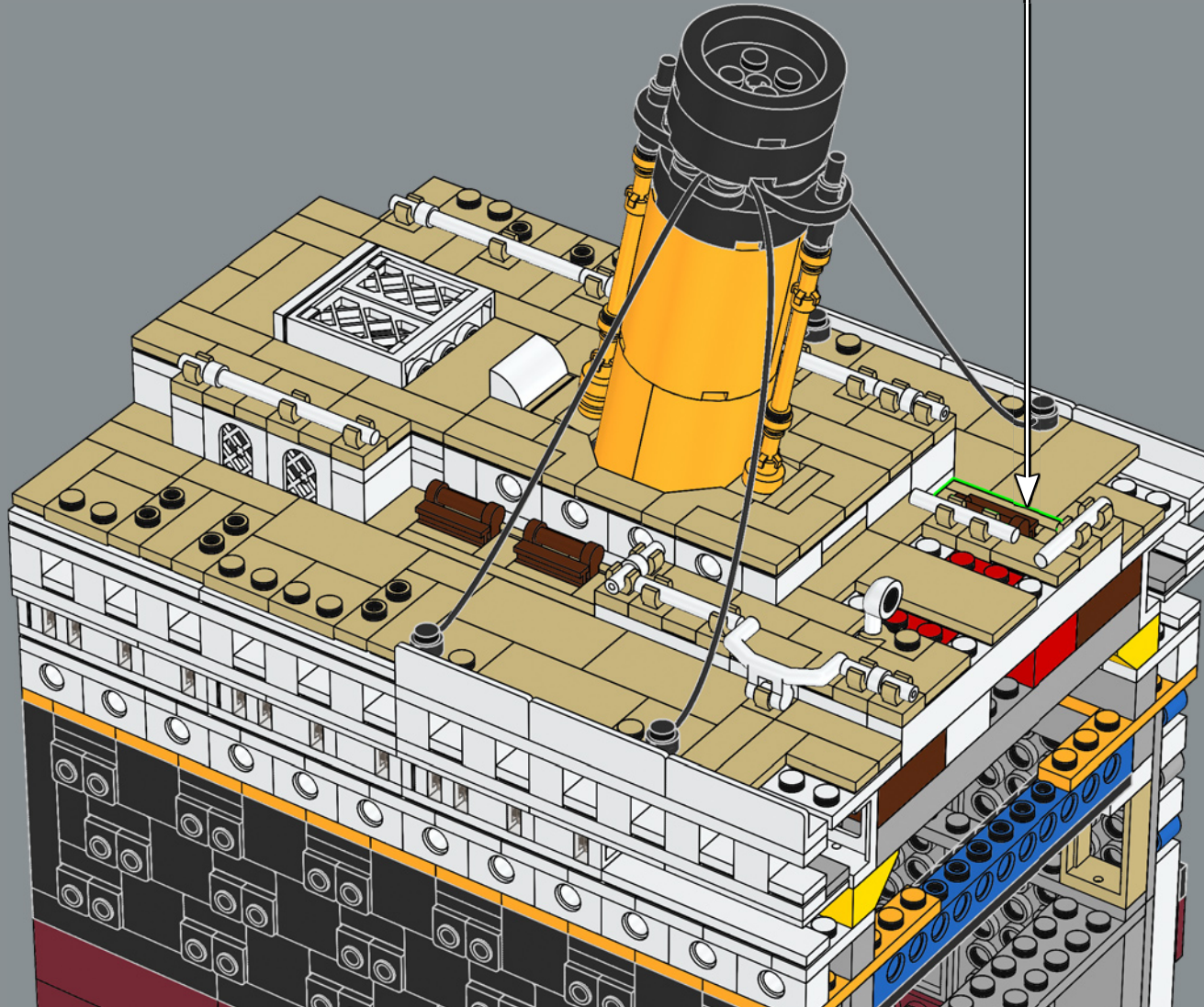
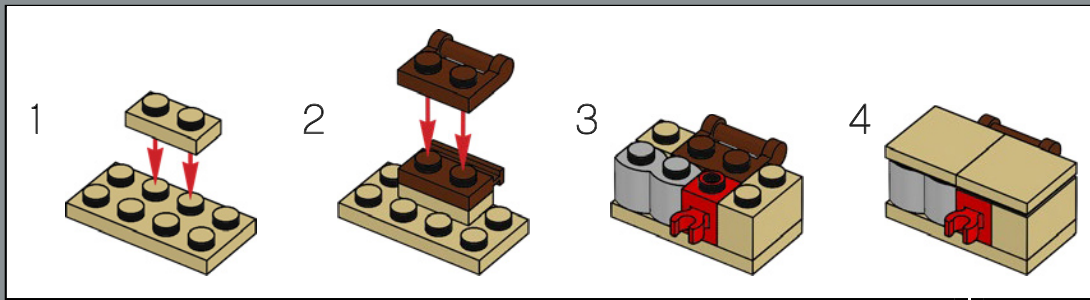

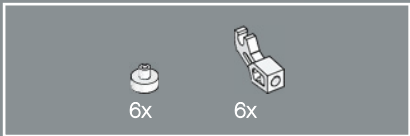

139

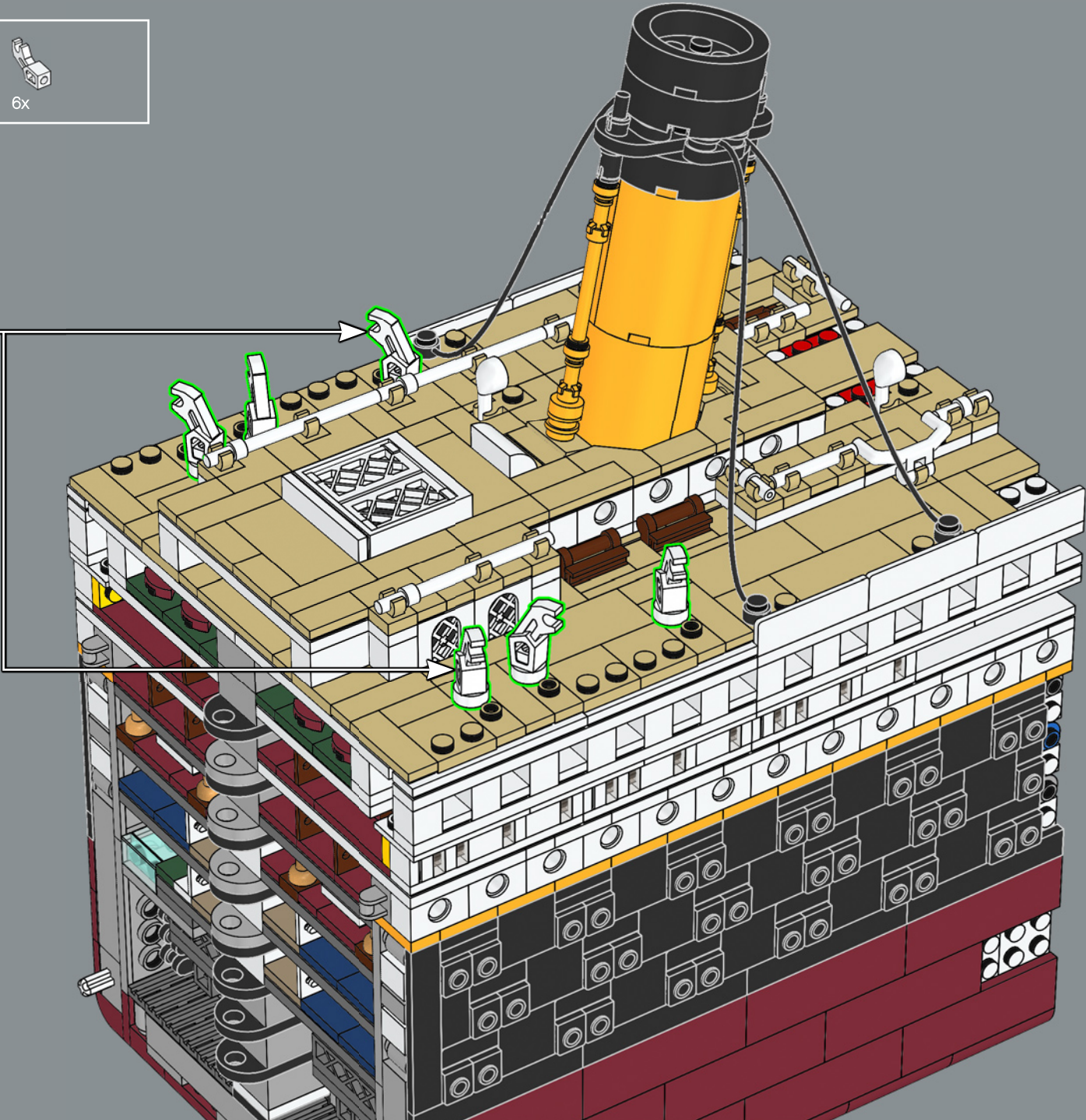
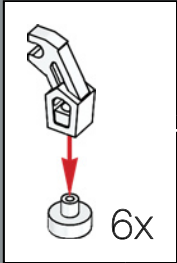

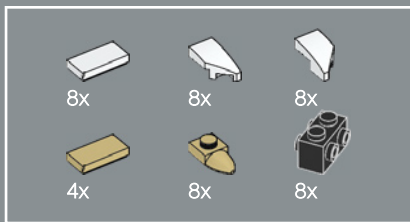

140

船上配有 20 艘救生艇，其中 14 艘为标准的木制救生艇，每艘可容纳 65 人；4 艘“可折叠式”救生艇，每艘可容纳 47 人。

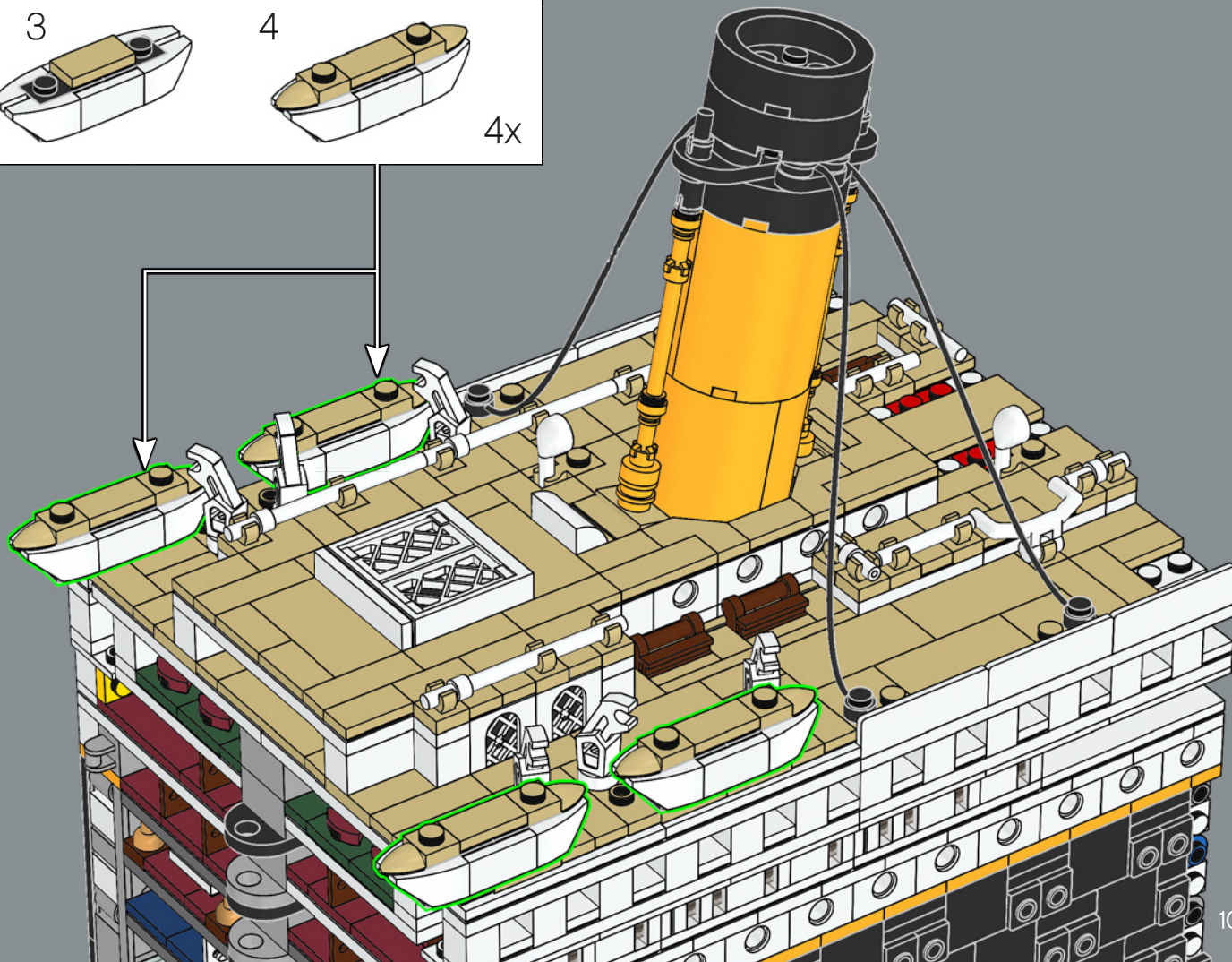
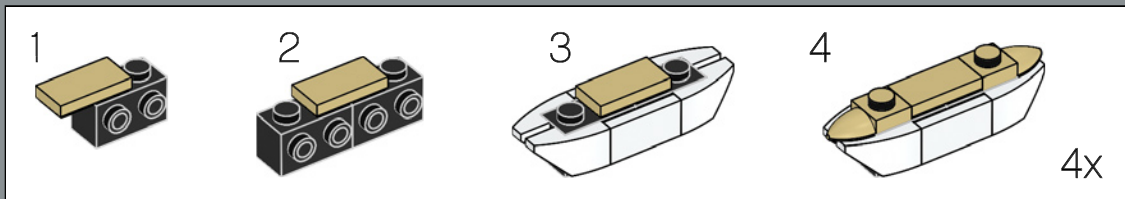

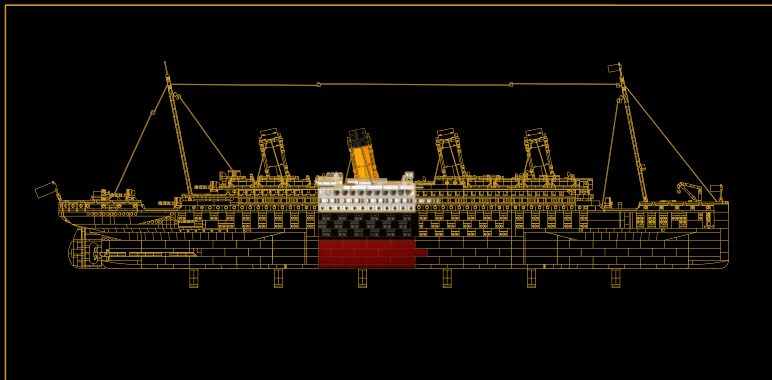

第4部分：

烟囱和罗盘

这部分包括泰坦尼克号大型引擎室的一部分，以及放置主罗盘的中间高架结构。罗盘之所以放在高处，是为了将船体中大量铁的干扰降至最低。还有一个小的子组件，其代表长凳，可供乘客在欣赏轮船上层甲板的风光时休息。



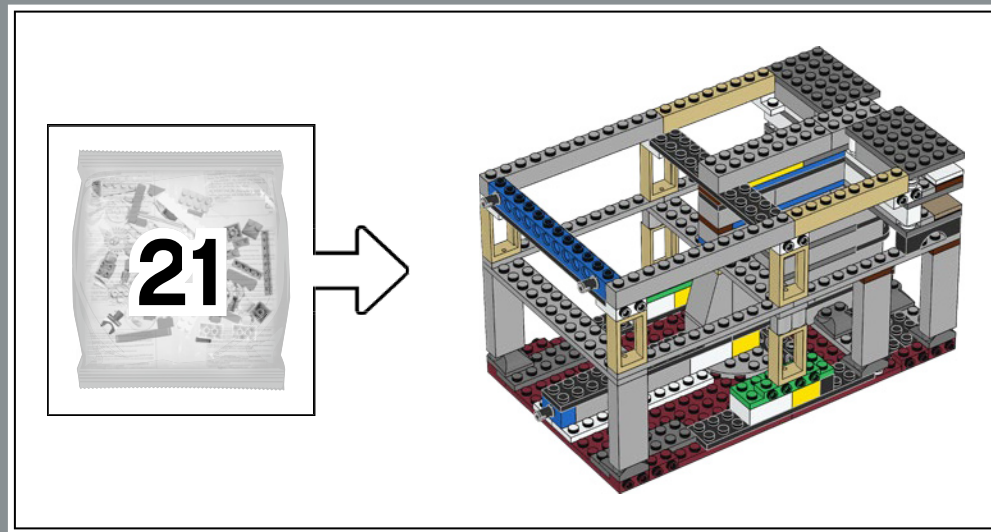

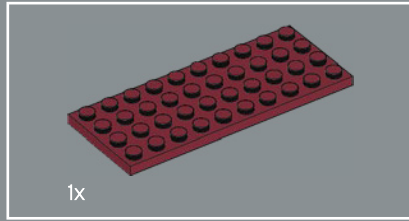
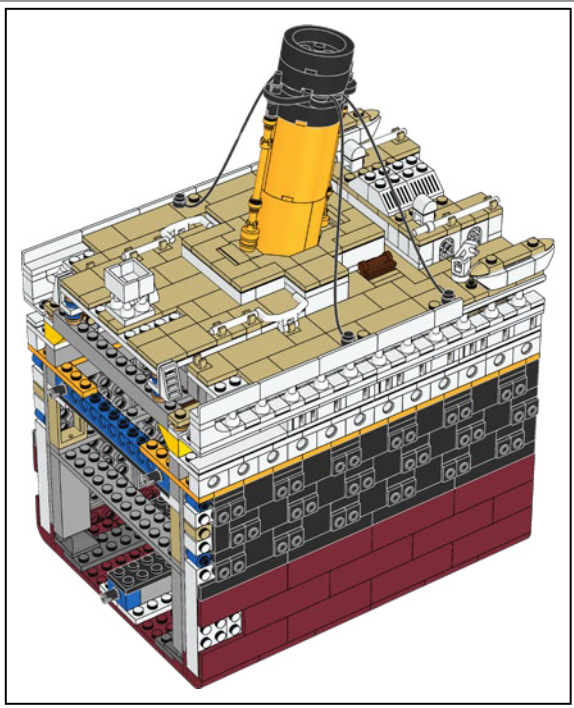

141

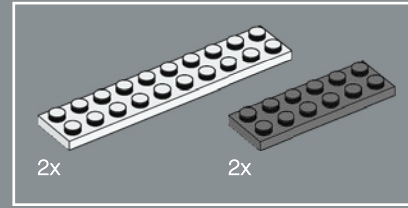
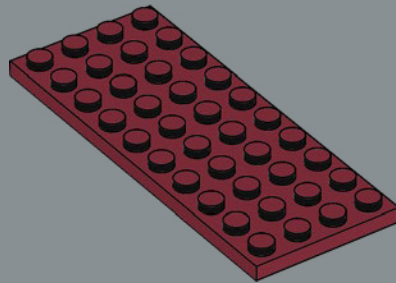

142

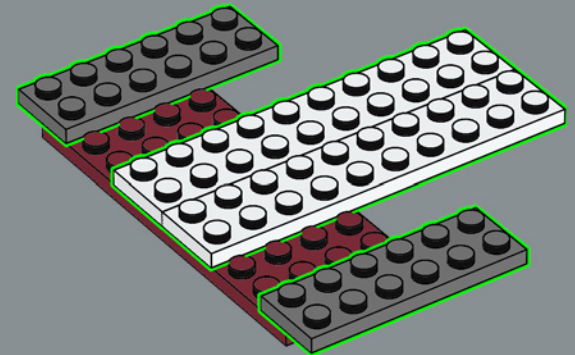

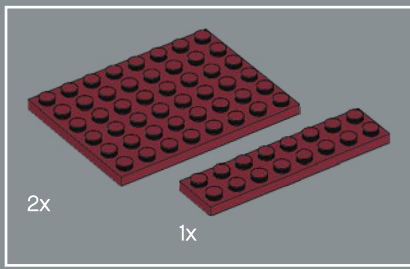

143

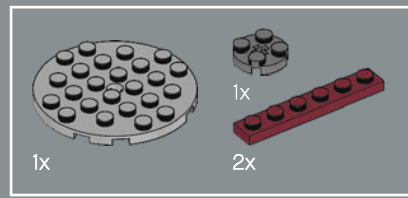
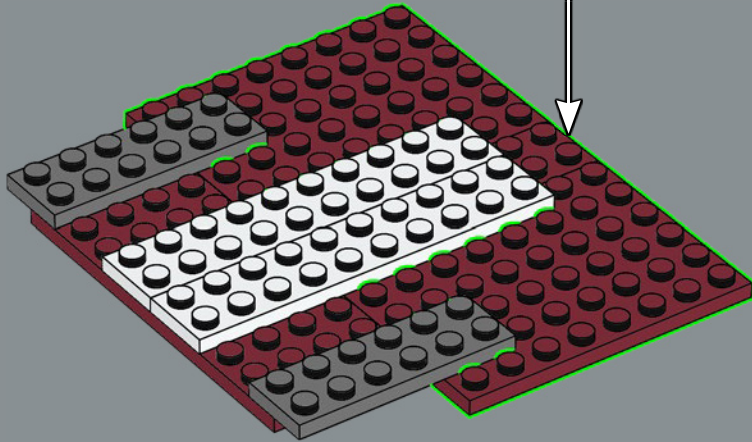
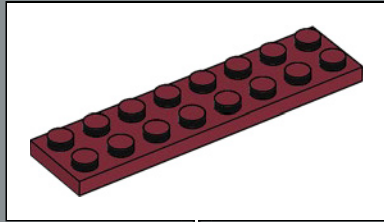

144

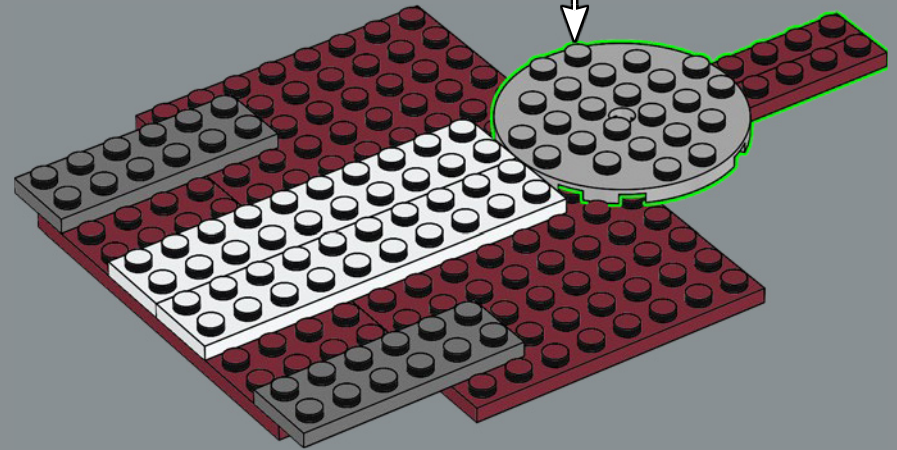
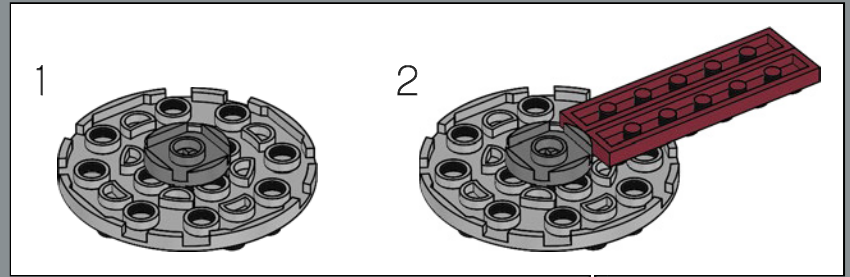

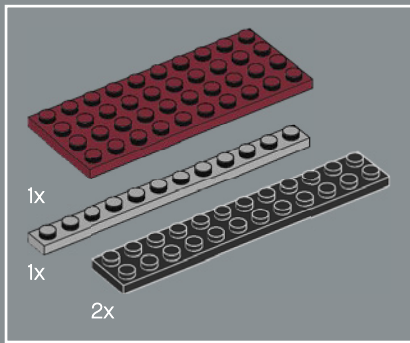

147

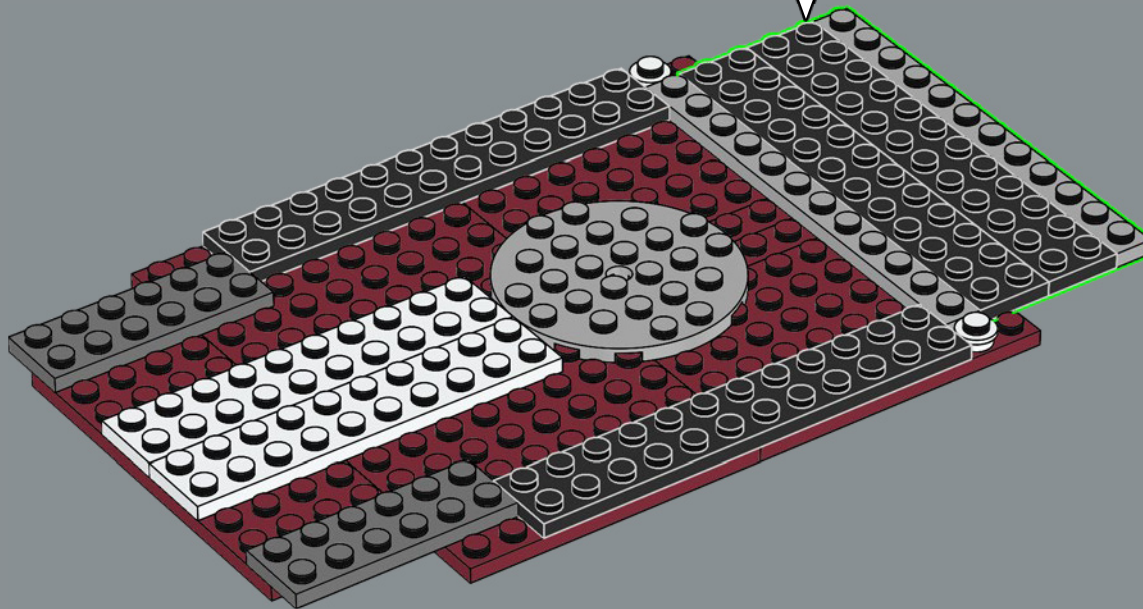
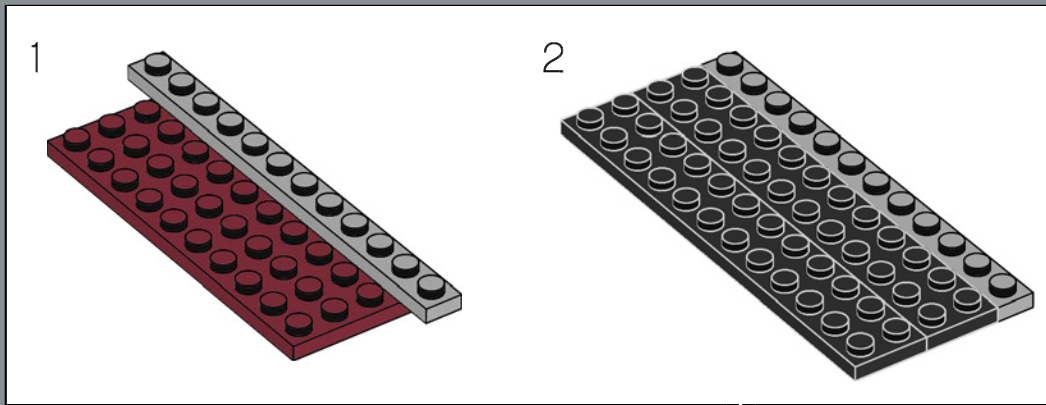



148

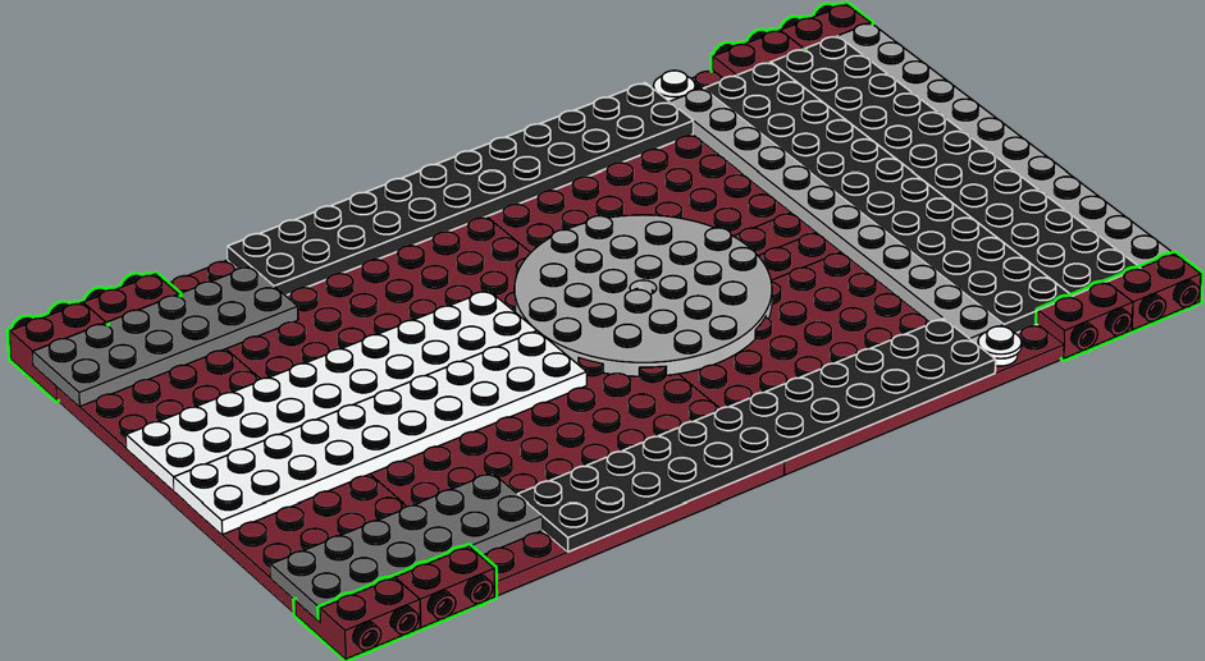

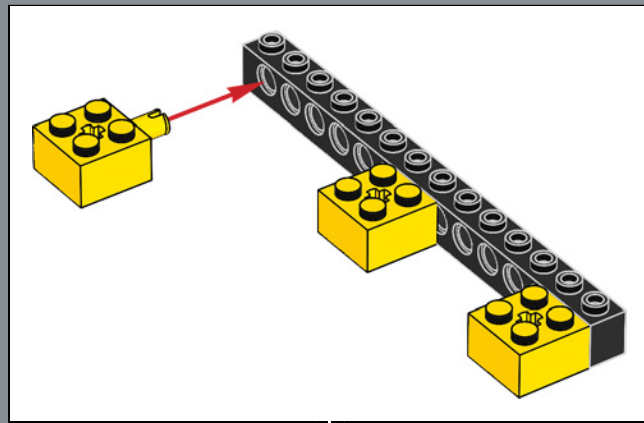
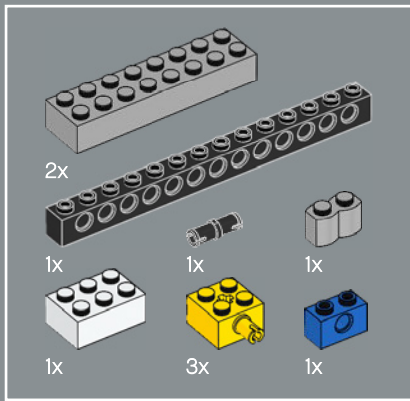

149

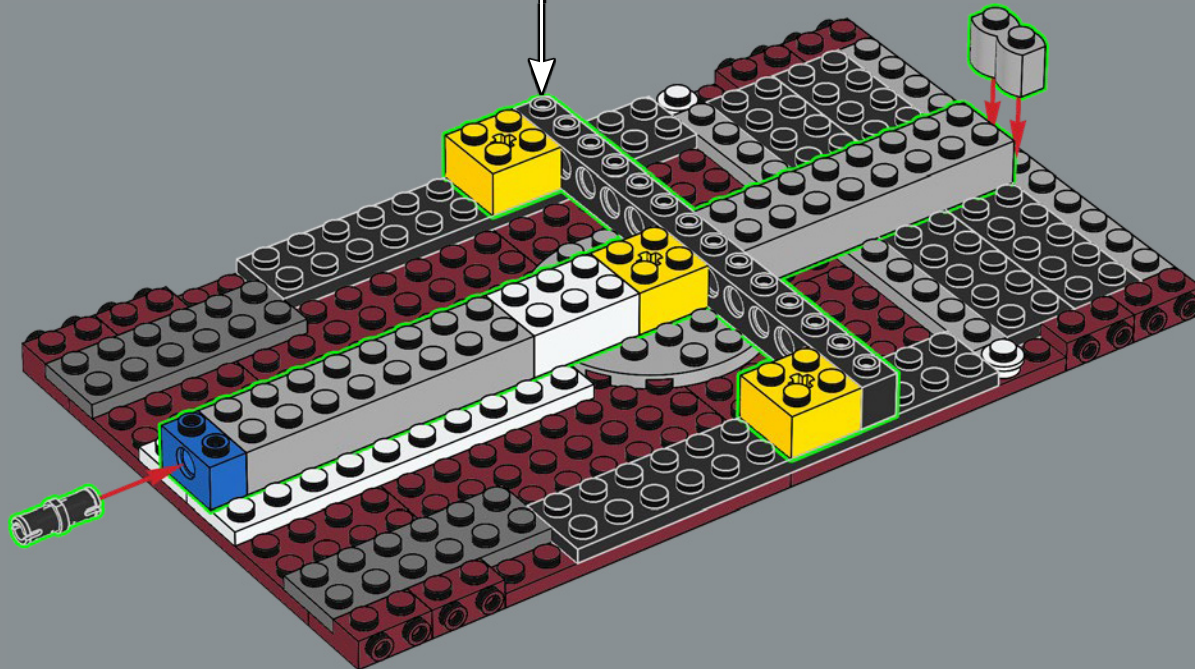

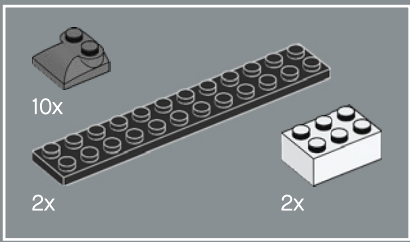

150

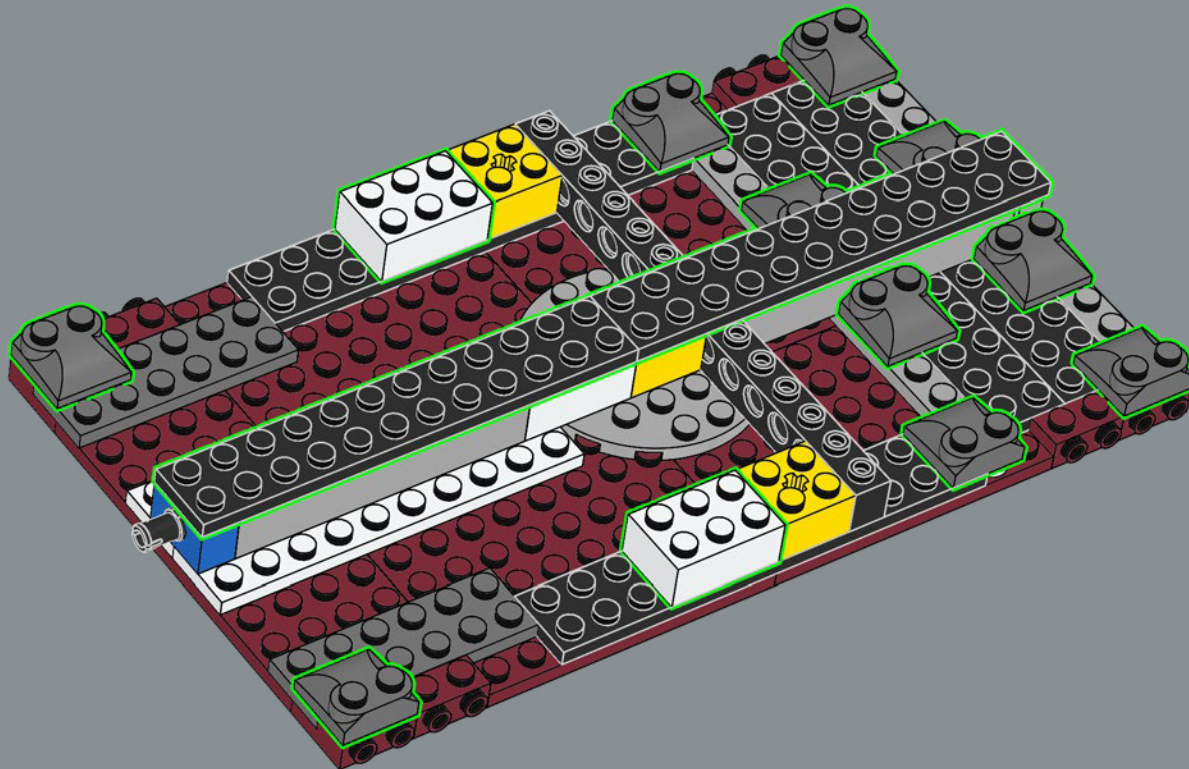

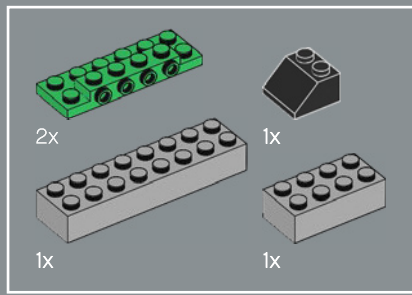

151

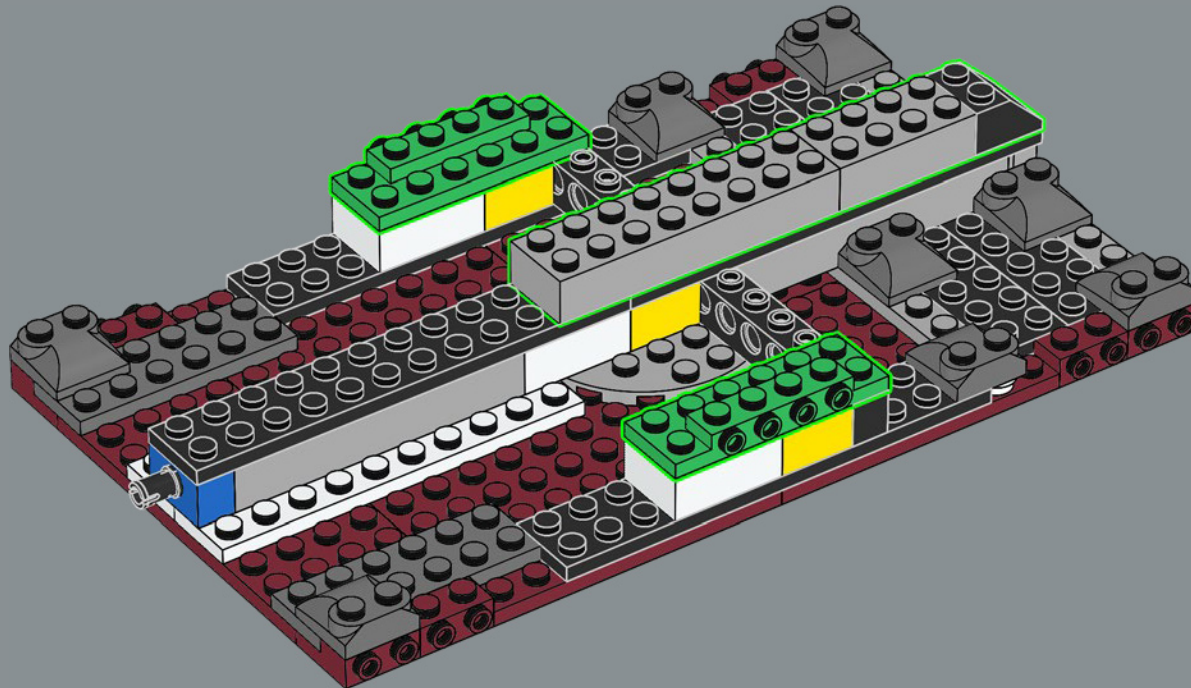

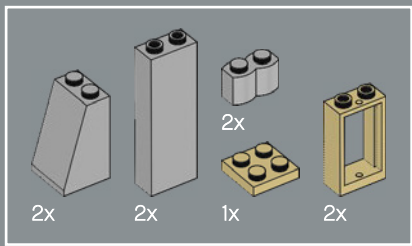

152

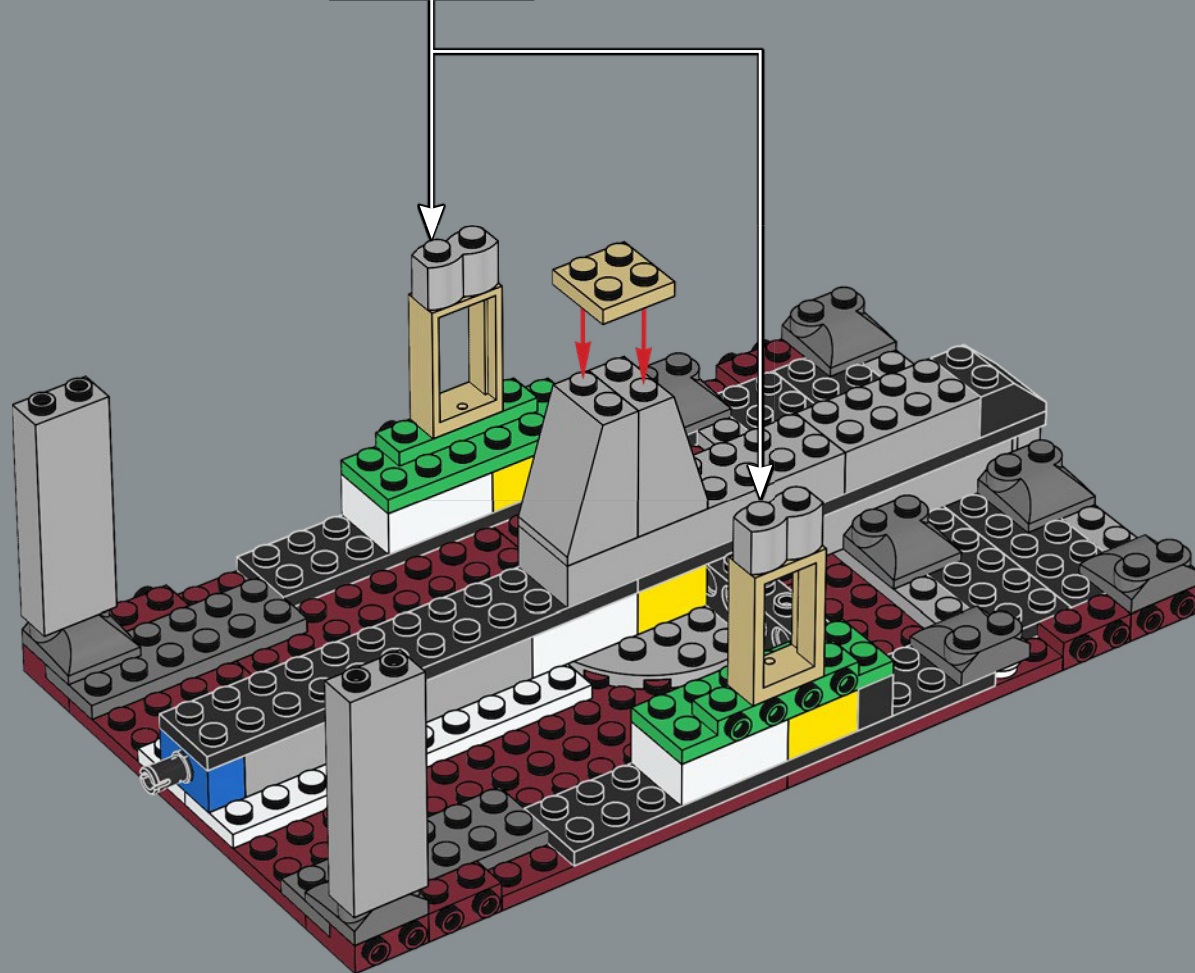
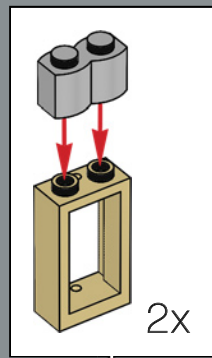

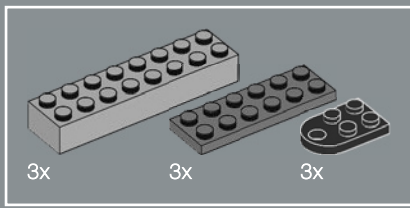

153

1

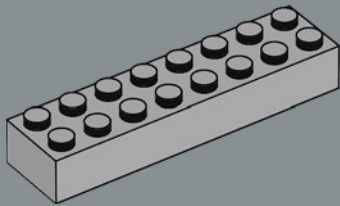

2

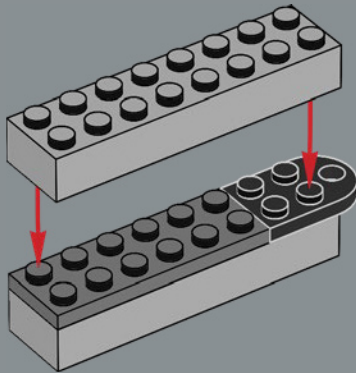

3

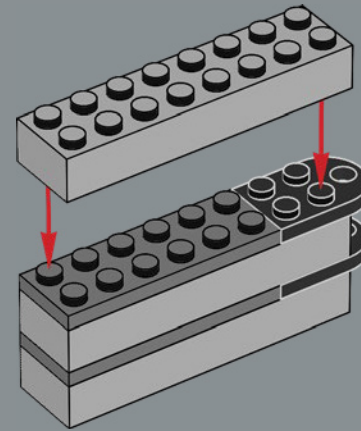

4

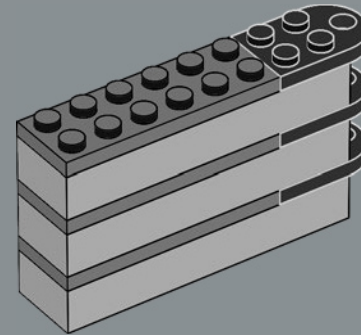

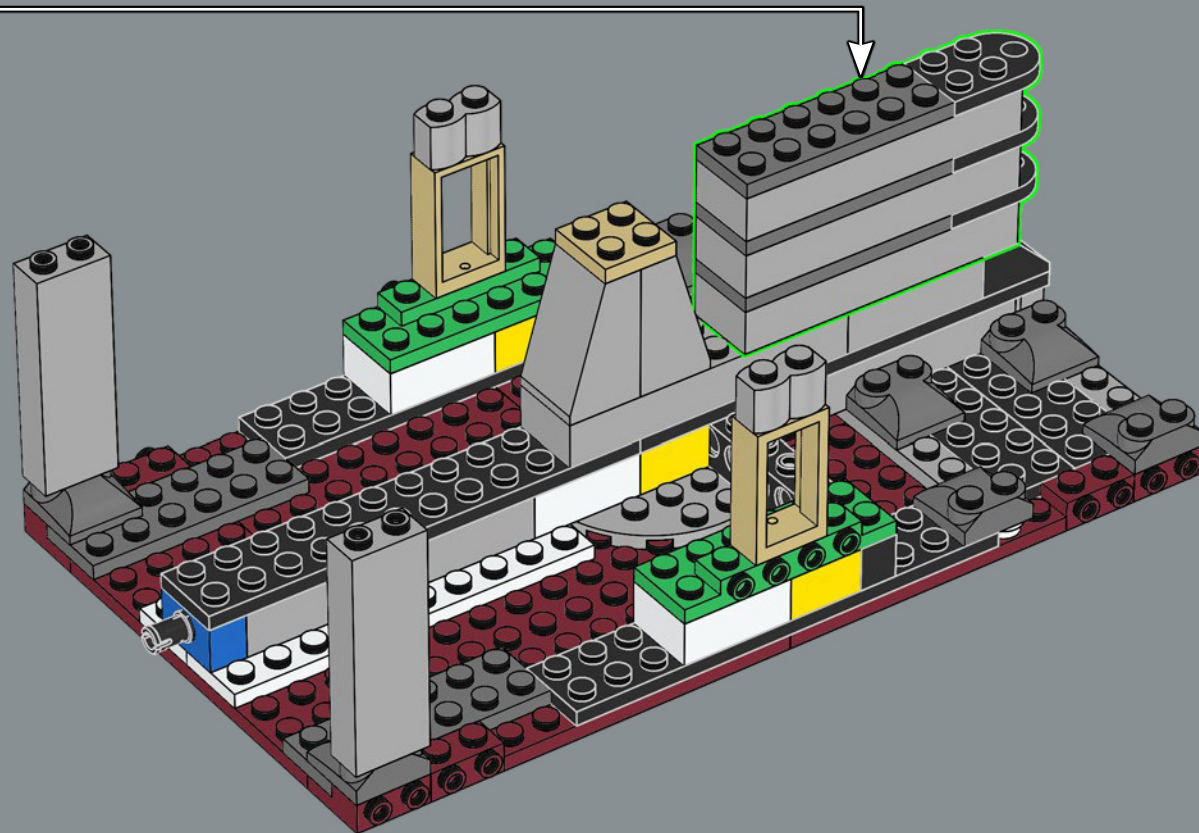

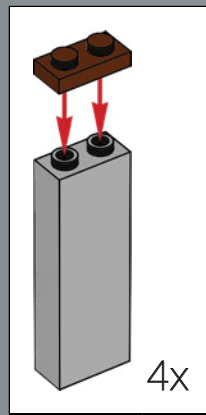
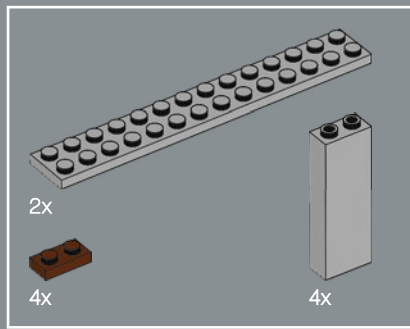

154

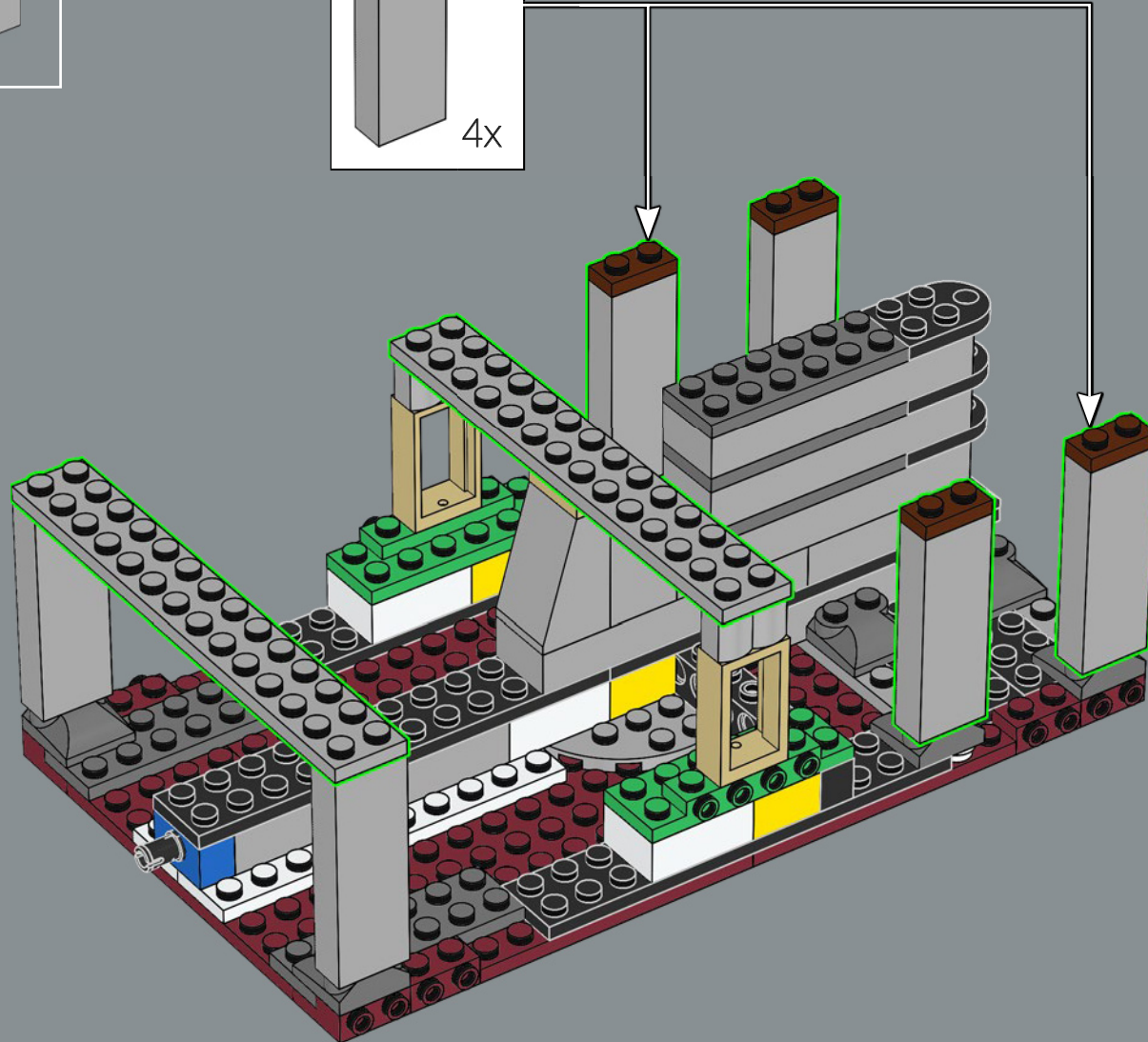

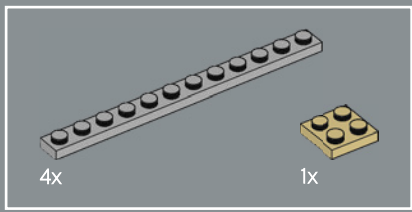

155

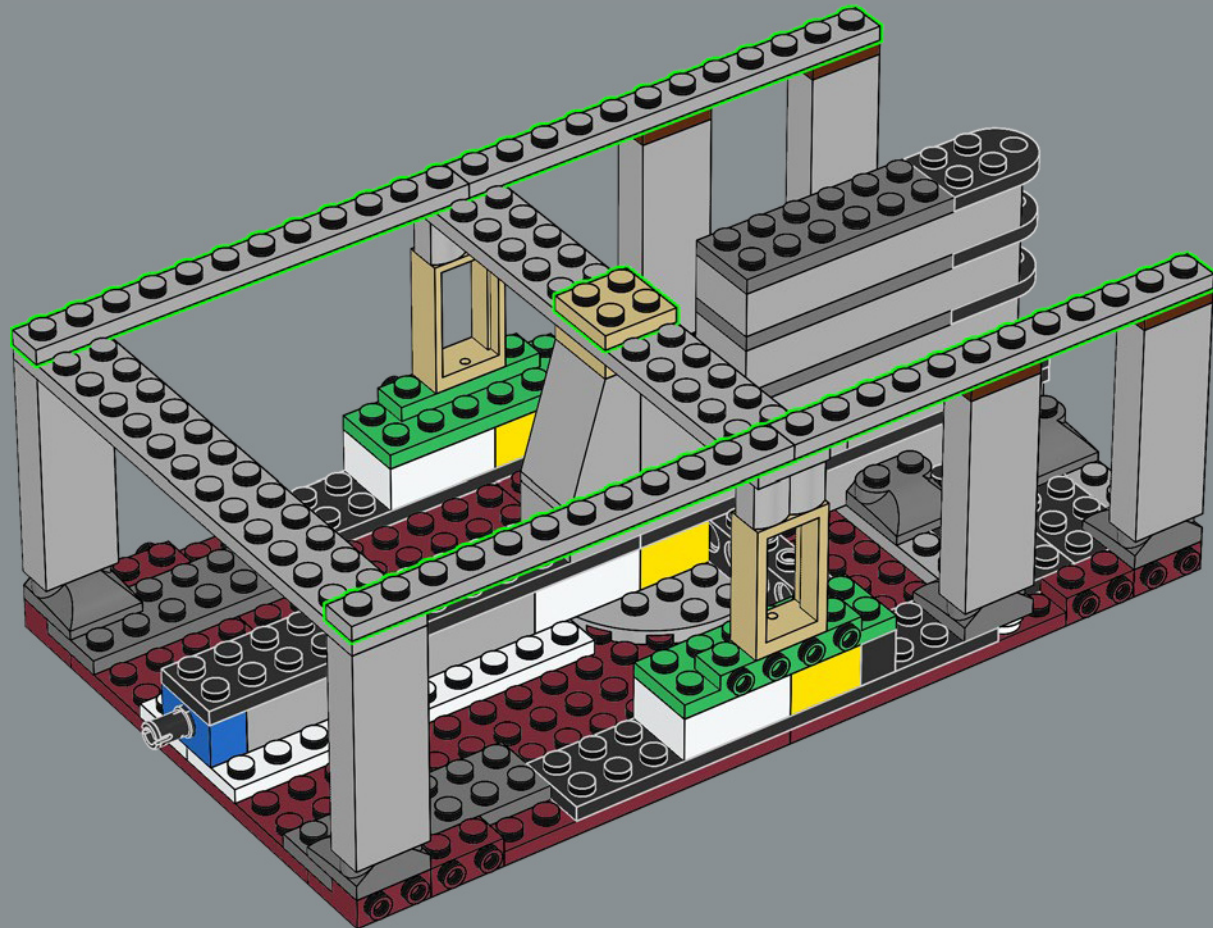

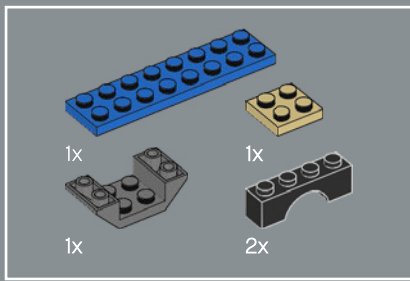

156

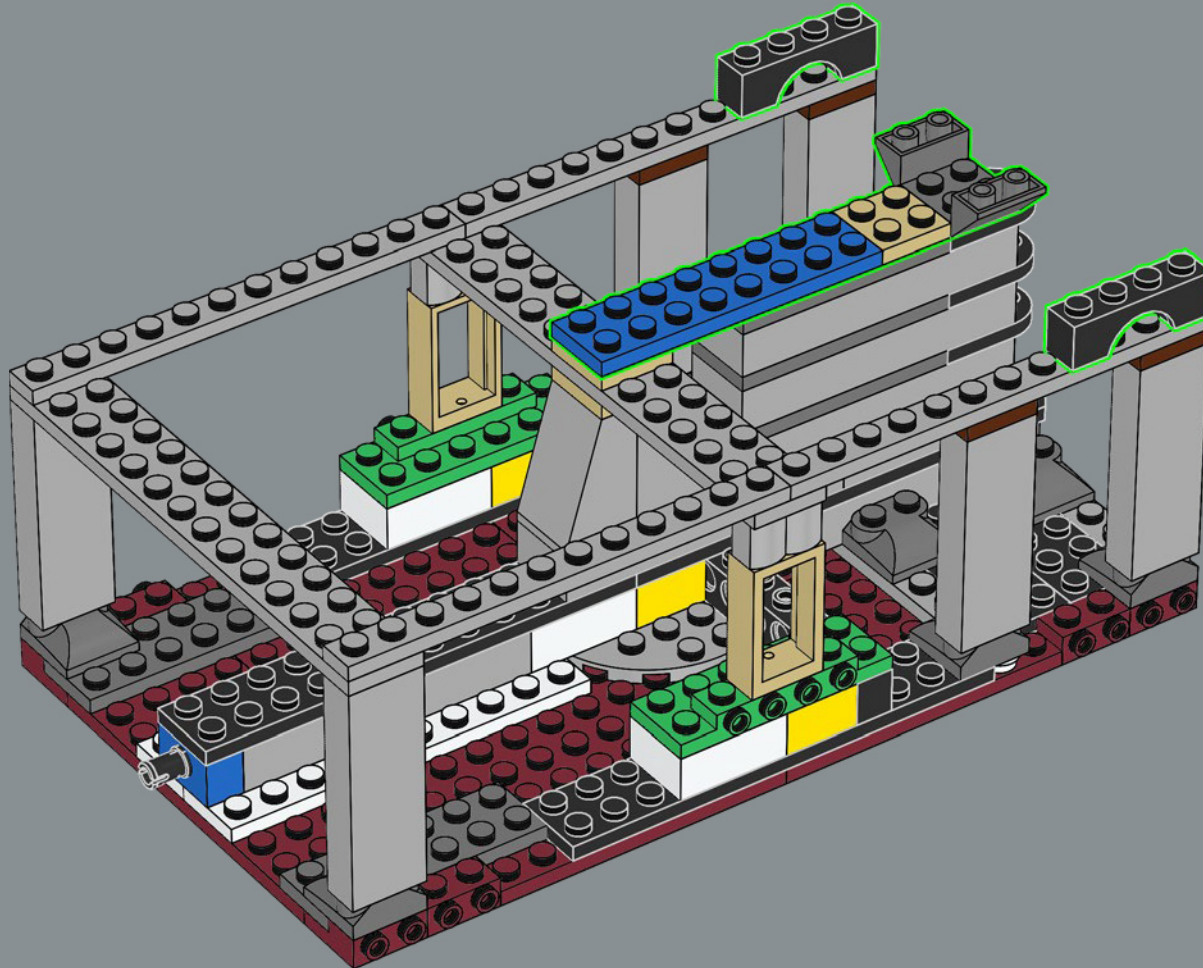

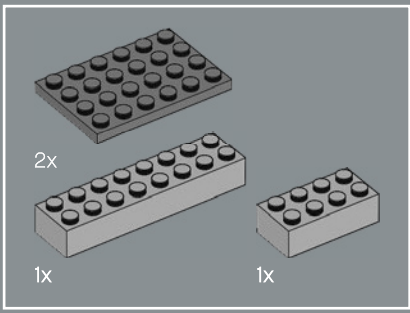

157

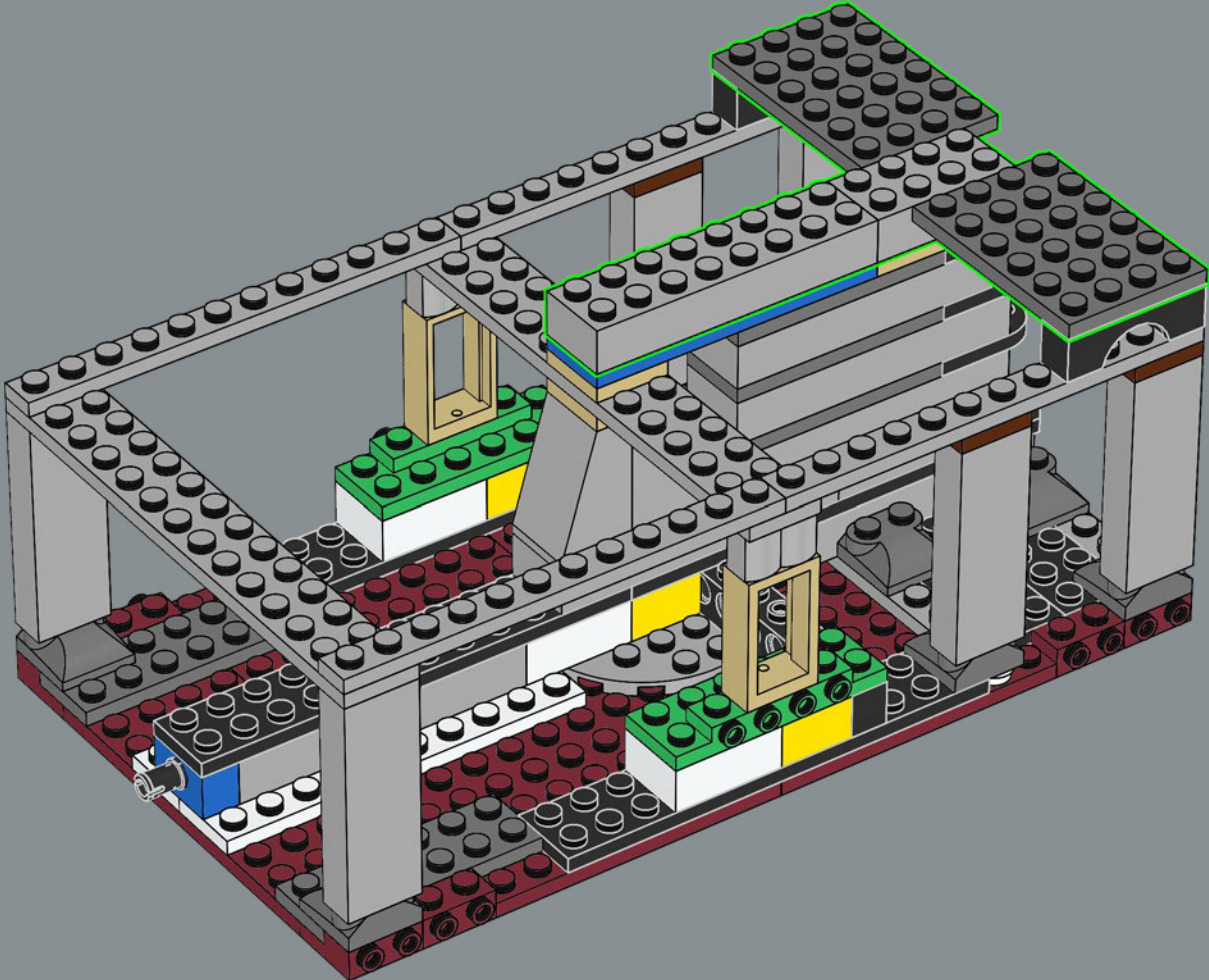

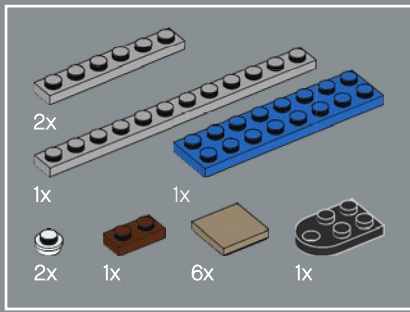

158

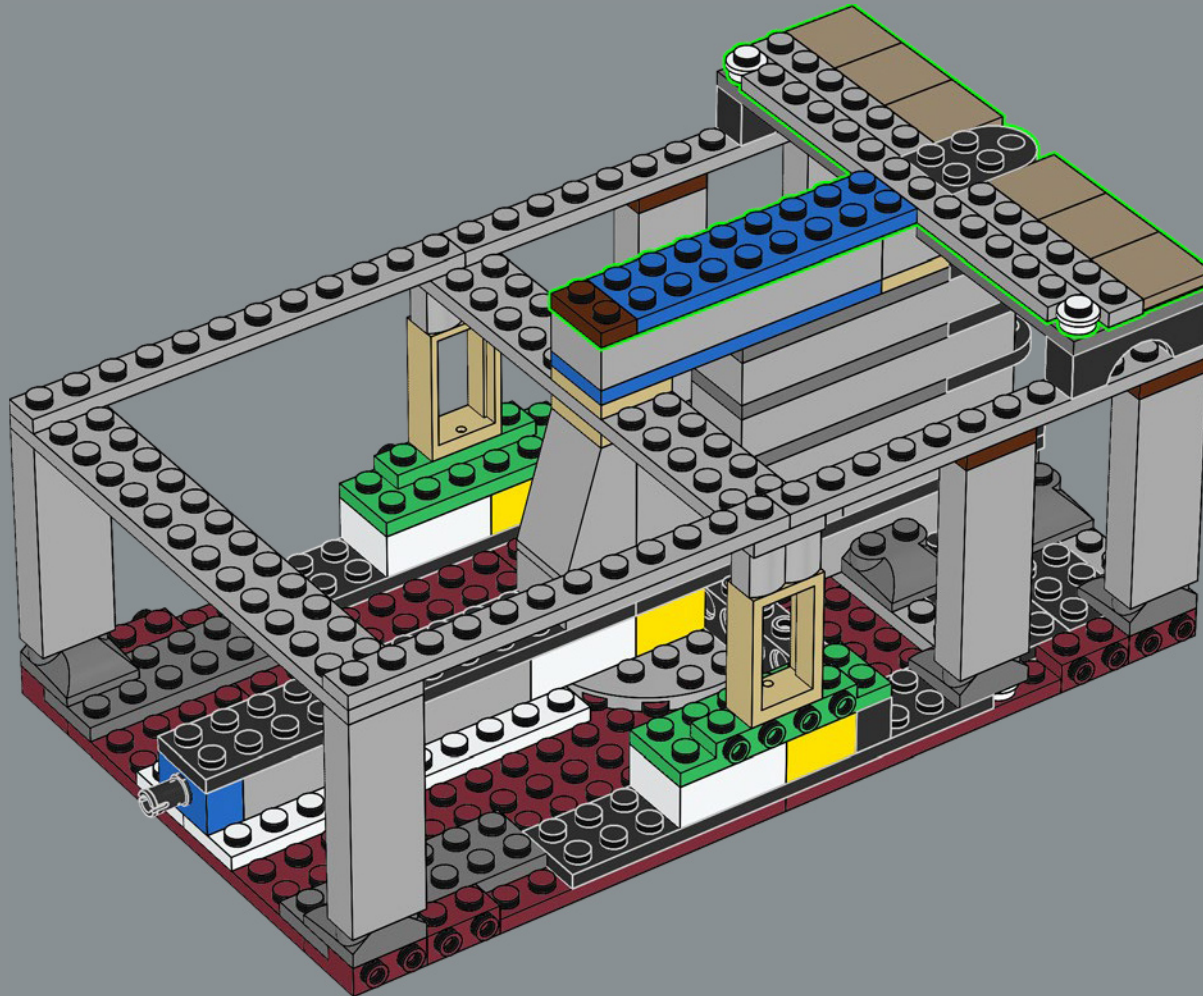

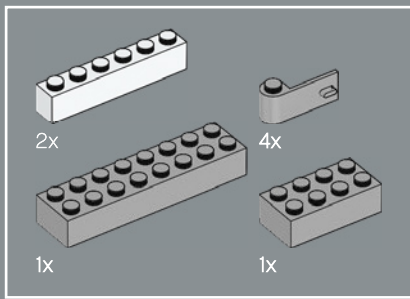

159

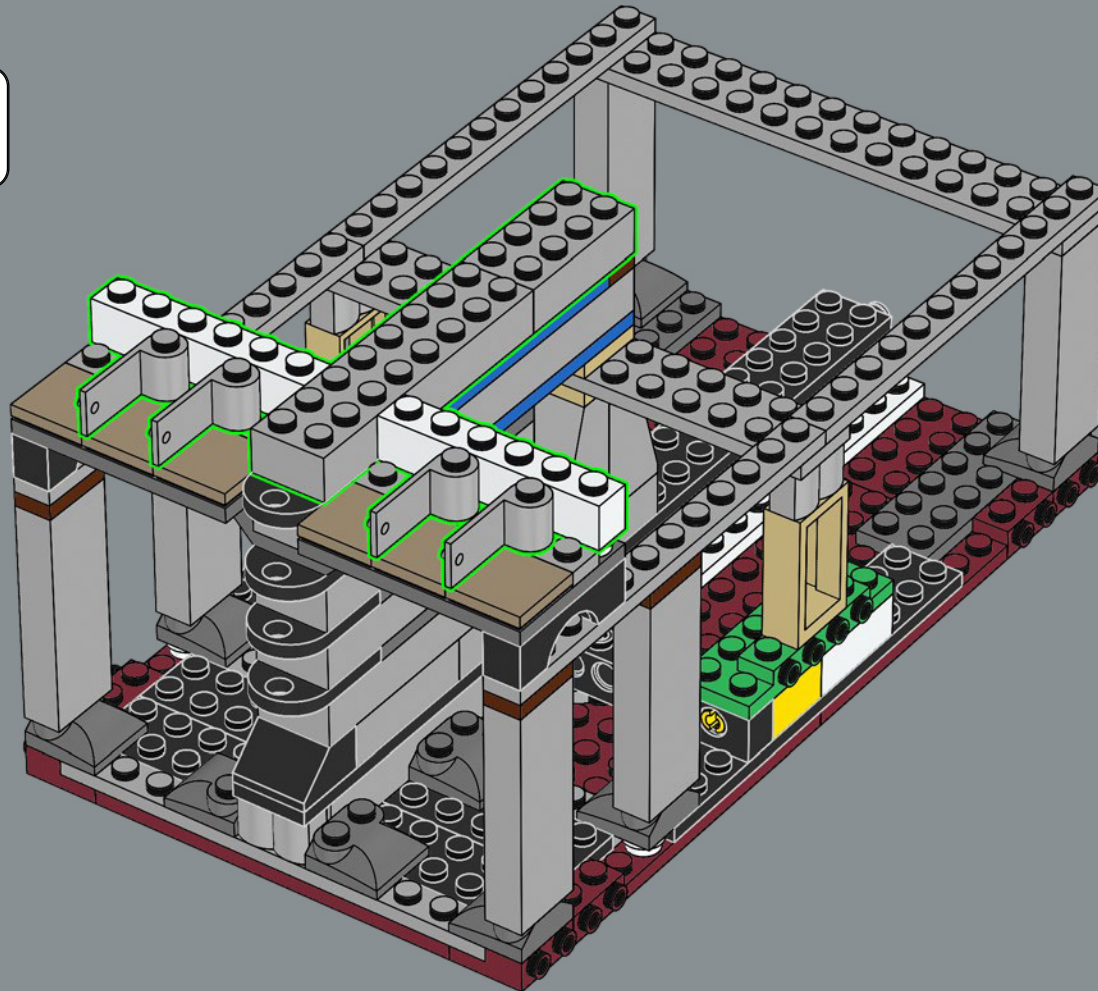

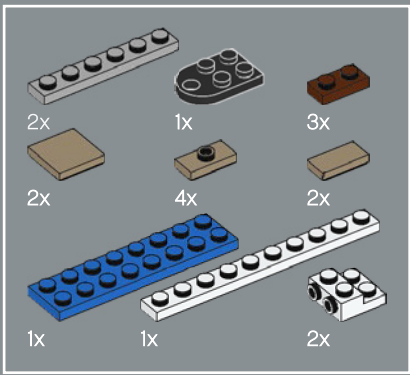

161

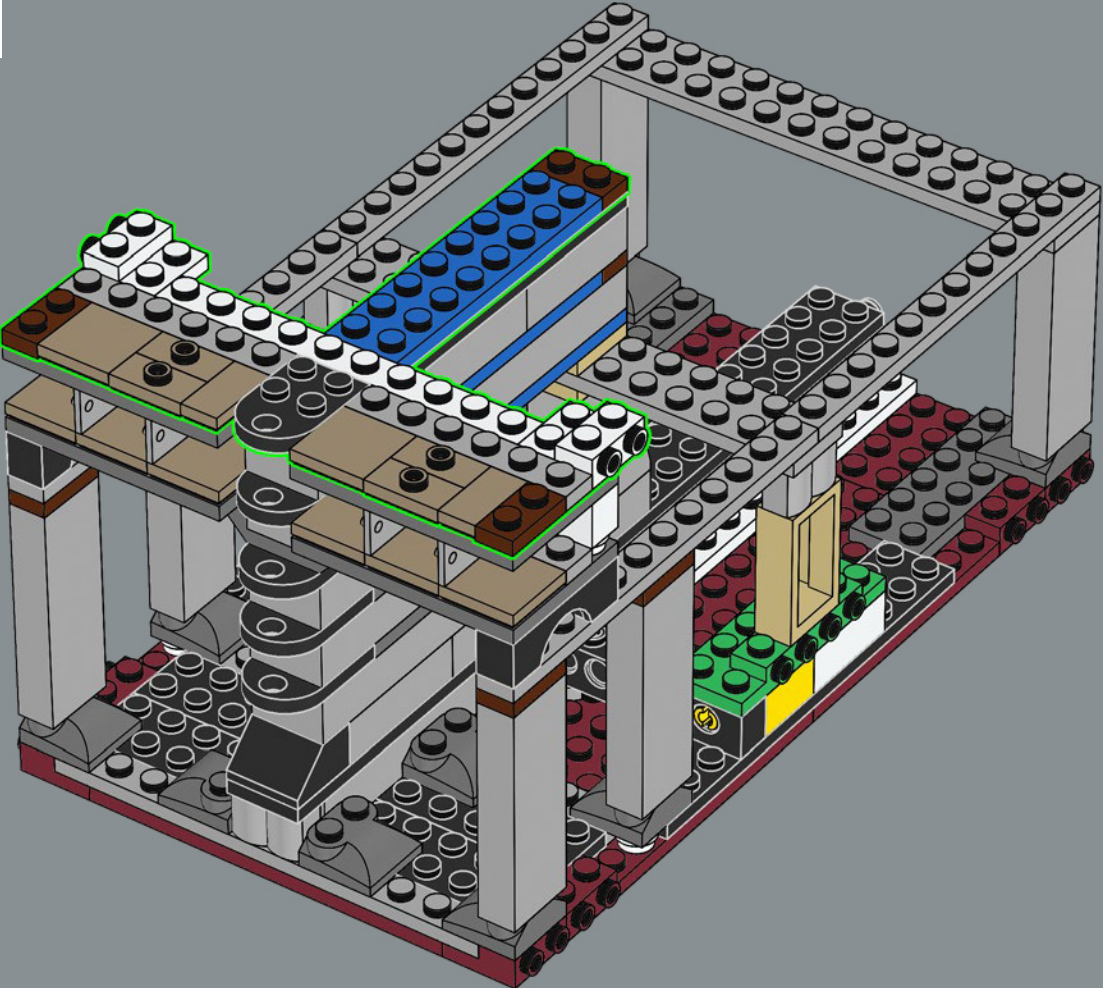

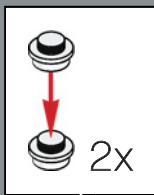
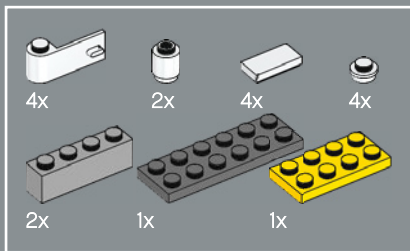

162

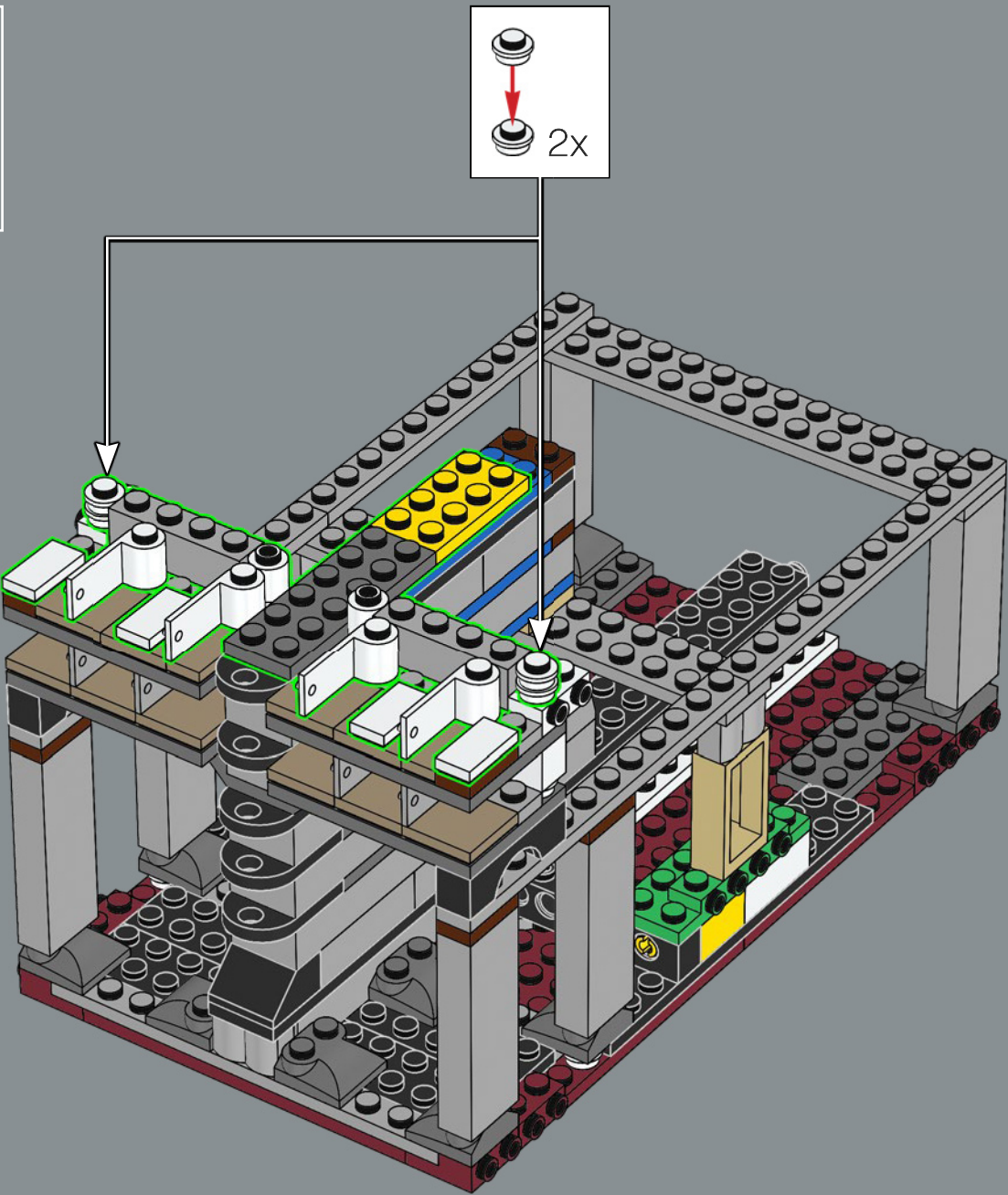

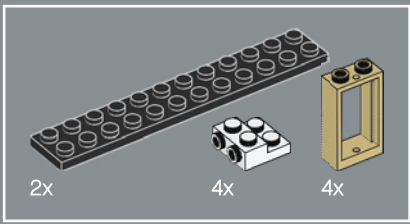

163

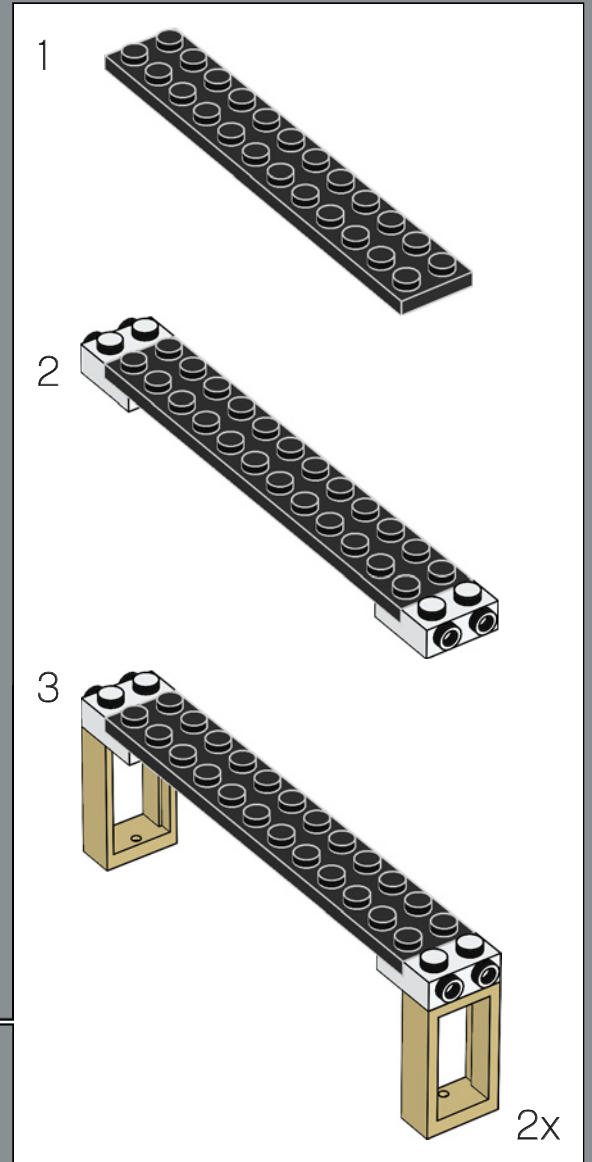
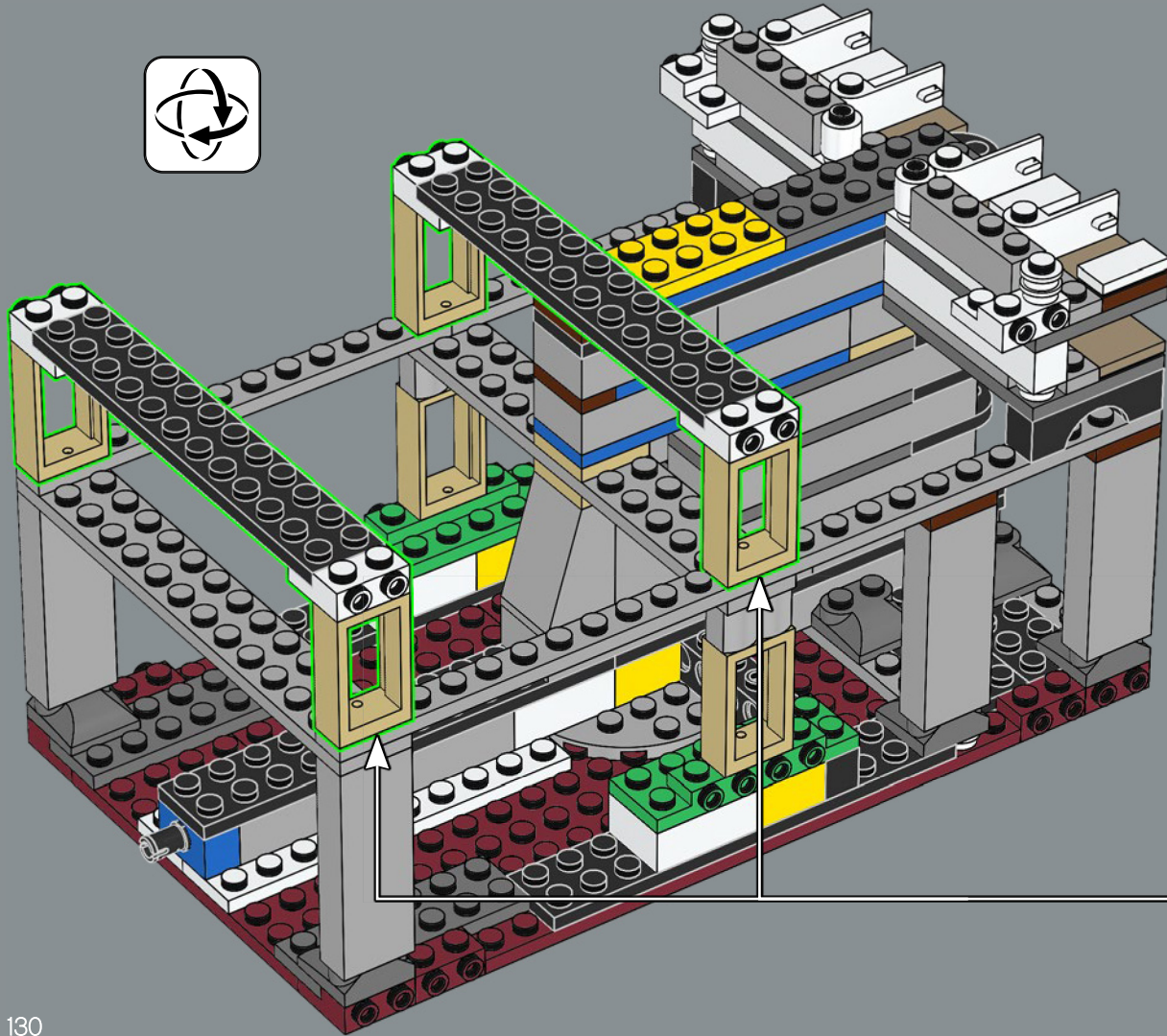

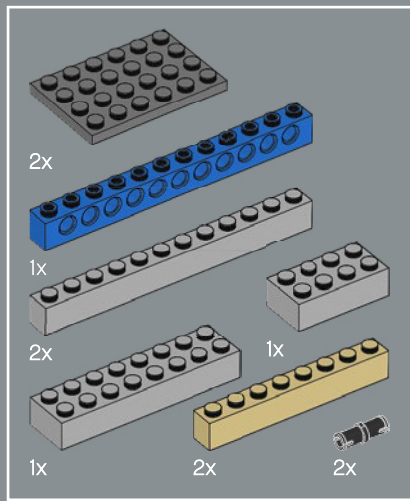

164

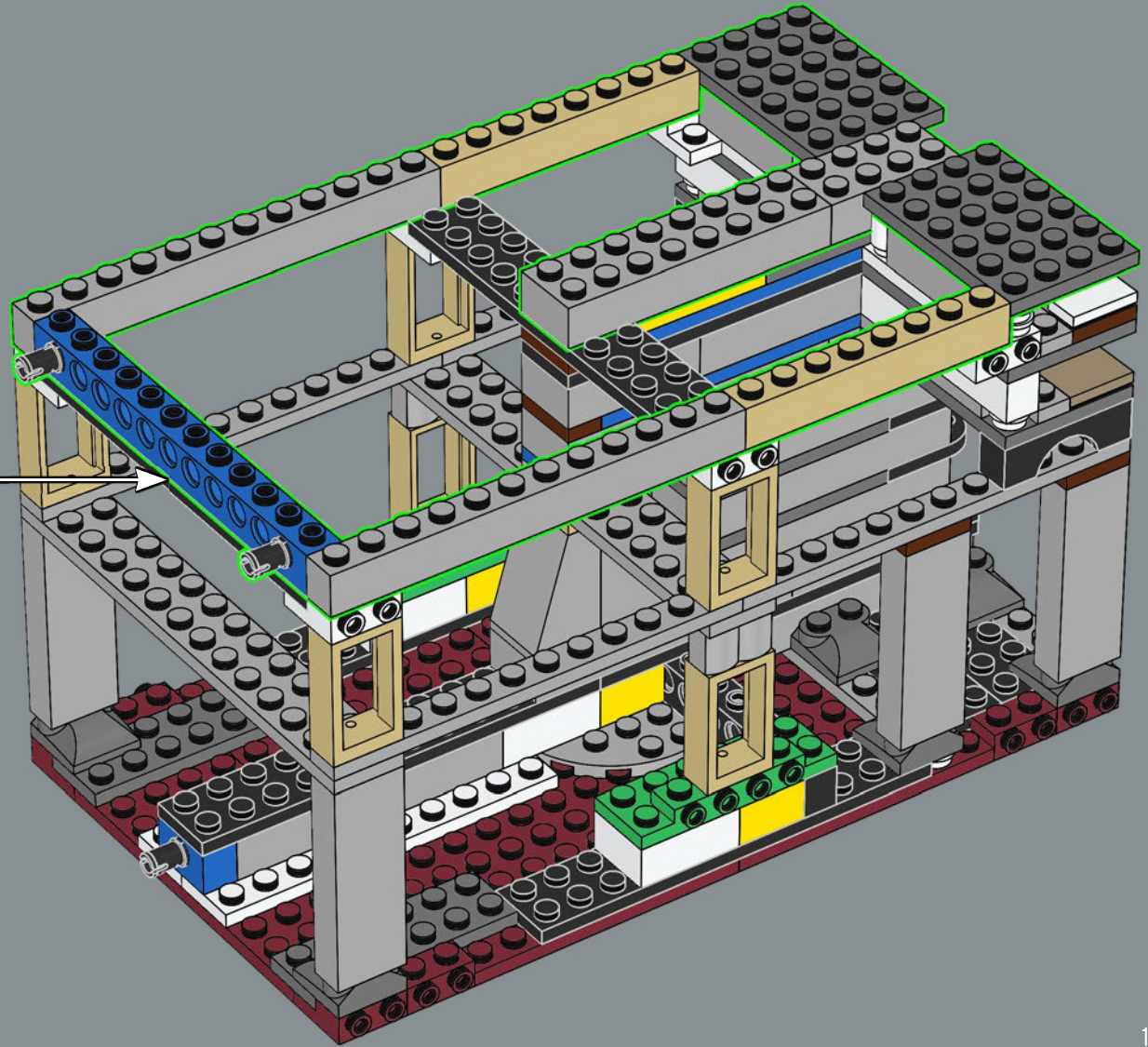
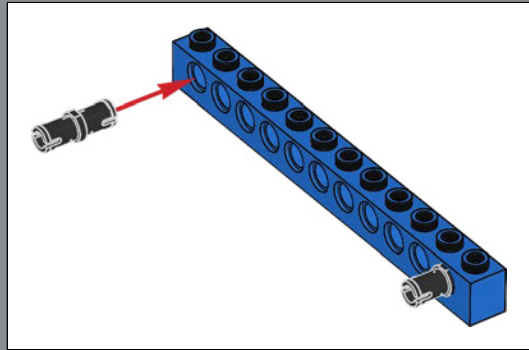

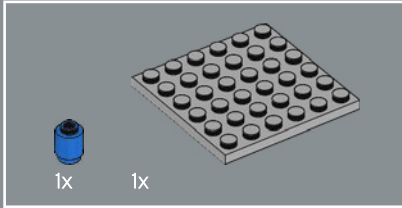
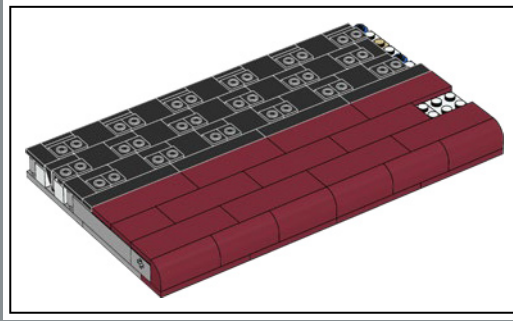
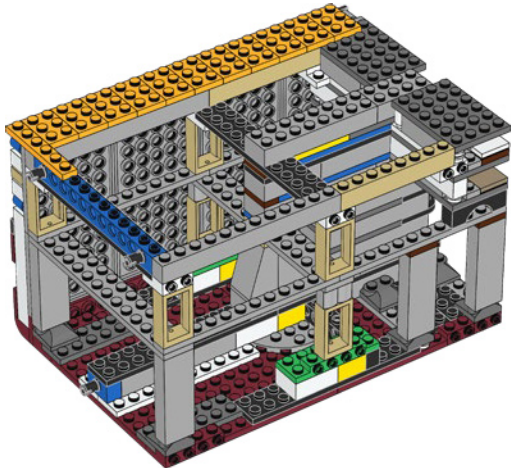
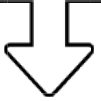

165

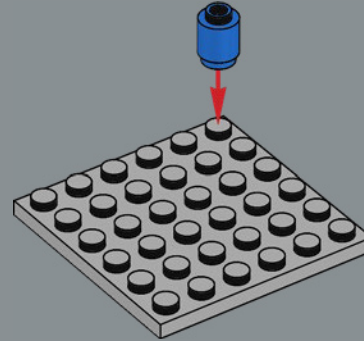

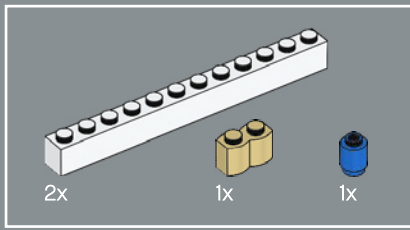

166

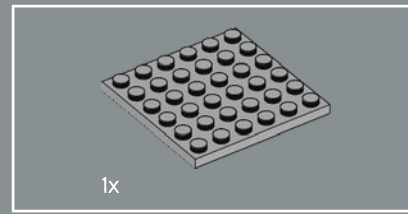
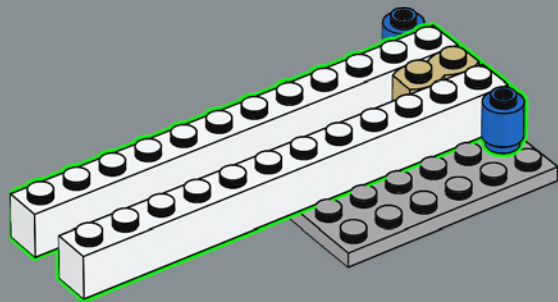

167

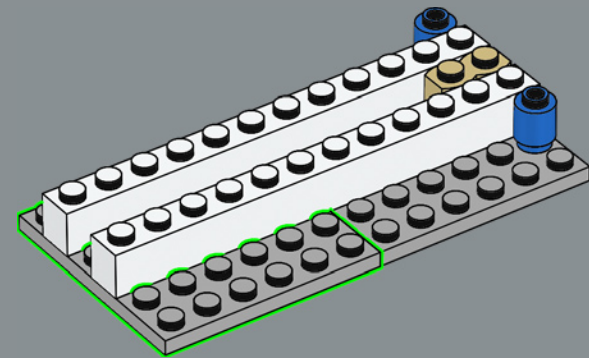

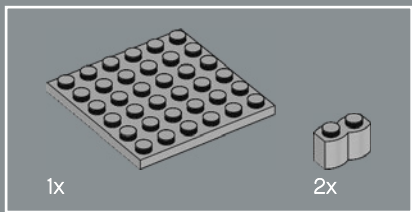

168

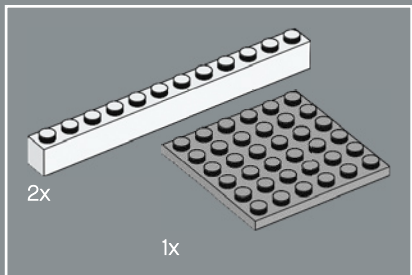
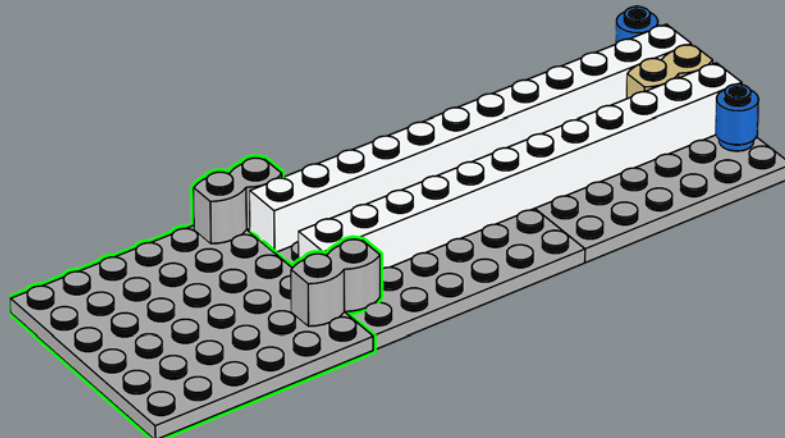

169

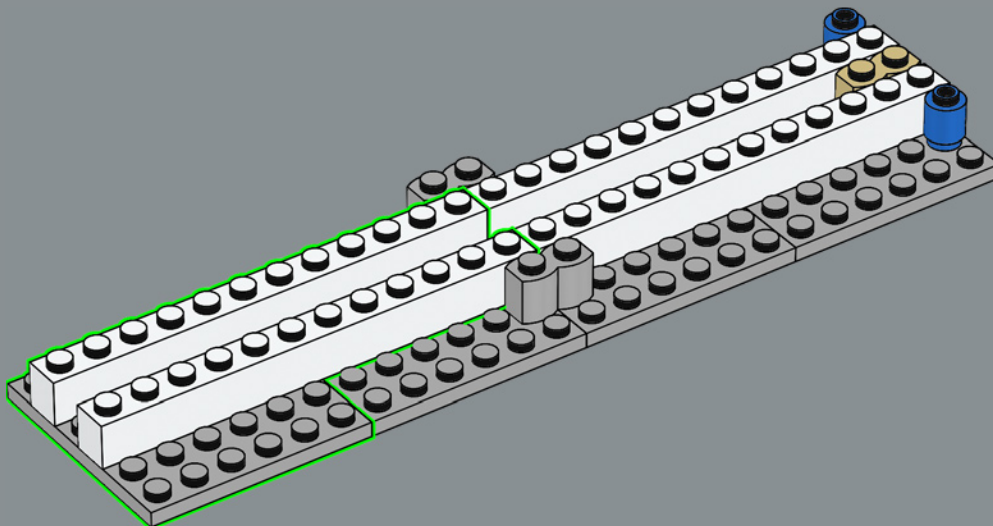



170

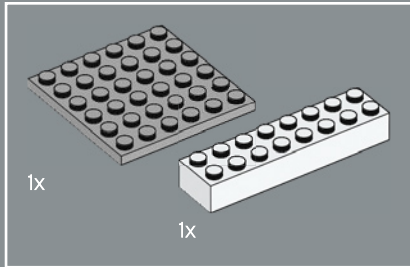
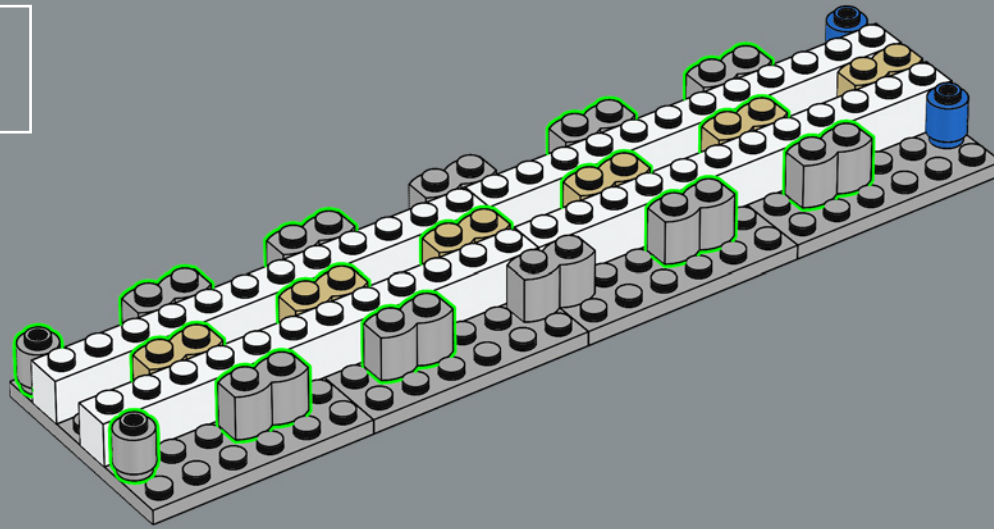

171

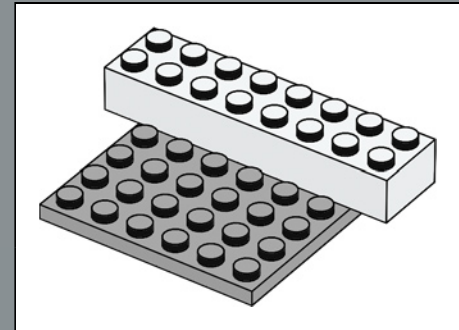
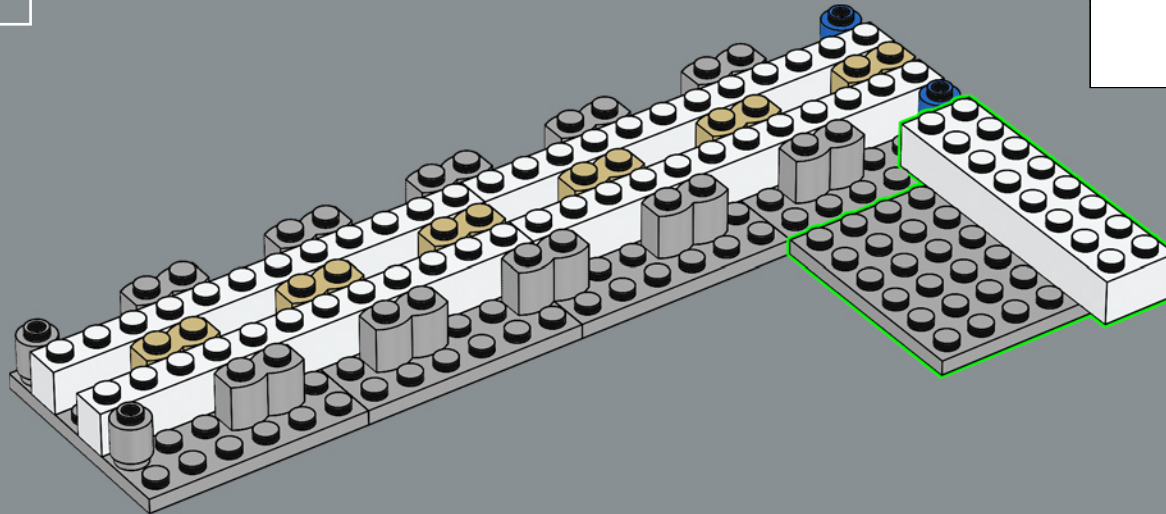

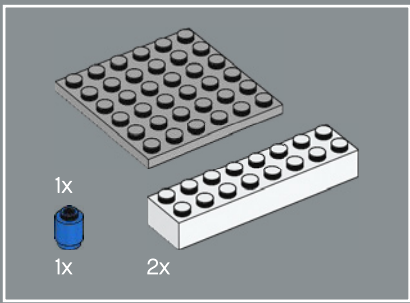

172

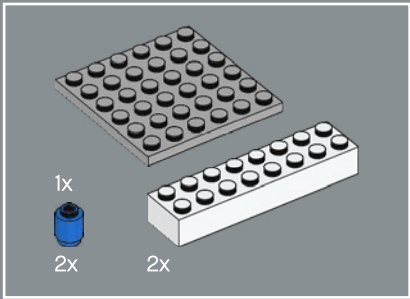
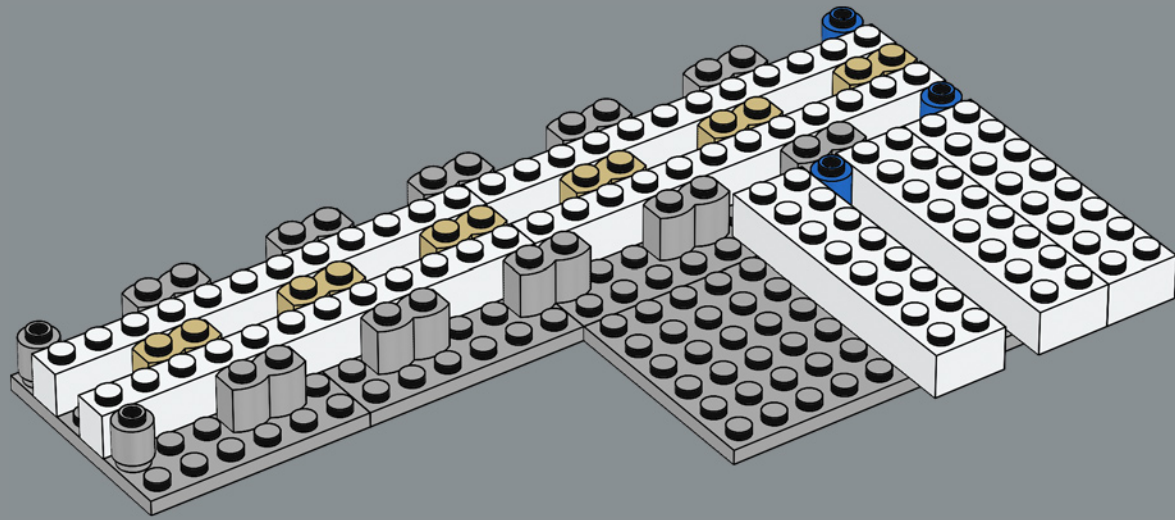

173

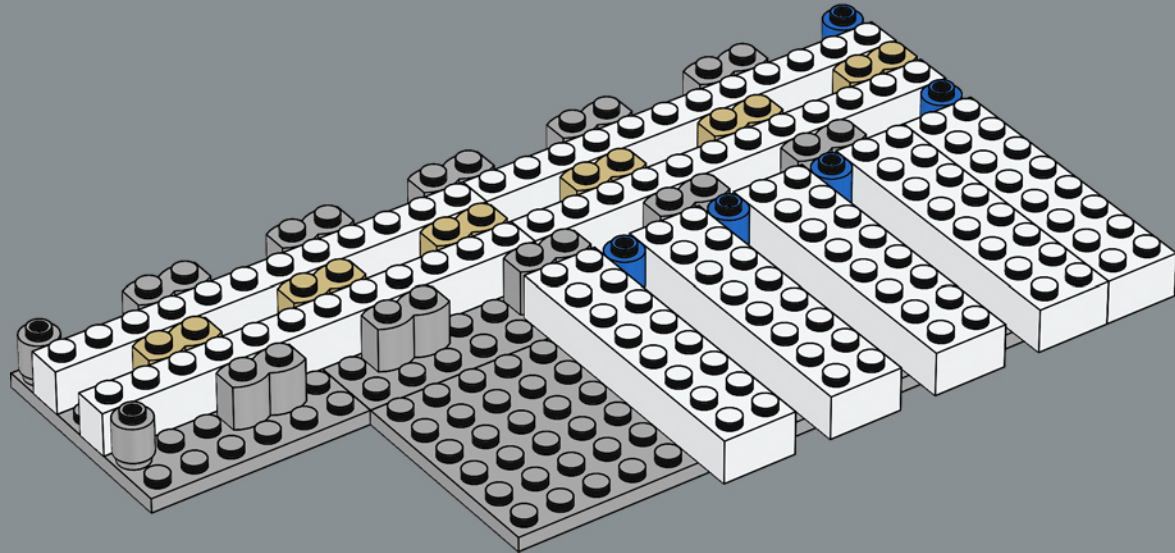

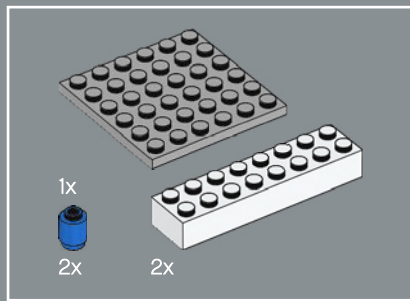

174

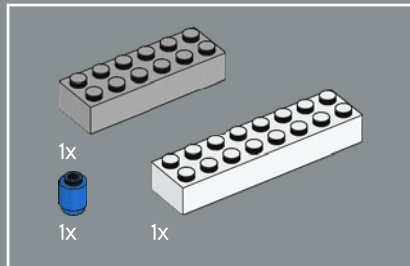
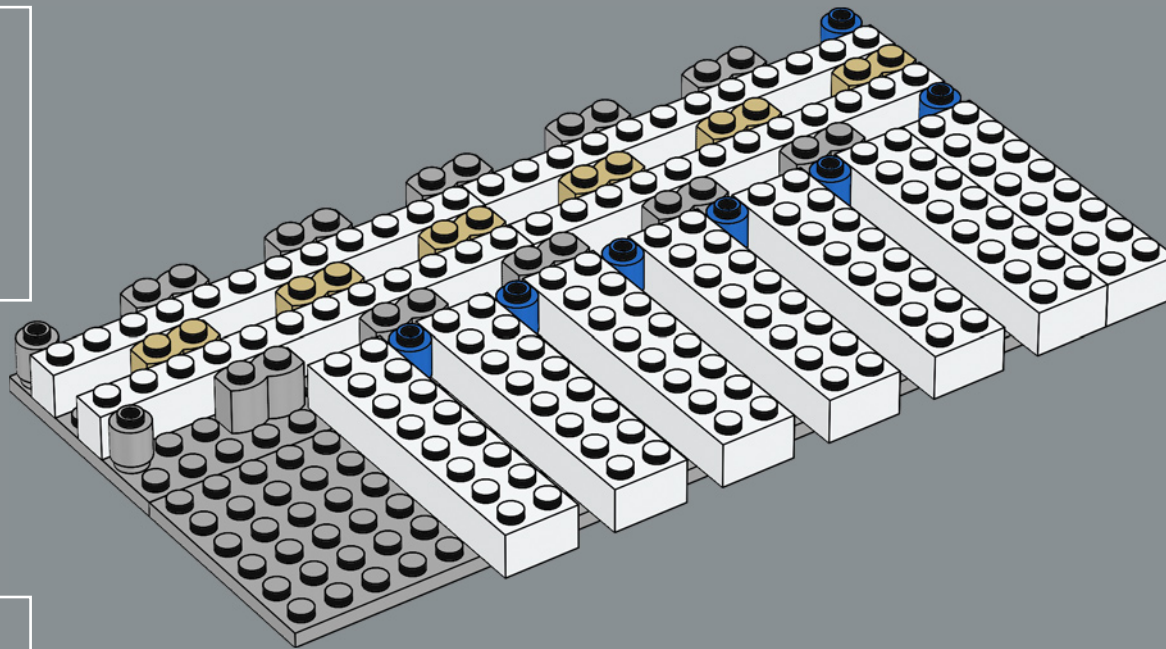

175



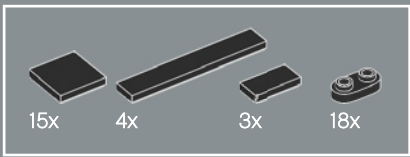

176

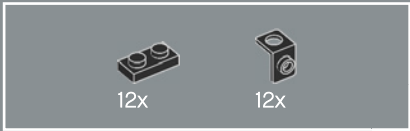
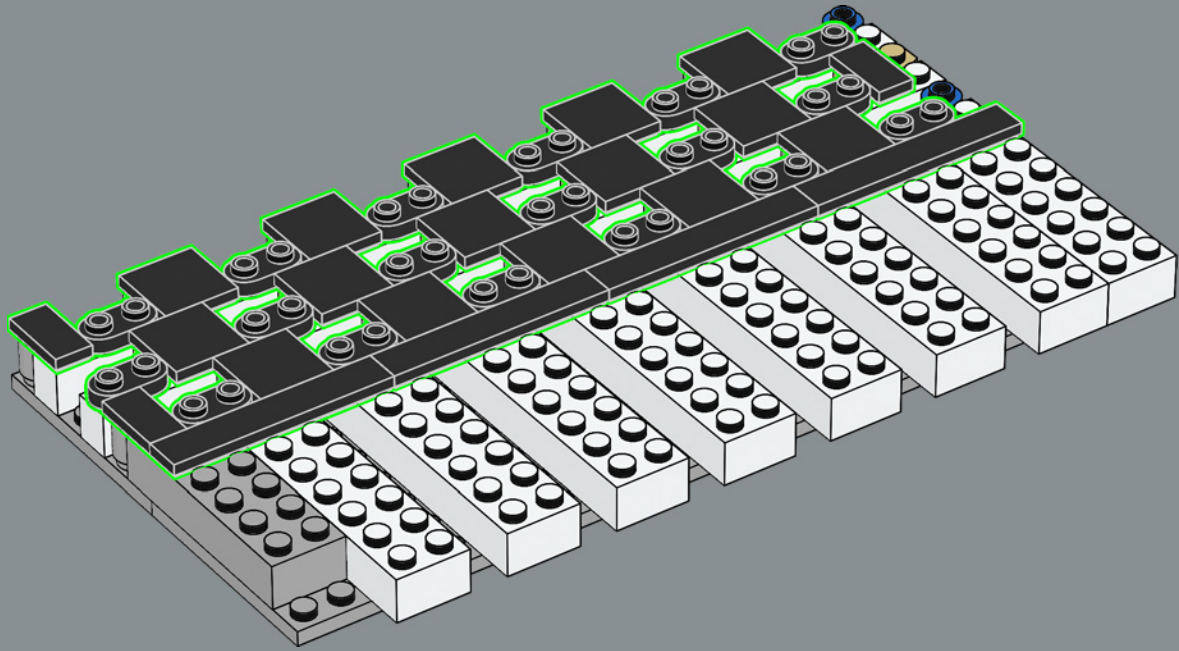

177

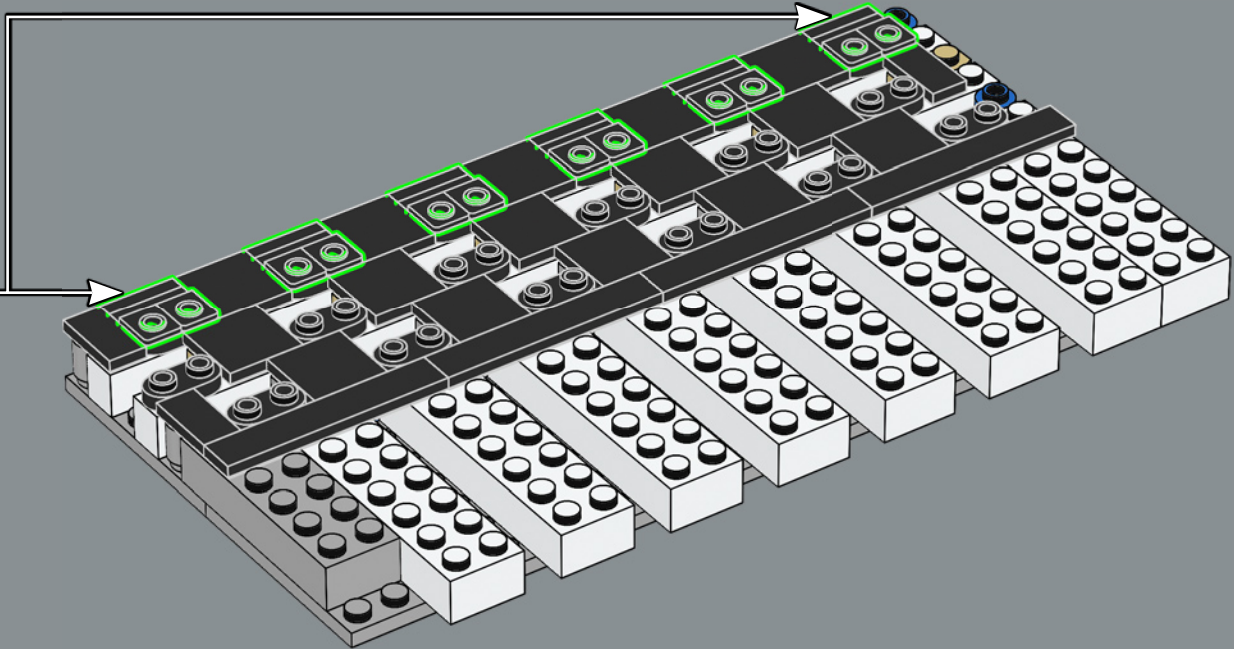
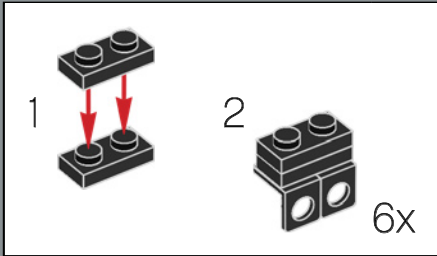



178

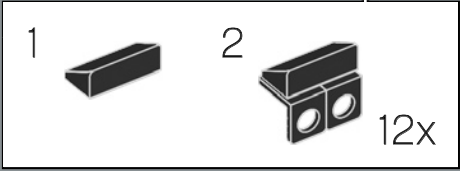
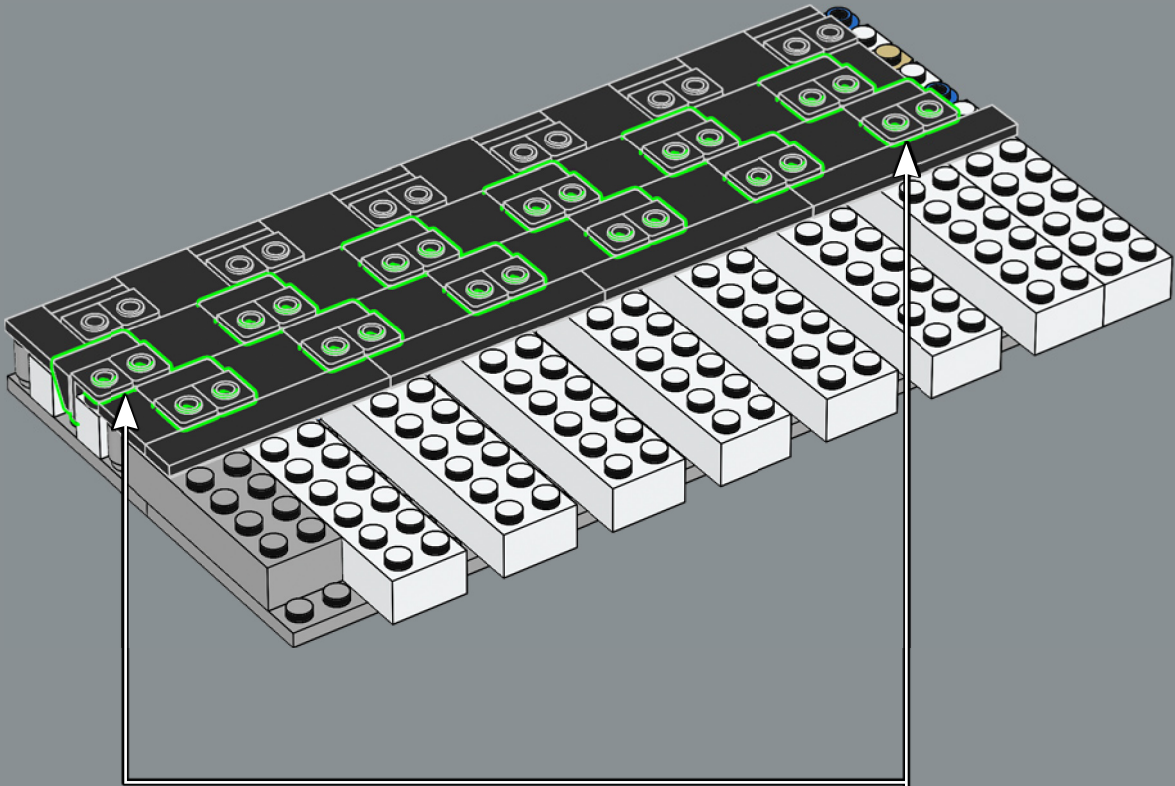

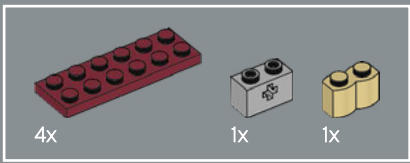

179

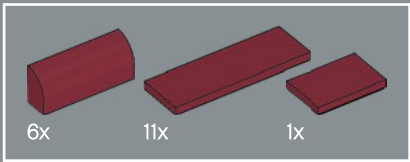
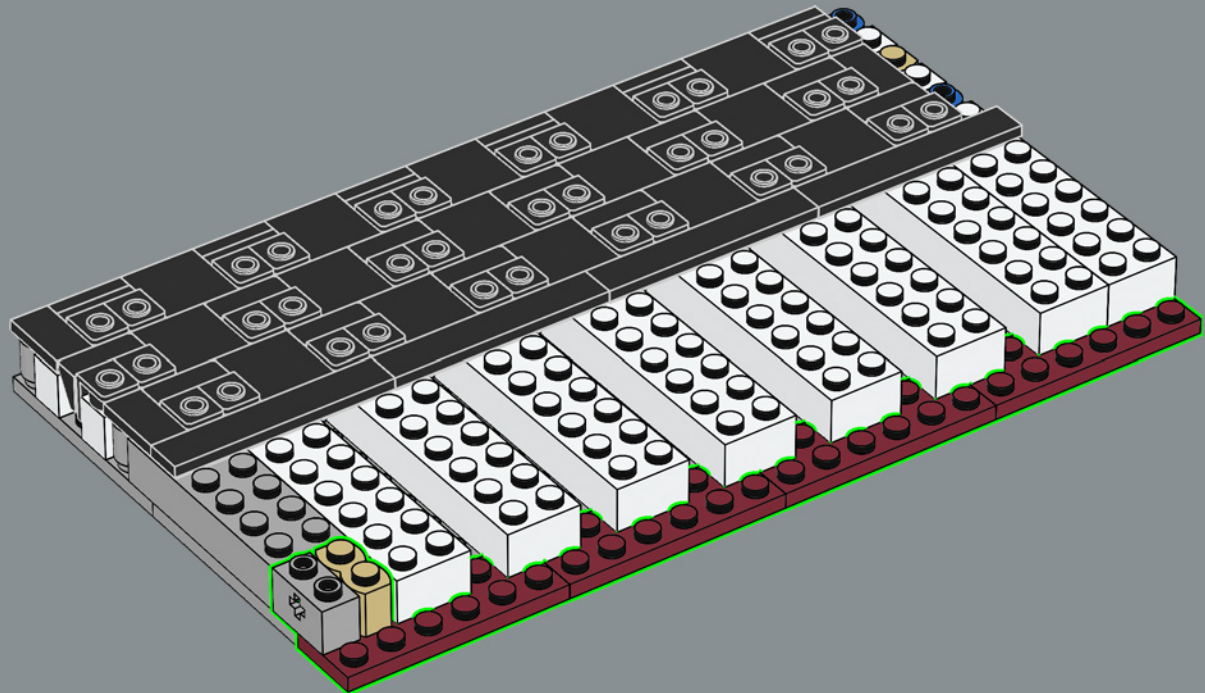

180

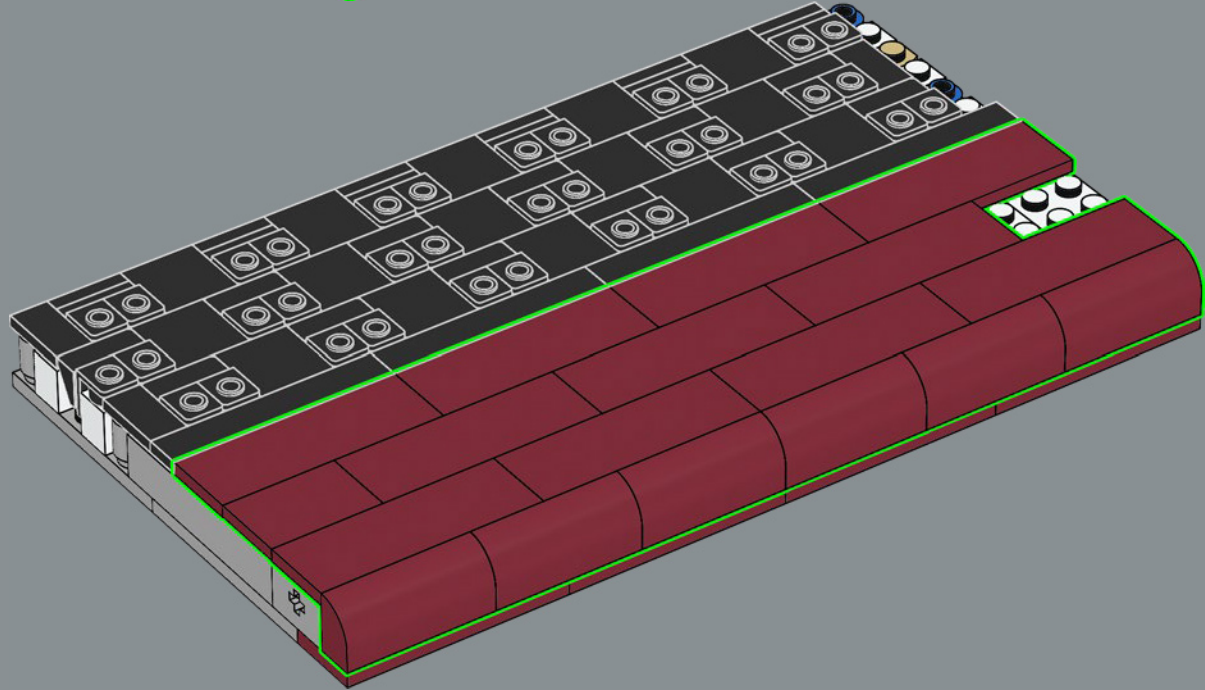

这艘船的船体被超过 300 万个钢铁铆钉
连接在一起, 这些铆钉总重超过 1200 公吨
(1322.7 美吨)。

181

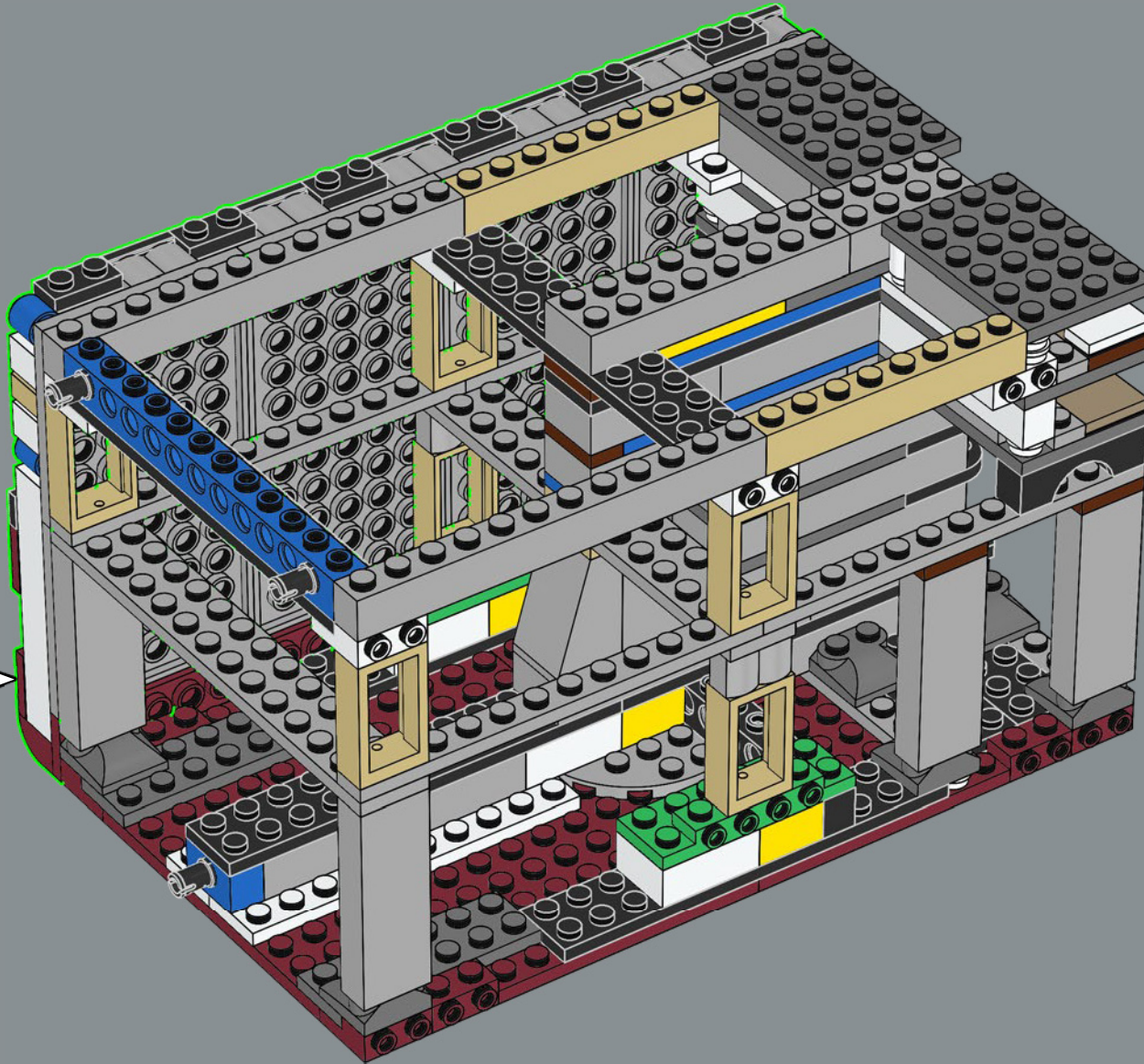

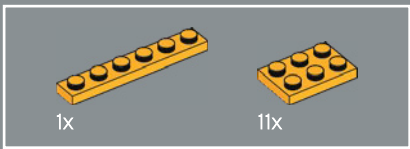

182

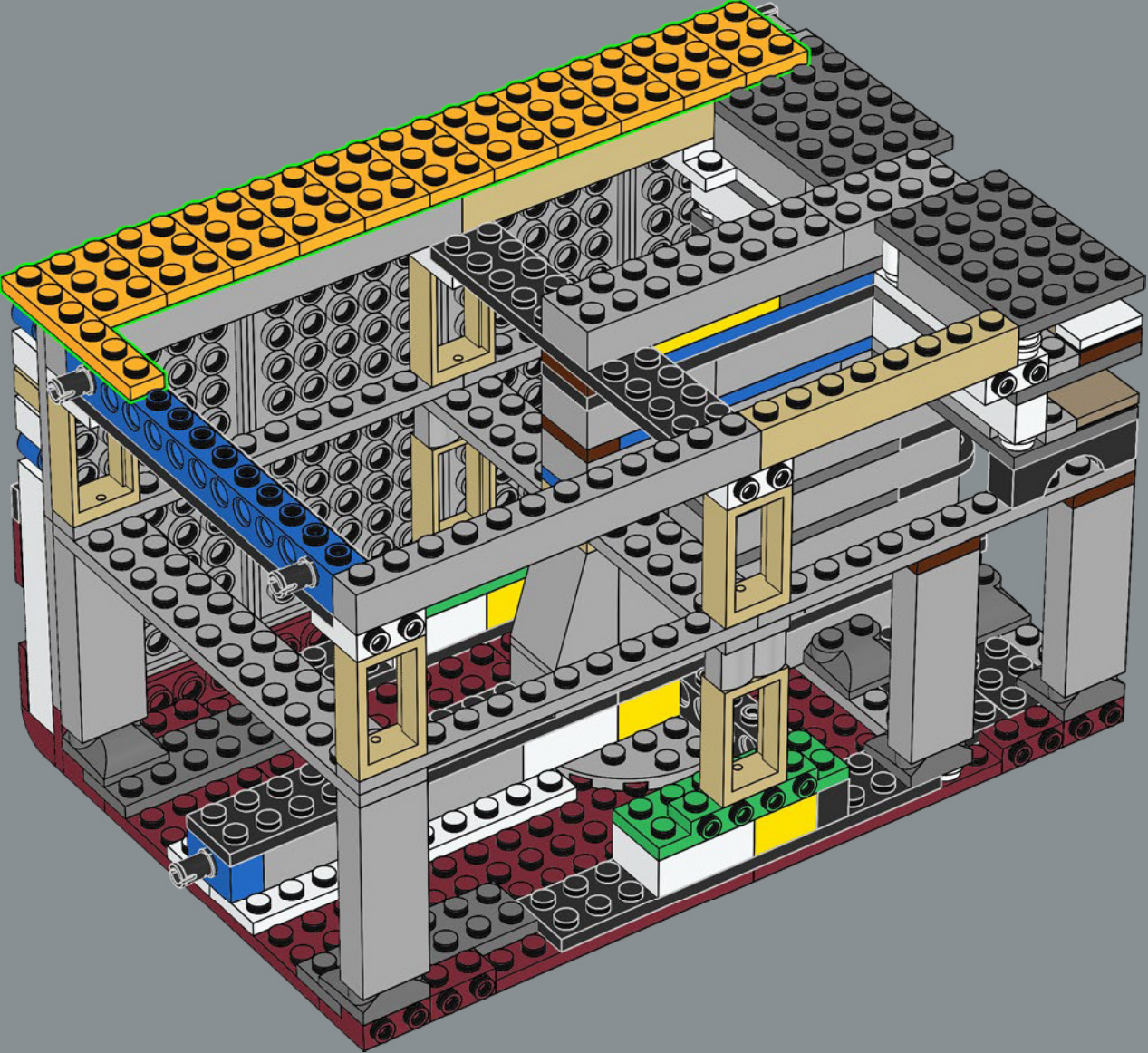

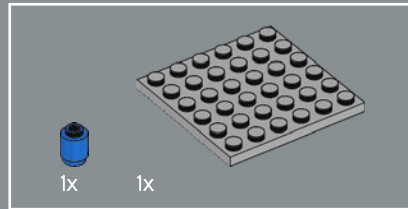
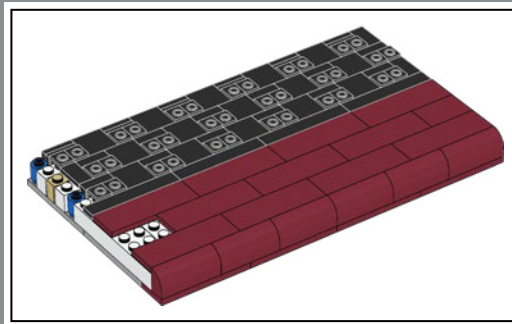
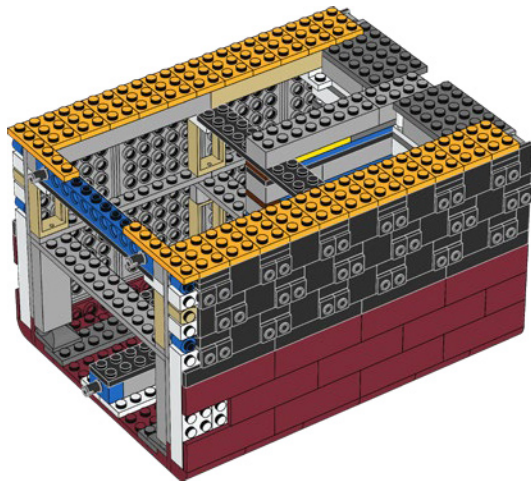
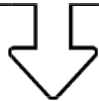

183

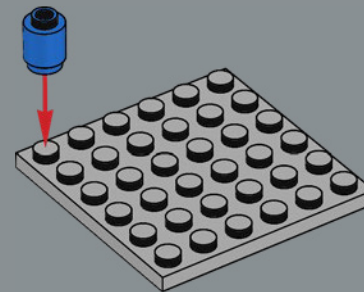

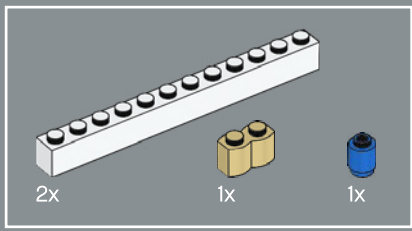

184

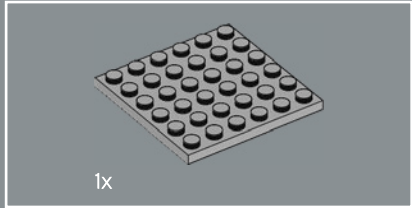
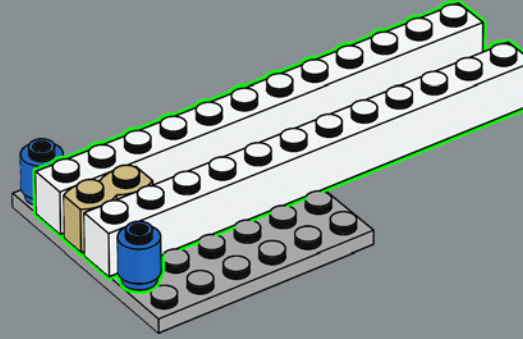

185

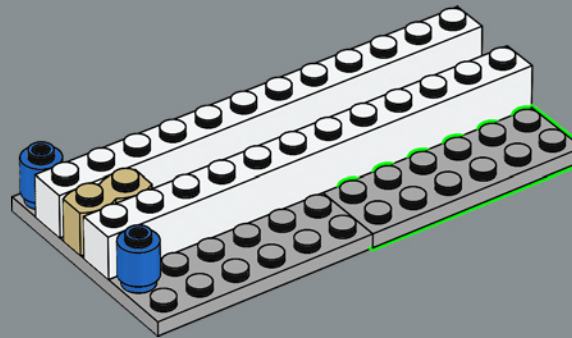

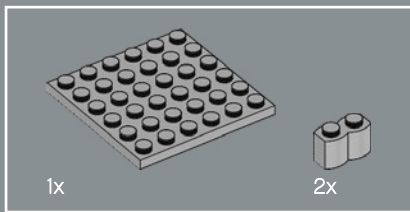

186

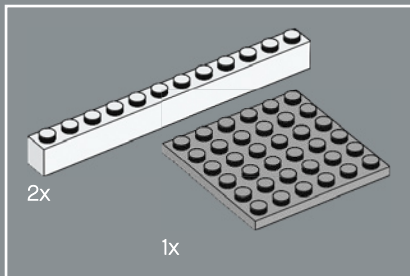
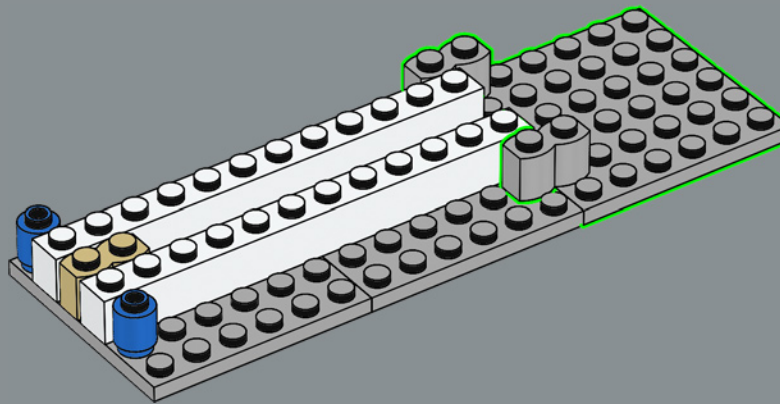

187

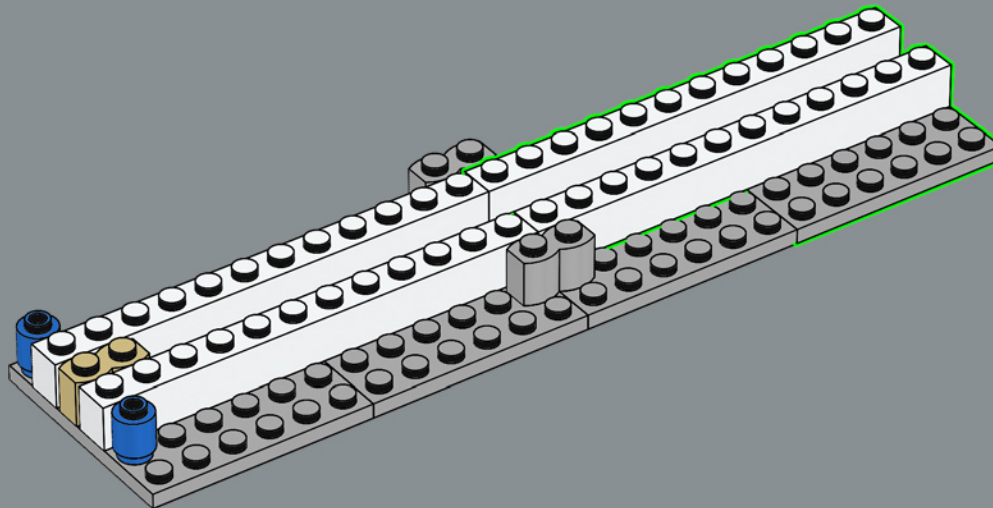



188

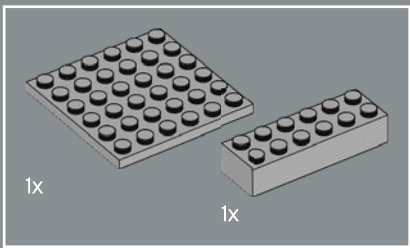
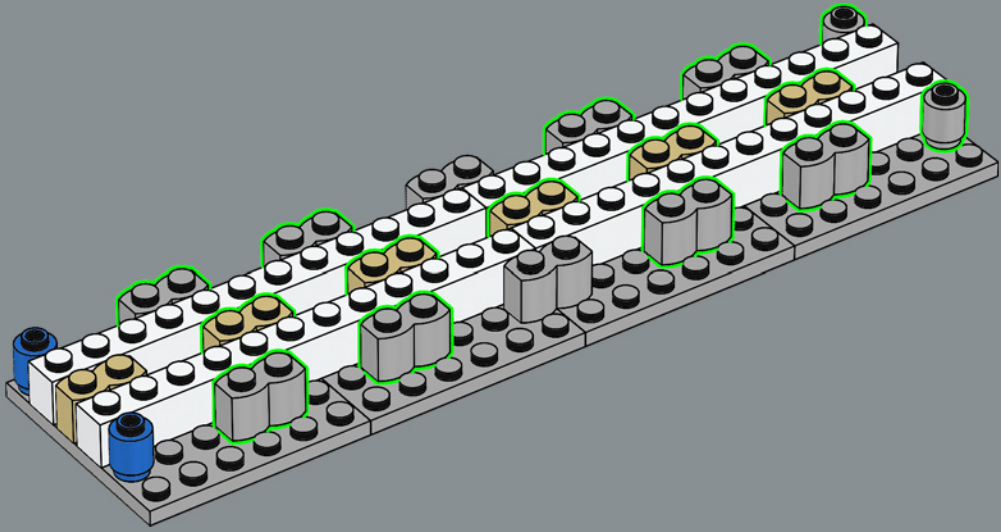

189

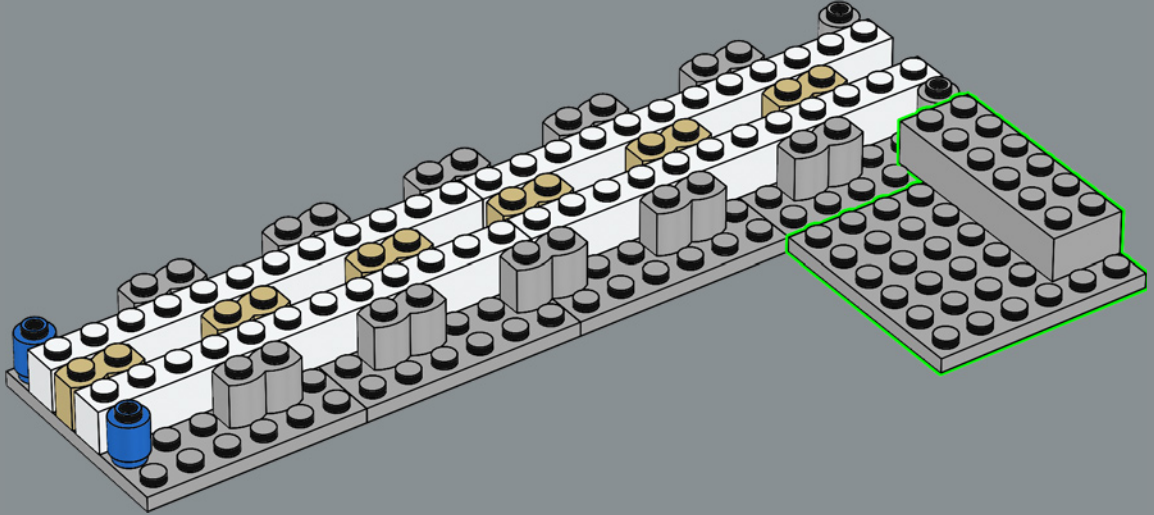

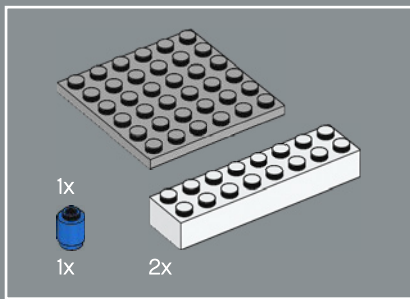

190

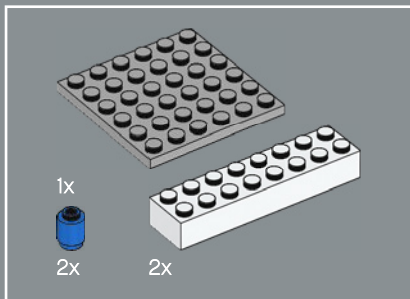
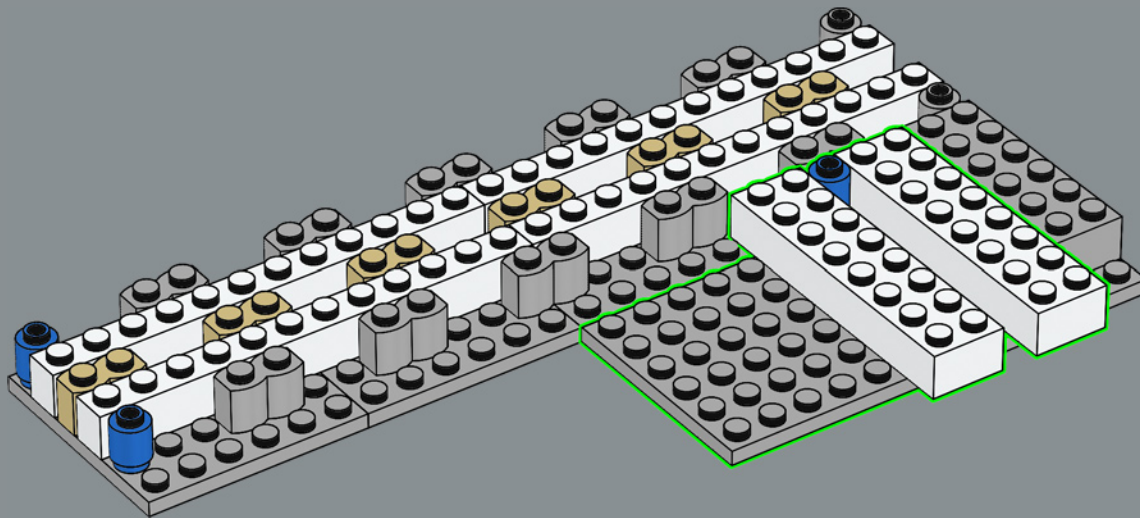

191

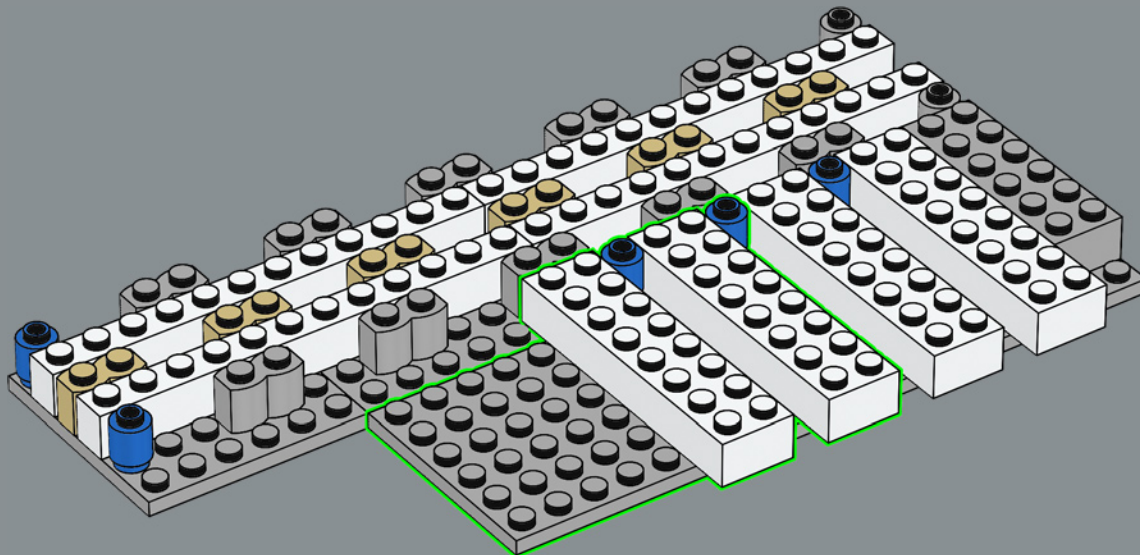

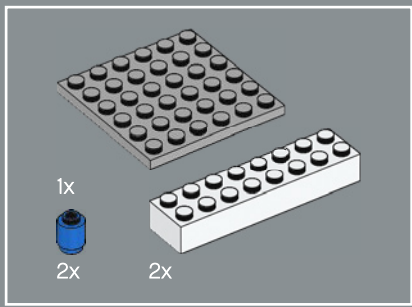

192

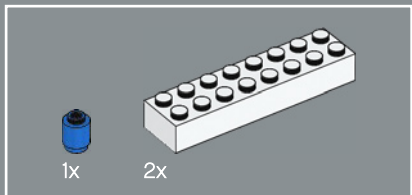
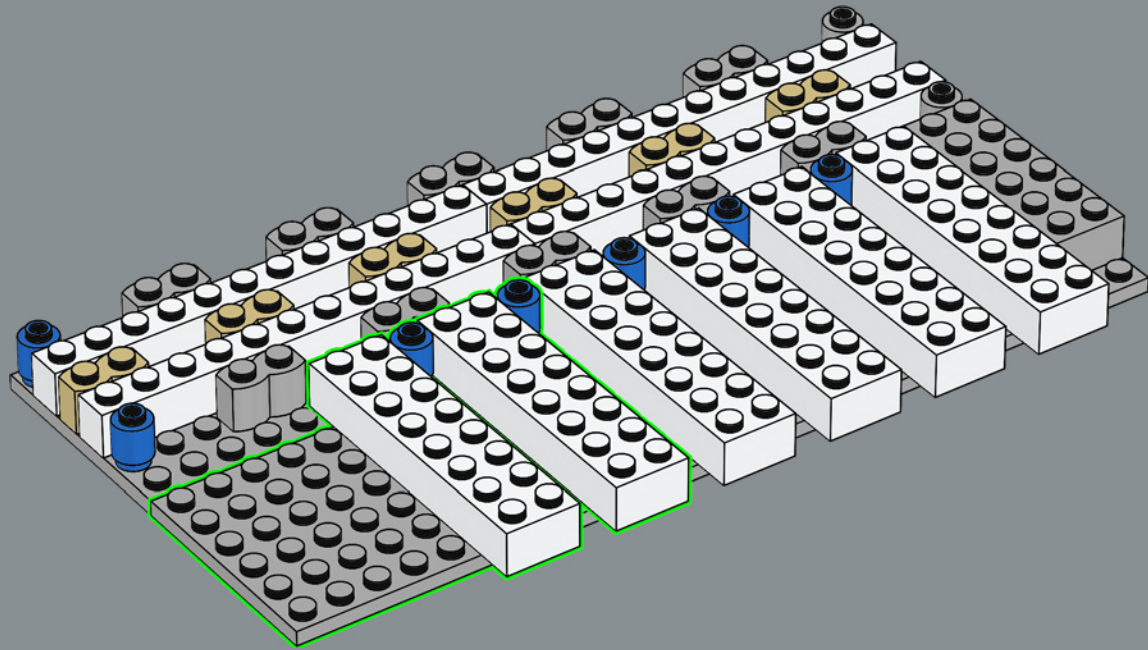

193

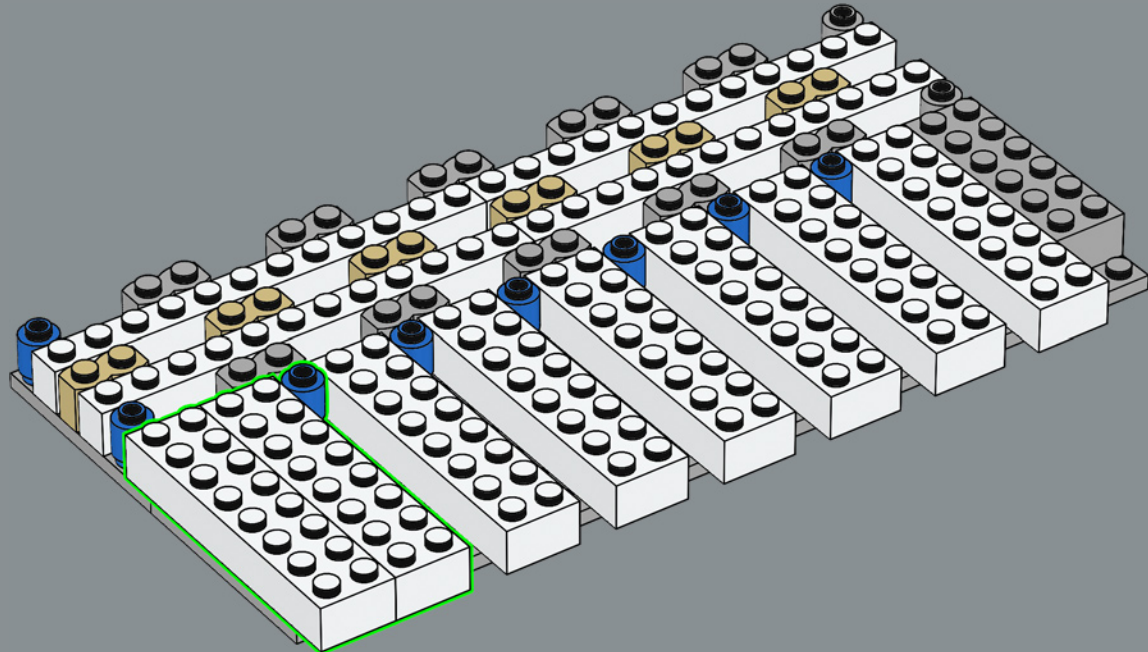

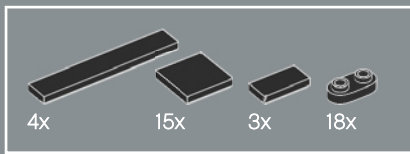

194

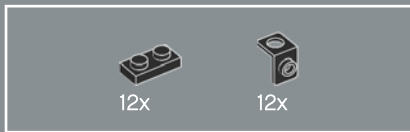
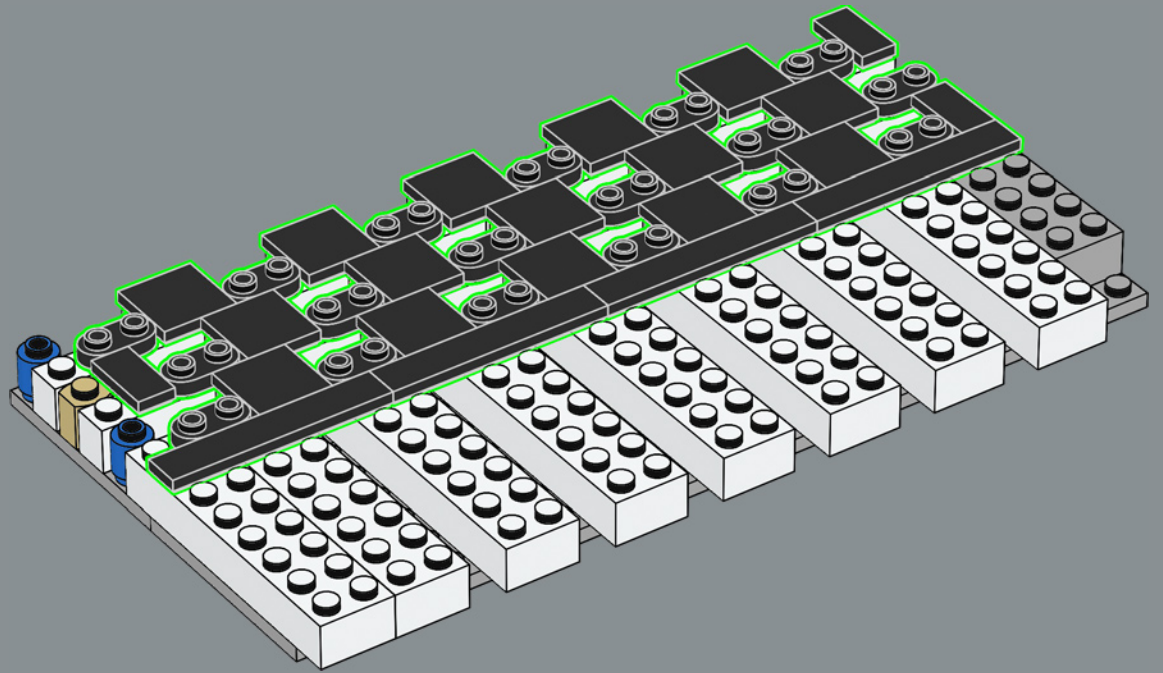

195

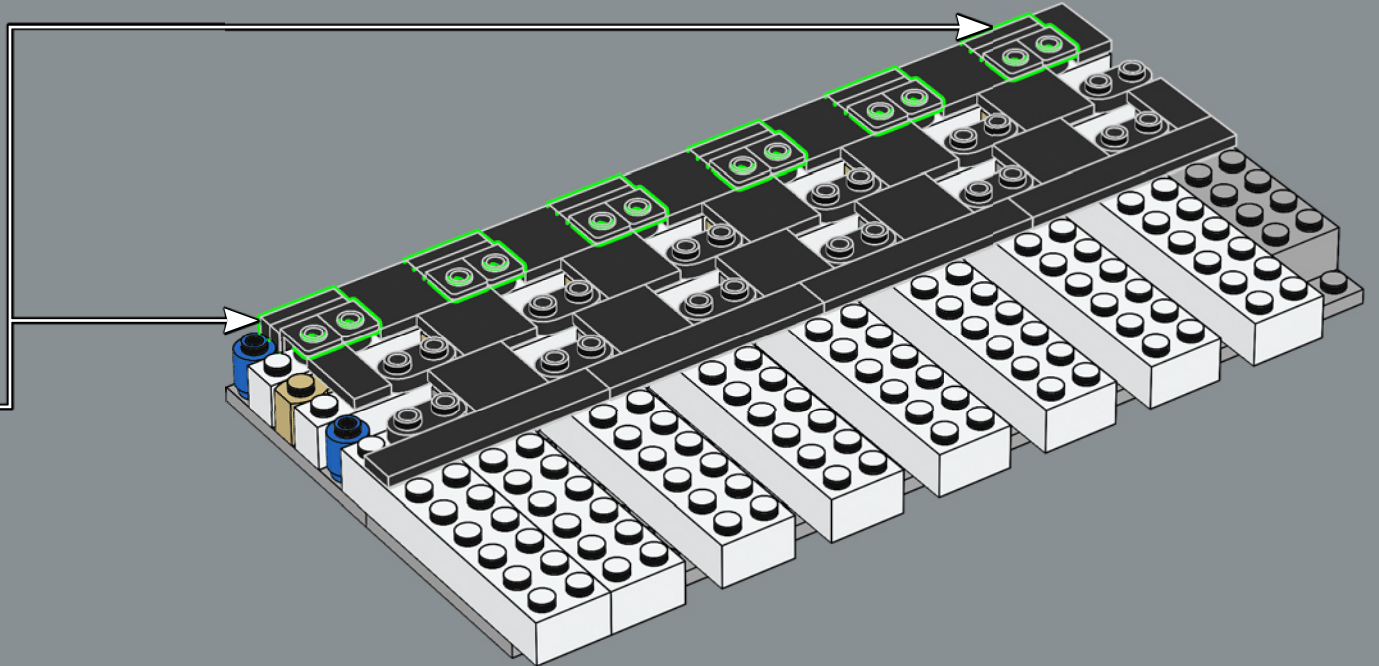
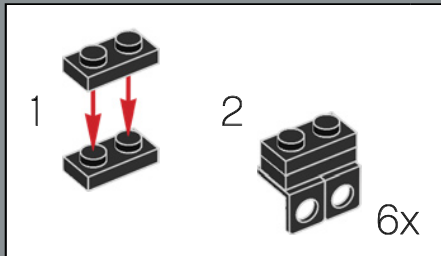

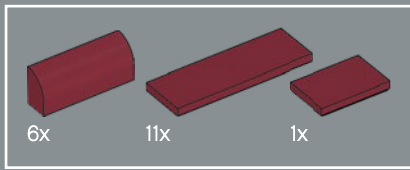

198

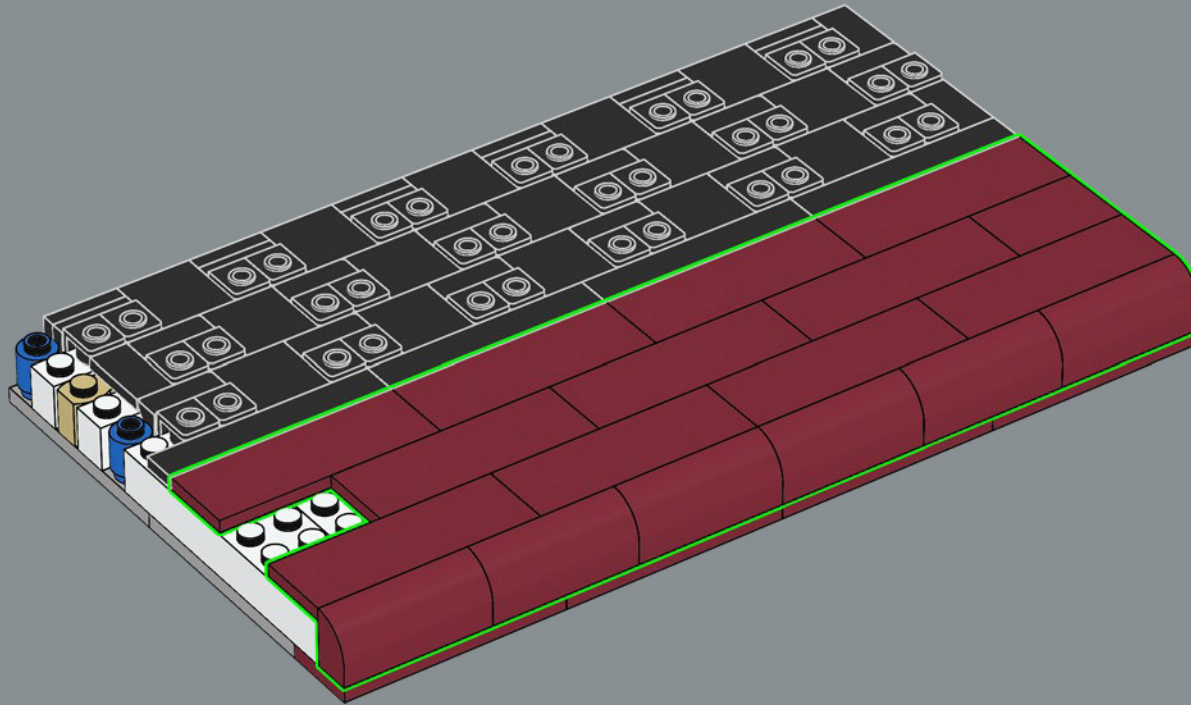

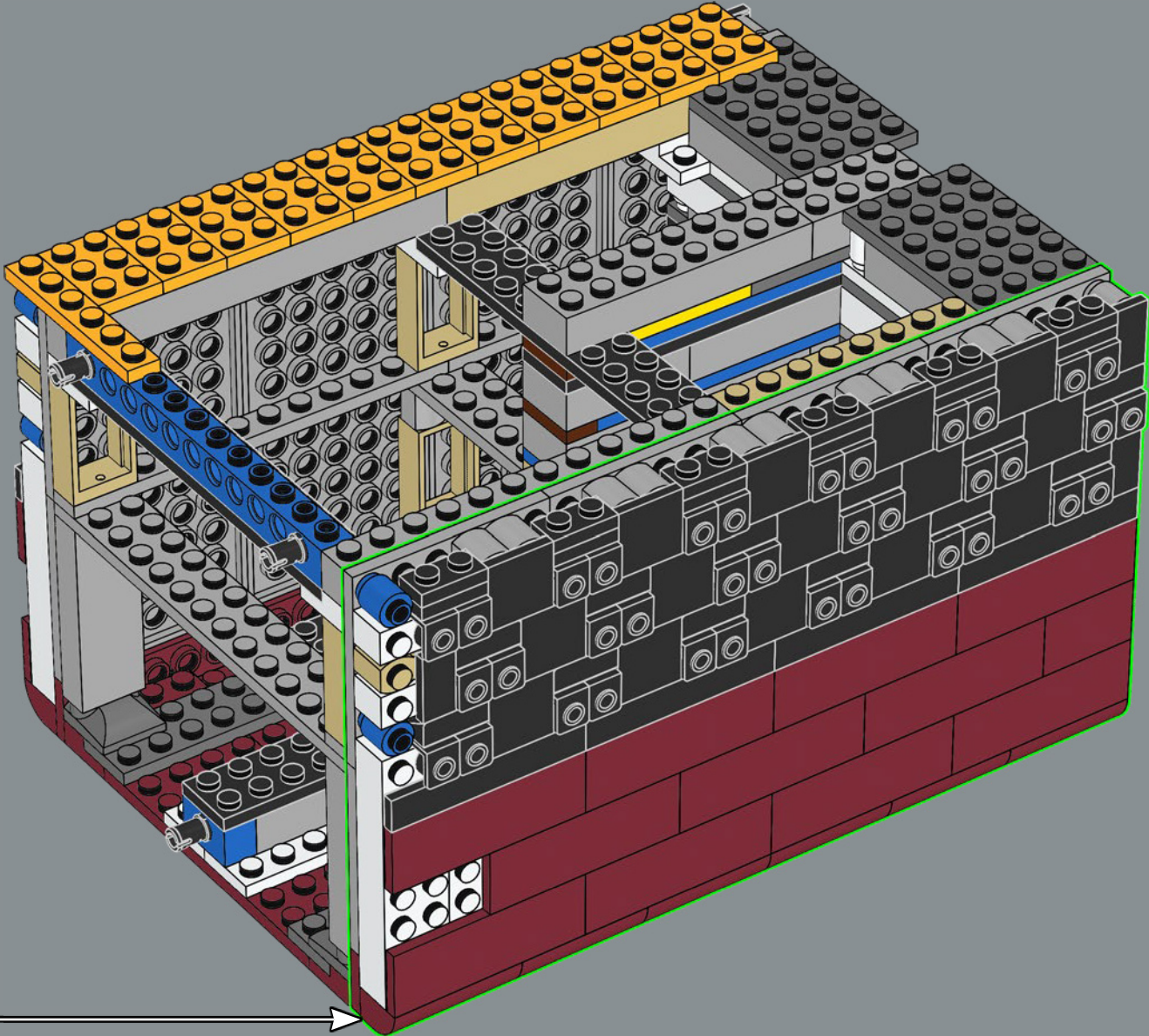

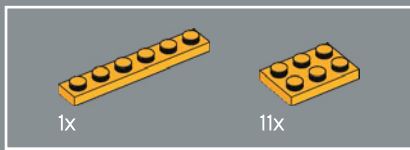

200

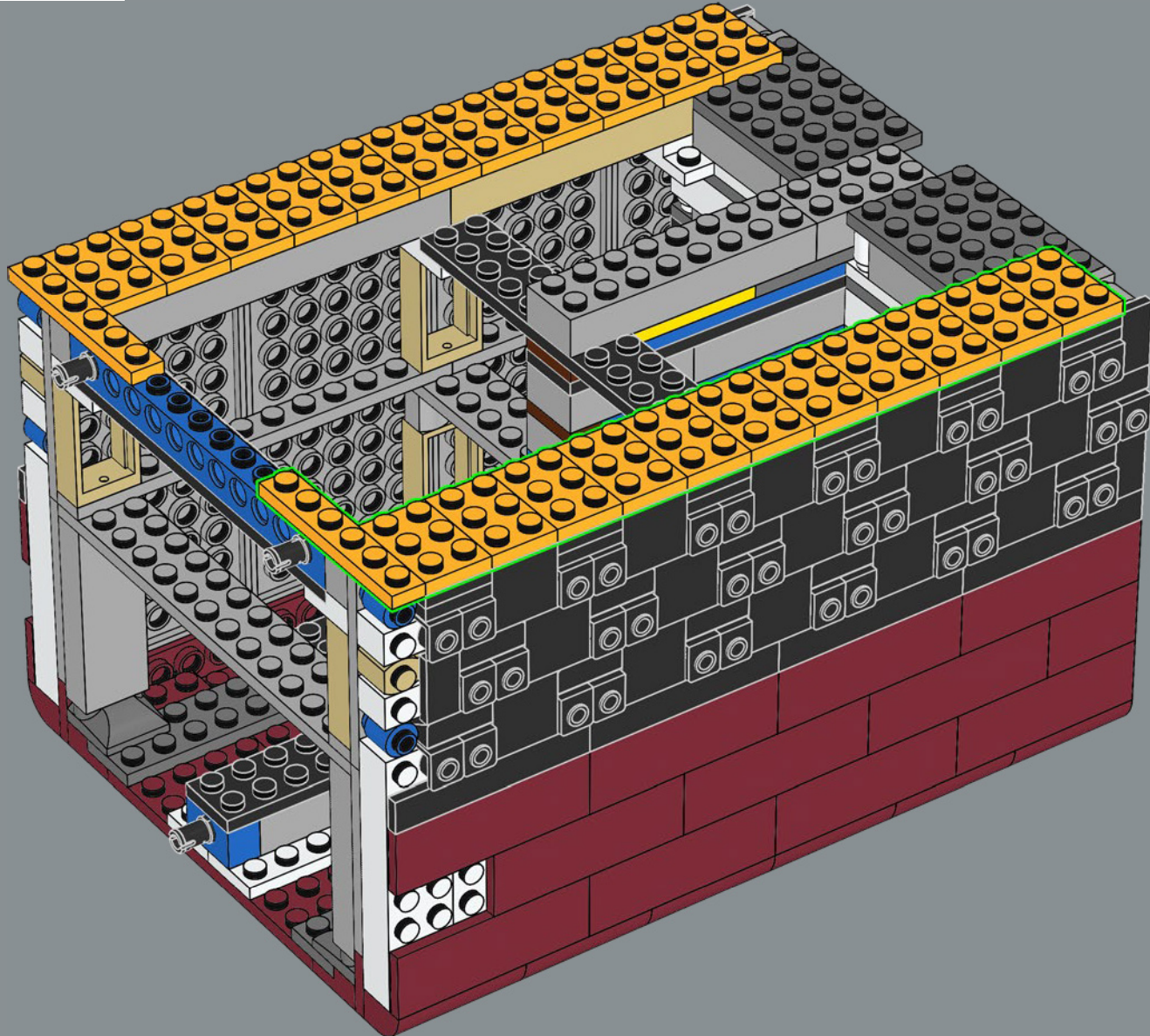

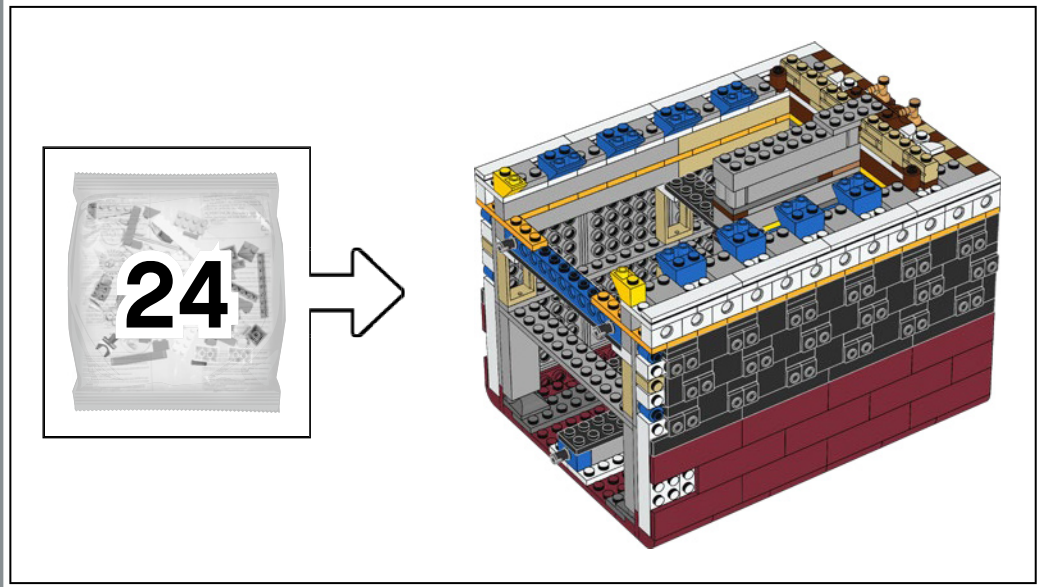

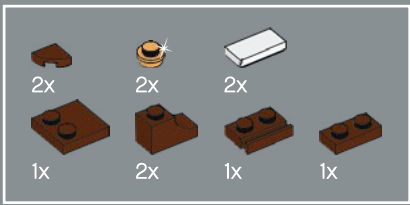

202

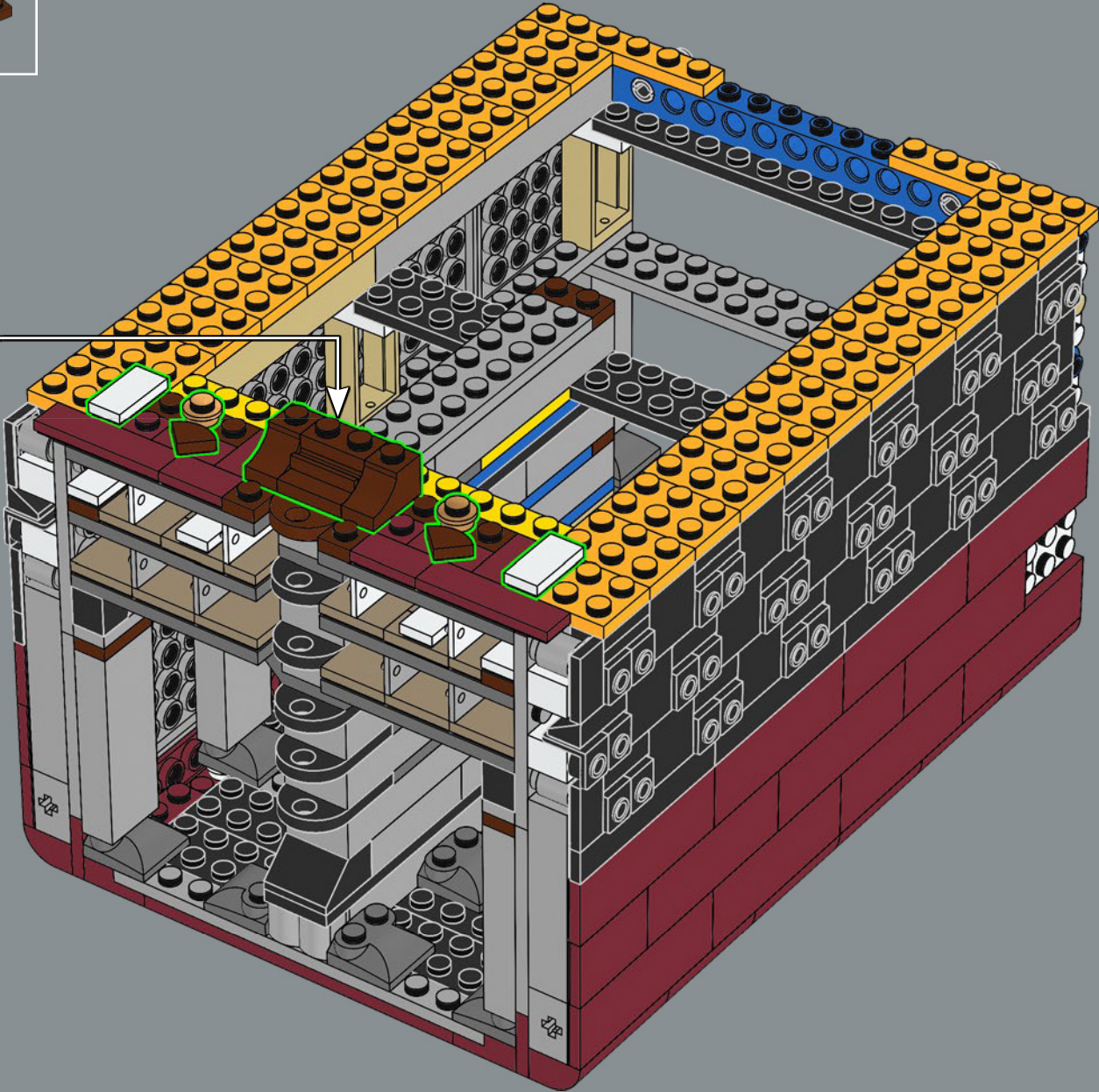
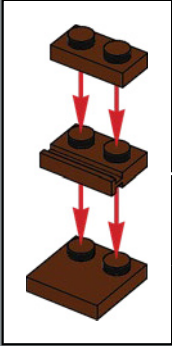

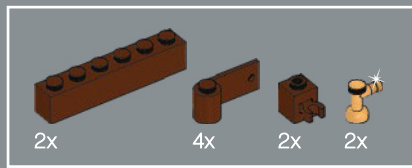

203

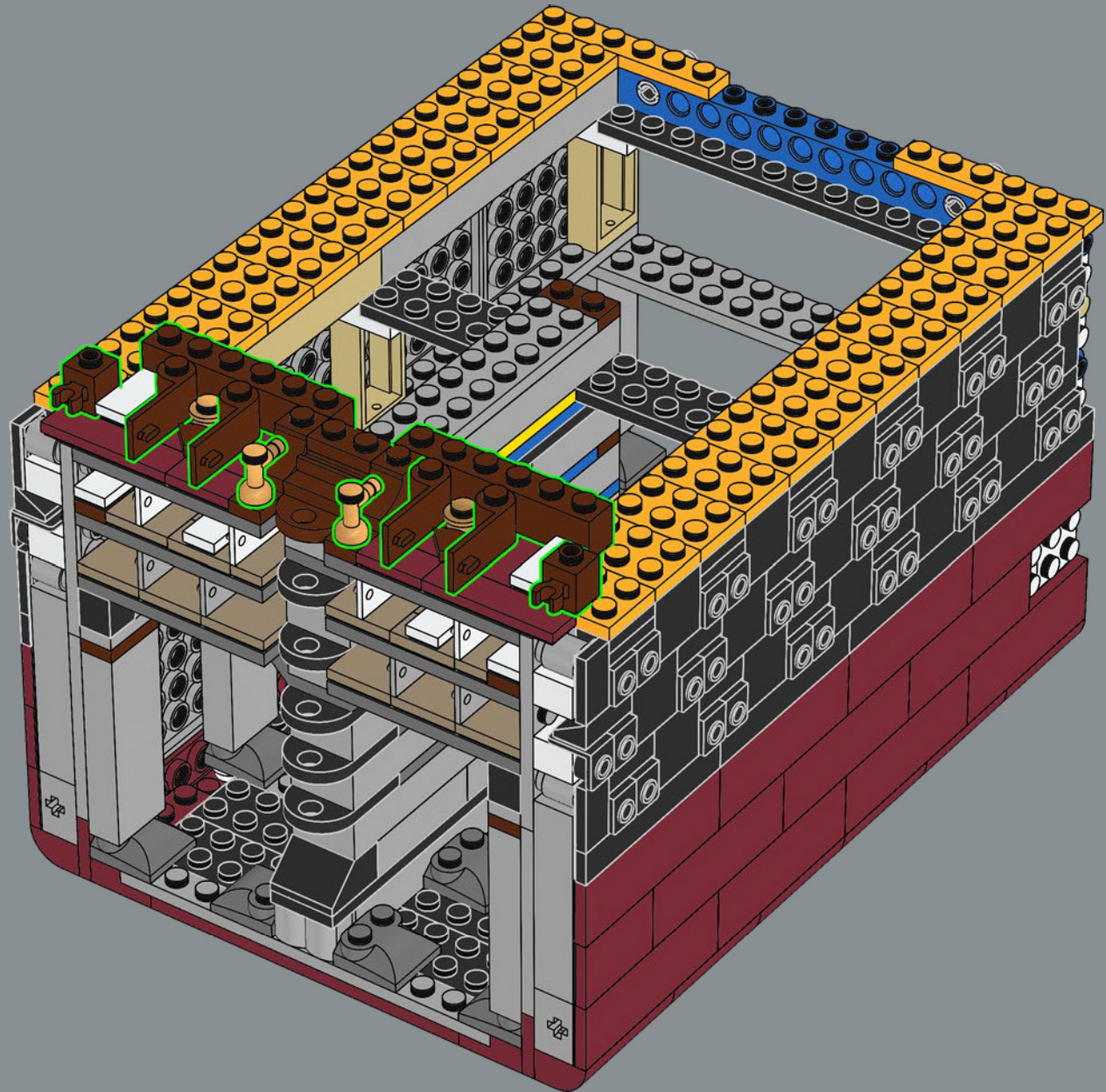

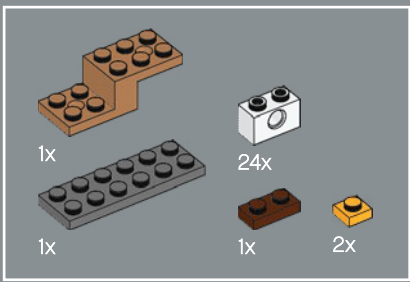

204

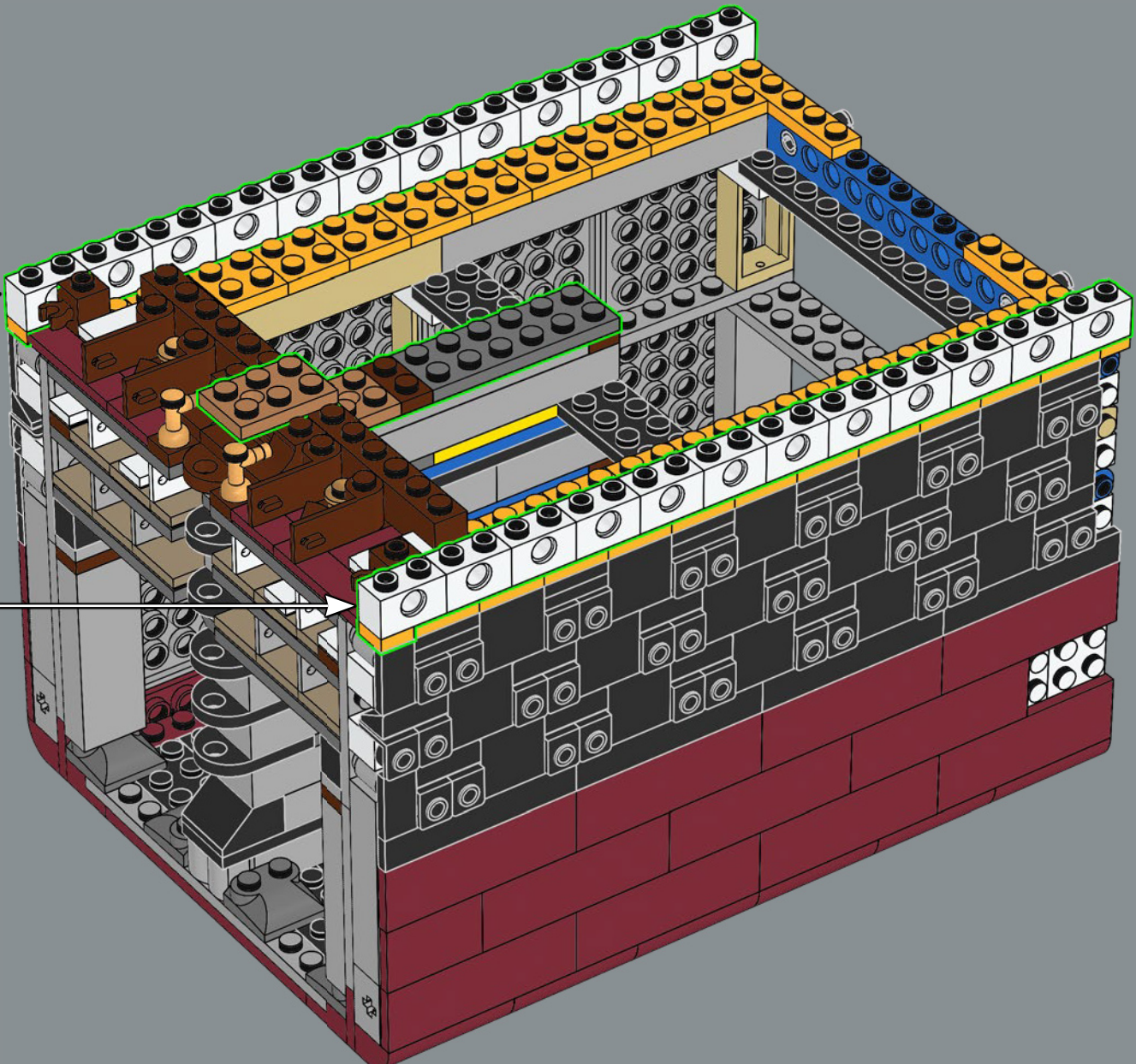
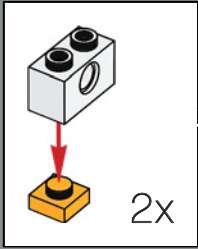

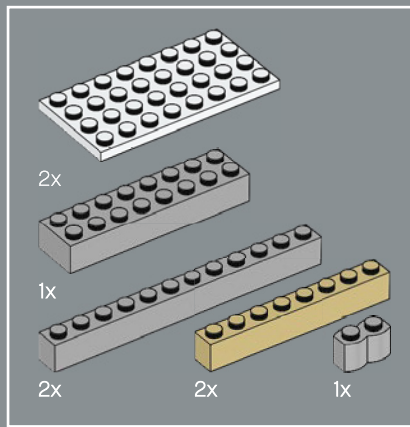

205

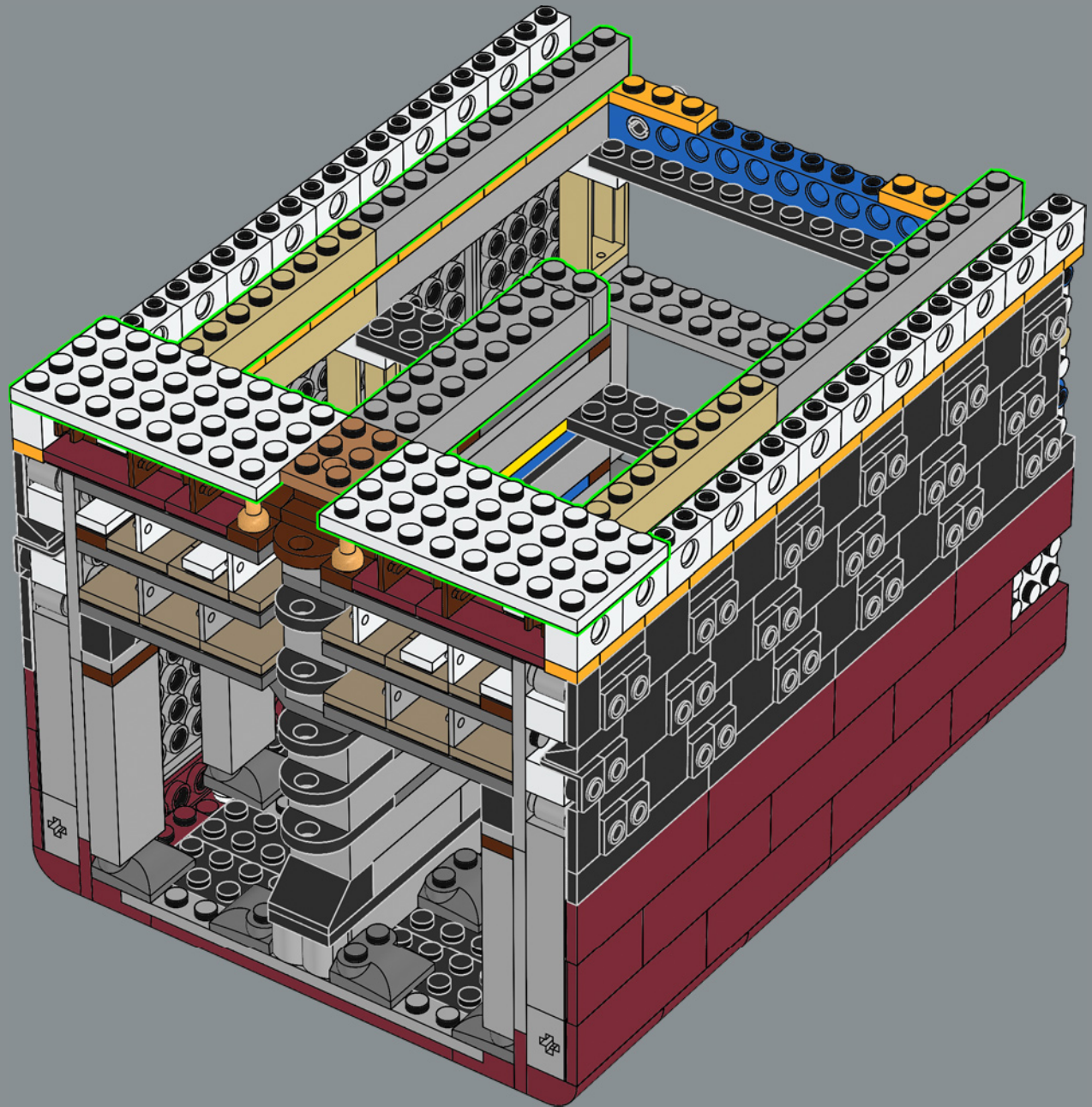

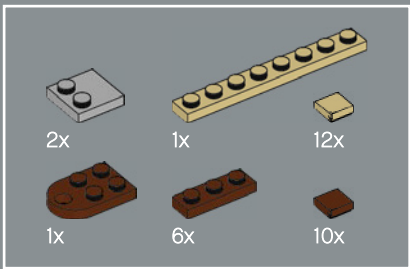

206

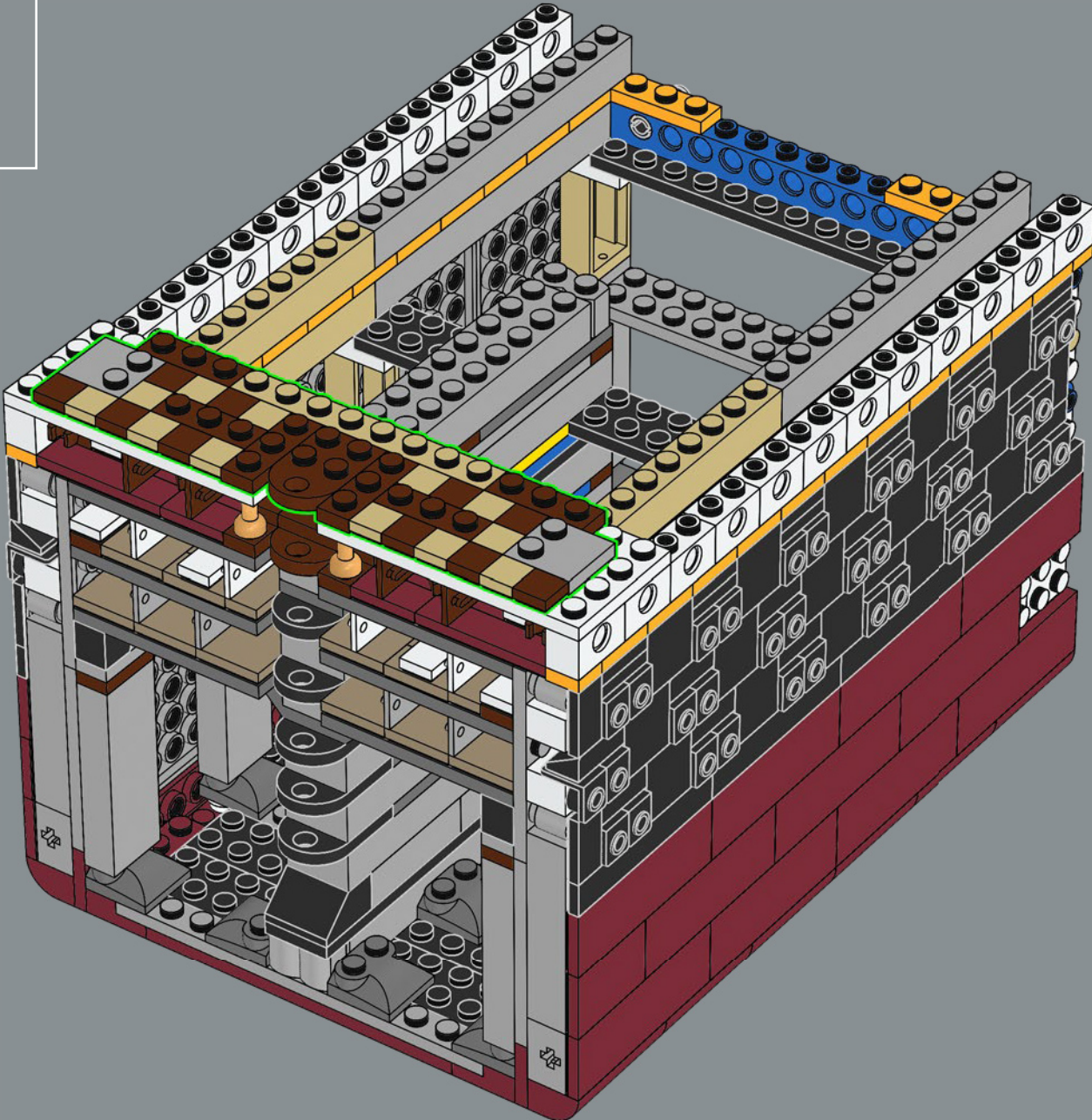

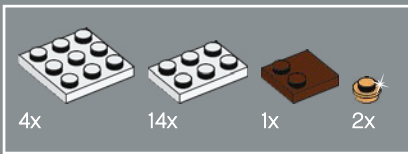

207

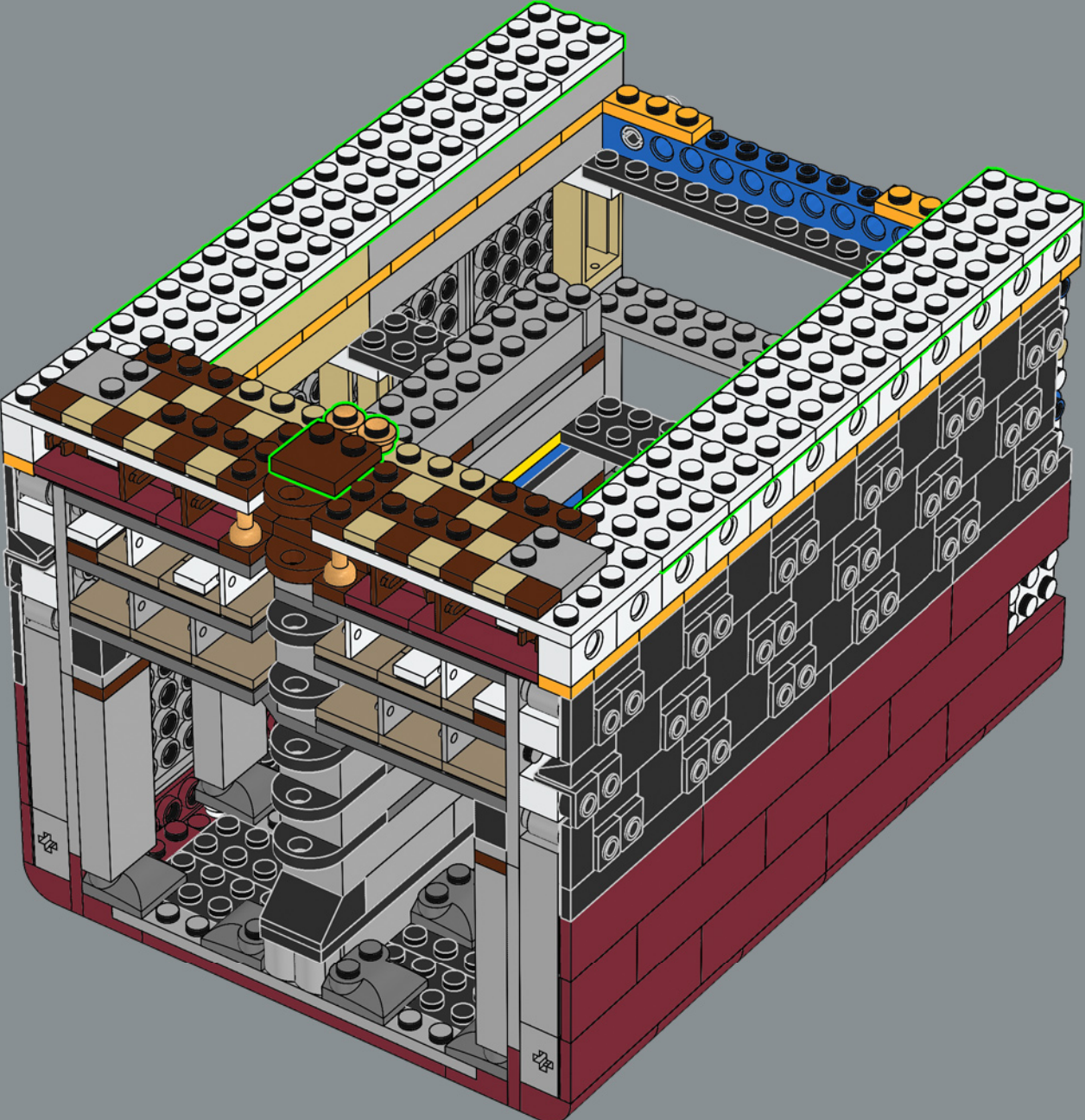

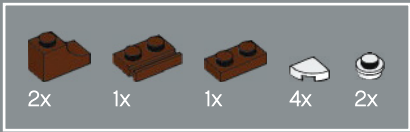

208

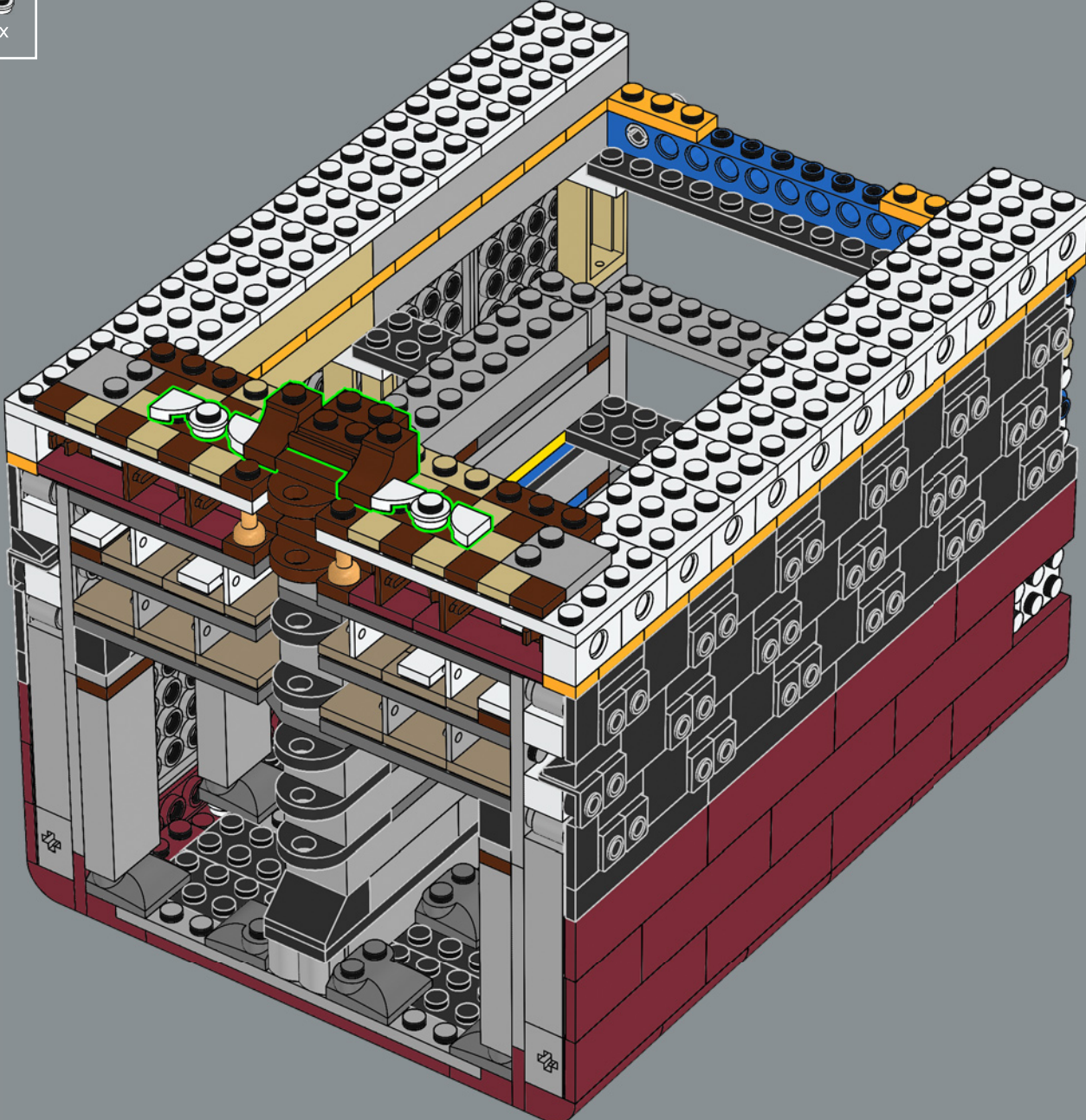

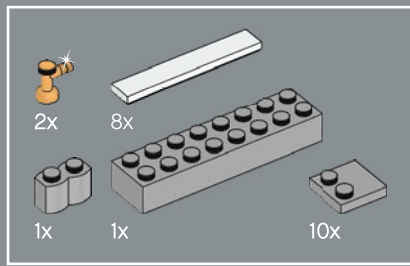

209

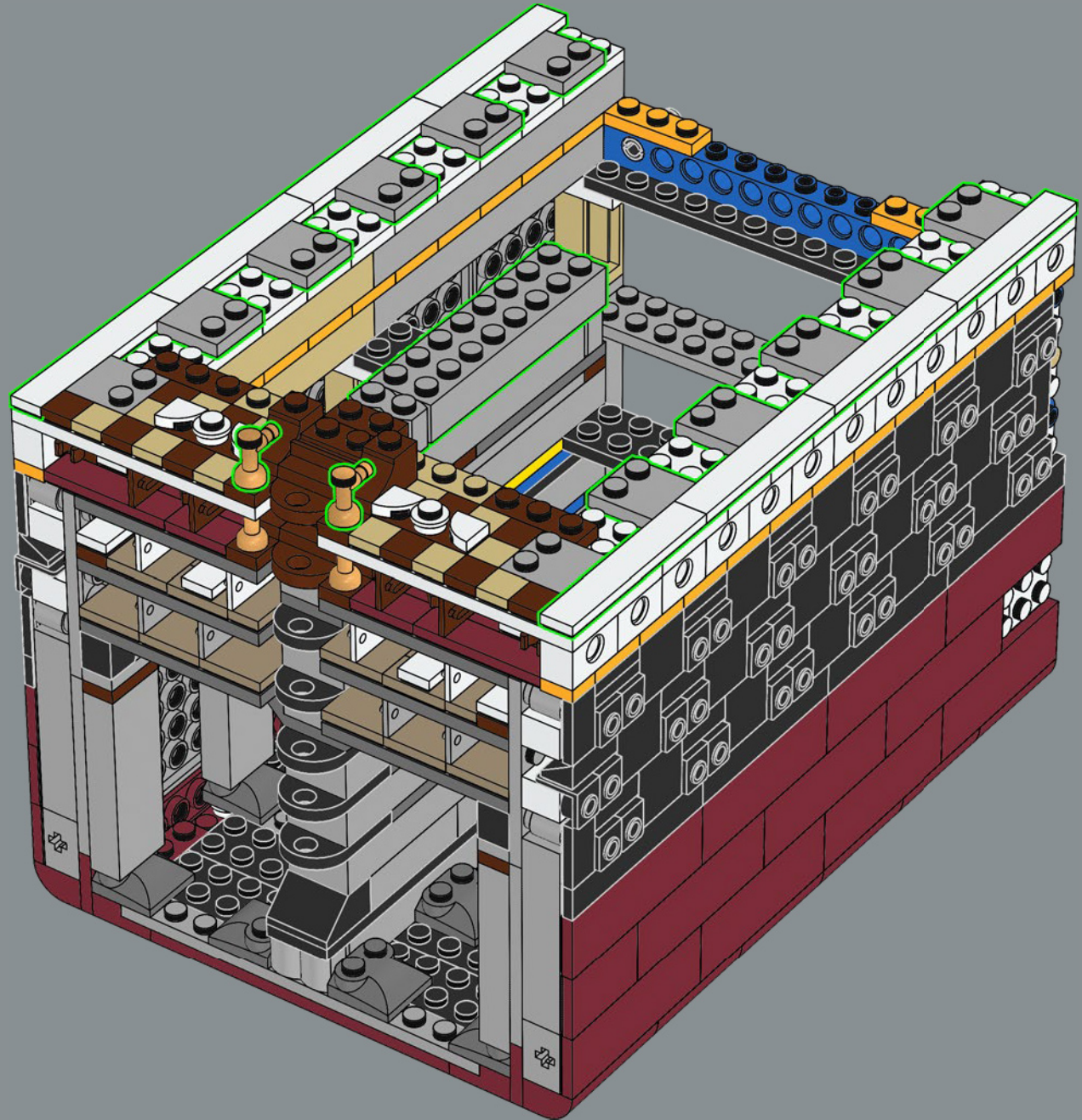

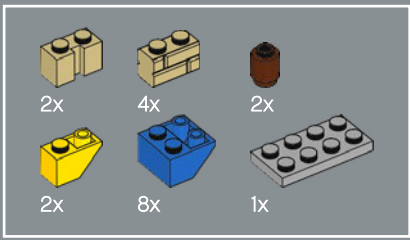

210

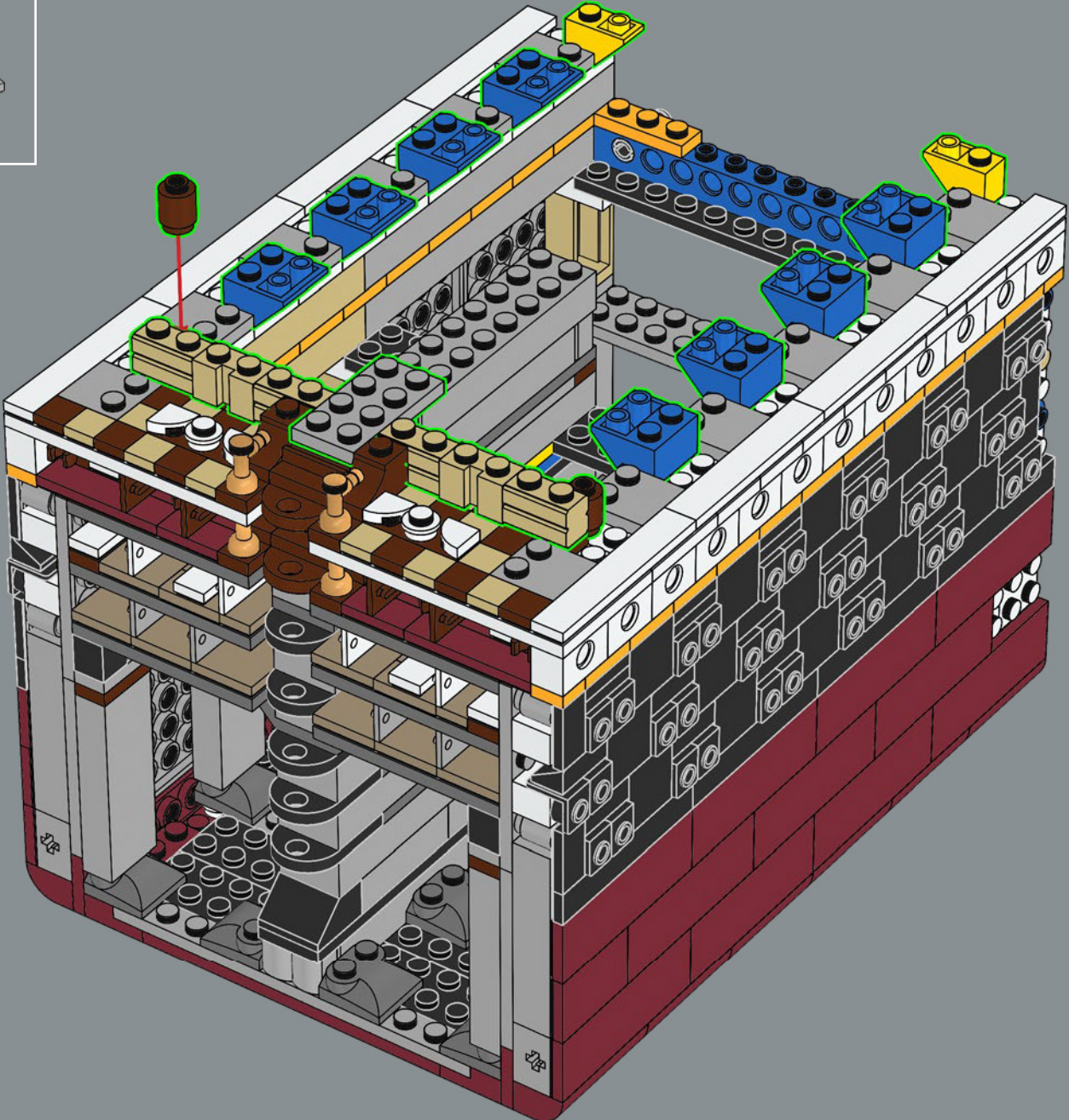

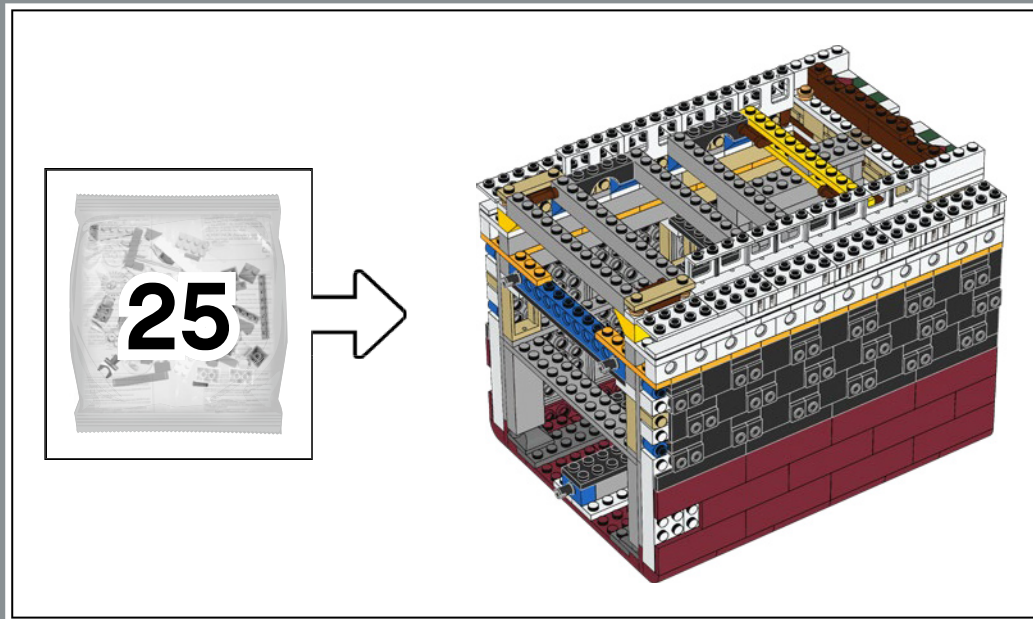



211

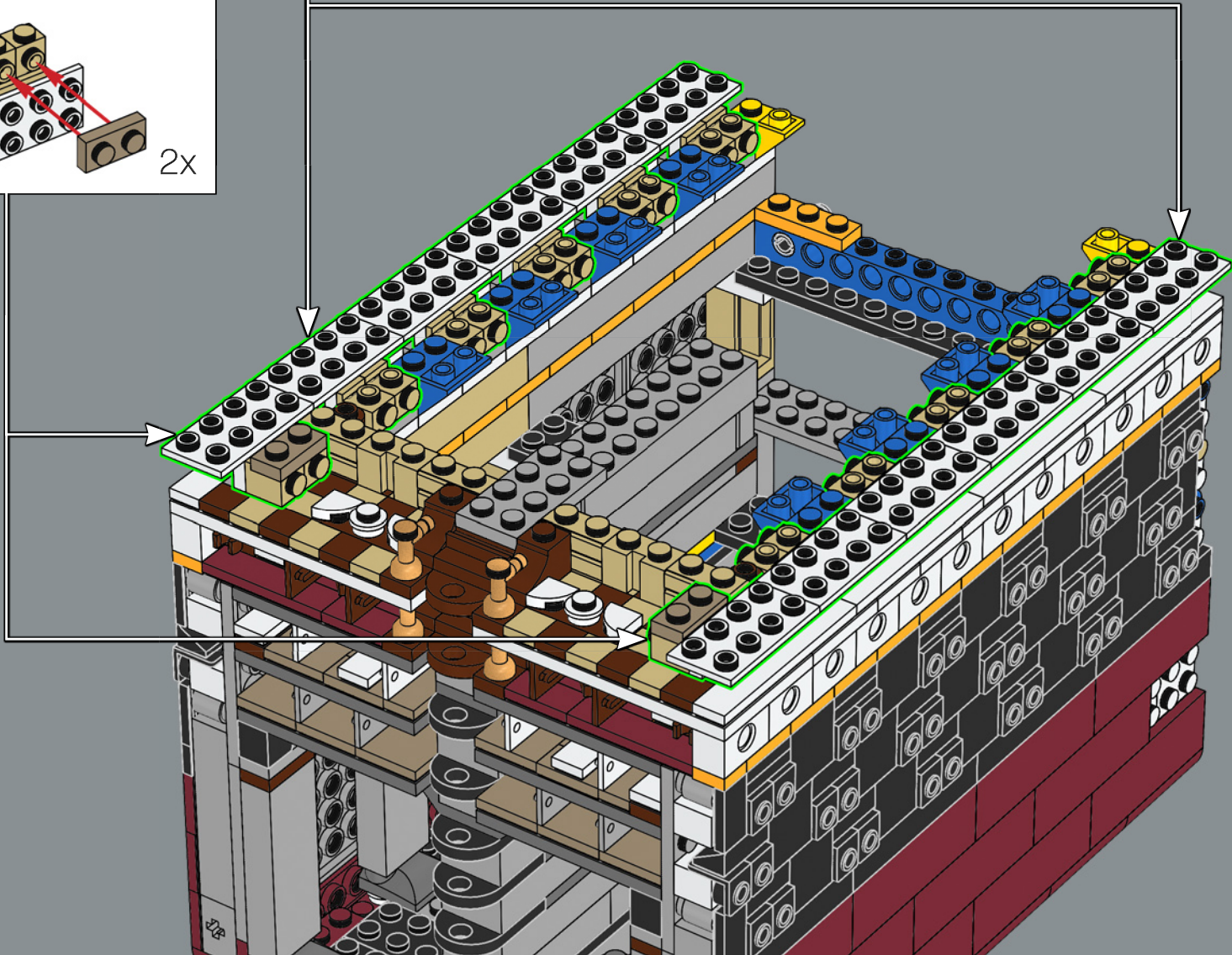
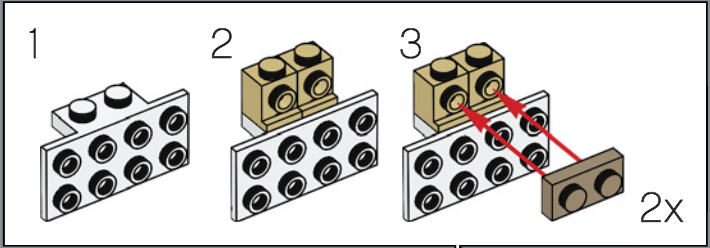
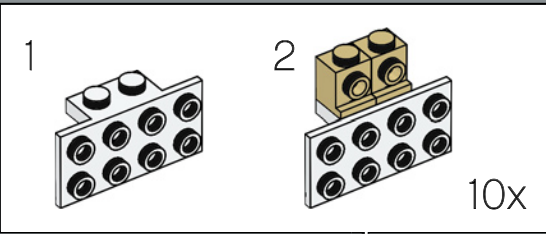

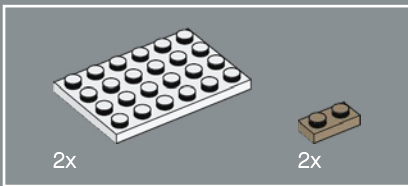

212

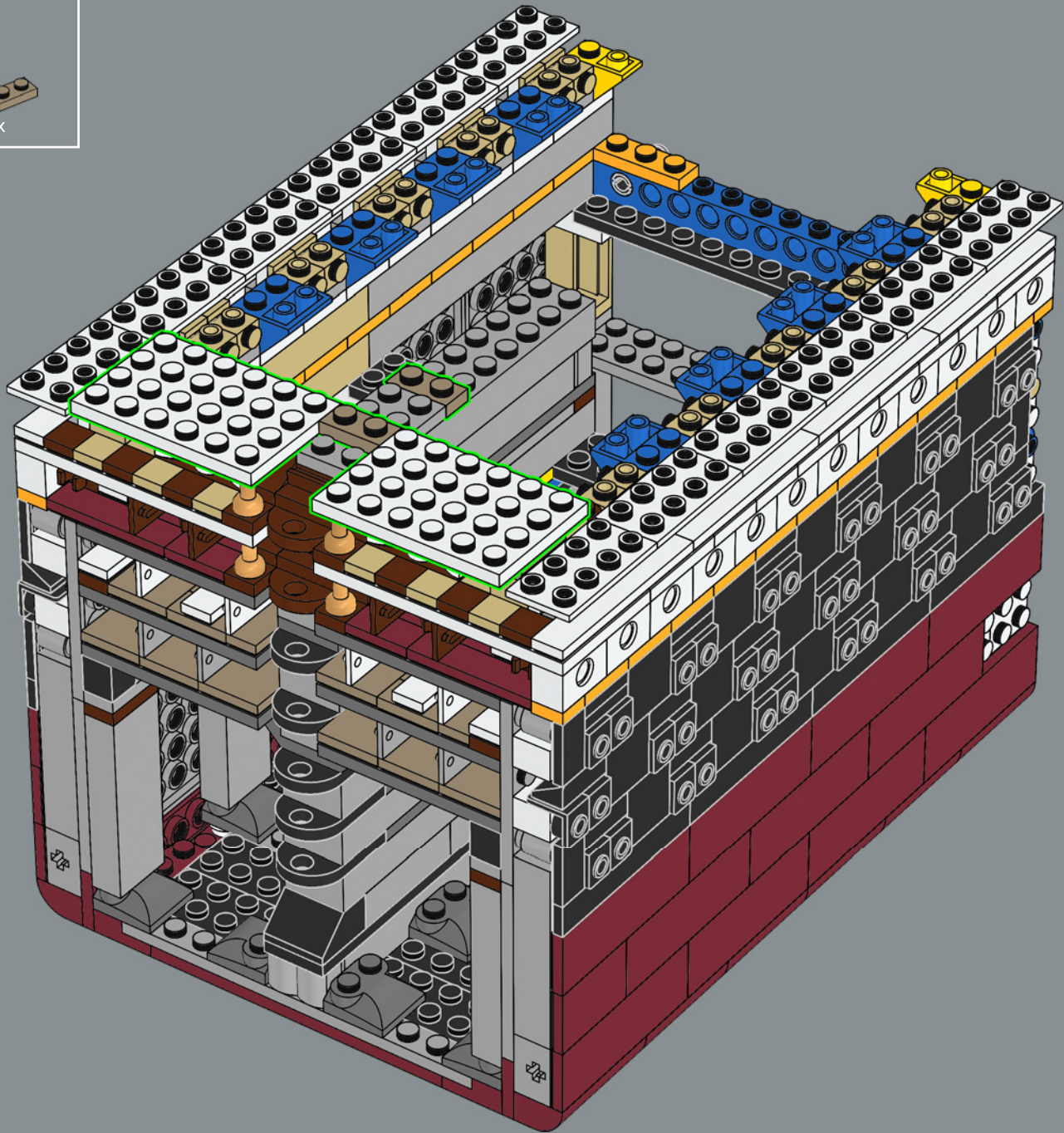

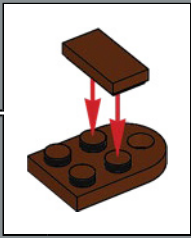
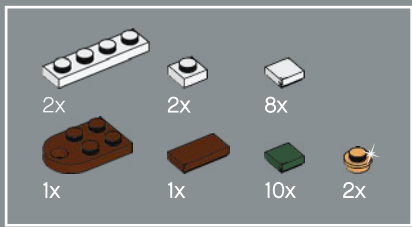

213

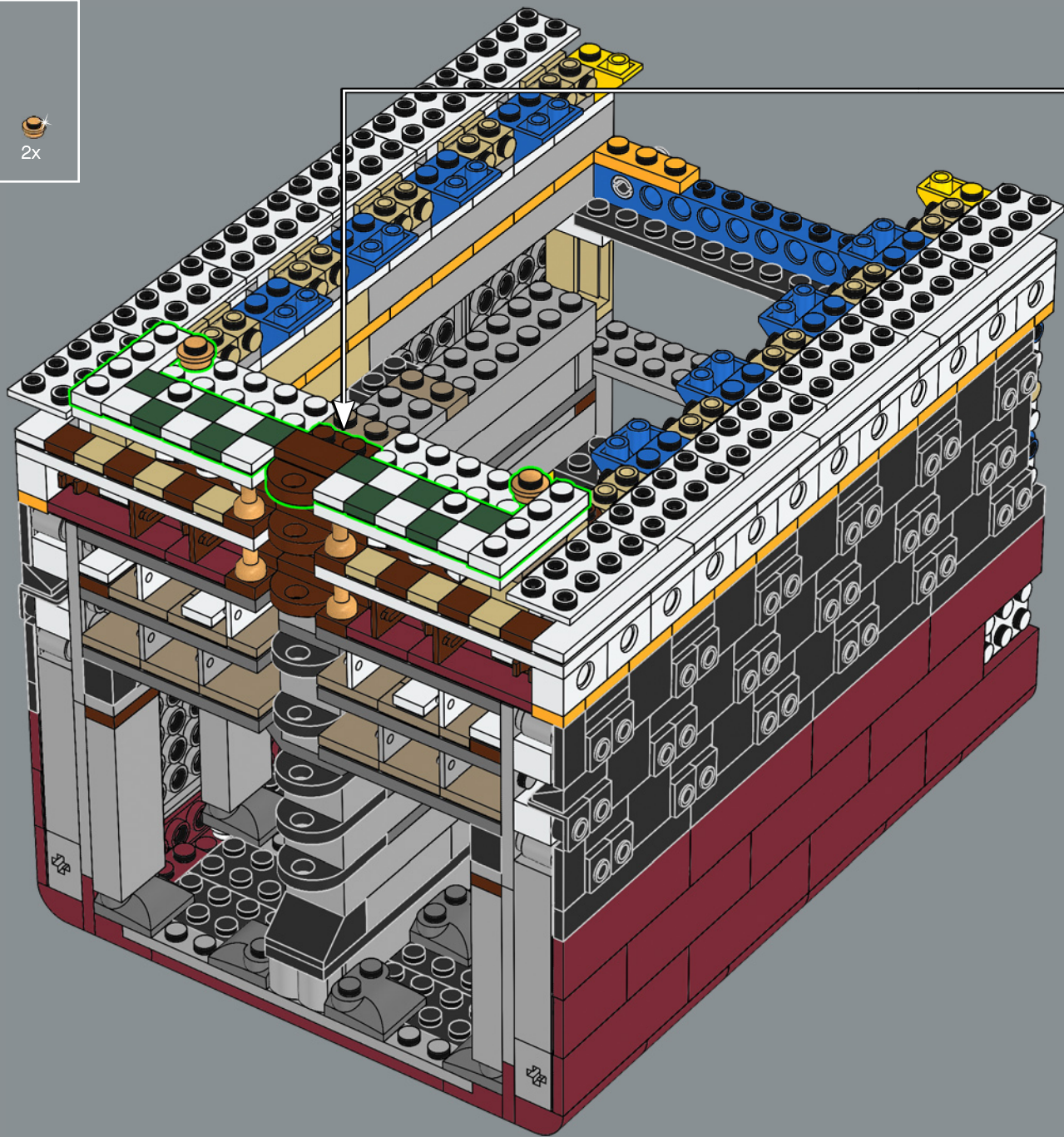

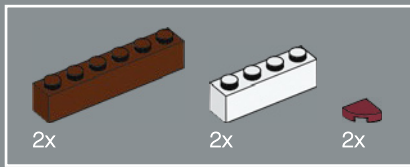

214

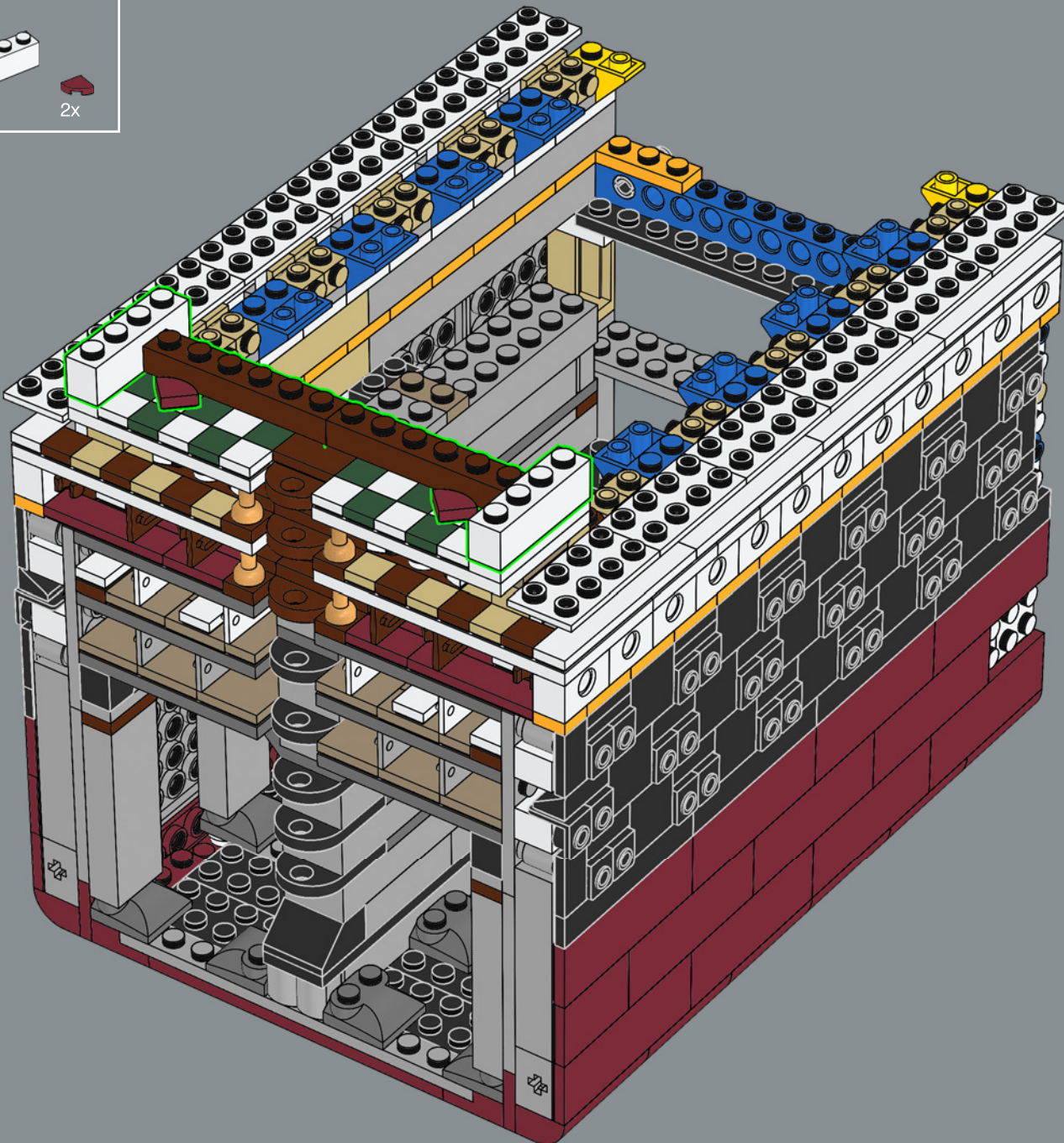

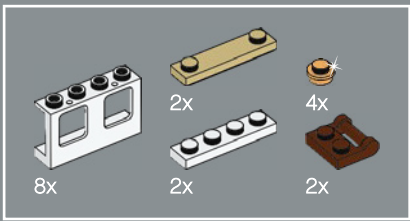

215

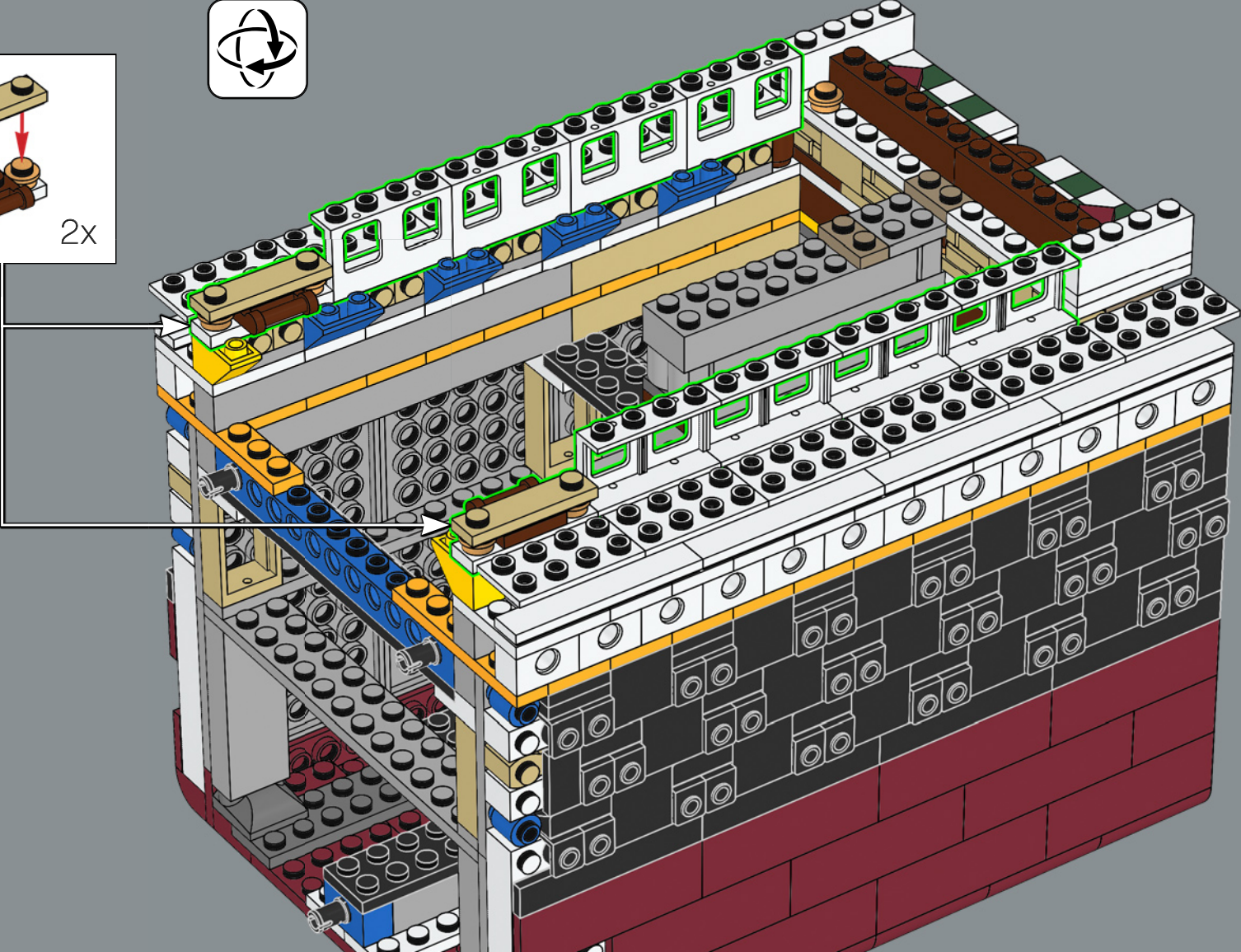
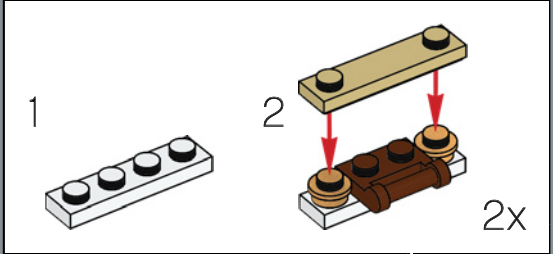

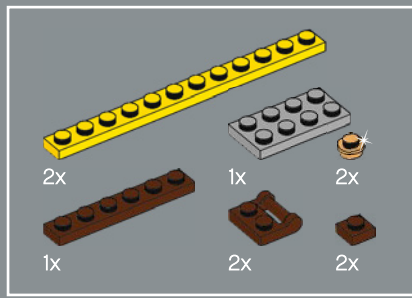

216

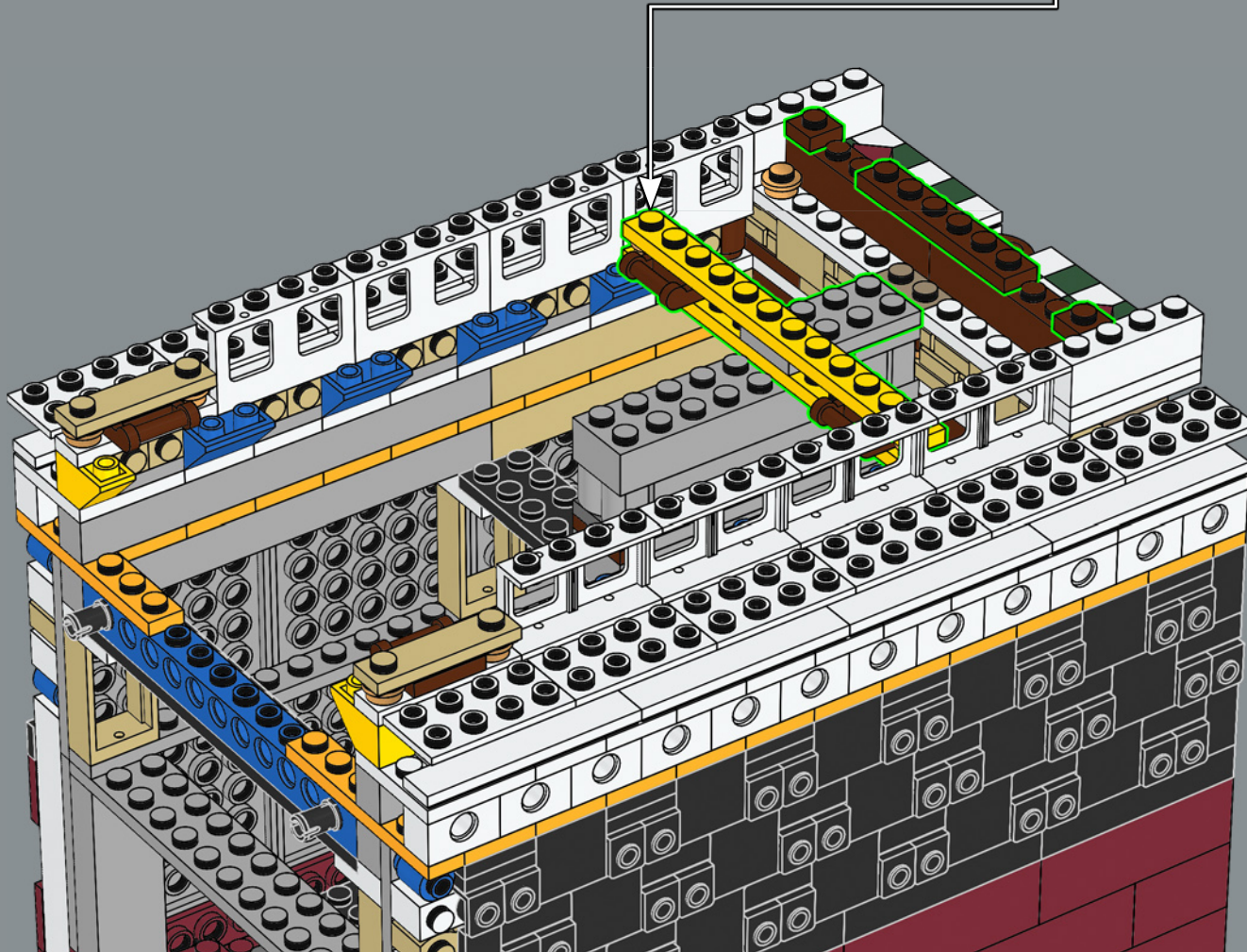
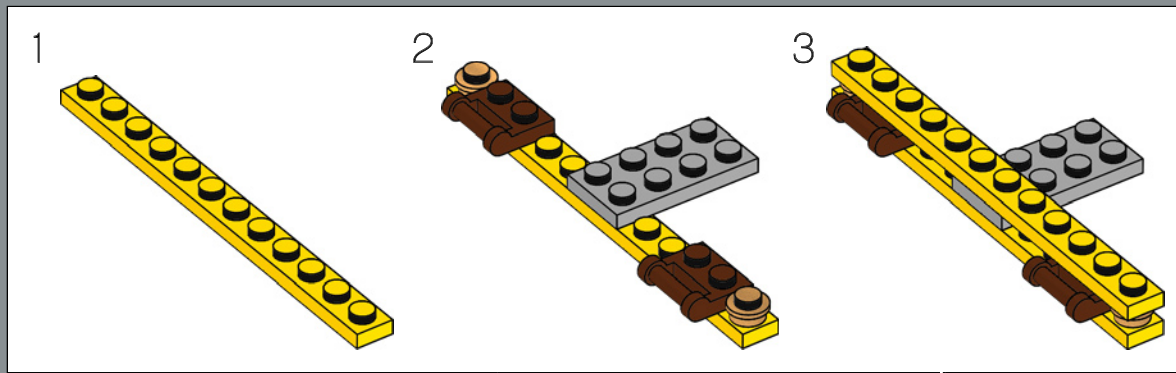

奥林匹克号和泰坦尼克号的建造成本高达300万英镑(约合410万美元),相当于今天的3亿英镑(4.167亿美元)。

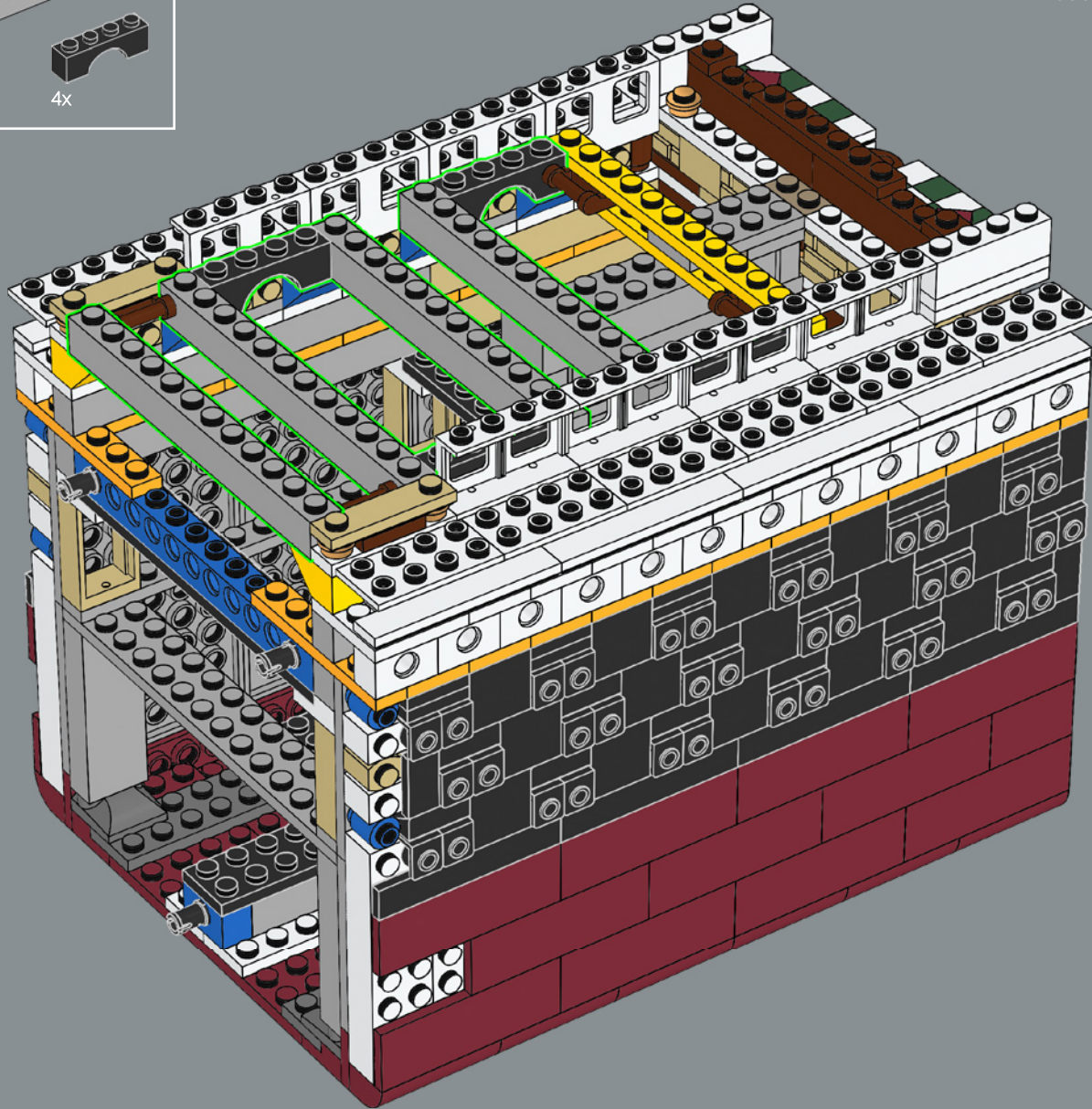

217

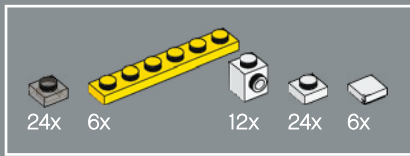

218

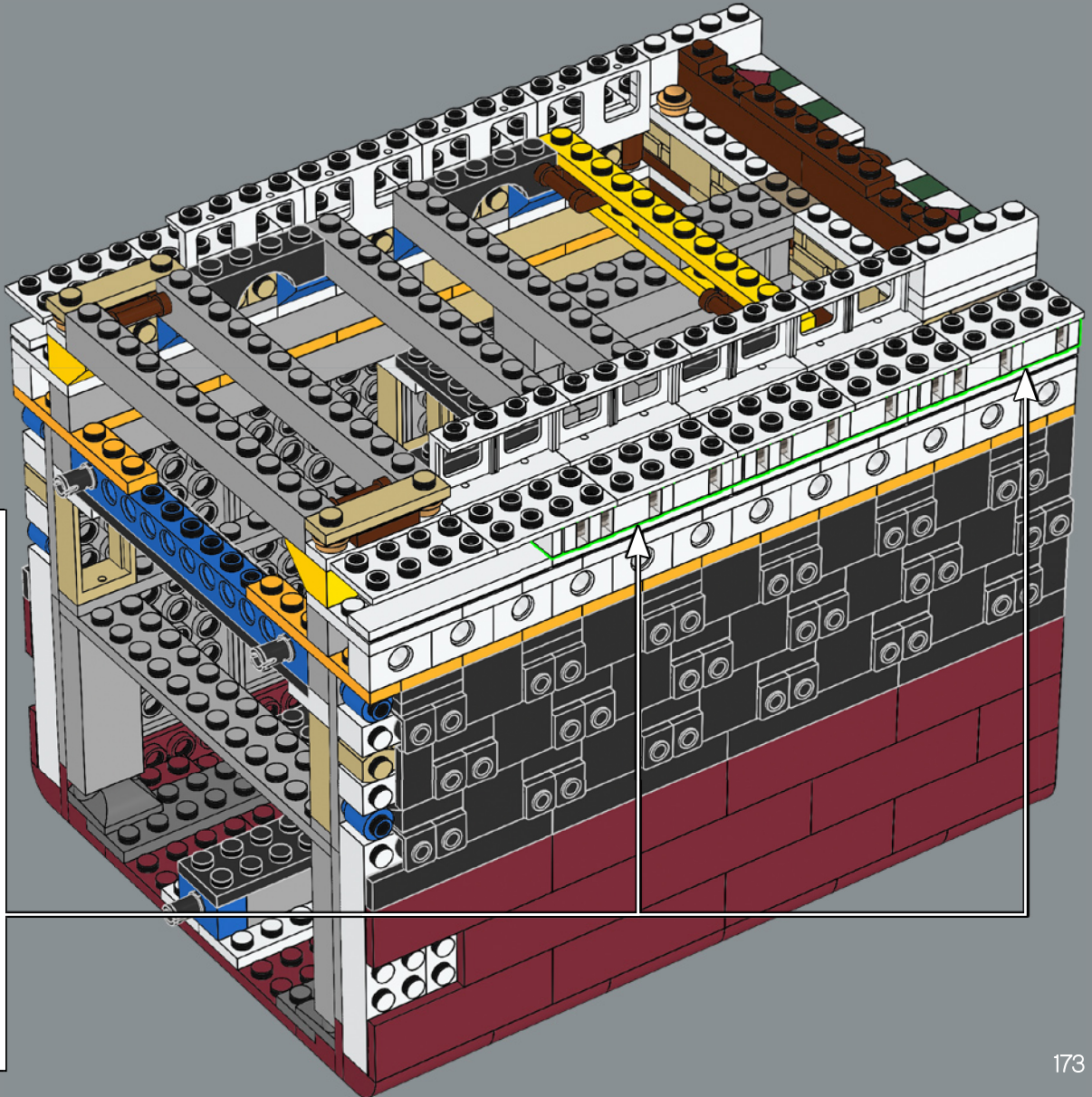
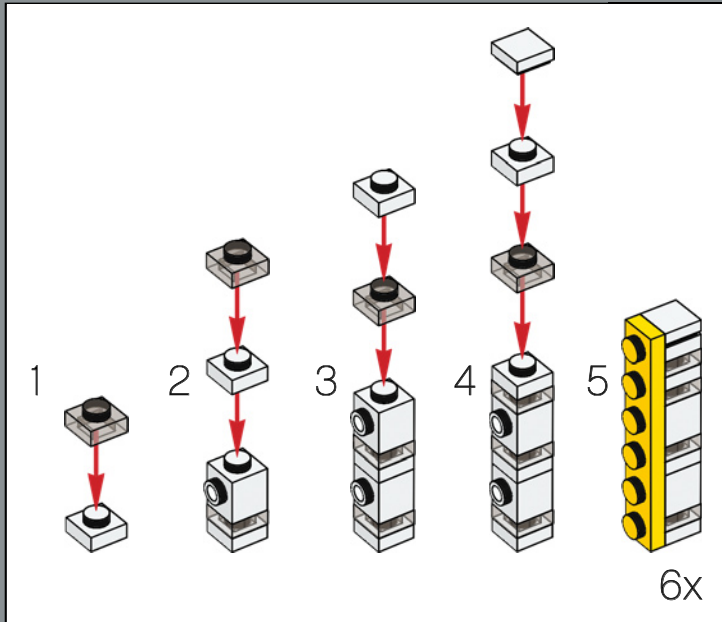

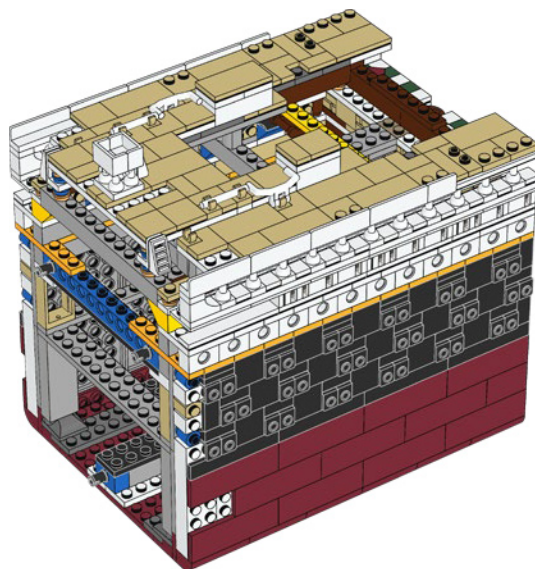
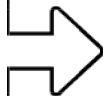

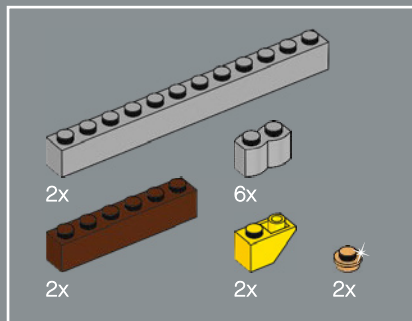

219

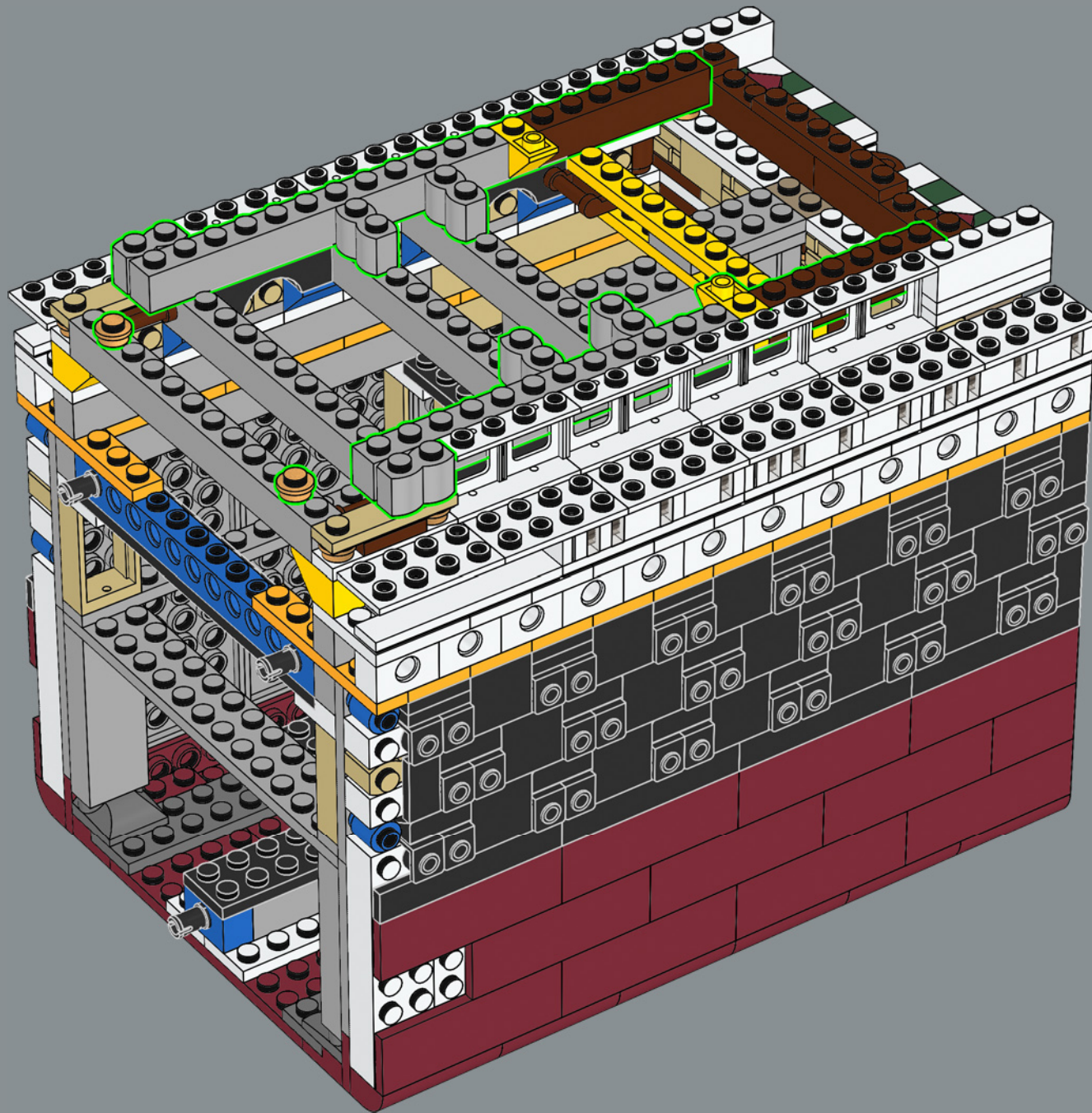

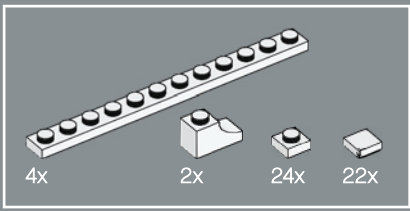

220

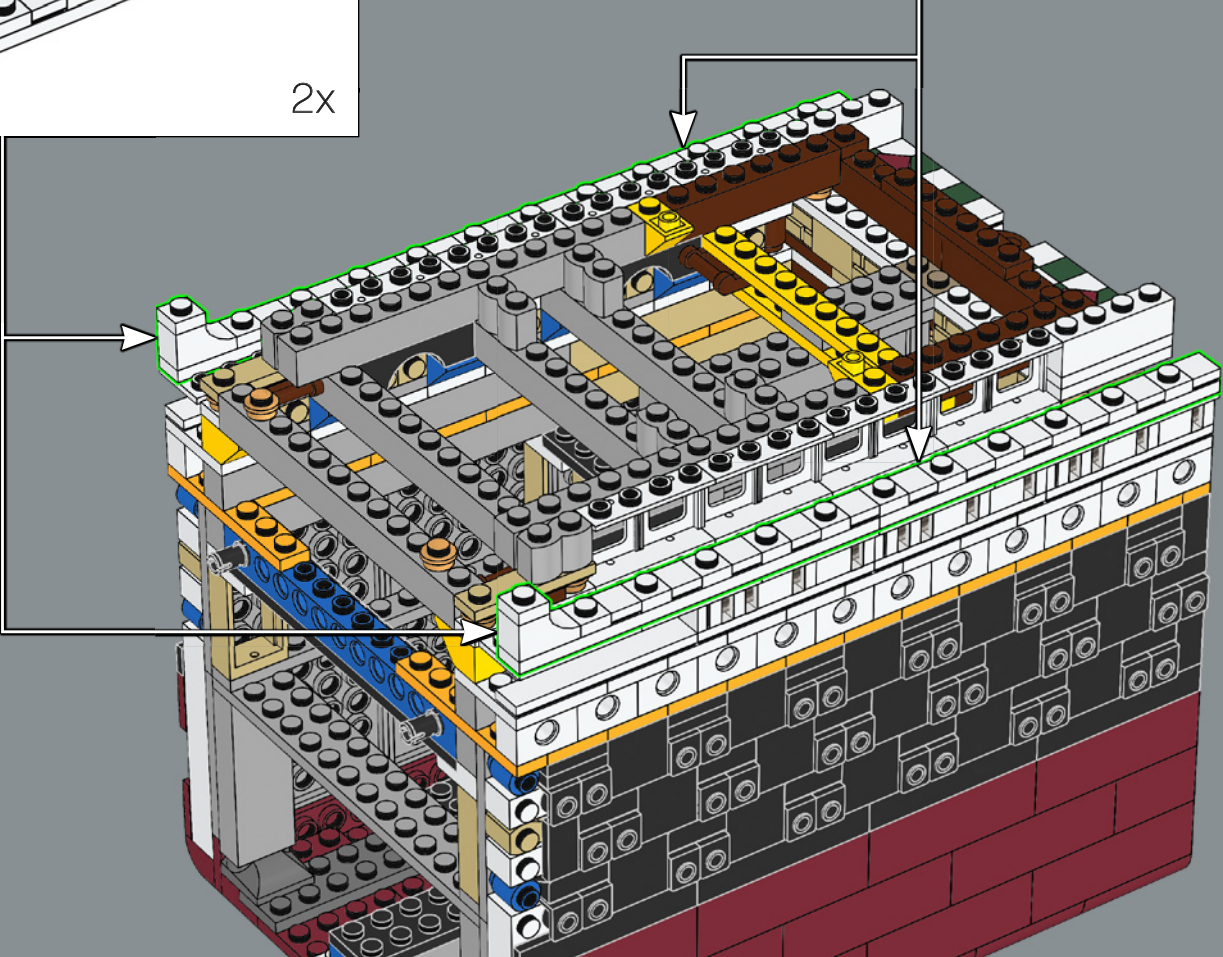
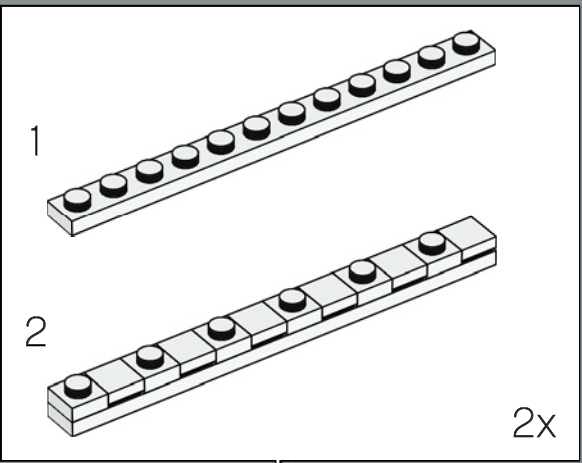
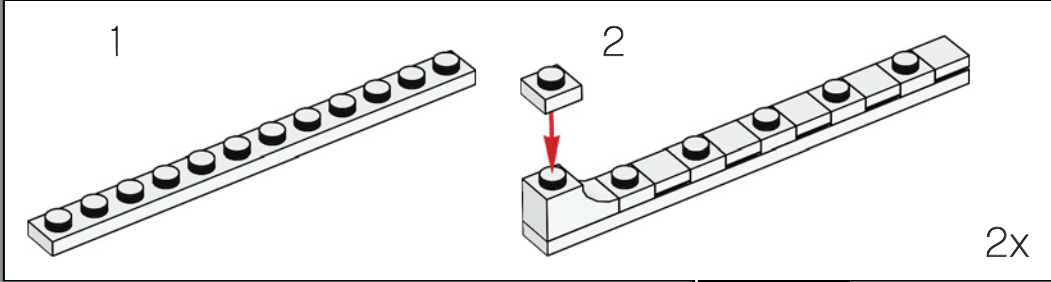

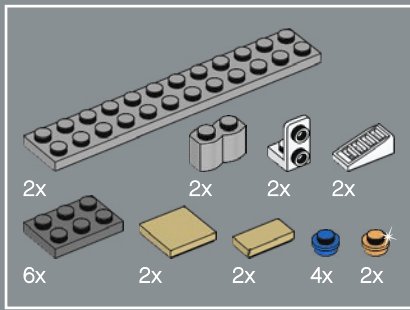

221

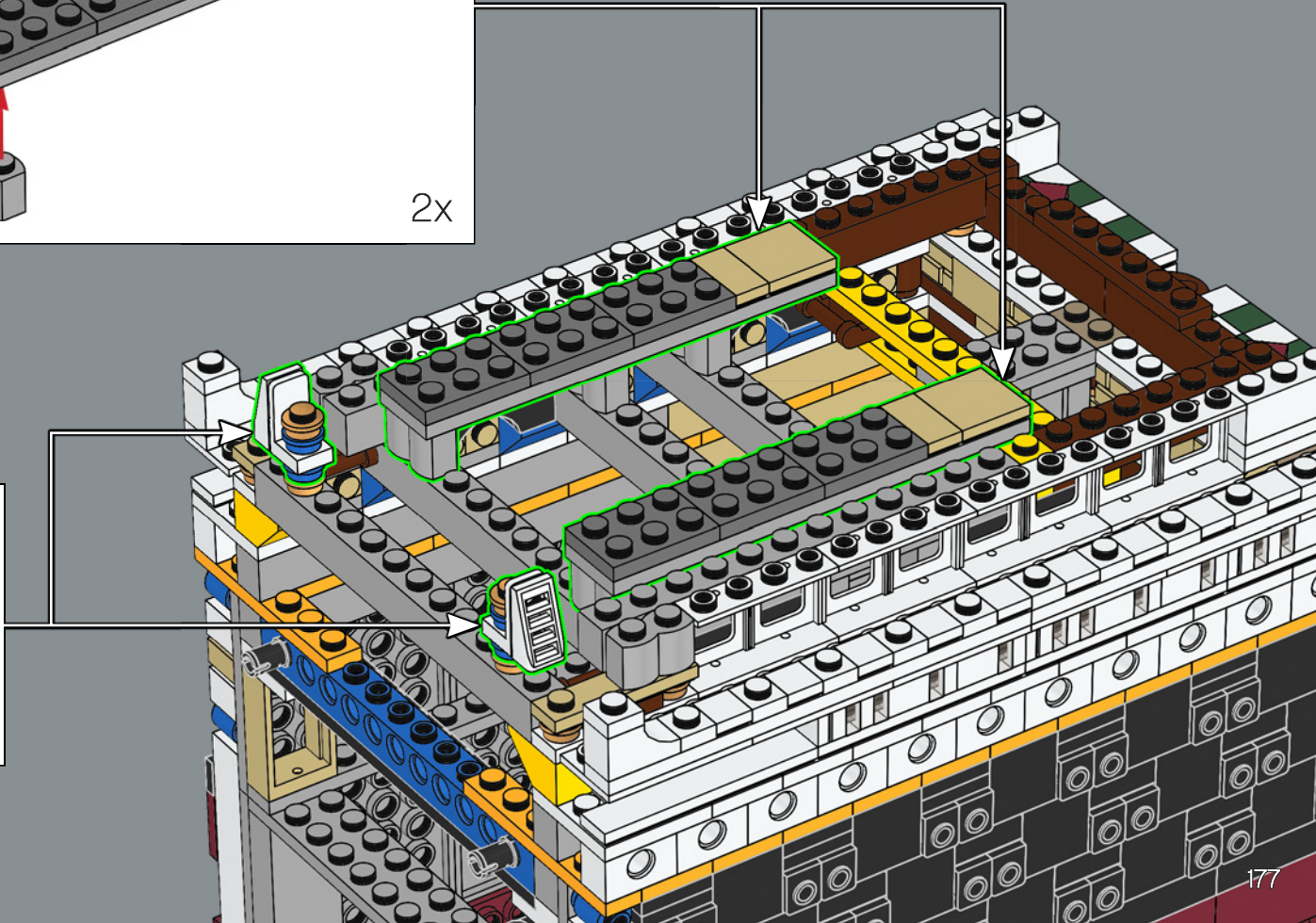
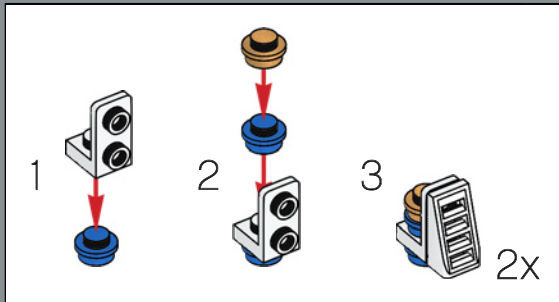
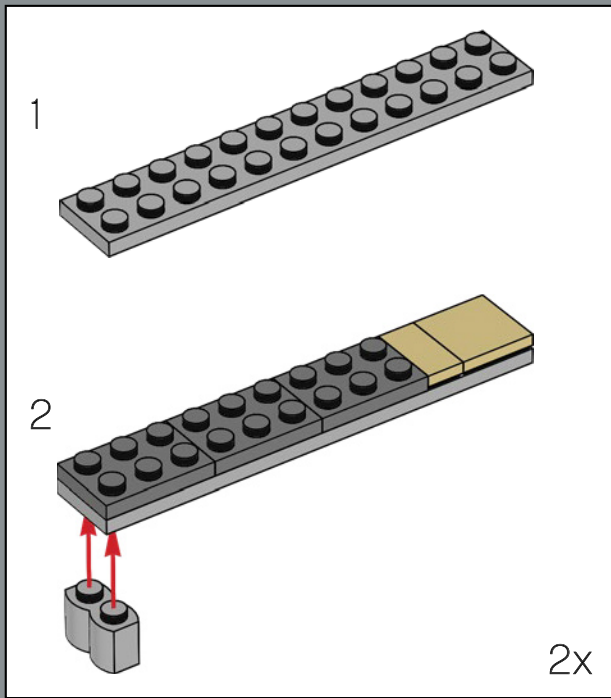

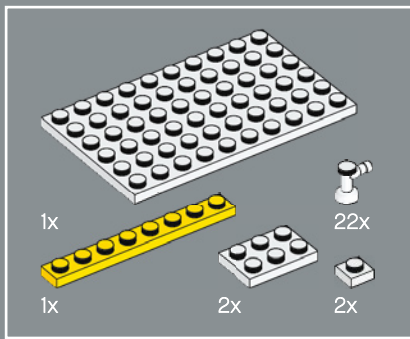

222

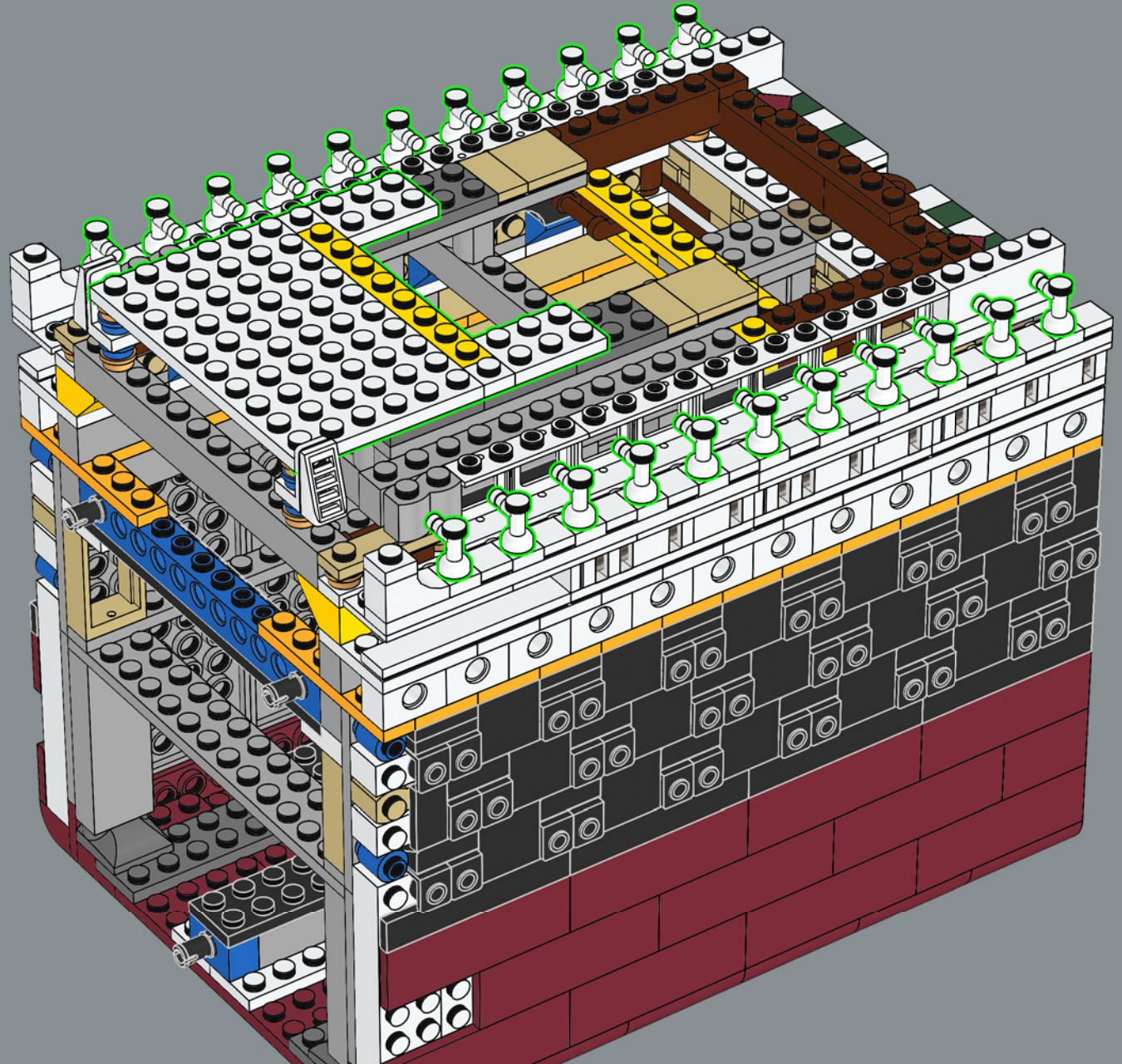

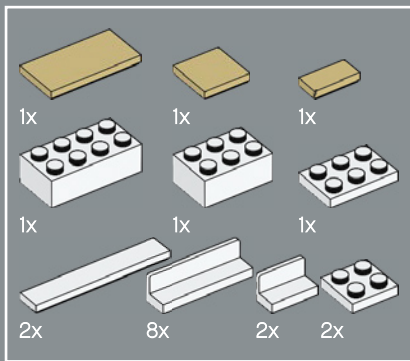

223

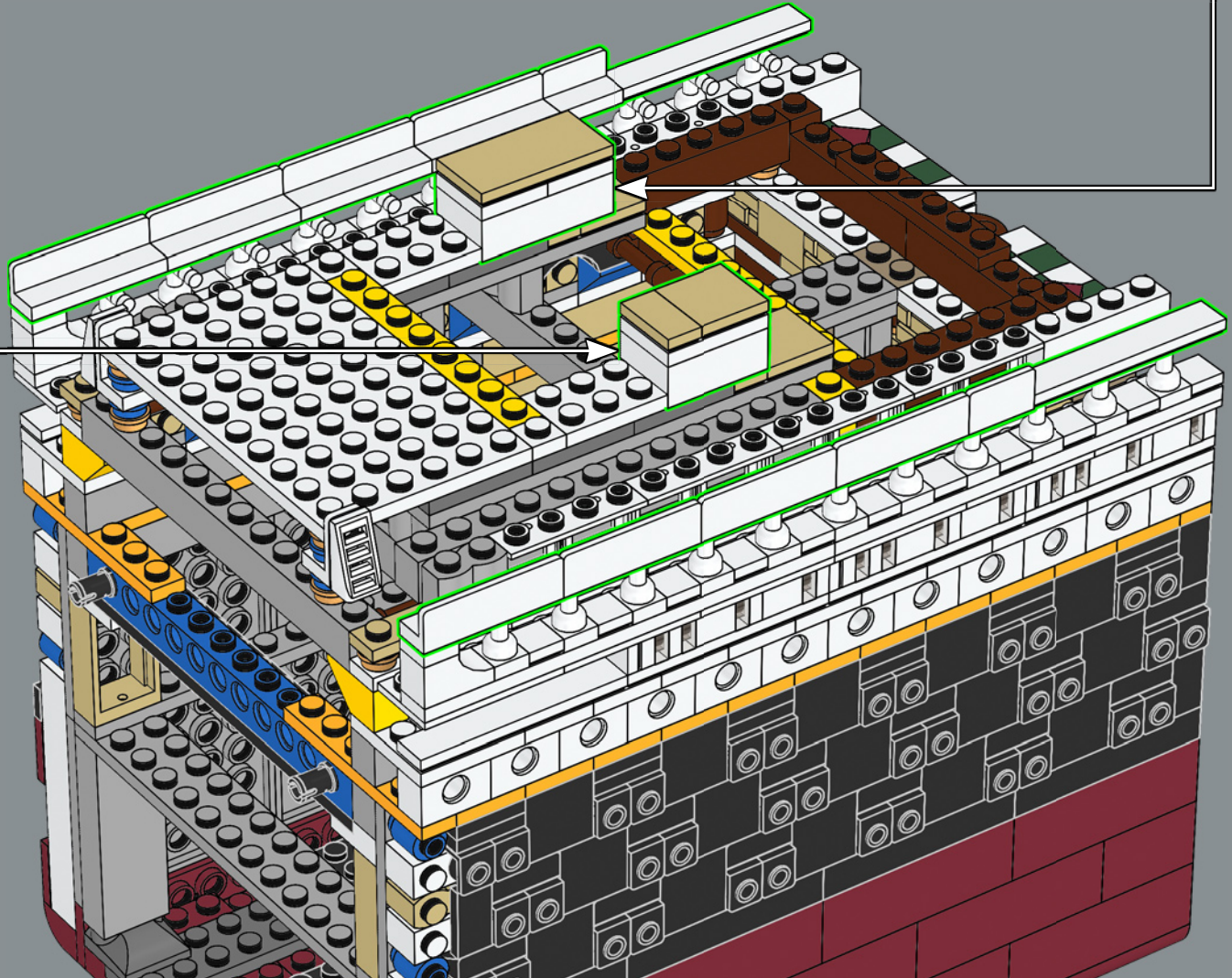
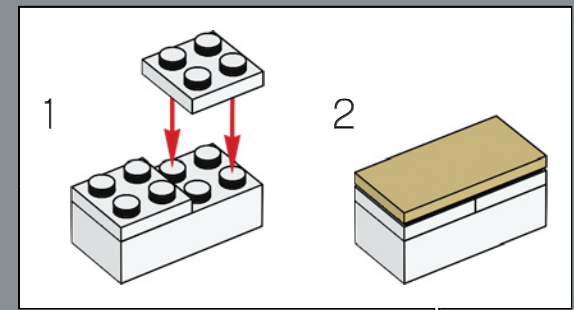
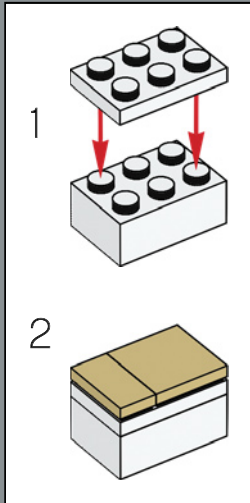

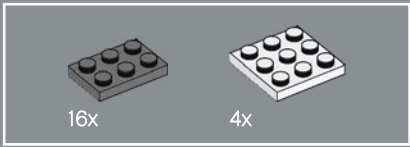

224

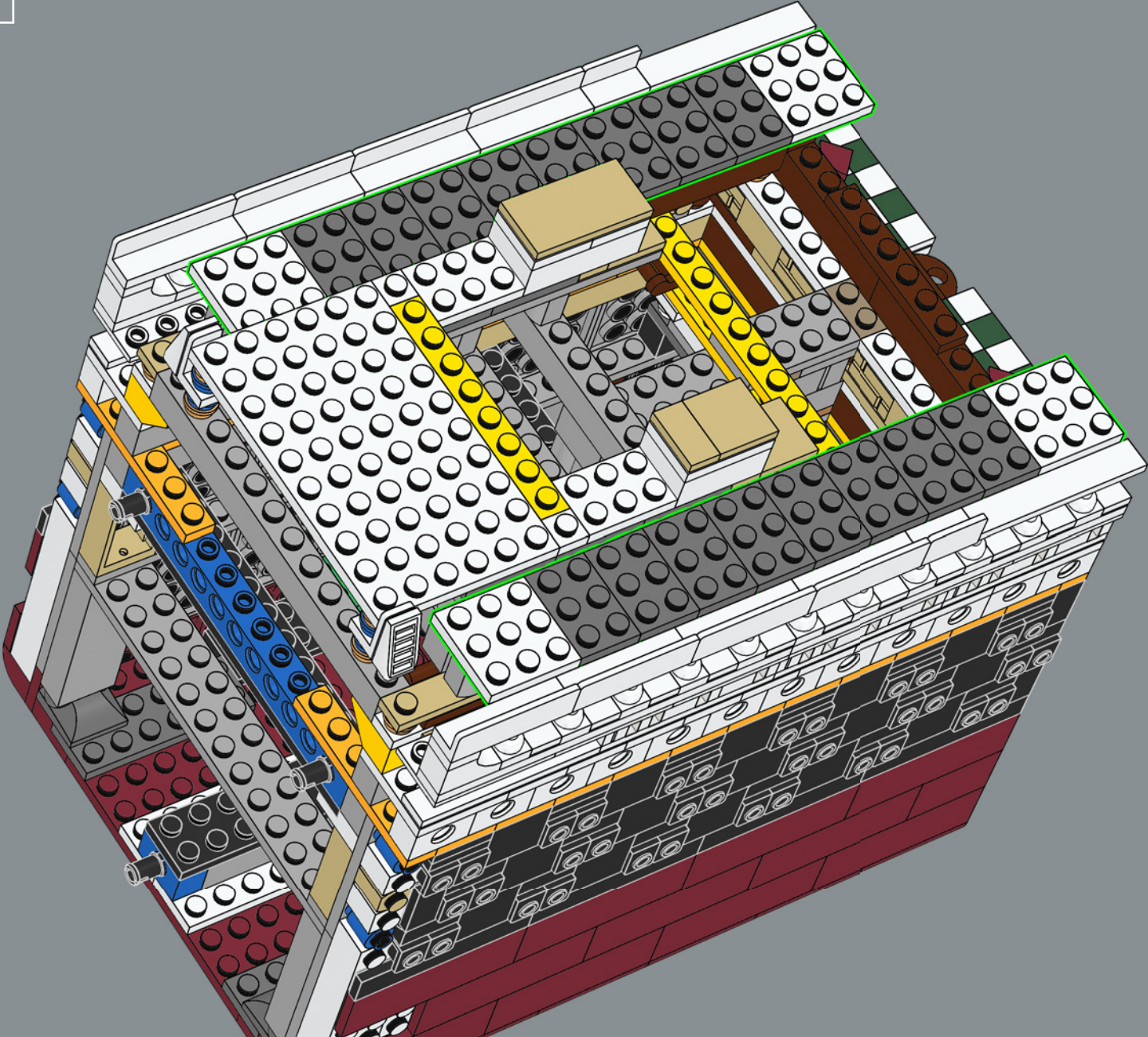

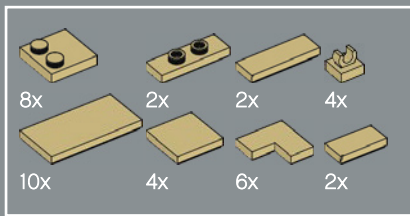

225

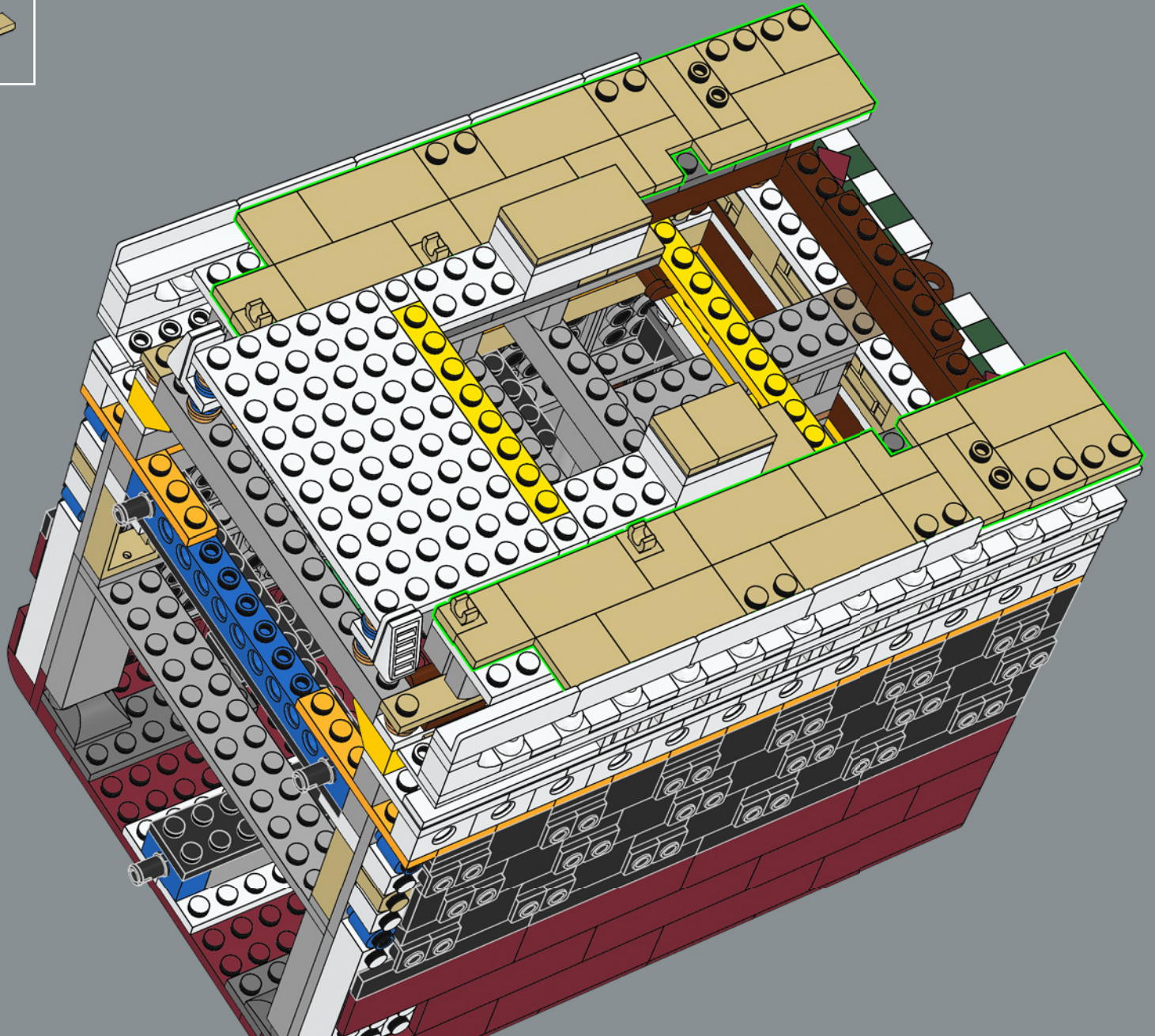

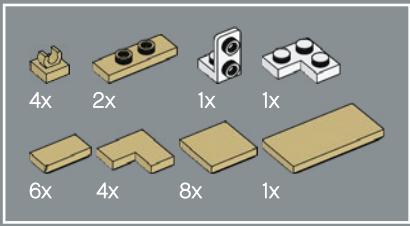

226

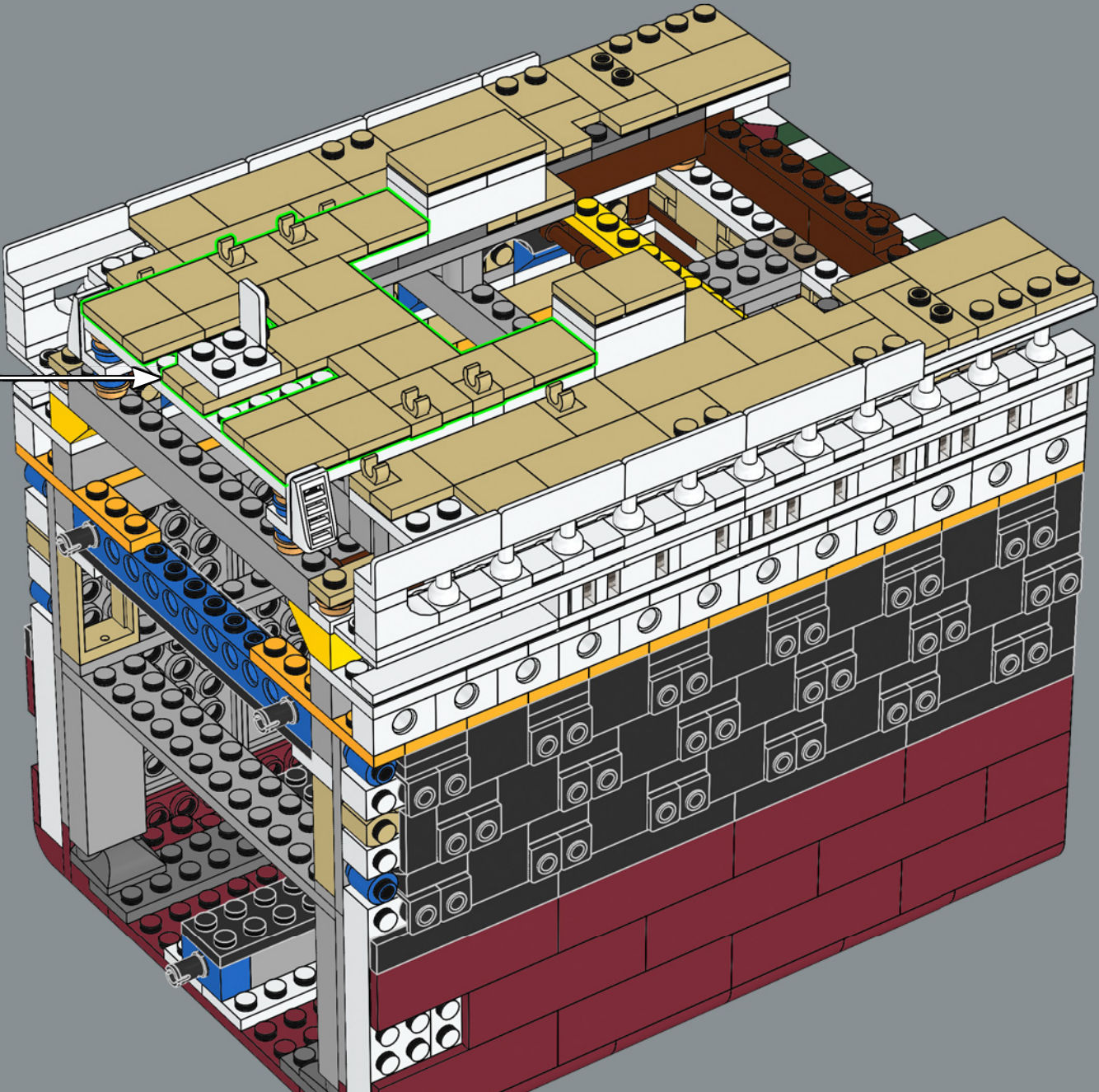
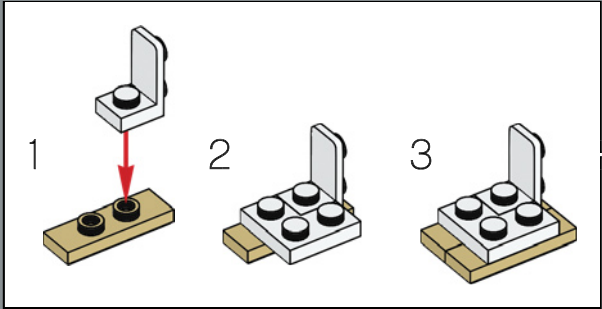



227

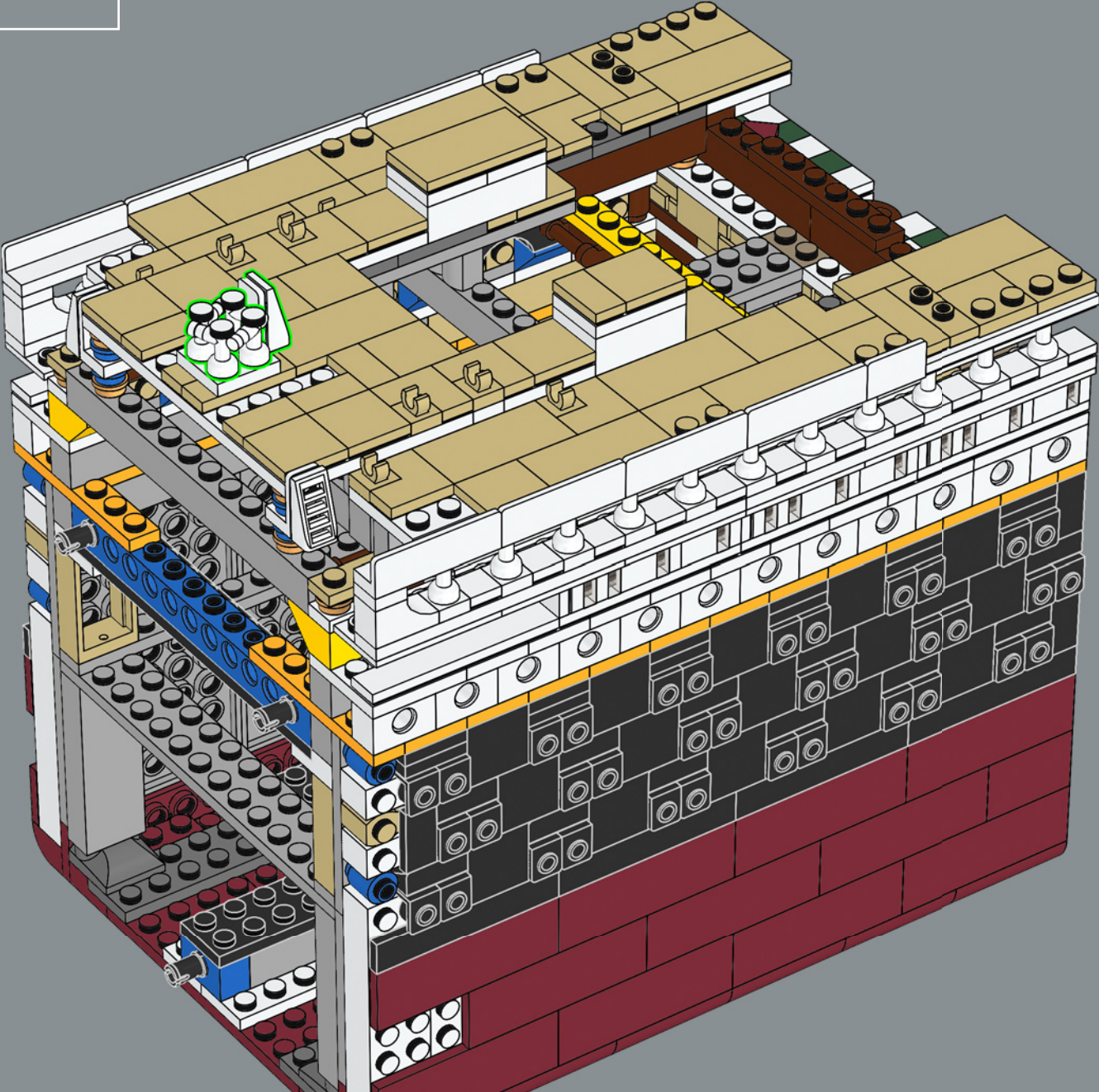

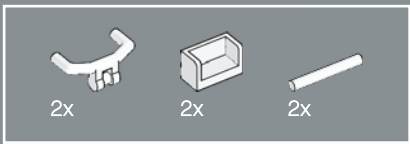

228

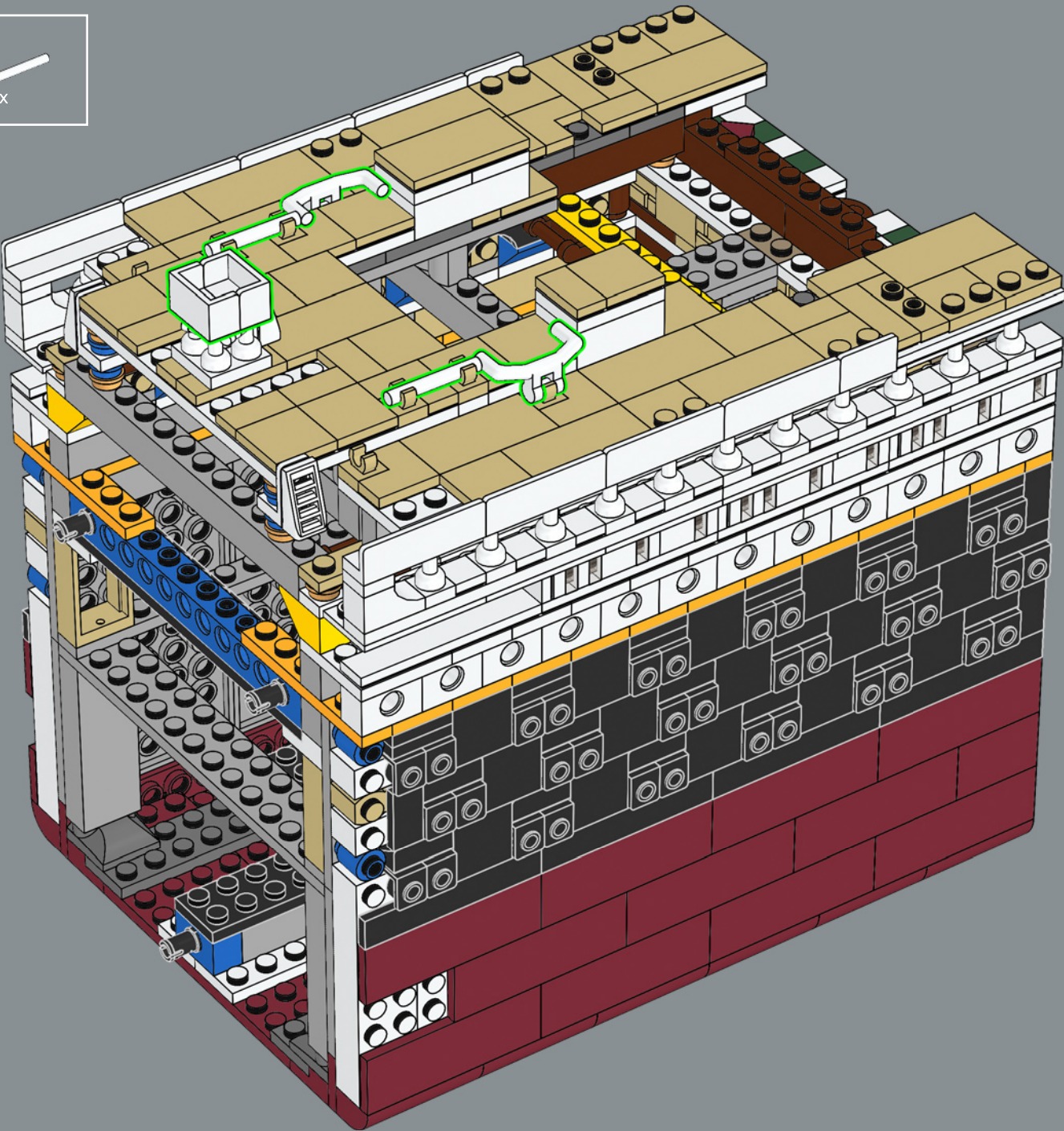

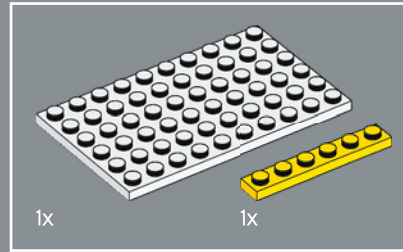
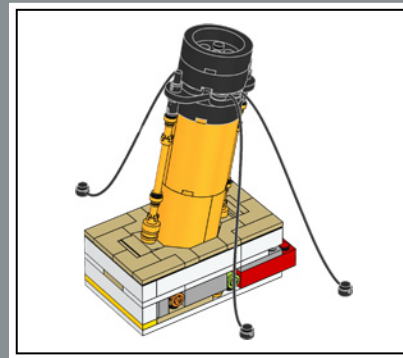
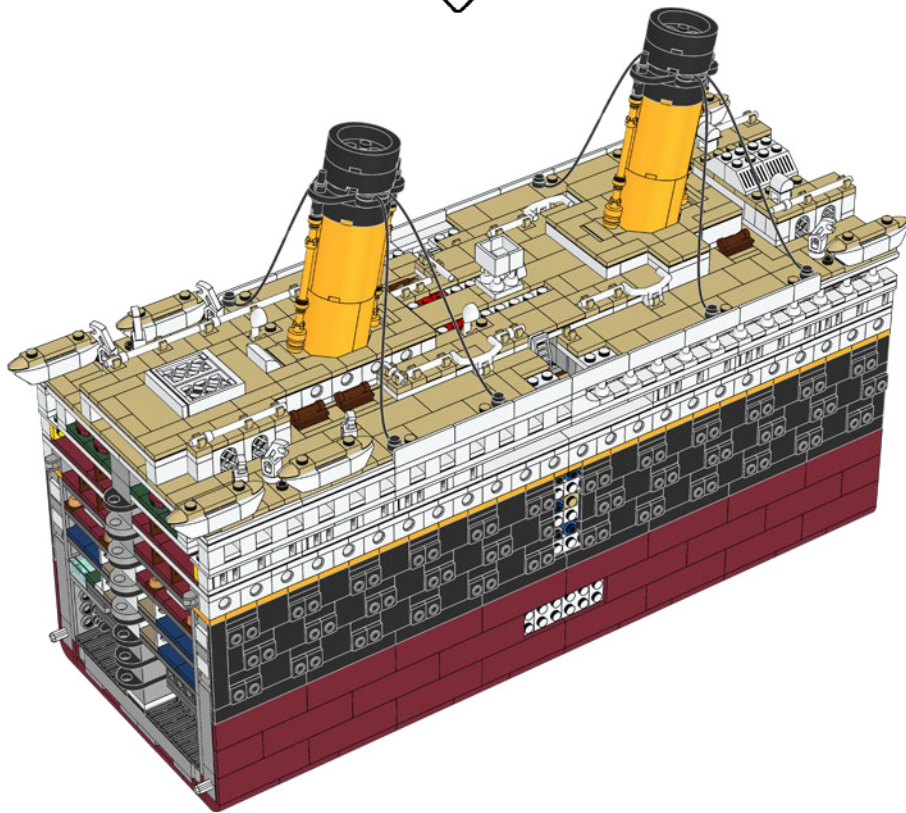
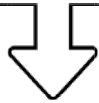

229

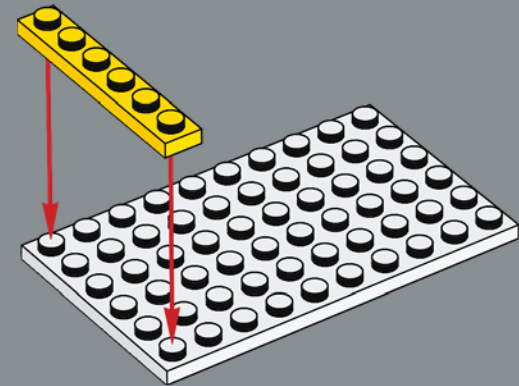

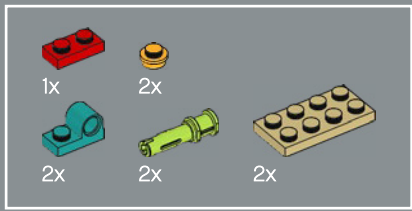

230

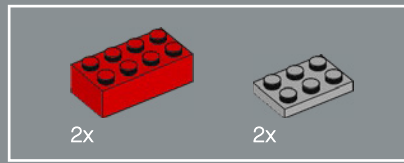
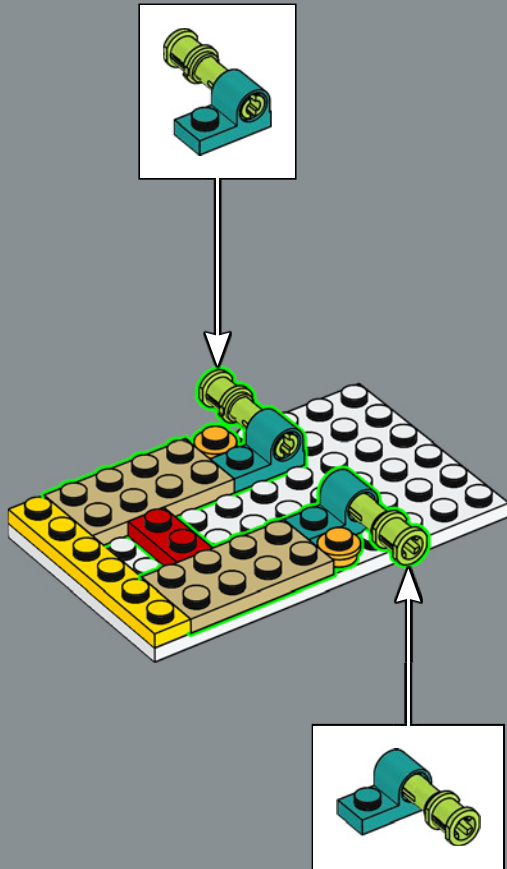

231

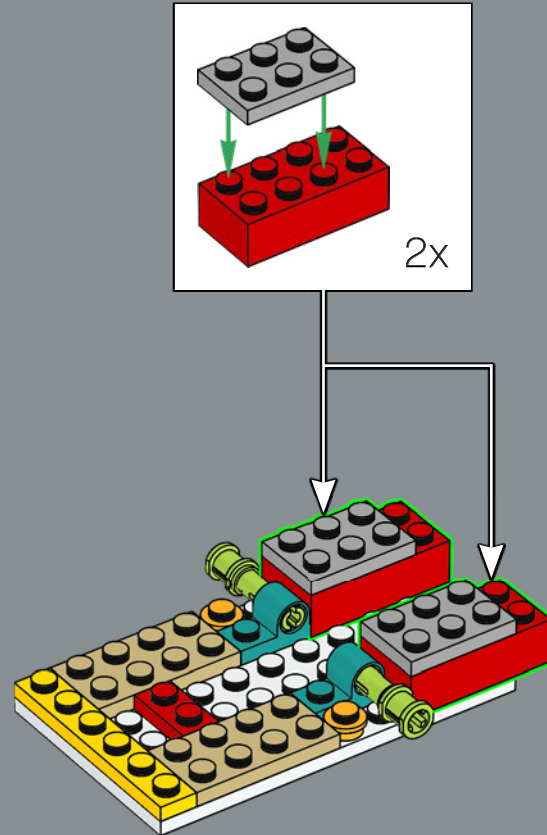

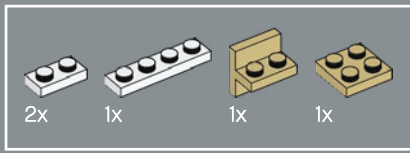

232

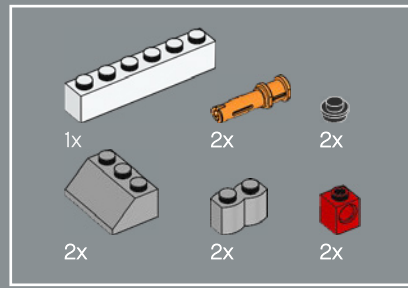
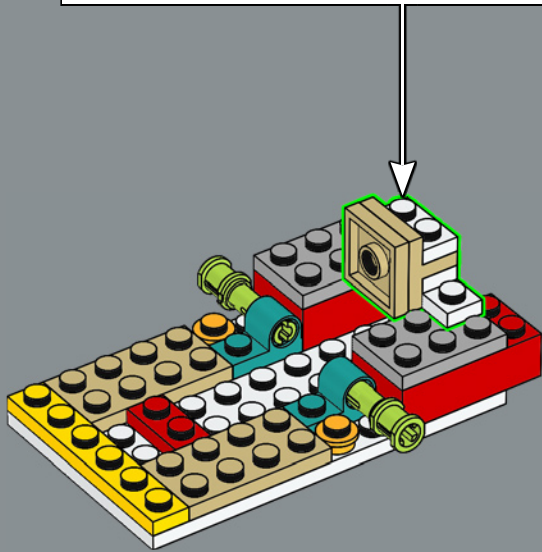
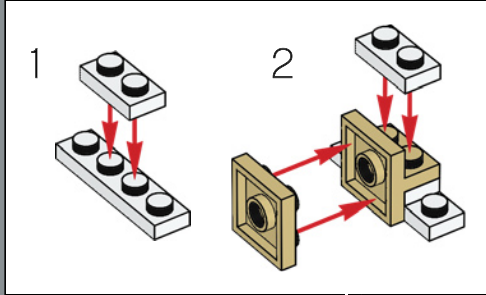

233

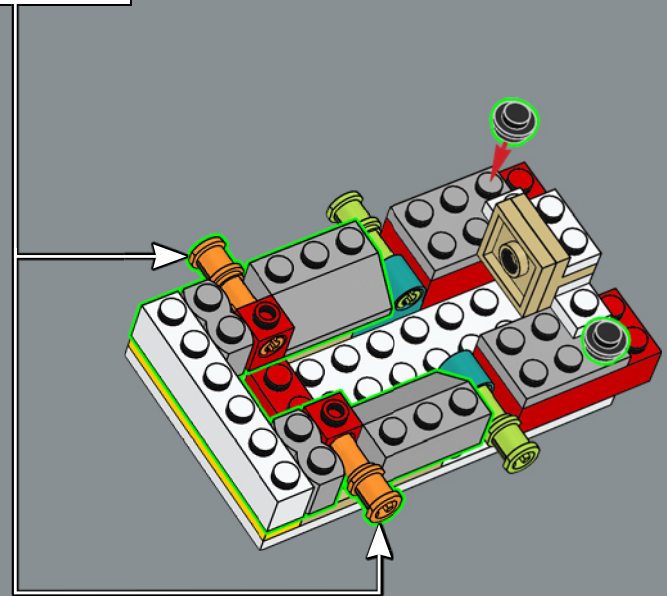
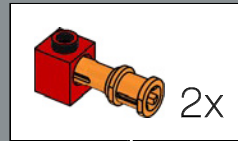

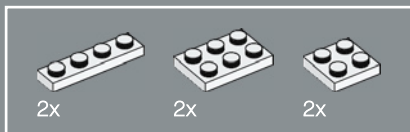

234

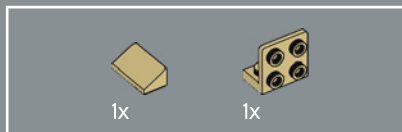
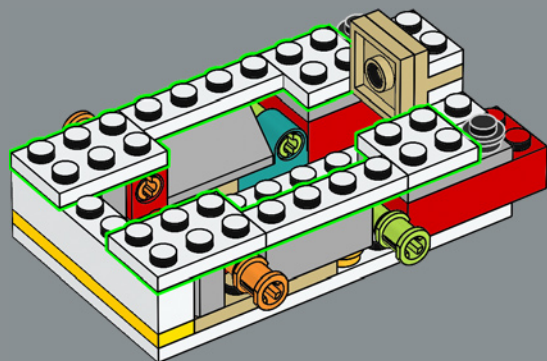

235

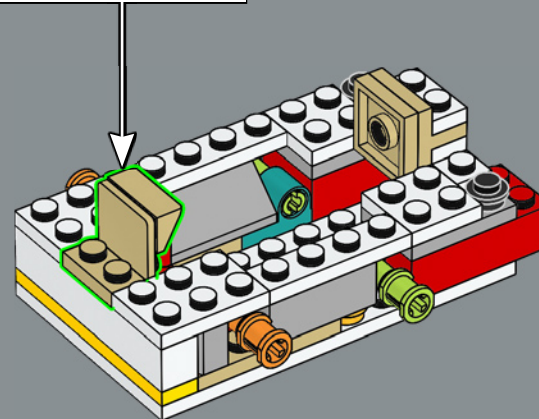
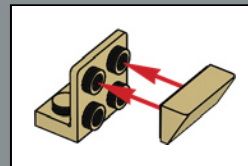

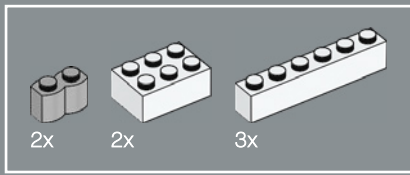

236

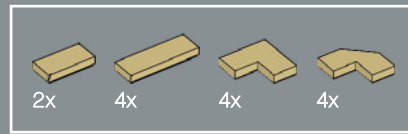
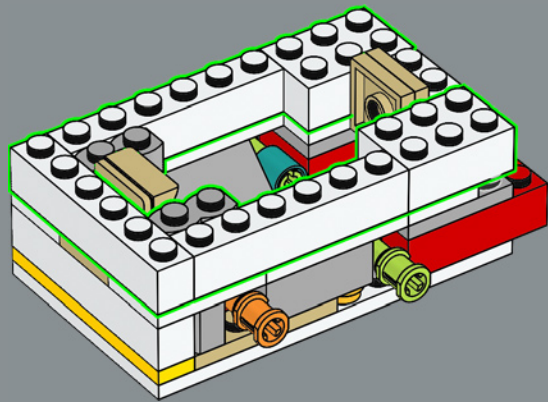

237

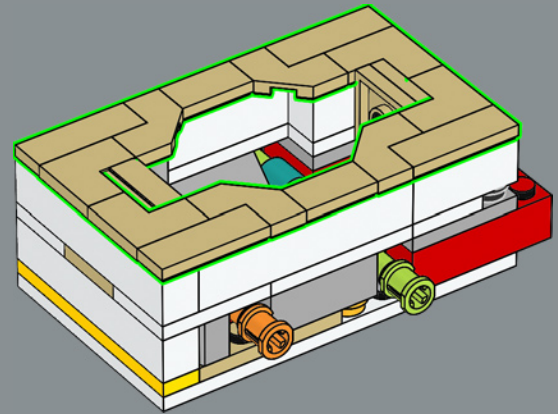

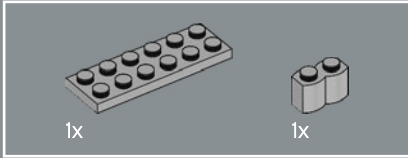
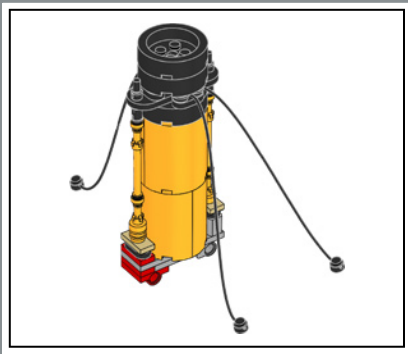

238

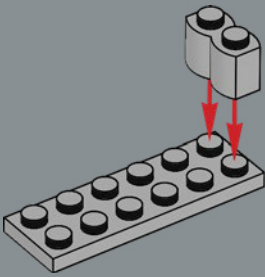

239

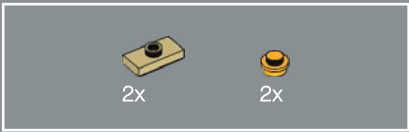
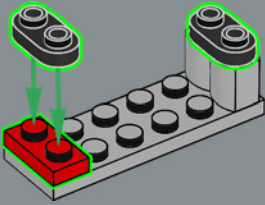

240

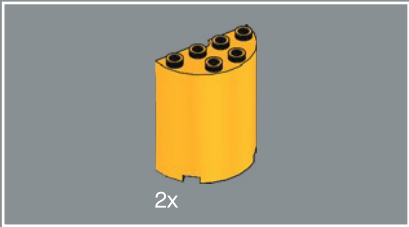
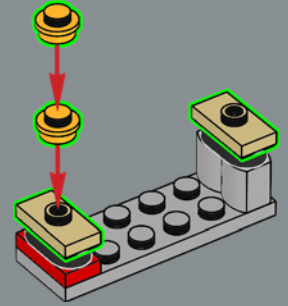

241

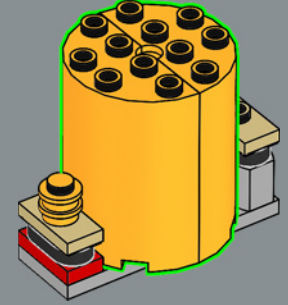

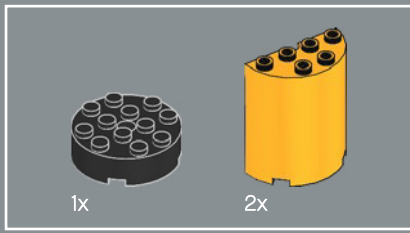

242

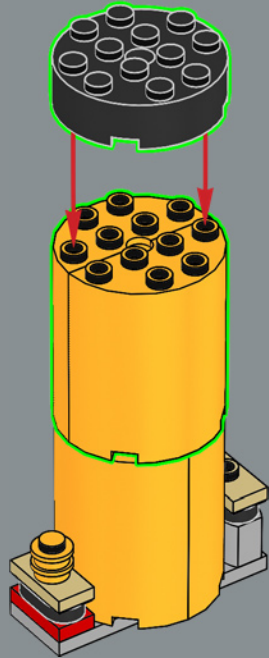

243

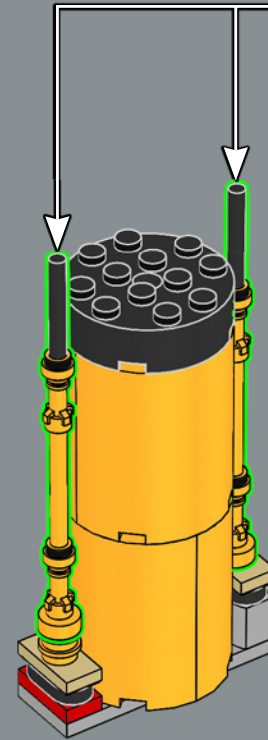
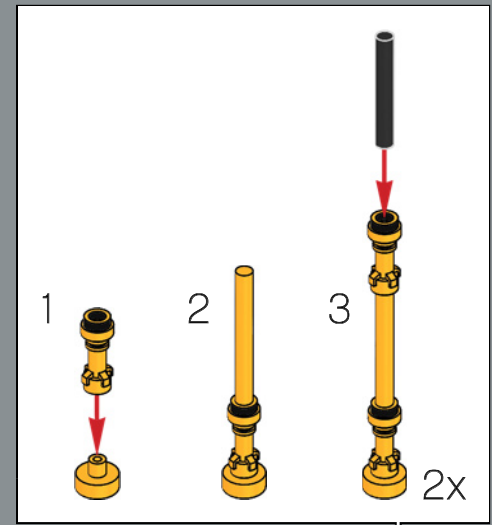

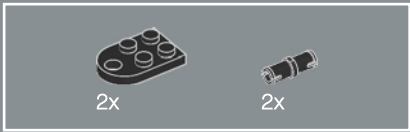

244

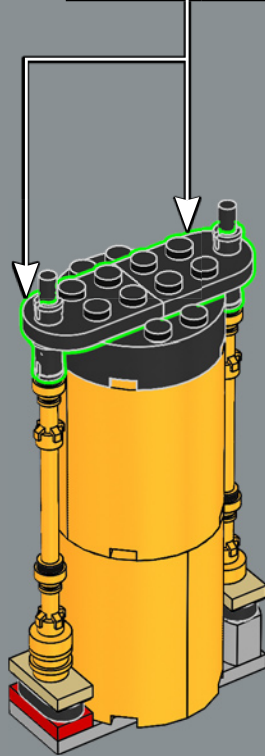
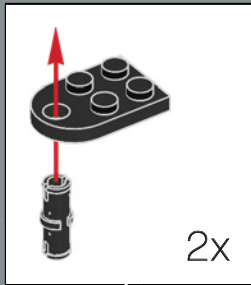

245

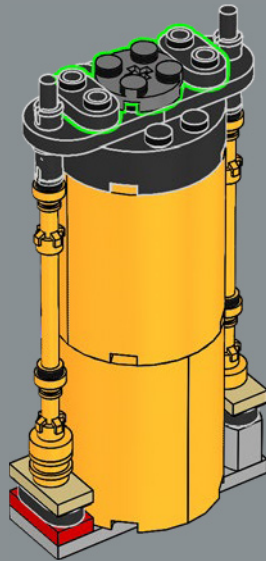



246

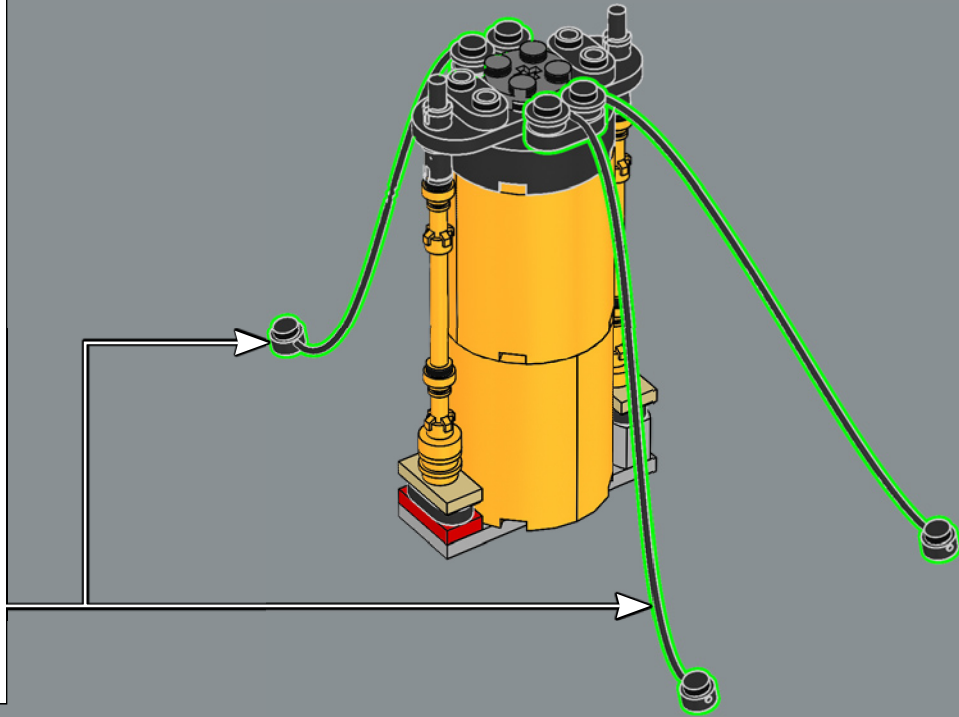
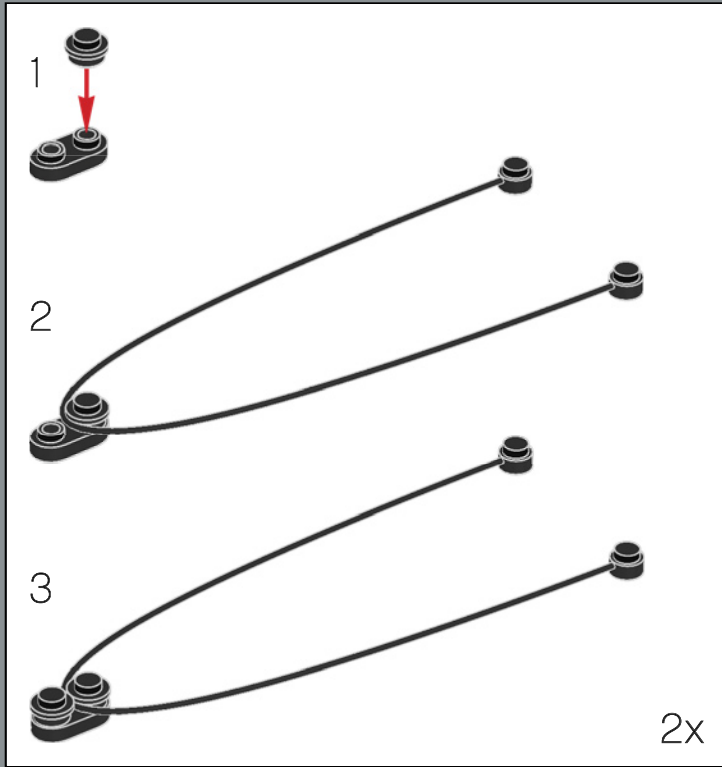

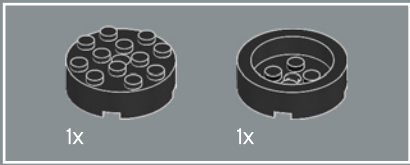

247

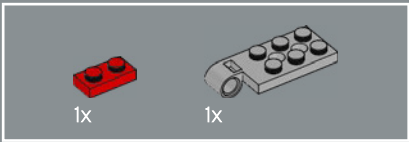
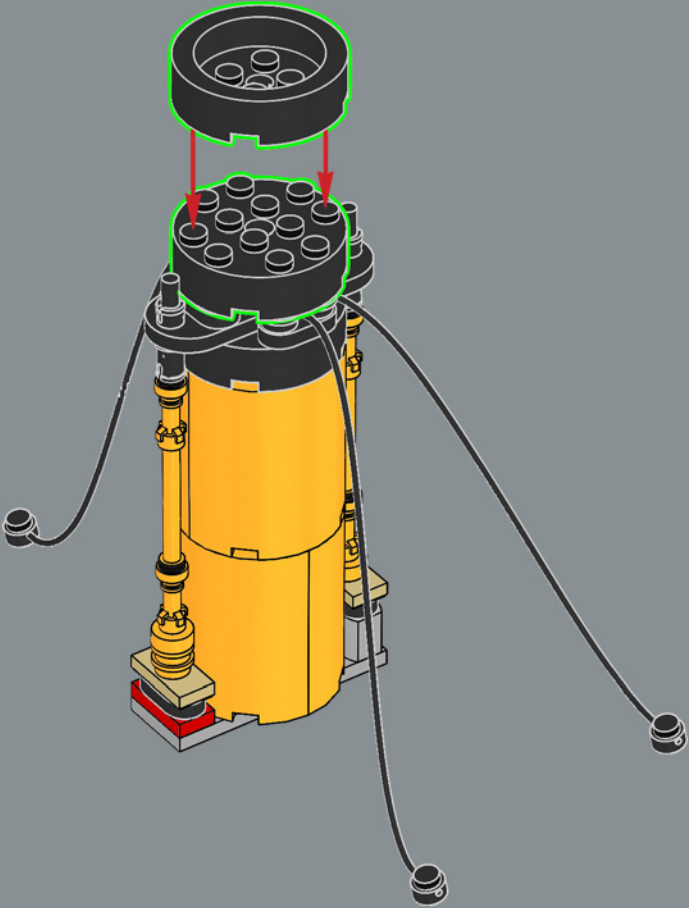

248

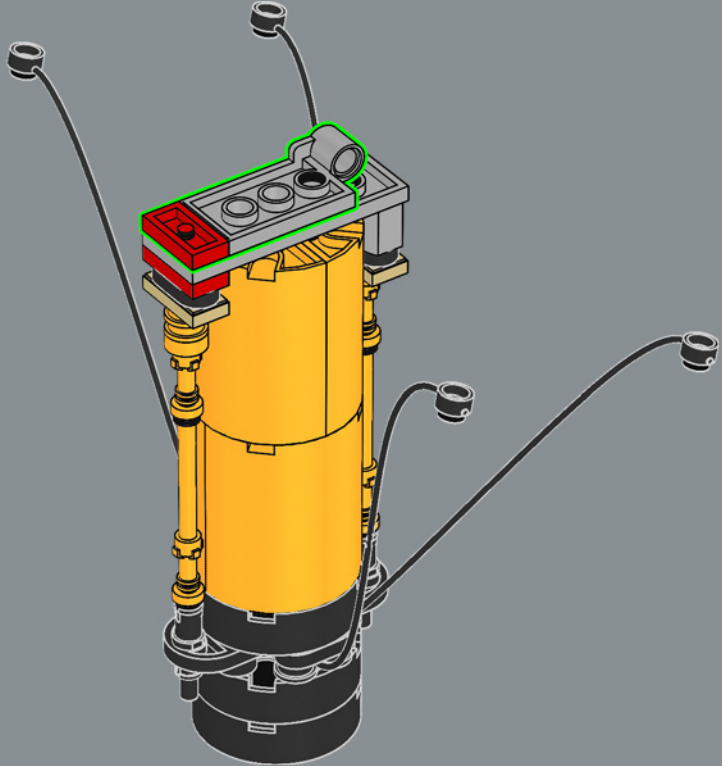

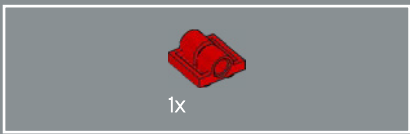

249

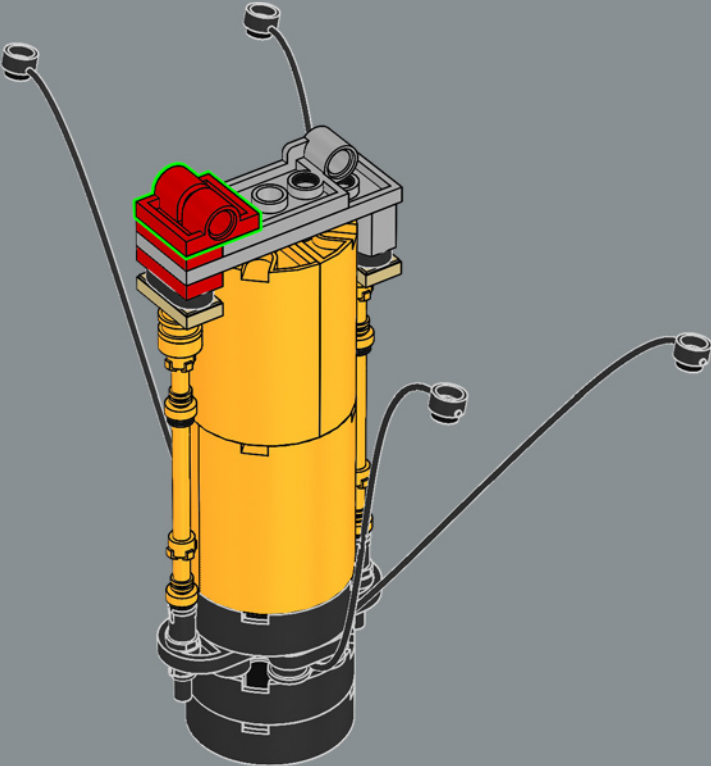

250

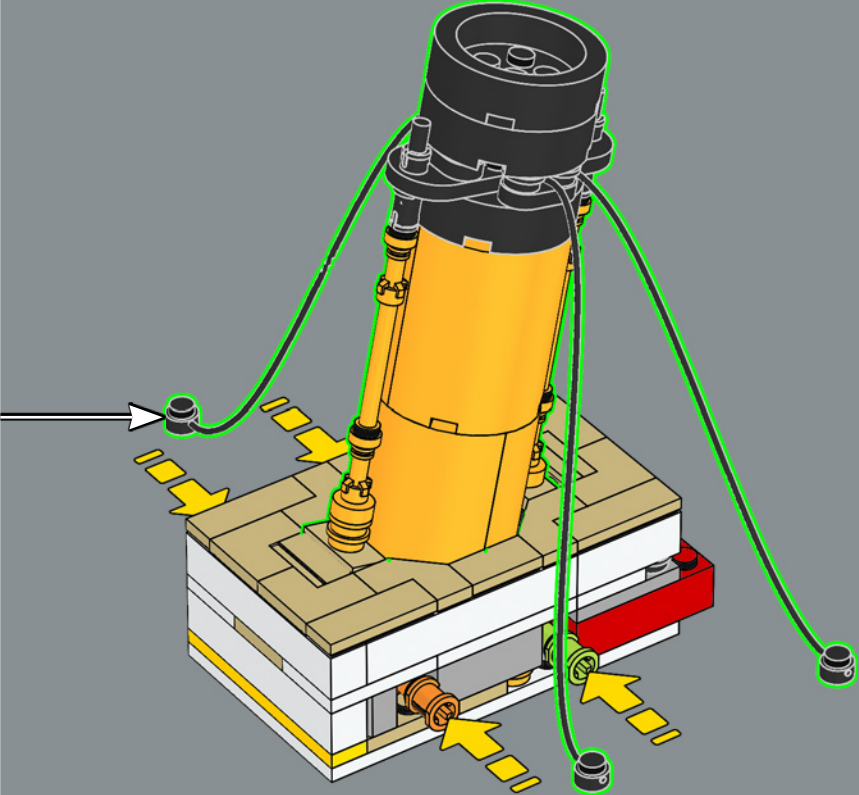

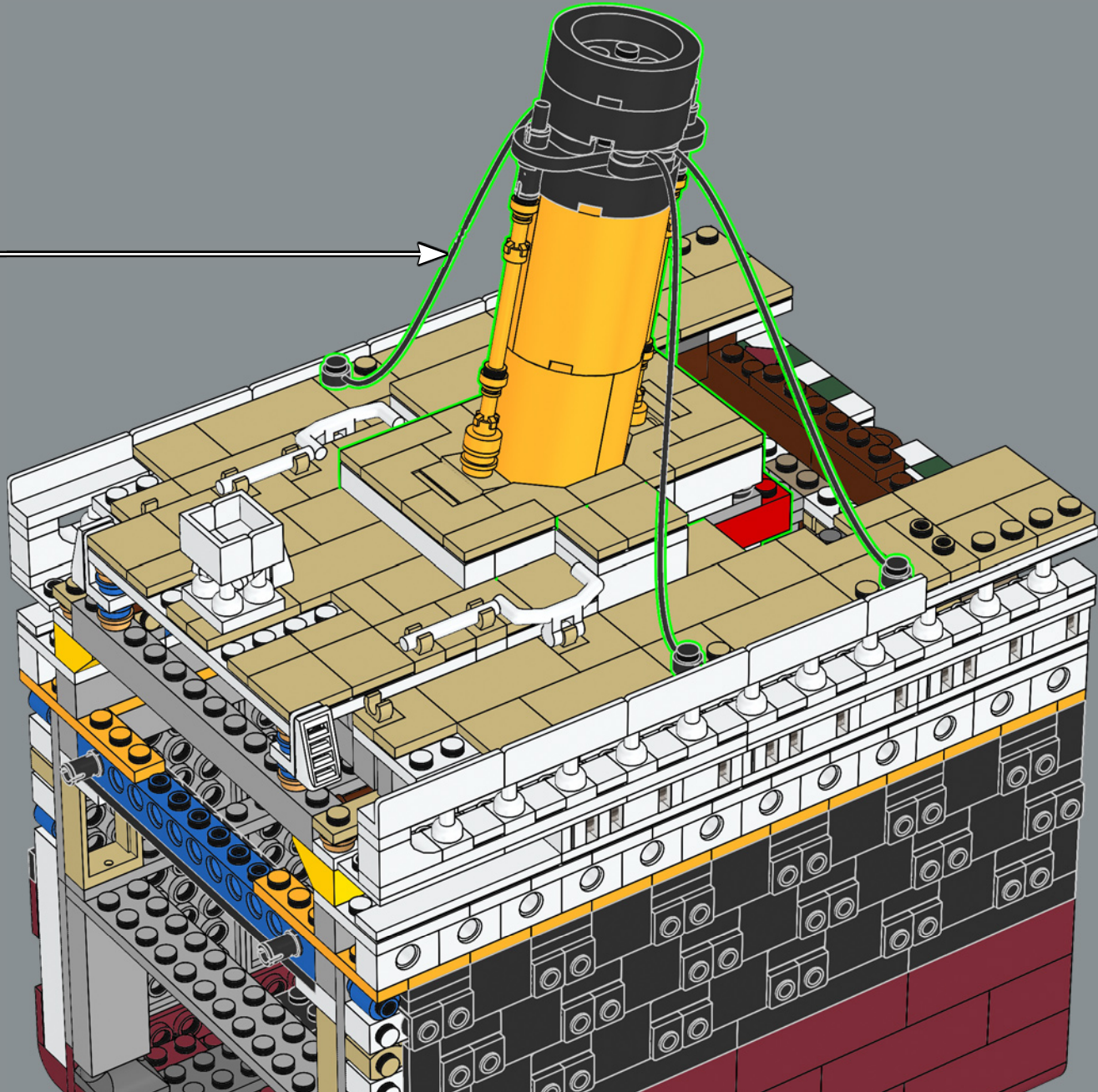

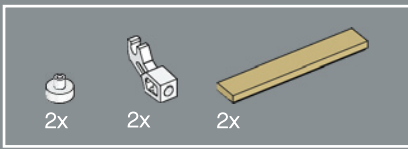

252

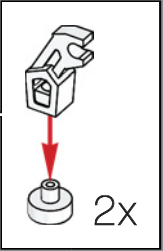
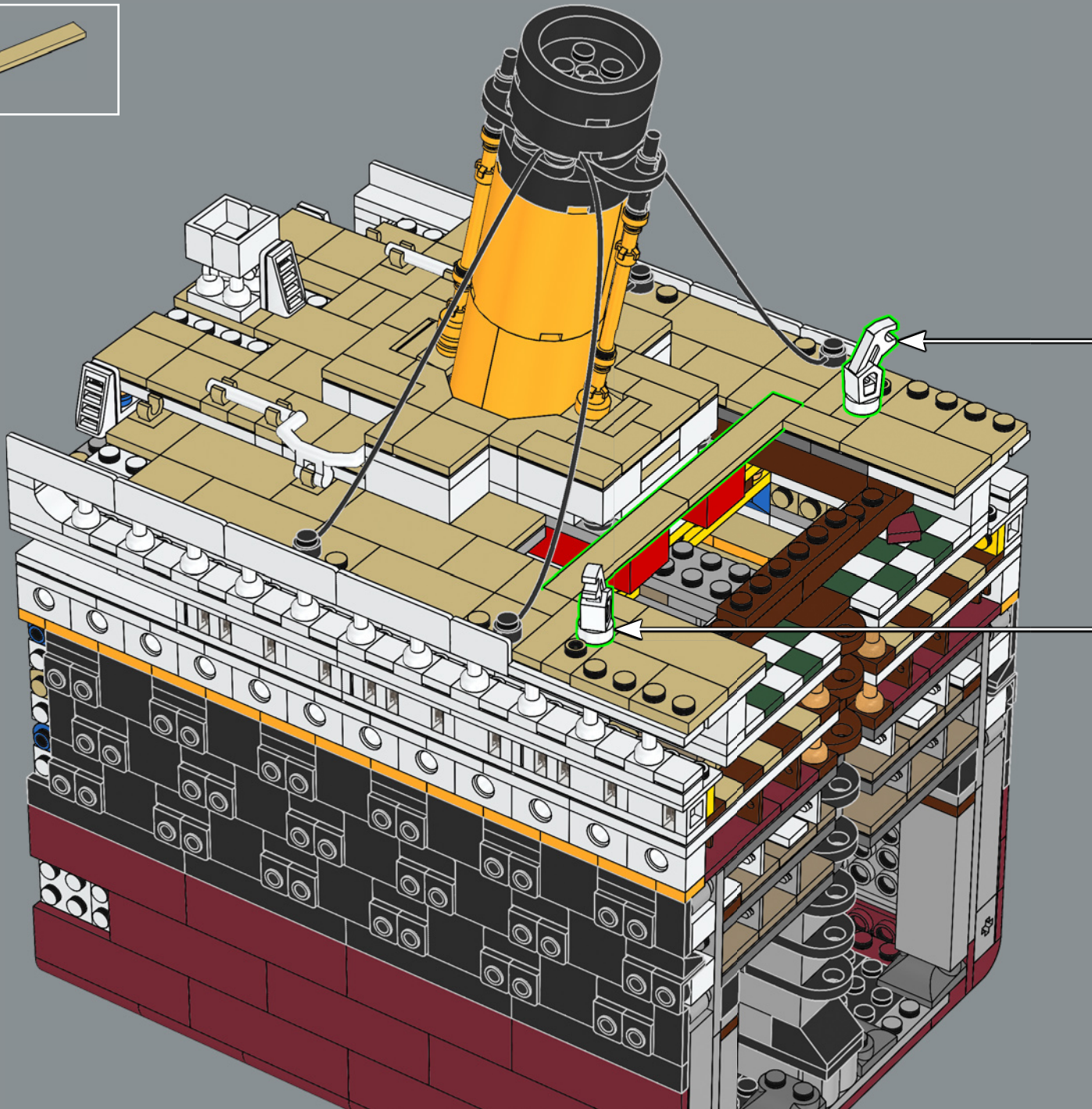

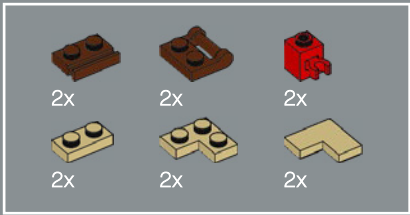

253

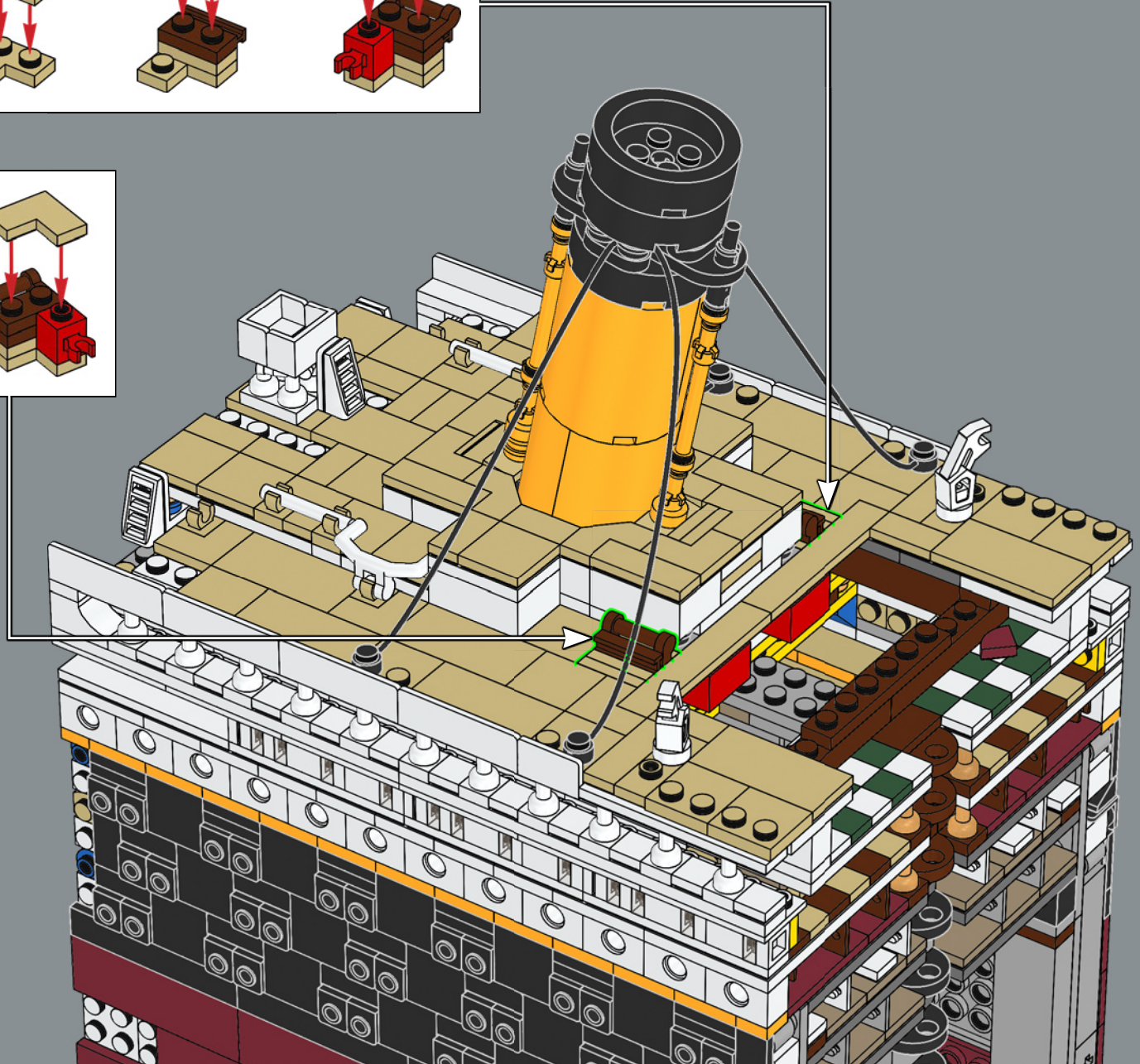
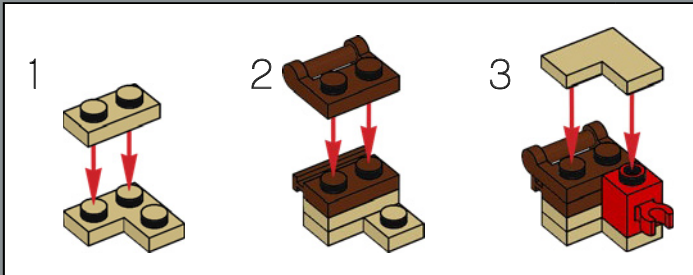
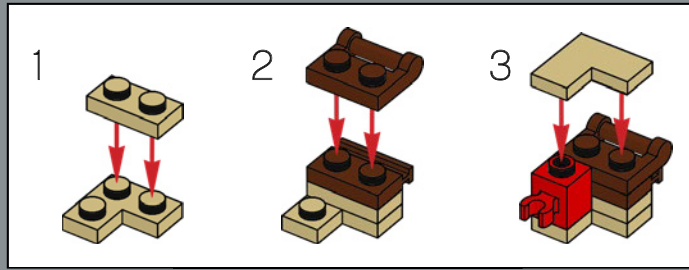

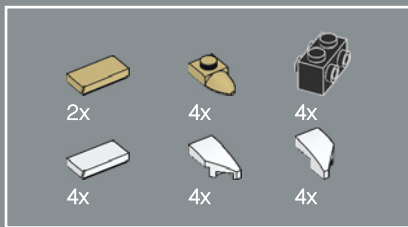

254

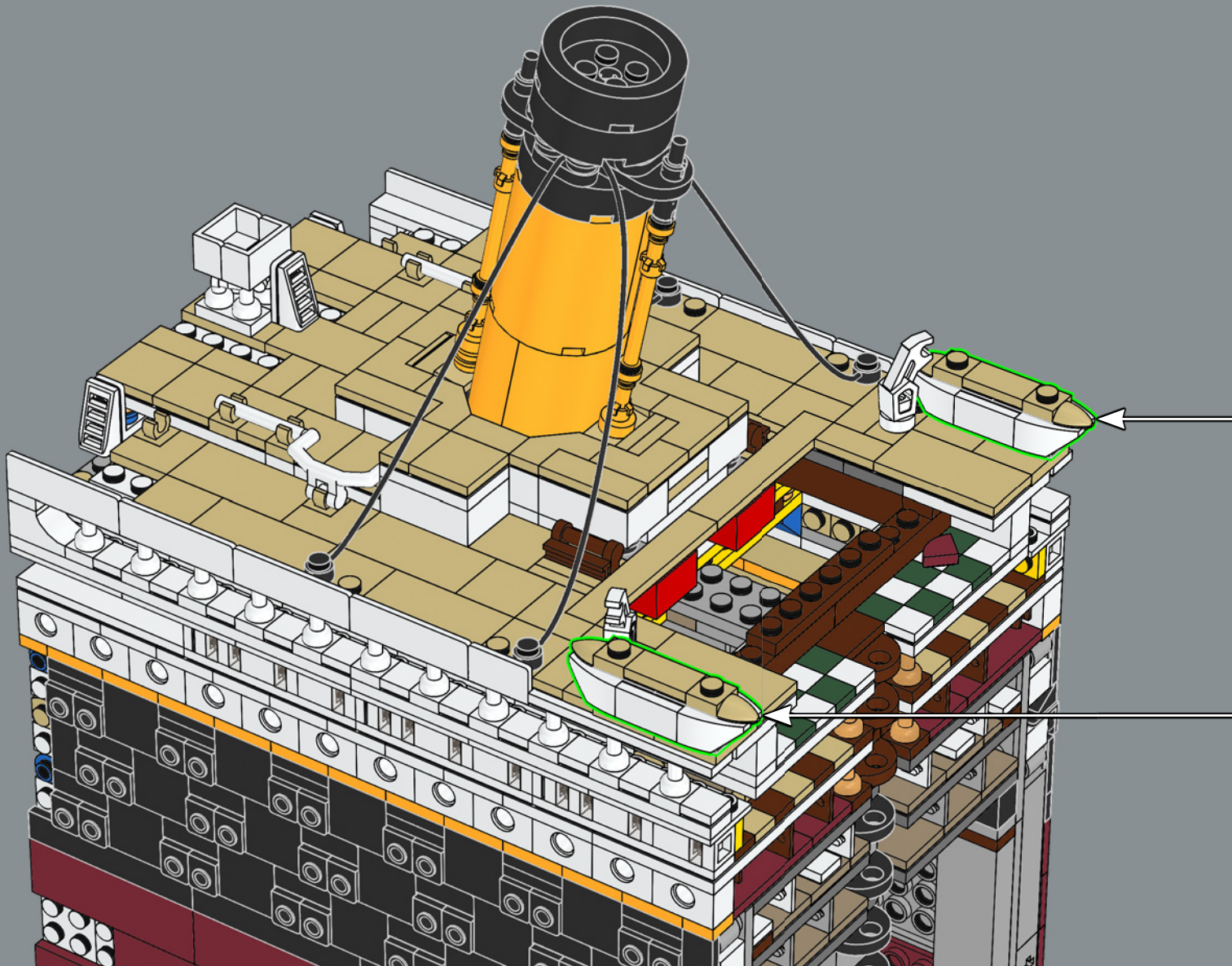
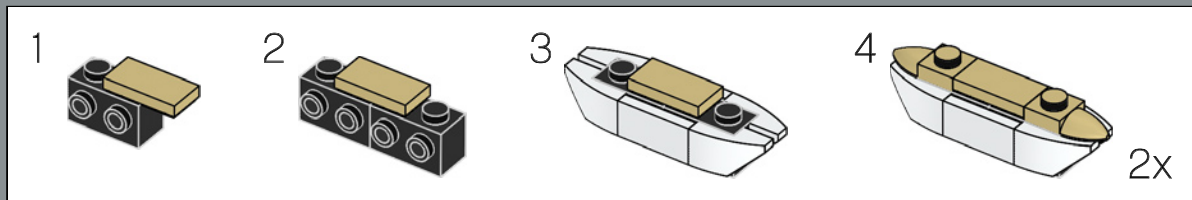

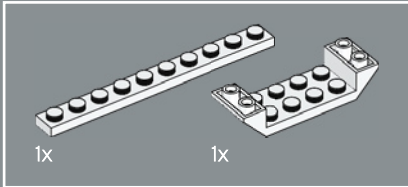
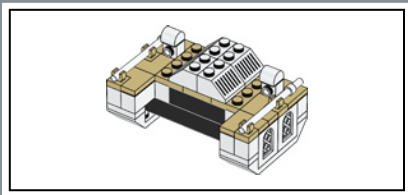

255

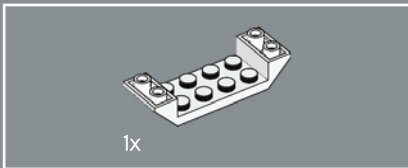
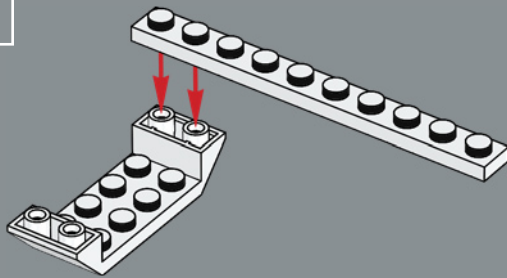

256

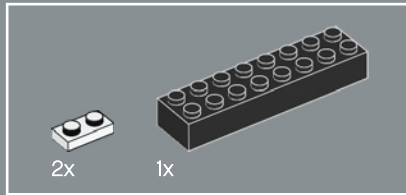
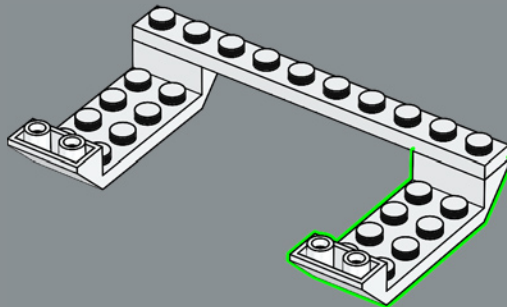

257

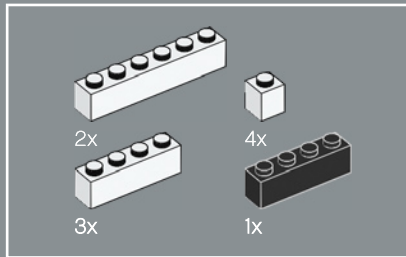
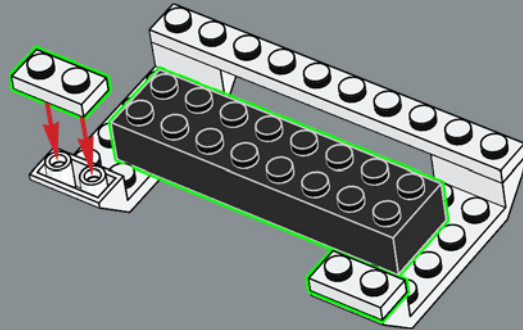

258

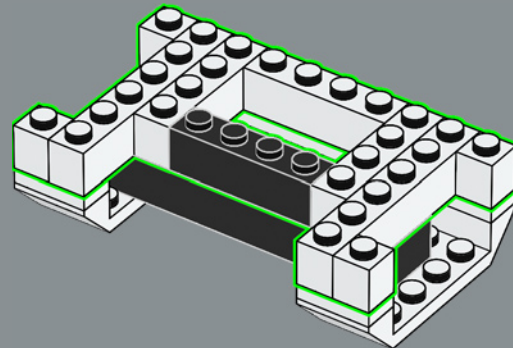

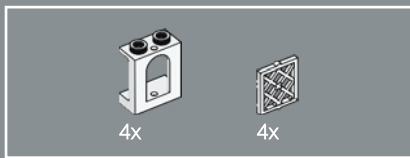

259

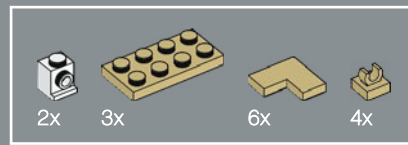
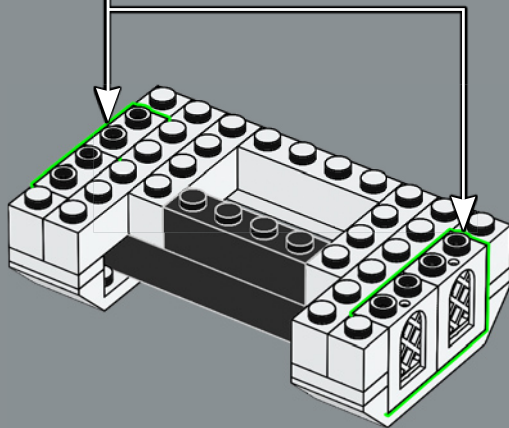
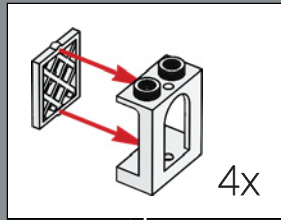

260

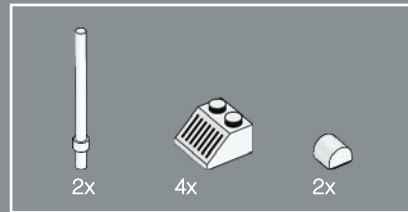
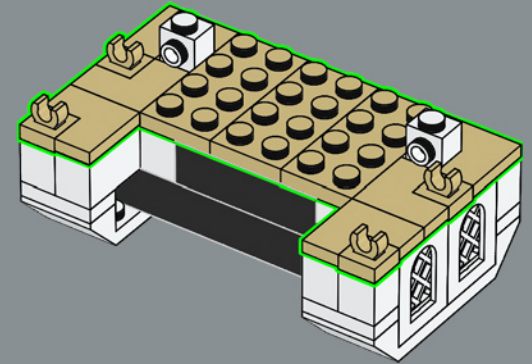

261

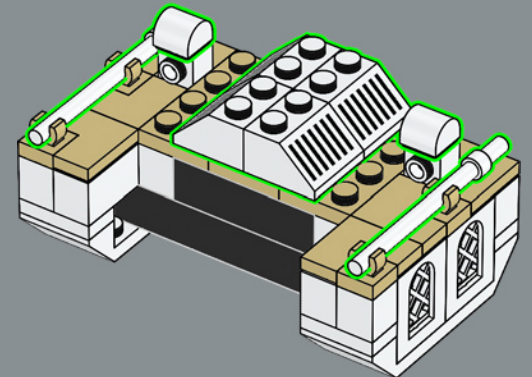

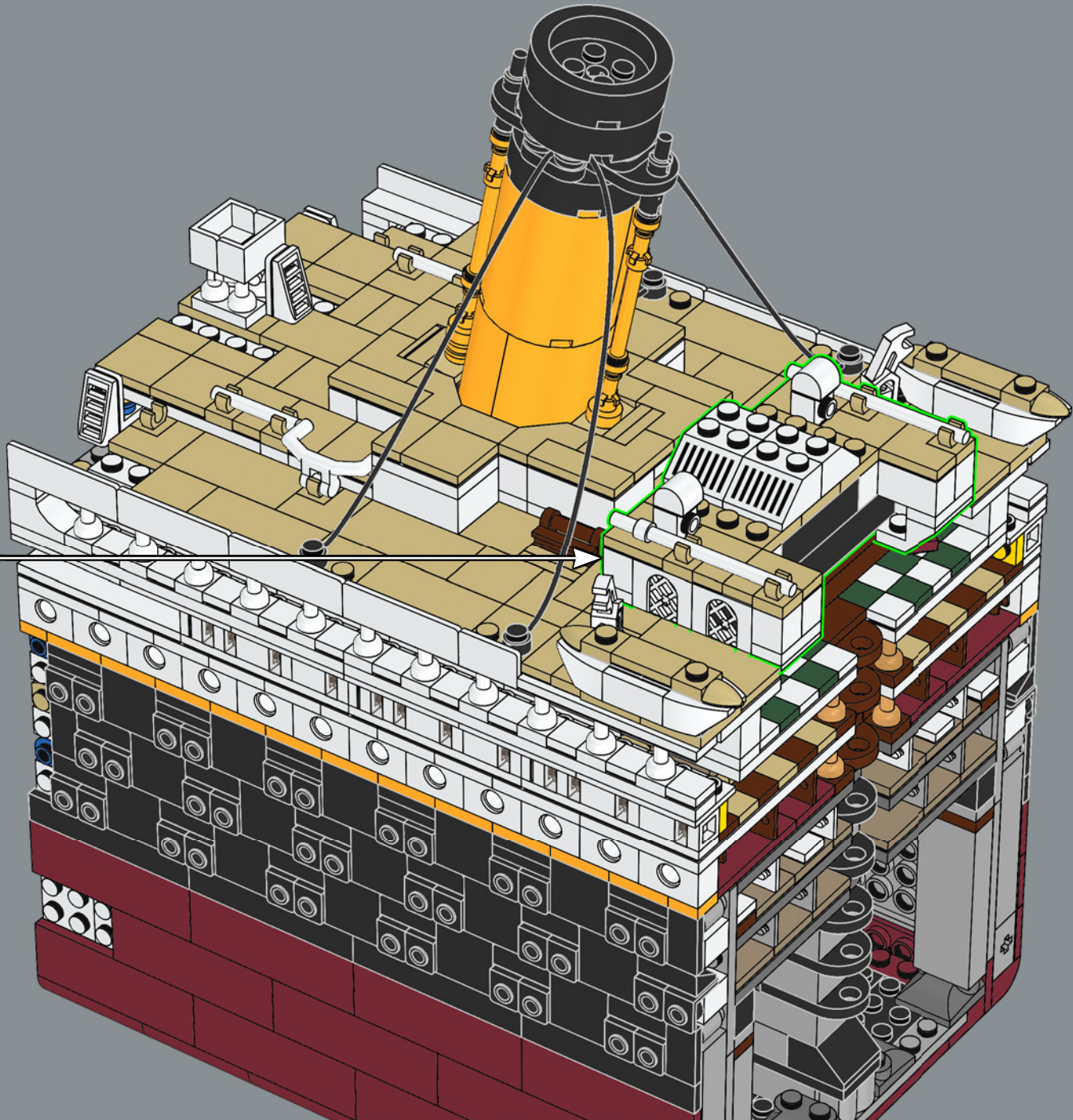

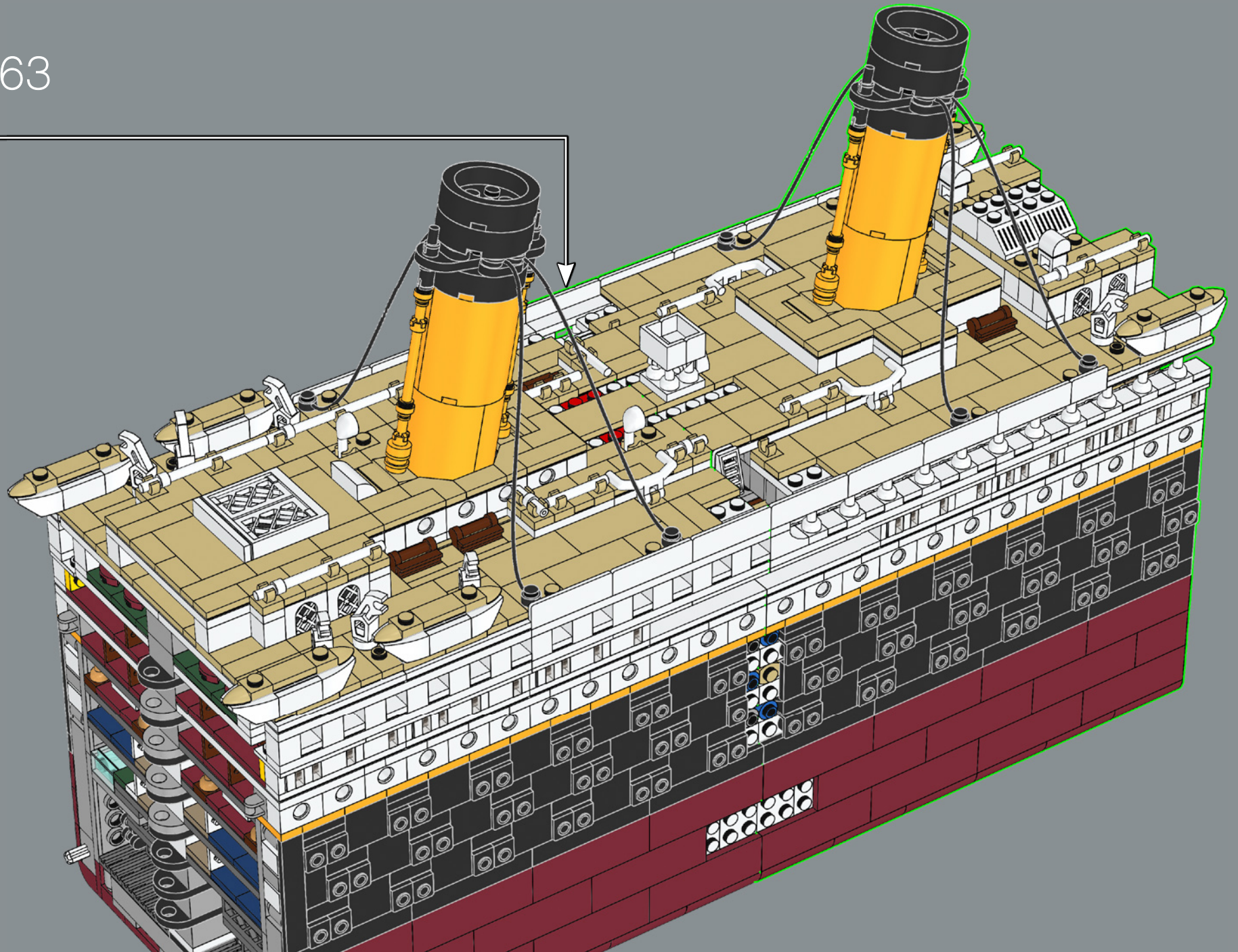

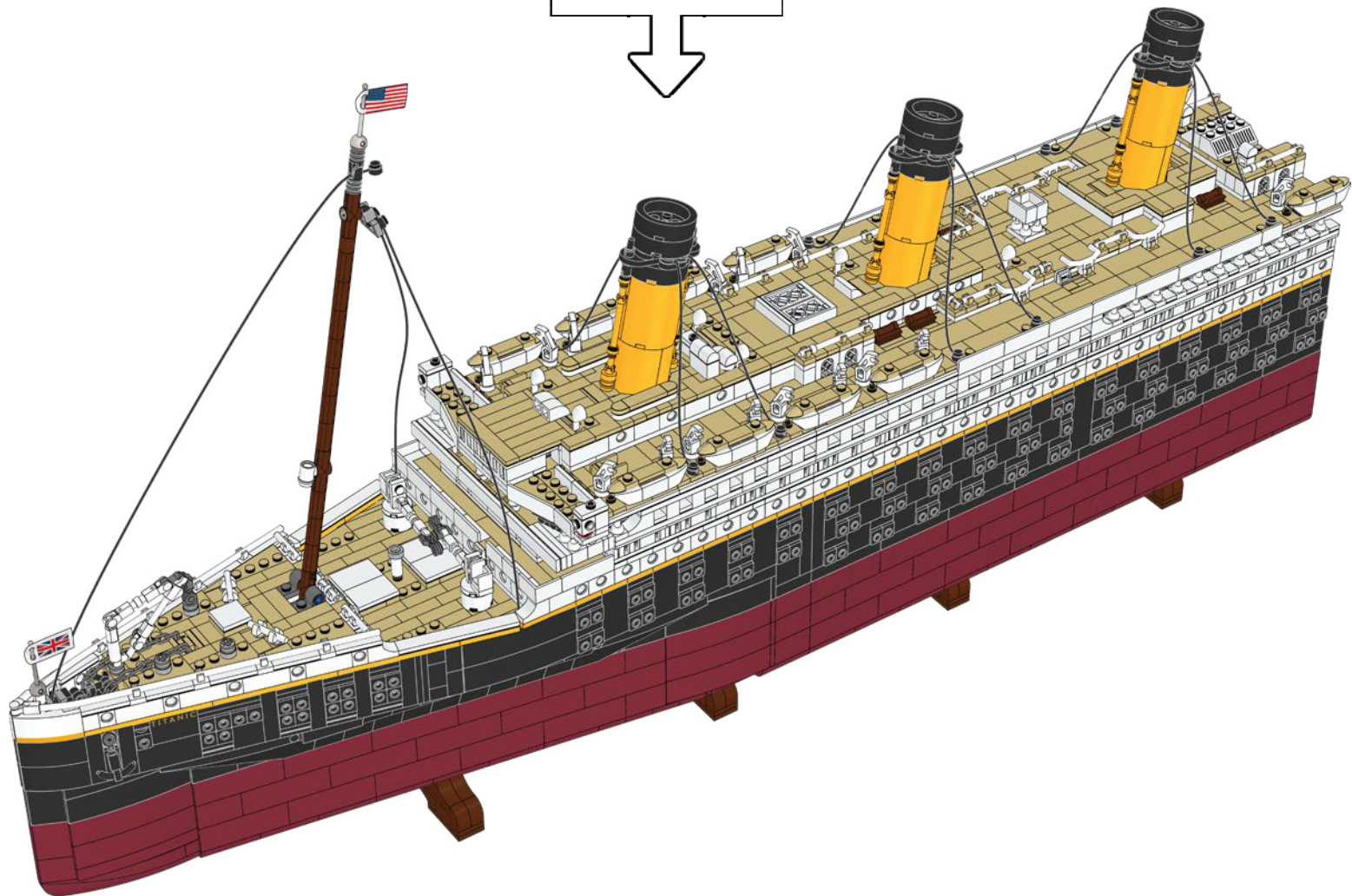

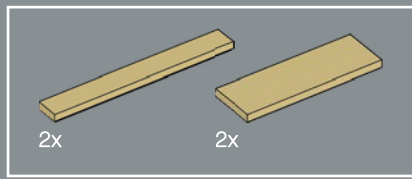

264

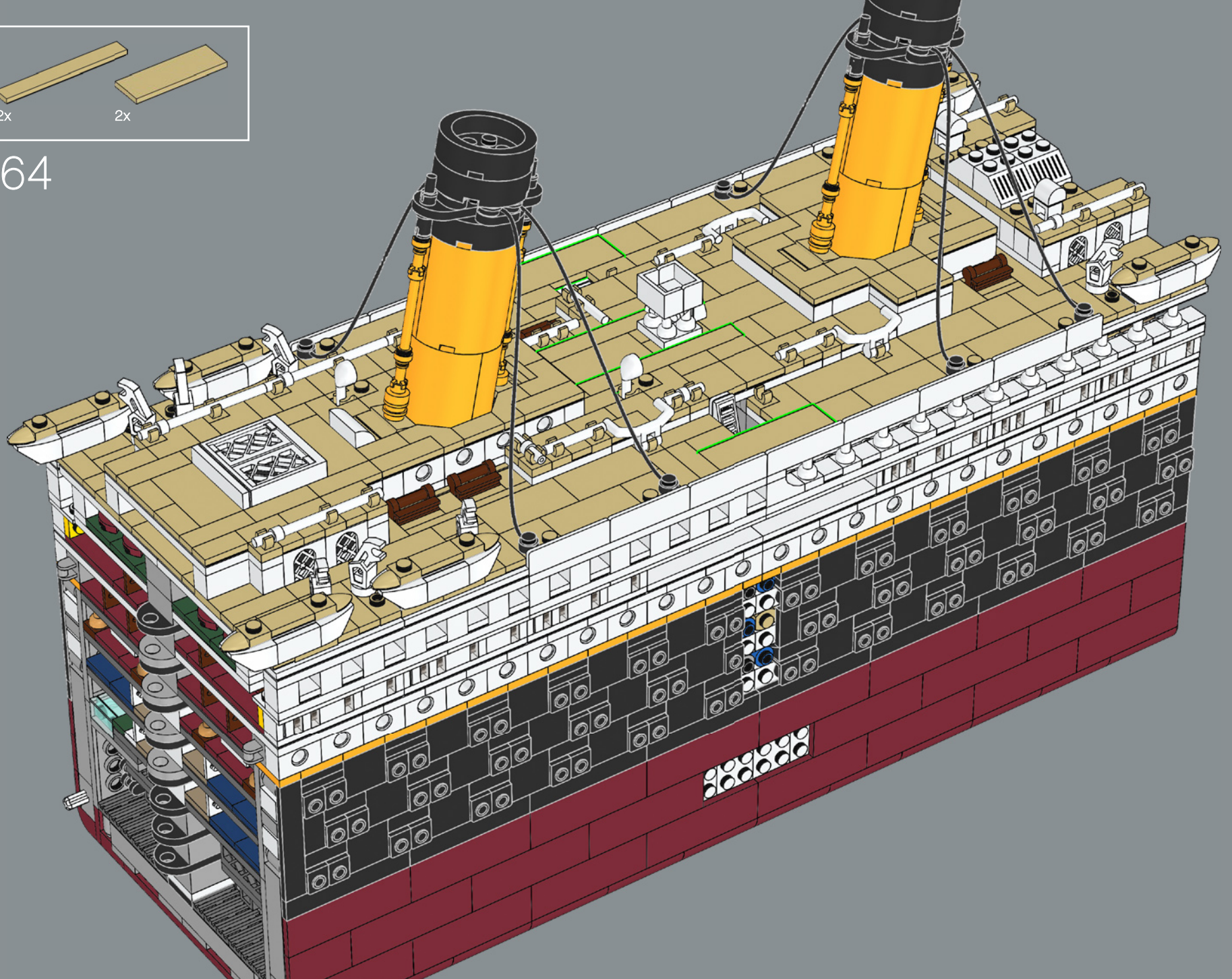

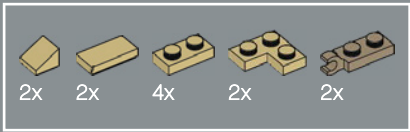

265

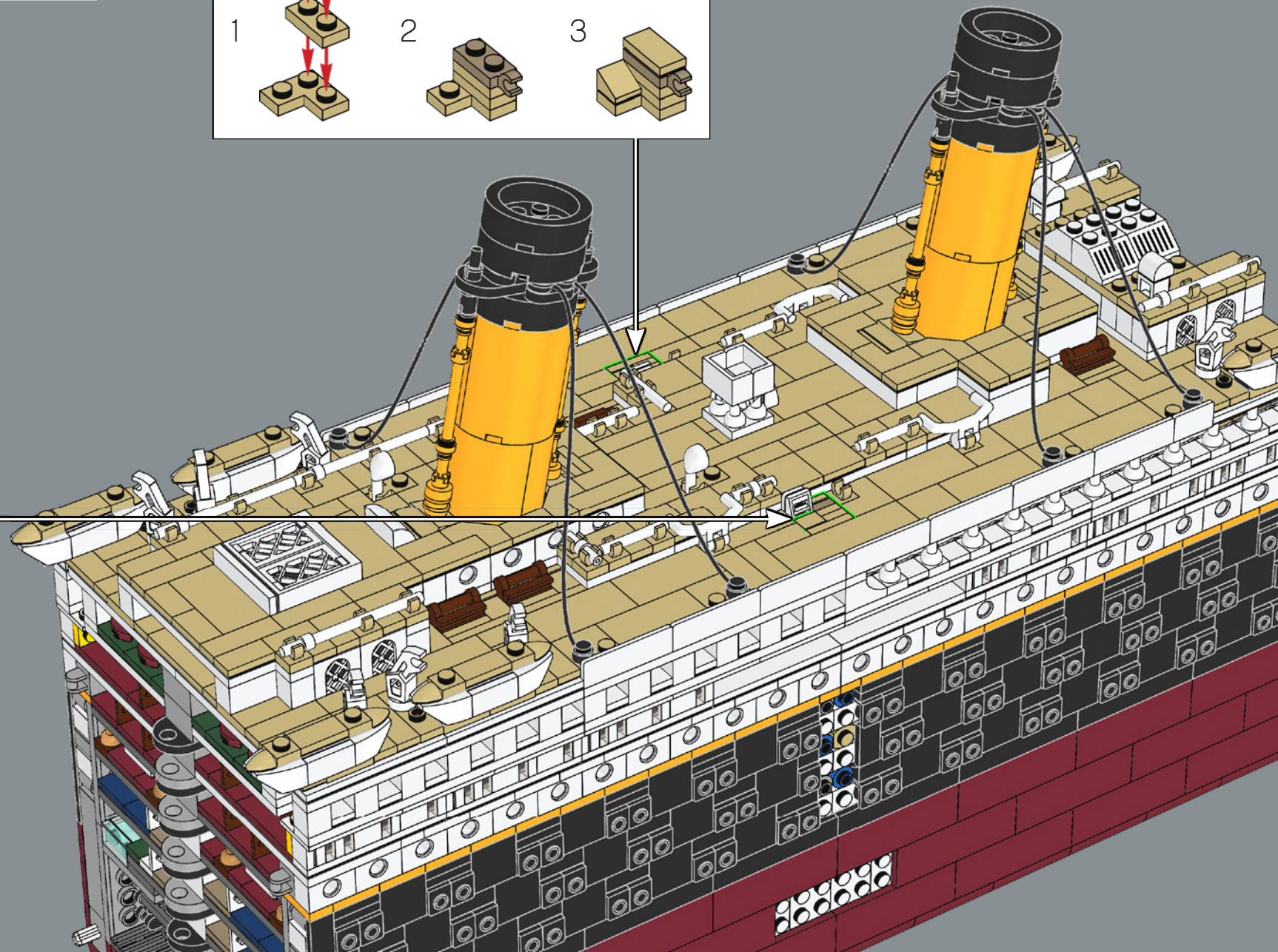
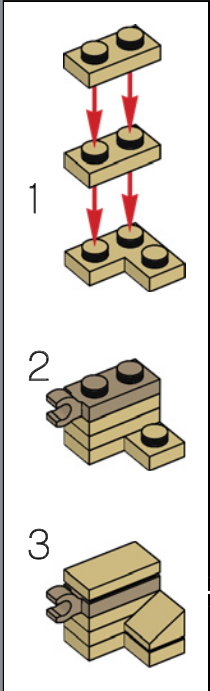
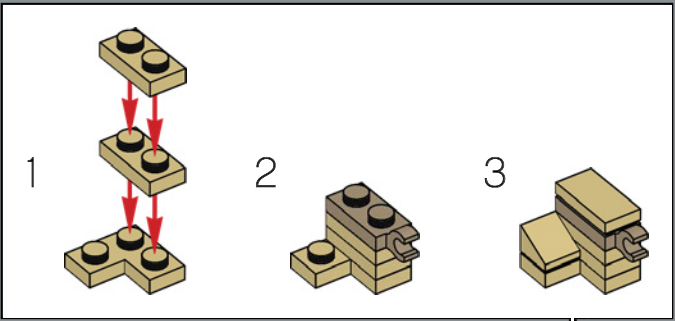

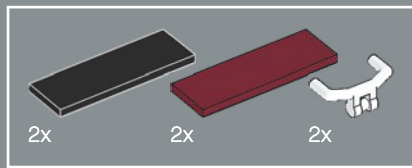

266

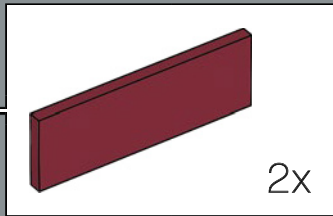
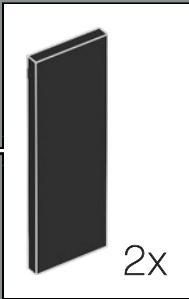
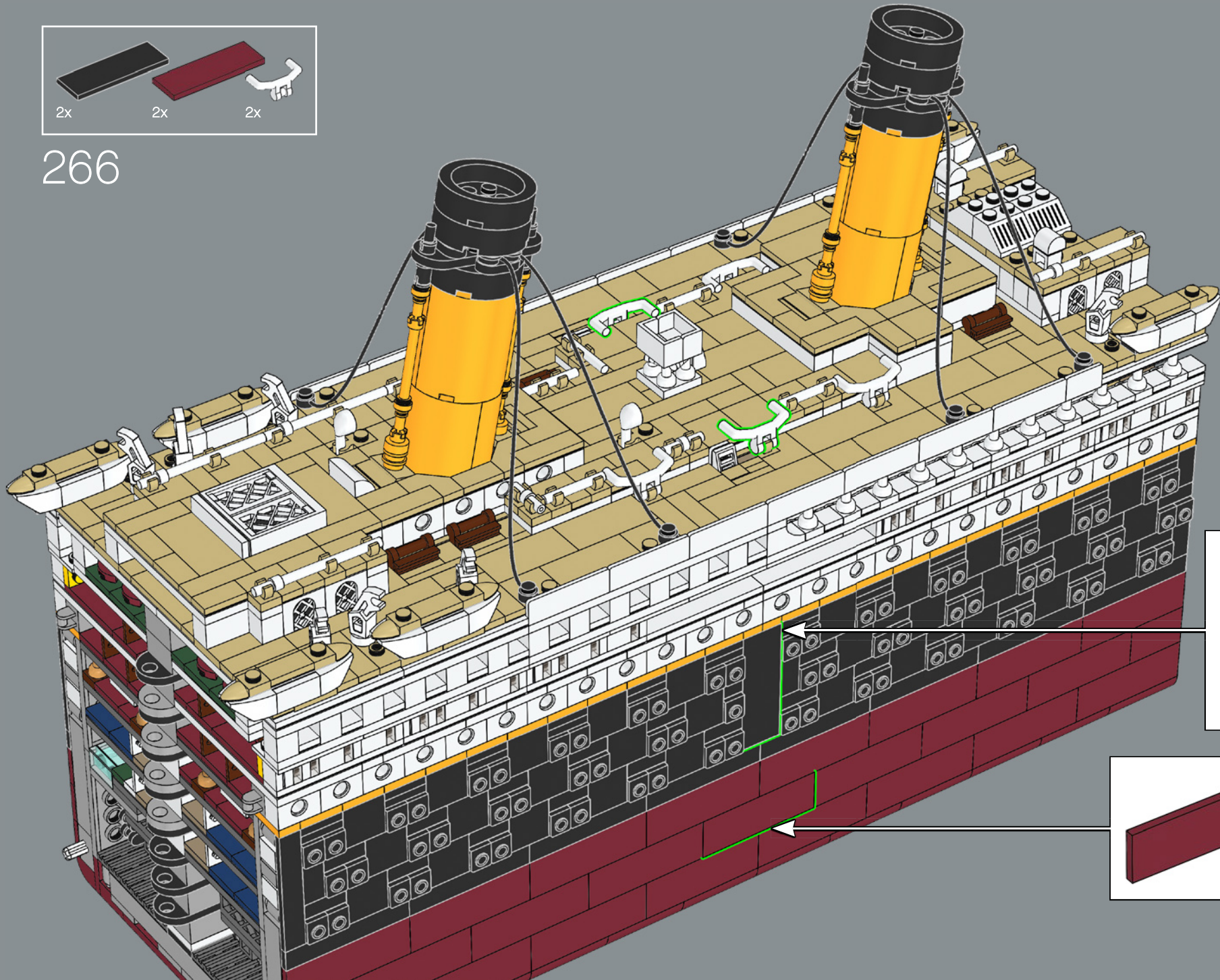

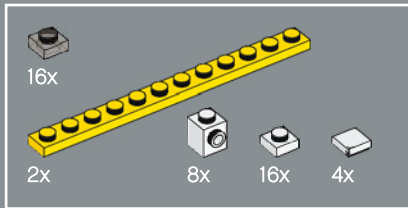
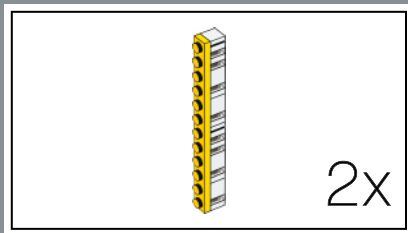

267

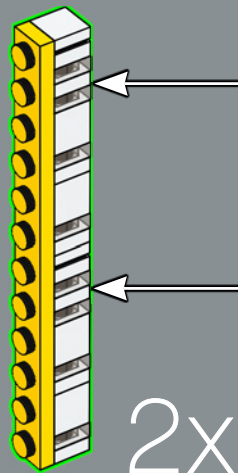
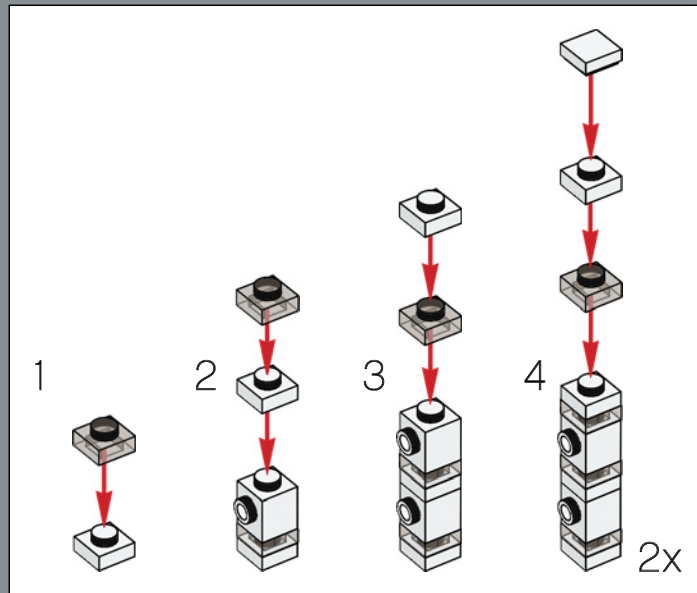

268

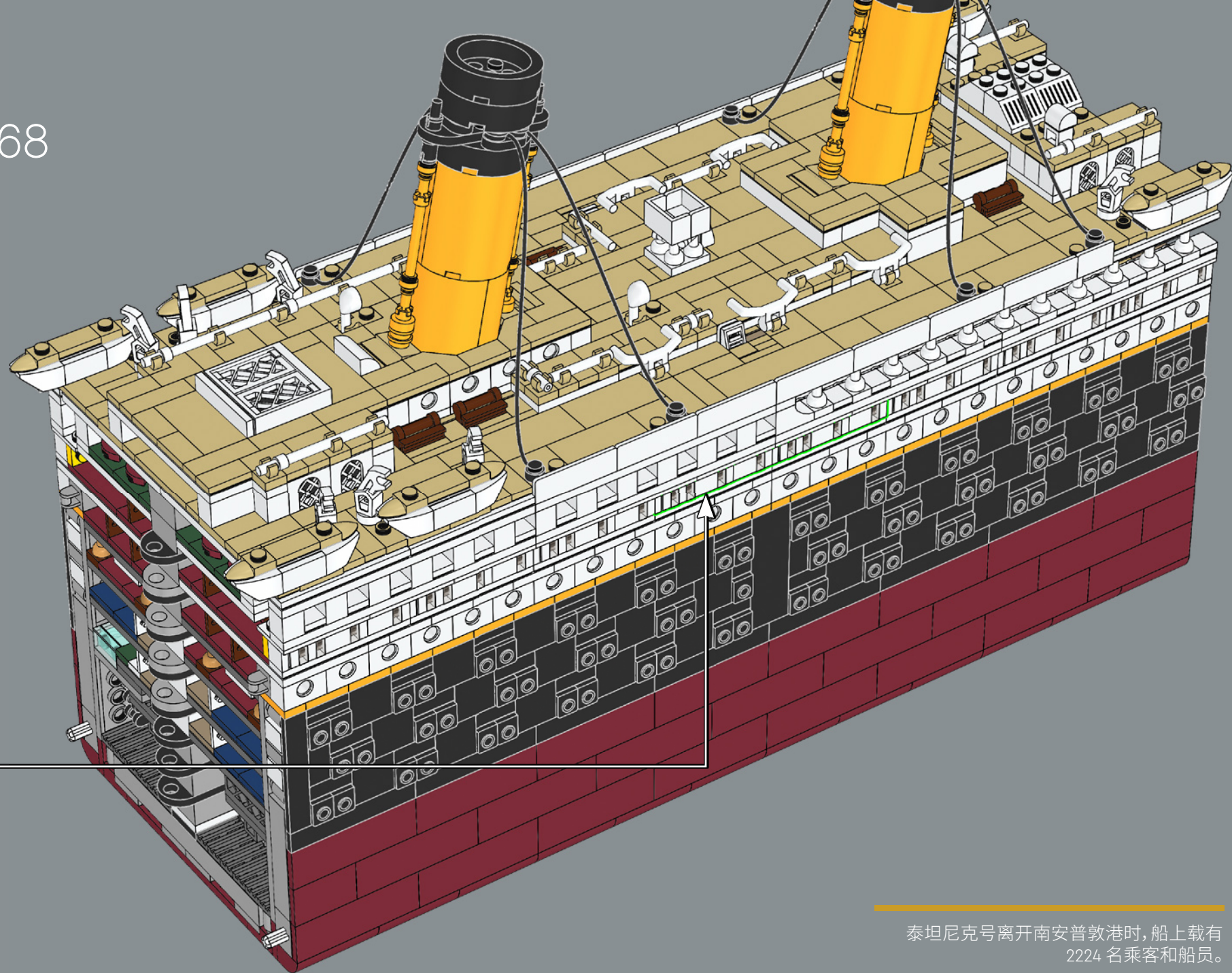

泰坦尼克号离开南安普敦港时，船上载有
224 名乘客和船员。 209

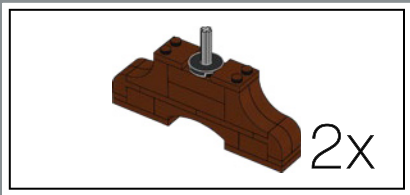

269

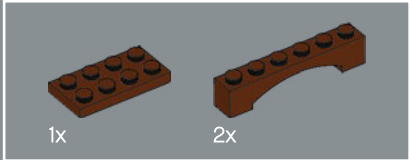
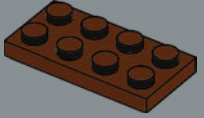

270

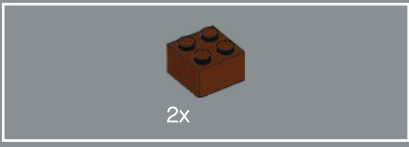
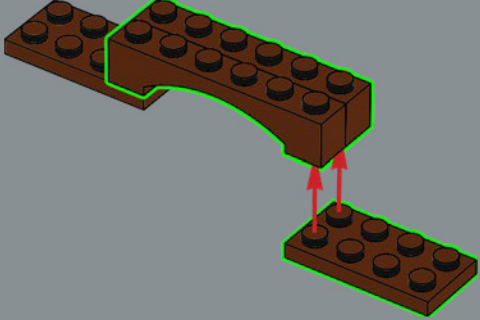

271

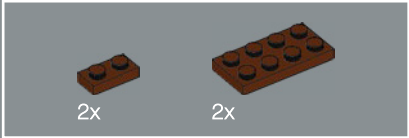
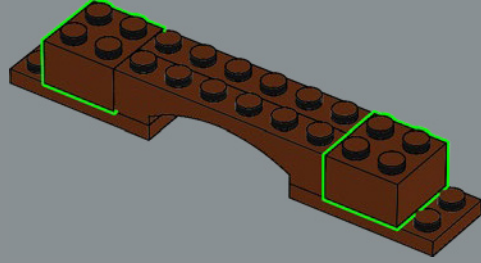

272

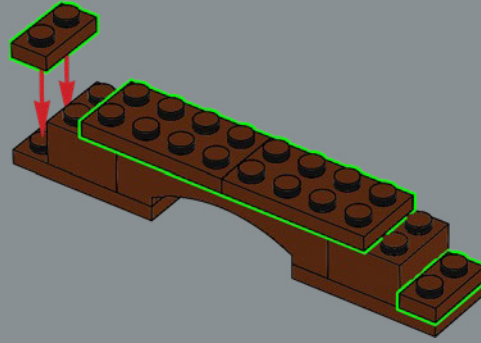



273

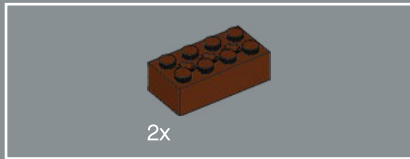
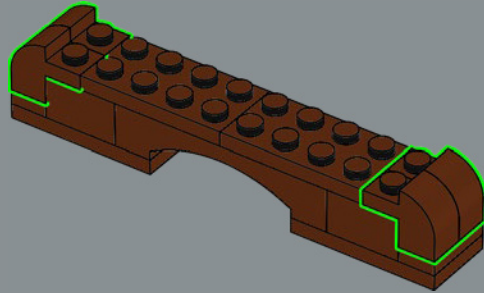

274

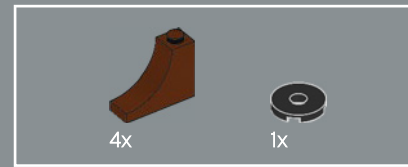
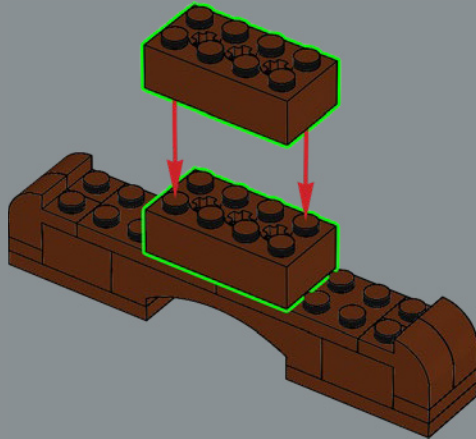

275

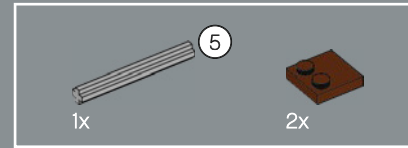
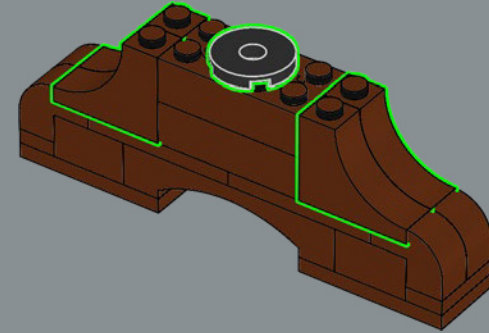

276

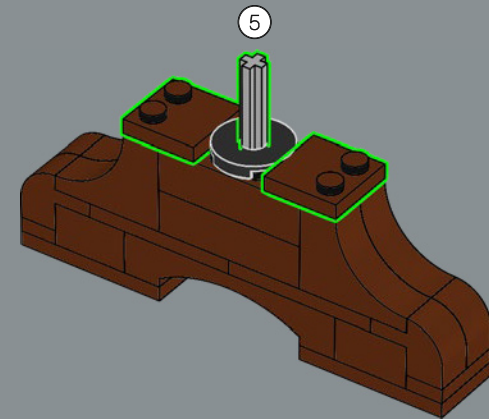

2x



277

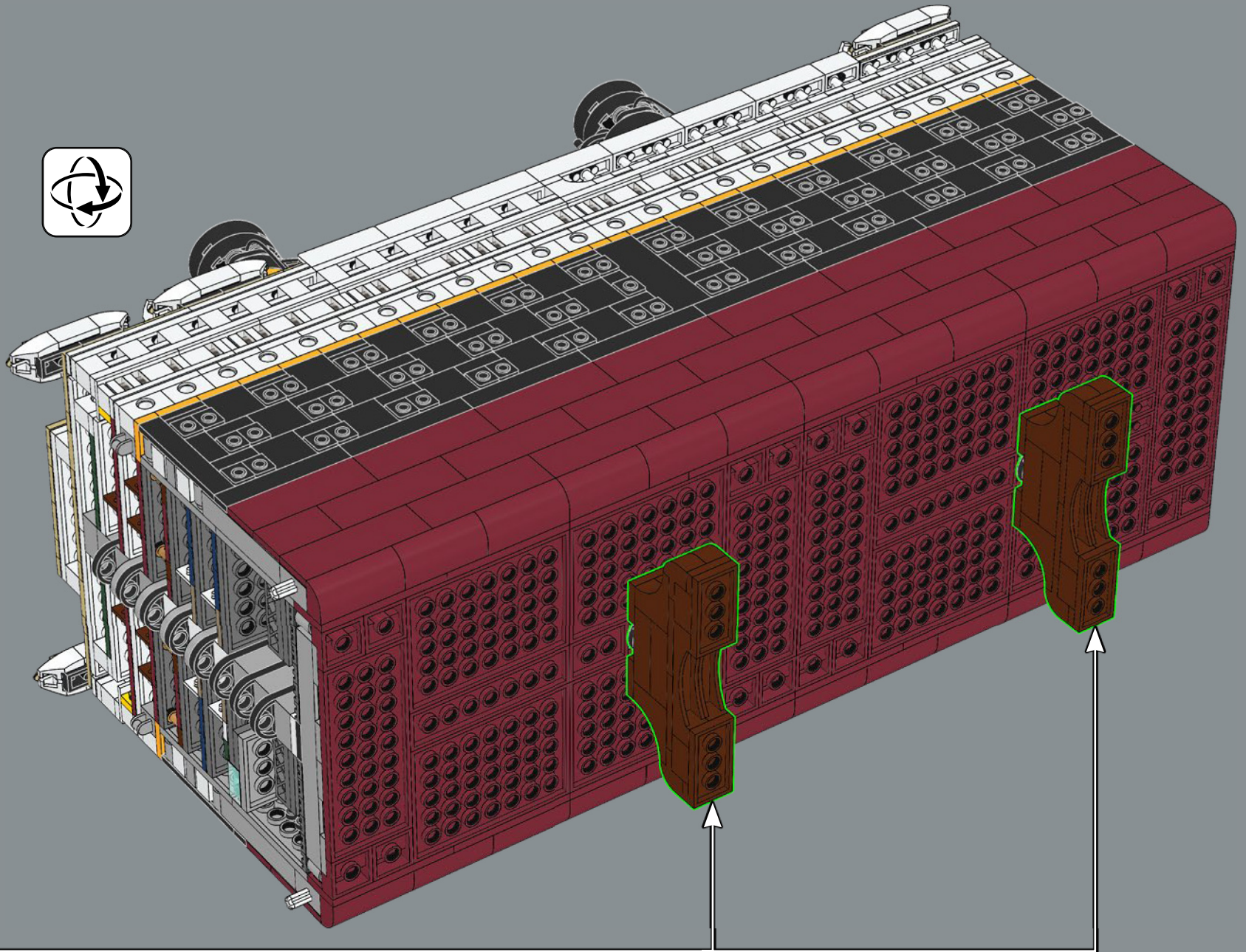

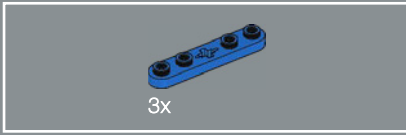
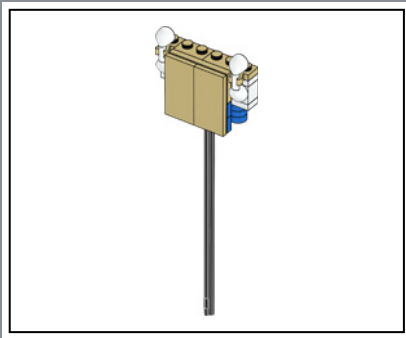

278

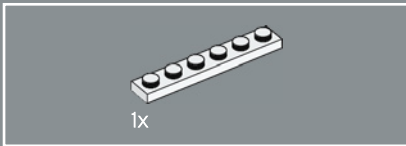
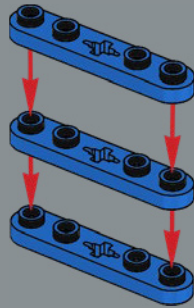

279

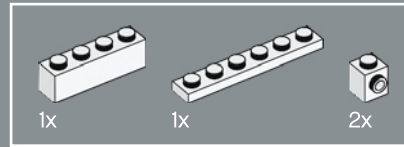
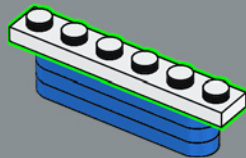

280

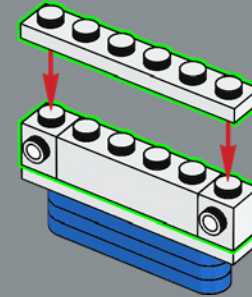

281

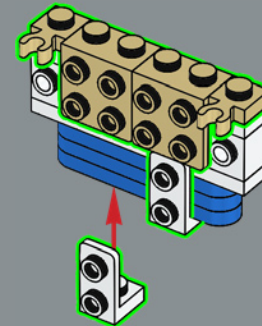

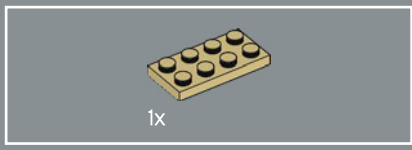

282

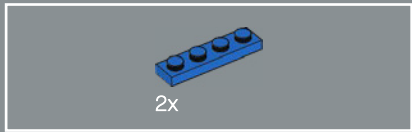
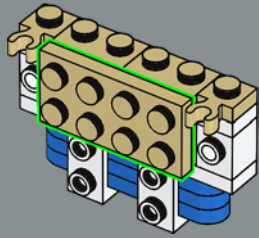

283

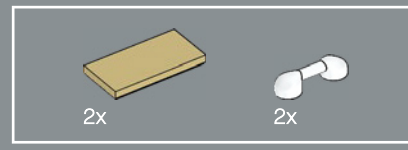
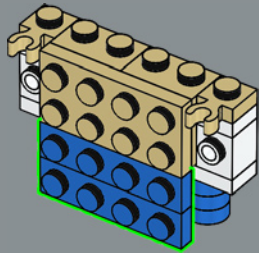

284

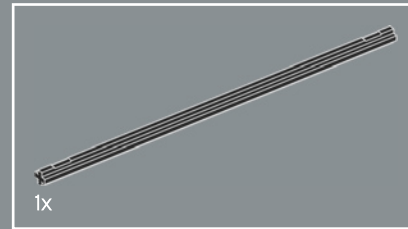
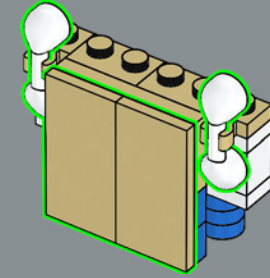

285

