





# BIENVENIDOS

Lo que comenzó como un proyecto personal que ocupaba las noches y fines de semana de nuestros diseñadores en 2007 ha crecido hasta convertirse en un vibrante centro urbano lleno de hermosa arquitectura, ricos interiores, un astuto uso de los ladrillos y una impresionante población de alegres minifiguras. Y qué mejor manera de celebrar estos 15 años de la serie Modular Buildings que creando uno de los modelos más solicitados por los fans.

¡Bienvenidos al precioso y mítico **Hotel Boutique**! Inspirada en la arquitectura europea de principios de siglo, la singular estructura en cuña luce un sinfín de elegantes formas y delicados detalles. También está repleta de pequeñas historias y sutiles referencias a los anteriores modelos de la serie Modular Buildings. ¡A ver cuántas podéis descubrir!







*De izquierda a derecha:*

Michael Psiaki  
Astrid Graabæk  
Wesley Alan Talbott  
Torben Kidde Skov  
Anderson Ward Grubb  
Chris McVeigh  
Jamie Berard

¡Han sido 15 emocionantísimos años de Modular Buildings! Estos son todos los modelos y muchos de los diseñadores que los hicieron realidad.



Anderson Ward Grubb  
Diseñador del Hotel Boutique (10297)



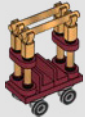
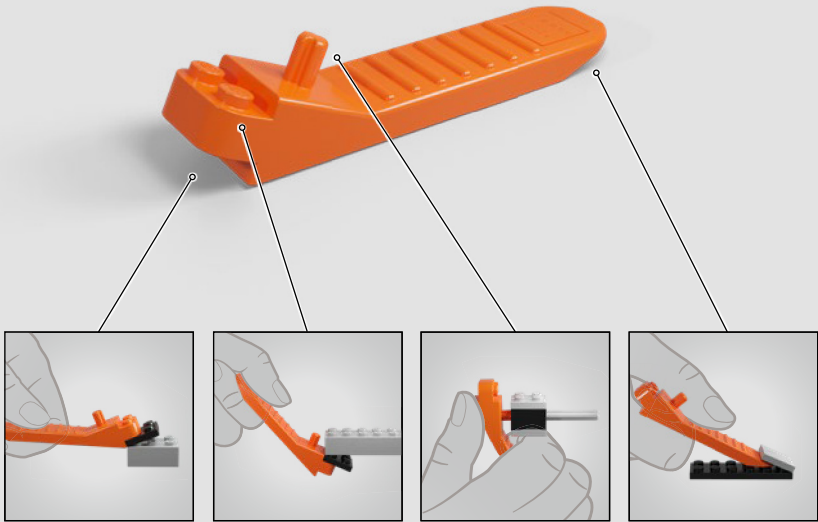
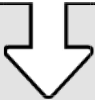
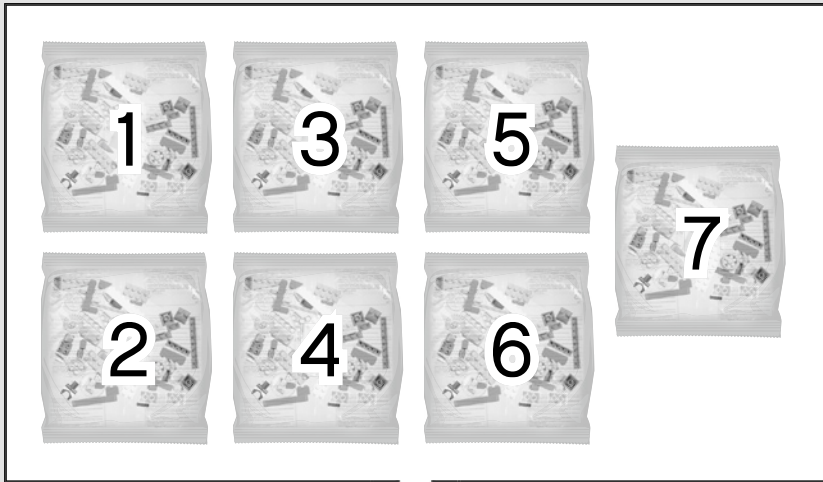



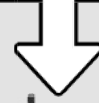
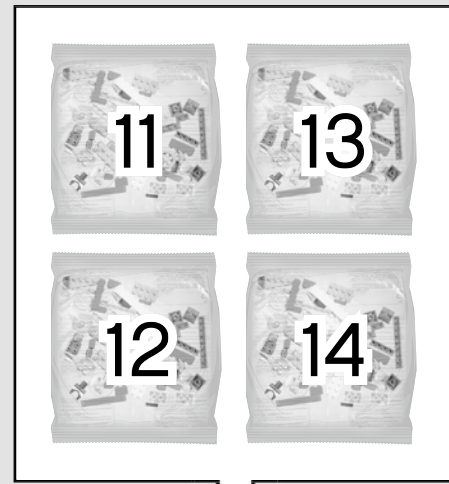
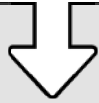



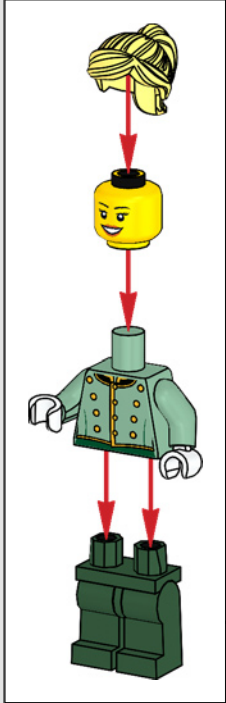
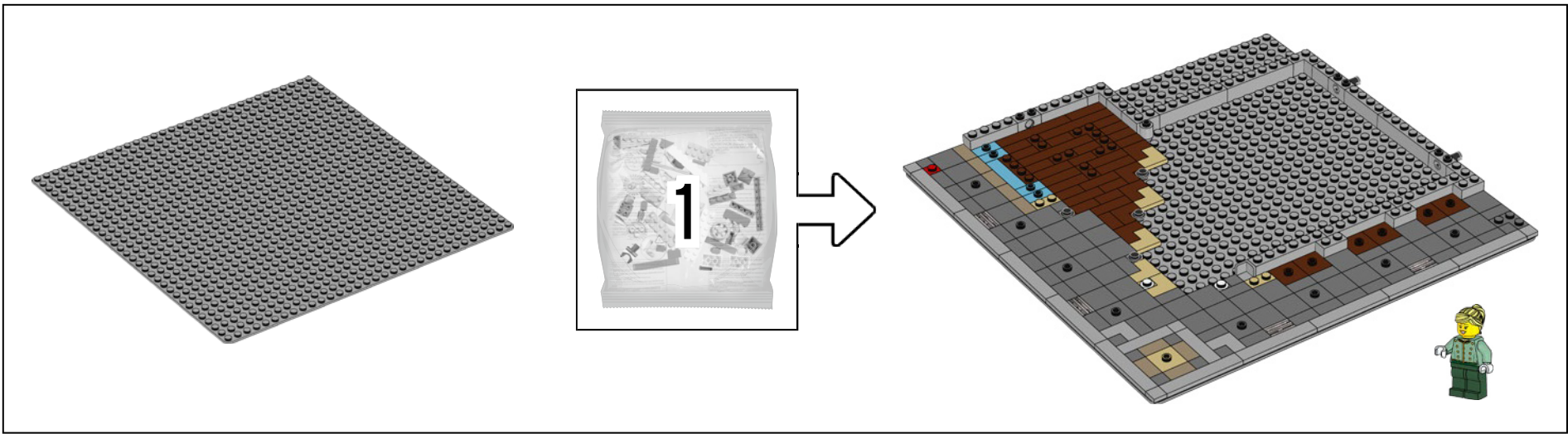

¿Buscas algo que hacer durante tu estancia?  
Pregunta a la recepcionista sobre su tienda  
favorita en el set Centro Comercial (10211) o  
la mejor comida de la ciudad en Chez Albert.



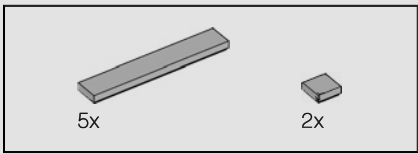

1

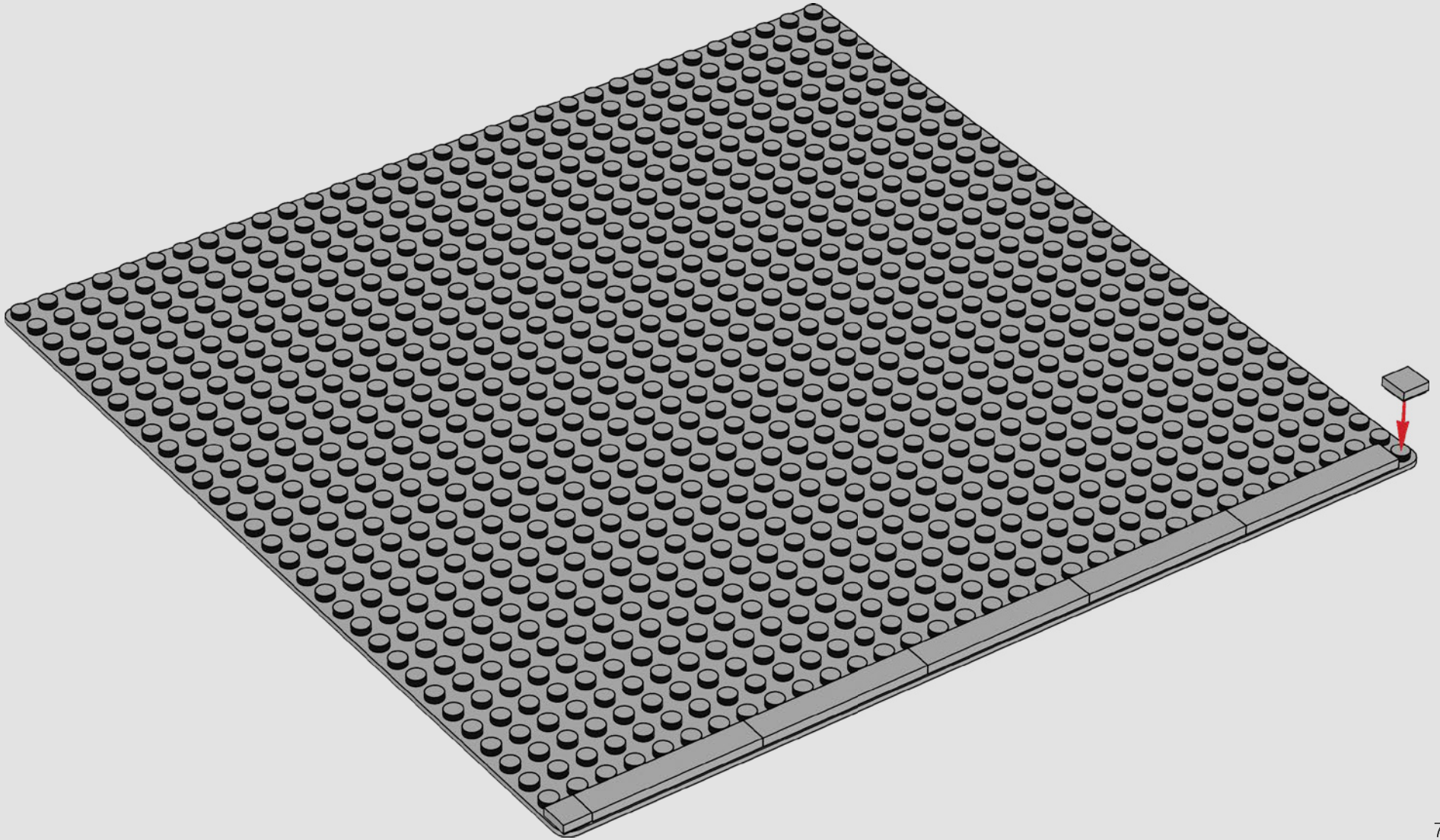



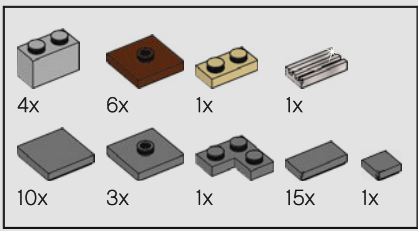

2

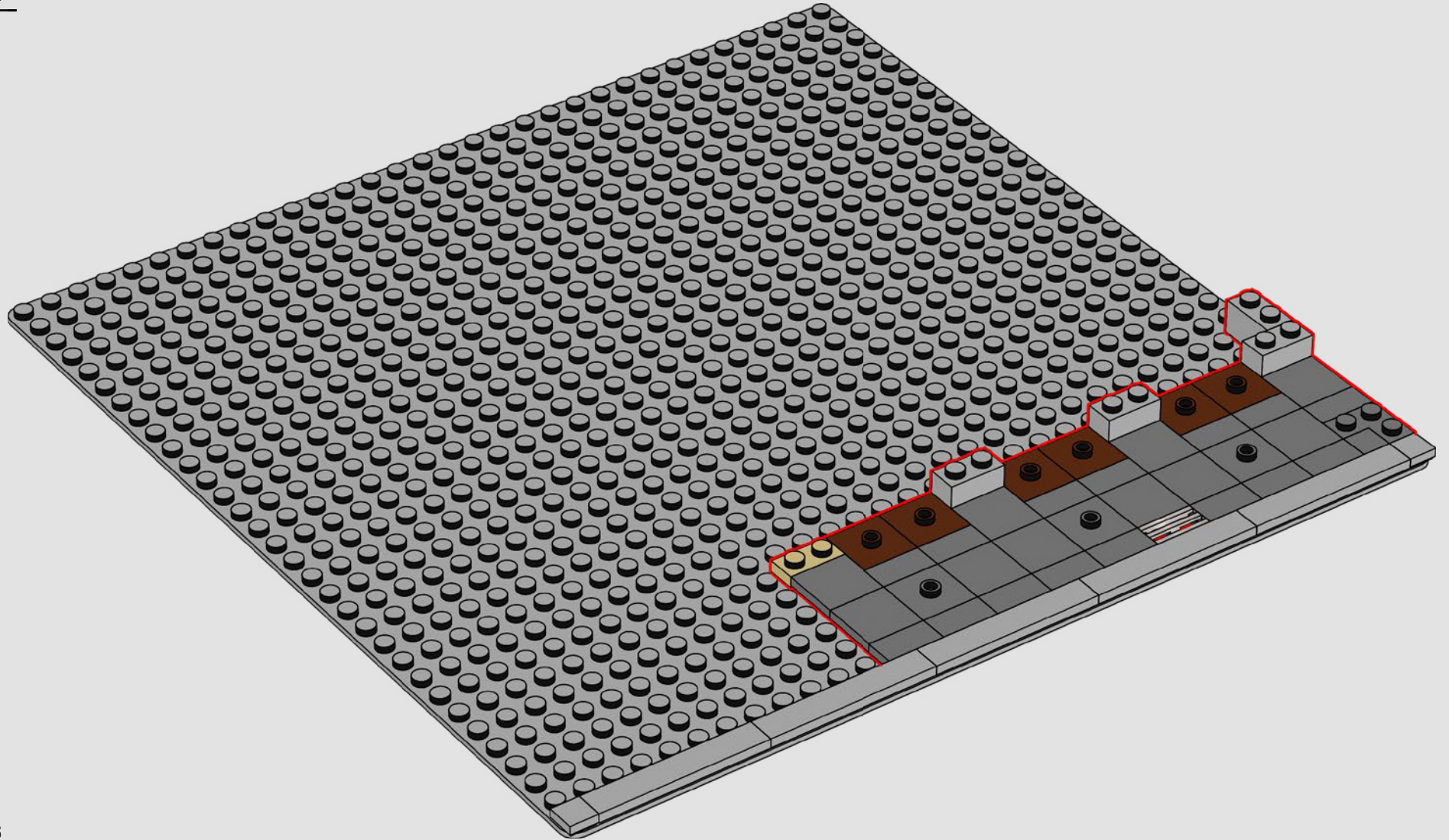



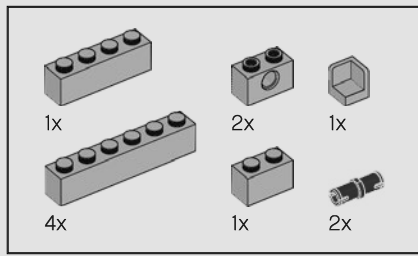

3

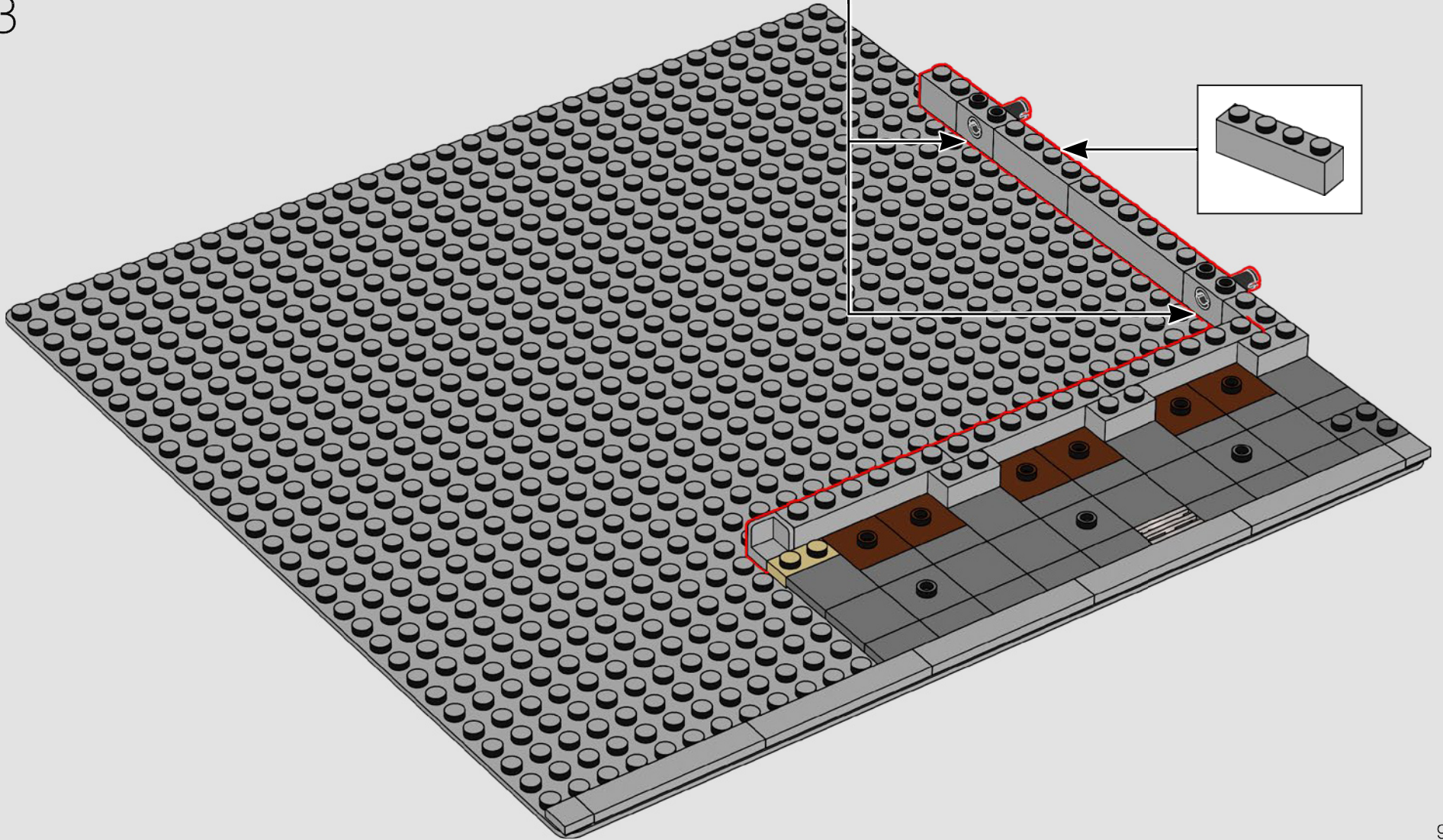
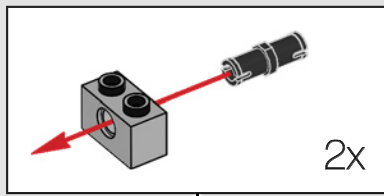

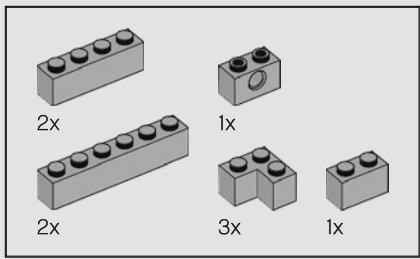

4

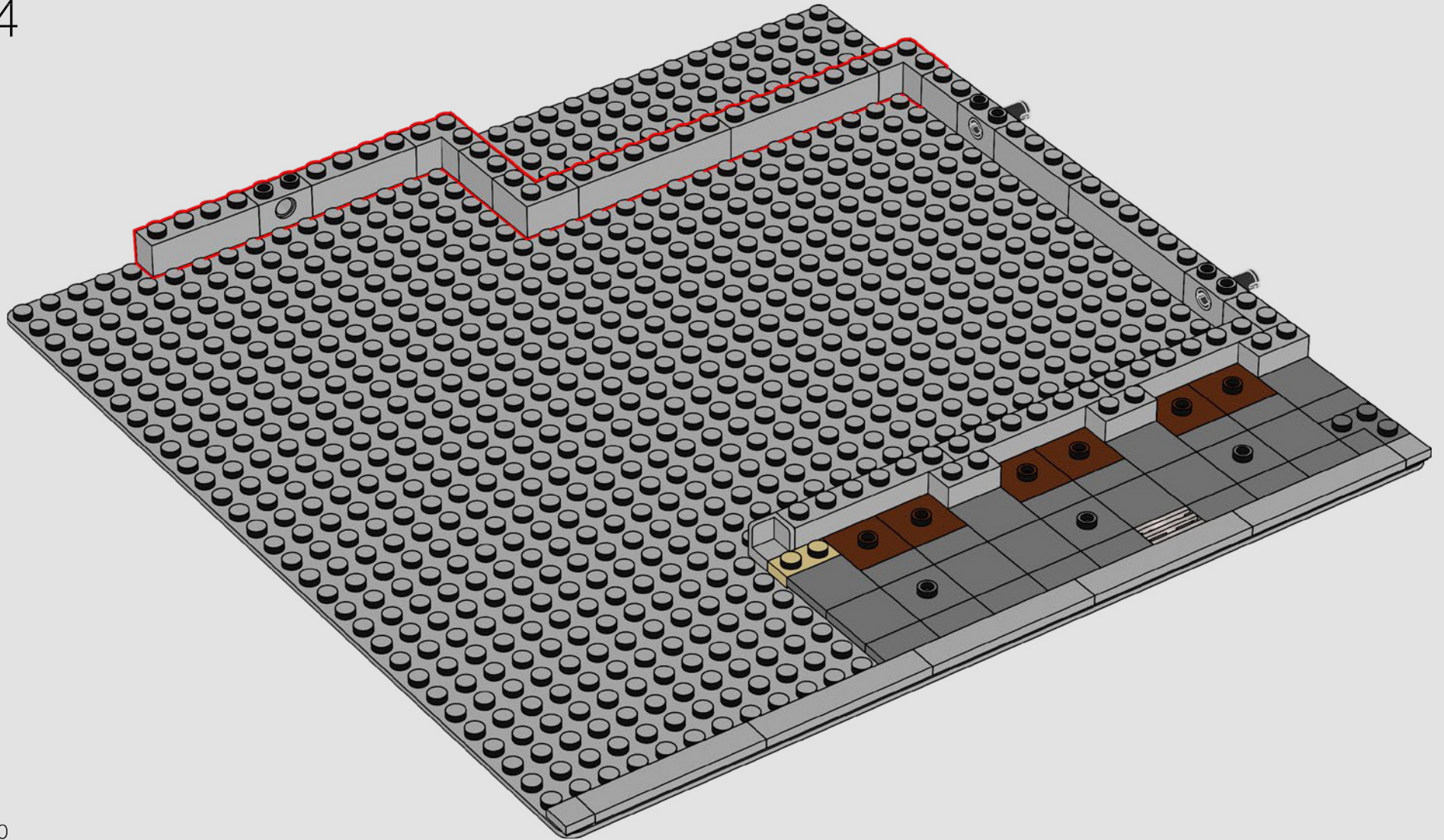



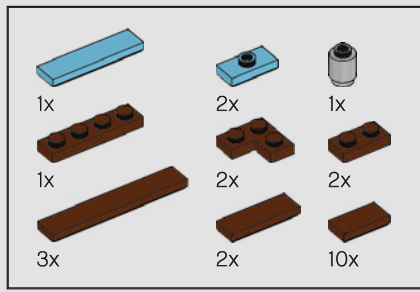

5

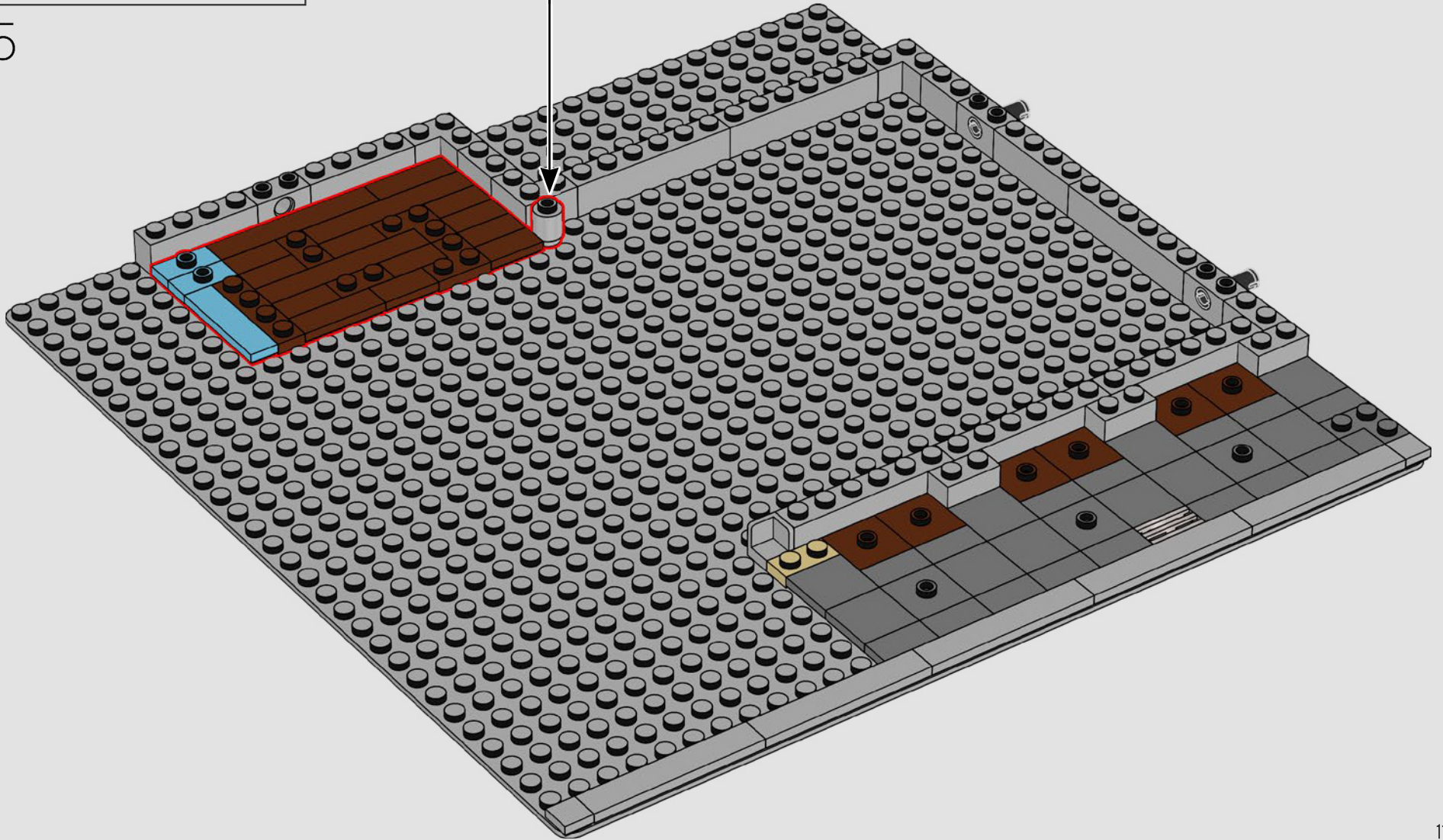
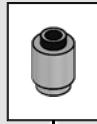



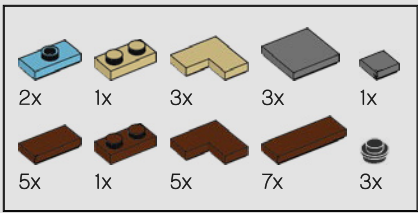

6

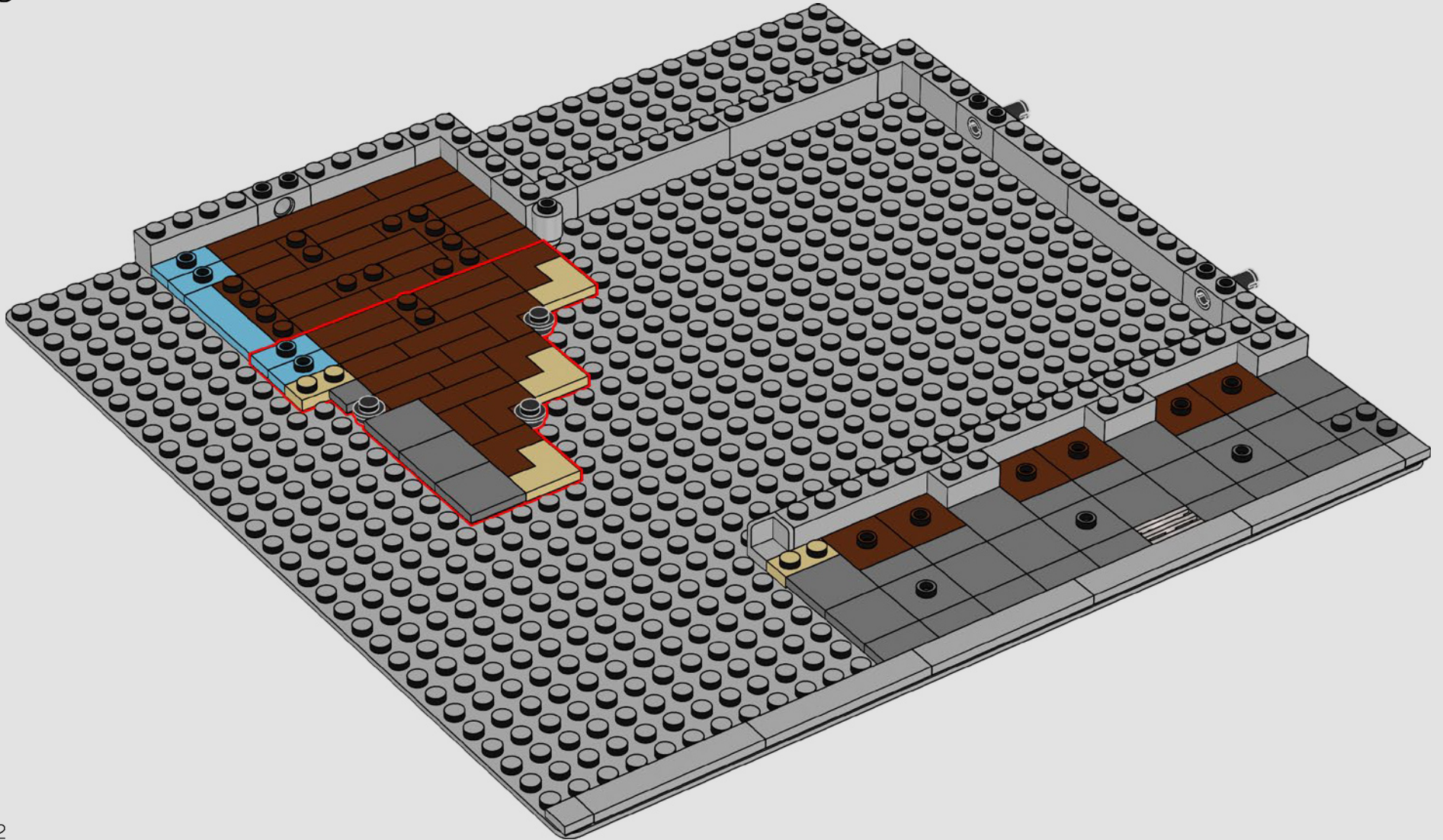

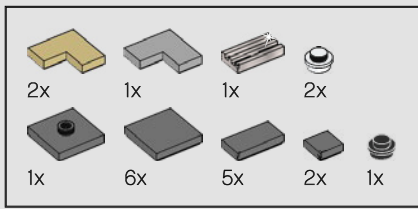

7

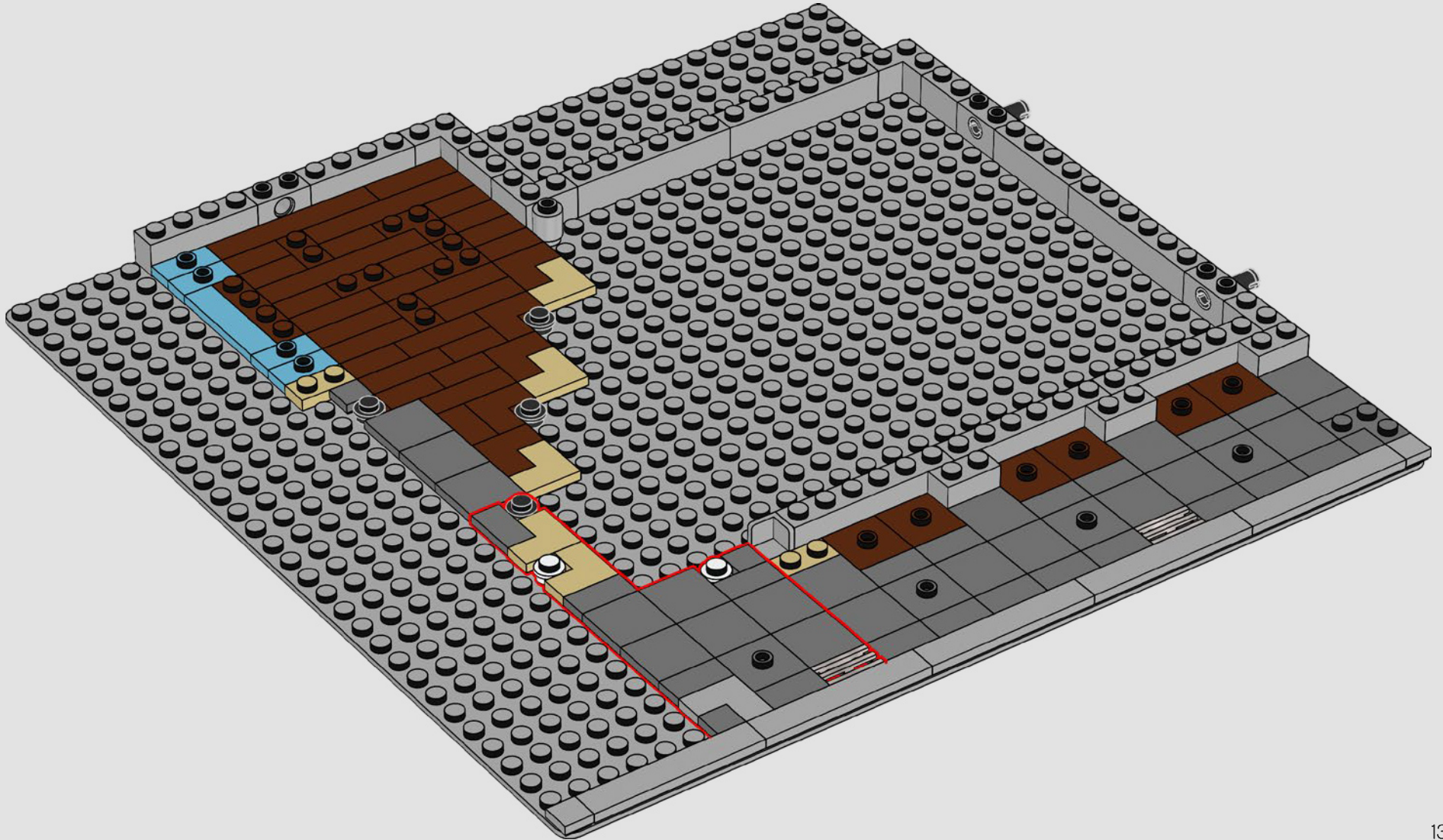



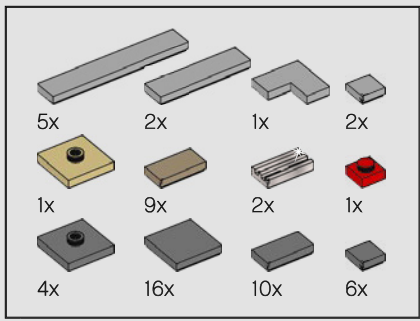

8

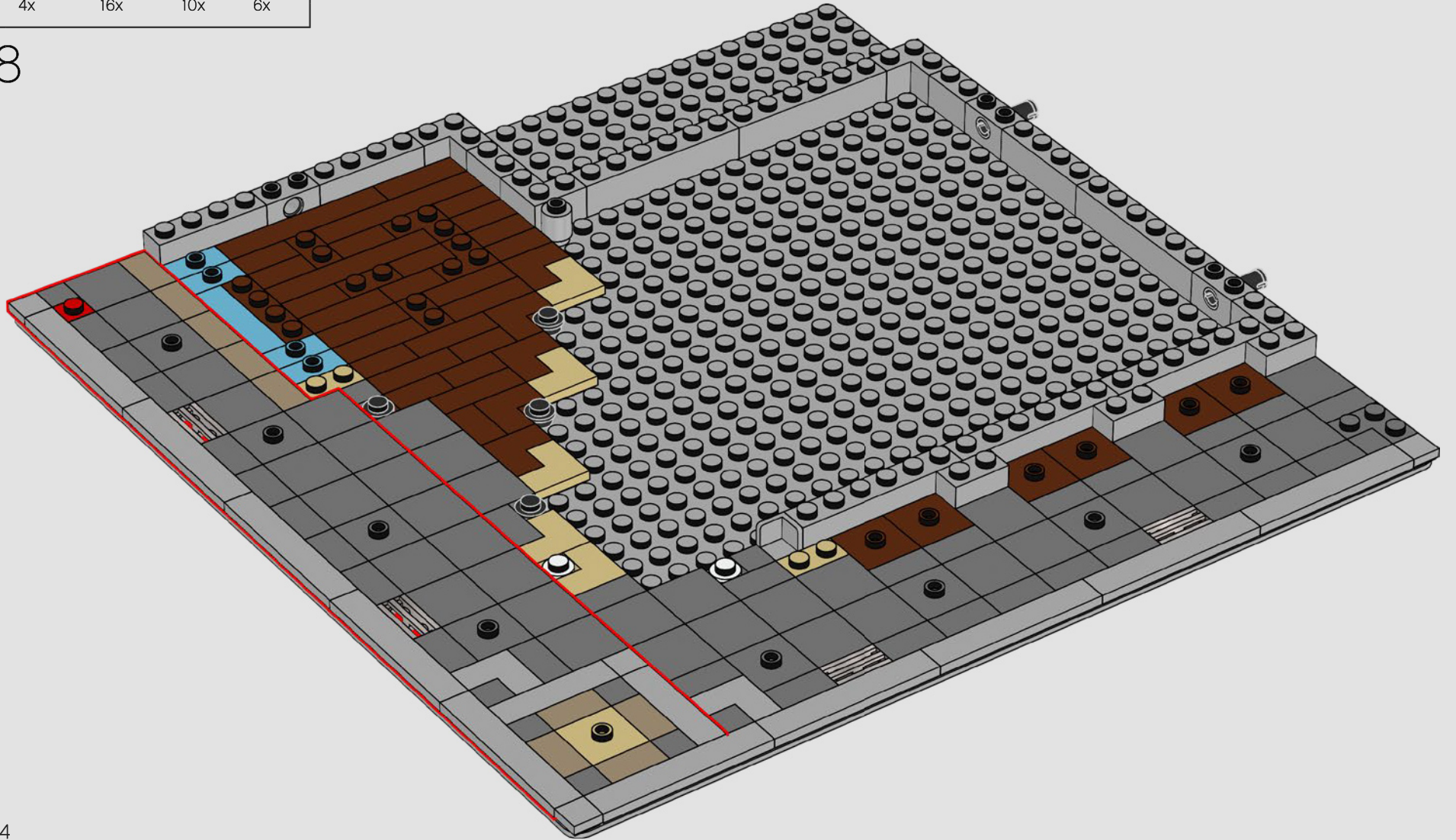



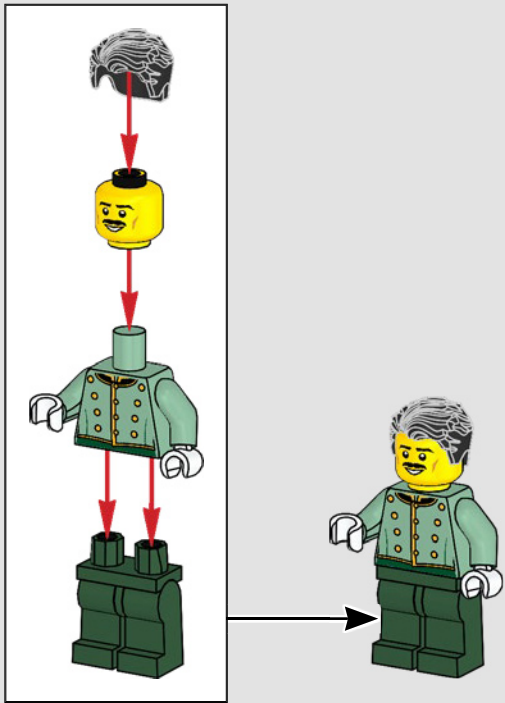
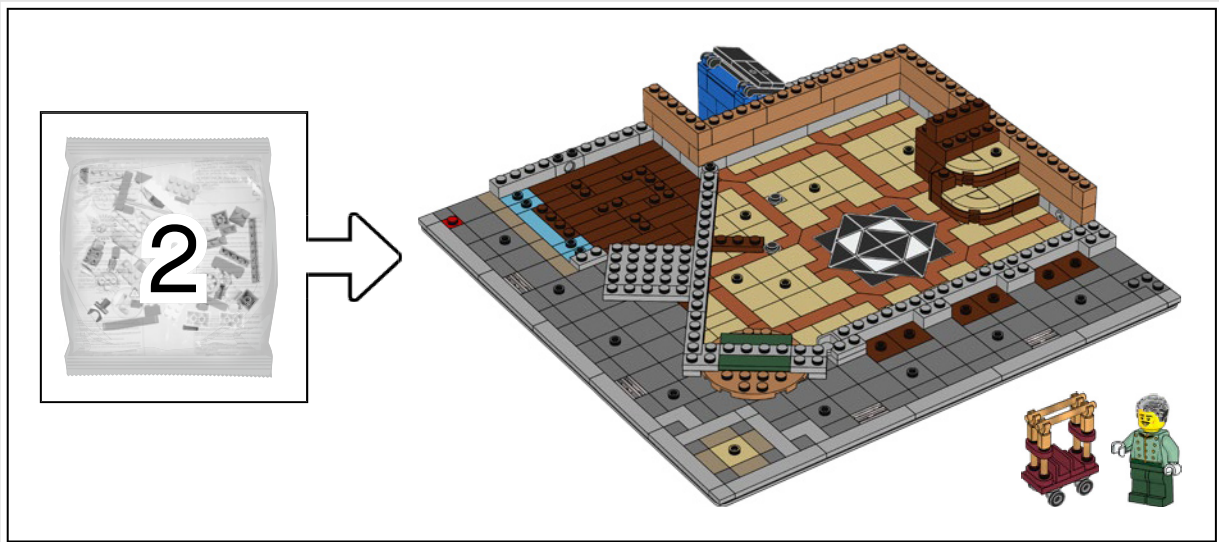

El botones estará encantado de ayudarte a subir tu equipaje por las escaleras del hotel hasta tu habitación.

¡Acuérdate de darle propina! 15

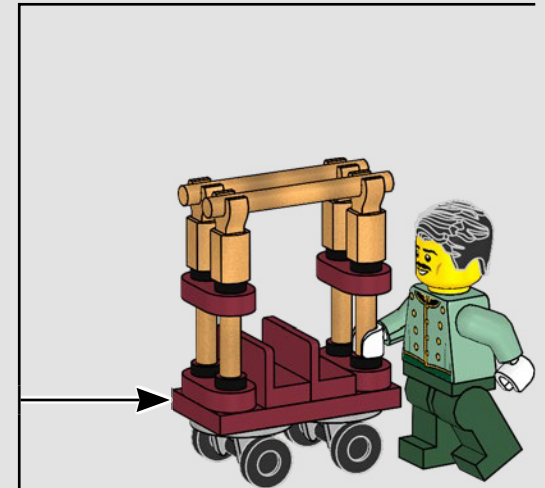
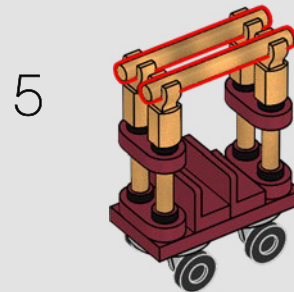
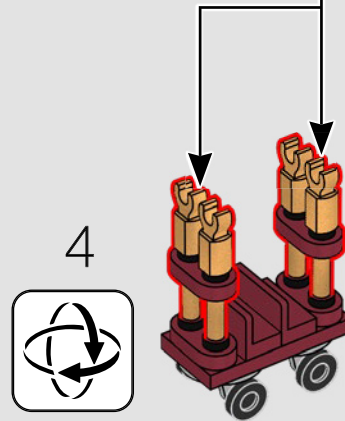
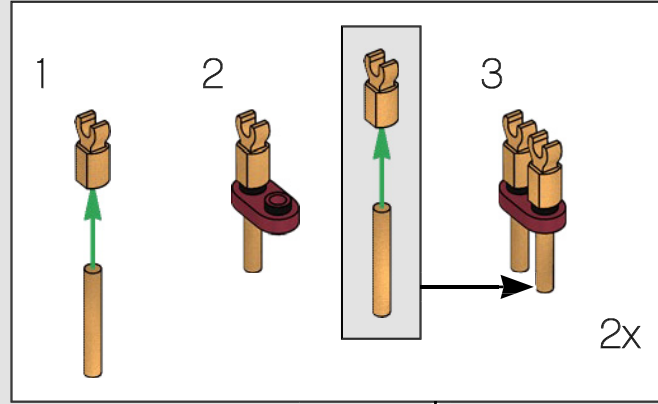
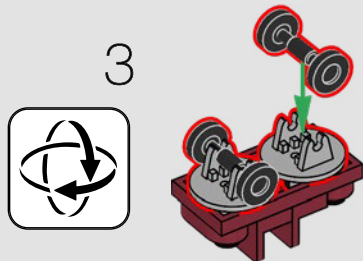
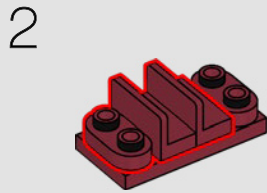
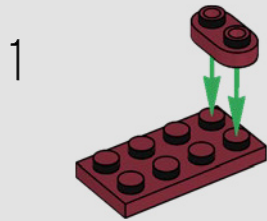
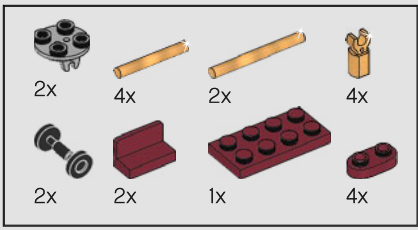



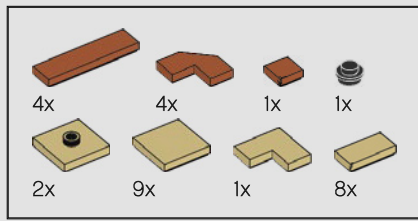

9

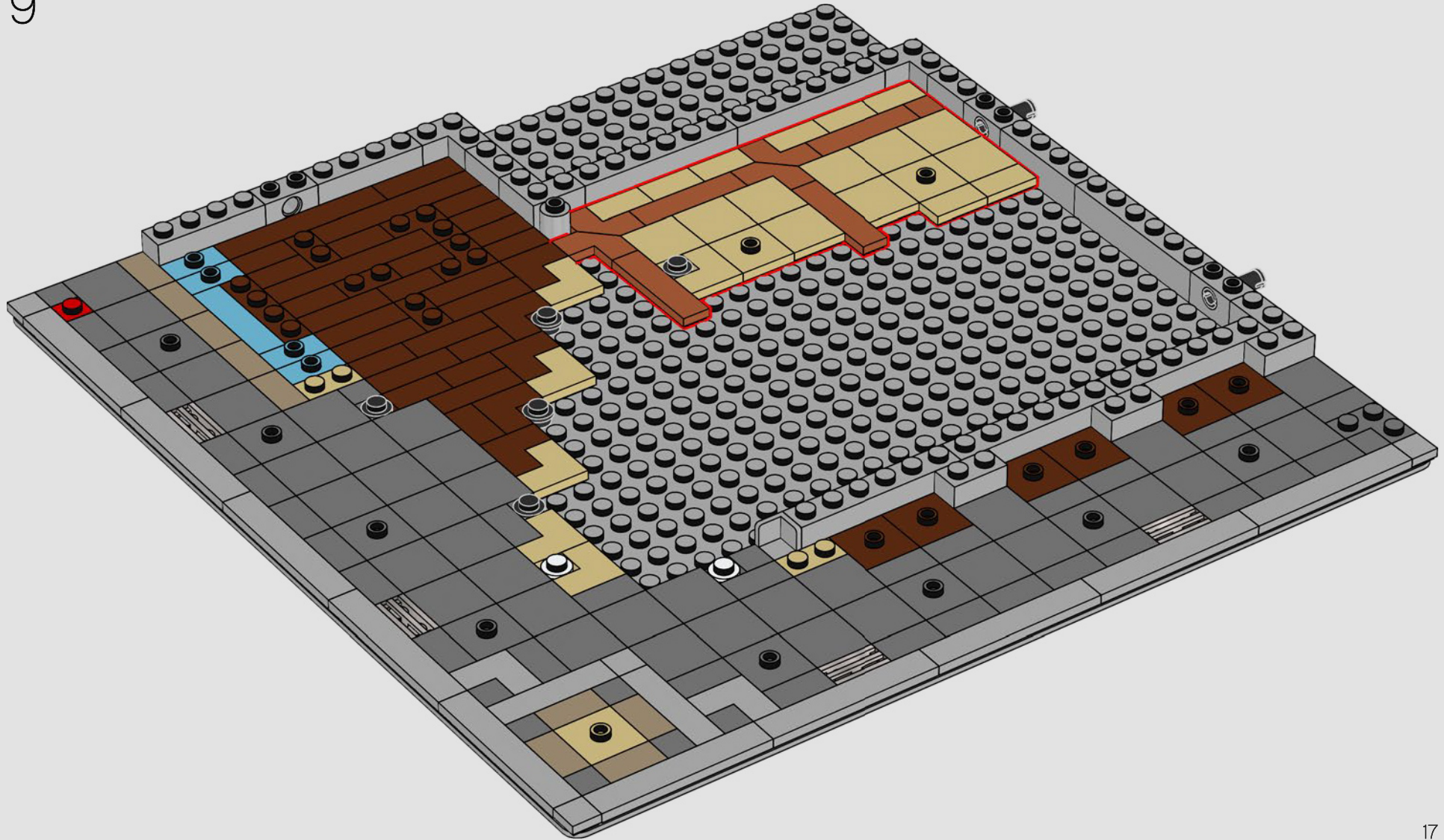

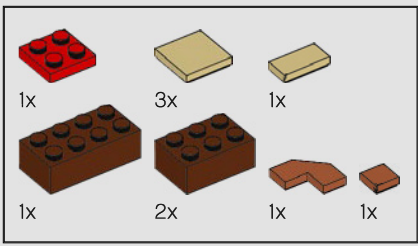

10

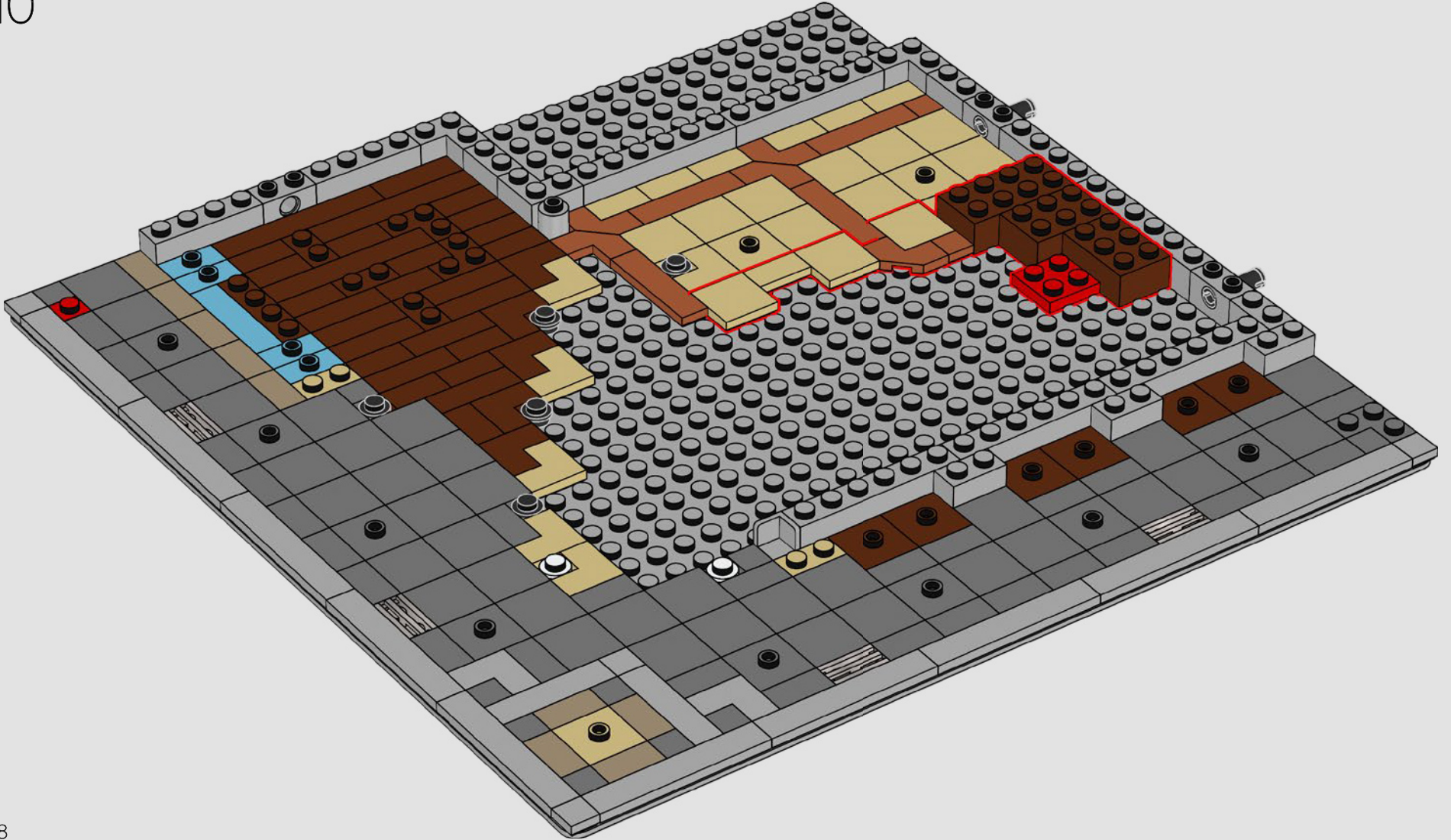



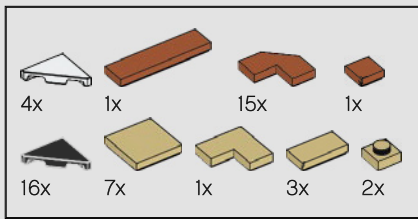

11

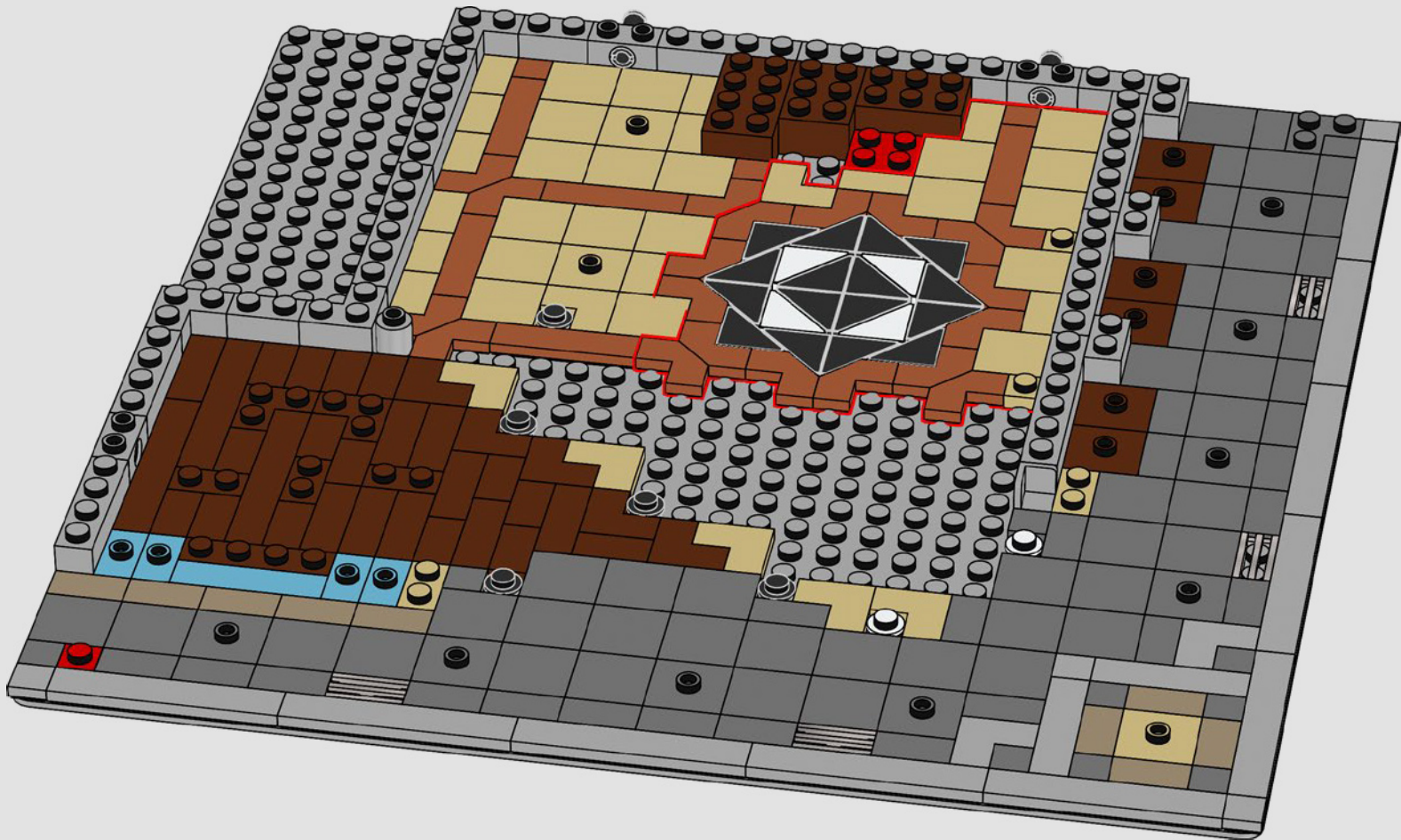

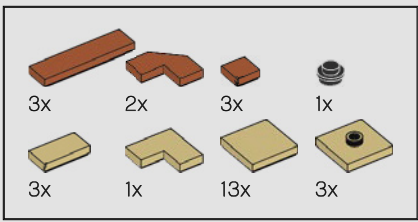

12

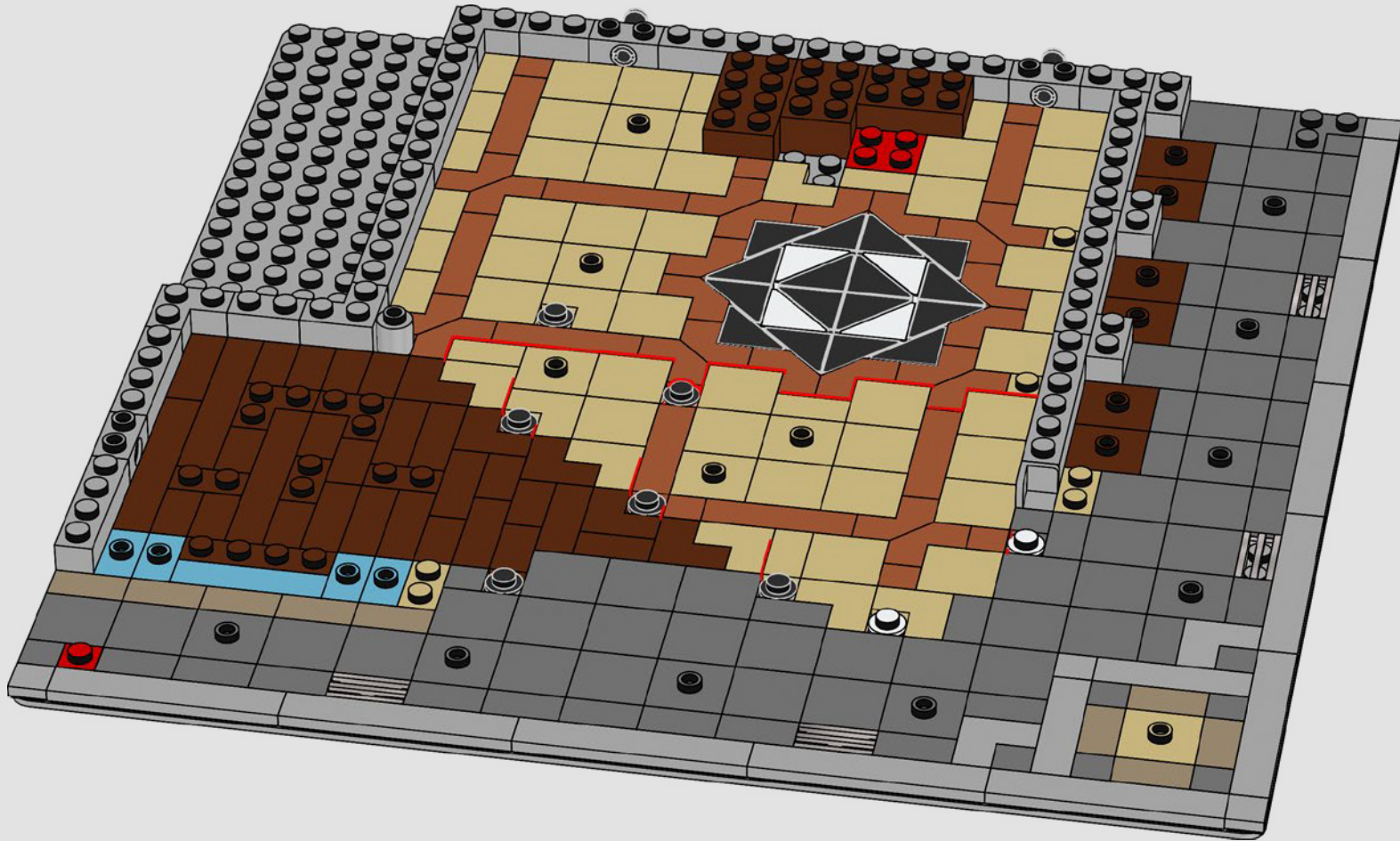



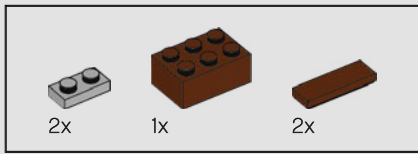

13

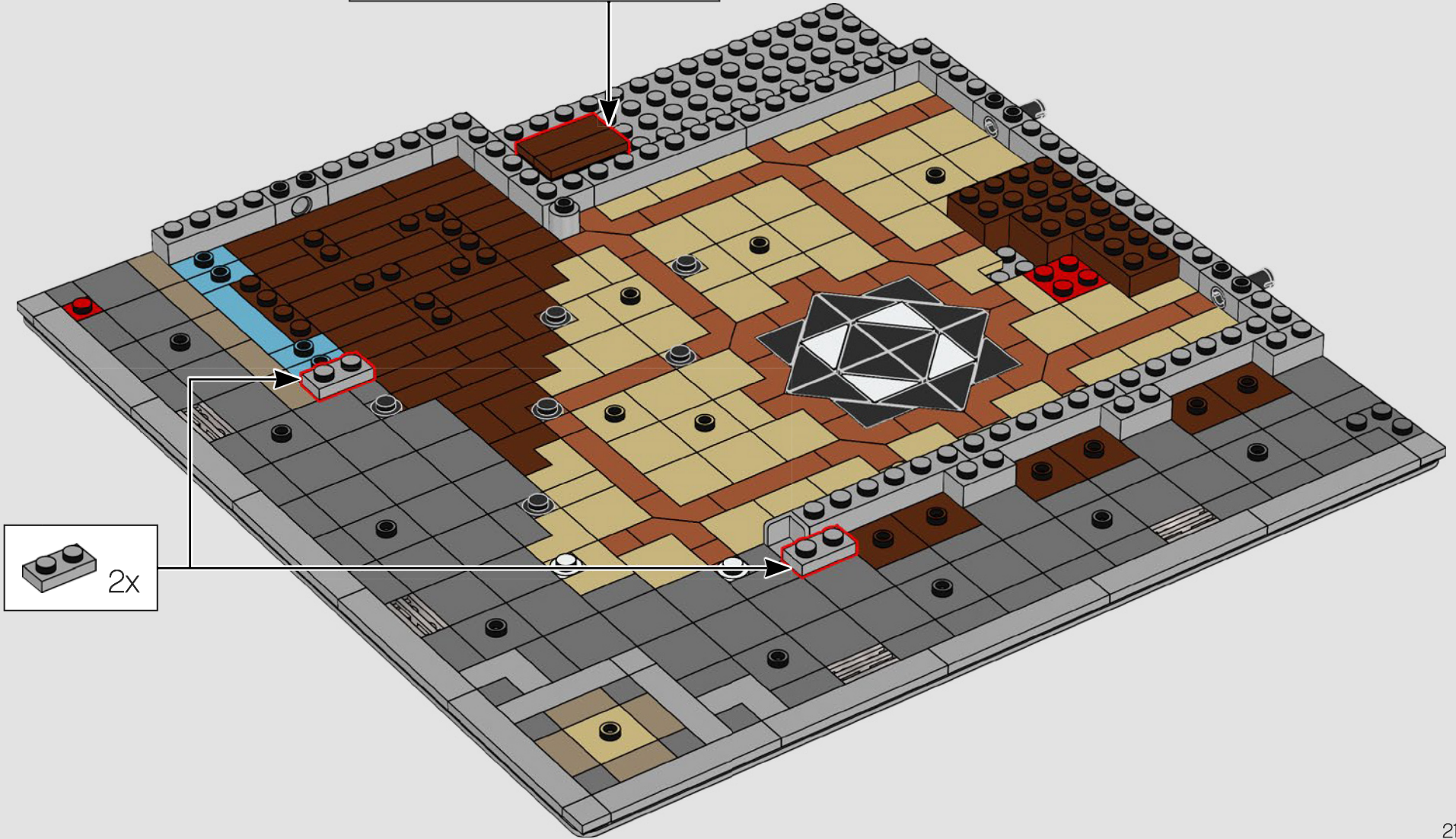
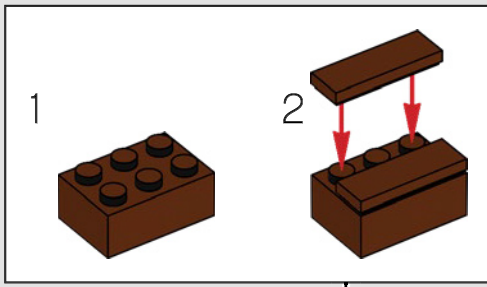

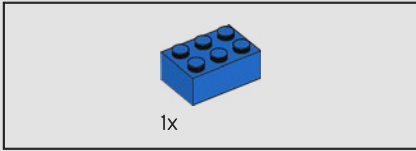
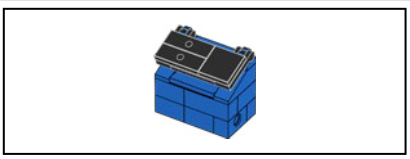

14

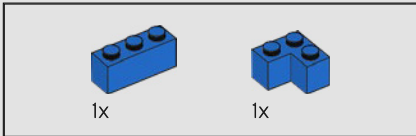
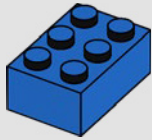

15

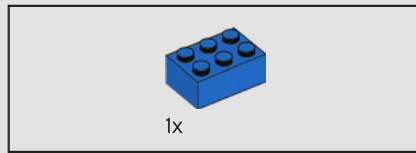
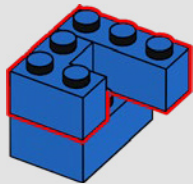

16

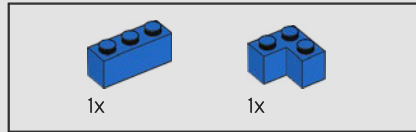
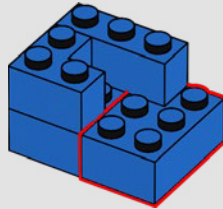

17

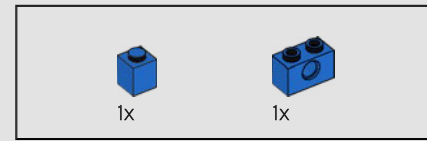
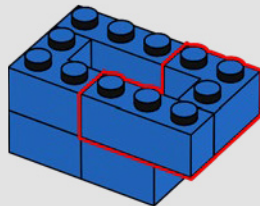

18

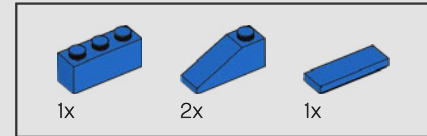
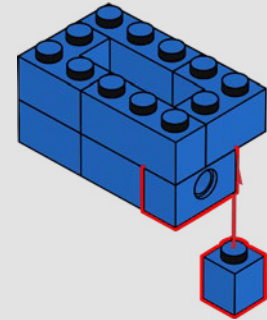

19

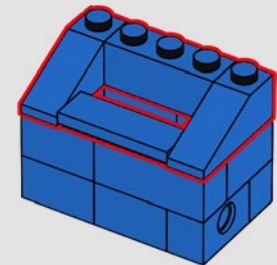



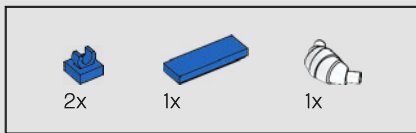

20

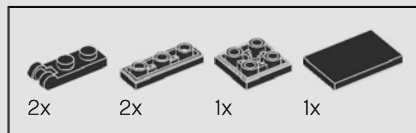
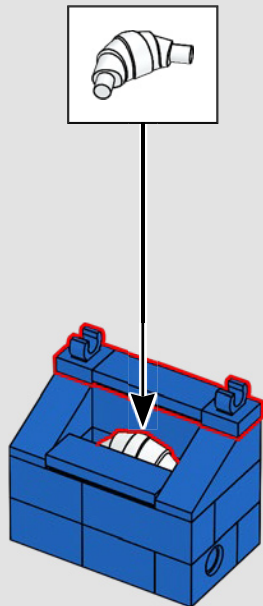

21

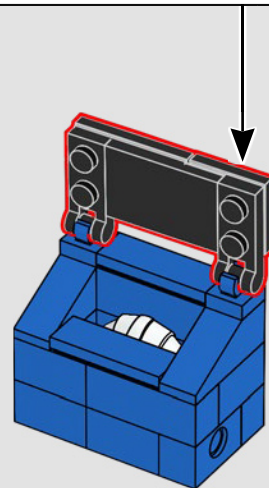
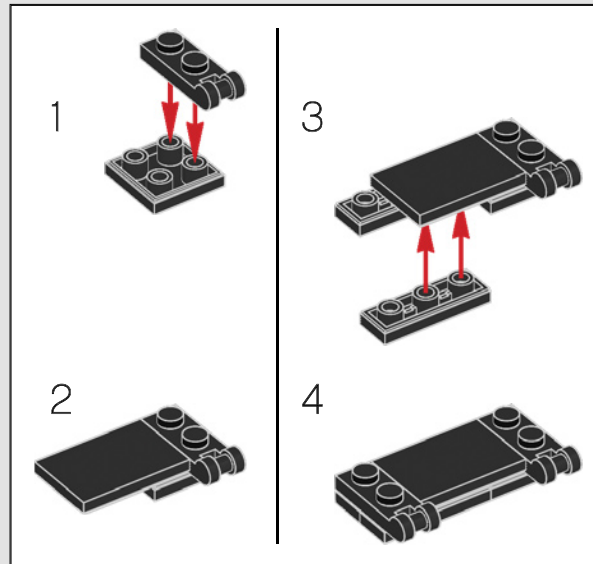

22

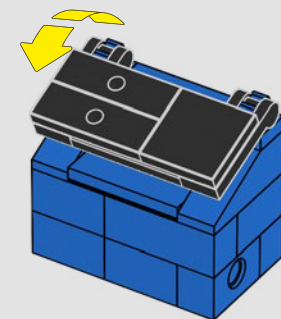

Este cruasán aparecía en el set Restaurante Parisino (10243), ¿pero para qué querría alguien un cruasán blanco de yeso?

23

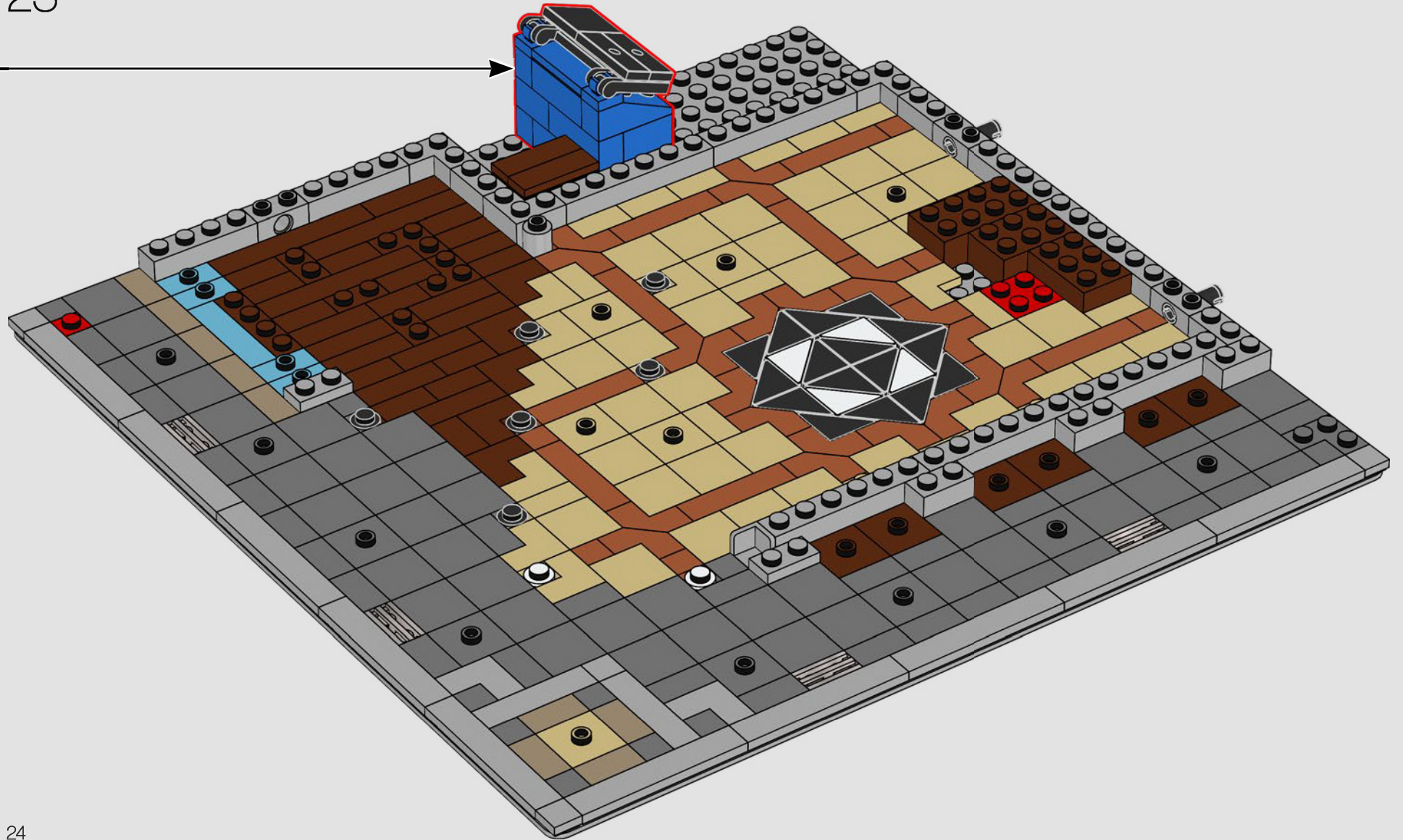

24



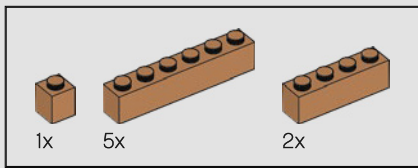

24

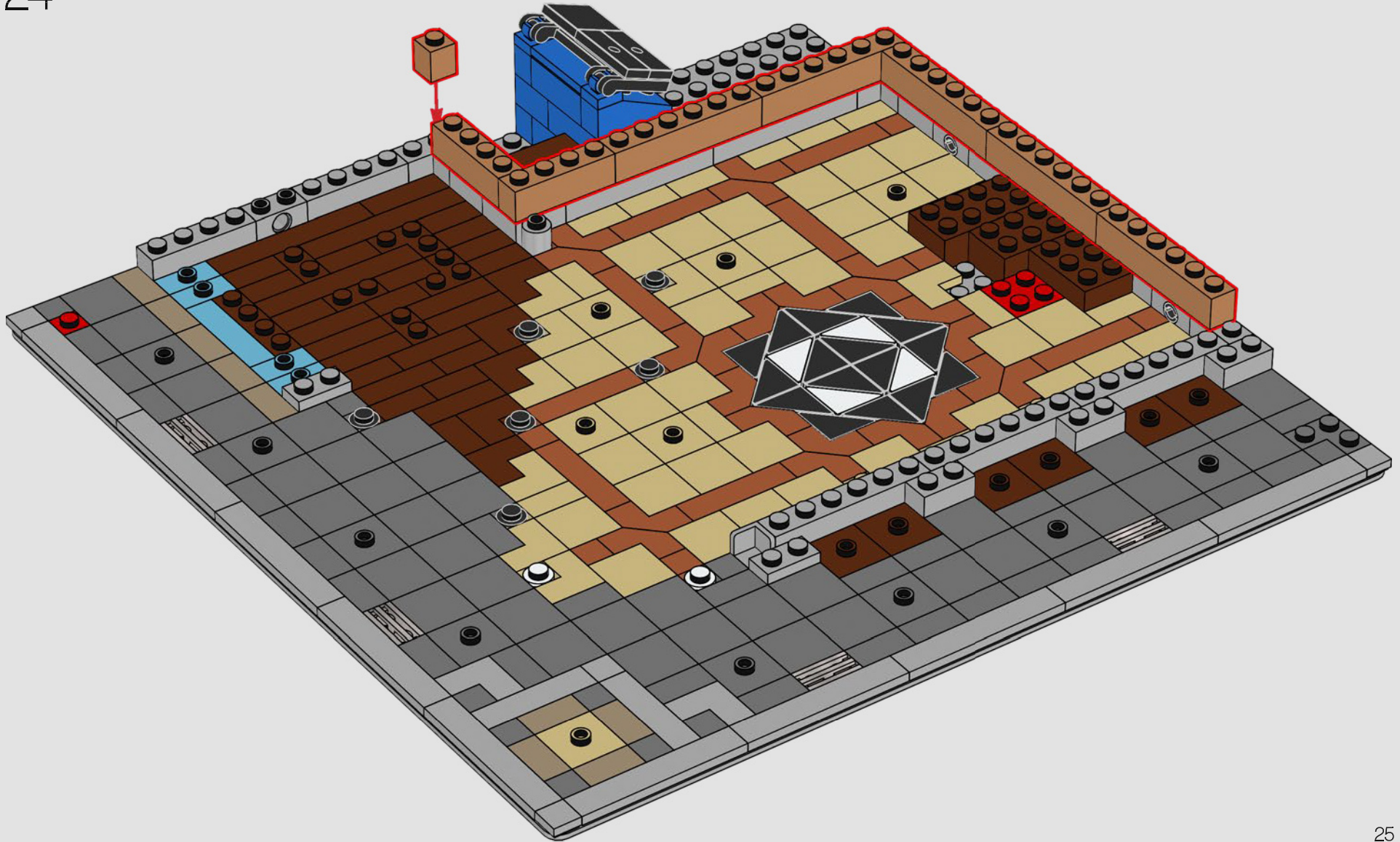

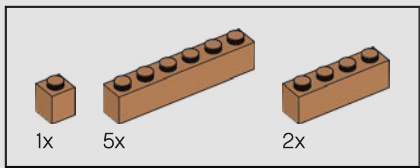

25

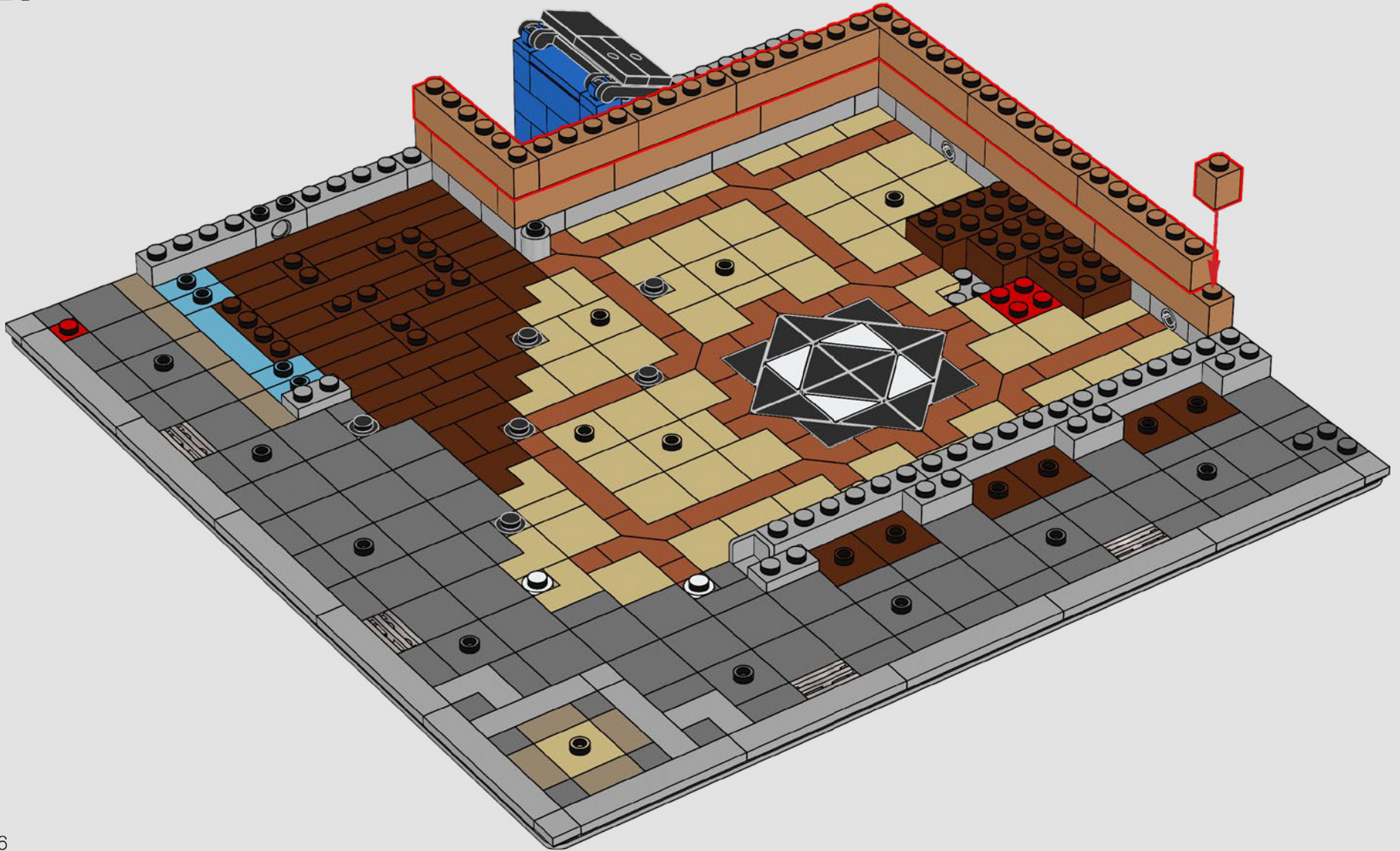



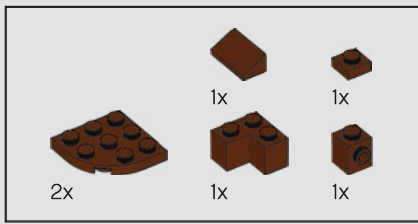

26

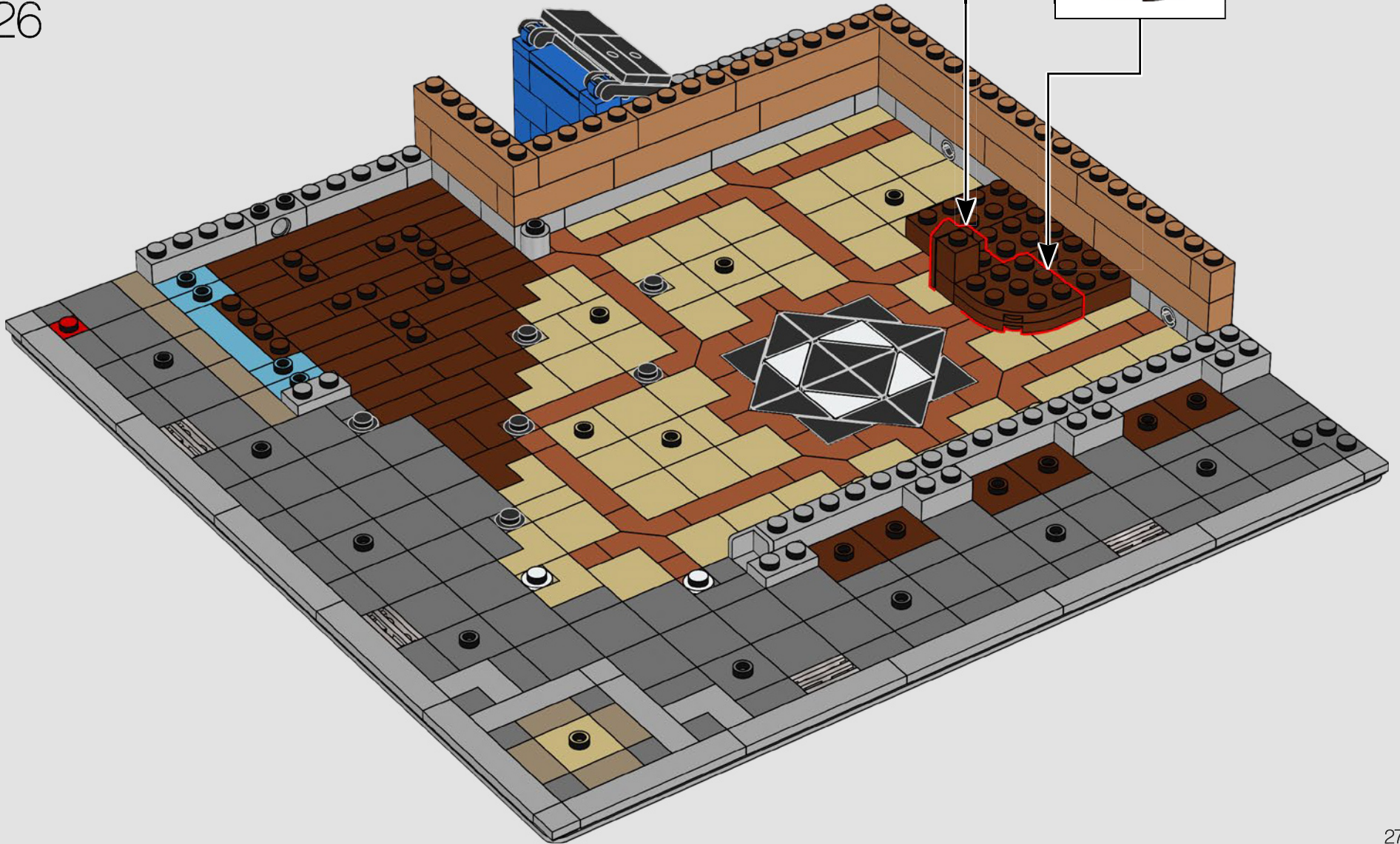
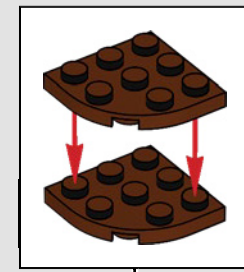
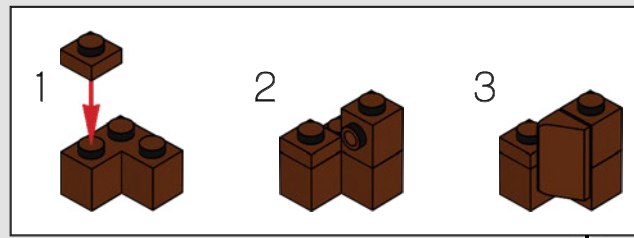

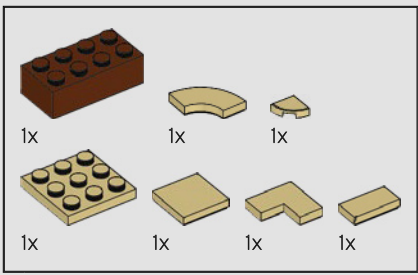

27

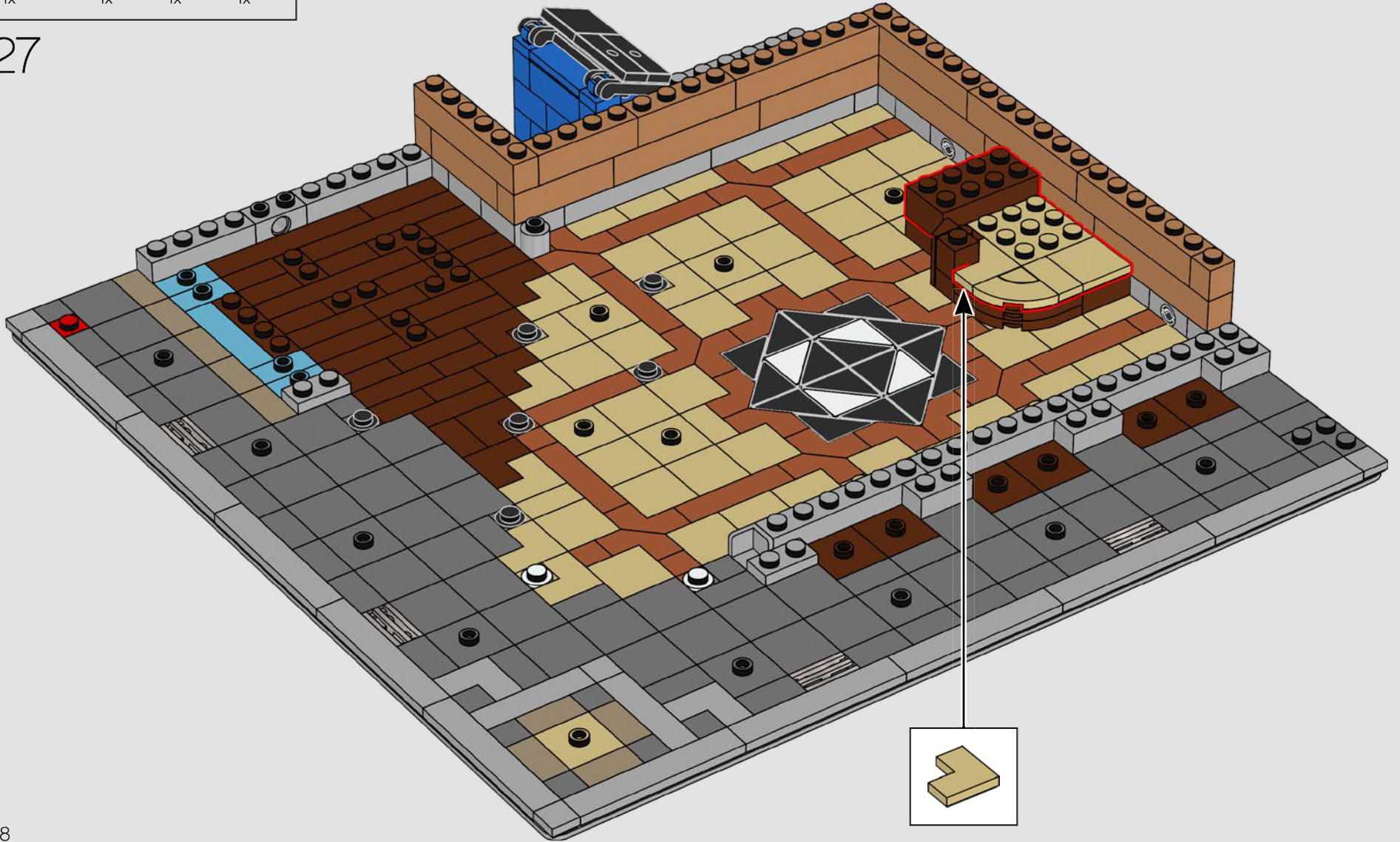

28



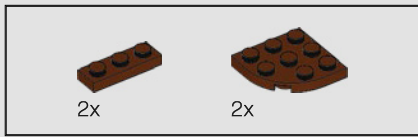

28

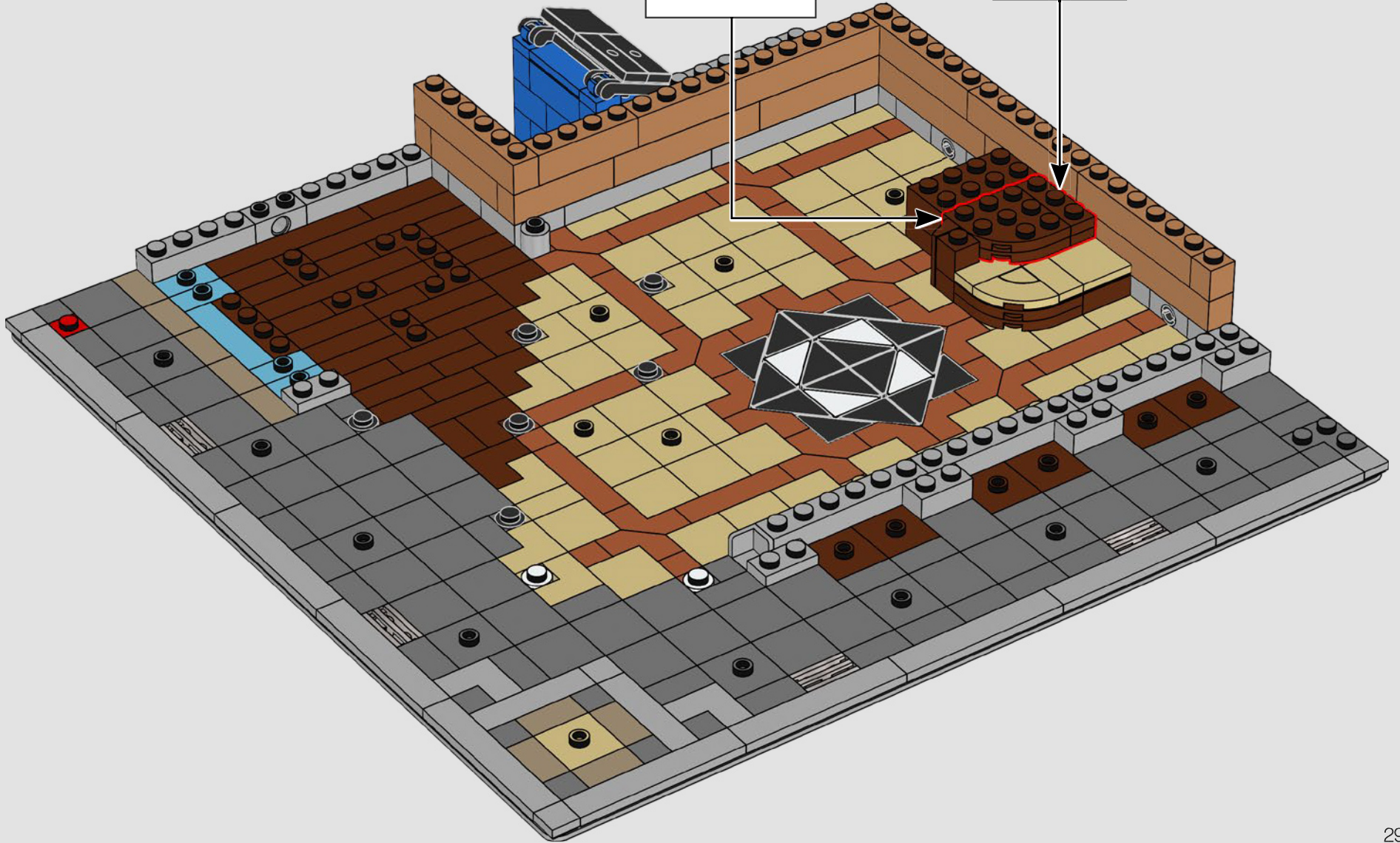
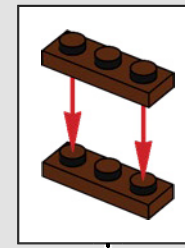
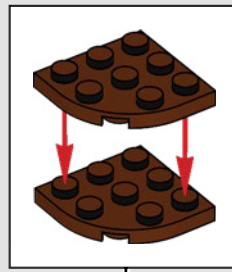

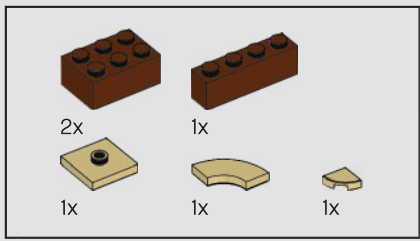

29

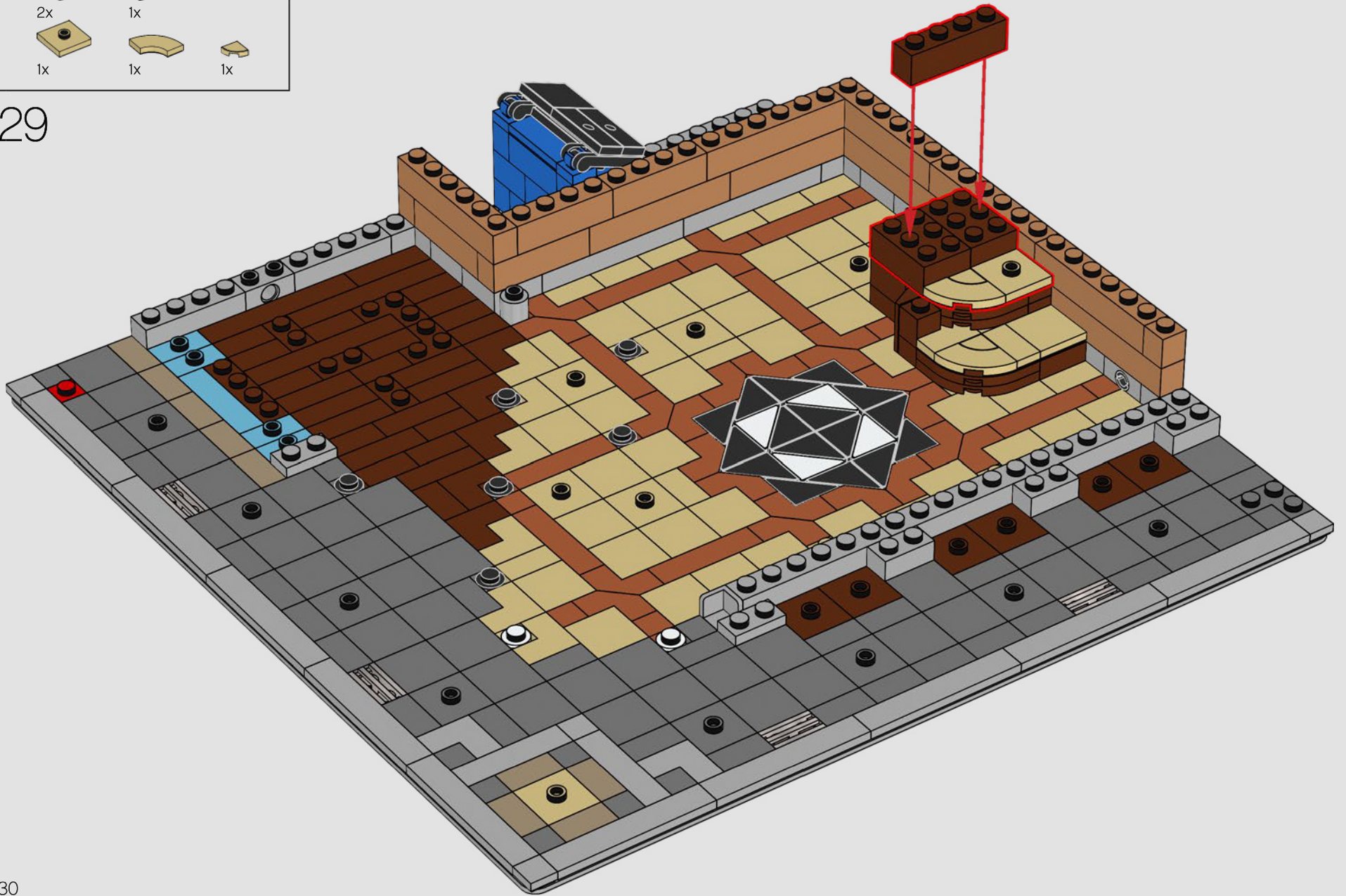



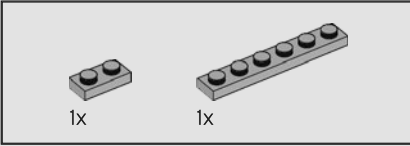
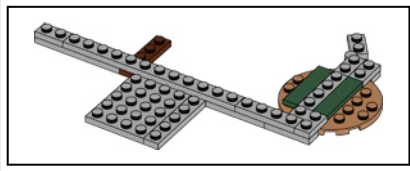

30

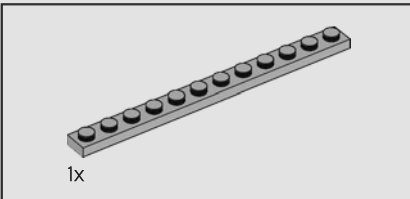
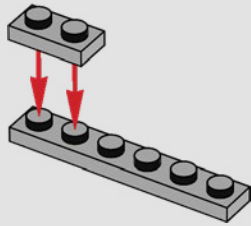

31

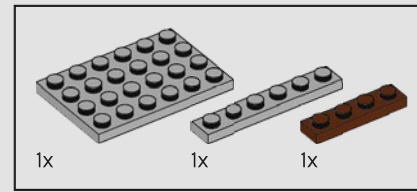
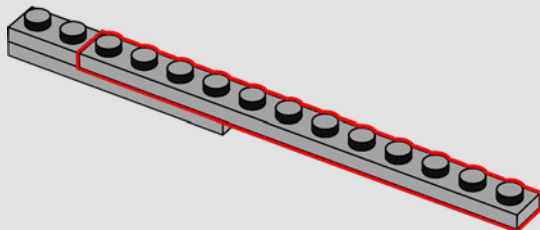

32

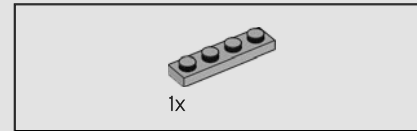
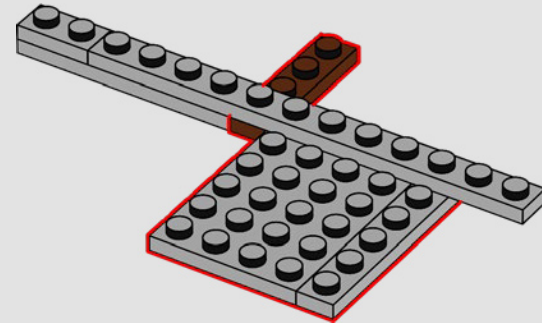

33

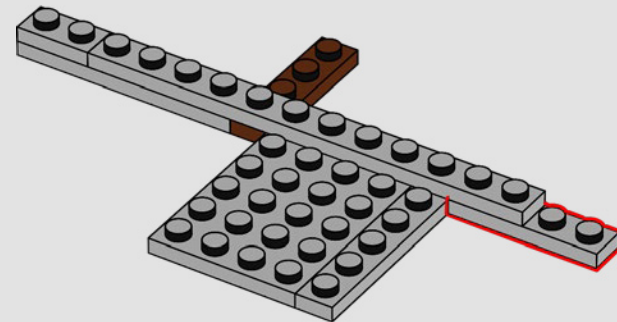

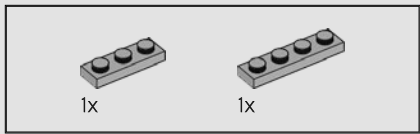

34

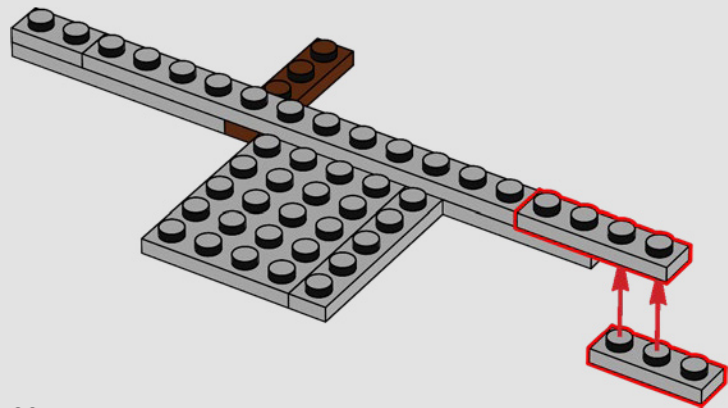

32

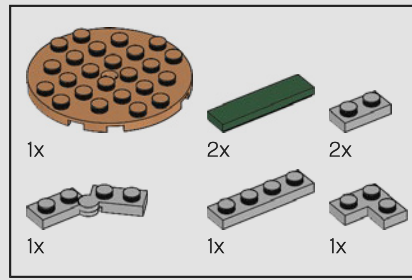

35

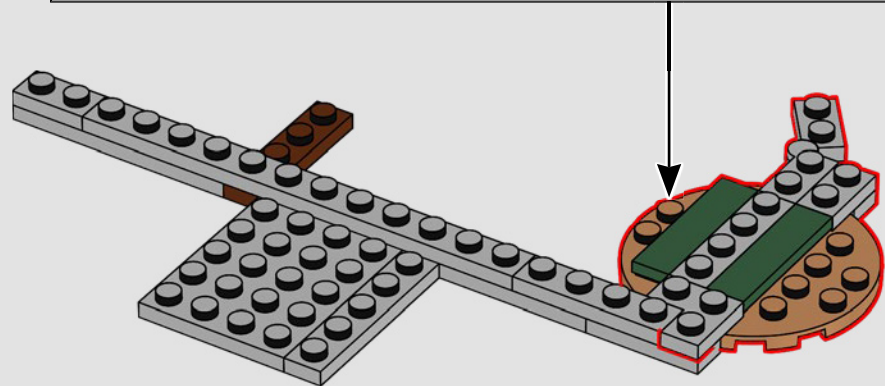
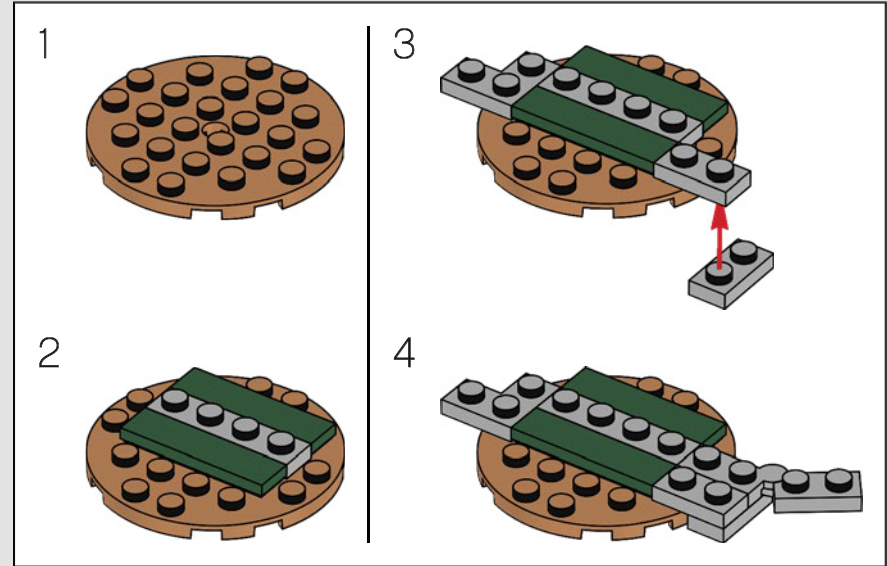



36

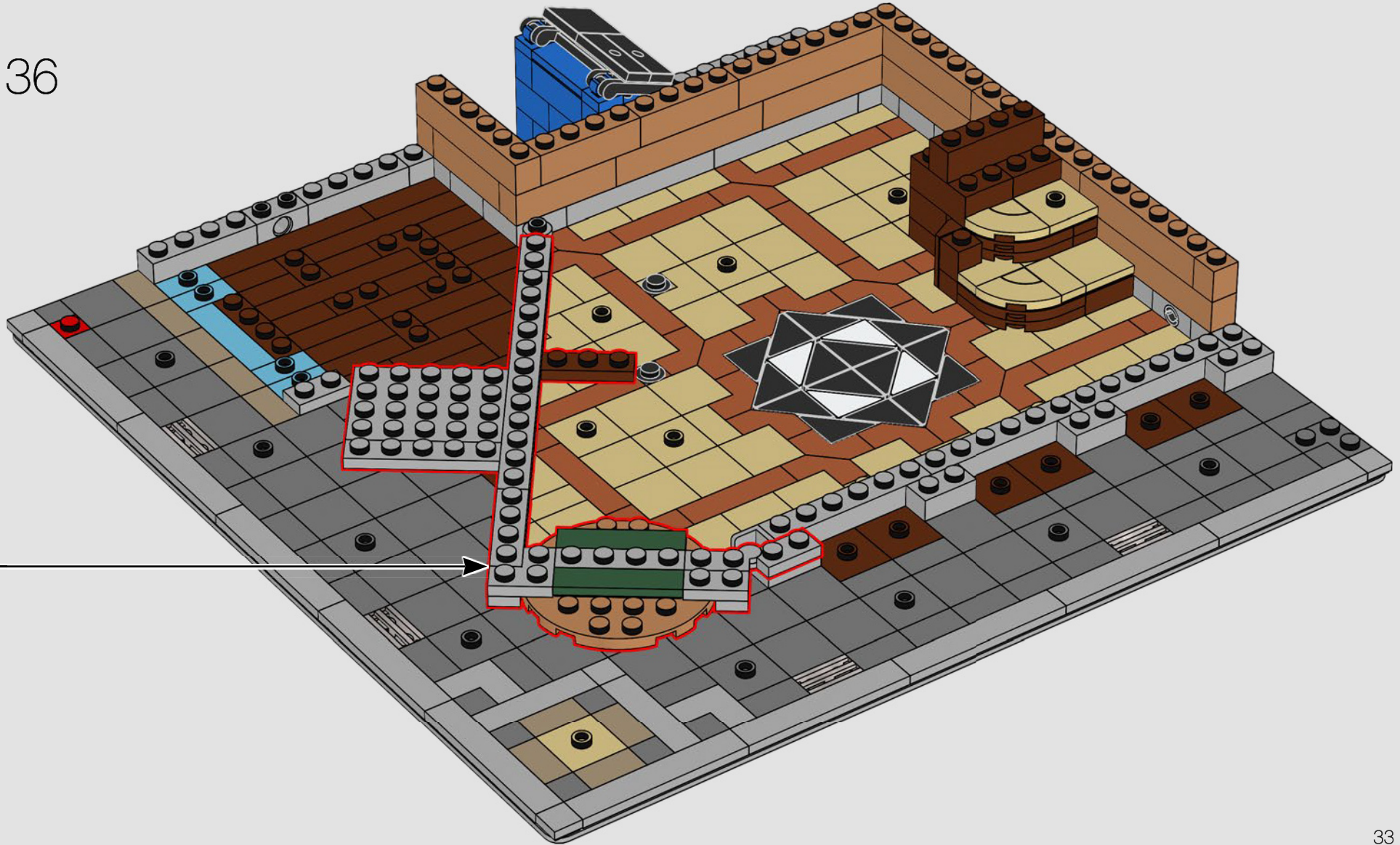

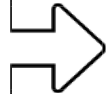



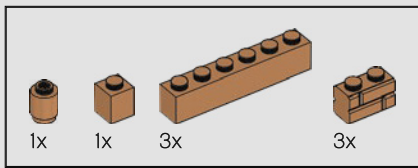

37

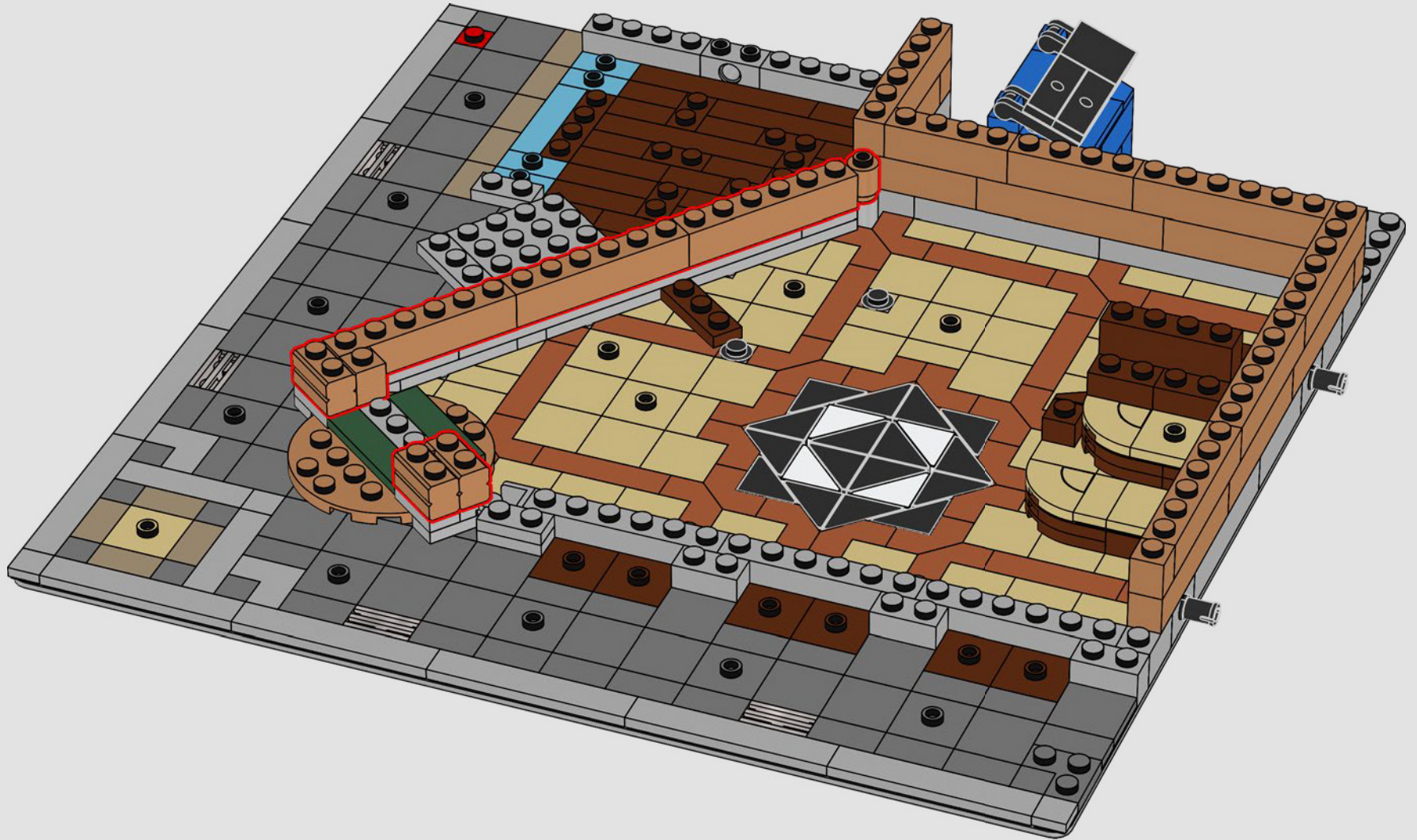

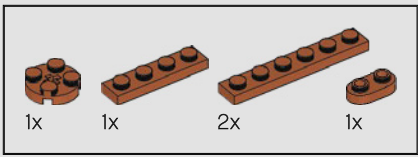

38

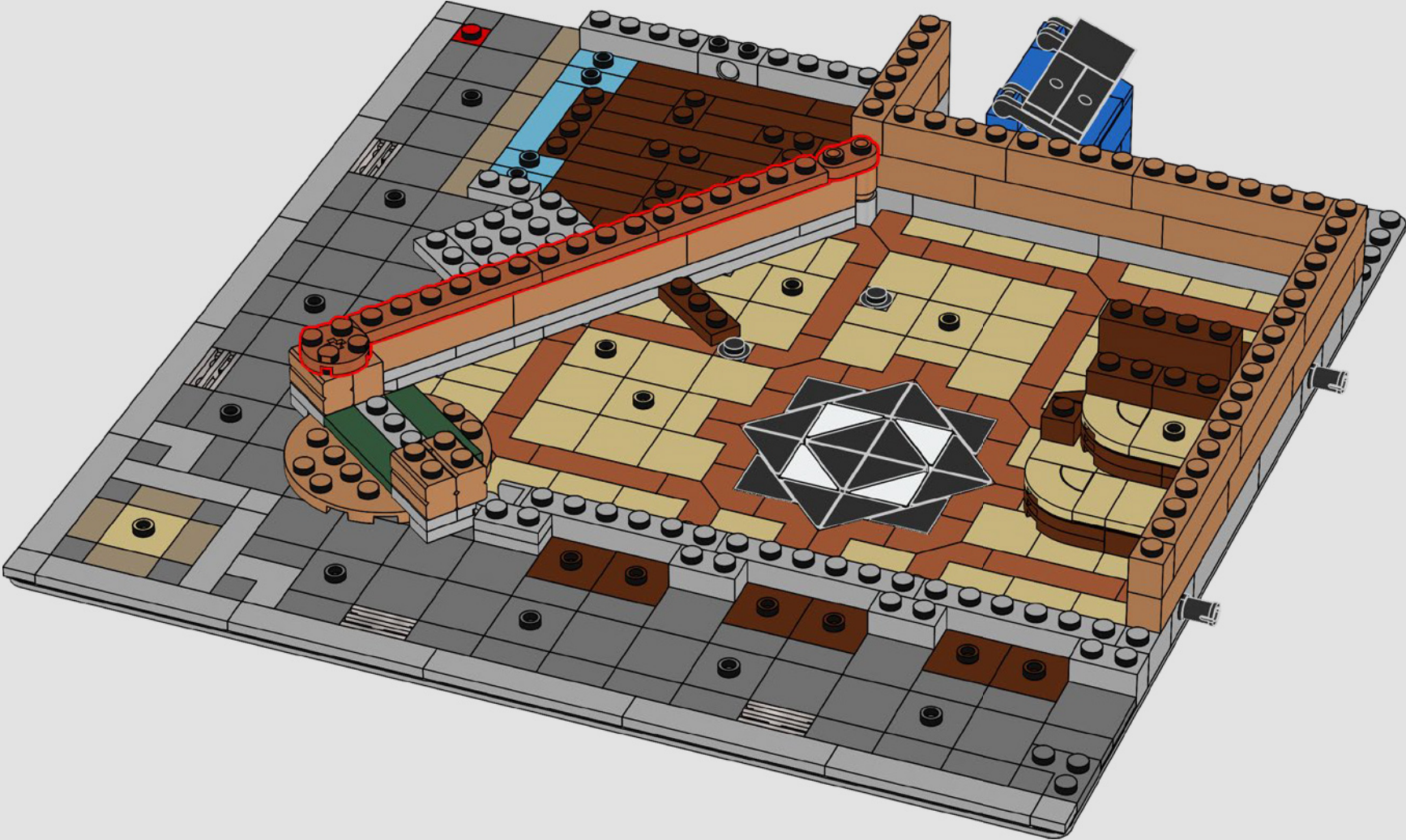



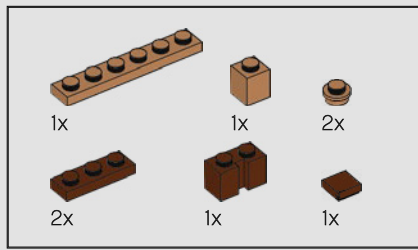

39

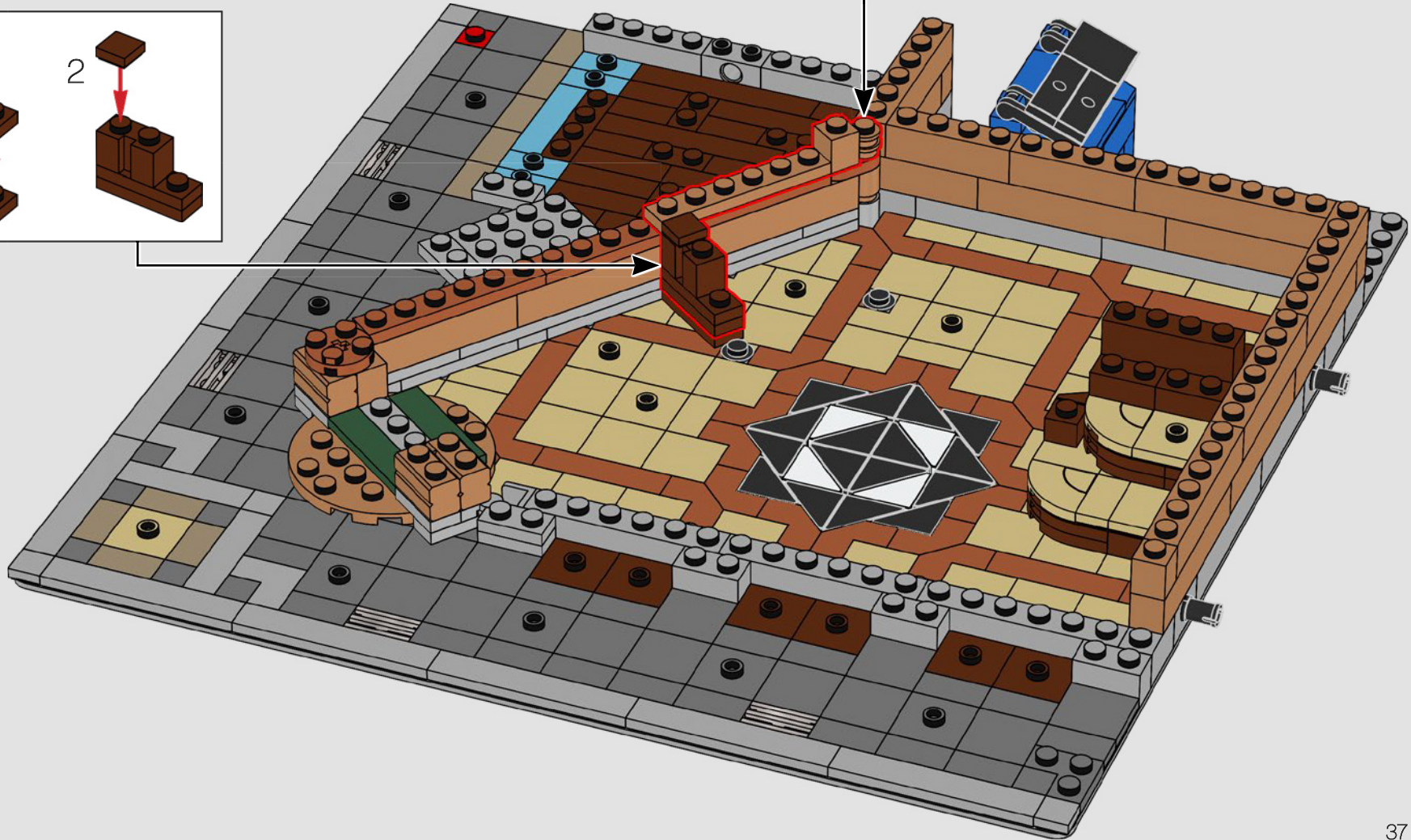
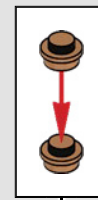
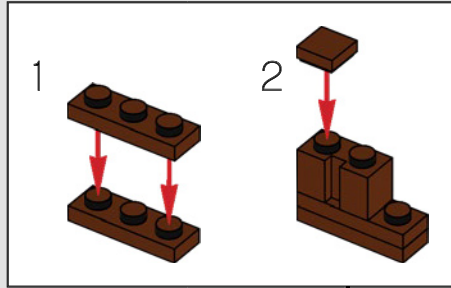

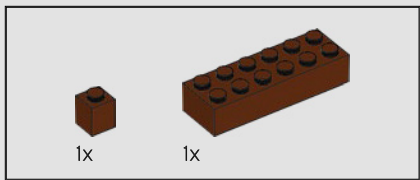

40

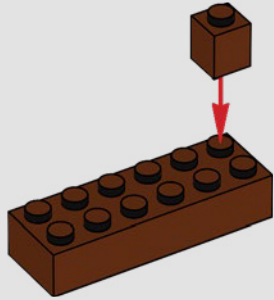

41

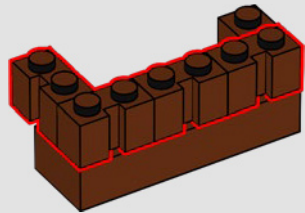

42

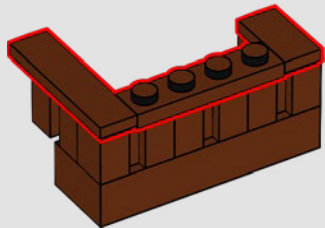

¡Muchos de los huéspedes que se han alojado en este hotel son residentes de antiguos sets Modular Buildings! ¿Puedes identificarlos?

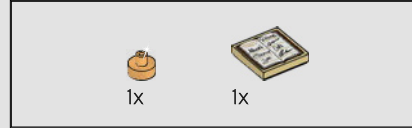

43

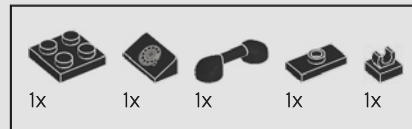
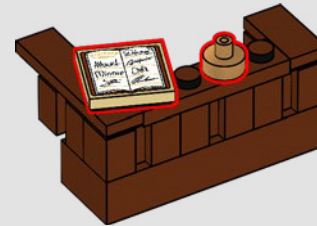

44

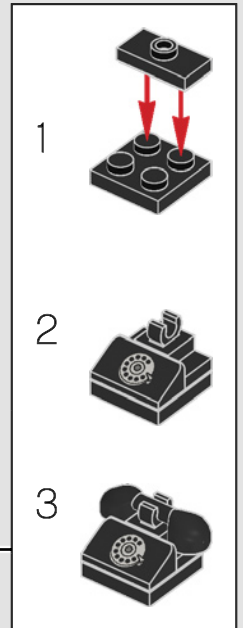
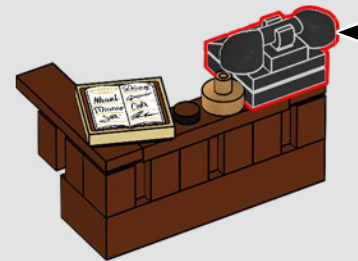





A la recepcionista le encanta llamar a la  
teniente del set Comisaría de Policía (10278)  
usando este teléfono. ¡Son muy amigas!

45

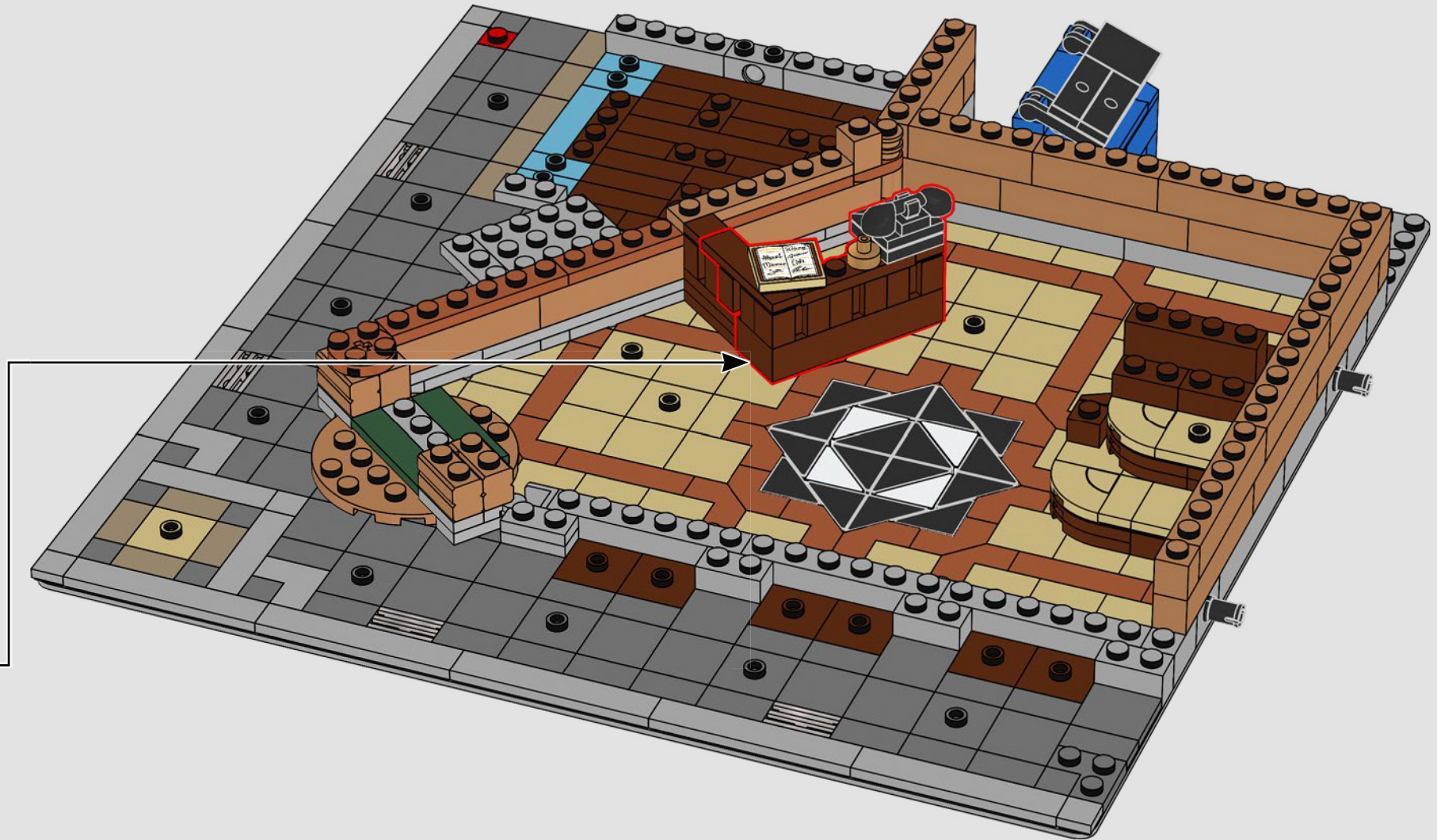

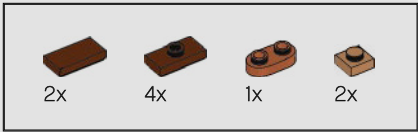

46

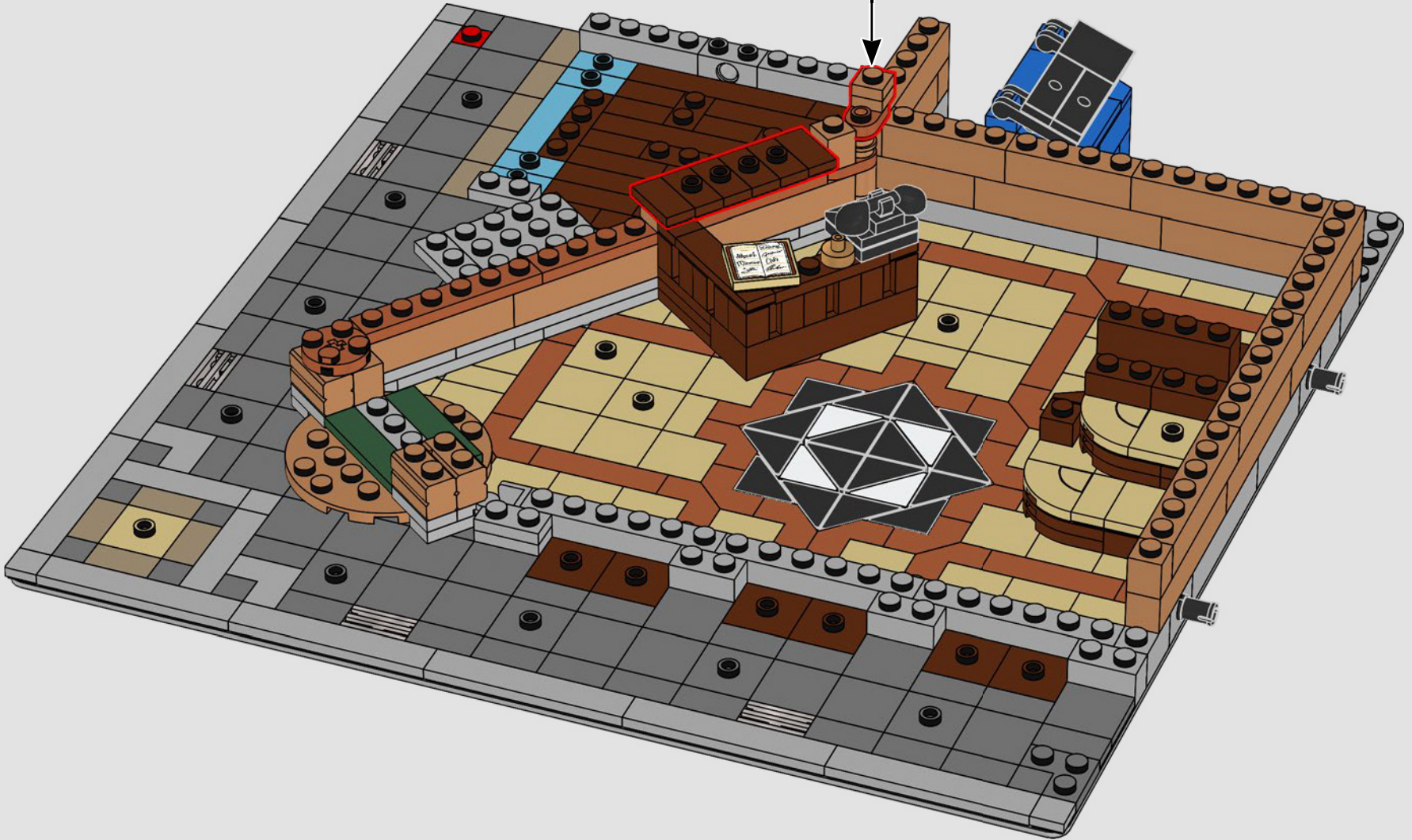
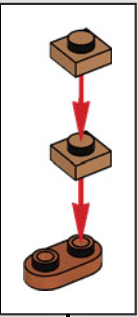



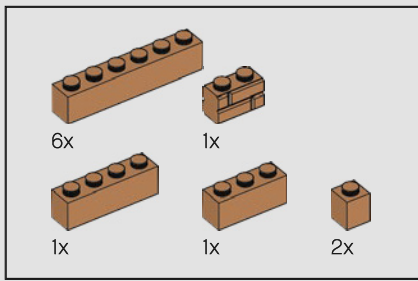

47

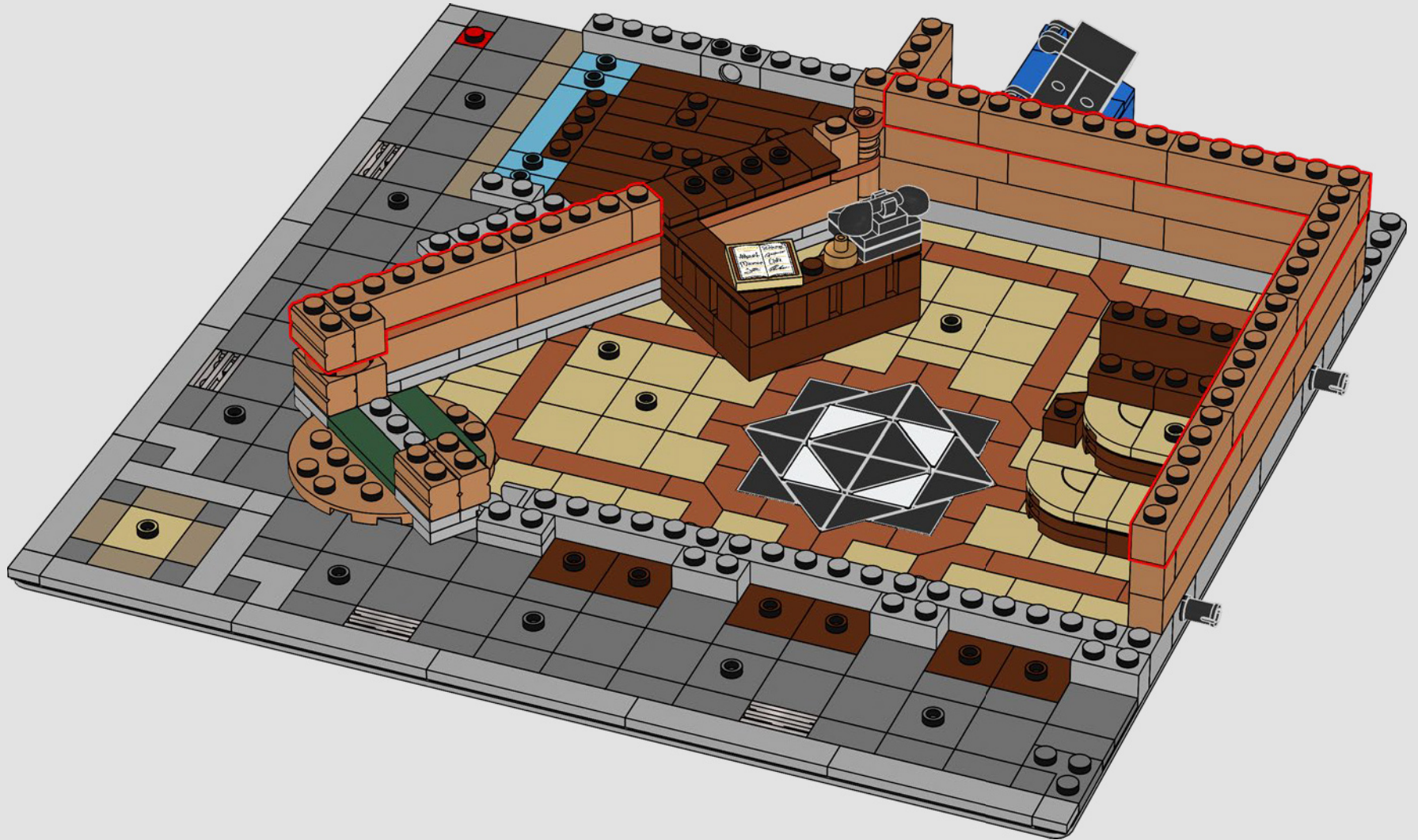

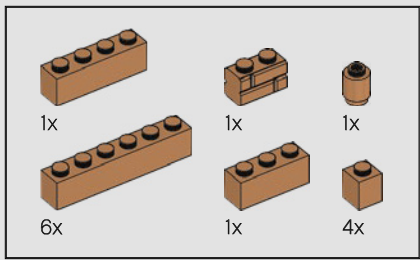

48

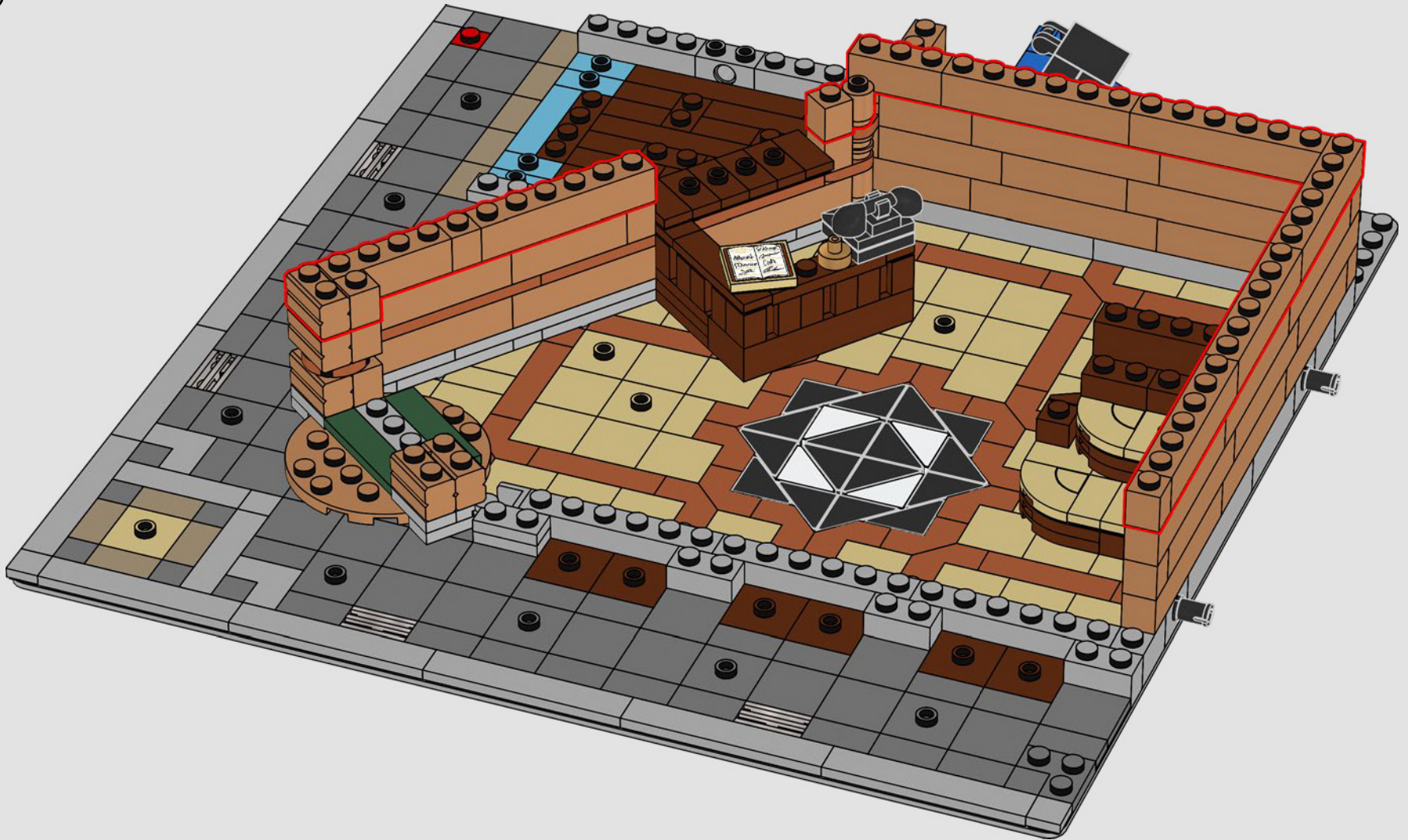



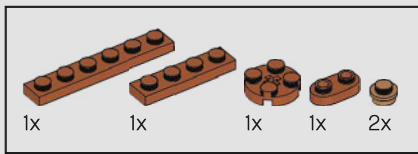

49

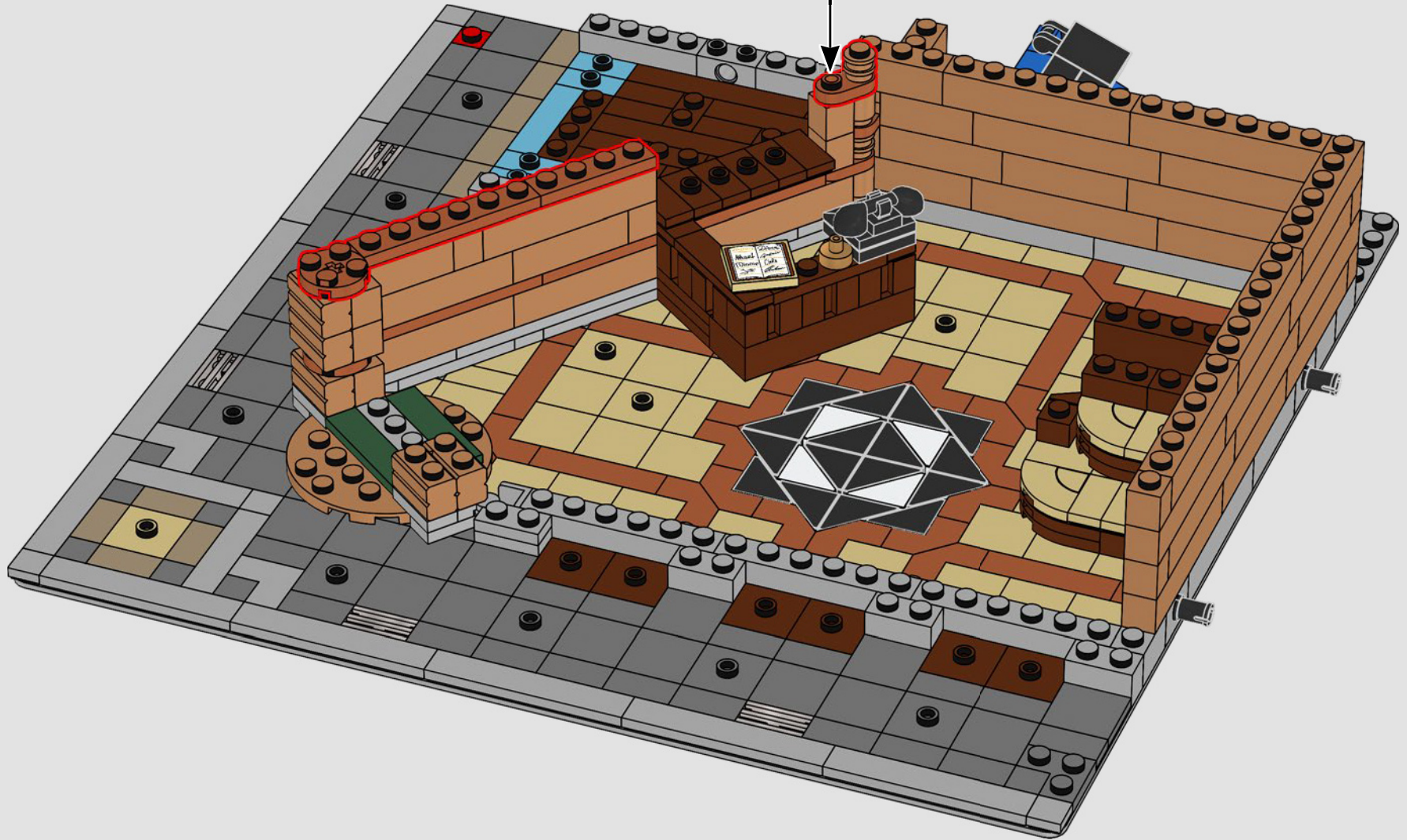
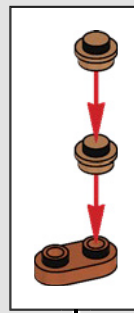

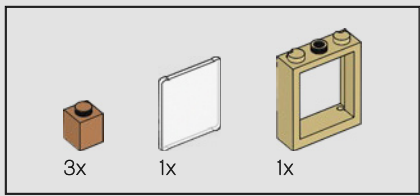

50

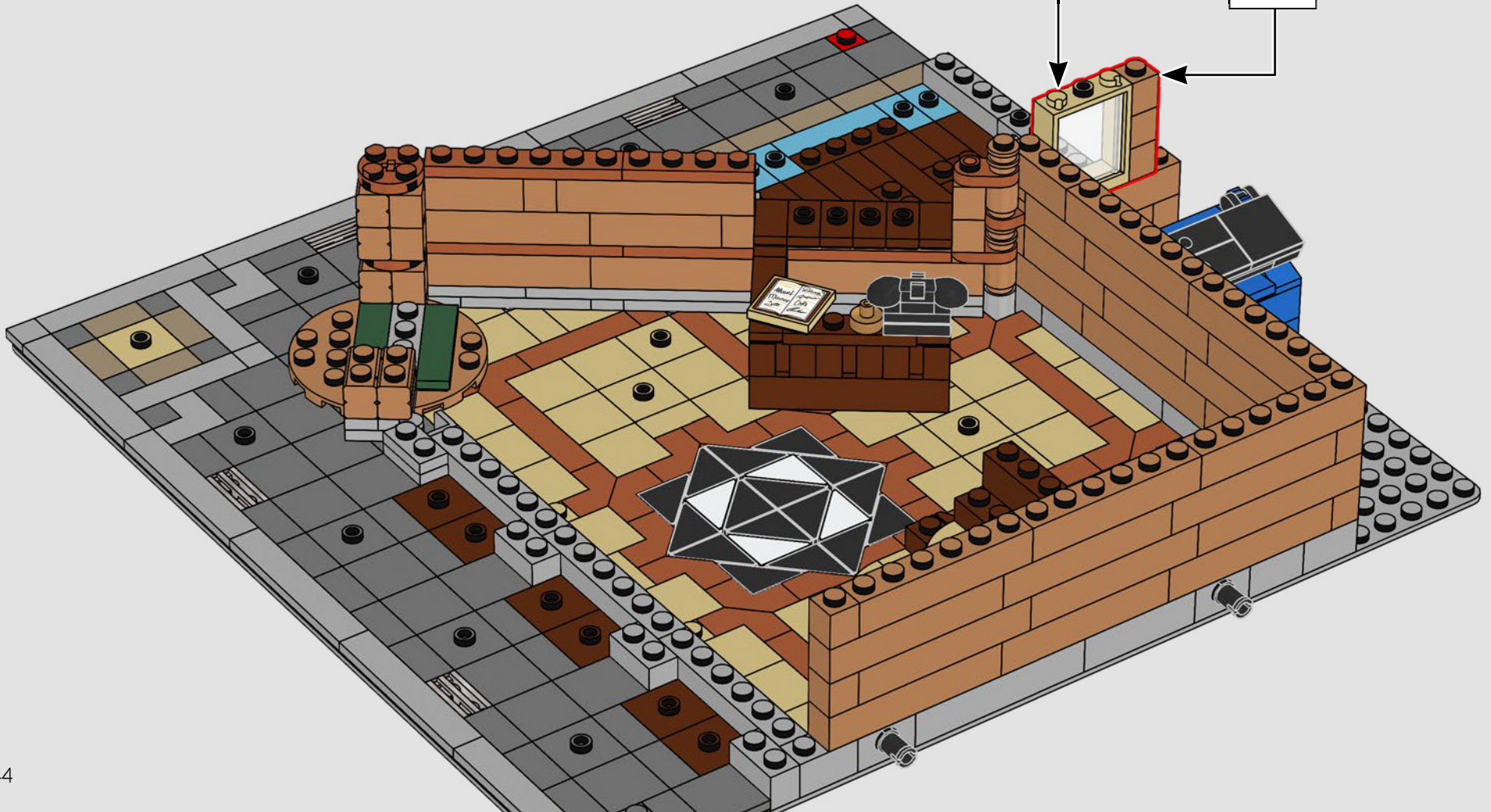
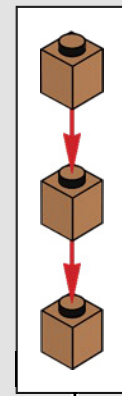
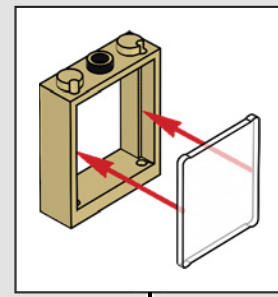



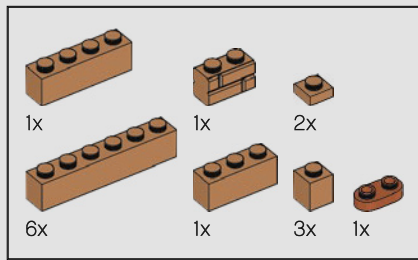

51

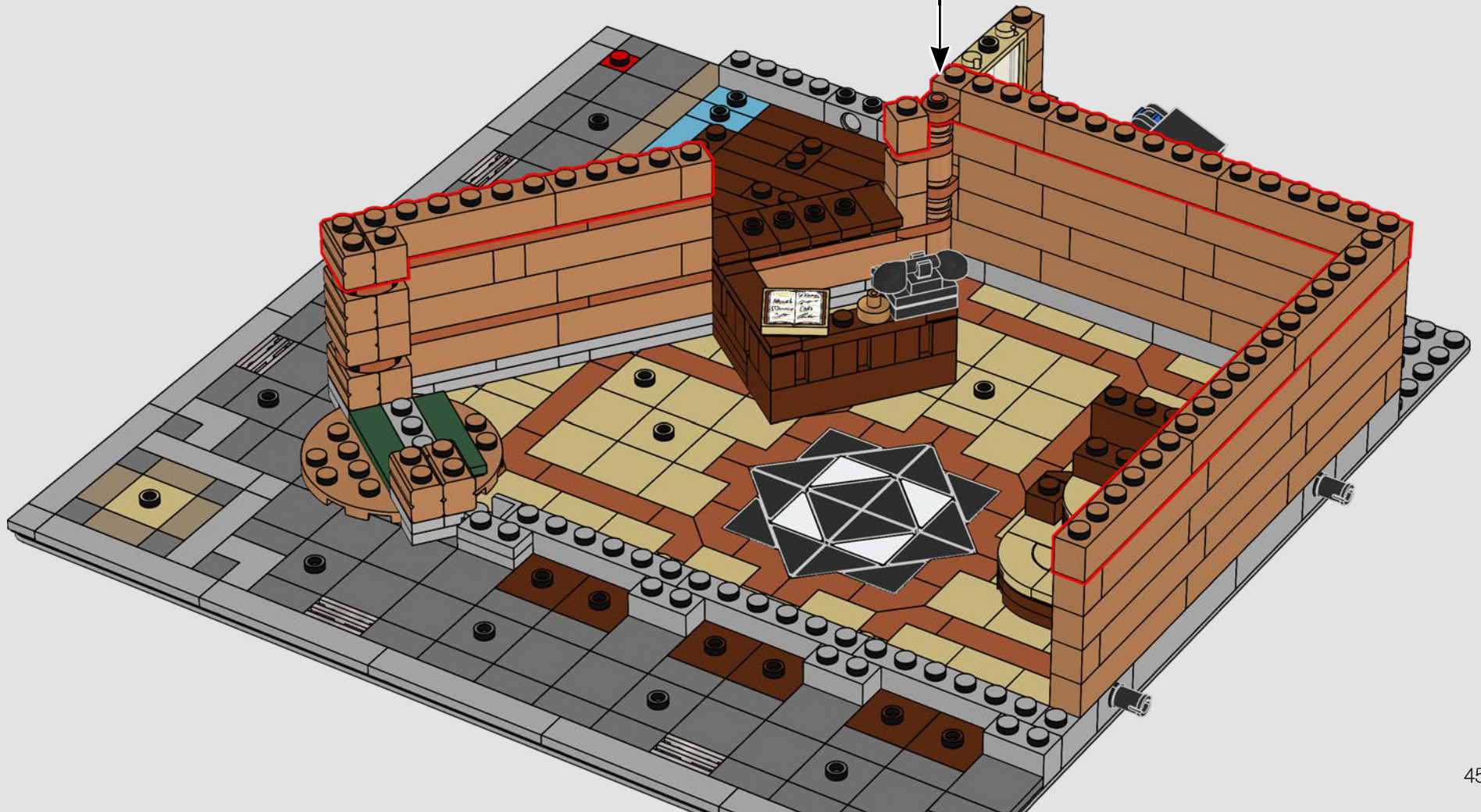
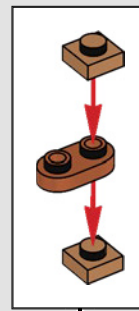



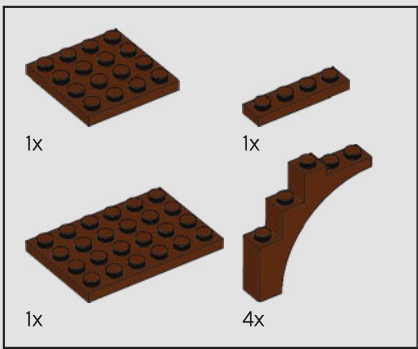

52

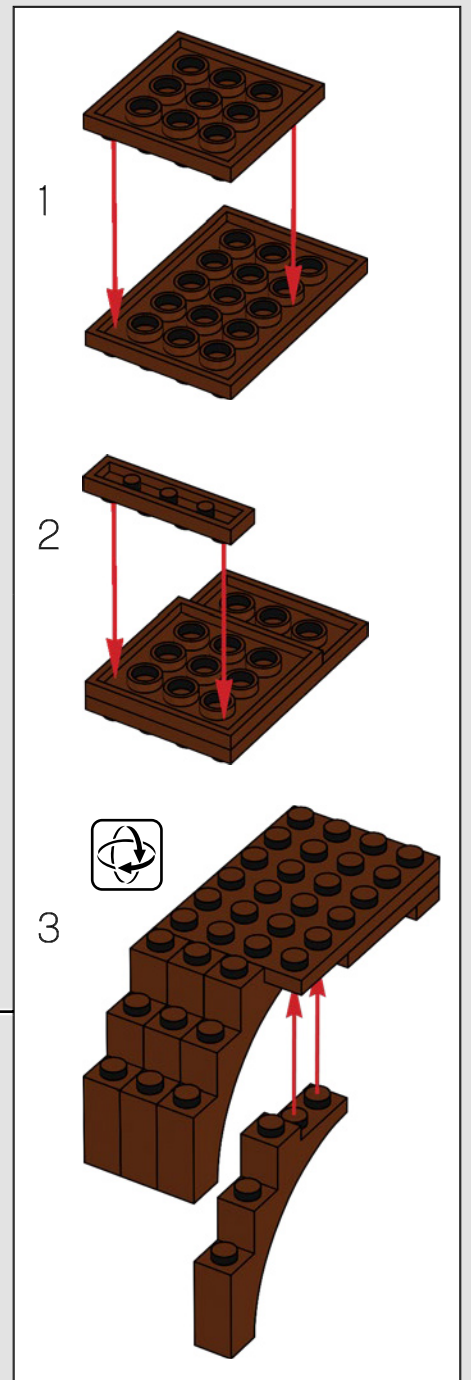
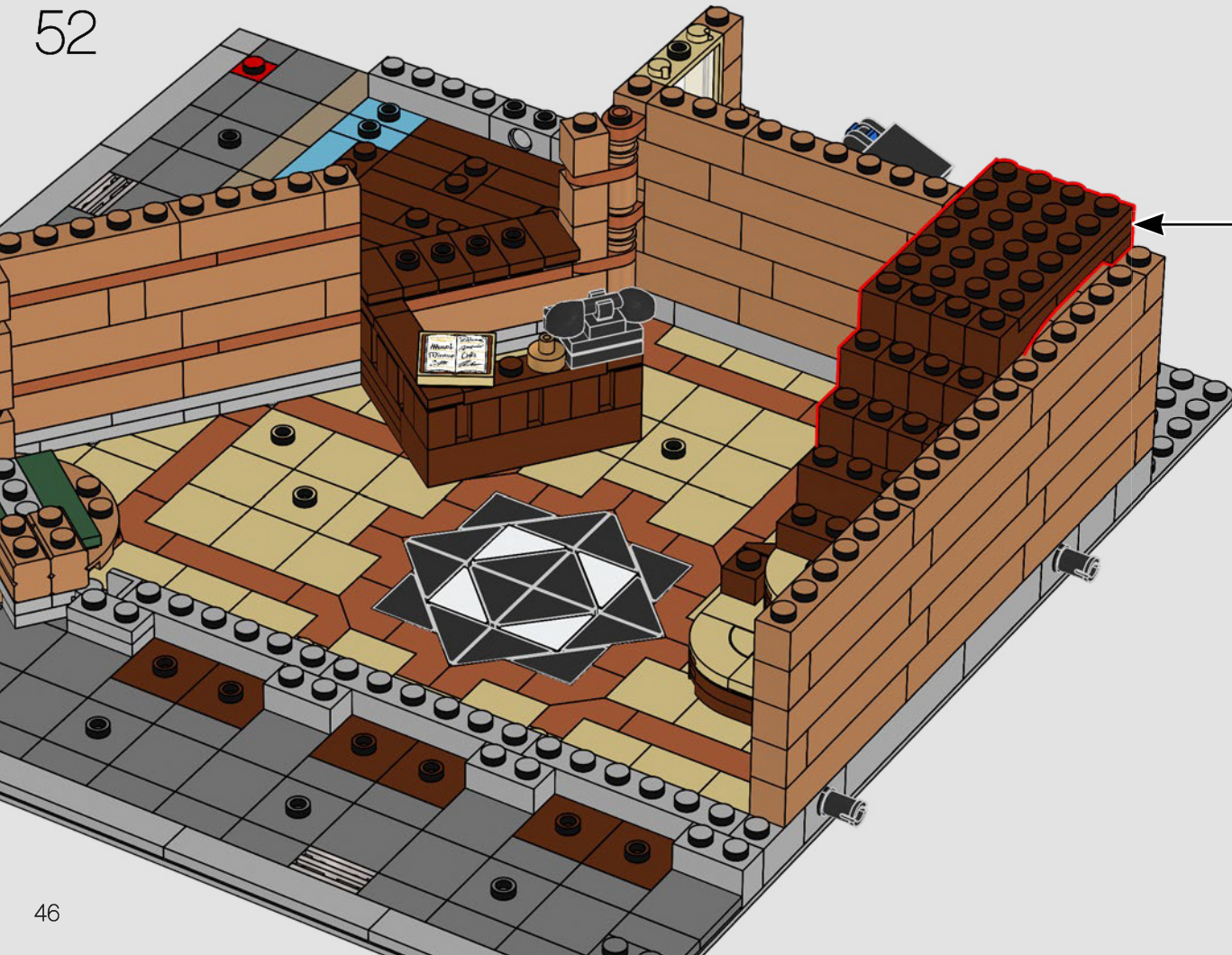





53

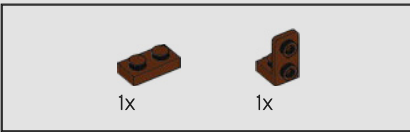
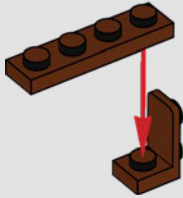

54

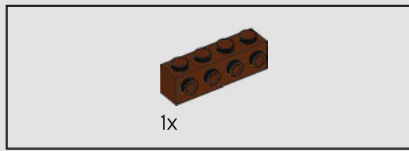
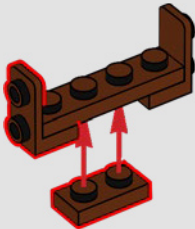

55

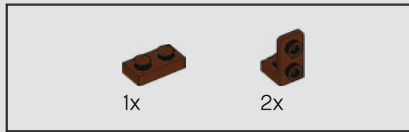
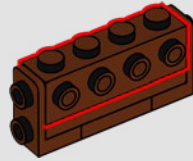

56

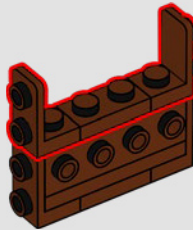

57

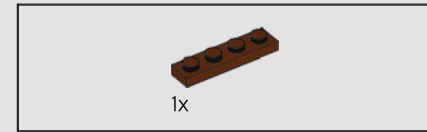
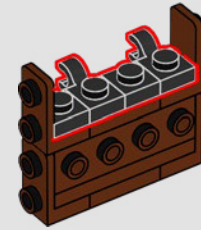

58

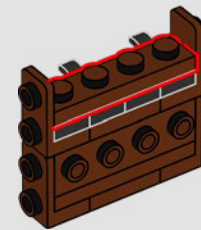



59

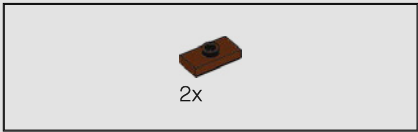
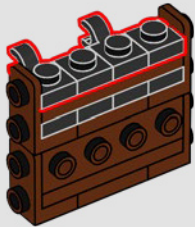

60

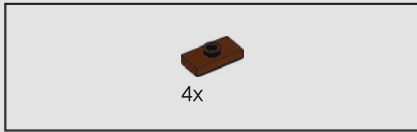
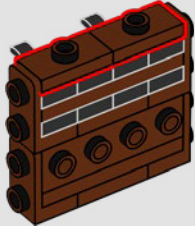

61

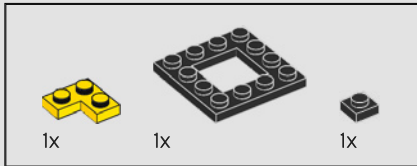
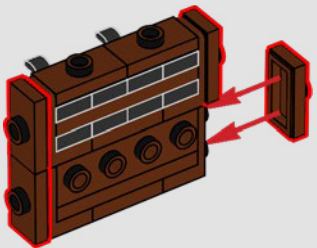

62

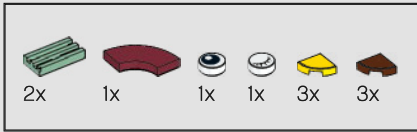
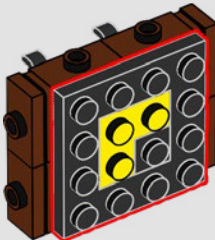

63

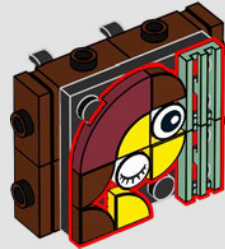

64

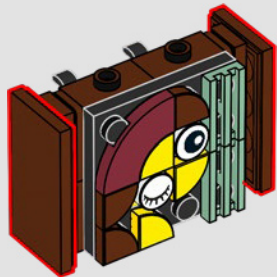



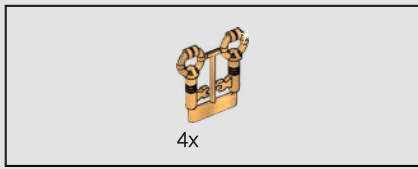

65

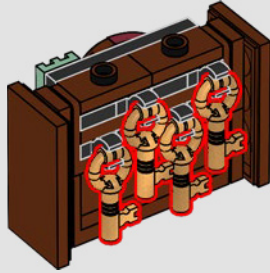

66

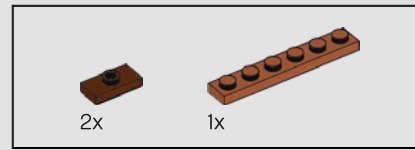
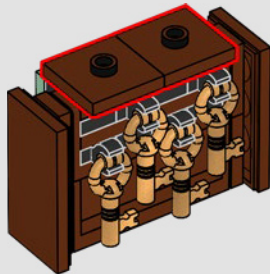

67

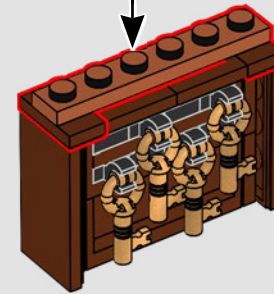
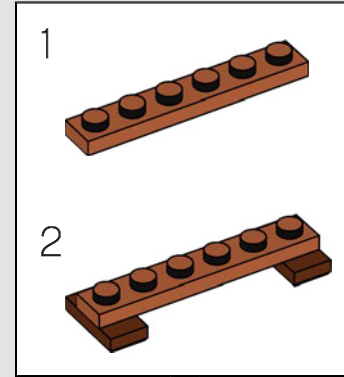

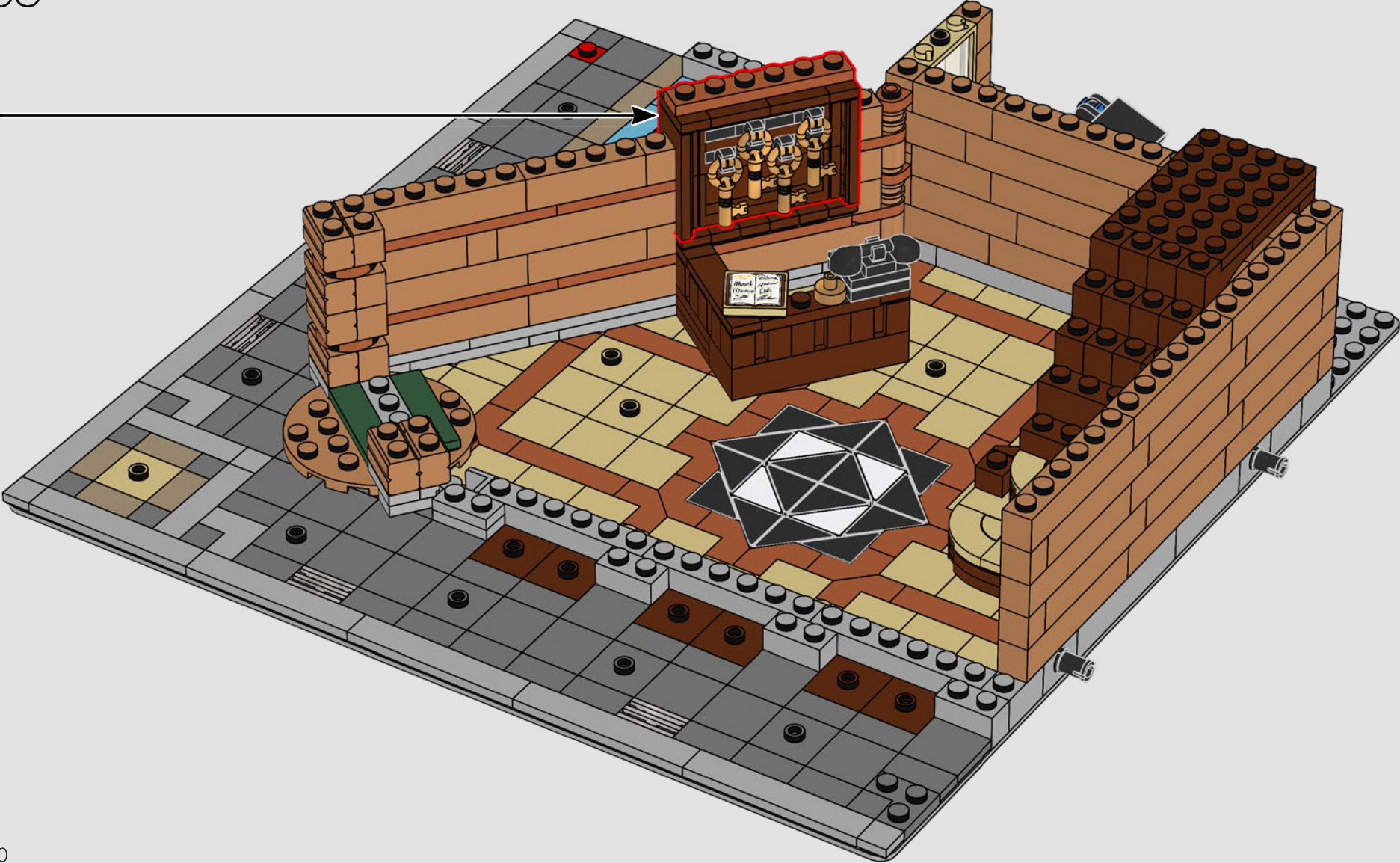



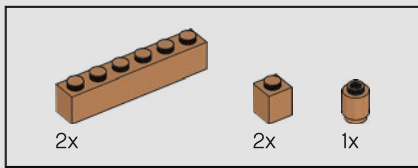

69

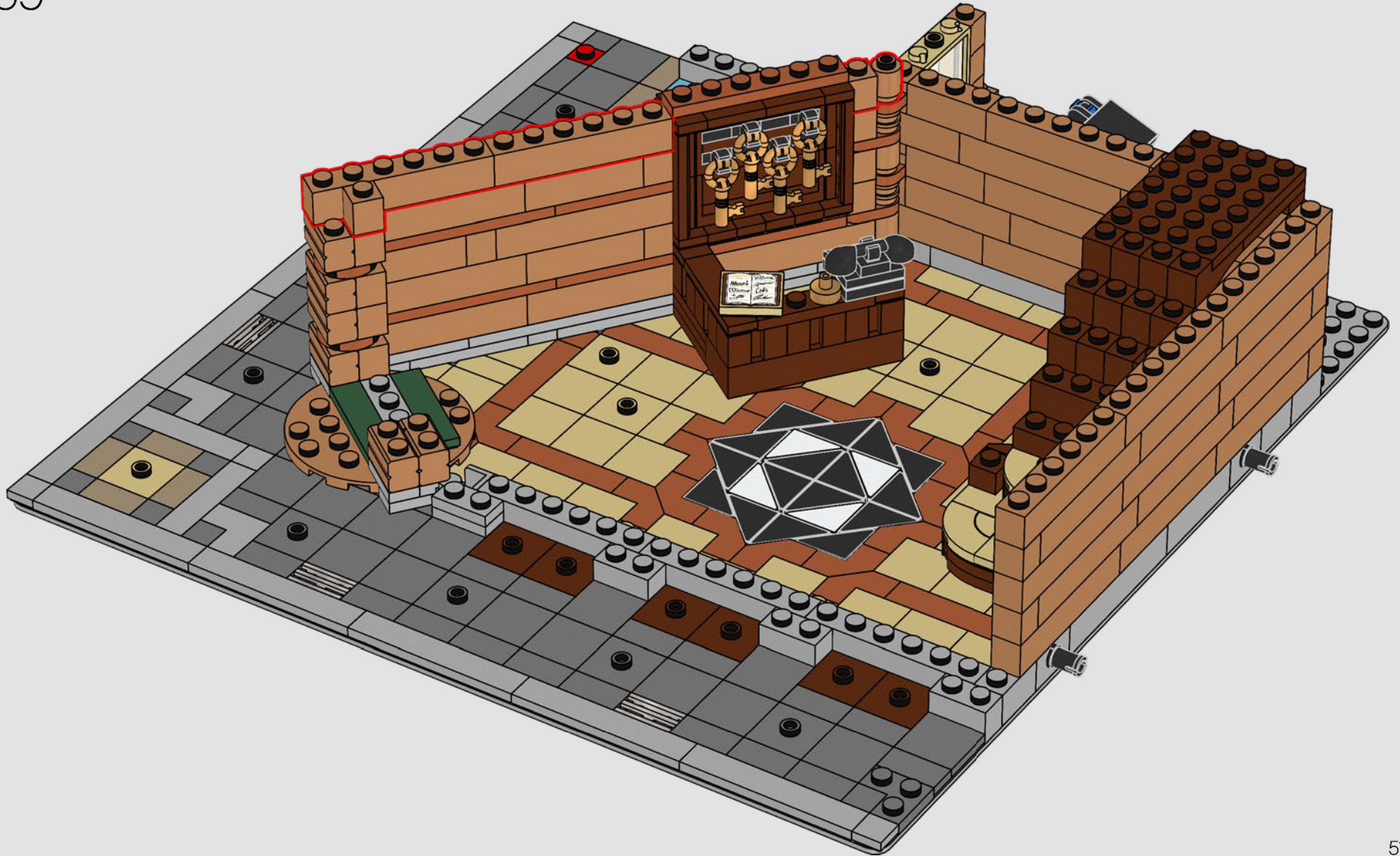



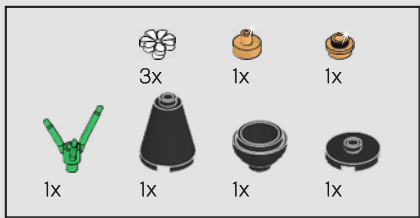

70

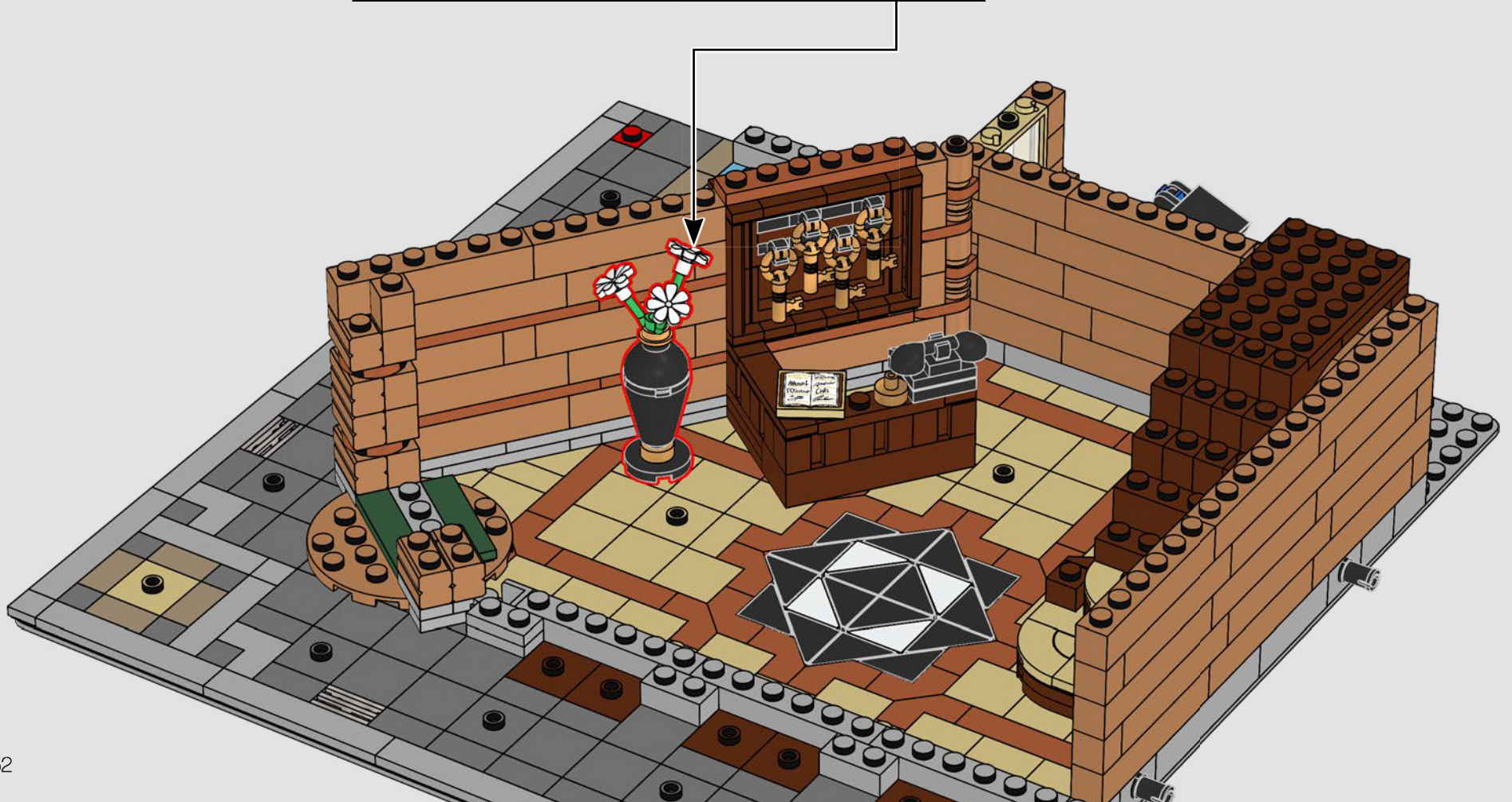
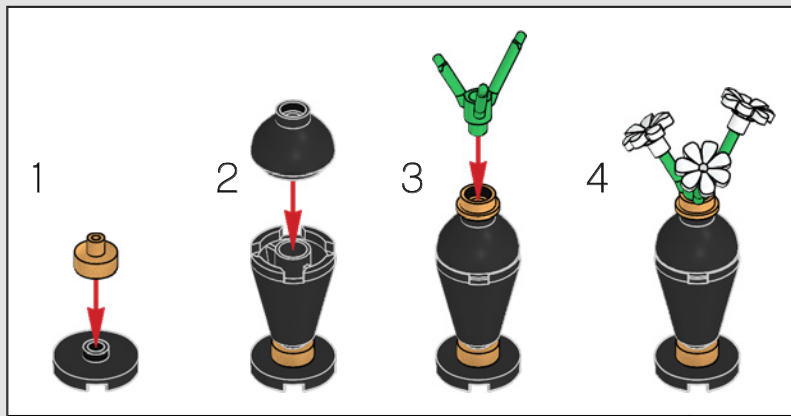



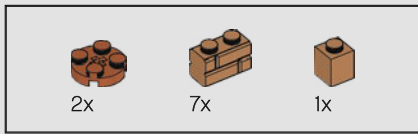

71

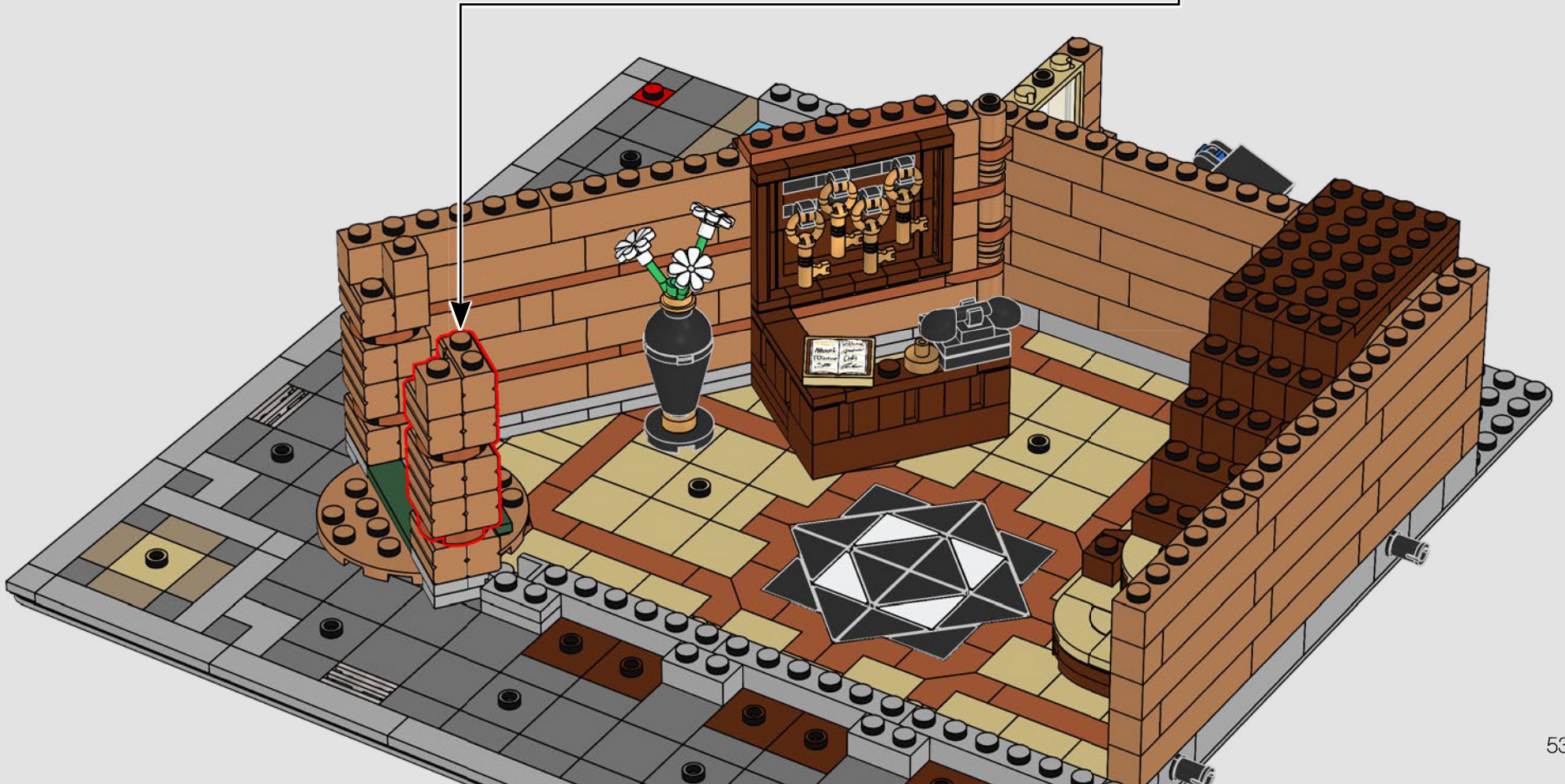
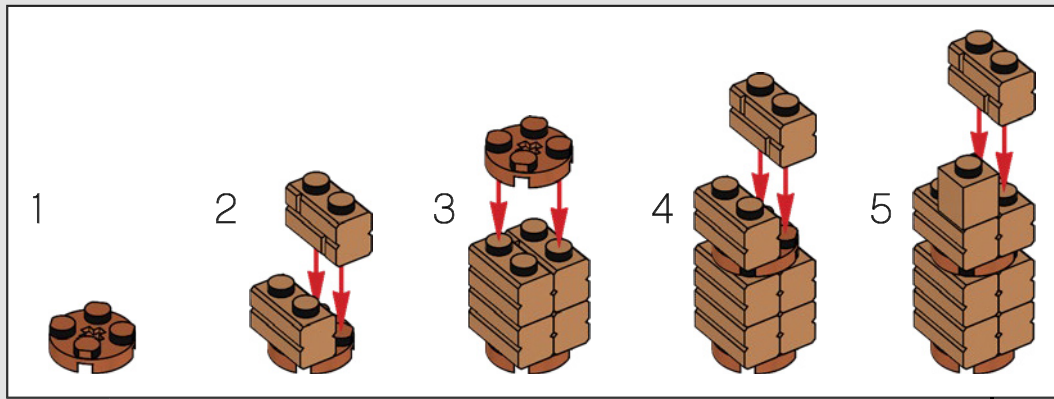



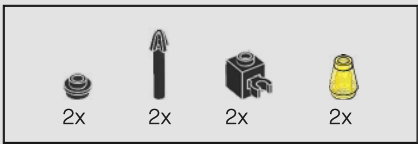

72

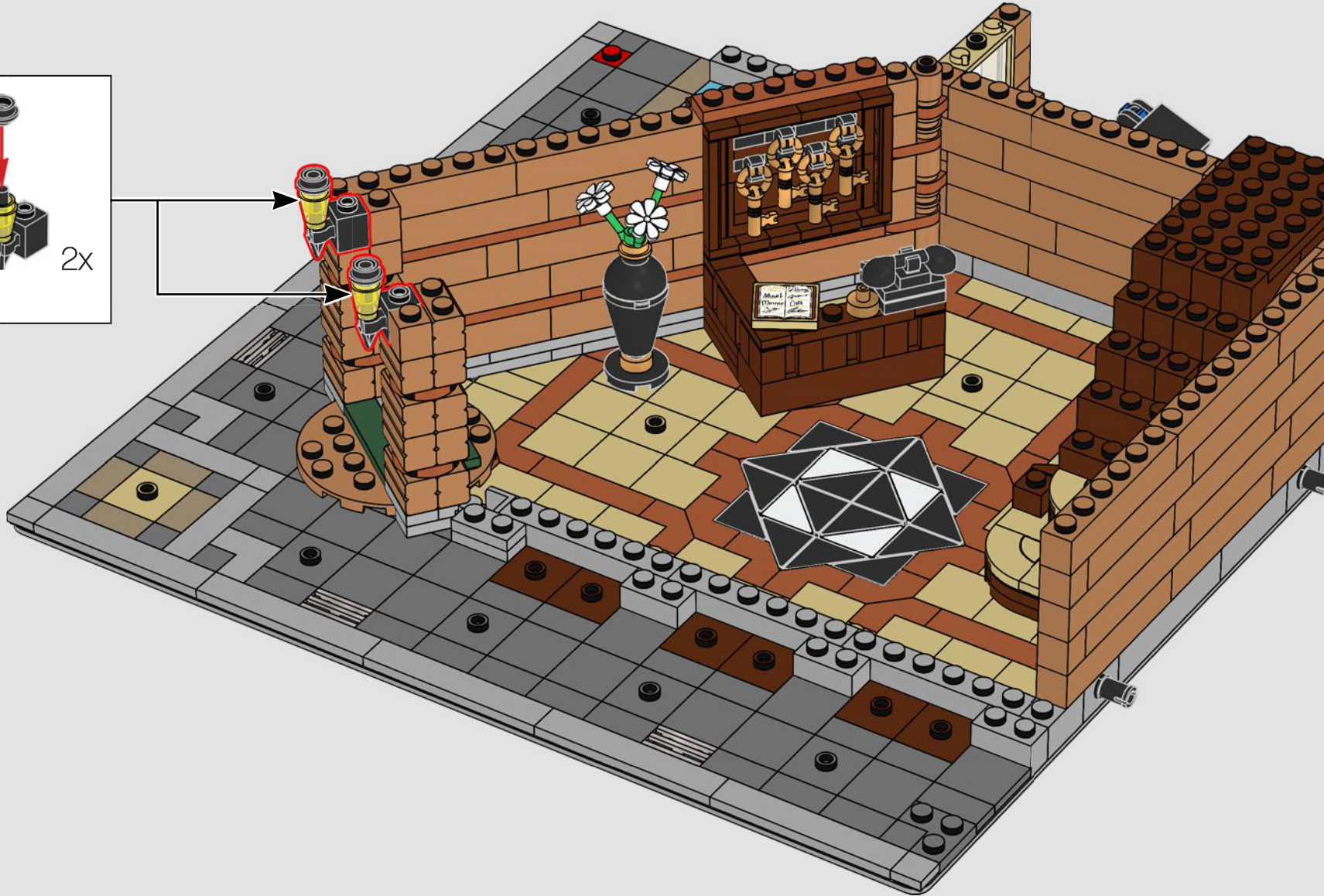
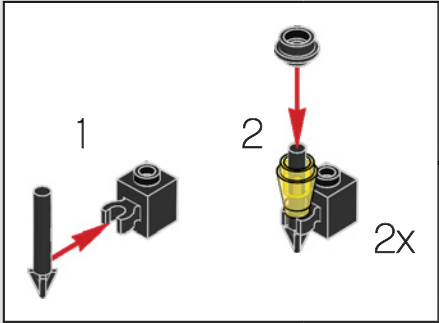



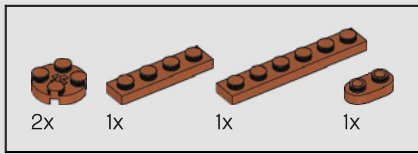

73

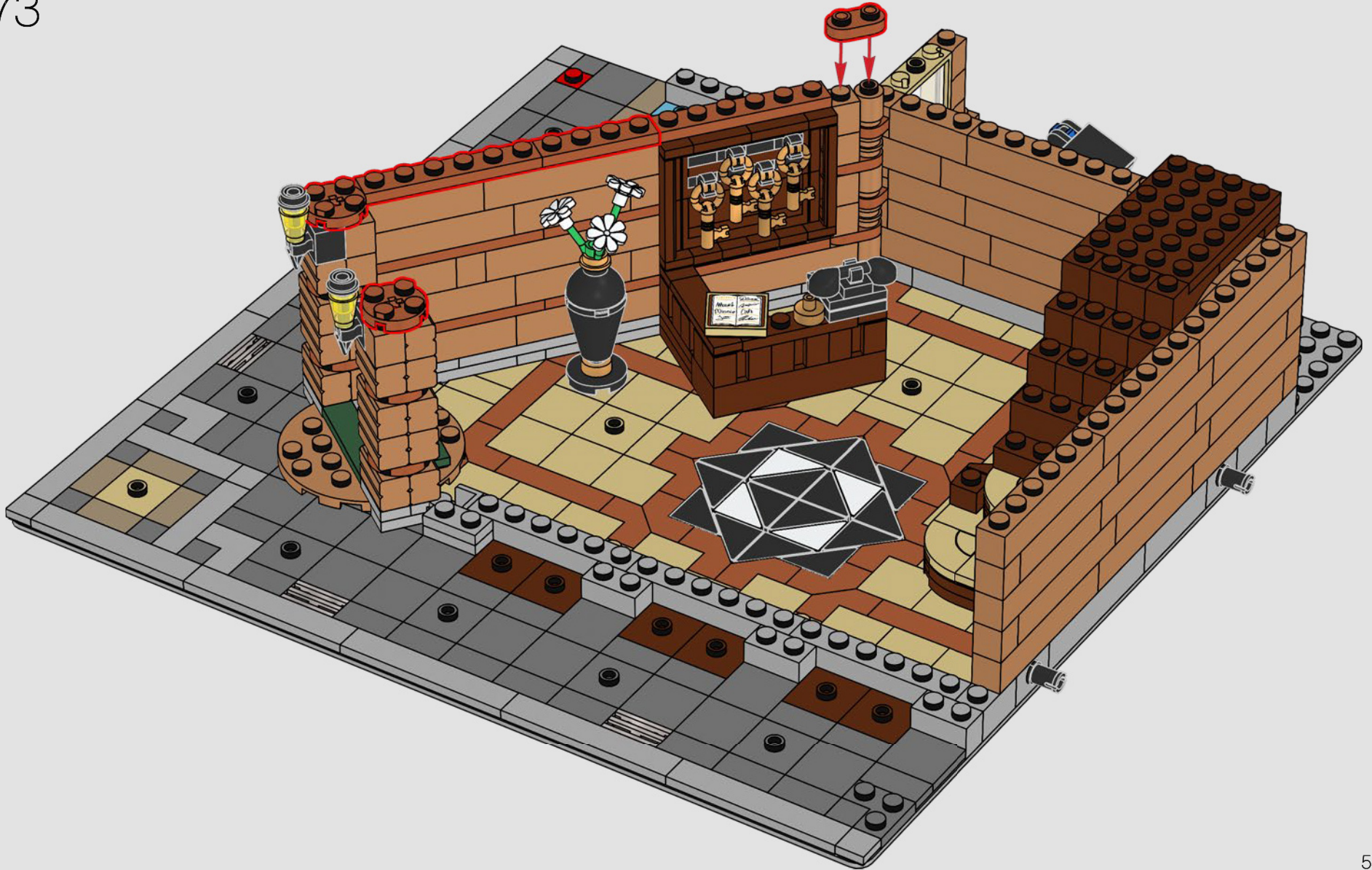

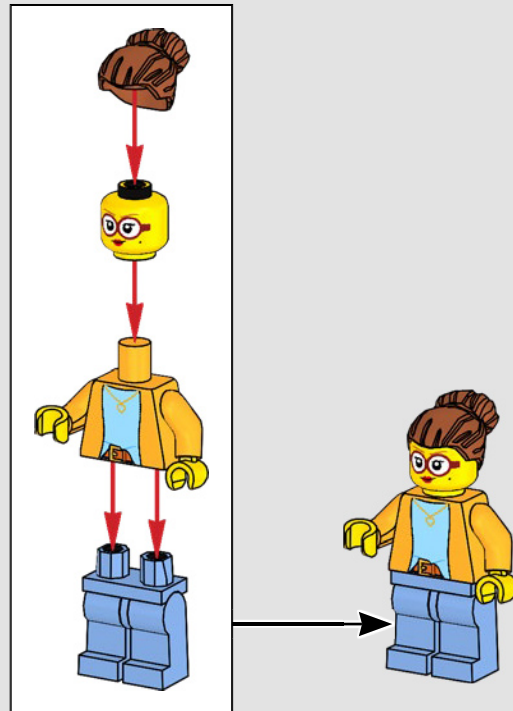



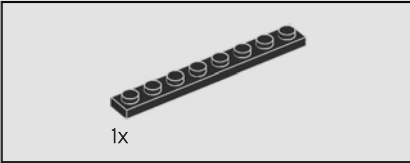
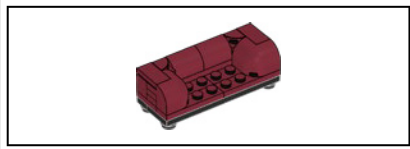

74

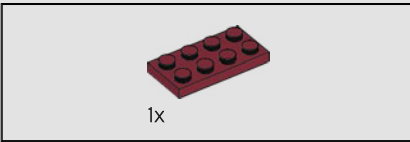
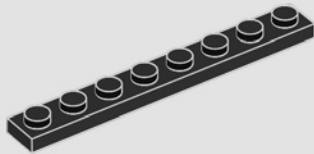

75

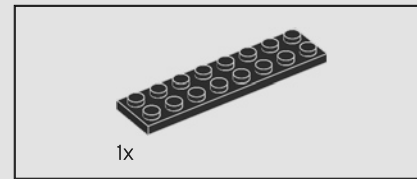
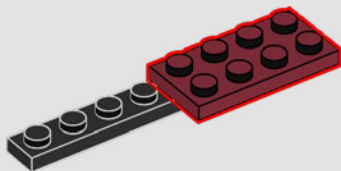

76

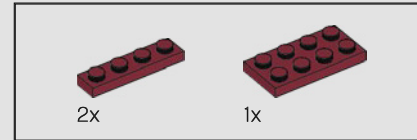
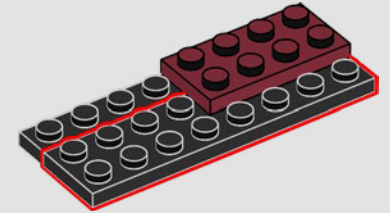

77

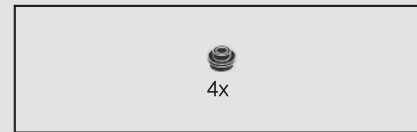
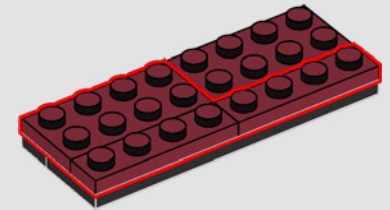

78

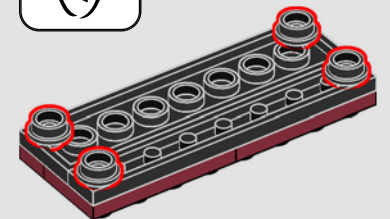
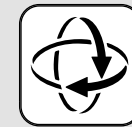

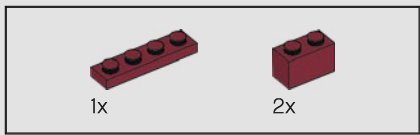

79

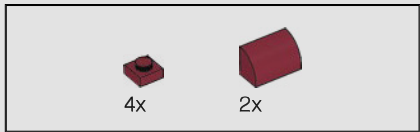
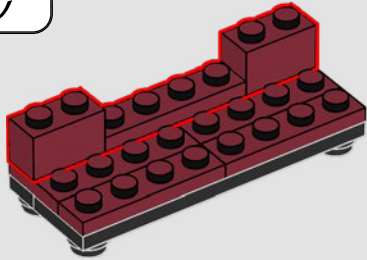

80

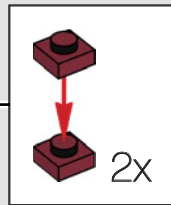
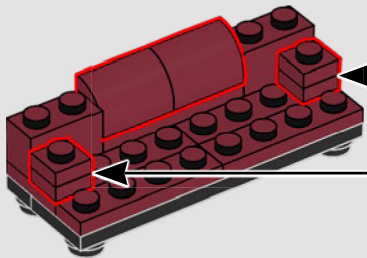

81

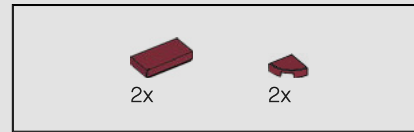
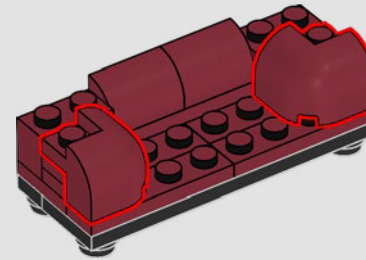

82

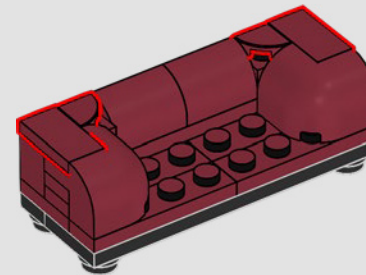







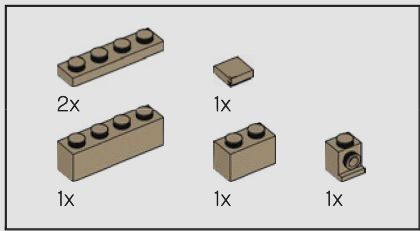

84

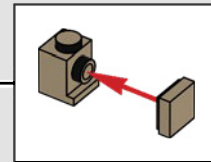
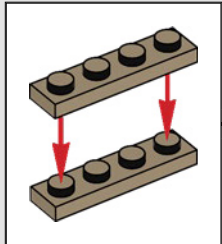
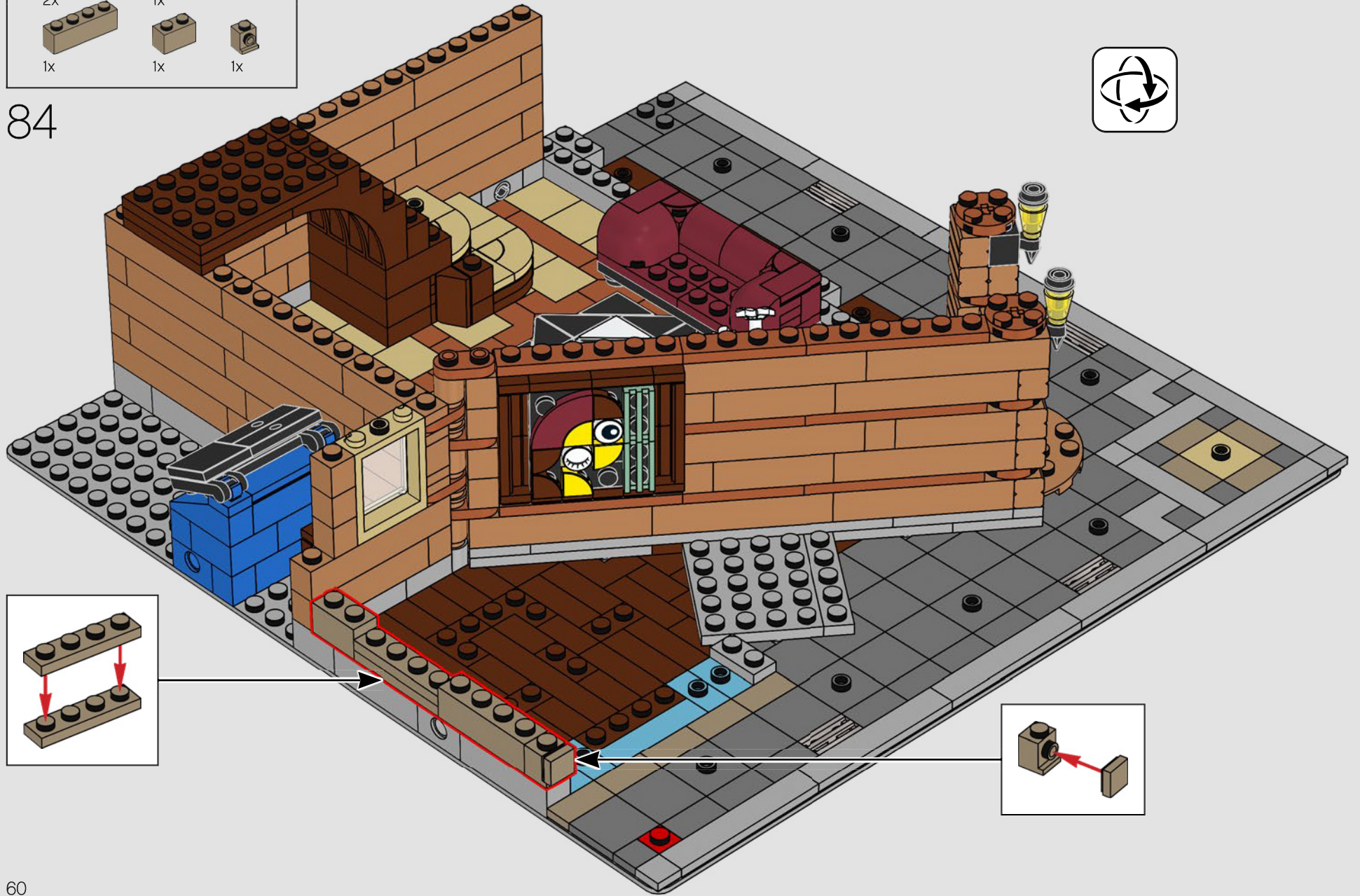
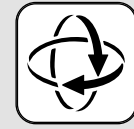



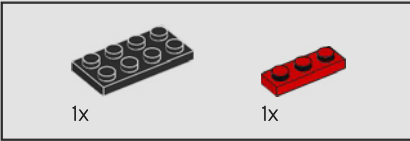

85

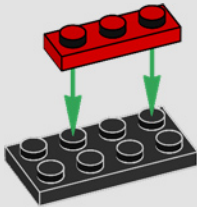

86

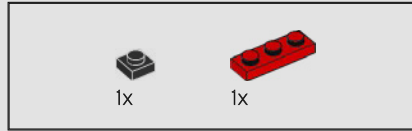
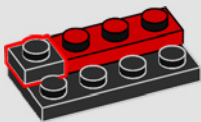

87

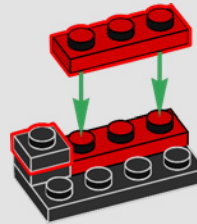

88

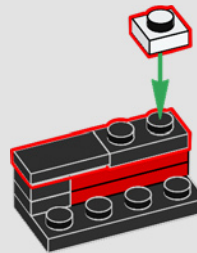

89

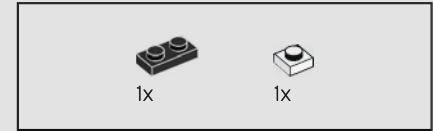
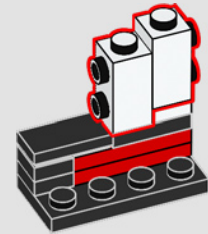

90

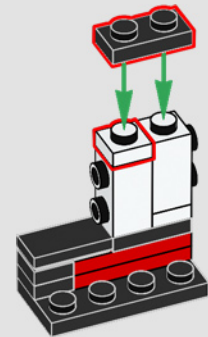

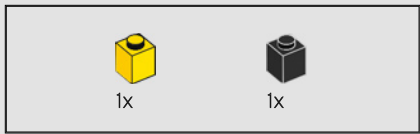

91

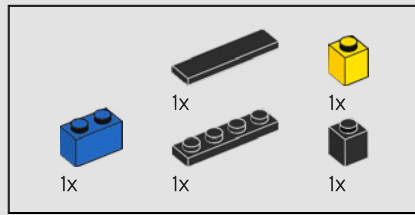
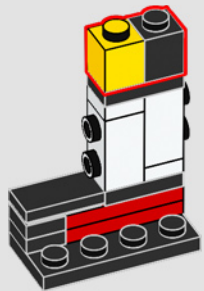

92

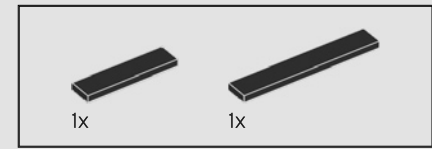
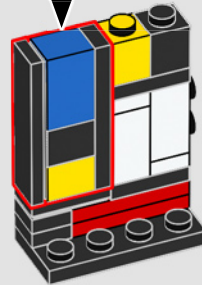
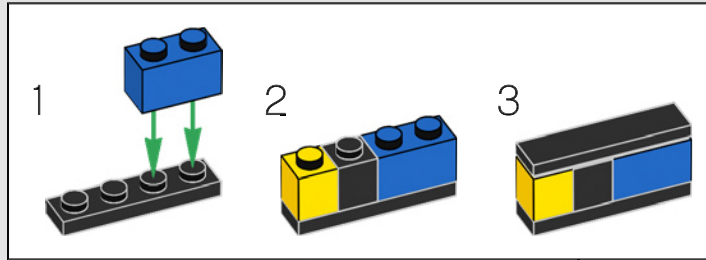

93

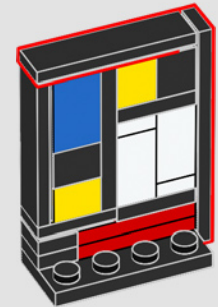



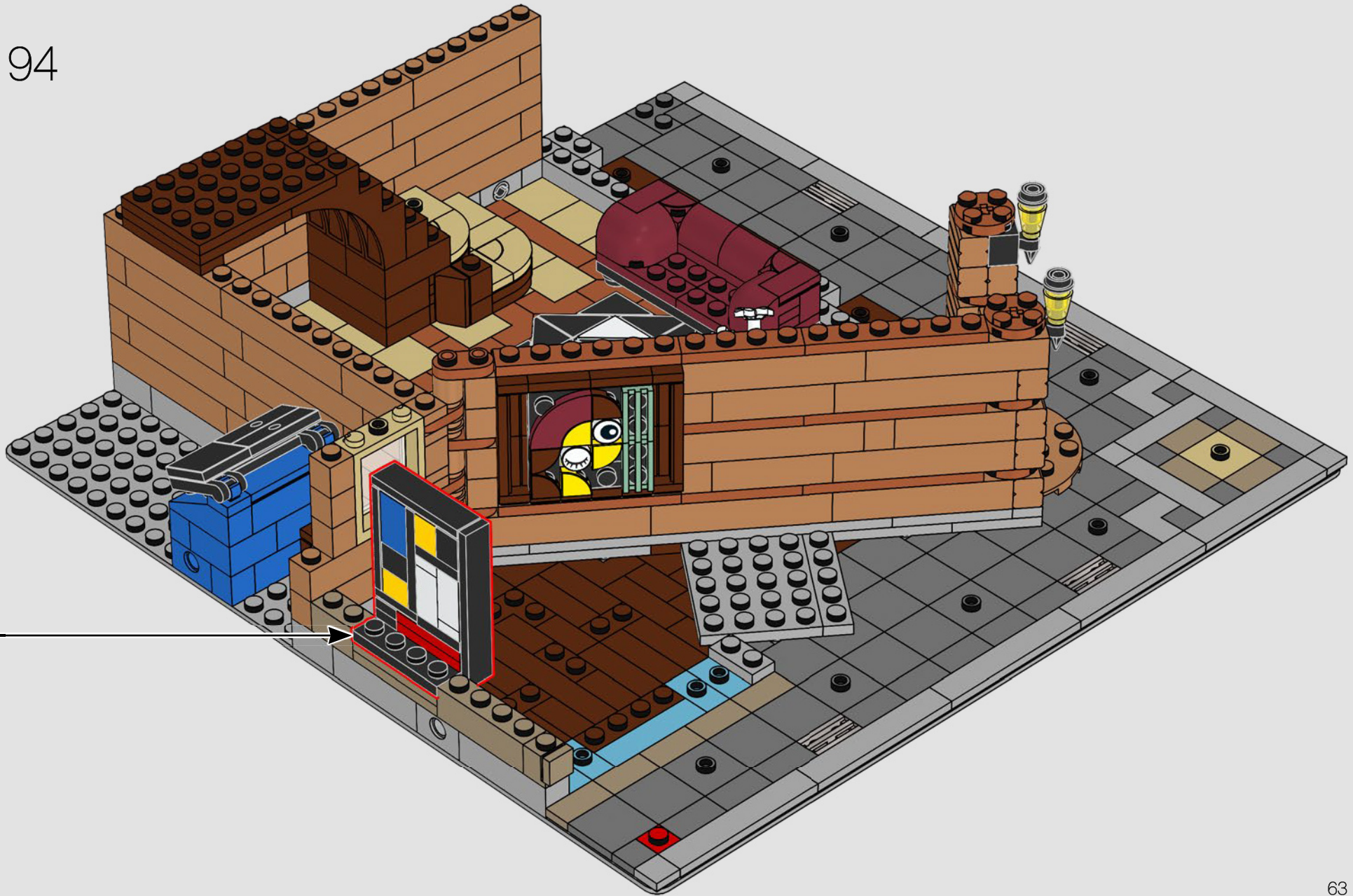



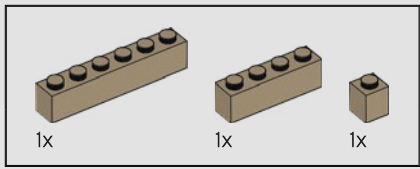

95

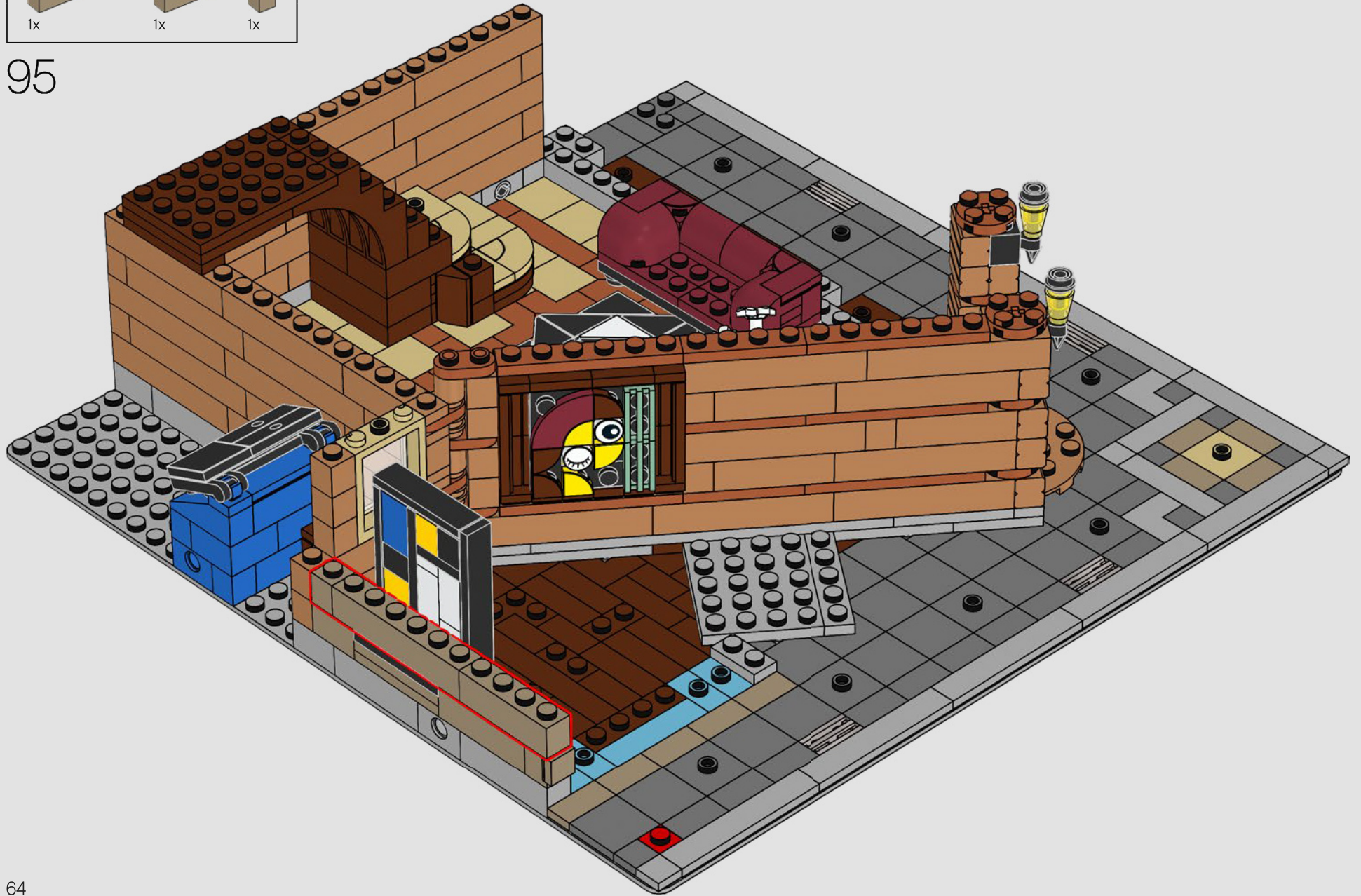



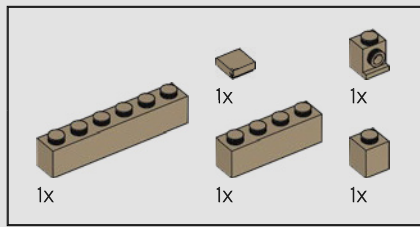

96

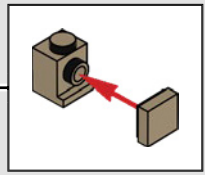
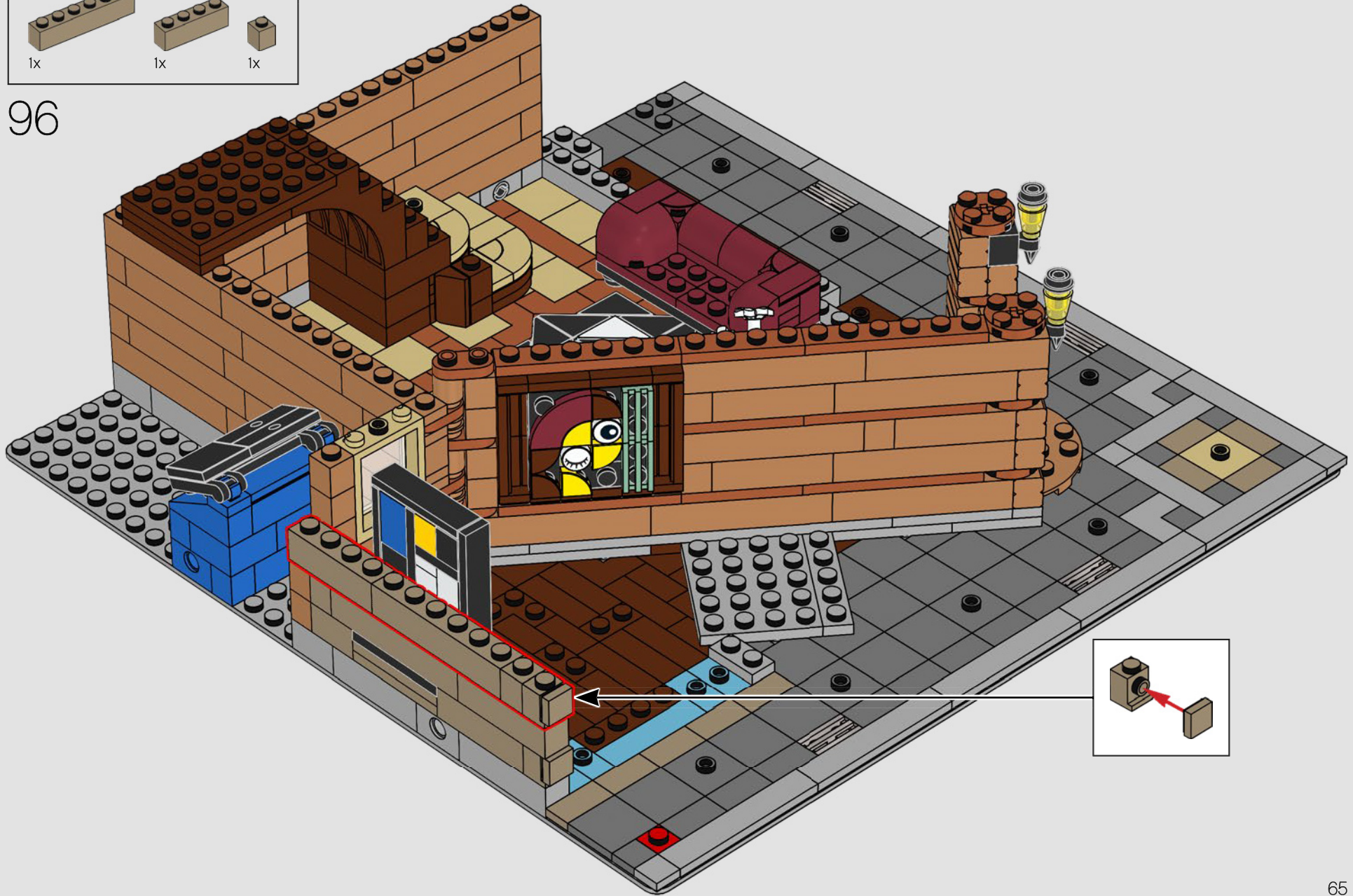



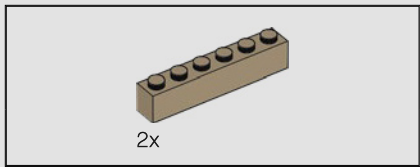

97

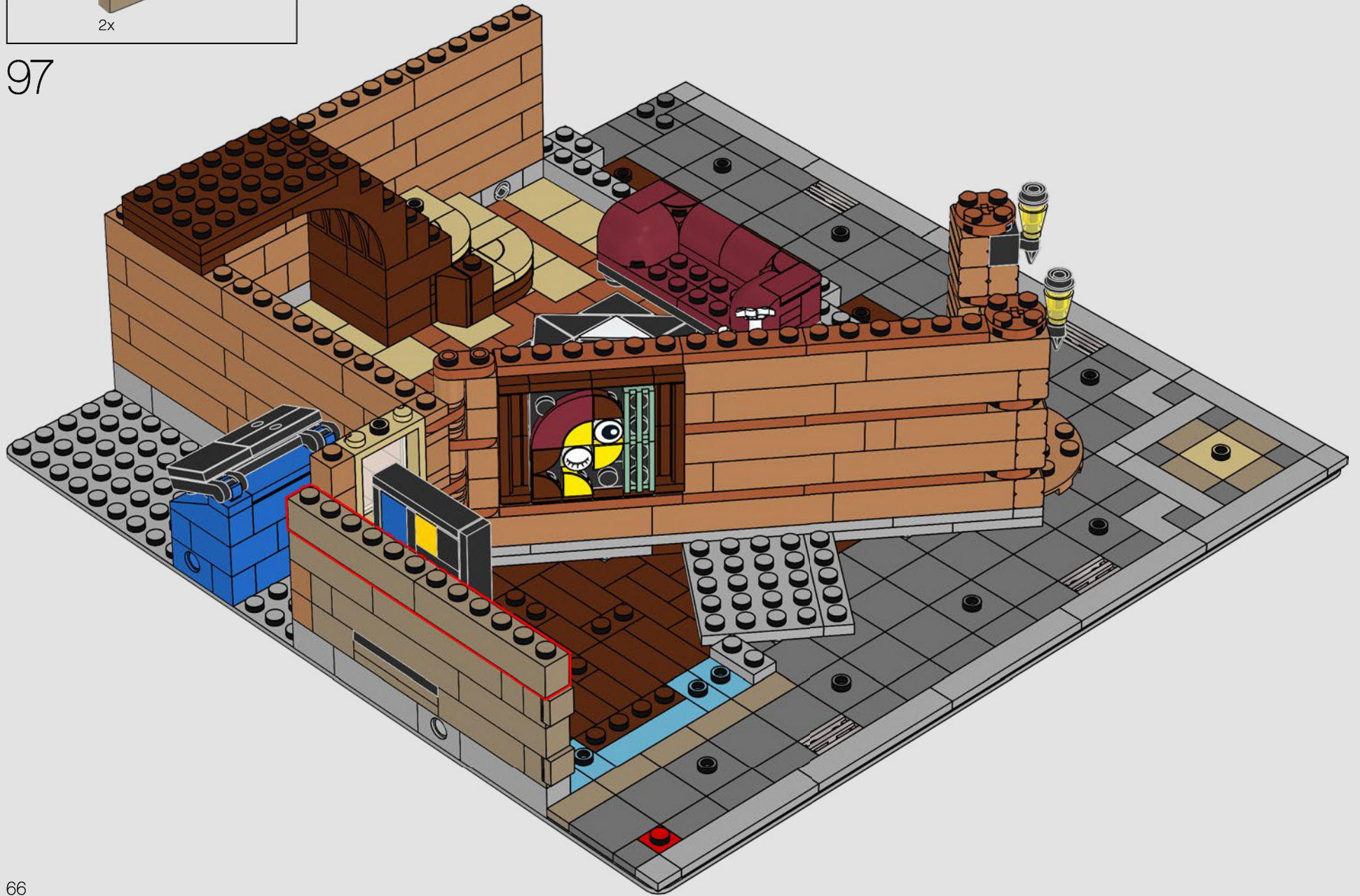



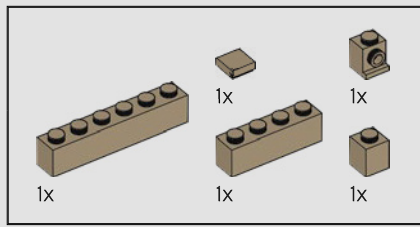

98

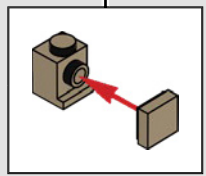
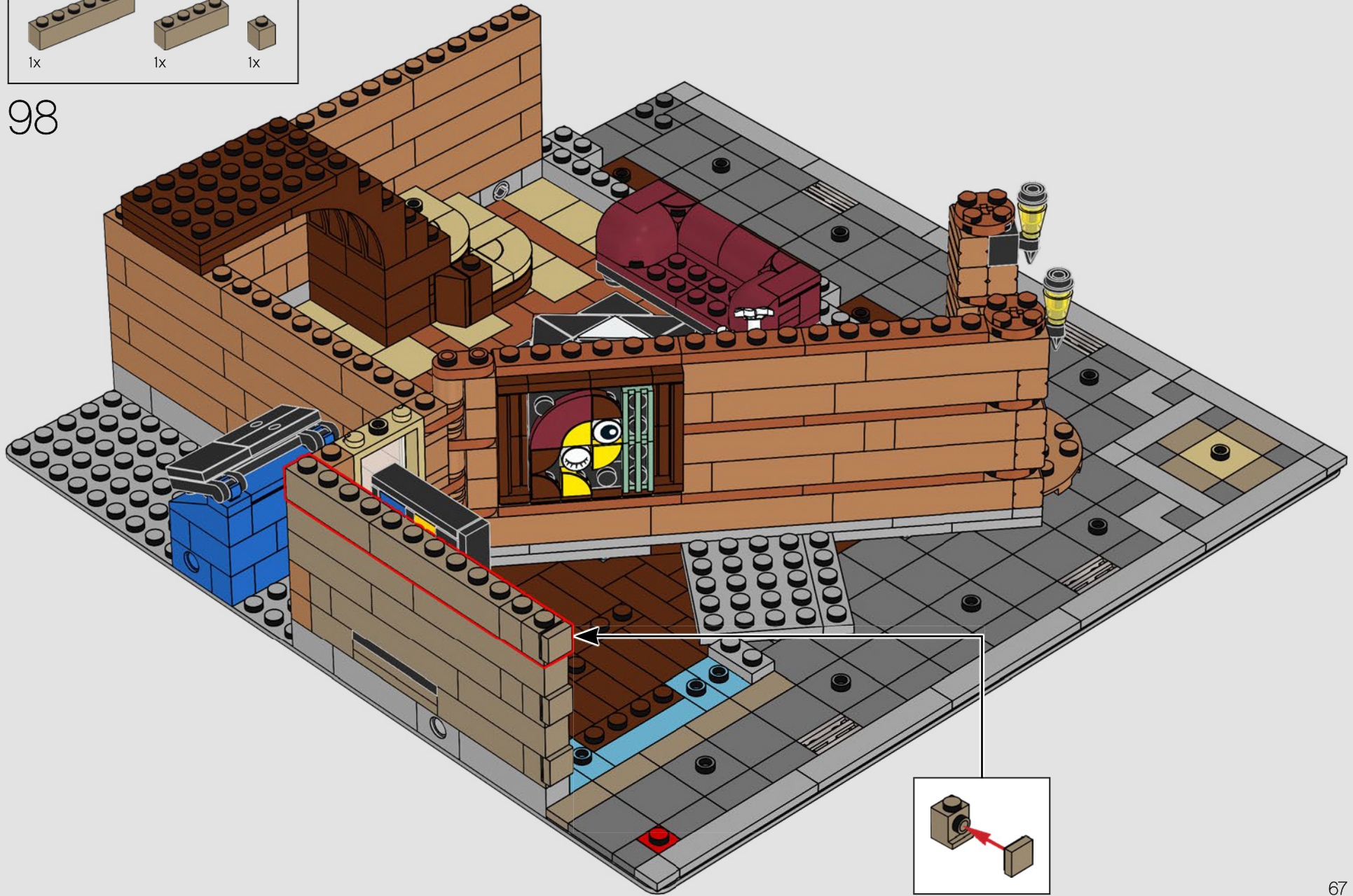



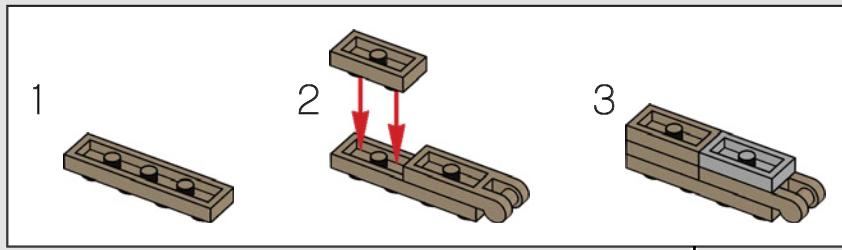
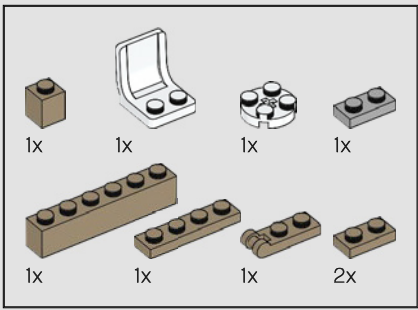

99





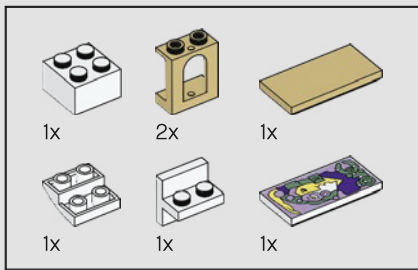

100

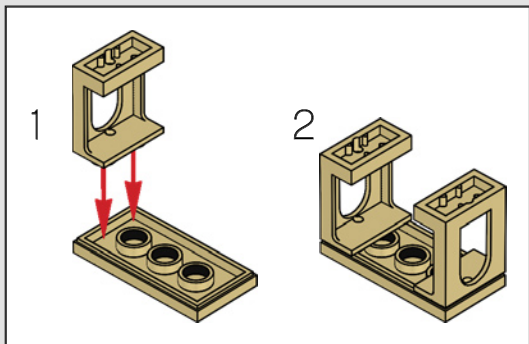
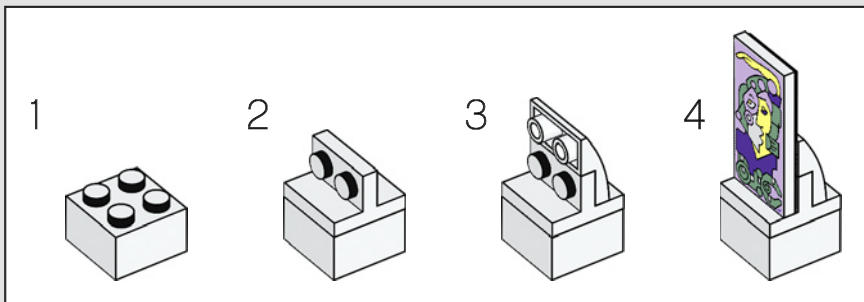

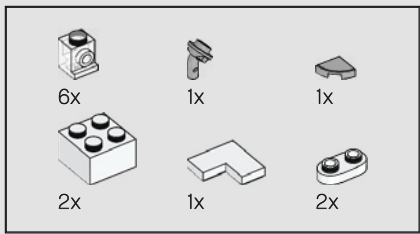

101

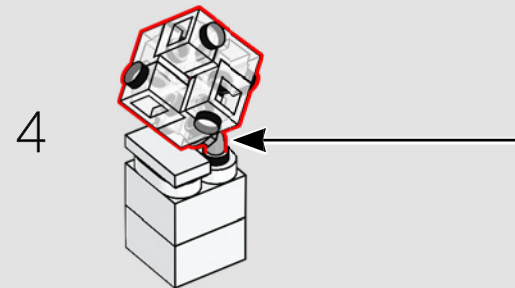
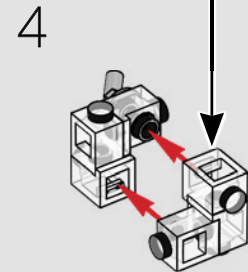
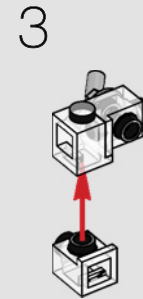
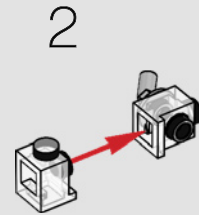
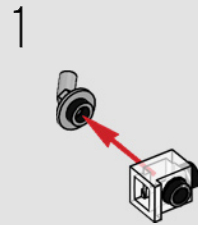
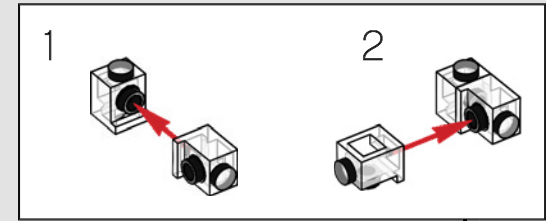
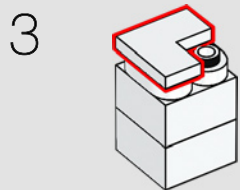
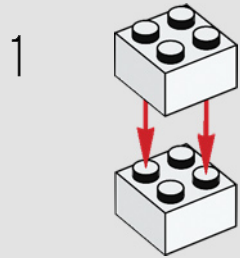

¡La propietaria de la galería está entusiasmada con la inauguración de su colección de arte cubista! Su obra favorita, sin embargo, no es cubista: es simplemente un cubo magistralmente elaborado.



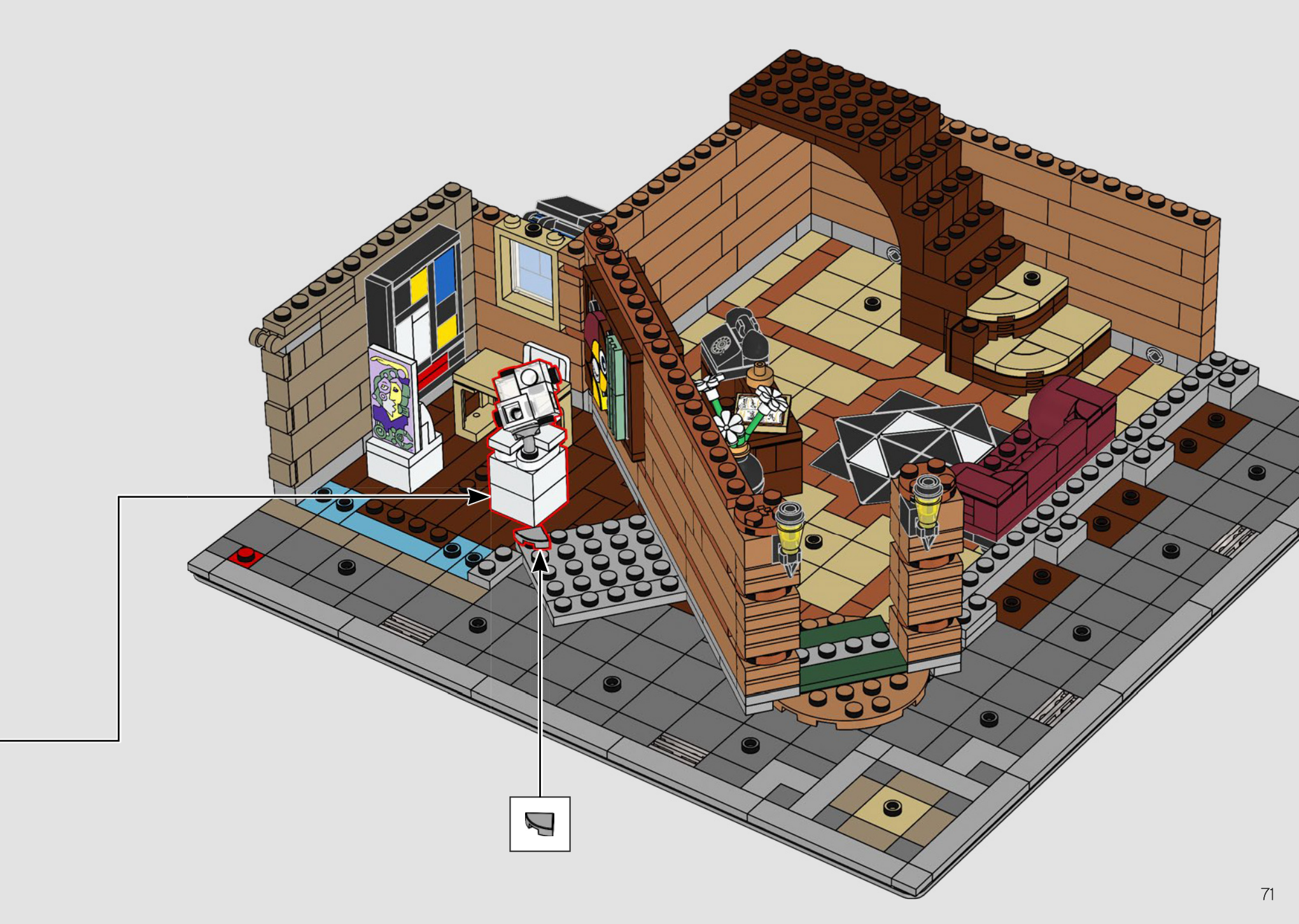

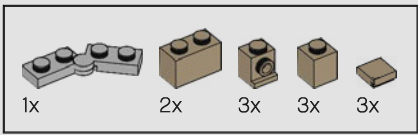

102

1

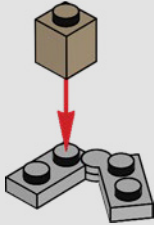

2

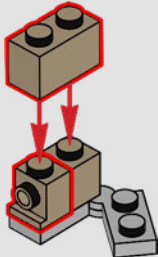

3

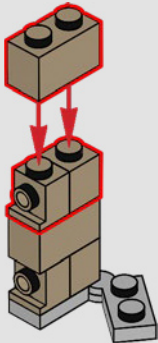

4

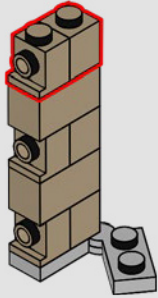

5

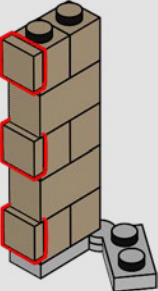



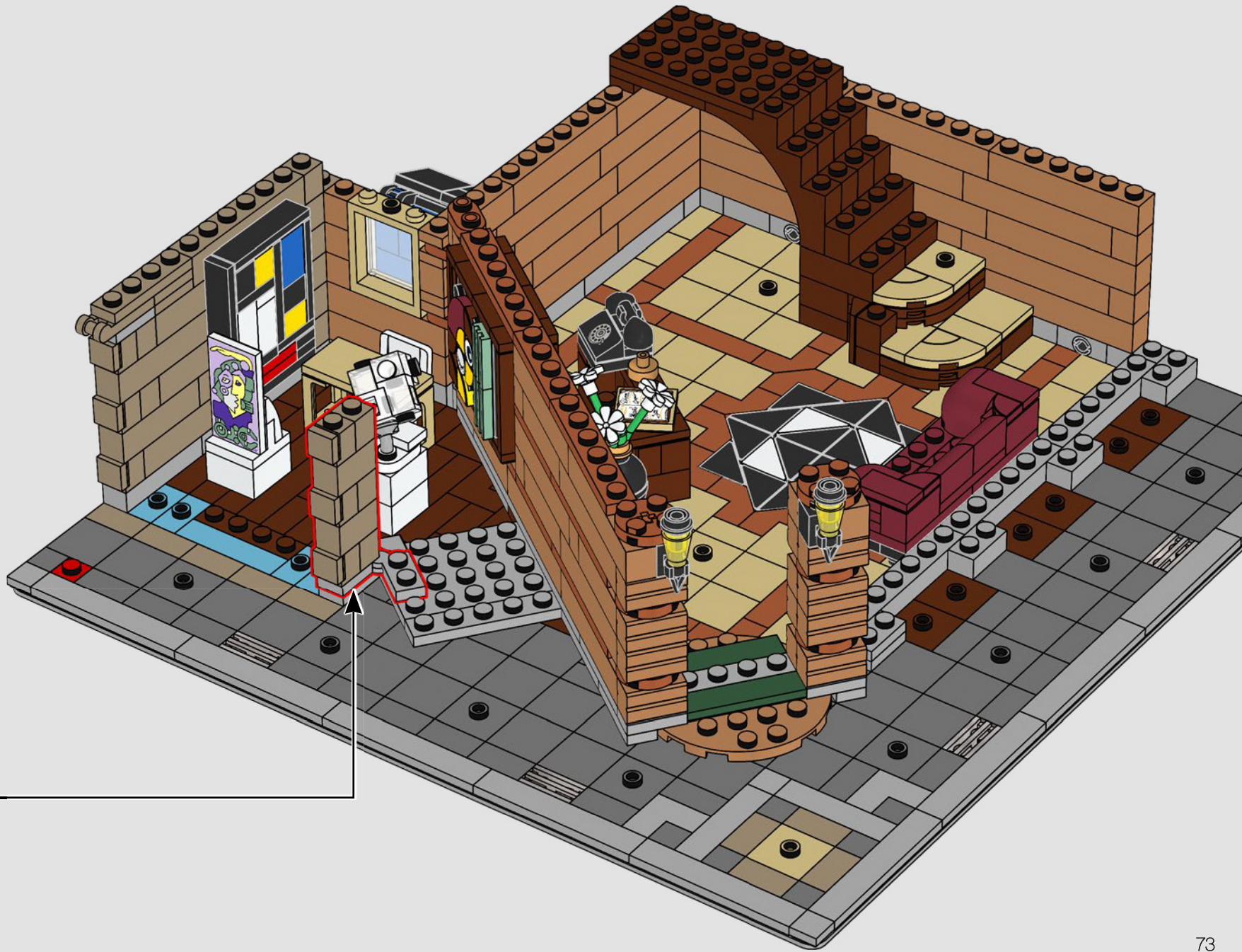

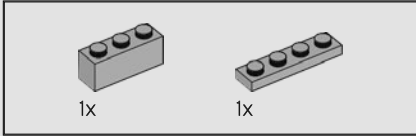
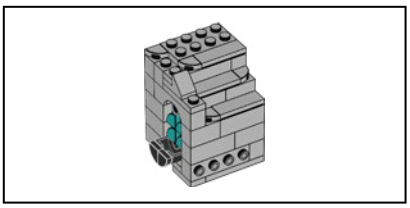

103

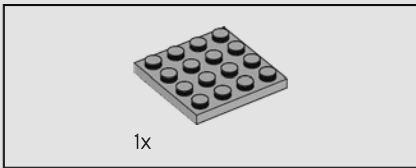
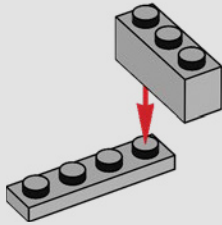

104

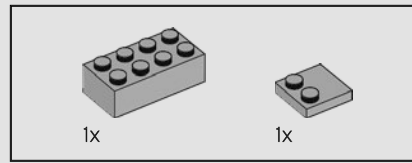
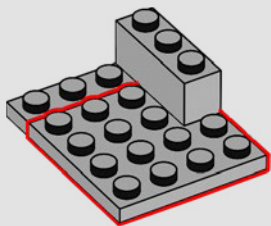

105

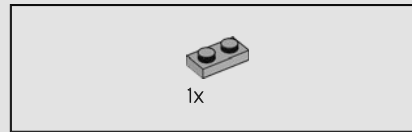
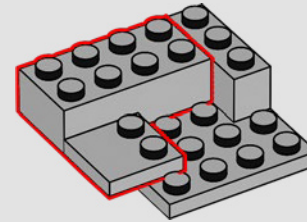

106

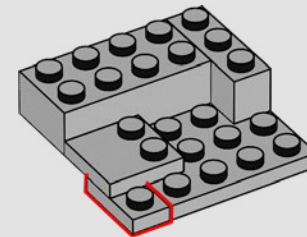



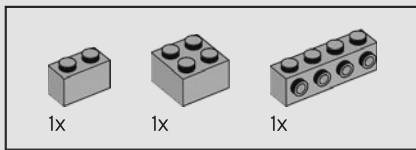

107

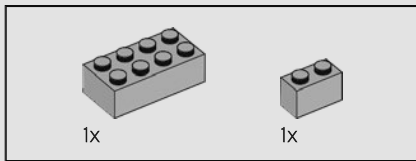
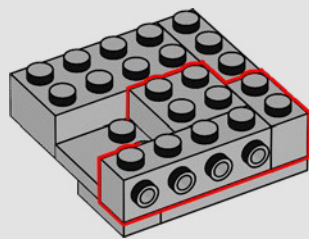

108

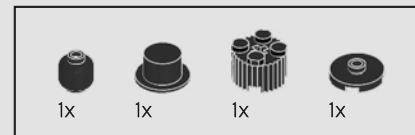
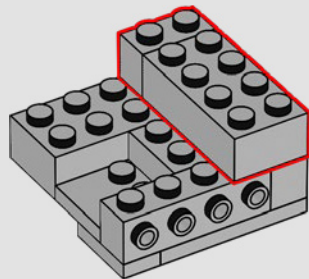

109

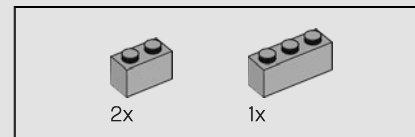
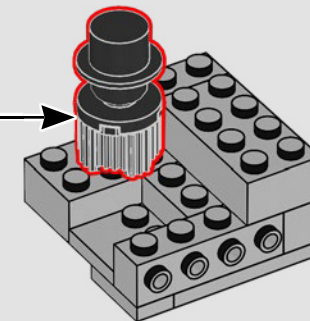
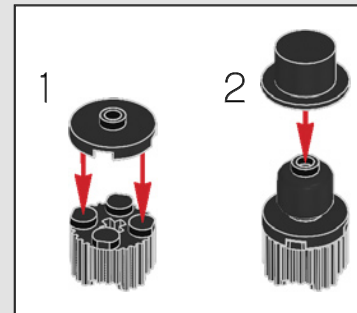

110

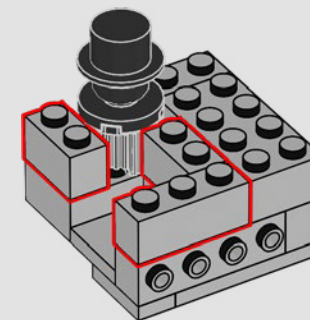

Este busto es del mismo artista que talló el busto blanco del vestíbulo del set Ayuntamiento (10224). 75

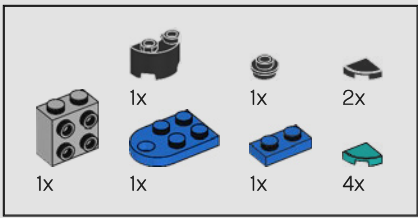

111

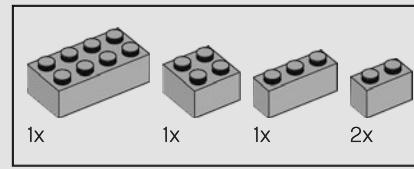
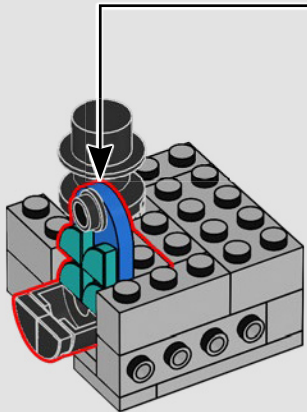
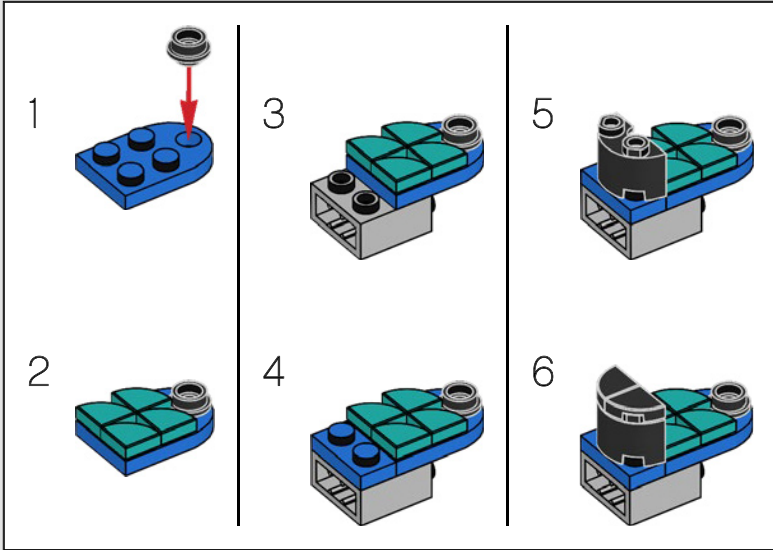

112

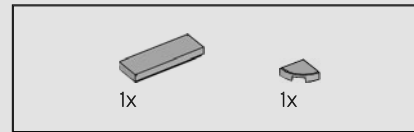
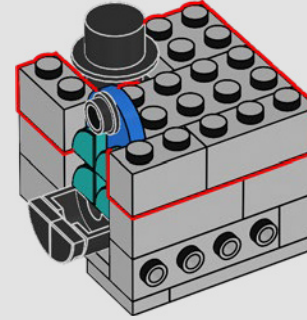

113

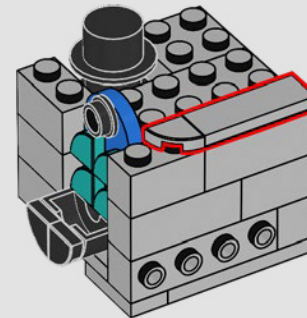



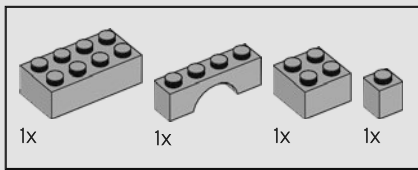

114

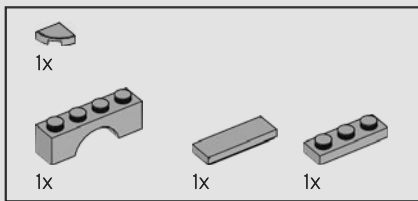
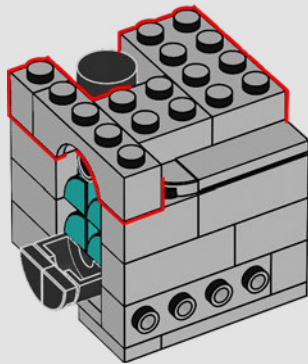

115

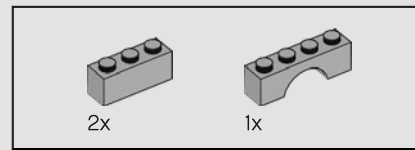
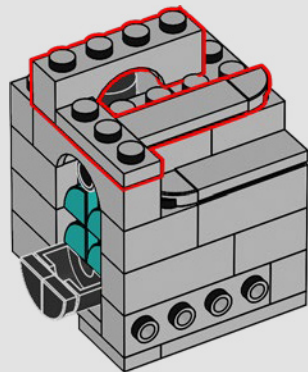

116

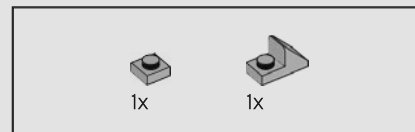
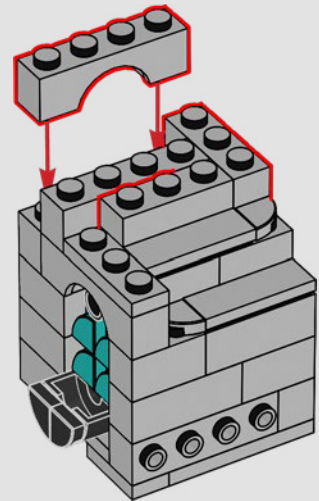

117

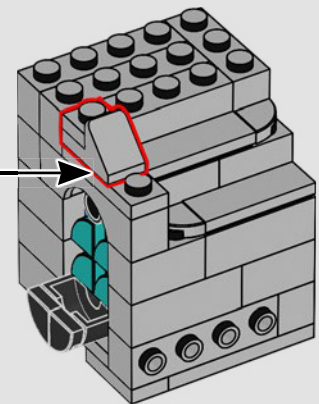
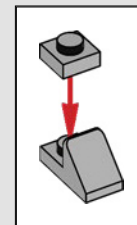

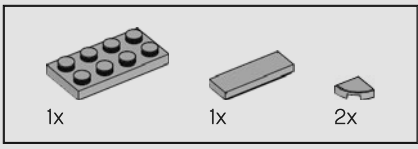

118

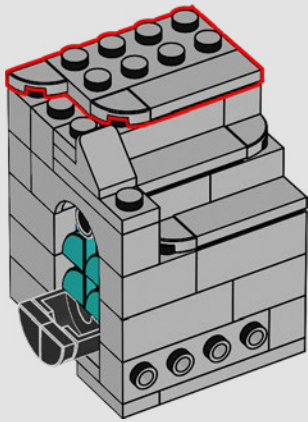

119

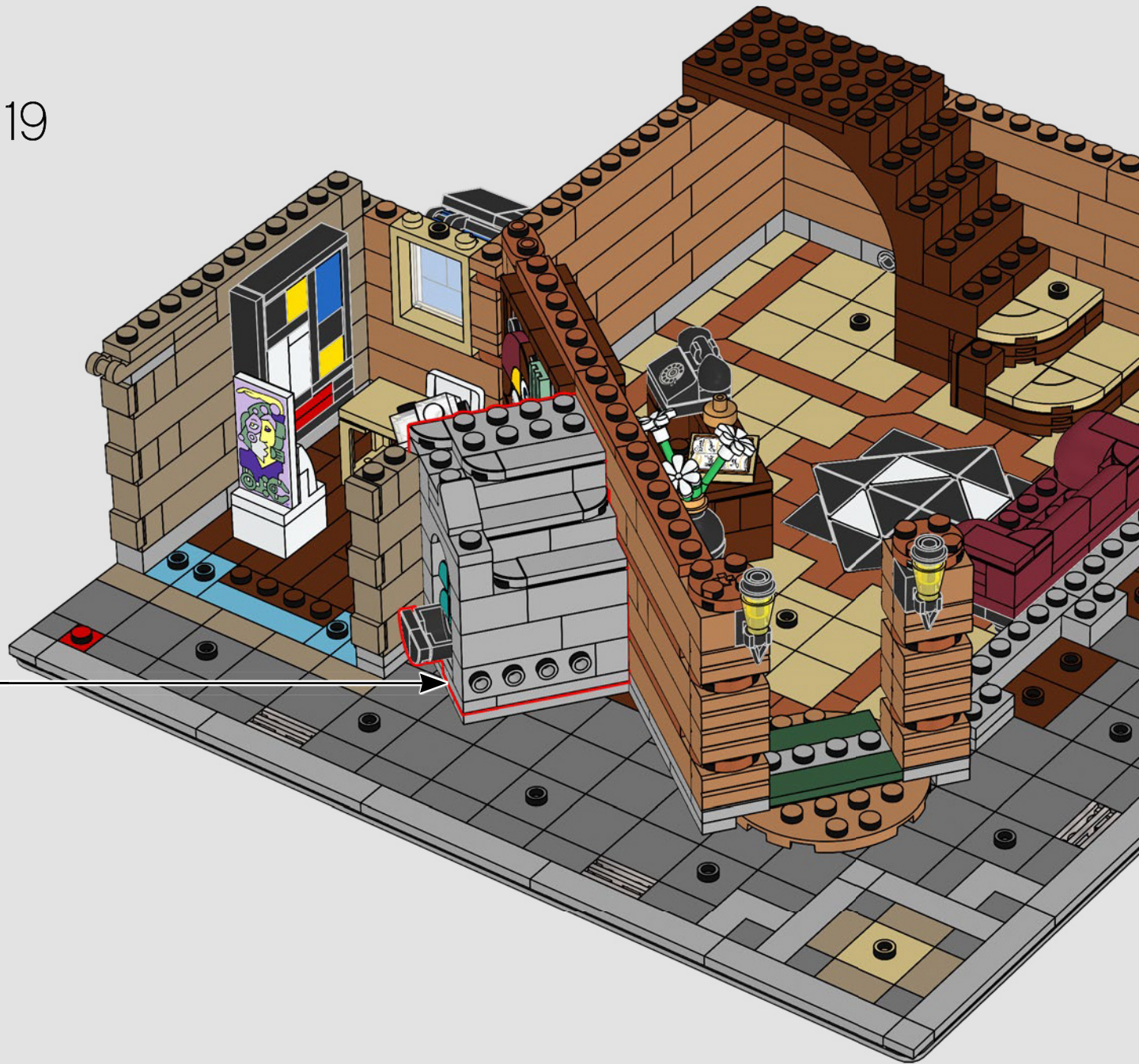



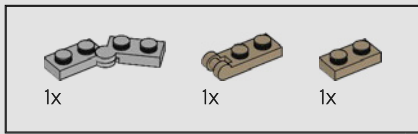

120

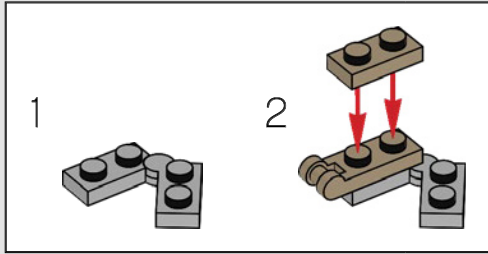

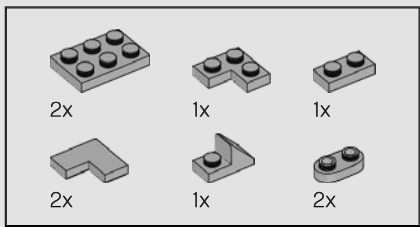

121

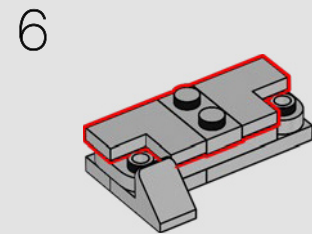
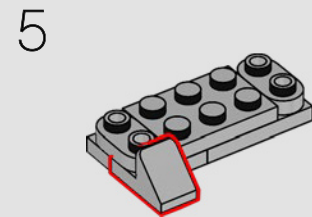
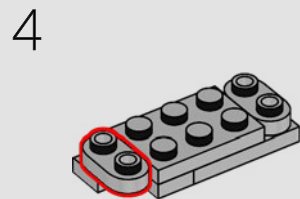
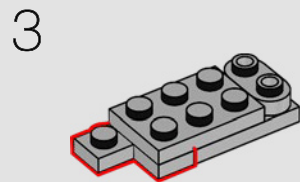
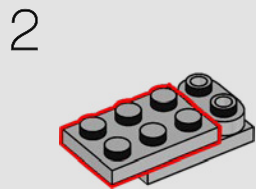
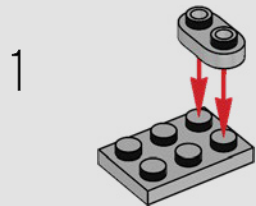





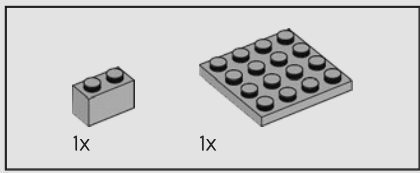

122

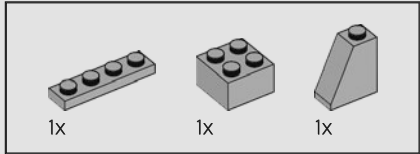
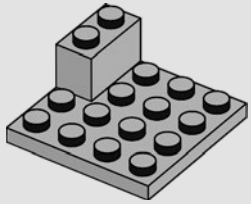

123

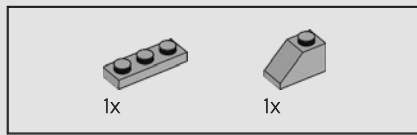
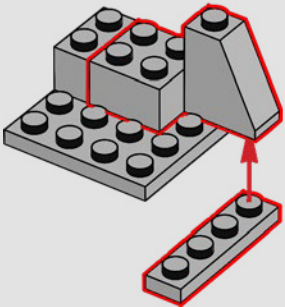

124

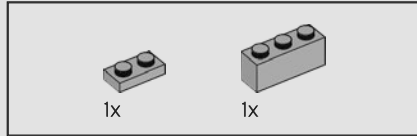
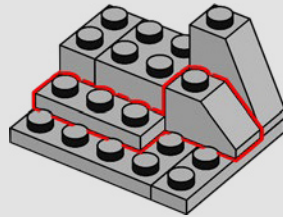

125

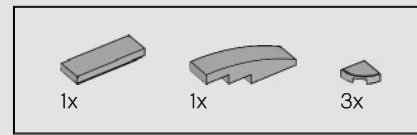
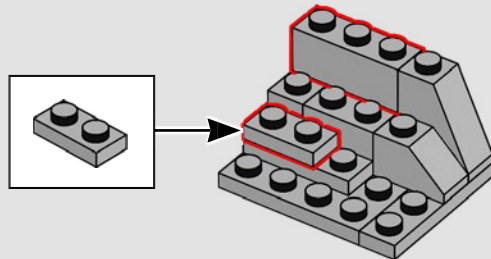

126

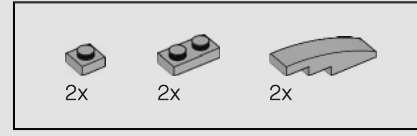
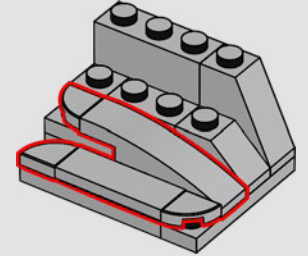

127

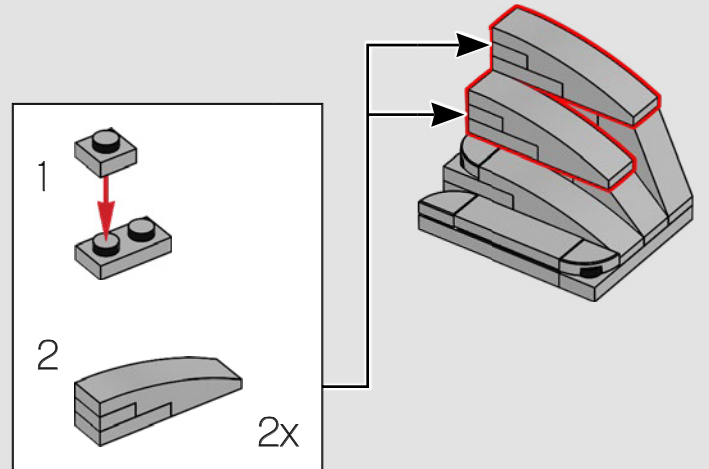



128

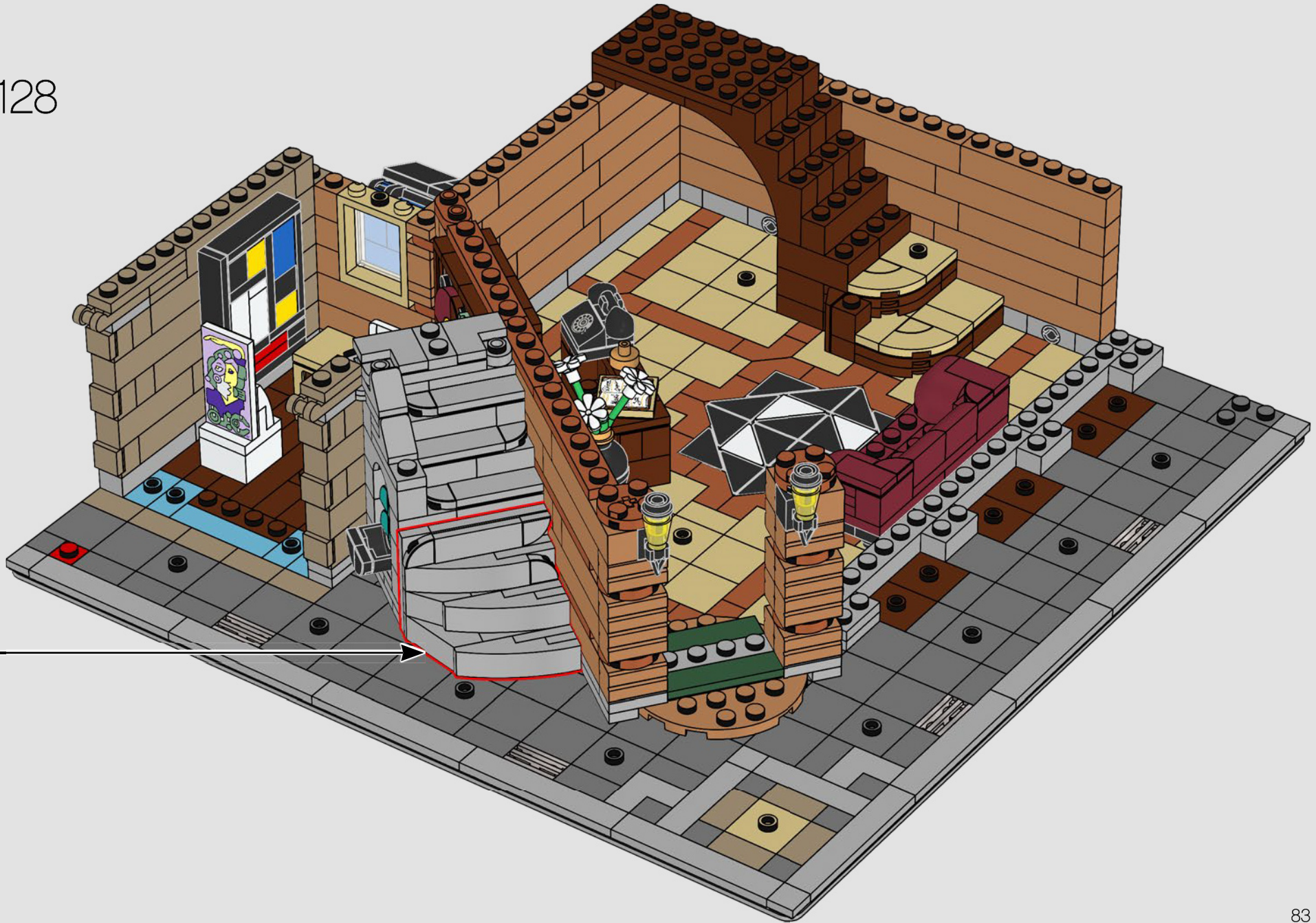

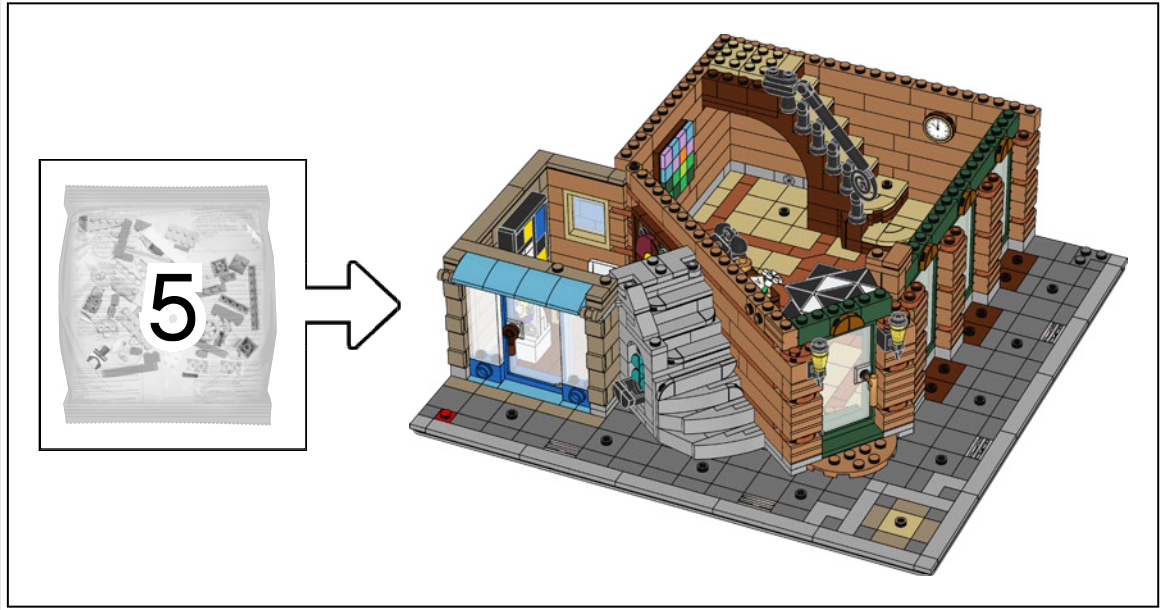



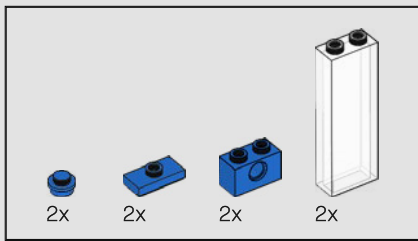

129

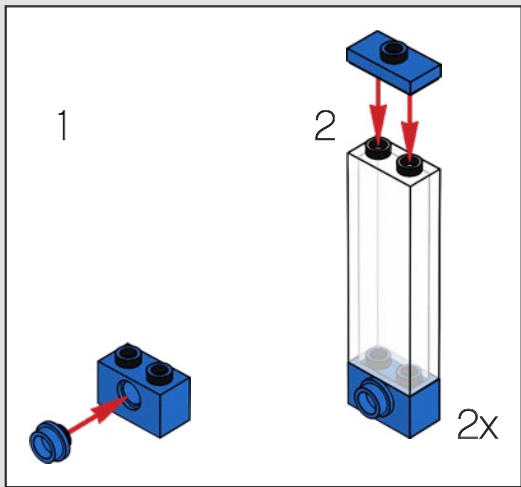



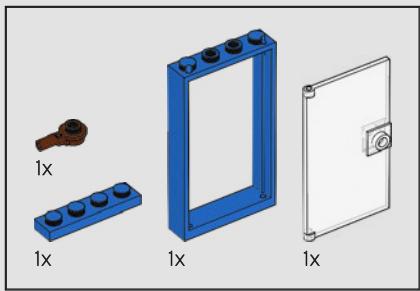

130

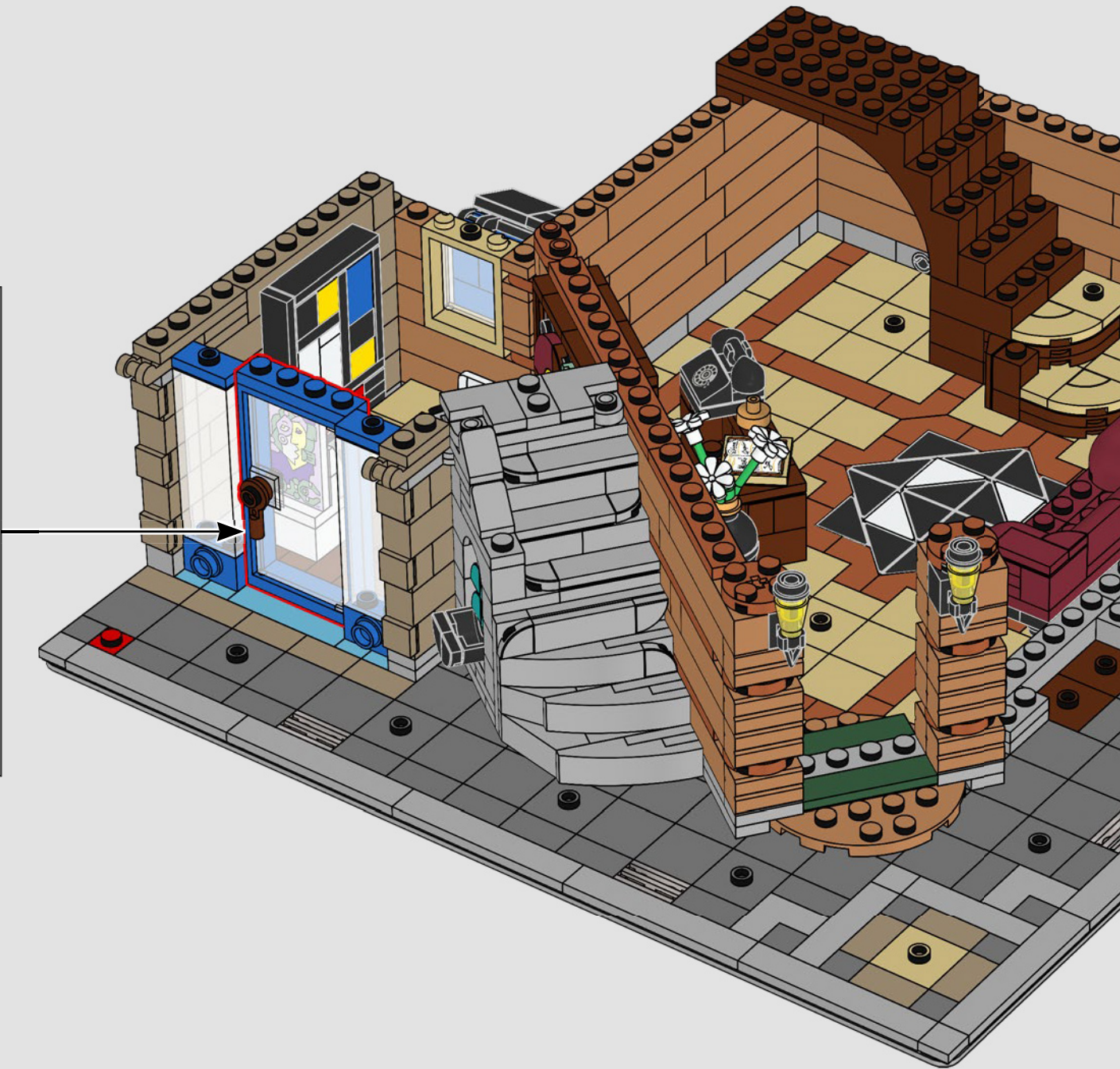
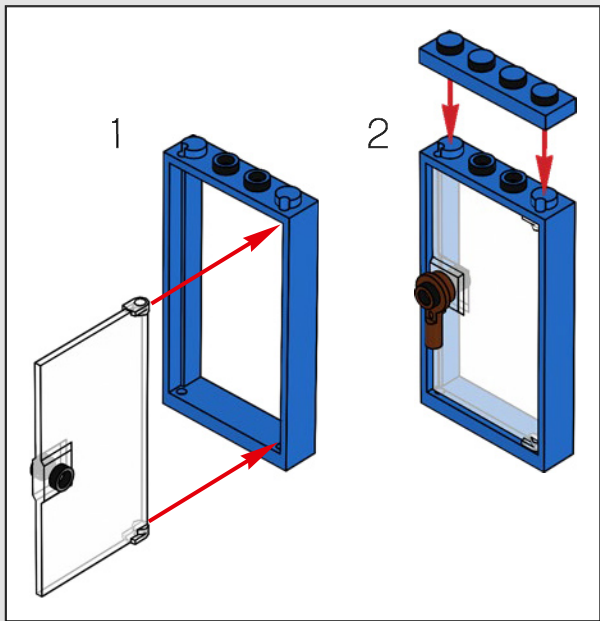



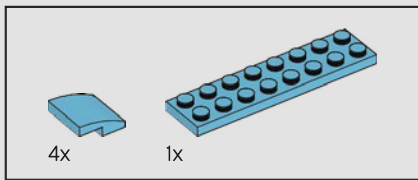

131

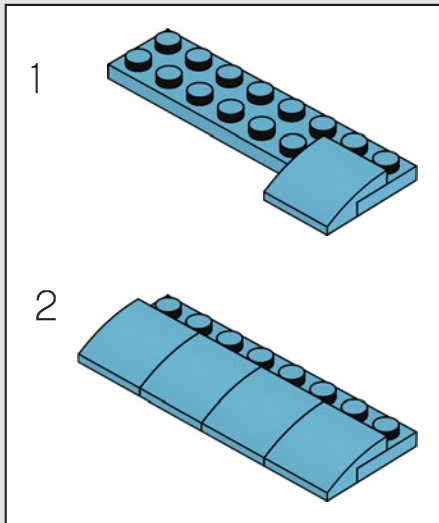



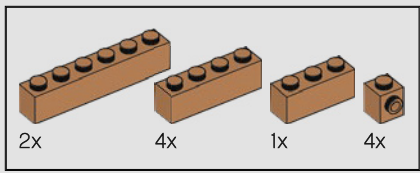

132





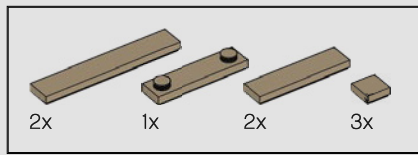

133





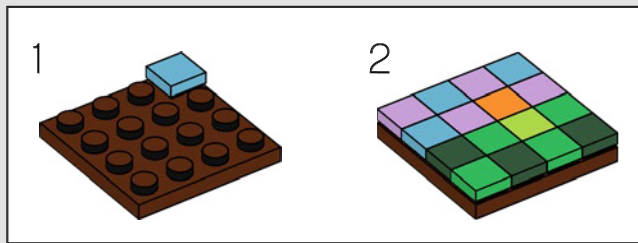
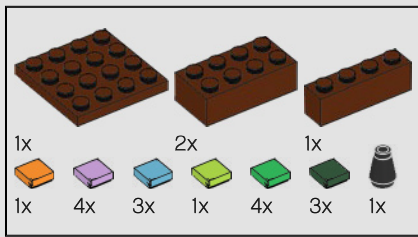

Este cuadro es obra del artista cuyo estudio está en el ático del set Restaurante Parisino (10243).

134





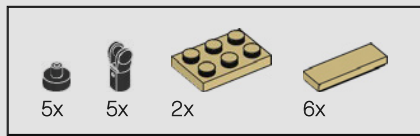

135

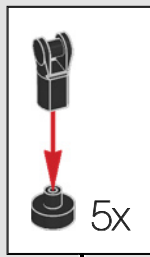





136

- 1
- 2
- 3
- 4





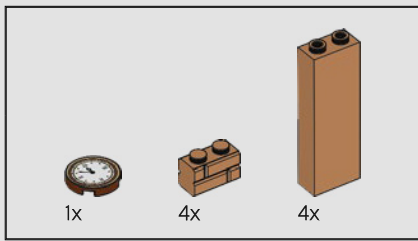

137

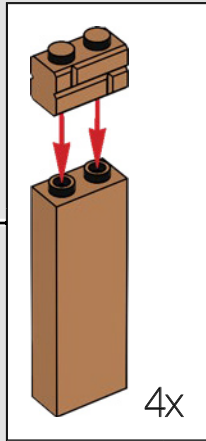



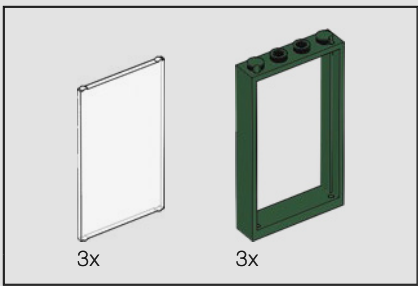

138

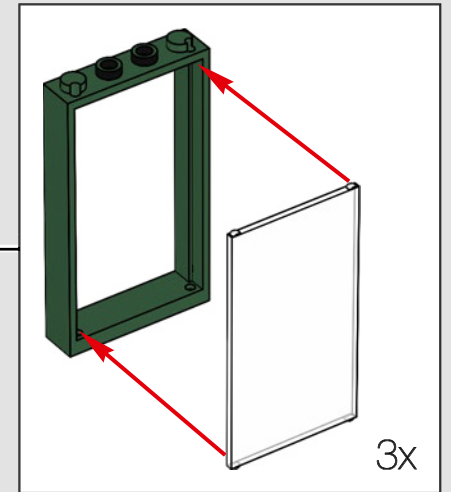



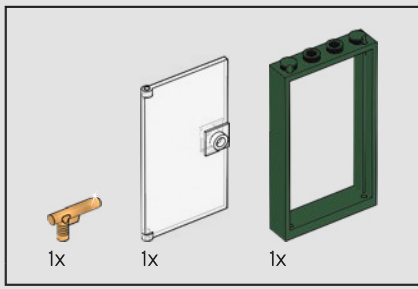

139

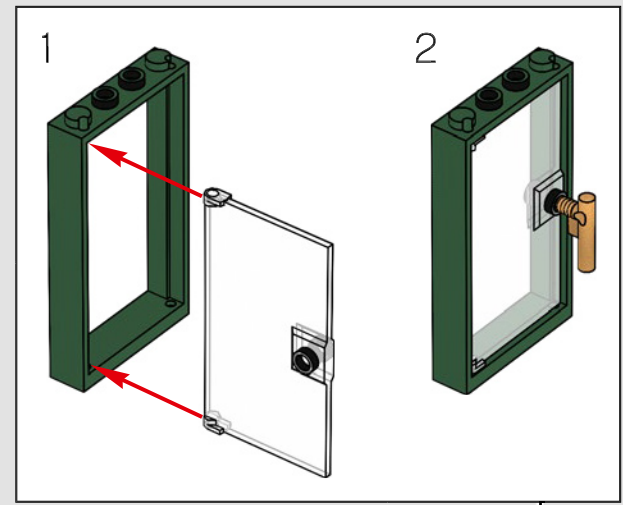



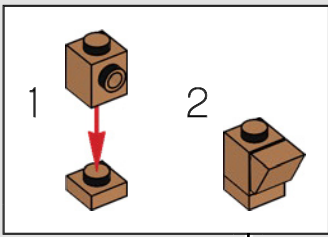
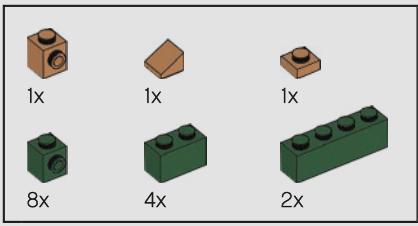

140







141





-  12x
-  20x
-  1x
-  1x
-  1x

142

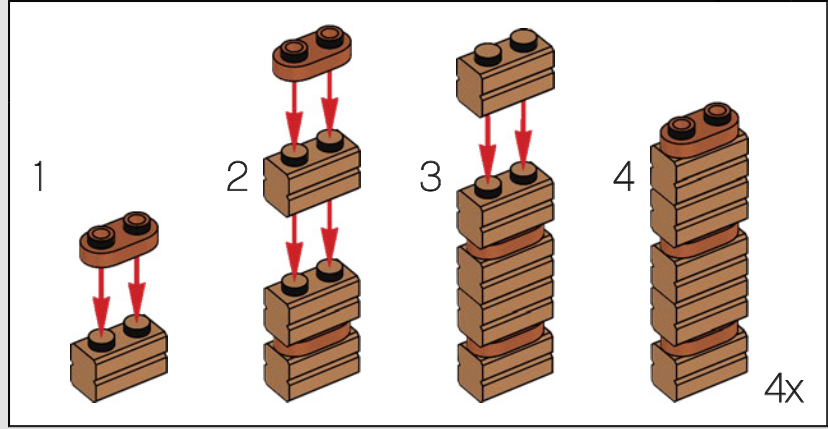
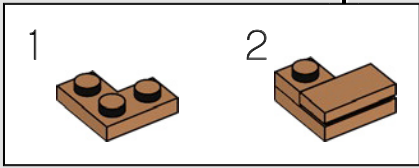



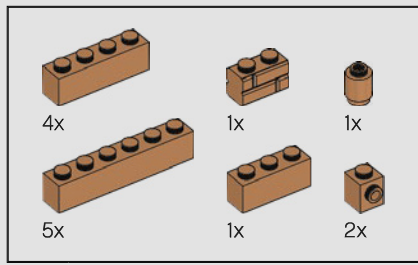

143



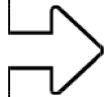



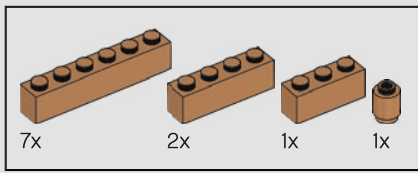

144





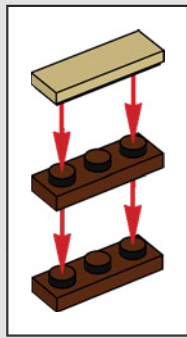
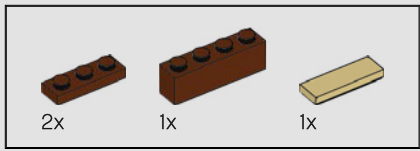

145





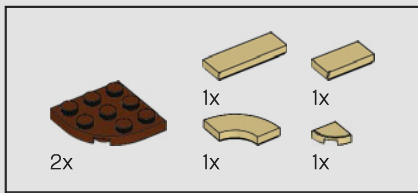

146

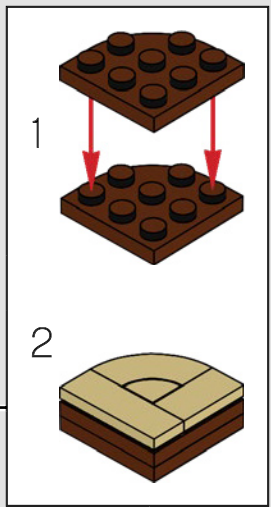



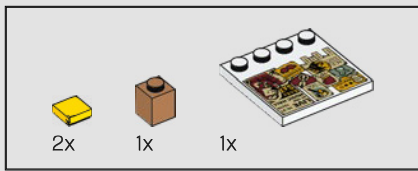

147

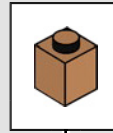
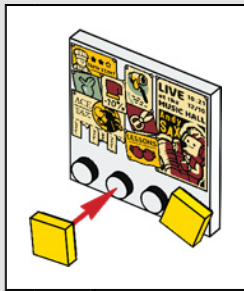

★★★★★  
Todos los avisos de este tablón publicitario anuncian artículos y servicios de sets Modular Buildings anteriores. ¡Intenta reconocer las referencias!





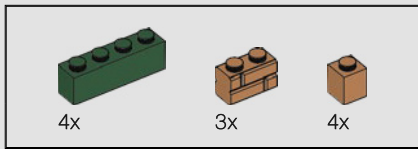

148

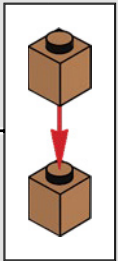



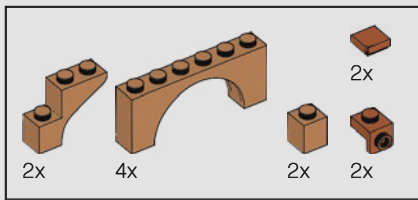

149

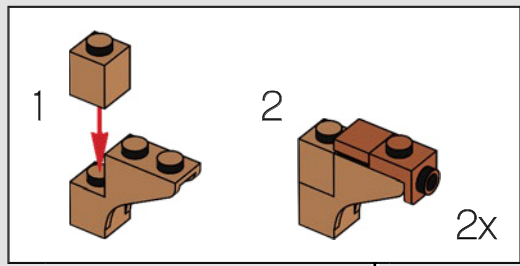



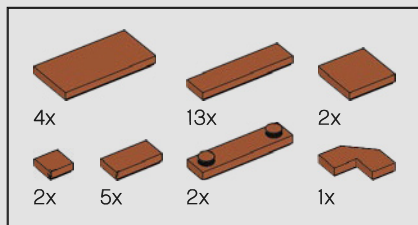

150





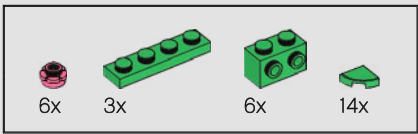

151

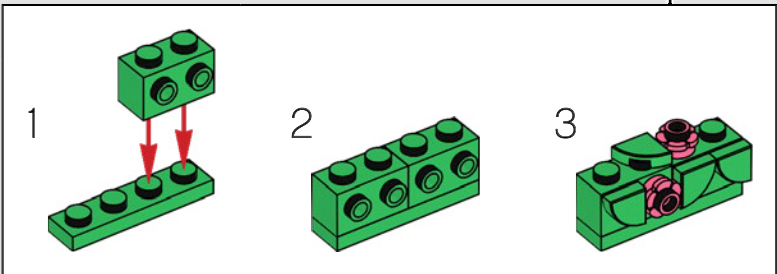
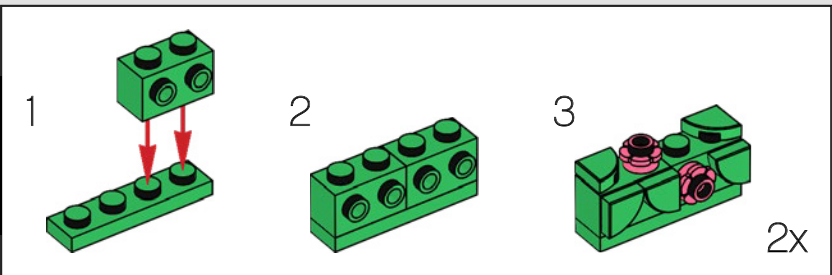



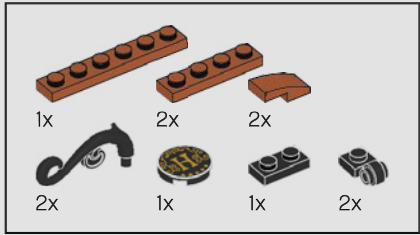
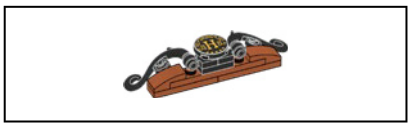

152

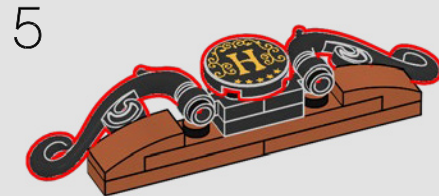
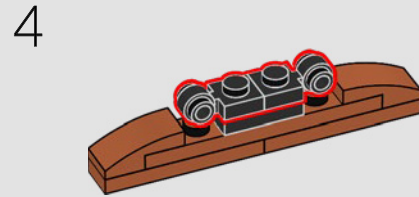
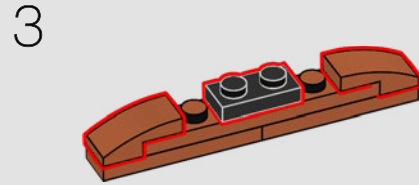
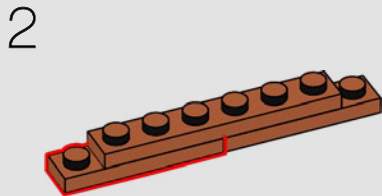
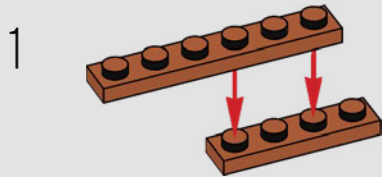





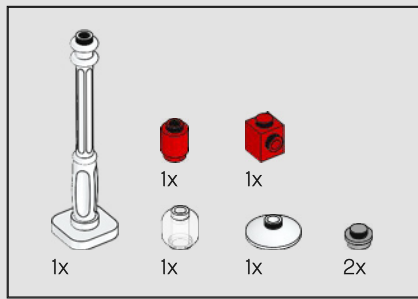

153

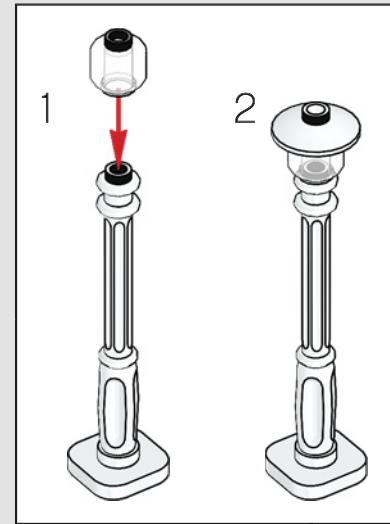
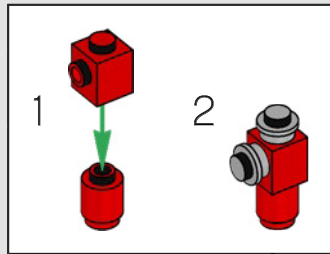

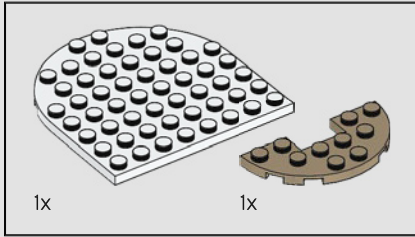
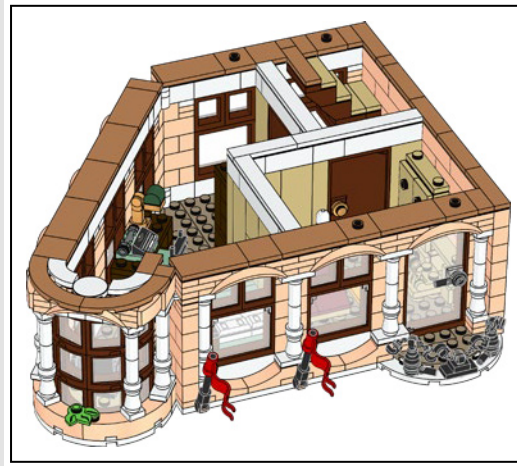
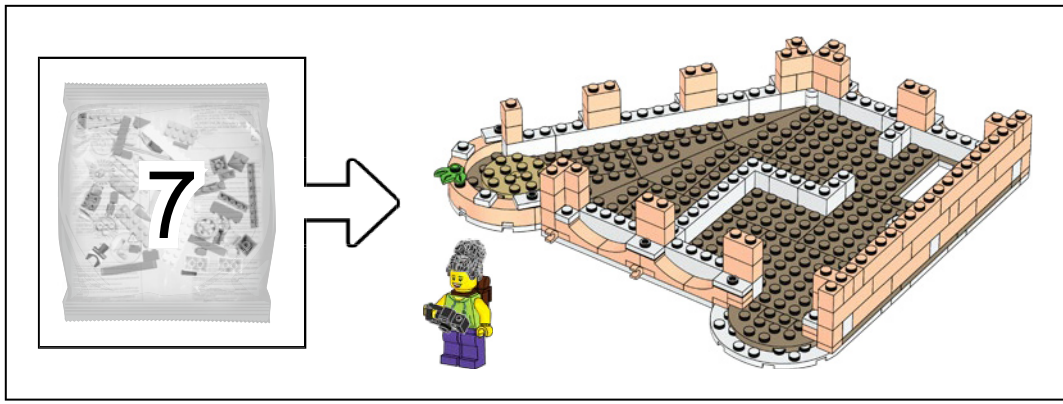

154

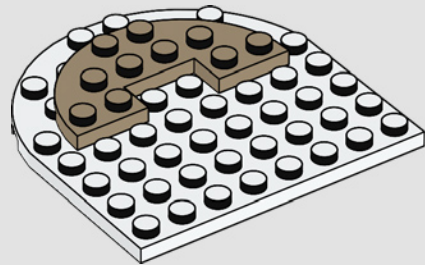
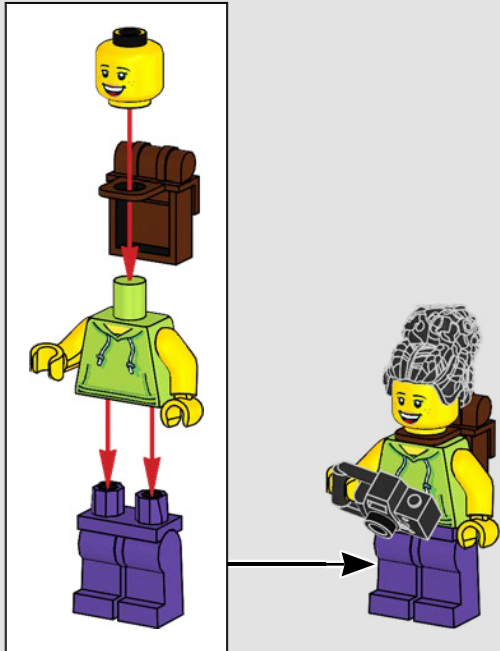

¡La mochilera está viajando por el mundo!  
Tiene que ajustarse al presupuesto, por lo que  
se aloja en la habitación económica del hotel.



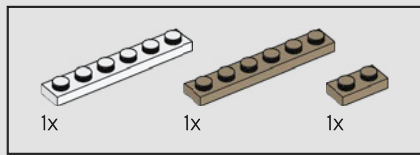

155

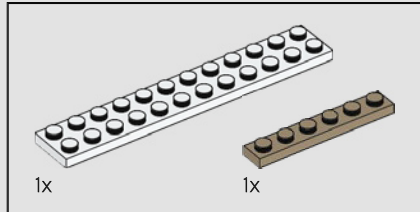
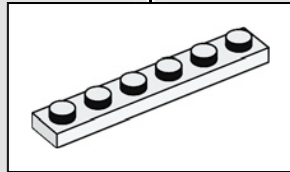
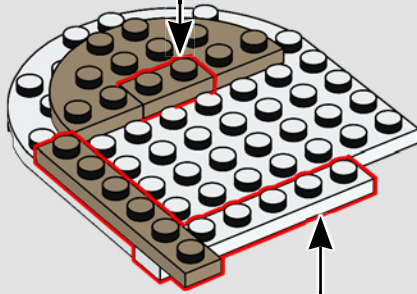
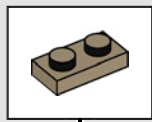

156

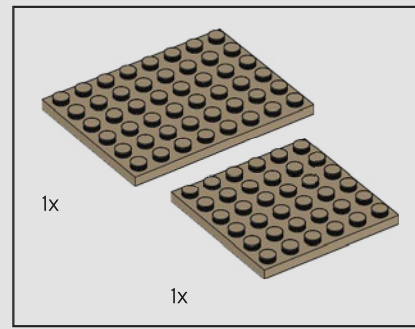
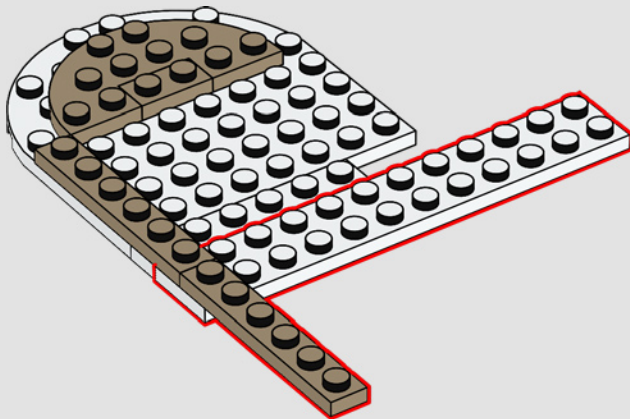

157

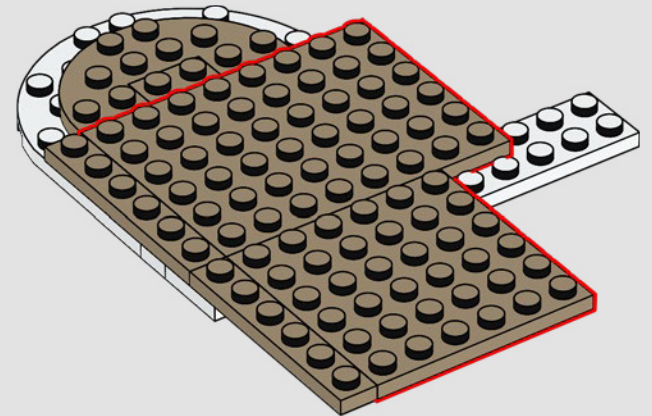

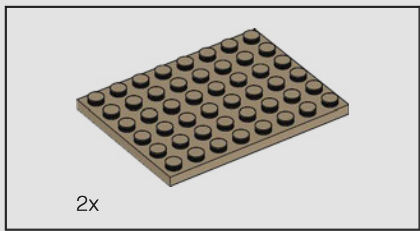

158

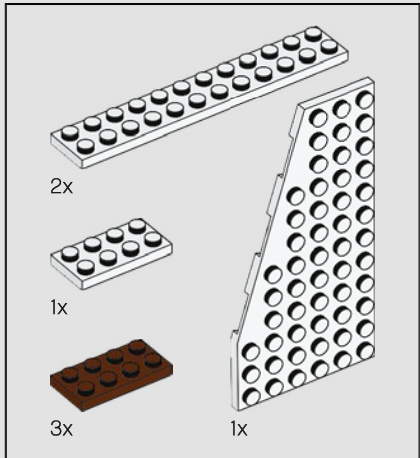
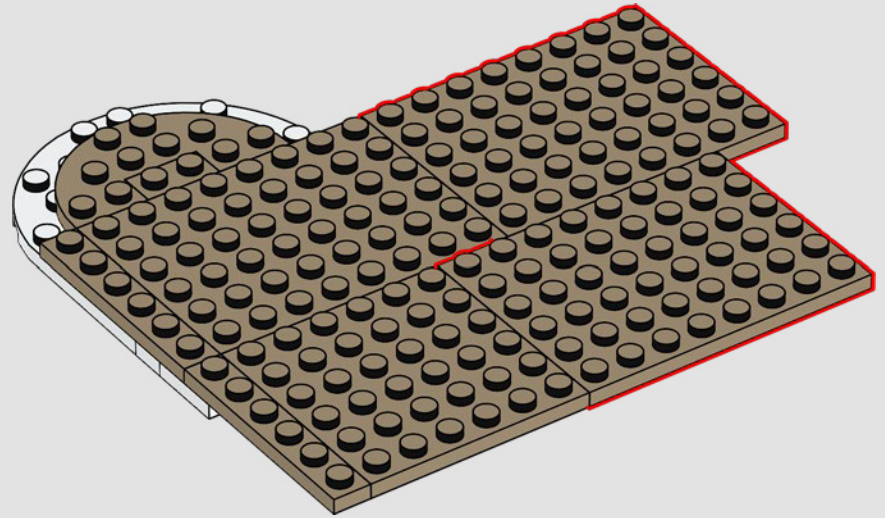

159

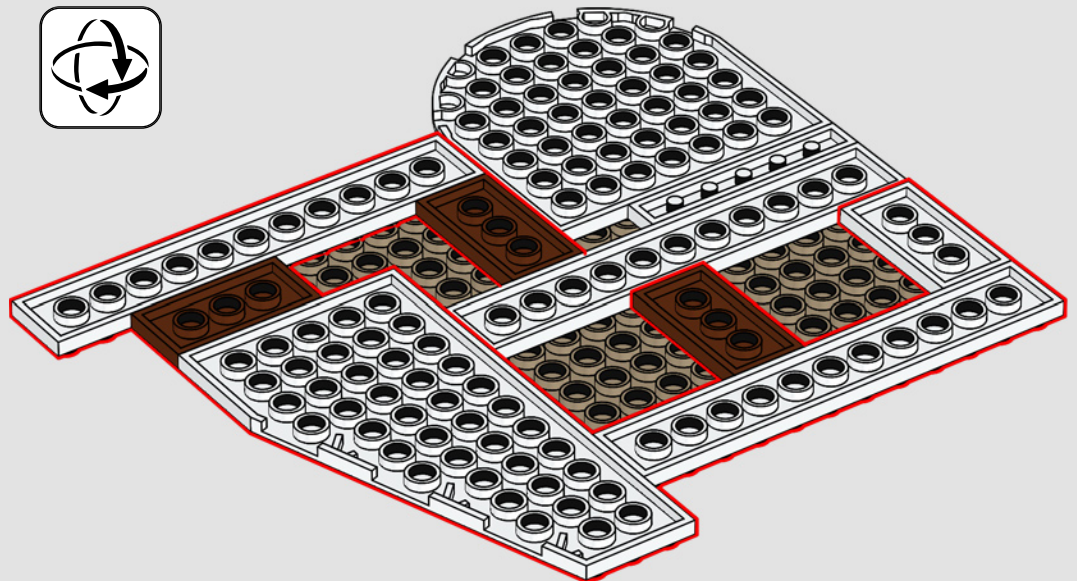
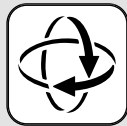



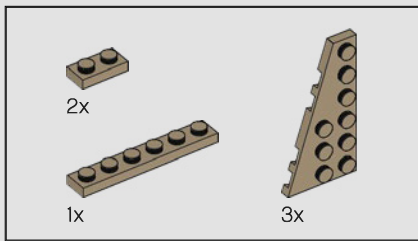

160

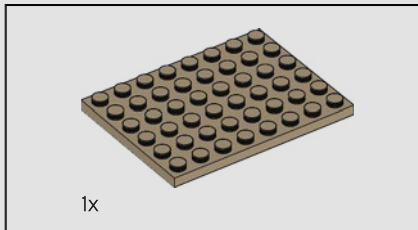
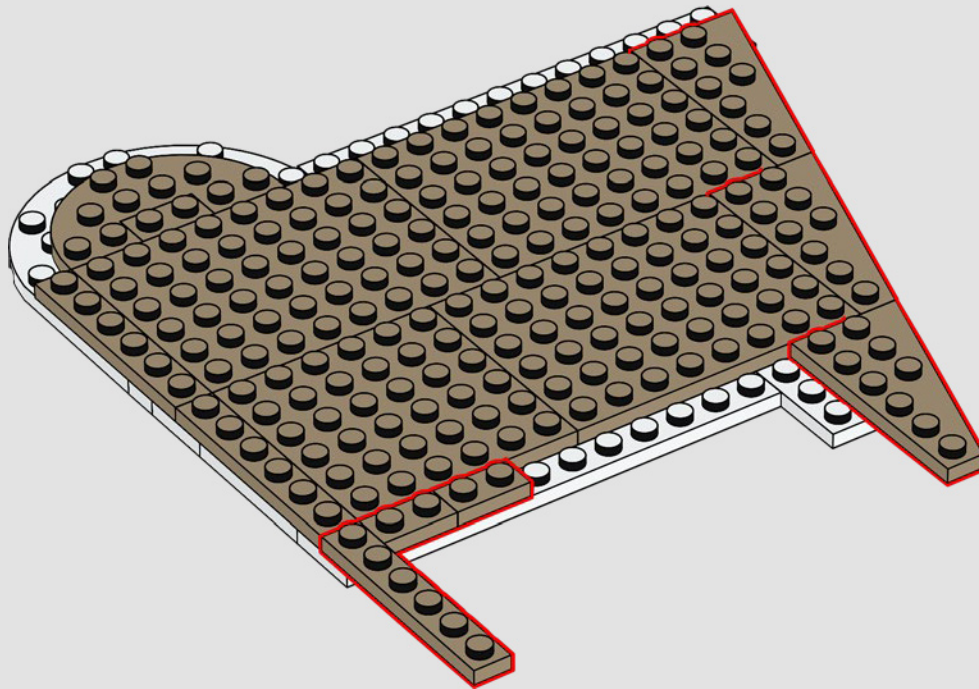

161

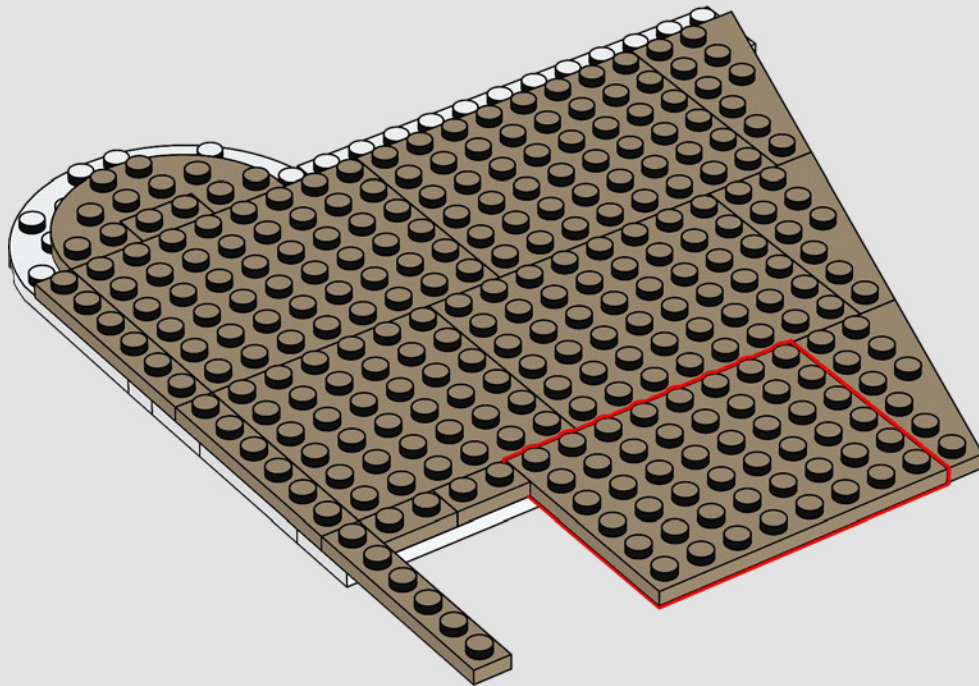

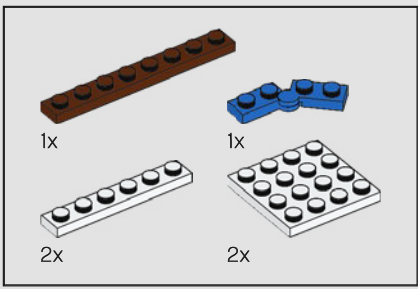

162

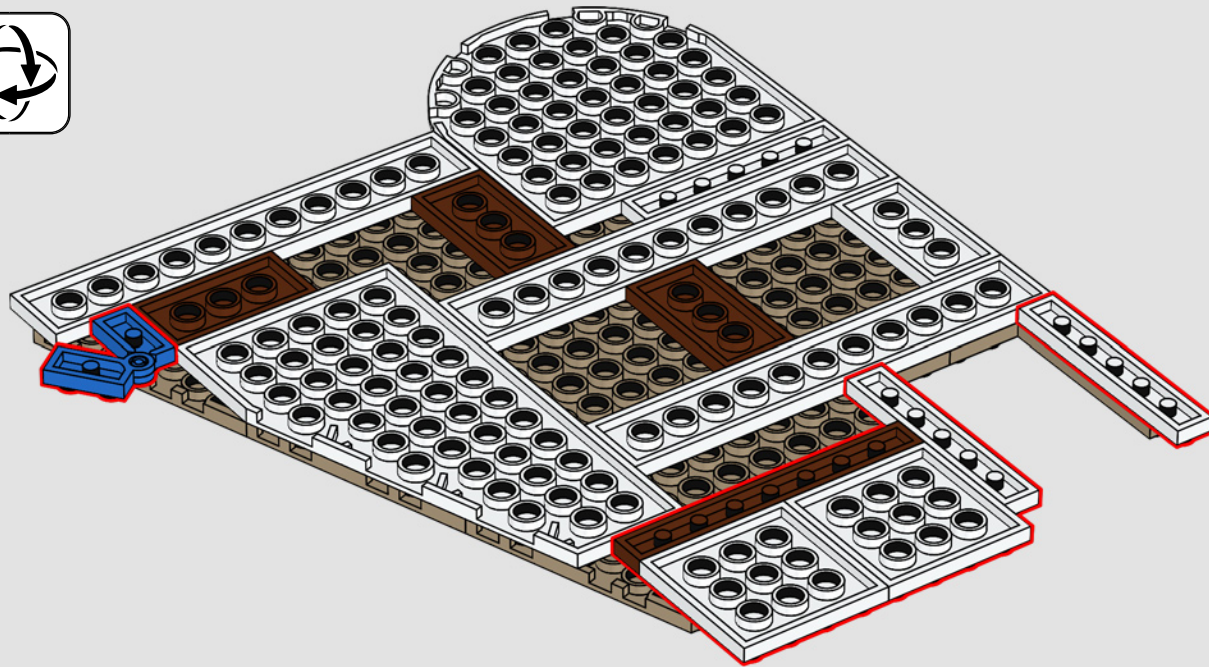



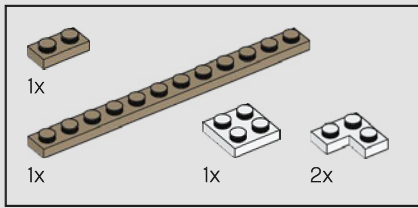

163

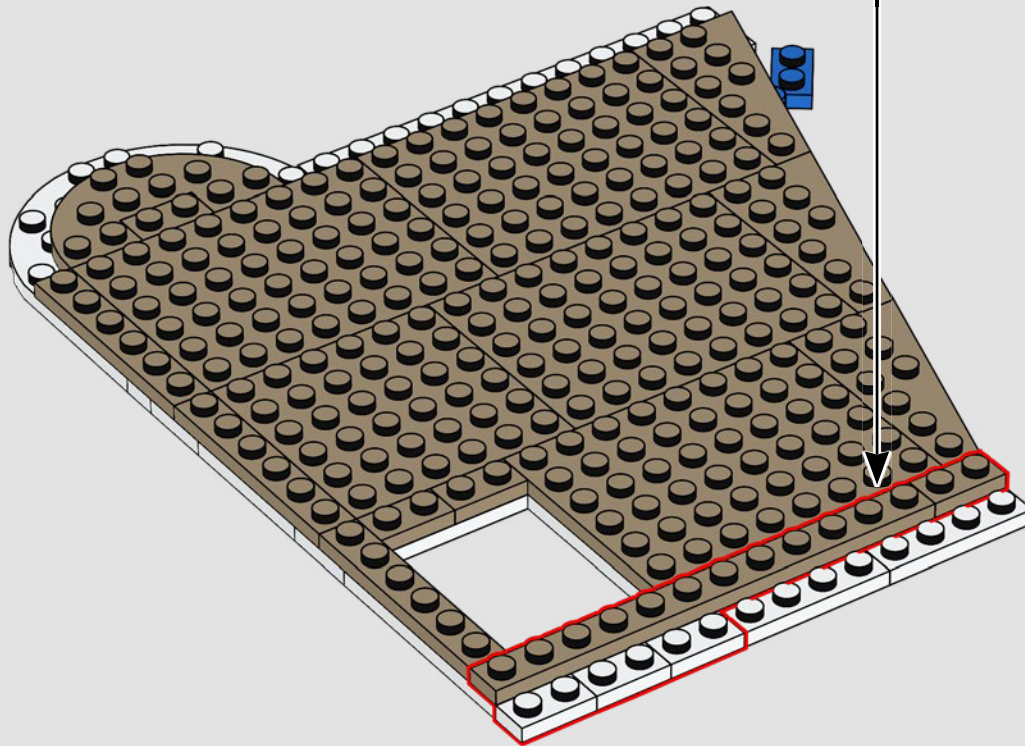
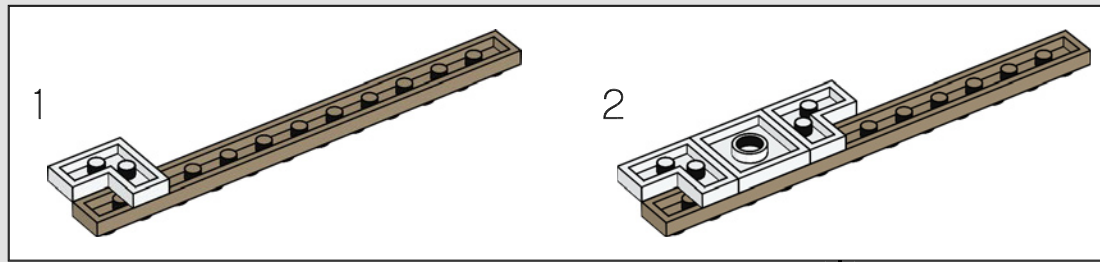

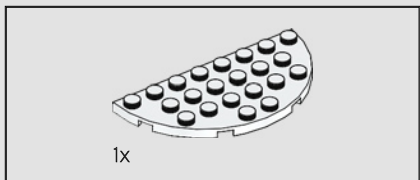

164

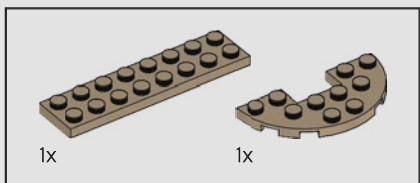
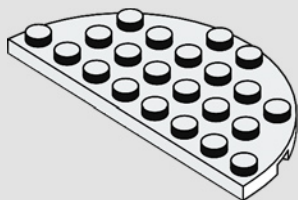

165

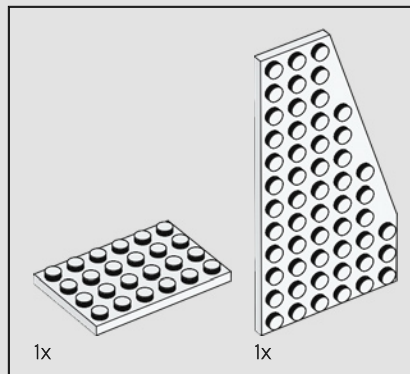
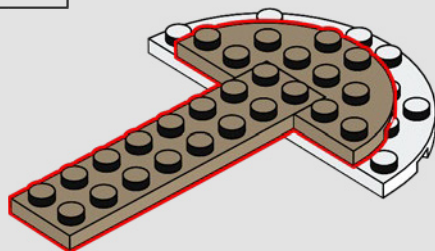

166

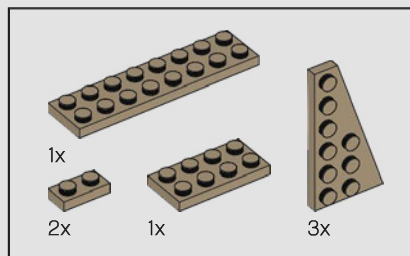
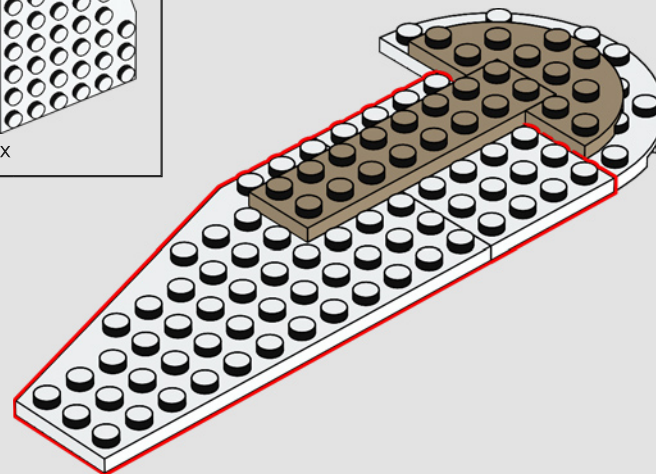

167

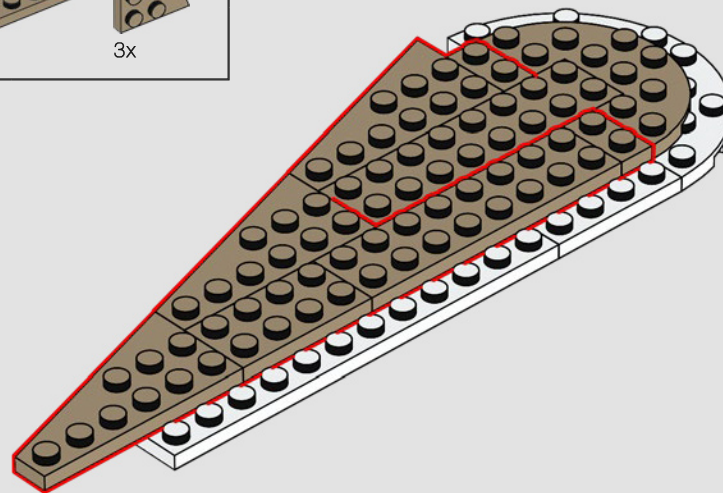



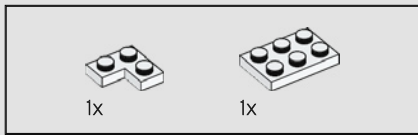

168

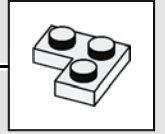
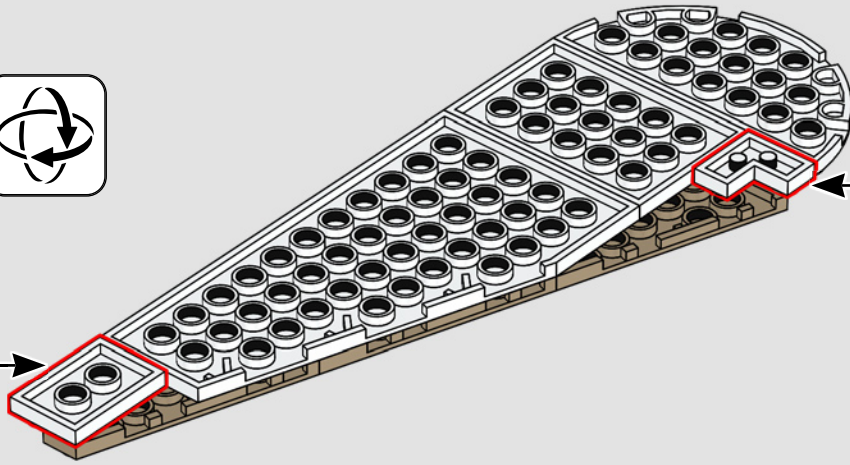
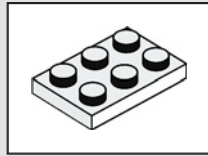

169

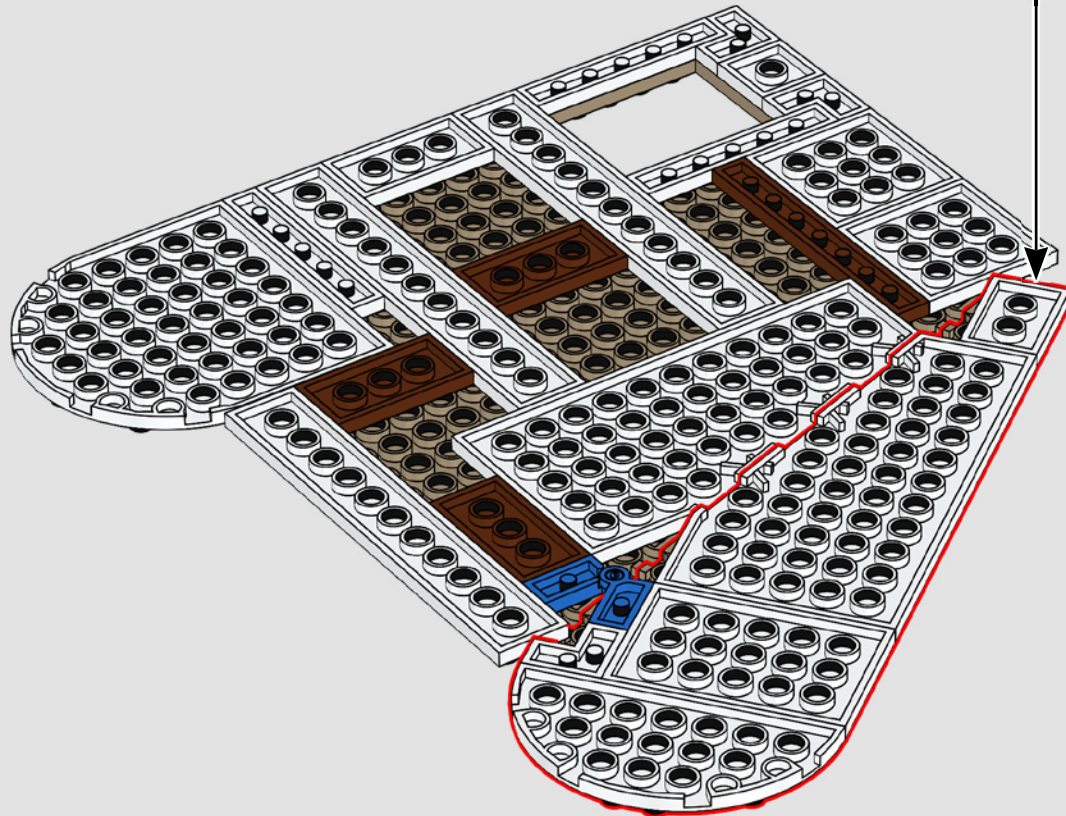

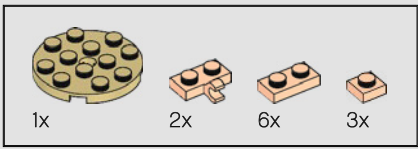

170

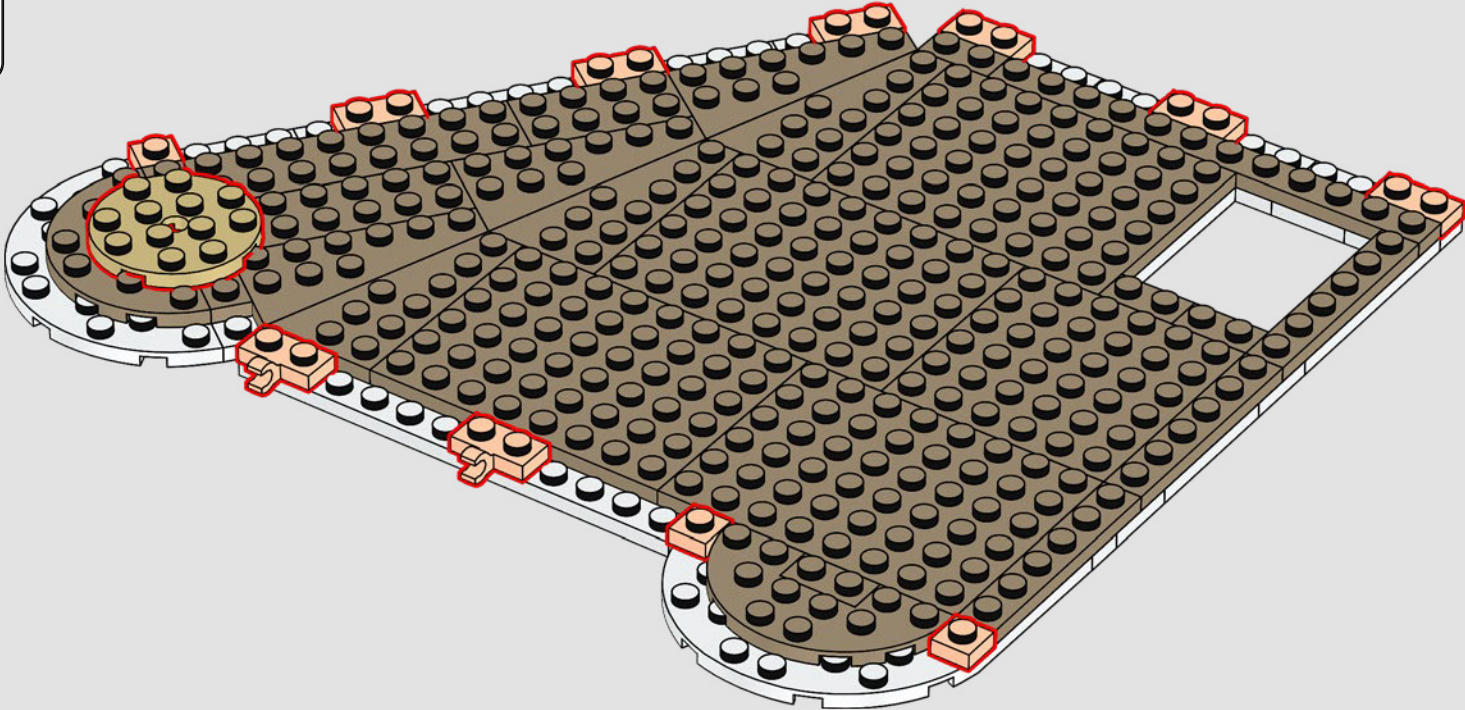



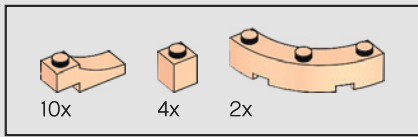

171

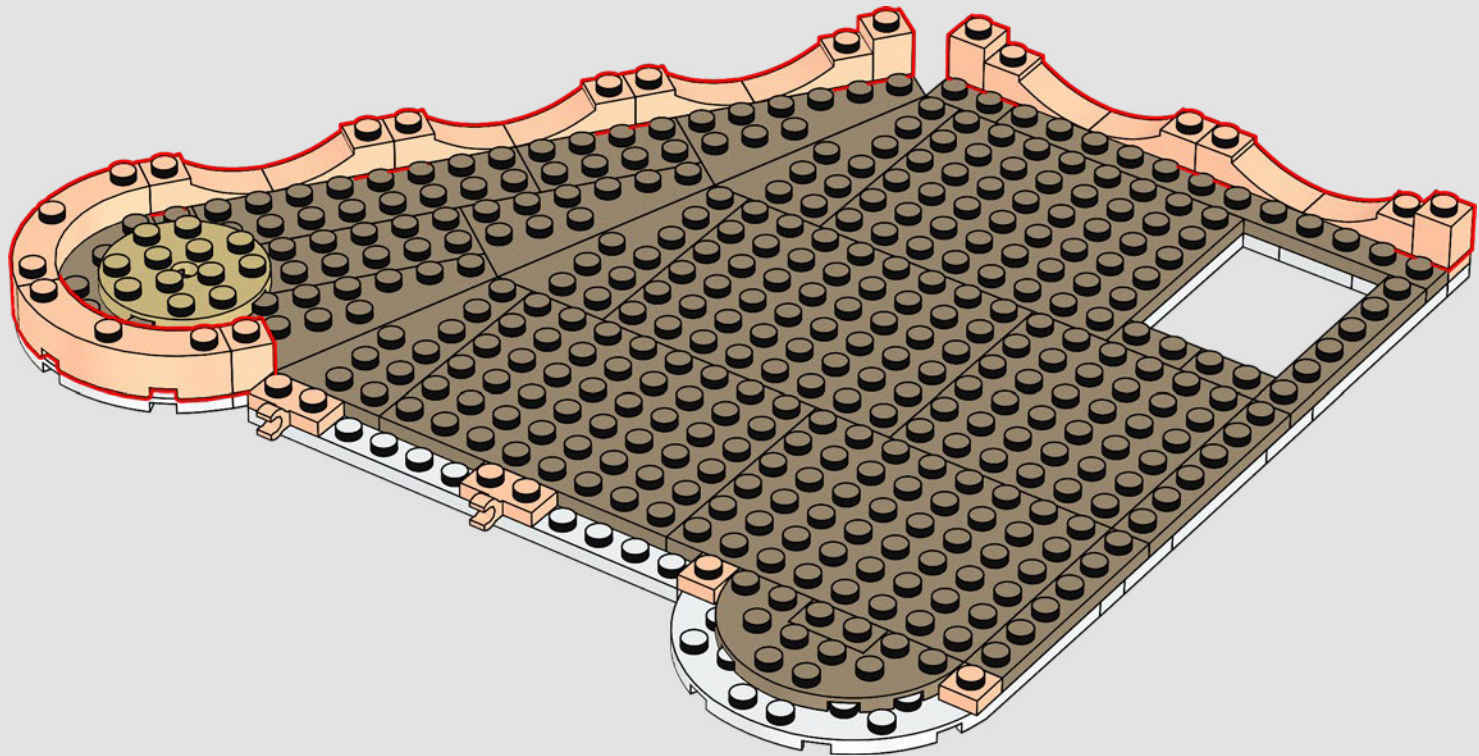

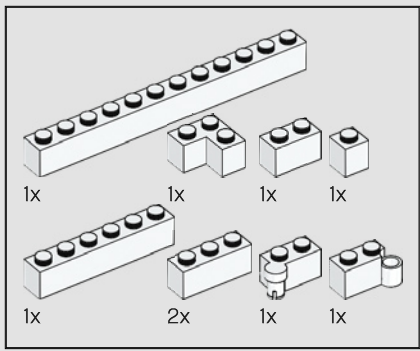

172

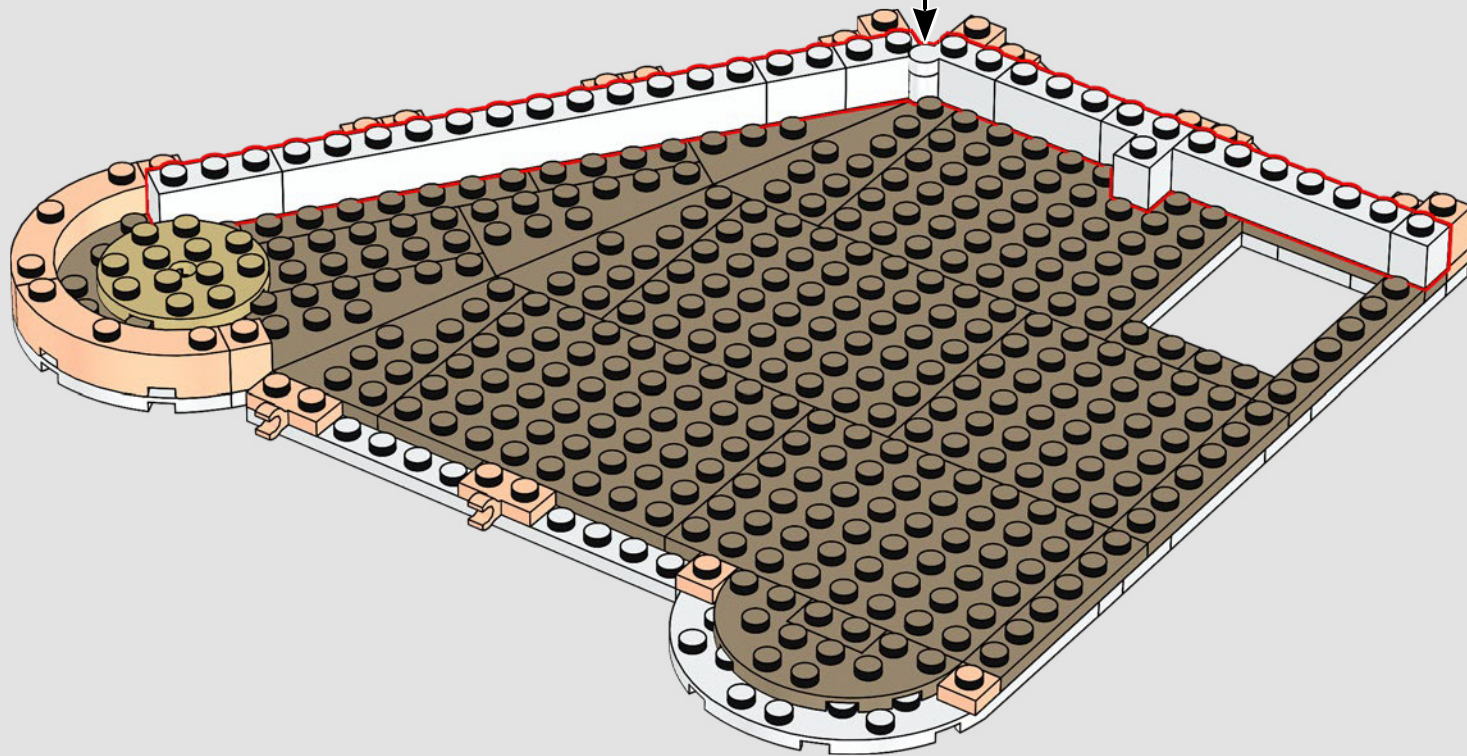
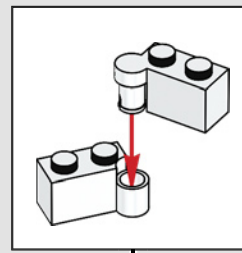



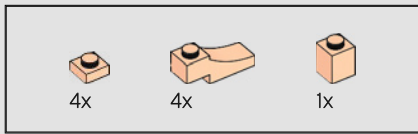

173

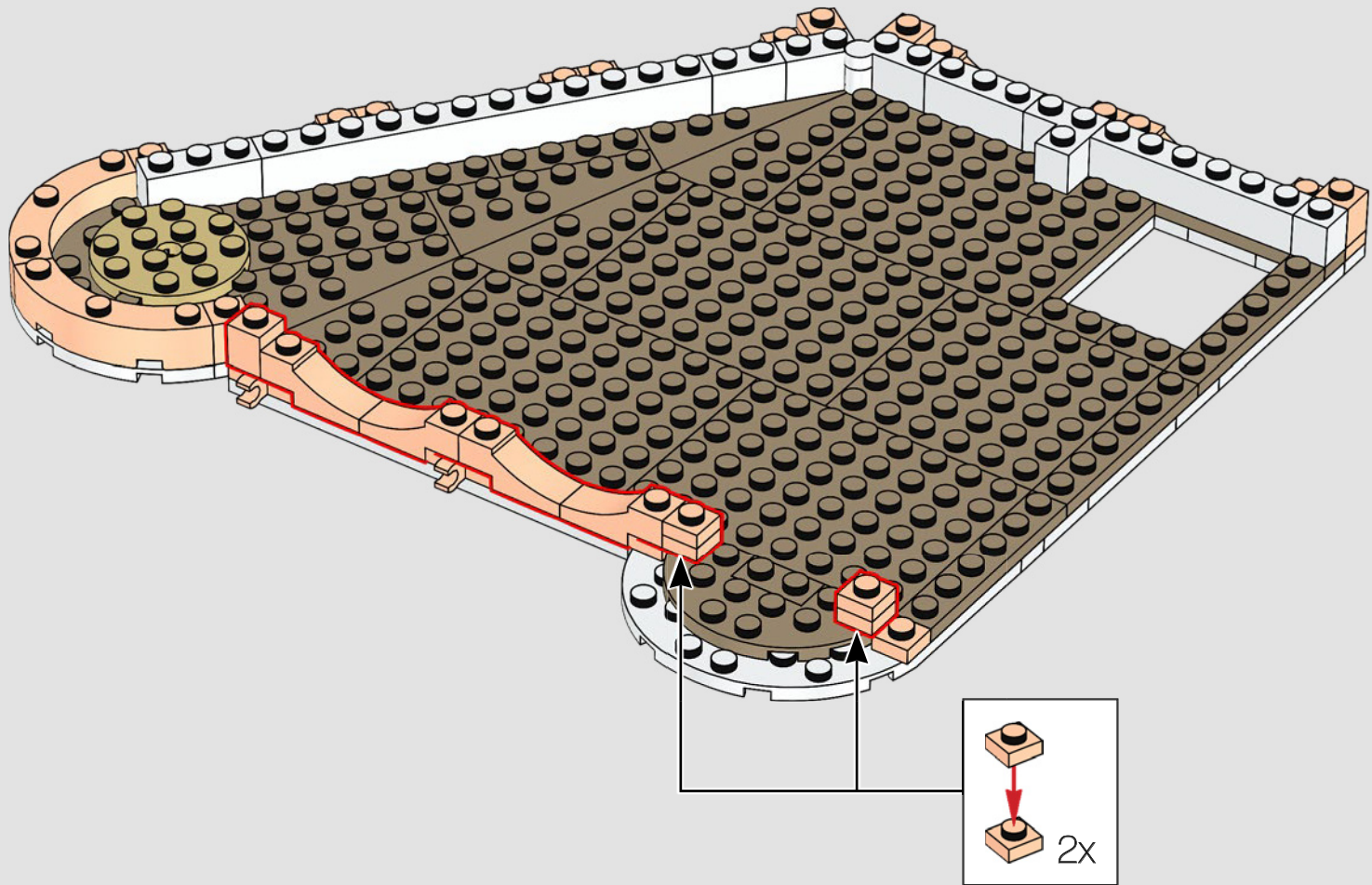

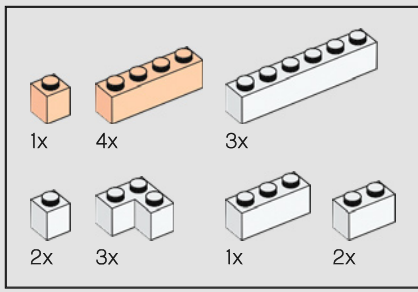

174

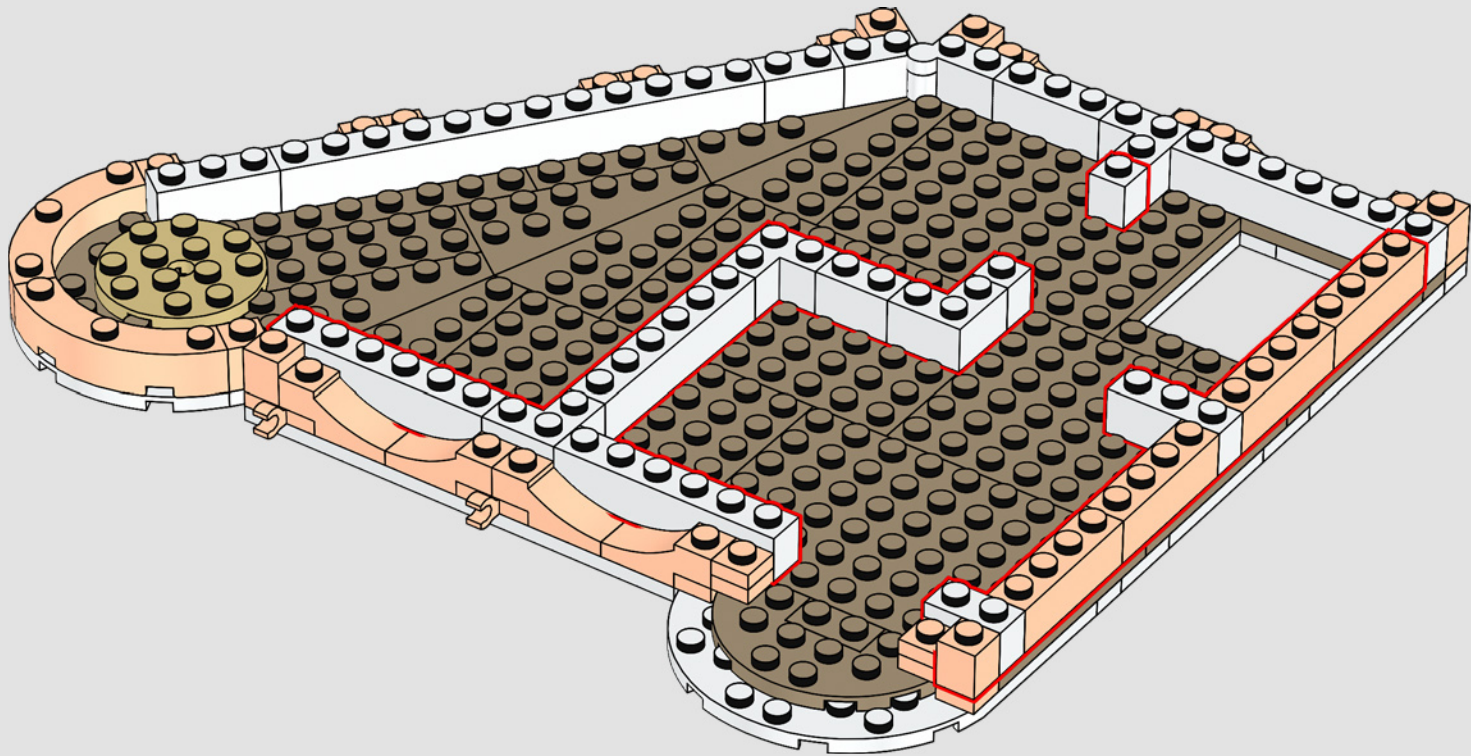



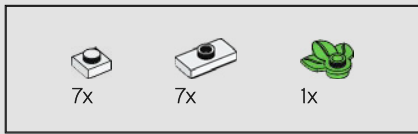

175

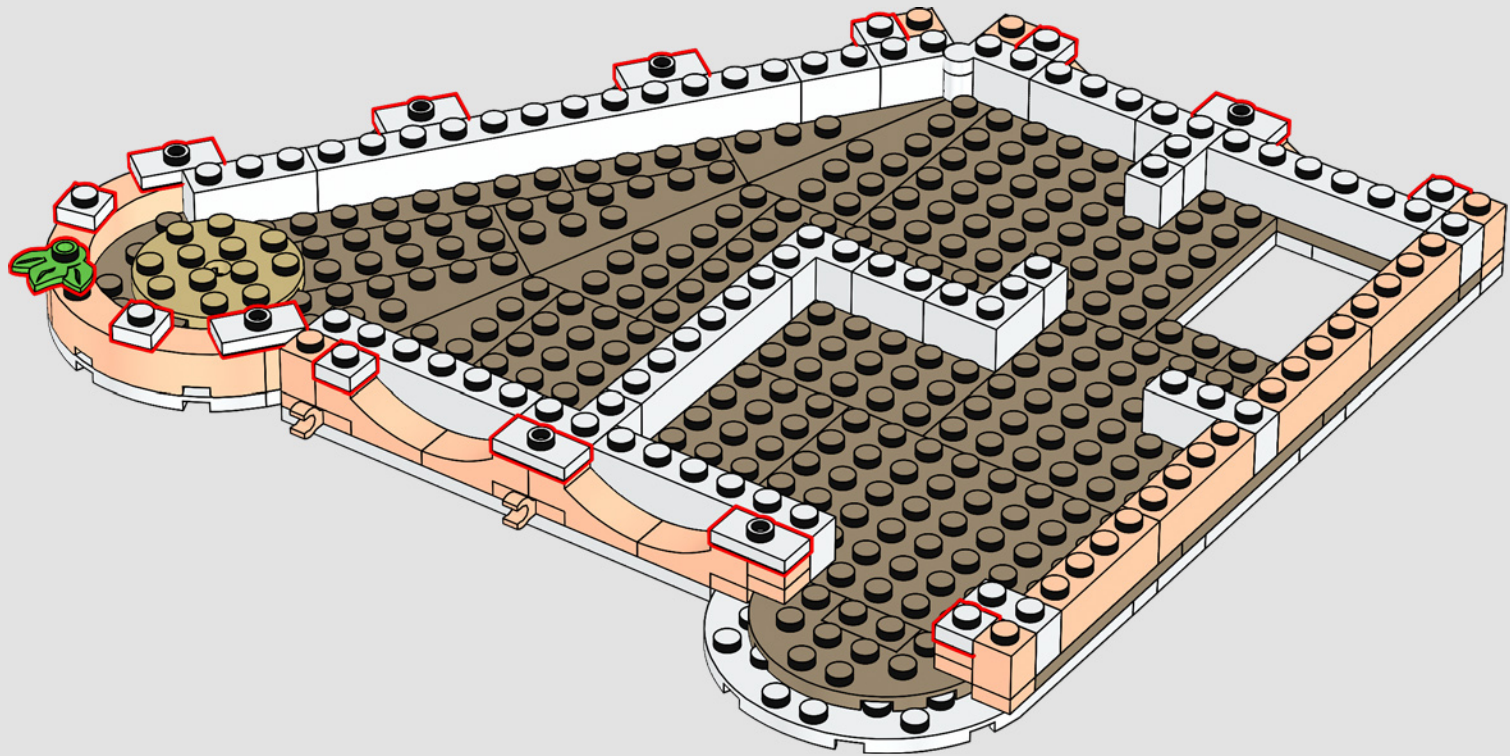

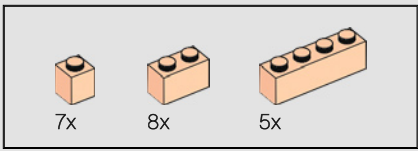

176

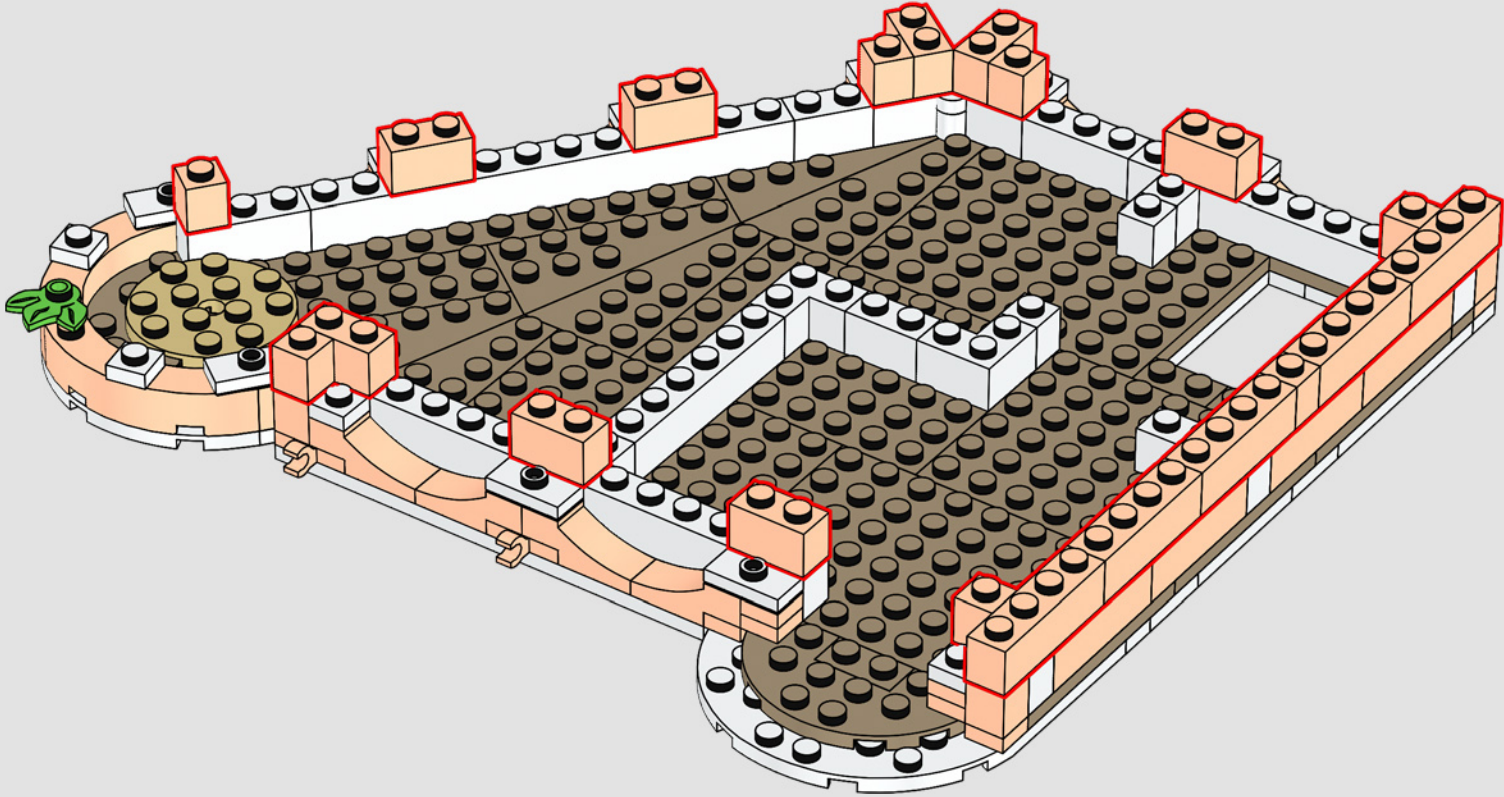



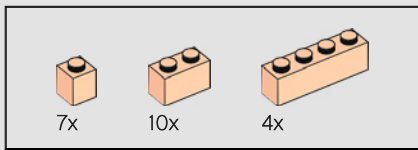

177

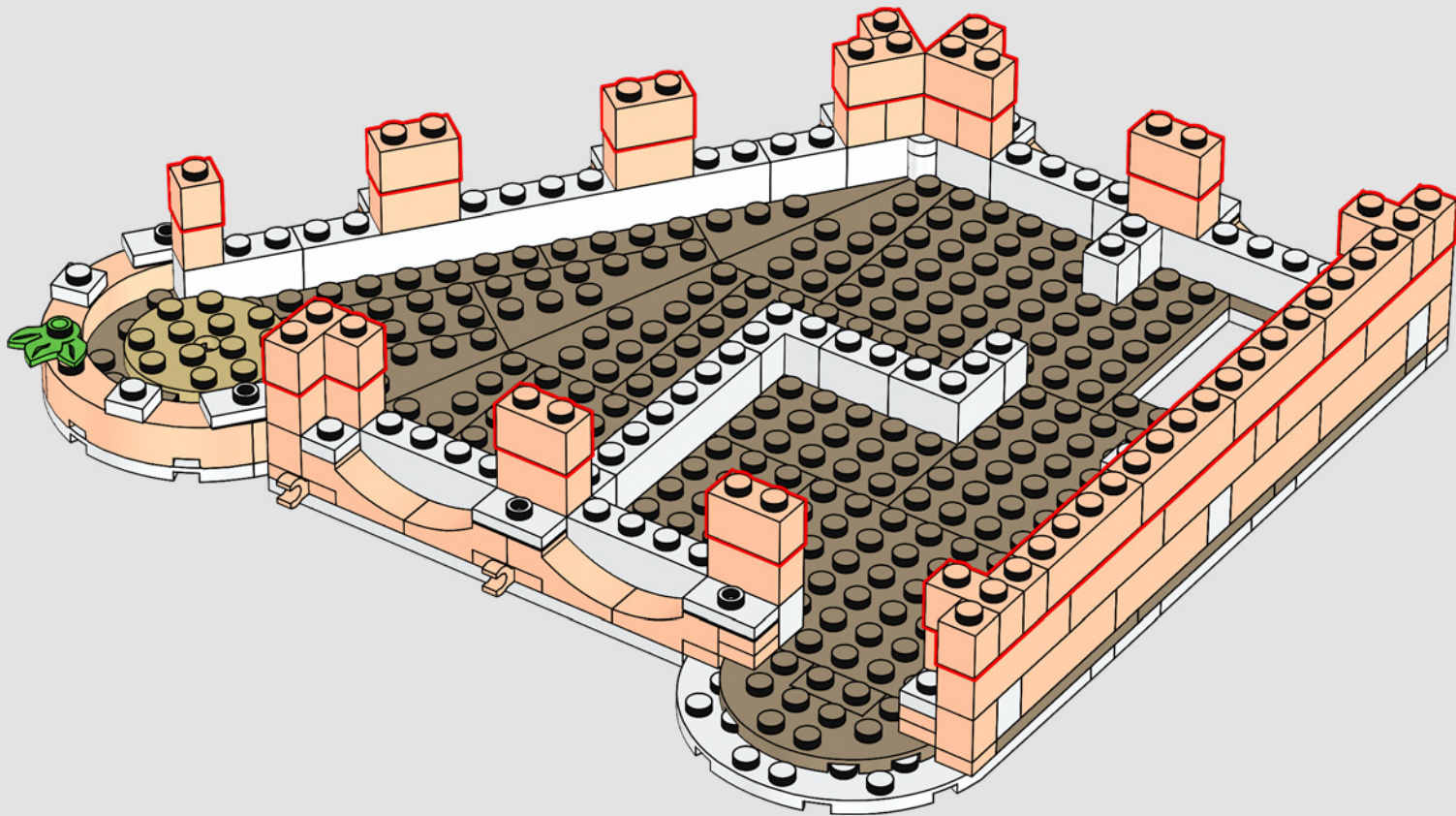

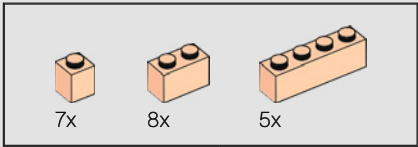
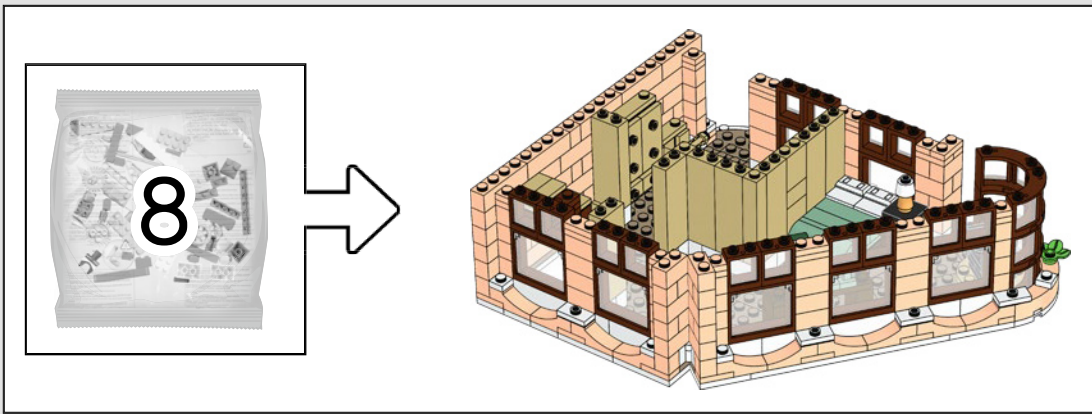

178

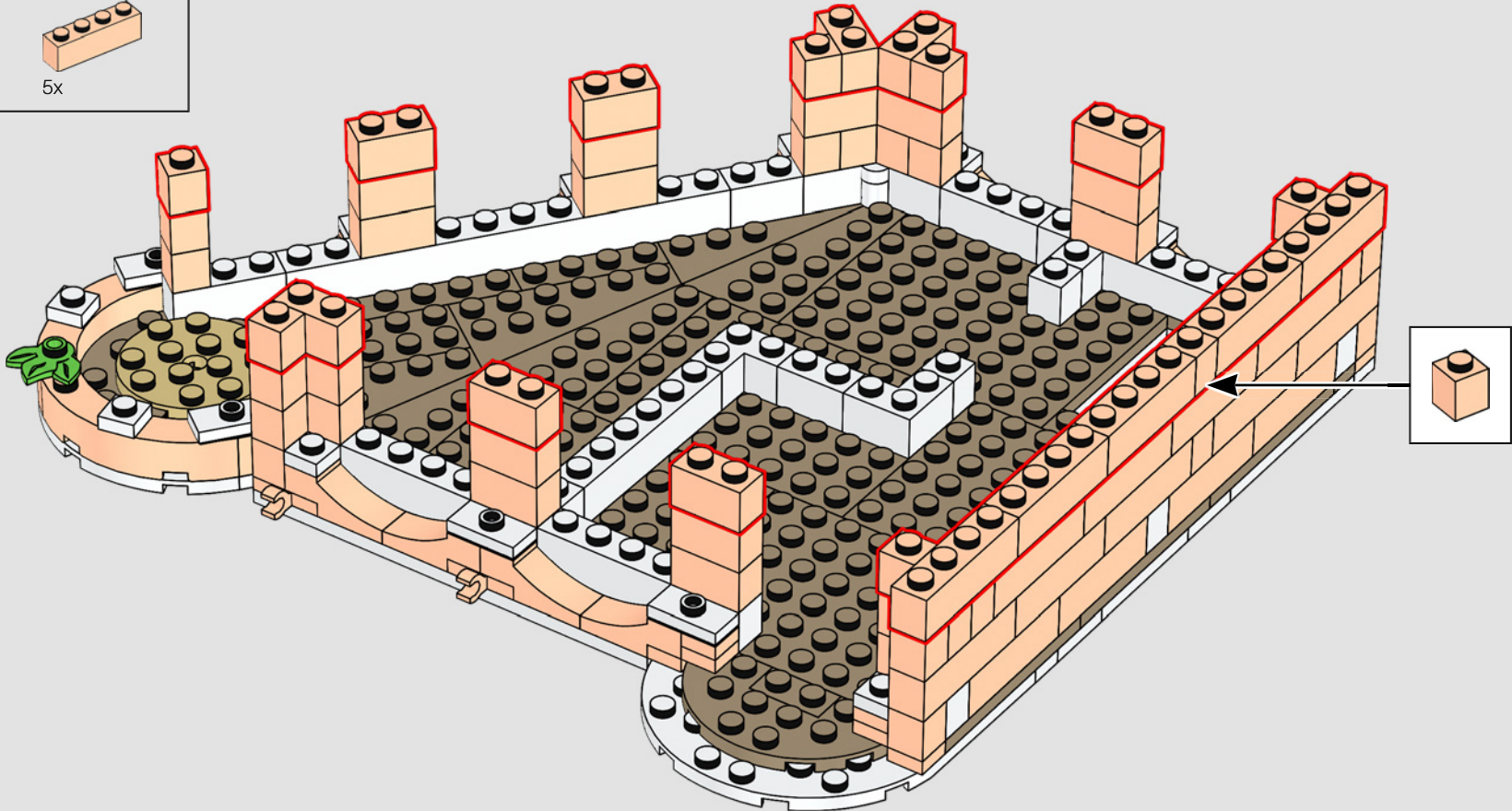



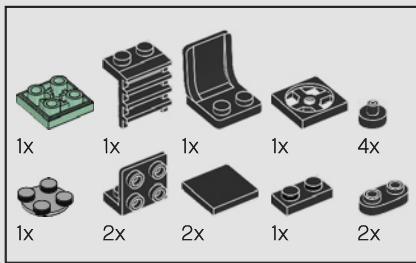

179

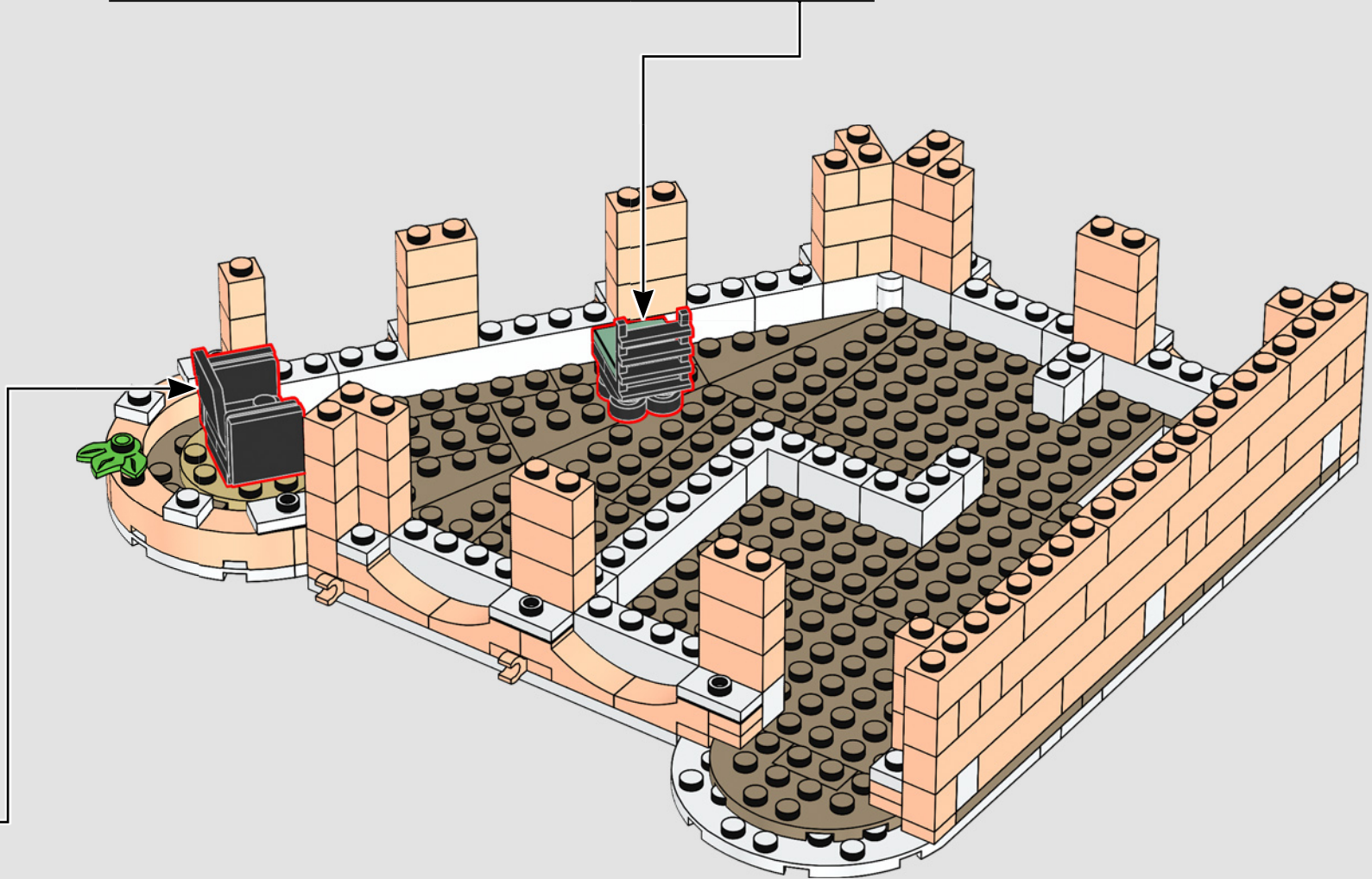
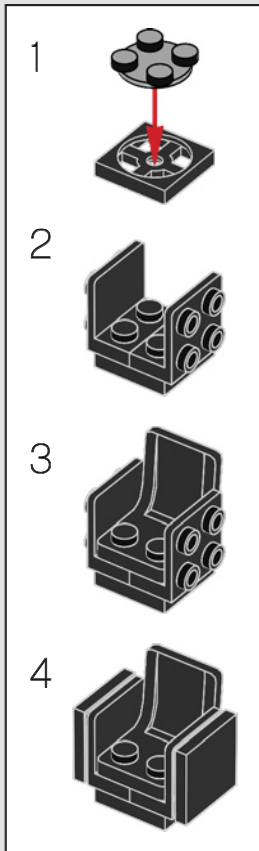
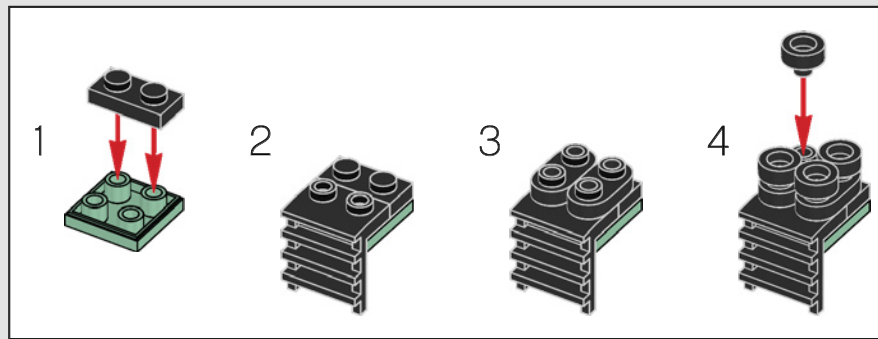

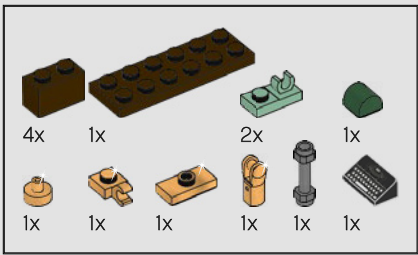

180

1

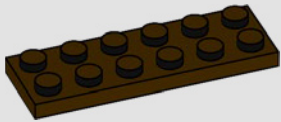

2

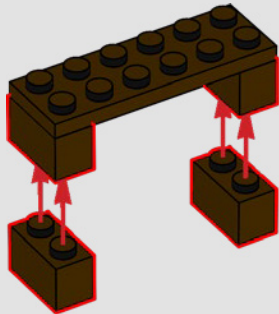

3

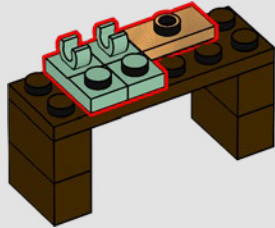

4

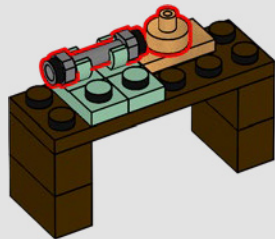

5

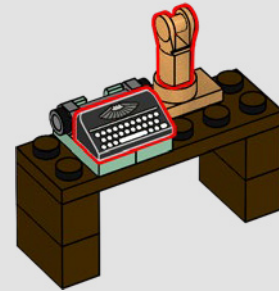

6

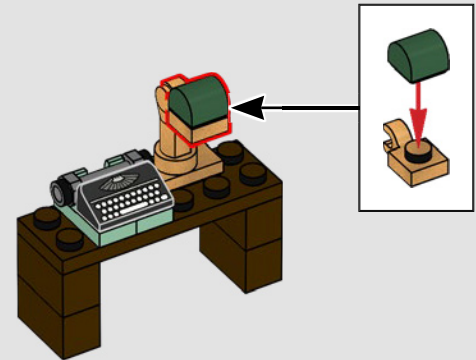

Hace poco, la empresa local de máquinas de escribir cerró grandes ventas de productos con el hotel y la Comisaría de Policía (10278).



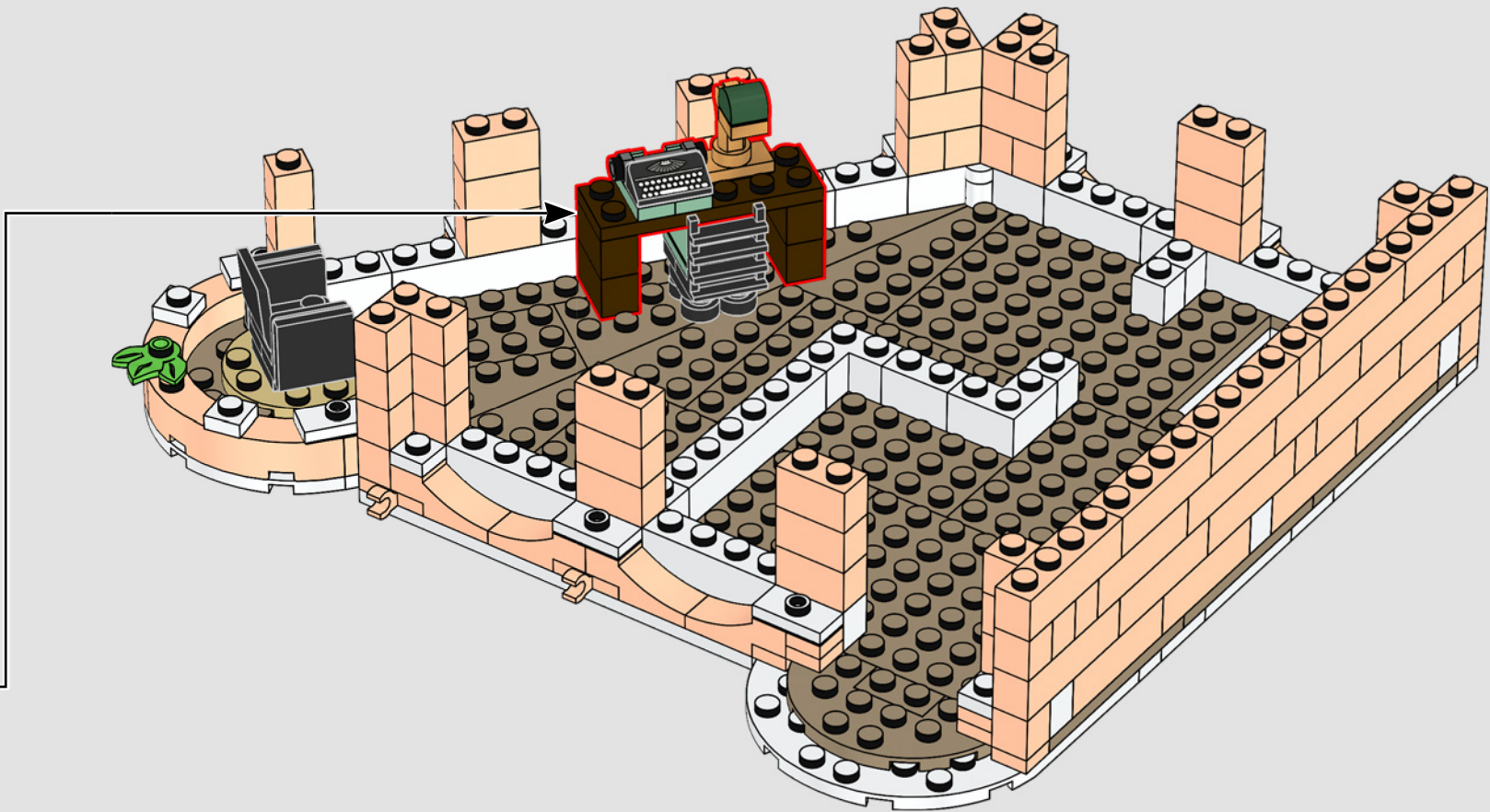





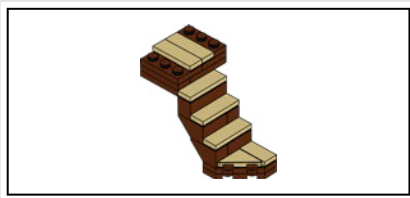

182

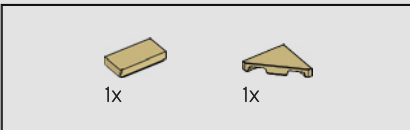
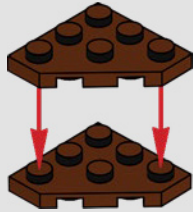

183

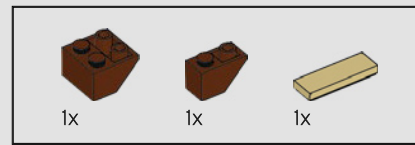

184

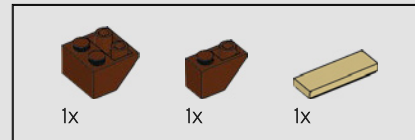
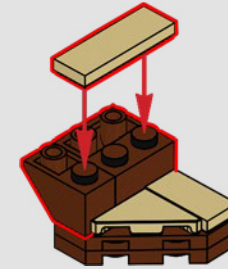

185

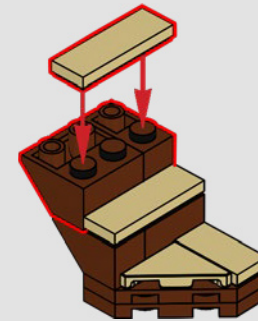

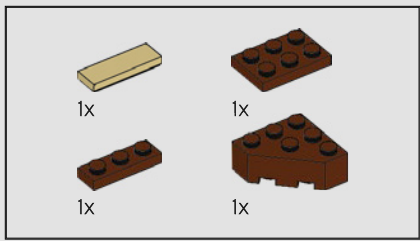

186

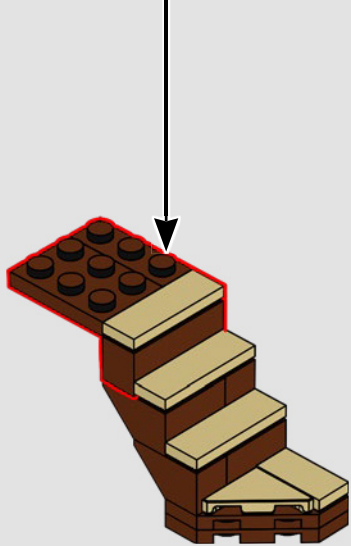
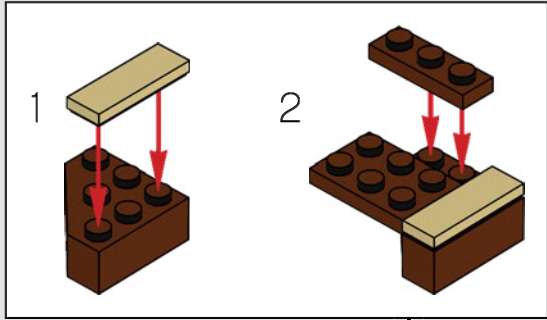

187

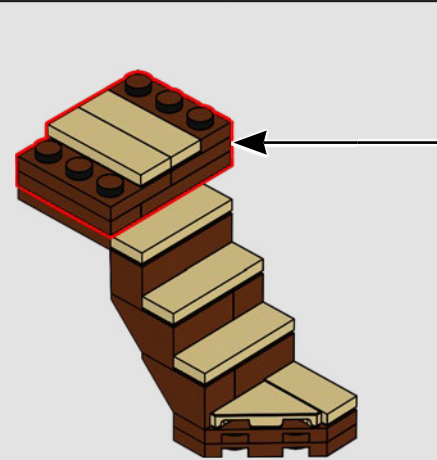
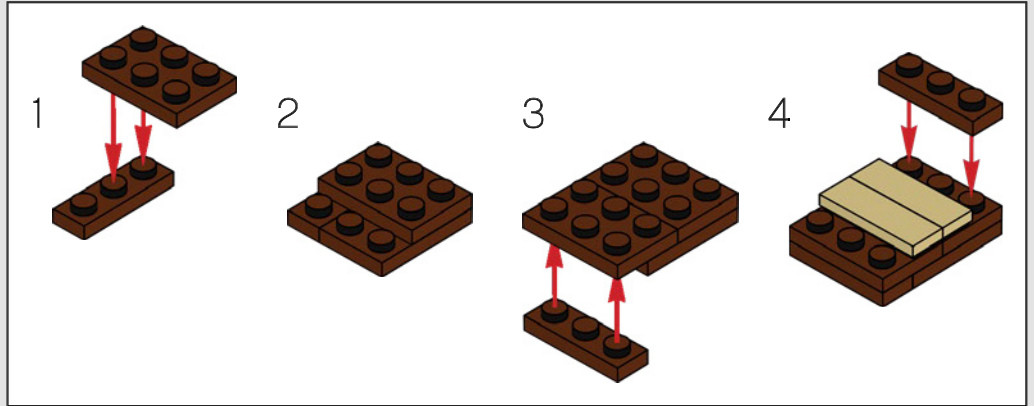



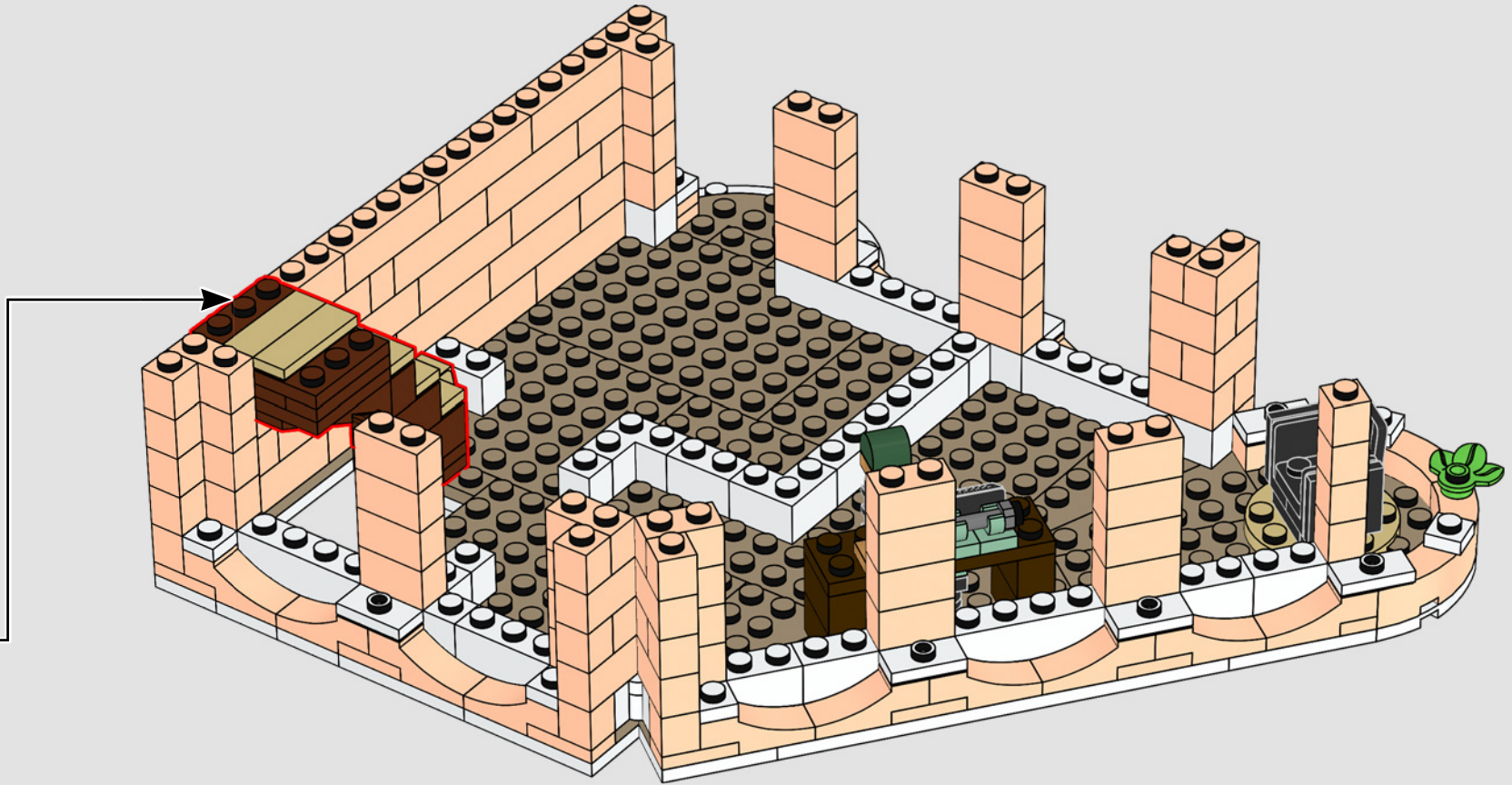

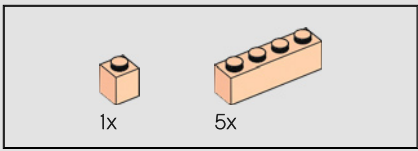

189

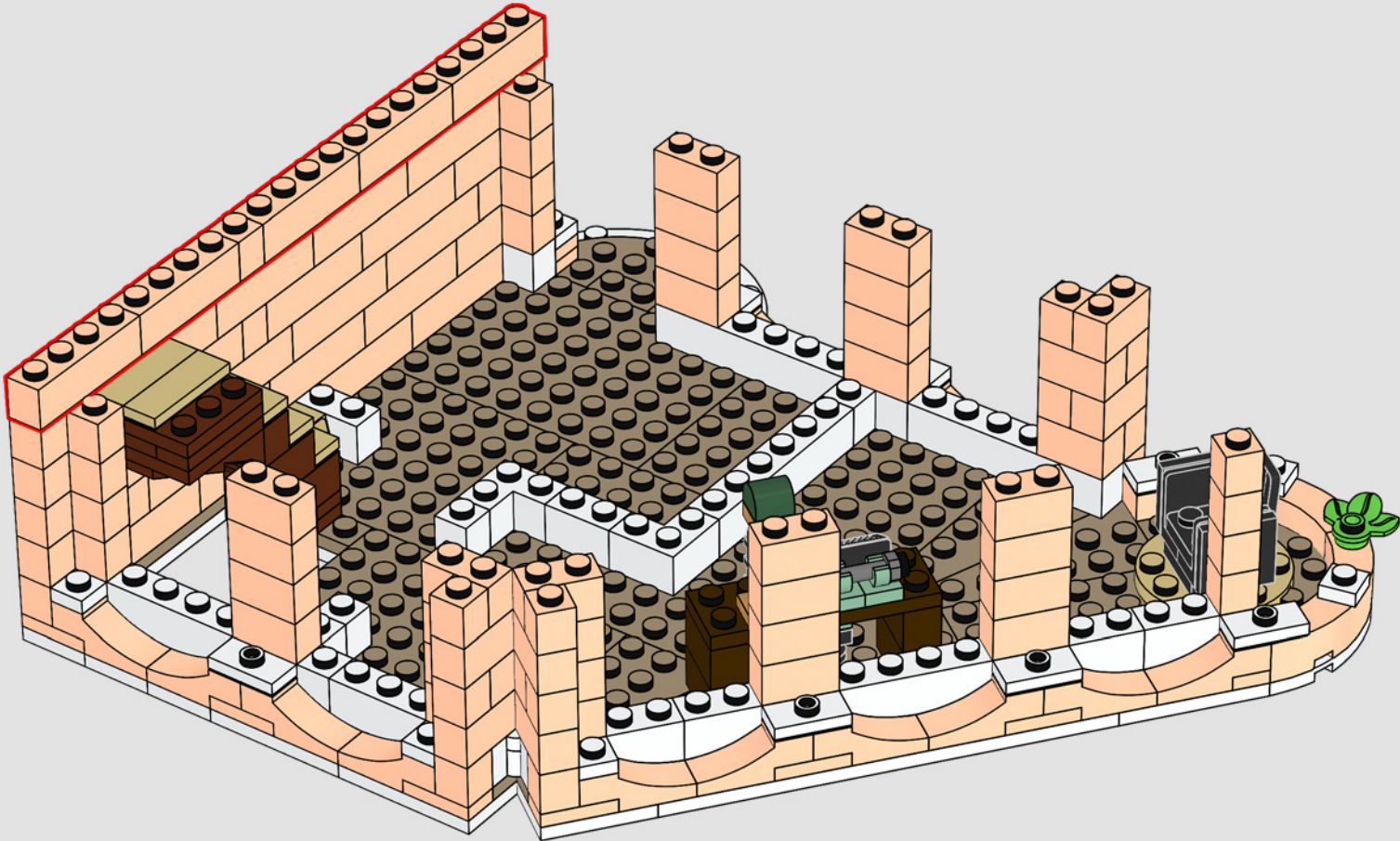



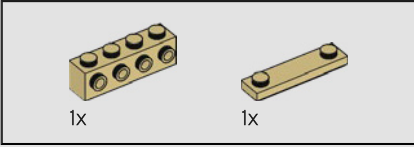
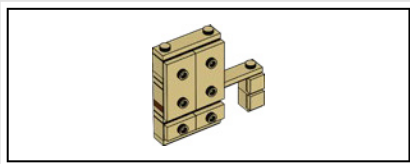

190

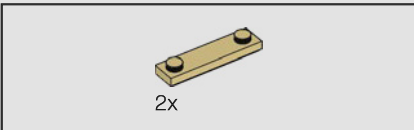
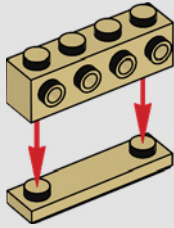

191

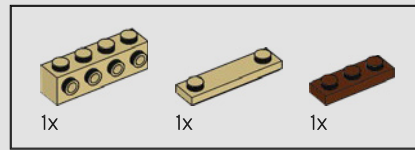
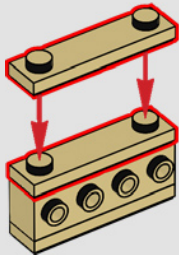

192

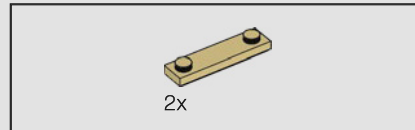
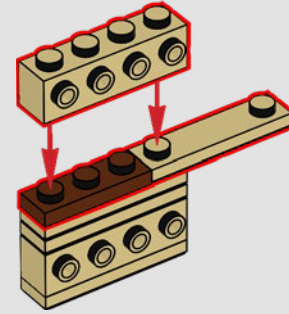

193

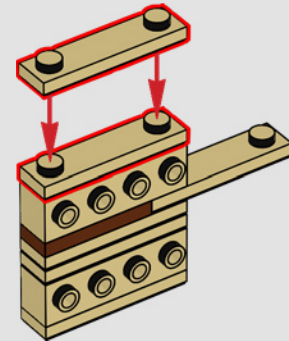

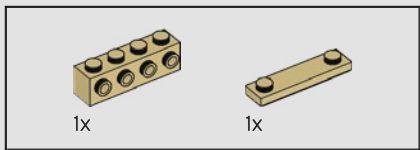

194

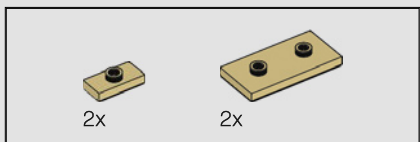
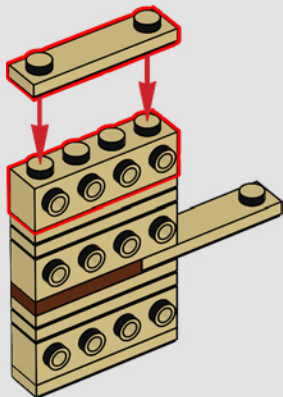

195

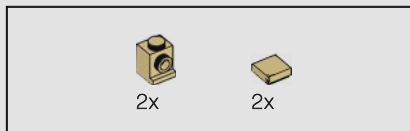
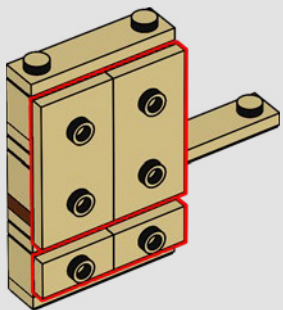

196

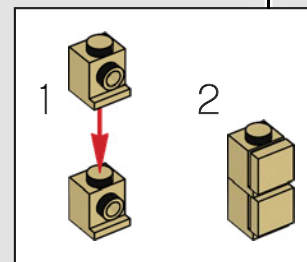
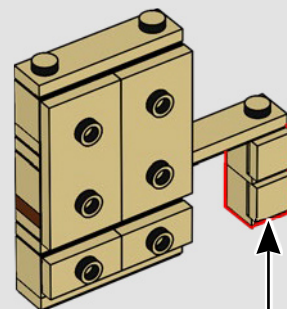



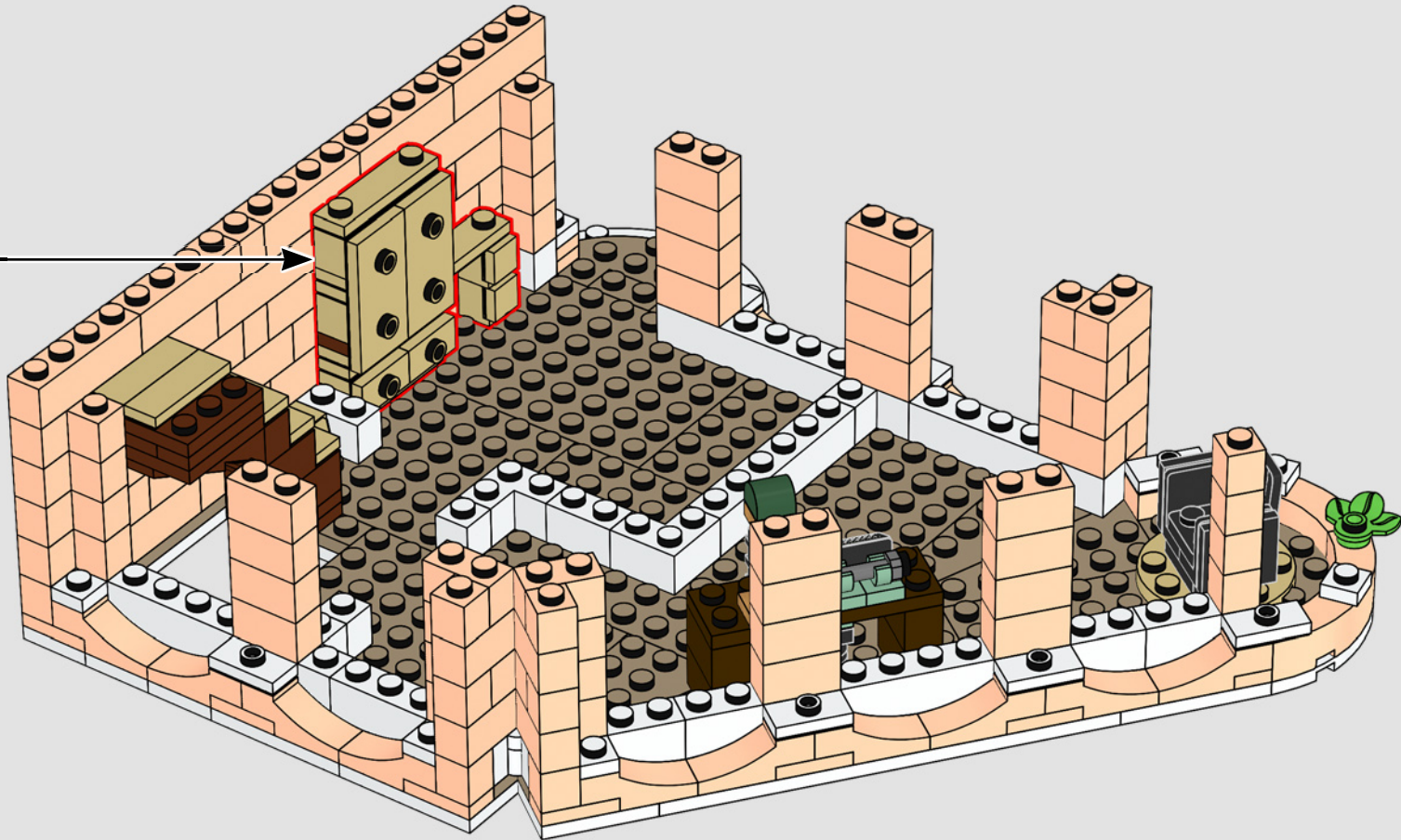

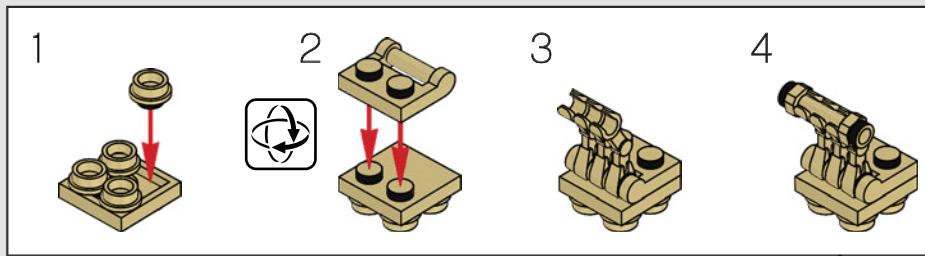
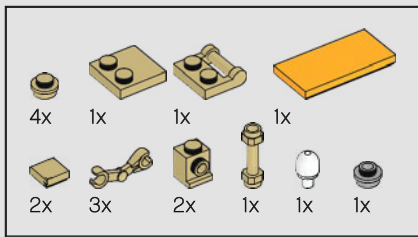

198

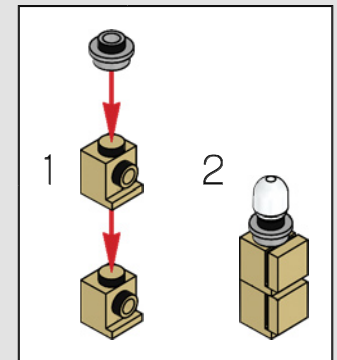
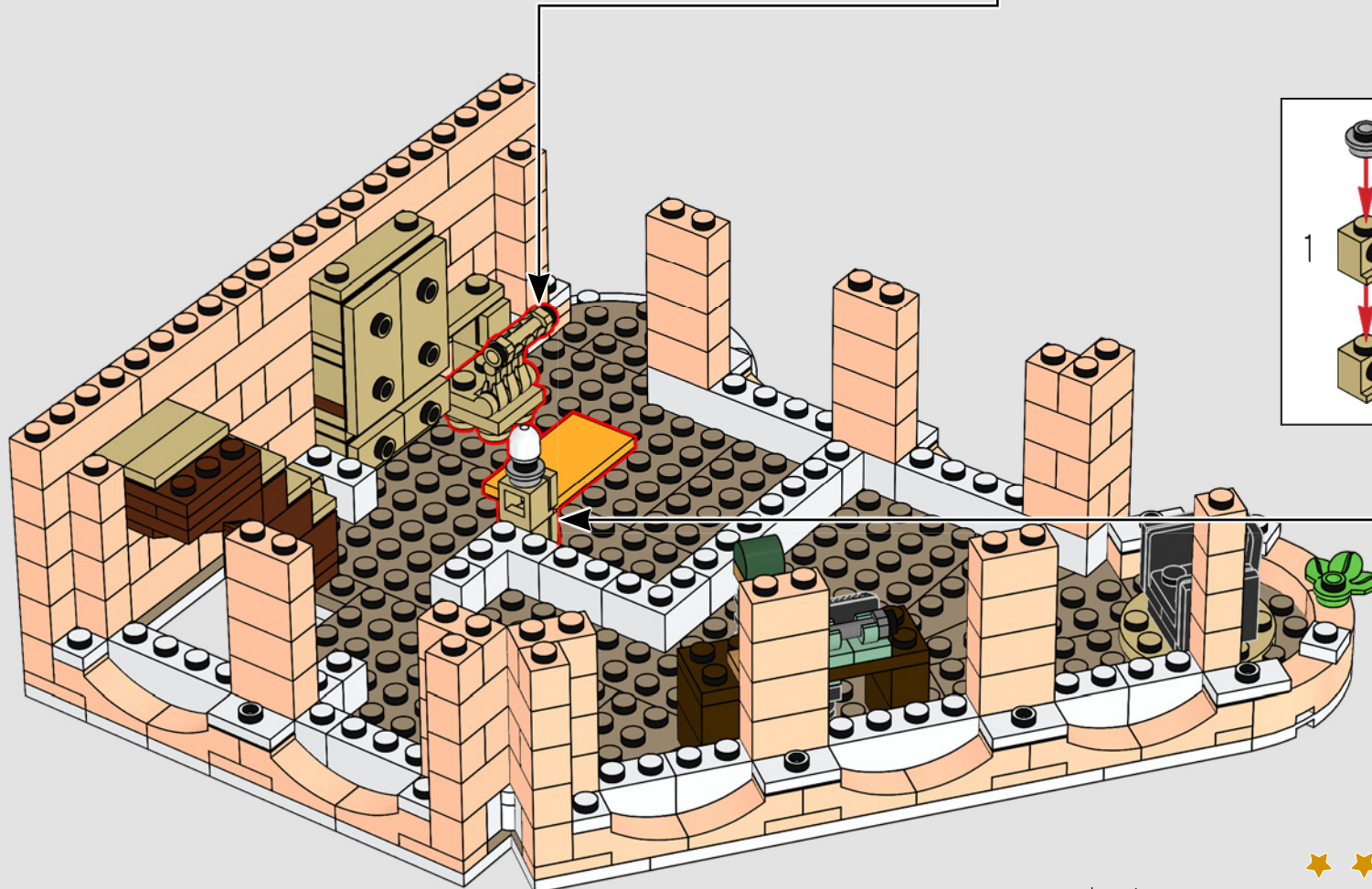

No es la primera vez que se usan estos brazos de robot en un modelo Modular Buildings: también puedes encontrarlos en las barandillas de los balcones del set Calle del Mercado (10190).



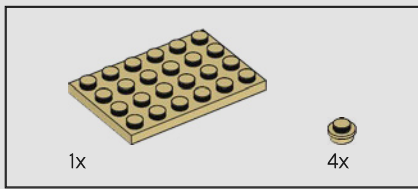

199

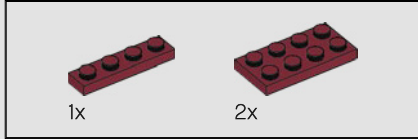
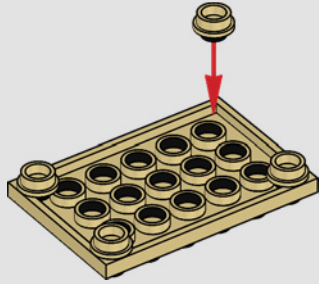

200

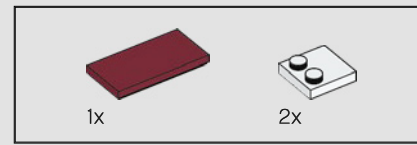
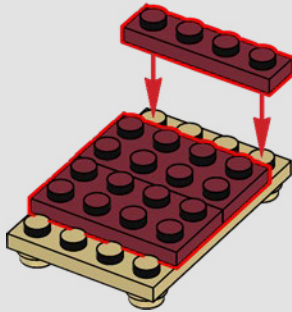

201

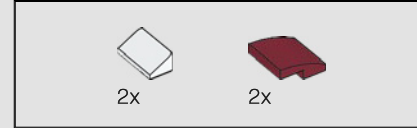
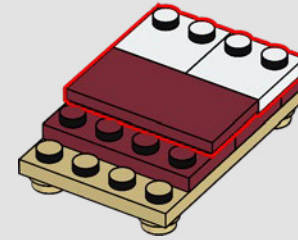

202

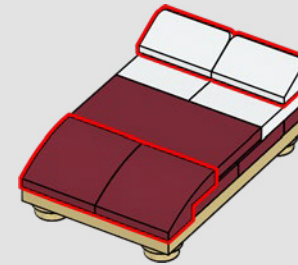

203

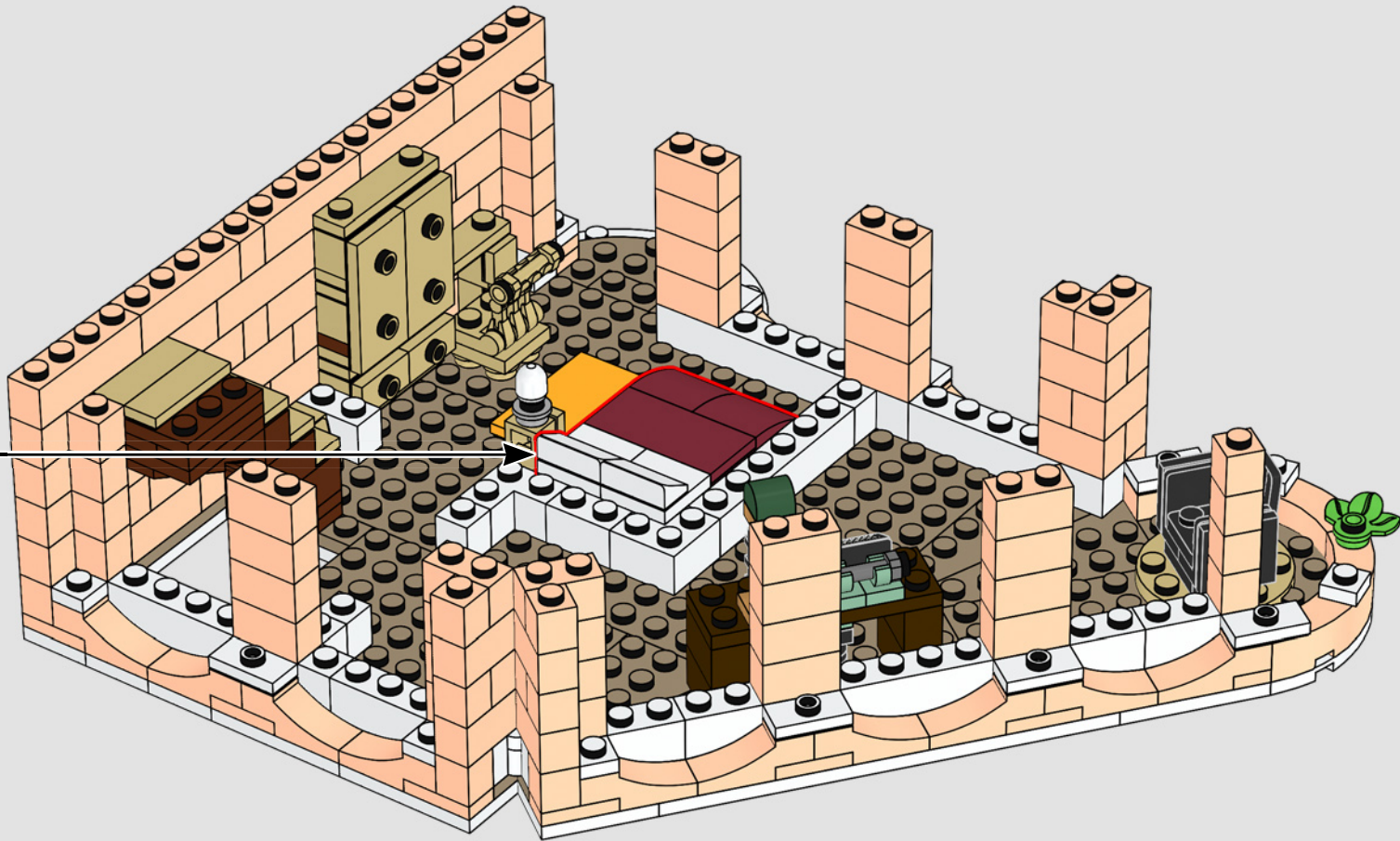



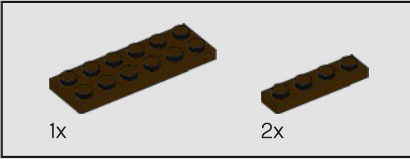
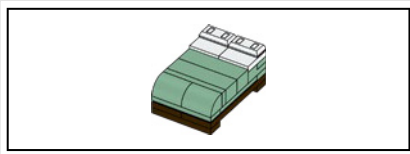

204

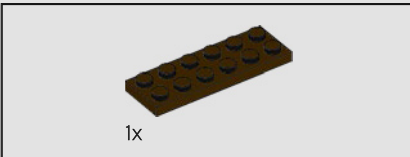
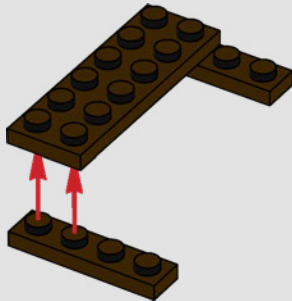

205

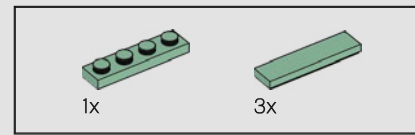
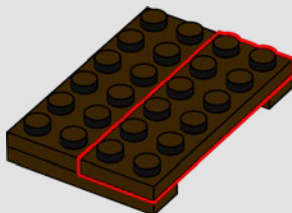

206

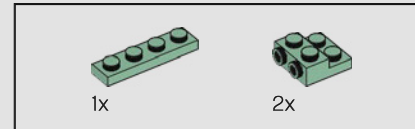
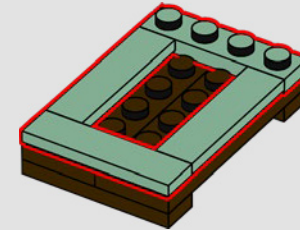

207

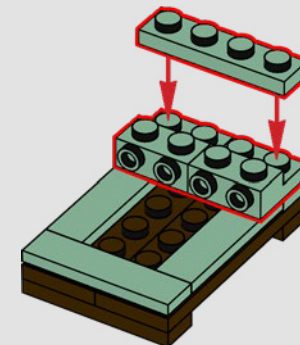





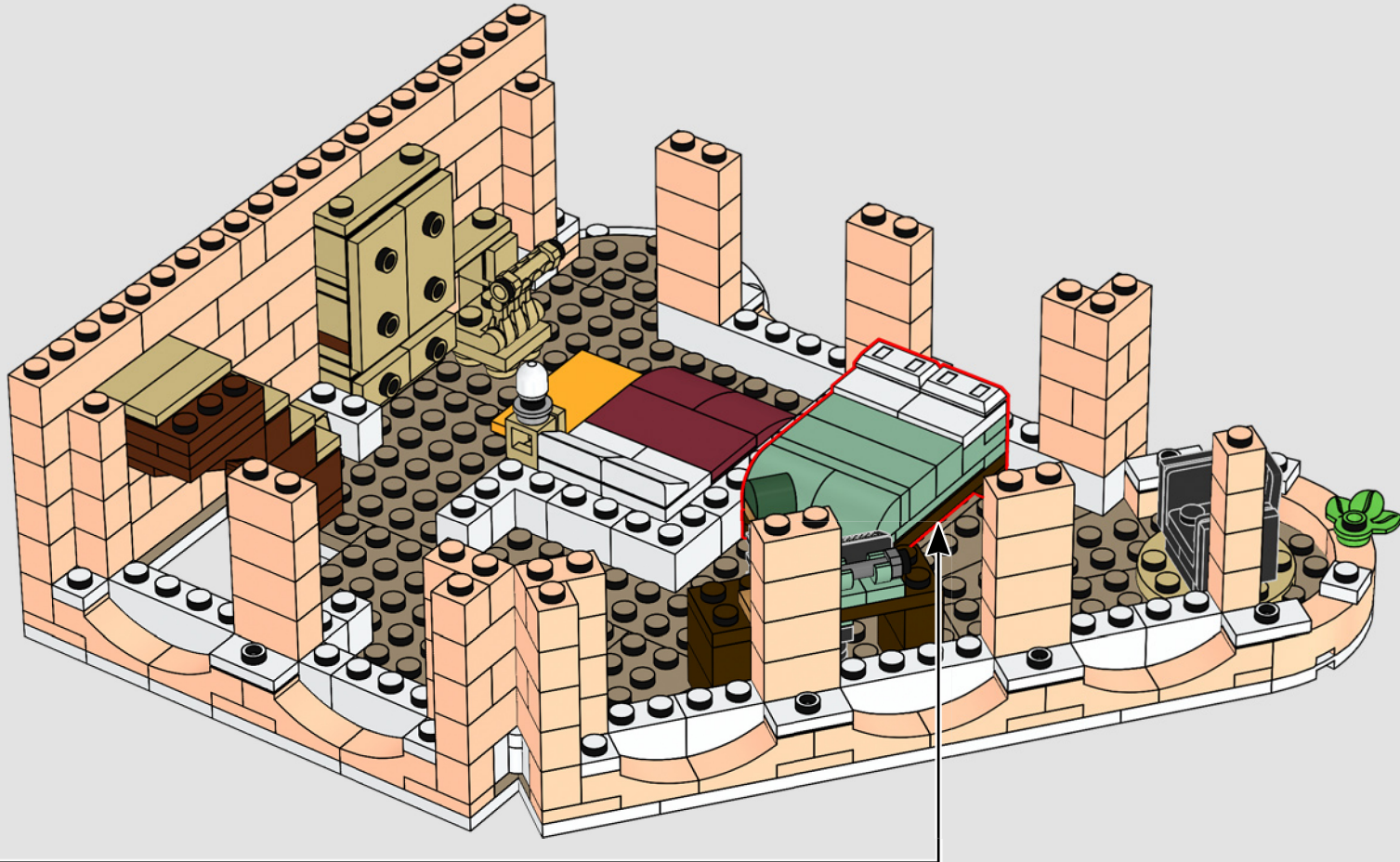

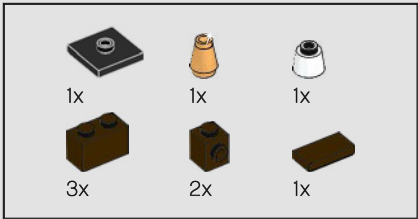

212

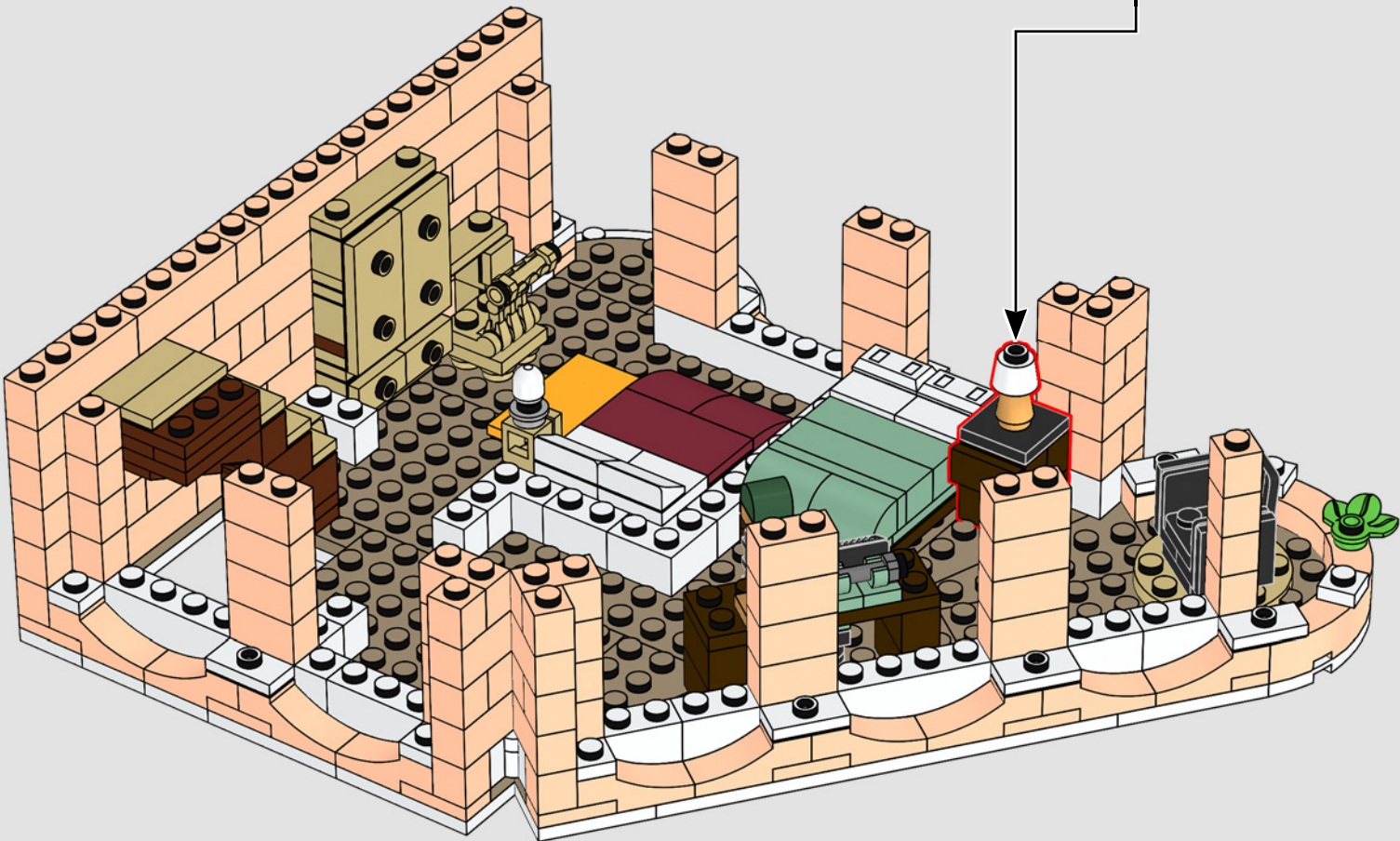
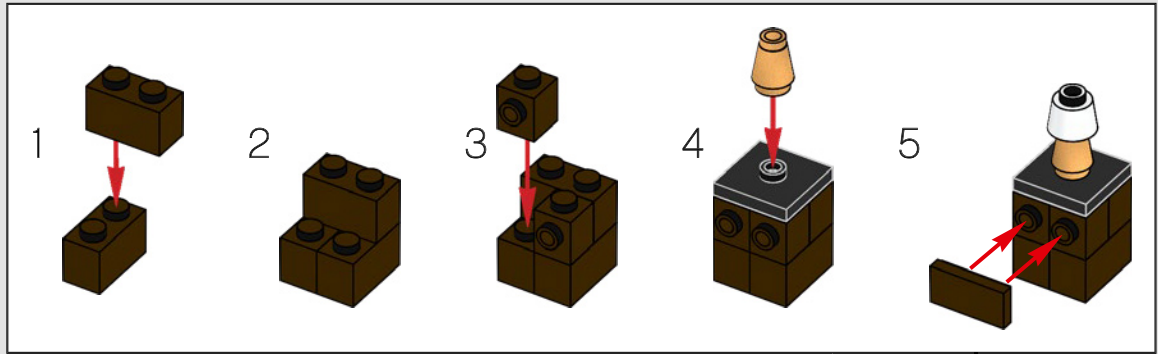



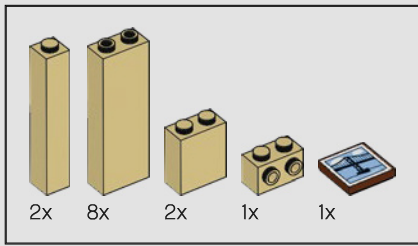

213

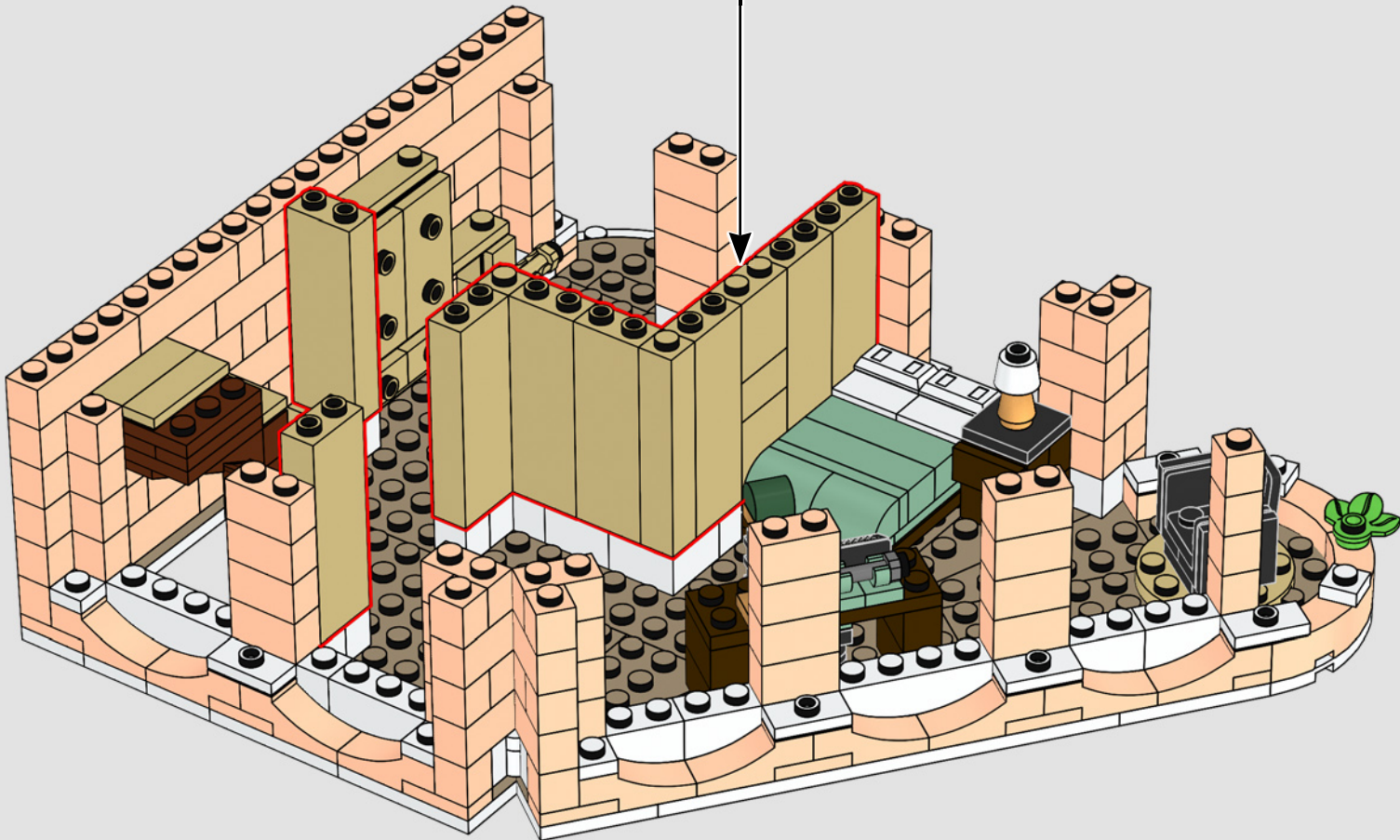
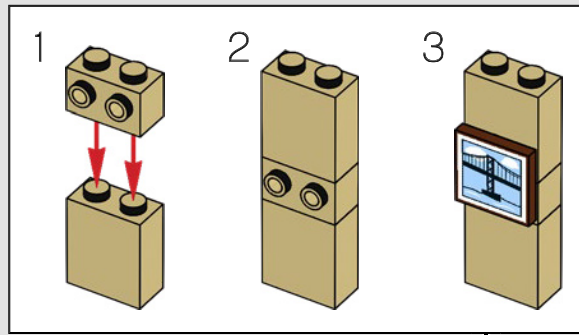

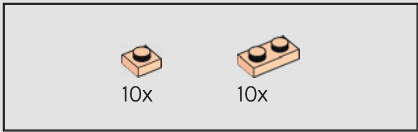

214

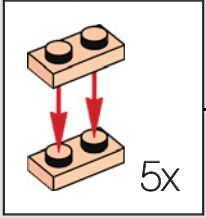
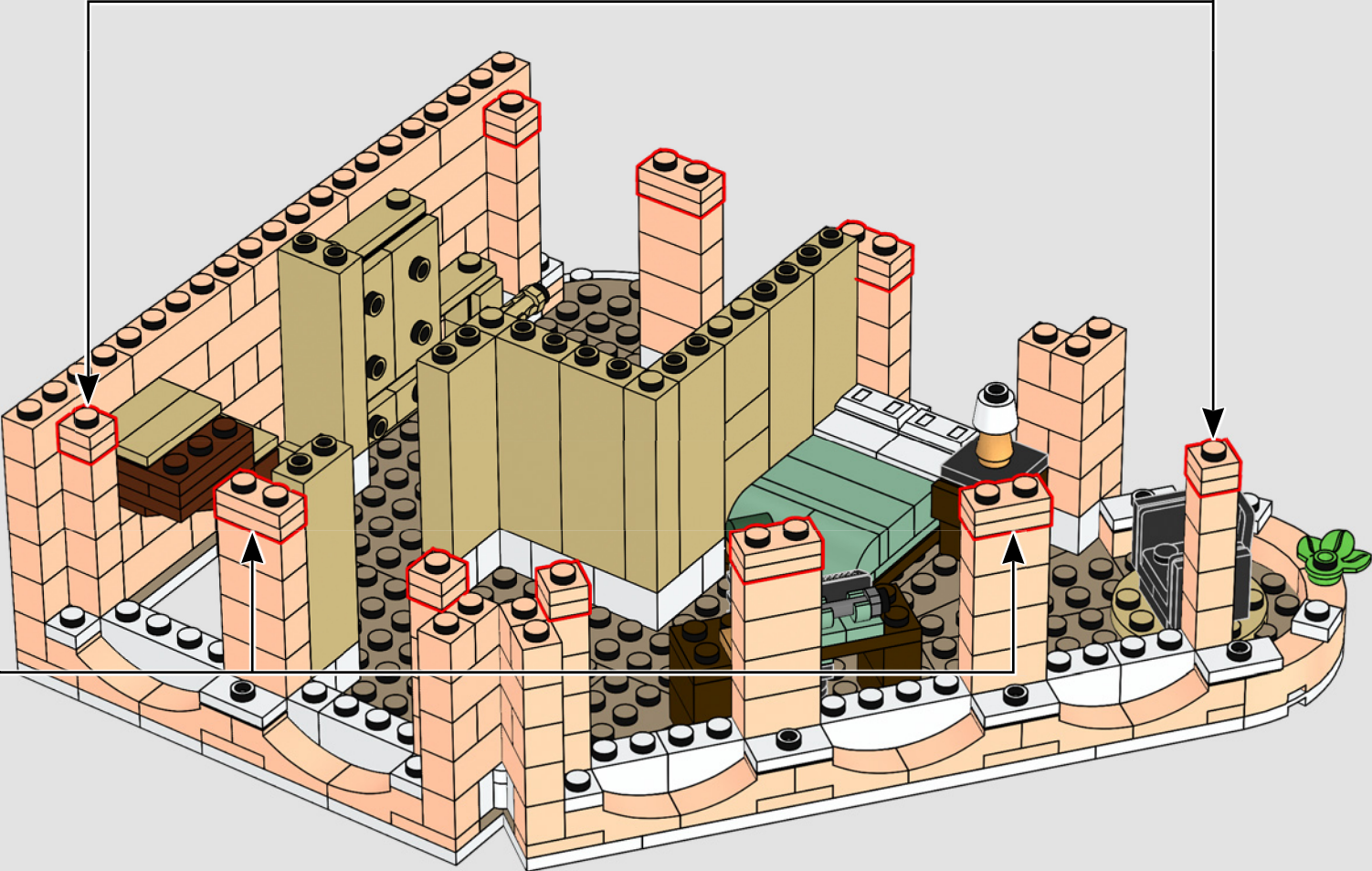
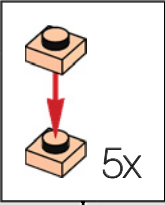



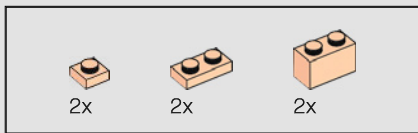

215

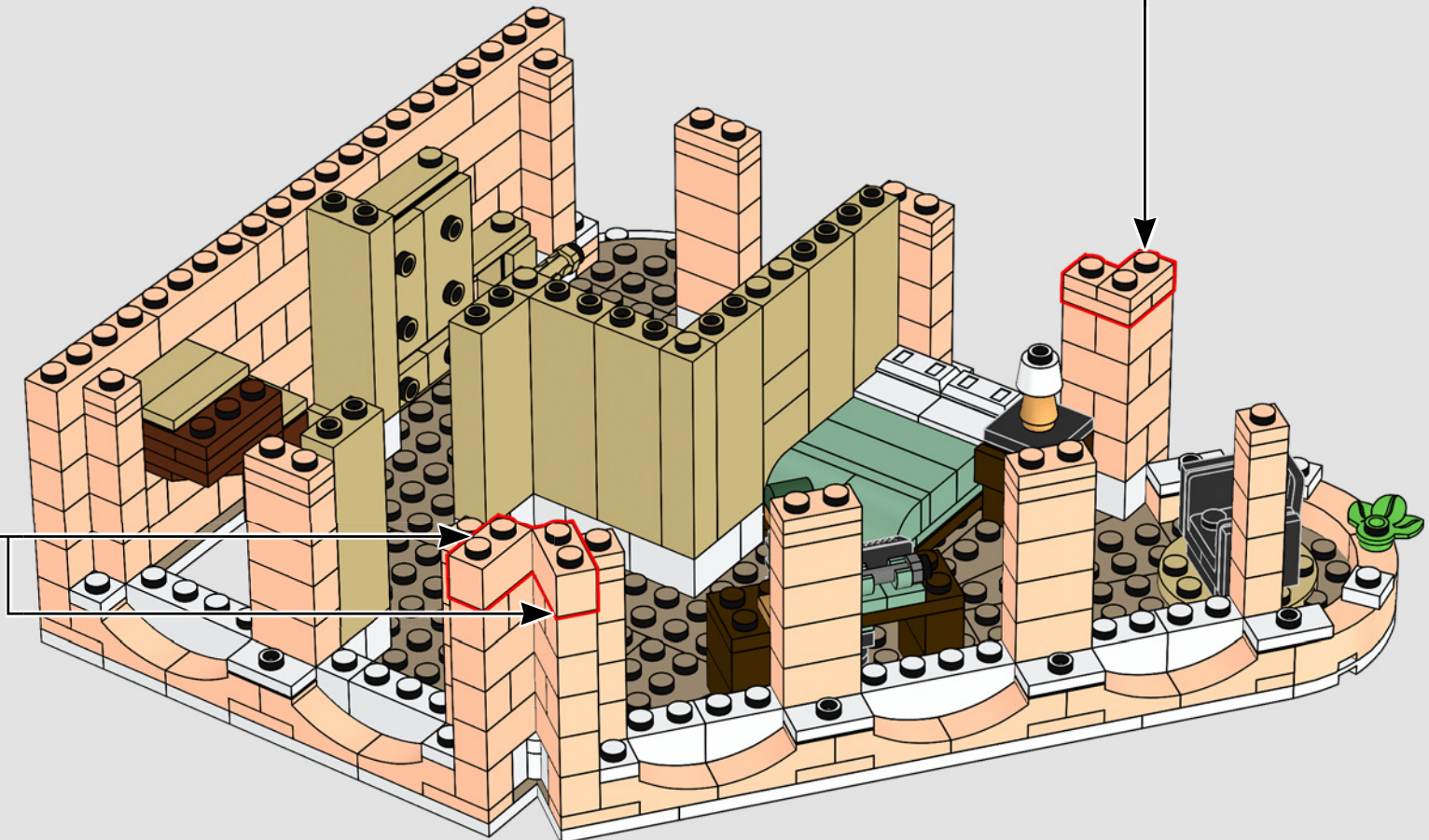
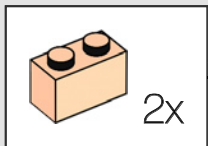
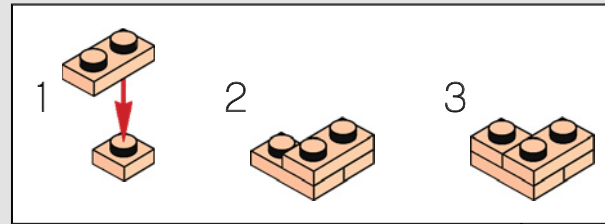

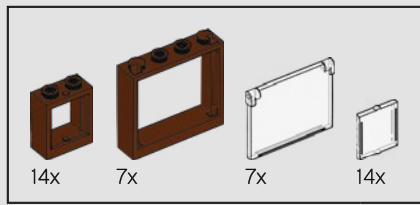

216

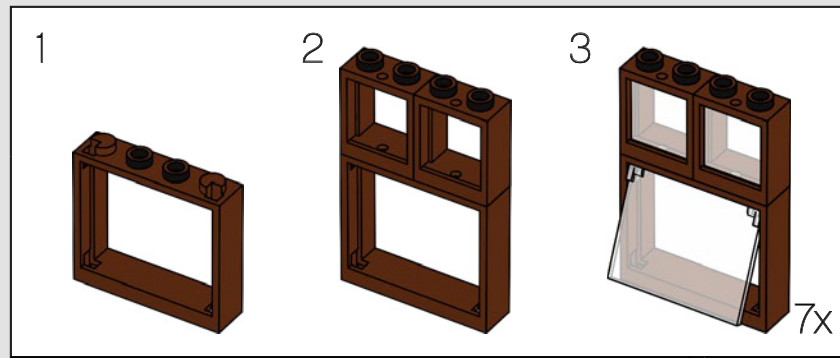



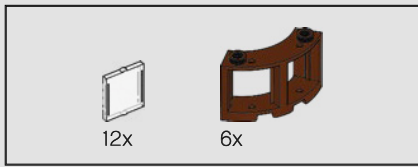

217

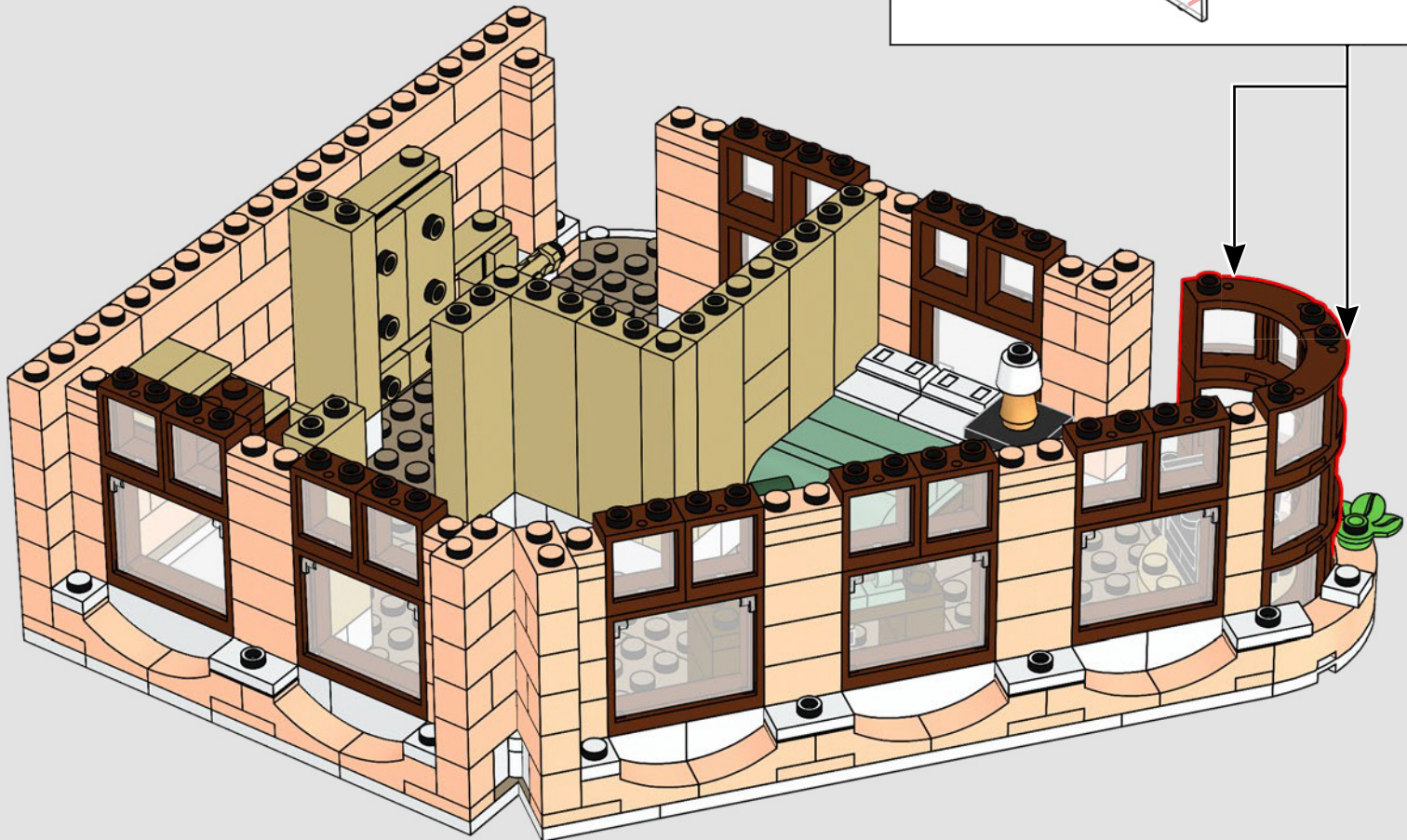
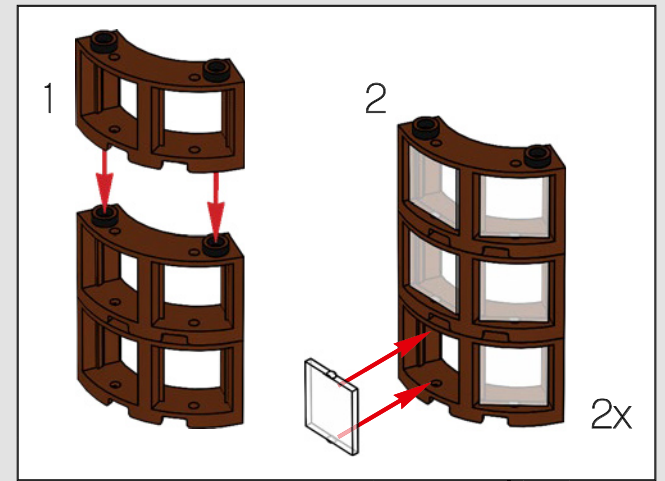

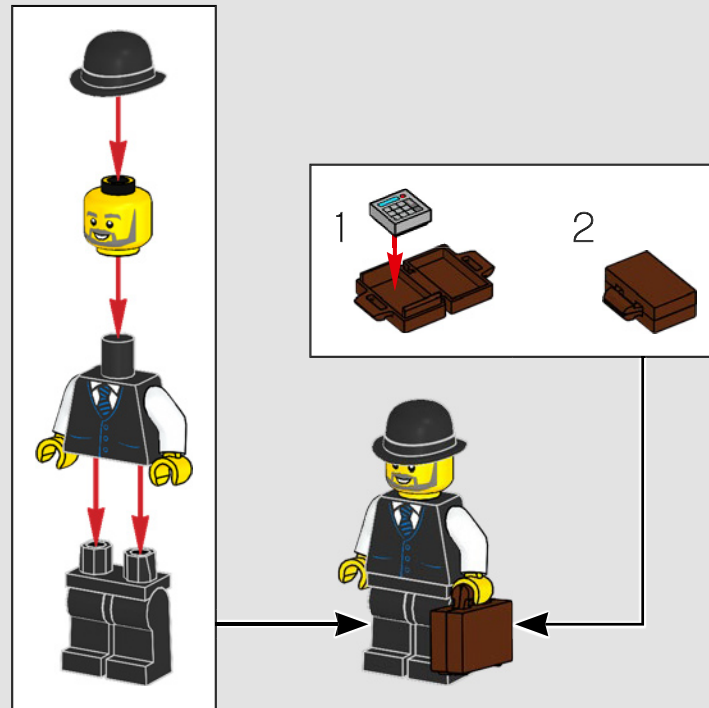
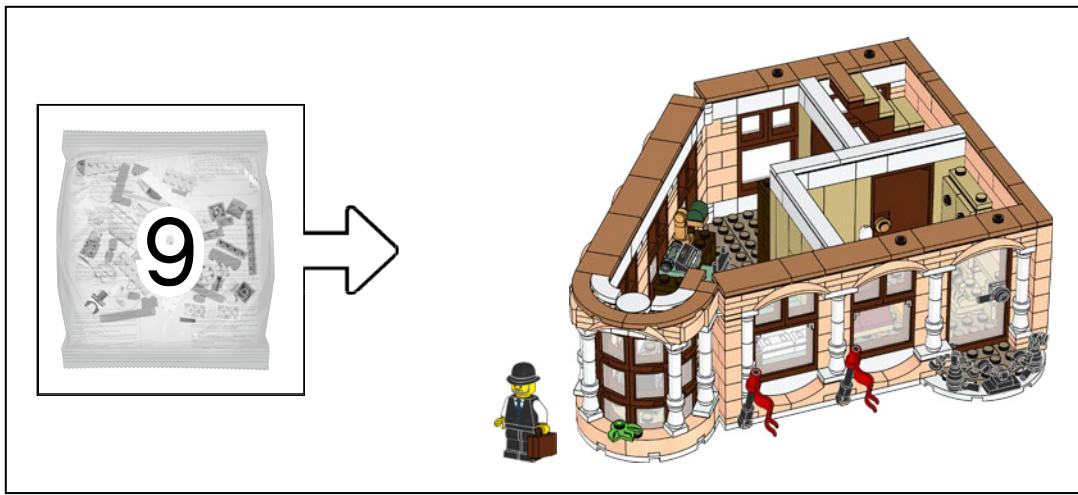

El contable está en la ciudad para ayudar con la venta de las obras maestras de la galería de arte. No obstante, también le han pedido que audite las cuentas del set Banco (10251).



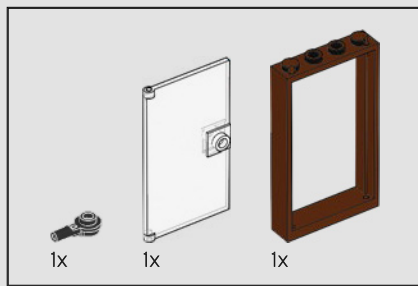

218

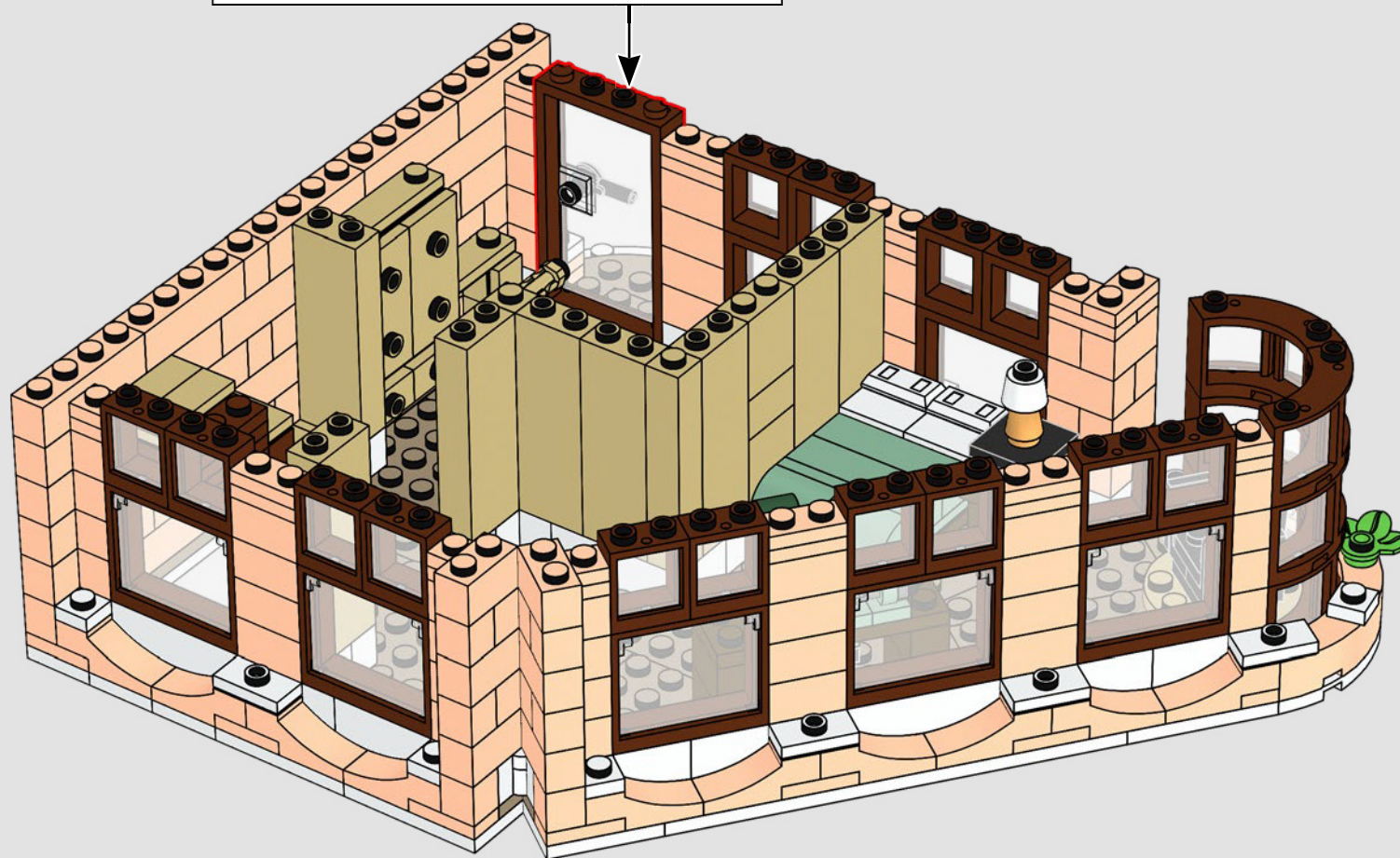
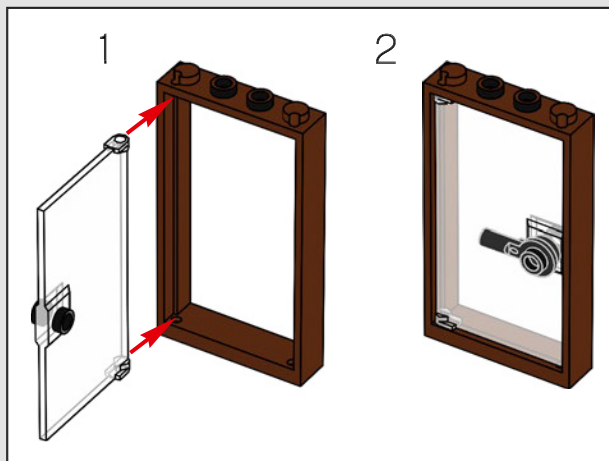

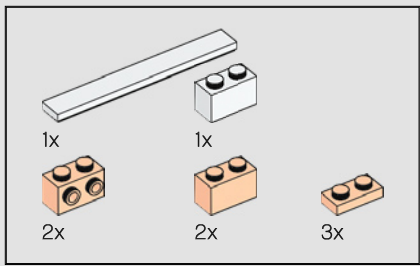

219

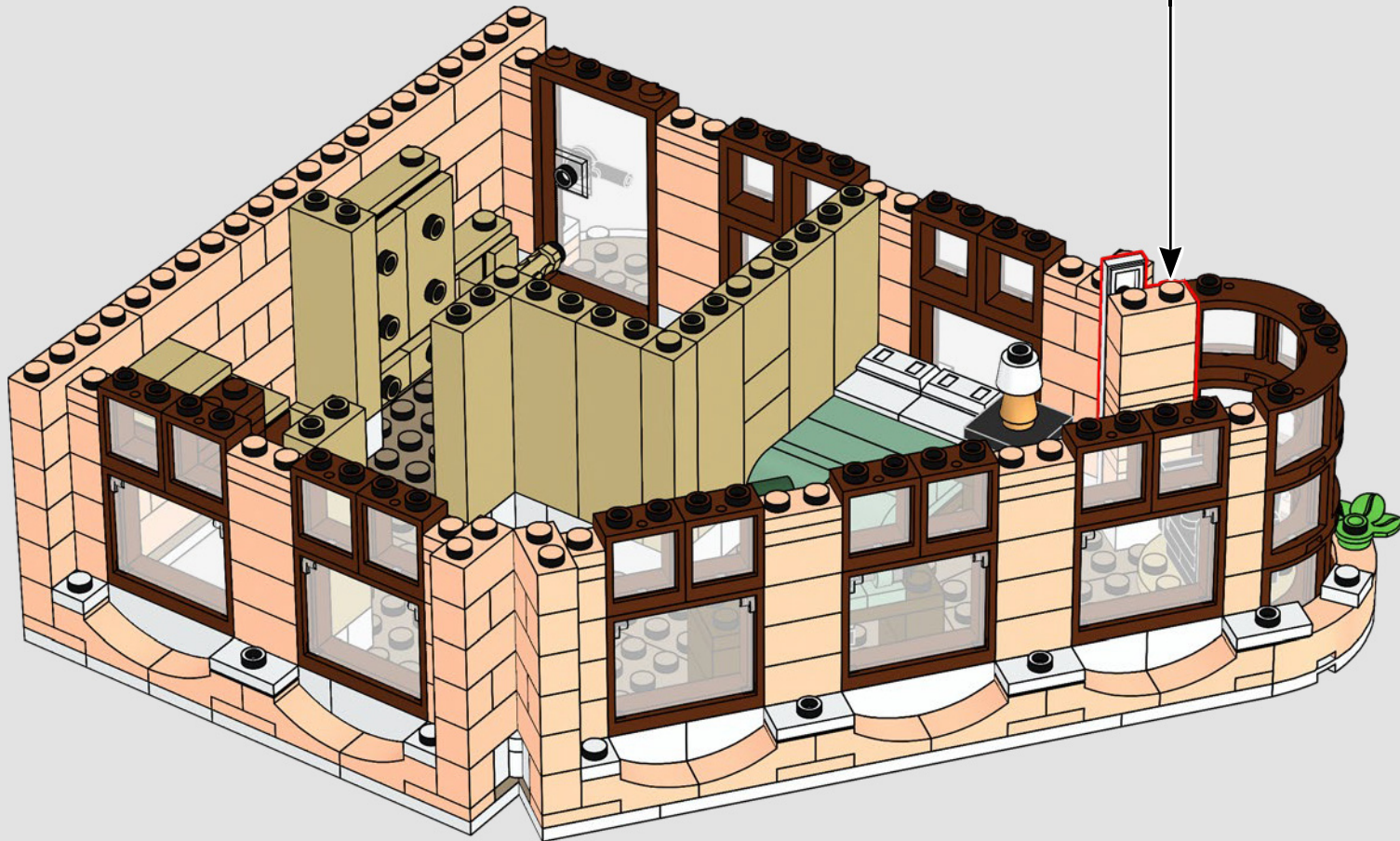
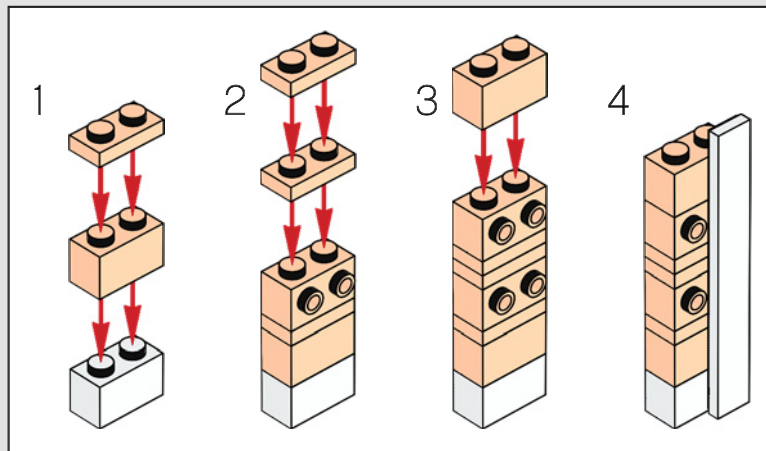



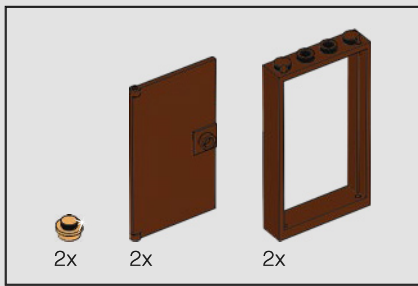

220

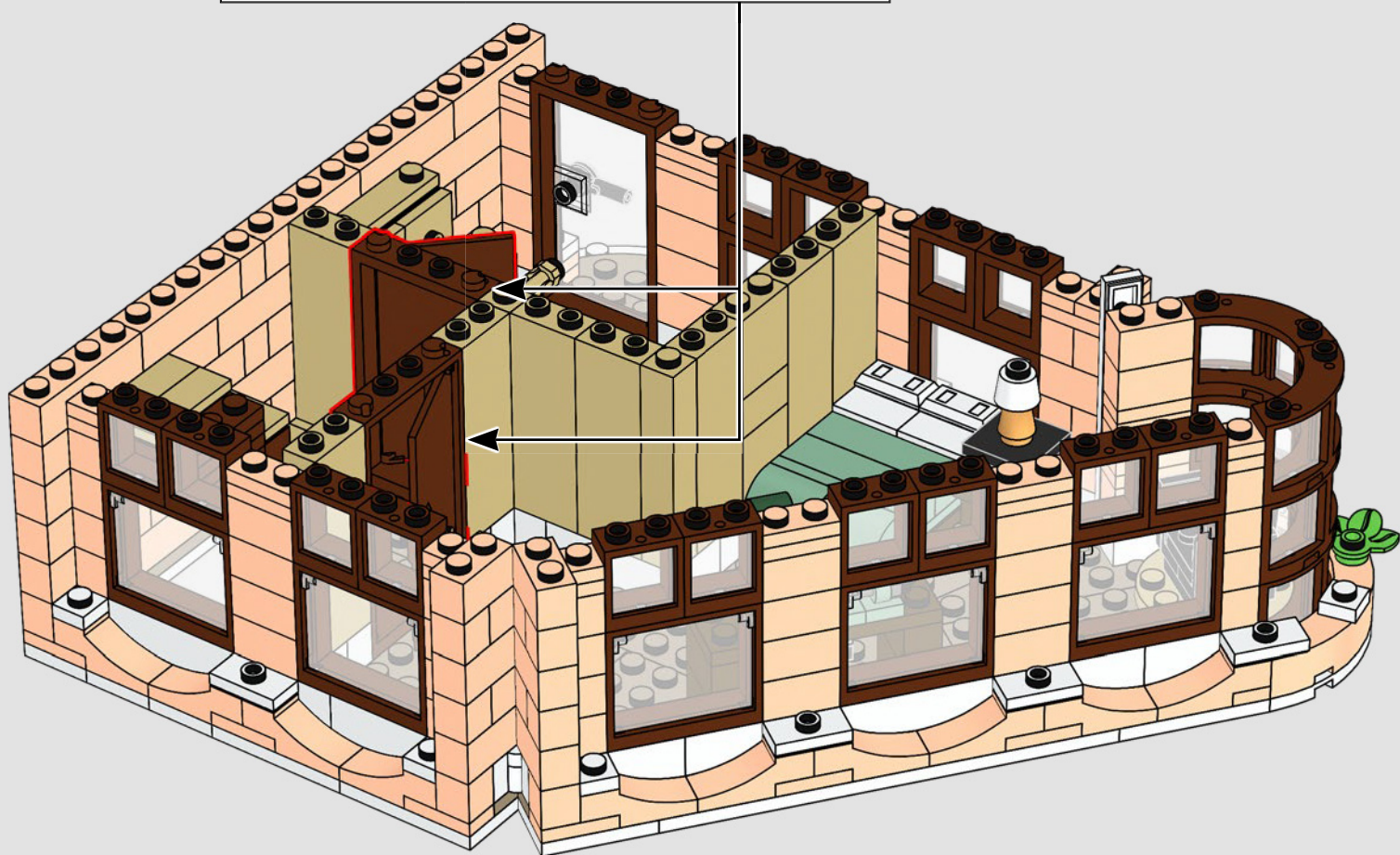
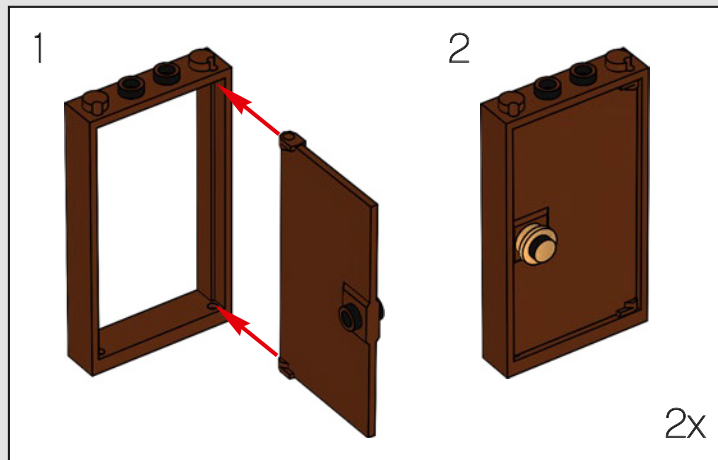

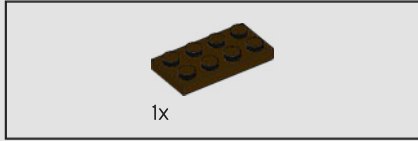
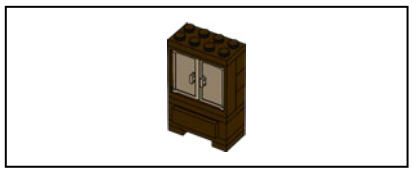

221

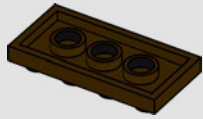

222

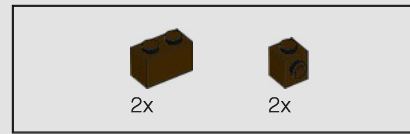
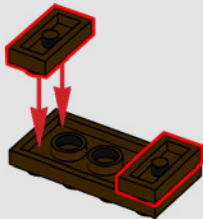

223

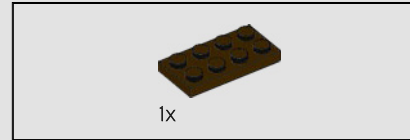
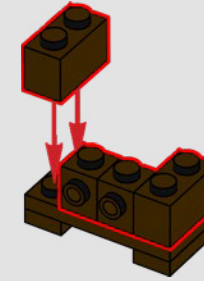
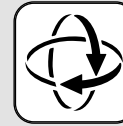

224

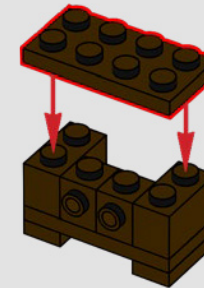



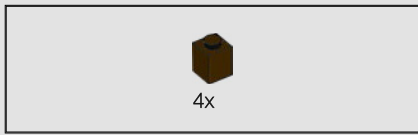

225

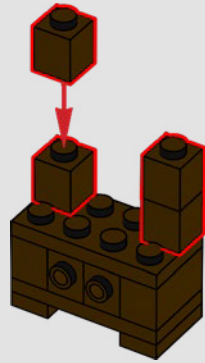

226

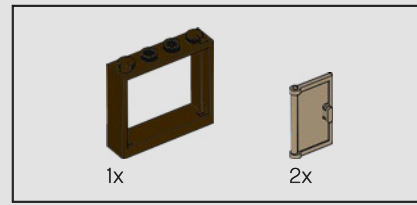
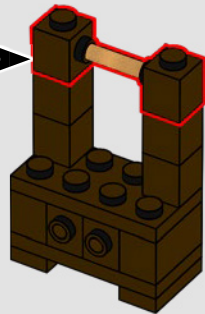
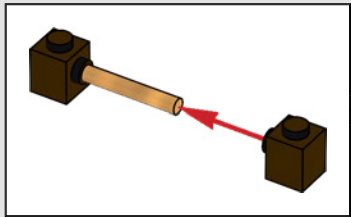

227

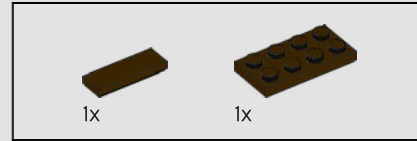
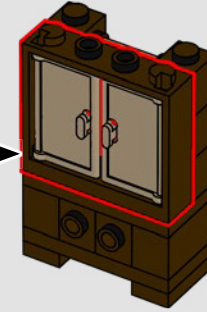
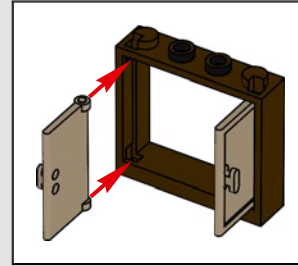

228

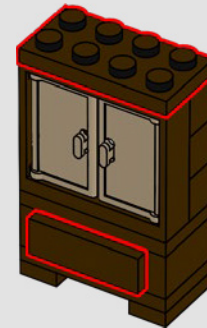

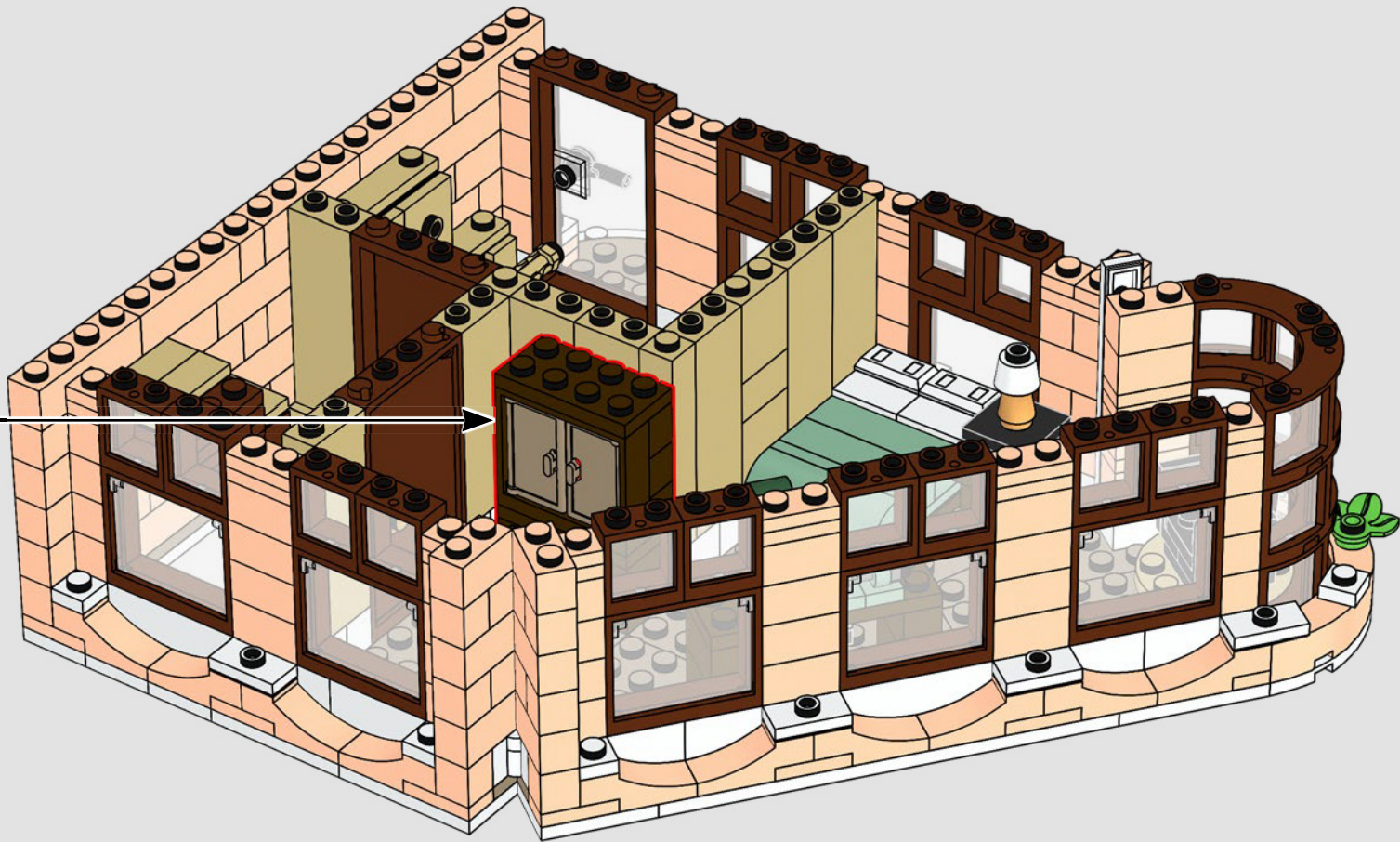





230

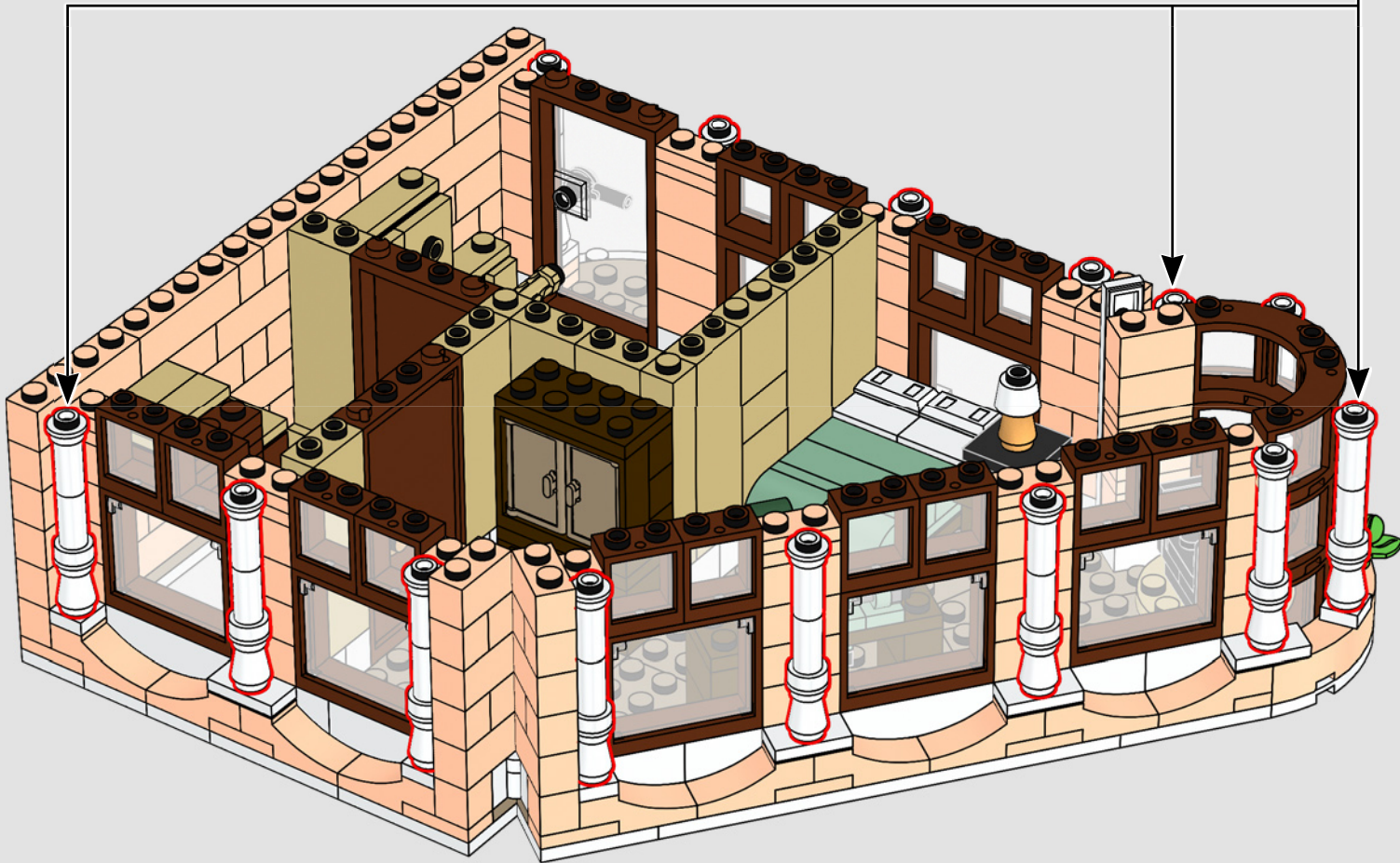
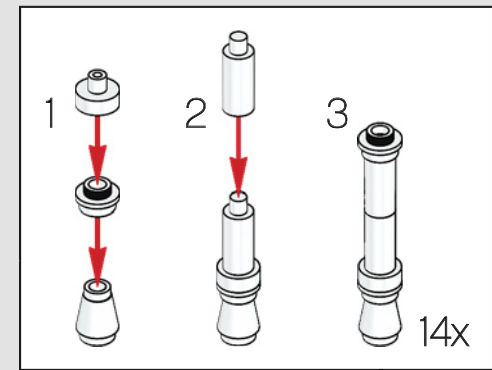

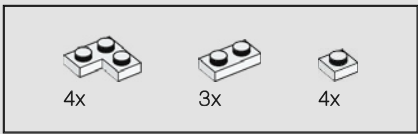

231

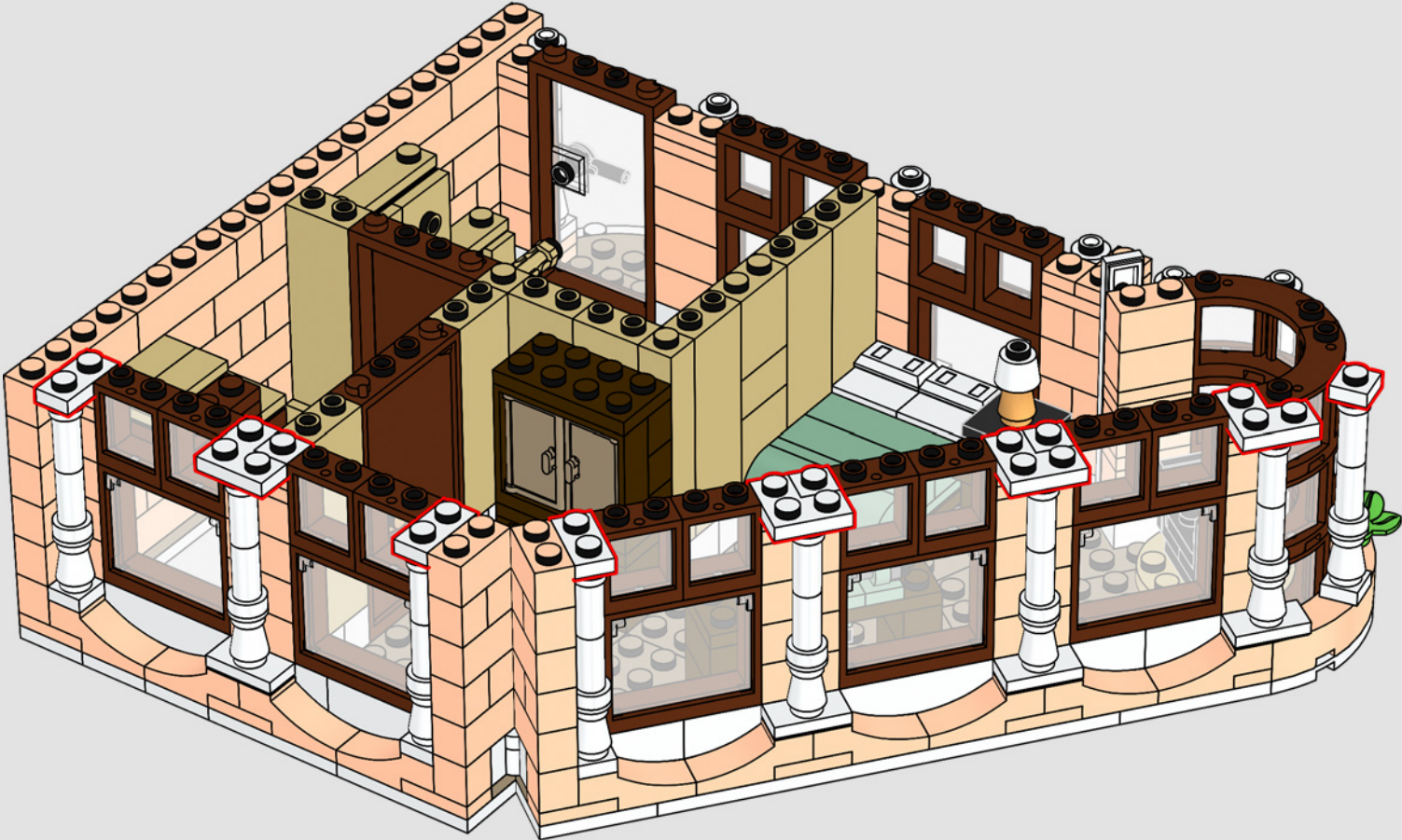



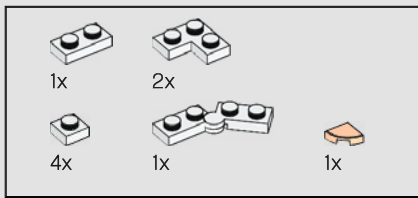

232

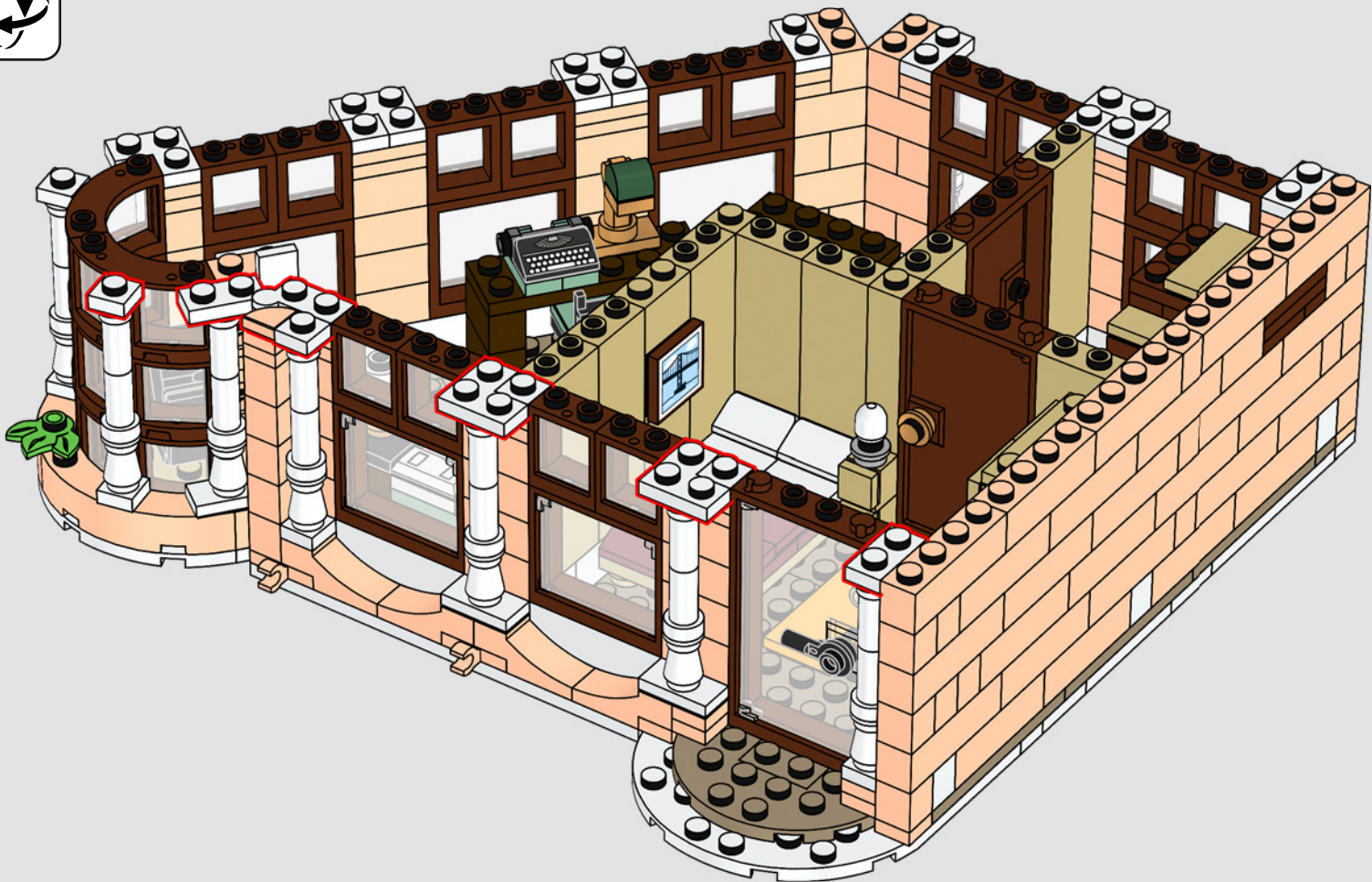





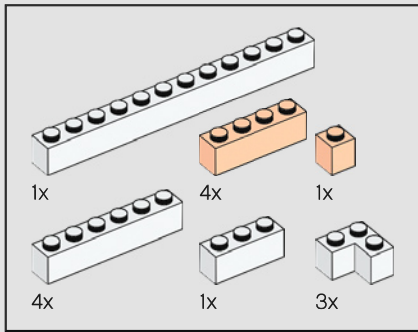

234



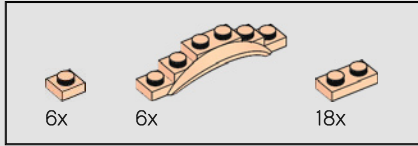
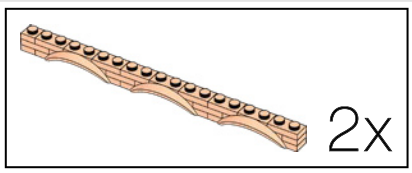

235

1

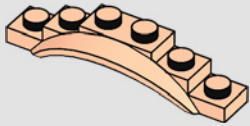

2

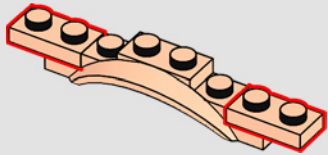

3

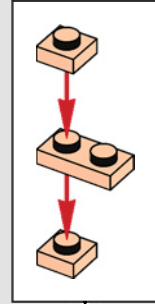
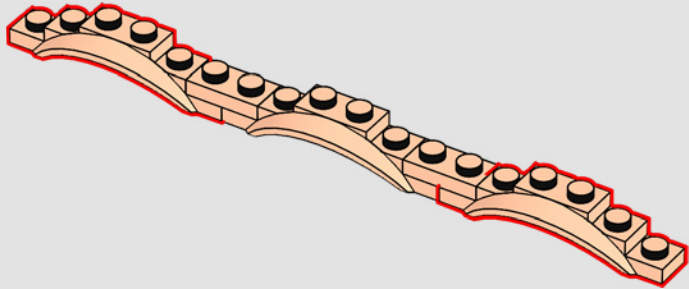

4

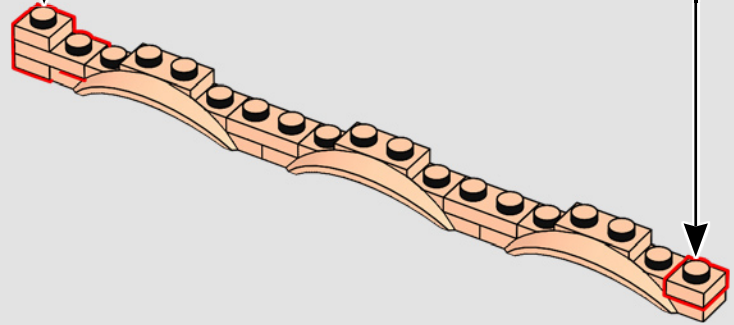

5

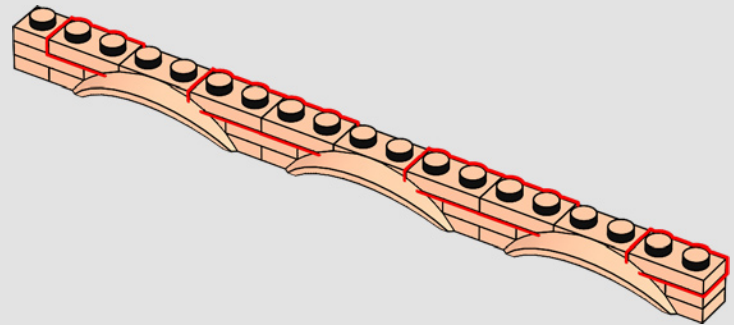

2x



236



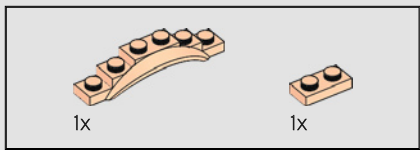

237

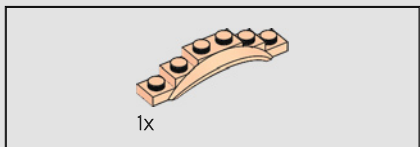
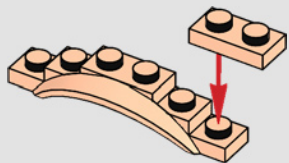

238

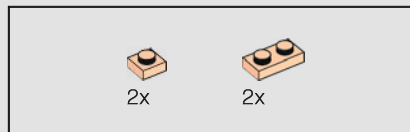
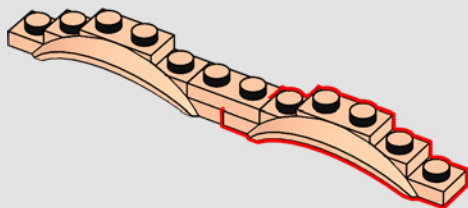

239

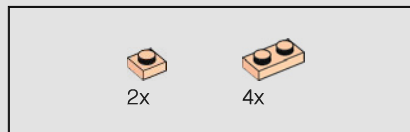
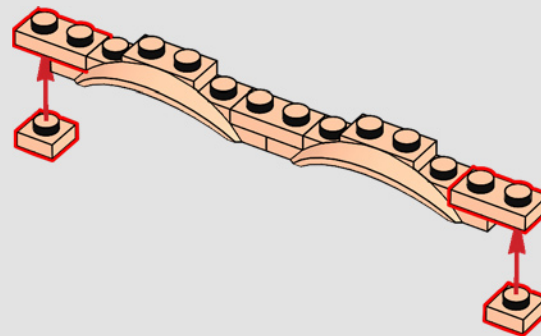

240

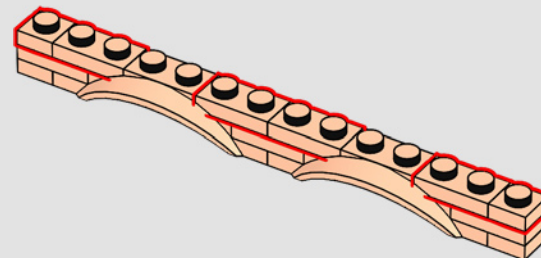



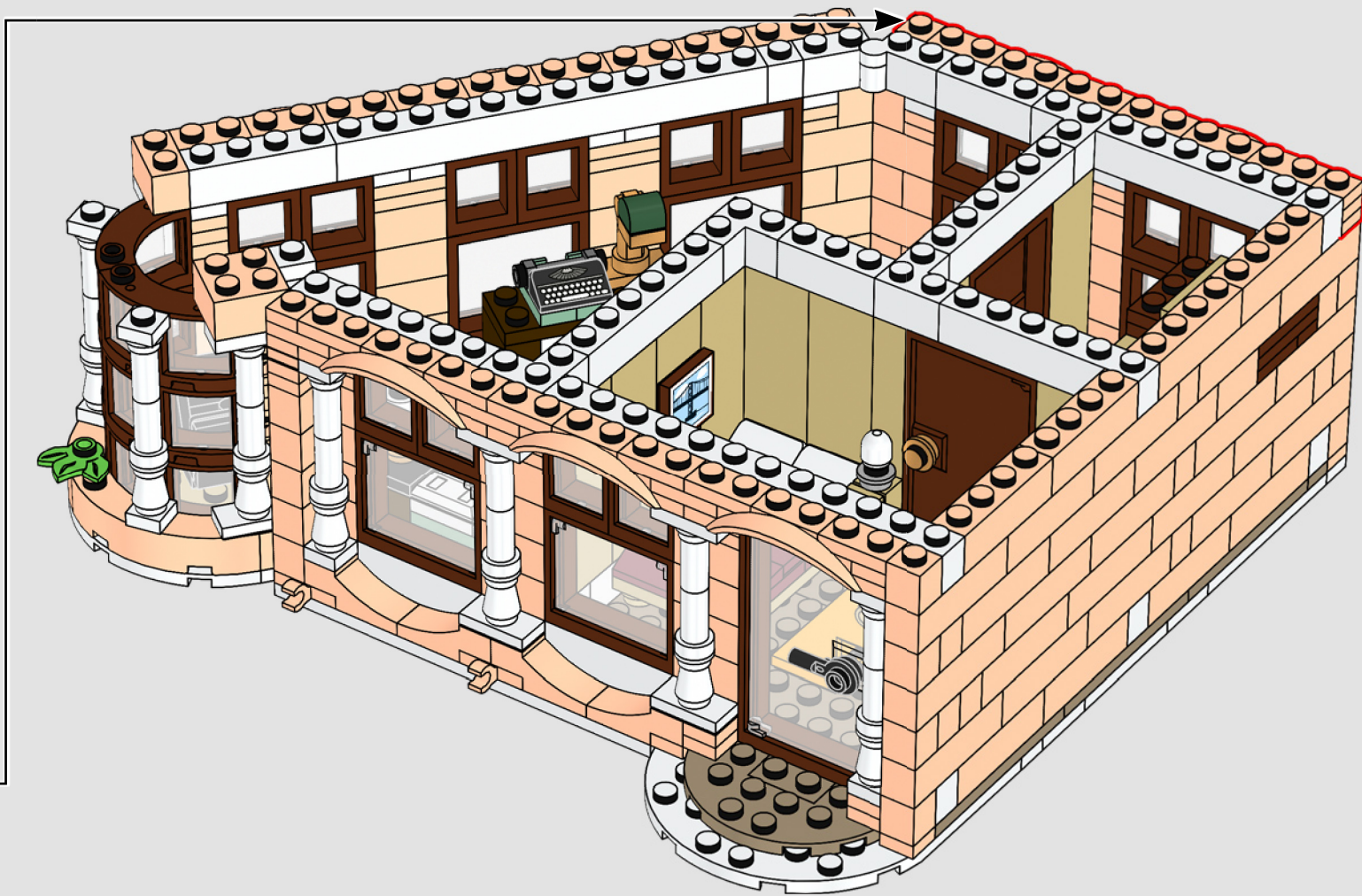

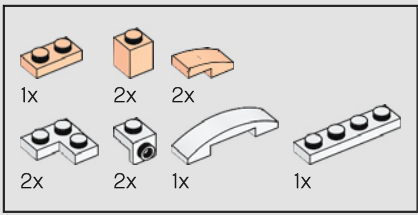

242

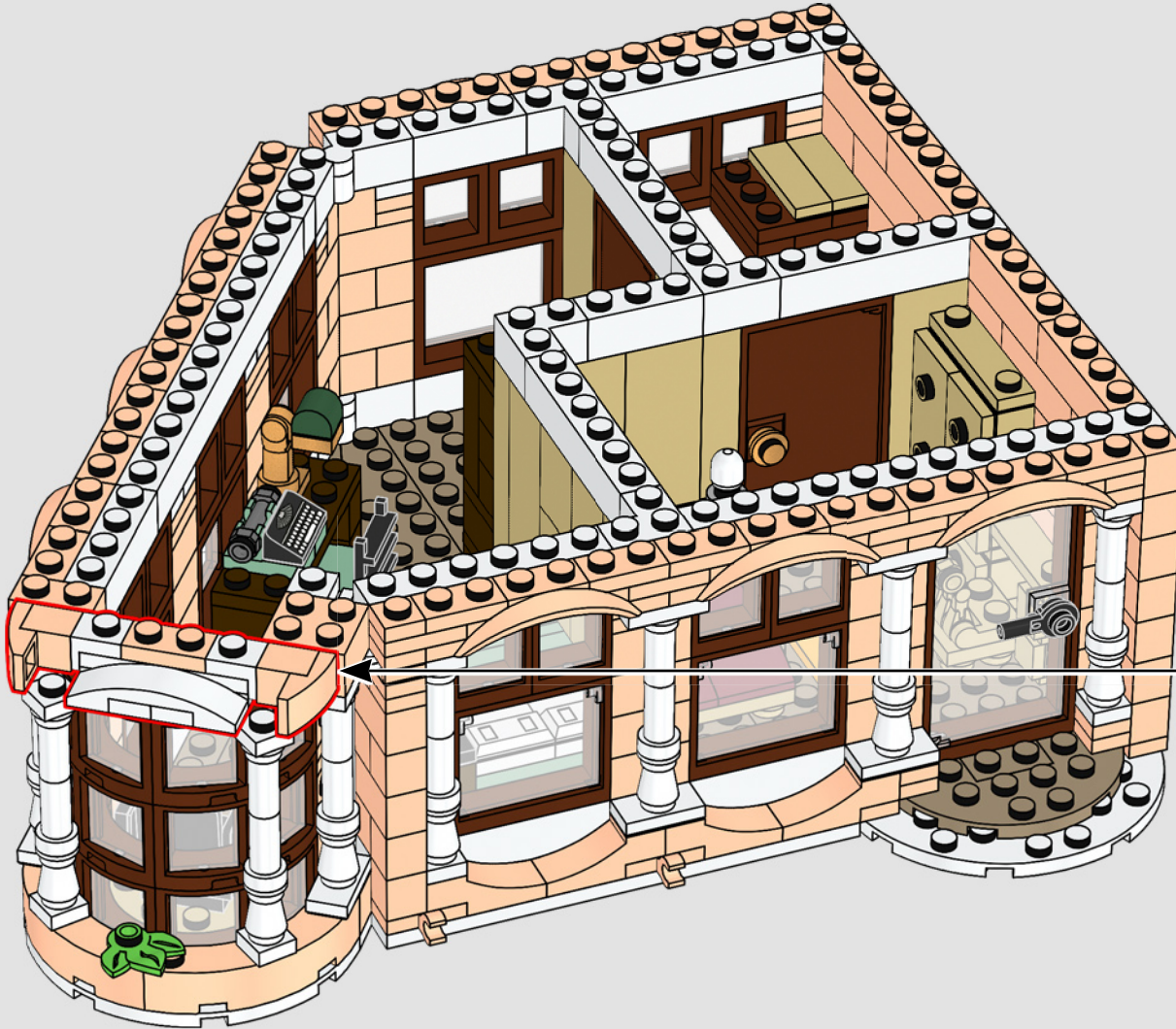
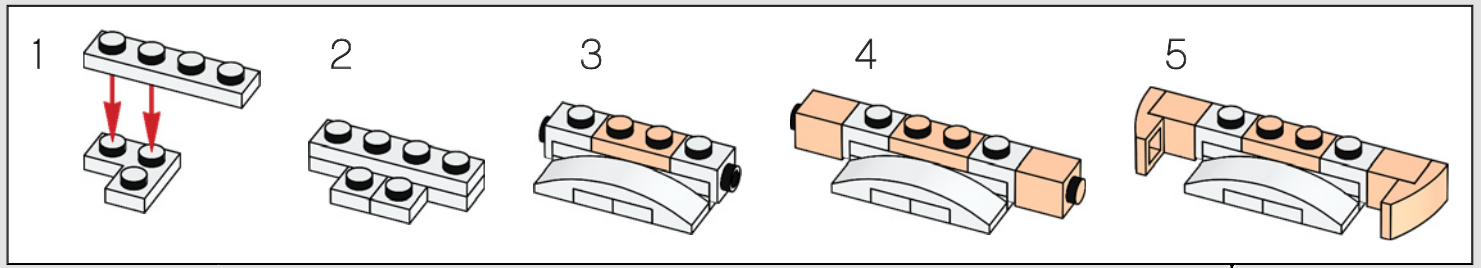



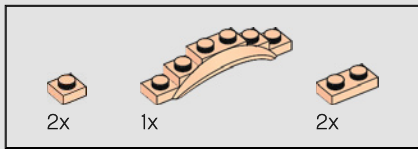

243

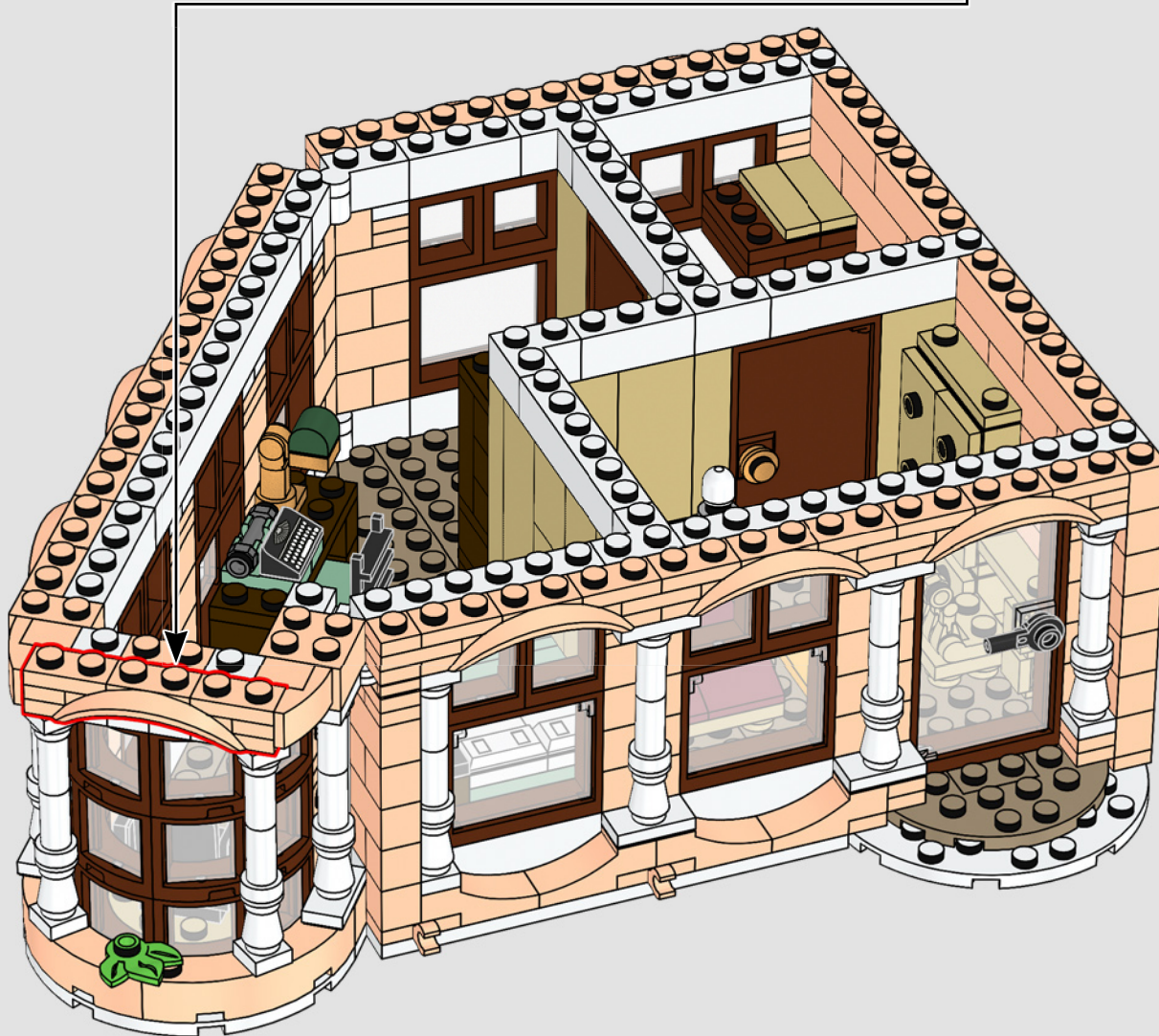
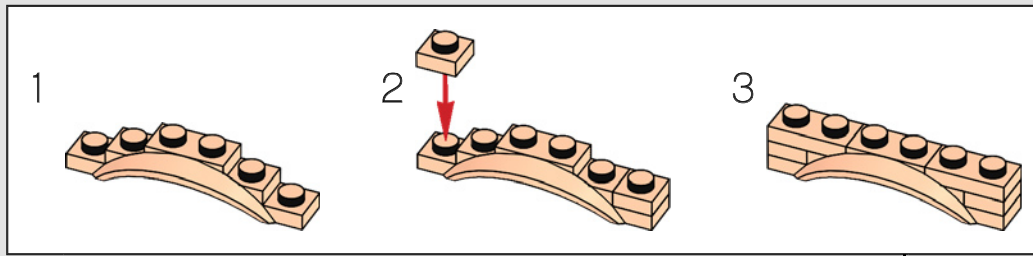

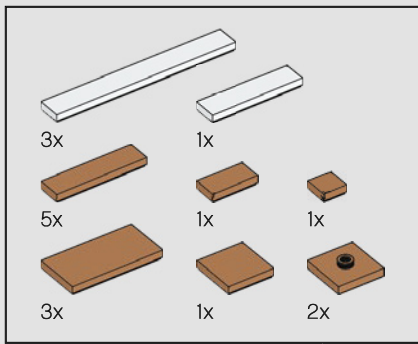

244





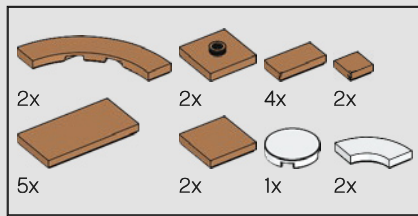

245

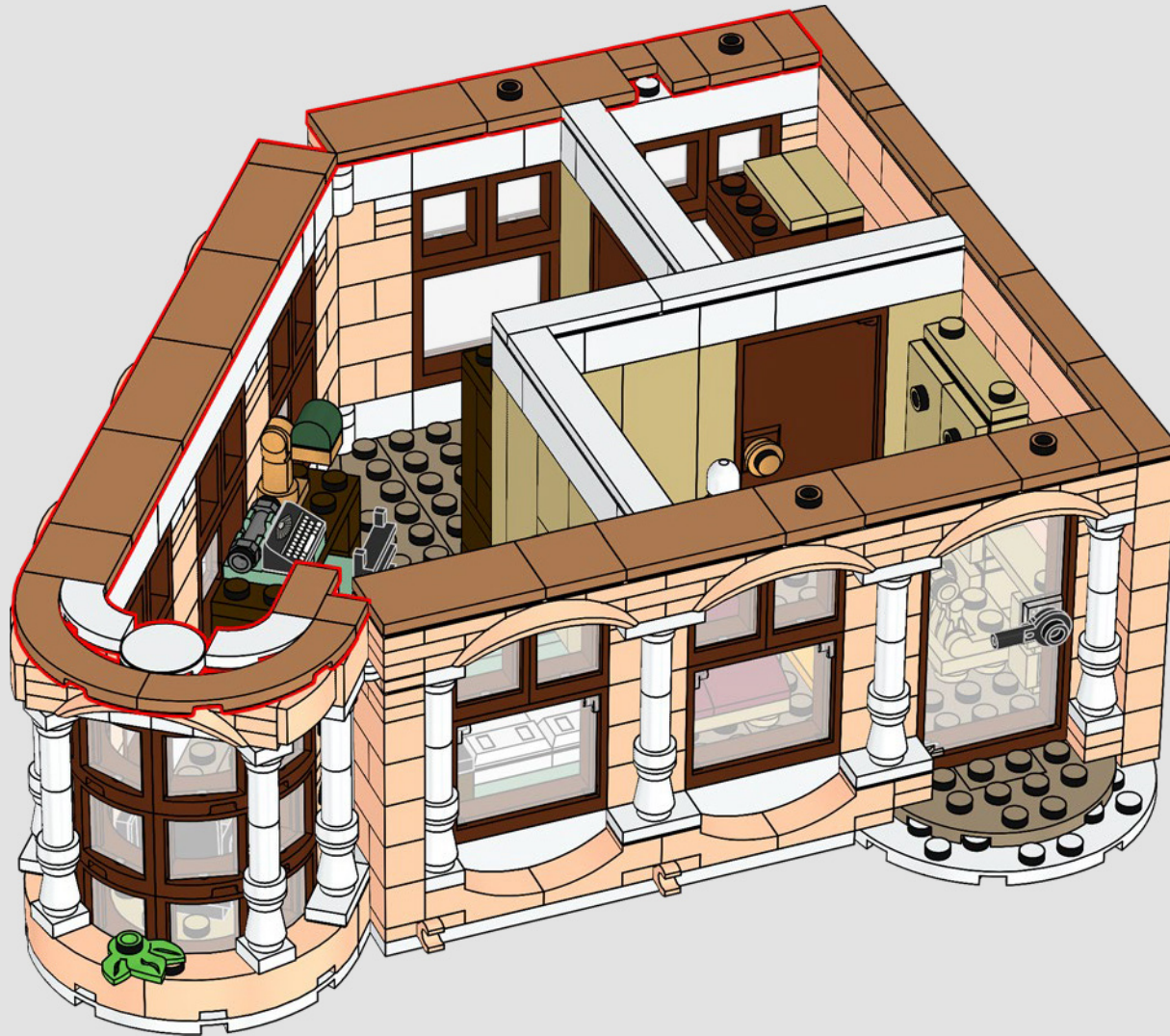

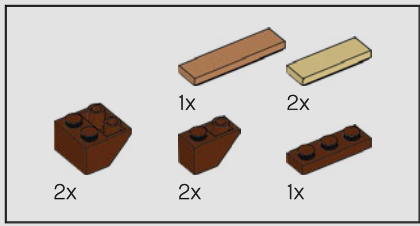

246

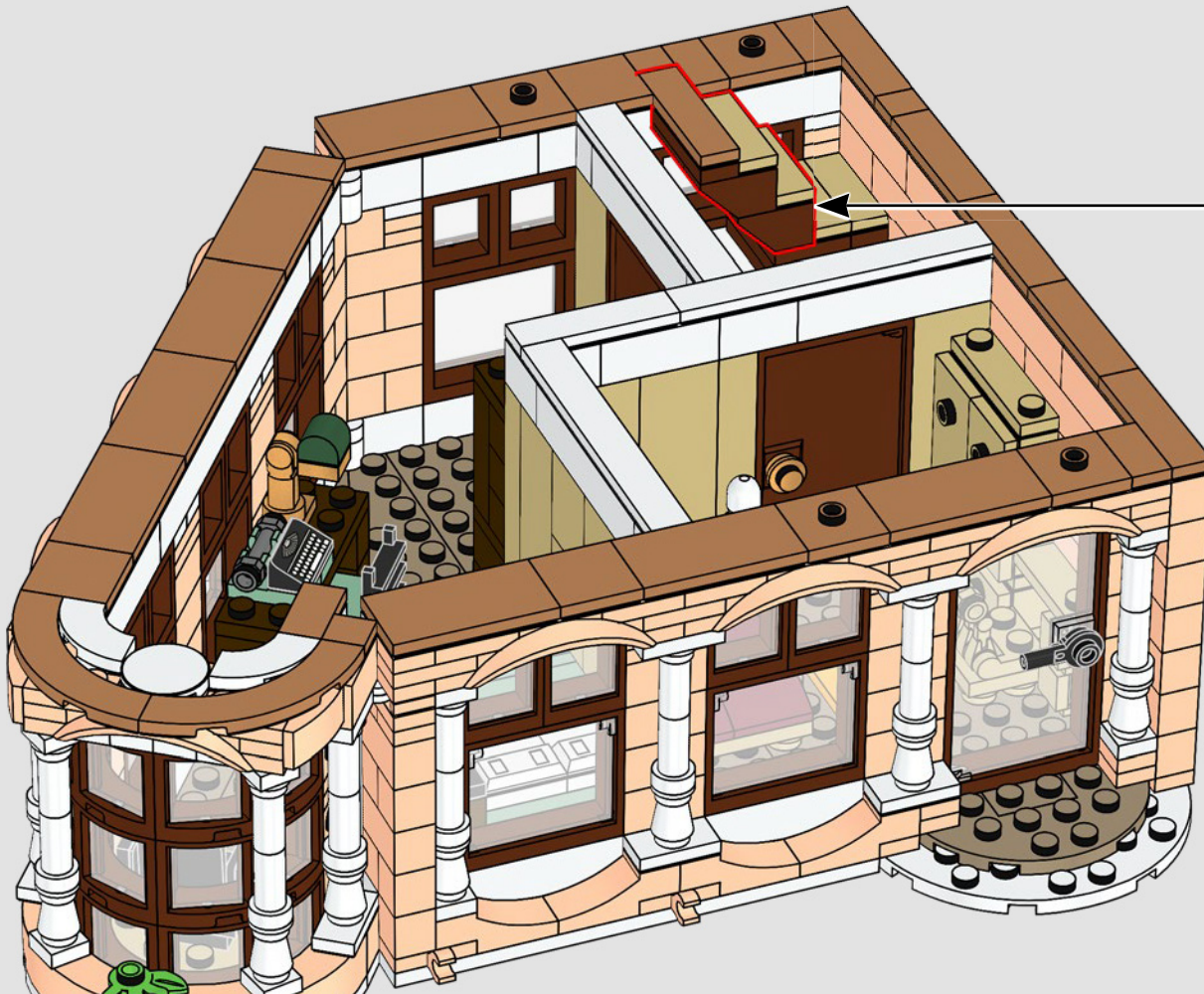
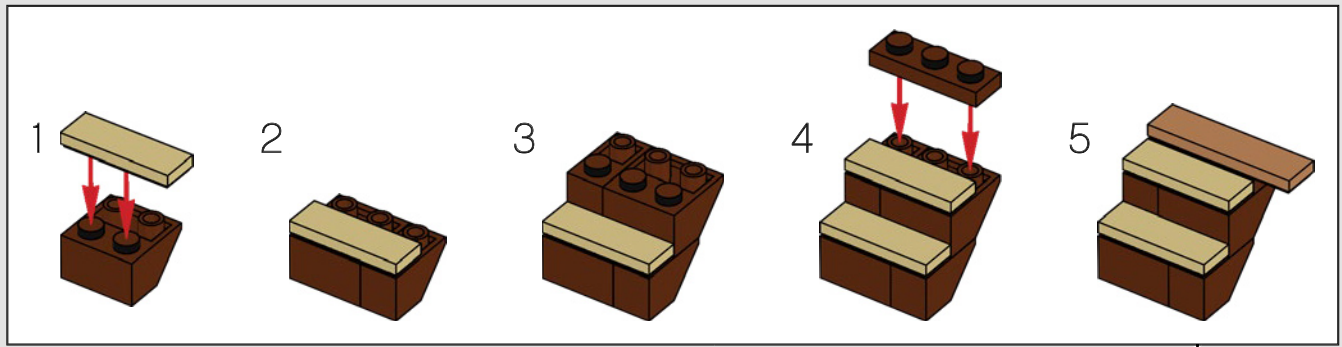



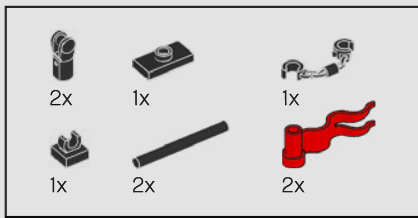

247

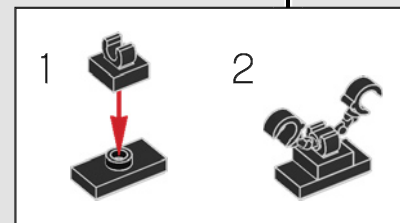
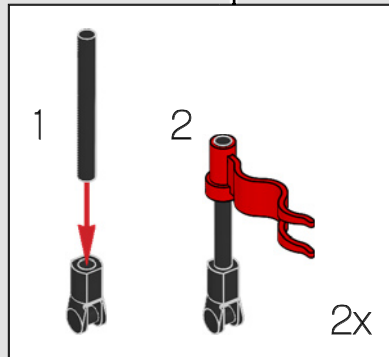



248



Las piernas de minifiguras de esqueleto se usaron por primera vez como detalle en el balcón del set Tienda de Verduras (10185).

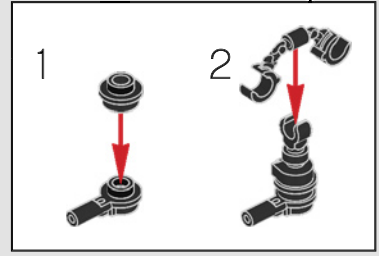
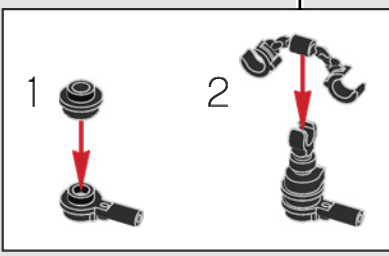
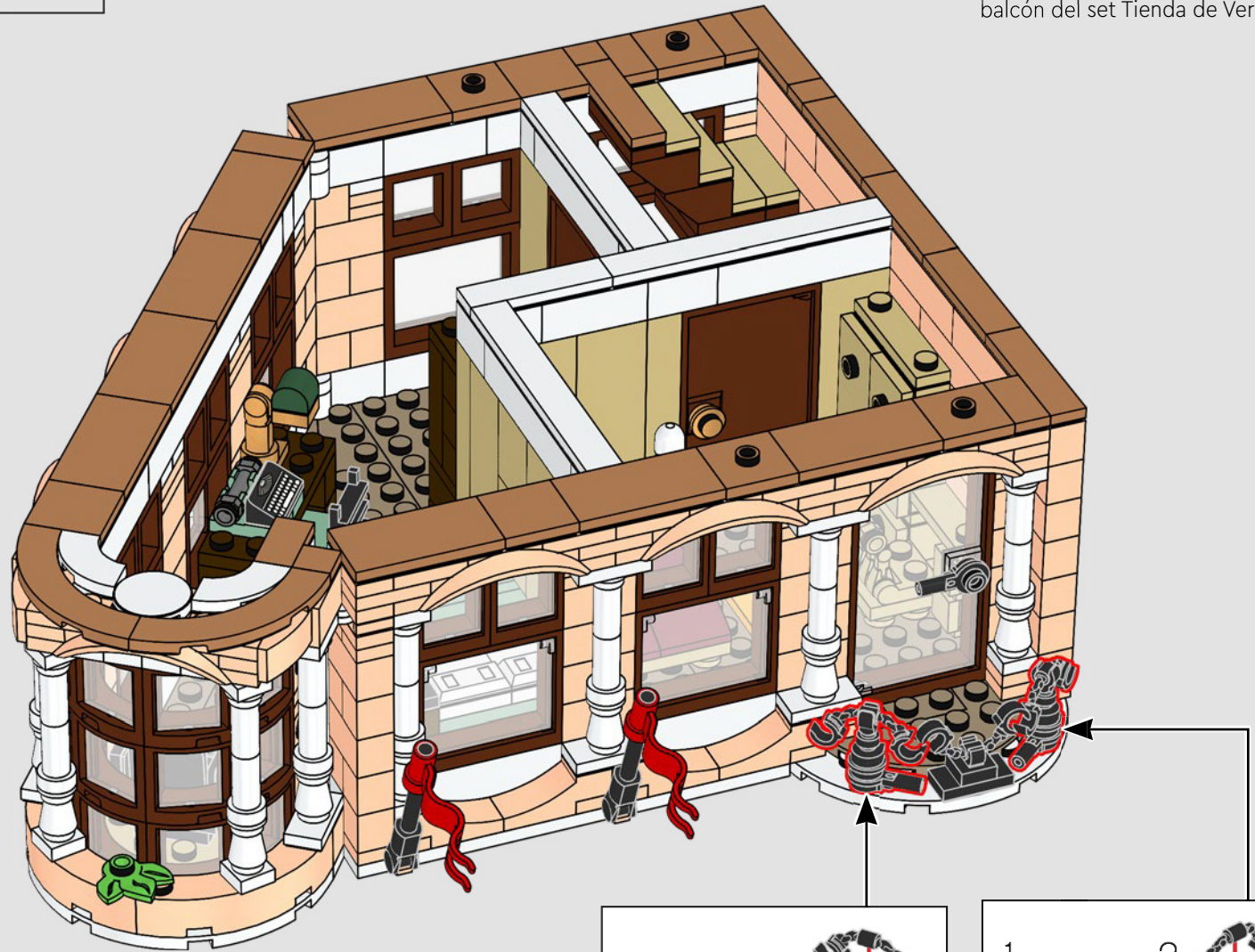





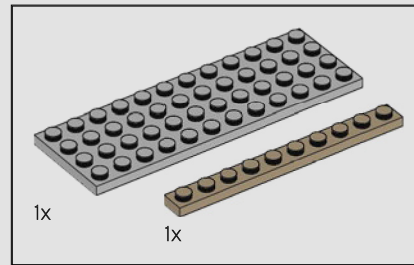
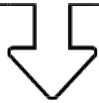

250

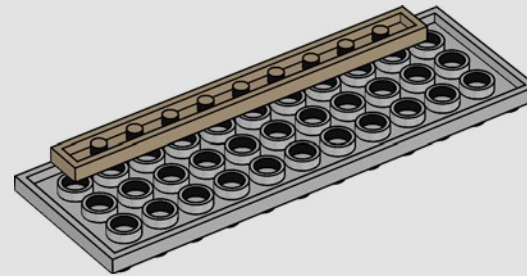



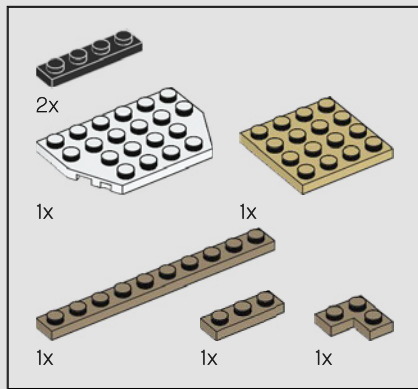

251

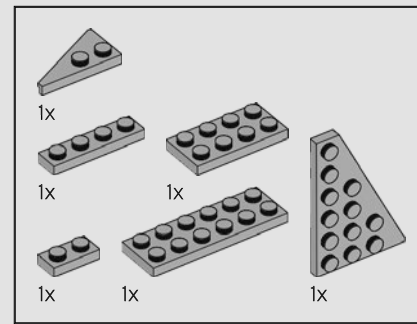
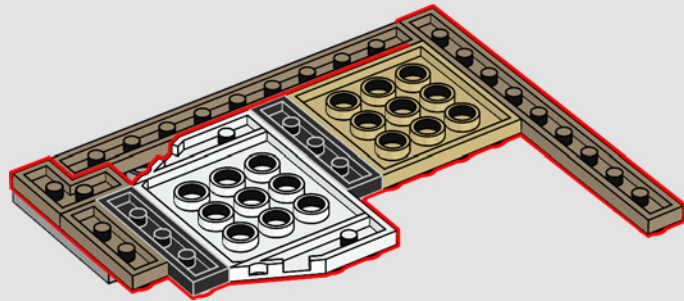

252

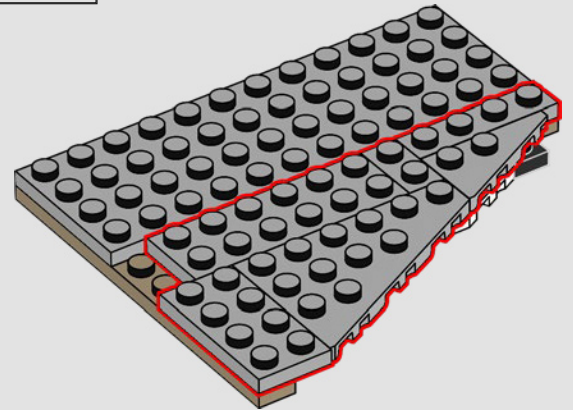
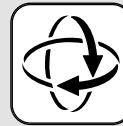

253

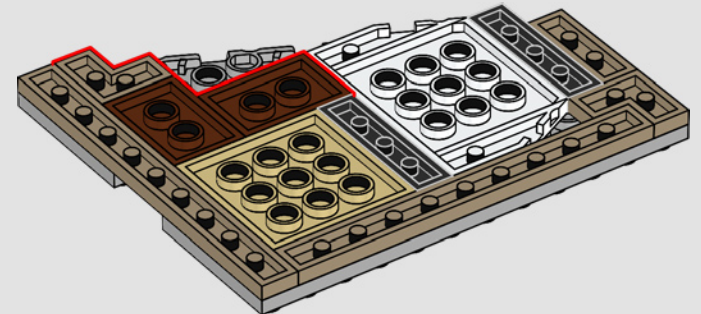

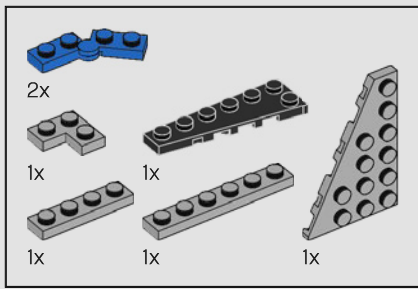

254

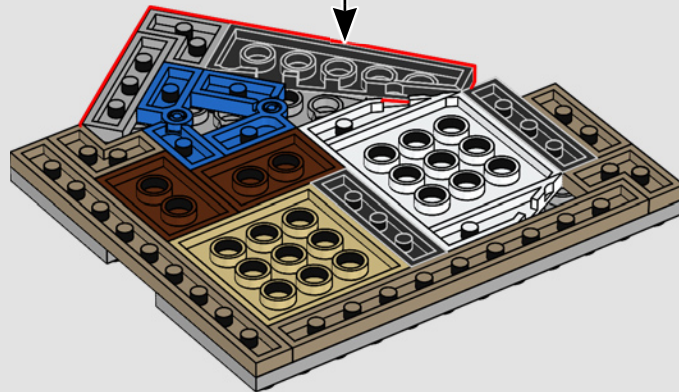
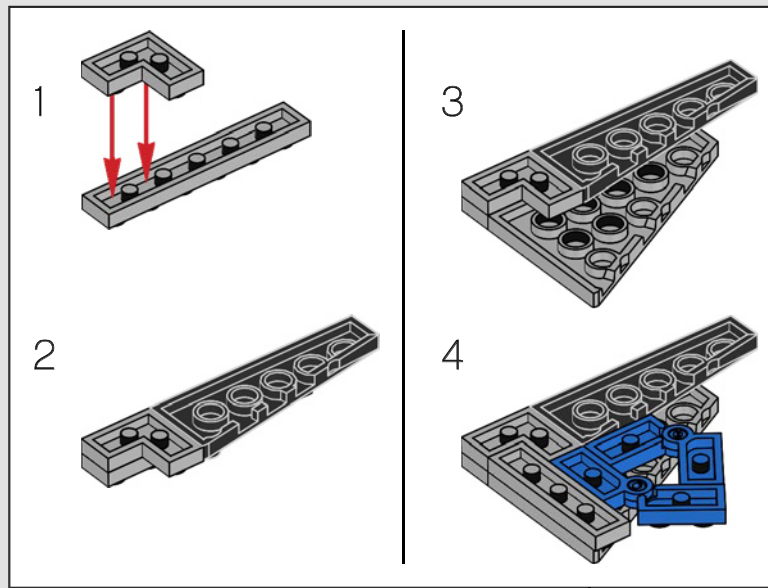

La terraza se construye aplicando geometría de triángulos invertidos. En combinación con el propio edificio del hotel, esto da lugar a triángulos pitagóricos que encajan a la perfección con la retícula del sistema LEGO®.

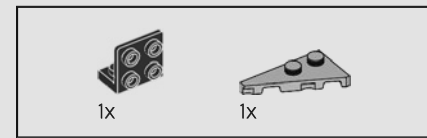

255

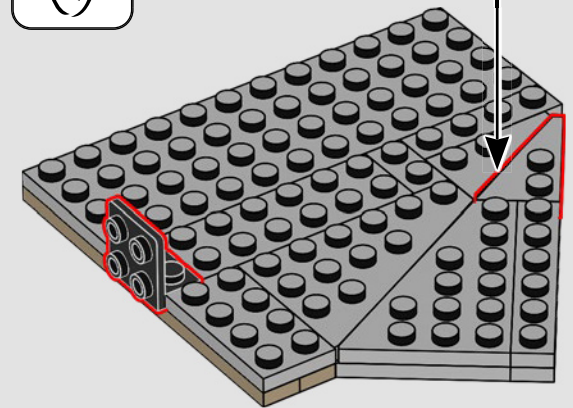
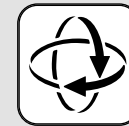
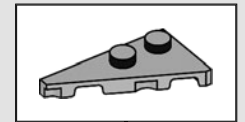



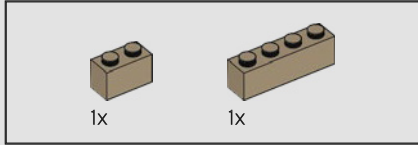
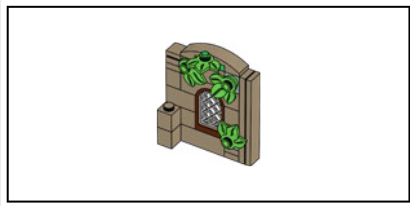

256

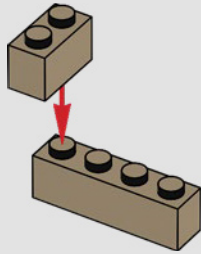

257

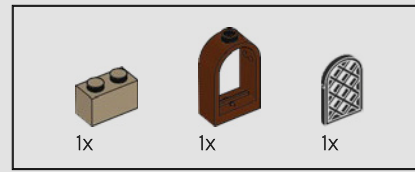
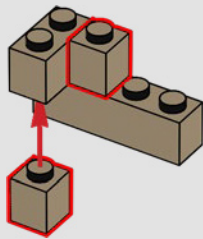

258

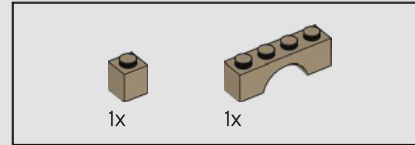
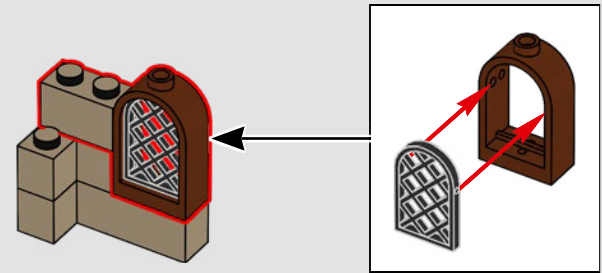

259

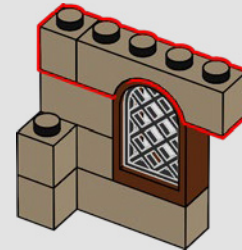

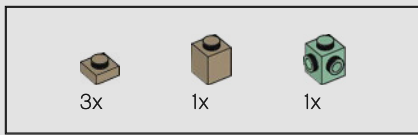

260

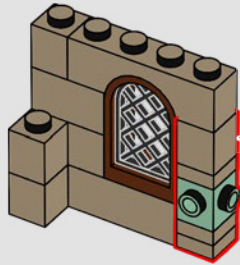
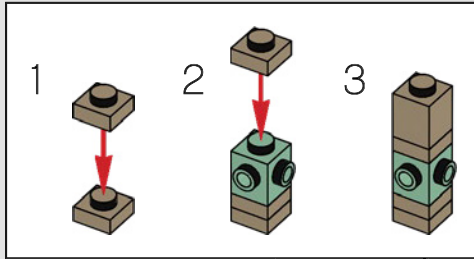

261

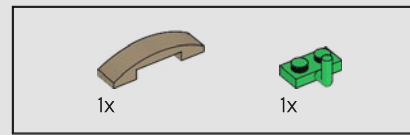
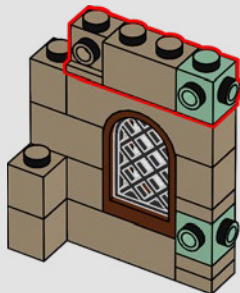

262

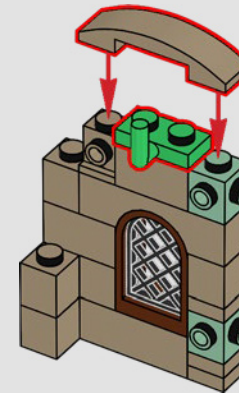



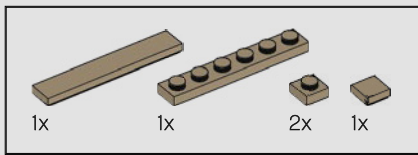

263

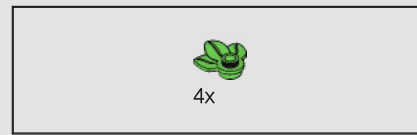
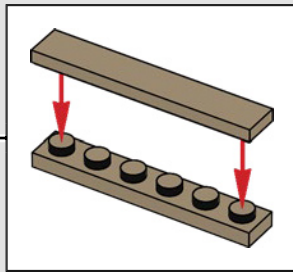
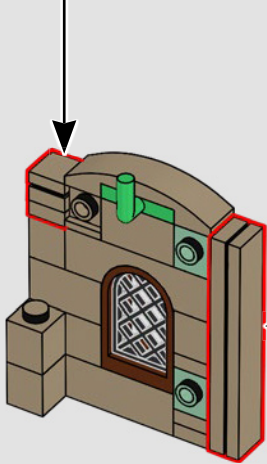
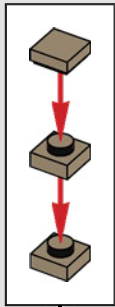

264

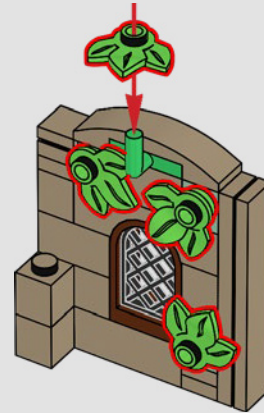

265

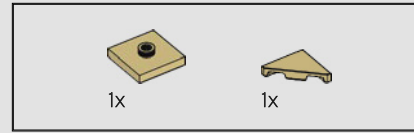
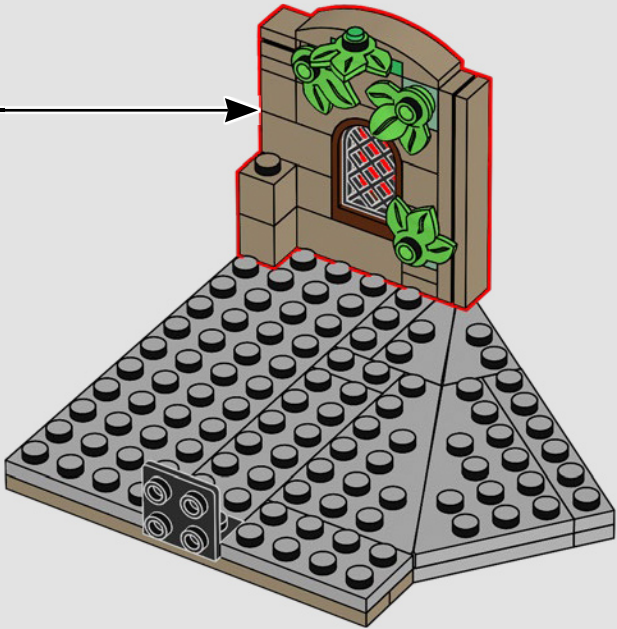

266





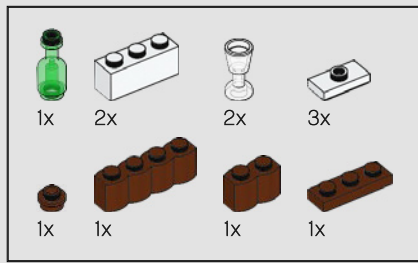

267

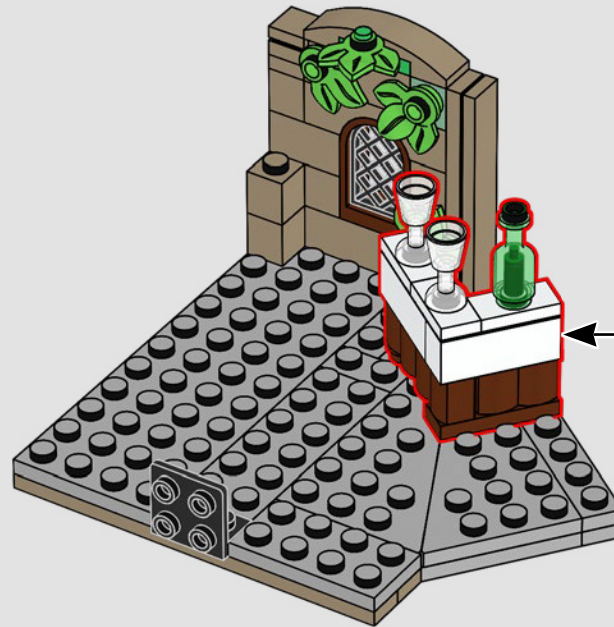
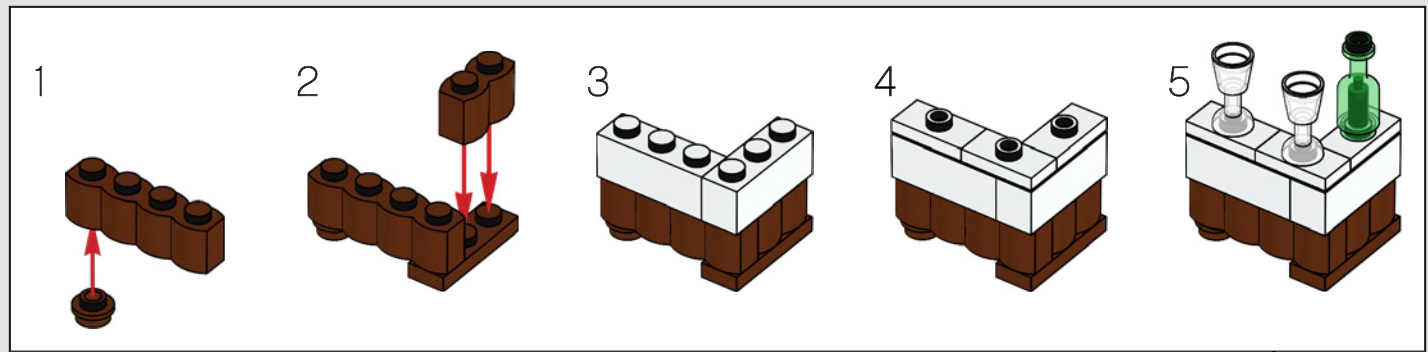

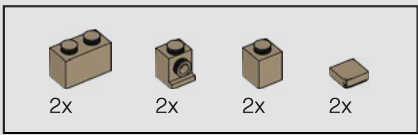

268

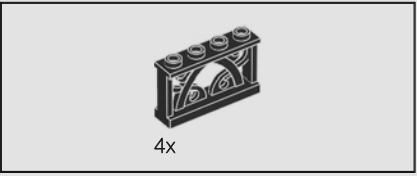
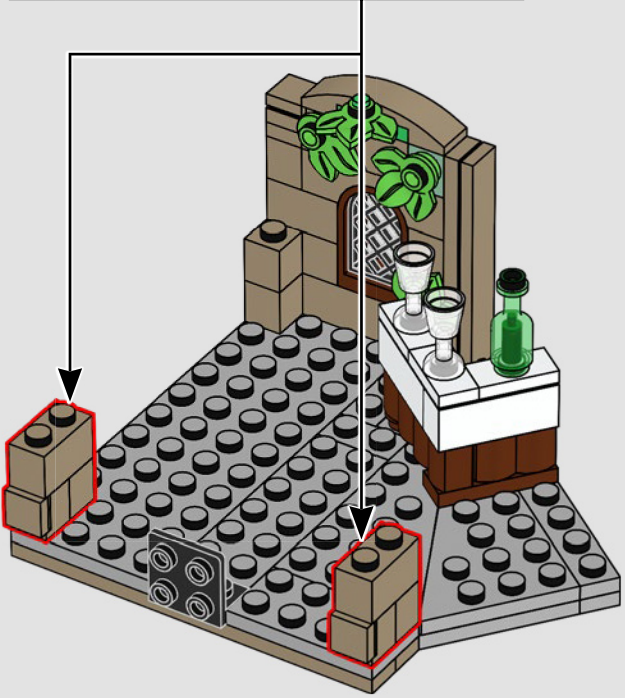
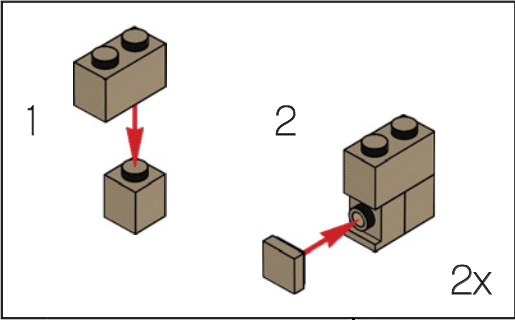

269





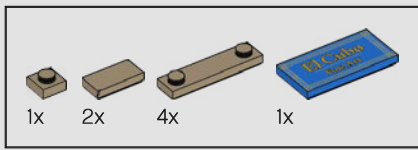

270

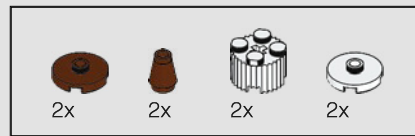
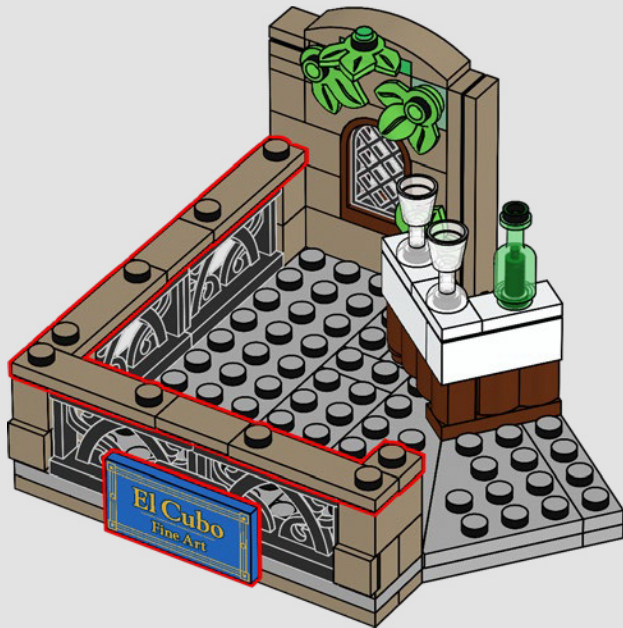

271

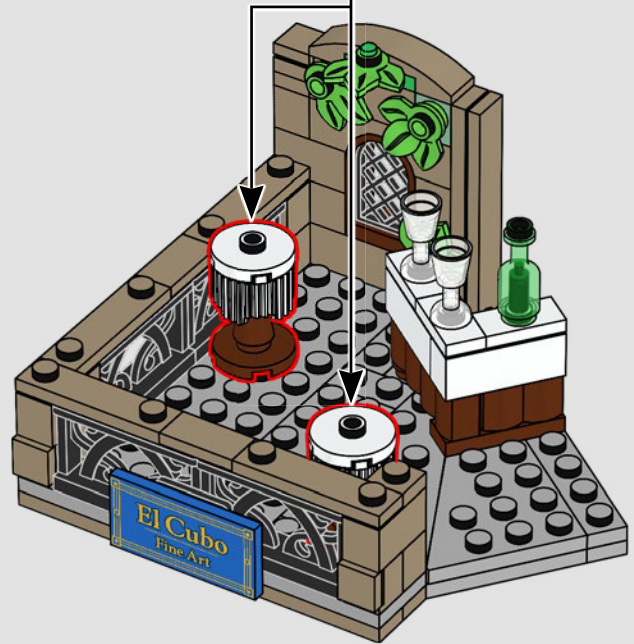
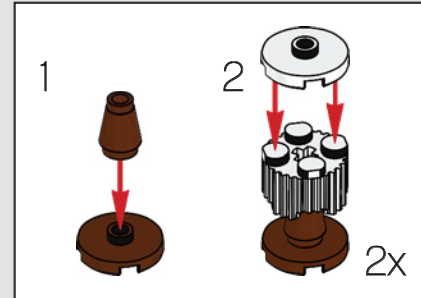

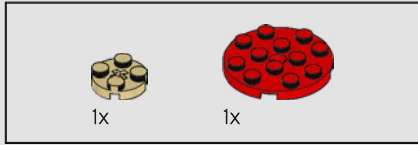

272

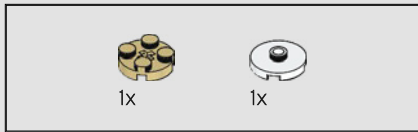

273

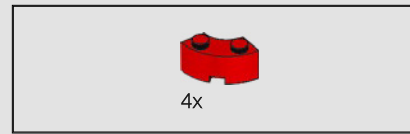
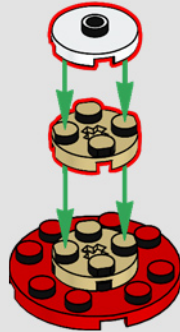

274

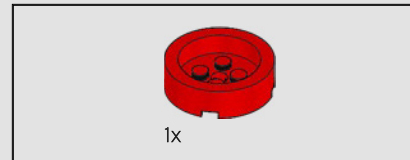
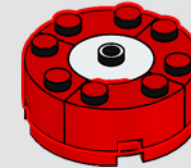

275

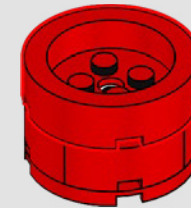



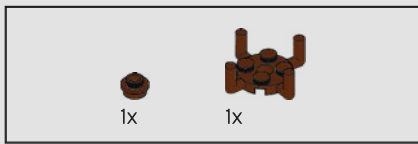

276

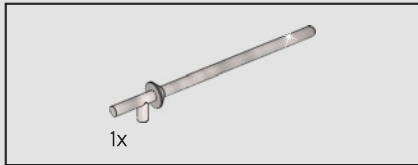
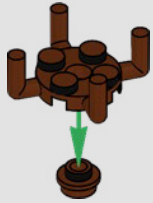

277

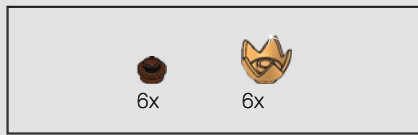

278

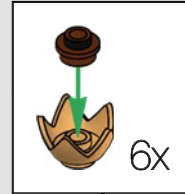

279

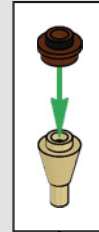

280



5x

281

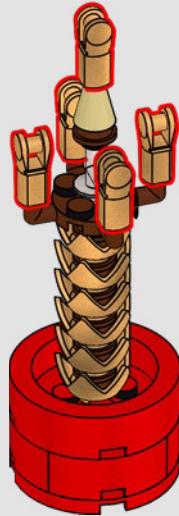

5x

282

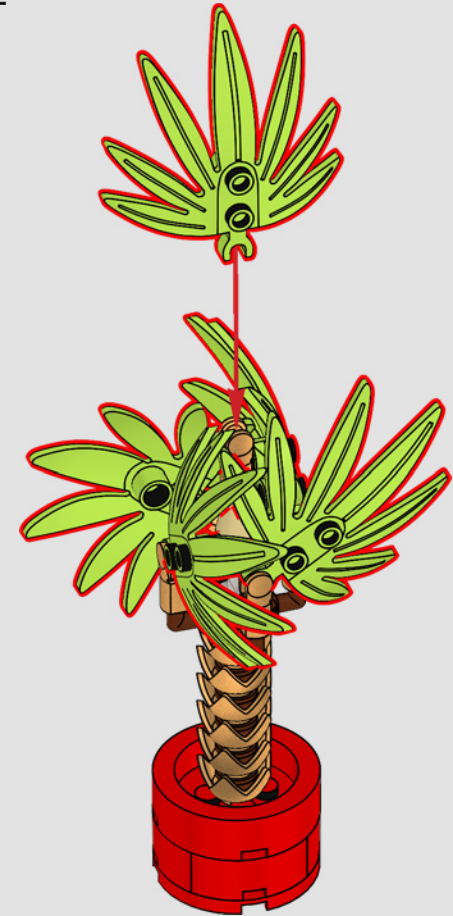

Los elementos que se usan para hacer el tronco de la palmera se crearon para representar la corona de la Reina Soyloque Quiera en LA LEGO® PELÍCULA 2.



283

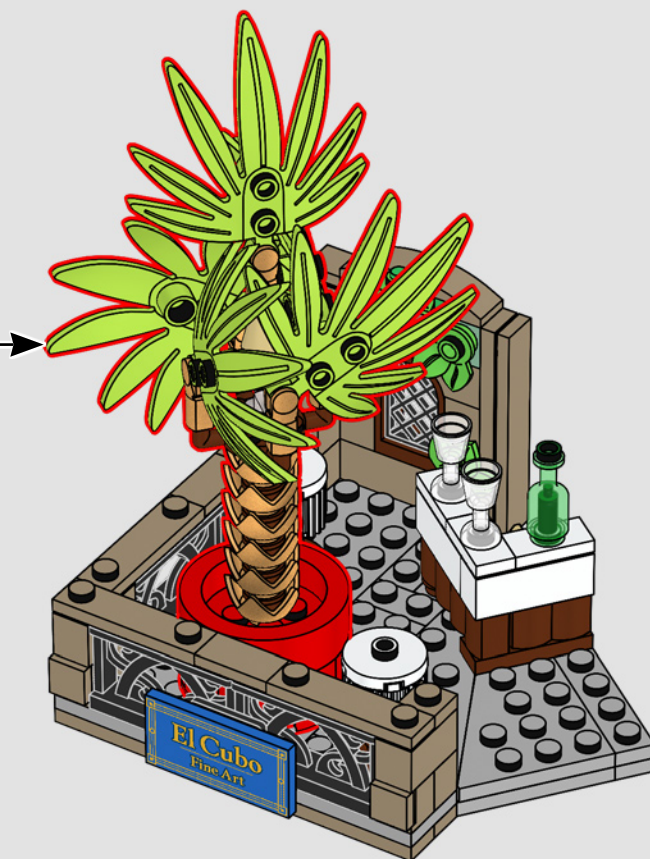

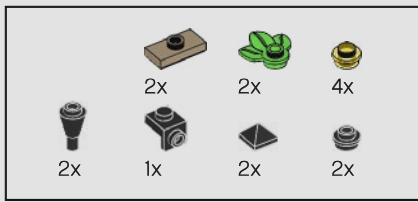

284

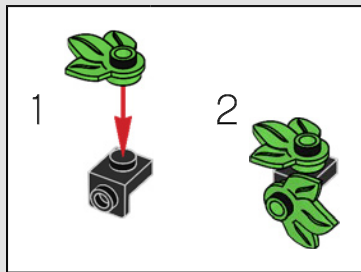
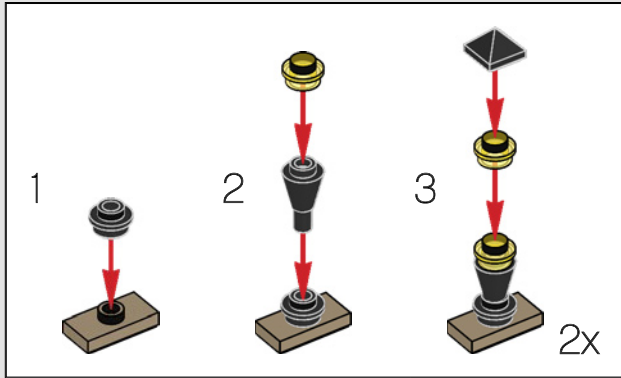



285



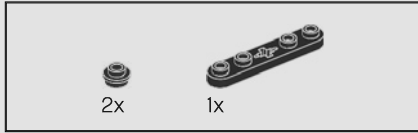

286

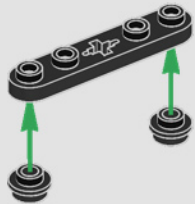

287

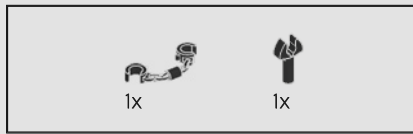
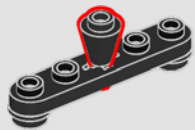

288

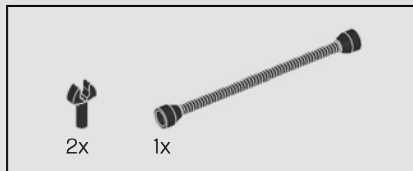
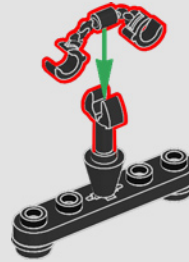

289

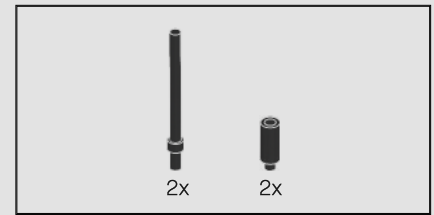
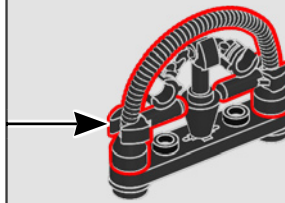
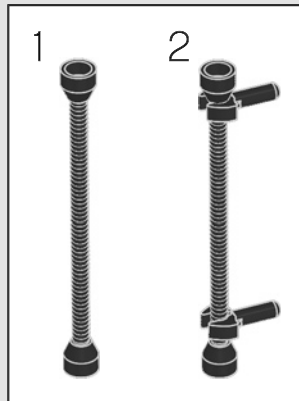

290

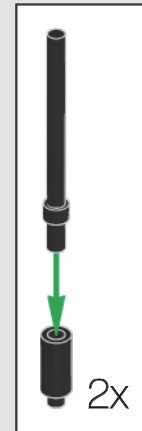
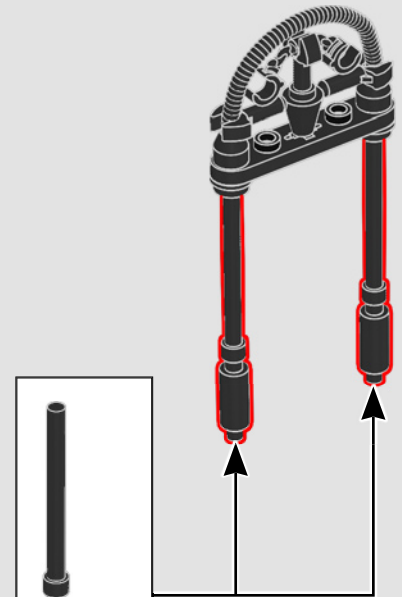





El set Calle del Mercado (10190) fue el primero en incluir una puerta de hierro forjado. Aquella destacaba por el uso de látigos de minifigura para crear detalles orgánicos curvos.

291





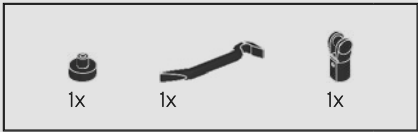

292

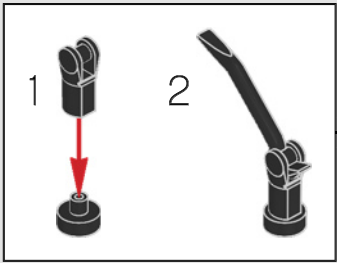



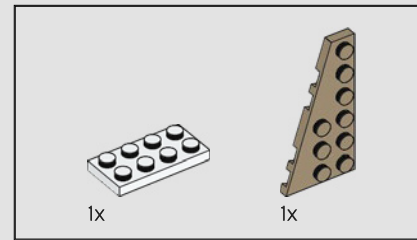
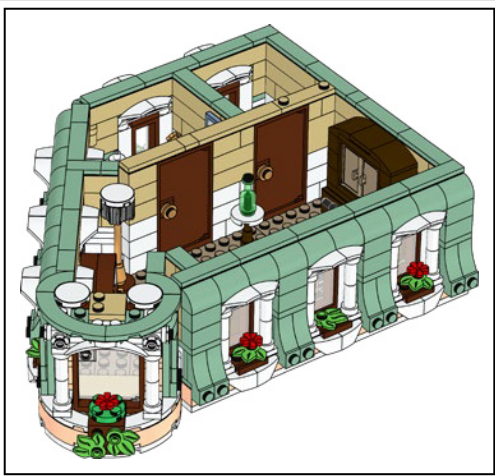
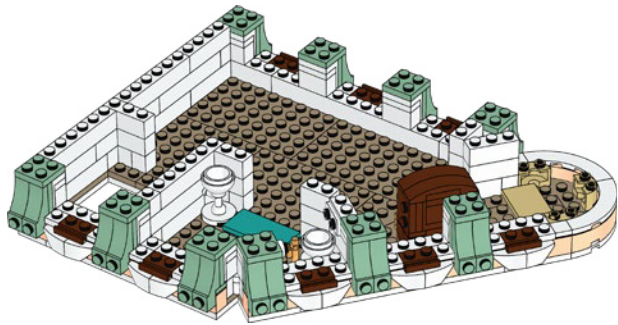
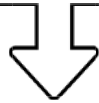

293

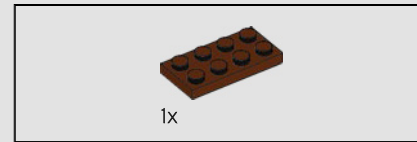
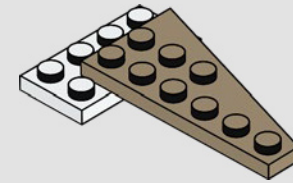

294

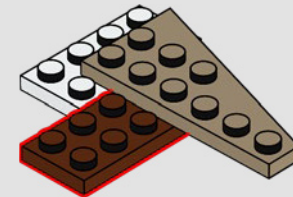

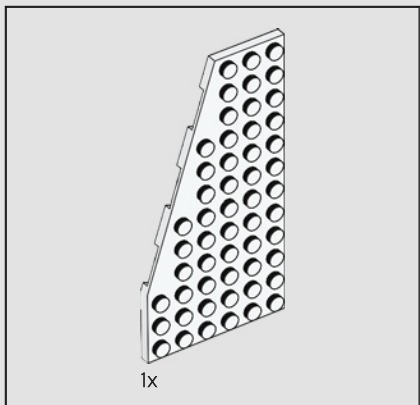

295

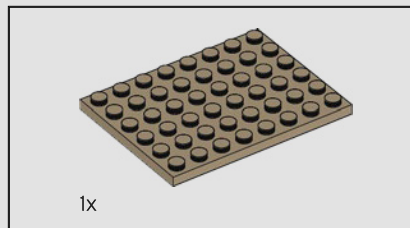
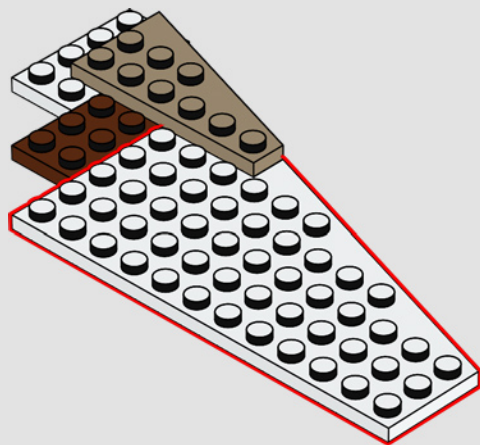

296

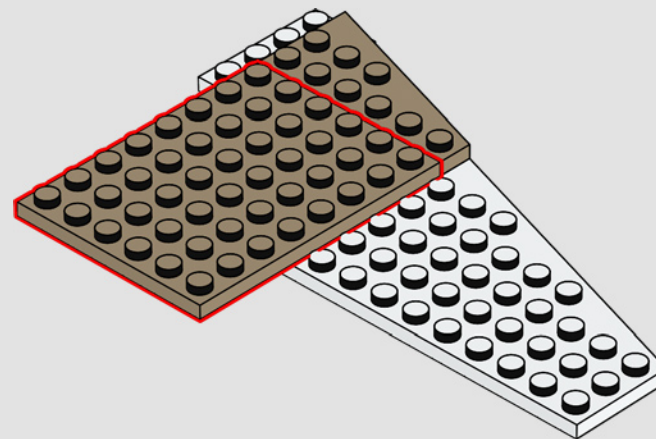



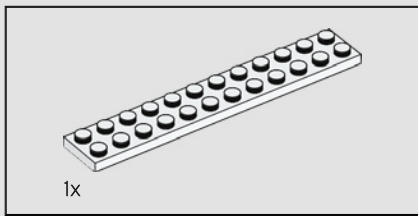

297

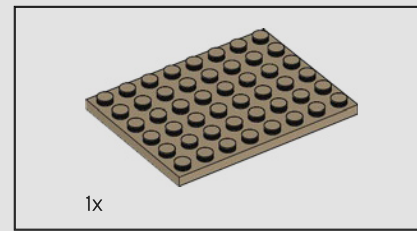
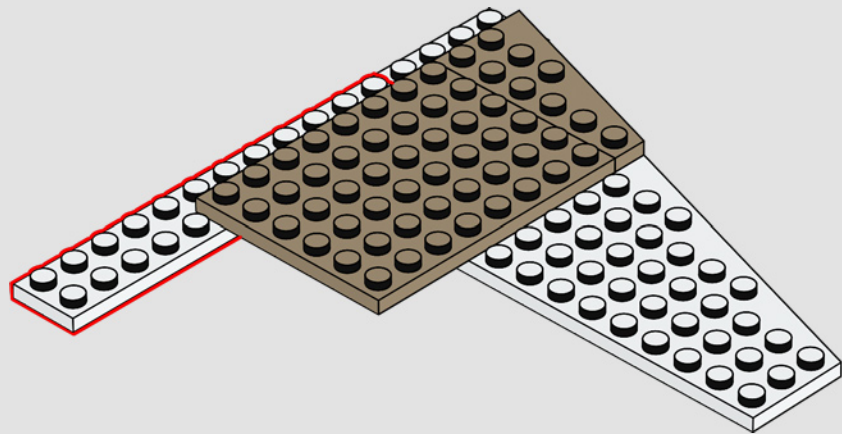

298

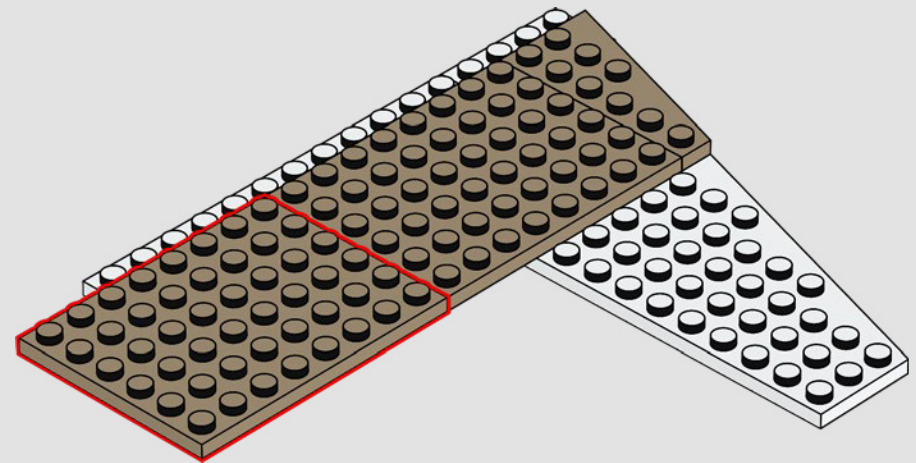

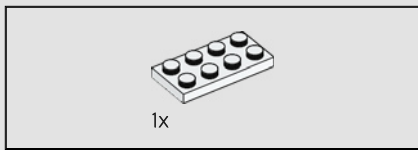

299

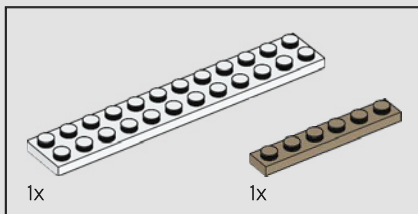
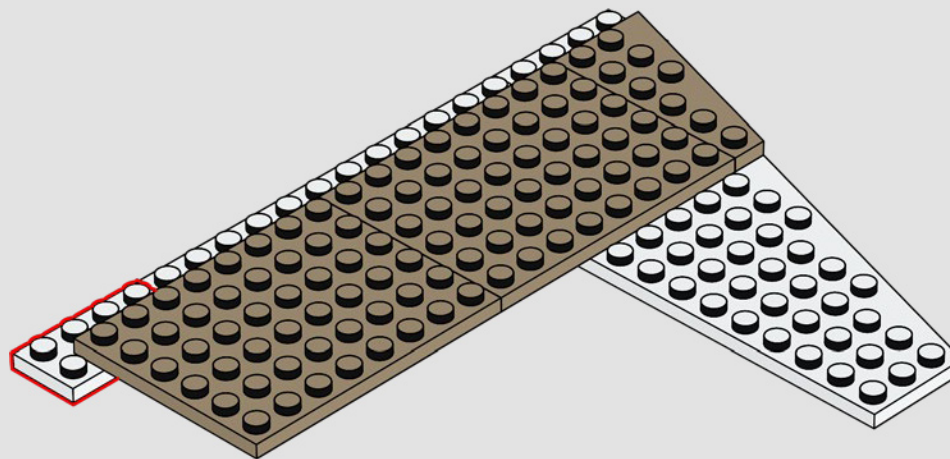

300

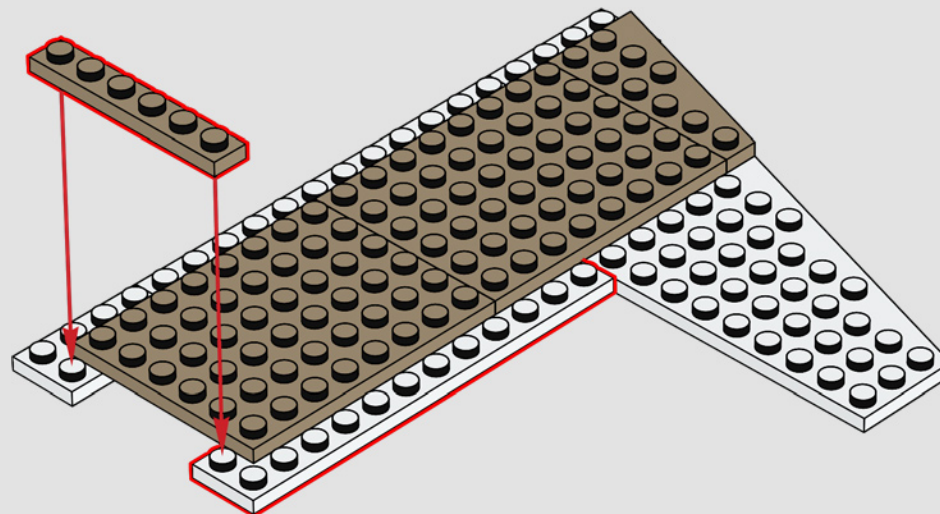



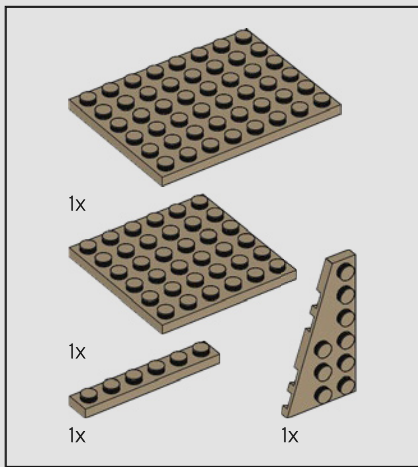

301

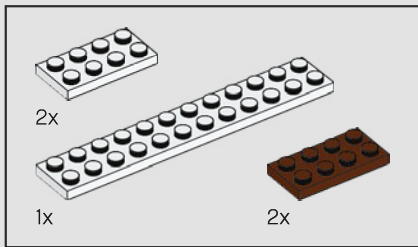
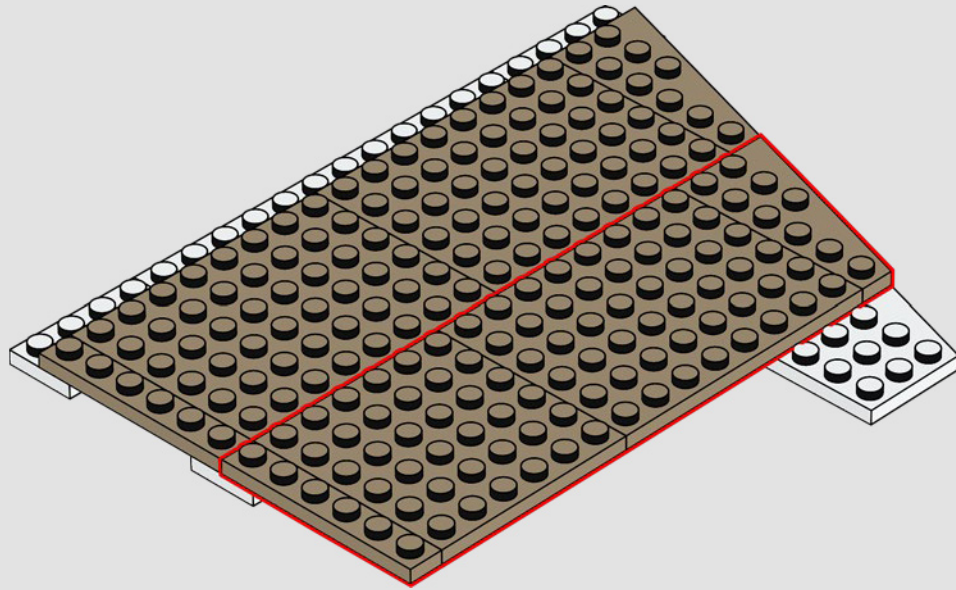

302

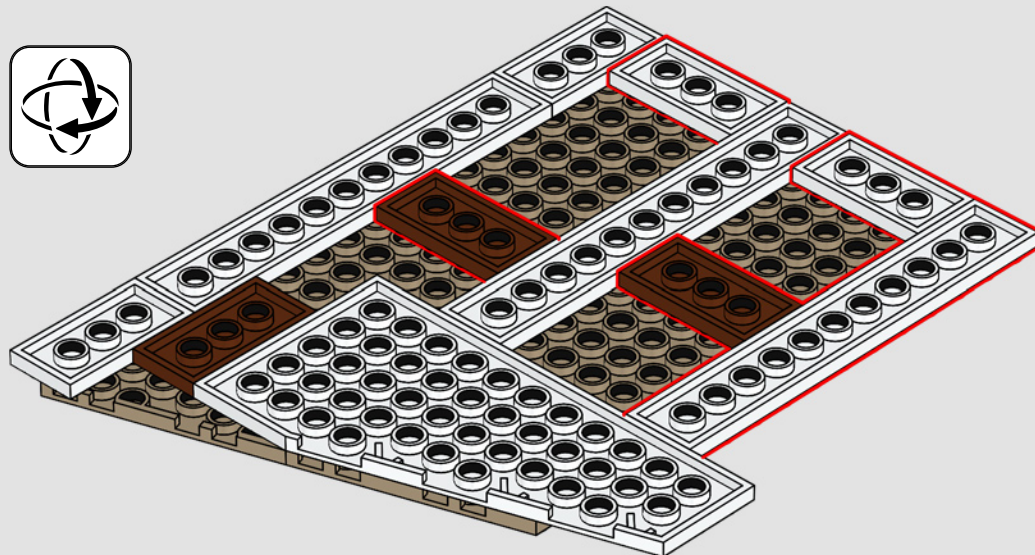

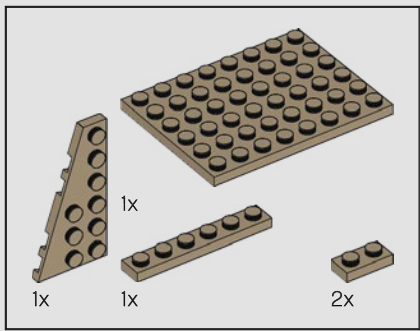

303

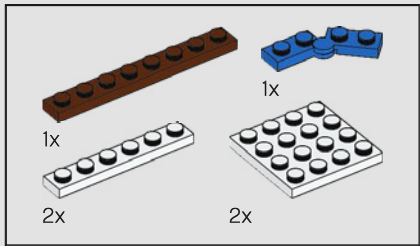
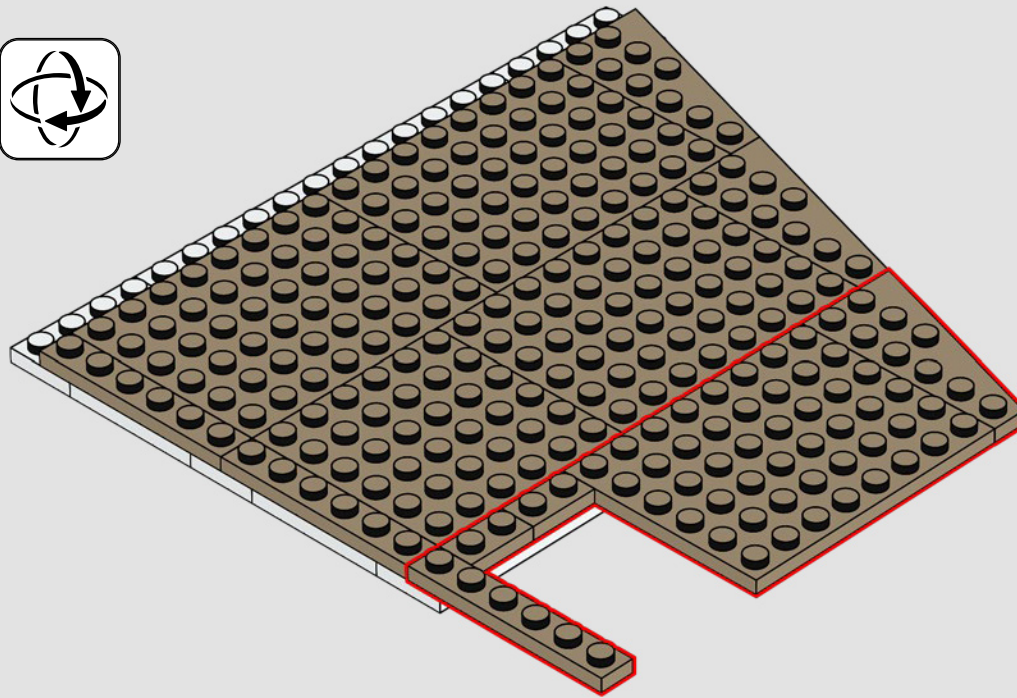

304

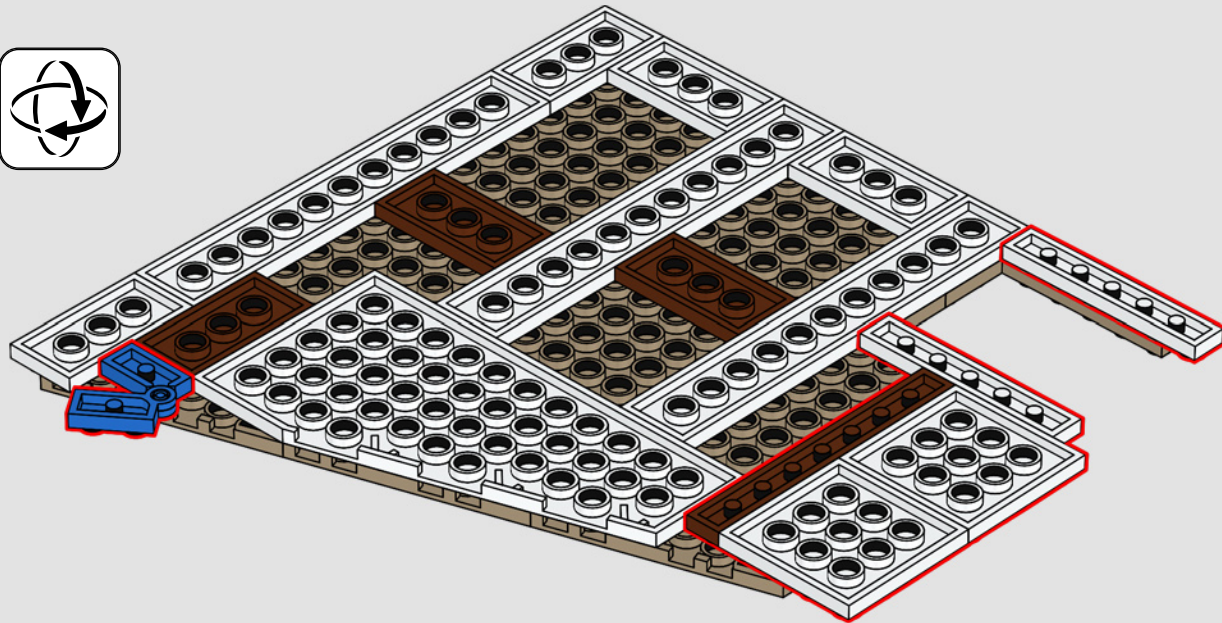



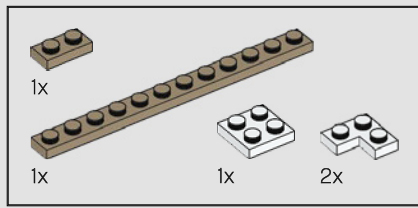

305

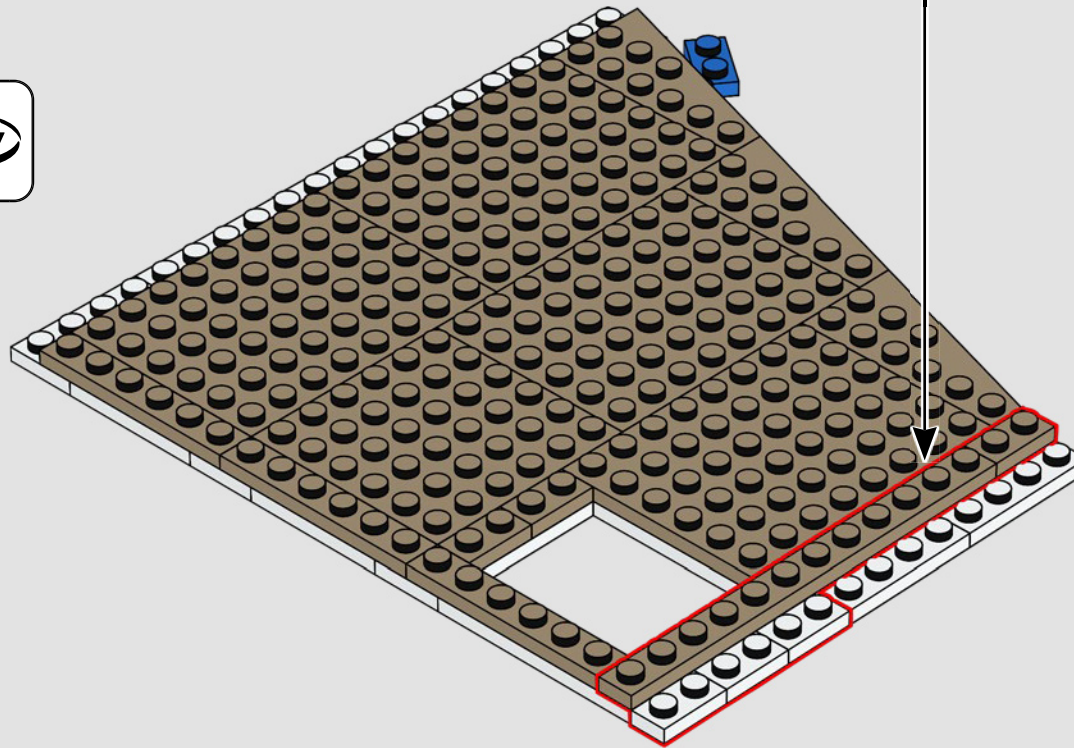
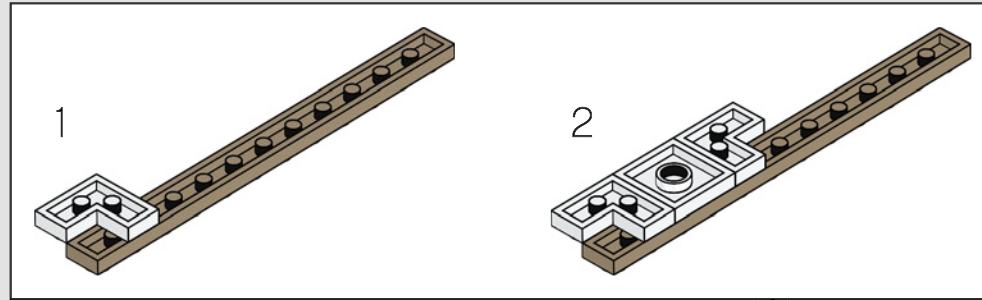

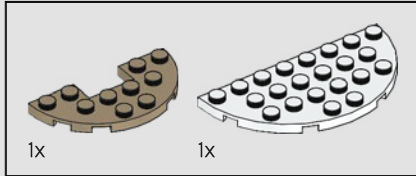
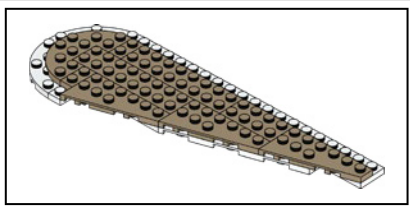

306

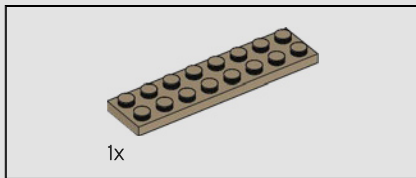
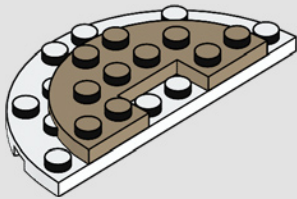

307

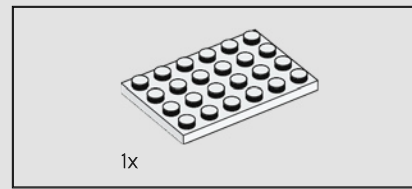
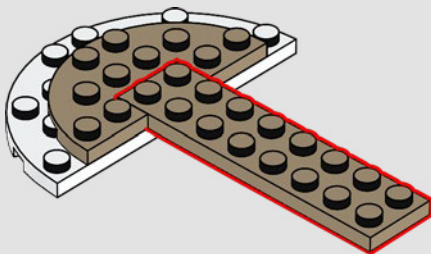

308

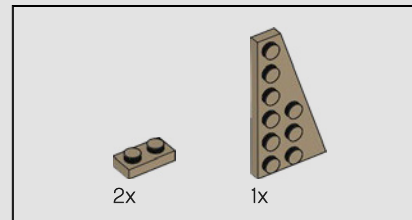
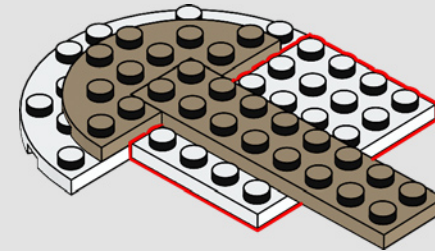

309

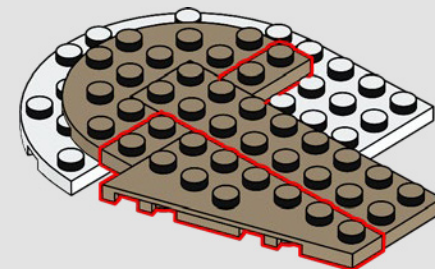



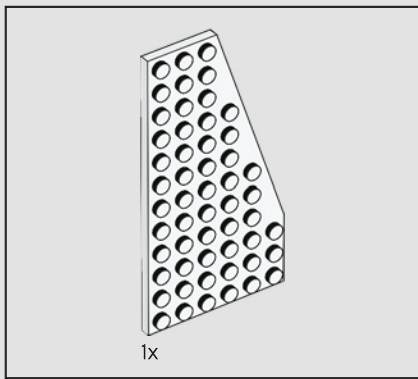

310

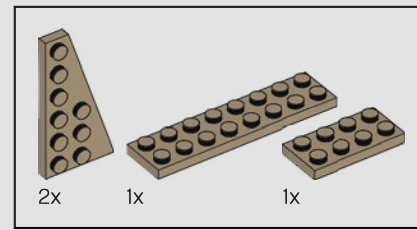
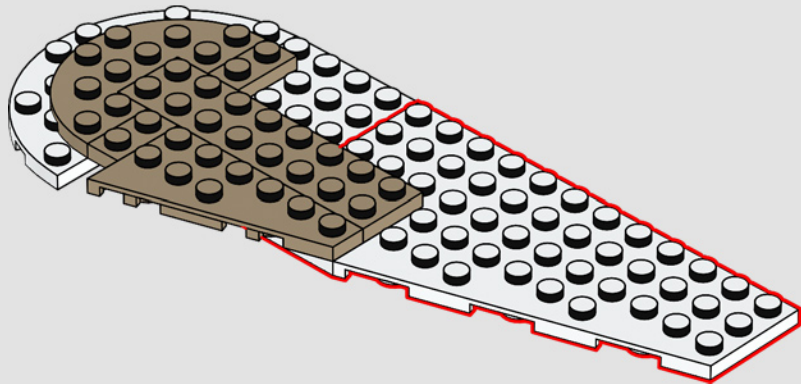

311

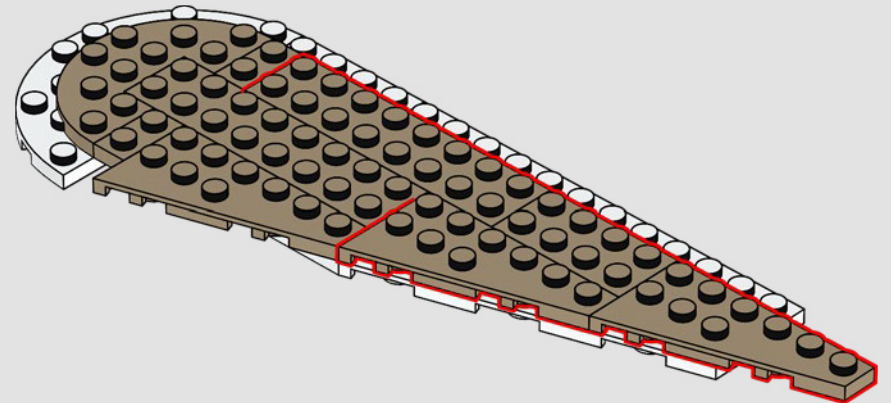

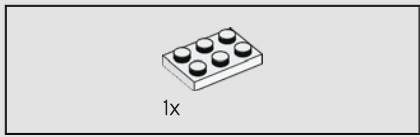

312

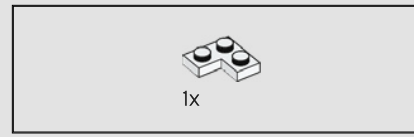
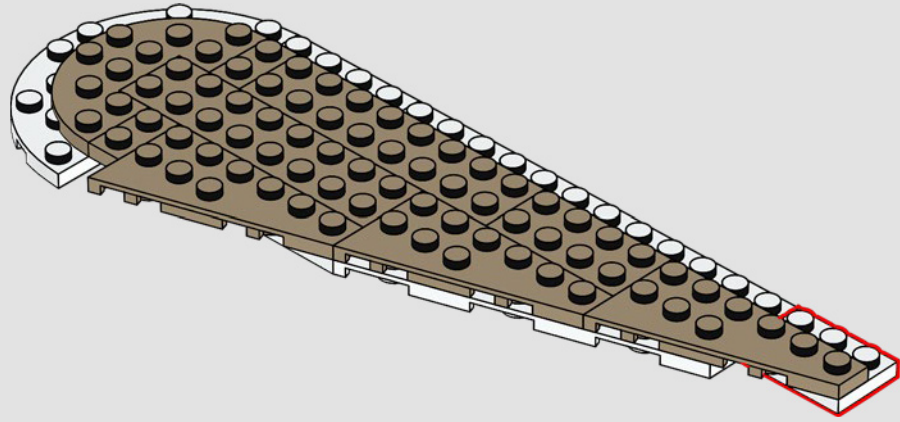

313

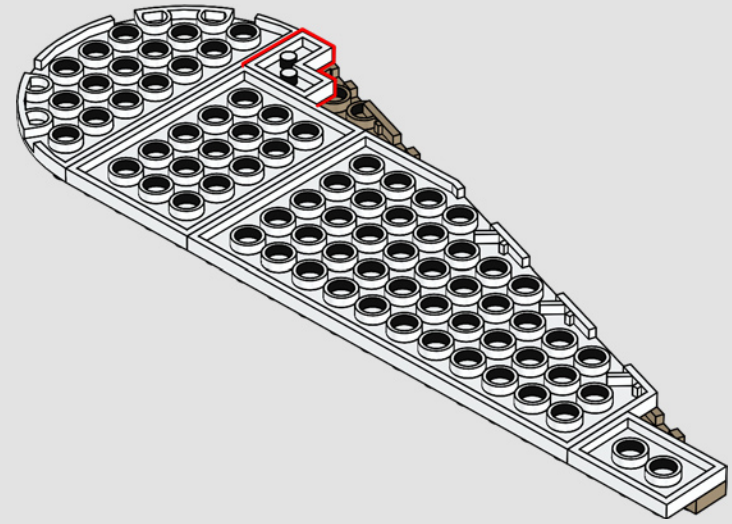
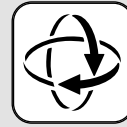



314

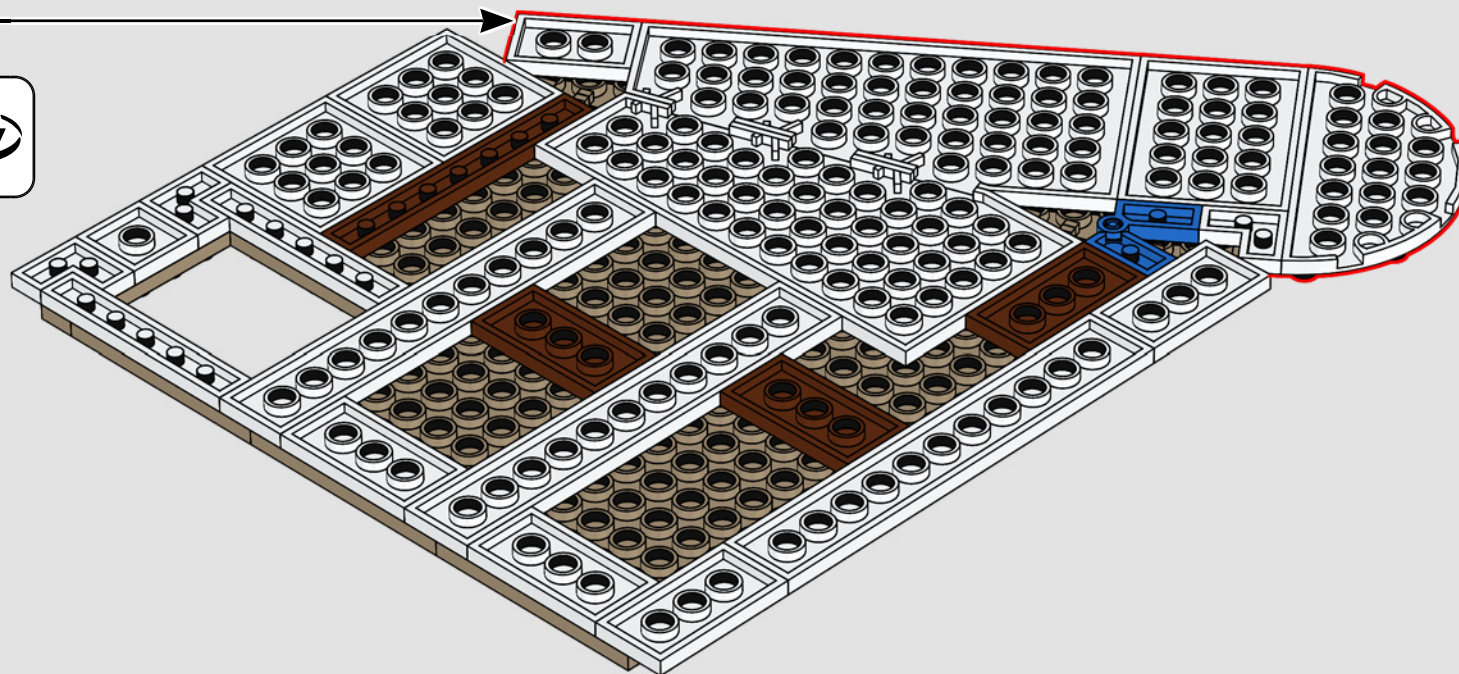

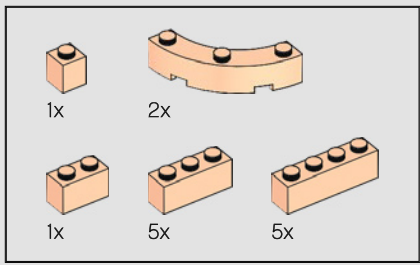

315

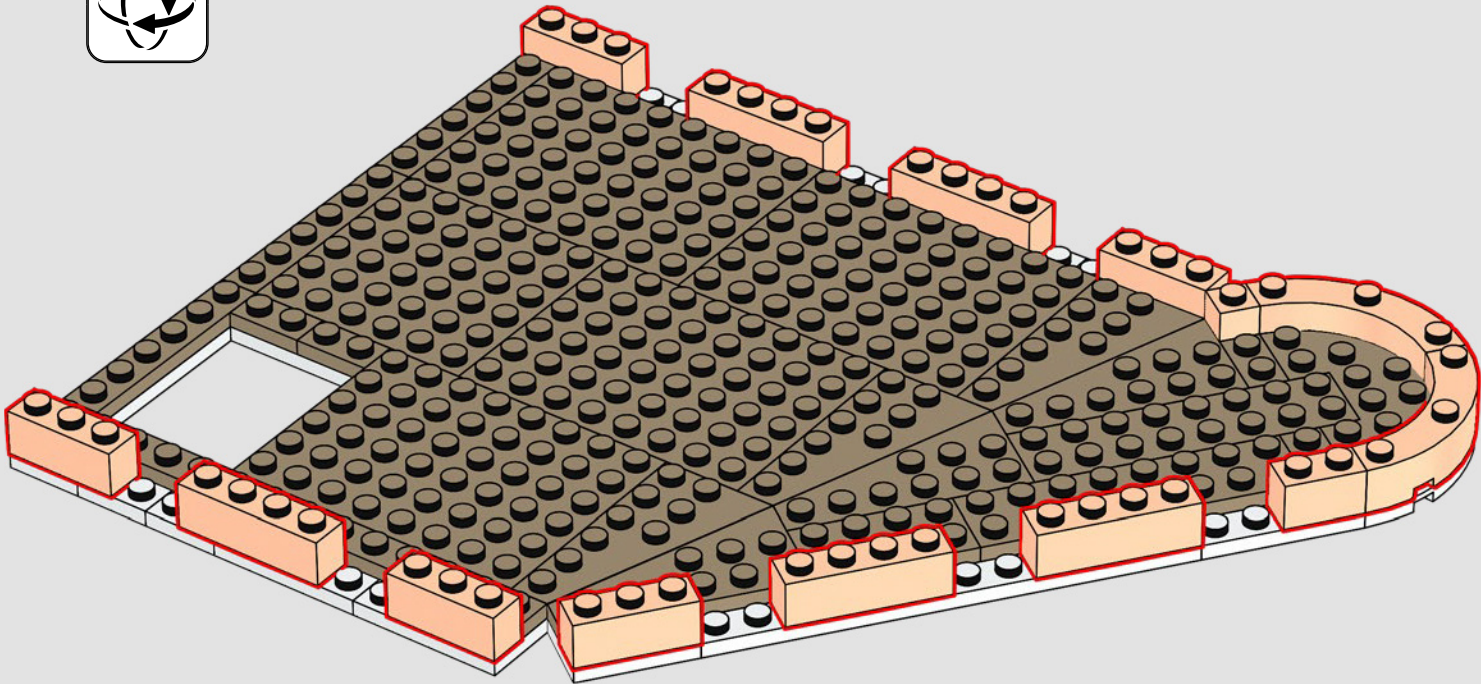



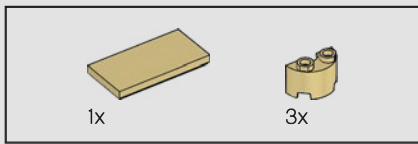

316

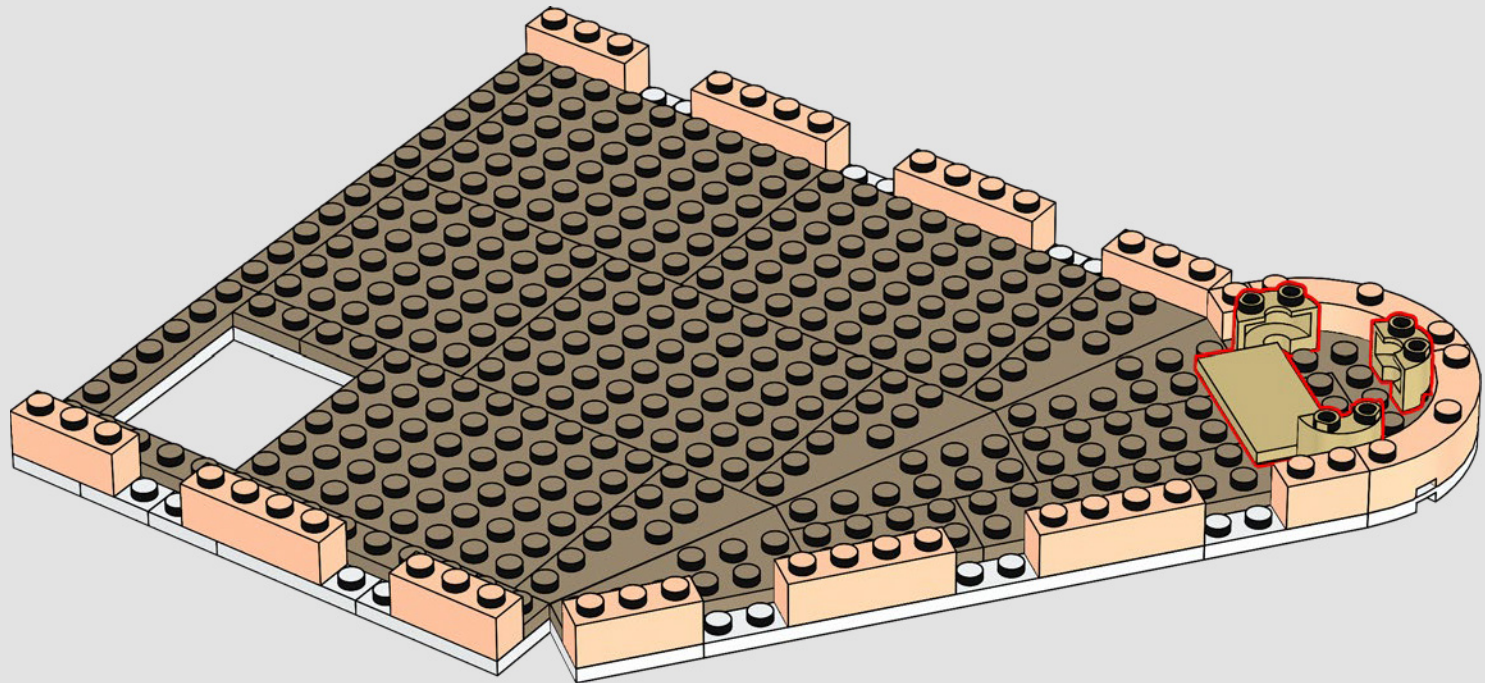

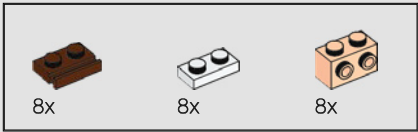

317

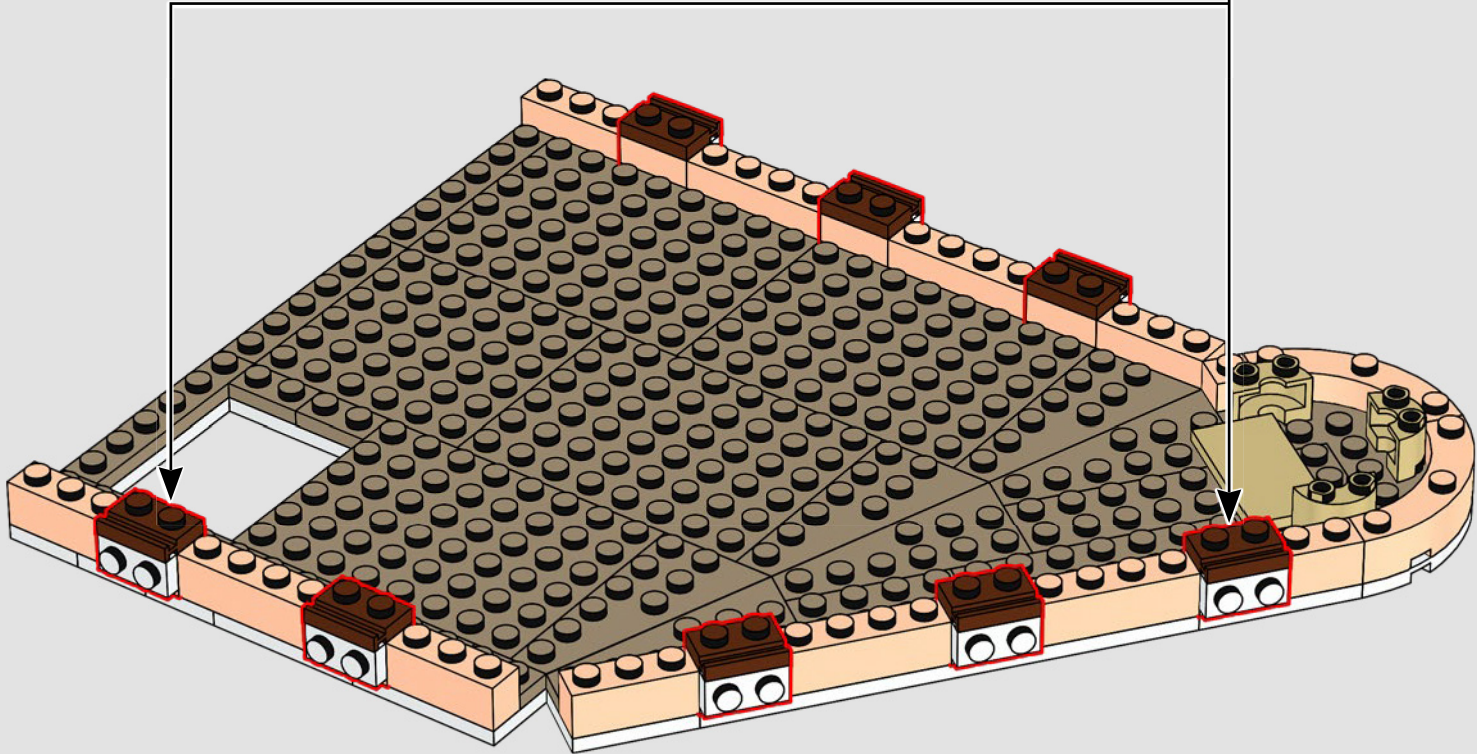
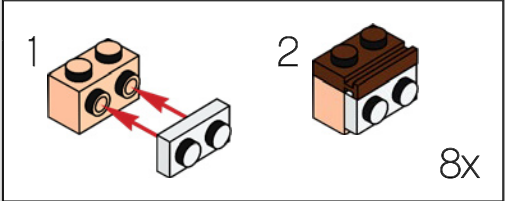



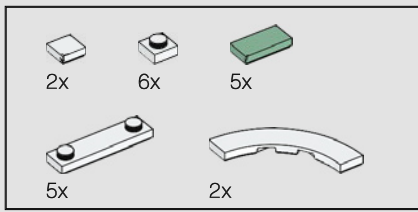

318

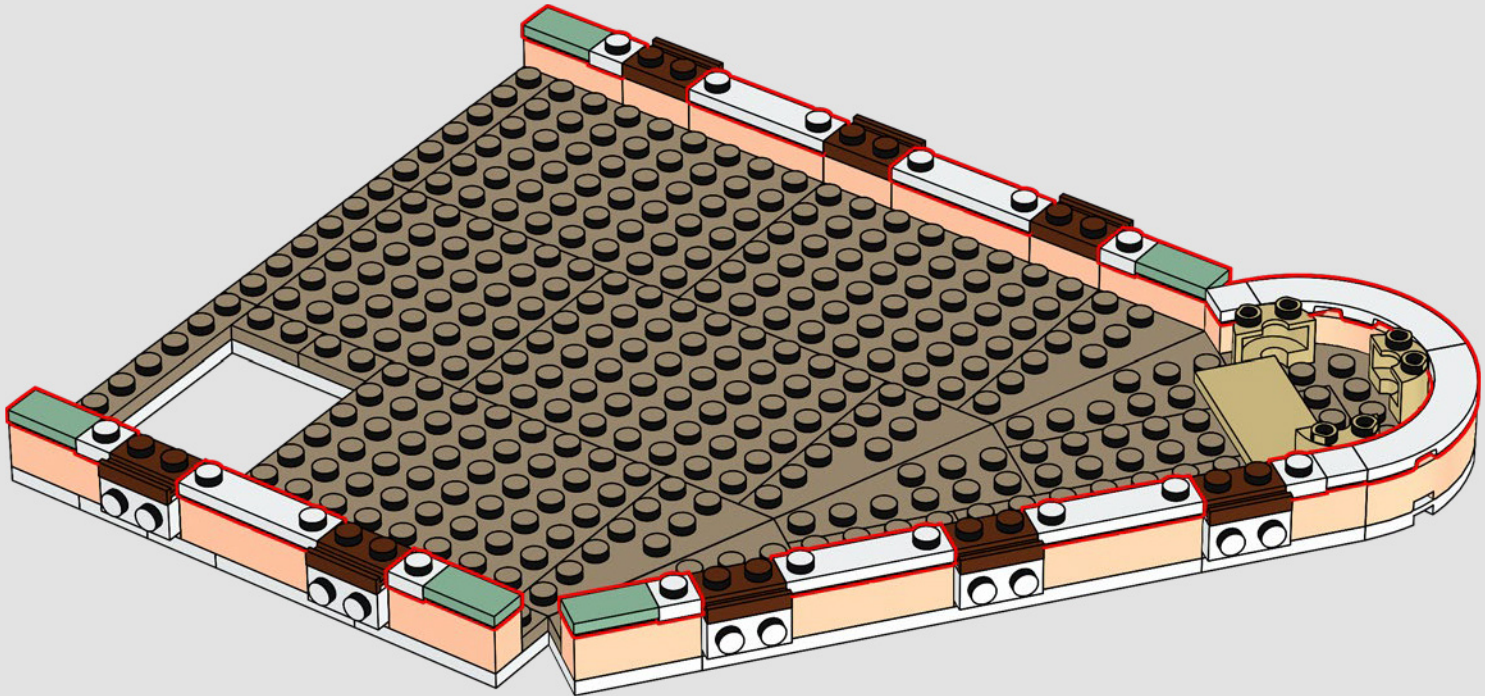

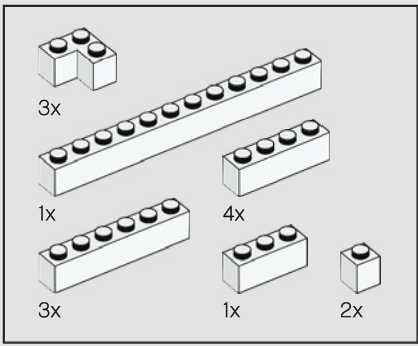

319

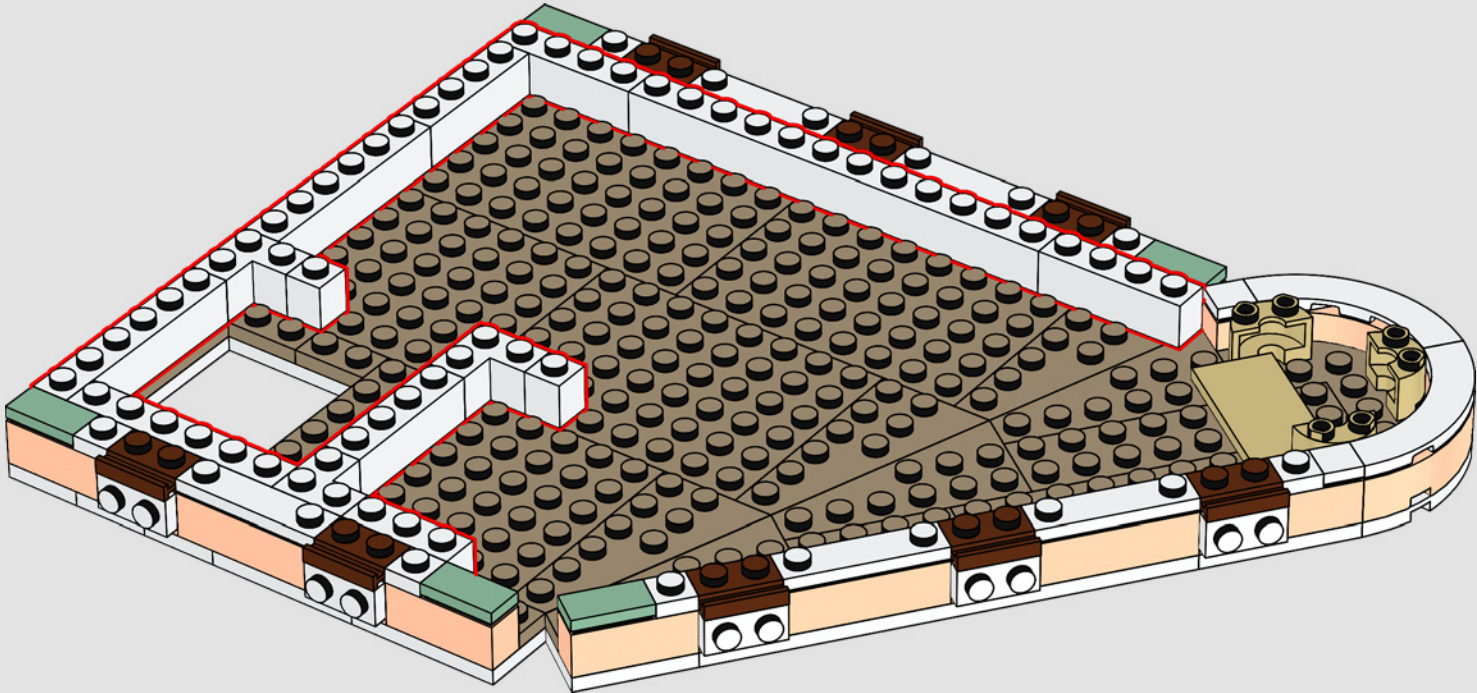



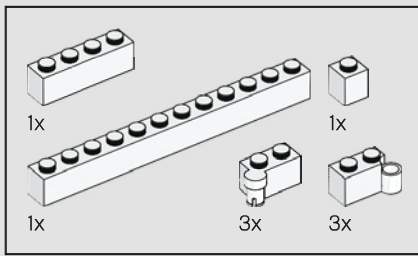

320

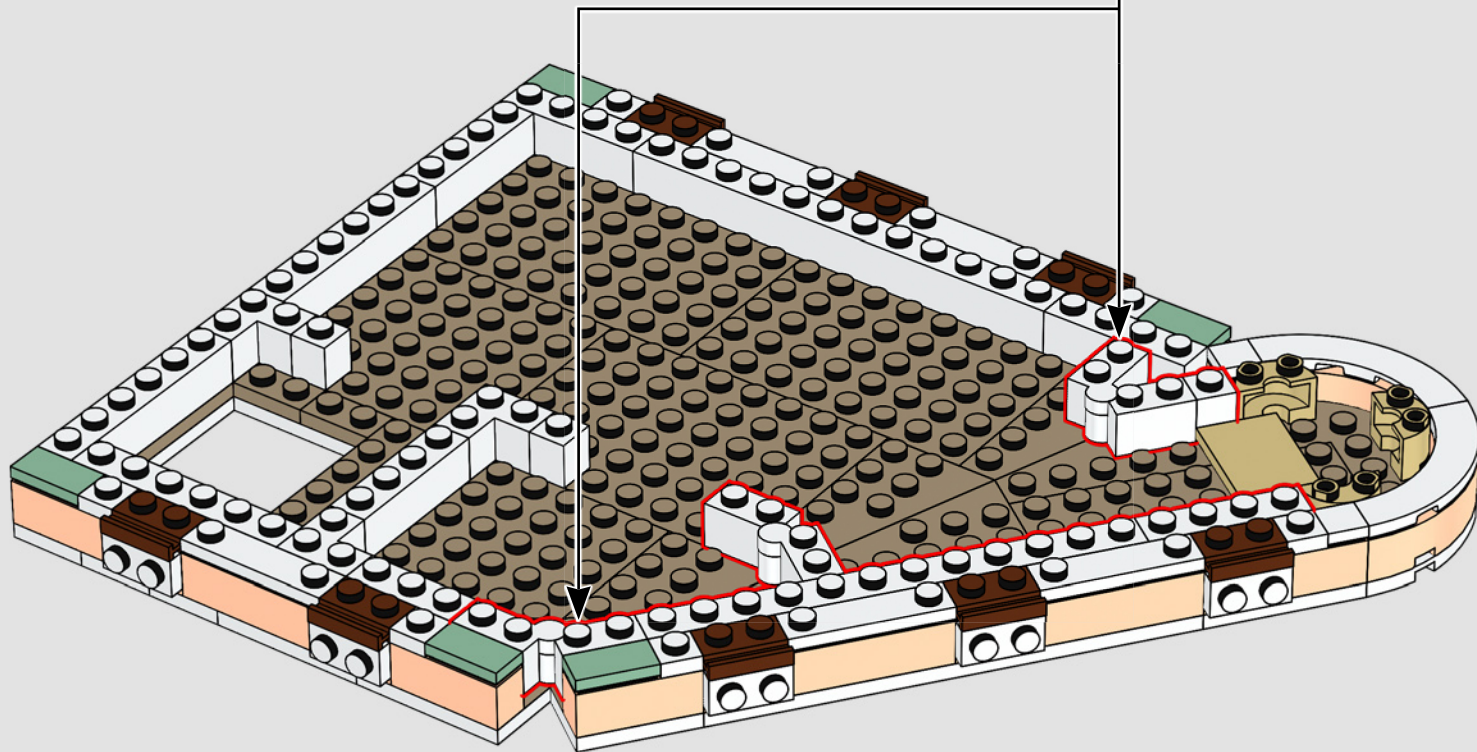
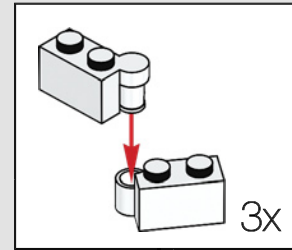

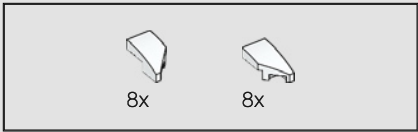

321

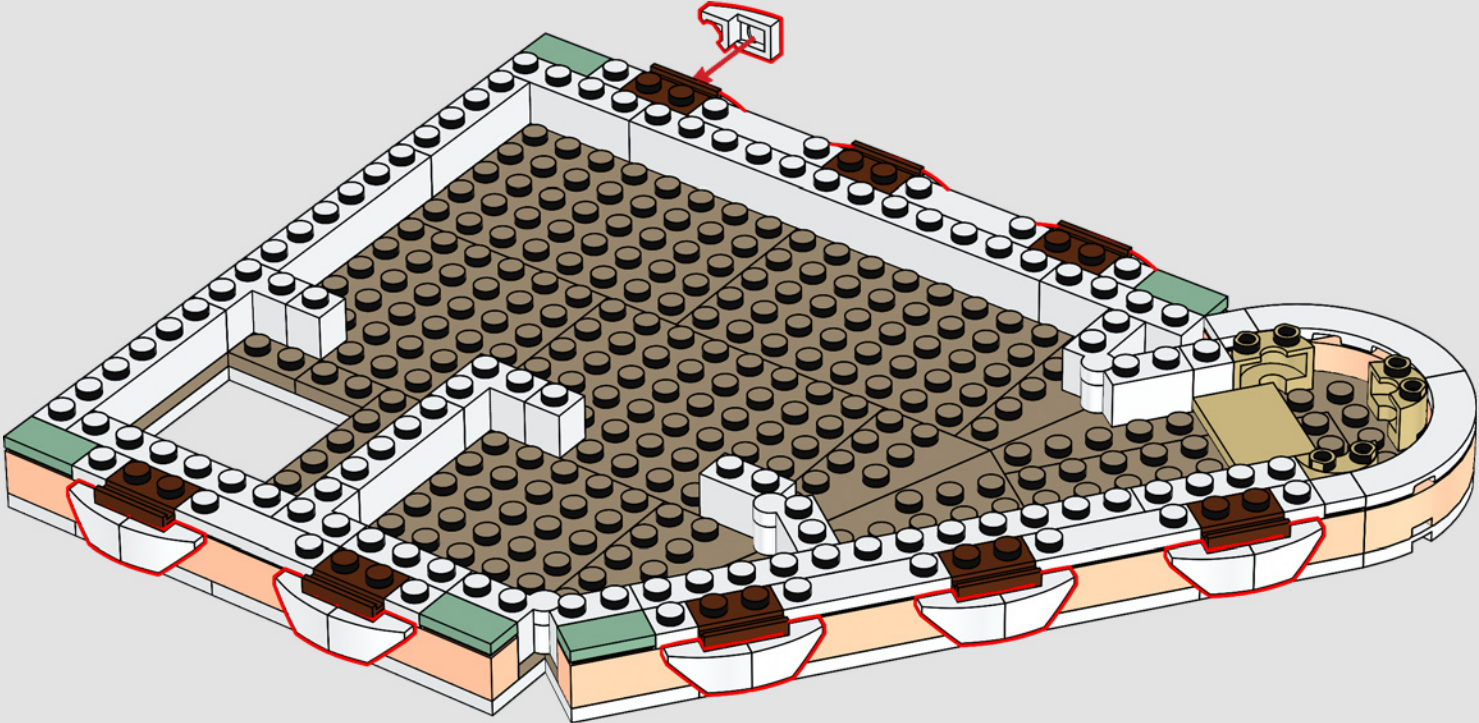



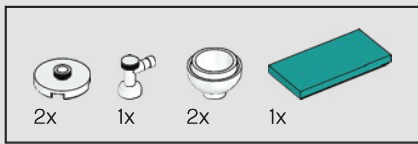

322

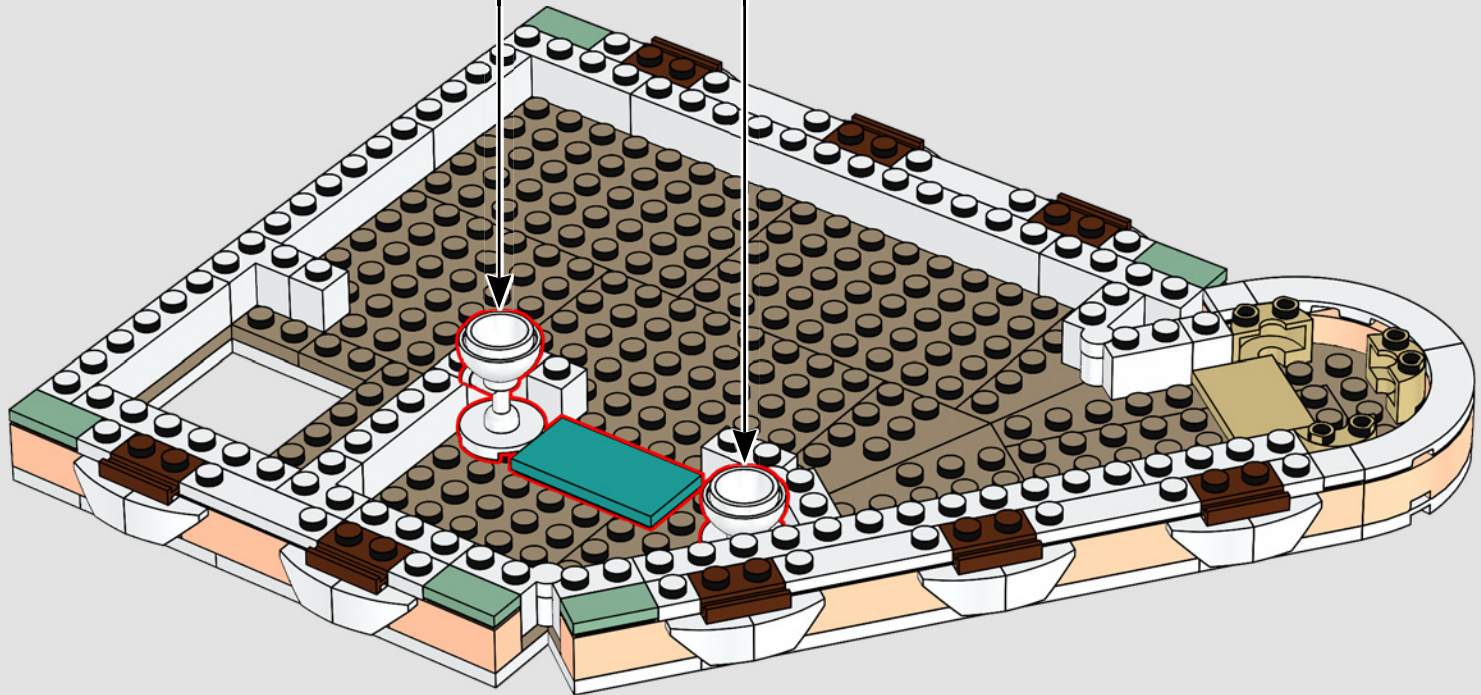
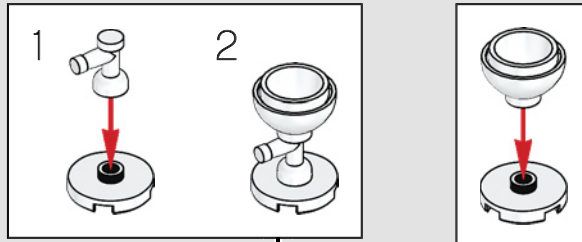

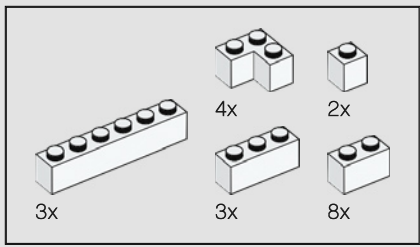

323

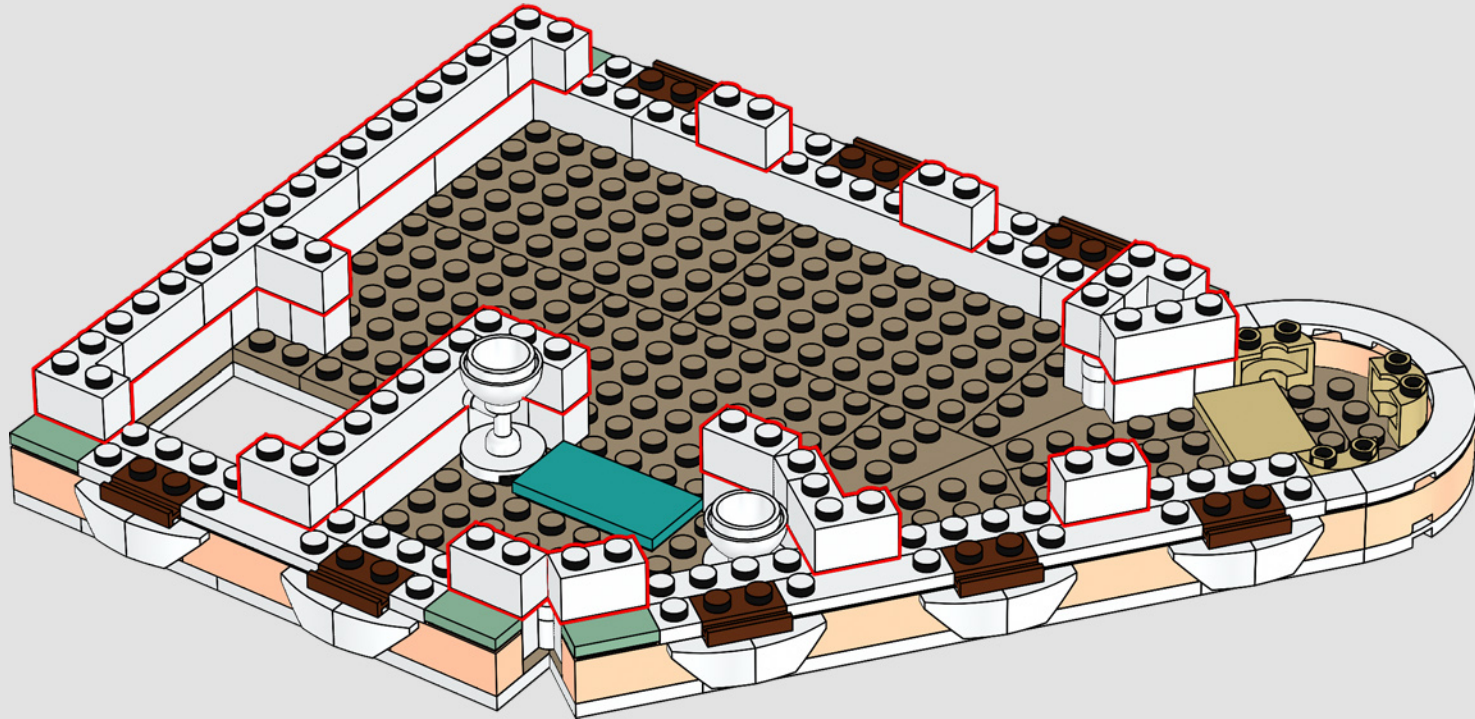



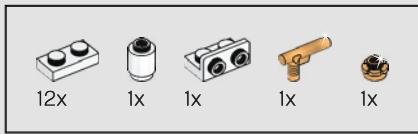

324

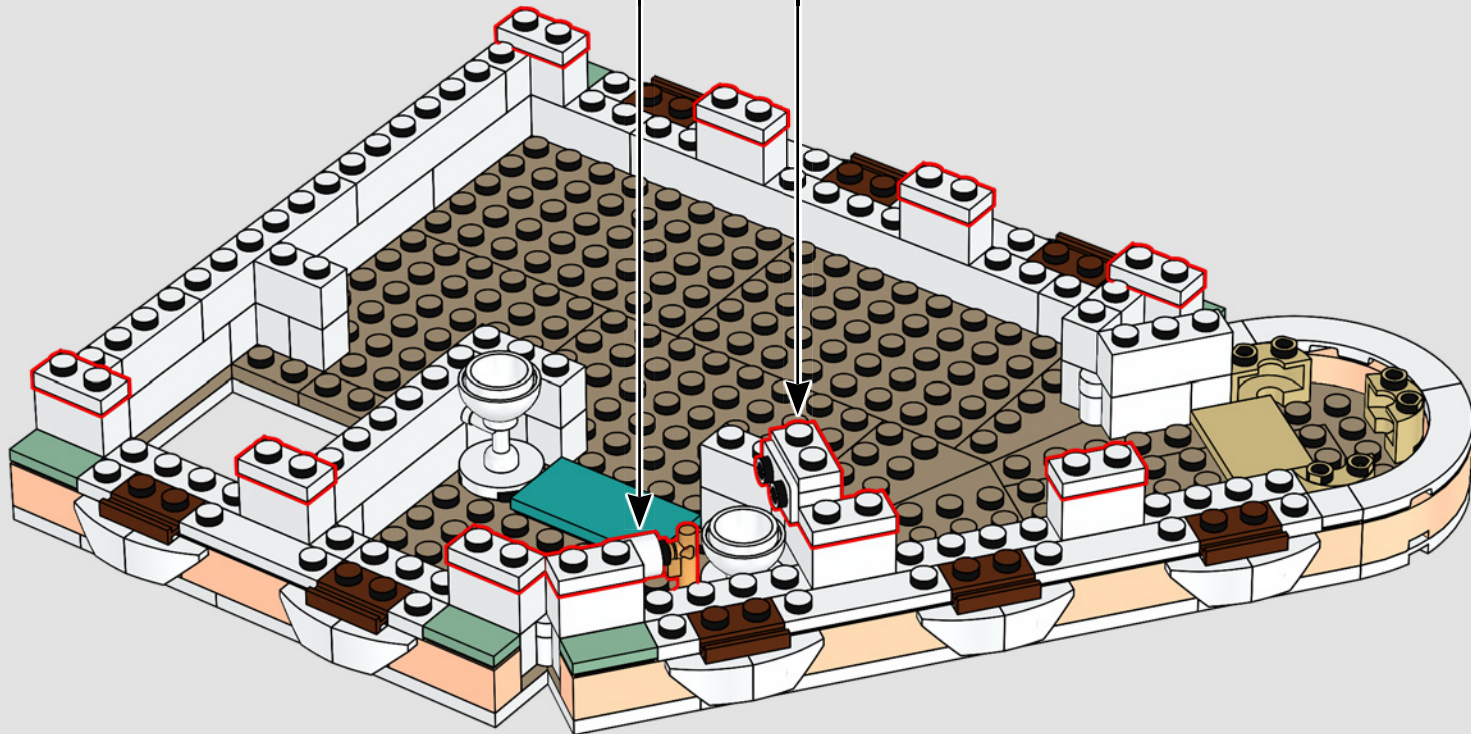
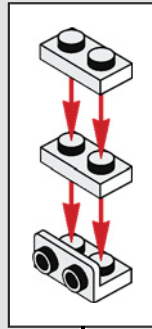
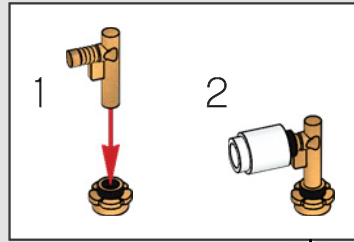

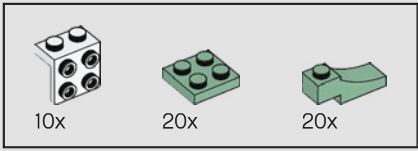

325

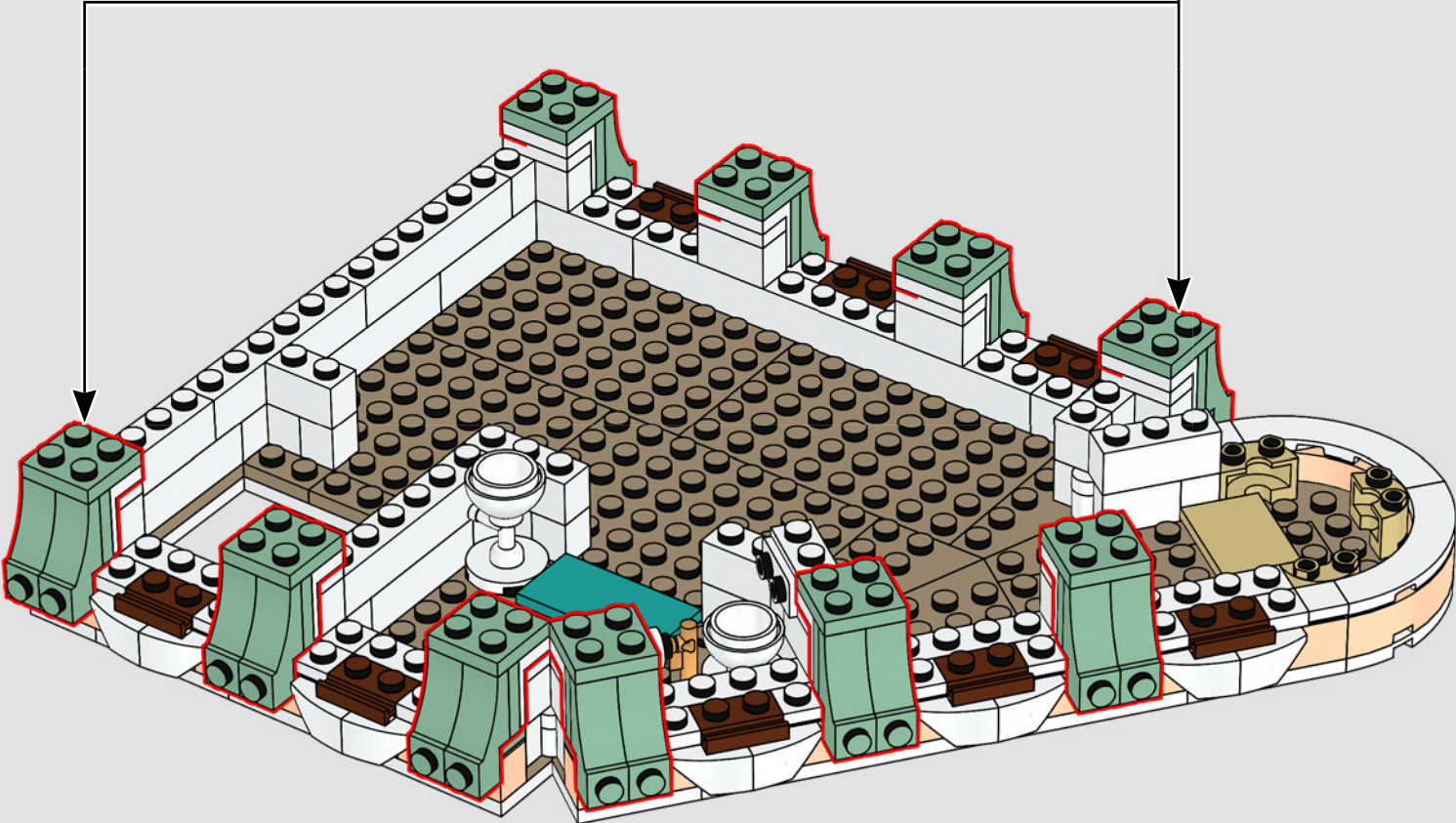
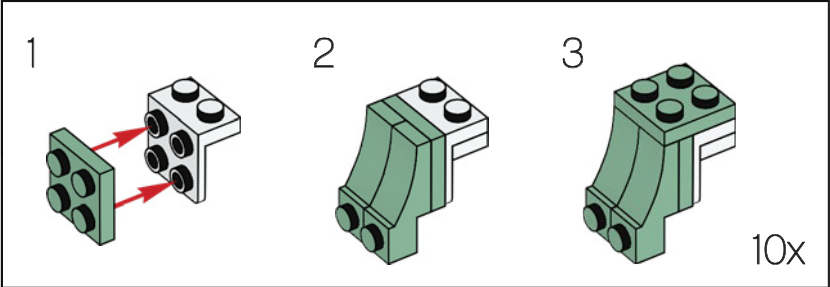



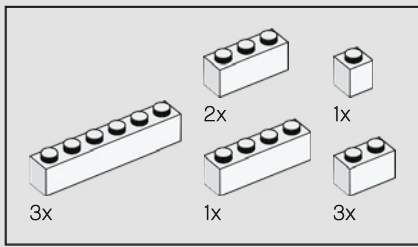

326

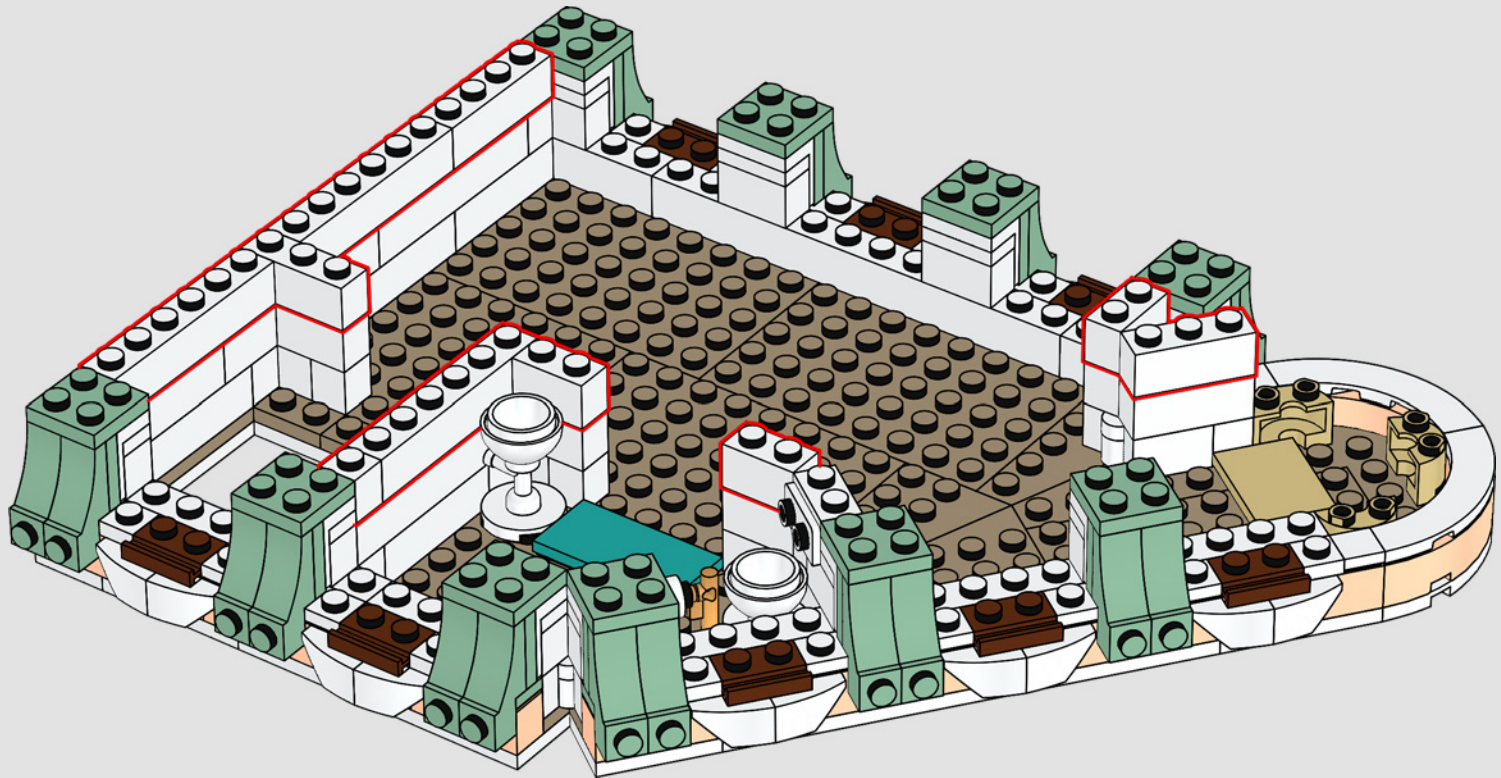

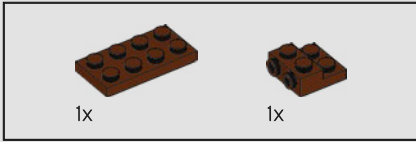

327

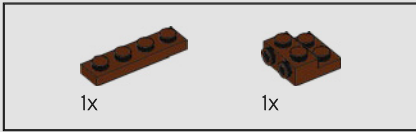
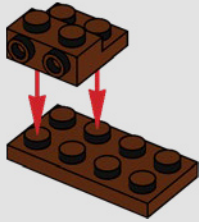

328

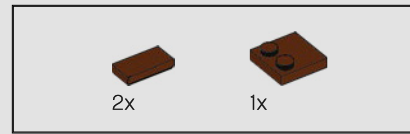
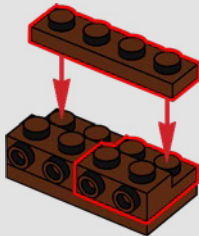

329

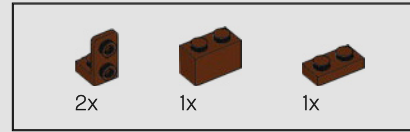
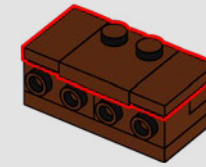

330

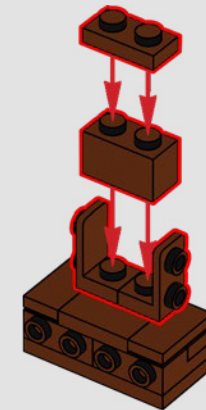



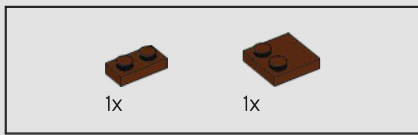

331

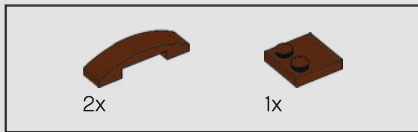
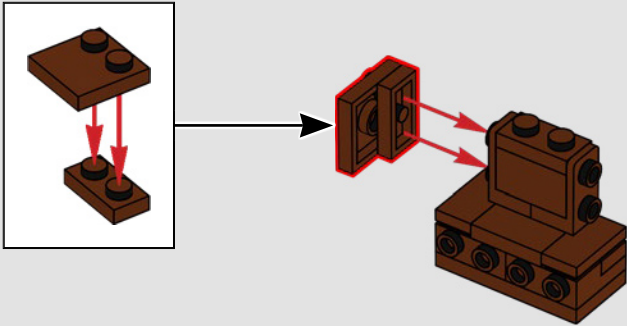

332

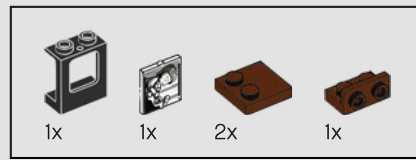
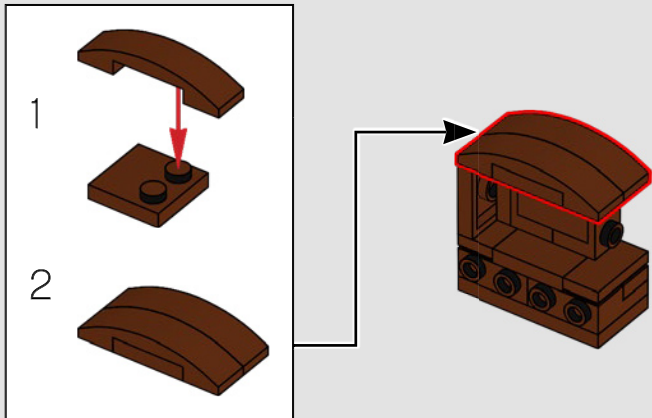

333

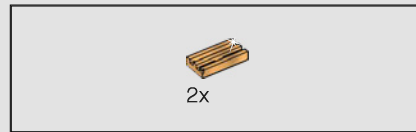
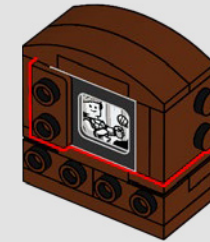
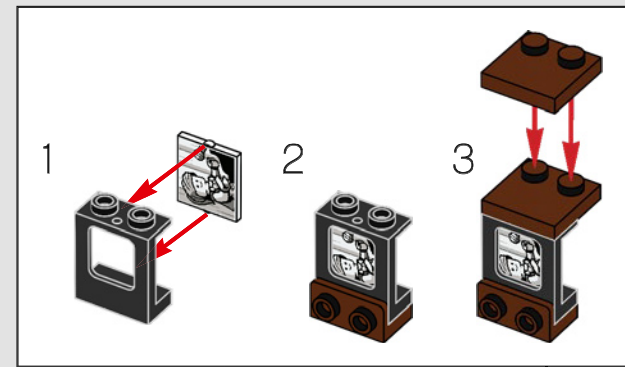

334



335

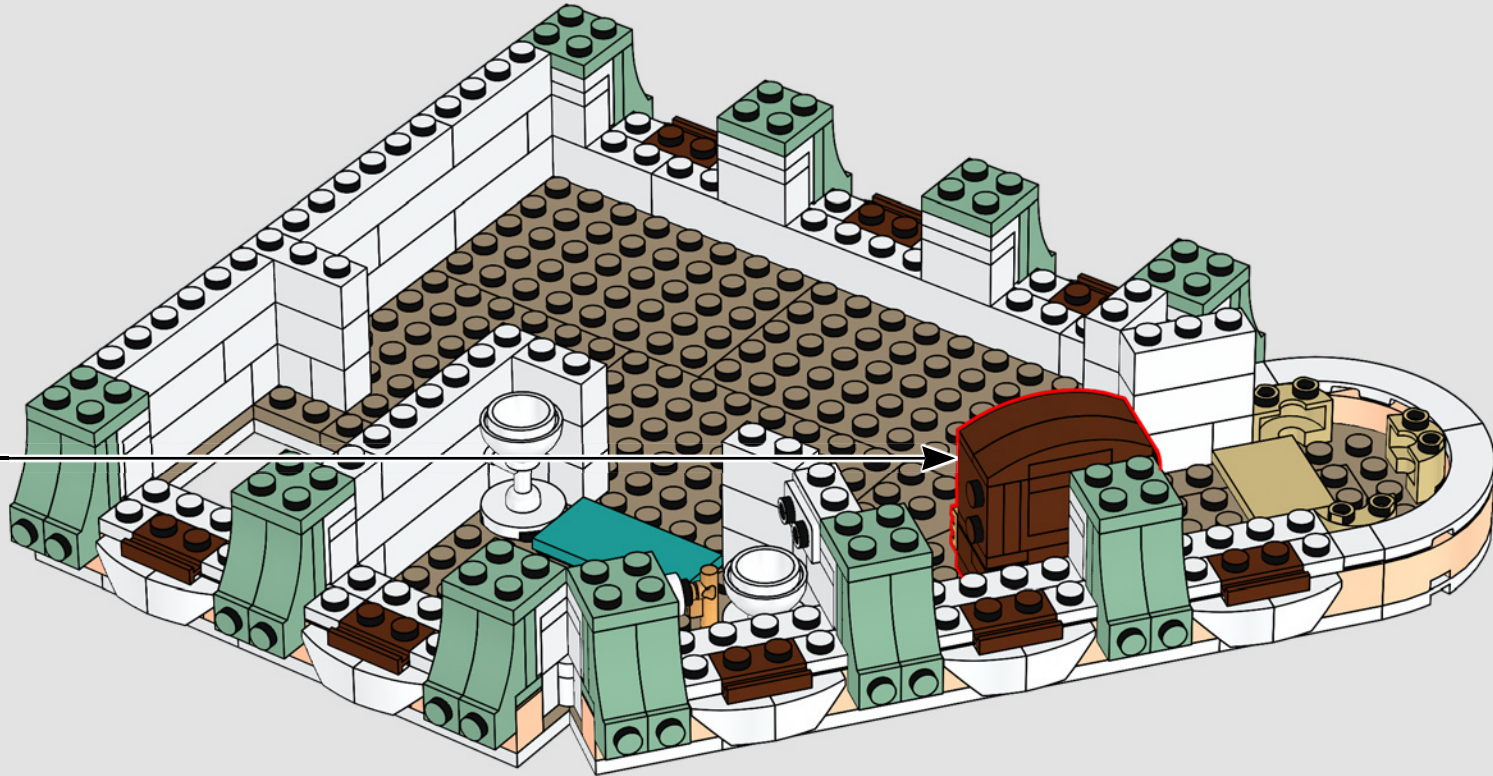





La trotamundos ha recorrido todo el planeta,  
pero adora regresar al Hotel Boutique para  
disfrutar de una relajante estancia.

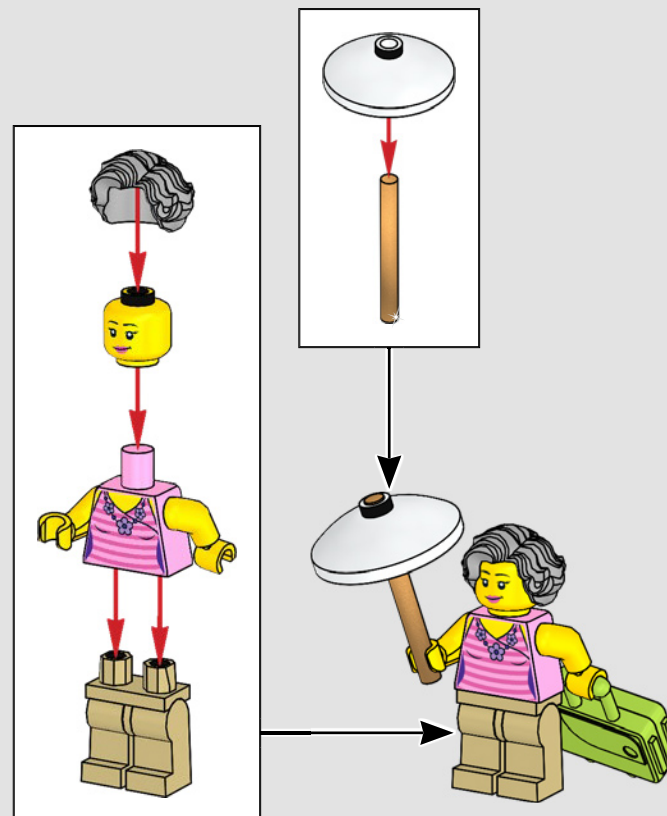
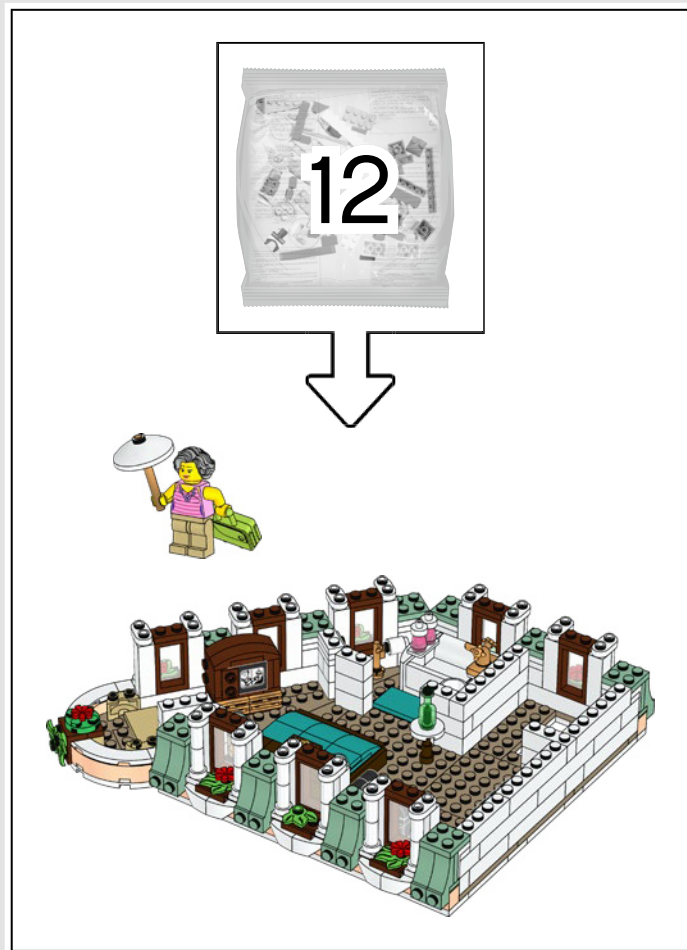

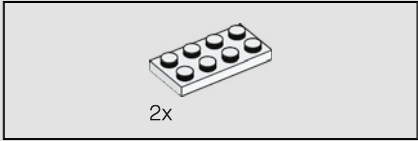
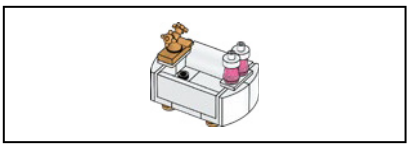

2x

336

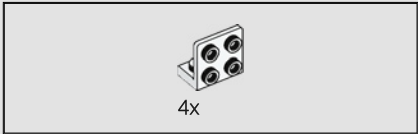
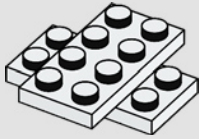

4x

337

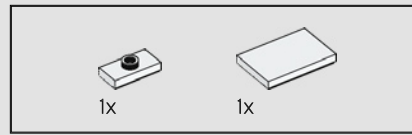
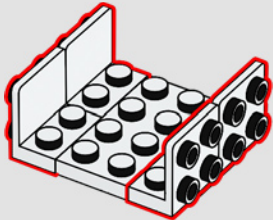

1x

1x

338

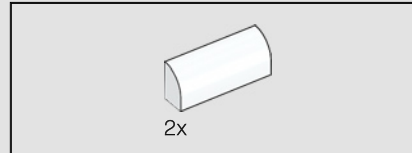
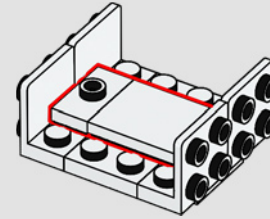

2x

339

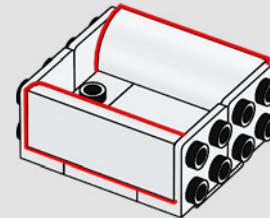



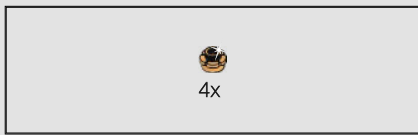

340

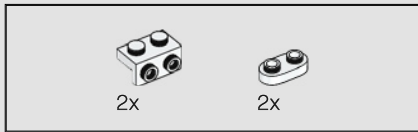
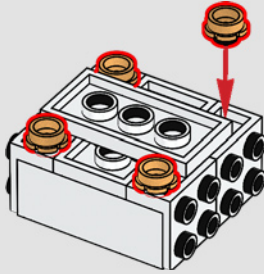

341

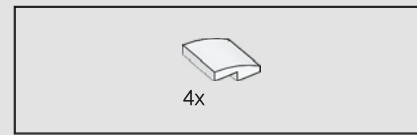
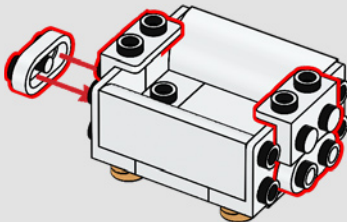

342

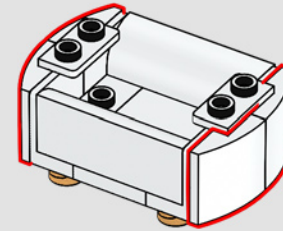

343

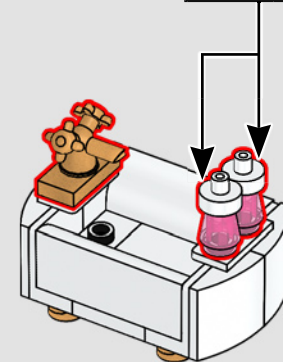
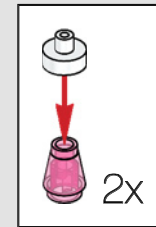

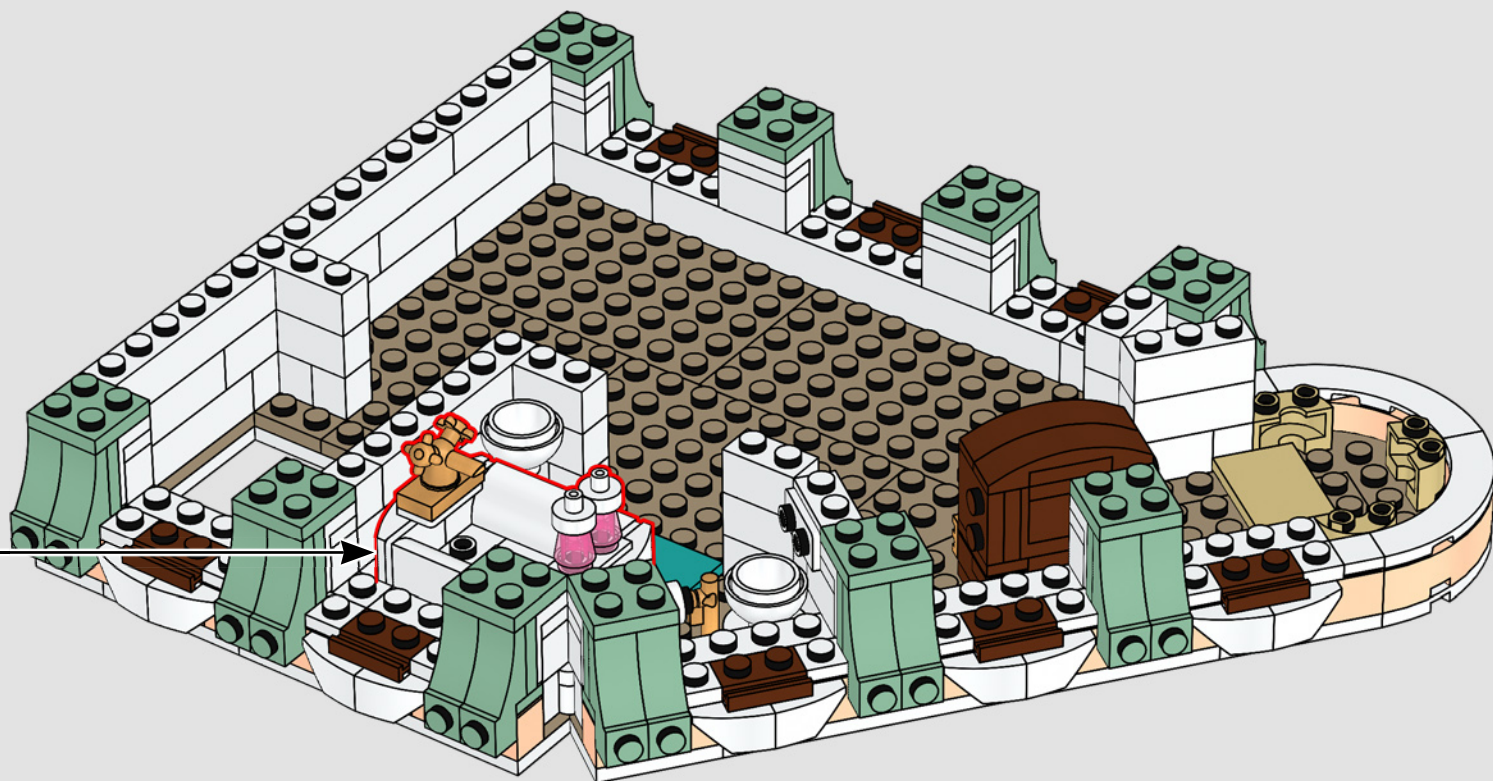



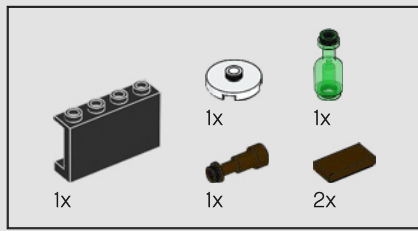

345

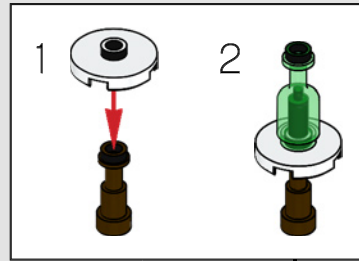

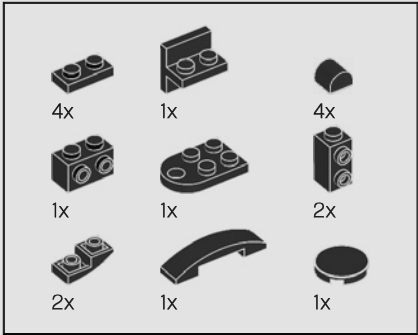

346

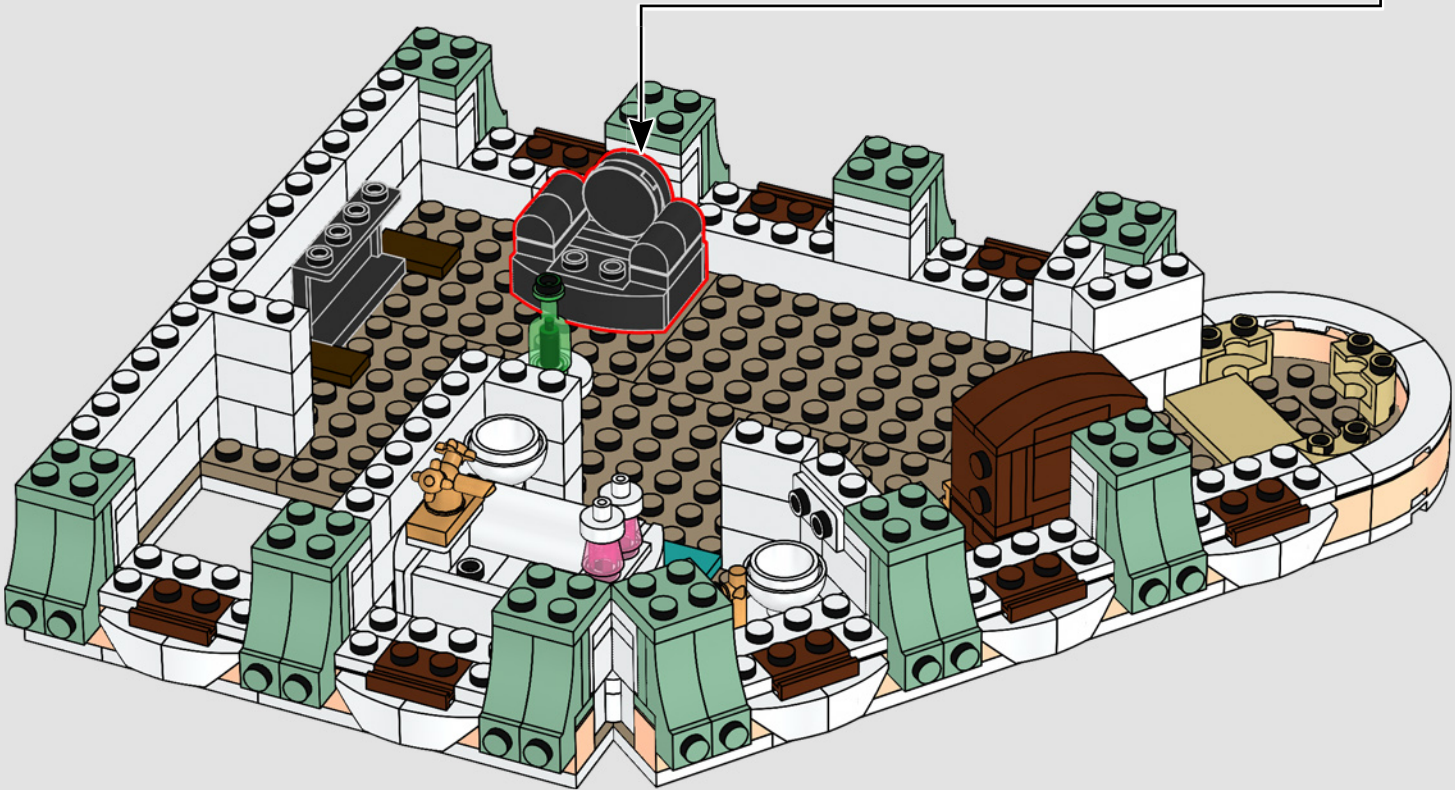
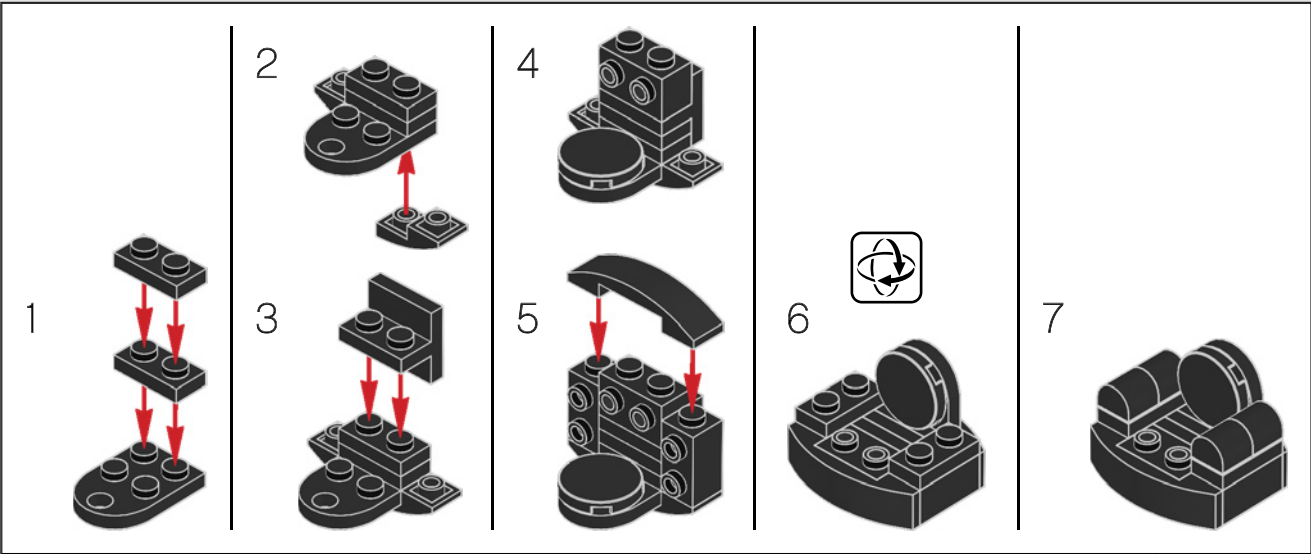





Esta pantalla de aquí es, en realidad, un elemento LEGO® Friends que se usa como pastelillo.

347

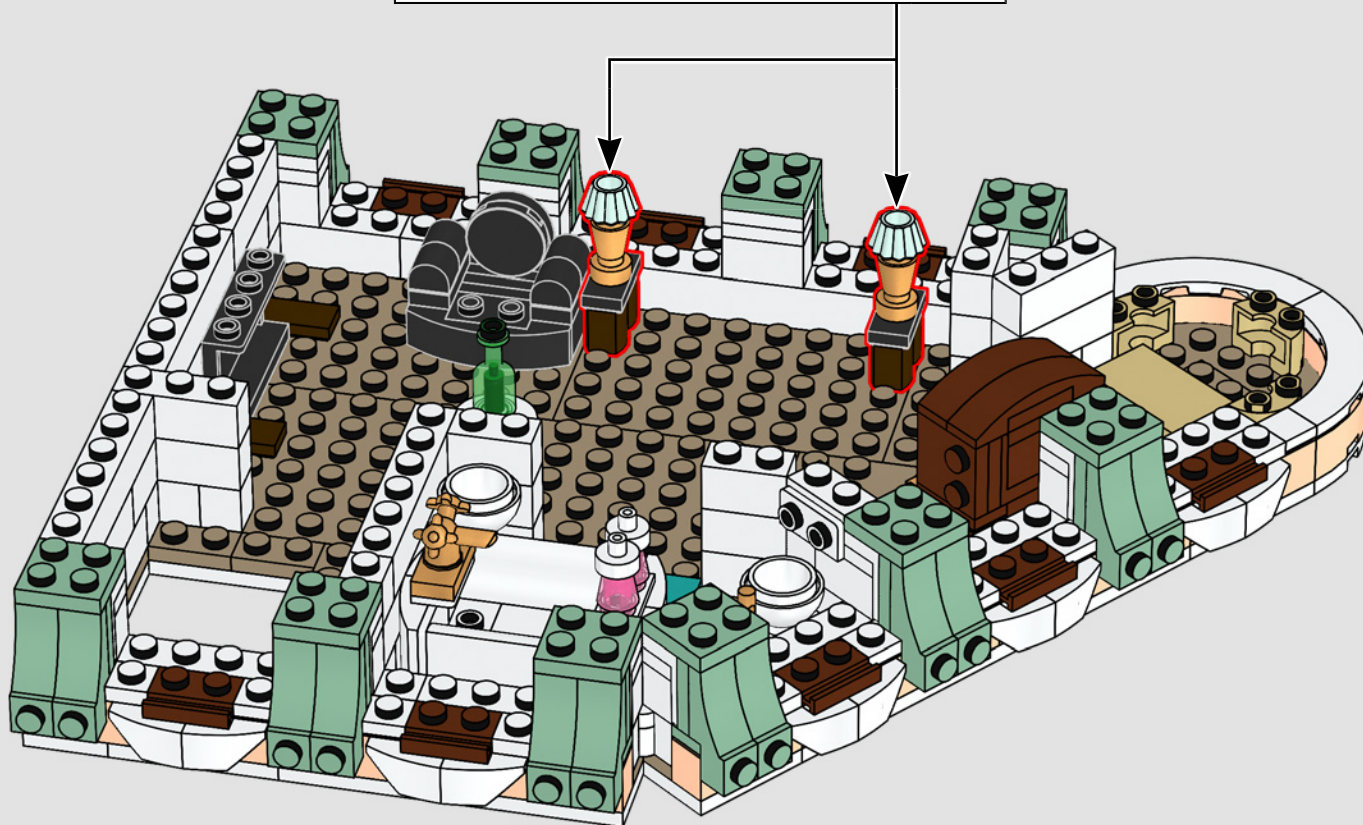
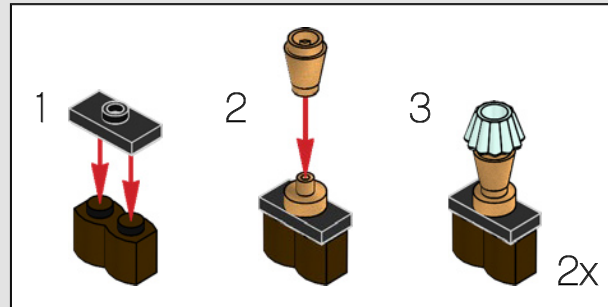

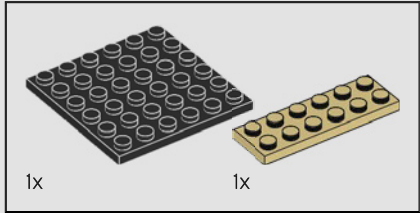
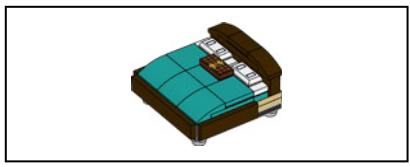

348

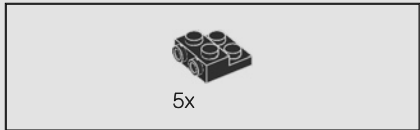
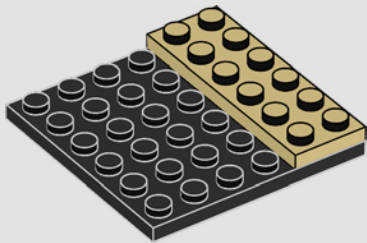

349

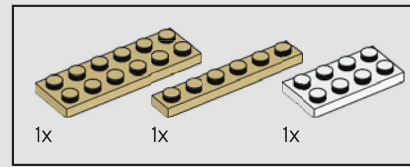
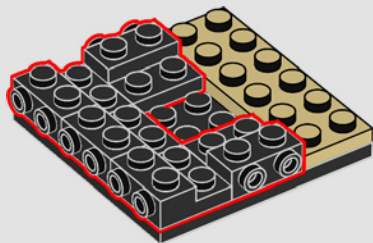

350

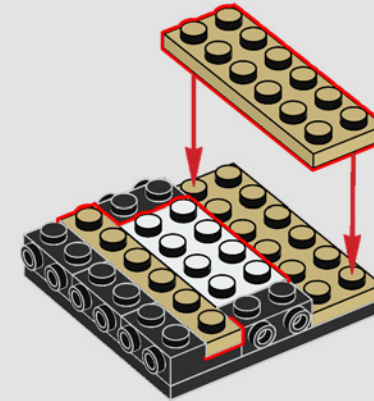

351

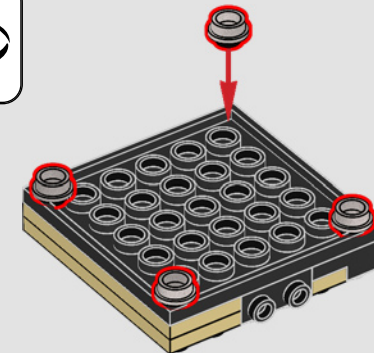
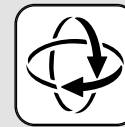



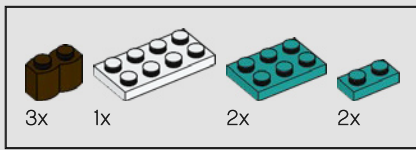

352

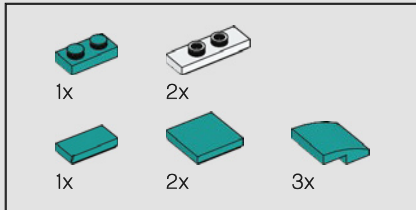
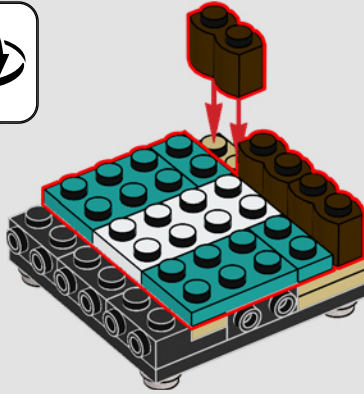

353

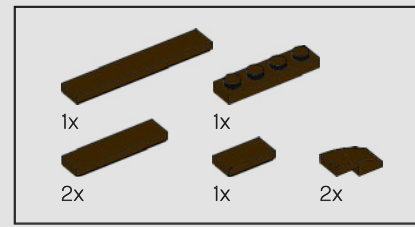
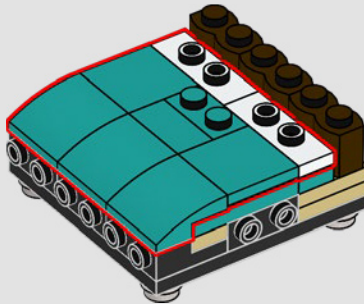

354

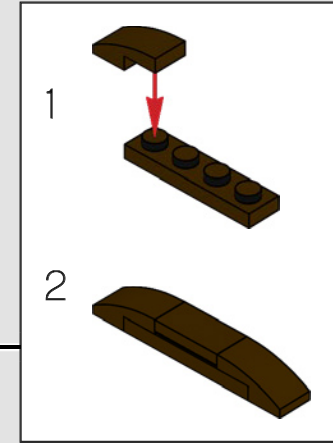
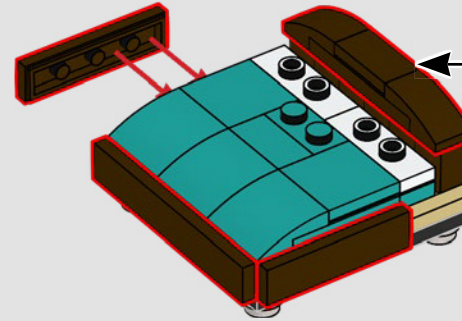

355

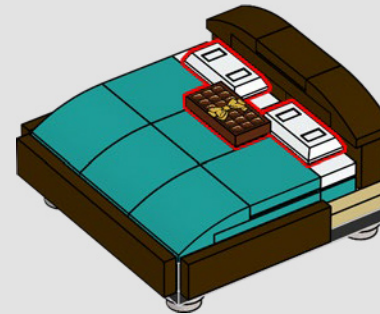

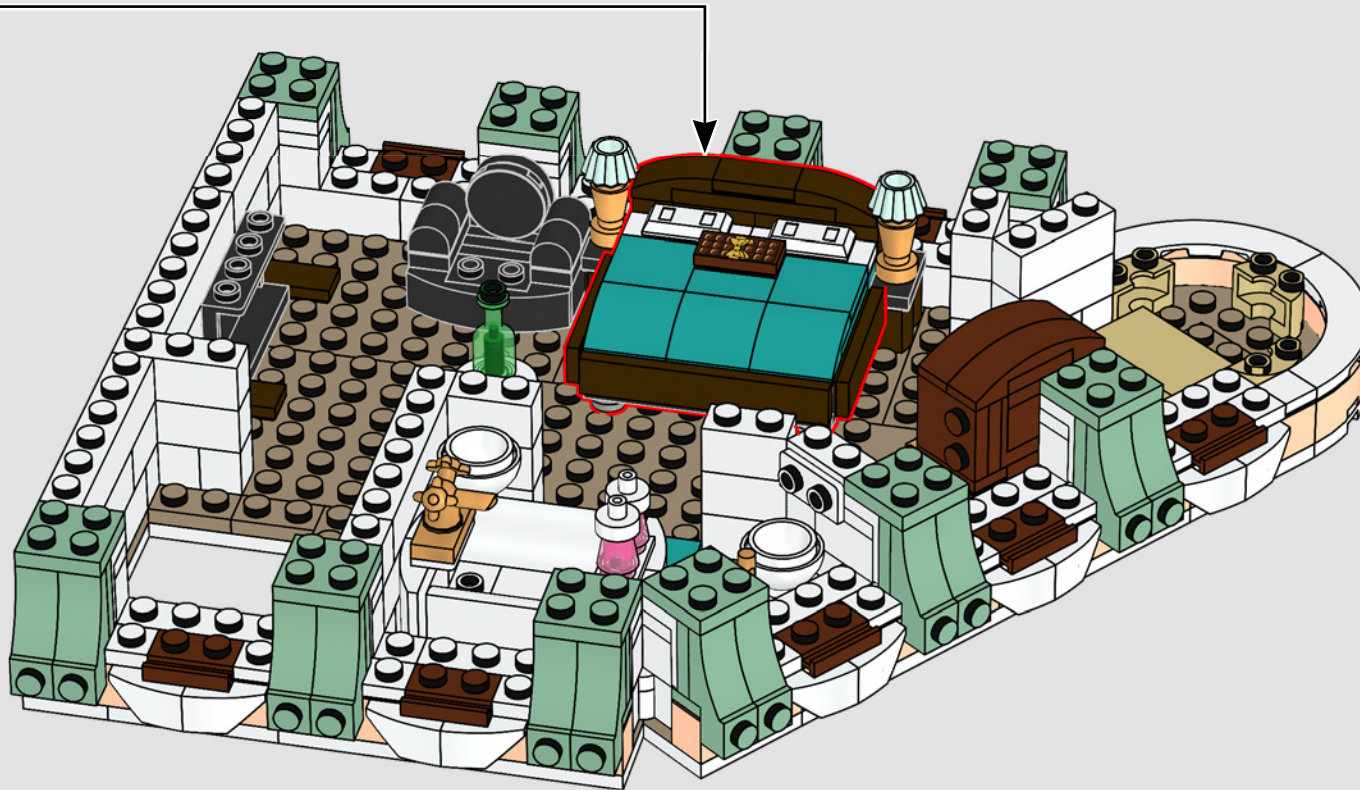



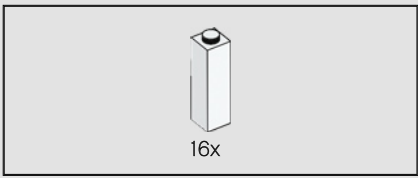

357

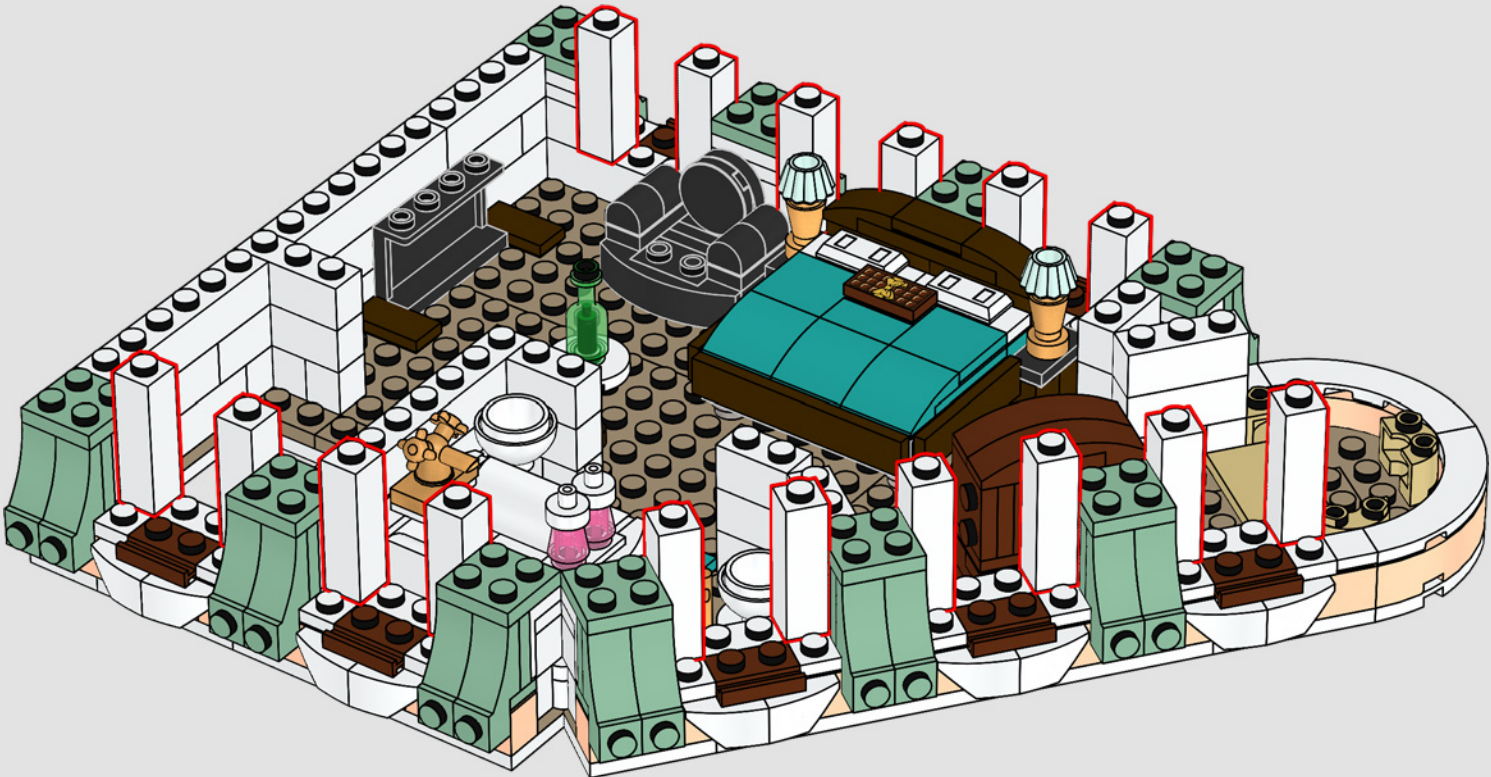

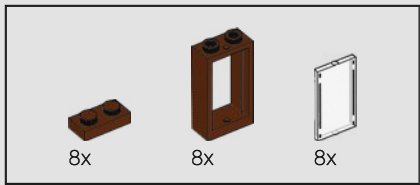

358

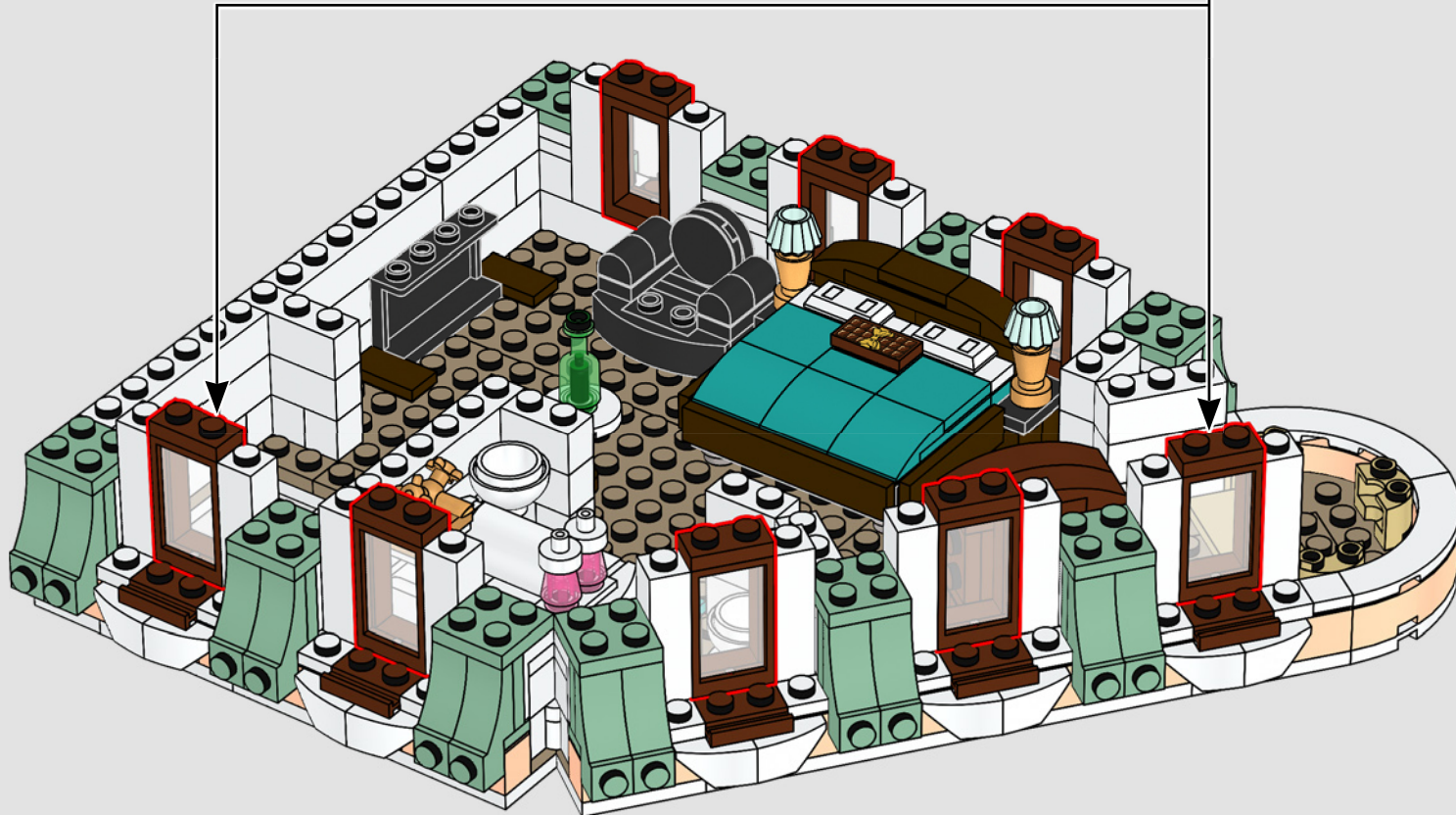
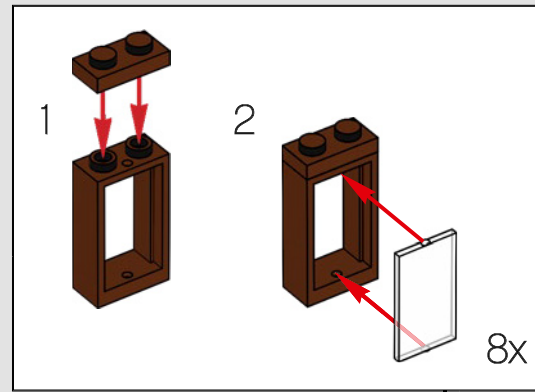



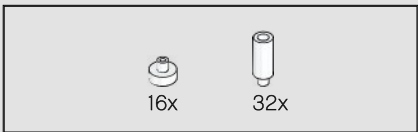

359

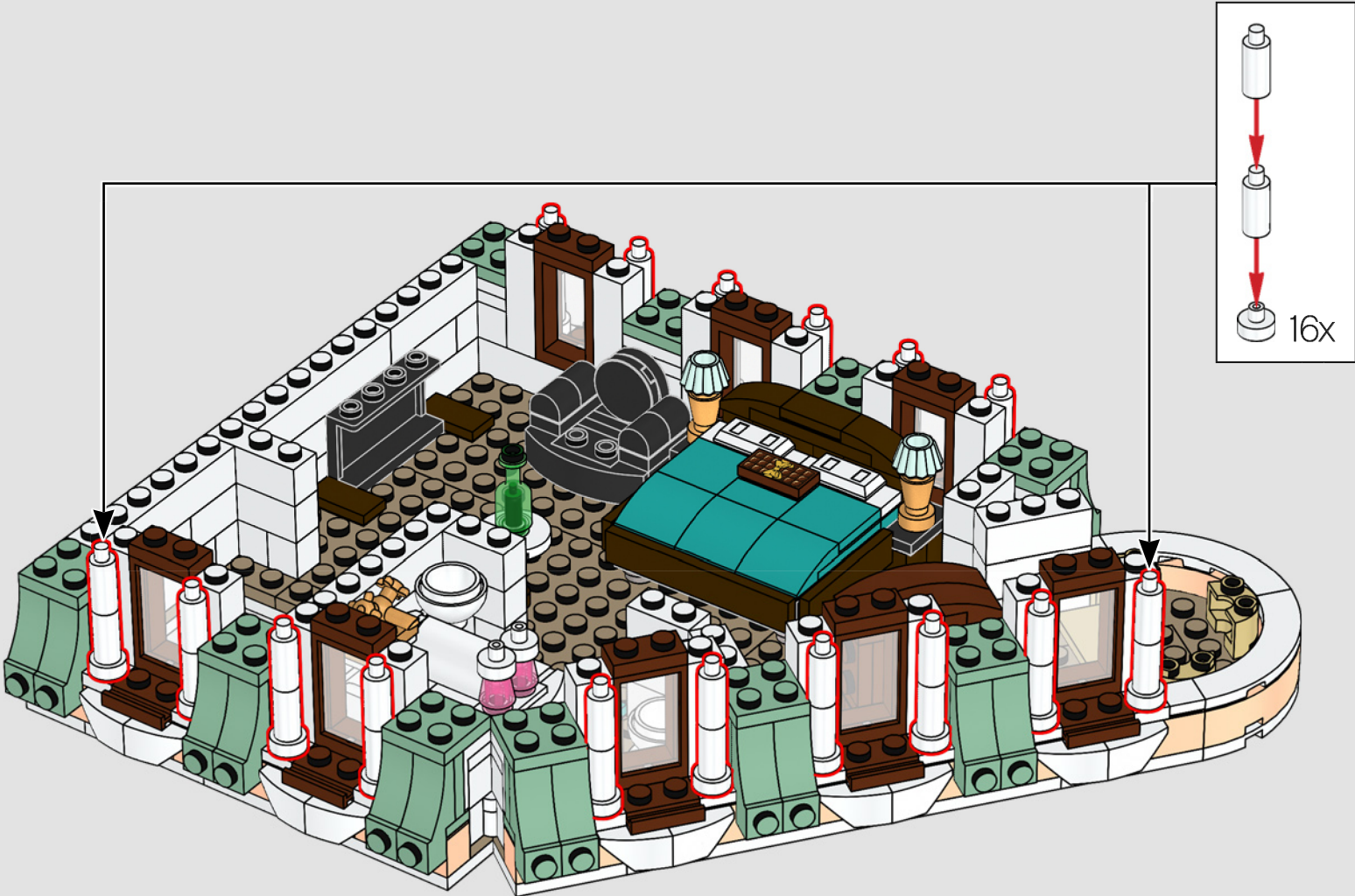



16x

360

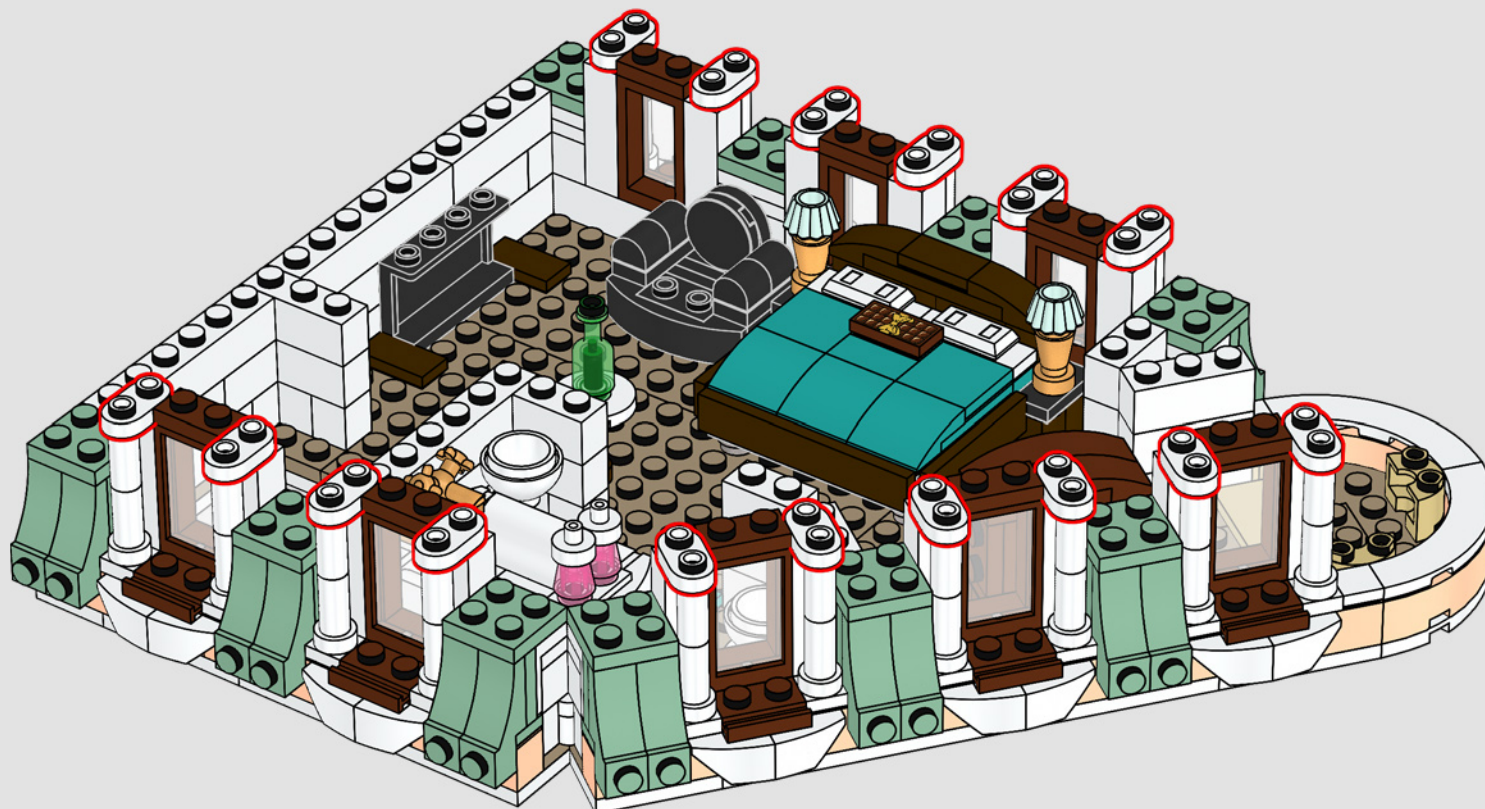



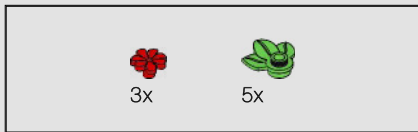

361

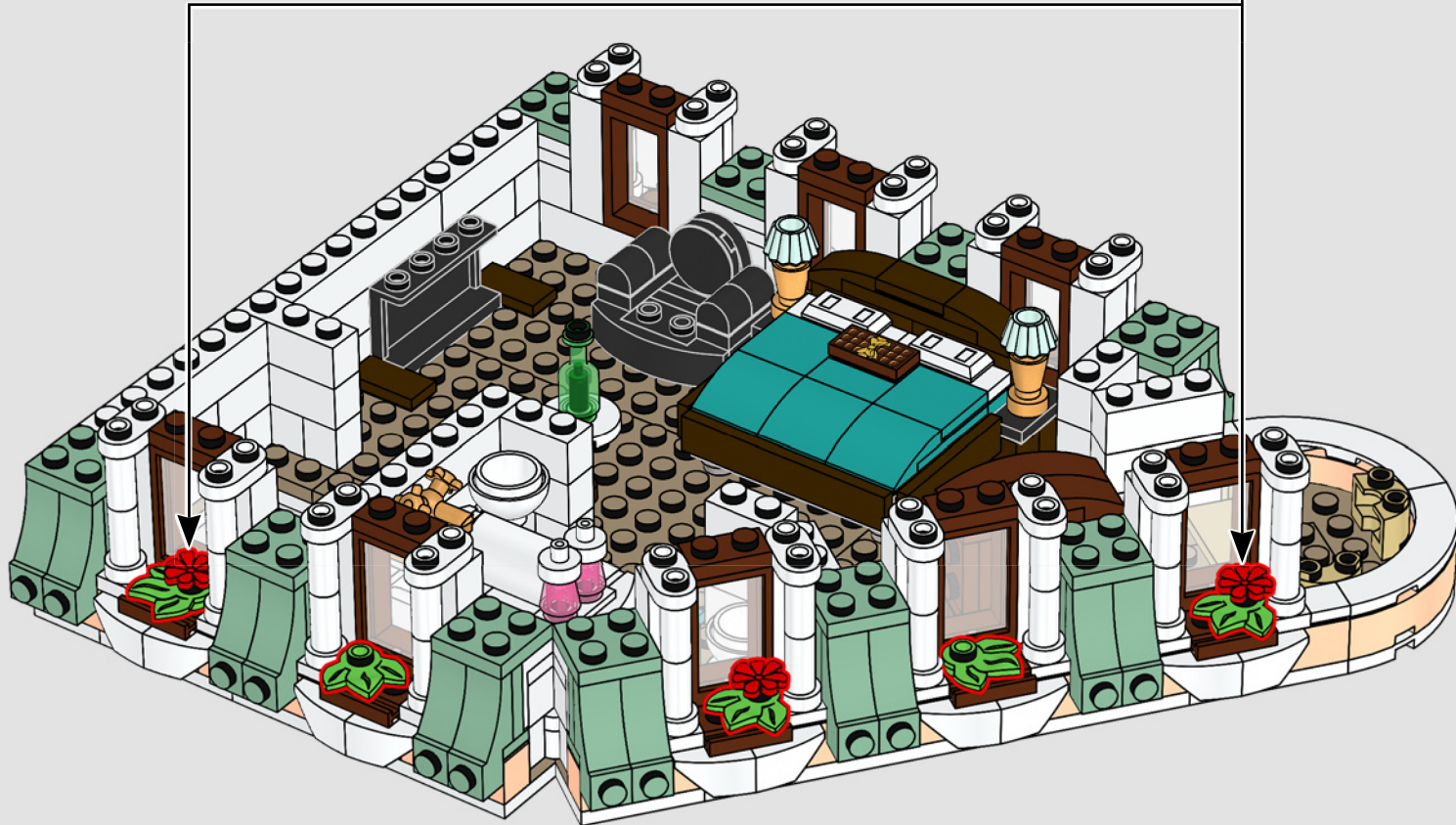
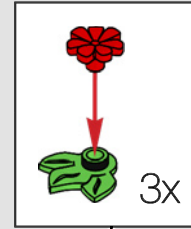

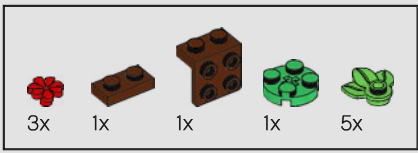

362

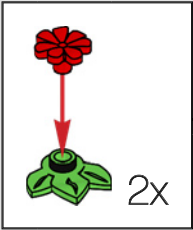
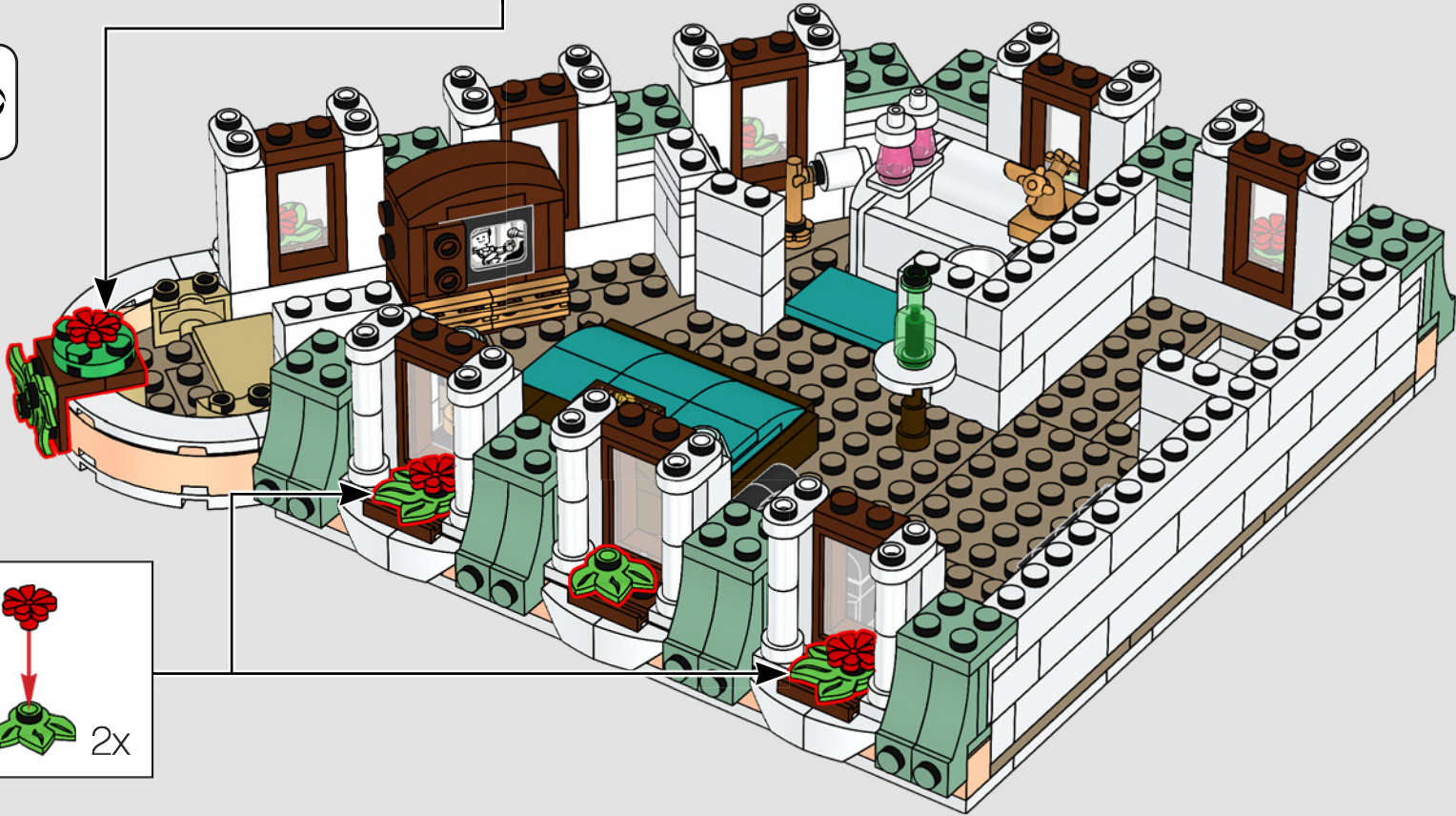
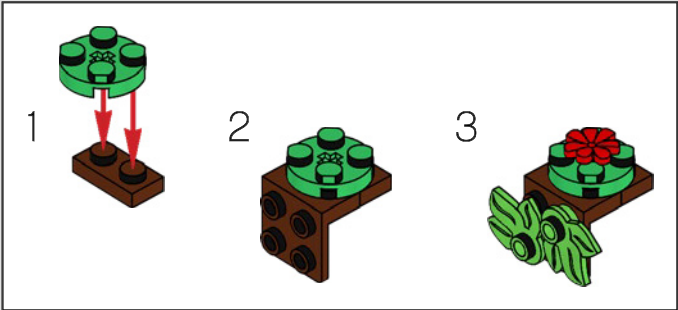



13

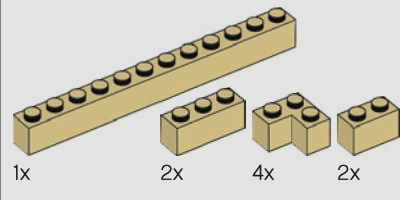
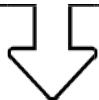

363

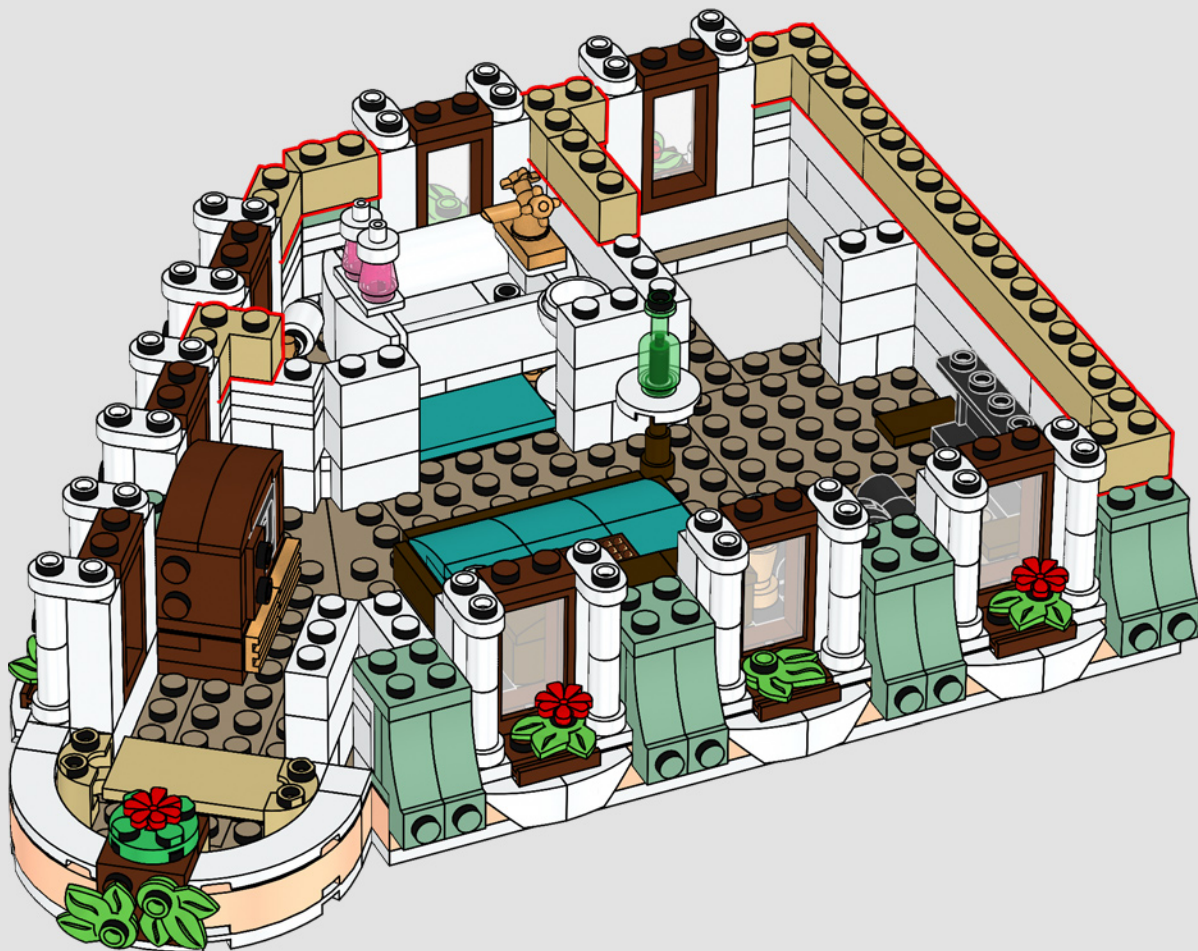

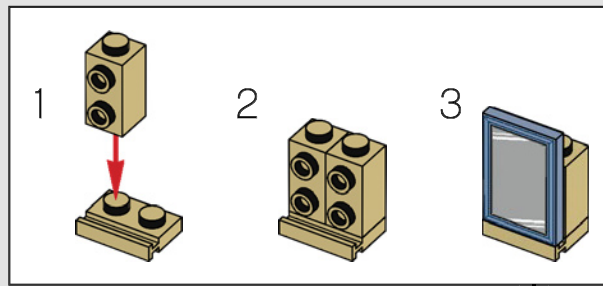
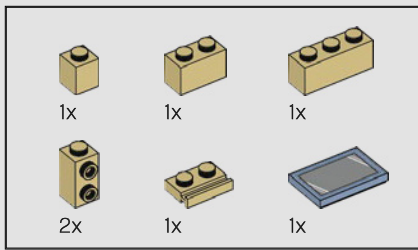

364

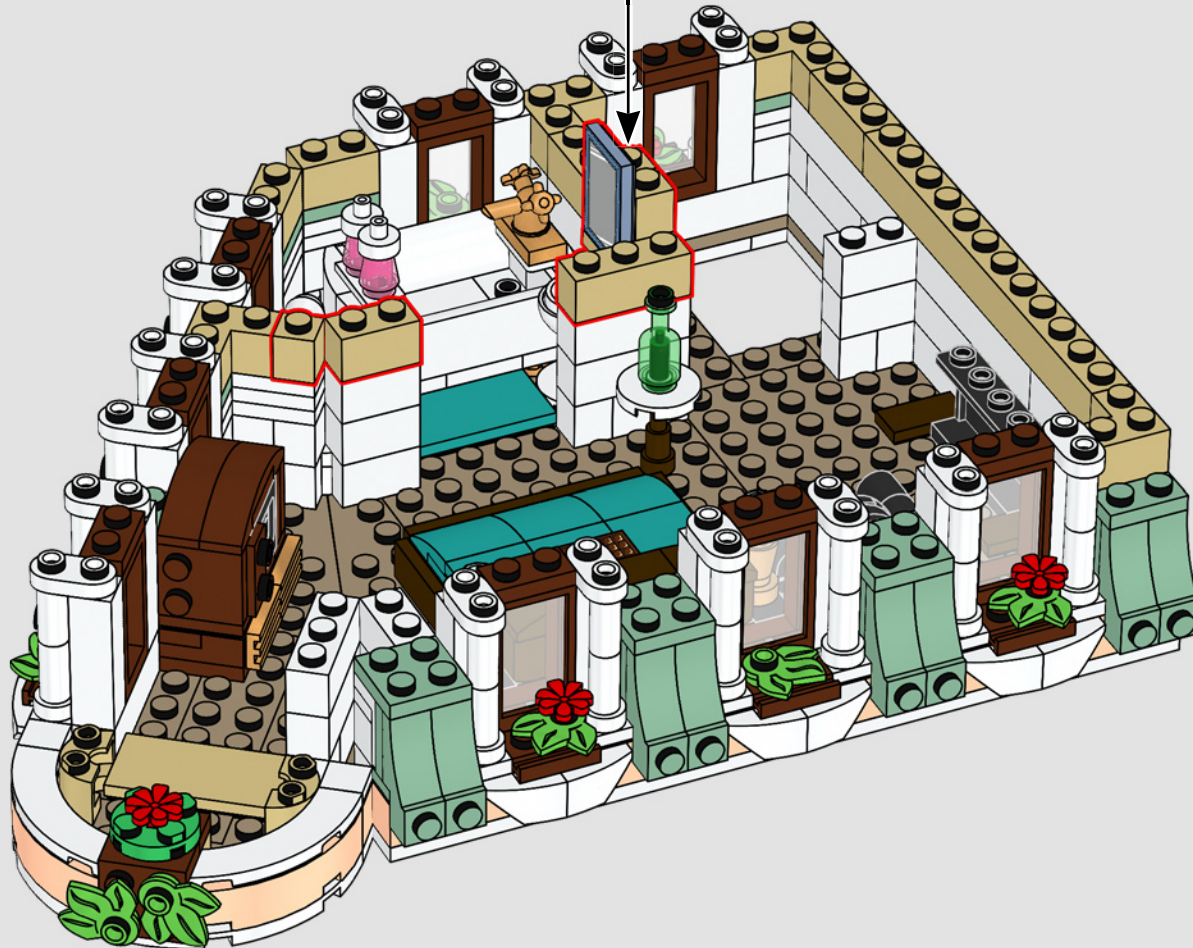



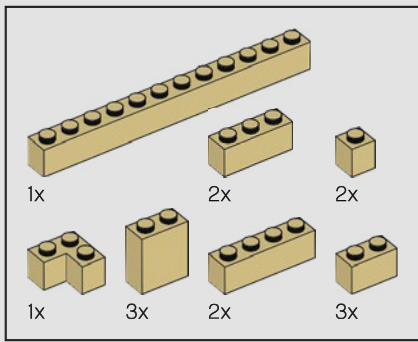

365



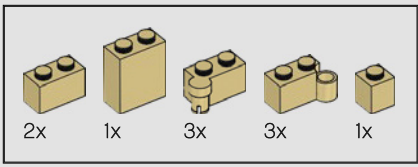

366

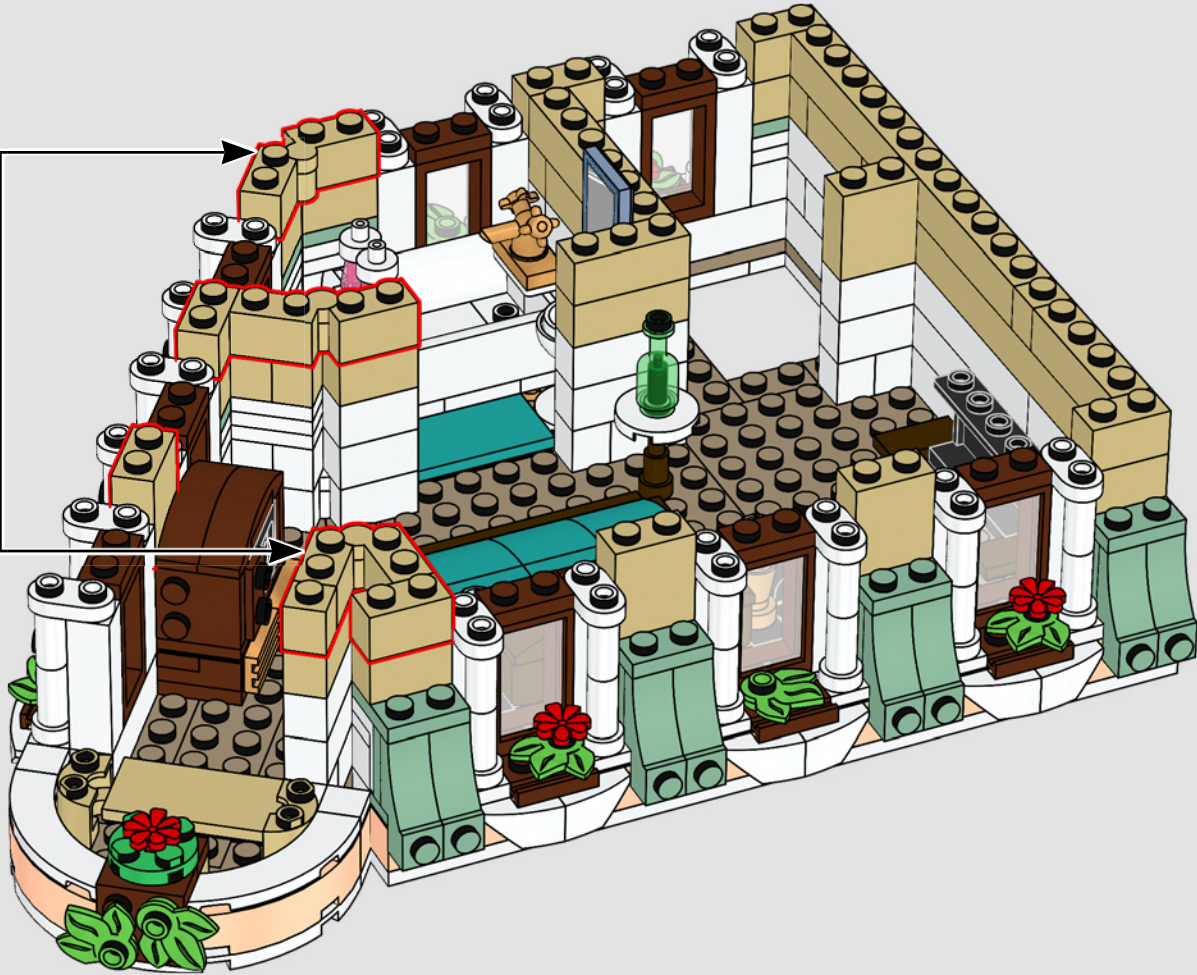
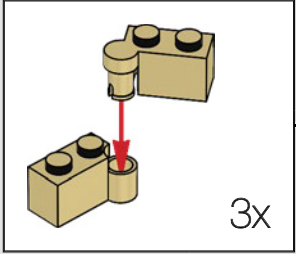



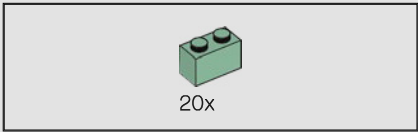

367

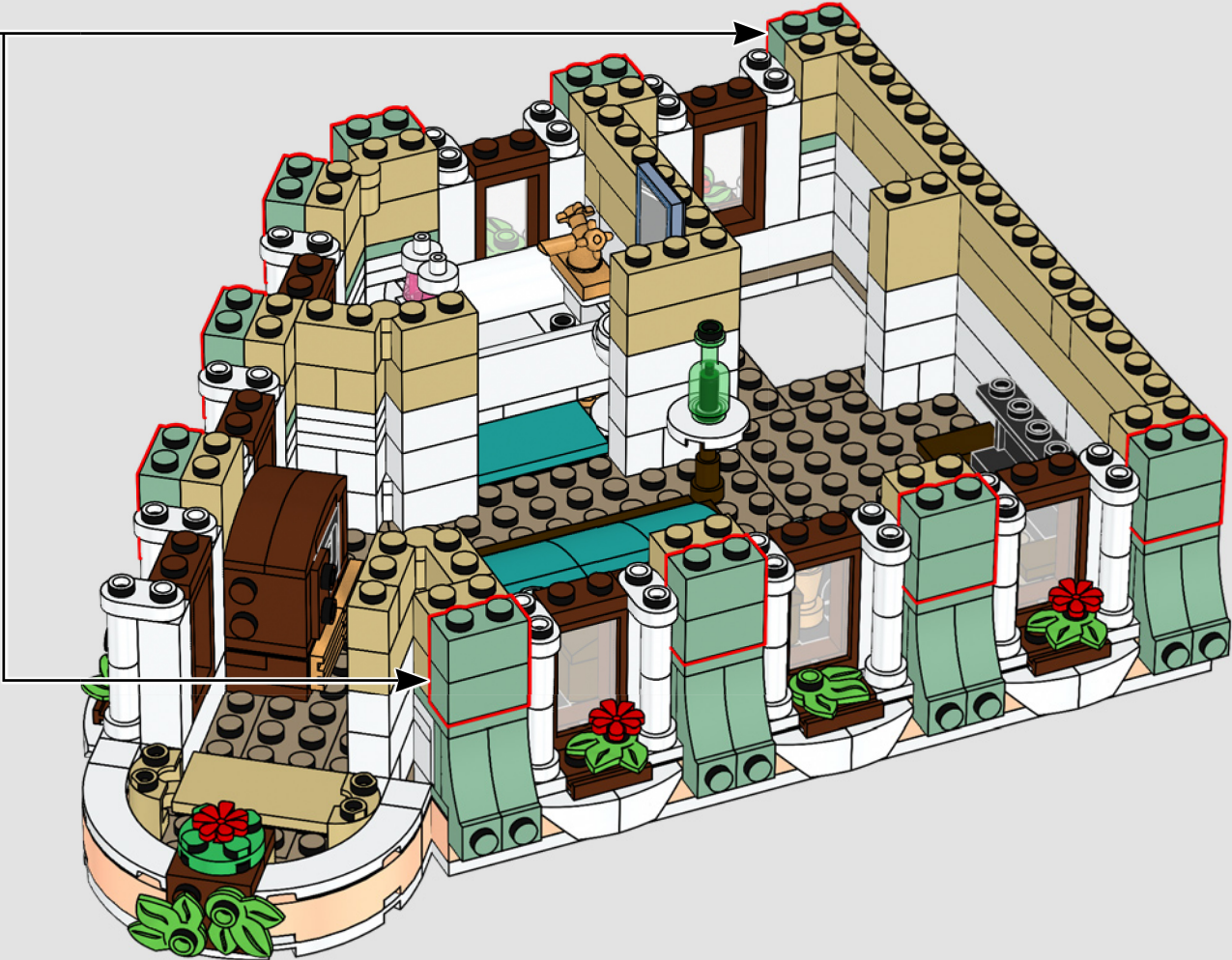
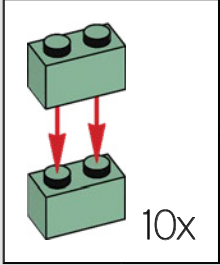

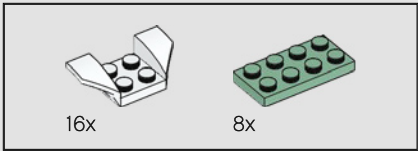

368

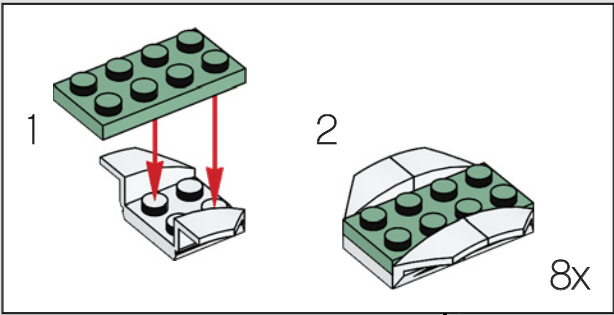



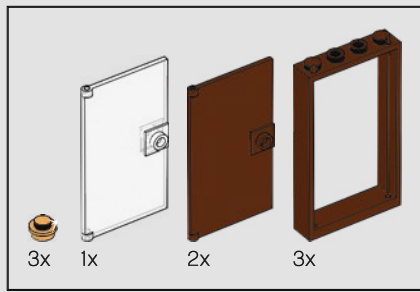

369

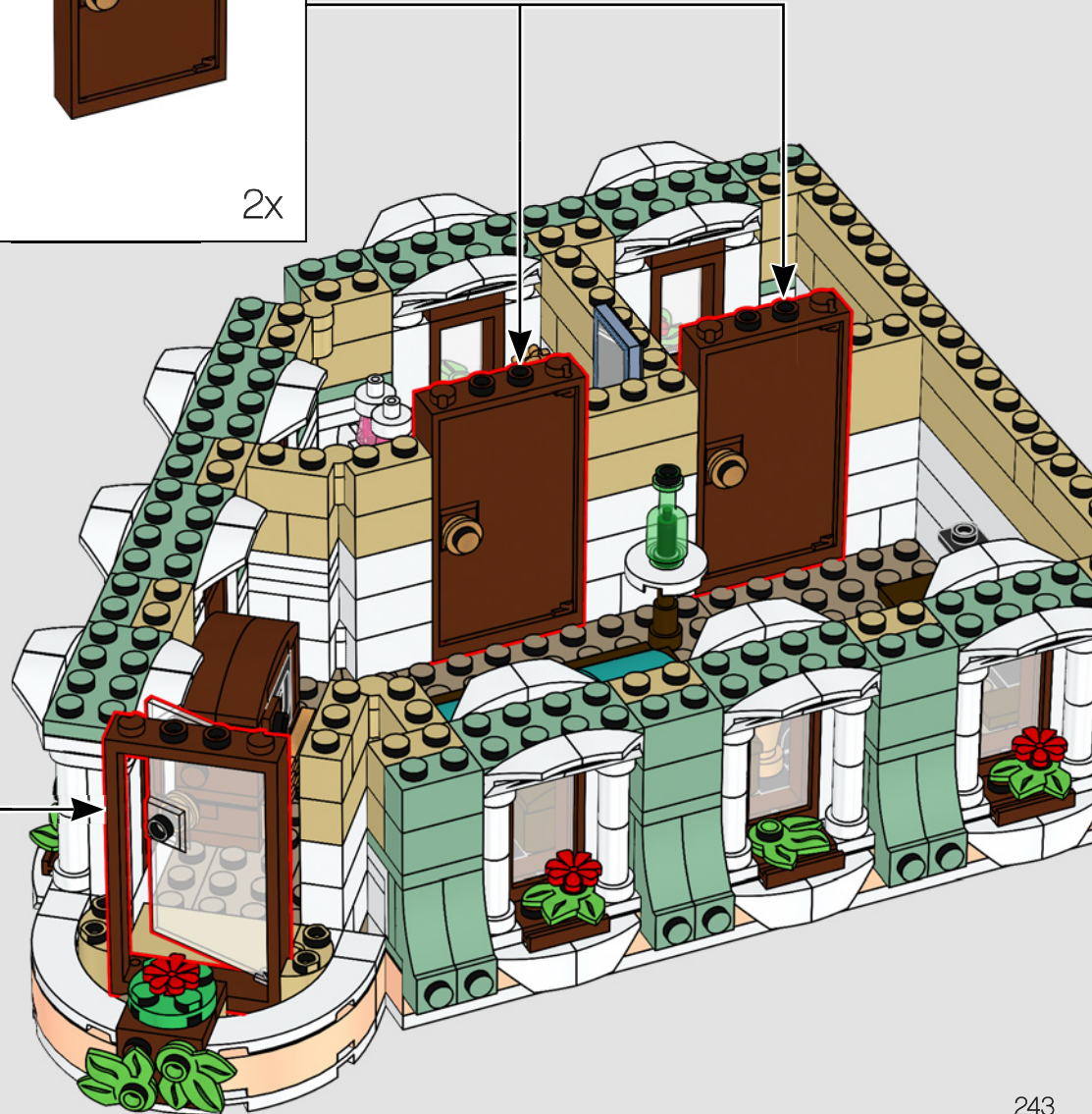
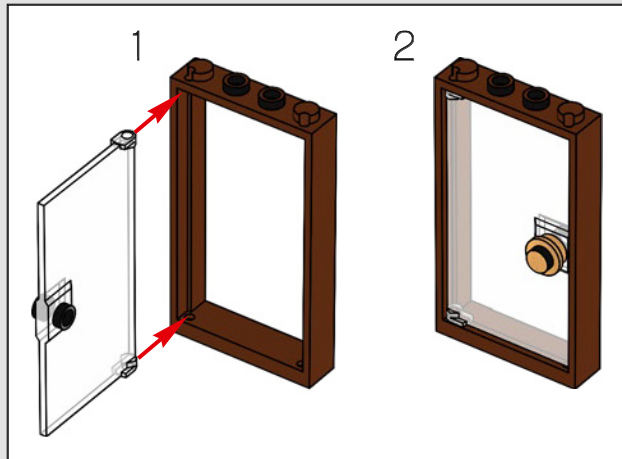
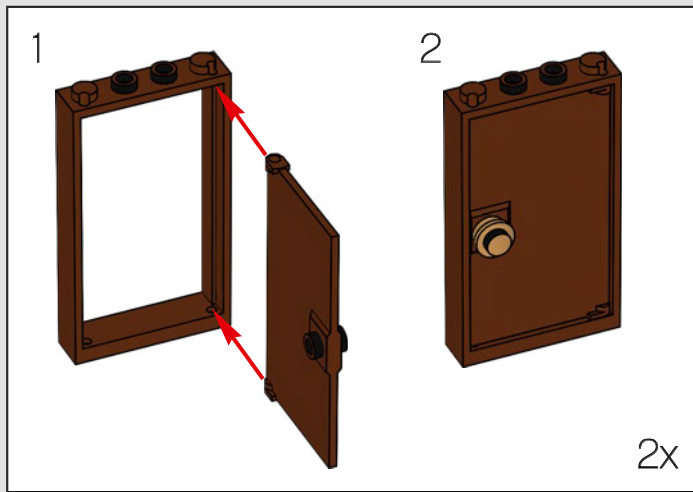

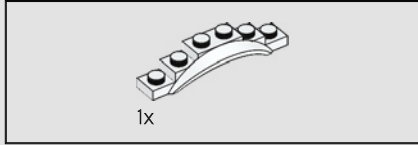
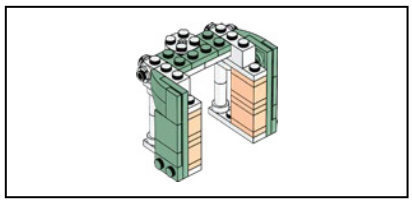

370

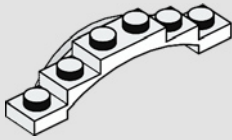

371

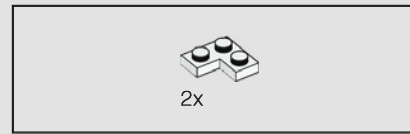
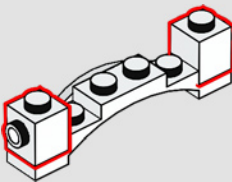

372

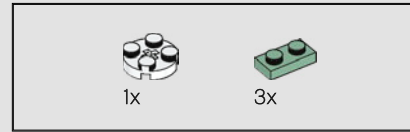
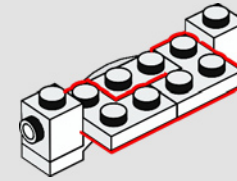

373

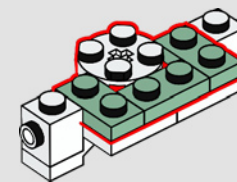





374

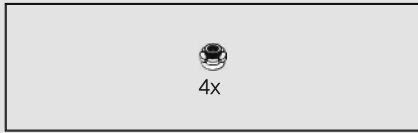
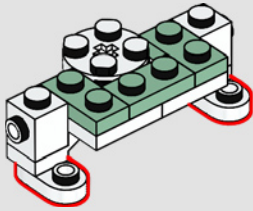

375

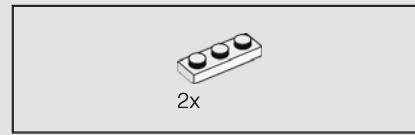
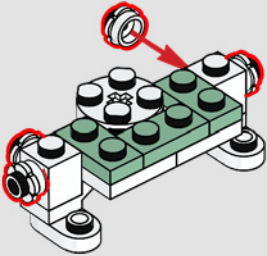

376

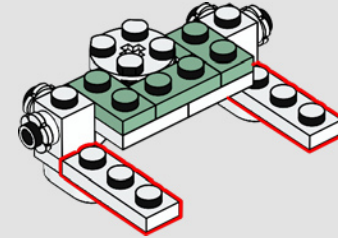

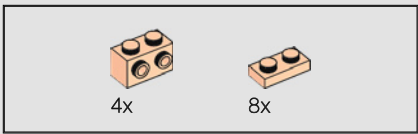

377

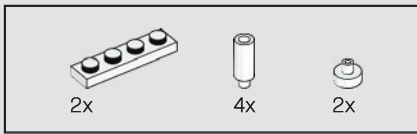
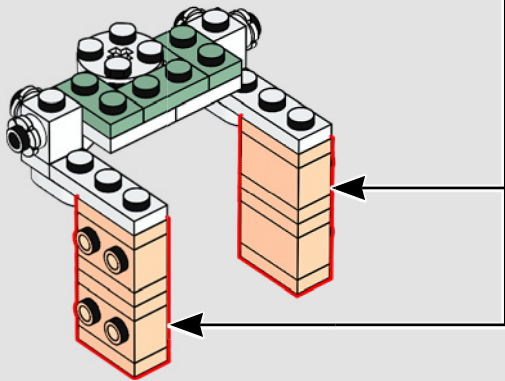
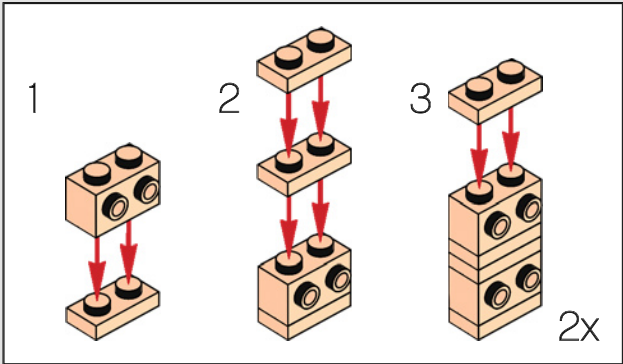

378

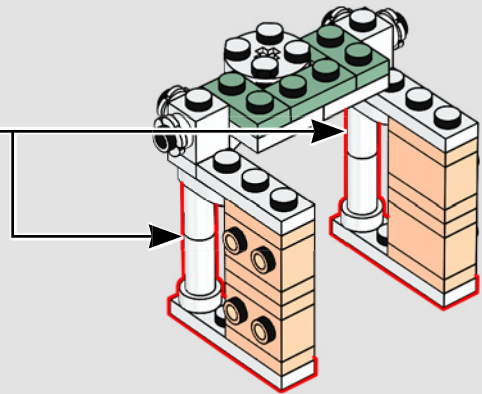
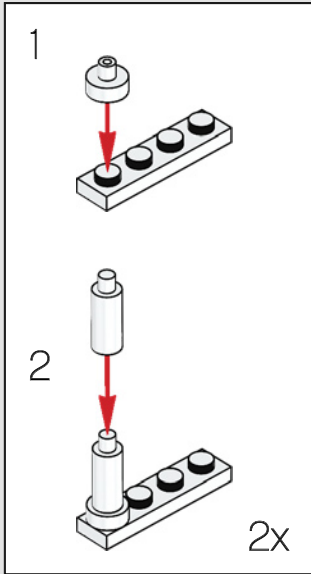



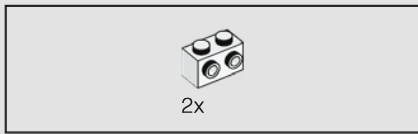

379

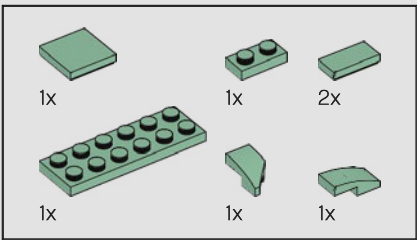
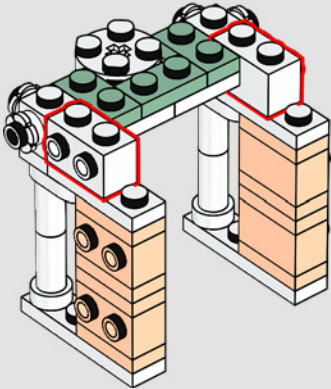

380

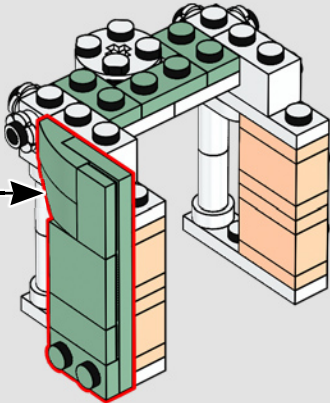
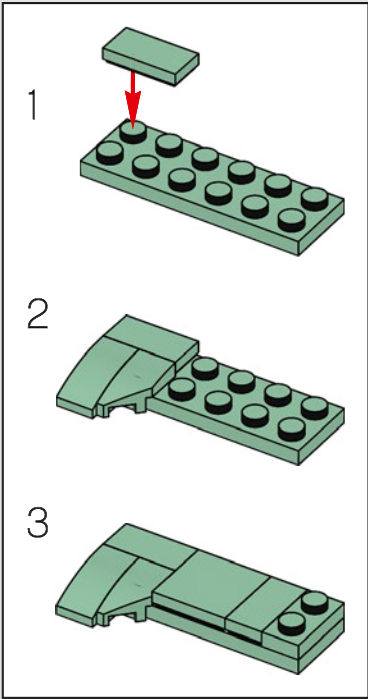

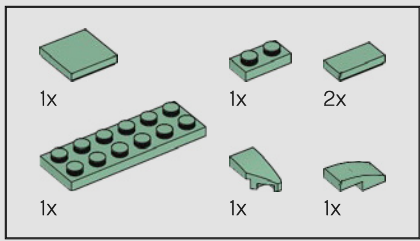

381

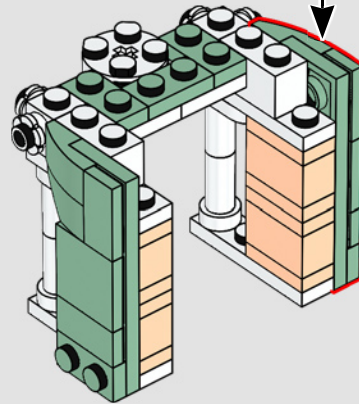
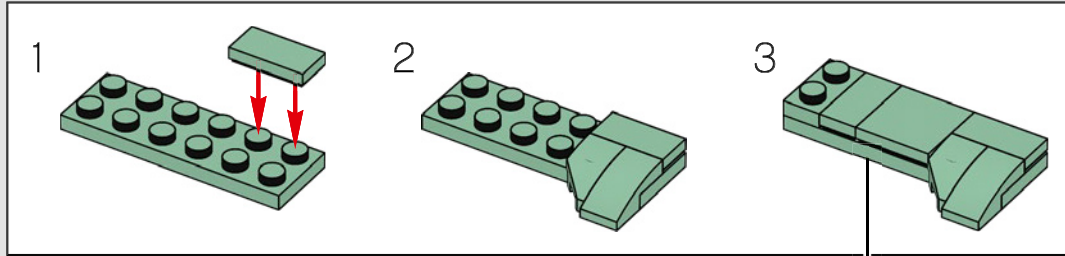



382



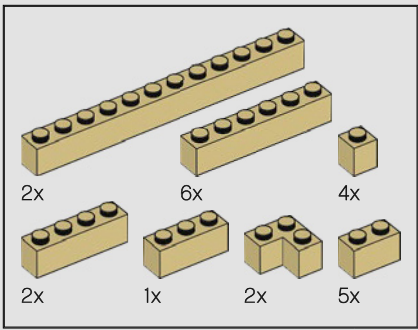

383

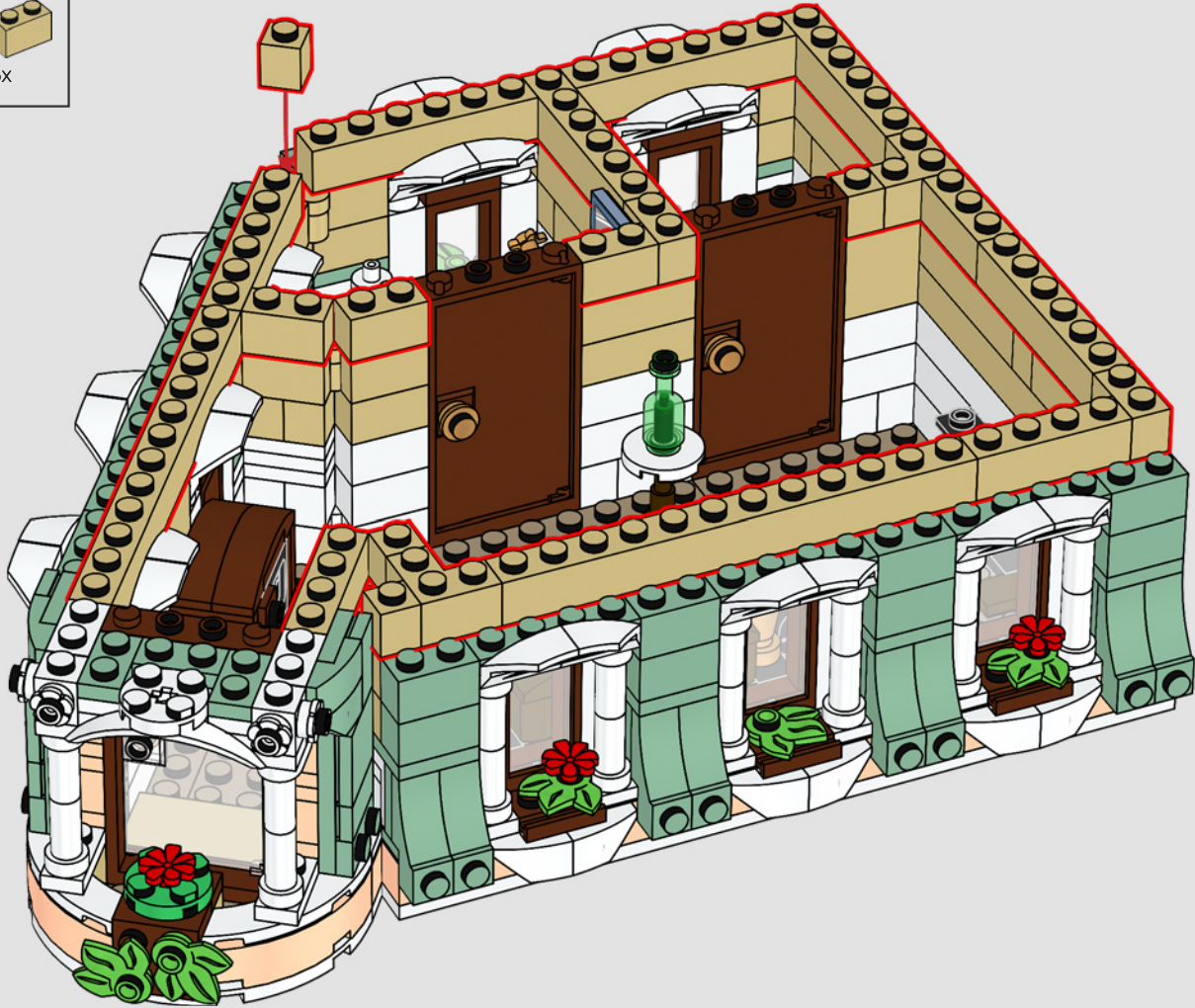



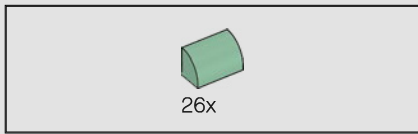

384



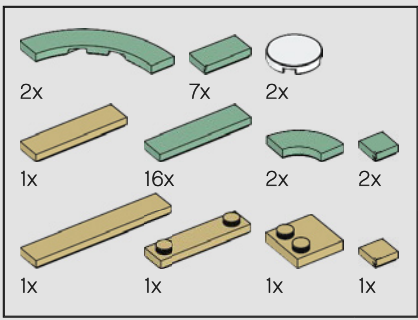

385

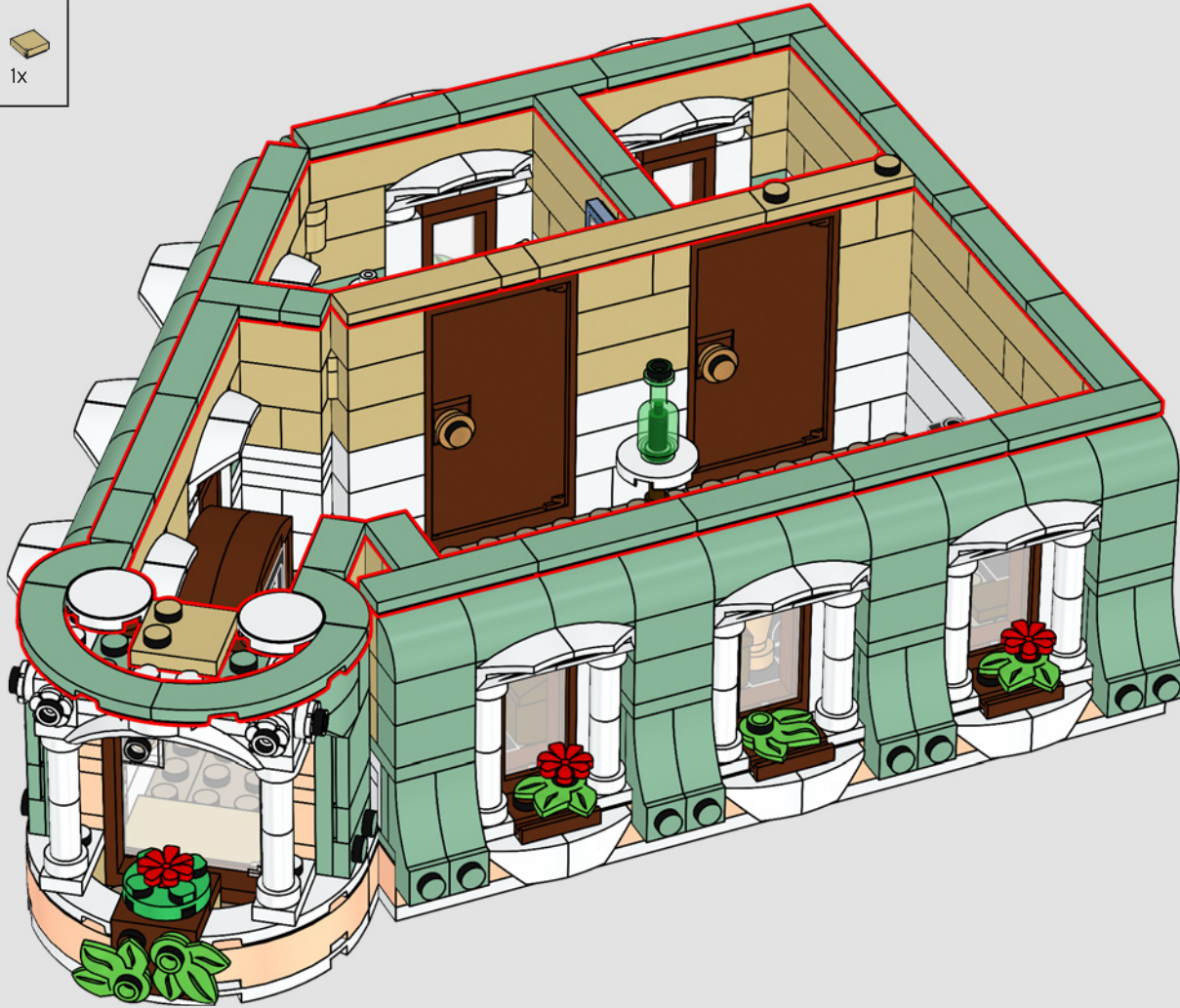



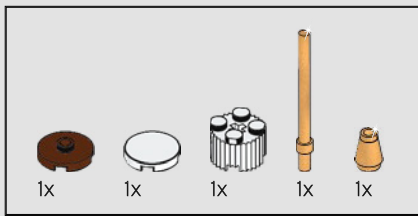

386

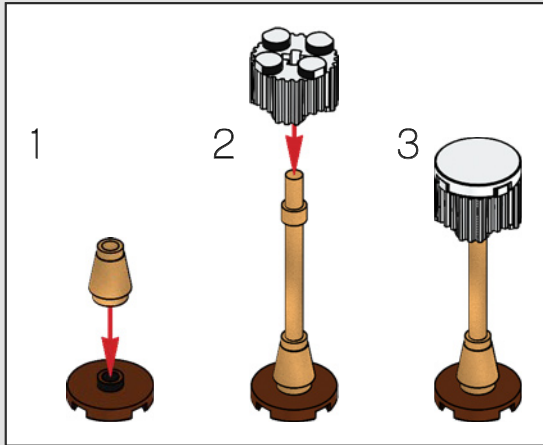

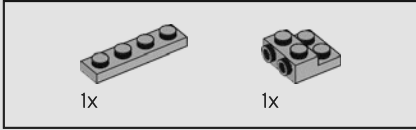
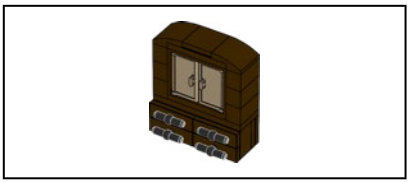

387

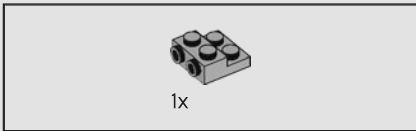
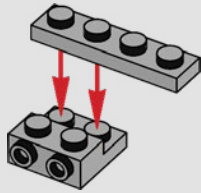

388

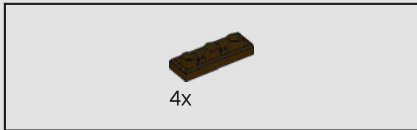
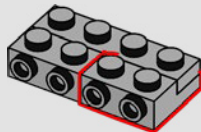

389

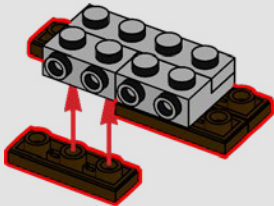

390

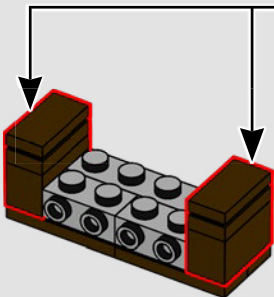
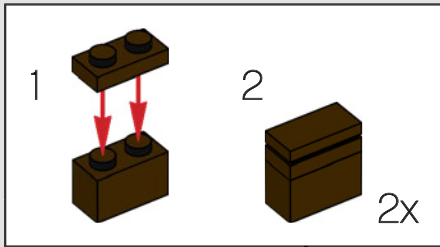



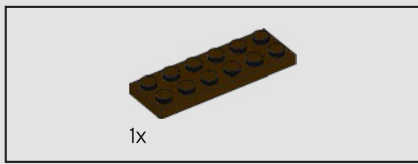

391

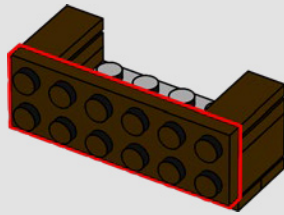

392

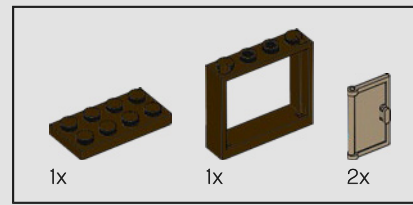
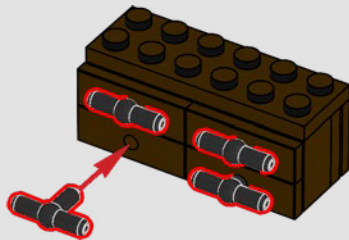

393

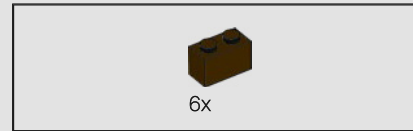
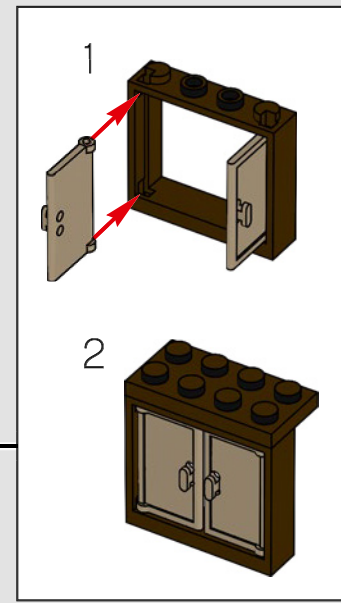
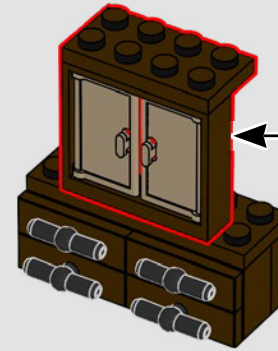

394

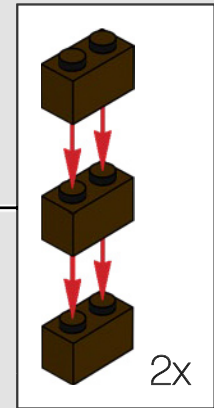
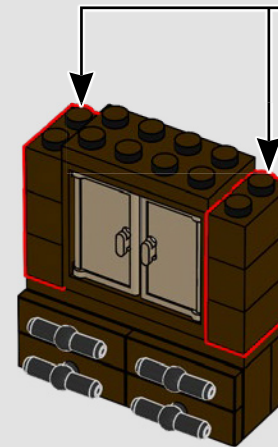

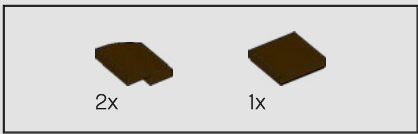

395

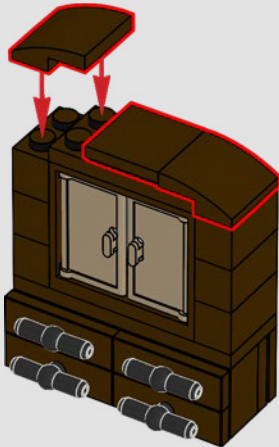

396





397

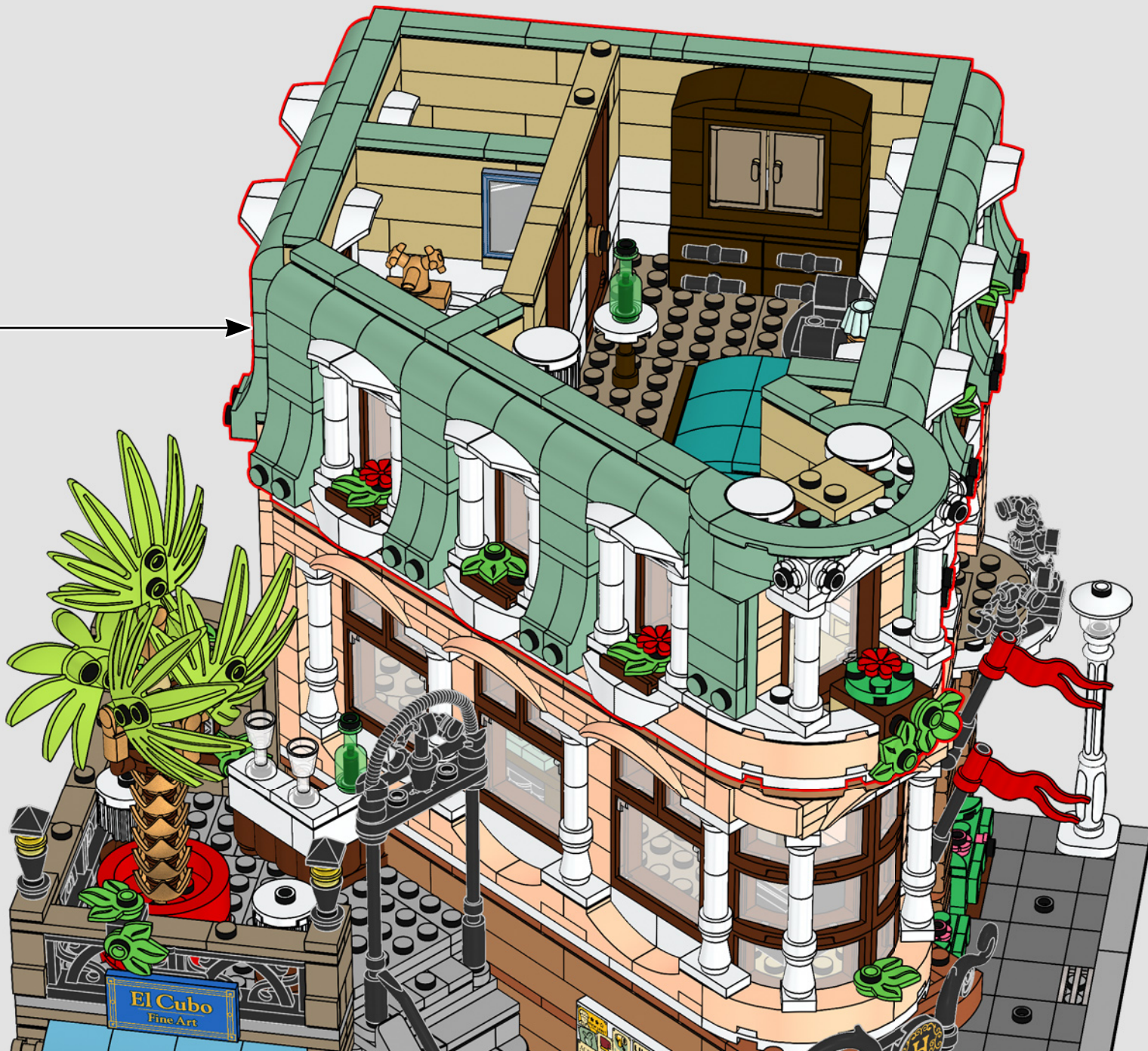

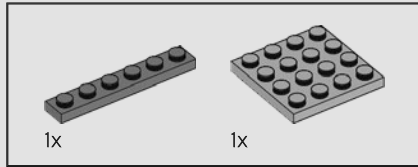
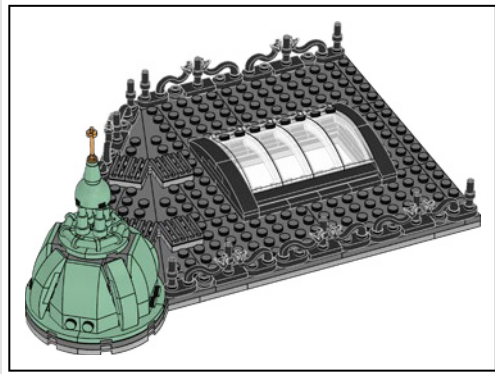
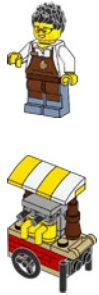
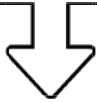

398

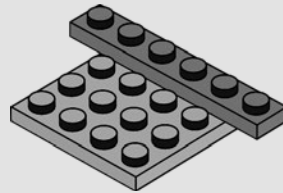



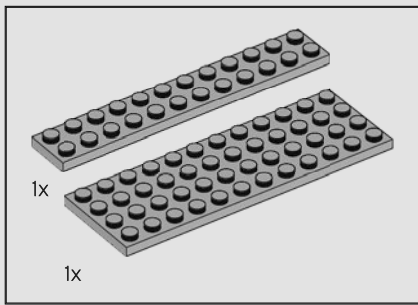

399

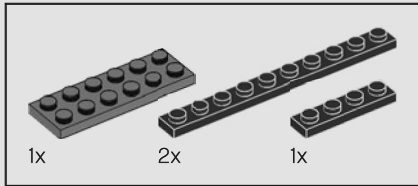
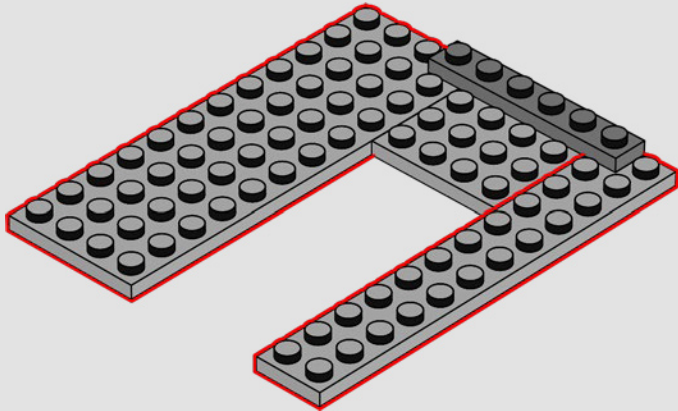

400

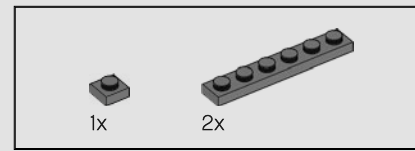
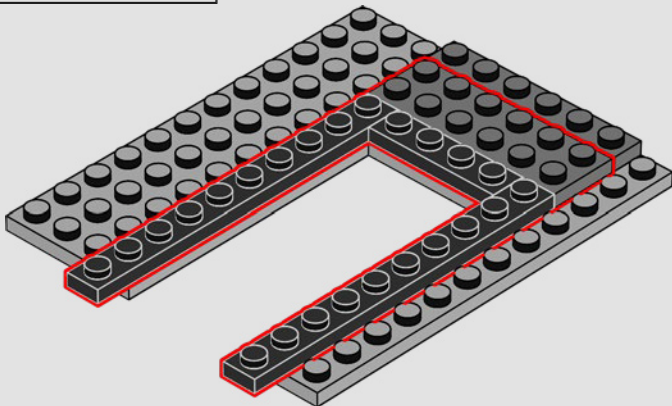

401

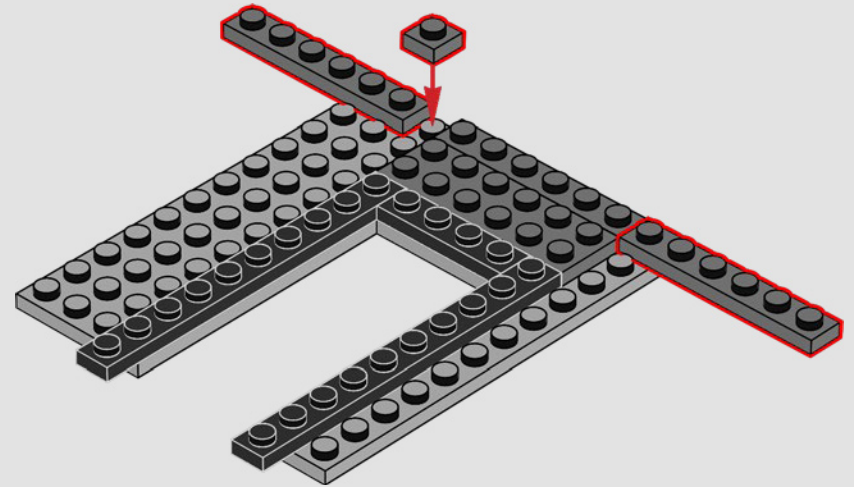

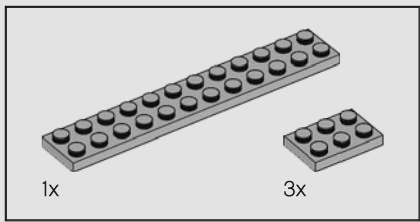

402

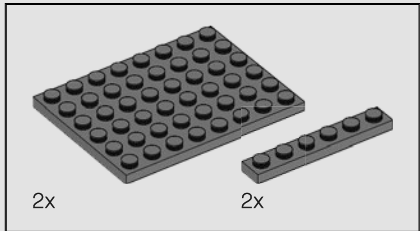
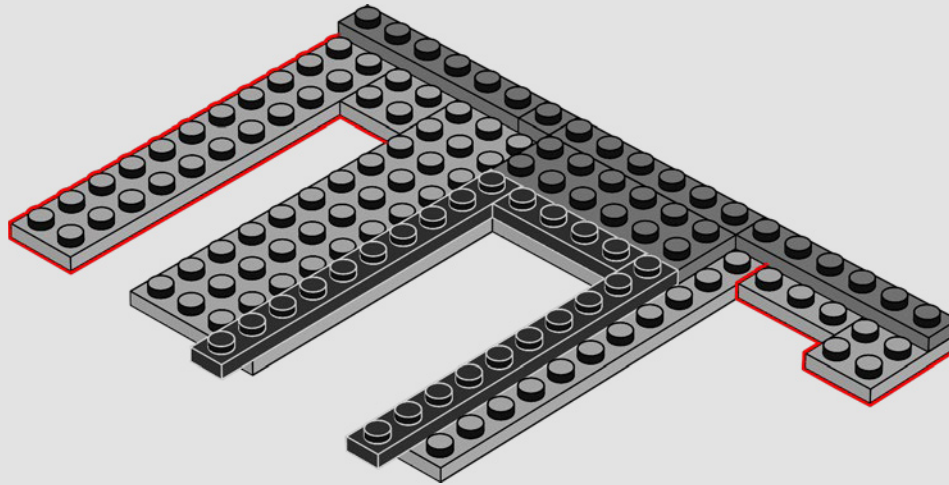

403

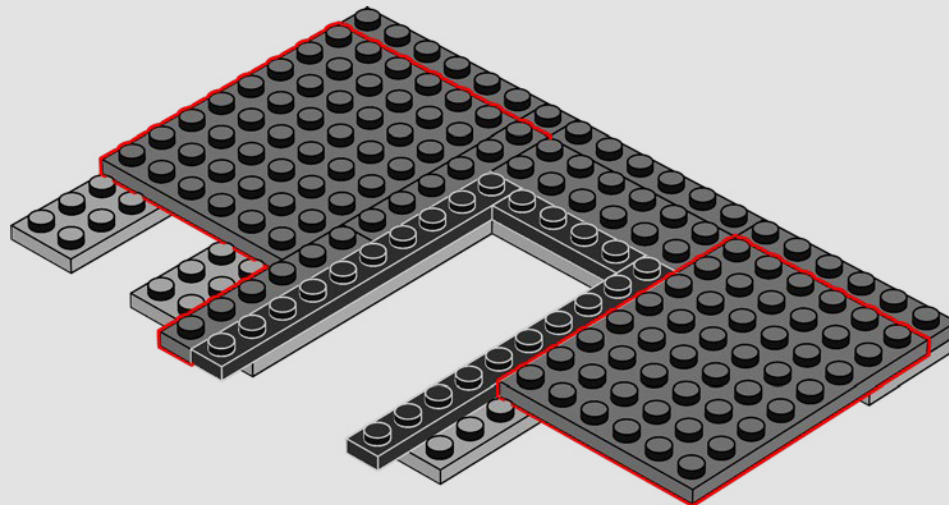



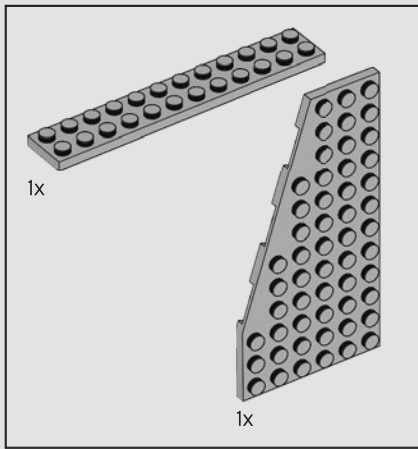

404

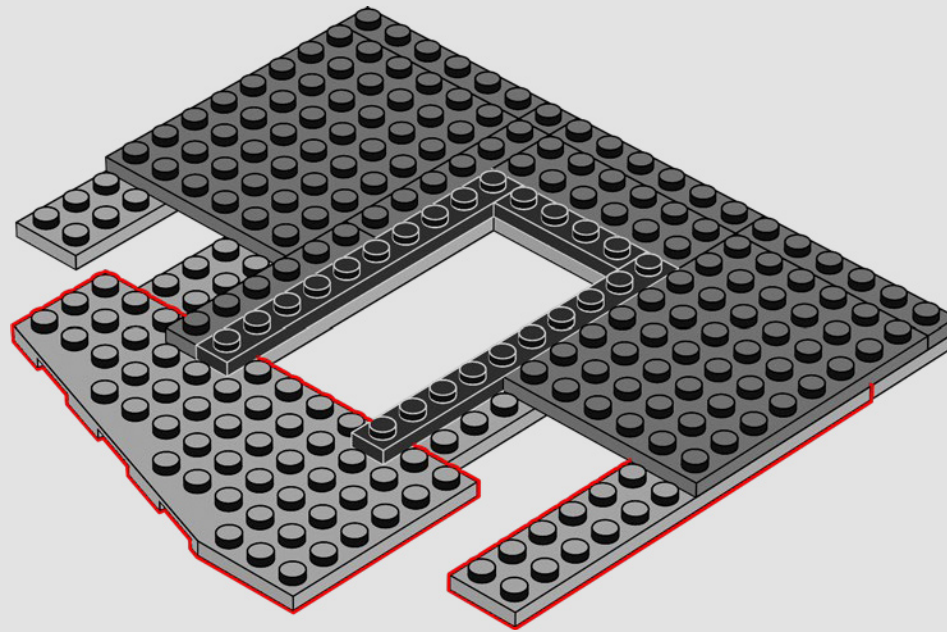

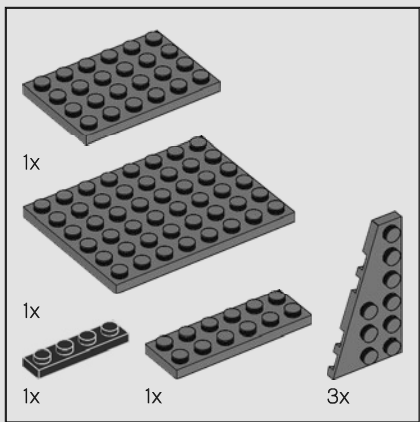

405

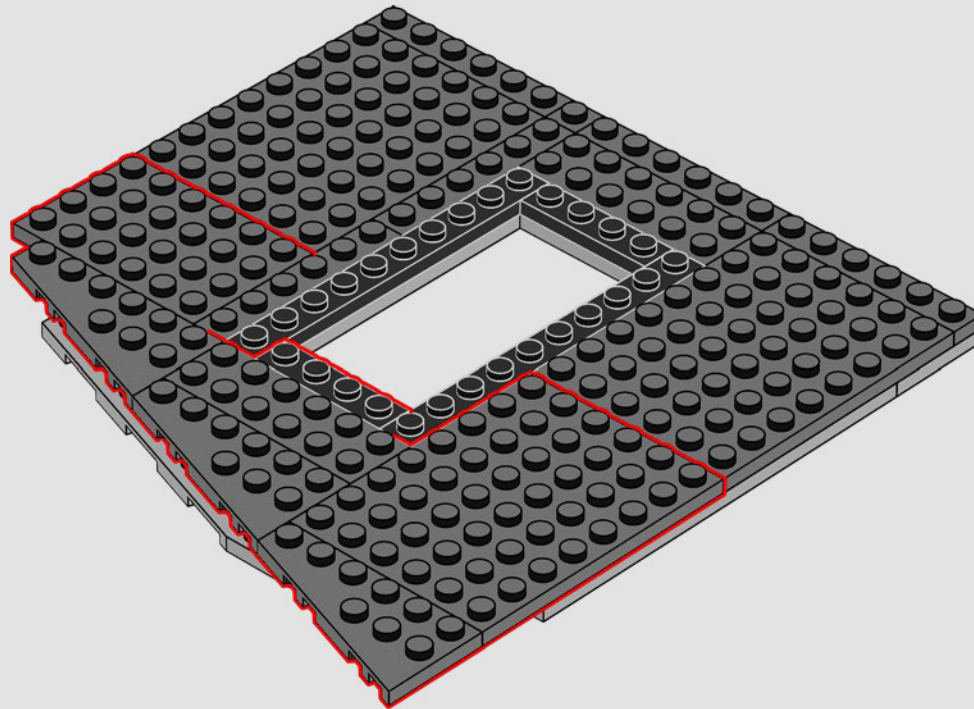



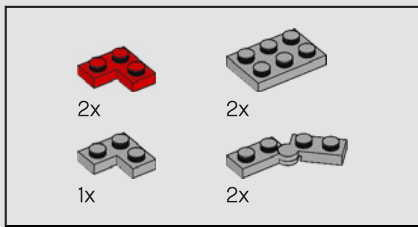

406

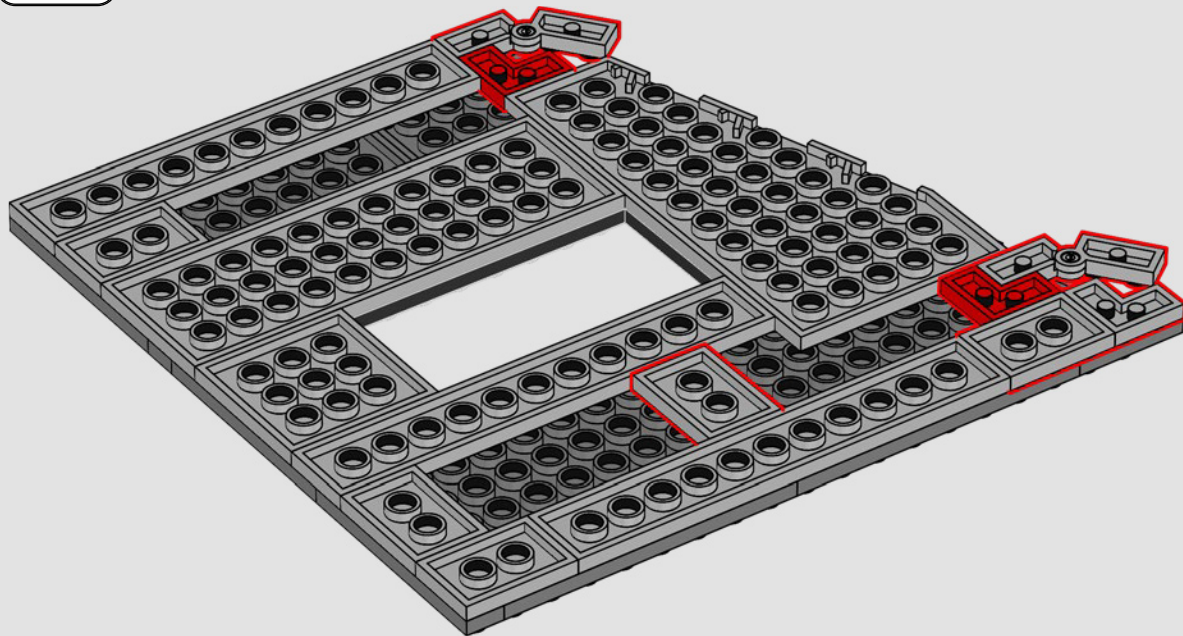
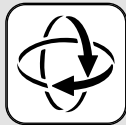



1x

407

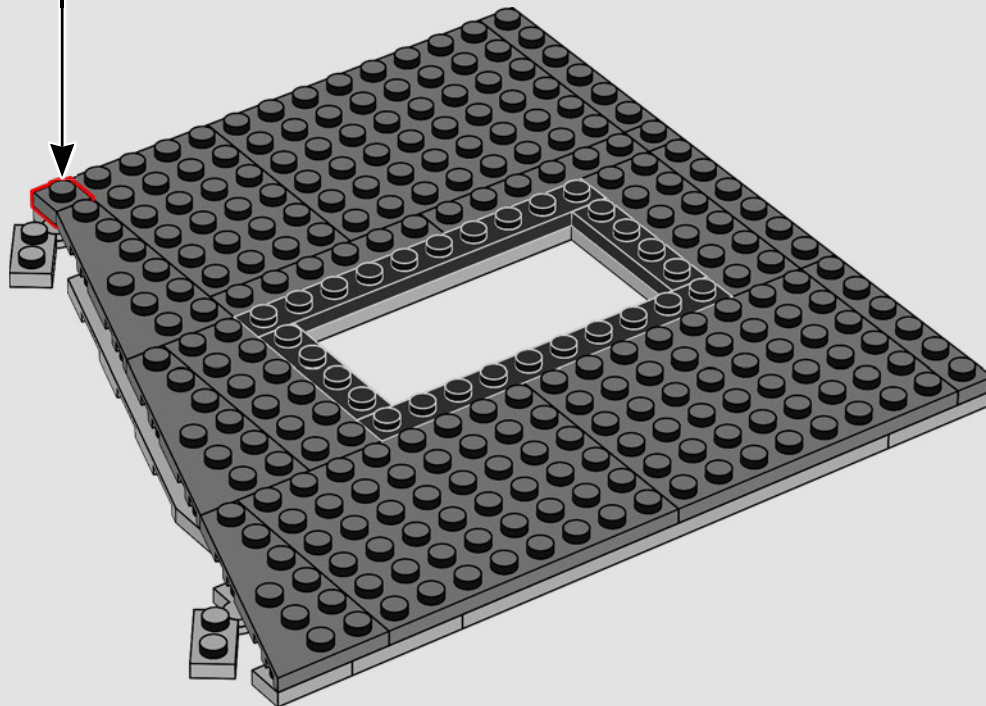
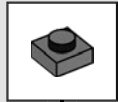



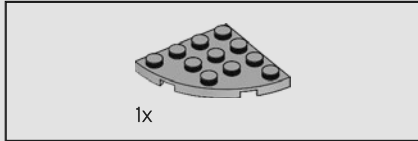
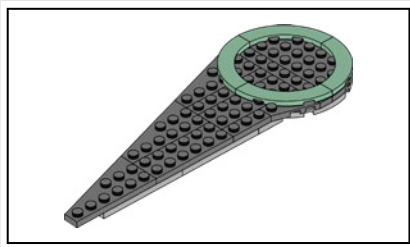

408

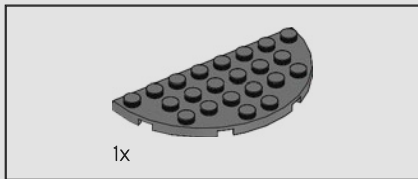
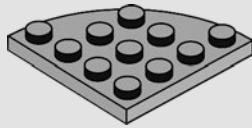

409

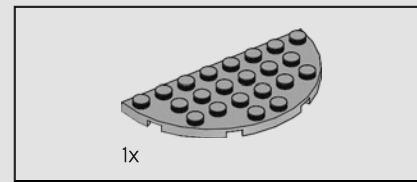
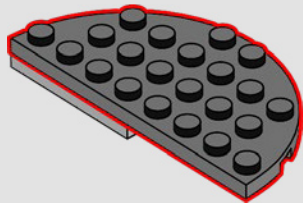

410

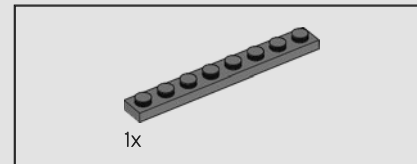
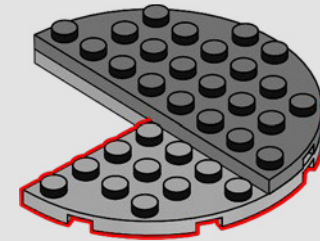

411

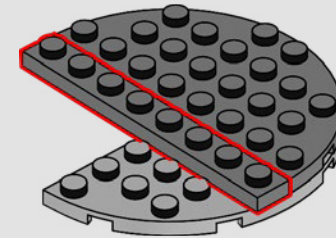

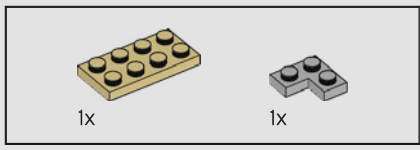

412

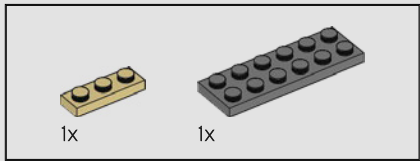
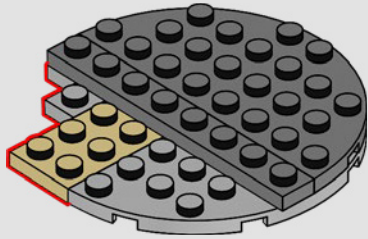

413

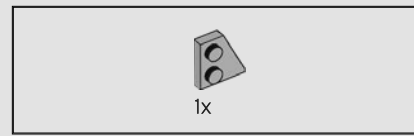
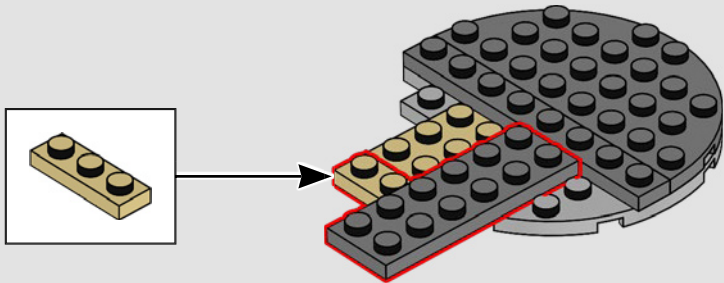

414

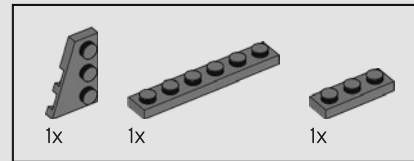
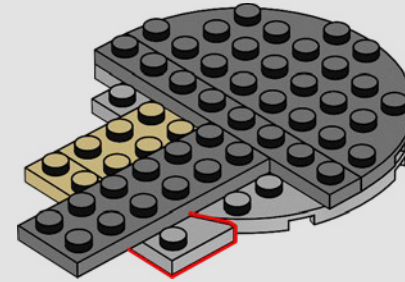

415

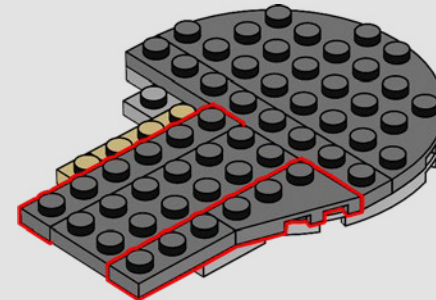



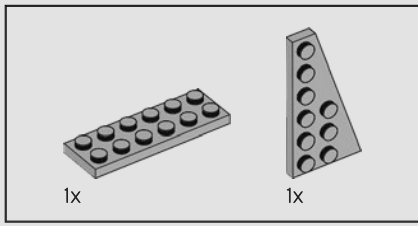

416

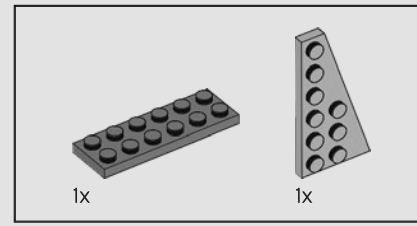
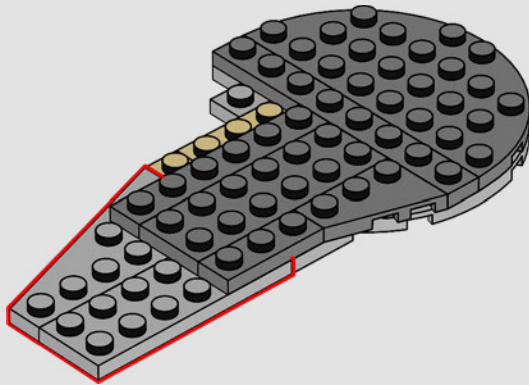

417

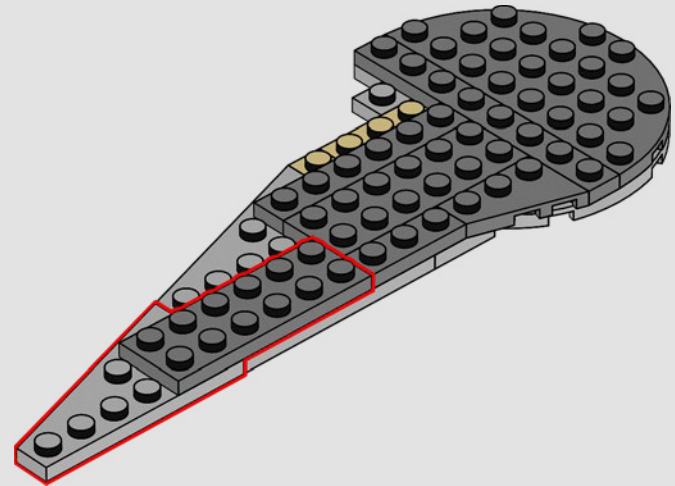

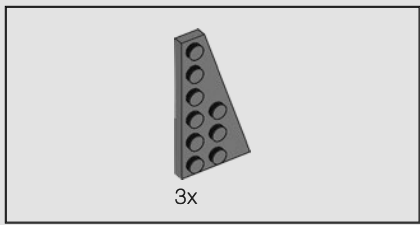

418

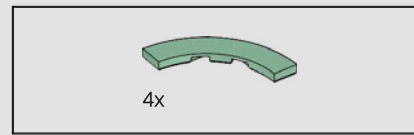
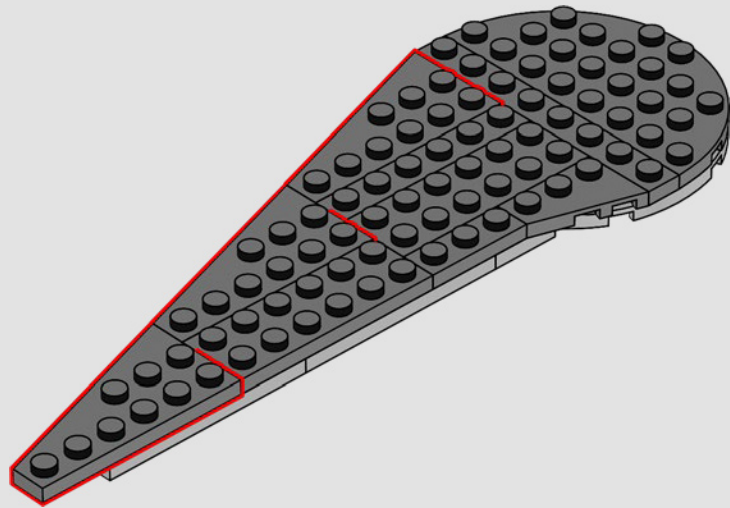

419

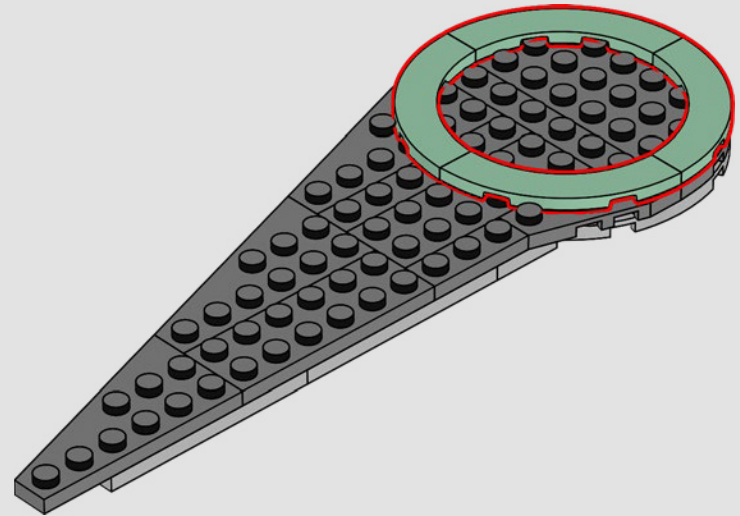

420

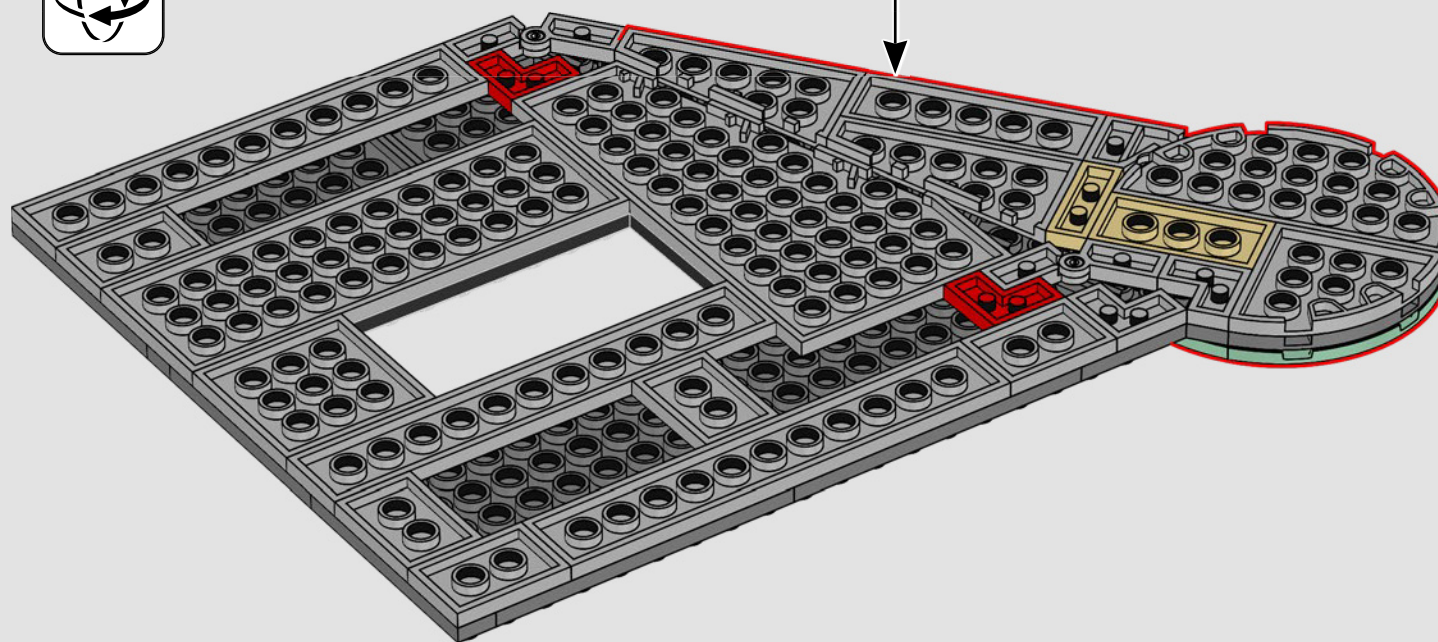





421

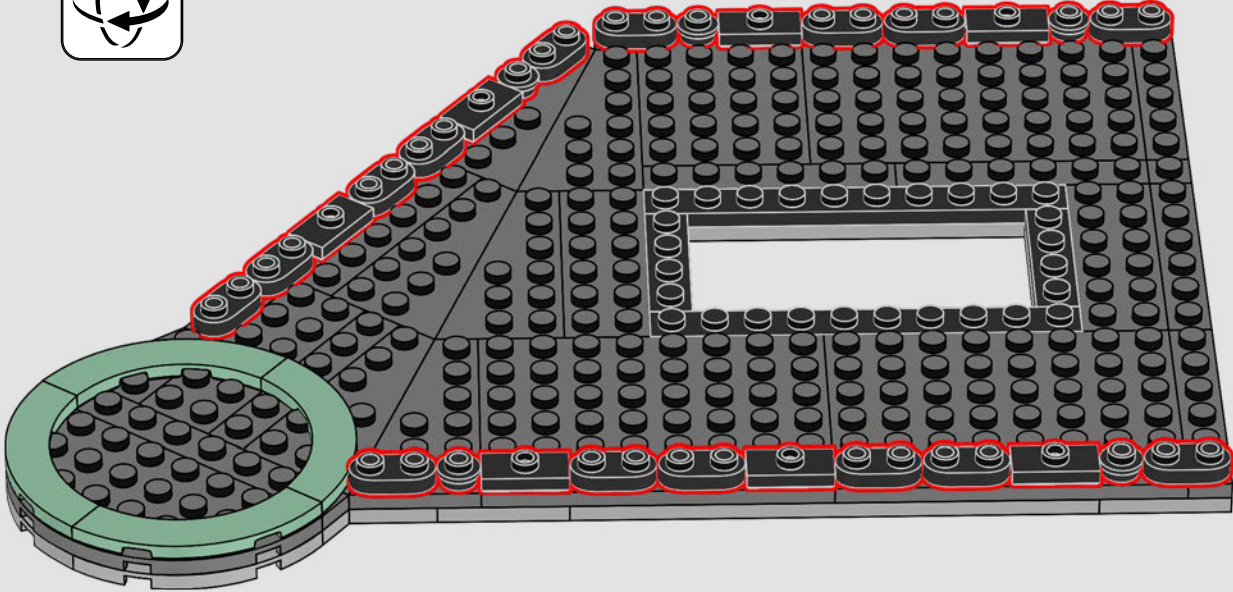

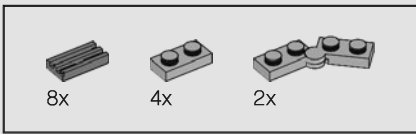

422

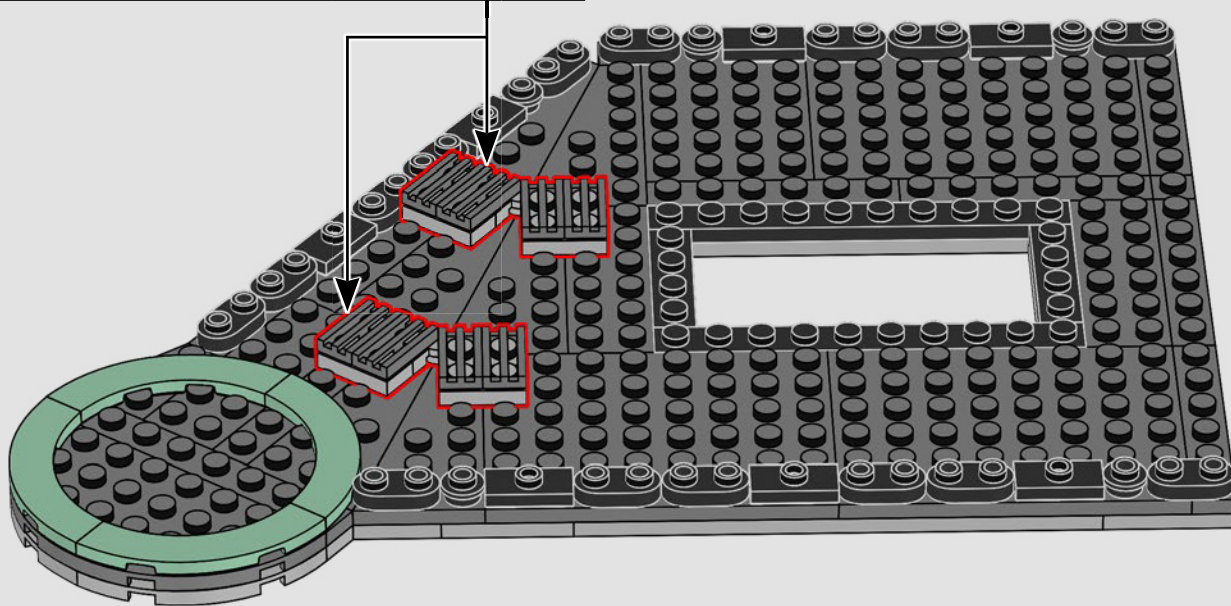
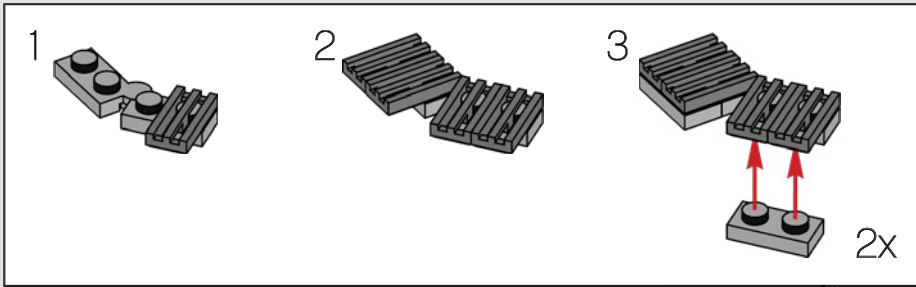



12x

423

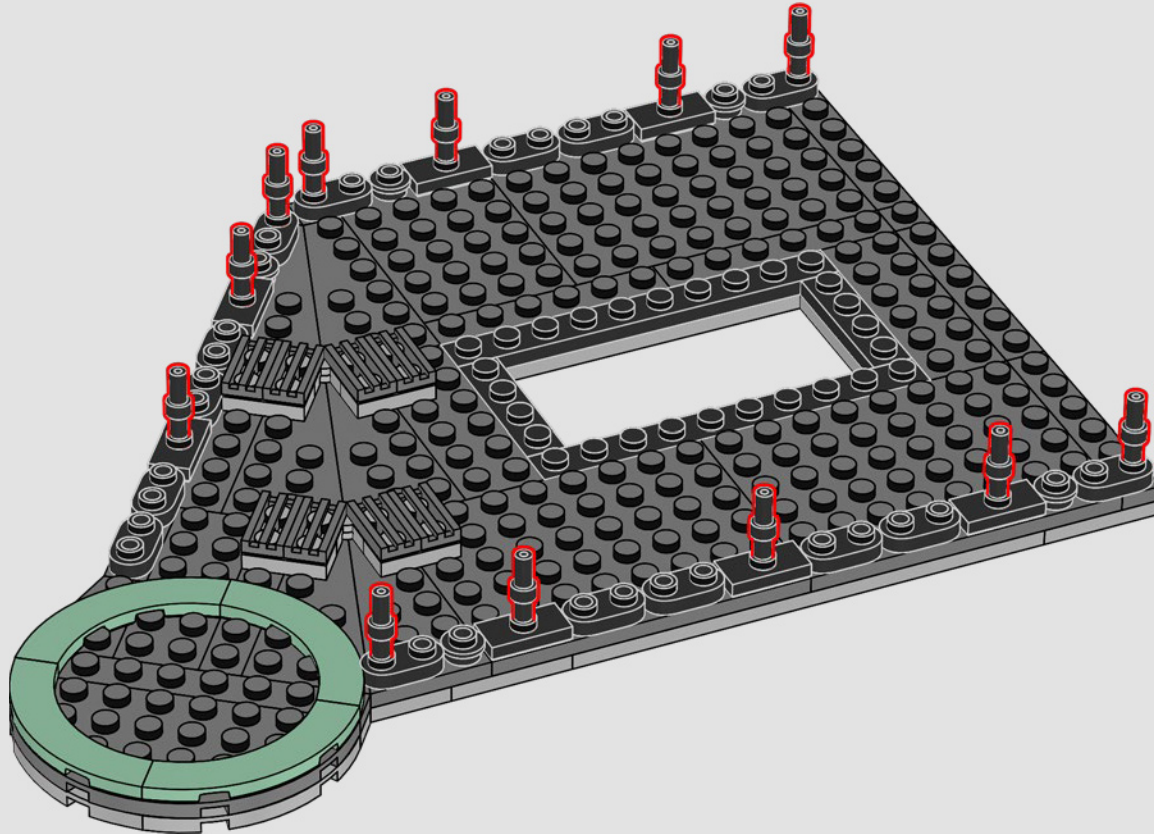





424



Los elementos que se usan para crear las curvas de estos detalles de hierro forjado aparecieron por primera vez en los sets NINJAGO®, donde representaban cabezas de serpiente.

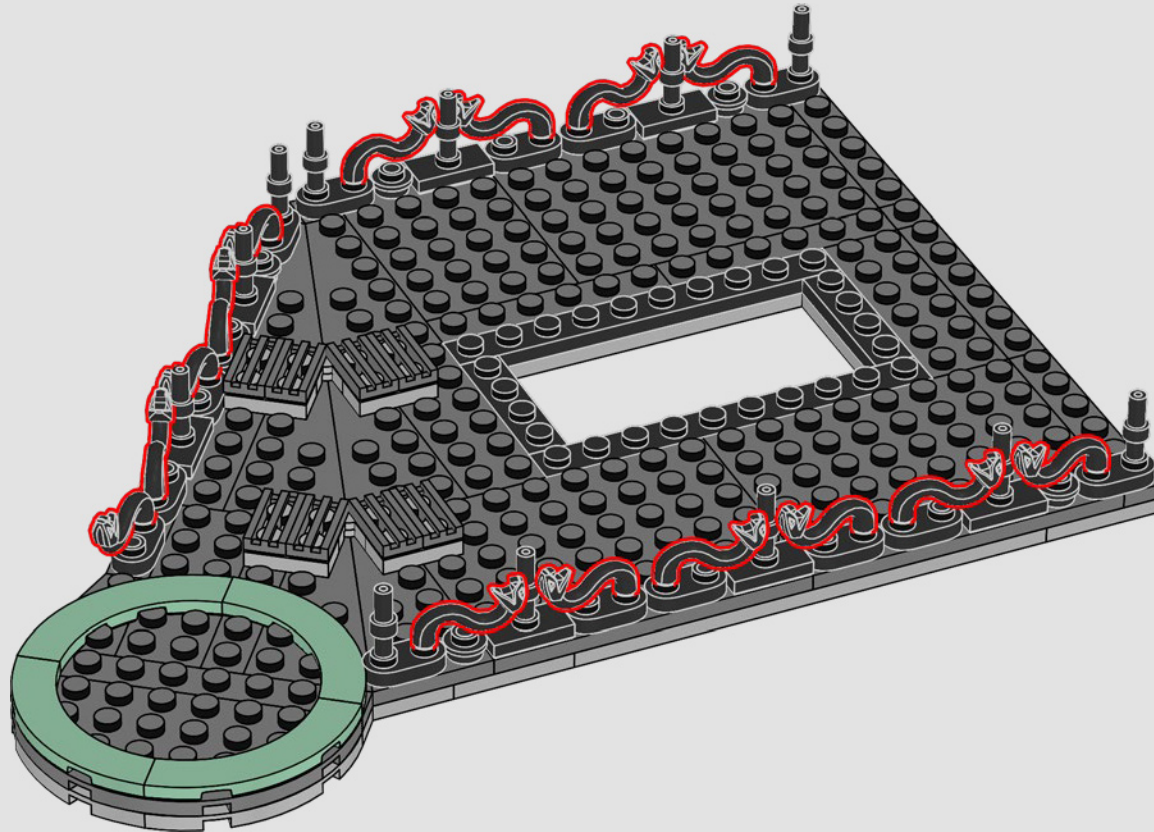

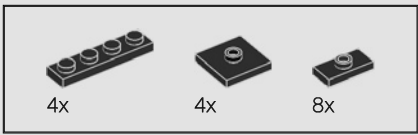

425

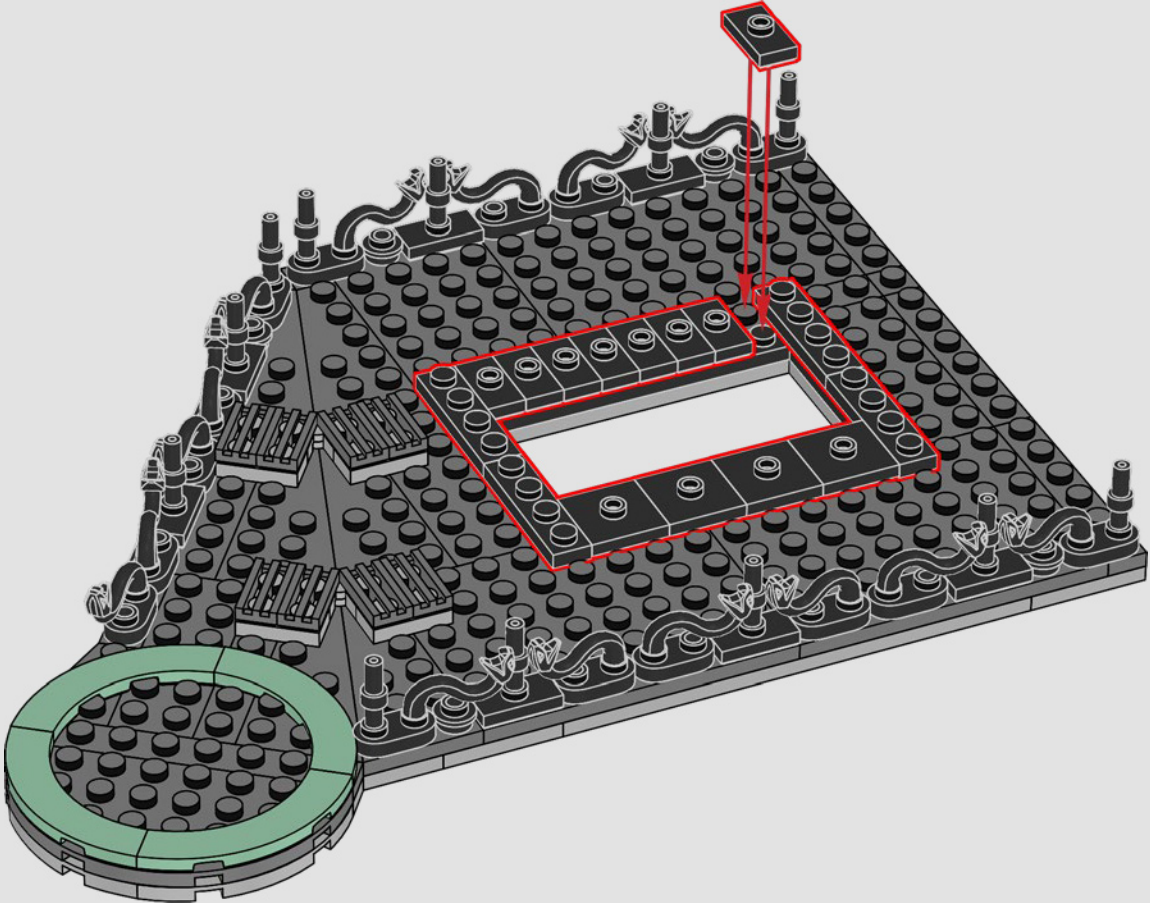

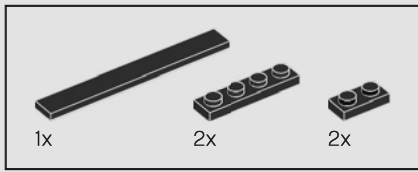

426

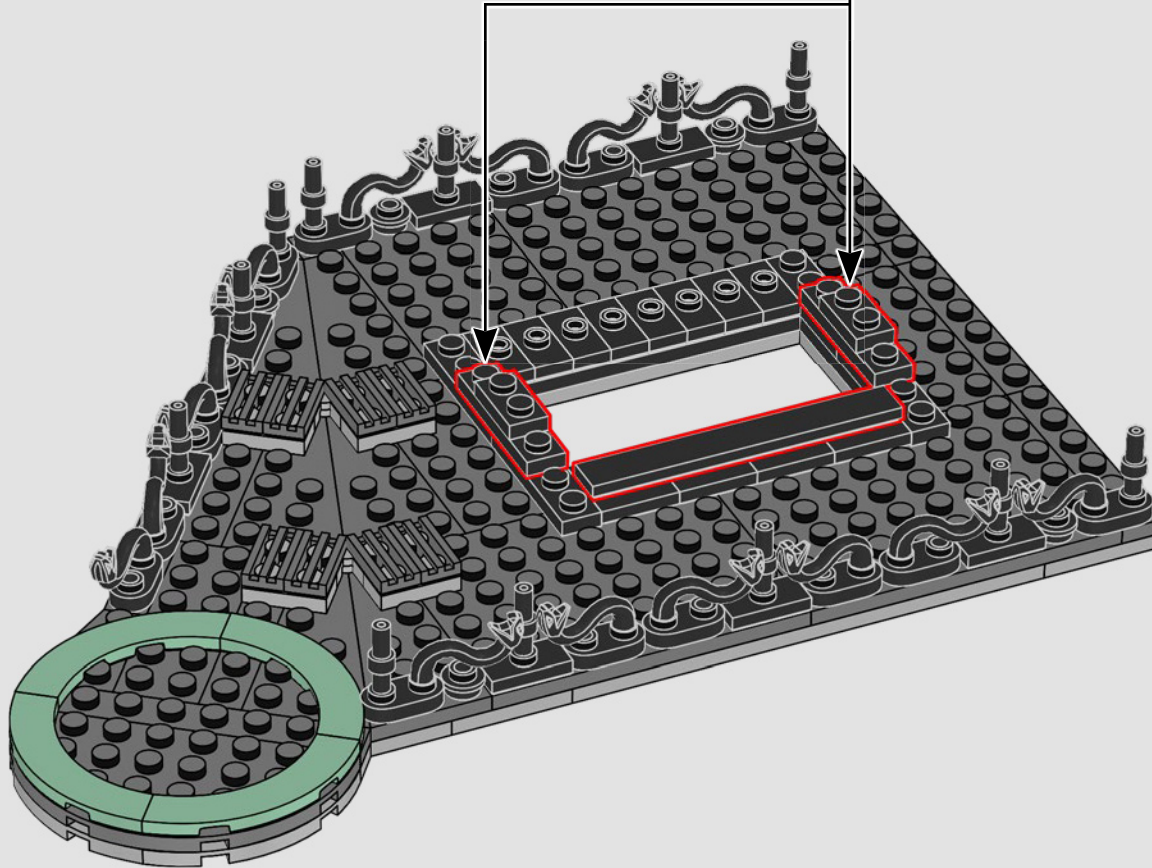
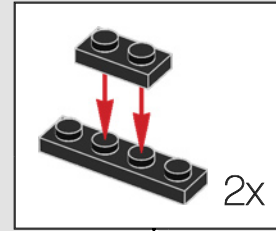





427

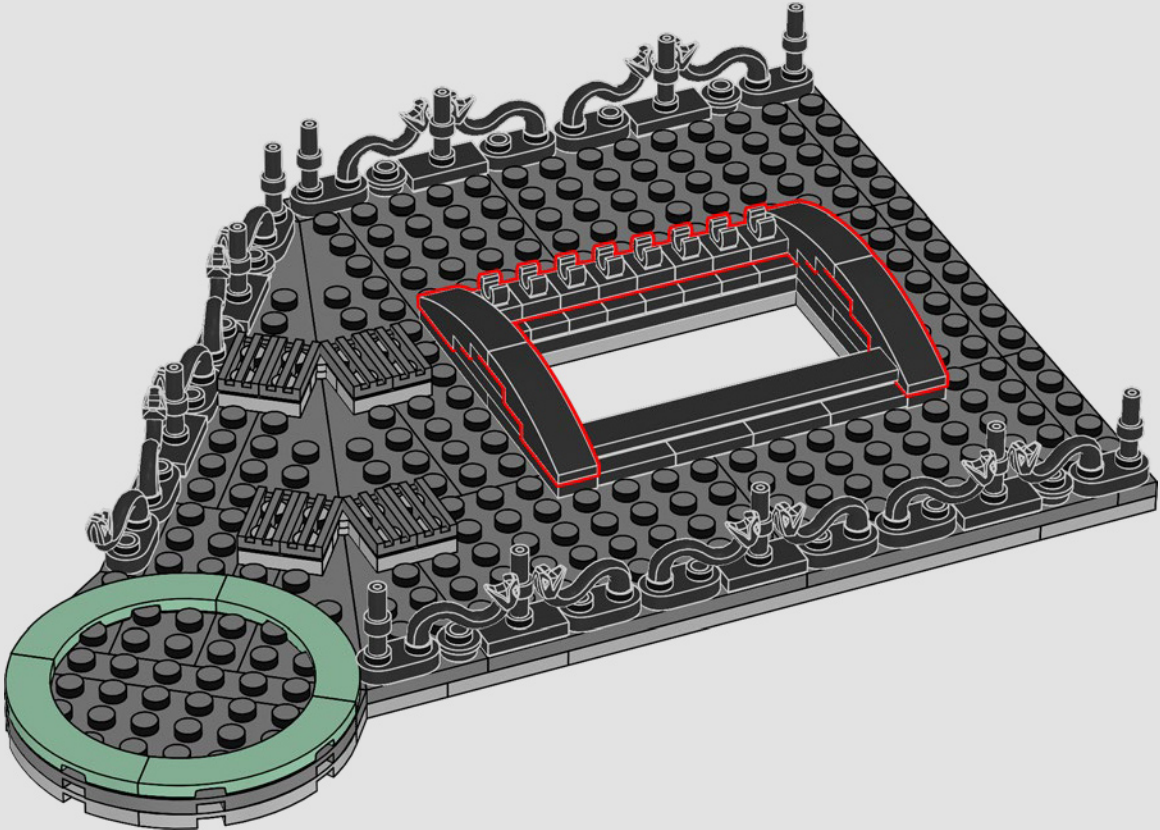

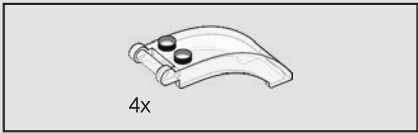

428

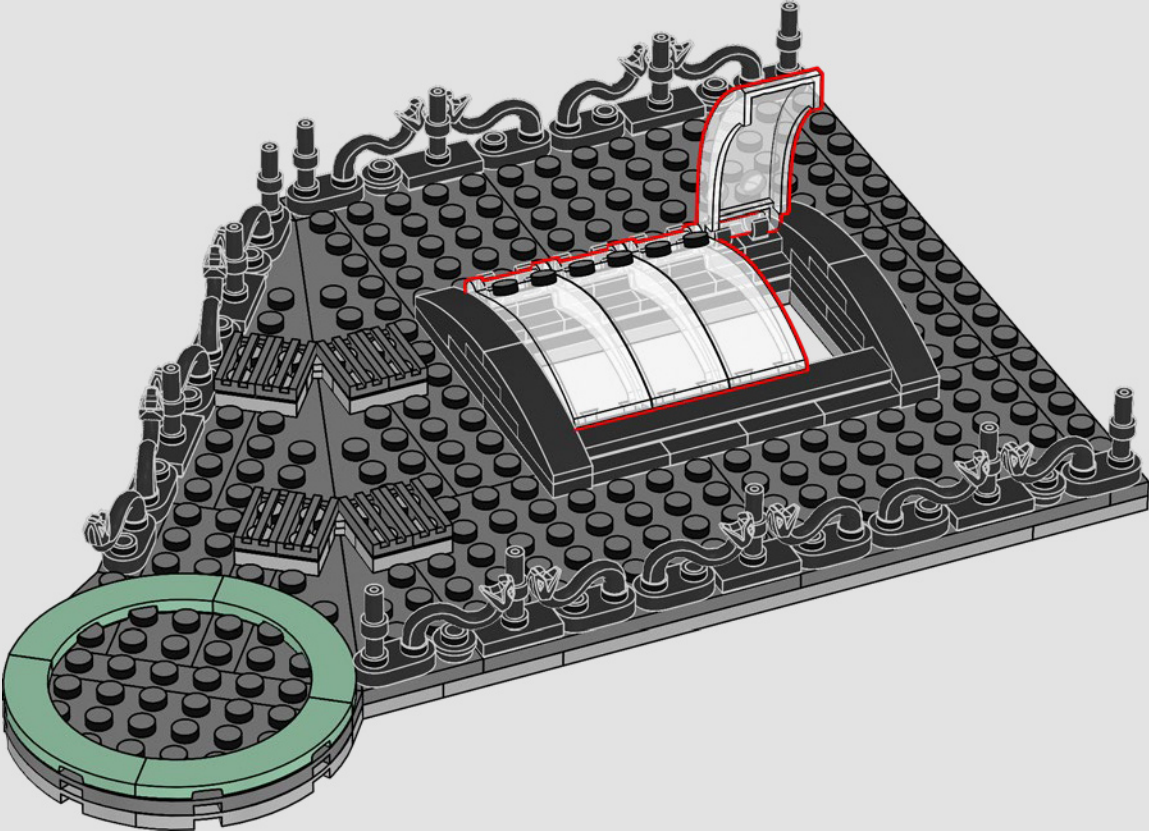

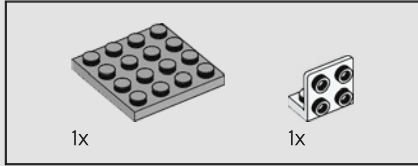
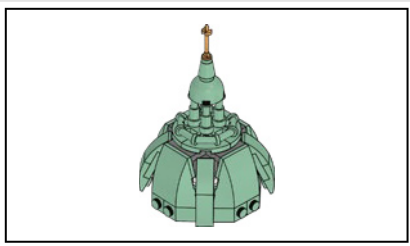

429

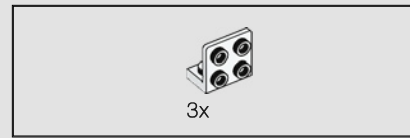
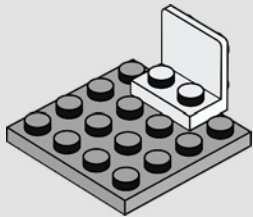

430

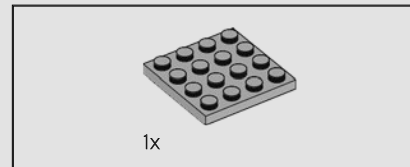
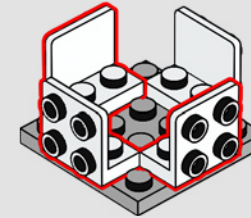

431

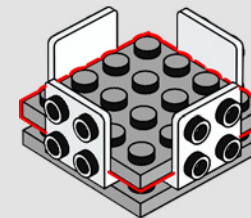



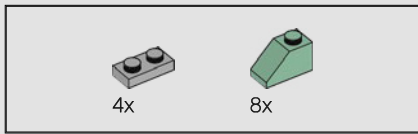

432

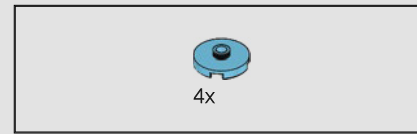
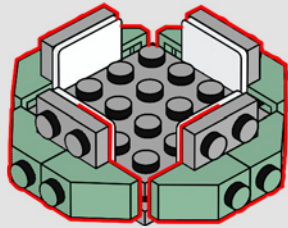

433

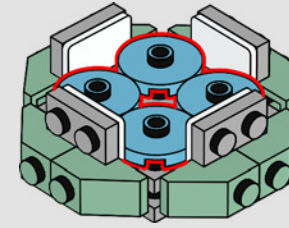

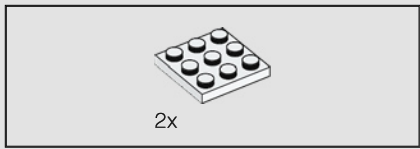

434

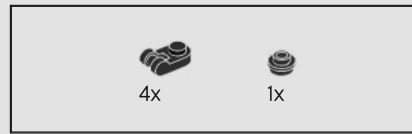
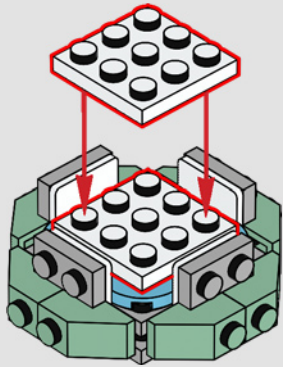

435

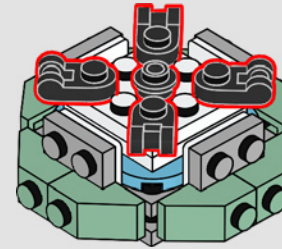

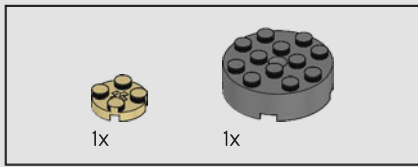

436

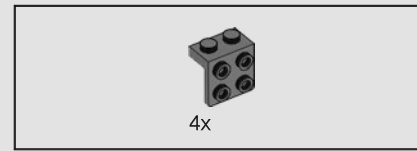
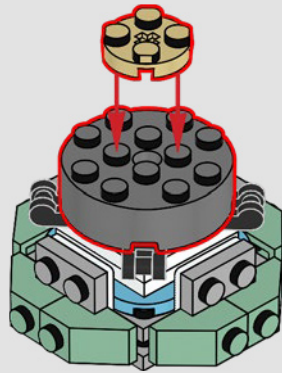

437

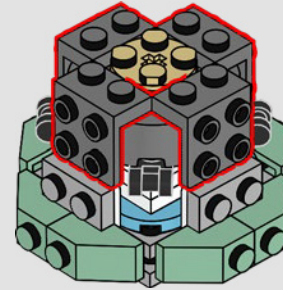



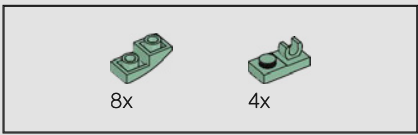

438

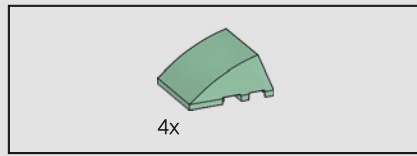
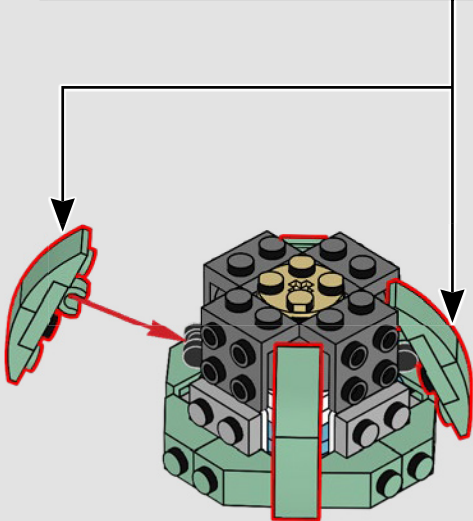
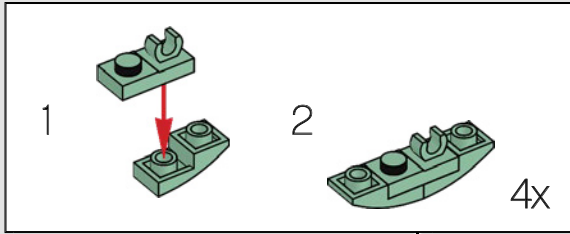

439

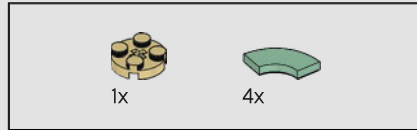
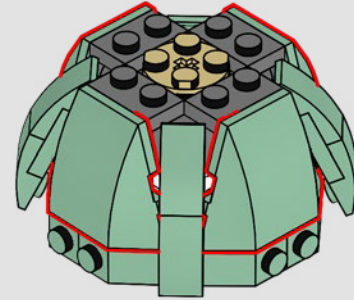

440

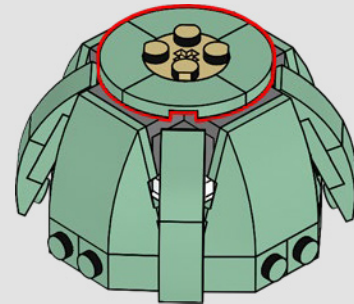

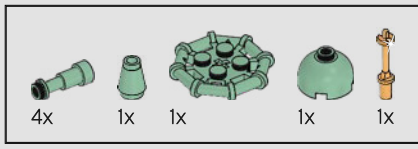

441

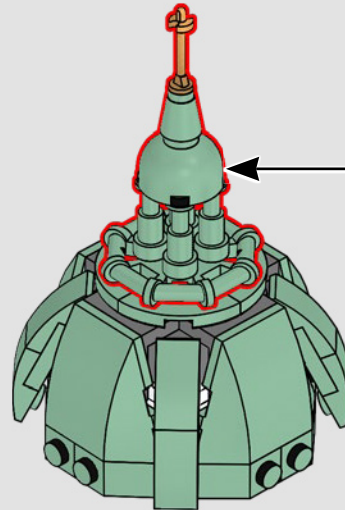
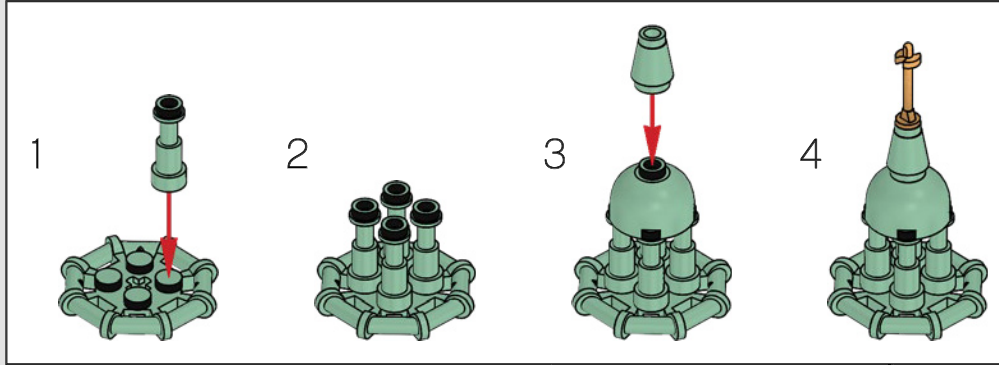

442

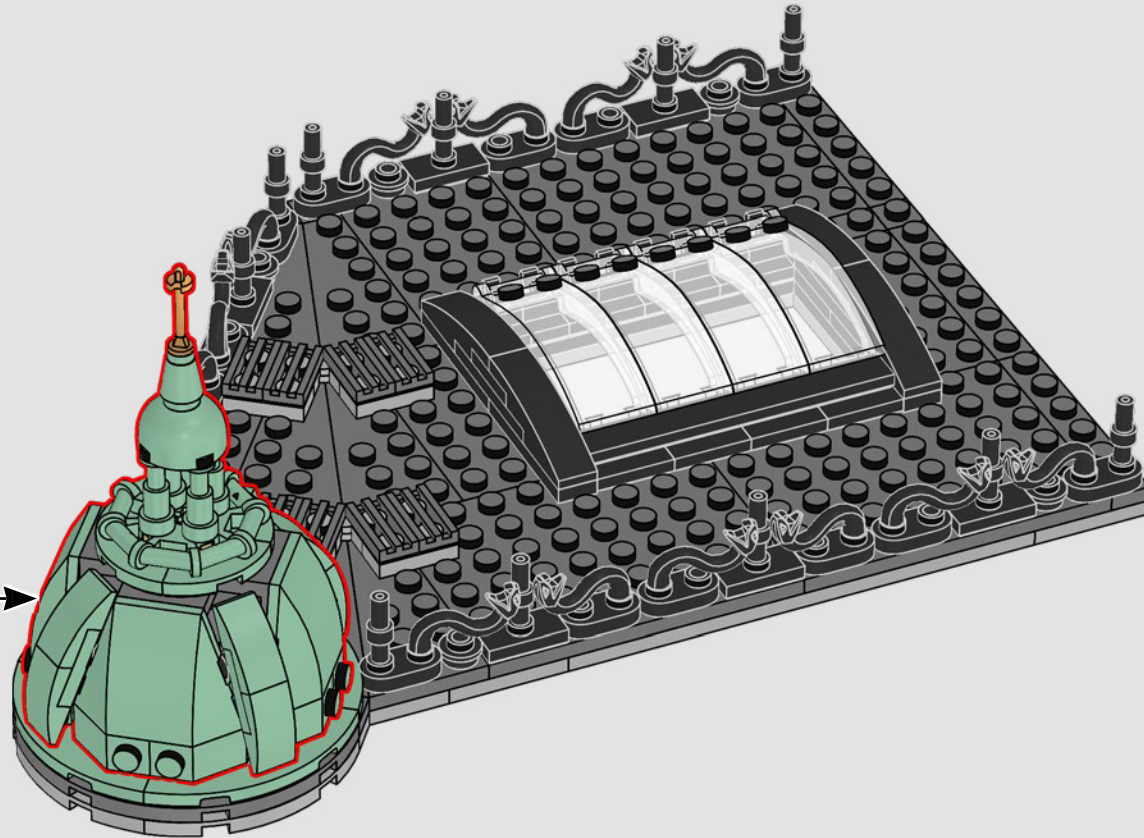



443

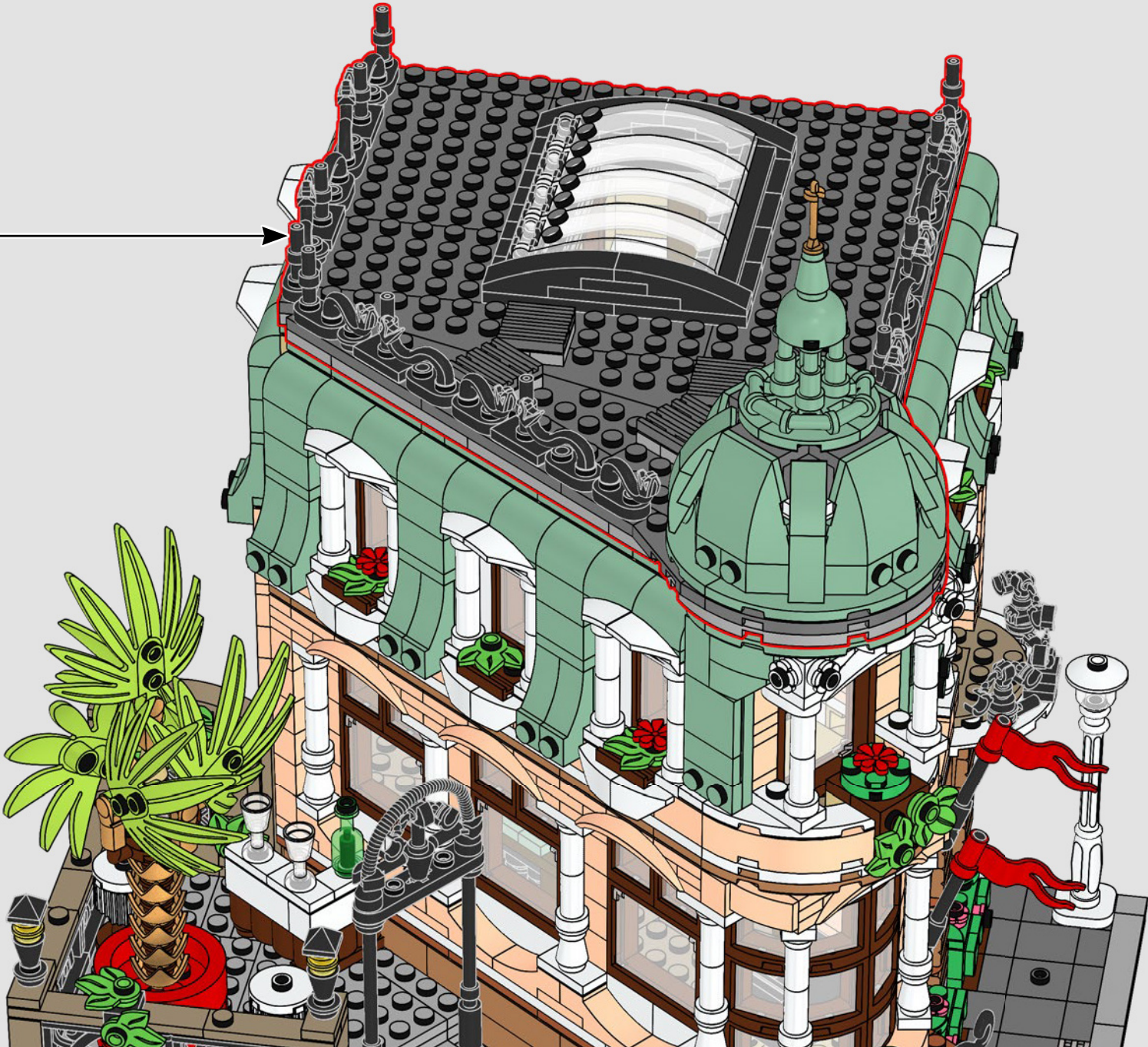

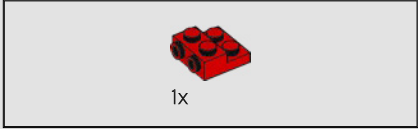

1

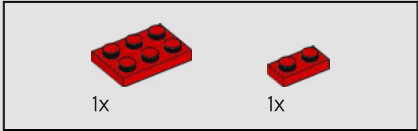
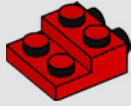

2

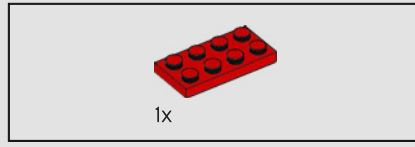
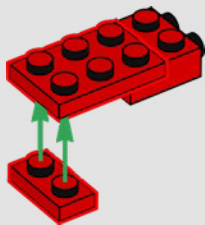

3

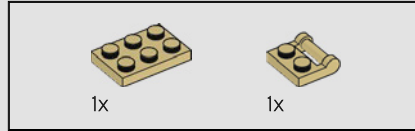
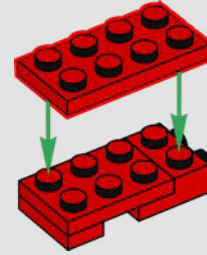

4

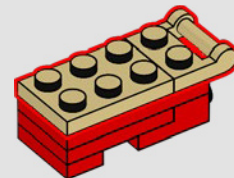



5

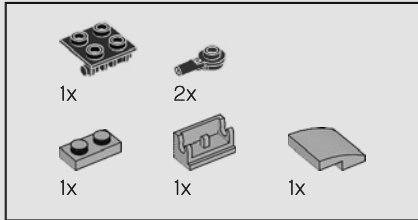
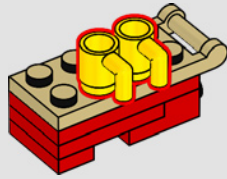

6

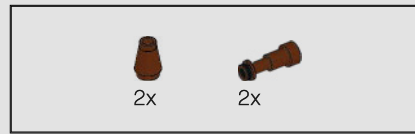
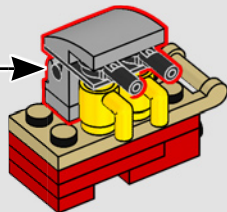
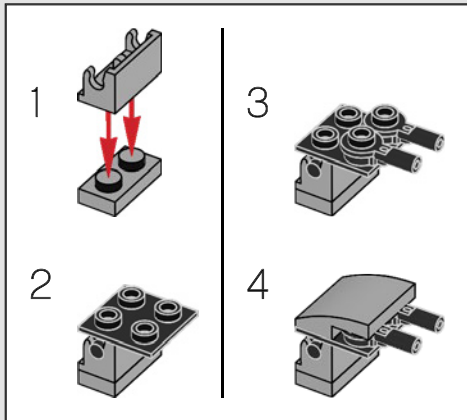

7

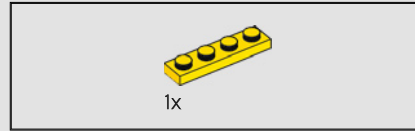
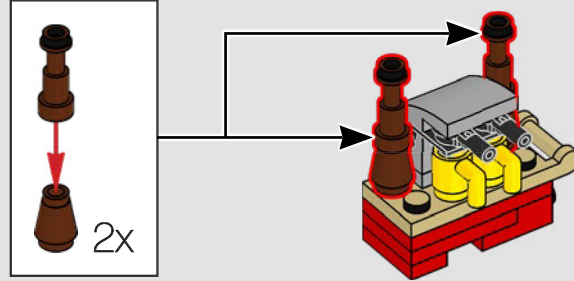

8

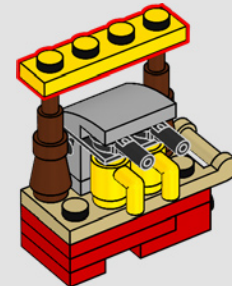



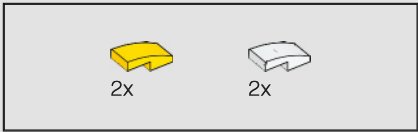

9

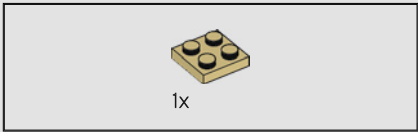
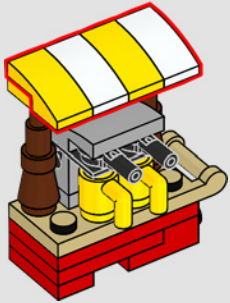

10

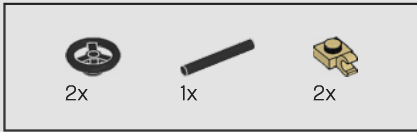
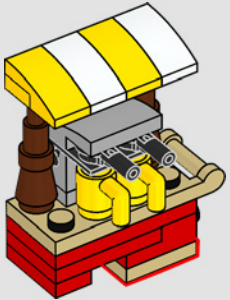

11

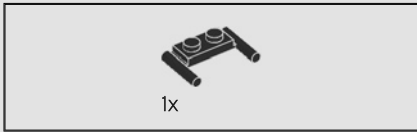
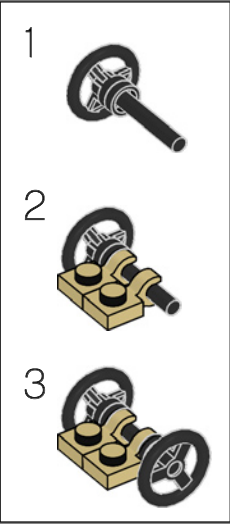
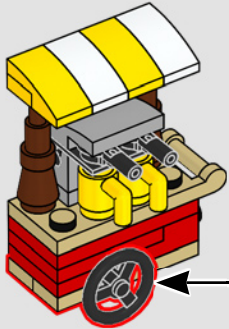

12

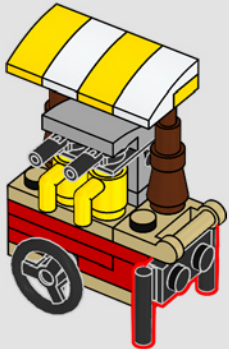

Esta cafetería ambulante es una extensión móvil del set Esquina del Café (10182): el primer modelo Modular Buildings. El toldo y las tazas de café amarillas son como los del edificio original.

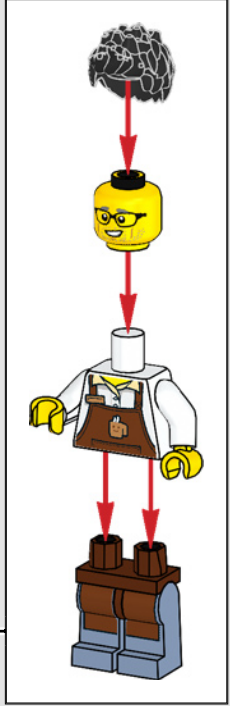





# FEEDBACK AND WIN



## FEEDBACK AND WIN

Your feedback will help shape the future development of this product series.

Please visit:

## FEEDBACK UND GEWINNEN

Dein Feedback trägt zur Weiterentwicklung dieser Produktreihe bei.

Geh auf:

## COMMENTEZ ET GAGNEZ

Vos commentaires nous aideront à concevoir les futurs produits de cette gamme.

Rendez-vous sur :

## COMENTA Y GANA

Tu opinión nos ayudará a dar forma al desarrollo de esta serie de productos en el futuro.

Visita:

## 反馈有奖

您的反馈将有助于我们在今后改进本系列产品。

请访问：

[LEGO.com/productfeedback](https://www.lego.com/productfeedback)

By completing, you will automatically enter a drawing to win a LEGO® set.

Terms & Conditions apply.

Durch Ausfüllen nimmst du automatisch an der Verlosung eines LEGO® Preises teil.

Es gelten die Teilnahmebedingungen.

En envoyant vos commentaires, vous serez automatiquement inscrit(e) à un tirage au sort qui vous permettra de remporter un prix LEGO®.

Offre soumise à conditions.

Al contestar, participarás automáticamente en el sorteo y podrás ganar un set LEGO®.

Sujeto a Términos y Condiciones.

完成我们的反馈调查，即可自动进入抽奖环节，赢取乐高®套装。

适用《条款和条件》。



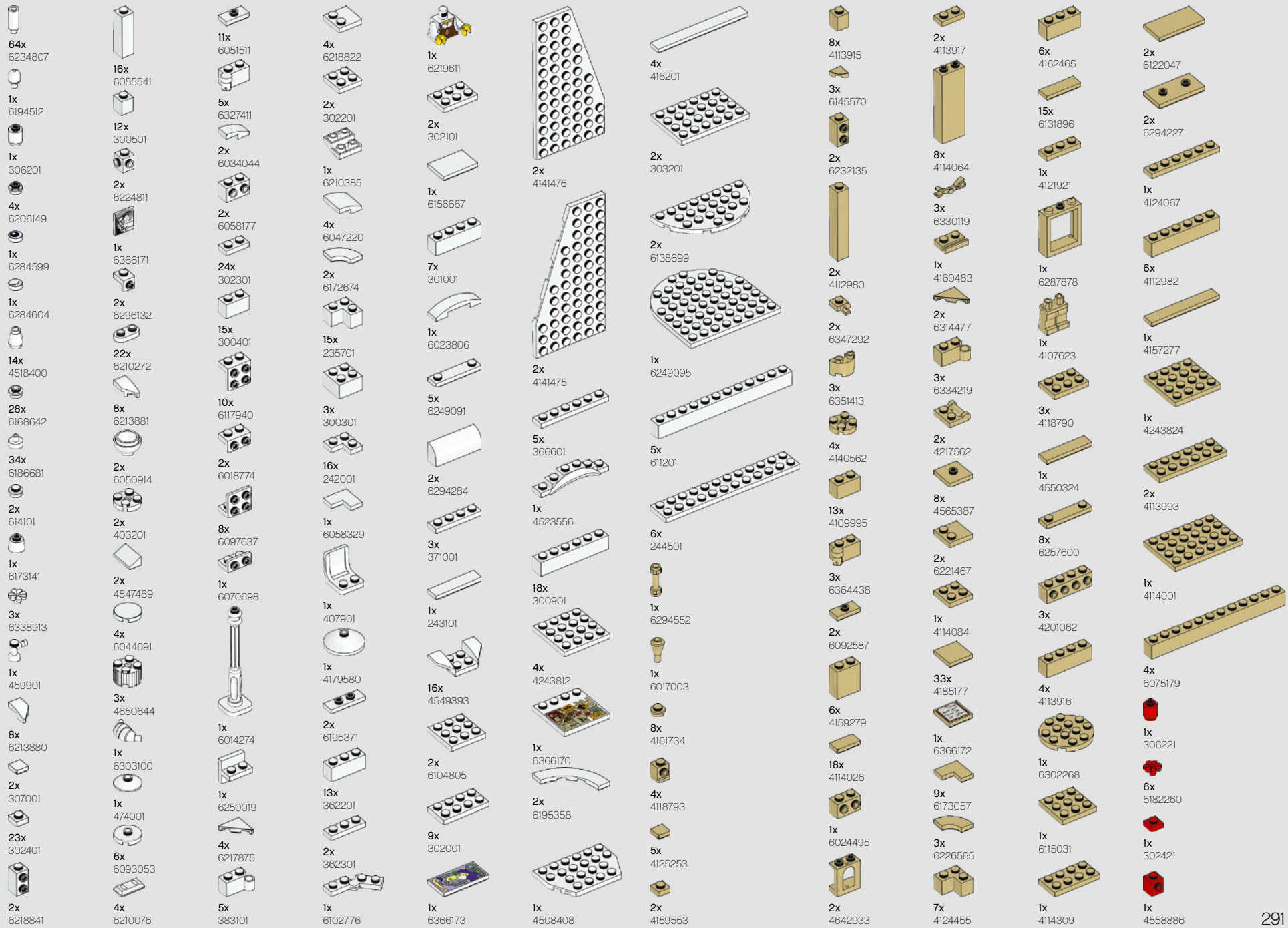

1x 302321	2x 6092582	1x 6218235	2x 6210496	1x 6224071	1x 6323420	1x 6323421	1x 6323421	1x 6323421	5x 4565323	1x 4613153	1x 6327402	1x 6357937	8x 6252258
1x 302221	1x 300423	1x 4651443	9x 6321194	12x 6371584	1x 6323421	1x 6323421	19x 6092585	1x 368026	1x 368026	11x 371026	1x 303426	6x 4616027	26x 6254552
2x 242021	1x 302323	1x 6116616	2x 6240496	1x 6173105	1x 6024730	1x 6138173	1x 6013867	1x 6013867	1x 6013867	4x 6037746	1x 303426	5x 4614158	1x 6278710
4x 4567445	2x 4558606	1x 6103171	1x 4529236	1x 6299338	1x 6024730	1x 6138173	1x 4124096	1x 4124096	1x 4124096	2x 243126	1x 395826	2x 6186009	1x 6278710
1x 6061711	3x 362223	1x 6288015	3x 6056234	4x 6308000	1x 6269081	1x 306926	5x 6052126	5x 6052126	2x 243126	1x 611517	2x 447726	2x 6186423	2x 6251285
2x 362321	2x 4587840	1x 6211710	19x 6168646	15x 6380639	1x 6102341	2x 6147050	2x 4515368	2x 4515368	4x 611517	4x 6138726	2x 447726	23x 6253425	2x 6251285
2x 6268946	2x 428623	2x 307024	10x 6186675	1x 6134617	1x 6092664	3x 6000650	1x 407926	1x 407926	4x 6138726	1x 6280168	4x 4558593	2x 6257603	3x 6256058
1x 302121	1x 317623	1x 6195183	6x 614126	2x 6336977	1x 6070695	1x 6250020	2x 6272184	2x 6272184	1x 6280168	1x 302026	14x 6150607	5x 6074892	3x 6256058
1x 4515348	4x 6102759	2x 389924	3x 6195183	4x 6104209	2x 6057397	1x 6285241	1x 6219624	1x 6219624	1x 6280168	1x 302026	1x 6269971	21x 6074893	4x 6247362
1x 6313597	2x 300223	2x 6029947	2x 389924	2x 6281993	1x 4105175	16x 6214807	1x 6219624	1x 6219624	1x 302026	1x 663626	1x 6261358	4x 6058089	4x 6247362
1x 302021	1x 371023	1x 242024	2x 6029947	2x 6312449	1x 6366174	4x 6252201	1x 317626	1x 317626	1x 663626	1x 663626	6x 6129807	4x 6058089	7x 6253734
2x 614123	1x 371023	1x 371024	1x 242024	4x 6273589	2x 6195325	1x 6336989	2x 6116604	2x 6116604	1x 6058118	1x 6058118	3x 371028	6x 6253418	4x 6244793
2x 6344028	1x 371023	7x 302426	1x 242024	2x 6312449	1x 4106552	1x 6151289	1x 6162892	1x 6162892	1x 6162892	1x 6344427	17x 6182261	2x 6166107	4x 6240216
1x 300523	1x 6262960	10x 6335388	1x 371024	4x 6157554	2x 249626	1x 6093525	1x 6162892	1x 6162892	1x 6344427	1x 6344427	10x 6143431	1x 6168665	2x 6337597
3x 370023	1x 6366175	2x 6172383	2x 6170421	5x 6196548	1x 9339	2x 306826	2x 6286835	2x 6286835	1x 346026	1x 346026	17x 6369194	1x 6168665	2x 6337597
292		5x 6290456	2x 6228987	2x 6279875	10x 302326	1x 302226	1x 6186698	1x 6186698	1x 416226	1x 416226	2x 6248949	6x 6244796	2x 6247364

1x 6047056	12x 6055172	1x 6167936	2x 4530712	1x 6134280	8x 6083976	4x 4539114	1x 6335285	4x 4211222	8x 4565394	5x 4216668
1x 4558595	9x 6273590	5x 6001822	2x 6232137	2x 6223913	4x 4649065	2x 6311890	1x 4621543	14x 6382102	1x 6122977	1x 4211181
4x 6240467	6x 4549436	1x 6310832	2x 6232137	1x 6221730	2x 6133896	4x 6212040	4x 4529242	5x 6103004	1x 4211200	6x 6343651
1x 6213779	13x 6001824	2x 6175927	8x 4251796	2x 6223225	20x 6186823	2x 6341767	9x 6215659	1x 6139435	4x 4211221	3x 4211225
3x 6213777	4x 6334209	5x 6257599	2x 6275088	1x 6221729	1x 6186828	2x 4539090	1x 4211242	1x 4212422	5x 6221608	2x 4658005
3x 6223665	2x 6092591	3x 4626904	1x 6312450	1x 6278544	6x 6299637	2x 6274681	1x 4221744	1x 4211288	2x 4211257	1x 4211194
2x 6273853	8x 4521914	2x 4267874	3x 6055171	16x 4616578	2x 6223171	2x 4539102	3x 6149677	1x 6146301	1x 6146301	7x 4211190
2x 6249417	11x 4496699	3x 6096108	8x 6055222	20x 4616581	20x 6369375	2x 6107758	1x 6062574	1x 4211149	1x 6313506	1x 6153594
1x 6223065	14x 4528604	4x 4245570	4x 4245570	6x 6360075	2x 6385228	1x 6172632	1x 6062574	20x 4211150	11x 6100769	1x 6153594
2x 6337637	6x 6002849	3x 4507047	2x 6223126	28x 6278541	1x 6223219	1x 6172632	6x 6341553	20x 4211151	13x 4211152	7x 4595889
1x 4537251	6x 6002849	7x 6015424	2x 6223126	4x 6278541	3x 6100234	2x 6359685	1x 6306775	8x 6058084	4x 6248918	7x 4595889
1x 6192789	6x 6002851	6x 4247151	8x 6278553	2x 6278553	19x 6192923	4x 4539061	1x 6035291	2x 6310449	1x 6117976	6x 6262952
1x 6226630	2x 4550168	7x 6015424	5x 4655080	8x 6278553	2x 4521947	1x 6186003	1x 6268828	1x 6310449	1x 6174856	6x 4283660
5x 6313098	2x 6135607	4x 4246957	4x 6262972	5x 4655080	2x 6194726	1x 6186003	1x 6179942	3x 6102360	8x 4645103	2x 6075207
1x 6366169	1x 6132768	2x 4543949	6x 6177823	2x 6196591	2x 6177823	5x 4539071	1x 4645103	1x 4211180	5x 6196221	6x 4211189



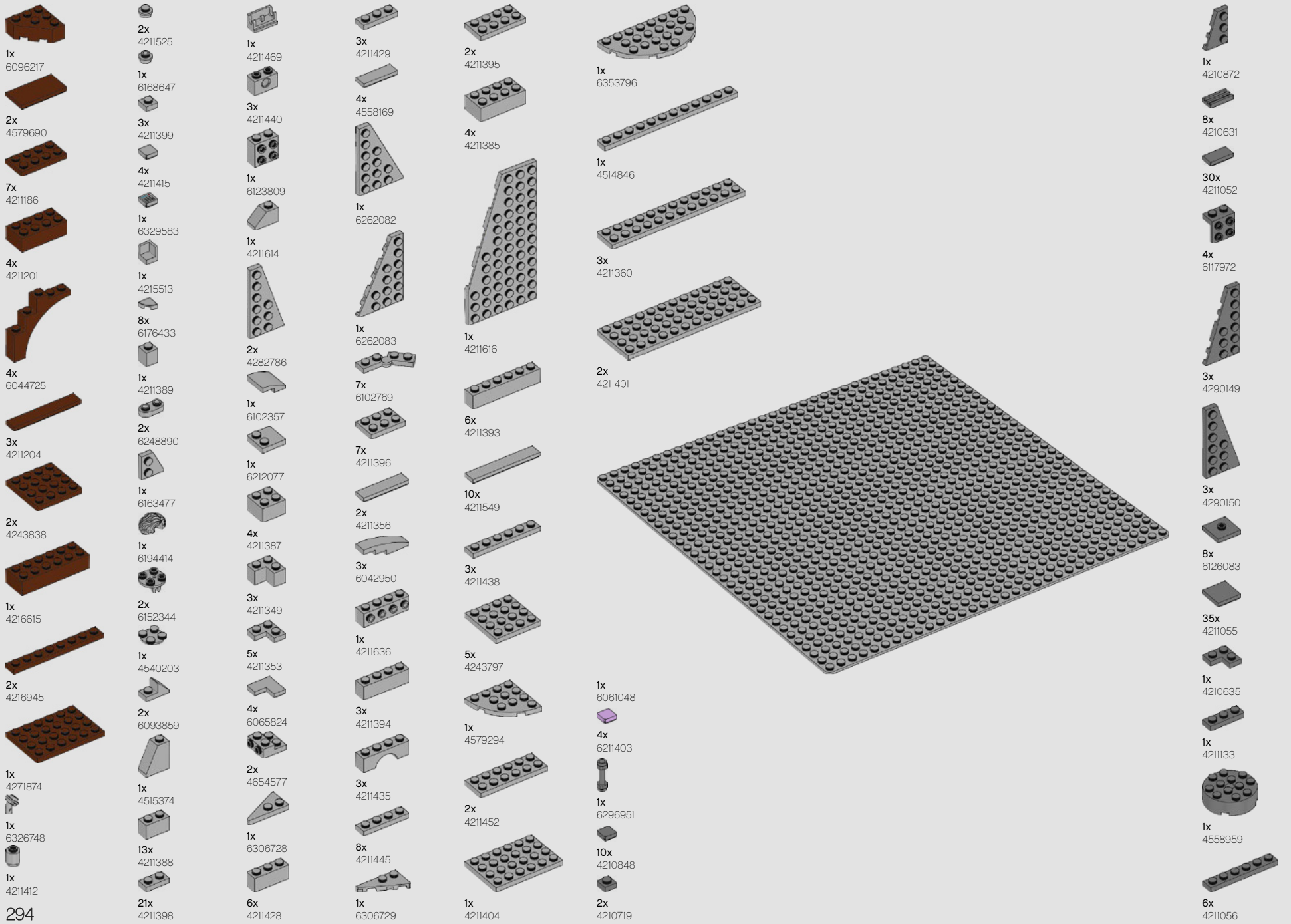



4x  
4211002



1x  
4210998



1x  
4211115



1x  
6141856



3x  
4210794



1x  
6107399



1x  
6092833



1x  
4586410



38x  
6369191



31x  
6357797



1x  
6275872



57x  
6369188



43x  
6369189



2x  
6357796



2x  
6343511



14x  
6325881



1x  
6297283



5x  
6357794



14x  
6369190



35x  
6378419



9x  
6369187



4x  
6369192



1x  
6170470



1x  
6292254



4x  
6252838



6x  
6296657



5x  
6209691



4x  
4529247



1x  
6190252



5x  
6186672



5x  
4523159



1x  
6284379



6x  
6257048



2x  
6167585



2x  
4490599



1x  
6245261



1x  
6092594



2x  
6022033



5x  
6093529



3x  
6147169



4x  
6226437



6x  
6251021



5x  
4519970



6x  
4566688



2x  
6046943



4x  
6058221



17x  
6058257



1x  
4538950



1x  
6179803



2x  
6047037



4x  
6272145



1x  
6167928



2x  
6313874



3x  
6252667



2x  
6328181



4x  
6226792



1x  
6295366



4x  
4518687



5x  
6300103



4x  
6167641



26x  
6057986



1x  
6167690



7x  
6215606



3x  
6177146



7x  
6314190



41x  
4656783



6x  
6021997



4x  
6186400



2x  
4568955



17x  
6223183



6x  
6102998



8x  
6218359



47x  
6099341



1x  
6295464



4x  
6106193



2x  
6387478



1x  
6345302



3x  
6102990



4x  
6102994



1x  
6177535



6x  
6192922



4x  
4633691



4x  
4619636



1x  
4611884



3x  
4655243



4x  
6136419



4x  
6331949



4x  
6119126



1x  
4624705



1x  
6253666



2x  
6361352



8x  
6251591



6x  
6295242



1x  
6240515

Customer Service  
Kundenservice  
Service Consommateurs  
Servicio Al Consumidor  
LEGO.com/service or dial





