



1



Es war einmal ...

Es war einmal eine große Ritterburg. Dort gab es wackere Ritter, Pferde, Könige, Königinnen und Turniere. Und jeden Tag viele neue Abenteuer.

So lautete damals die Einleitung der Produktbeschreibung im LEGO® Katalog, als das

heute legendäre Set 375 aus der Themenwelt „Castle“ im Jahr 1978 herauskam. Heute wird das Modell gern als die „gelbe“ oder die „ursprüngliche“ Ritterburg bezeichnet. Das war der Auftakt für unzählige Abenteuer im Mittelalter, die ohne Unterbrechung bis

1999 fortgesetzt wurden. Zur Feier des 90-jährigen LEGO Jubiläums möchten wir diese beliebte Themenwelt mit der neuen „Burg der Löwenritter“ würdigen, der das klassische Set „King's Castle“ (6080) aus dem Jahr 1984 als Vorbild diente.

1978



375 Castle

Die Ritterburg, mit der alles begann! Die markanten gelben Mauern dieser Ritterburg waren mit Scharnieren versehen, um mehrere Konfigurationen zu ermöglichen und besser in der Burg spielen zu können. Die gelben Mauern wurden rasch von realistischeren grauen Mauern abgelöst. Die Mauerkonstruktion mit Scharnieren ist auch heute noch in vielen LEGO Ritterburgen zu sehen. Die Pferde aus LEGO Steinen und der klassische Astronautenhelm mit neuem Visier für die Ritter waren nur einige der Kuriositäten in diesem Set.

1984



6080 King's Castle

1986



6074 Black Falcon's Fortress

1987



6066 Camouflaged Outpost

Das Geheimversteck der Waldbewohner! Eine uralte Eiche hat ihre Wurzeln um einen riesigen Felsbrocken geschlungen. Doch das Modell birgt auch ein Geheimnis! Eine drehbare Geheimtür in dem Felsbrocken gewährt den Waldbewohnern Zutritt zur Höhle. Und die Rückseite lässt sich aufklappen, um in der Hohle spielen zu können. Das Set beinhaltet neben dem rätselhaften Anführer noch 5 weitere Waldbewohner.

1992



6086 Black Knight's Castle

Der Inbegriff einer klassischen Ritterburg! Diese imposante Festung wurde auf einer erhöhten Bauplatte errichtet, um unter dem Burghof Platz für ein Verlies zu schaffen. Auch in diesem Modell sind wieder eine funktionierende Zugbrücke und ein Fallgitter vorhanden. Außerdem lässt die Geheimtür auf der Rückseite die Ritter schnell entkommen oder zu nächtlichen Abenteuern aufbrechen. Im Black Knight's Castle lebten 4 Ritter in ihren Rüstungen und mit ihren Pferden, 6 Landsknechte, ein „Wolfpack Renegade“ und sogar ein Geist!

1992



6038
Wolfpack Renegades

1997



6097
Night Lord's
Castle

2000



6091
King Leo's
Castle

2004



8781 Große Ritterburg
von Morcia

2009



10193 Medieval Market Village

Medieval Market Village heißt eines der wenigen Sets, die das Leben hinter den Burgmauern darstellen. Das Set besteht aus zwei detailreichen Fachwerkhäusern, einem Wasserrad, das den Schiedehammer bewegt, Landsknechten, Ställen, einem Pferdewagen und sogar zwei Kühen!

2016



70317
Fortrex

Ein neuer Klassiker unter den Ritterburgen

Es ist immer heikel, eine überaus beliebte LEGO® Themenwelt wieder aufleben zu lassen und neu zu interpretieren. Doch unsere neue „Burg der Löwenritter“ ist nicht nur ein komplexeres LEGO Bauprojekt, sondern spiegelt auch den Geist der ursprünglichen Ritterburgen wie des Sets King's Castle (6080) wider. Das Ergebnis ist ein Modell voller spannender Funktionen.

Zunächst haben wir den Hauptturm auf eine große LEGO Felsformation gesetzt, um das Modell größer erscheinen zu lassen. Dadurch war es dann auch möglich, verborgene Räume und dunkle Verliese unter der Burg zu erschaffen. Die Mauern sind beweglich, und das Modell lässt sich zerteilen, um besser in der Burg spielen zu können. In der aufgeklappten Burg kann man viele Falltüren, Geheimgänge und Verstecke entdecken.

2022



In dieser neuen Version einer klassischen Ritterburg kommen moderne Bautechniken zum Tragen. Und mit vielen spannenden Funktionen würdigen wir unsere ursprünglichen Ritterburgen.

Im Jahr 2022 feiern wir 90 Jahre LEGO Spielspaß. Aus diesem Anlass haben wir die Fans abstimmen lassen, welche klassischen Themenwelten wir mit einem besonderen Jubiläumsset wieder aufleben lassen sollten. Zehntausende Fans haben an der Umfrage teilgenommen, und die Themenwelt Classic Castle war einer der klaren Gewinner!

90 years of play

LEGO YELLOW CASTLE, 1978

Anmerkungen des Designteams

Als die LEGO® Designer Mike Psiaki und Milan Madge noch Kinder waren, zählten die klassischen Ritterburgen immer zu ihren Lieblingsthemenwelten. Deshalb hatten die beiden auch immer davon geträumt, an einer großen LEGO Ritterburg zusammenarbeiten zu dürfen. Mike beschreibt, wie sich das Modell entwickelt hat:

Das Modell ging aus einer Abstimmung hervor, die aus Anlass des 90-jährigen LEGO Jubiläums im Jahr 2022 durchgeführt wurde. Wir haben dann versucht, möglichst viele beliebte frühere Ritterburgen zu einem ultimativen neuen Burgenmodell zu vereinen. Wir haben lange daran getüftelt, welche Form und Größe die Burg haben sollte. Wir haben zunächst kleine Mauersegmente, Fachwerkture und Zugbrücken gebaut. Dann haben wir mit verschiedenen Funktionen und ästhetischen Elementen herumexperimentiert, um herauszufinden, was gut funktionieren würde. Schon sehr früh entdeckte Milan eine Zugbrücke, die nicht mit den sonst üblichen vorne angebrachten Ketten bewegt wurde, sondern mithilfe eines Gegengewichts an der Rückseite. Wir wussten sofort, dass wir diese Zugbrücke irgendwo in der Burg unterbringen wollten. Doch erst ziemlich spät in der Entwicklung wurde sie zum Haupttor.

Der LEGO Graphic Designer Ashwin Visser hatte wesentlichen Anteil daran, der Burg mit unzähligen kleinen Details und Facetten den letzten Feinschliff zu verleihen. Hierzu zählten auch die Überarbeitung des grafischen Designs der Löwenritter, die Gestaltung neuer Flaggen und Wappen für die Burgmauern und Zinnen und der Entwurf der Schabracken in Blau und Rot für die beiden Pferde. Der neue Umhang und das Wappen für die Burgherrin waren das Tüpfelchen auf dem i.

1984



2022



Erkennst du die Unterschiede?

Das klassische Design der LEGO Löwenritter bedurfte einer Auffrischung, um besser zu den Schwarzfalkenrittern aus dem neueren Set „Schmiede“ (21325) zu passen. Der Entwurf des neuen Wappens der Löwenritter war besonders knifflig, denn die Fans kennen und lieben ja dieses legendäre Symbol. Deshalb musste das neue Wappen unbedingt immer noch zu erkennen sein.

Ashwin Visser, LEGO Graphic Designer



Von links nach rechts
Michael Psiaki, LEGO® Design Master
Milan Madge, LEGO® Designer
Ashwin Visser, LEGO® Graphic Designer

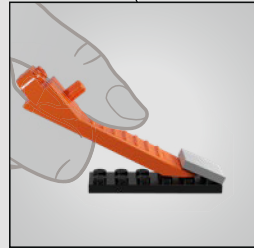
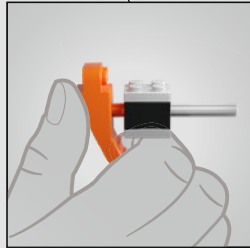
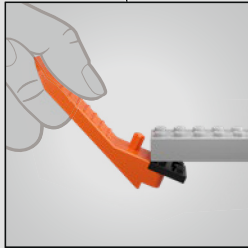
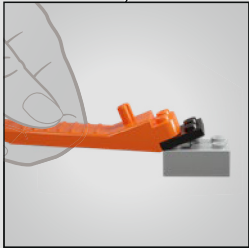
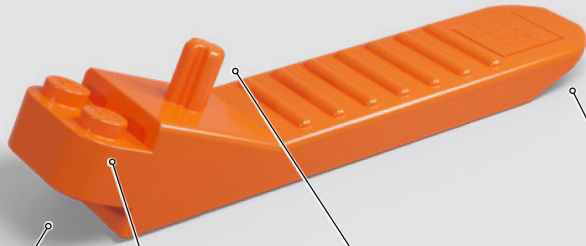

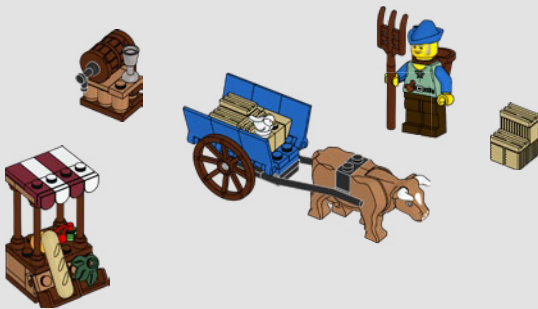
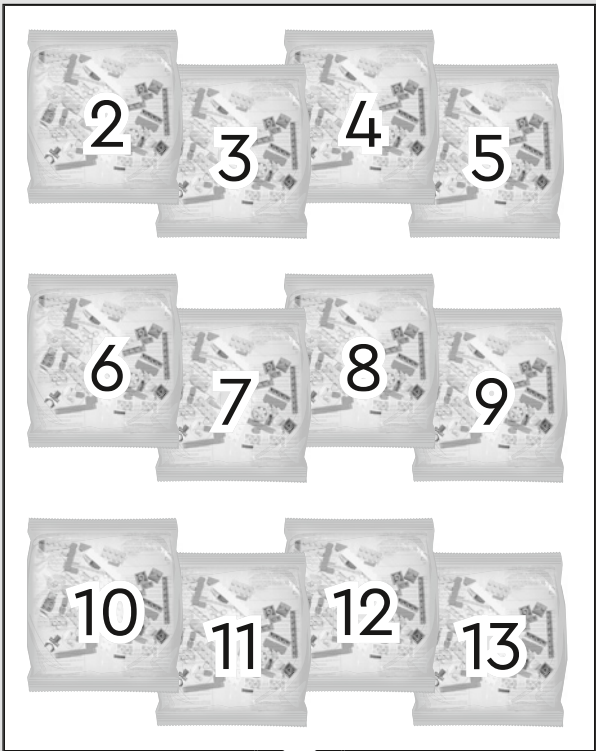

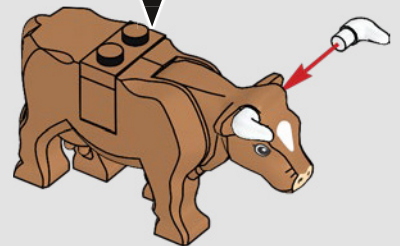
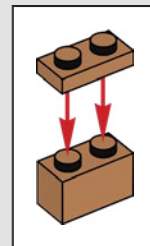
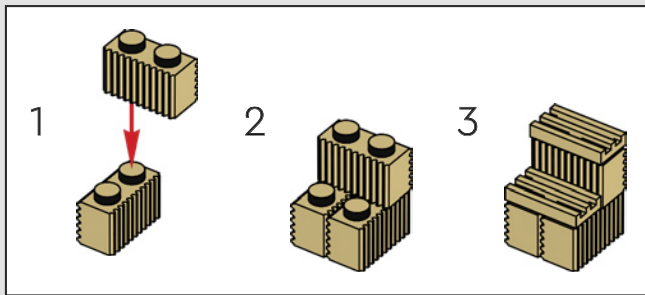
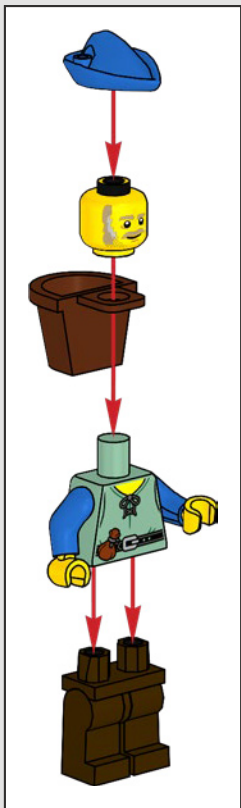

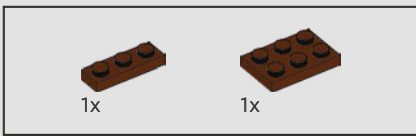

1

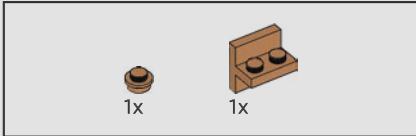
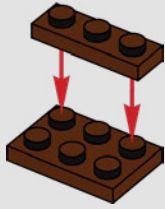

2

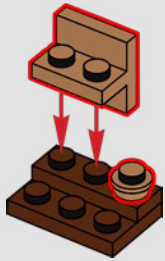

3

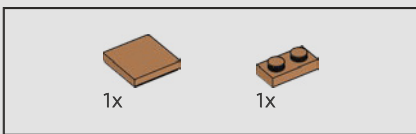
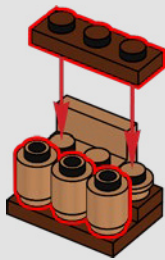

4

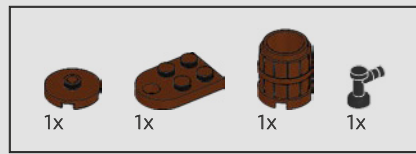
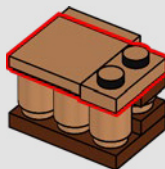

5

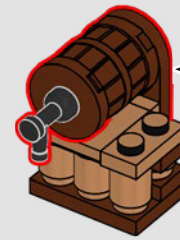
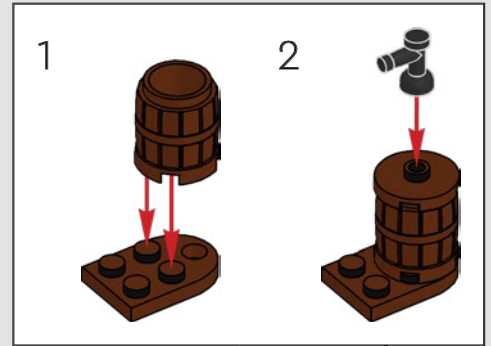

6



Jenes Fässchen enthält einen starken Trank, der deinen Bart ergrauen lässt!

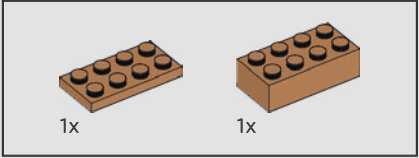

1

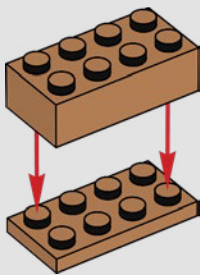

2

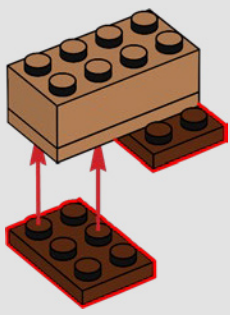

3

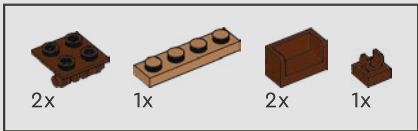
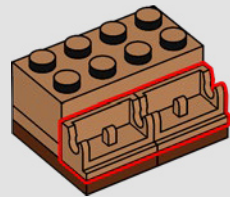

4

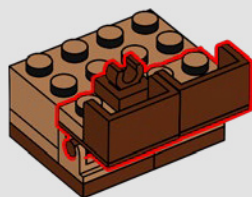
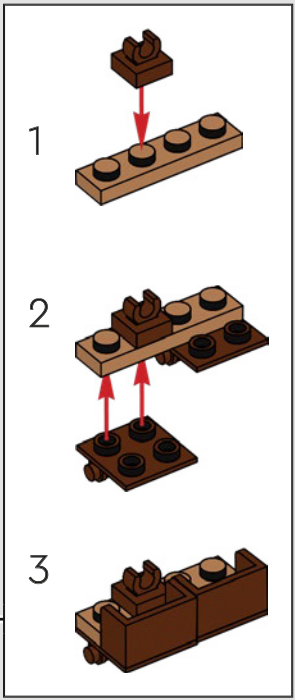

5

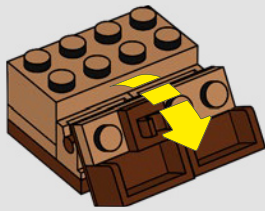

6

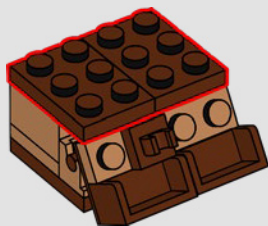

7

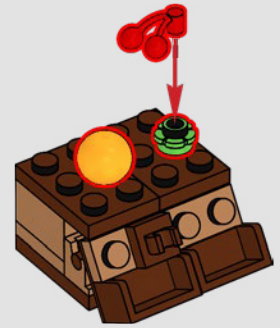
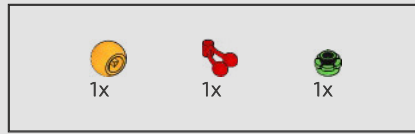

8

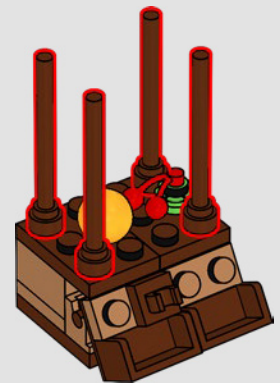

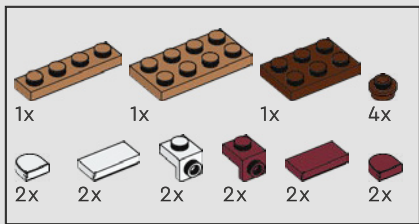

9

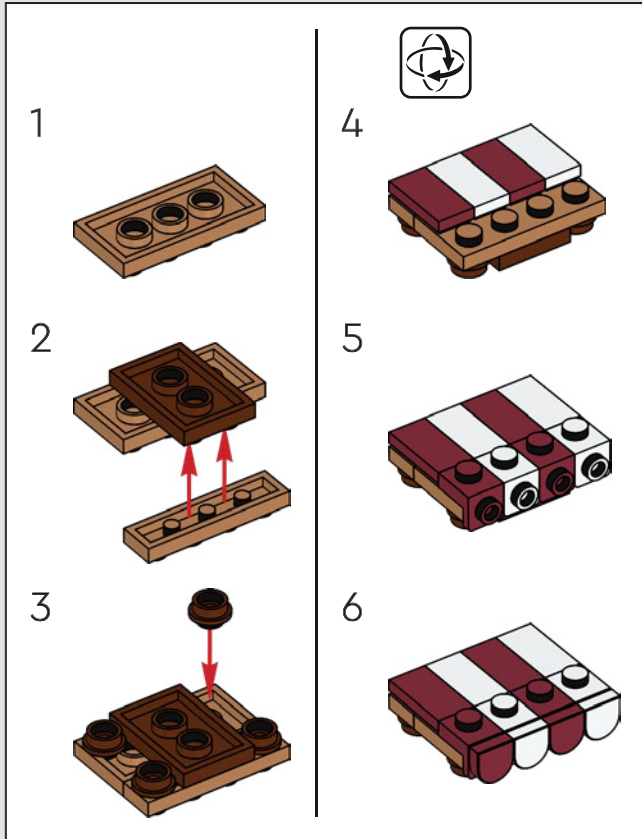

10

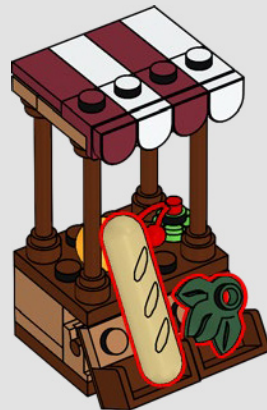

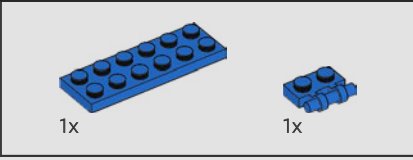
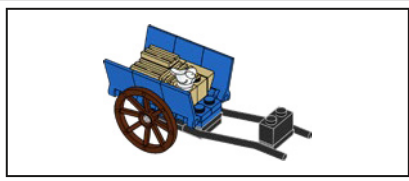

1

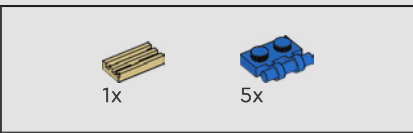
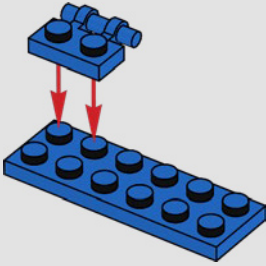

2

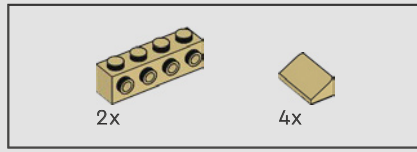
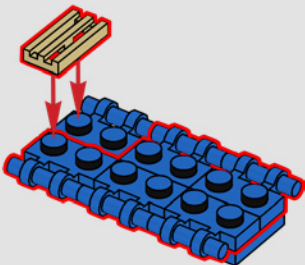

3

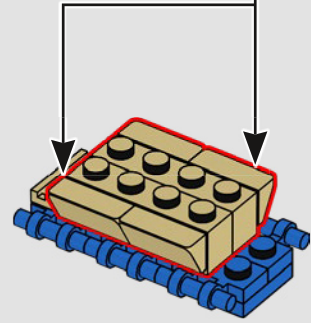
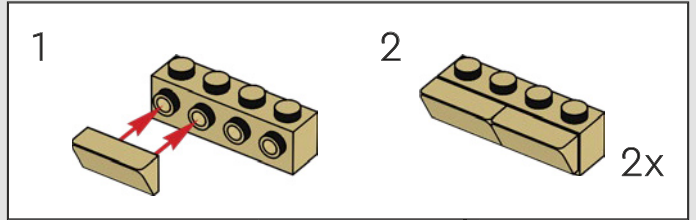

4

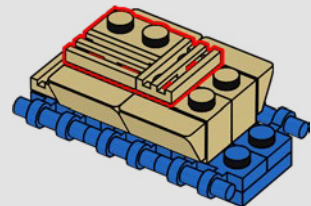

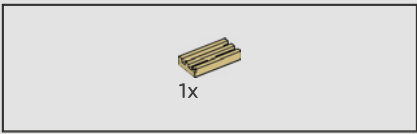

5

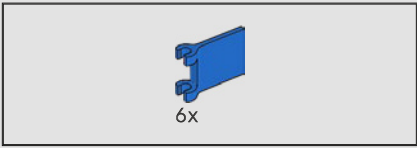
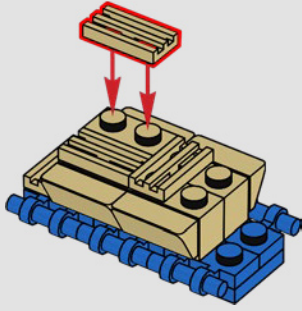

6

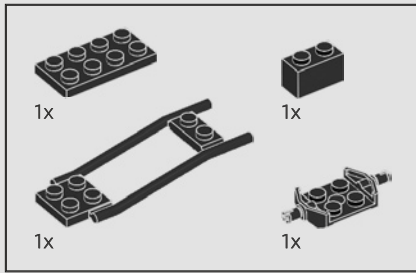
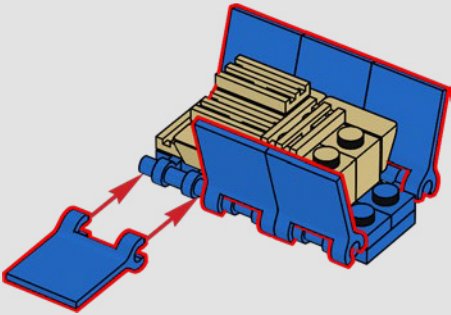

7

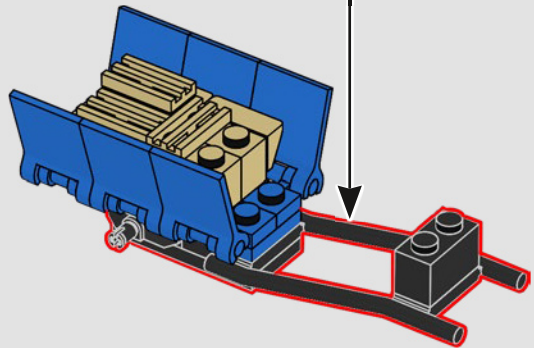
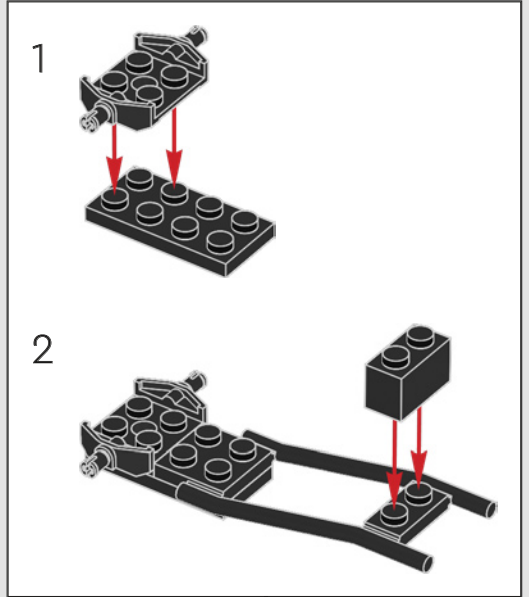



Jener Karren wird von Ochsen gezogen?
Was für eine Kuriosität. *Erinnert mich an
das Windschiff von Cousine Willa.*

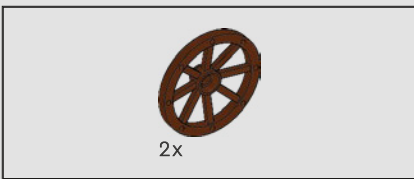

8

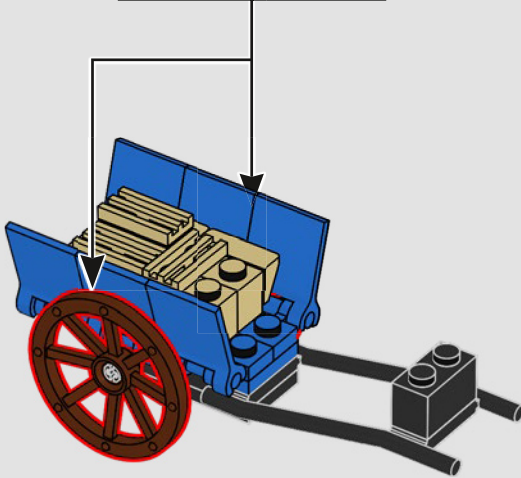
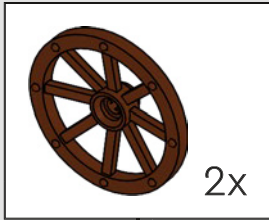

9

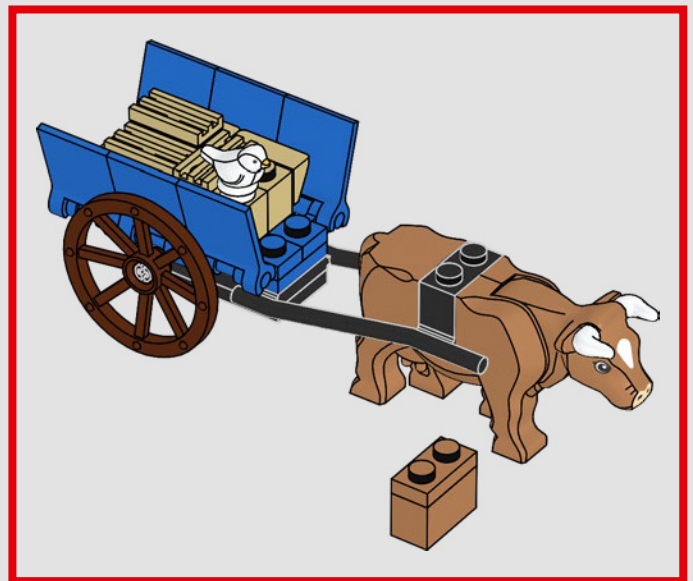
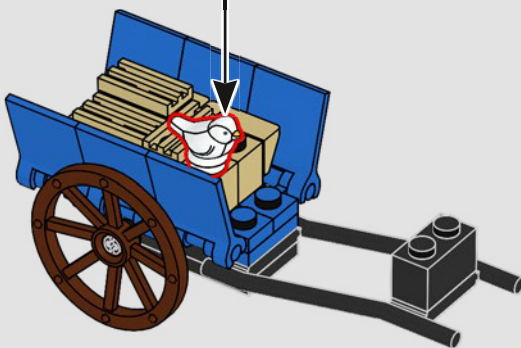

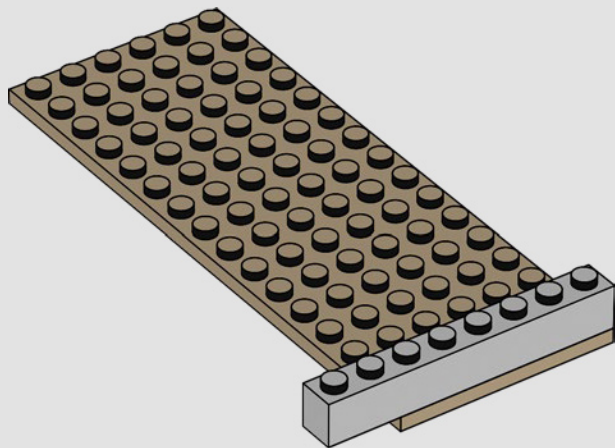
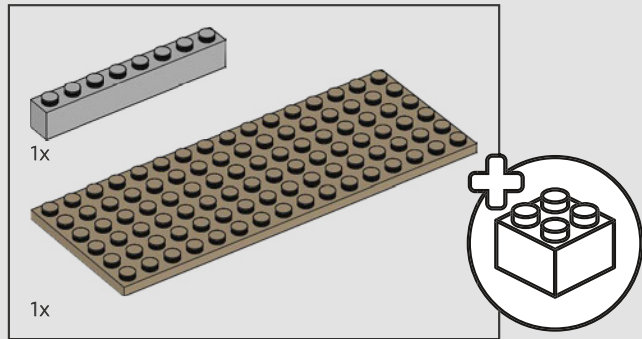
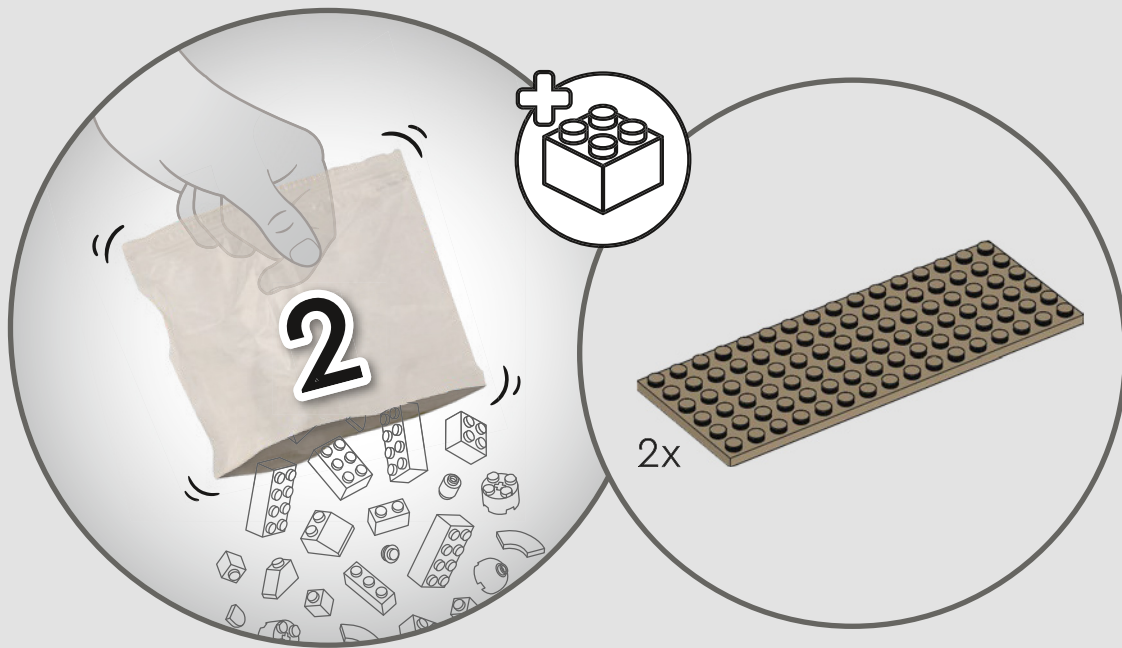

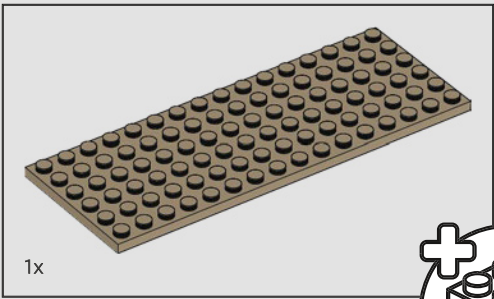

1x

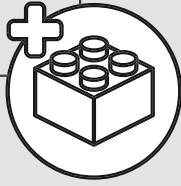

2

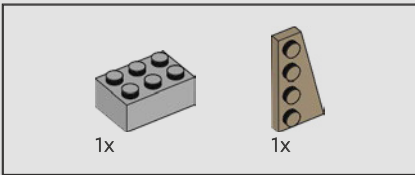
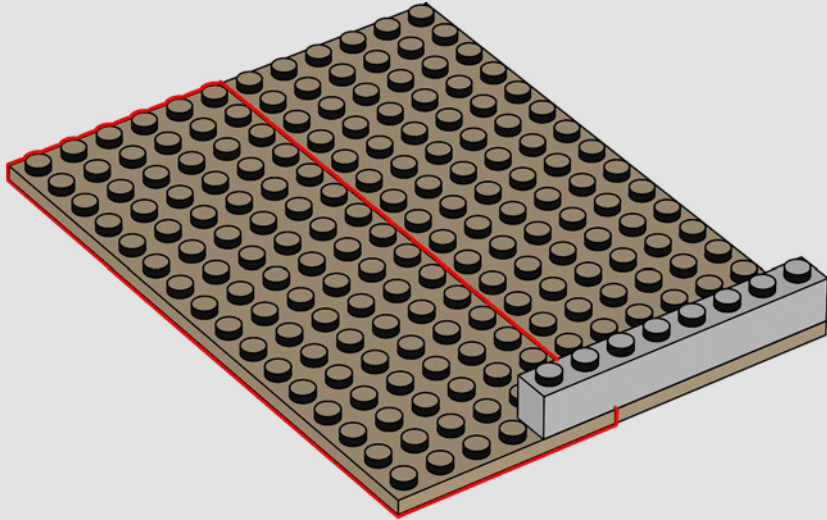

1x

1x

3

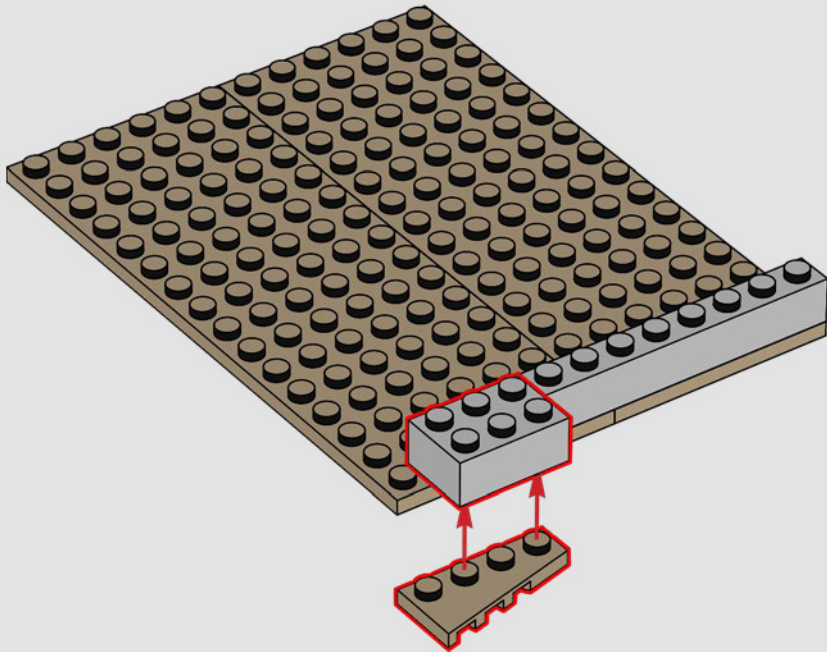

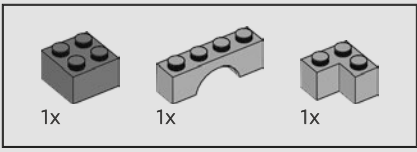

4

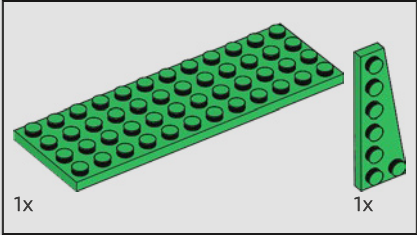
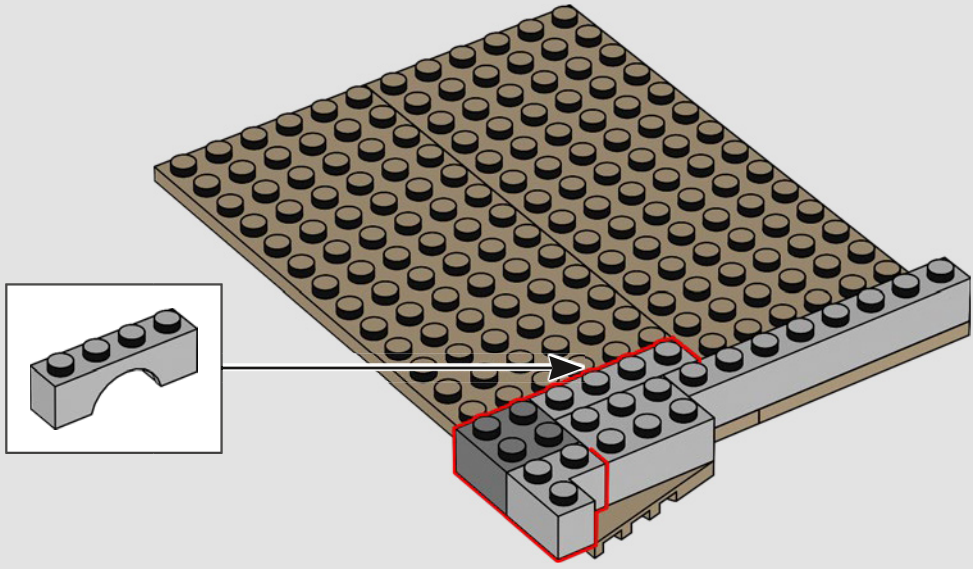

5

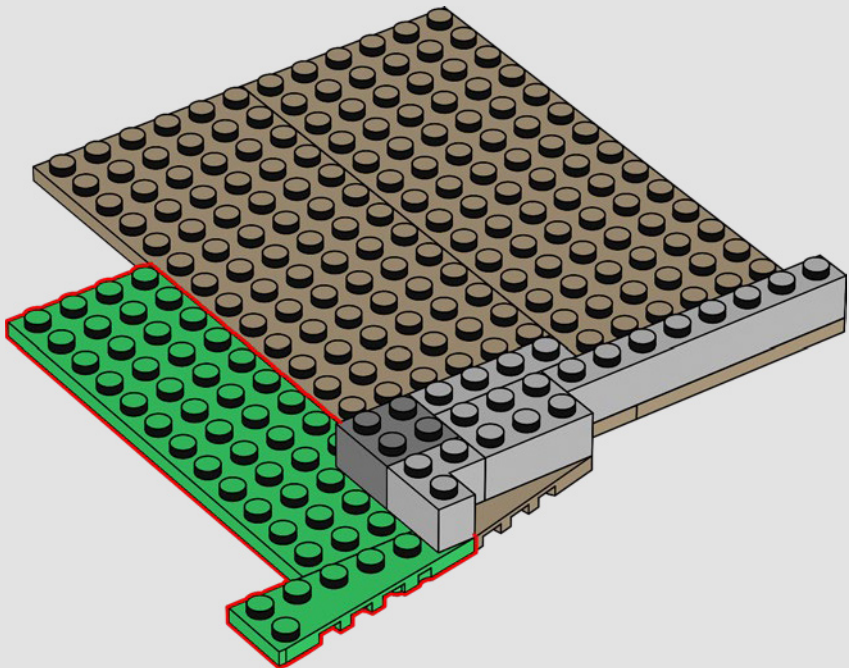

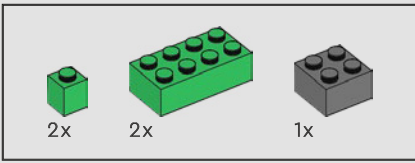

6

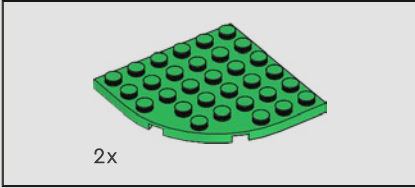
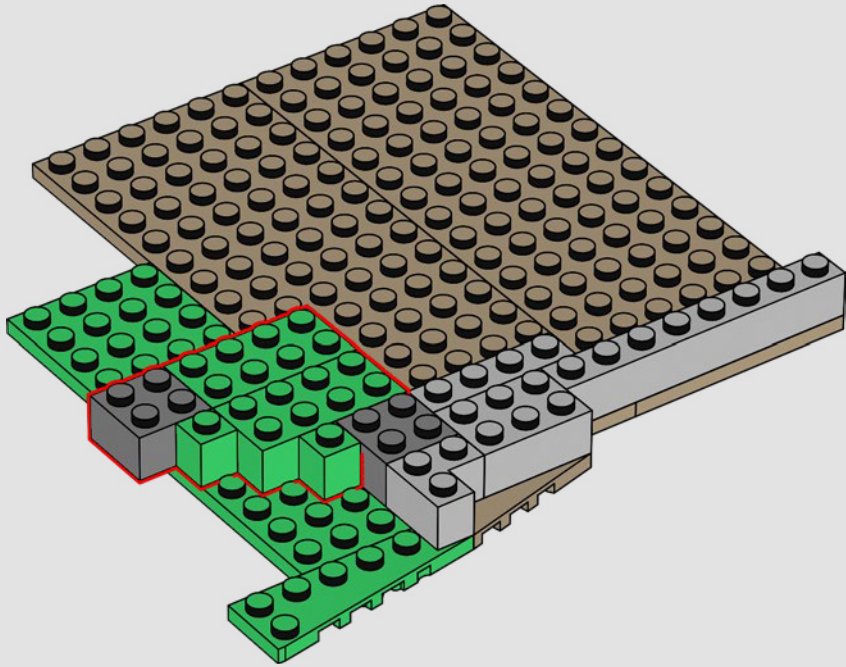

7

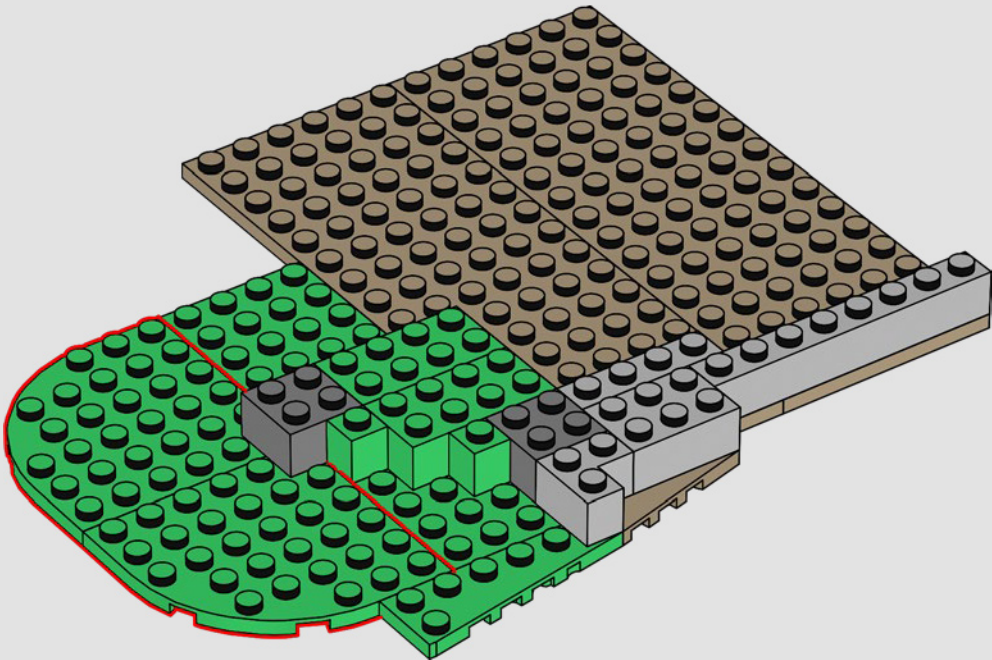

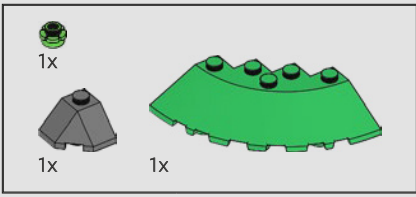

8

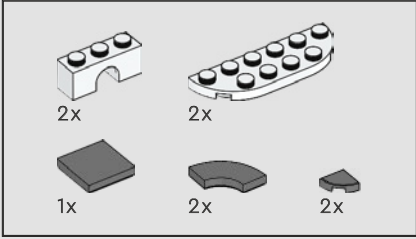
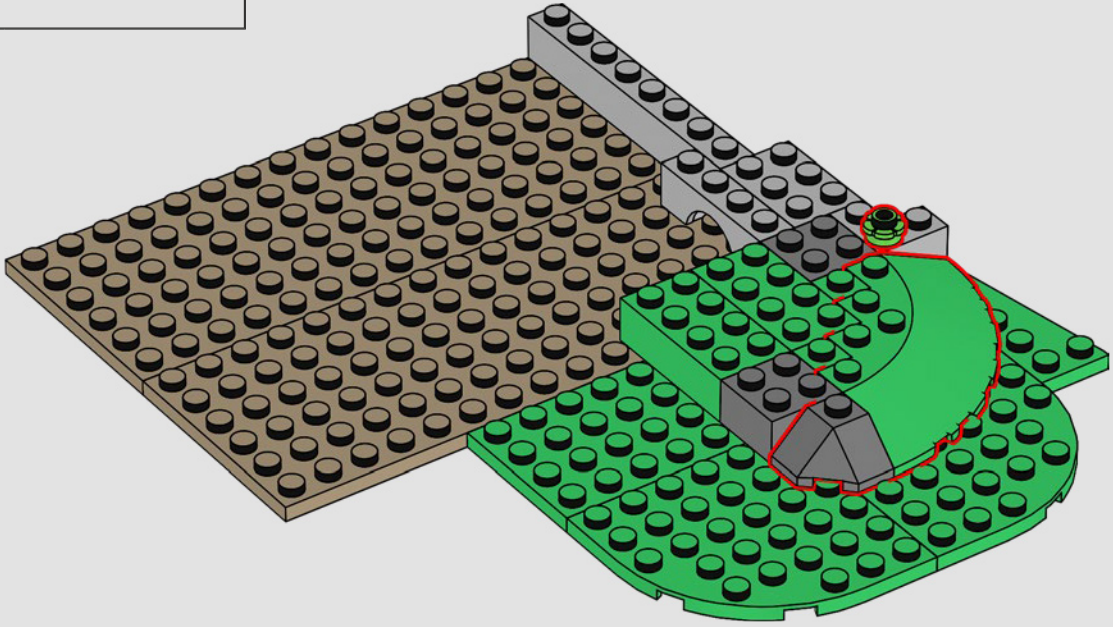

9

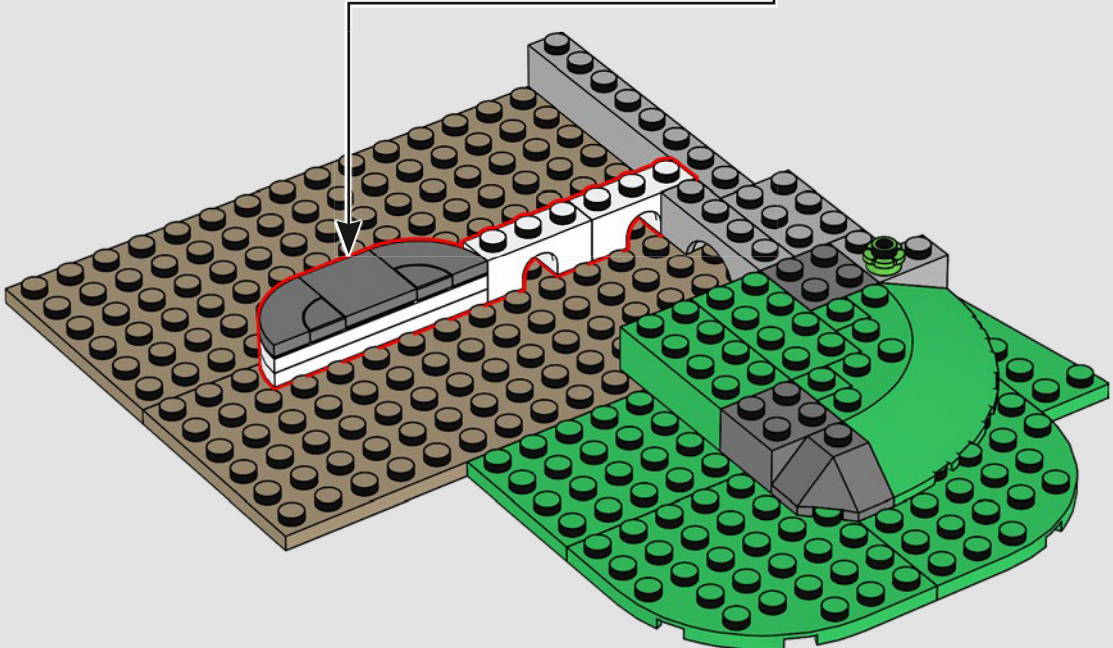
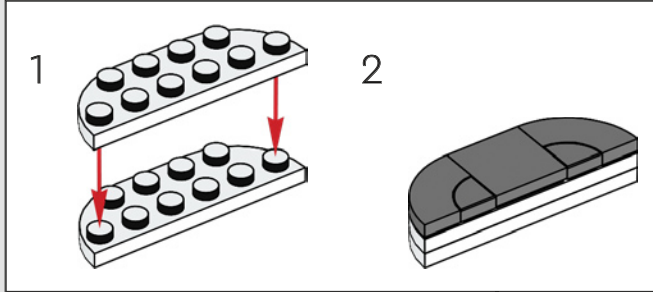

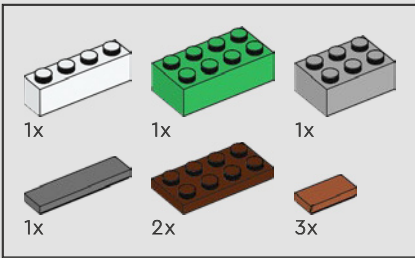

10

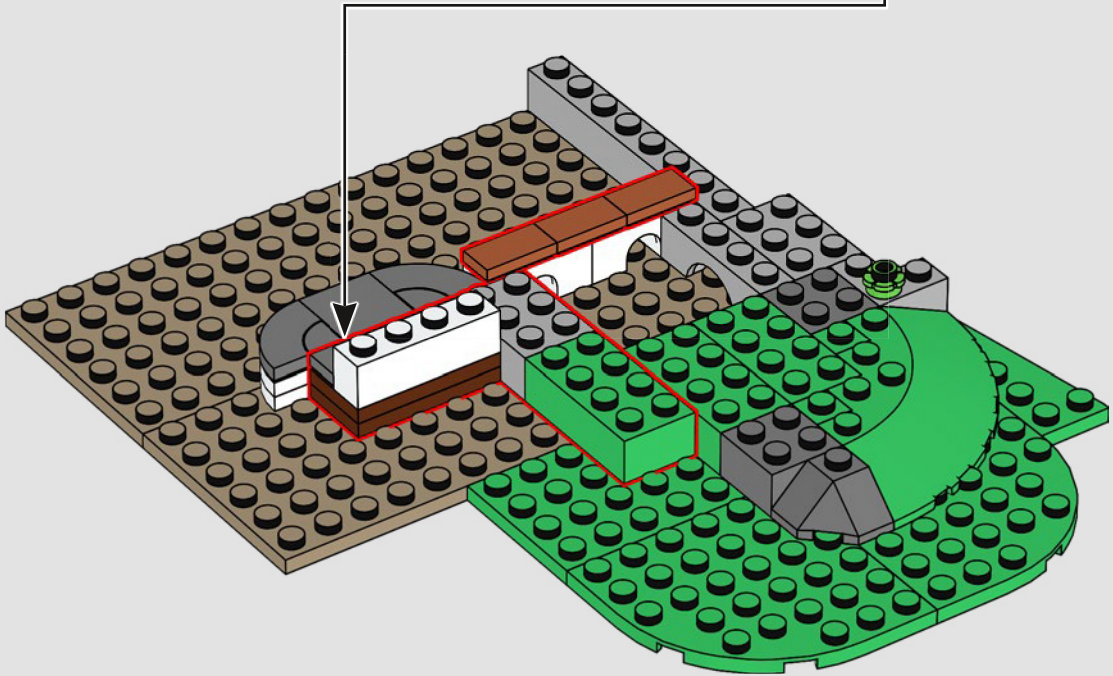
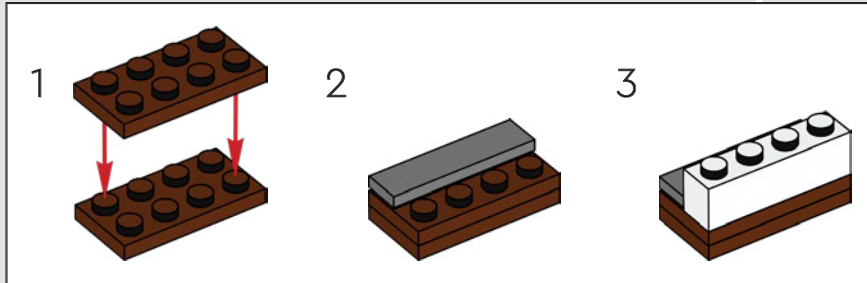

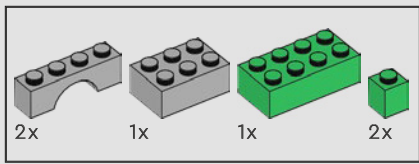

11

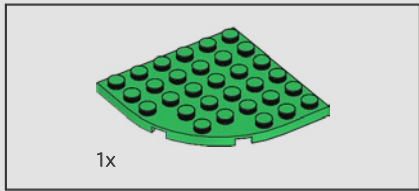
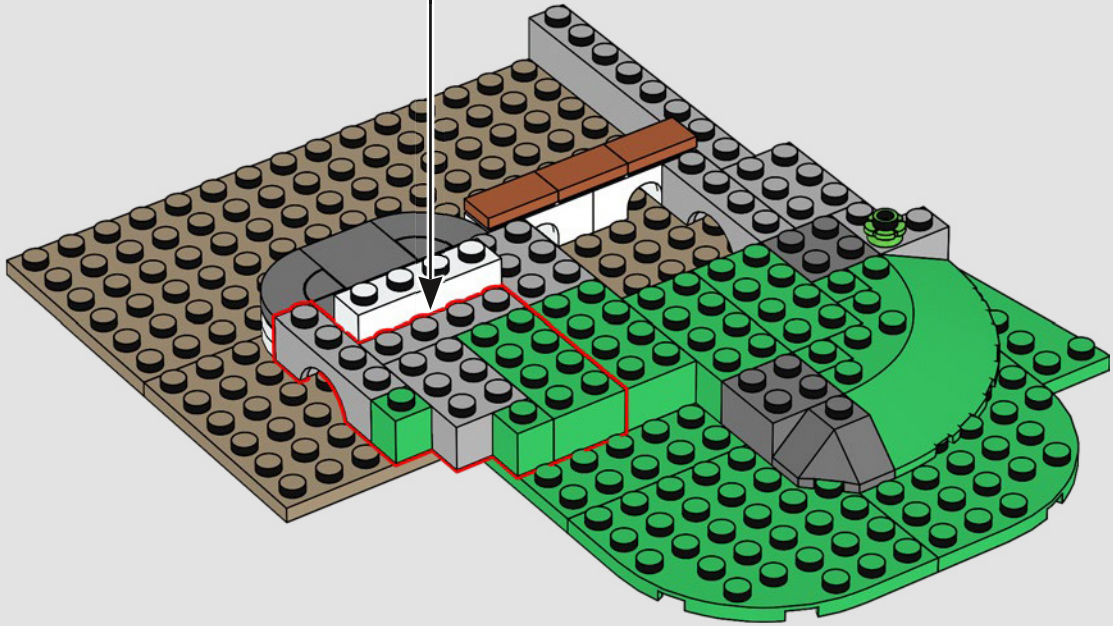
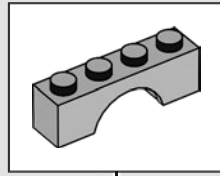

12

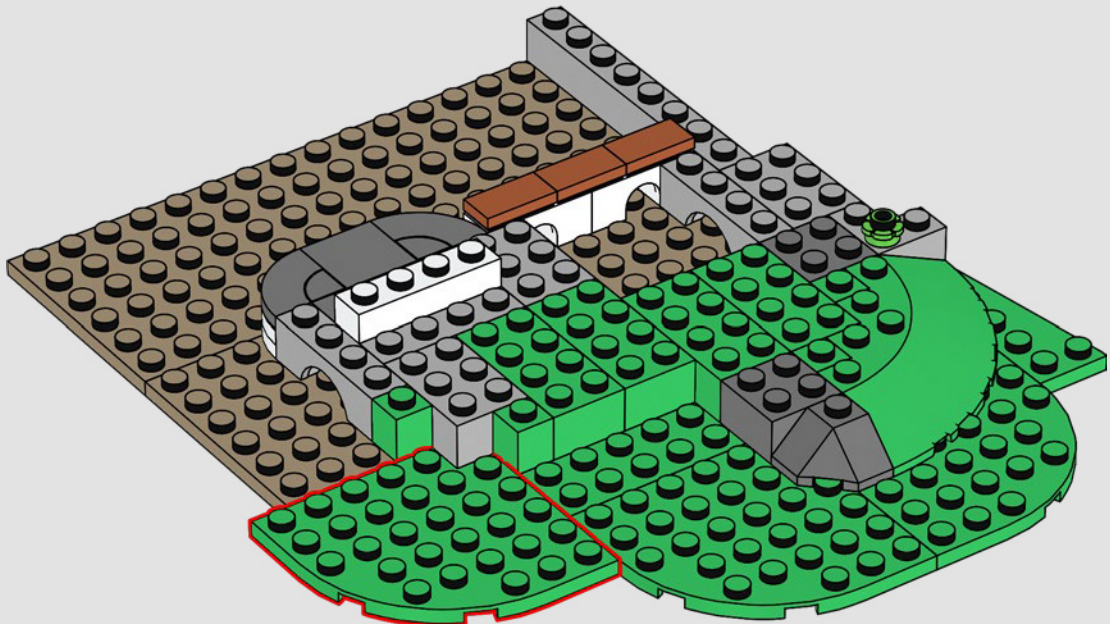

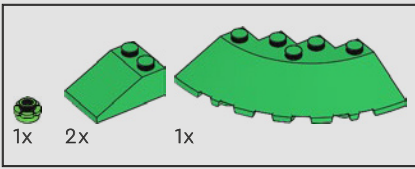

13

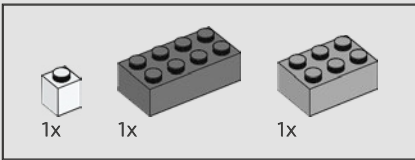
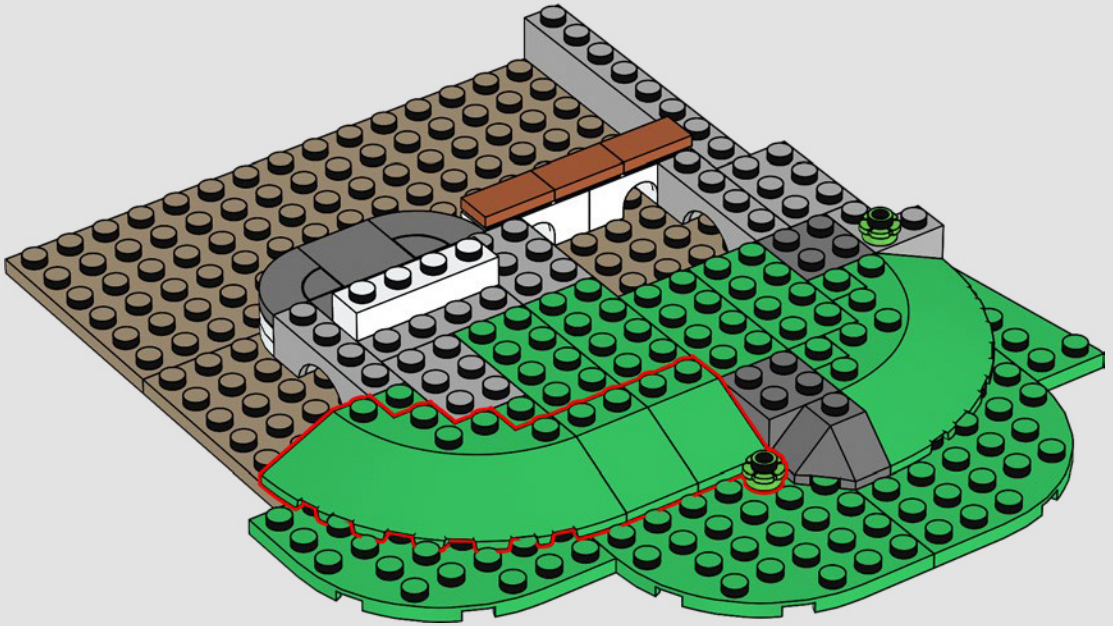

14

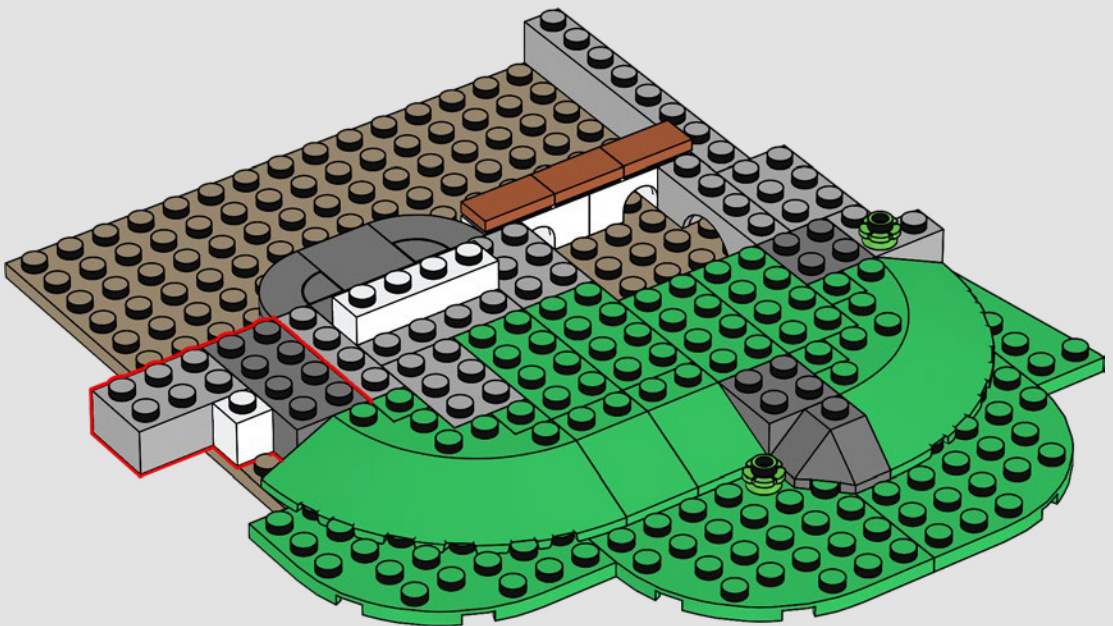

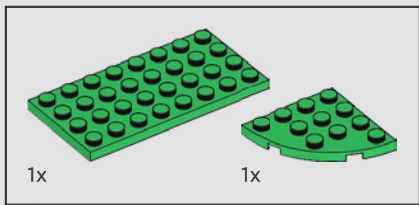

15

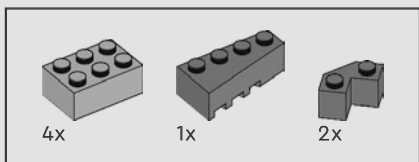
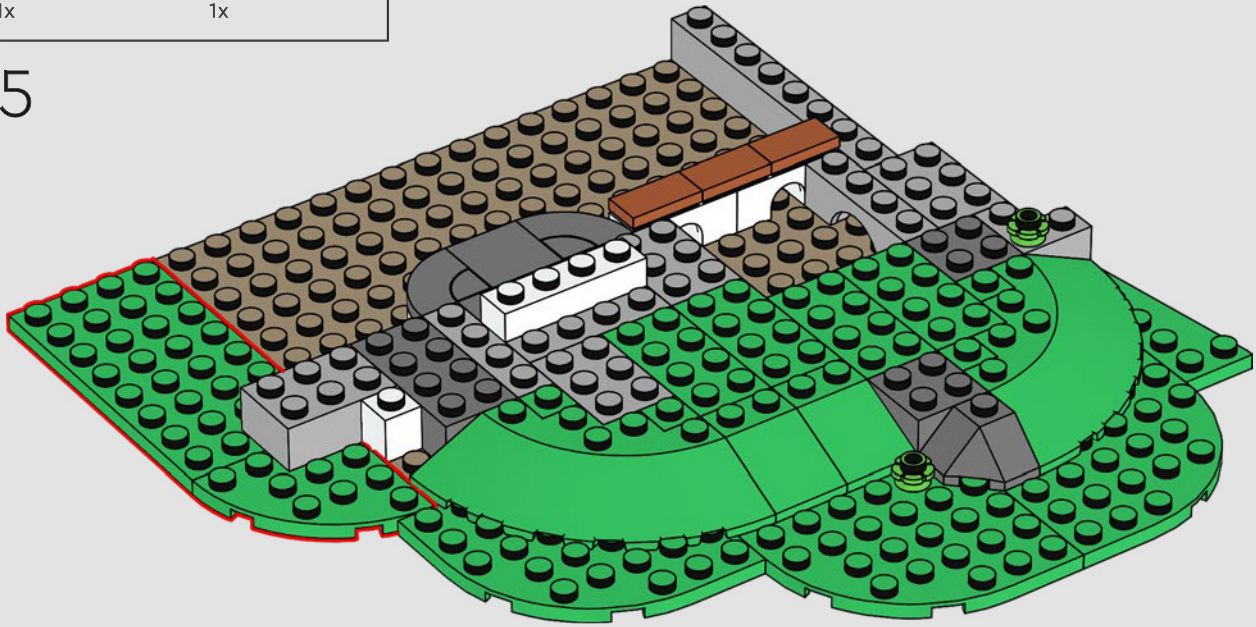

16

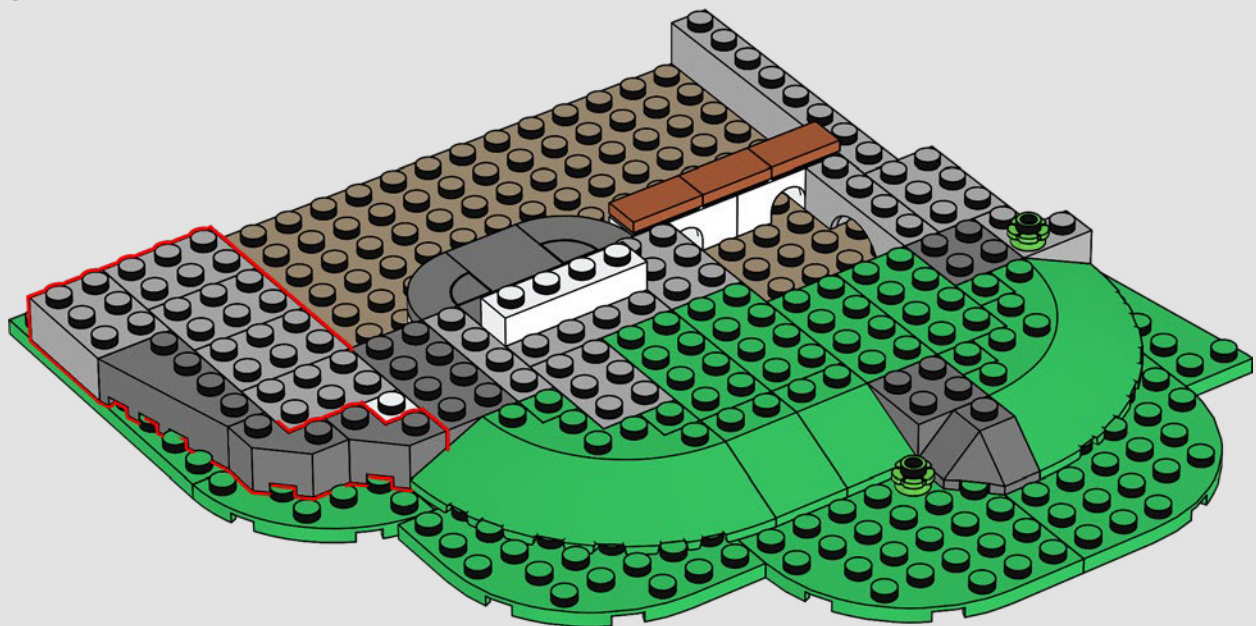

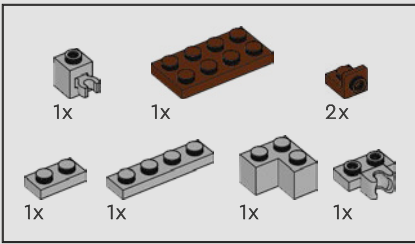

17

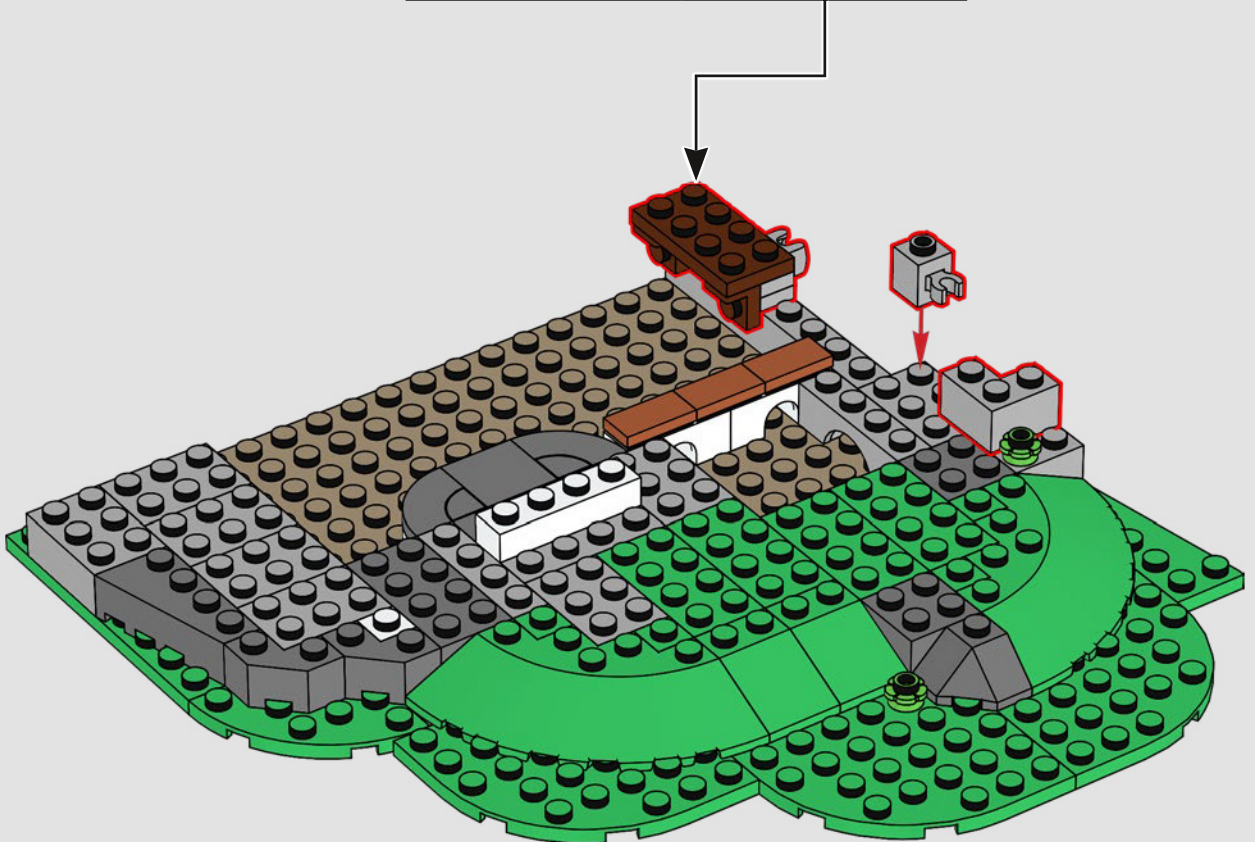
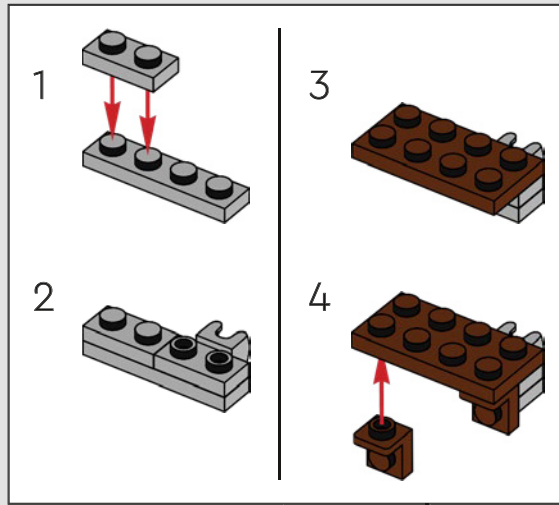

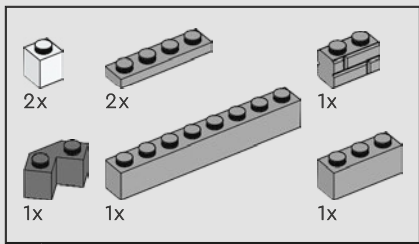

18

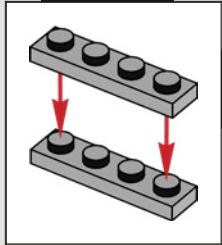
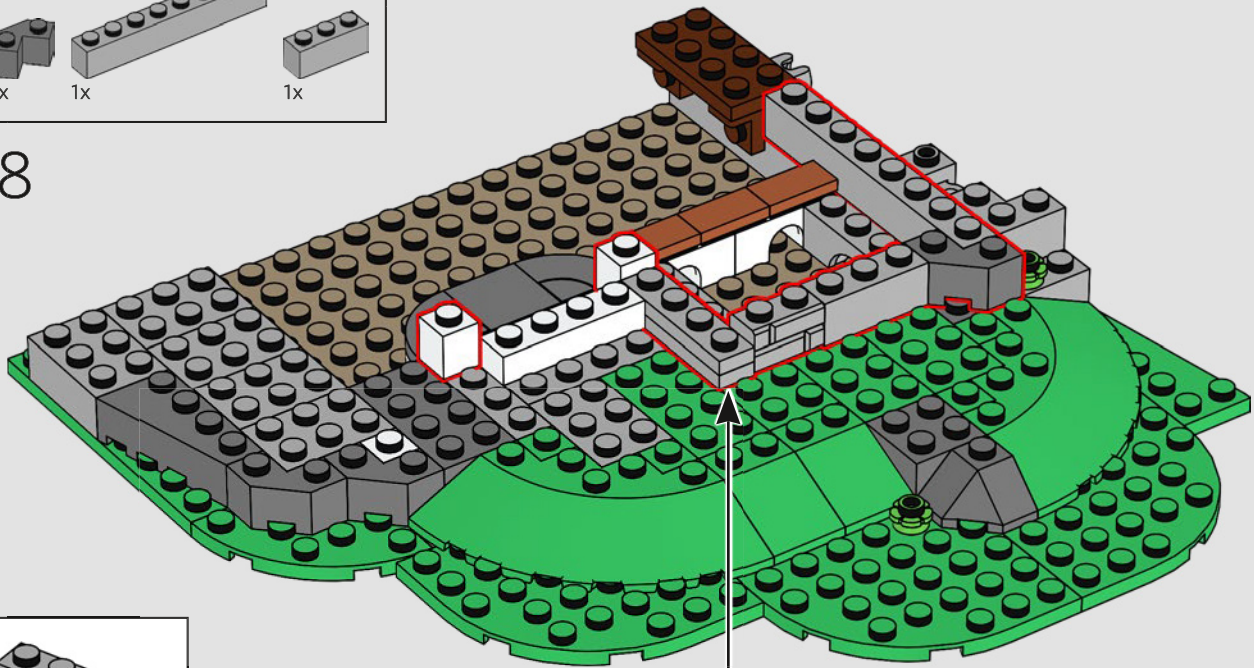

19

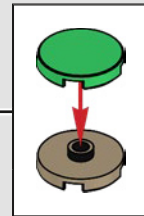
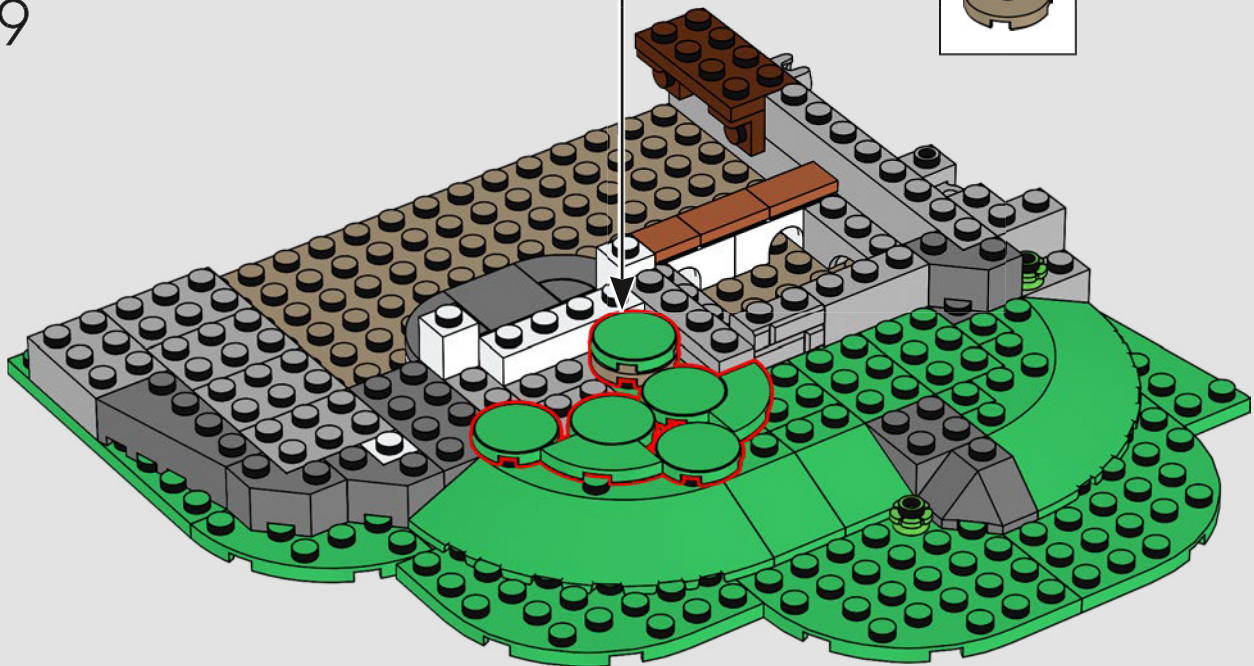

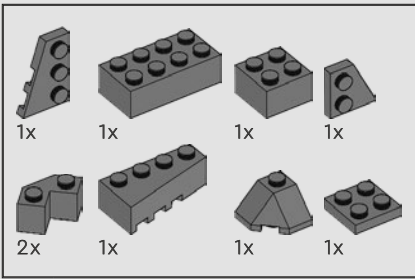

20

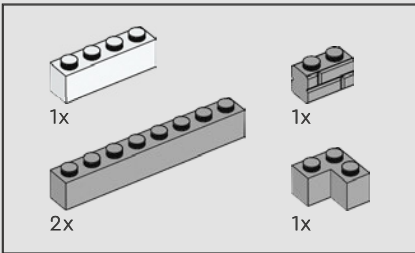
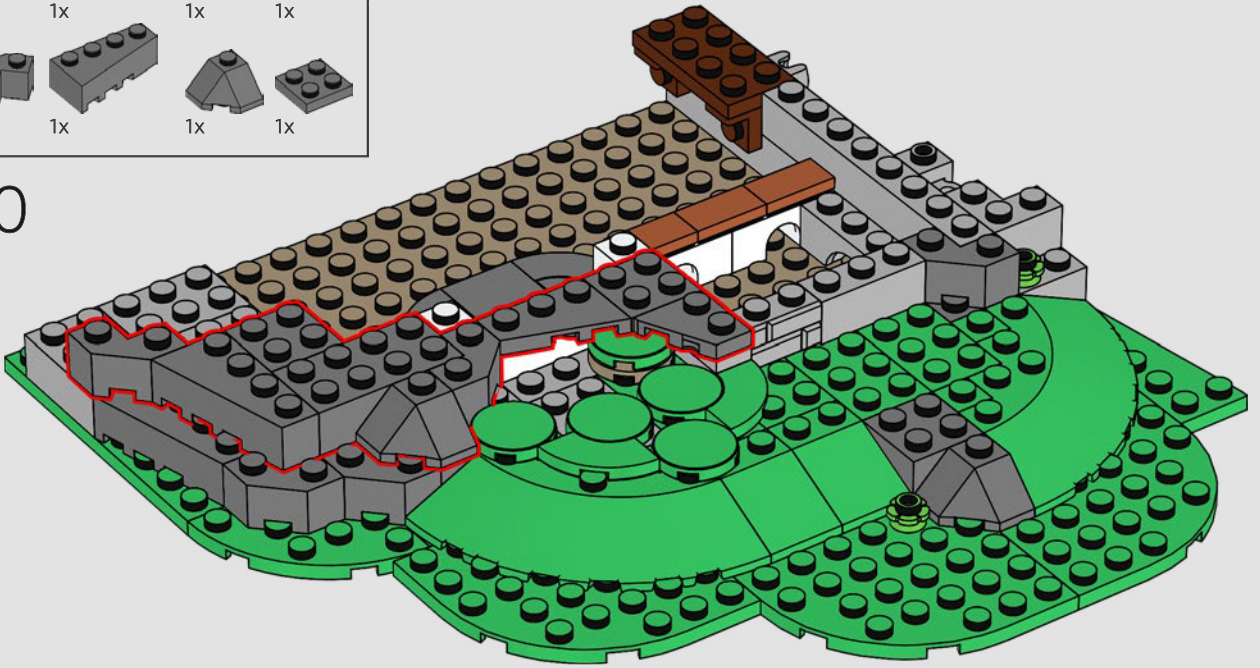

21

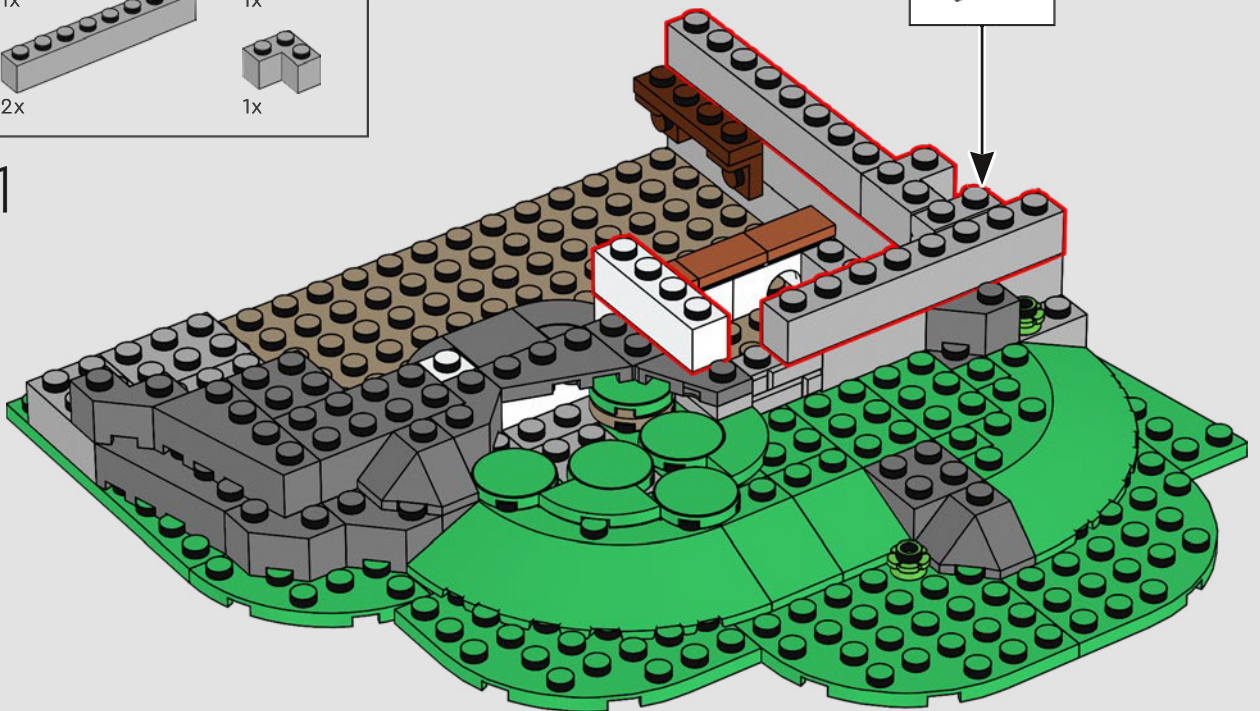
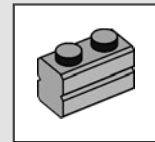

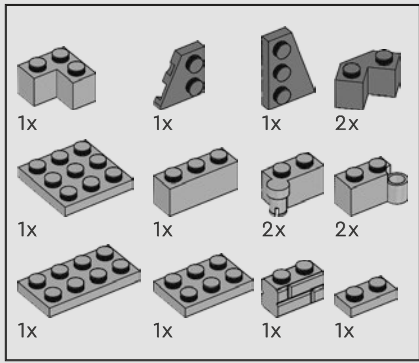

22

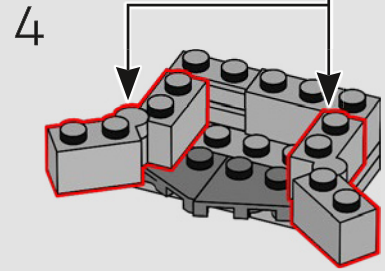
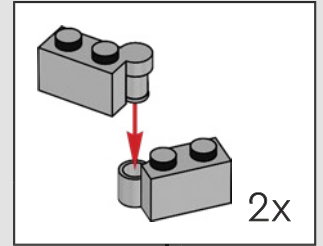
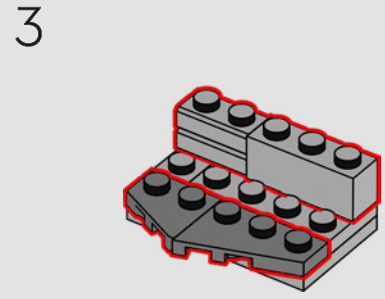
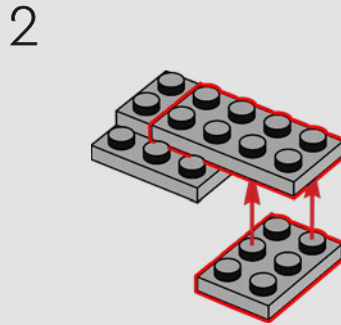
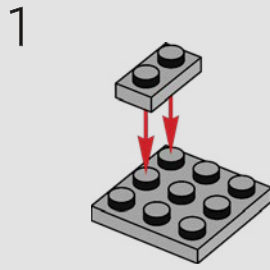

Wie können diese Mauern
zusammenpassen? Solche Magie gab
es hier noch nie!

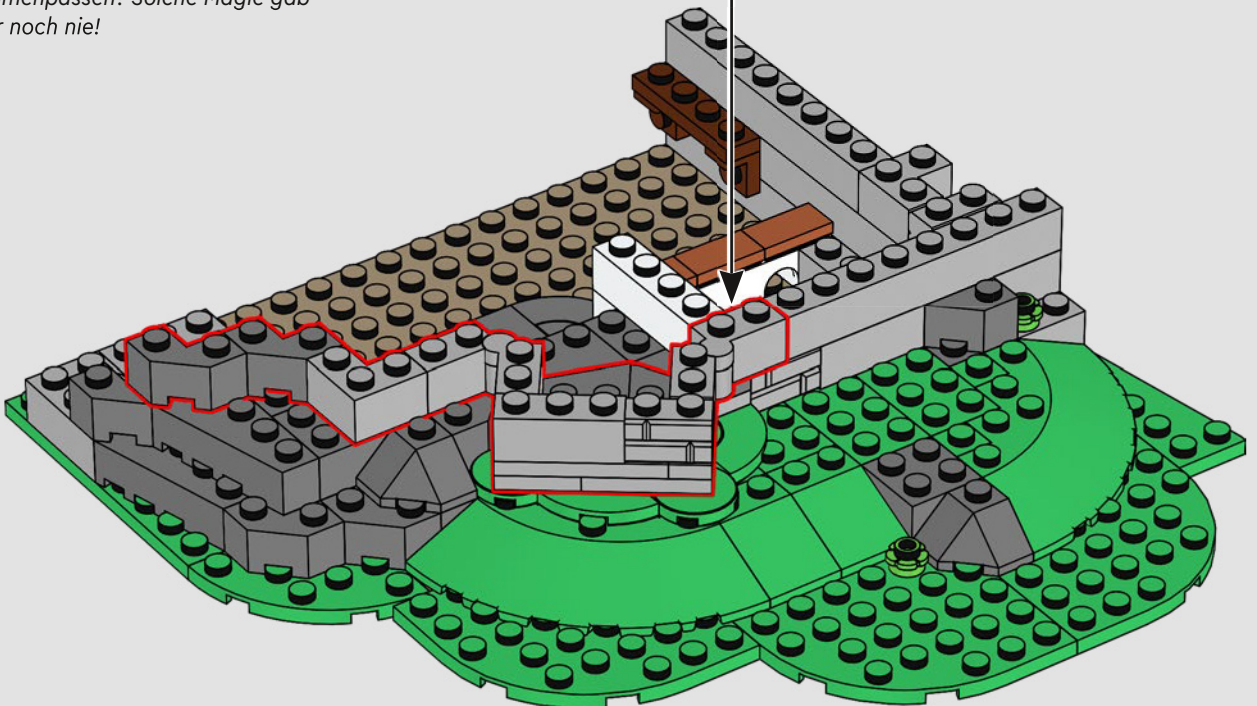

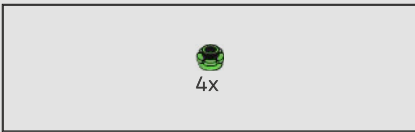

23

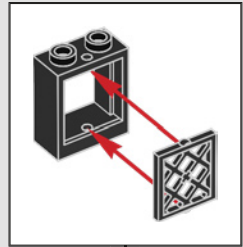
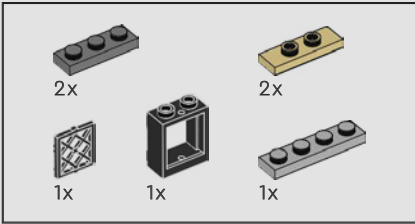
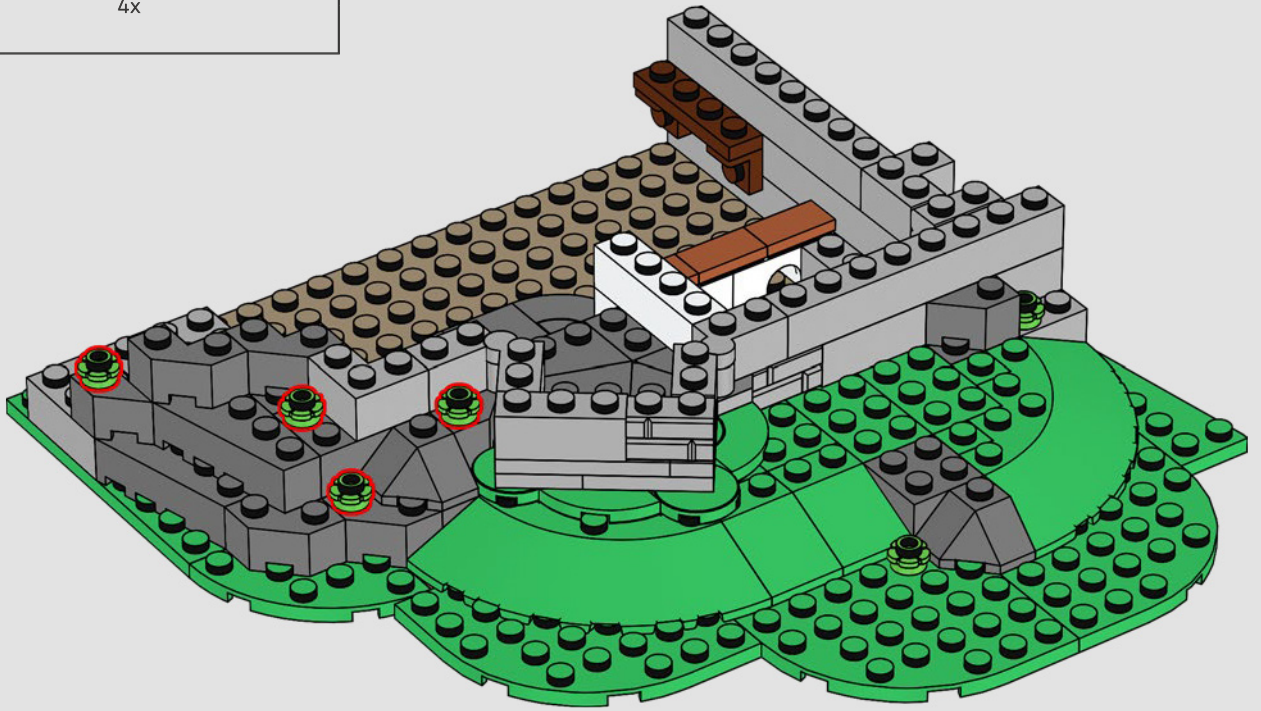

24

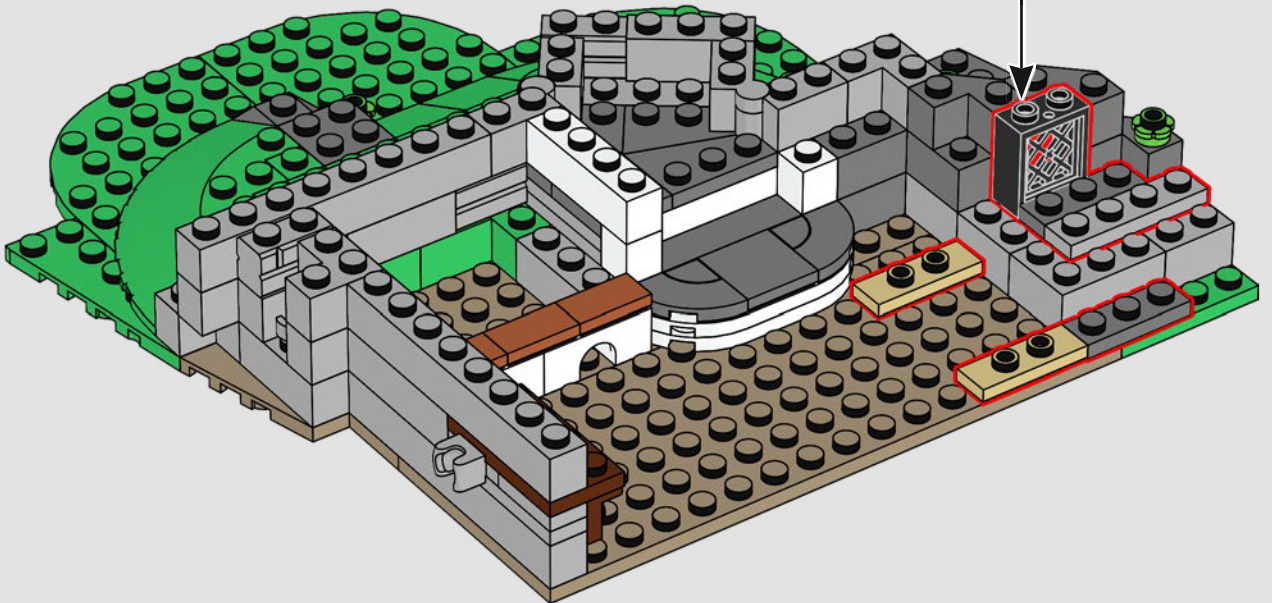



Sieht so aus, als hätte sich jemand auf einen 1x1 Stein gesetzt! Oder wurde eine Platte gestreckt?

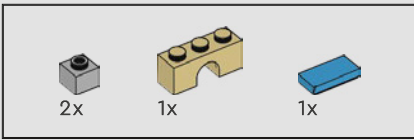

25

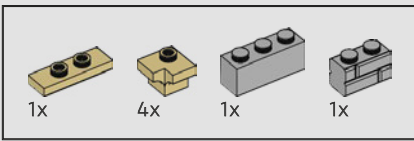
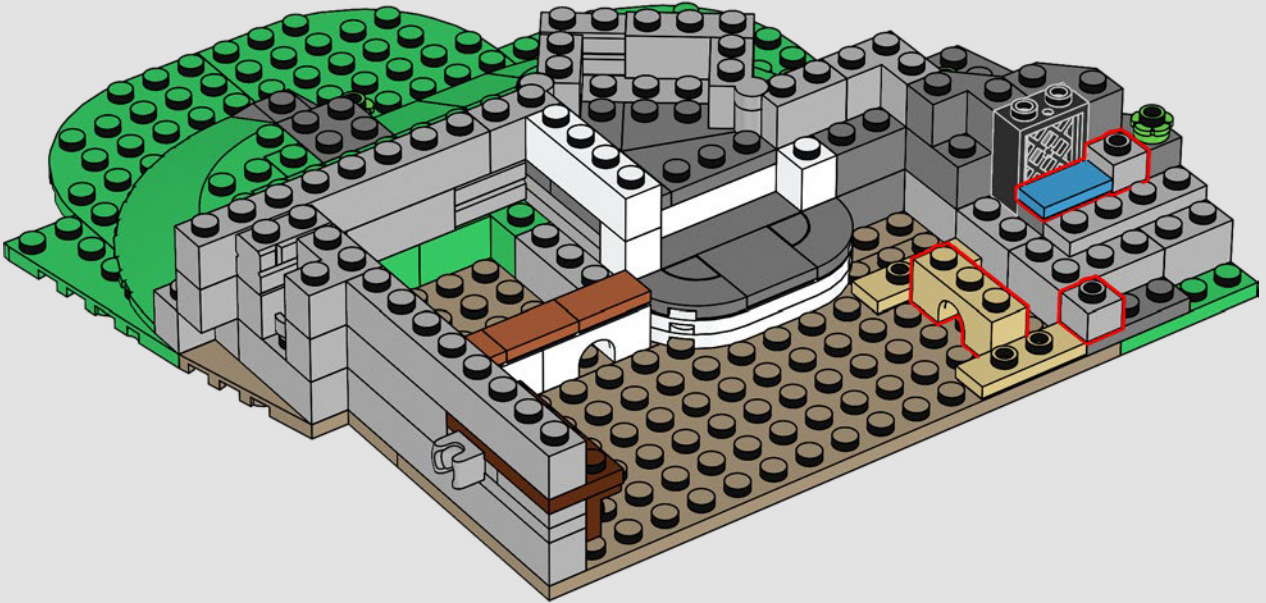

26

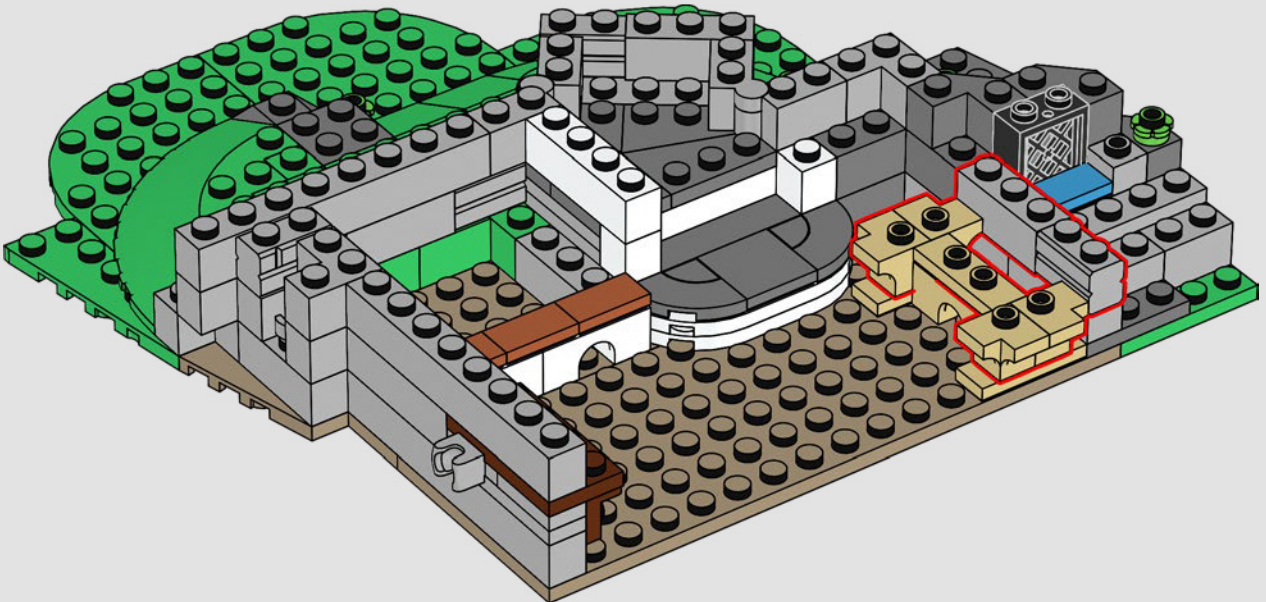

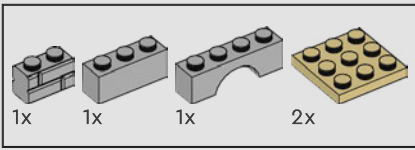

27

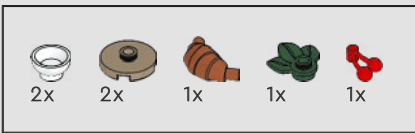
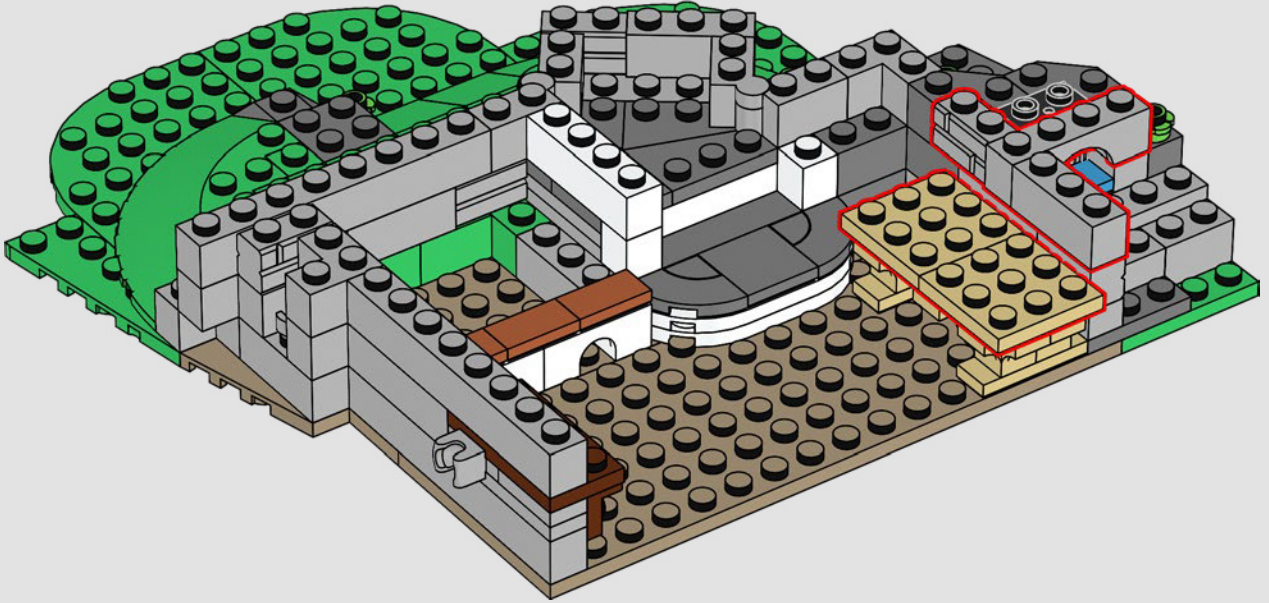

28

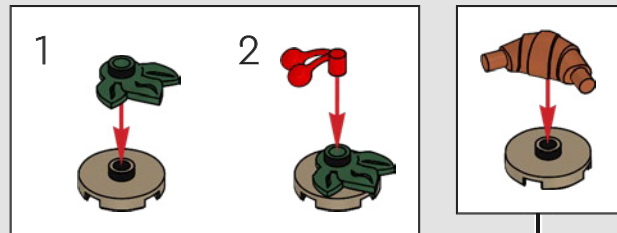

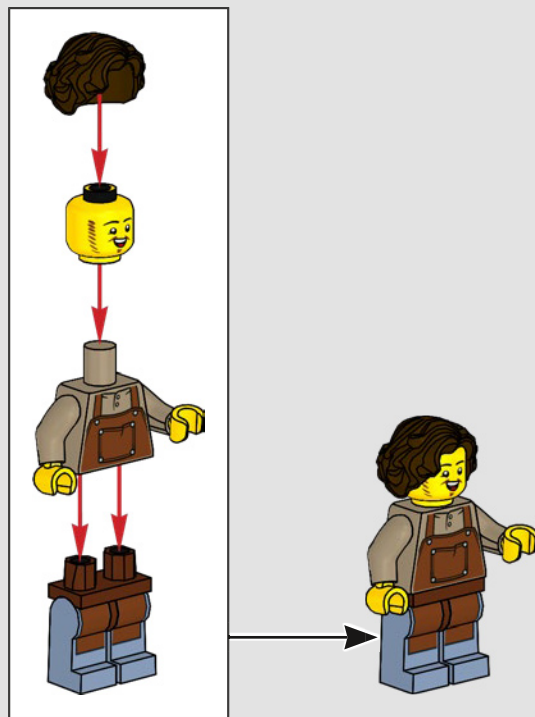



Was wird von einer so seltsam platzierten
Kerze beleuchtet?

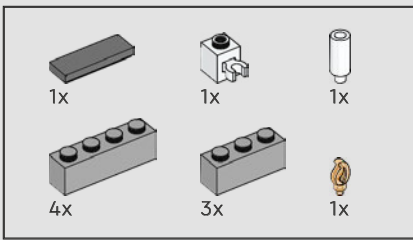

29

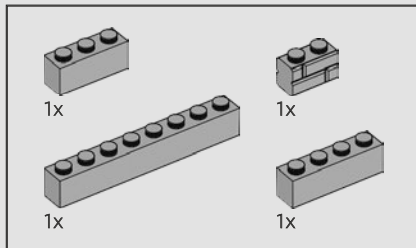
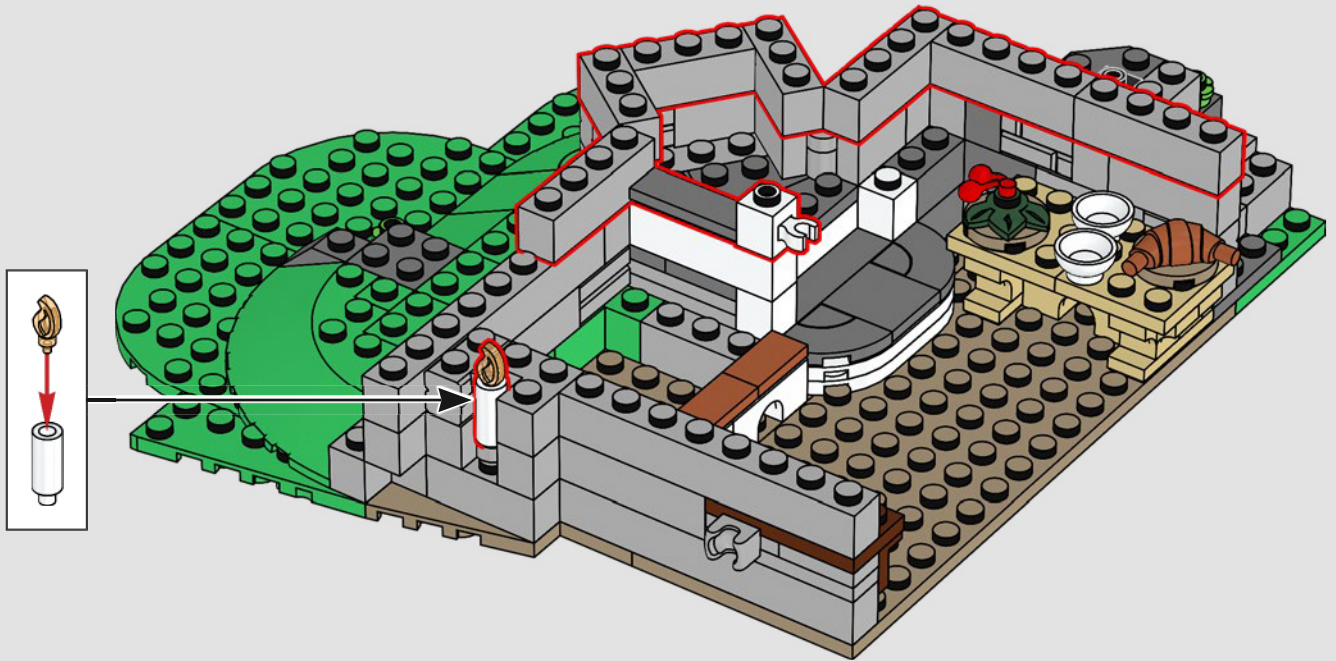

30

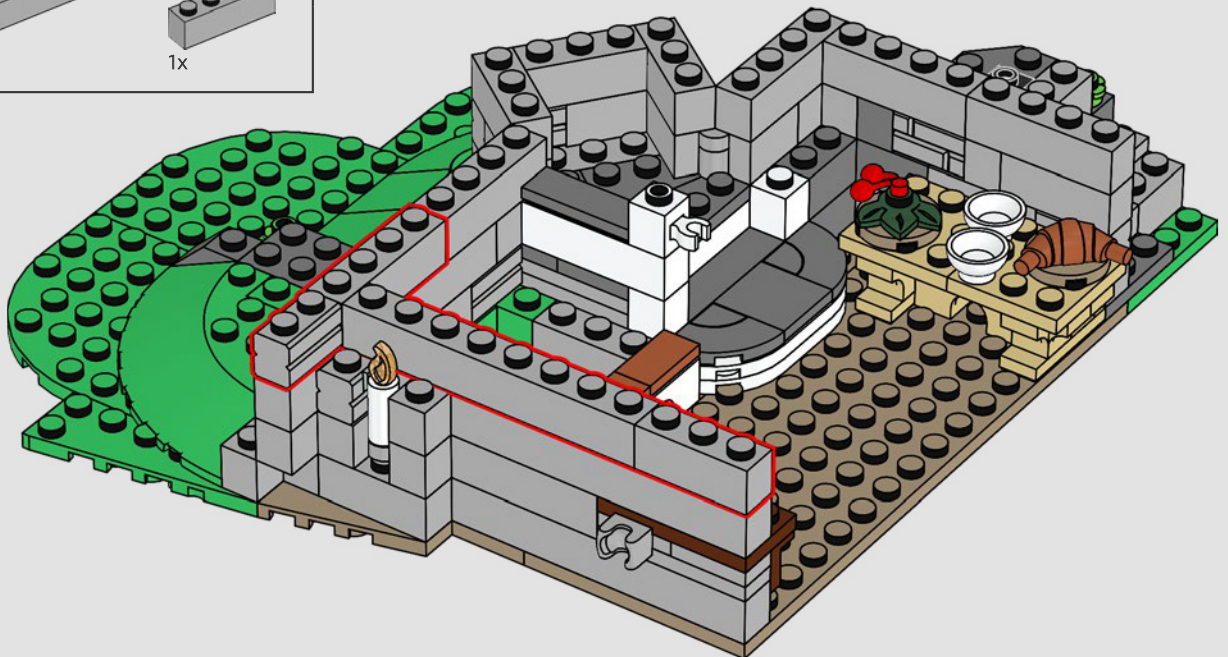

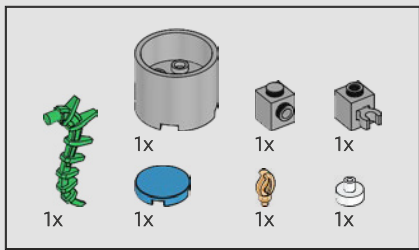

31

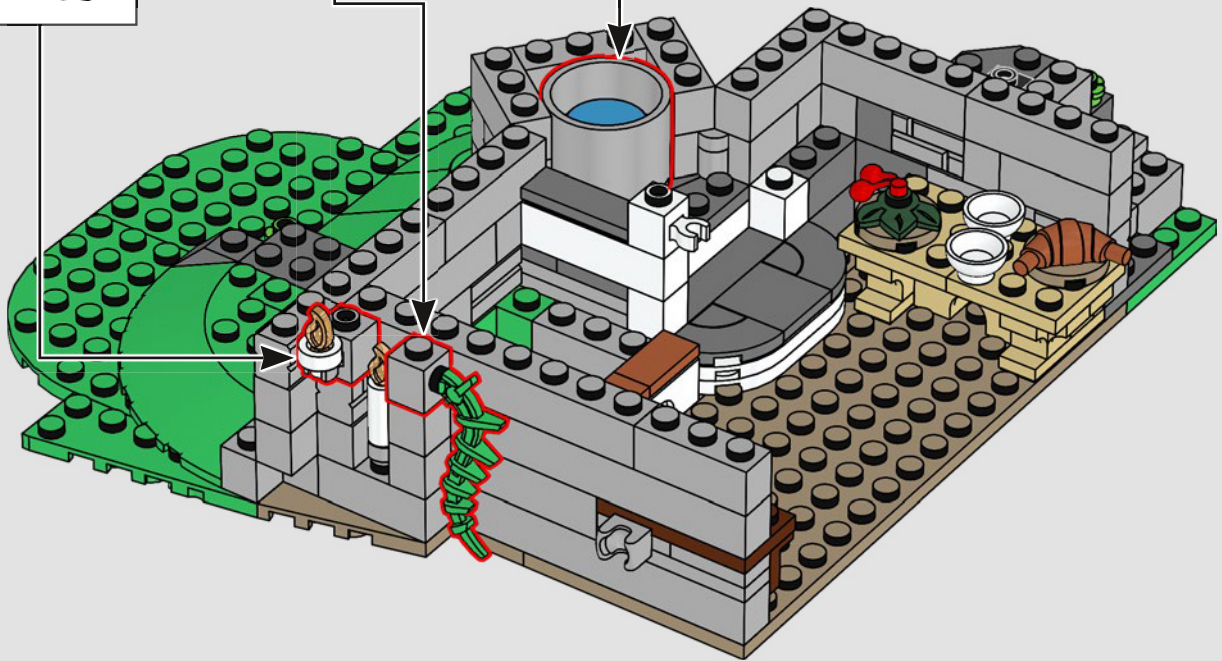
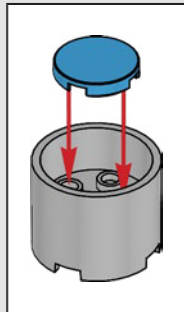
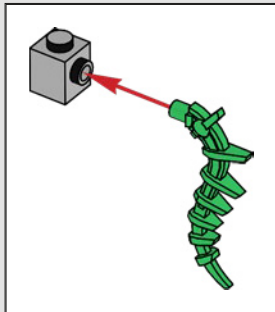
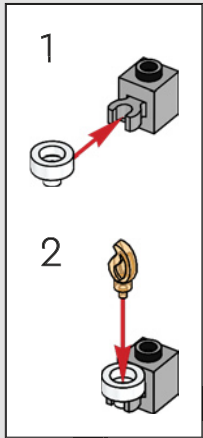

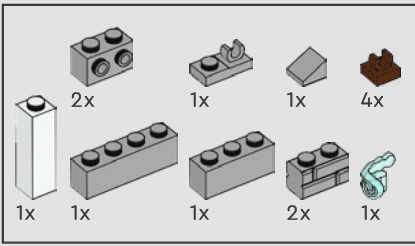

32

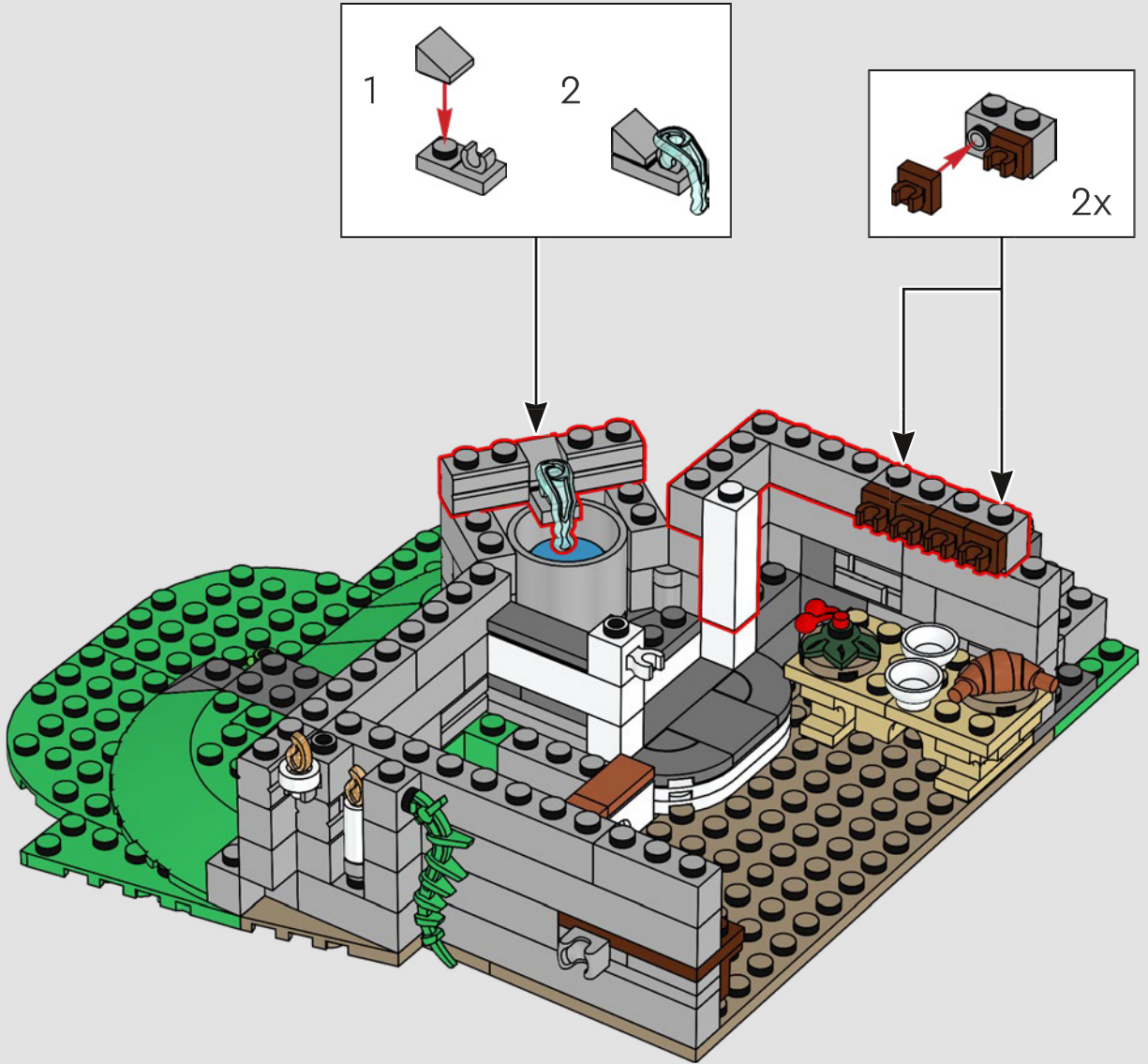

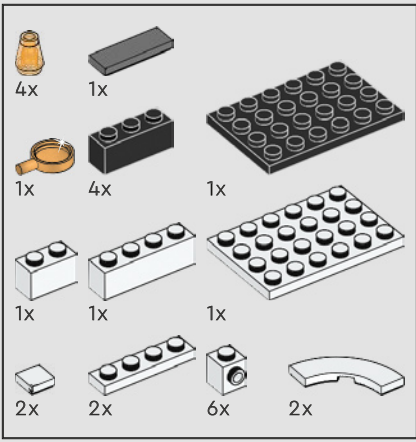

33

1

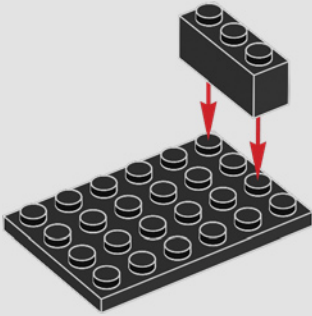

2

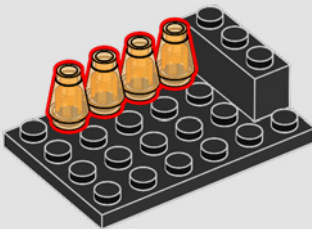

3

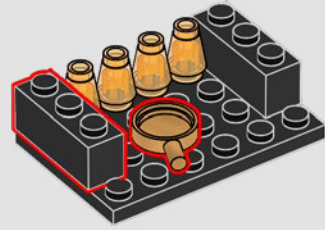

4

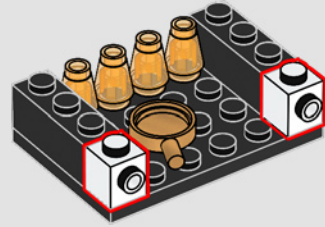

5

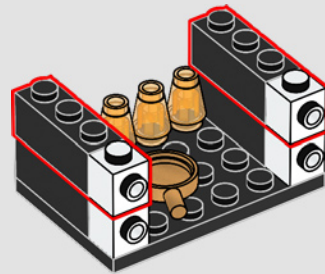

6

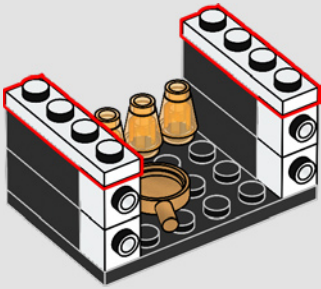

8

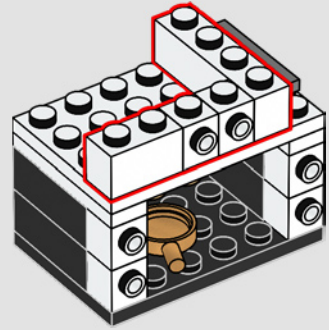

7

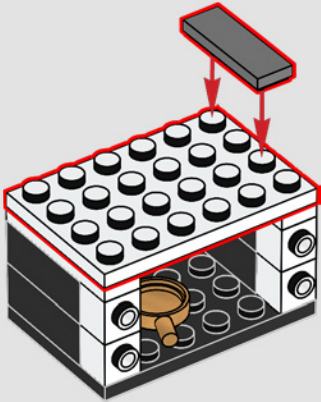

9

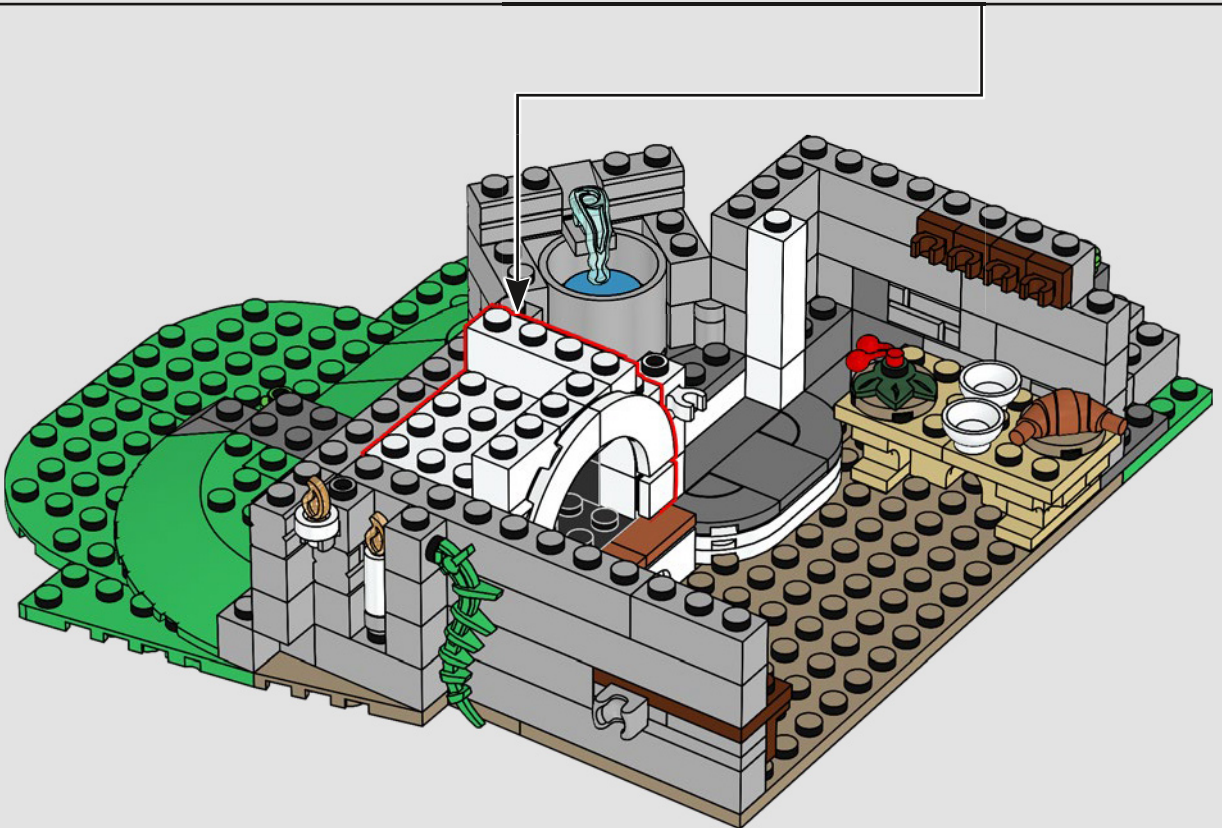
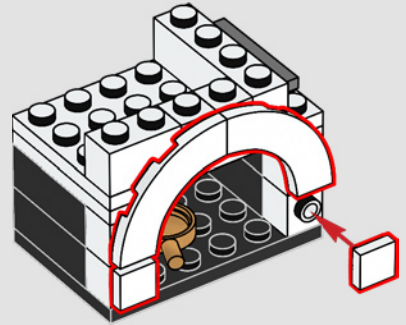

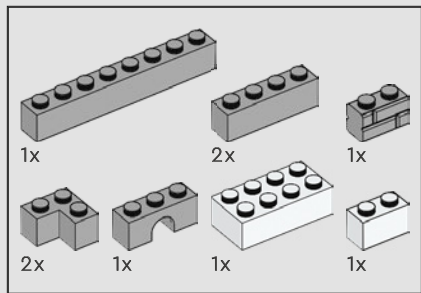

34

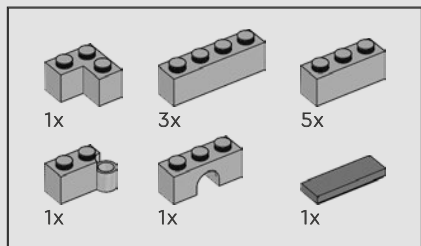
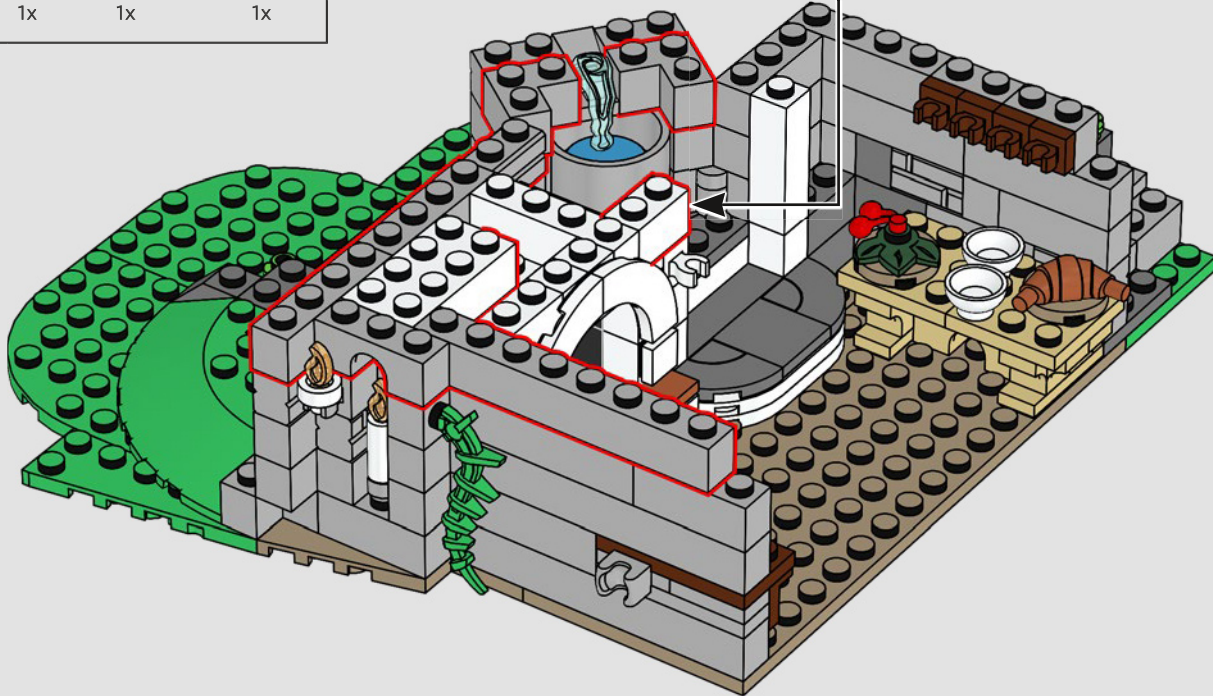

35

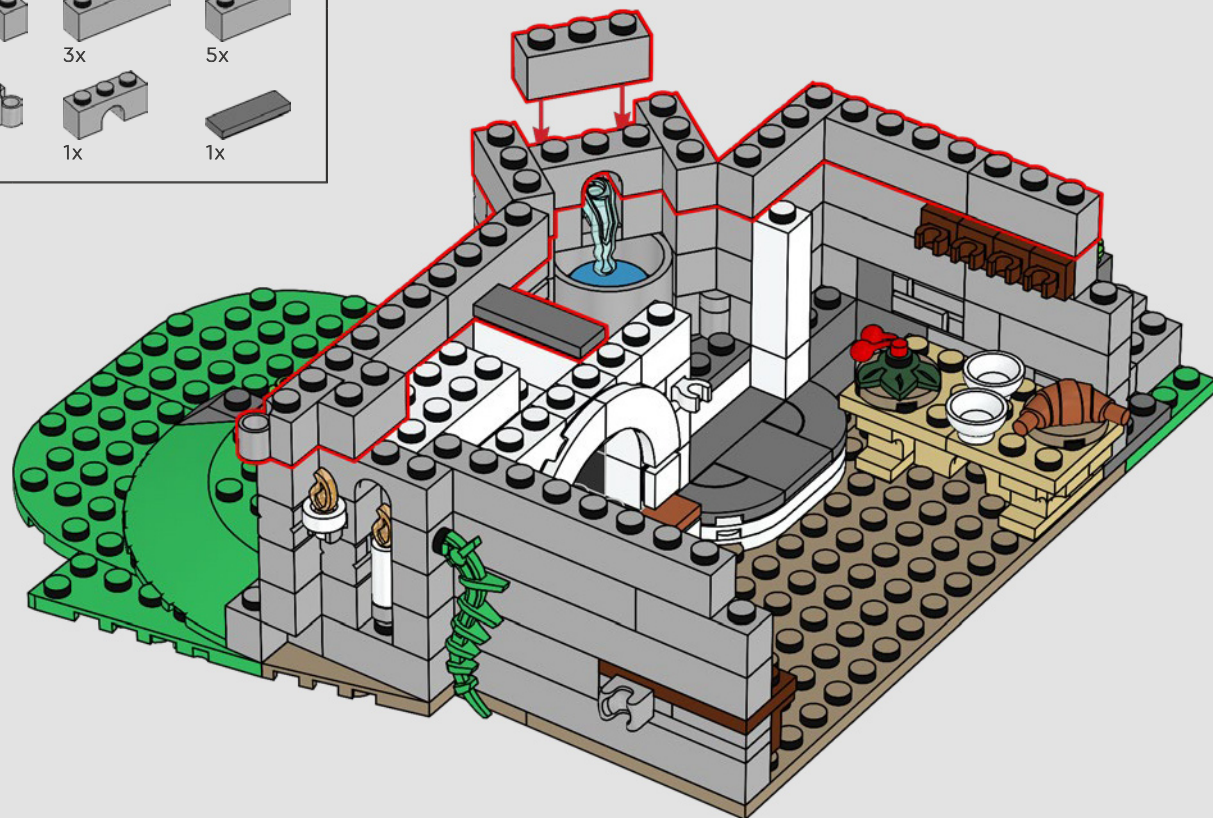

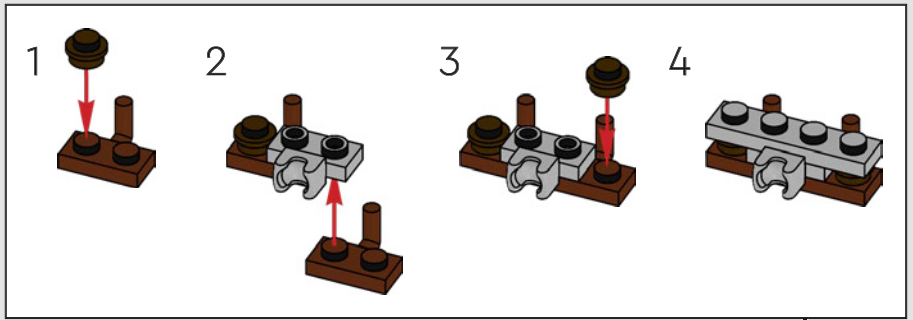
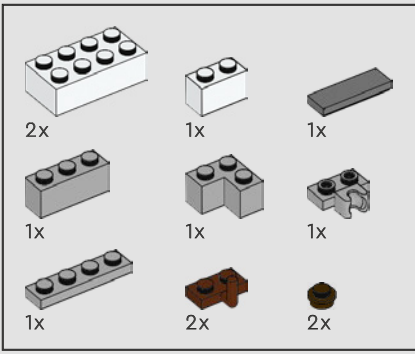

36

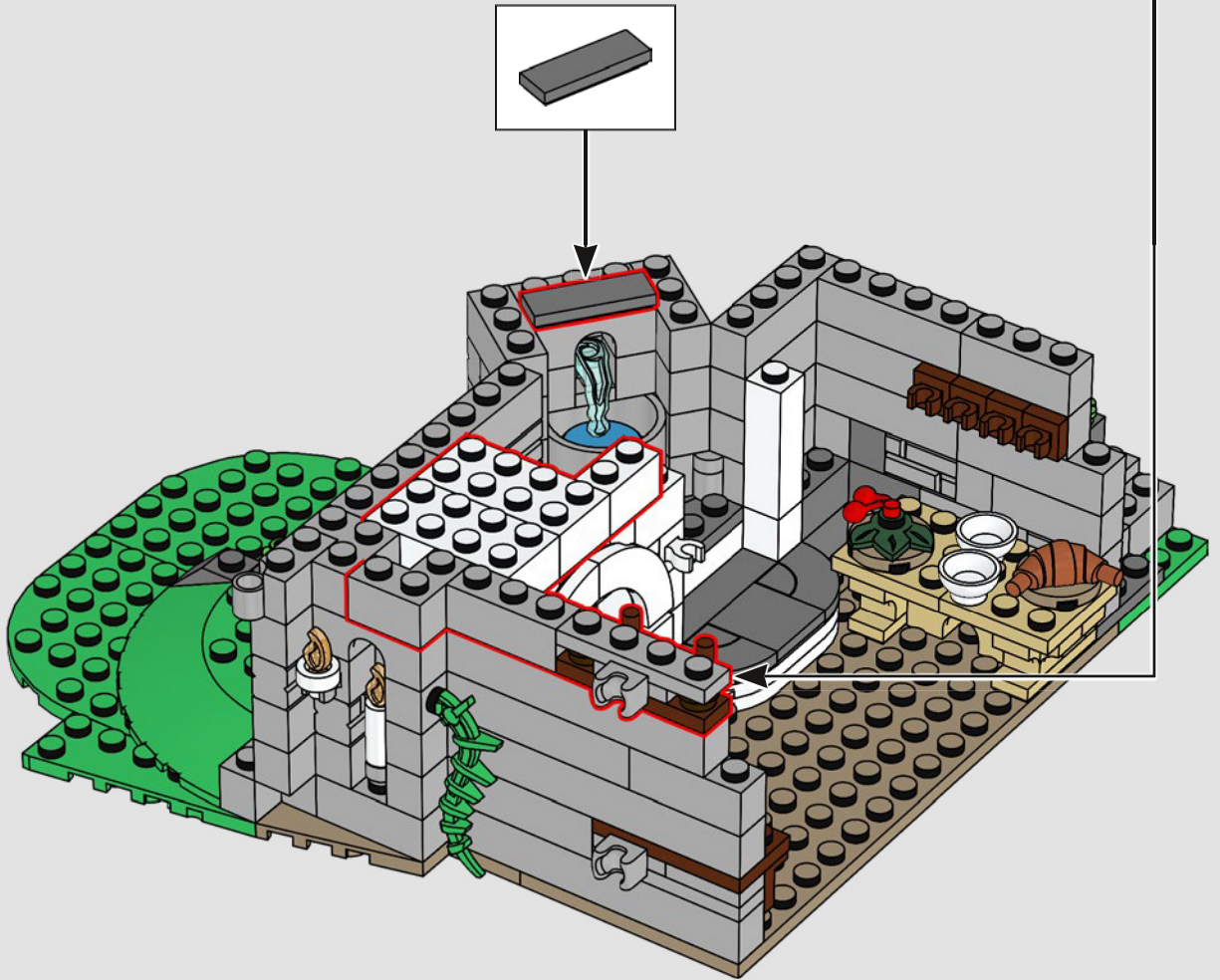

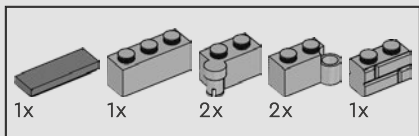

37

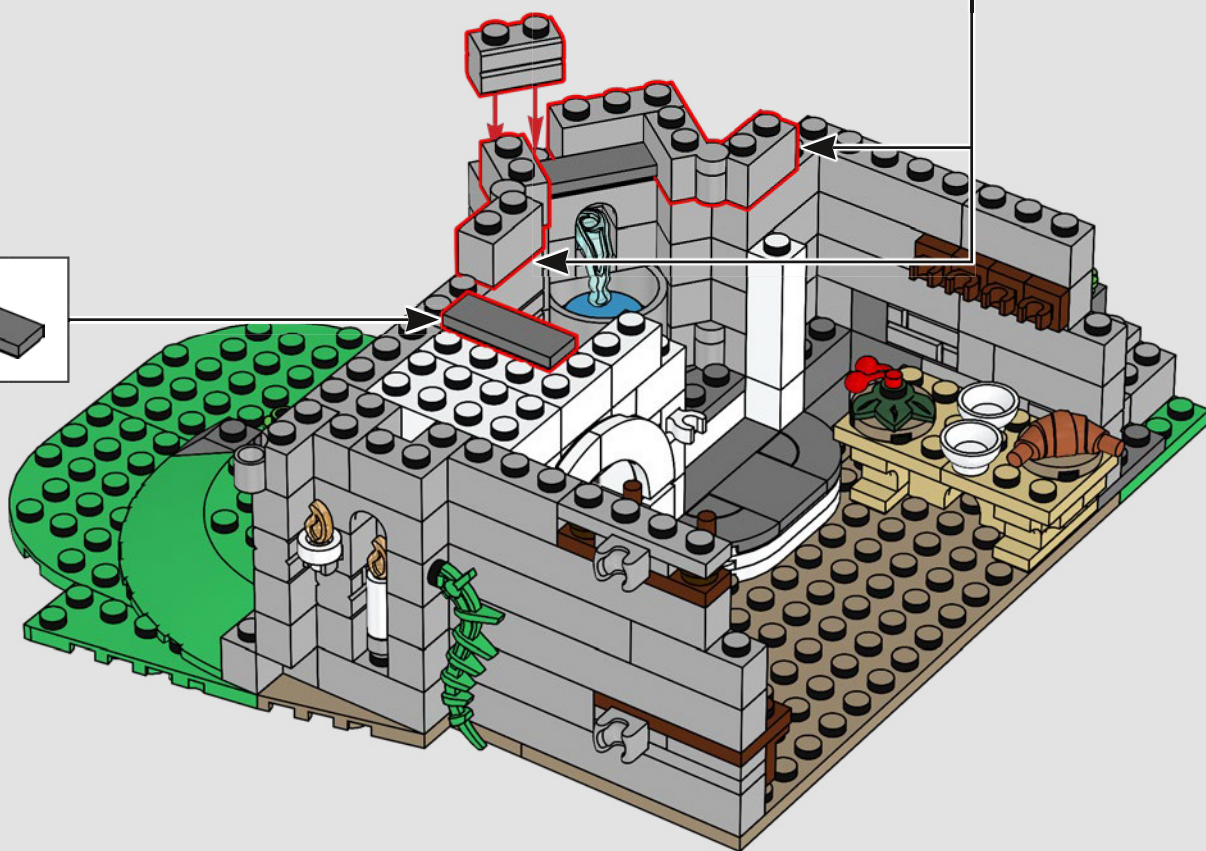
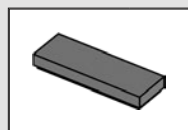
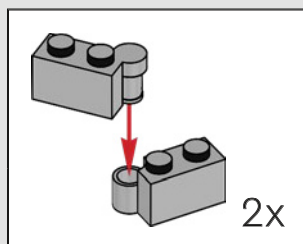

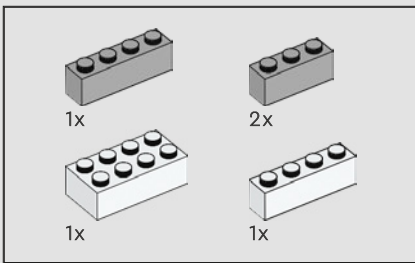

38

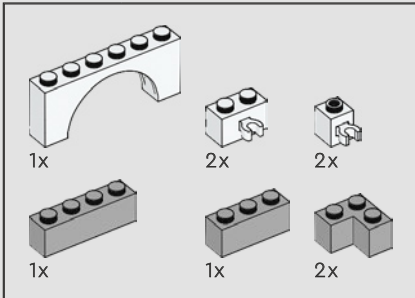
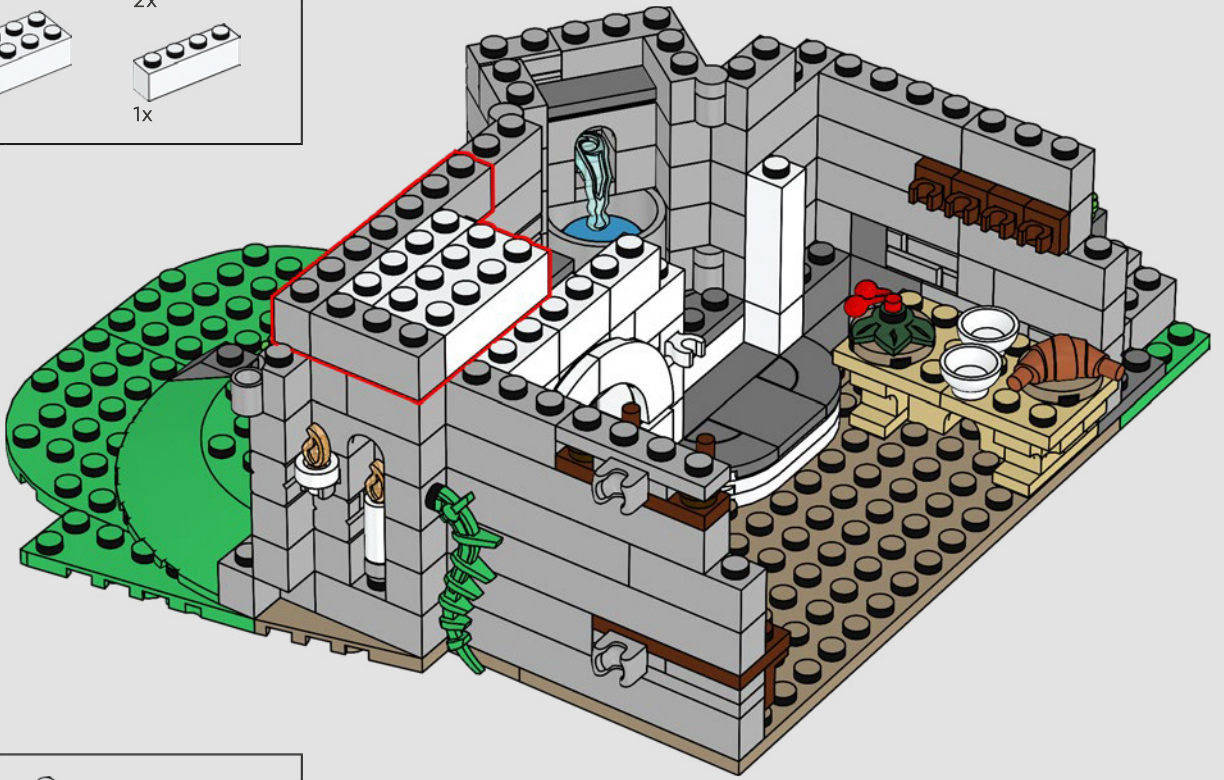

39

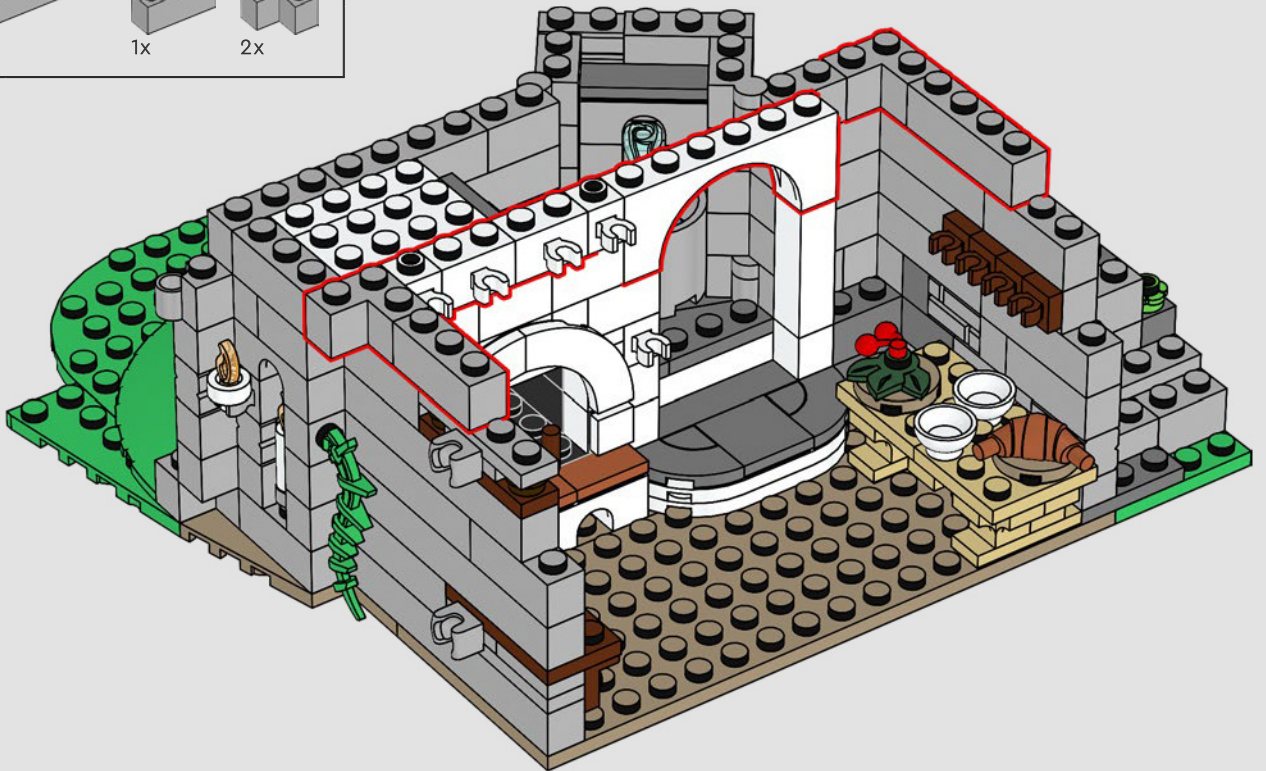



40

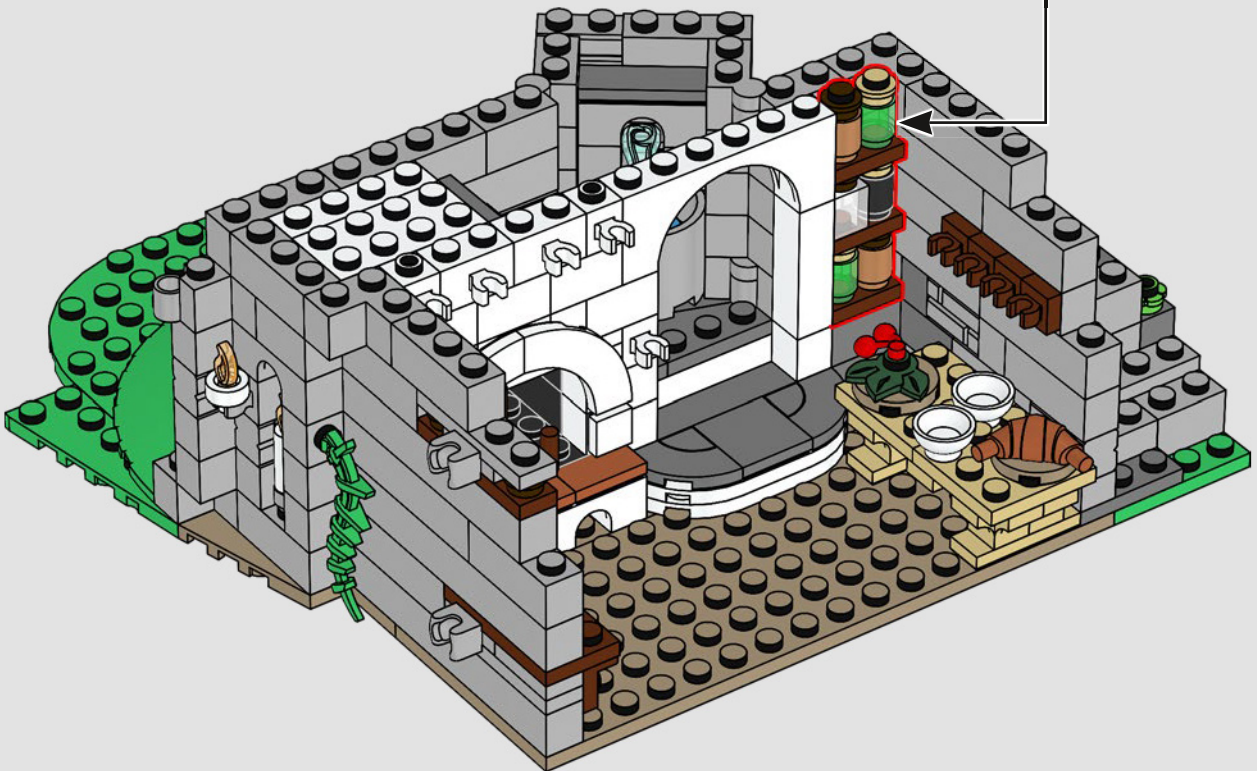
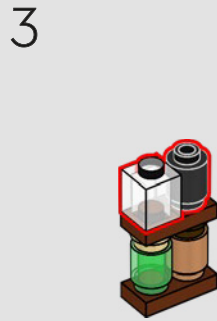
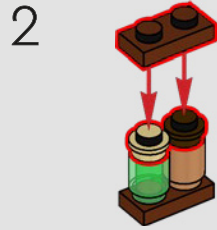
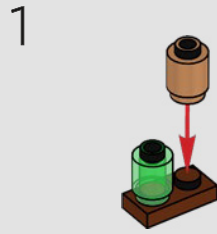



Sind das Steckrüben oder Karotten? An der Farbe lässt sich das nicht erkennen.

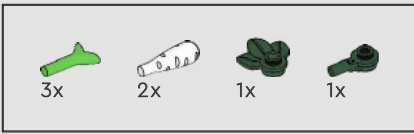

41

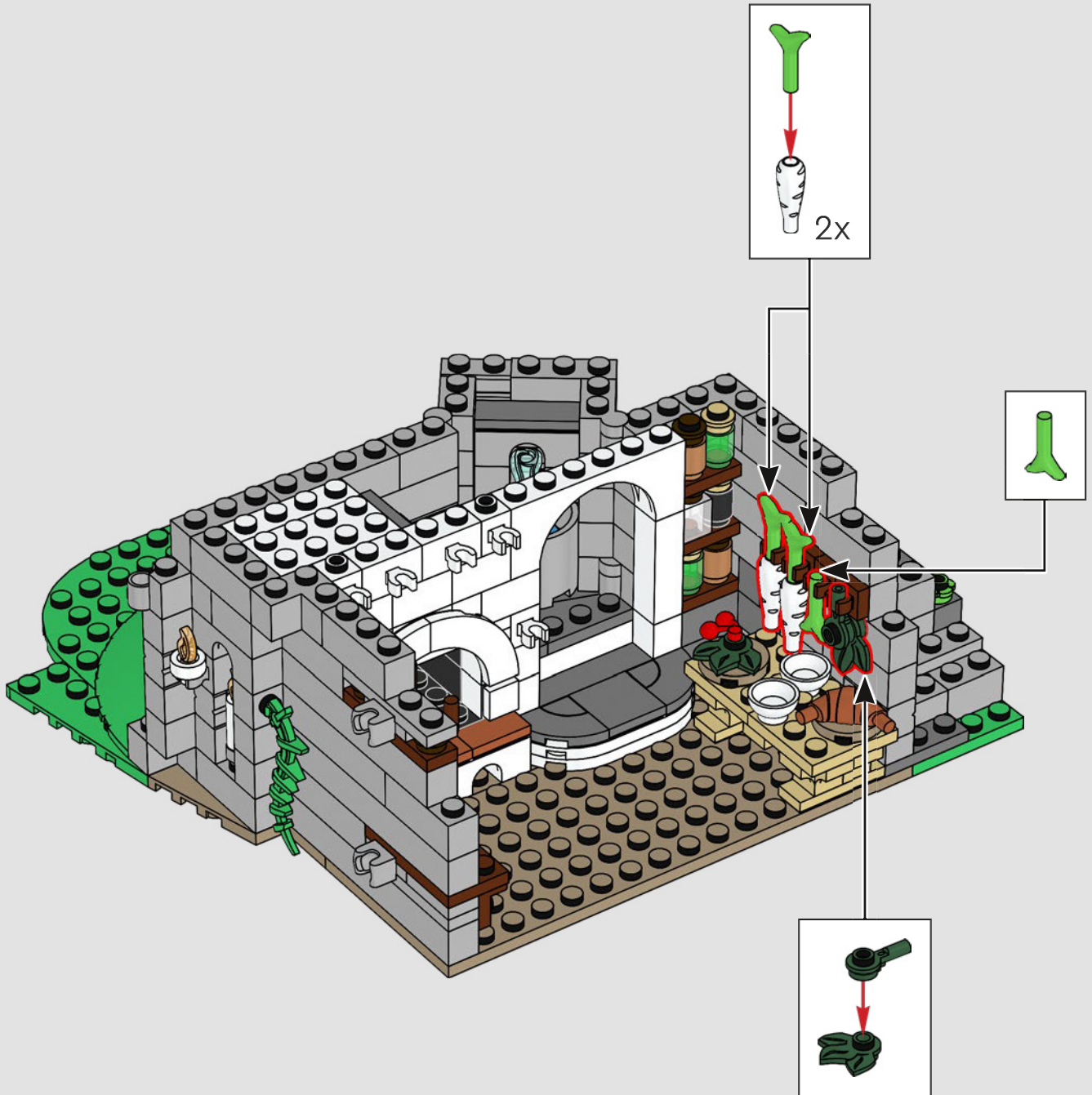

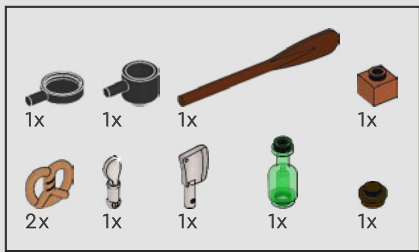

42

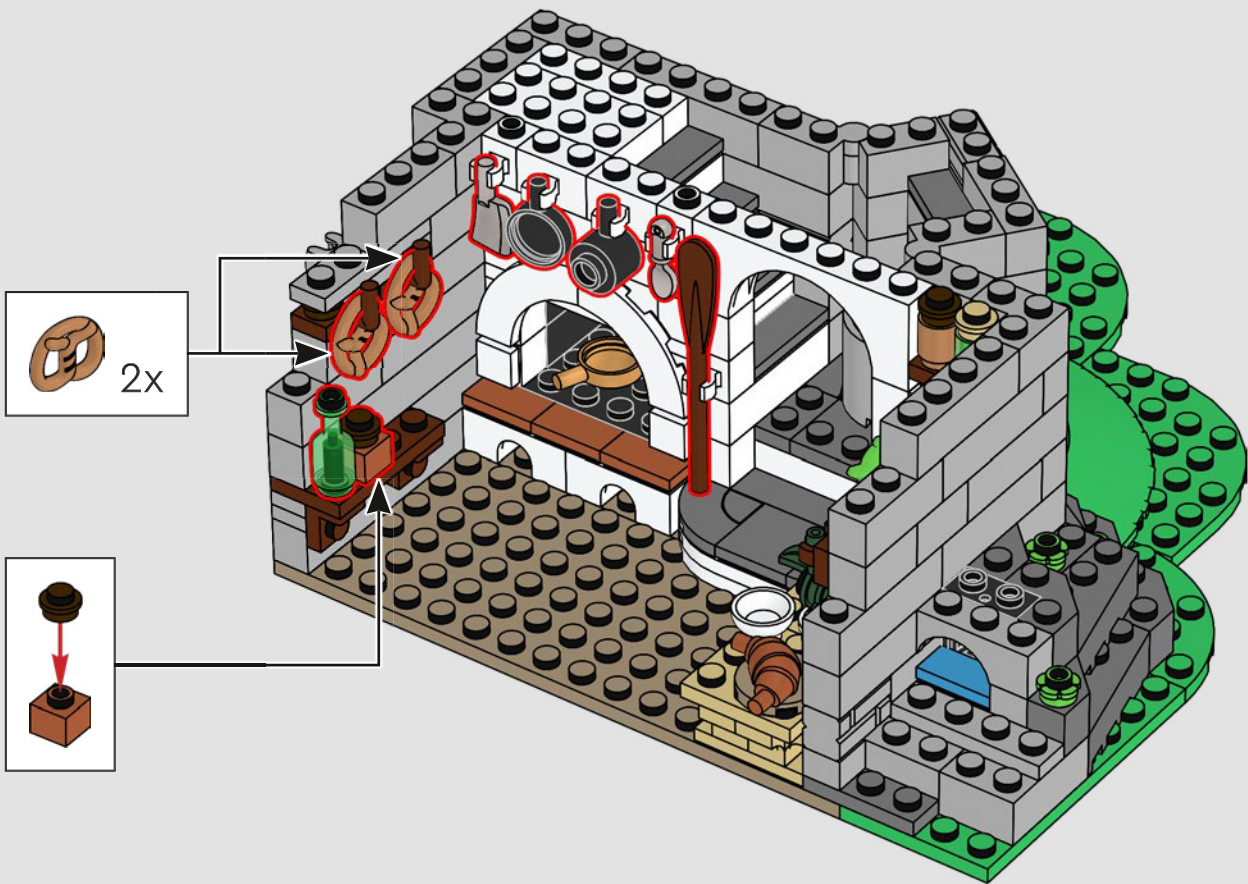

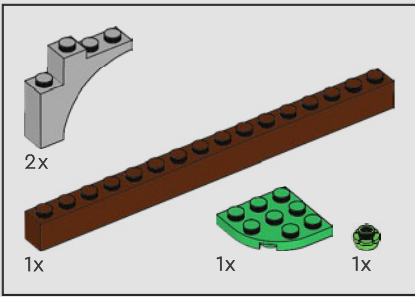

43

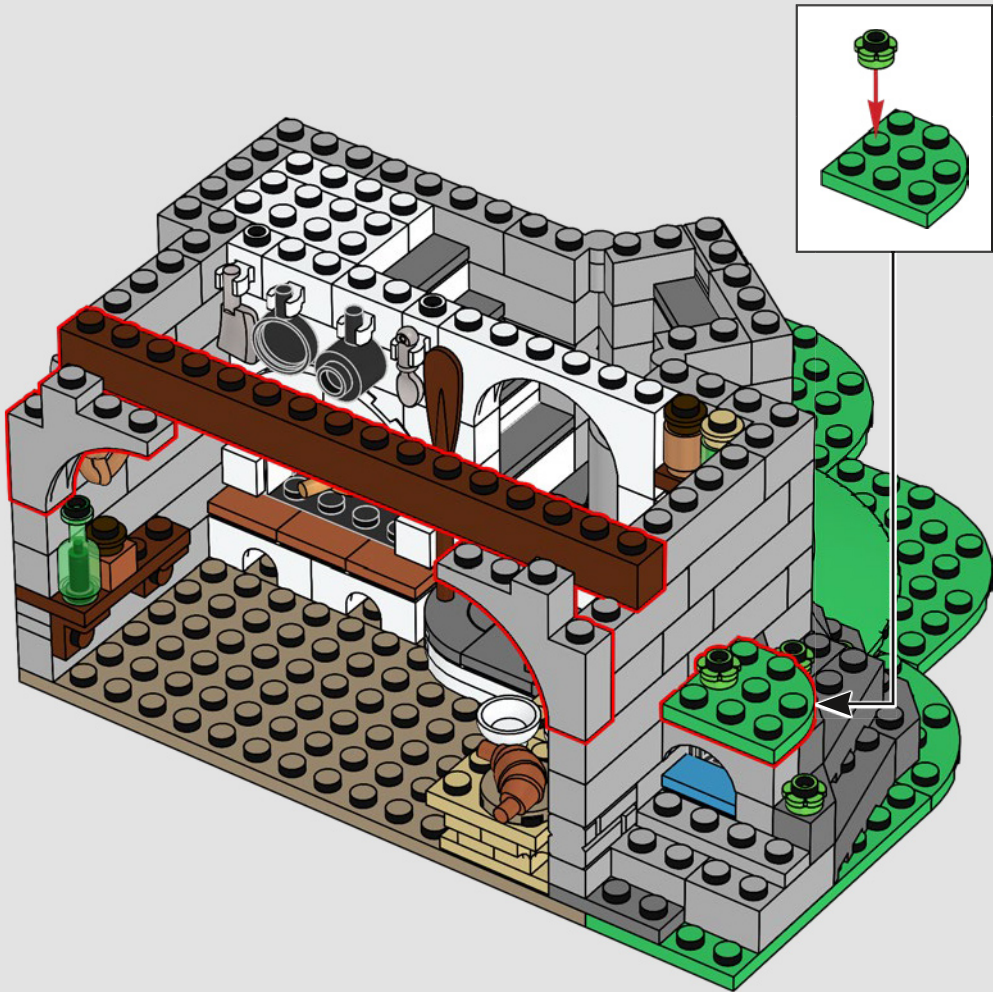

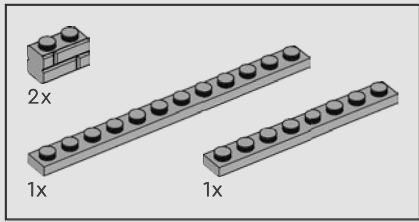

44

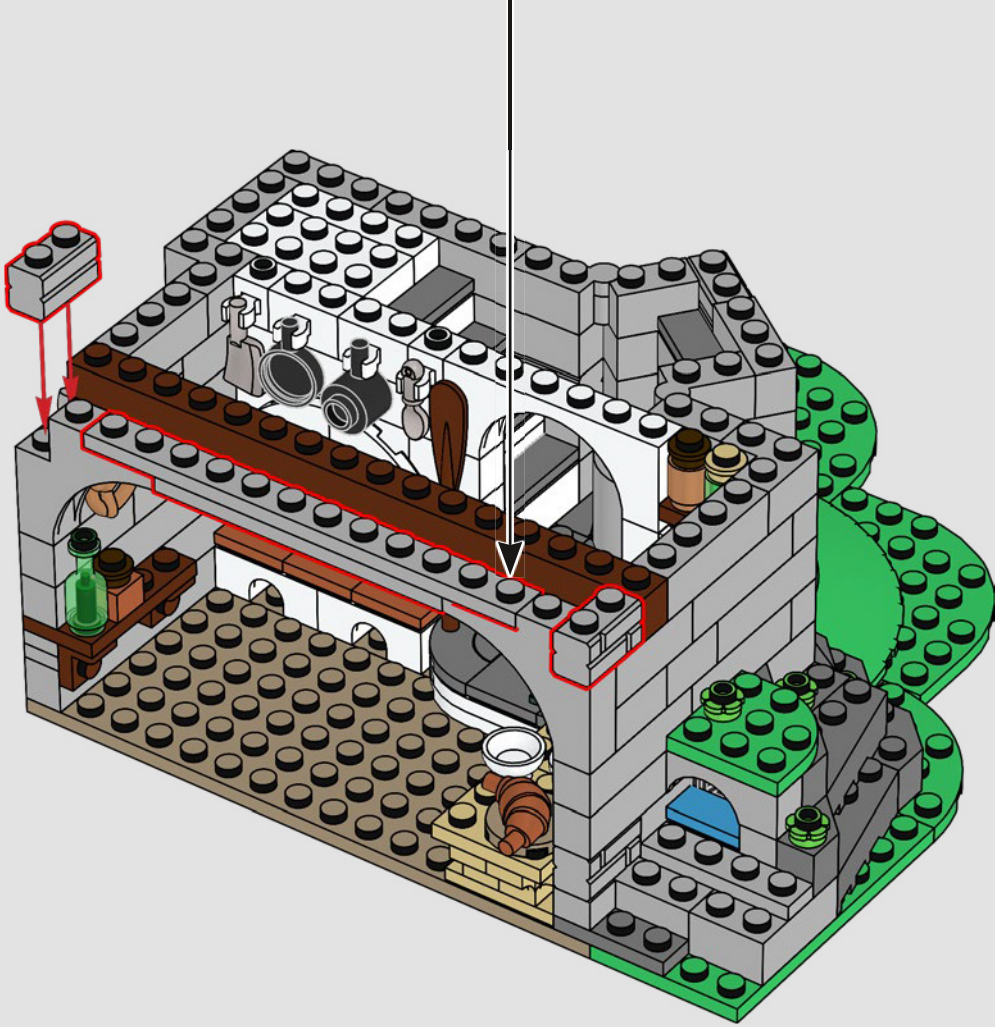
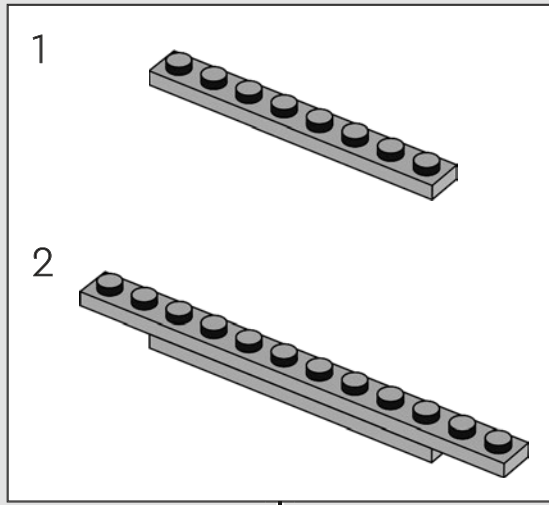

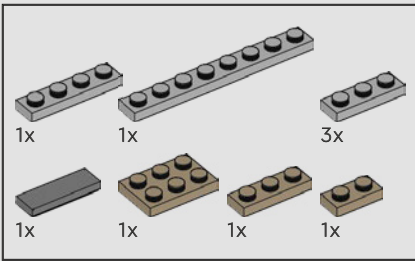

45

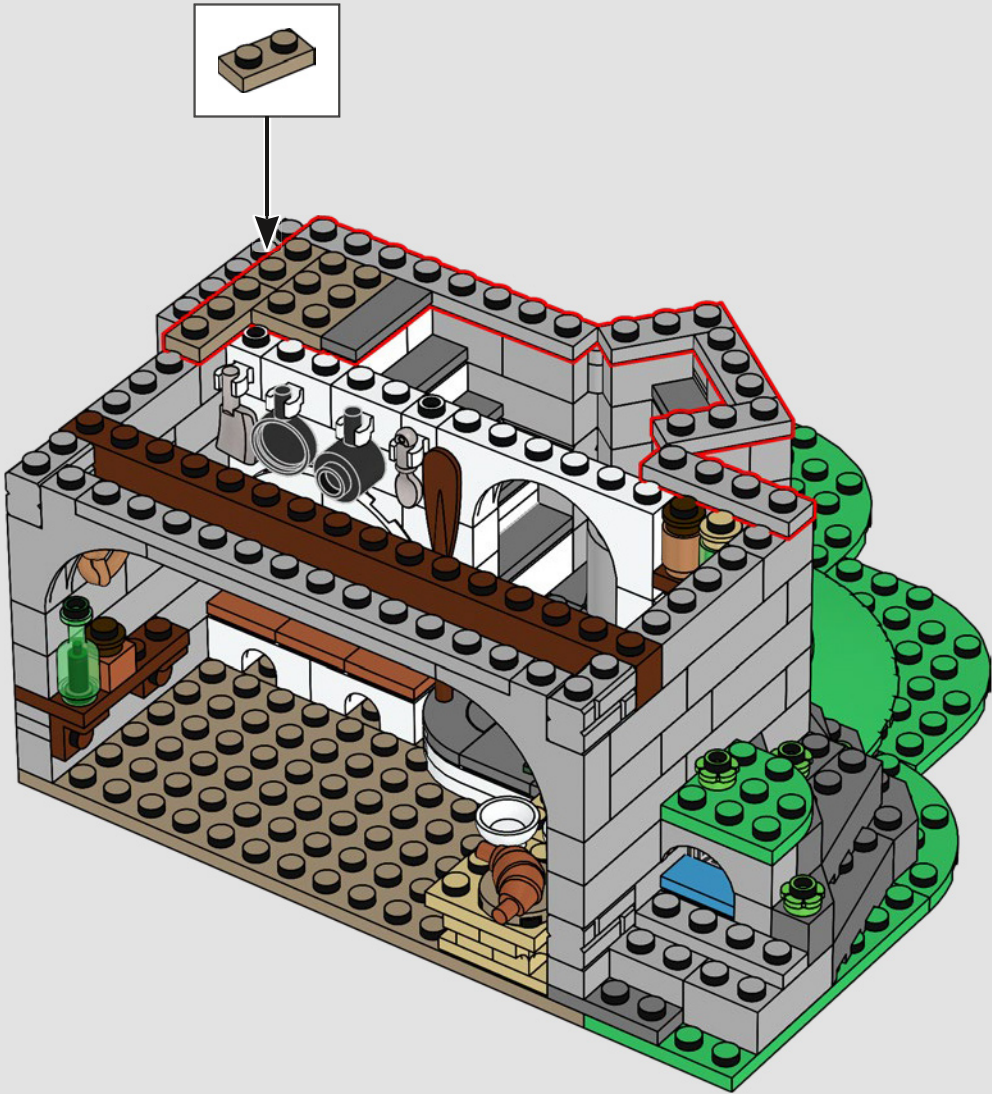

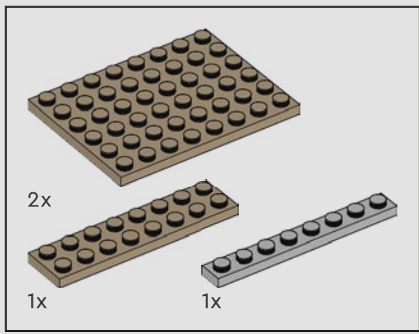

46

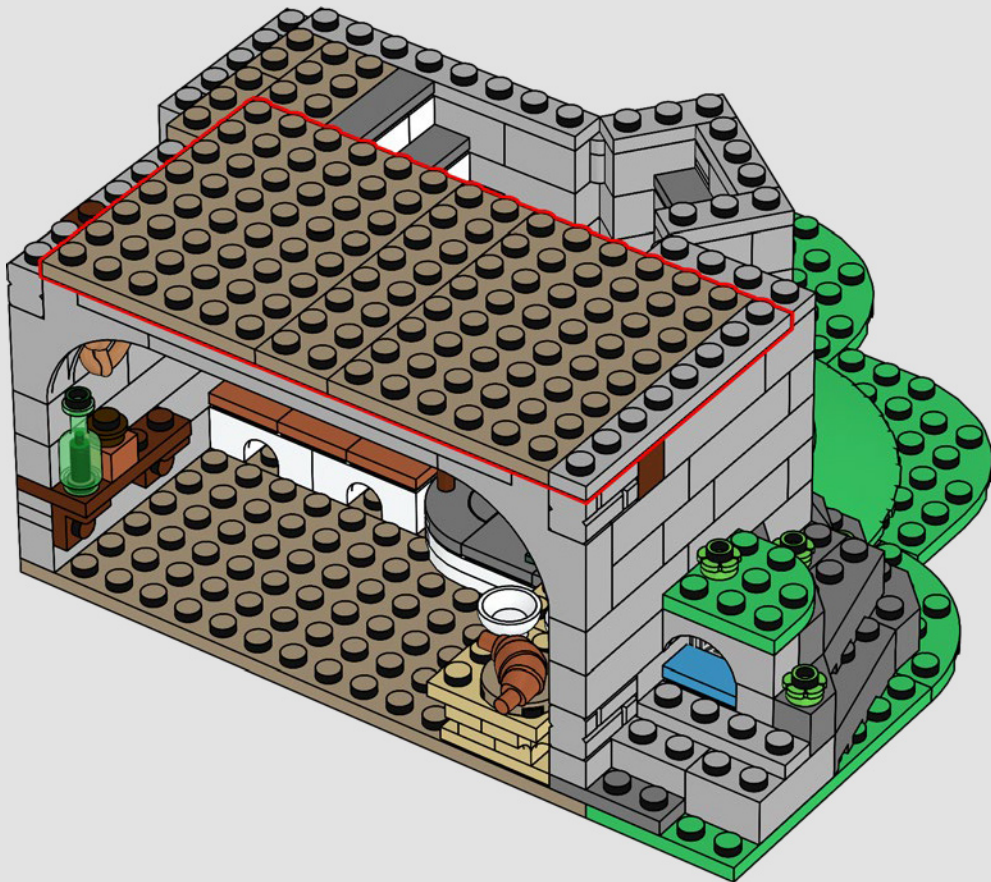

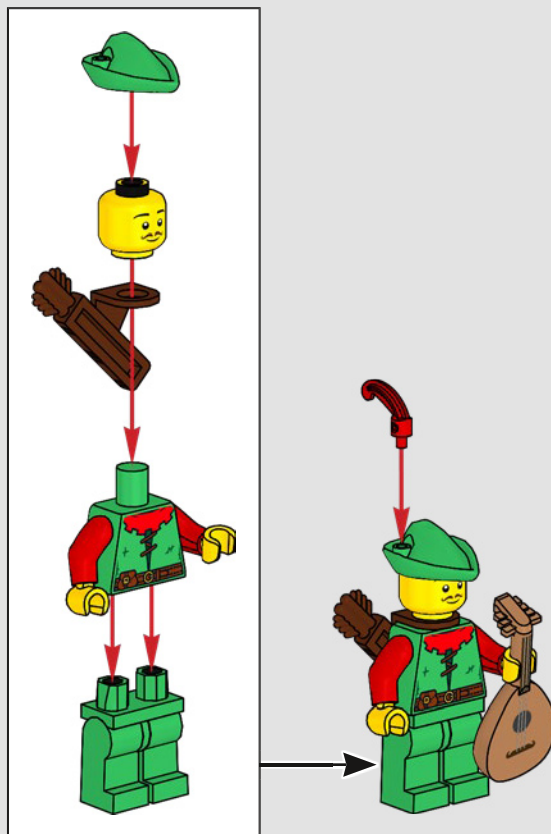

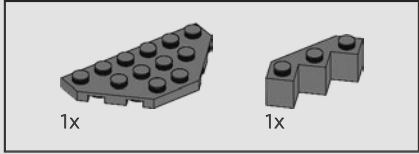
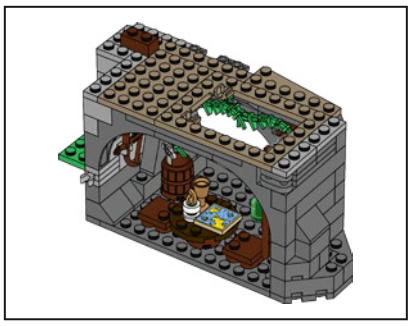

47

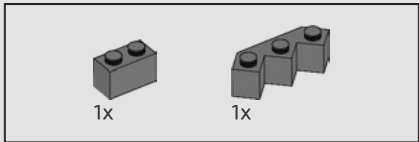
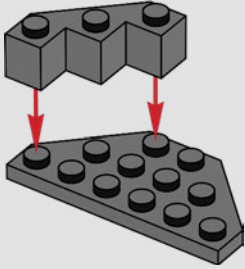

48

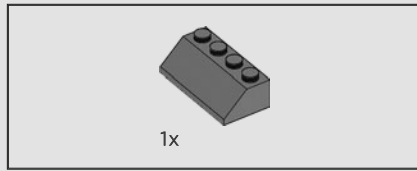
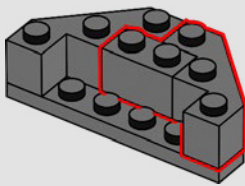

49

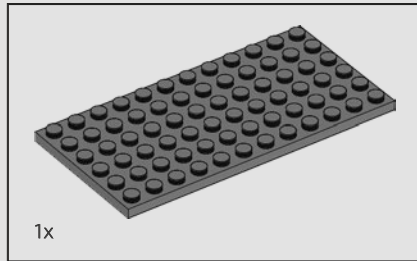
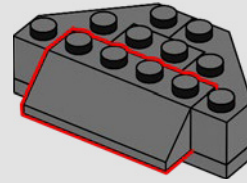

50

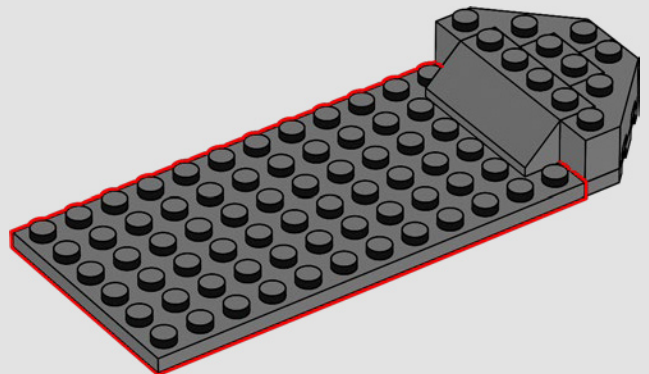

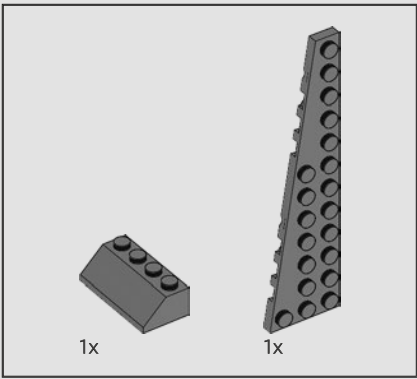

51

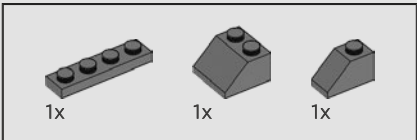
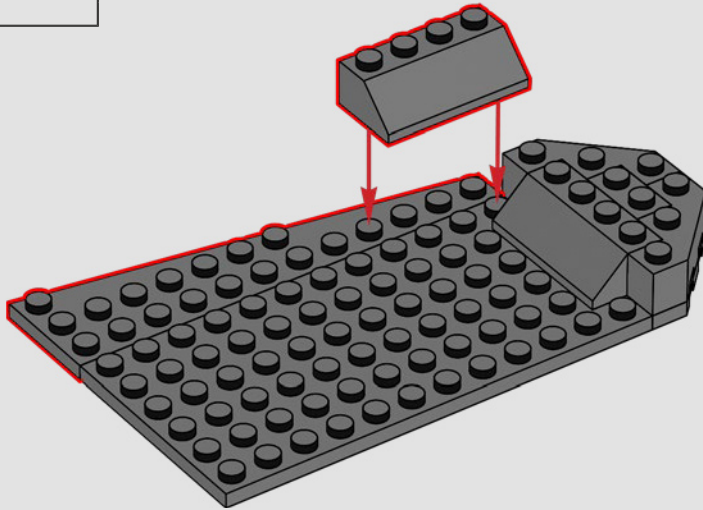

52

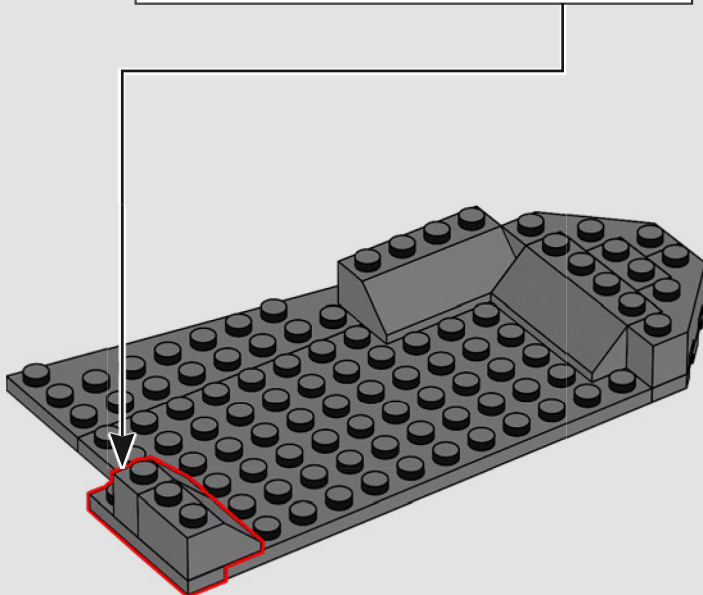
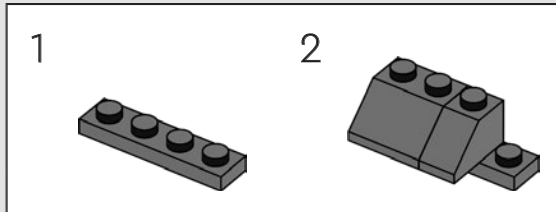

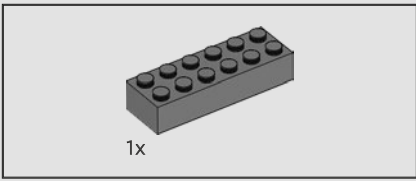

53

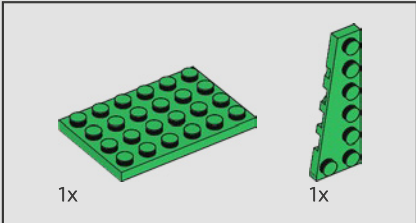
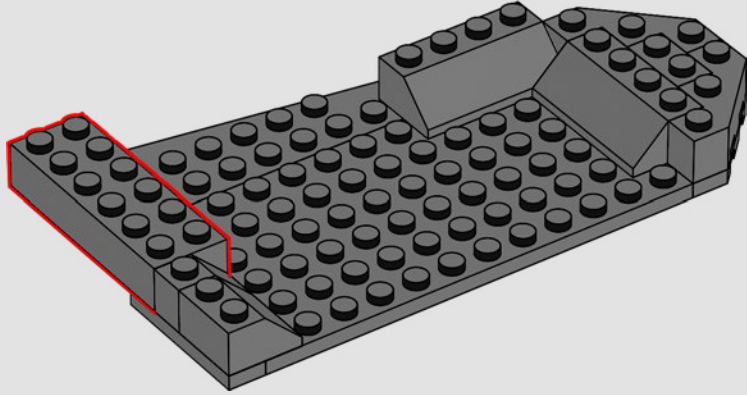

54

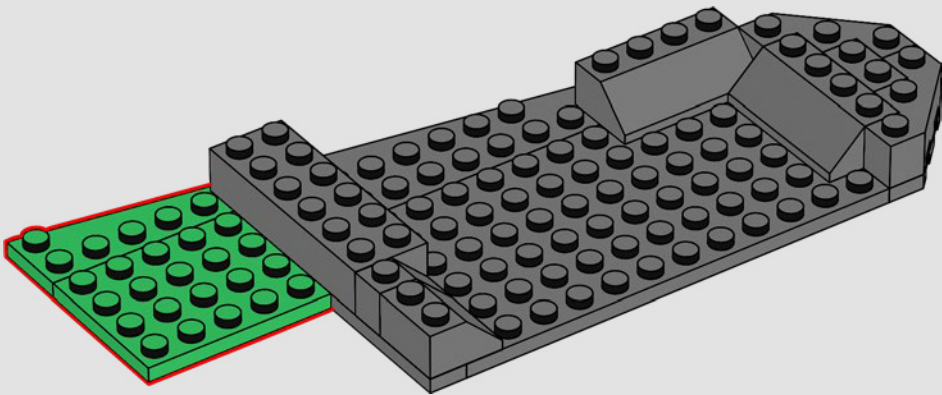

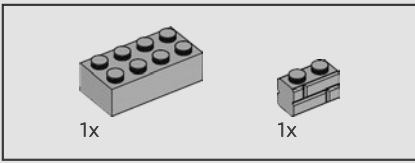

55

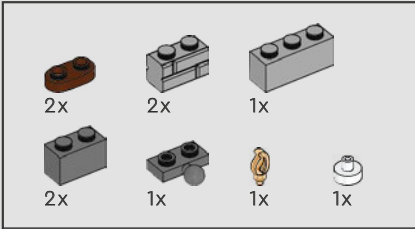
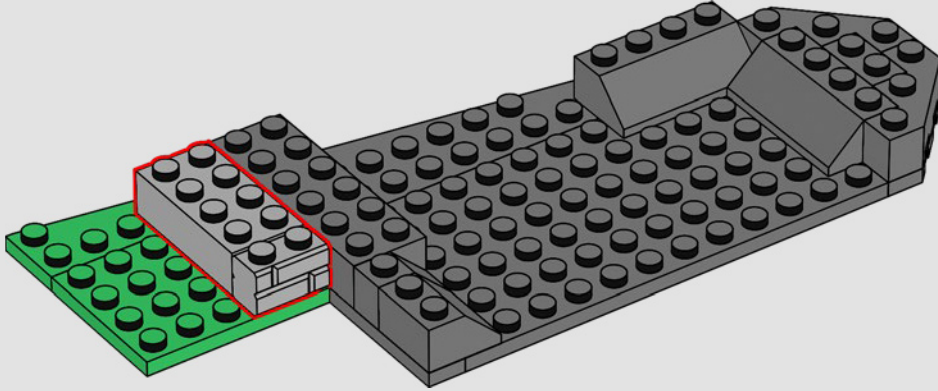

56

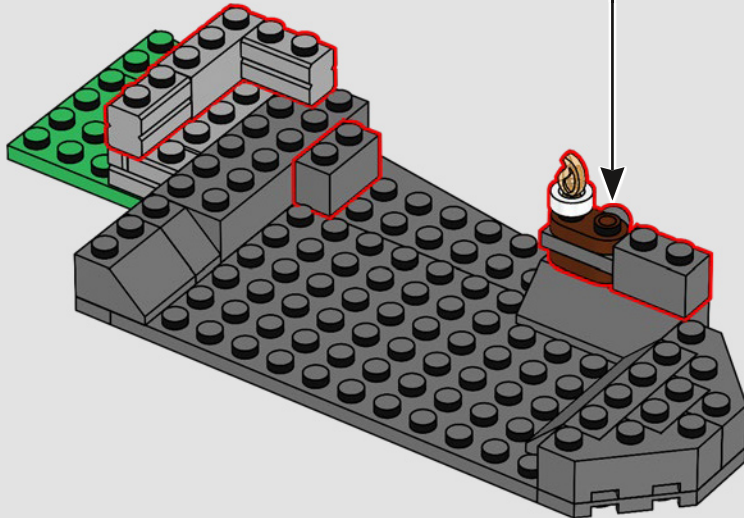
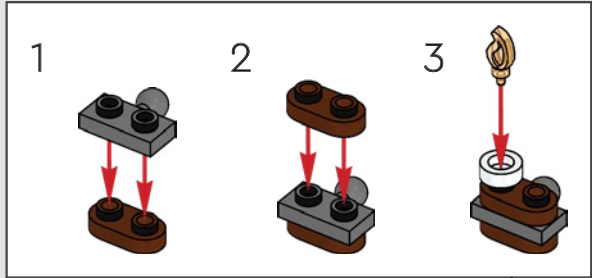

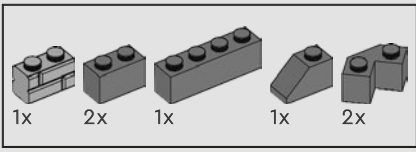

57

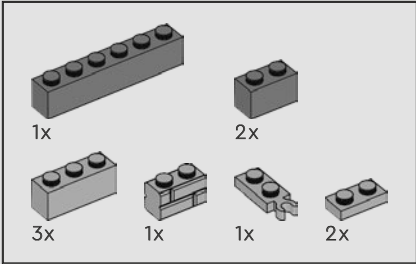
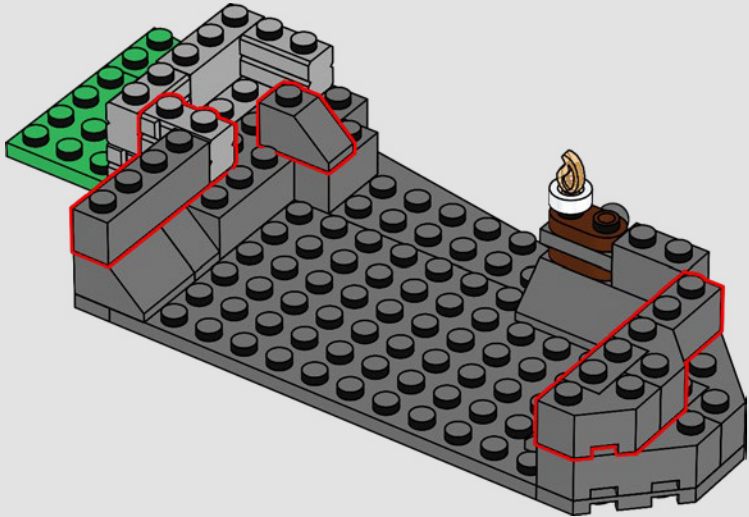

58

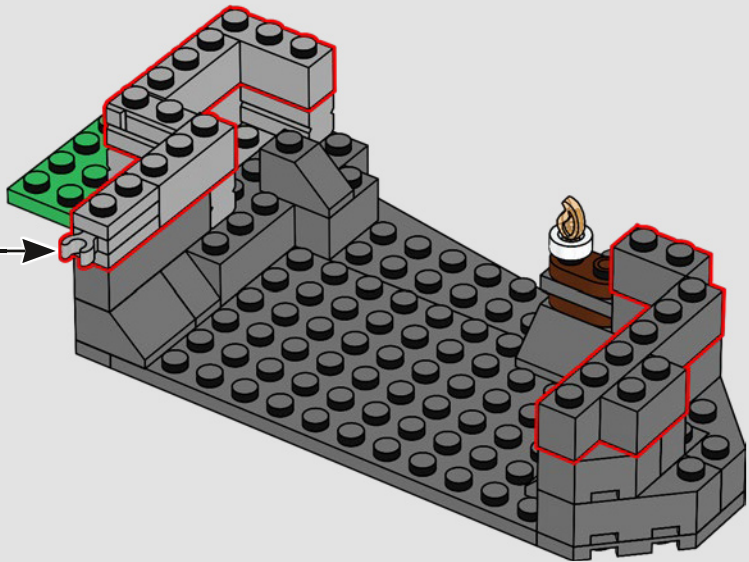
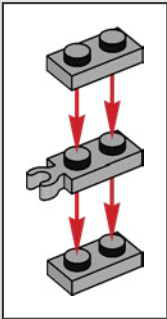

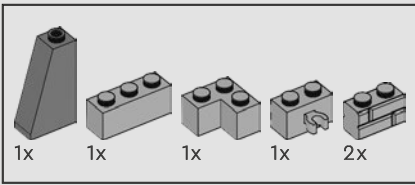

59

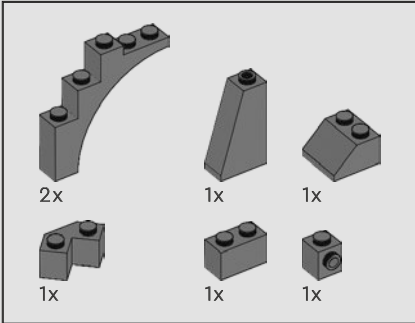
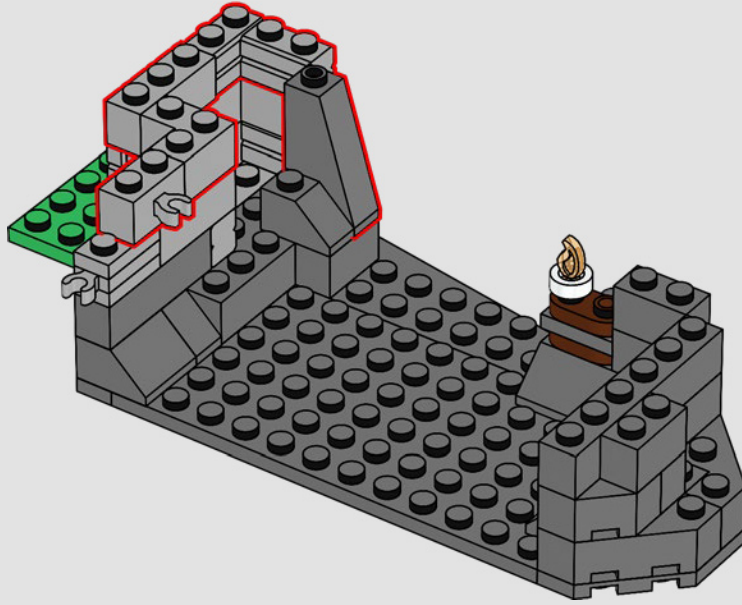

60

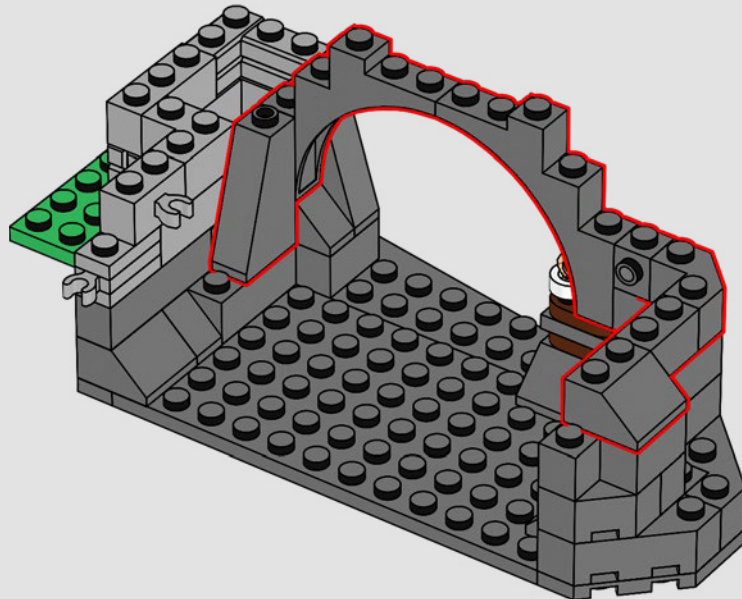

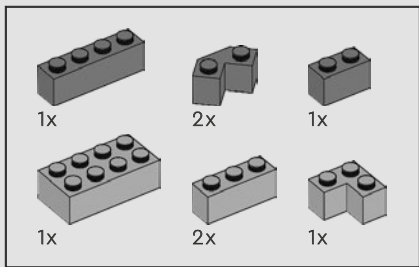

61

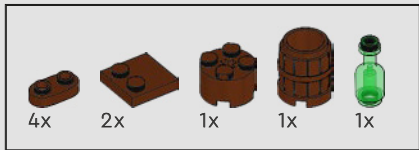
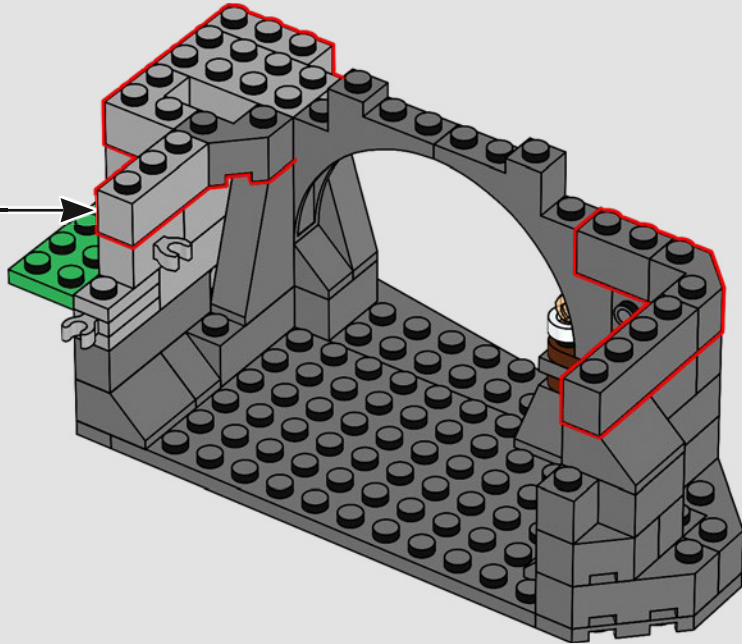
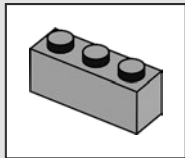

62

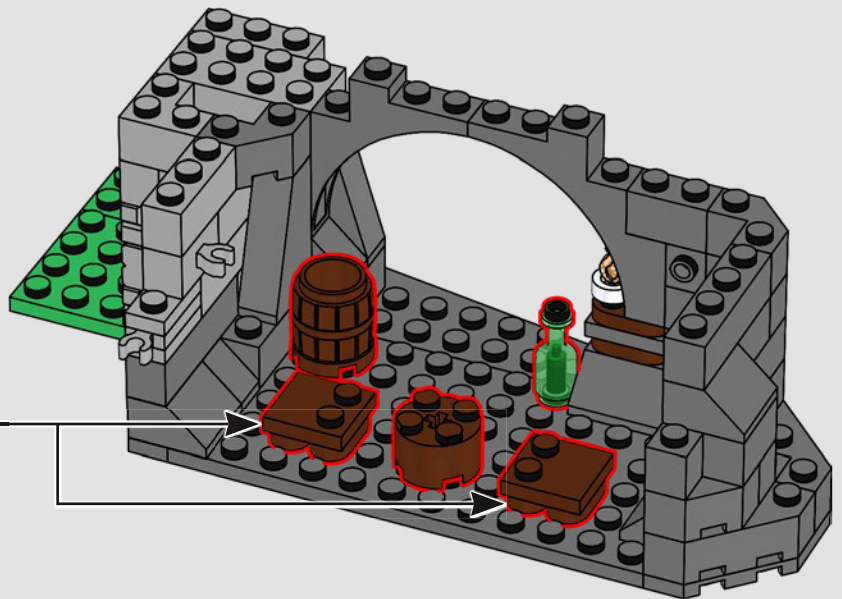
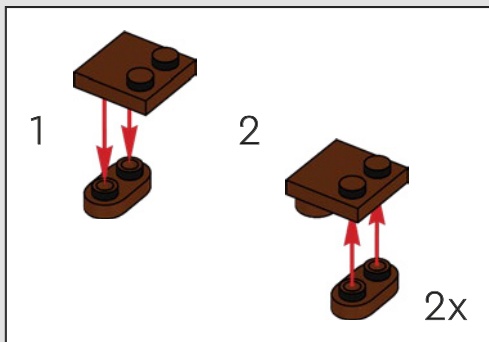



Mit diesem Ziel könnte ein Bogenschütze vortrefflich üben.

63

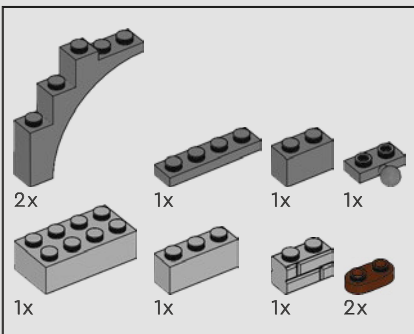
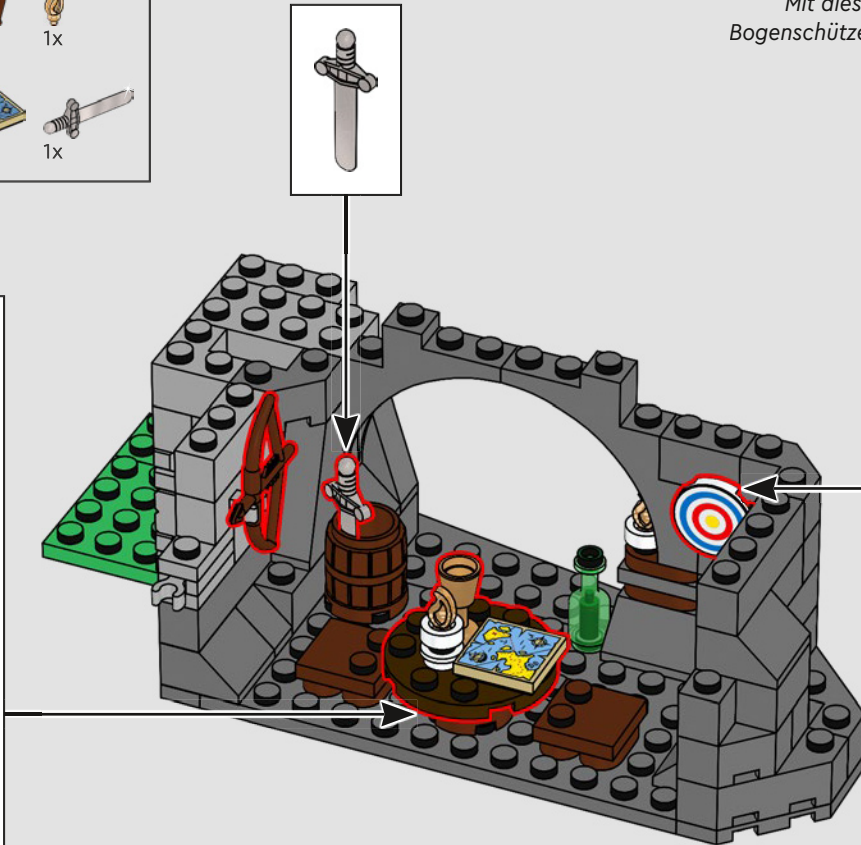
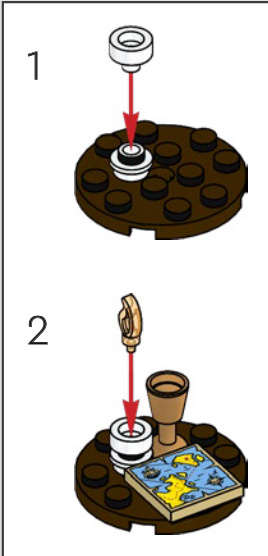

64

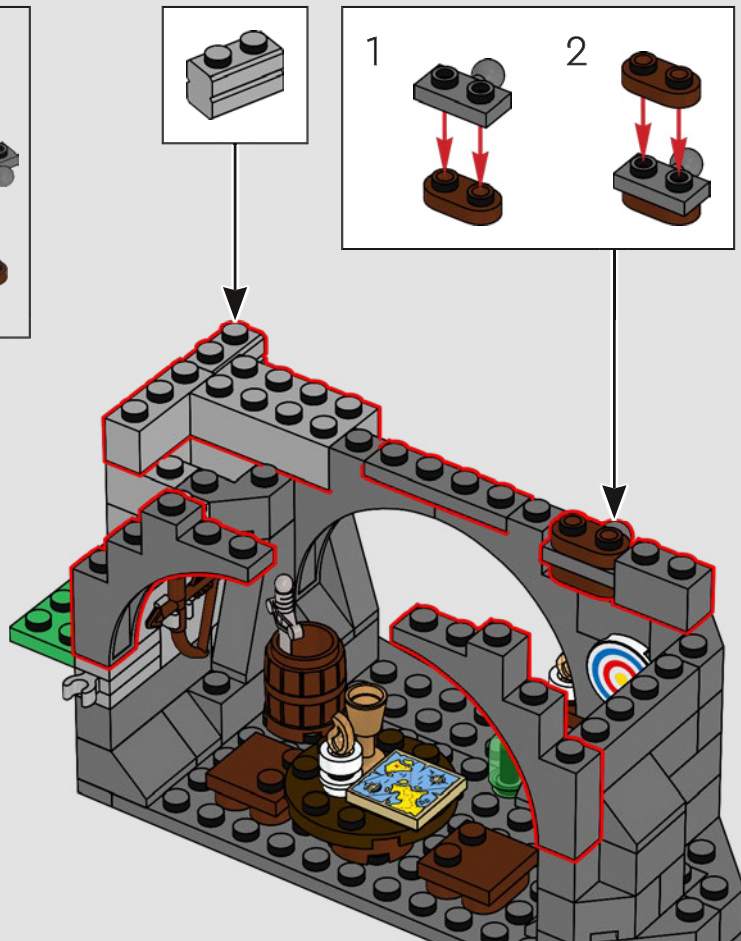

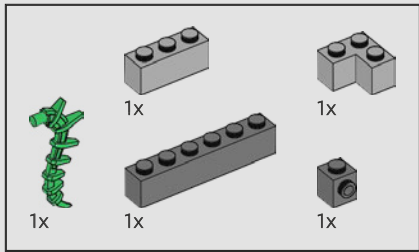

65

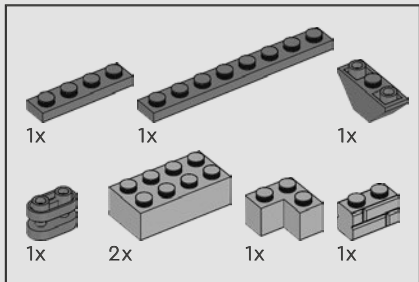
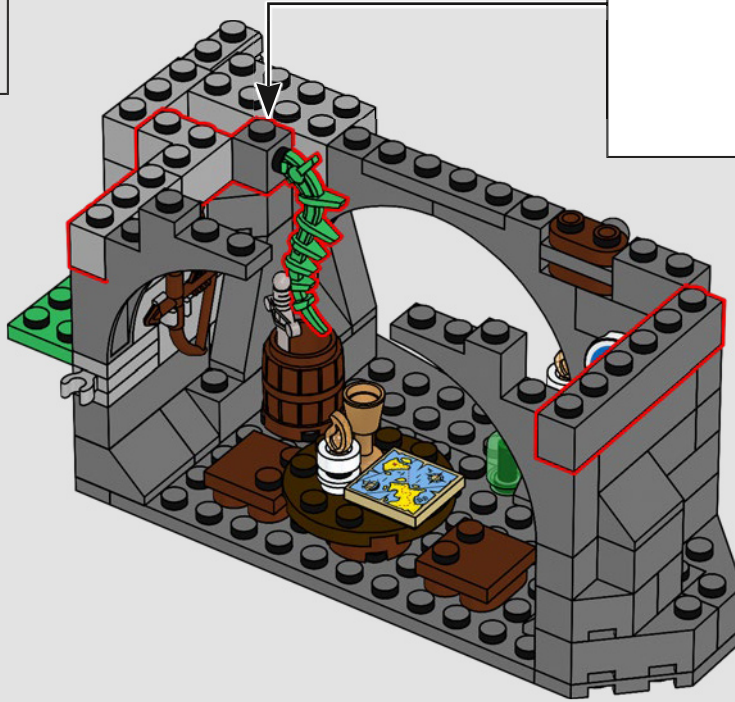
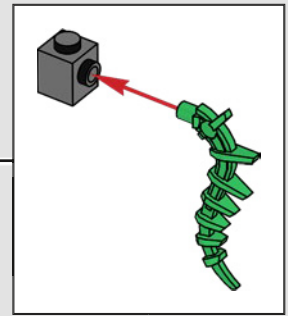

66

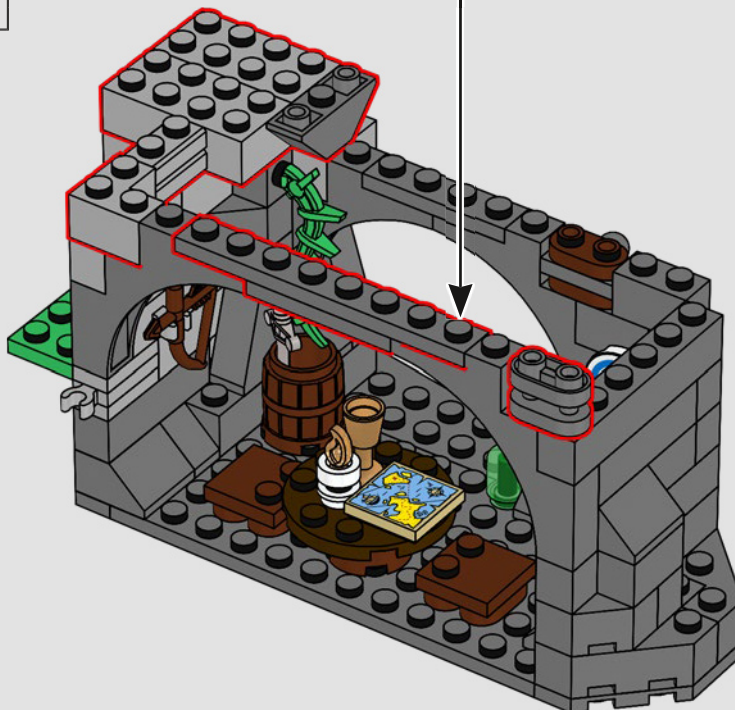
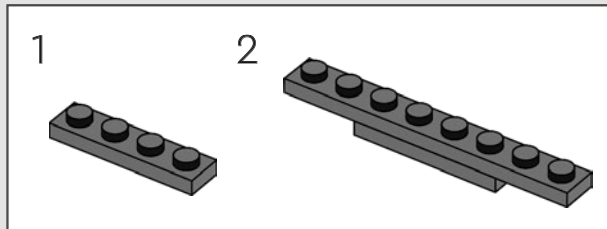

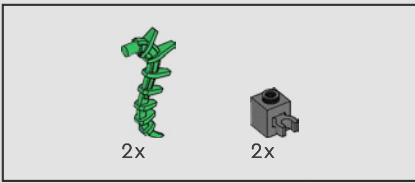

67

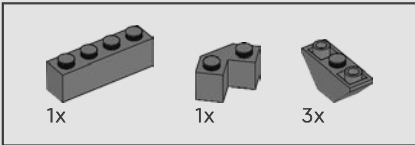
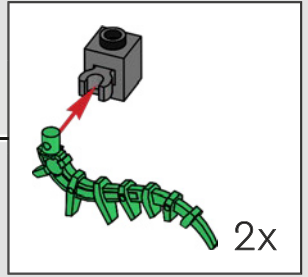
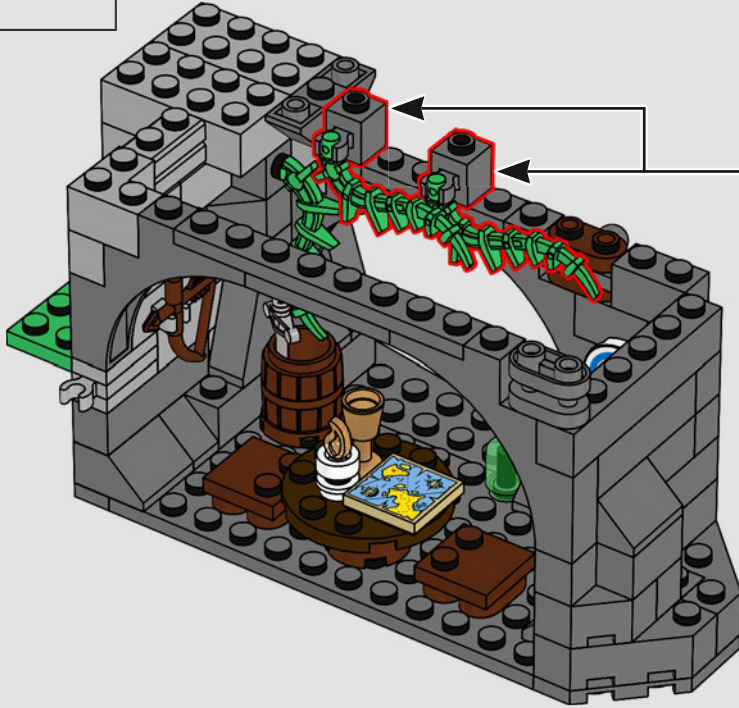

68

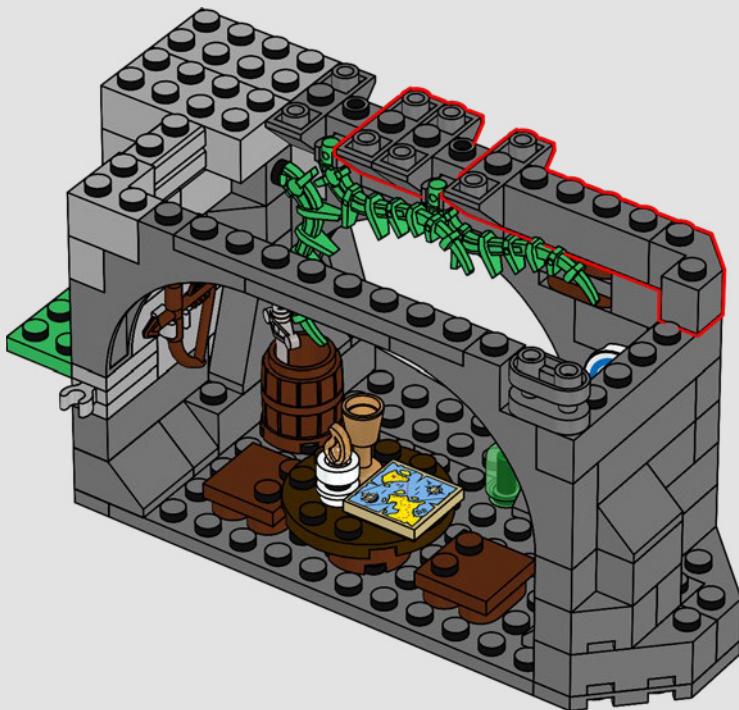

Was für eine sonderbare Karte.
Was die blaue Farbe wohl darstellt?
Kein Meer könnte so groß sein ...

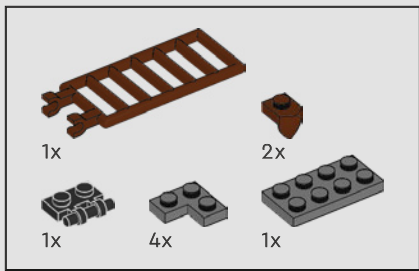

69

1

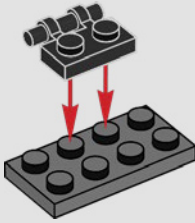

2

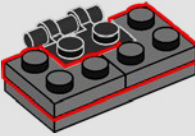

3

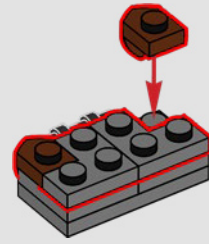

4

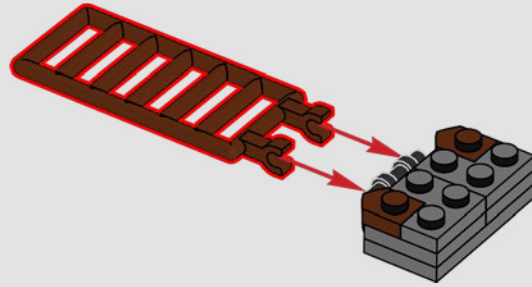

5

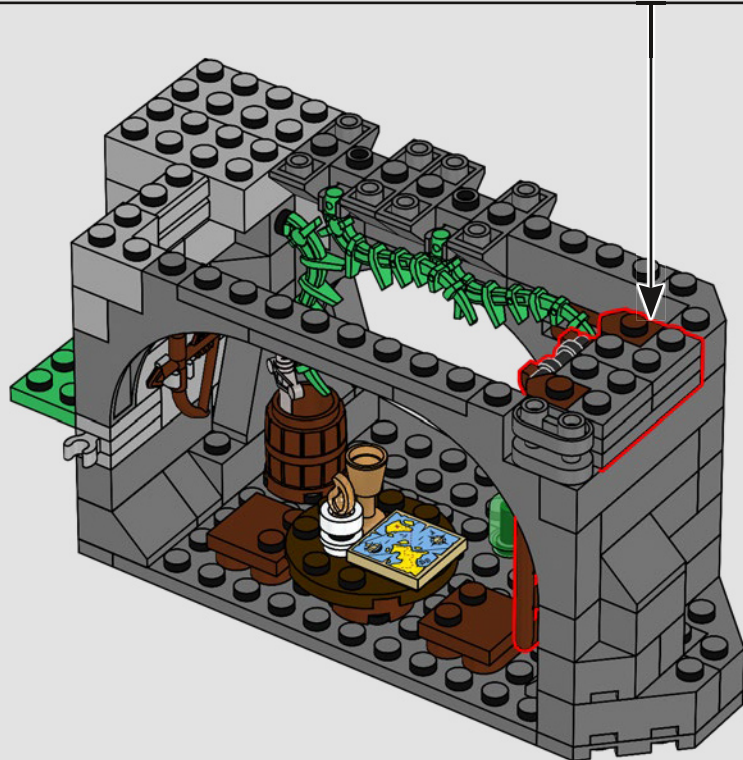
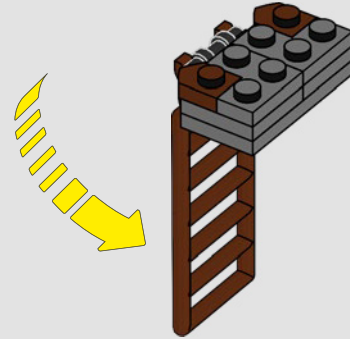

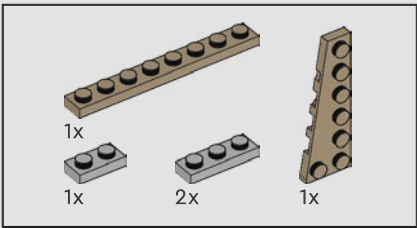

70

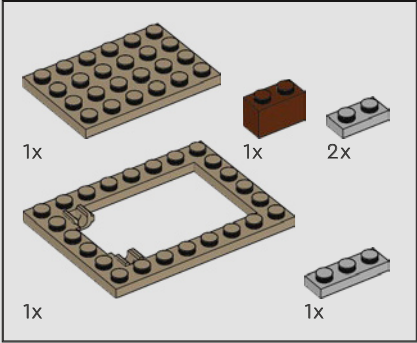
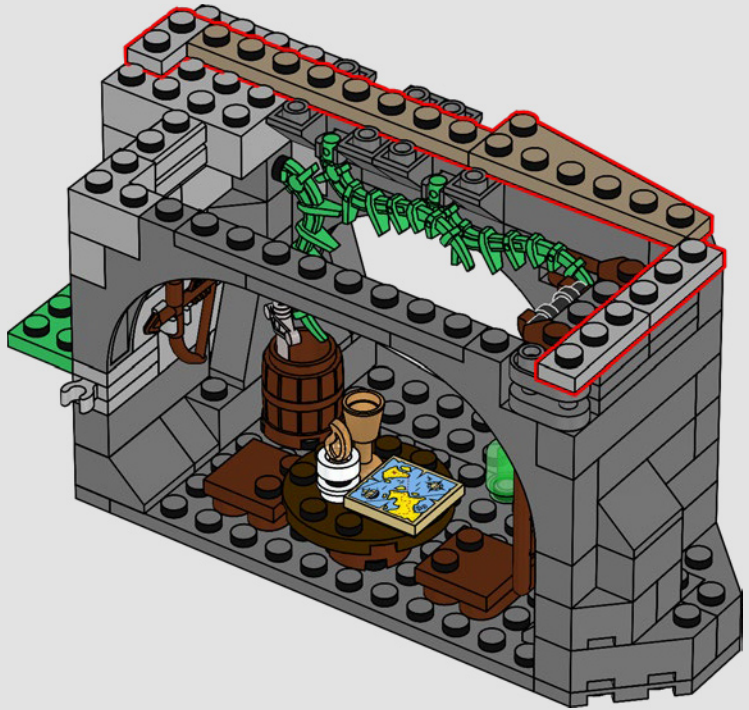

71

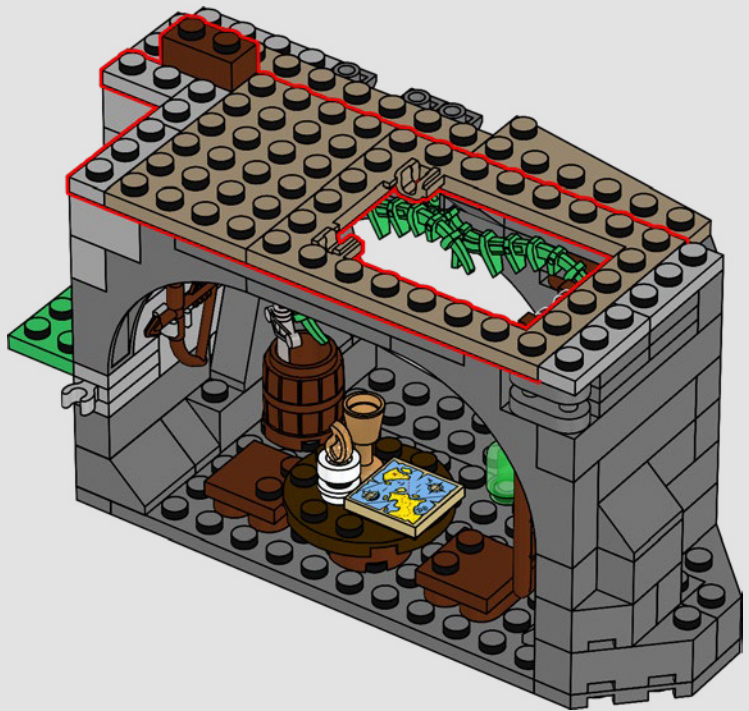

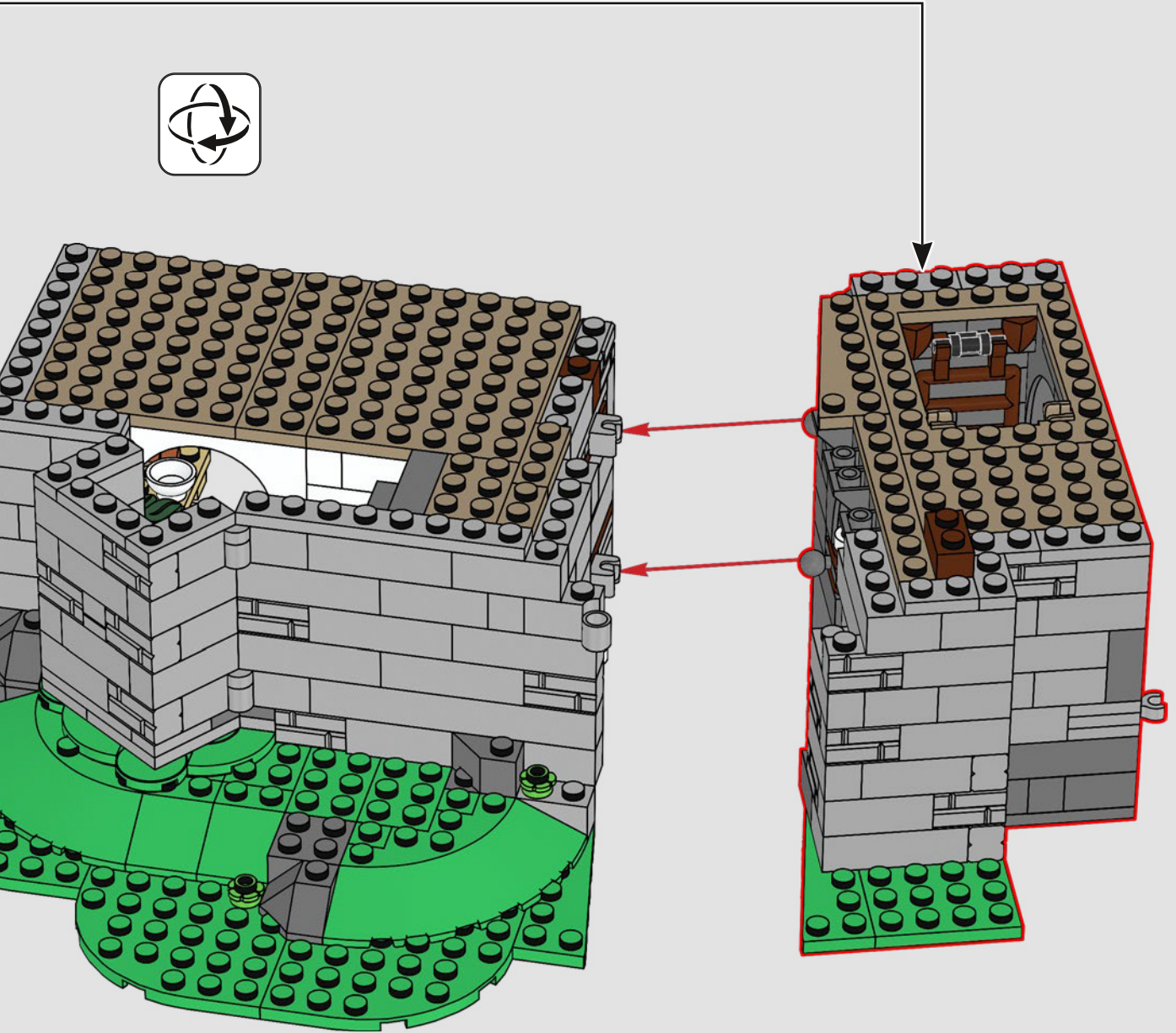

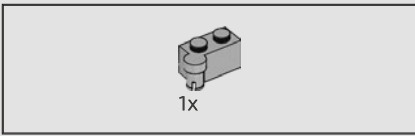

73

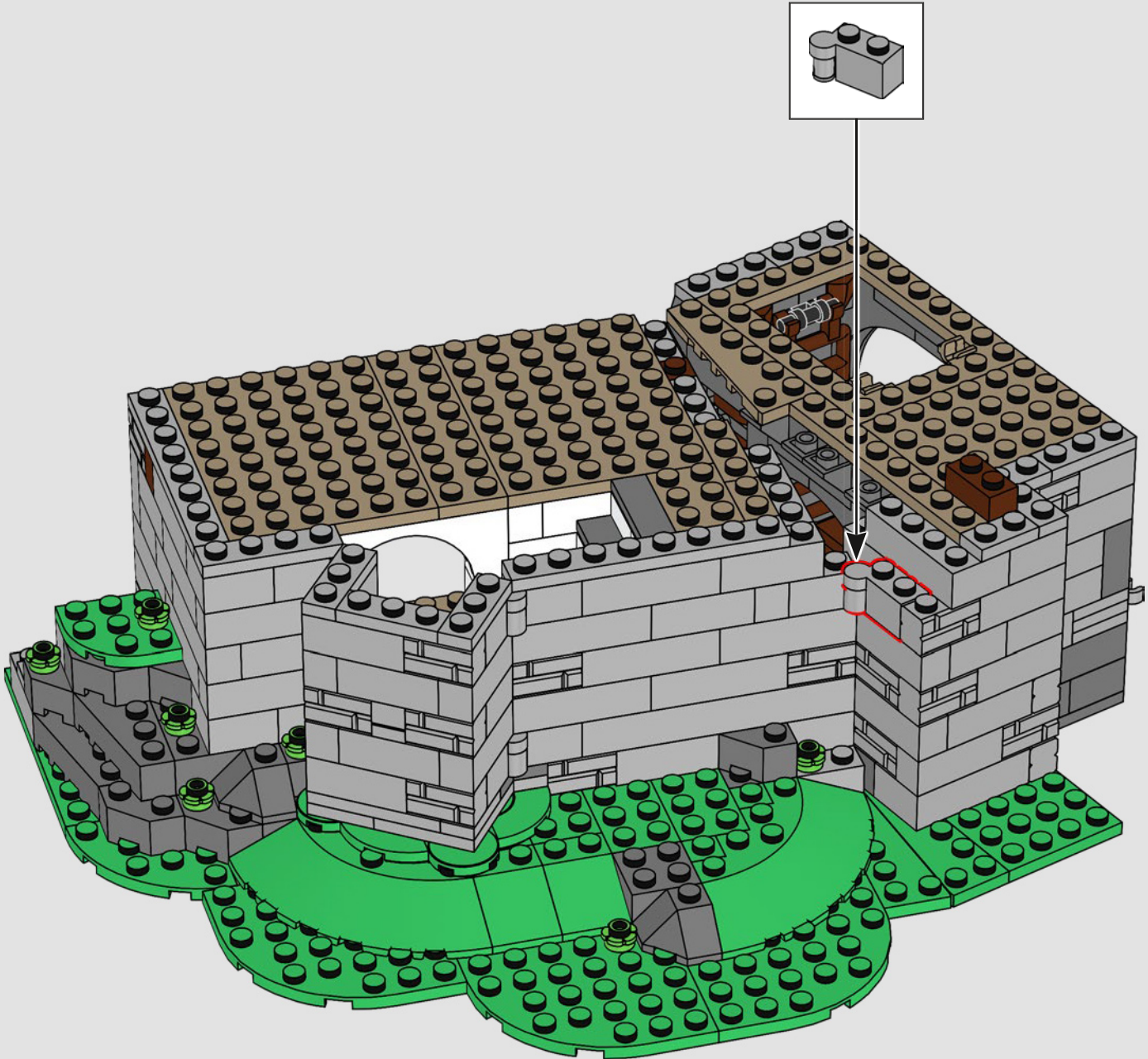

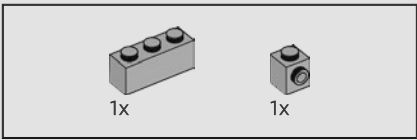

74

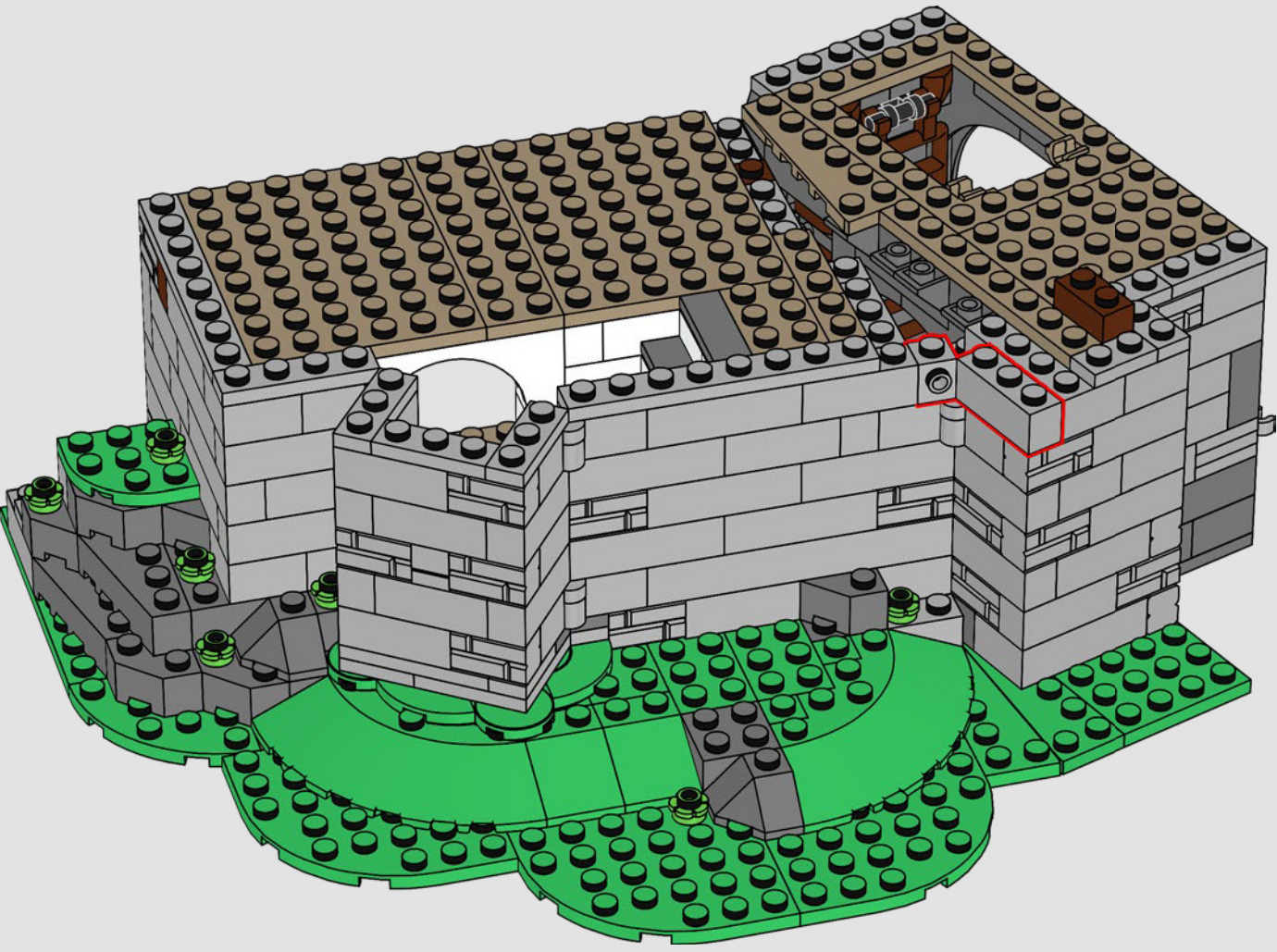

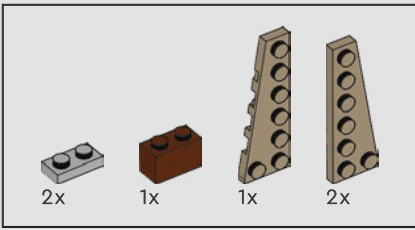

75

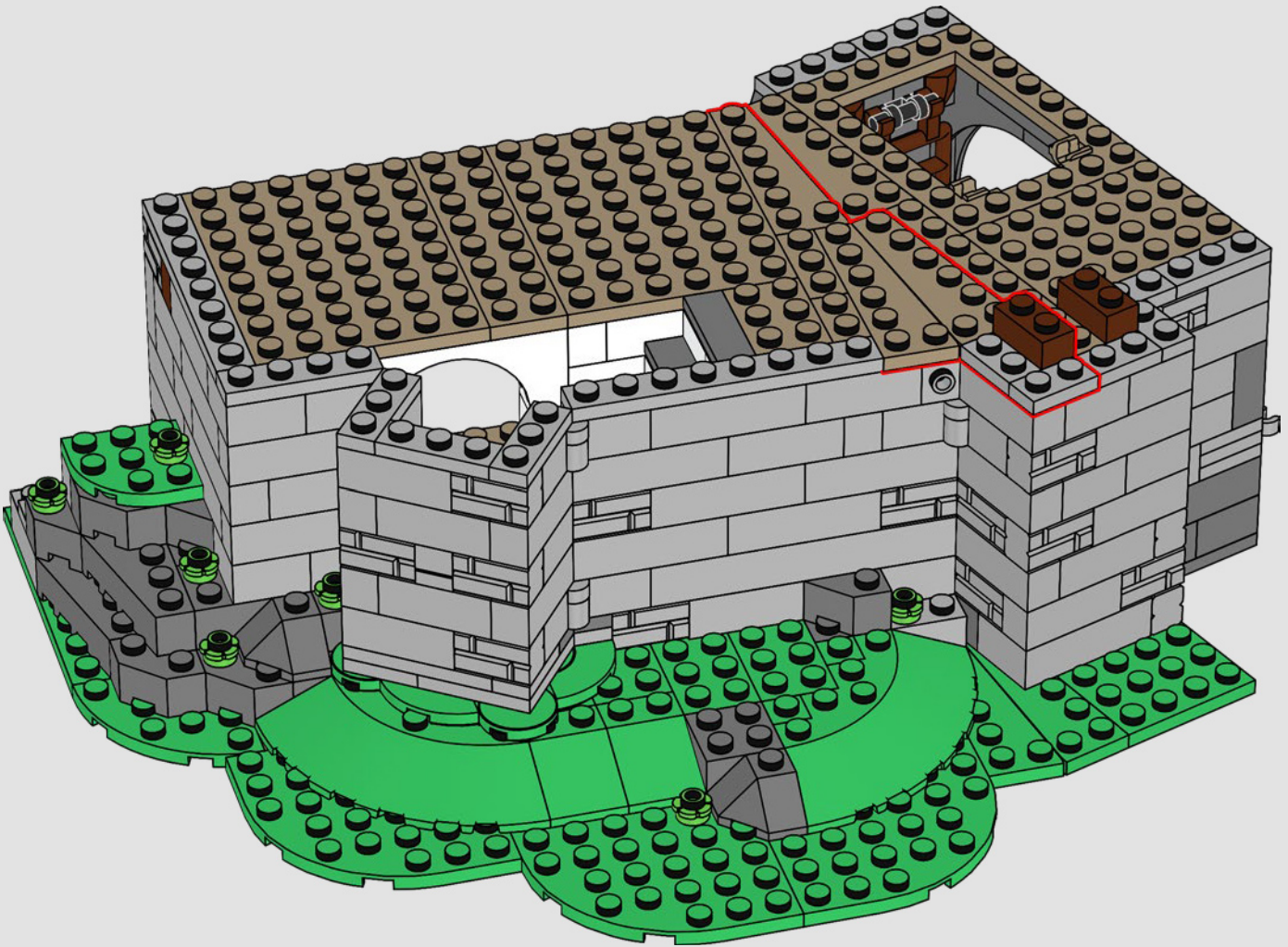

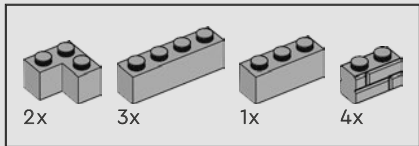

76

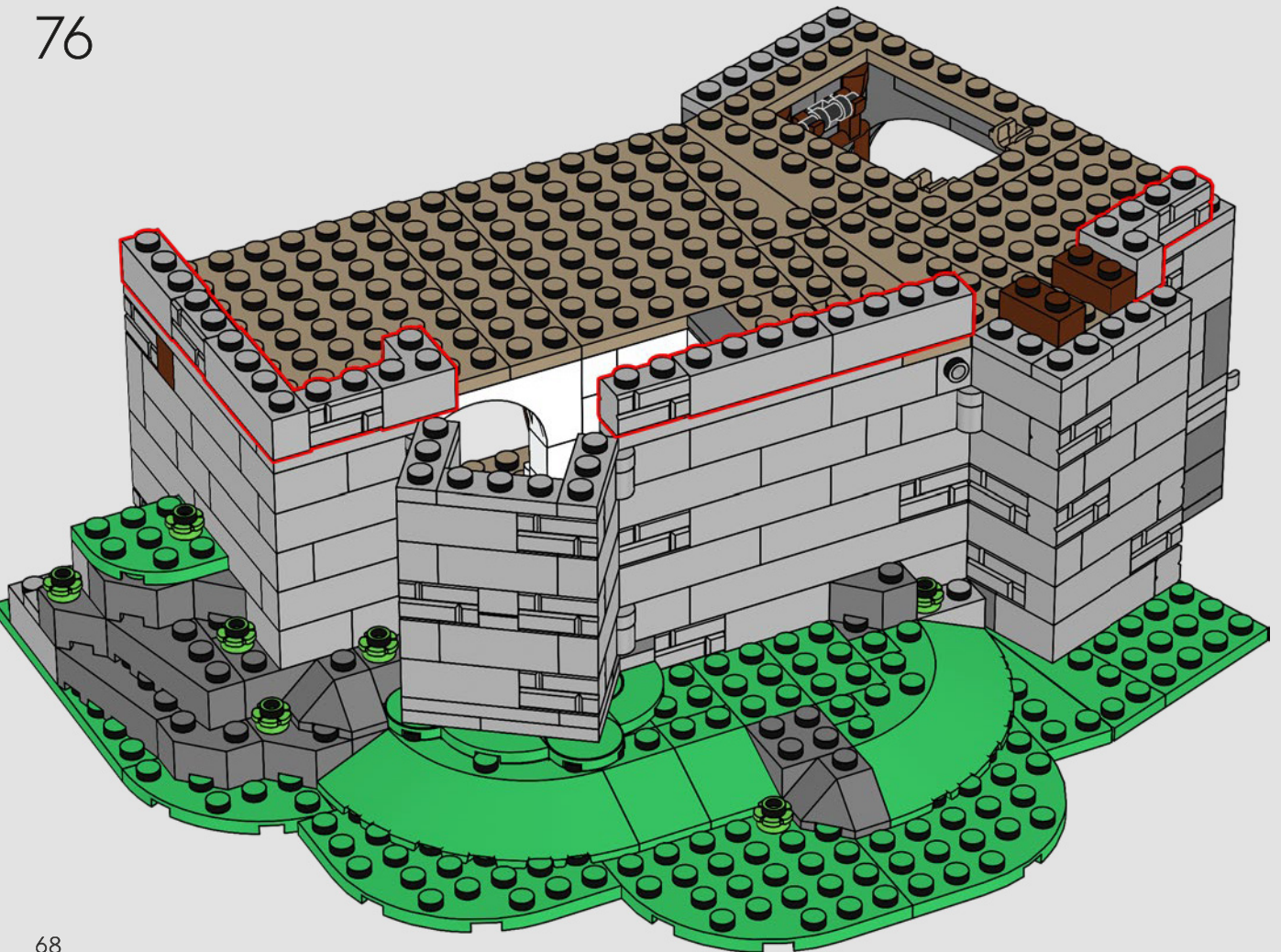

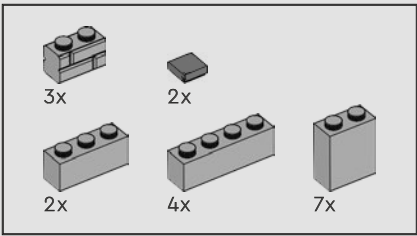

77

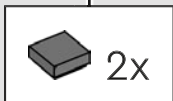
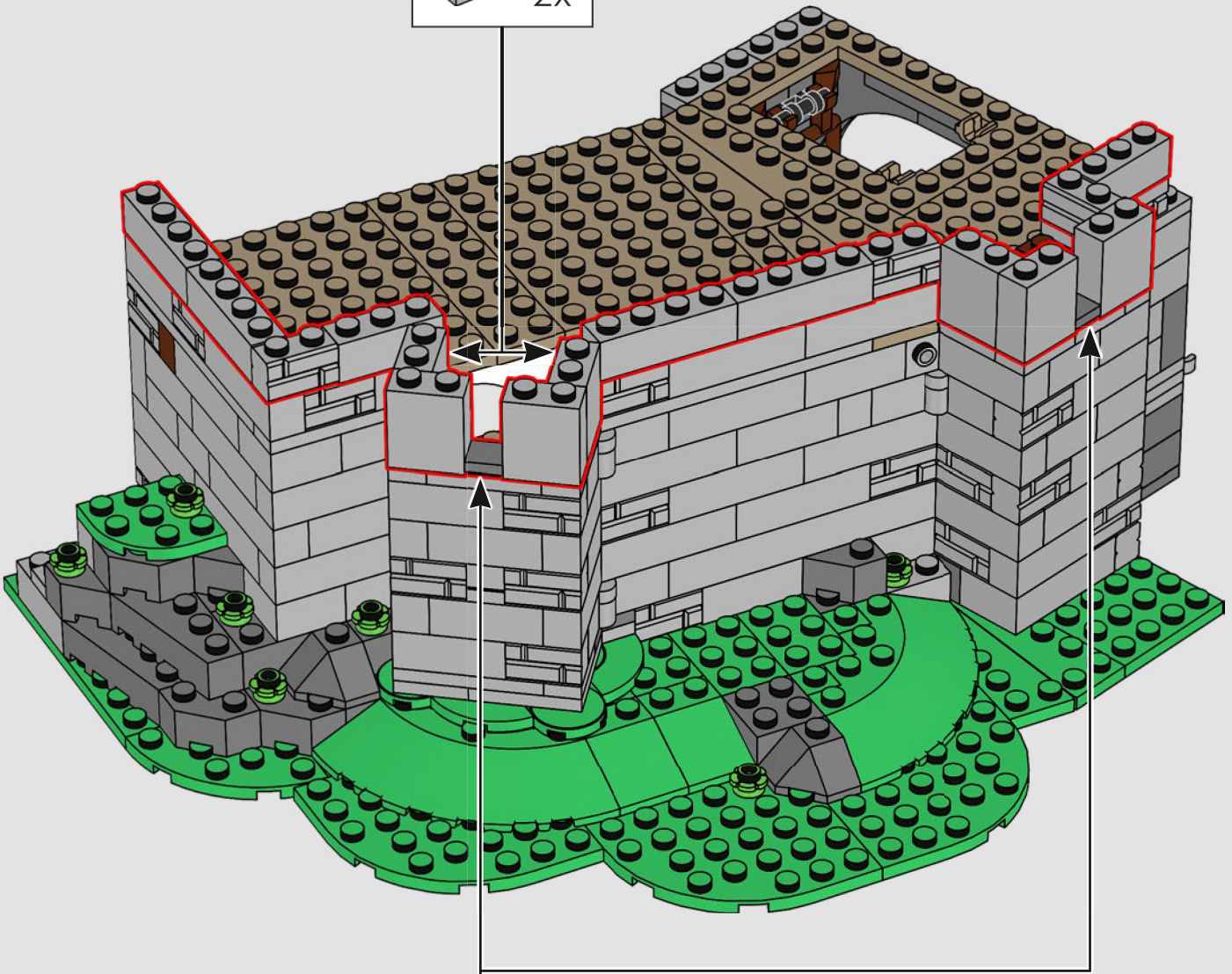
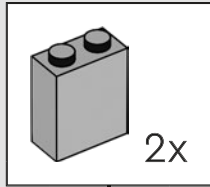

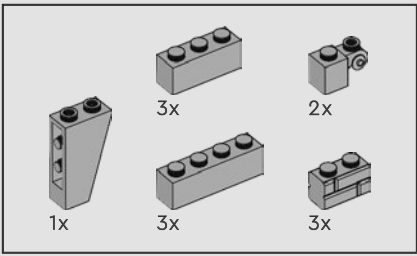

78

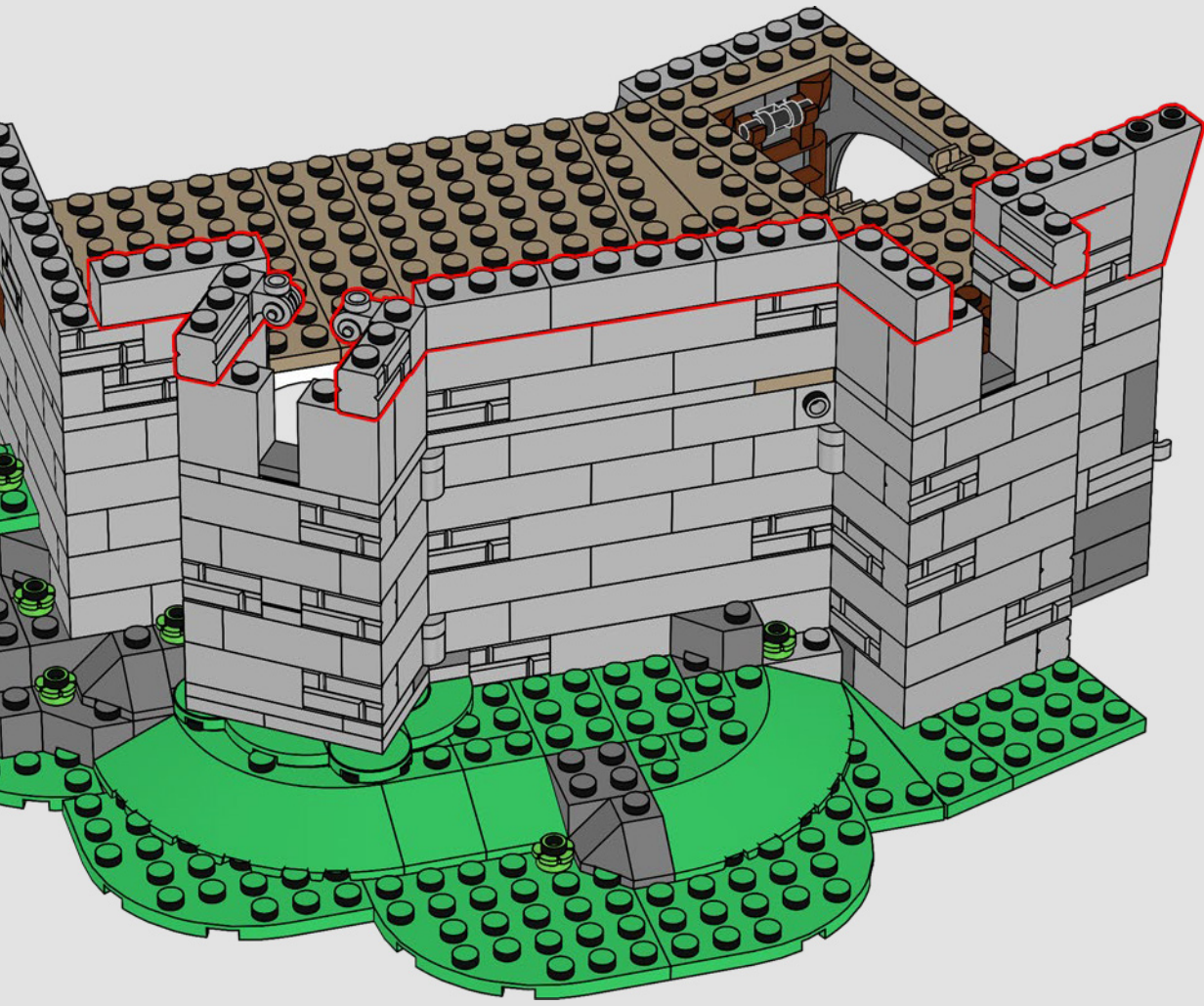

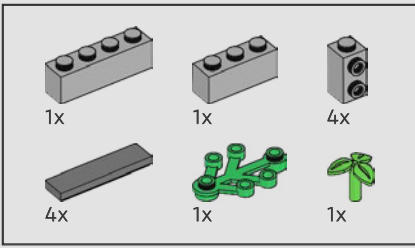

79

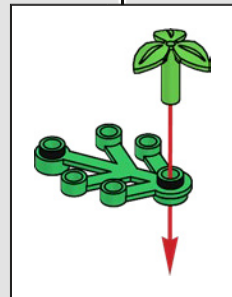
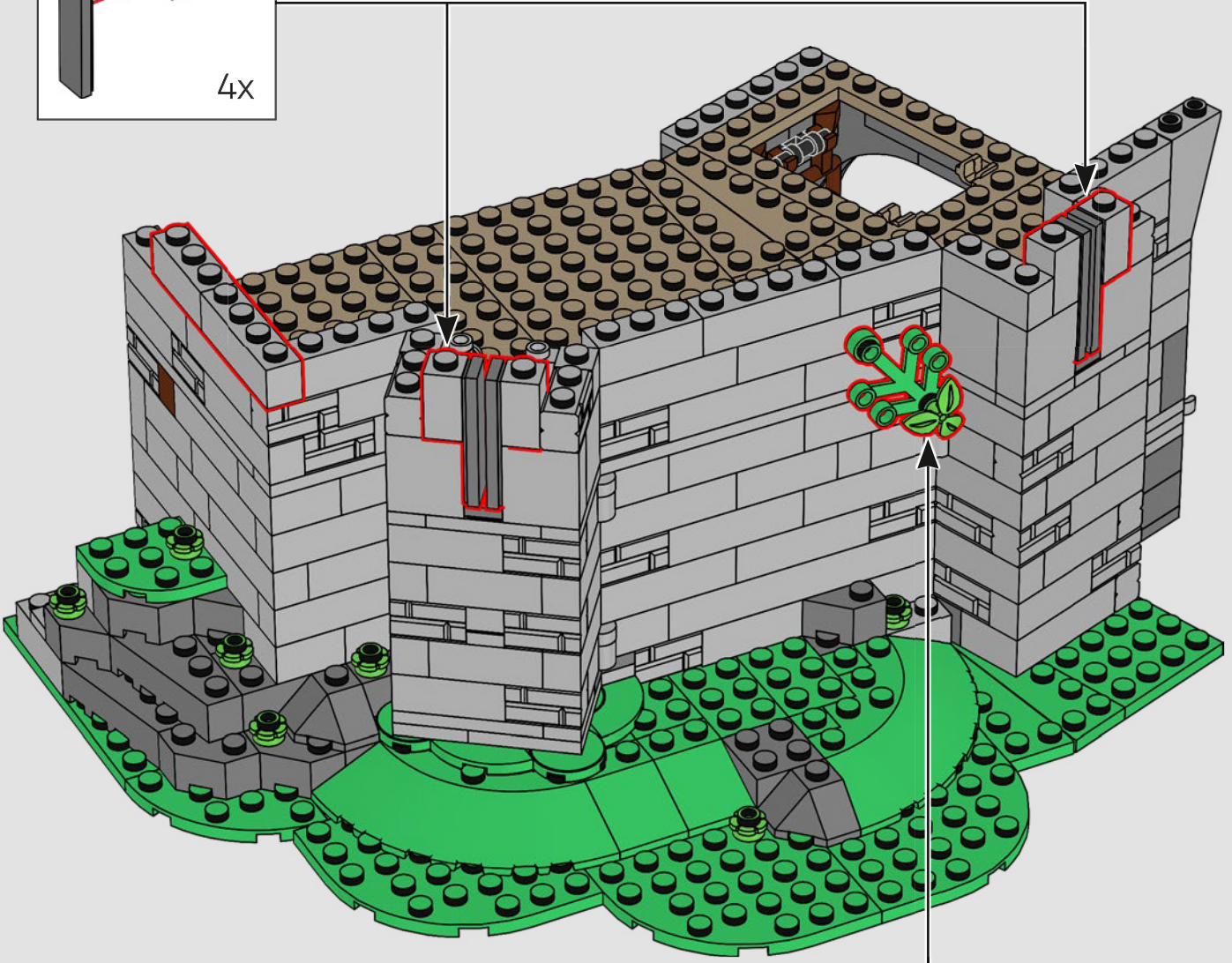
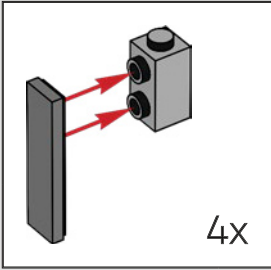

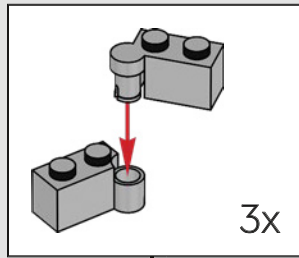
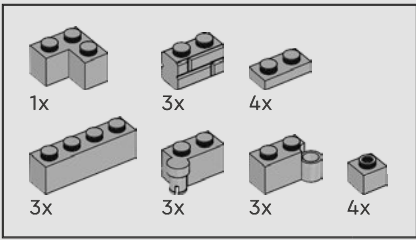

80

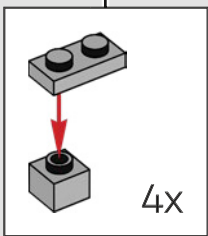
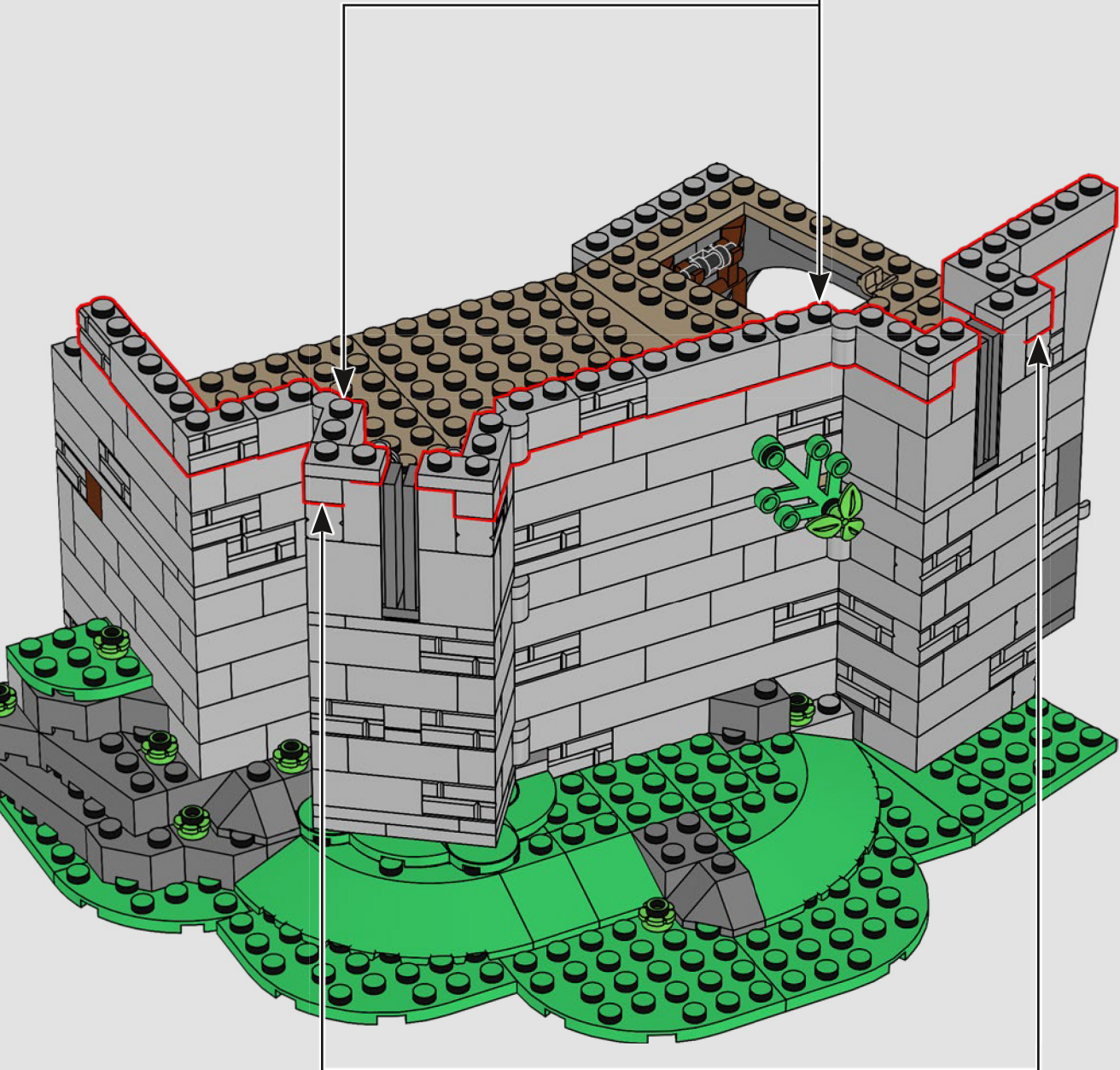

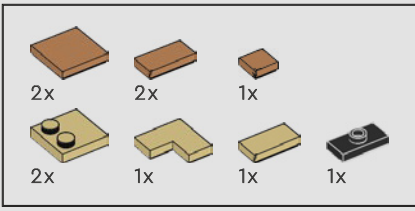

81



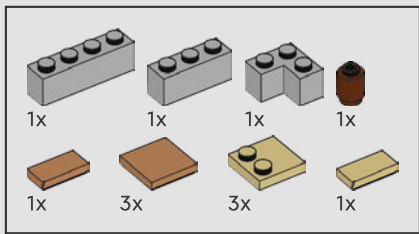

82

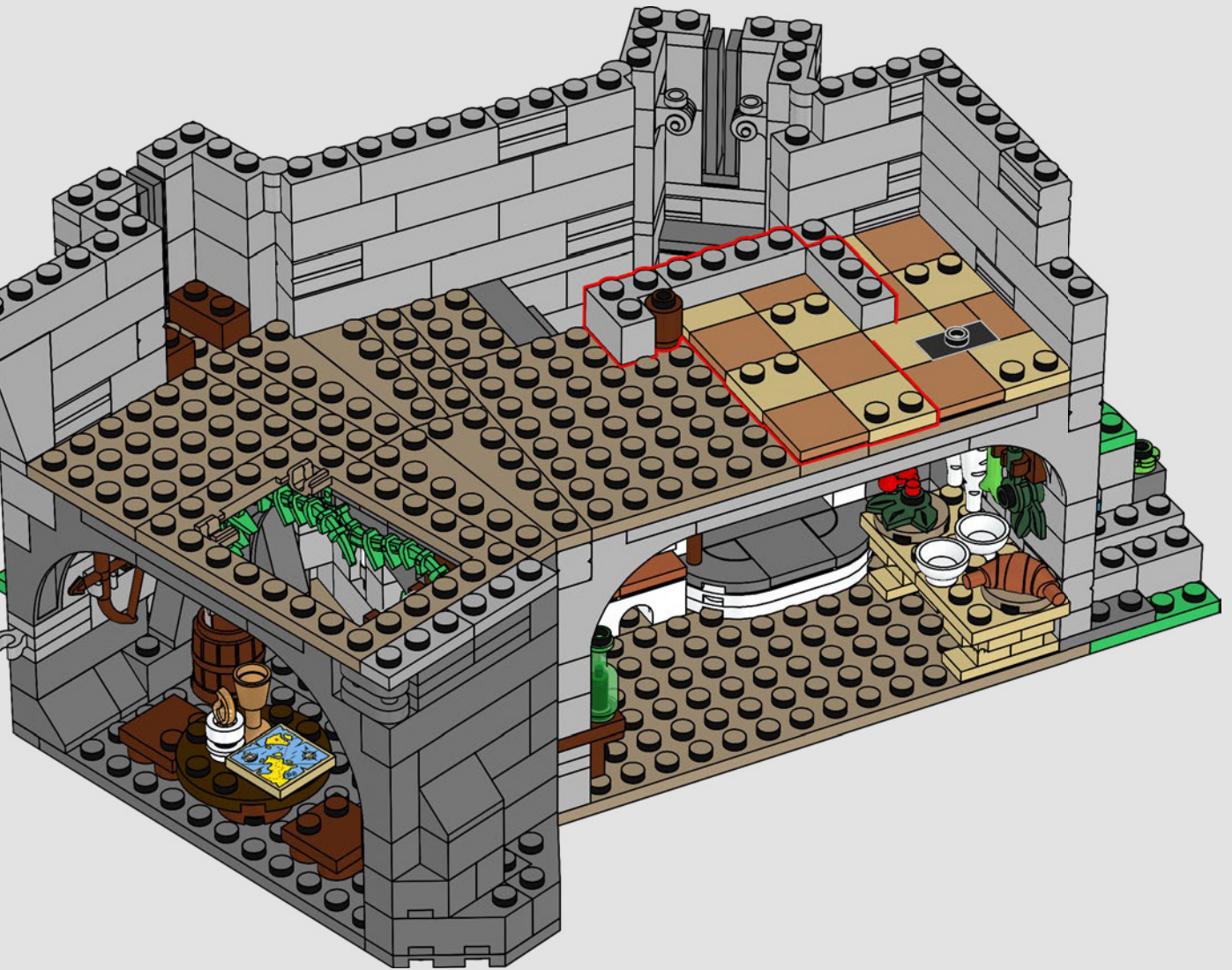

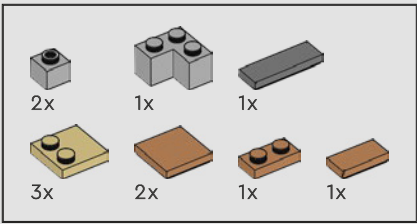

83





Warum nur ist dieser Zugang abgedeckt?
Soll der Burgherrin die Kammer dort
unten etwa verborgen bleiben?

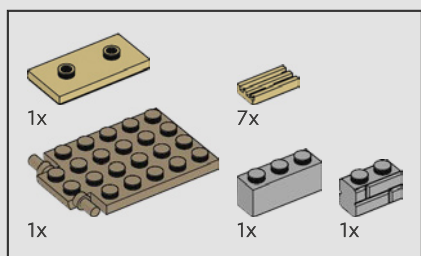

84

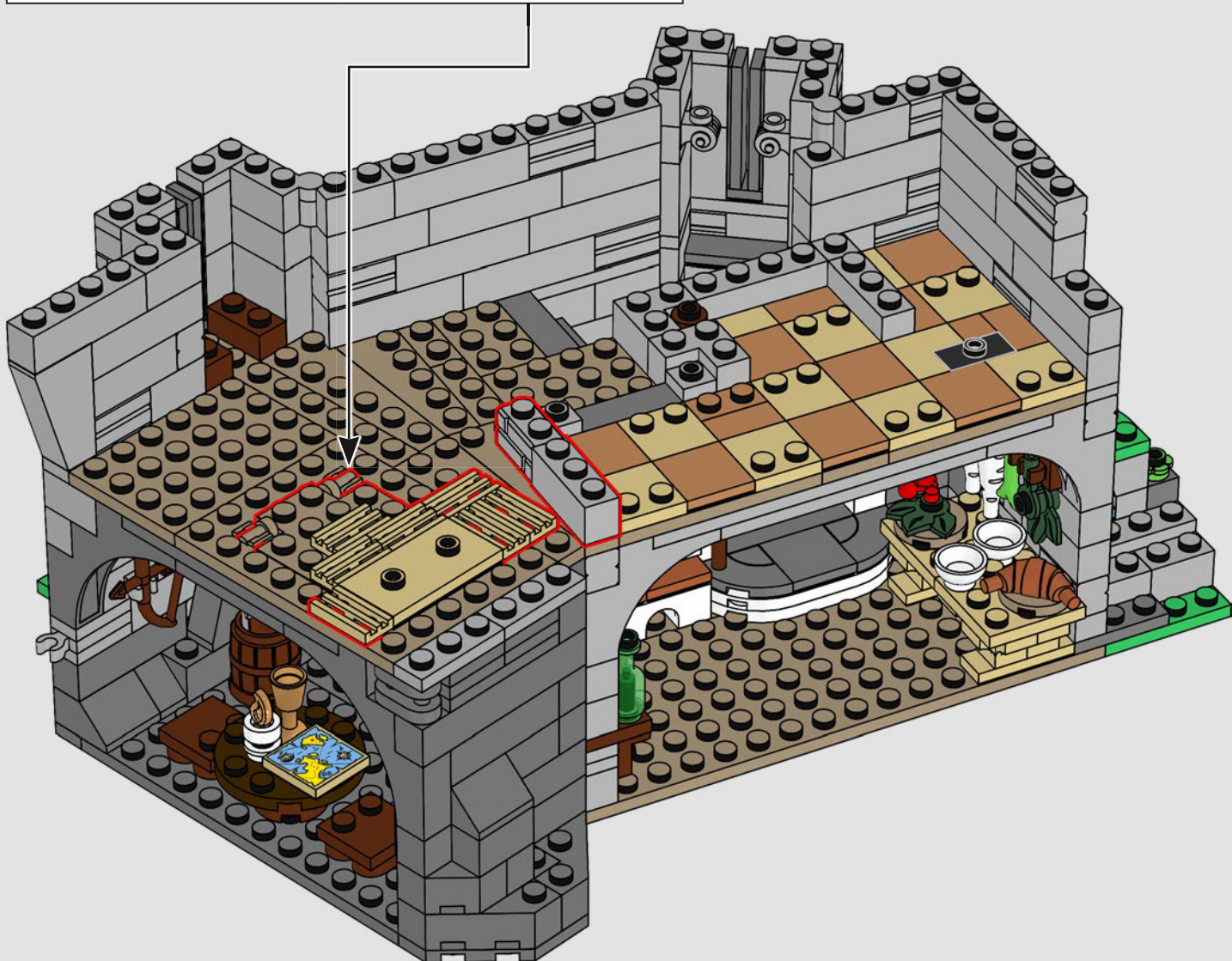
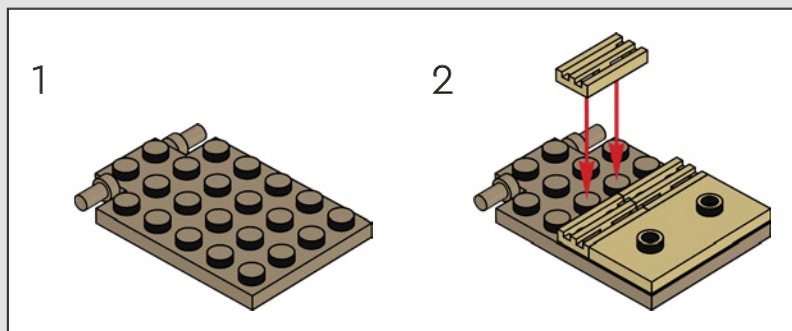

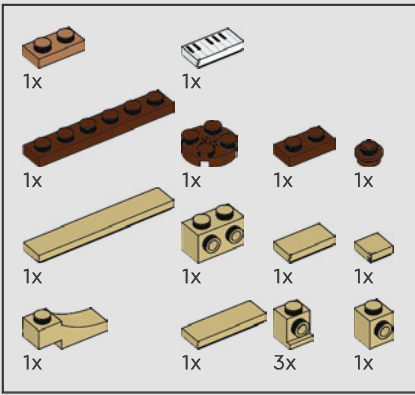

85

1

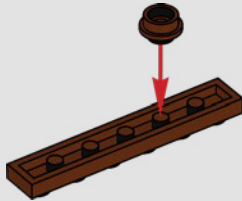

2

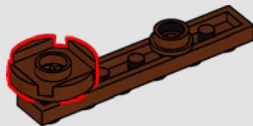

3

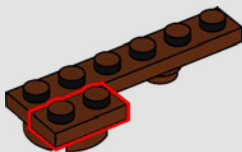

4

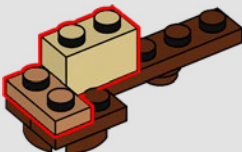

5

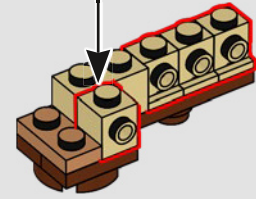
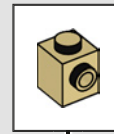

6

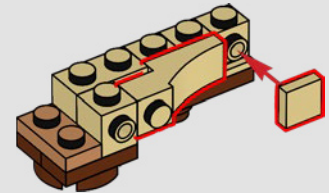

7

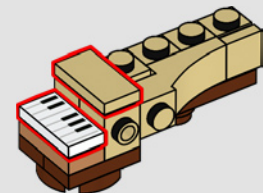

8

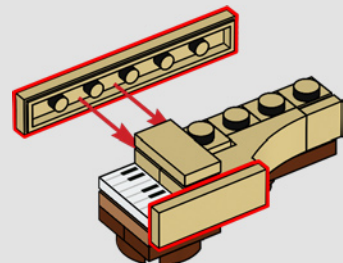



Hör nur! Stammen diese melodischen Klänge etwa von einem Cembalo? Was für ein Wunderwerk moderner Musik!

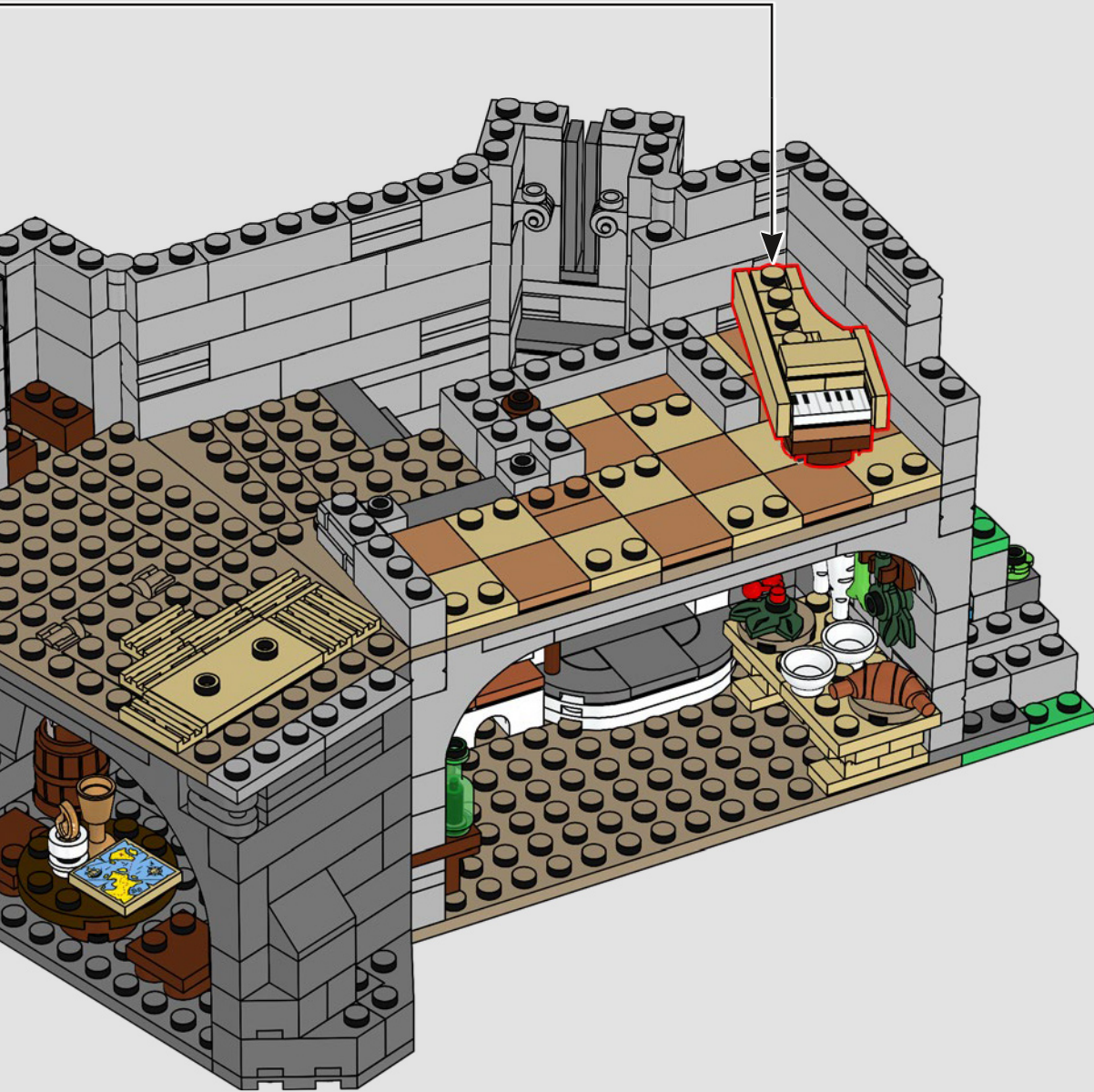

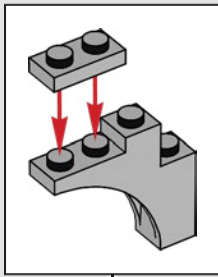
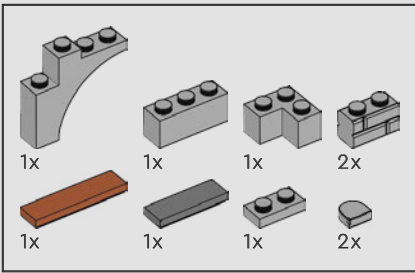

86

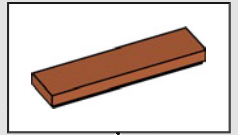
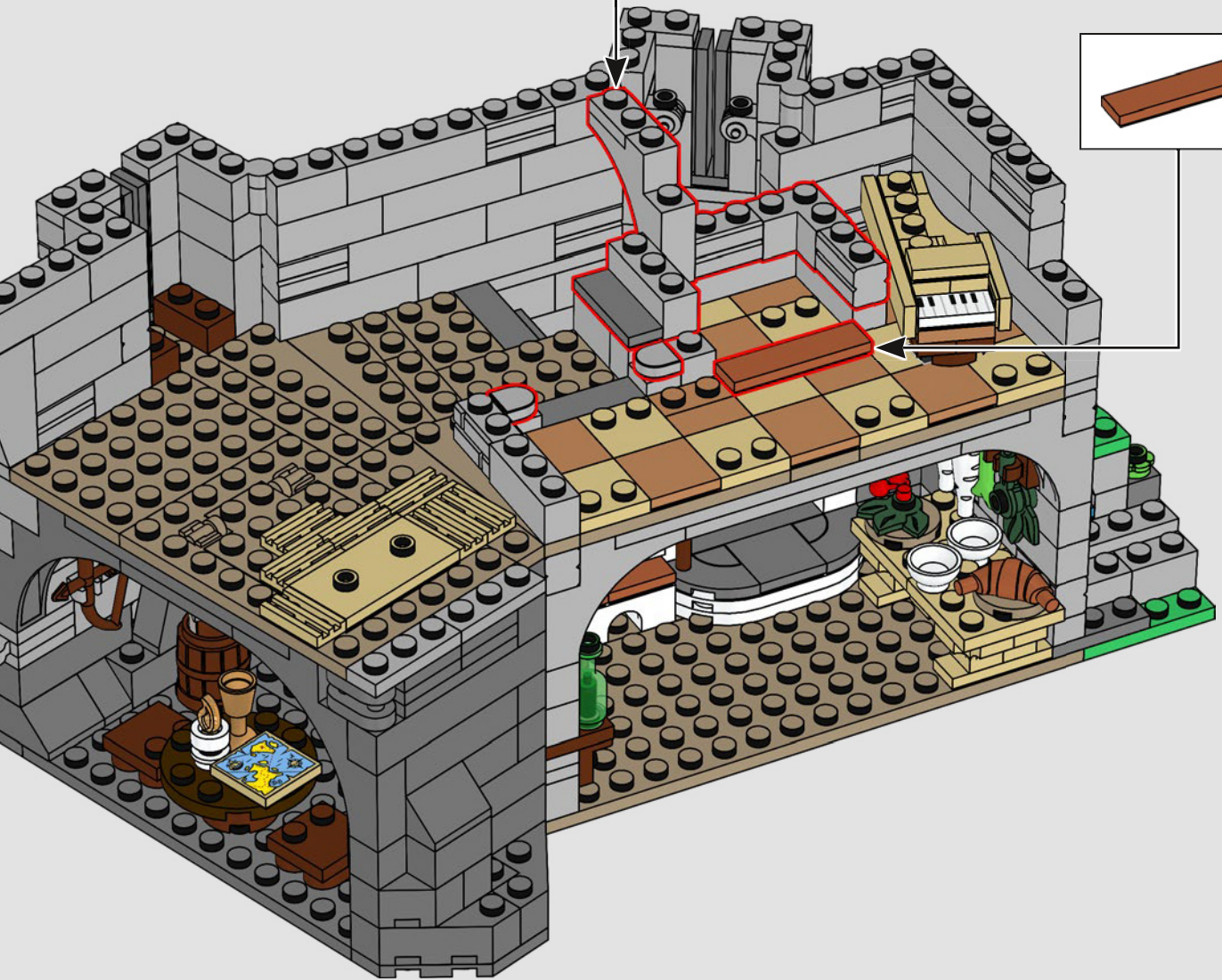

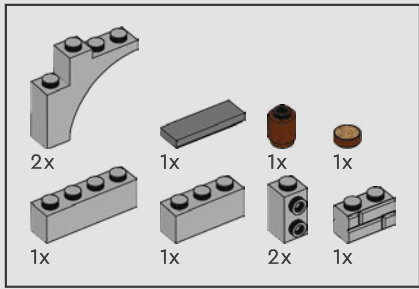

87

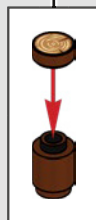
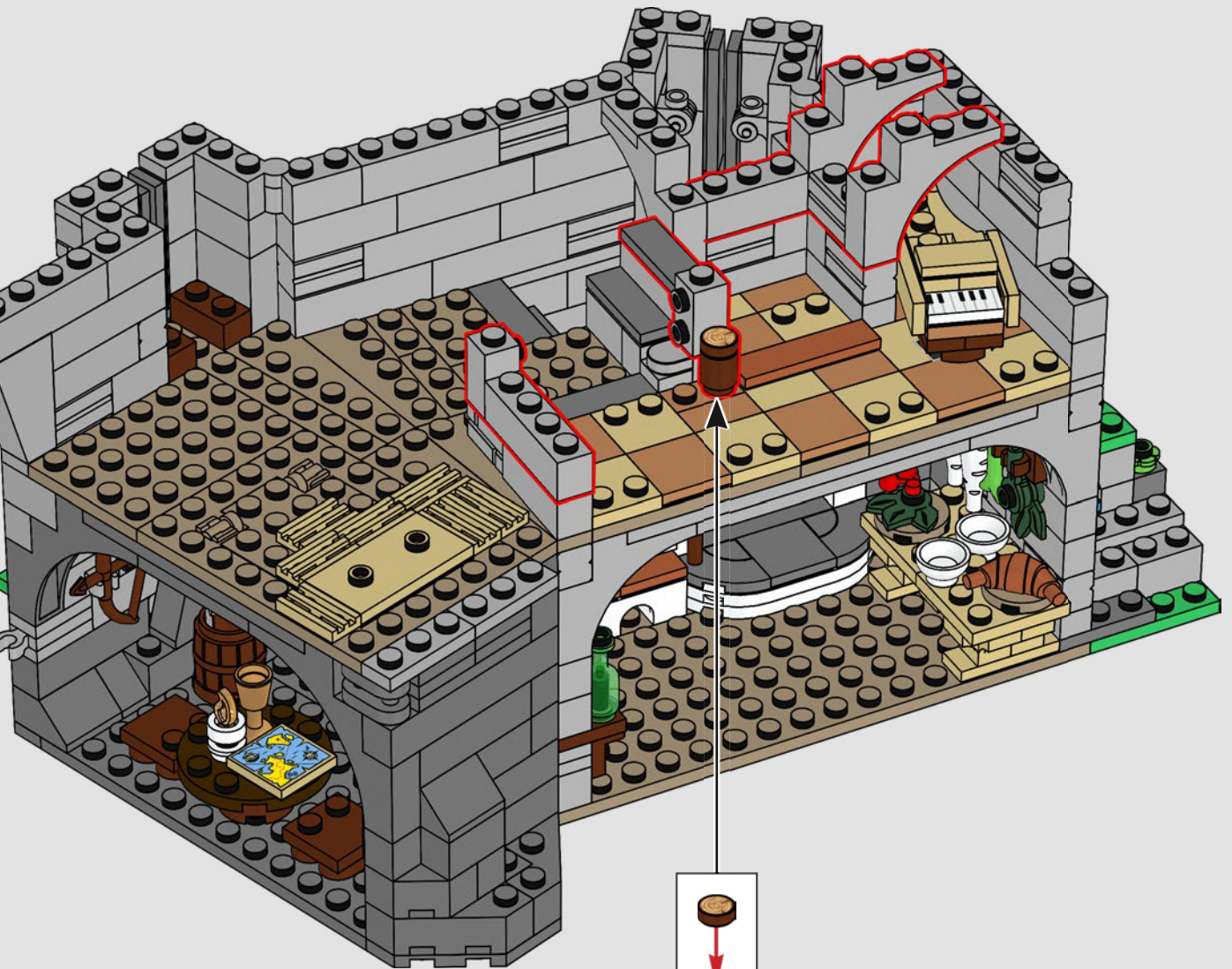

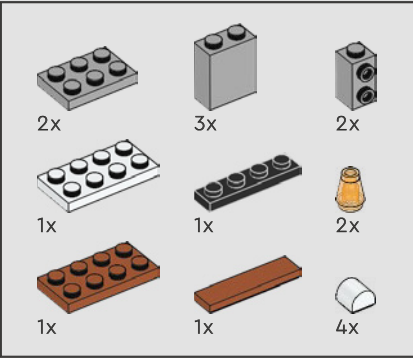
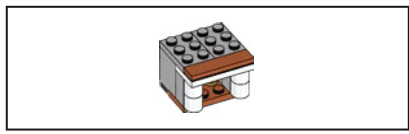

88

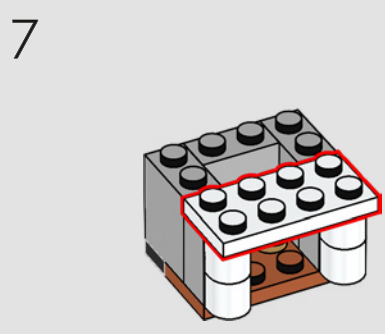
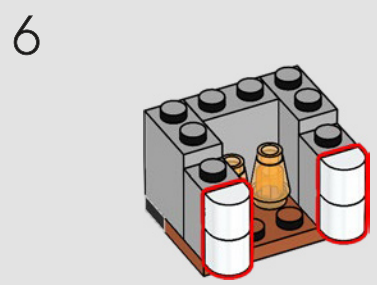
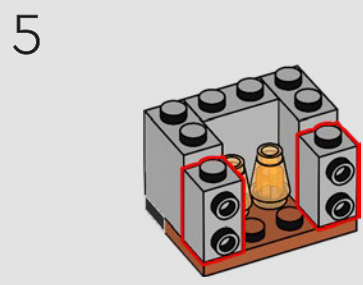
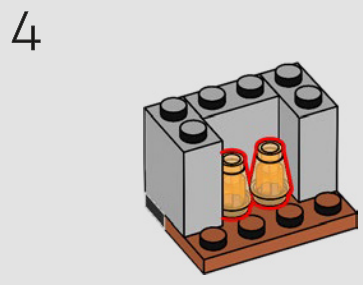
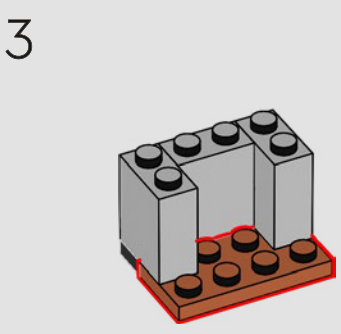
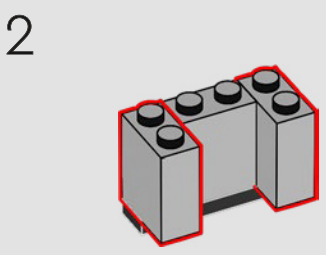
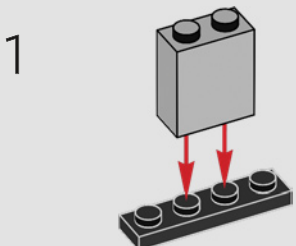

8

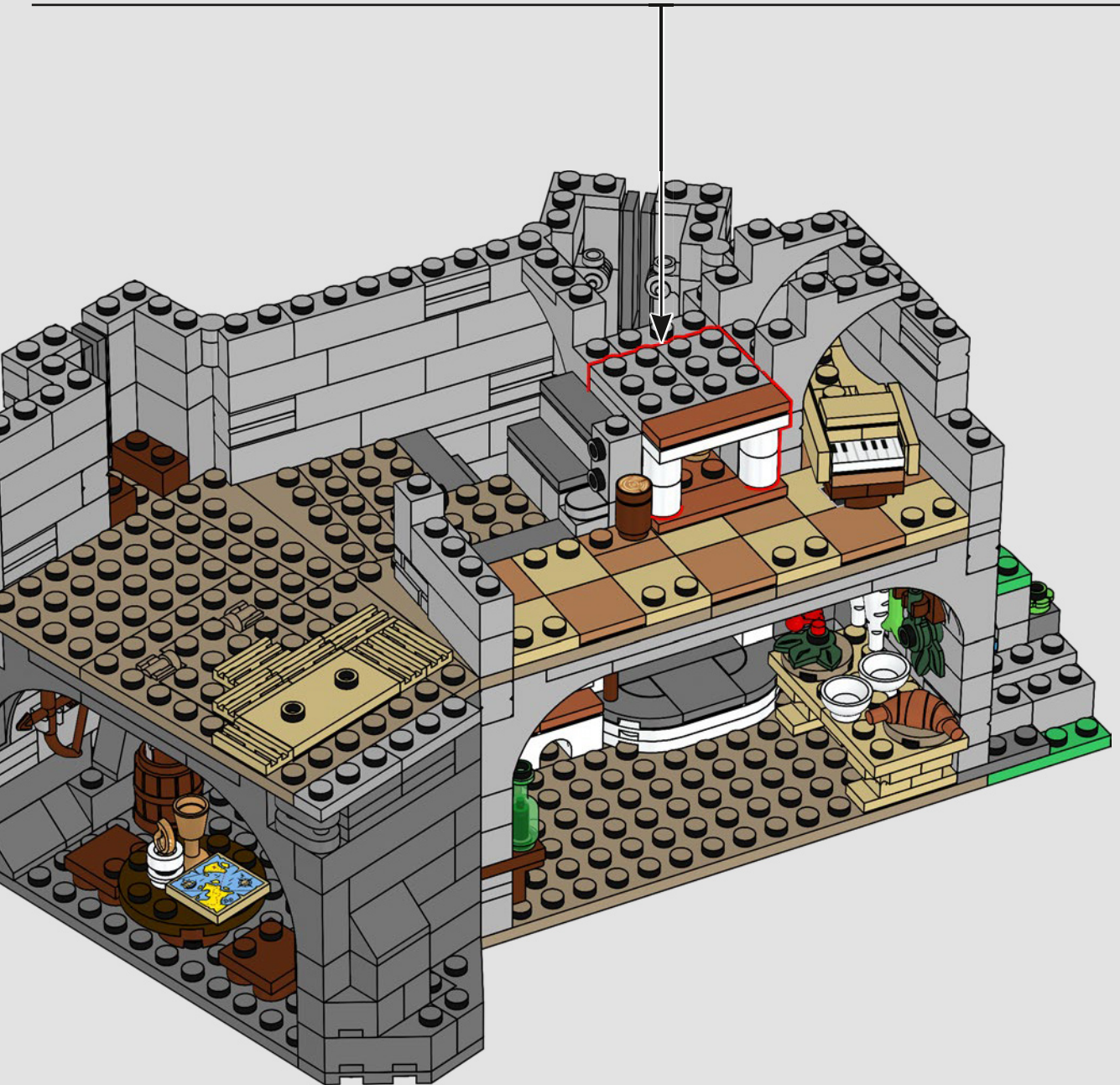
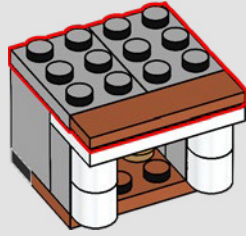

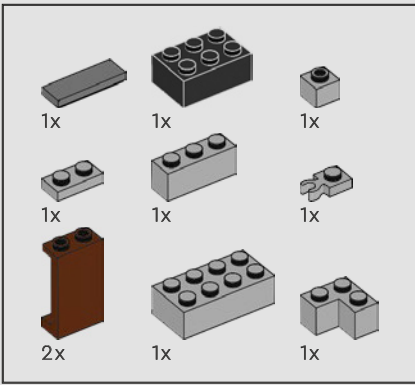

89

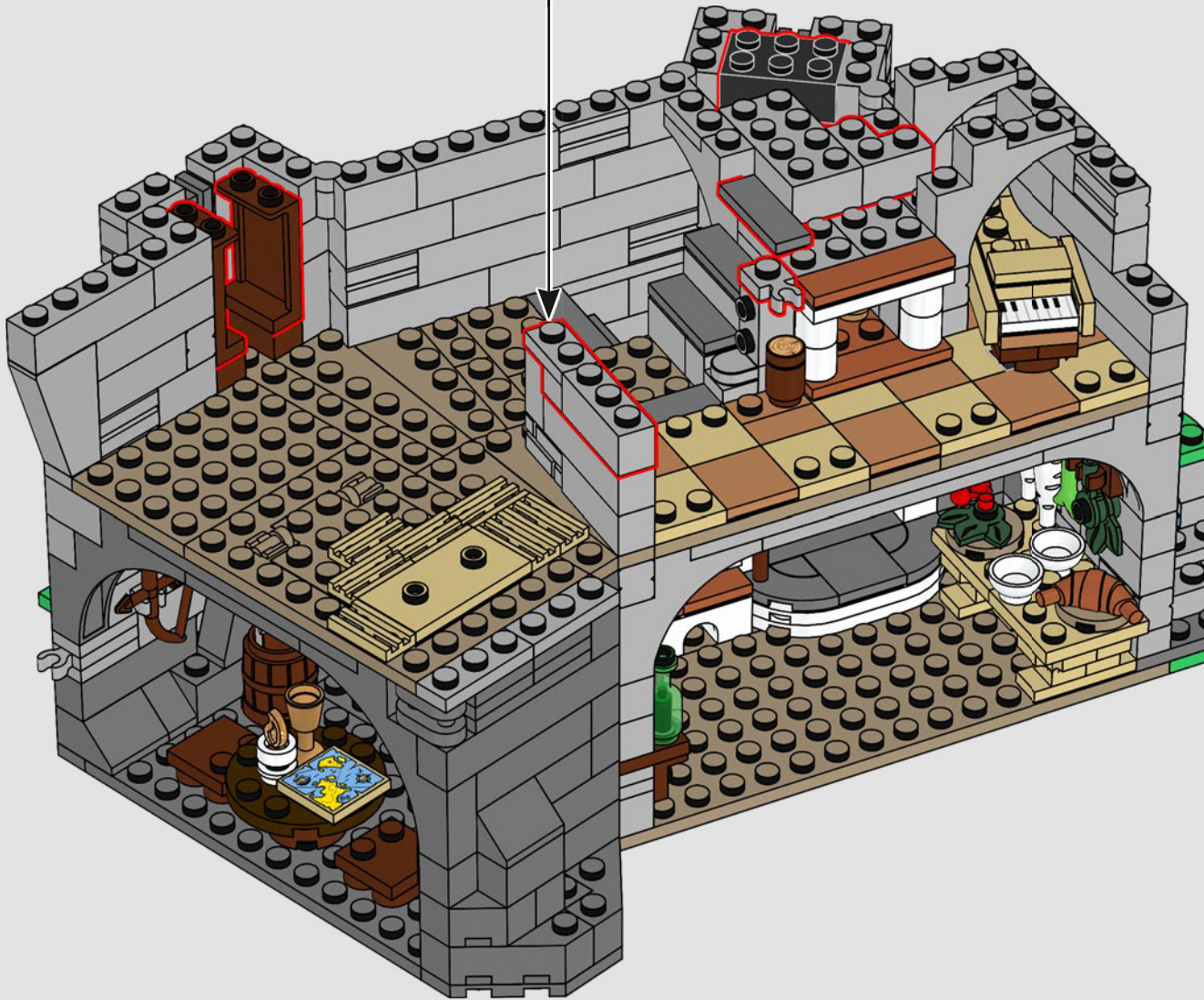
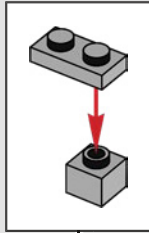

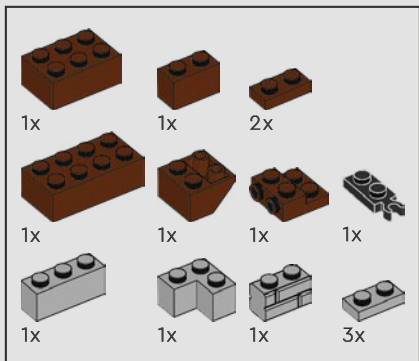

90

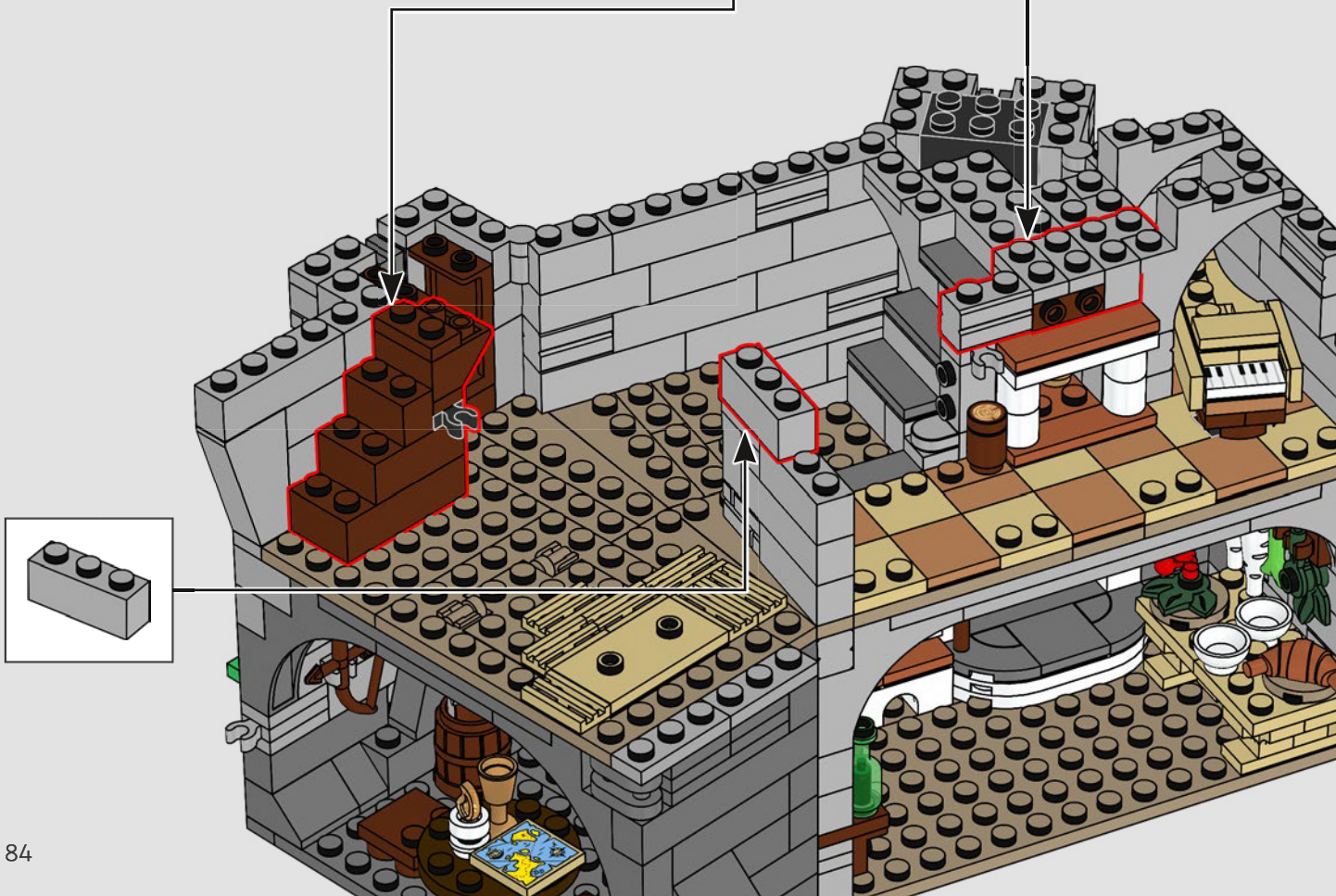
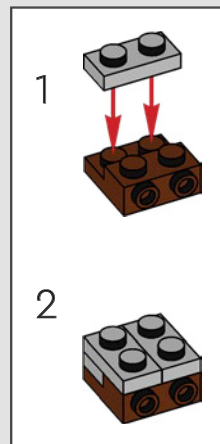
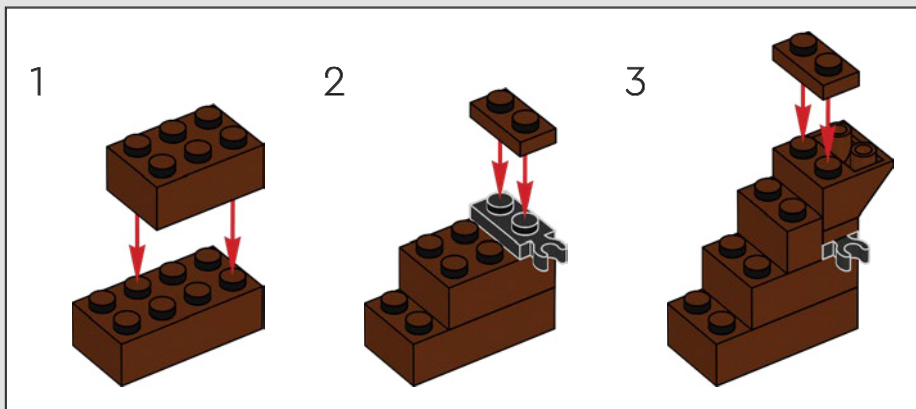

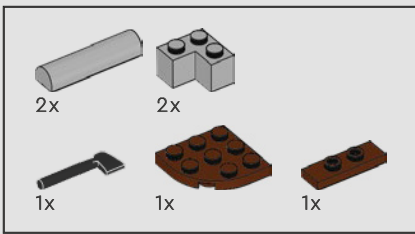

91

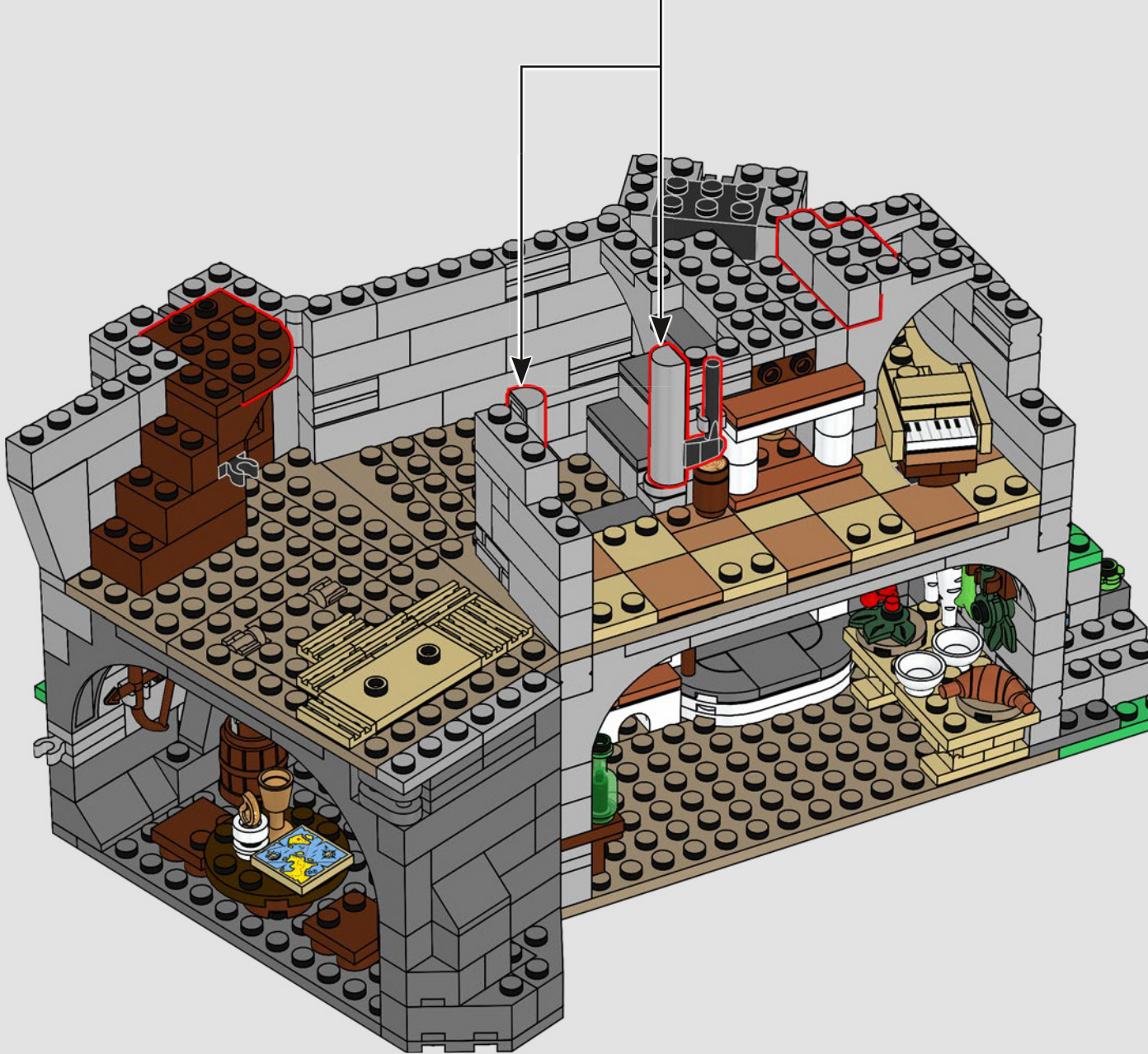
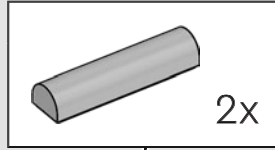

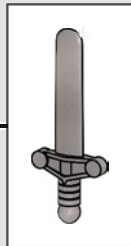
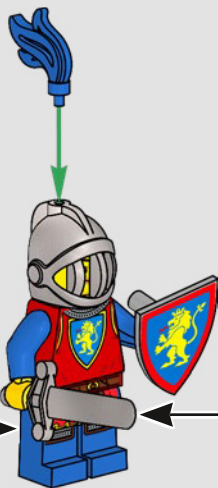
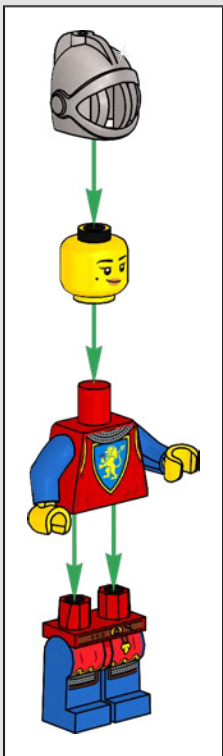

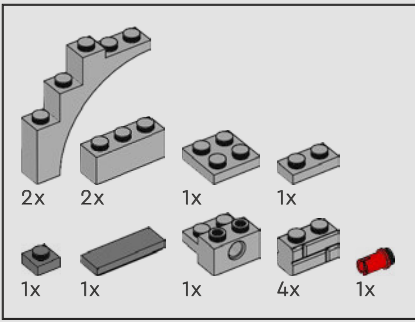

92

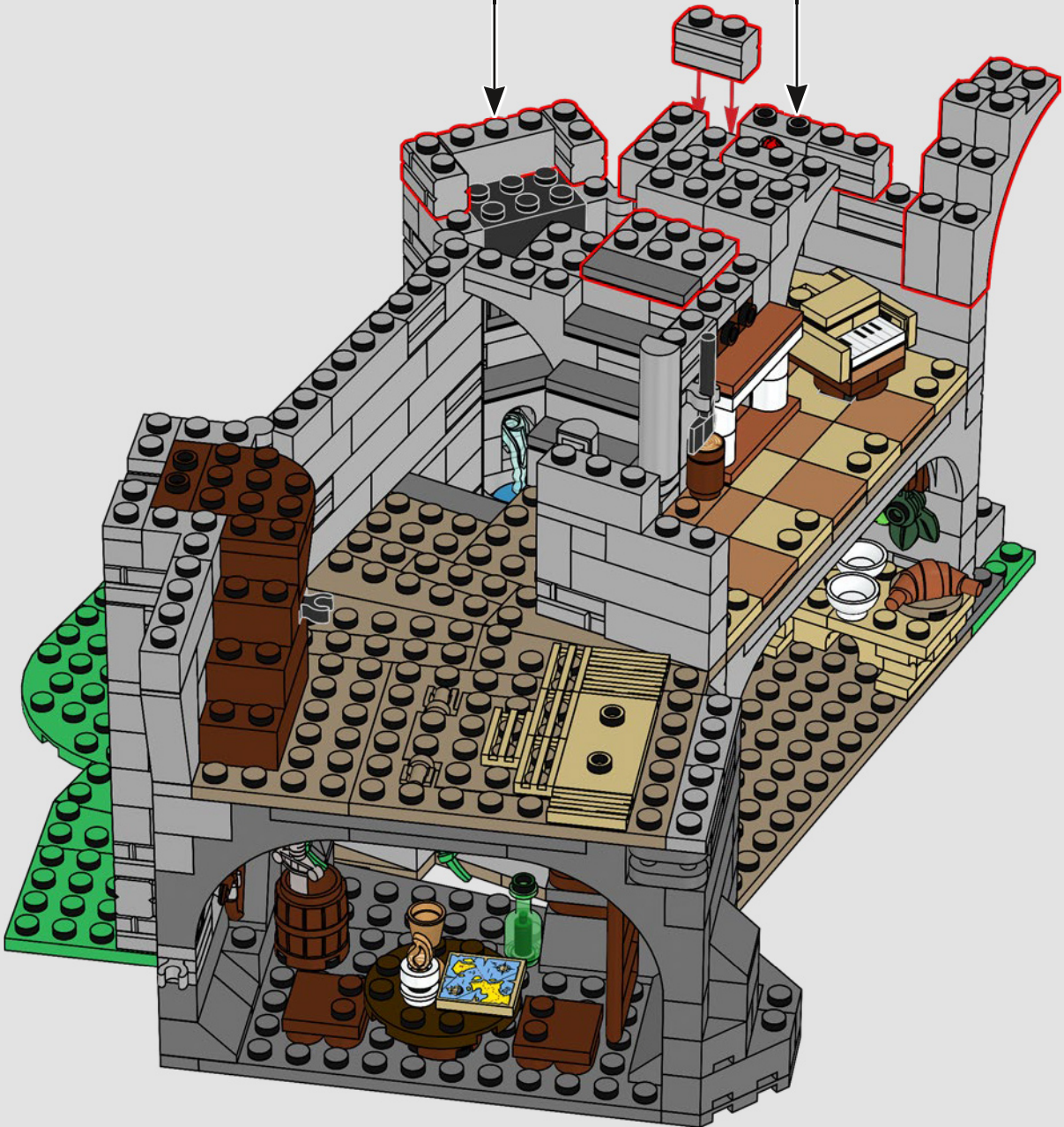
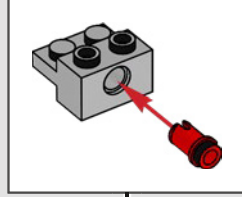
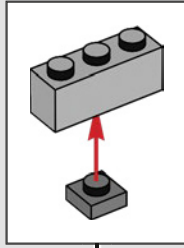

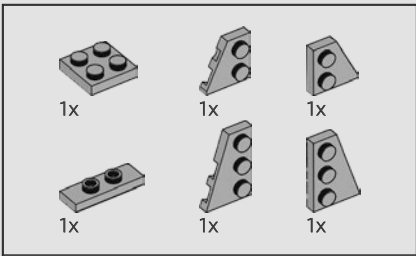

93

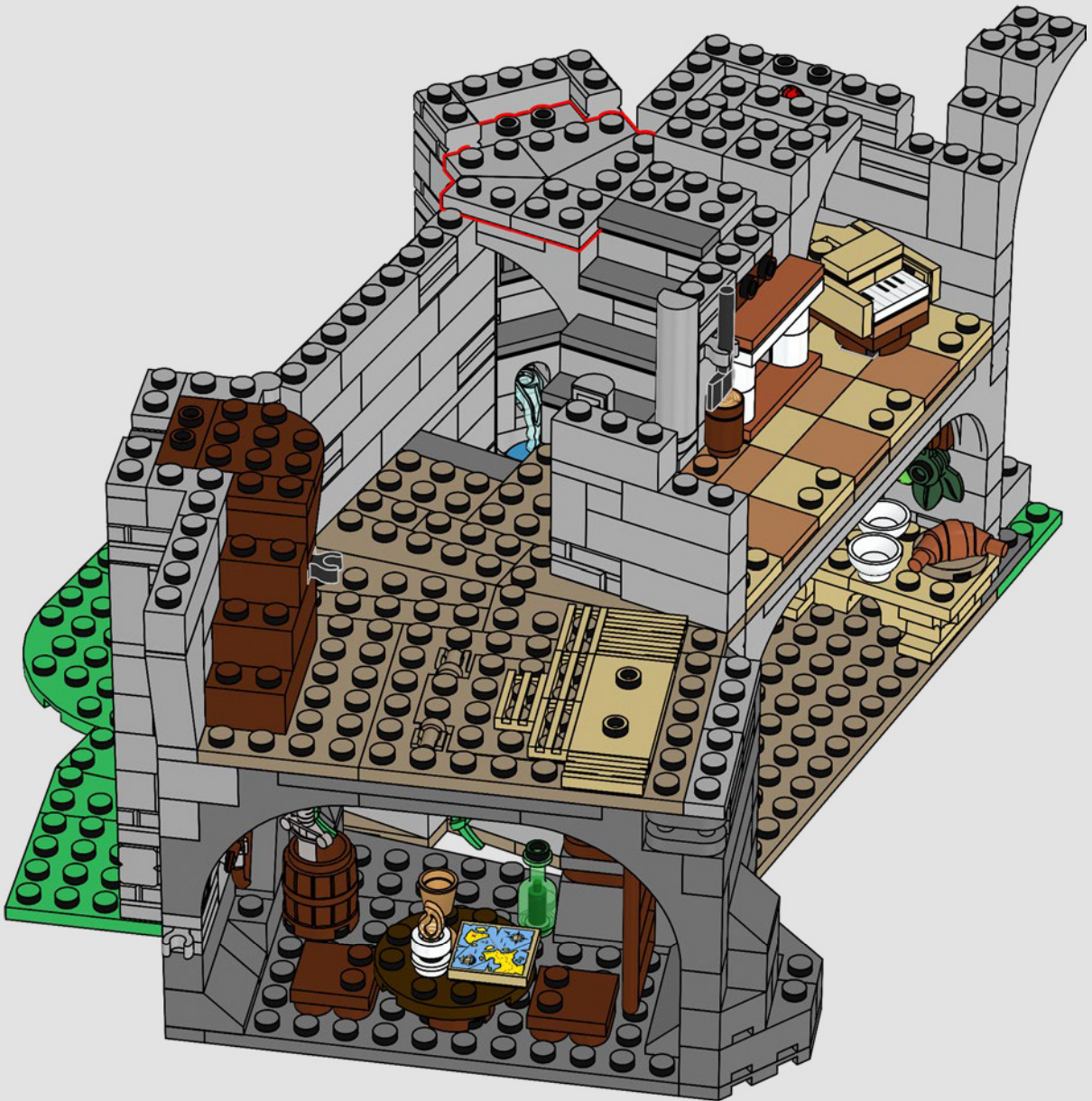

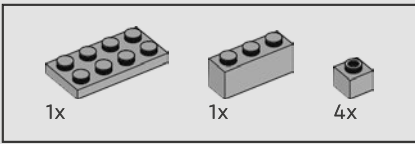

94

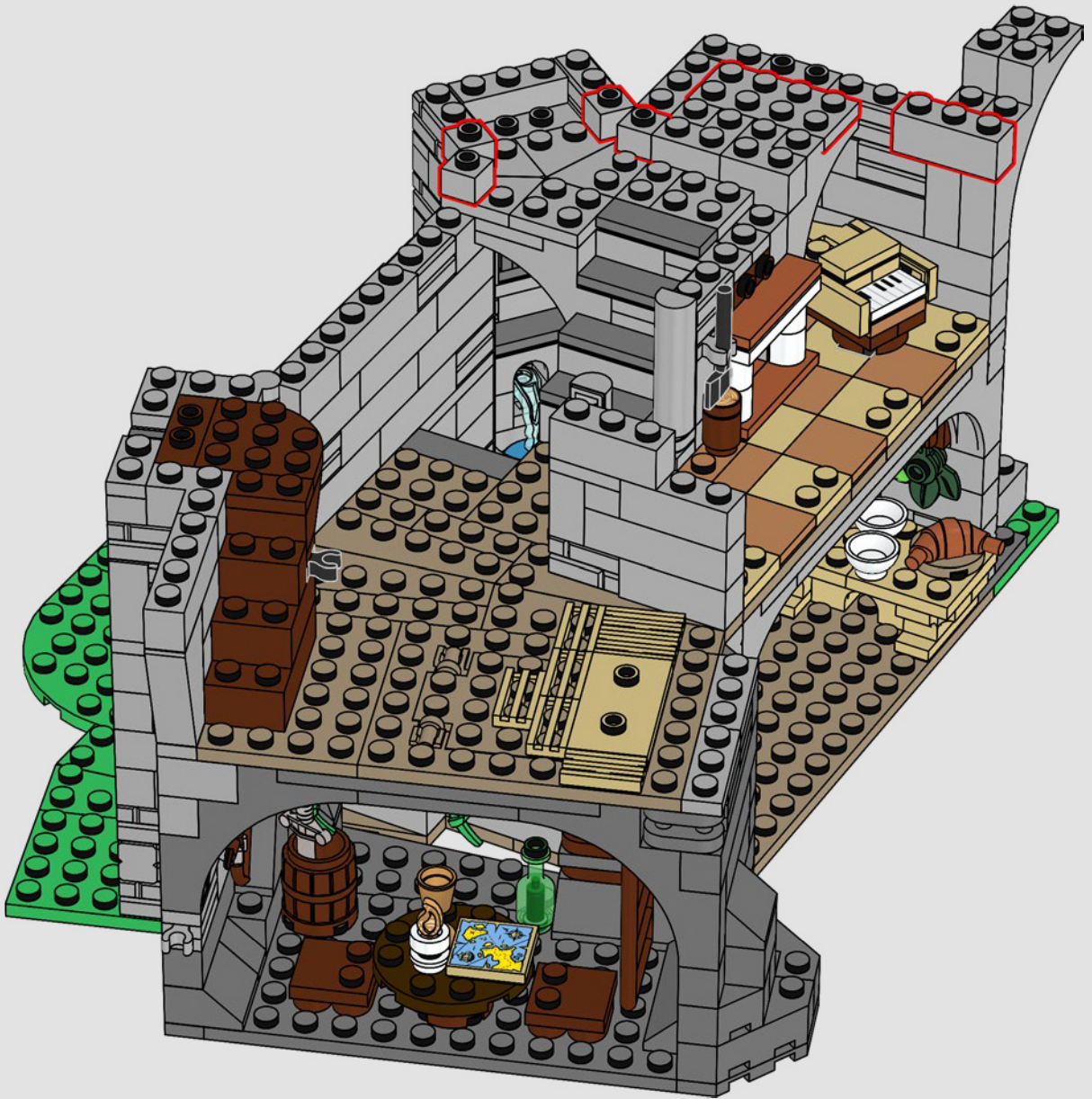

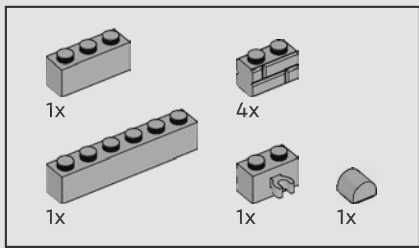

95

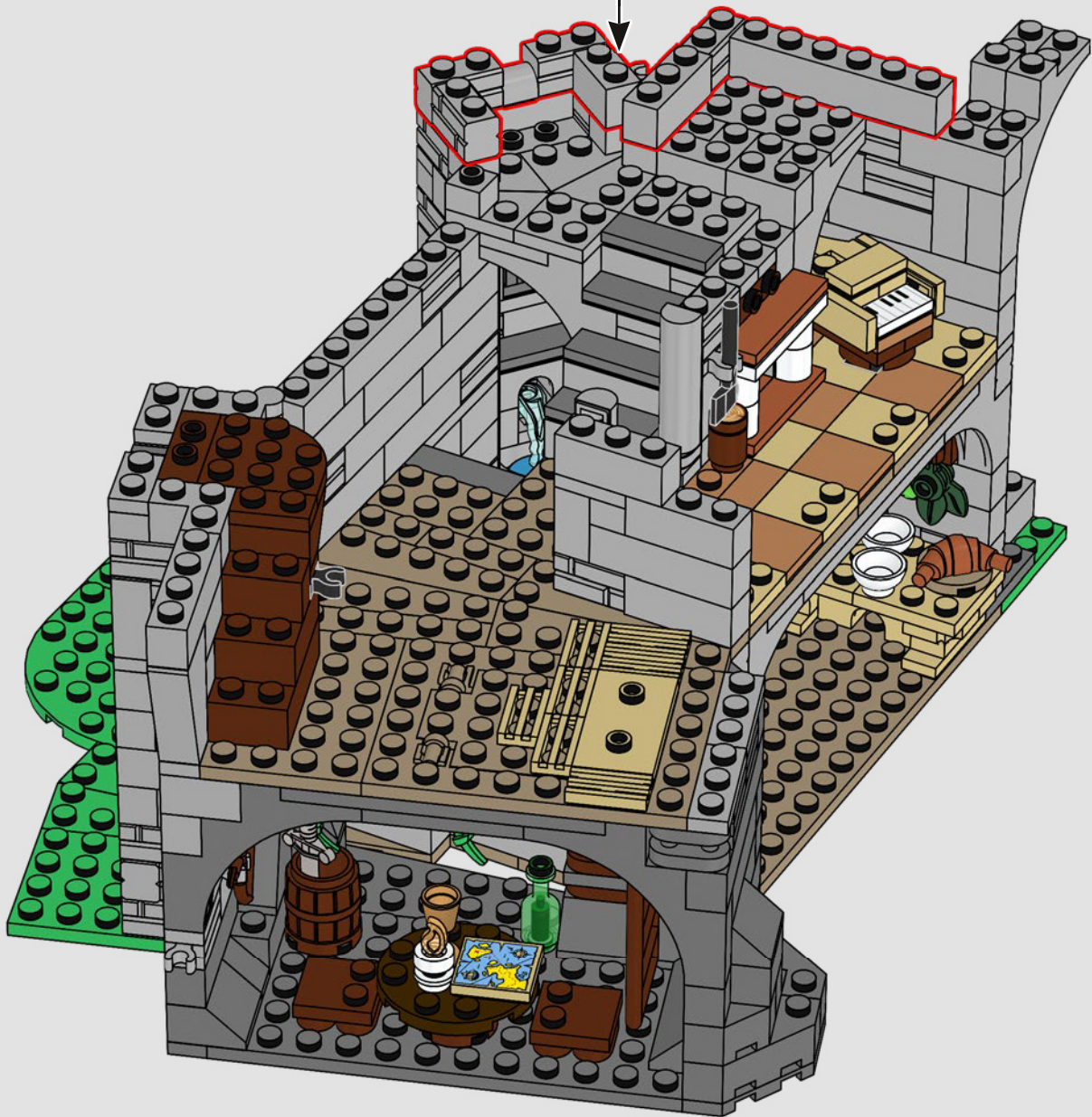
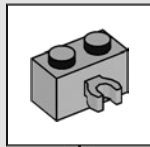

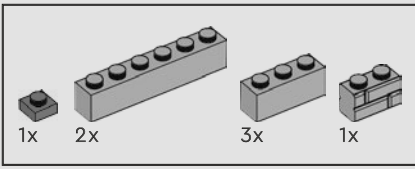

96

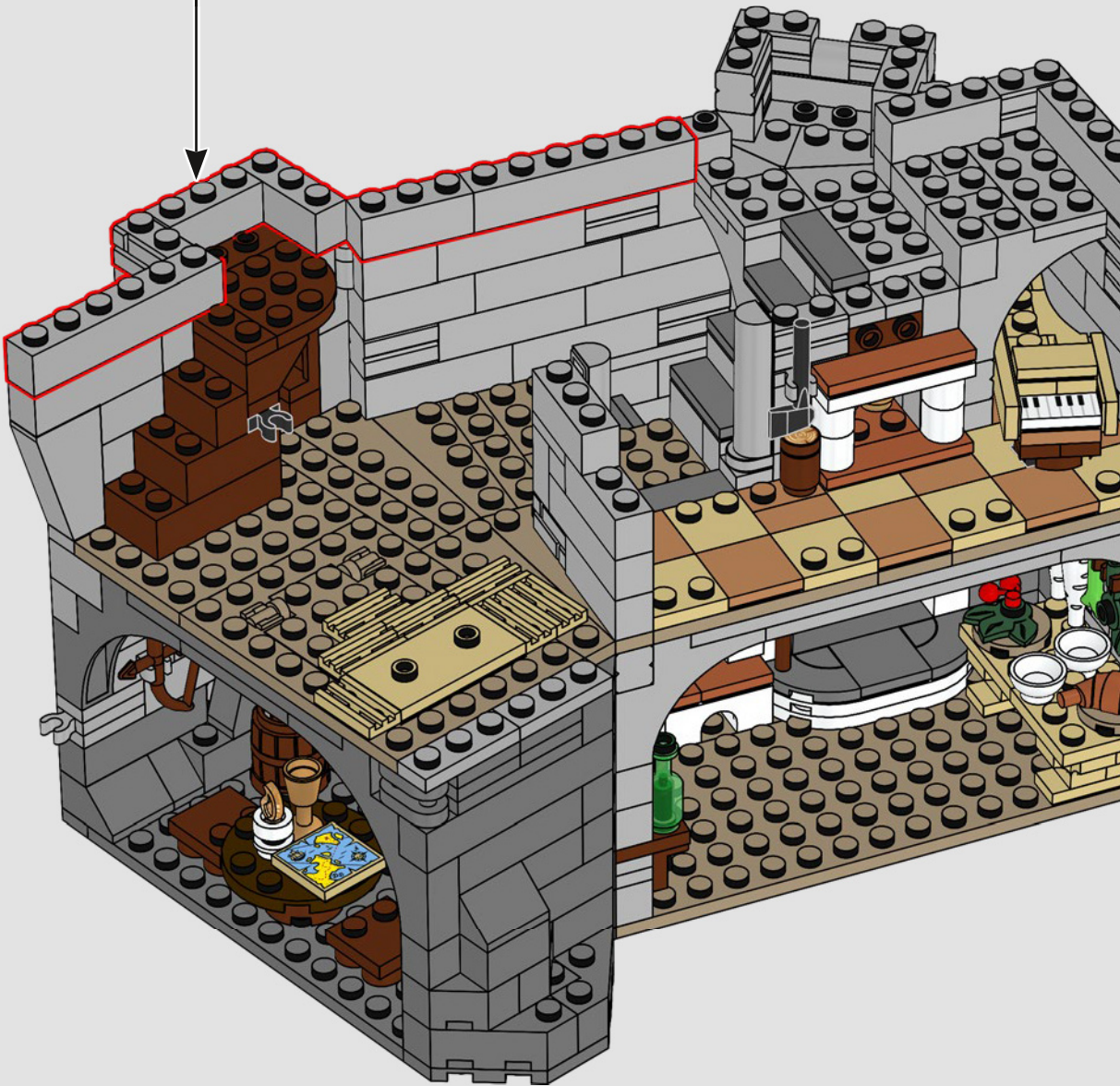
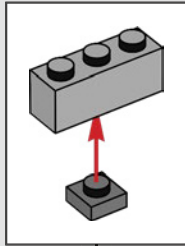

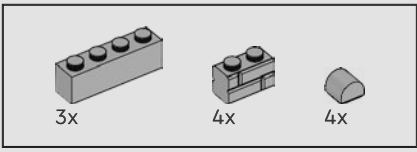

97

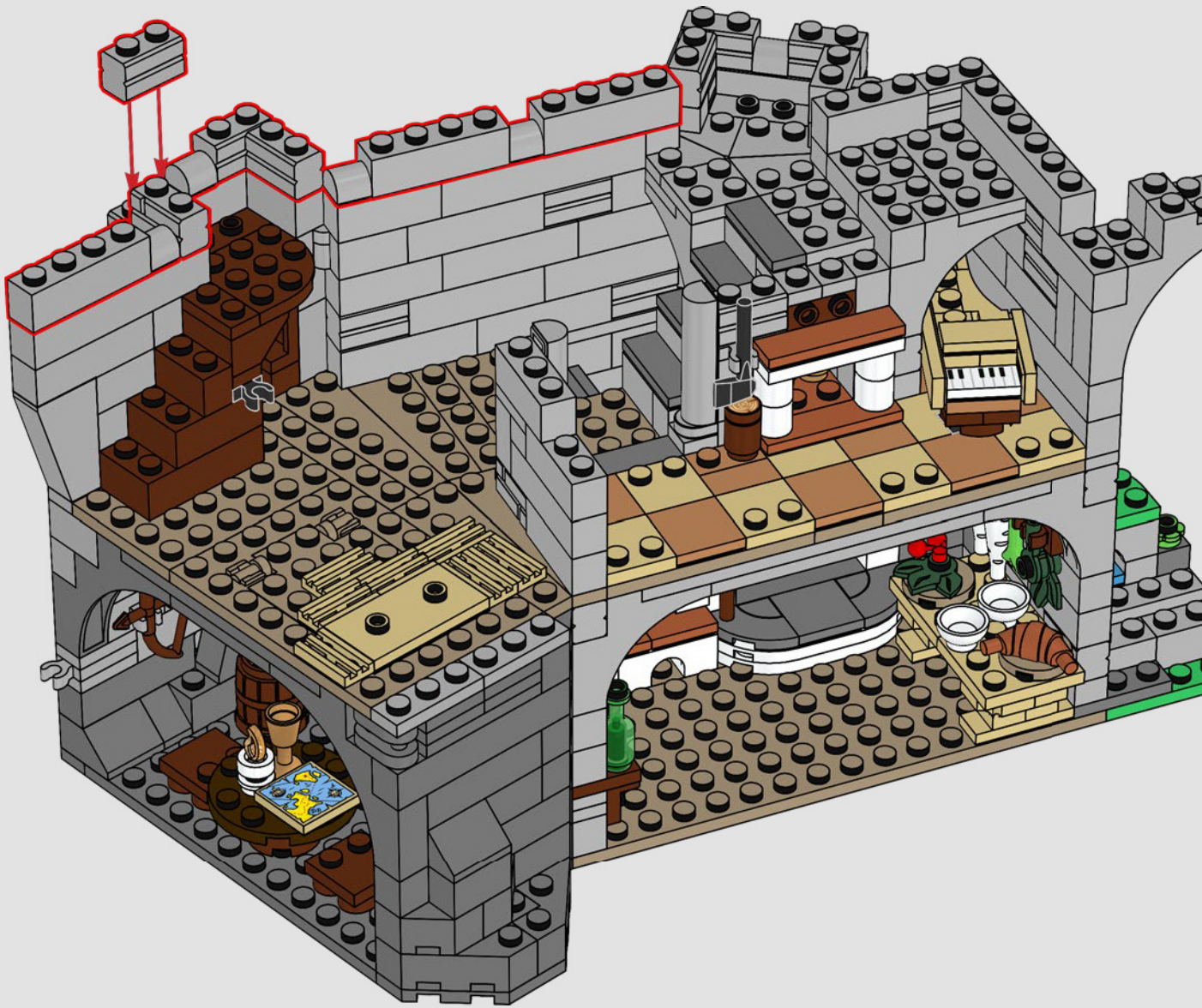



Was für majestätische Zinnen auf
jener Ringmauer!

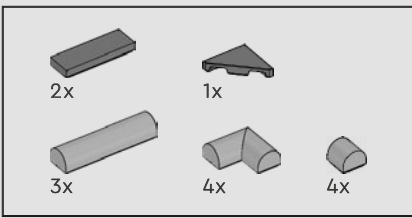

98



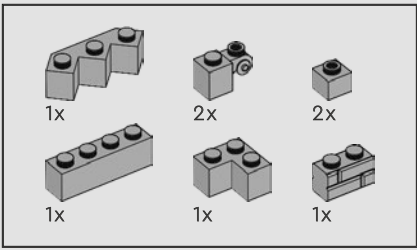

99

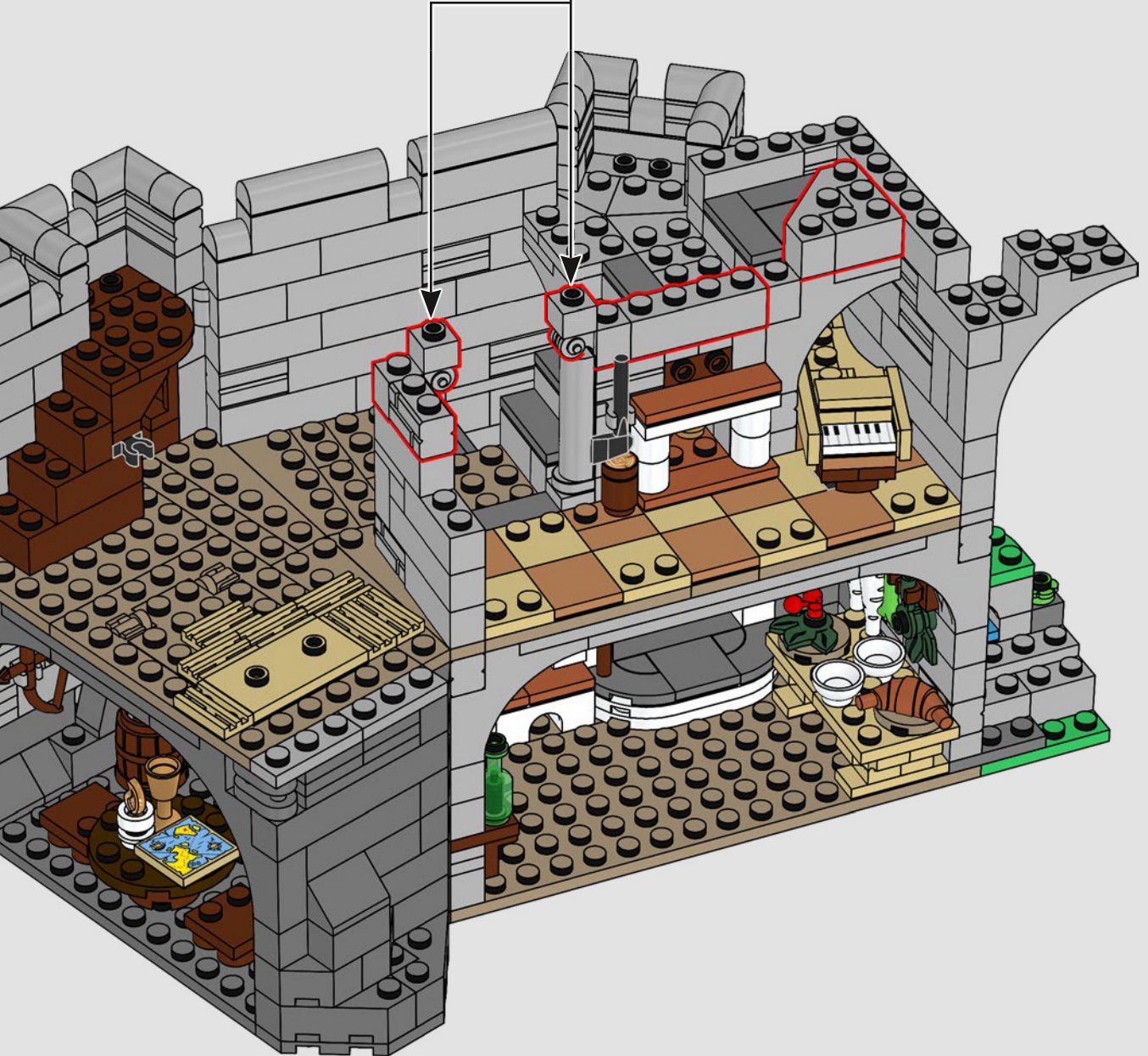
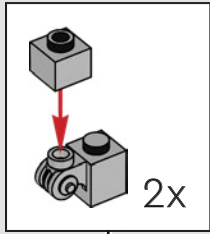

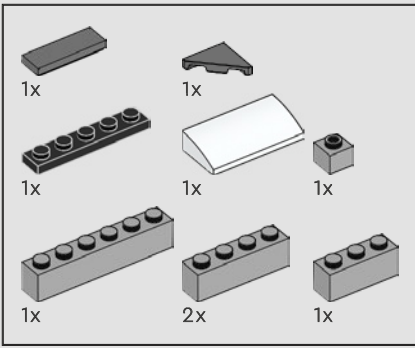

100

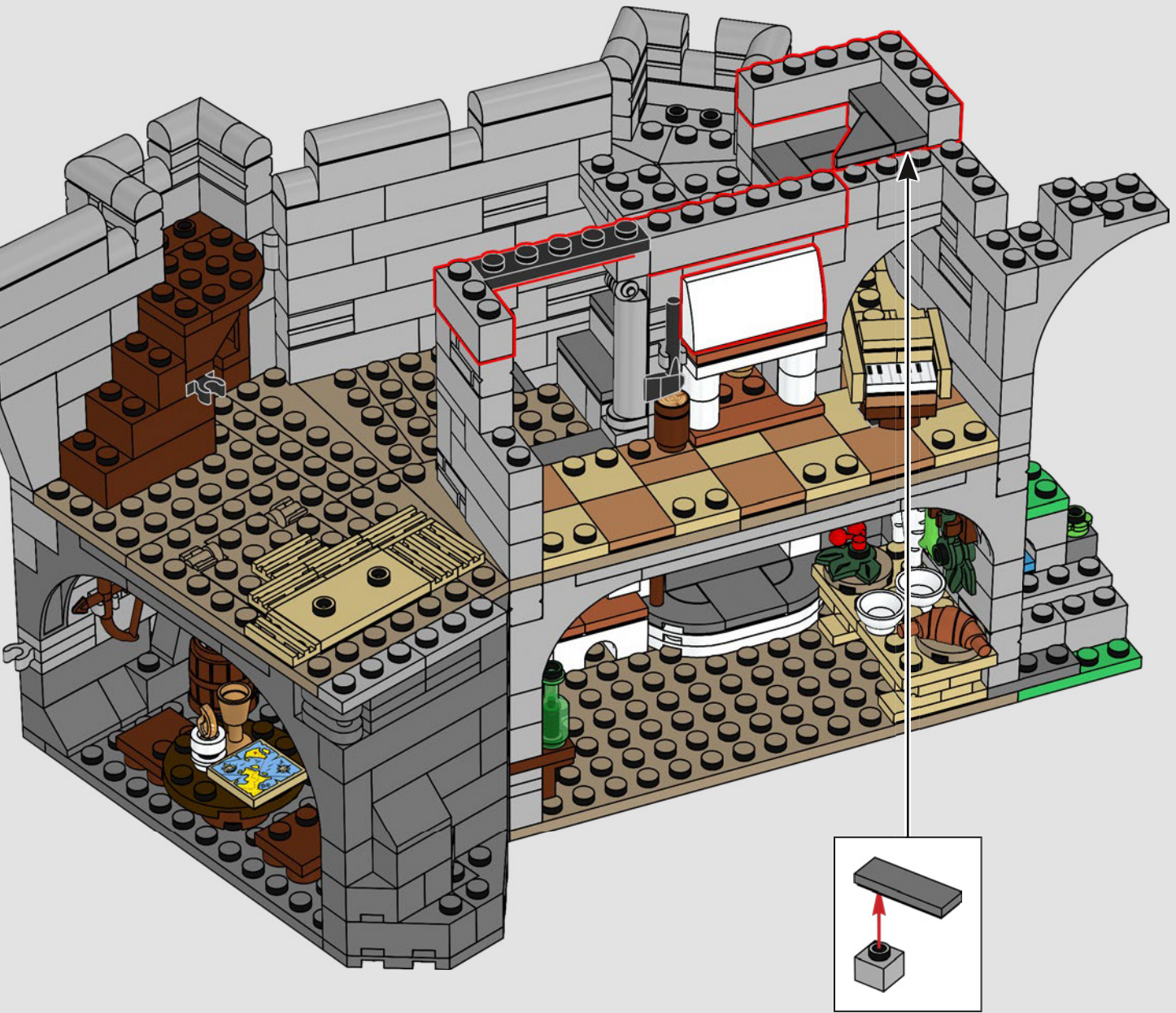

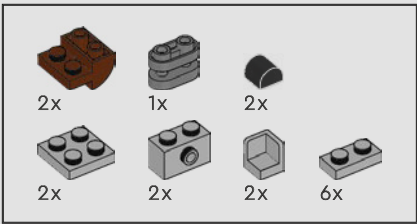

101

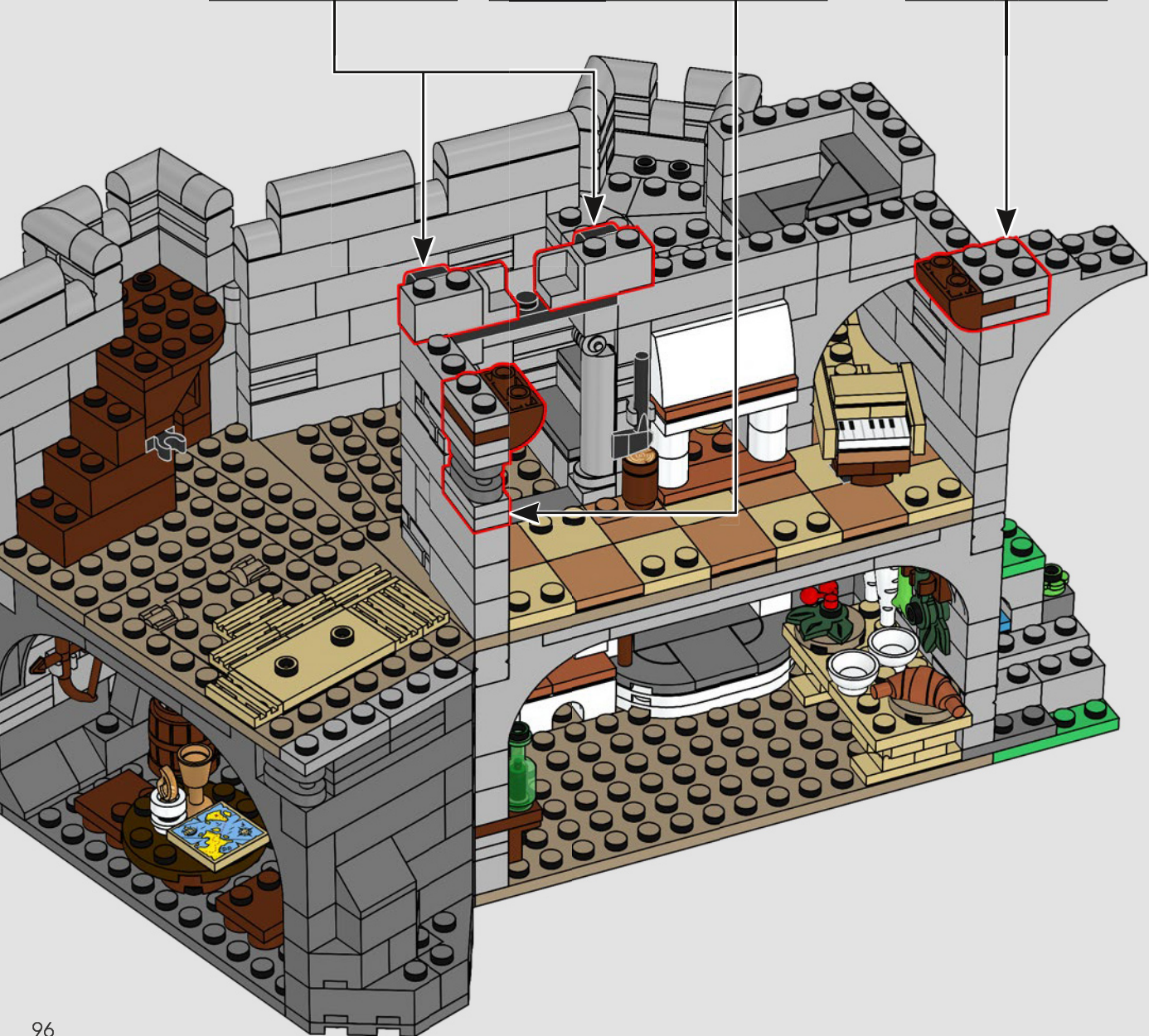
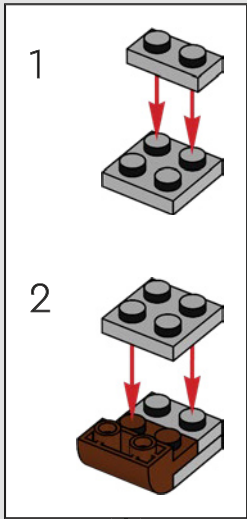
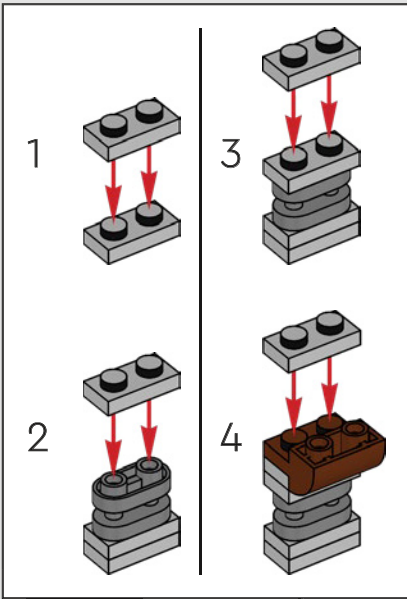
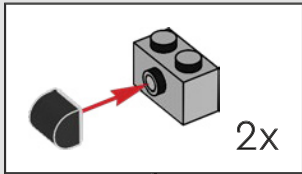

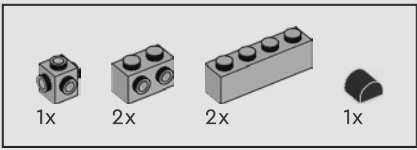

102

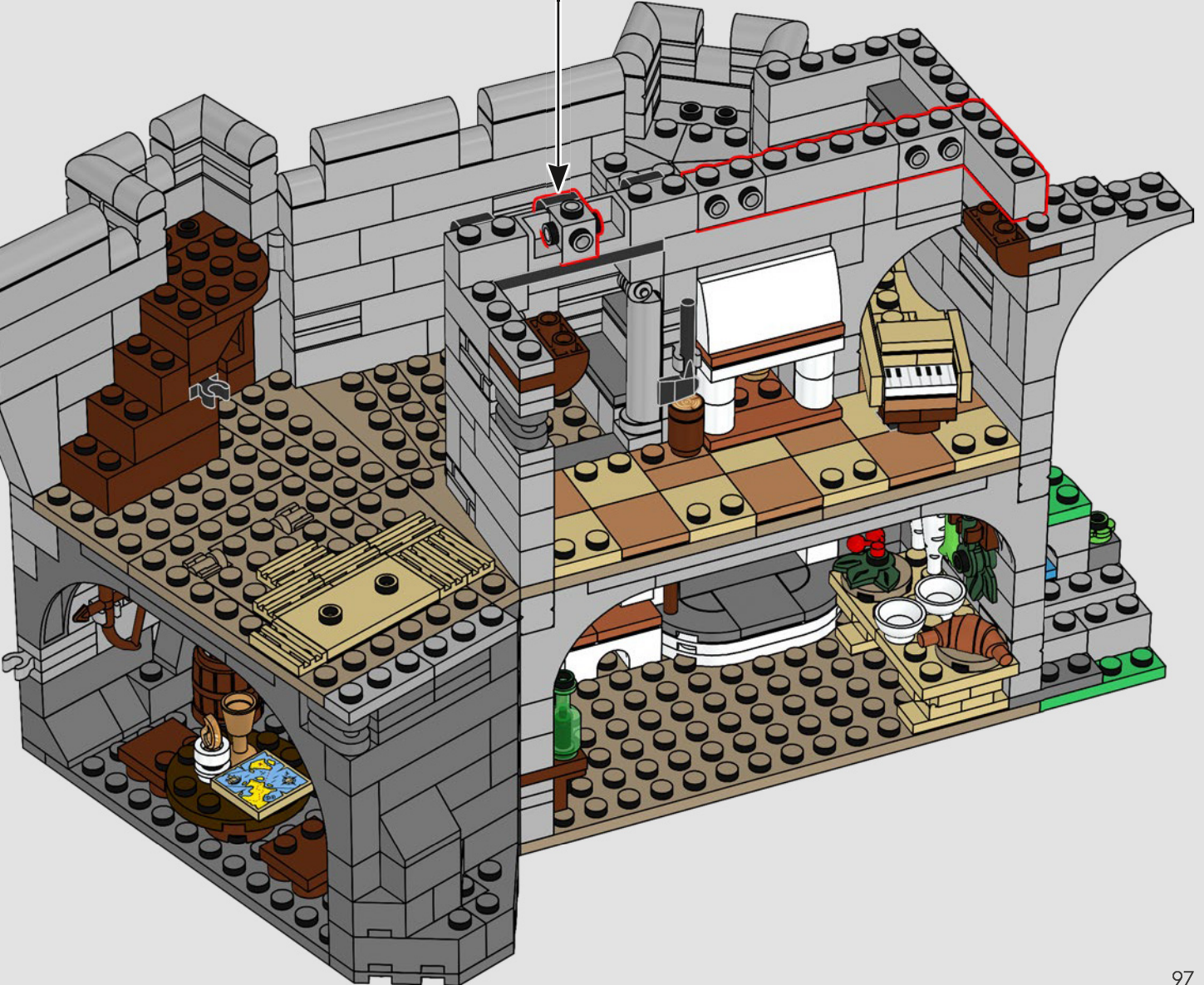
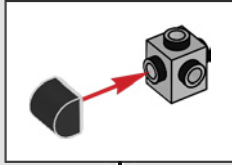

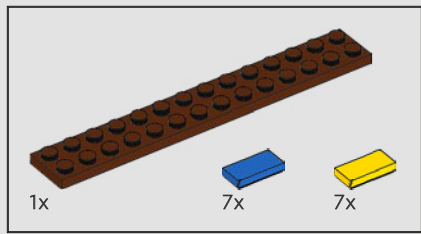

103

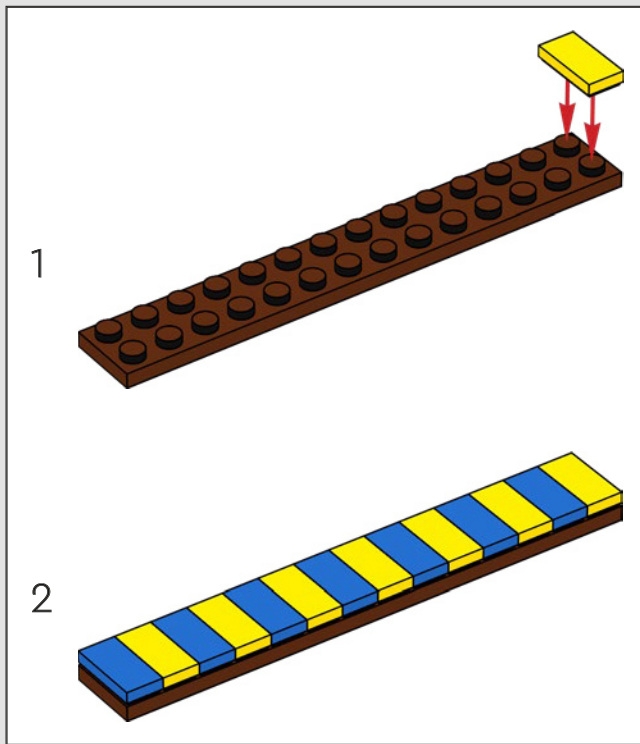

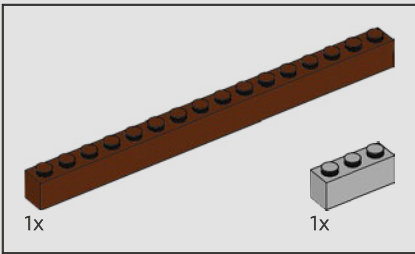

104



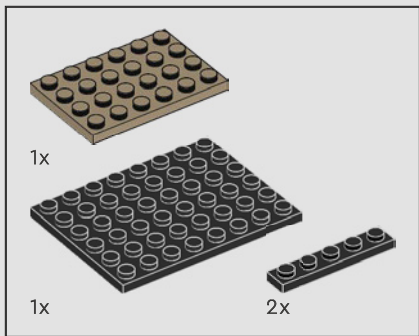

105

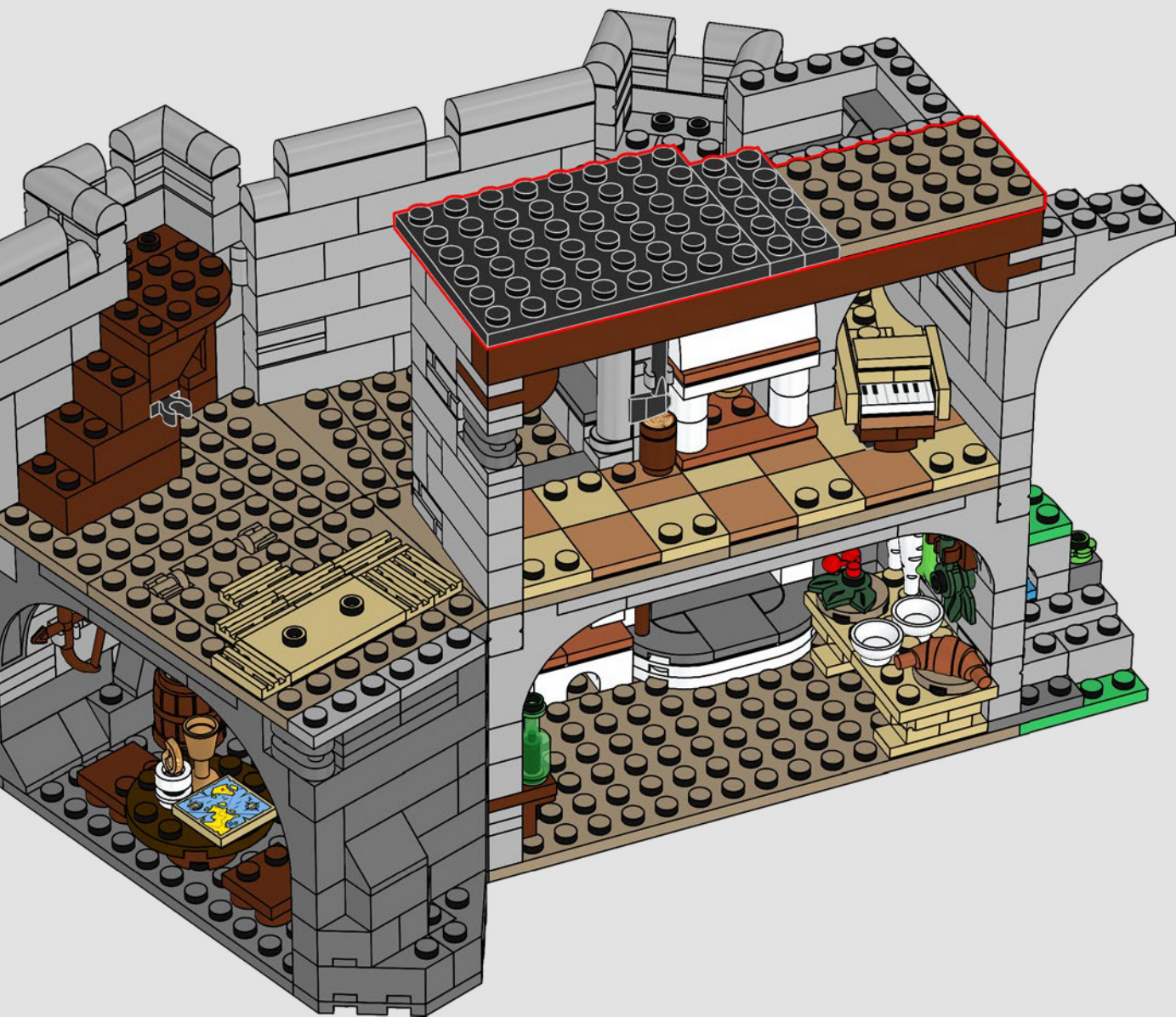

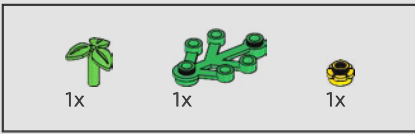

106

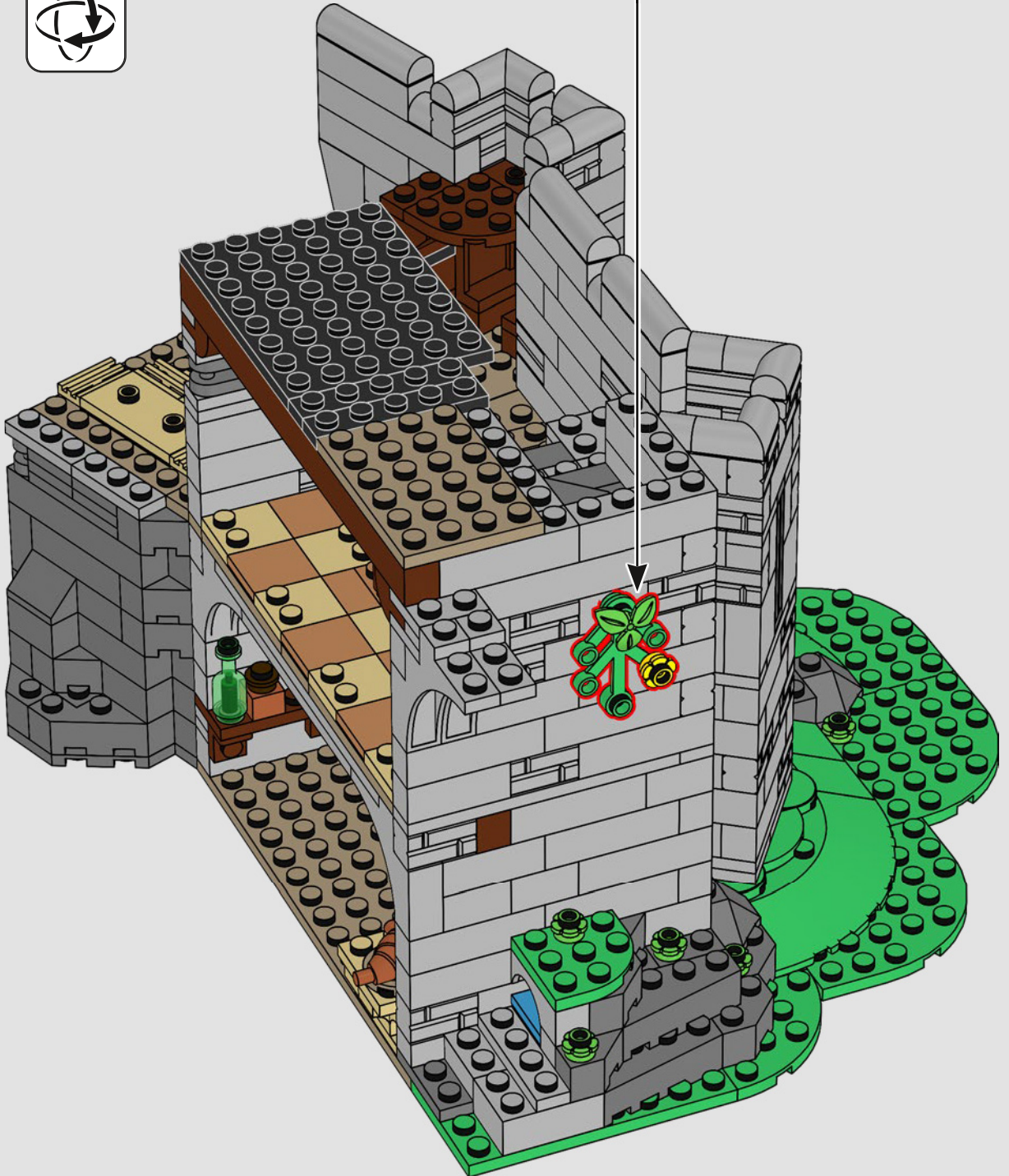
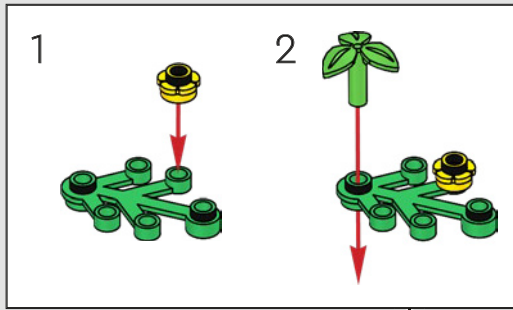

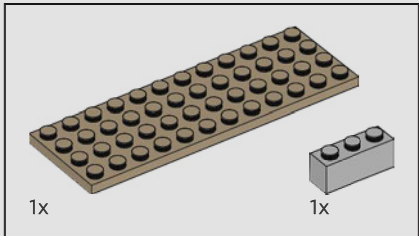
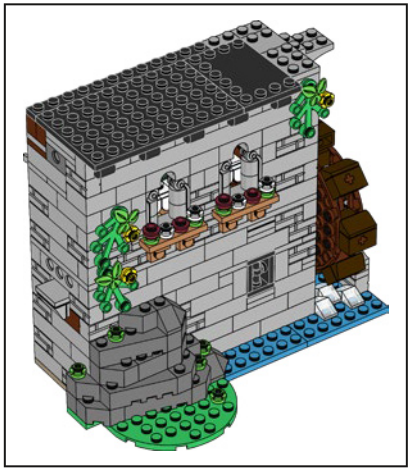

107

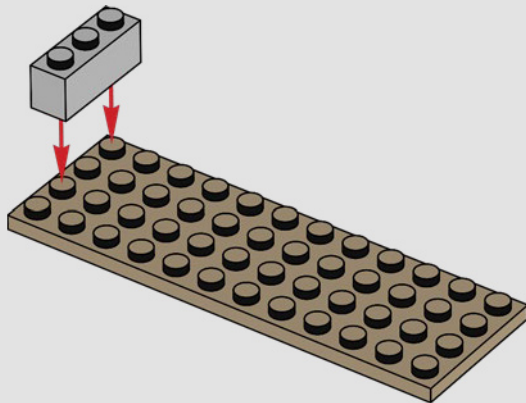

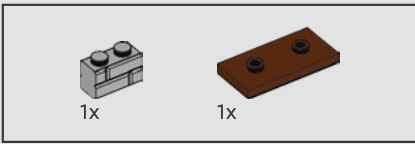

108

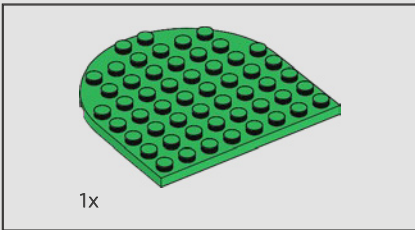
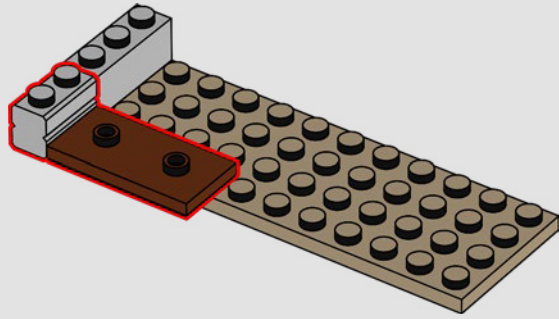

109

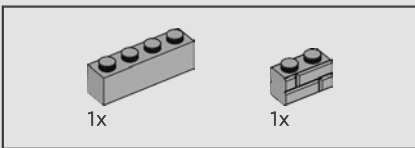
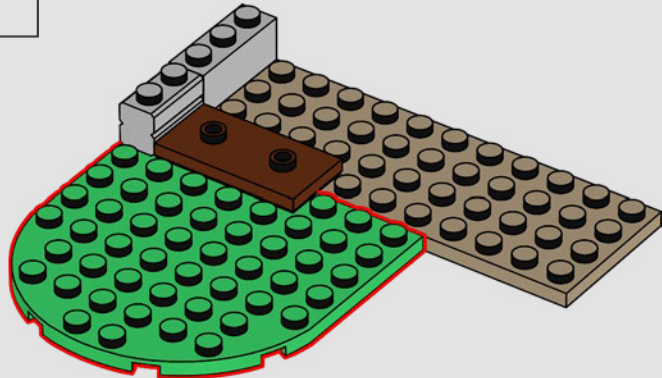

110

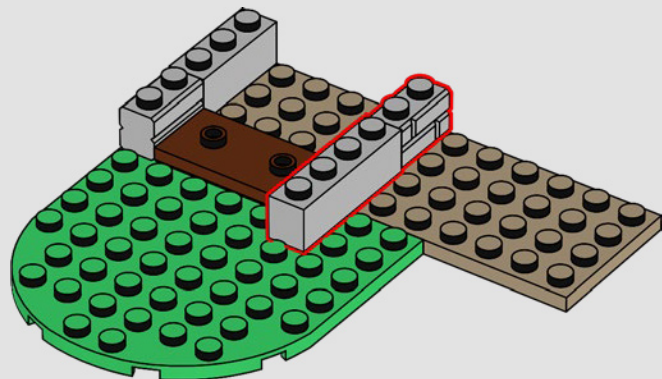

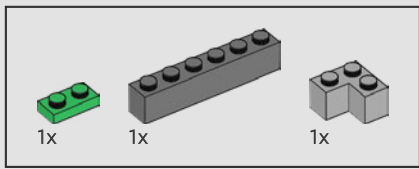

111

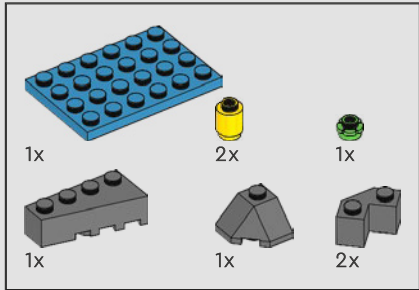
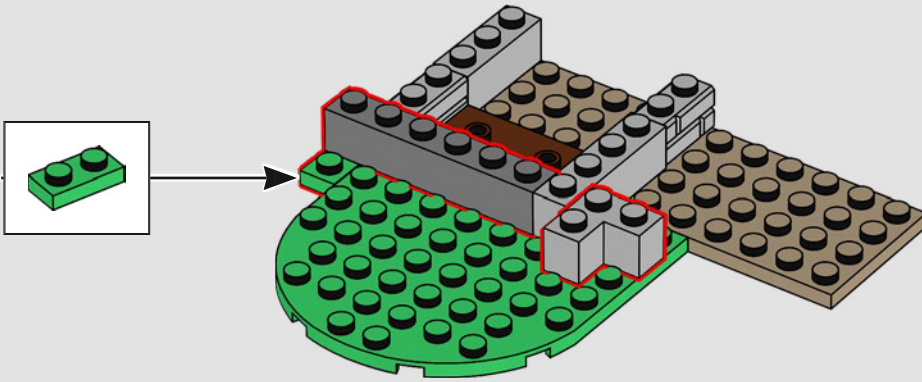

112

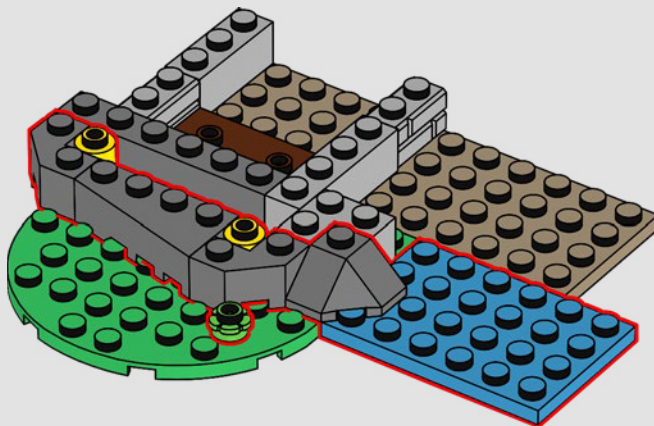

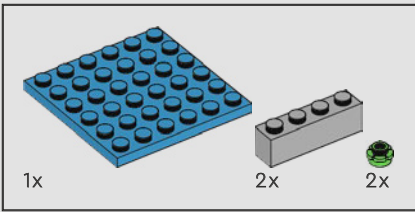

113

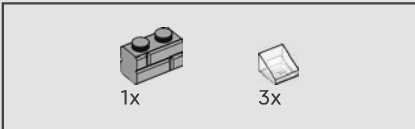
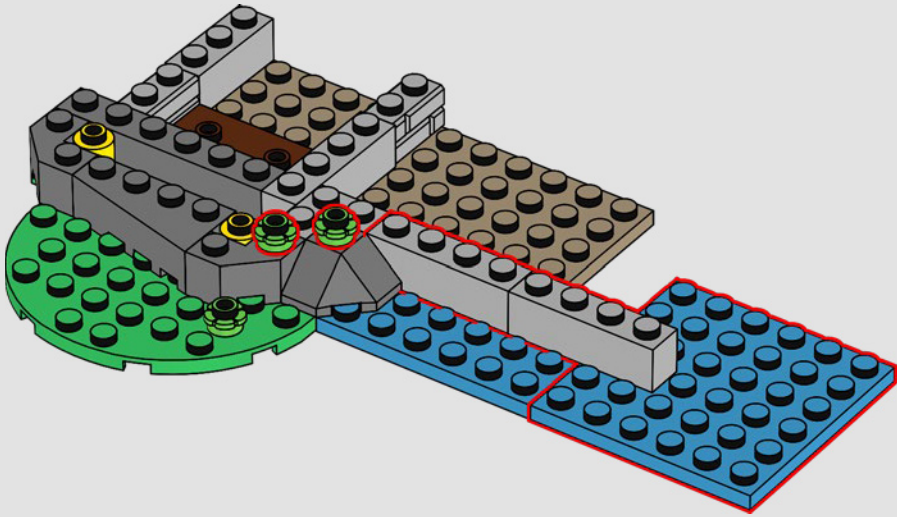

114

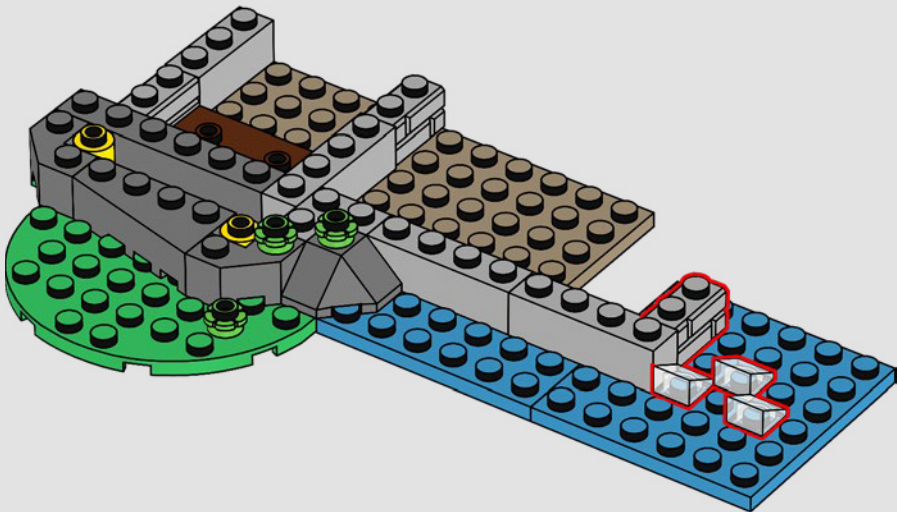

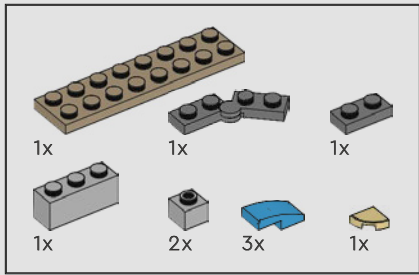

115

1

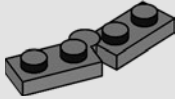

2

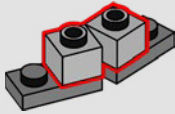

3

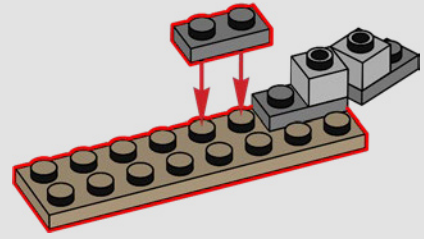

4

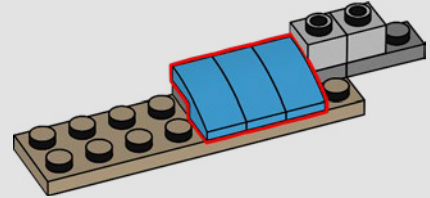

5

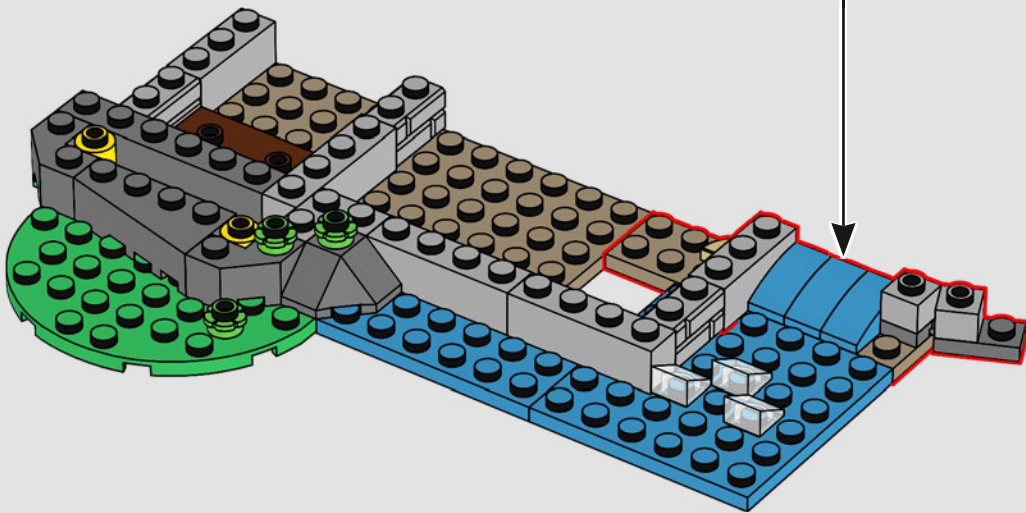
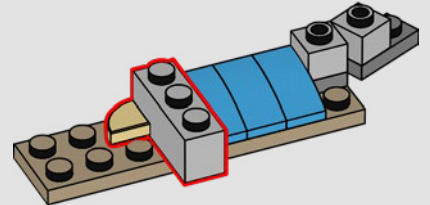

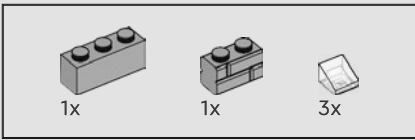

116

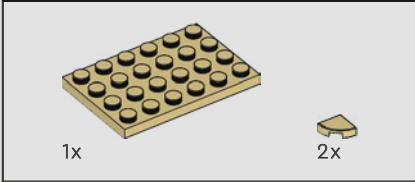
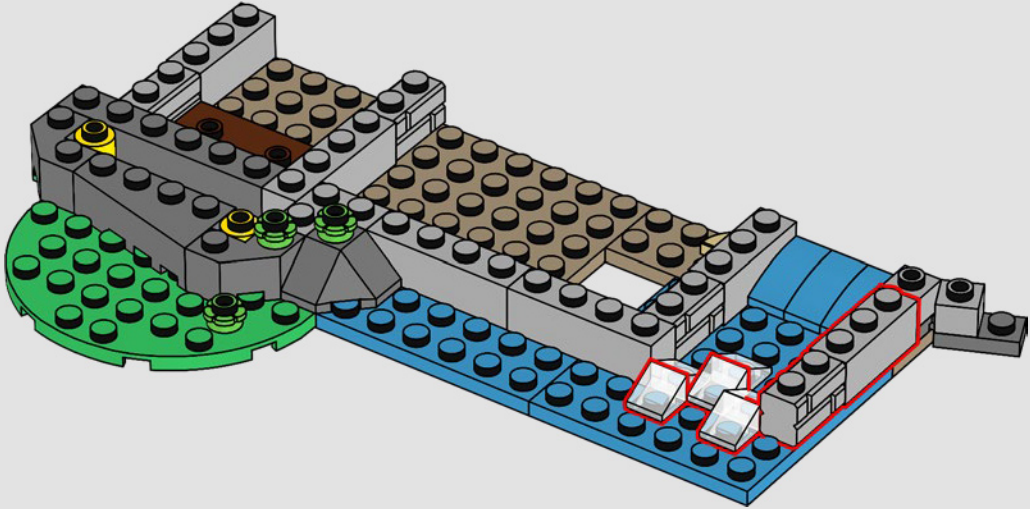

117

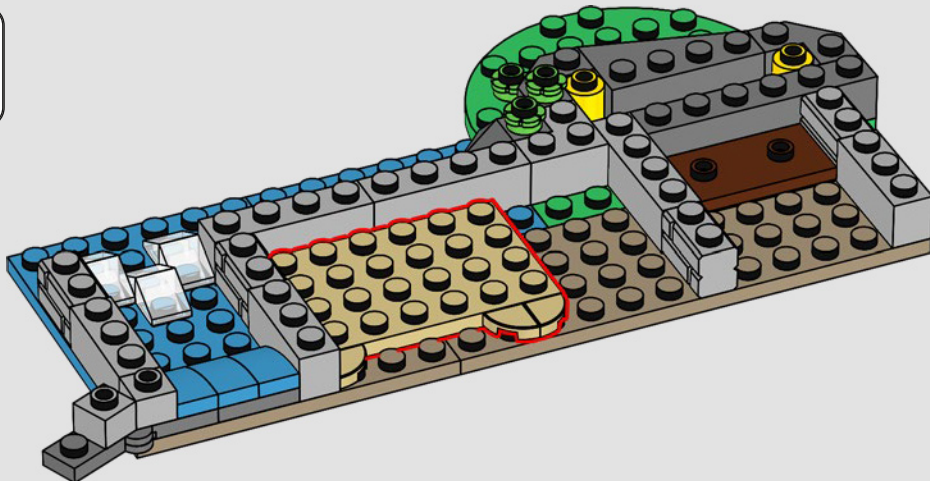



*Eine gute Stelle für einen Mühlstein.
Jener Bach könnte ihn sogar
antreiben ...*

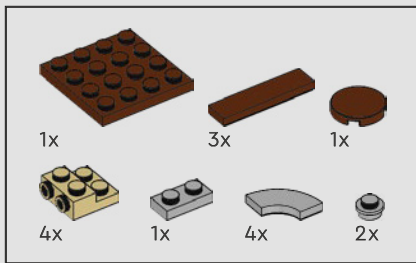

118

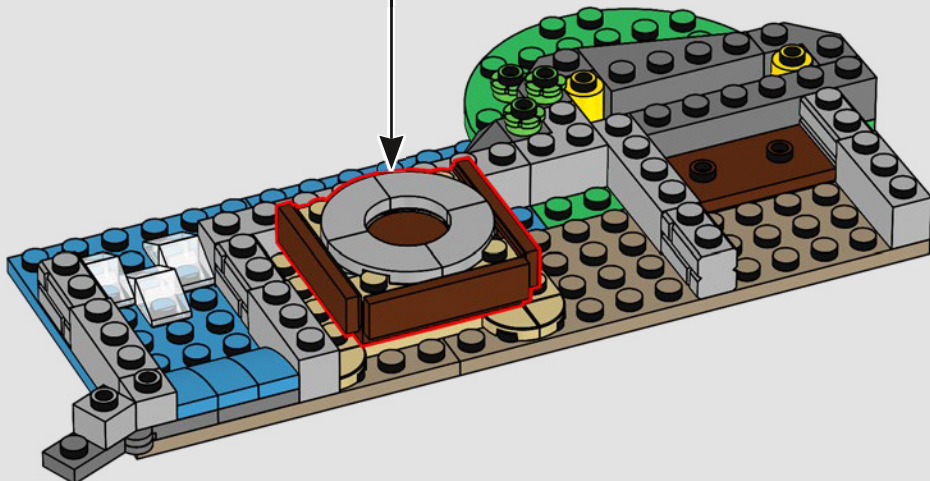
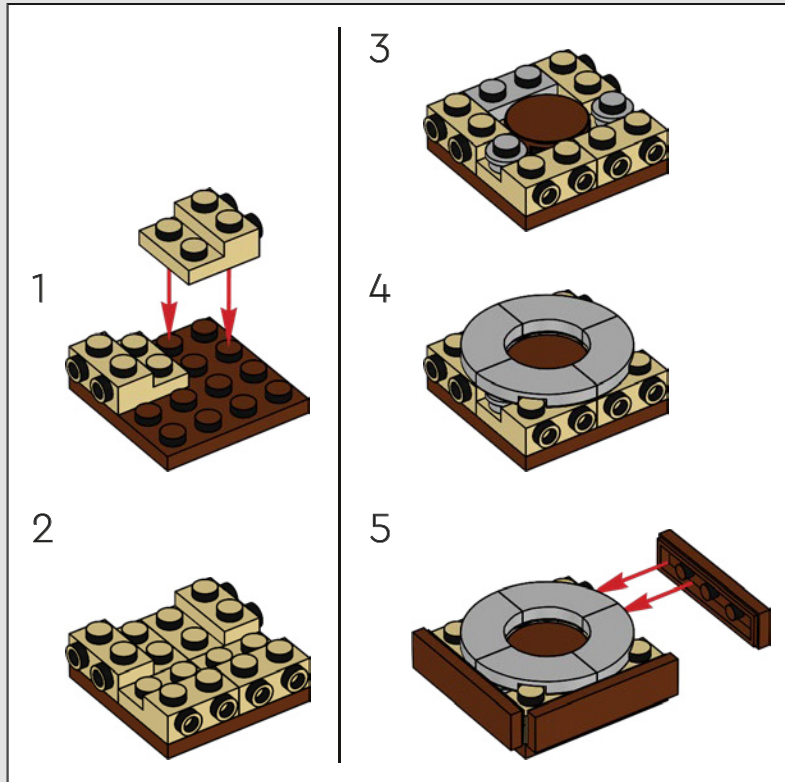

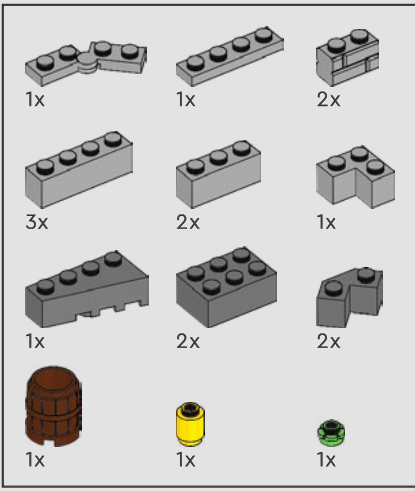

119

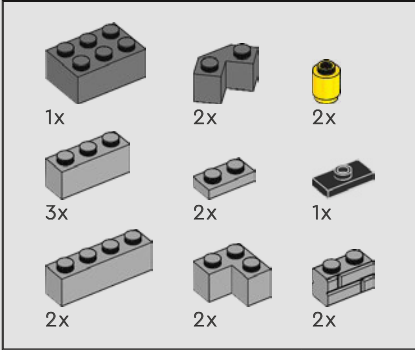
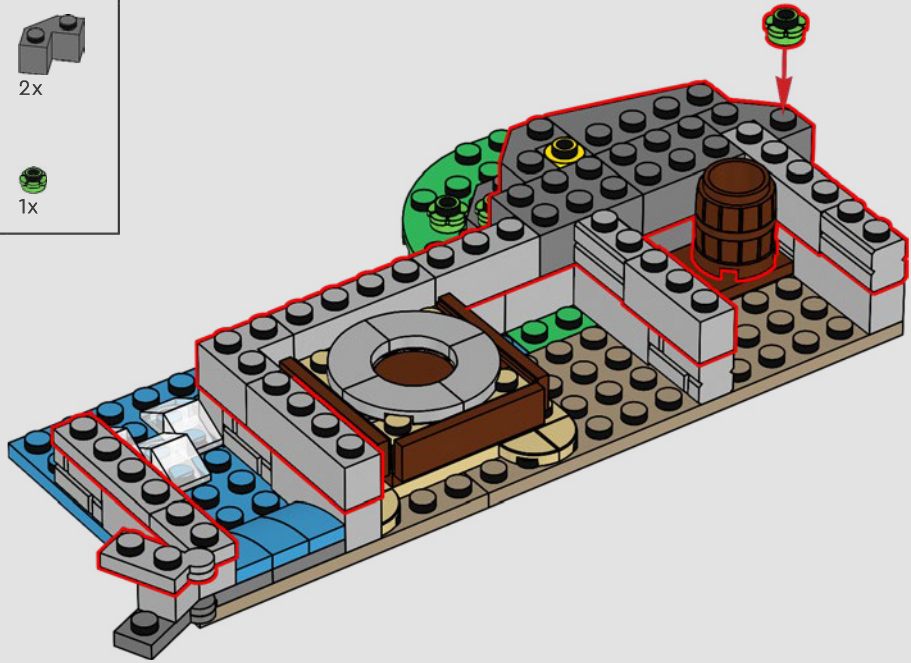

120

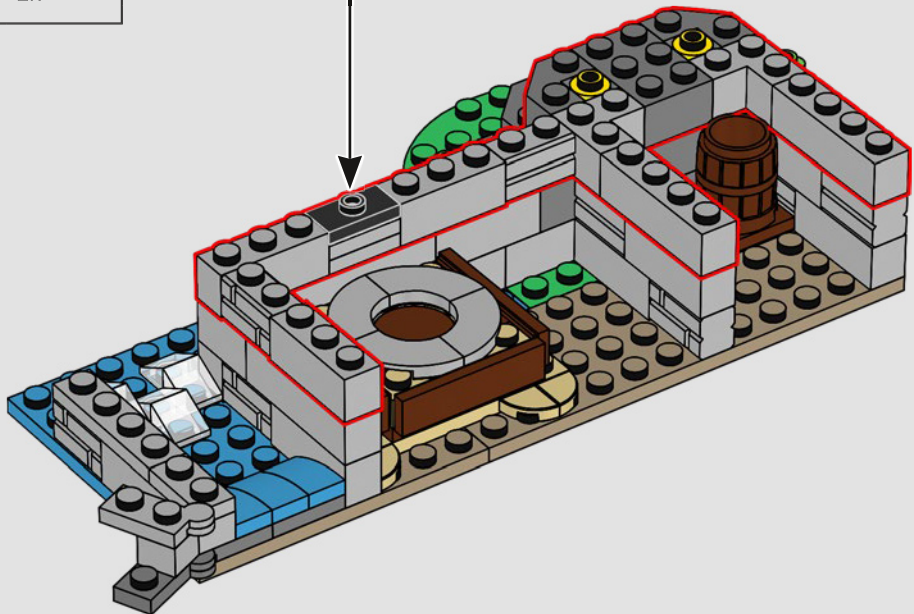
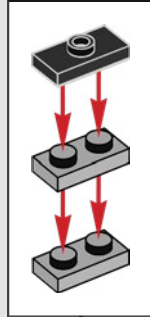

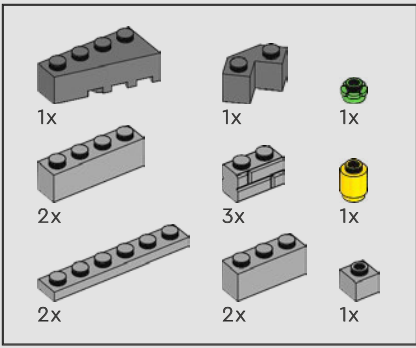

121

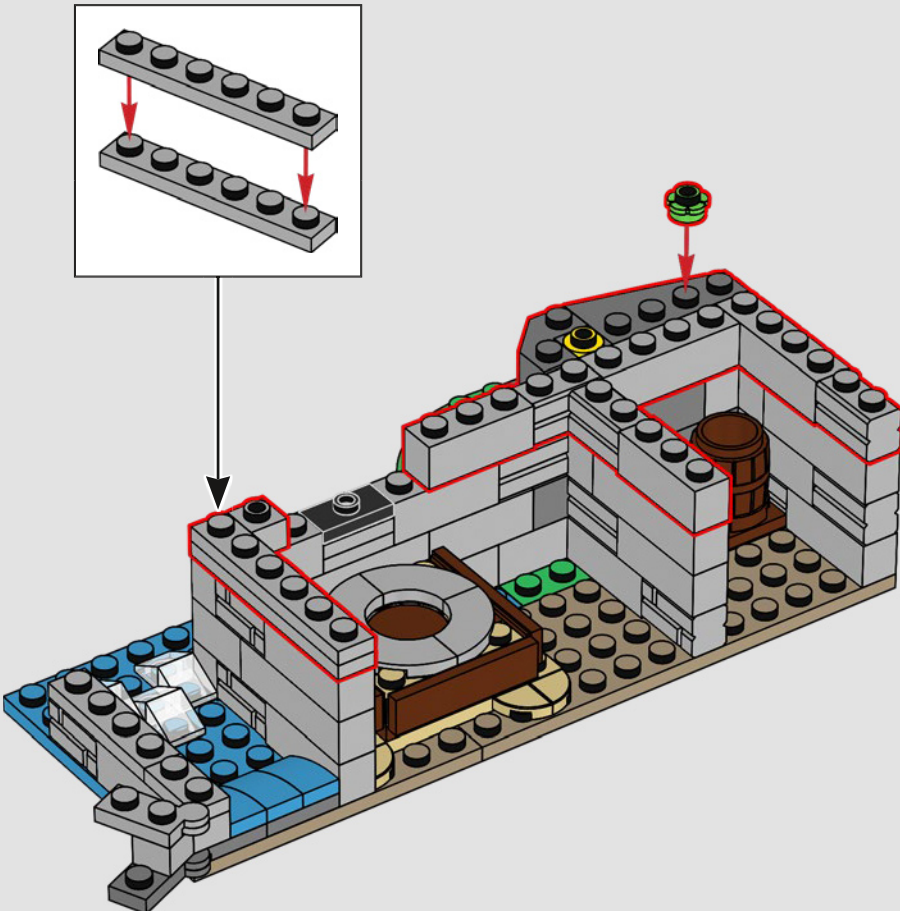

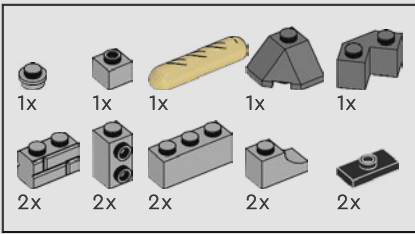

122

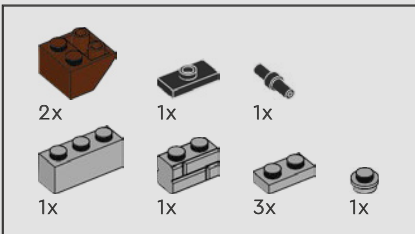
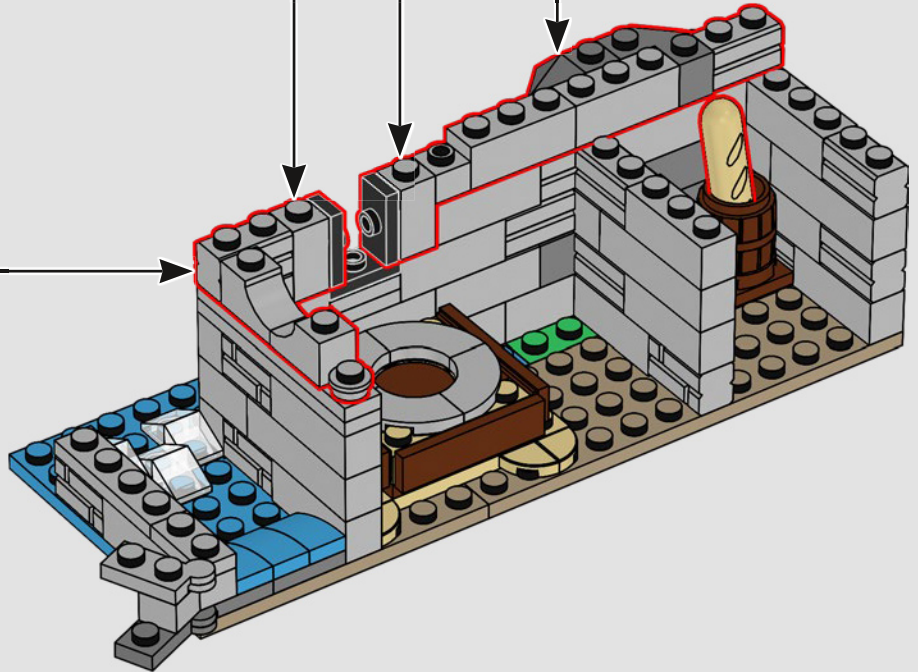
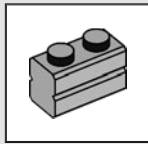
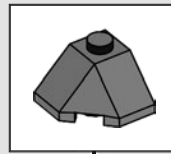
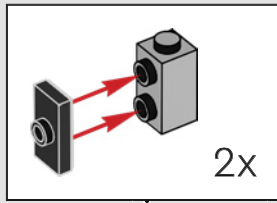

123

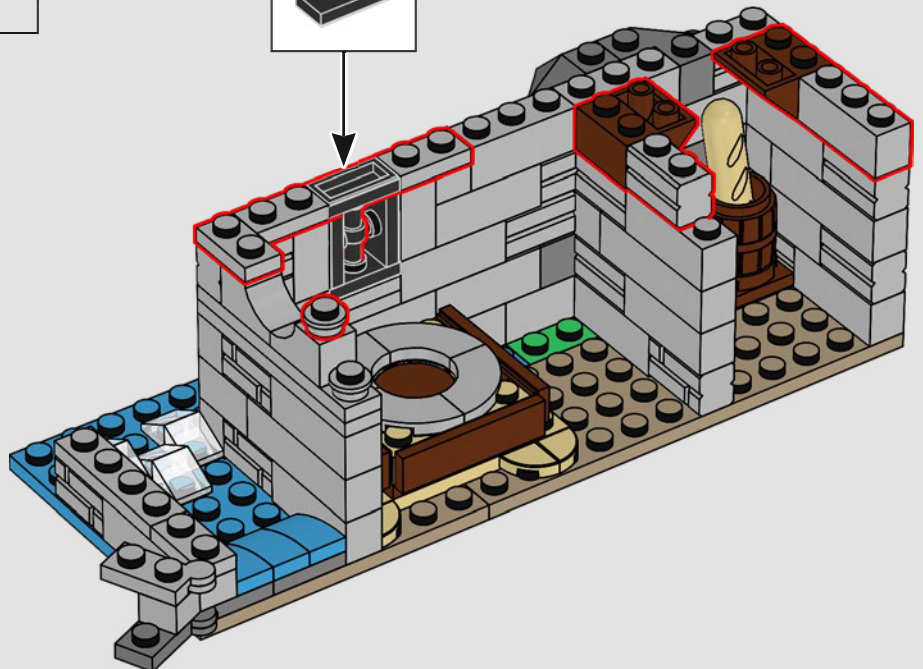
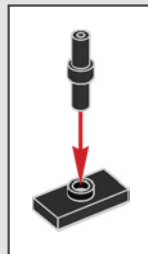

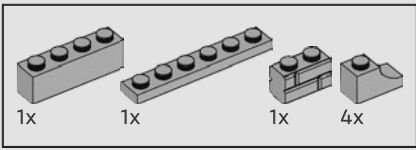

124

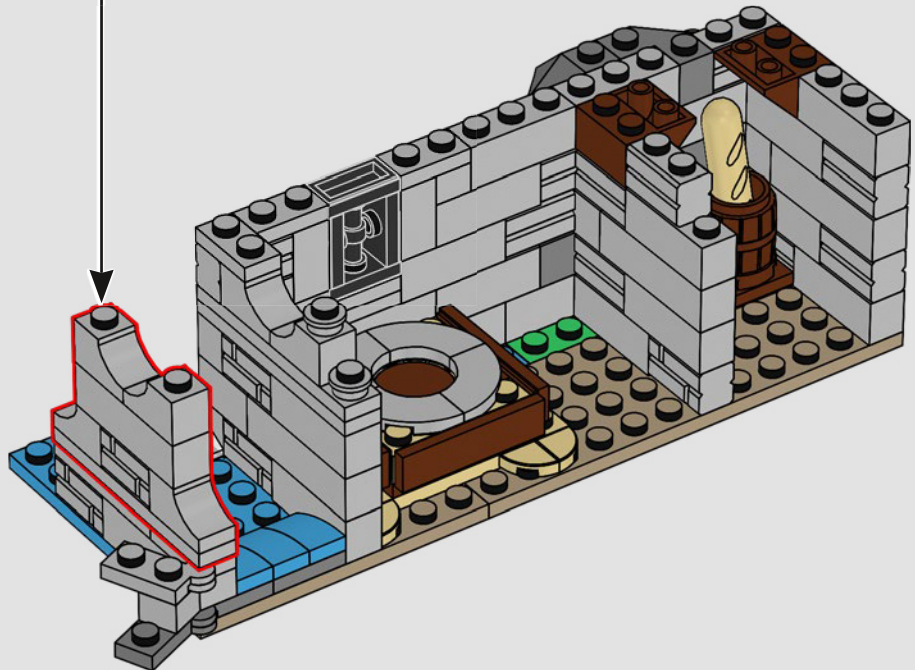
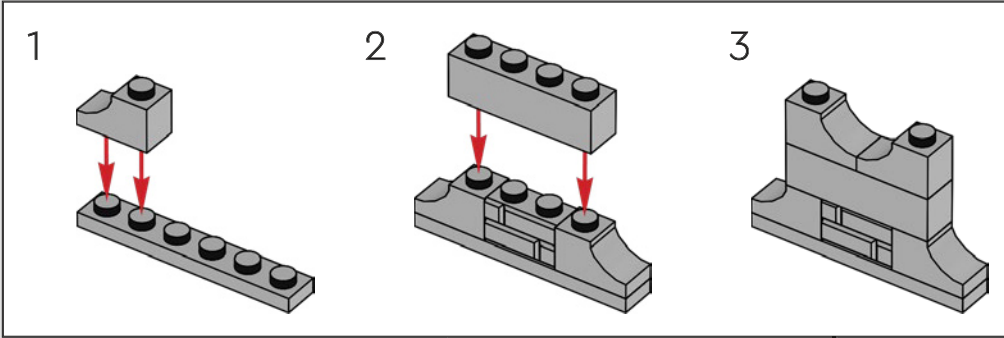

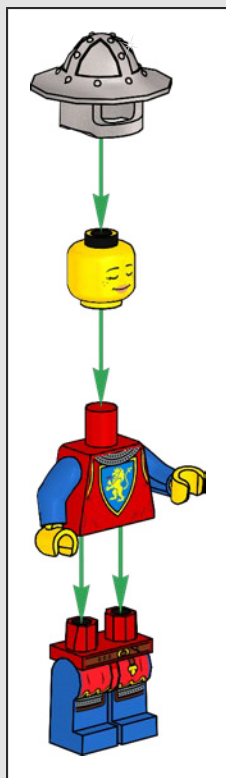

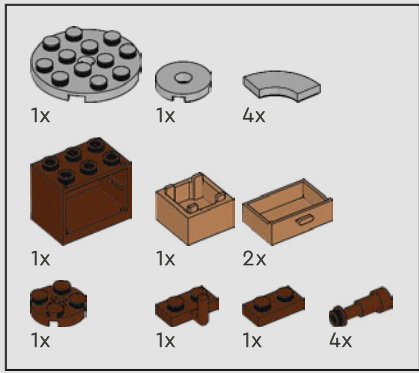

125

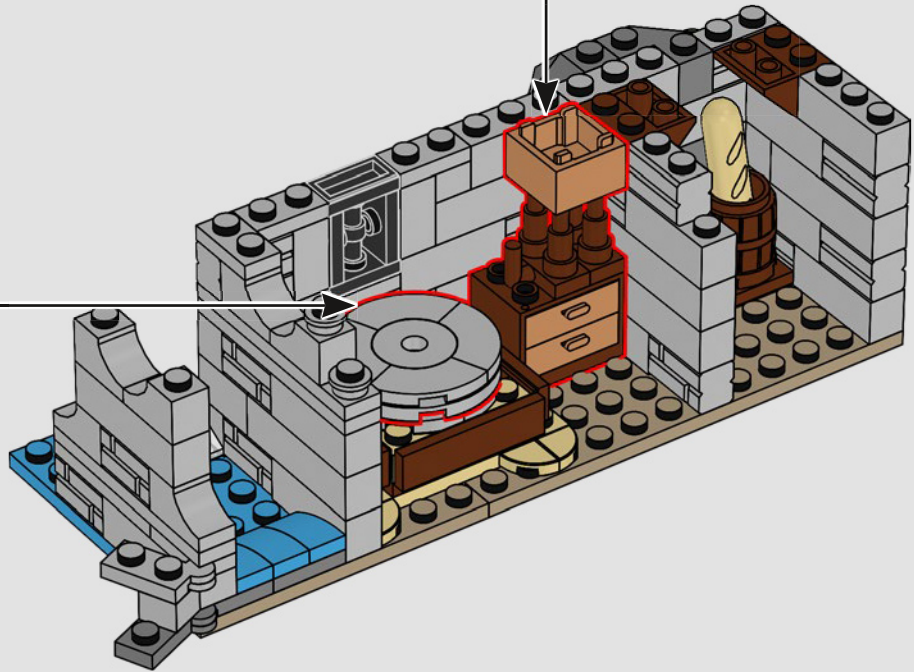
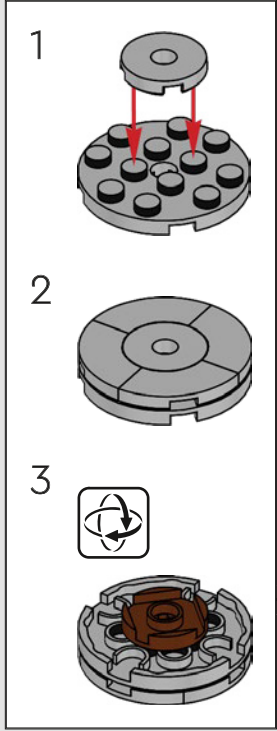
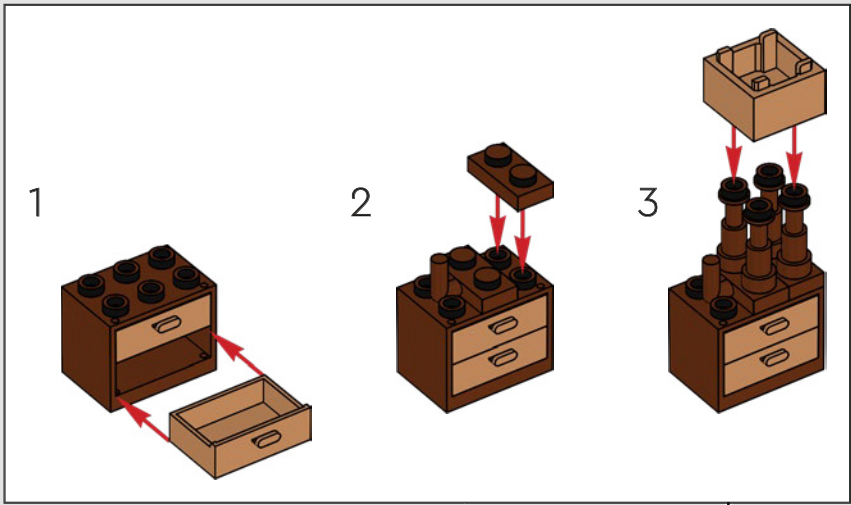

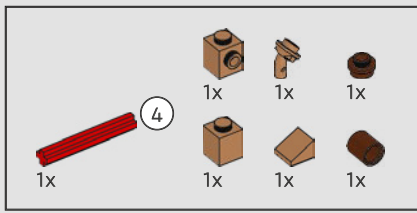

126

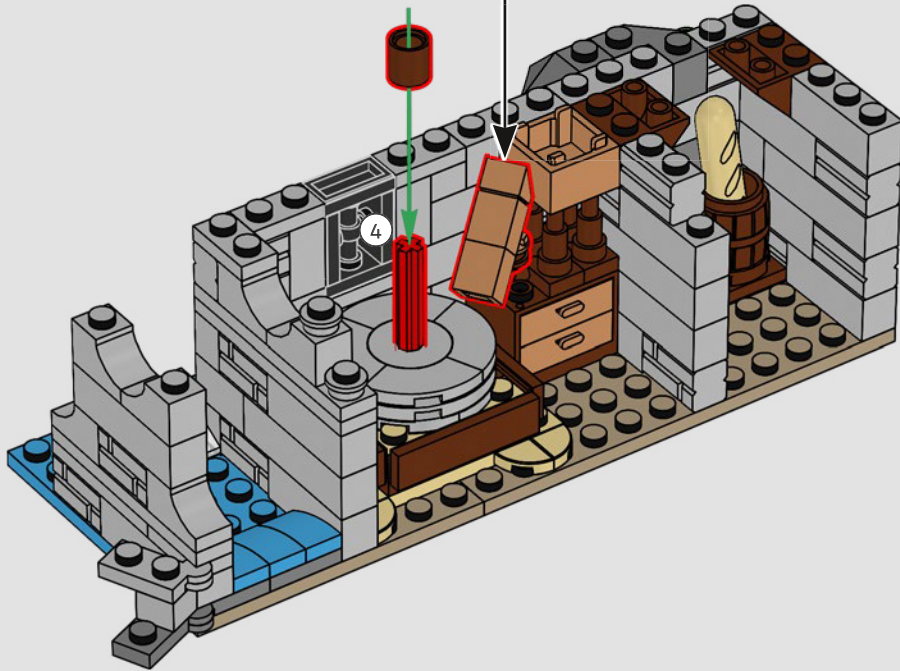
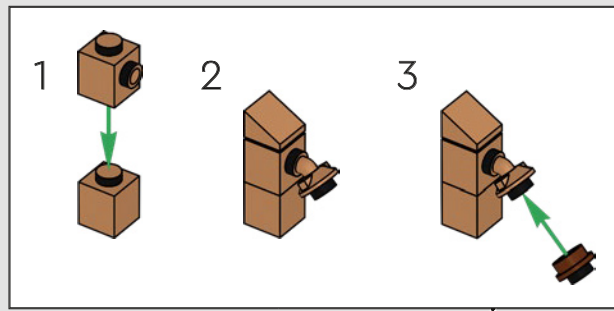

127

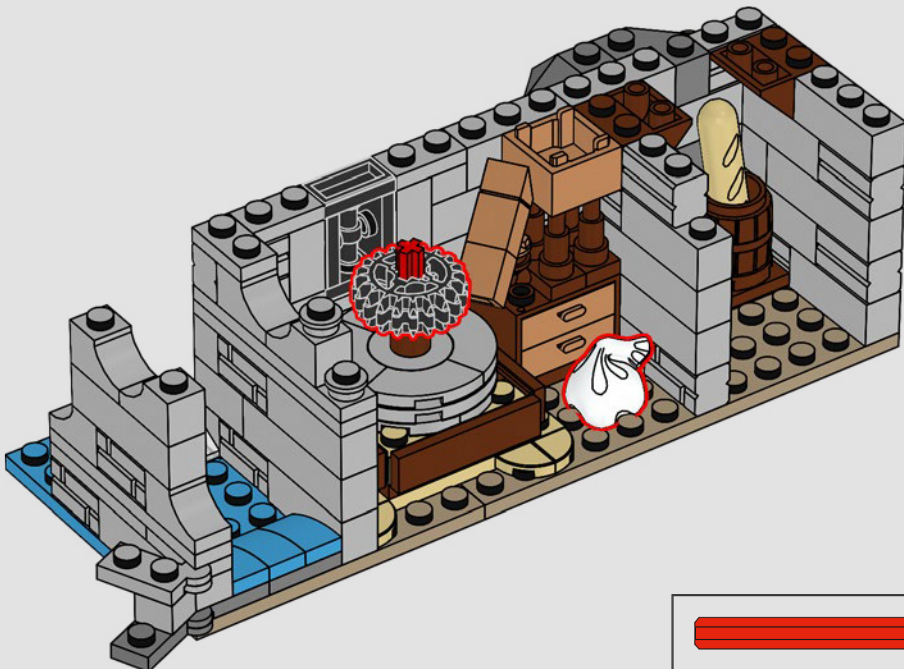

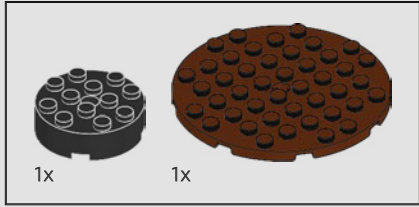
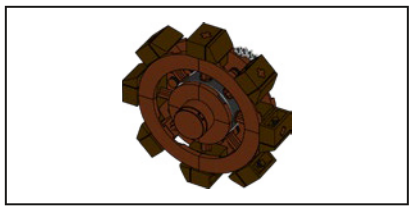

128

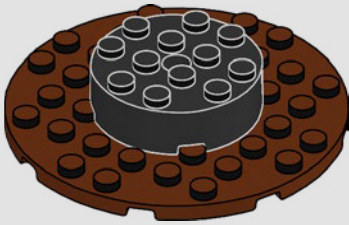

129

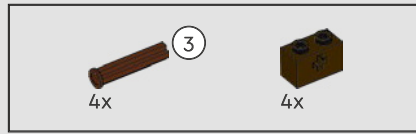
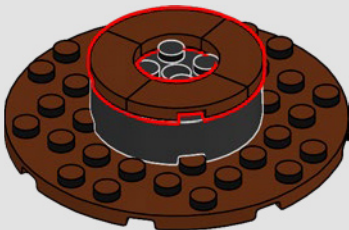

130

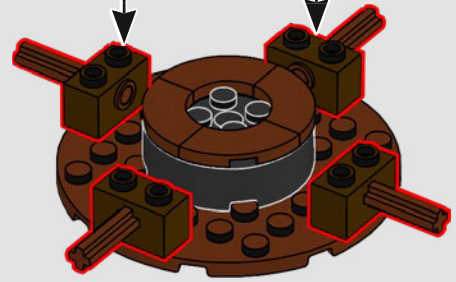
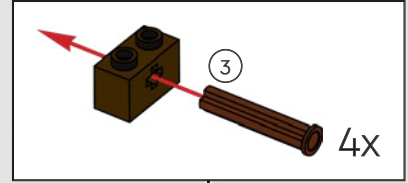

131

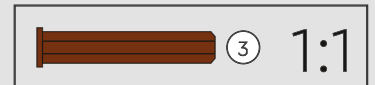
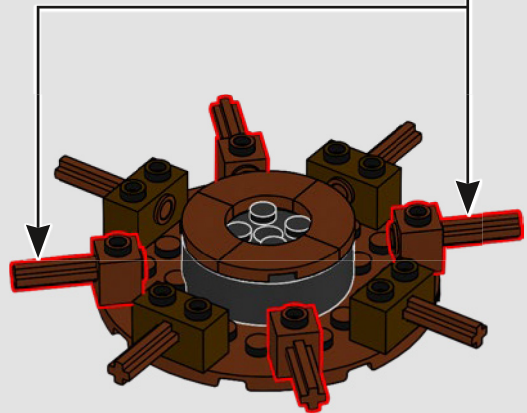
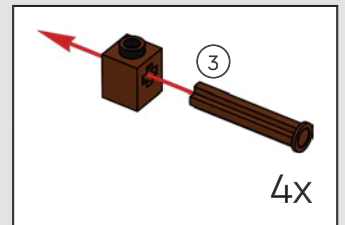

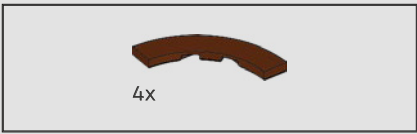

132

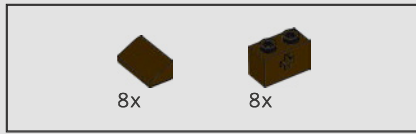
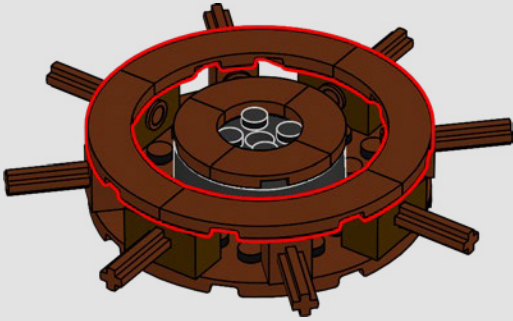

134

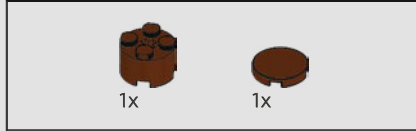
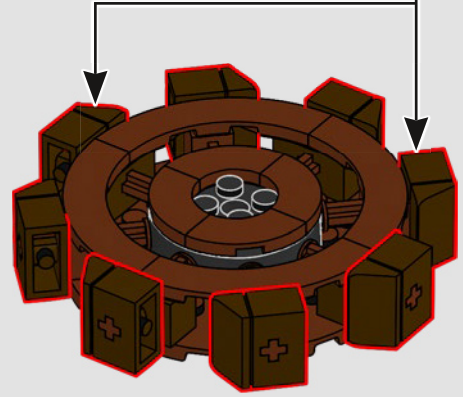
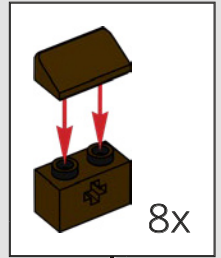

135

133

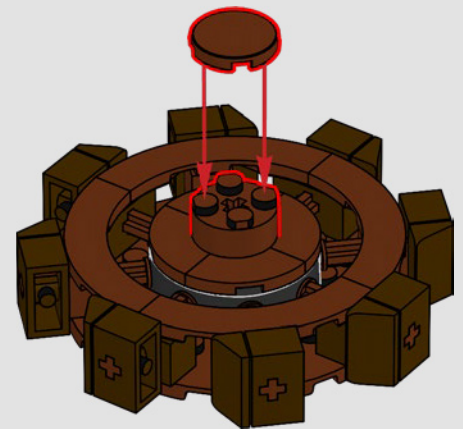
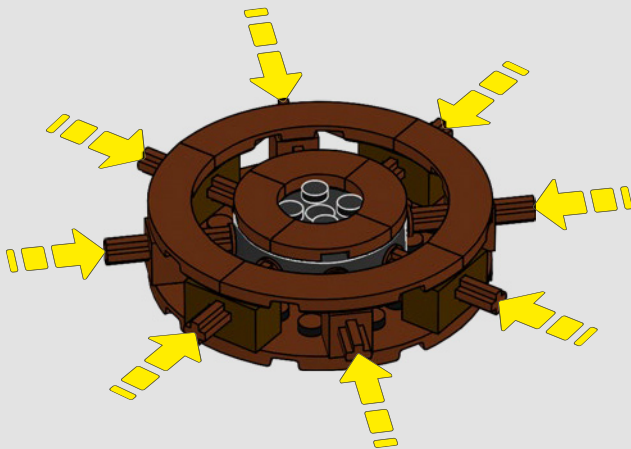

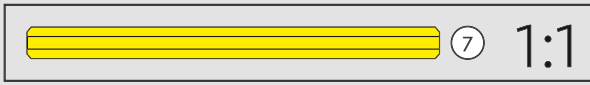
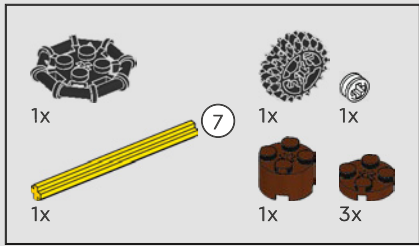

136

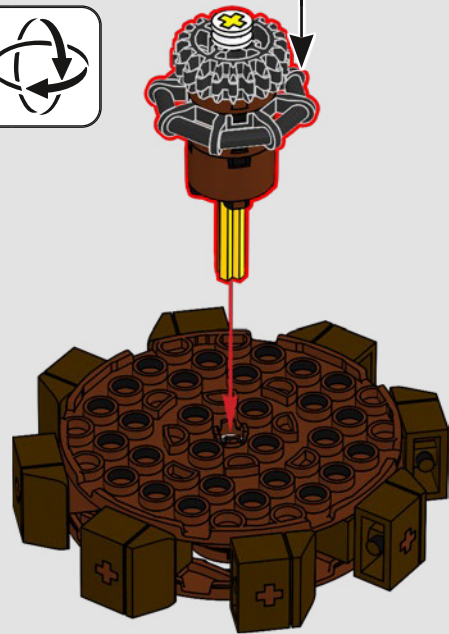
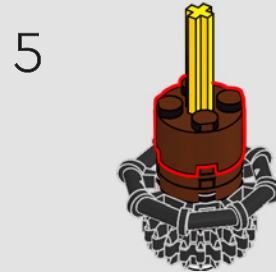
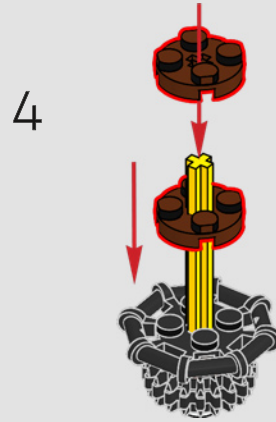
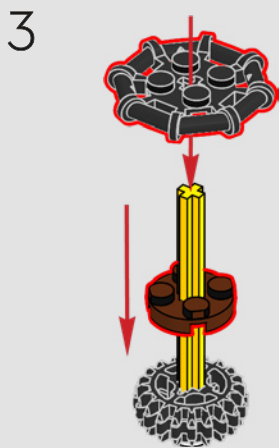
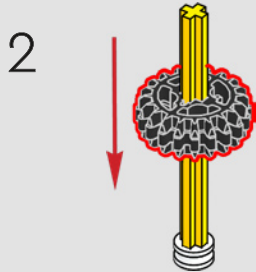
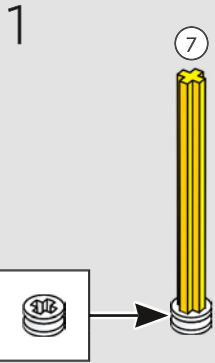



Die Kraft dieses Wasserrads ist gewaltig!
Damit lässt sich der Mühlstein perfekt drehen!

137

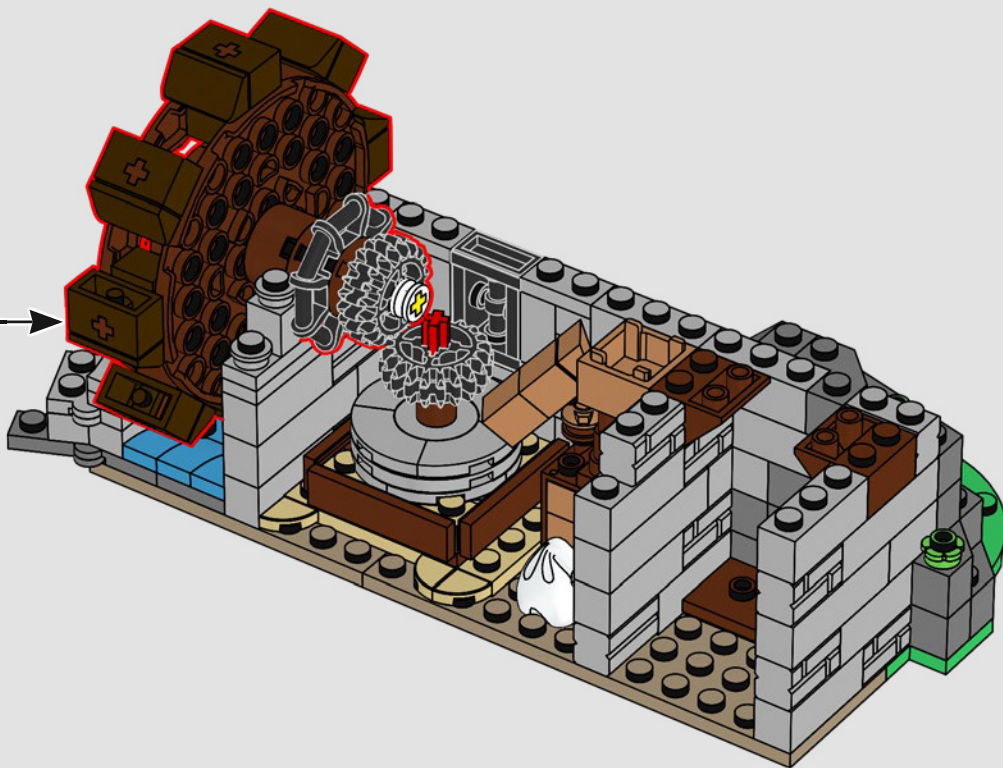

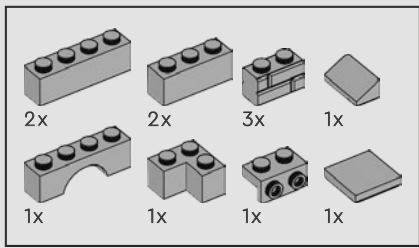

138

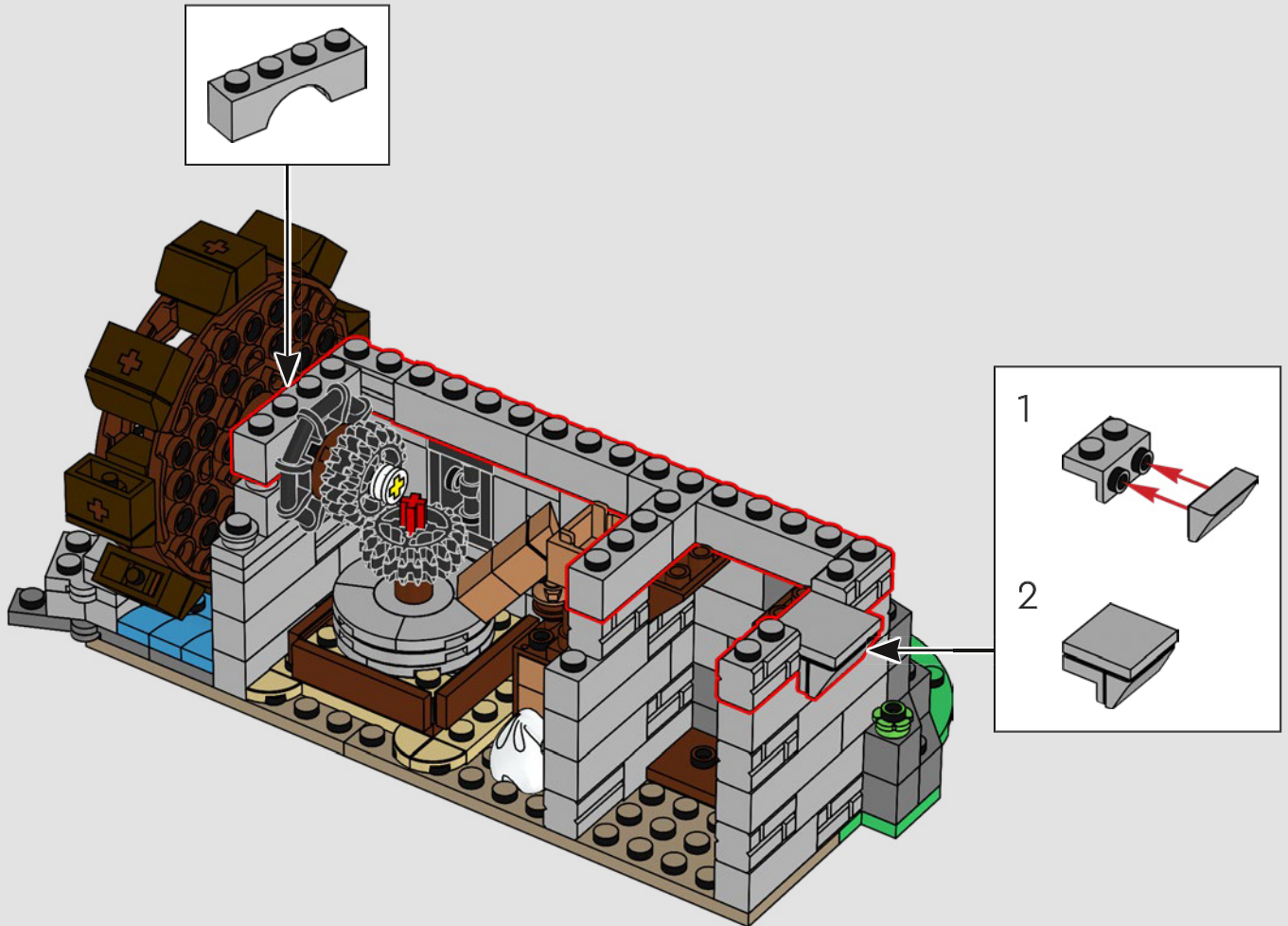



Ein Vogelnest!

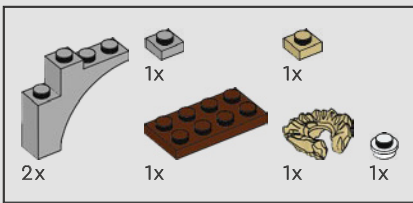

139

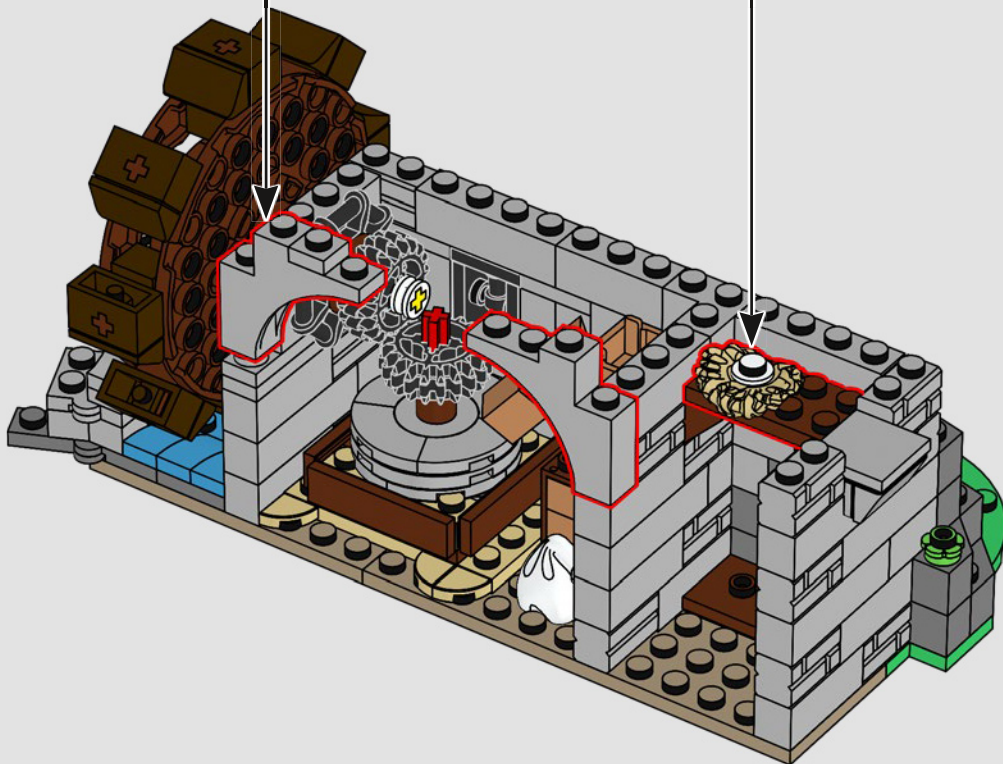
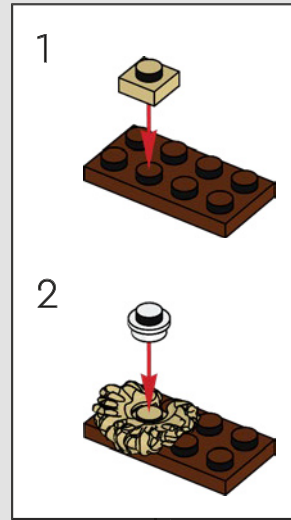
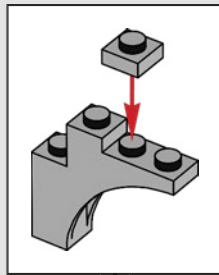

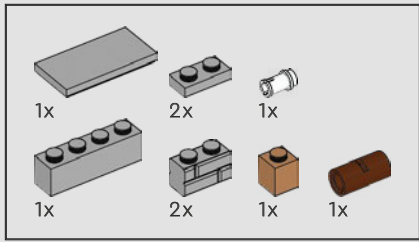

140

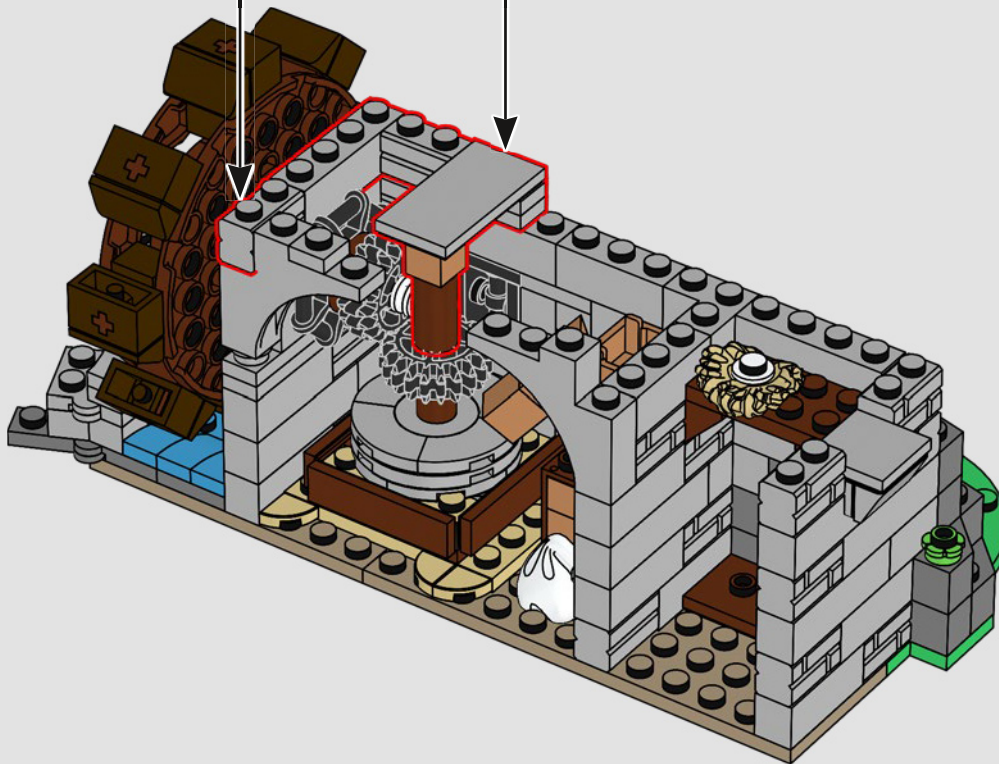
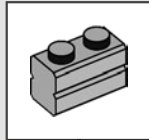
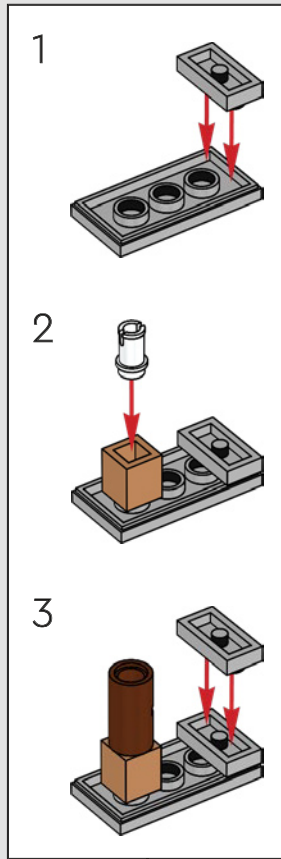

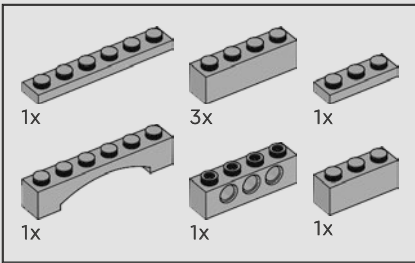

141

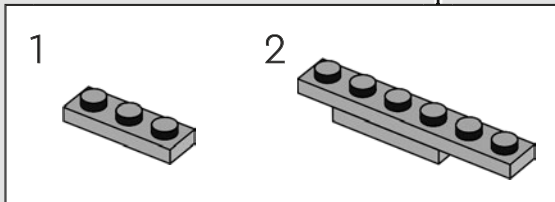
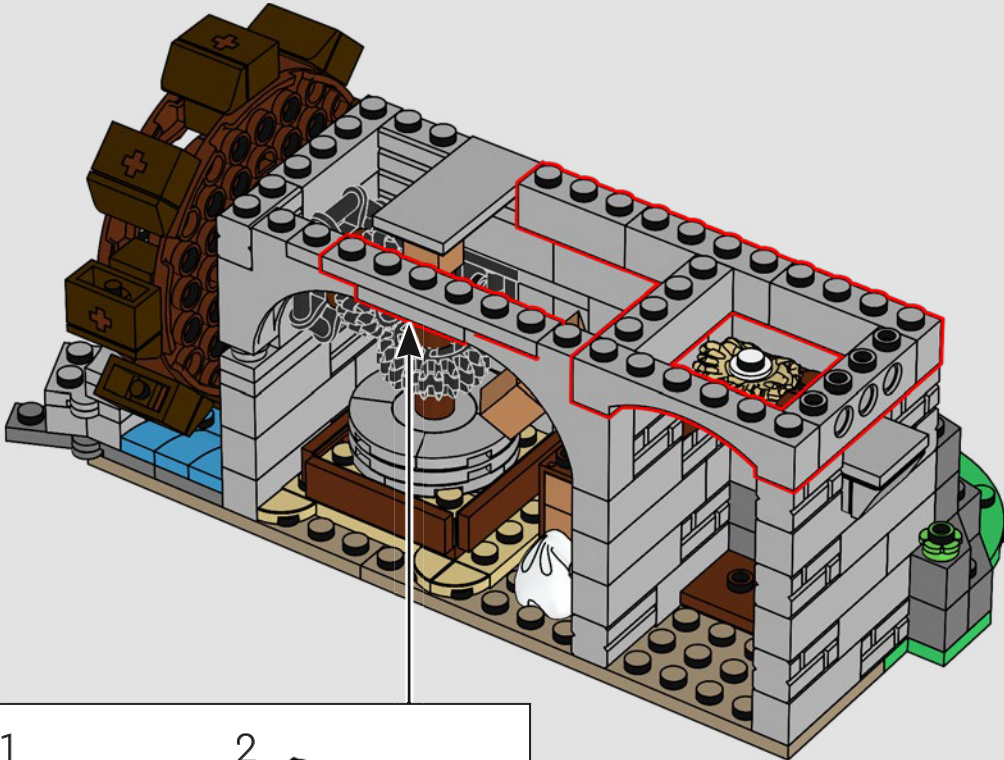

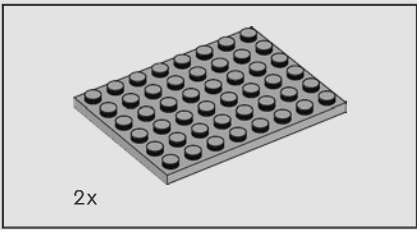

142

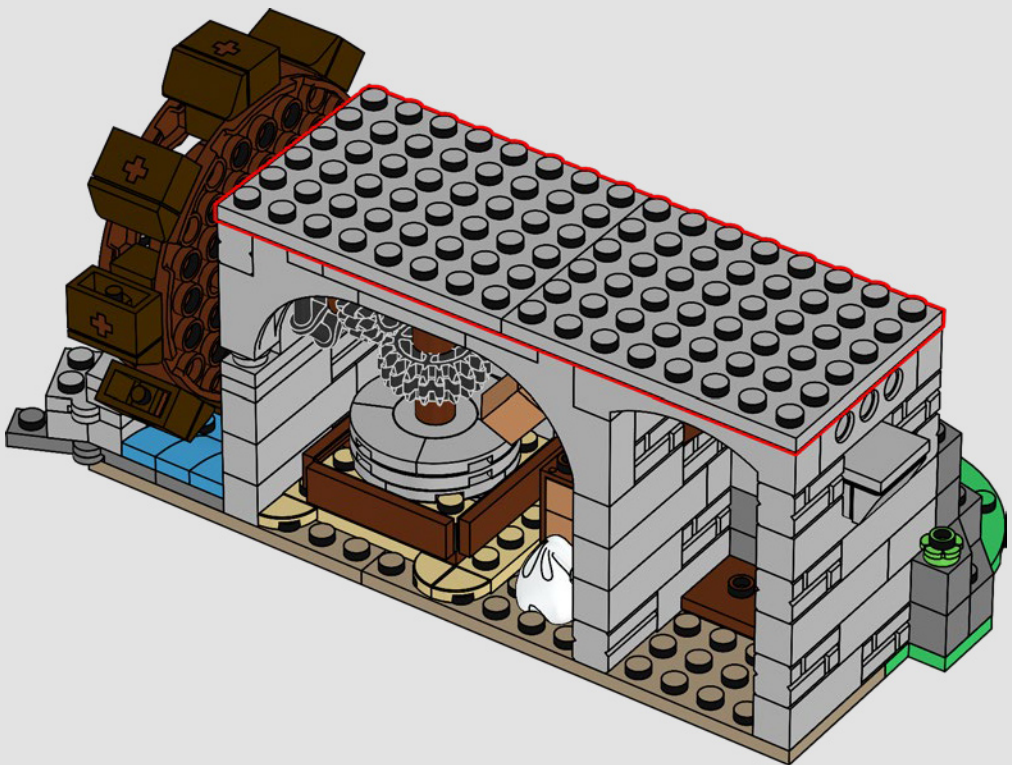

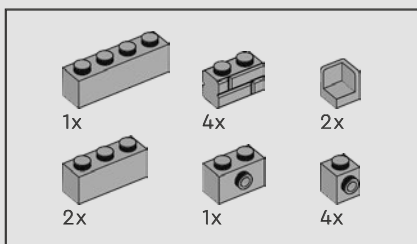

143

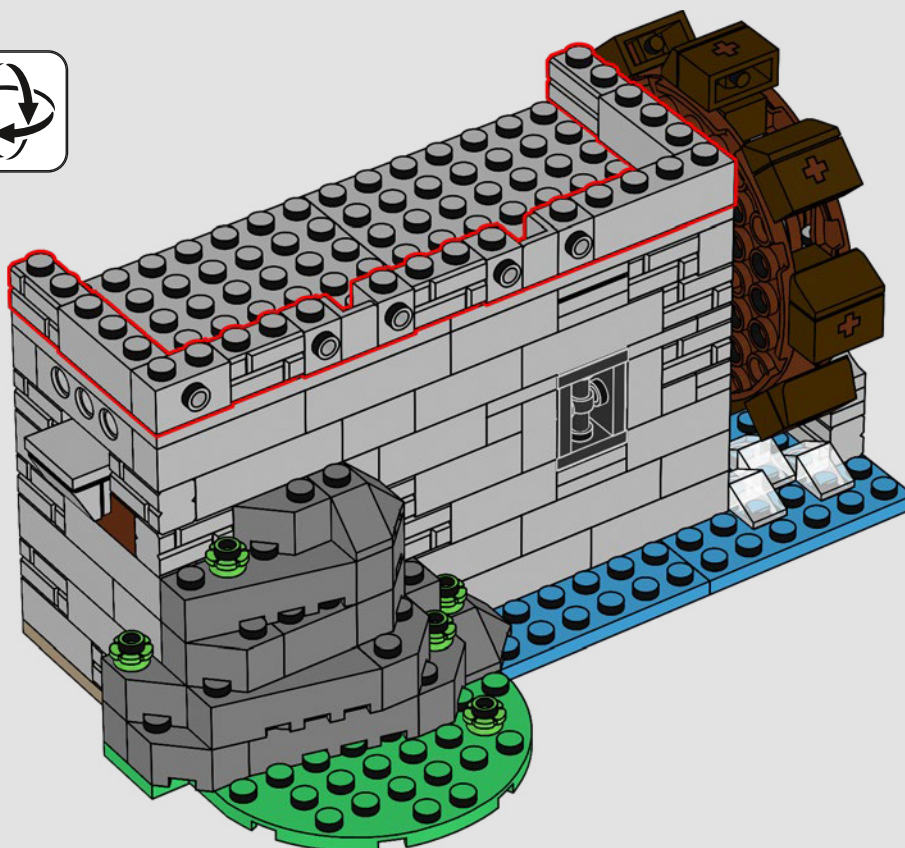

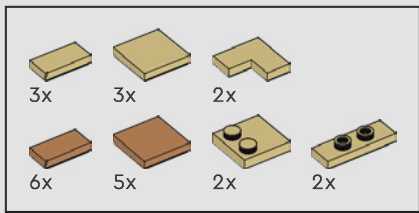

144

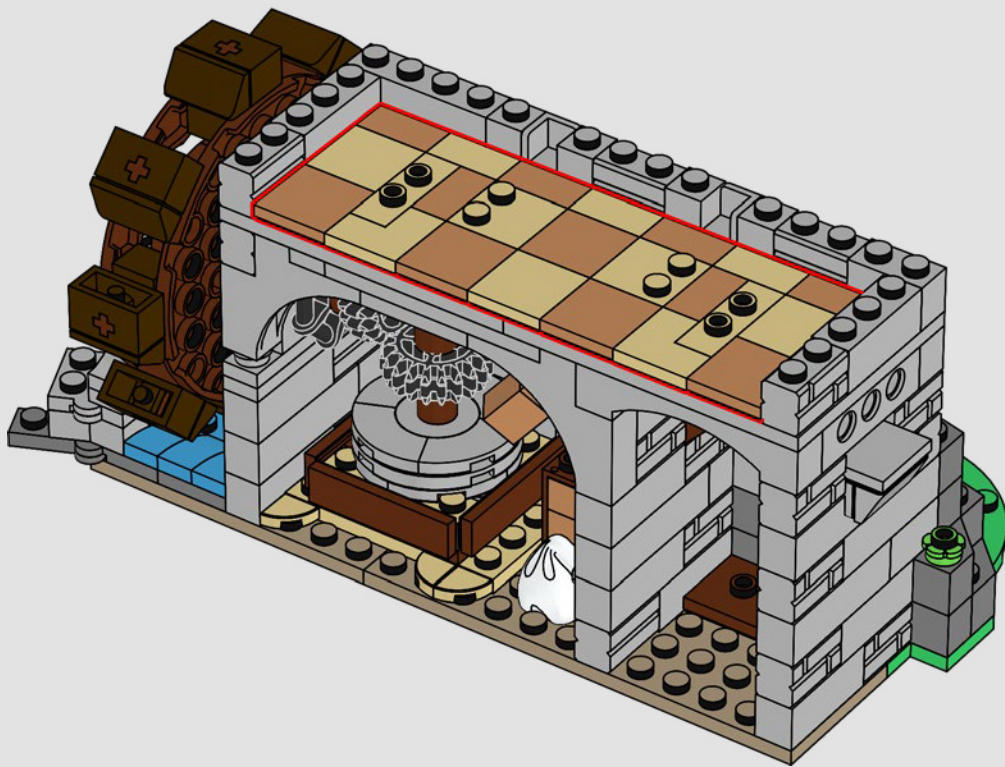

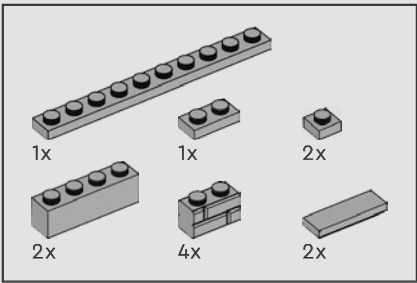

145

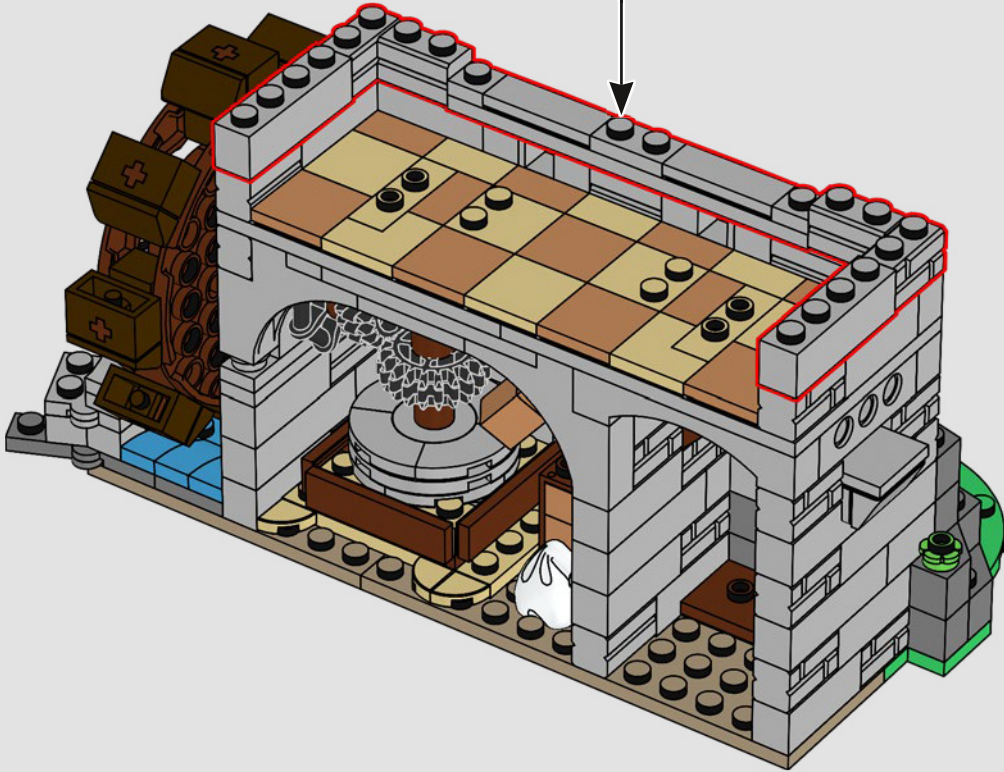
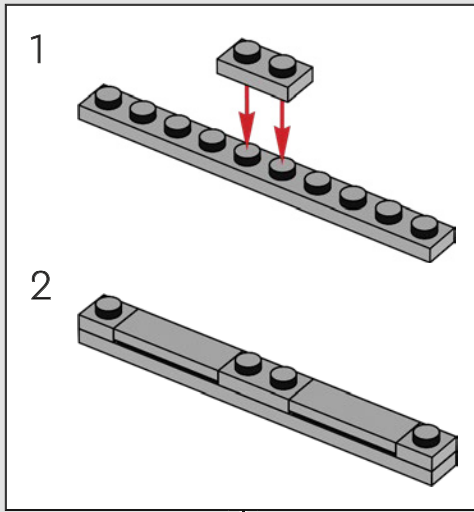

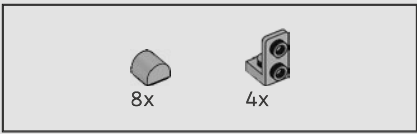

146

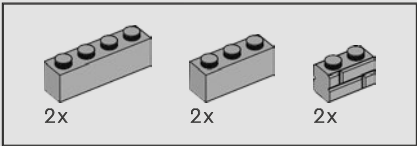
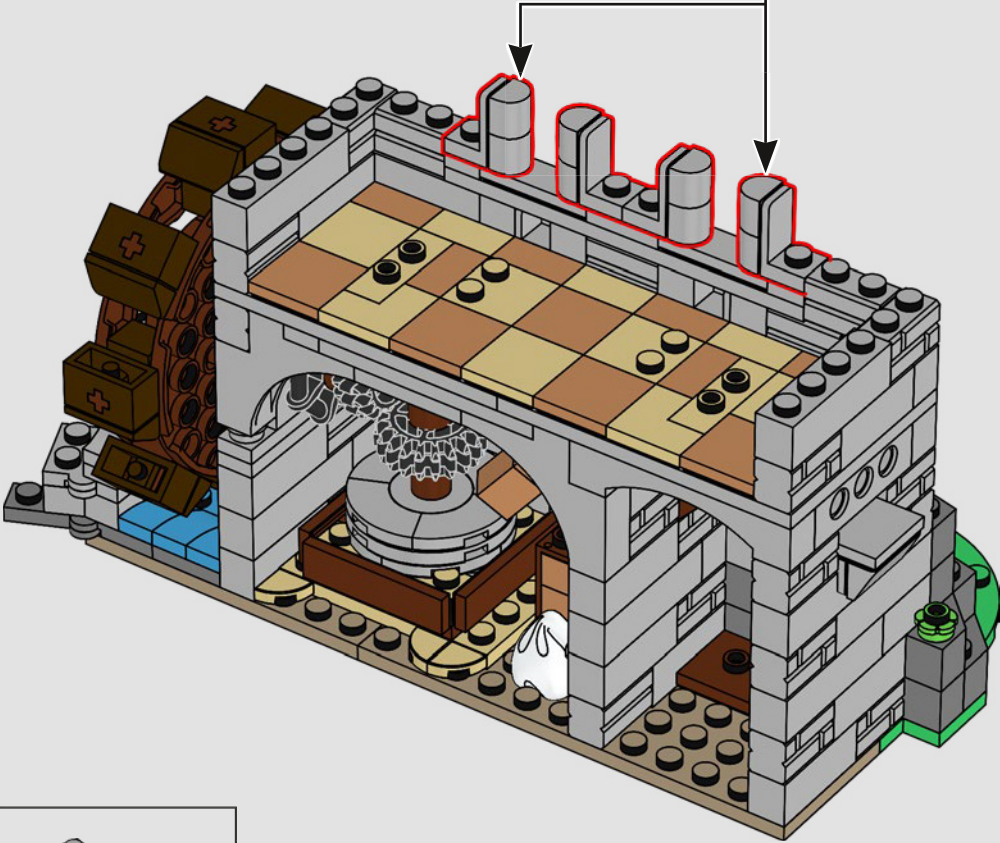
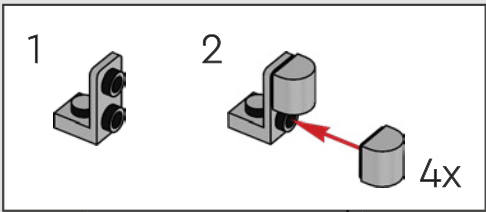

147

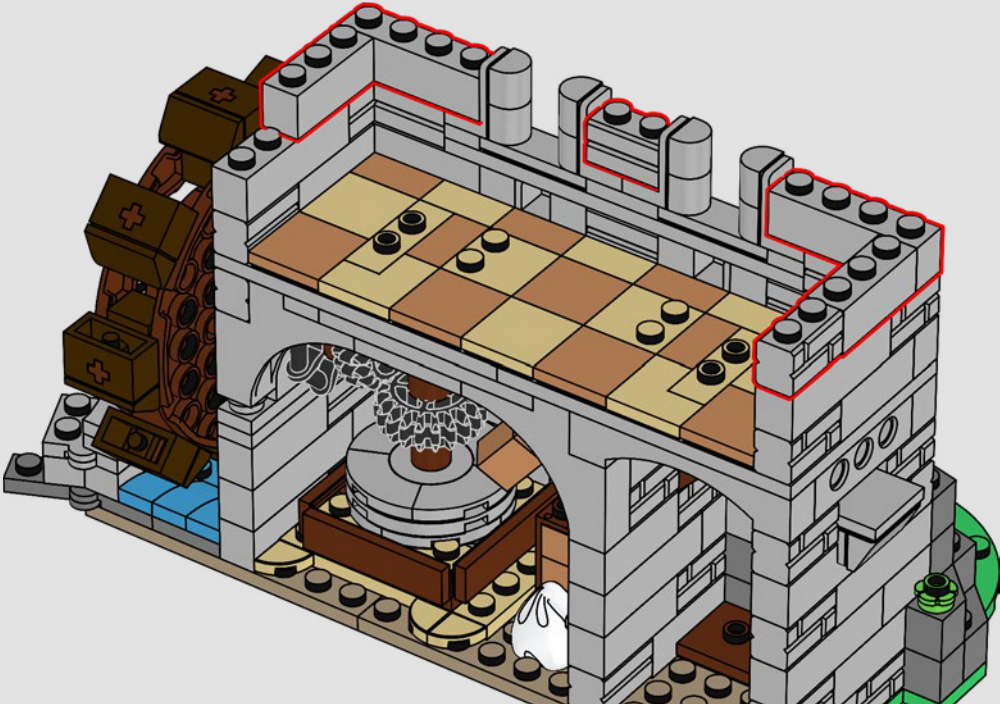

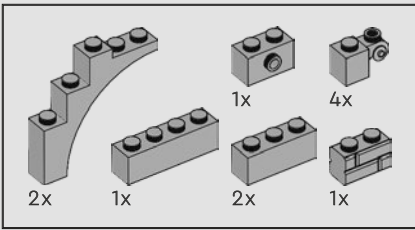

148

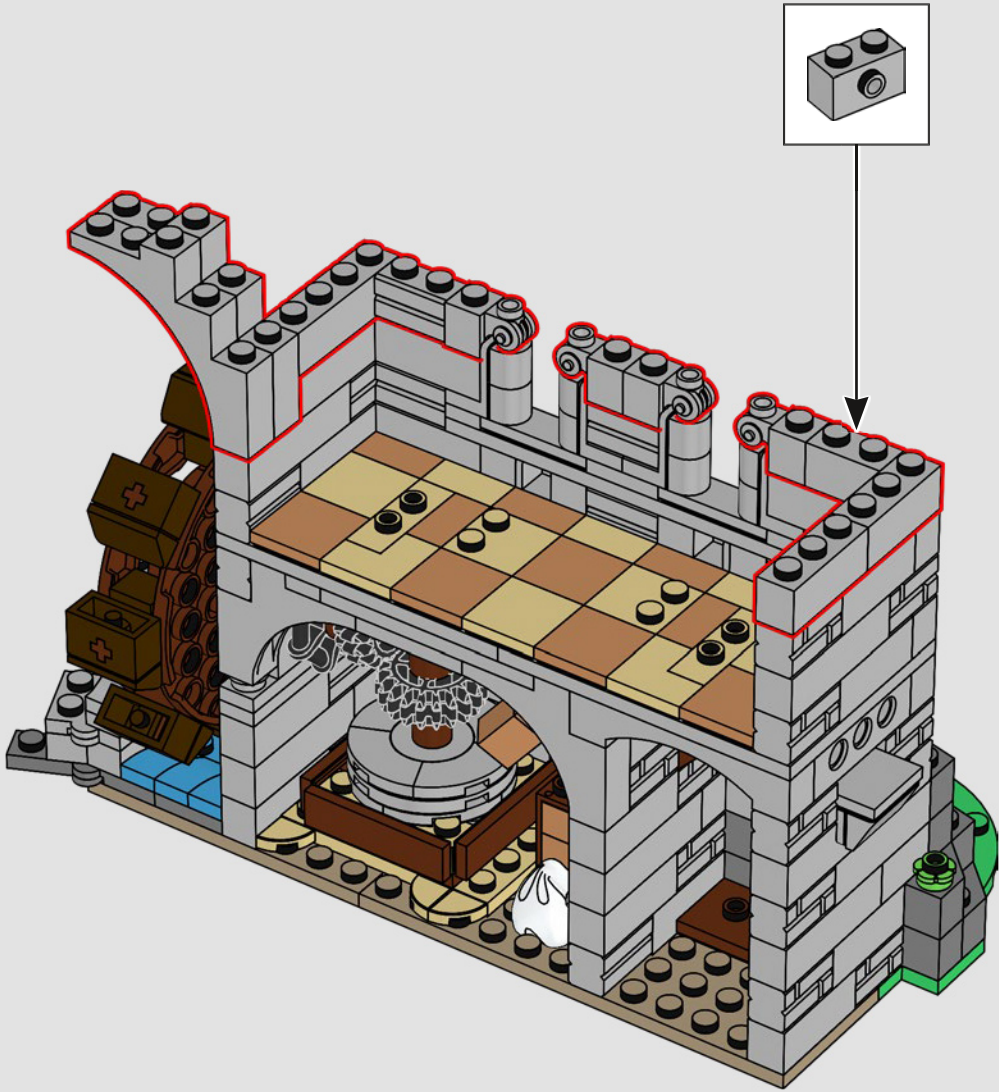

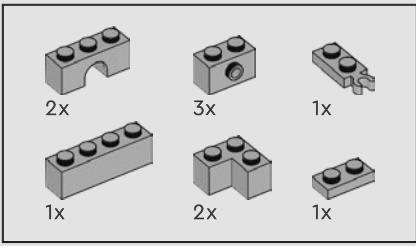

149

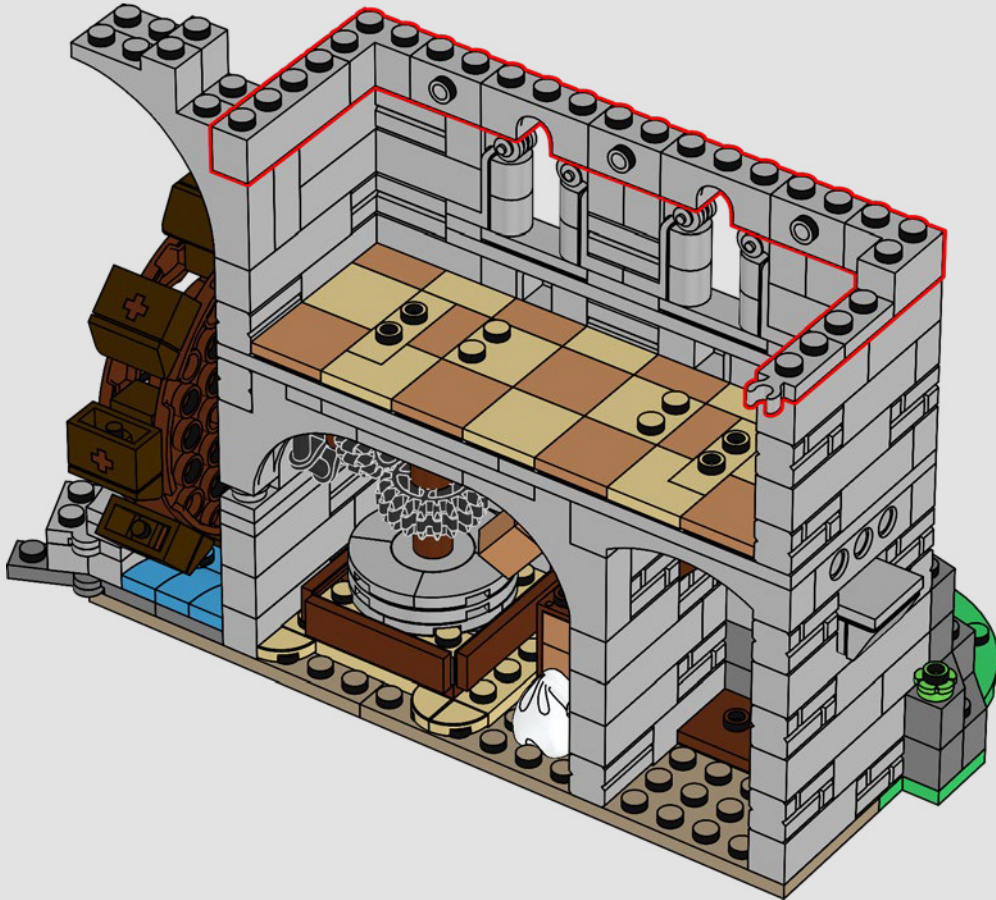

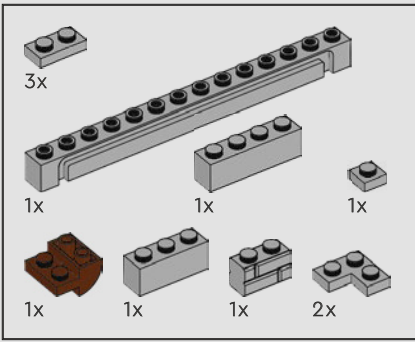

150

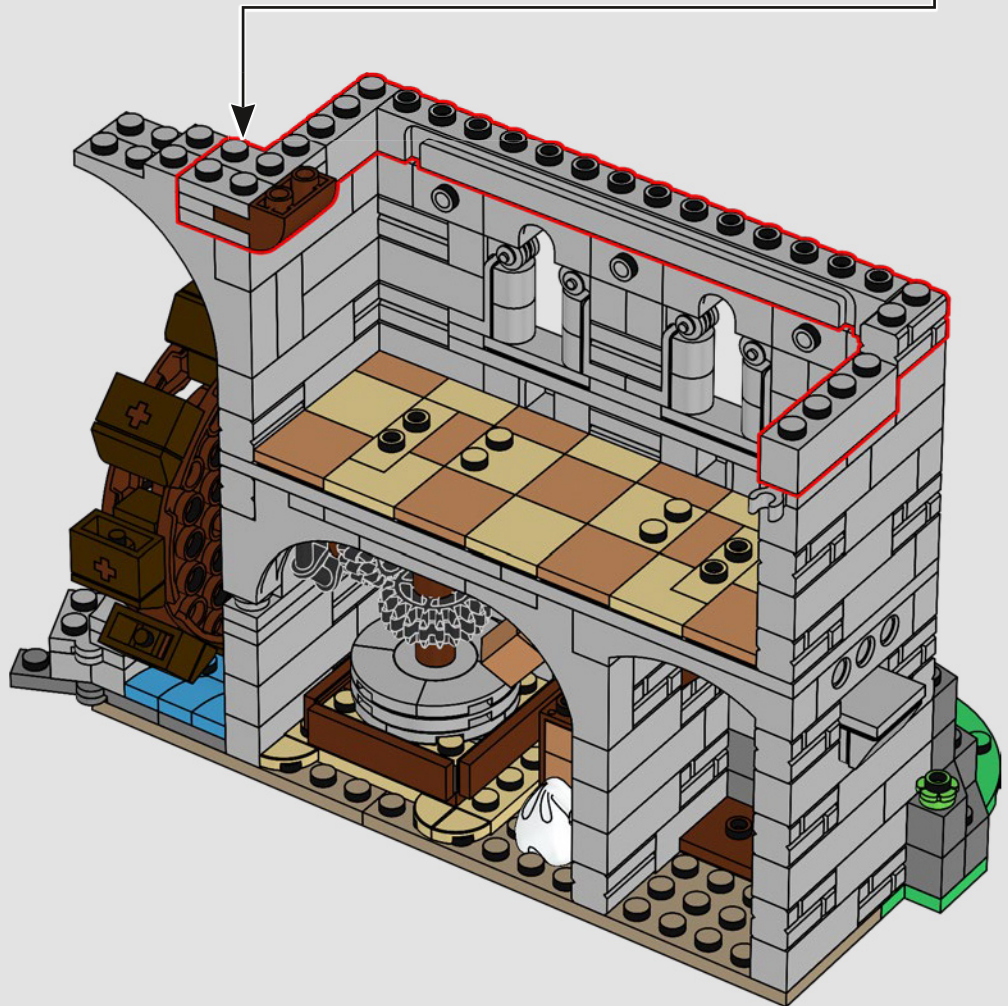
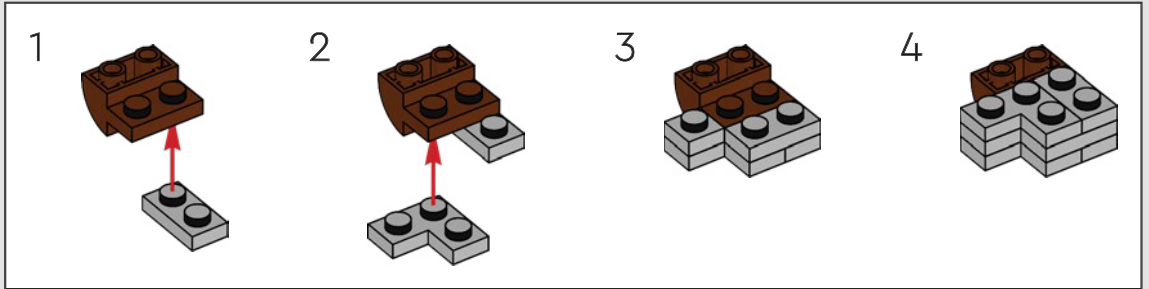

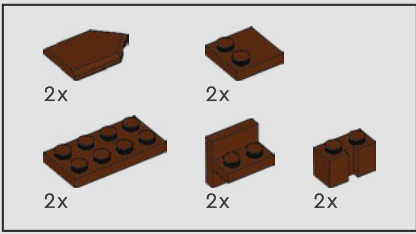

151

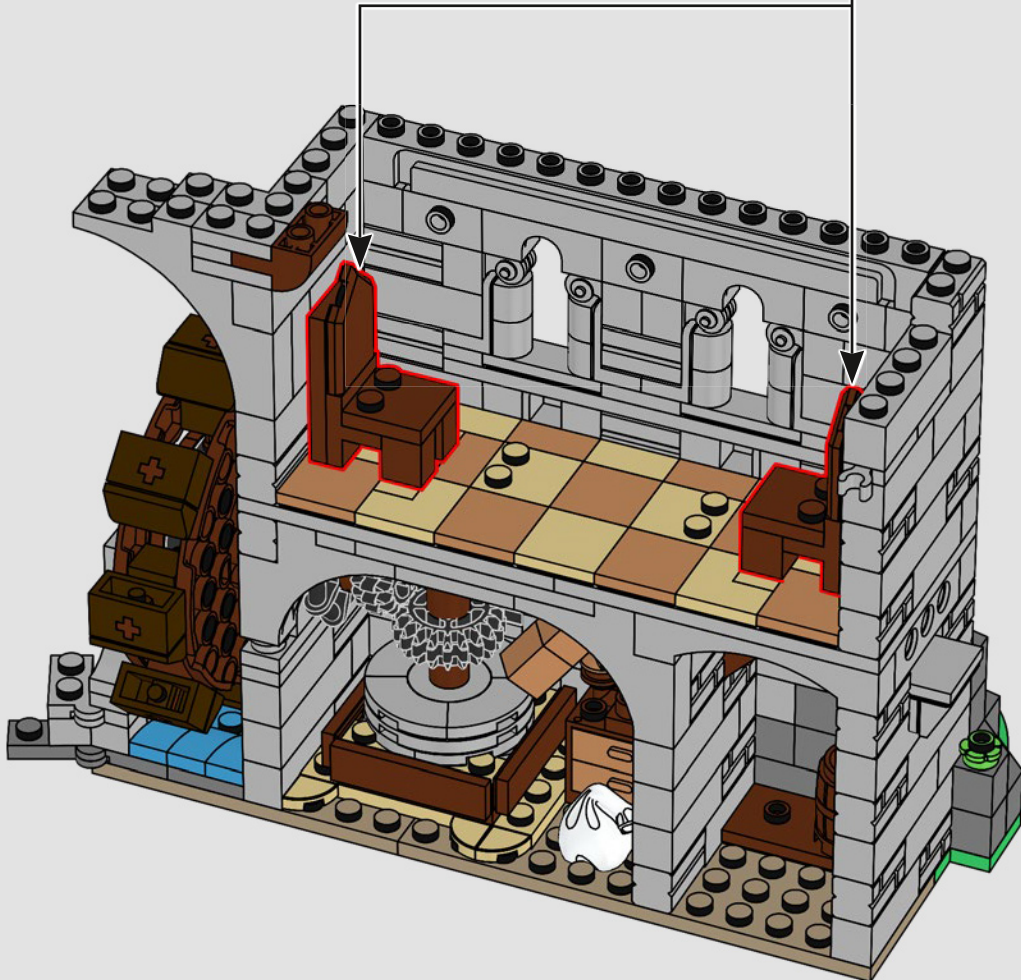
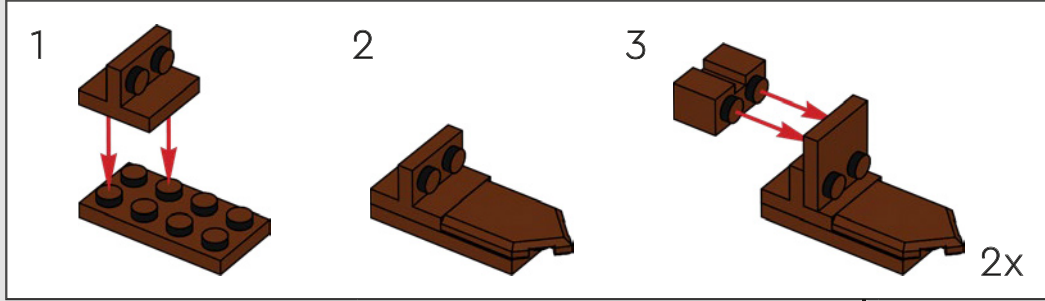



Die Tafel ist gedeckt. Aber wo sind die Gäste?

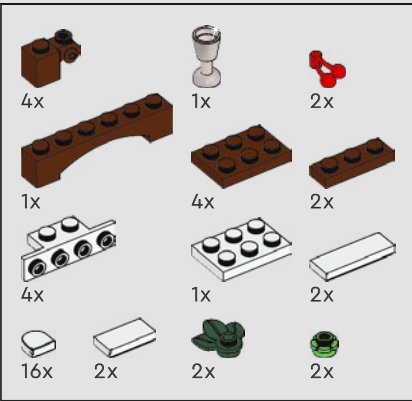
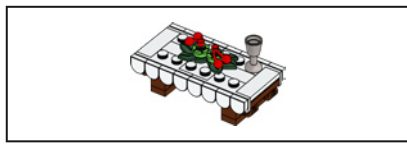

152

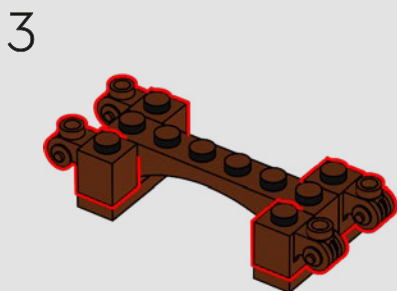
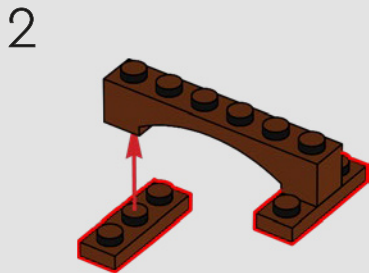
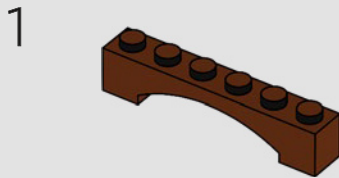

4

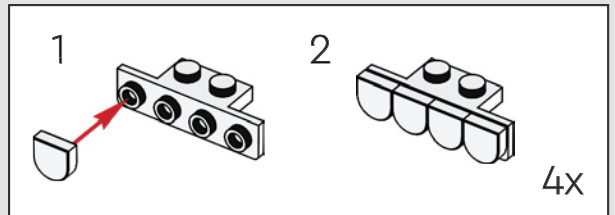
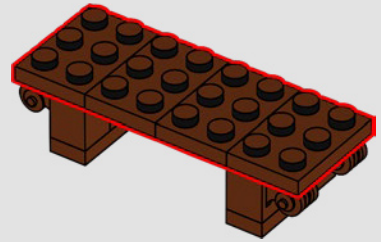

5

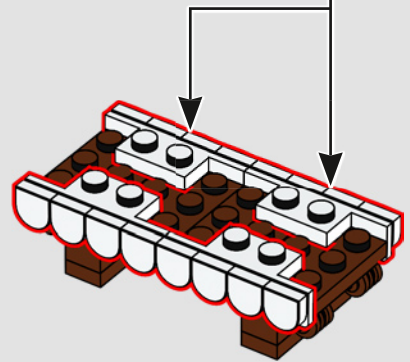

6

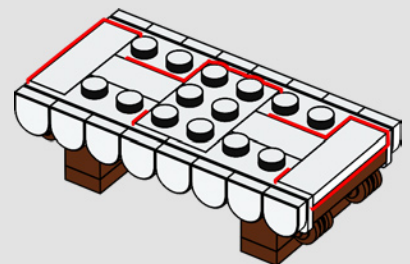

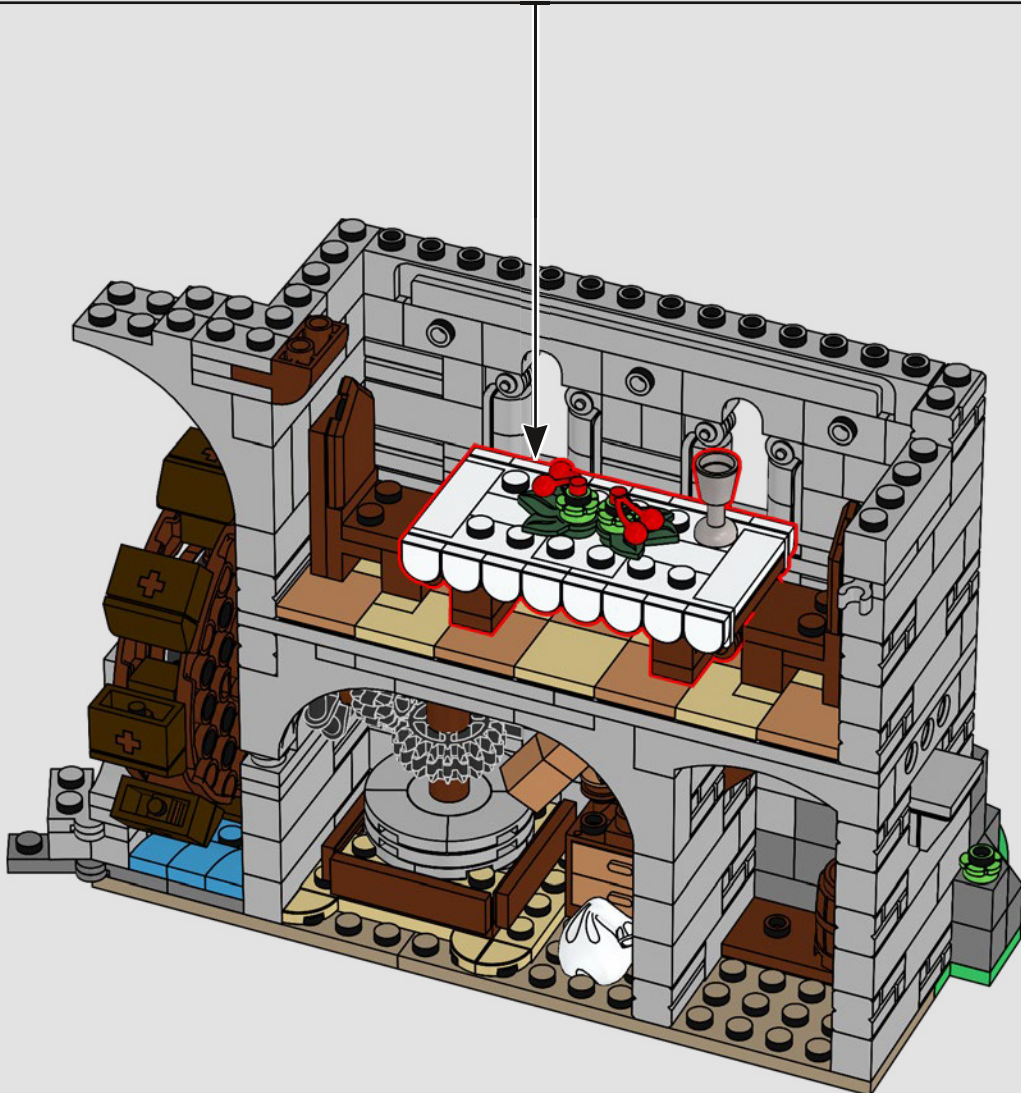
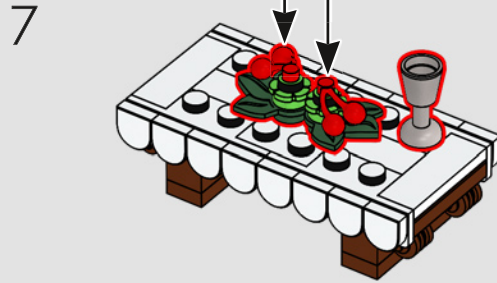
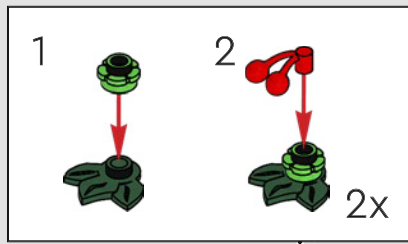

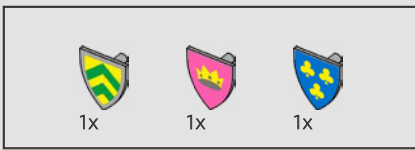

Was für ein hübscher Rosaton. Jene alten
Wappen erinnern an einfachere Zeiten ...

153



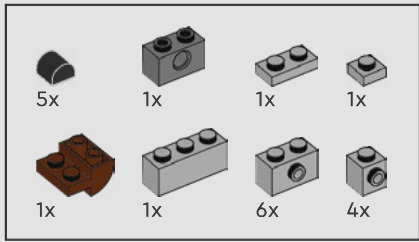

154

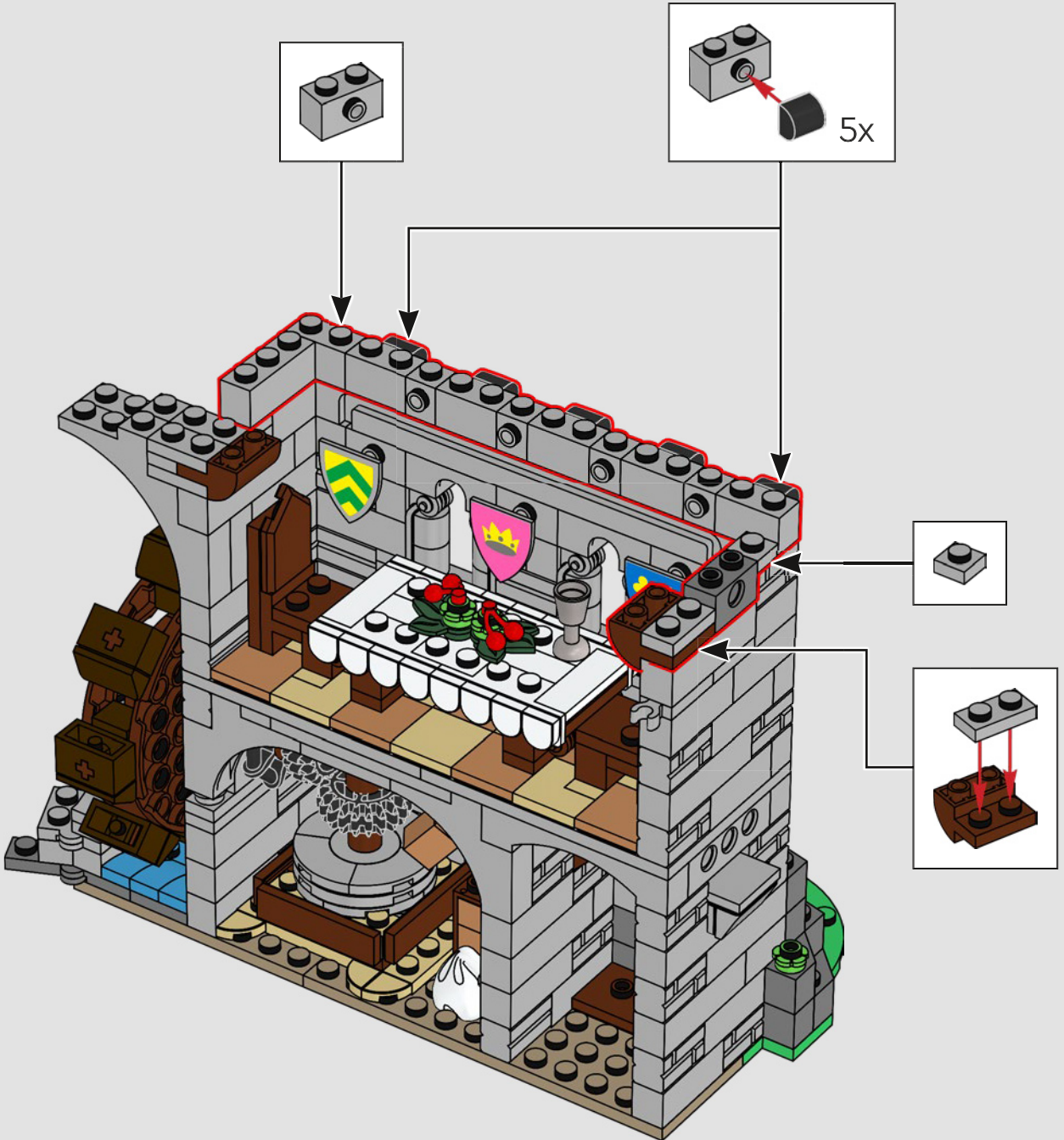

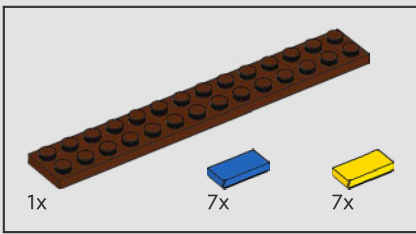

155

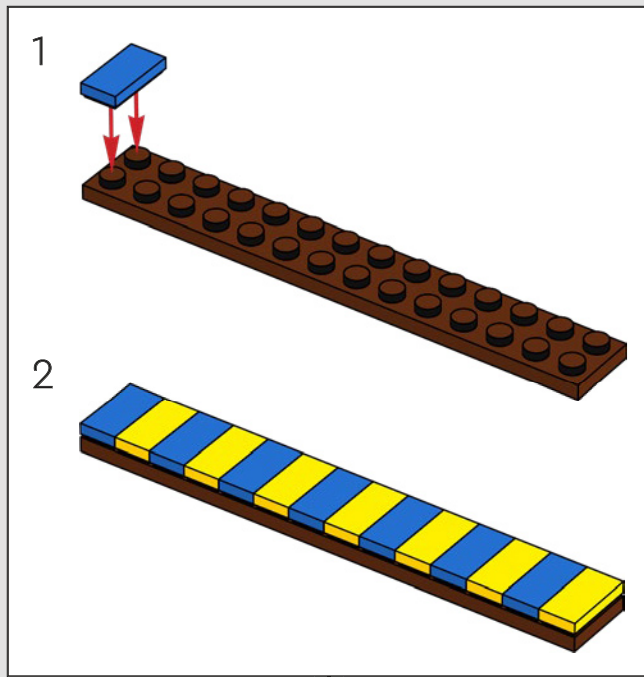

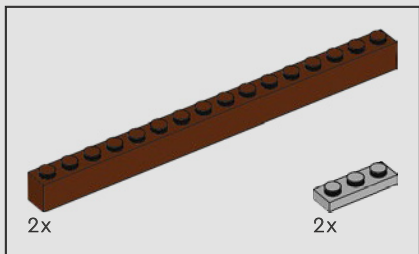

156

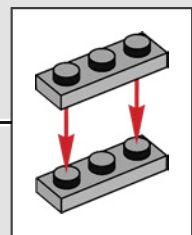

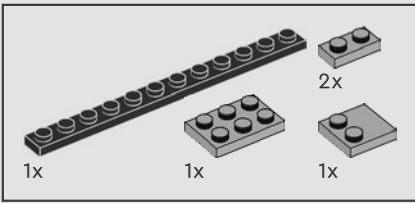

157

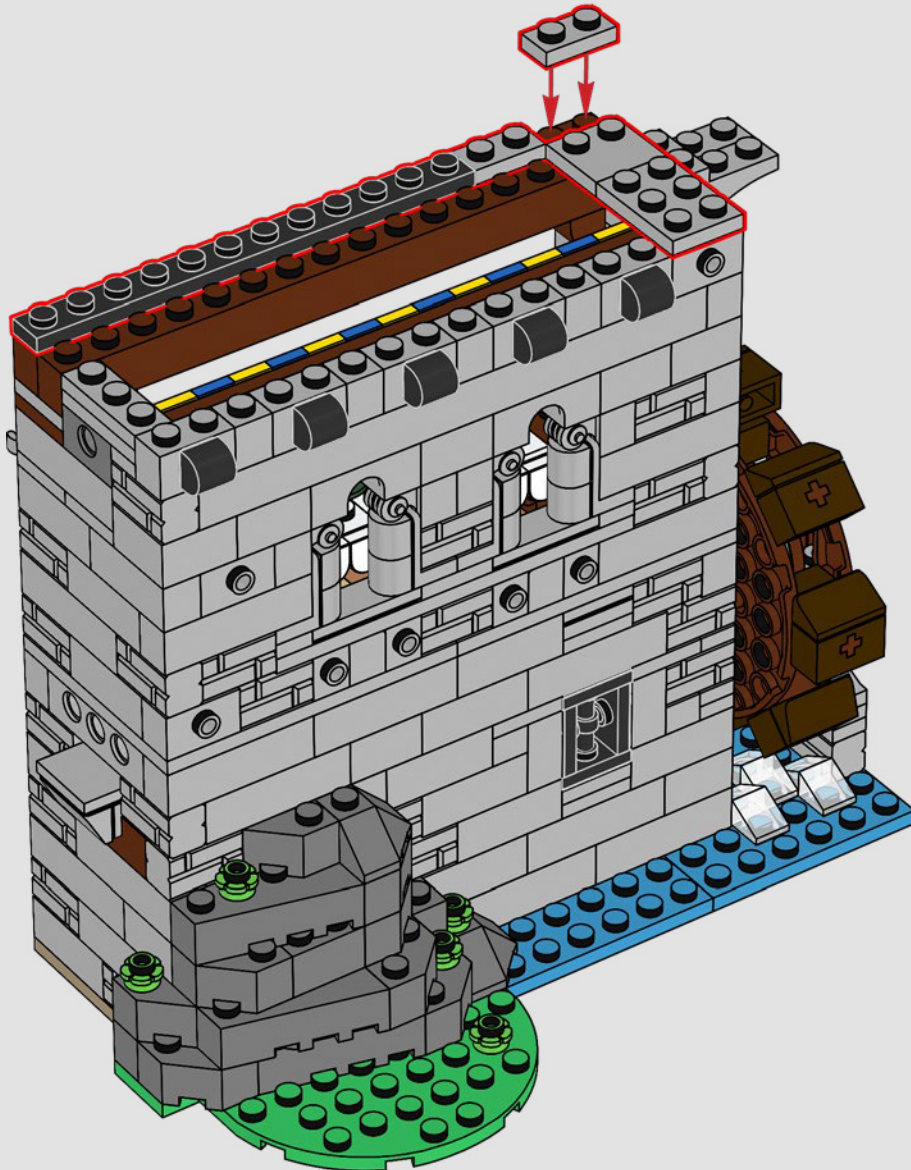

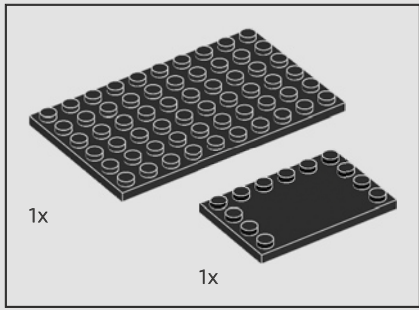

158

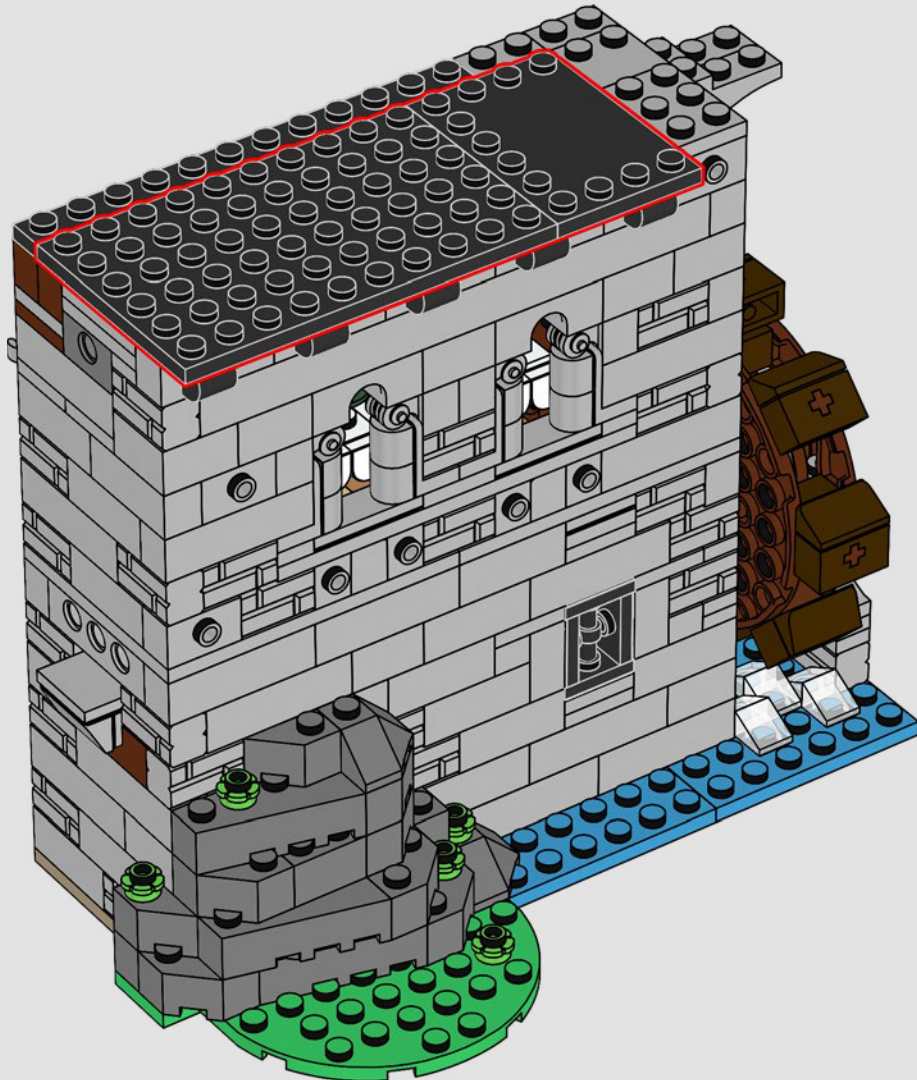



159

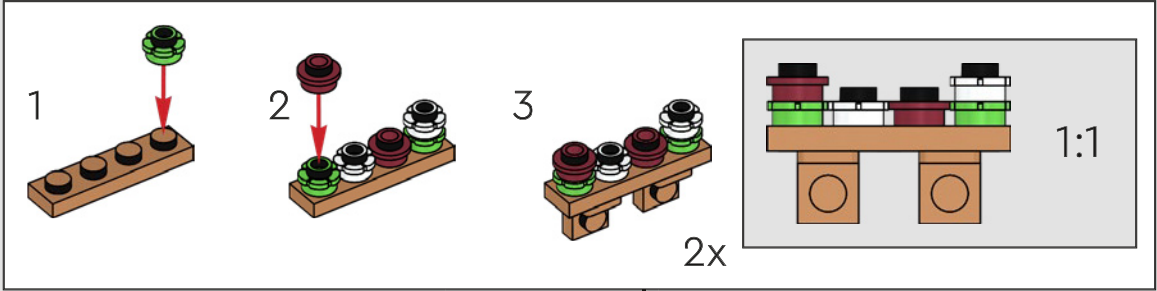

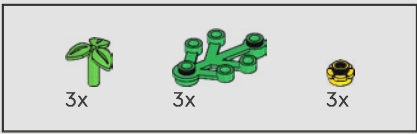

160

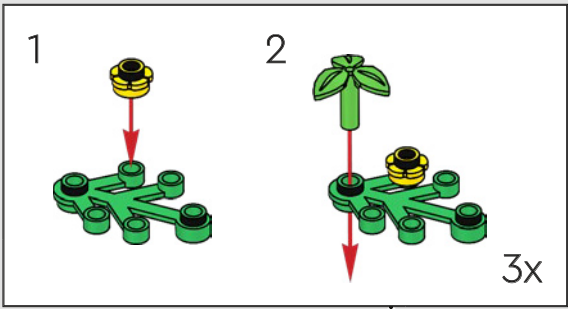

161

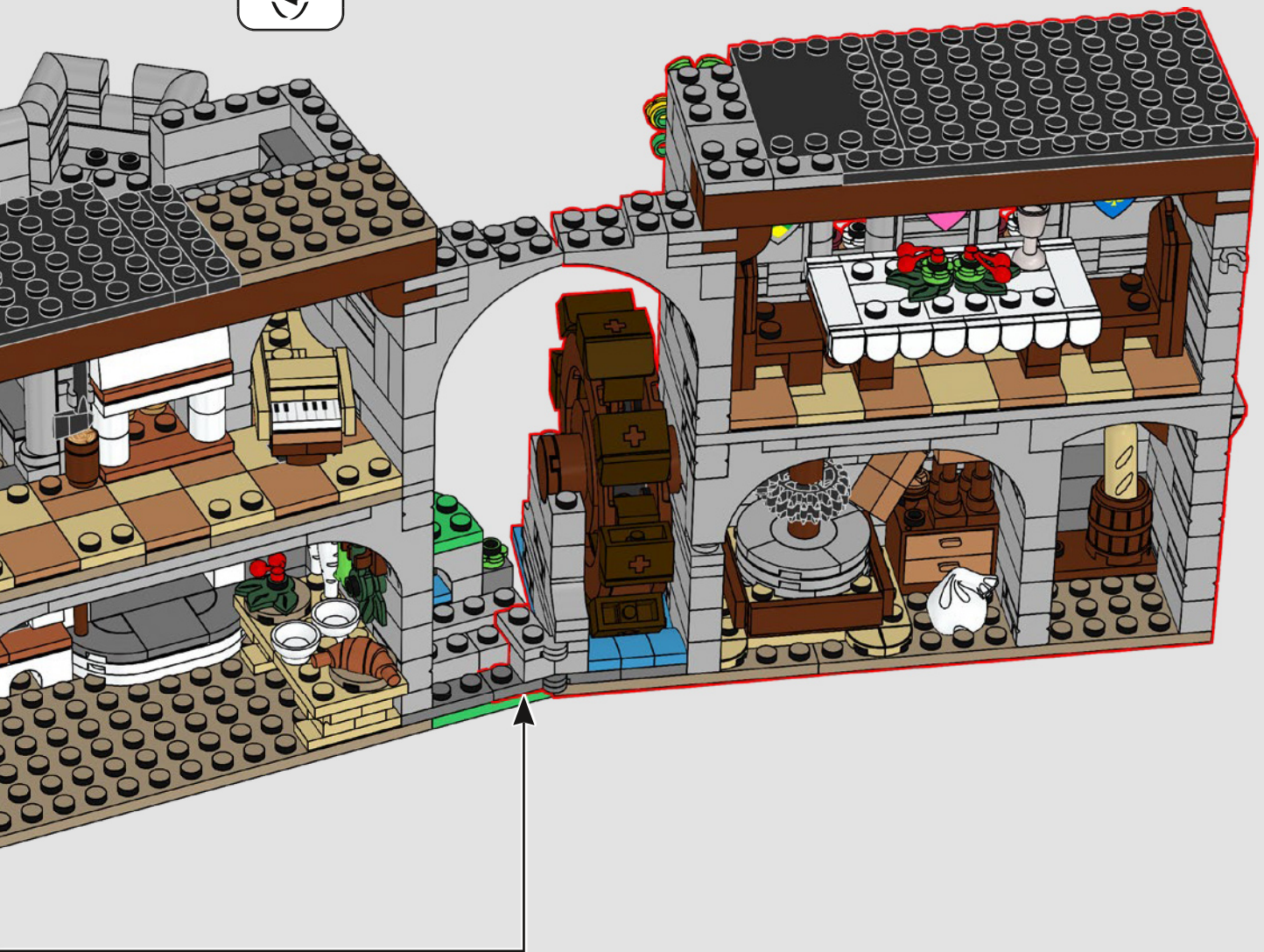

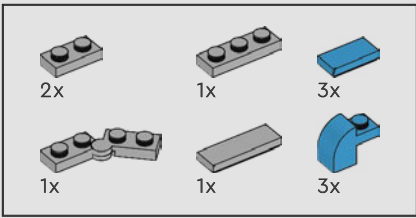

162

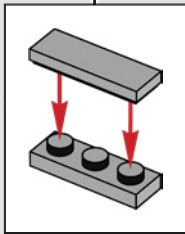
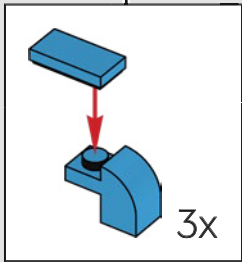
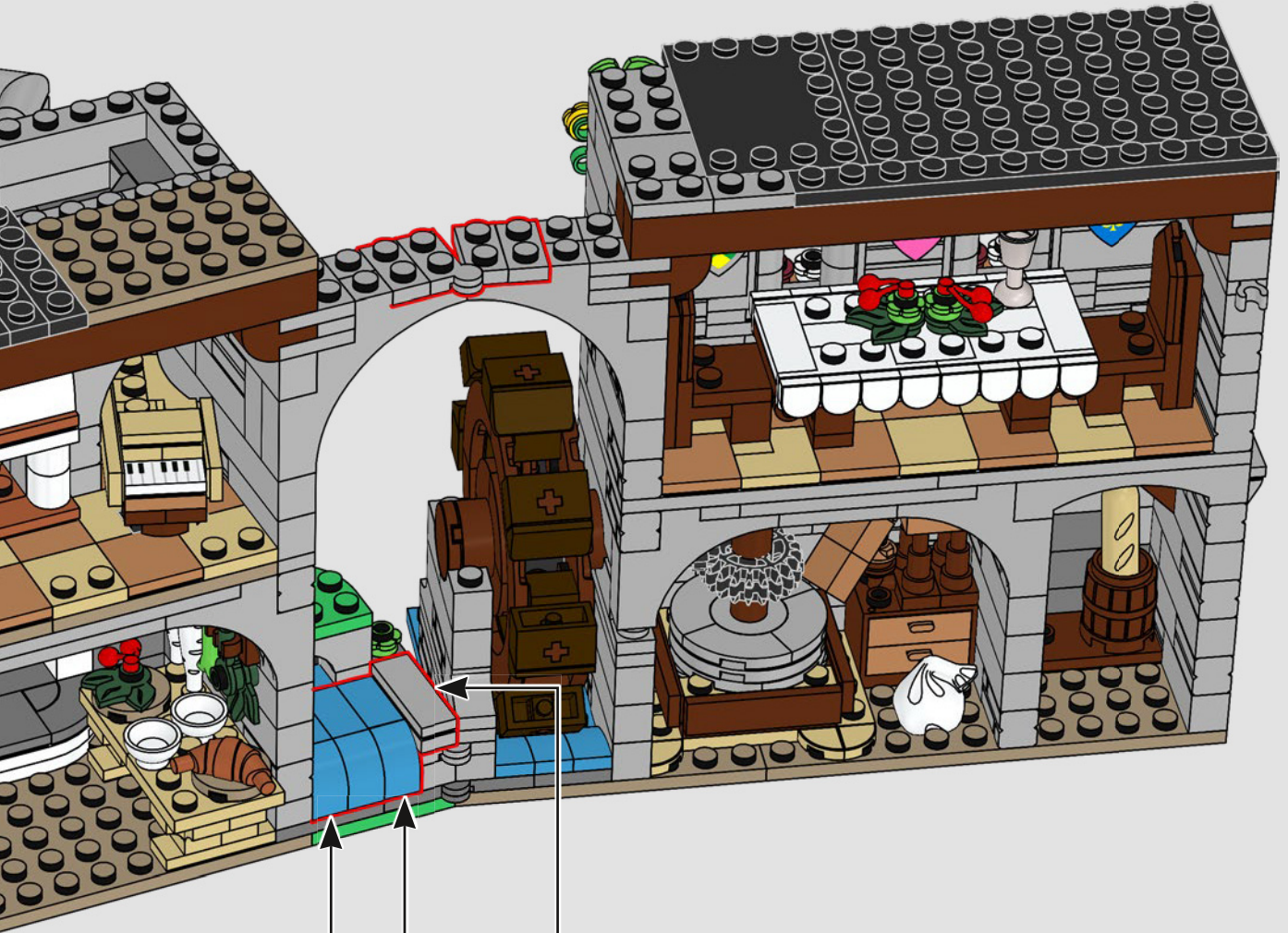

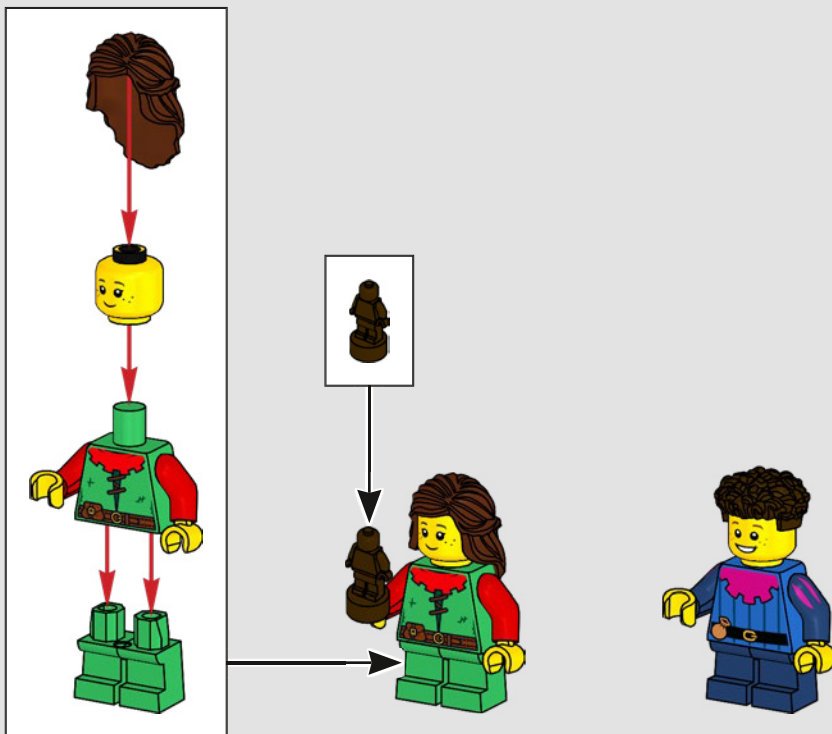

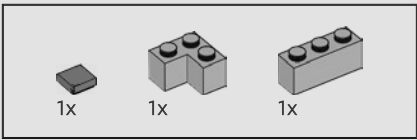

163

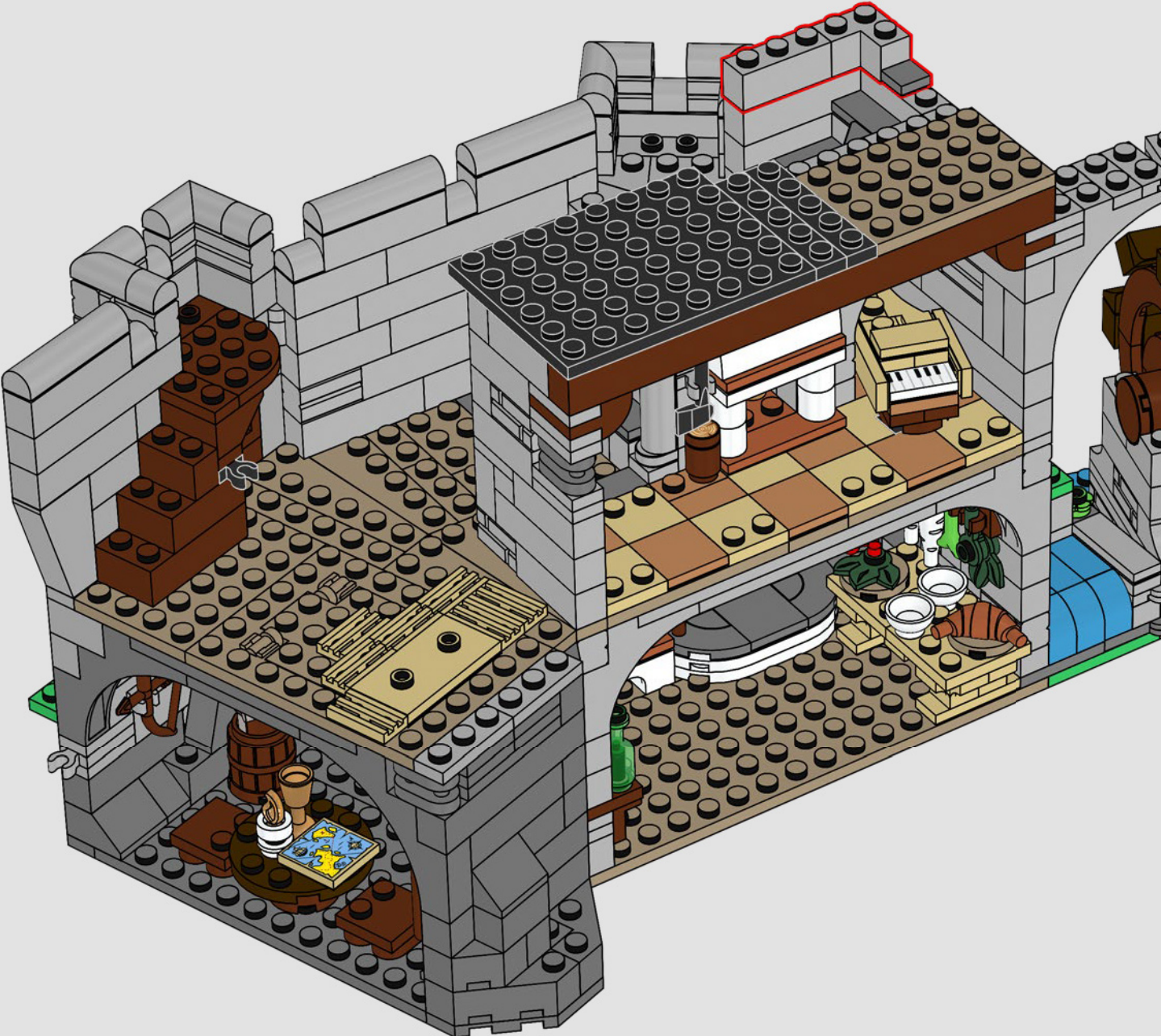

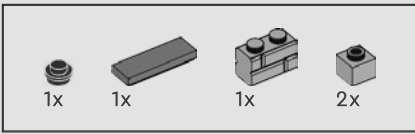

164

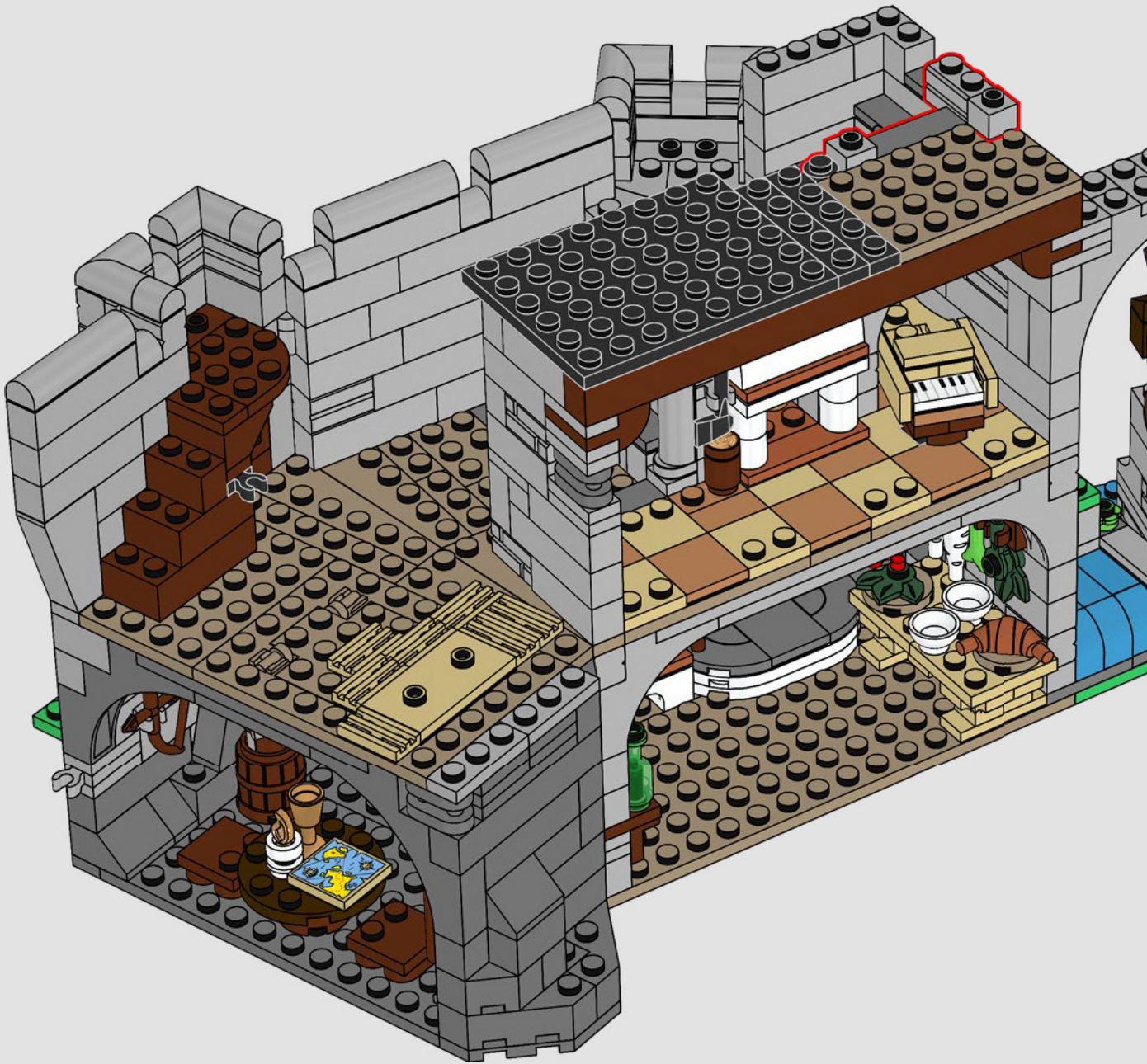

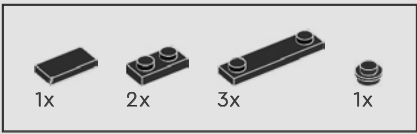

165



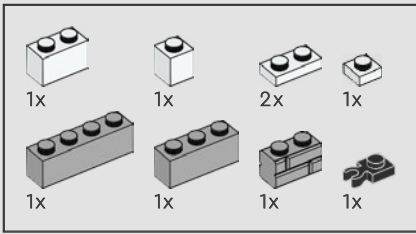

166

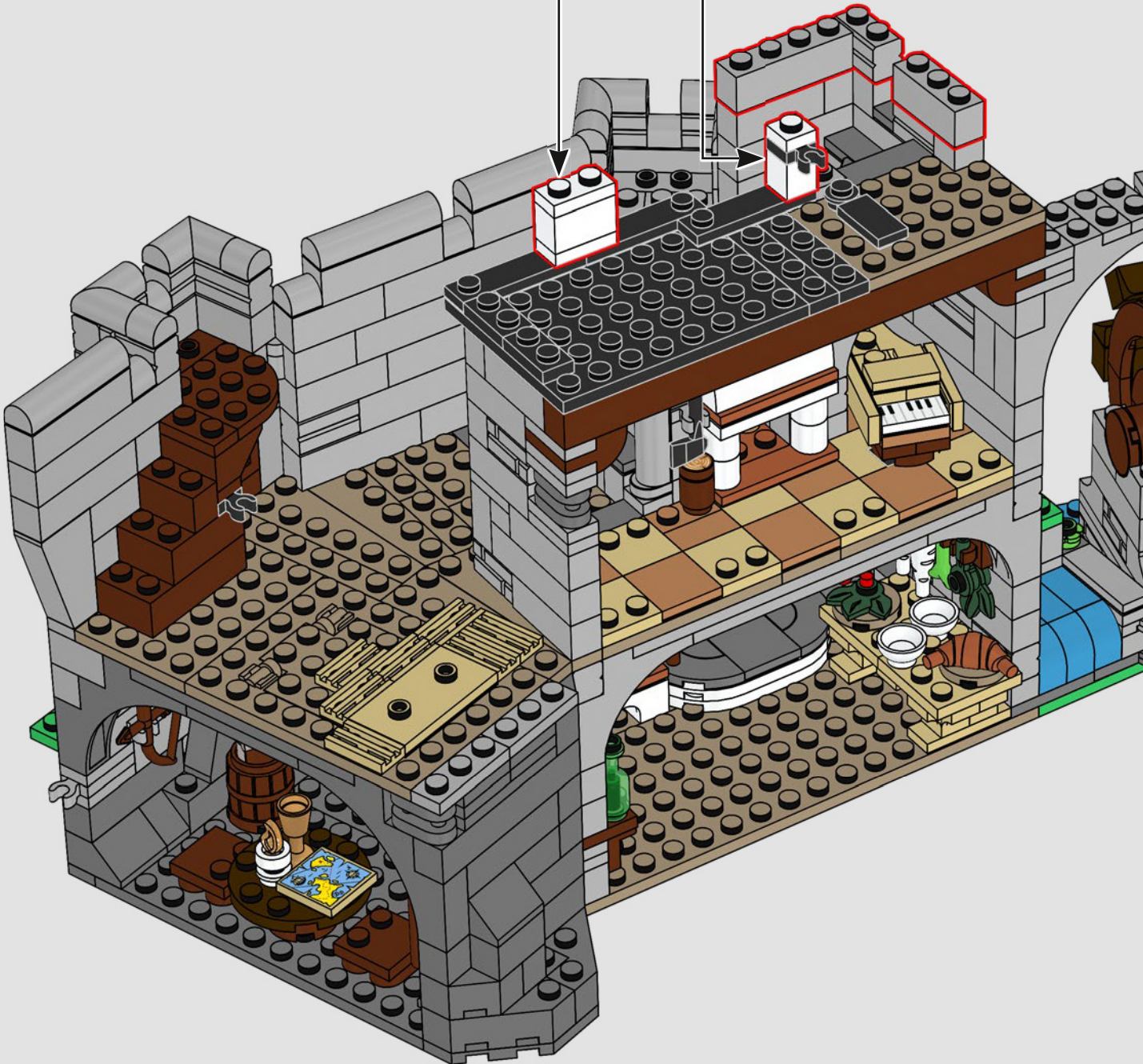
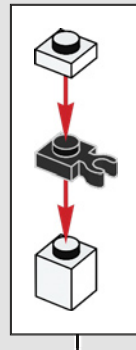
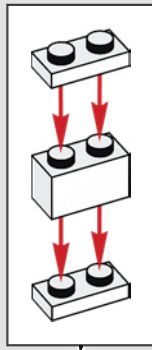

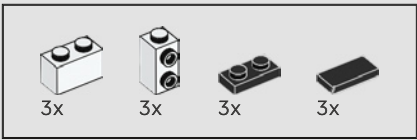

167

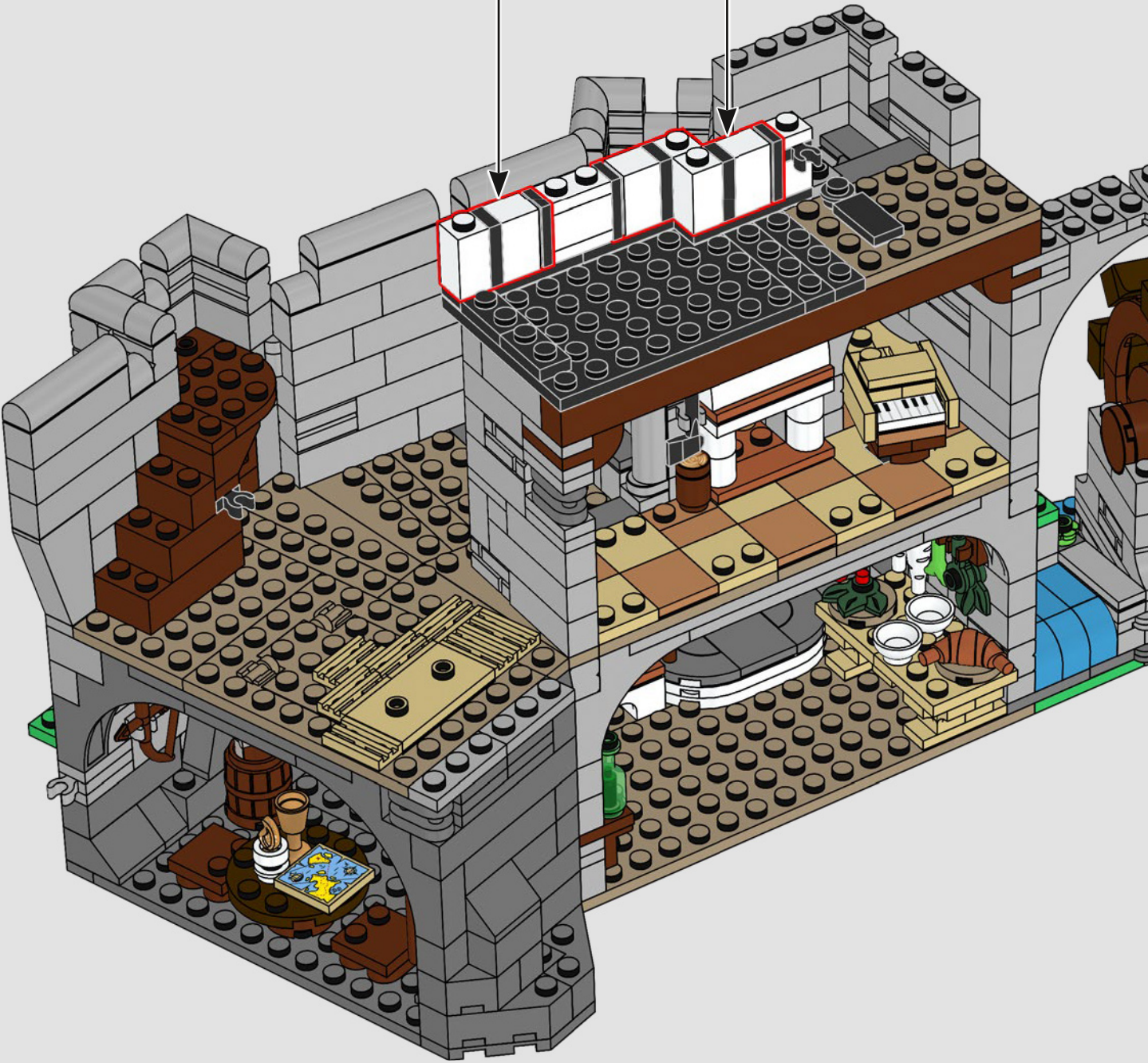
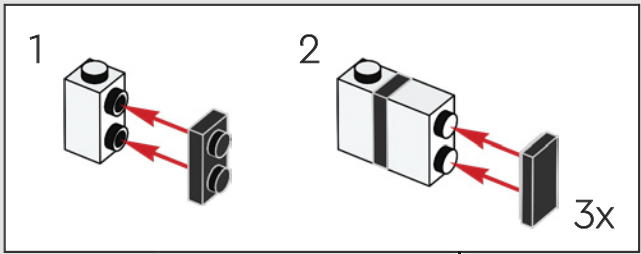

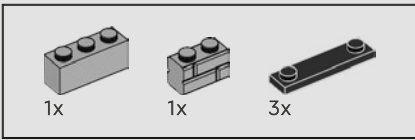

168

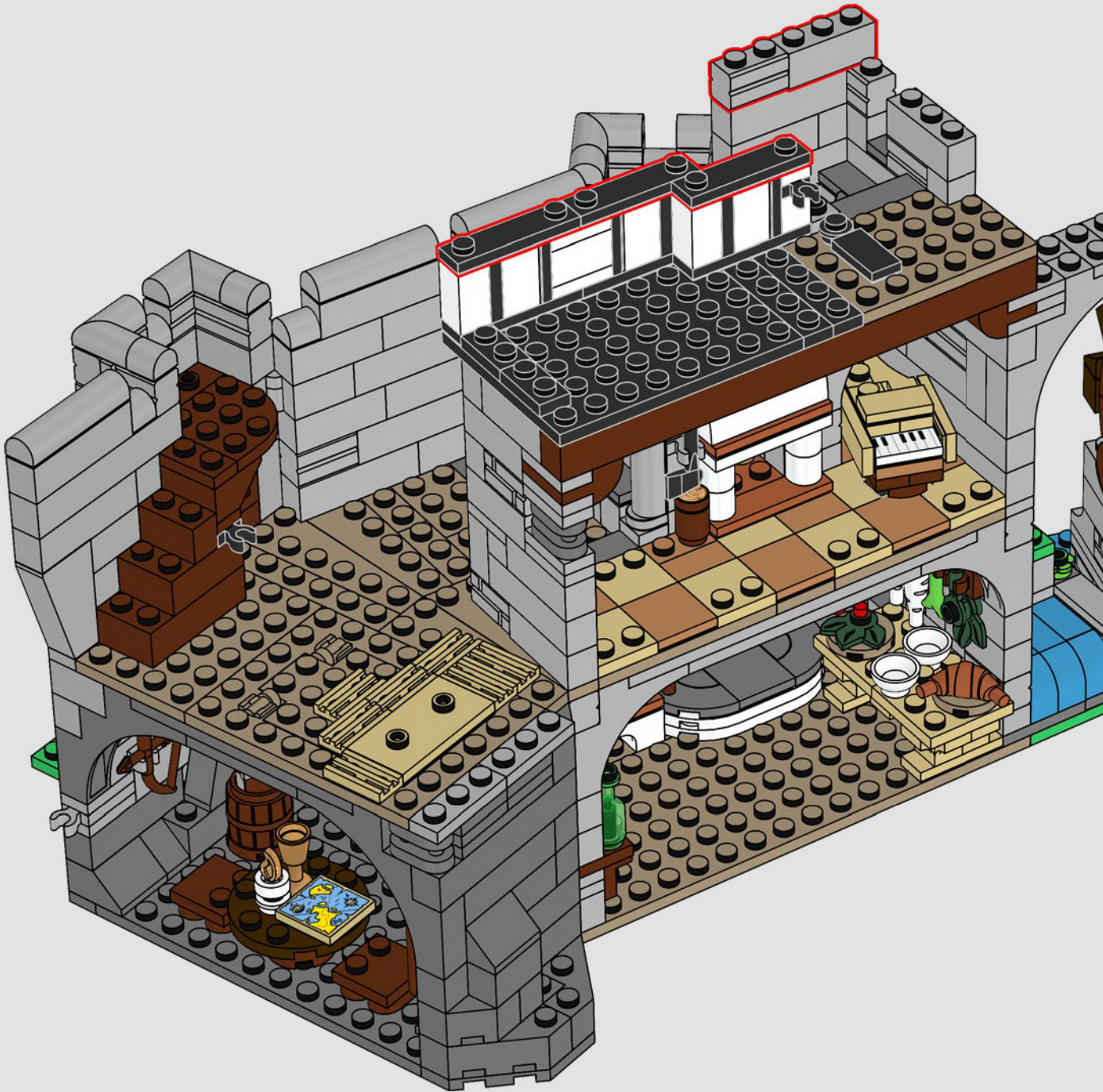

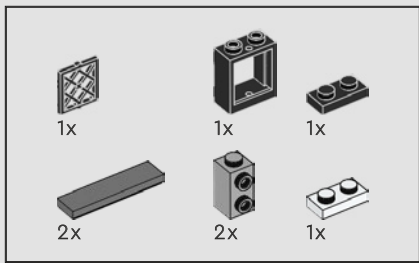

169

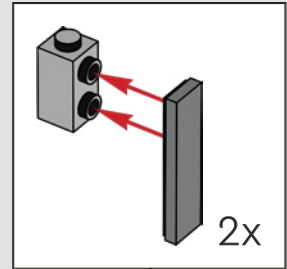
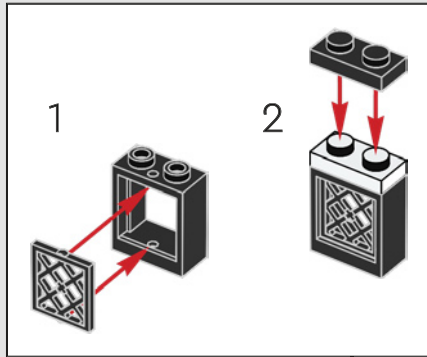

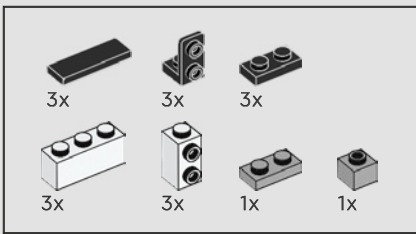

170

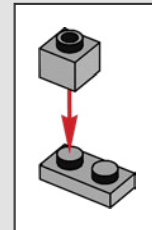
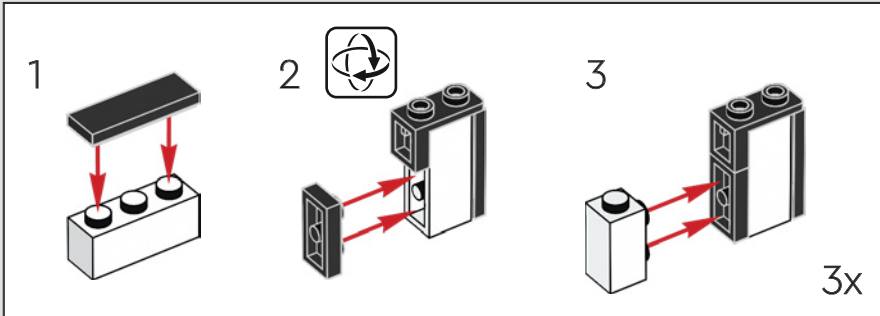

3x

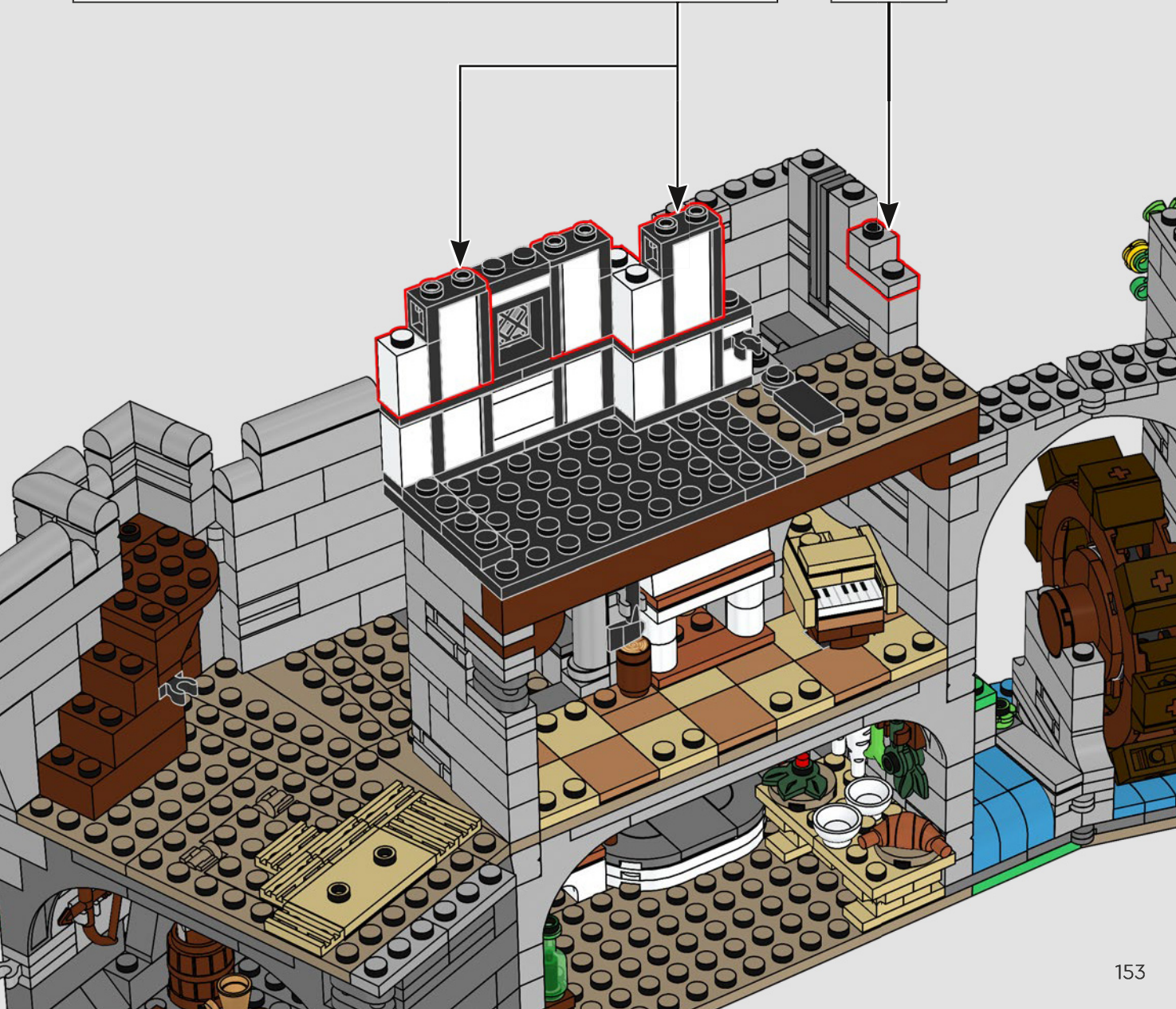

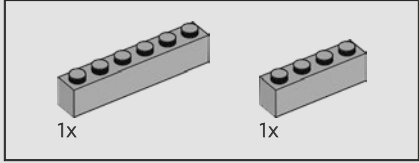
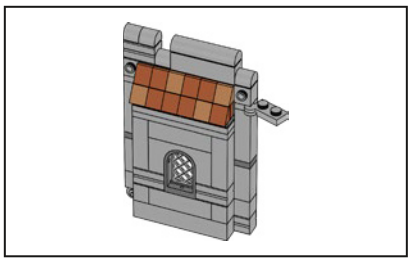

171

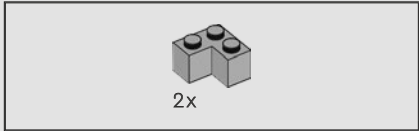
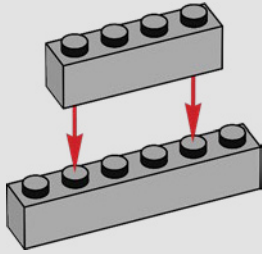

172

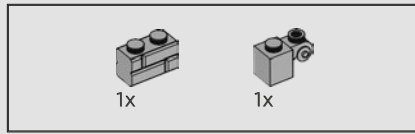
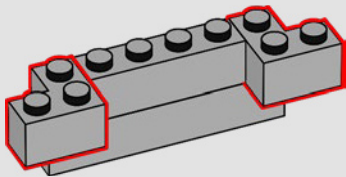

173

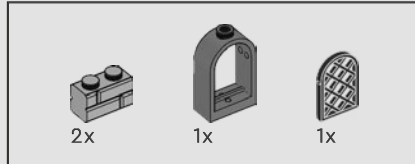
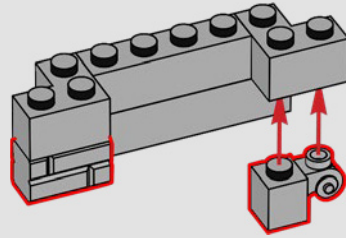

174

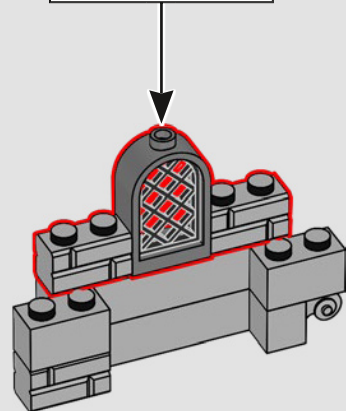
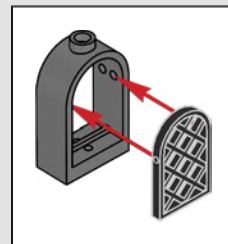

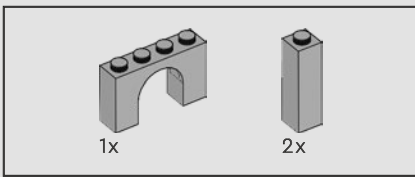

175

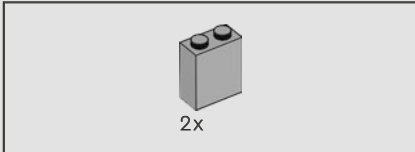
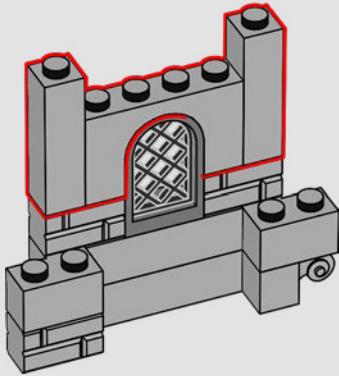

176

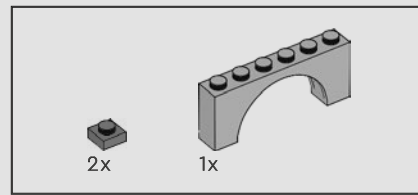
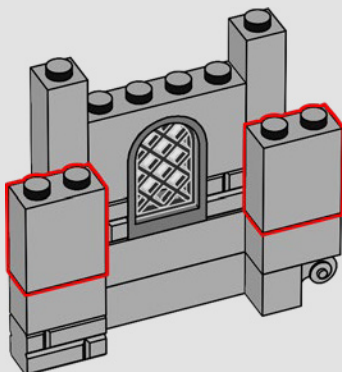

177

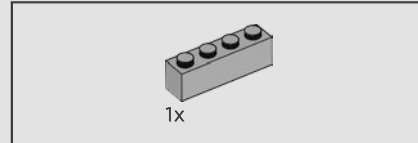
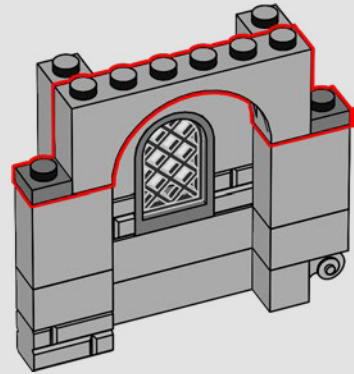

178

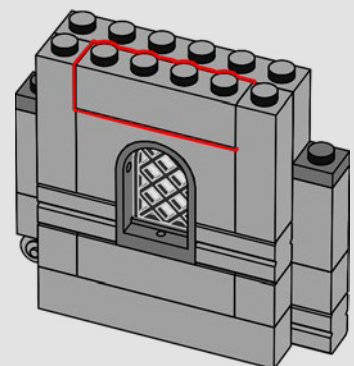

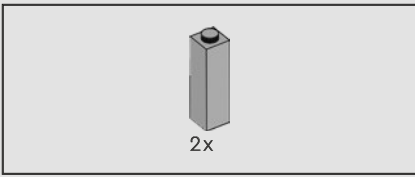

180

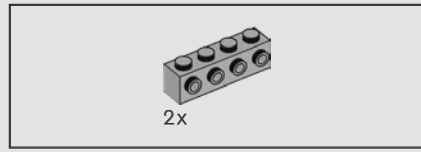
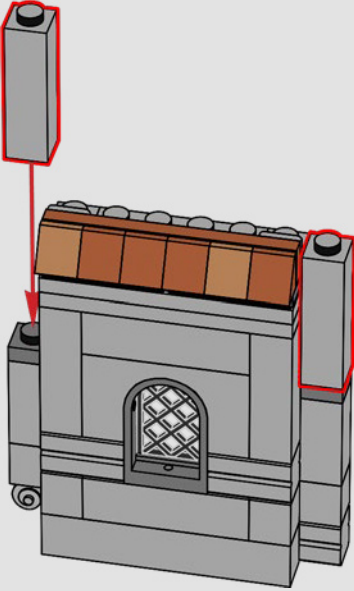

182

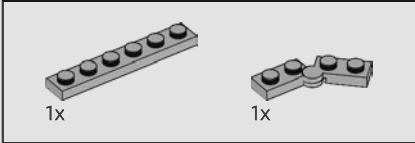
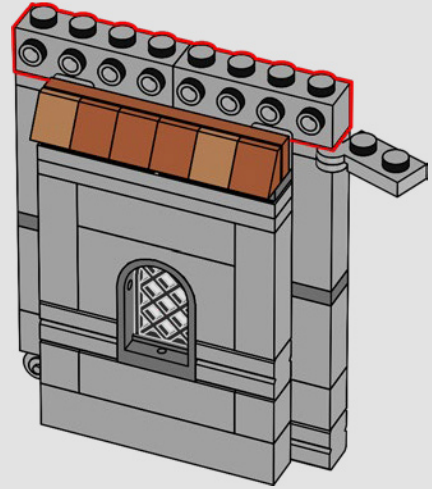

181

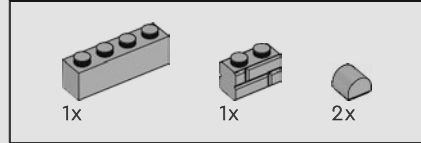
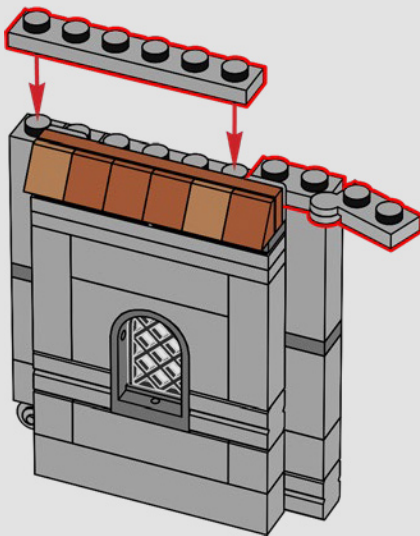

183

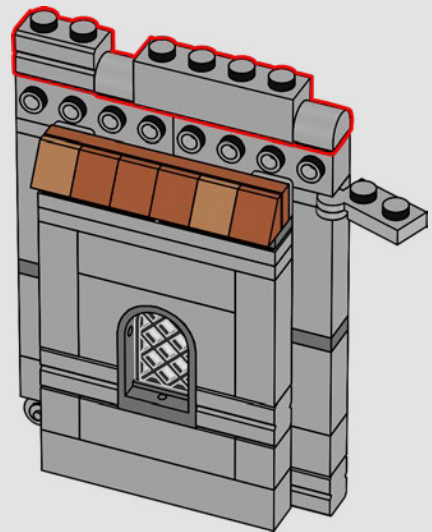

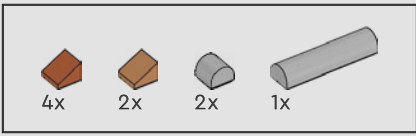

184

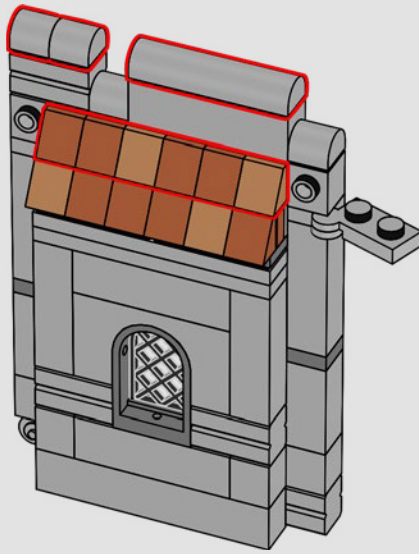

185

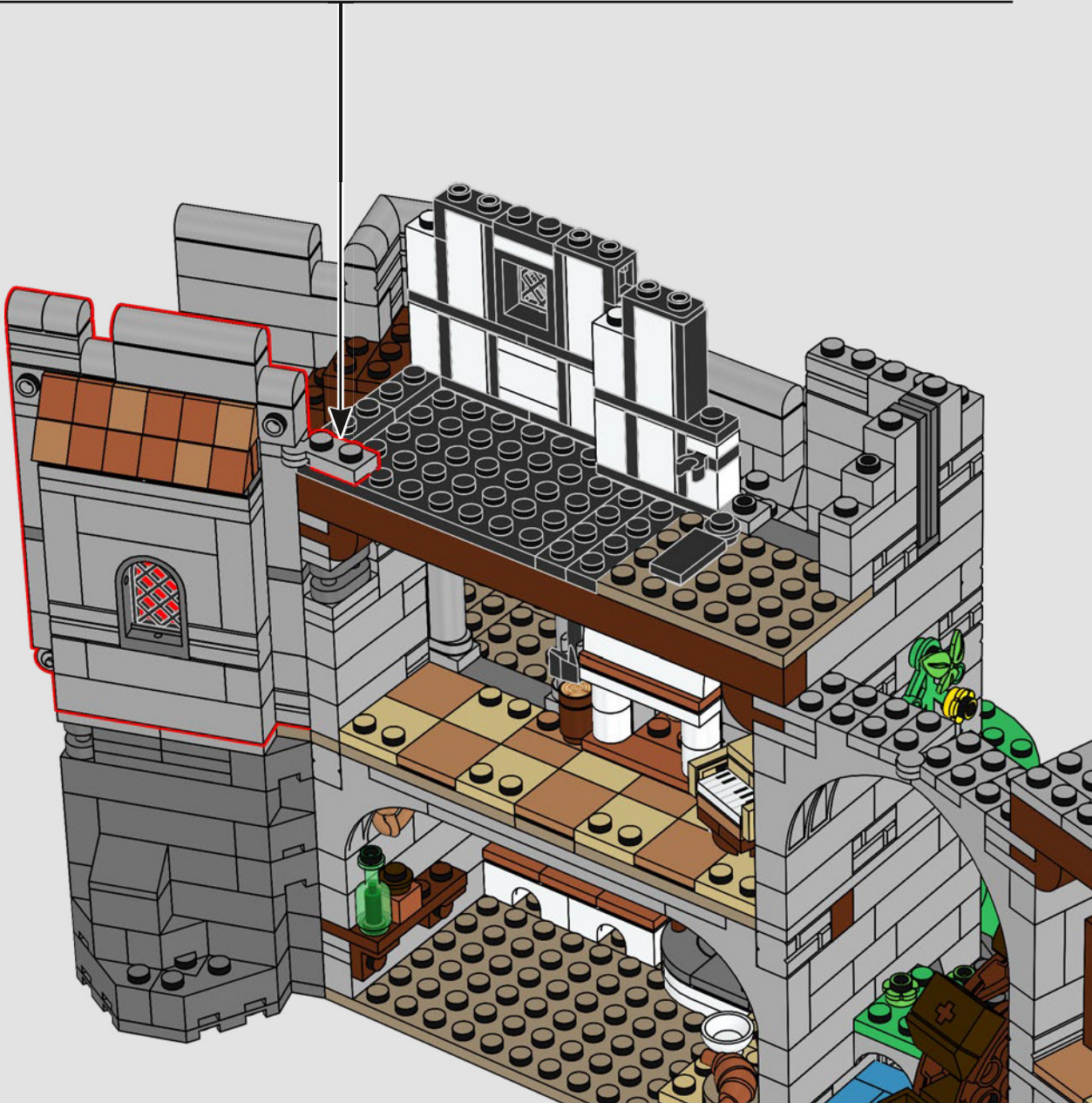

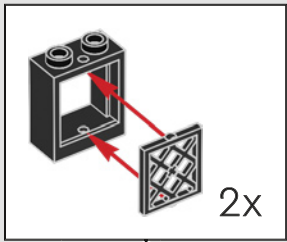

6

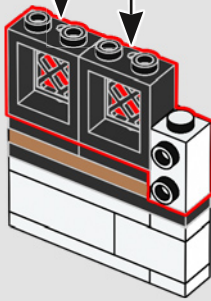

7

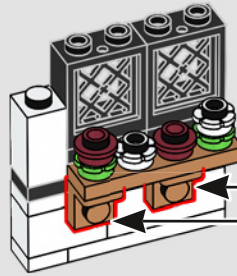

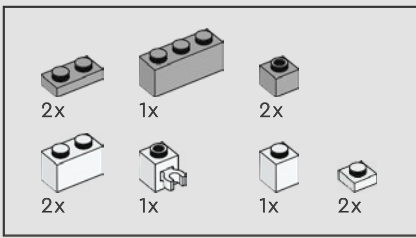

187

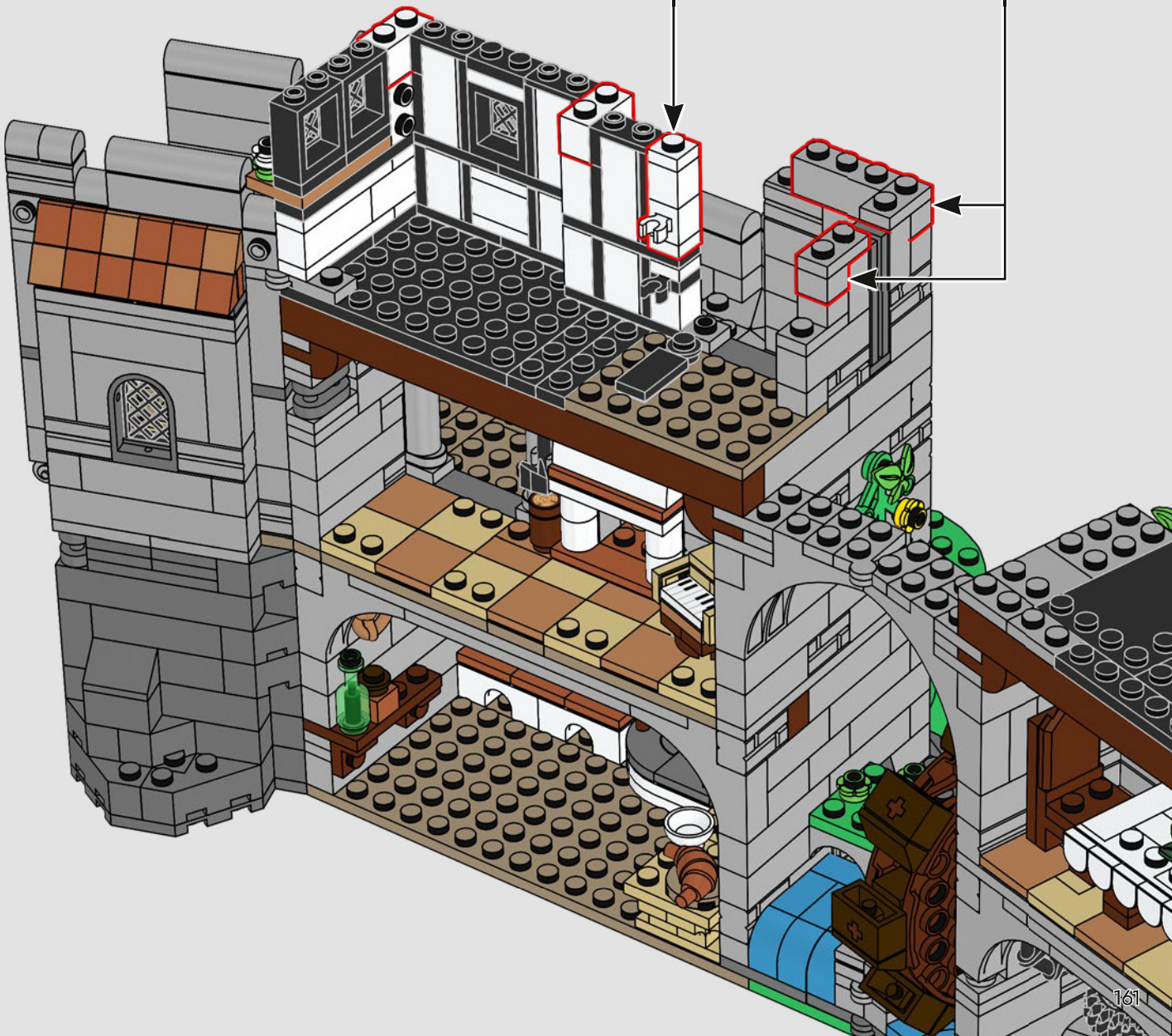
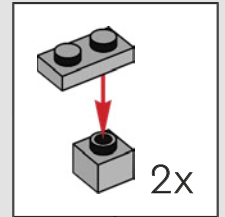
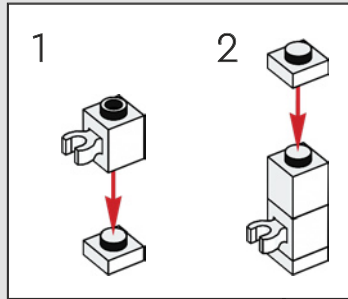

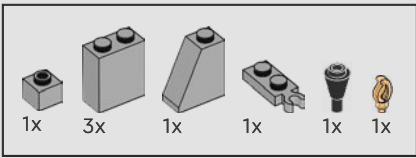

188

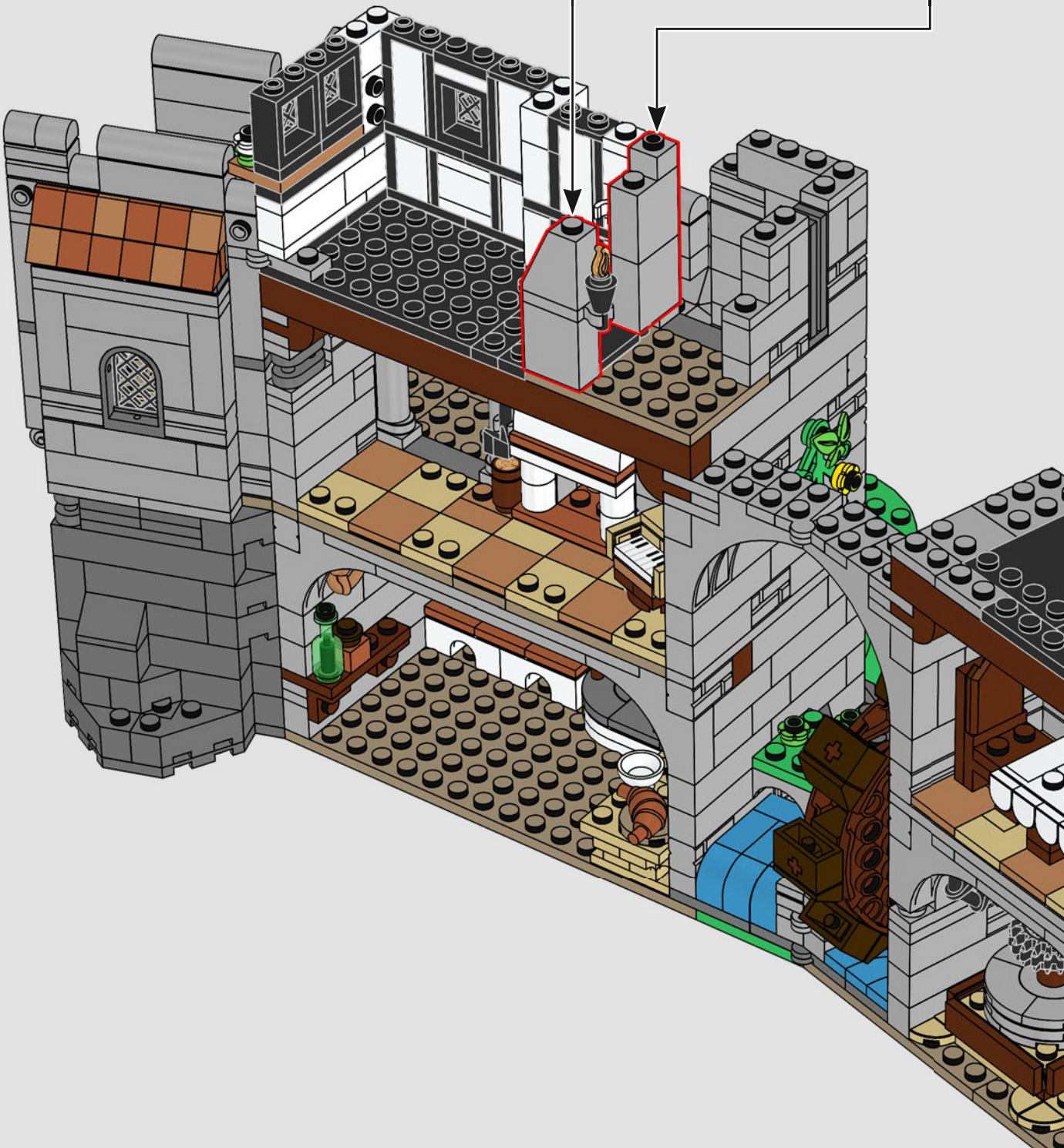
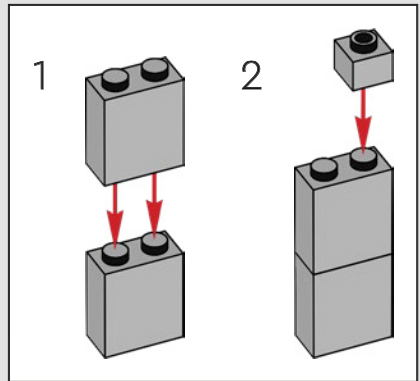
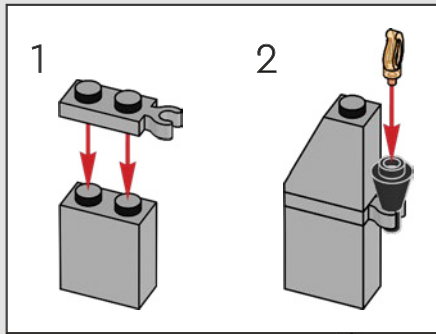

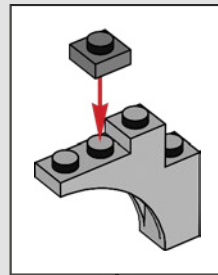
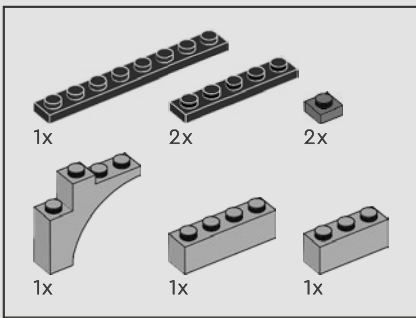

189

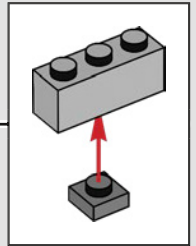
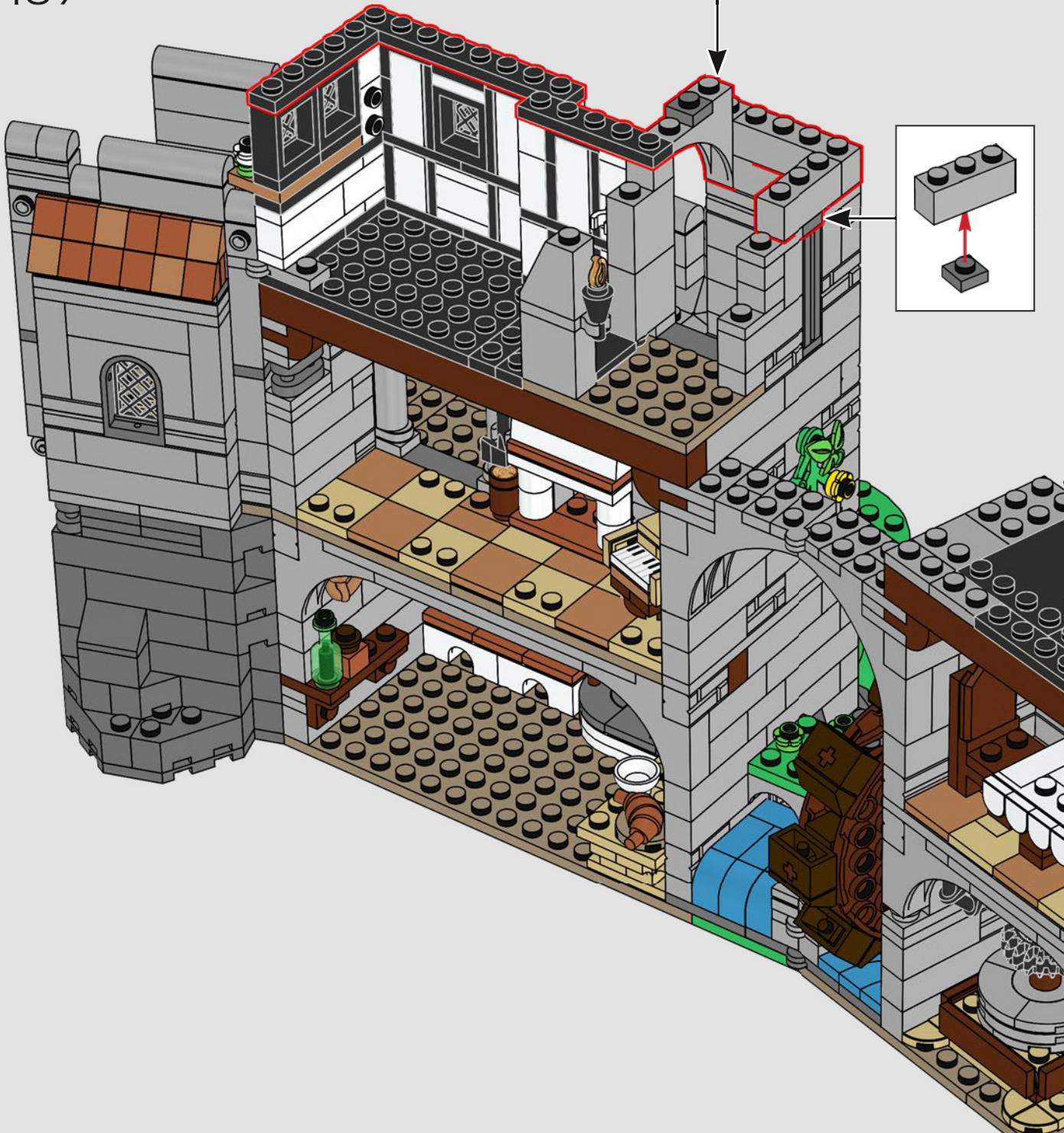

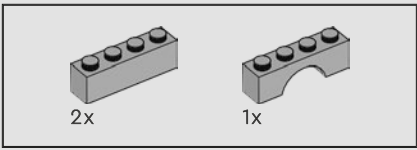

190

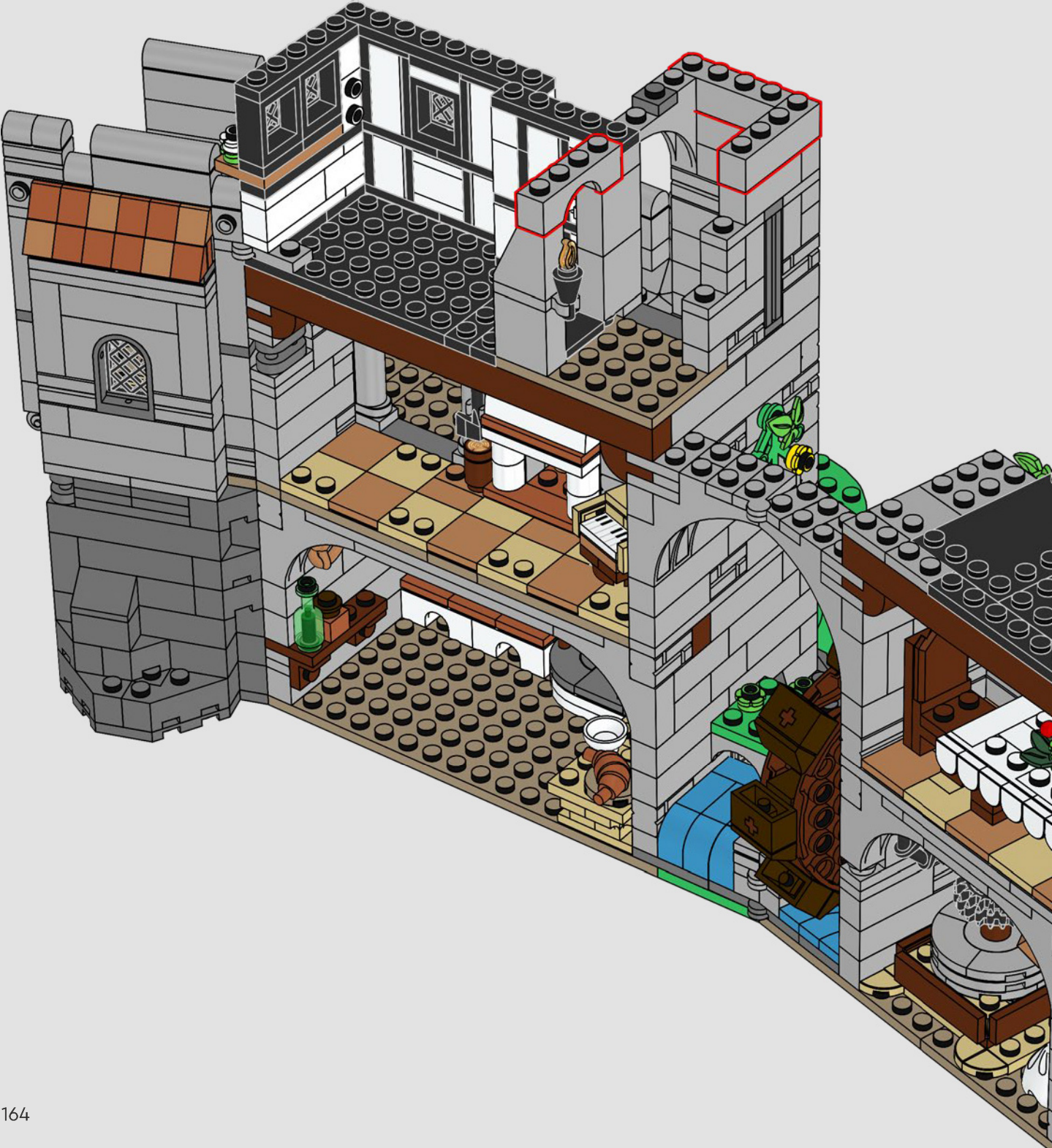



Welch eine wunderbare Kuriosität!
Erinnert mich an eine Burg vor
einigen Generationen ...



191

1

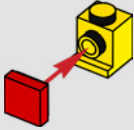

2

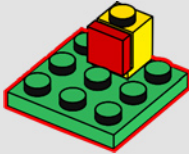

3

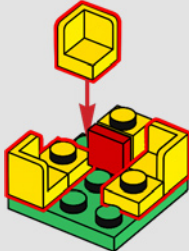

4

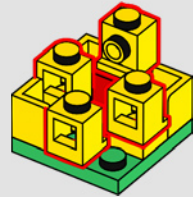

5

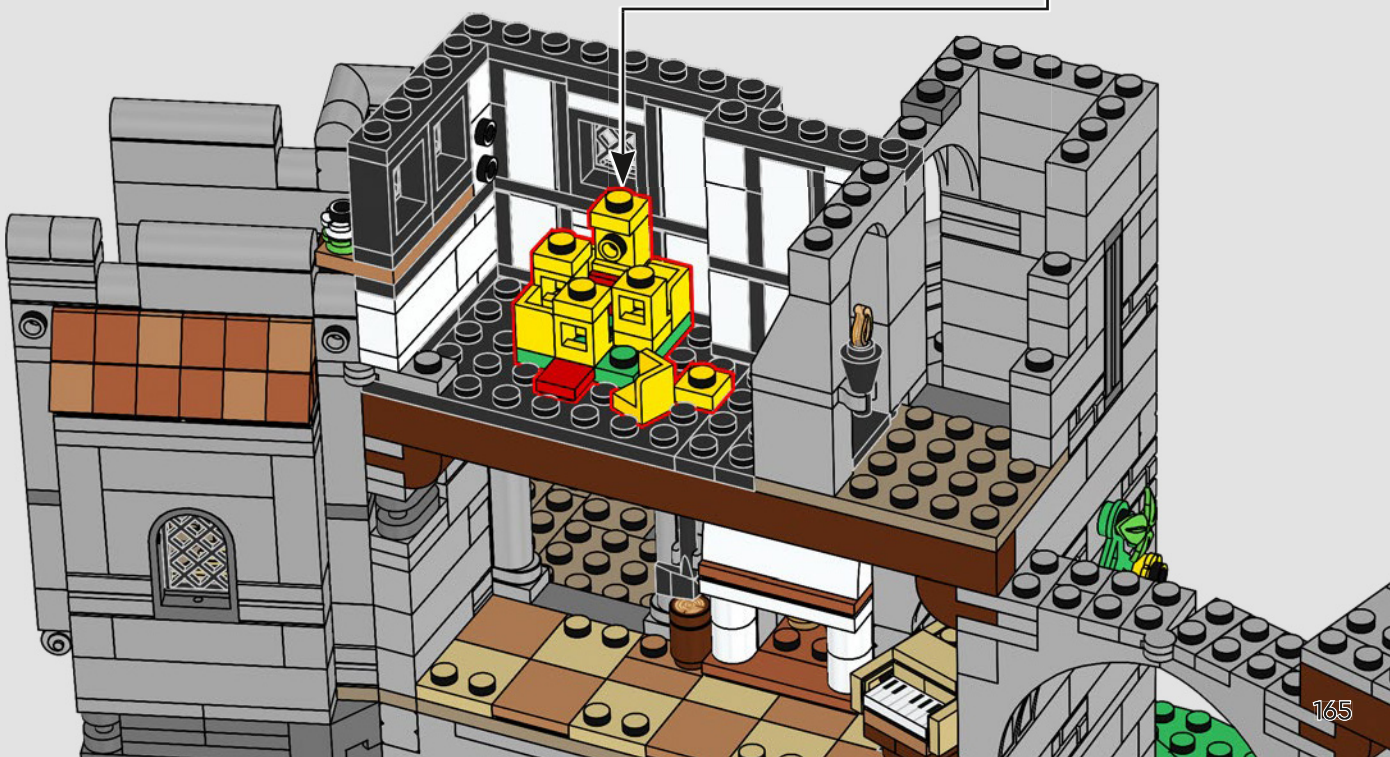
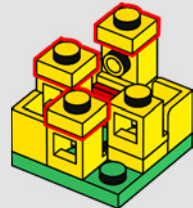

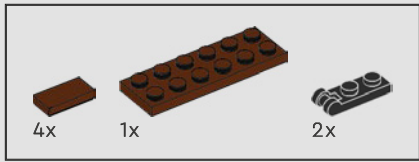

192

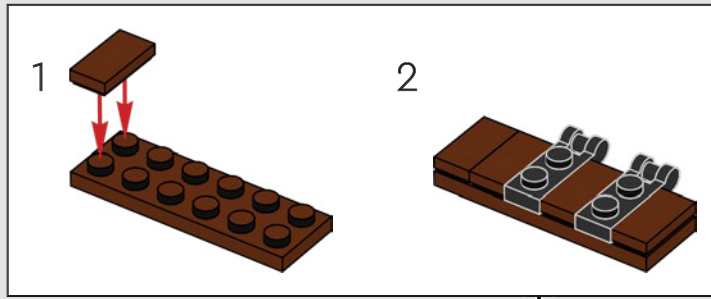

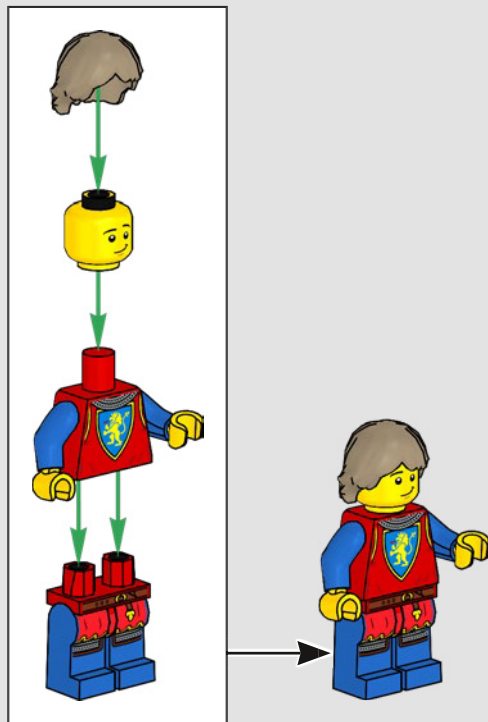

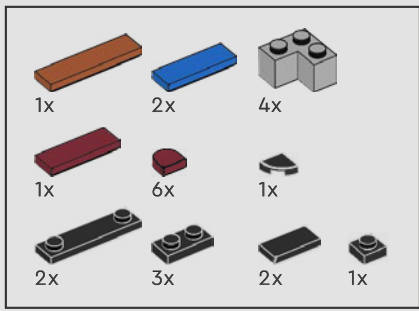

193

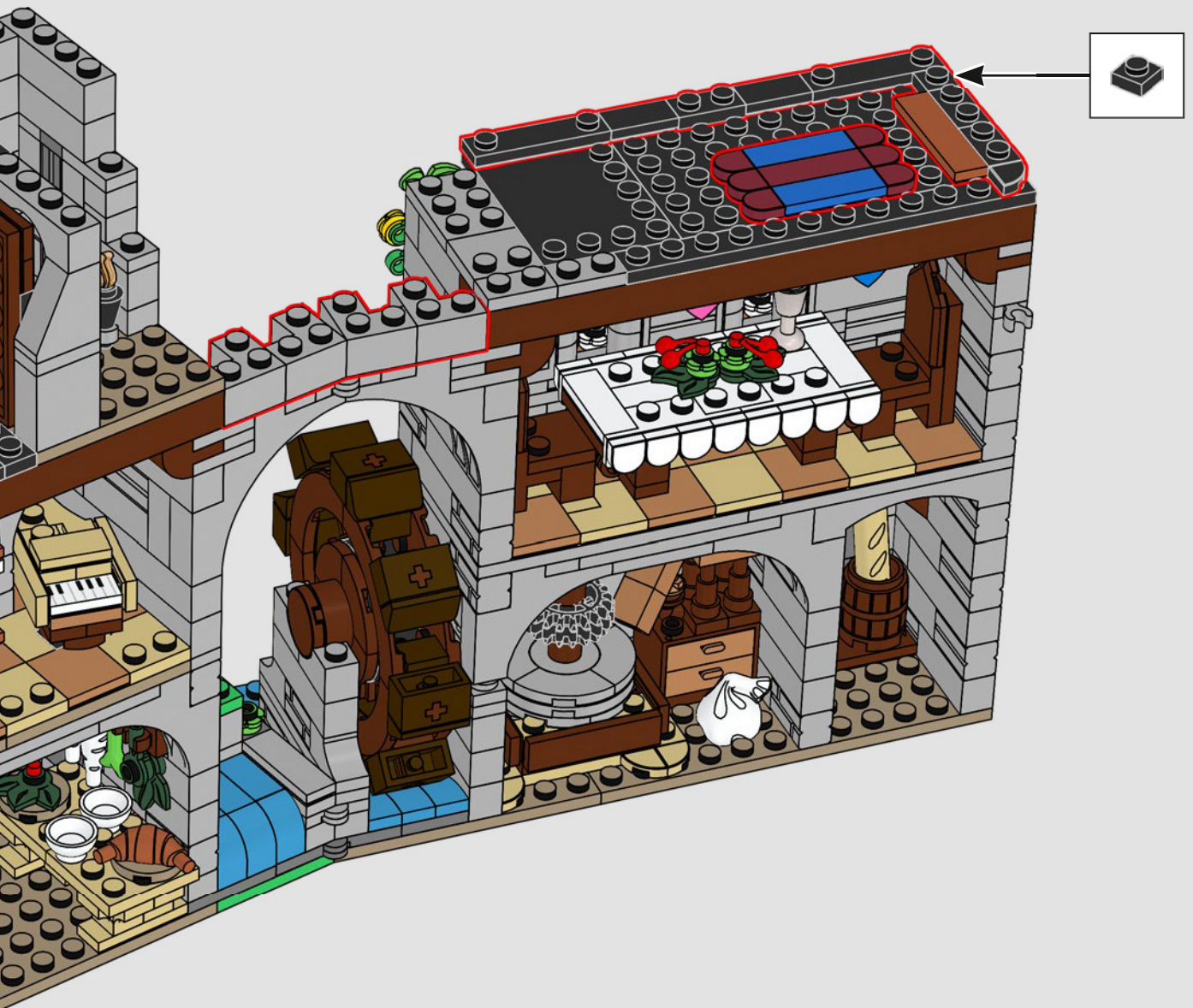

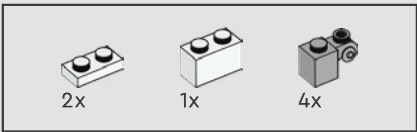

194

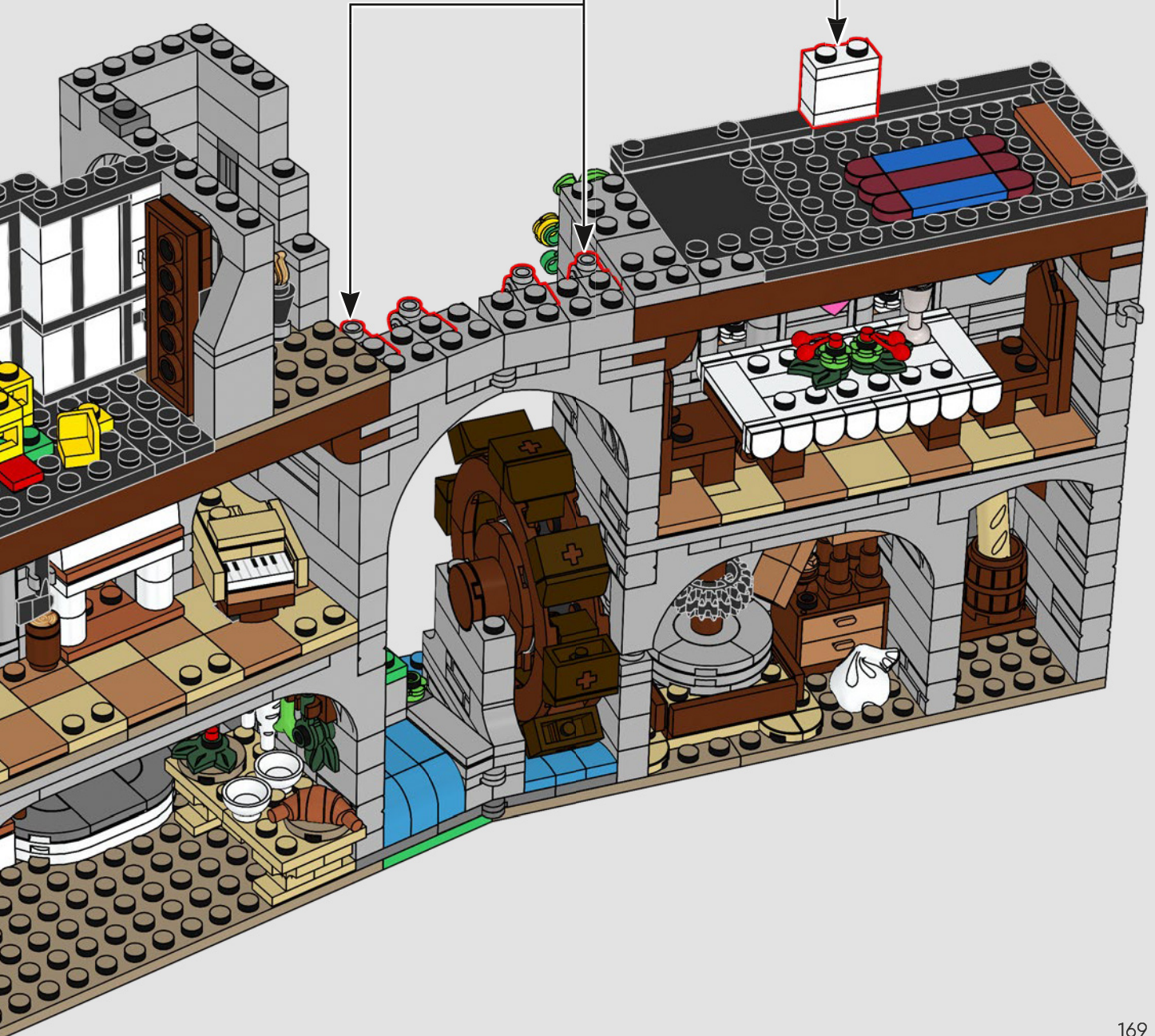
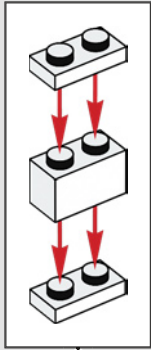
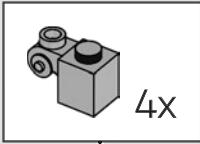

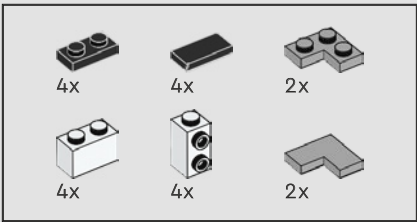

195

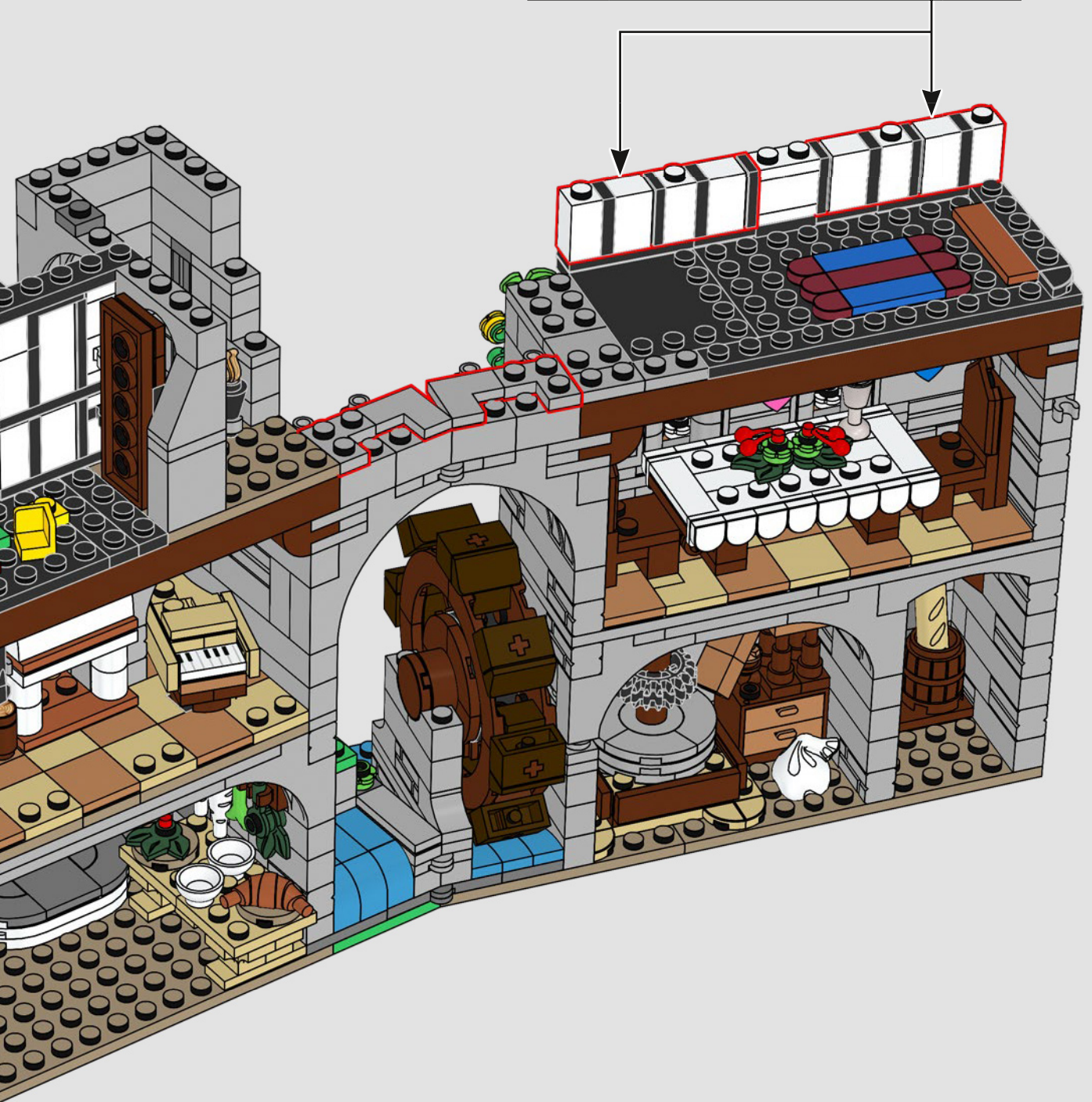
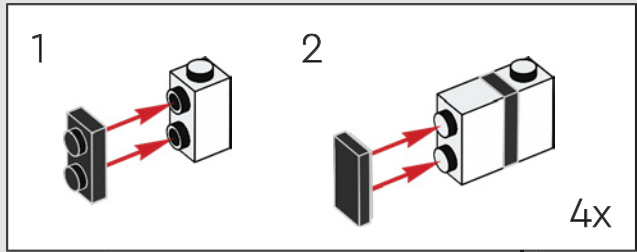

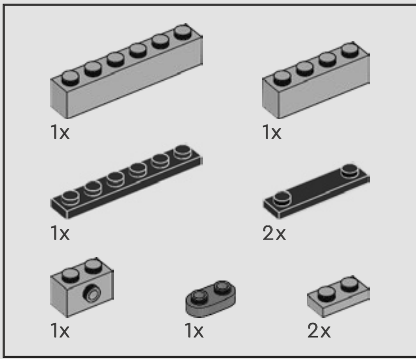

196

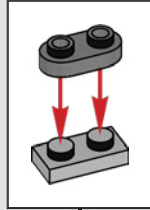

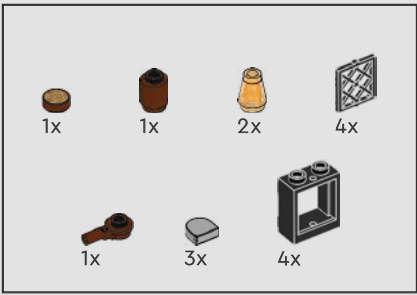

197

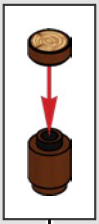
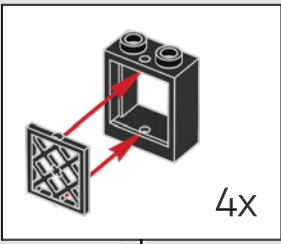

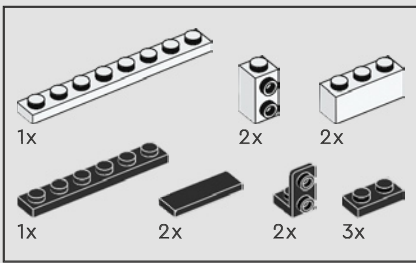

198

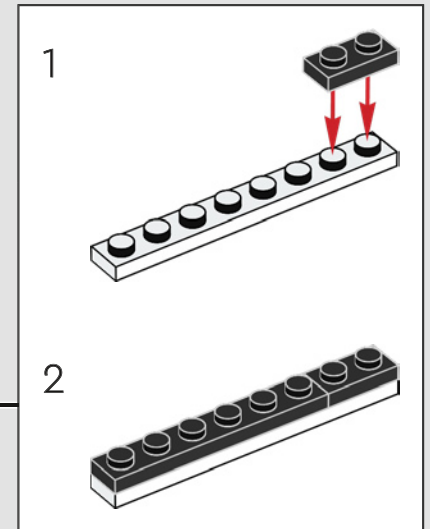
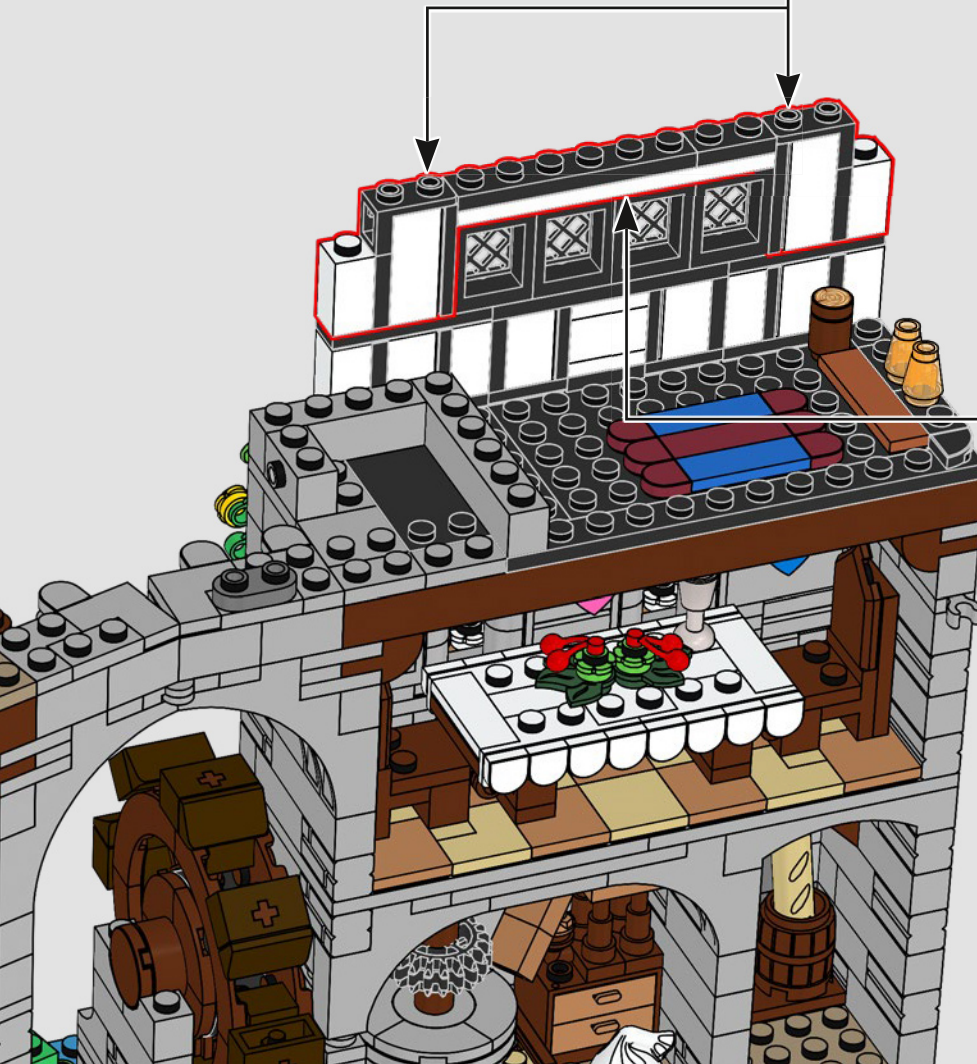
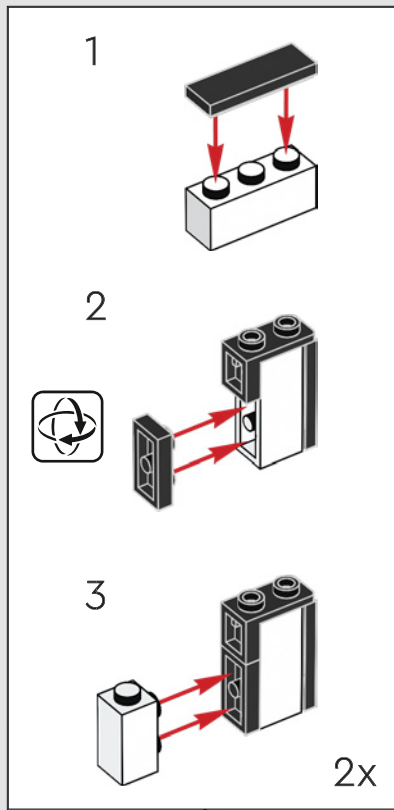

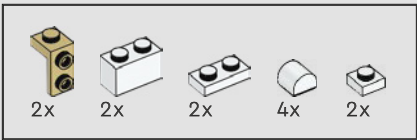

199

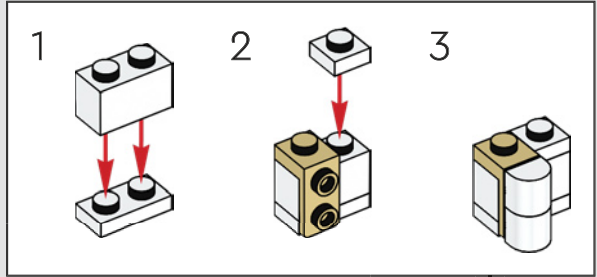
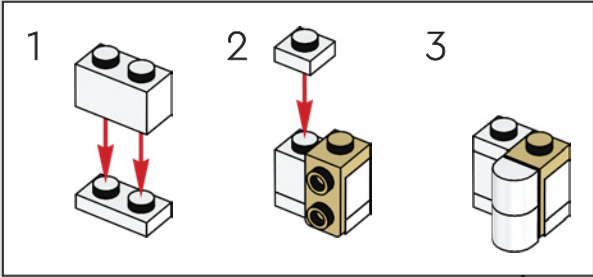

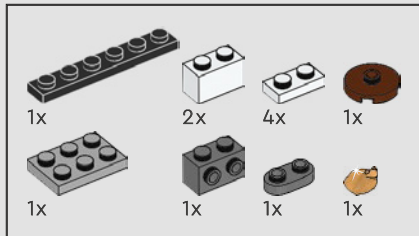

200

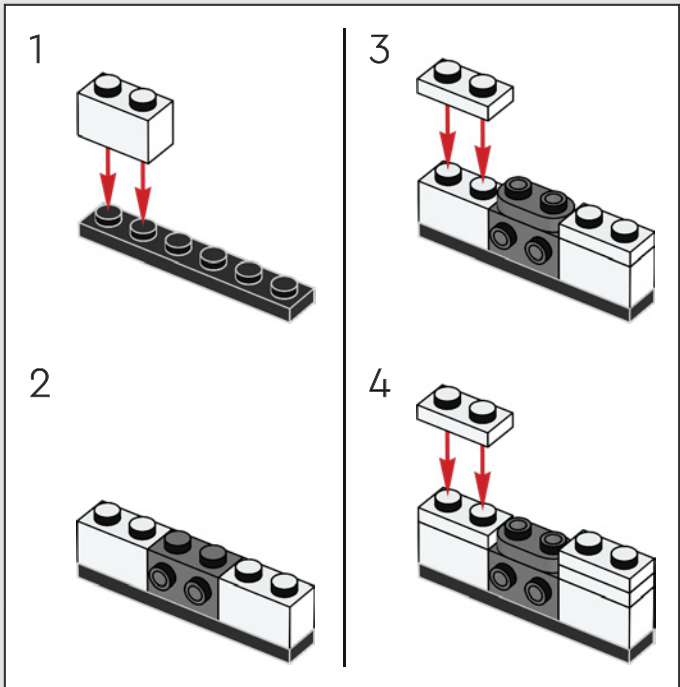
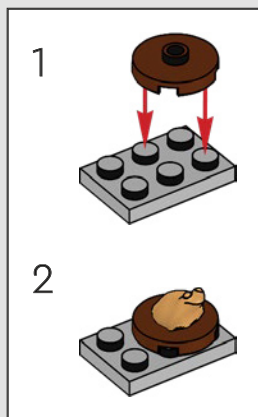

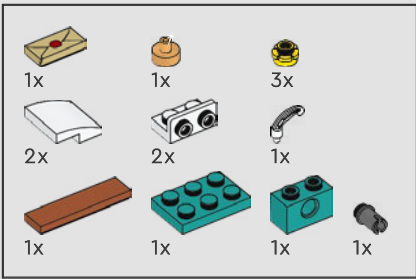

201



Was liegt da für ein seltsamer Brief auf dem Tisch? Und warum trägt er das Siegel von Lord Basil?

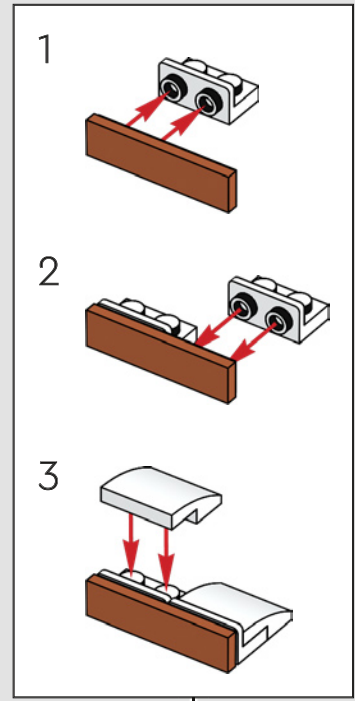
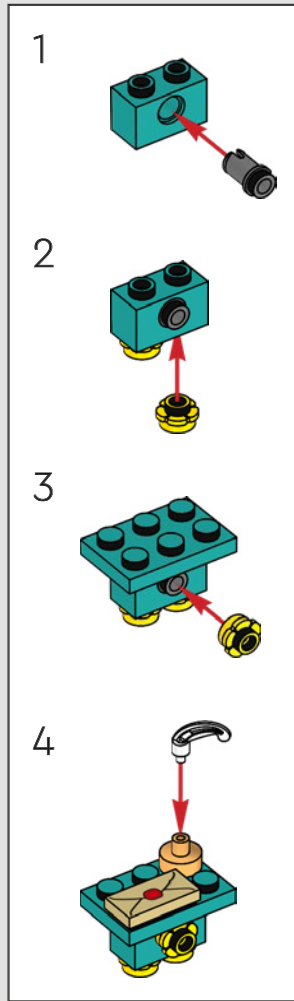

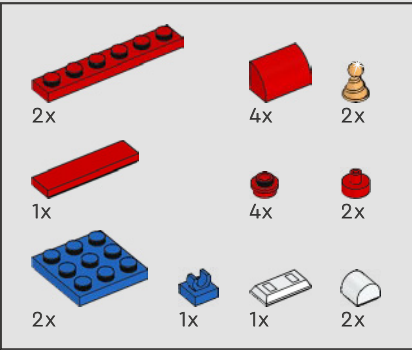
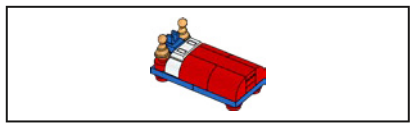

202

1

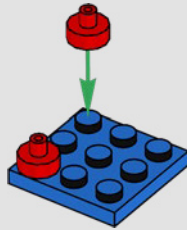

2

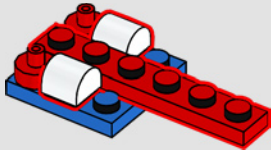

3

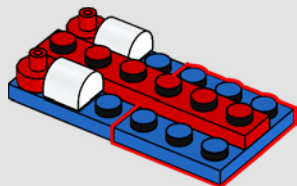

4

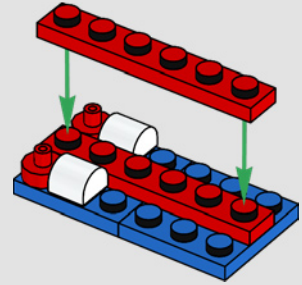

5

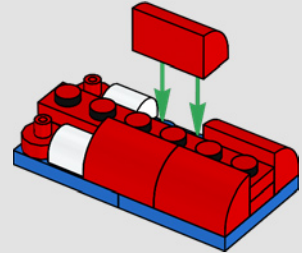

6

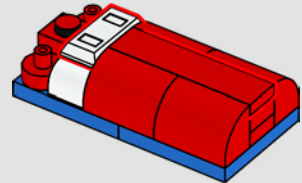

7

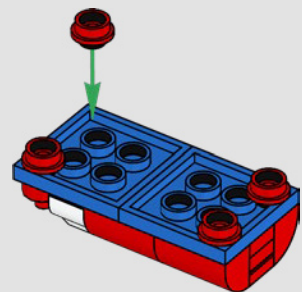

8

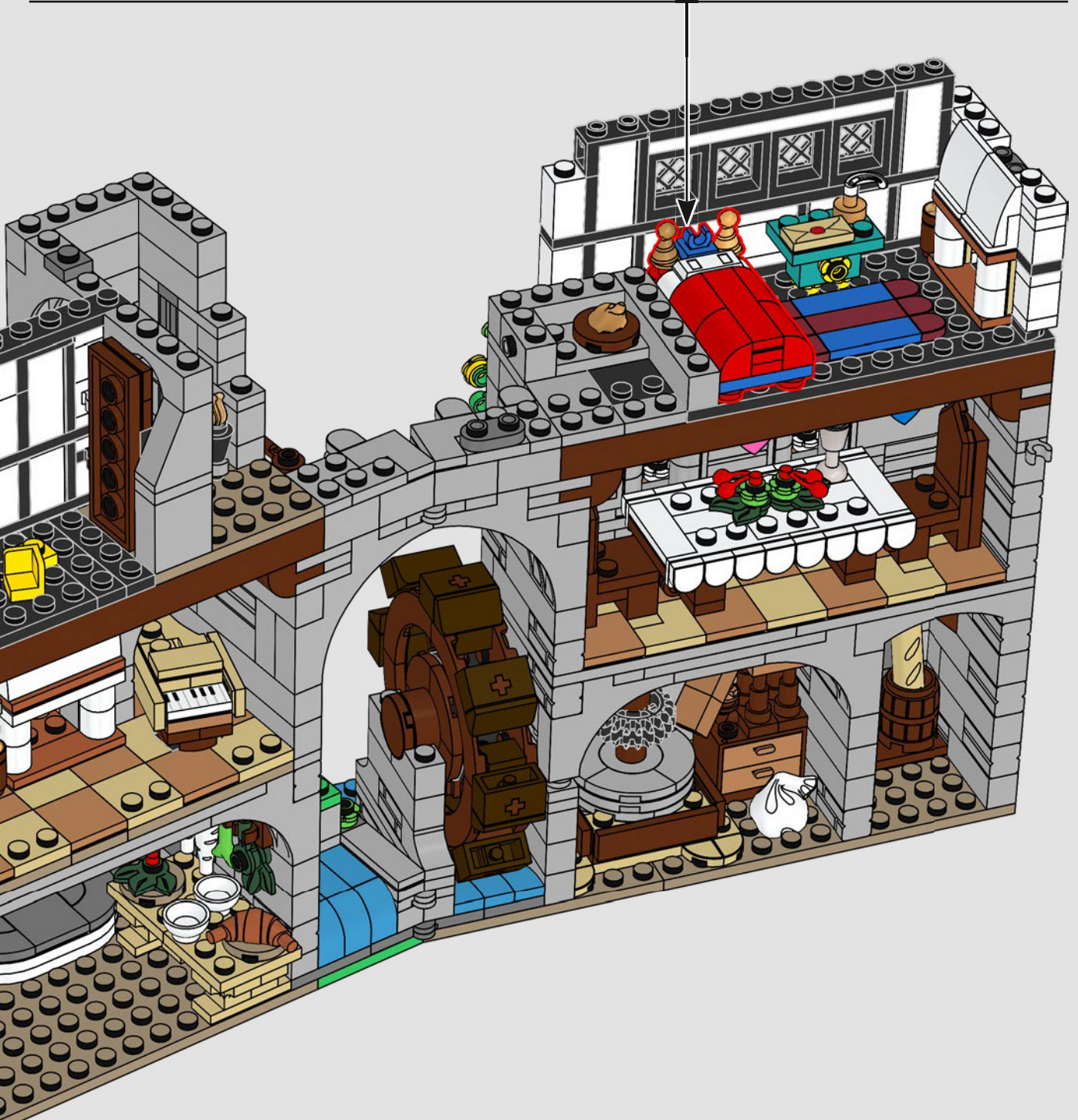
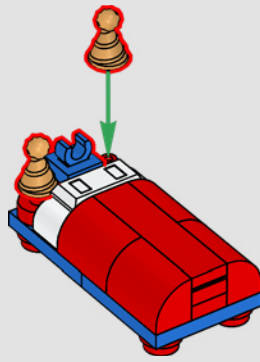

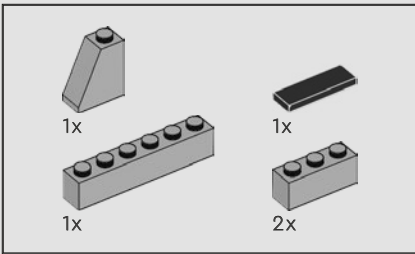

203

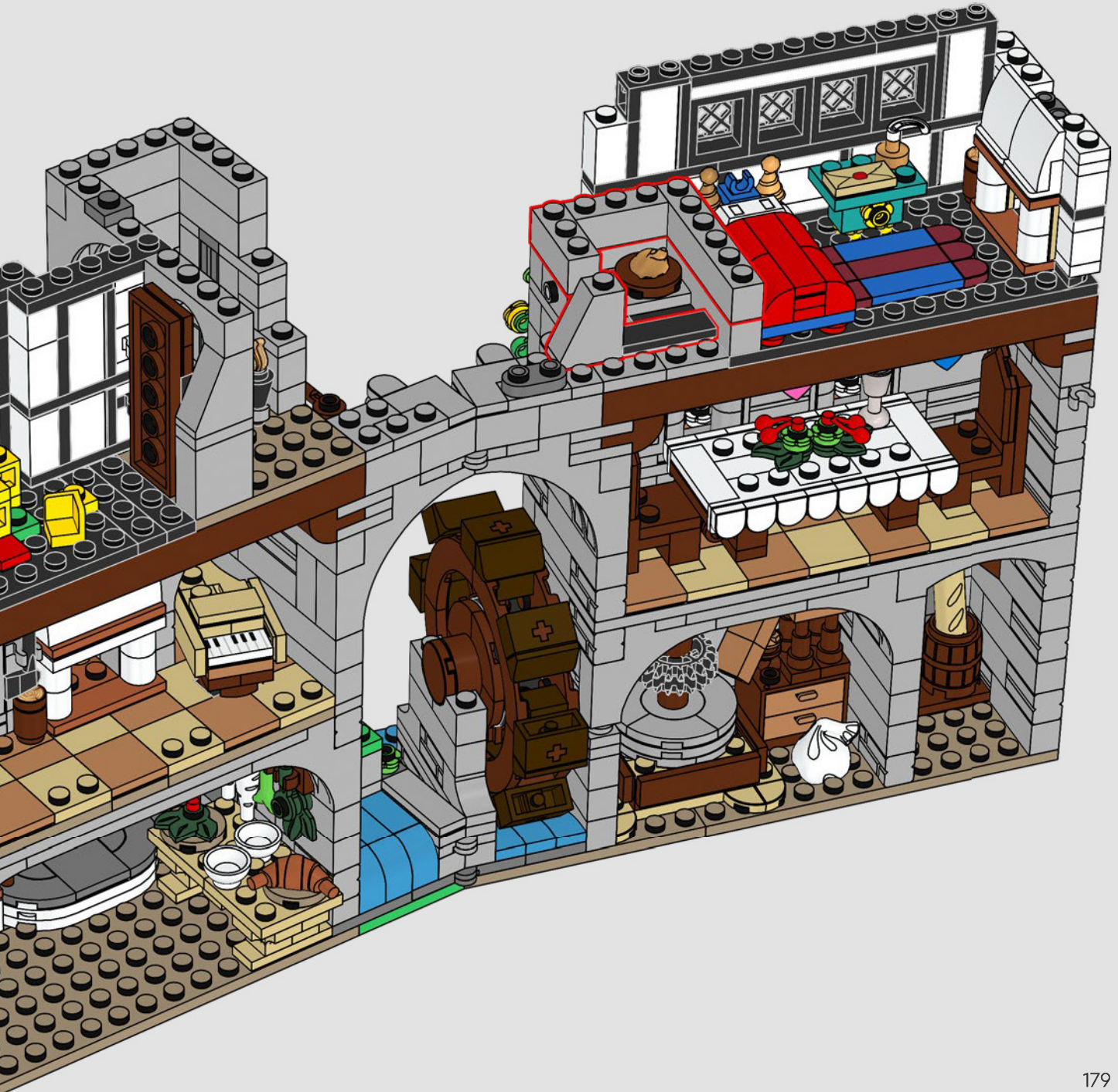

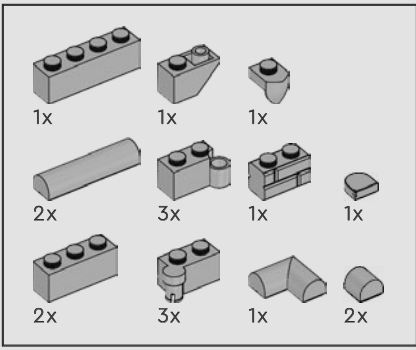

204

1

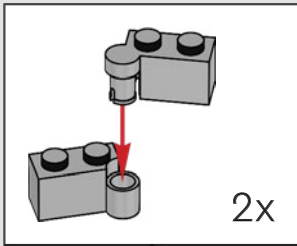
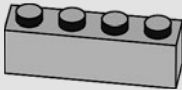

2

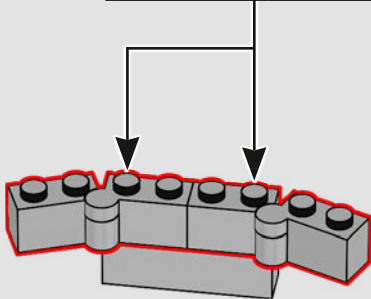

3

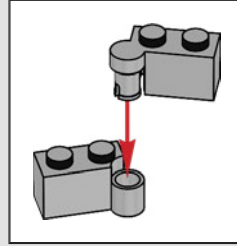
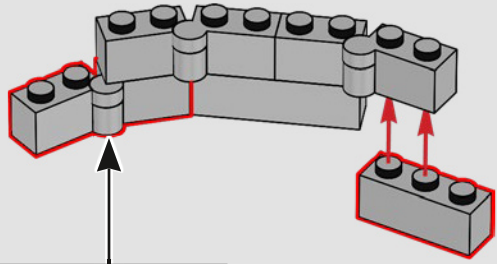

4

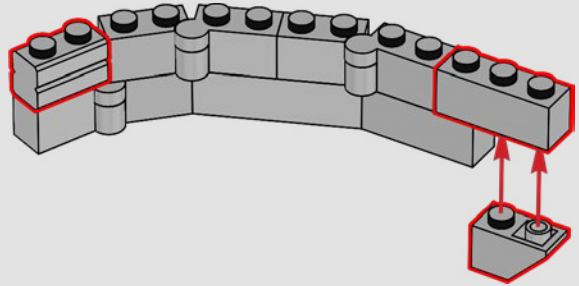

5

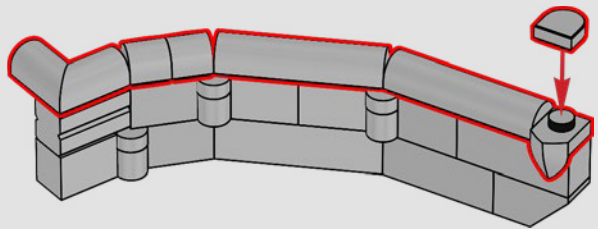

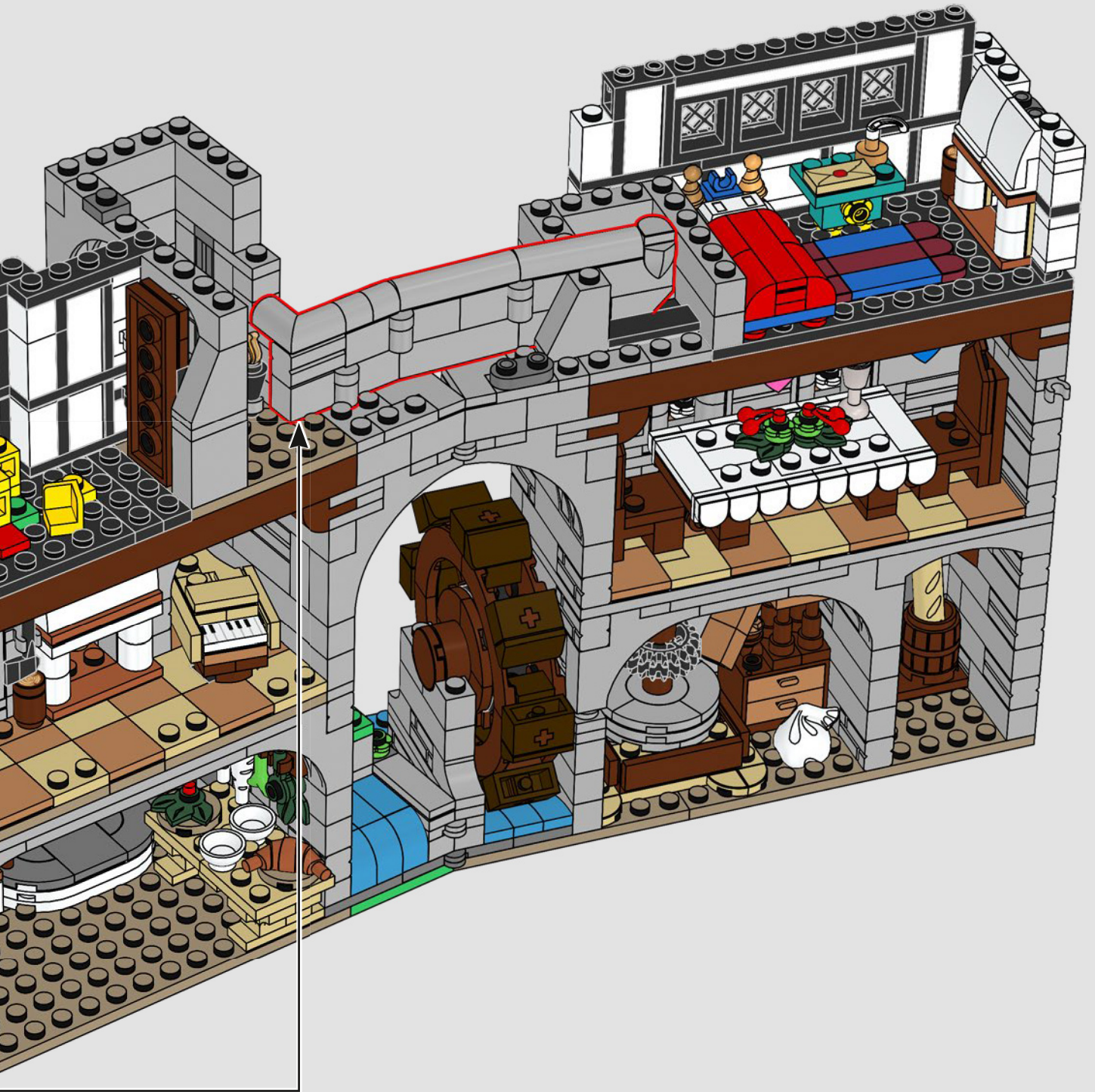



*Dieser Mauer wohnt Magie inne!
Um dieses Rätsel zu ergründen, sind
weitere Studien erforderlich.*

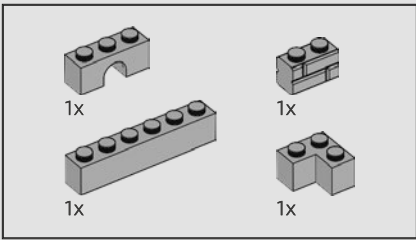

205

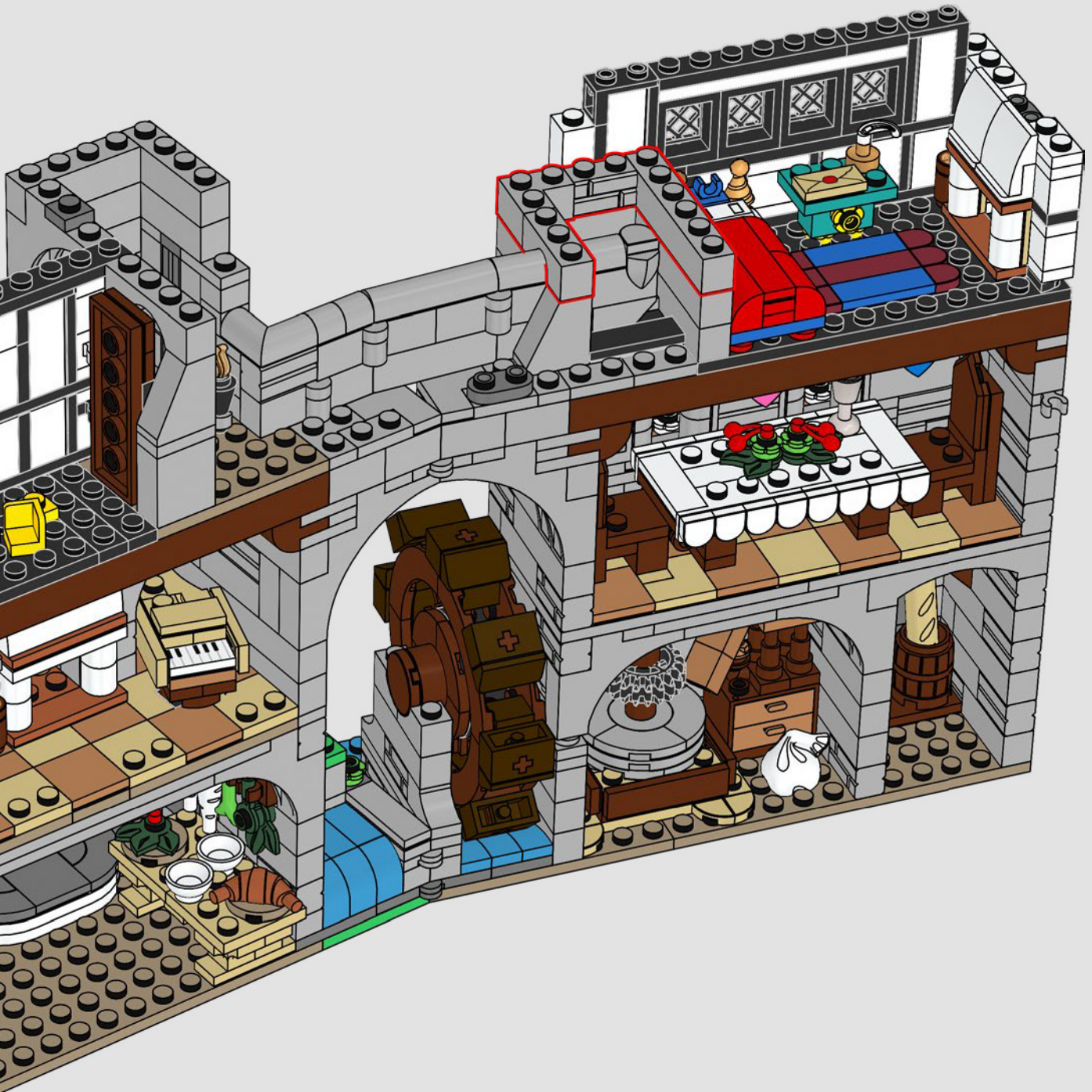

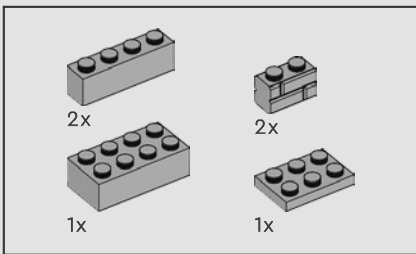

206

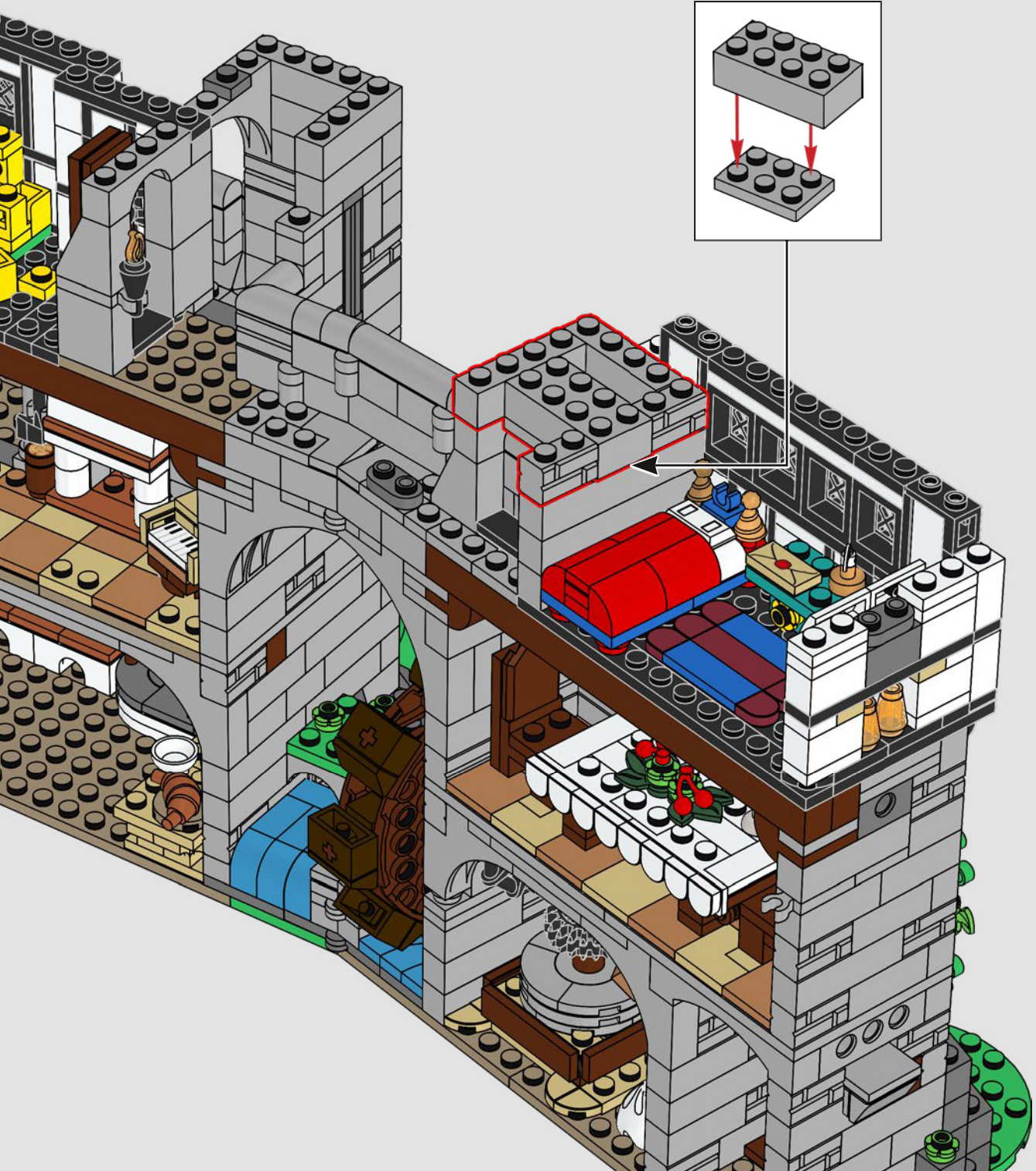

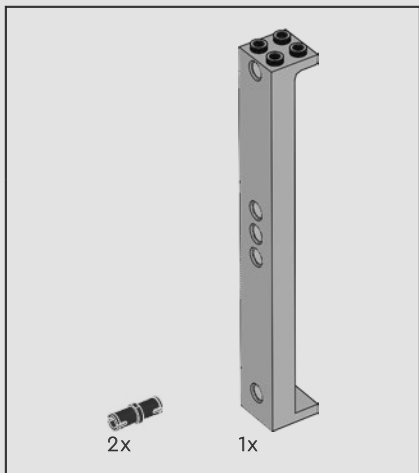

207

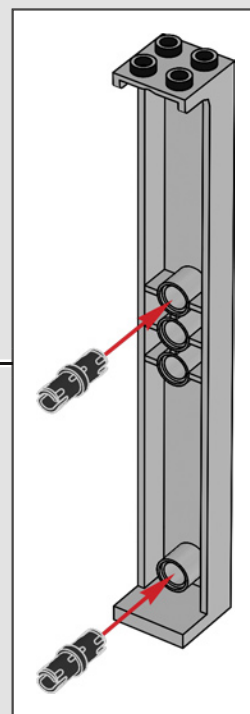
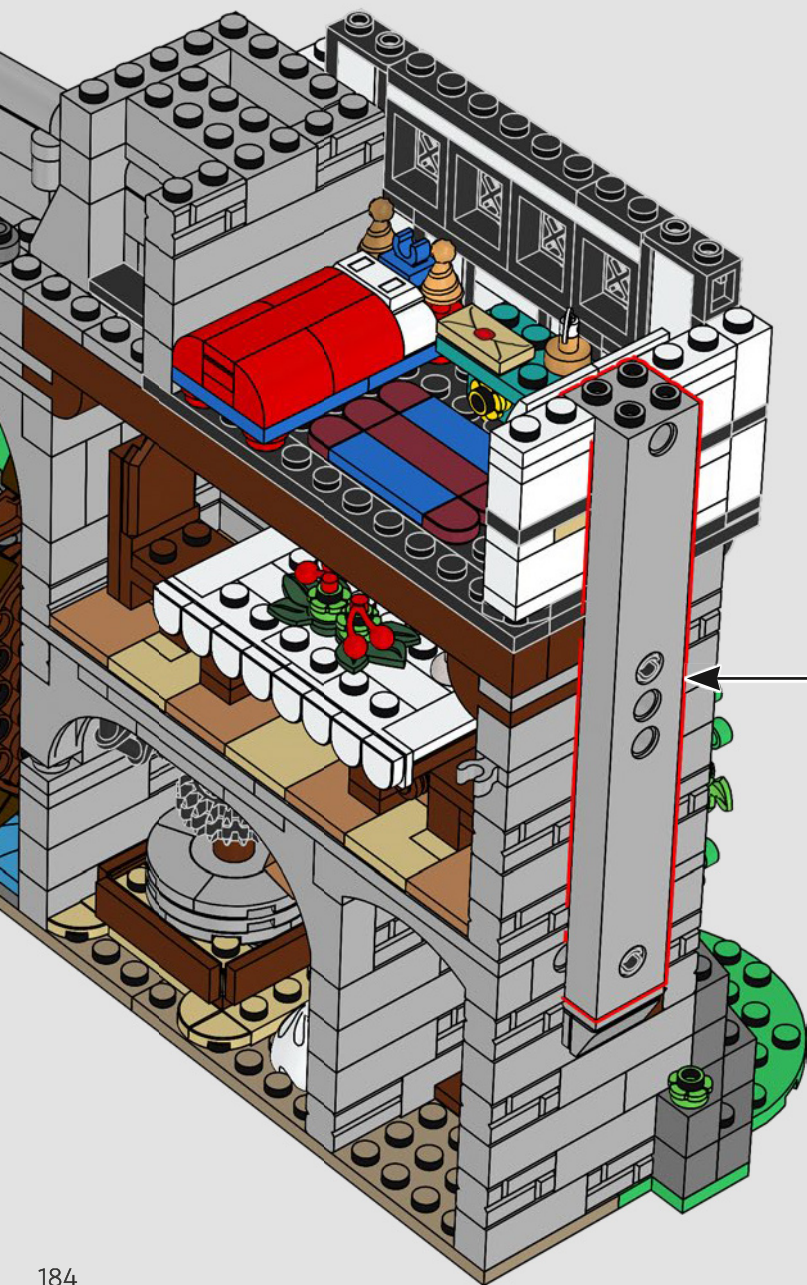

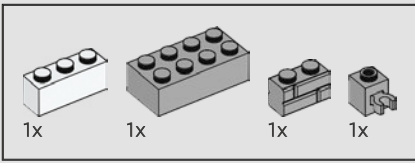

208



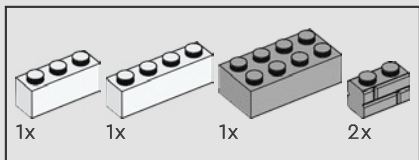

209



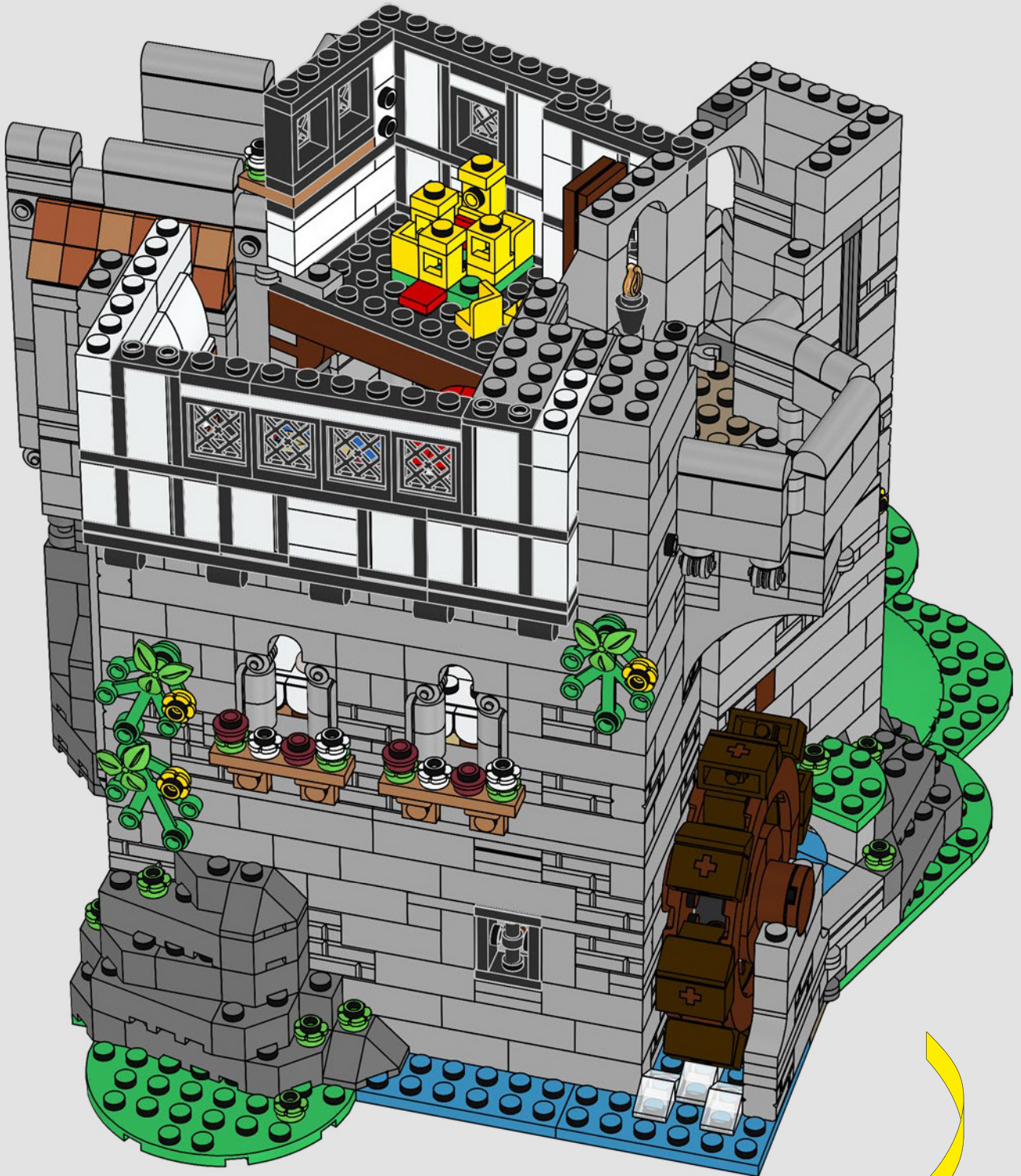

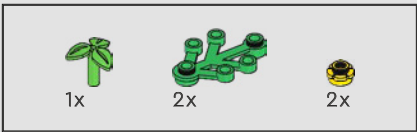

211

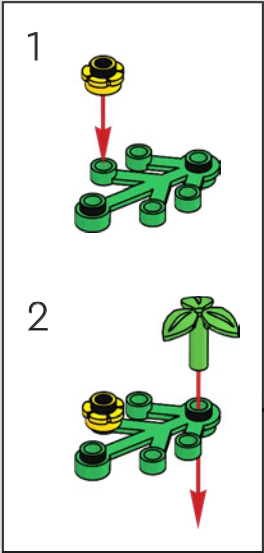
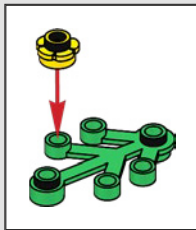

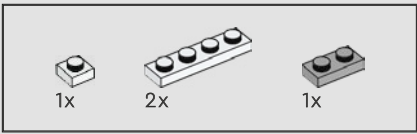

214

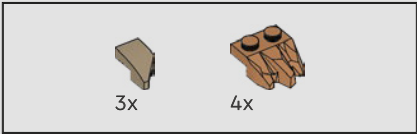
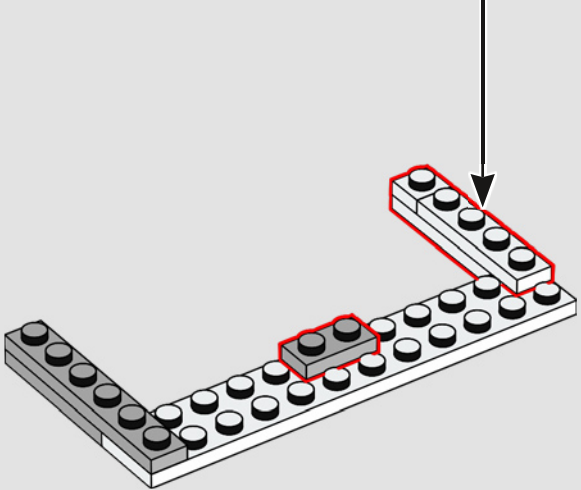
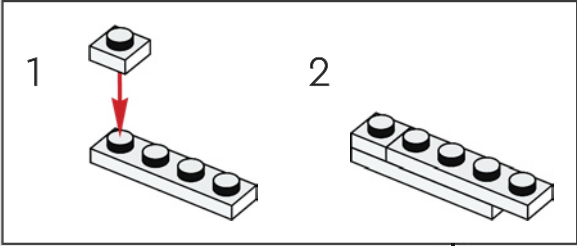

215

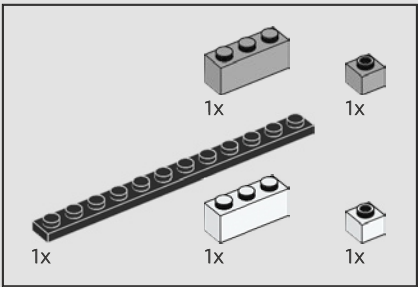
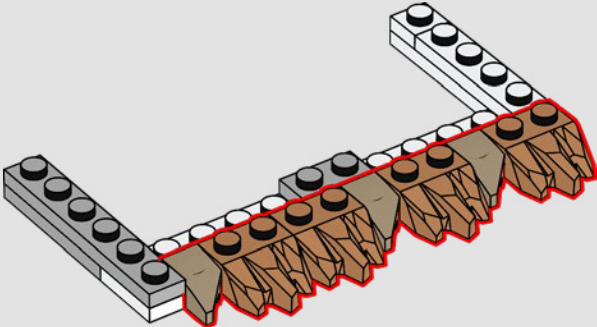

216

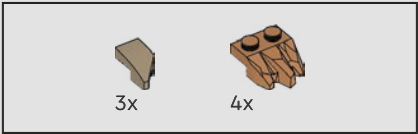
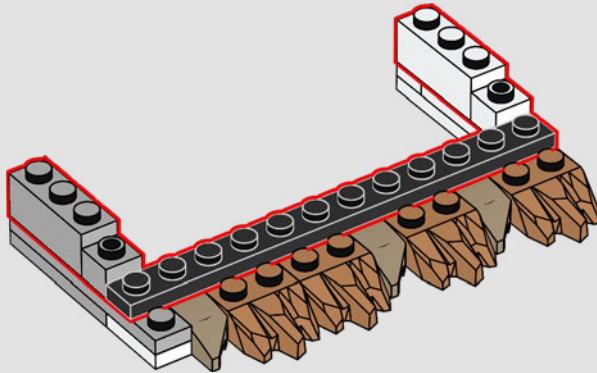

217

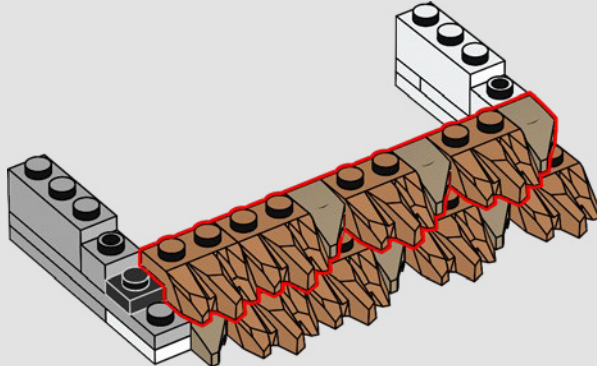

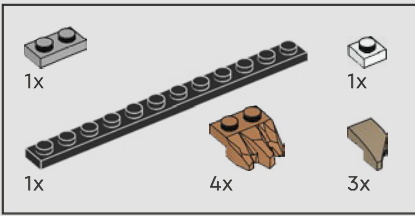

218

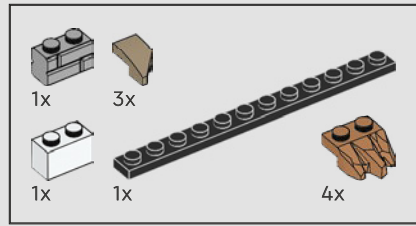
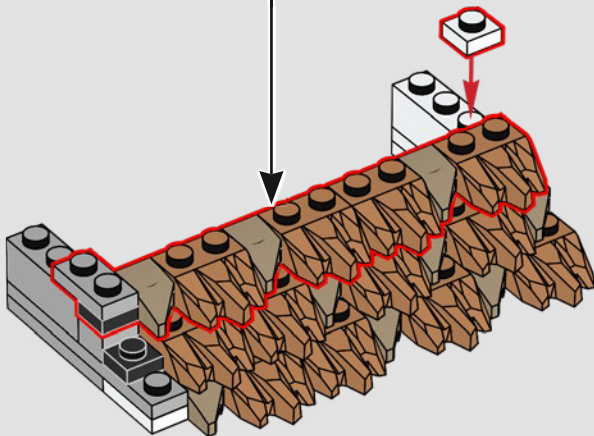
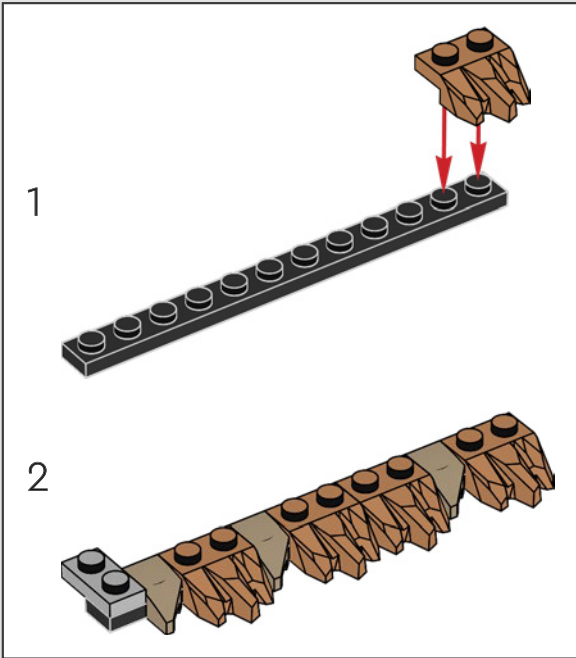

219

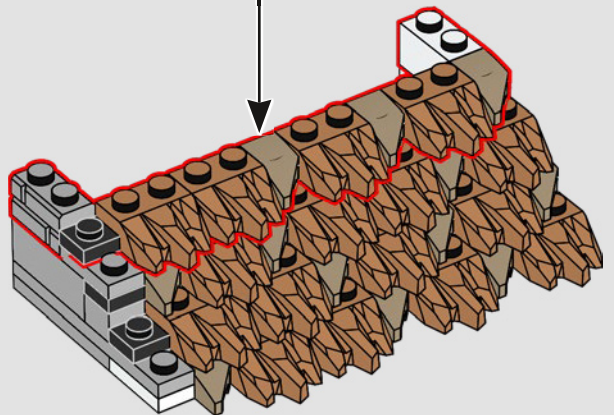
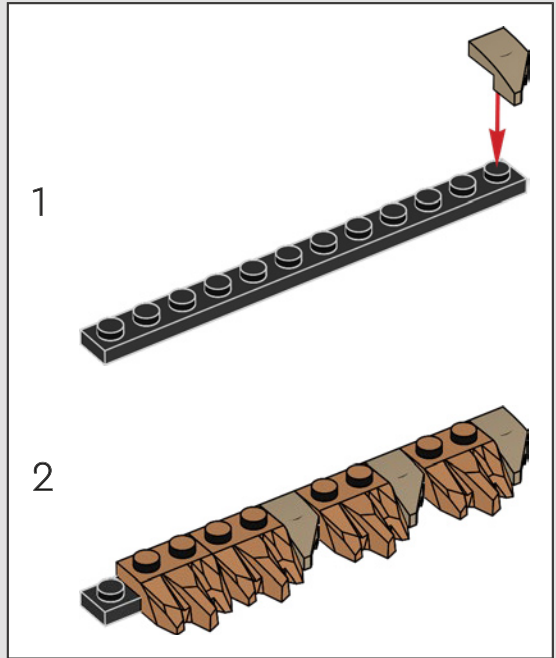

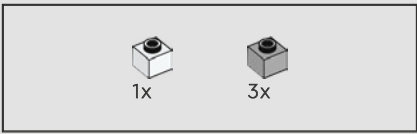

220

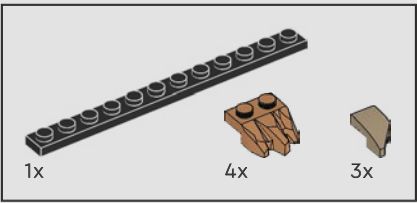
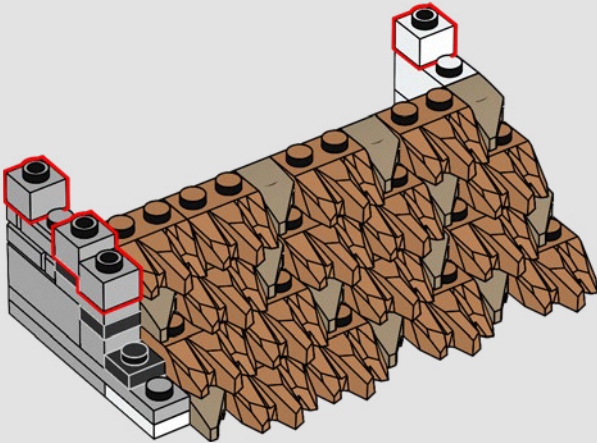

221

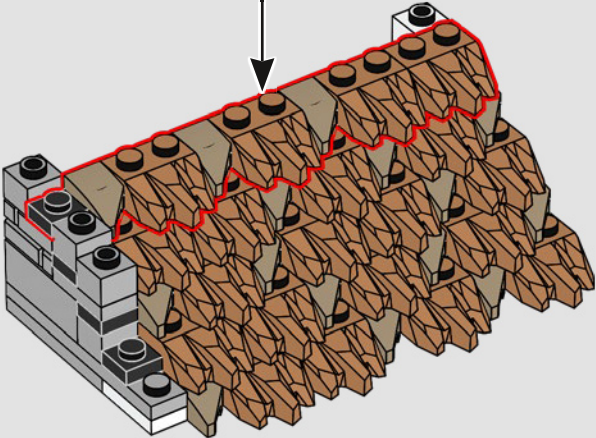
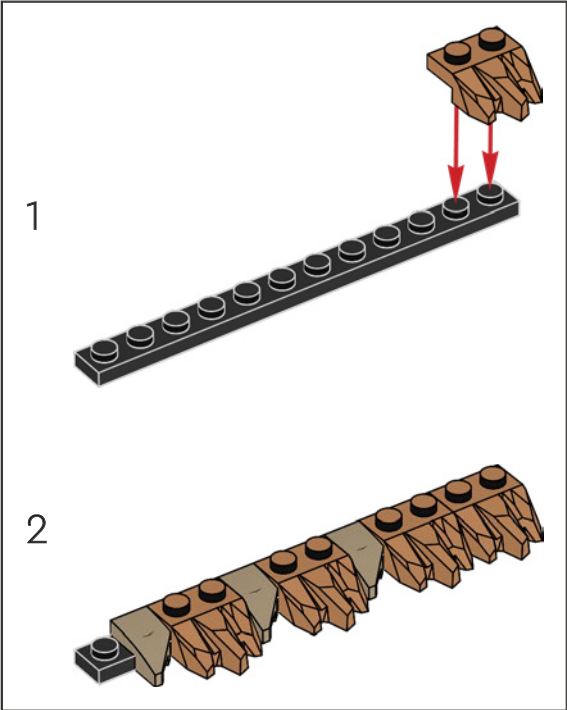

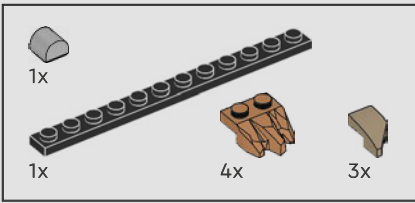

222

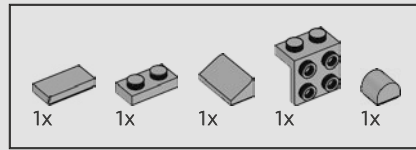
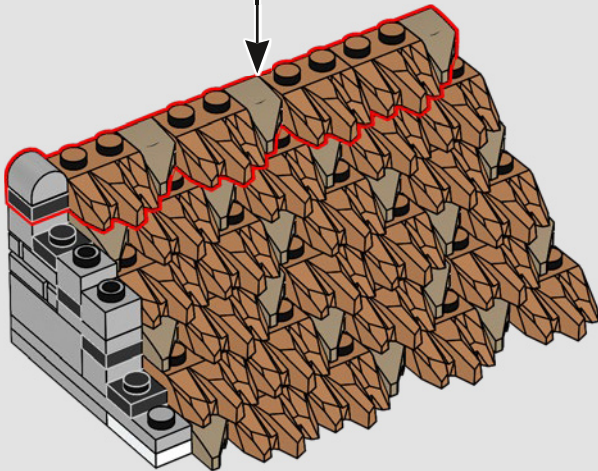
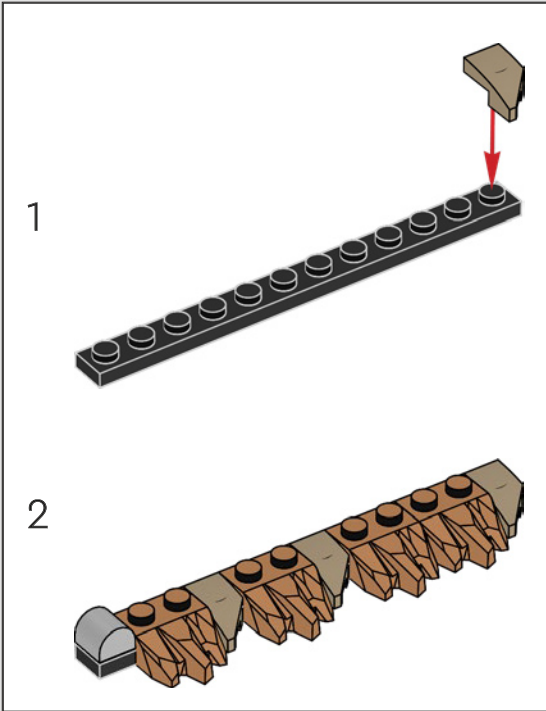

223

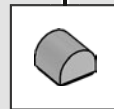
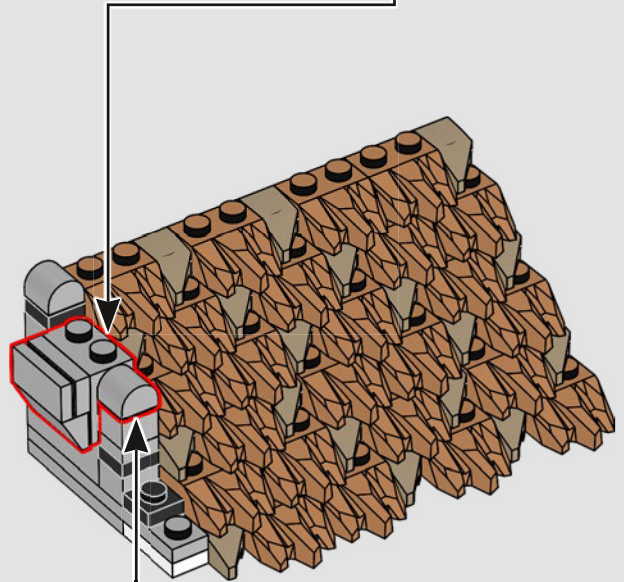
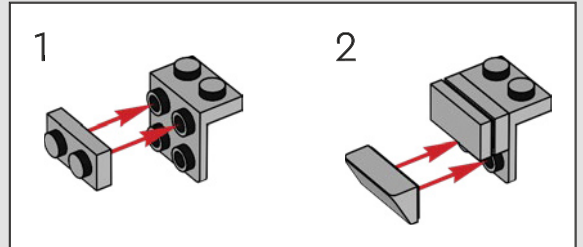



*Dieses Dach sollte die Kammern
warm und trocken halten. Stroh ist
schon ein geniales Baumaterial!*

224



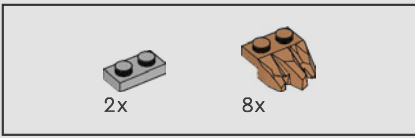

225

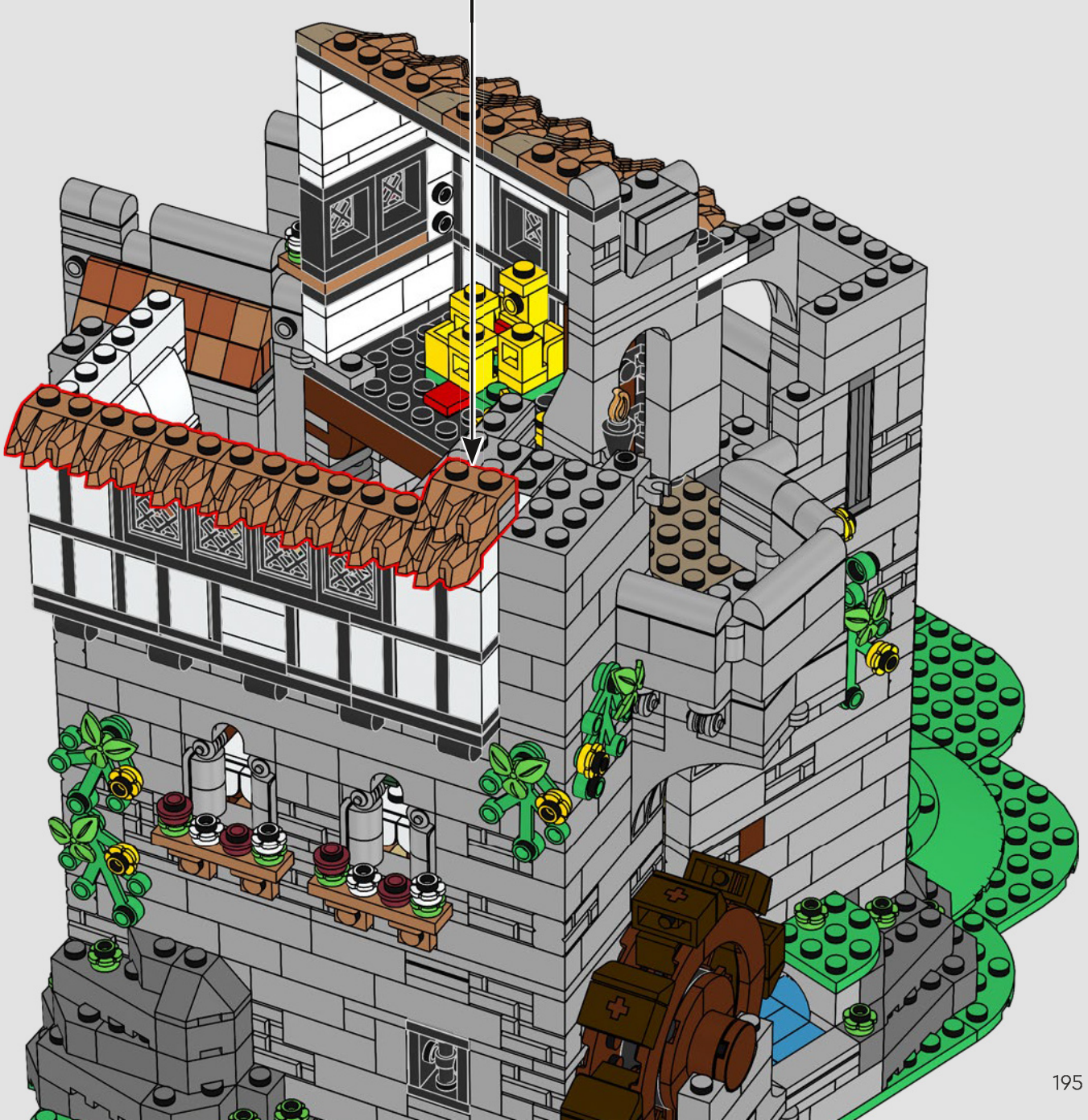
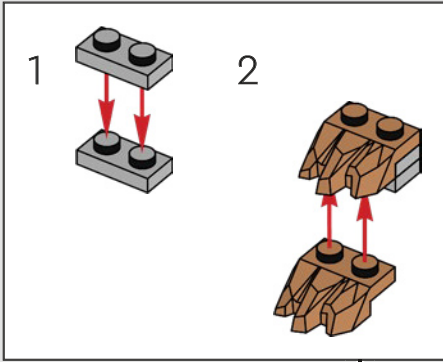

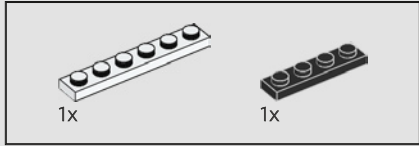
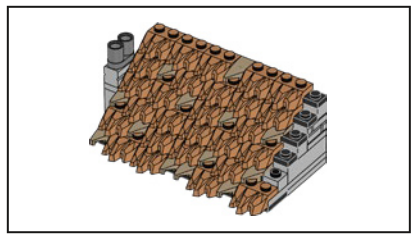

226

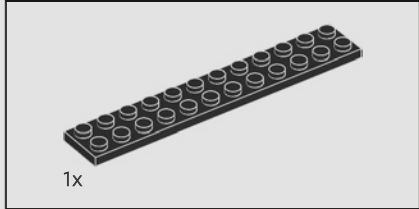
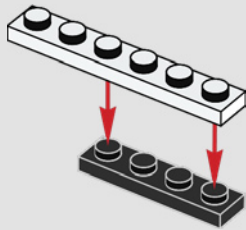

227

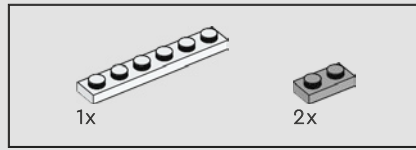
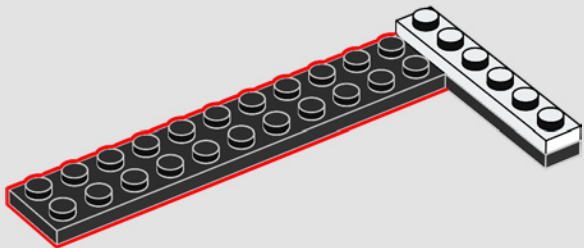

228

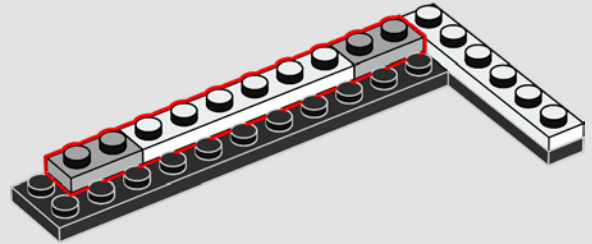

229

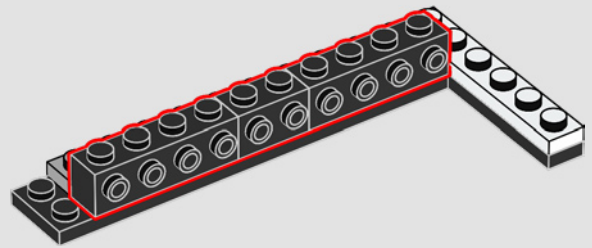

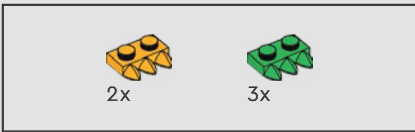

230

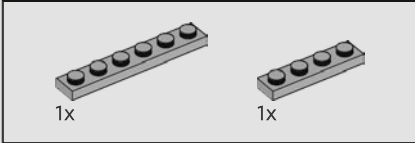
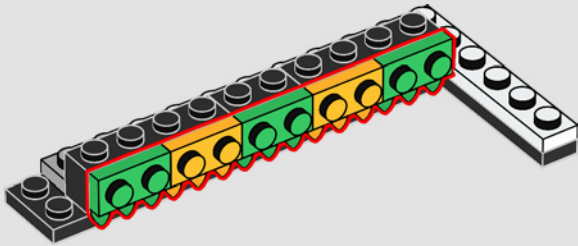

231

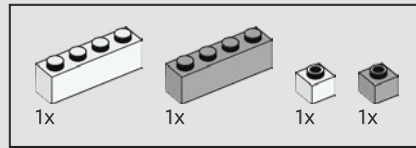
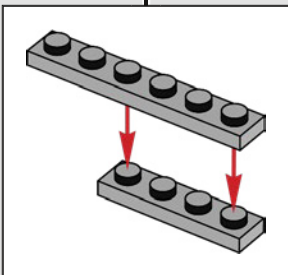
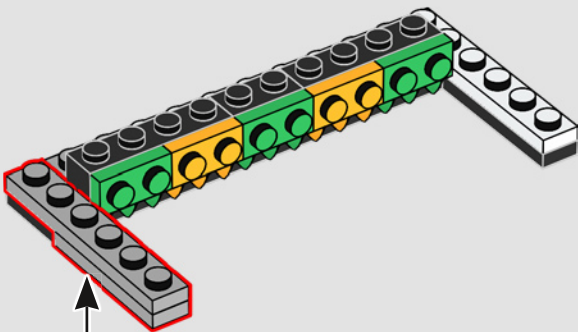

232

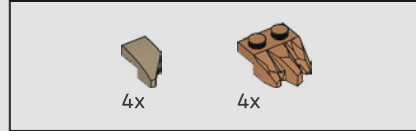
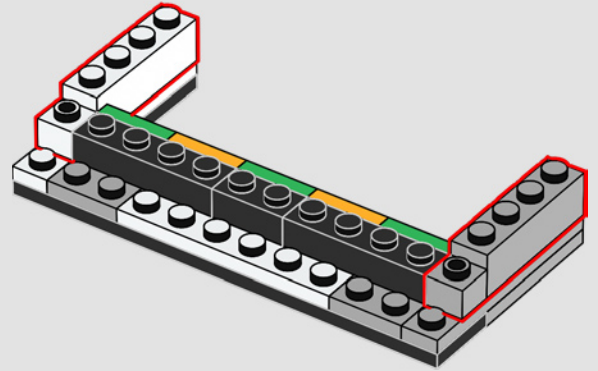
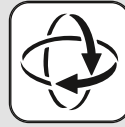

233

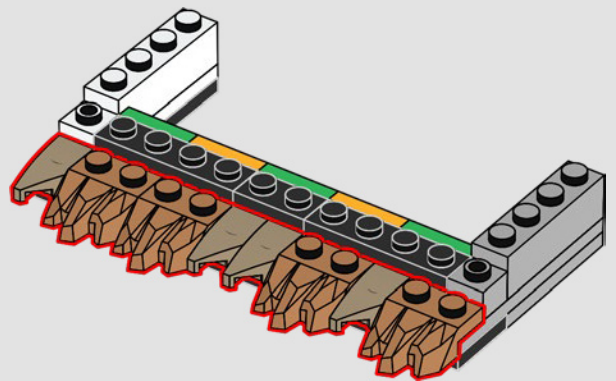

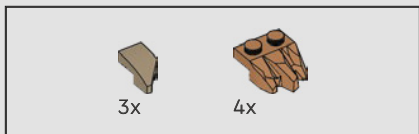

234

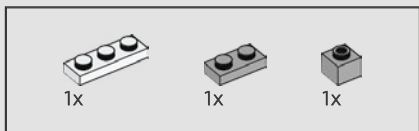
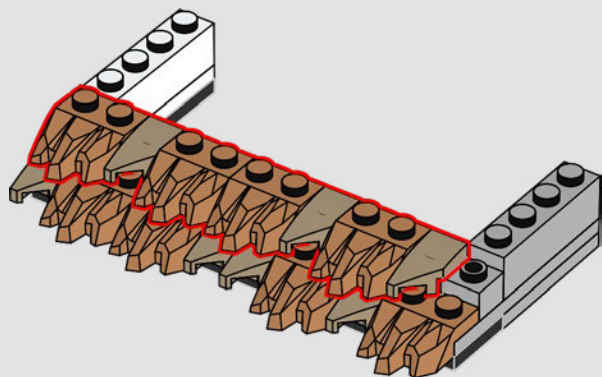

235

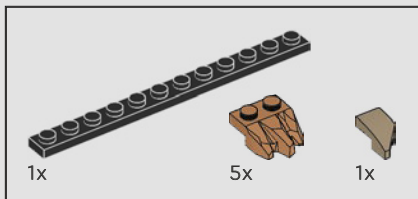
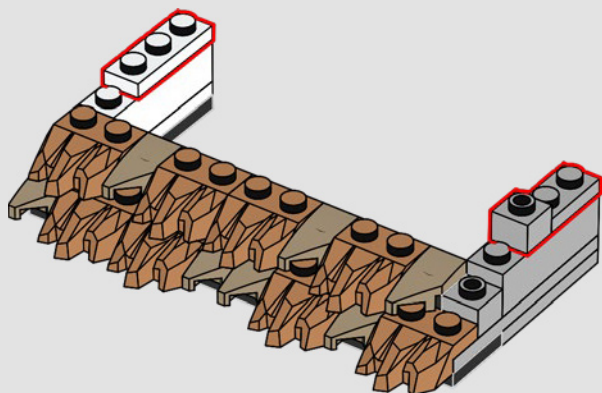

236

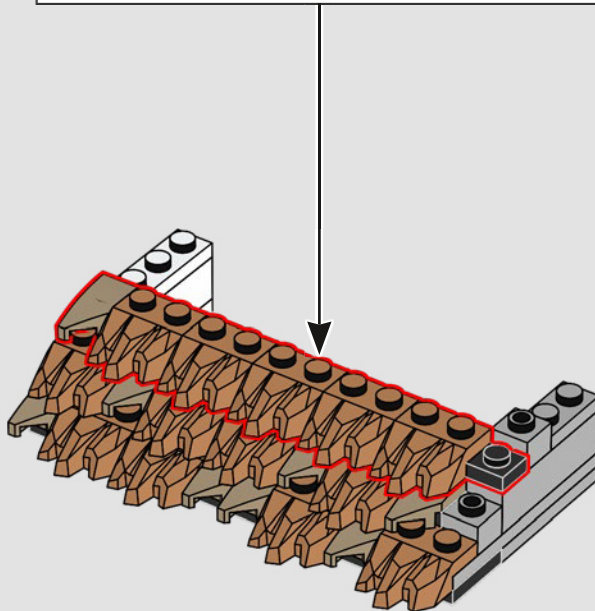
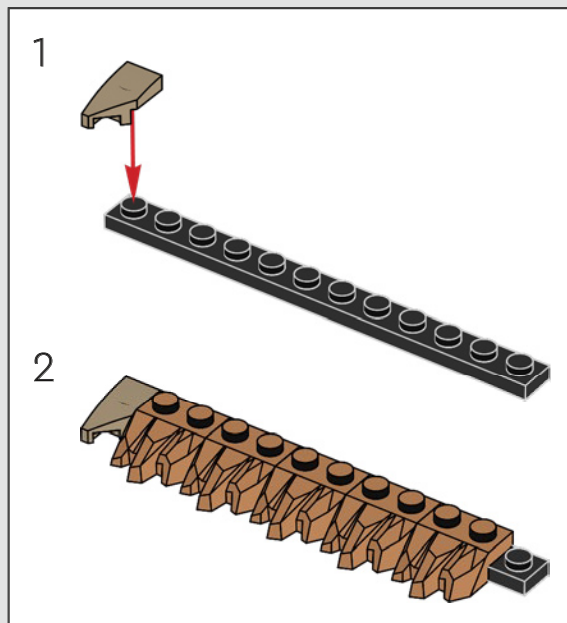

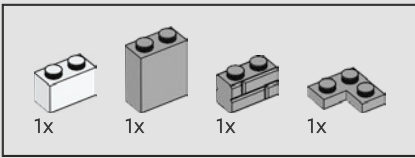

237

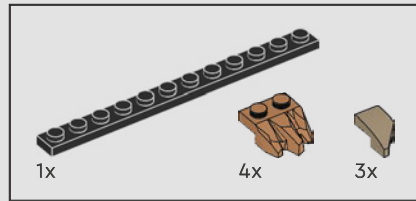
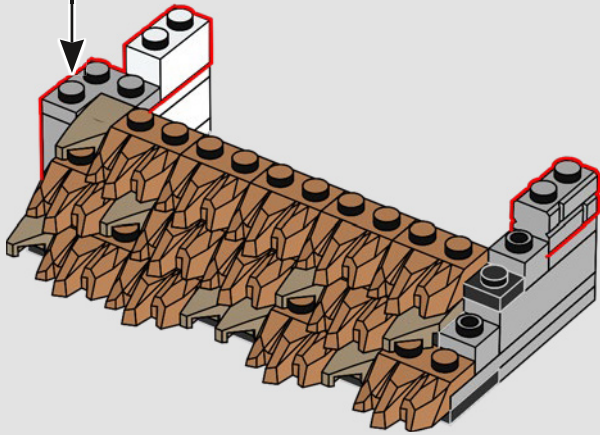
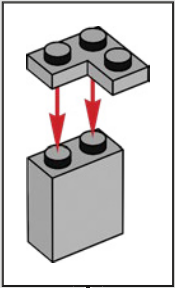

238

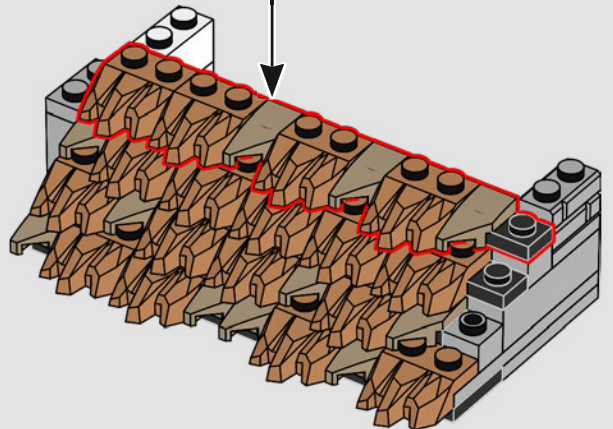
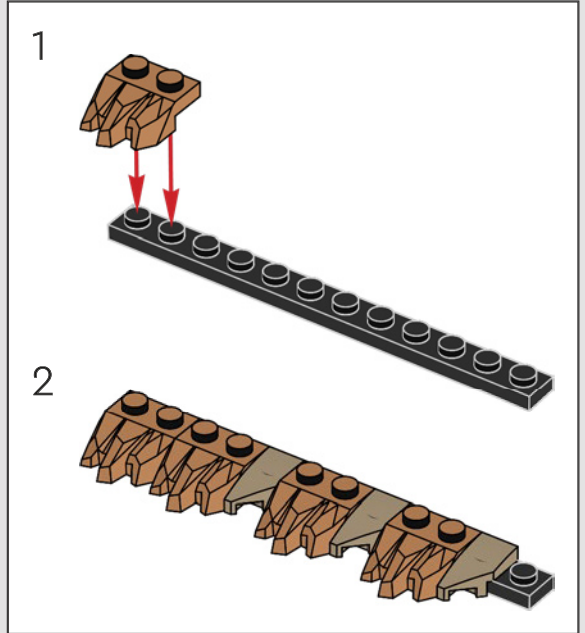

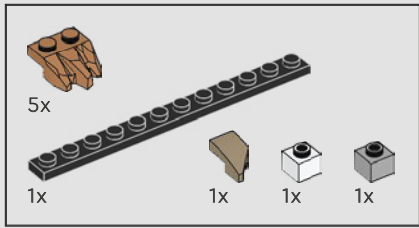

239

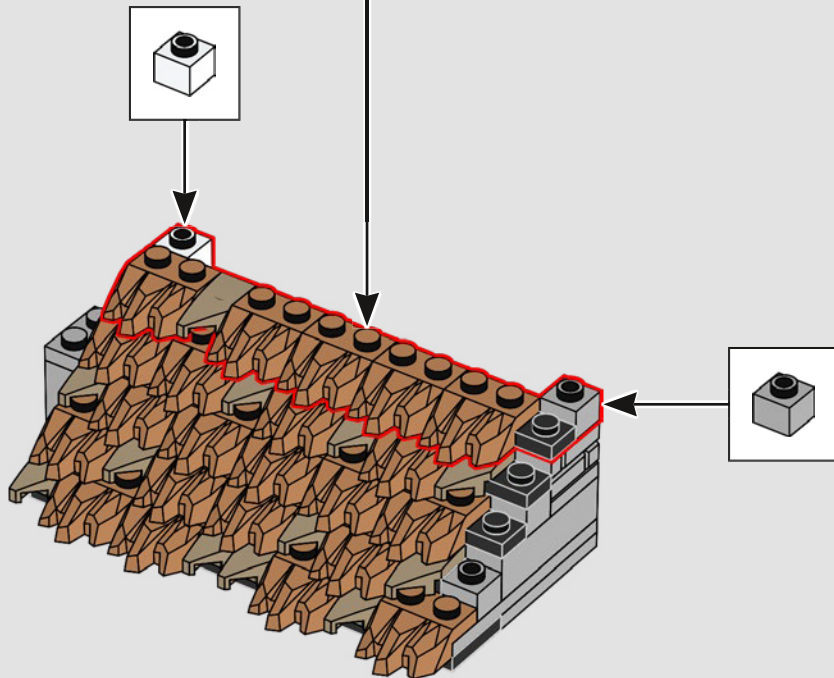
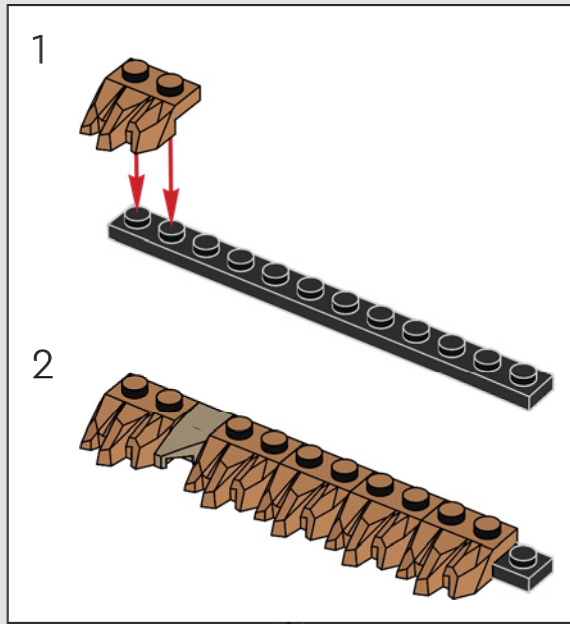

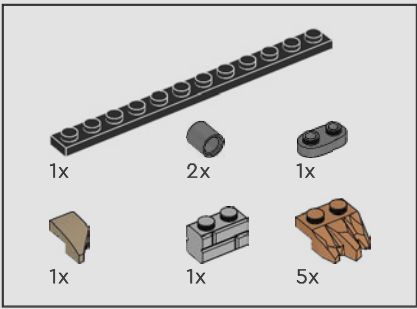

240

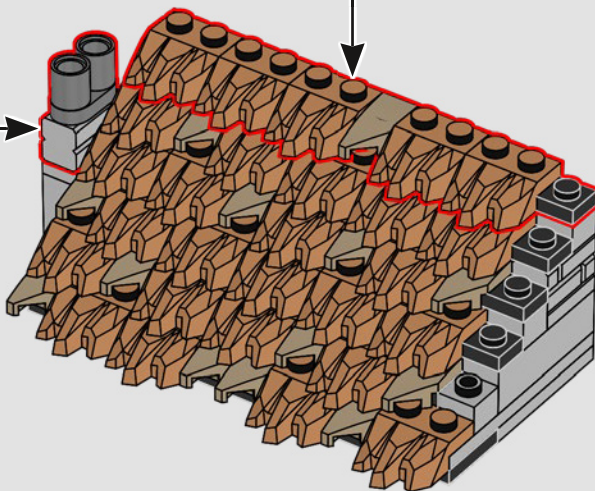
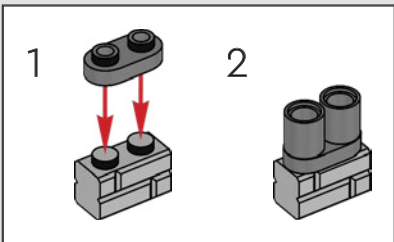
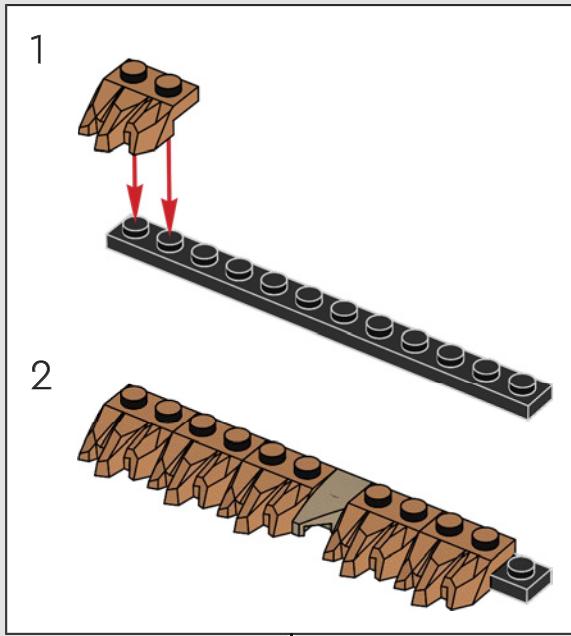

241

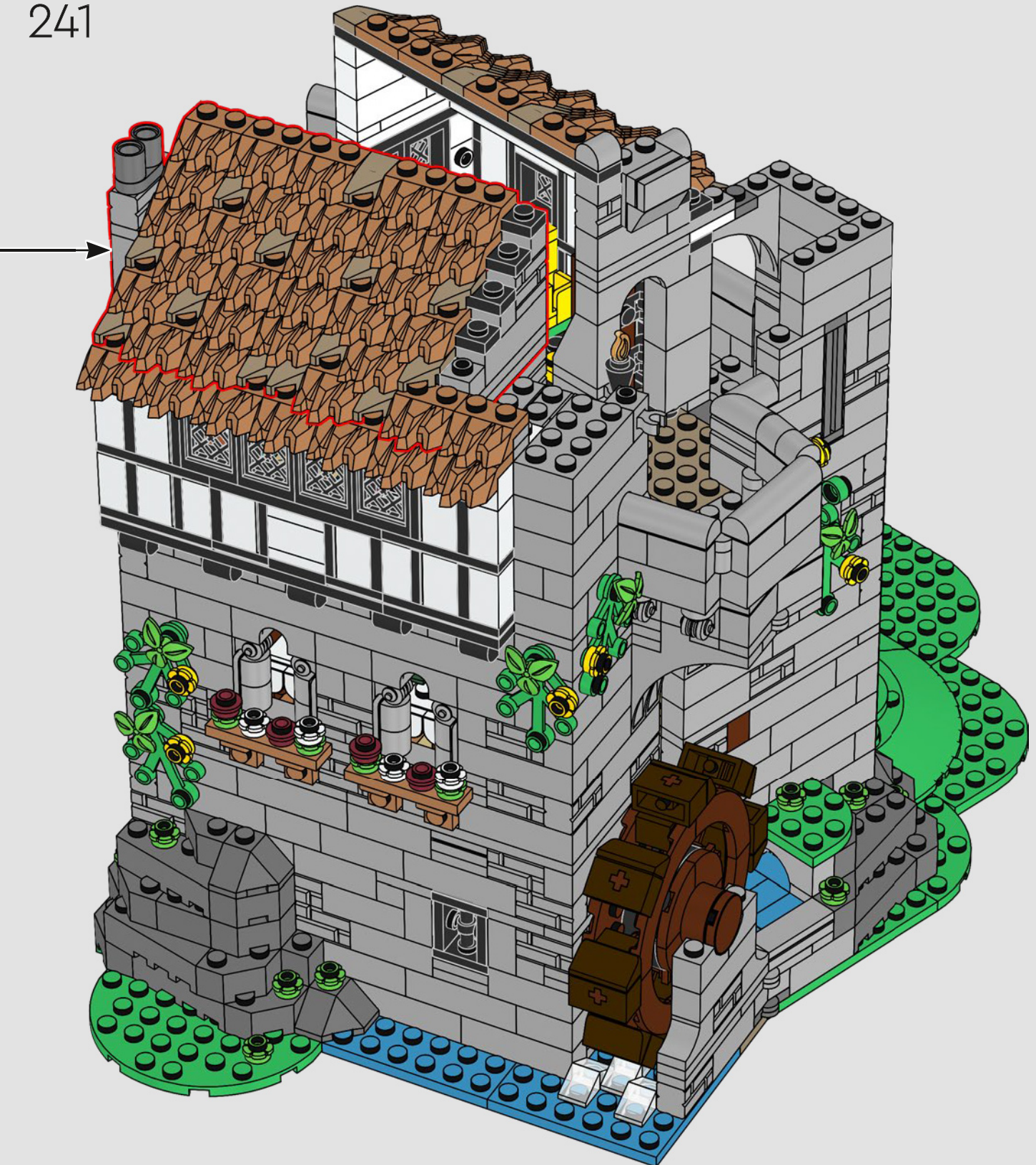

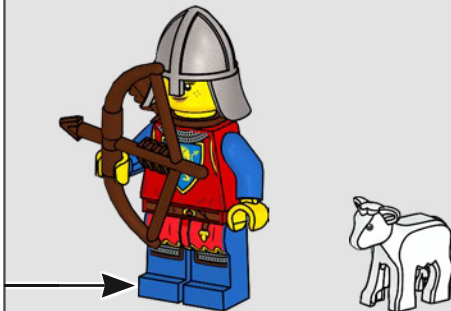
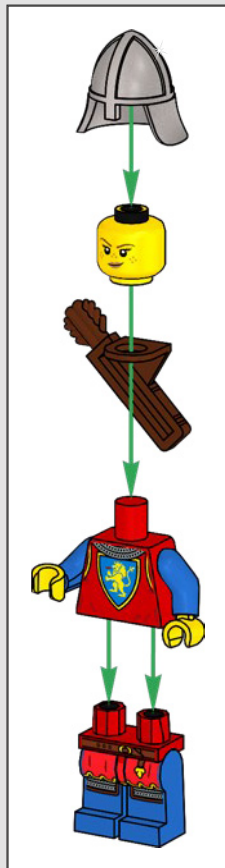

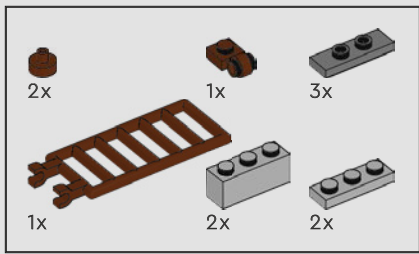

242

1

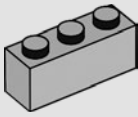

2

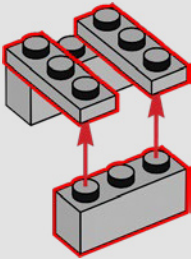

3

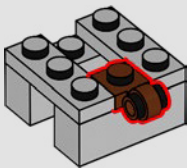

4

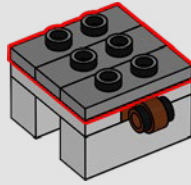

5

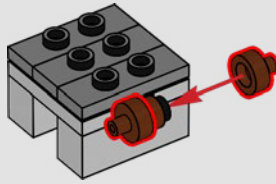

6

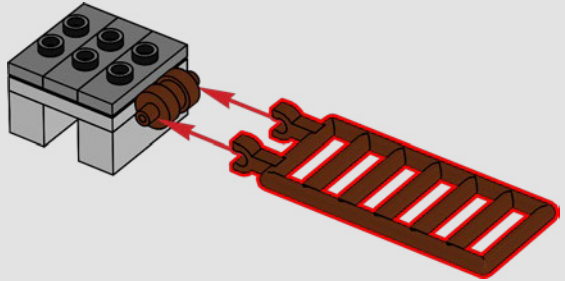

7

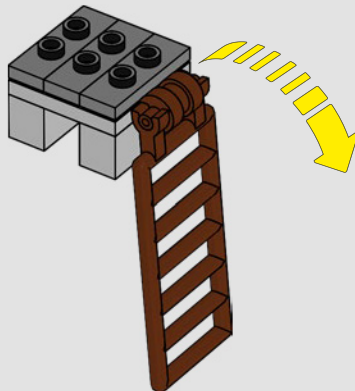



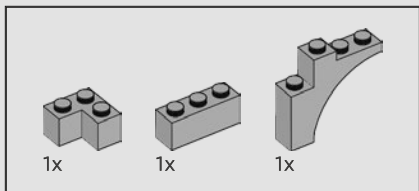

243



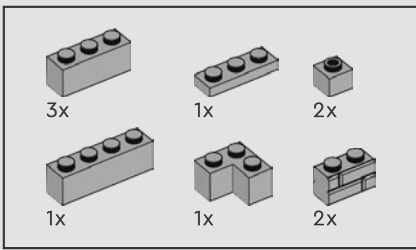

244



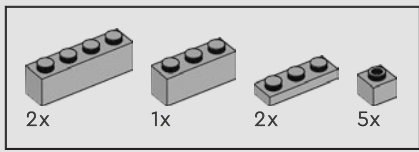

245



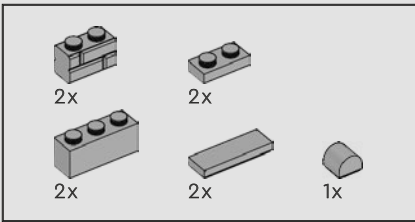

246

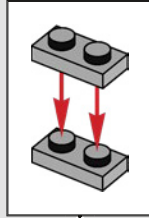

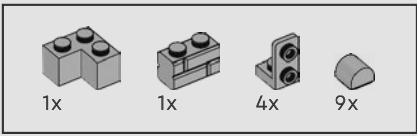

247

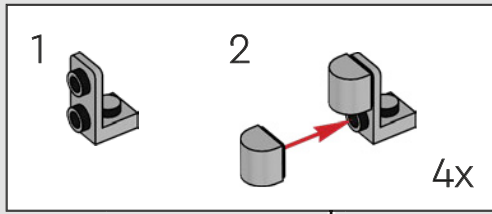

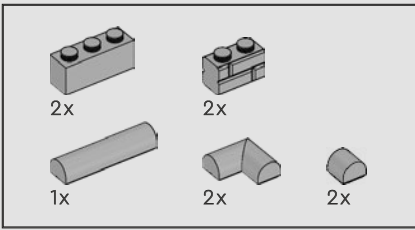

248



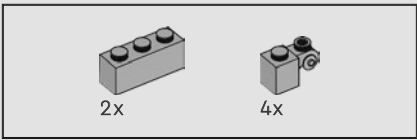

249



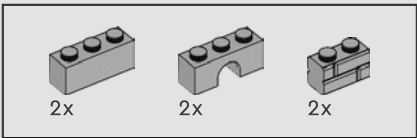

250



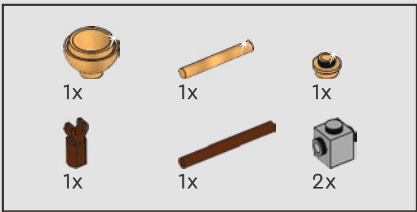

*Diese Glocke wird das Stadtvolk
alarmieren, falls die Plünderer eines
Tages zurückkehren sollten ...*

251

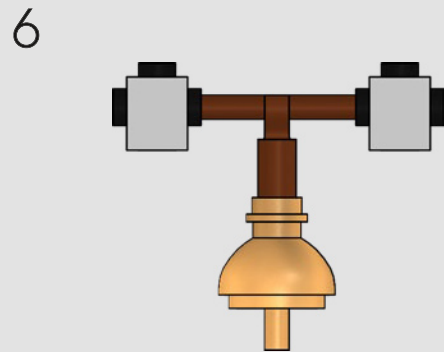
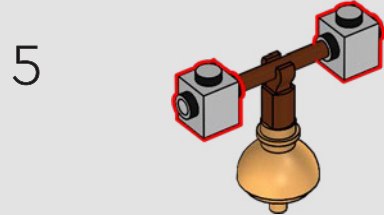
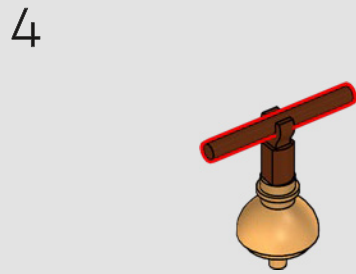
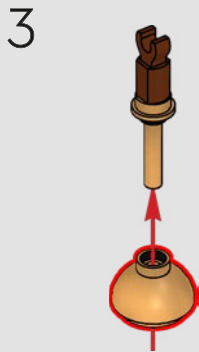
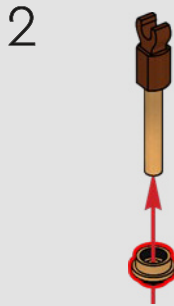
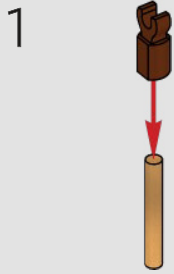

1:1



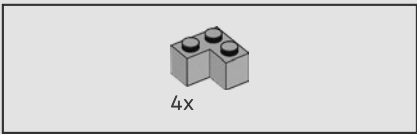

252





2x



4x

253



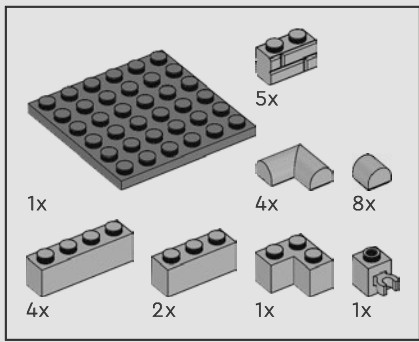

254

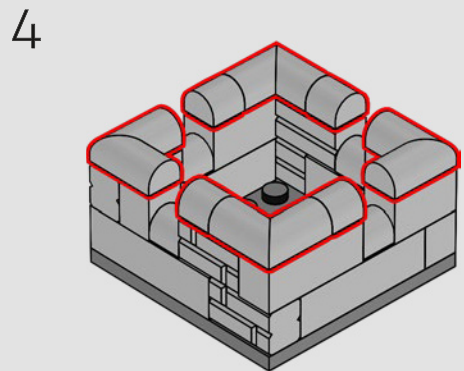
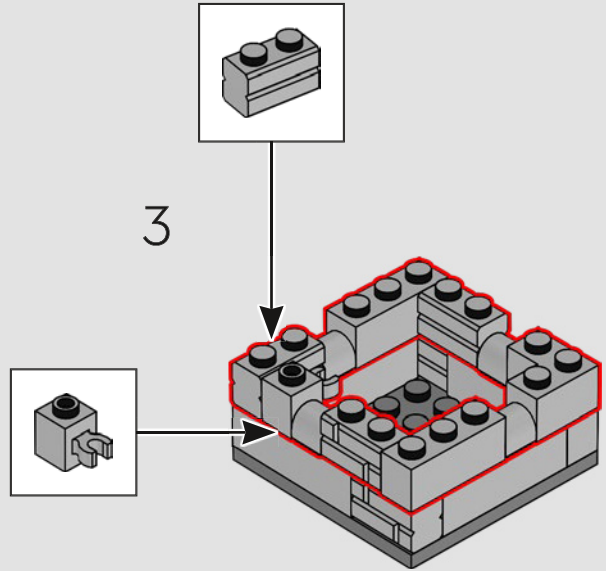
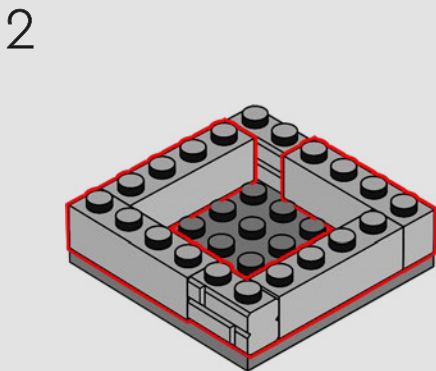
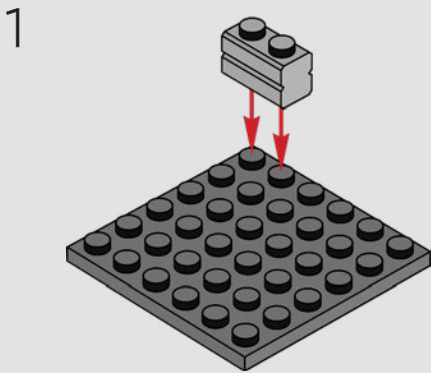



12x

255

12x



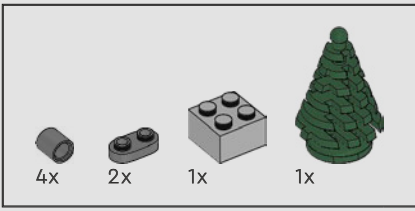

256

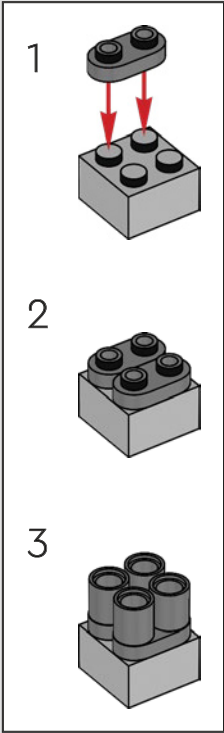

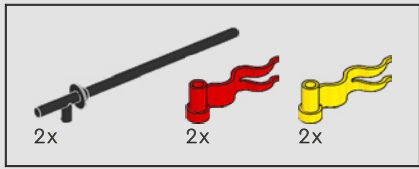

257

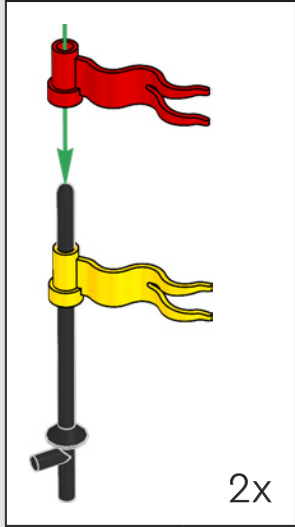

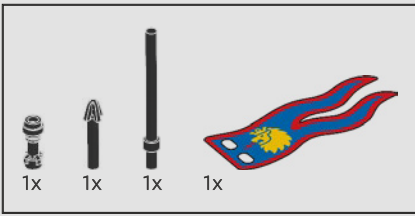

258

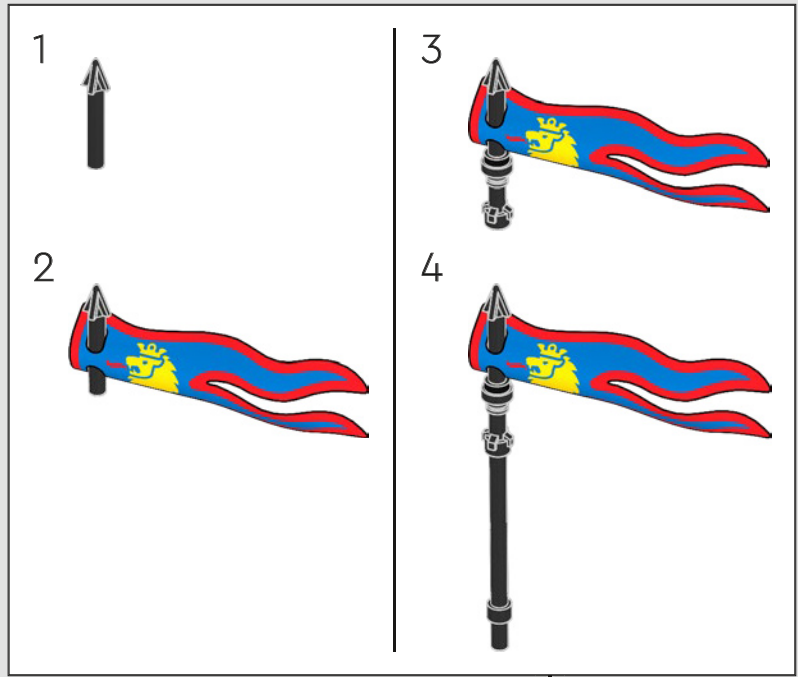



Diese dunklen Kiefern stehen voll im Saft. Einen solch dunklen Grün ton hatten sie noch nie ...

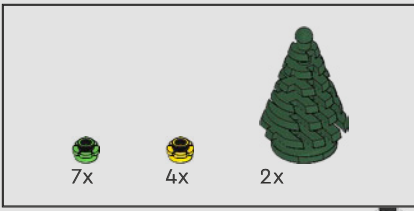

259

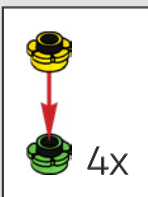

224

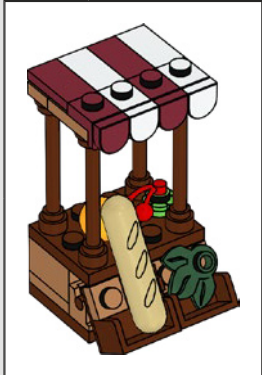

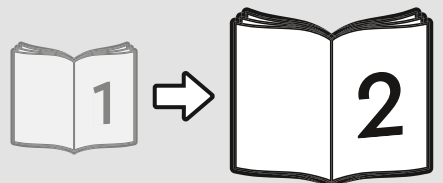



FEEDBACK AND WIN

FEEDBACK AND WIN

Your feedback will help shape the future development of this product series.

Please visit:

FEEDBACK UND GEWINNEN

Dein Feedback trägt zur Weiterentwicklung dieser Produktreihe bei.

Geh auf:

COMMENTEZ ET GAGNEZ

Vos commentaires nous aideront à concevoir les futurs produits de cette gamme.

Rendez-vous sur :

COMENTA Y GANA

Tu opinión nos ayudará a dar forma al desarrollo de esta serie de productos en el futuro.

Visita:

反馈有奖

您的反馈将有助于我们在今后改进本系列产品。

请访问：

[LEGO.com/productfeedback](https://www.lego.com/productfeedback)

By completing, you will automatically enter a drawing to win a LEGO® set.

Terms & Conditions apply.

Durch Ausfüllen nimmst du automatisch an der Verlosung eines LEGO® Preises teil.

Es gelten die Teilnahmebedingungen.

En envoyant vos commentaires, vous serez automatiquement inscrit(e) à un tirage au sort qui vous permettra de remporter un prix LEGO®.

Offre soumise à conditions.

Al contestar, participarás automáticamente en el sorteo y podrás ganar un set LEGO®.

Sujeto a Términos y Condiciones.

完成我们的反馈调查，即可自动进入抽奖环节，赢取乐高®套装。

适用《条款和条件》。

