





LEGO.com/sustainable-packaging



ANDERSON WARD GRUBB
Diseñador del Club de Jazz (10312)

TE DAMOS LA BIENVENIDA

¡Prepárate para una inolvidable velada con música en directo, entretenimiento y la comida más deliciosa! Inspirado en la arquitectura clásica e indiscutiblemente impregnado de nuestras piezas favoritas de la era dorada del jazz, este nuevo recinto dedicado a la música es una refrescante incorporación a la serie LEGO® Modular Buildings. Tanto si se trata de tu primer set modular como si comenzaste a urbanizar tu barrio LEGO desde el principio, siempre estás invitado a construir a tu ritmo.



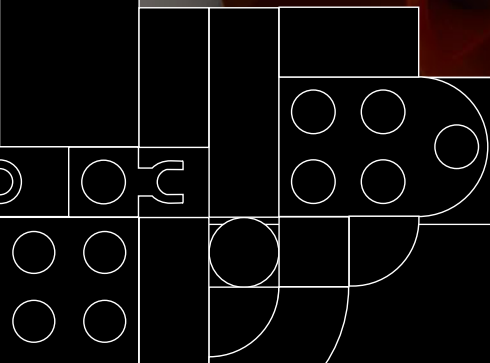

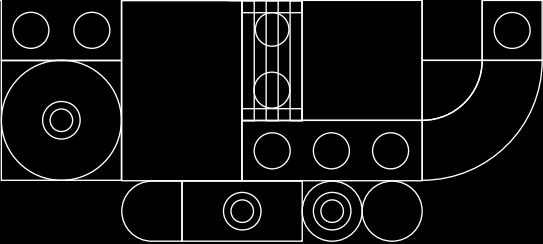

Se dice que, en el jazz, las notas que no se tocan son tan importantes como las que los músicos nos regalan con la ayuda de sus instrumentos. Ya sea que interpretes melodías o construyas con ladrillos LEGO®, ¡no olvides hacerlo a tu manera!



QUE SUENE LA MÚSICA

La música puede funcionar como una máquina del tiempo virtual que te hace viajar instantáneamente a tus recuerdos y momentos más entrañables, así como a destinos que jamás soñaste visitar. Reproduce tu álbum favorito en nuestro tocadiscos de estilo antiguo, mueve el cuerpo al compás de las notas del Club de Jazz LEGO® Icons y emocionate con la sensacional atmósfera de mediados del siglo XX de este vibrante crisol donde se mezclan la música y la magia con artistas tan creativos como apasionados, los mejores chefs y un público conoecedor. Mira el espectáculo desde la oficina de la encargada, cultiva verduras para la cocina en el invernadero de la azotea, siente el nerviosismo de estar en el camerino justo antes de salir a actuar, pide un tentempié de medianoche o disfruta de una completísima comida en el café con terraza una cálida noche de verano. No necesitas entrada ni reserva: tu imaginación te garantiza el acceso vip.



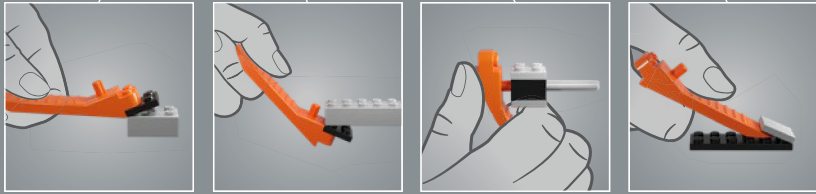
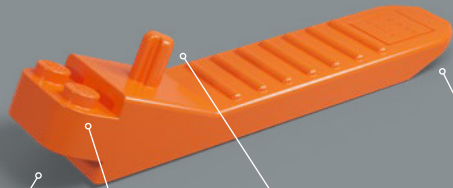

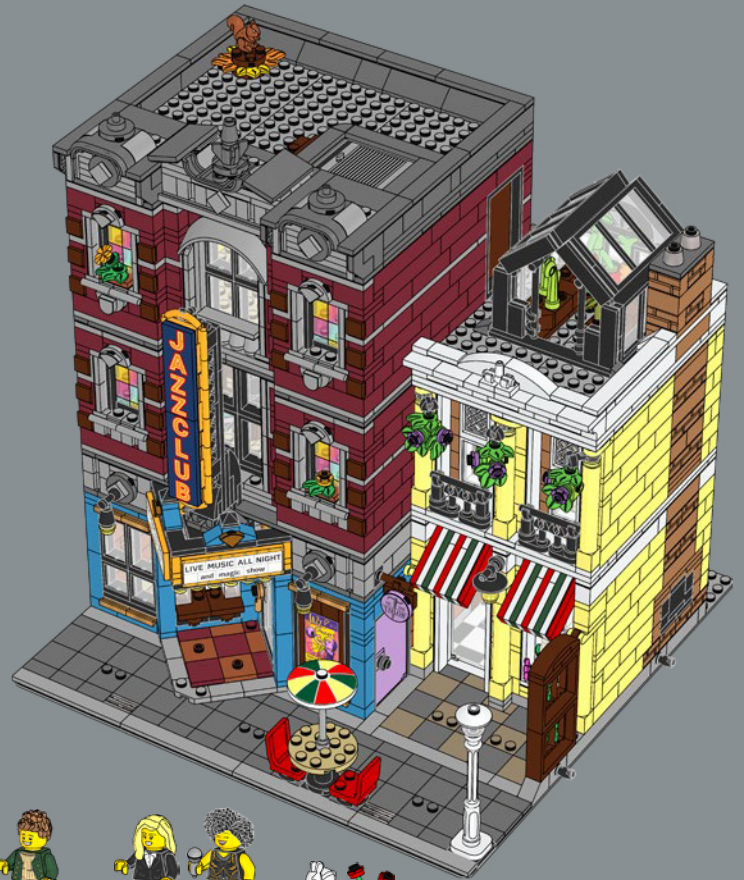
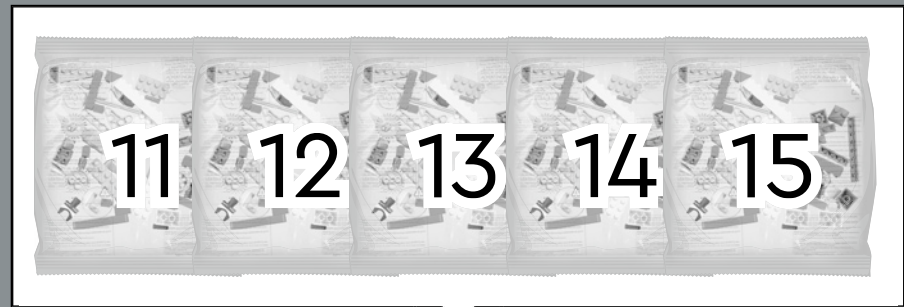
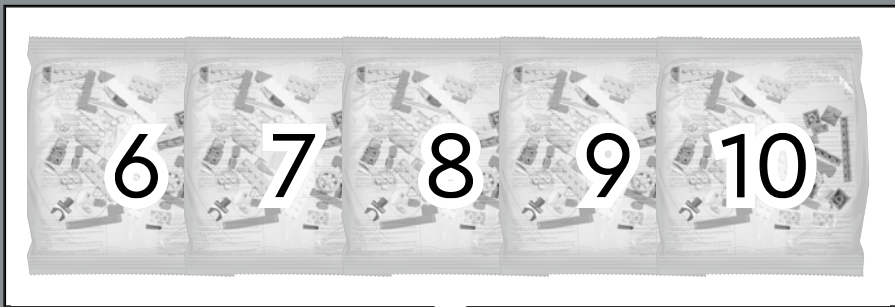

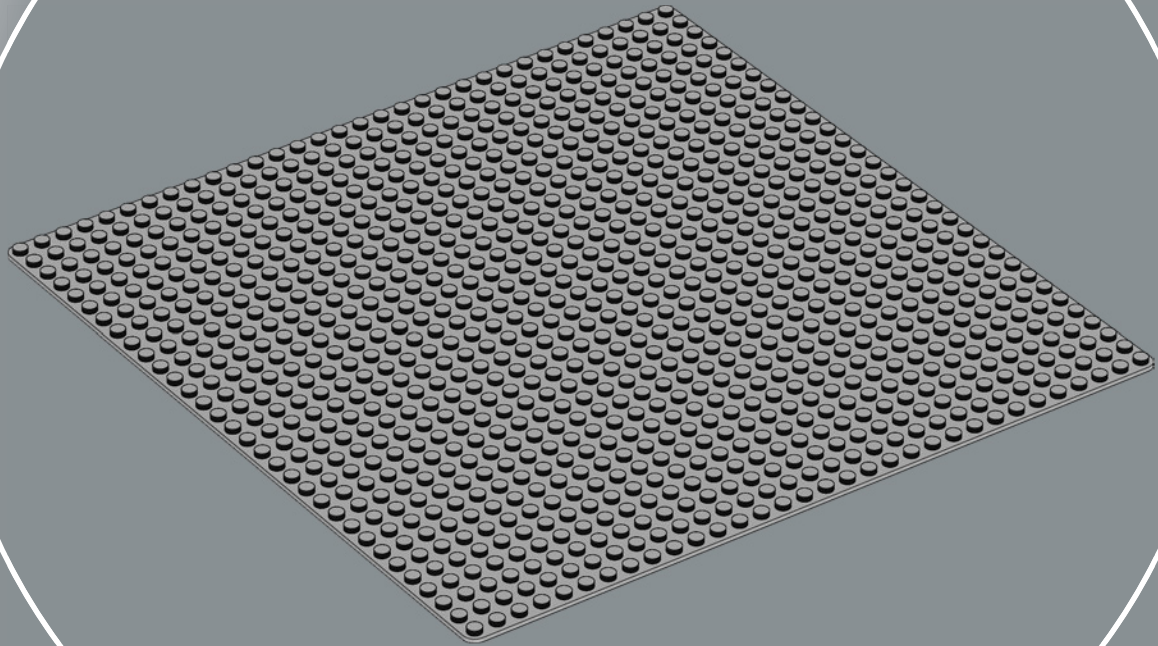
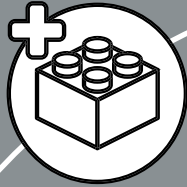

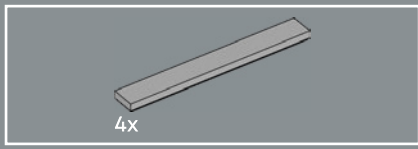

1

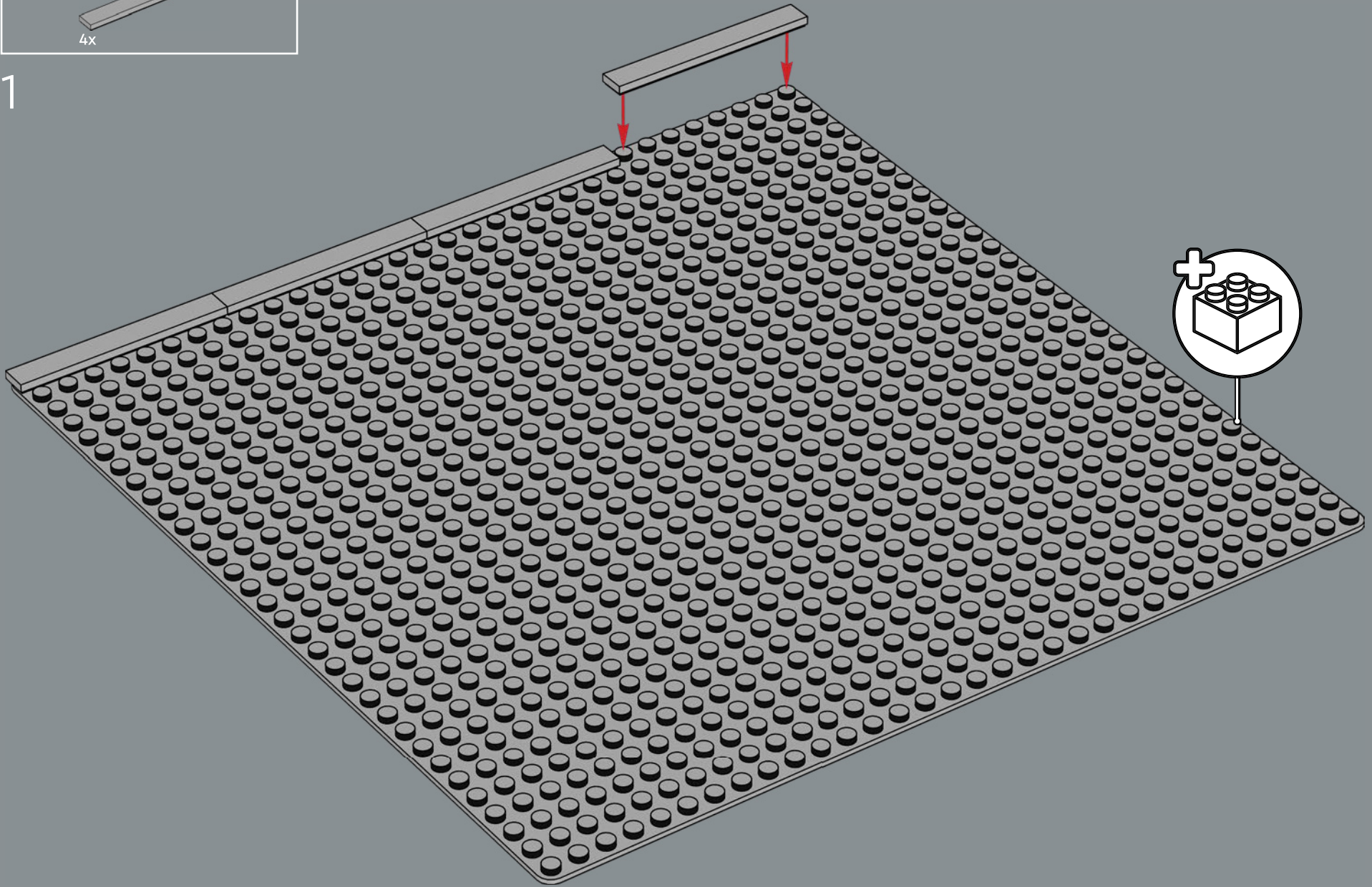

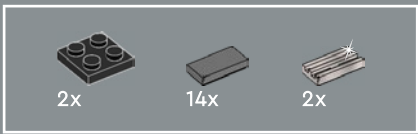

2

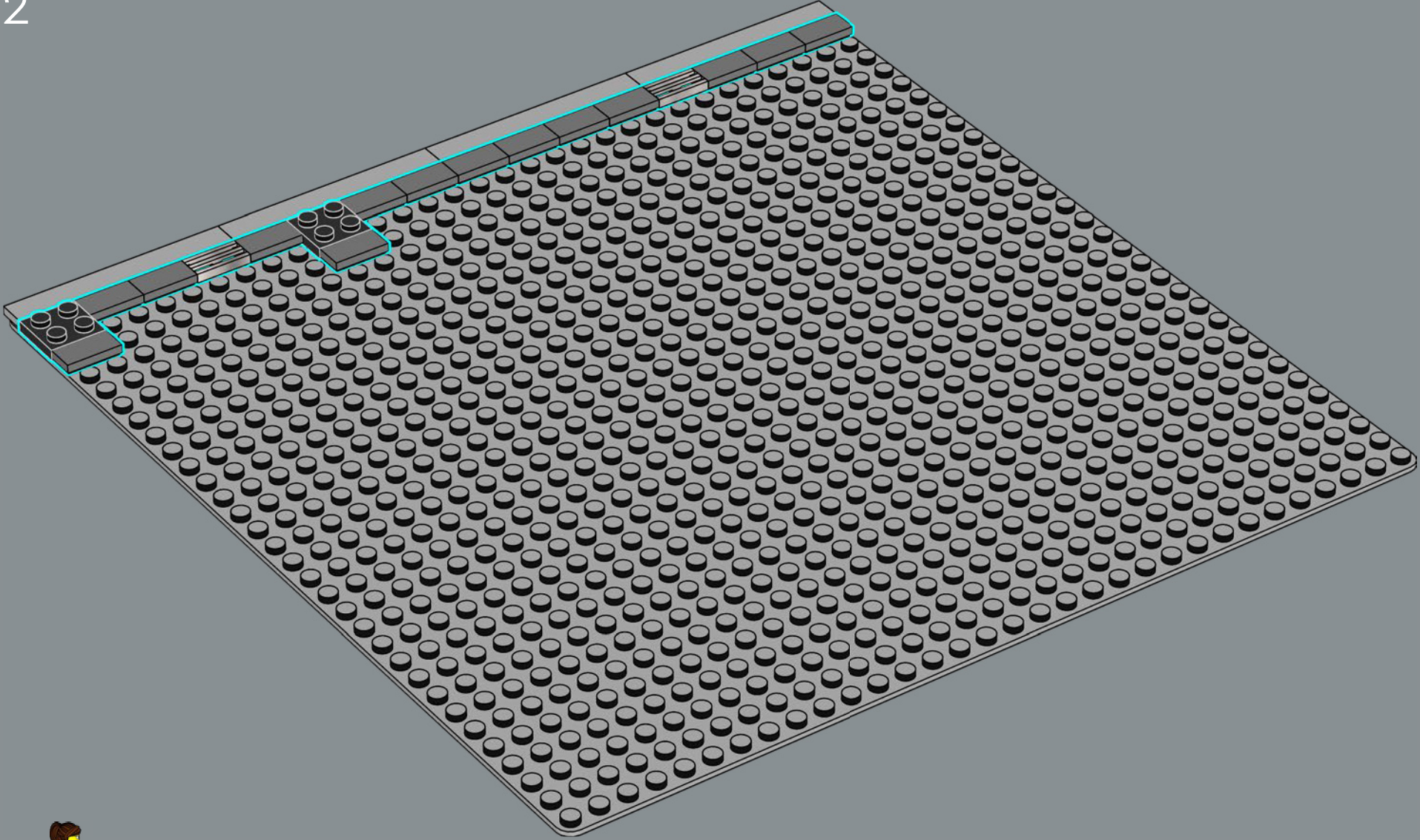

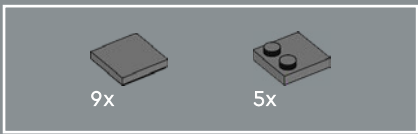

3

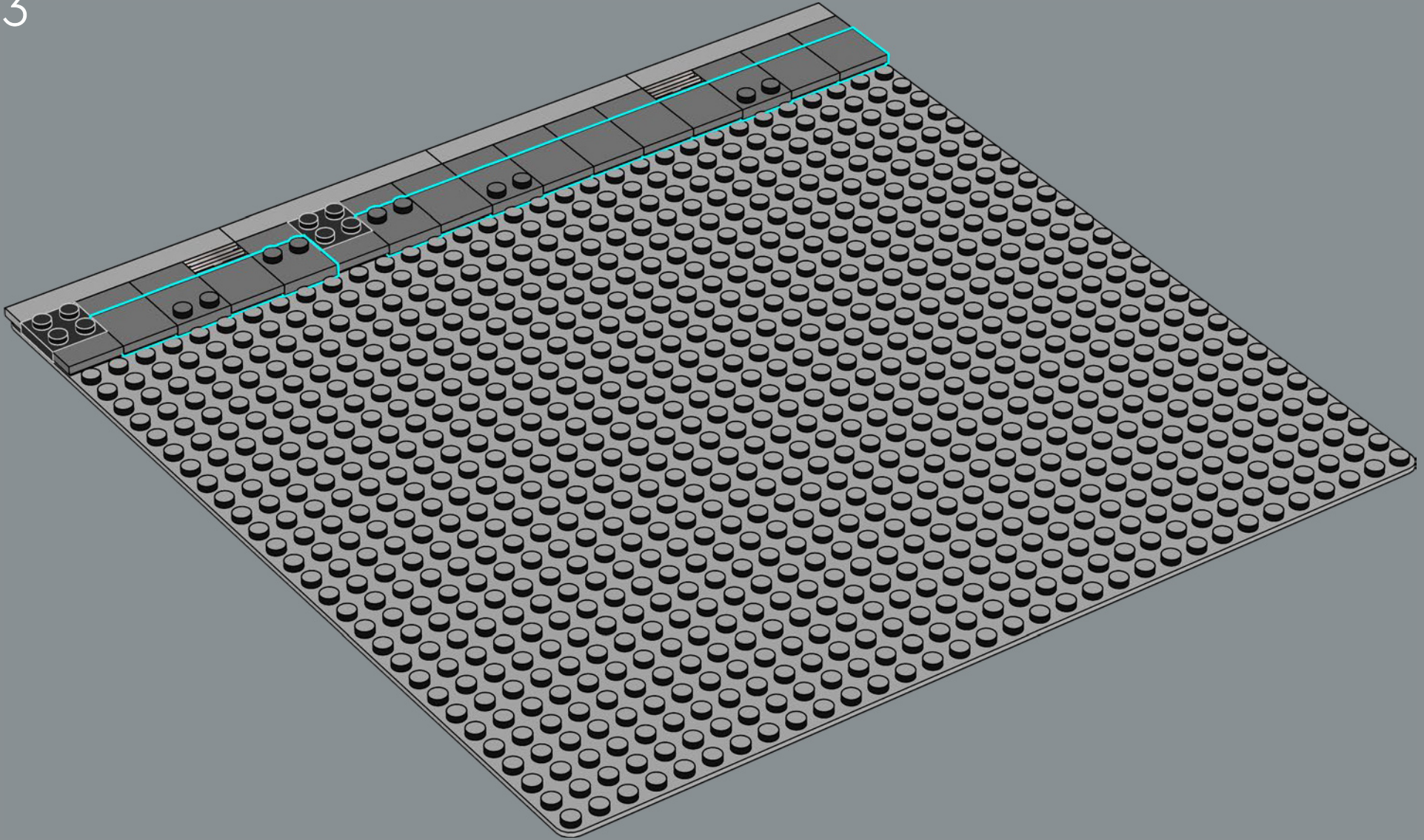

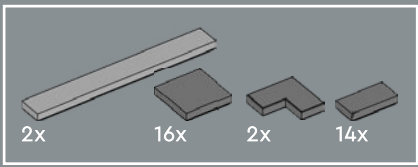

4

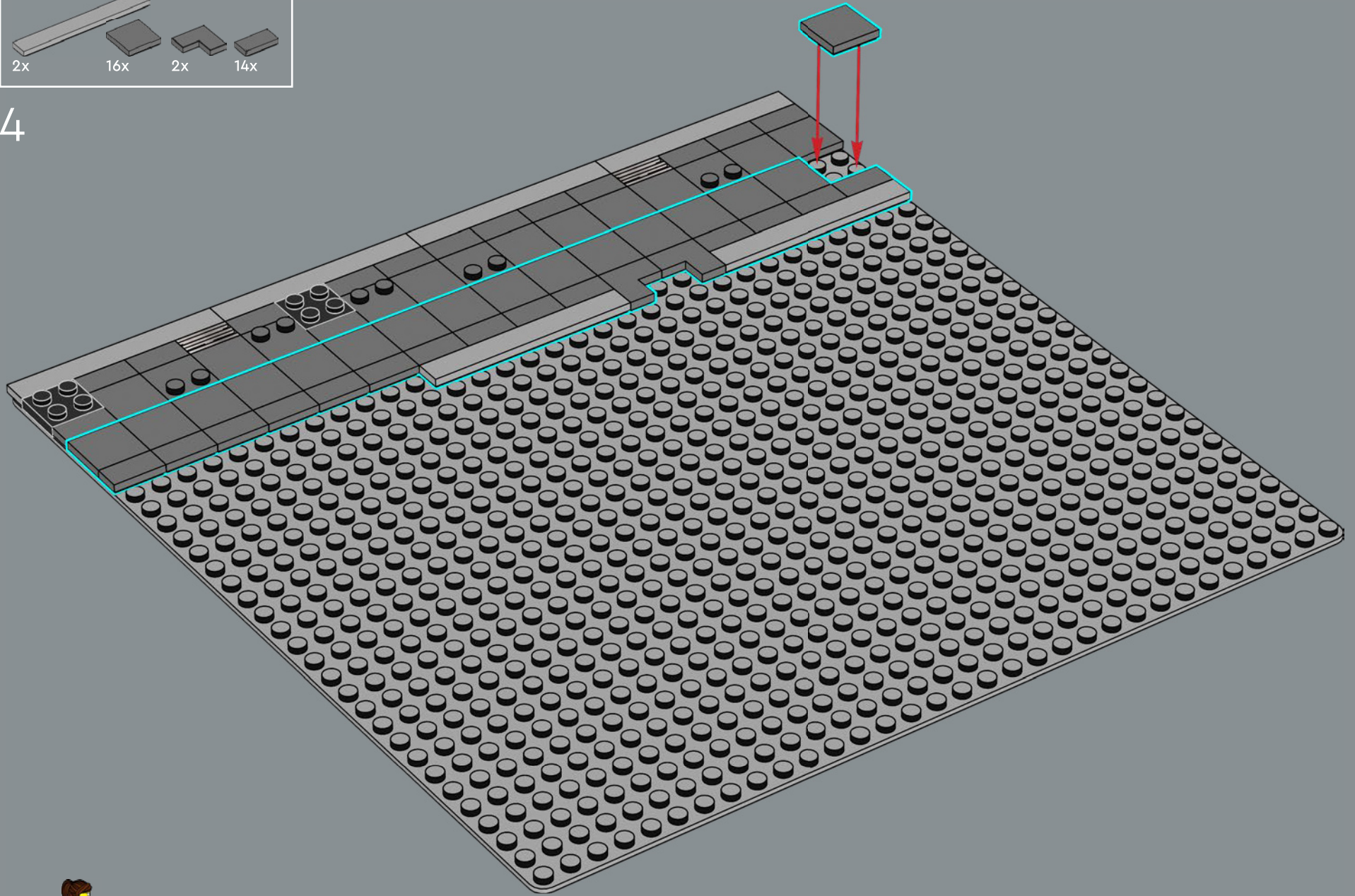

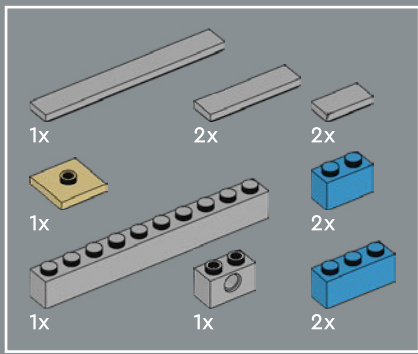

5

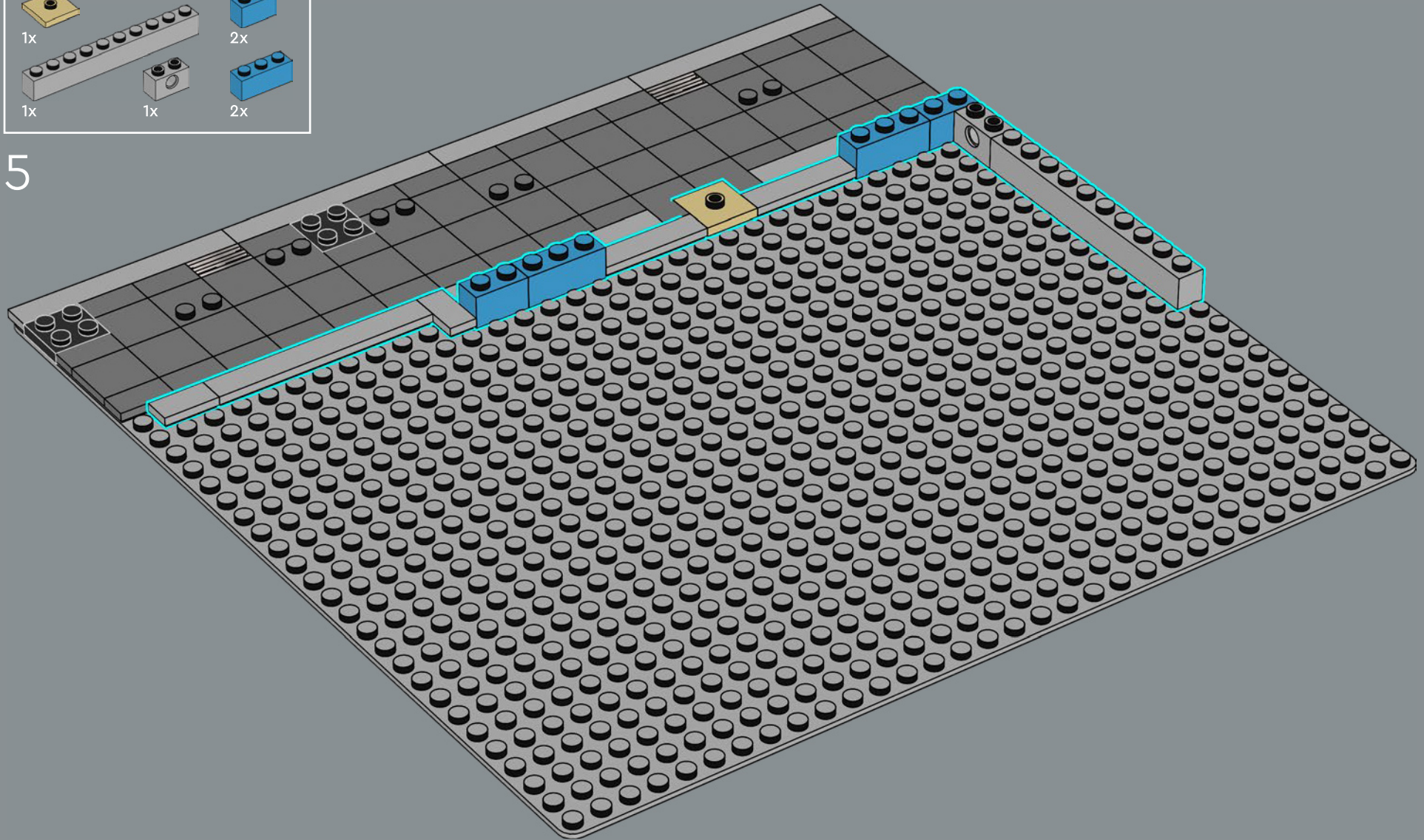

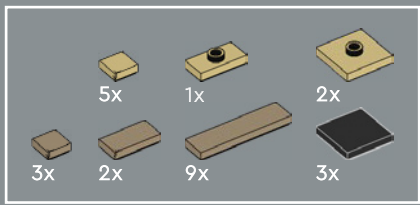

6

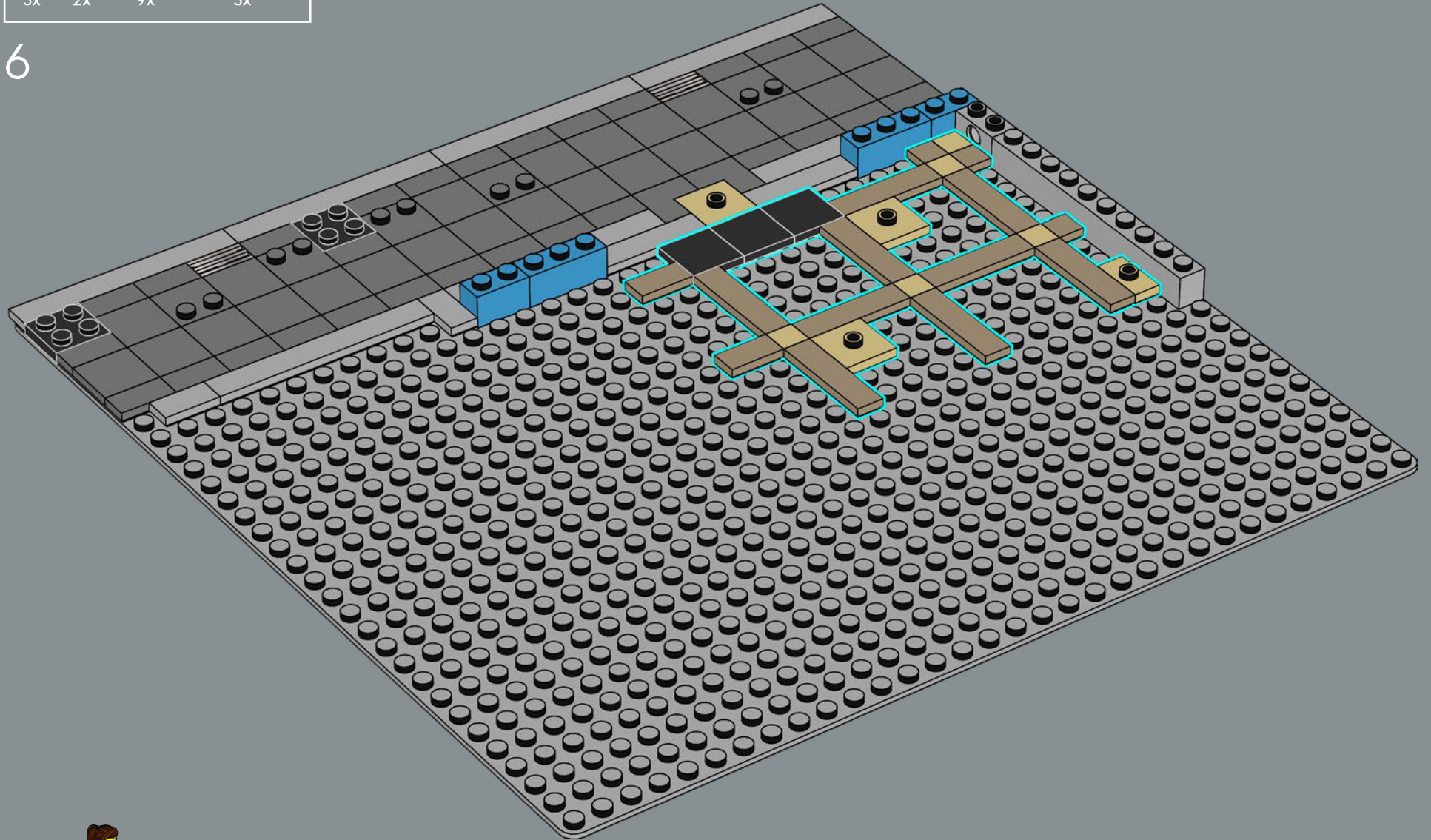

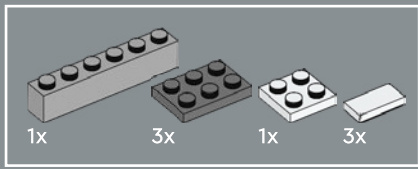

7

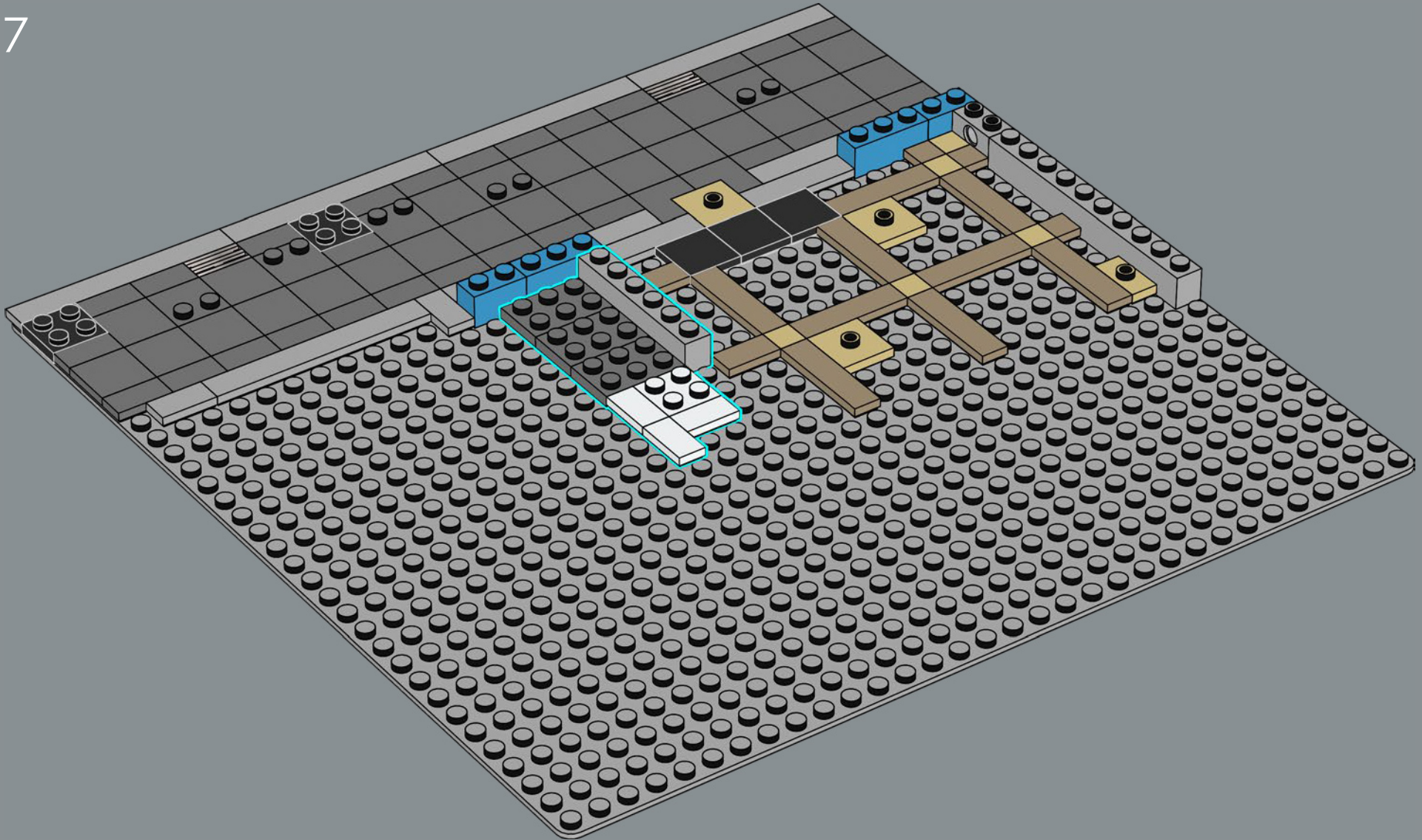

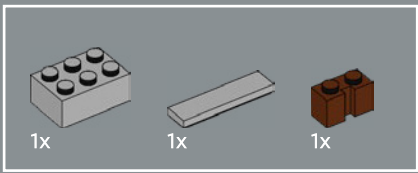

8

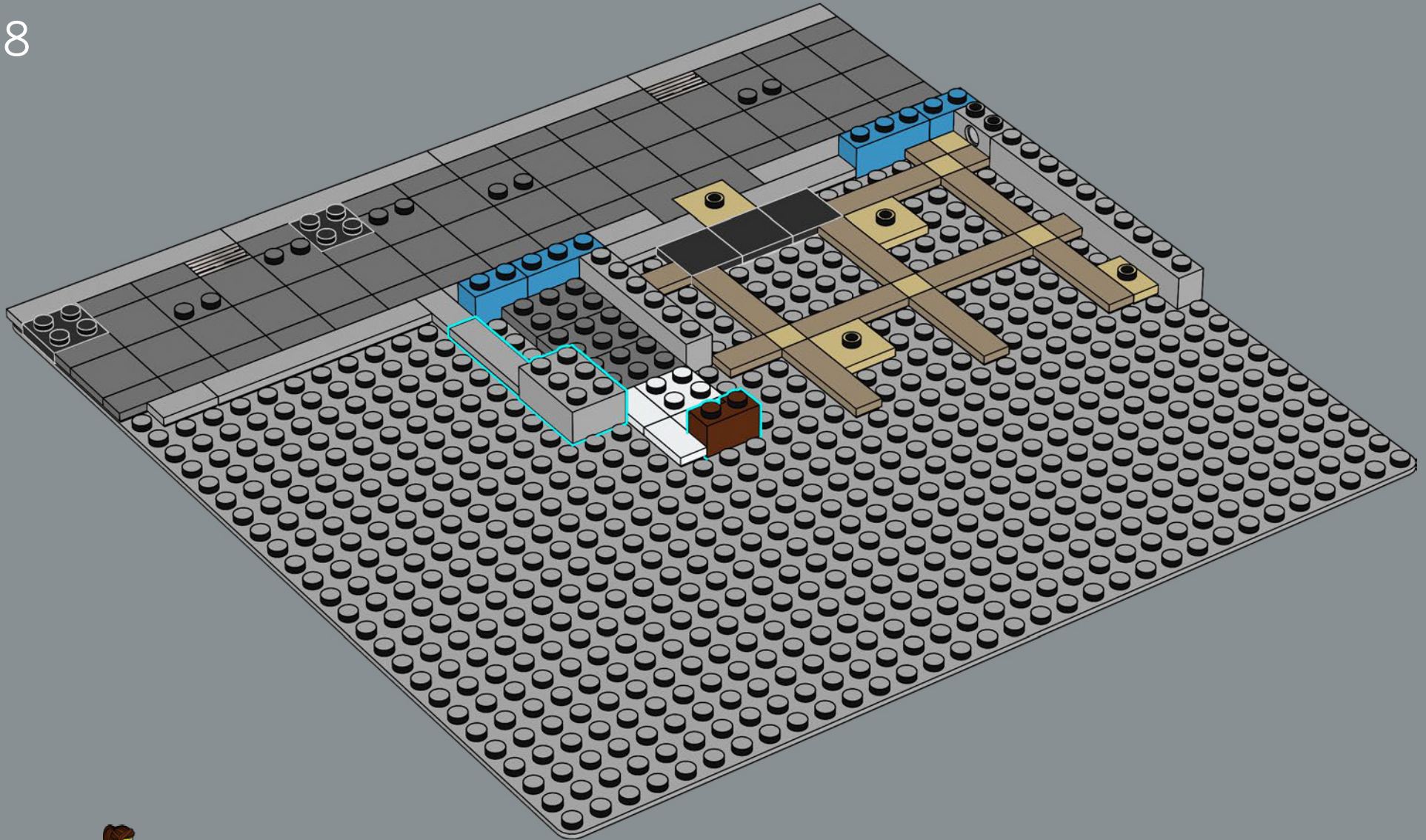

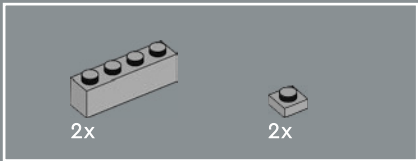

10

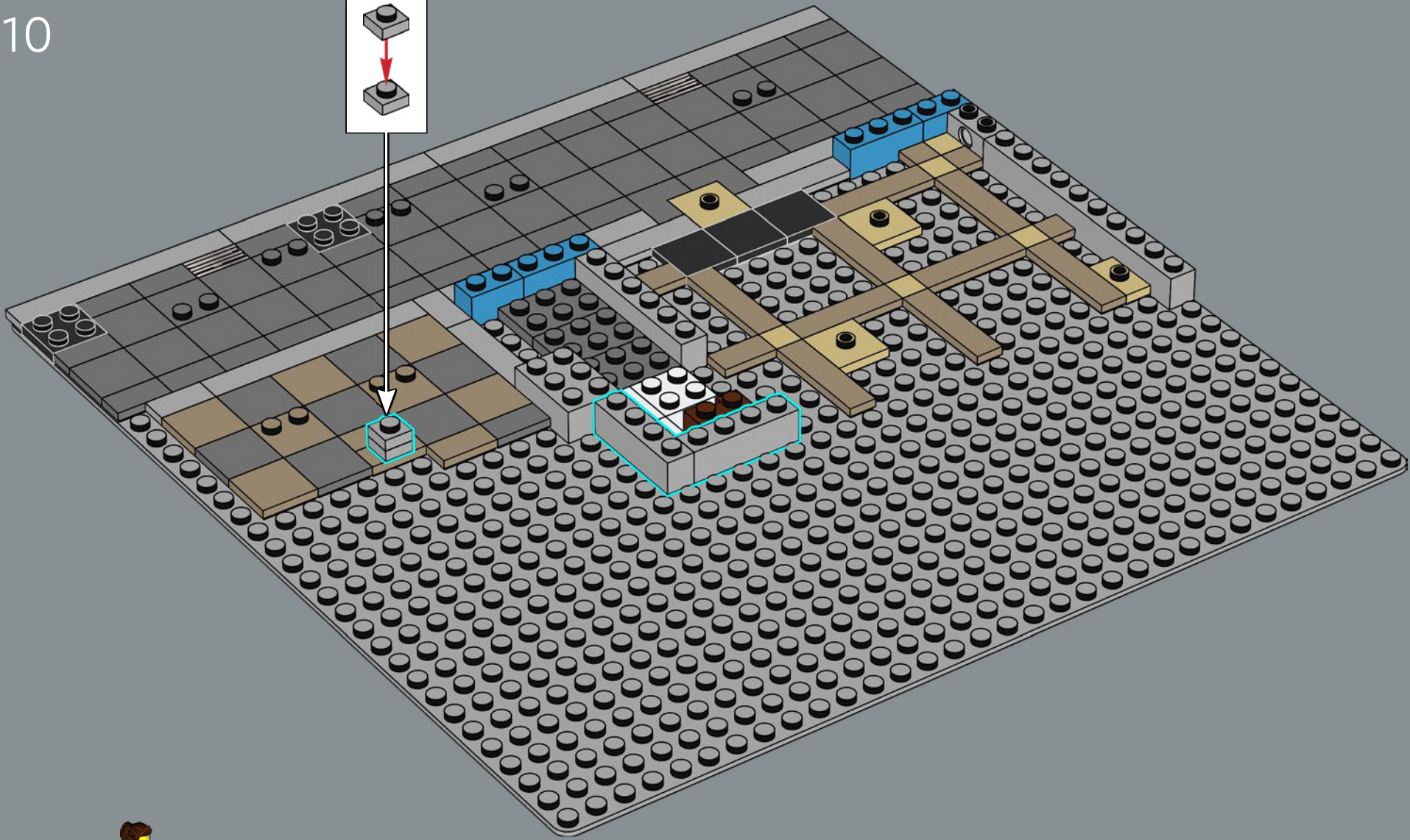
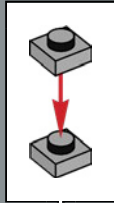

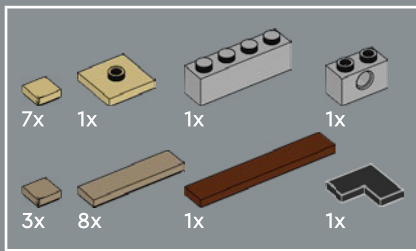

11

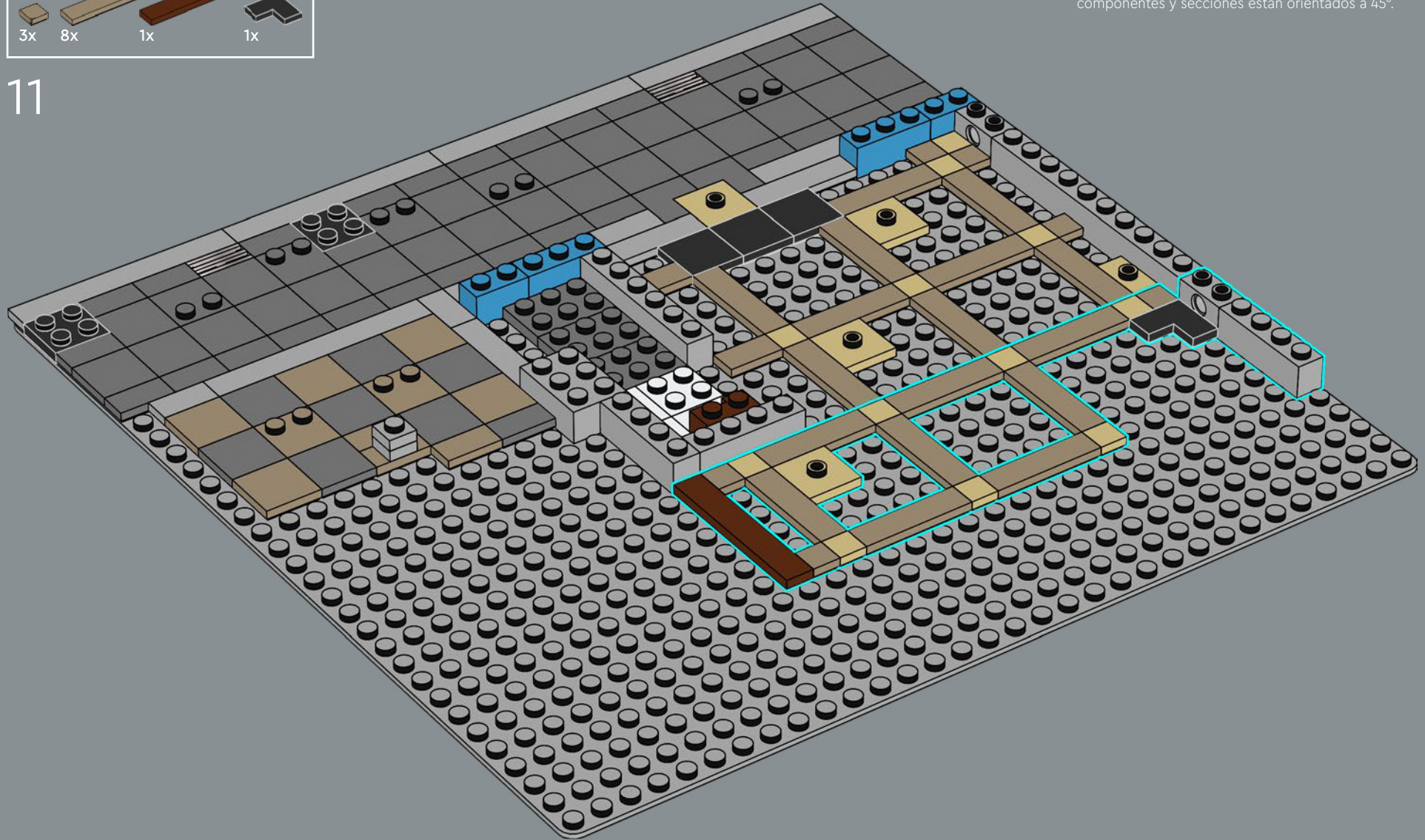

La colocación de estos elementos crea una línea que forma un ángulo de 45° con respecto de la cuadrícula LEGO® del modelo en general. Descubrirás que un rasgo distintivo del Club de Jazz es que muchos componentes y secciones están orientados a 45°.

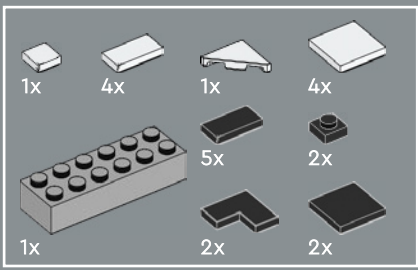

12

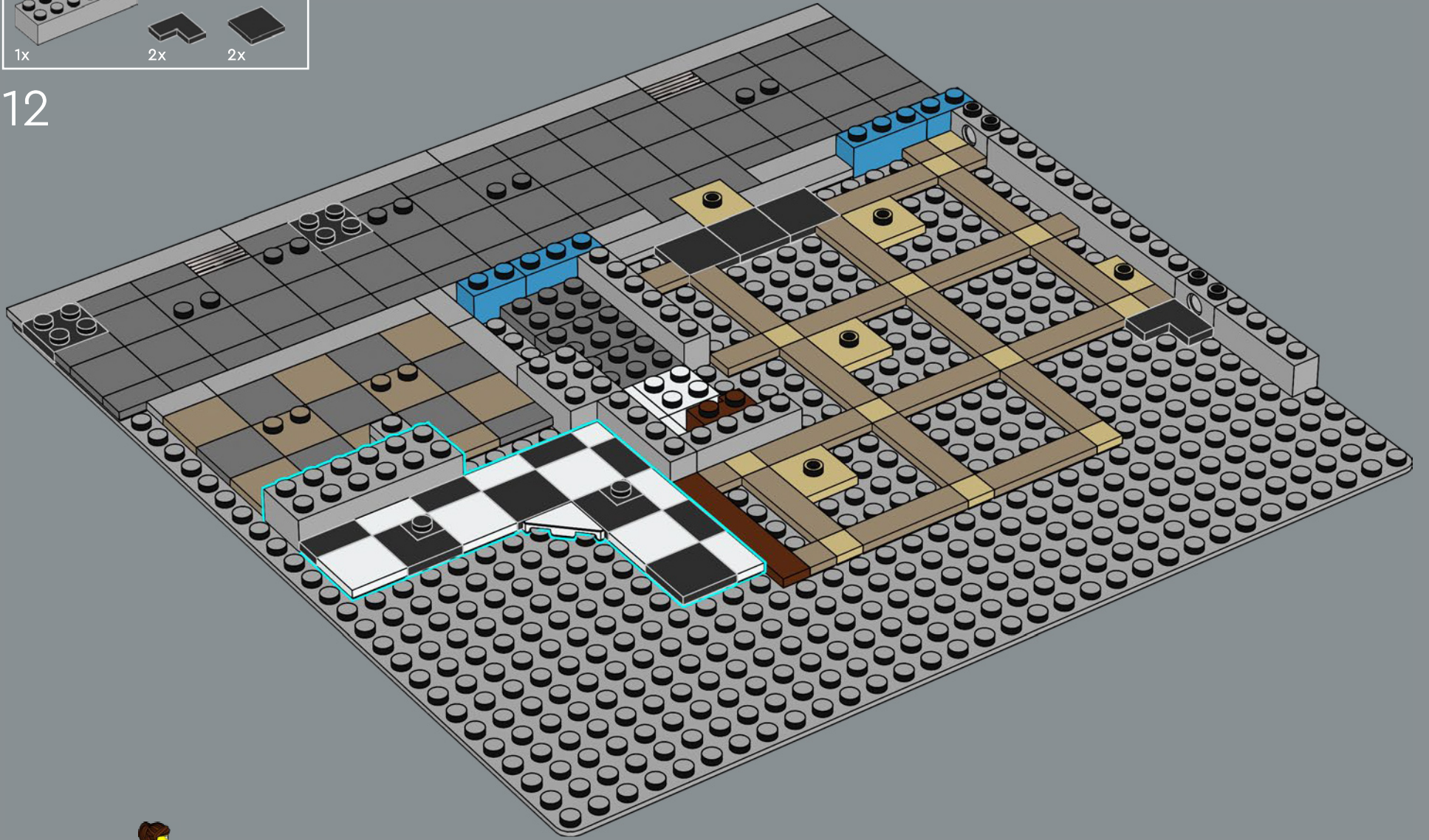

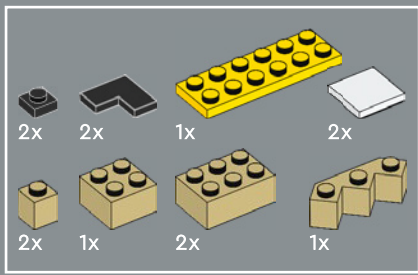

13

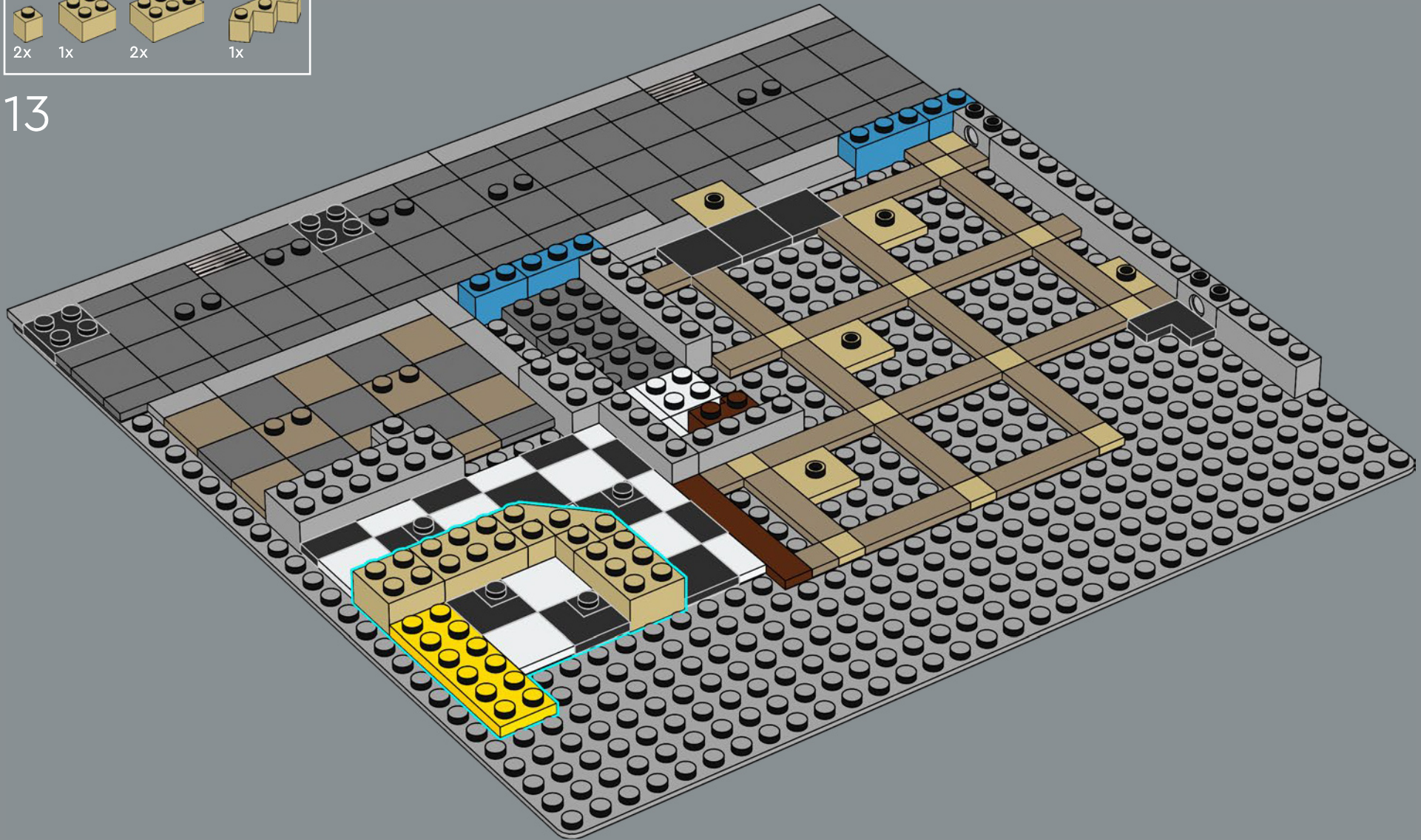

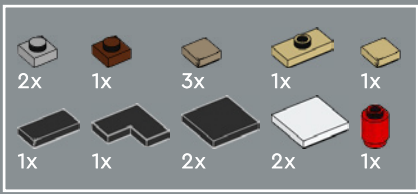

14

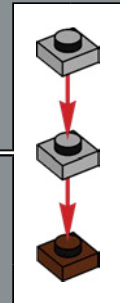
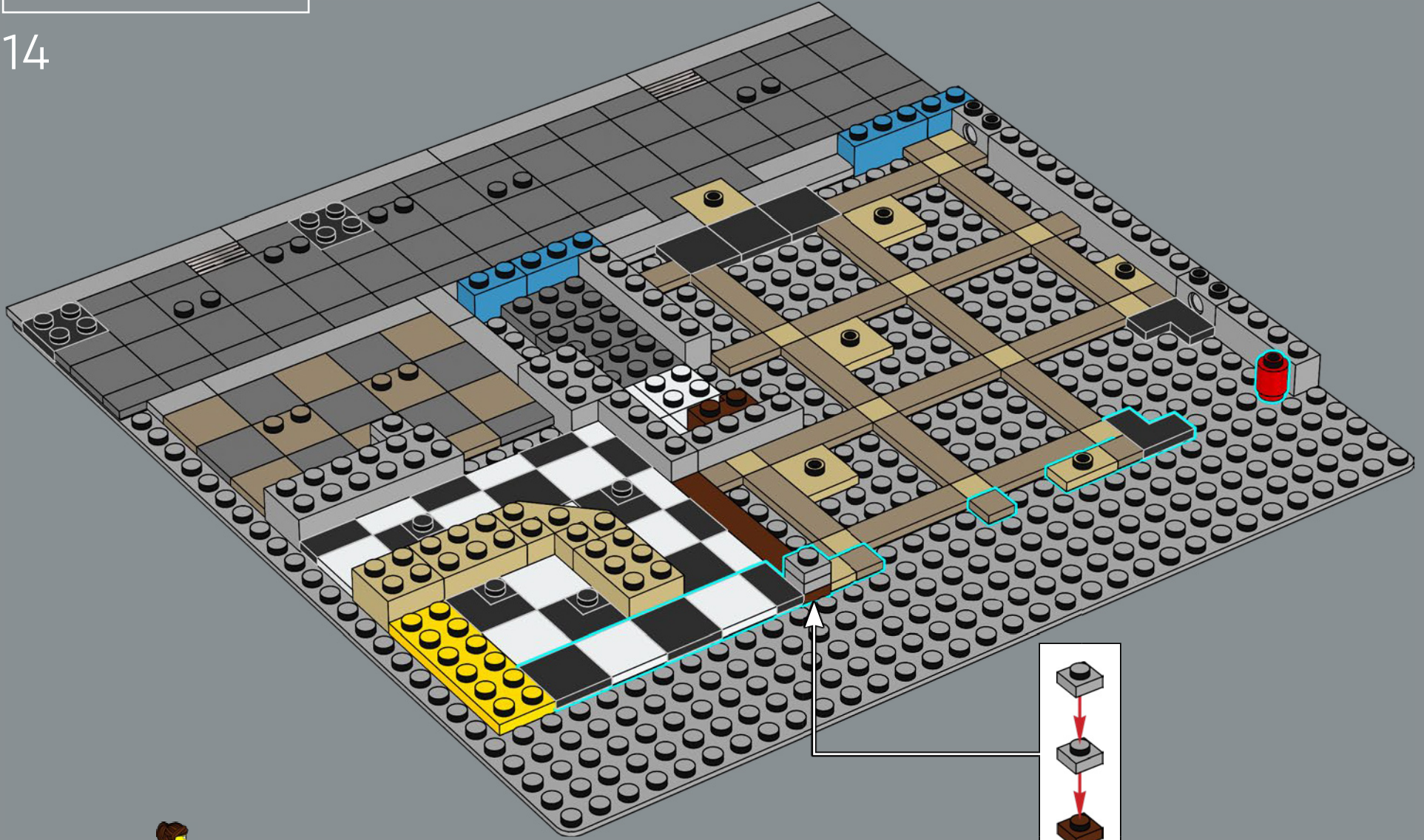

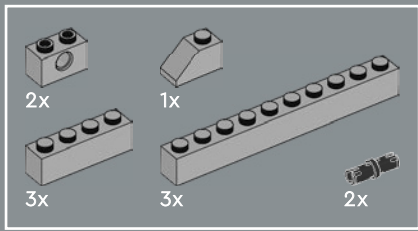

15

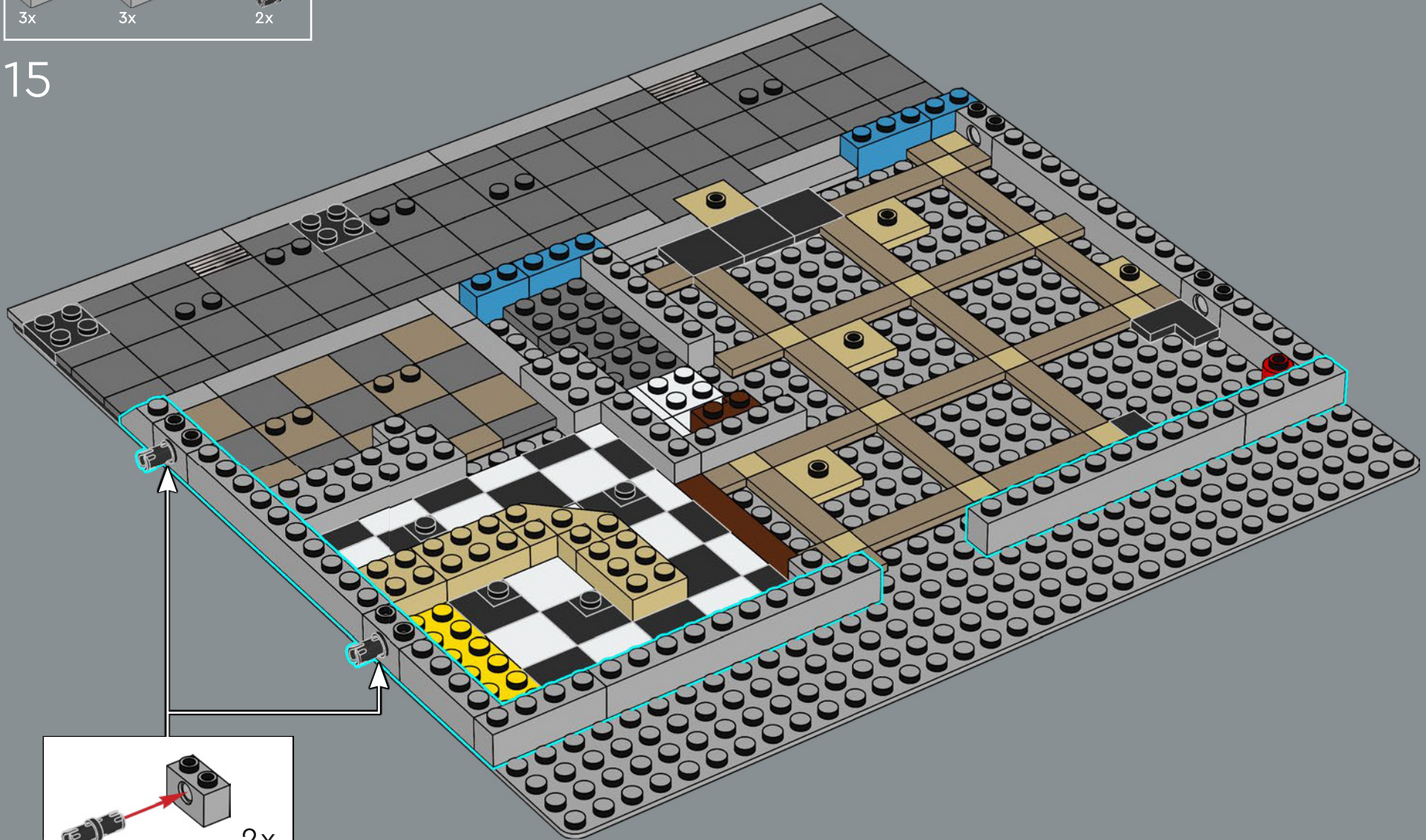

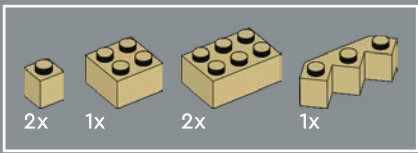

16

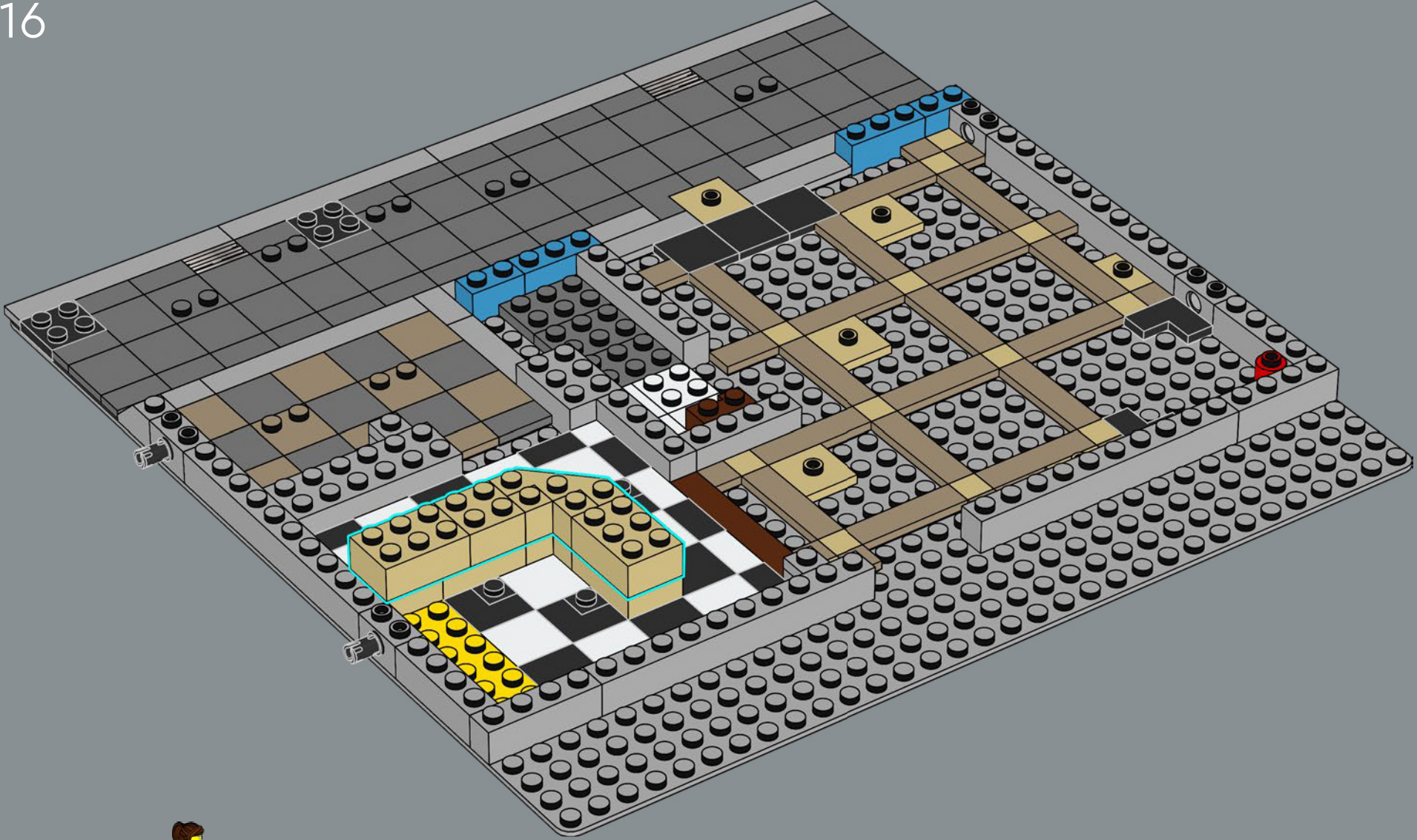



La percusionista está probando la nueva batería que está a la venta en la tienda de música de la Gran Plaza LEGO® (10255), ¡y no podría estar más emocionada!

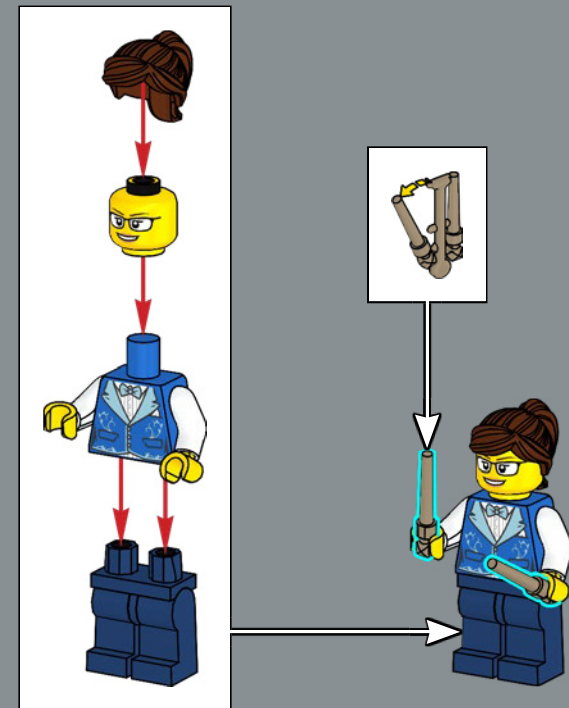

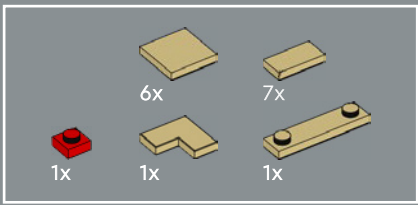

17

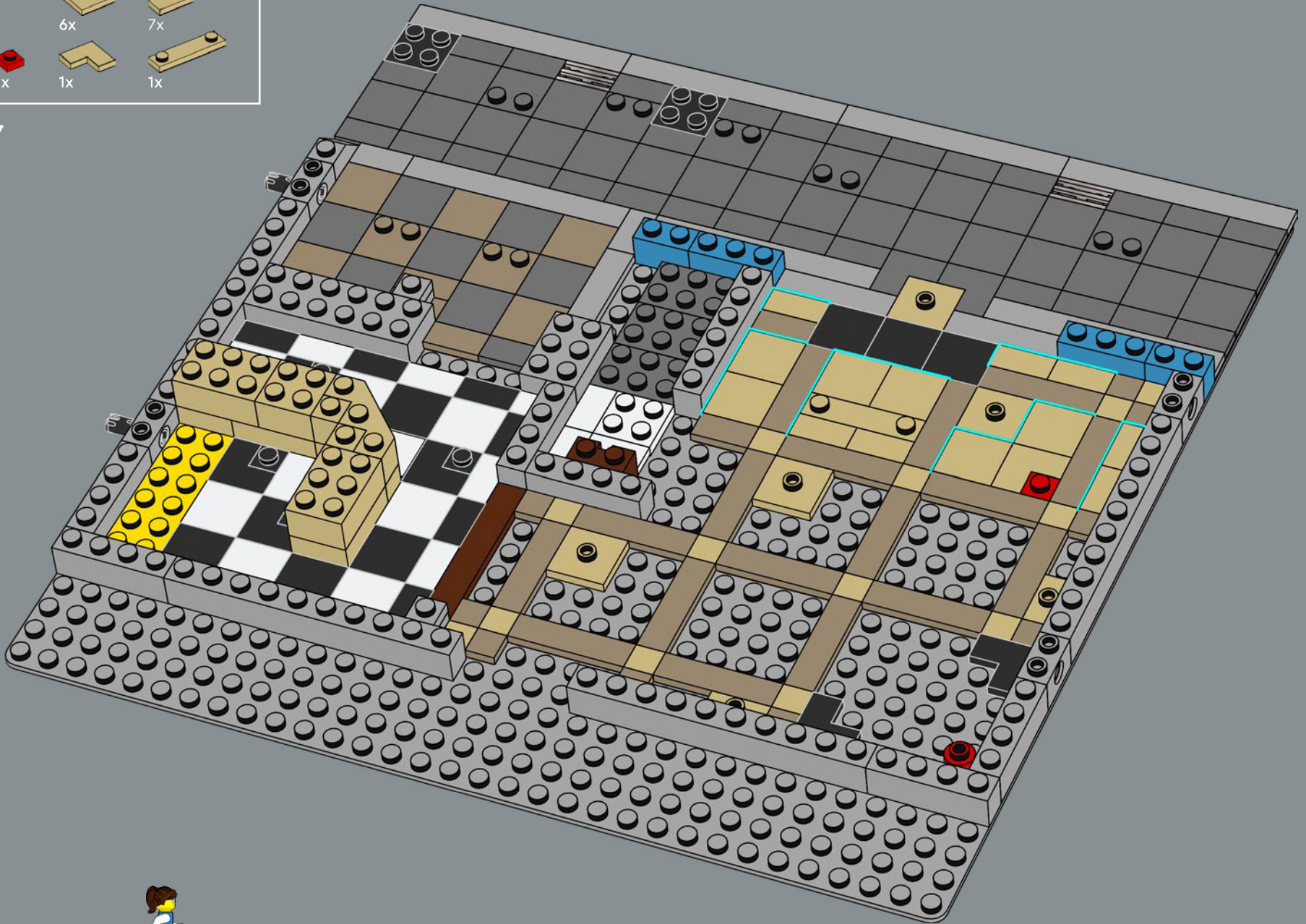

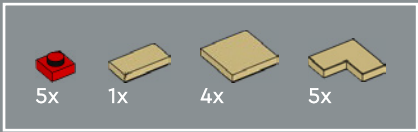

18

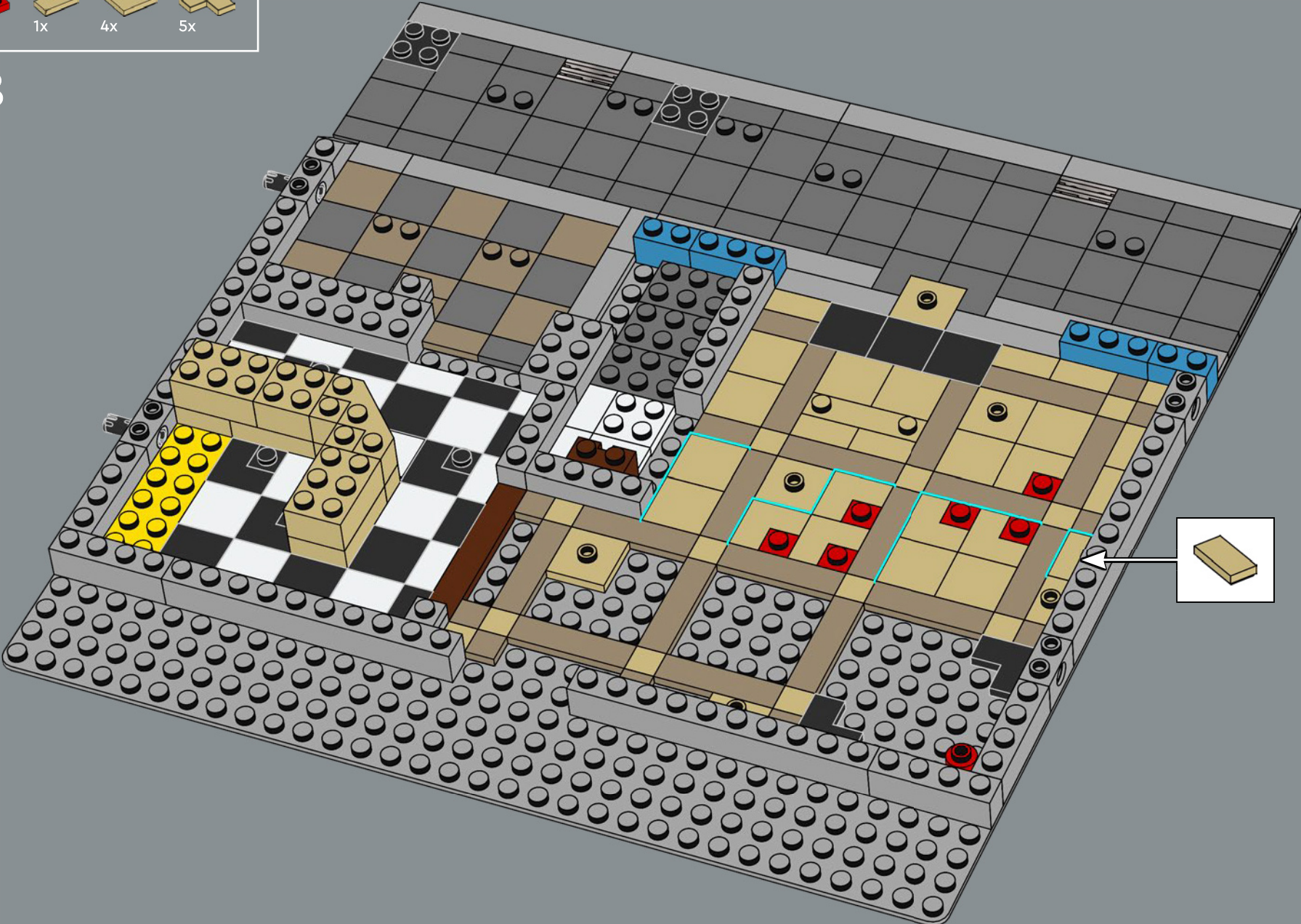

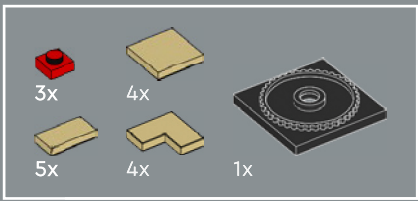

19

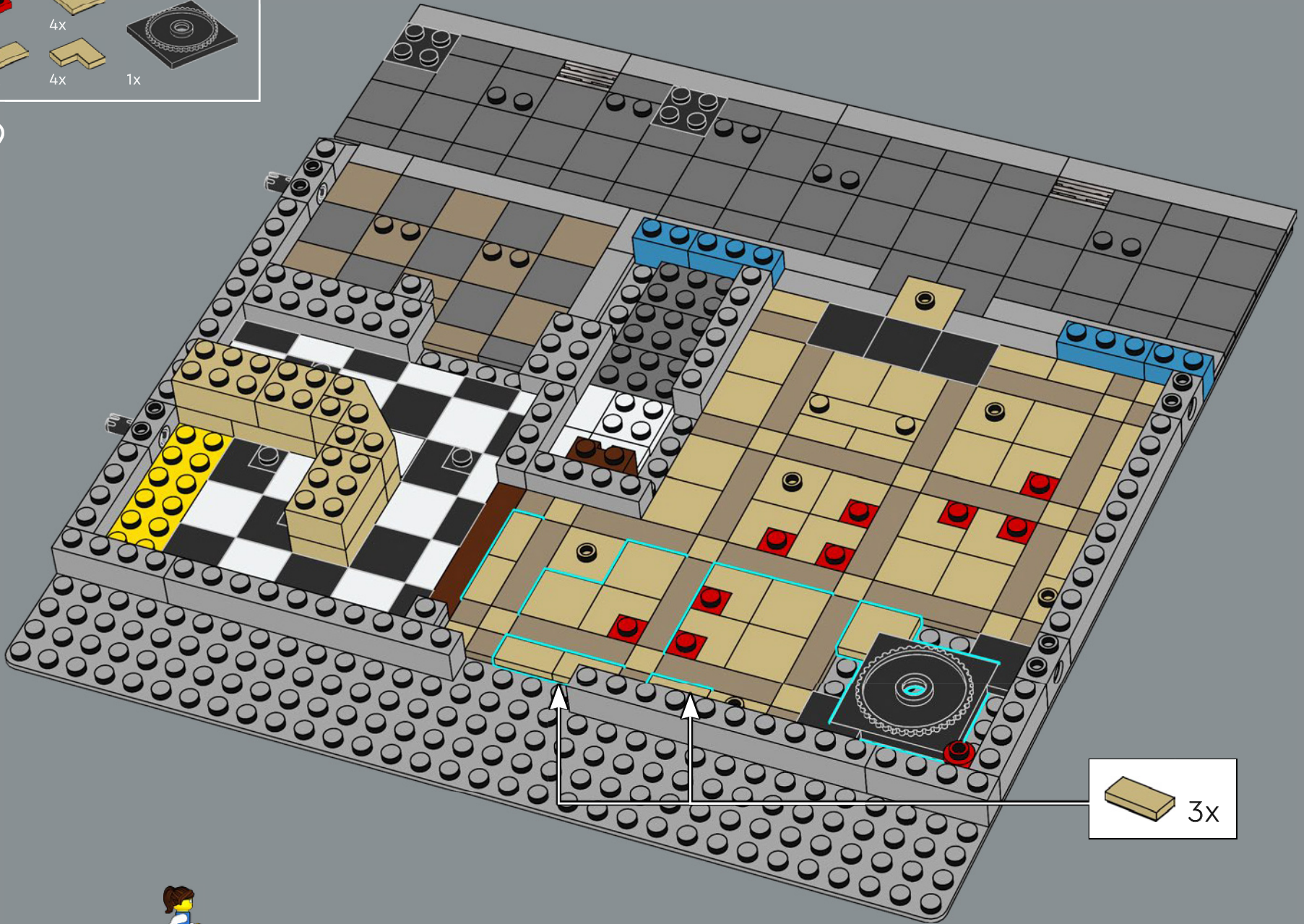

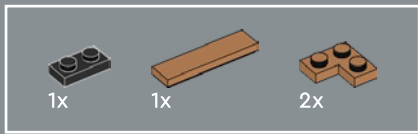

20

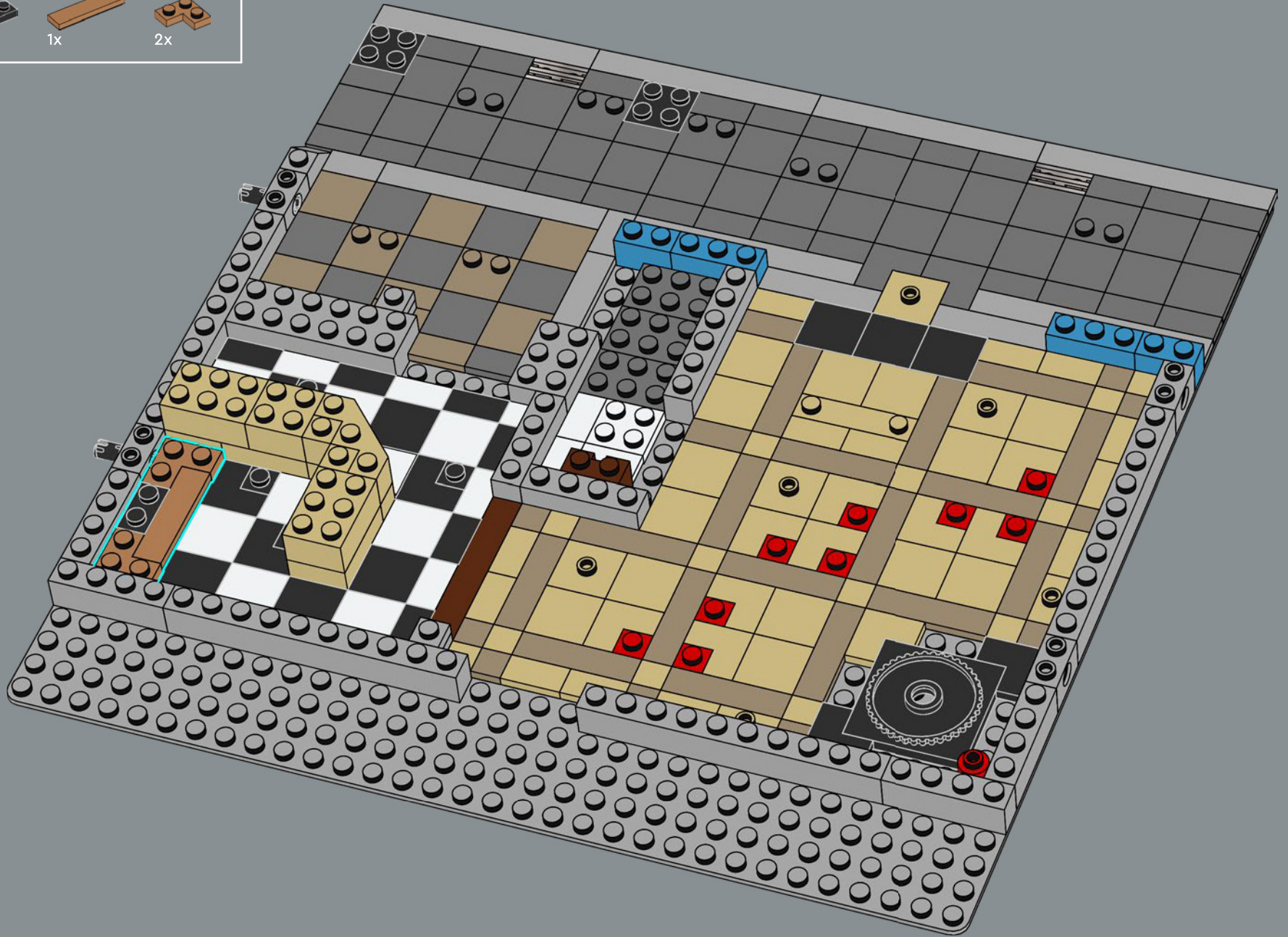

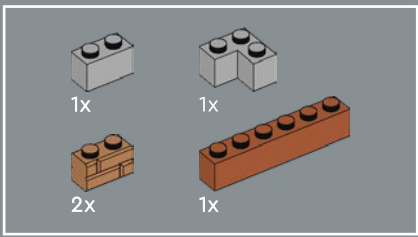

21

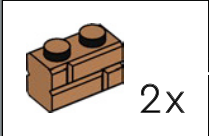
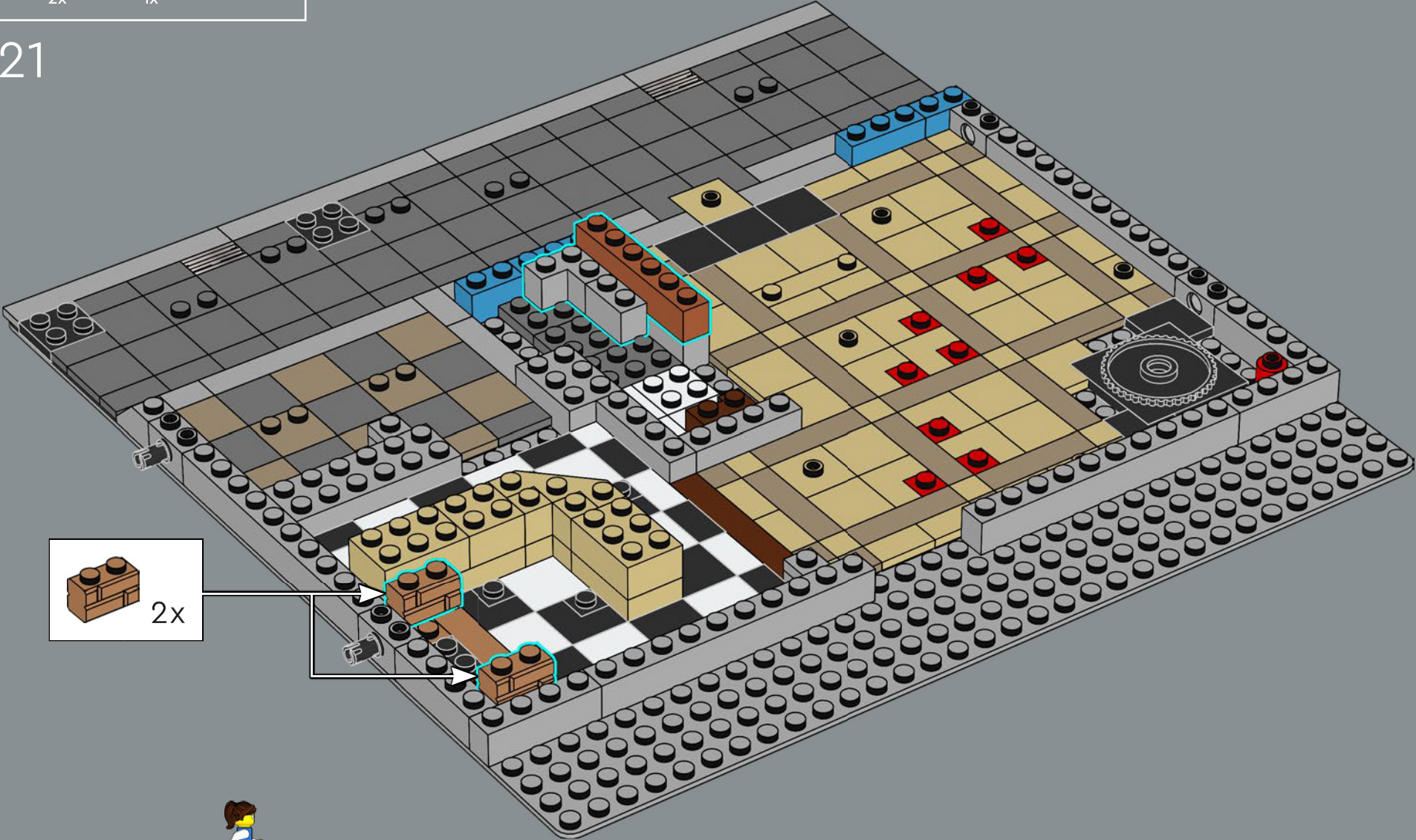

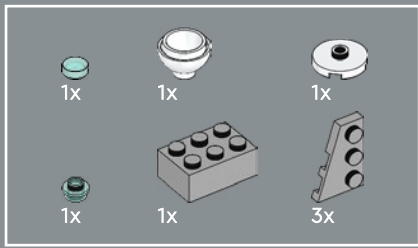

22

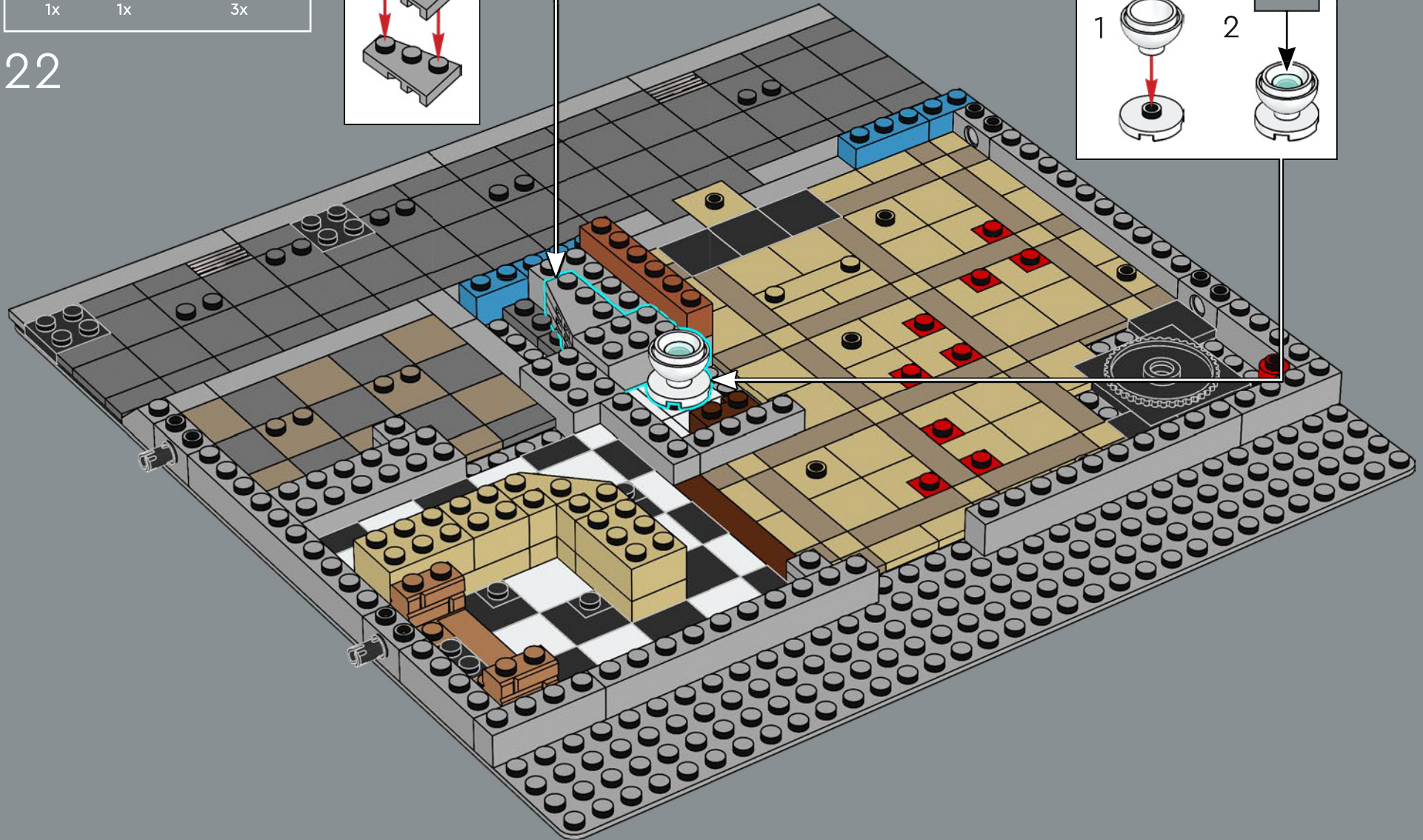
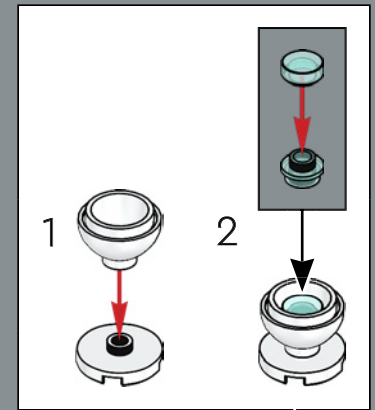
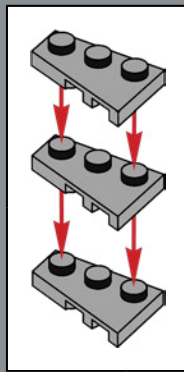

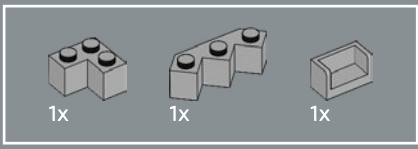

23

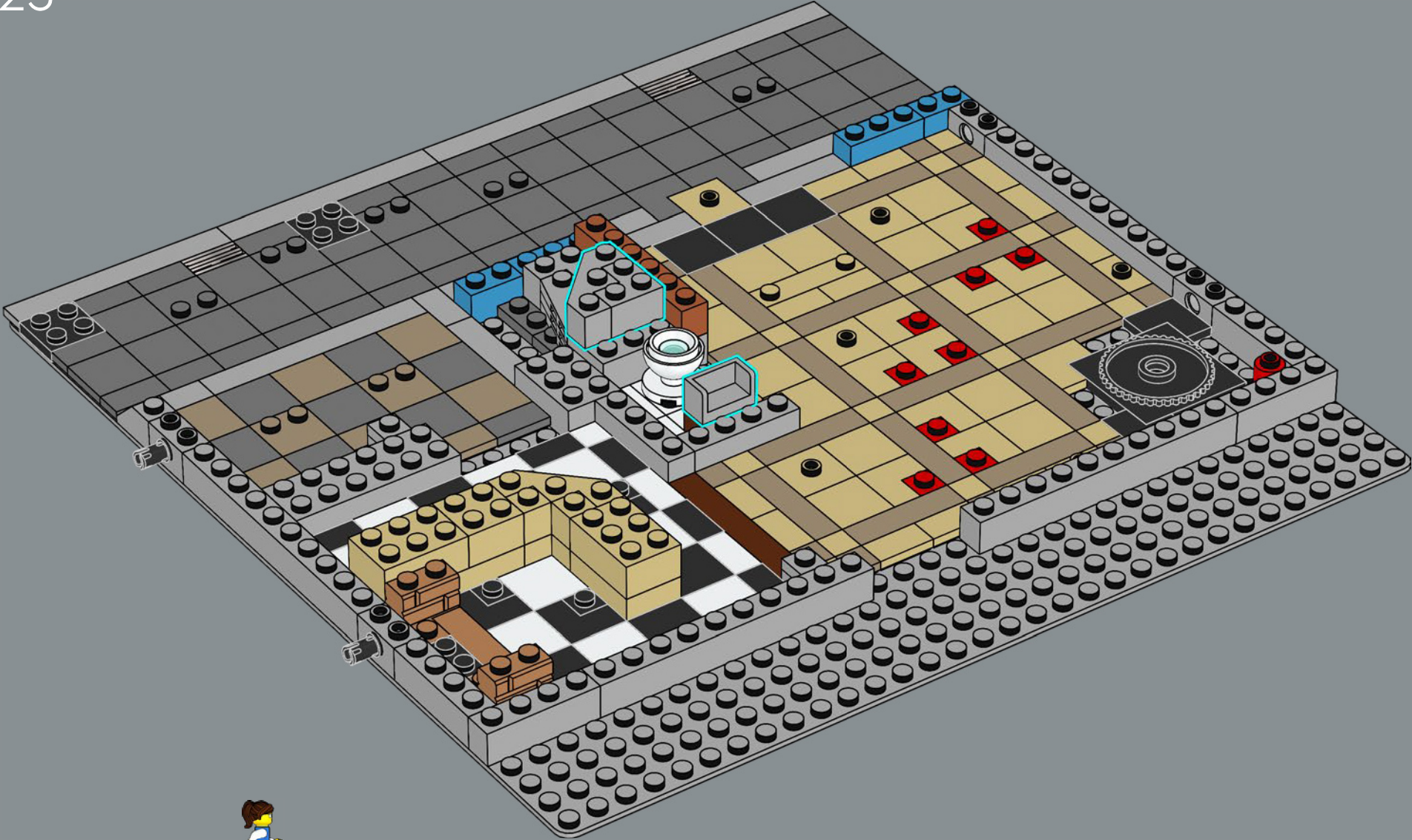

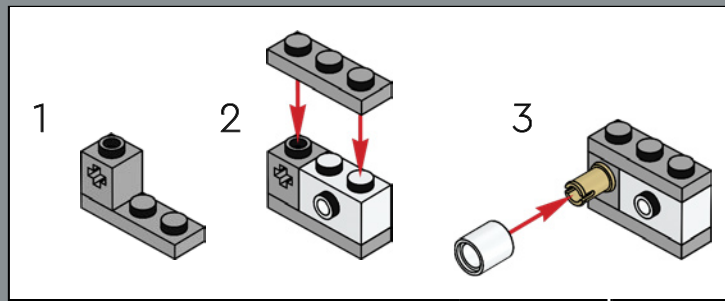
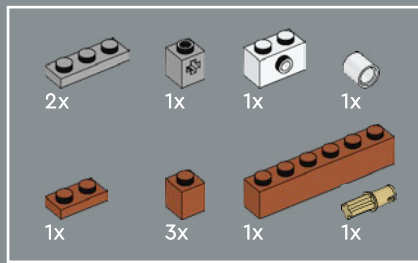

24

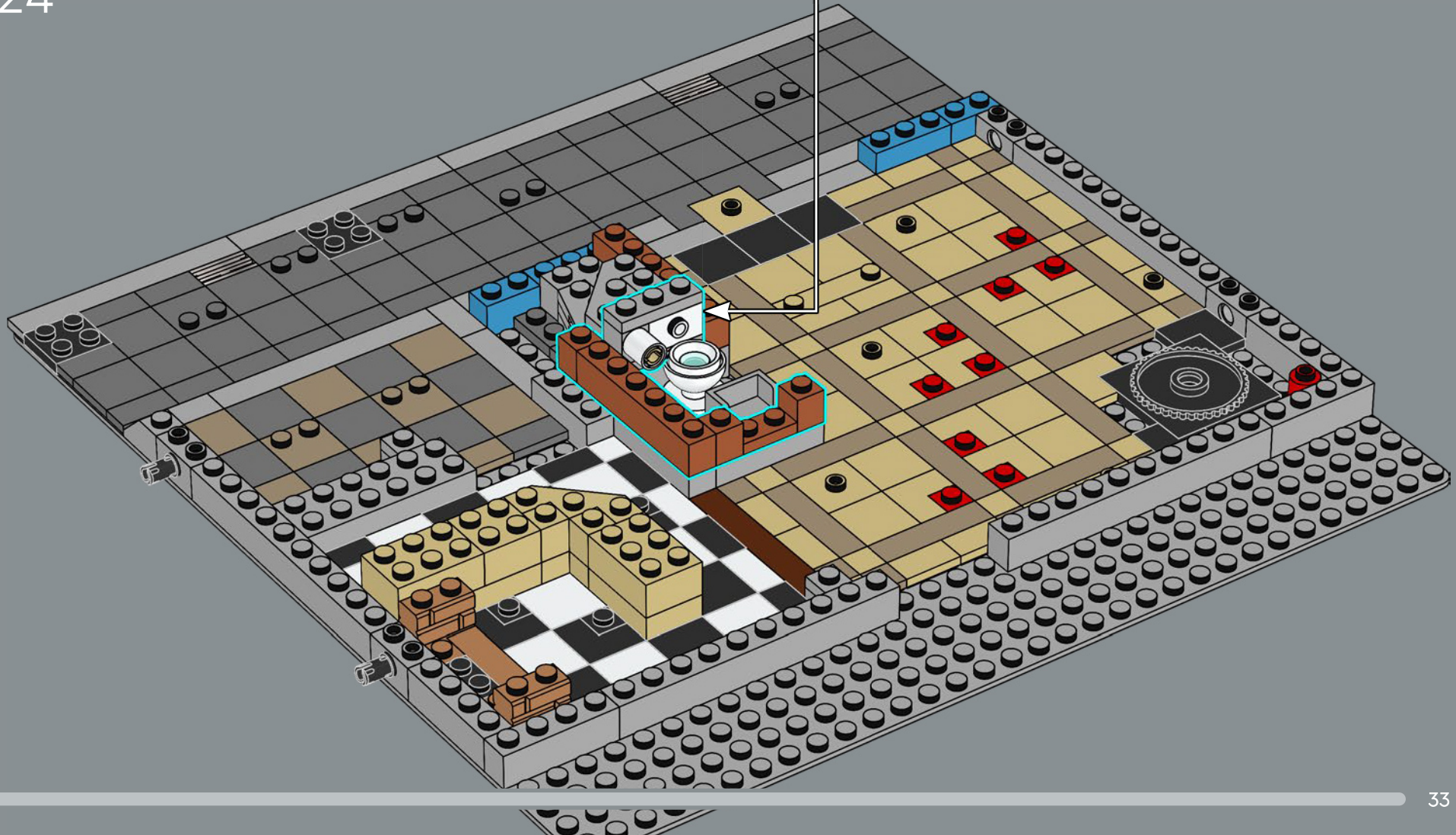

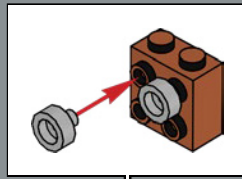
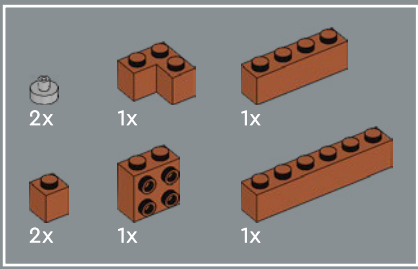

25

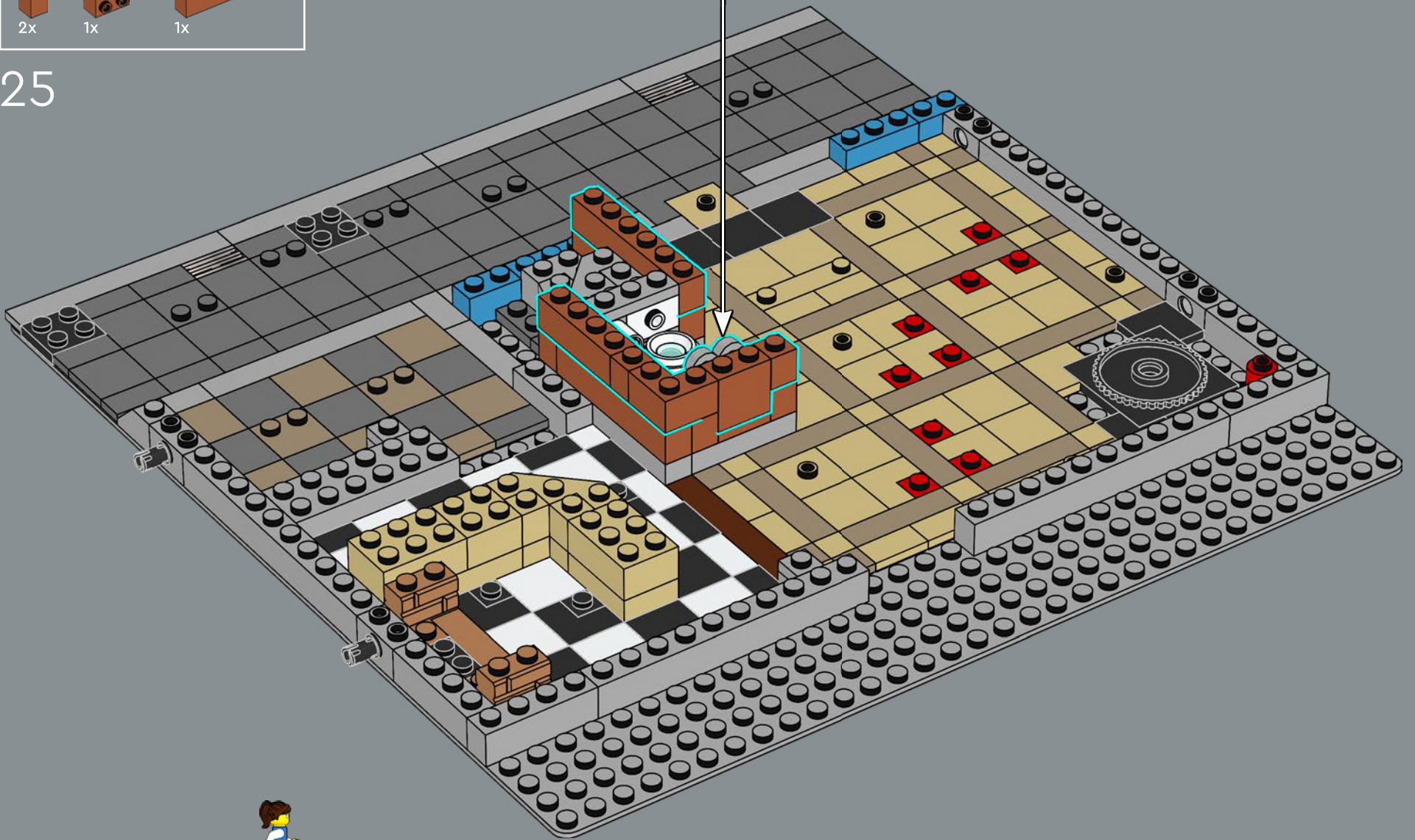

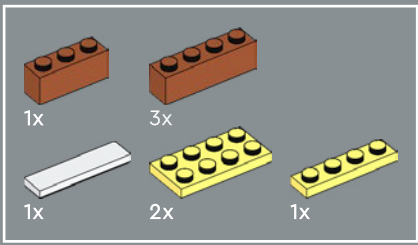

27

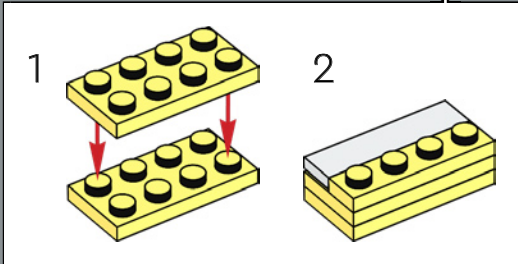
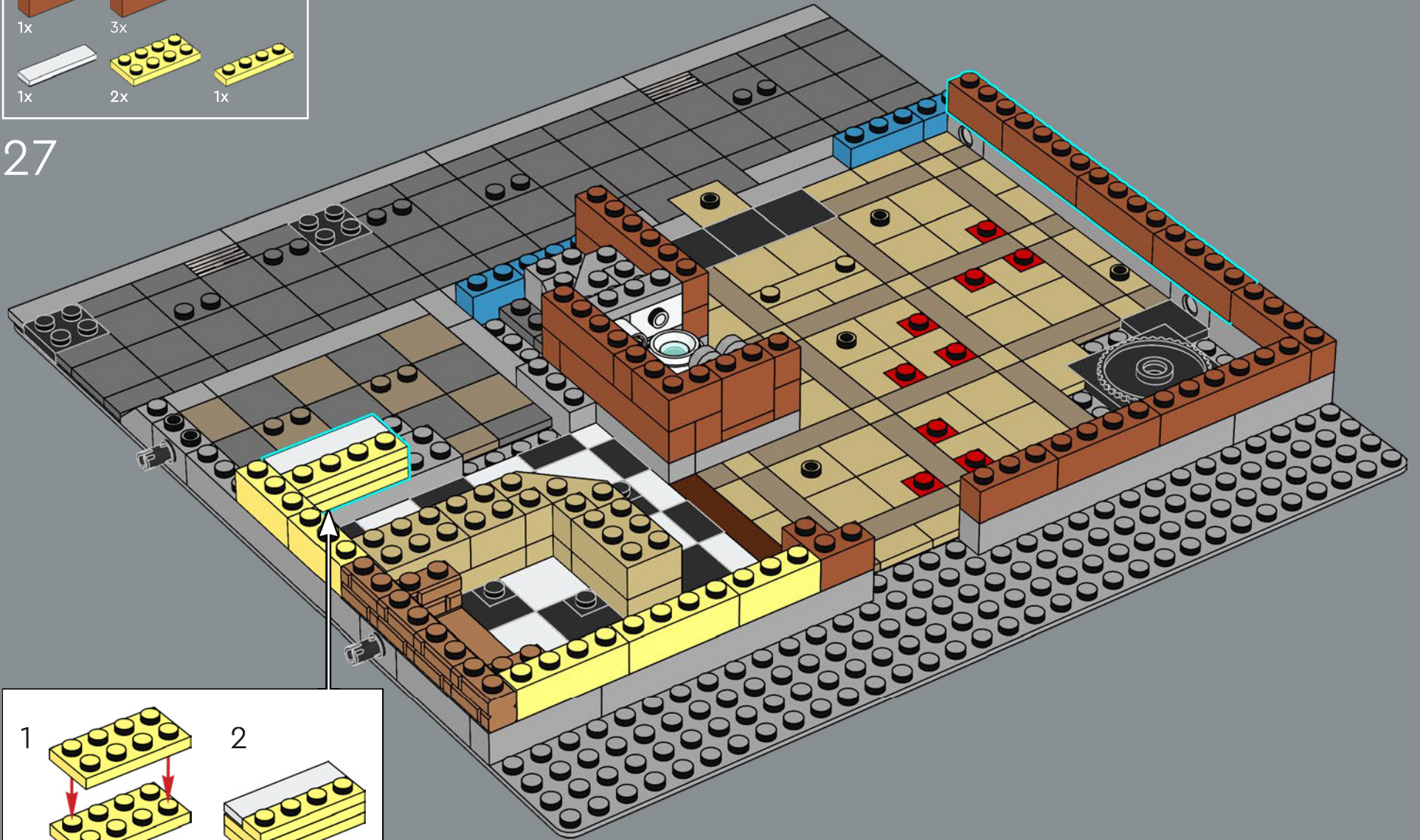

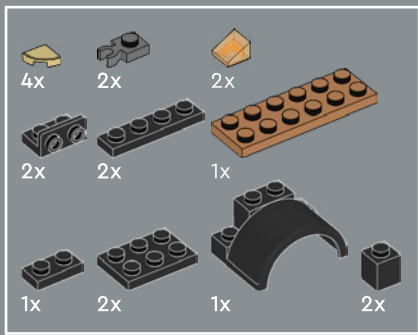

28

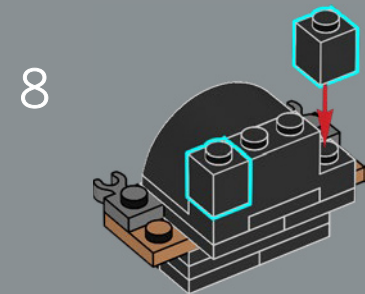
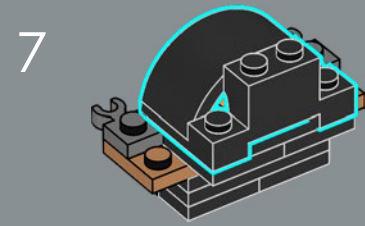
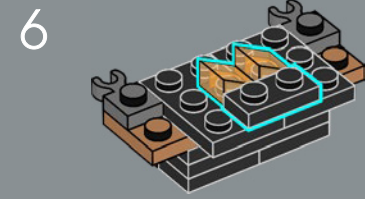
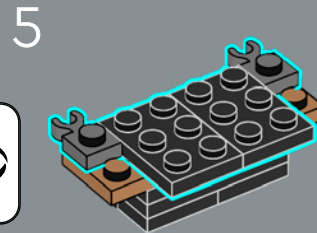
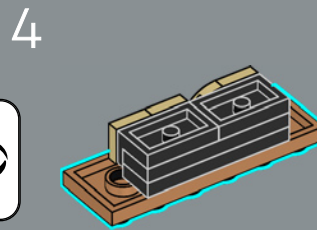
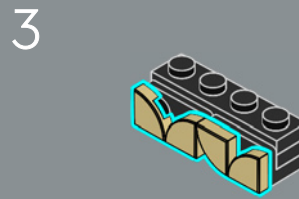
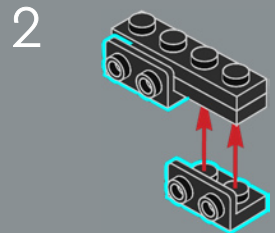
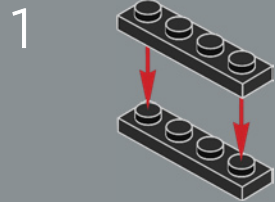

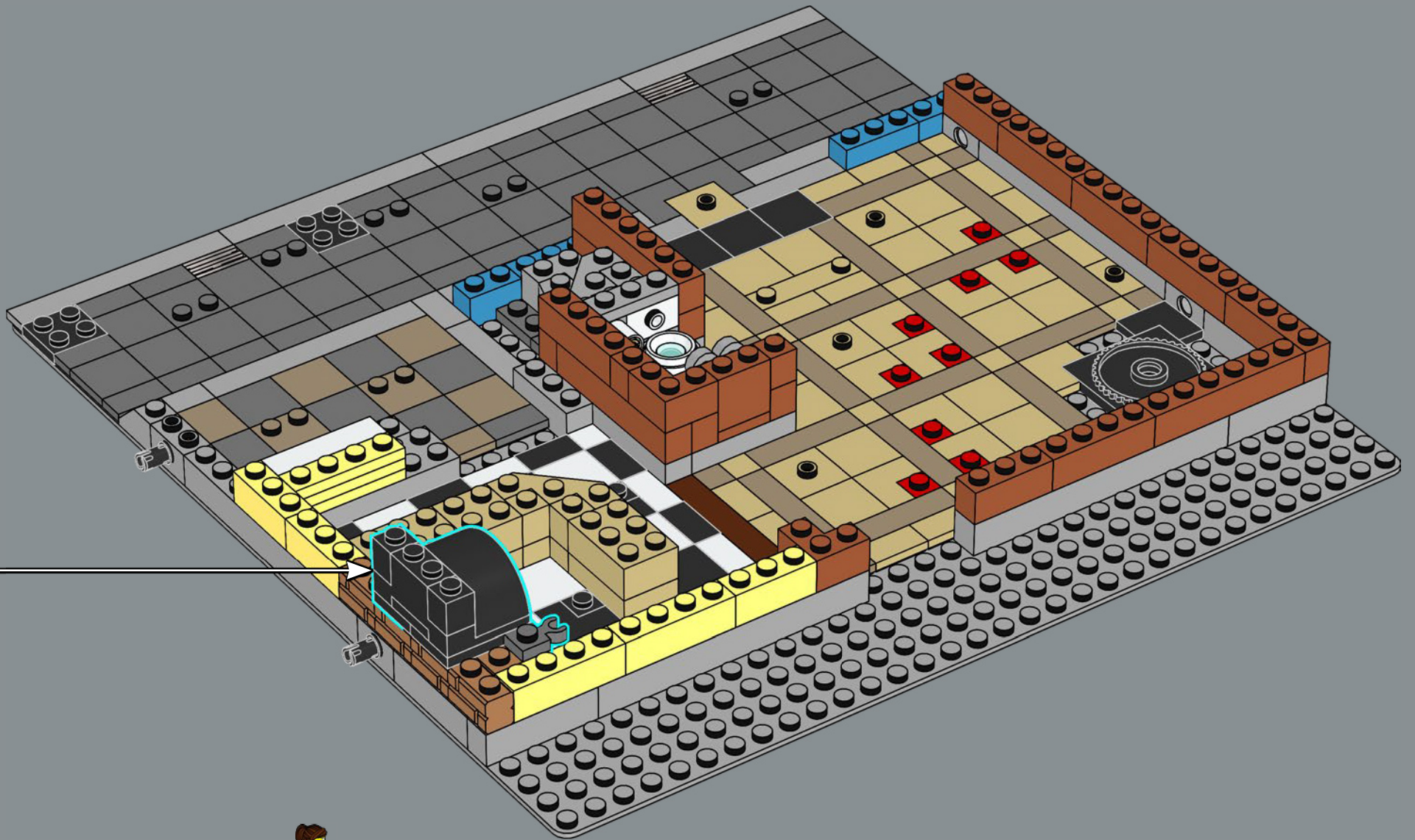

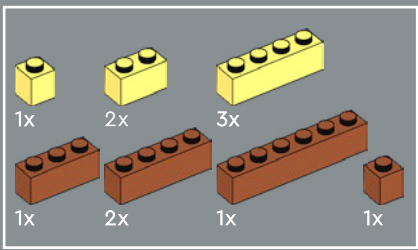

30

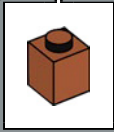
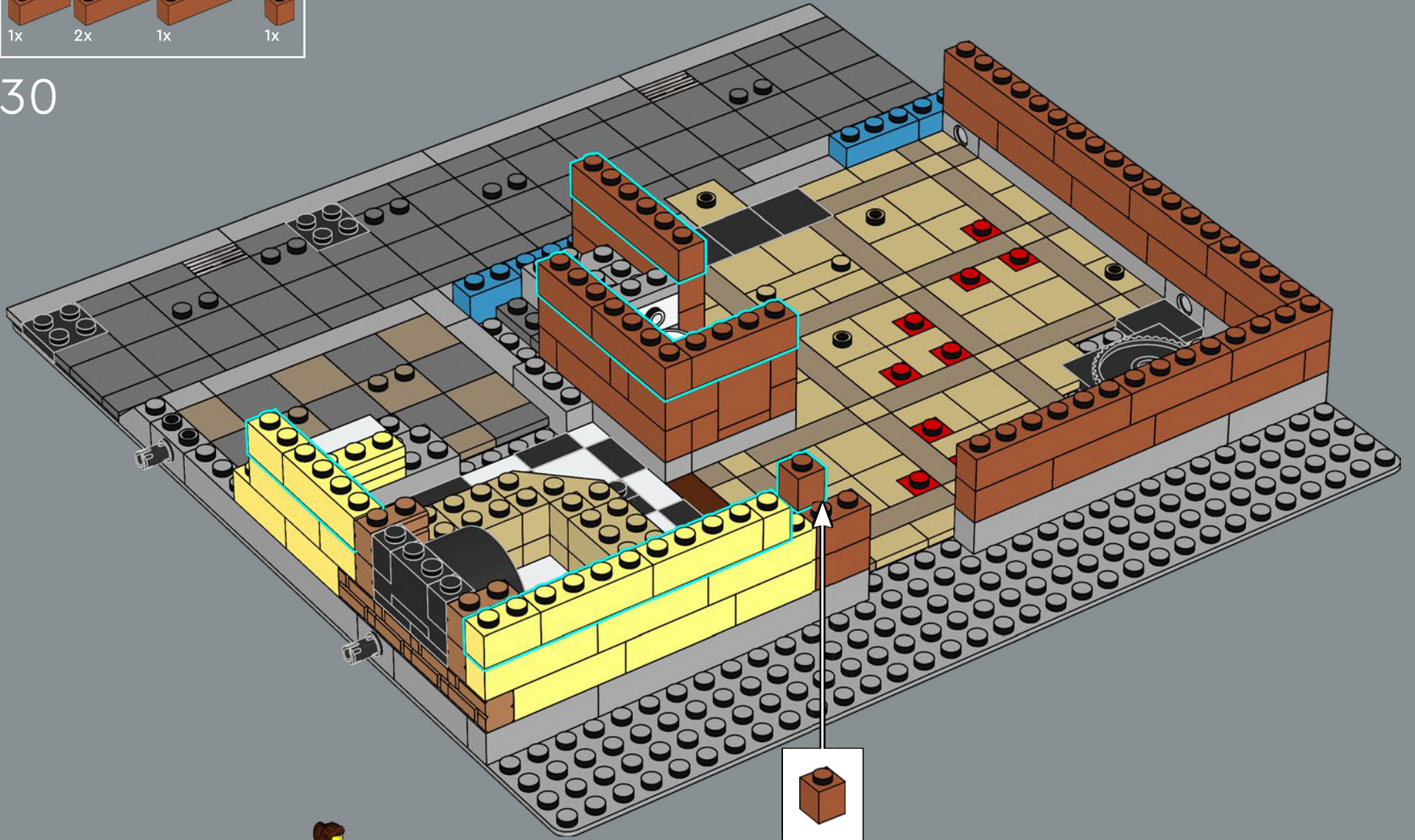

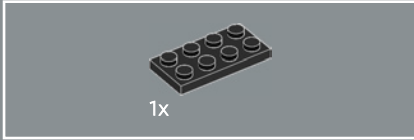

31

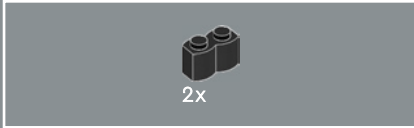
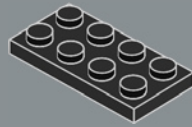

32

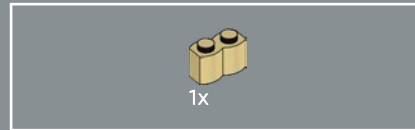
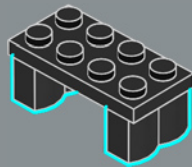

33

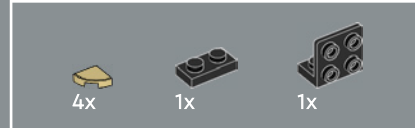
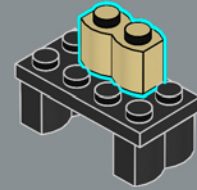

34

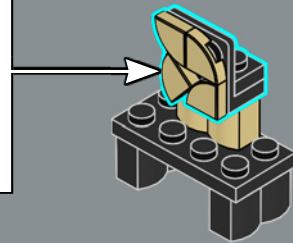
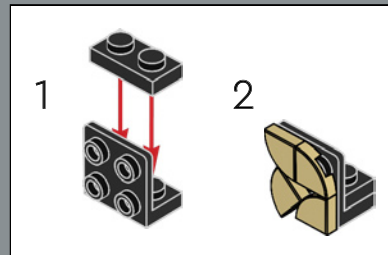

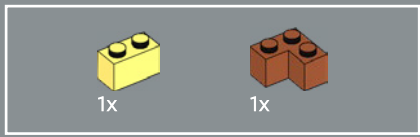

35

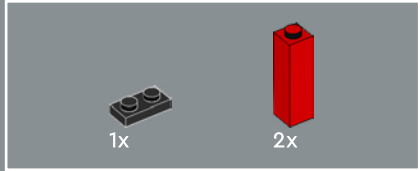
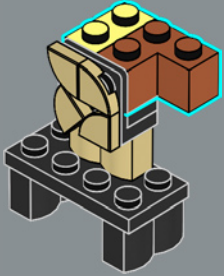

36

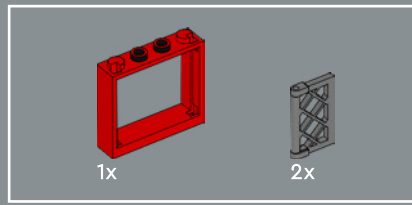
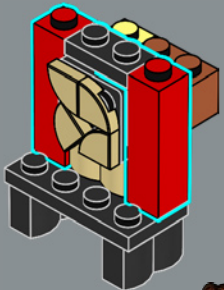

37

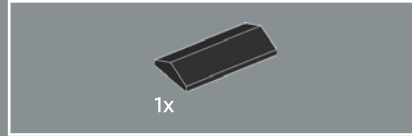
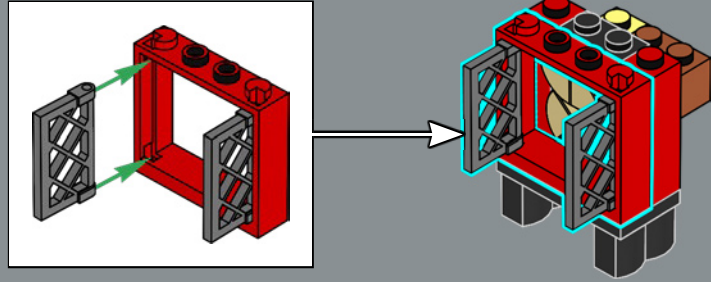

38

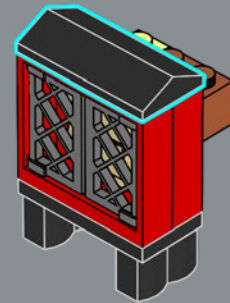



El horno de leña para cocinar *pizza* está caliente y listo para usarse. Podrás encontrar leña adicional detrás del edificio.

39

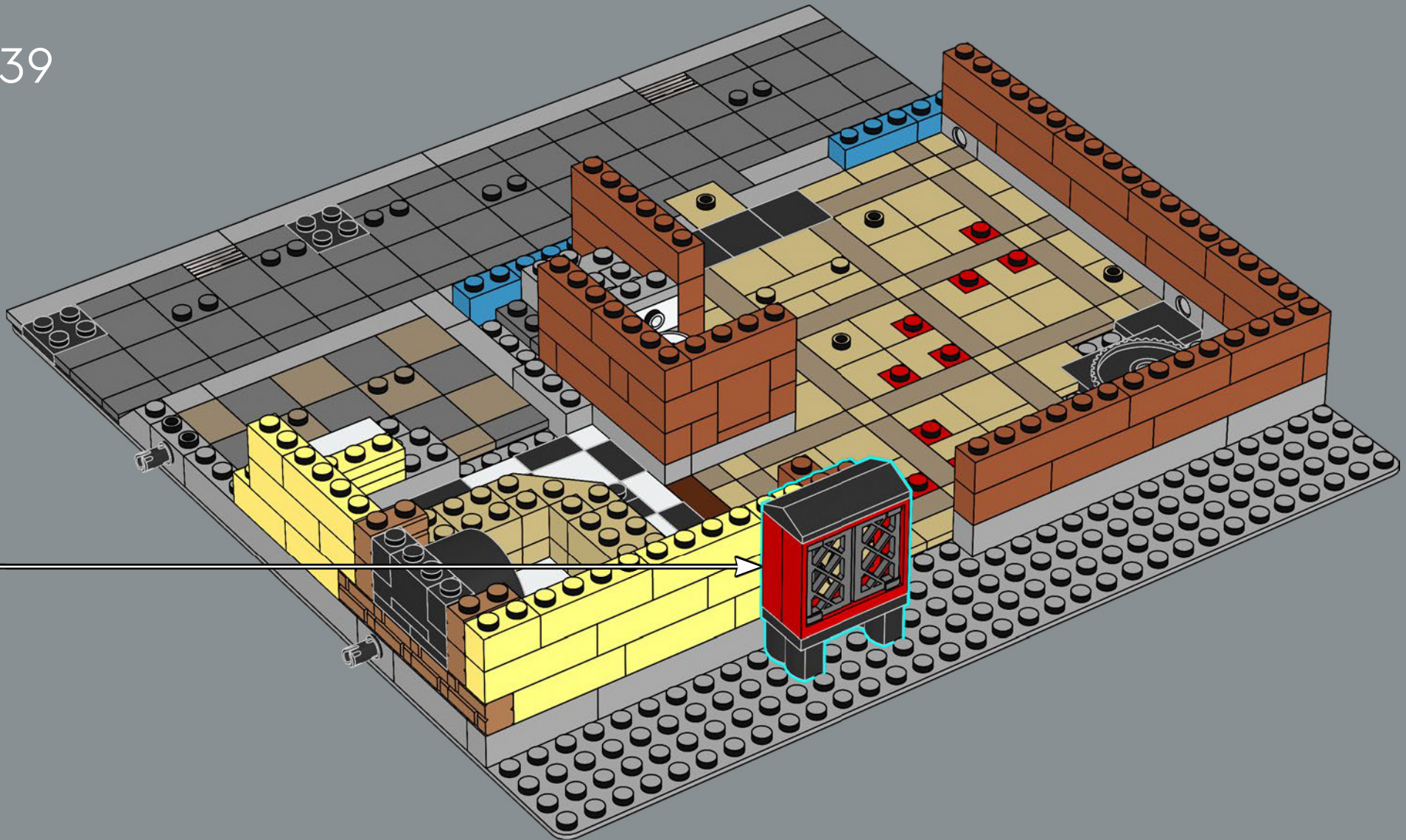

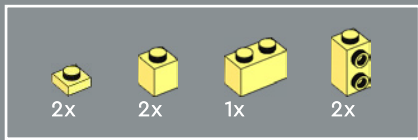

41

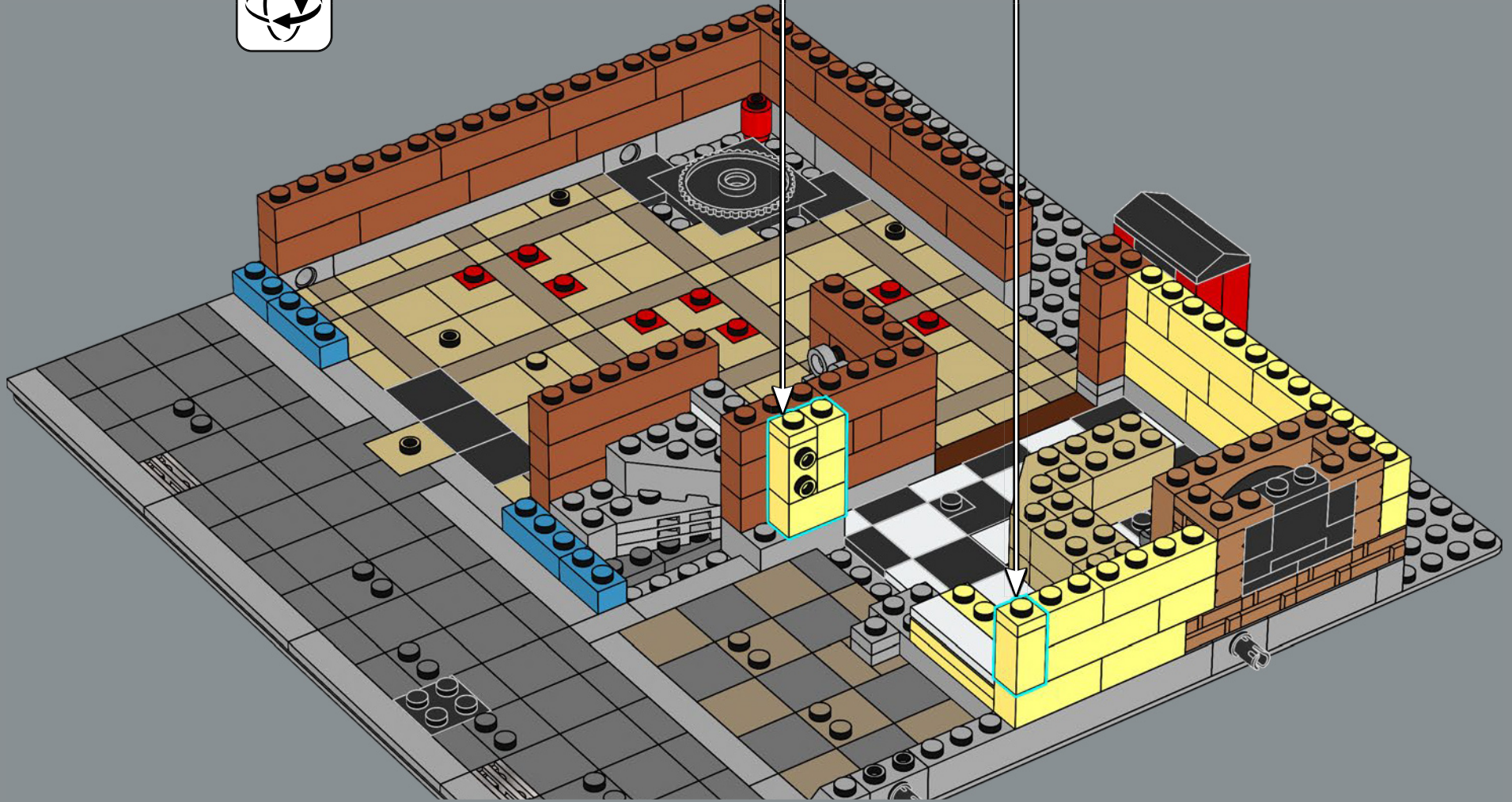
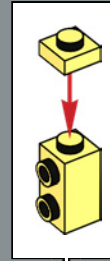
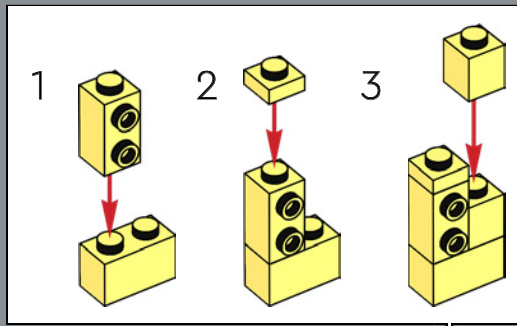

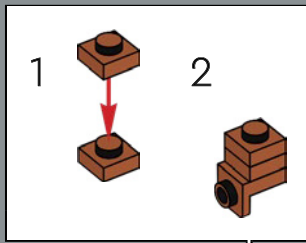
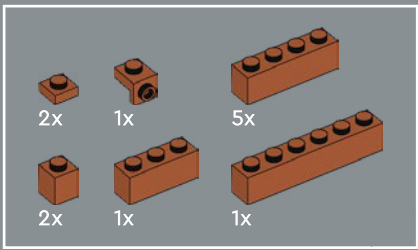

42

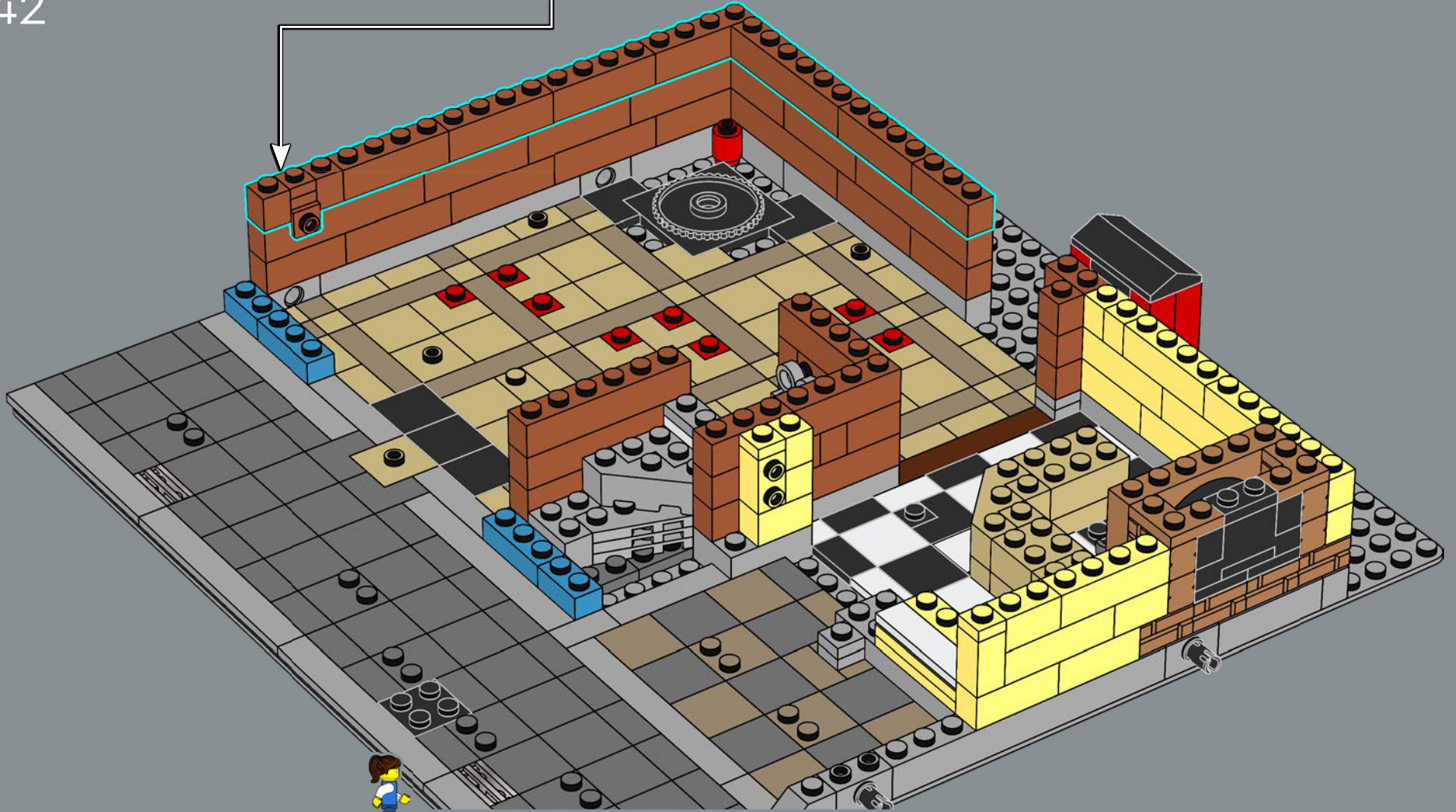

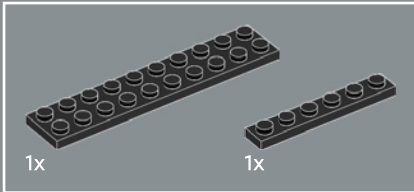
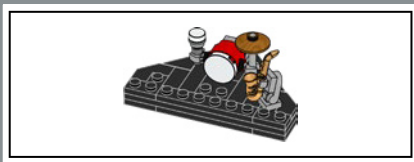

43

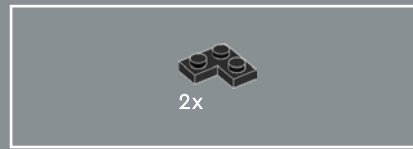
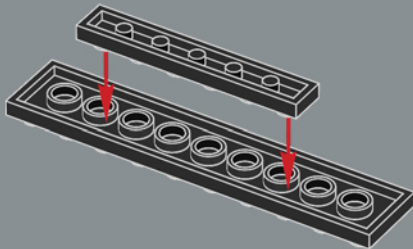

44

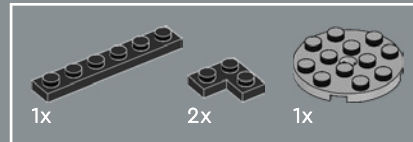
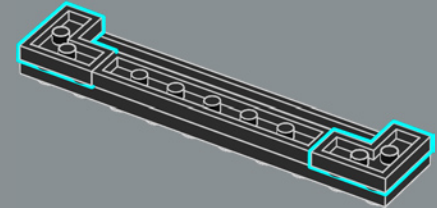

45

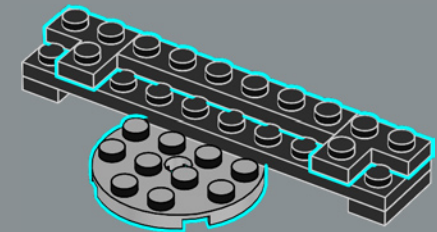

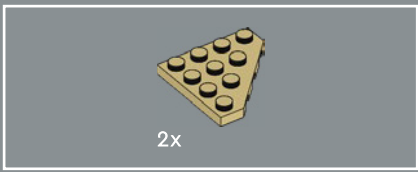

46

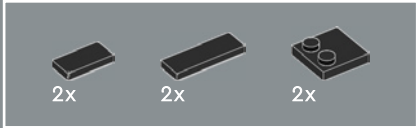
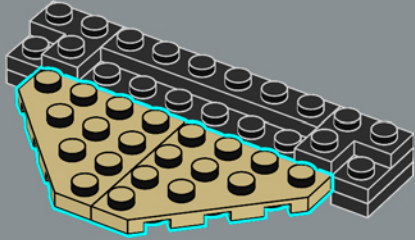

47

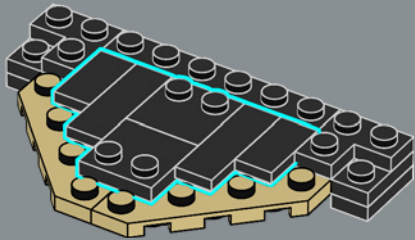

48

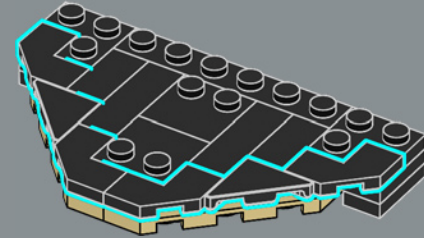

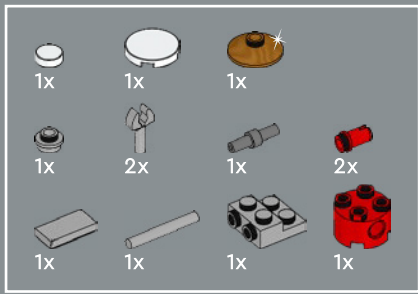

49

1

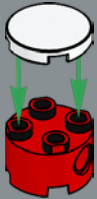

2

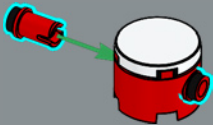

3

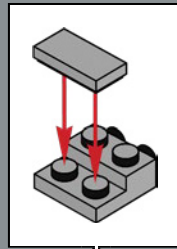

4

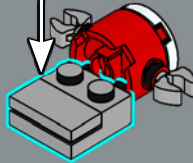

5

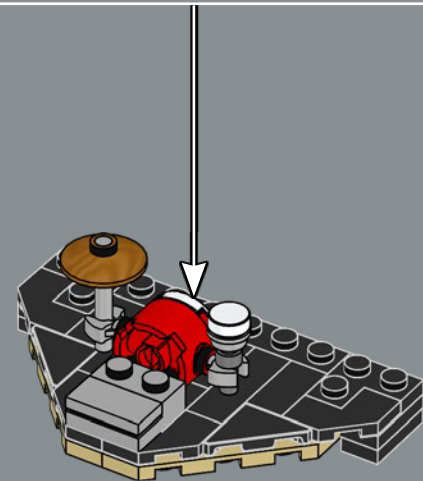
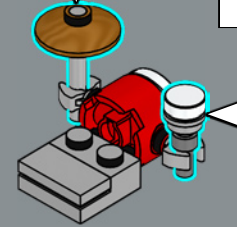
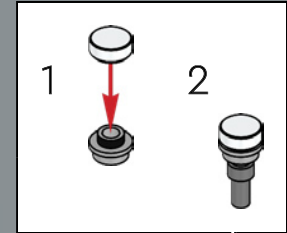
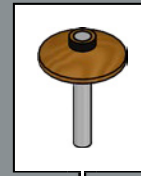



¿Escuchas el "bum-cht" del bombo y la caja,
y el "tss-tss" del platillo?

50

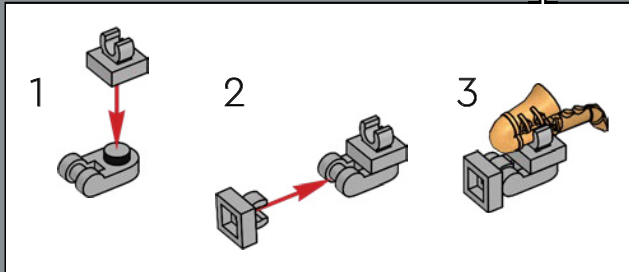
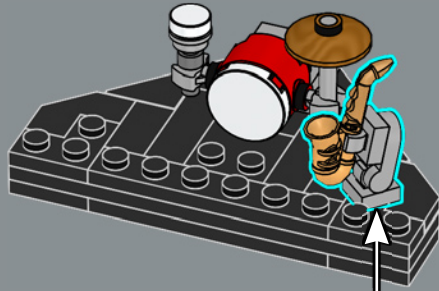

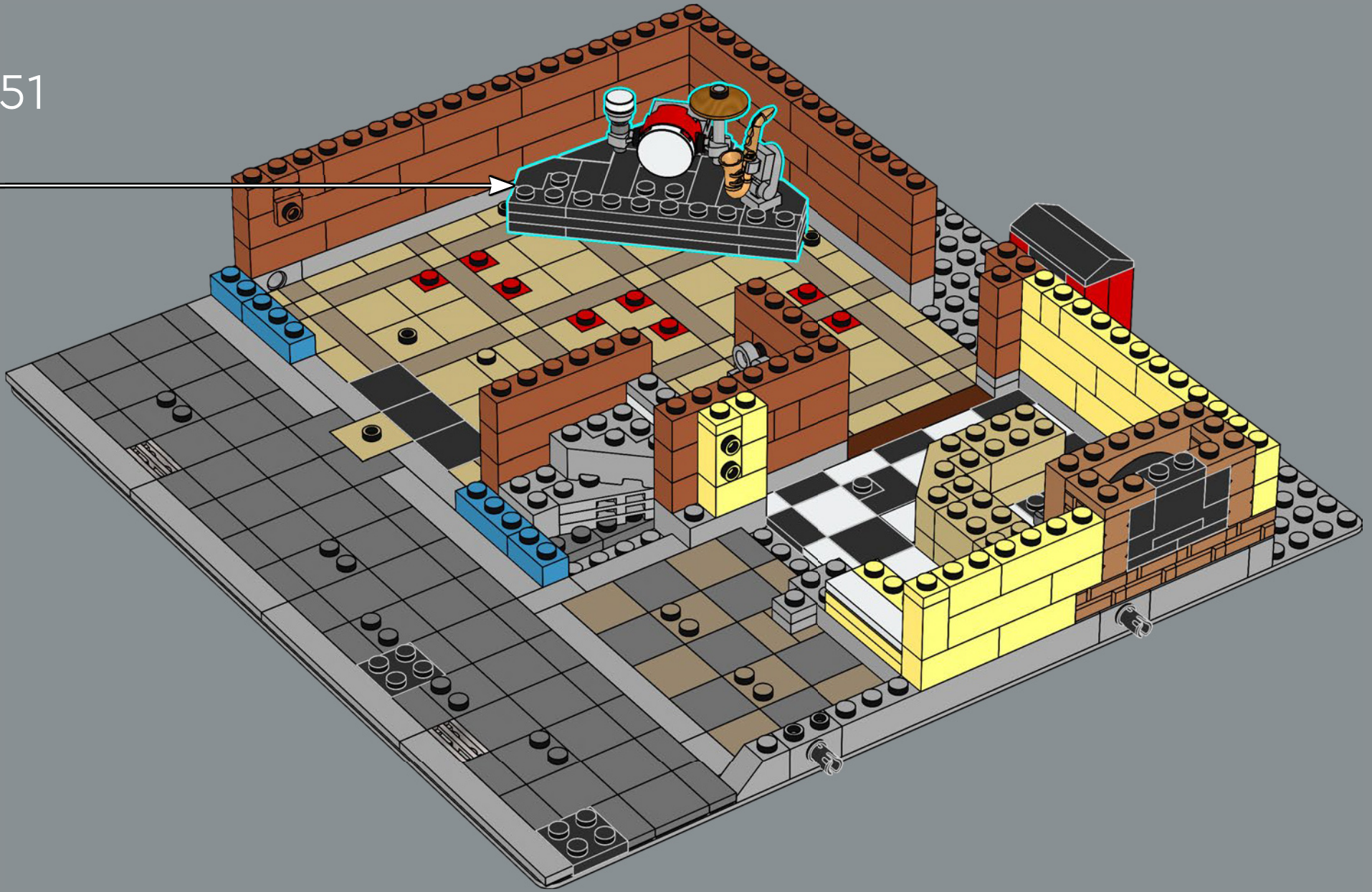



El pizzero cultiva algunos de sus ingredientes en el invernadero de la azotea. Otros los adquiere frescos en la Tienda de Verduras LEGO® (10185).

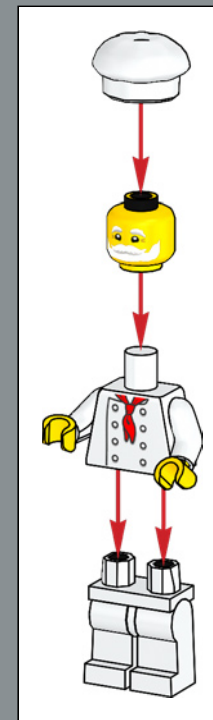

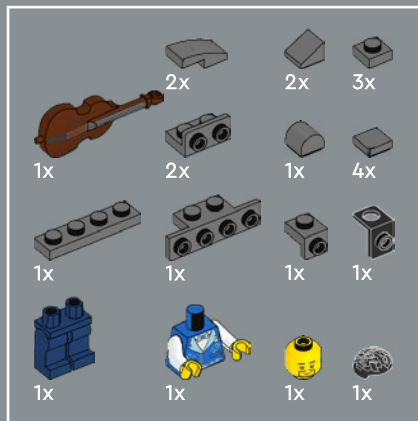

Esta noche es muy especial porque tendrá lugar la primera actuación del contrabajista. El tiempo que le queda después de trabajar en el Palace Cinema LEGO® (10232) lo ha estado dedicando a practicar muy duro.

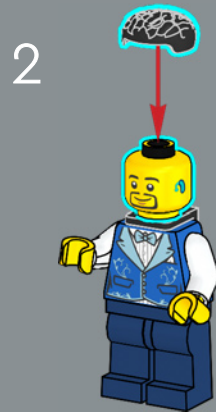
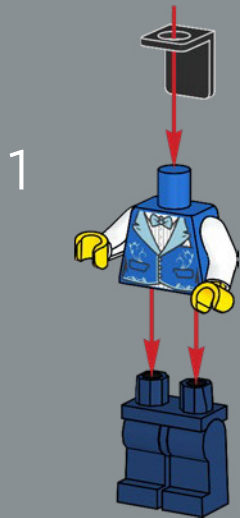
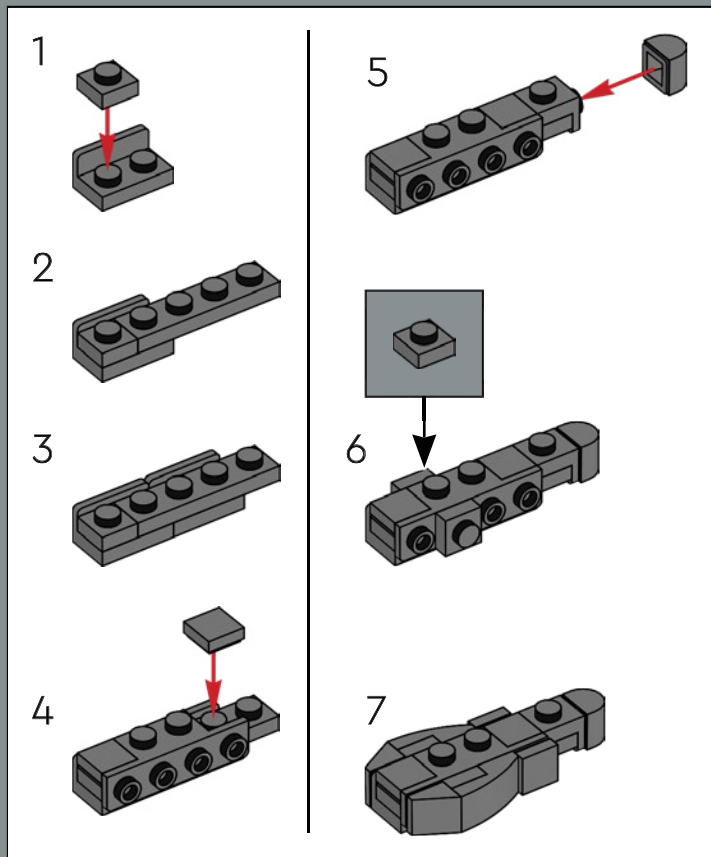



52

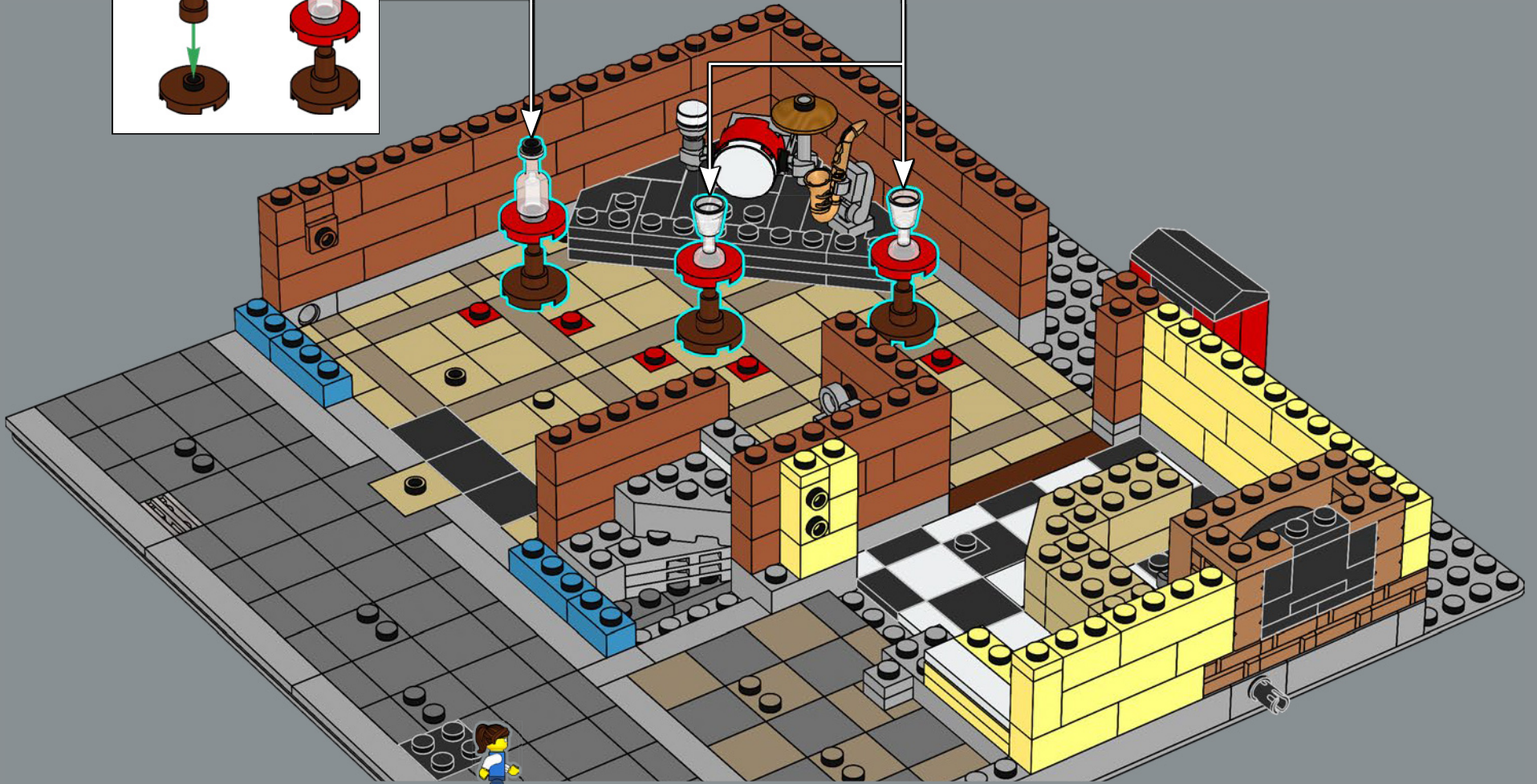
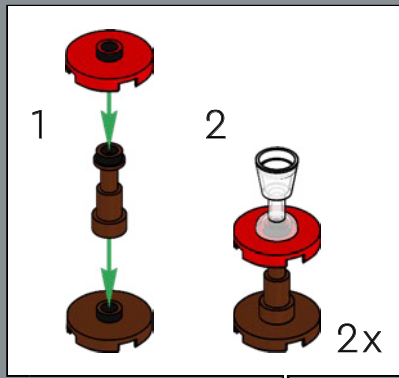
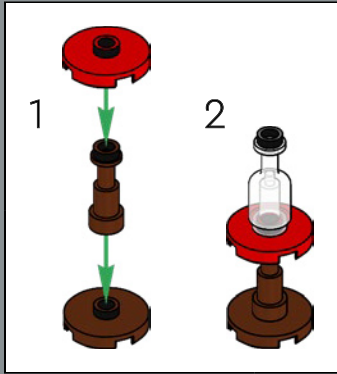



53

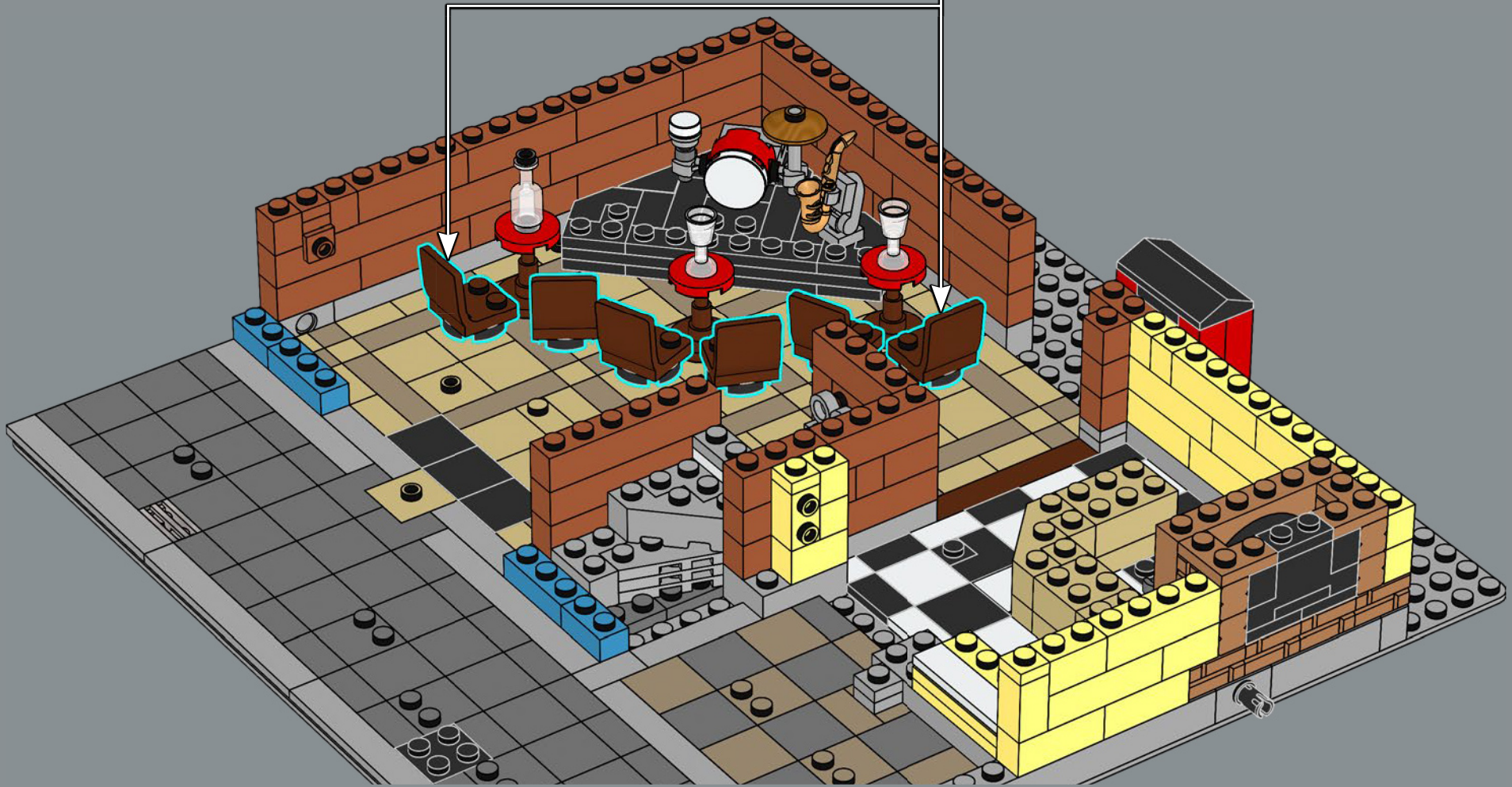
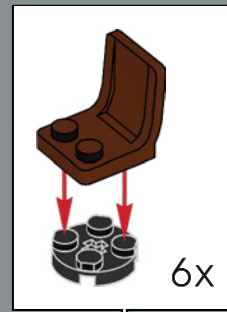

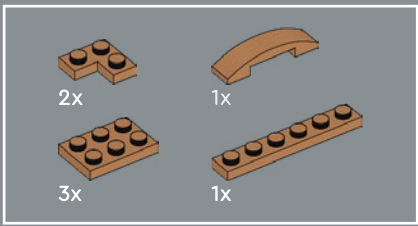

54

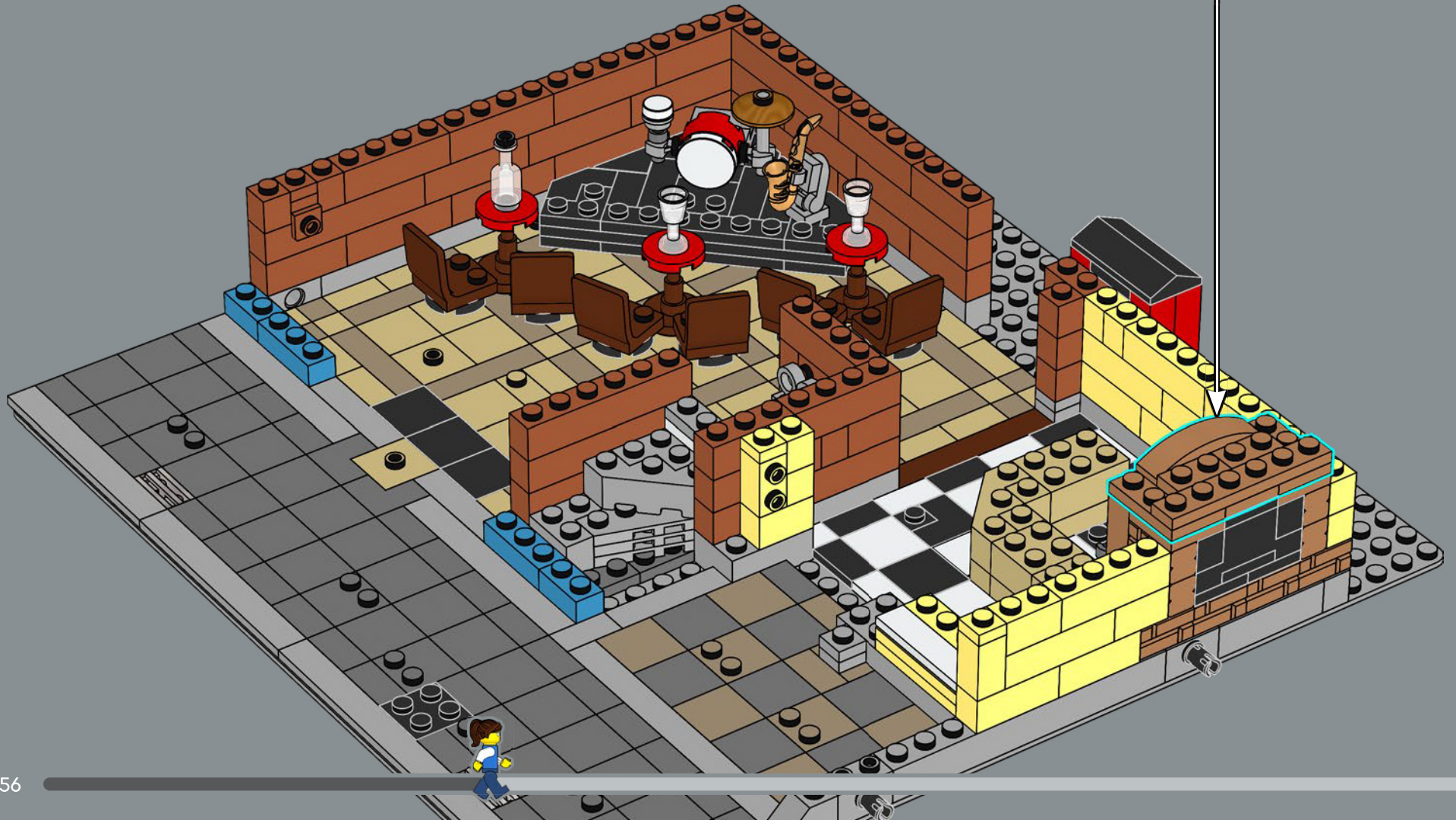
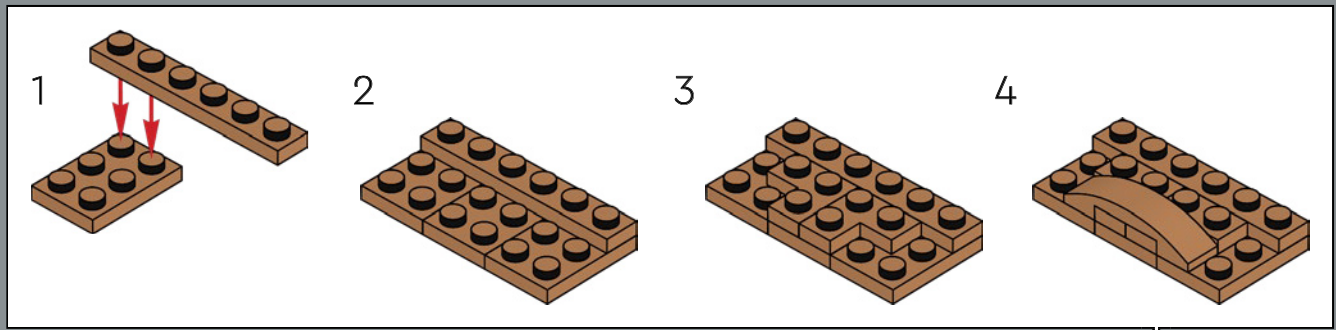

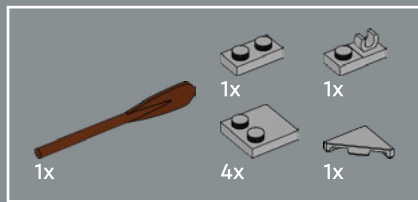

55

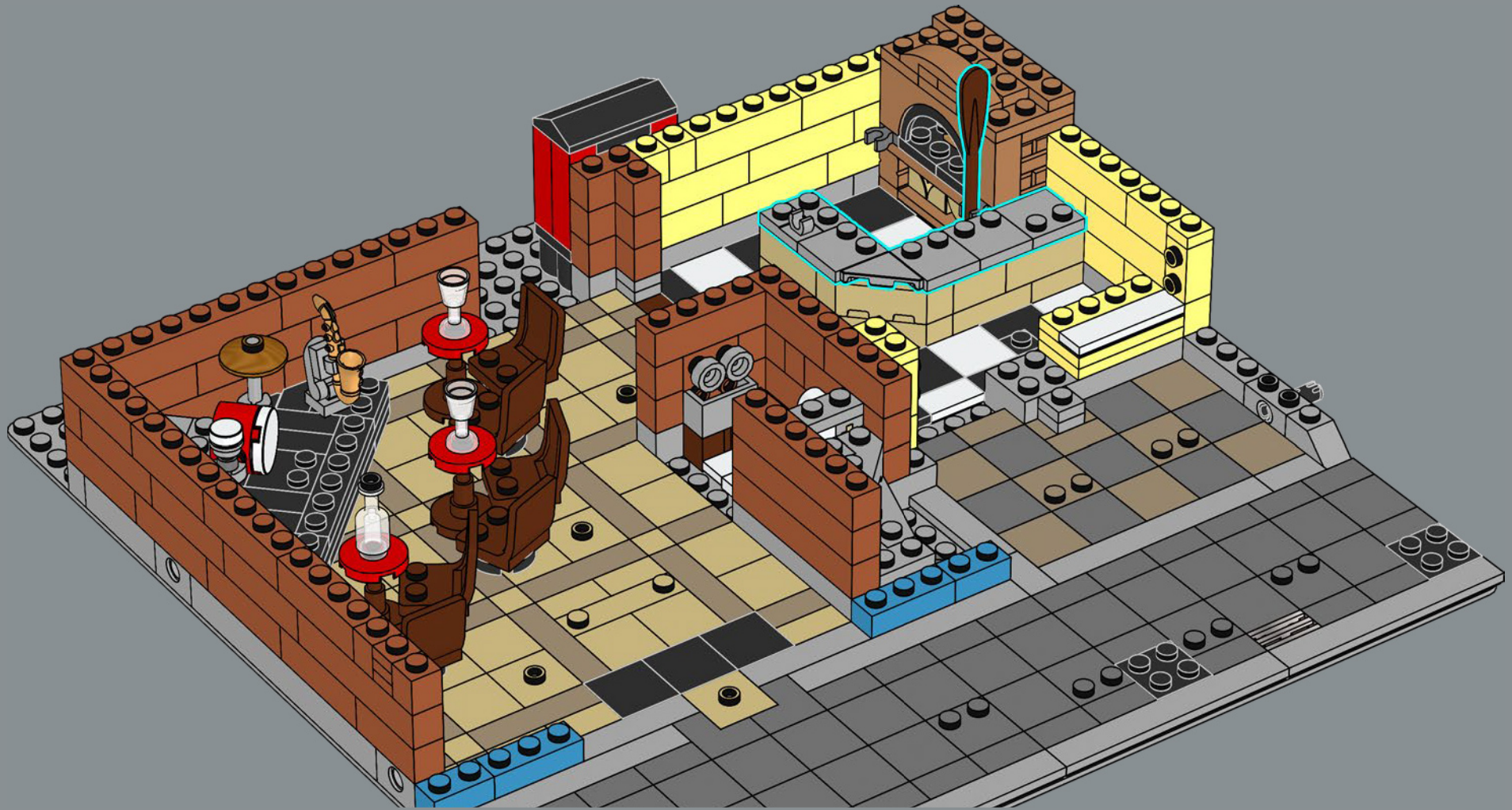

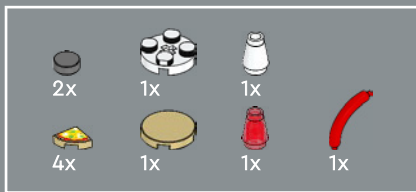

57



¡Marchando una deliciosa *pizza* margarita!
Los clientes pueden disfrutarla completa o comprar solo una porción.

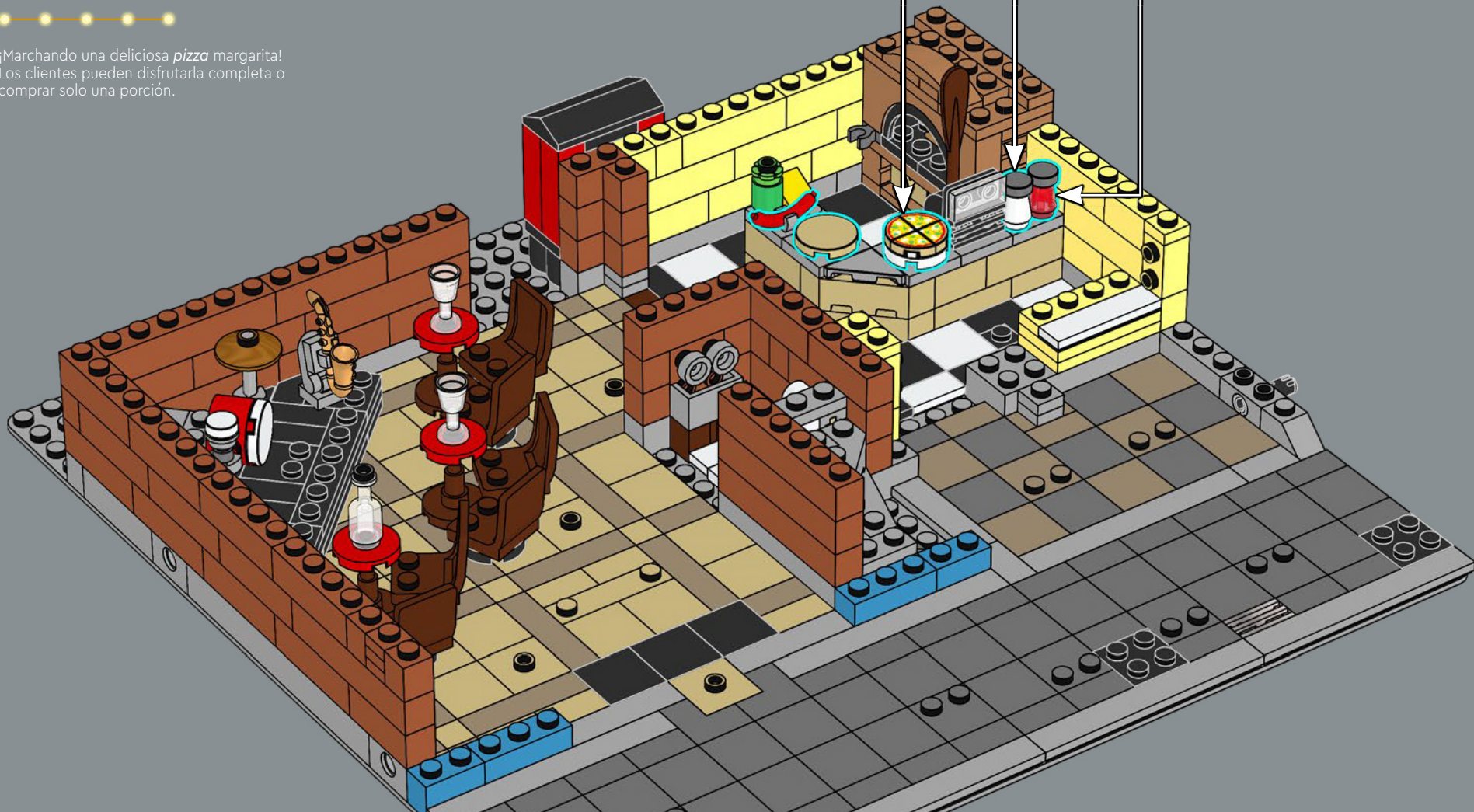

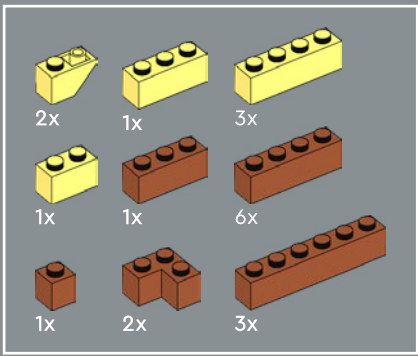

58

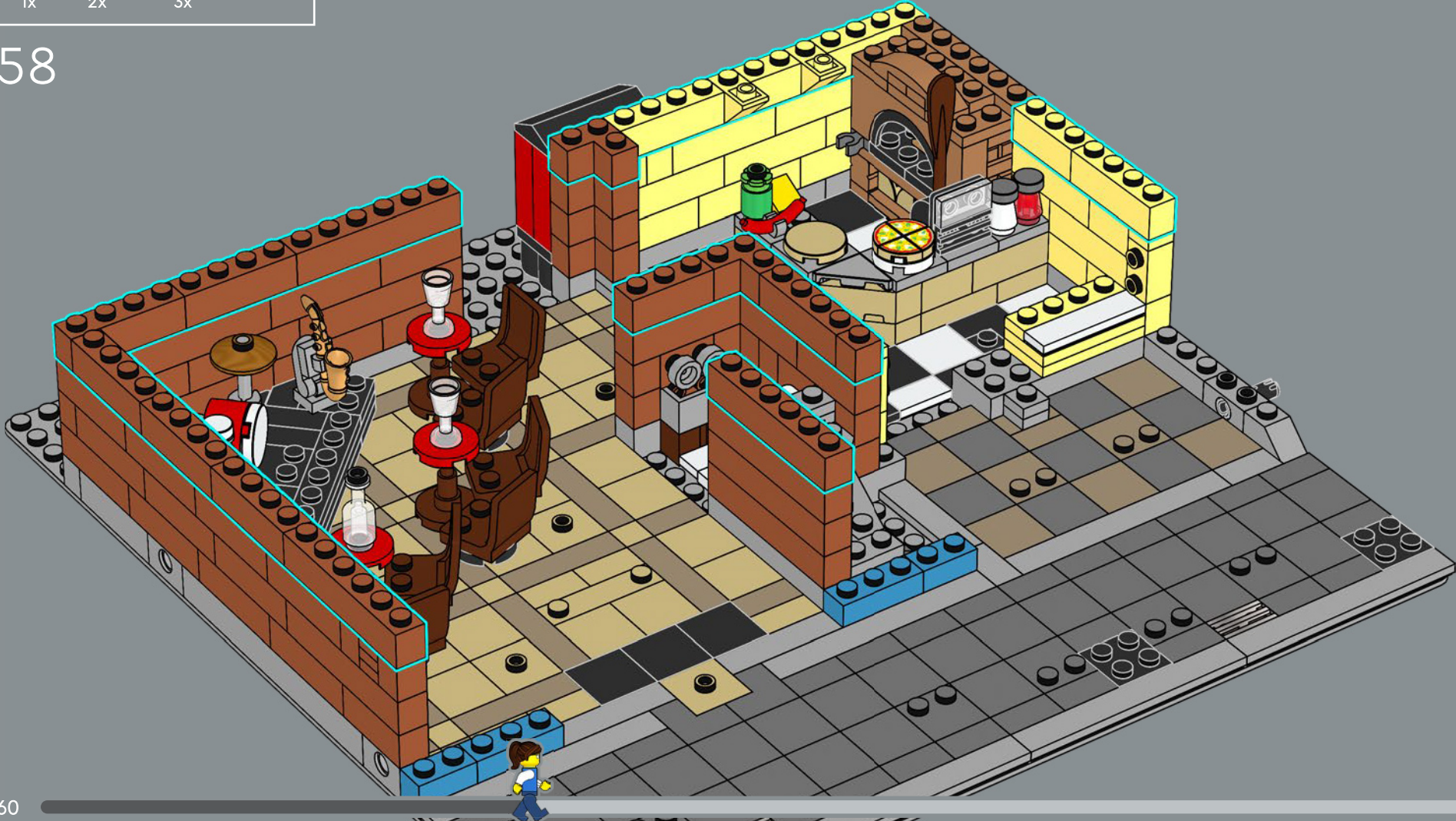

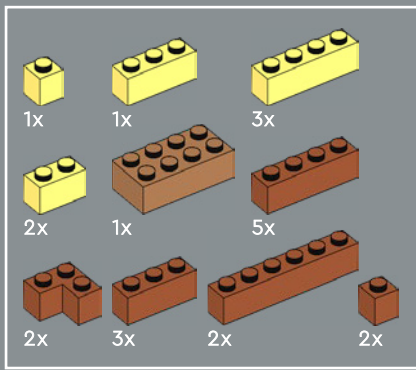

59

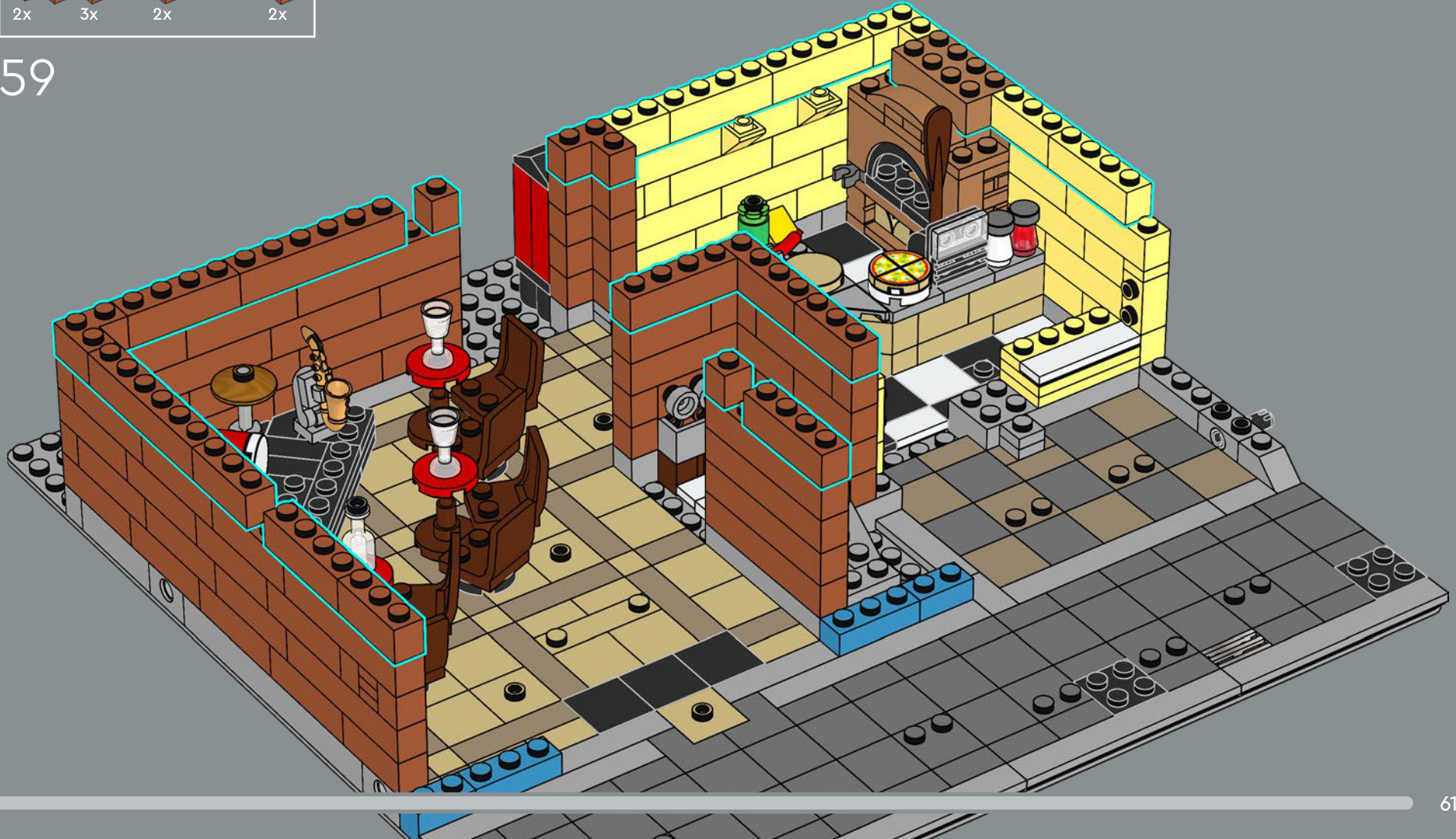

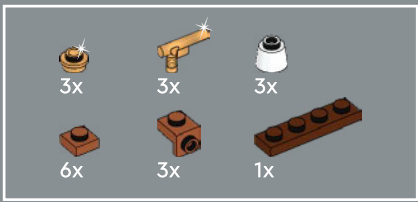

60

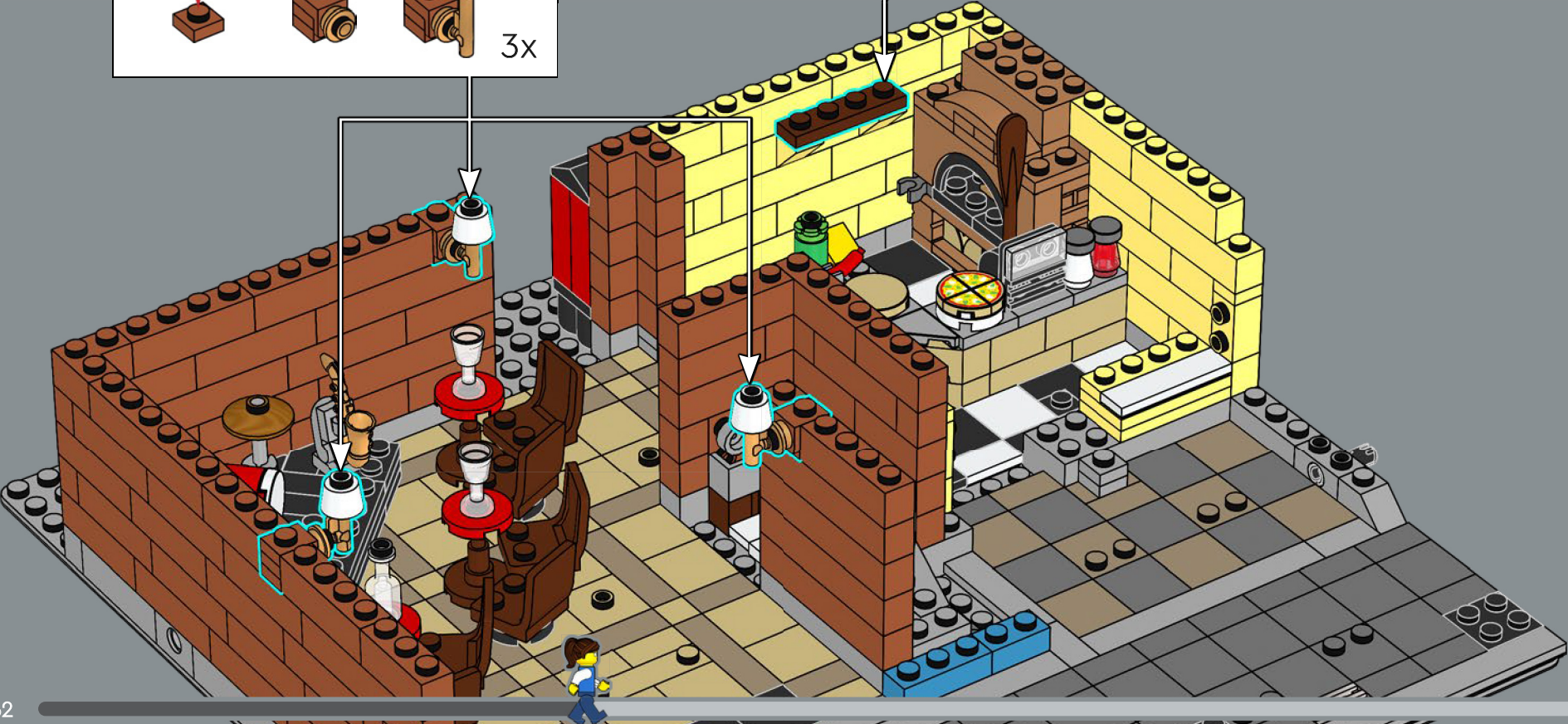
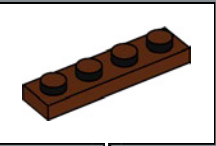
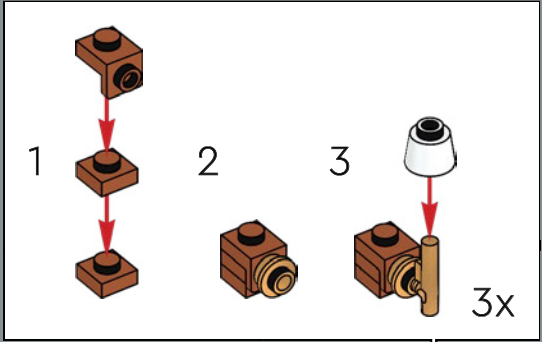

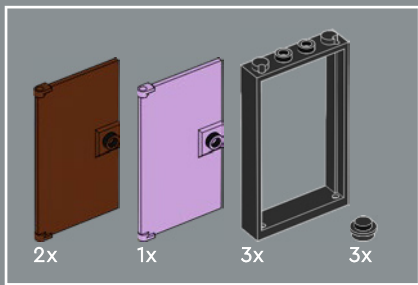

61

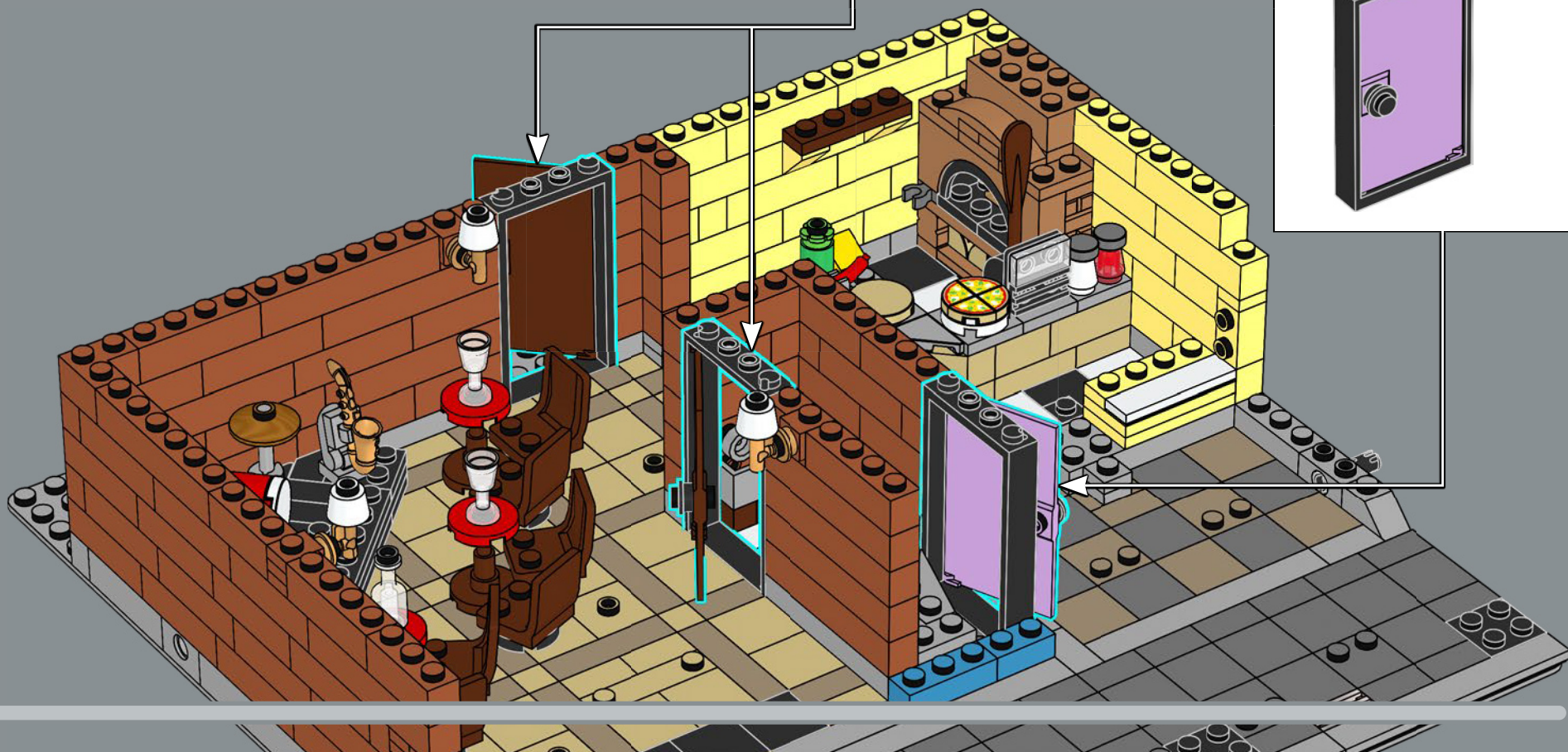
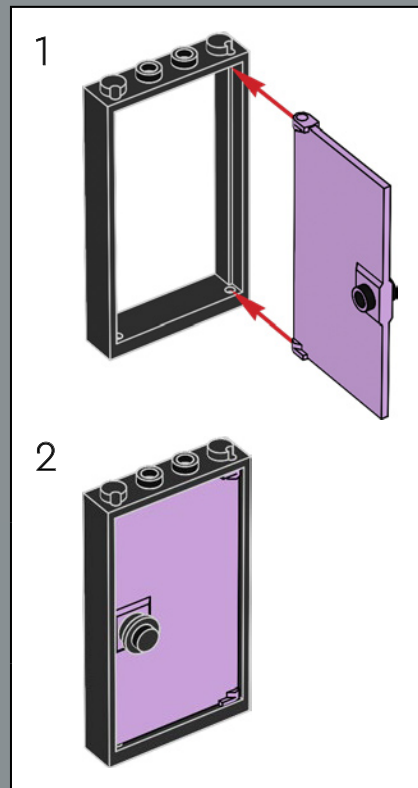
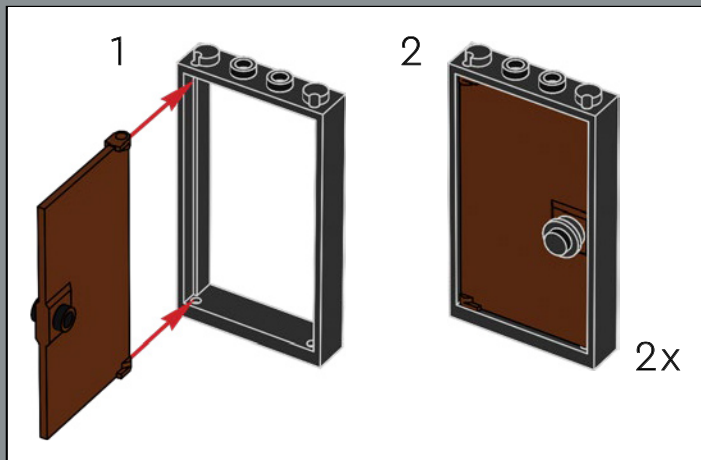

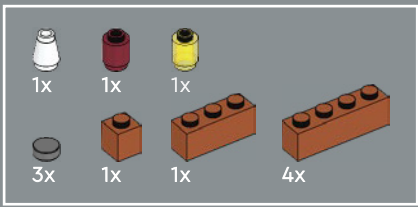

62

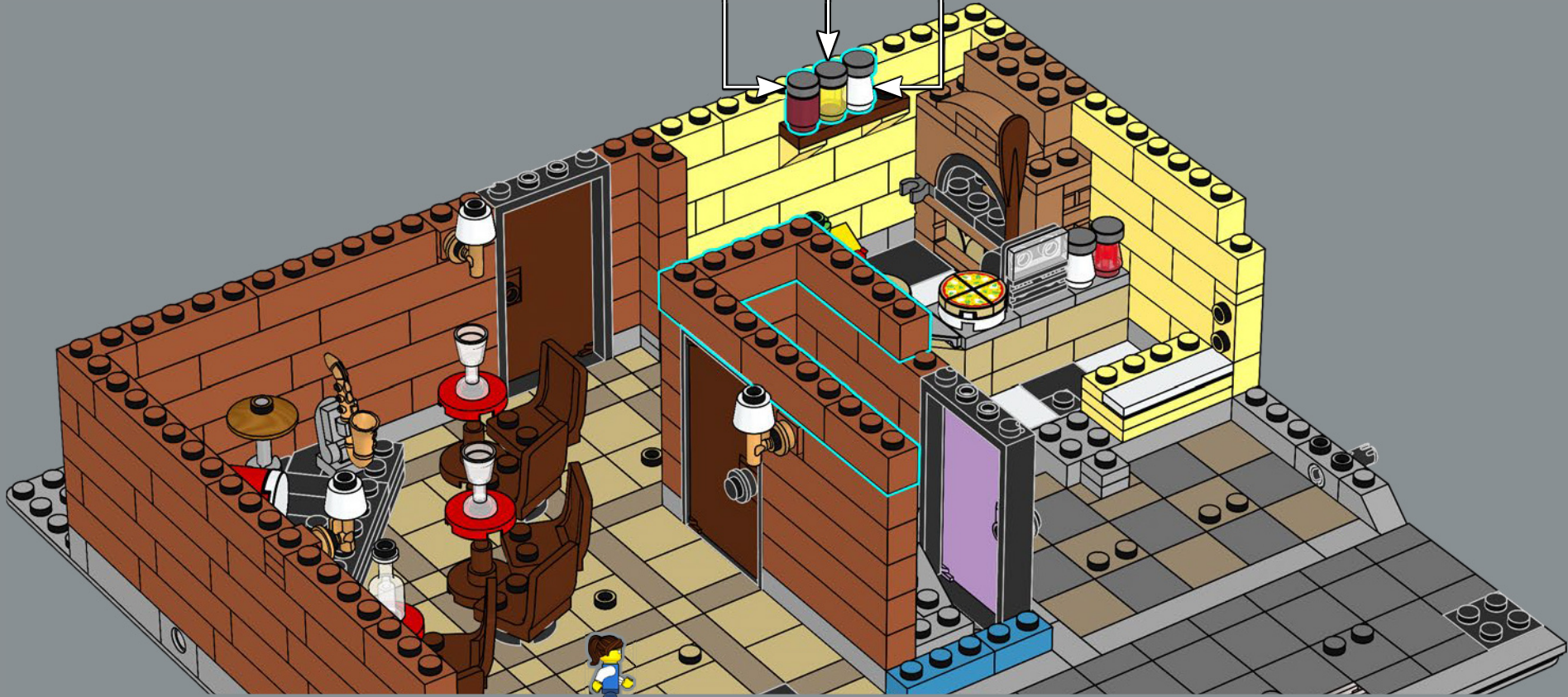
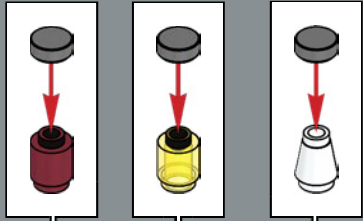

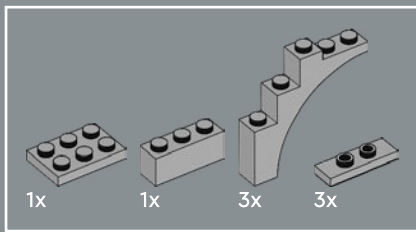

63

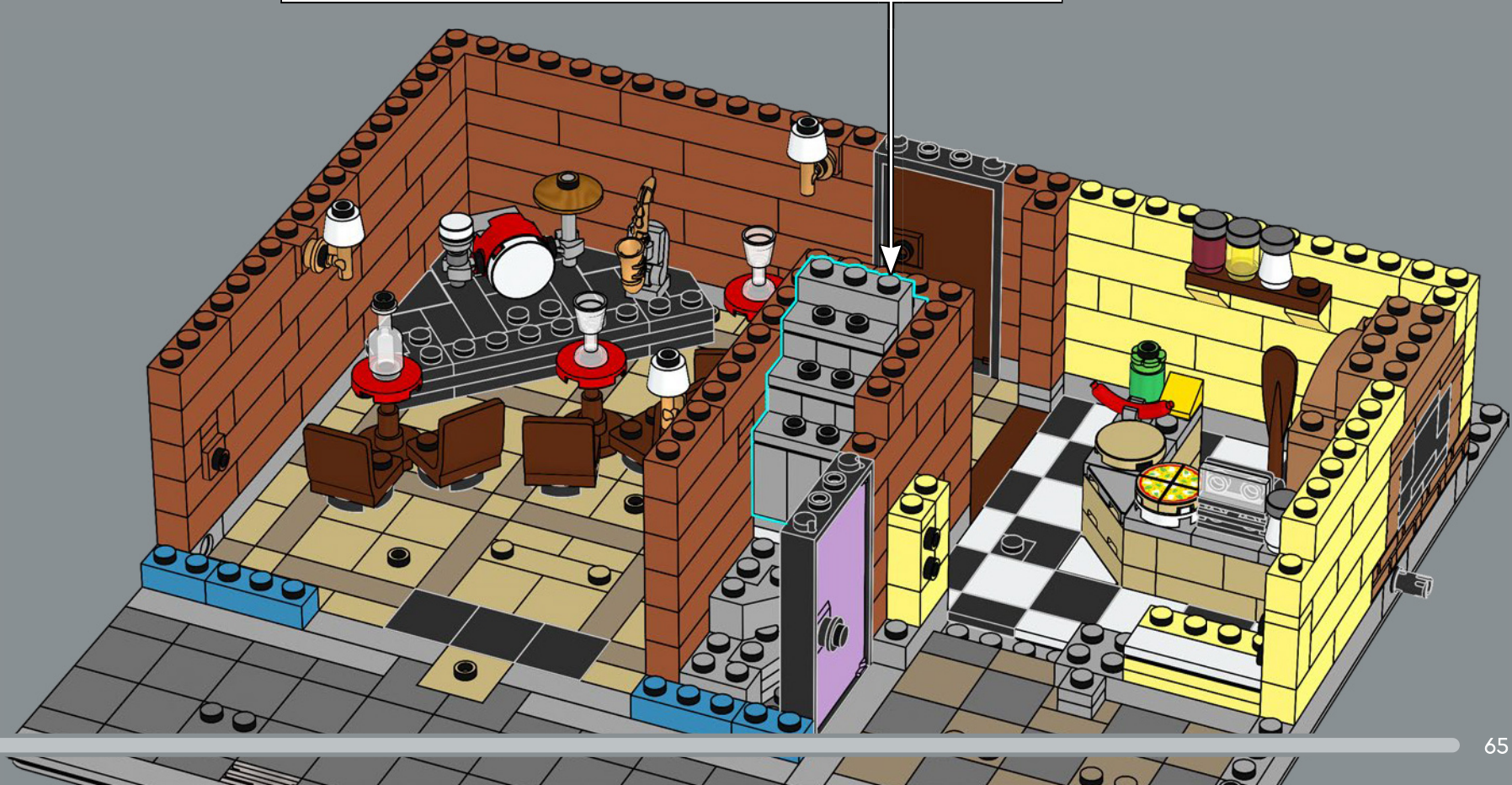
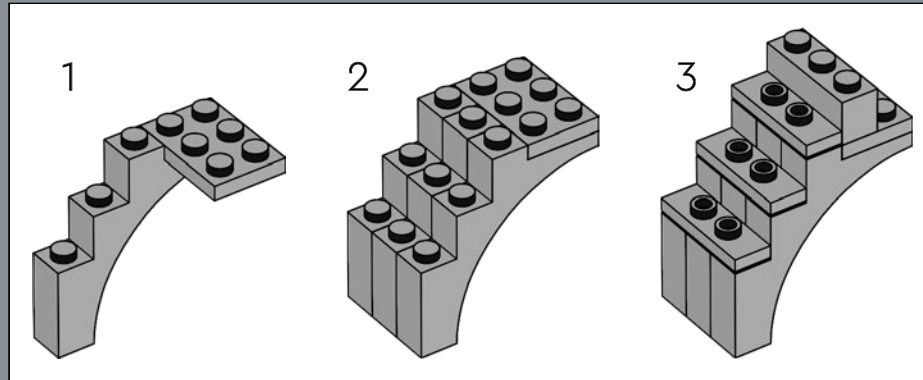

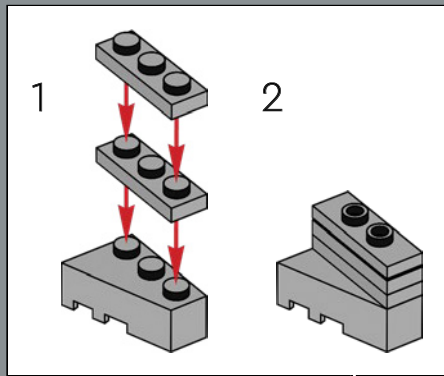
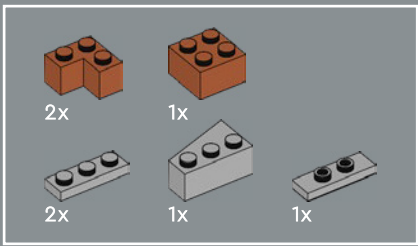

64

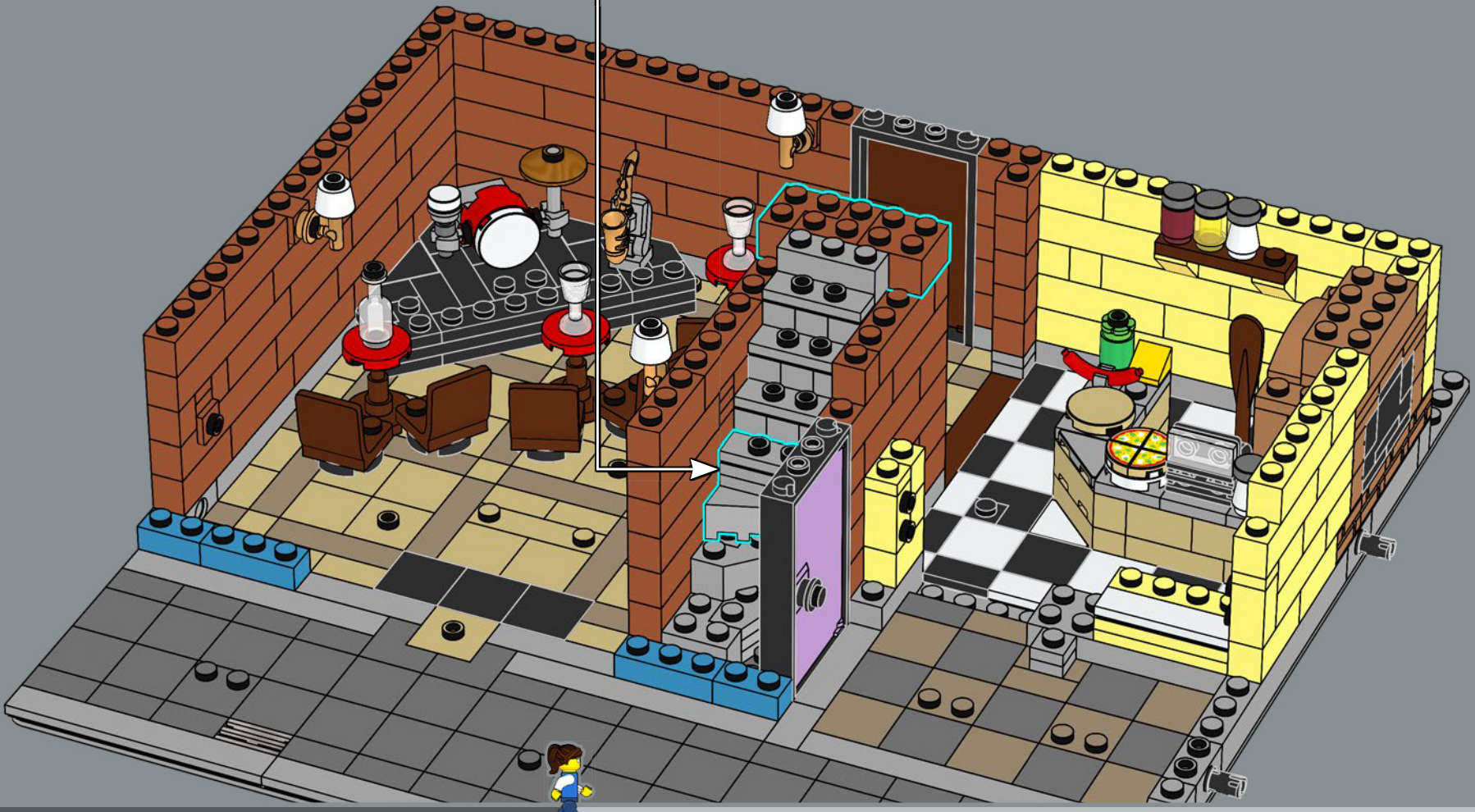

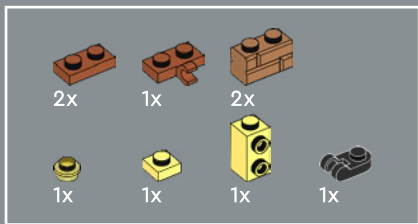

65

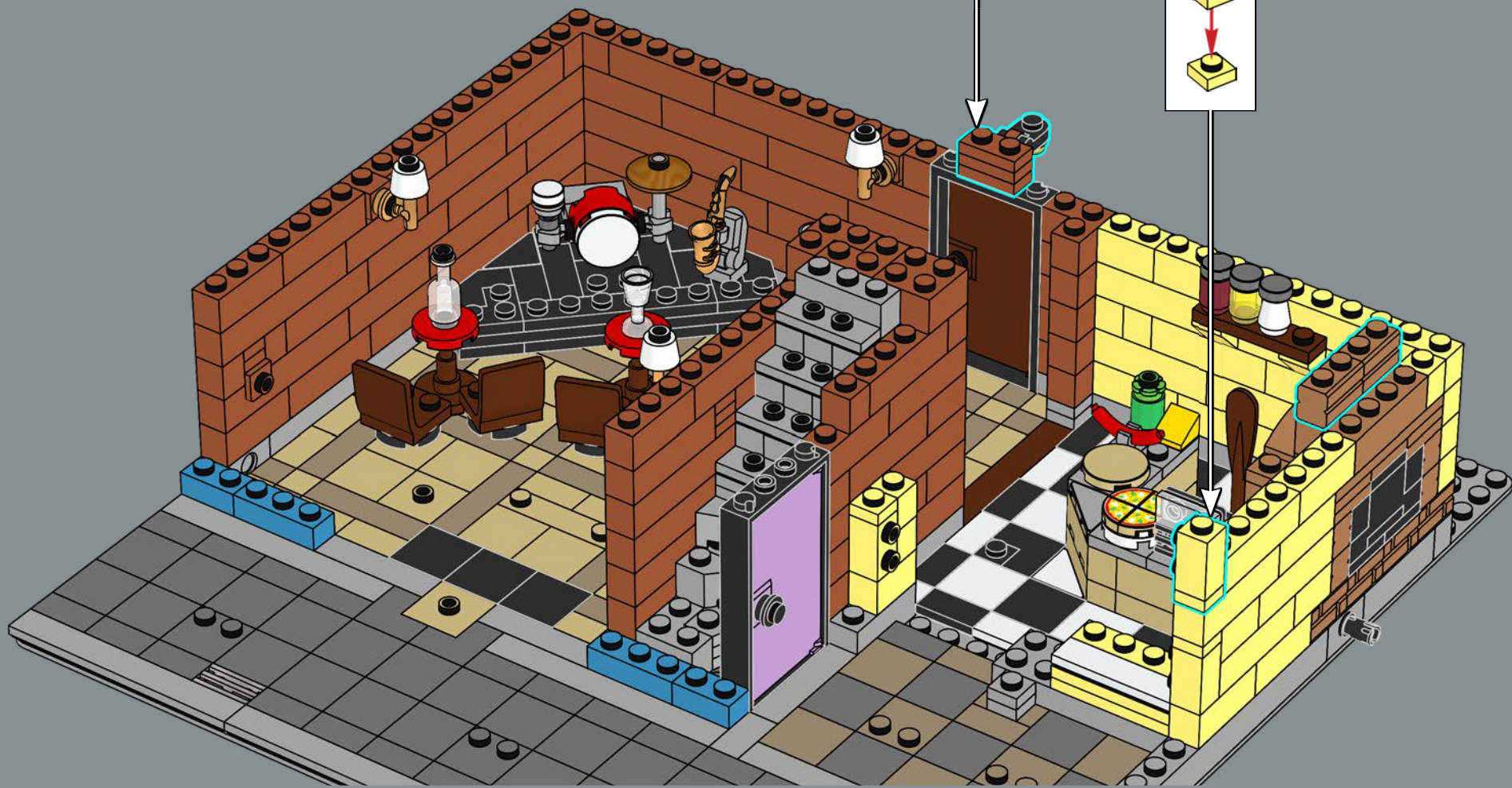
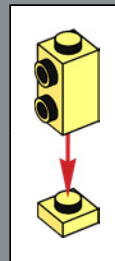
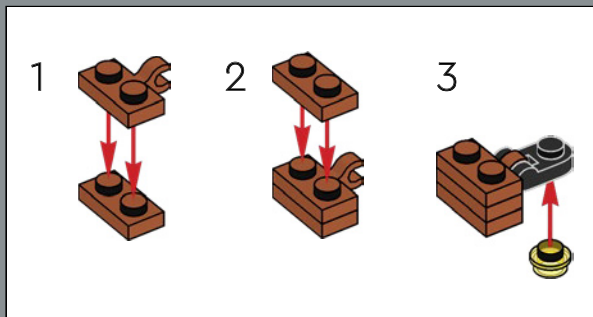

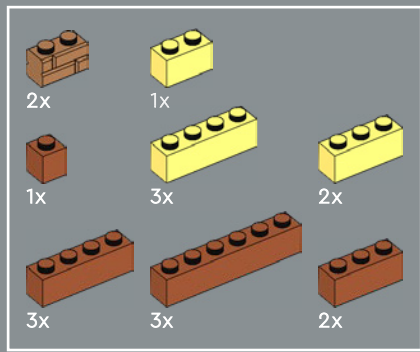

66



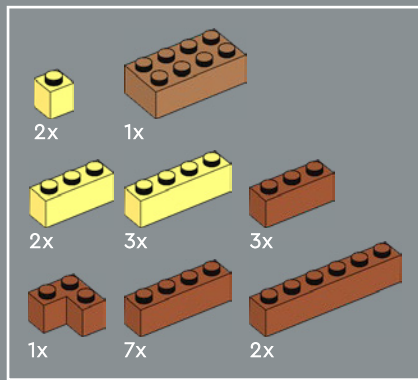

67



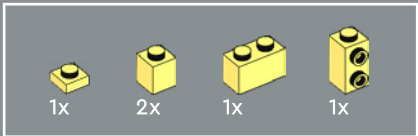

68

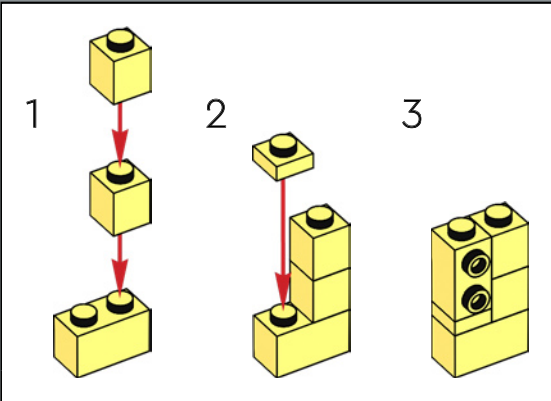

6

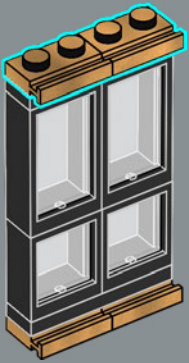

7

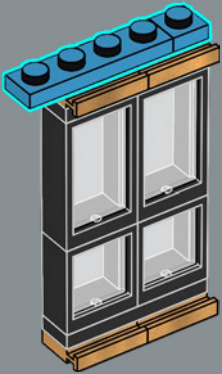

8

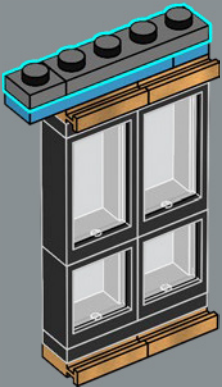

9

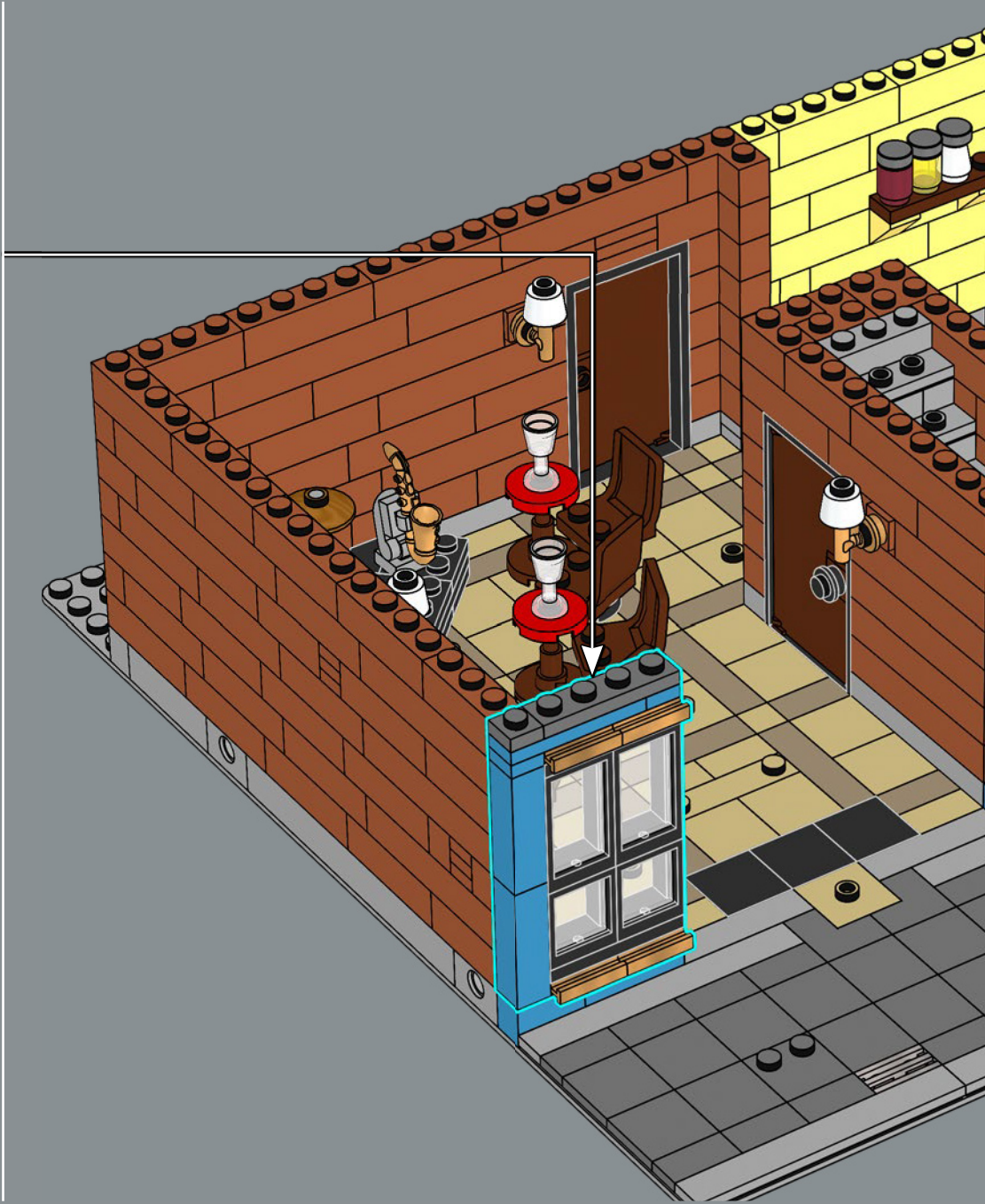
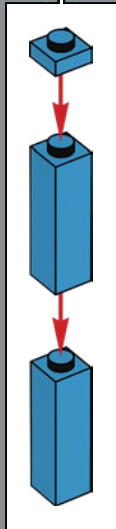
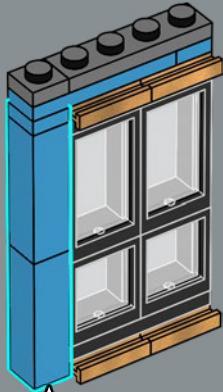

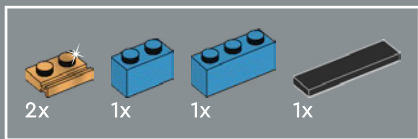

70

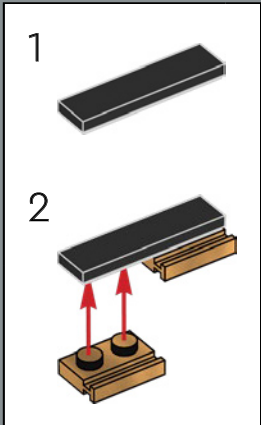
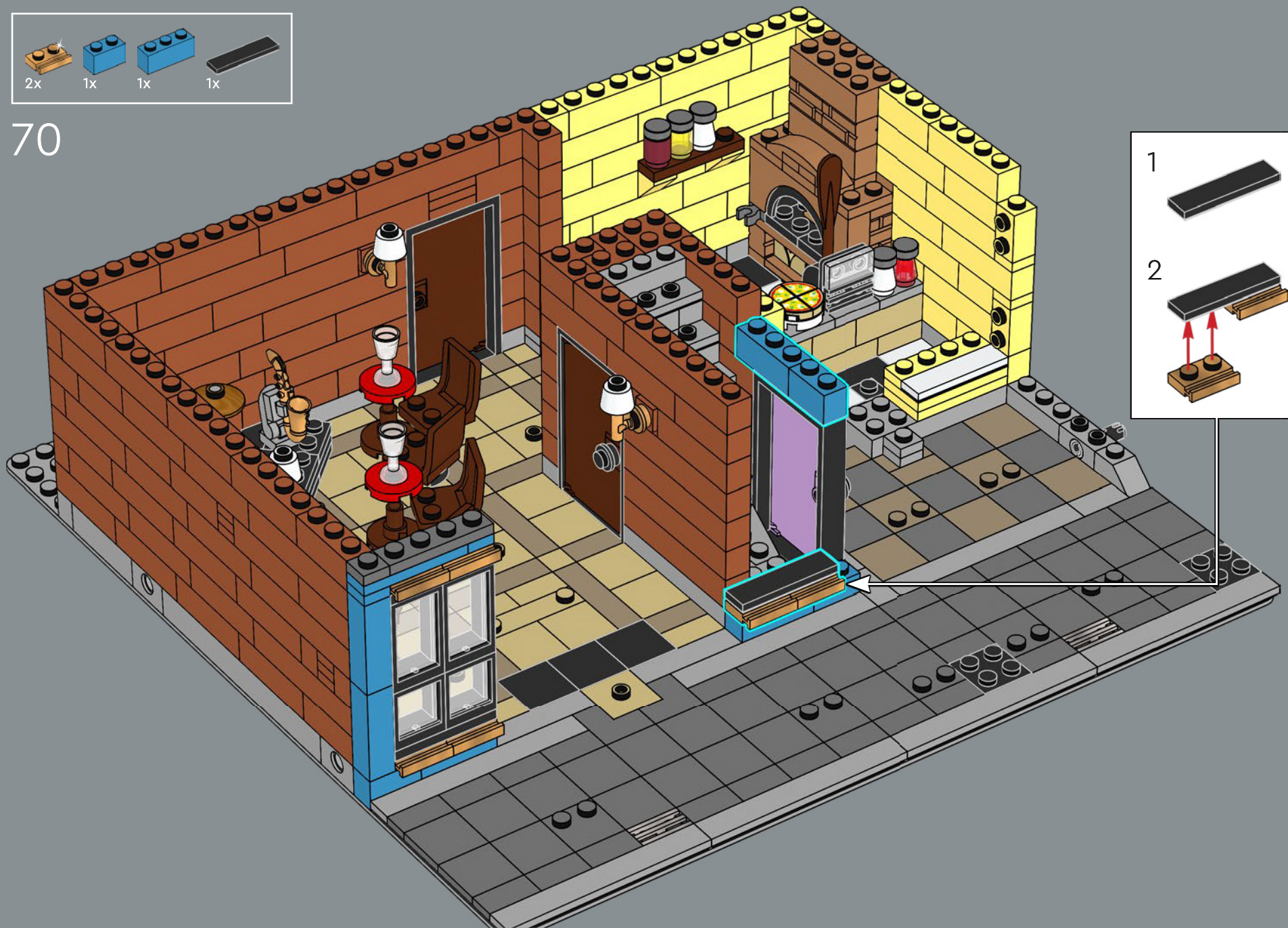

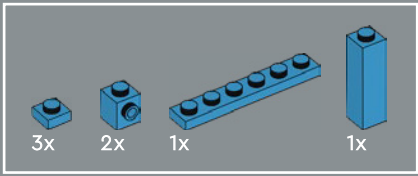

71

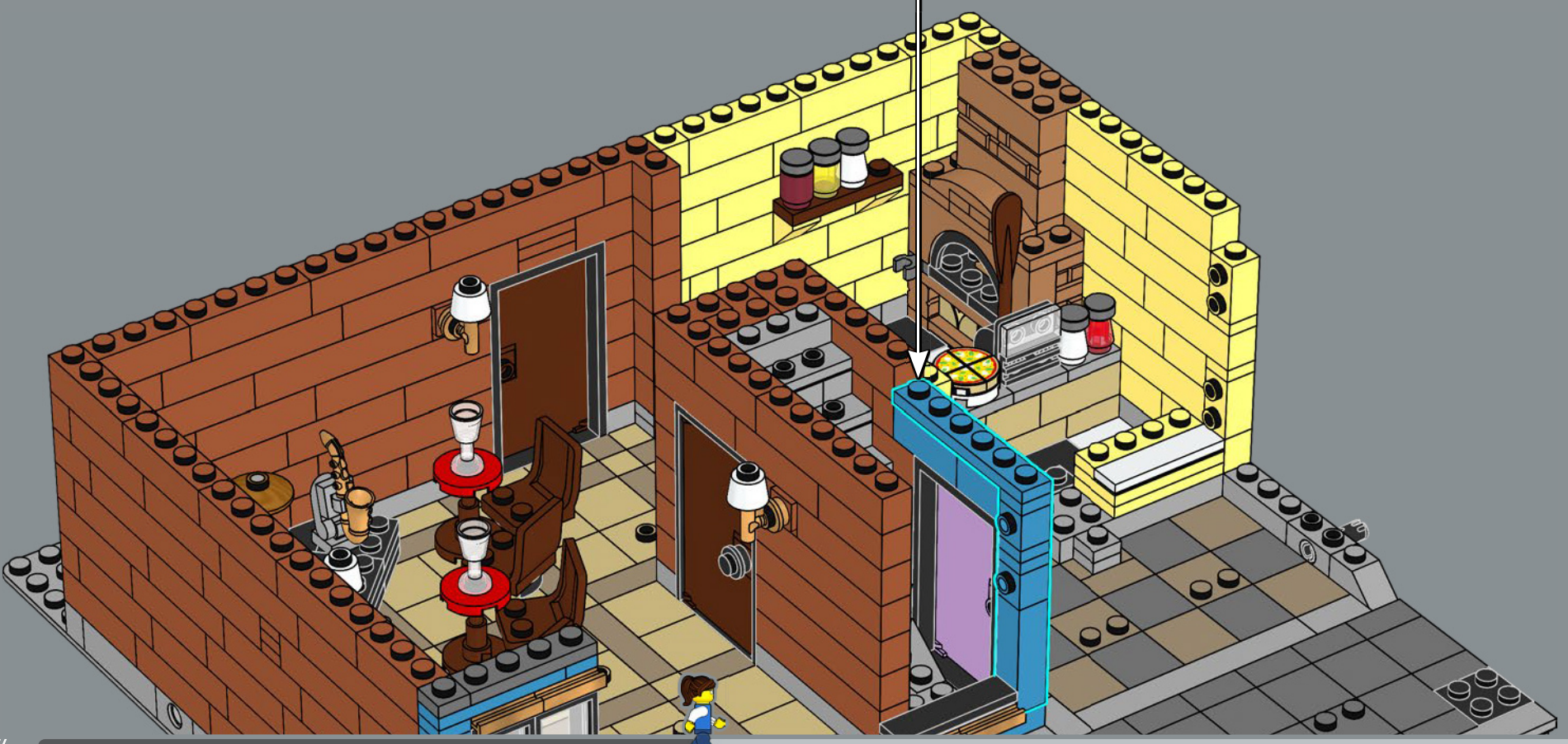
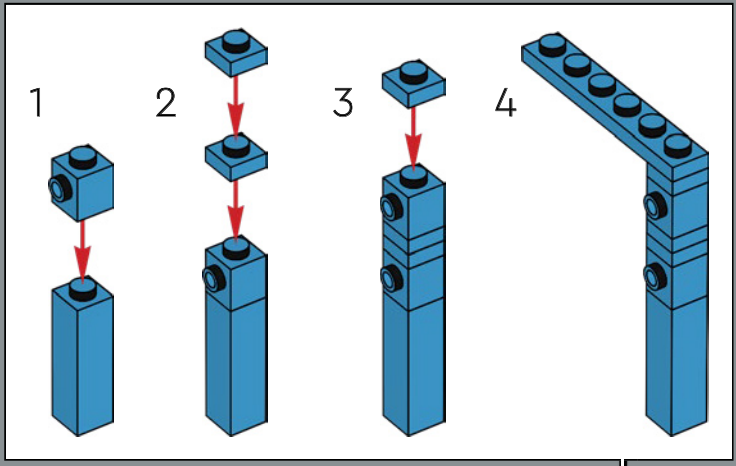

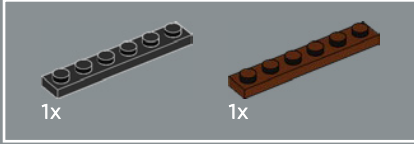

72

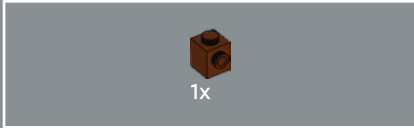
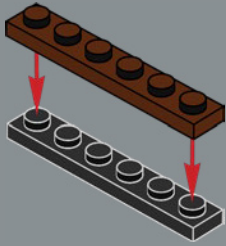

73

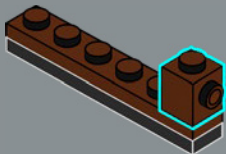

74

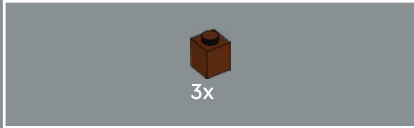

75

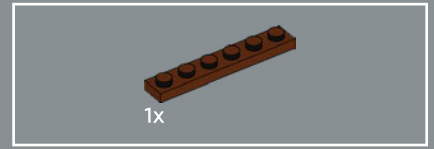

76

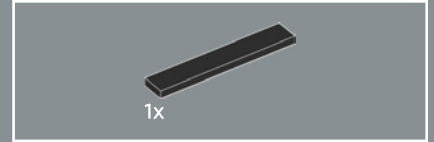

77



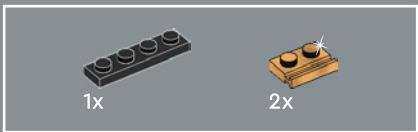

78

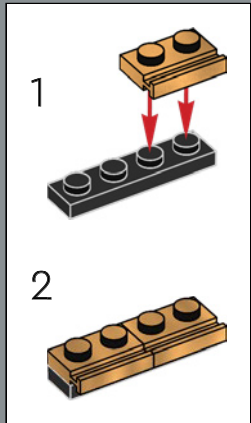

79



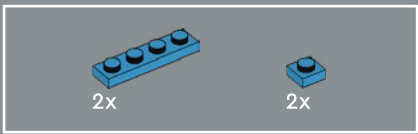

80

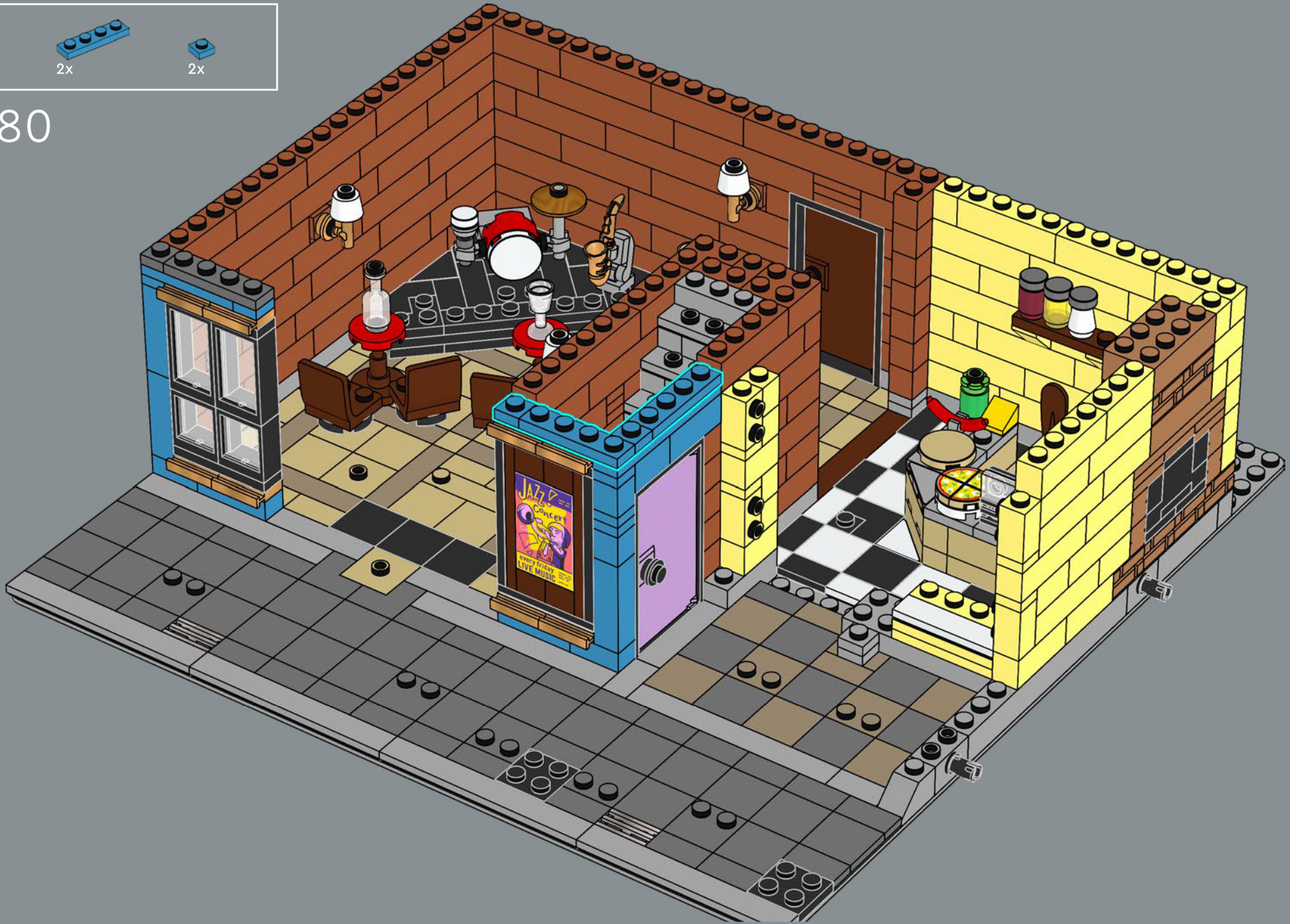

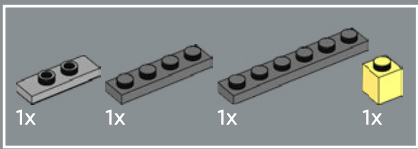

81



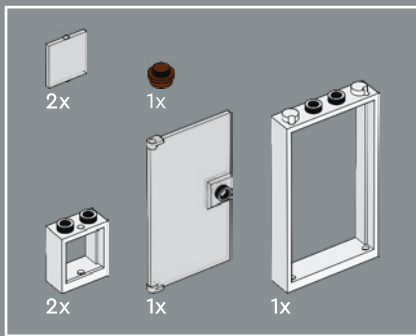

82

1

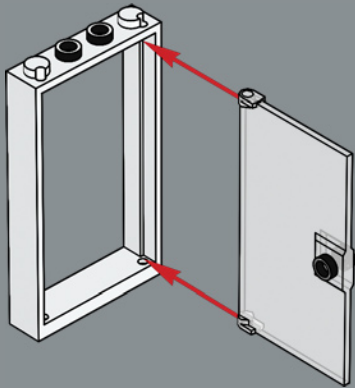

2



3

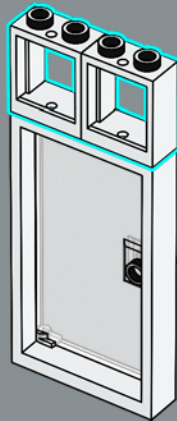

4

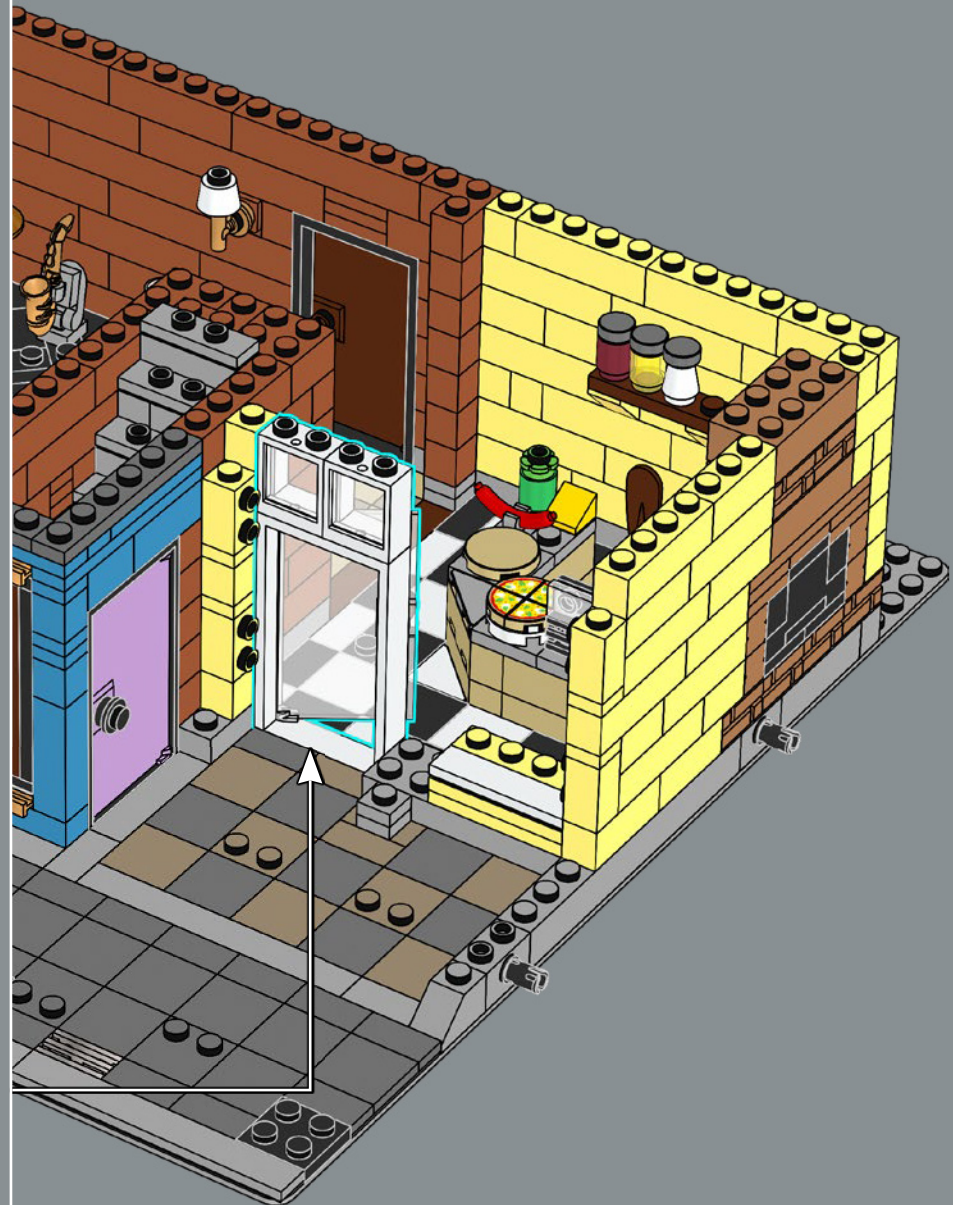
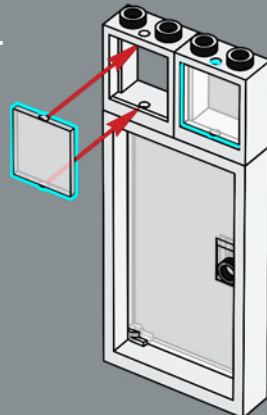

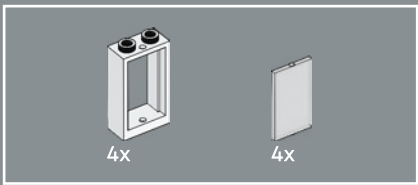

83

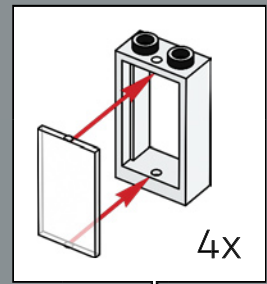

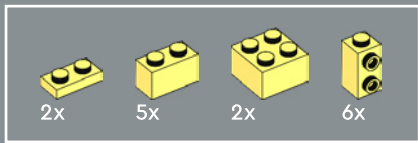

84

1

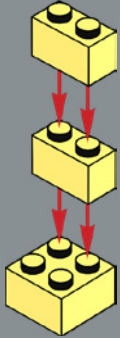

2

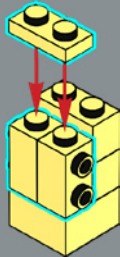

3

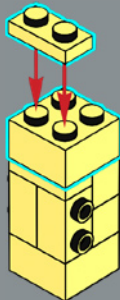

4

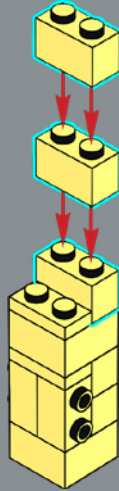

5

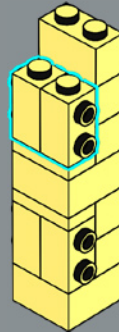

6

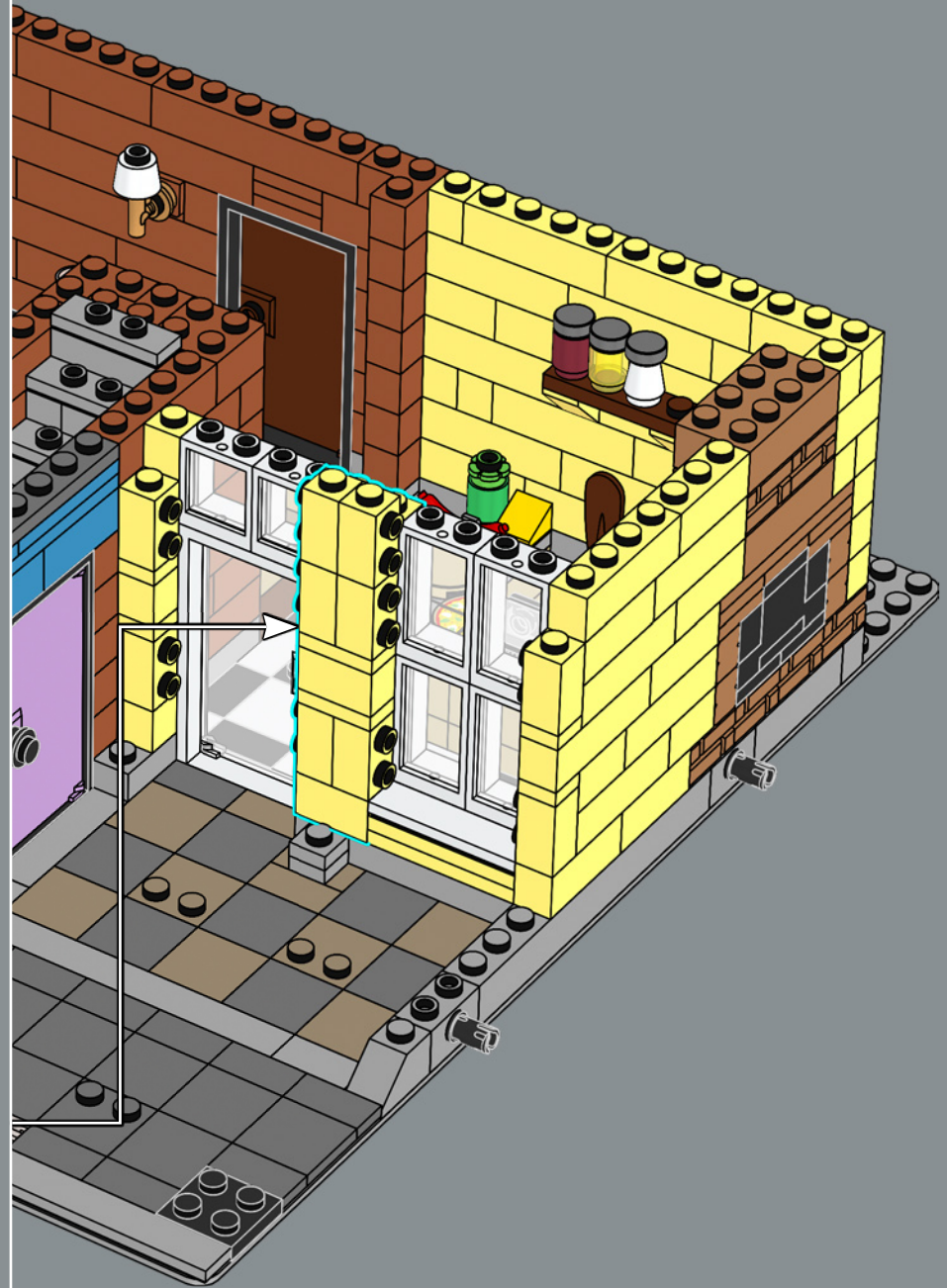
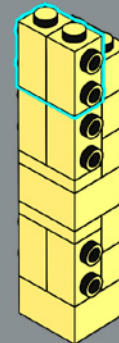



3x

85





87

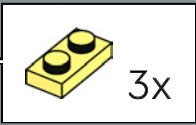
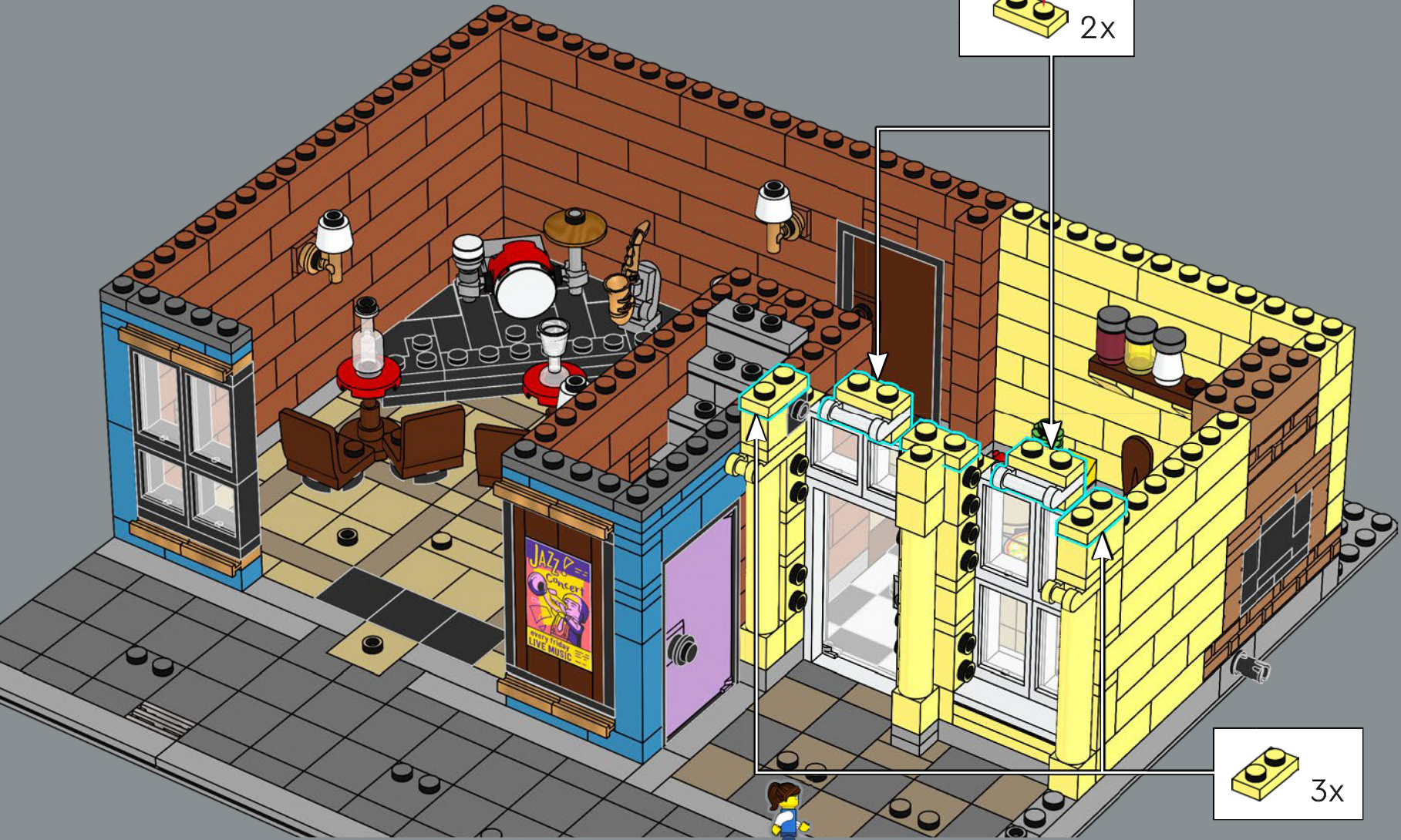
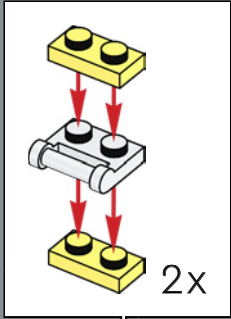

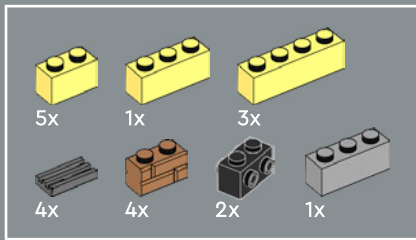

Incluye estas unidades de ventilación para mantener fresco el ambiente. El horno, al igual que la música, ¡puede alcanzar temperaturas demasiado altas!

88

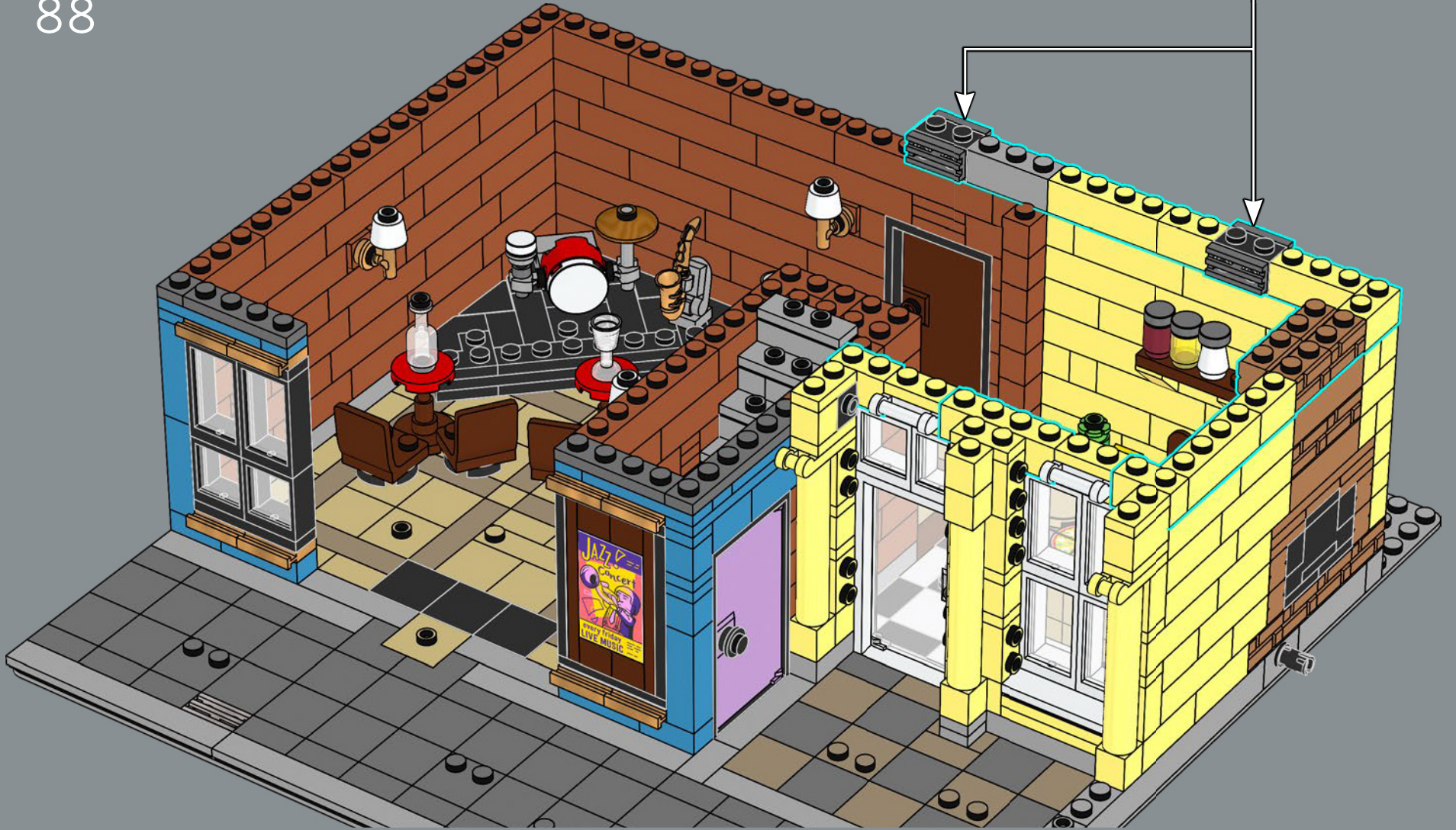
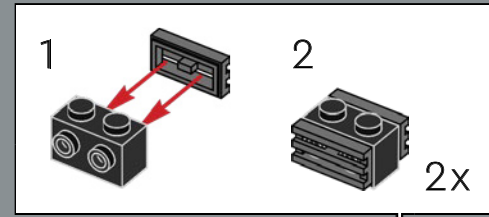

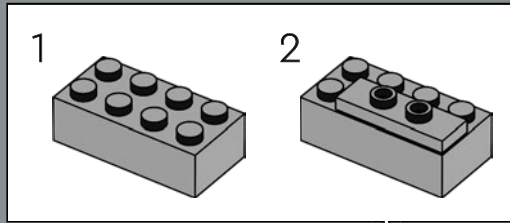
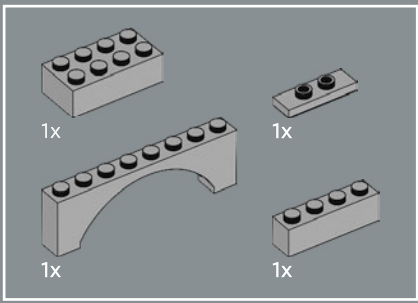

89



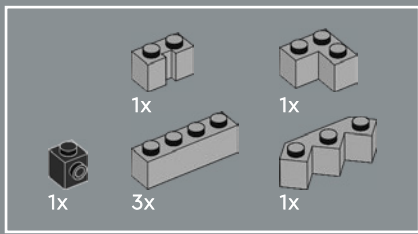

90



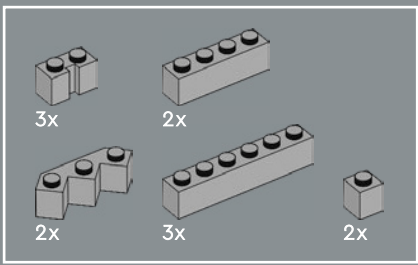

91



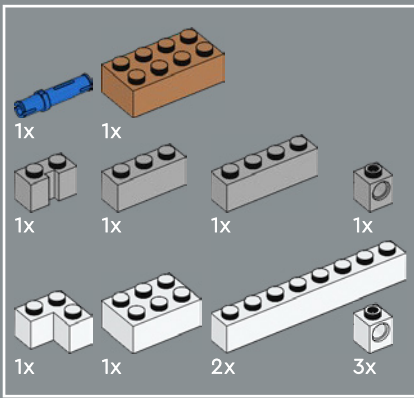

92

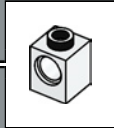
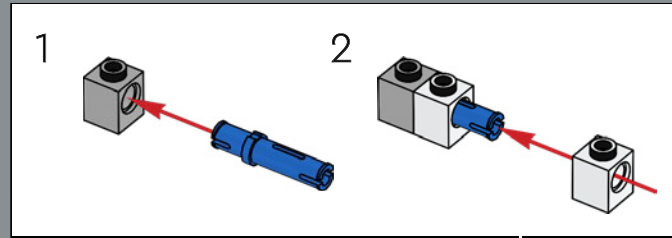

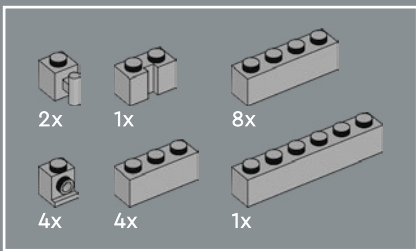

93



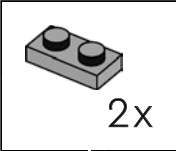
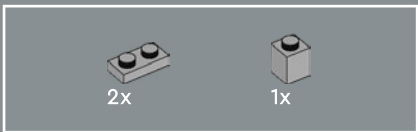

94



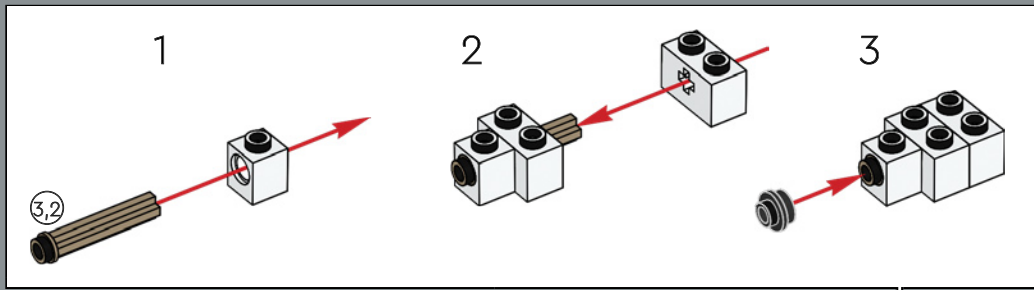
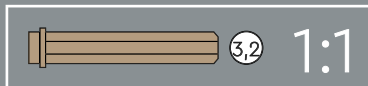
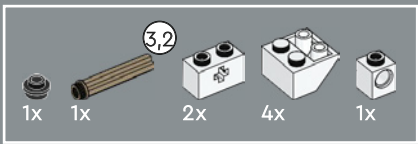

95



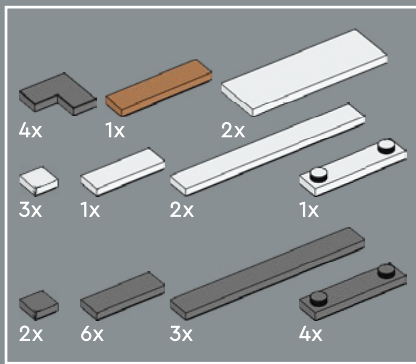

96



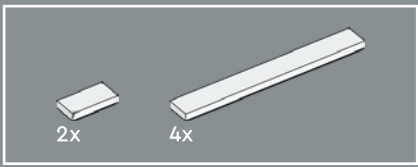

97

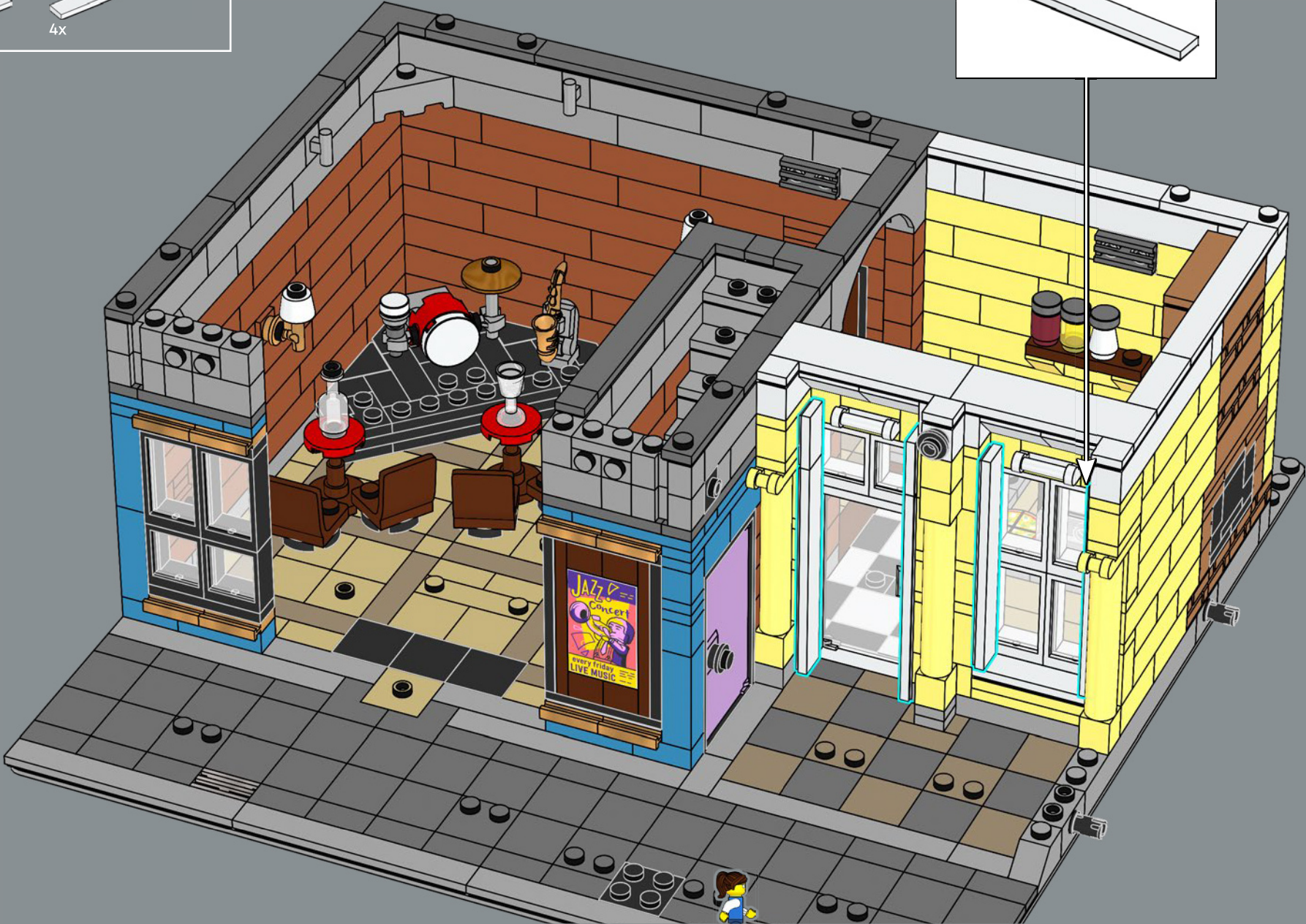
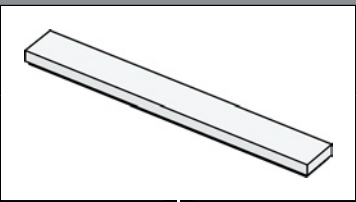



98

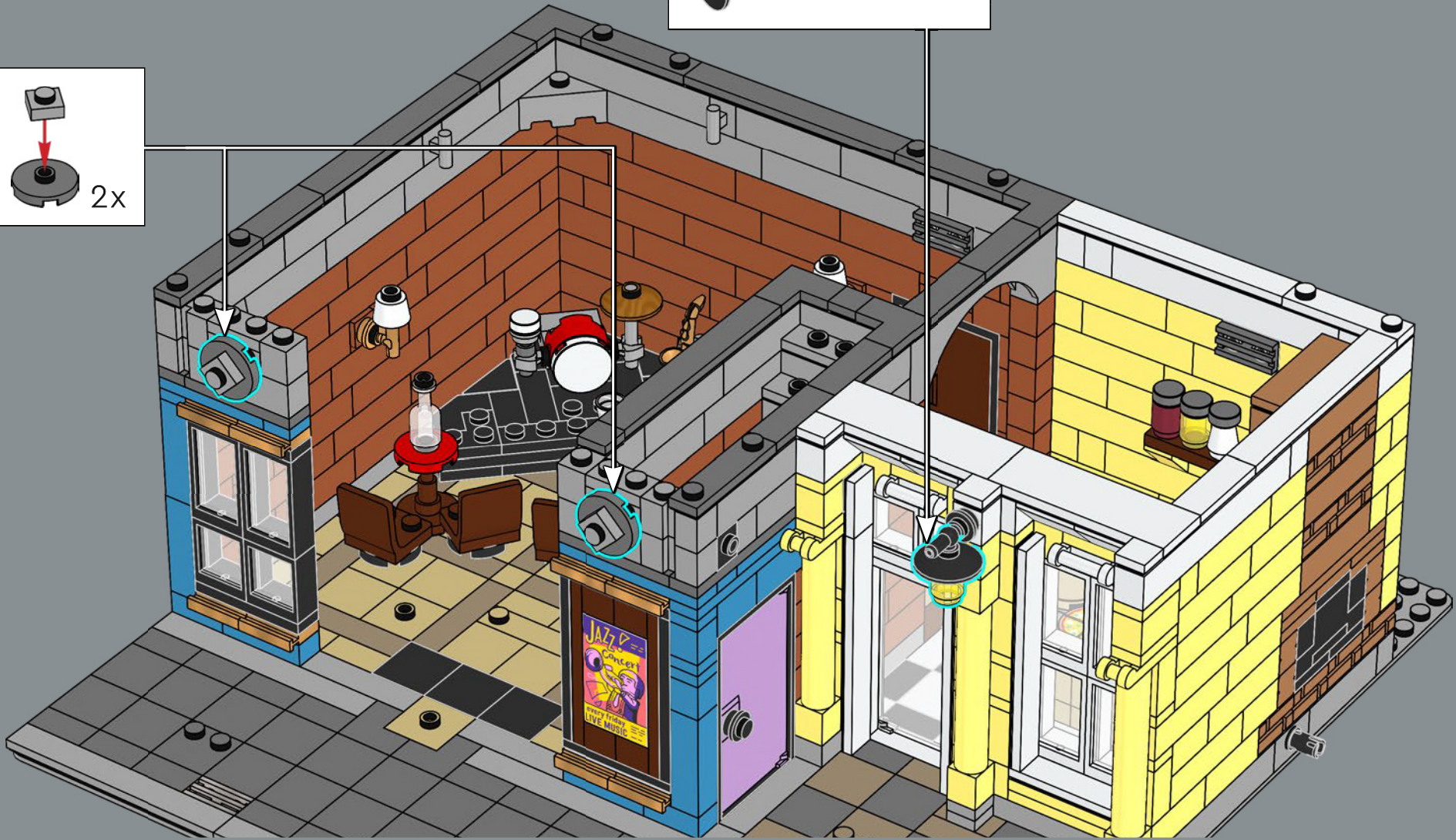
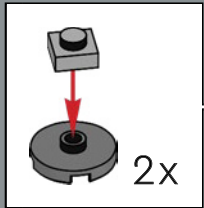
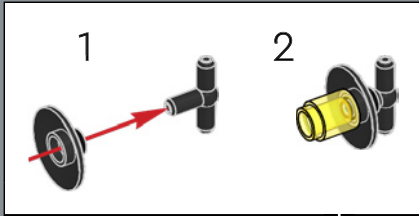

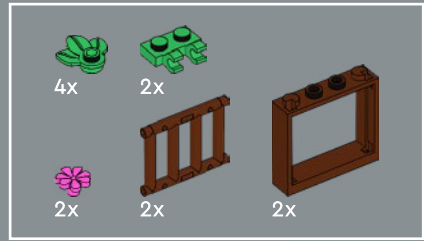

99

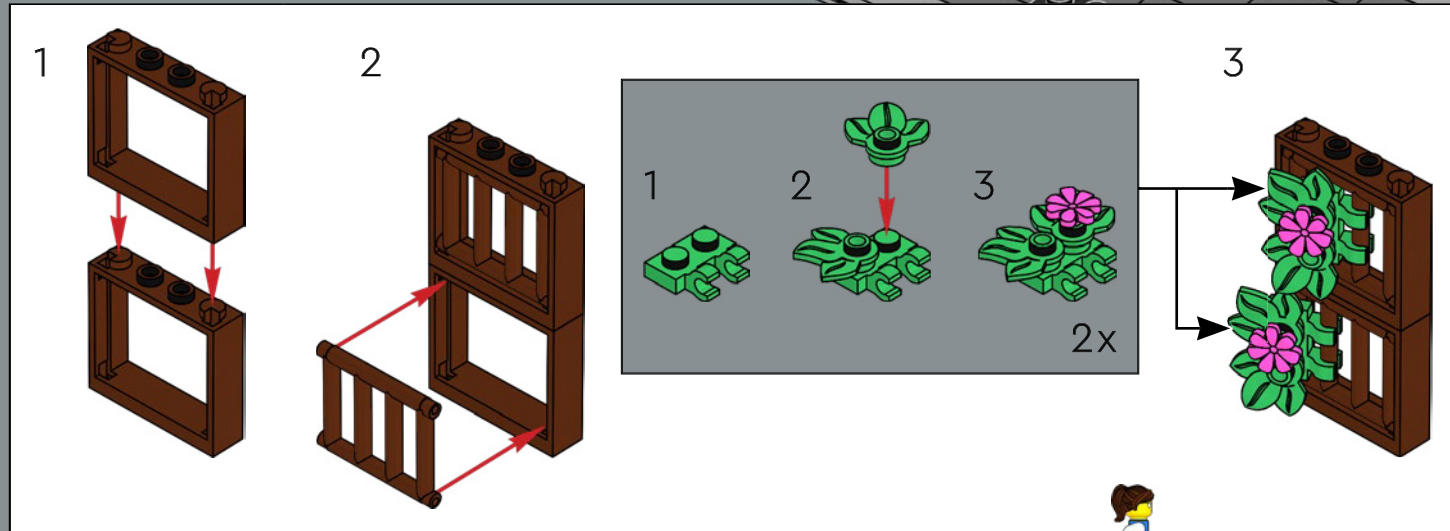



100

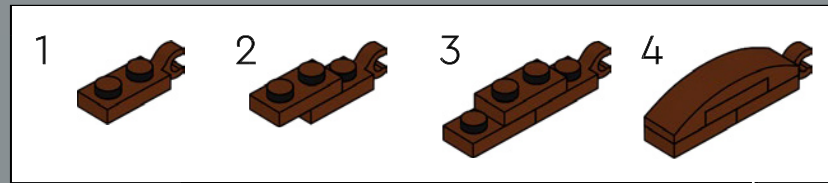

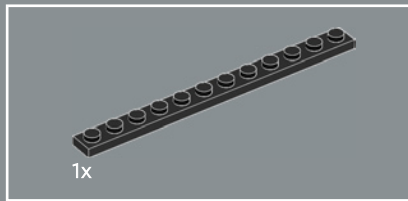

101

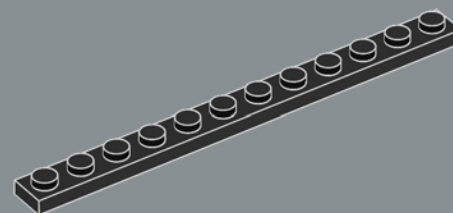

102

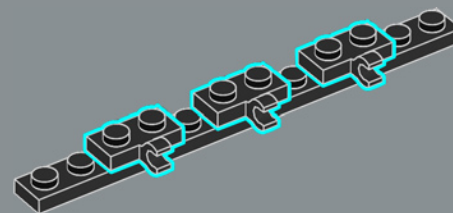

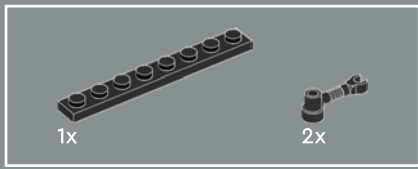

103

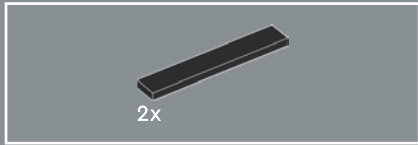
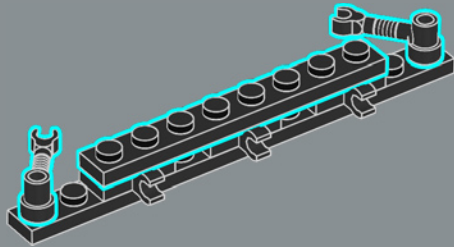

104

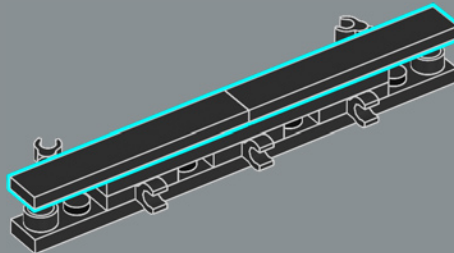

105

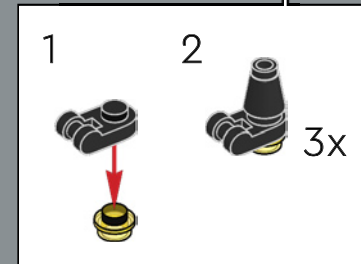
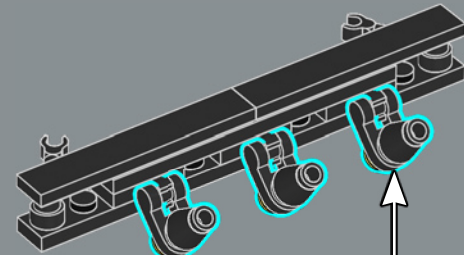

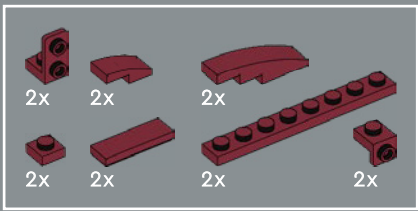

106

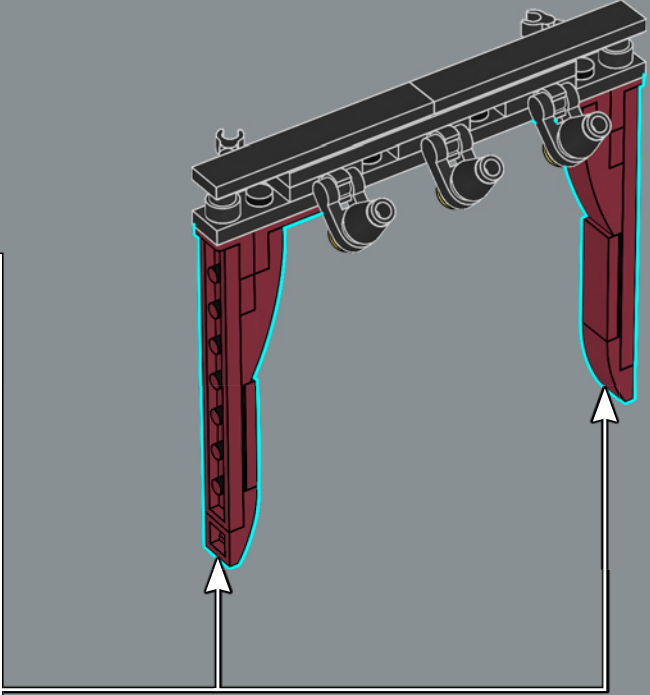
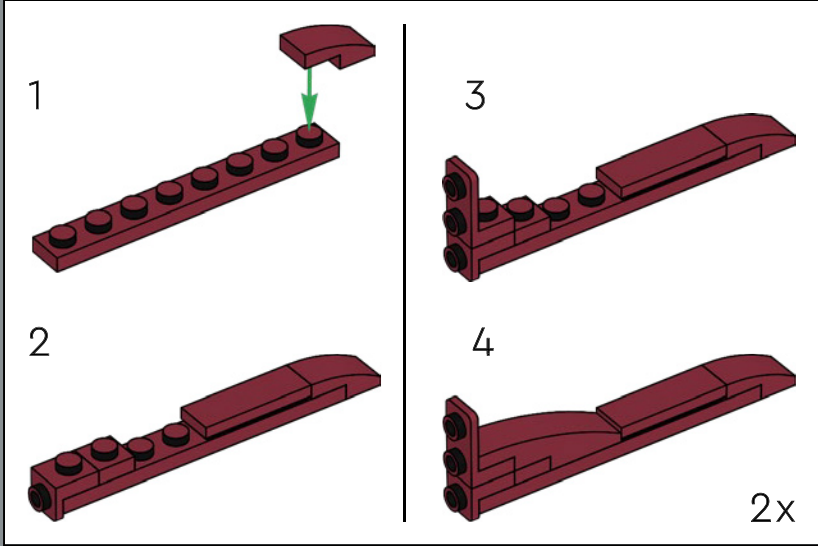

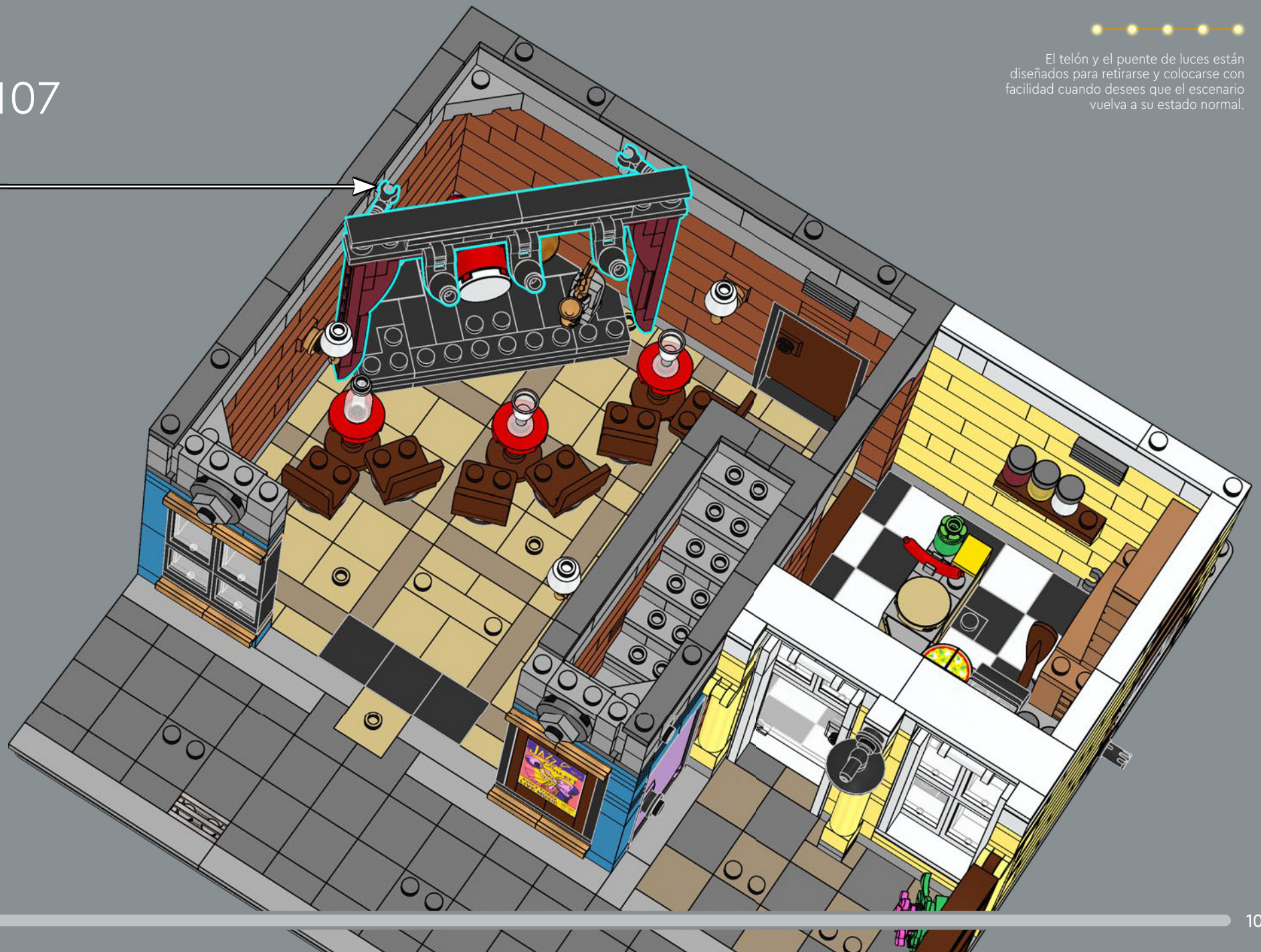

El telón y el puente de luces están diseñados para retirarse y colocarse con facilidad cuando desees que el escenario vuelva a su estado normal.

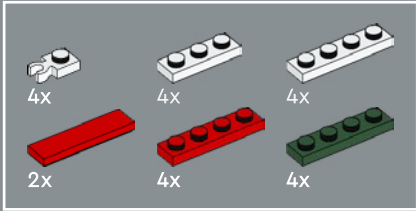

108

1

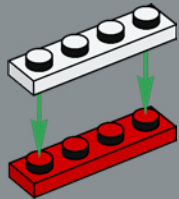

2

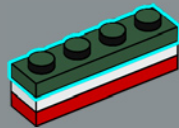

3

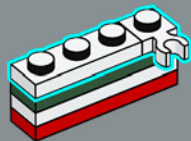

4

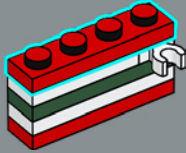

5

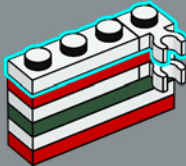

6

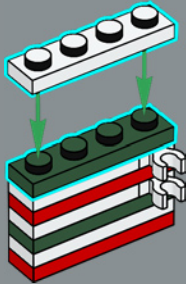

7

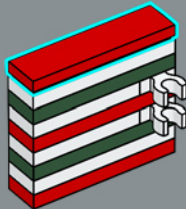

2x





109

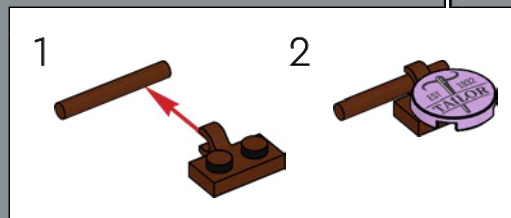
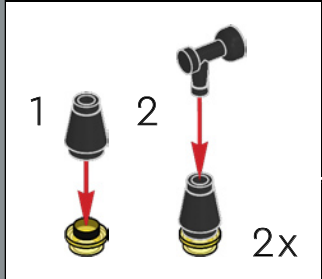

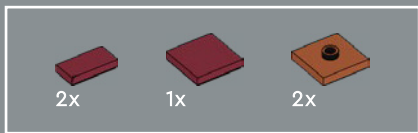

115

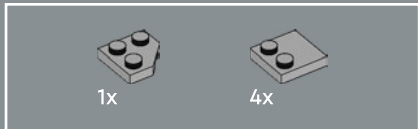
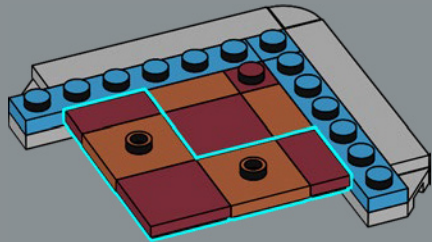

116

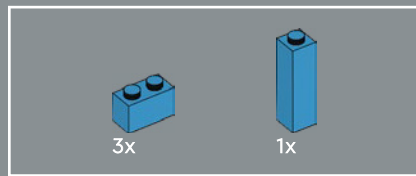
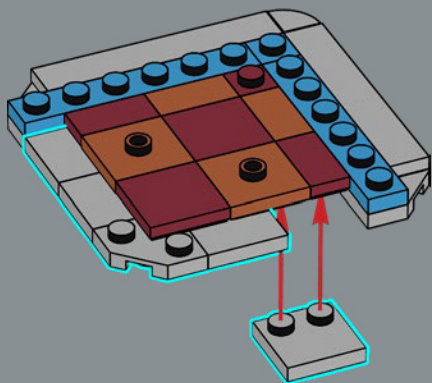

117

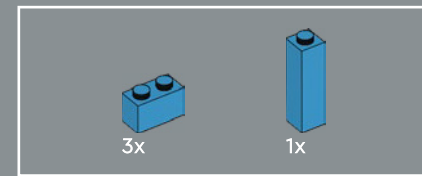
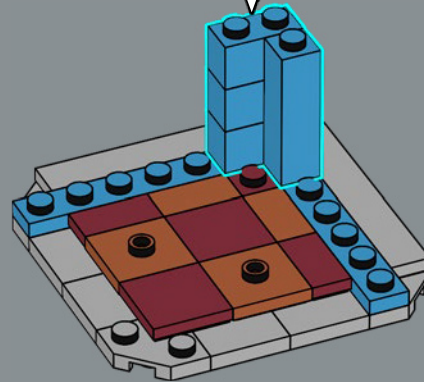
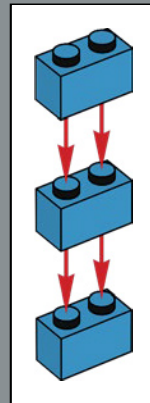

118

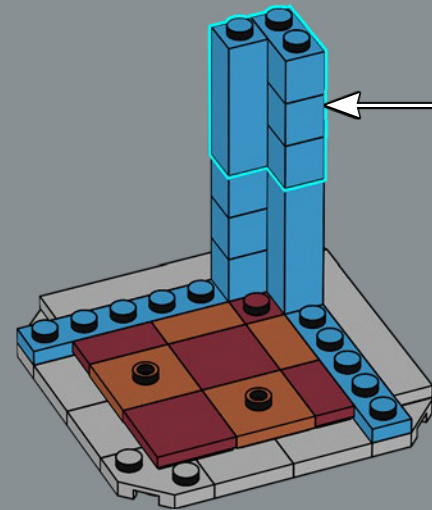
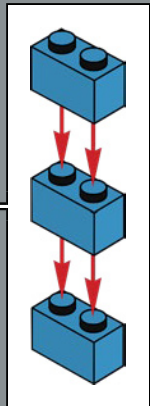

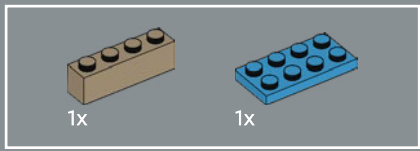

119

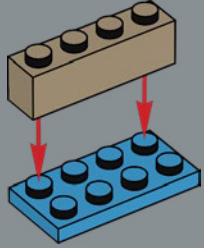

120

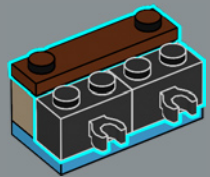

121

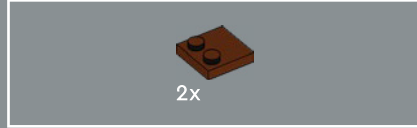
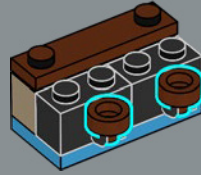

122

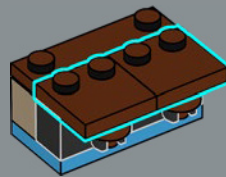

123

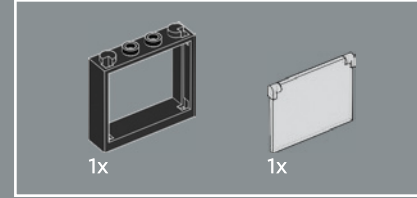
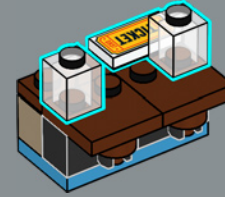

124

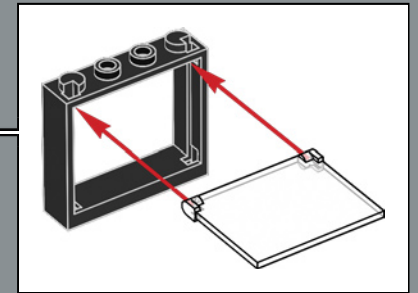
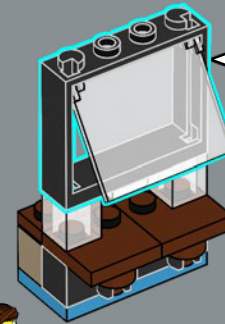

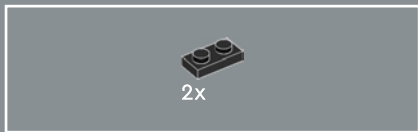

125

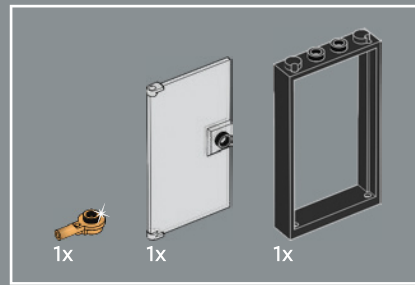
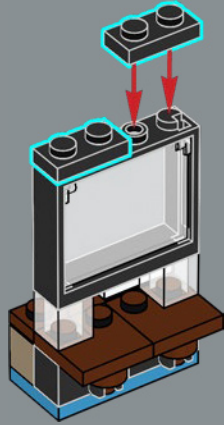

127

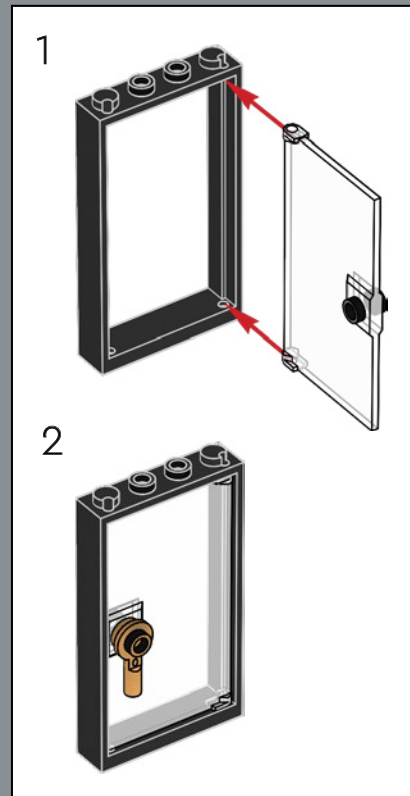

126

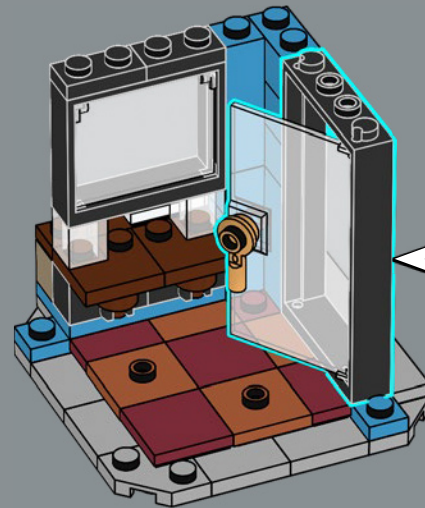
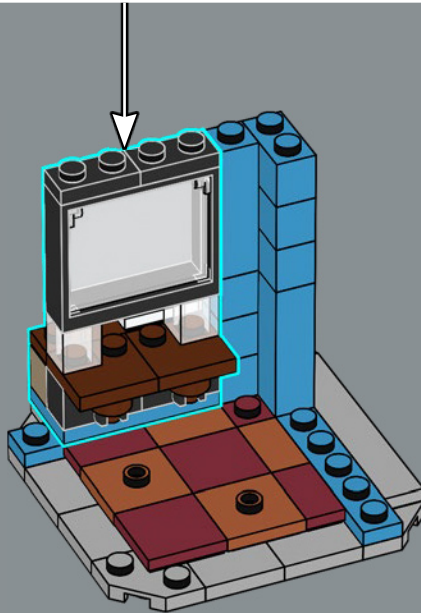



4x

128

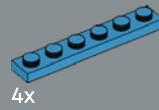
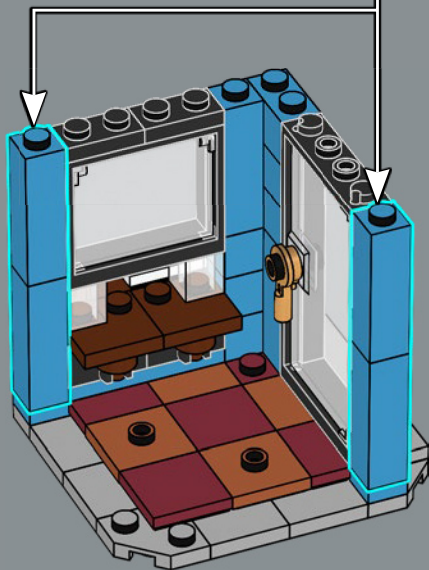
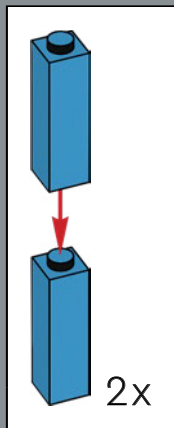

4x



2x

129

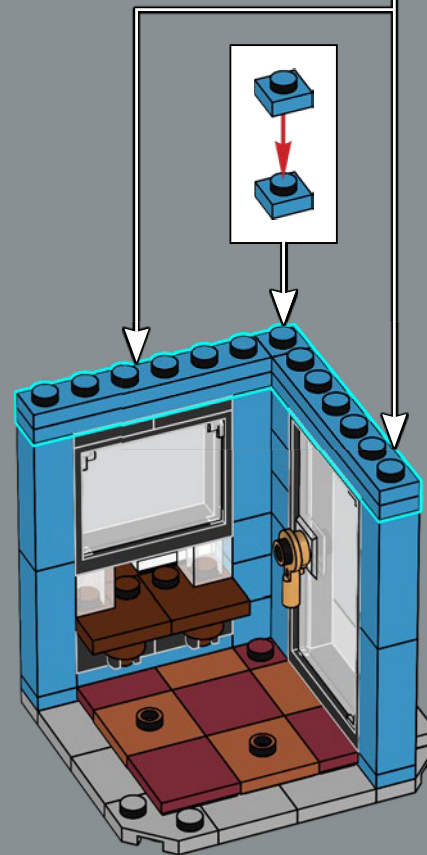
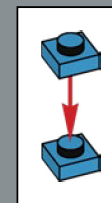
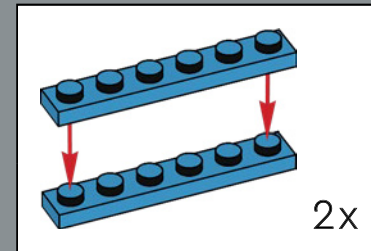

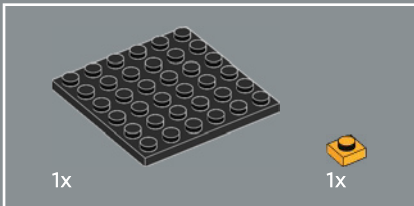

130

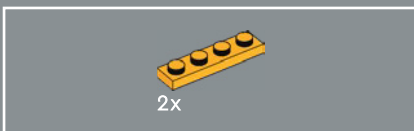
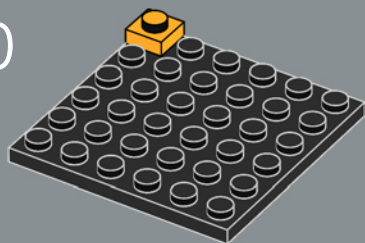

131

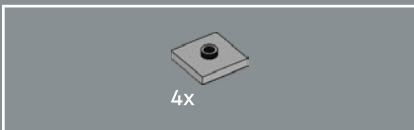
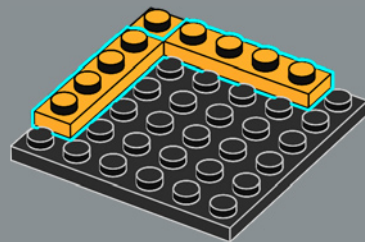

132

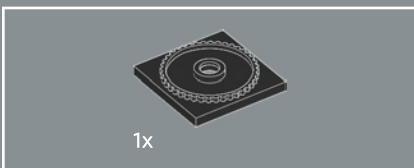
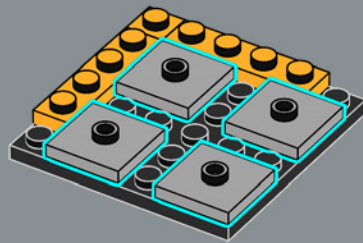

133

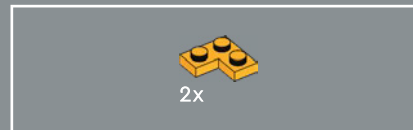
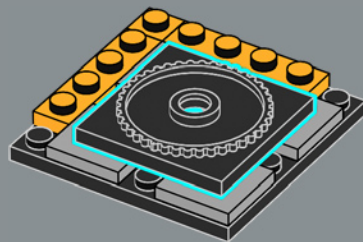

134

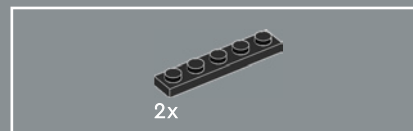
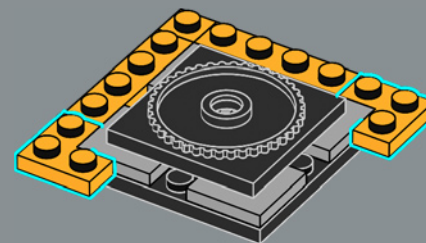

135

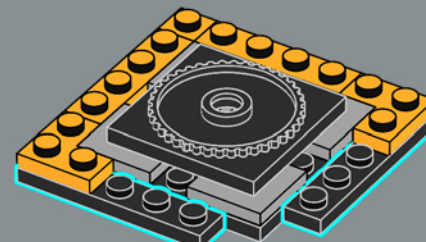

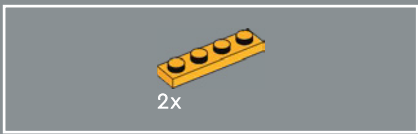

136

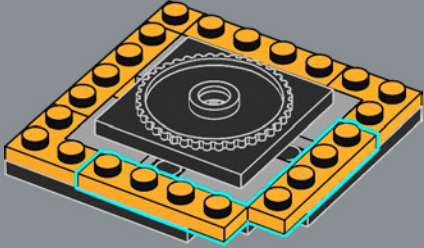

137

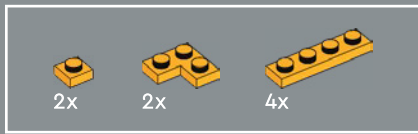
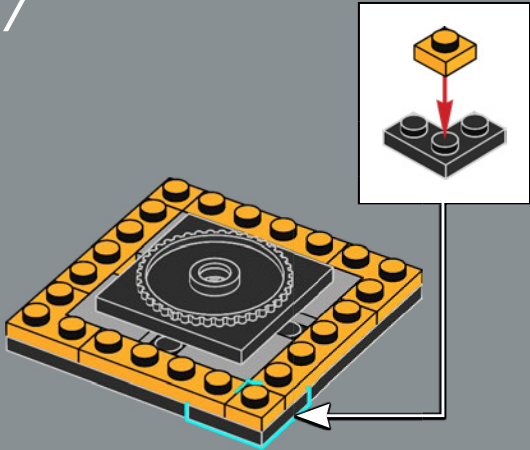

138

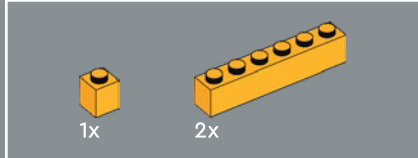
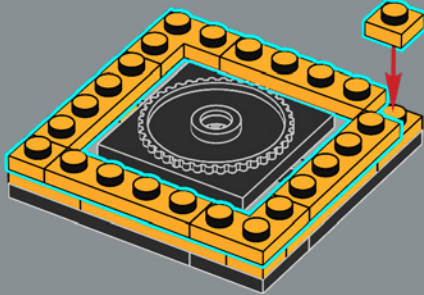

139

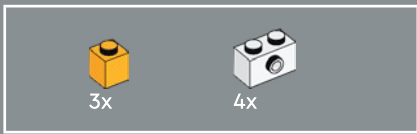
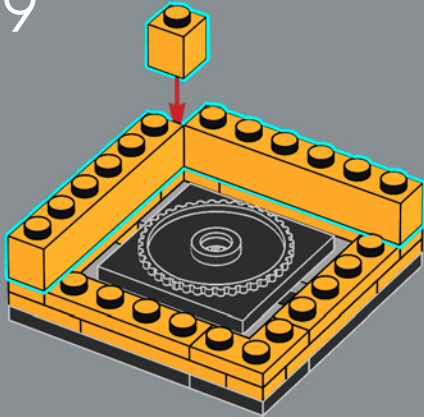

140

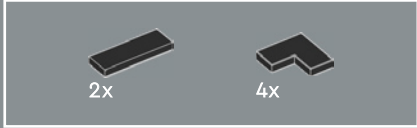
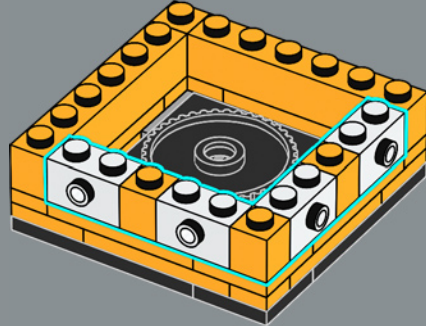

141

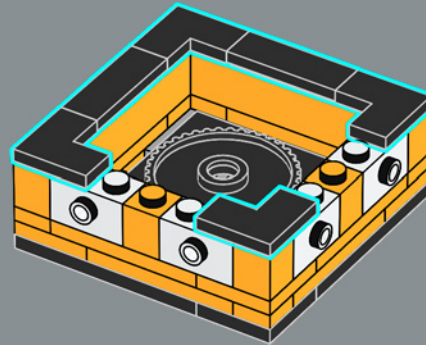



142

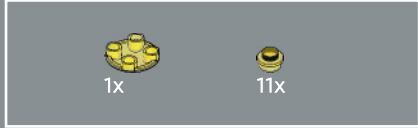
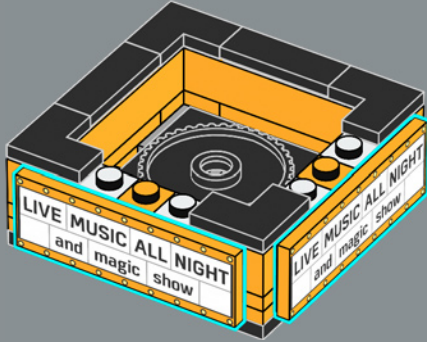

143

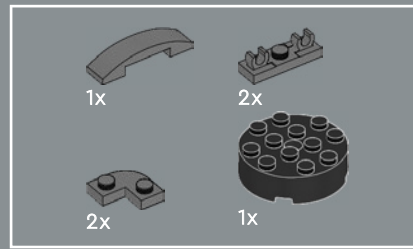
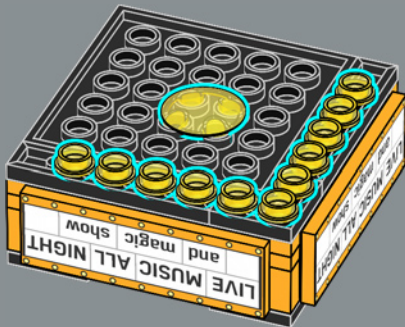

144

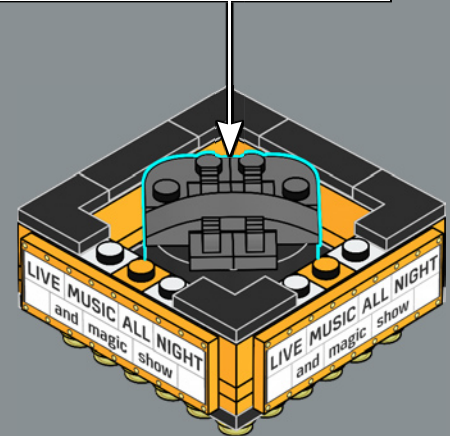
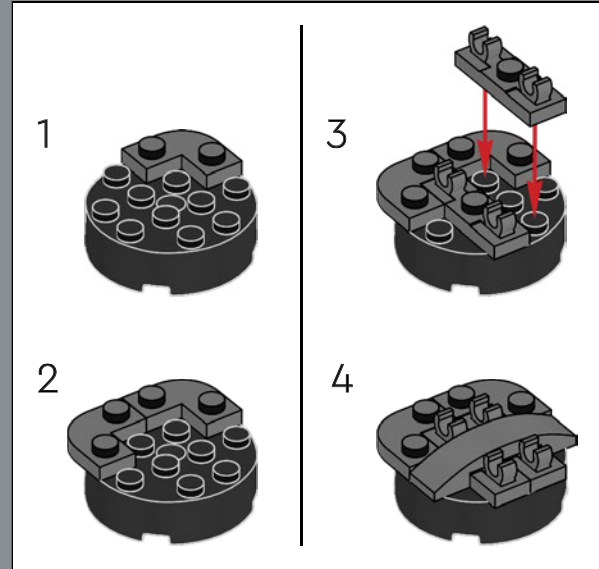



145

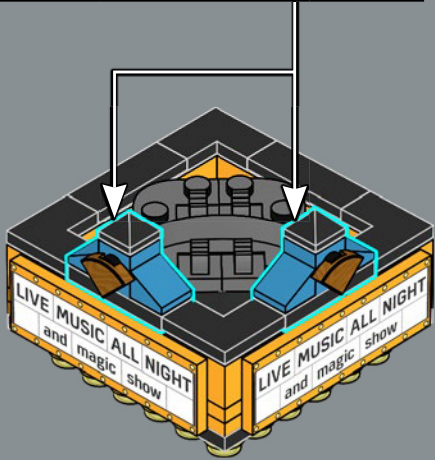
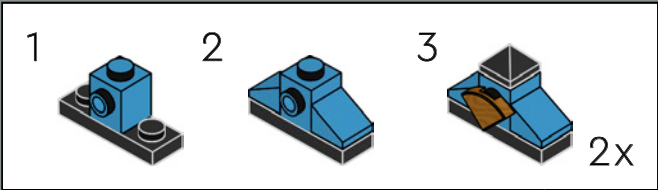

Además de apoyar la música, el Club de Jazz alberga todo tipo de artes escénicas. Si te quedas un poco más, podrás ver los nuevos trucos que la maga local tiene bajo la manga.

146

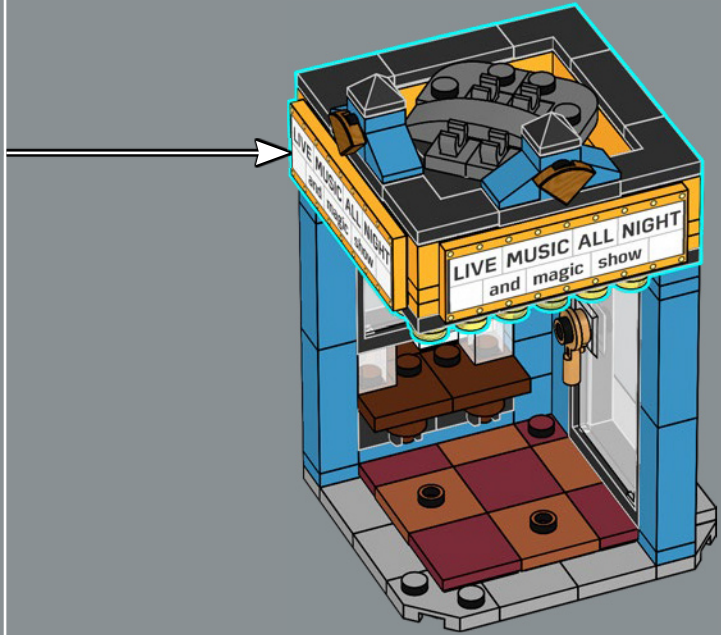

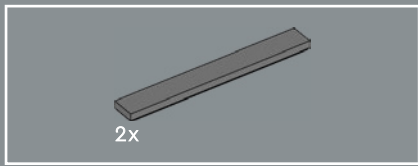

147

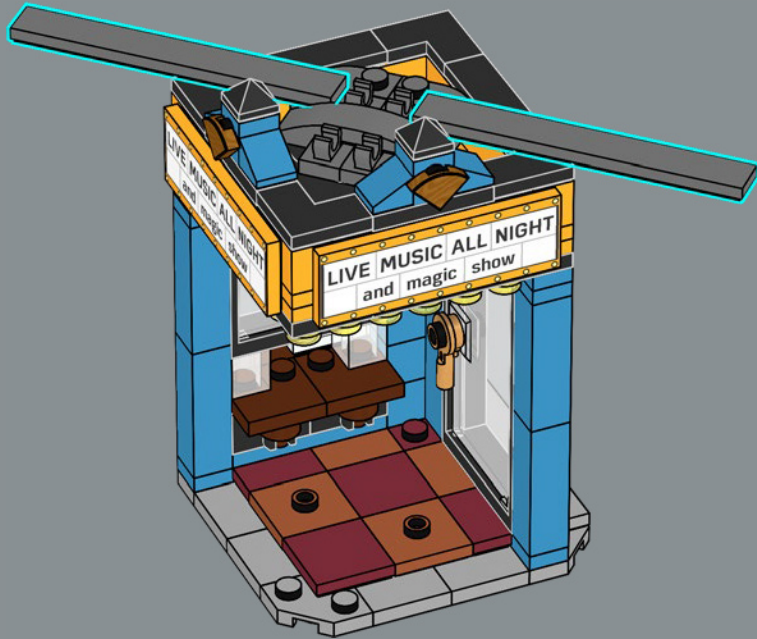

148



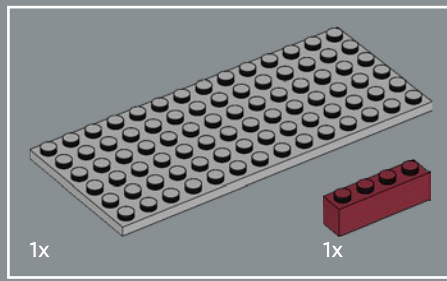

149

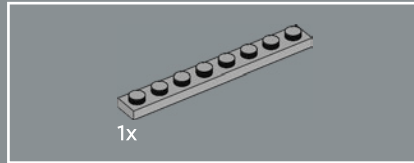
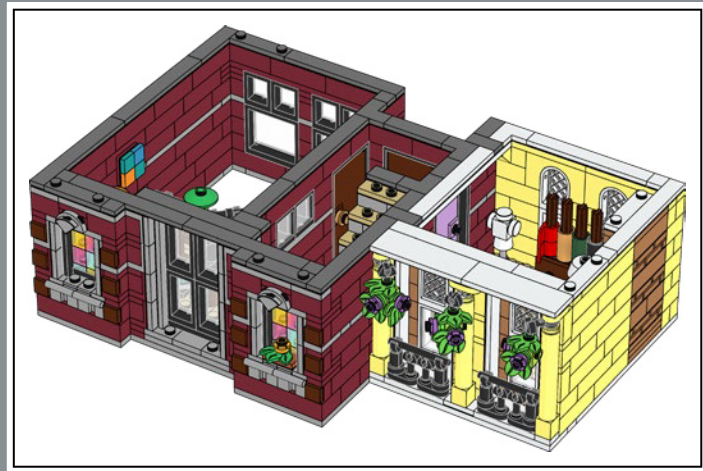
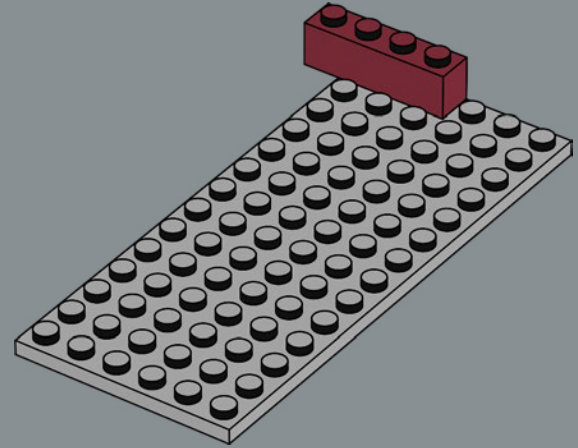

150

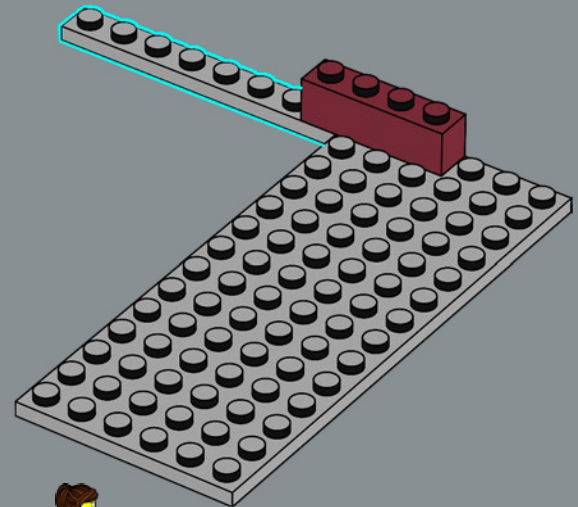

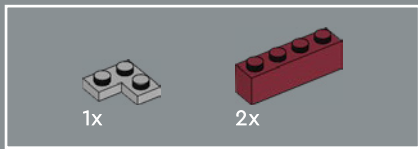

151

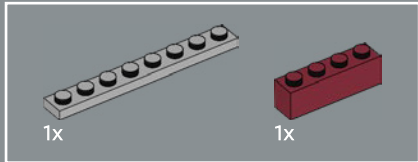
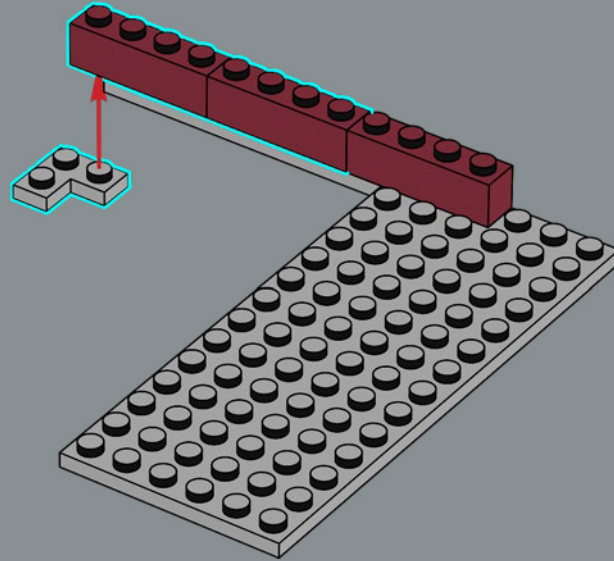

152

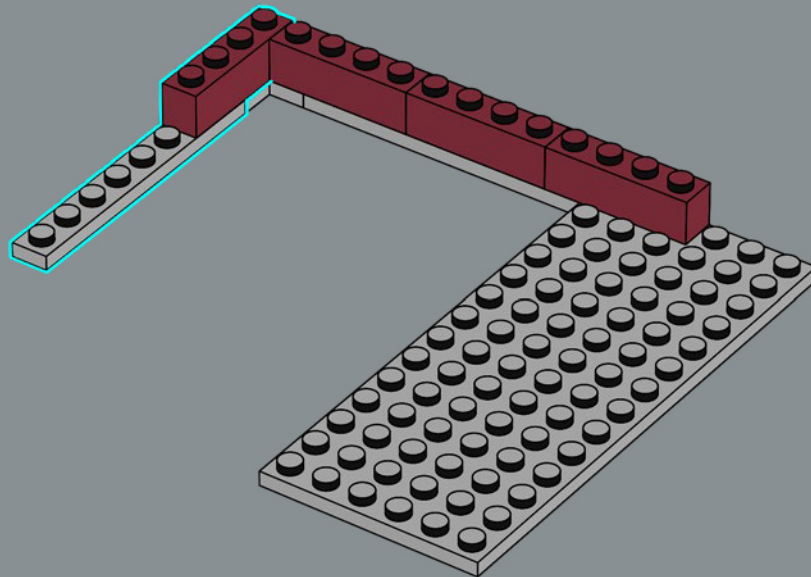

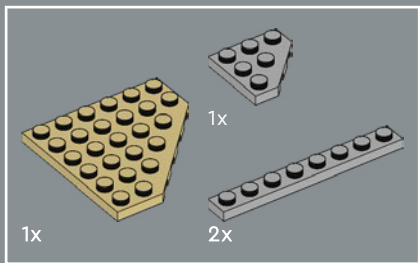

153

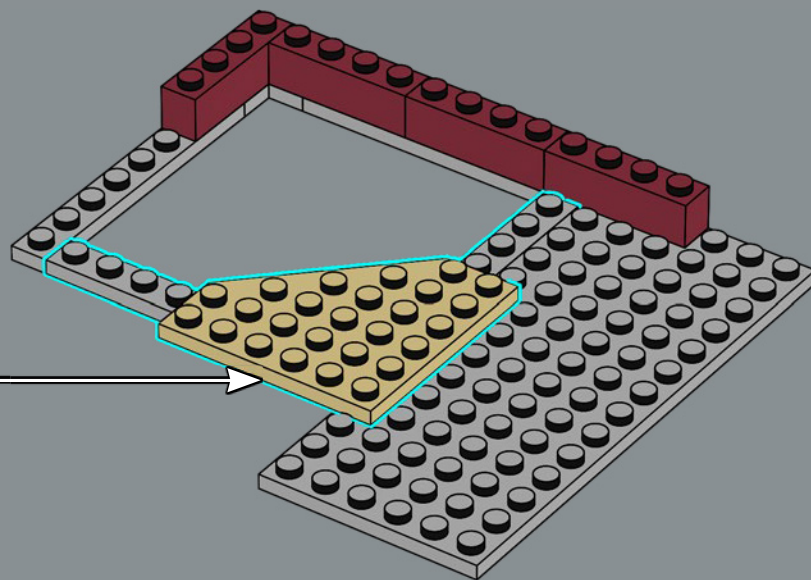
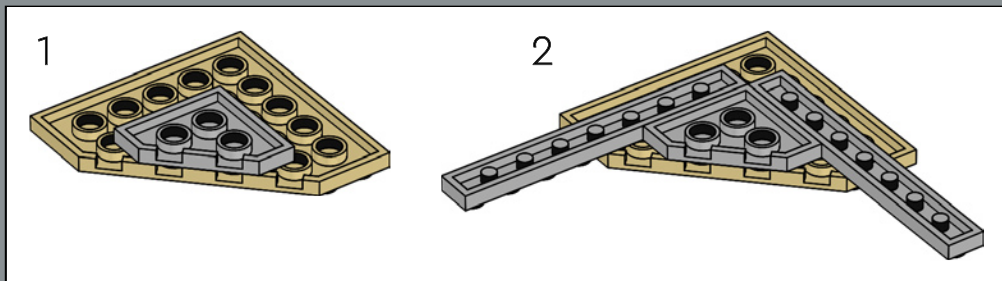

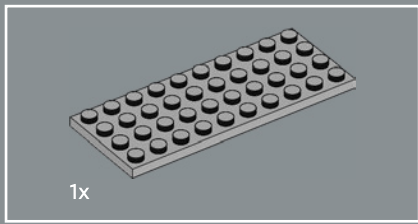

154

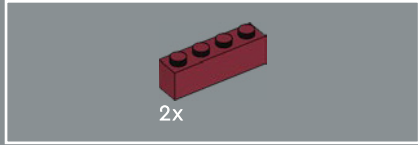
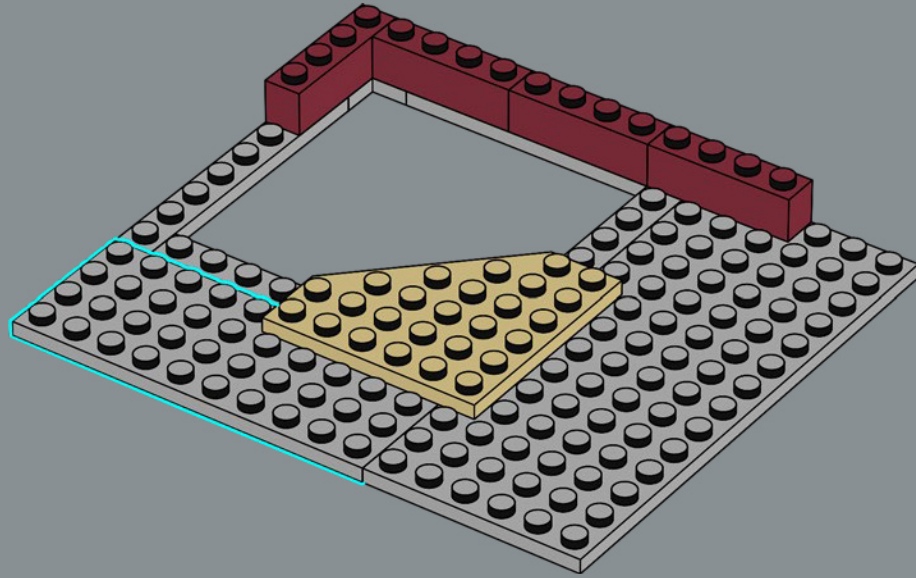

155

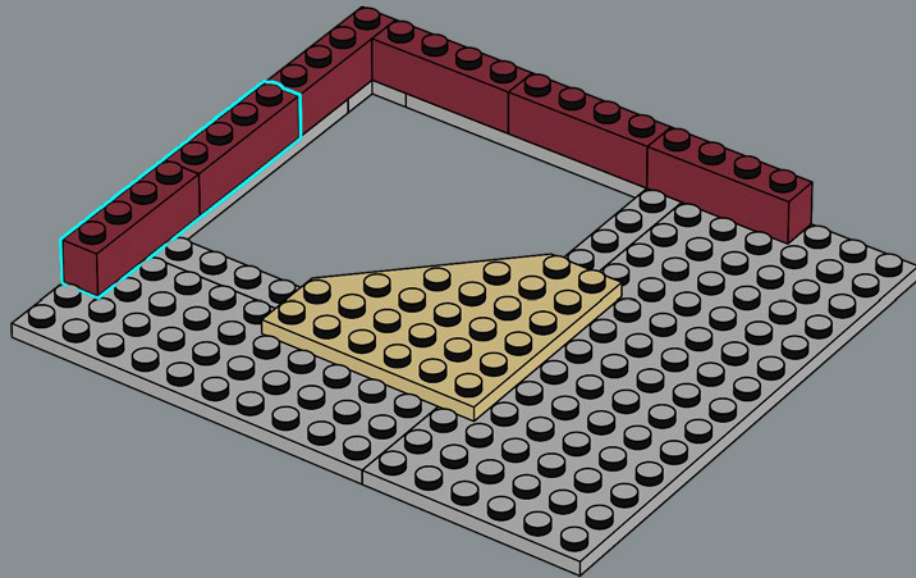

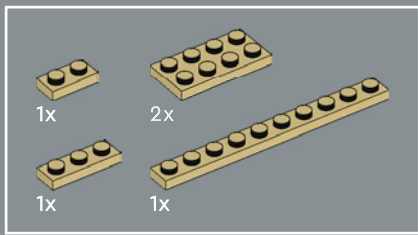

156

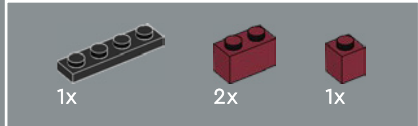
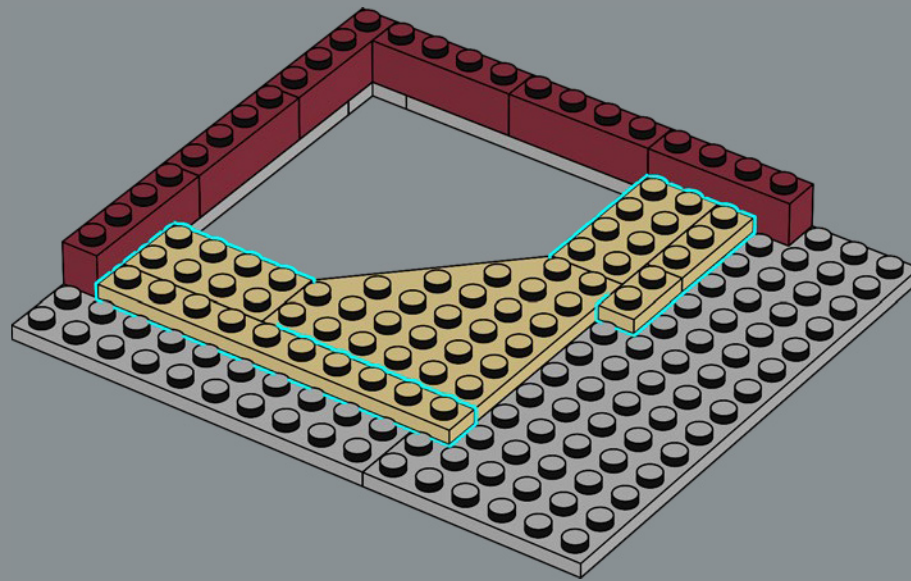

157

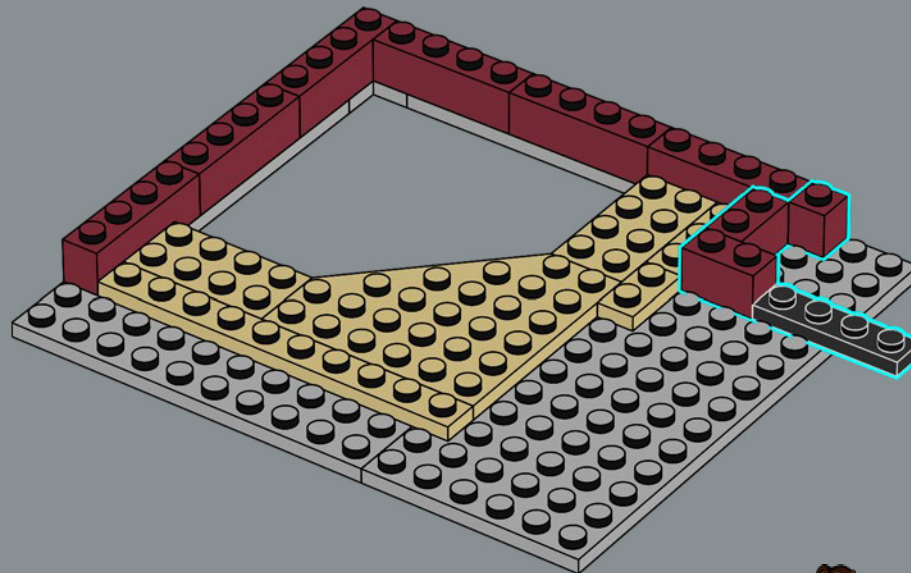

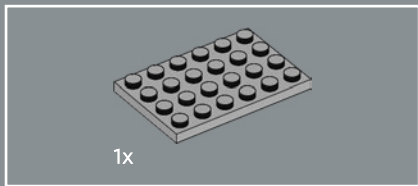

158

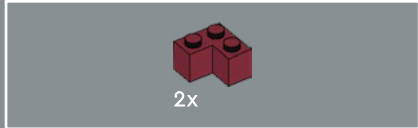
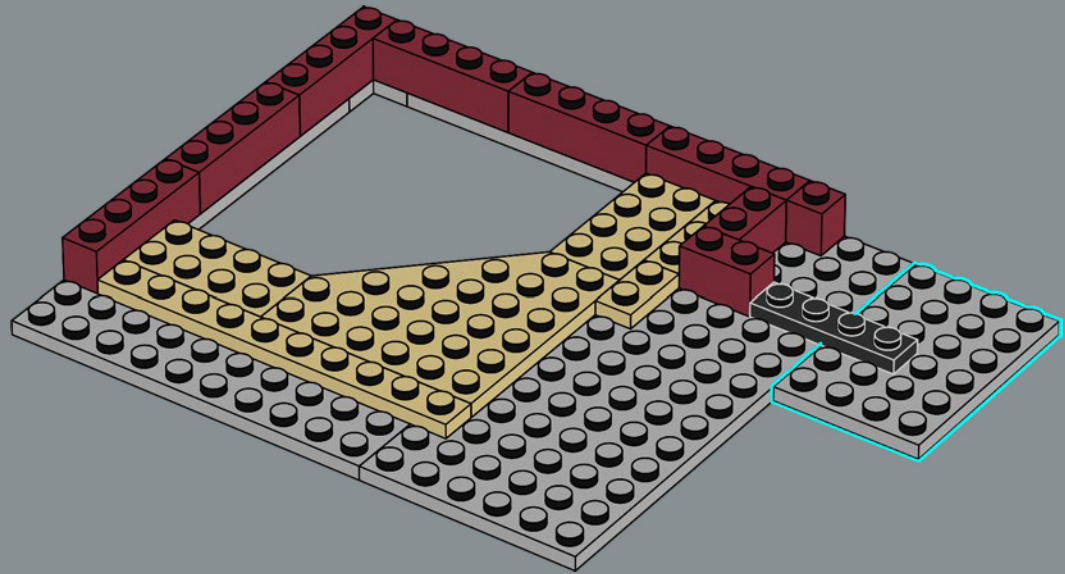

159

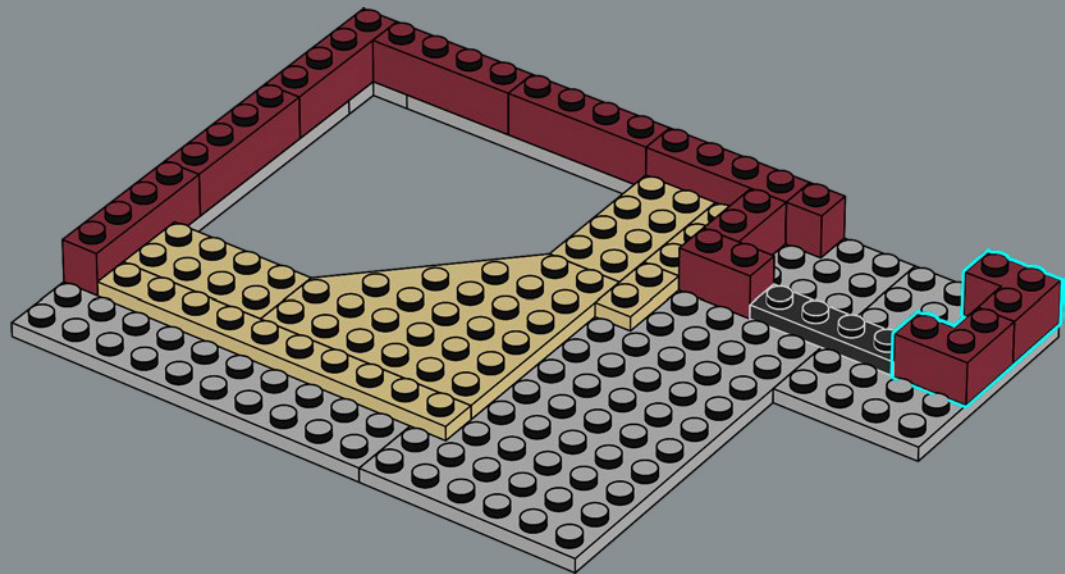

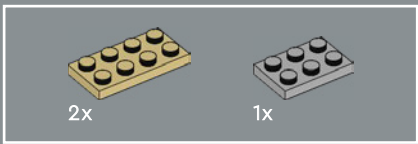

160

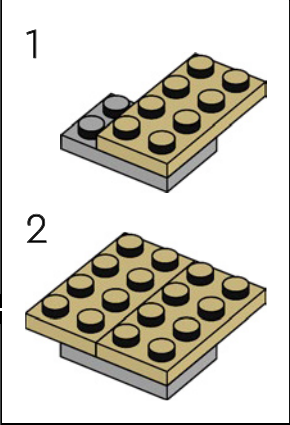
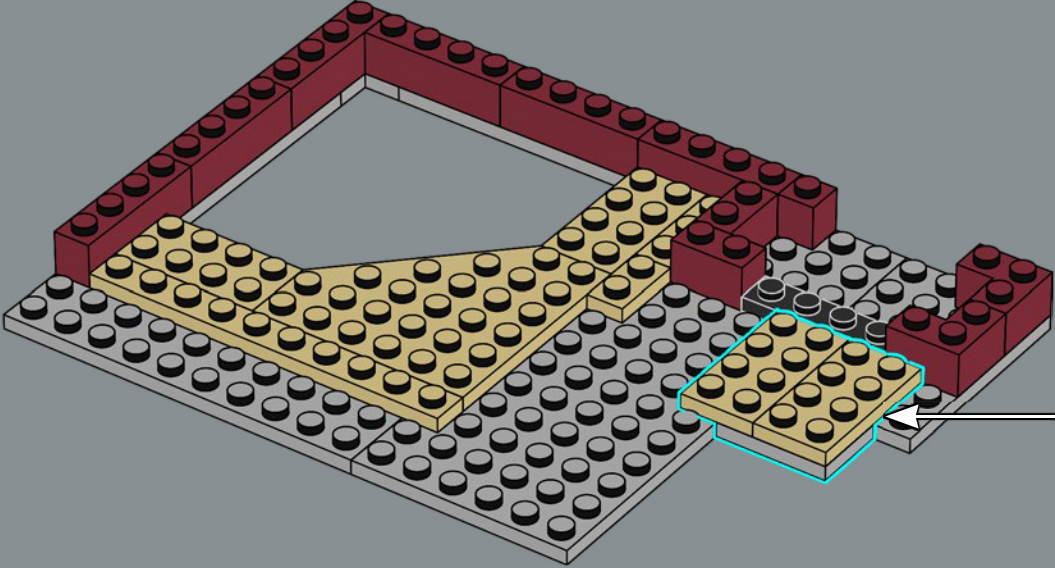

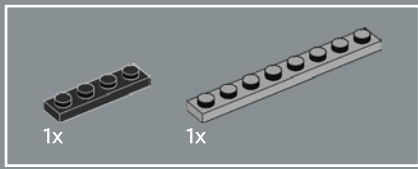

161

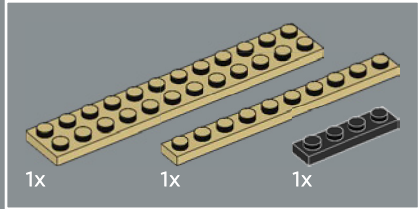
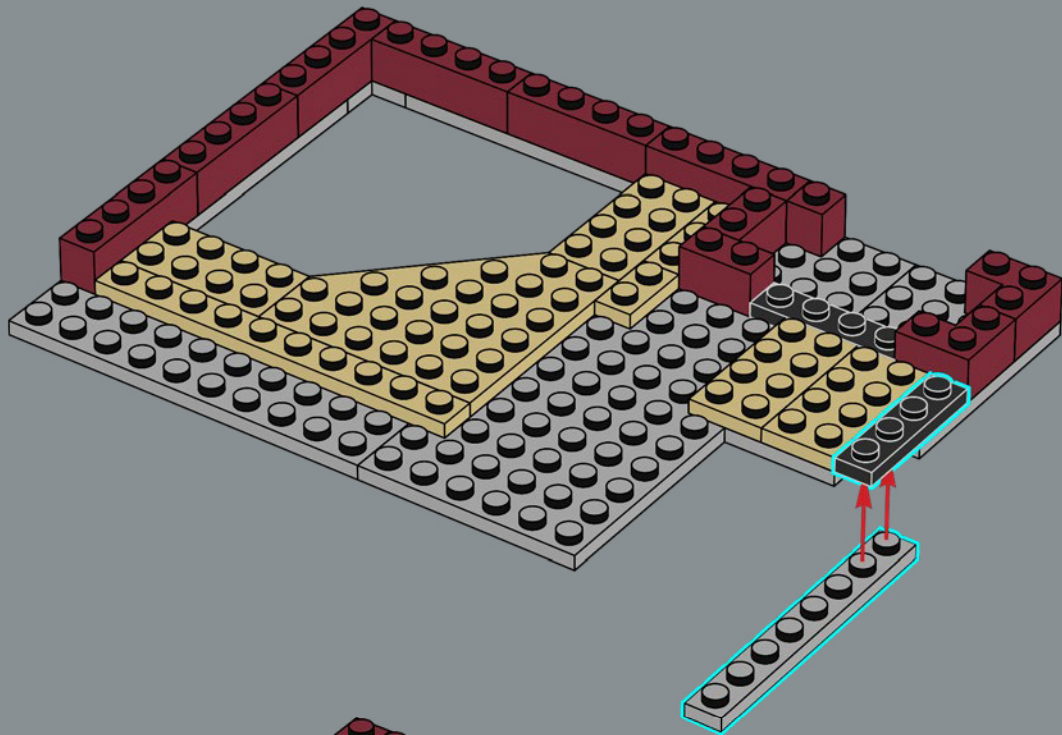

162

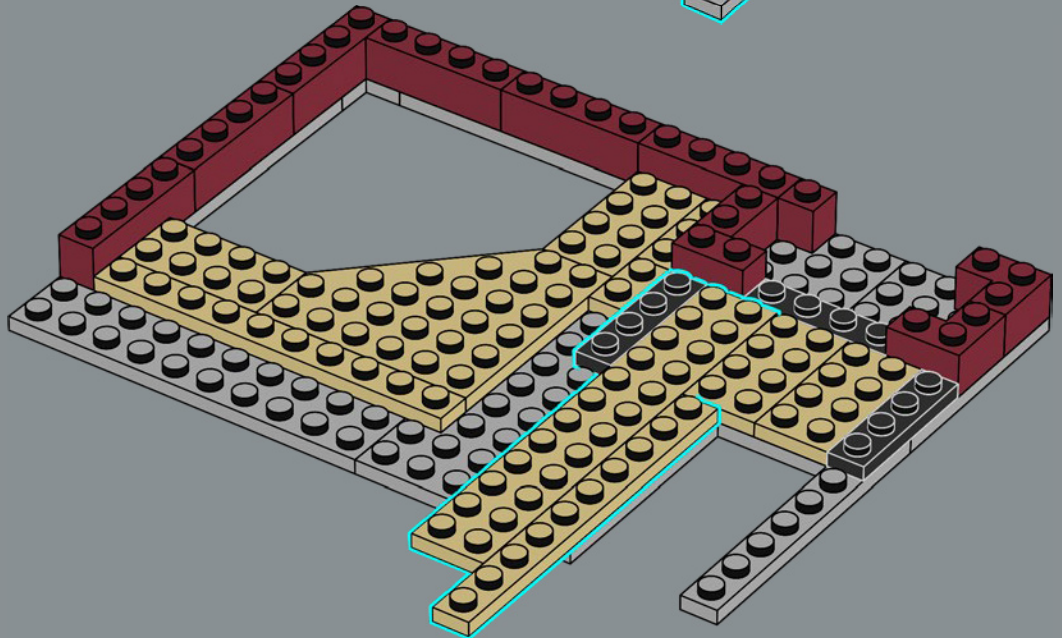

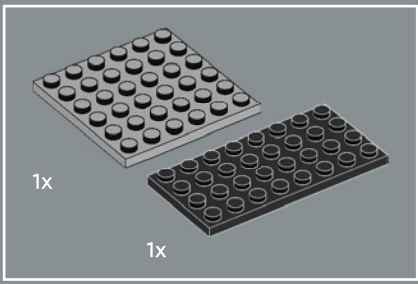

163

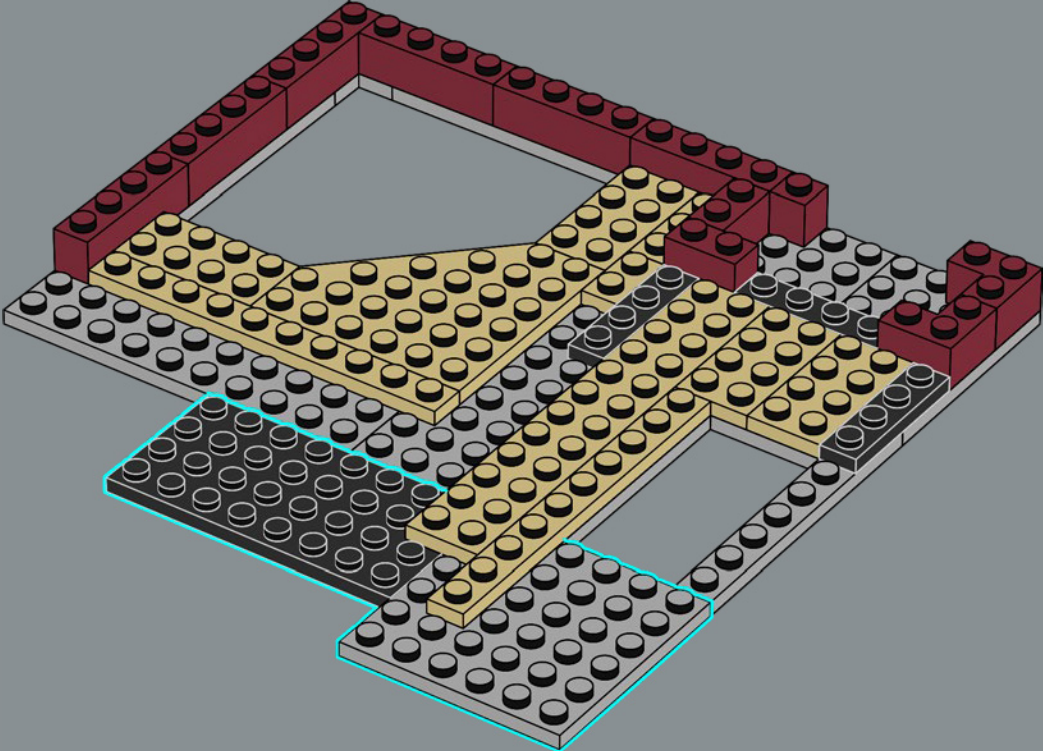

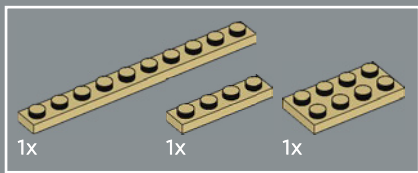

164

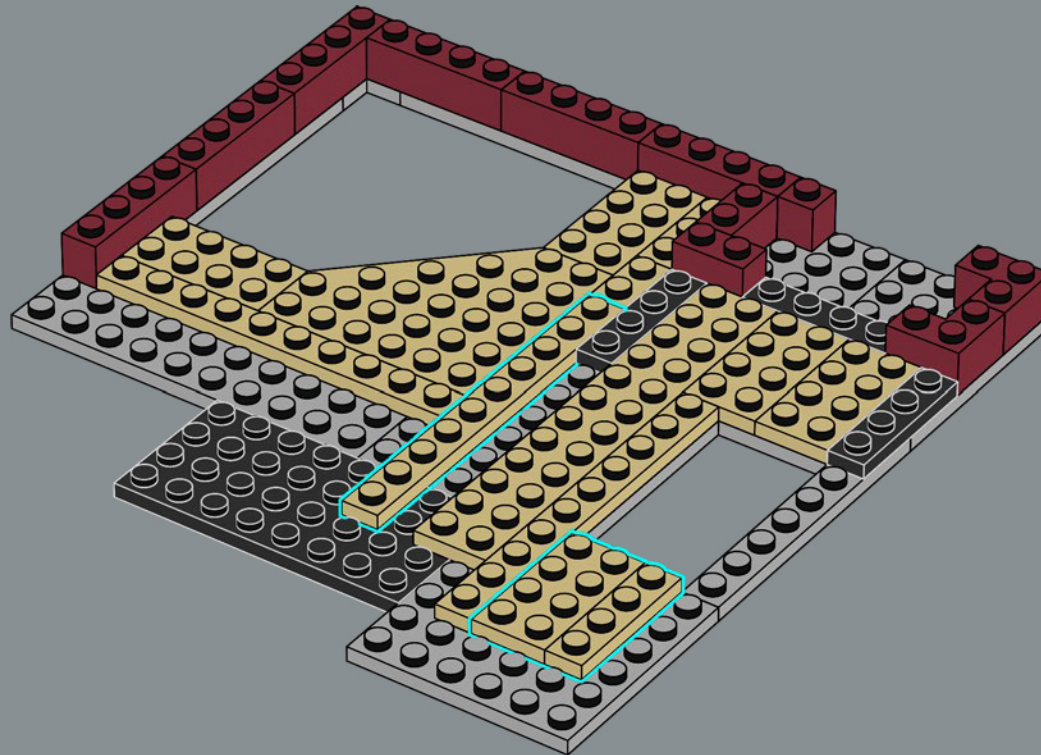

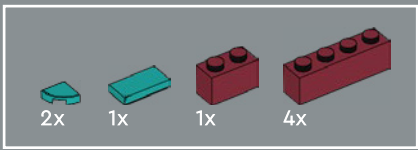

165

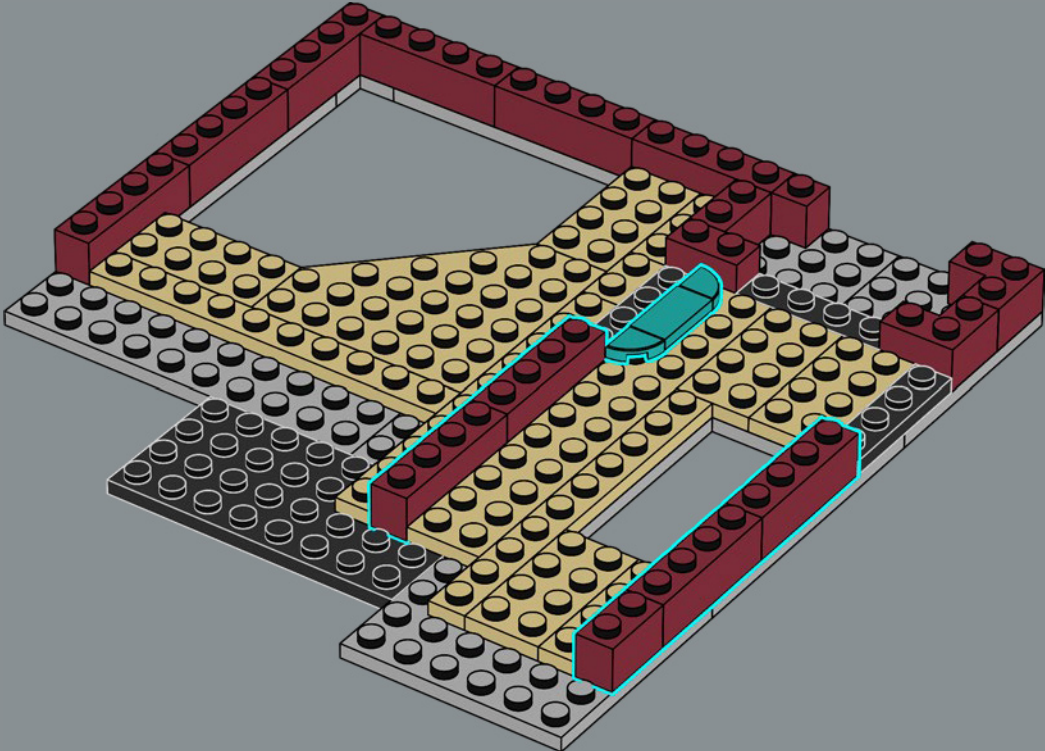

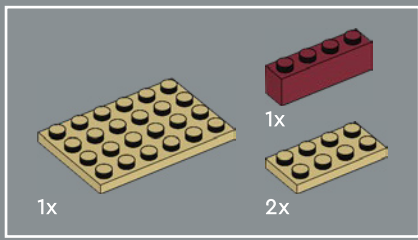

166

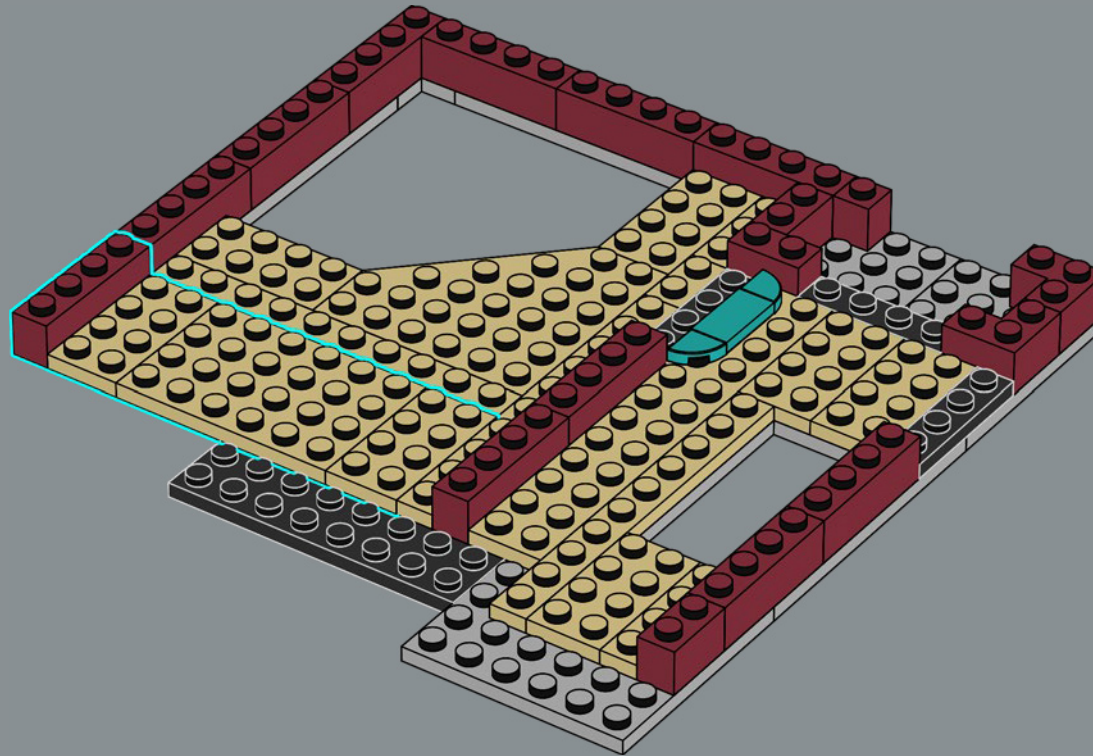

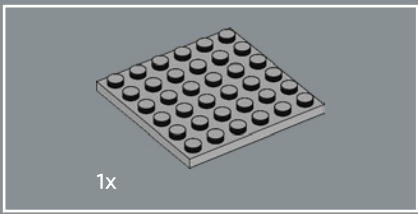

167

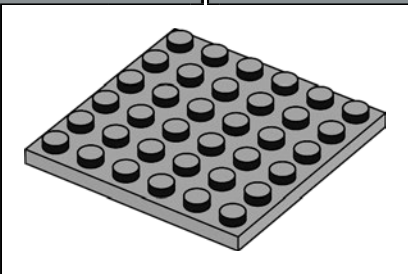
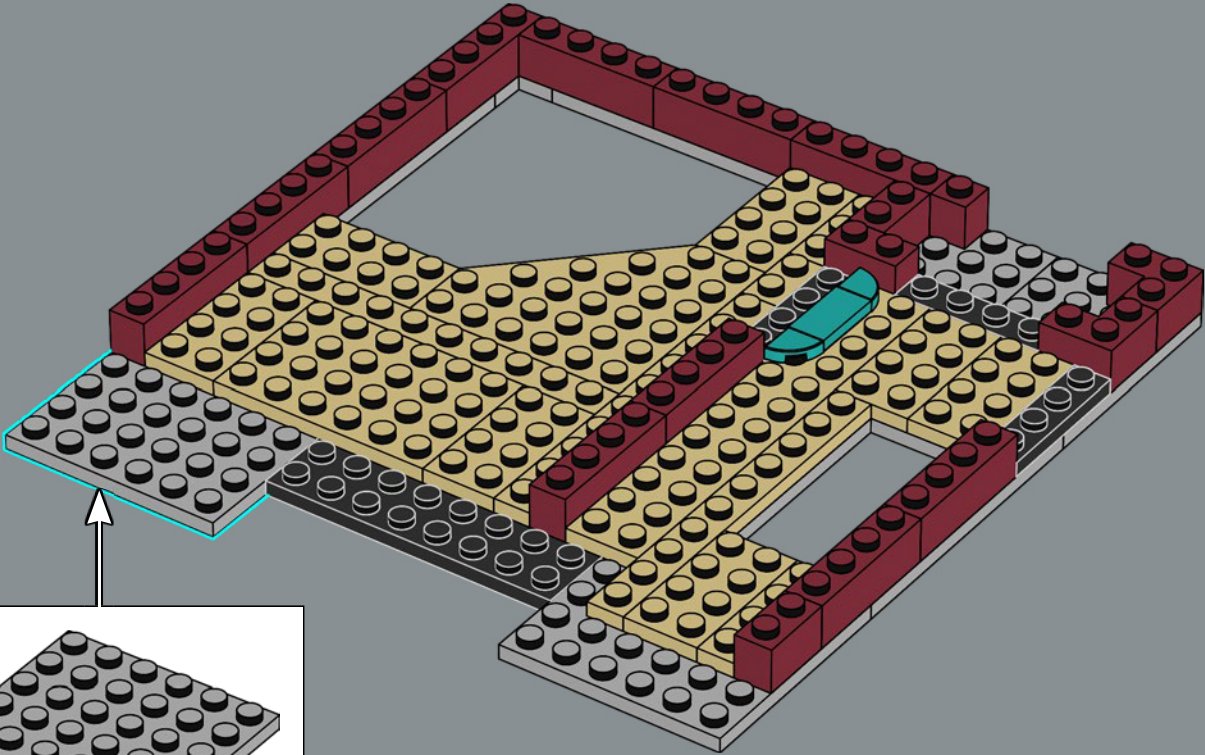

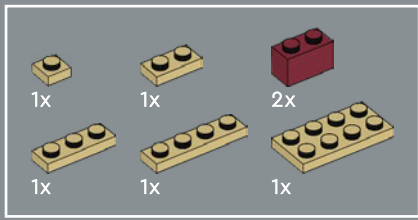

168

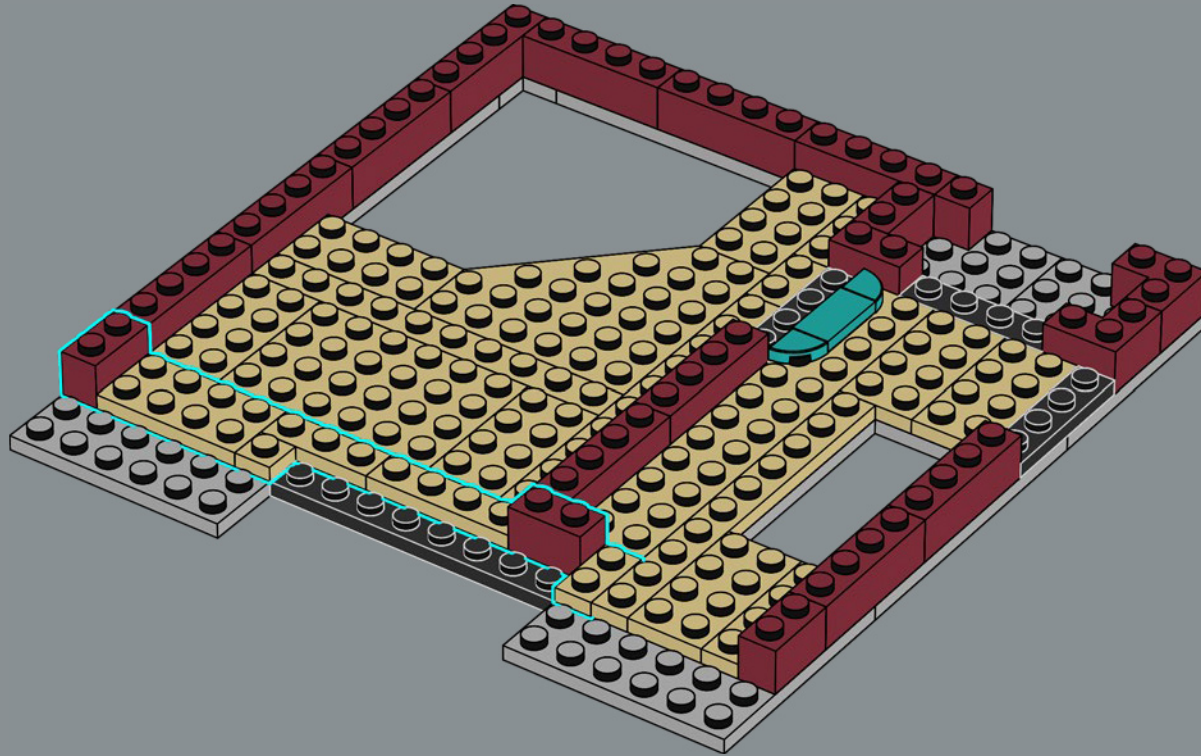

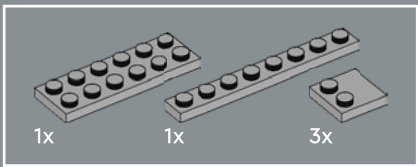

169

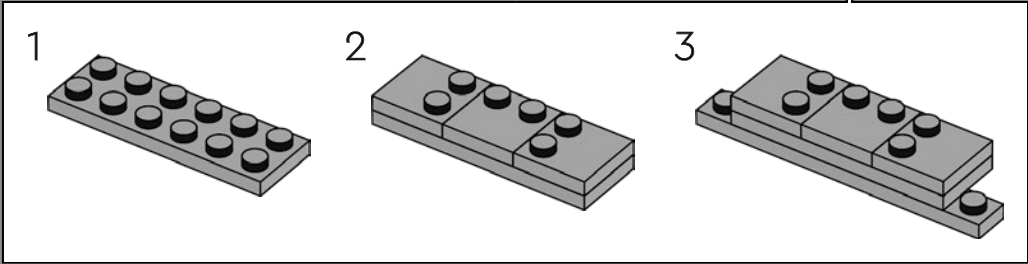
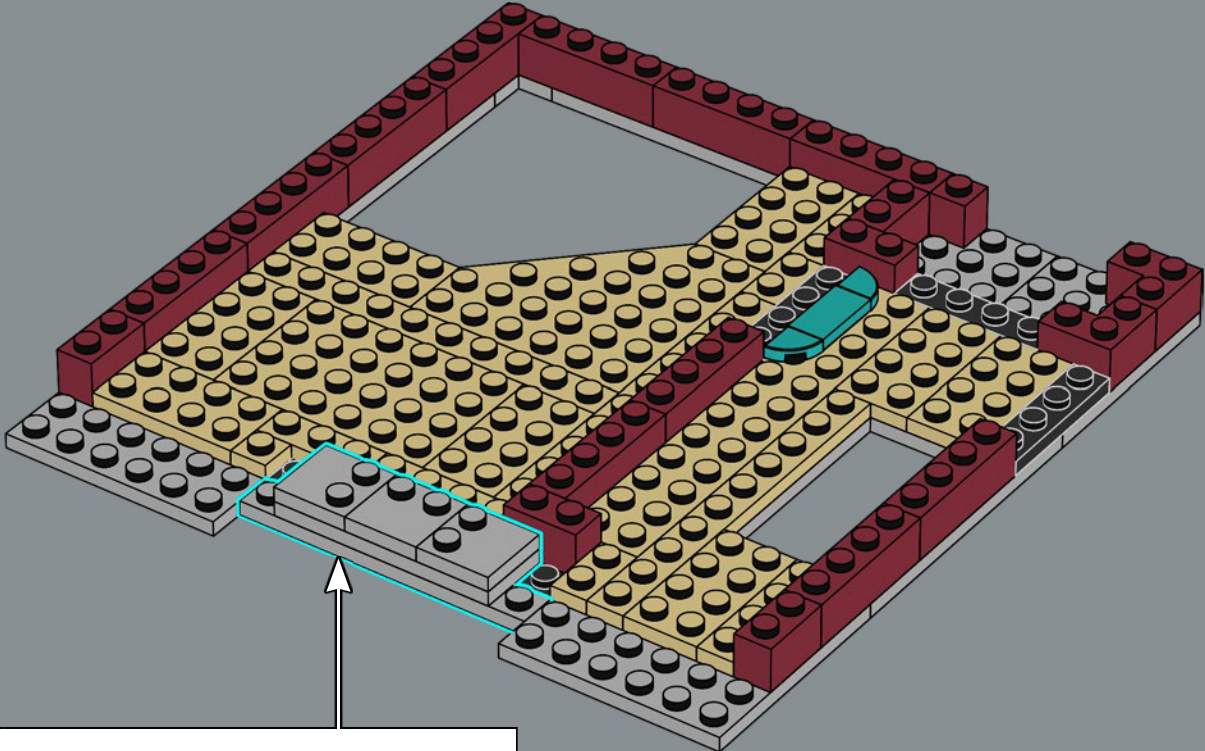

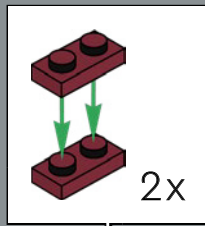
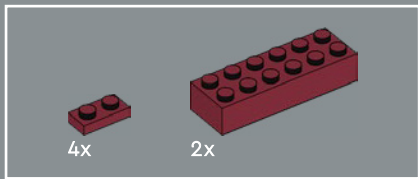

170

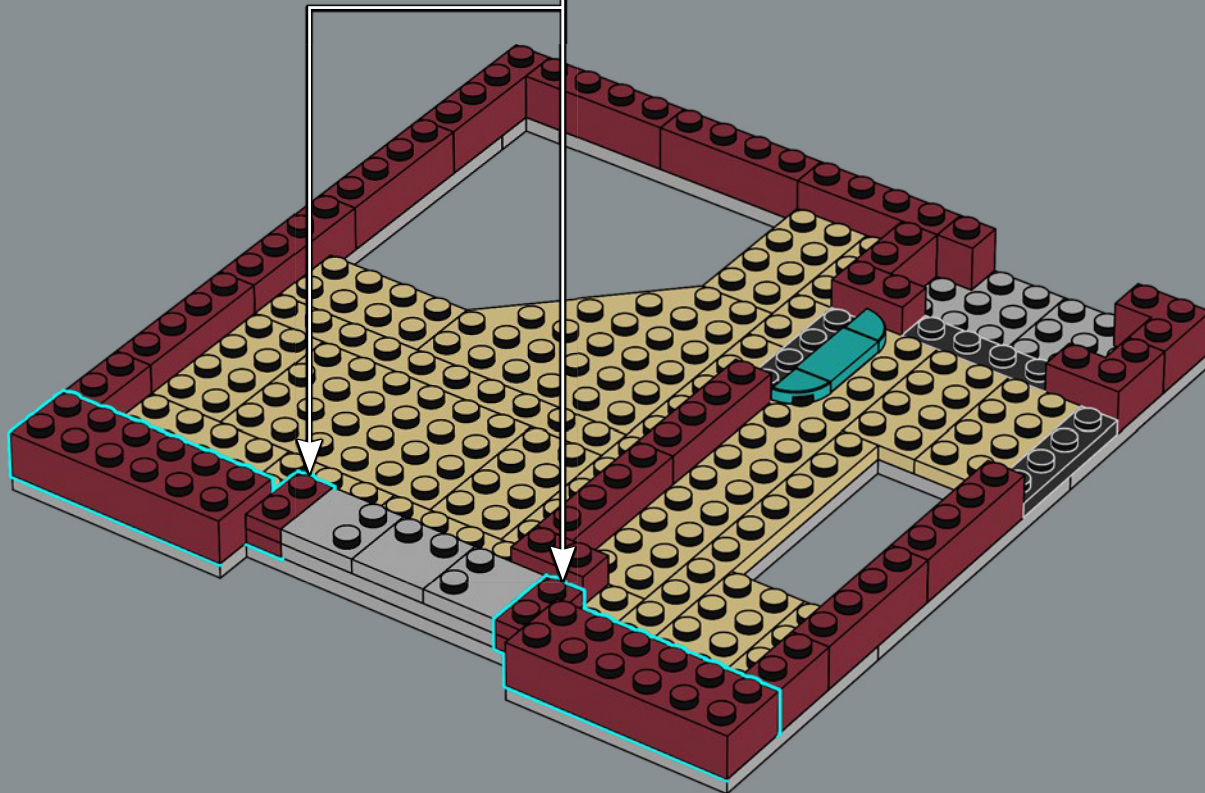

5x 4x

171

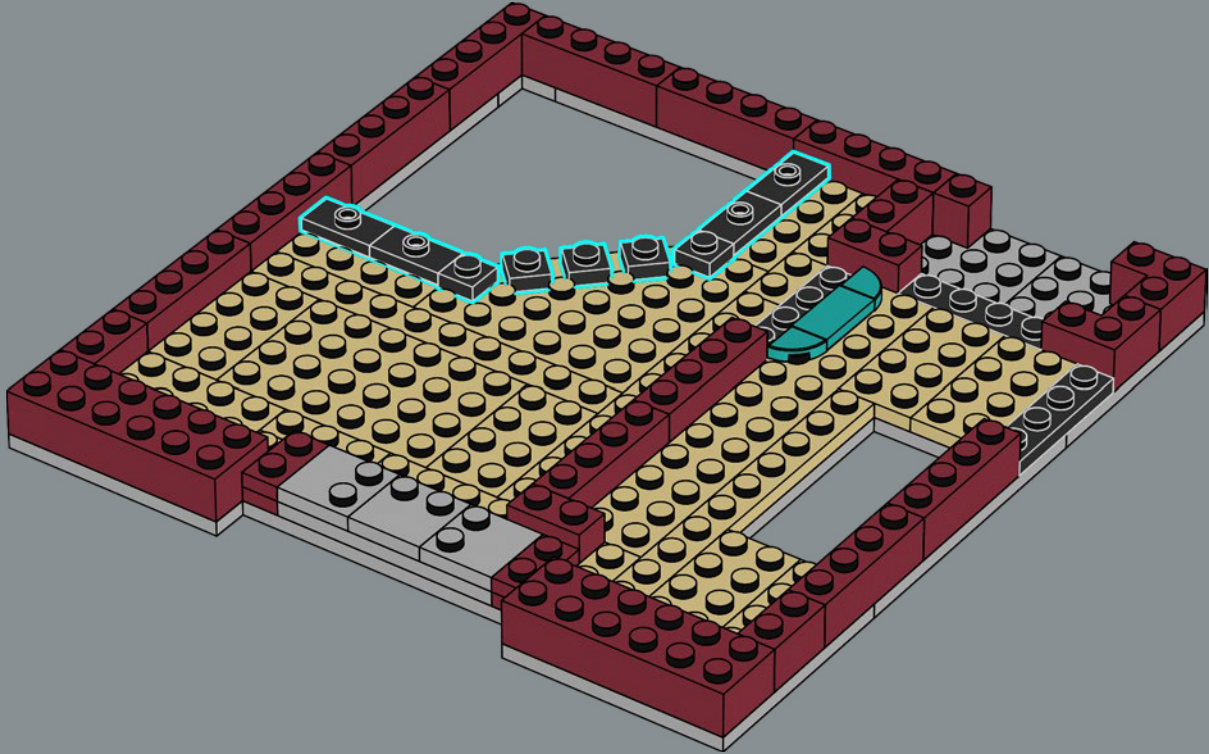

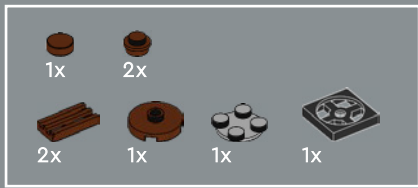

172

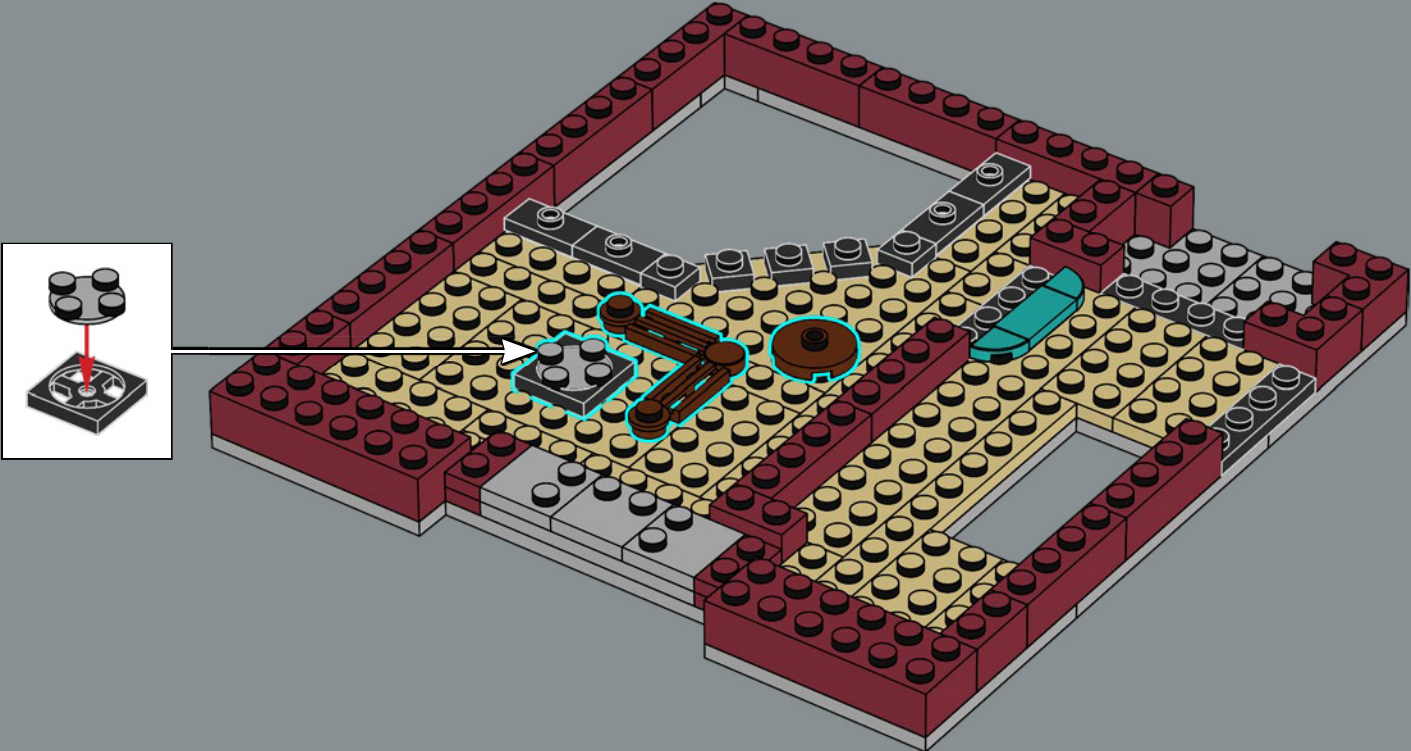

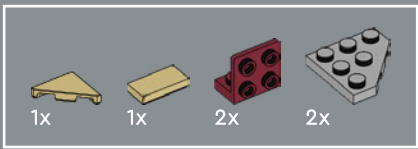

173

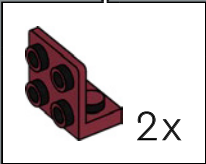
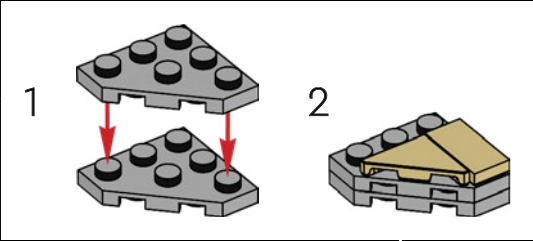
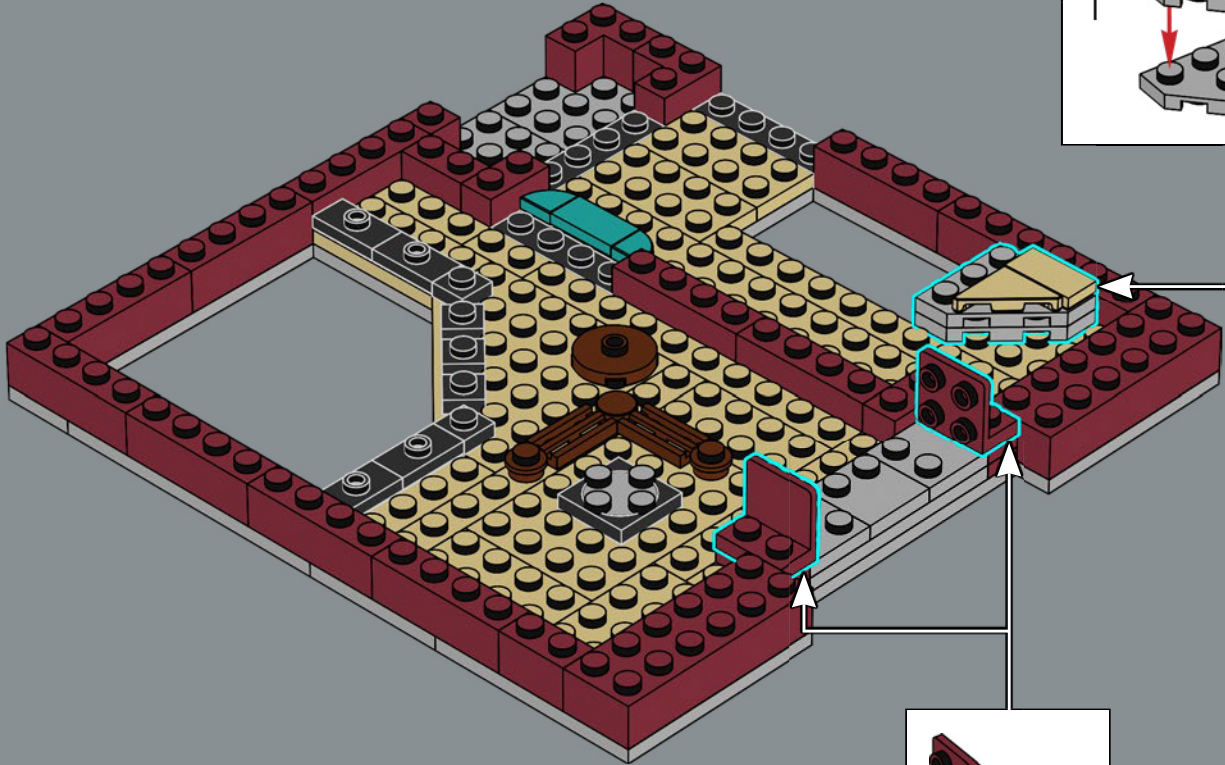

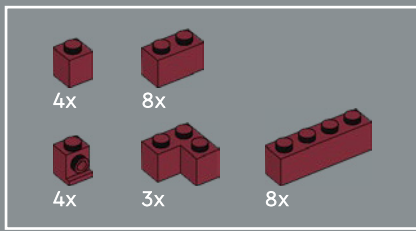

174

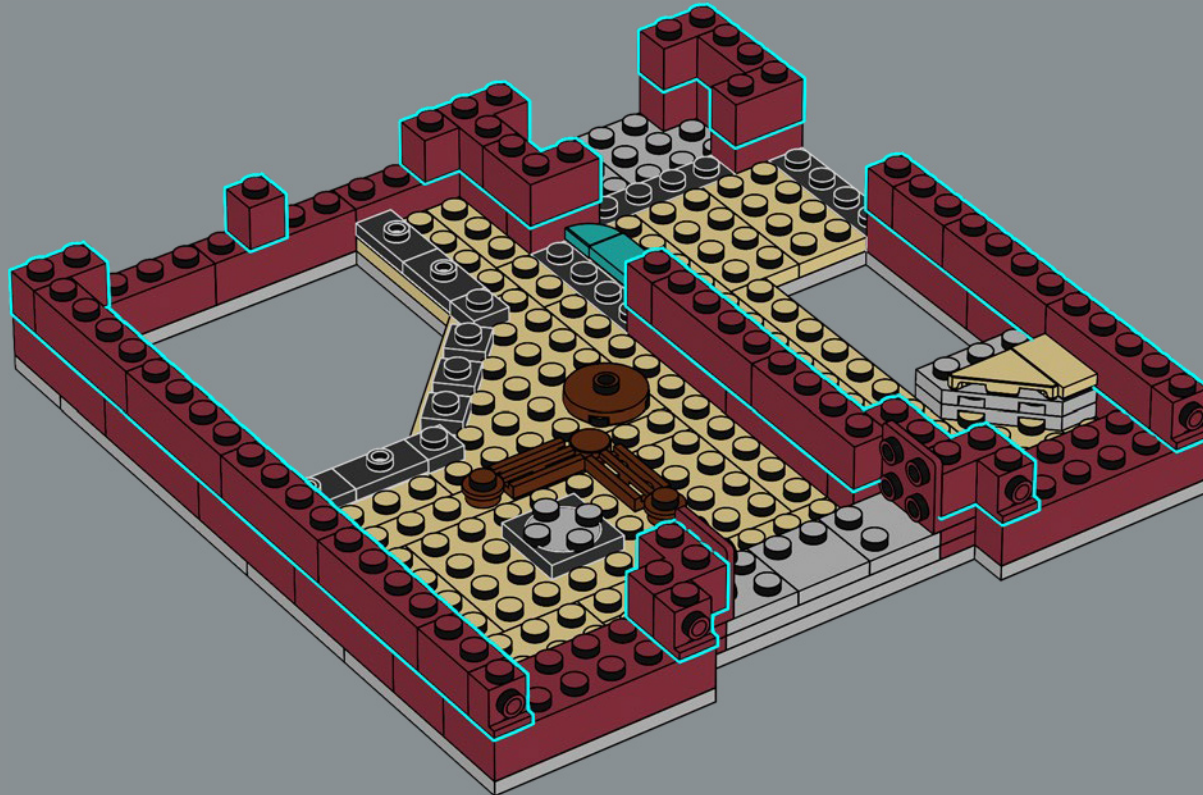

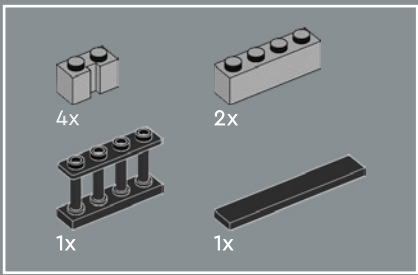

175

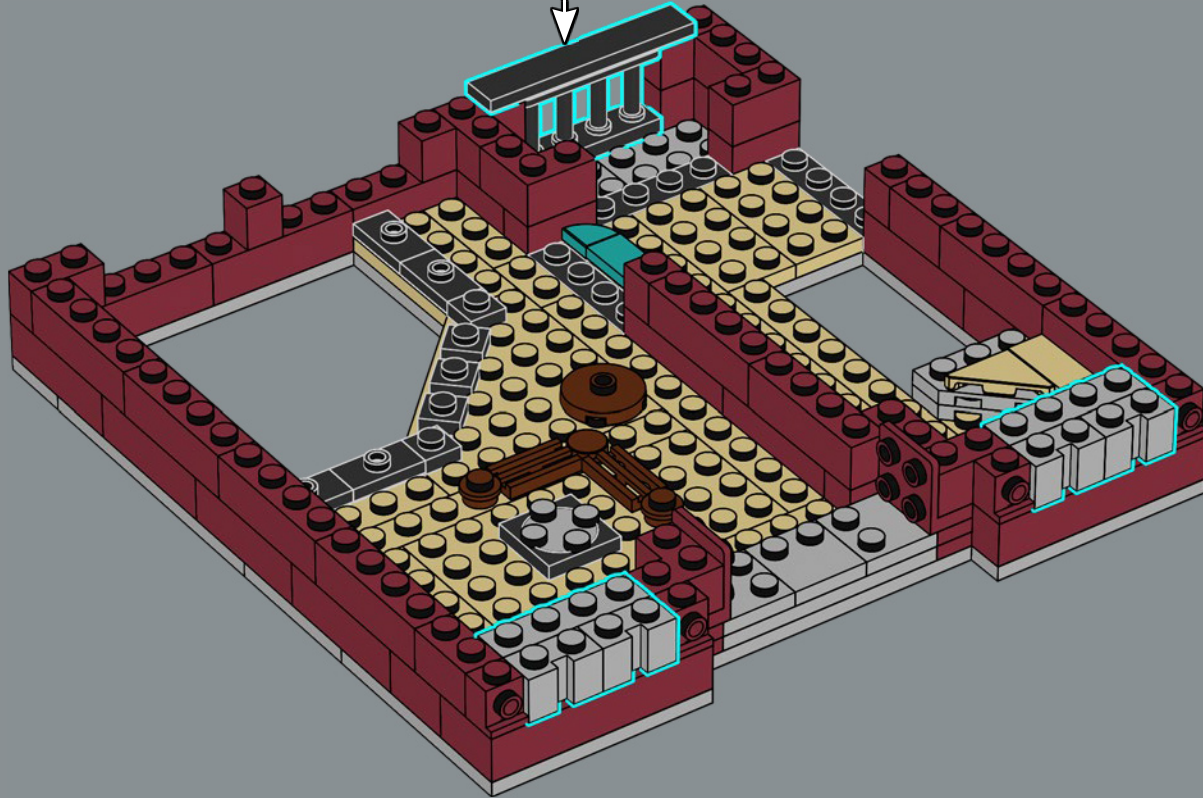
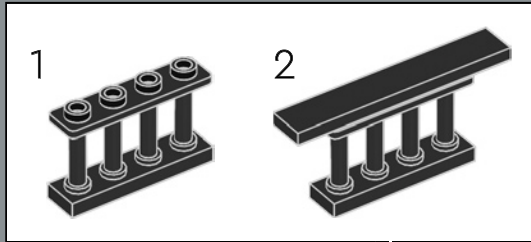

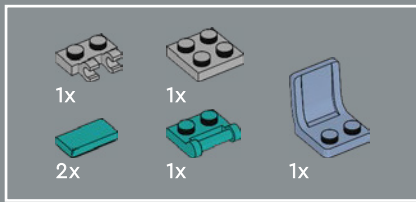

176

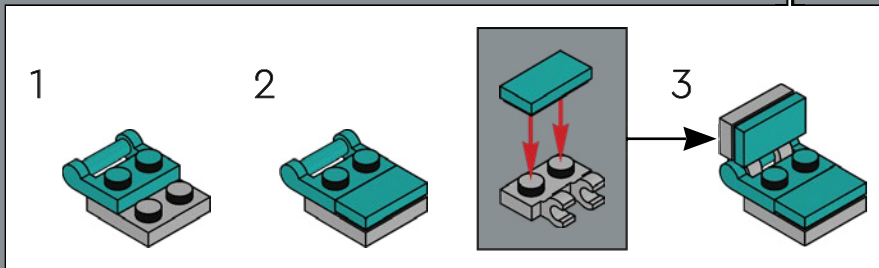
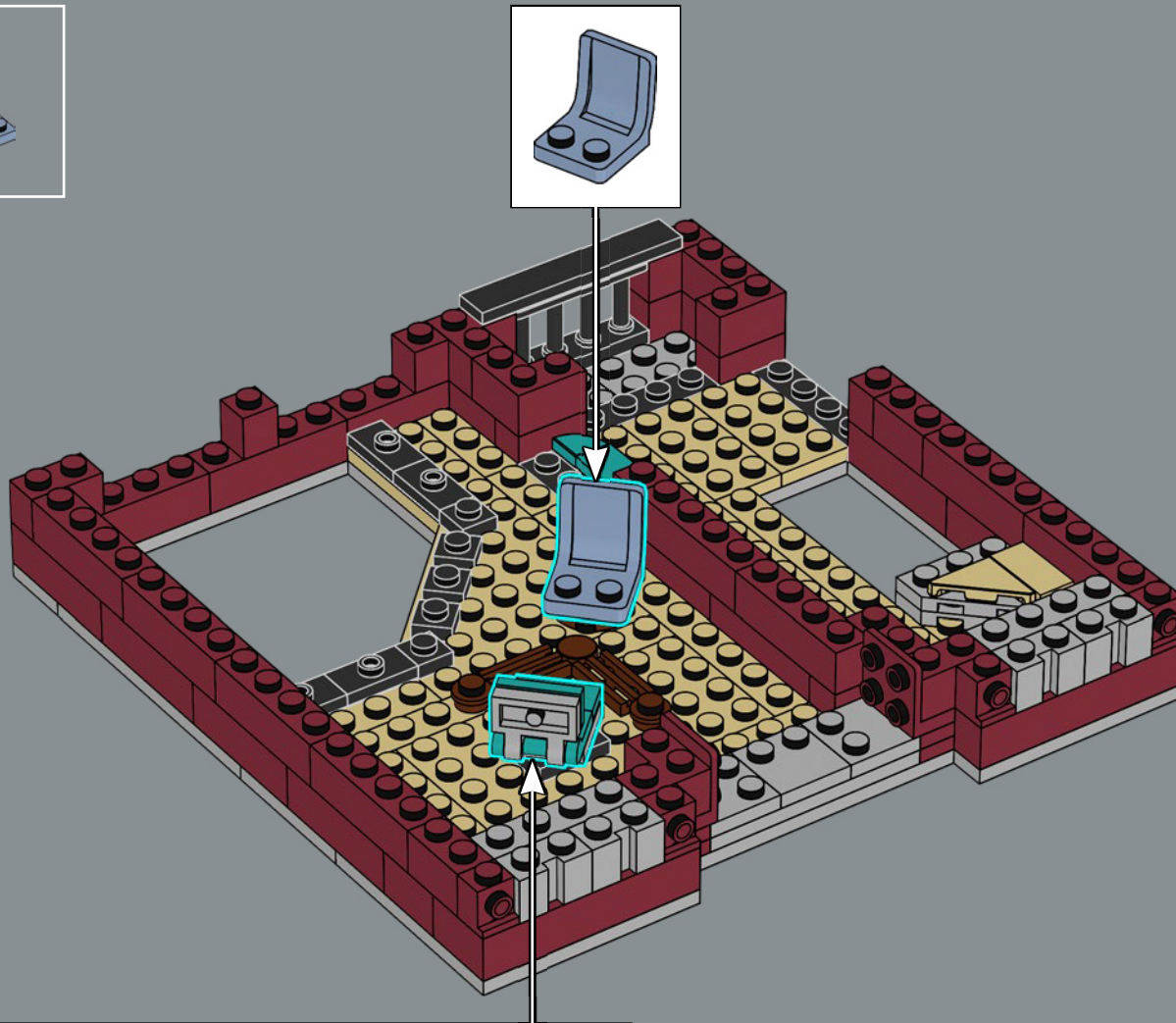



177

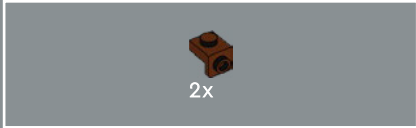
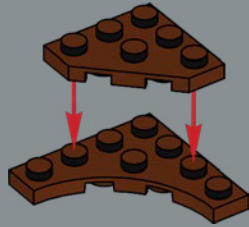

178

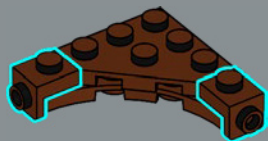

179

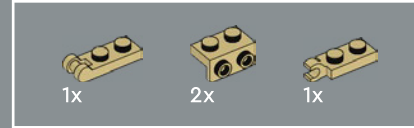
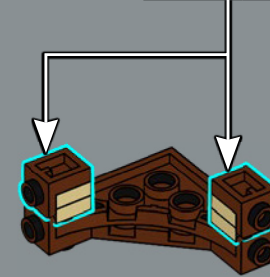
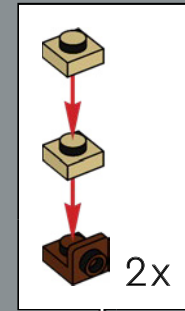

180

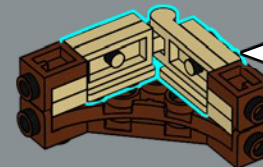
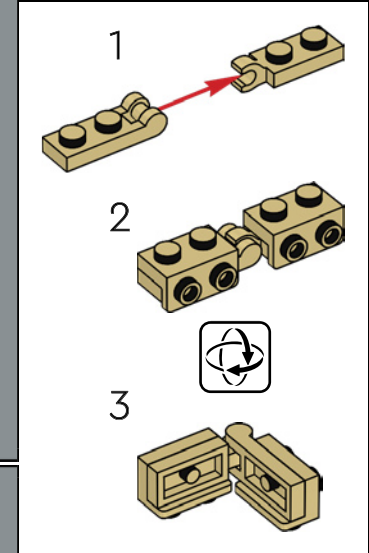

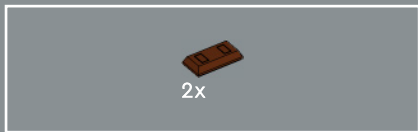

181

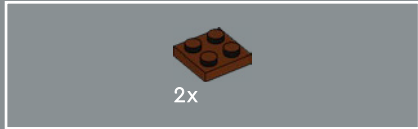
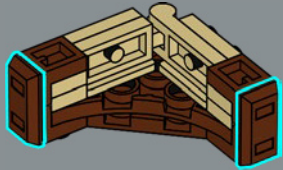

182

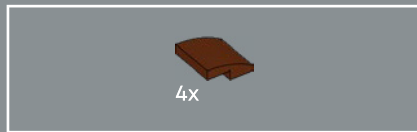
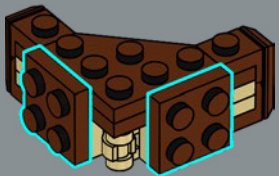

183

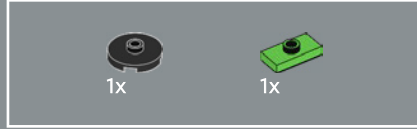
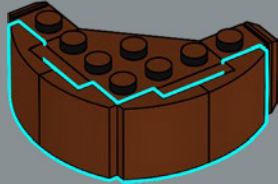

184

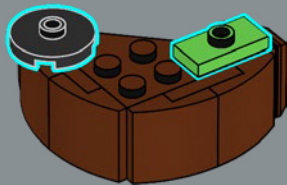

La propietaria del club quería que su oficina fuera muy especial, así que la equipó con un singular escritorio orientado a 45°.

185

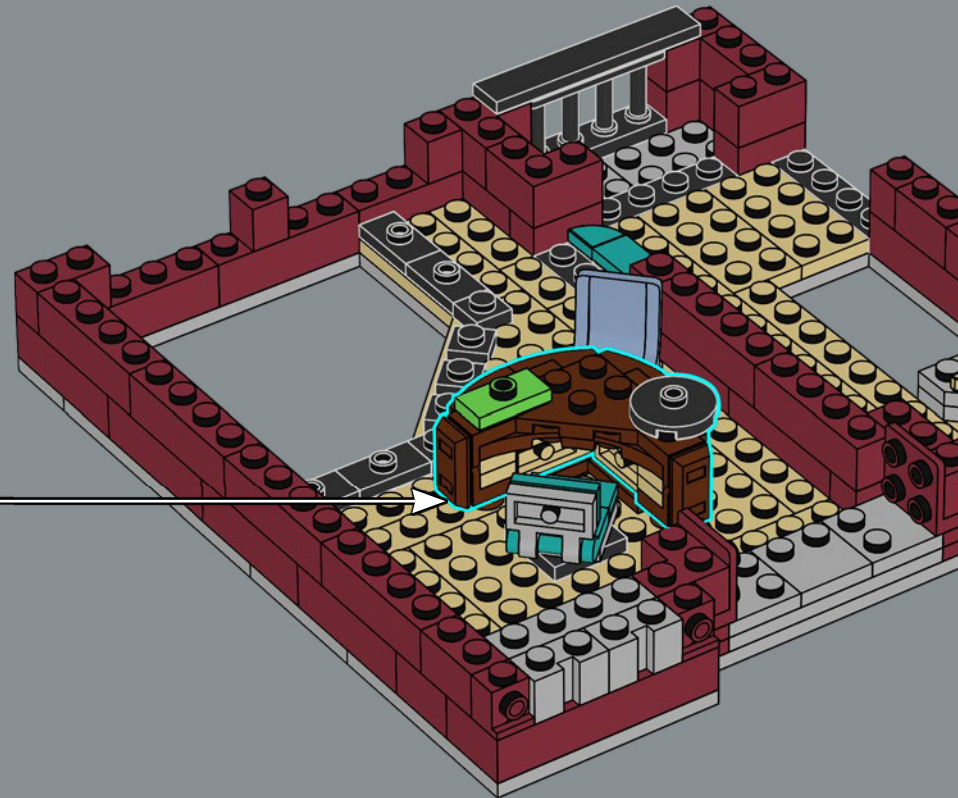

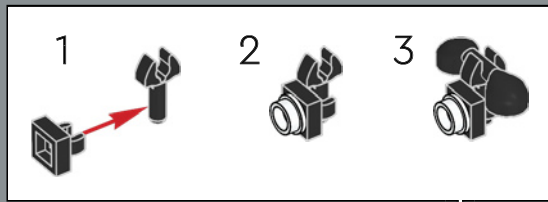

186

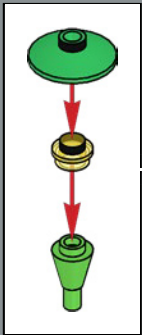
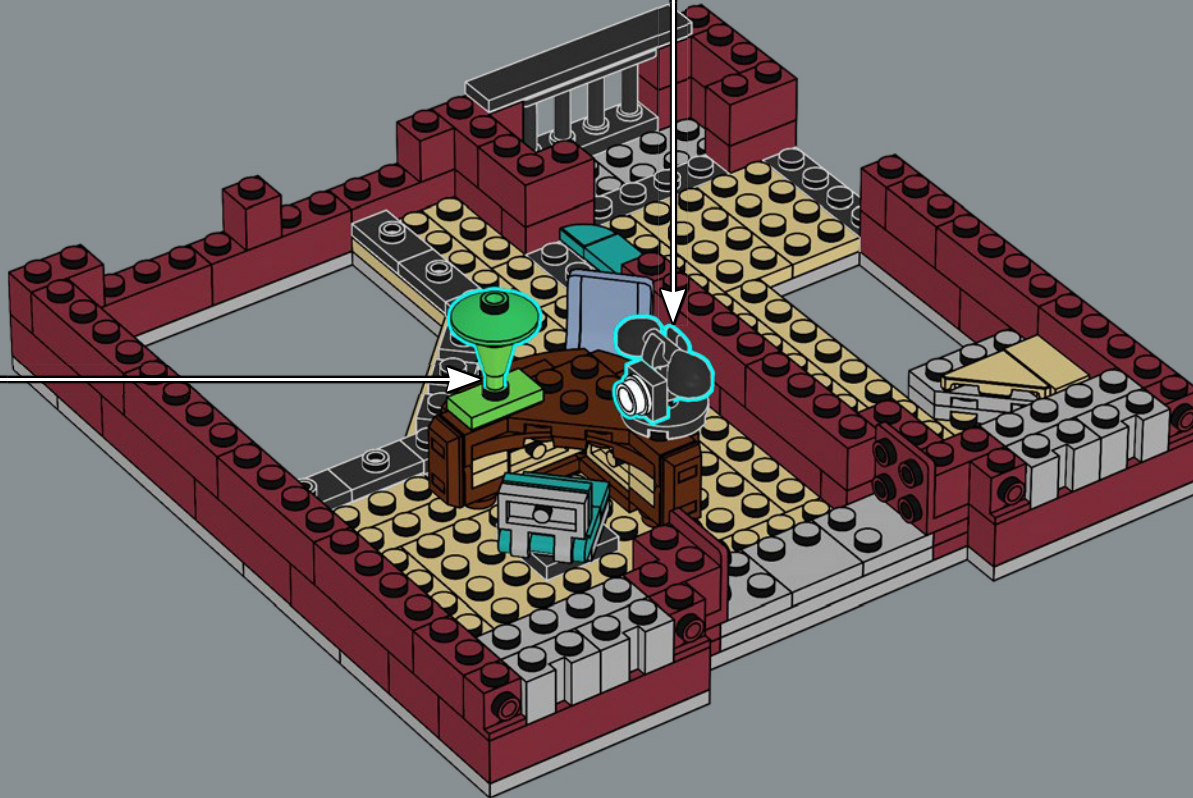



A la propietaria del club le encanta descubrir nuevos artistas y darles la oportunidad de brillar en el escenario. Fue una de las primeras en reconocer el talento del saxofonista de la Gran Plaza LEGO® (10255).

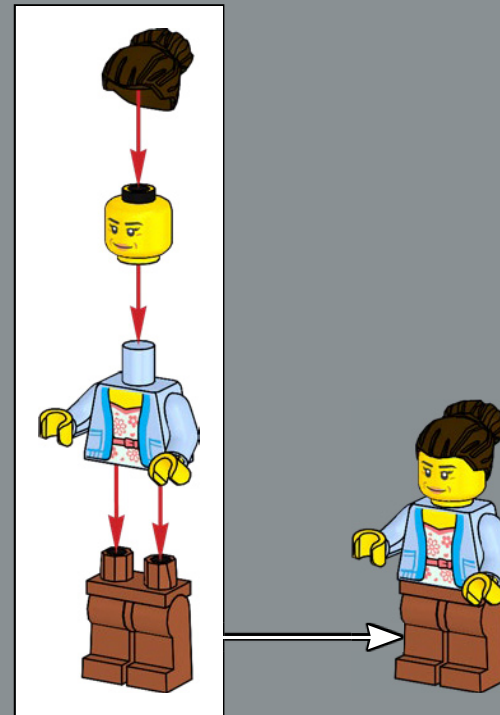



187

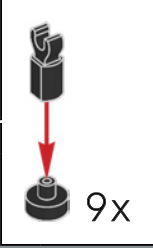
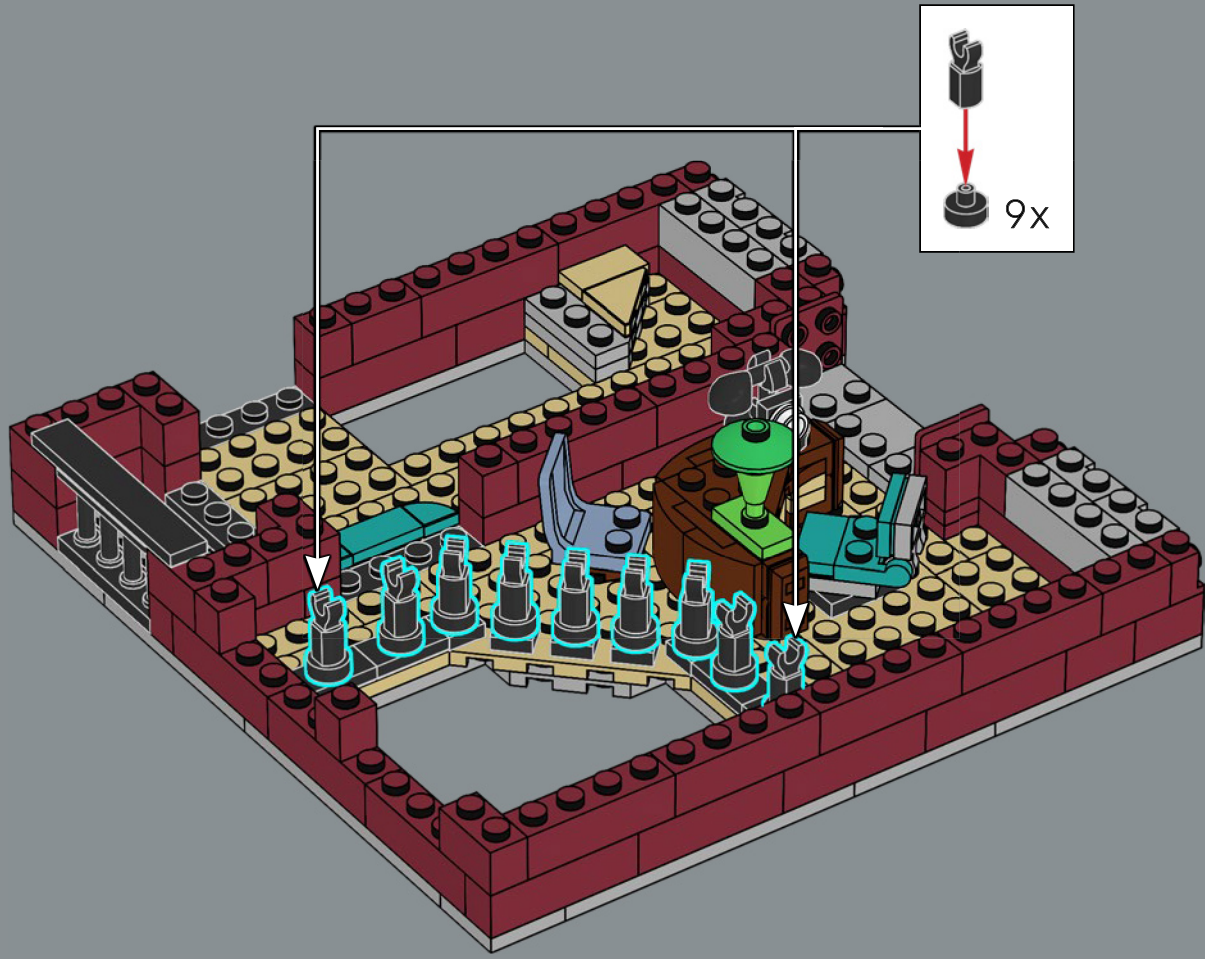



La encargada tiene su propio balcón desde donde puede escuchar las actuaciones de cada noche.

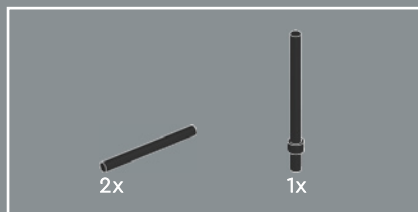

188

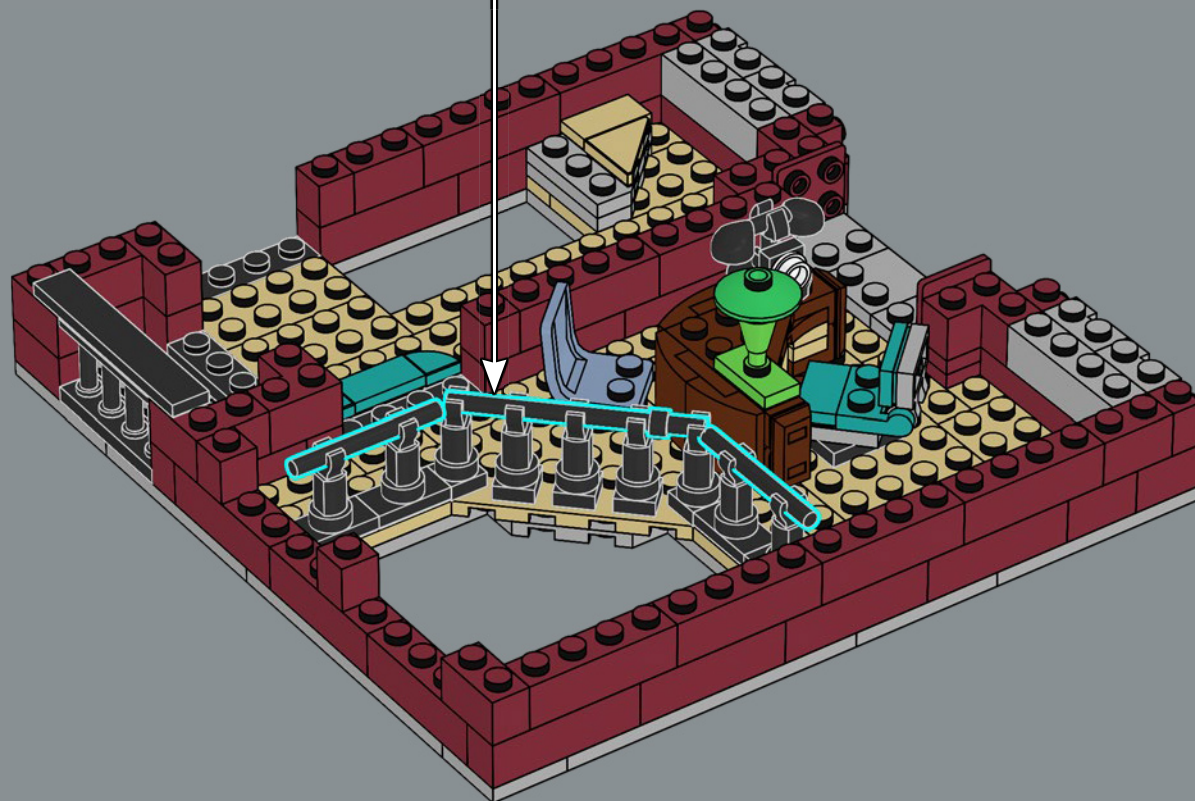

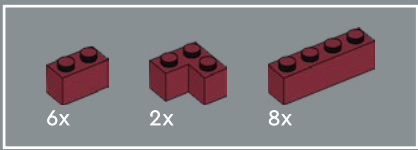

189

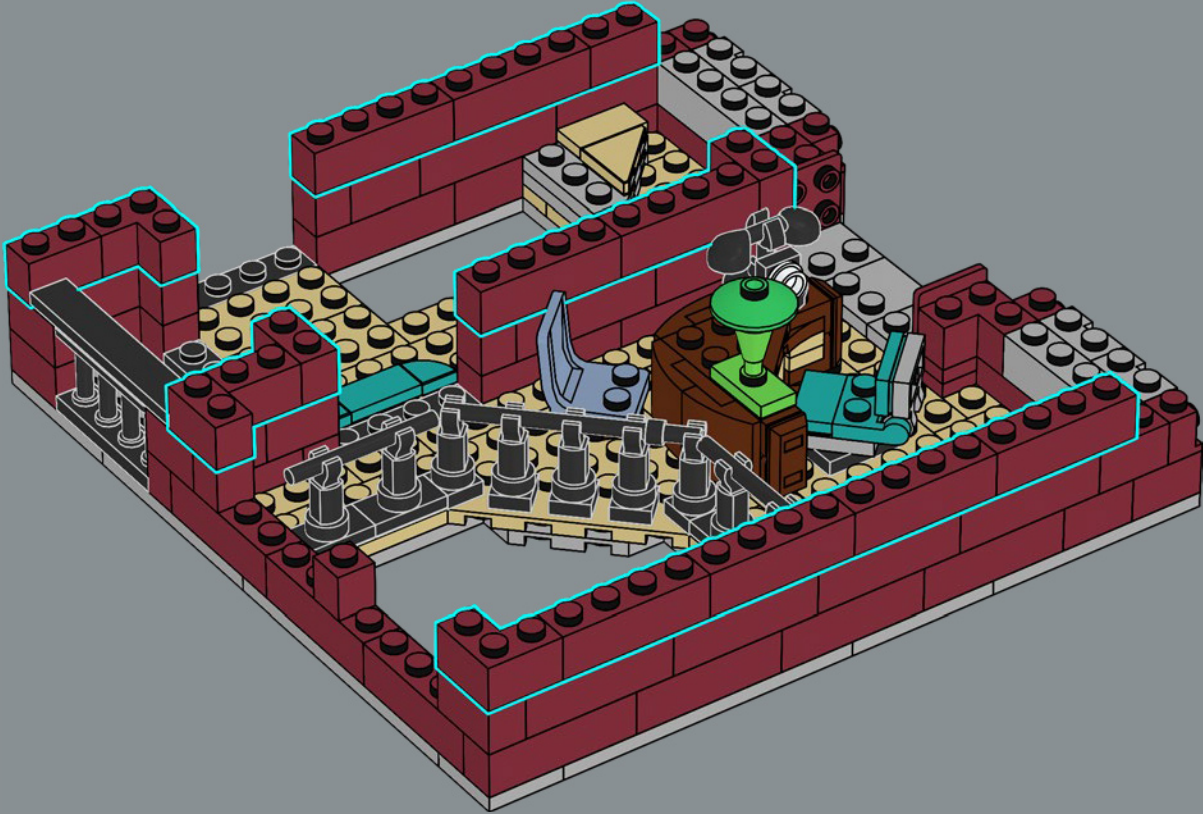

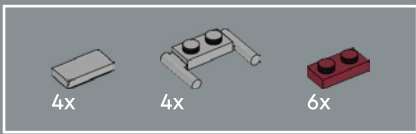

190

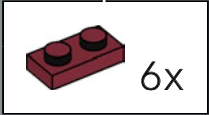

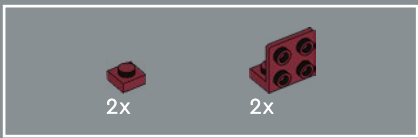

191

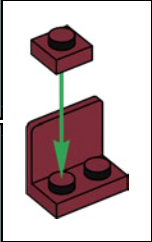
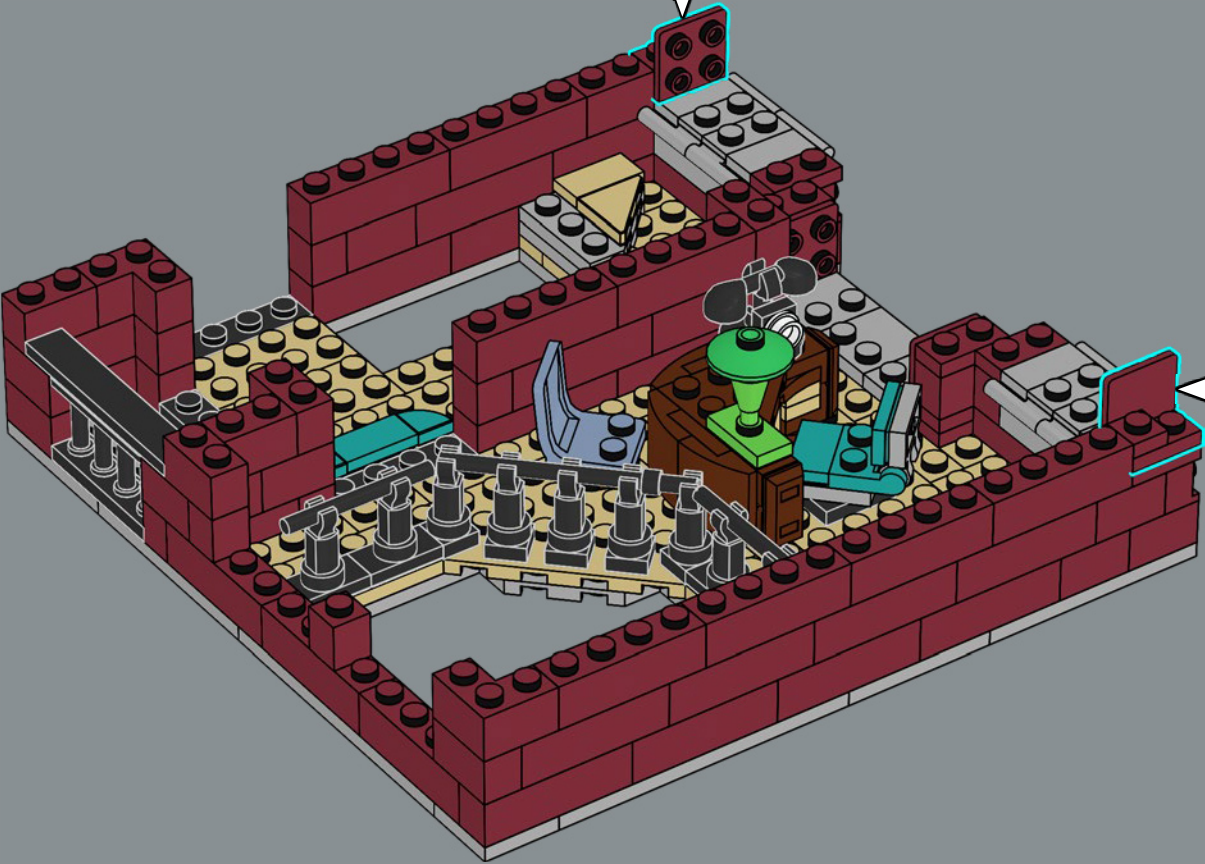
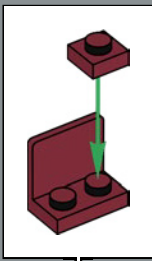



192

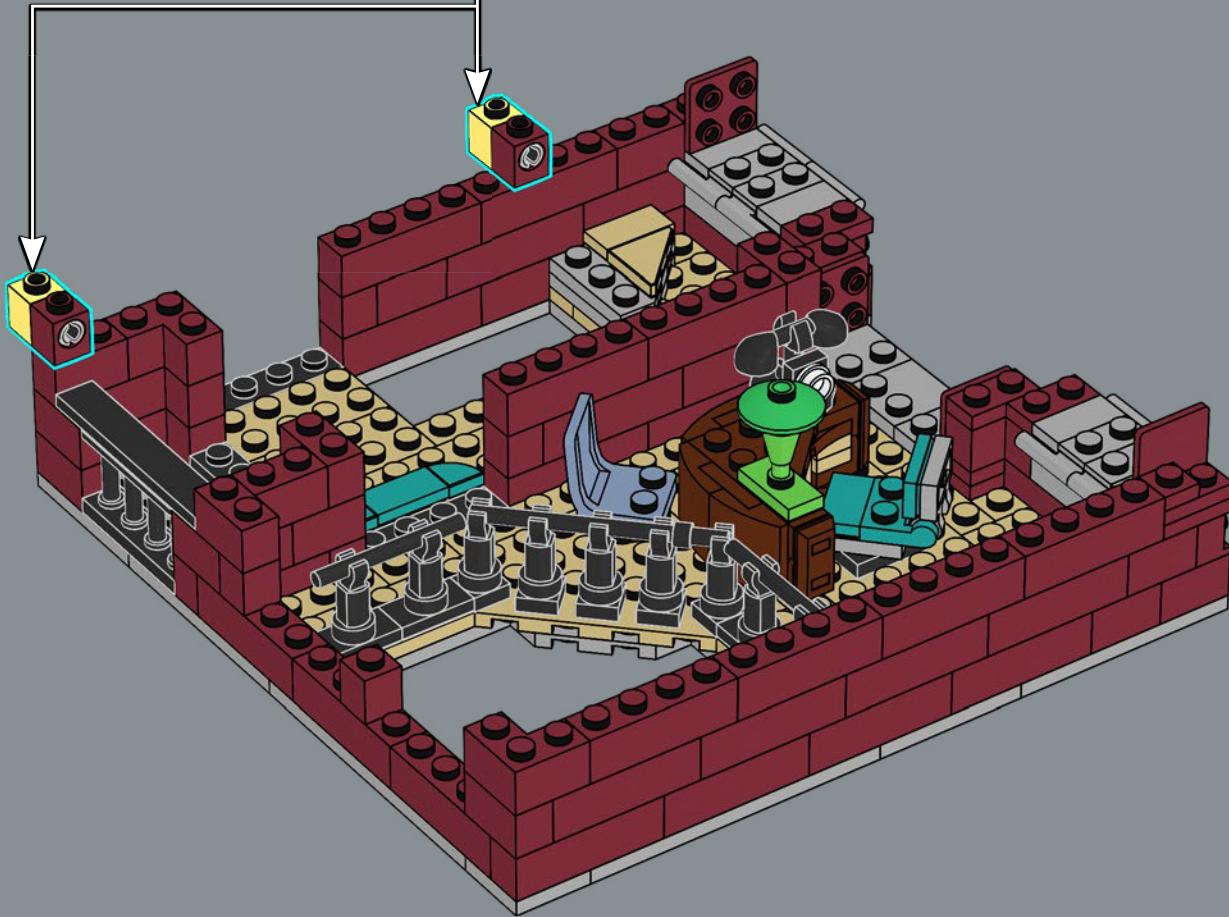
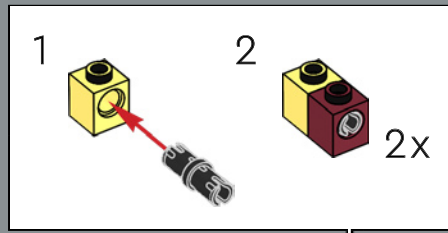

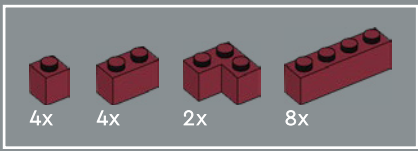

193

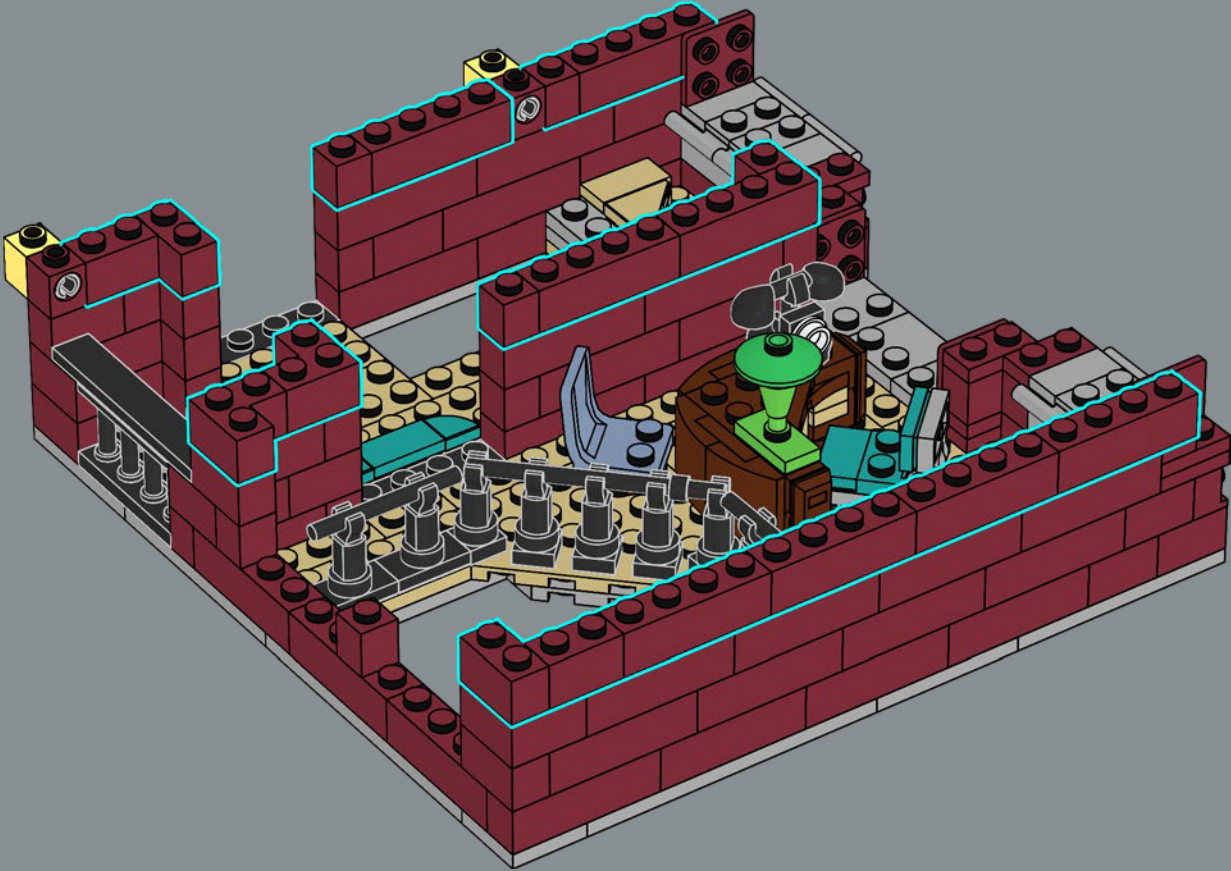

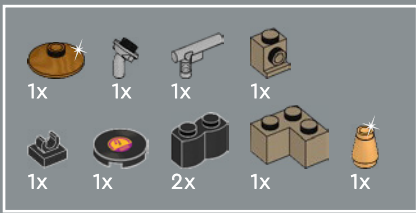

194

1

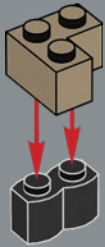

2

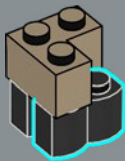

3

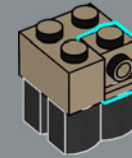

4



5

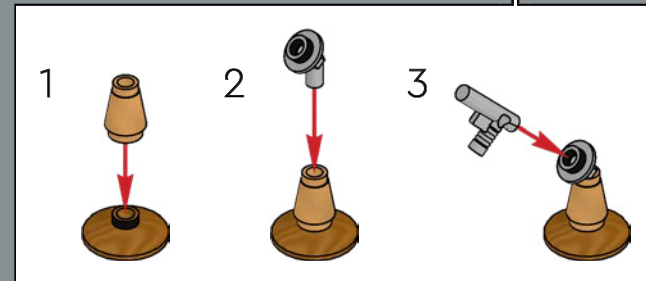



Además de la música en directo, a la propietaria del club le encanta escuchar las últimas novedades en discos de vinilo. Hace poco escuchó el exitosísimo nuevo álbum de la estrella de rock del Restaurante del Centro LEGO® (10260).

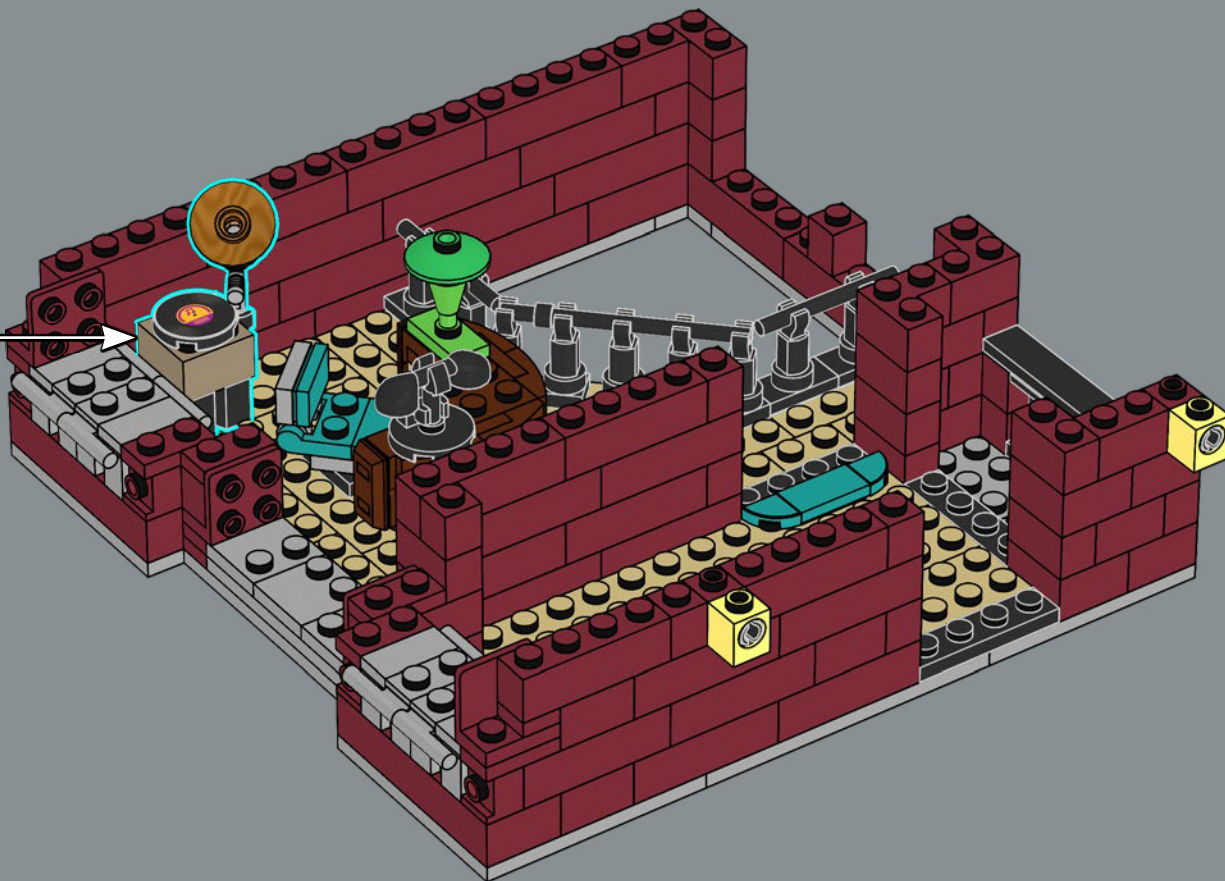

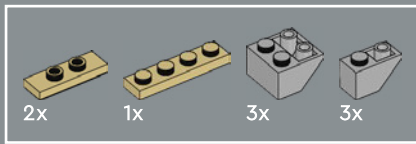

195

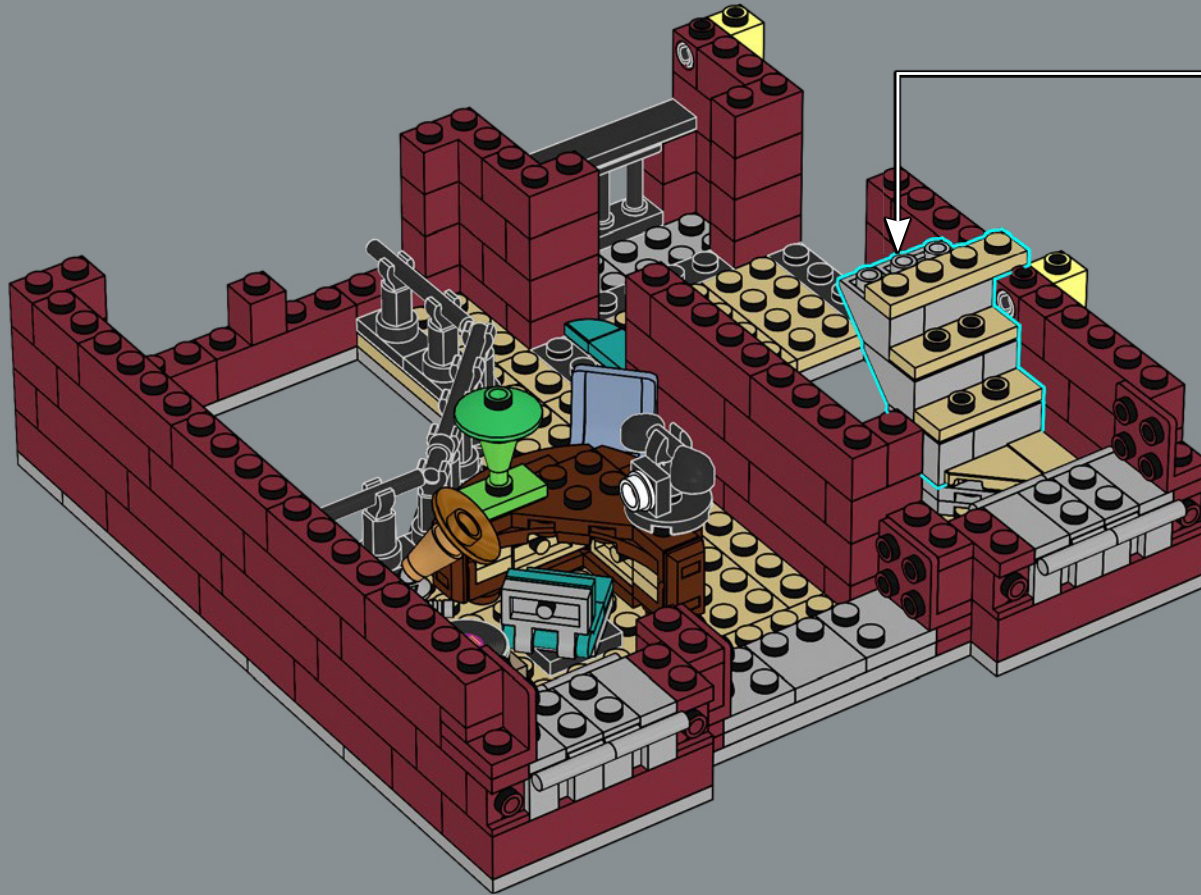
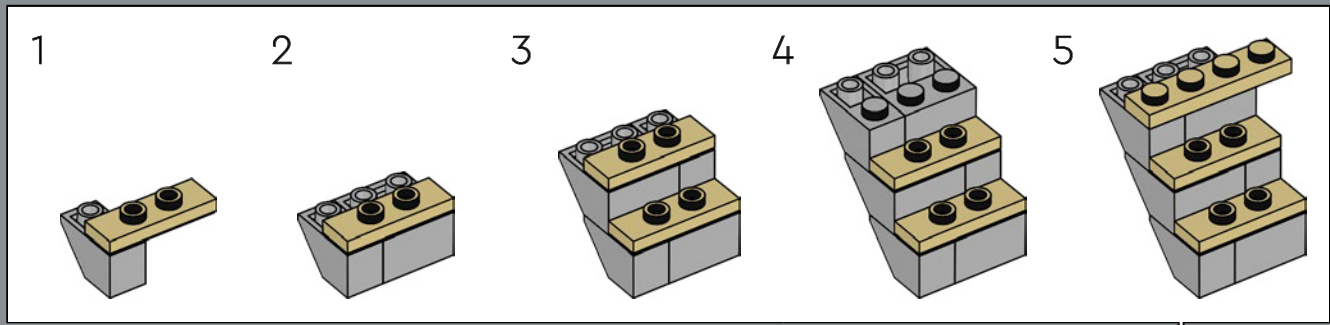



4x

196

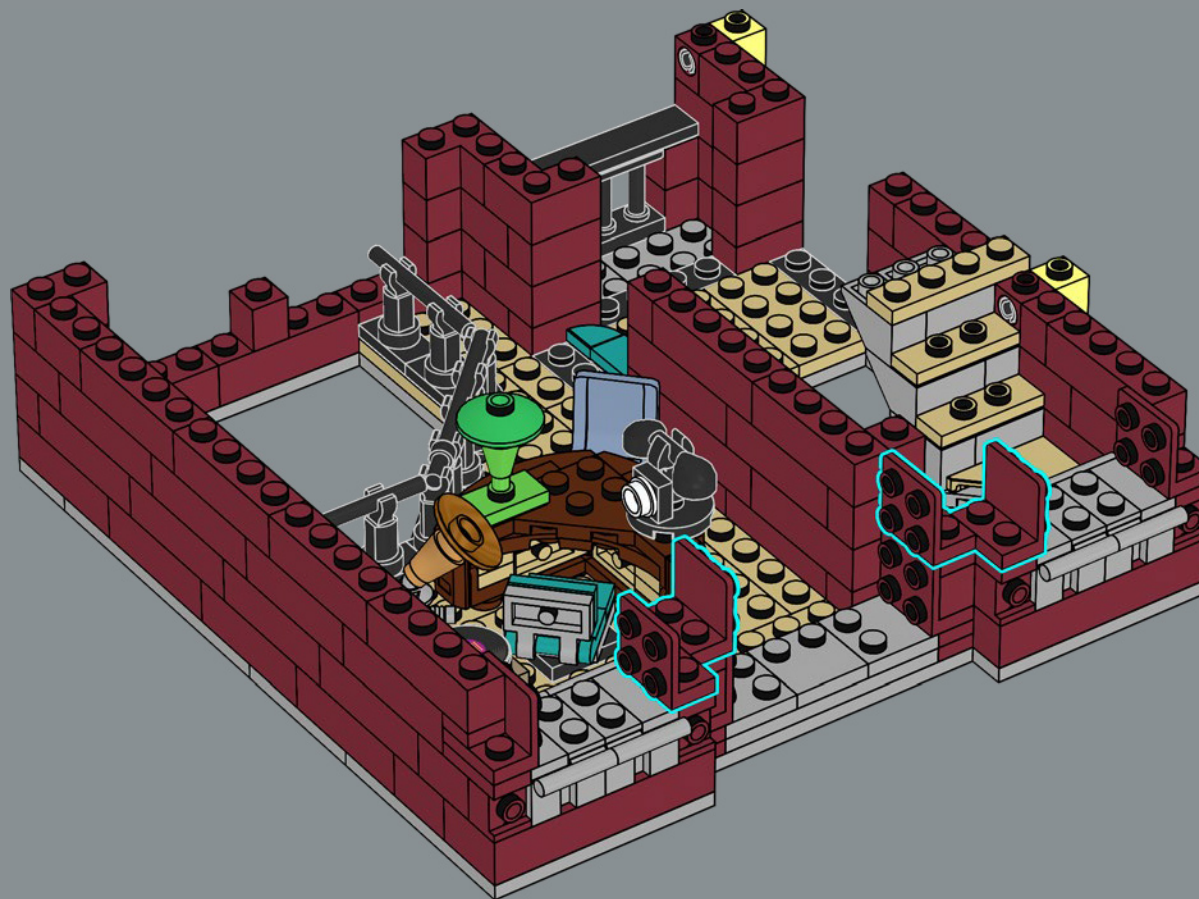

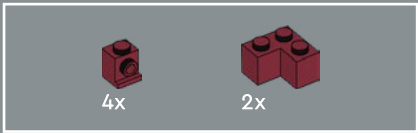

197

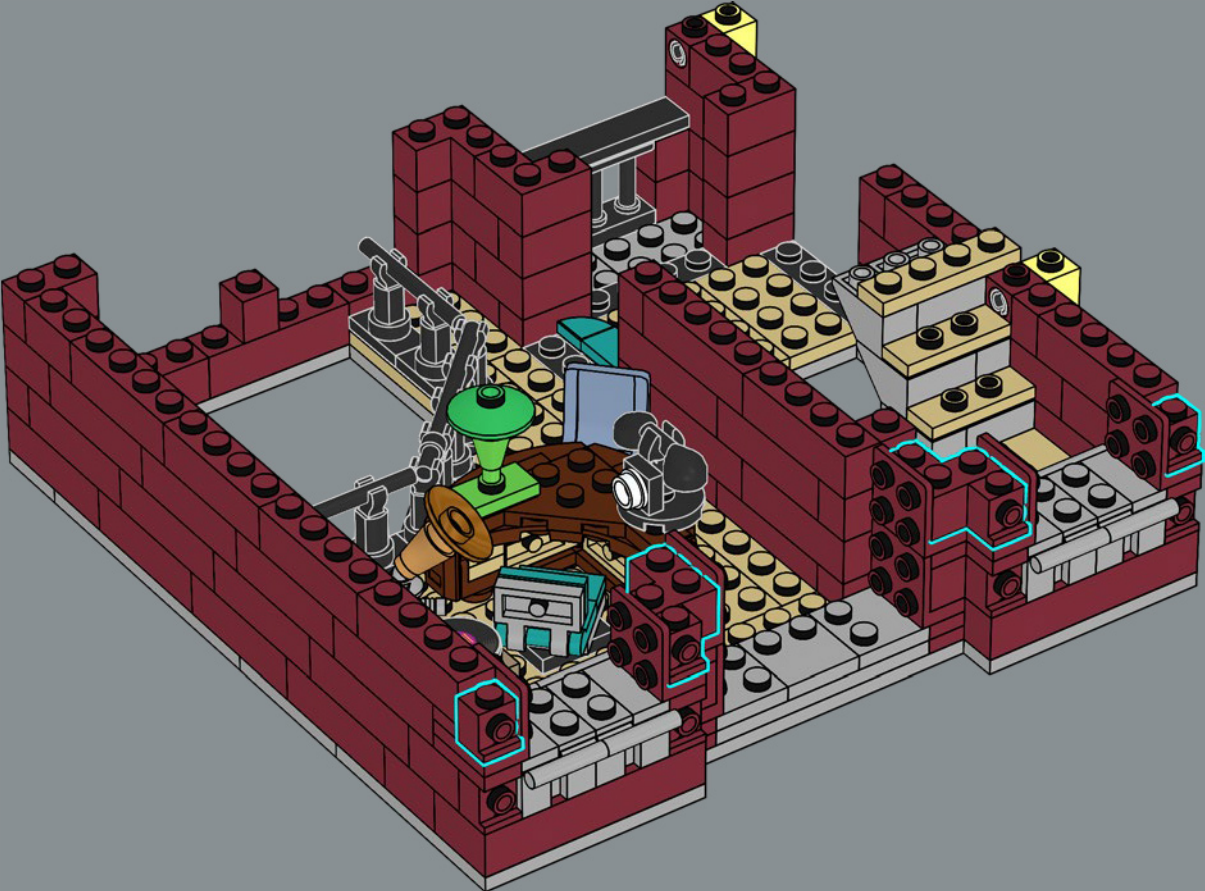

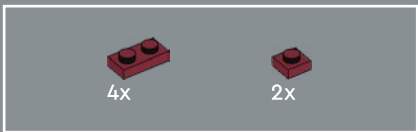

198

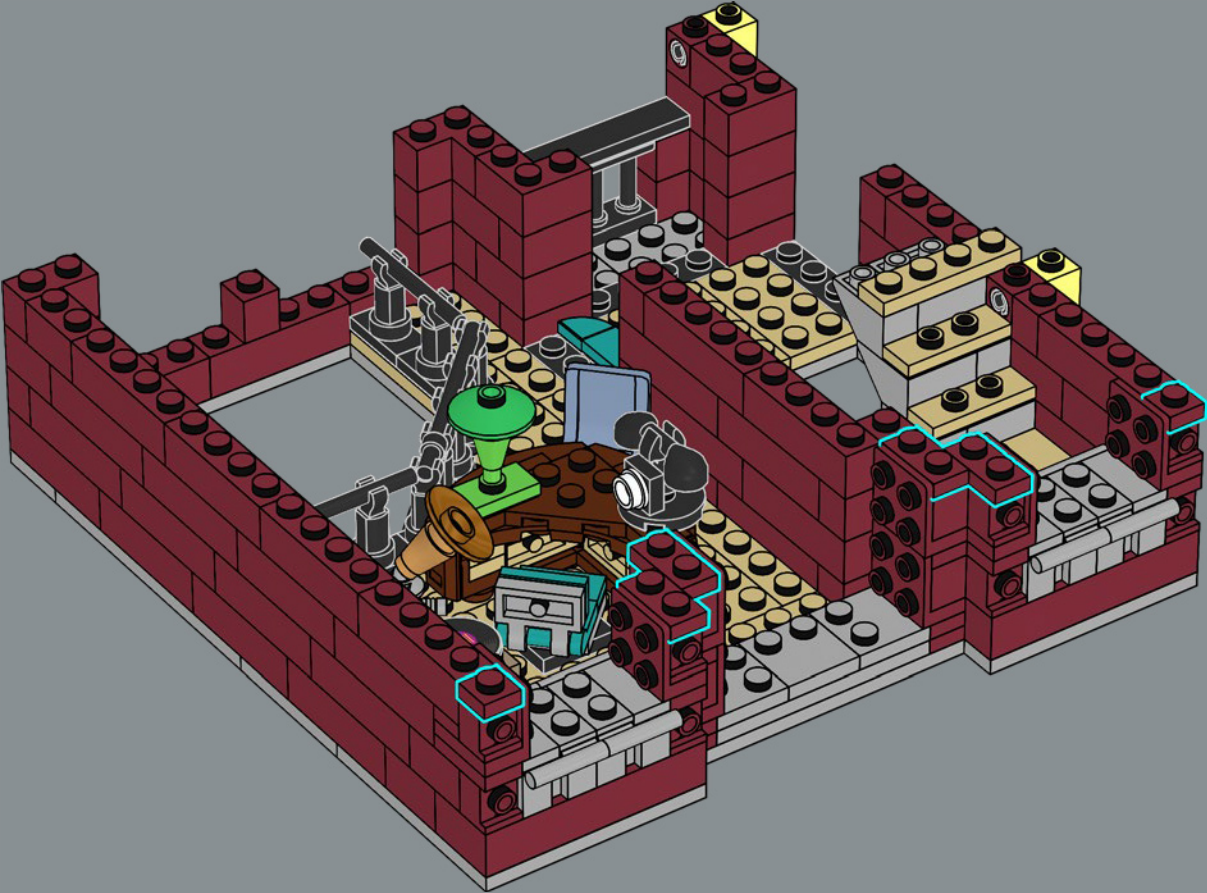

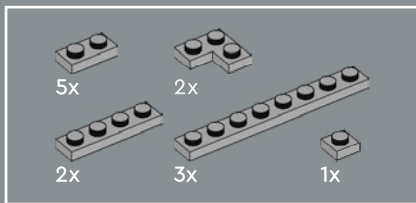

199

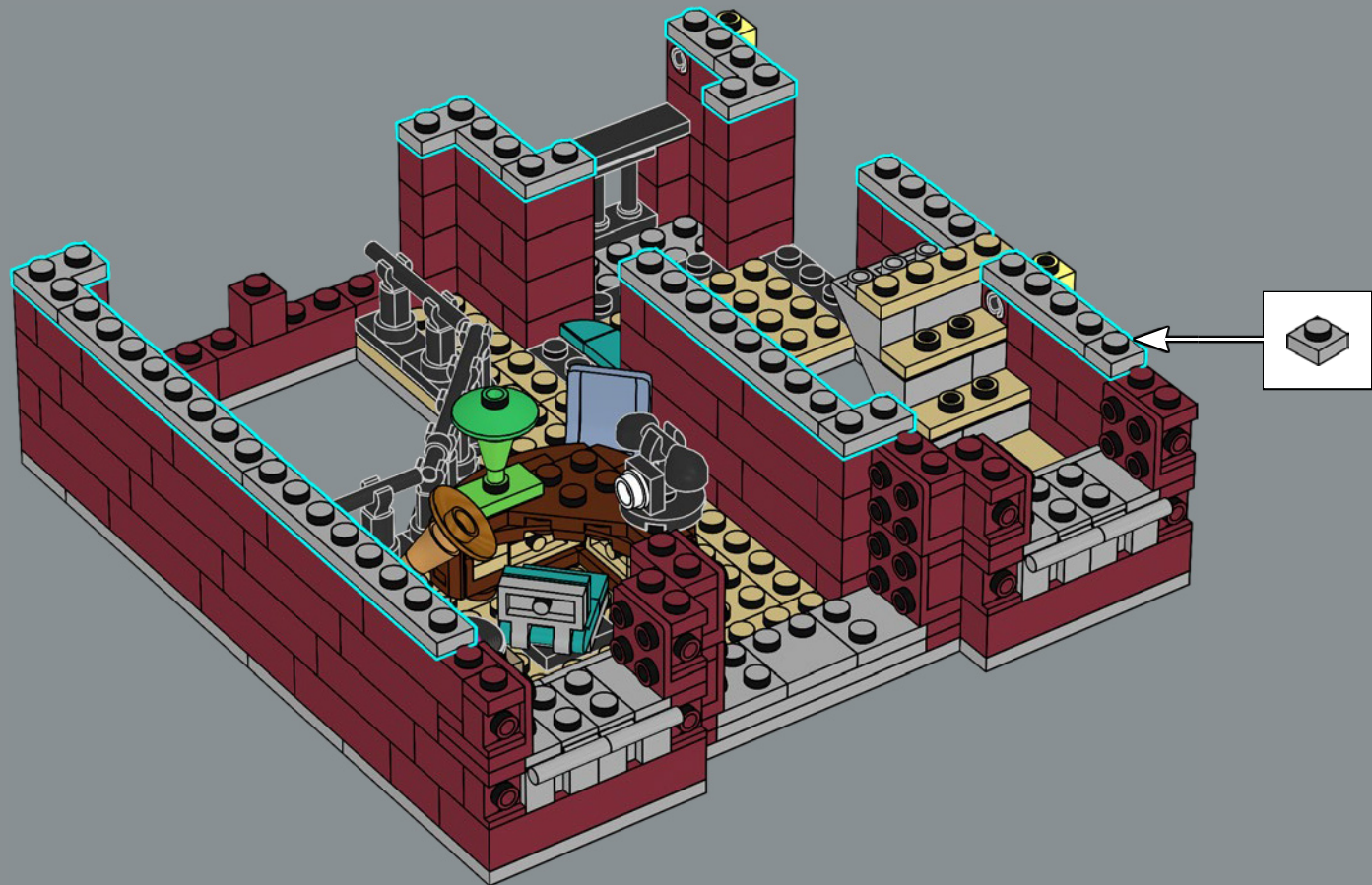



6x

200

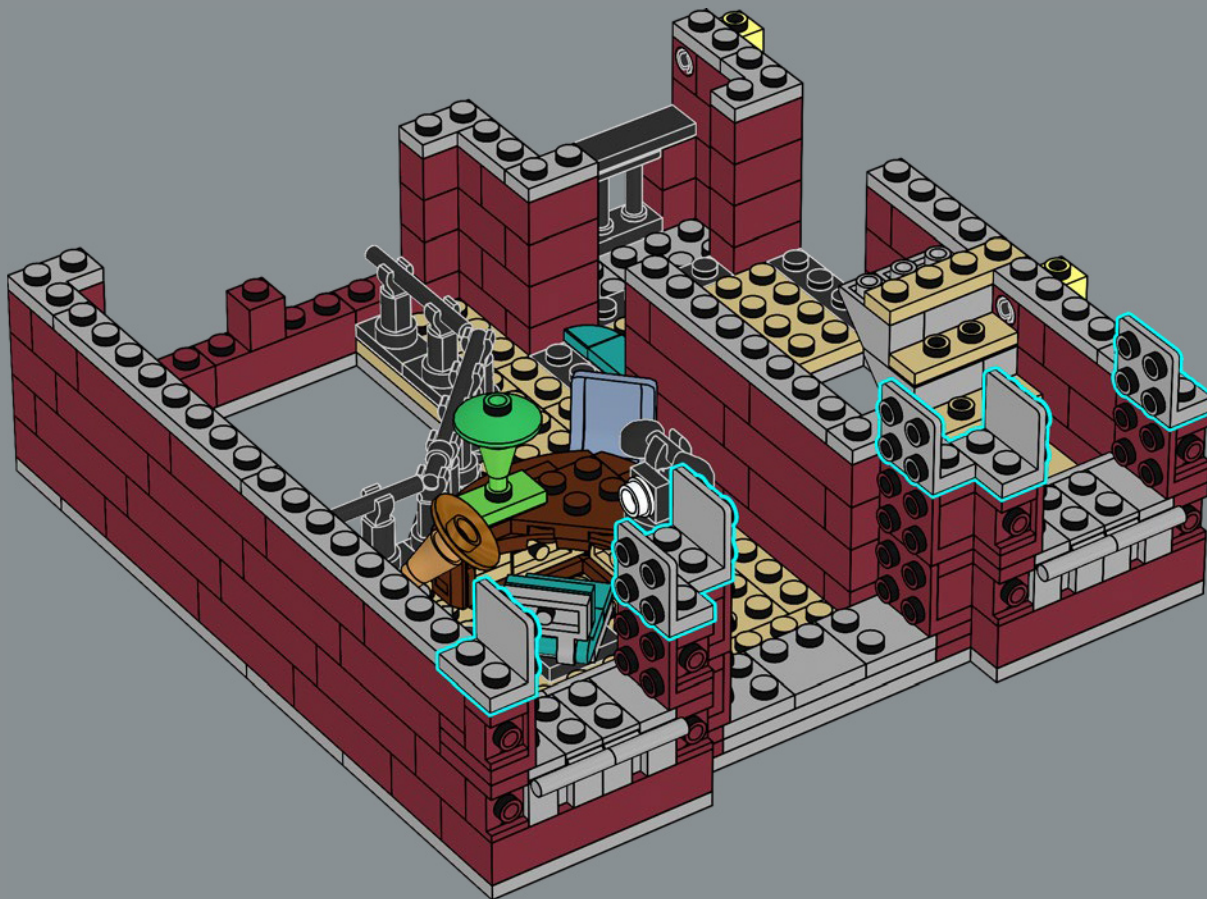



El cuadro de la oficina es una pequeña creación de la artista que vive en el ático del Restaurante Parisino LEGO® (10243).

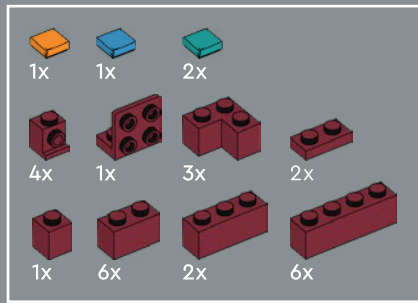

201

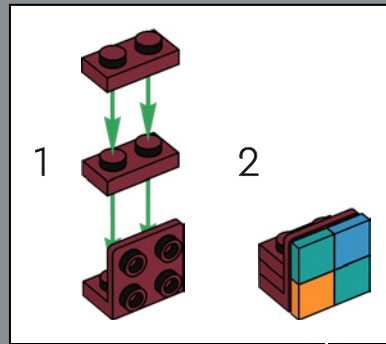

1

2

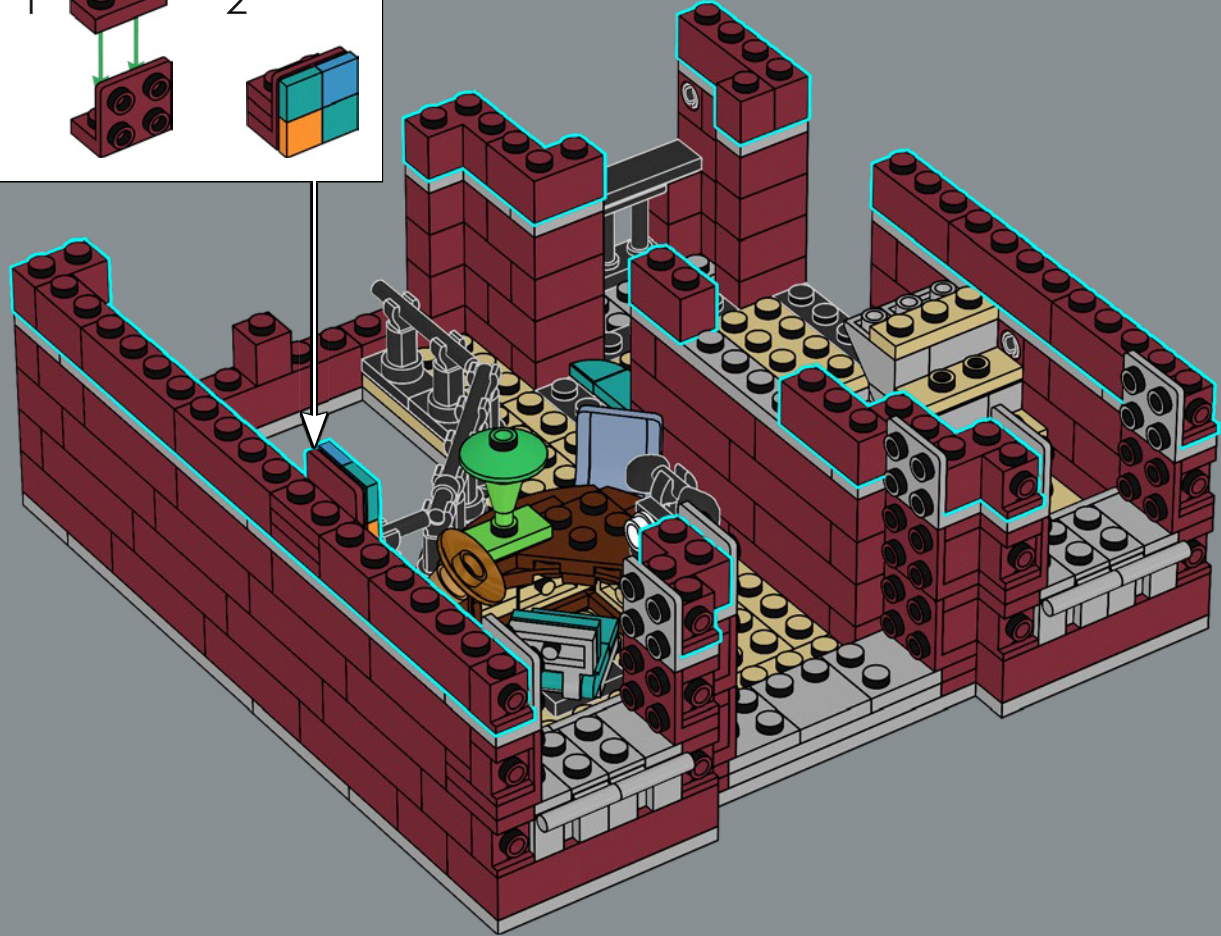



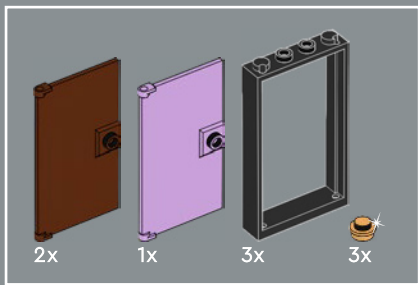

202

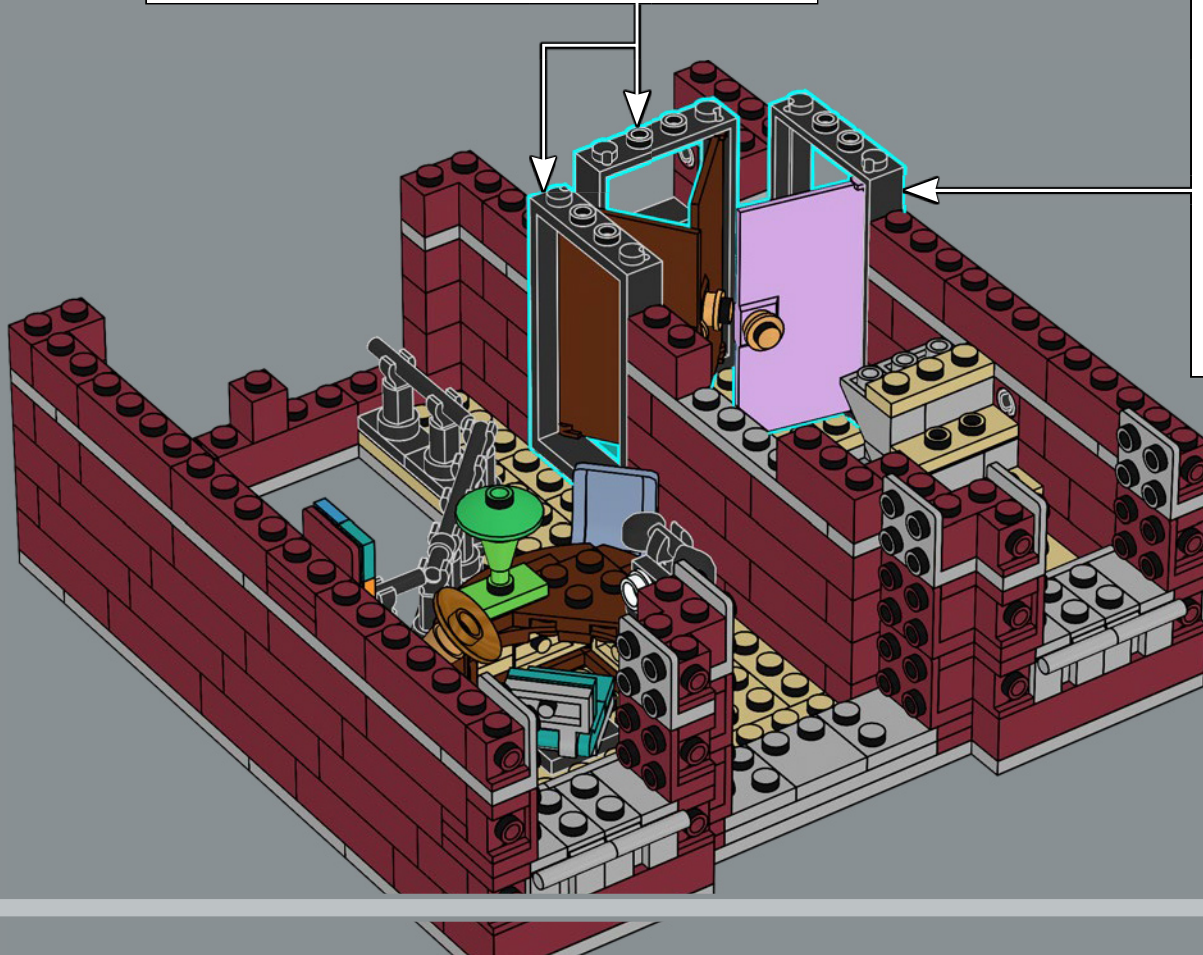
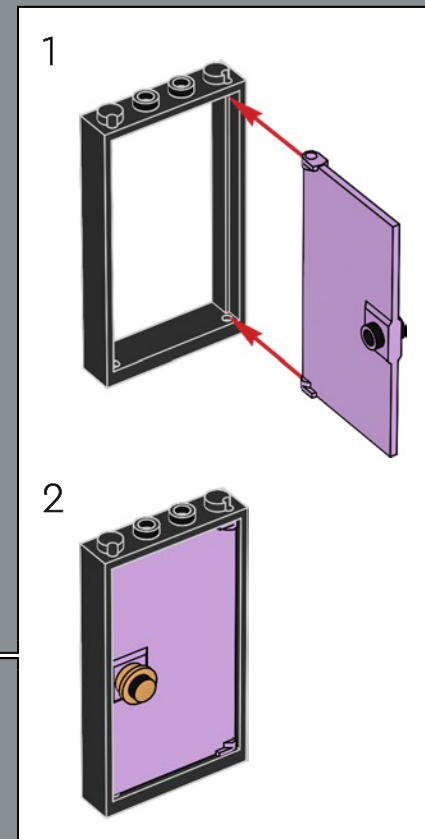
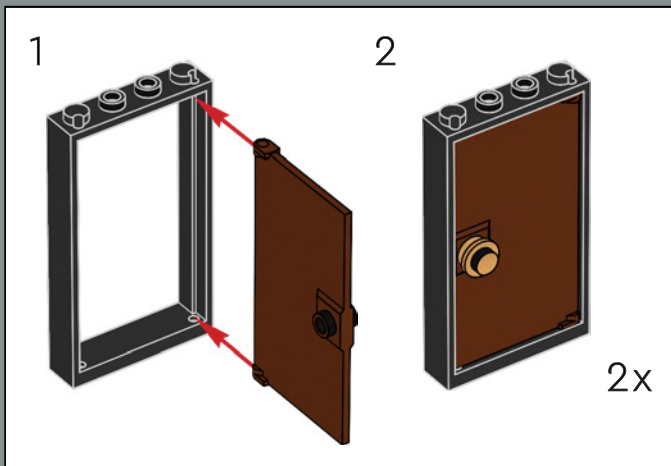

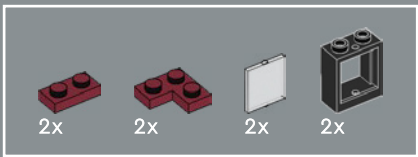

203

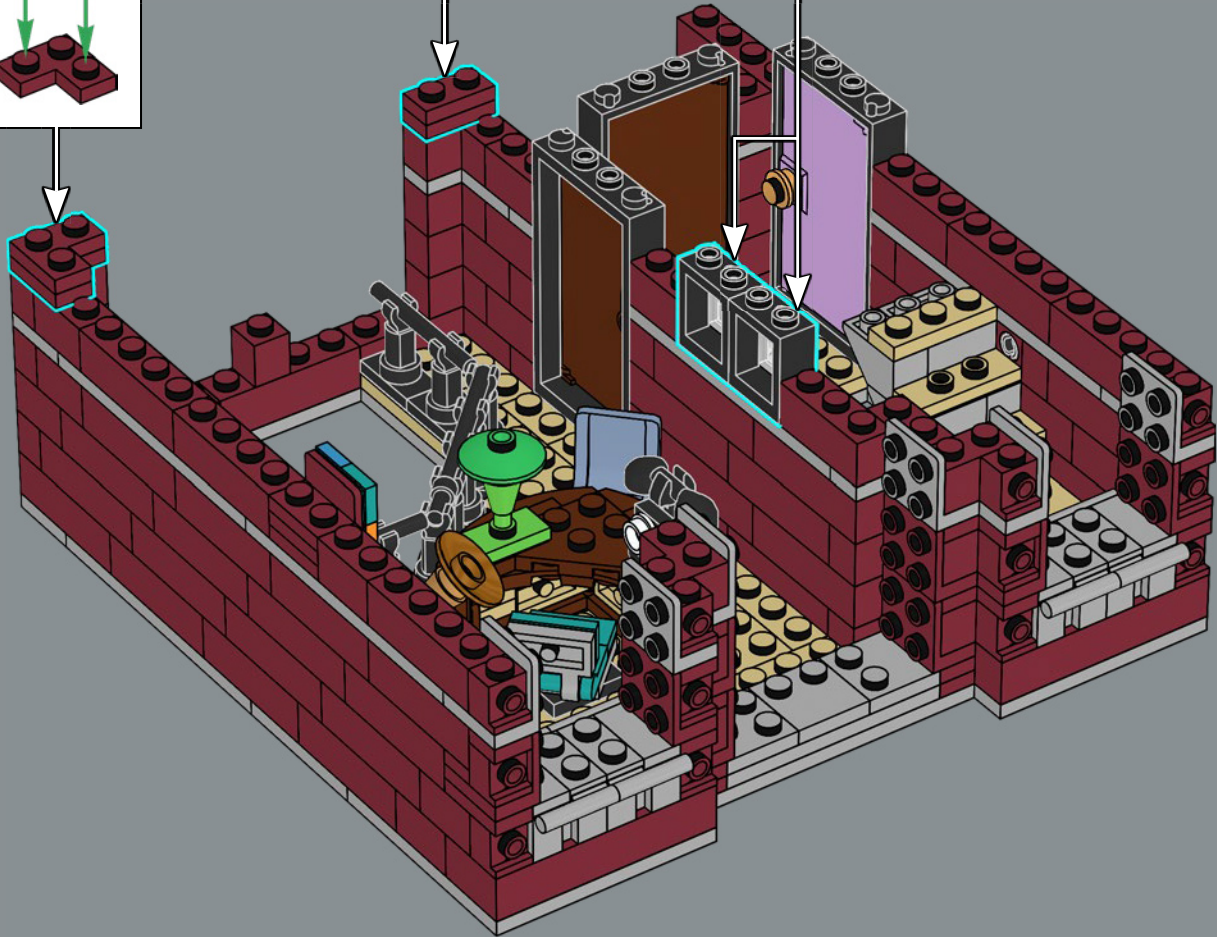
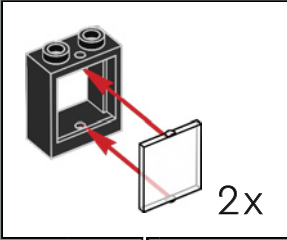
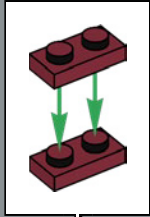
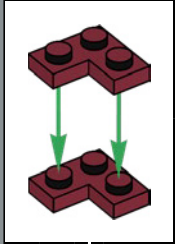

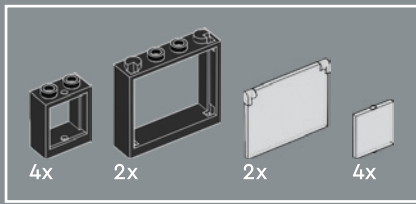

204

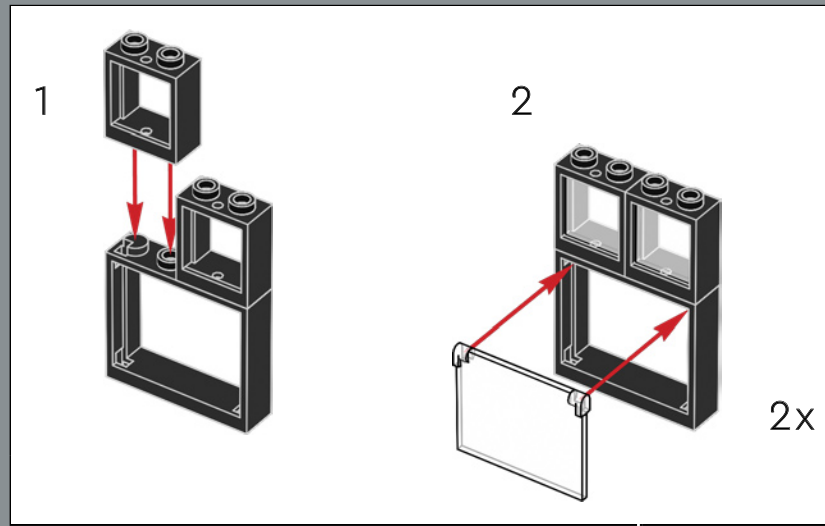



205

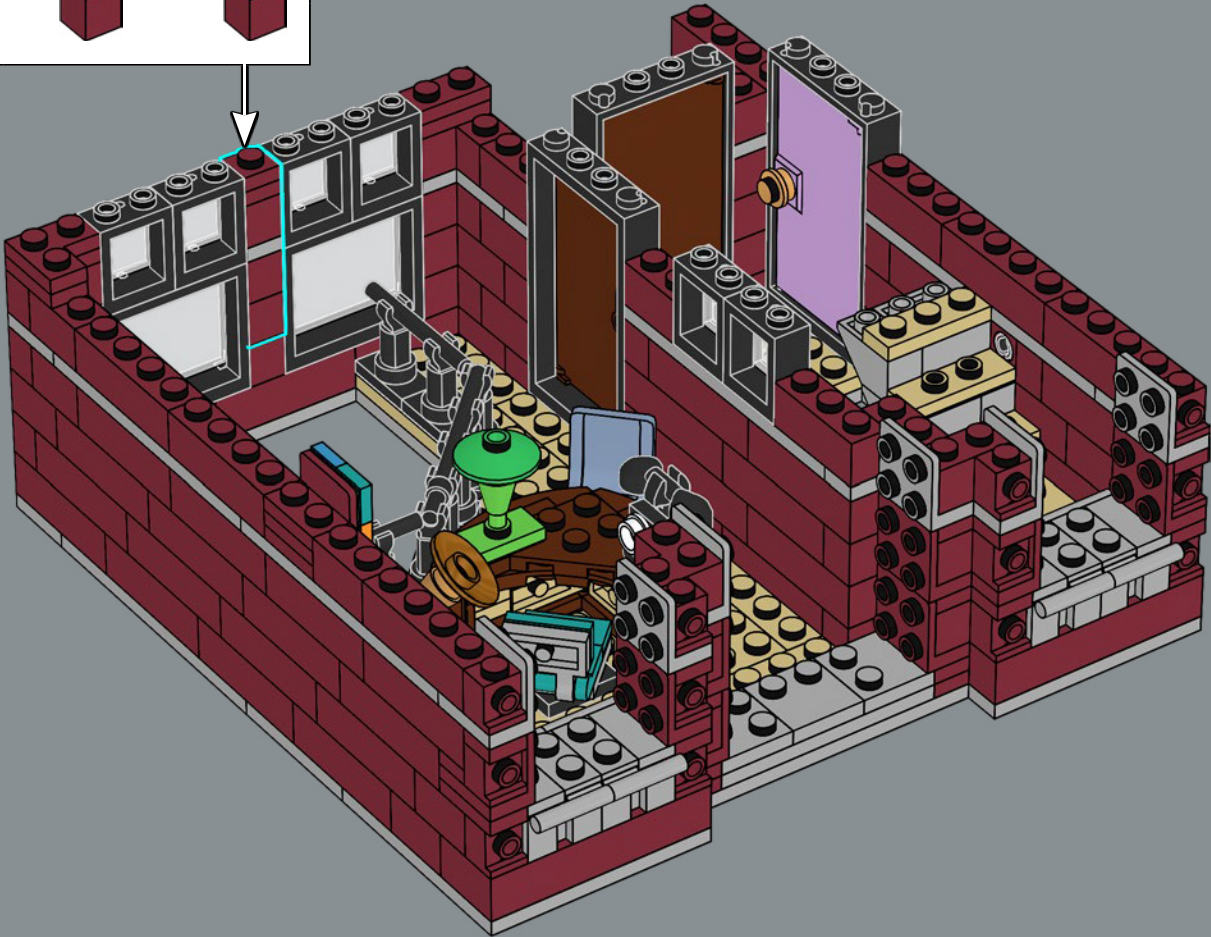
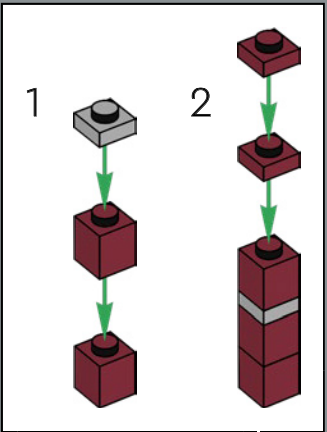

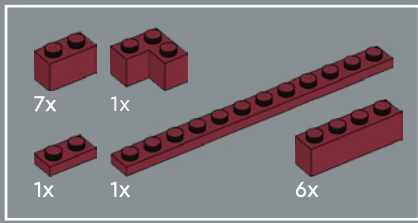

206

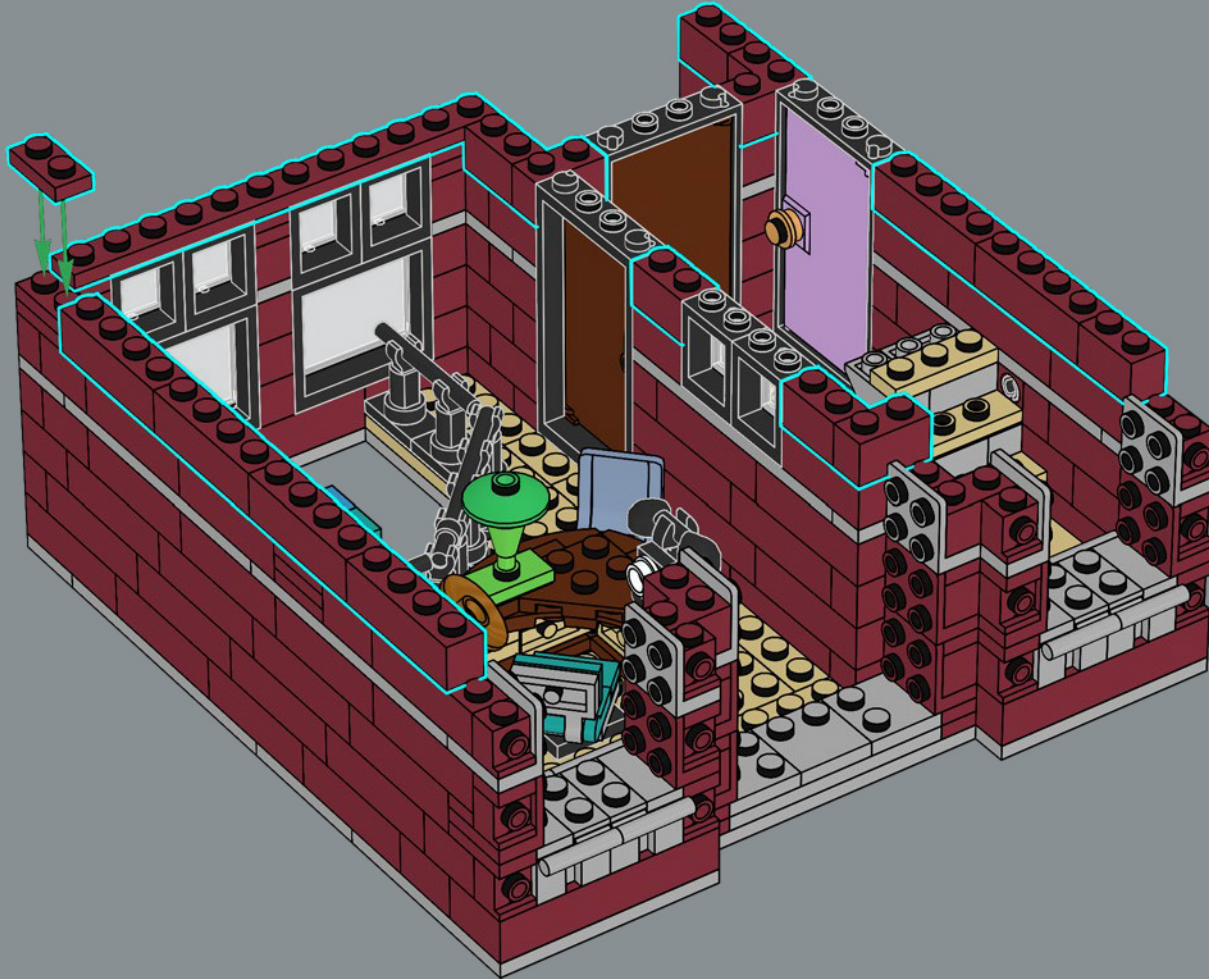



207

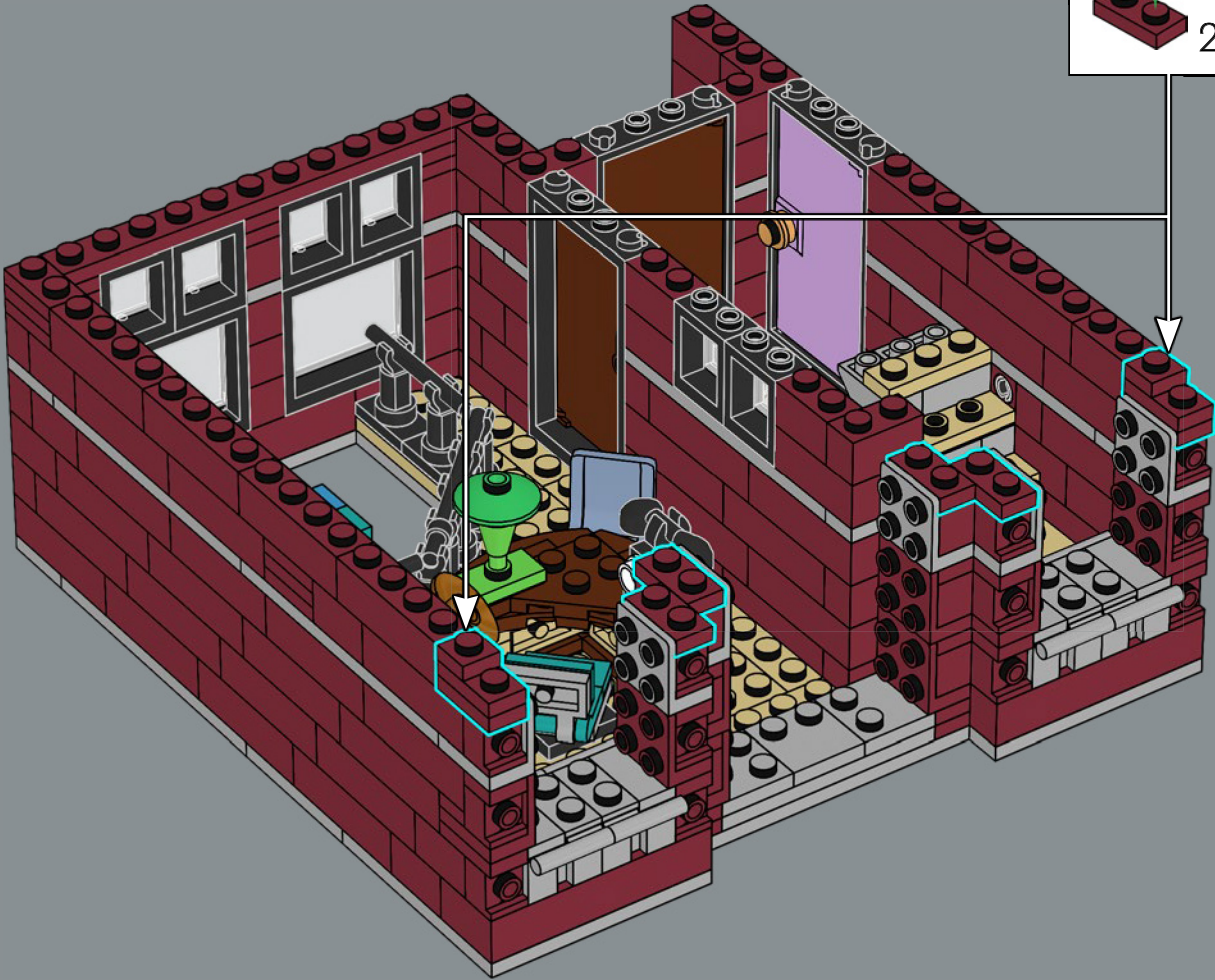
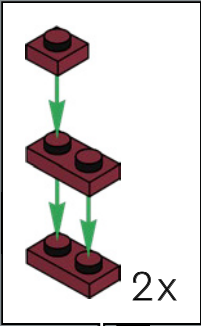

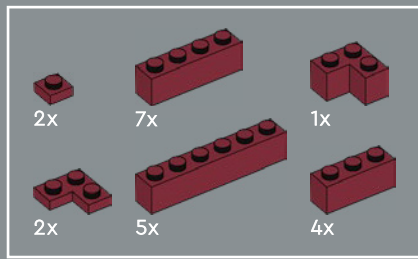

208

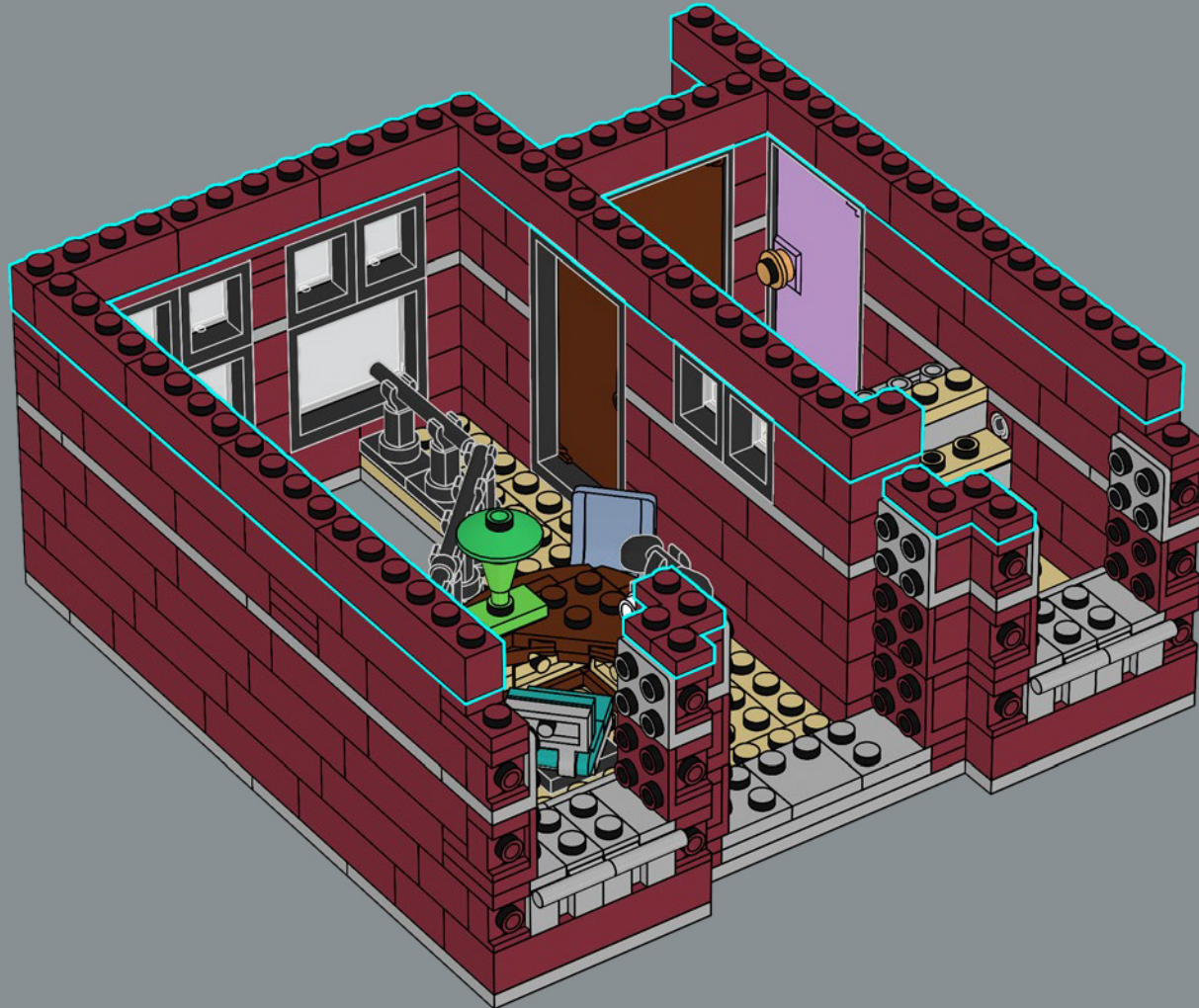



8x

209

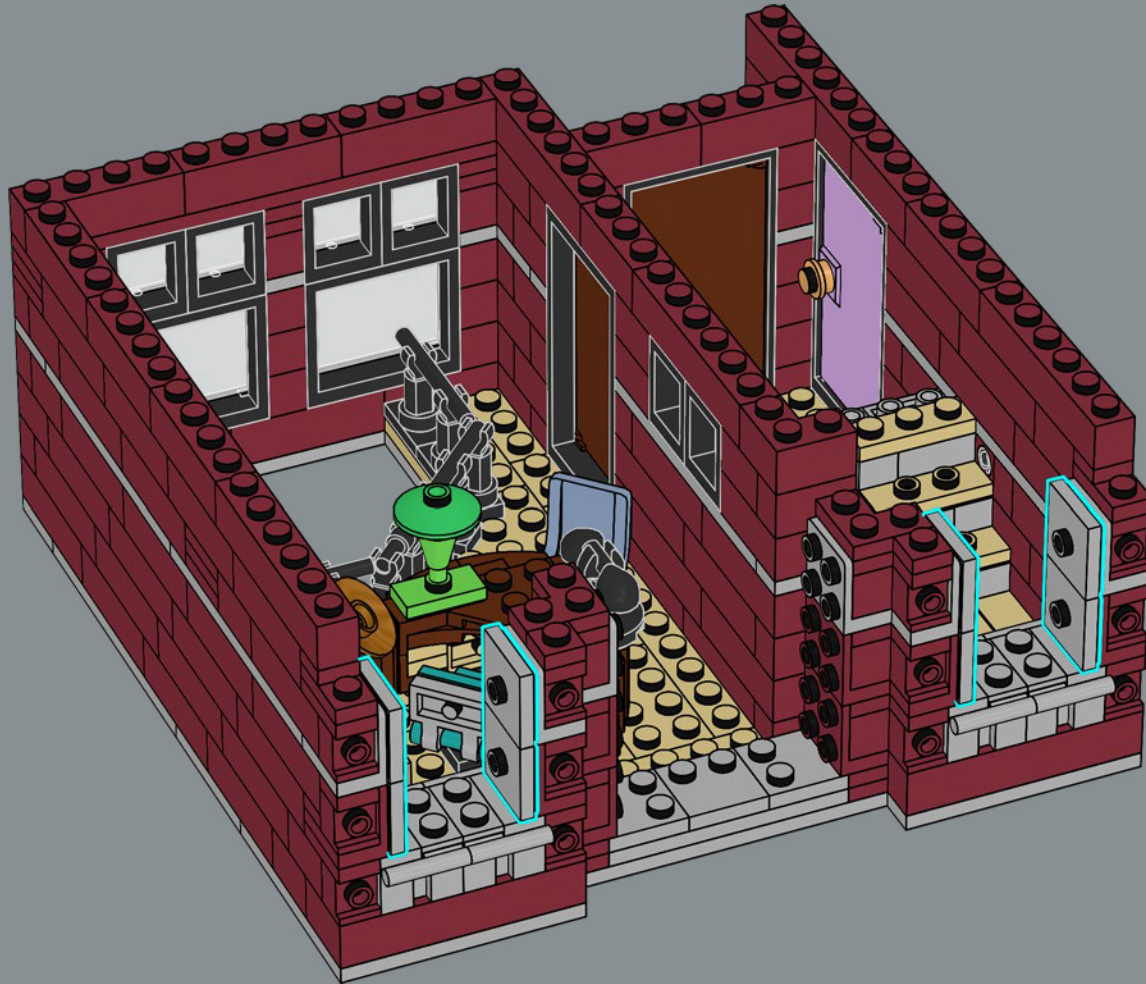

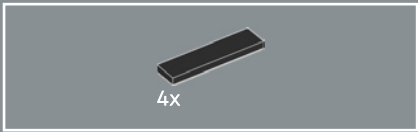

210

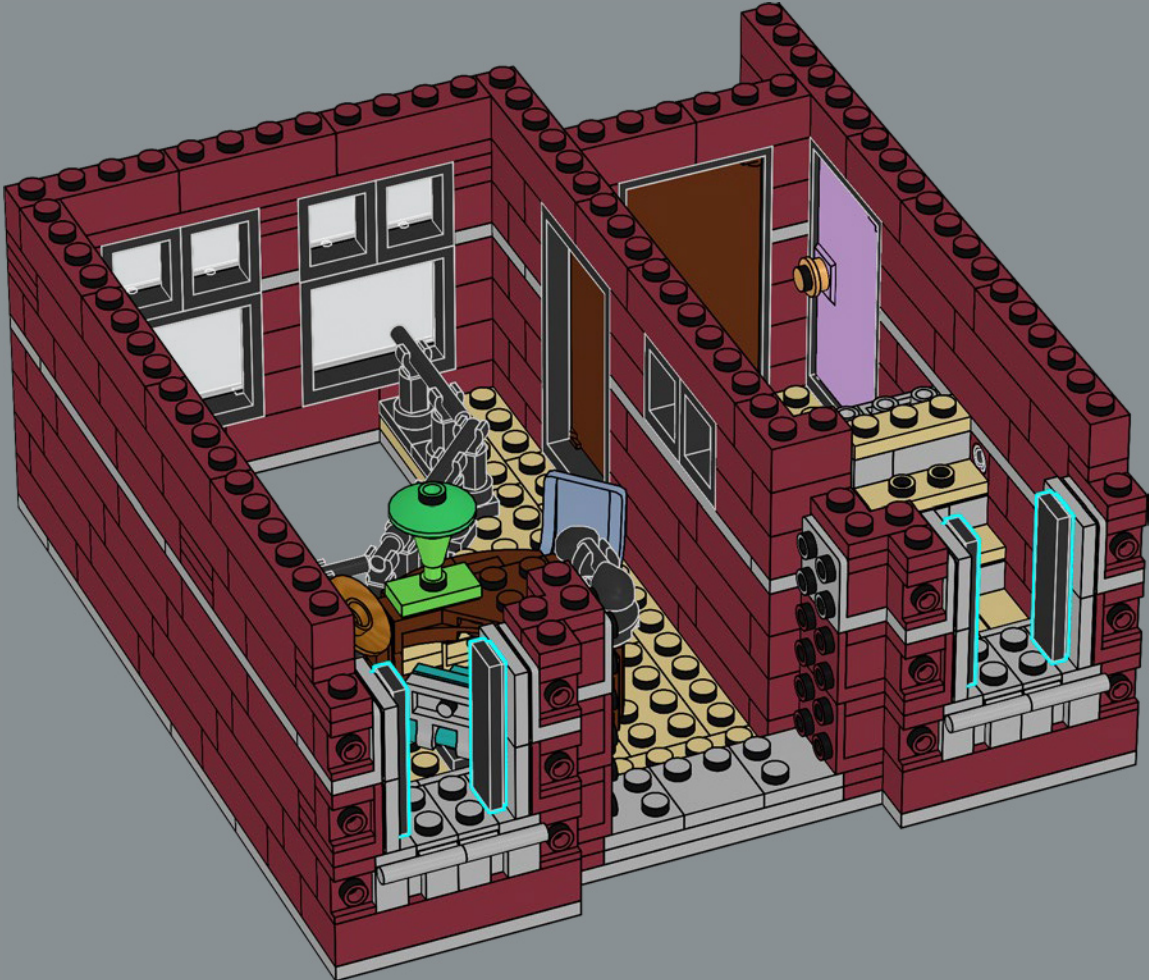

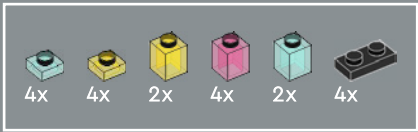

211

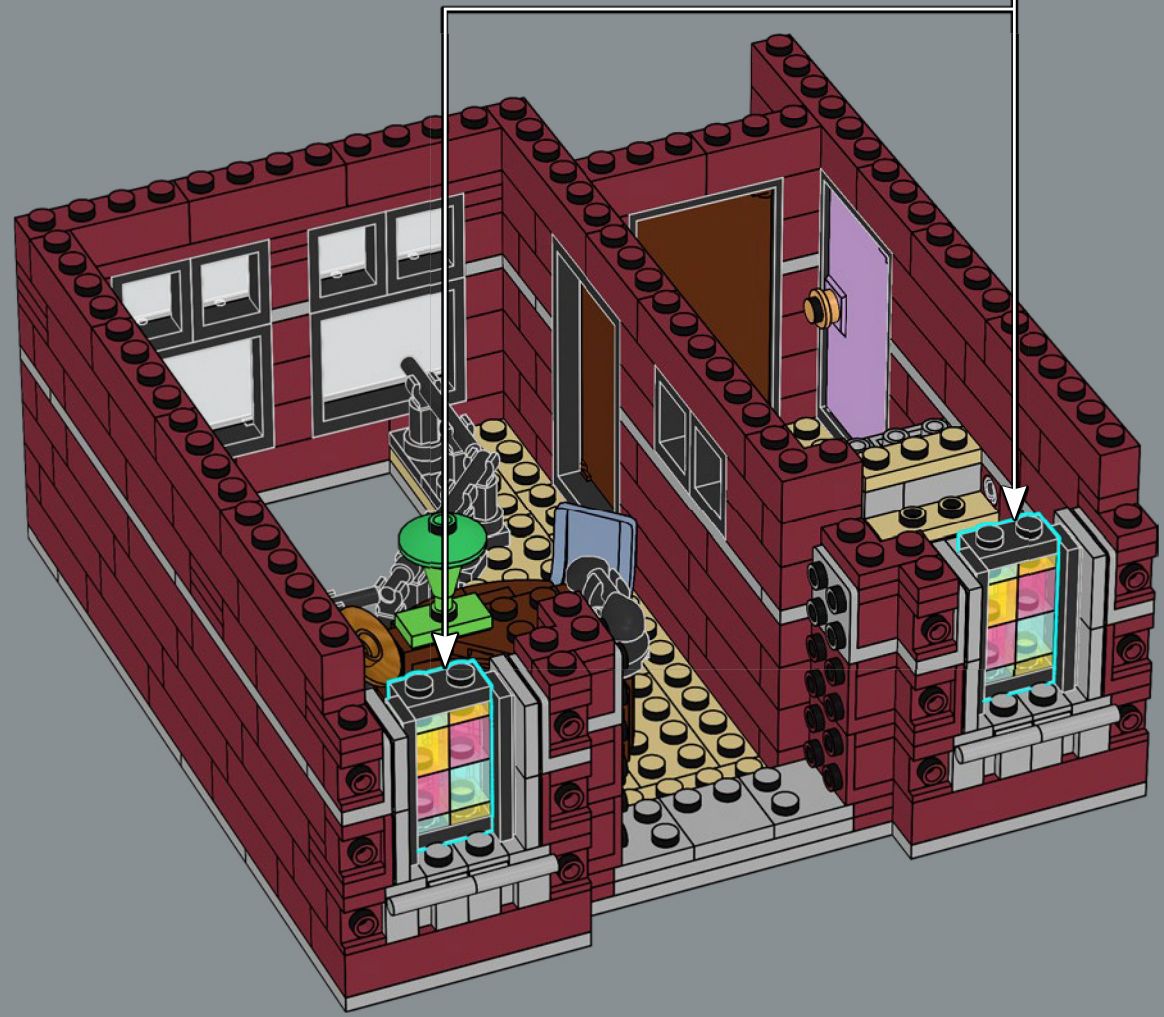
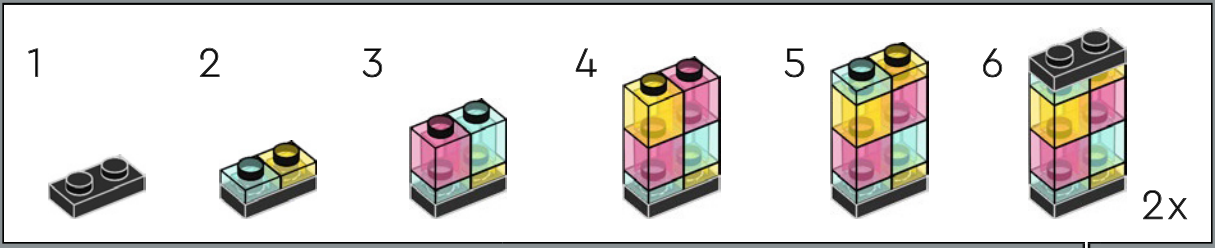

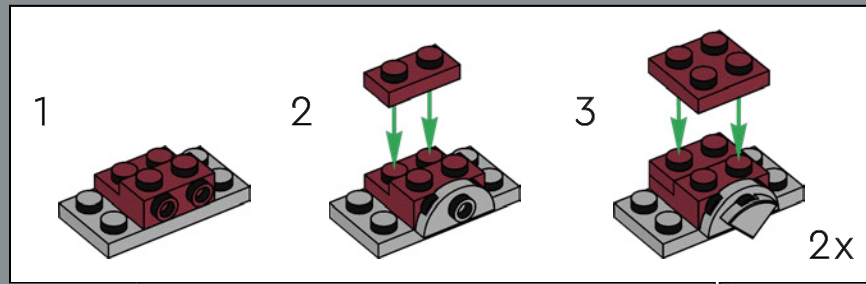
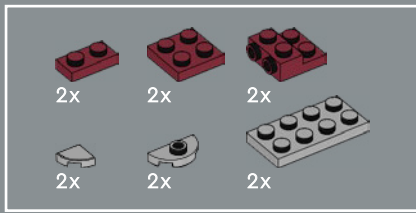

212

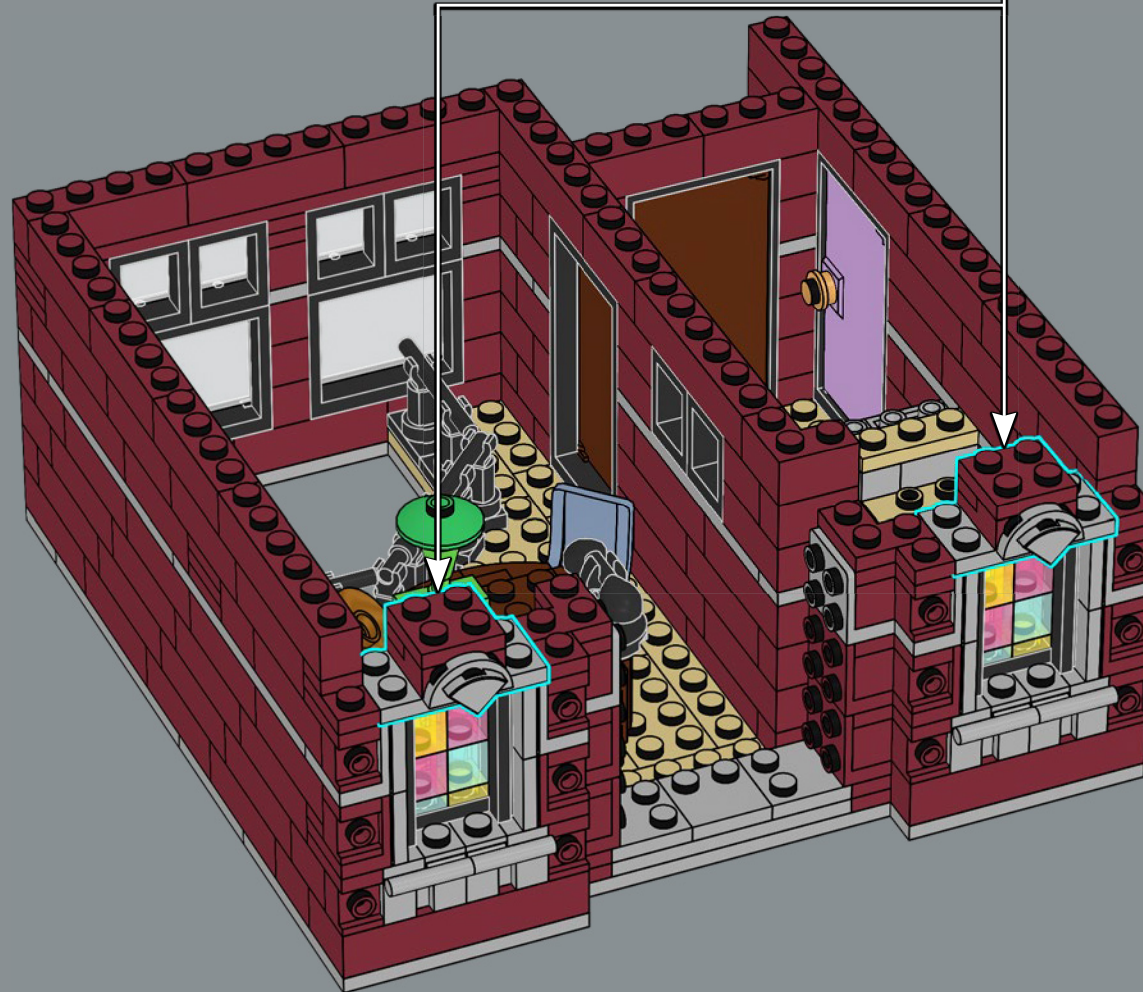

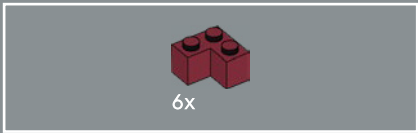

213

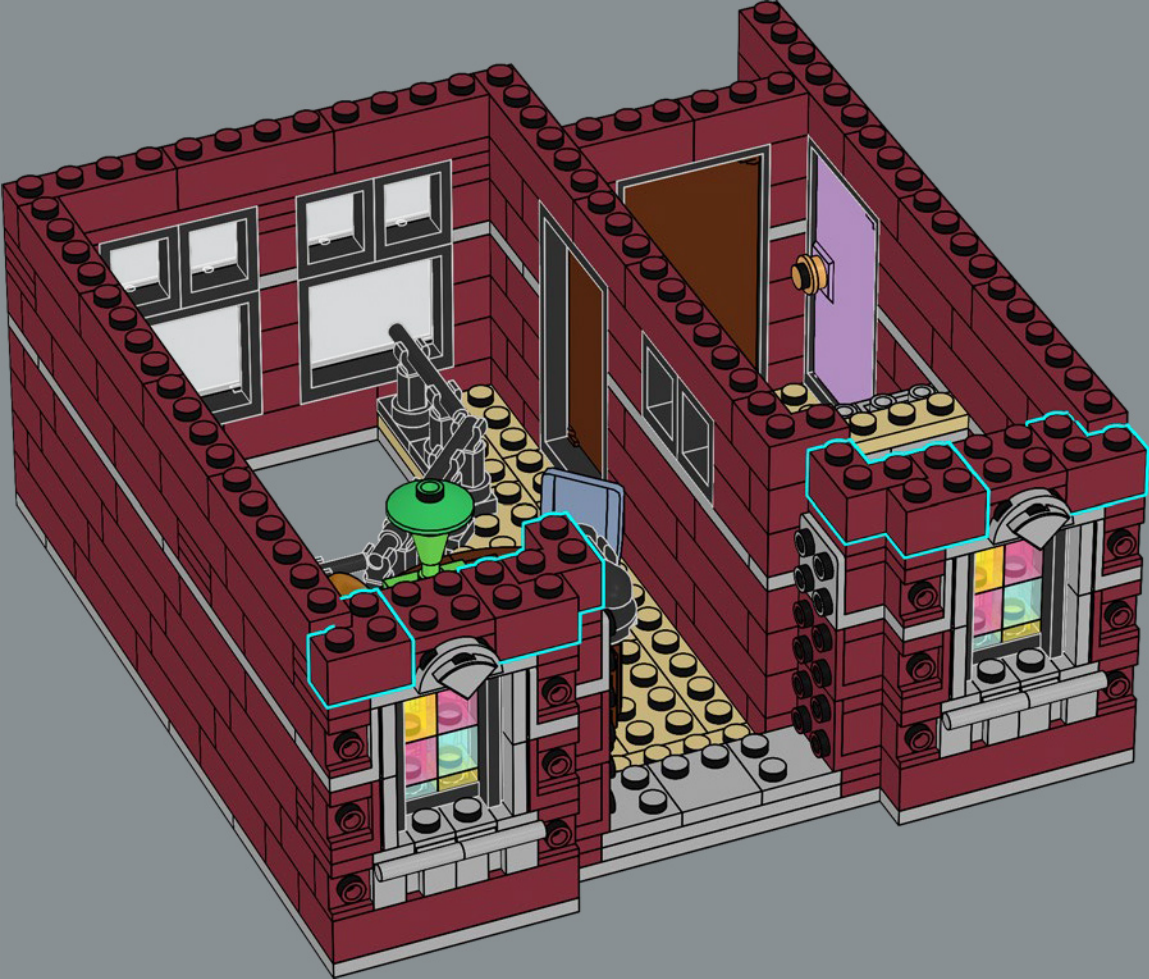

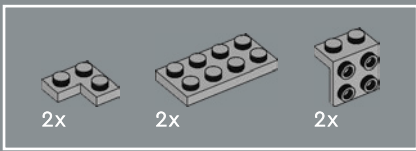

214

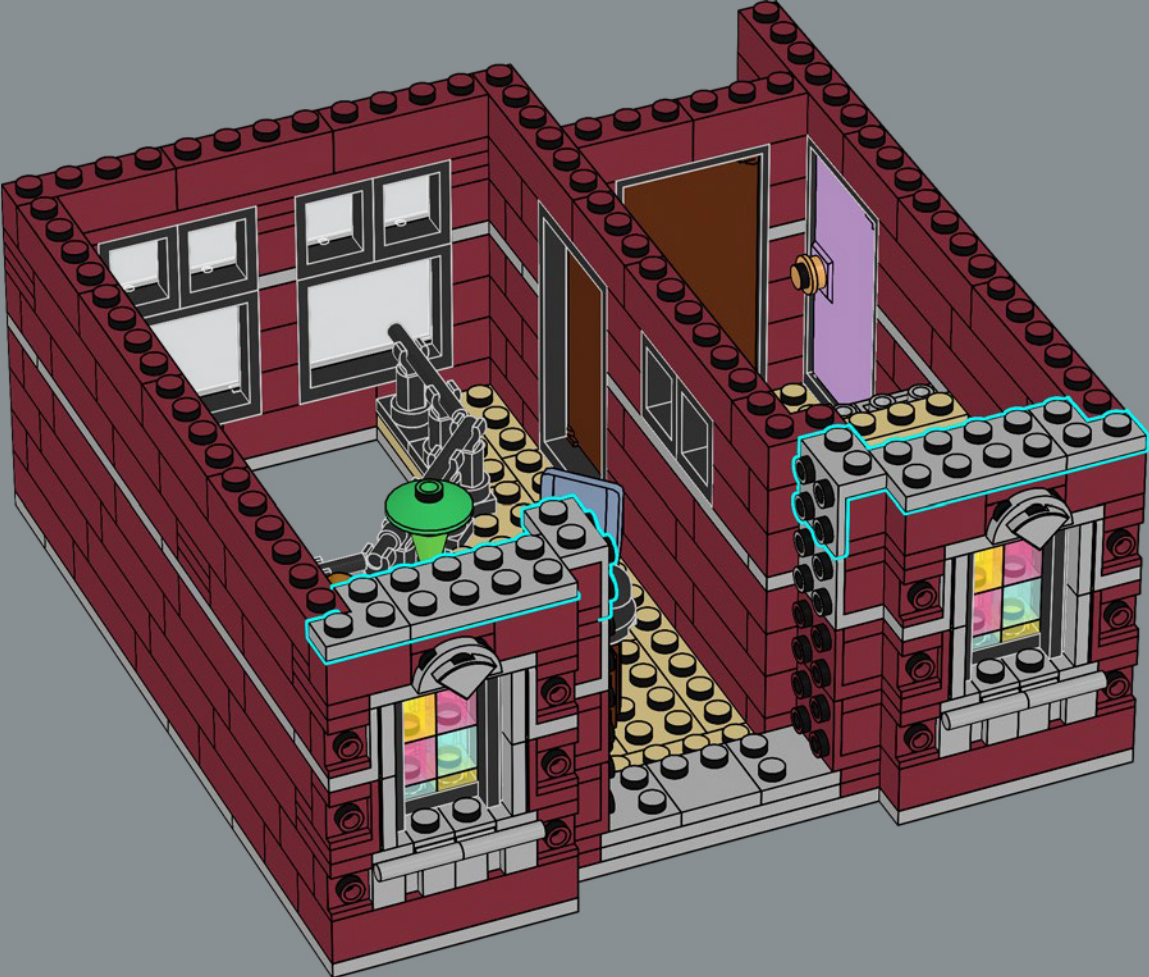



8x

215

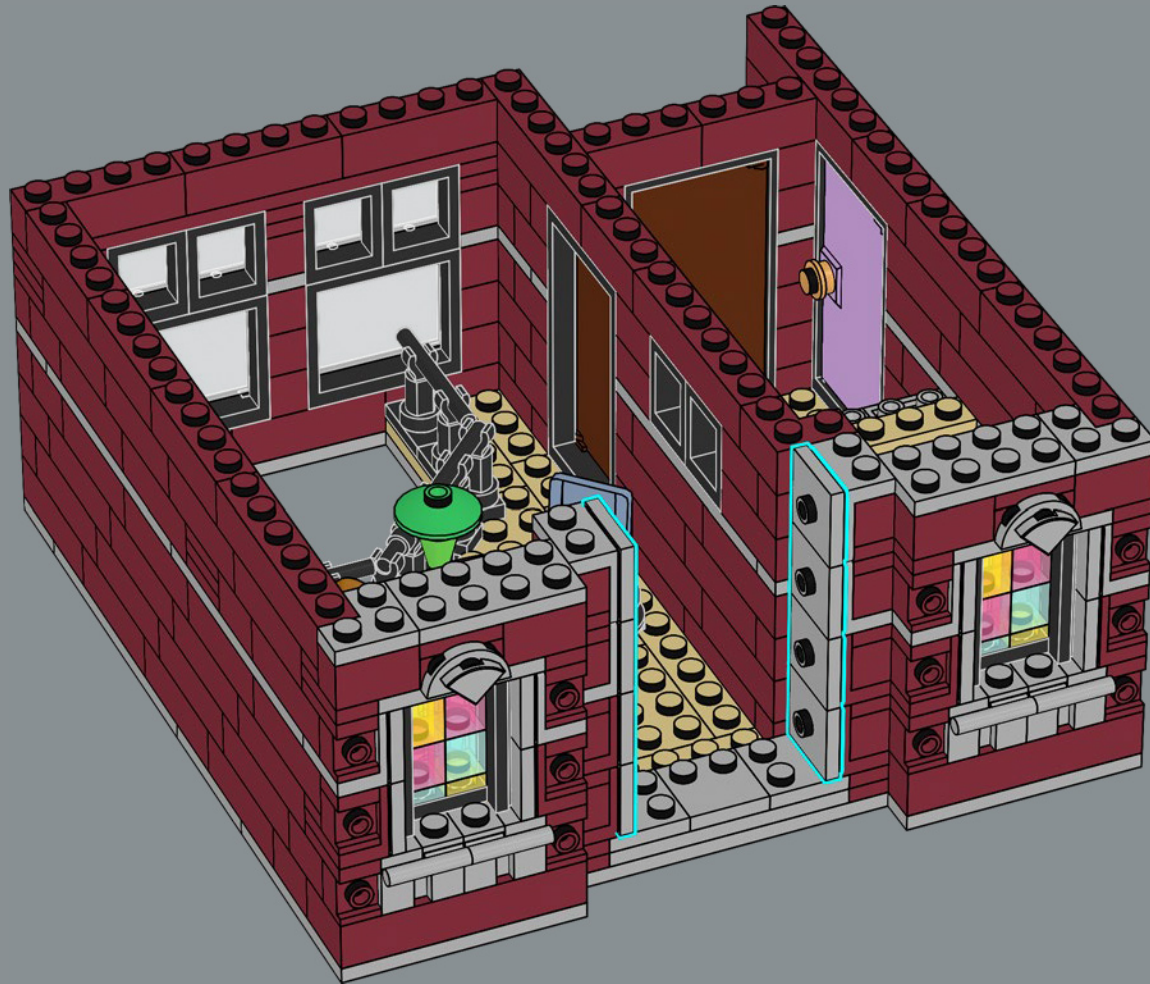

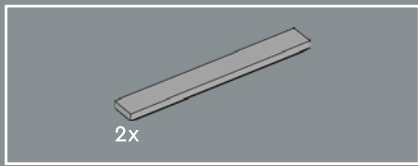

216

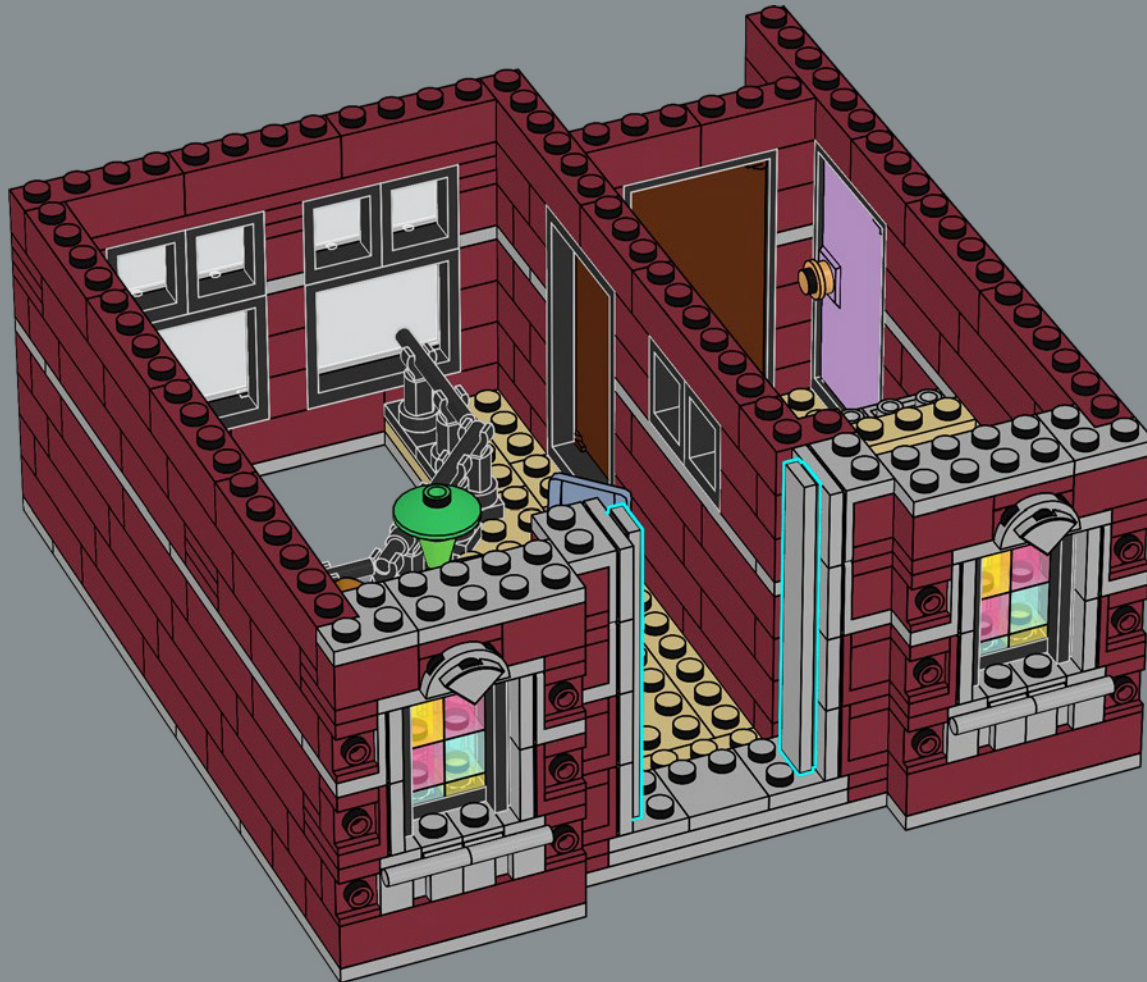

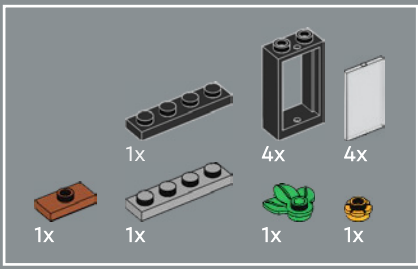

217

1

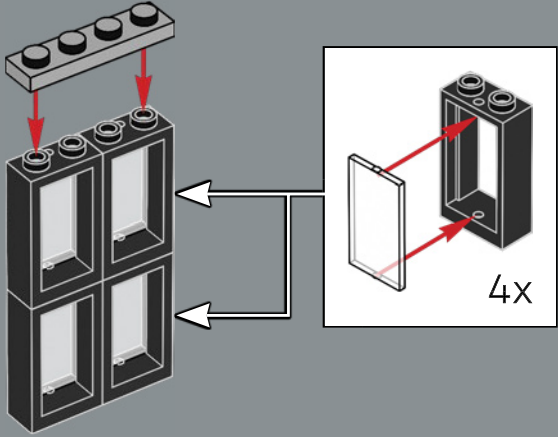

2

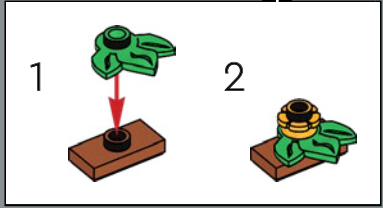
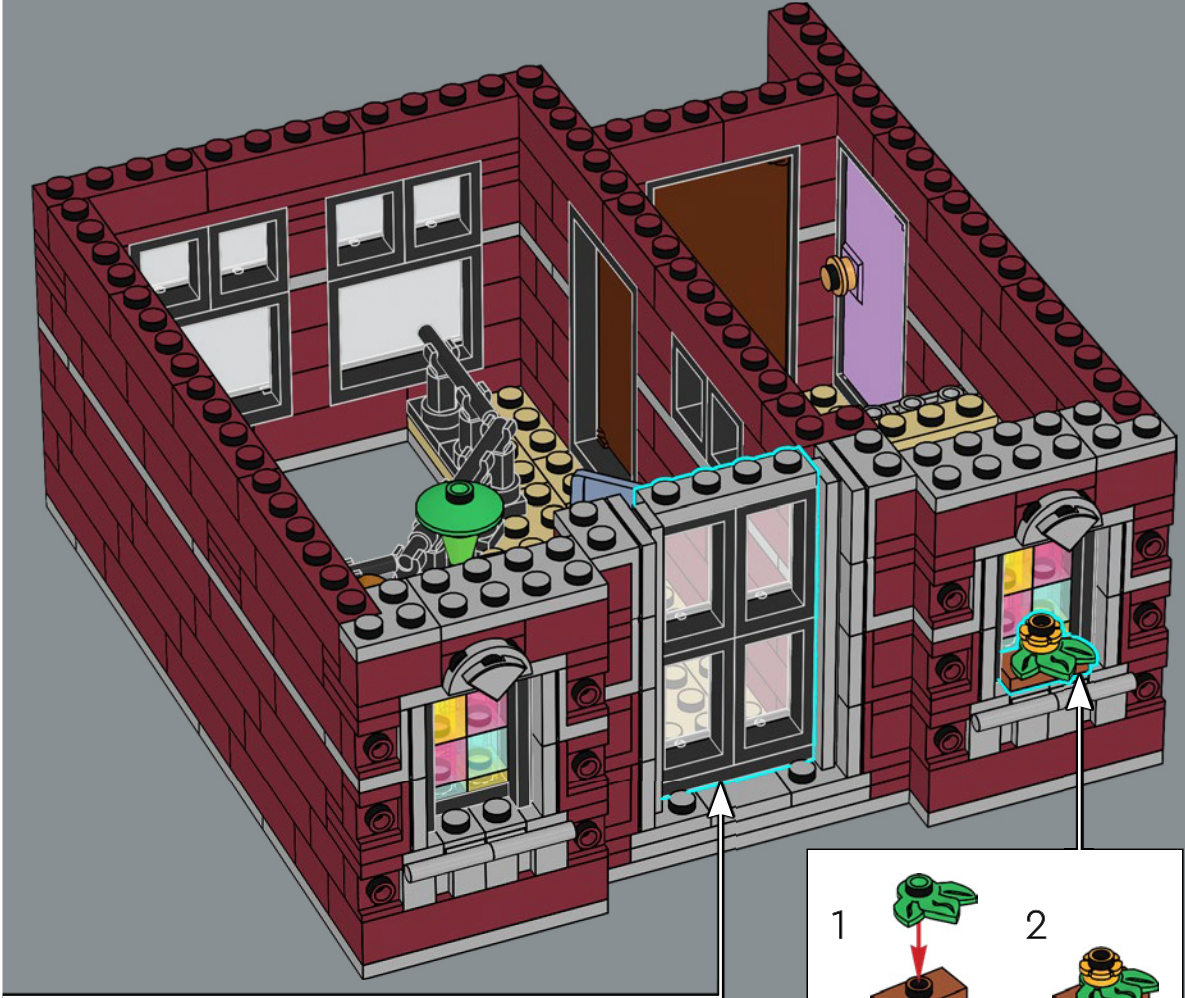
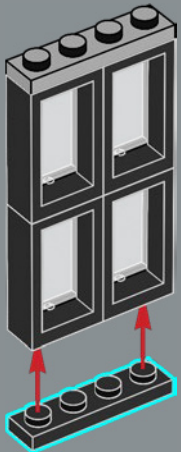

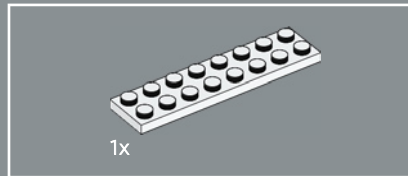
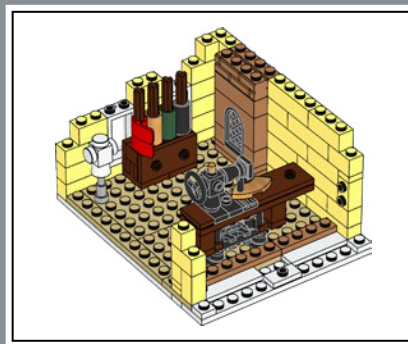
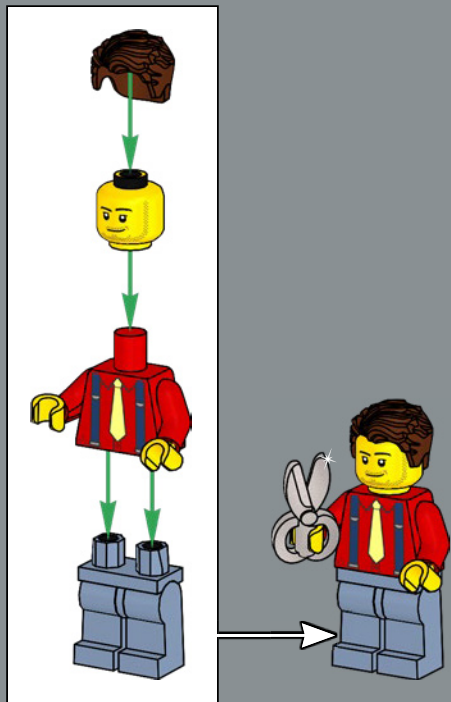

1x

218

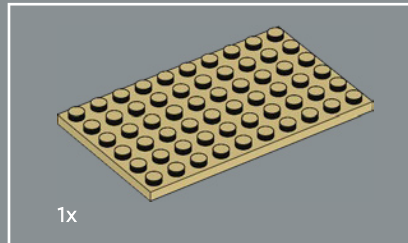

1x

219



¿Te has comprado ropa en el Centro Comercial LEGO® (10211), pero no te sienta bien? Visita al sastre, que estará encantado de atenderte como mereces.

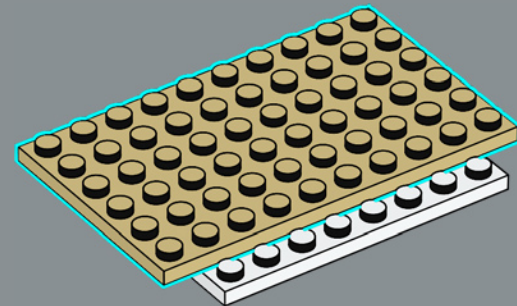
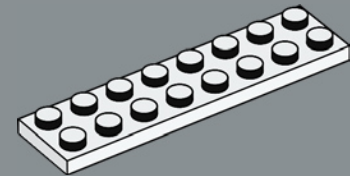

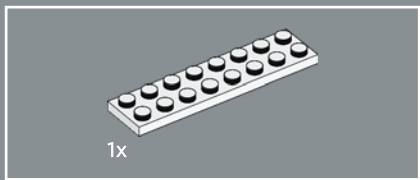

220

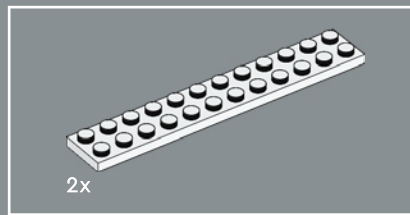
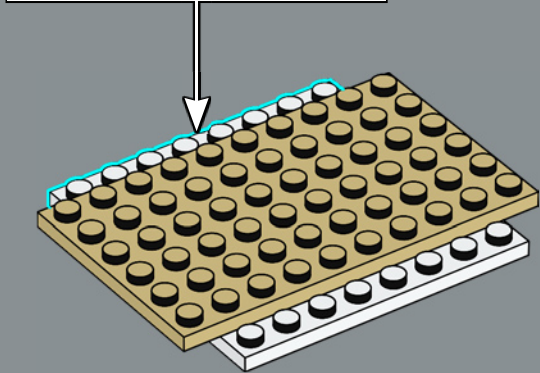
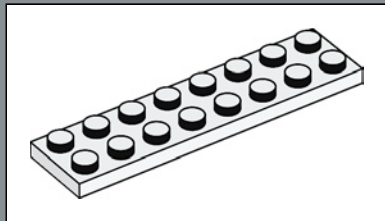

221

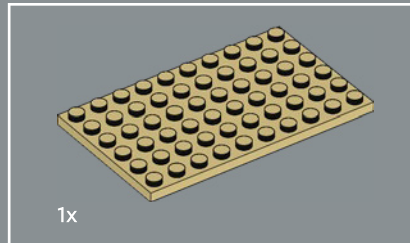
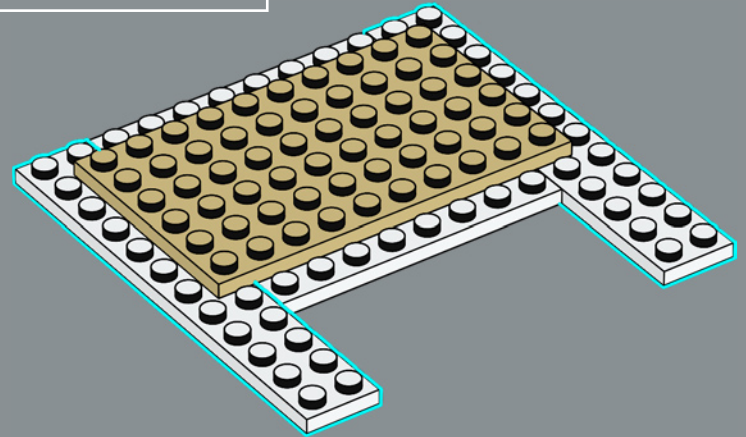

222

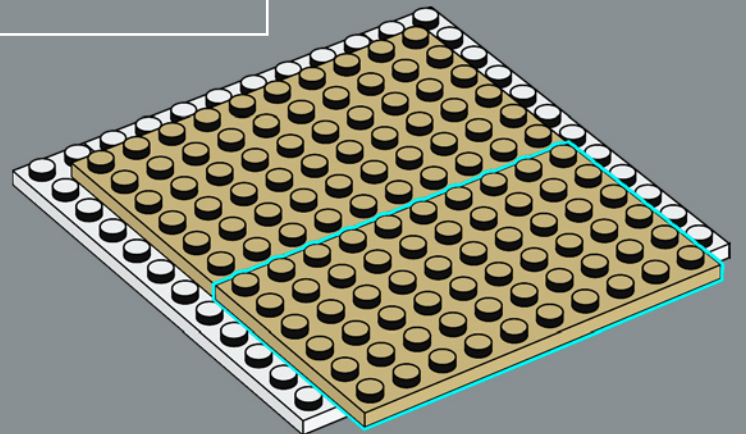

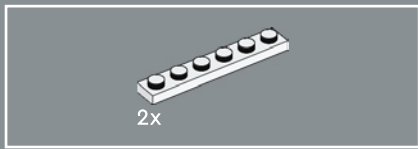

223

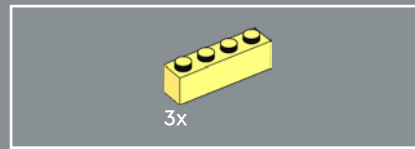
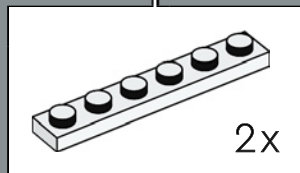
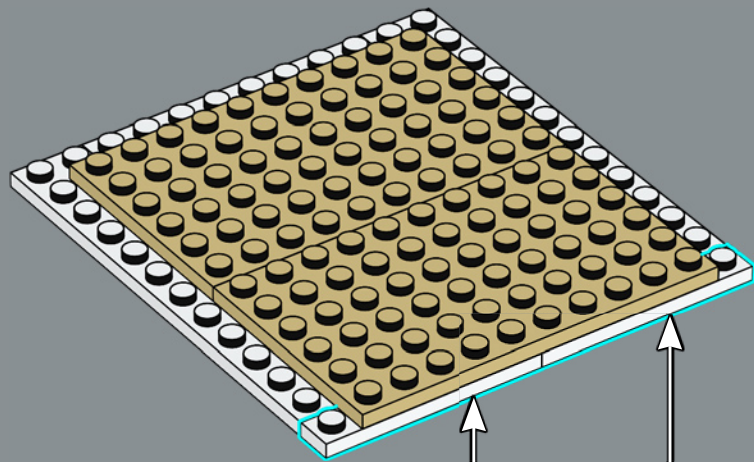

224

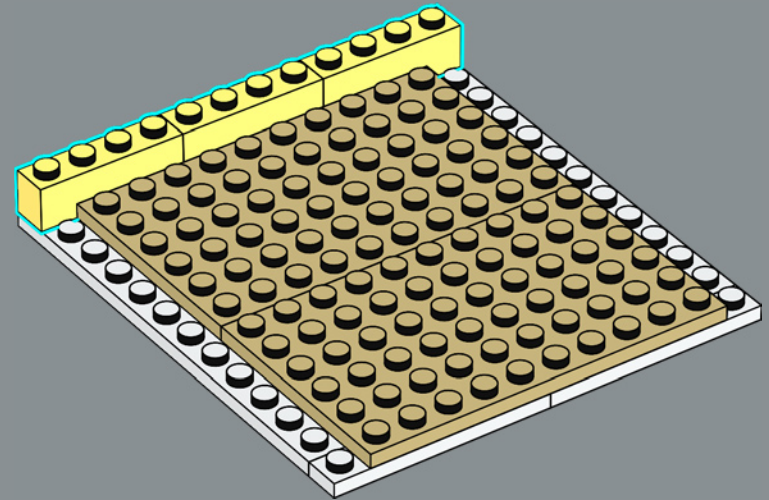

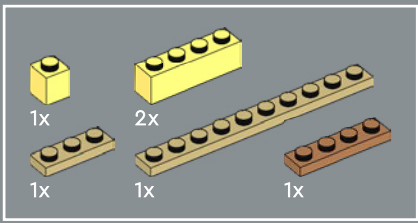

225

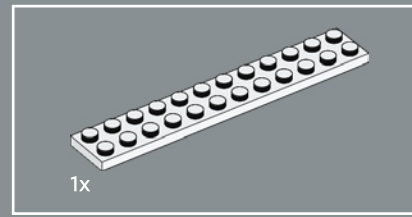
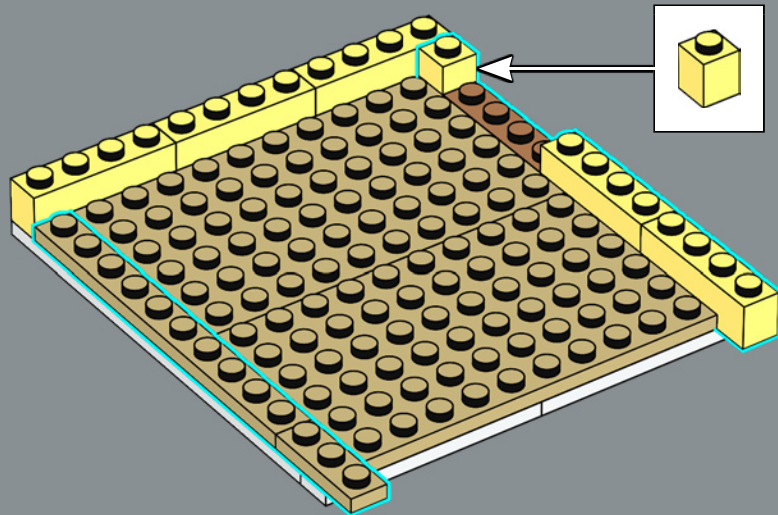

226

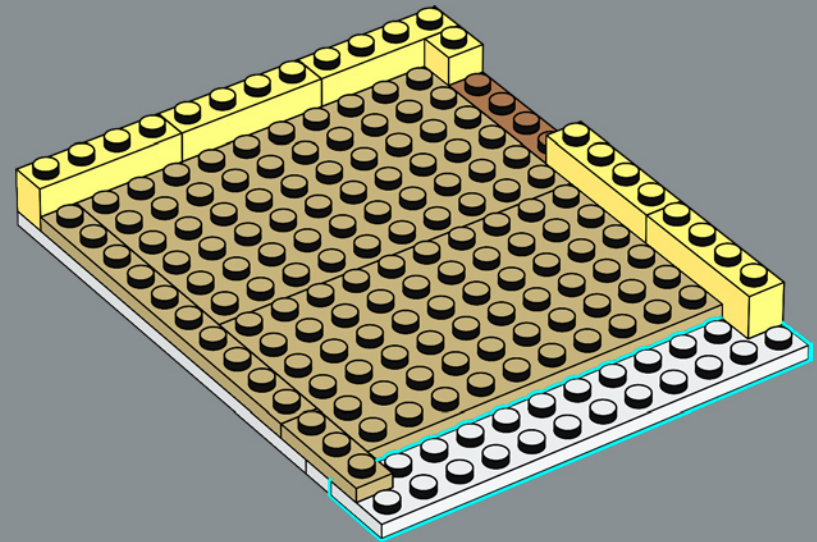

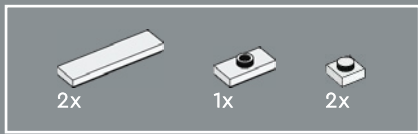

227

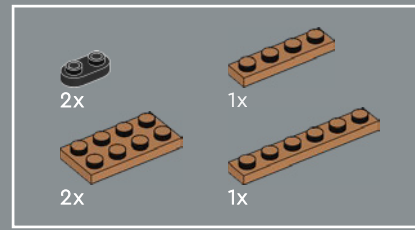
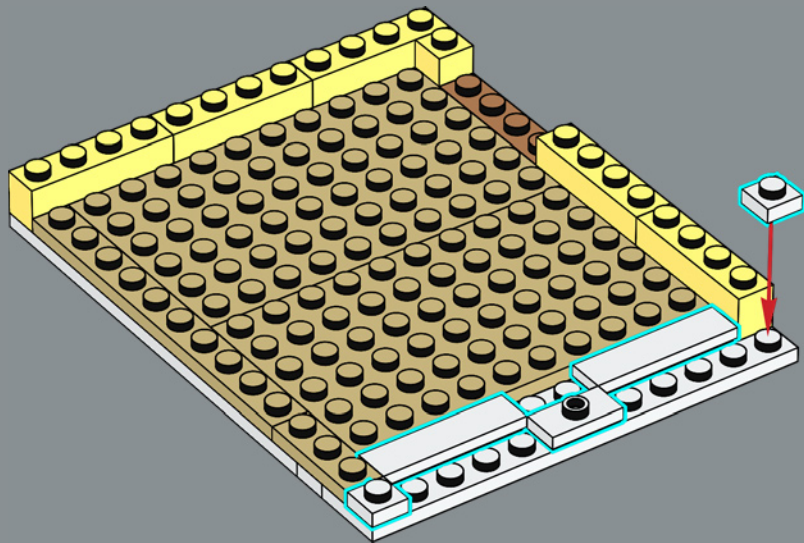

228

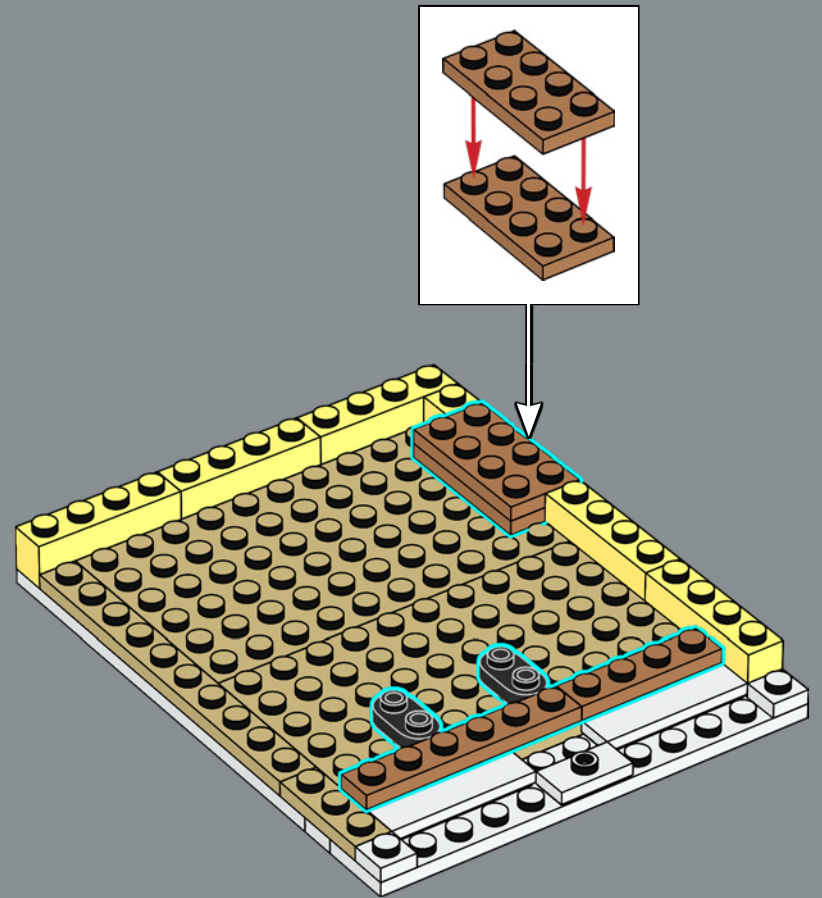

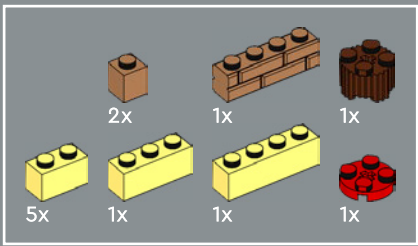

229

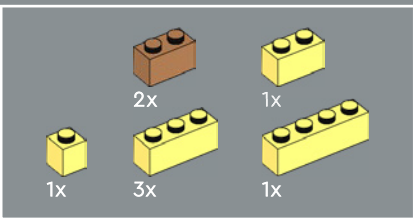
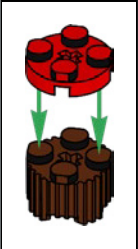

230

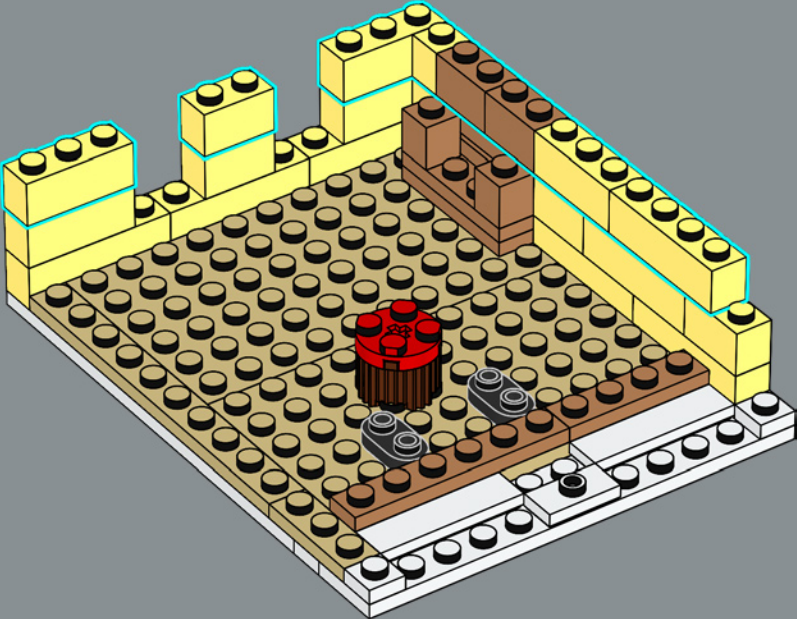



231

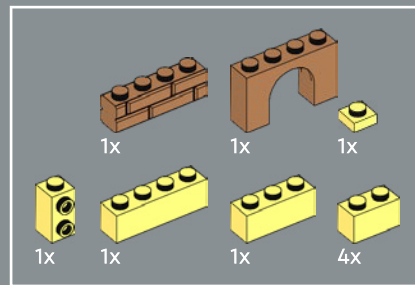
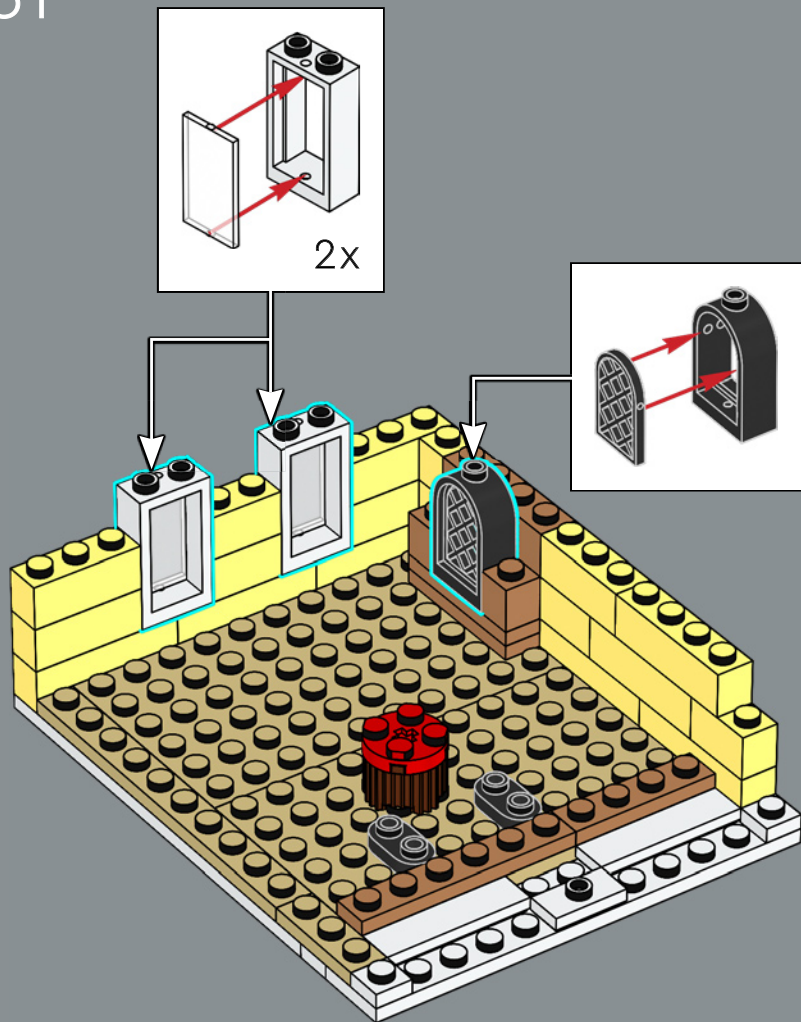

232

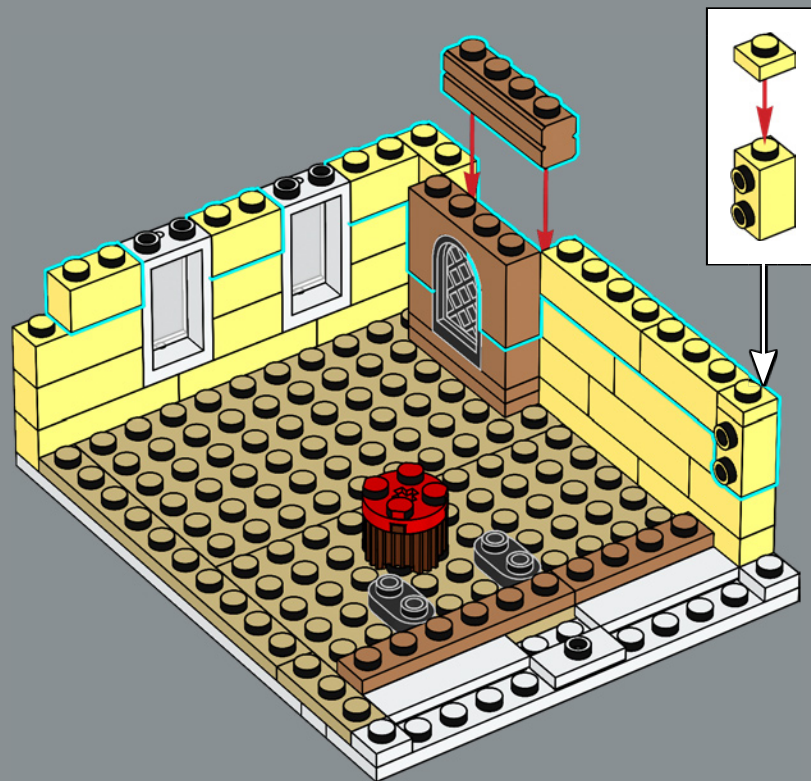

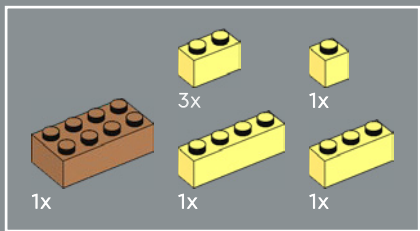

233

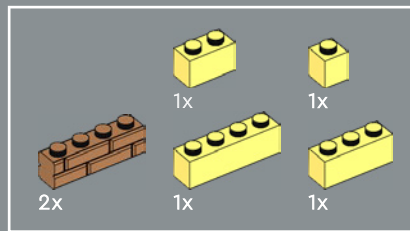
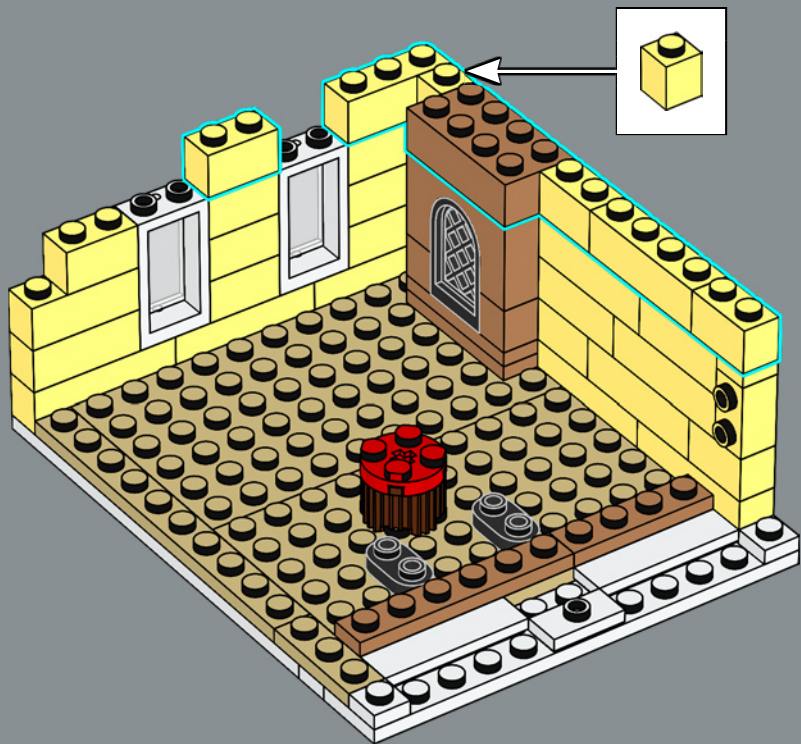

234

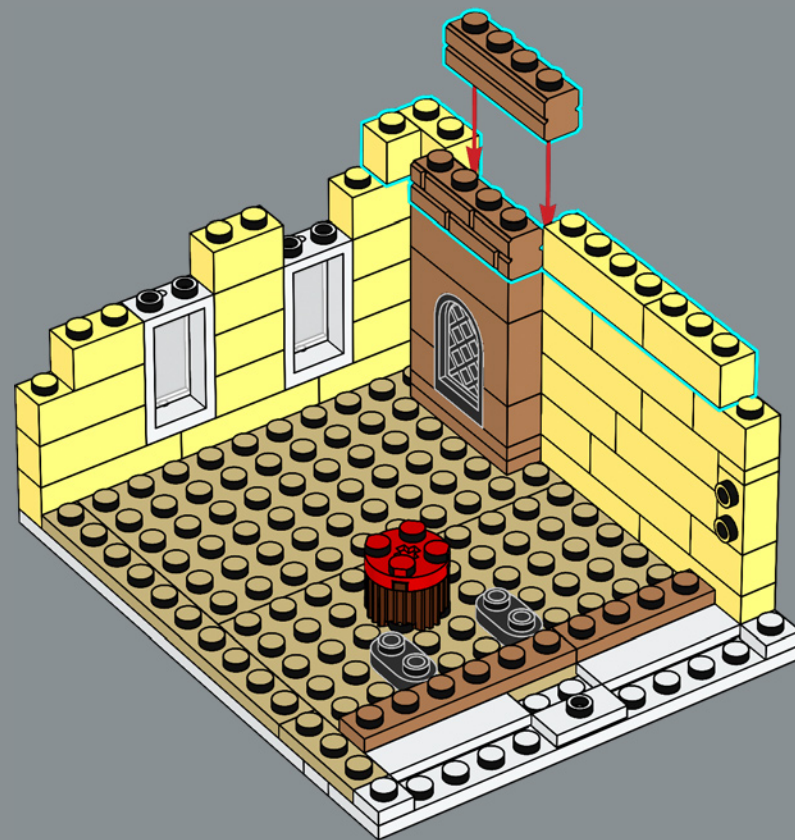

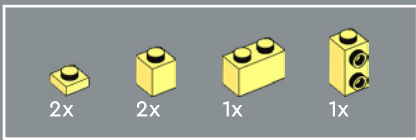

235

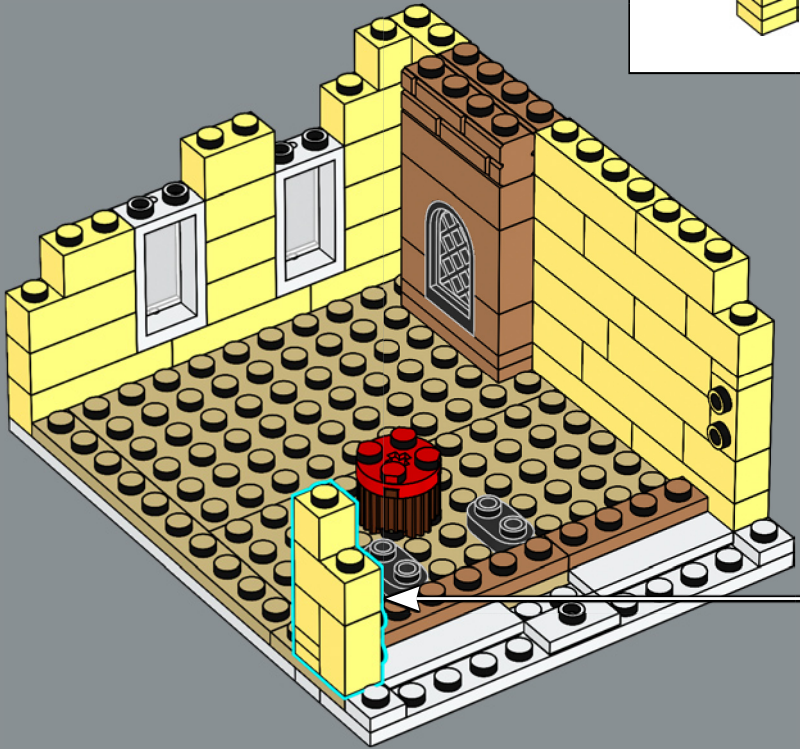
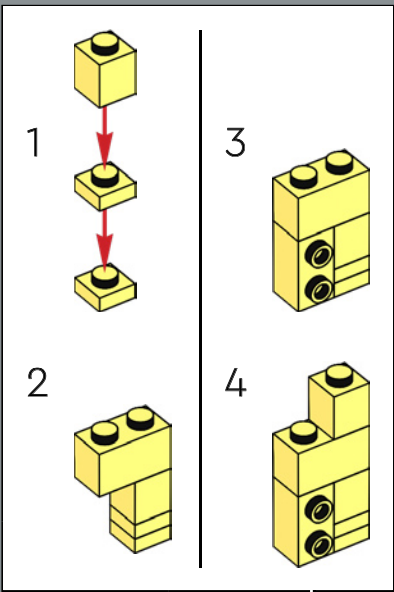

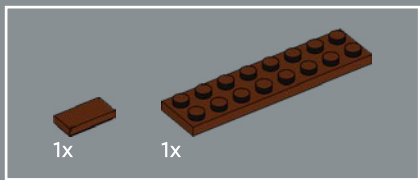

236

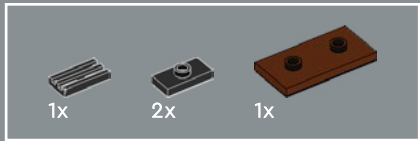
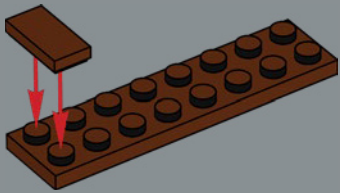

237

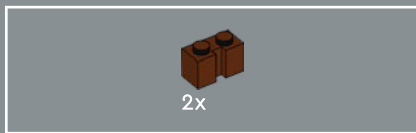
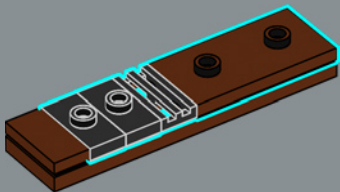

238

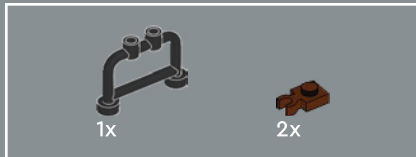
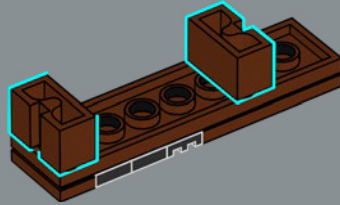

239

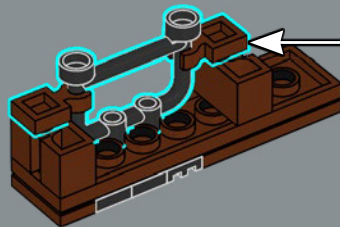
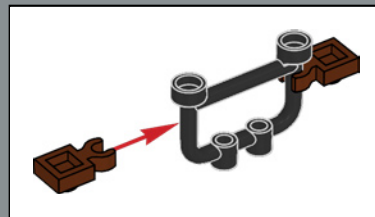

240

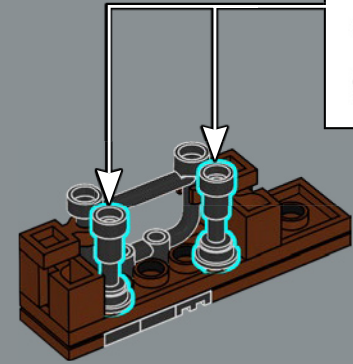
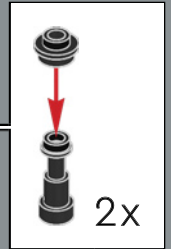

241

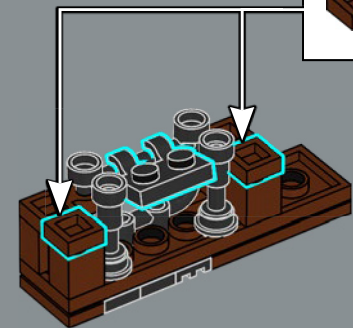

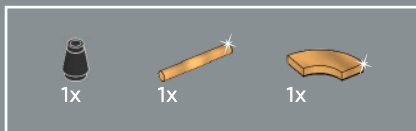

242

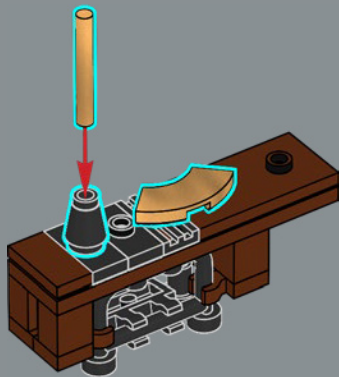

243

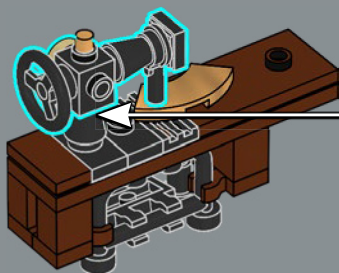
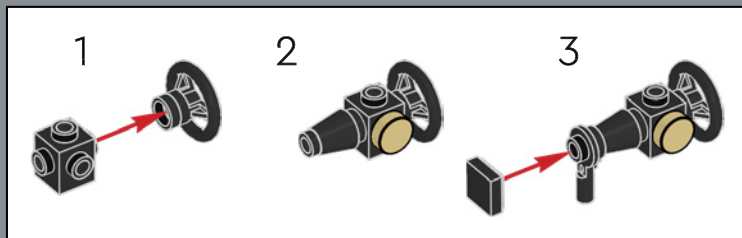

El sastre acaba de terminar el vestido de la cantante;
¡todavía hay hilo y tela dorados encima de su
máquina de coser!

244

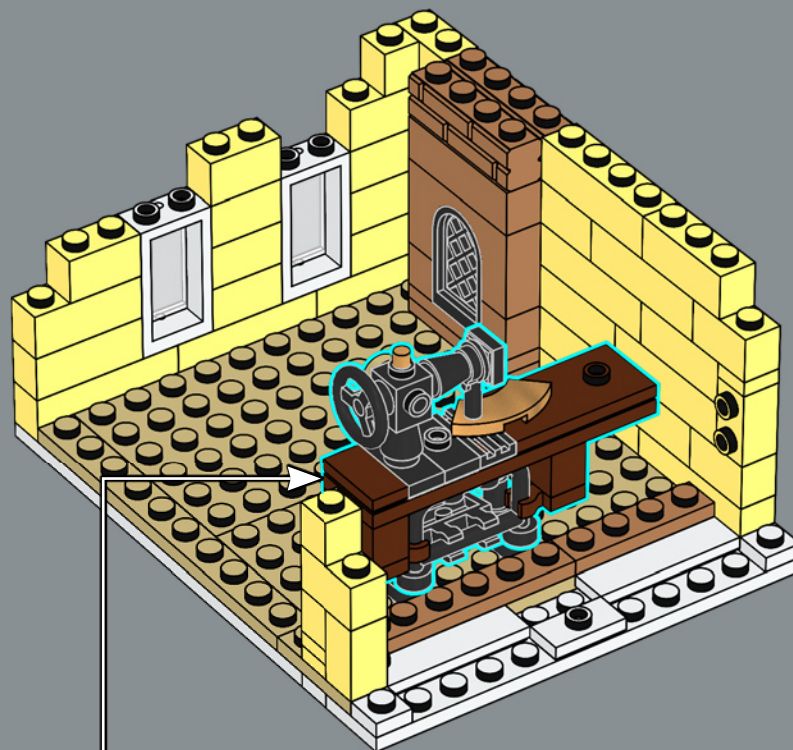

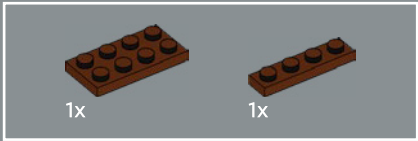

245

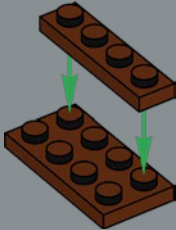

246

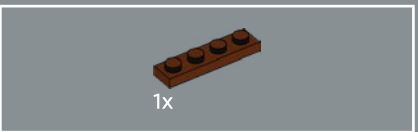
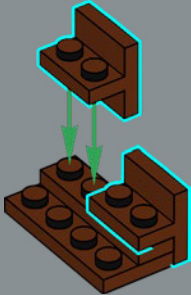

247

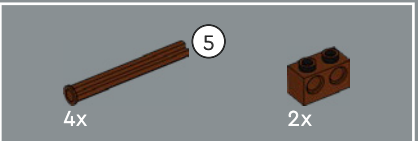
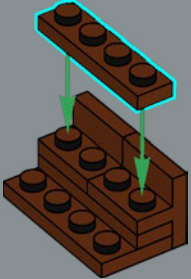

248

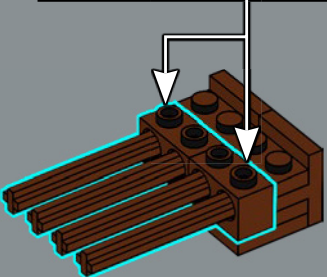
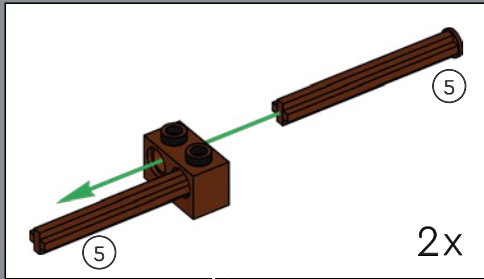

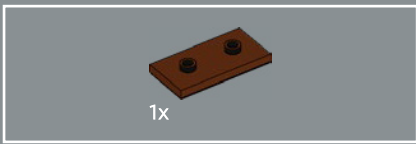

249

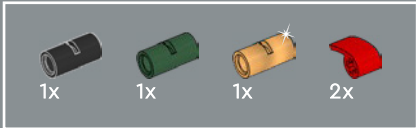
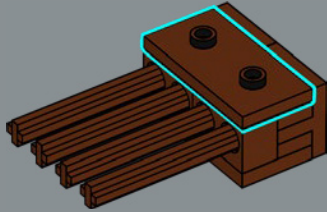

250

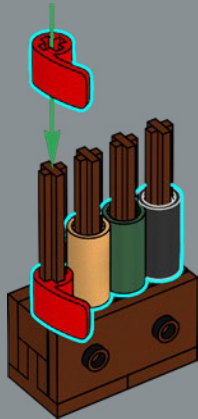

Los elementos que componen el tejido rojo aparecieron por primera vez en sets LEGO® Technic.

251

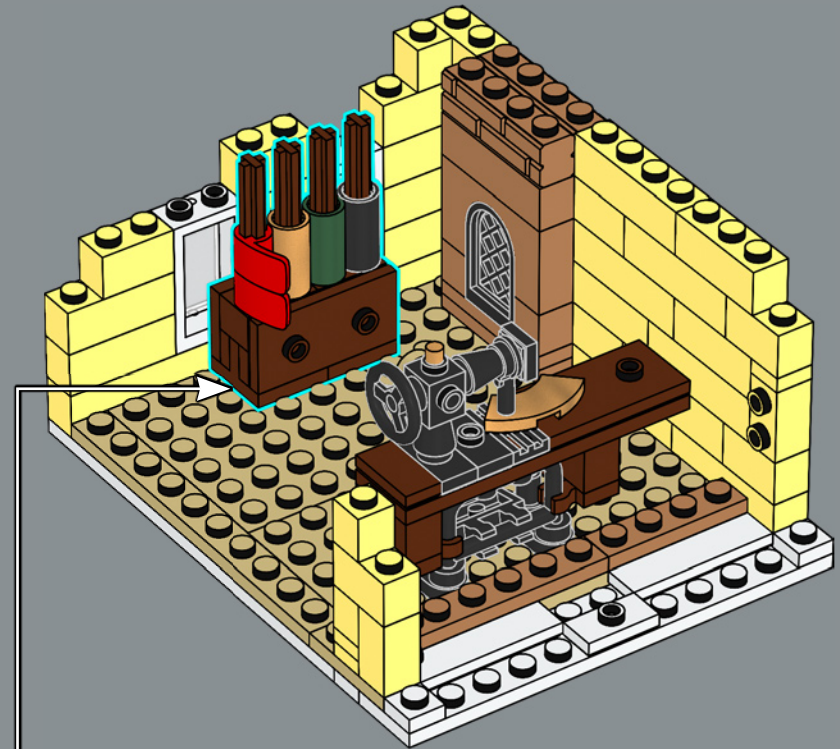

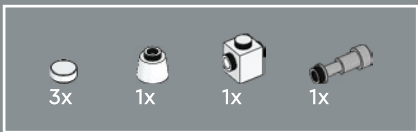

252

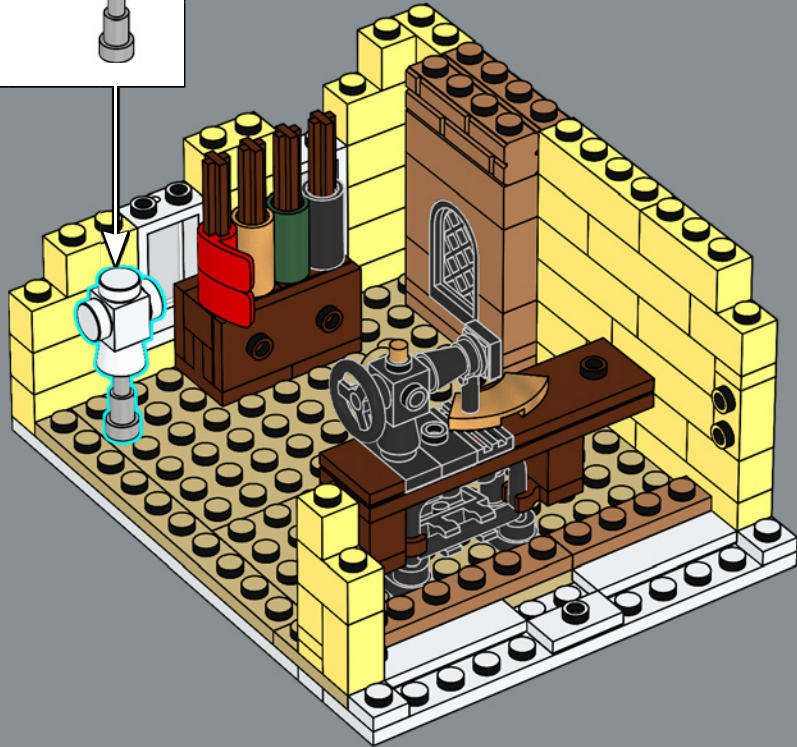
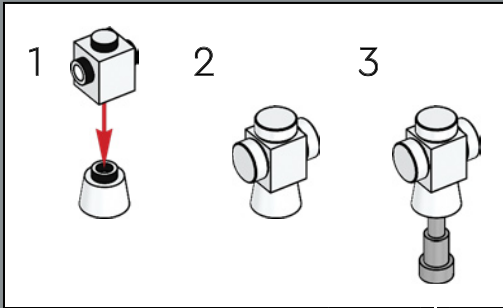

253

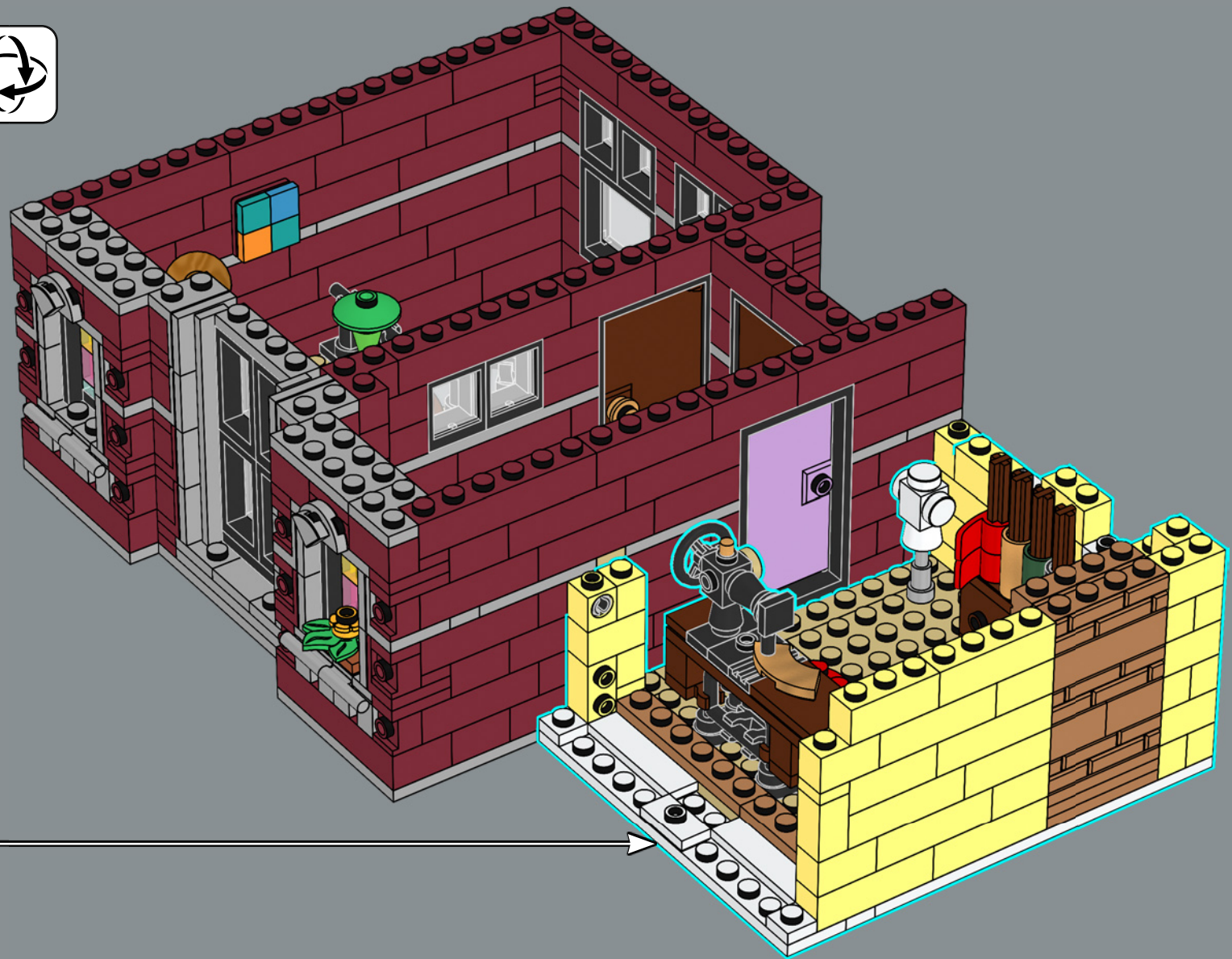

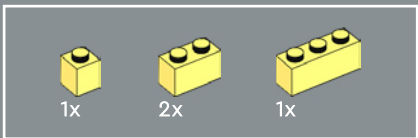

254

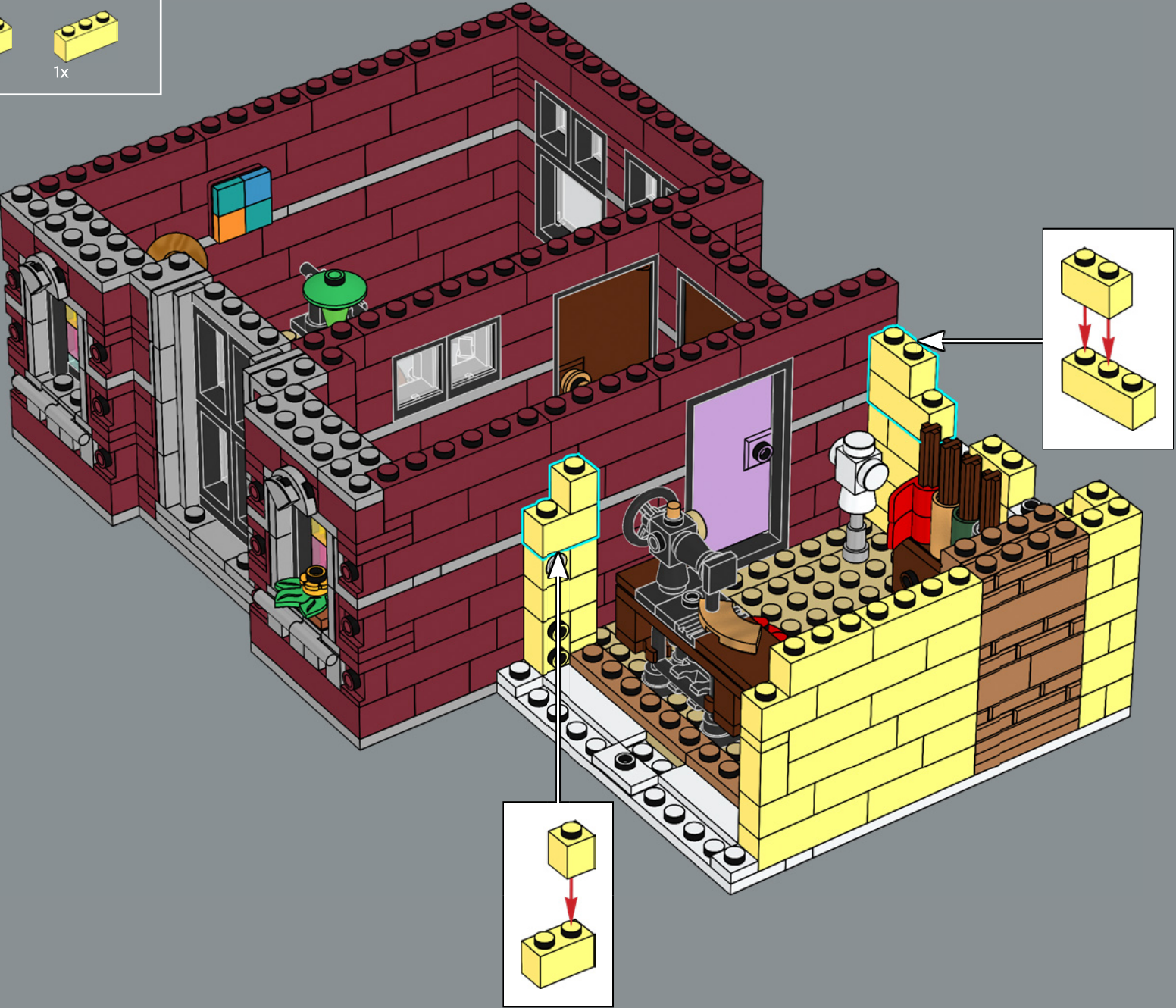

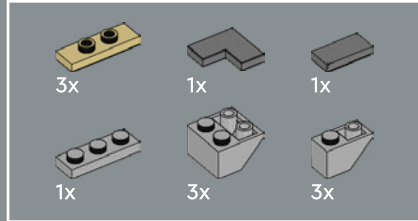

255

1

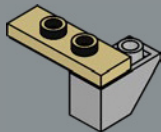

2

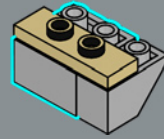

3

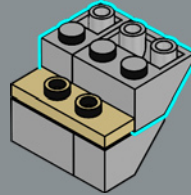

4

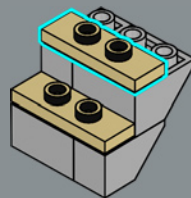

5

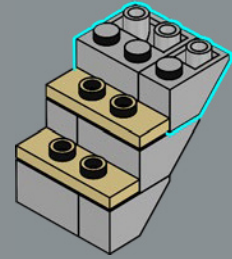

6

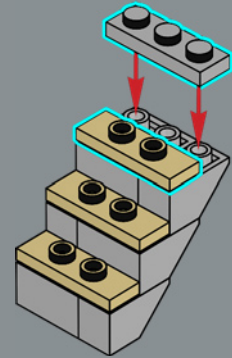

7

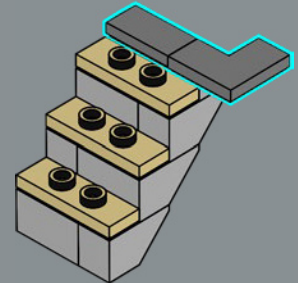





12x

256

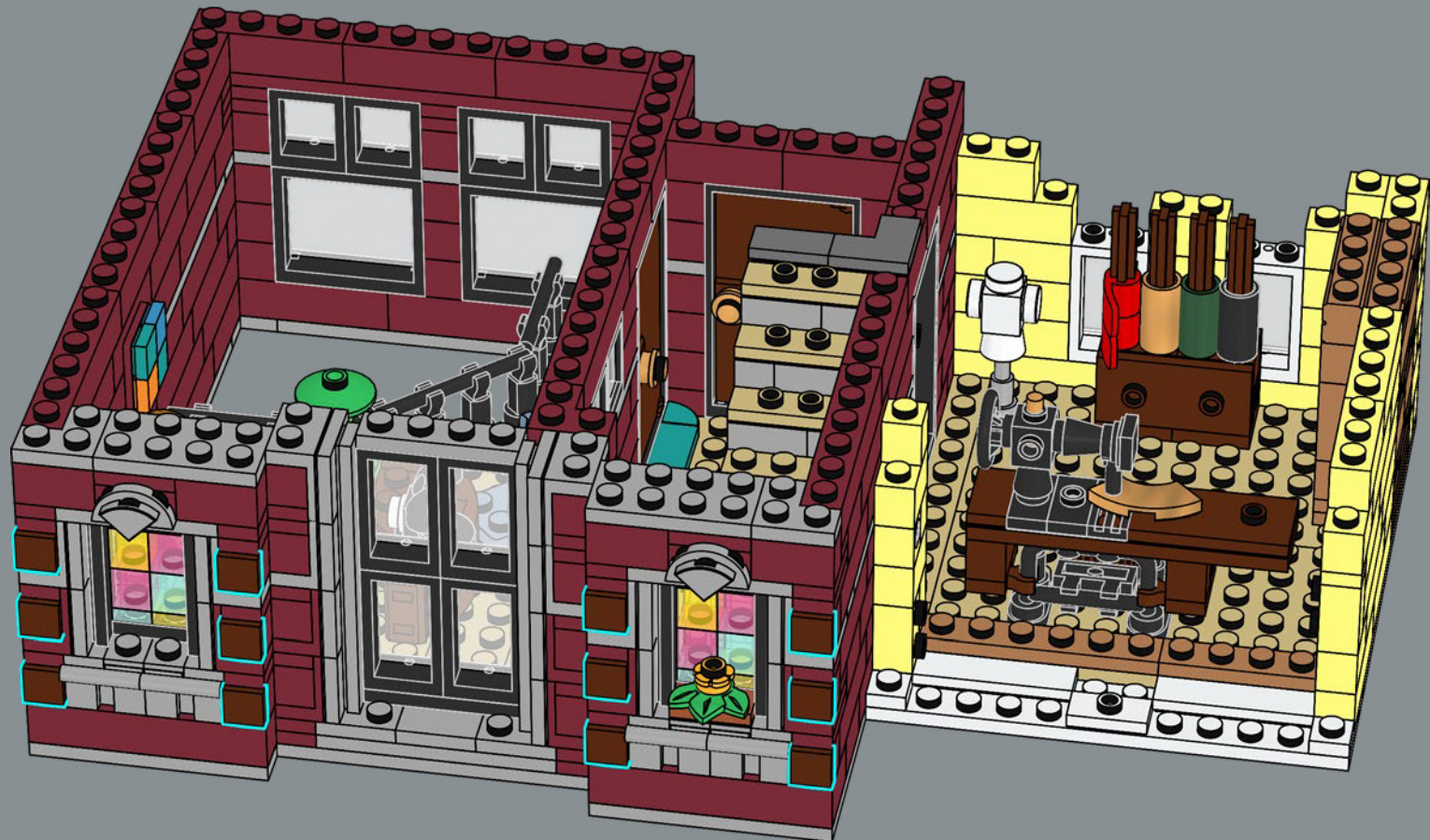

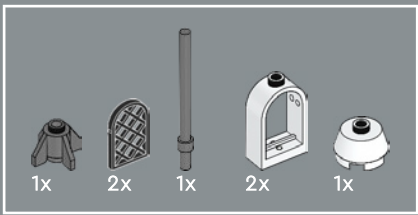

257

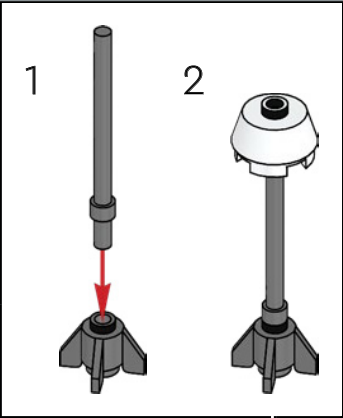
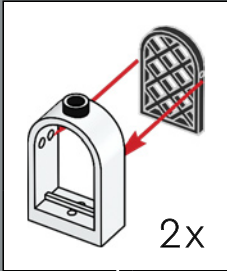
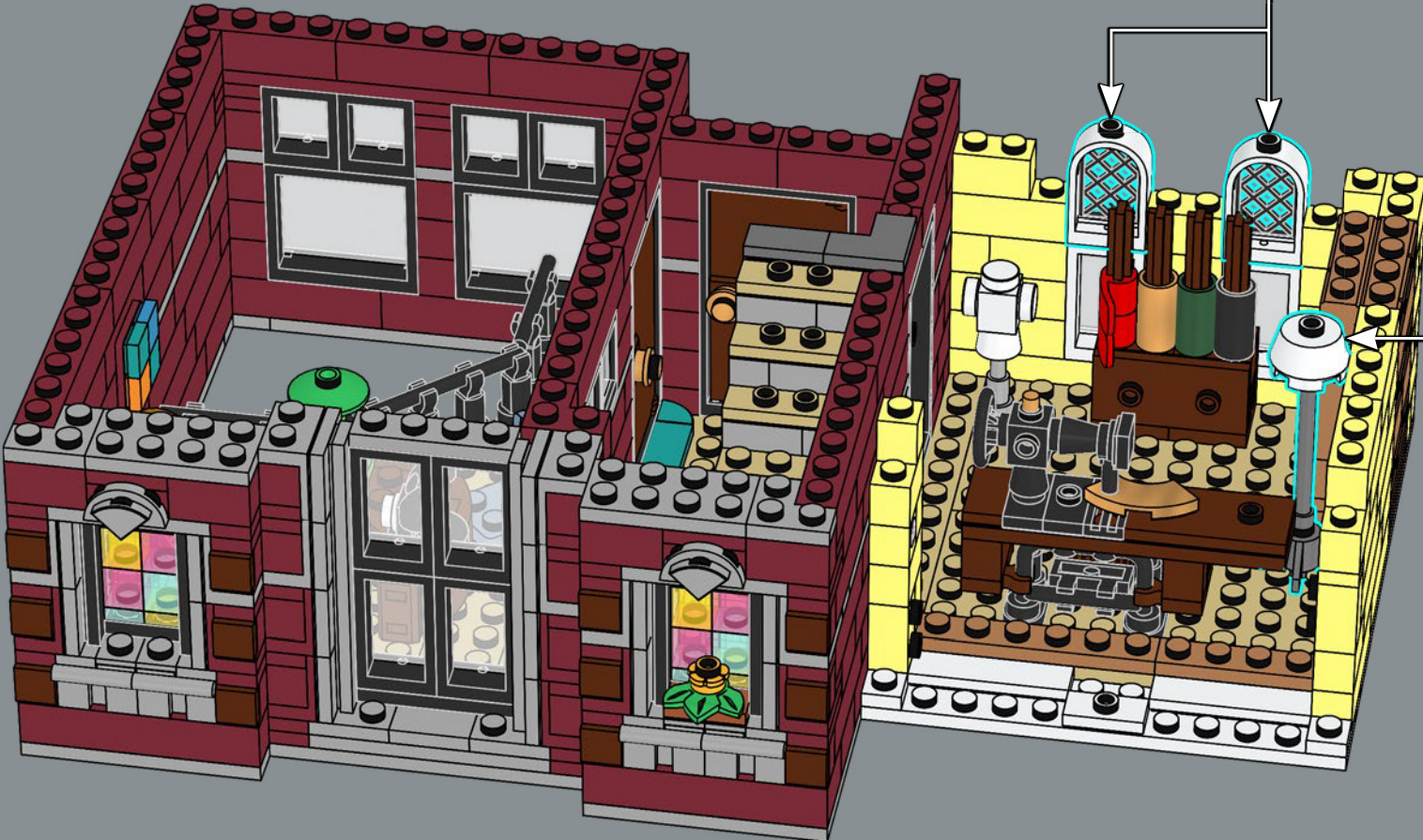

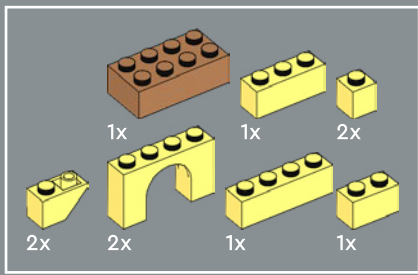

258

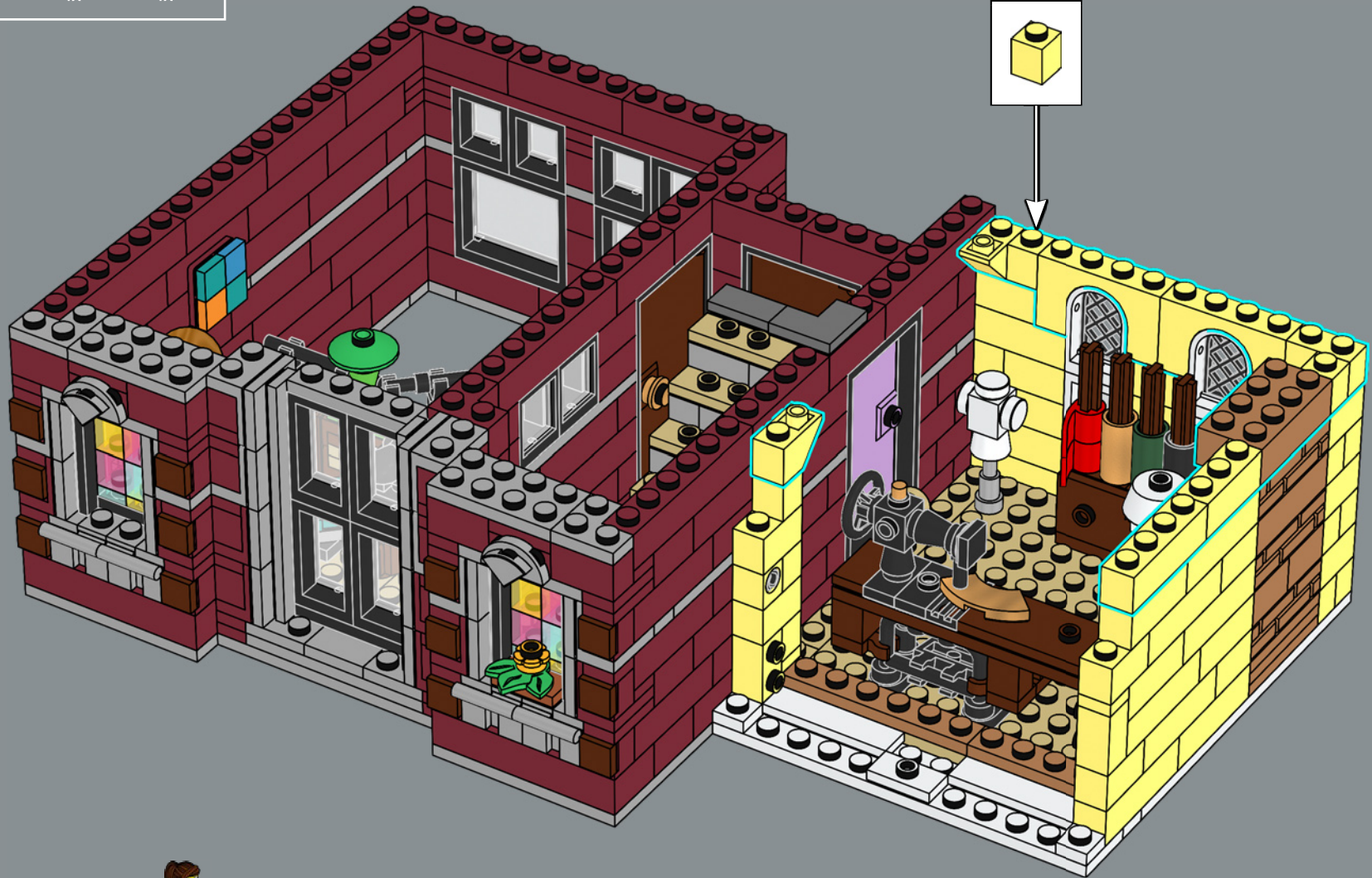



259

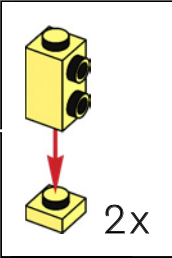
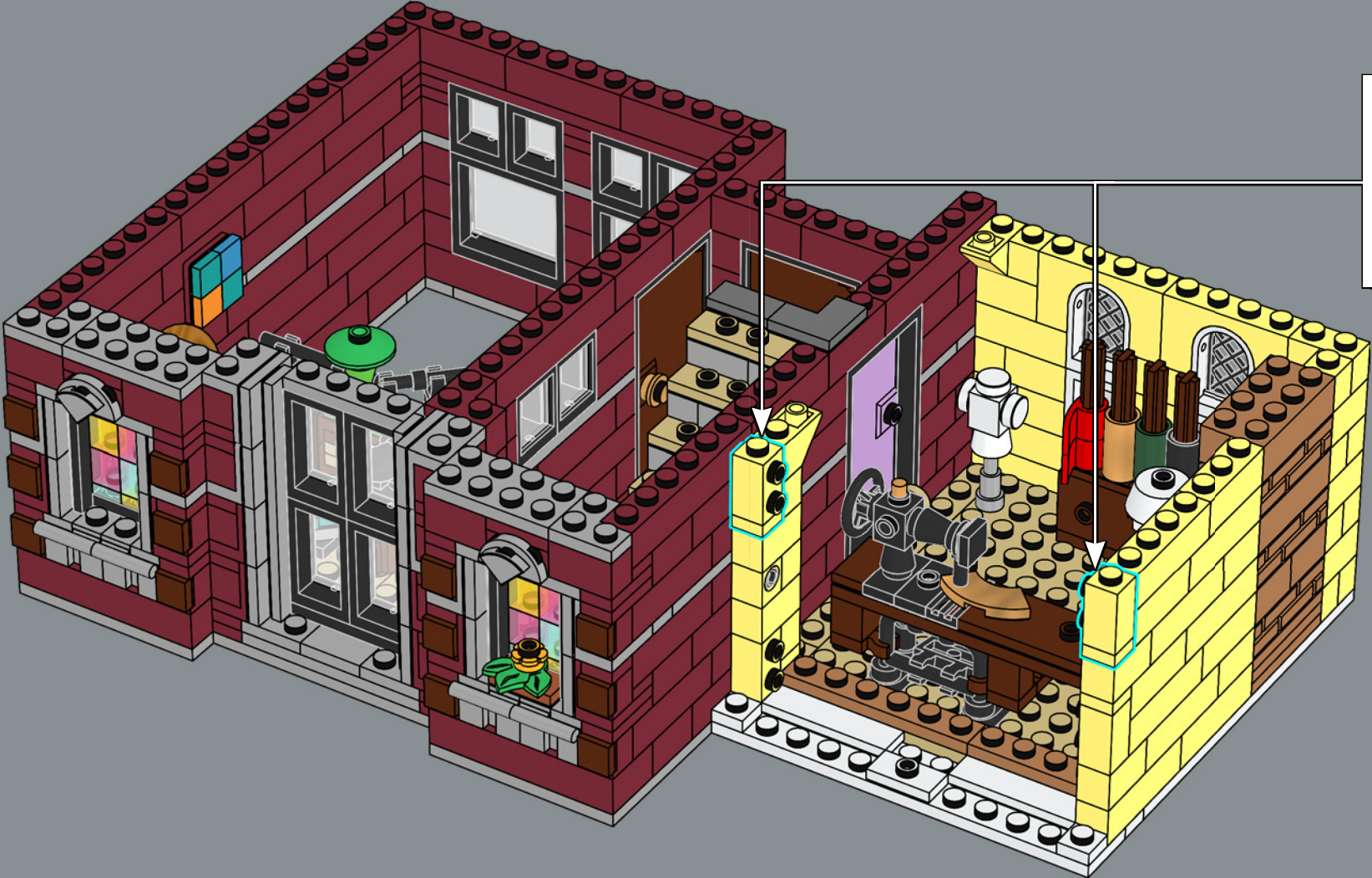

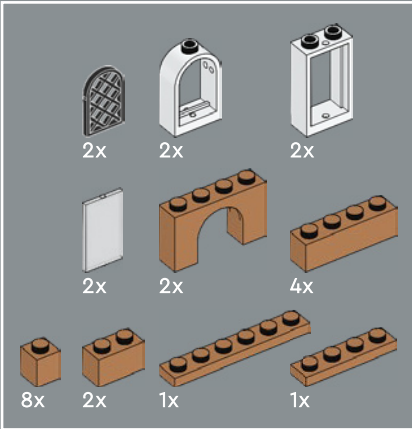
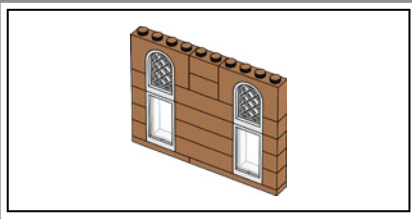

260

1

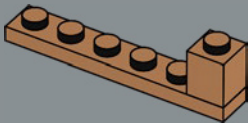

2

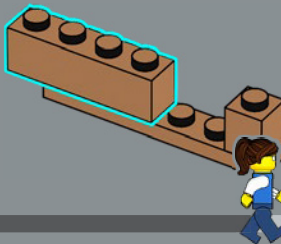

3

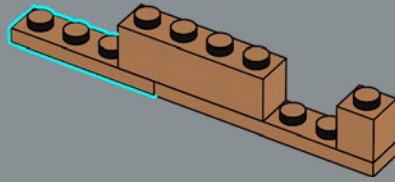

4

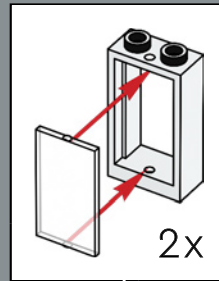
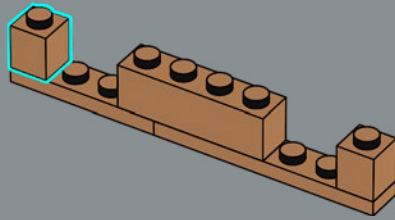

5

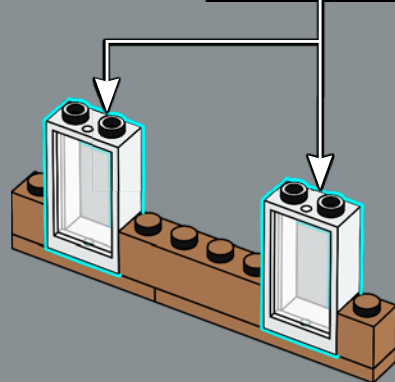

6

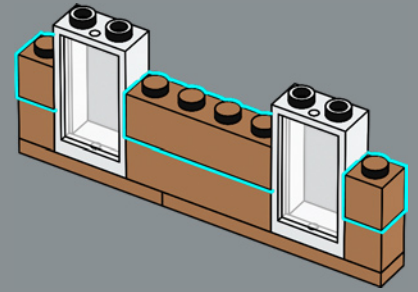

7

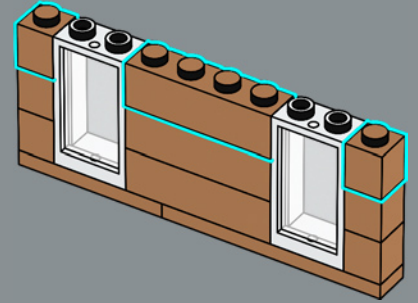

8

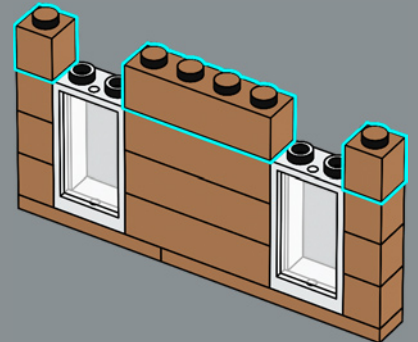

9

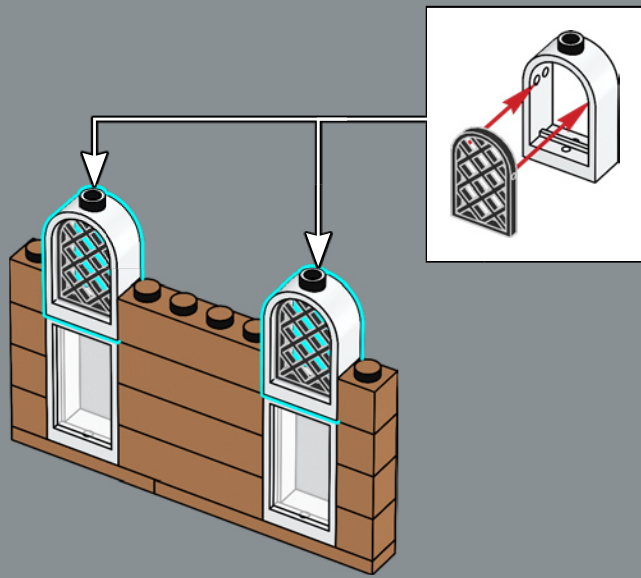

10

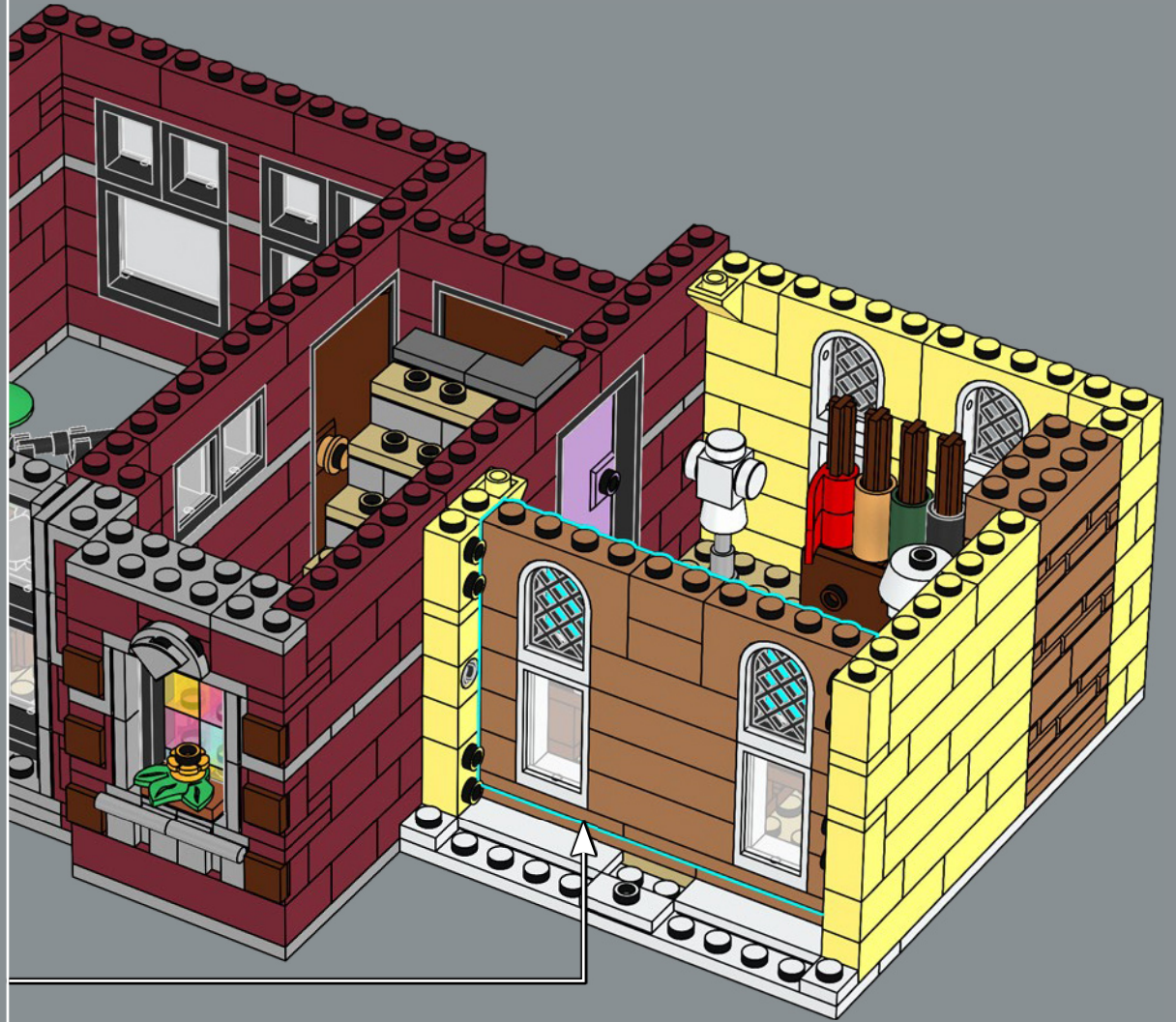
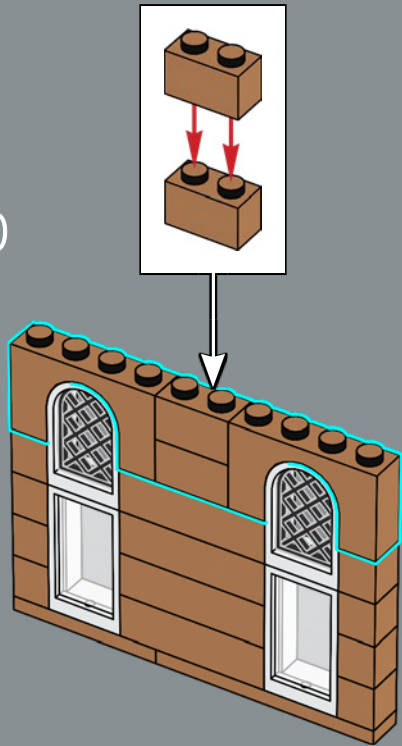

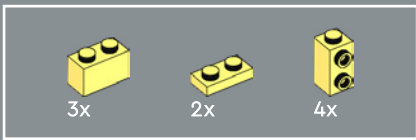

261

1

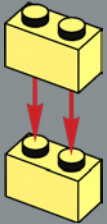

2

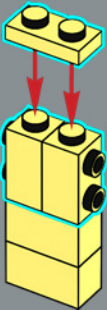

3

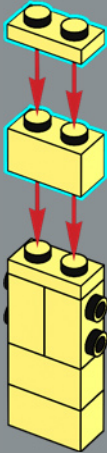

4

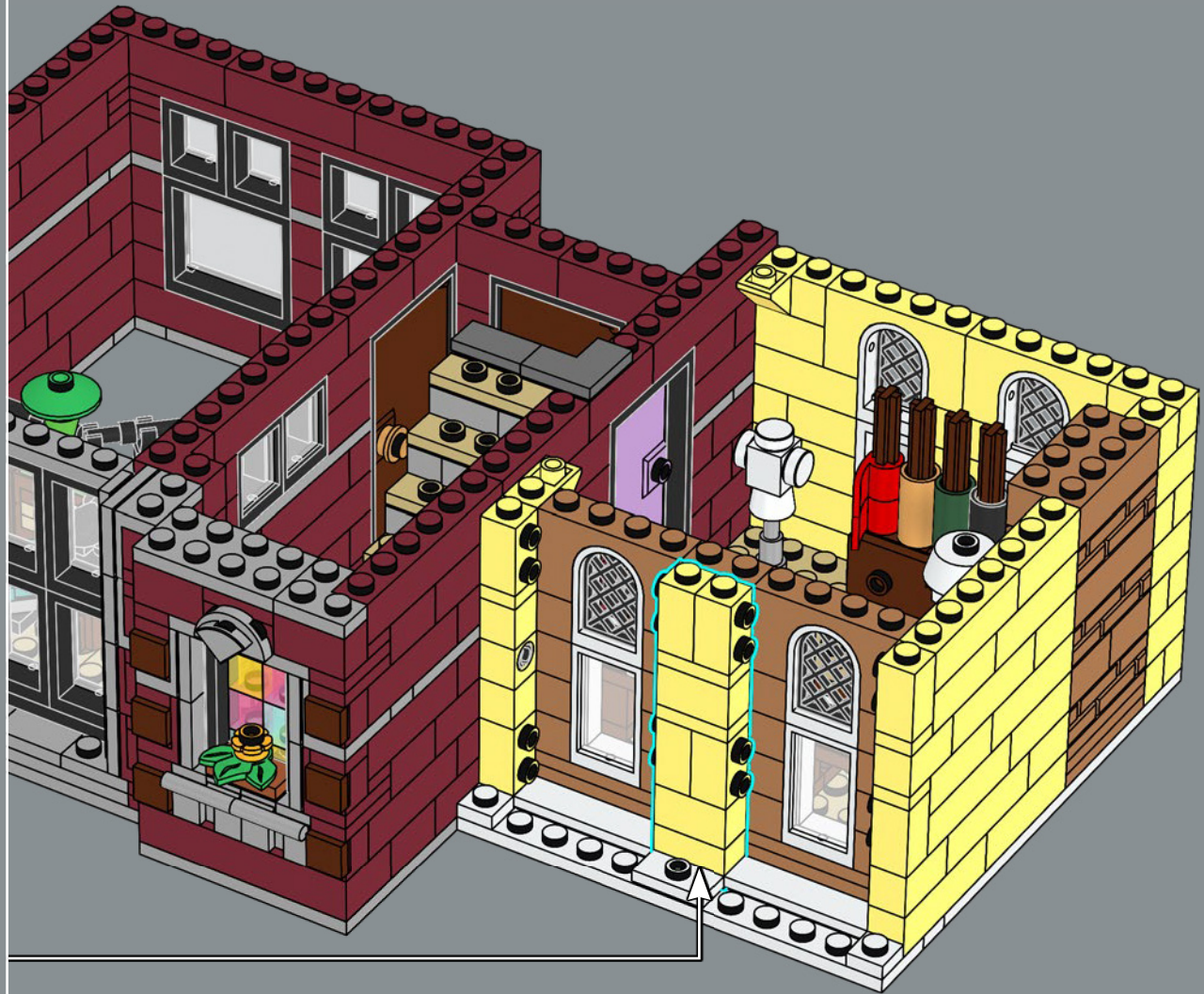
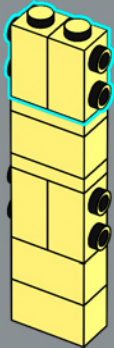

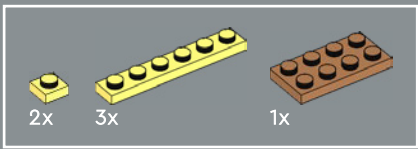

262

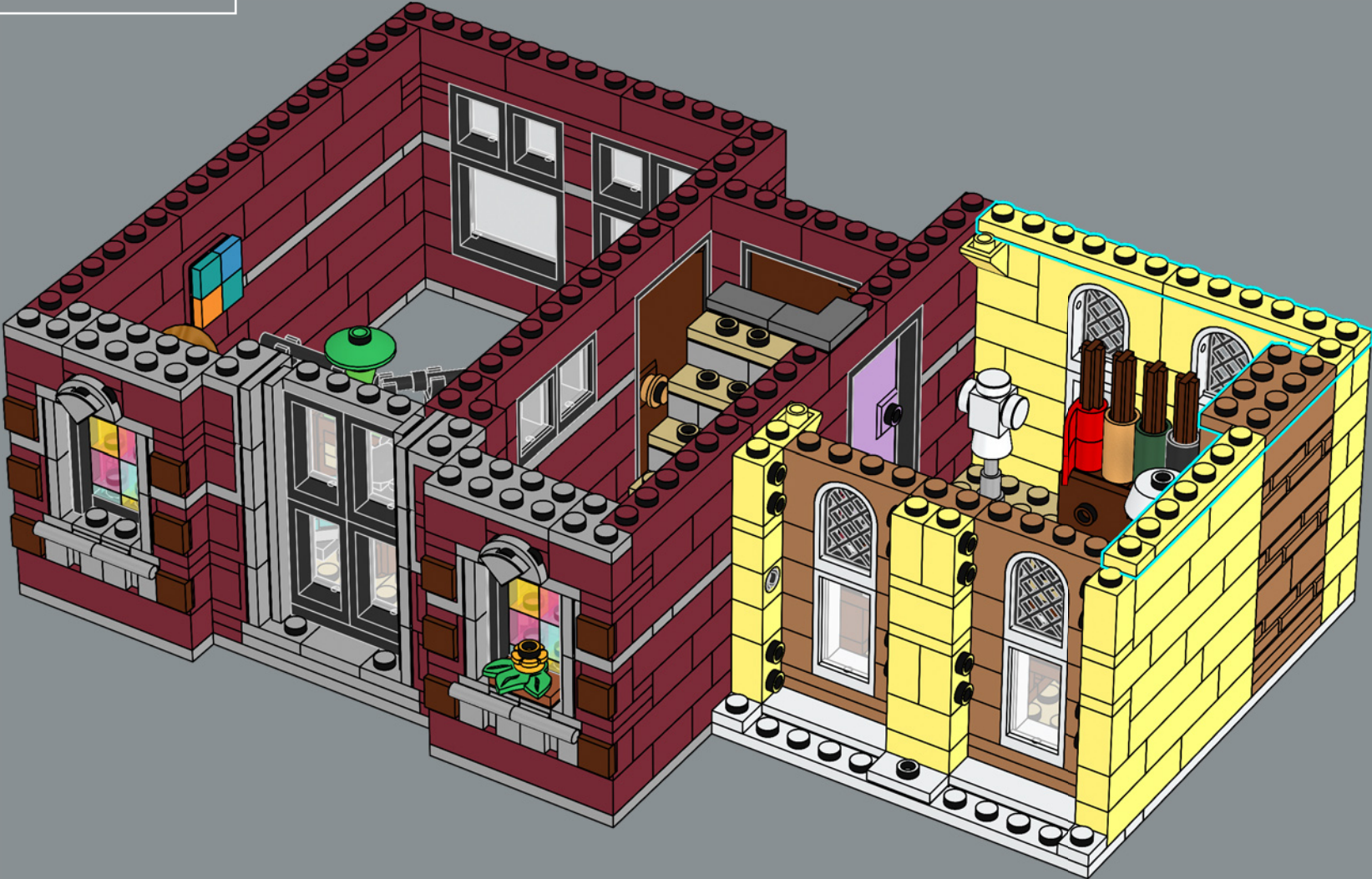

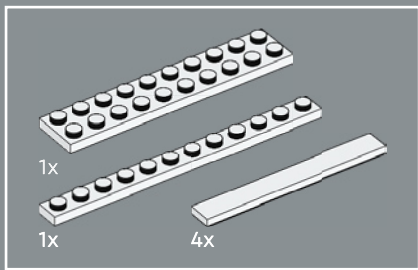

263

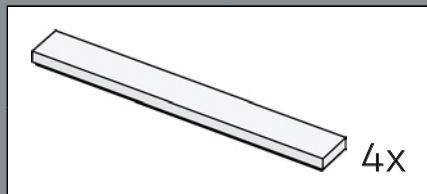

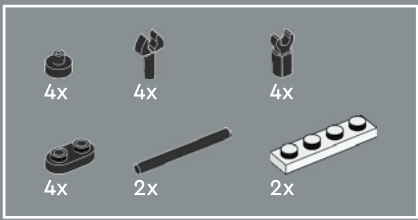

264

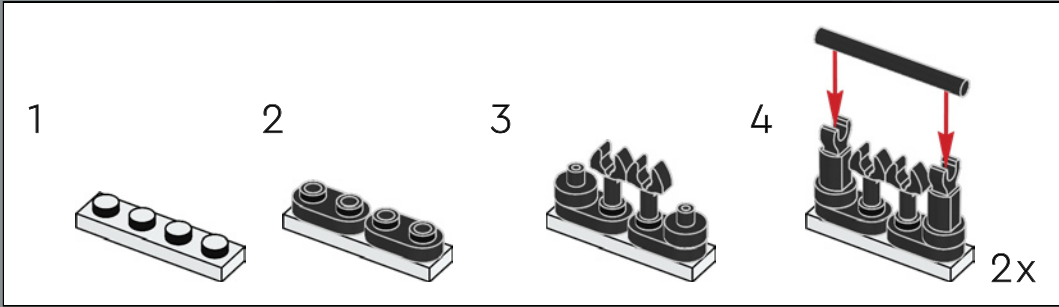

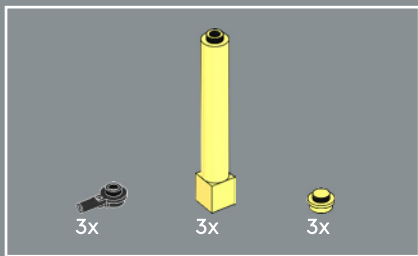

265

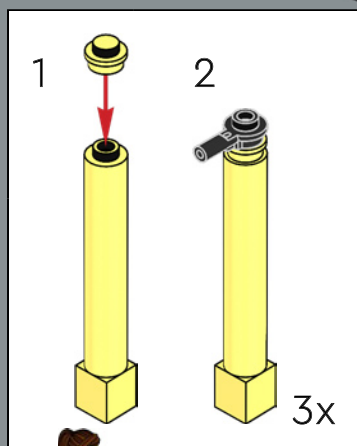
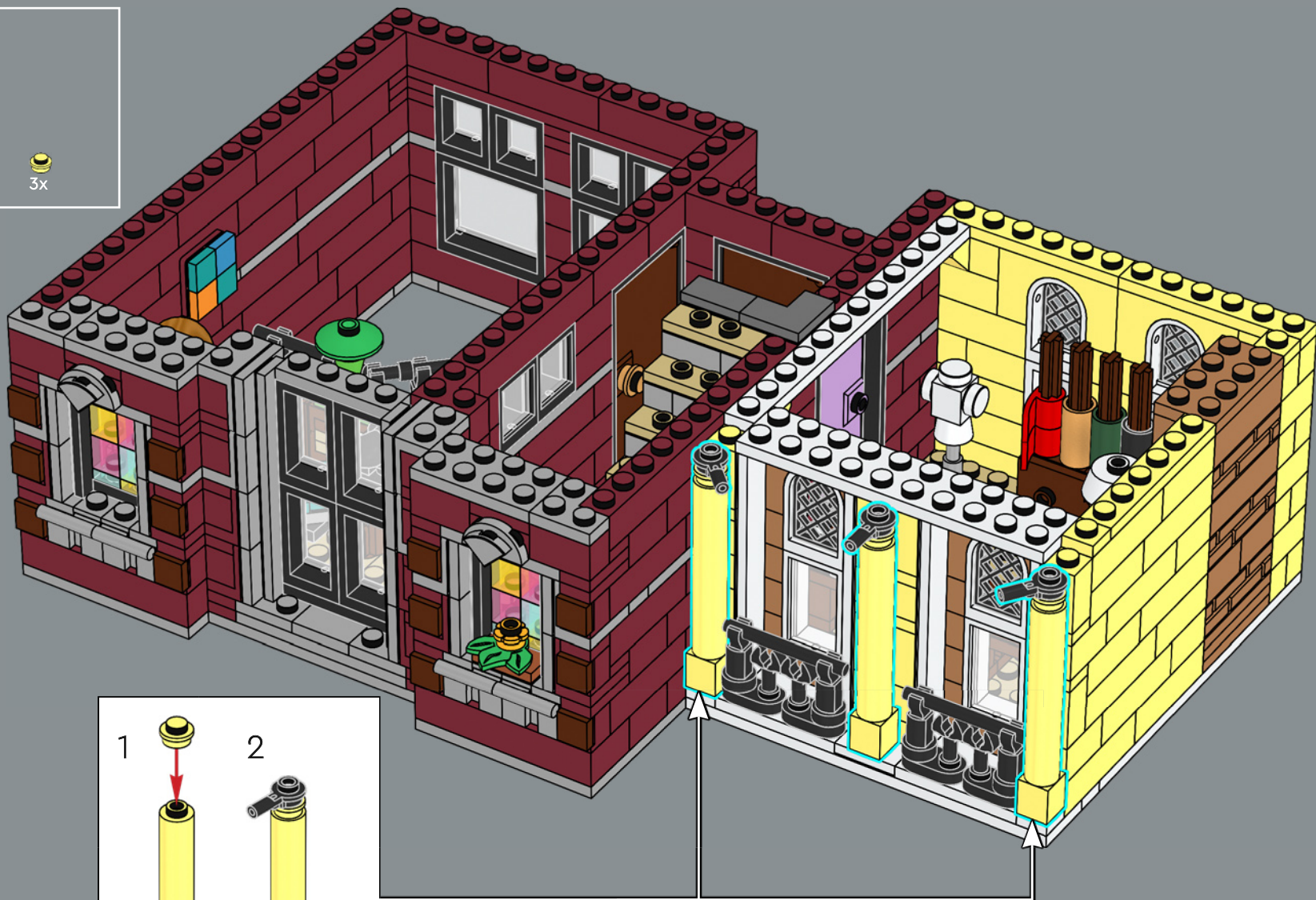



3x

266

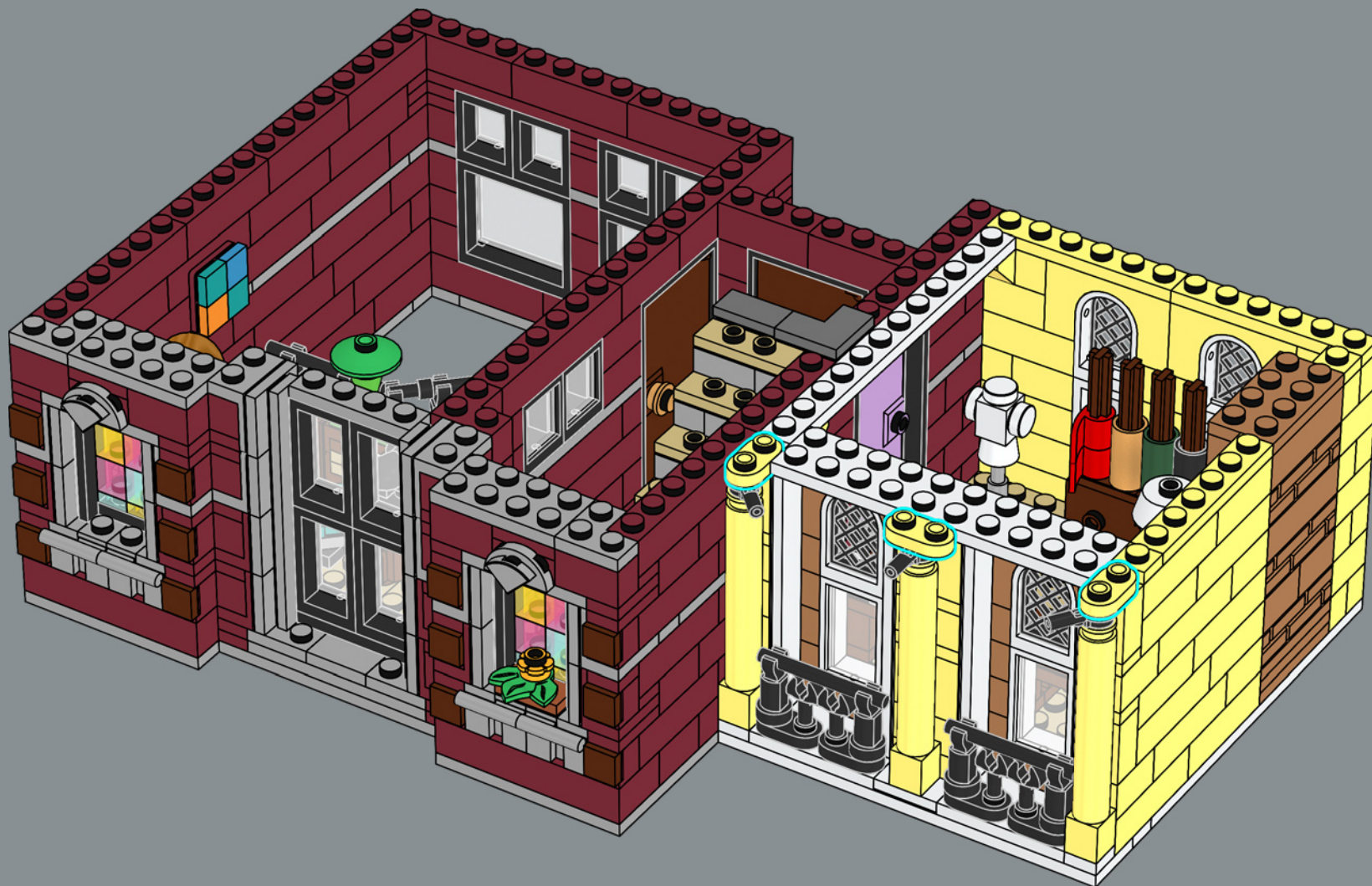

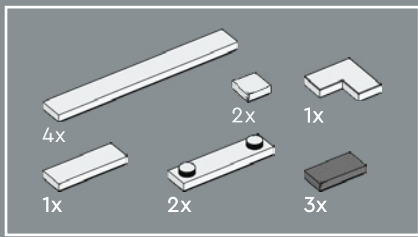

267

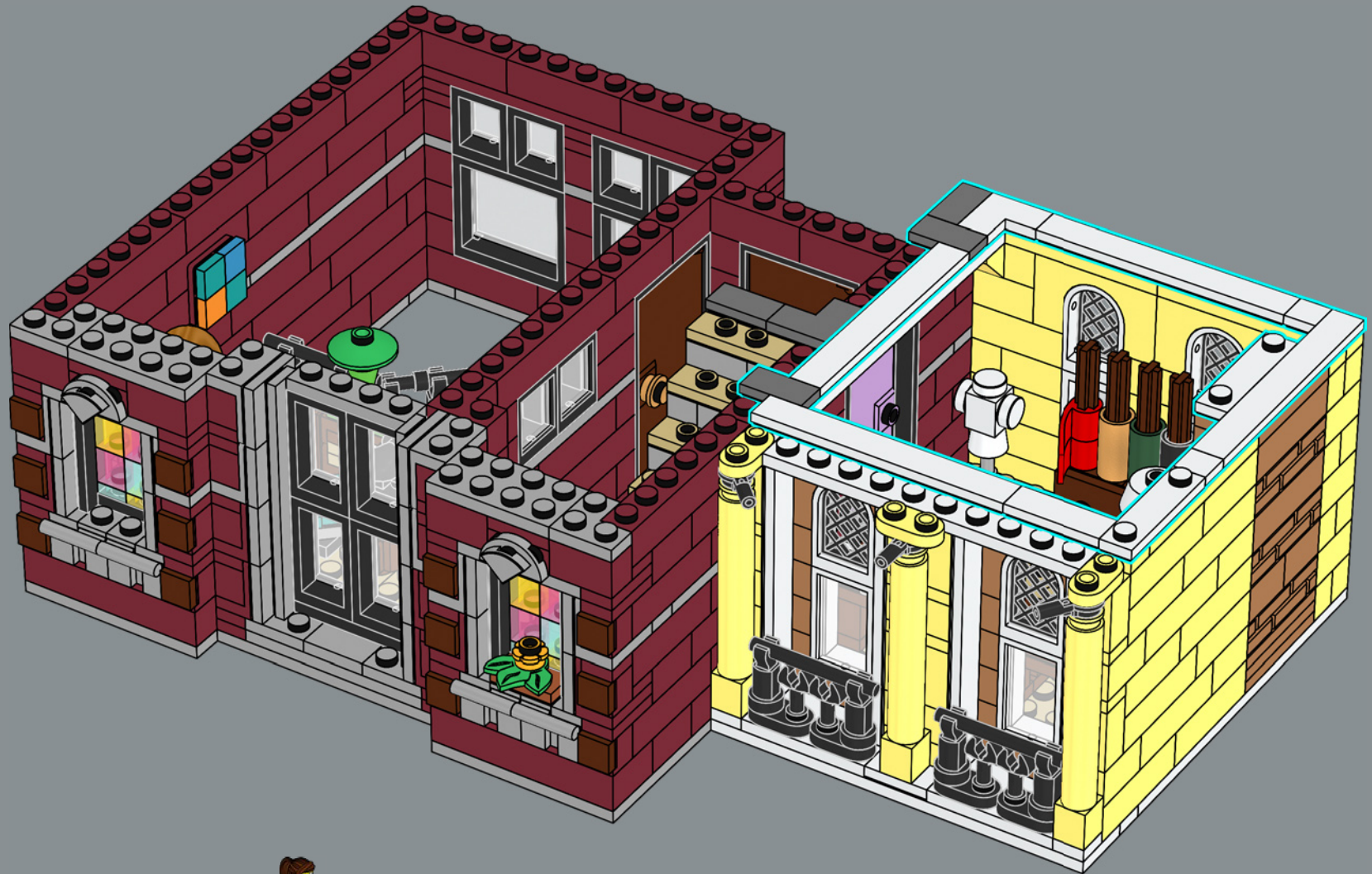

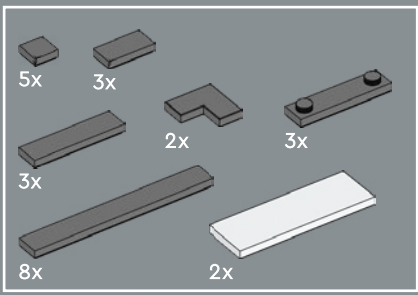

268

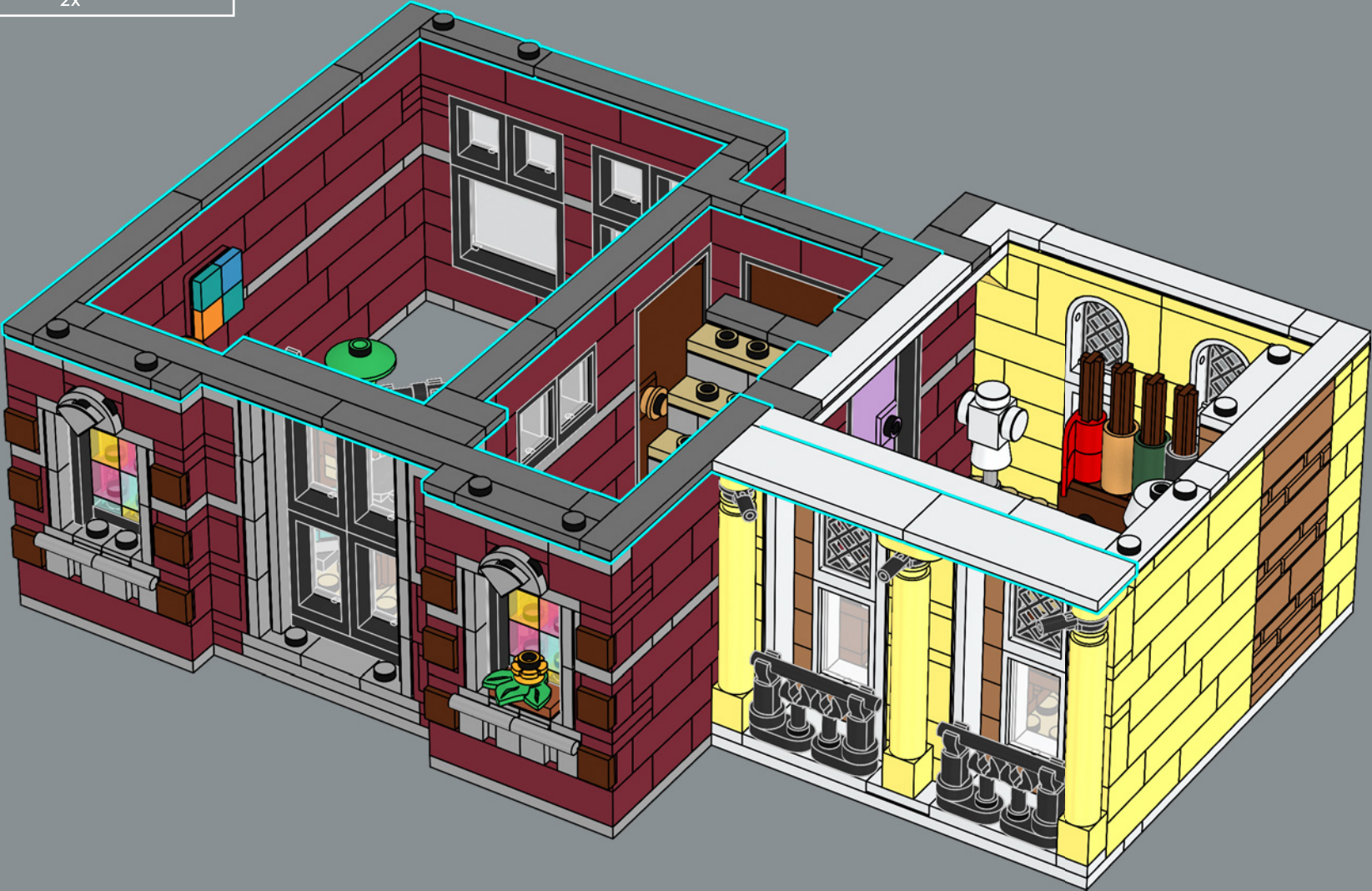



269



Flores de lavanda colgantes, un letrero y puertas de color lavanda... Si necesitas visitar al sastre, ¡solo tienes que seguir este elegante tono!

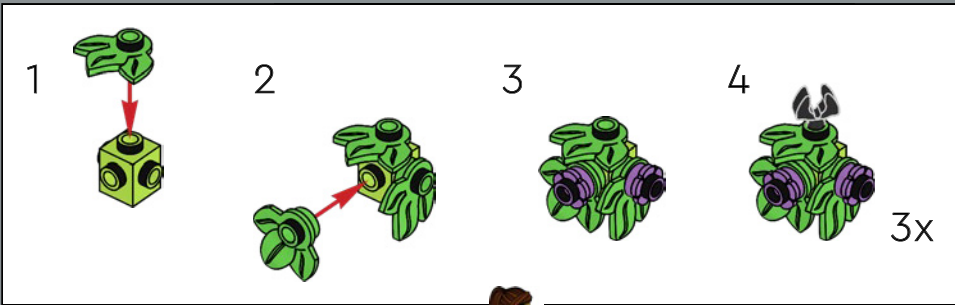

270





La cantante está casi lista para el espectáculo de esta noche. Ya ha recogido su vestido en la sastrería, ha comido algo en la pizzería, ha pasado a charlar un momento con la encargada y ahora está terminando de prepararse en el camerino.

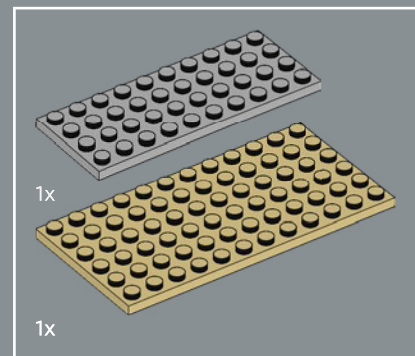
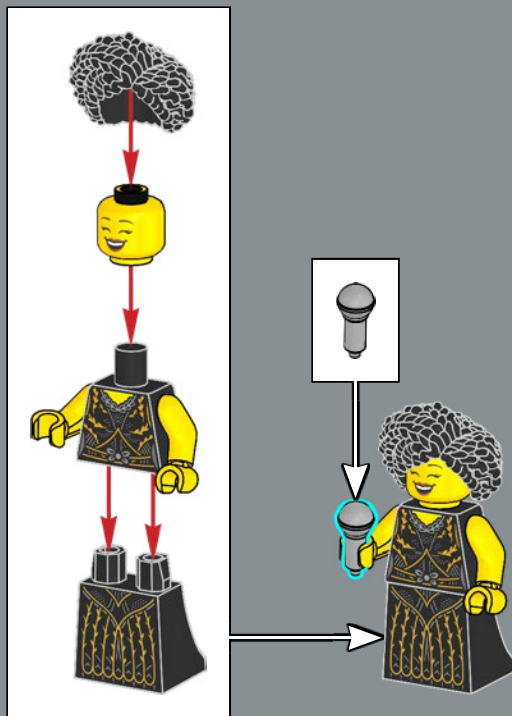
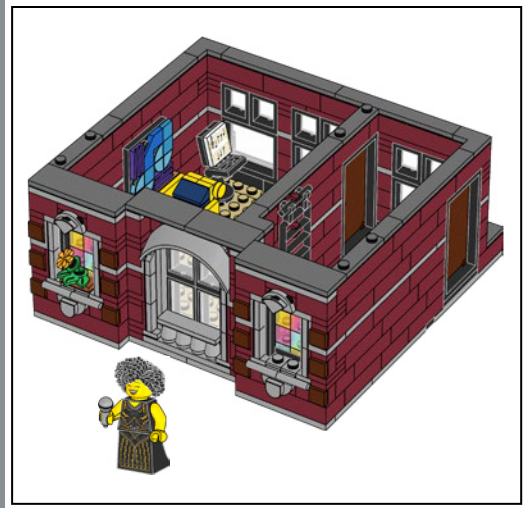

271

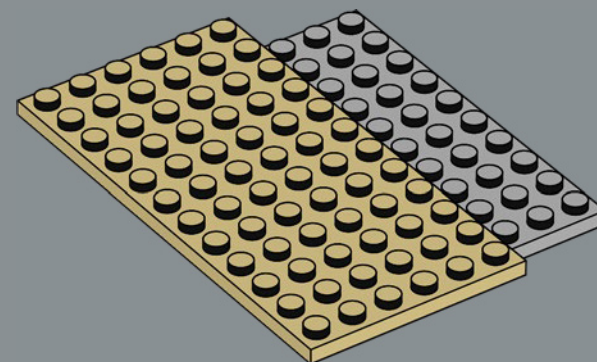

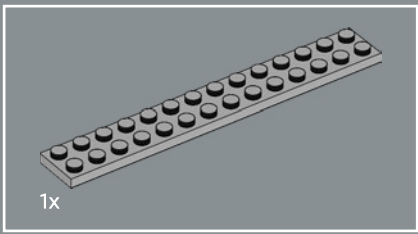

272

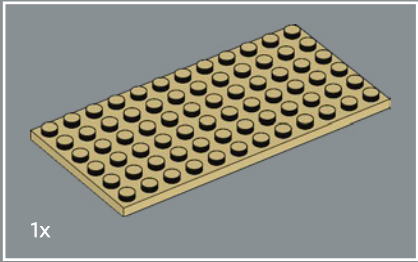
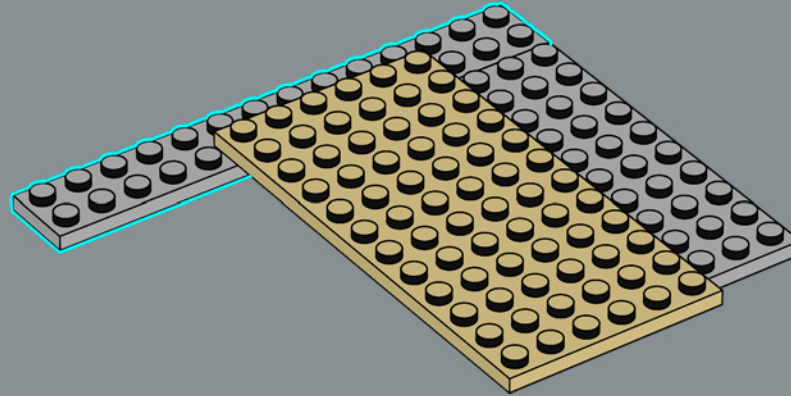

273

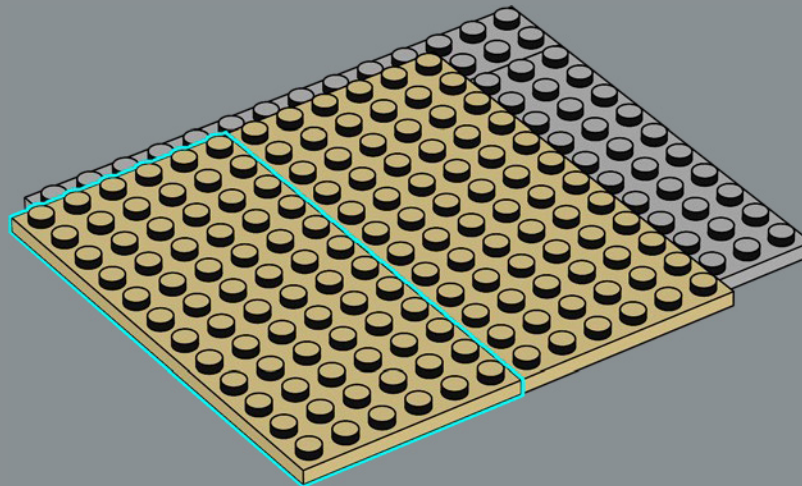

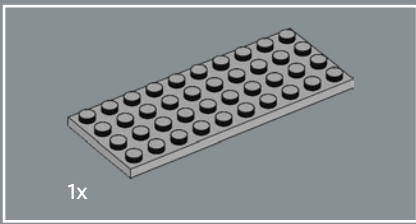

274

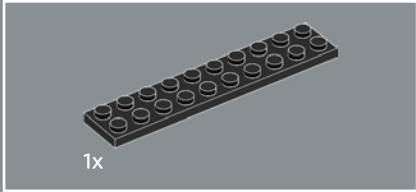
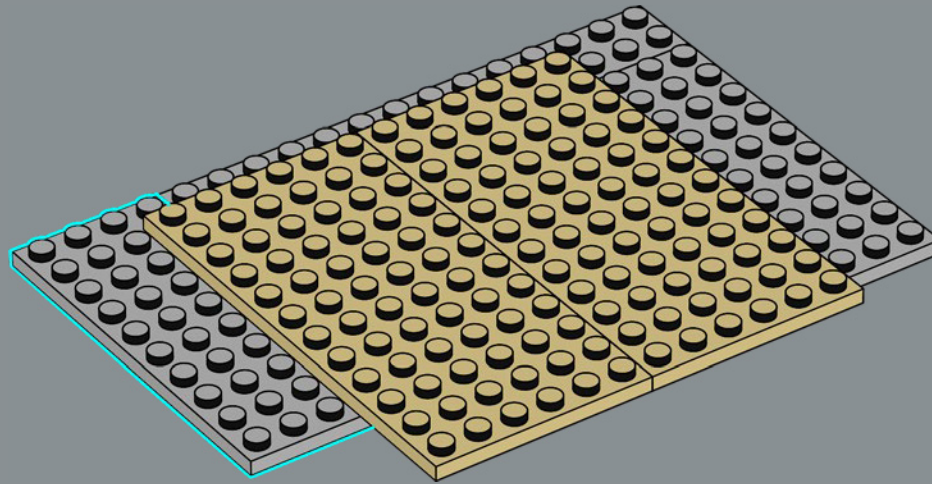

275

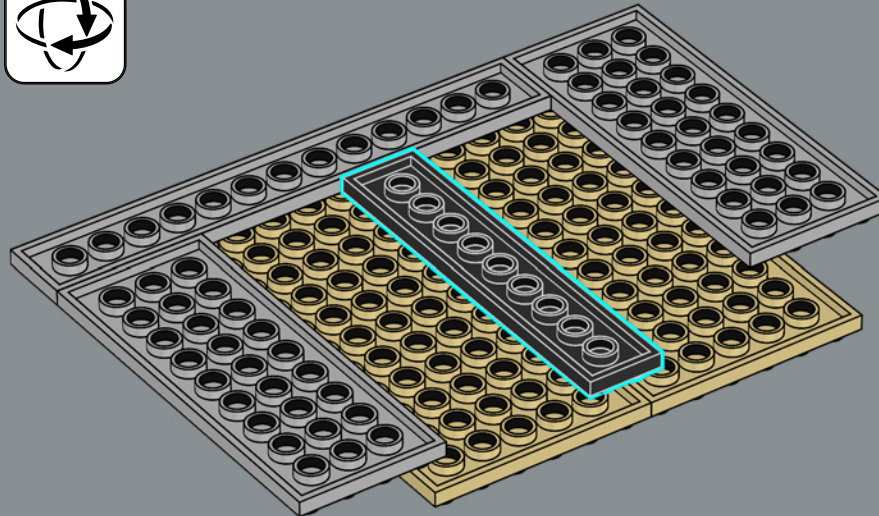

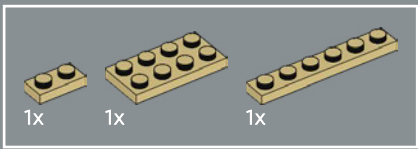

276

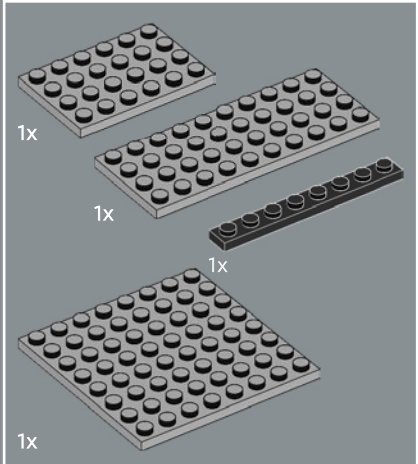
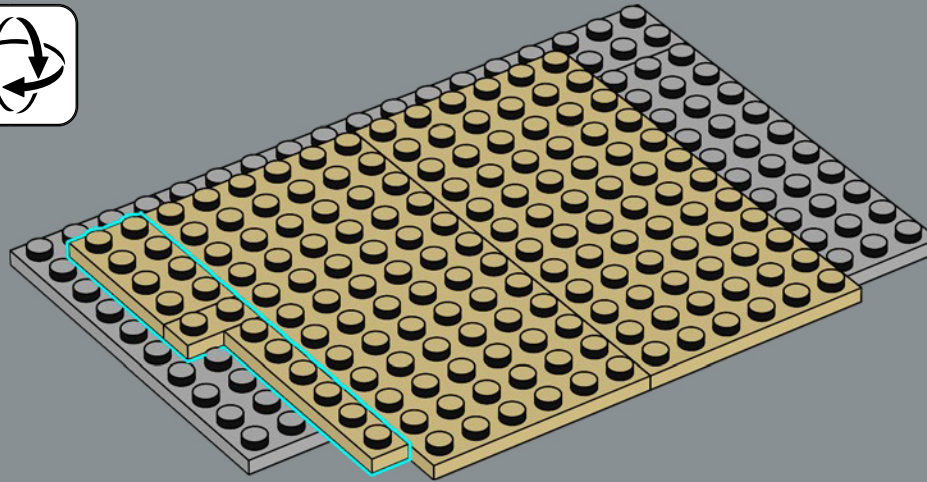

277

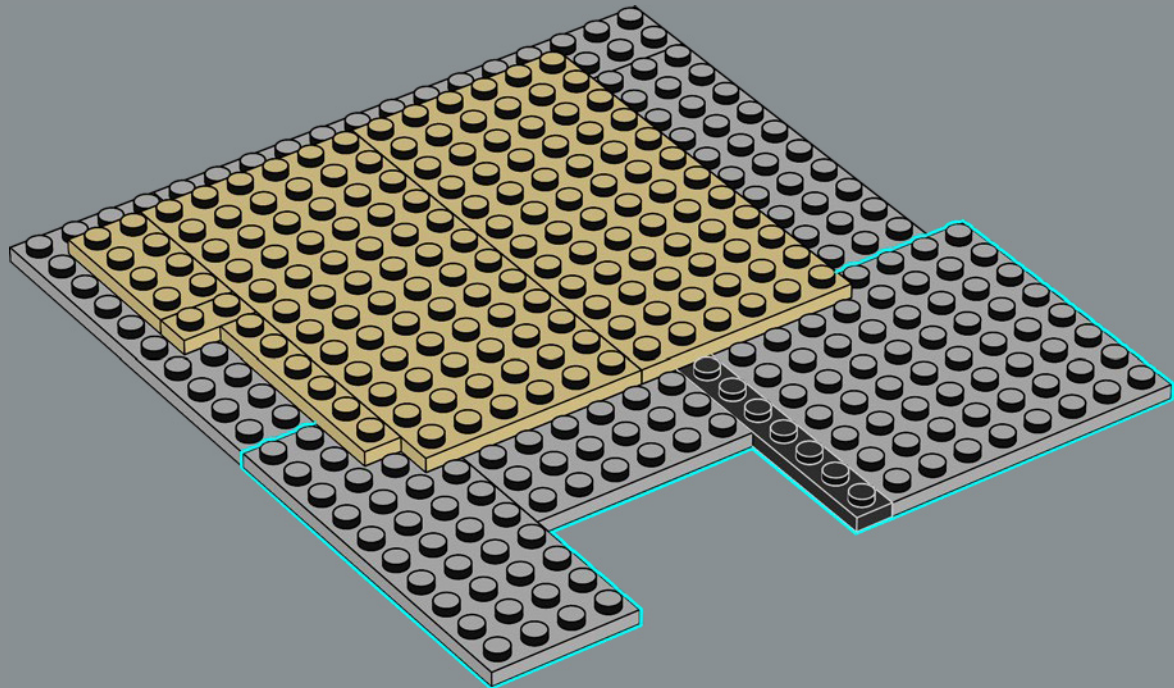

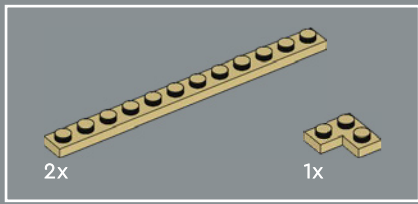

278

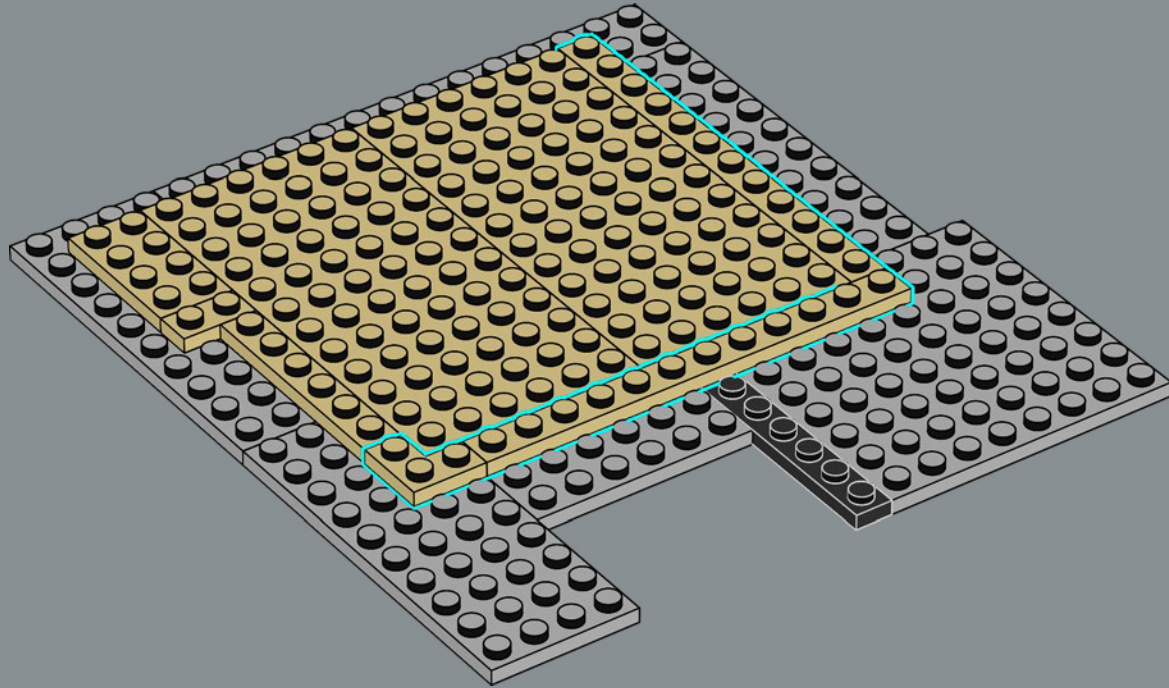

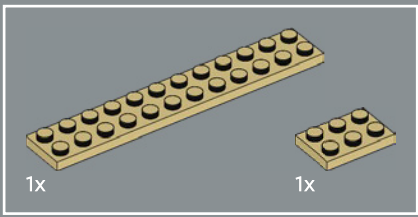

279

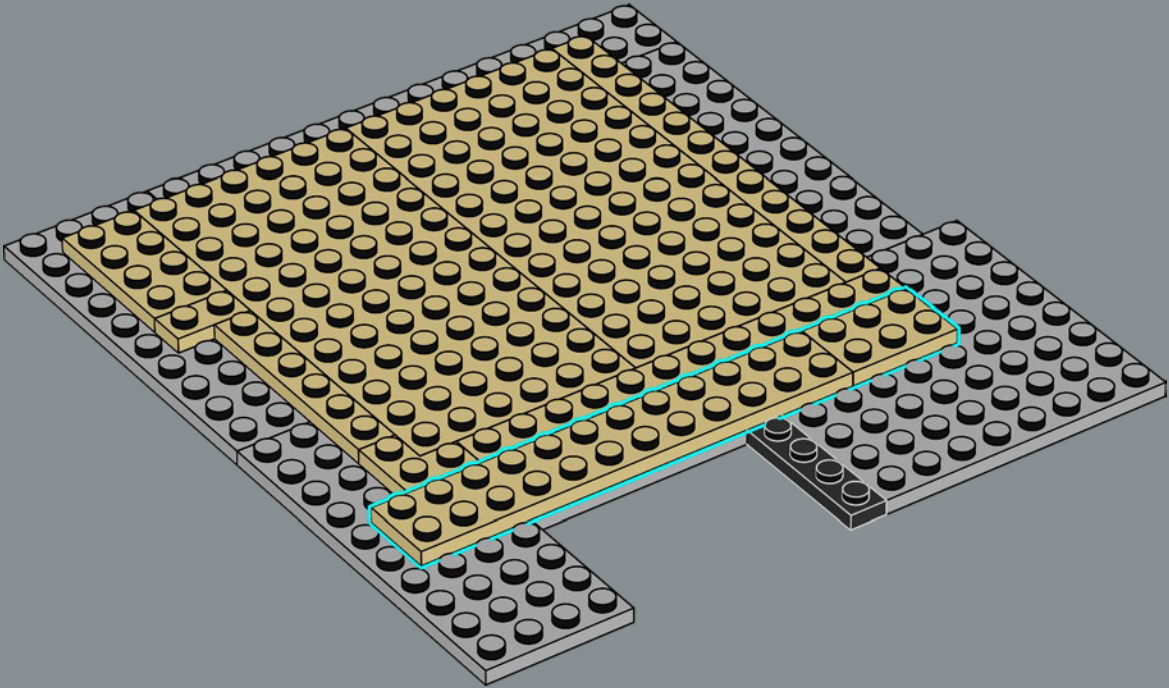

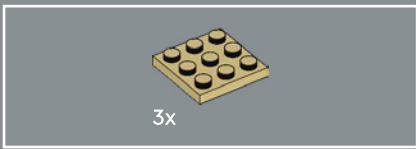

280

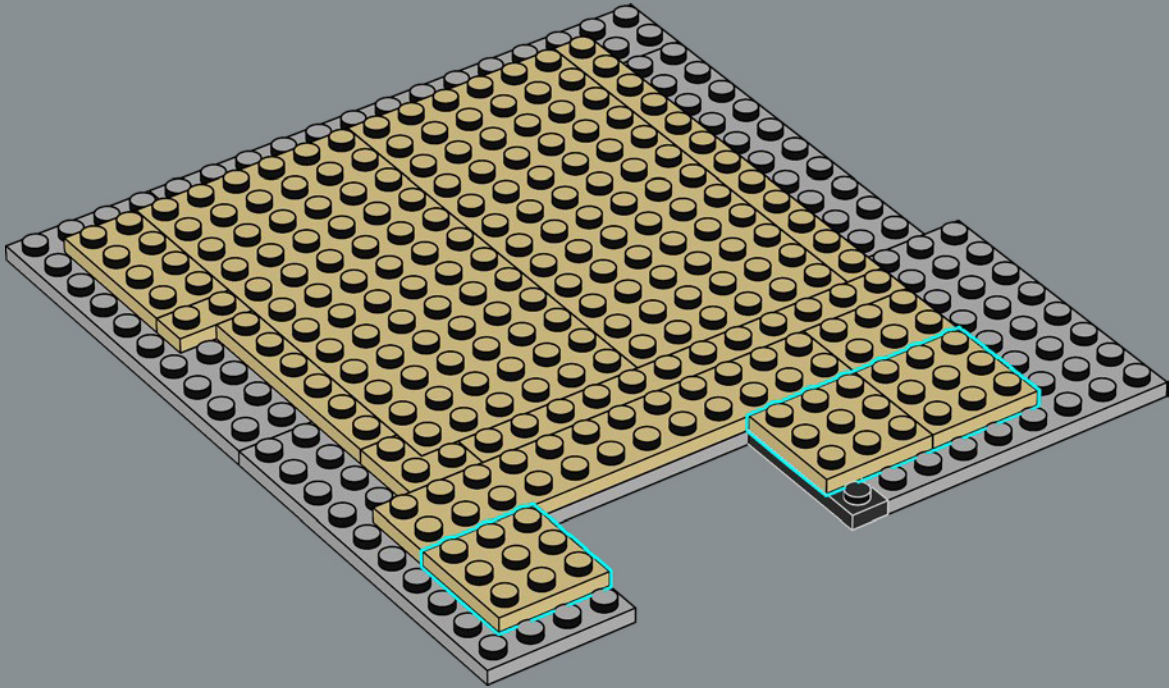

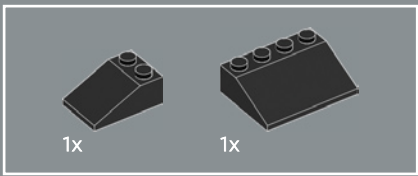

281

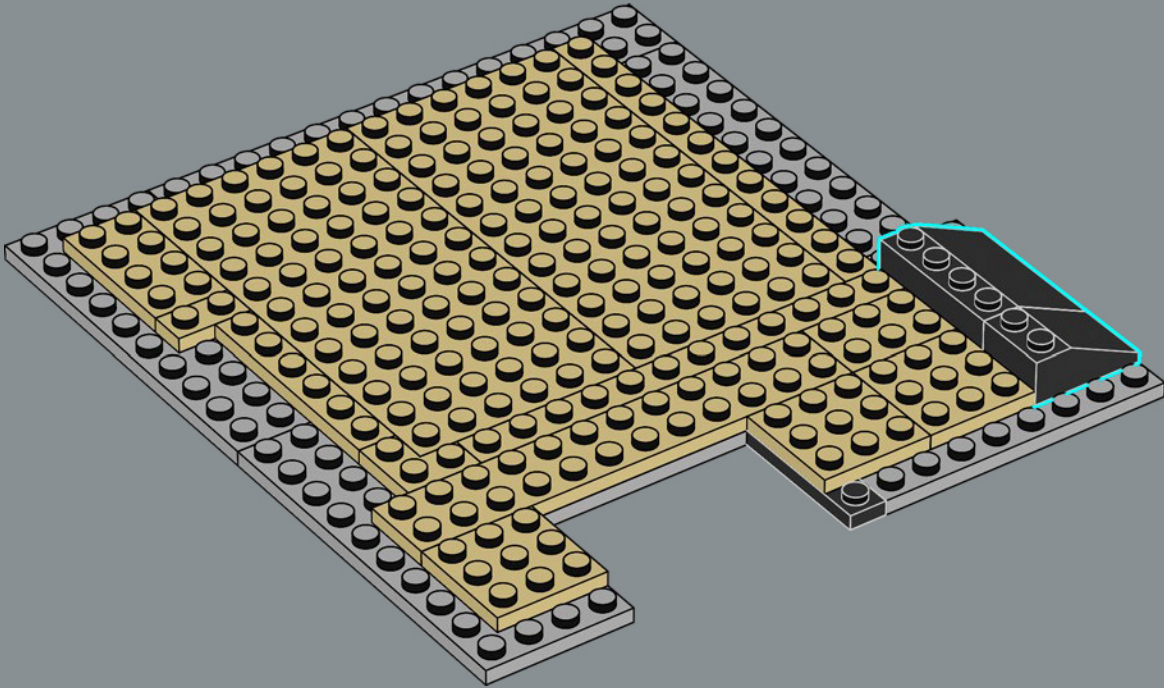

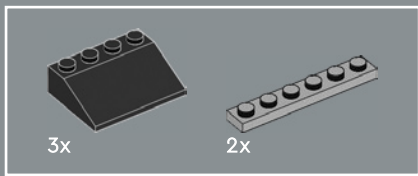

282

1

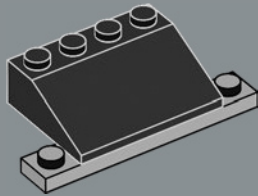

2

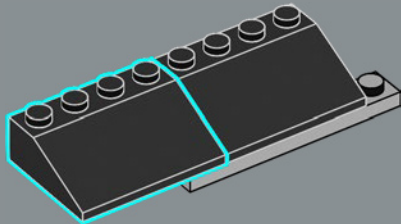

3

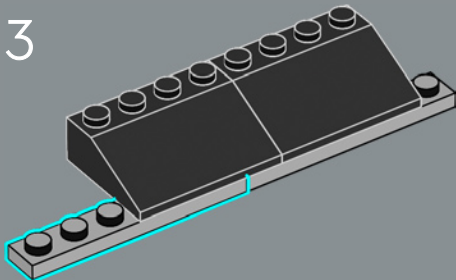

4

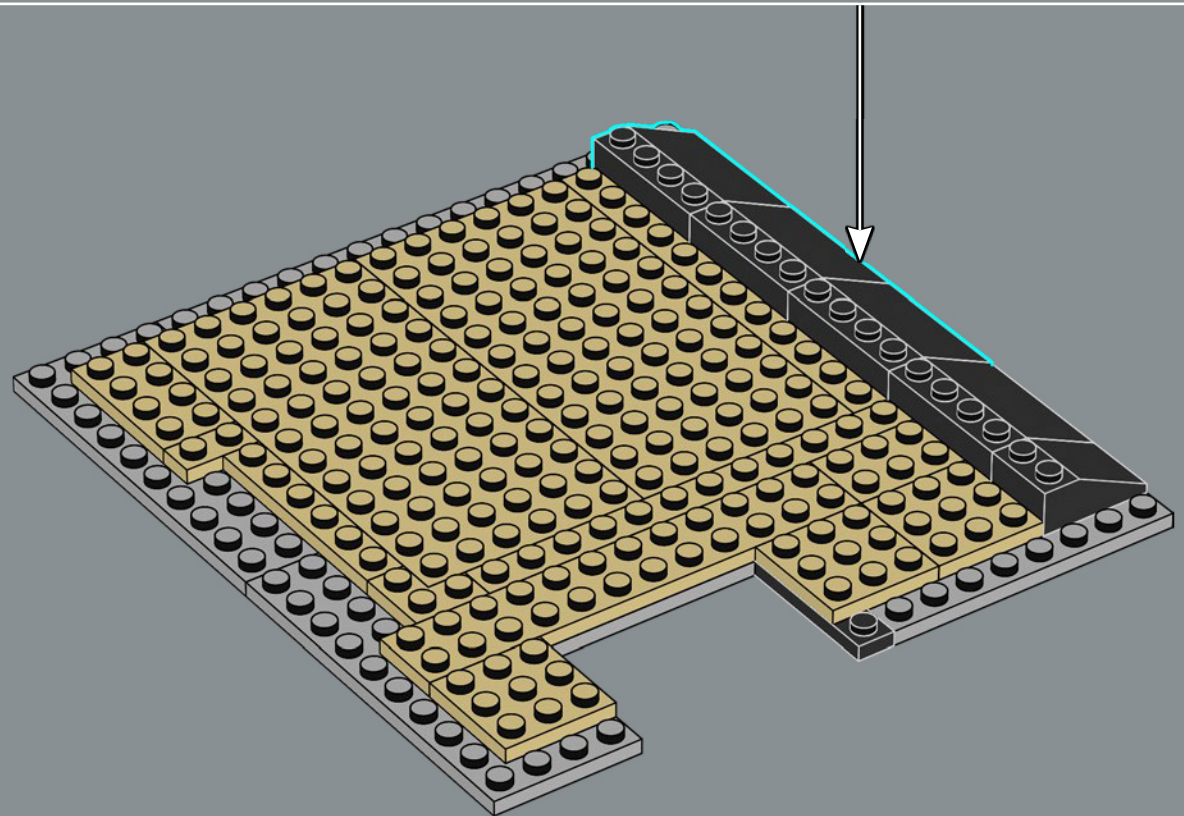
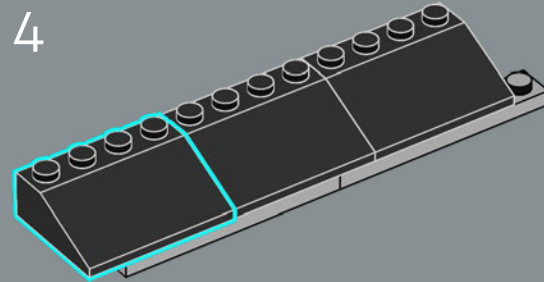

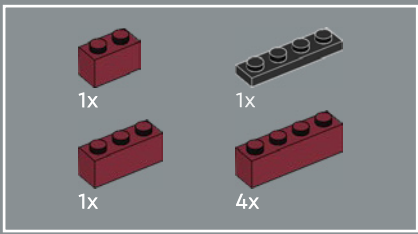

283

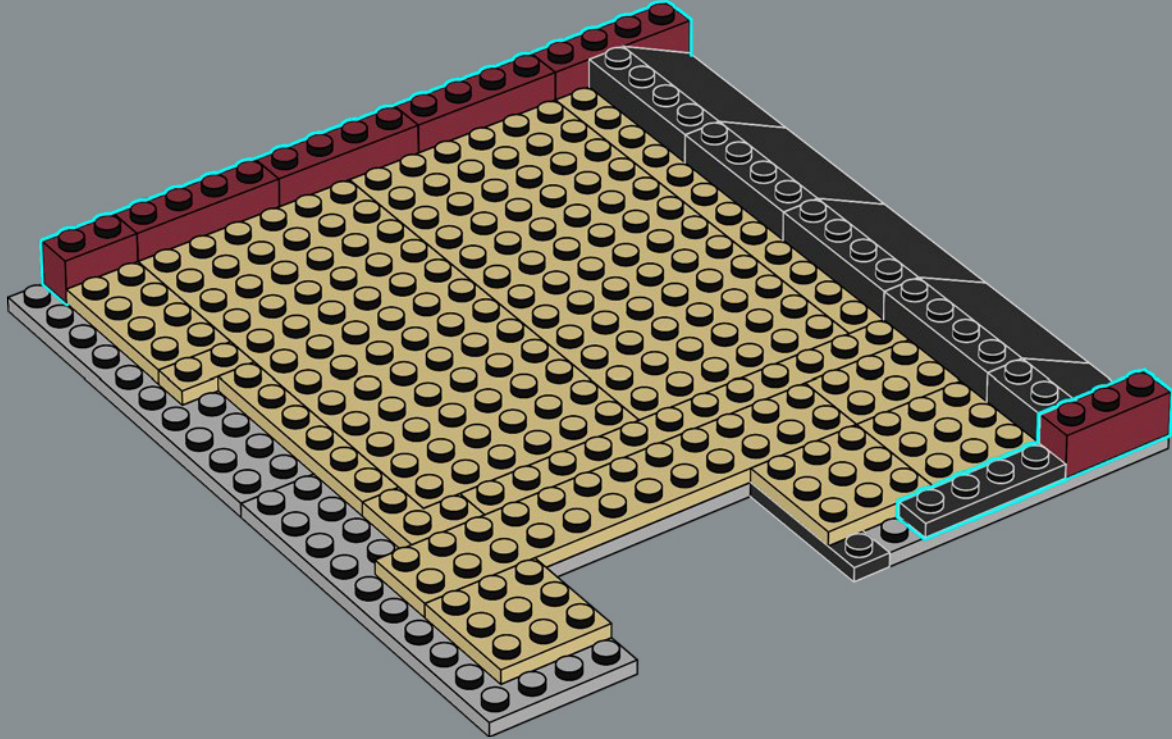

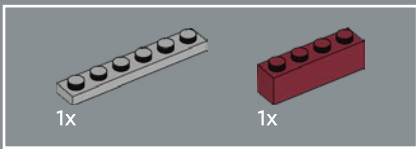

284

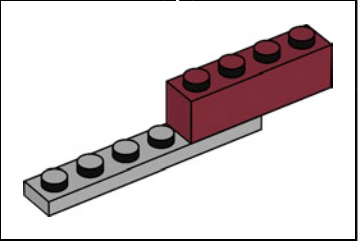
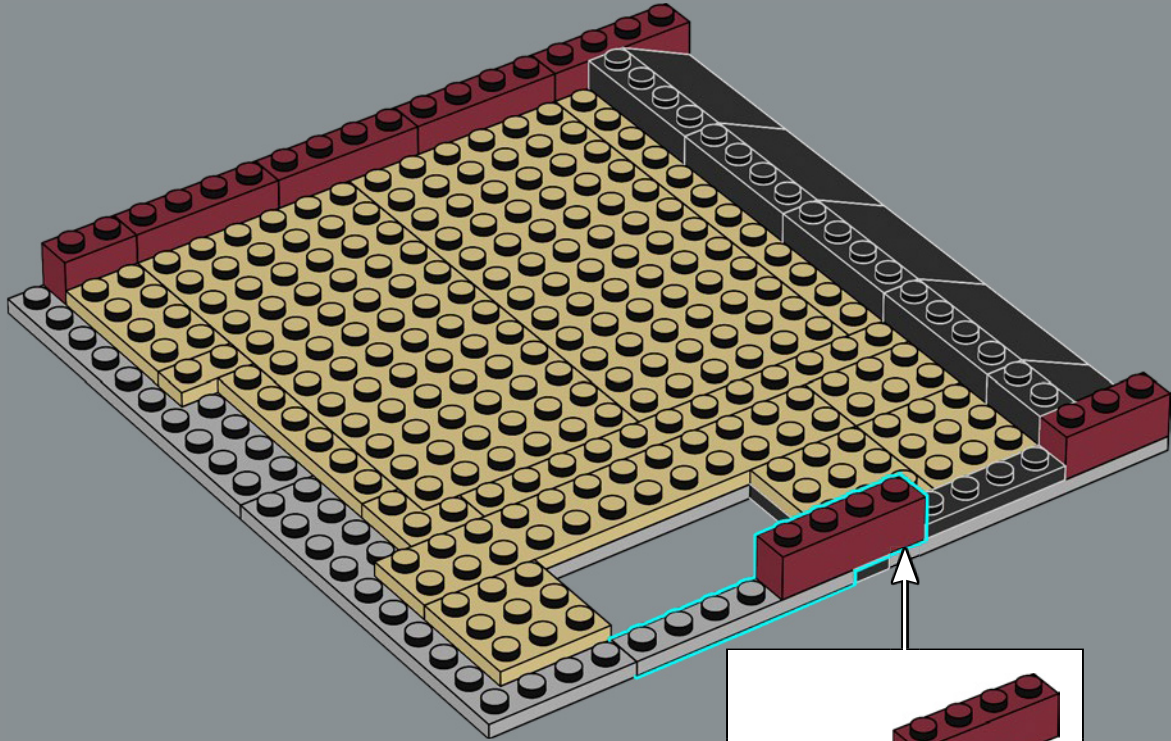

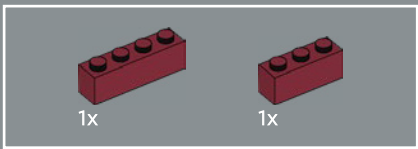

285

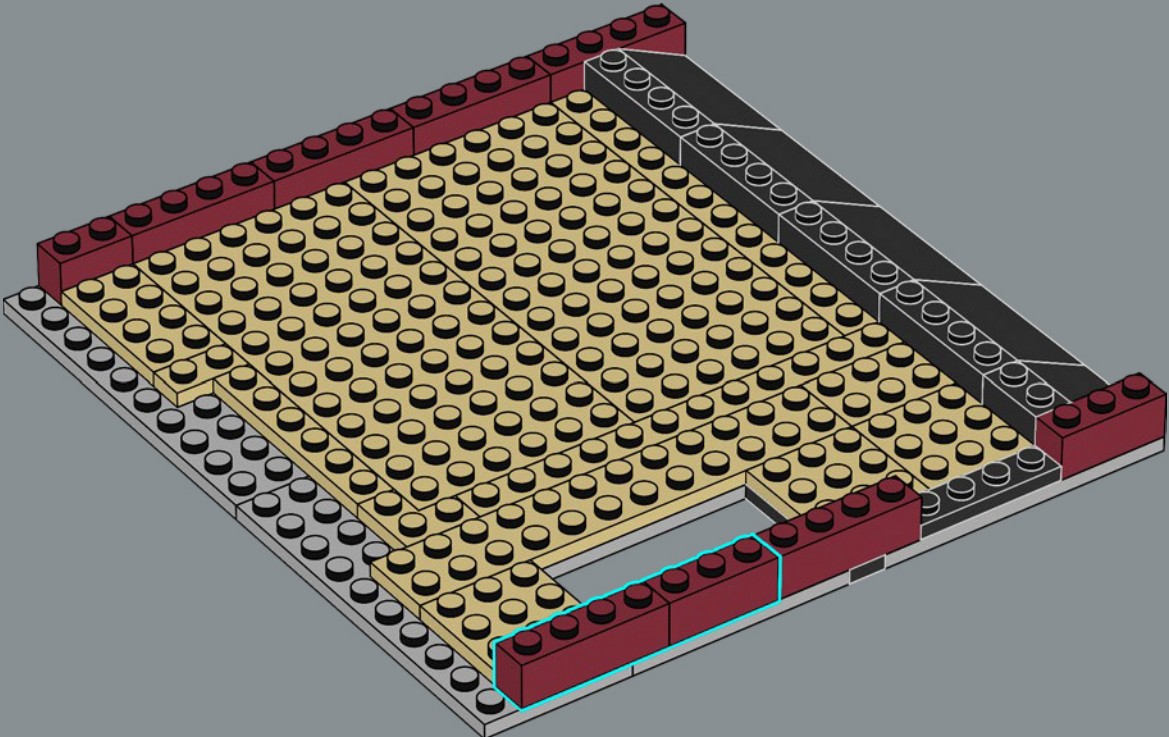

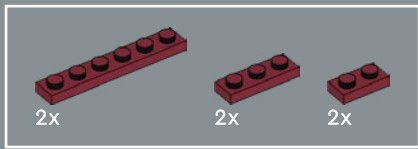

286

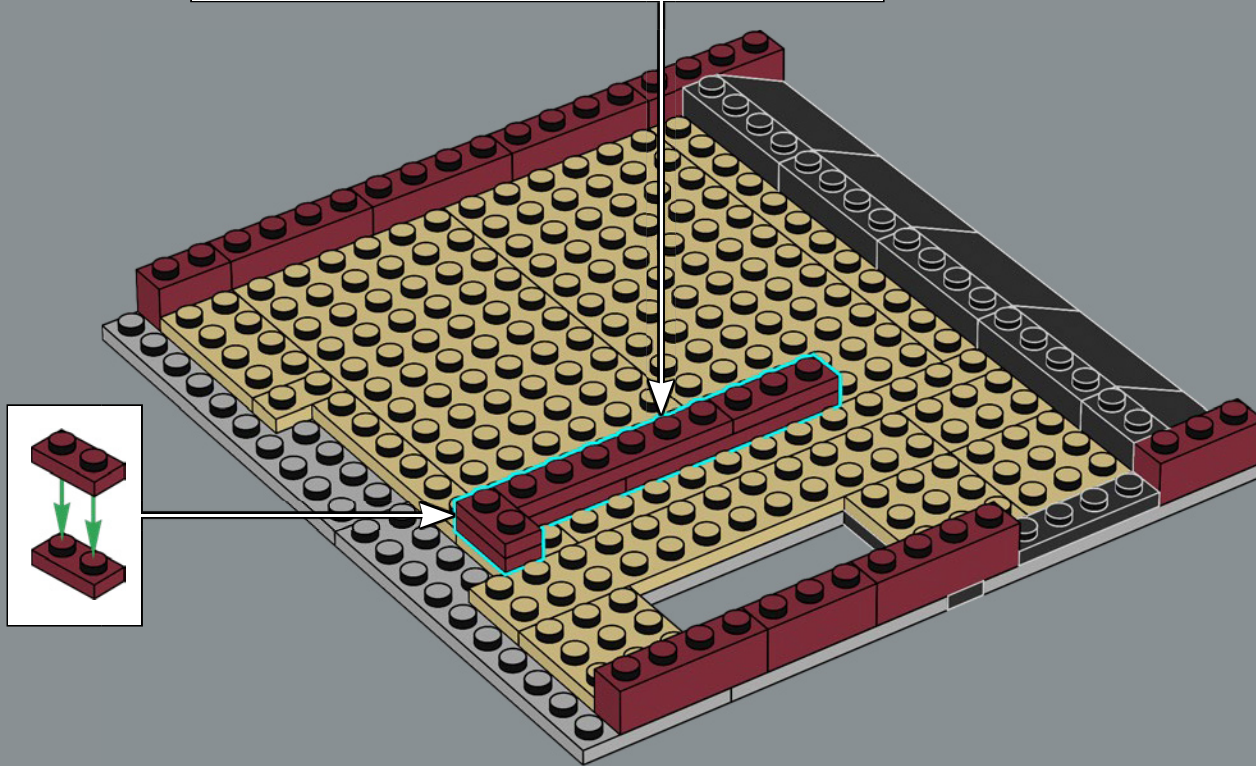
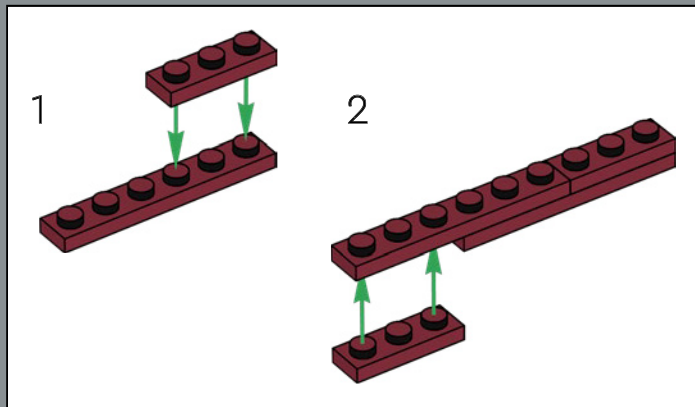

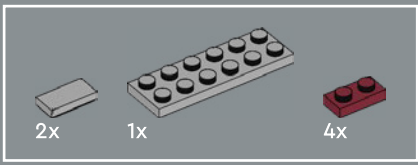

287

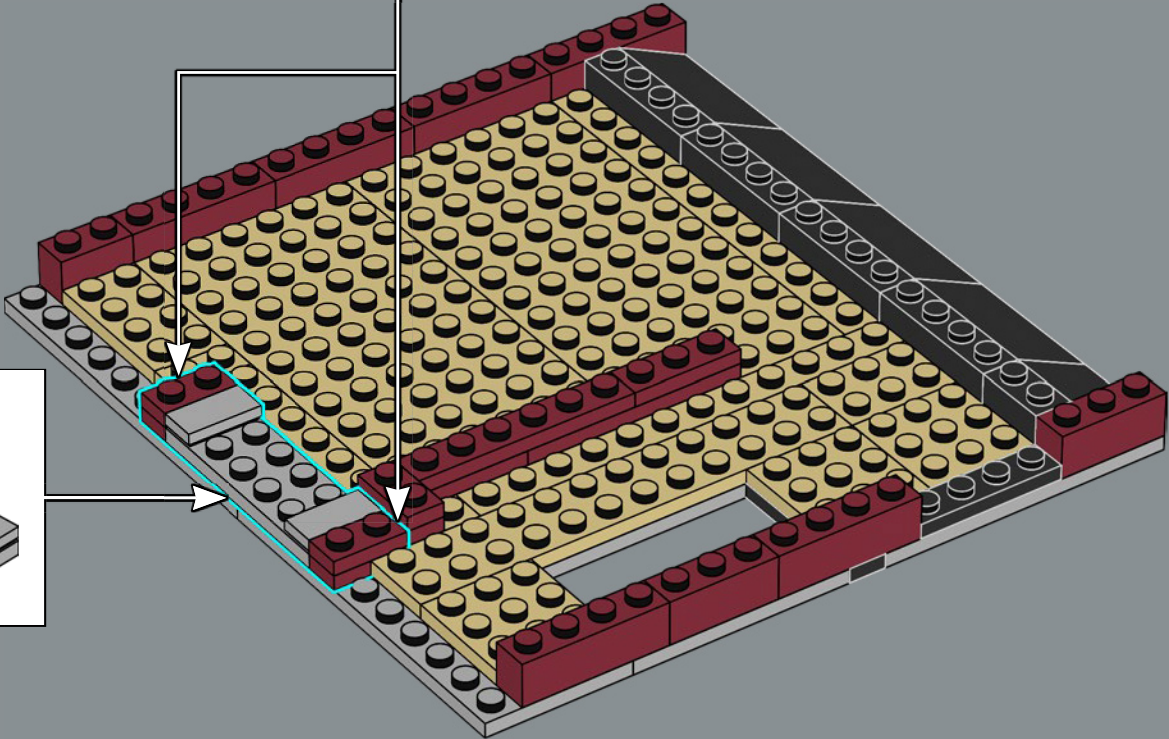
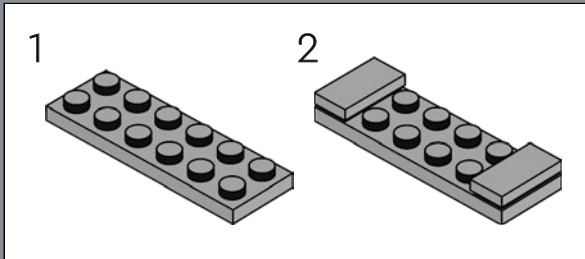
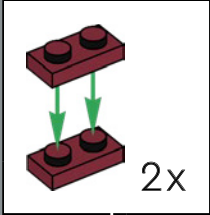

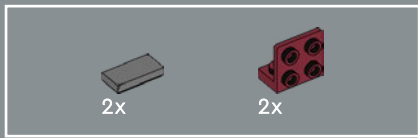

288

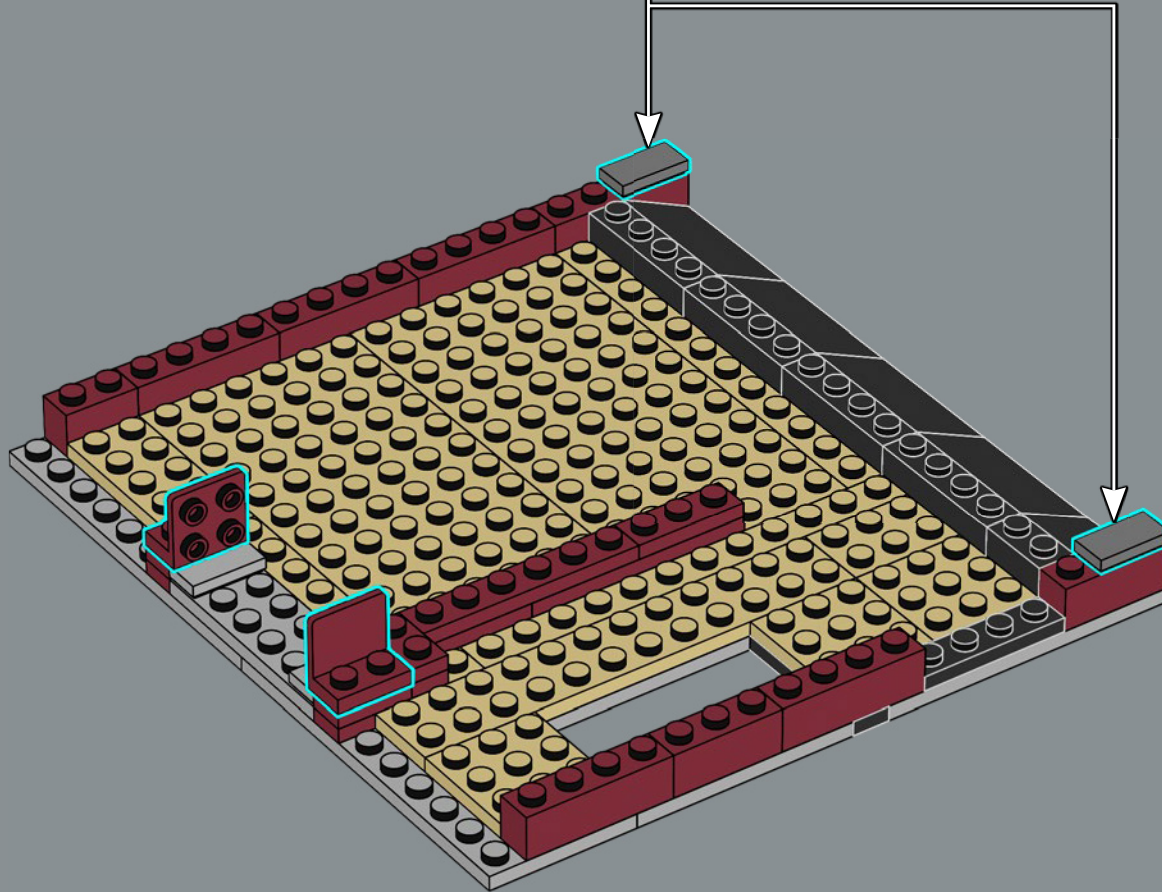

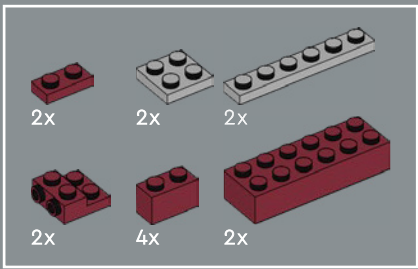

289

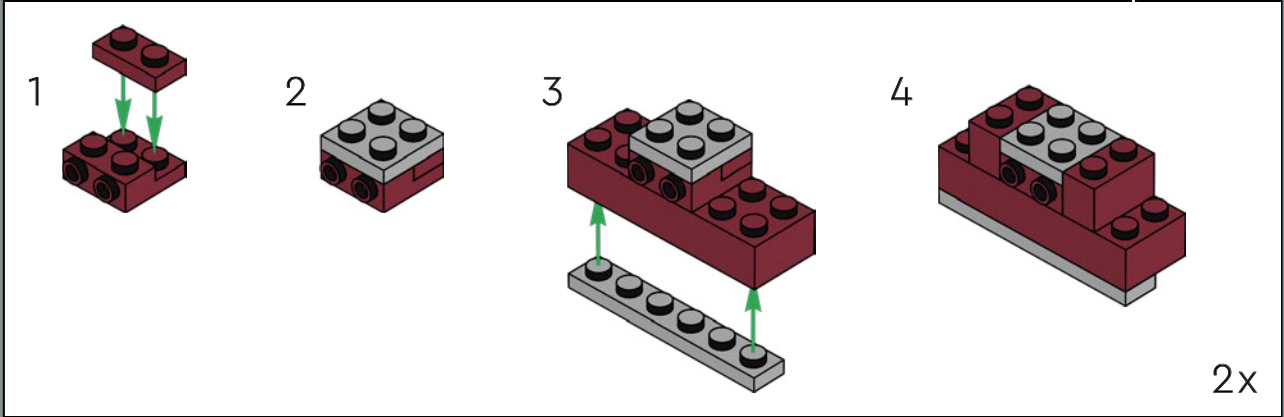
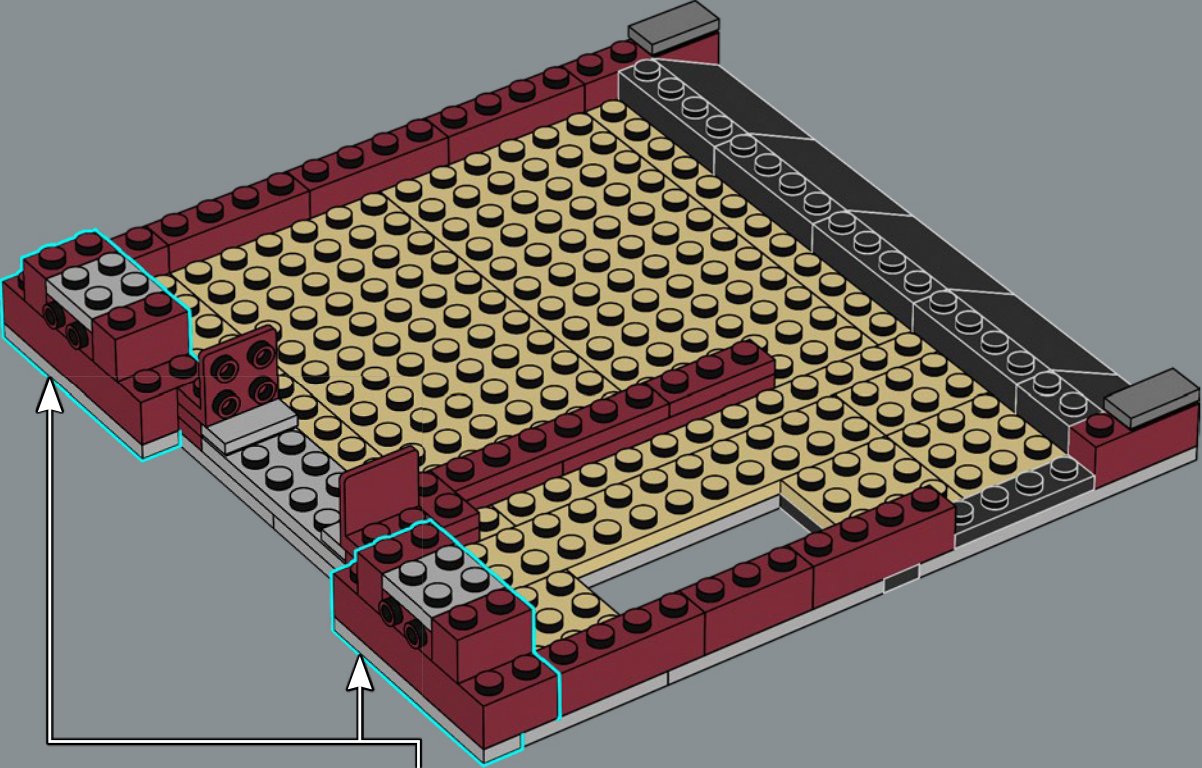

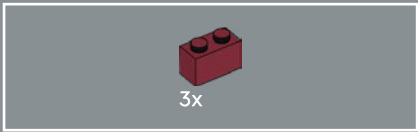

290

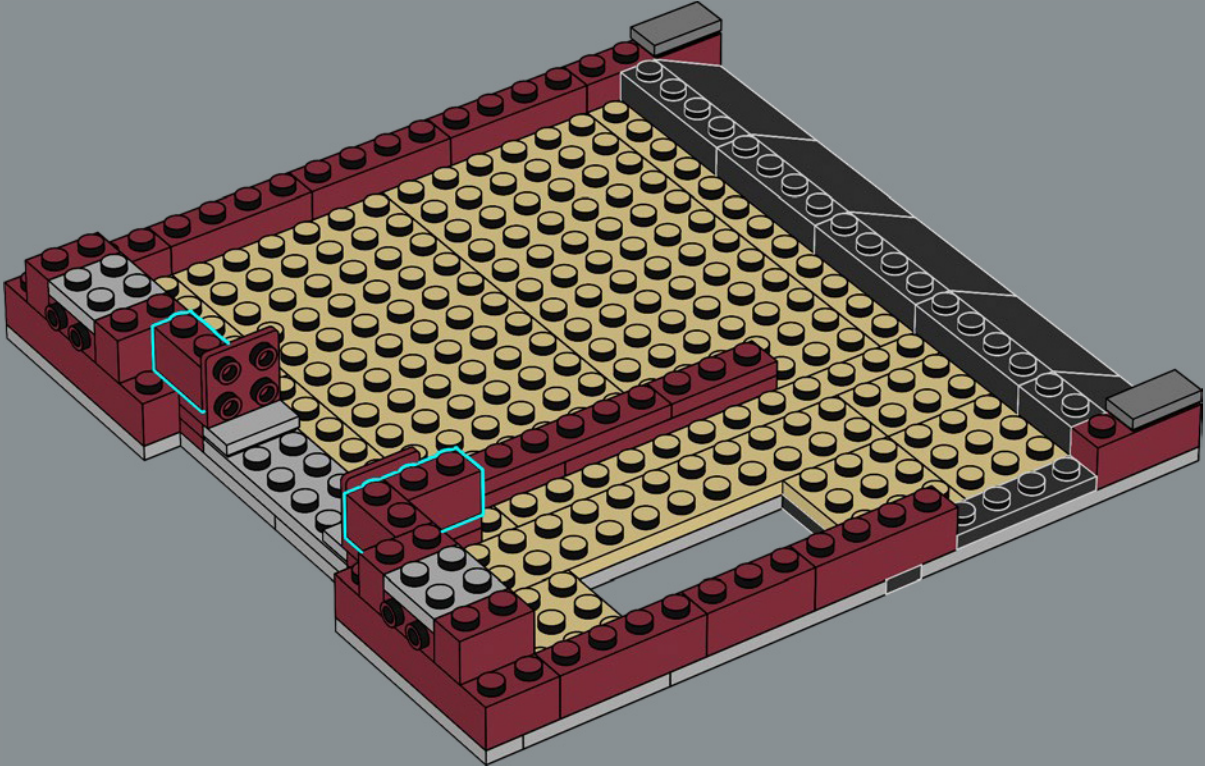



292

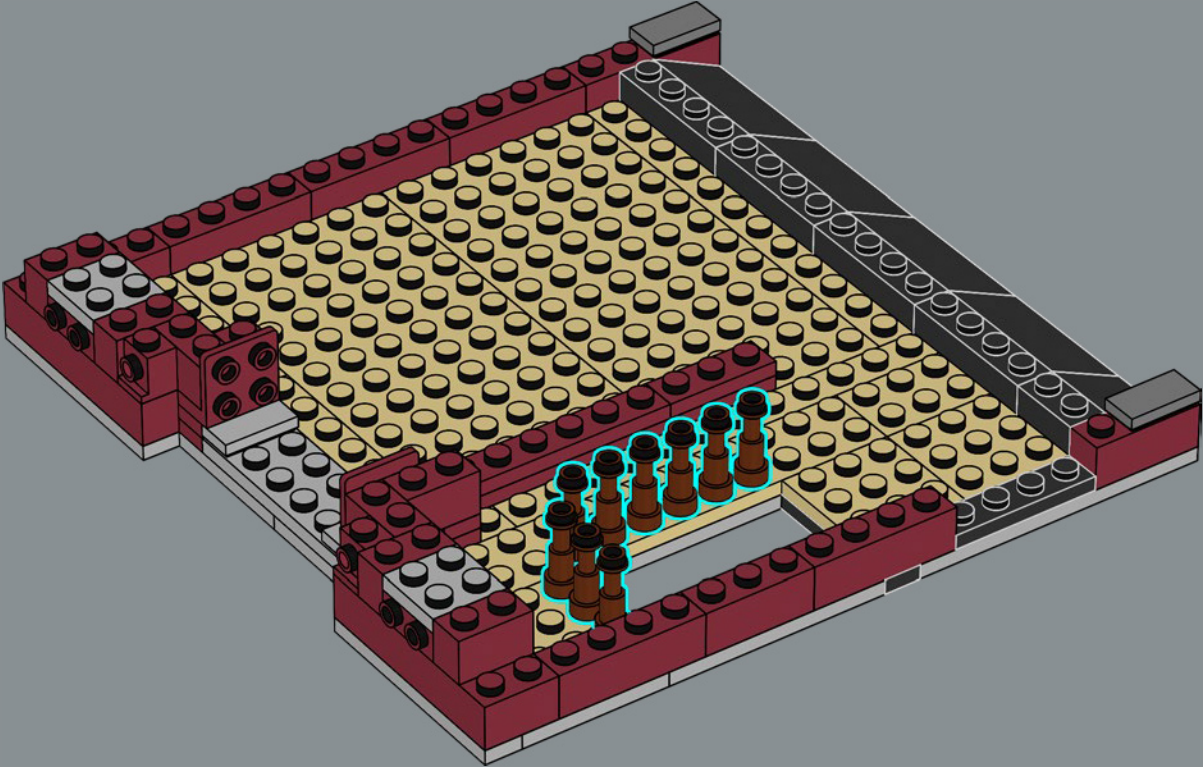

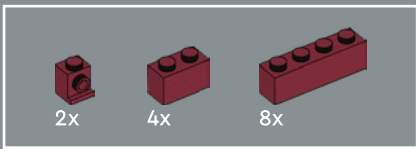

294

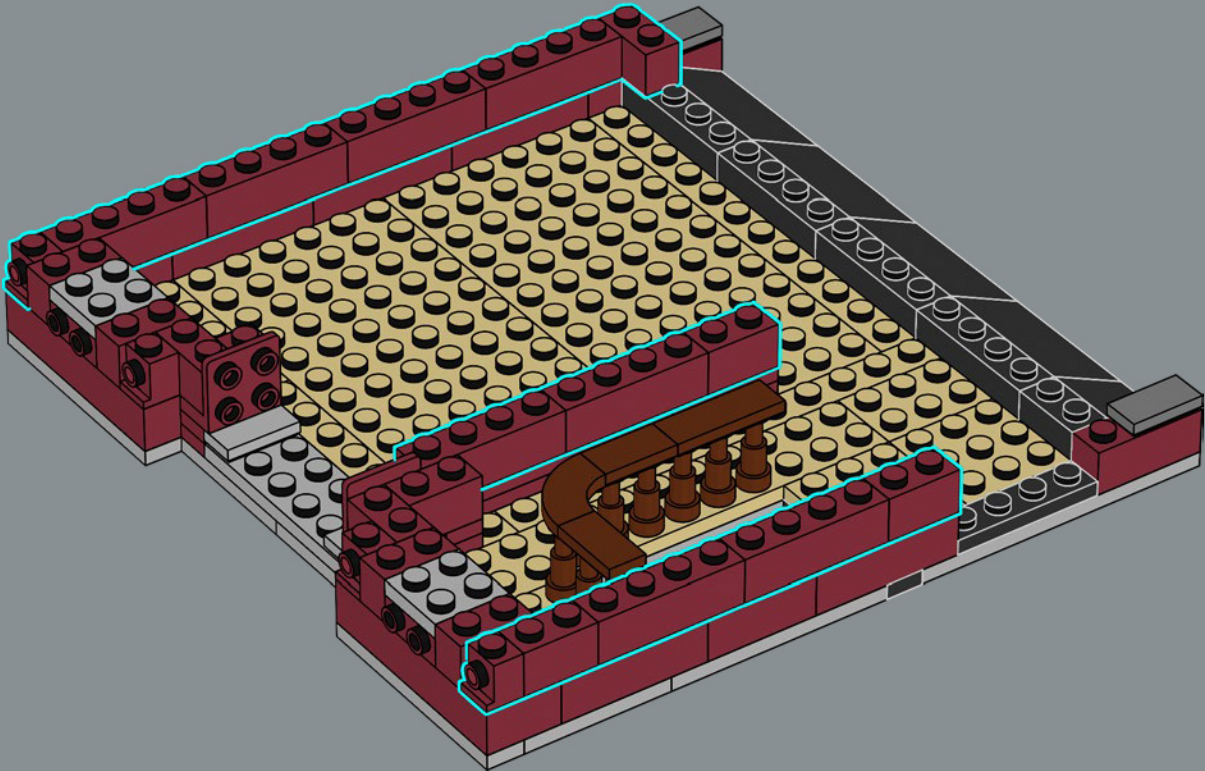

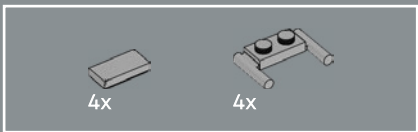

295



¡Los elementos utilizados para el alféizar de las ventanas (placas 1×2 con asas) forman parte del surtido LEGO® System desde 1978!

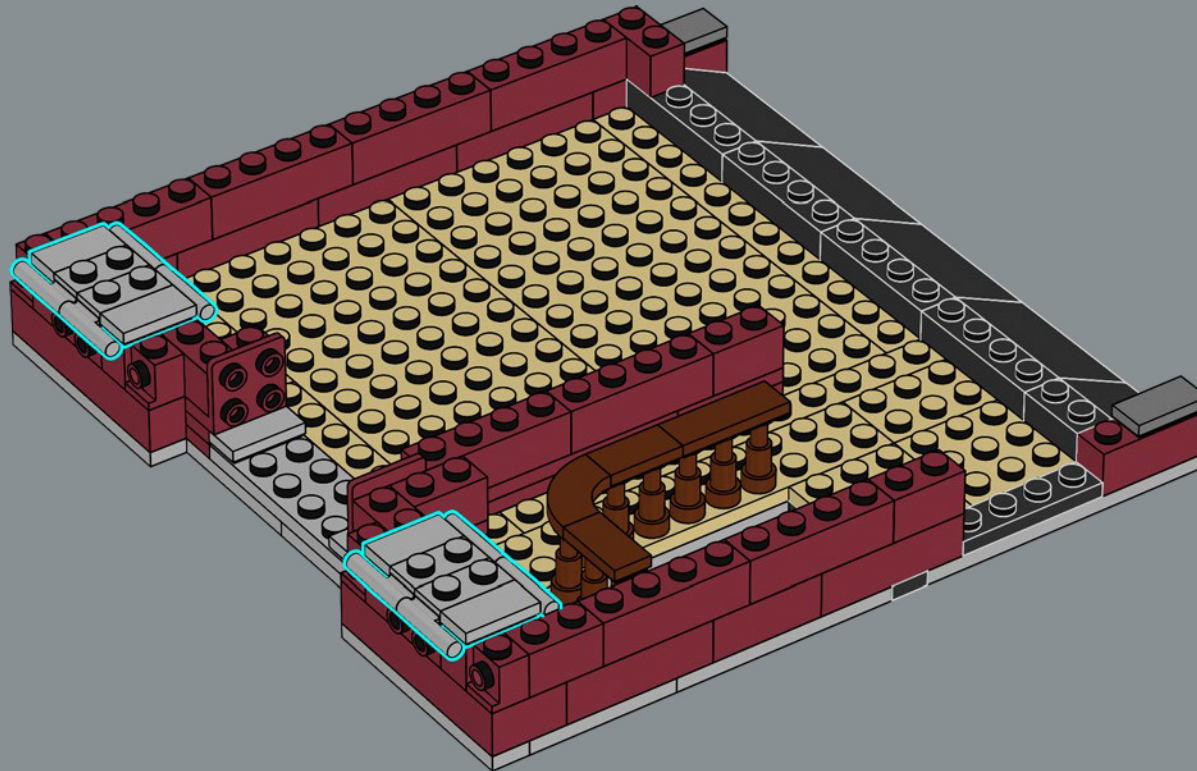

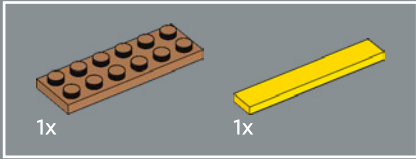
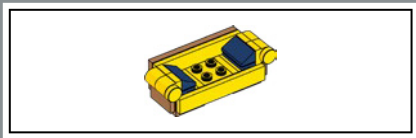

297

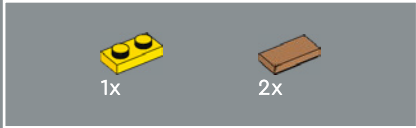
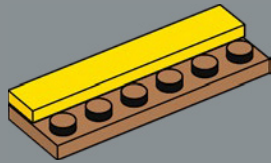

298

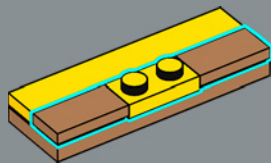

299

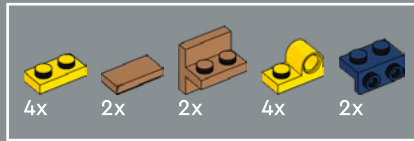
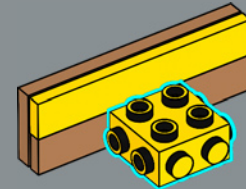

300

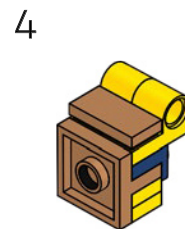
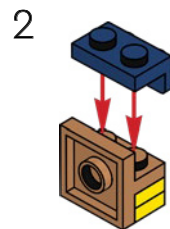
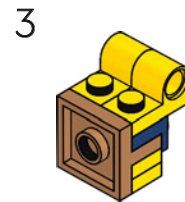
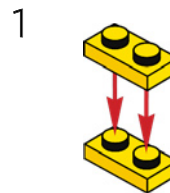

2x

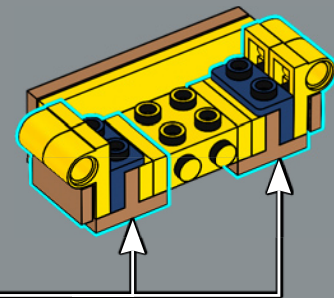

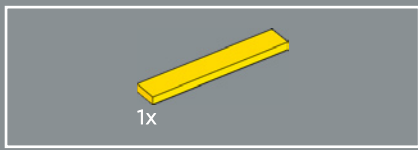

301

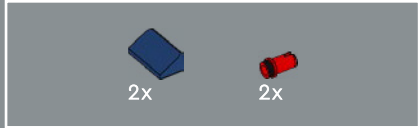
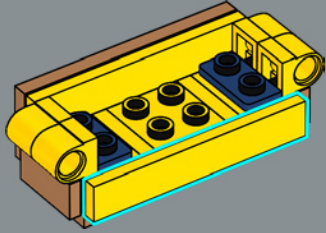

302

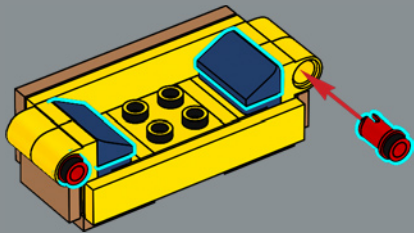

303

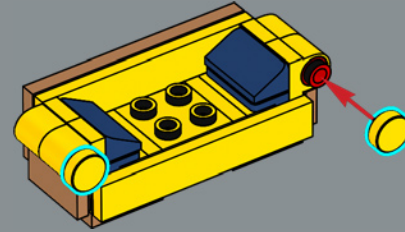

304

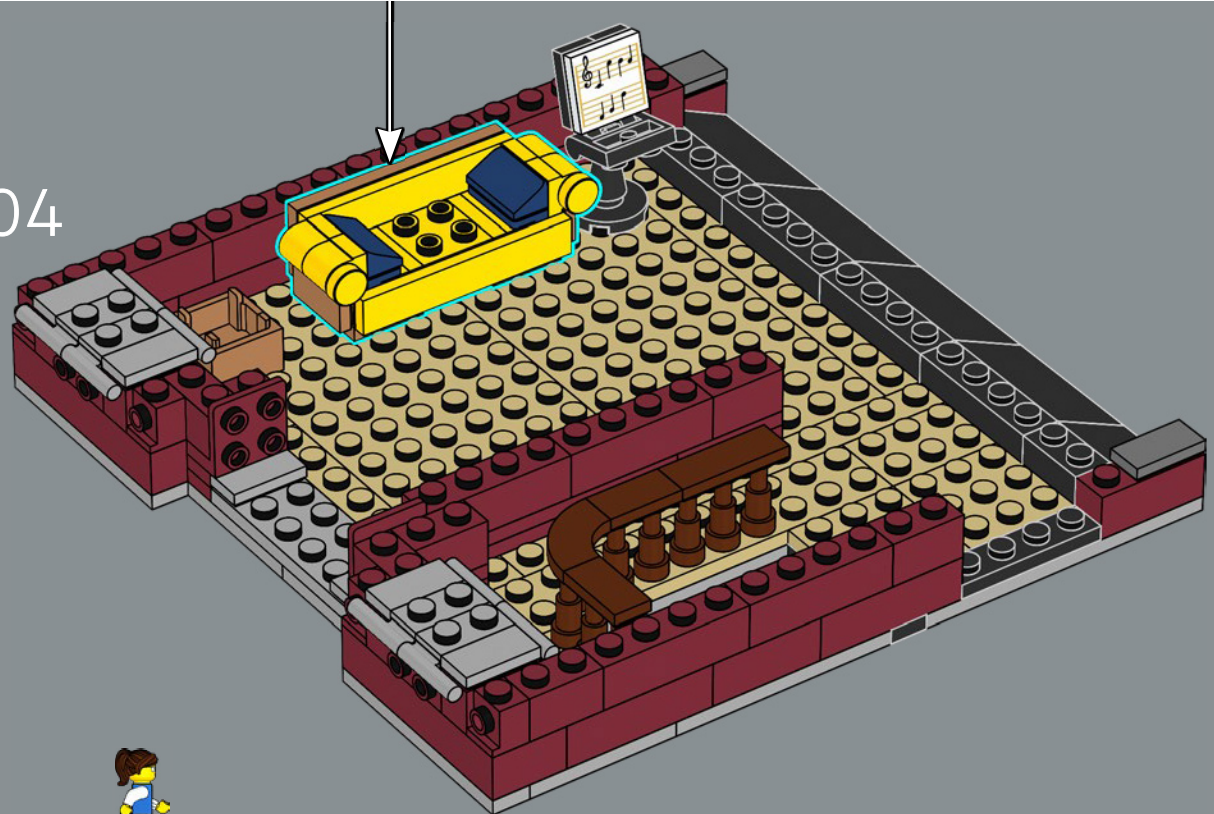

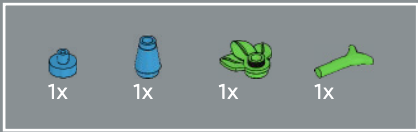

305

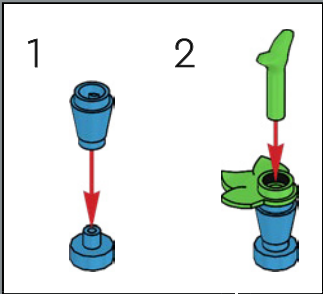

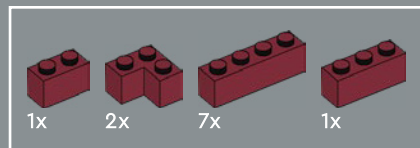

306

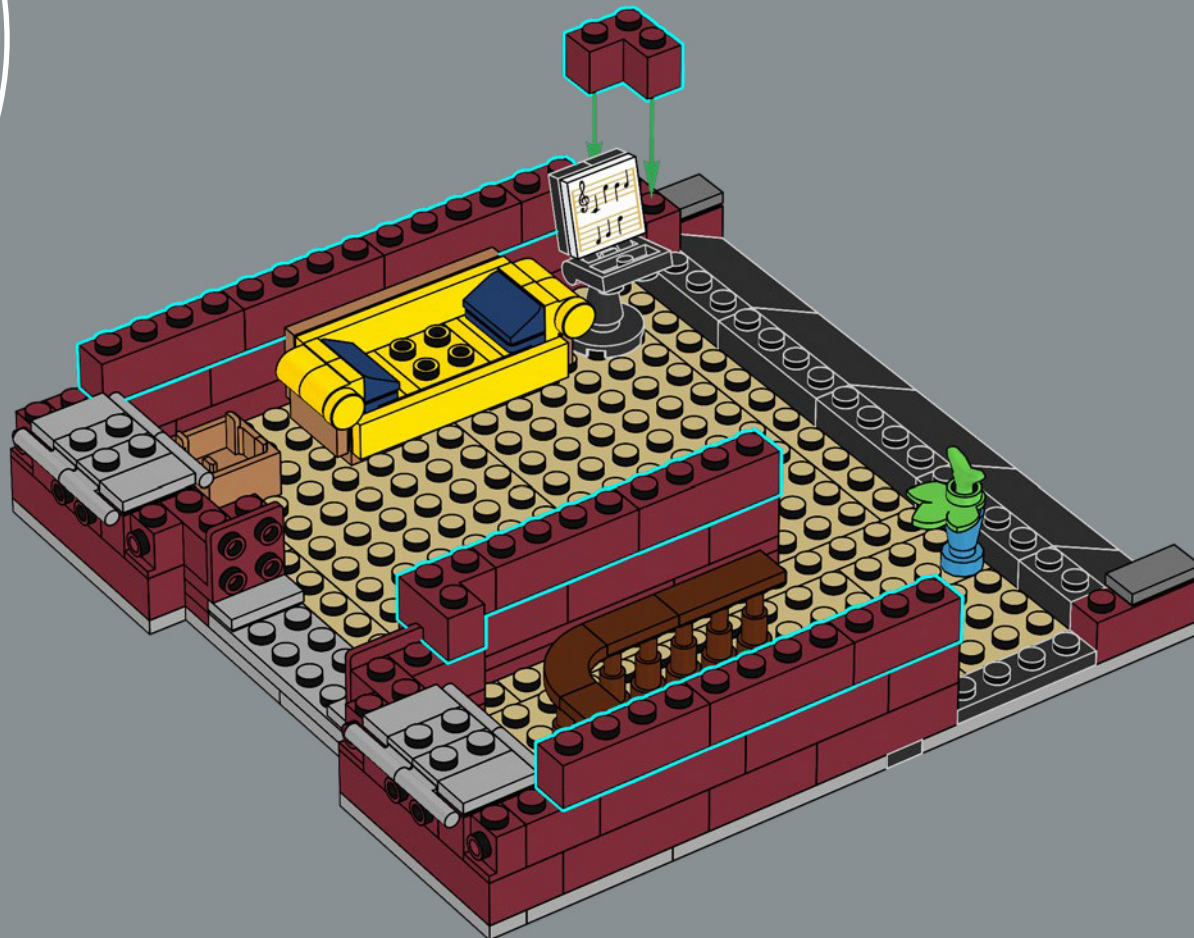

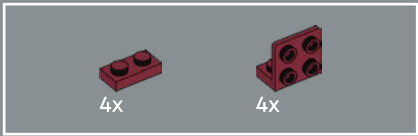

307

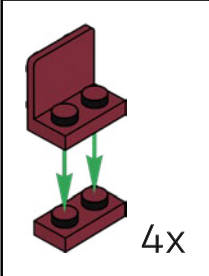

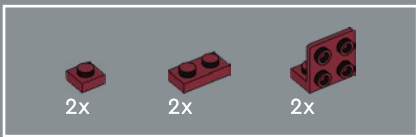

308

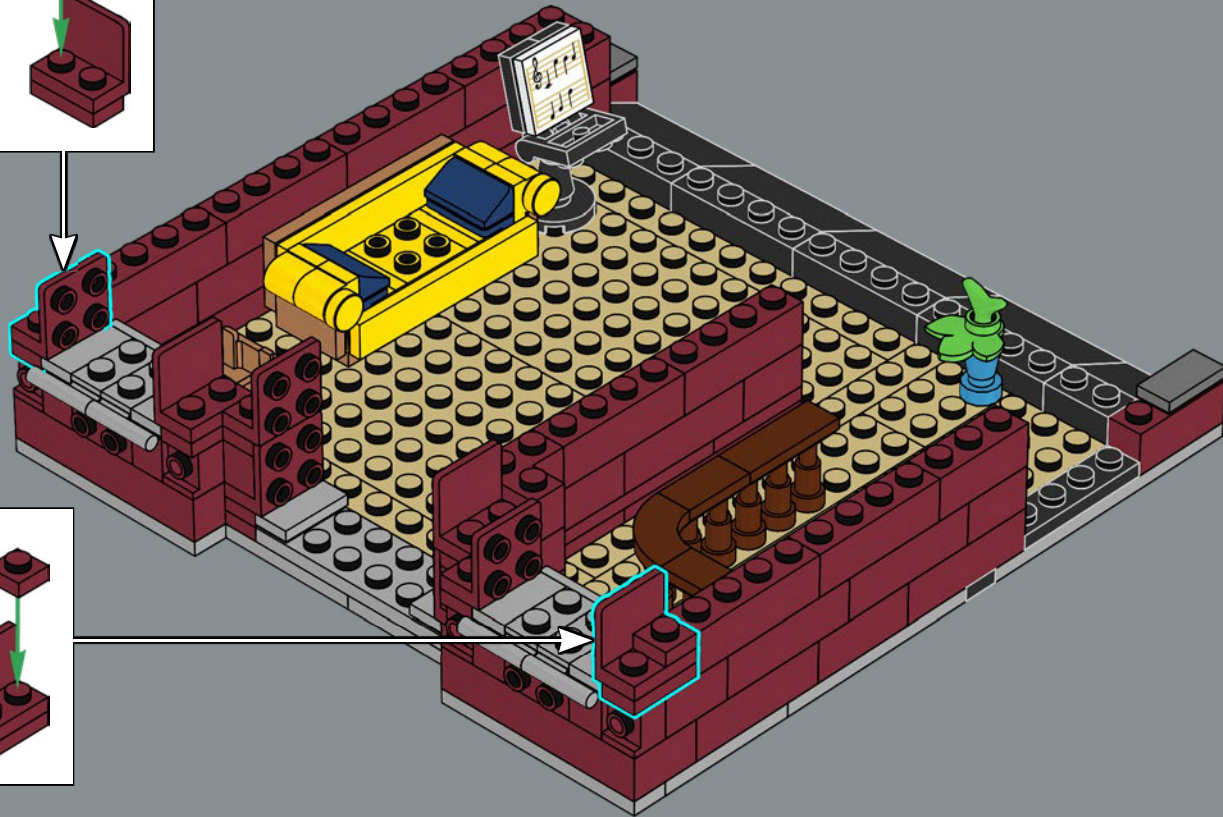
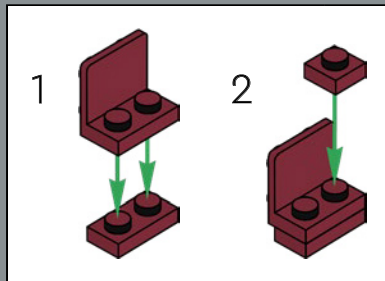
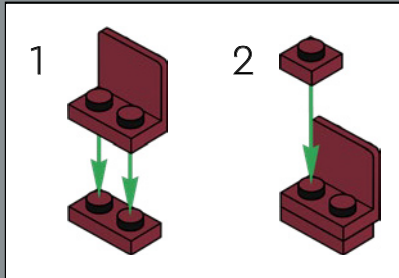

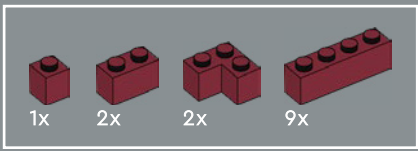

309

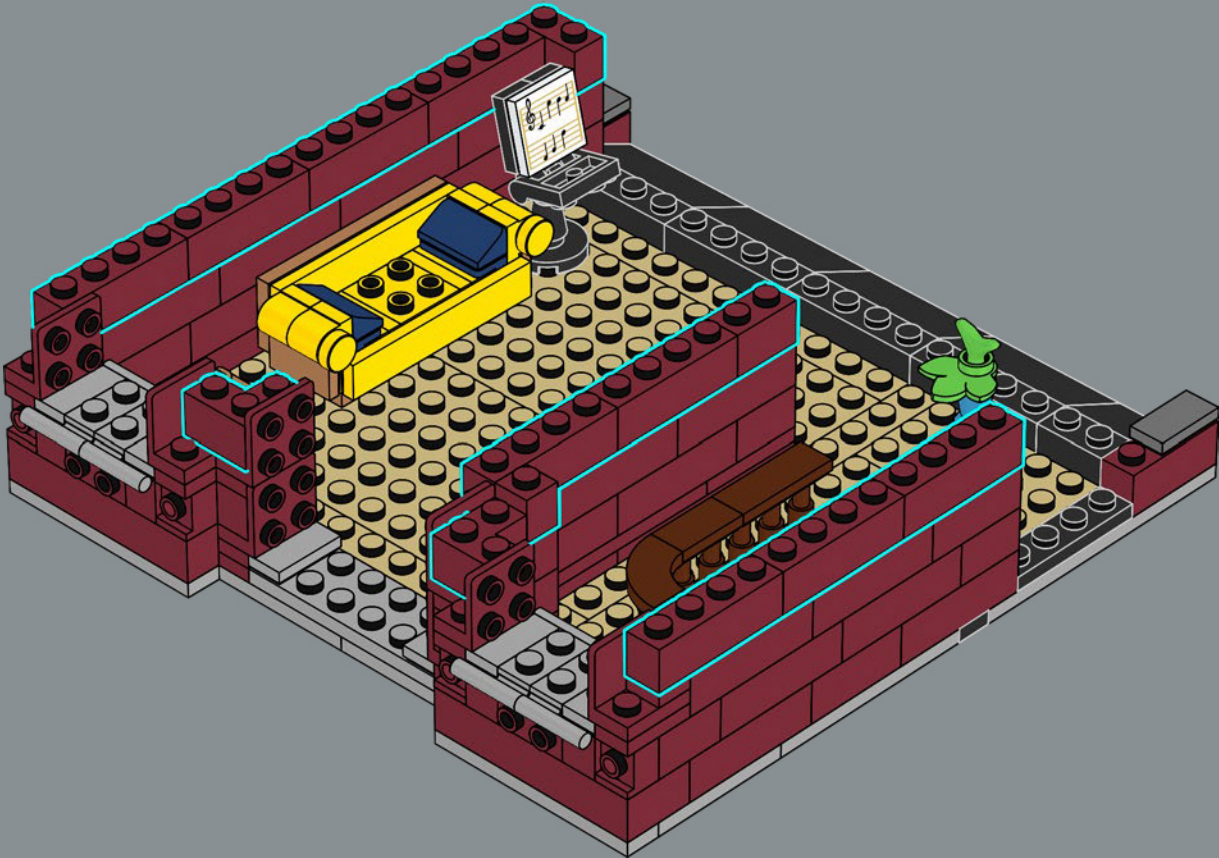



4x

310

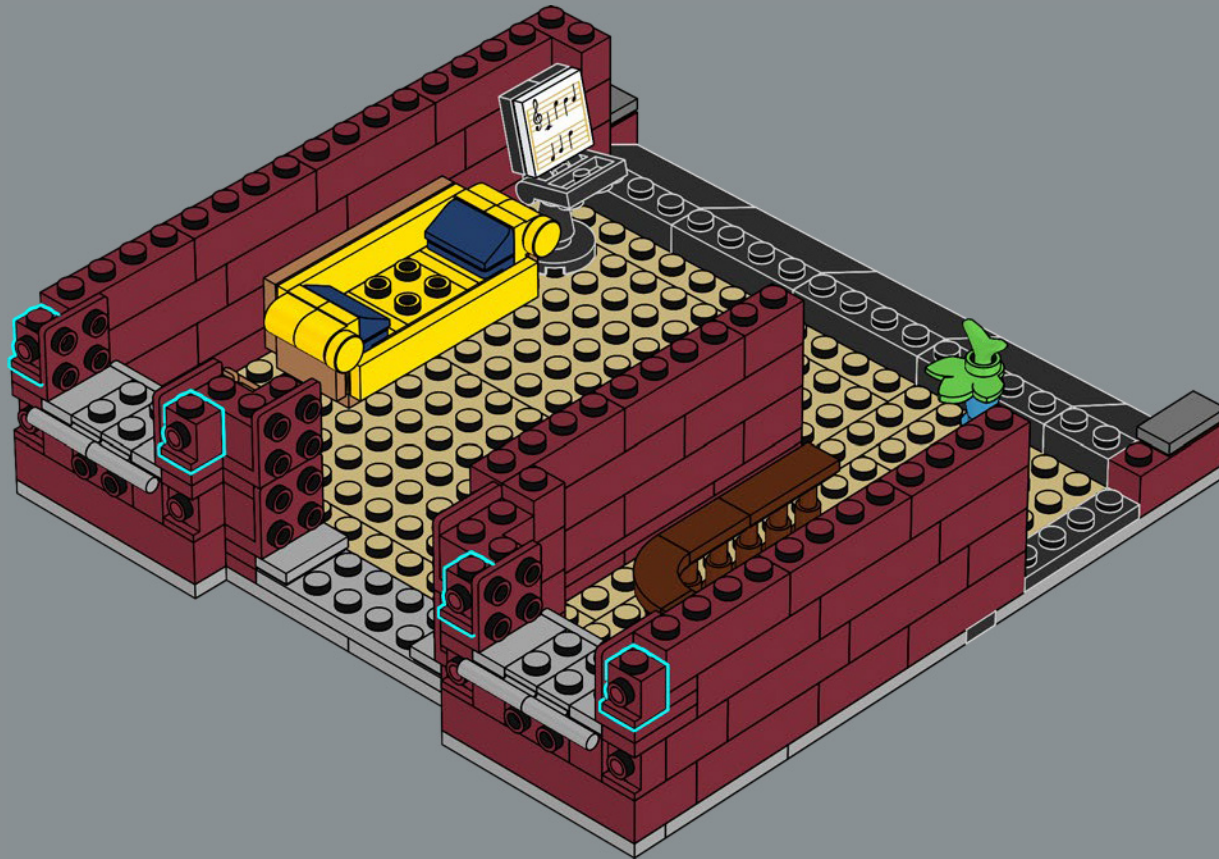

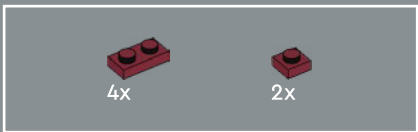

311

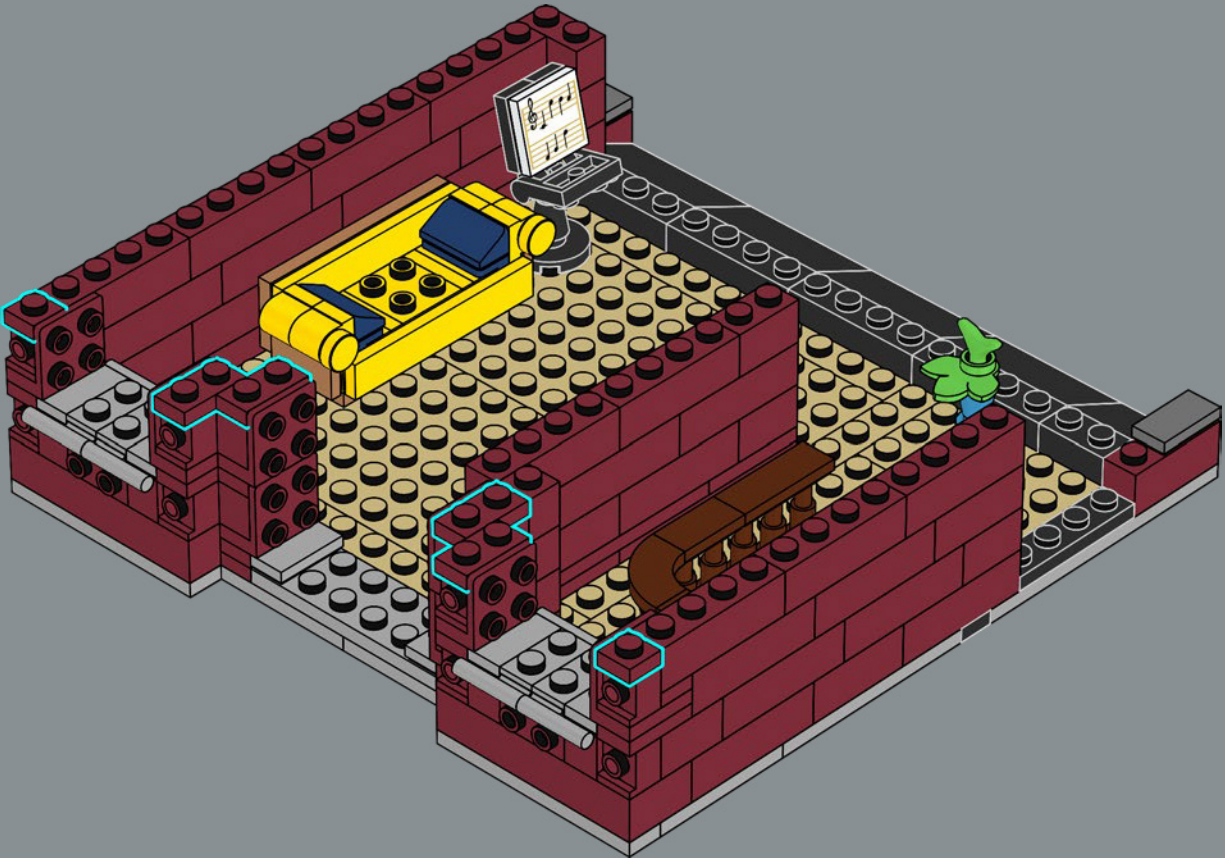

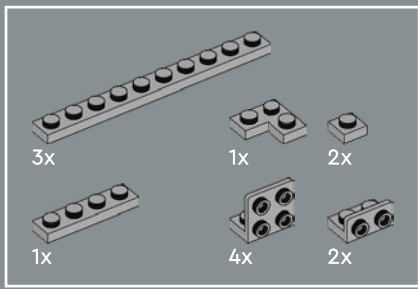

312

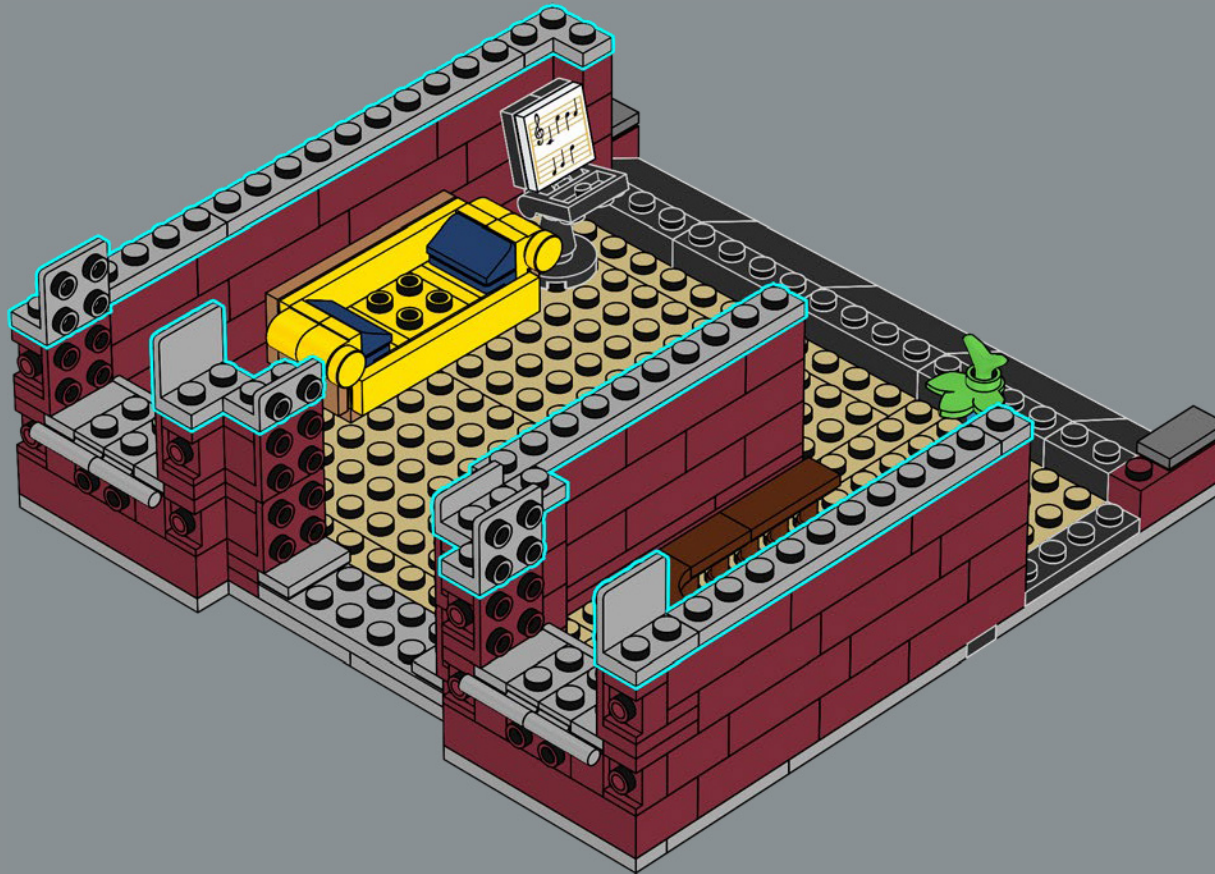

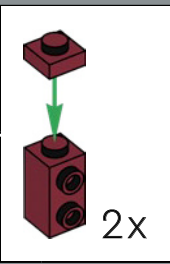
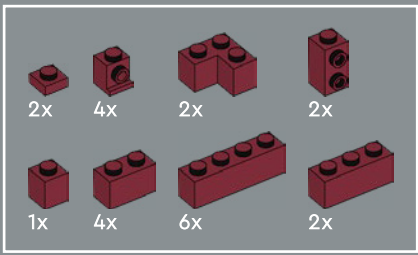

313

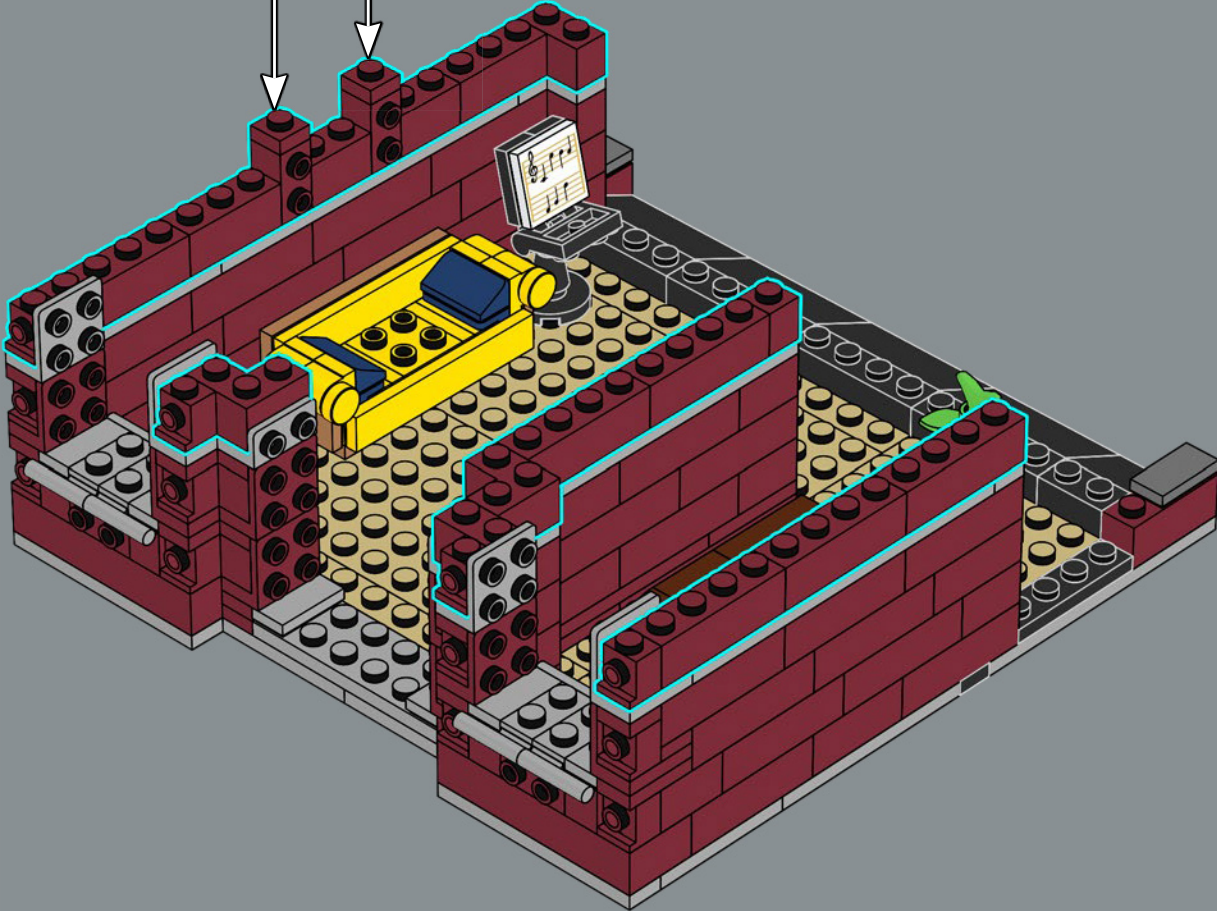

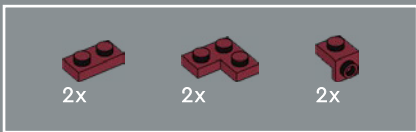

314

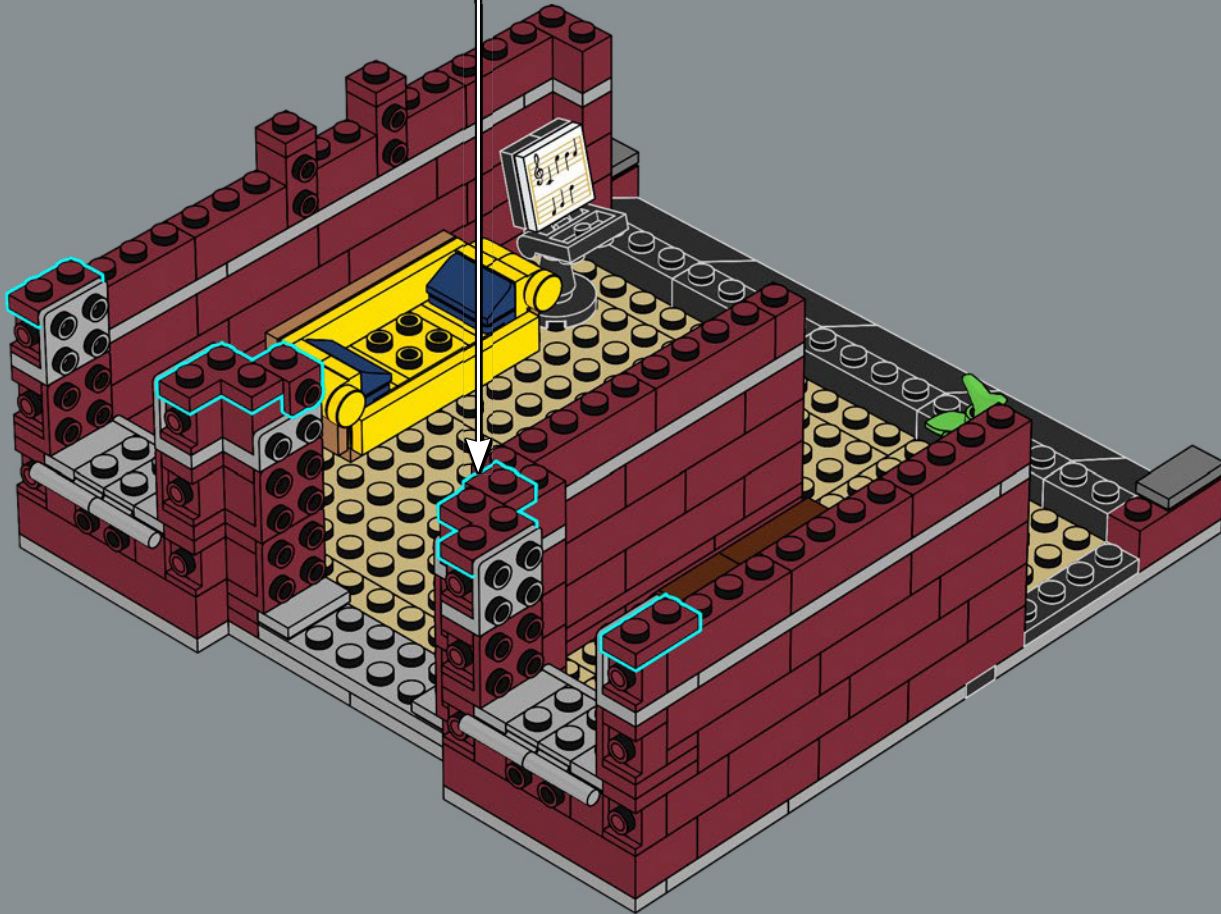

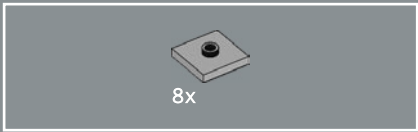

315

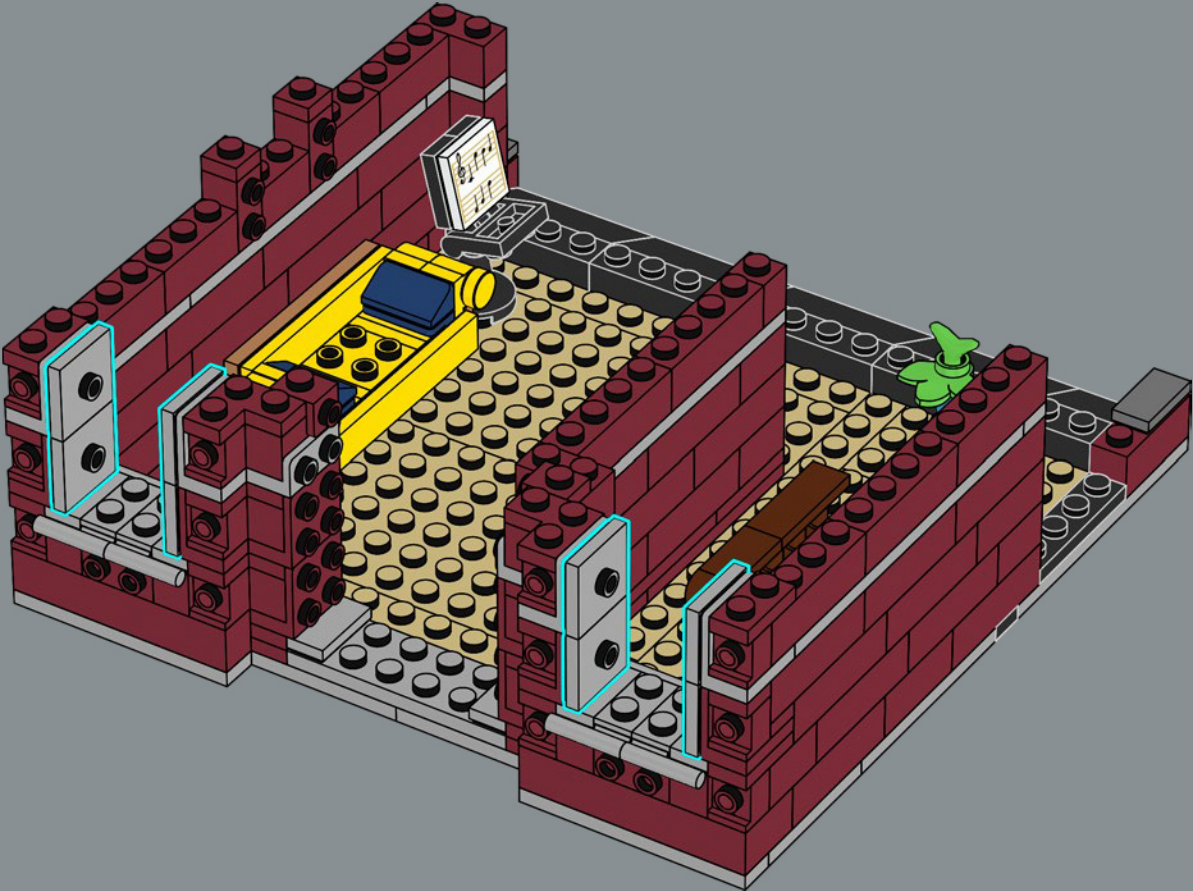

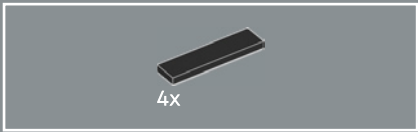

316

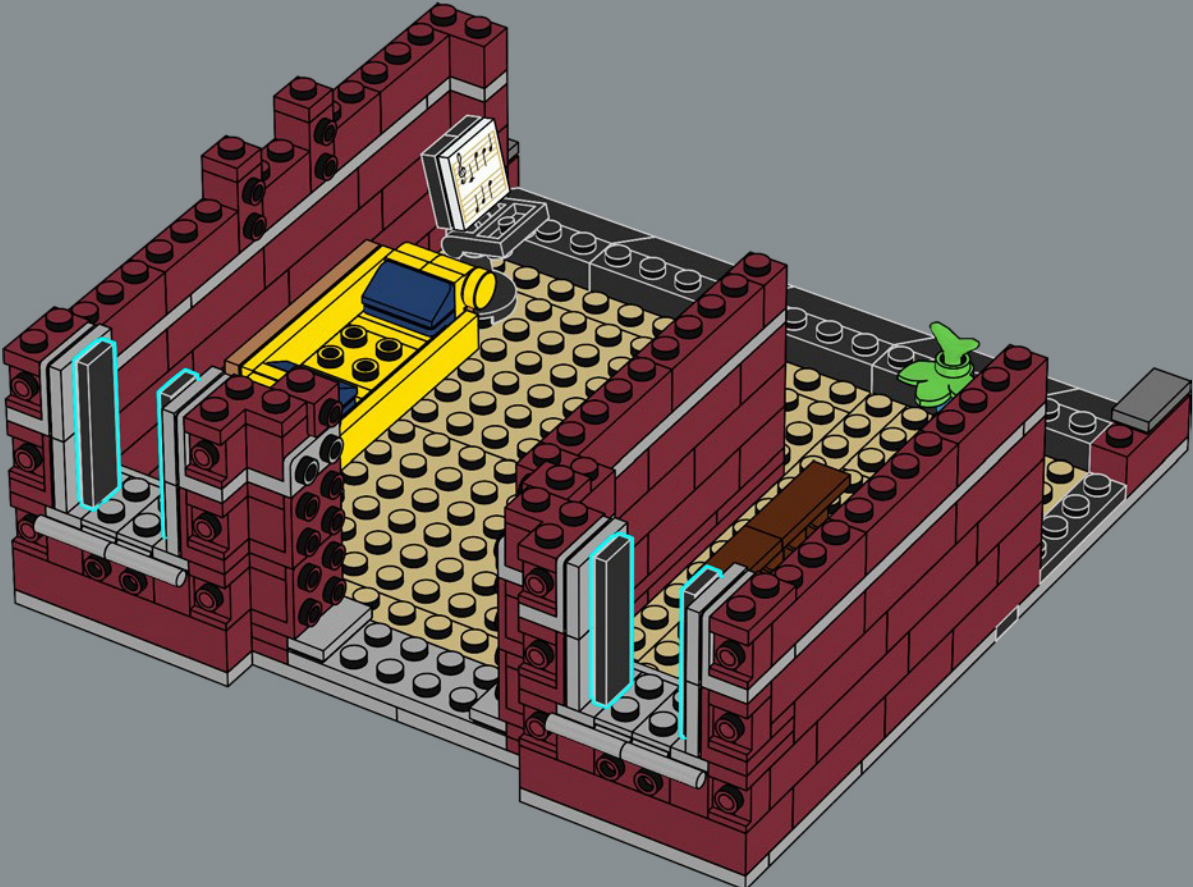



317

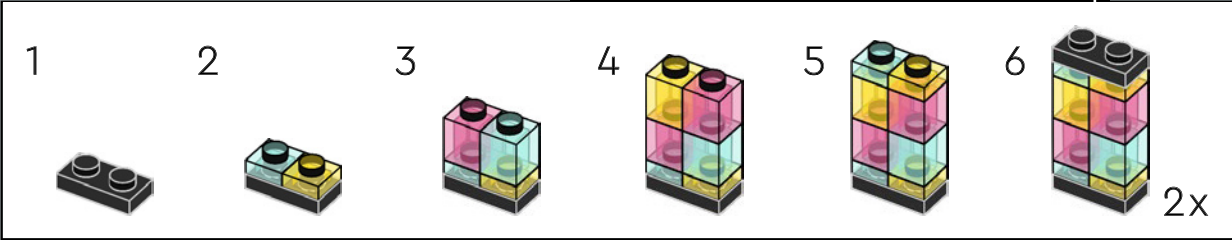
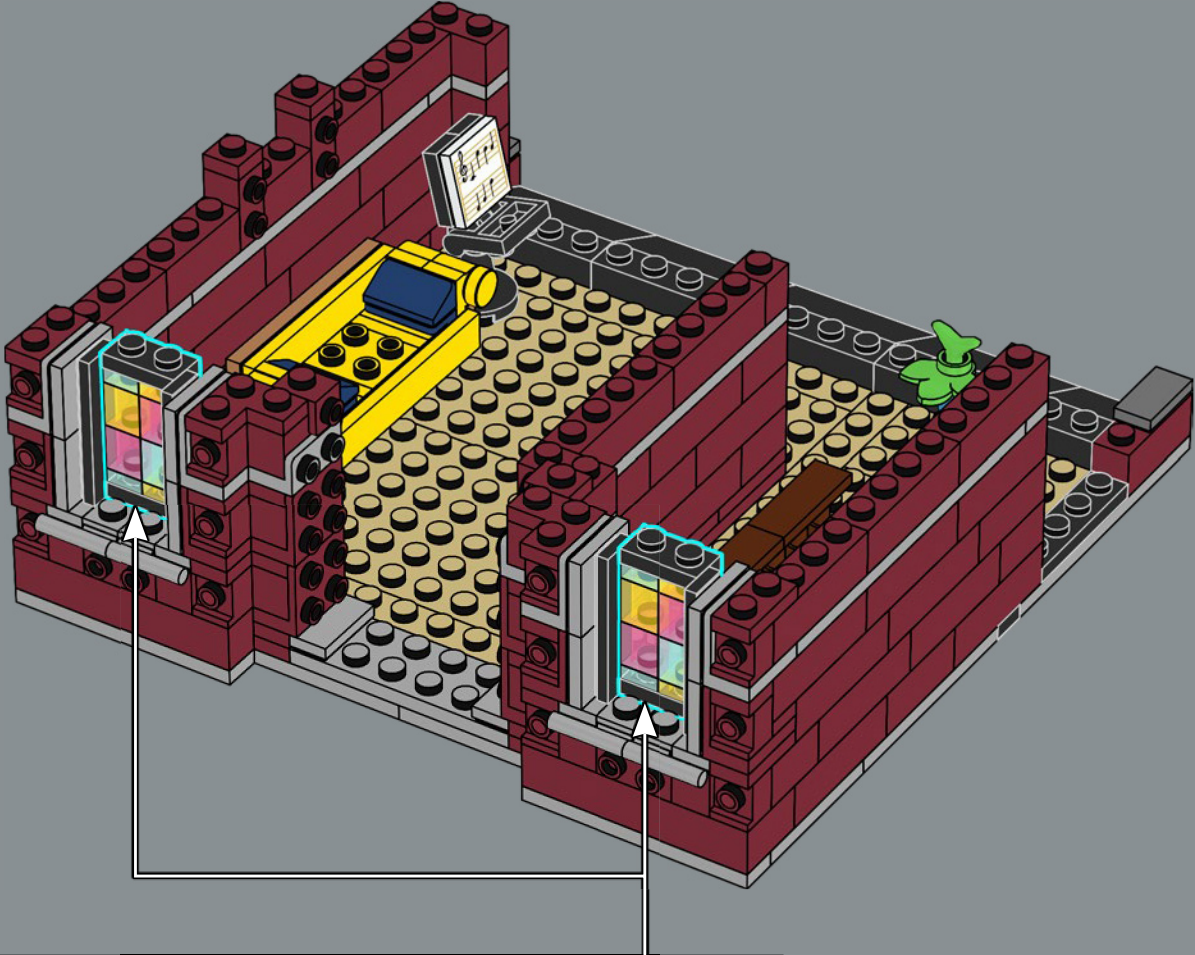

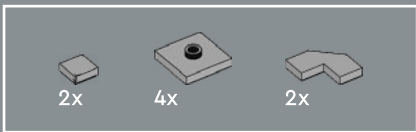

318

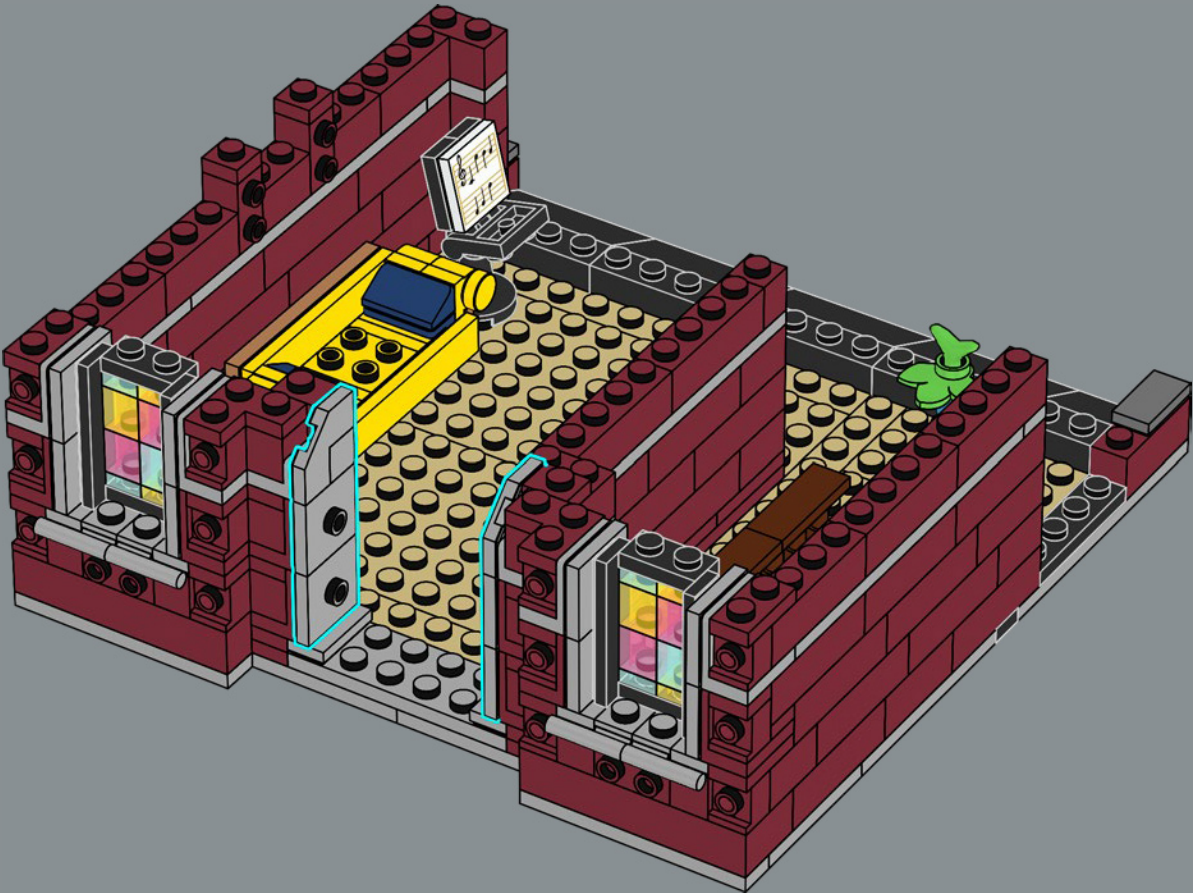

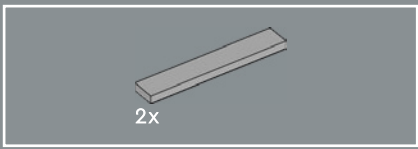

319

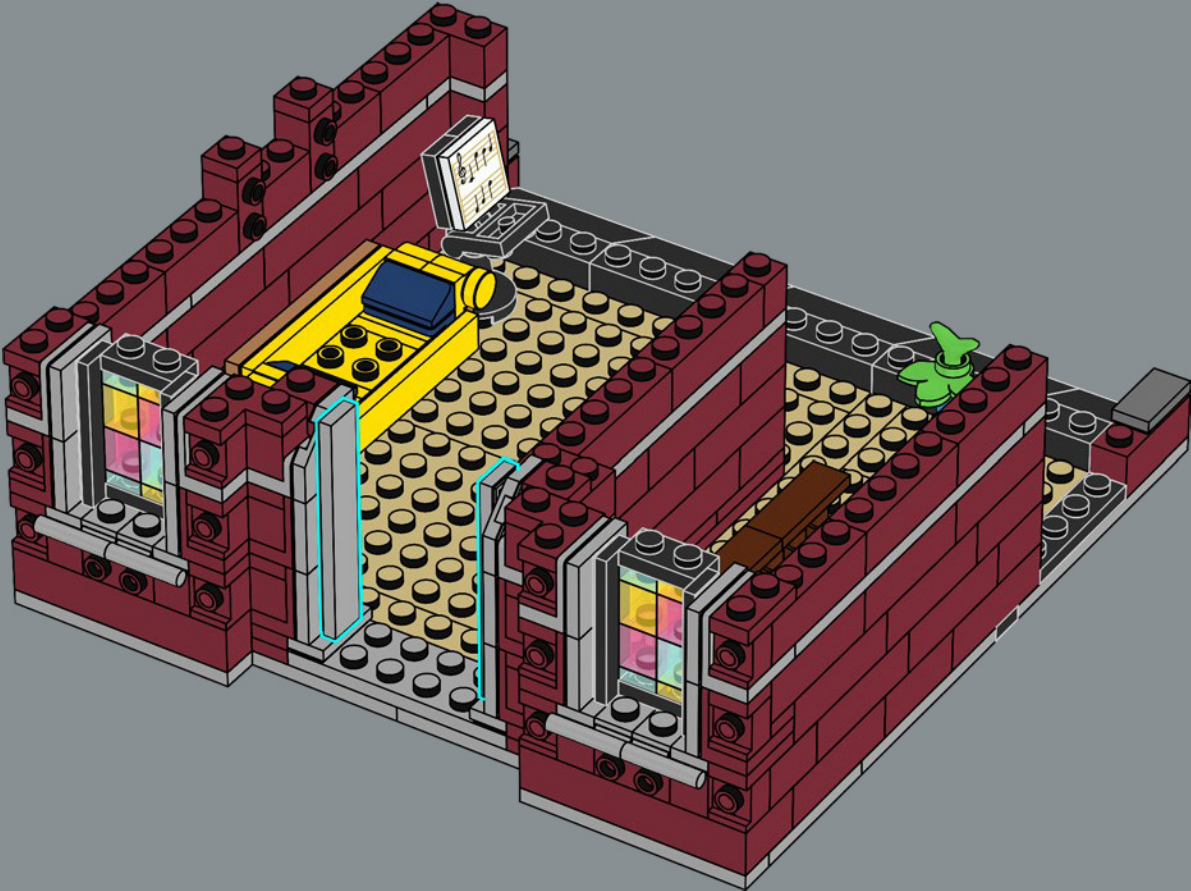

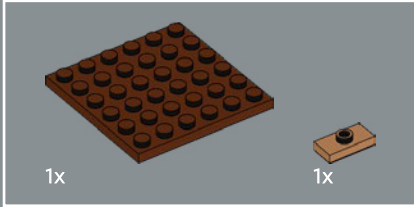

320

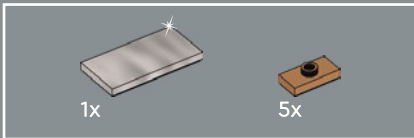
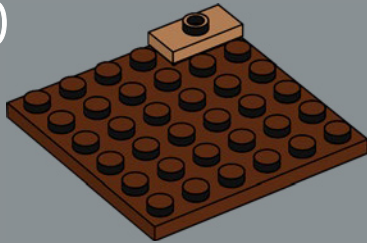

321

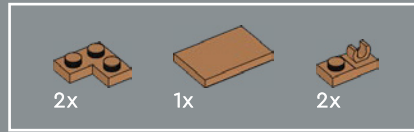
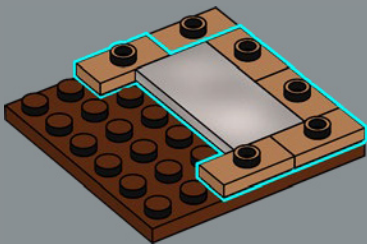

322

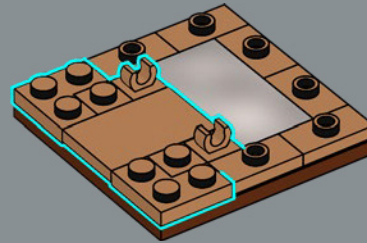

323

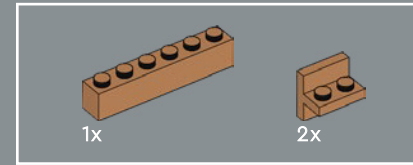
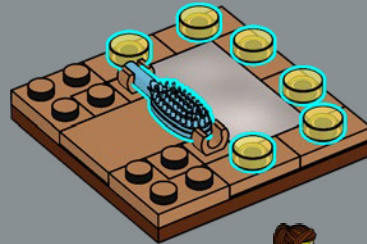

324

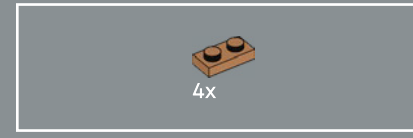
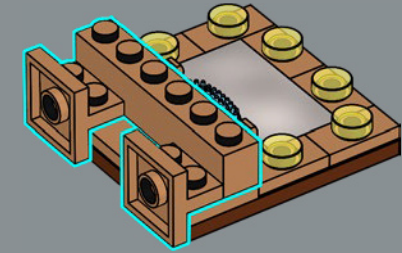

325

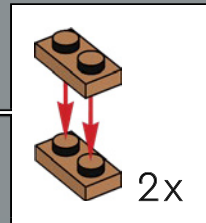
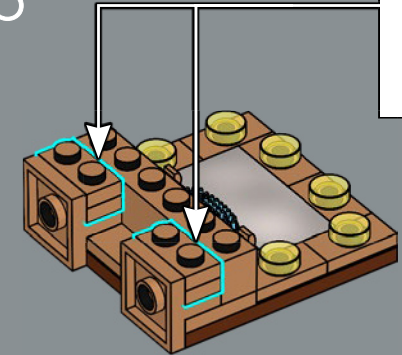

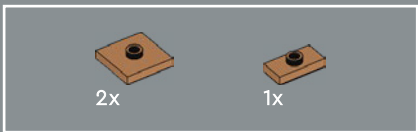

326

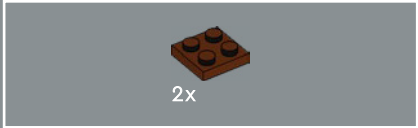
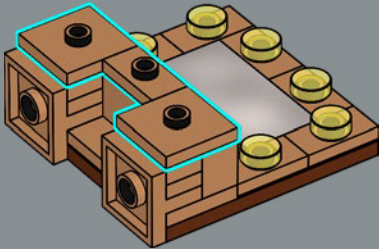

327

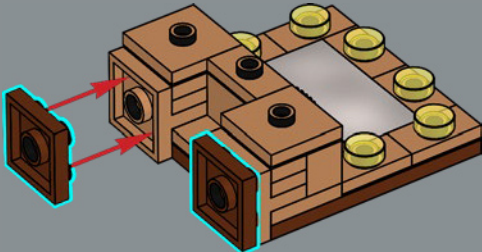

328

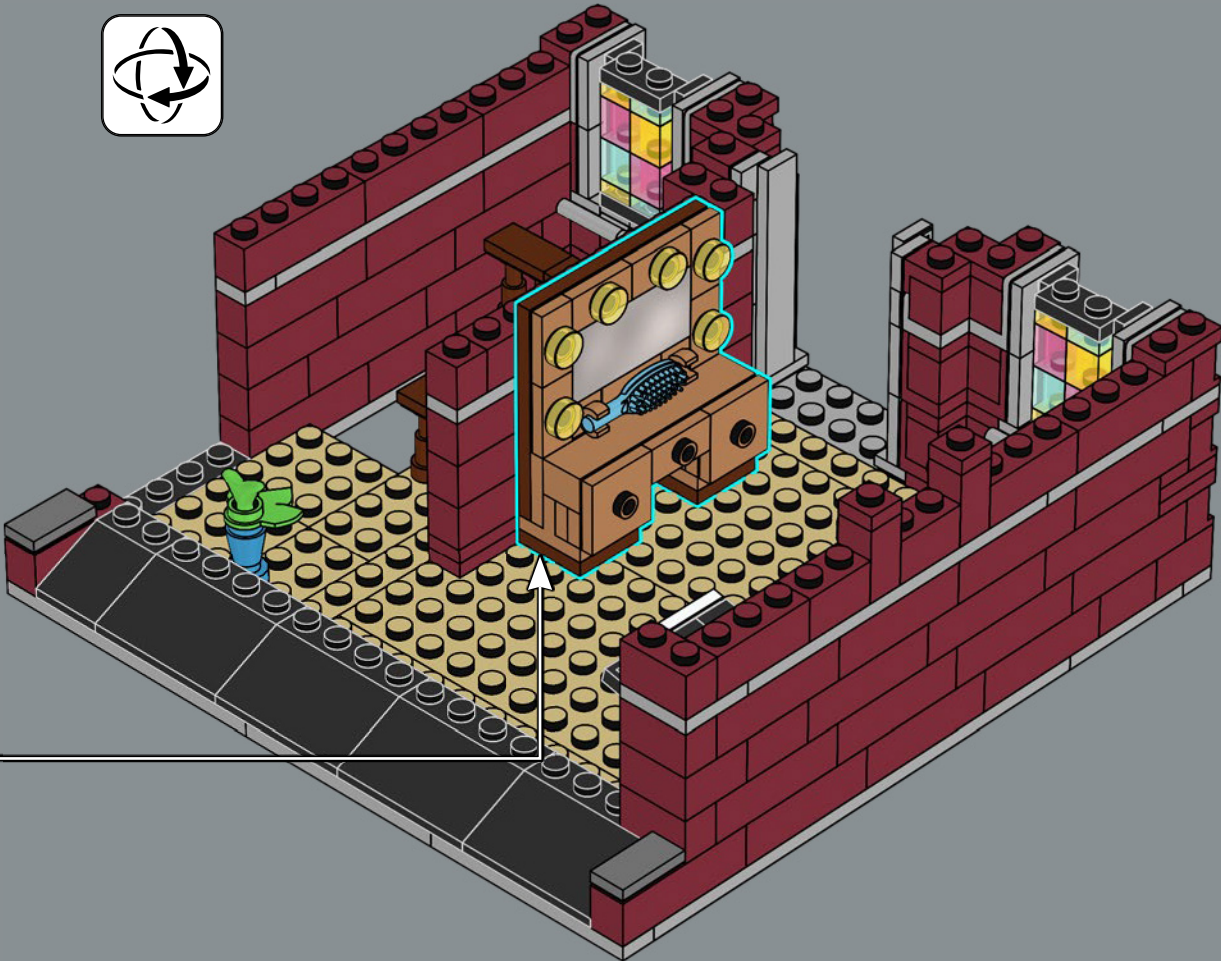

Antes de adueñarte del escenario, dedícate unos minutos en la mesa de maquillaje para asegurarte de que vas a estar impresionante bajo los focos.

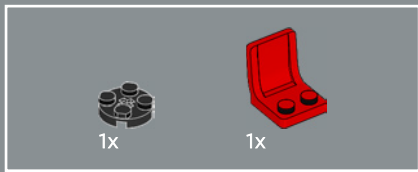

329

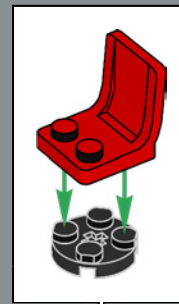

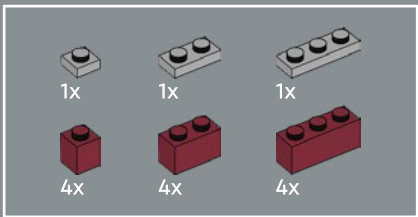

330

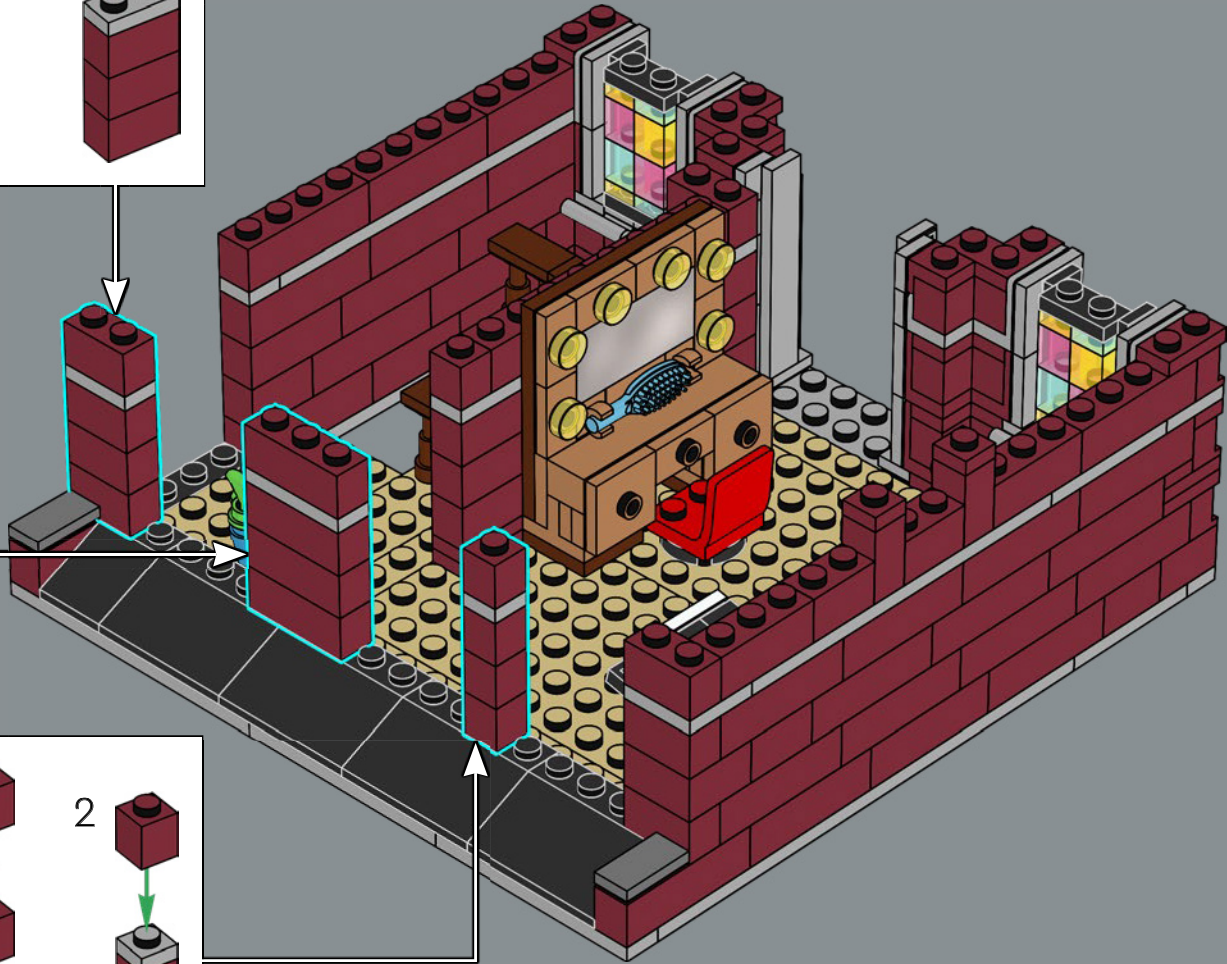
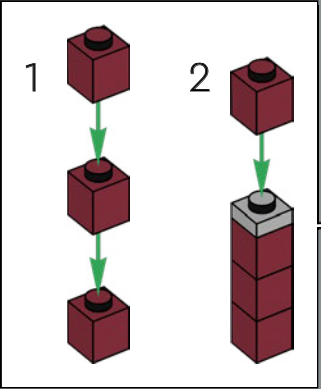
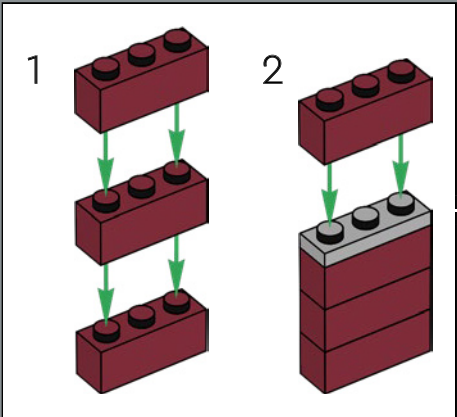
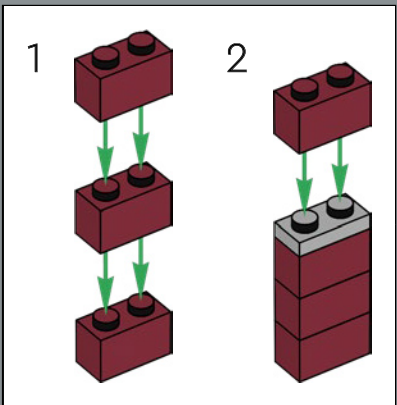

La maga encontró al conejo, su fiel
compañero de actuaciones, en la
Tienda de Mascotas LEGO® (10218).

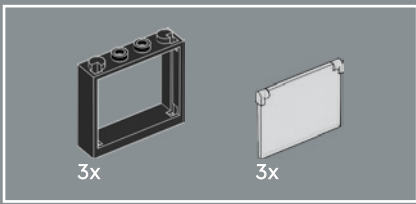

331

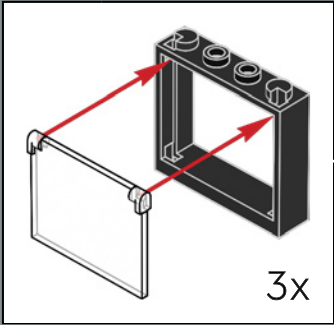
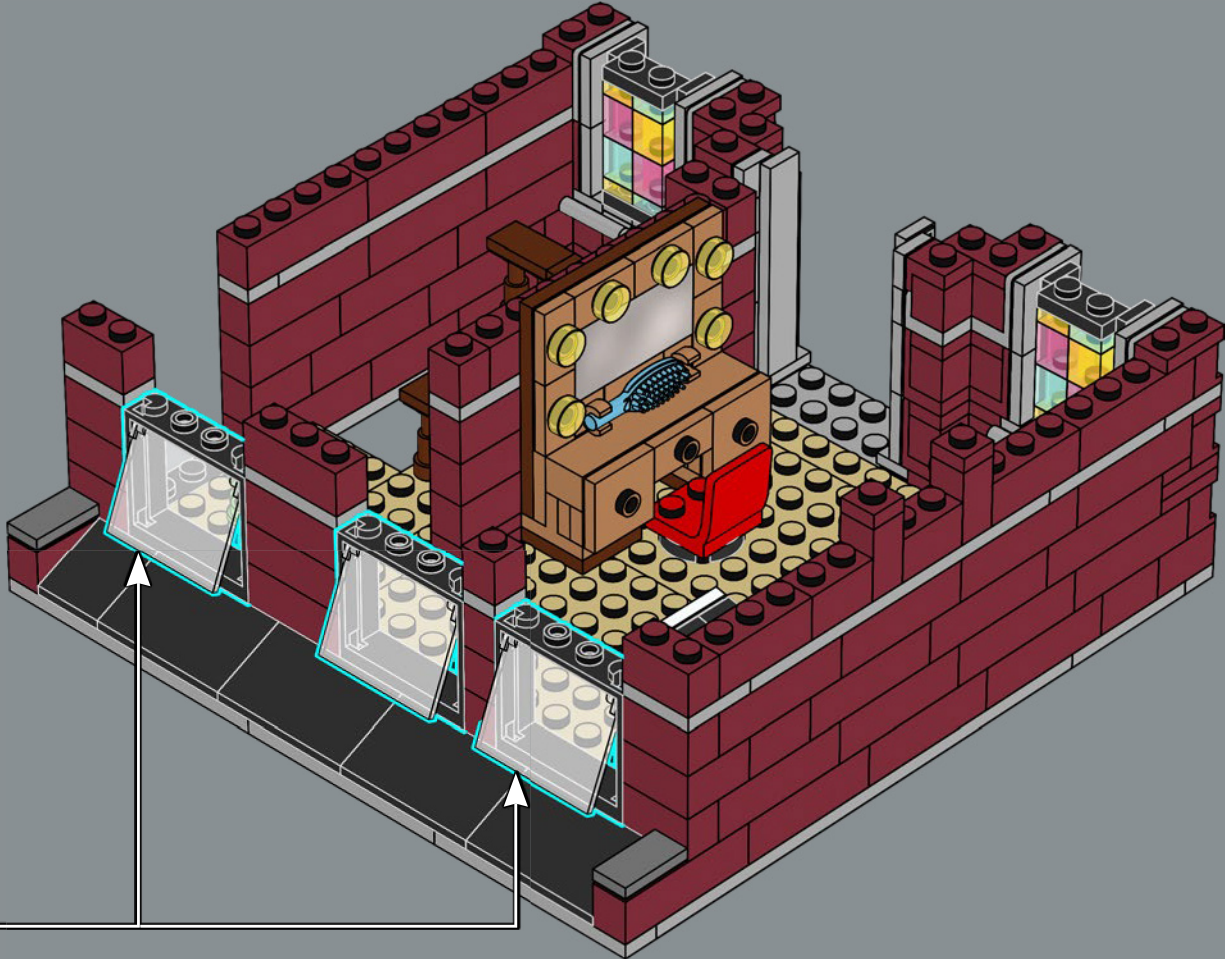

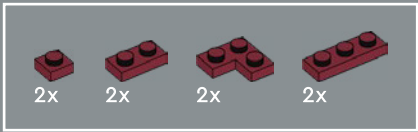

332

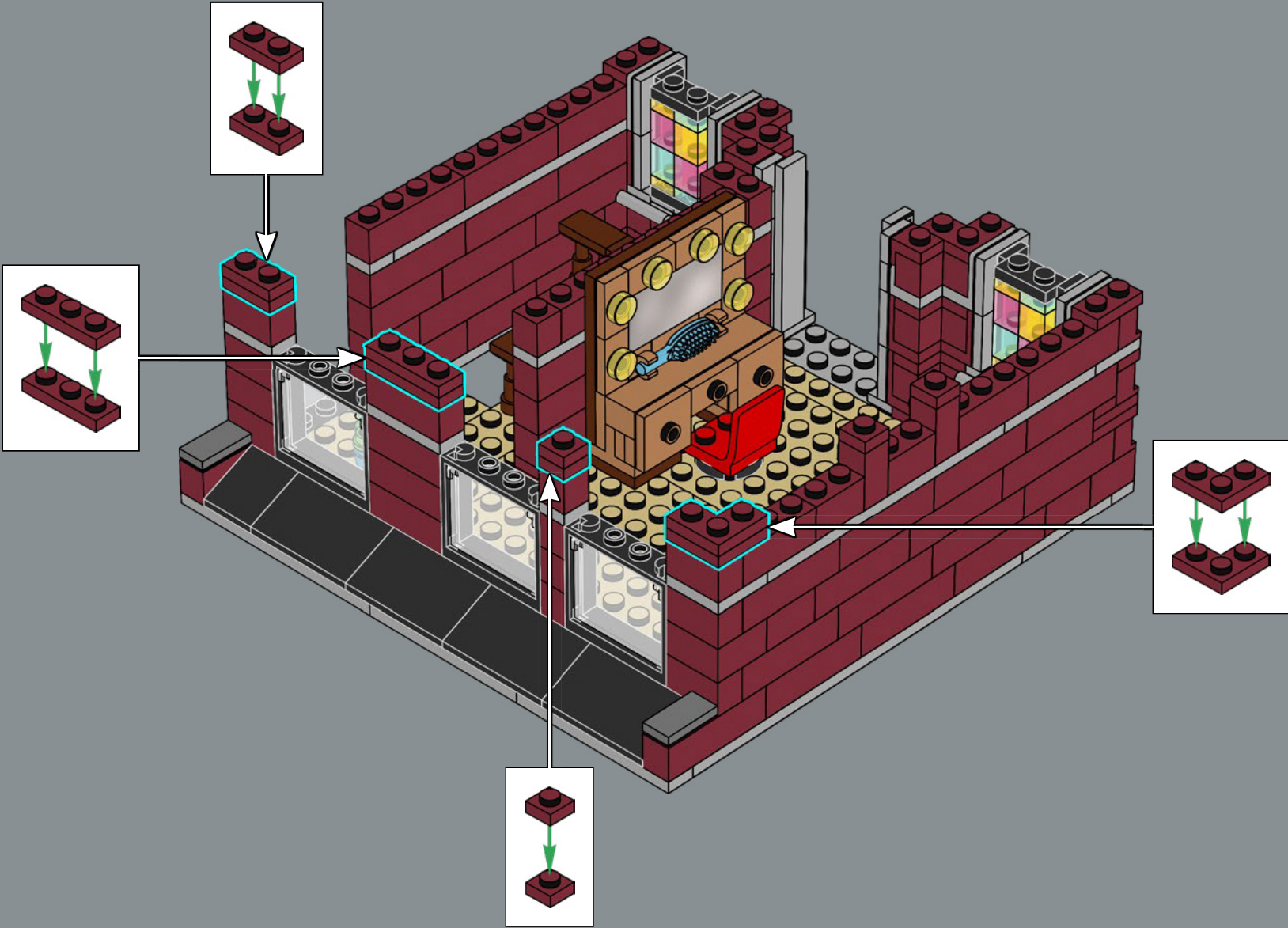

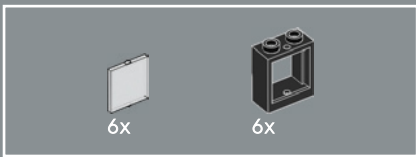

333

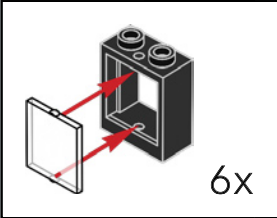

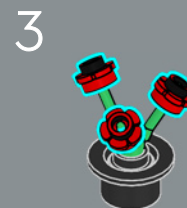
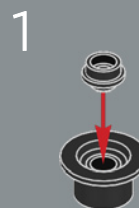
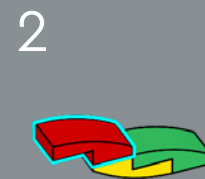
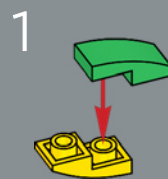
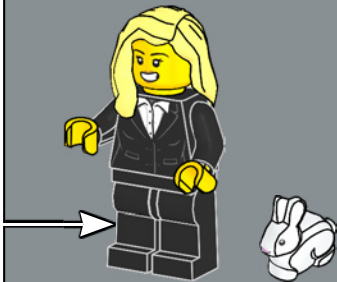
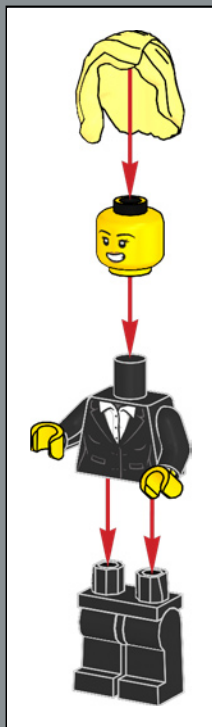

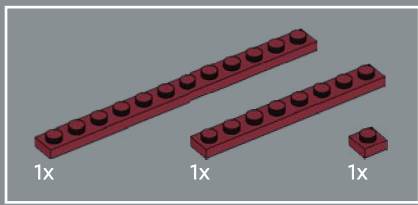

334



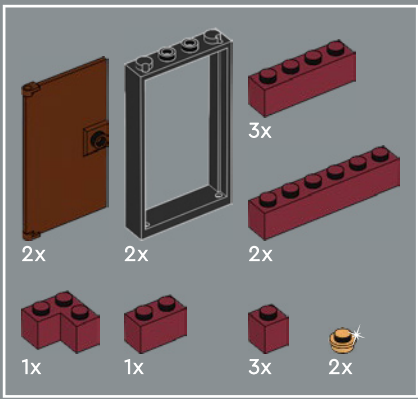

335

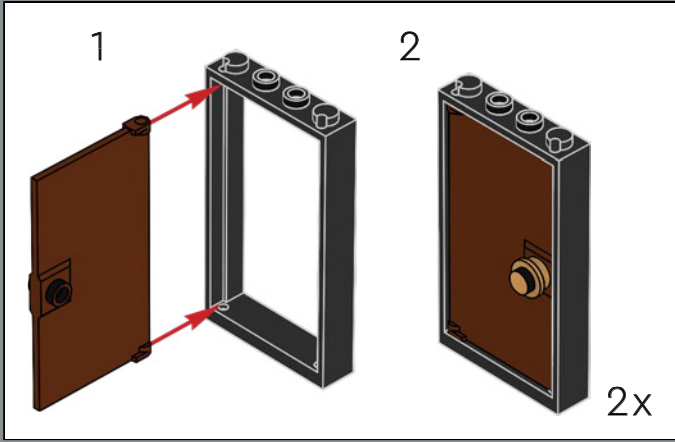

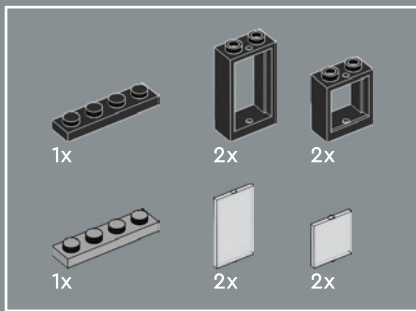

336

1

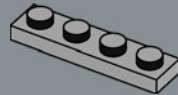

2

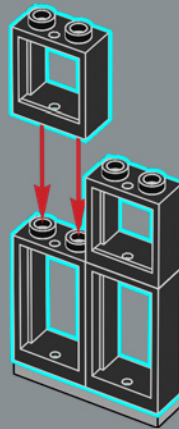

3

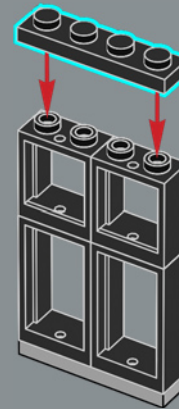

4

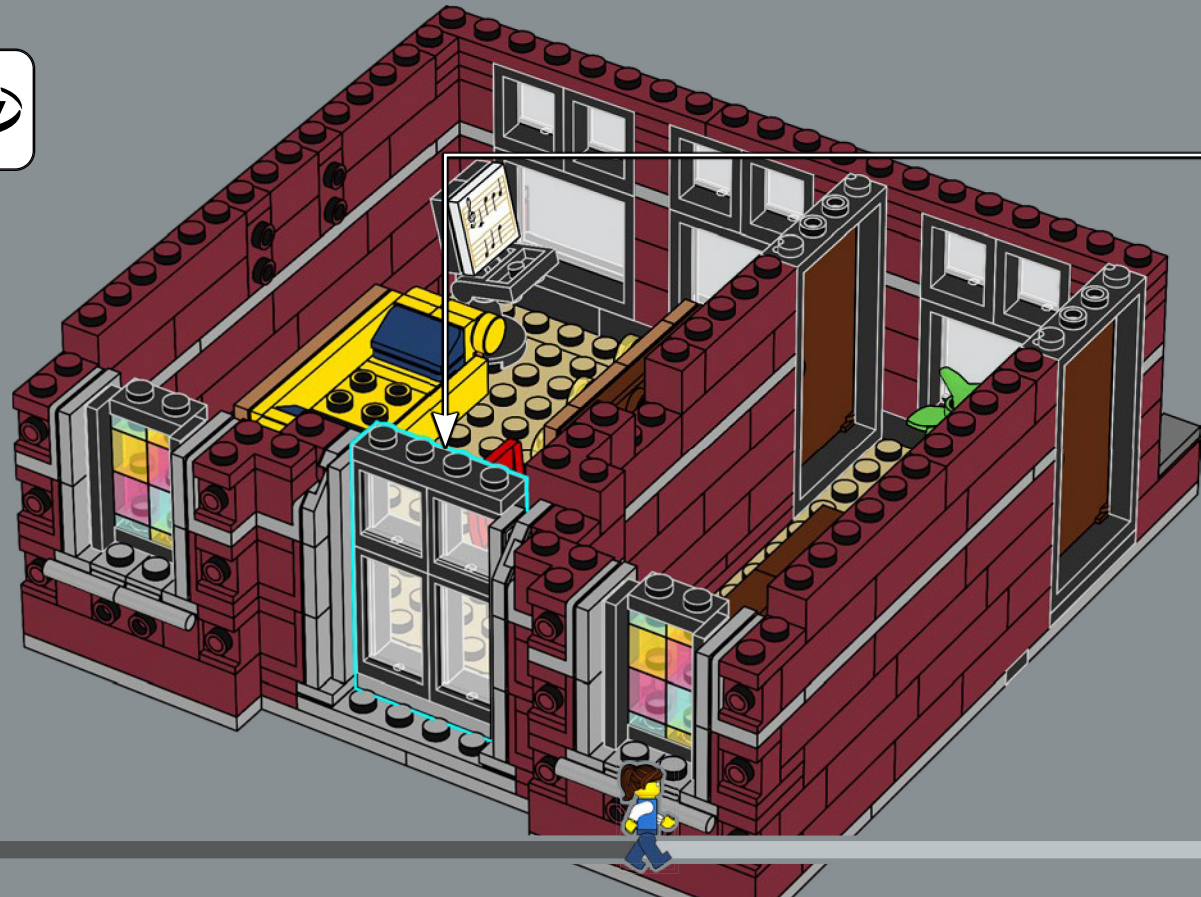
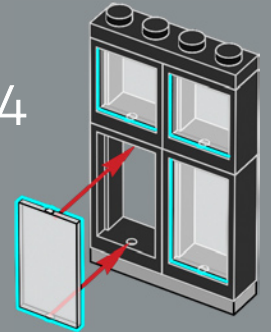

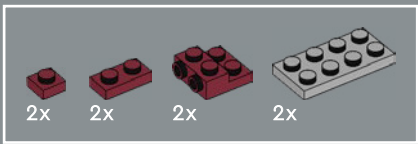

337

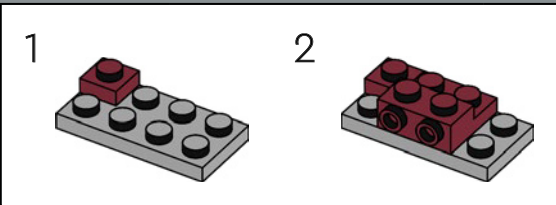
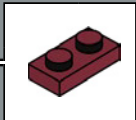
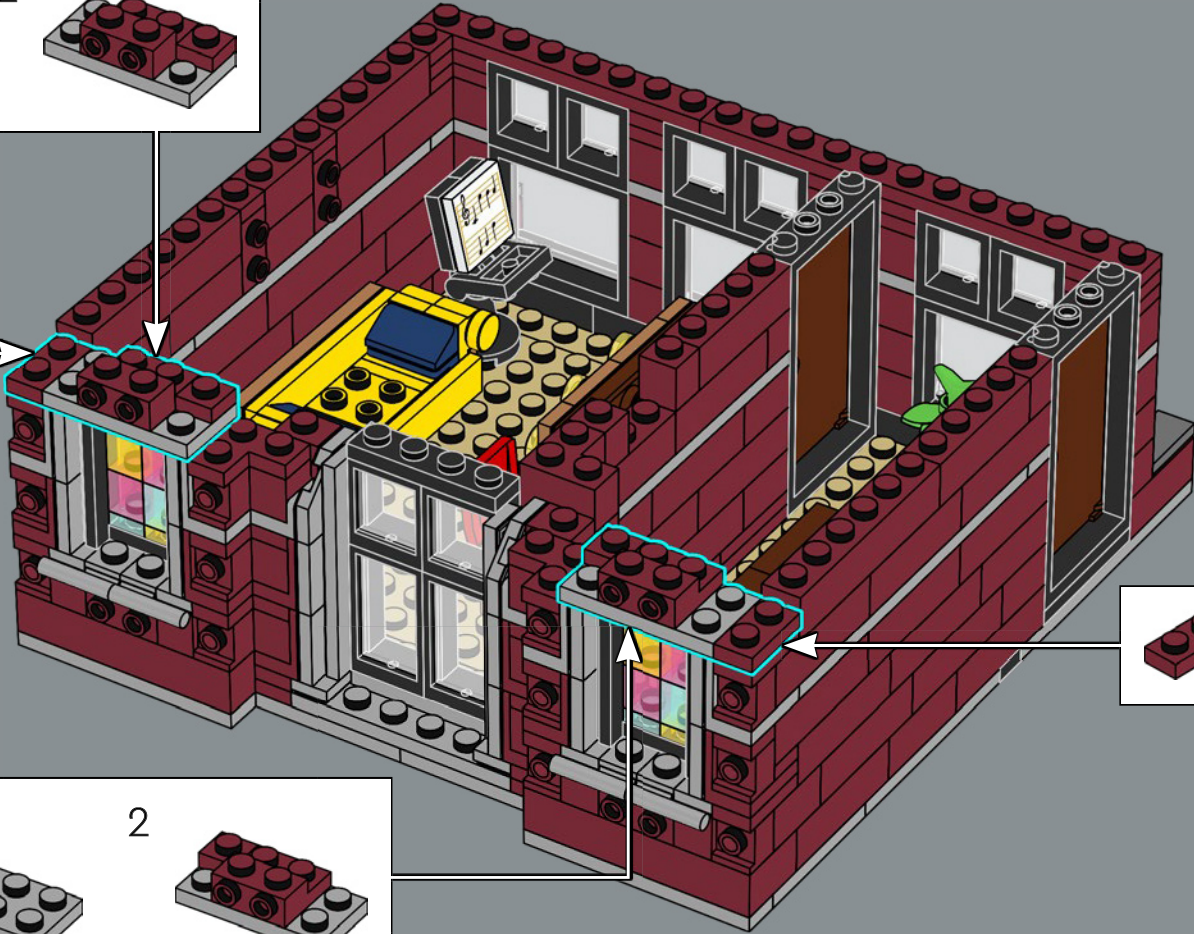
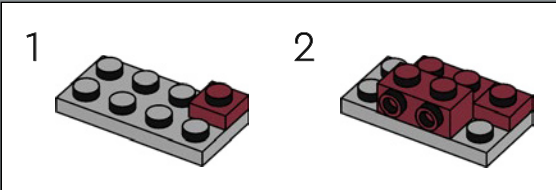

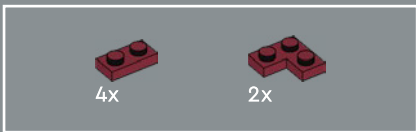

338

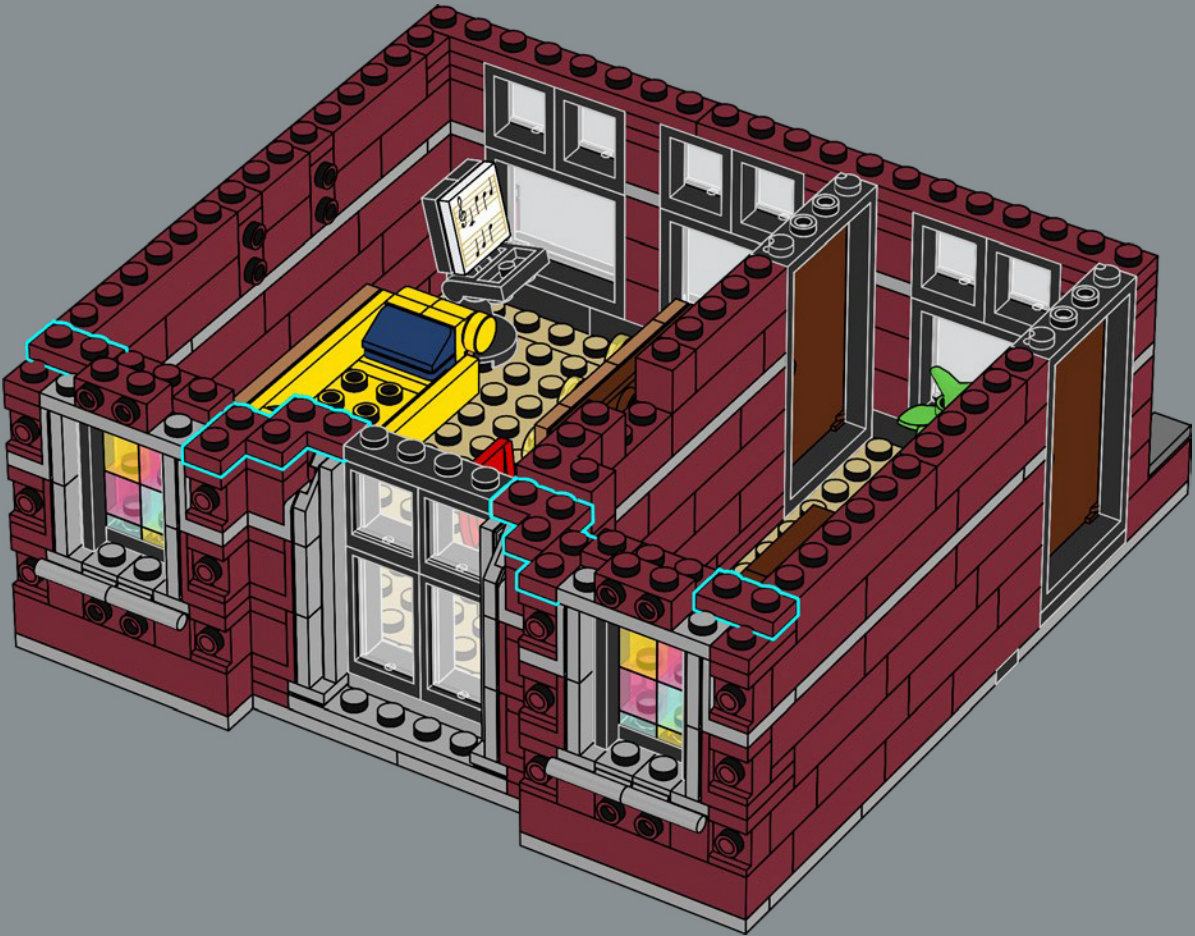

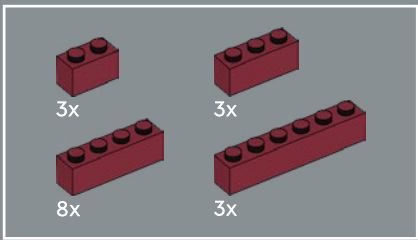

339

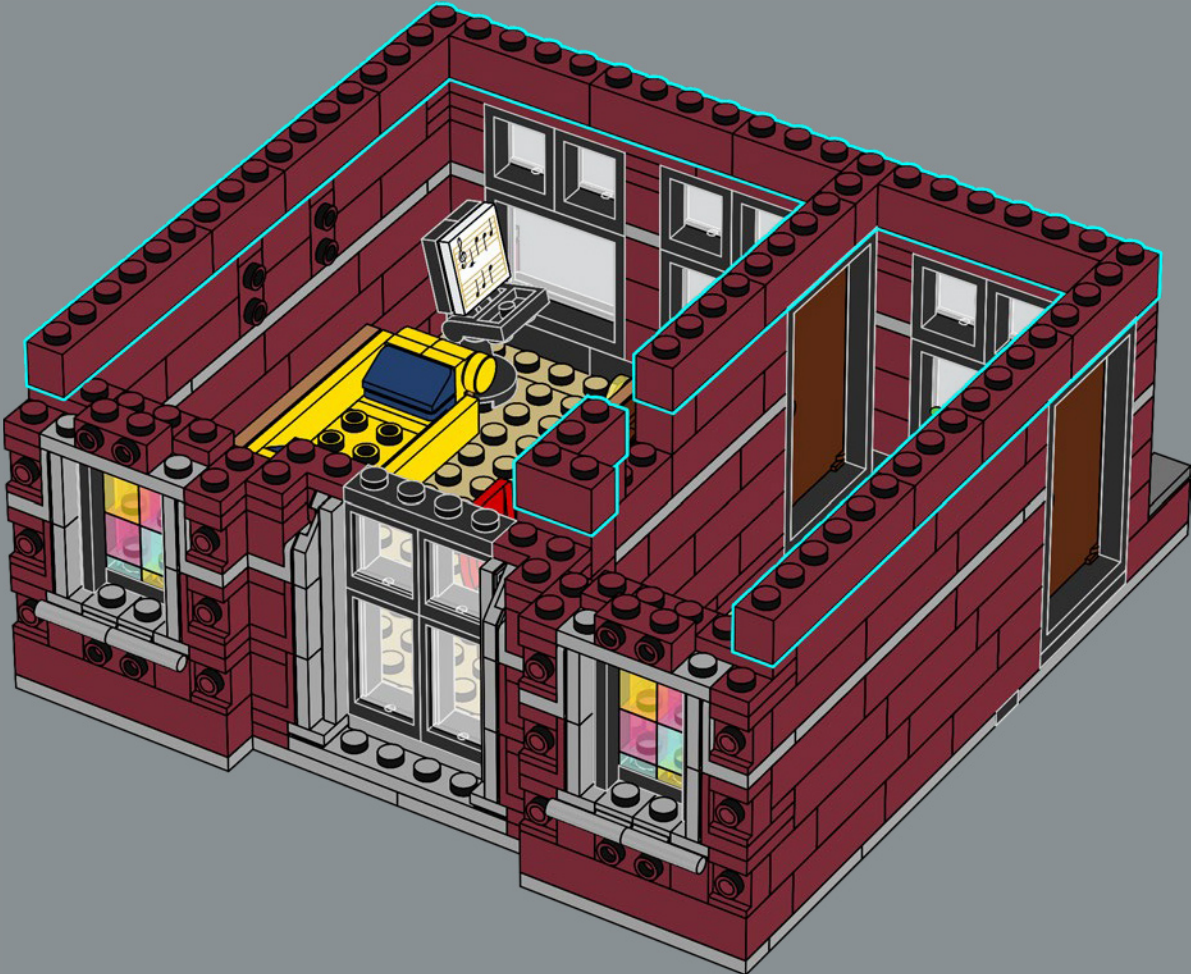

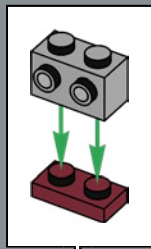
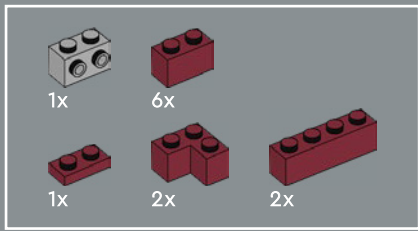

340

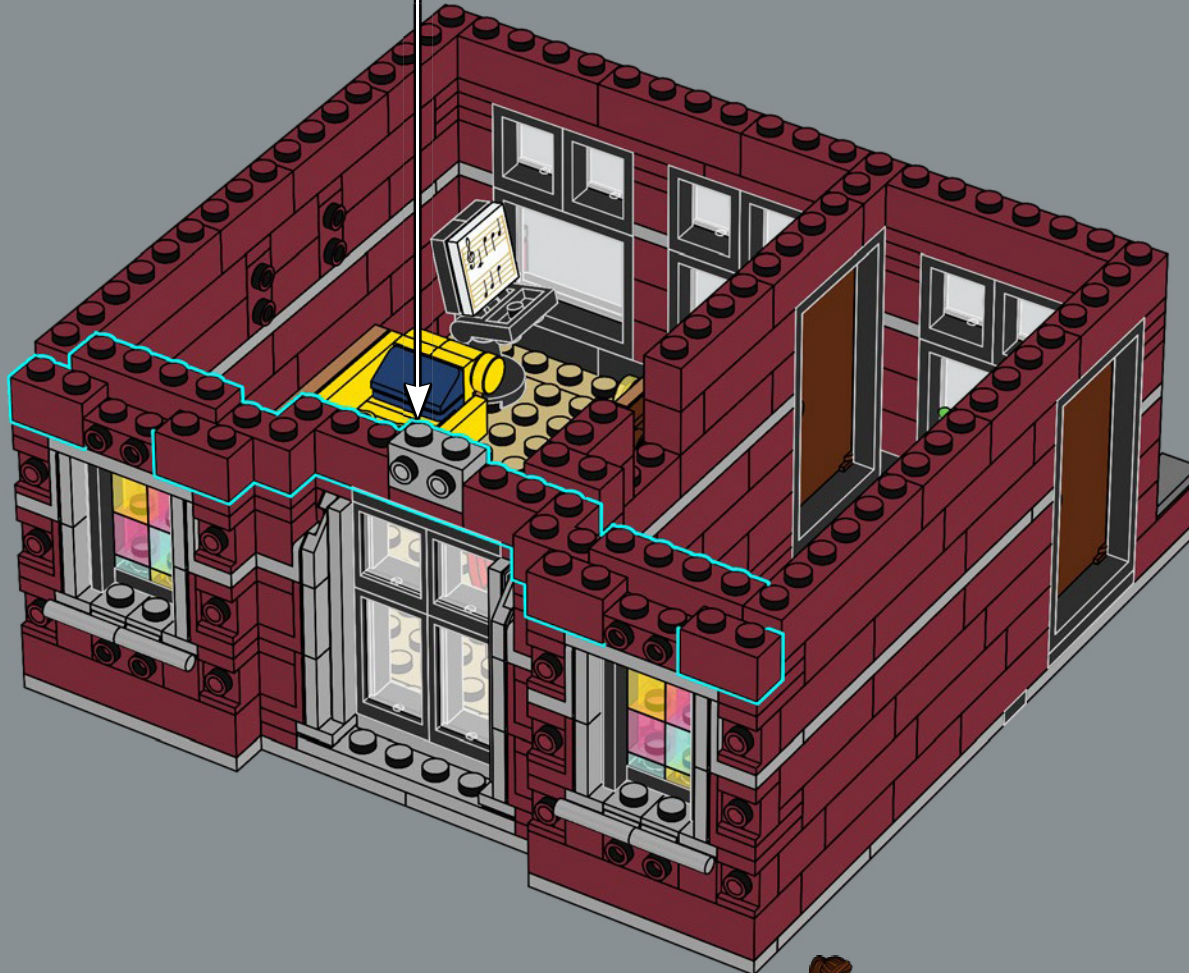

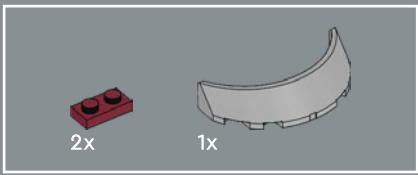

341

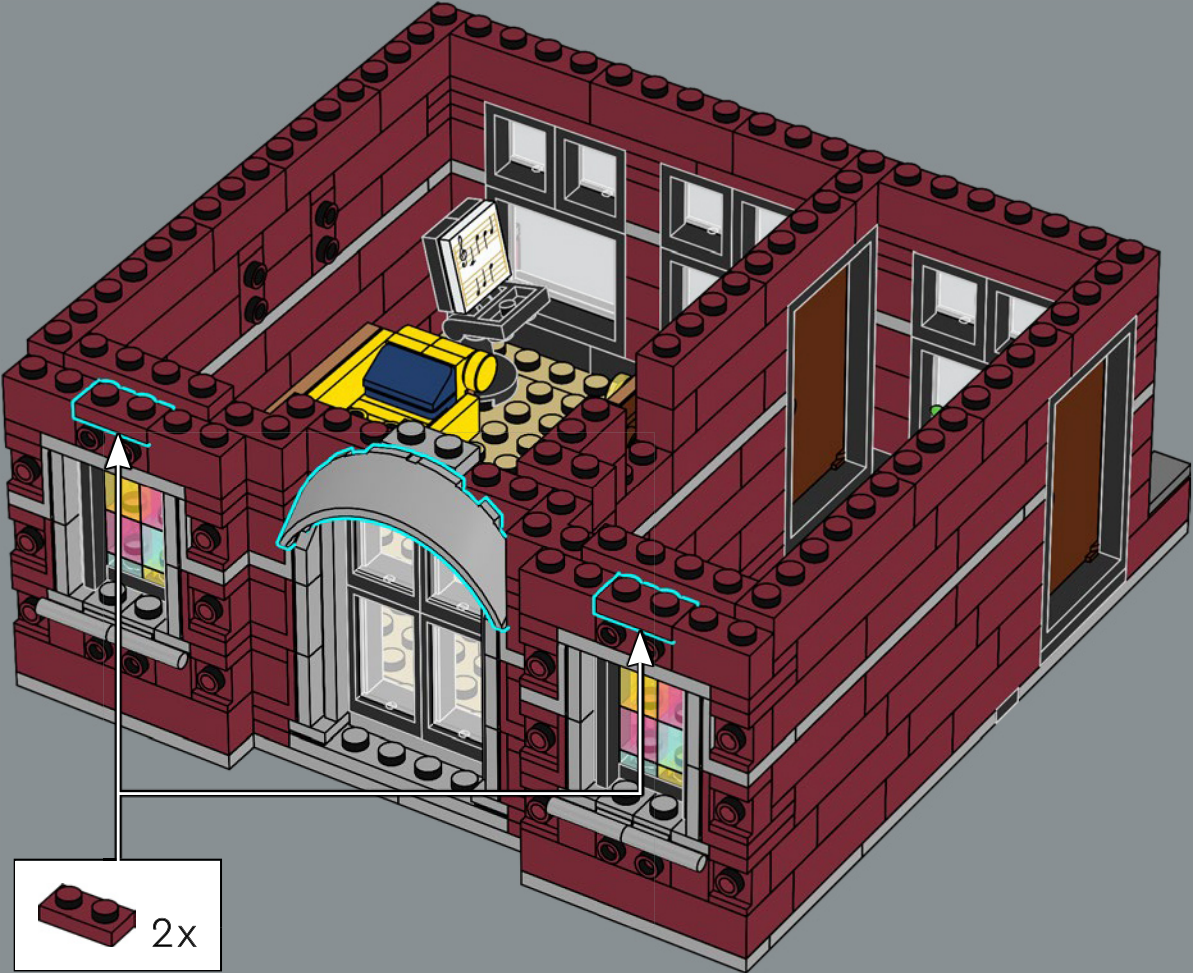

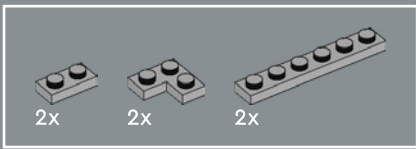

342

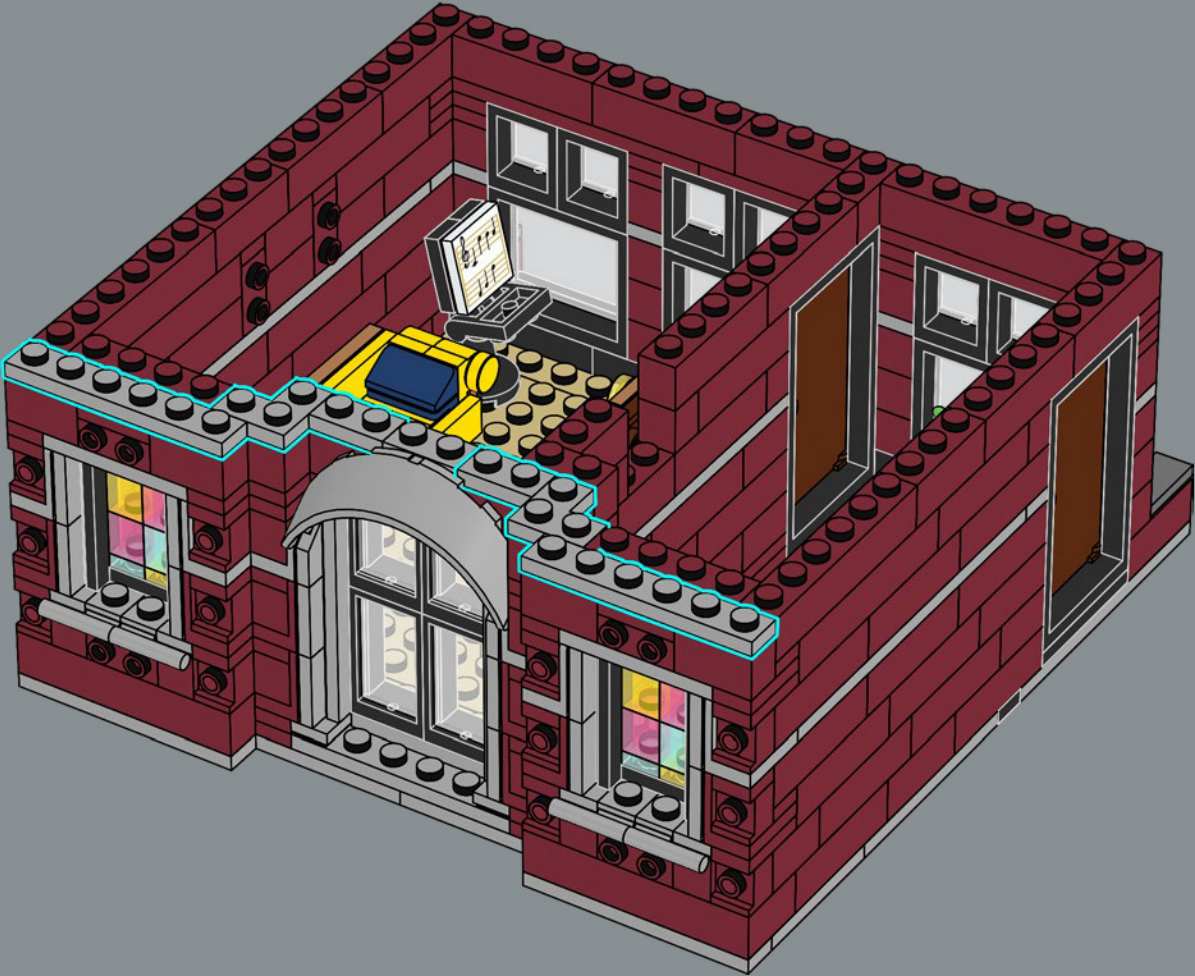

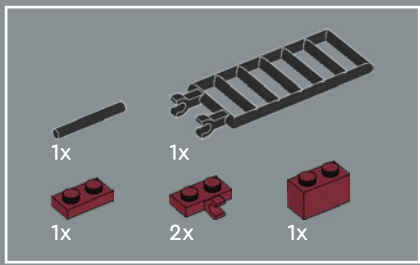

343

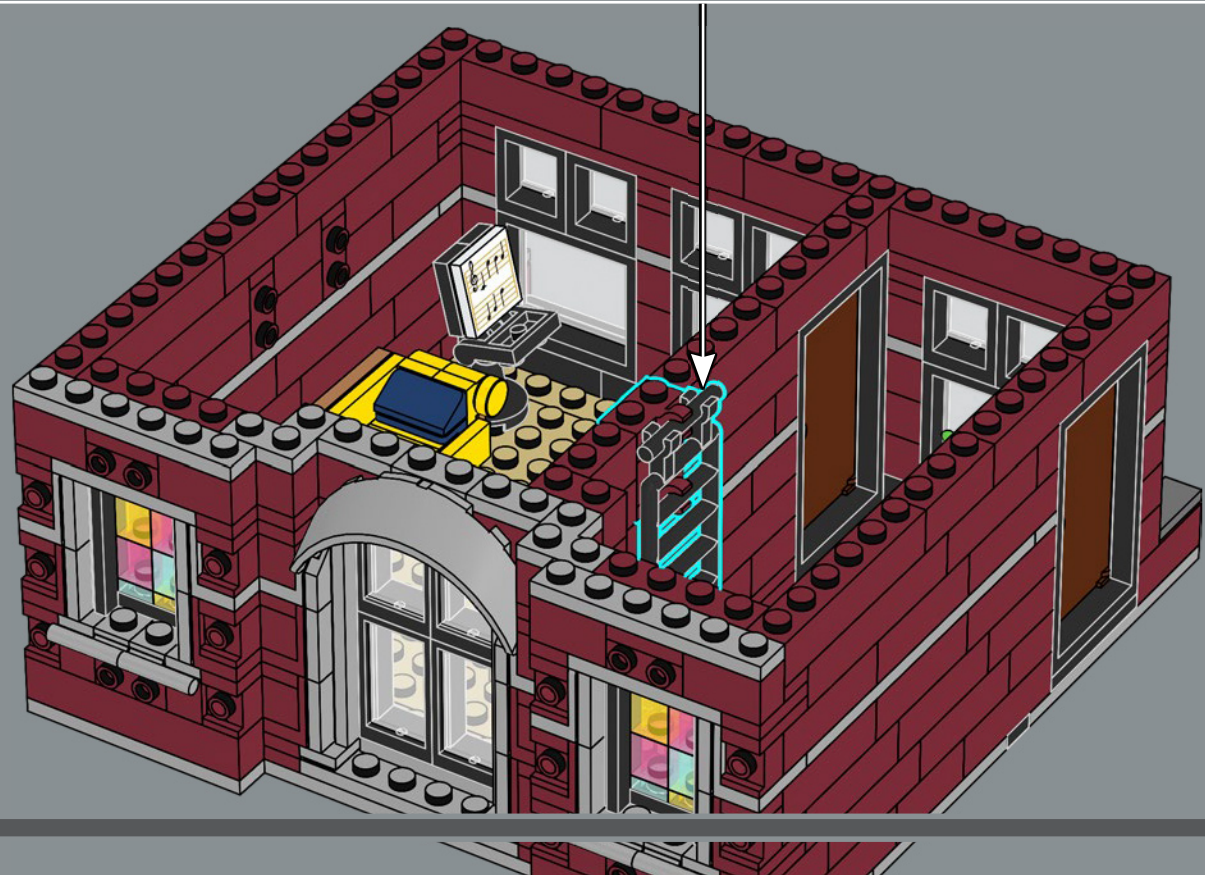
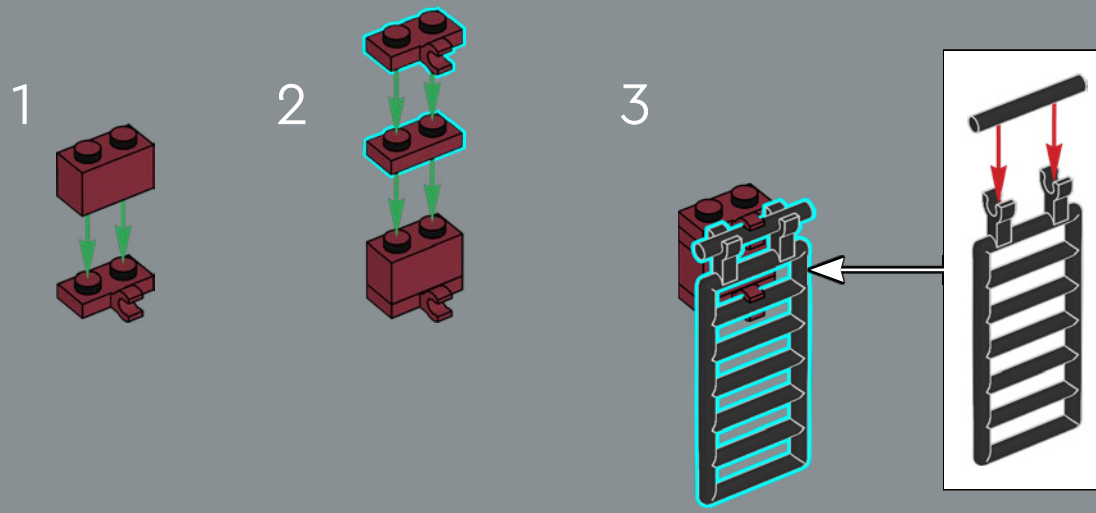

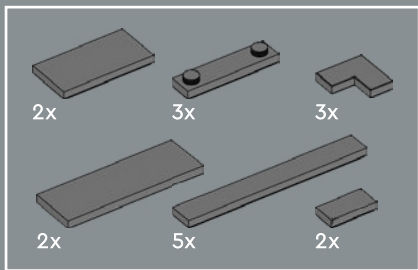

344

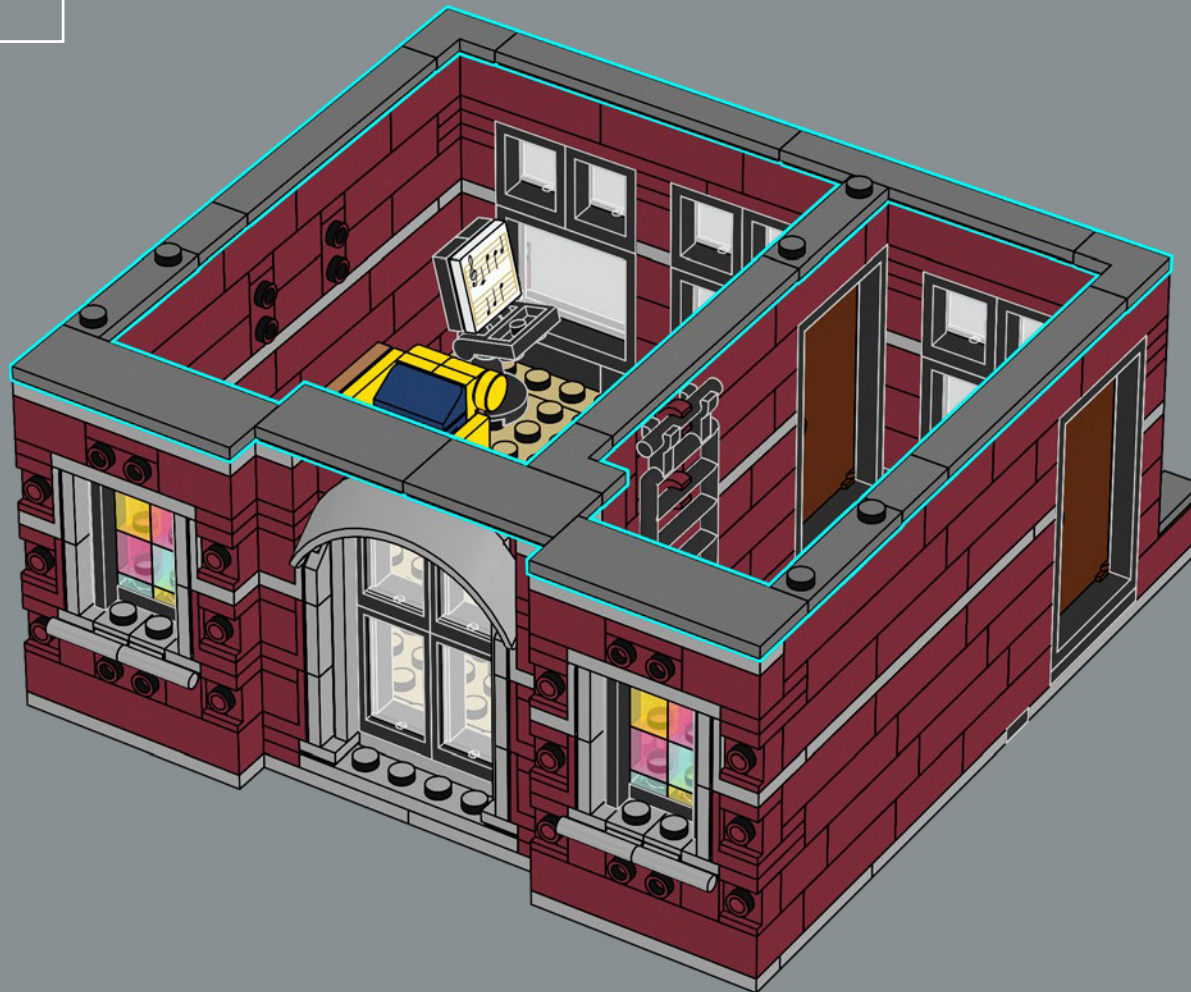

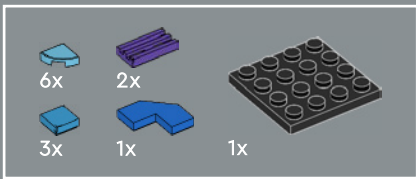

345

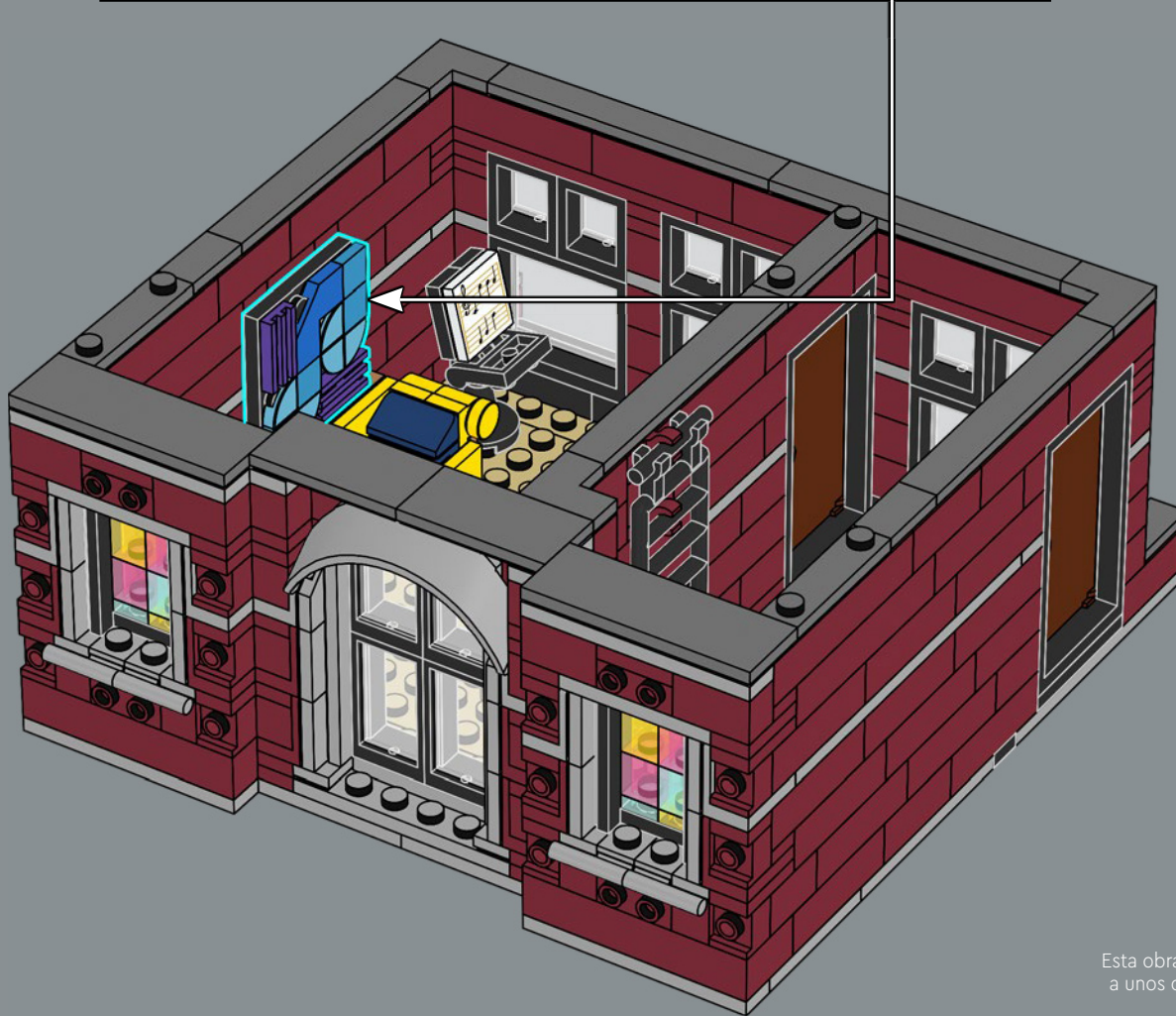
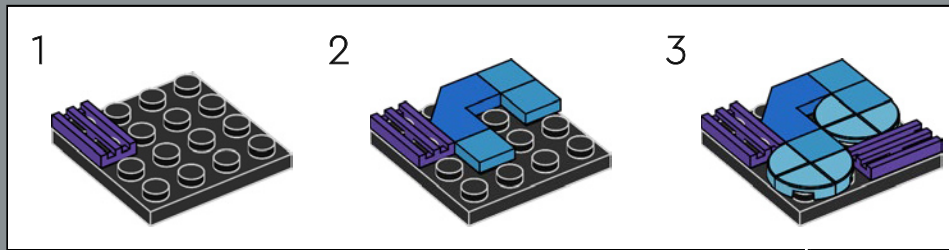

Esta obra, titulada *La nostalgia*, acaba de venderse a unos cuantos pasos de aquí, en la galería de arte del Hotel Boutique LEGO® (10297).

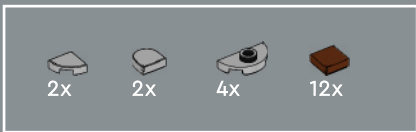

346

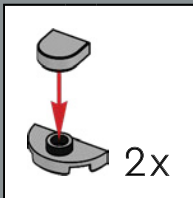
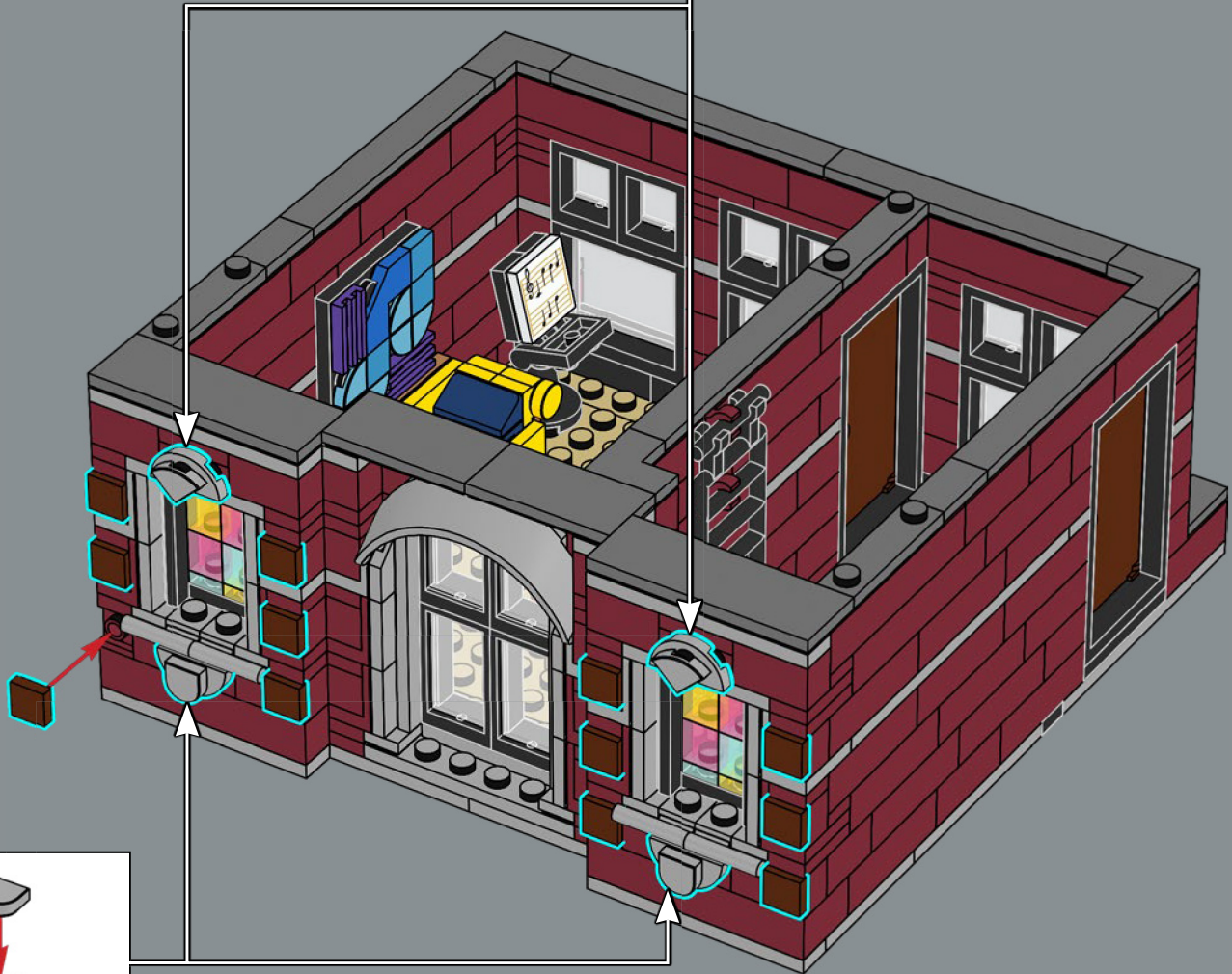
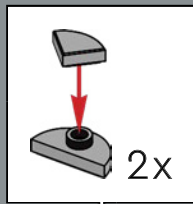

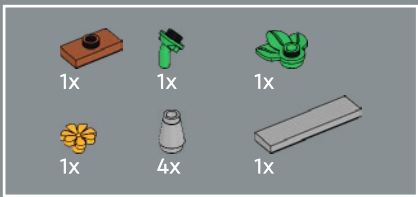

347

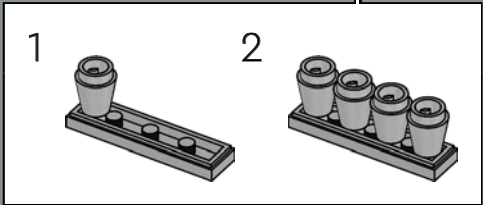
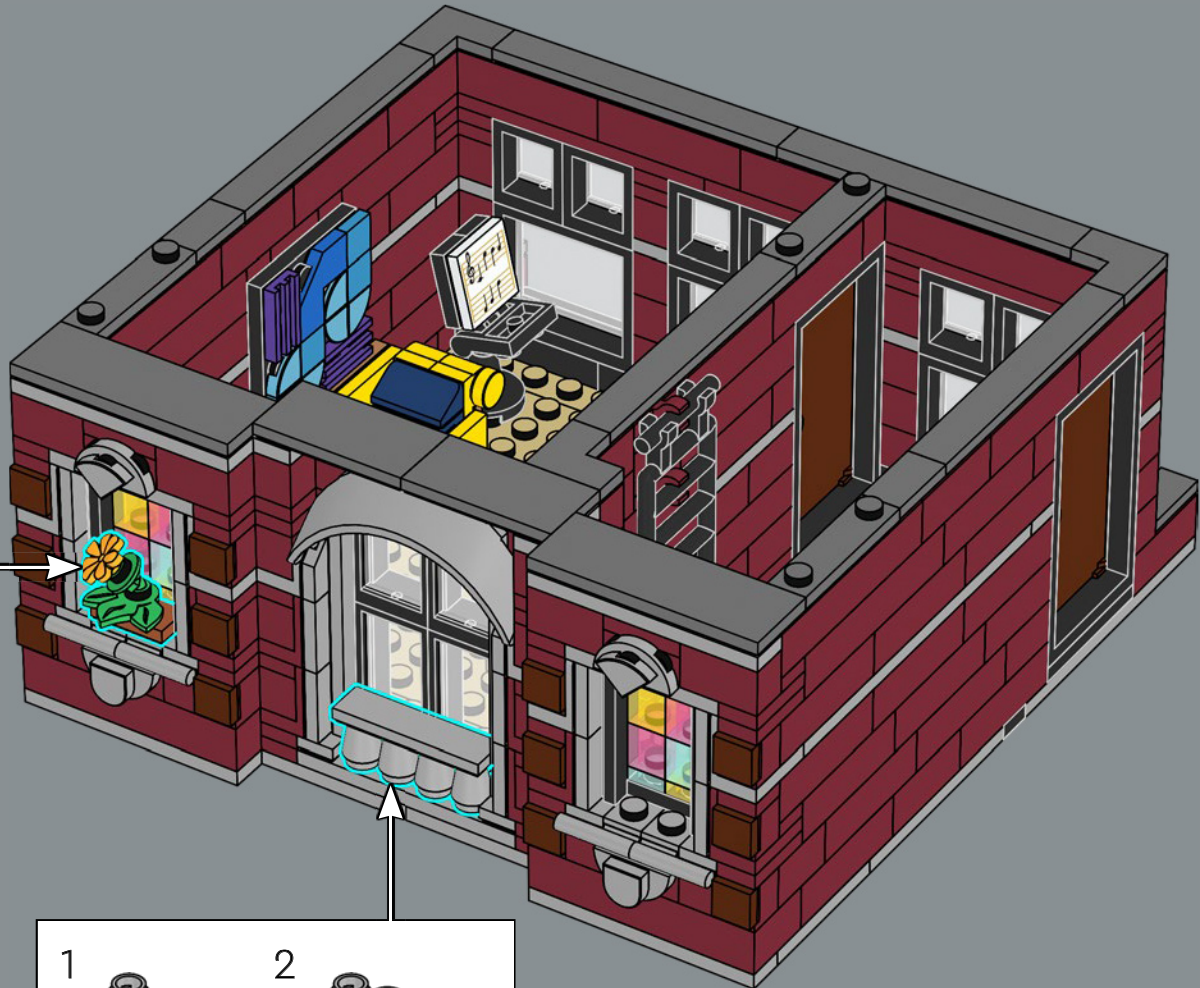
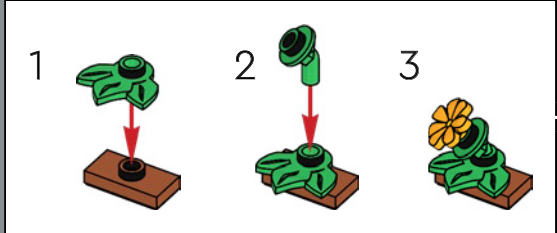

348



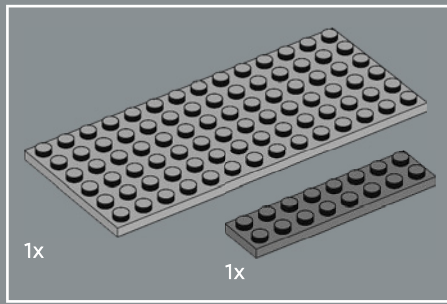

349

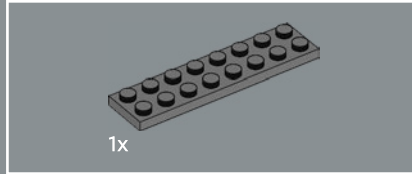
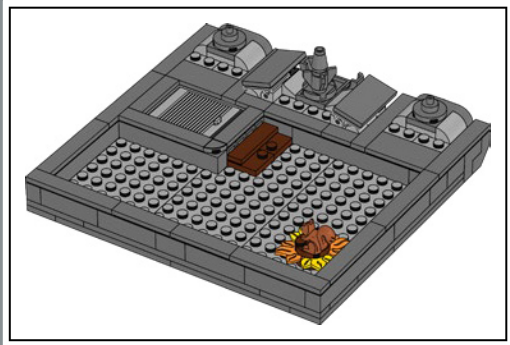
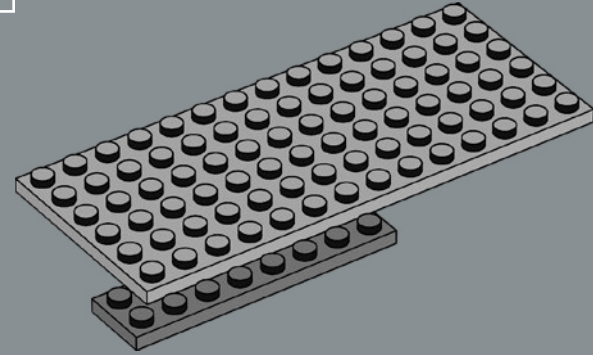

350

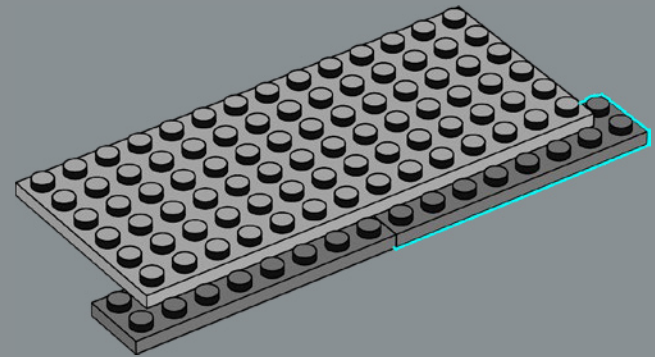

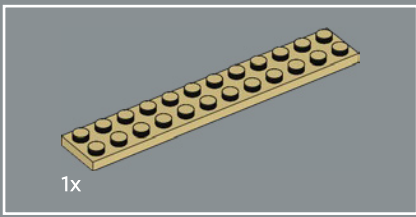

351

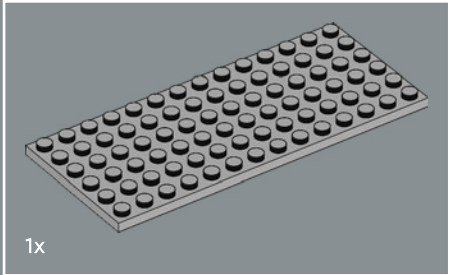
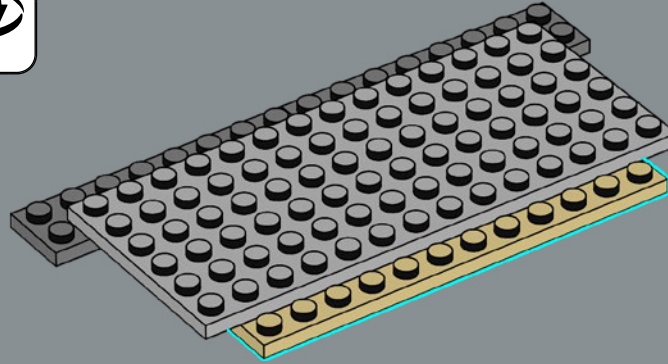

352

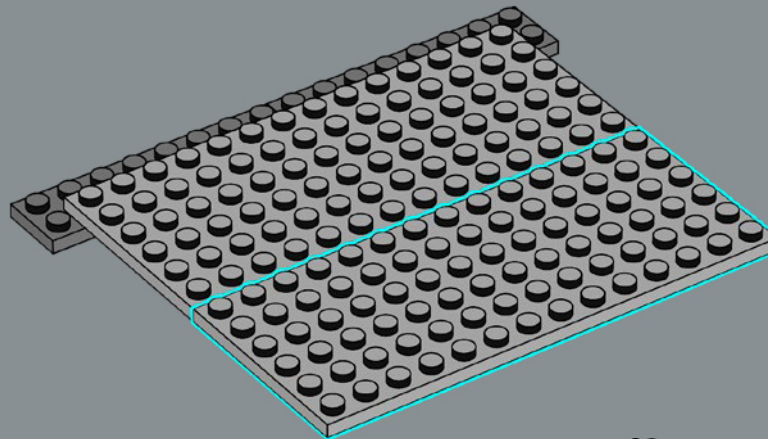

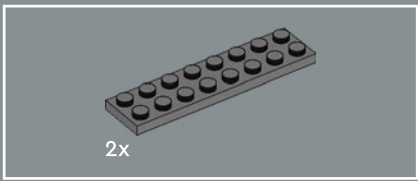

353

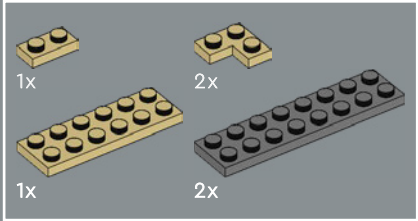
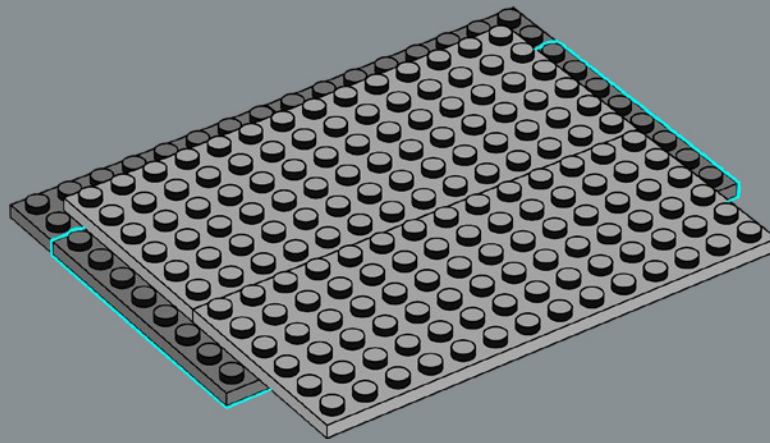

354

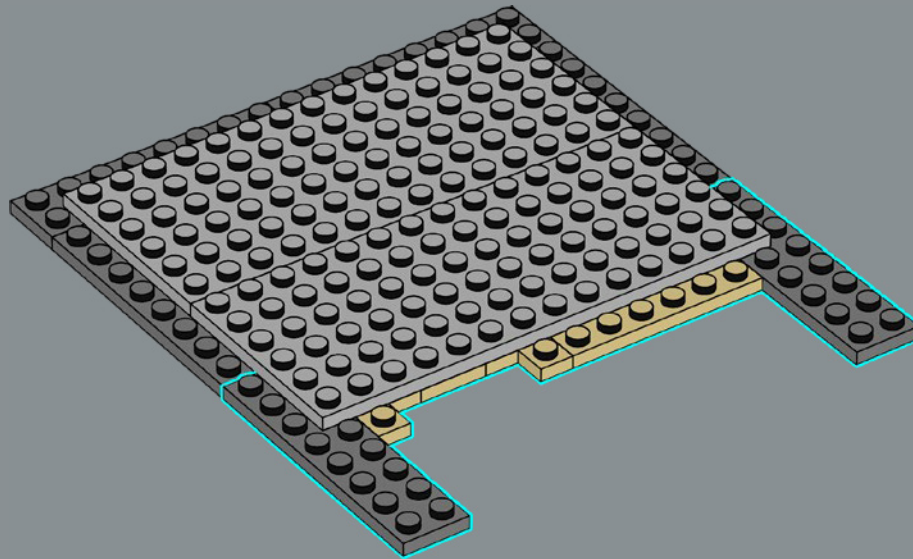

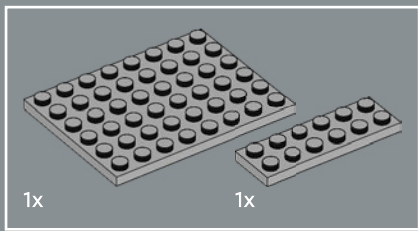

355

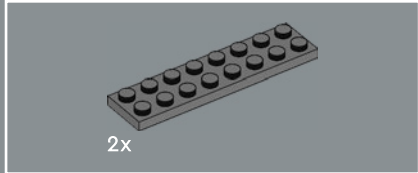
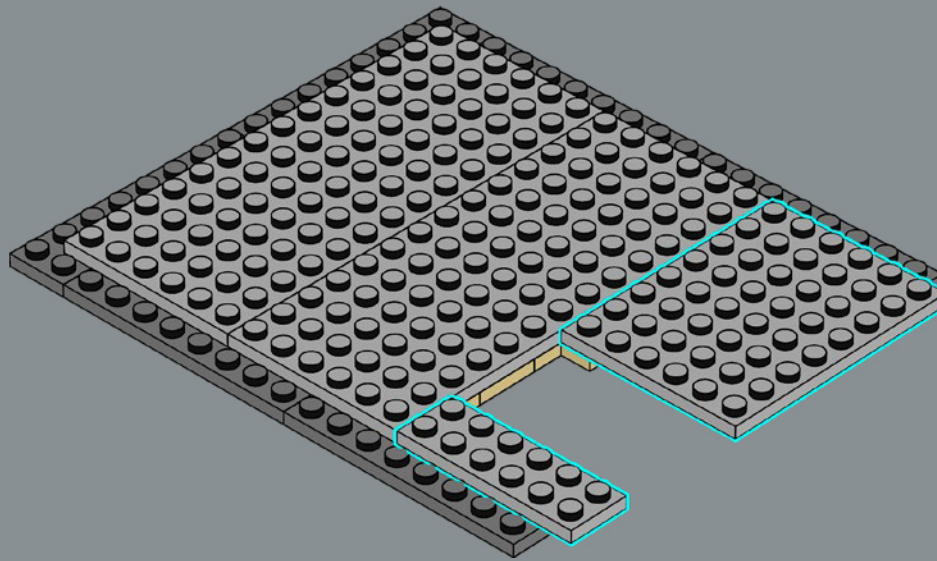

356

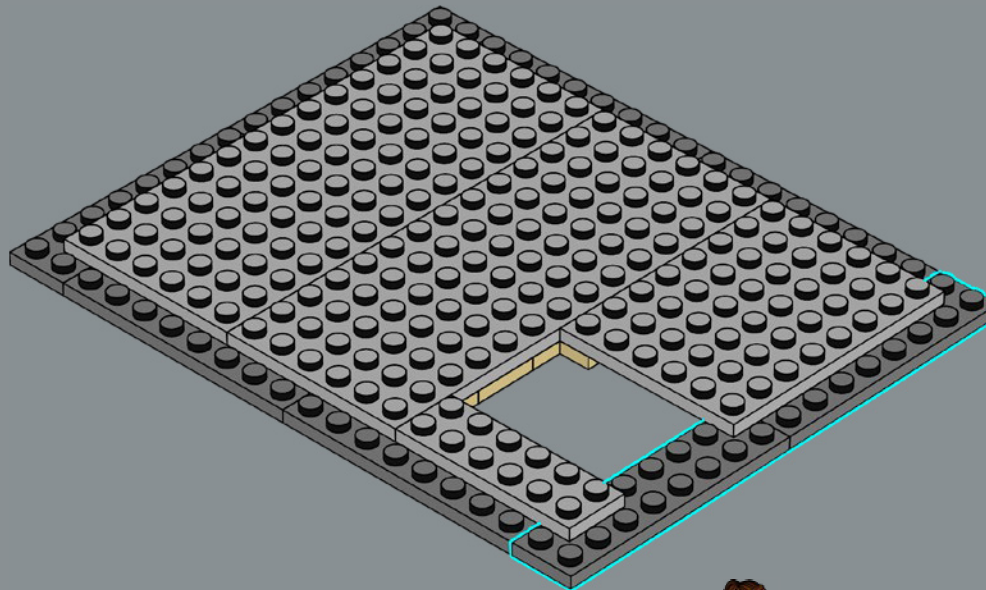

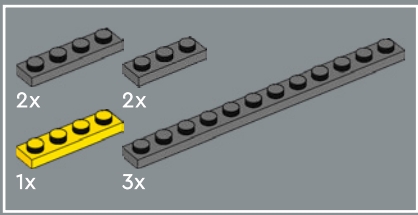

357

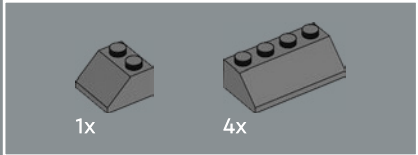
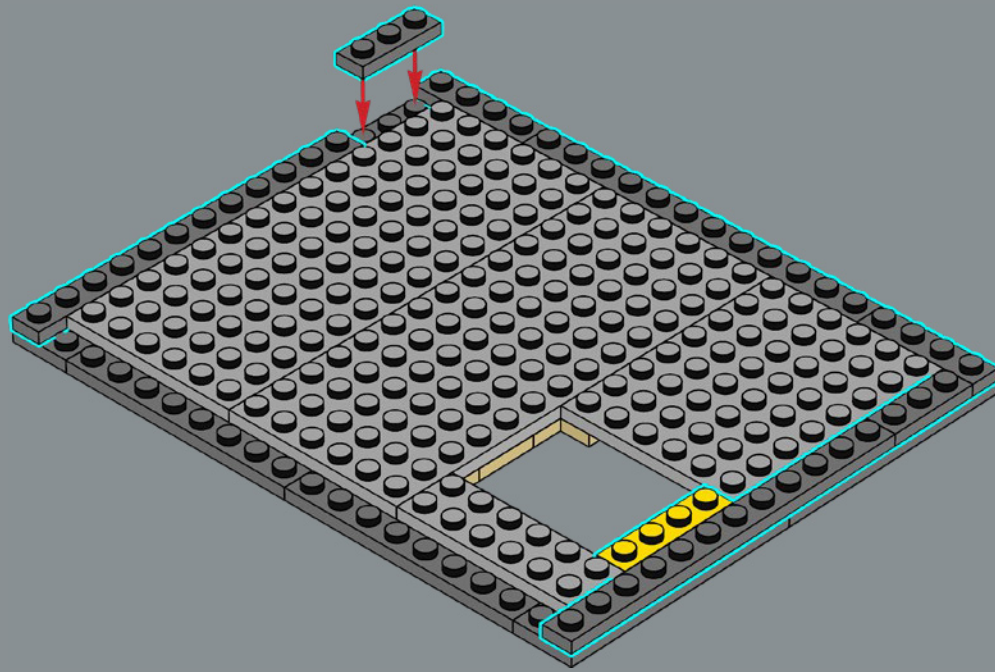

358

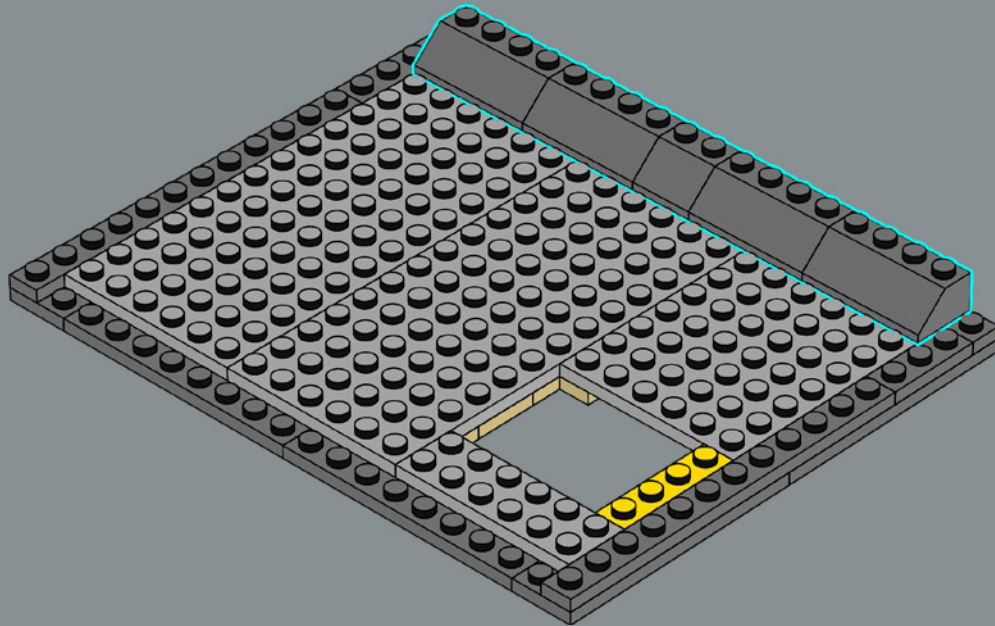

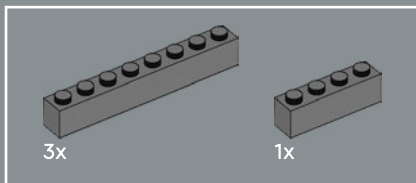

359

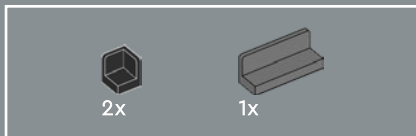
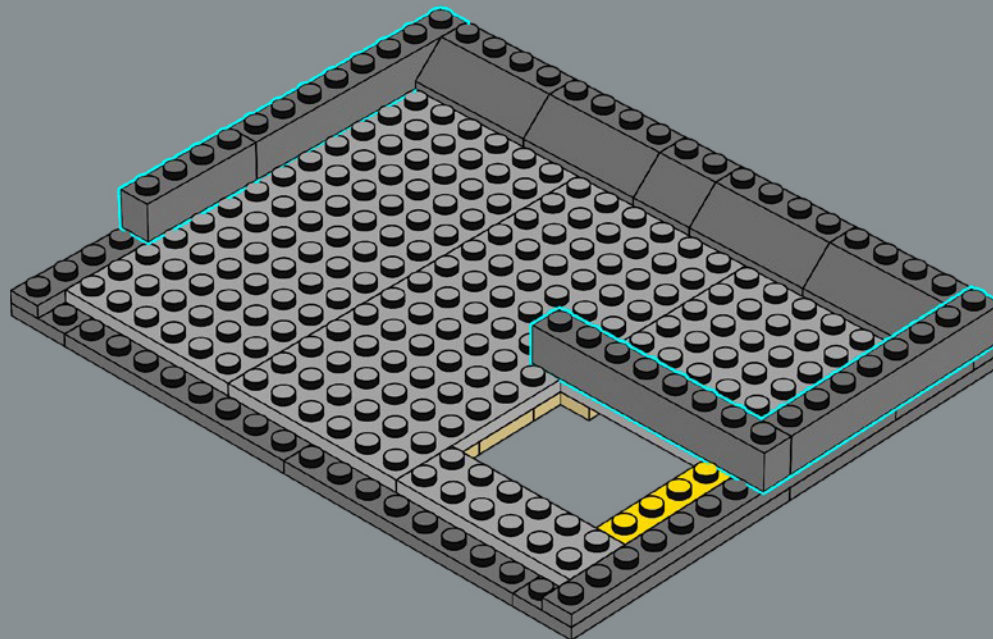

360

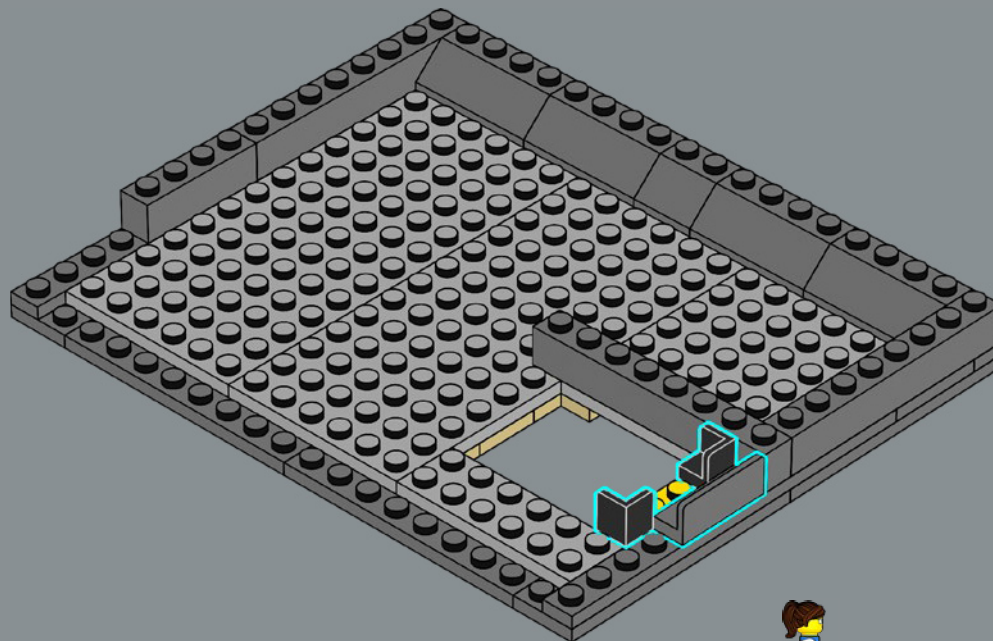

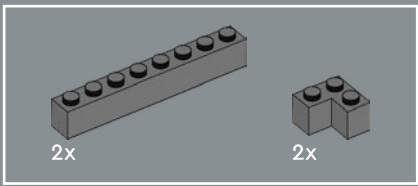

361

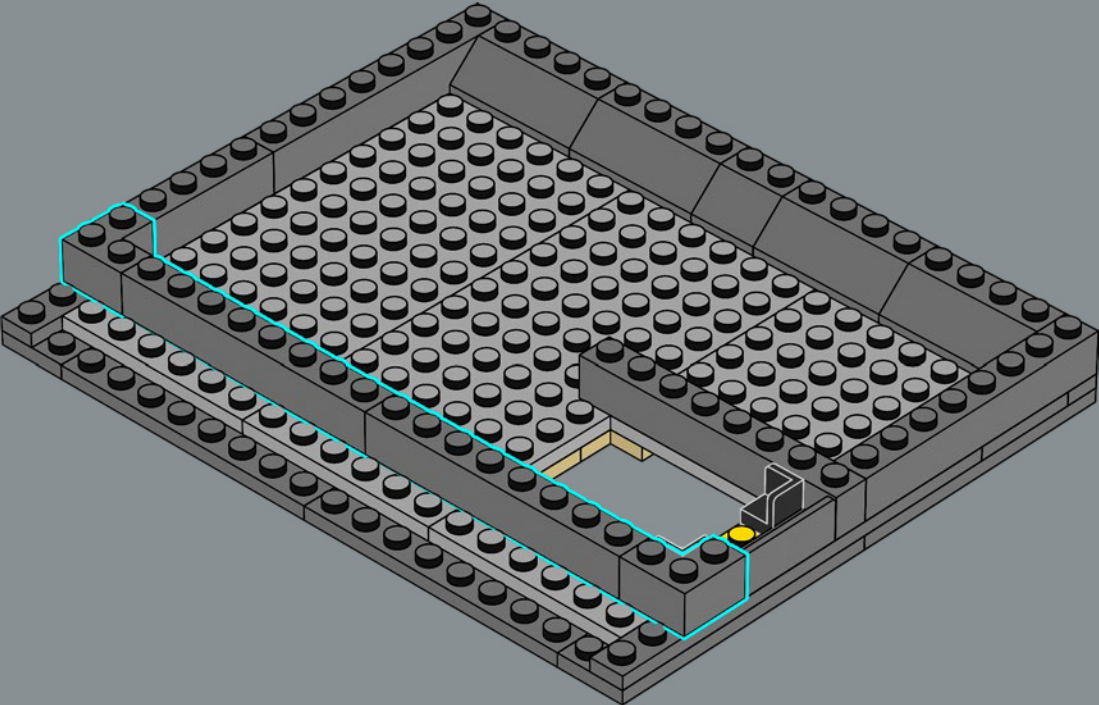

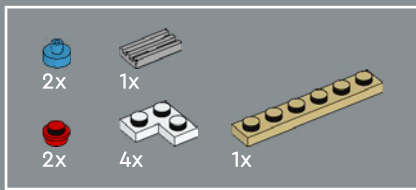

362

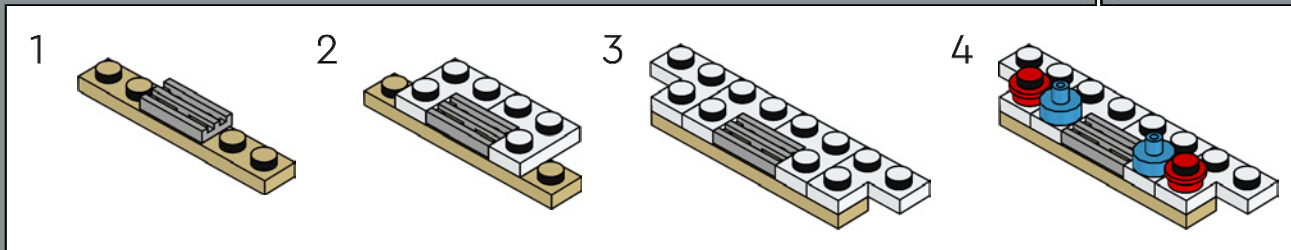
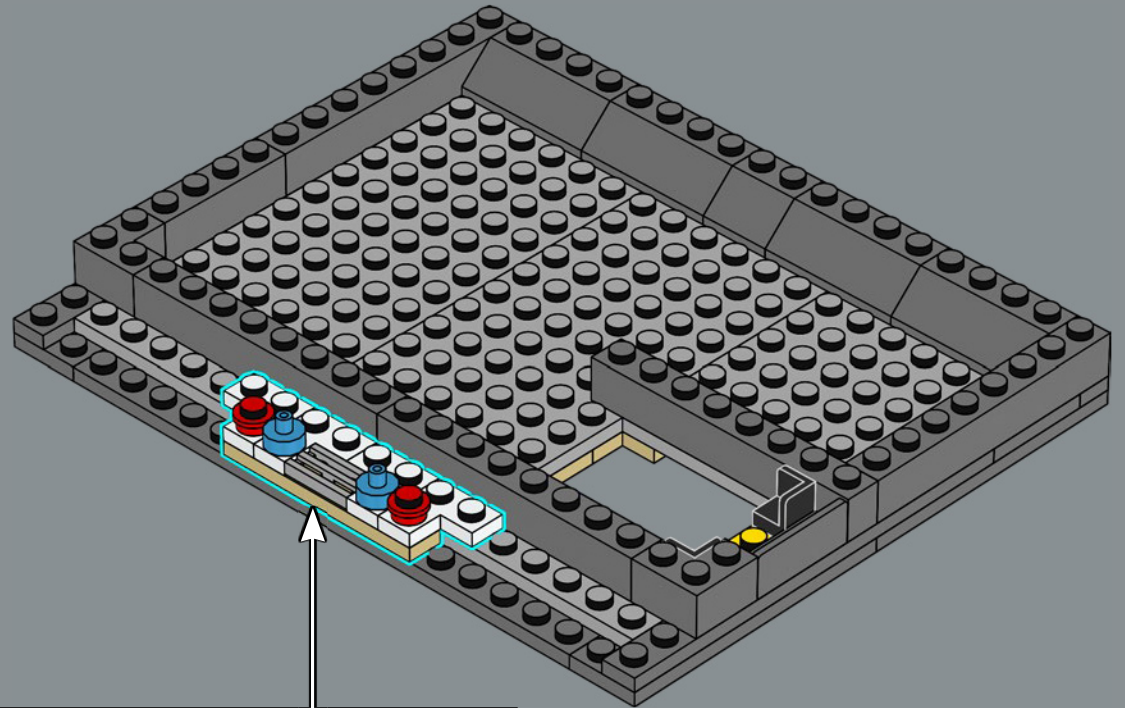

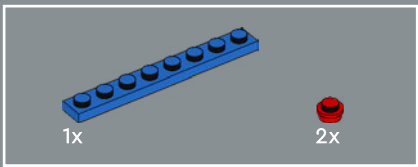

363

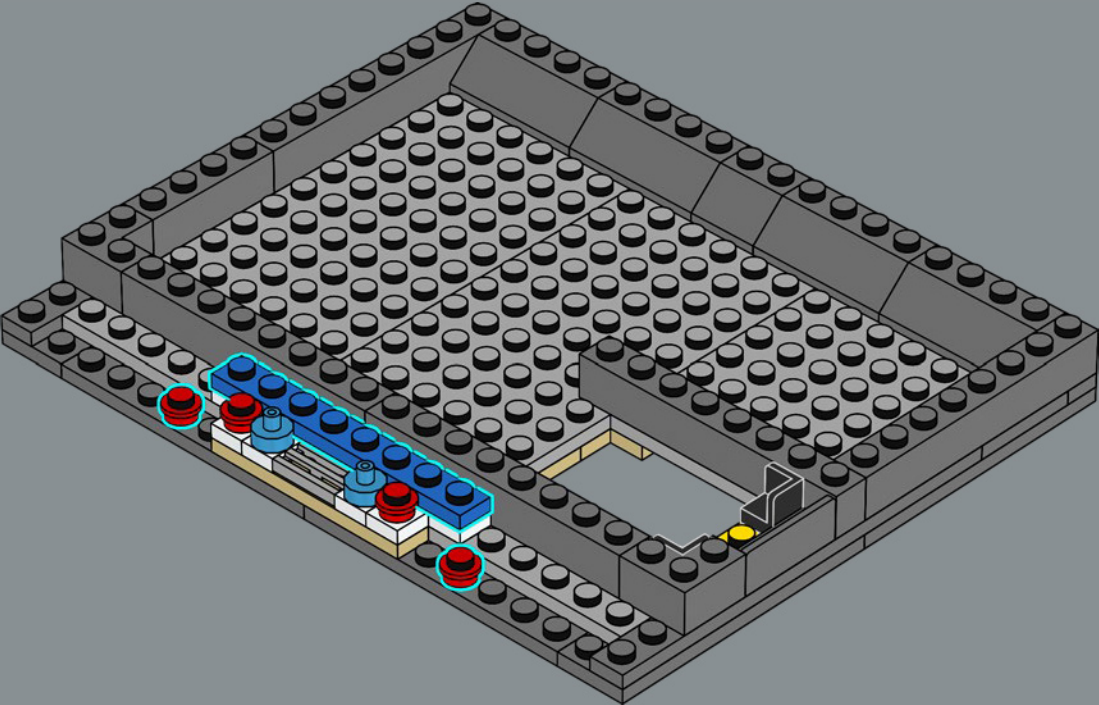

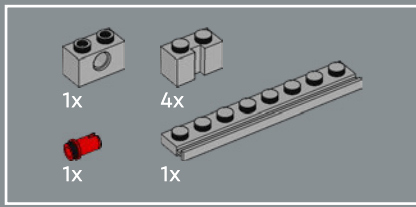

364

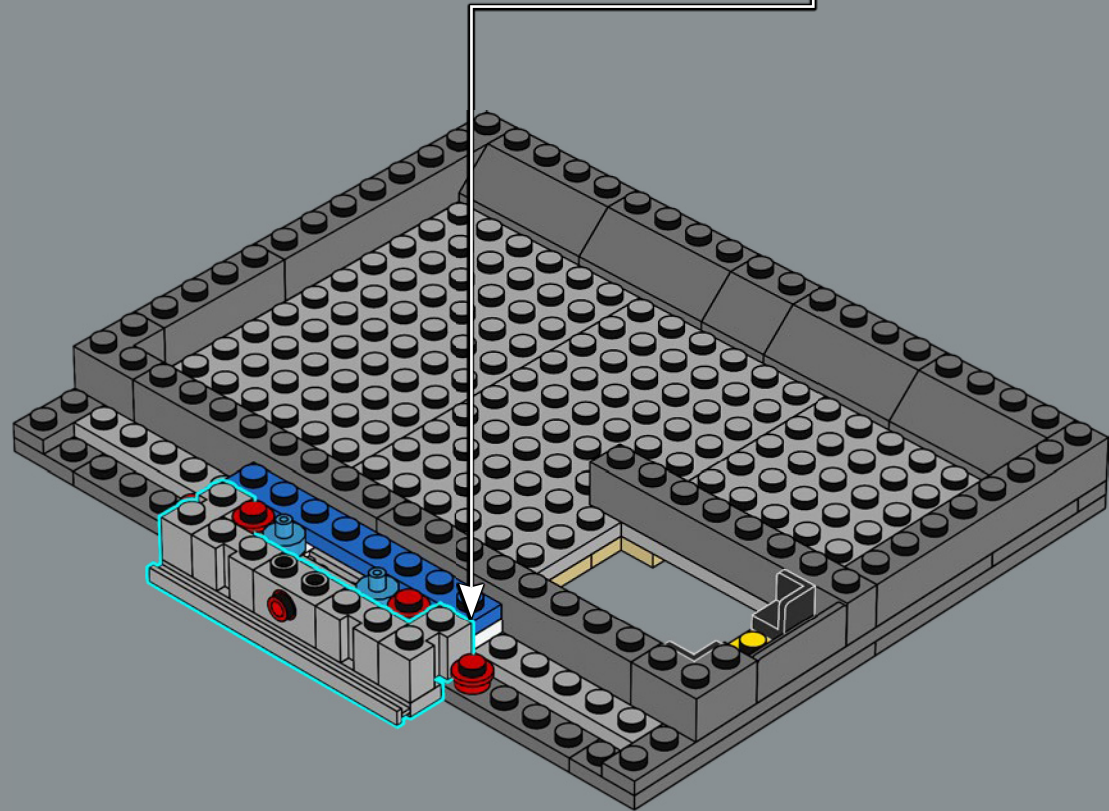
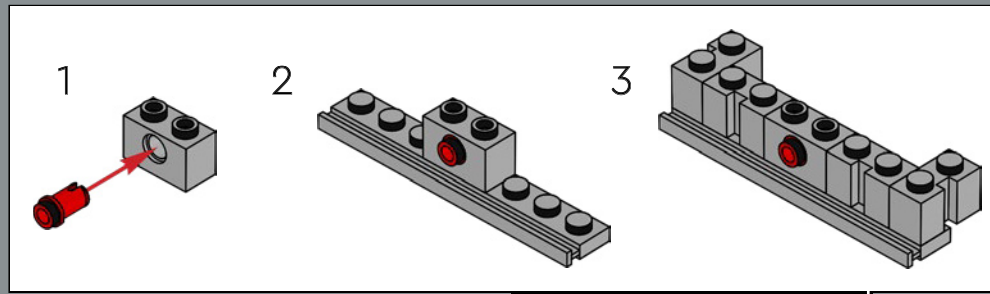

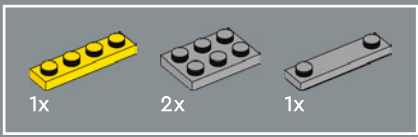

365

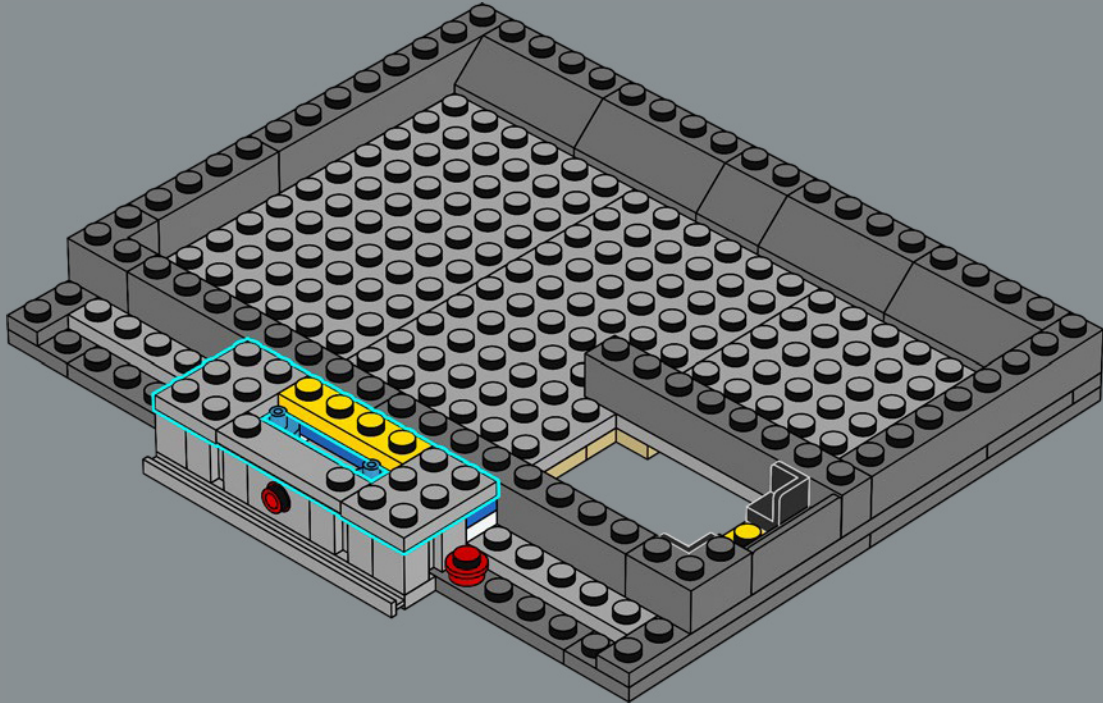

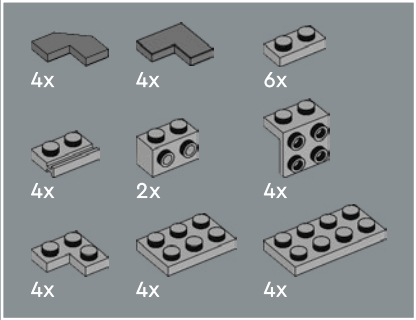
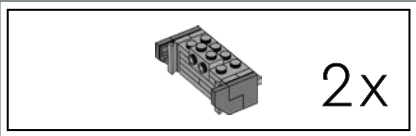

366

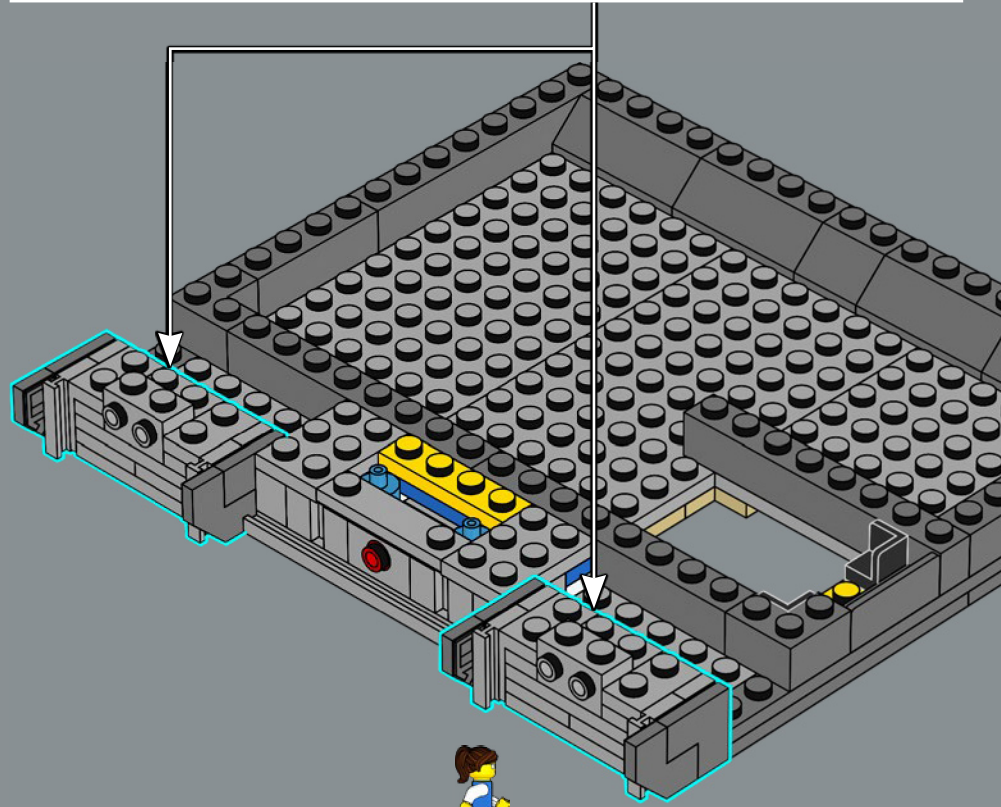
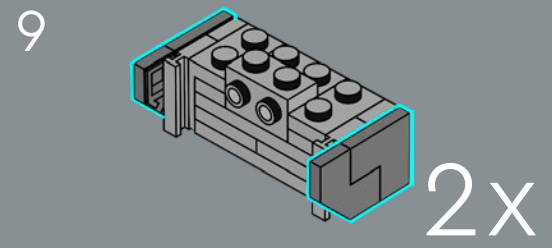
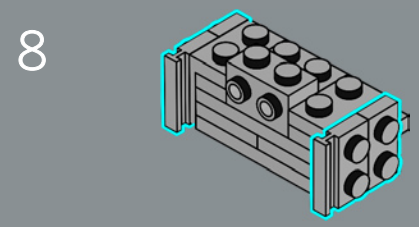
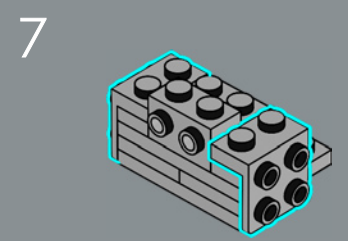
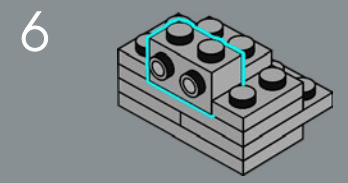
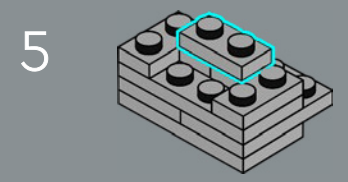
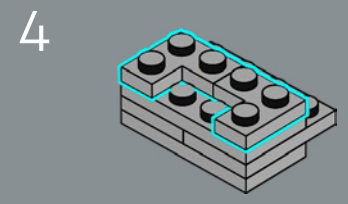
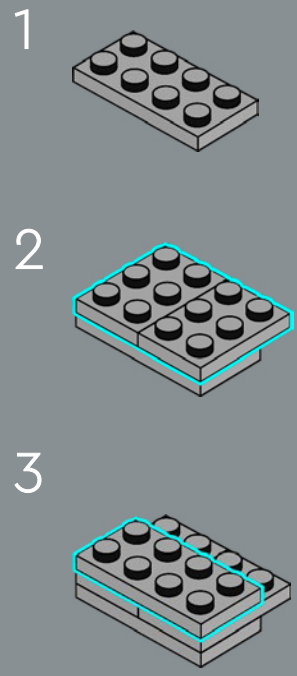

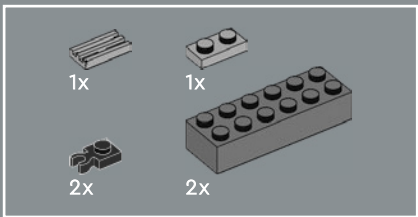

367

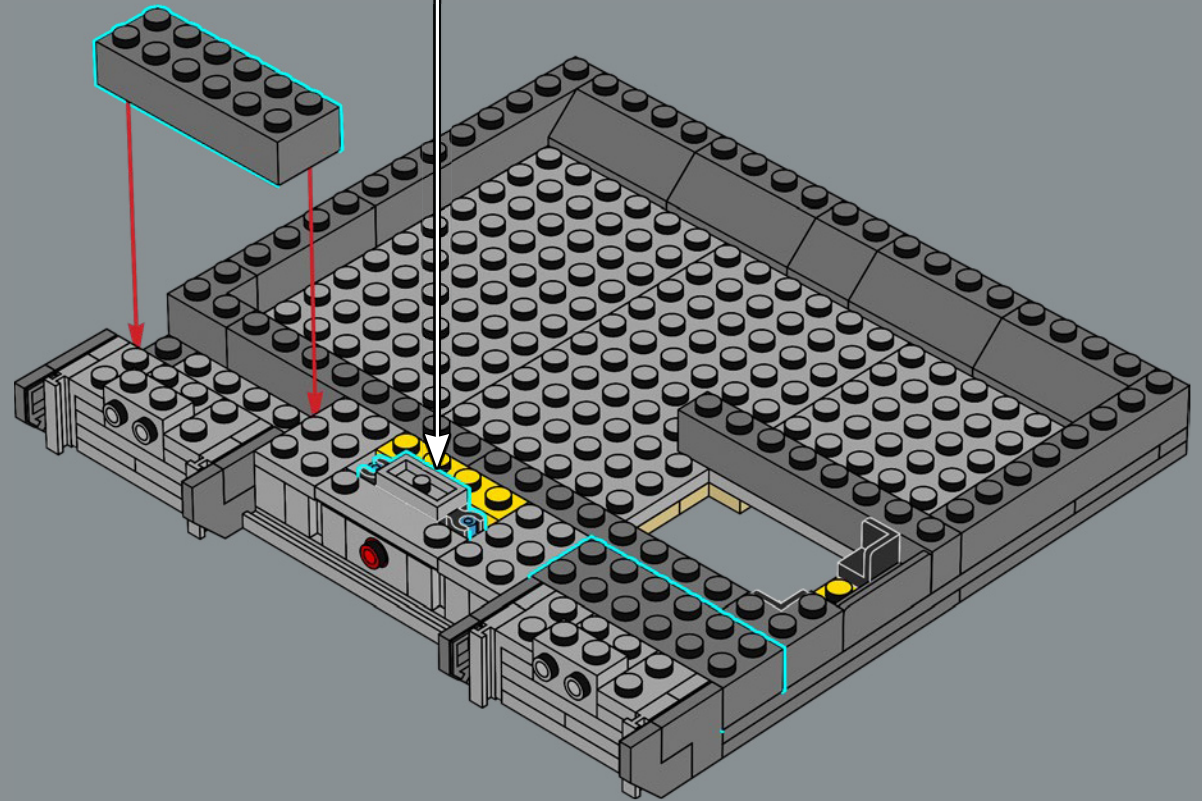
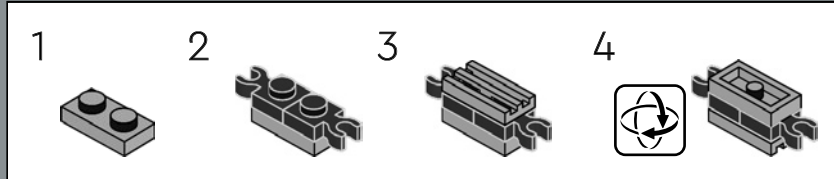

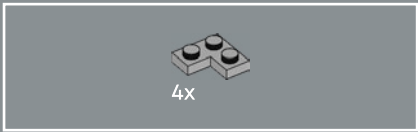

368

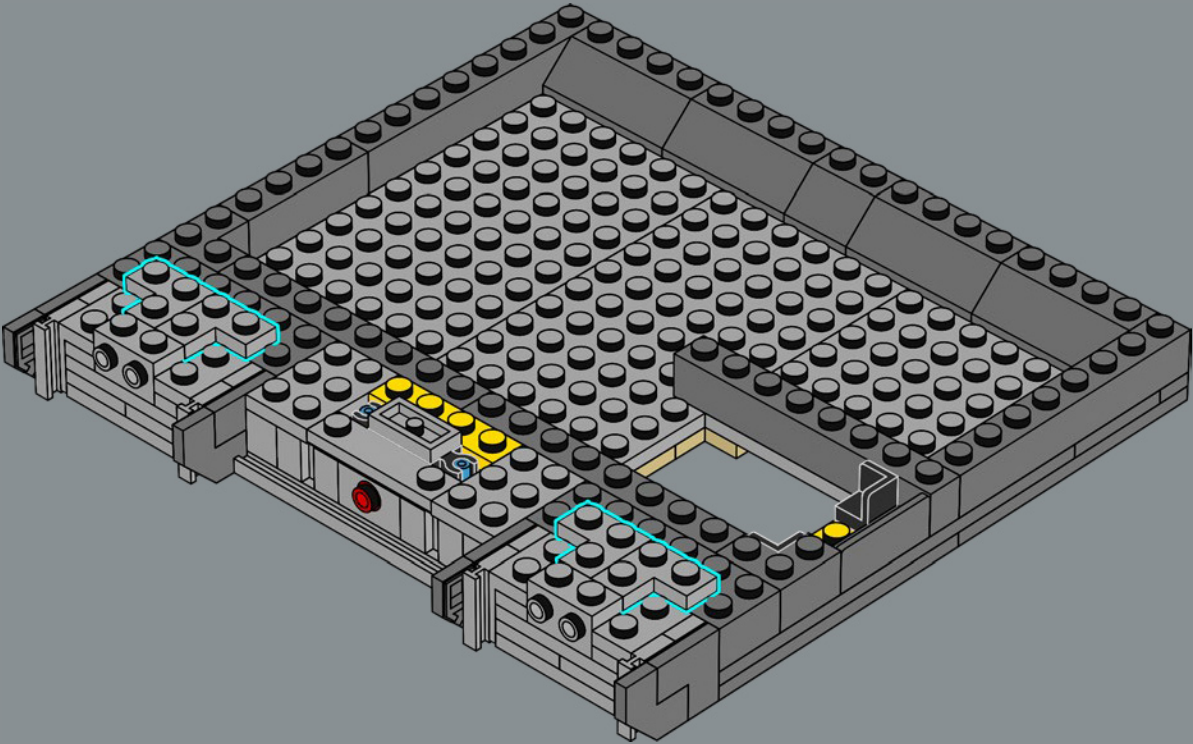

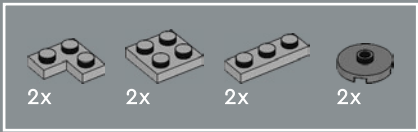

369

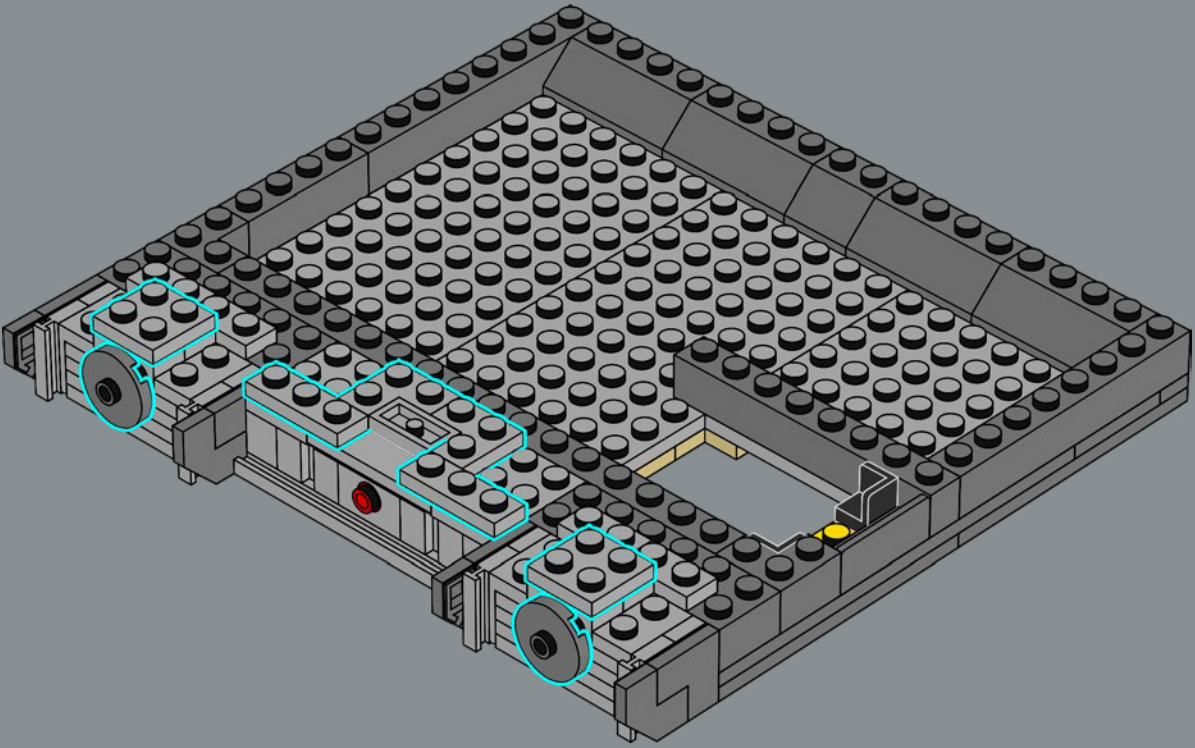



370

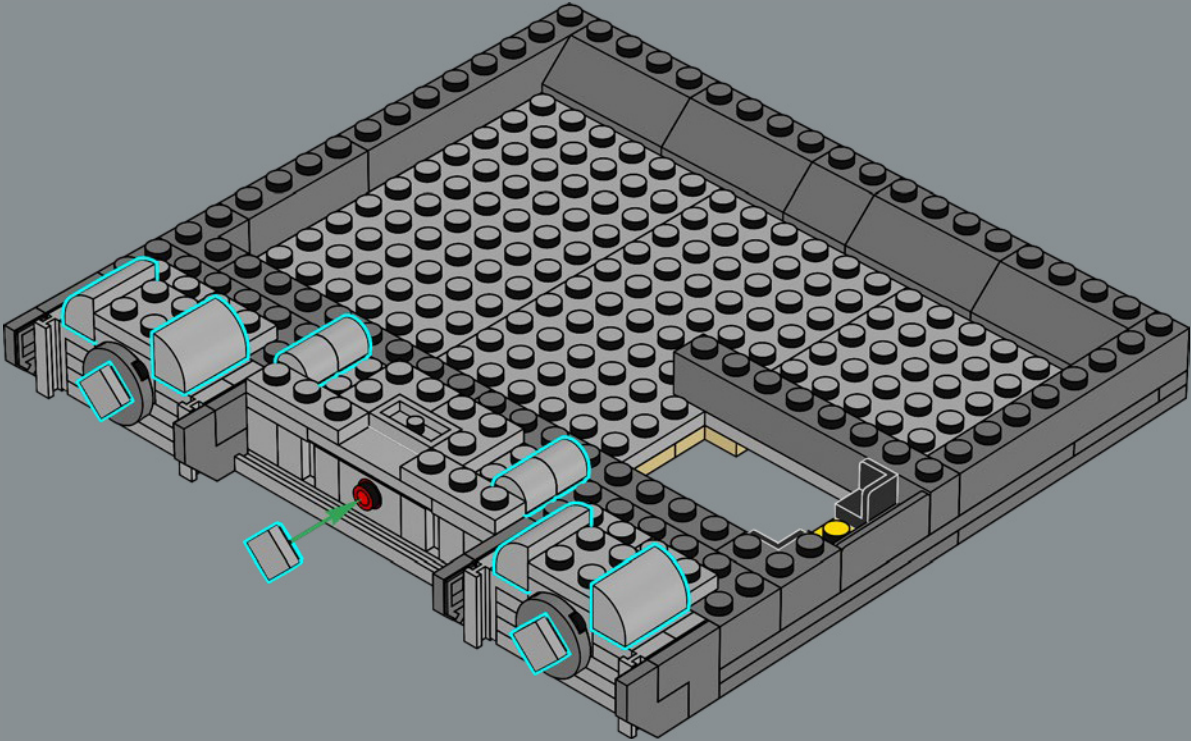

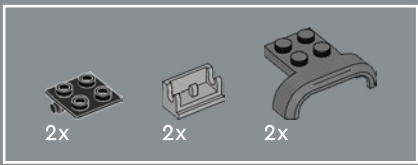

371

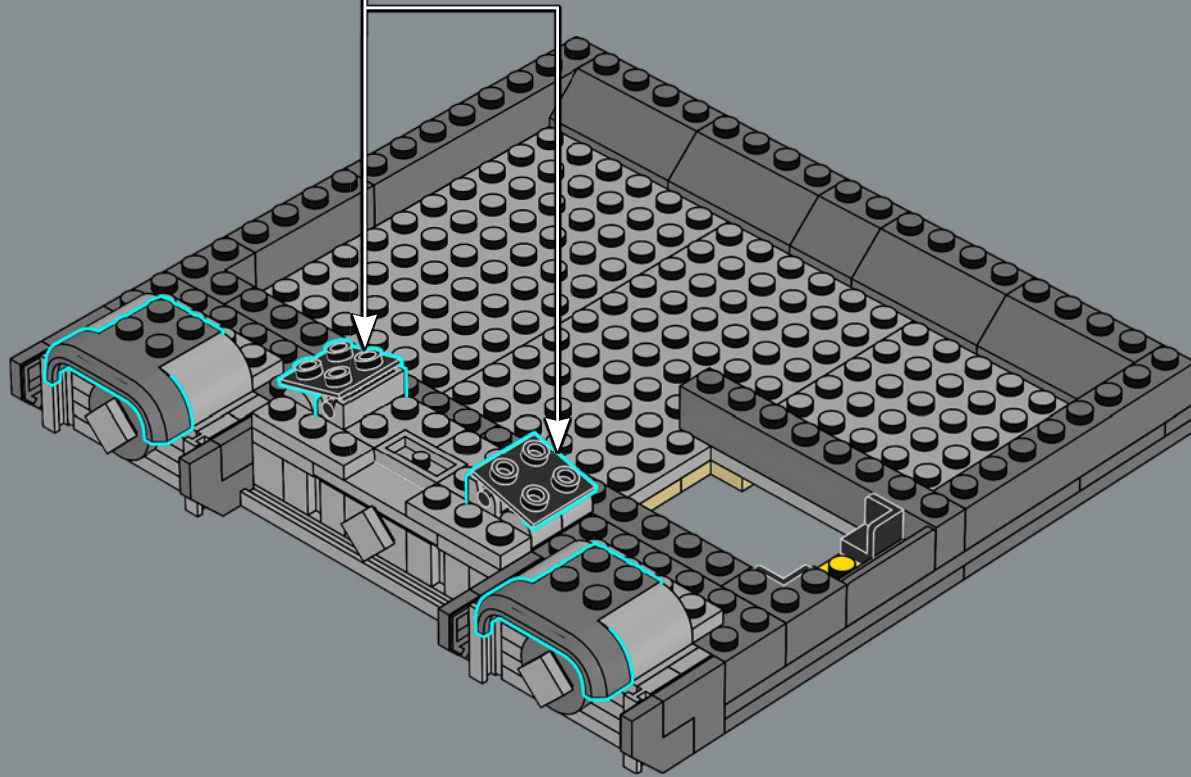
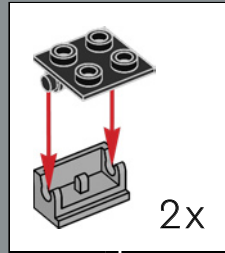

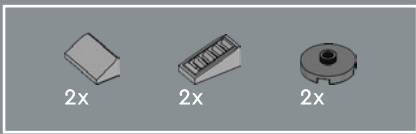

372

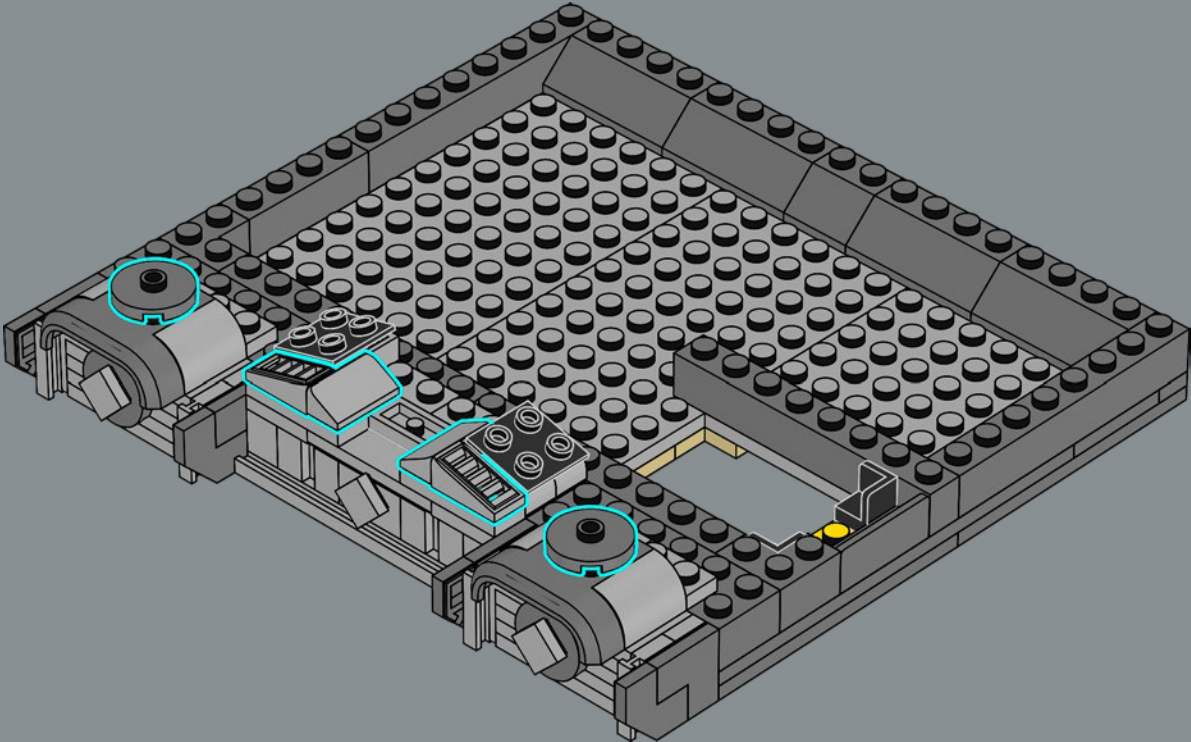

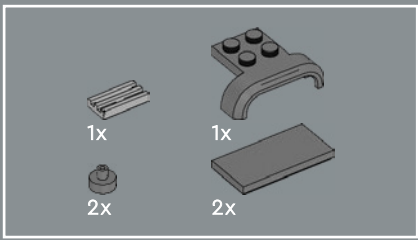

373

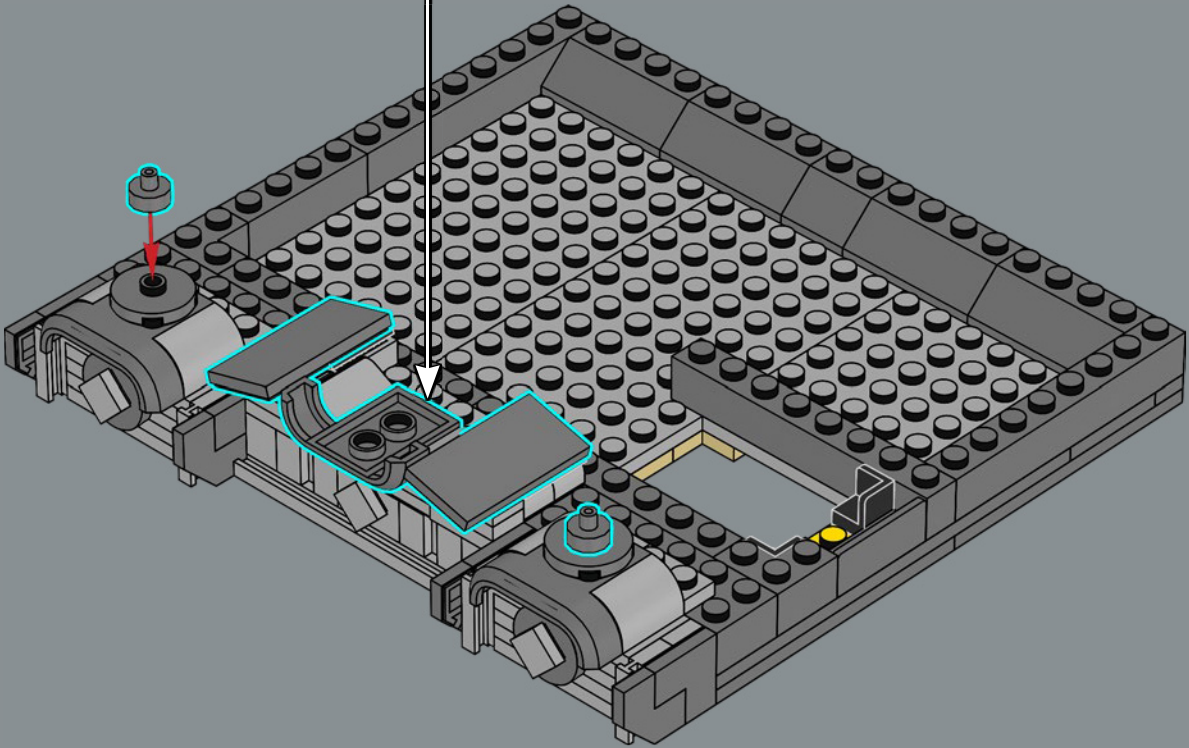
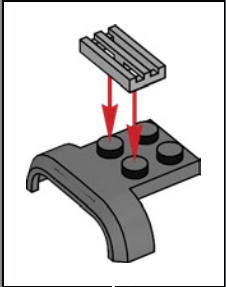

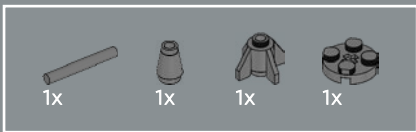

374

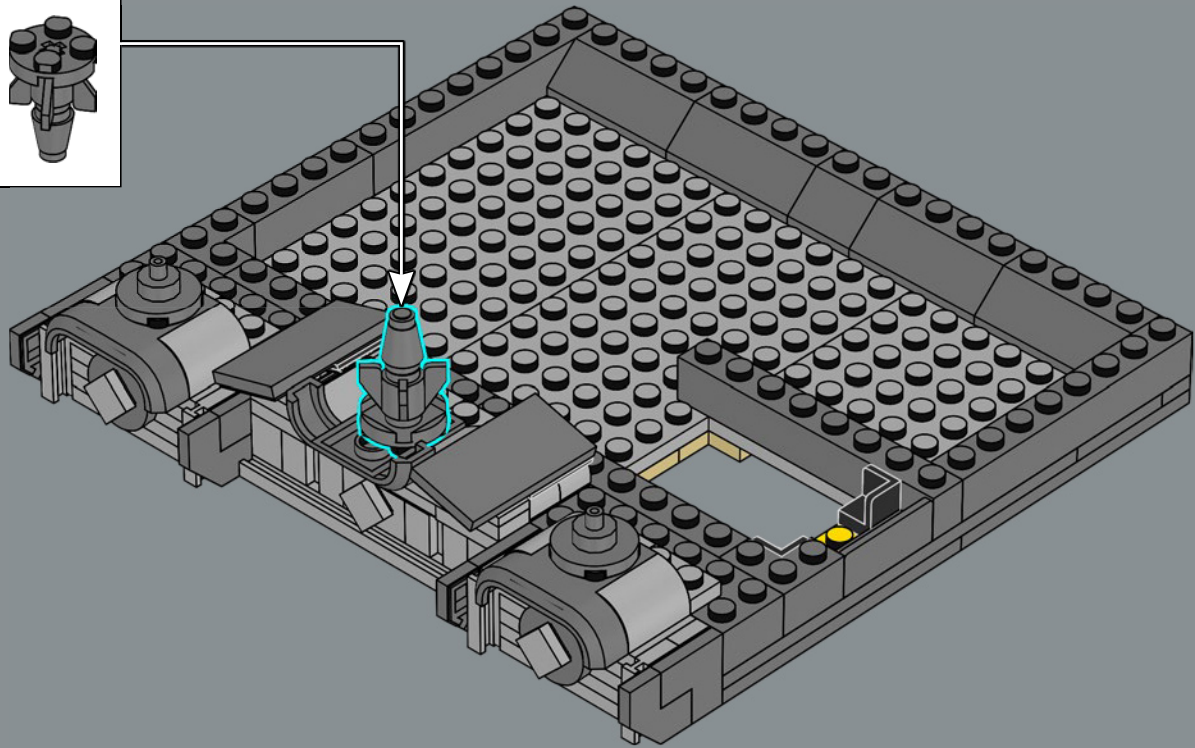
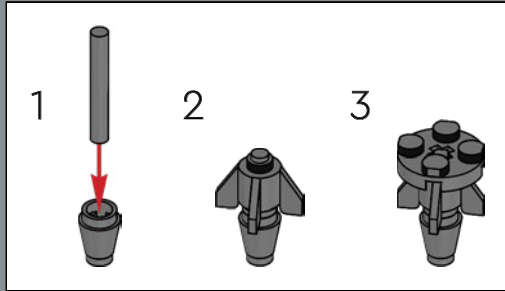

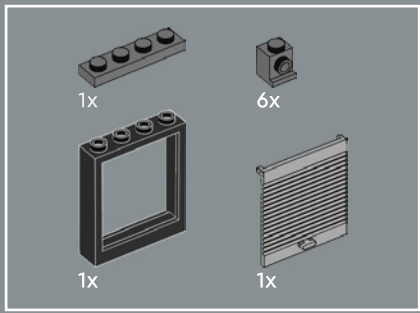

375

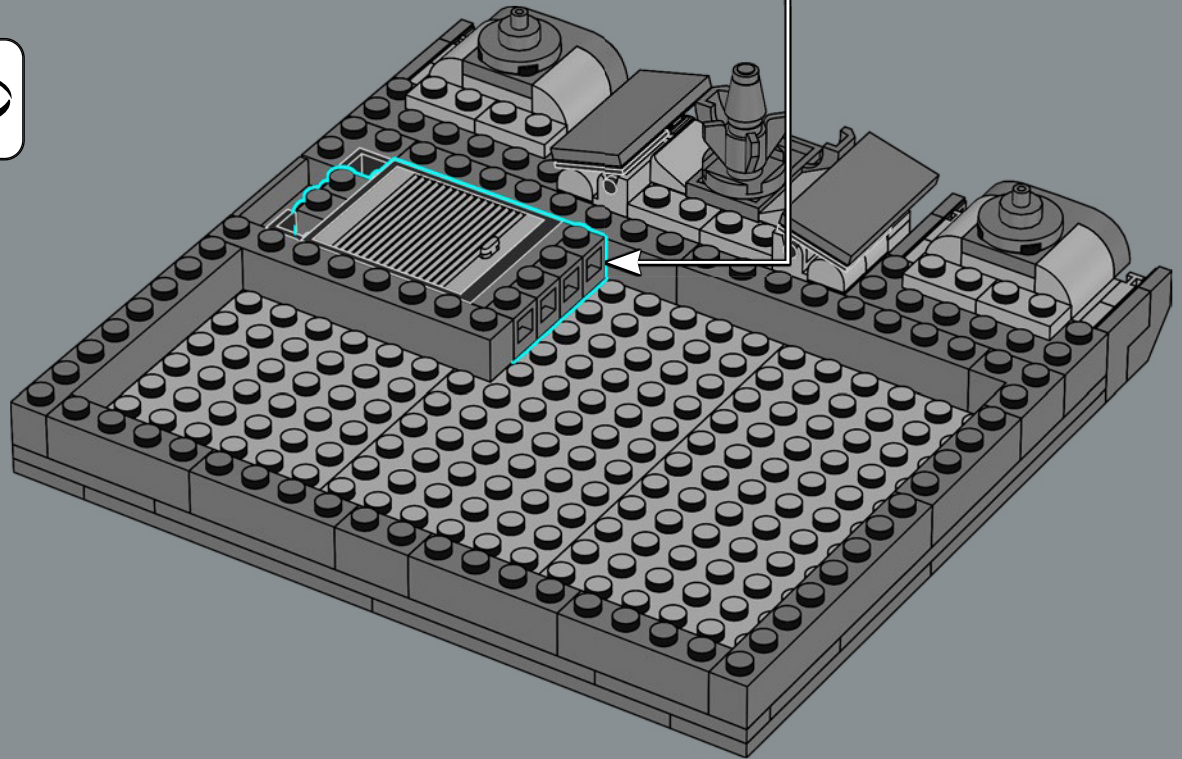
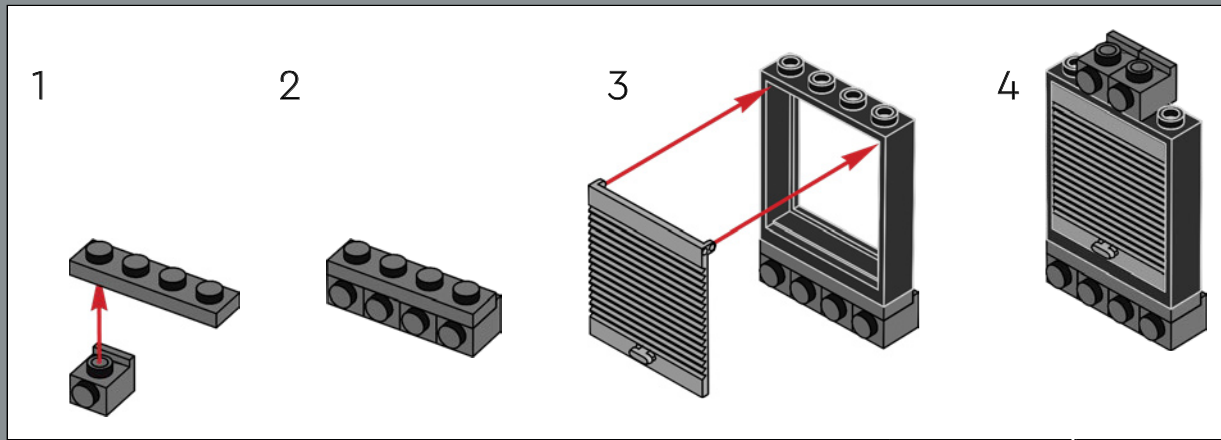

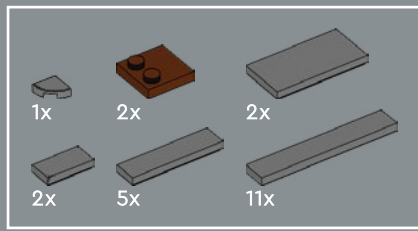

376

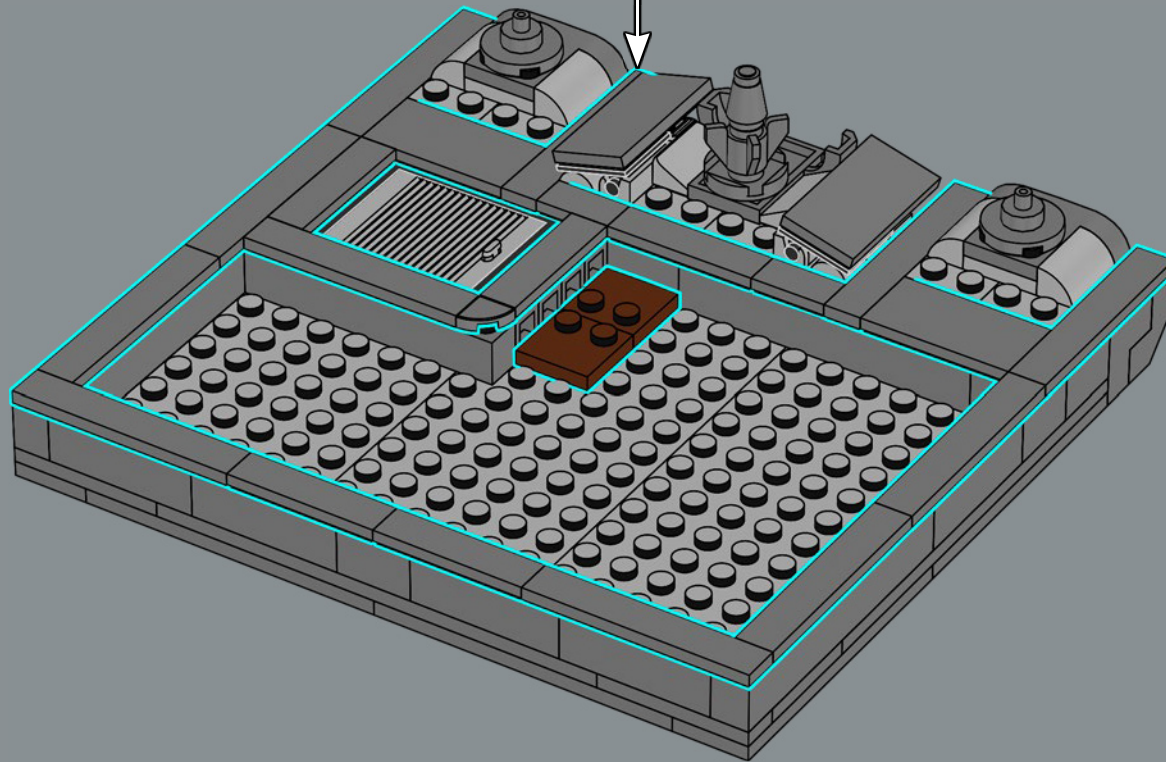
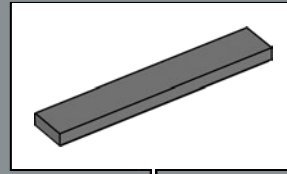

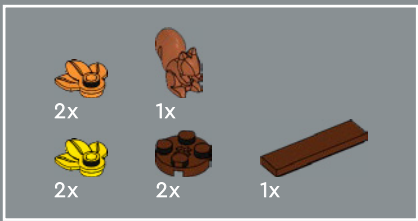

377

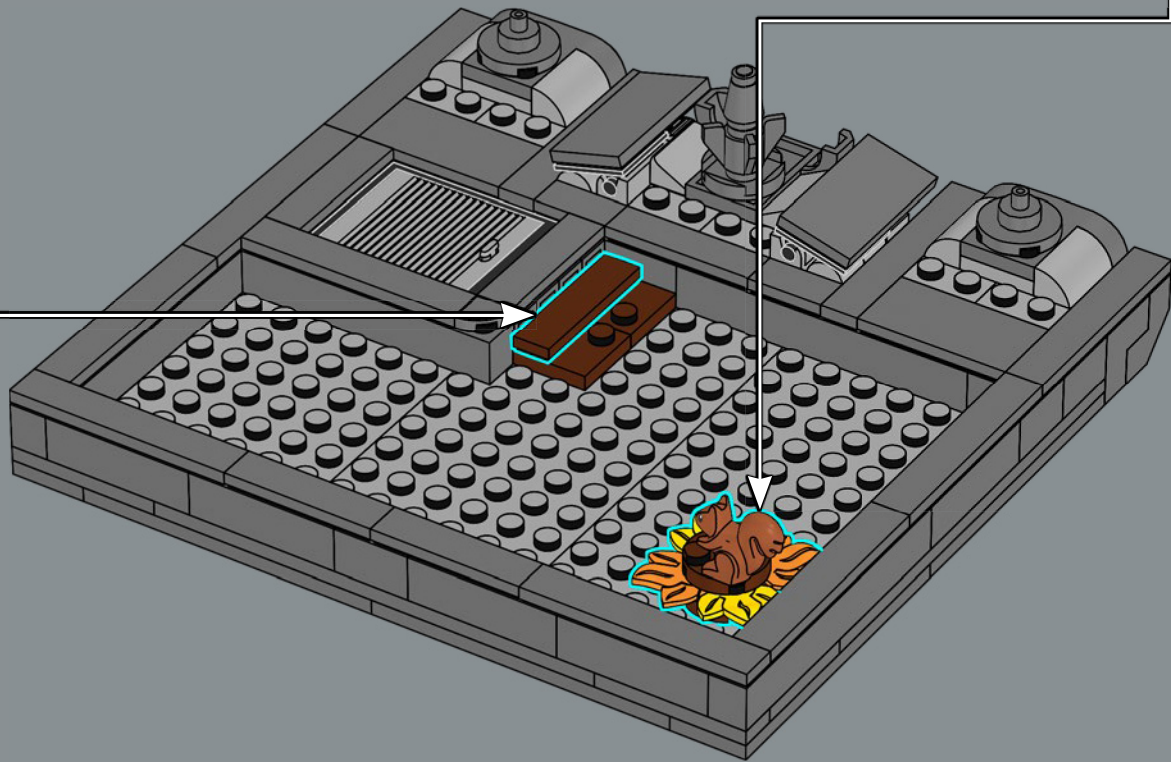
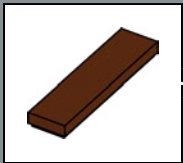

¡No pierdas de vista a la traviesa ardilla! Si te detienes a comer una deliciosa porción de *pizza*, ¡podrías verla desaparecer de tus manos y terminar en la azotea!

378



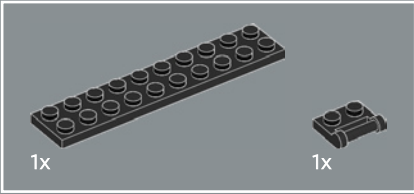

379

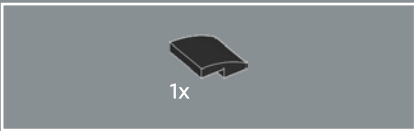
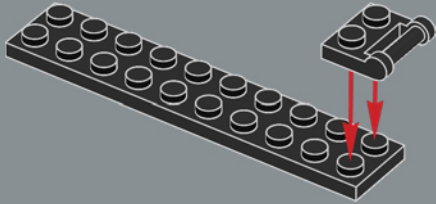

380

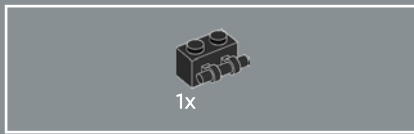
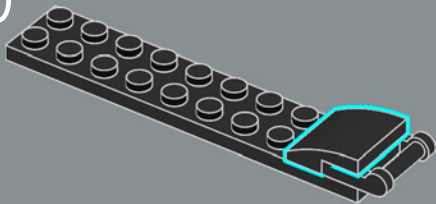

381

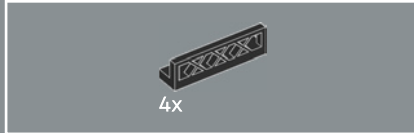
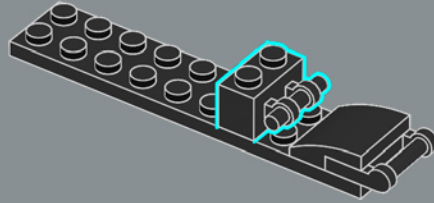

382

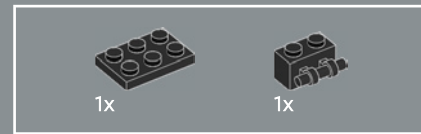
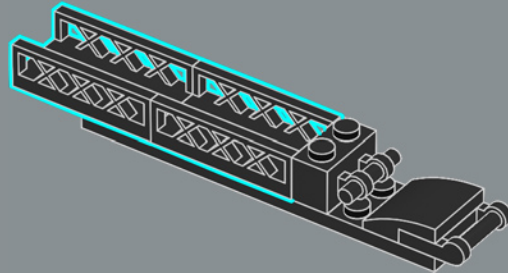

383

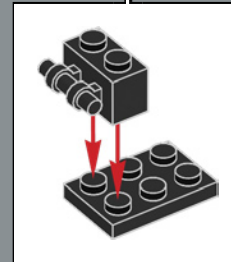
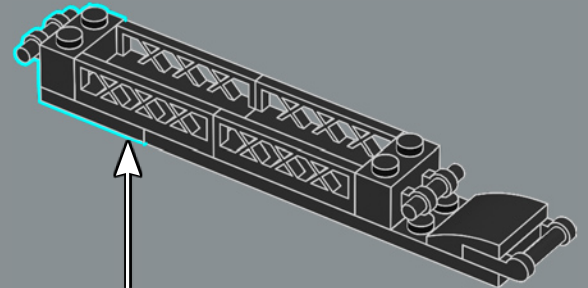

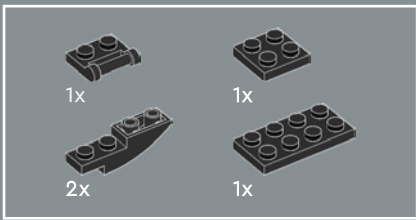

384

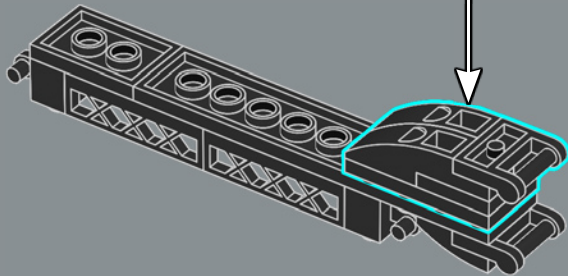
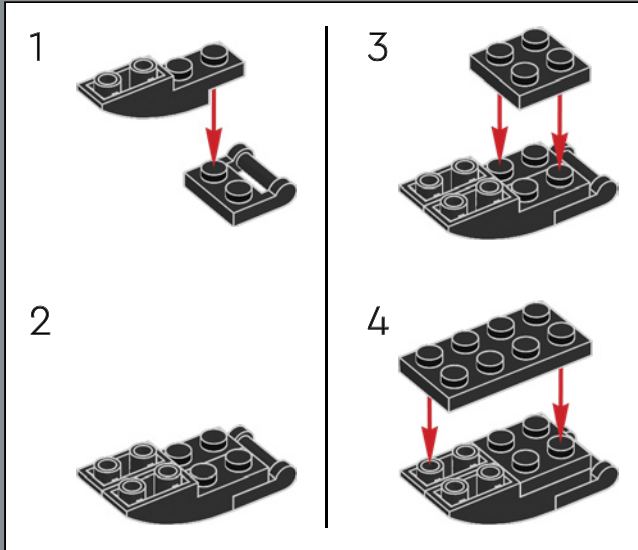

385

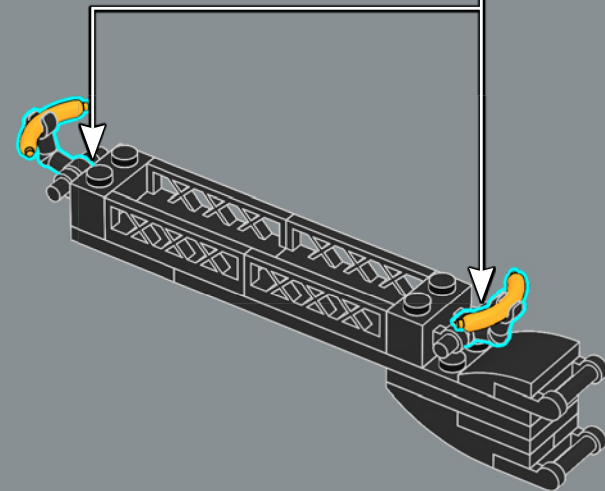
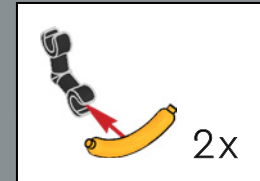

La salchicha LEGO® ha demostrado ser un elemento increíblemente útil. Ha aparecido en 9 colores en decenas de sets LEGO.



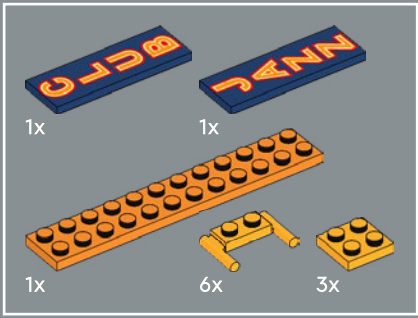

386

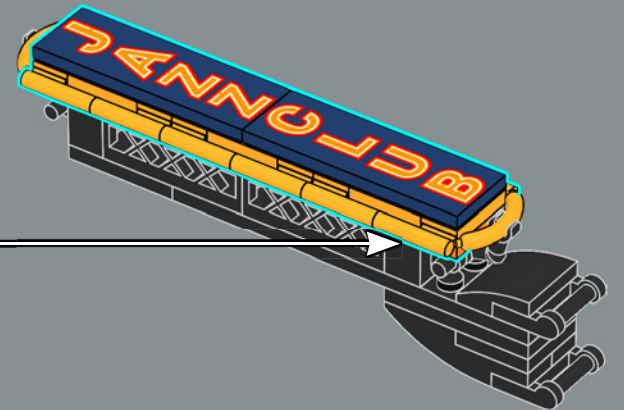
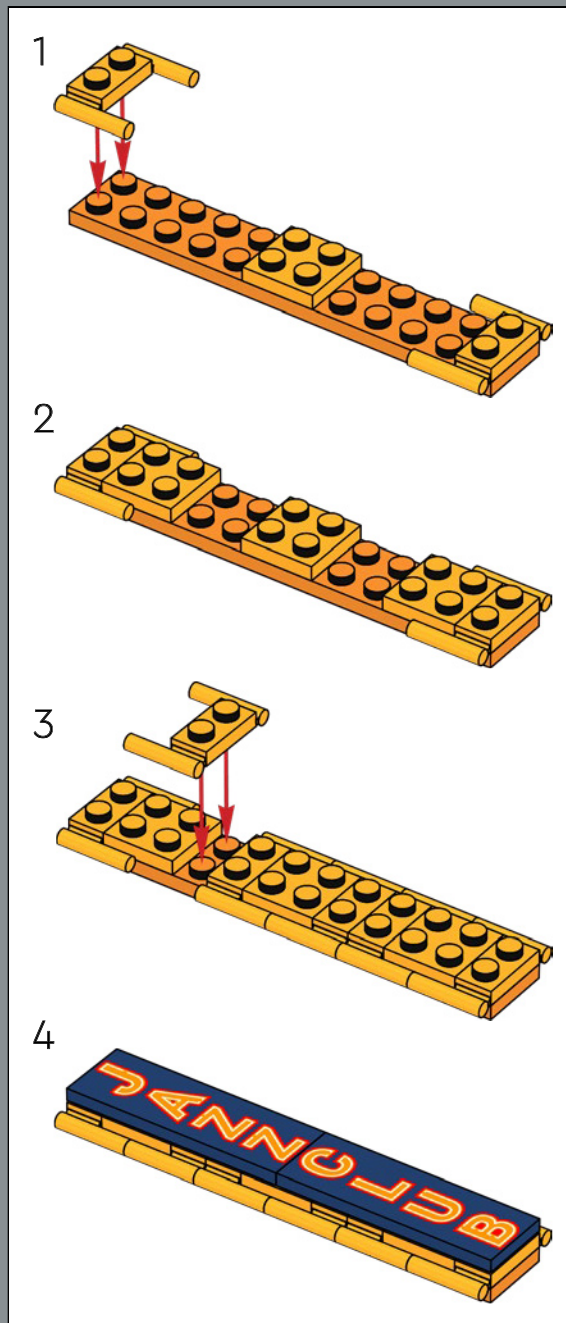

387

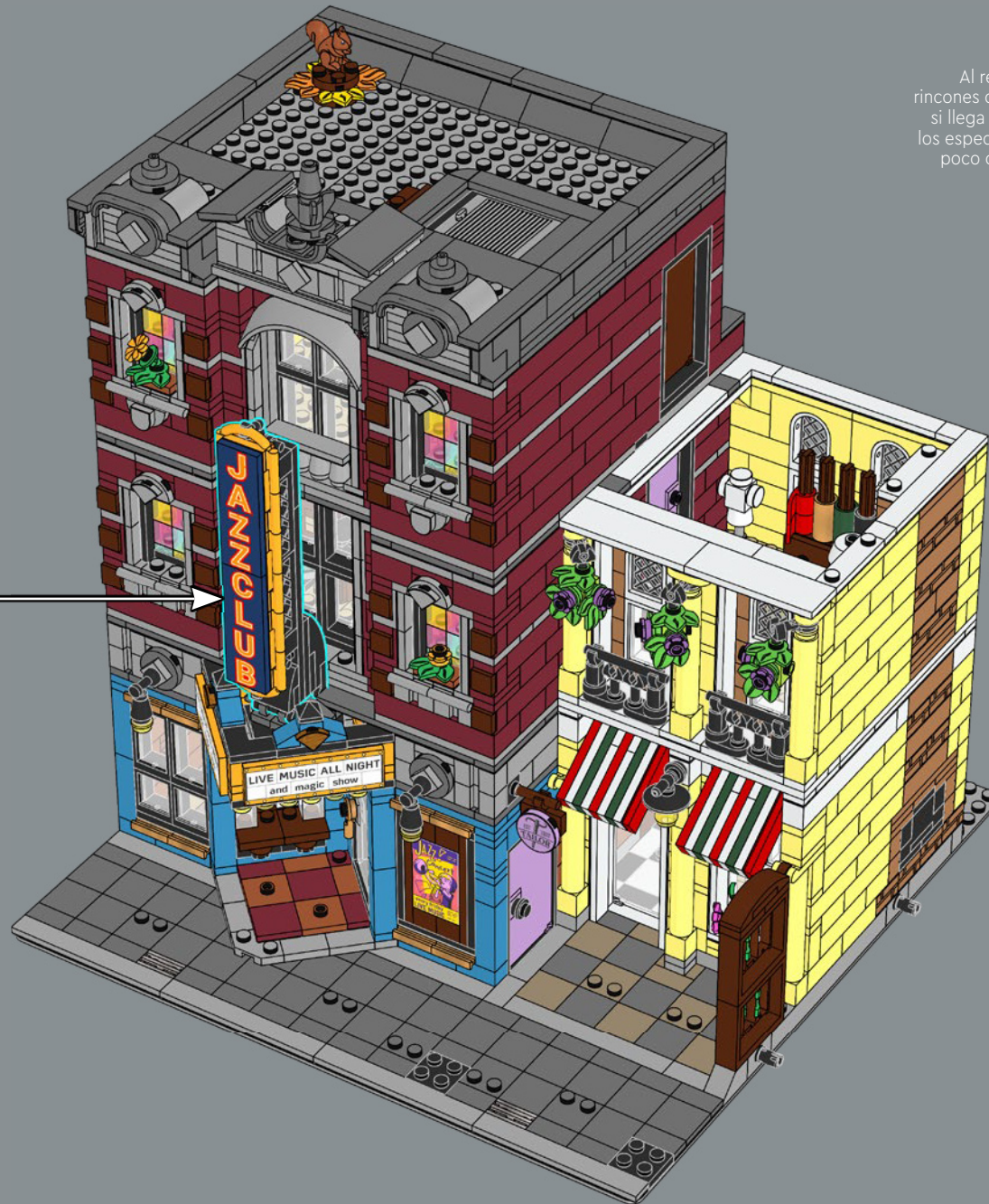

Al repartidor le encanta llevar pizzas a todos los rincones de la ciudad. Aunque no debes sorprenderte si llega algo tarde. Le fascina escuchar la música de los espectáculos del Club de Jazz y puede resultar un poco complicado hacer que se aleje de este lugar.



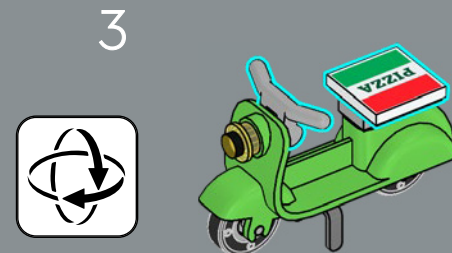
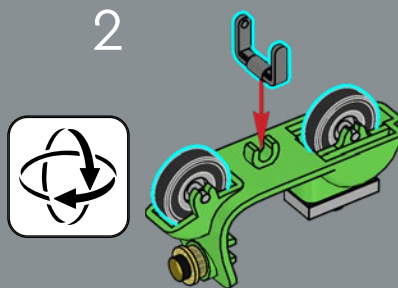
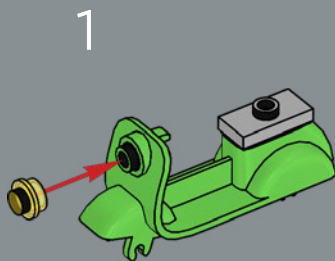
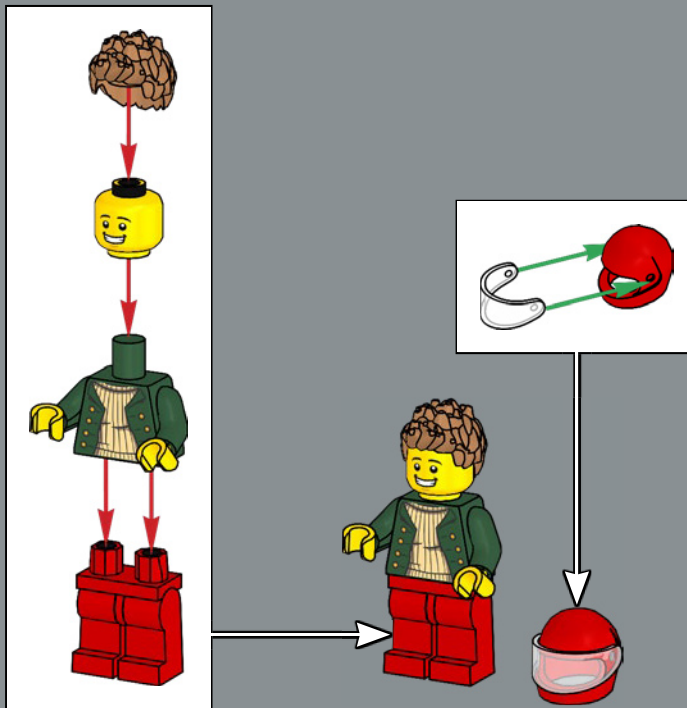

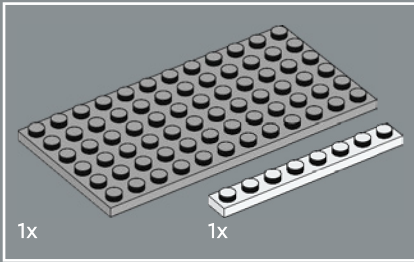
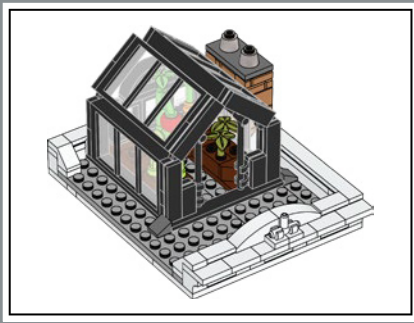

388

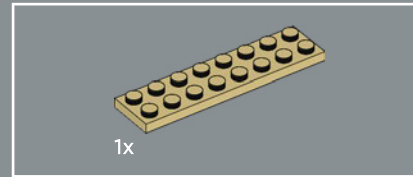
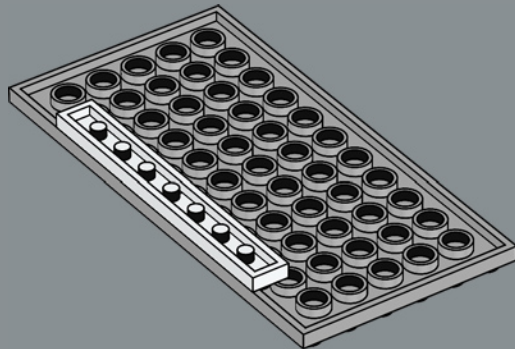

389

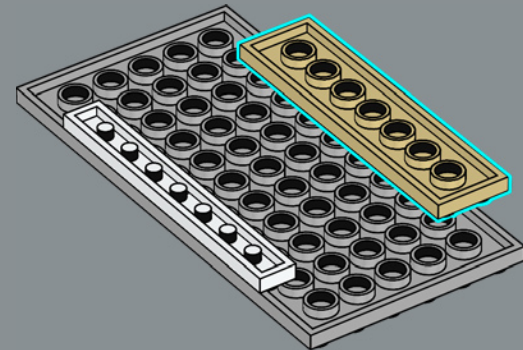

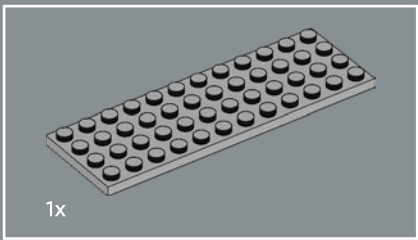

390

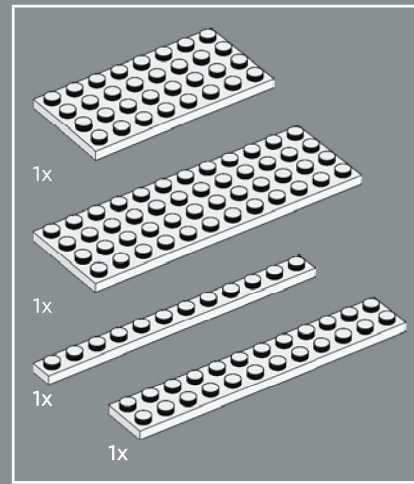
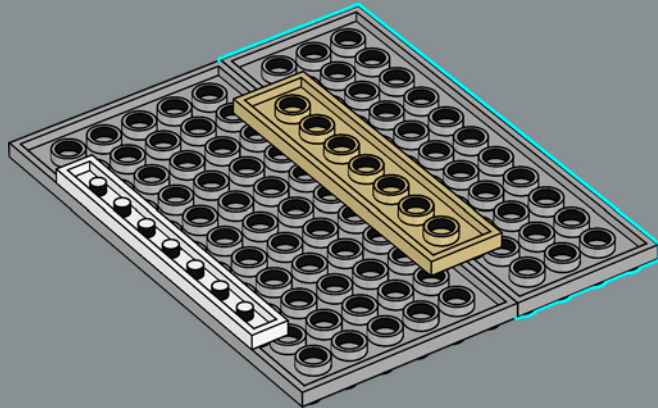

391

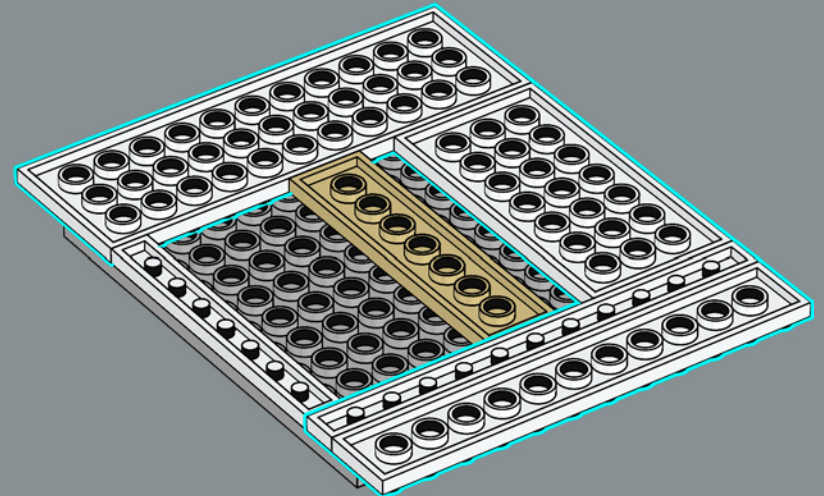

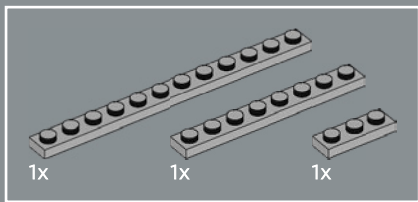

392

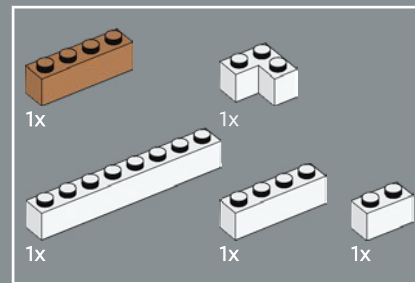
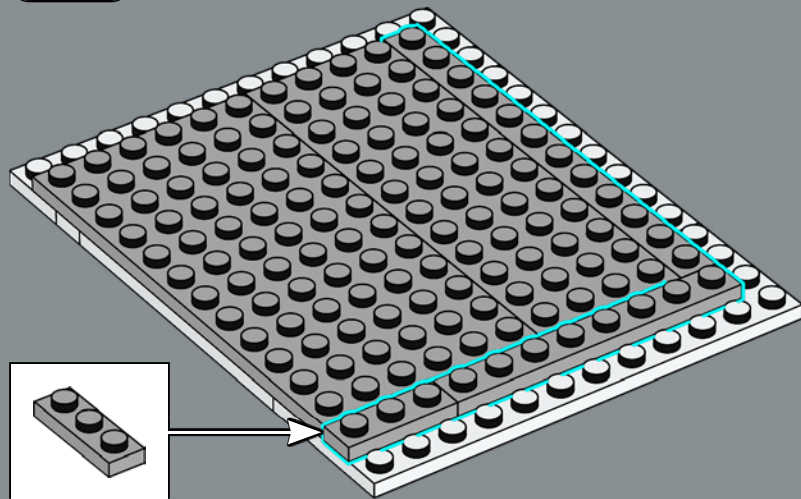

393

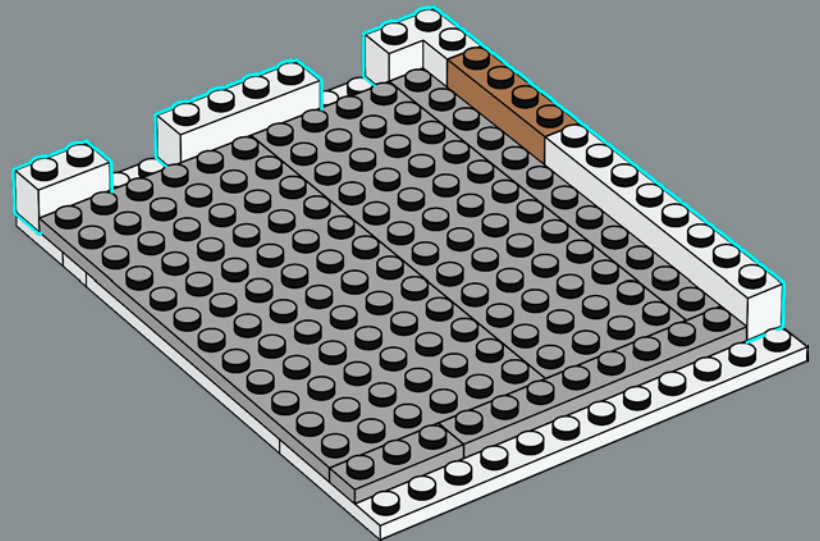



3x

394

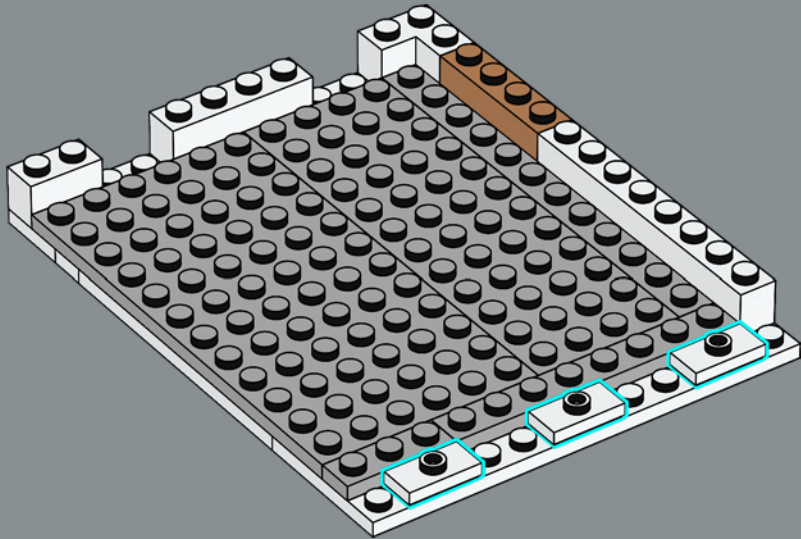

1x



1x

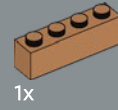

1x

395

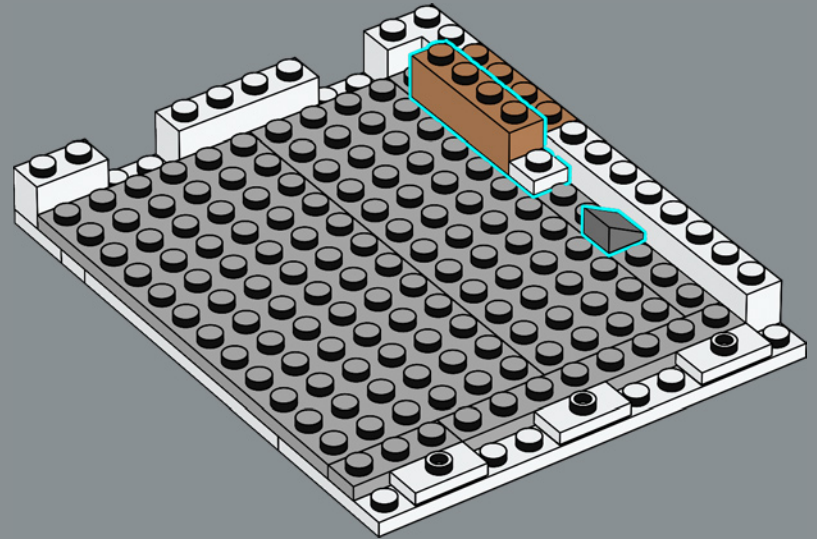

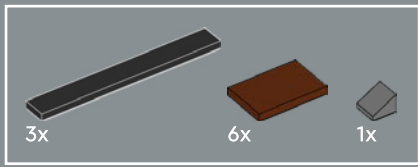

396

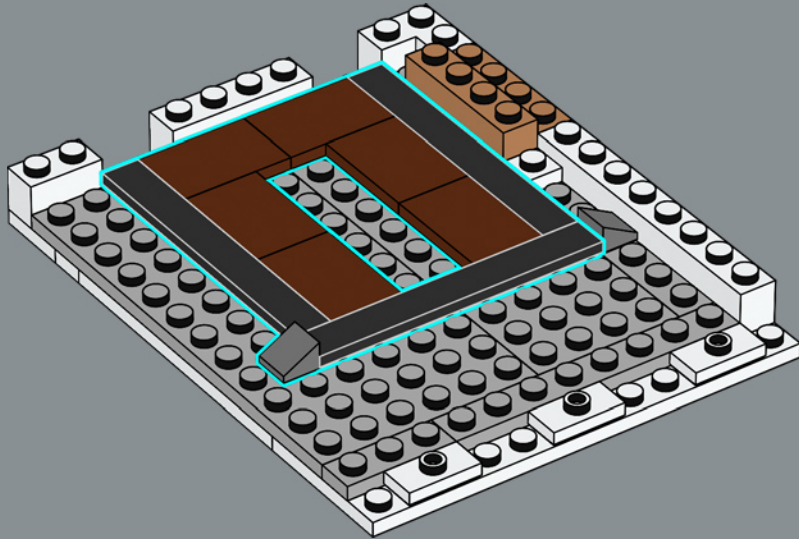

397

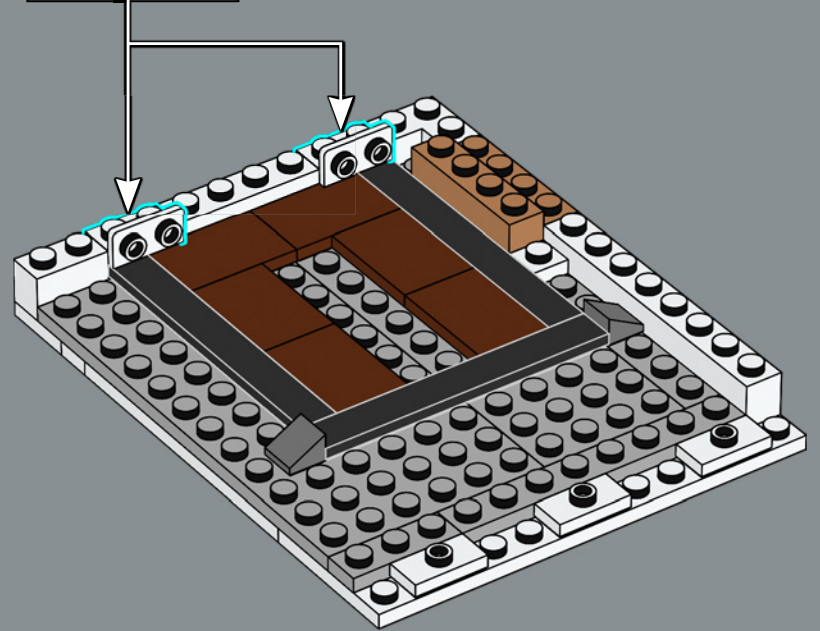
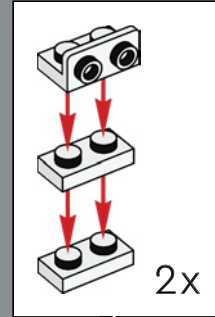

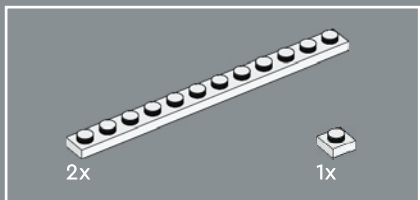

398

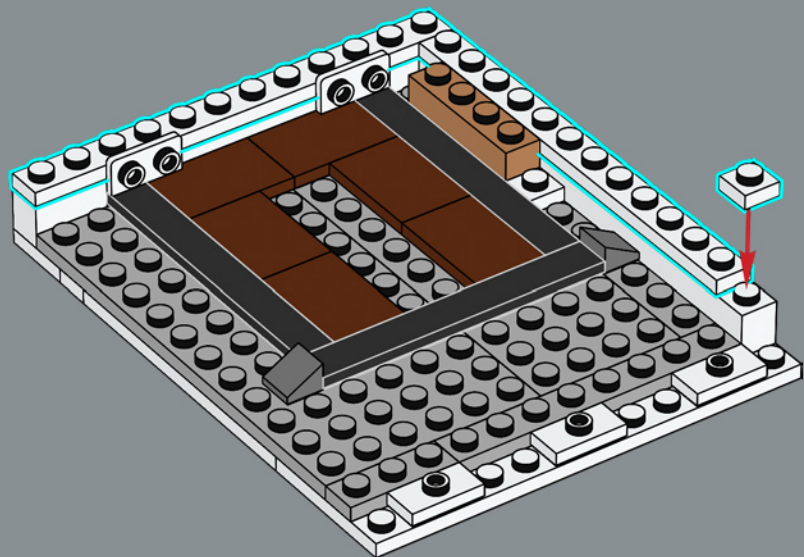

399

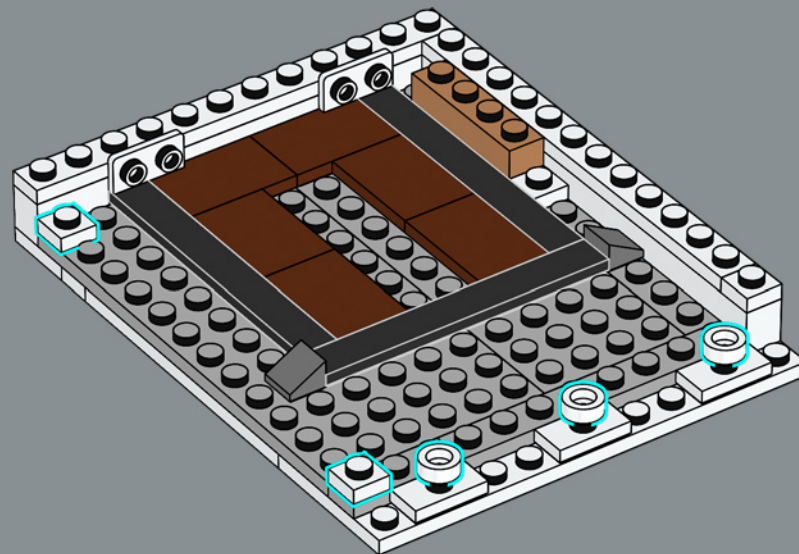



400

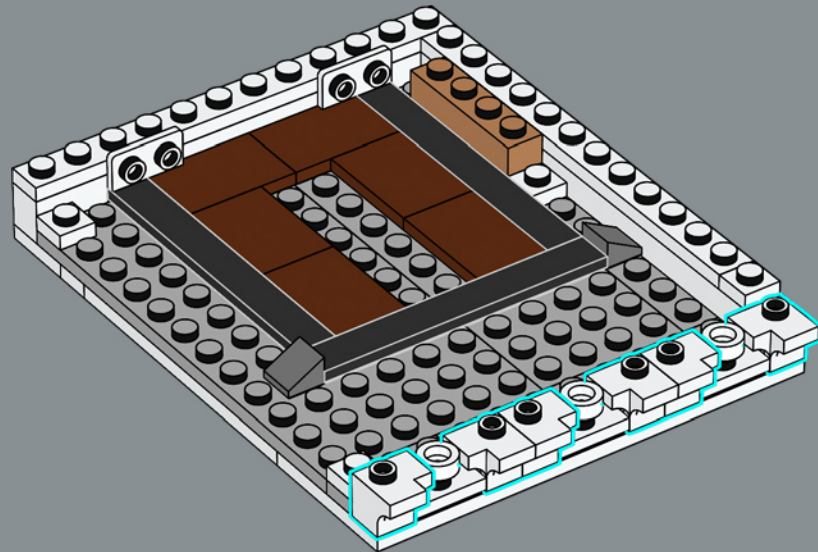

401

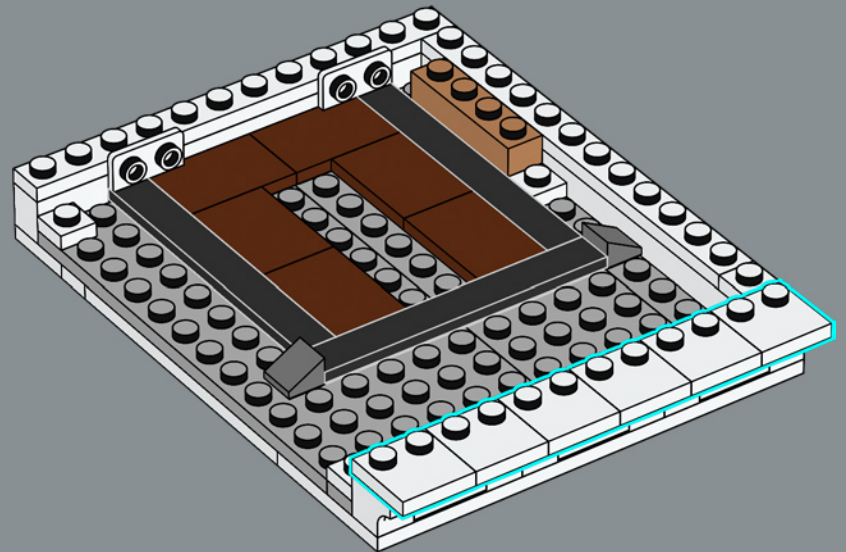

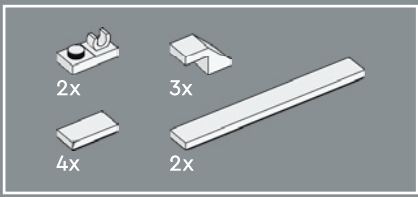

402

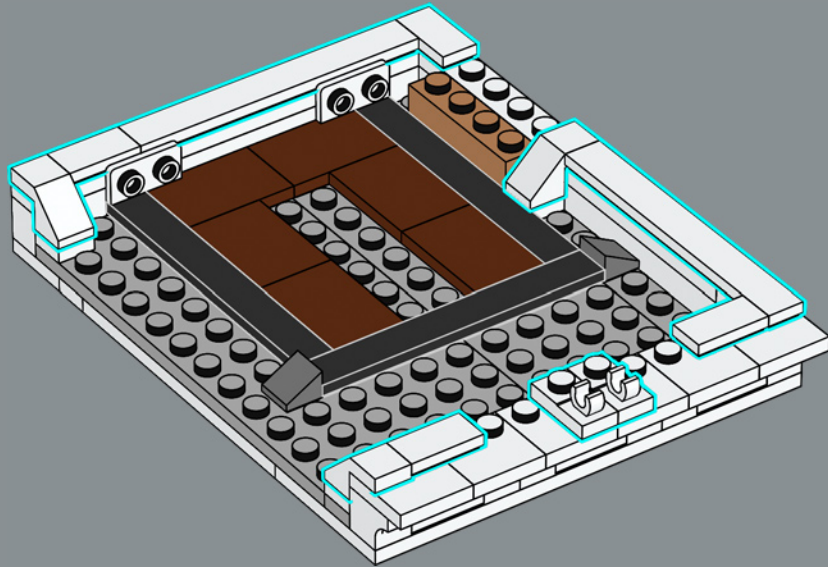

403

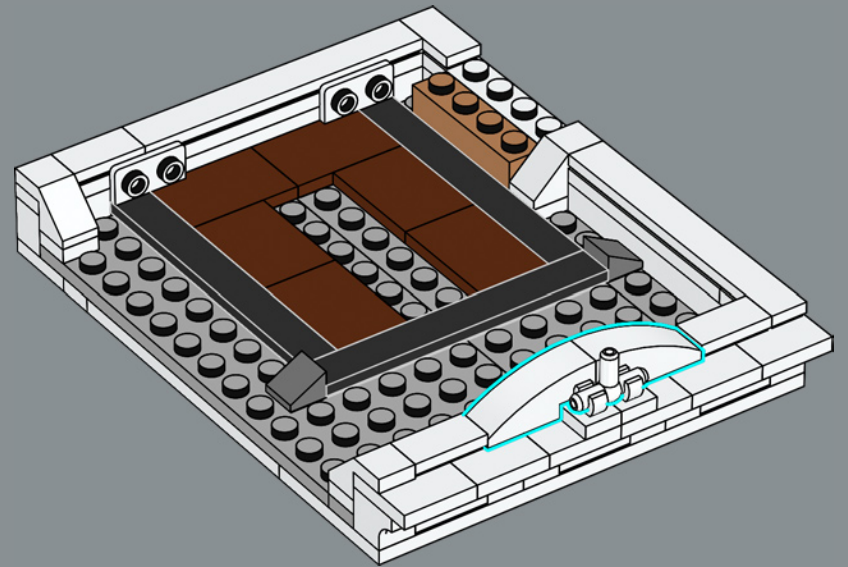

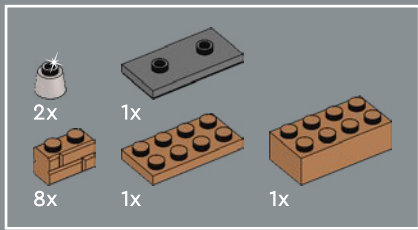

404

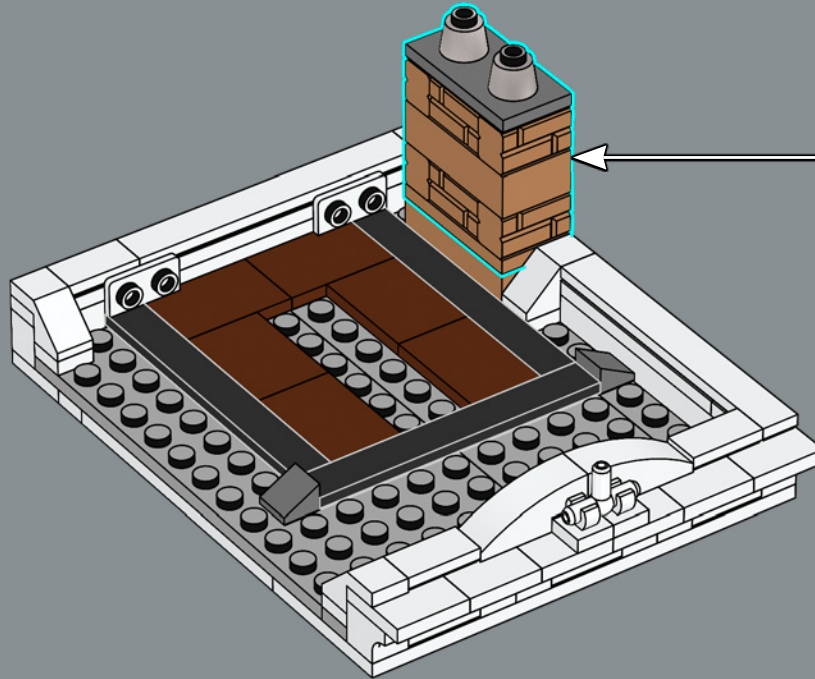
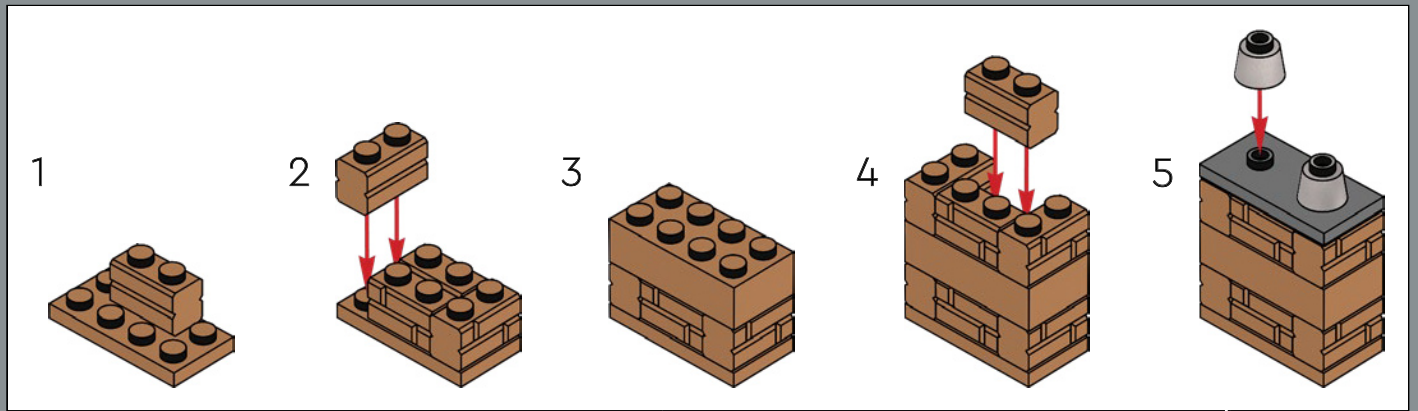

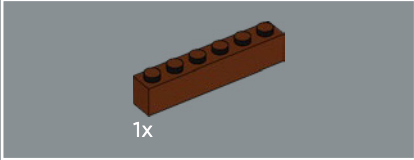

405

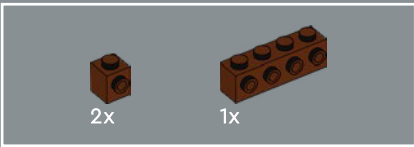
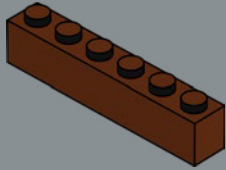

406

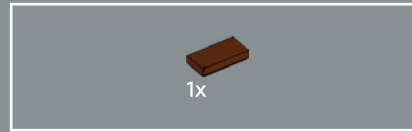
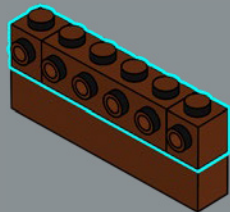

407

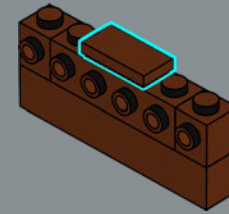

408

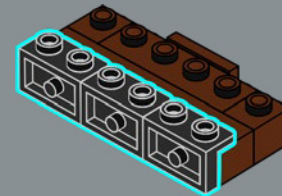

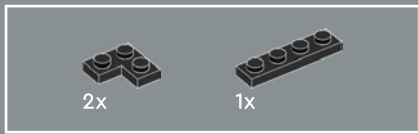

409

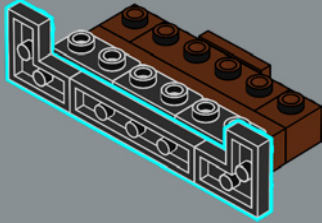

410

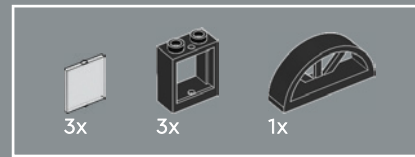
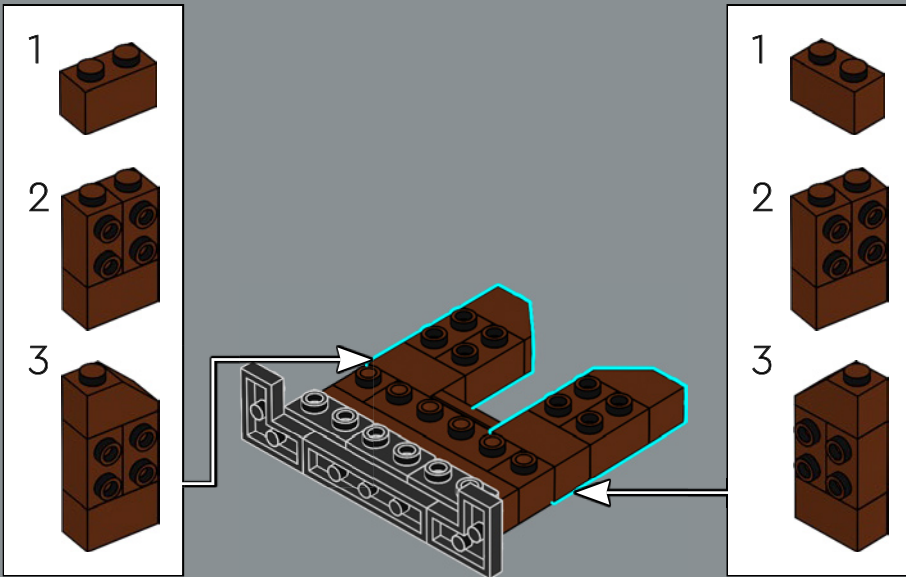

411

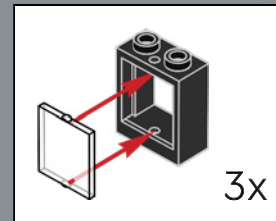
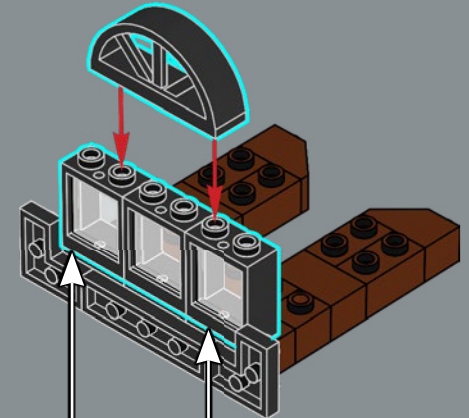

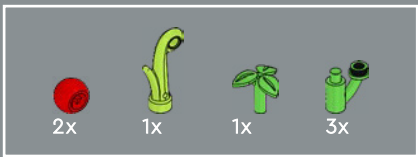

412

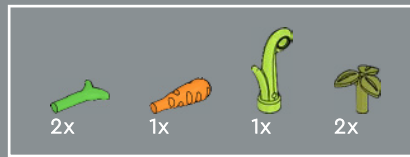
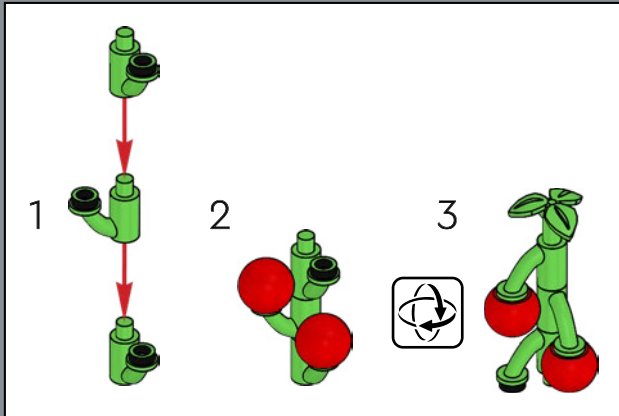

413



El pizzero cultiva sus propios tomates y algunas hierbas para sus pizzas. La zanahoria, no obstante, está reservada para el conejo de la maga.

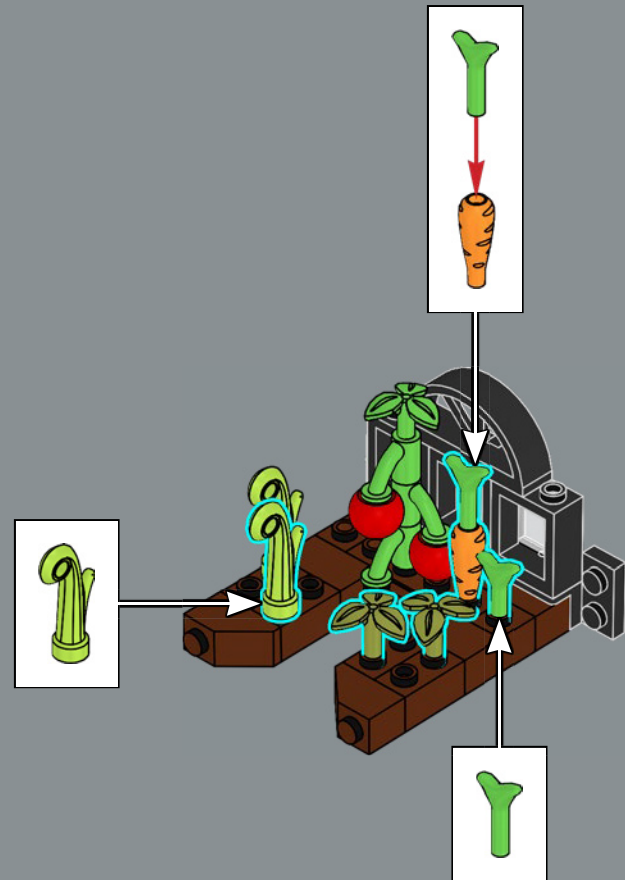

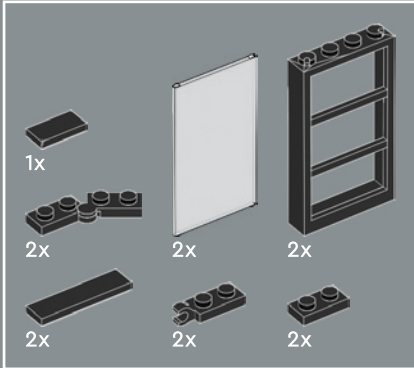

414

1



2

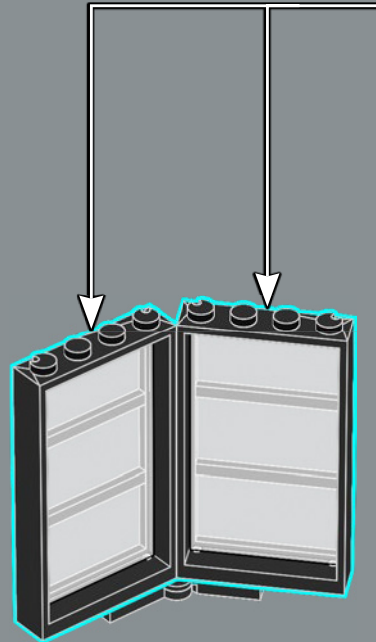

3

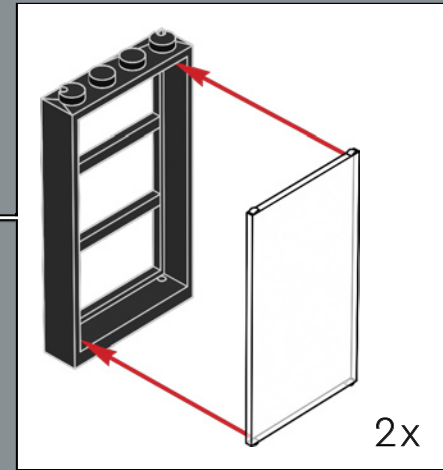
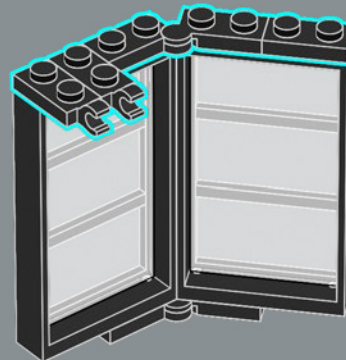

4

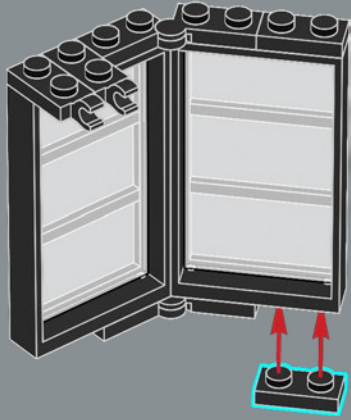

5

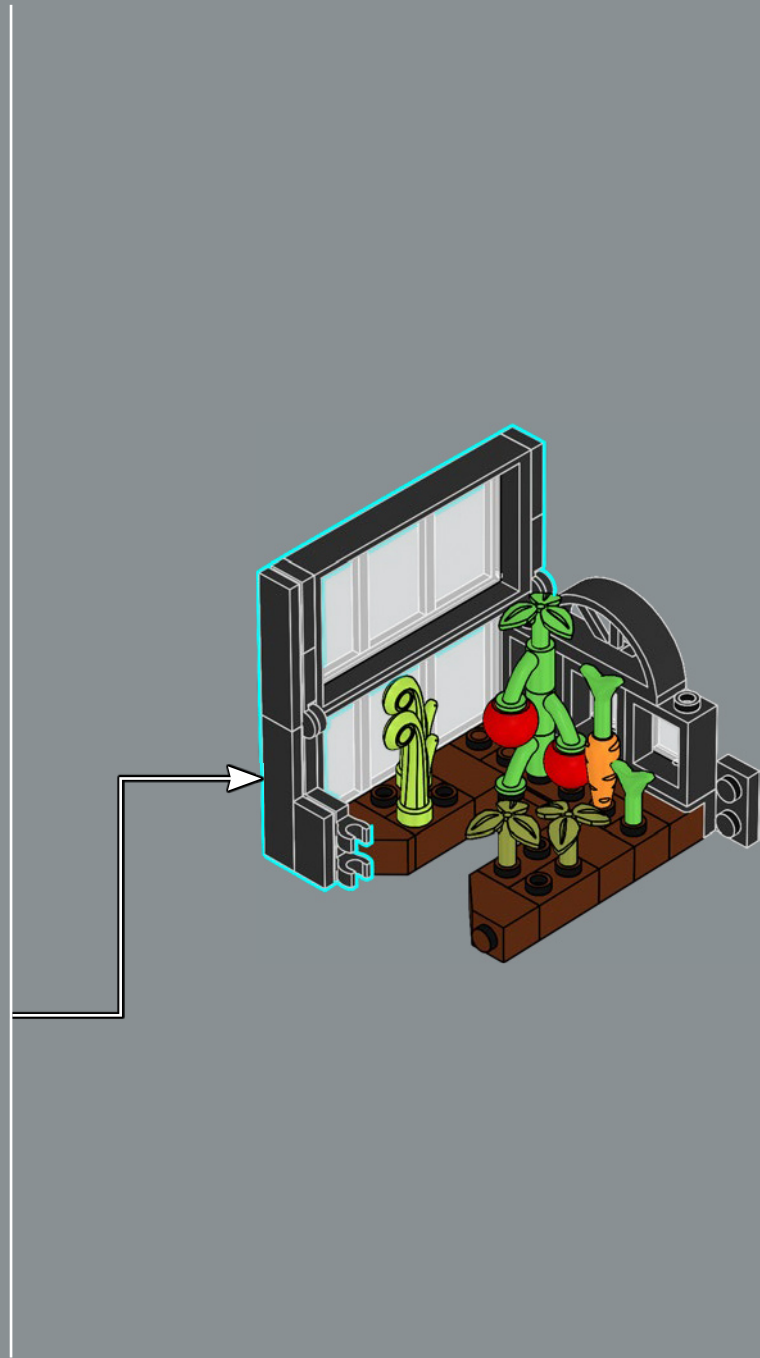
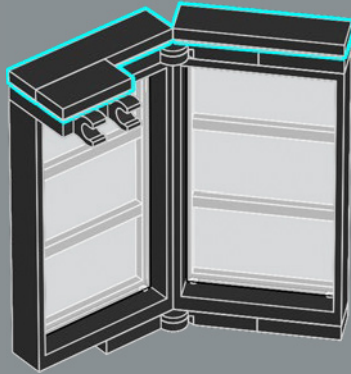

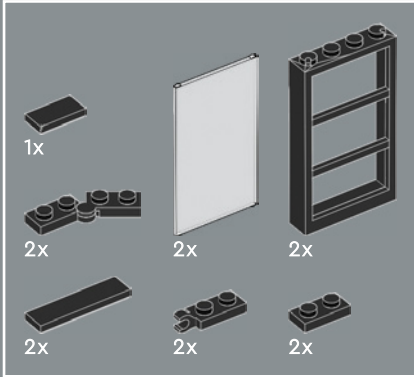
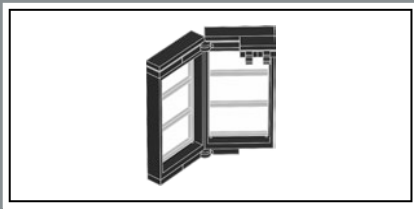

1

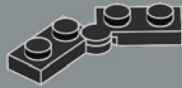

2

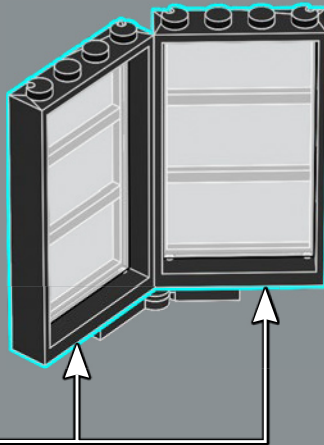

415

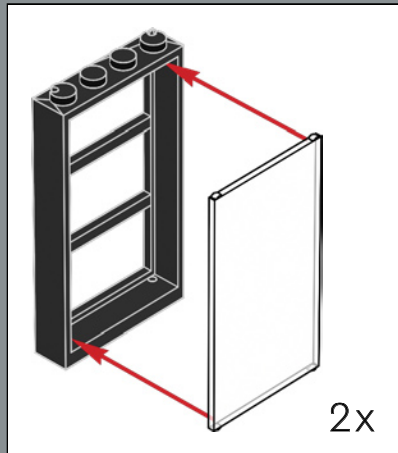

3

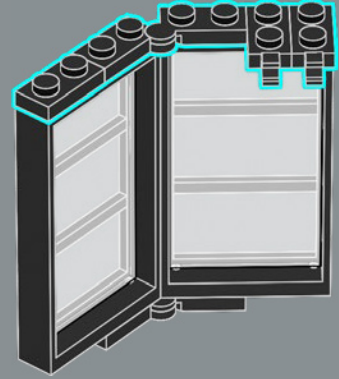

4

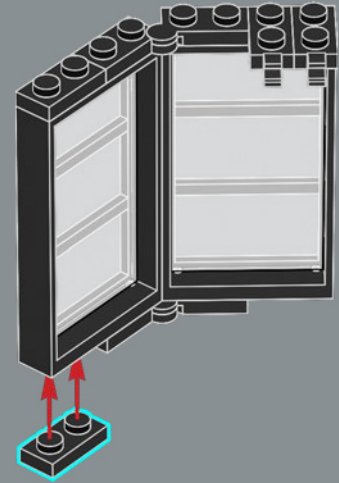

5

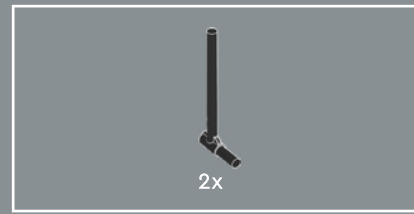

2x

416

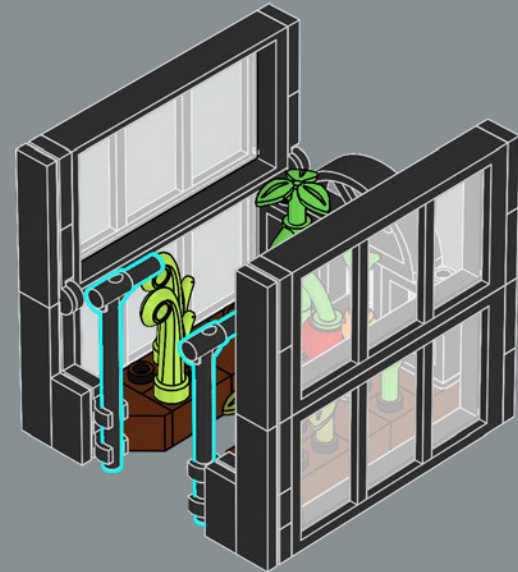
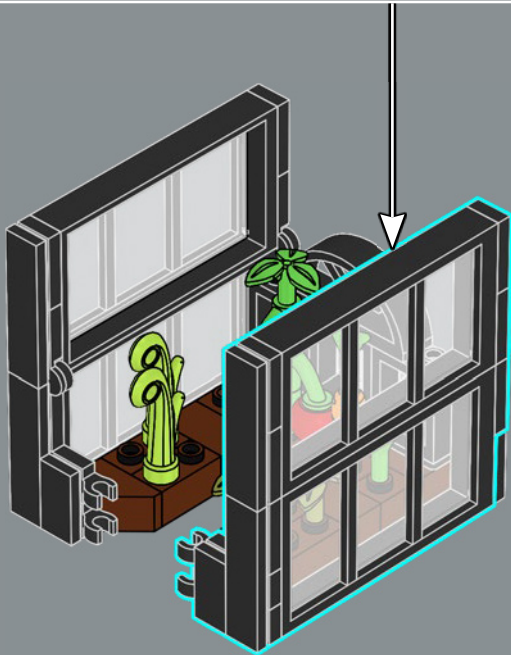

417



418

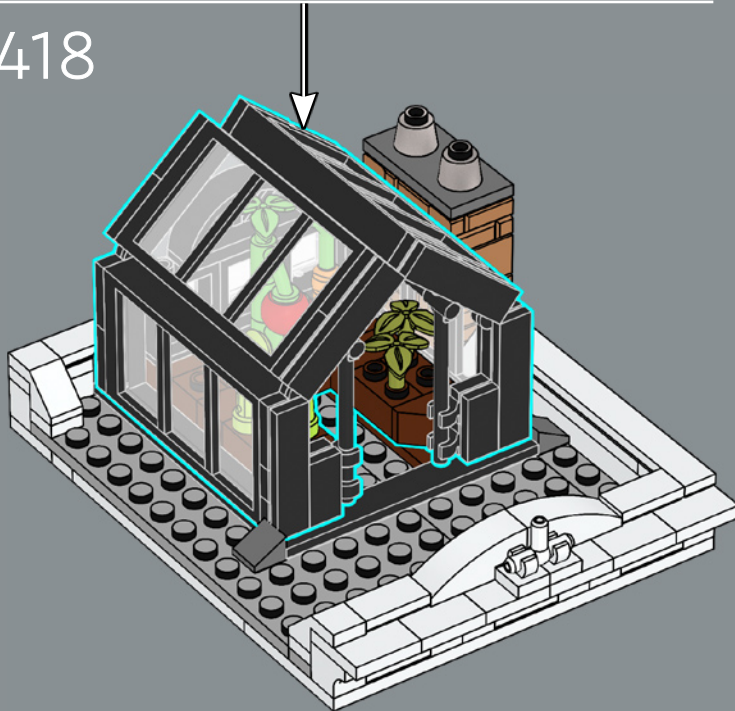

419

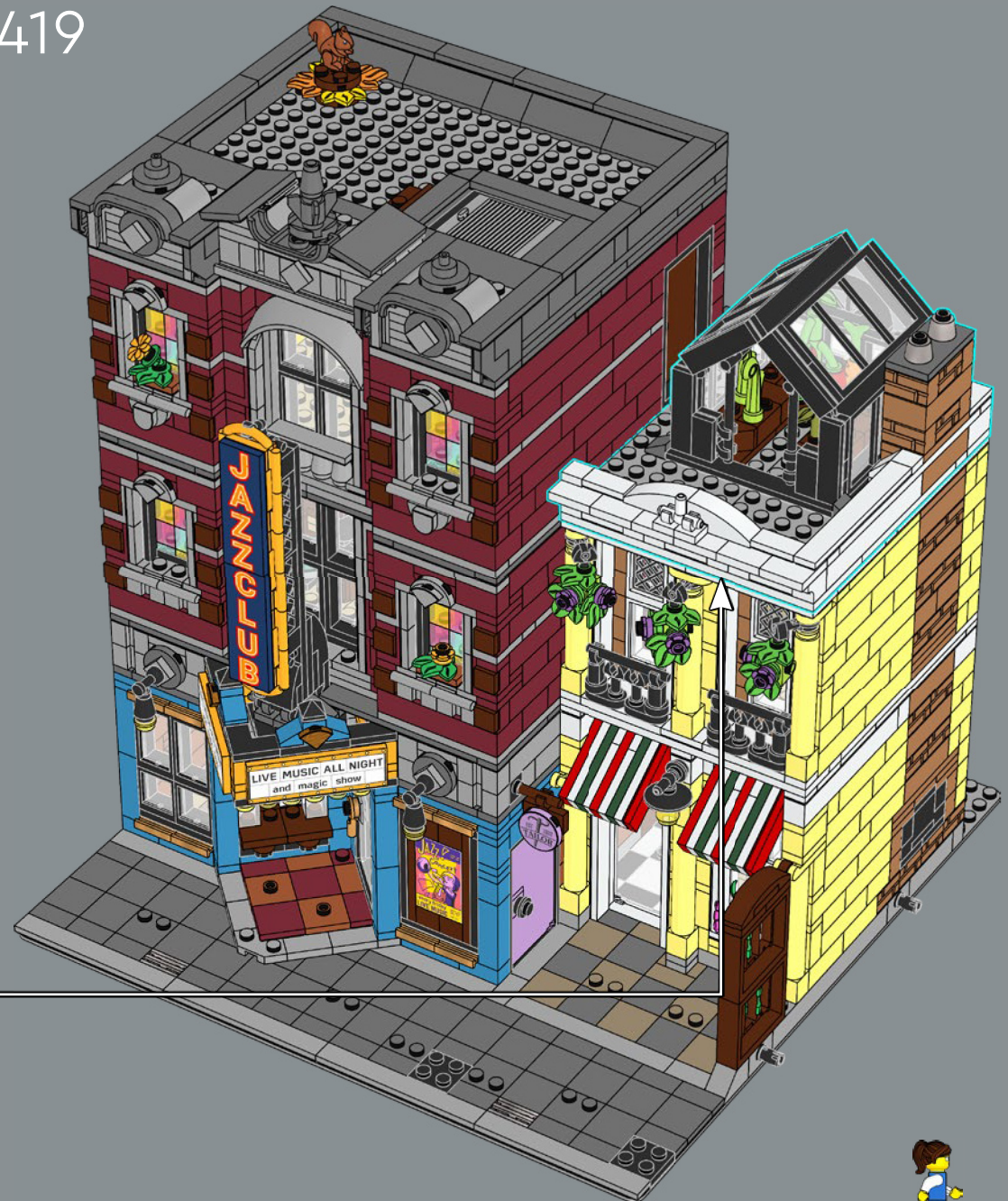



420

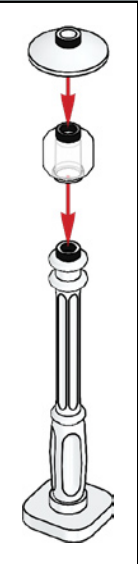
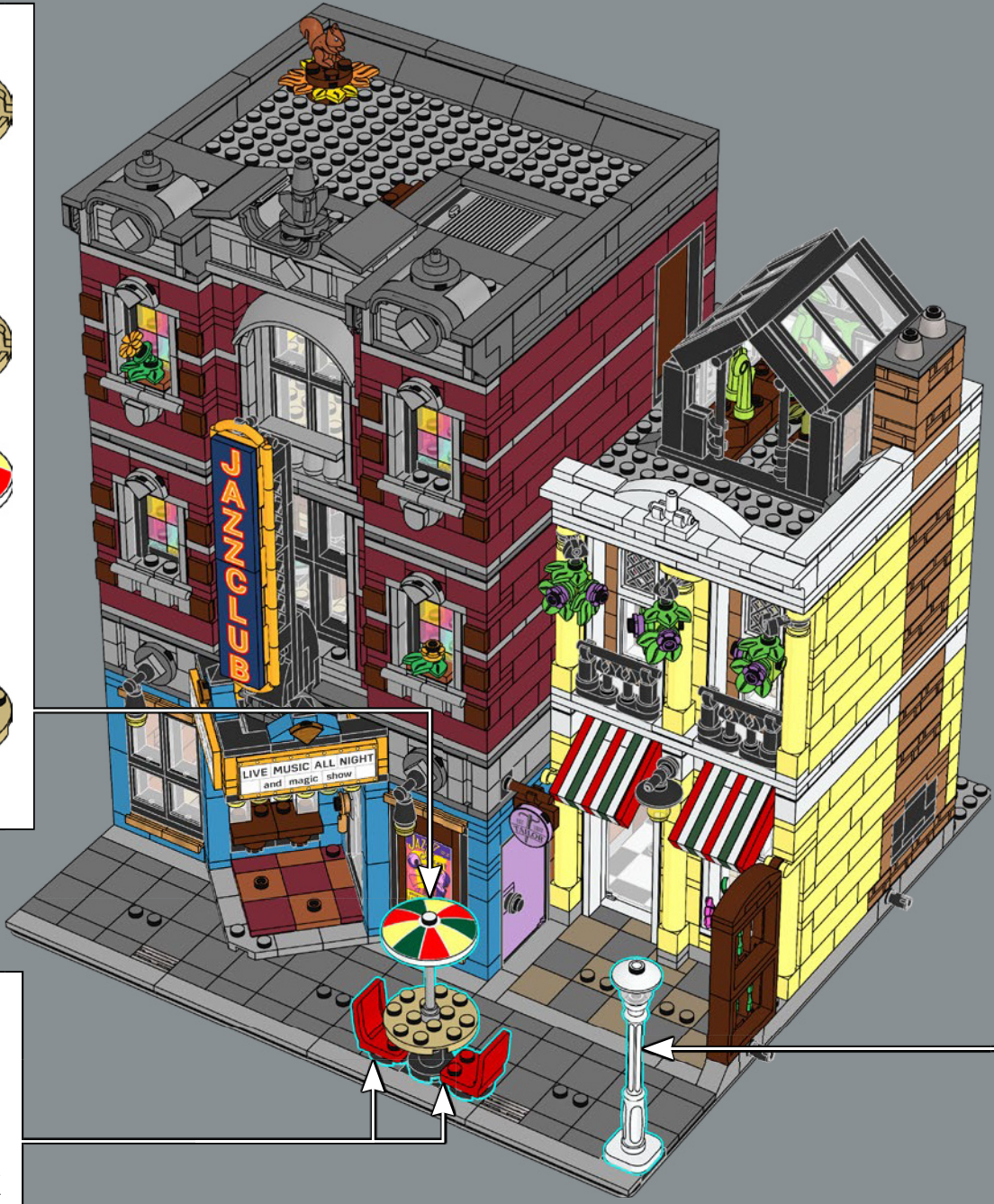
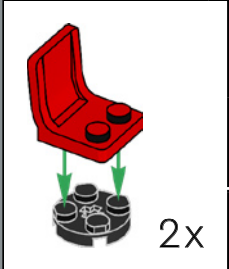
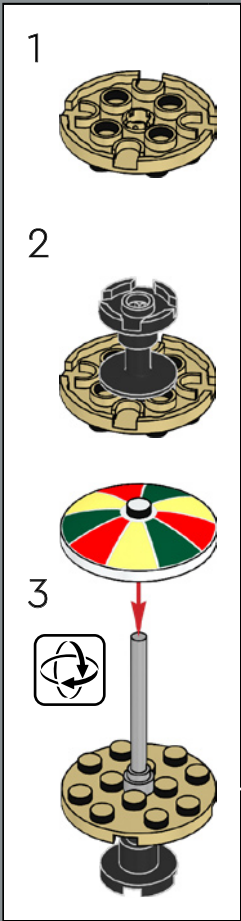



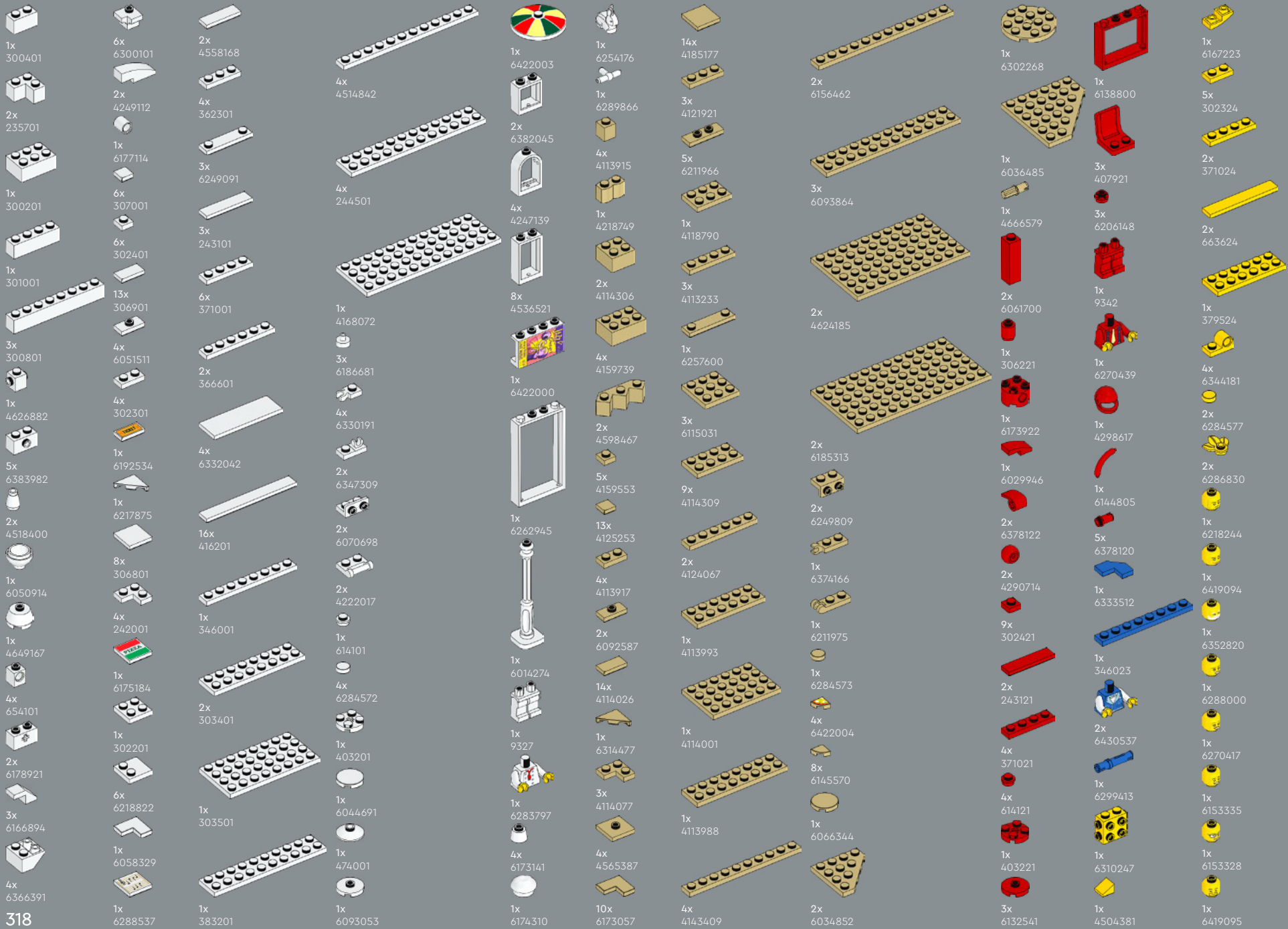



- 3x 4570877
- 2x 4614158
- 2x 6092602
- 2x 6315197
- 4x 6248949
- 1x 6313129
- 1x J5 6172566
- 1x 6384077
- 2x 6220959
- 1x 6251294
- 16x 6252258
- 21x 6254552
- 4x 6256058
- 6x 6253734
- 32
- 1x 4267425
- 2x 6213782
- 3x 6213779
- 1x 6210775
- 2x 6240467
- 8x 6240553
- 3x 6174006
- 4x 6240551
- 8x 6252043
- 1x 6274739
- 1x 6306726
- 1x 6283590
- 4x 6277483
- 2x 6238674
- 8x 6252045
- 6x 6274740
- 19x 6240216
- 1x 6171728
- 1x 6168665
- 1x 6244787
- 2x 6166107
- 1x 6247369
- 1x 6337596
- 4x 6240551
- 1x 6274739
- 1x 6306726
- 1x 4558595
- 2x 6253884
- 1x 6103249
- 1x 6240515
- 1x 6313826
- 1x 6001822
- 1x 6273590
- 9x 6055172
- 4x 4496699
- 1x 6092591
- 5x 4507045
- 2x 6396392
- 17x 6175927
- 1x 6270031
- 1x 6031821
- 2x 6216905
- 1x 6422001
- 1x 6422002
- 2x 6350417
- 2x 4162916
- 103x 6052777
- 10x 4541528
- 4x 6089268
- 2x 6311108
- 24x 4539092
- 1x 4539099
- 2x 6267414
- 2x 6173168
- 2x 6042953
- 24x 4539114
- 2x 4539090
- 61x 4539097
- 10x 4585751
- 2x 4585479
- 23x 4541376
- 70x 4539102
- 31x 4541379
- 18x 6264025
- 2x 4539105
- 4x 4539076
- 2x 4583299
- 2x 4539062
- 3x 4541507
- 2x 6253142
- 4x 6384234
- 2x 6359683
- 2x 6313126
- 17x 6335330
- 6x 6359716
- 3x 6003033
- 8x 6020073
- 2x 6422005
- 6x 6331205
- 1x 6209681
- 1x 6212994
- 2x 6430410
- 2x 6245265
- 4x 6061685
- 2x 6186542
- 4x 6073040
- 4x 6099714
- 4x 6020923
- 1x 6409778
- 1x 6349342
- 2x 4211199
- 4x 6146858
- 1x 4658005
- 24x 4211288
- 3x 4221744
- 2x 4211150
- 2x 4224243
- 4x 4211151
- 4x 4216695
- 4x 6196221
- 1x 6100769
- 6x 6311441
- 1x 6257604
- 3x 4211190
- 1x 4211194
- 2x 6307618
- 1x 4211186
- 1x 4211204
- 2x 4221590
- 1x 4211211
- 1x 4217848
- 2x 6186673
- 2x 6401027
- 2x 6238874
- 1x 6313124
- 2x 6290983
- 1x 6338135
- 3x 4216581
- 1x 6284586
- 2x 4211159
- 4x 6102360
- 1x 6342958
- 1x 6075207
- 1x 6228841
- 1x 6428805
- 1x 6267760
- 1x 6093515
- 1x 6422007
- 6x 6248918
- 2x 6271128
- 2x 4595889
- 6x 4211206
- 12x 6310449
- 4x 6159763
- 1x 4609635
- 2x 6261744
- 3x 4211242
- 2x 4211149
- 1x 4211193
- 4x 6201911
- 3x 6062574
- 3x 6103004
- 1x 6153594
- 1x 6036503
- 2x 6151461

- 4x 4210719
- 2x 4211133
- 2x 4210875
- 1x 4211054
- 2x 6365692
- 1x 638209
- 11x 6058014
- 1x 6173654
- 1x 6273854
- 2x 6313600
- 4x 6151658
- 11x 4210848
- 3x 4211043
- 1x 4210875
- 4x 4211127
- 1x 6271127
- 13x 6201647
- 1x 6093529
- 2x 6313600
- 10x 6151664
- 1x 4648256
- 8x 4211053
- 4x 4211127
- 5x 6284596
- 1x 6038163
- 1x 6167585
- 3x 6347304
- 3x 6133728
- 4x 4210631
- 6x 4211001
- 1x 6199549
- 1x 6022084
- 3x 6167585
- 4x 6313599
- 4x 4210631
- 6x 4211001
- 6x 6029948
- 1x 4211042
- 4x 6167585
- 4x 6313599
- 42x 4211052
- 10x 6257592
- 1x 6170420
- 6x 6115080
- 2x 6022083
- 2x 6296524
- 7x 6292154
- 1x 6210675
- 16x 6247784
- 1x 6307616
- 2x 6411395
- 2x 6022064
- 4x 6292154
- 7x 6151657
- 32x 4211055
- 6x 4560184
- 19x 6201646
- 2x 6212064
- 4x 6218360
- 3x 6151657
- 5x 6309059
- 6x 4560184
- 35x 6036232
- 2x 6411395
- 2x 6296524
- 4x 6218360
- 3x 6223733
- 4x 4211056
- 1x 6170420
- 2x 6388124
- 19x 6201646
- 2x 6102994
- 1x 4258308
- 4x 6177079
- 1x 4211056
- 6x 6209684
- 3x 6319958
- 8x 6177535
- 1x 4258308
- 6x 4568734
- 11x 4210651
- 1x 6245283
- 6x 629684
- 4x 4569382
- 1x 6102990
- 1x 6420734
- 3x 6178912
- 1x 6245283
- 1x 6149768
- 4x 6055309
- 3x 6334099
- 2x 6096993
- 2x 6331222
- 1x 643106
- 1x 6431074
- 4x 6055309
- 3x 6334099
- 9x 6420725
- 6x 4211044
- 1x 6187006
- 9x 6004943
- 2x 6278156
- 1x 4529240
- 3x 6178912
- 2x 6000606
- 1x 6102998
- 2x 6102998
- 9x 6004943
- 2x 6278156
- 4x 4504378
- 2x 6331222
- 18x 4211008
- 2x 6344038
- 2x 6102998
- 3x 6154879
- 2x 4211469
- 6x 4211044
- 2x 6285465
- 4x 6070301
- 6x 6154879
- 4x 6004938
- 2x 6251591
- 1x 4529240
- 6x 4211044
- 2x 6150307
- 8x 6190252
- 1x 6404754
- 1x 6093494
- 4x 6093494
- 2x 6078236
- 1x 4504378
- 4x 4504378
- 3x 6133611
- 1x 6058368
- 2x 6102580
- 5x 4523159
- 3x 6174192
- 3x 6295464
- 4x 6133838
- 1x 6227939



 [LEGO.com/service](https://www.LEGO.com/service)



YOU COULD WIN



YOU COULD WIN

Your feedback will help shape the future development of this product series.

Visit:

DU KÖNNTEST GEWINNEN

Dein Feedback trägt zur Weiterentwicklung dieser Produktreihe bei.

Geh auf:

VOUS POURRIEZ GAGNER

Vos commentaires nous aideront à concevoir les futurs produits de cette gamme.

Visitez :

POTRESTI VINCERE TU

La tua opinione ci aiuterà a migliorare la creazione futura di questa linea di prodotti.

Visita:

PUEDES GANAR

Tu opinión contribuirá al futuro de esta serie de productos.

Visita:

轻松获奖

您的反馈将有助于我们在今后改进本产品系列。

请访问:

[LEGO.com/productfeedback](https://www.lego.com/productfeedback)

You also have the chance to win a LEGO® set.

Terms and conditions apply.*

Außerdem hast du die Chance, ein LEGO® Set zu gewinnen.

Es gelten die Teilnahmebedingungen.*

Vous pourriez également gagner un ensemble LEGO®.

Des conditions s'appliquent.*

Hai anche la possibilità di vincere un set LEGO®.

Termini e condizioni sono applicabili.*

También tienes la oportunidad de ganar un set LEGO®.

Aplican términos y condiciones.*

您还有机会赢取乐高®套装。

条款和条件适用。*

*[LEGO.com/productfeedback-terms](https://www.lego.com/productfeedback-terms)

