





[LEGO.com/sustainable-packaging](https://LEGO.com/sustainable-packaging)



**MILAN MADGE**  
*Model Designer pour  
le groupe LEGO*

## PASSIONNÉS DE FLEURS

🌸 « Que ce soit pour agrandir votre collection de modèles botaniques LEGO® ou pour réaliser votre première composition florale LEGO, vous êtes probablement aussi passionné(e) de fleurs que nous. Ce bouquet est un beau mélange de fleurs que l'on trouve facilement dans la nature ou dans un jardin. Nous avons associé des couleurs et des espèces complémentaires du monde entier pour rendre hommage à la biodiversité de notre planète et à la beauté tranquille de la nature.

Bonne construction ! »

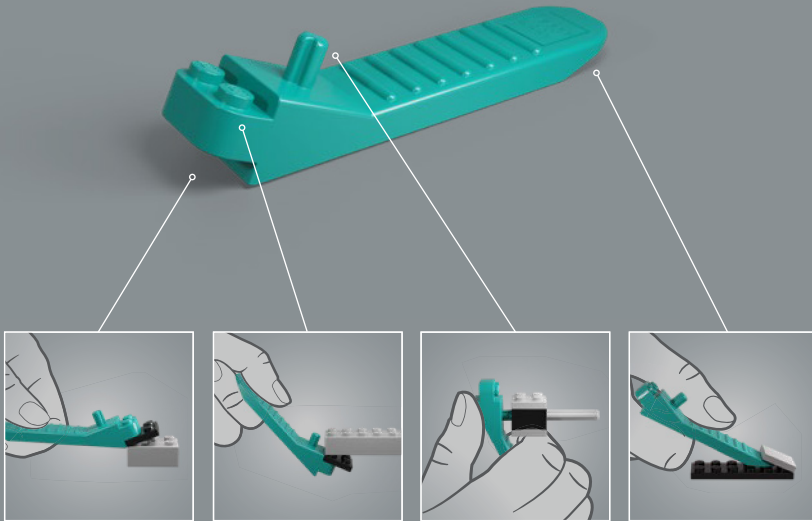

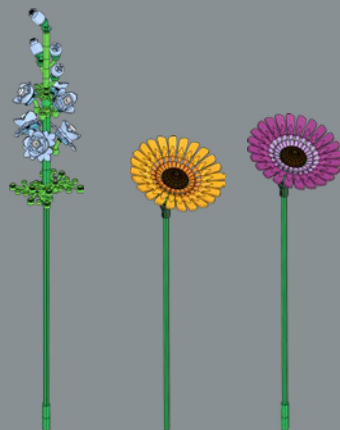
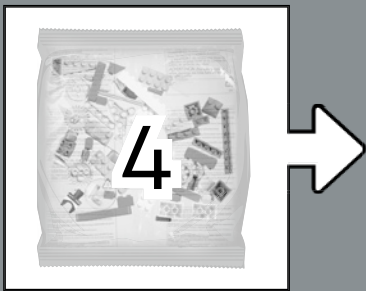
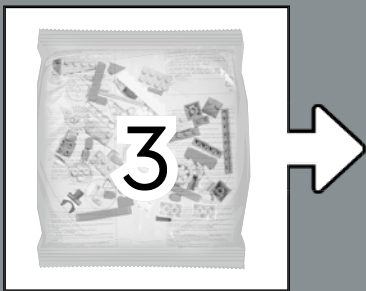
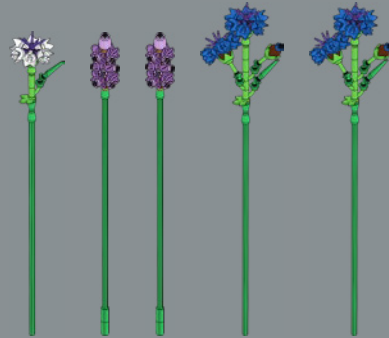
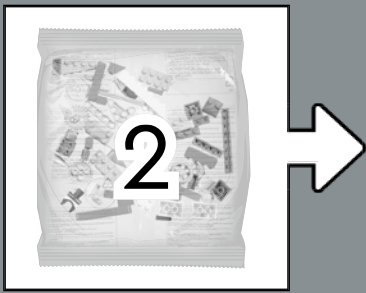
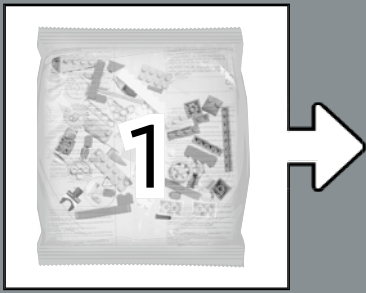

# FOUGÈRE DES FLEURISTES

(*Rumohra adiantiformis*)

✿ Originaire de la plupart des climats tropicaux de l'hémisphère sud, la luxuriante Fougère des fleuristes est désormais connue des propriétaires de jardins du monde entier. Bien qu'elle ne produise pas de fleurs, son feuillage plumeux décoratif est très apprécié dans les bouquets de fleurs.

# CERFEUIL SAUVAGE/ DENTELLE DE LA REINE ANNE

(*Anthriscus Sylvestris*)

✿ Cette plante aérienne en forme de parapluie compte d'innombrables petites fleurs blanches. Elle se trouve dans les zones ombragées de toute l'Europe, en Asie et en Afrique. Ses grappes de fleurs sont un régal pour les abeilles, les mites, les papillons et autres insectes à la recherche de pollen au début du printemps. Saviez-vous qu'elle est également souvent utilisée comme répulsif contre les moustiques ?

# PAVOT DU PAYS DE GALLES

(*Meconopsis cambrica/  
Papaver cambricum*)

✿ Le doux Pavot jaune du Pays de Galles marque l'arrivée du printemps et de l'été dans les îles britanniques et en Europe de l'Ouest. Il est présent dans les haies, les champs et sur les bords de route. Malgré la délicatesse de sa tige et de ses pétales, il prospère également dans les environnements rocheux avec très peu de terre, entre les pavés des jardins ou sur les trottoirs de la ville.



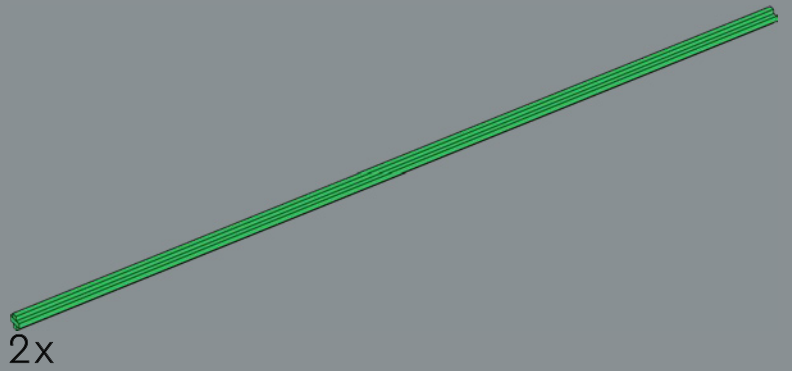
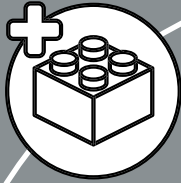

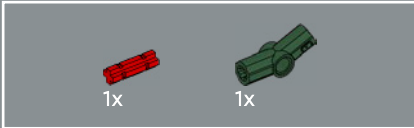

1

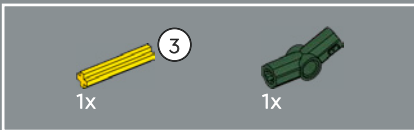
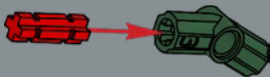

2

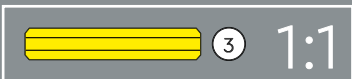
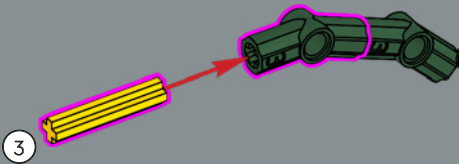

3

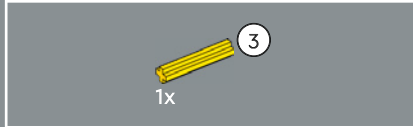
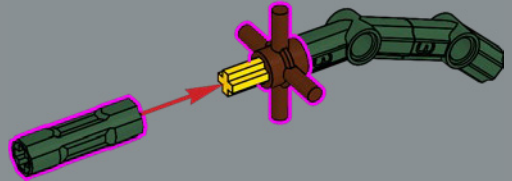

4

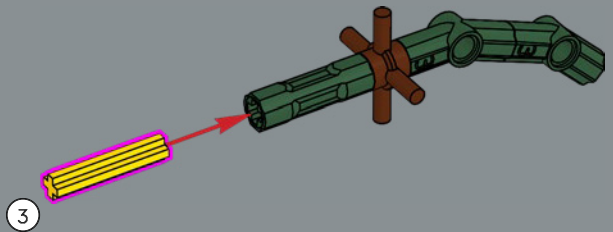



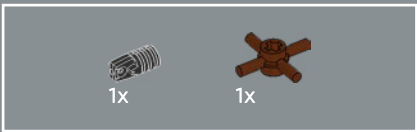

5

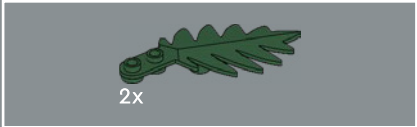
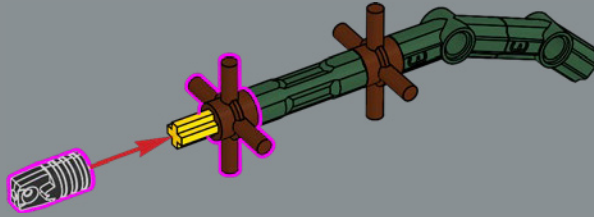

6

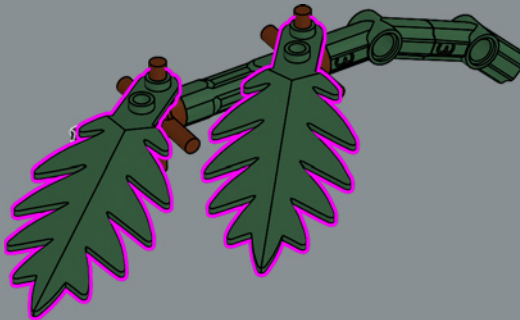

L'élément feuille de palmier a fait sa première apparition dans notre thème LEGO® Pirates dans les années 1990. Il est aujourd'hui détourné de sa fonction initiale pour créer la fougère des fleuristes.

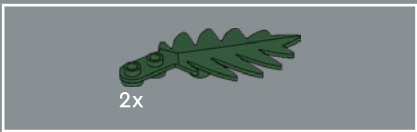

7

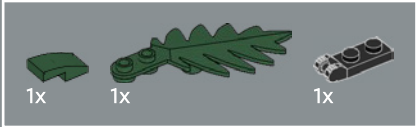

8

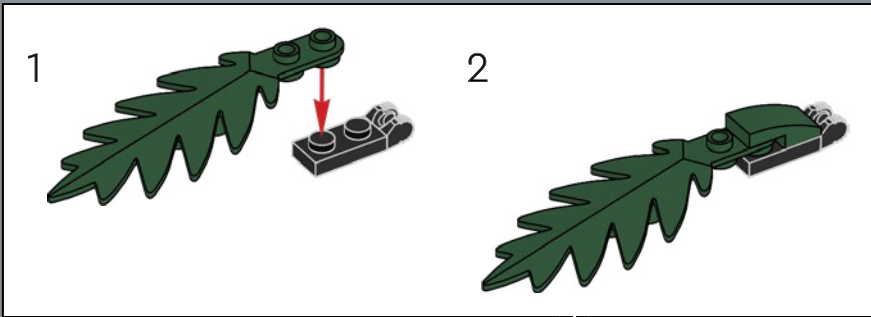

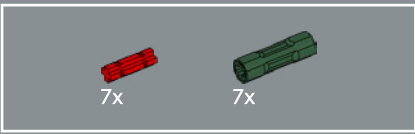

9

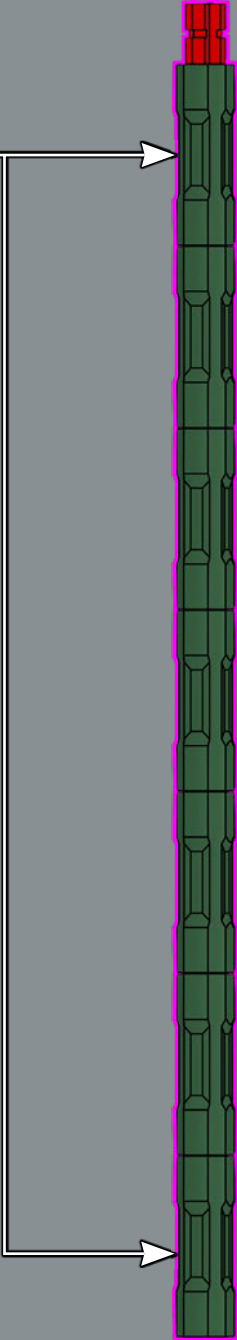
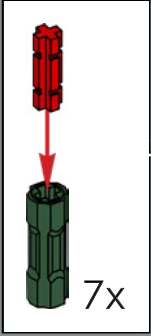

1:1

10

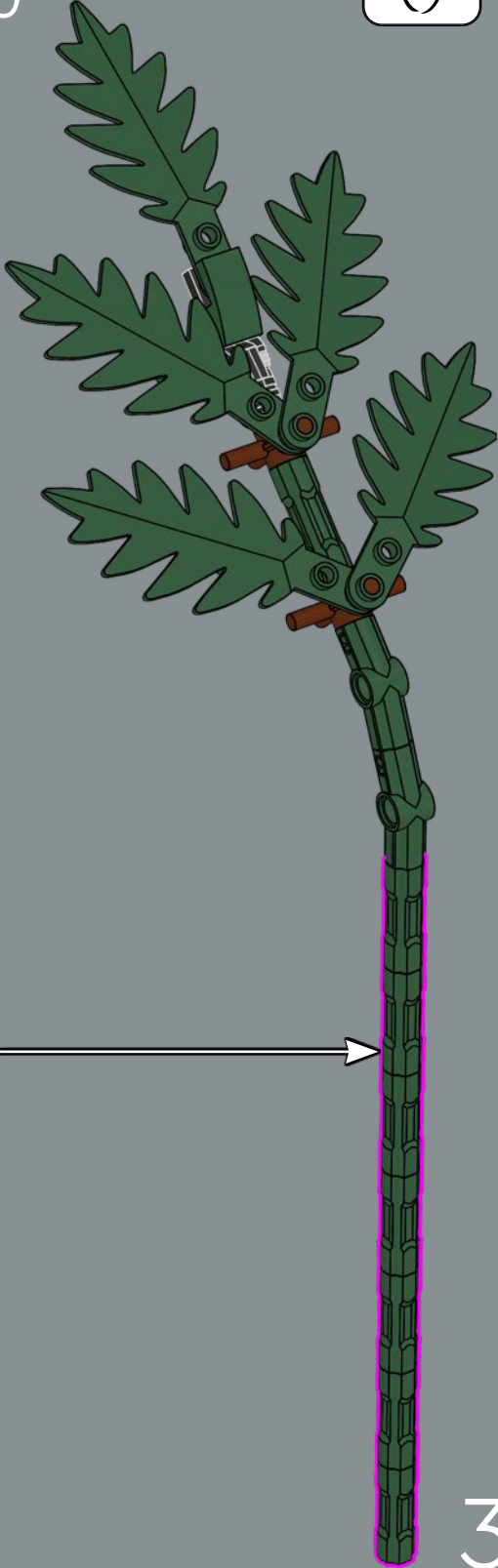

3x

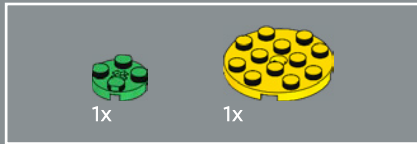
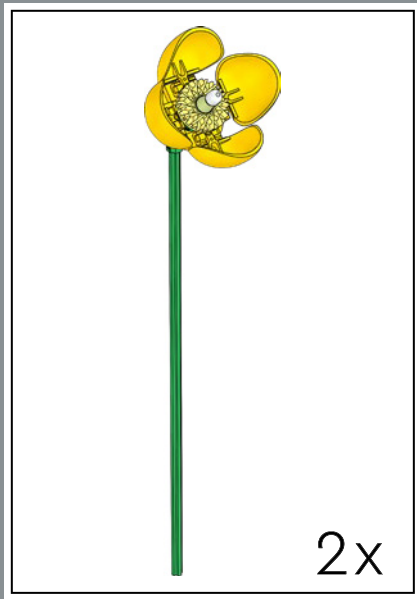

1

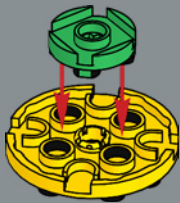

2

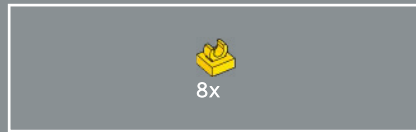

3

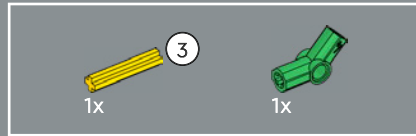
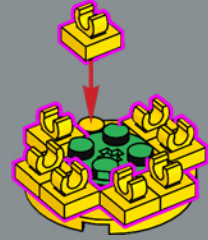

4

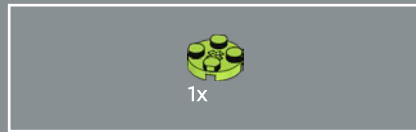
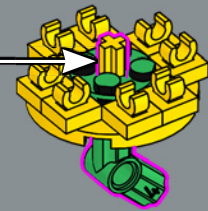
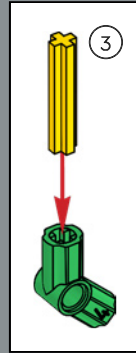

5

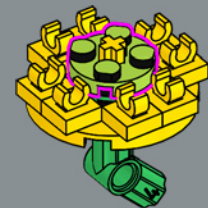



Le détournement d'éléments existants est au cœur de la construction LEGO®. Ici, un moyeu est utilisé pour représenter le stigmate au centre du Pavot jaune.

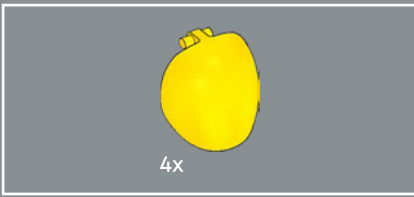

6

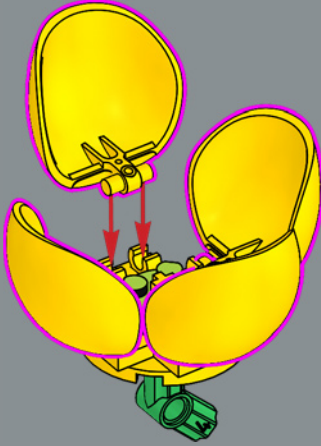

7

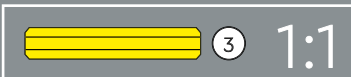
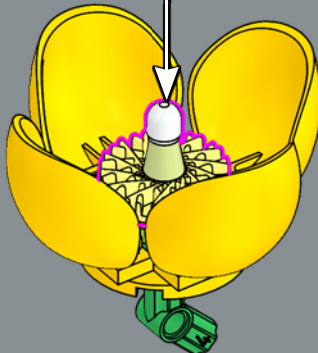
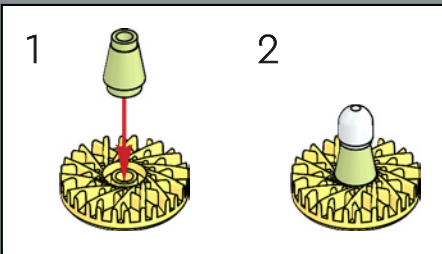

8



2x

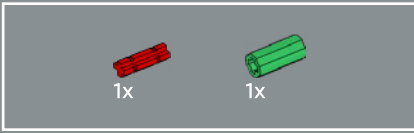
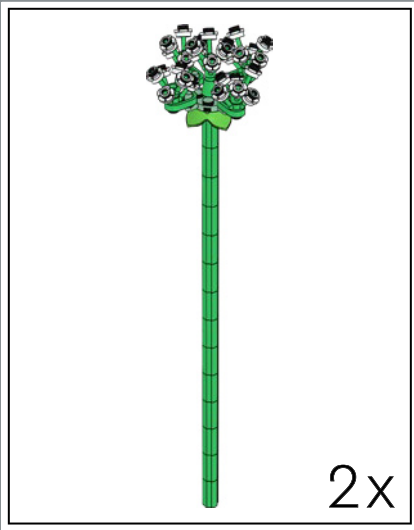

1

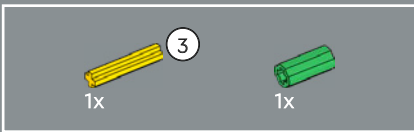

2

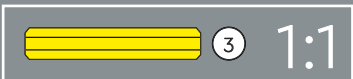

3

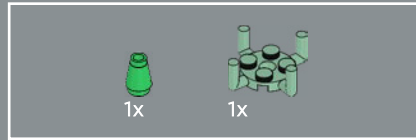

4

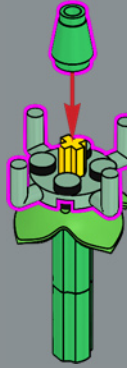

5

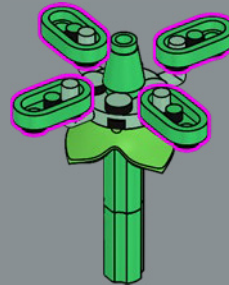

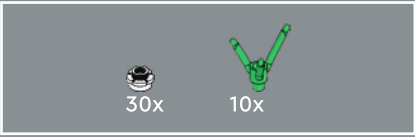
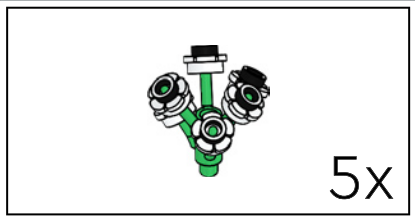

6

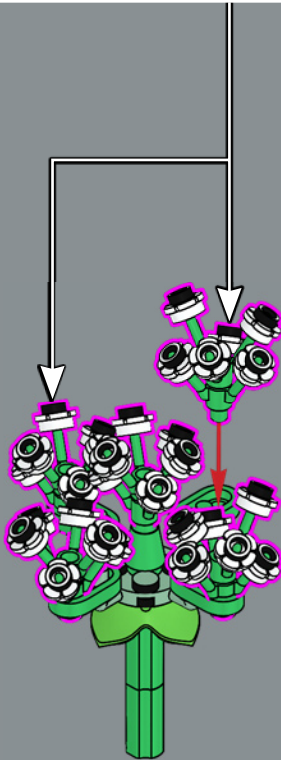
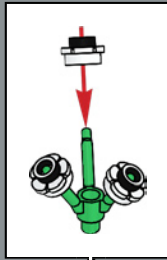
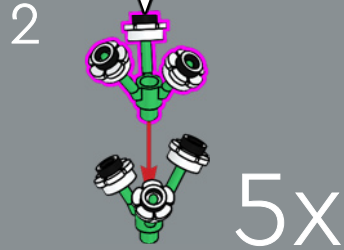
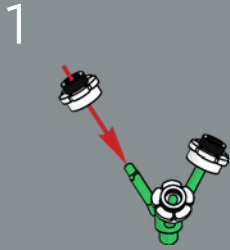

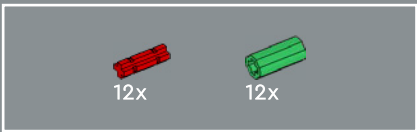

7

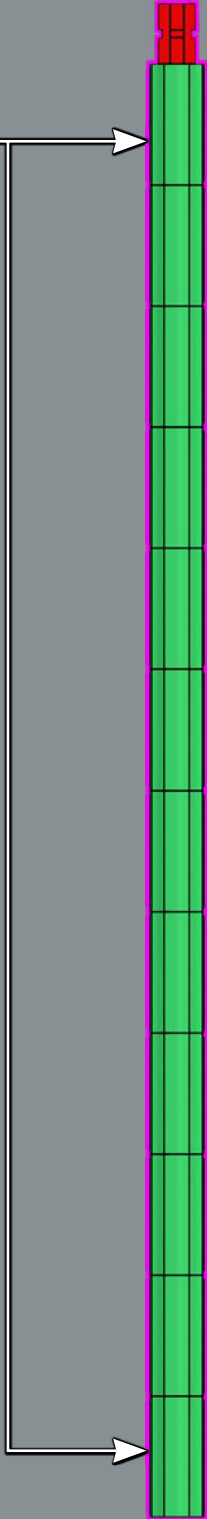
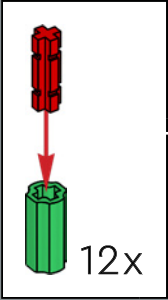

Son surnom, Dentelle de la reine Anne, remonte à un vieil adage selon lequel les fleurs fleuriraient pour Anne, la reine de Grande-Bretagne (1702-1707), et ses dames d'honneur pour compléter leurs robes en dentelle.

8

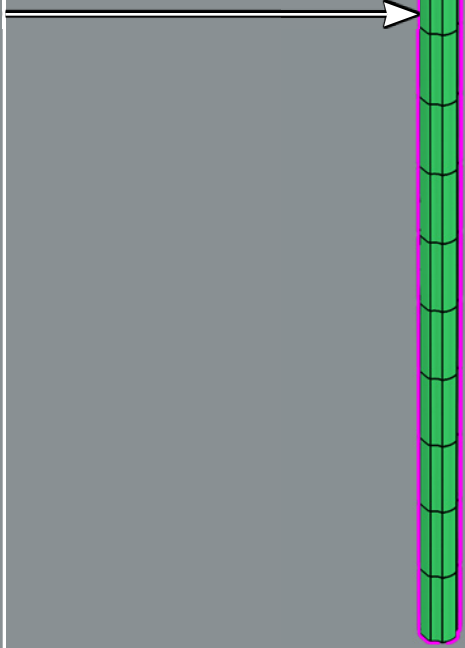



# BLEUET

*(Centaurea cyanus)*

✿ Léger comme une plume, le Bleuet aux couleurs vives teinte les champs et les jardins de blanc, rose et bleu du début jusqu'à la moitié de l'été, en Europe, en Amérique du Nord et en Asie. Son parfum délicat et son nectar attirent les papillons et les abeilles, ce qui fait du bleuet un compagnon séduisant pour votre potager ou votre verger.



# LAVANDE

*(Lavandula)*

✿ Arbuste à feuilles persistantes avec des touches éclatantes de violet et un arôme apaisant, la Lavande ornementale est aussi utile que décorative. Originaires de la Méditerranée, du Moyen-Orient et d'Afrique du Nord, elle est largement utilisée en cuisine pour son arôme, dans la distillation d'huiles essentielles pour les cosmétiques et dans la fabrication de plantes médicinales.

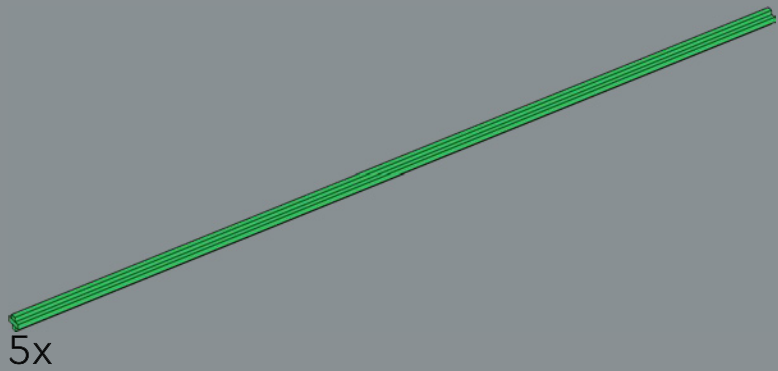
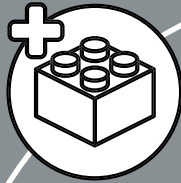

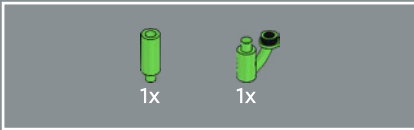
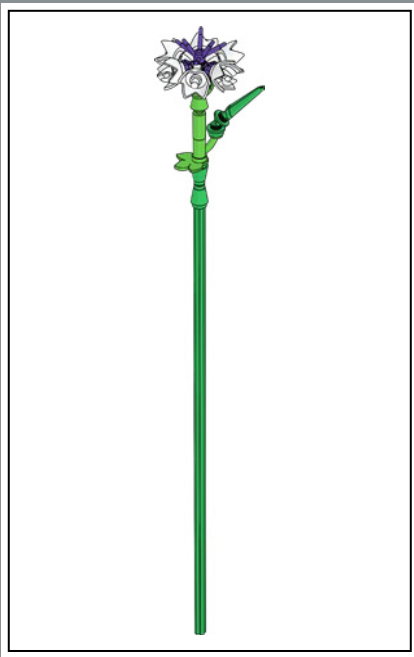

1

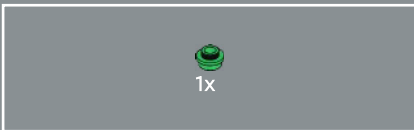

2

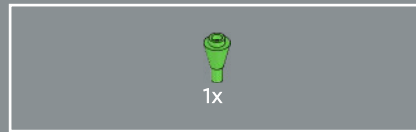
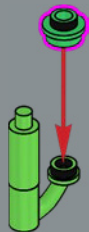

3

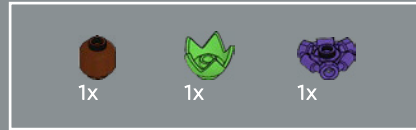
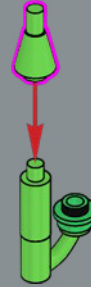

4

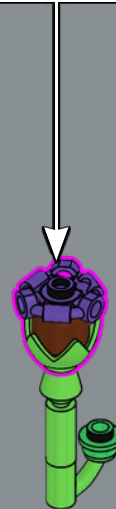



3x



3x

5

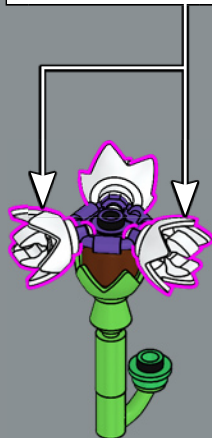
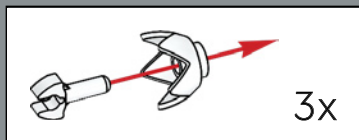

3x

6

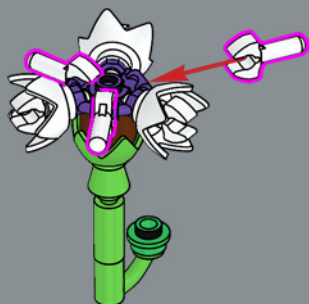

3x

7

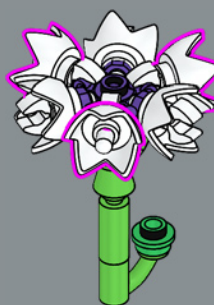

1x

8

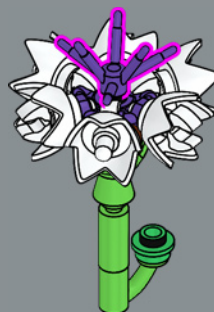

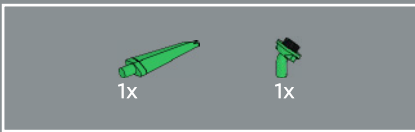

9

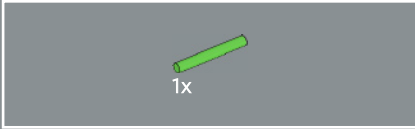
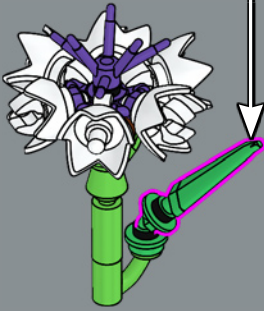
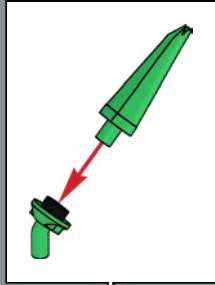

10

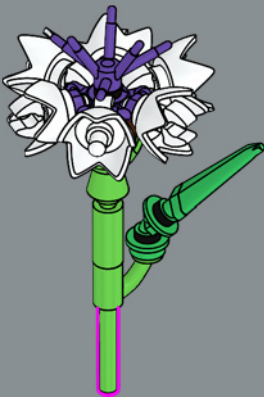

11

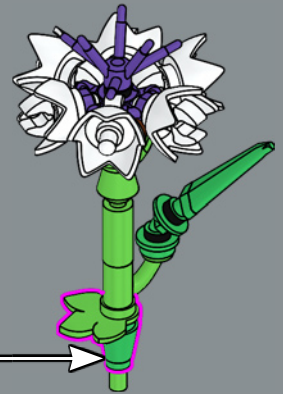
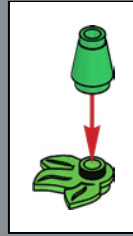



12

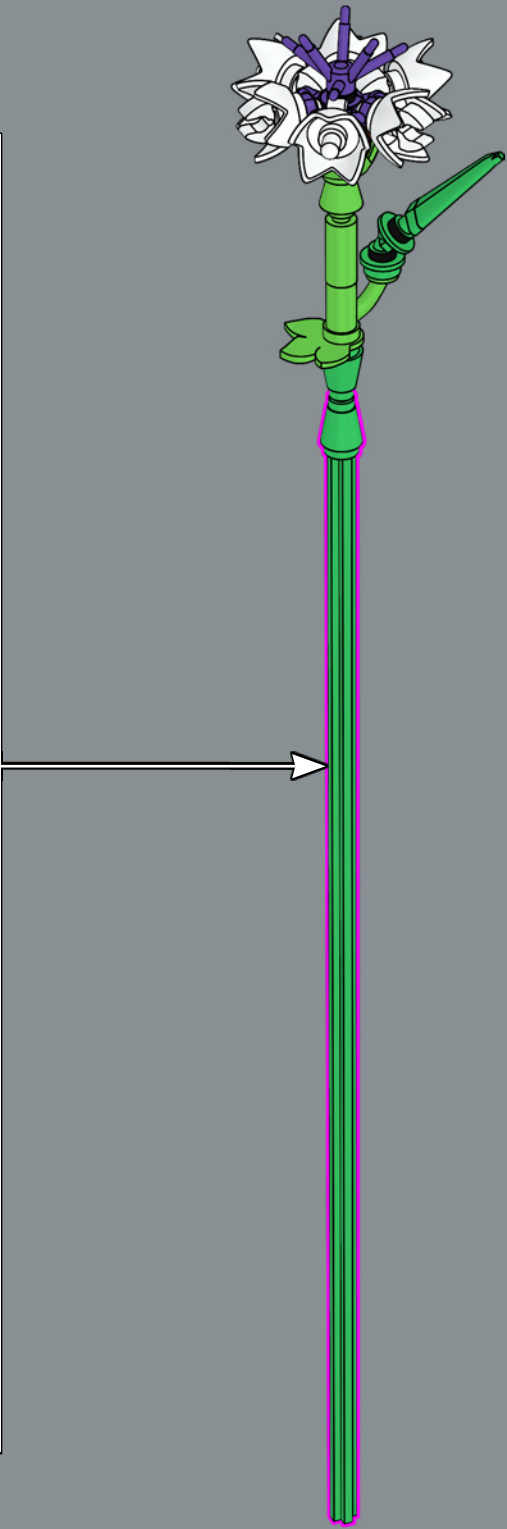
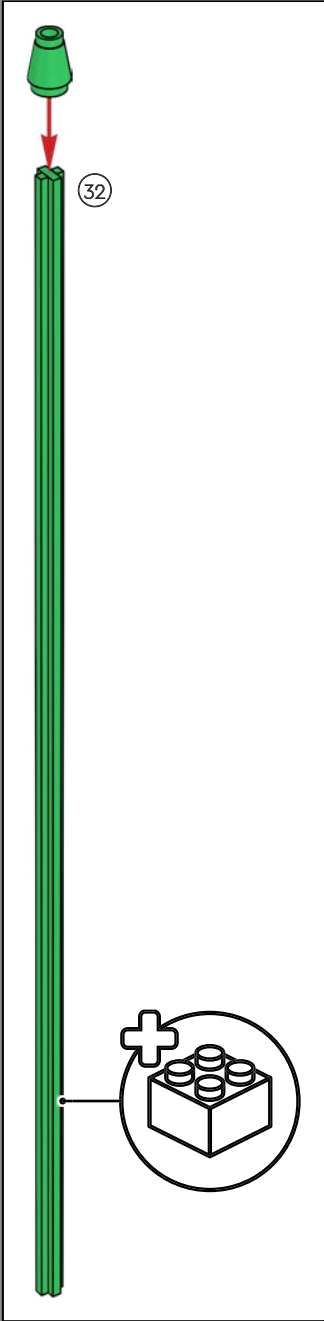

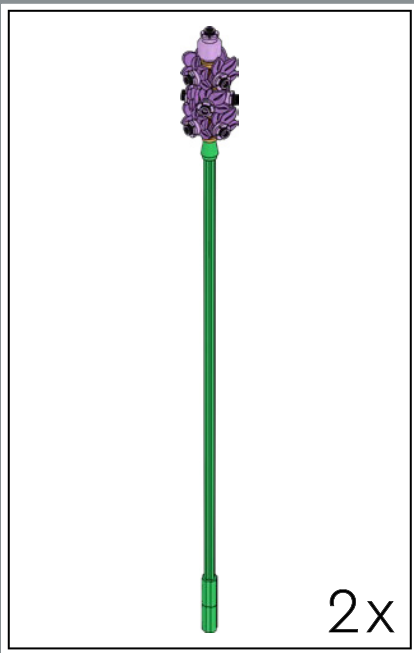

1



2



3

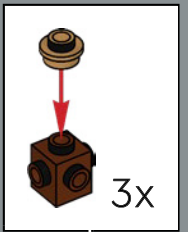

4

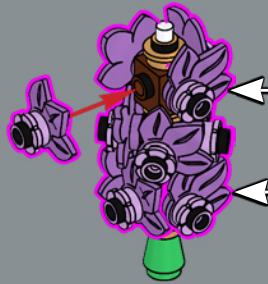
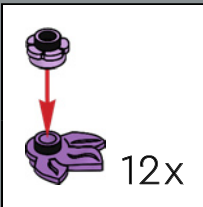

5





6

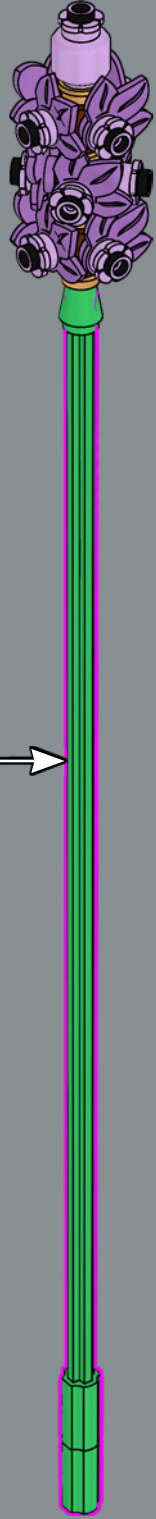
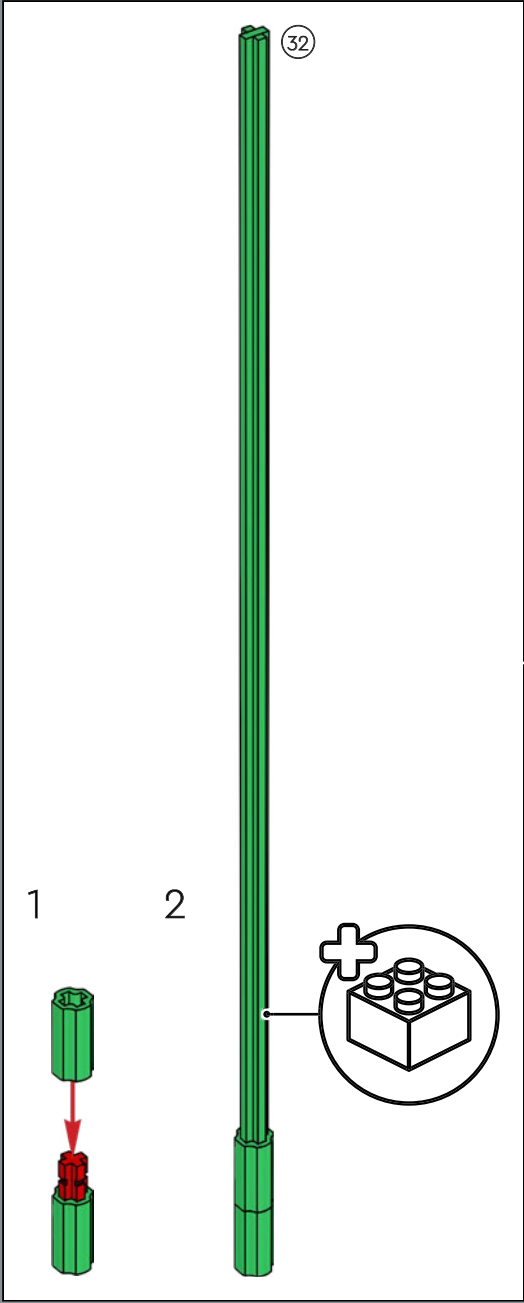

2x





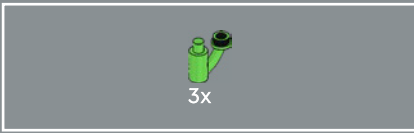
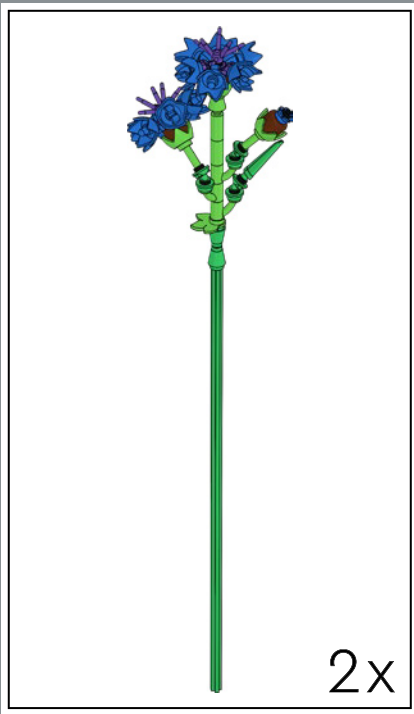

1

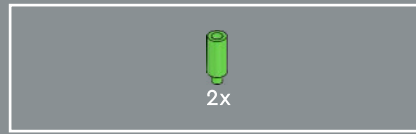

2

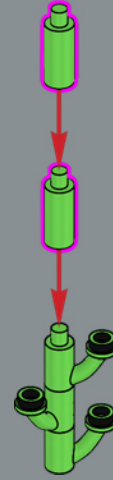

3

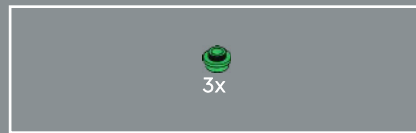
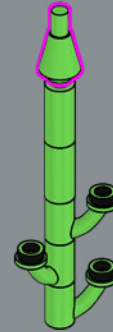

4

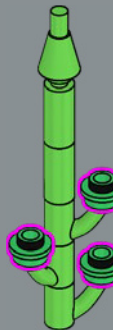

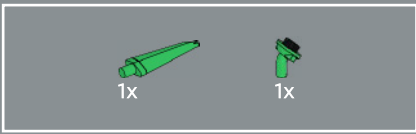

5

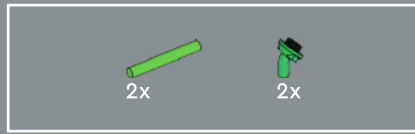
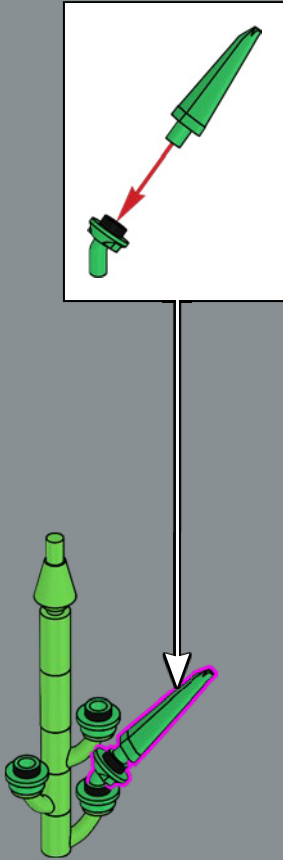

6

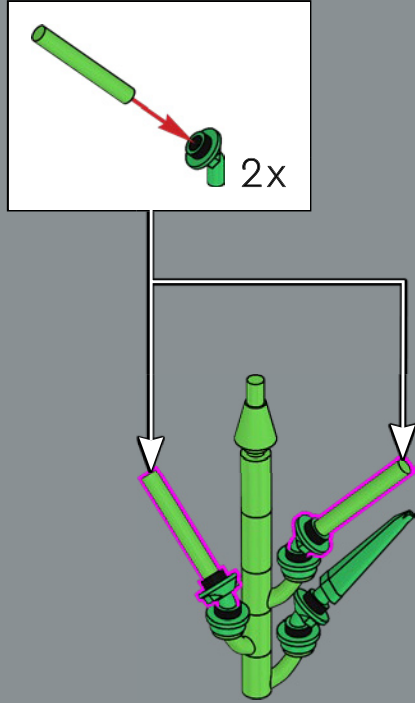

7

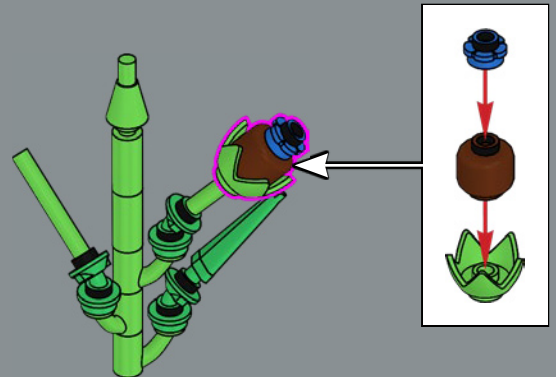

Le groupe LEGO s'efforce de construire un avenir plus durable pour les enfants. Désormais, plus de 80 éléments LEGO®, notamment des arbres, des feuilles et des buissons, sont en plastique d'origine végétale, fabriqué à partir de canne à sucre provenant de cultures certifiées durables. En somme, des plantes fabriquées avec des plantes ! Ces éléments sont les premières étapes dans la réalisation d'un objectif d'envergure : fabriquer des briques LEGO provenant de sources durables d'ici 2030.

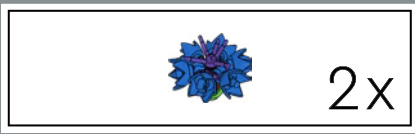

8



9



10

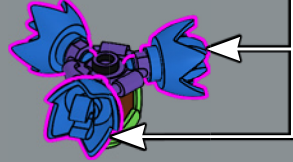
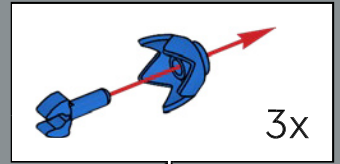

11

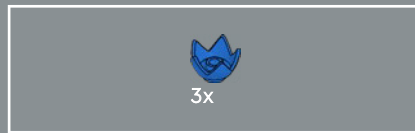
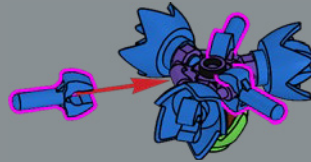

12

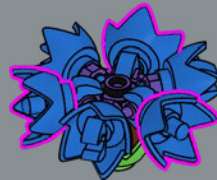



13

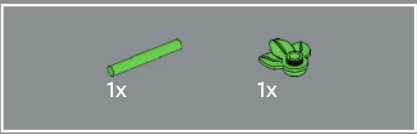
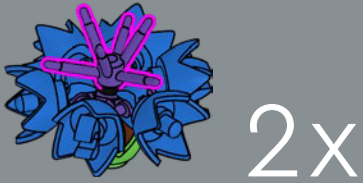

15

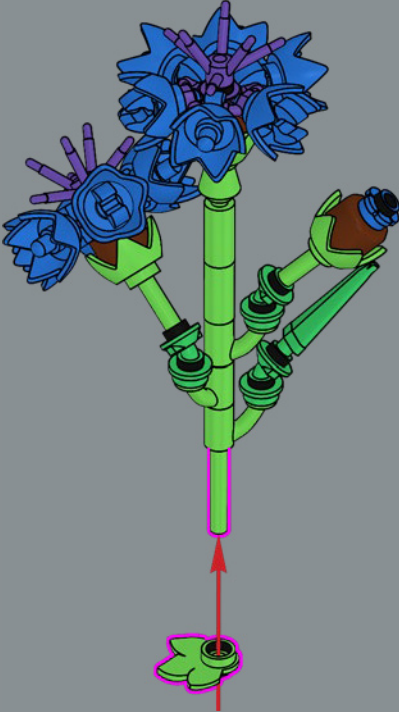

14

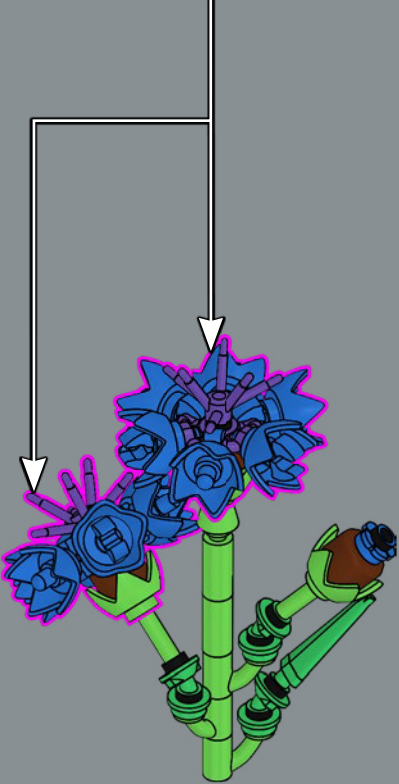

16

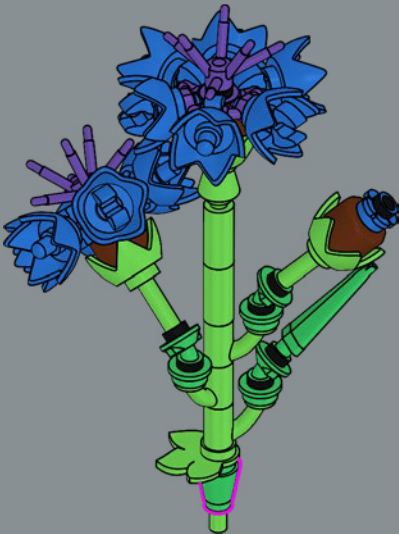



17

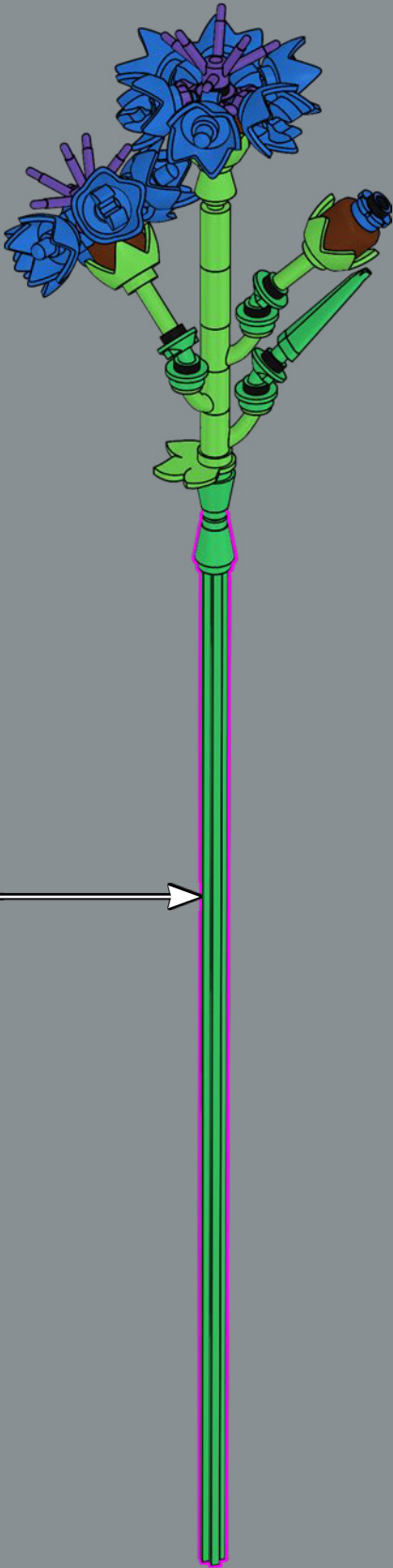
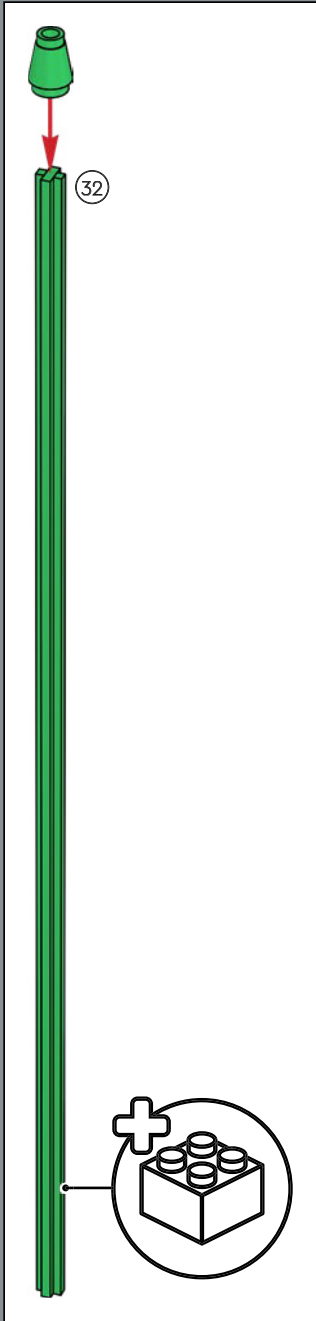

2x



# LUPIN

*(Lupinus)*

✿ Originaire d'Amérique du Nord, le Lupin prospère également à l'état sauvage en Méditerranée et en Europe. Ses épis aux multiples couleurs dégradées grimpent haut pour attirer l'attention des pollinisateurs – et la nôtre – à travers les prairies nord-américaines, le long des routes et dans les jardins du monde entier.

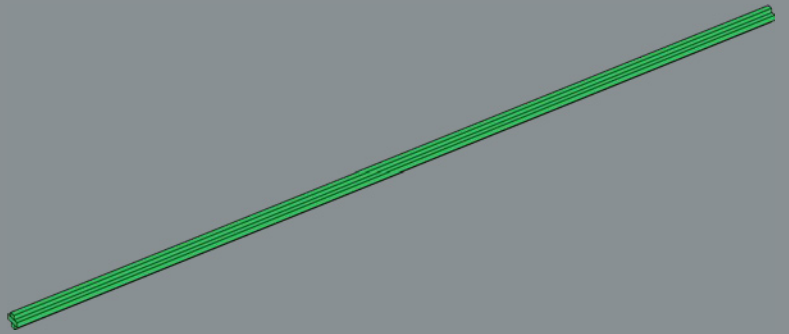
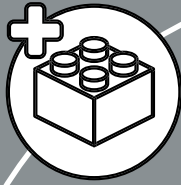

2x



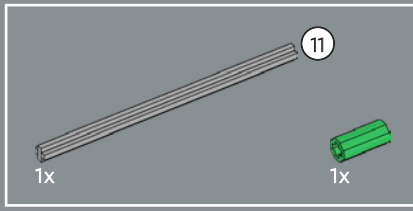
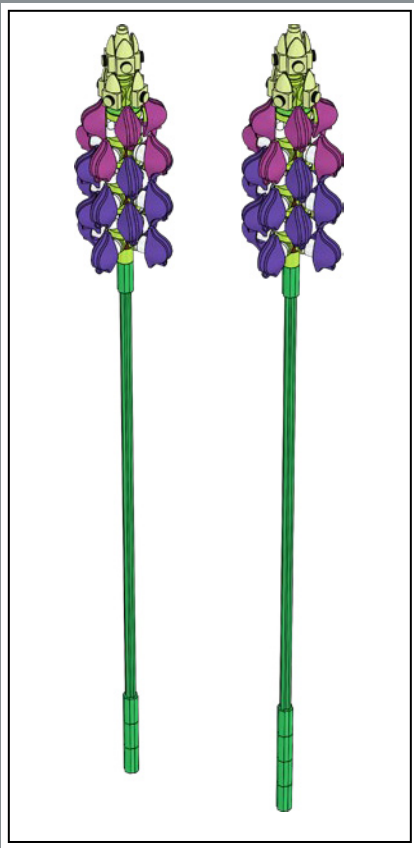

1

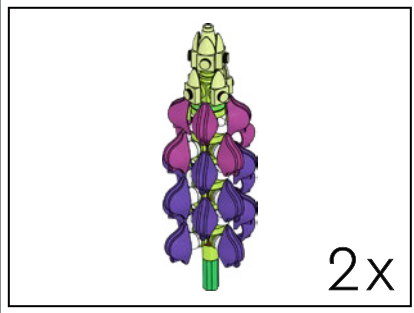
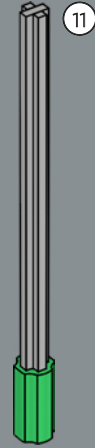

2

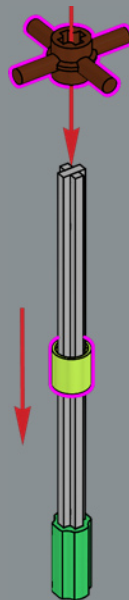





3

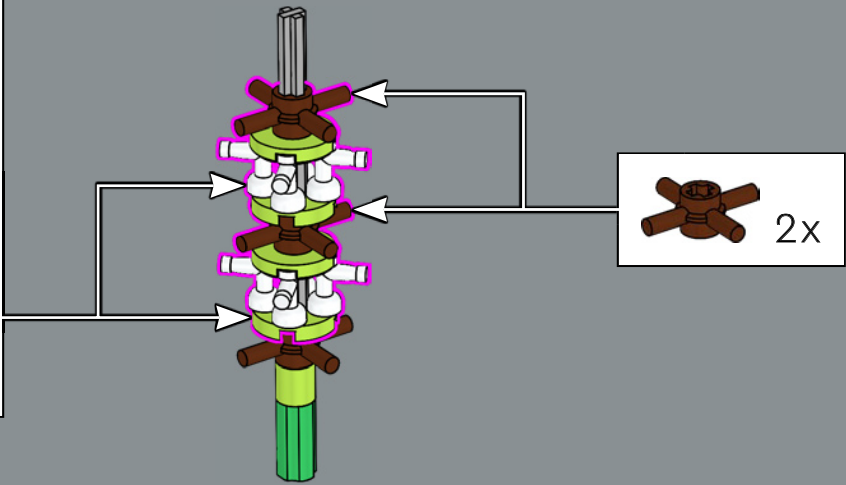
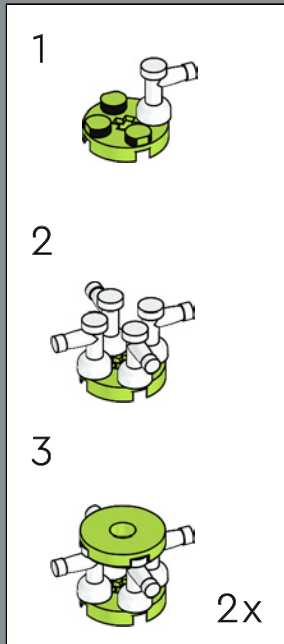

4

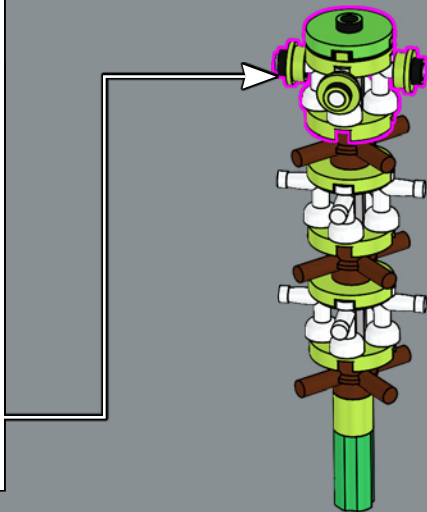
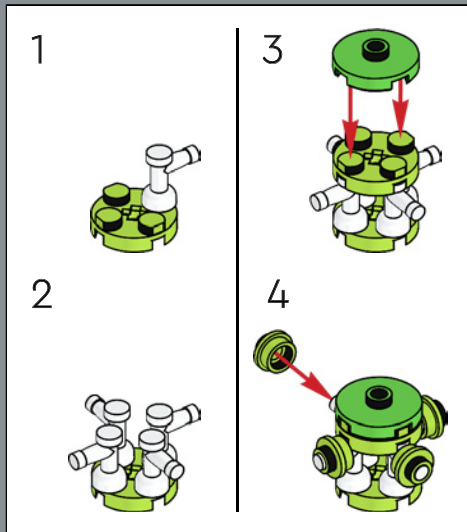

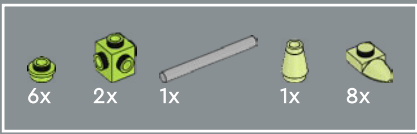

5

1



2

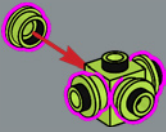

3



4

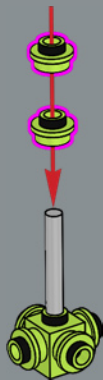

5



6



7

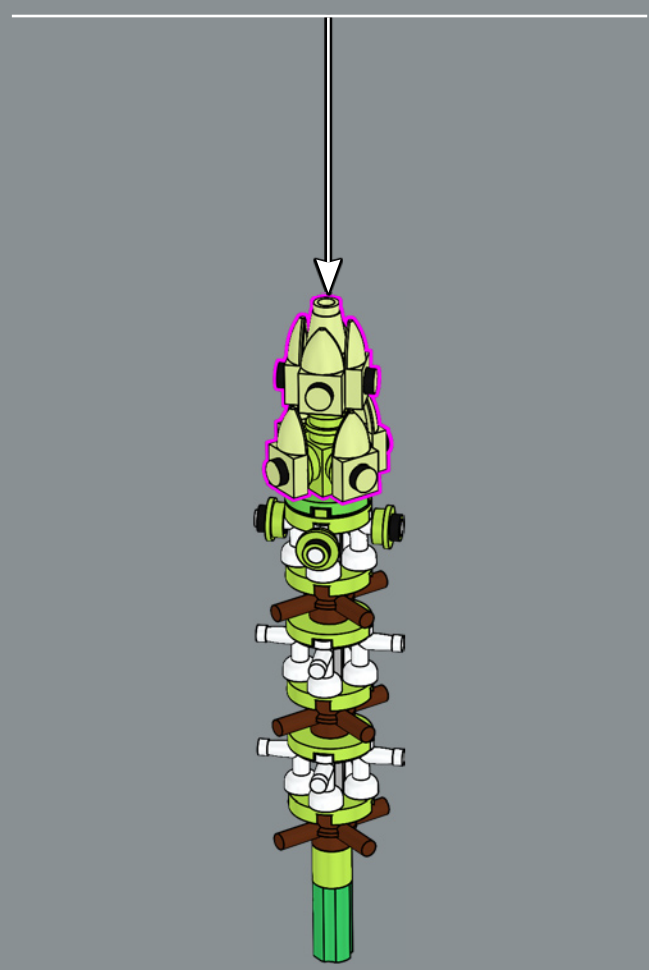



6

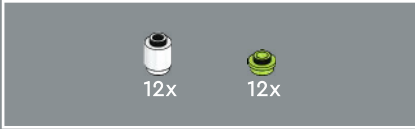
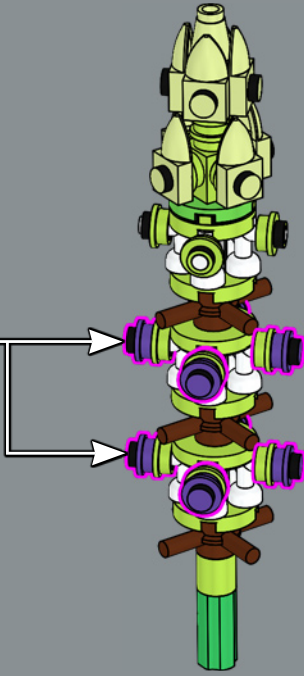
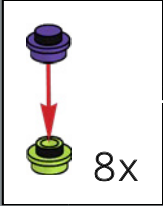

7

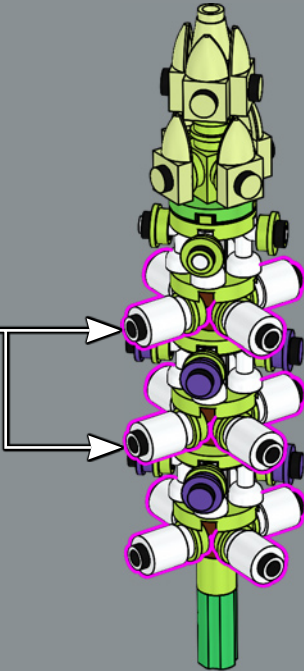
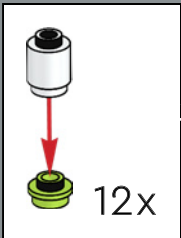

8

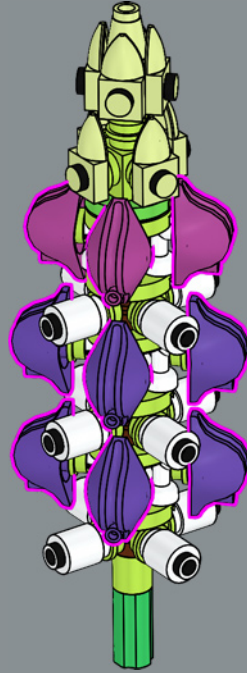

9

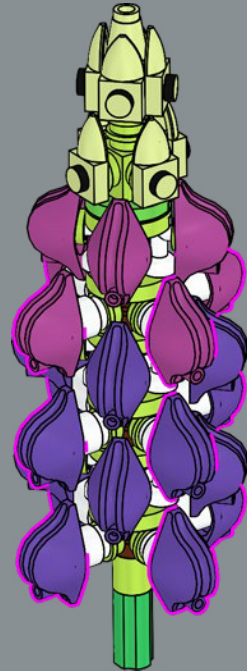

2x

10



Les minifigurines qui portaient ces chapeaux de pirates en 1989 n'auraient jamais pu imaginer que leur couvre-chef fantaisiste deviendrait un jour un pétale de Lupin !

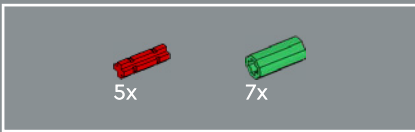

11

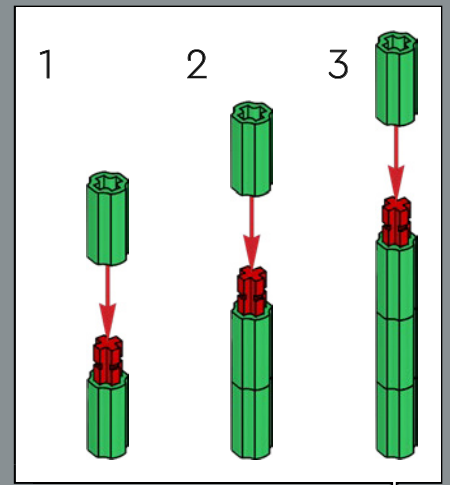
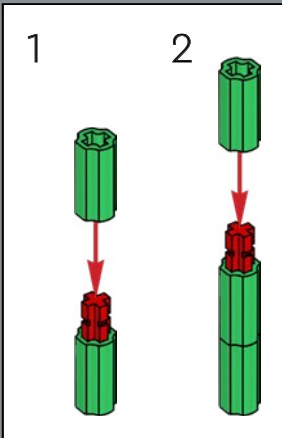
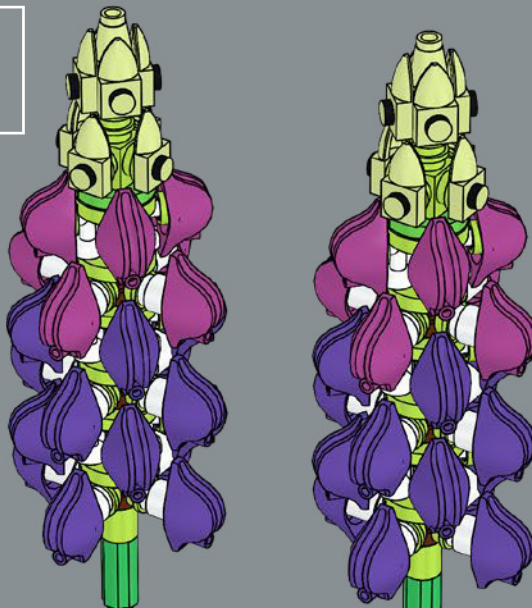

A collection of LEGO flowers. At the top is a tall, green stem with several blue, multi-petaled flowers and buds. Below it are two large, flat flowers: one yellow with a brown center and one pink with a purple center. The stems are green and the background is black.

## DELPHINIUM

*(Consolida ajacis)*

✿ Le Delphinium offre de magnifiques étendues de fleurs sauvages colorées dans les champs et les jardins de l'hémisphère nord. Cette espèce annuelle, qui arrive au tout début du printemps, apporte de la hauteur, un côté aérien et une élégante touche de couleur à votre bouquet, tout comme son cousin, le Delphinium vivace.

## GERBERA

*(Gerbera jamesonii)*

✿ Cousin du tournesol, le magnifique Gerbera se décline en un arc-en-ciel de couleurs. Originaire d'Afrique du Sud, il est également connu sous le nom de Marguerite africaine, Marguerite du Transvaal ou Marguerite de Hilton. Avec son parfum doux et sa couronne majestueuse et surélevée bordée de pétales de velours, il brille de mille feux dans n'importe quel jardin, champ ou bouquet.

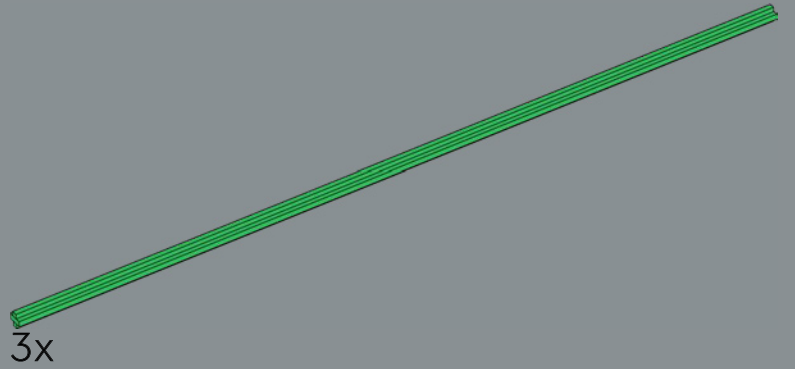
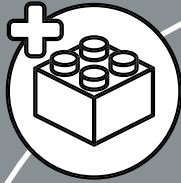

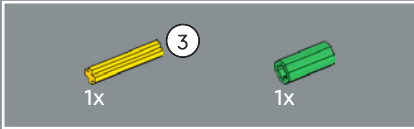
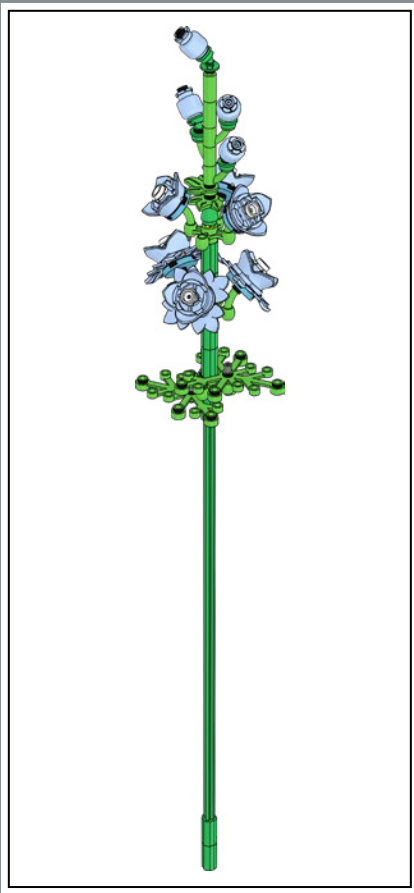

1

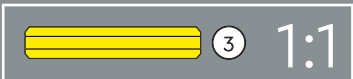
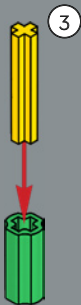

2

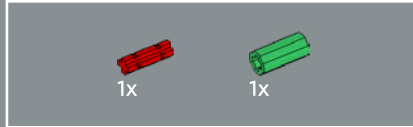
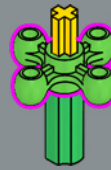

3

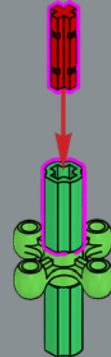



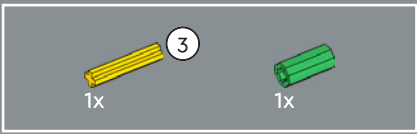

4

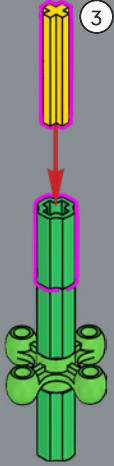

5

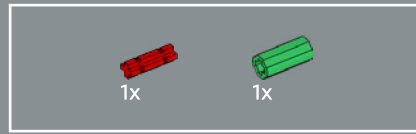
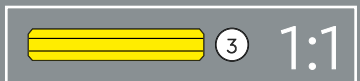
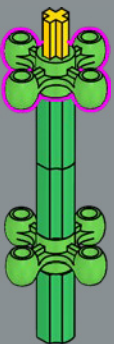

6

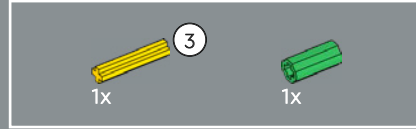
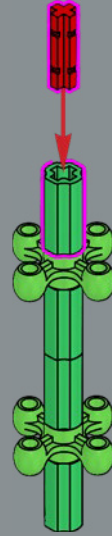

7

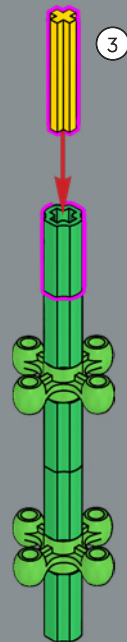

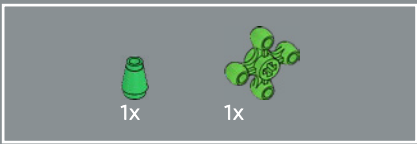

8

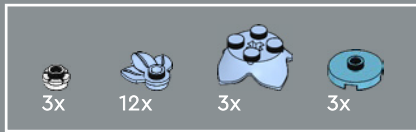
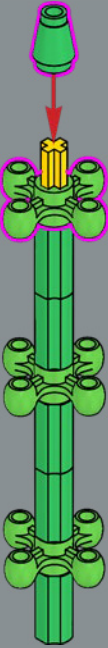

10

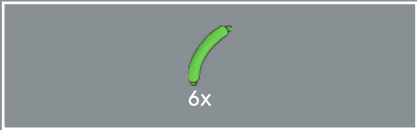
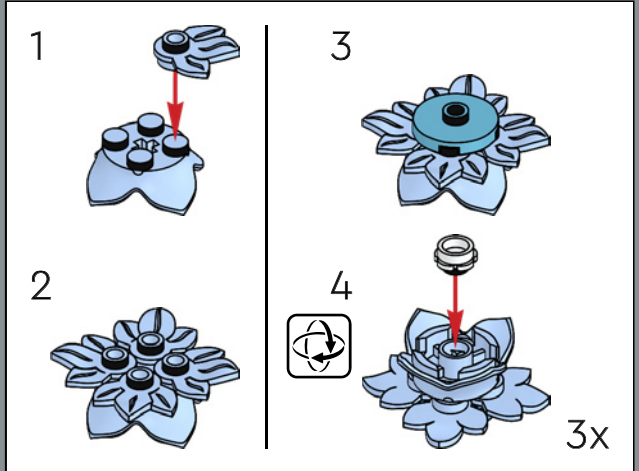

9

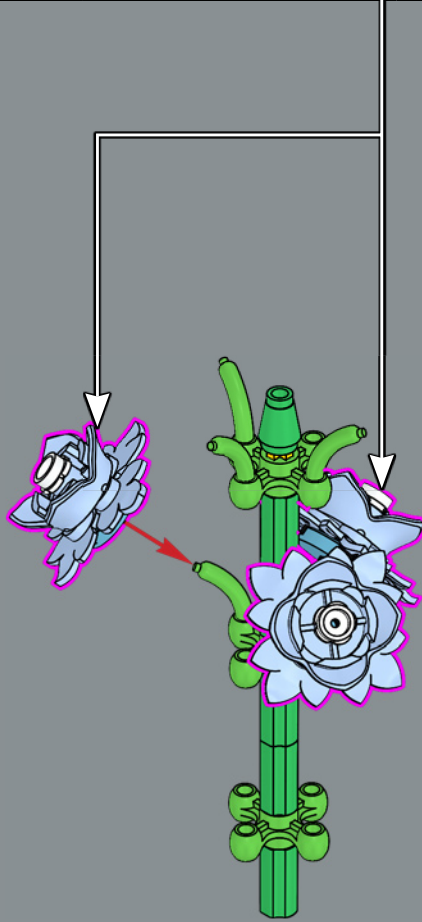
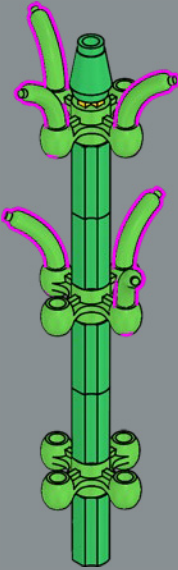



11

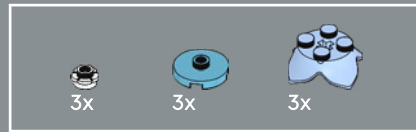
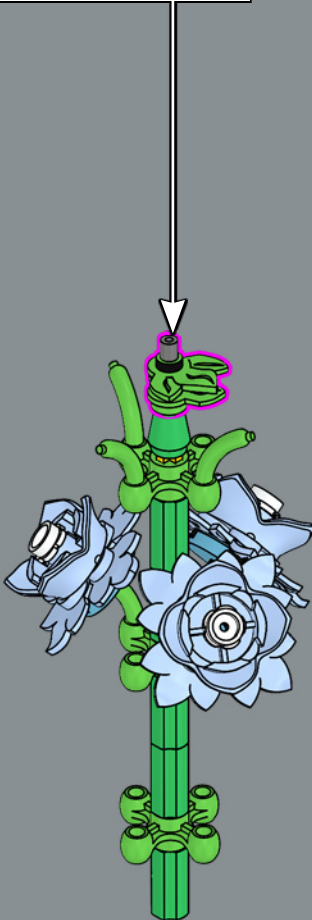
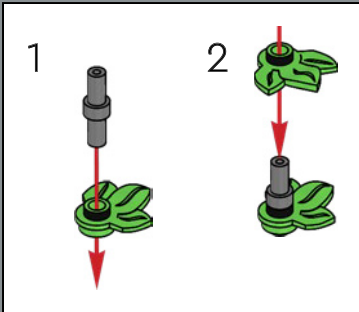

12

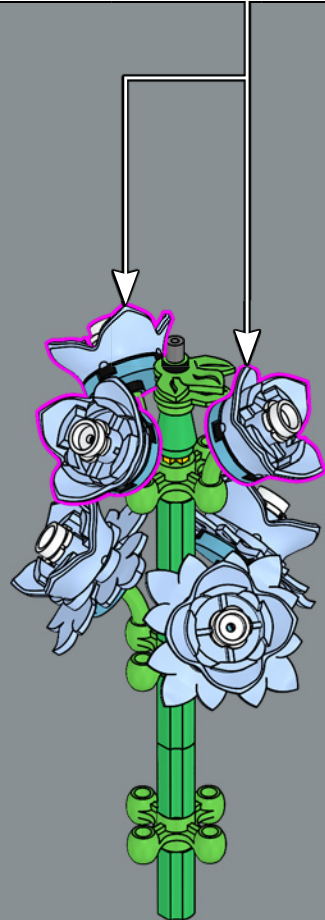
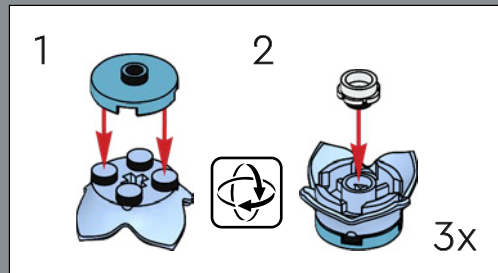

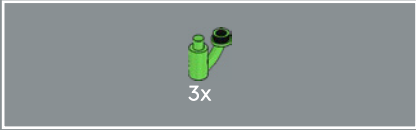
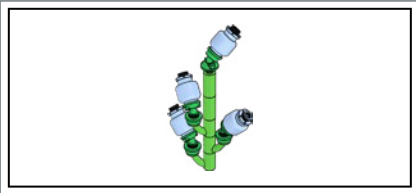

13



14

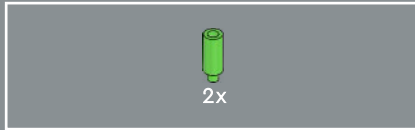
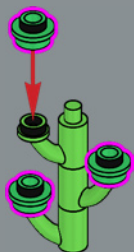

15

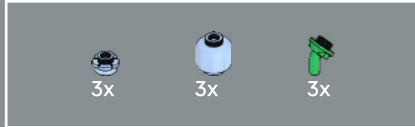
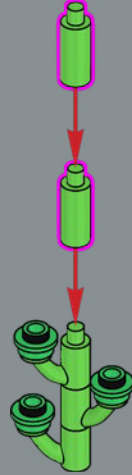

16

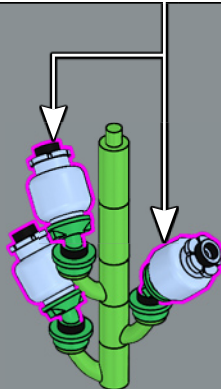
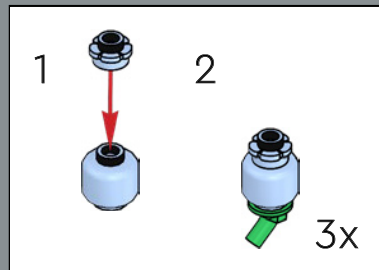



17

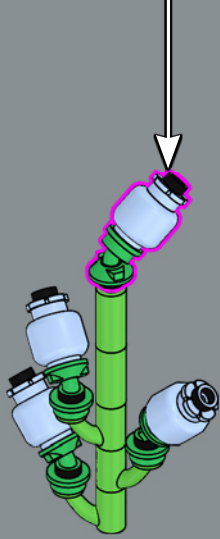
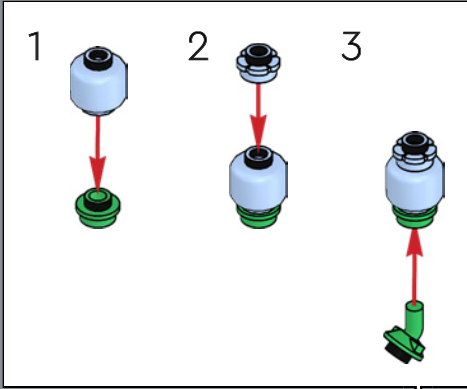

18

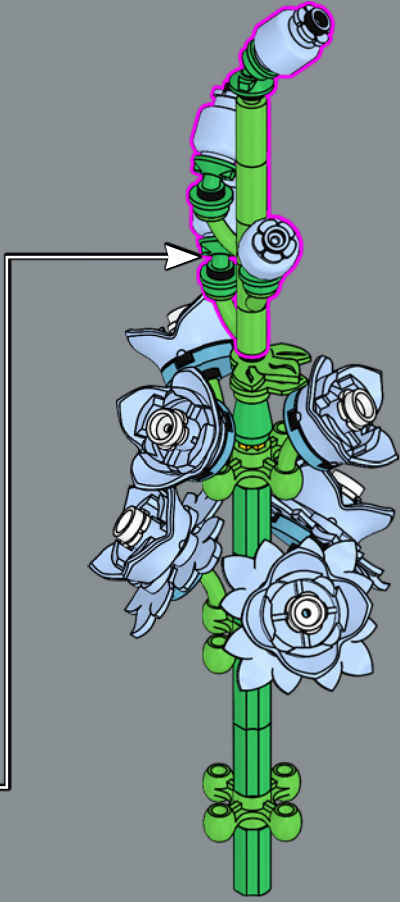

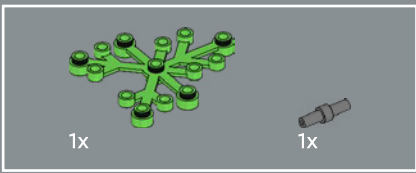

19

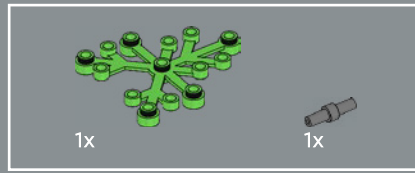
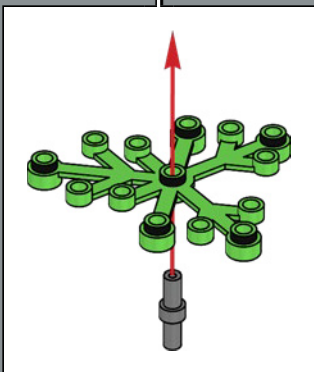
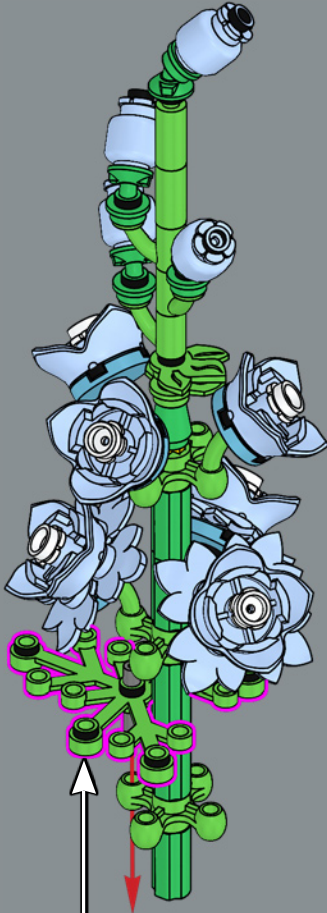

20

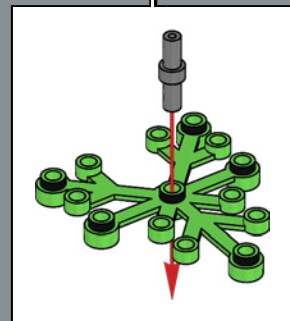
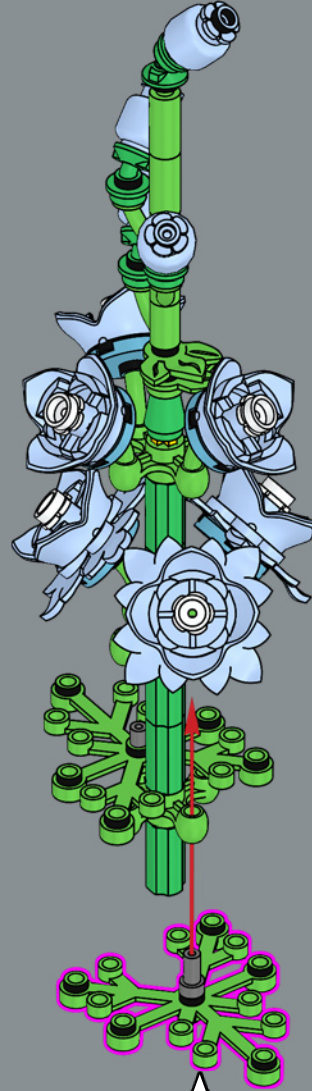

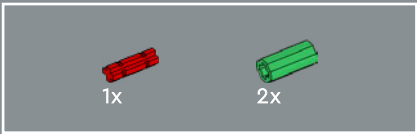

21

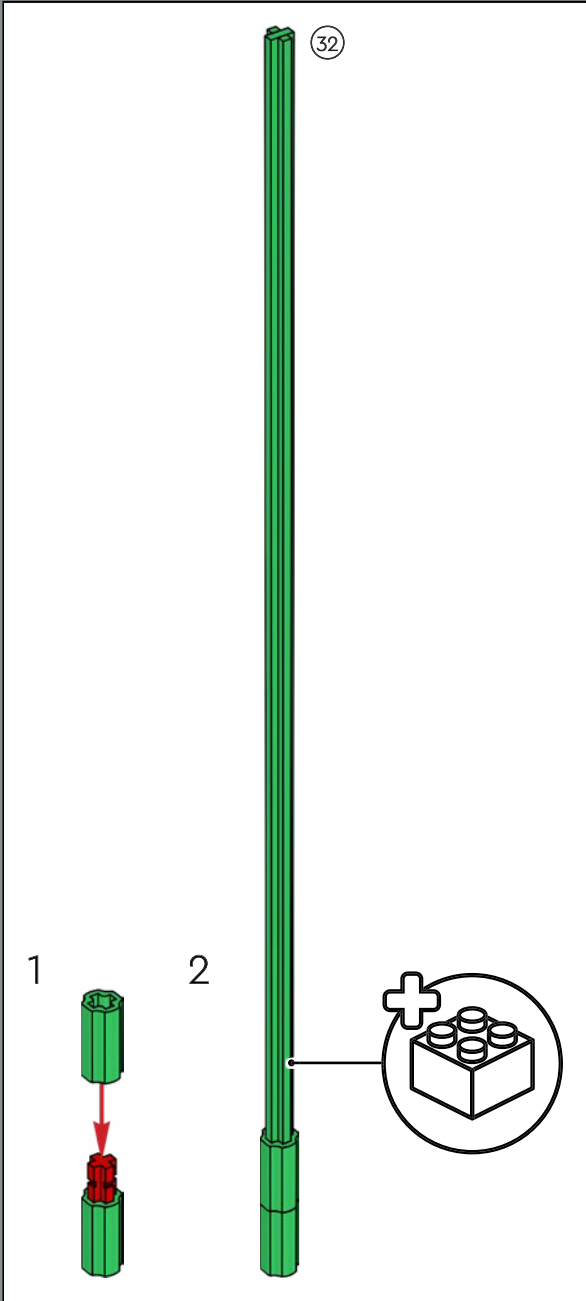
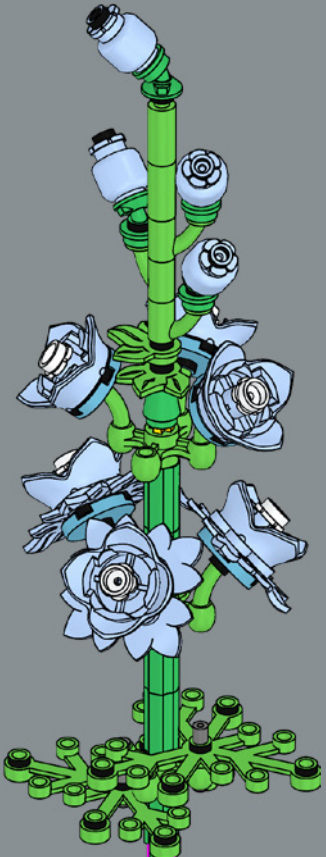

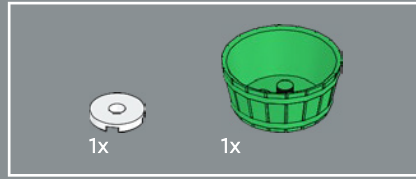
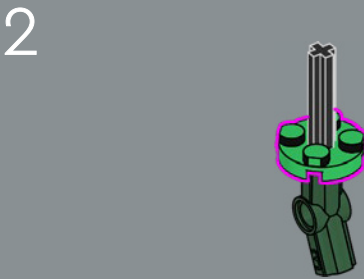
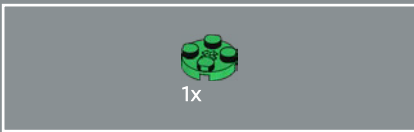
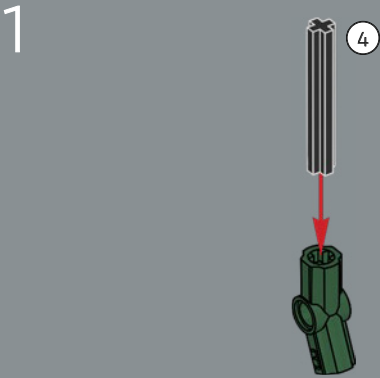
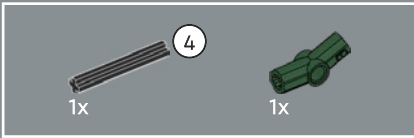

3

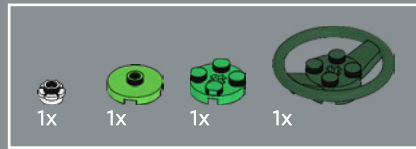
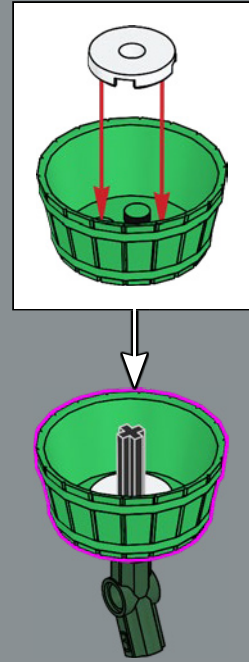

4

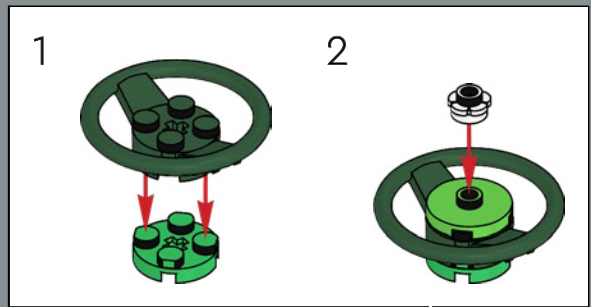



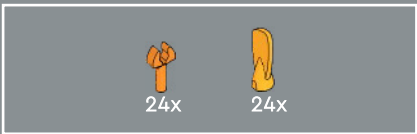

5

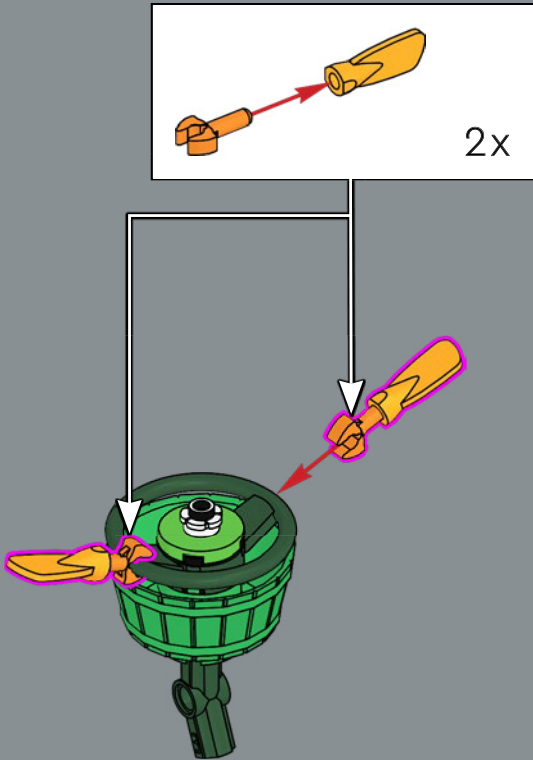

  
Ces délicats petits pétales sont en fait des rames de minifigurines !

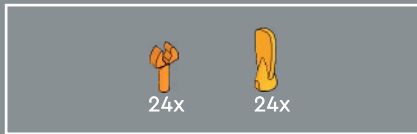

6

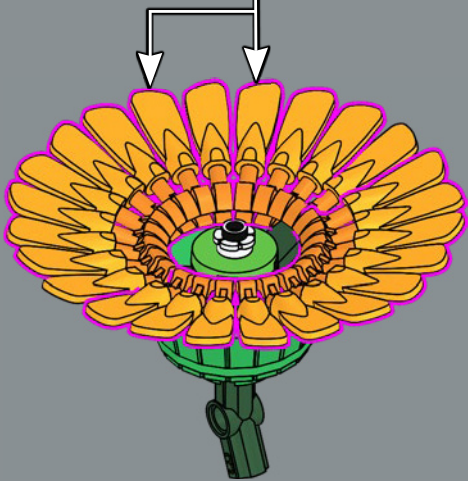
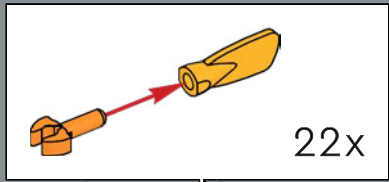

7



8

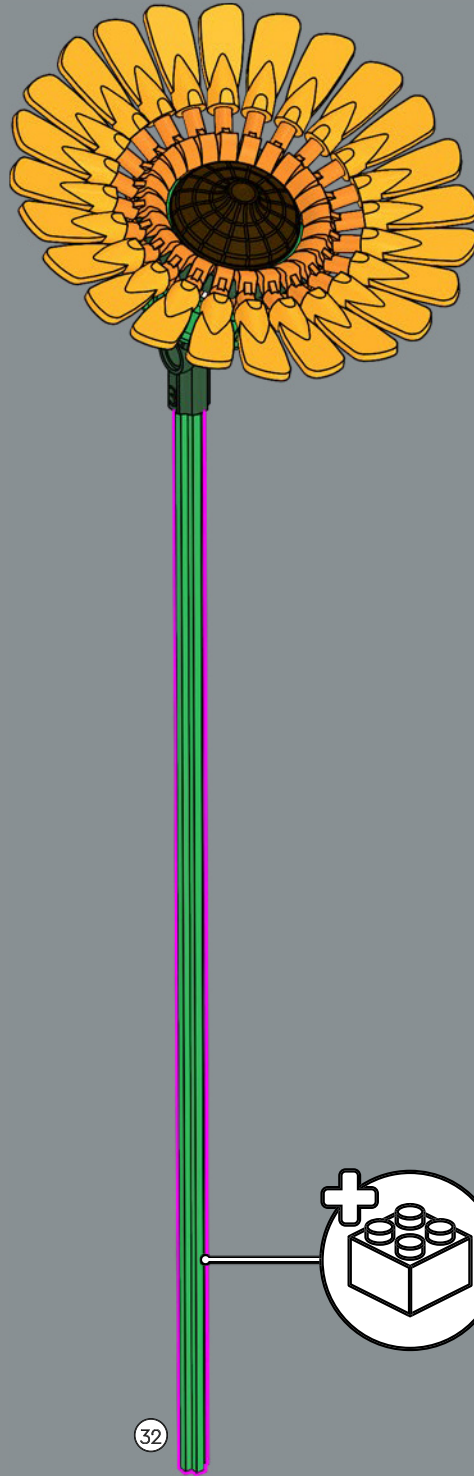



Apparu pour la première fois en 1983 avec le thème LEGO® Fabuland, ce seau a été utilisé de plusieurs manières, que ce soit dans des moteurs de fusée ou dans des seaux à fleurs.

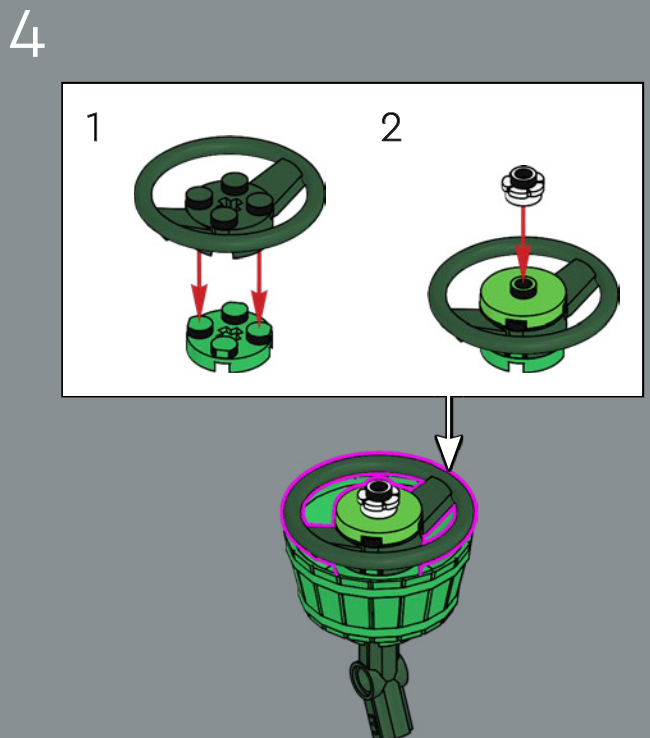
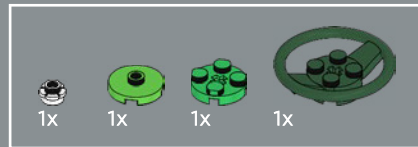
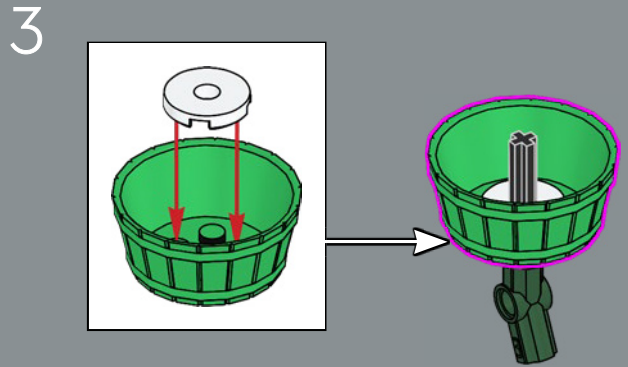
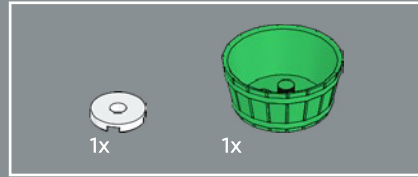
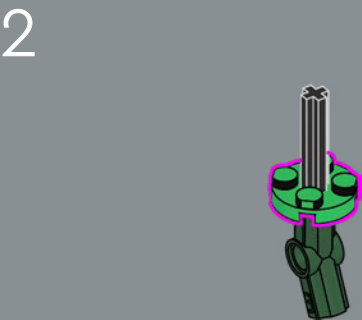
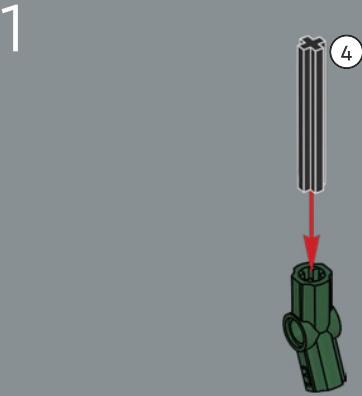
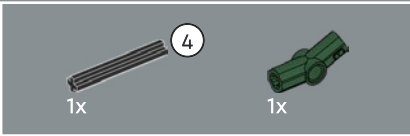



5

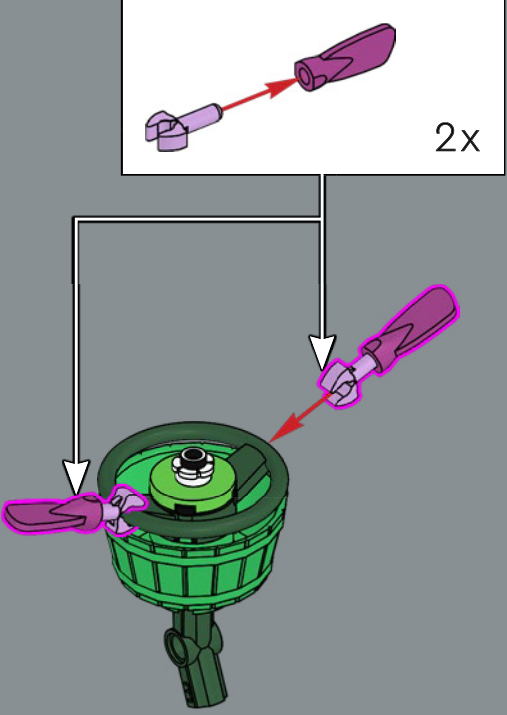

6

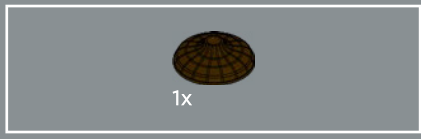
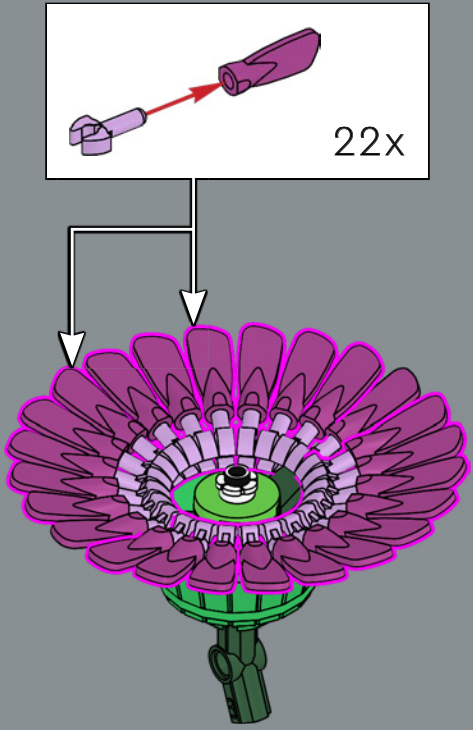

7



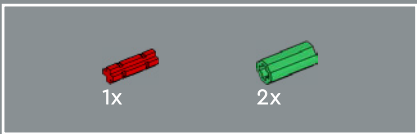

8

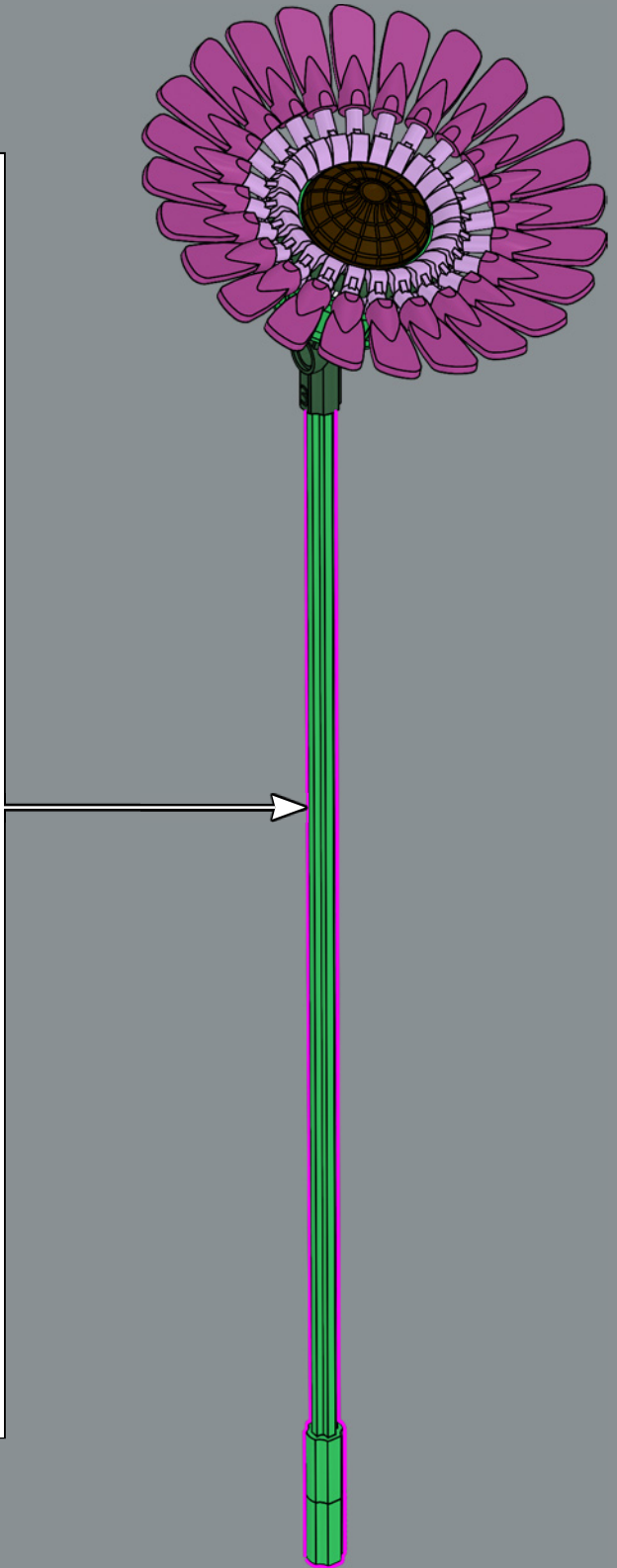
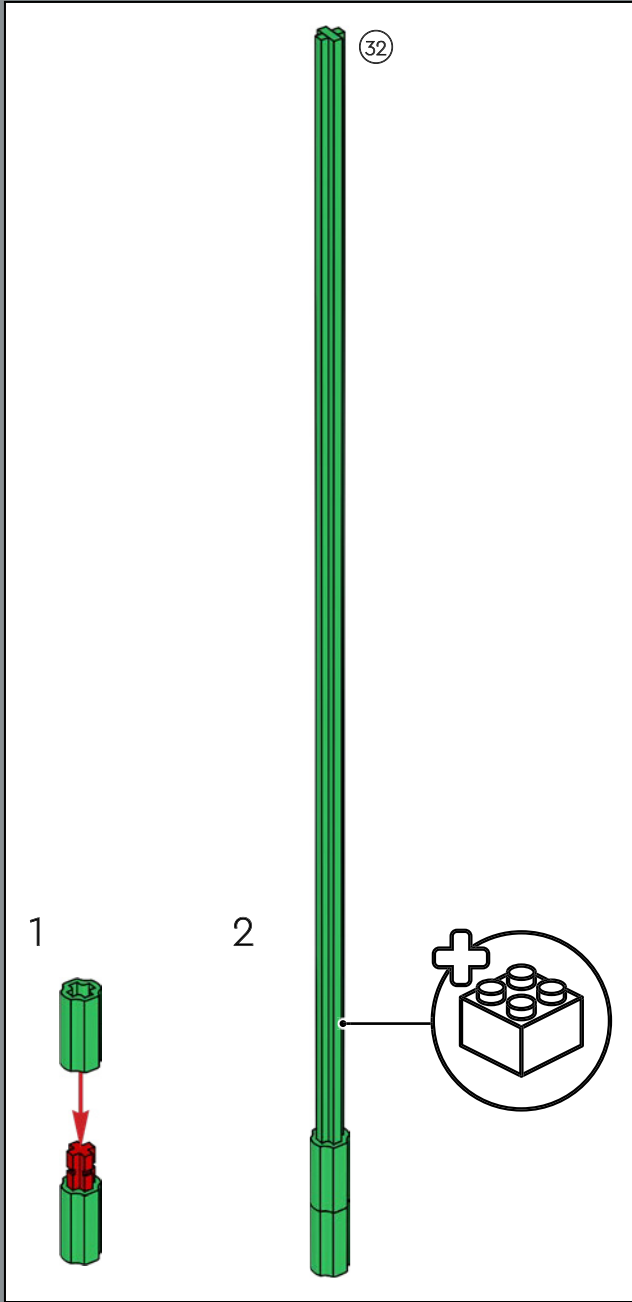

24x  
306201

2x  
6310185

24x  
459901

68x  
6206149

2x  
6170419

2x  
6194512

6x  
6259700

6x  
6339183

16x  
6348056

2x  
4515349

8x  
6420923

13x  
6130007

61x  
4142865

3x  
6055225

15x  
6420219

2x  
6329283

8x  
6344177

24x  
6330196

2x  
6329274

24x  
6424588

6x  
6133765

7x  
4211218

12x  
6316697

2x  
6382540

24x  
6420229

24x  
6420230

3x  
6350724

2x  
6116608

2x  
6178172

4x  
6209683

12x  
6420914

6x  
6420921

4x  
6294900

2x  
6420922

16x  
4566522

5x  
6420217

32x  
6420916

5x  
6420218

8x  
6190252

2x  
6416732

6x  
6136419

24x  
6210460

26x  
6214235

2x  
6329317

24x  
6420920

4x  
6420918

16x  
6267420

11x  
4529239

11x  
6338221

8x  
6210271

8x  
403228

2x  
6420221

2x  
6266964

20x  
6269971

11x  
6382575

3x  
6270084

50x  
6374076

2x  
6420635

12x  
6420964

4x  
6380676

10x  
6388070

5x  
6182261

2x  
6345196

7x  
6161772

7x  
6328327

7x  
6420228

3x  
6331087

6x  
6430093

3x  
6420915

1x  
6254100

24x  
6278159

4x  
6174006

2x  
6302741

60x  
6190251

10x  
6314224

4x  
6167483

16x  
6420919

24x  
6420220

3x  
6267045

3x  
6265699

2x  
370526

32



LEGO.com/service



## COMPOSEZ VOTRE BOUQUET

🌸 Votre Bouquet de fleurs sauvages est également conçu pour les bouquets mixtes. Trouvez l'inspiration pour réaliser des compositions florales créatives avec le set Bouquets de fleurs 10280.

