



Booklet available in English on
Heft in deutscher Sprache erhältlich auf
Livret disponible en français sur
Libretto disponibile in italiano su
Folleto en español disponible en
如需中文版手册, 请访问



FR
**DONNEZ
OU
RECYCLEZ**

ASSOCIATION
OU

MAGASIN
OU



DÉCHÈTERIE

Adresses sur quefairede mesdechets.fr

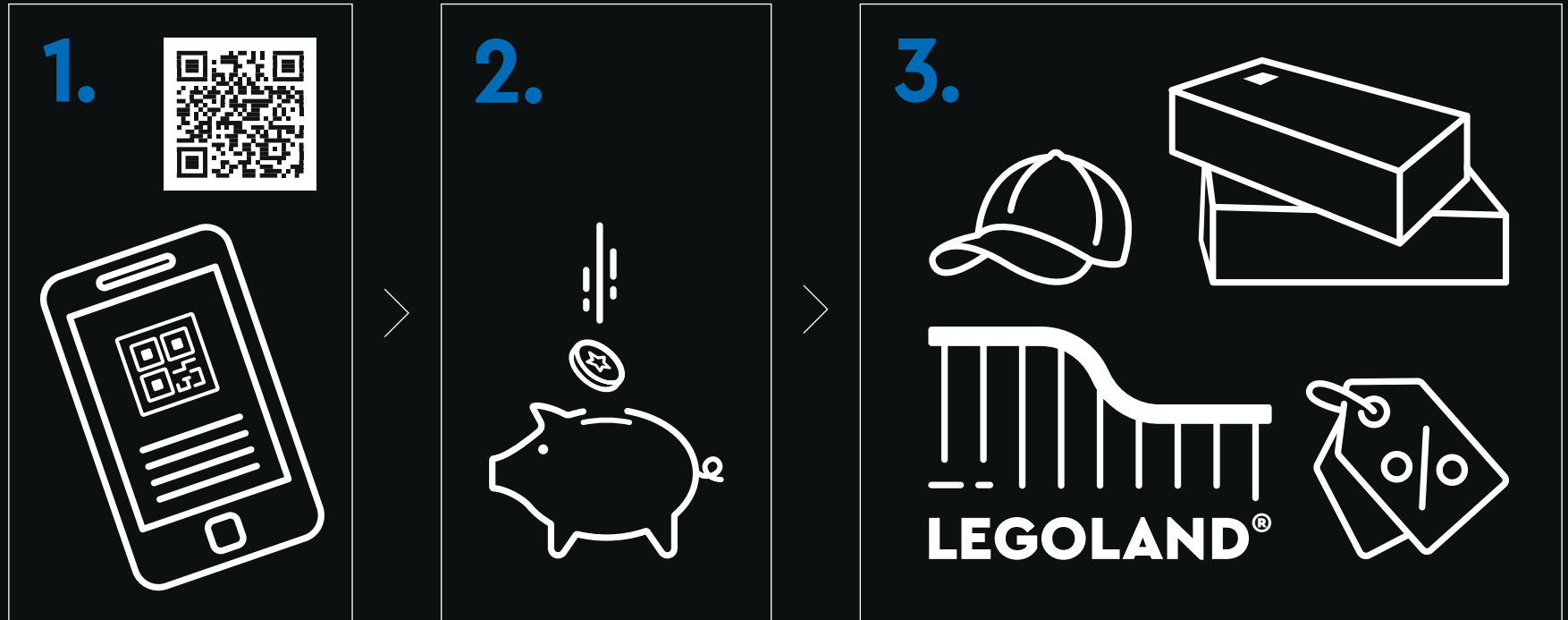

LEGO.com/sustainable-packaging

LEGO® VIP



1. Sign up **2.** Earn points for purchases **3.** Redeem points for rewards, experiences, discounts & more | **1.** Melde dich an **2.** Sammle Punkte bei jedem Kauf **3.** Löse die Punkte für Belohnungen, Erlebnisse, Rabatte und Ähnliches ein | **1.** Inscrivez-vous **2.** Gagnez des points lors de vos achats **3.** Échangez vos points contre des récompenses, des expériences, des remises et bien plus encore | **1.** Iscriviti **2.** Guadagna punti con i tuoi acquisti **3.** Riscatta punti per premi, esperienze, sconti e altro ancora | **1.** Regístrate **2.** Gana puntos por tus compras **3.** Canjea puntos por recompensas, experiencias, descuentos y mucho más | **1.** Registe-se **2.** Ganhe pontos em compras **3.** Troque os pontos para prémios, experiências, descontos e muito mais | **1.** 注册 **2.** 购物赚积分 **3.** 用积分兑换奖励、体验、折扣等 | **1.** Zarejestruj się **2.** Zdobywaj punkty za zakupy **3.** Wymieniaj punkty na rabaty, przygody i inne nagrody | **1.** Zaregistrujte se **2.** Sbírejte body za nákupy **3.** Vyměňujte body za odměny, zážitky, slevy a spoustu dalšího | **1.** Zaregistrujte se **2.** Získavajte body za nákupy **3.** Uplatnite si body a získajte odmeny, rôzne zážitky, zľavy a ešte viac | **1.** Regisztrálj **2.** Szerez pontokat minden vásárlással **3.** Váltsd be pontjaidat jutalmakra, élményekre, kedvezményekre és egyebekre | **1.** Înscrite-te **2.** Câștigă puncte pentru achiziții **3.** Valorifică puncte pentru recompense, experiențe, reduceri și multe altele | **1.** Регистрируйте се **2.** Получайте точки за покупки **3.** Используйте точки за награды, услуги, отстъпки и т.н. | **1.** Reģistrējies **2.** Pelni punktus par pirkumiem **3.** Izmanto punktus, lai saņemtu balvas, izklaides iespējas, atlaides un daudz ko citu | **1.** Registreeru **2.** Teeni ostude eest punkte **3.** Lunasta punktide eest preemiad, elamused, allahindlused ja muu | **1.** Užsiregistruokite **2.** Pelnykite taškų už pirkinius **3.** Panaudokite taškus atlygiui, funkcijoms, nuolaidoms ir ne tik





'These days,
being in Nature
is becoming a
rare occurrence.

We are an urban,

technology-dependent society. But we
need Nature to relate to each other and
understand ourselves. This LEGO® Tranquil
Garden, inspired by Japanese gardens, at
least symbolically brings Nature to your
mind. Which is one of the most important
things for our lives now.'

HOICHI KURISU

Japanese Garden Designer and Builder



Created for mindful living

- Follow the stepping stones to your private pavilion, make yourself at home, relax and be one with nature for a moment. Or stay as long as you like.

Inspired by the elements of millennia-old tranquil gardening traditions, this set has been created in collaboration with Hoichi Kurisu, who has several years of experience in creating mindful gardens. A serene retreat where you can reflect and recharge without distractions. Each element in the garden lets you dwell on the colourful wonders and playful beauty of Mother Earth. As you spend time with your garden, allow the seasons to come and go. Feel your creativity blossom with each visit, rearrange the scenery, plant new LEGO® vegetation, or add decorative ornaments that are meaningful to you. Prepare a pot of your favourite matcha tea, tune into a soothing nature soundtrack, slip into your softest slippers and take time to enjoy your mind's space.





Tend to your garden

● 'Building a LEGO® set can be an immersive escape – like reading a great book. It allows you to focus on something fun and gives you a feeling of pride and gratification, even long after it's completed. You can return to this garden as often as you like. Tend to the elements and change the landscape as you would an actual garden or maybe a bonsai tree. Prune or replant the blossoming cherry trees, lush evergreens and bamboo, or move the smooth stone lanterns to fit your style and mood. Or gaze at the vibrant Koi and water lilies in the burbling pond, and simply surrender to your creative freedom.'

'Give the set your own personal
touch to match your mood.'

MICHAEL PSIAKI & CARL MERRIAM
LEGO® Icons Model designers



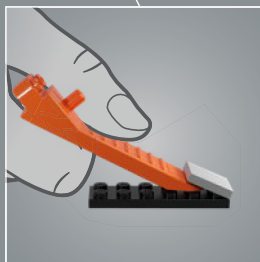
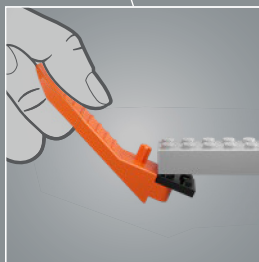
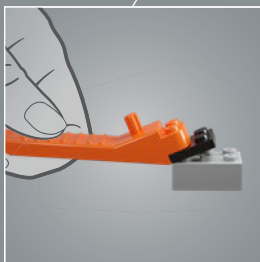
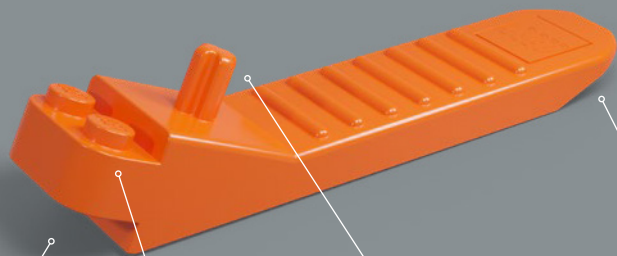

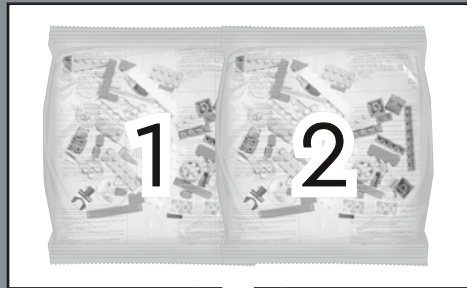

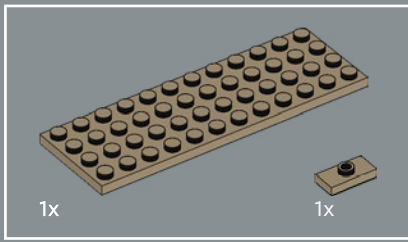
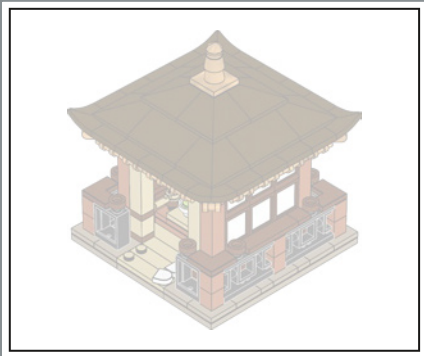

1

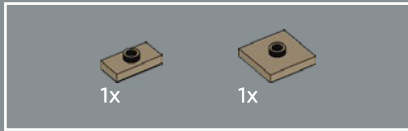
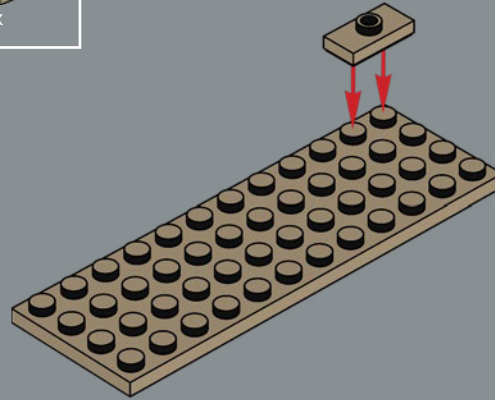

2

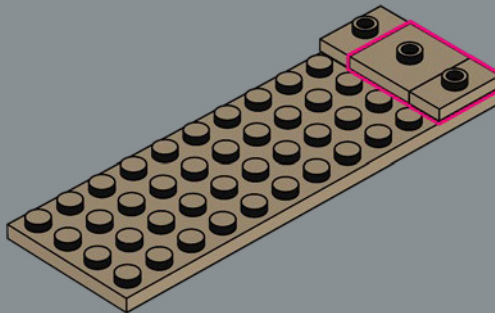

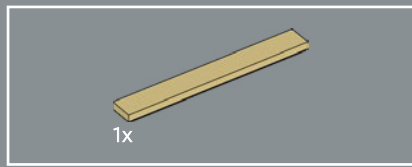

3

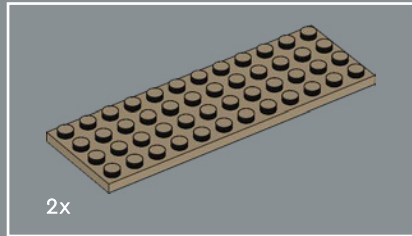
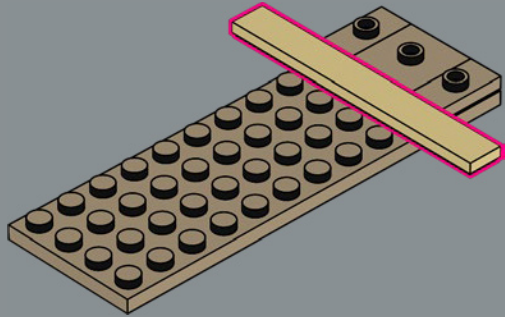

4

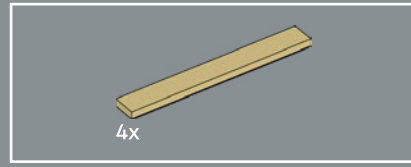
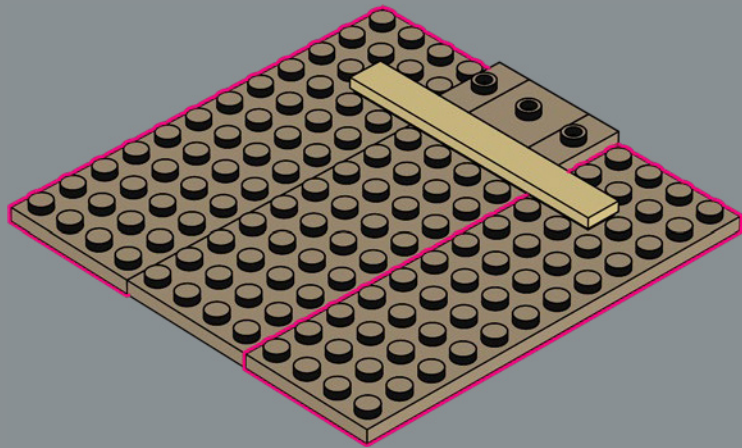

5

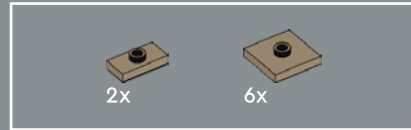
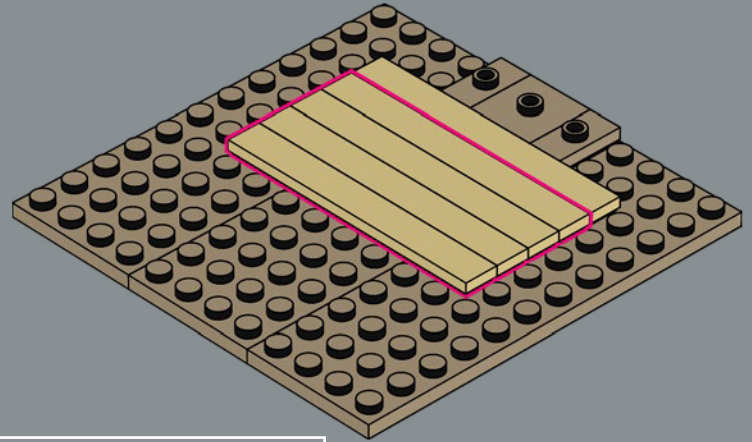

6

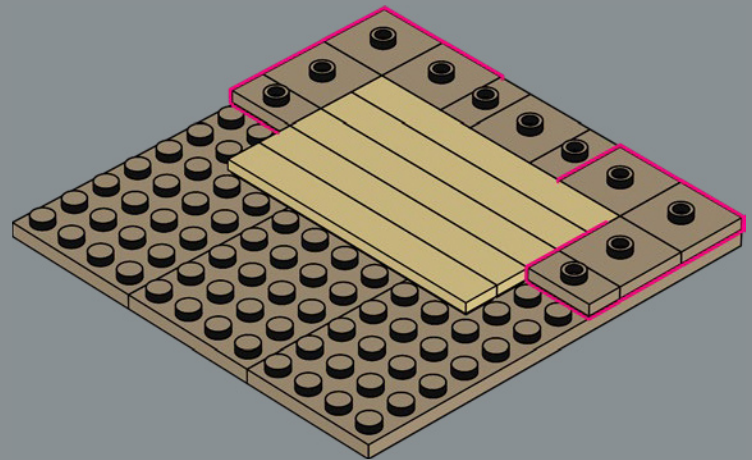

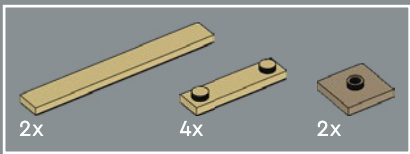

7

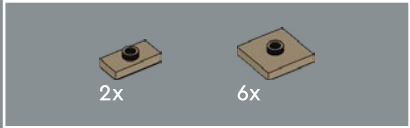
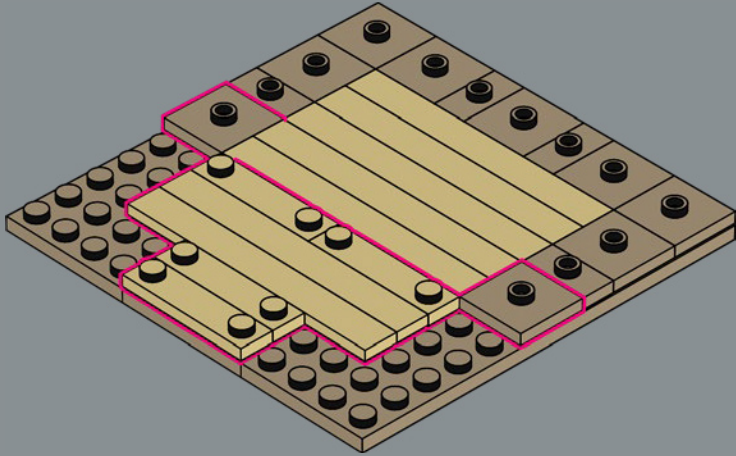

8

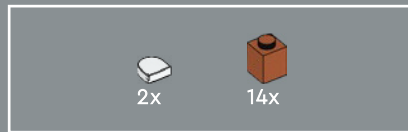
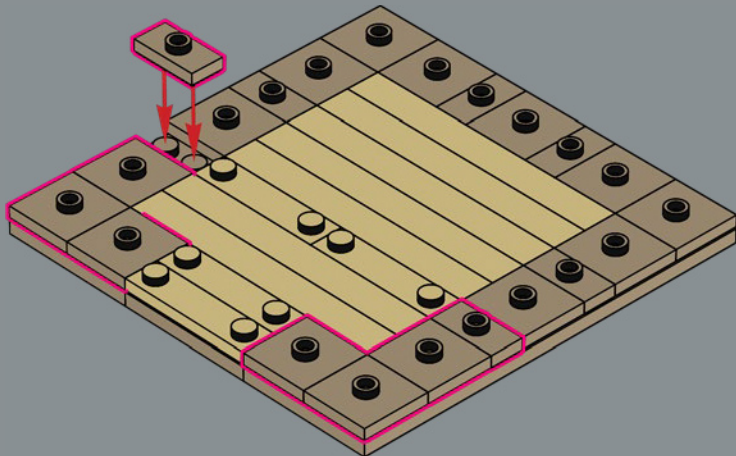

9

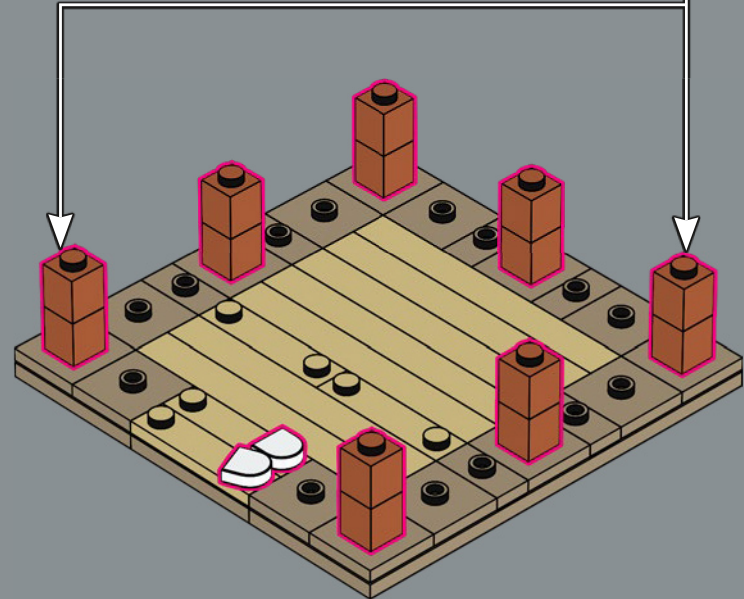
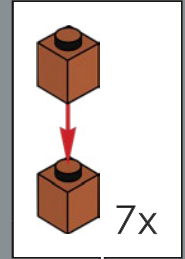

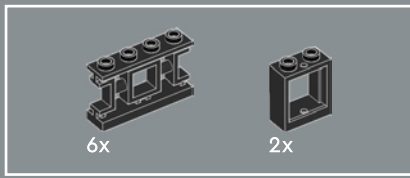

10

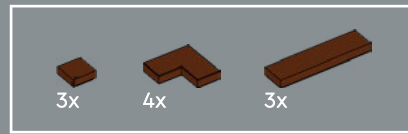
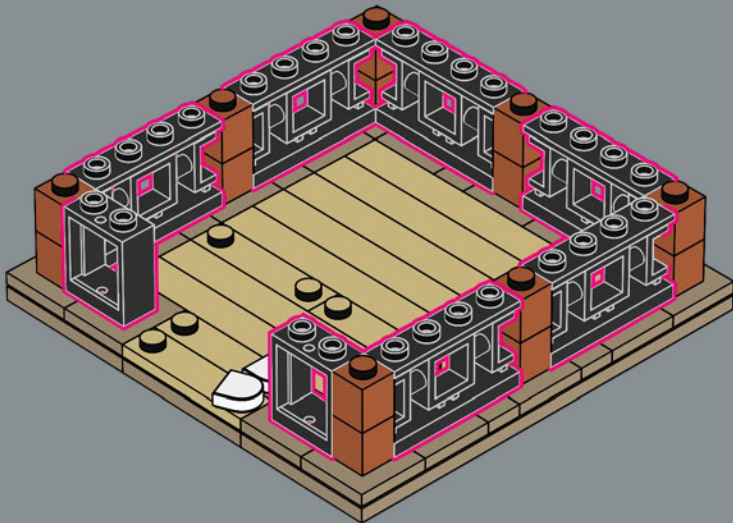

11

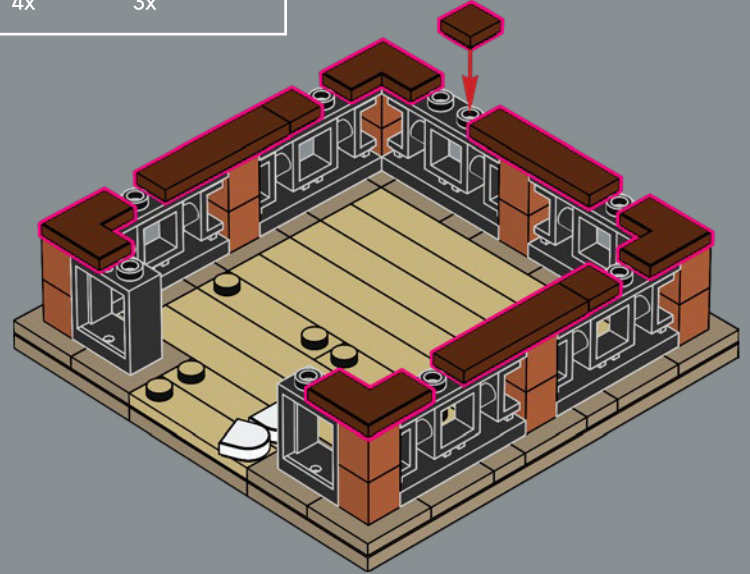

12

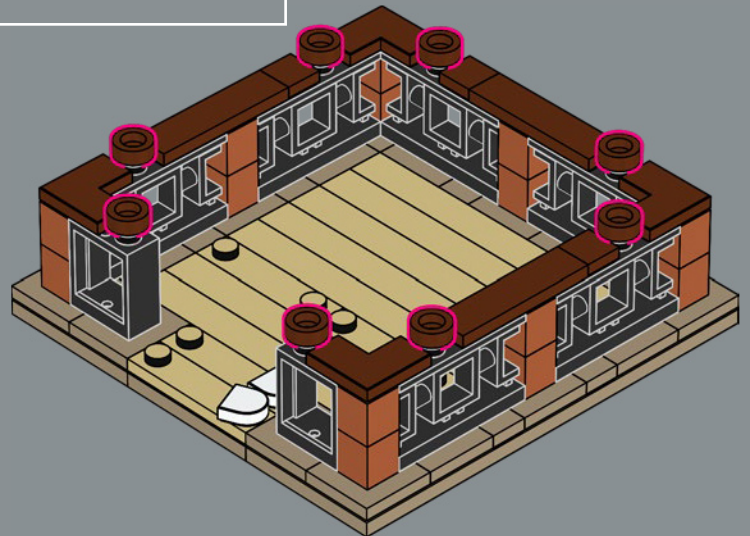

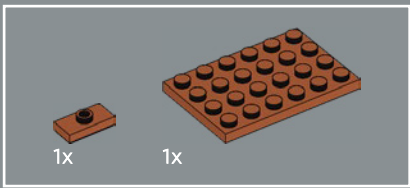

13

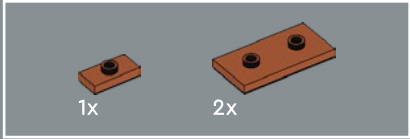
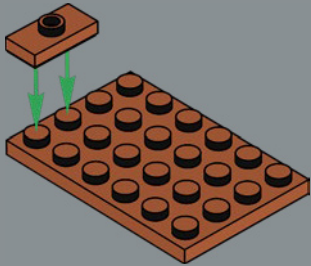

14

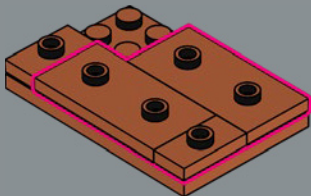

15

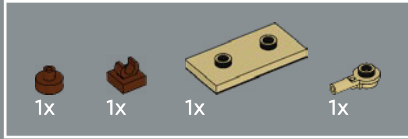
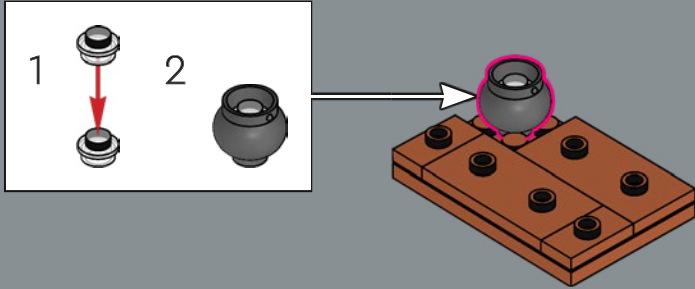

16

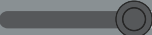
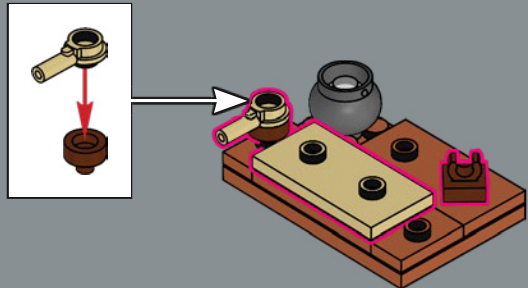

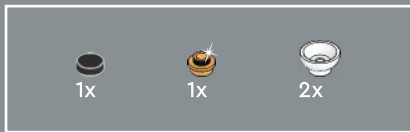

17

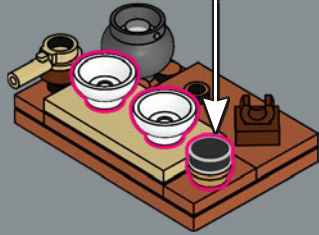
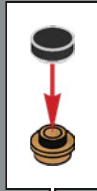

18

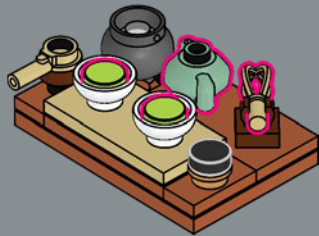

19



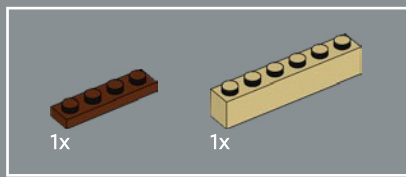

20

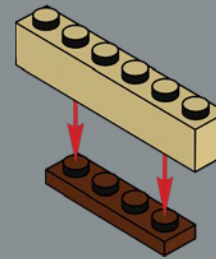

21

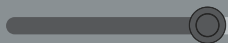
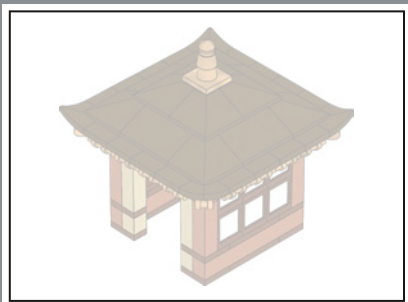
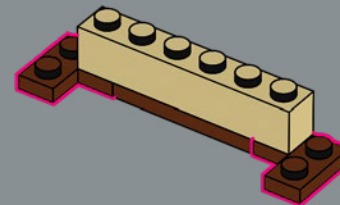

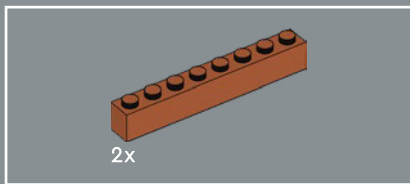

22

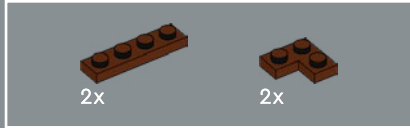
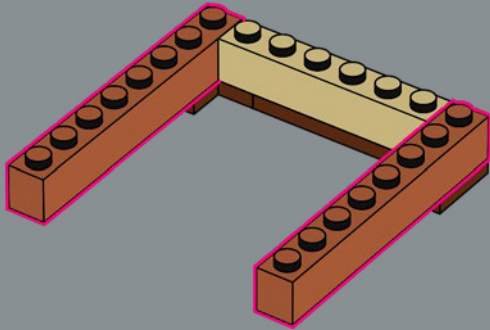

23

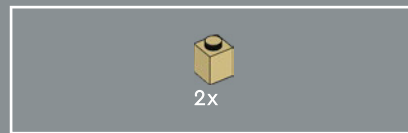
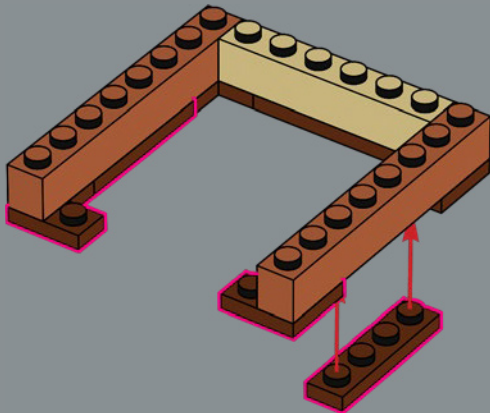

24

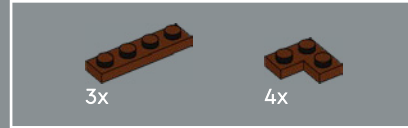
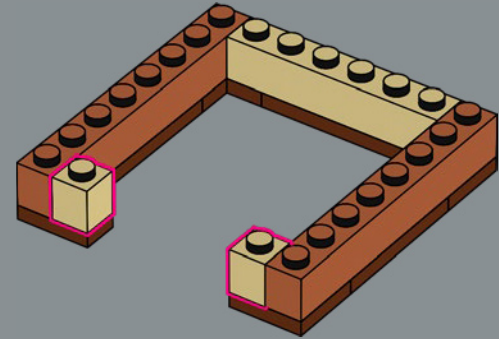

25

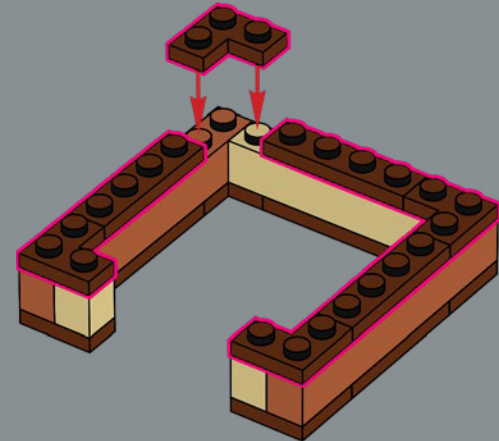

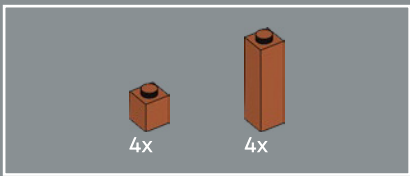

26

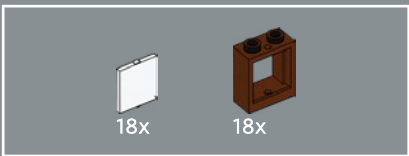
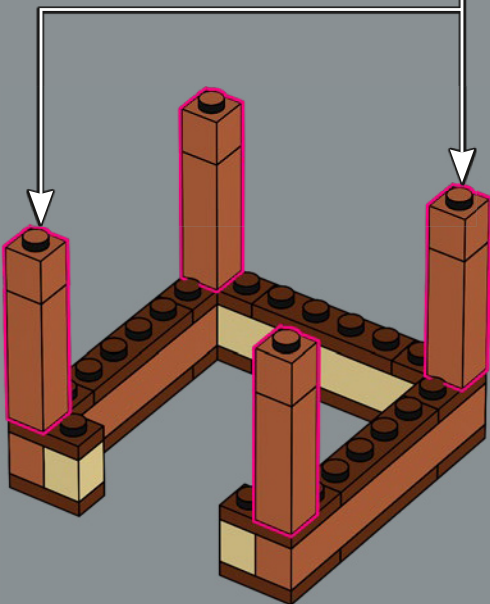
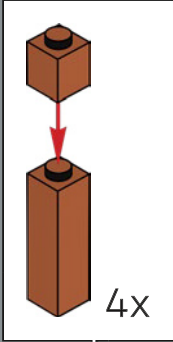

27

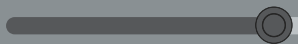
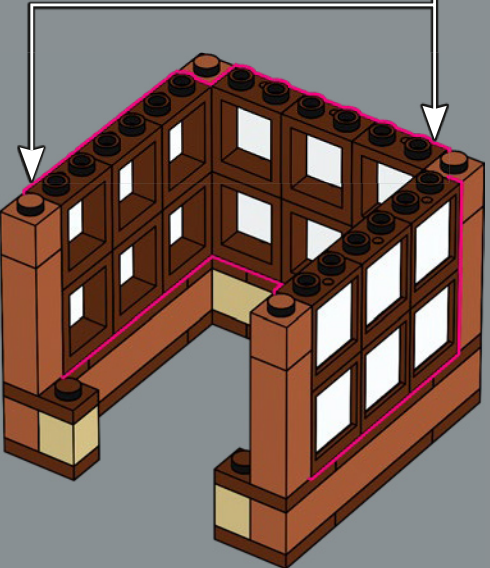
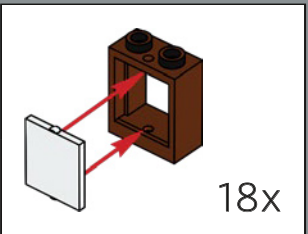

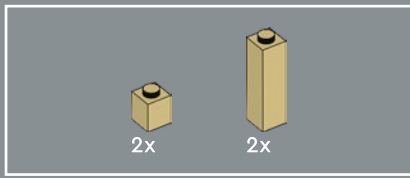

28

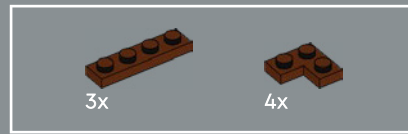
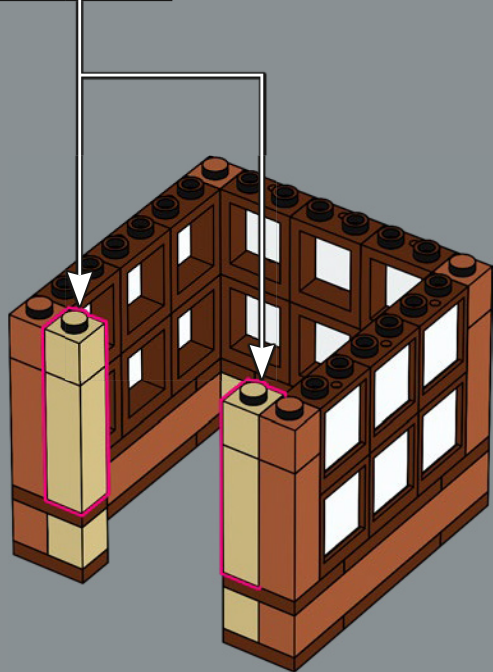
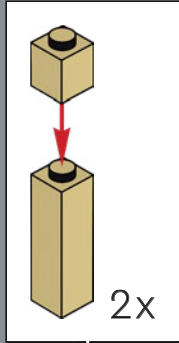

29

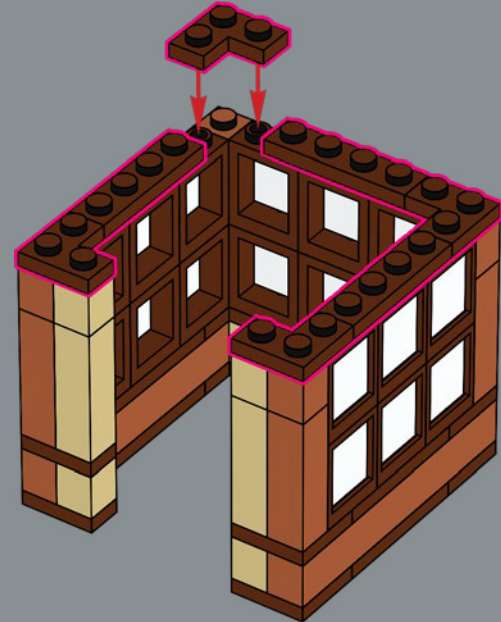

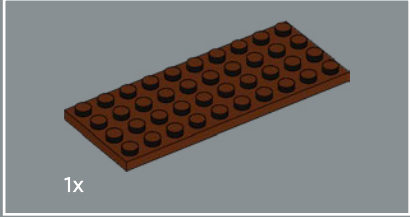
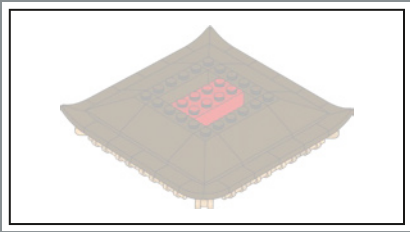

30

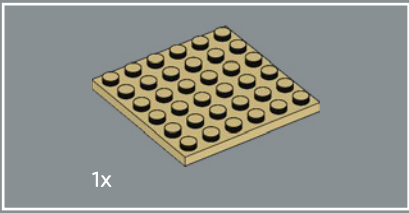
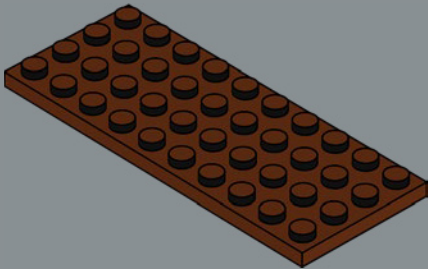

31

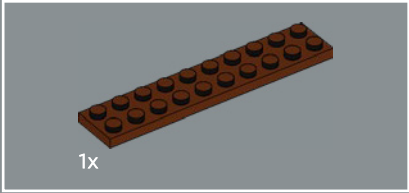
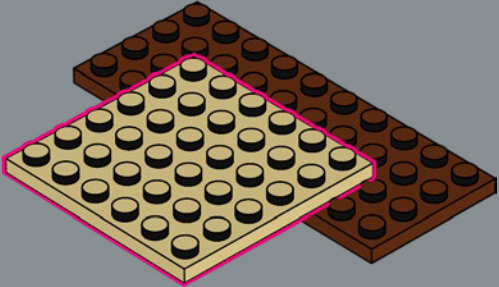

32

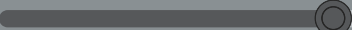
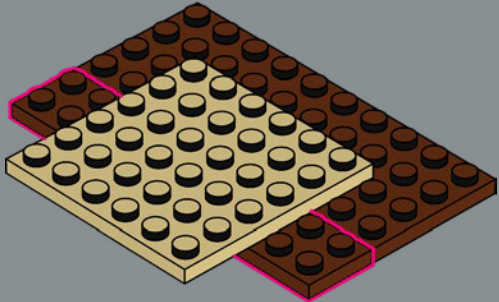

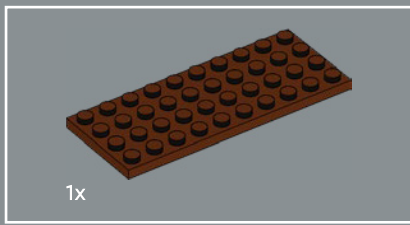

33

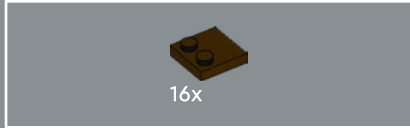
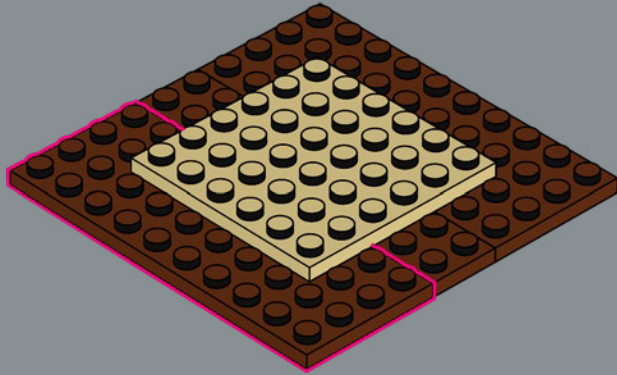

34

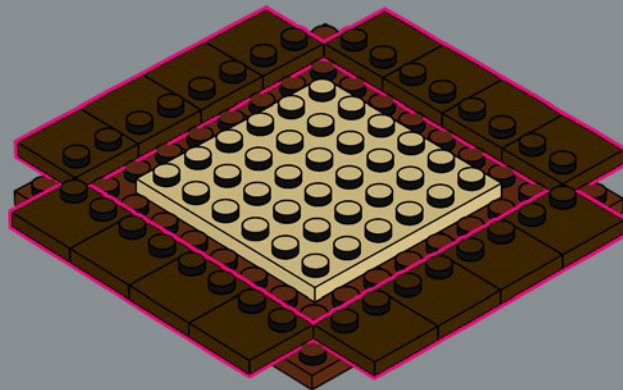

35

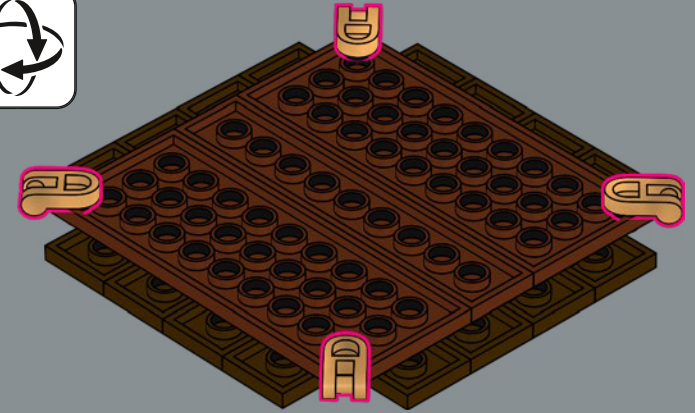

36



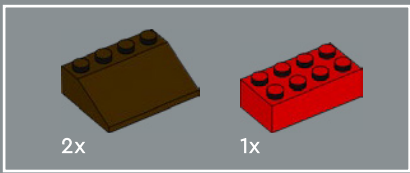

37

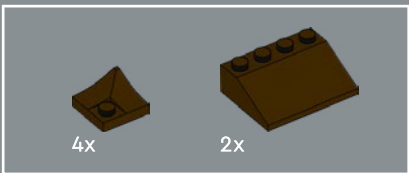
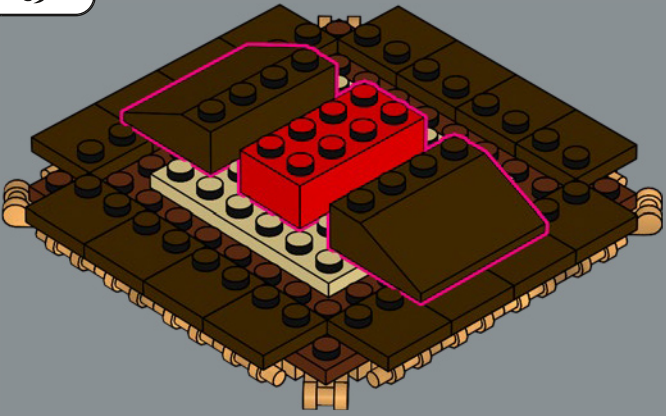

38

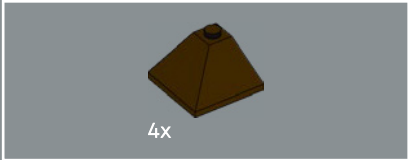
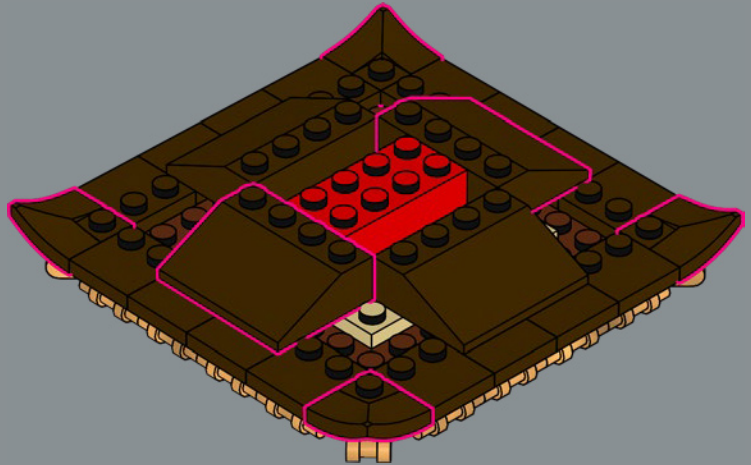

39

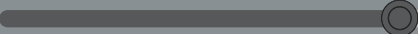
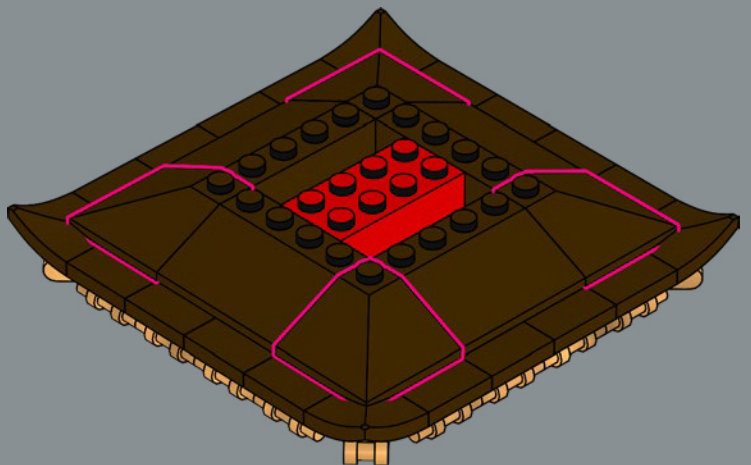

40



41

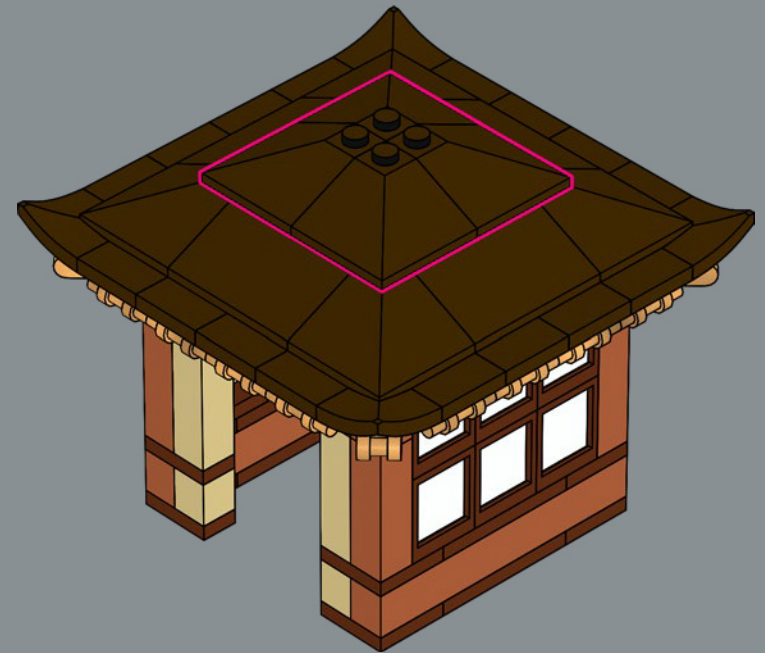
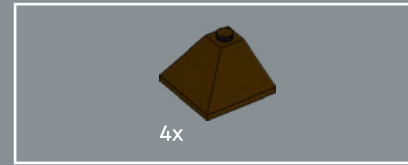

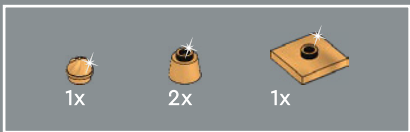

42

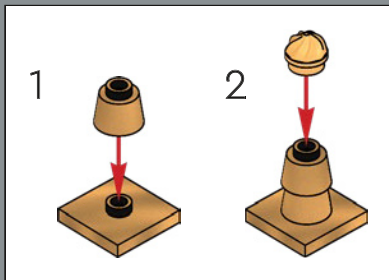

Most tranquil garden pavilions are made from wood to blend into the natural surroundings.

43

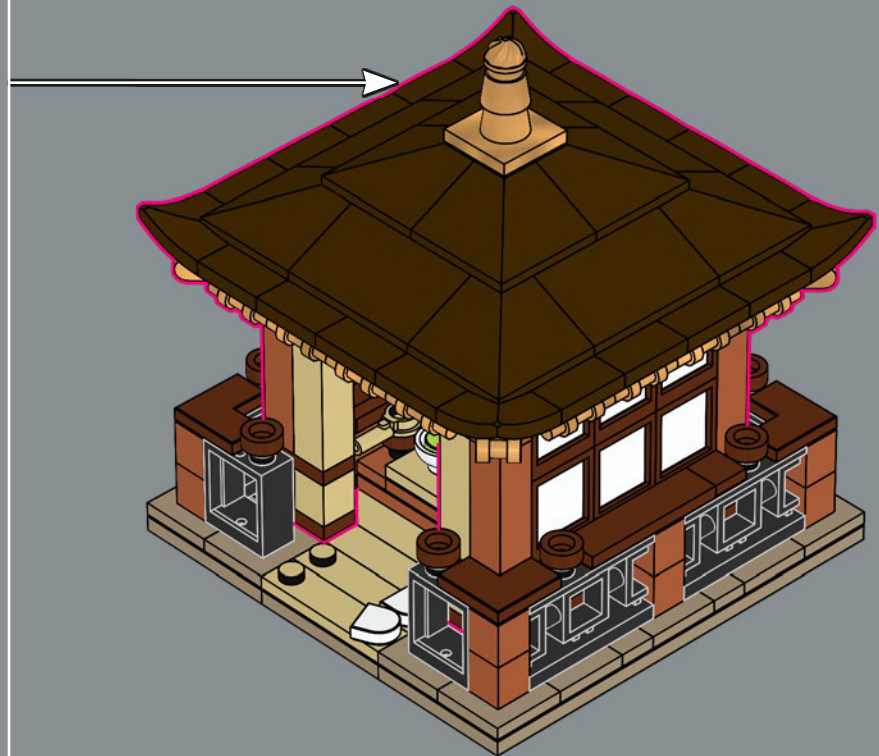

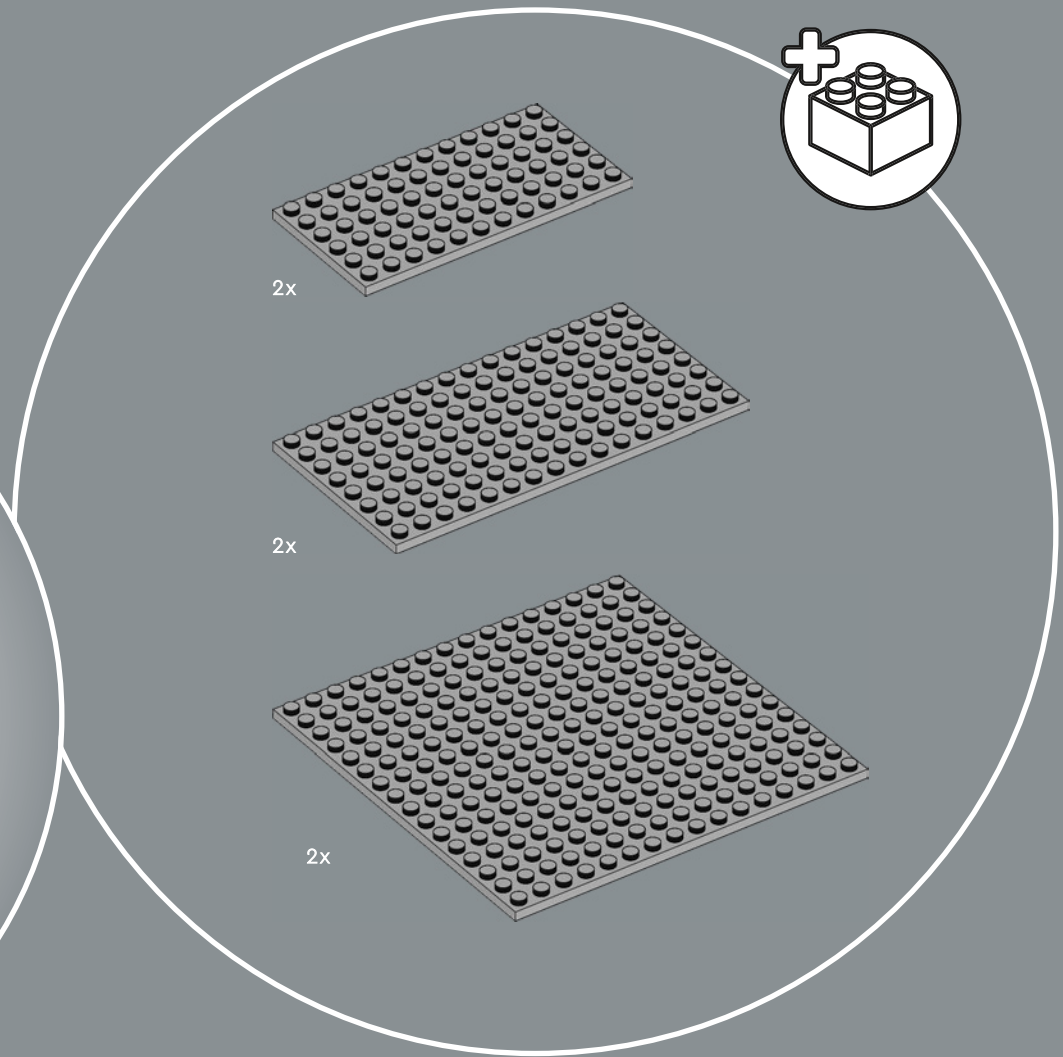

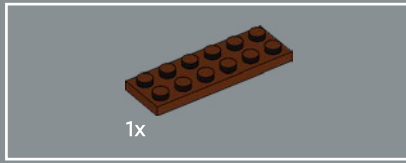
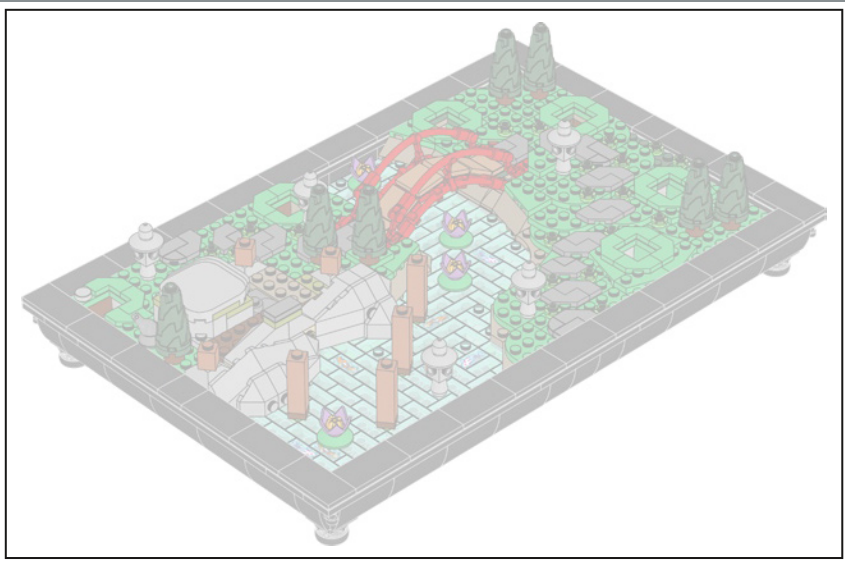

44

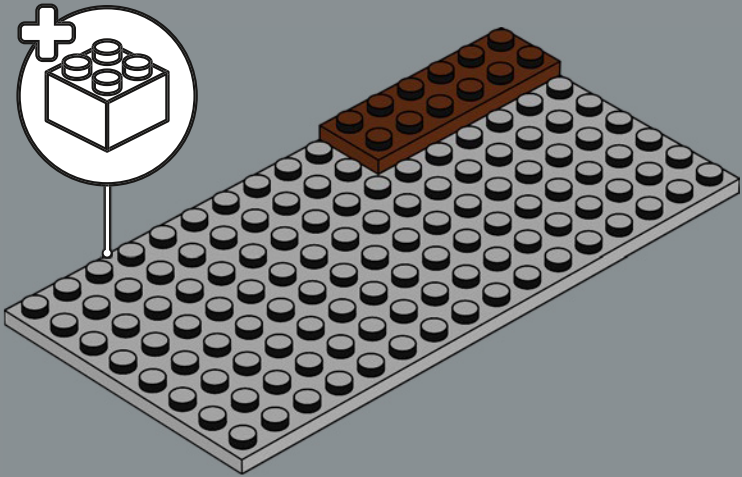

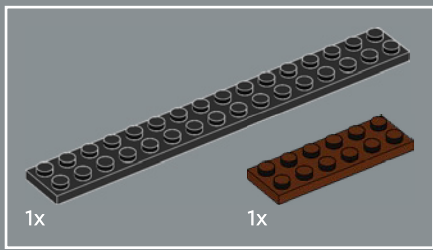

45

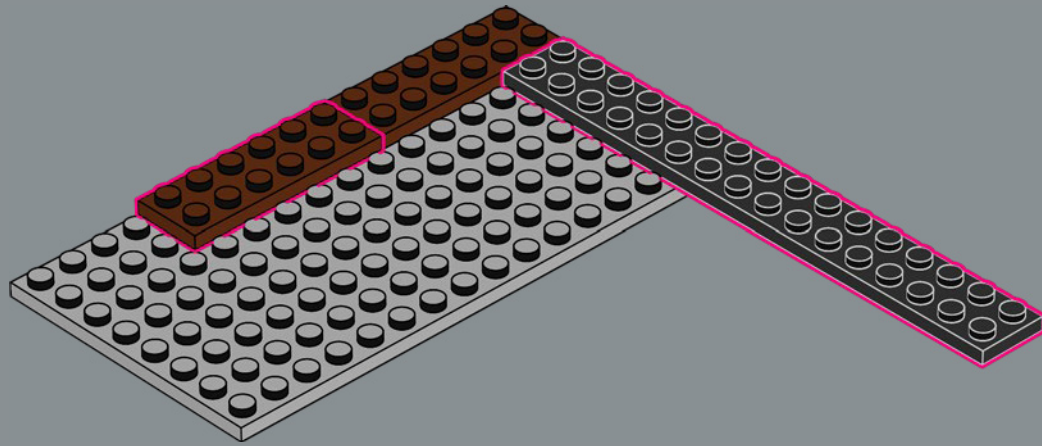

46

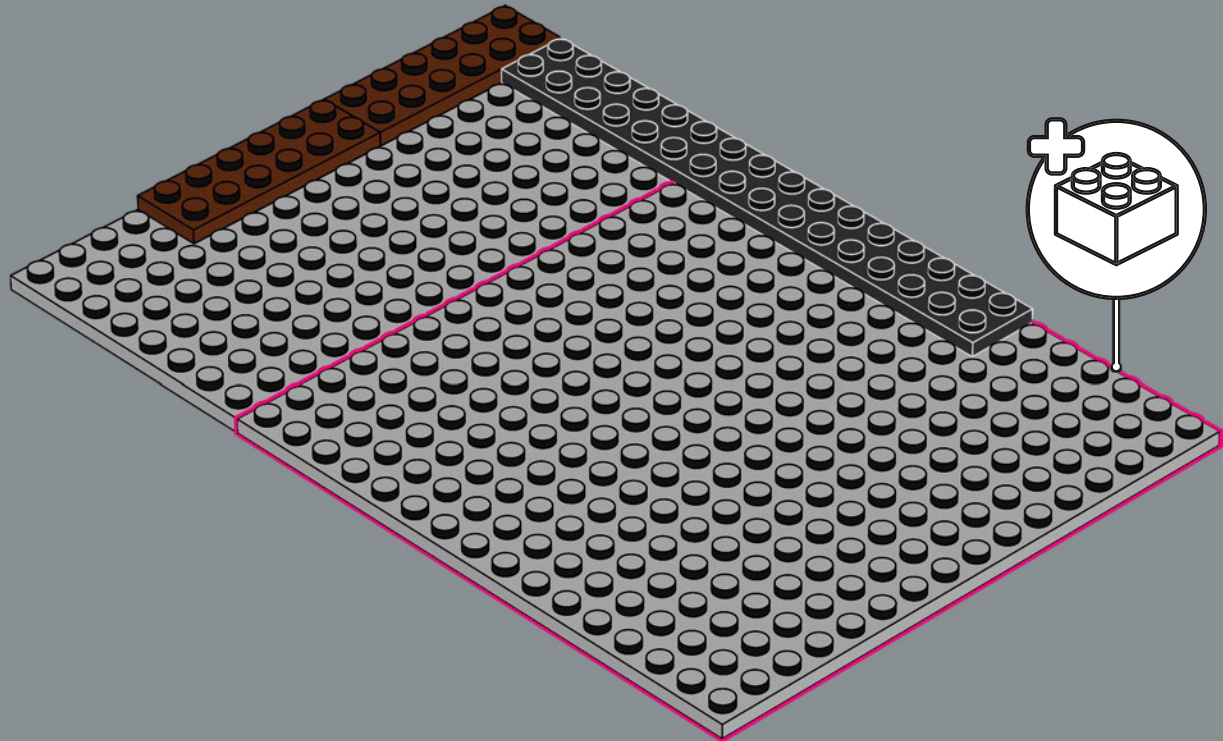

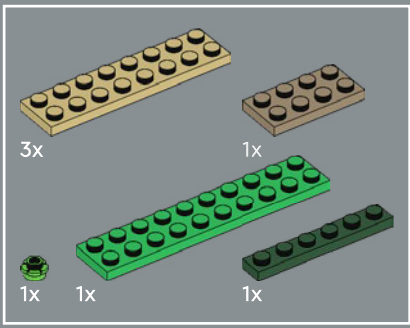

47

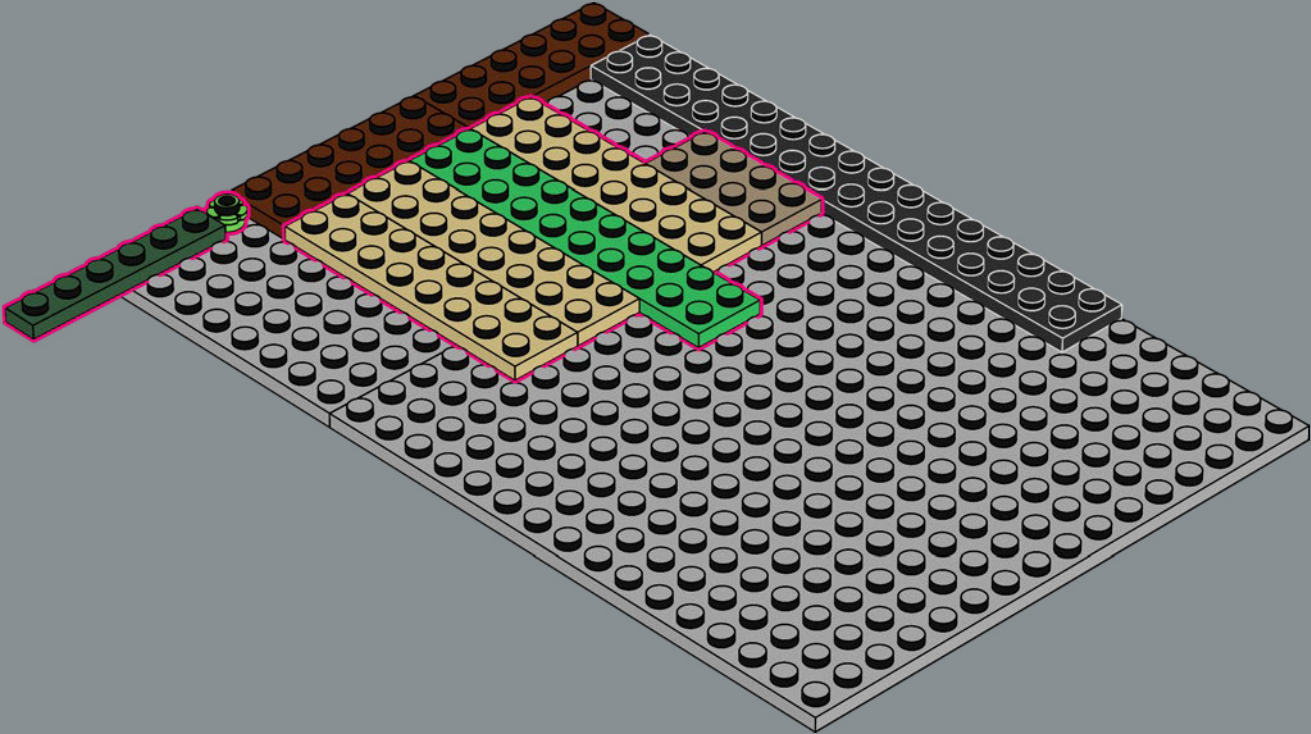

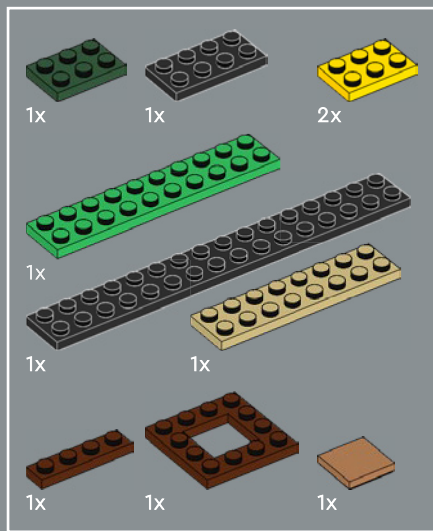

48

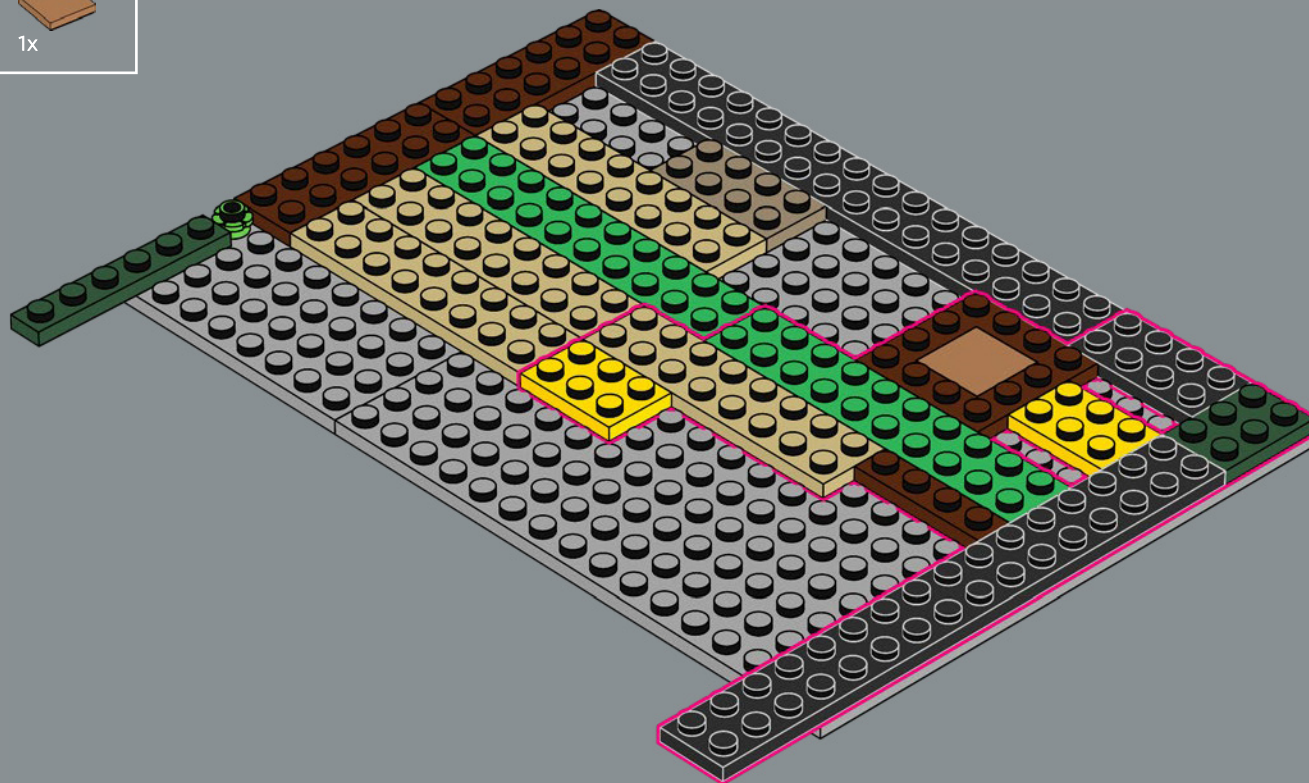

49

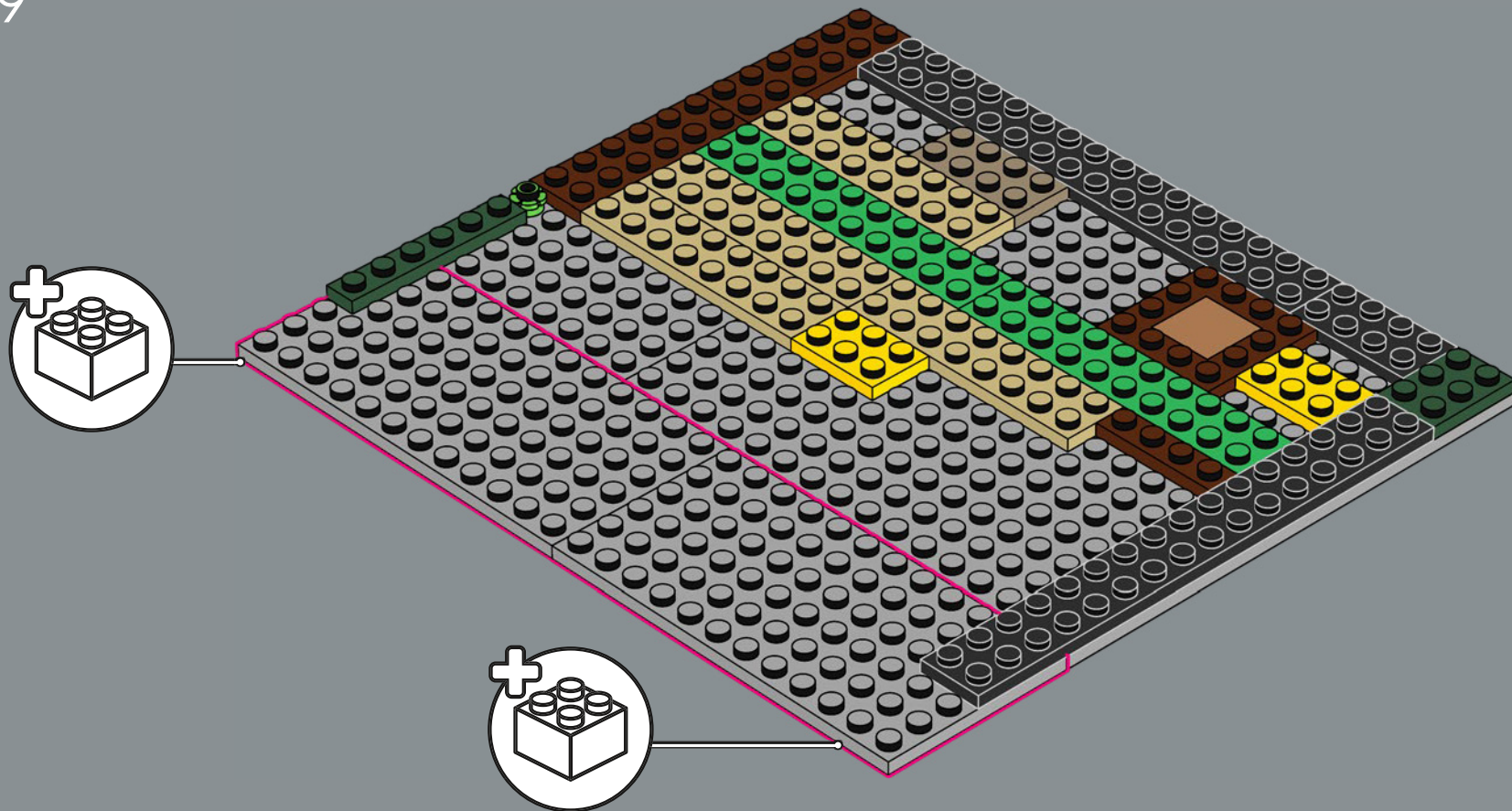

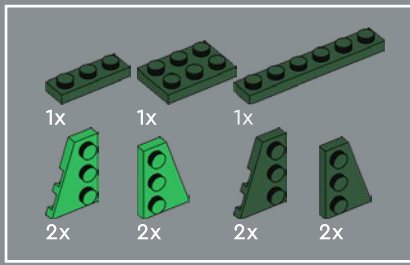

50

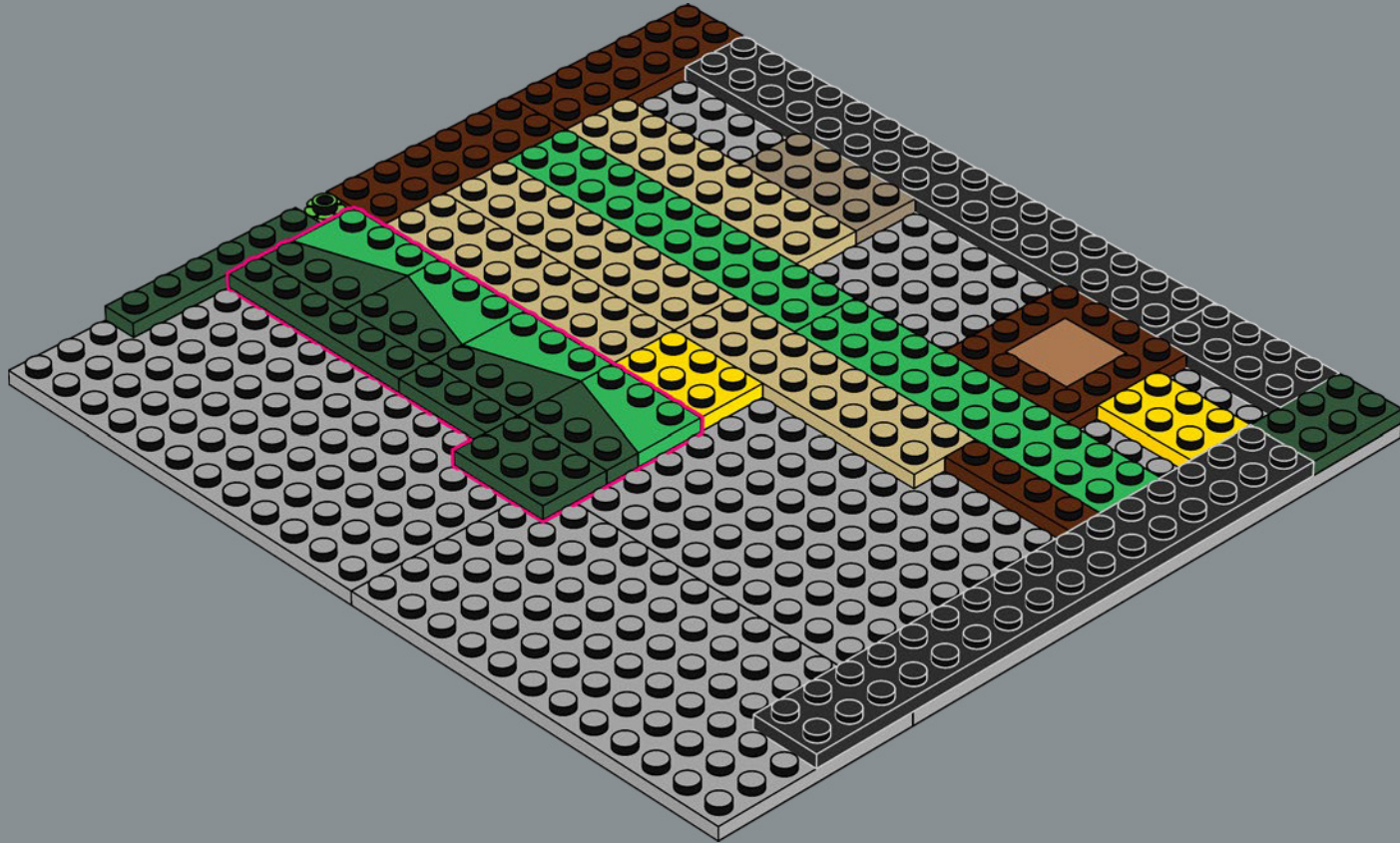

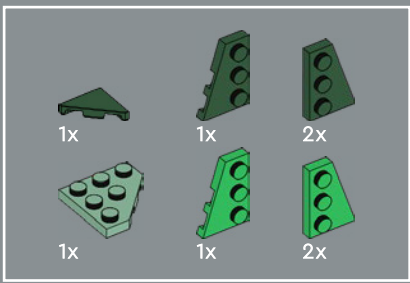

51

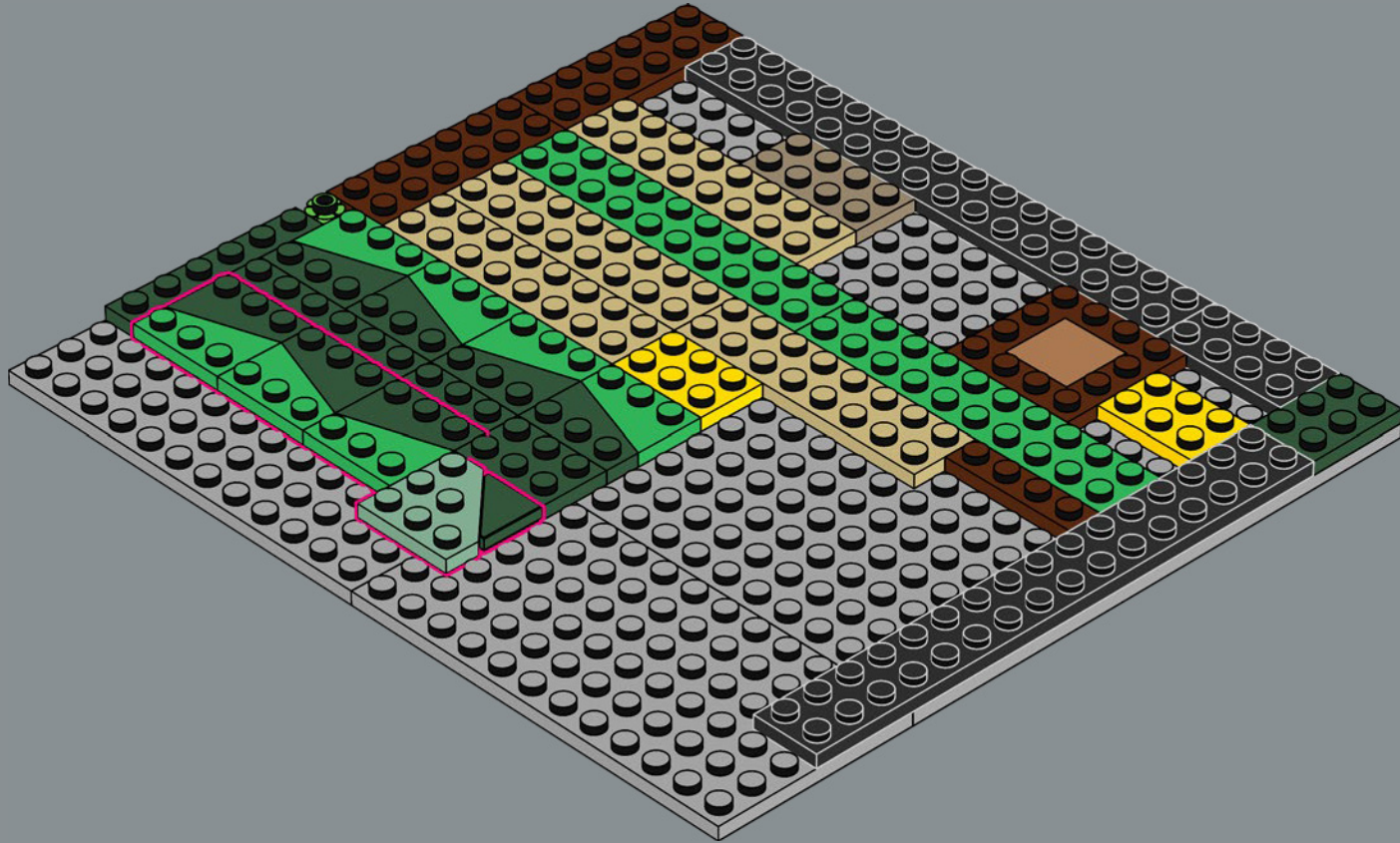

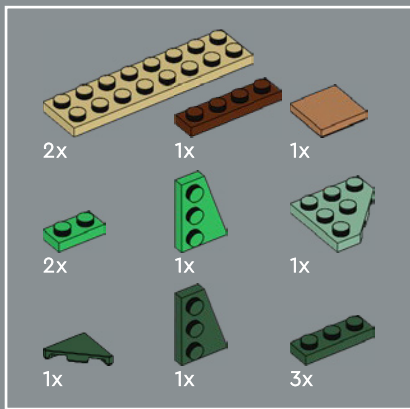

52

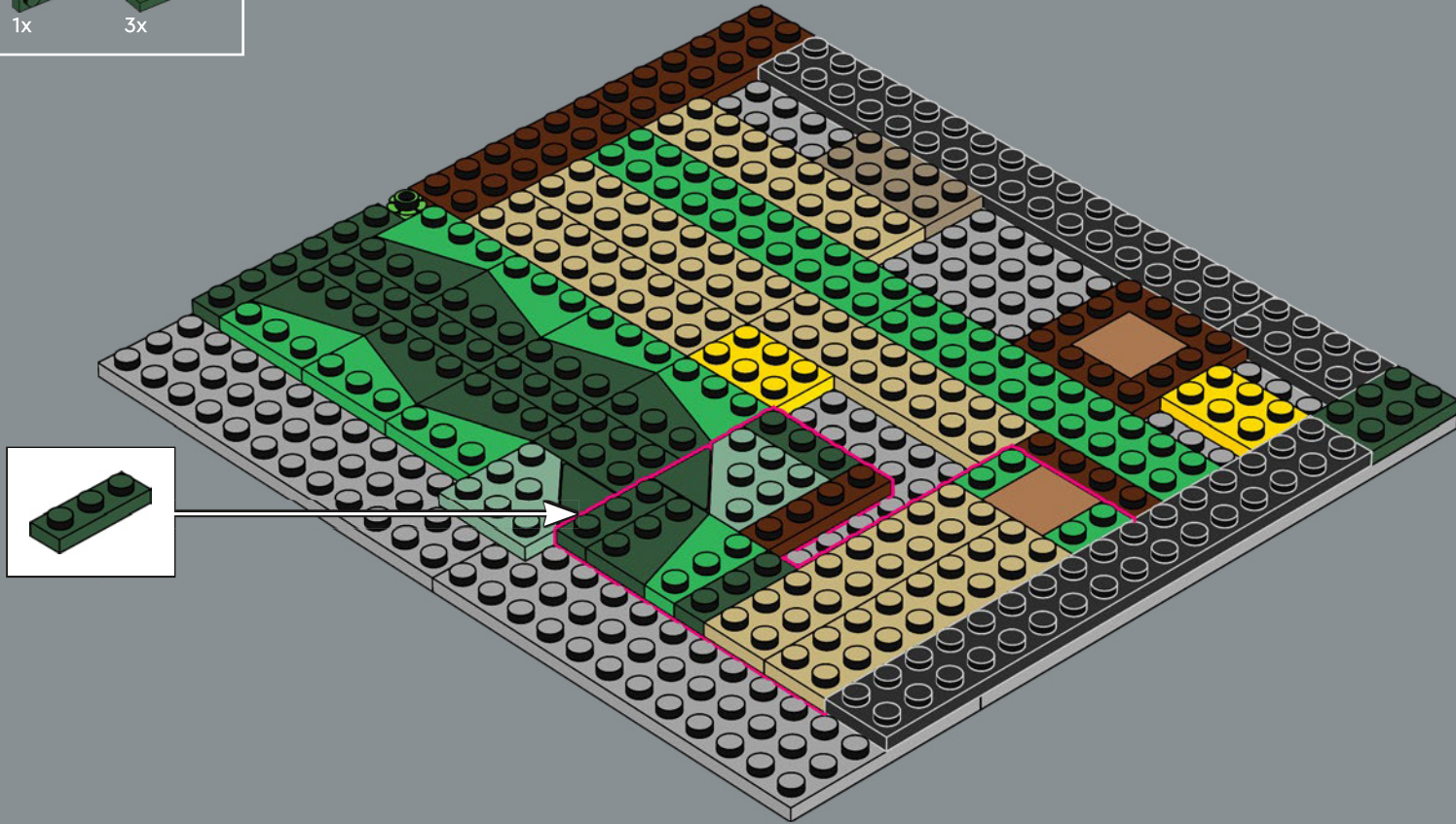

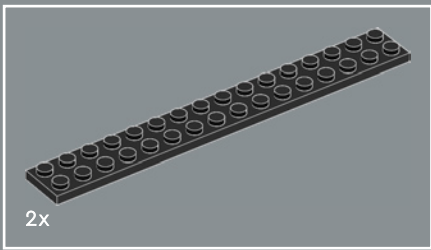

53

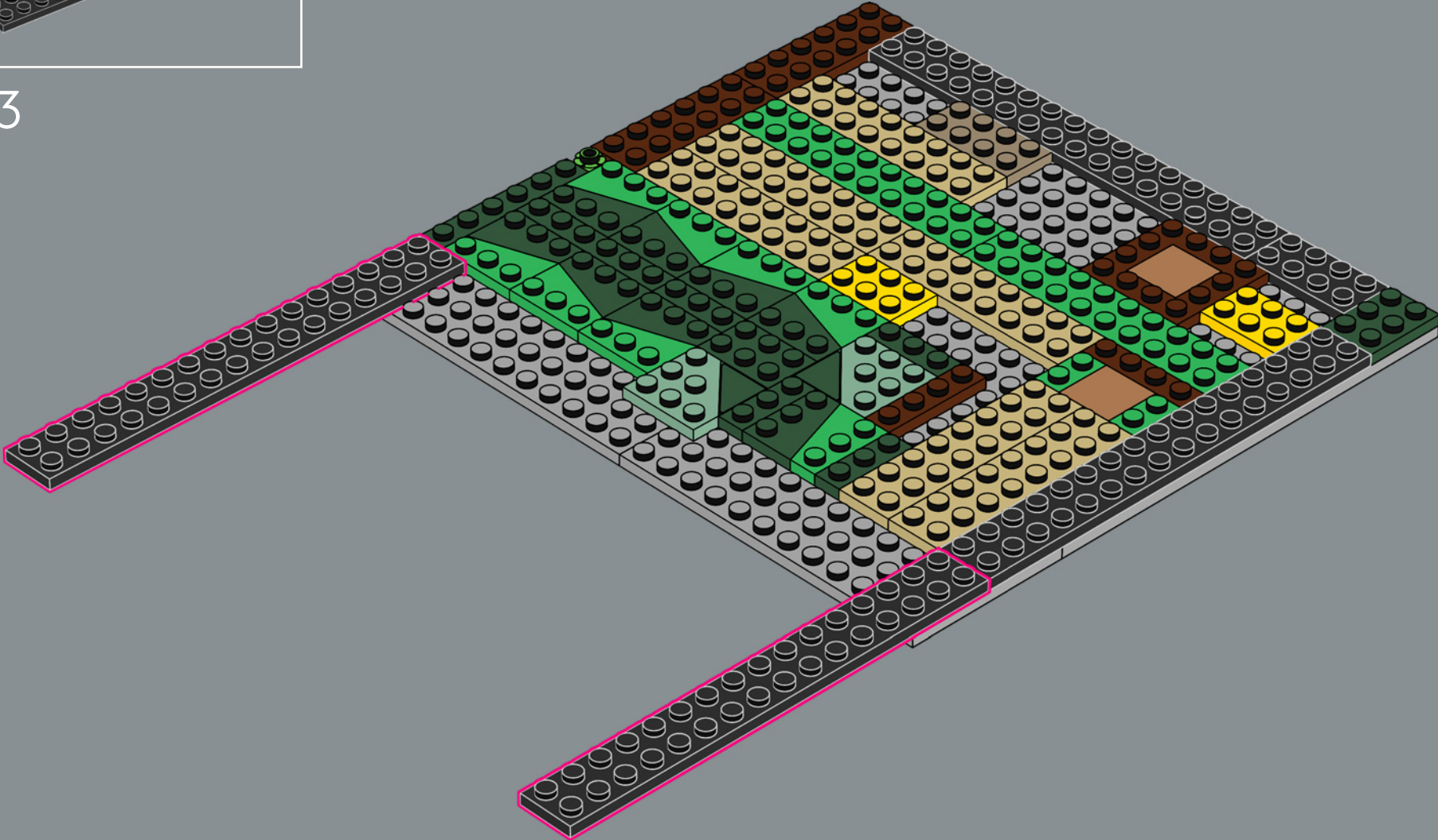

54

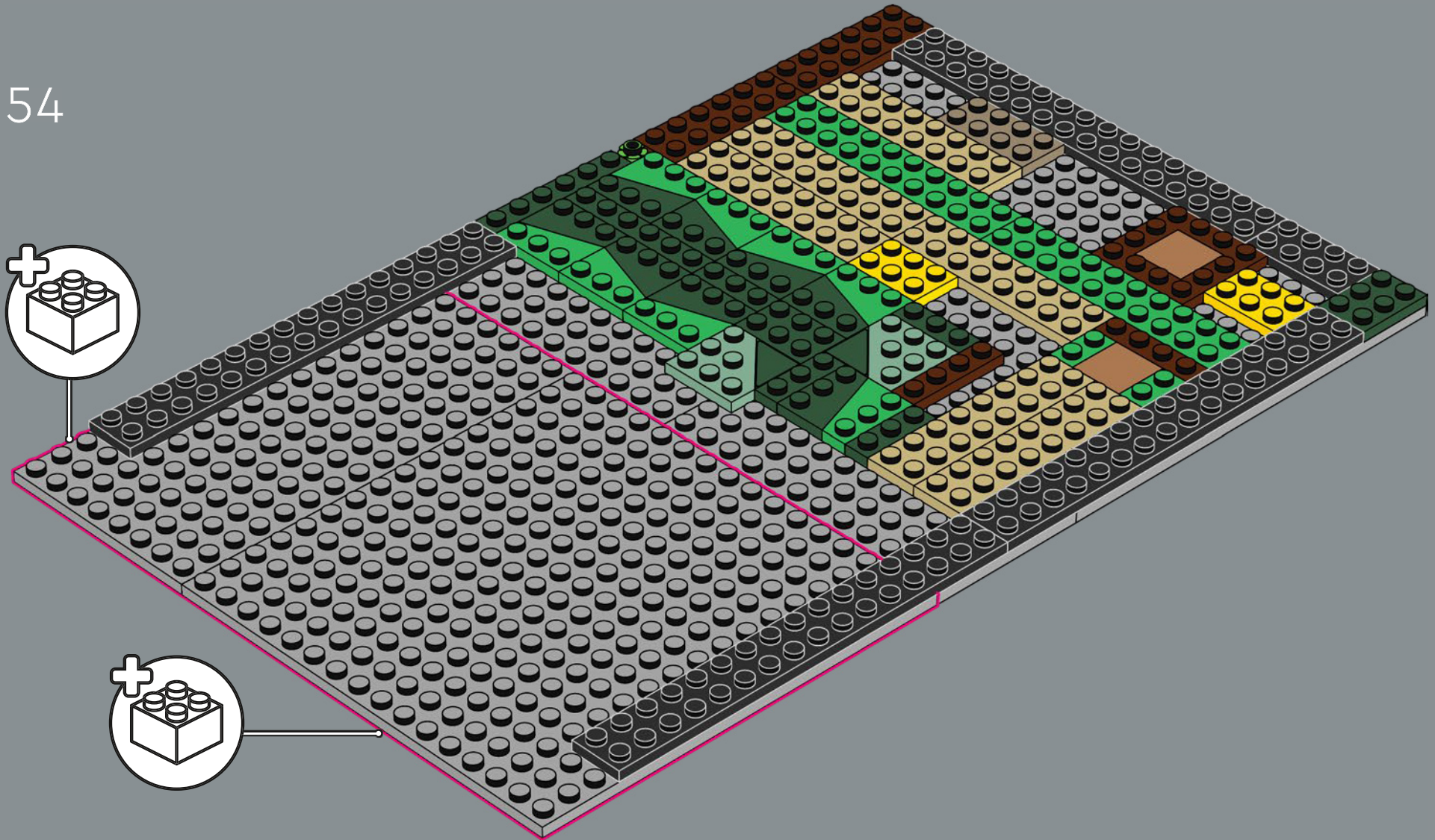

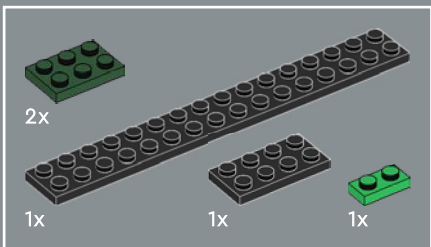

55

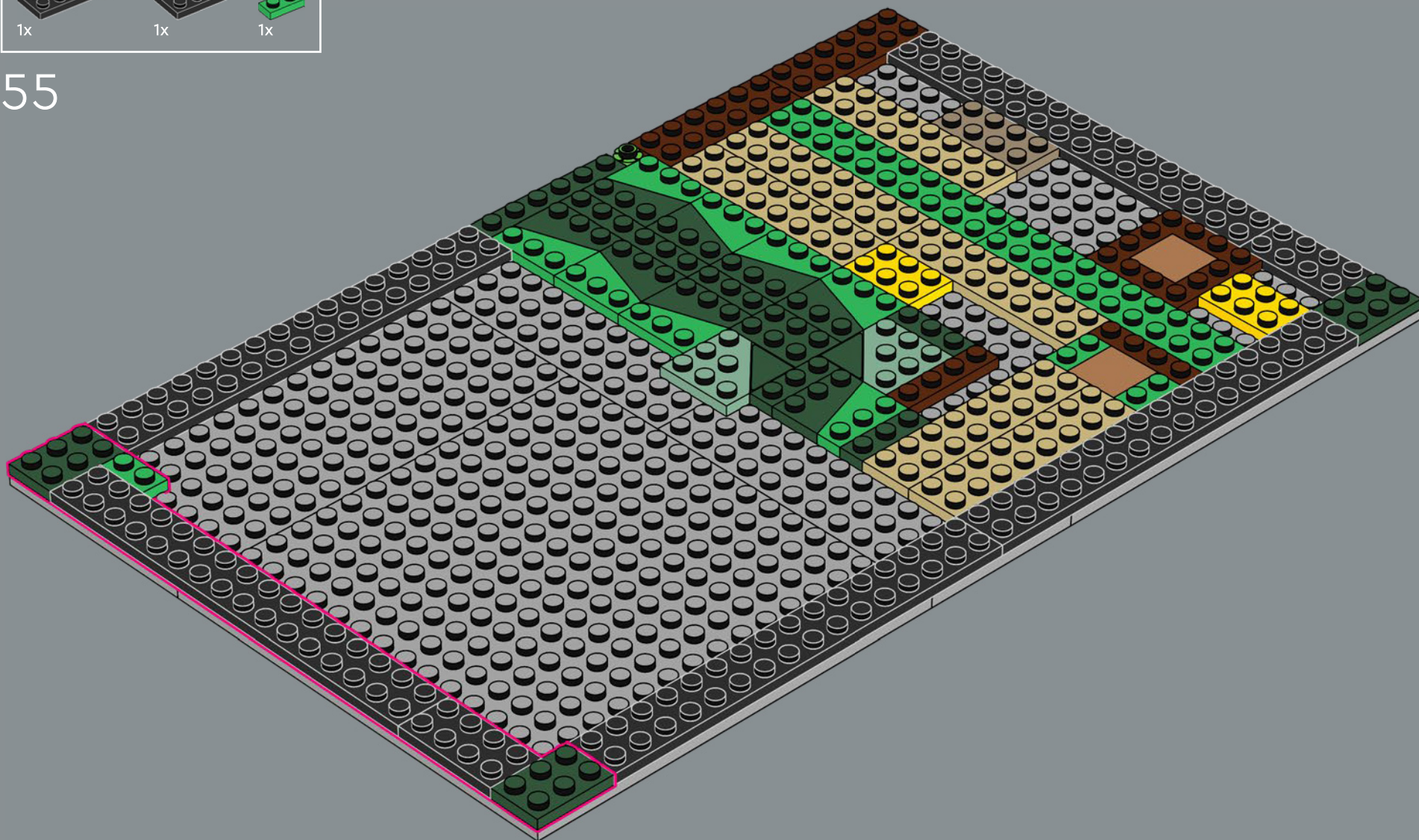

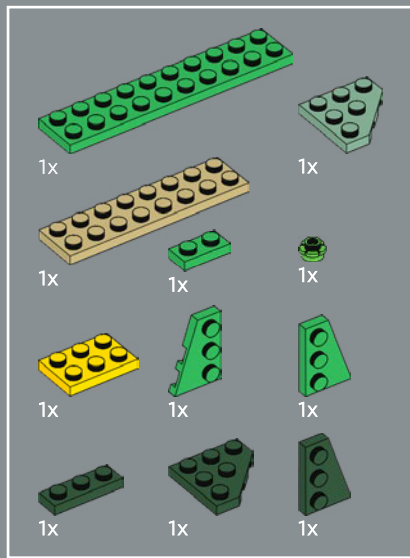

56

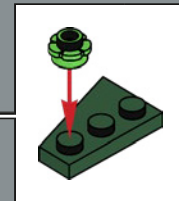
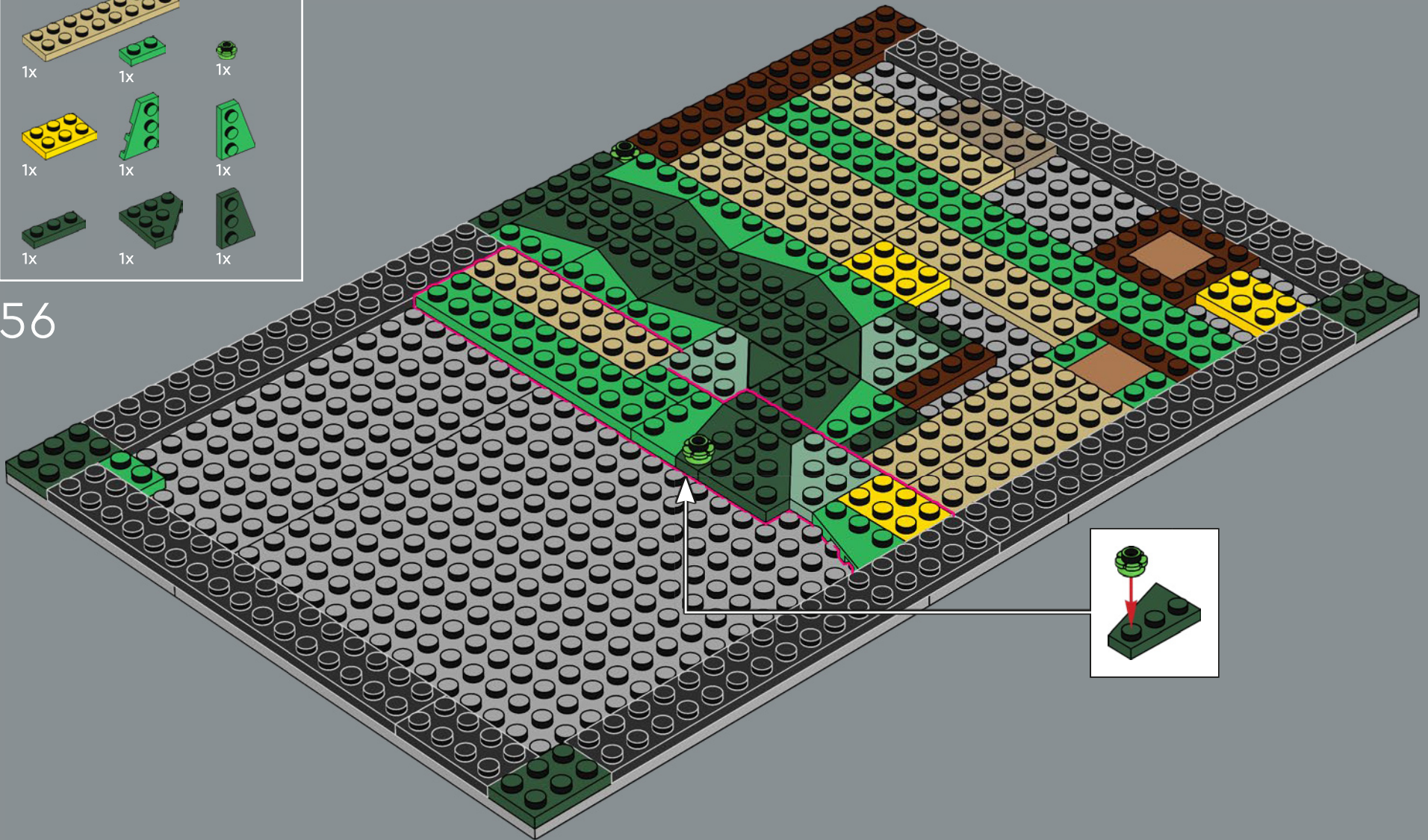

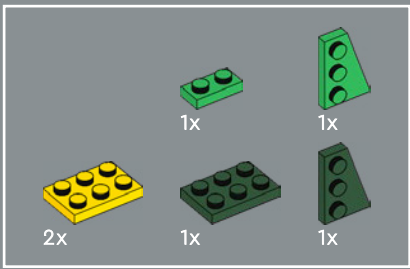

57

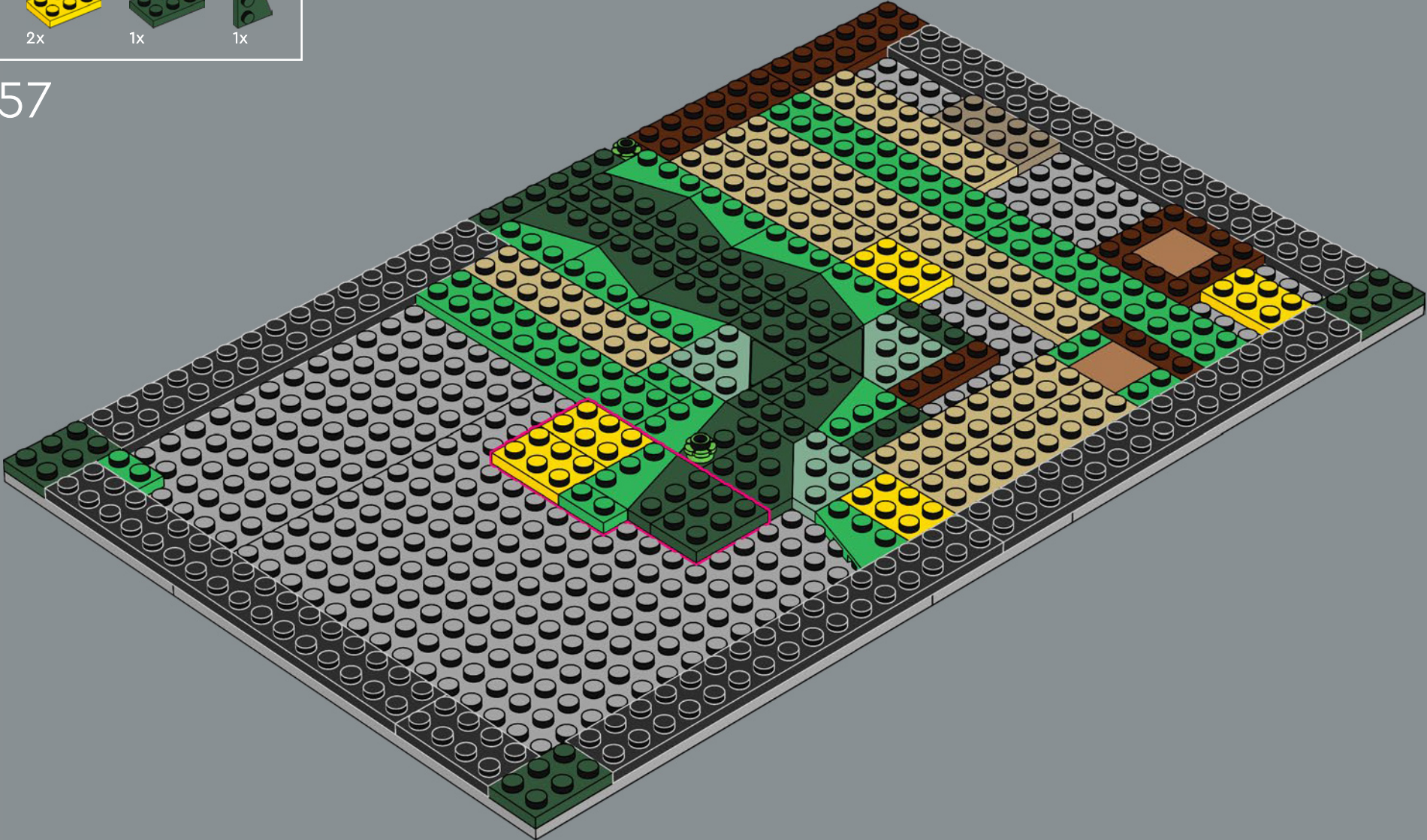

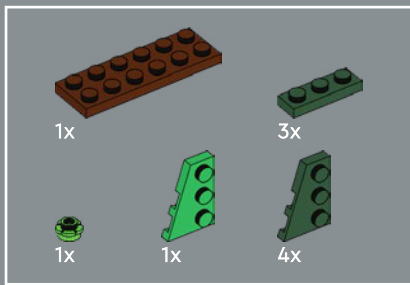

58

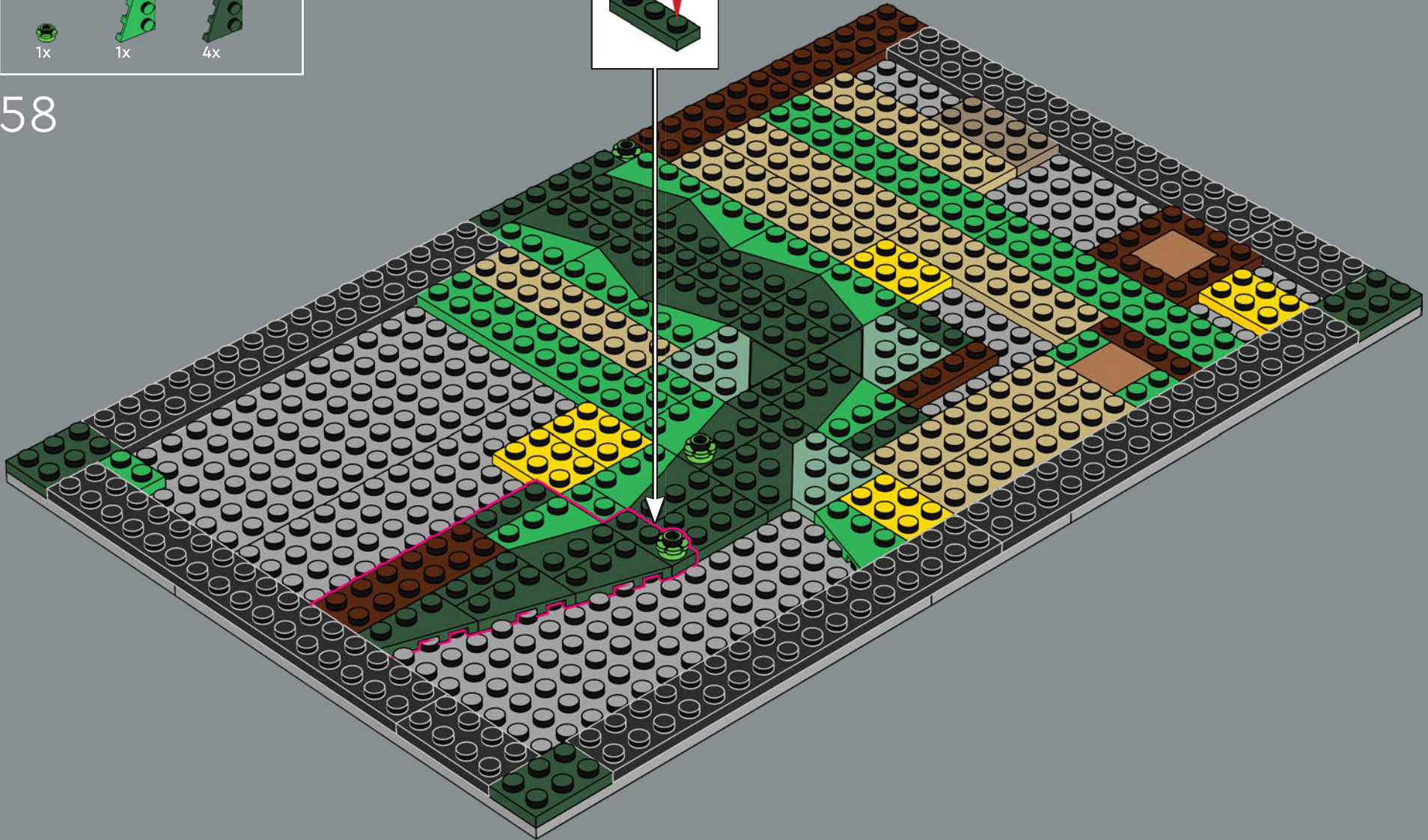
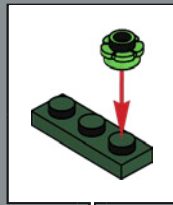

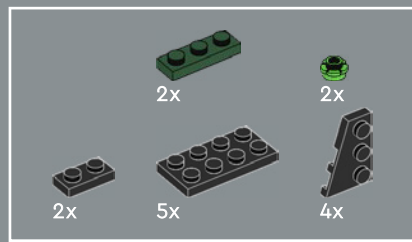

59

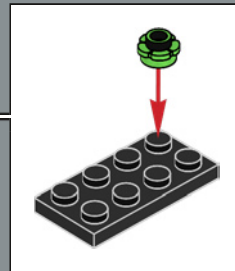
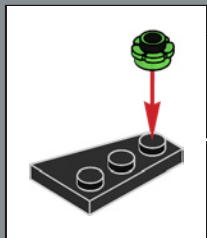
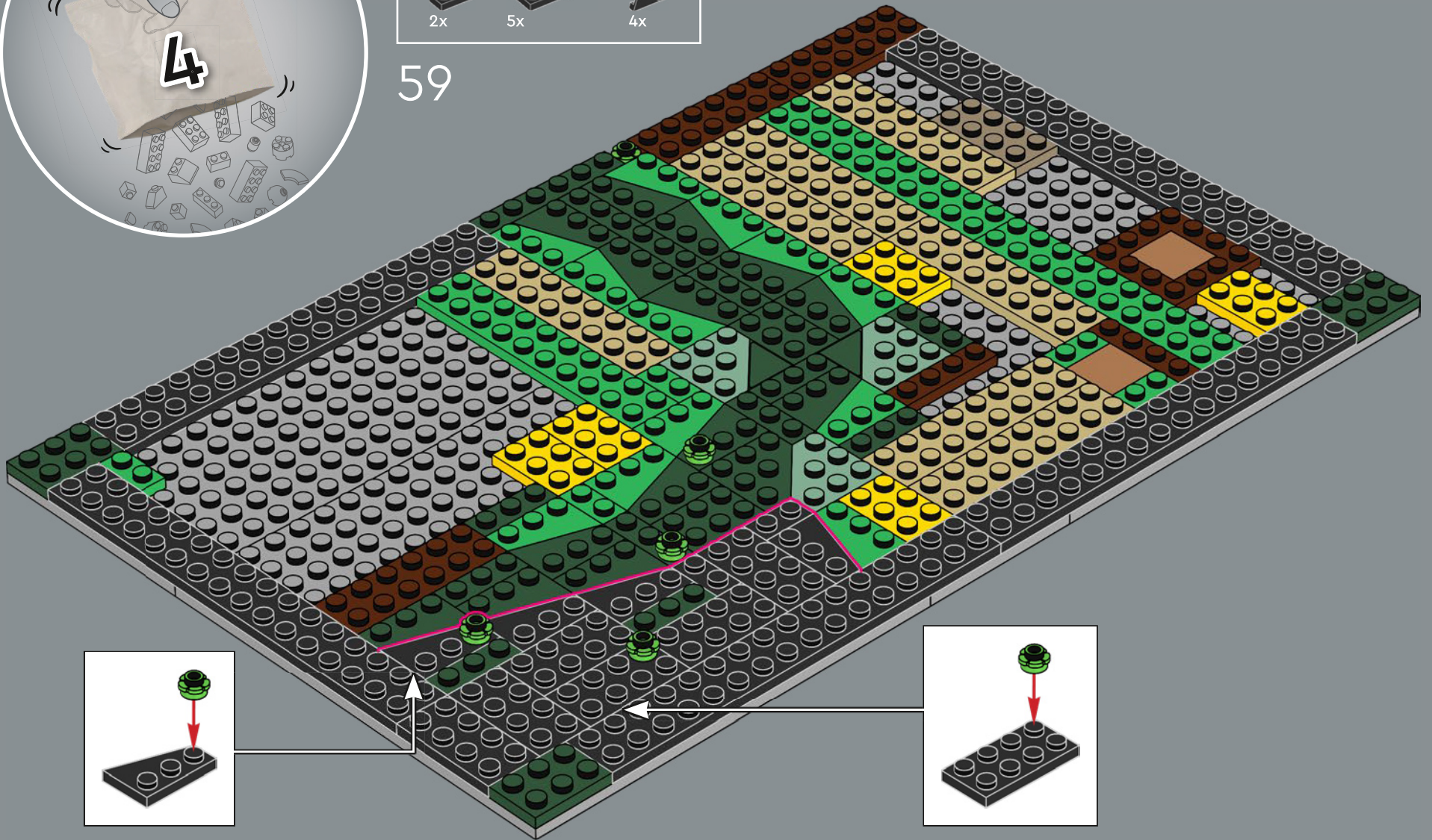

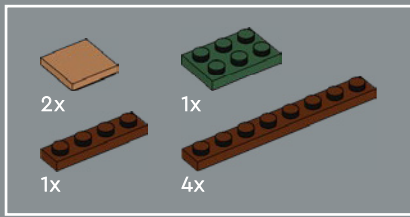

60

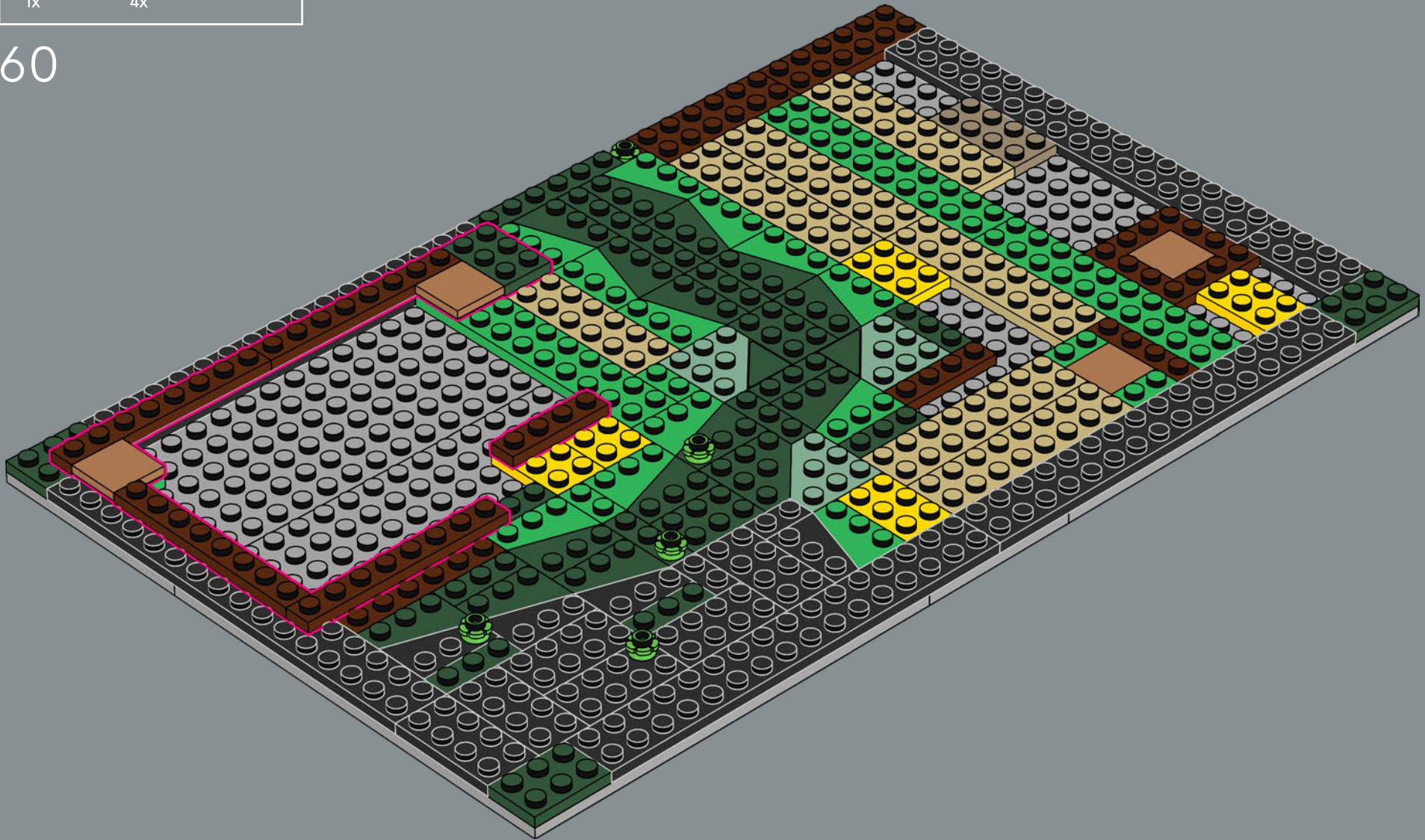

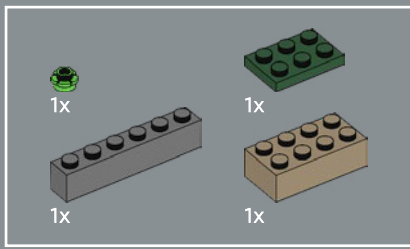

62

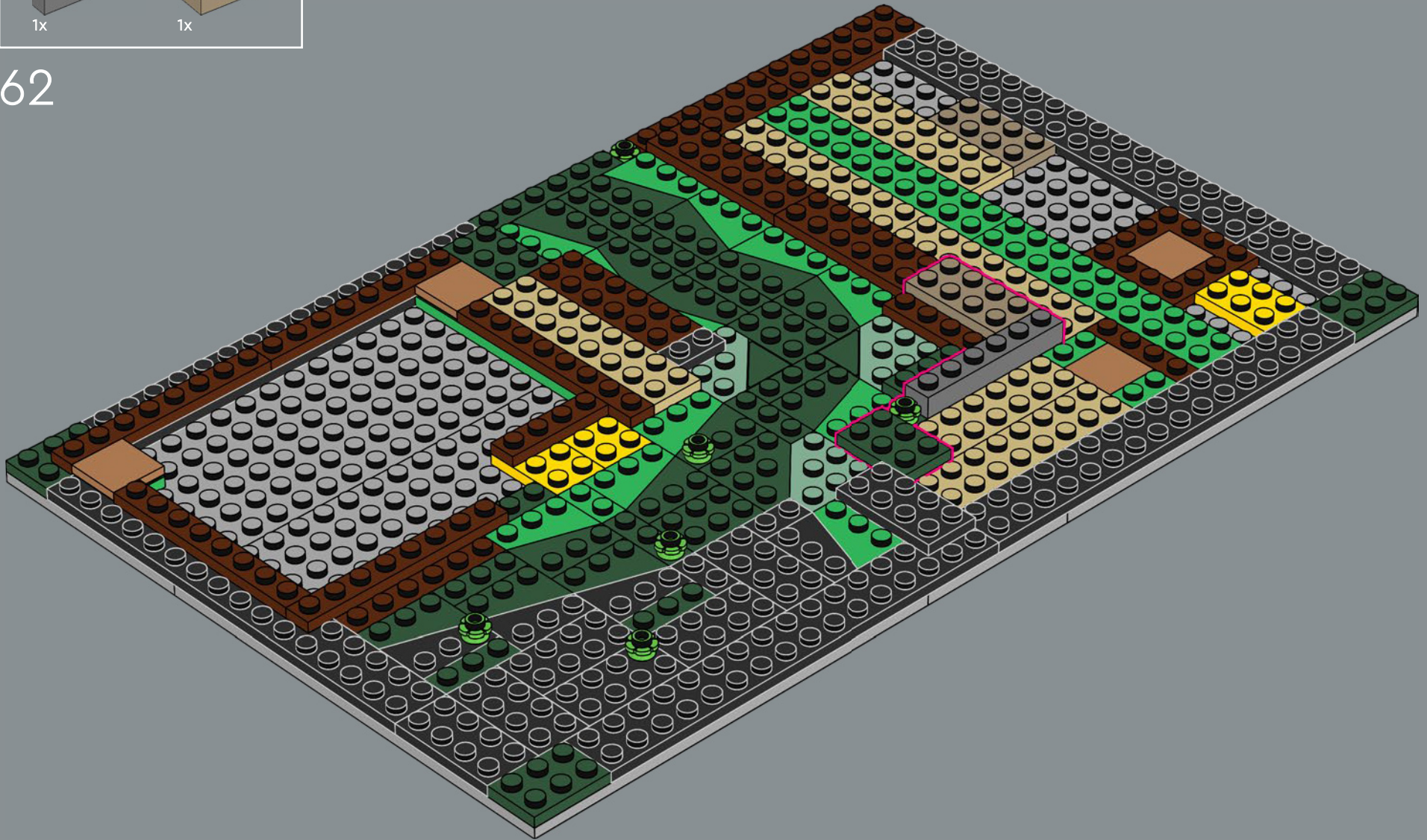

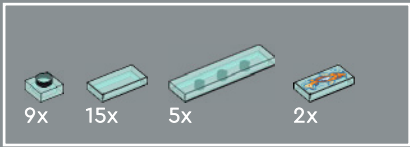

63

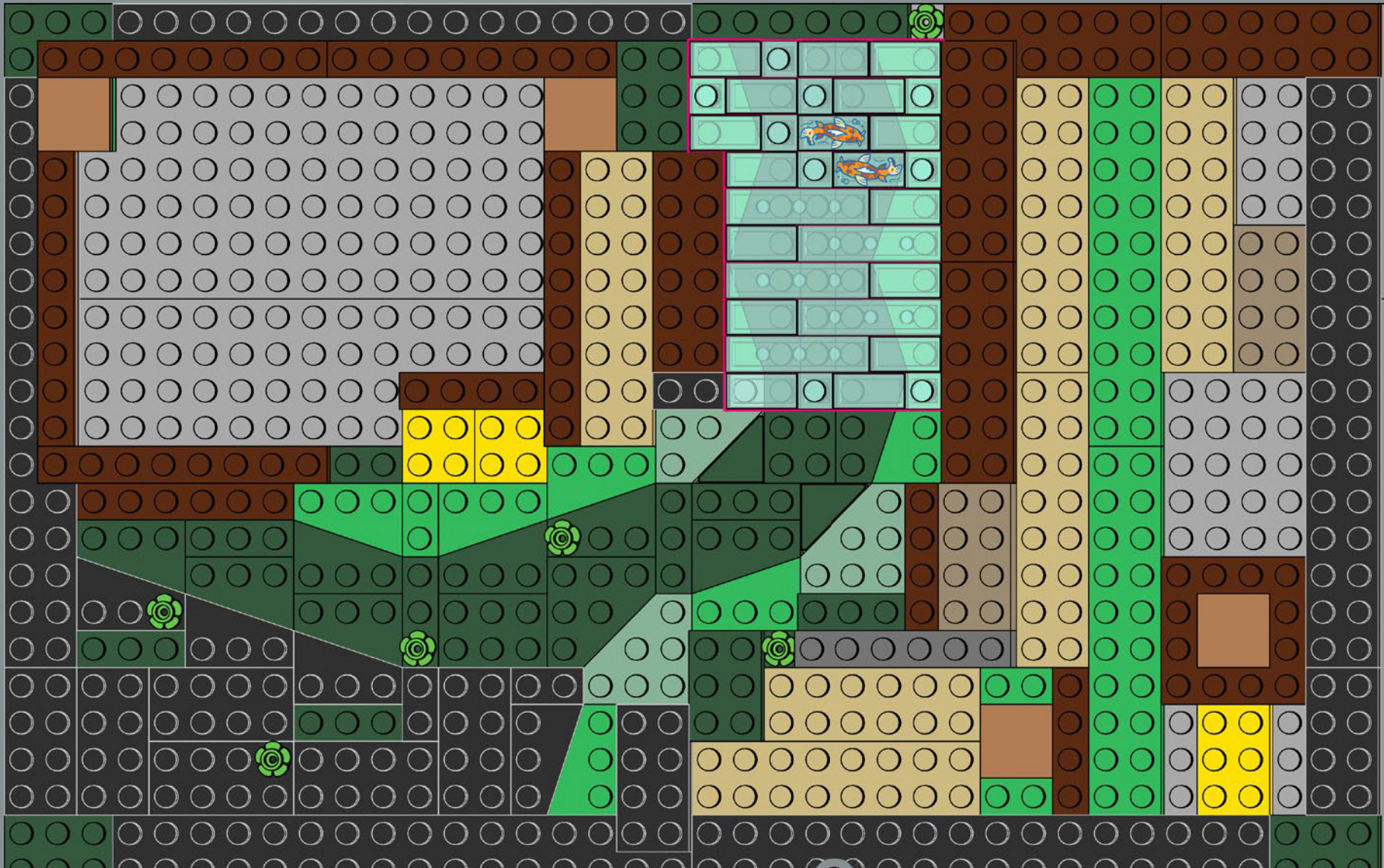



64

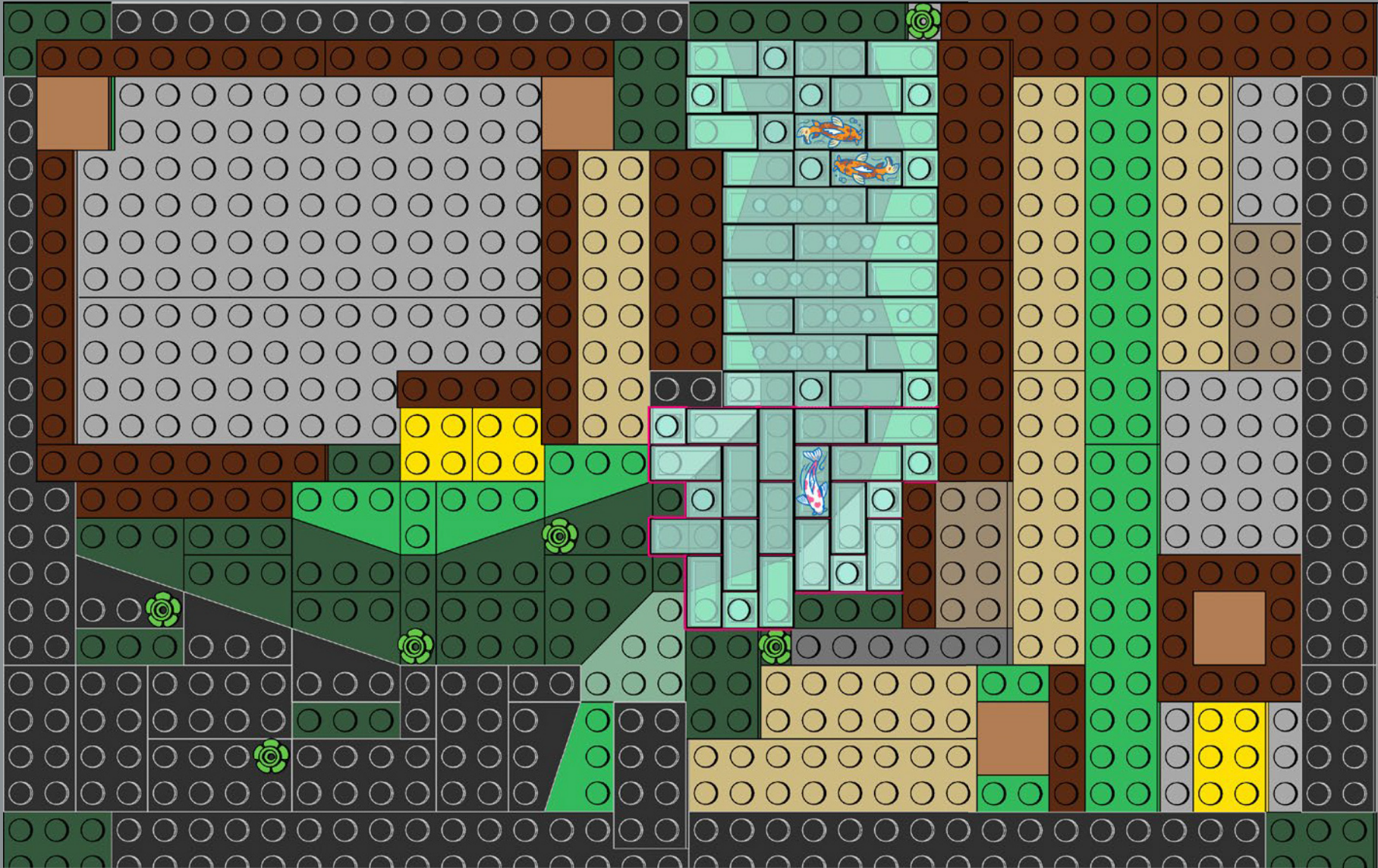



65

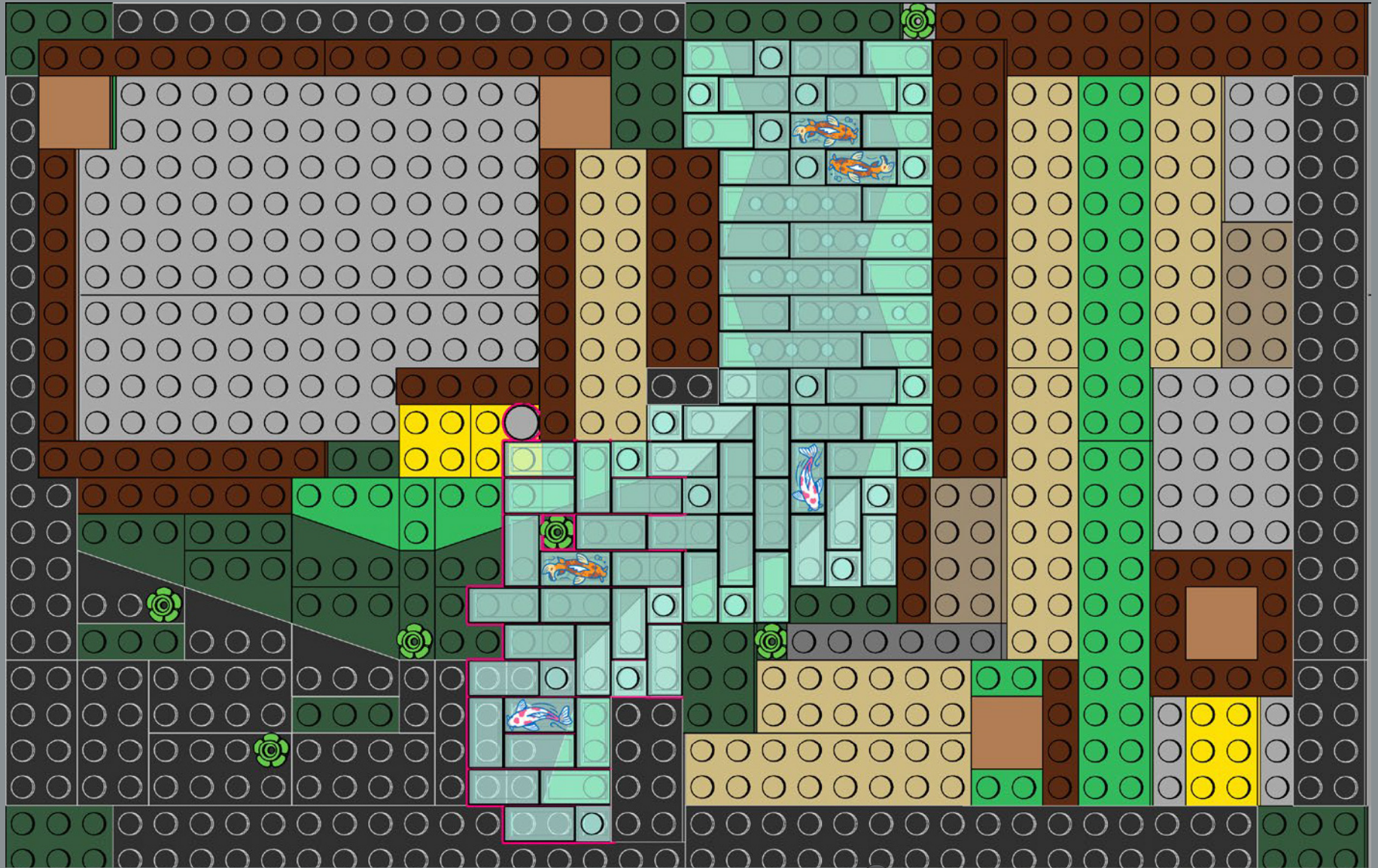

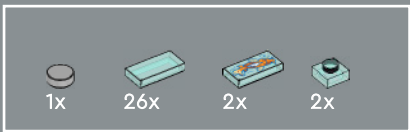

66

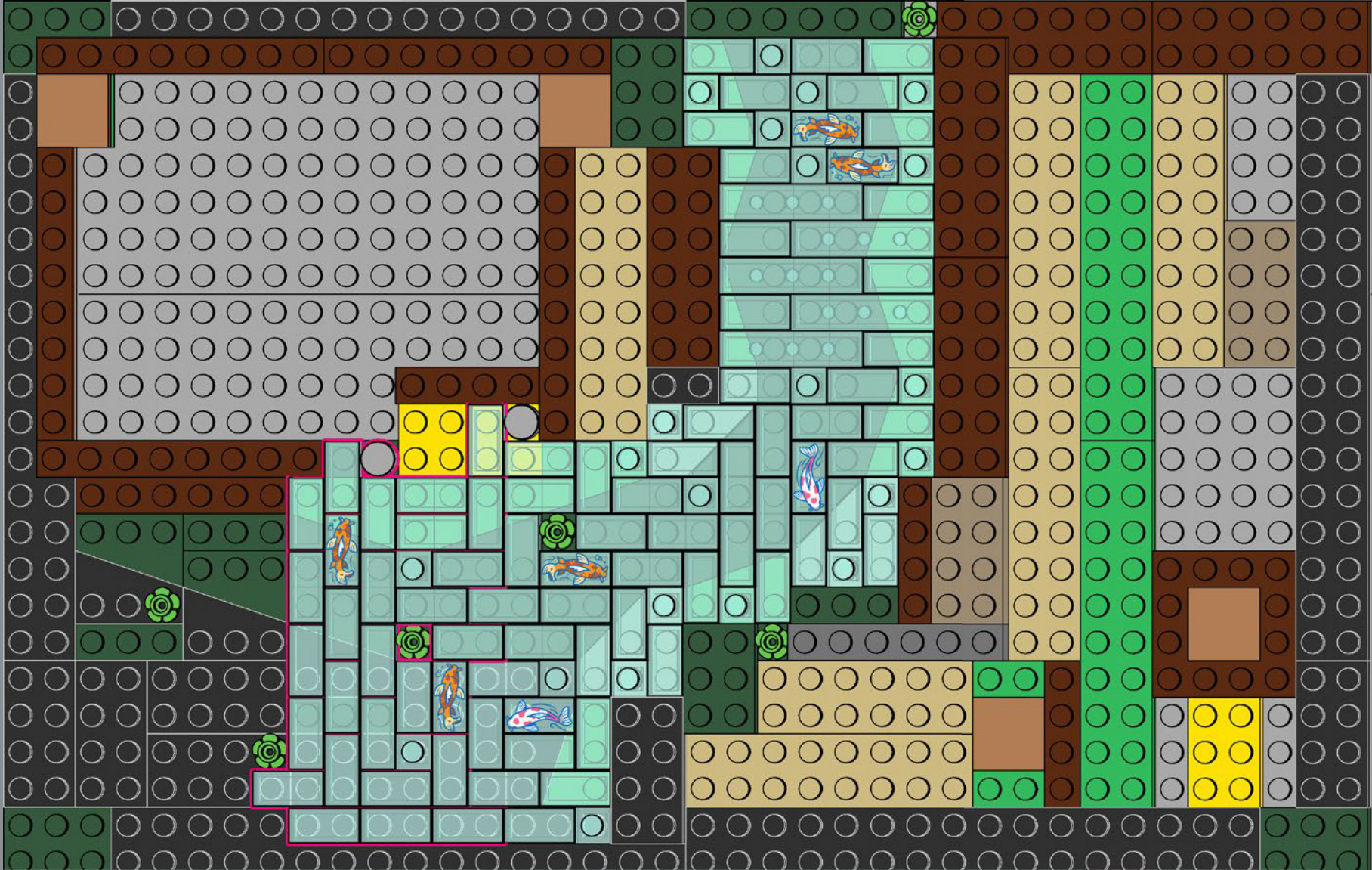

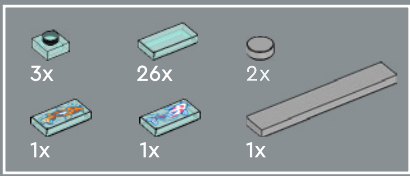

67

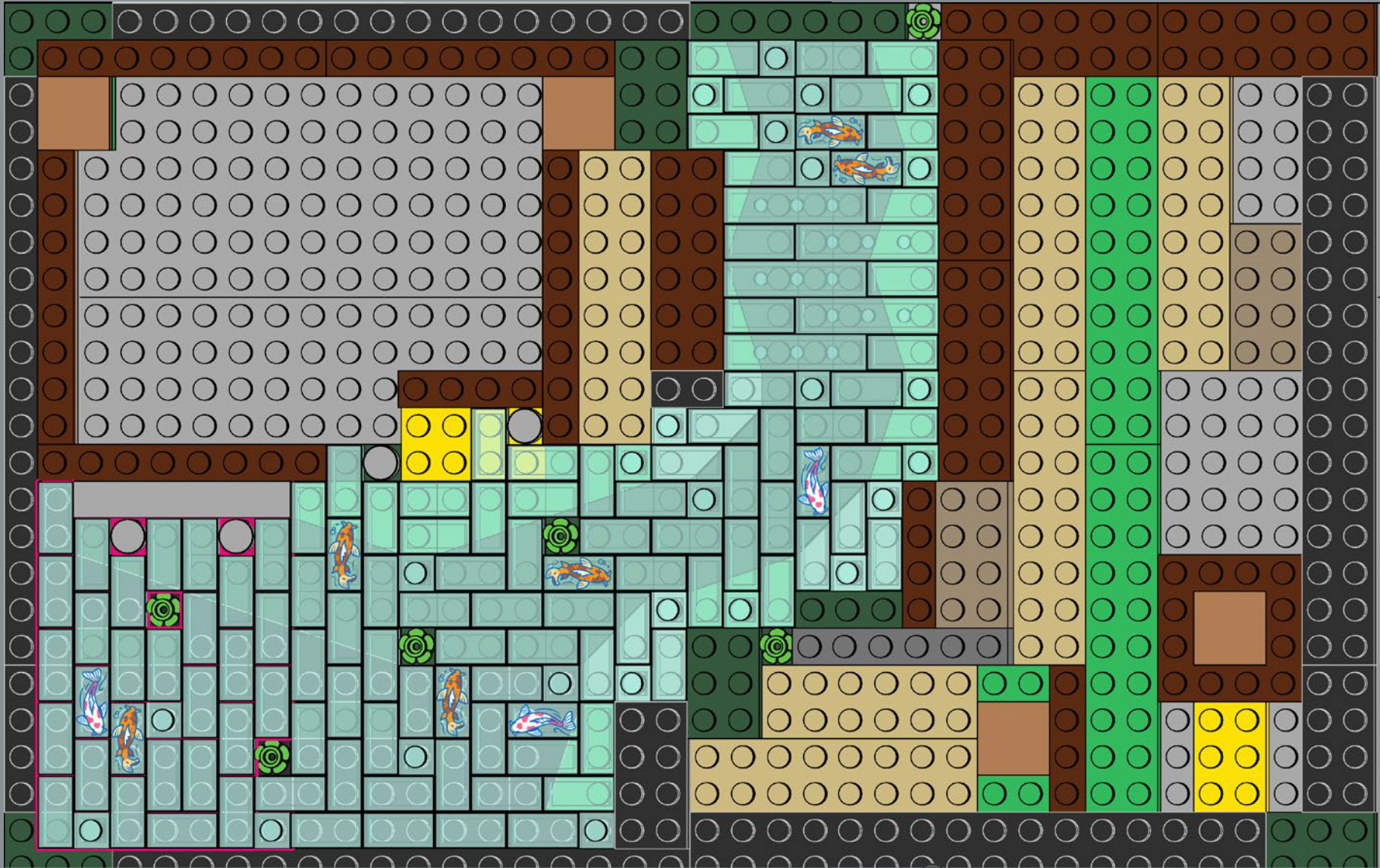



Pond shapes usually represent *kanji* (a system of Japanese writing) that carry significant meanings, such as *kokoro*, or "heart".

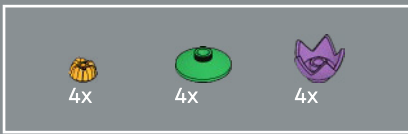

68

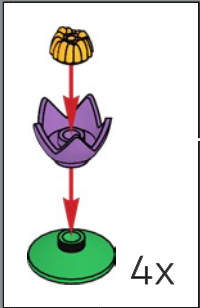

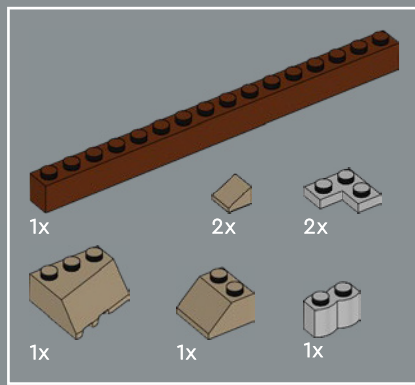

69



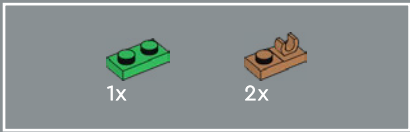

70



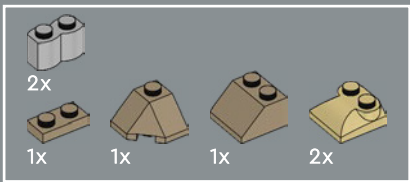

71

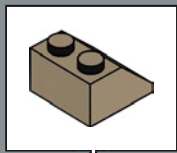
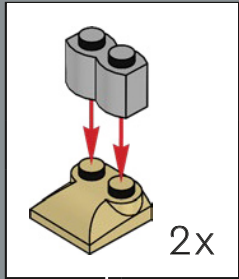

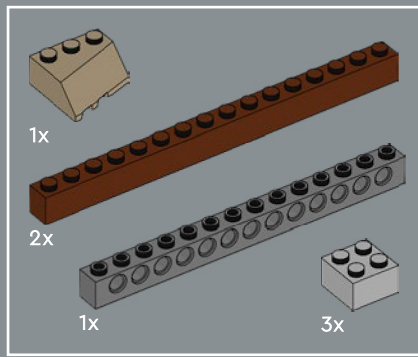

72



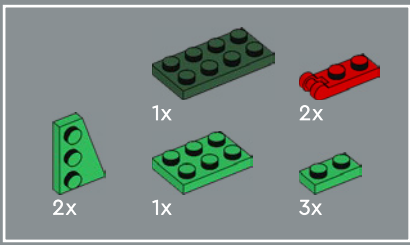

73

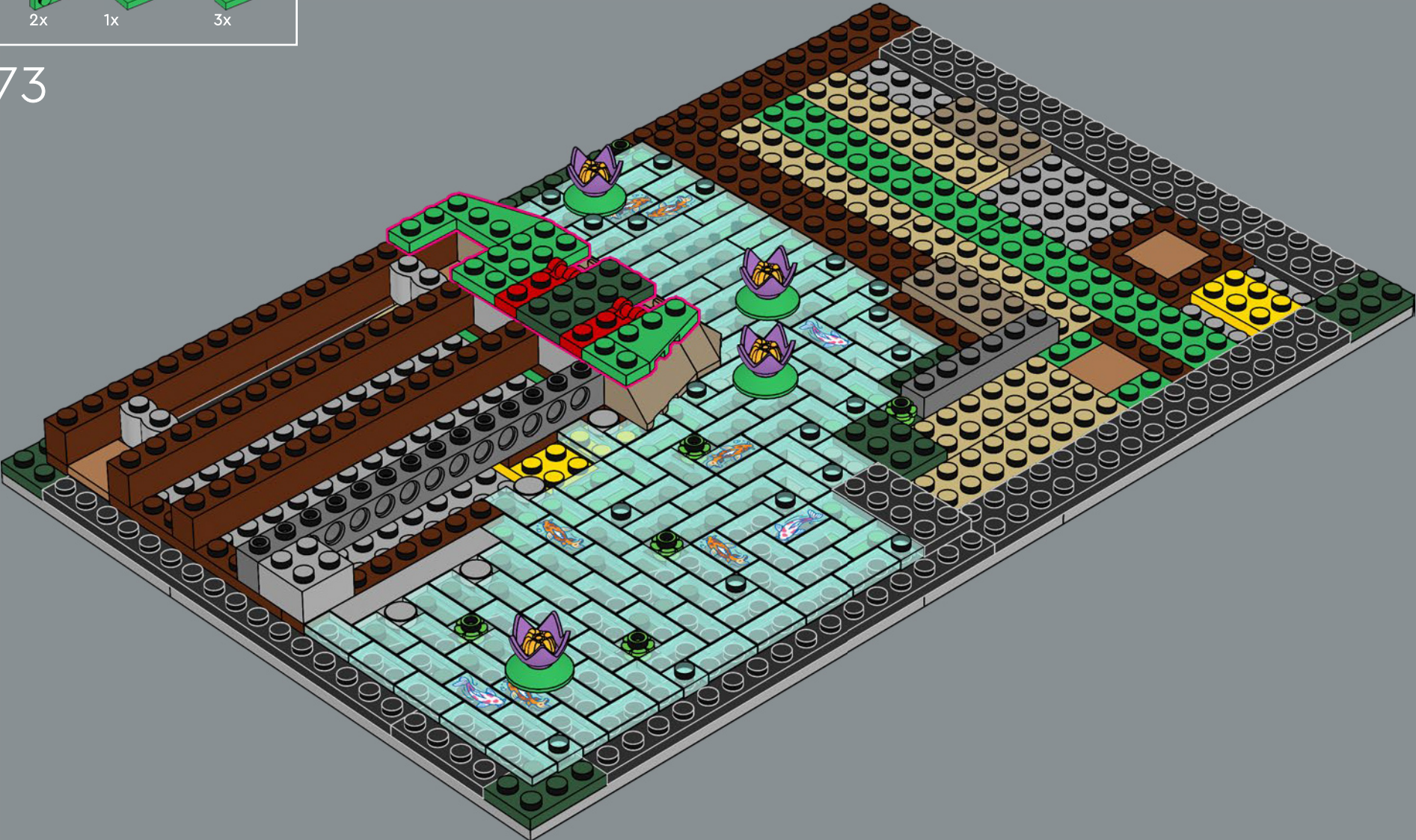

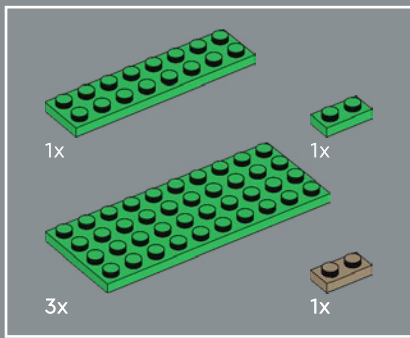

74



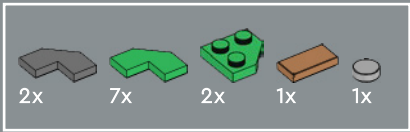

75



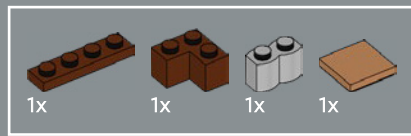

76



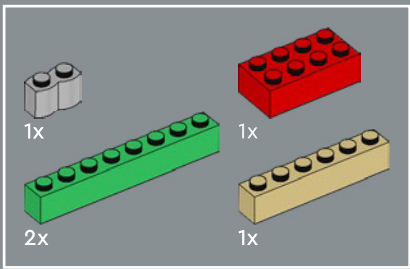

77



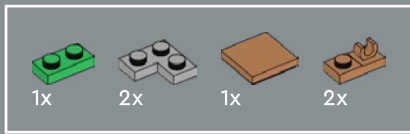

78

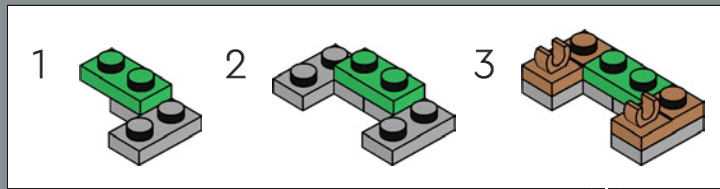

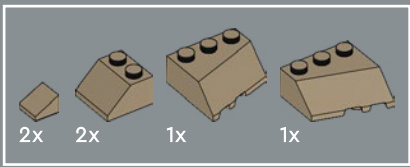

79



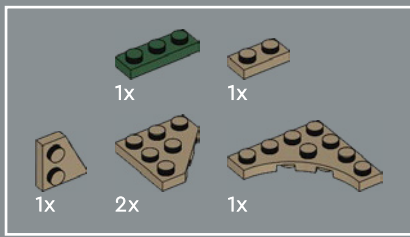

80



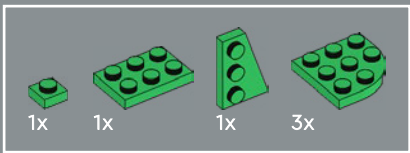

81



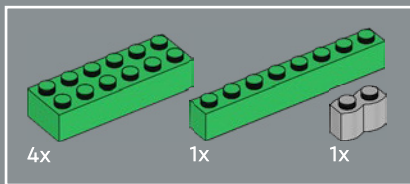

82



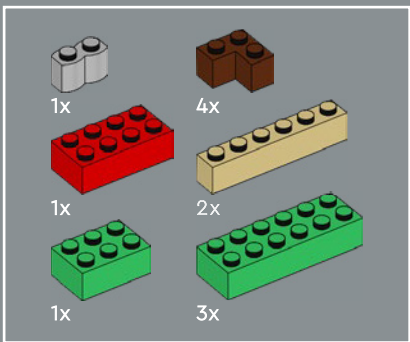

83



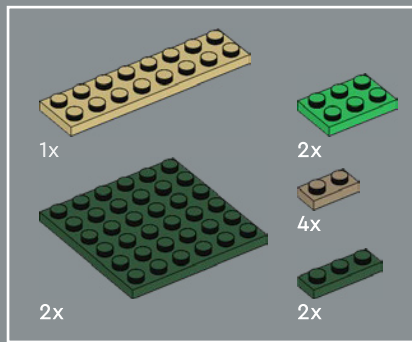

84



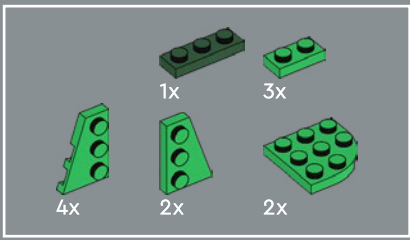

85



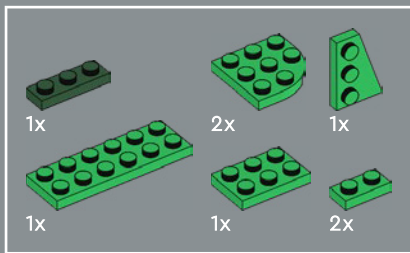

86



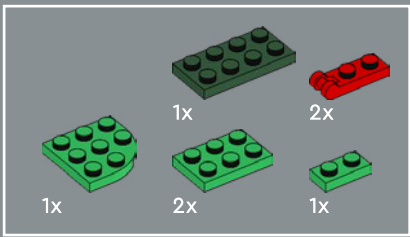

87



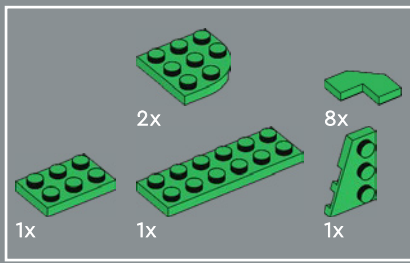

88





Tranquil garden islands can be symbols of mystical or mythical mountains, turtles, or cranes (often associated with longevity).

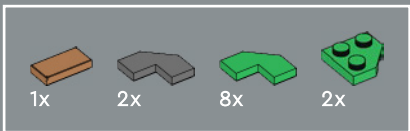

89



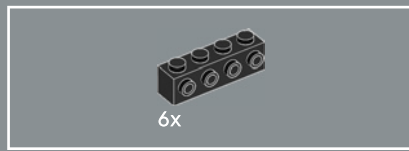

90



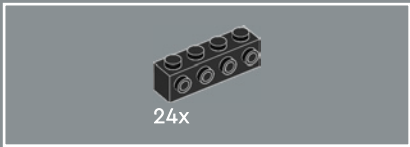

91



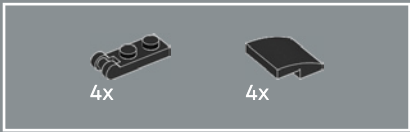

92

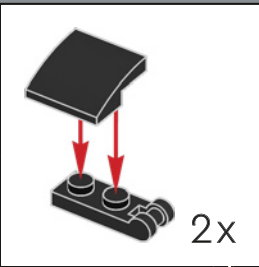
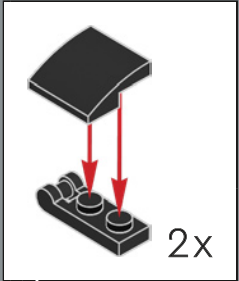

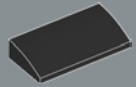

26x

93



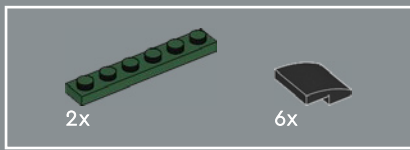

94

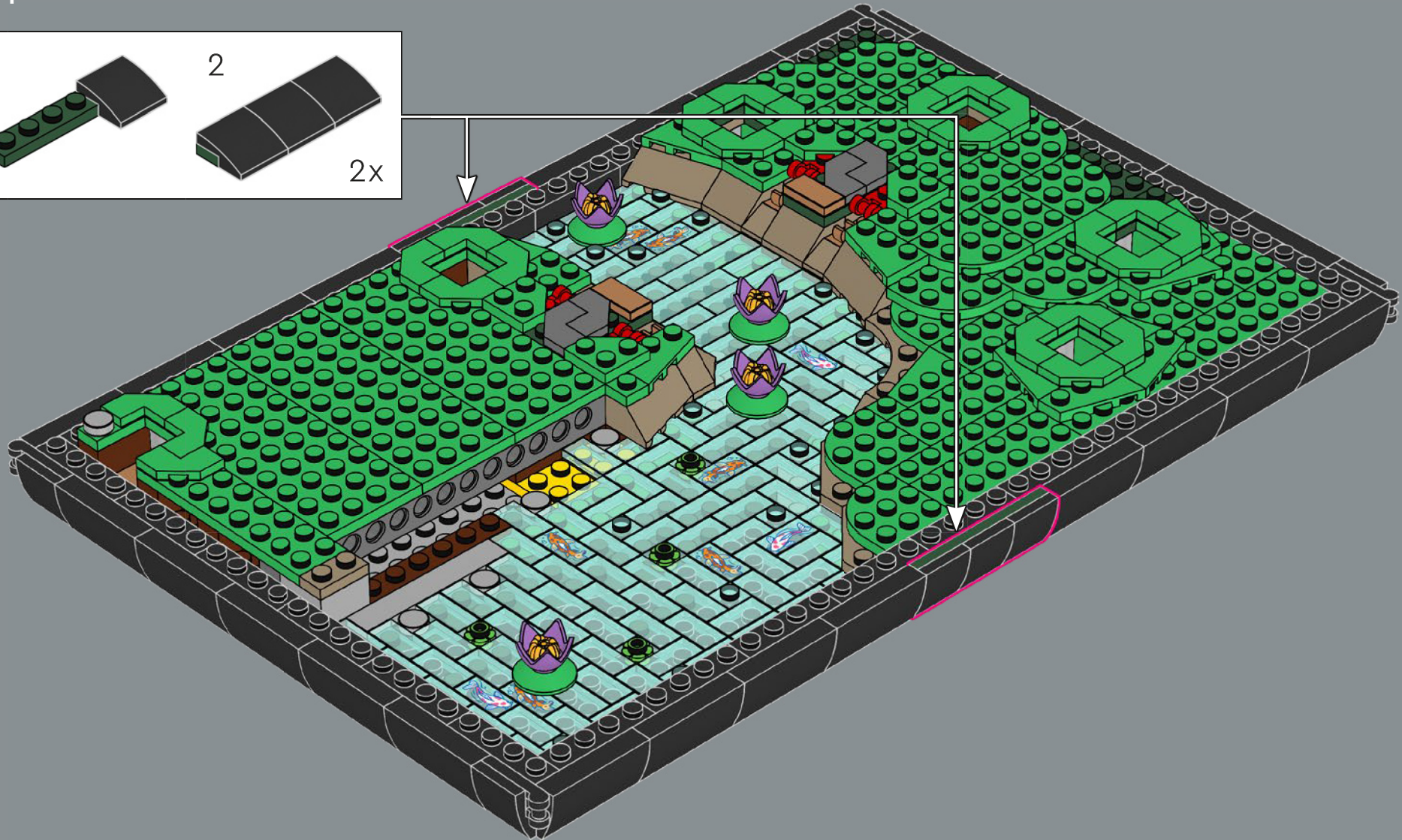
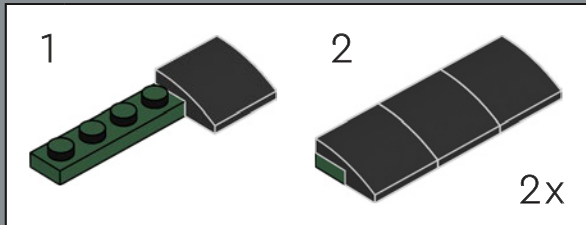

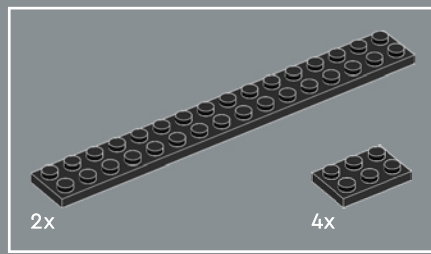

95

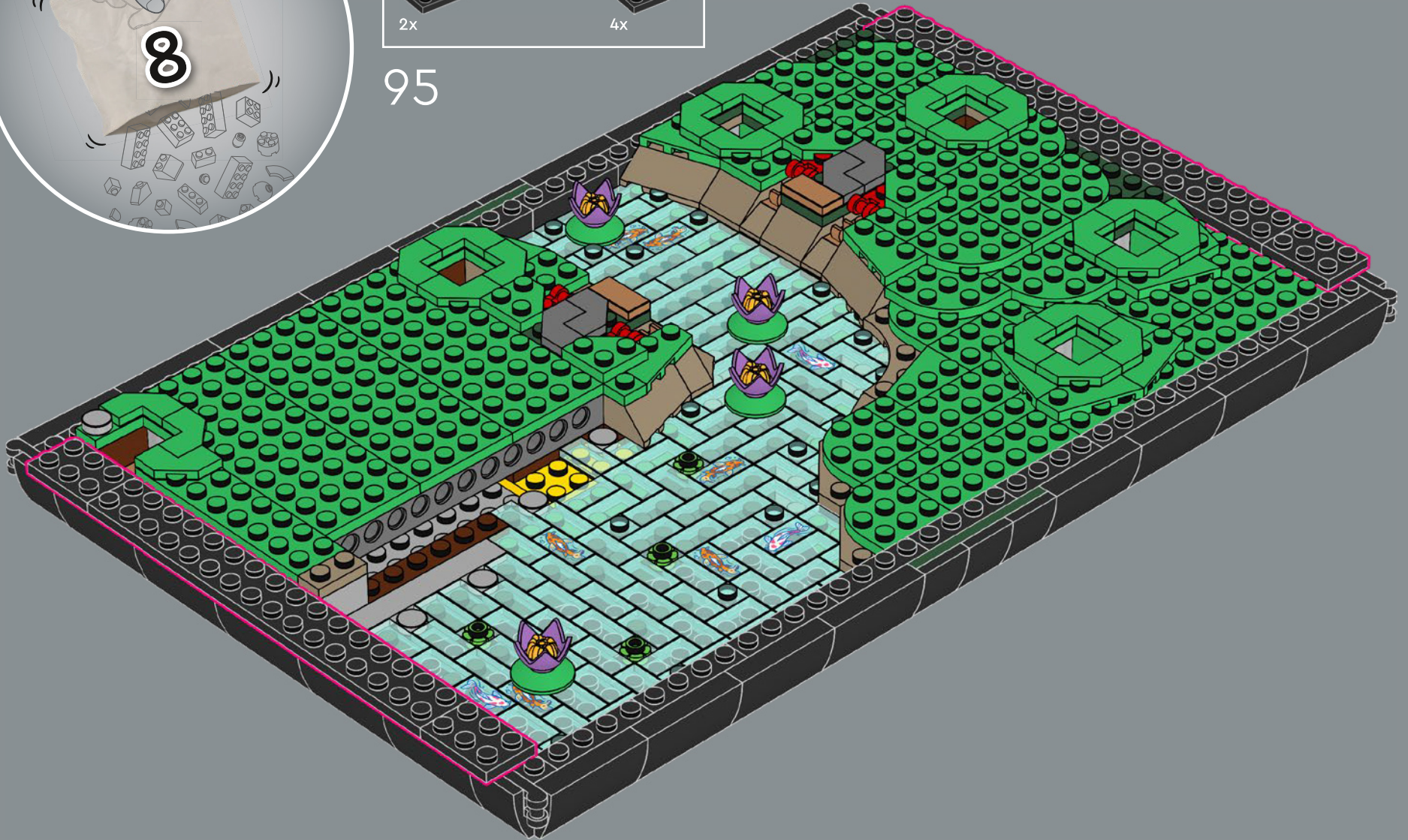

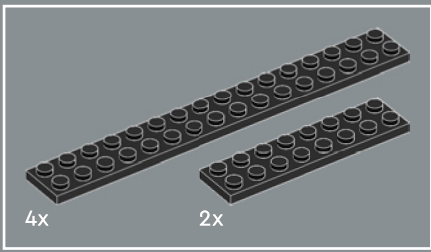

96



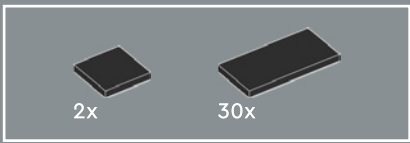

Recognise the base frame design for this model? We reused the flowerpot design from the LEGO® Icons 10281 Bonsai Tree set to emulate a similar look and feel.

97

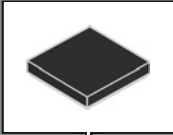

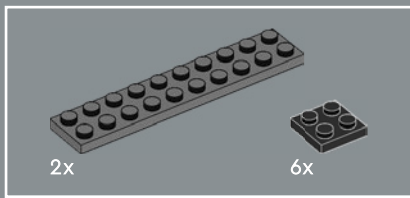

98

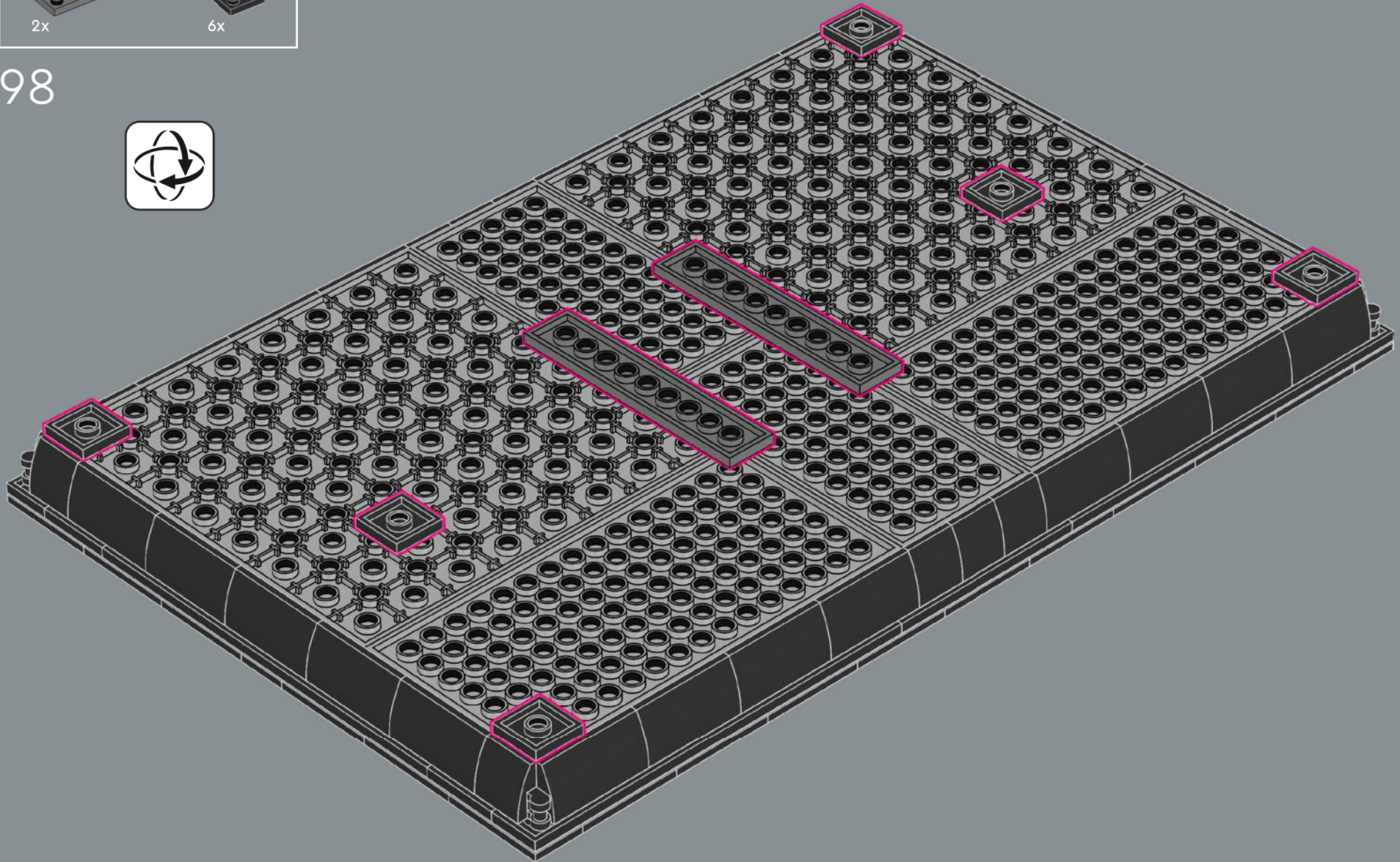



99

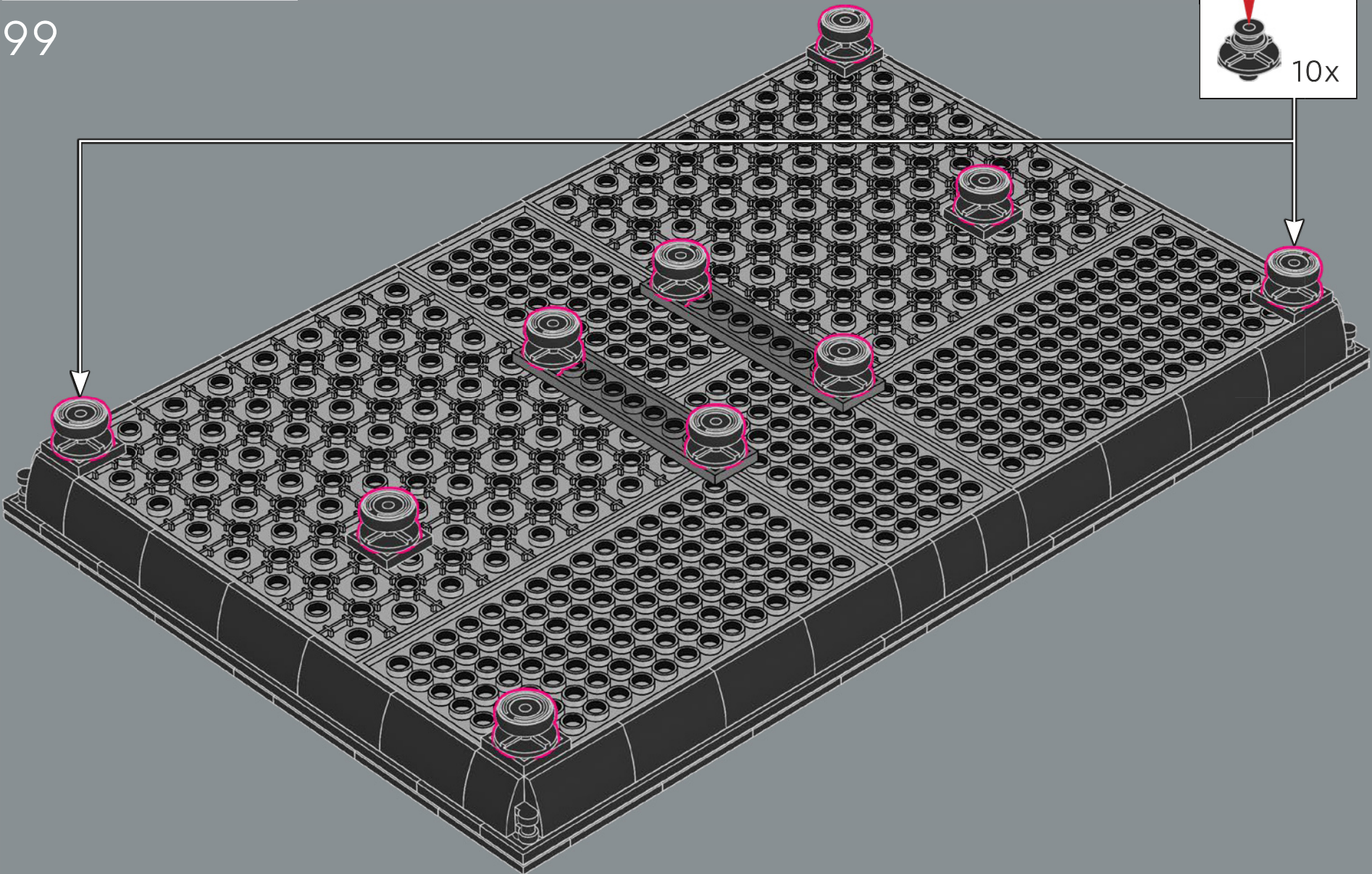
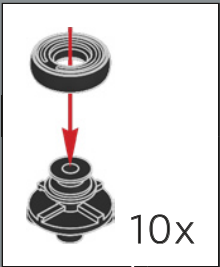



2x 12x 4x 16x



100

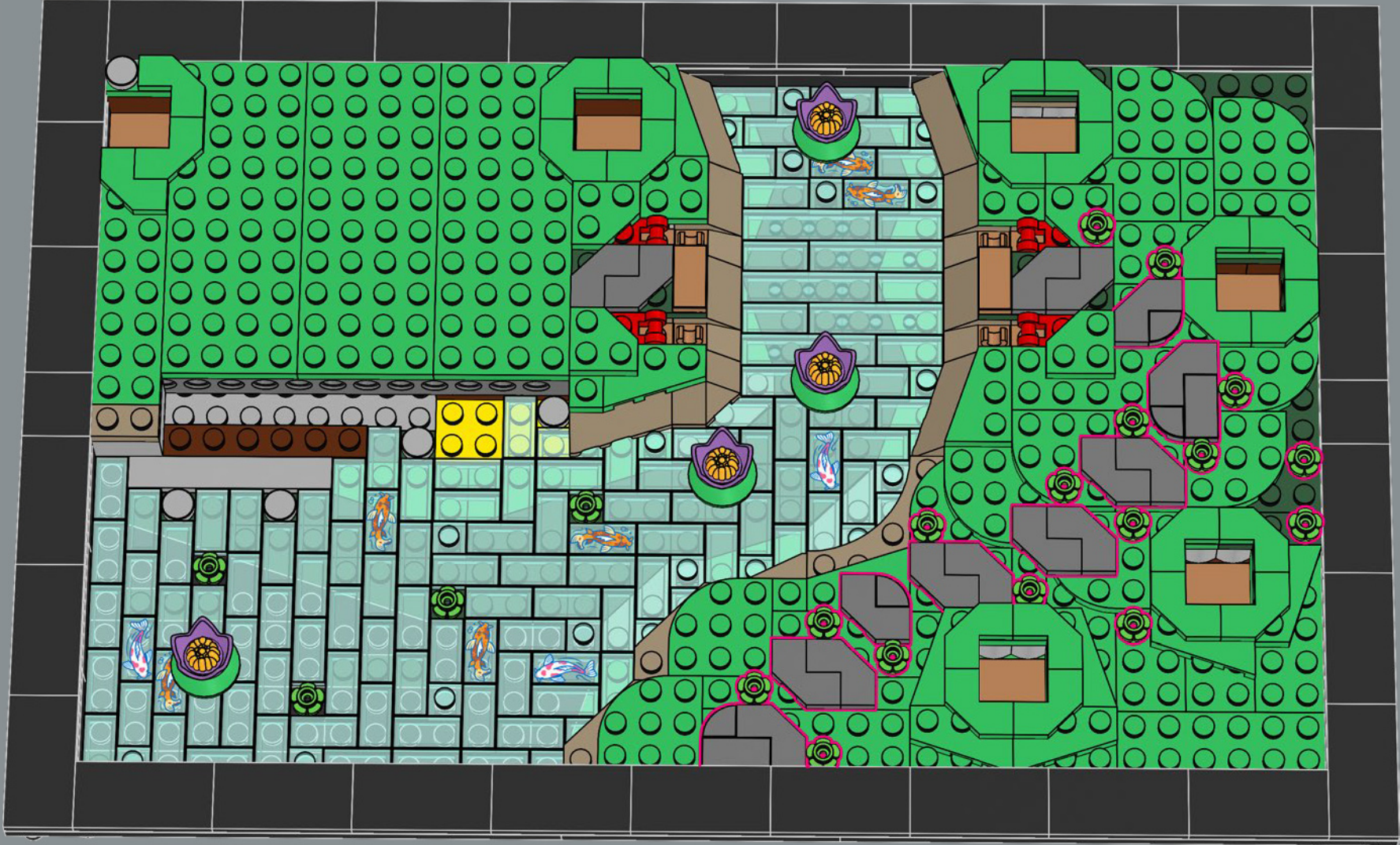

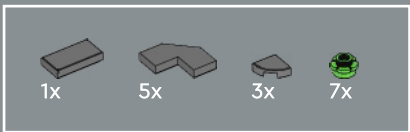

Winding pathways invite you to see the garden
(and maybe other things?) from different perspectives.

101

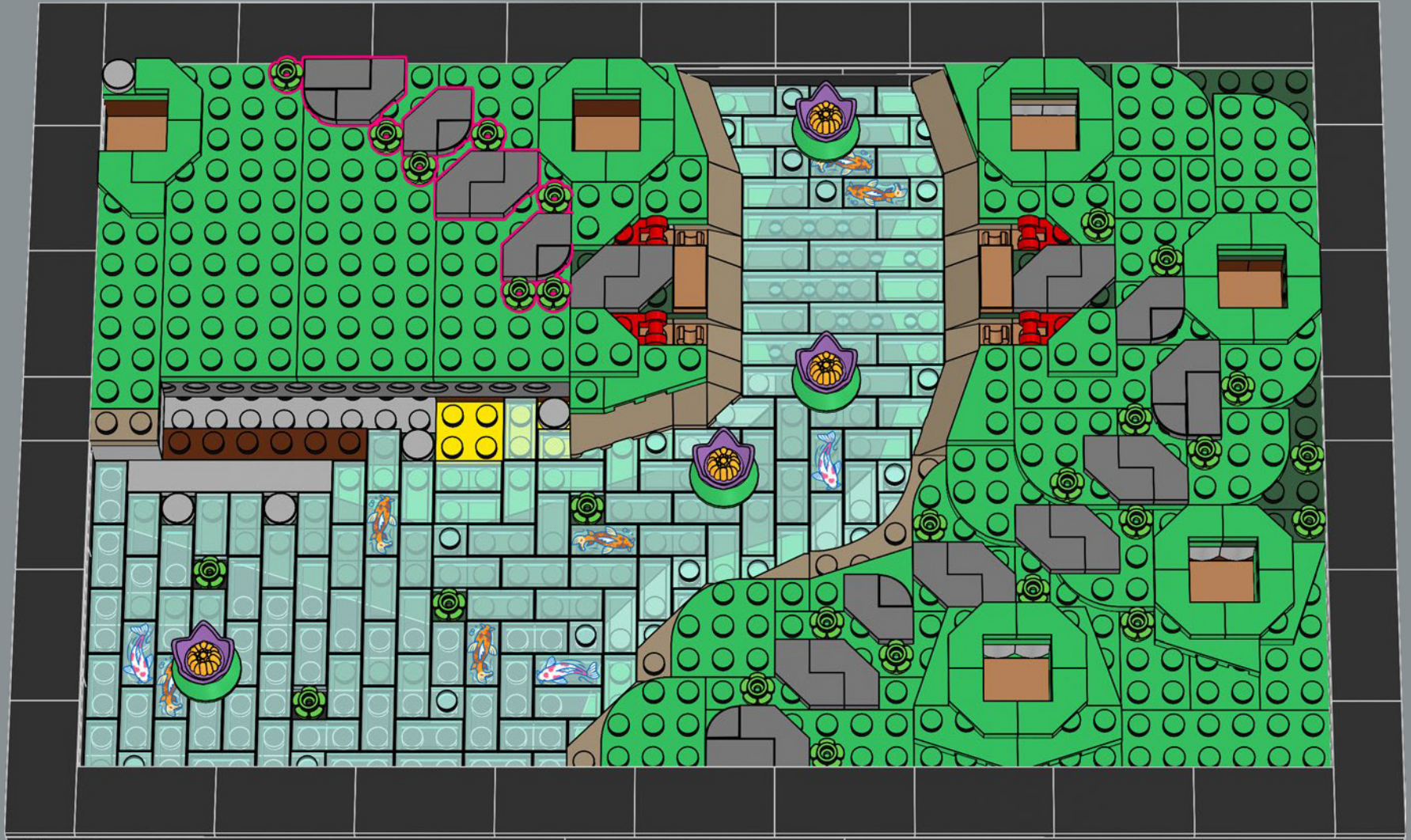

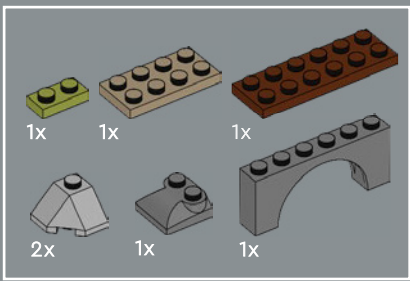

102

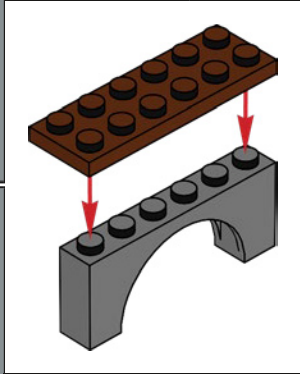

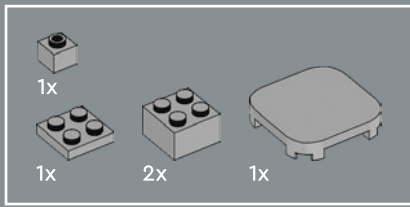

103

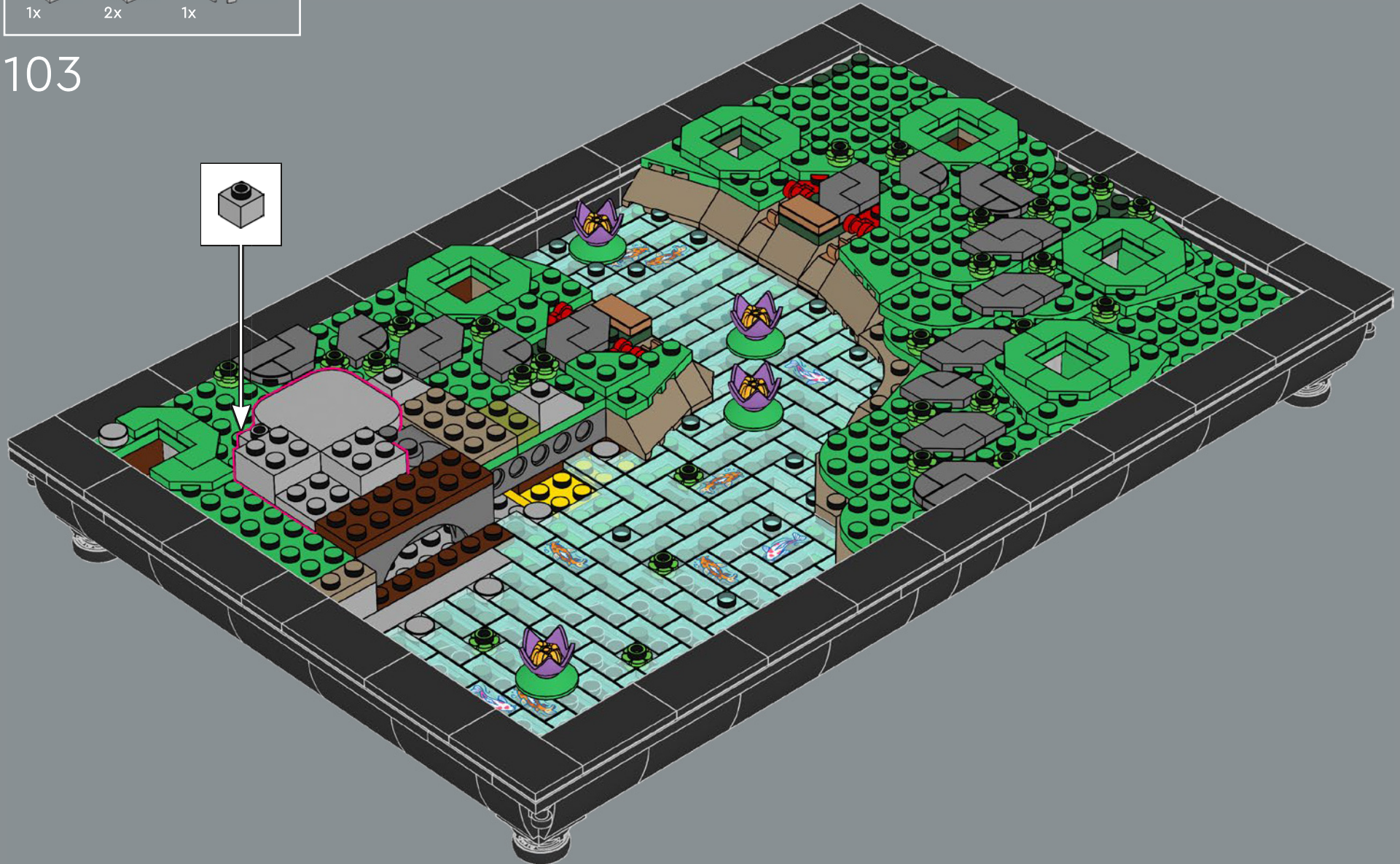

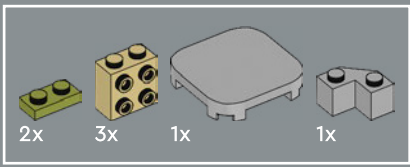

104

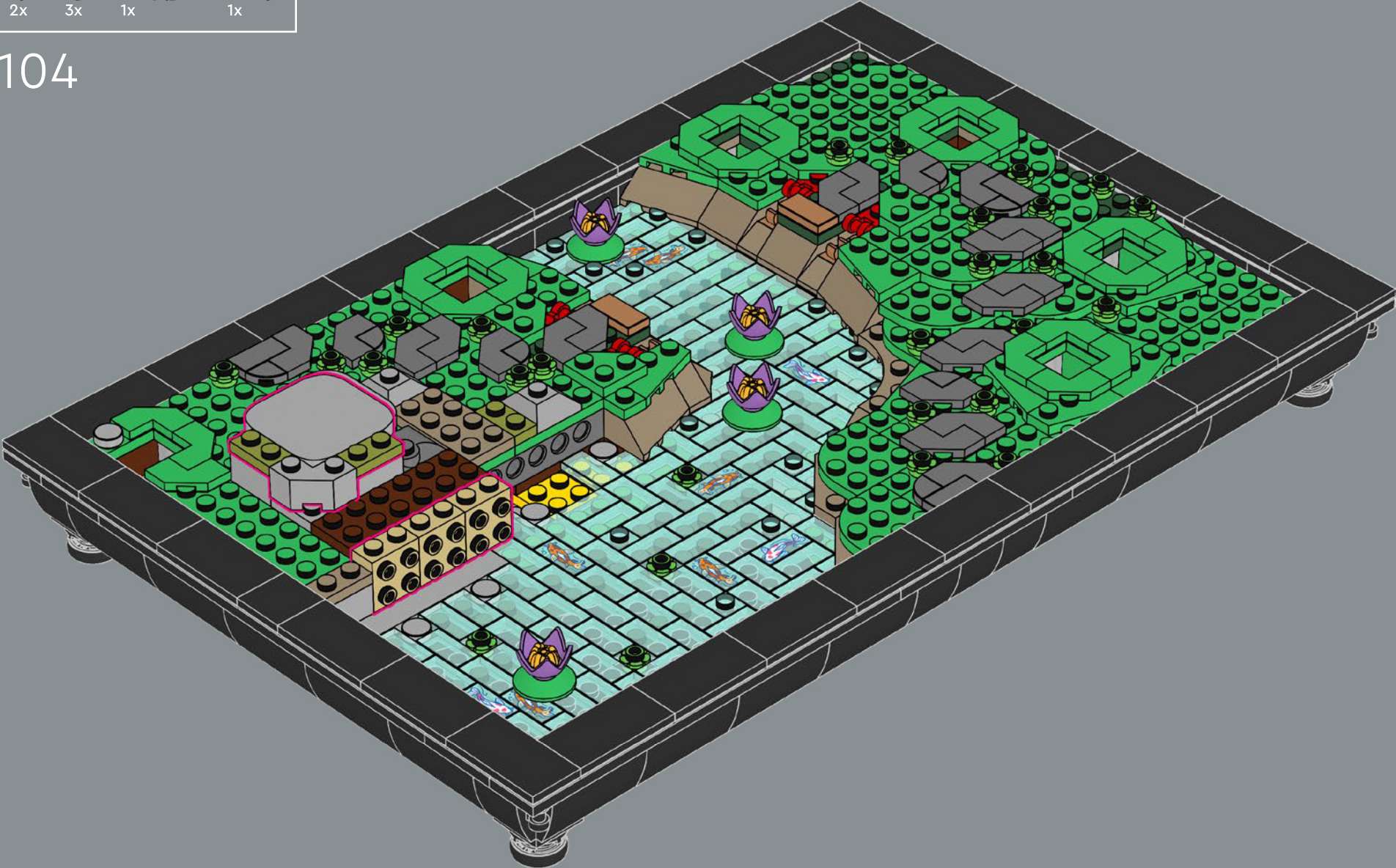

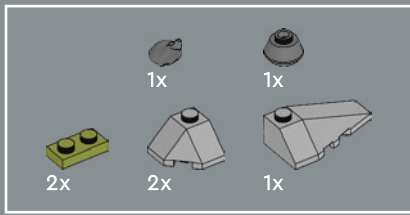

105

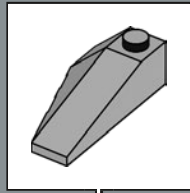

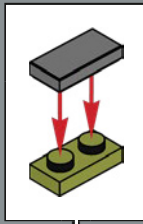
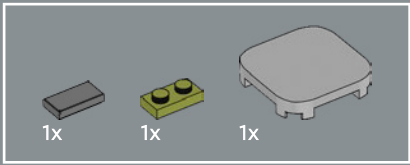

106



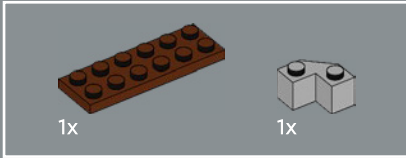
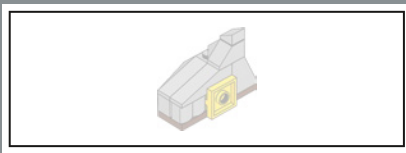

107

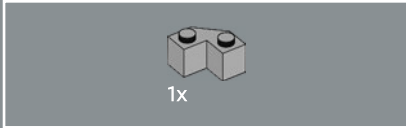
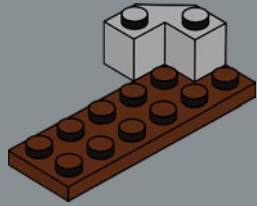

108

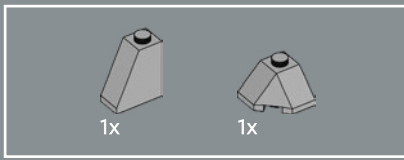
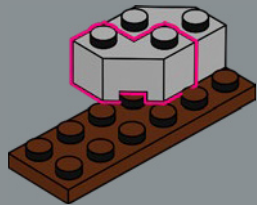

109

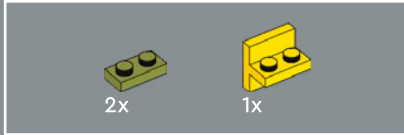
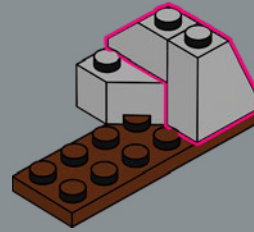

110

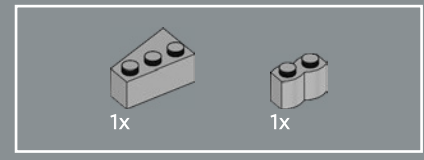
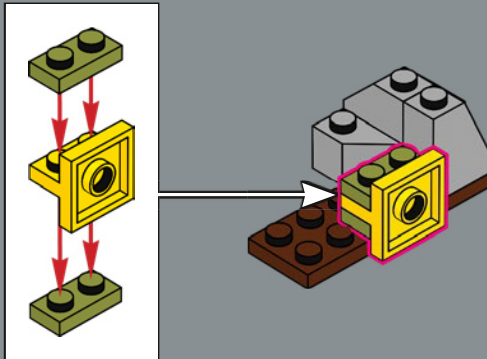

111

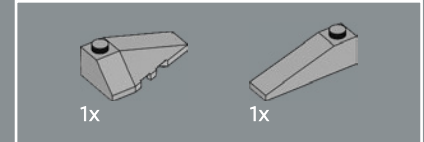
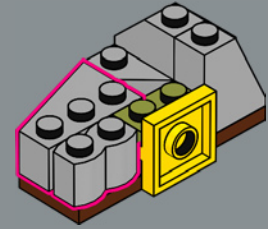

112

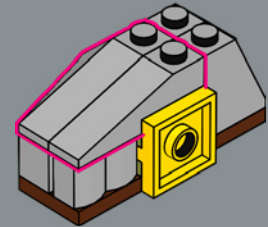

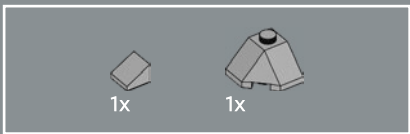

113

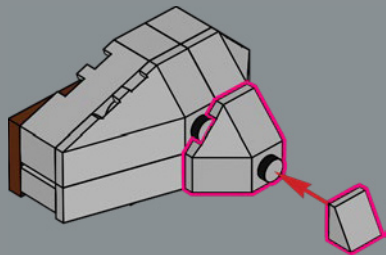

114



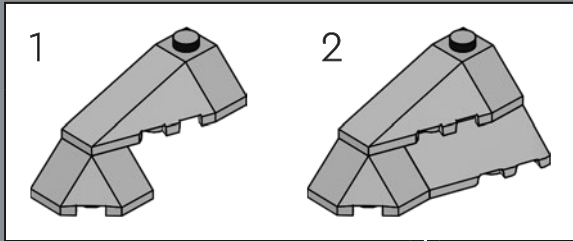
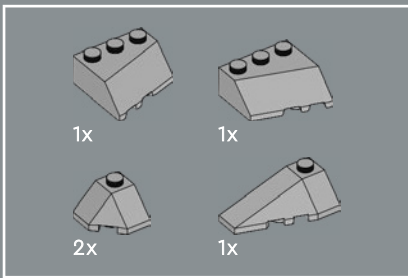

115

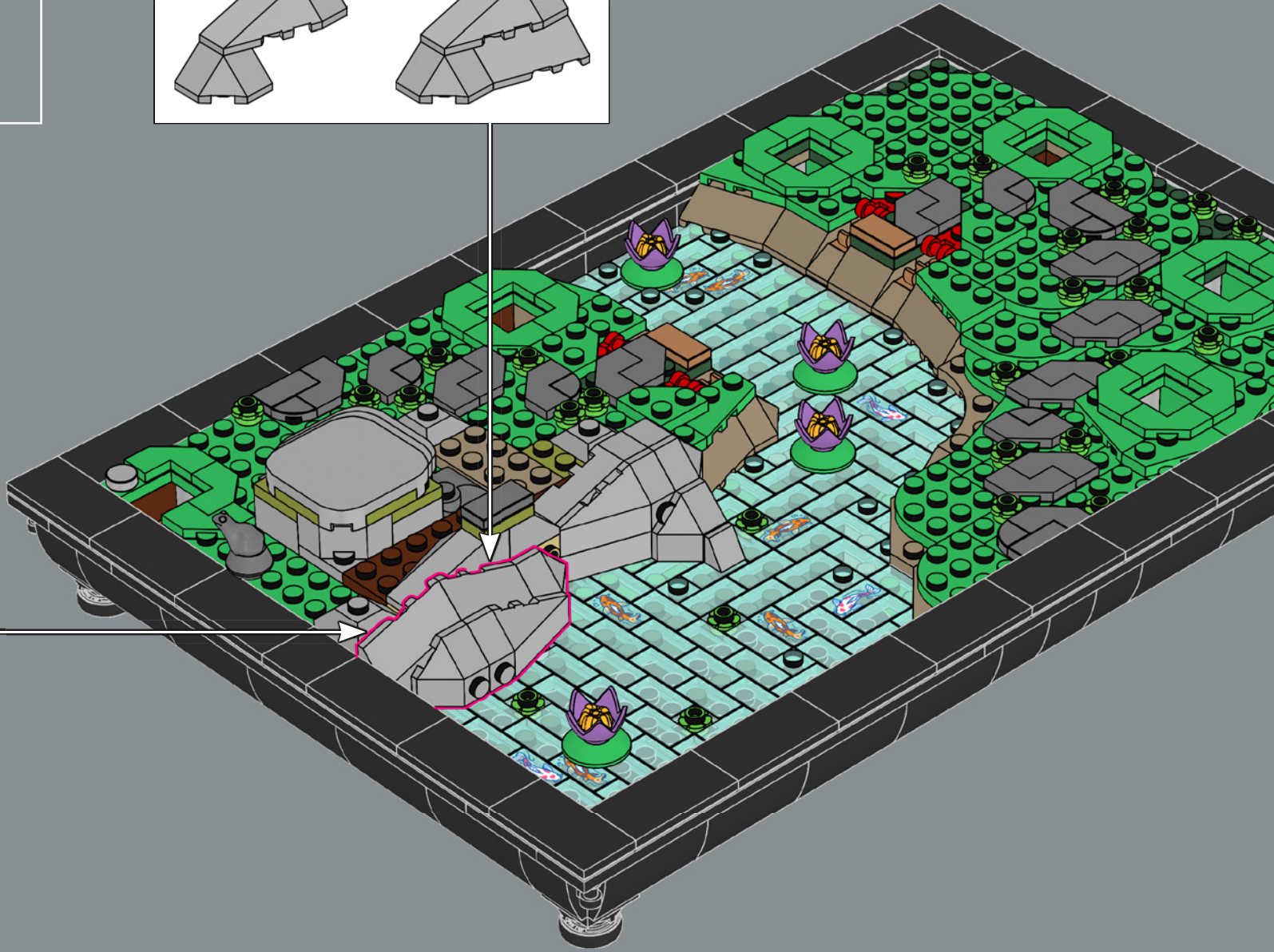
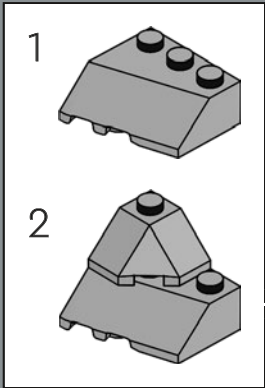

Stones, rocks and sand often bring deeper meaning to the grounds.

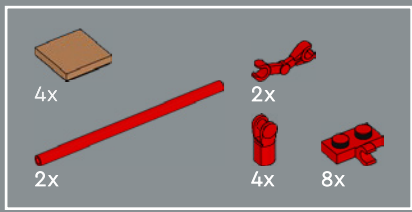

116

1

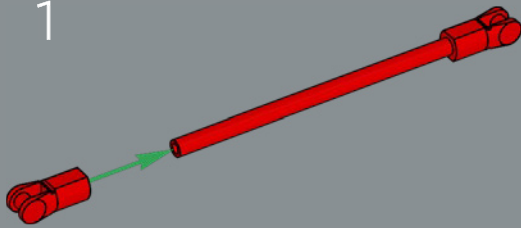

2

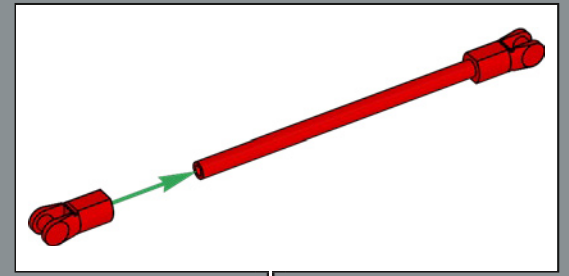
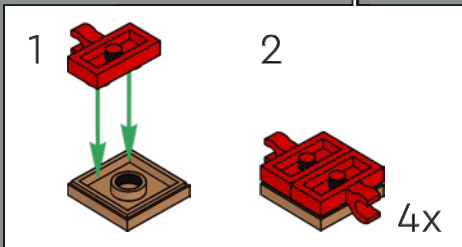
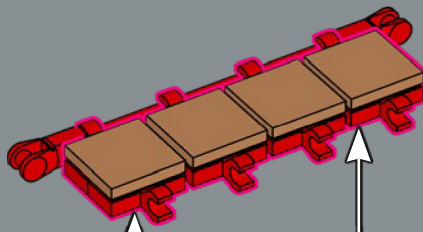

3

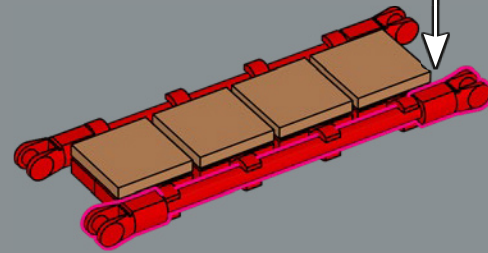

4

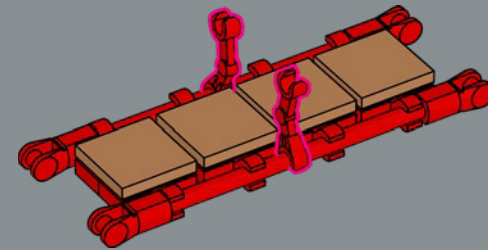

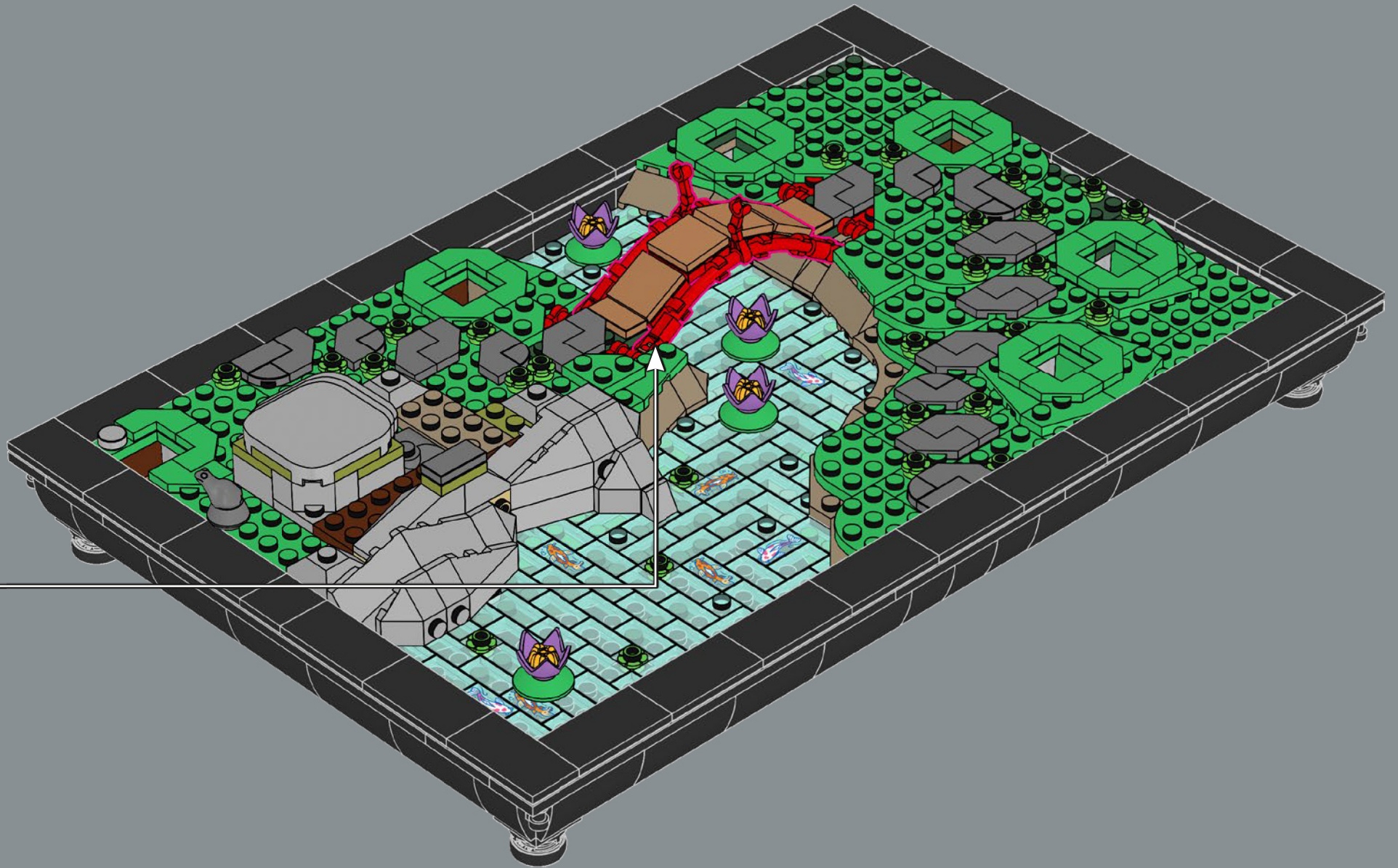

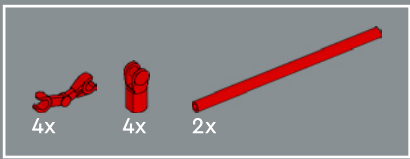

117

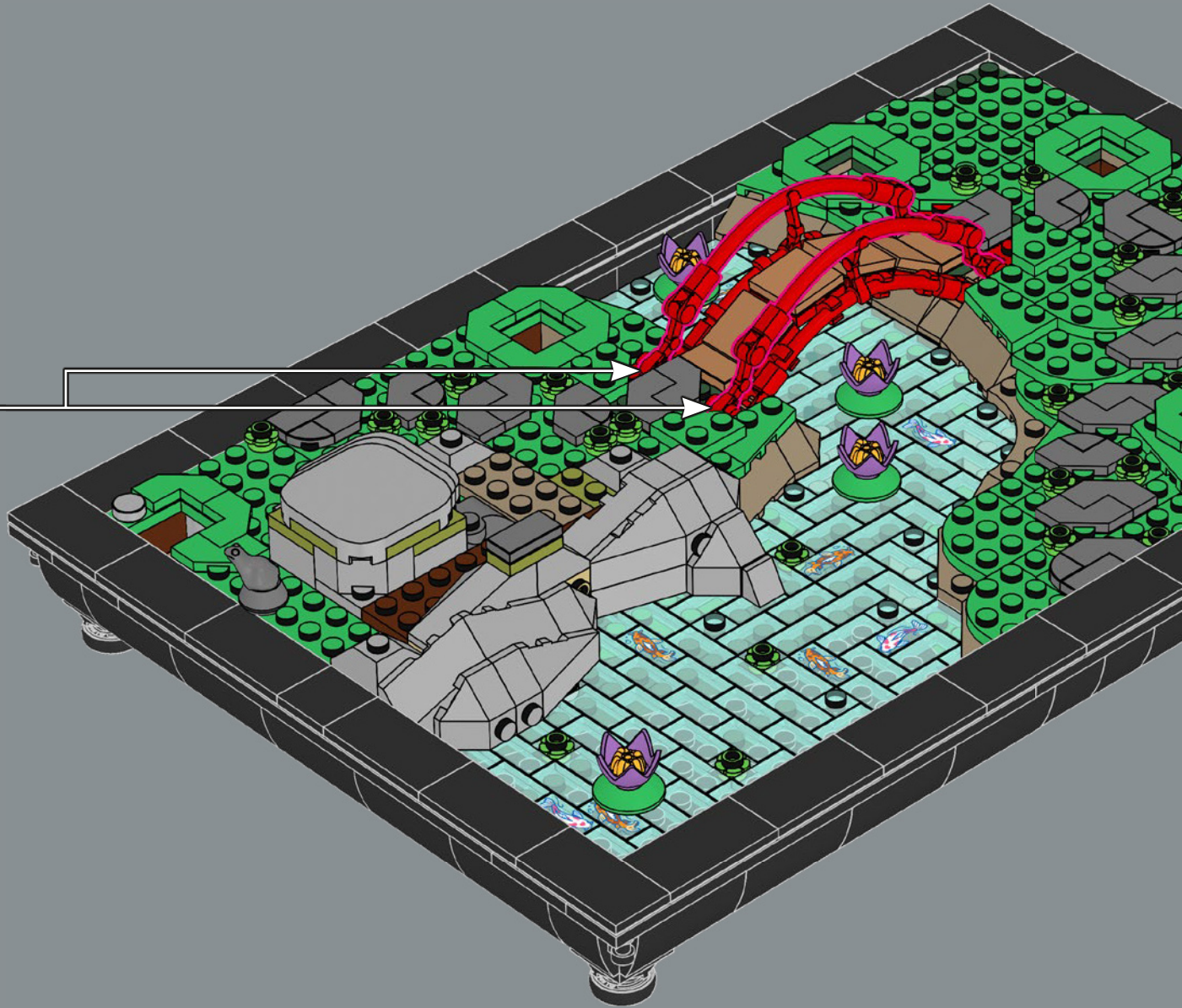
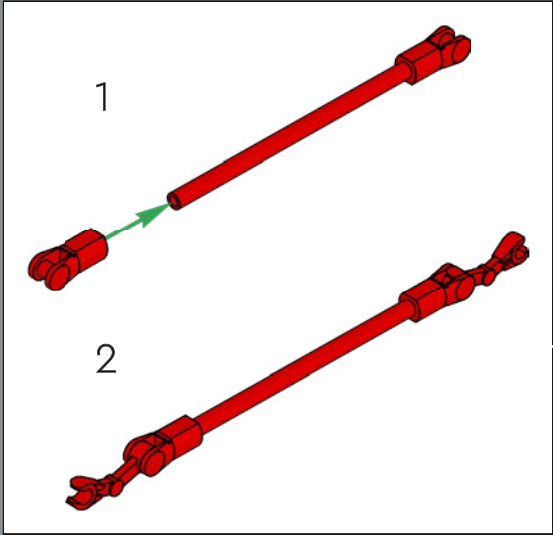

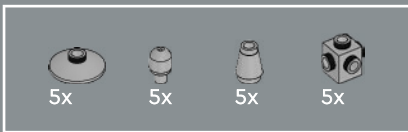

118

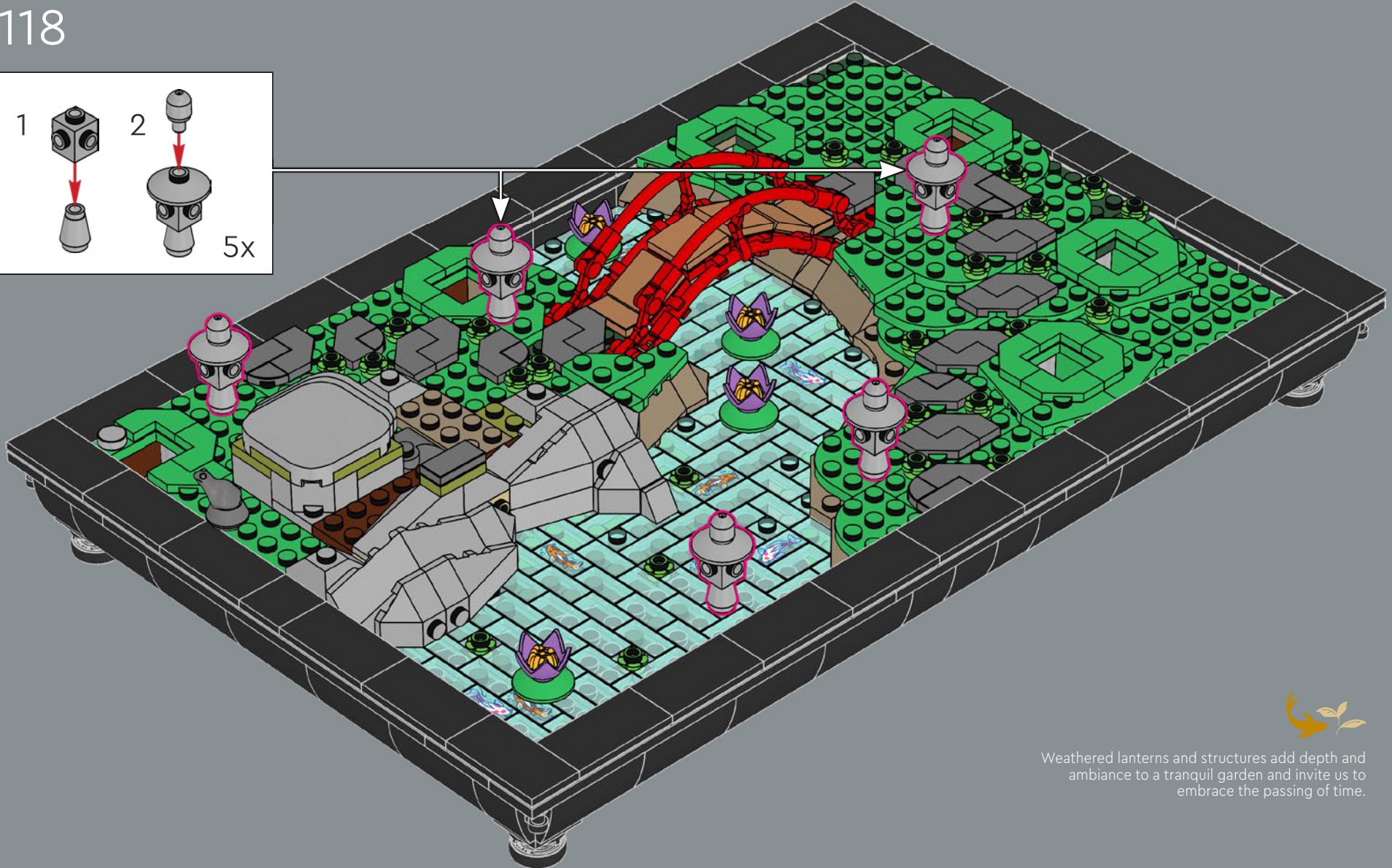
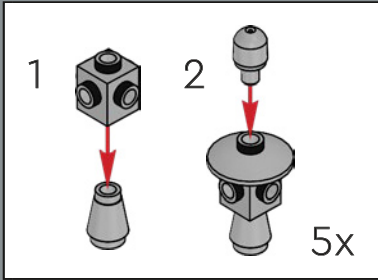

Weathered lanterns and structures add depth and
ambience to a tranquil garden and invite us to
embrace the passing of time.

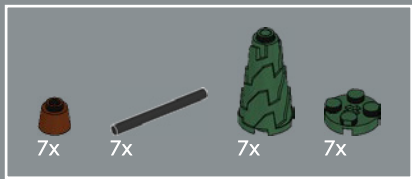

119

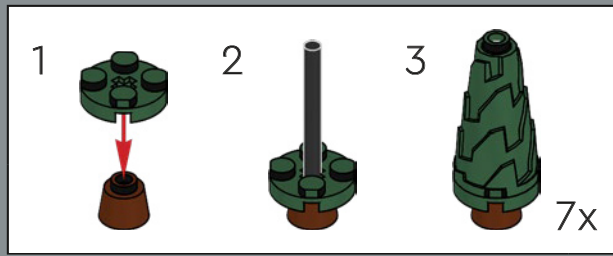

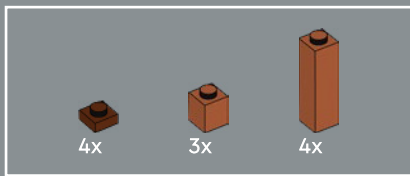

120

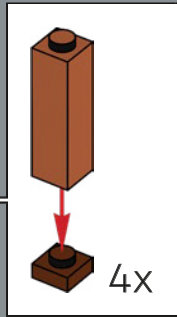
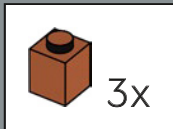

121



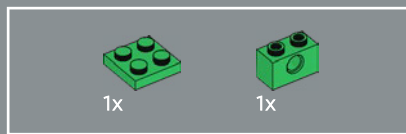
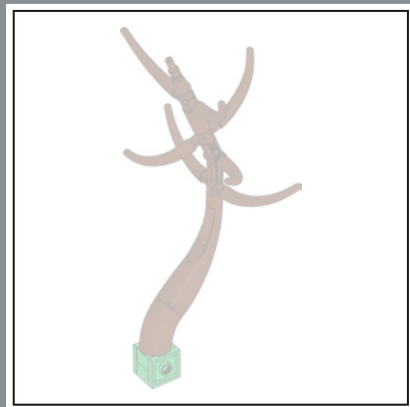

122

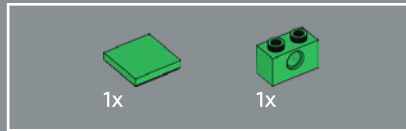
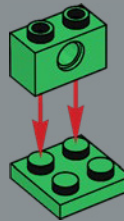

123

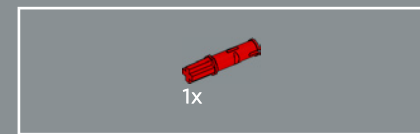
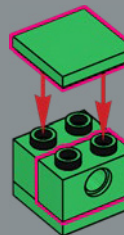

124

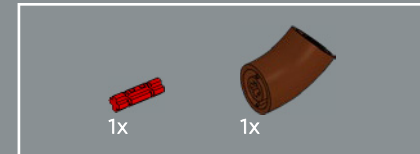
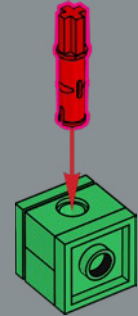

125

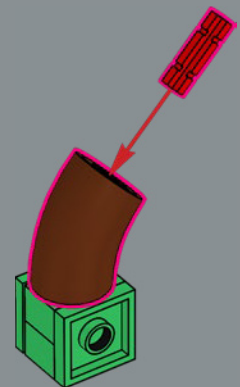

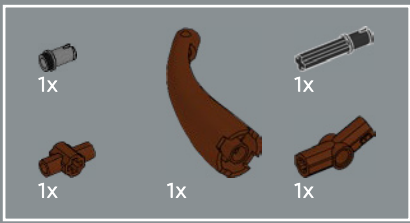

126

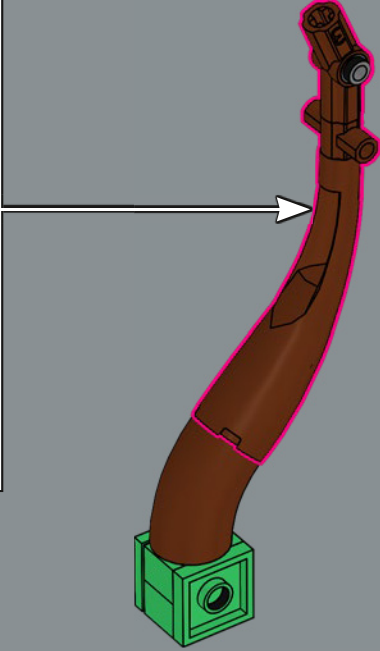
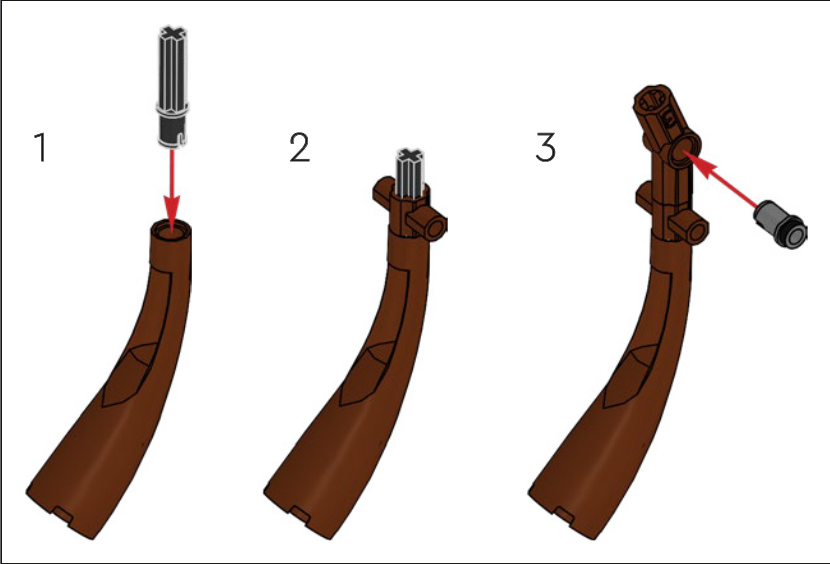

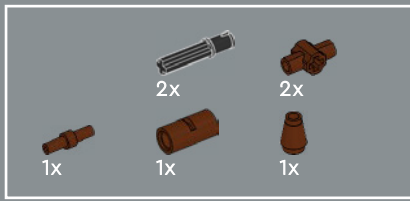

127

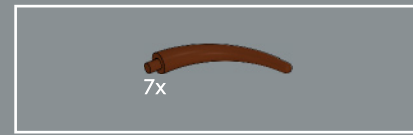
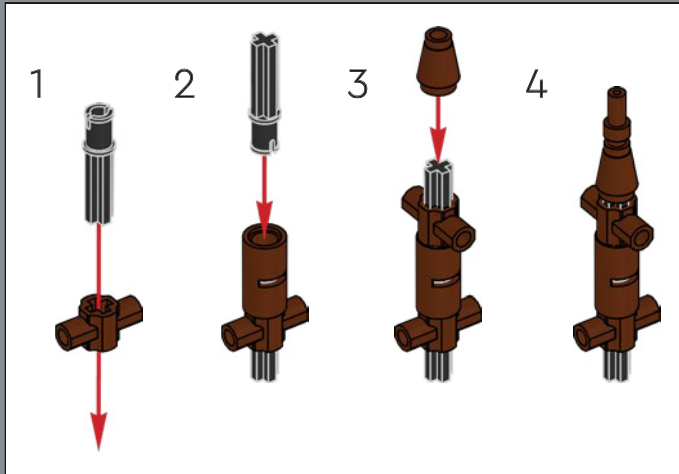

128





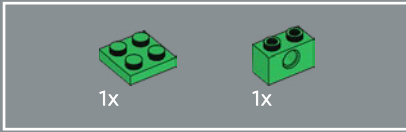
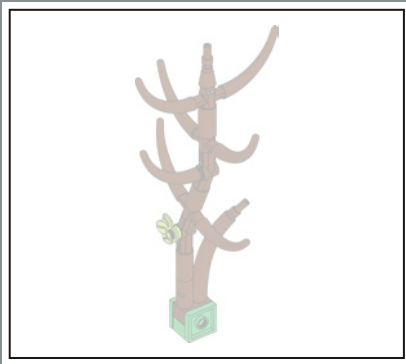

130

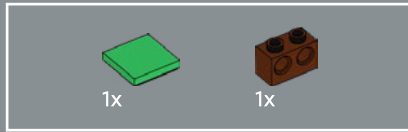
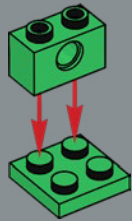

131

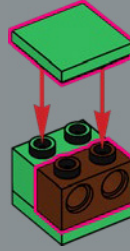

132

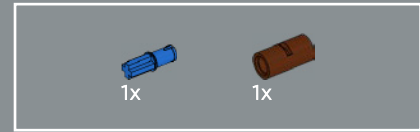
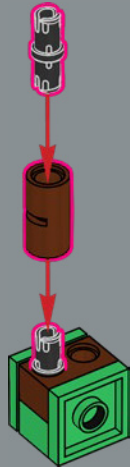

133

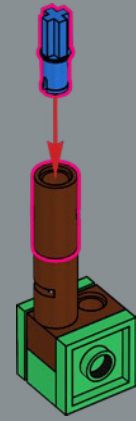

134

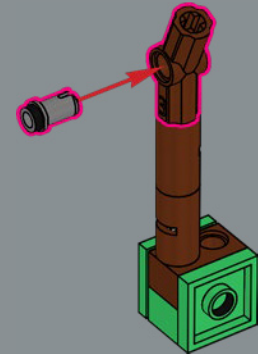

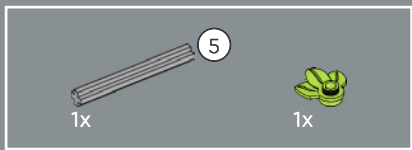

135

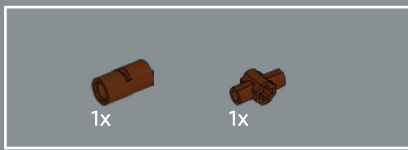
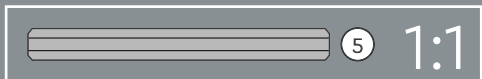

136

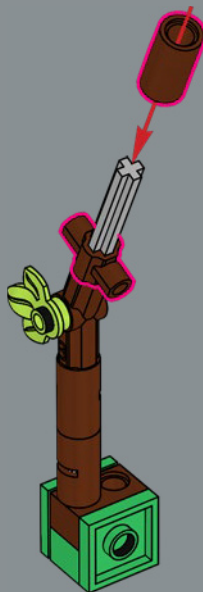

137



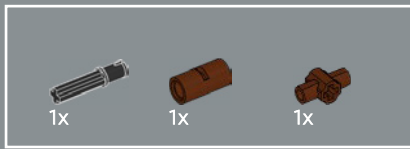

138

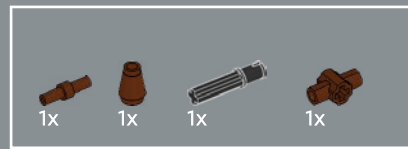
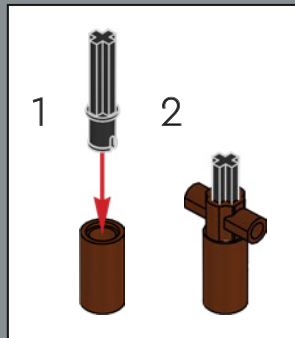

139

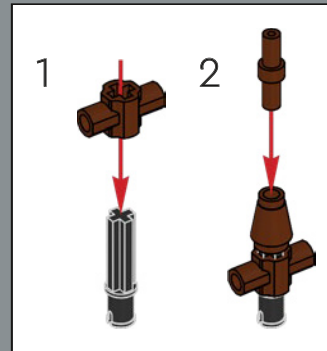

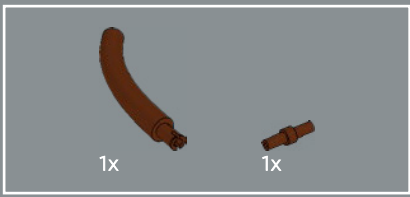

140

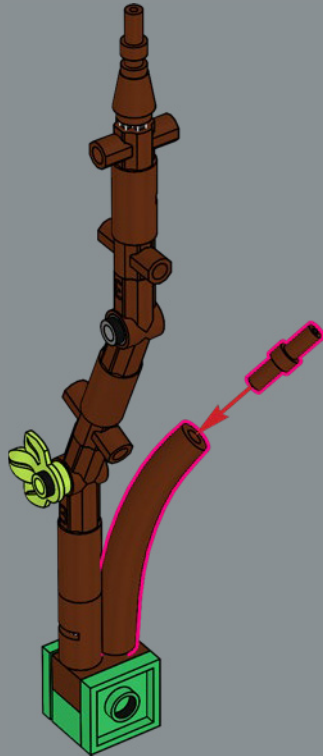

141

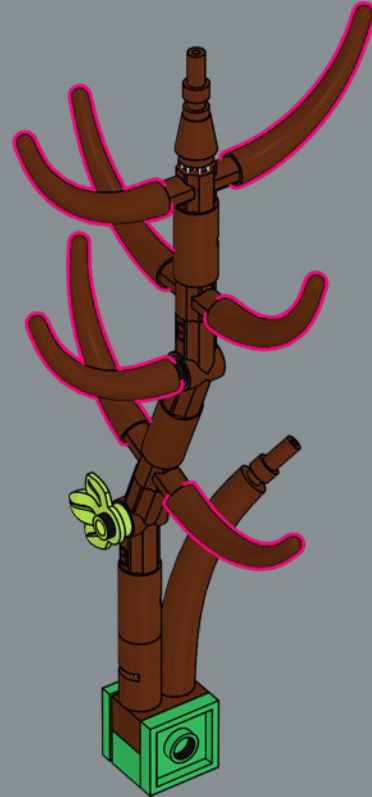

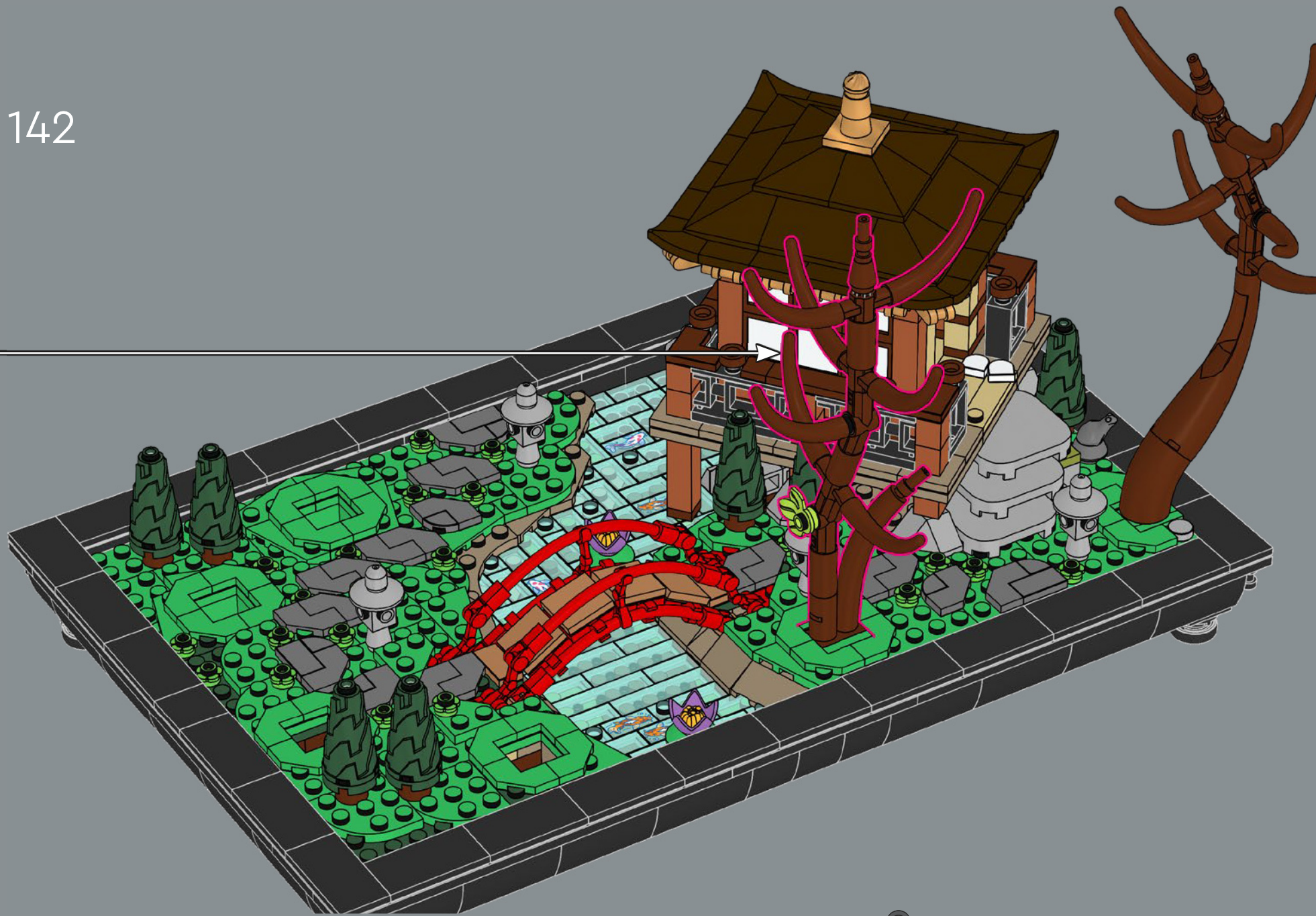

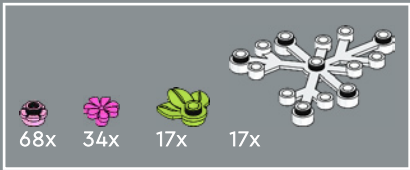

143

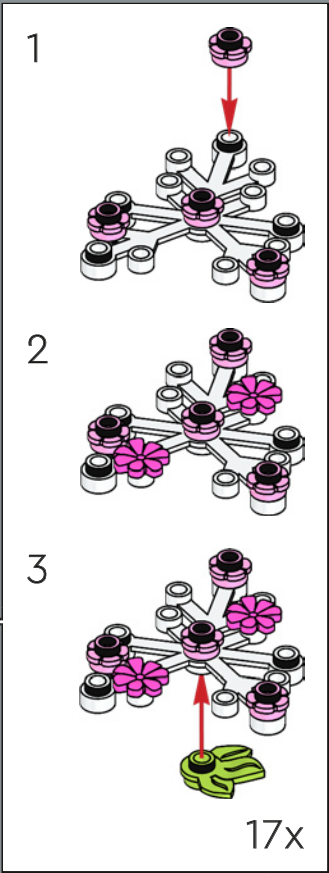

A balance of elements like water, carefully selected plants and different uses of rocks helps create a tranquil environment in your garden.

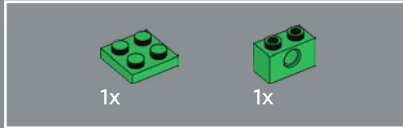
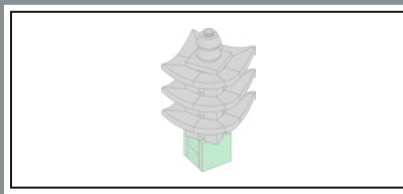

144

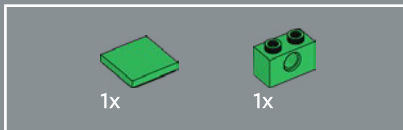
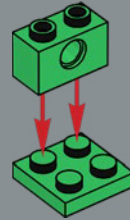

145

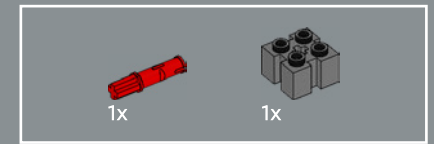
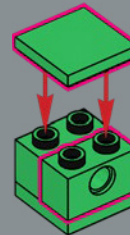

146

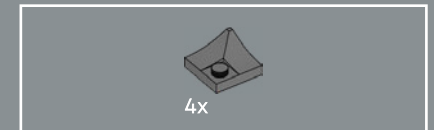
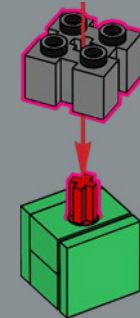

147

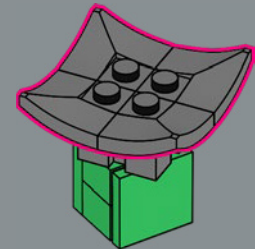

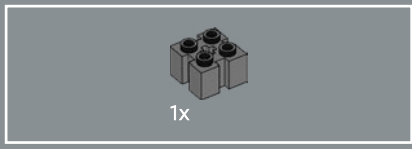

148

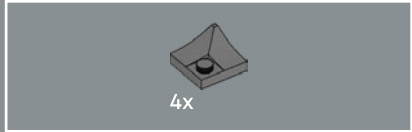
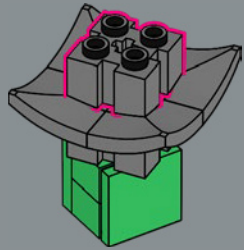

149

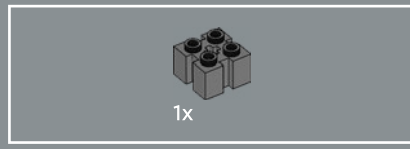
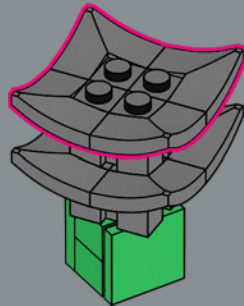

150

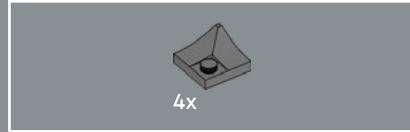
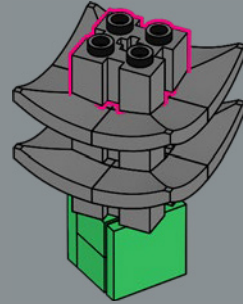

151

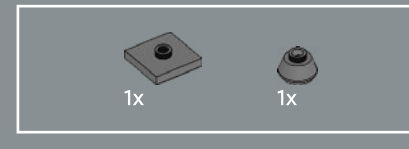
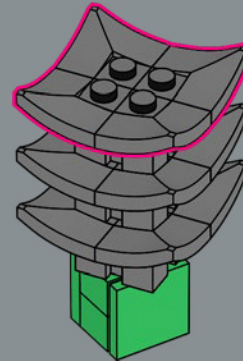

152

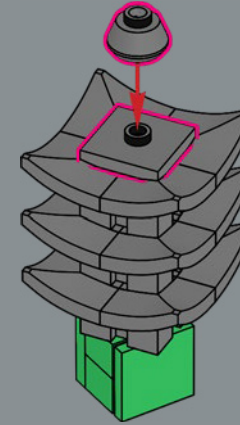

153

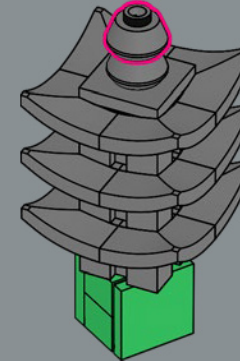

154



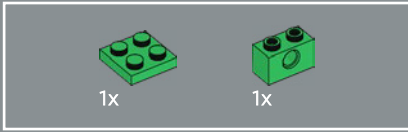
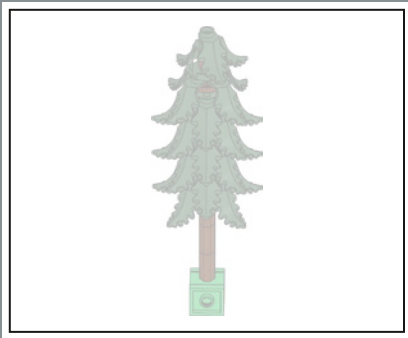

155

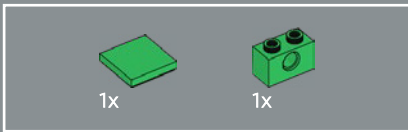
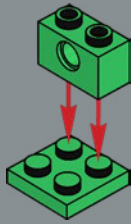

156

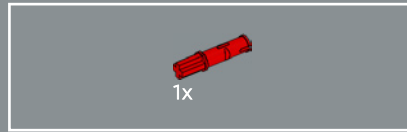
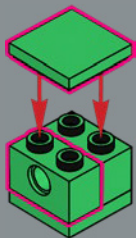

157

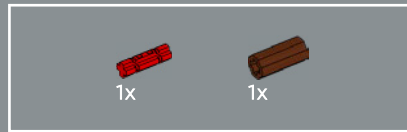
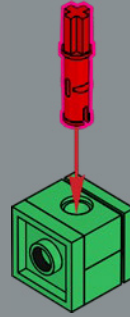

158

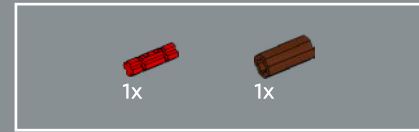
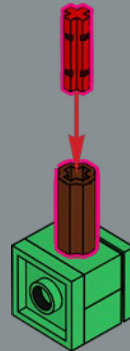

159

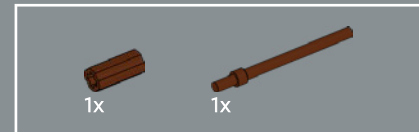
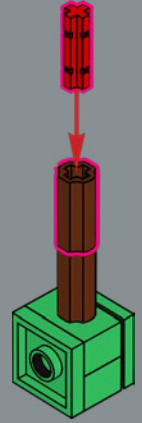

160

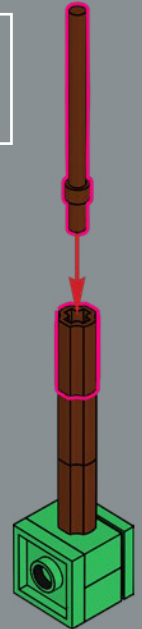



161

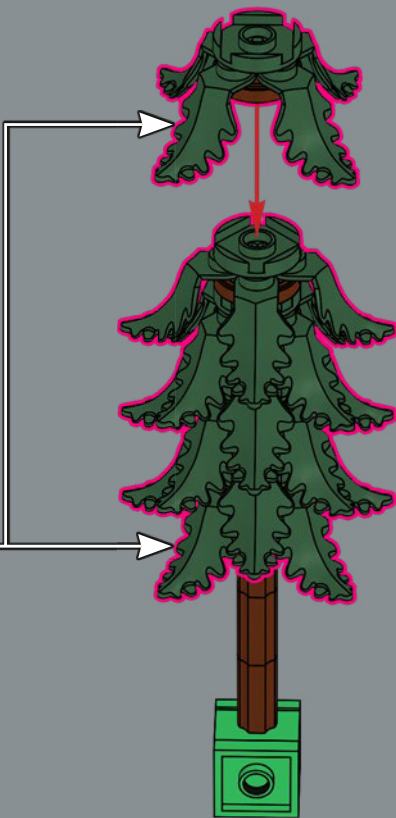

162

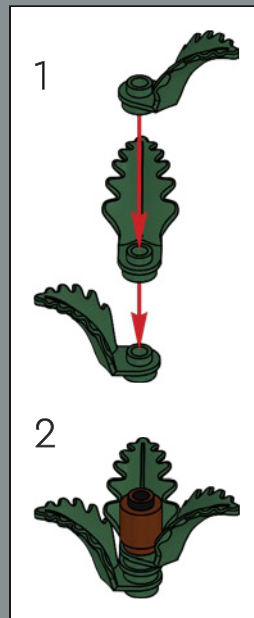



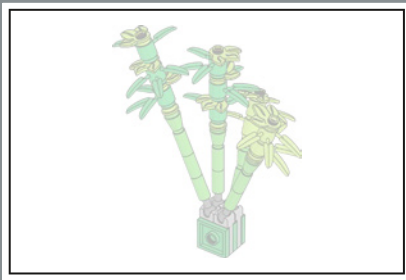

164

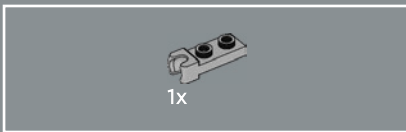
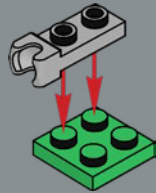

165

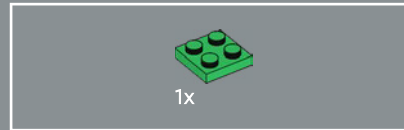
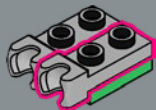

166

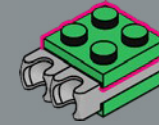

167

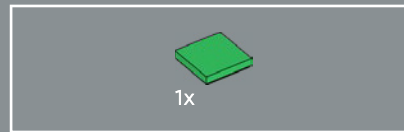
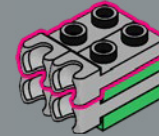

168

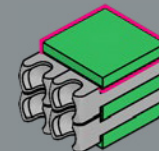



169

1



2

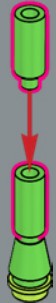

3

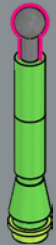

4



5

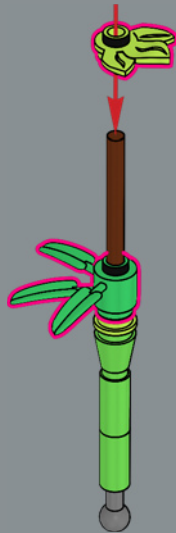

6

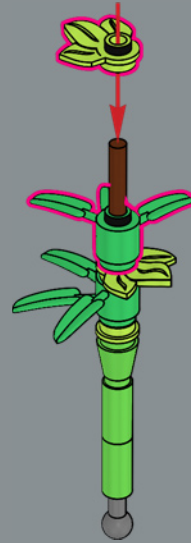

7

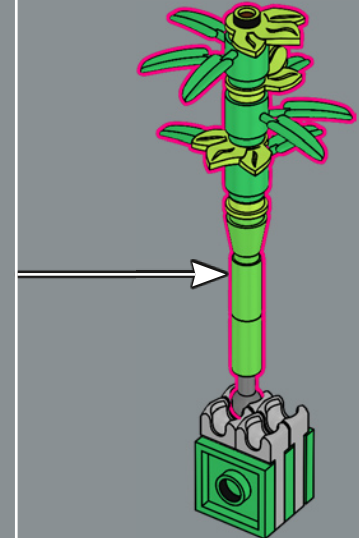
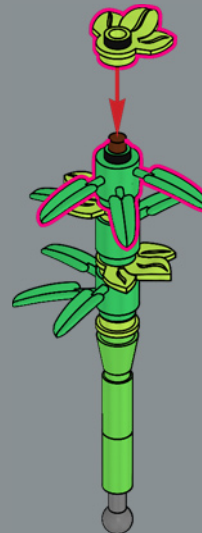

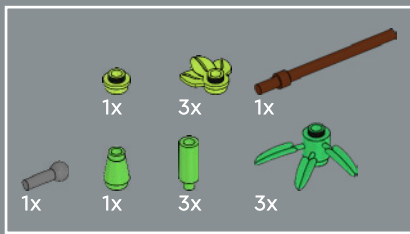

170 1

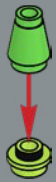

2

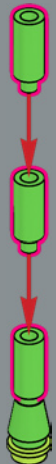

3



4



5

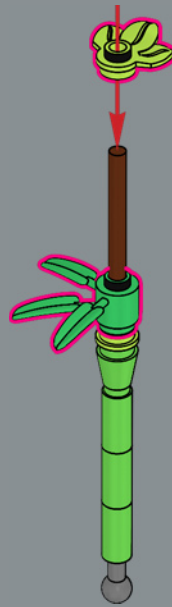

6

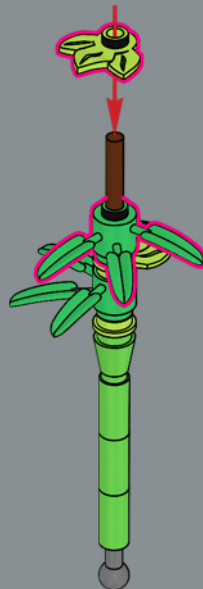

7

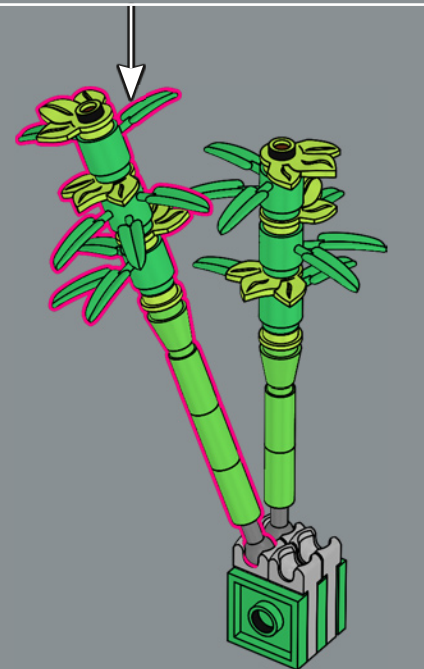

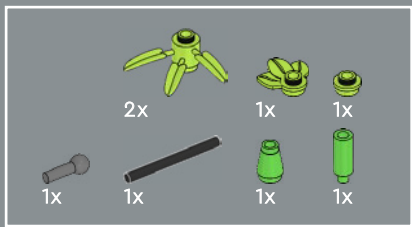

171

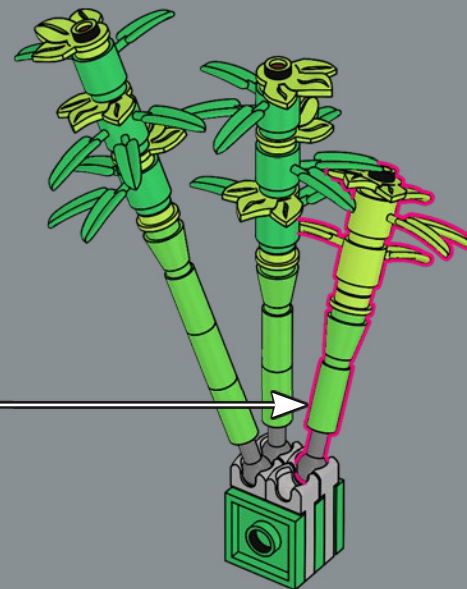
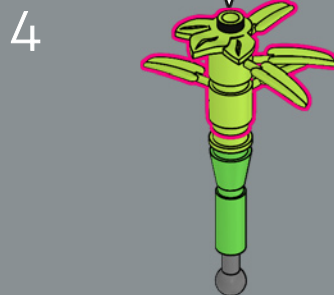
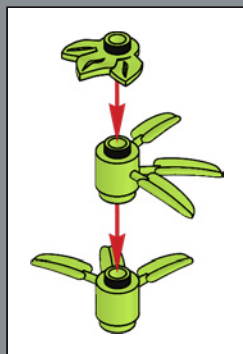
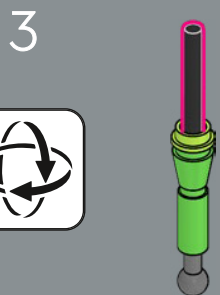
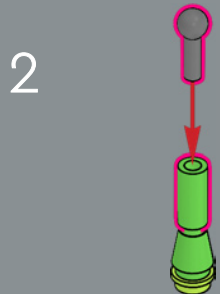
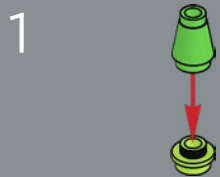

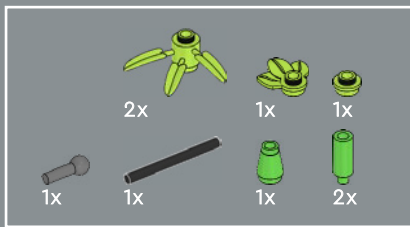

172

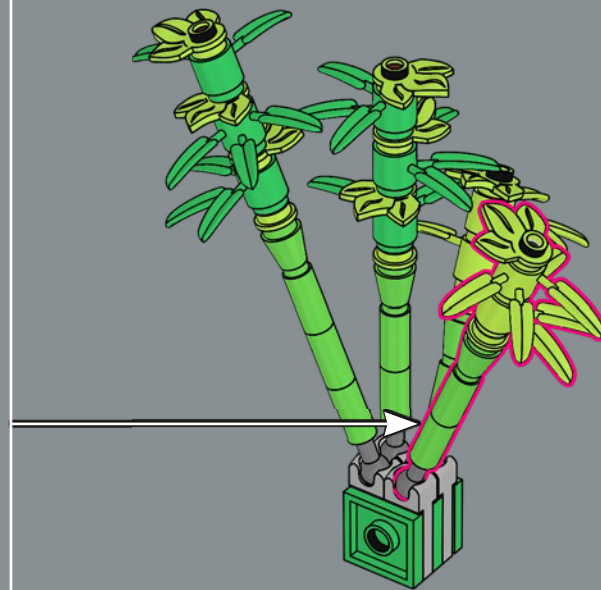
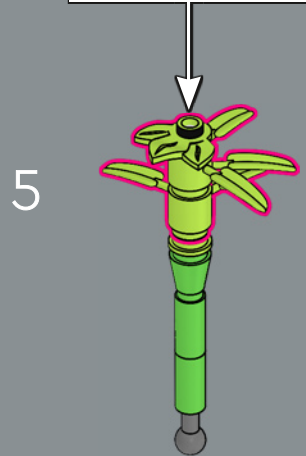
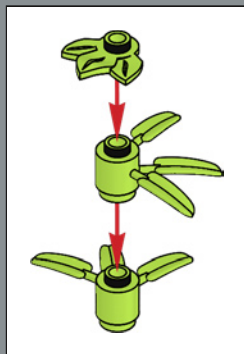
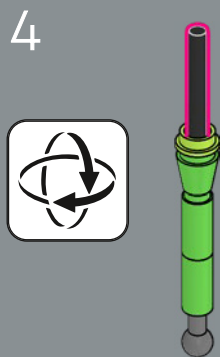
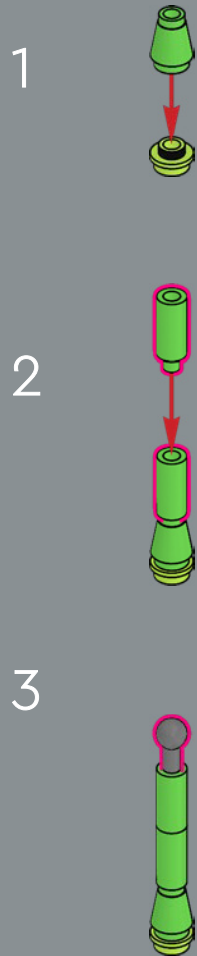



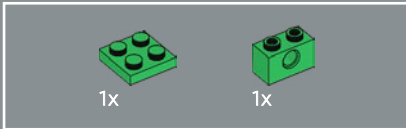
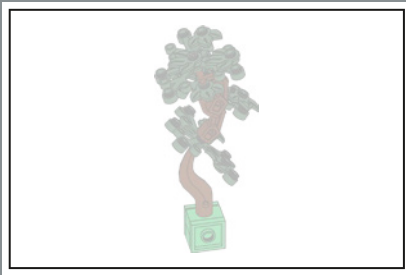

174

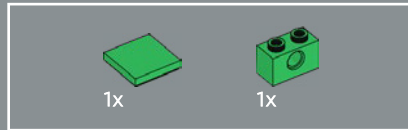
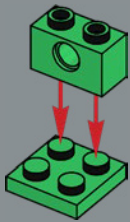

175

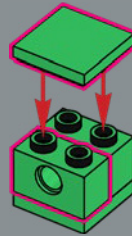

176

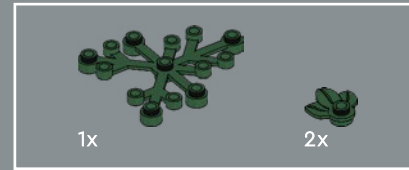
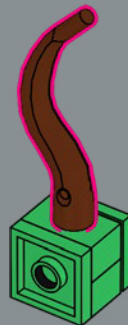

177

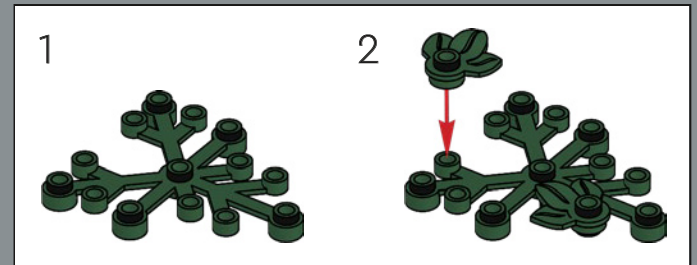

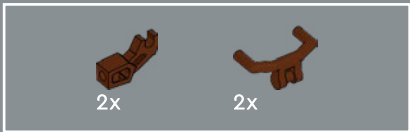

178

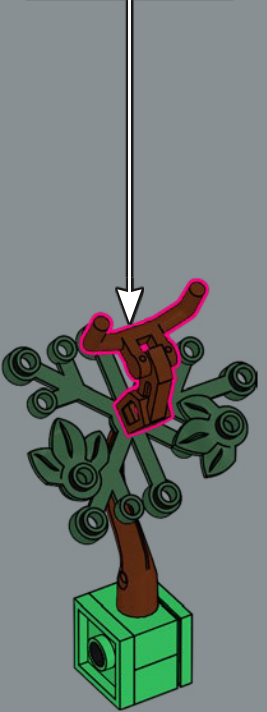
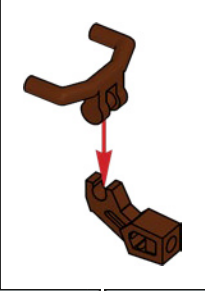

179

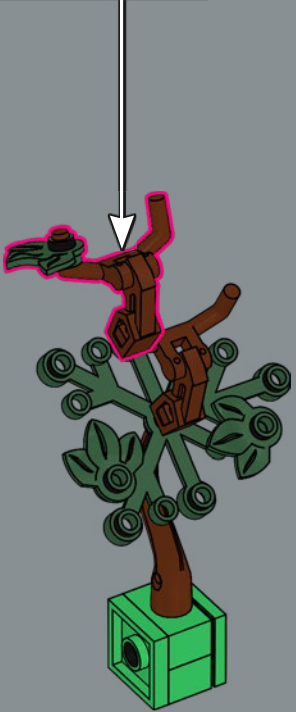
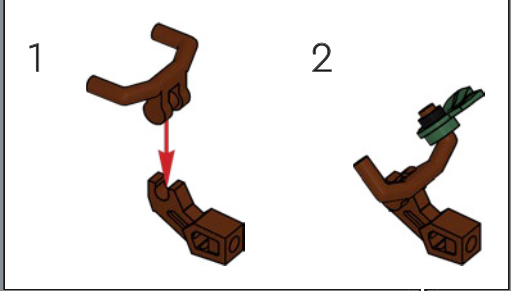

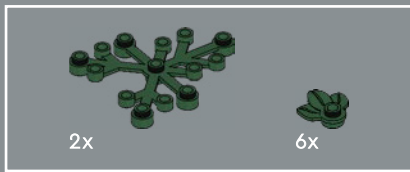

180

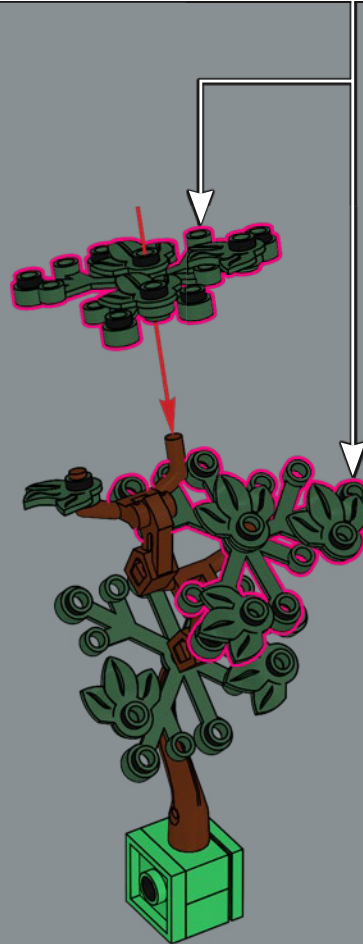
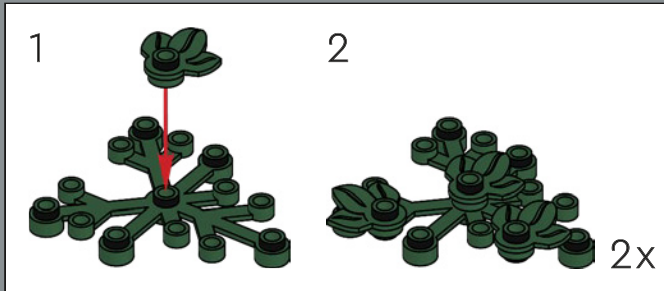



Want to add your personal touch to your model?
Be inspired by the five principles of tranquil gardens:
enclosure, balance, borrowed scenery, symbolism
and asymmetry.

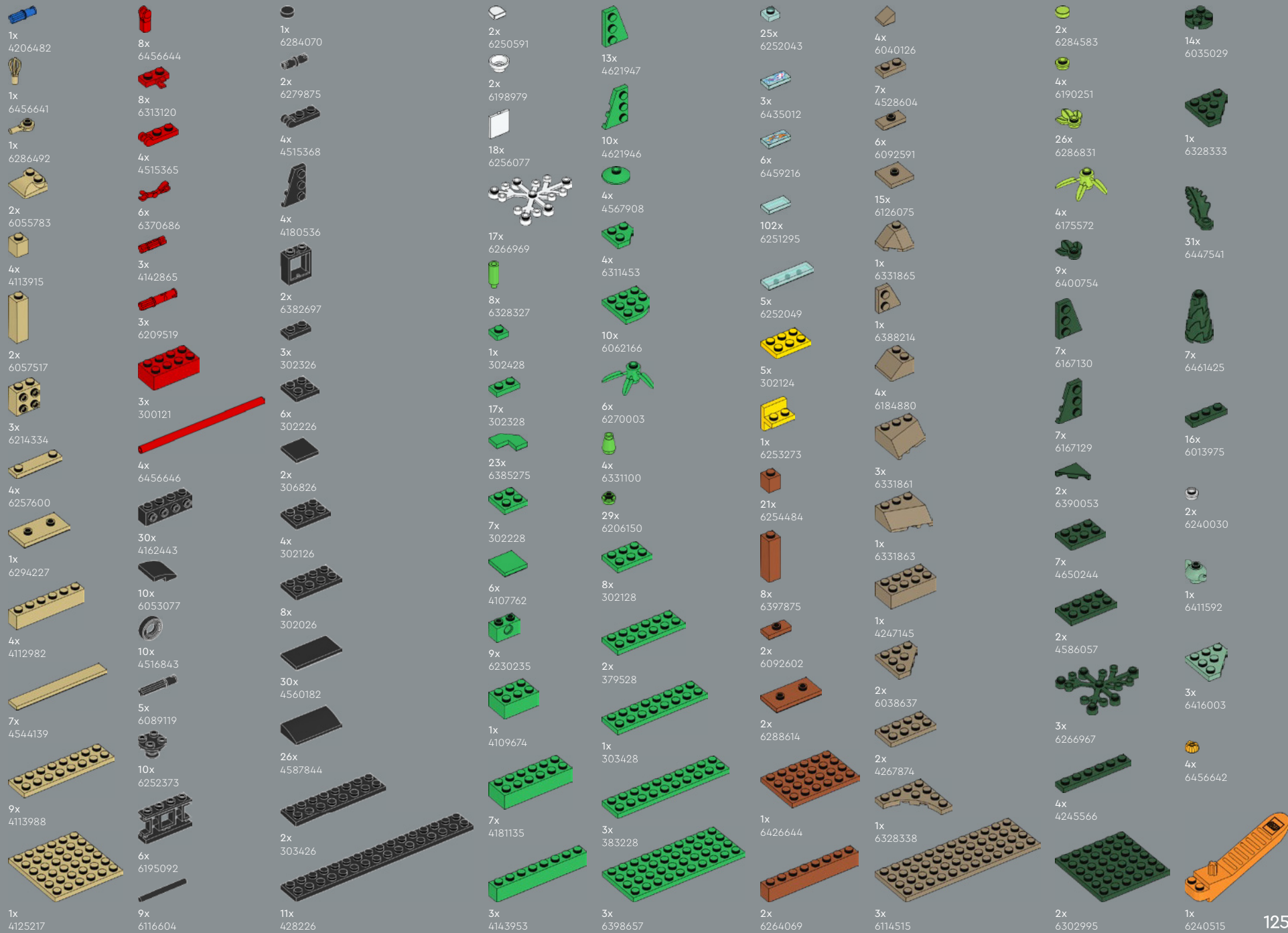

- 1x 4211183
- 3x 4211288
- 4x 4221744
- 1x 6151461
- 14x 4211190
- 5x 4216945
- 1x 4211214
- 2x 4225715
- 3x 6258989

- 1x 6348057
- 2x 4529242
- 7x 6173143
- 7x 6102360
- 3x 6451002
- 3x 4531751
- 2x 6276868
- 18x 6382102
- 1x 6326087
- 1x 6383996
- 1x 6327811

- 9x 6186673
- 12x 4211257
- 4x 6221608
- 2x 6327818
- 5x 6173132
- 3x 6261388
- 5x 4211200
- 3x 4211194
- 6x 6459423
- 3x 6170468
- 1x 6292952
- 14x 6372430
- 1x 6070442
- 8x 4211247

- 8x 4550325
- 5x 4211387
- 5x 4211511
- 3x 4651063
- 1x 4526932
- 1x 4521921
- 1x 4515374
- 8x 6034676
- 1x 6013497
- 1x 6315580
- 2x 4180418
- 1x 6315579

- 1x 4180408
- 1x 6401023
- 1x 4211397
- 1x 4211549
- 1x 4211639
- 5x 4211512
- 2x 4211400
- 2x 4598522
- 2x 4620130

5

- 5x 6284071
- 5x 6212288
- 5x 4529241
- 4x 4211353
- 4x 6043639
- 3x 6354325

- 3x 6395635
- 4x 6364352
- 7x 6199549
- 3x 6340333
- 1x 6171103
- 1x 4218696
- 1x 6126083
- 4x 4211052
- 21x 6177079
- 3x 6236949
- 12x 6447212
- 1x 4211100
- 1x 6106191
- 2x 4210678
- 1x 4211137

- 8x 6016483
- 34x 6206151
- 68x 6212501
- 1x 6186383
- 4x 6212377
- 16x 6279731
- 1x 6190252
- 2x 6173139
- 1x 6050916

- 8x 6456639
- 4x 6456643
- 4x 6456663
- 16x 6347604
- 2x 6021997
- 10x 6102990
- 4x 6347304
- 1x 6363146
- 4x 6456640



LEGO.com/service



YOU COULD WIN



YOU COULD WIN

Your feedback will help shape the future development of this product series.

Visit:

DU KÖNNTEST GEWINNEN

Dein Feedback trägt zur Weiterentwicklung dieser Produktreihe bei.

Geh auf:

VOUS POURRIEZ GAGNER

Vos commentaires nous aideront à concevoir les futurs produits de cette gamme.

Visitez :

POTRESTI VINCERE TU

La tua opinione ci aiuterà a migliorare la creazione futura di questa linea di prodotti.

Visita:

PUEDES GANAR

Tu opinión contribuirá al futuro de esta serie de productos.

Visita:

轻松获奖

您的反馈将有助于我们在今后改进本产品系列。

请访问:

[LEGO.com/productfeedback](https://www.lego.com/productfeedback)

You also have the chance to win a LEGO® set.

Terms and conditions apply.*

Außerdem hast du die Chance, ein LEGO® Set zu gewinnen.

Es gelten die Teilnahmebedingungen.*

Vous pourriez également gagner un ensemble LEGO®.

Des conditions s'appliquent.*

Hai anche la possibilità di vincere un set LEGO®.

Termini e condizioni sono applicabili.*

También tienes la oportunidad de ganar un set LEGO®.

Aplican términos y condiciones.*

您还有机会赢取乐高®套装。

条款和条件适用。*

*[LEGO.com/productfeedback-terms](https://www.lego.com/productfeedback-terms)



LEGO and the LEGO logo are trademarks of the LEGO Group.
©2023 The LEGO Group.

6491749