

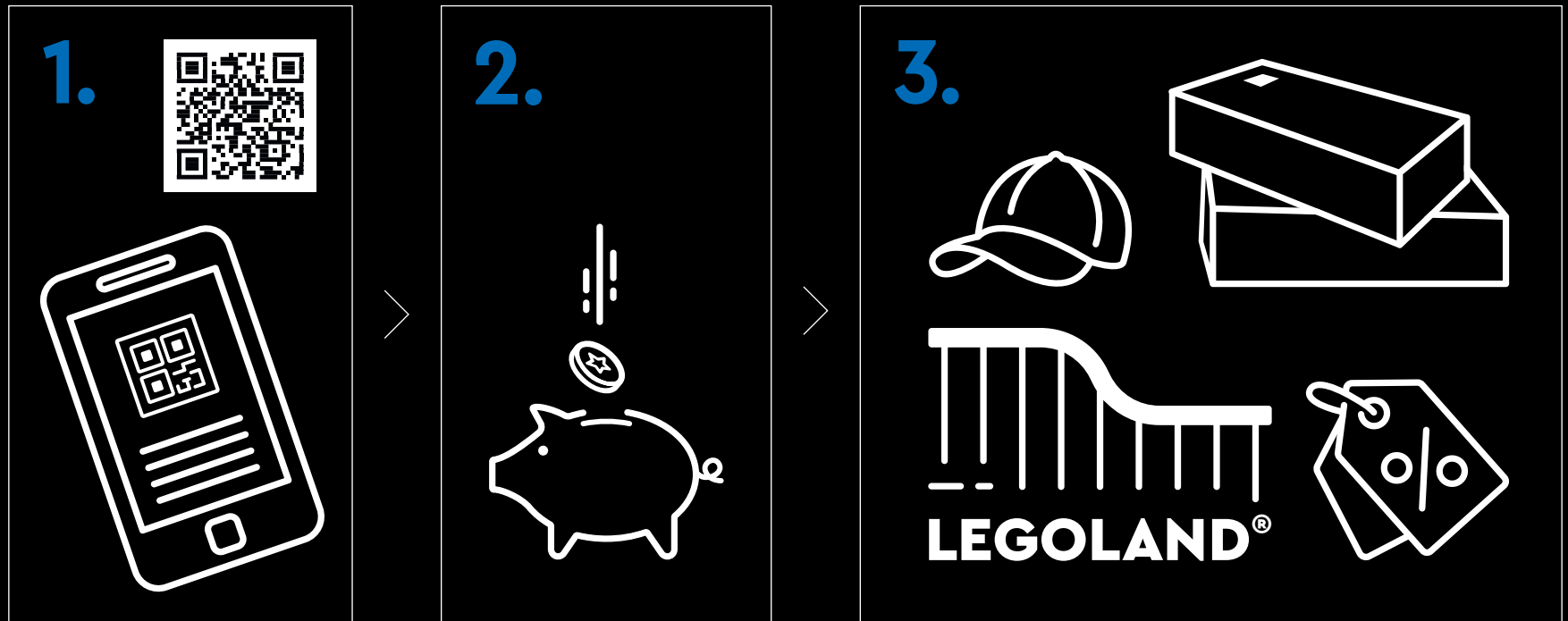



LEGO.com/sustainable-packaging

LEGO® VIP



1. Sign up **2.** Earn points for purchases **3.** Redeem points for rewards, experiences, discounts & more | **1.** Melde dich an **2.** Sammle Punkte bei jedem Kauf **3.** Löse die Punkte für Belohnungen, Erlebnisse, Rabatte und Ähnliches ein | **1.** Inscrivez-vous **2.** Gagnez des points lors de vos achats **3.** Échangez vos points contre des récompenses, des expériences, des remises et bien plus encore | **1.** Iscriviti **2.** Guadagna punti con i tuoi acquisti **3.** Riscatta punti per premi, esperienze, sconti e altro ancora | **1.** Regístrate **2.** Gana puntos por tus compras **3.** Canjea puntos por recompensas, experiencias, descuentos y mucho más | **1.** Registe-se **2.** Ganhe pontos em compras **3.** Troque os pontos para prémios, experiências, descontos e muito mais | **1.** 注册 **2.** 购物赚积分 **3.** 用积分兑换奖励、体验、折扣等 | **1.** Zarejestruj się **2.** Zdobywaj punkty za zakupy **3.** Wymieniaj punkty na rabaty, przygody i inne nagrody | **1.** Zaregistrujte se **2.** Sbírejte body za nákupy **3.** Vyměňujte body za odměny, zážitky, slevy a spoustu dalšího | **1.** Zaregistrujte se **2.** Získavajte body za nákupy **3.** Uplatnite si body a získajte odmeny, rôzne zážitky, zľavy a ešte viac | **1.** Regisztrálj **2.** Szerezz pontokat minden vásárlással **3.** Váltsd be pontjaidat jutalmakra, élményekre, kedvezményekre és egyebekre | **1.** Înscric-te **2.** Câștigă puncte pentru achiziții **3.** Valorifică puncte pentru recompense, experiențe, reduceri și multe altele | **1.** Регистрируйте се **2.** Получайте точки за покупки **3.** Используйте точки за награды, услуги, отстъпки и т.н. | **1.** Reģistrējies **2.** Pelni punktus par pirkumiem **3.** Izmanto punktus, lai saņemtu balvas, izklaides iespējas, atlaides un daudz ko citu | **1.** Registreeru **2.** Teeni ostude eest punkte **3.** Lunasta punktide eest preemiad, elamused, allahindlused ja muu | **1.** Užsiregistruokite **2.** Pelnykite taškų už pirkinius **3.** Panaudokite taškus atlygiui, funkcijoms, nuolaidoms ir ne tik





« De nos jours,
nous passons de
moins en moins
de temps dans la
nature. Nous vivons

dans une société urbaine dépendante
des technologies. Cependant, nous avons
besoin de la nature pour nous relier les uns
aux autres et comprendre qui nous sommes.
Ce set LEGO® Le jardin paisible, qui s'inspire
des jardins japonais, évoque la nature –
du moins d'un point de vue symbolique.
Aujourd'hui, c'est l'une des choses les plus
importantes dans nos vies. »

HOICHI KURISU

Concepteur et constructeur de jardins japonais



Créé pour vivre en pleine conscience

● Suivez les pierres de gué jusqu'à votre pavillon privé, faites comme chez vous, détendez-vous et ne faites qu'un avec la nature, le temps d'un instant. Ou bien restez aussi longtemps qu'il vous plaira.

Inspiré par les éléments issus des traditions millénaires des jardins paisibles, ce set a été créé en collaboration avec Hoichi Kurisu, créateur depuis plusieurs années de jardins favorisant la pleine conscience. Un sanctuaire où l'on peut réfléchir et se ressourcer sans distractions. Chaque élément du jardin permet de s'attarder sur les merveilles colorées et la beauté ludique de la Terre Mère. Passez du temps dans votre jardin et regardez les saisons aller et venir. Sentez votre créativité s'épanouir à chaque visite, réorganisez le paysage, plantez de nouveaux végétaux LEGO® ou ajoutez des ornements décoratifs qui ont du sens pour vous. Préparez une théière de votre thé matcha préféré, écoutez les sons apaisants de la nature, glissez-vous dans vos pantoufles les plus douces et prenez le temps de savourer le moment présent.





Occupez-vous de votre jardin

● « La construction d'un set LEGO® peut être un véritable moment d'évasion, comme lorsqu'on lit un bon livre. Elle permet de se concentrer sur quelque chose d'amusant et confère un sentiment de fierté et de satisfaction, longtemps après la fin de la construction. Vous pouvez revenir dans ce jardin aussi souvent que vous le souhaitez. Occupez-vous des éléments et modifiez le paysage comme vous le feriez dans un vrai jardin ou avec un bonsaï. Taillez ou replantez les cerisiers en fleurs, les conifères luxuriants et le bambou, ou bien déplacez les lanternes de pierre lisse pour les accorder à votre style et votre humeur. Vous pouvez également admirer les carpes koï et les nénuphars aux tons éclatants dans le bassin grouillant de vie, et simplement vous abandonner à votre liberté créative. »

« Donnez une touche personnelle au set afin qu'il s'adapte à votre humeur. »

MICHAEL PSIAKI ET CARL MERRIAM
Model designers LEGO® Icons



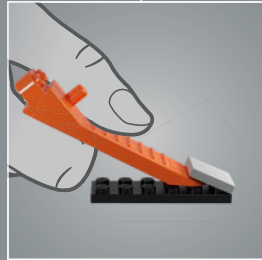
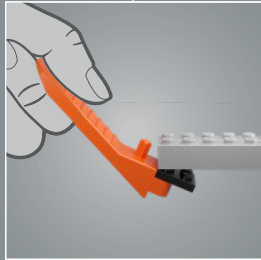
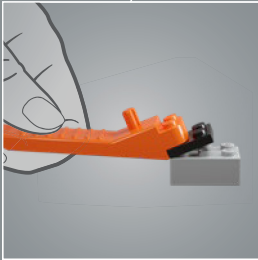
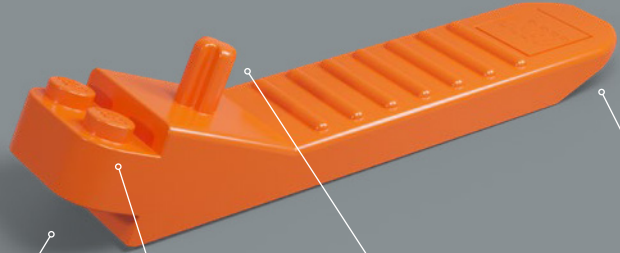

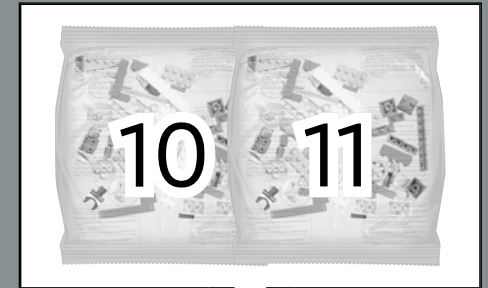
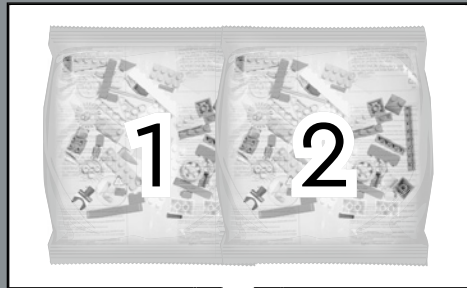

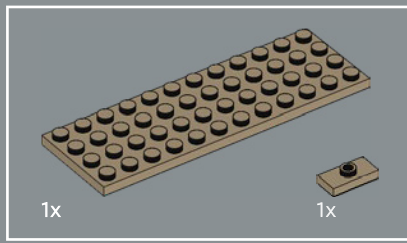
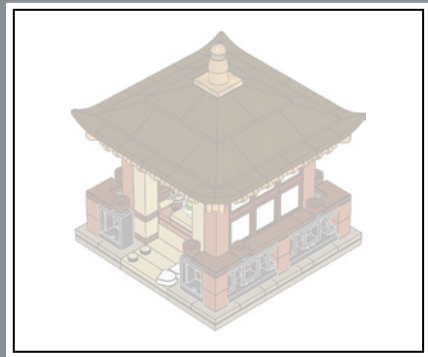

1

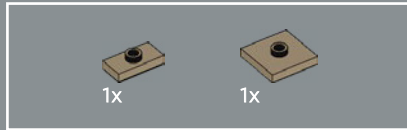
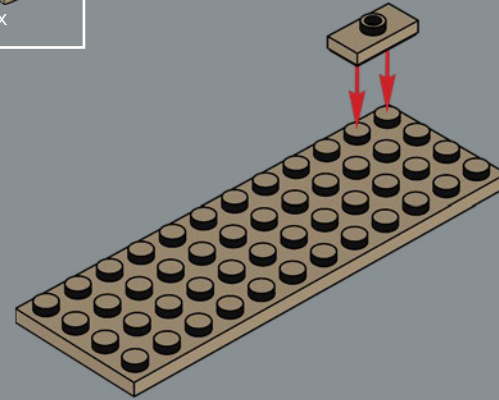

2

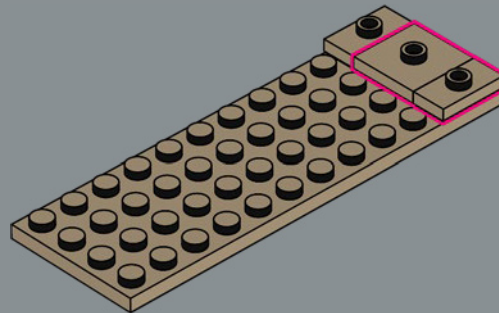

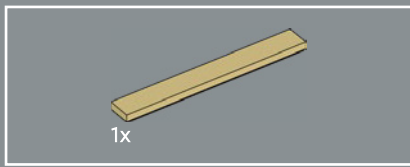

3

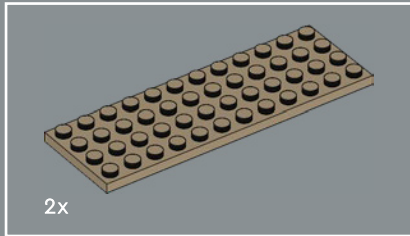
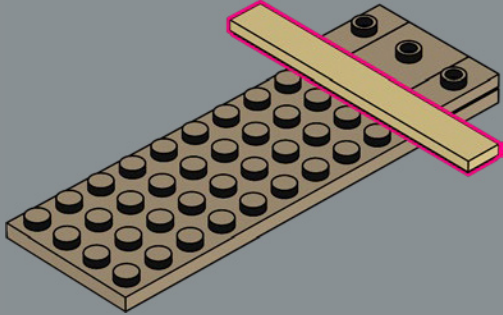

4

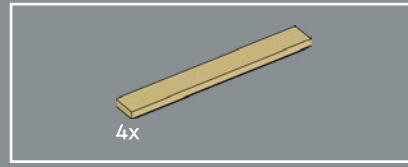
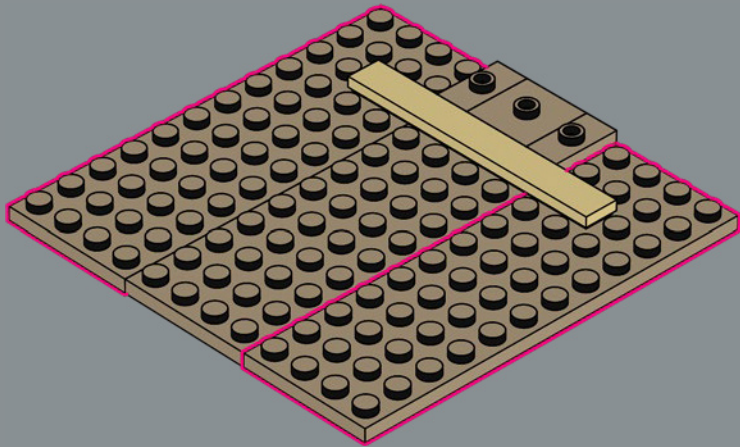

5

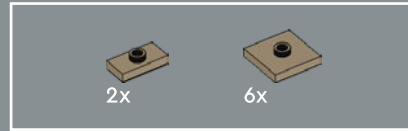
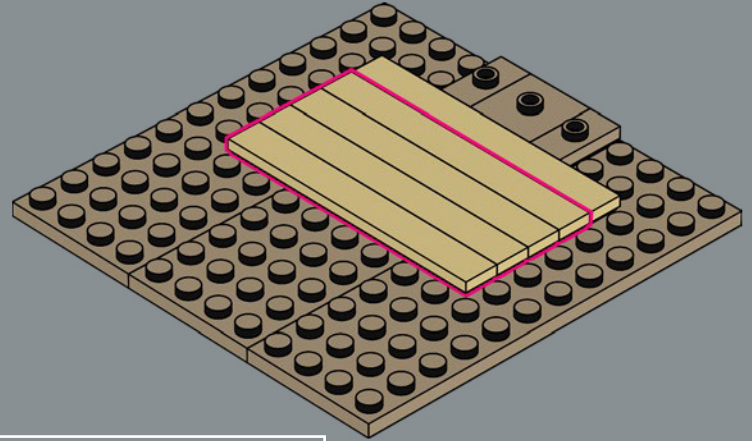

6

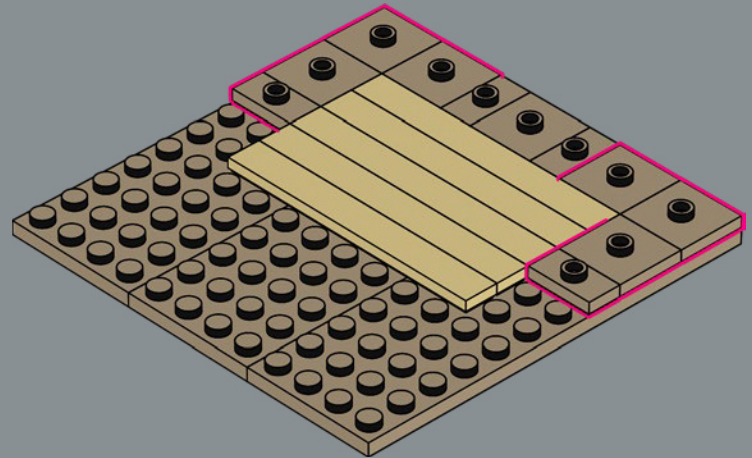

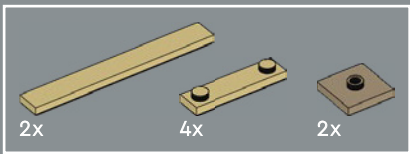

7

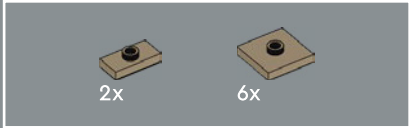
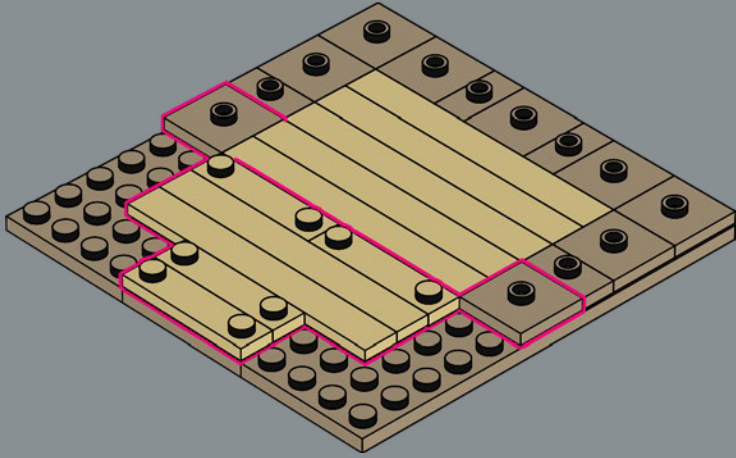

8

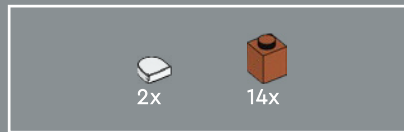
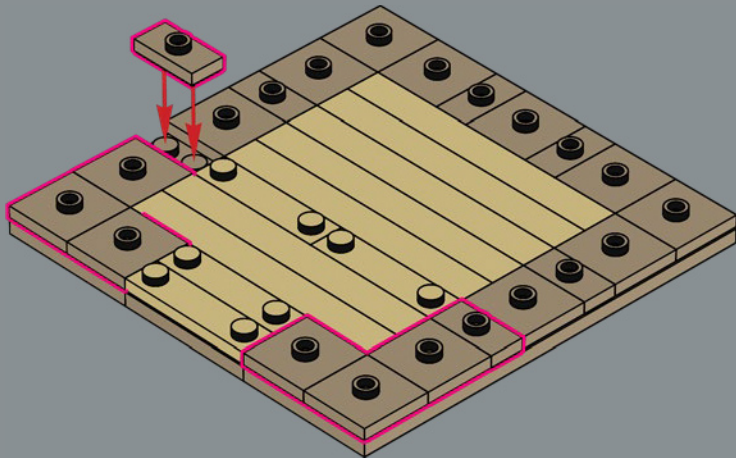

9

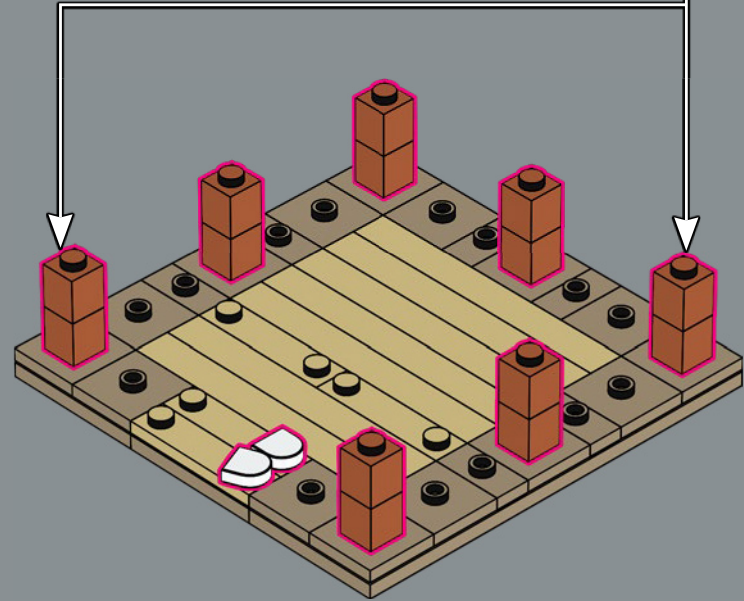
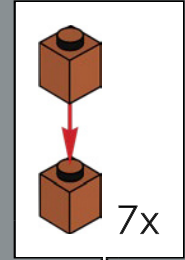

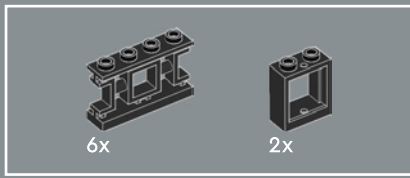

10

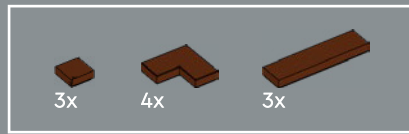
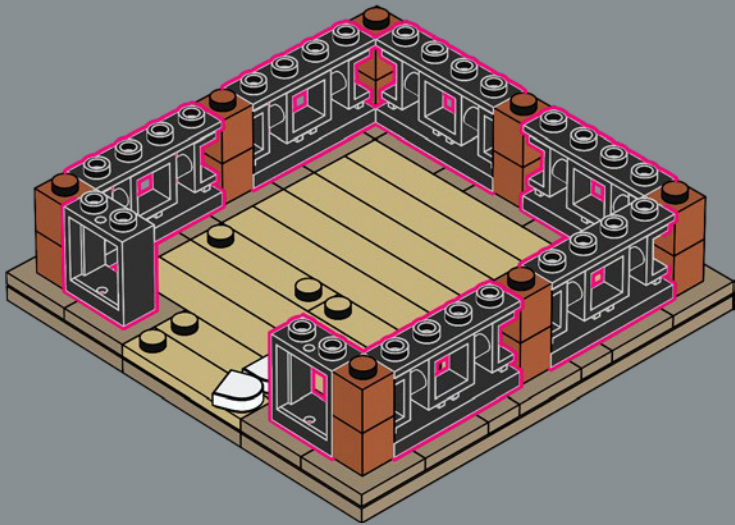

11

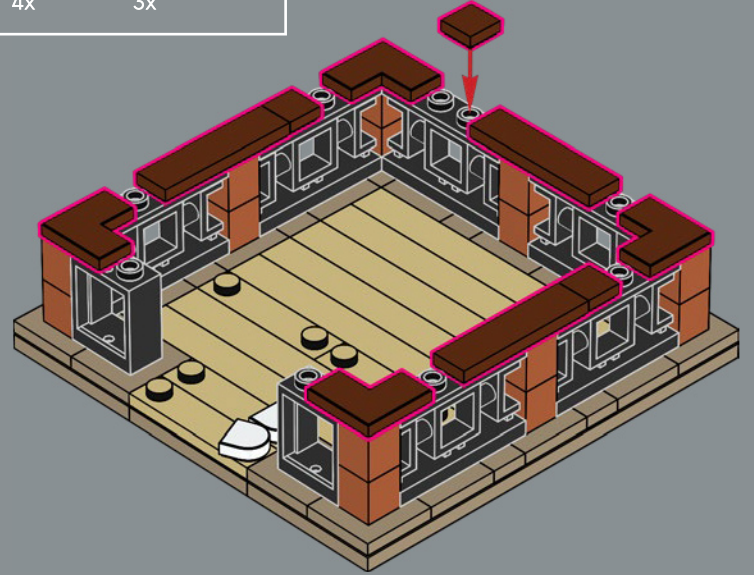

12

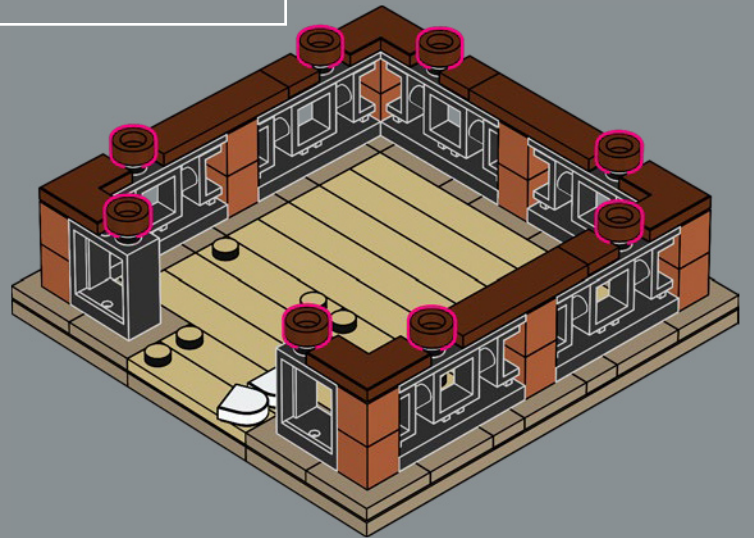

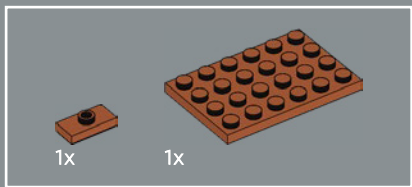

13

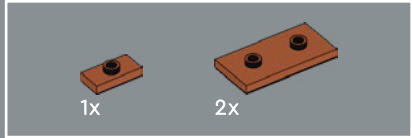
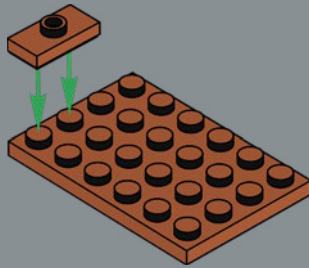

14

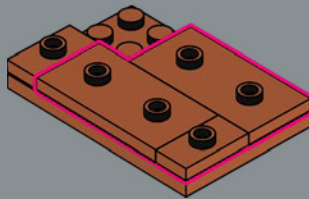

15

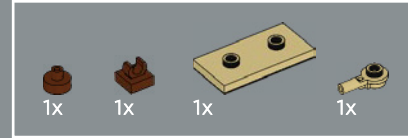
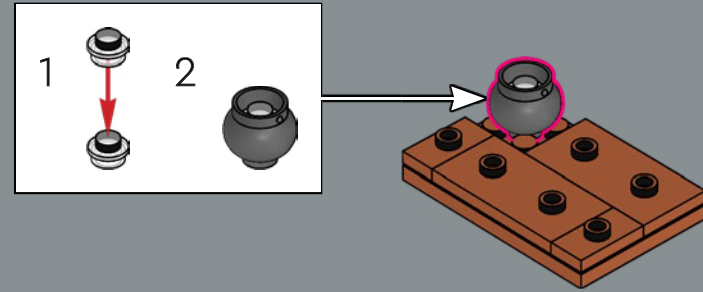

16

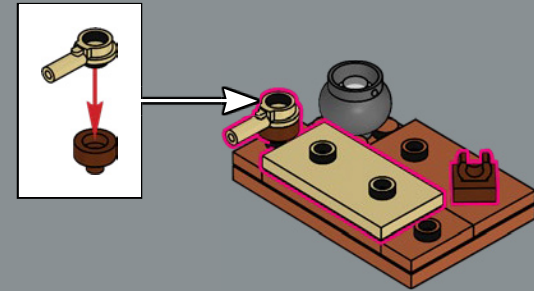

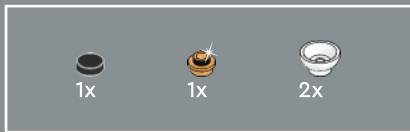

17

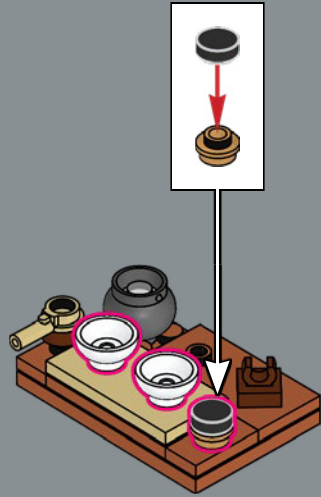

18

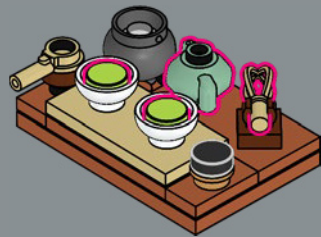

19



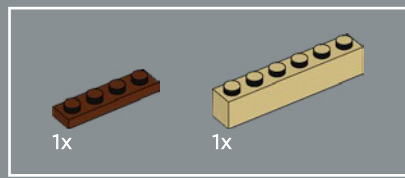

20

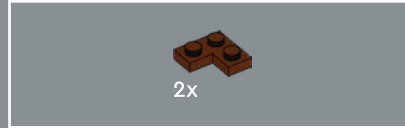
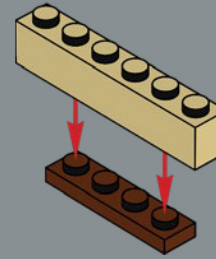

21

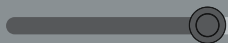
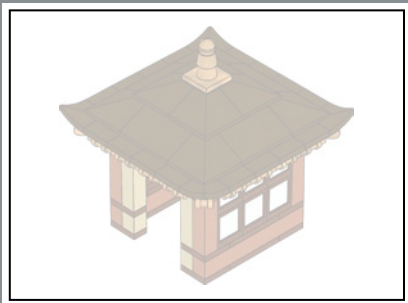
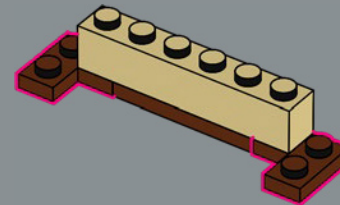

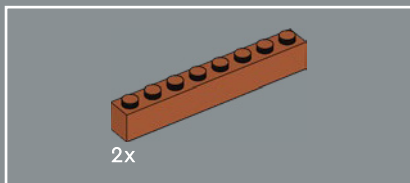

22

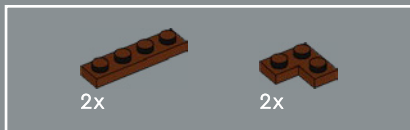
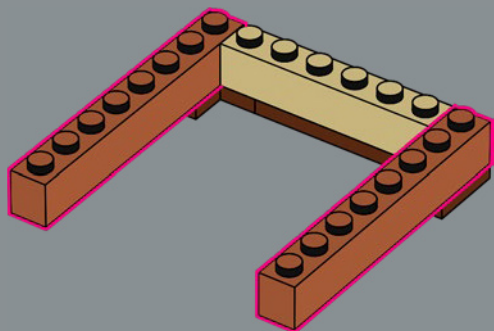

23

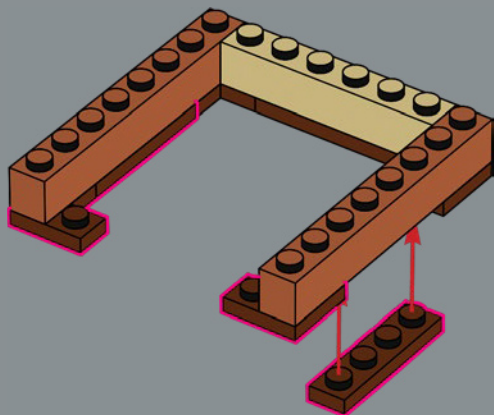

24

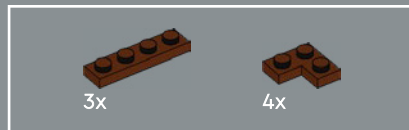
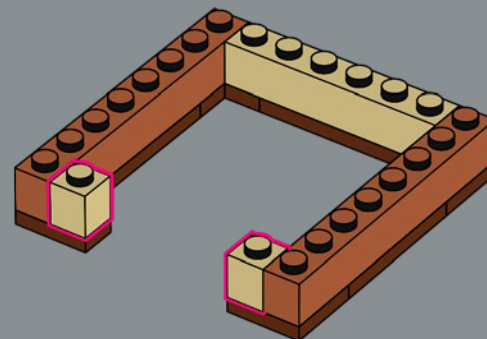

25

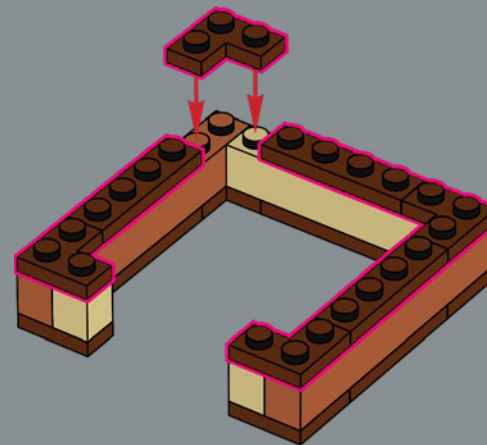

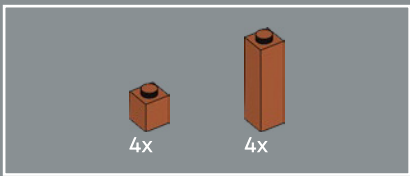

26

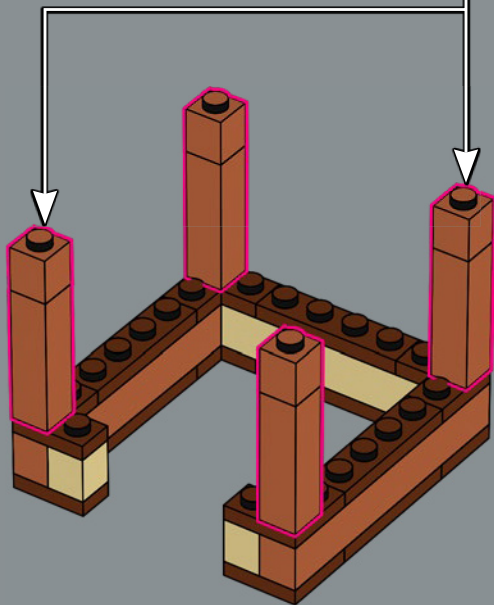
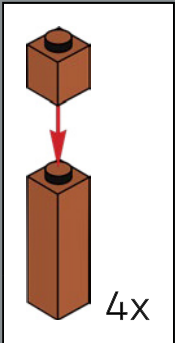

27

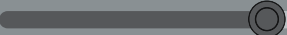
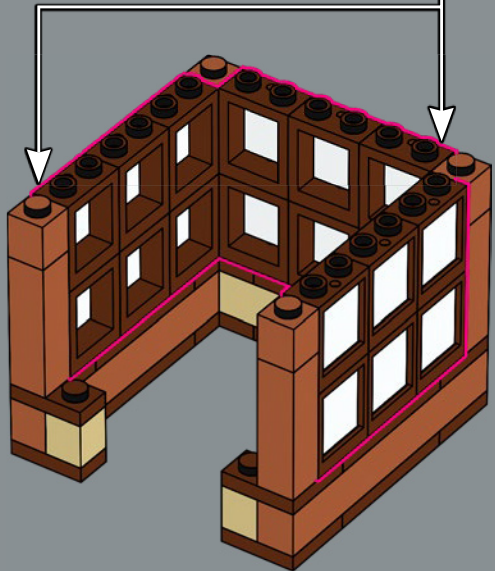
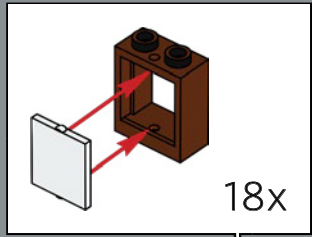

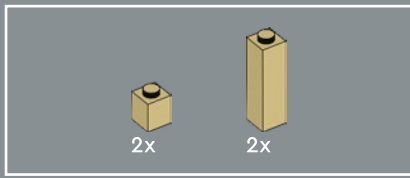

28

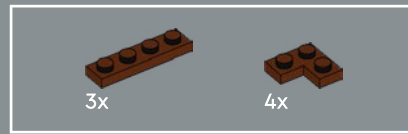
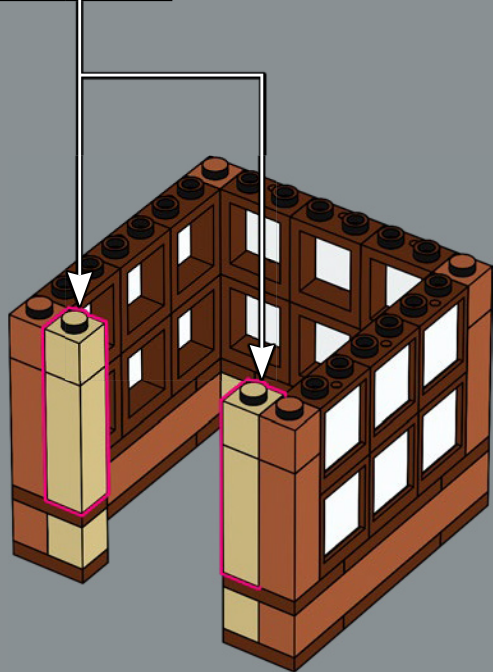
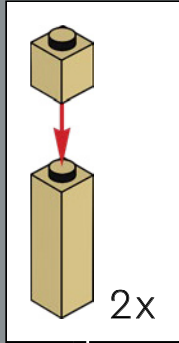

29

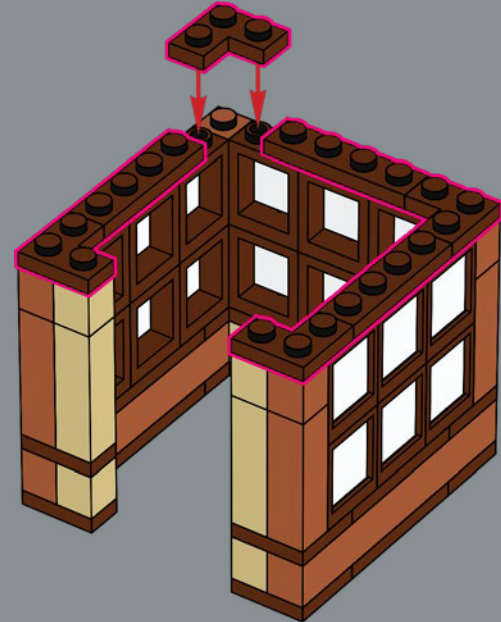

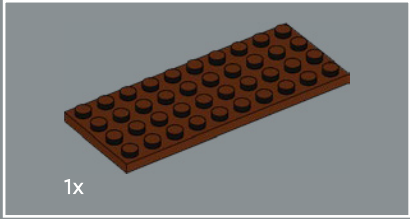
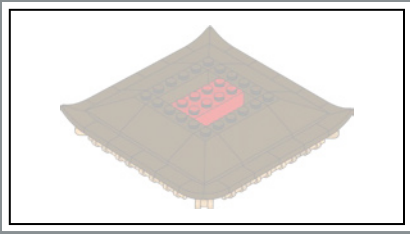

30

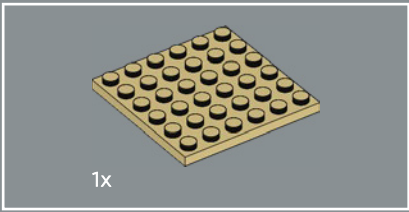
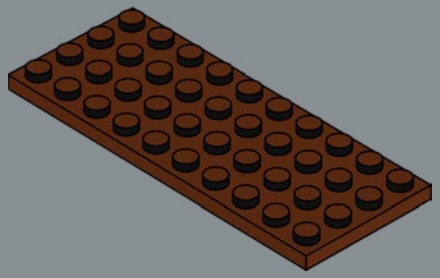

31

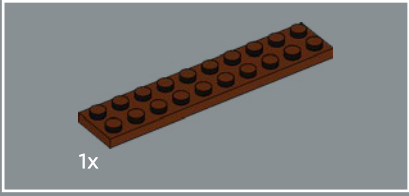
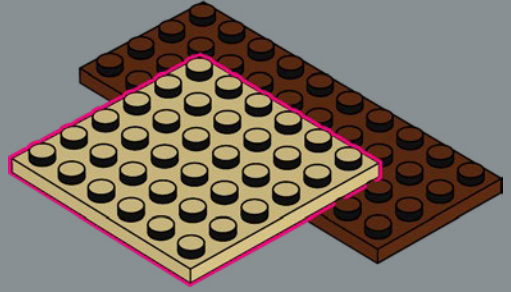

32

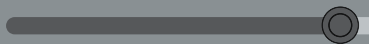
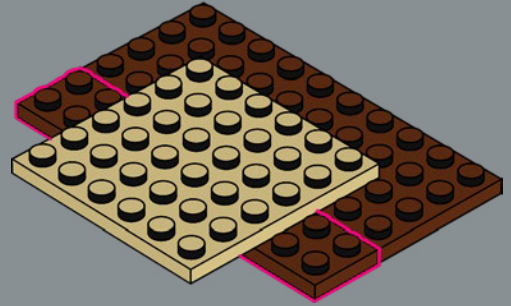

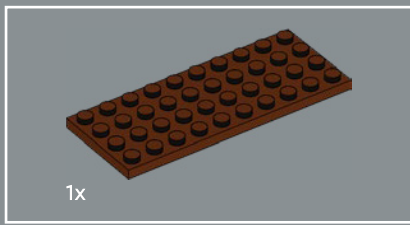

33

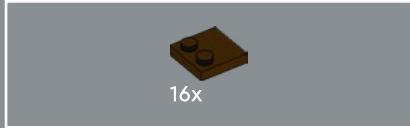
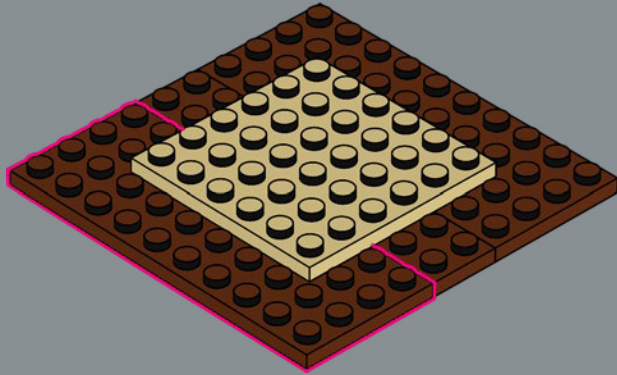

34

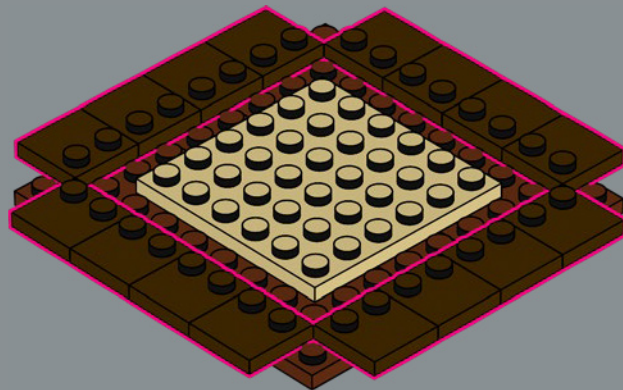

35

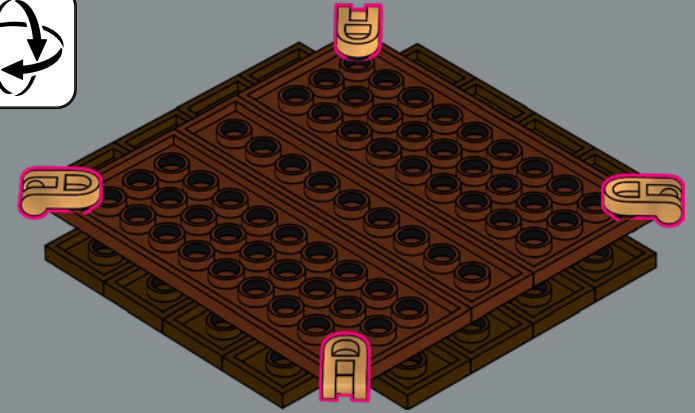

36



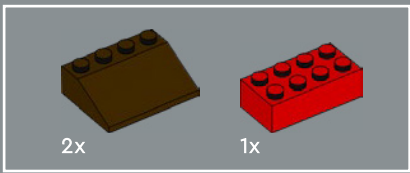

37

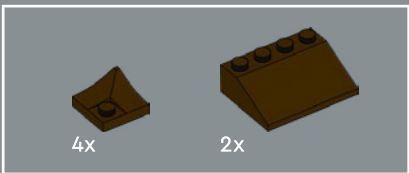
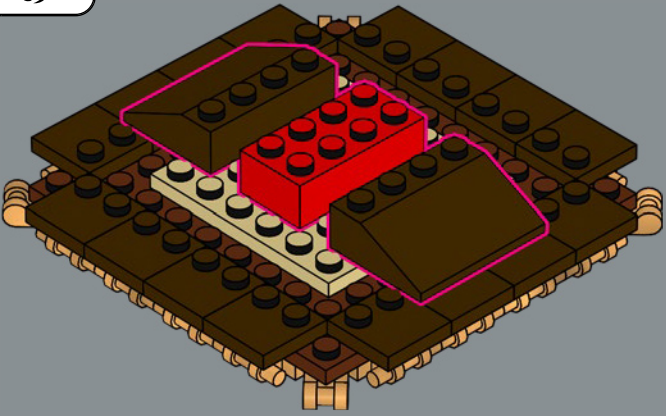

38

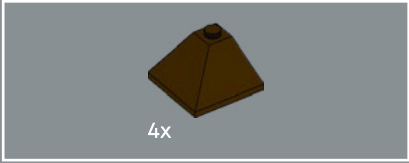
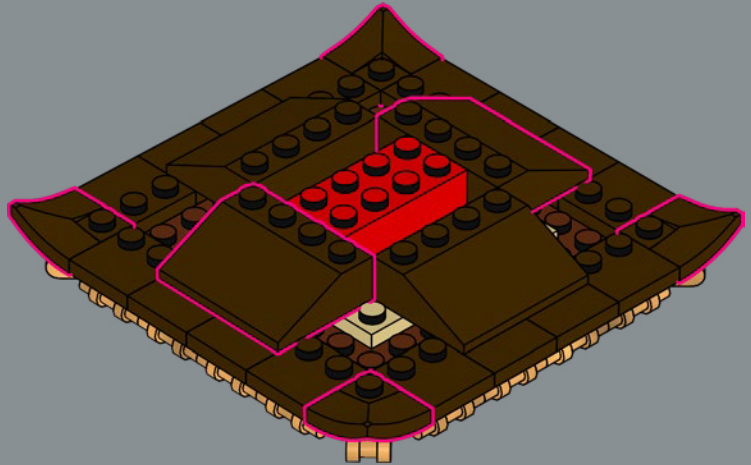

39

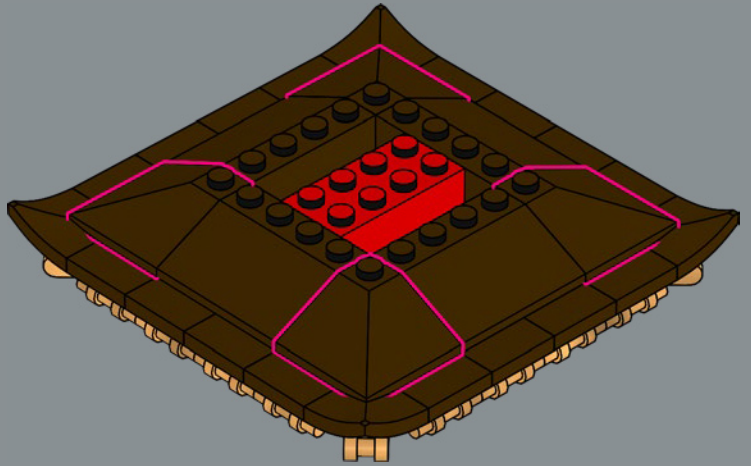

40



41

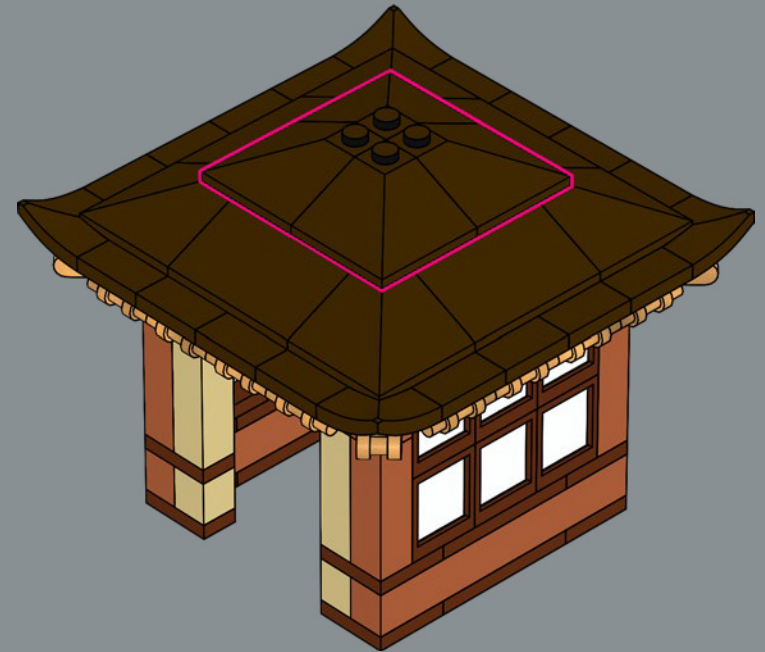
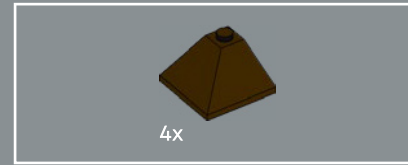



42

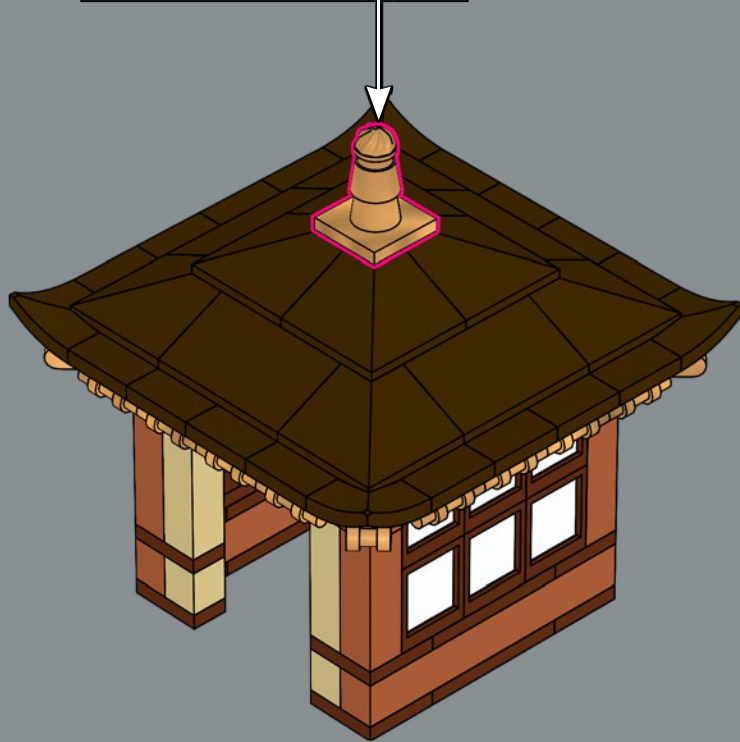
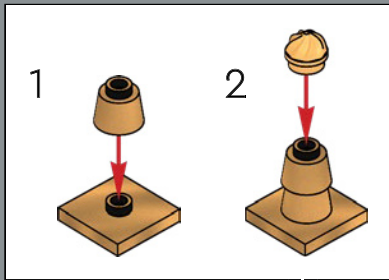

La plupart des pavillons de jardin zen sont en bois afin de se fondre dans le paysage.

43

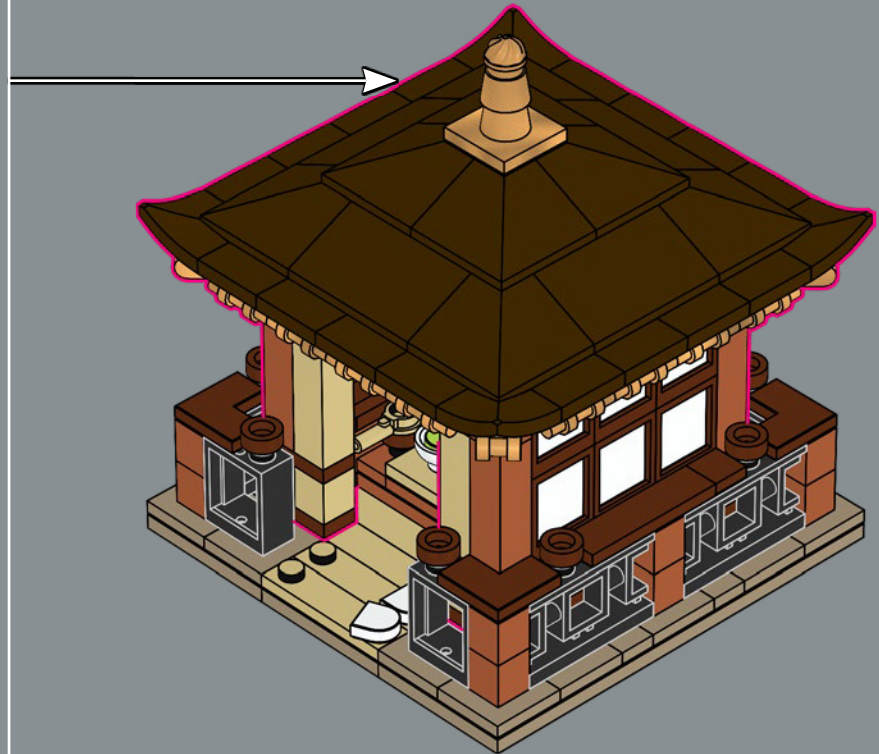

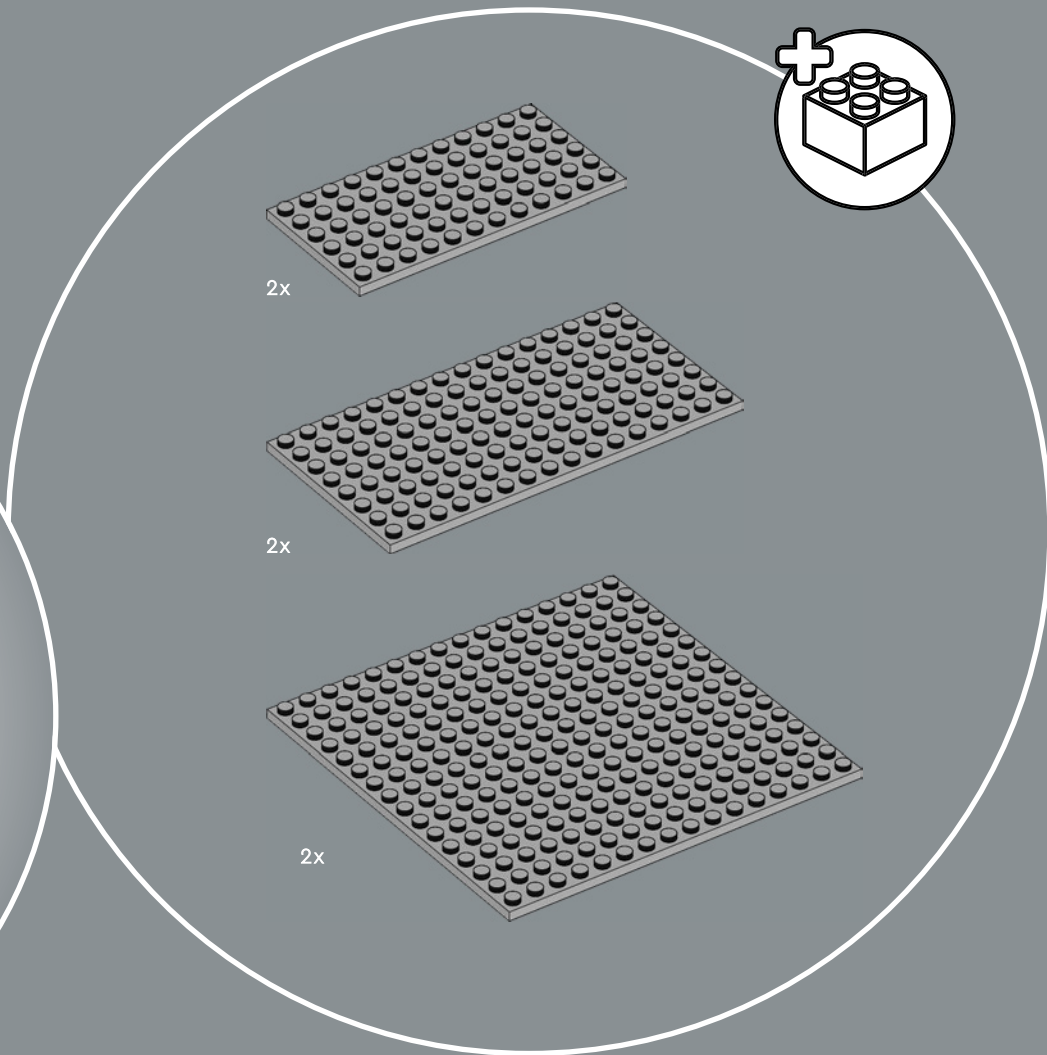

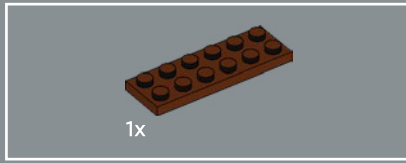
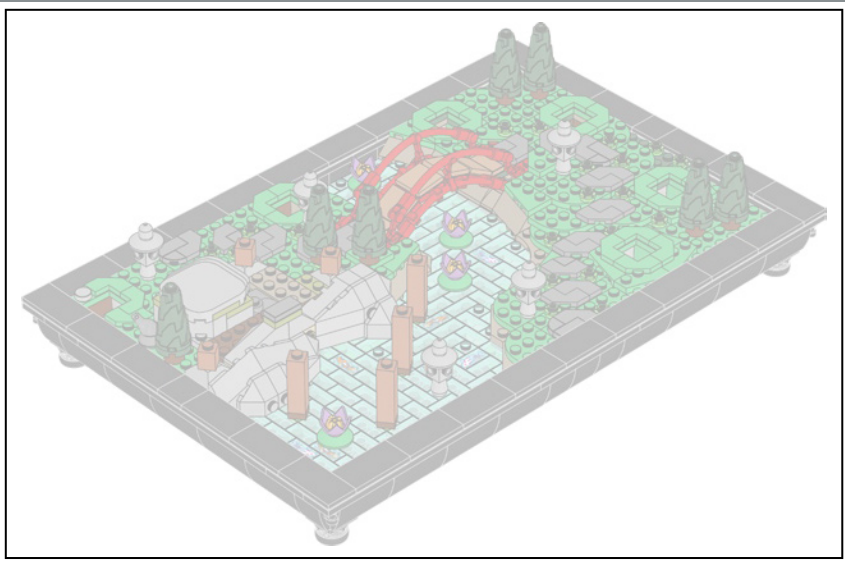

44

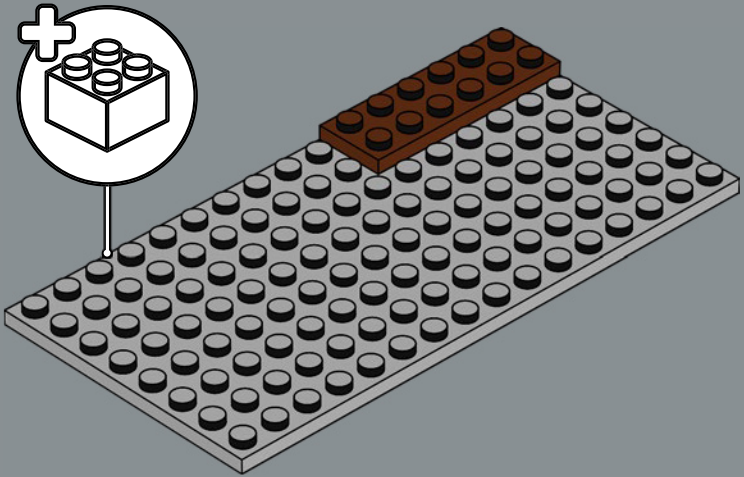

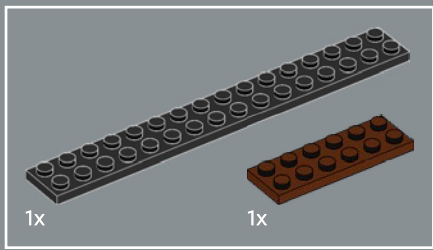

45

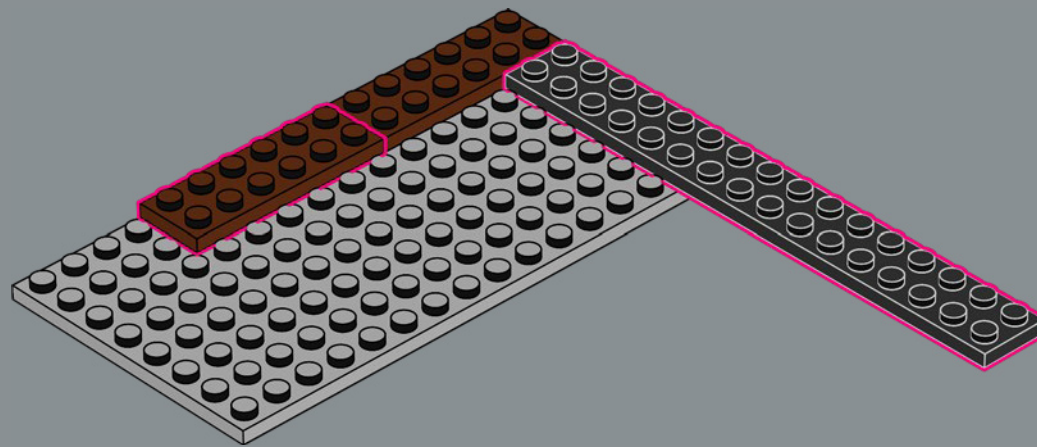

46

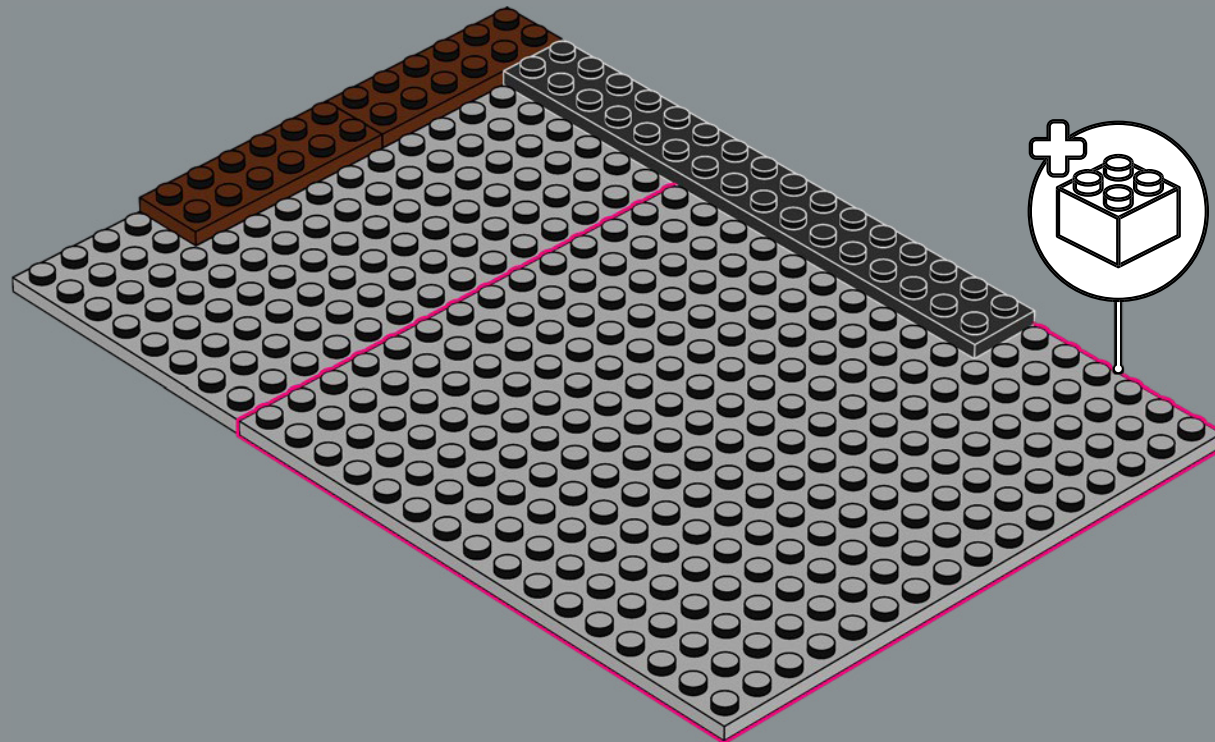

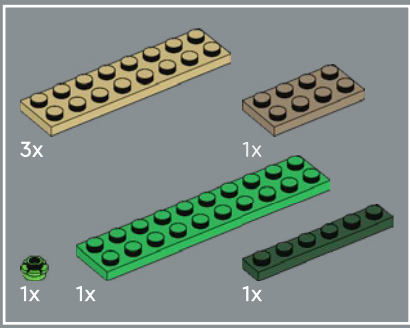

47

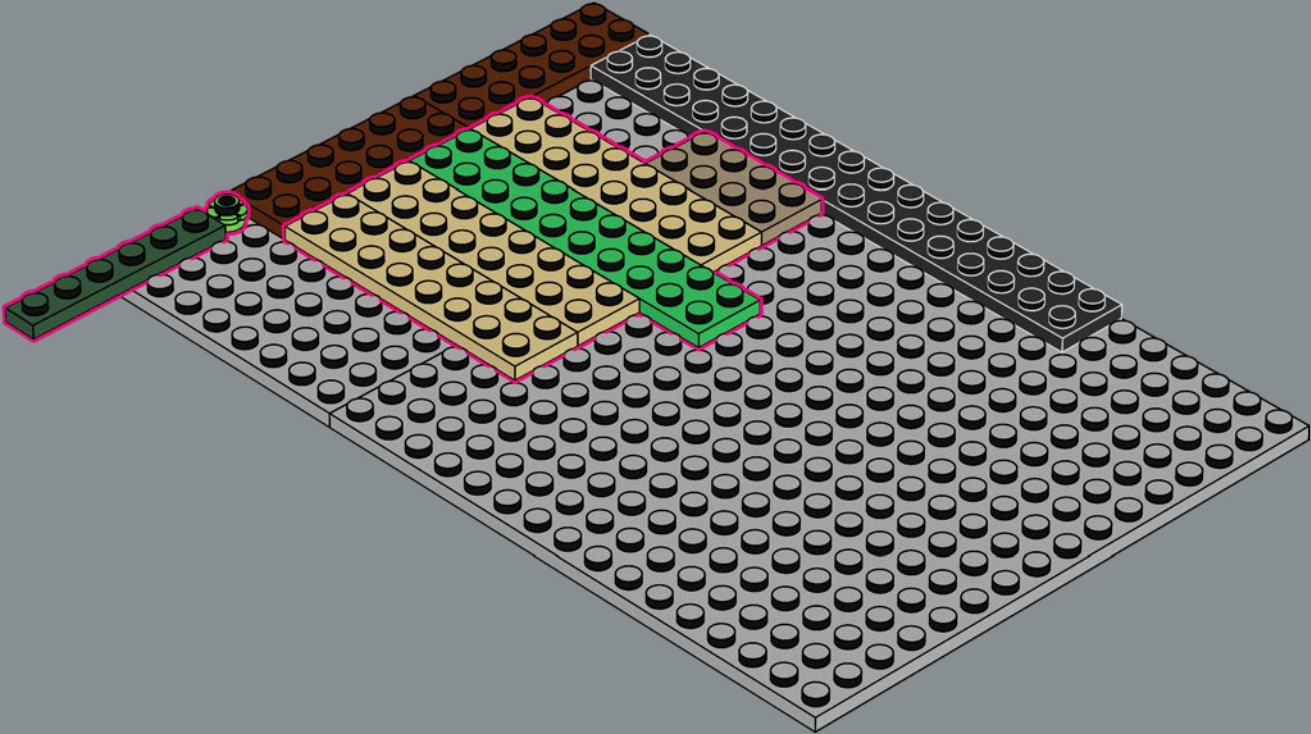

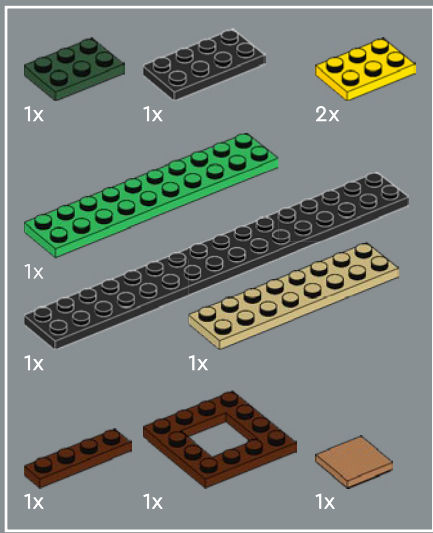

48

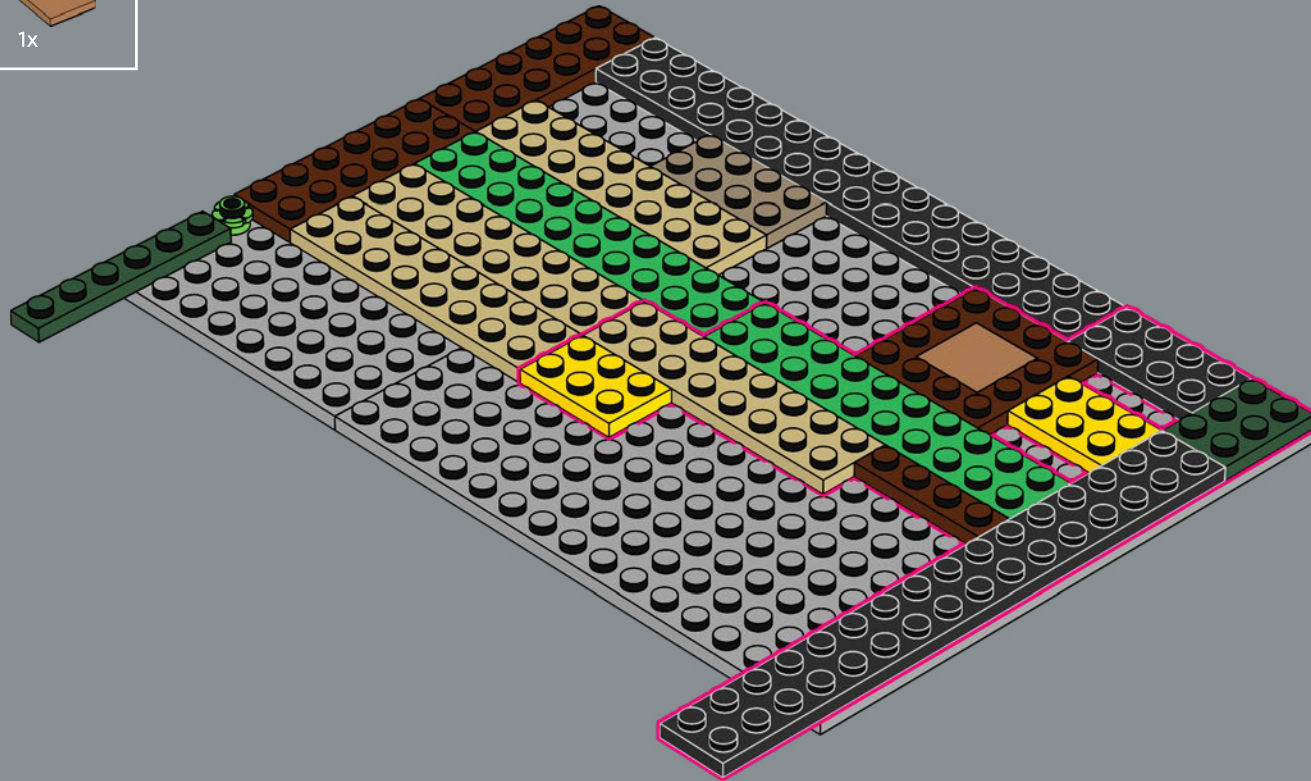

49

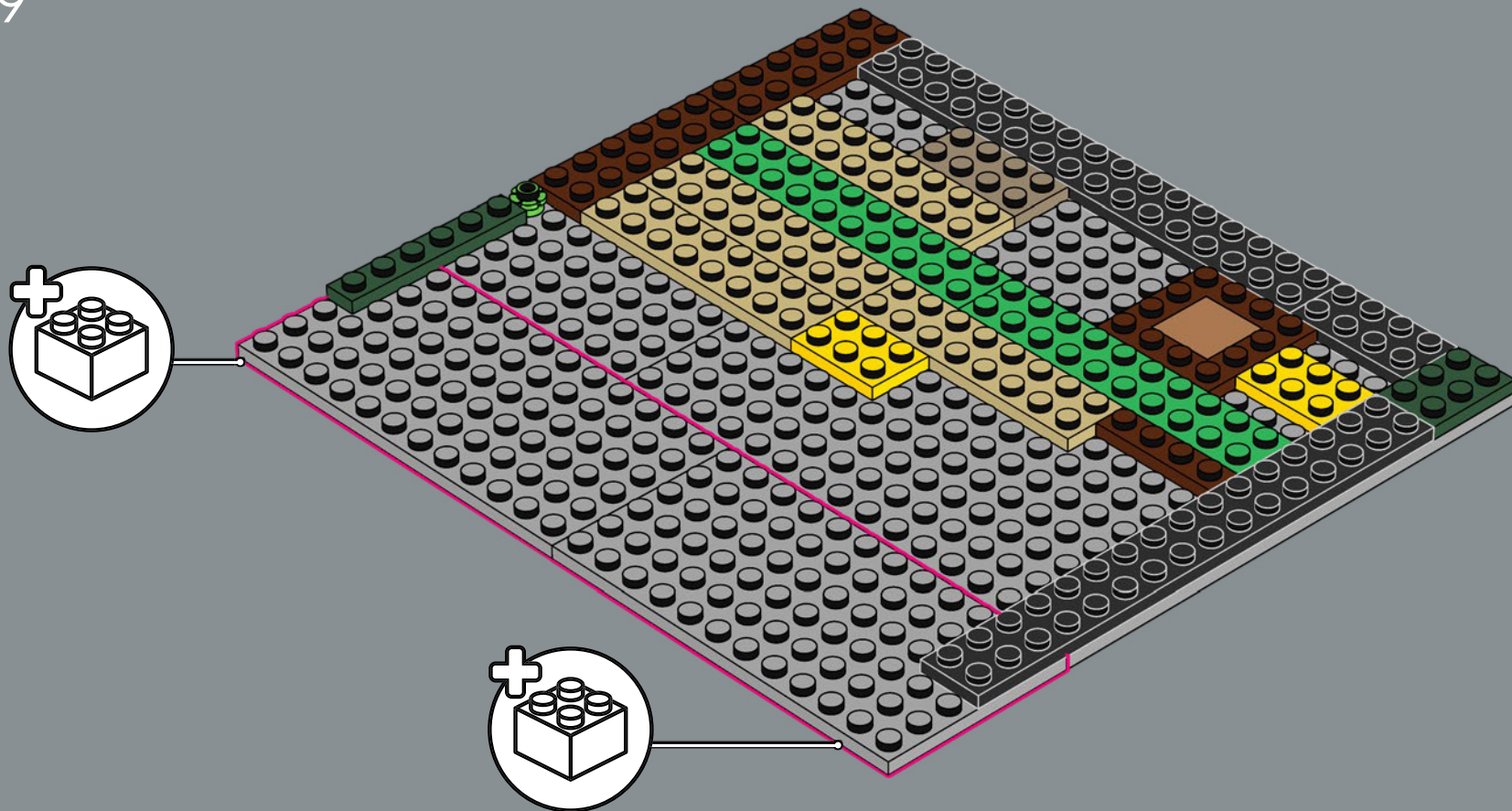

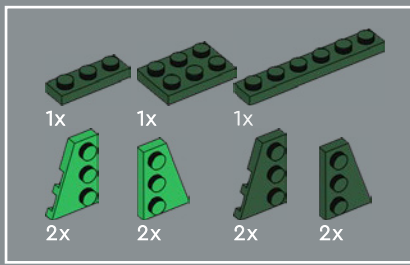

50

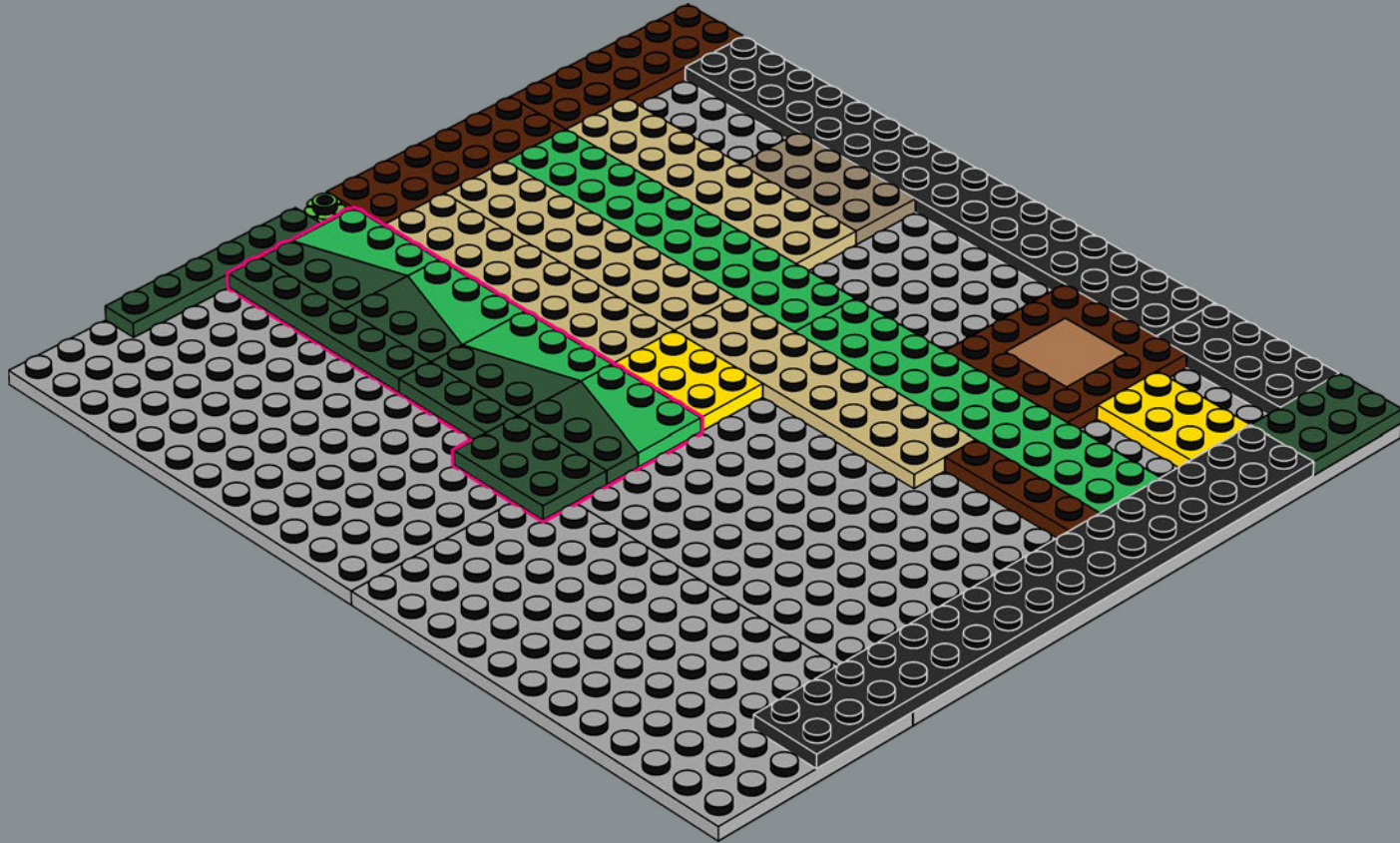

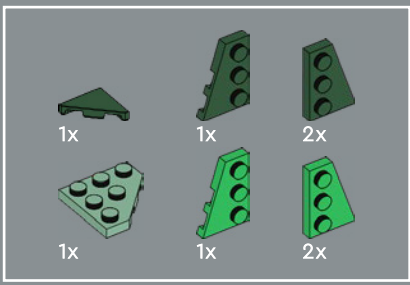

51

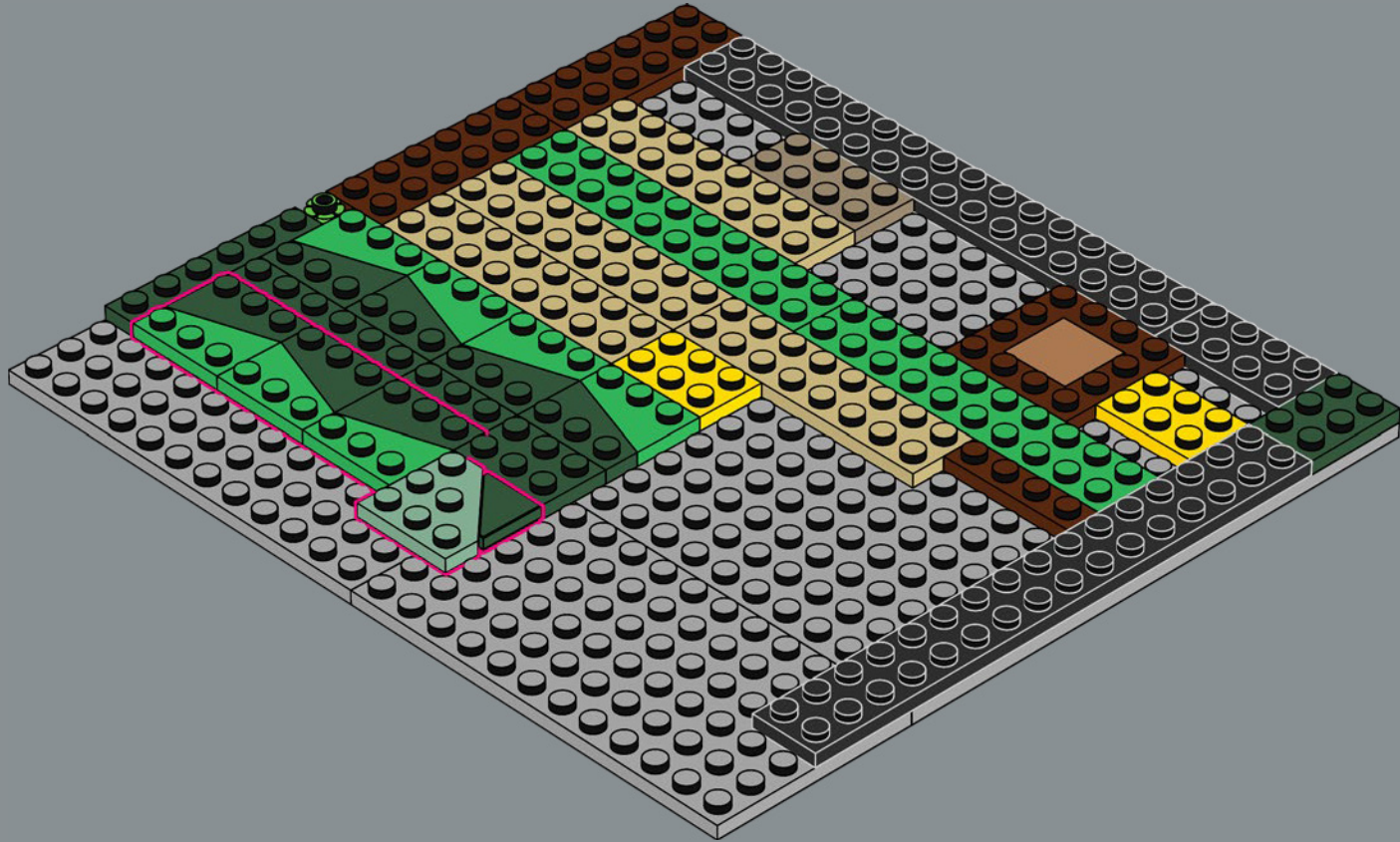

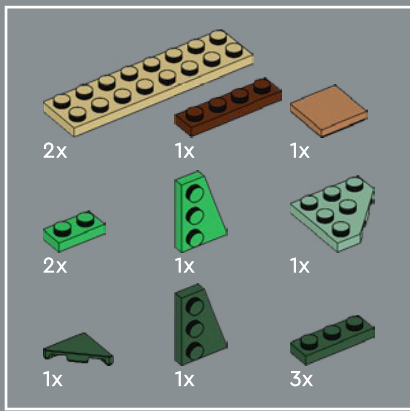

52

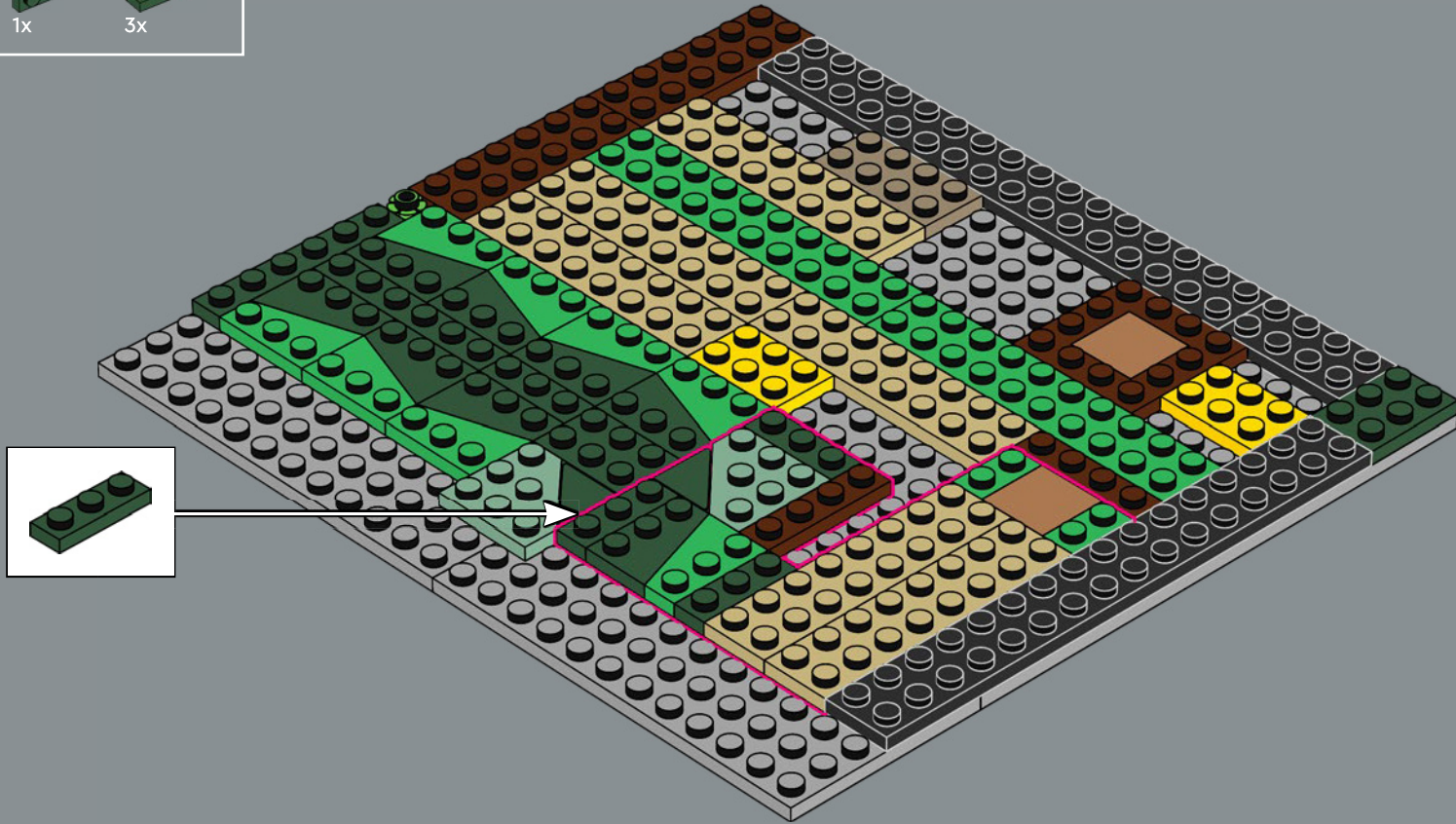

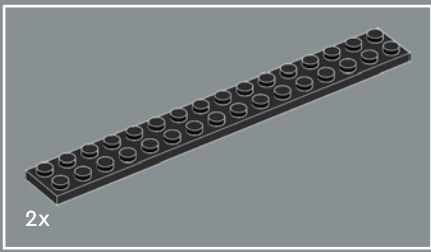

53

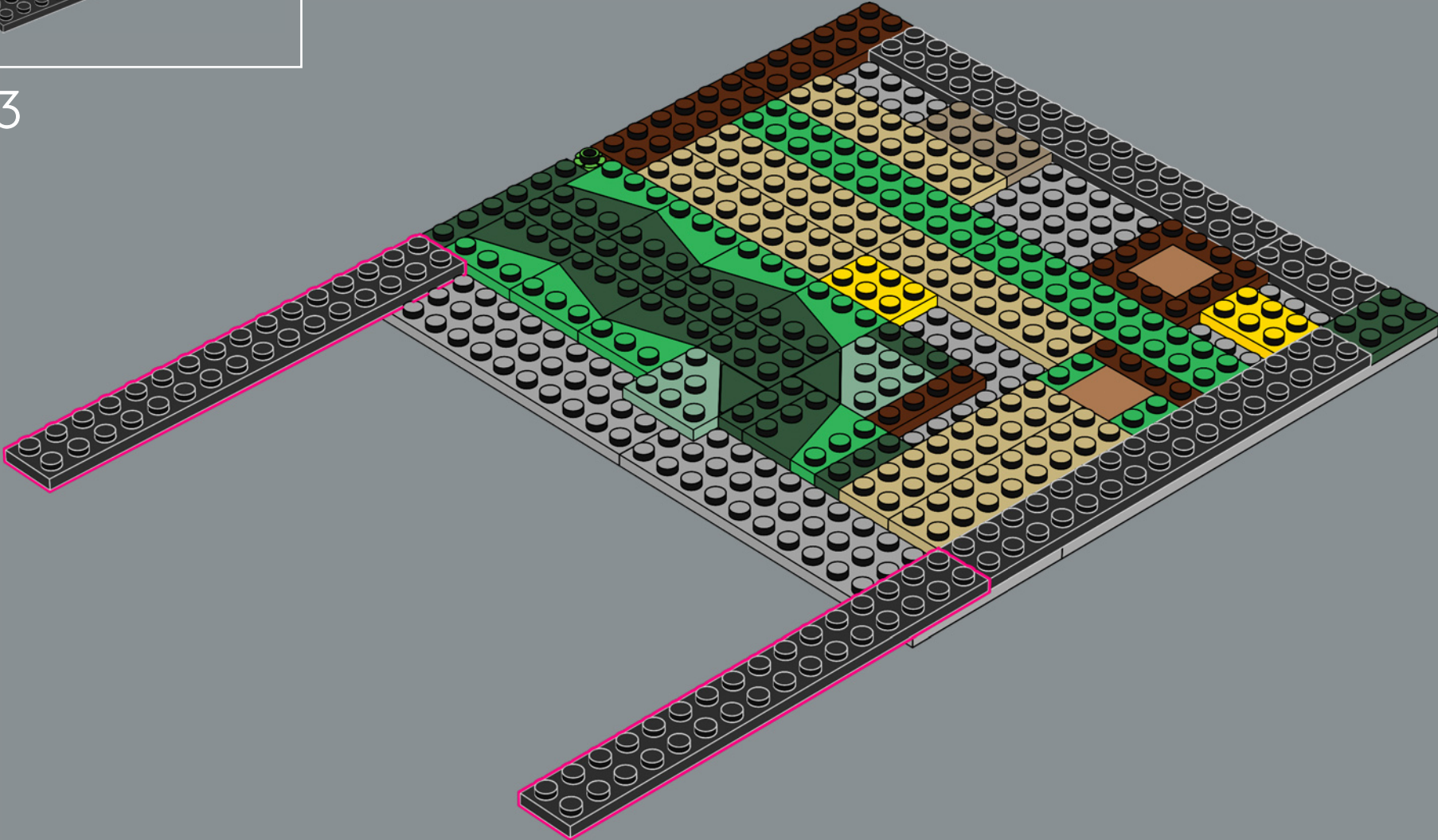

54

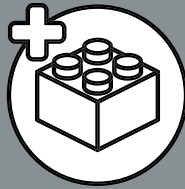
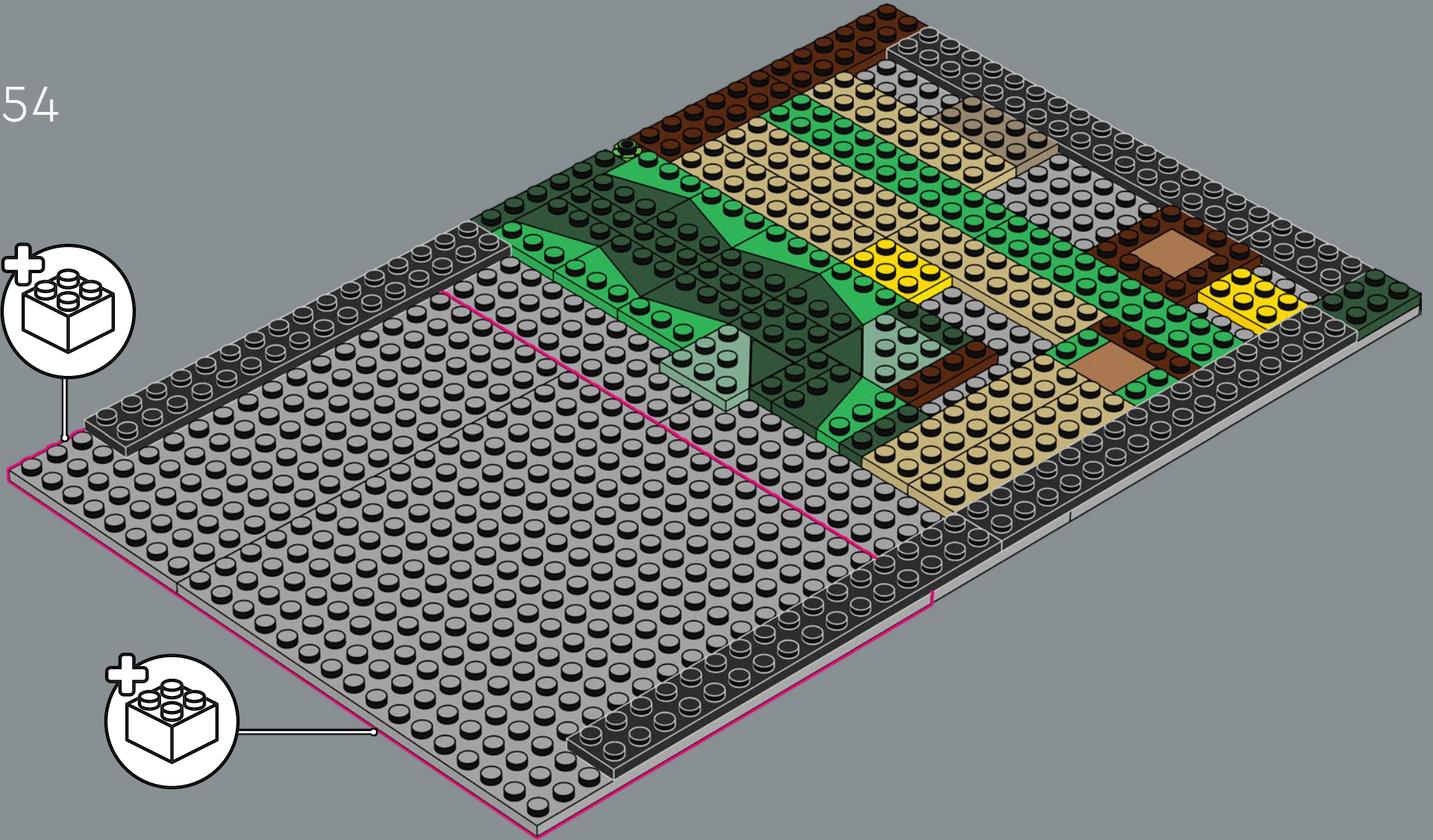
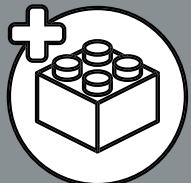

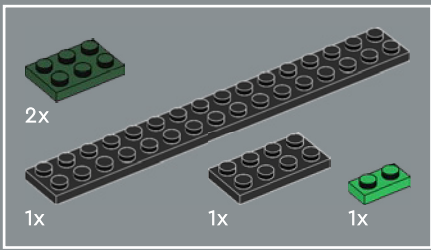

55

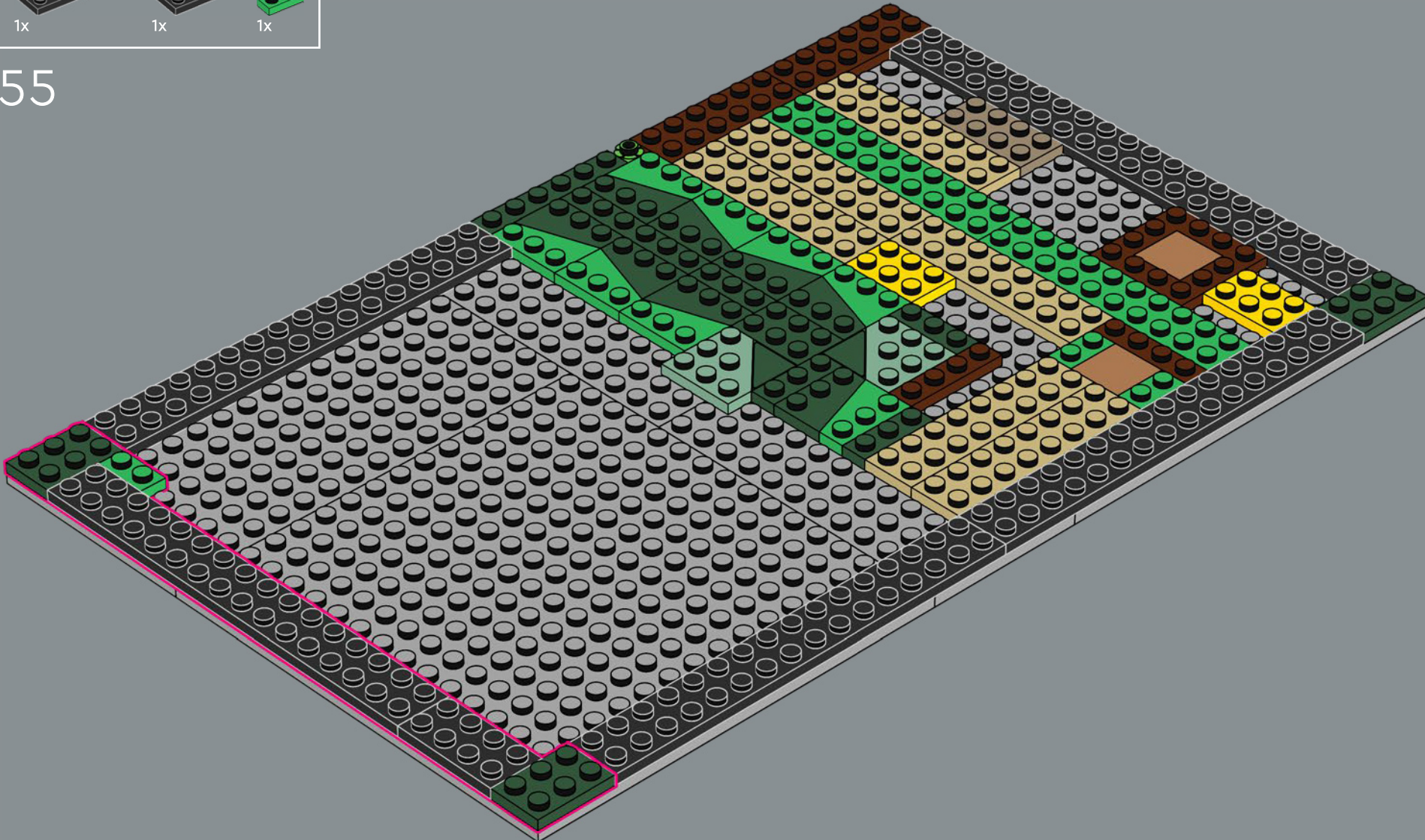

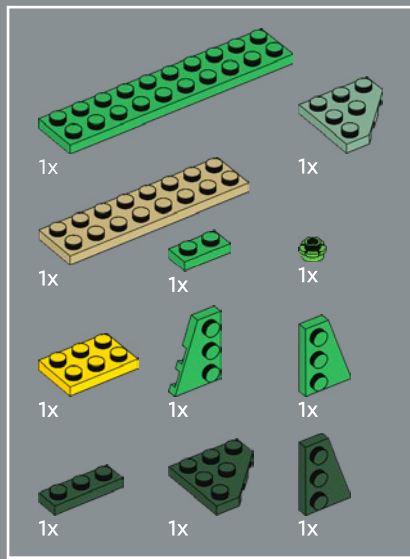

56

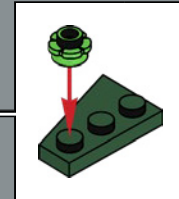
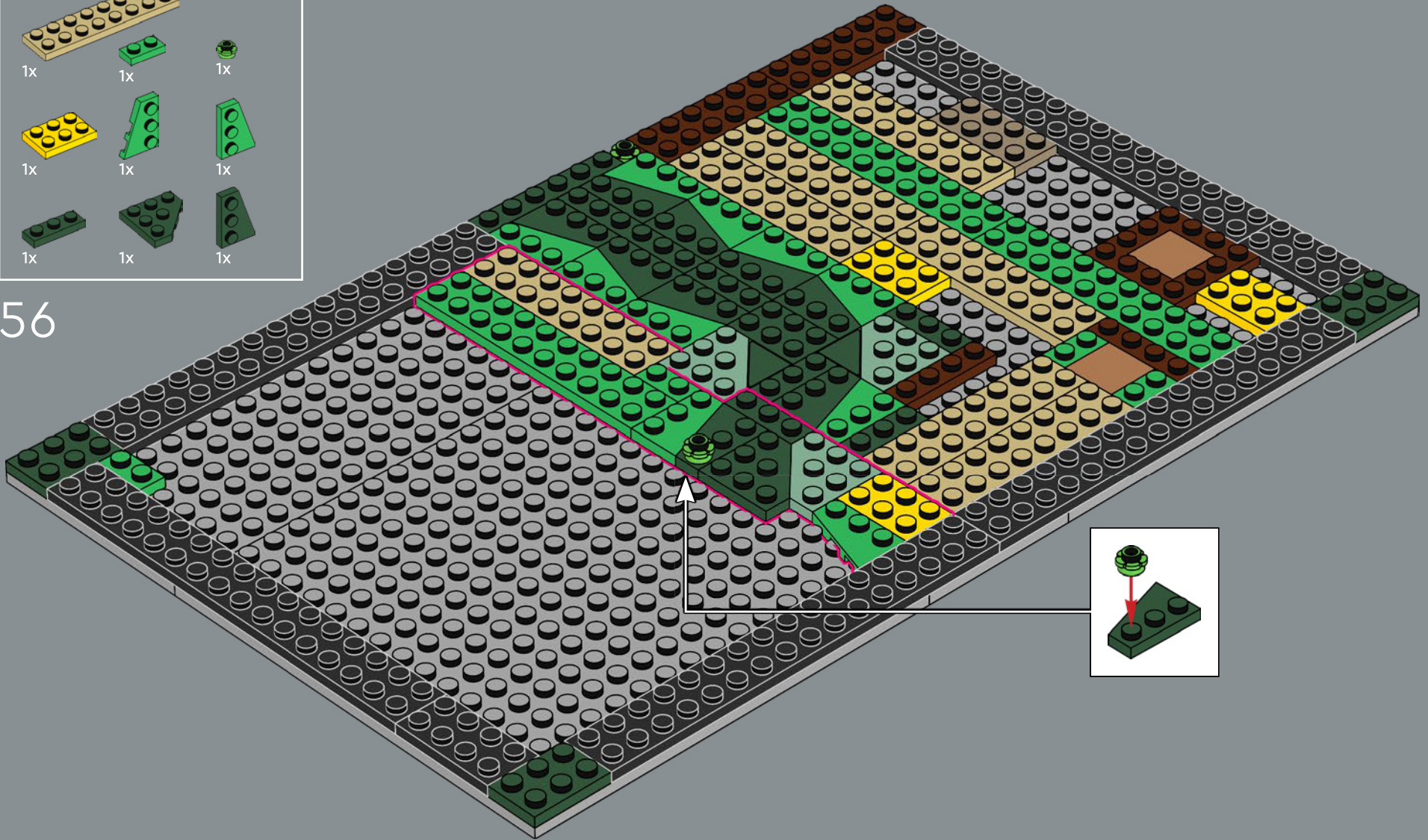

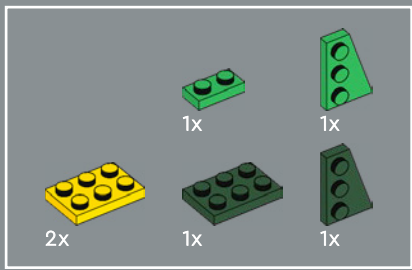

57

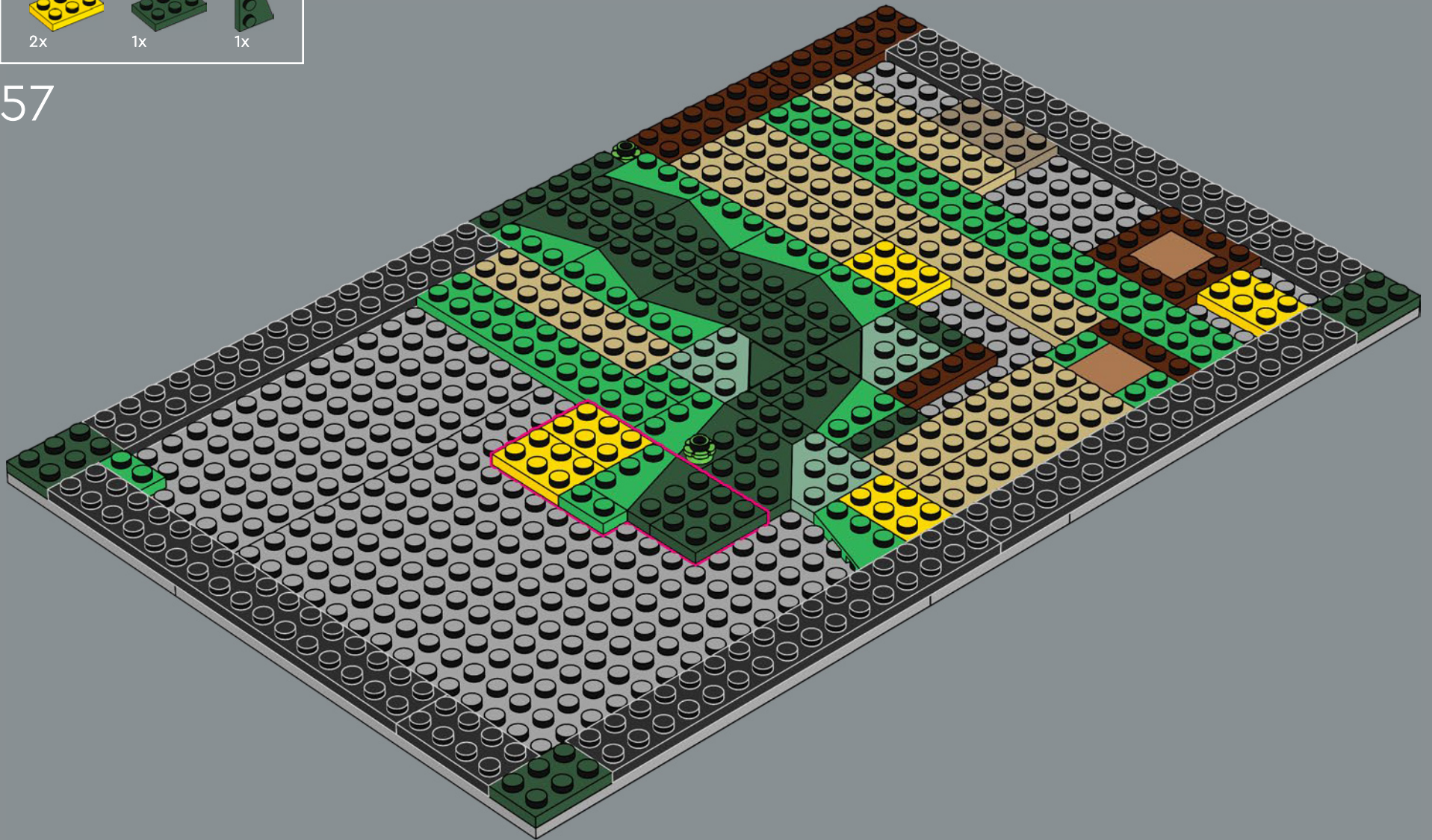

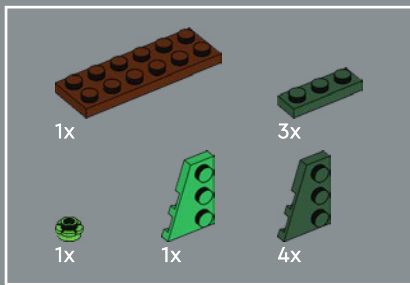

58

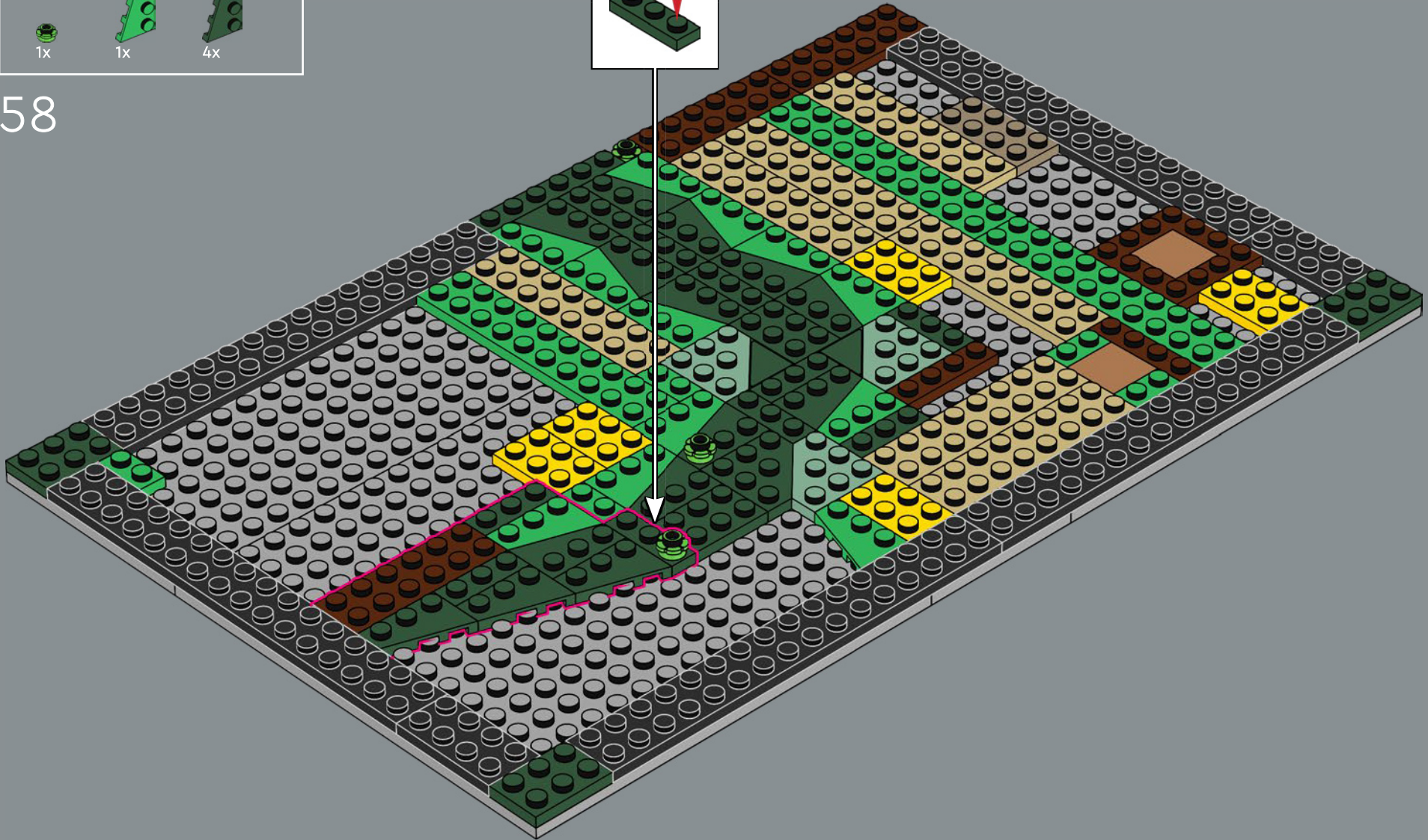
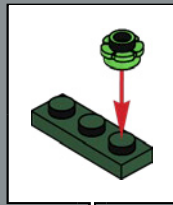

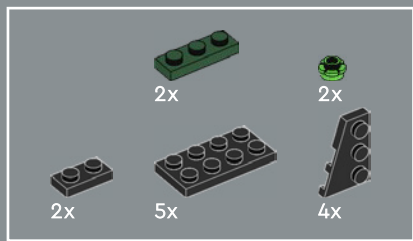

59

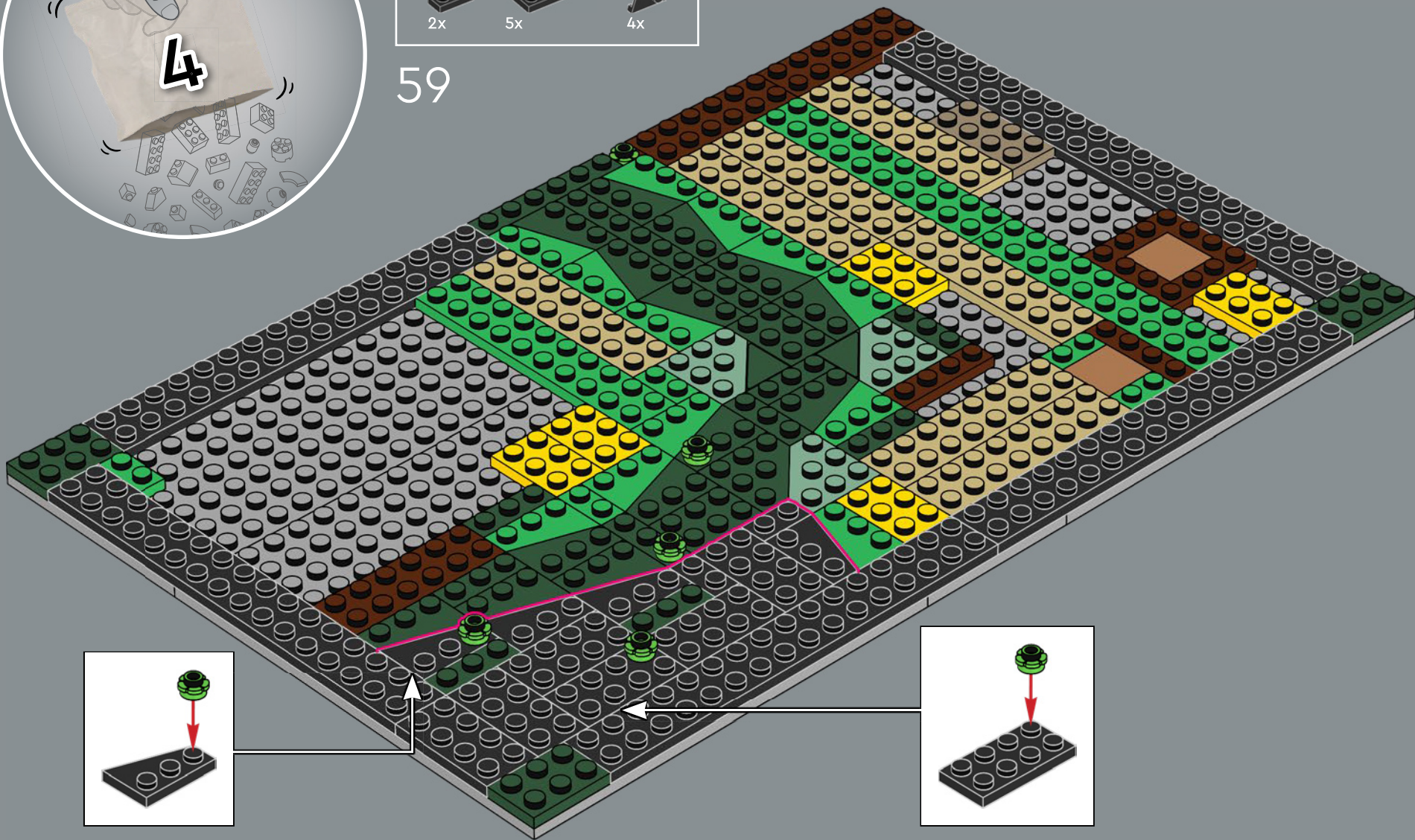

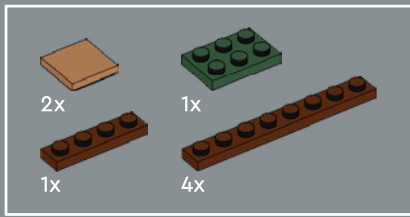

60

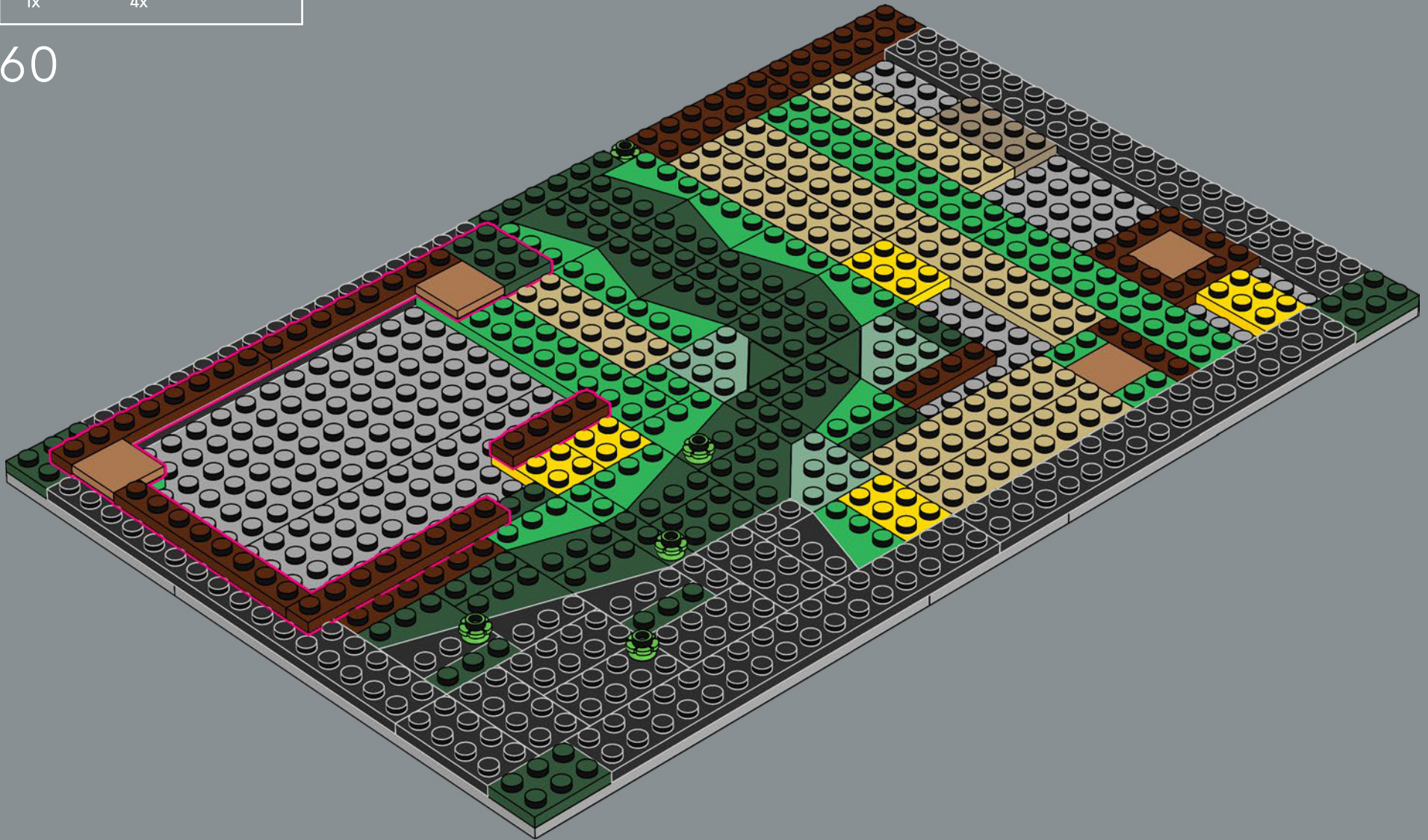

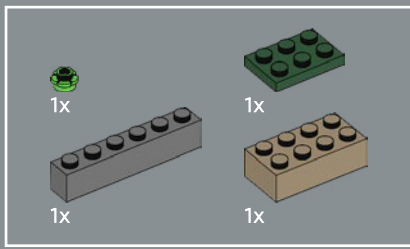

62

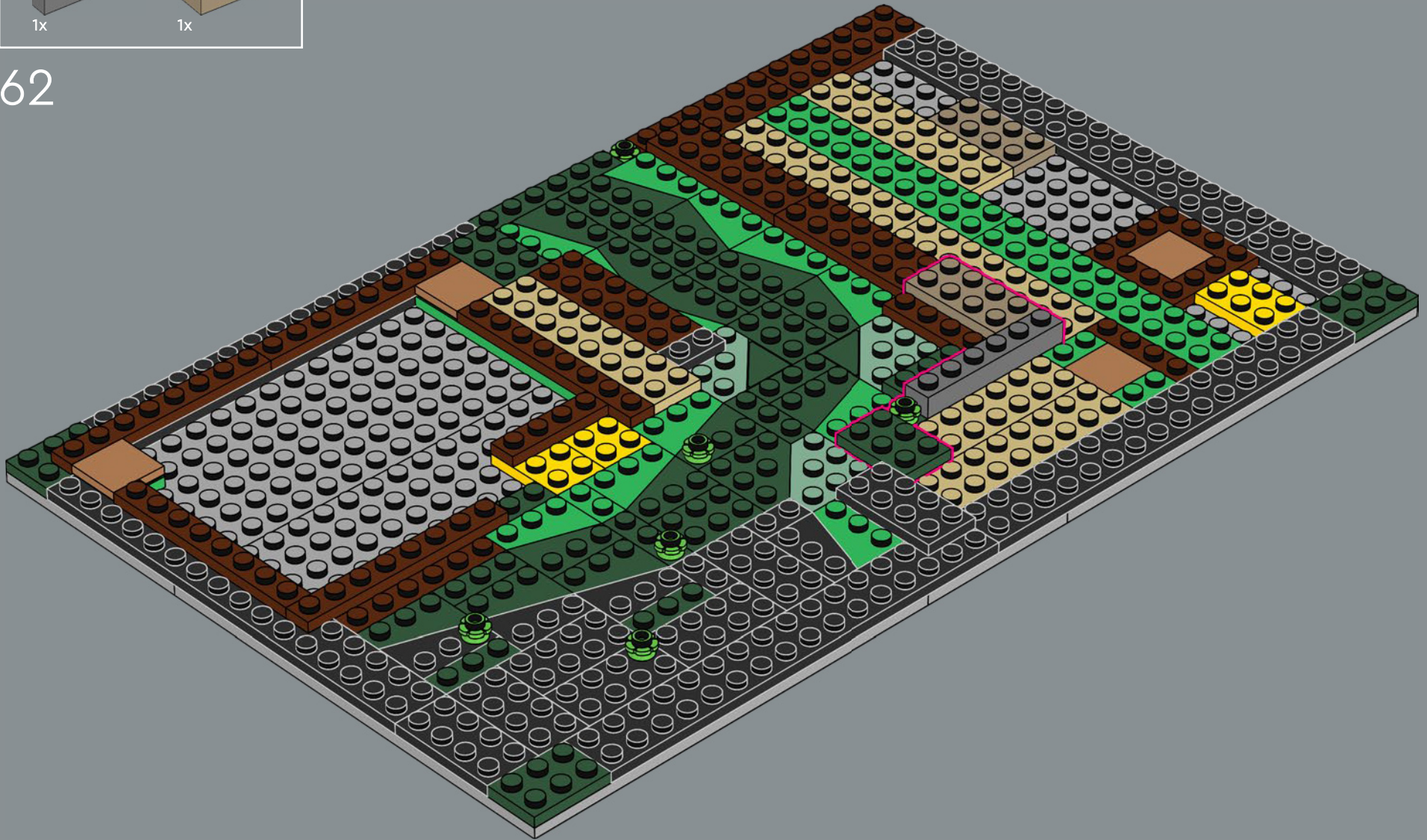

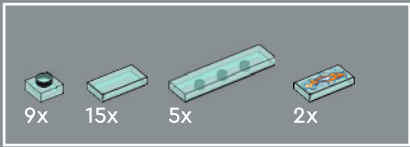

63

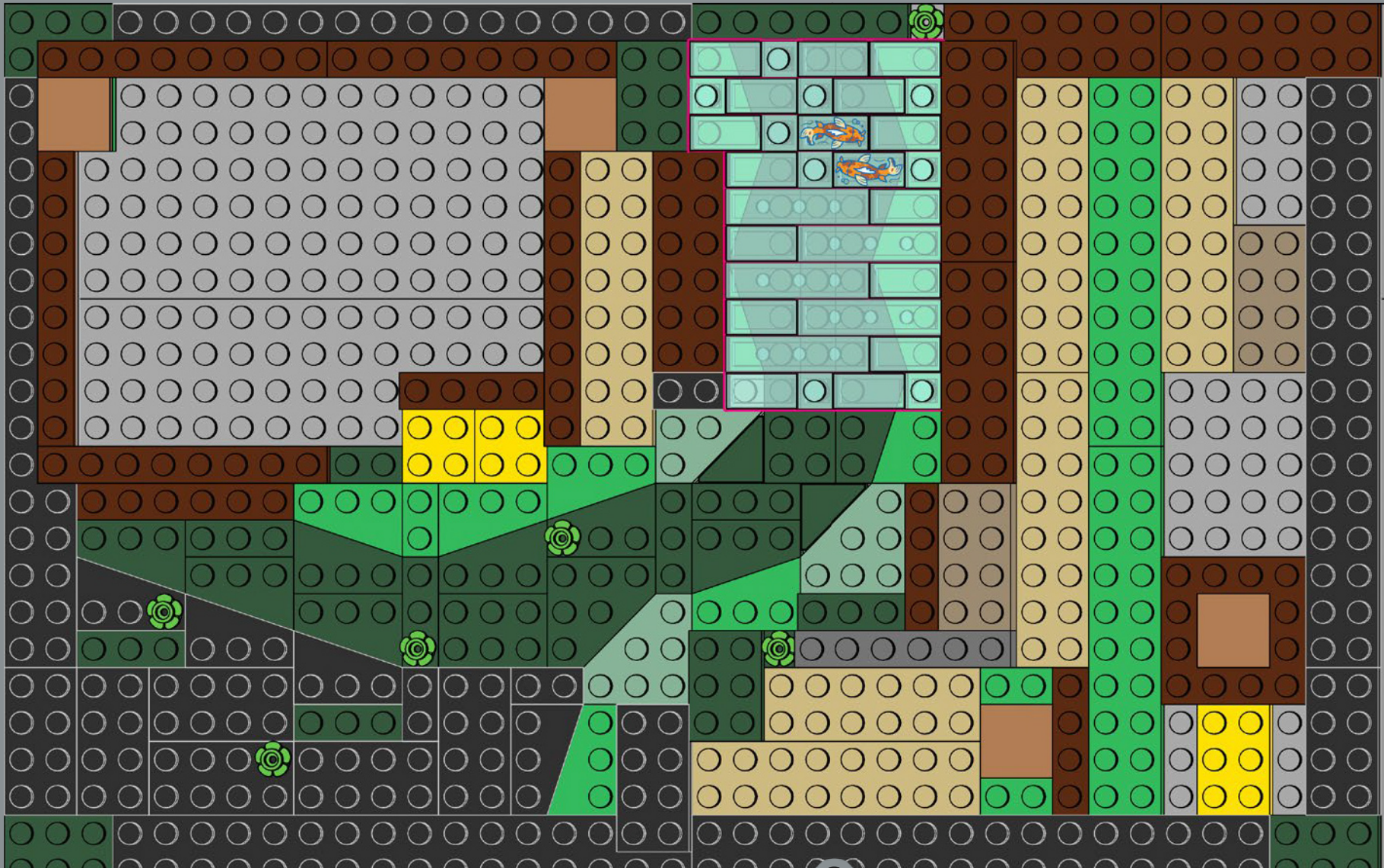



64

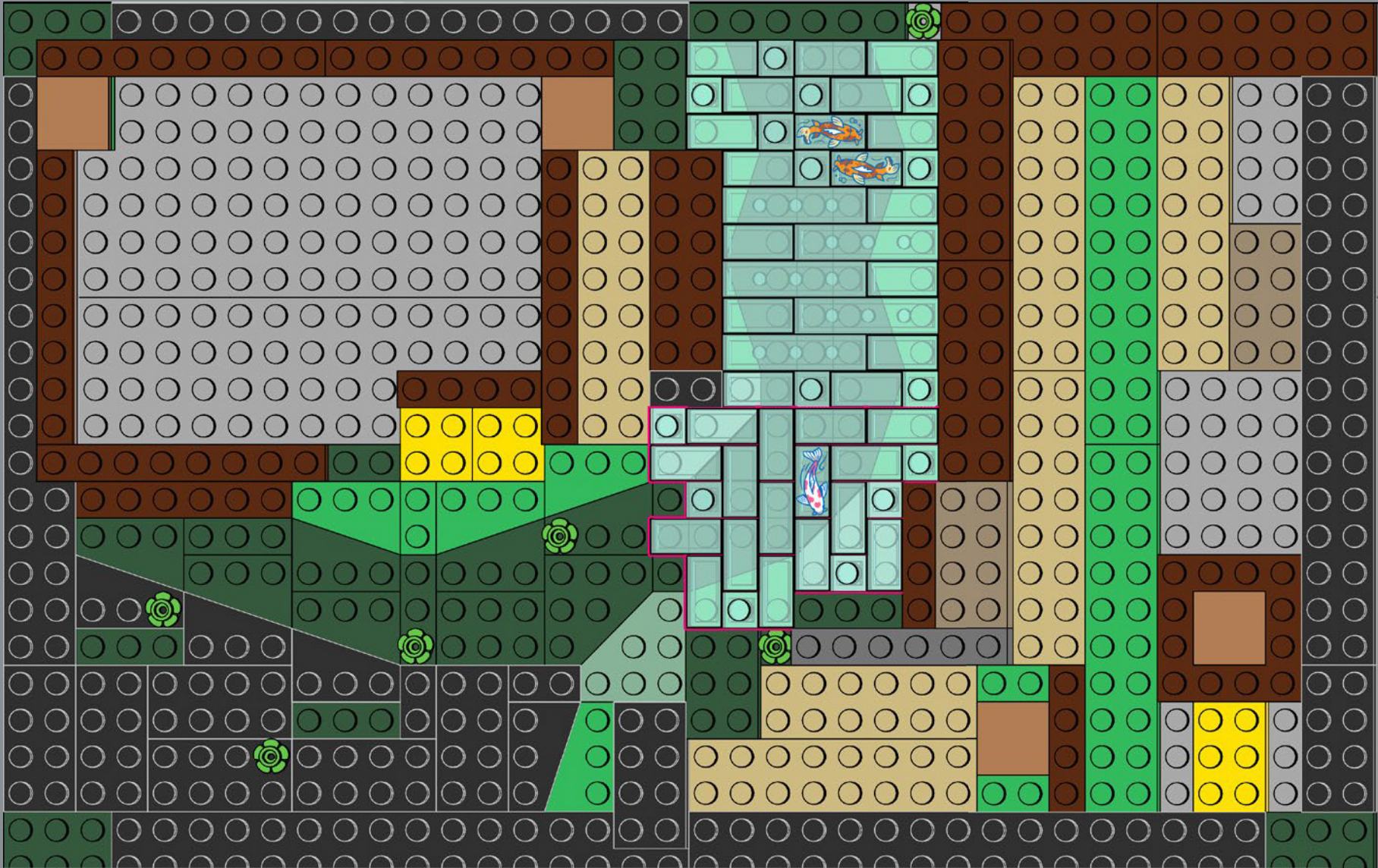

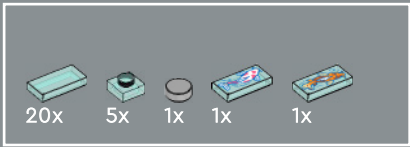

65

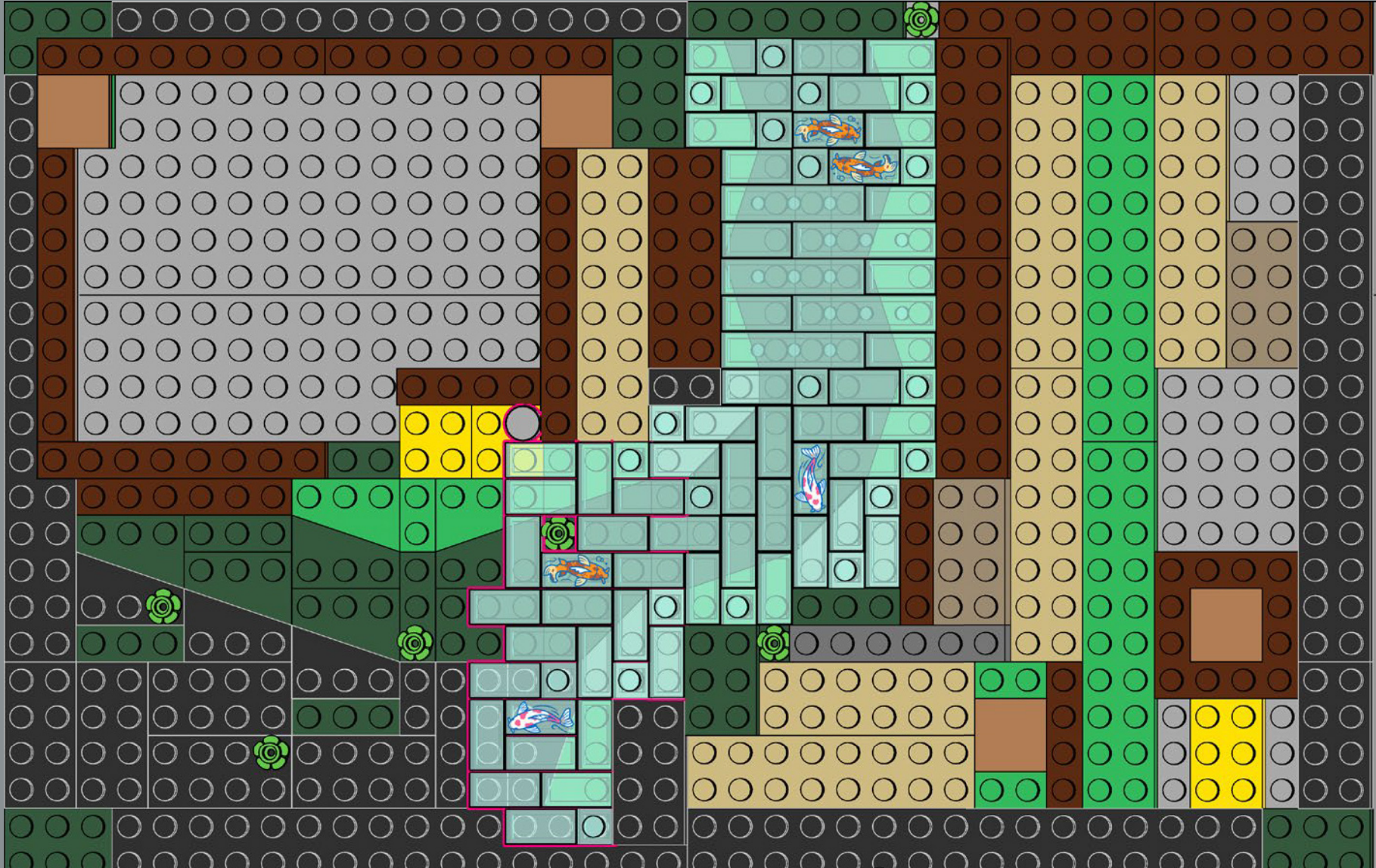

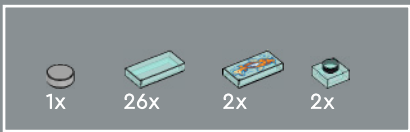

66

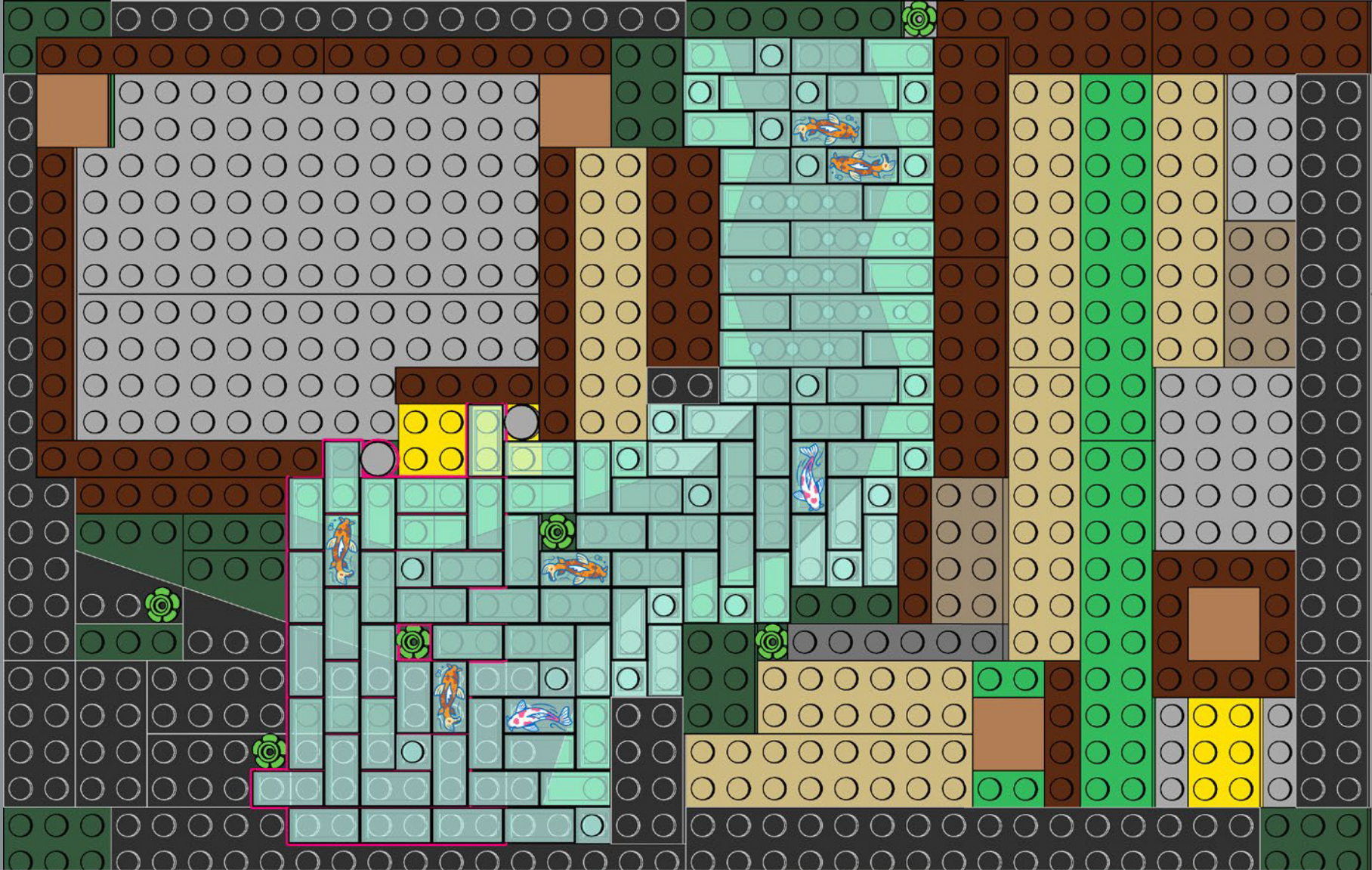

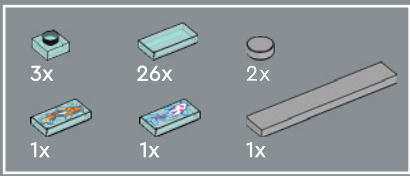

67

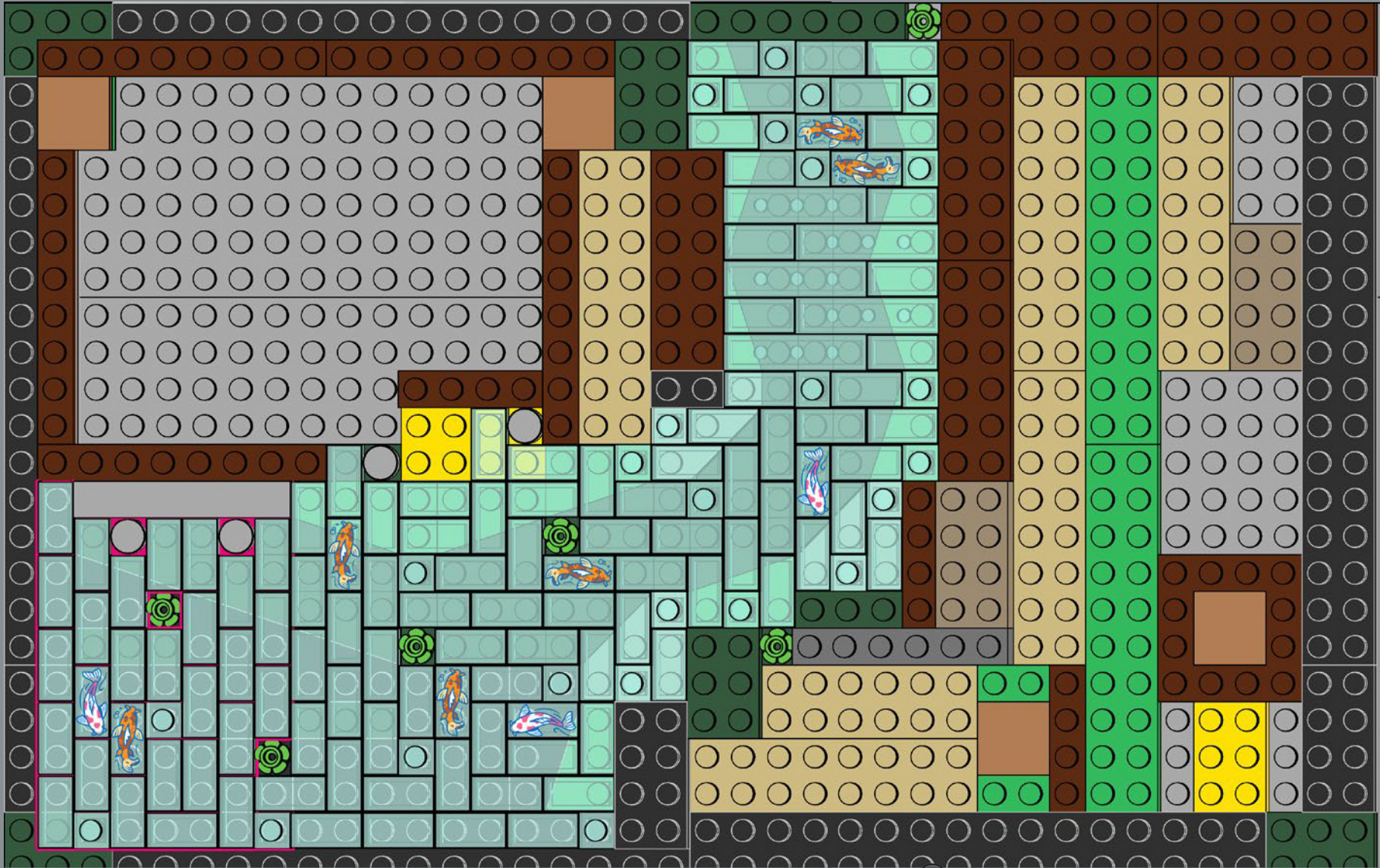



La forme des bassins représente généralement des *kanji* (système d'écriture japonais) qui ont un sens profond, comme *kokoro*, qui signifie « cœur ».

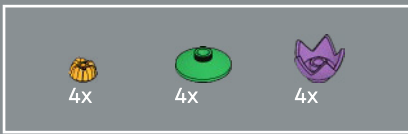

68

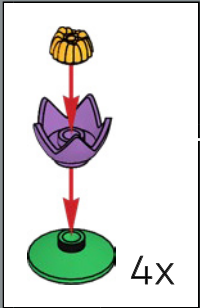

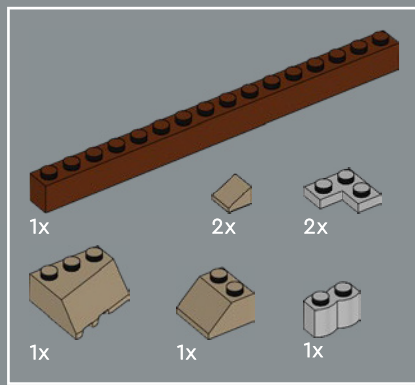

69



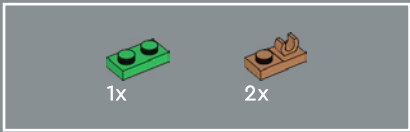

70



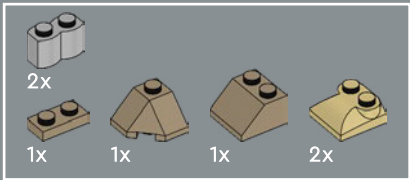

71

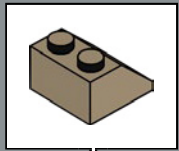
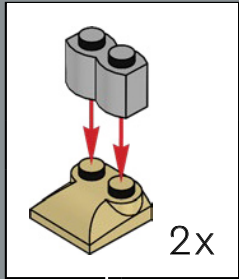

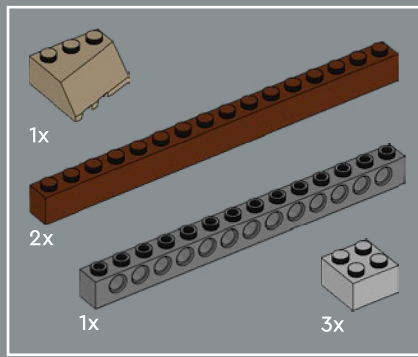

72



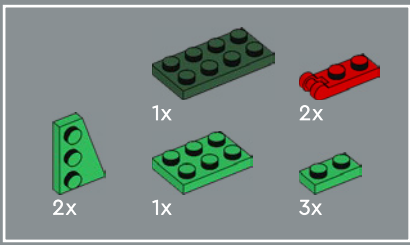

73

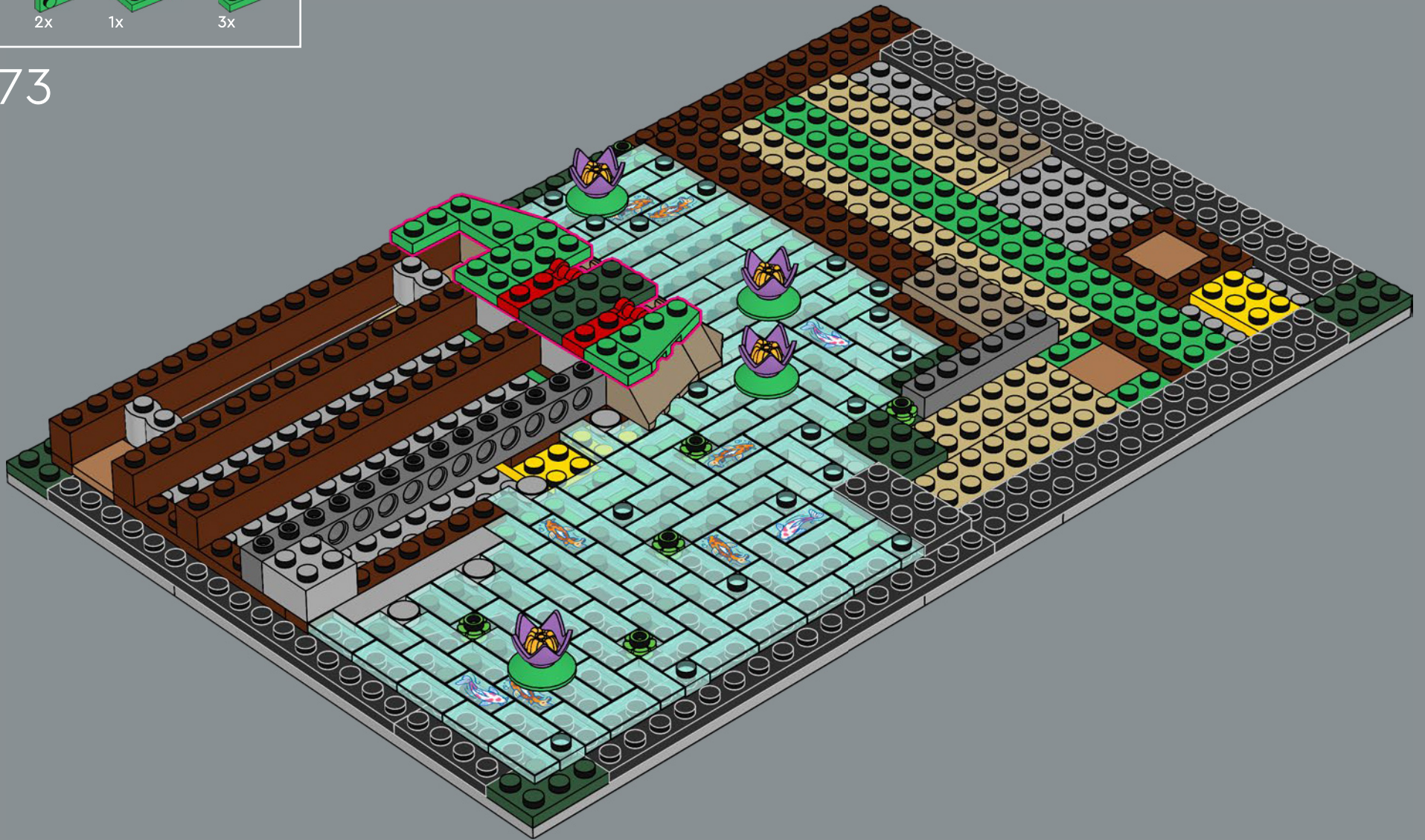

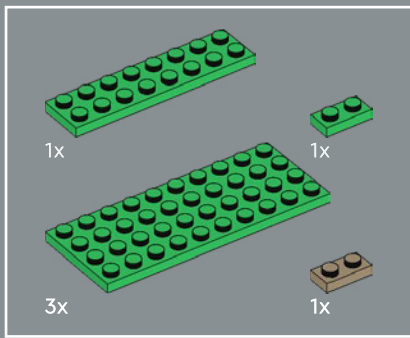

74



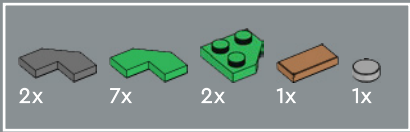

75



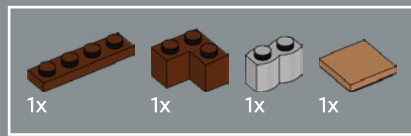

76



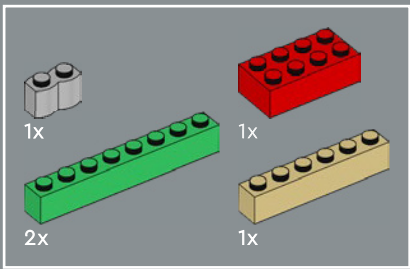

77



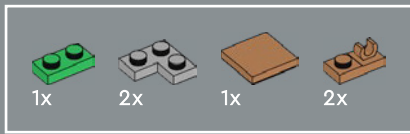

78

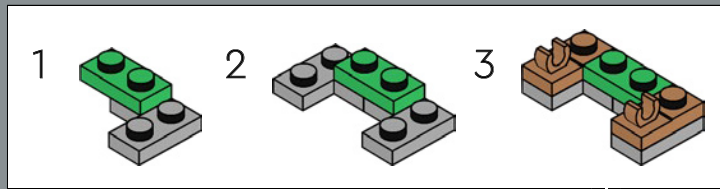

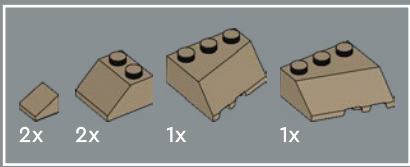

79

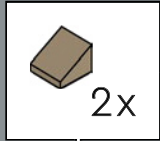

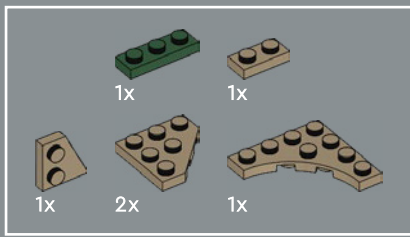

80



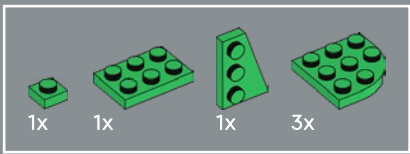

81



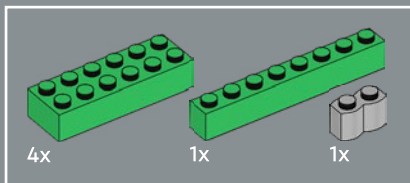

82



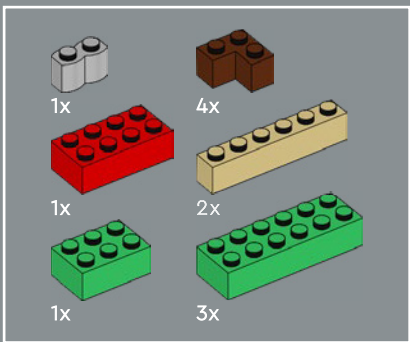

83



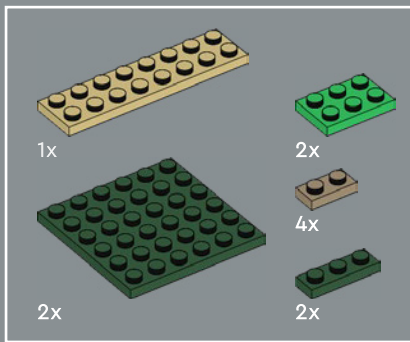

84



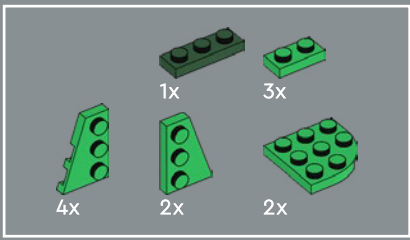

85



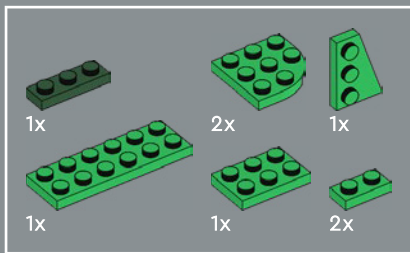

86



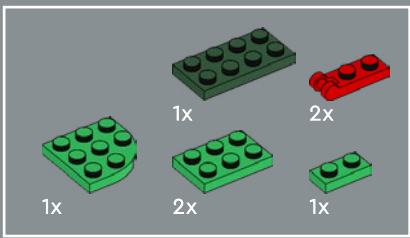

87



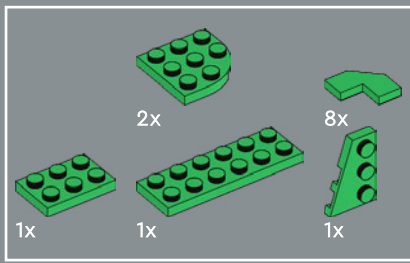

88





Les îles des jardins paisibles peuvent symboliser des montagnes mythiques ou mystiques, des tortues ou des grues (souvent associées à la longévité).

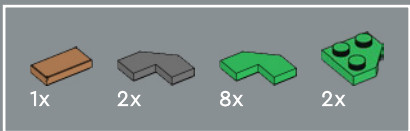

89



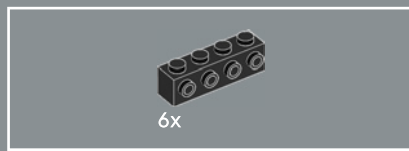

90



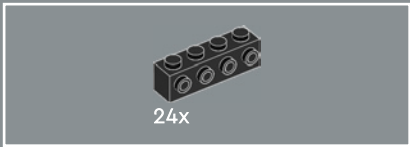

91



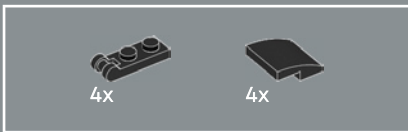

92

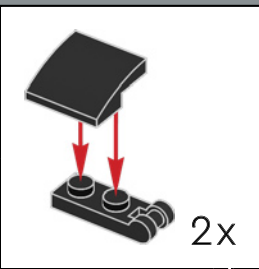
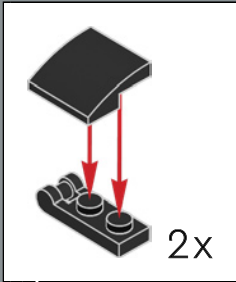

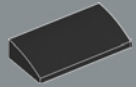

26x

93



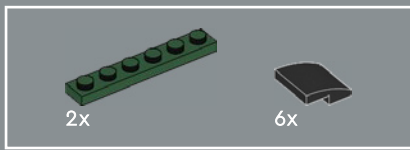

94

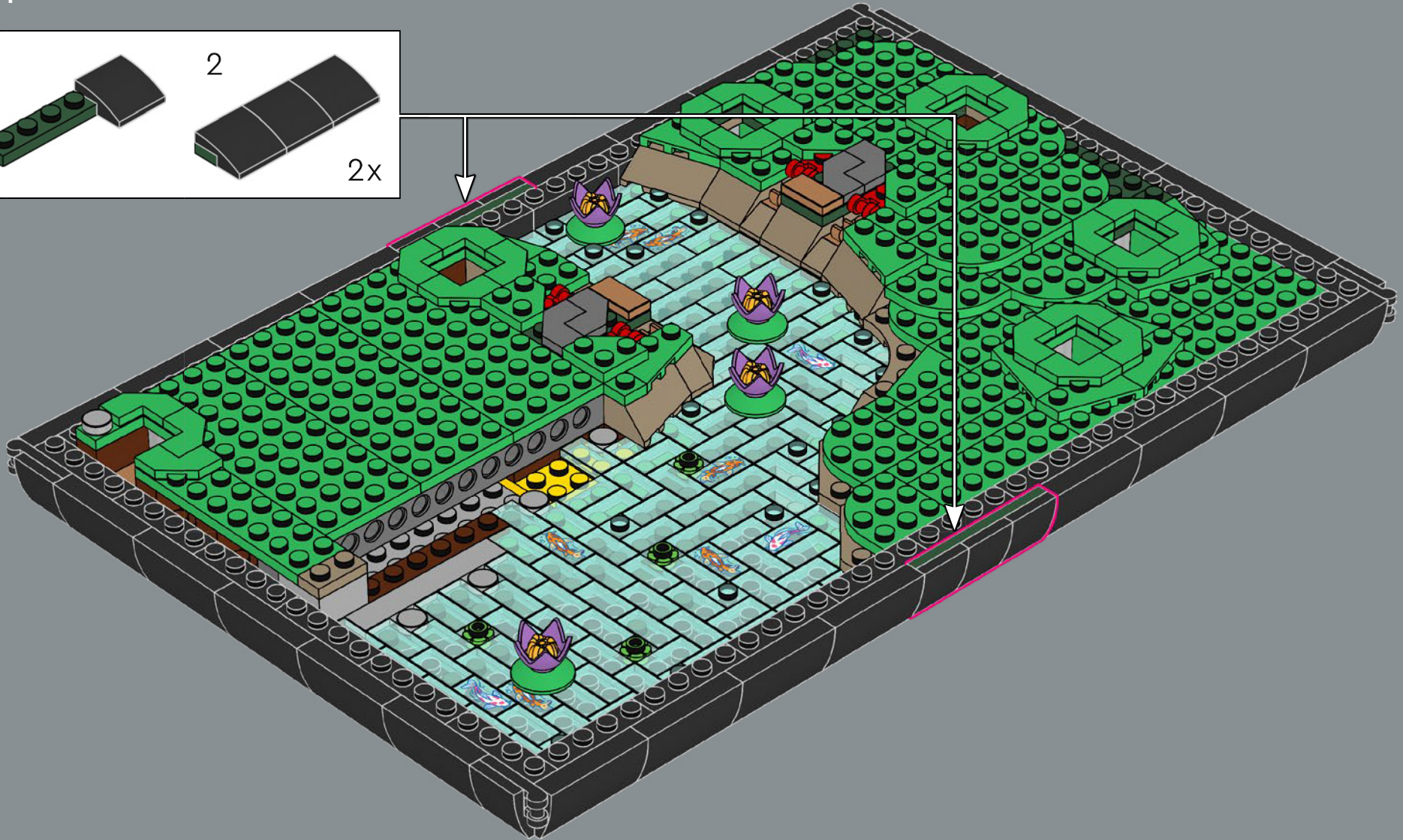
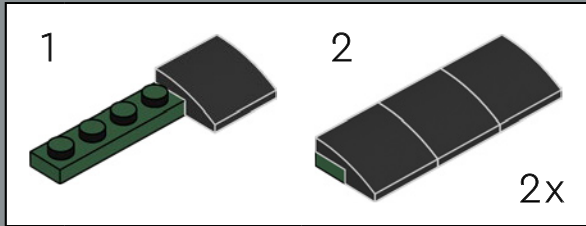

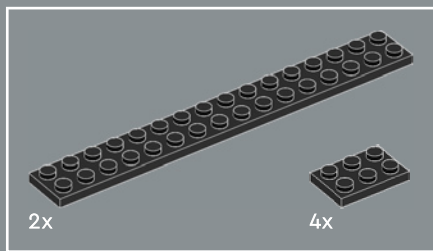

95



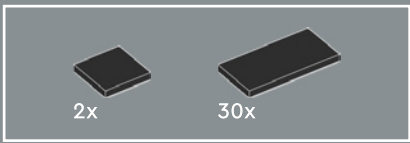

Vous reconnaissez le motif de la structure de base de ce modèle ?
Nous avons réutilisé le motif du pot de fleurs du set LEGO Icons
Bonsaï 10281 pour lui donner un aspect identique.

97

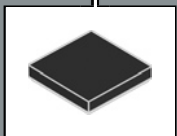
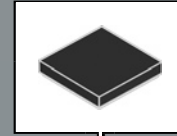

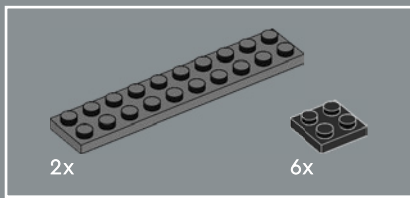

98

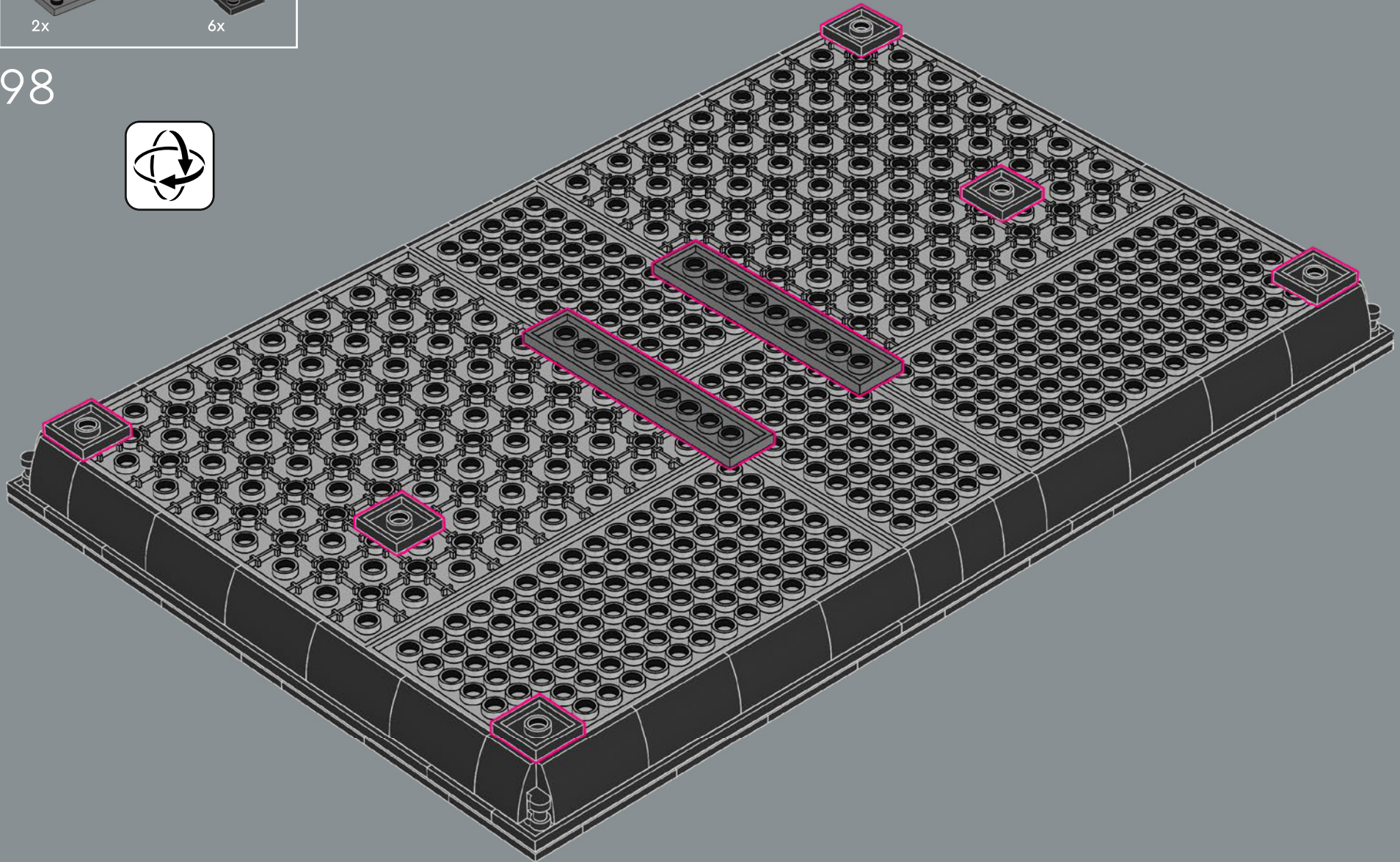



99

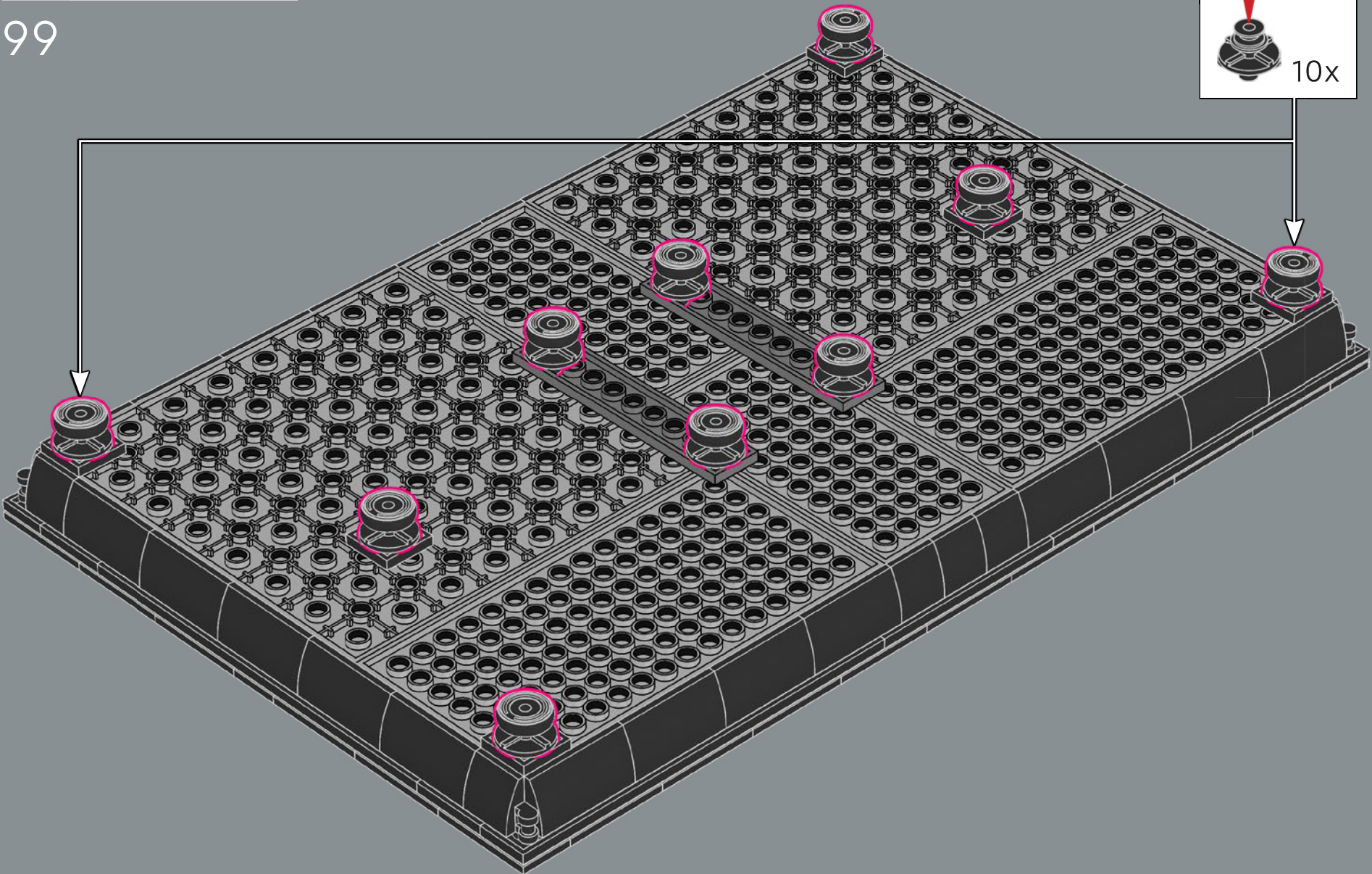
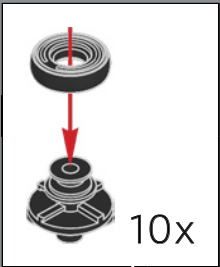



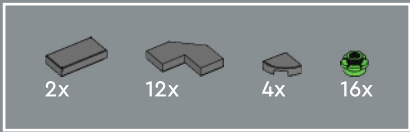

100

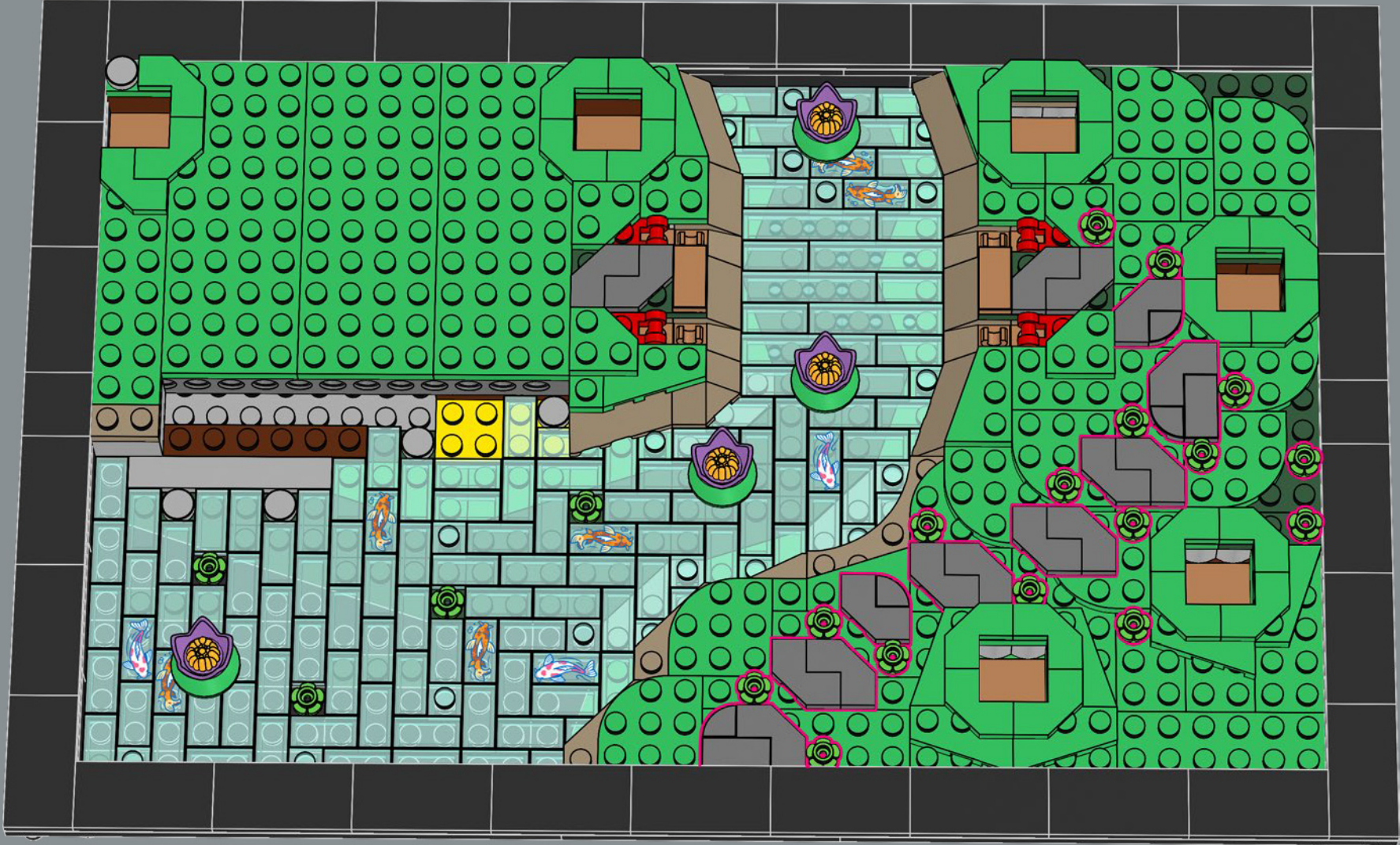

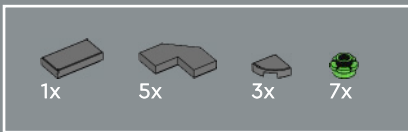

Des sentiers sinueux vous invitent à voir le jardin
(et peut-être d'autres choses ?) sous différents angles.

101

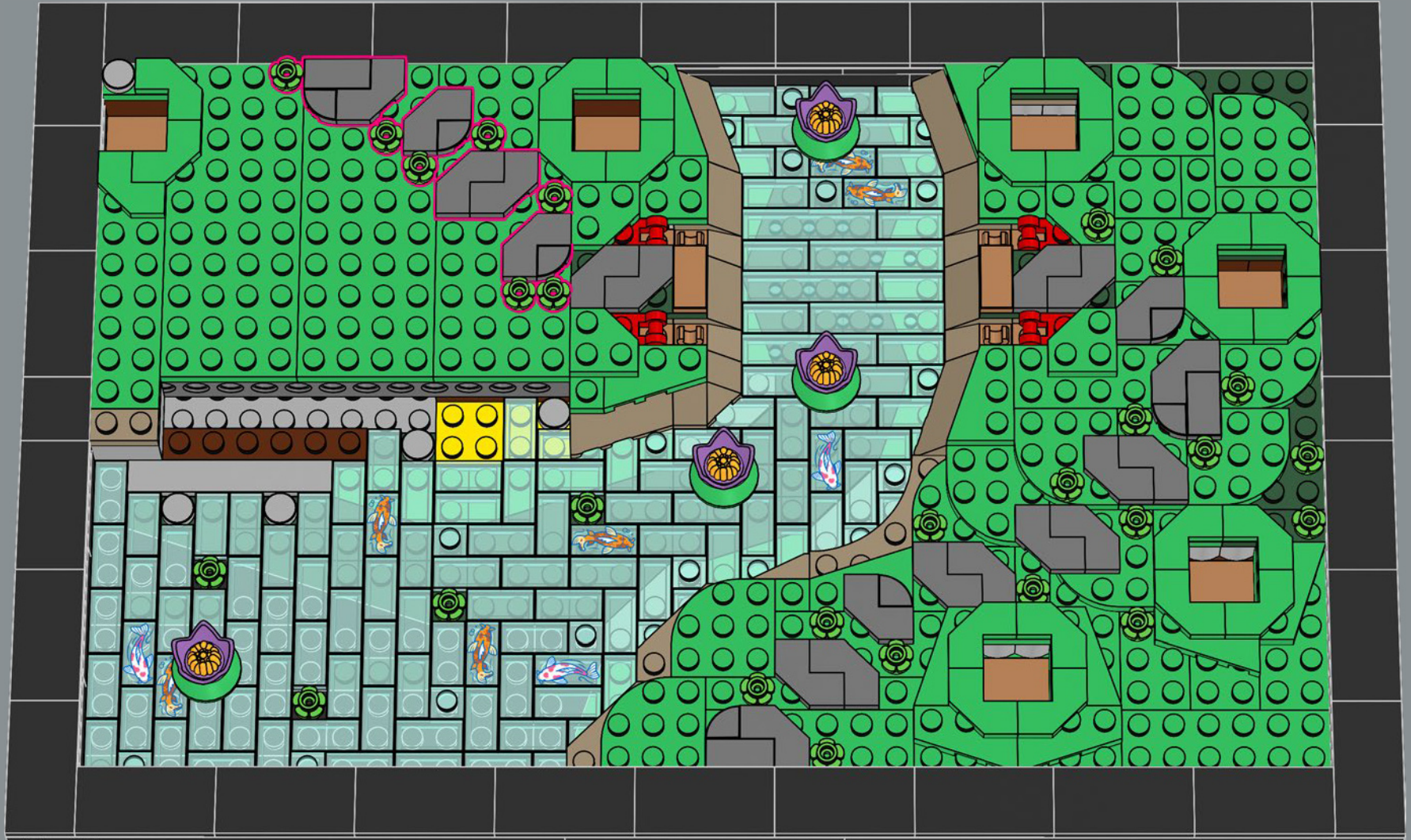

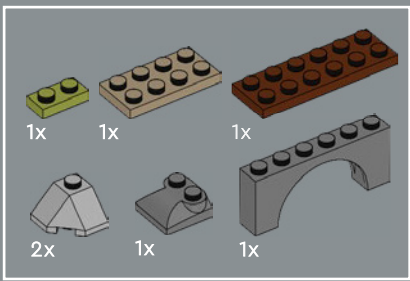

102

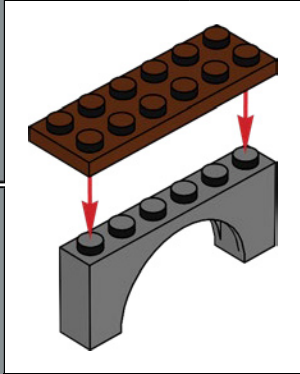

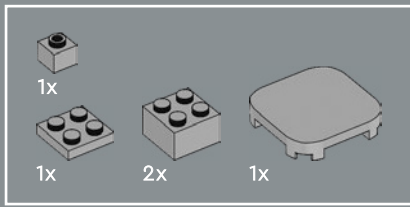

103



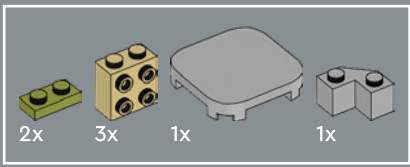

104

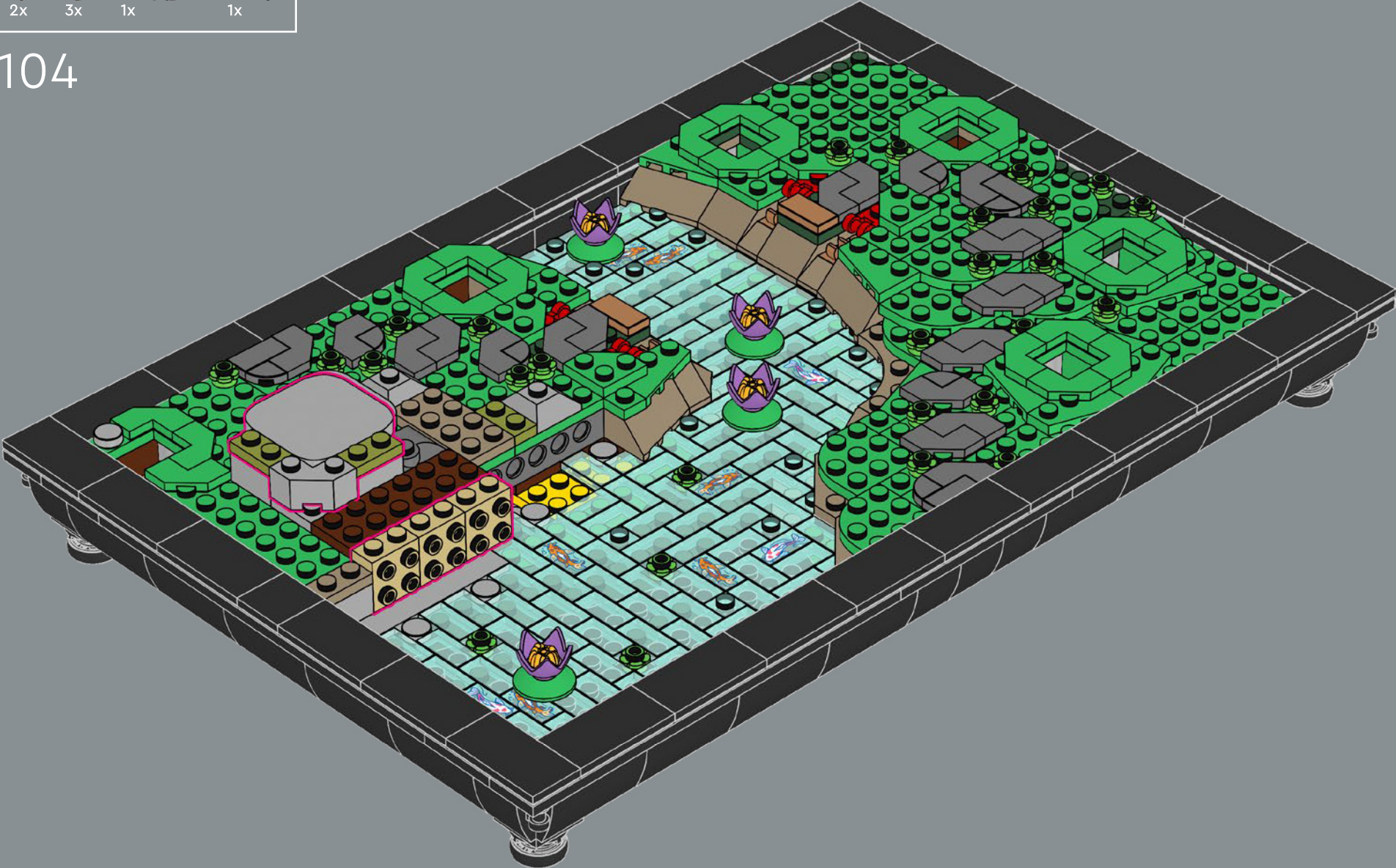

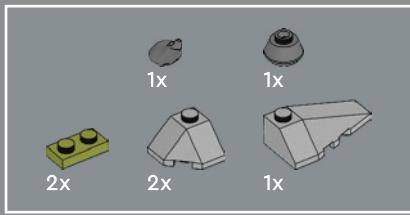

105

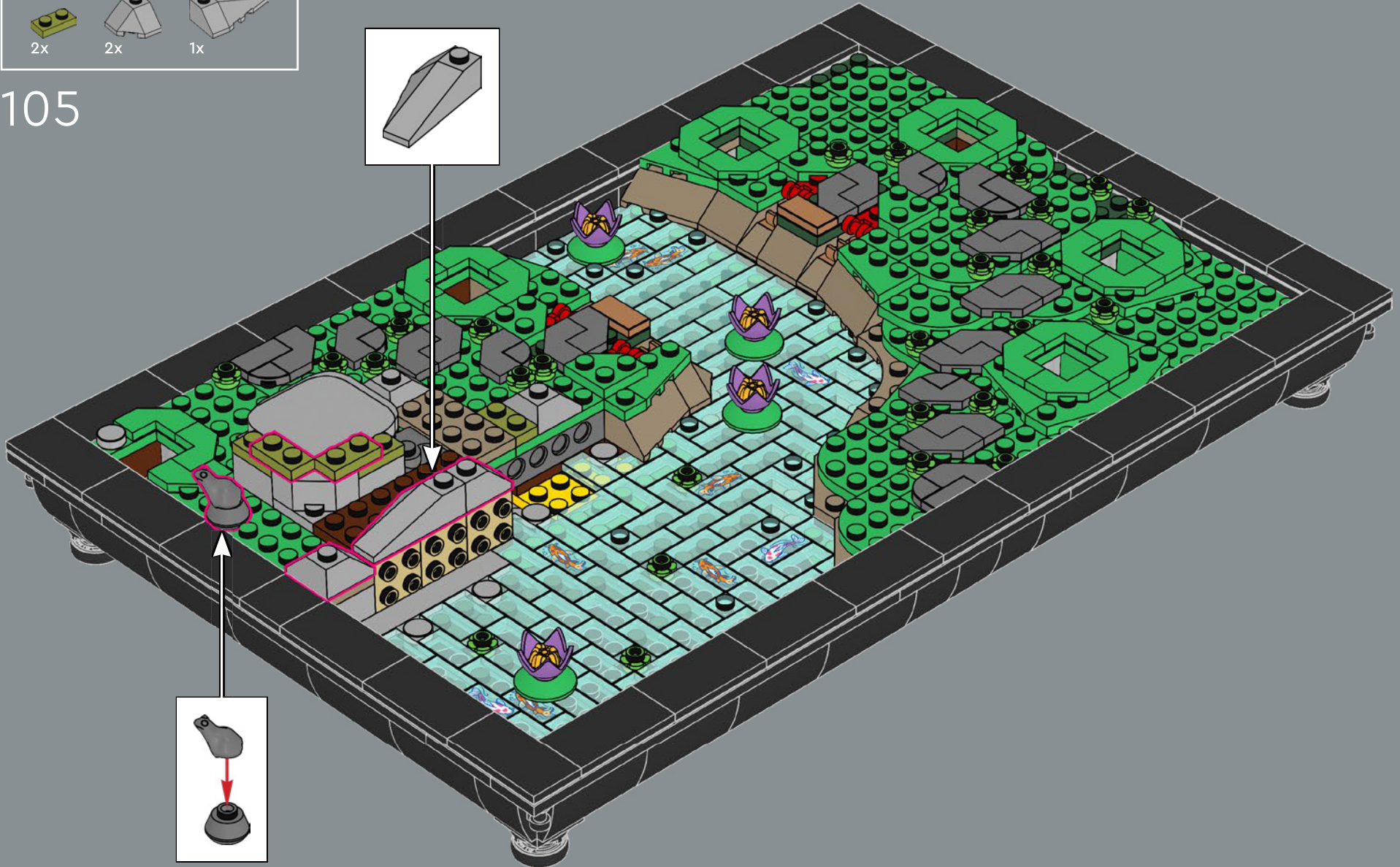
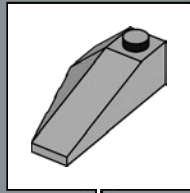

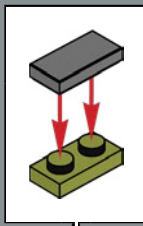
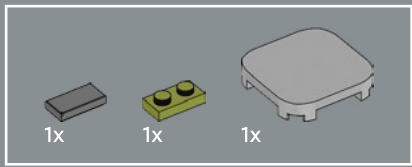

106



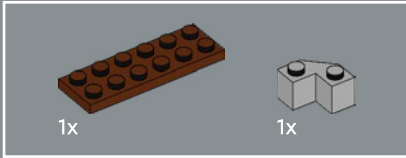
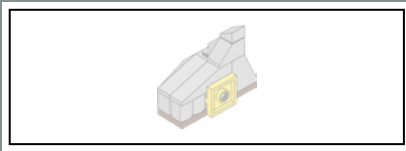

107

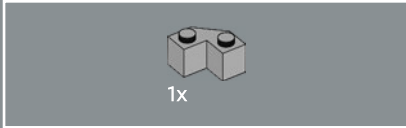
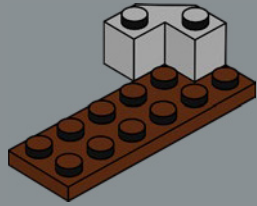

108

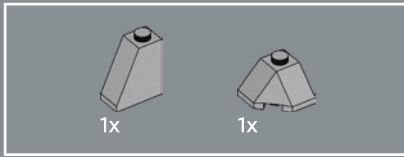
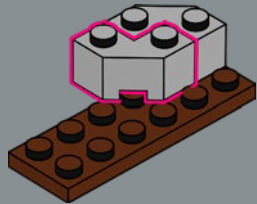

109

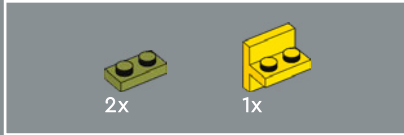
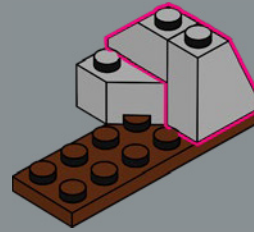

110

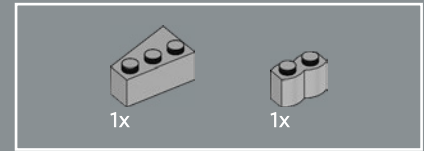
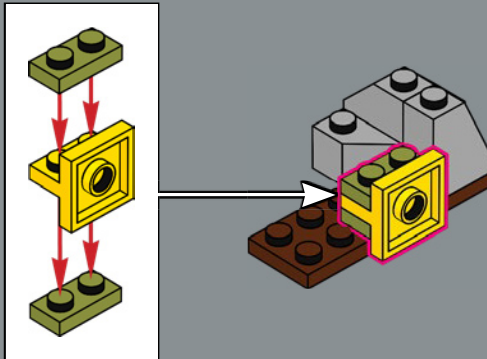

111

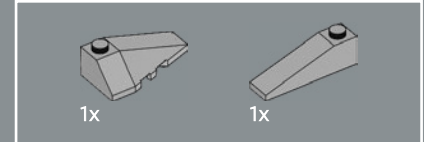
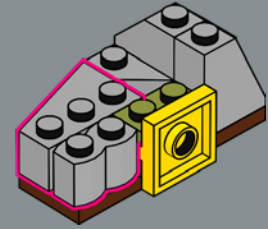

112

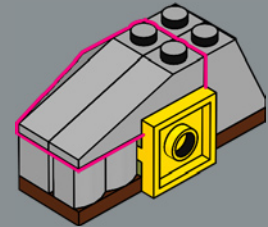

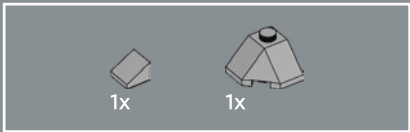

113

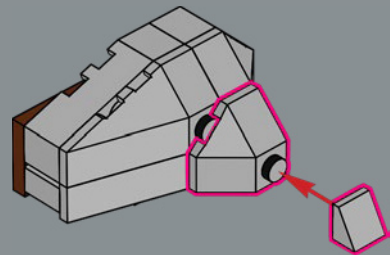

114



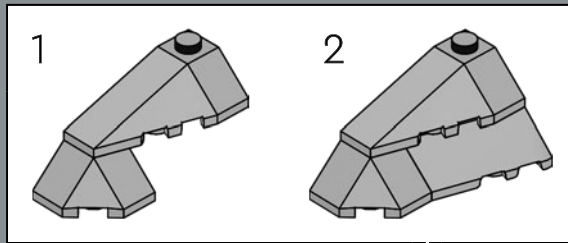
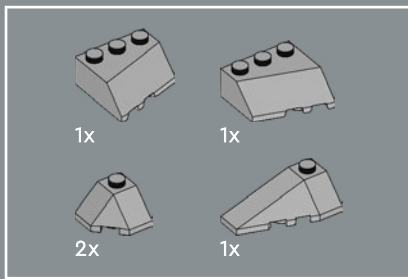

115

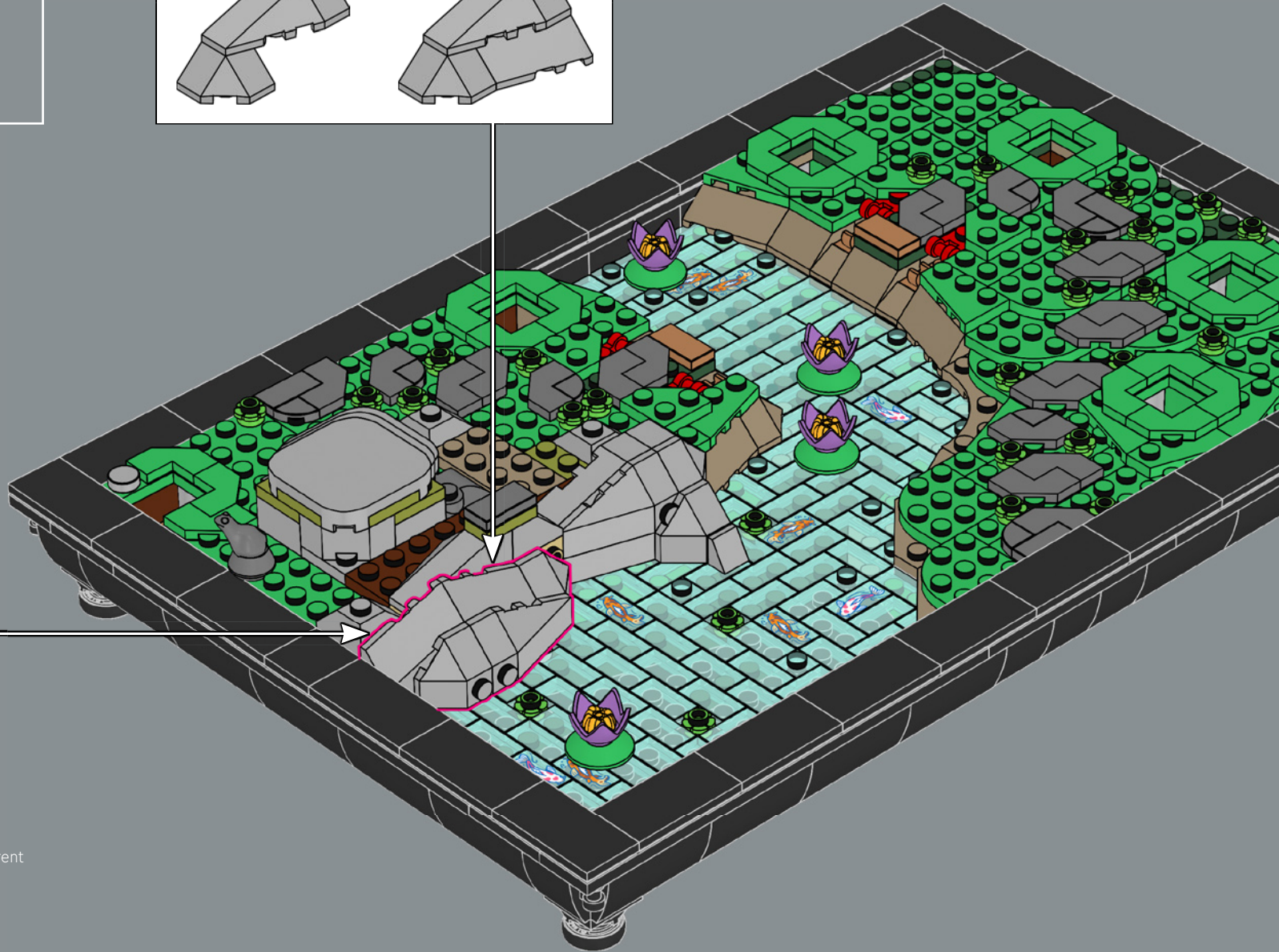
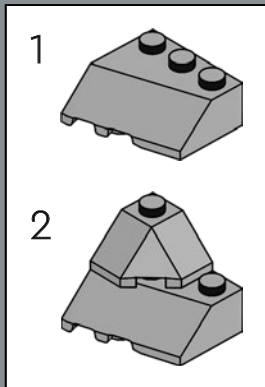

Les pierres, les roches et le sable confèrent souvent un sens plus profond au terrain.



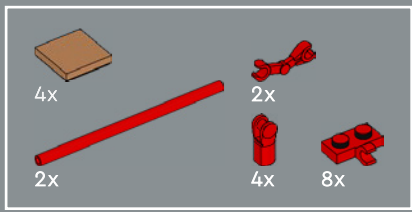

116

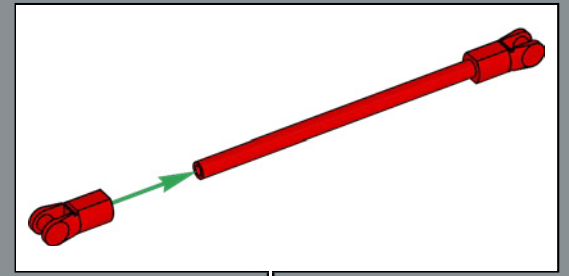
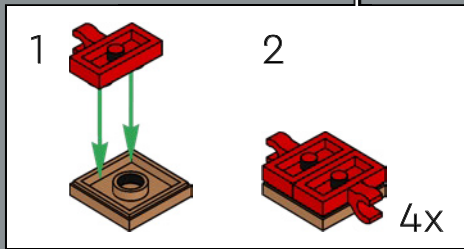
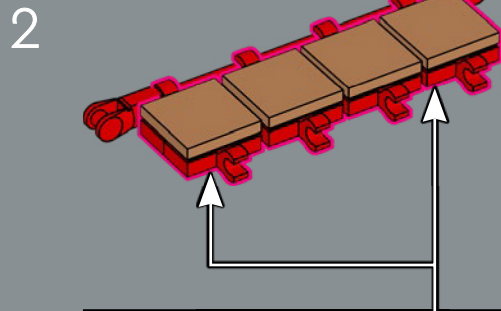
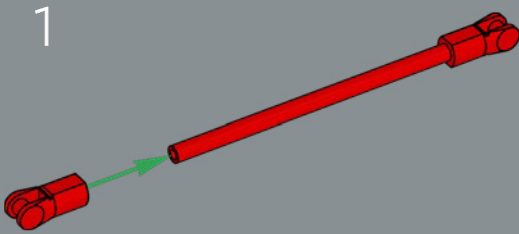

3

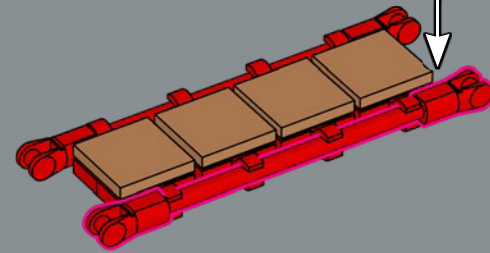

4

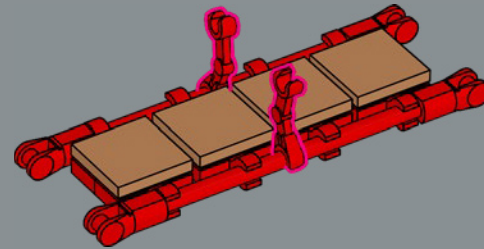

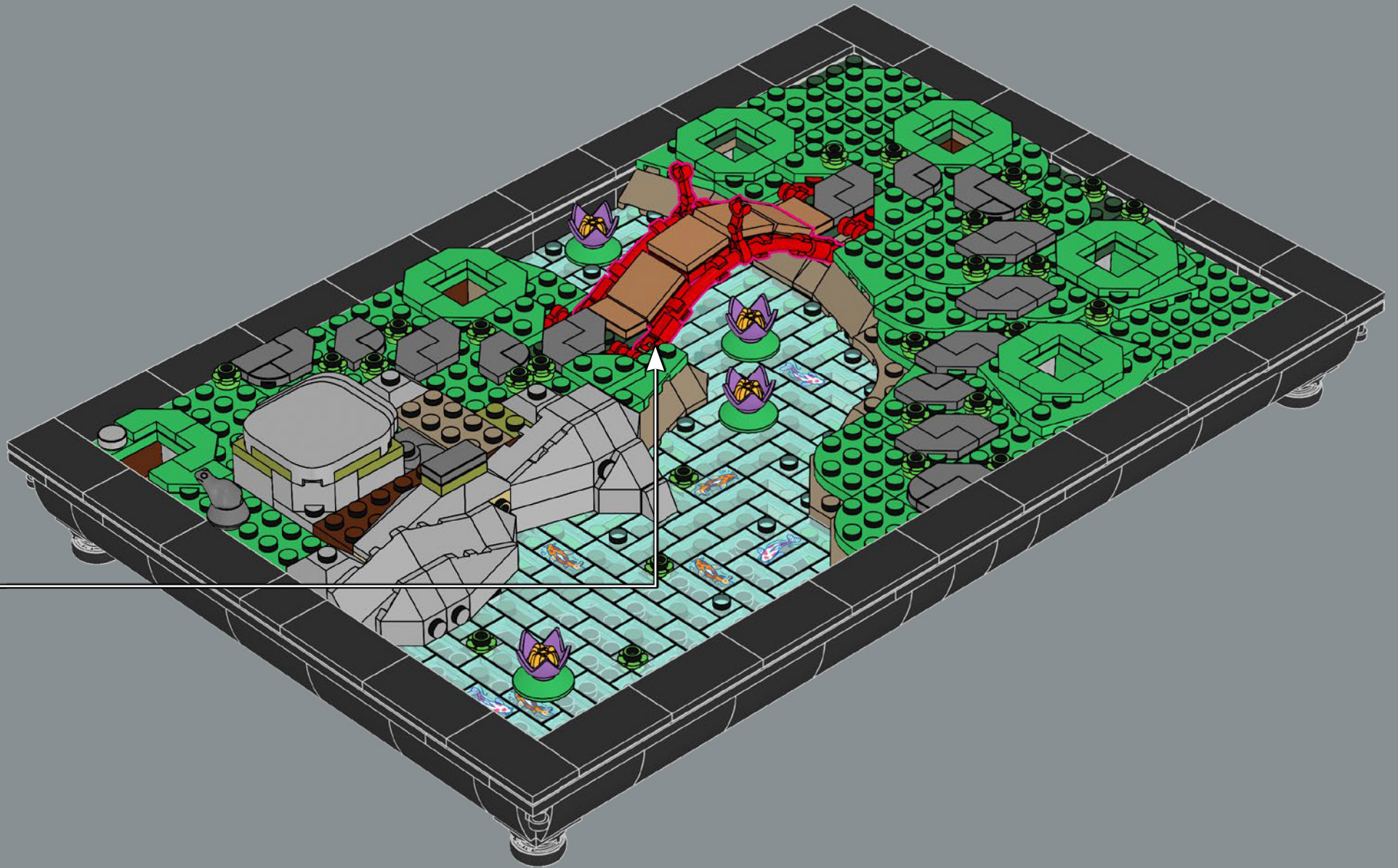

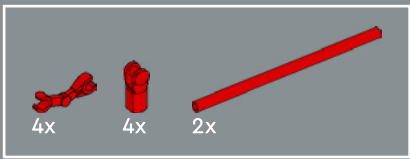

117

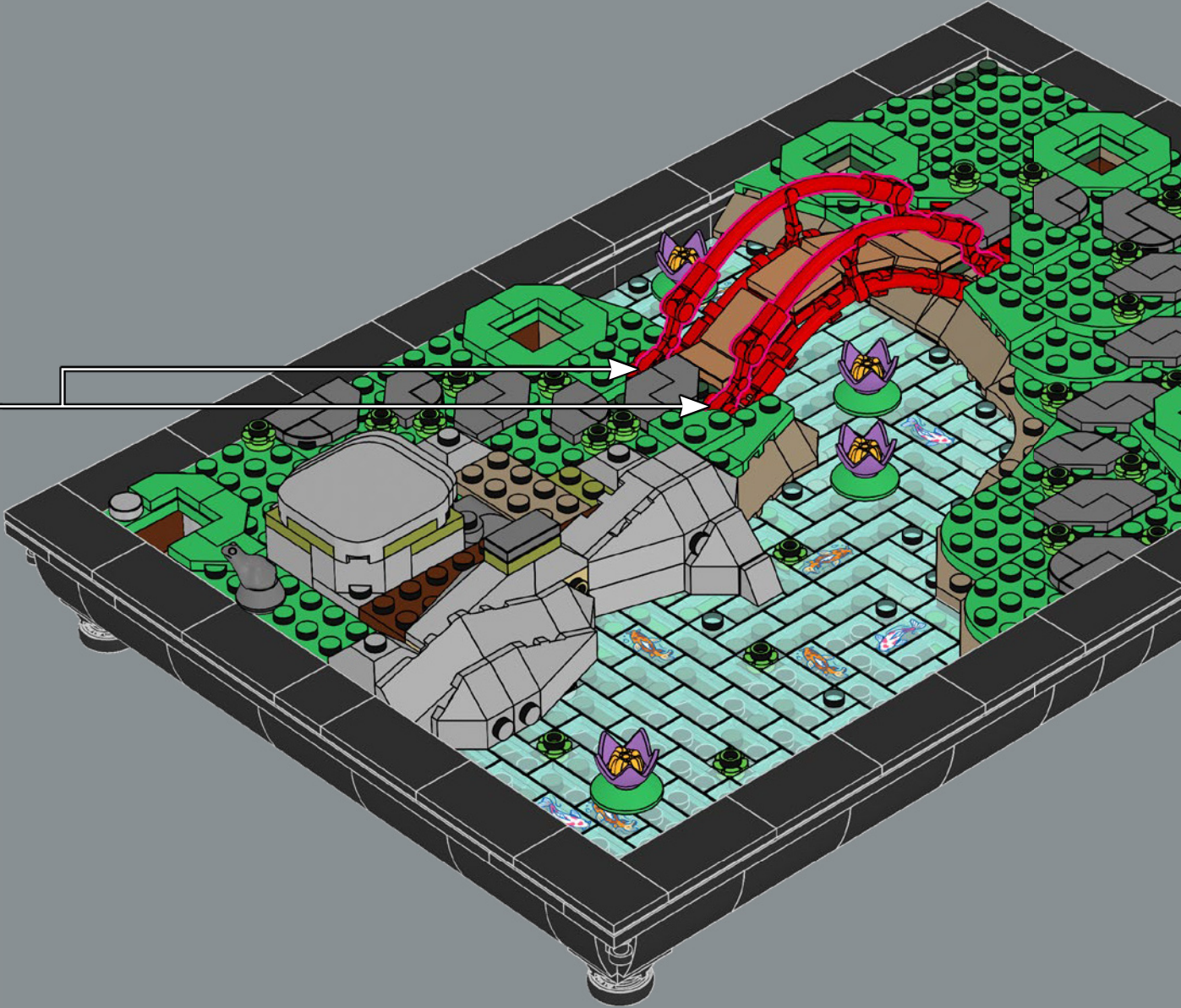
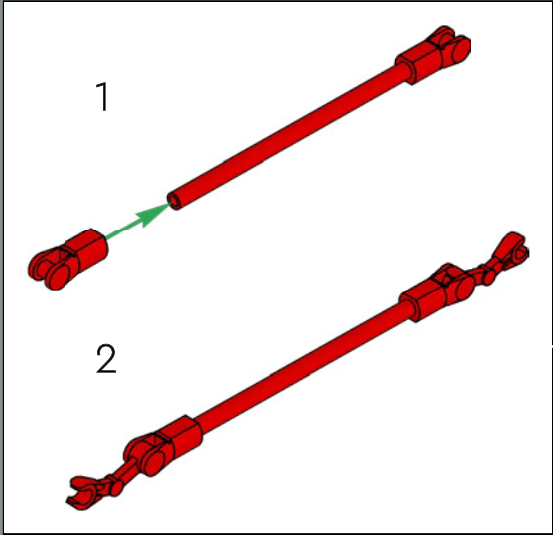



118

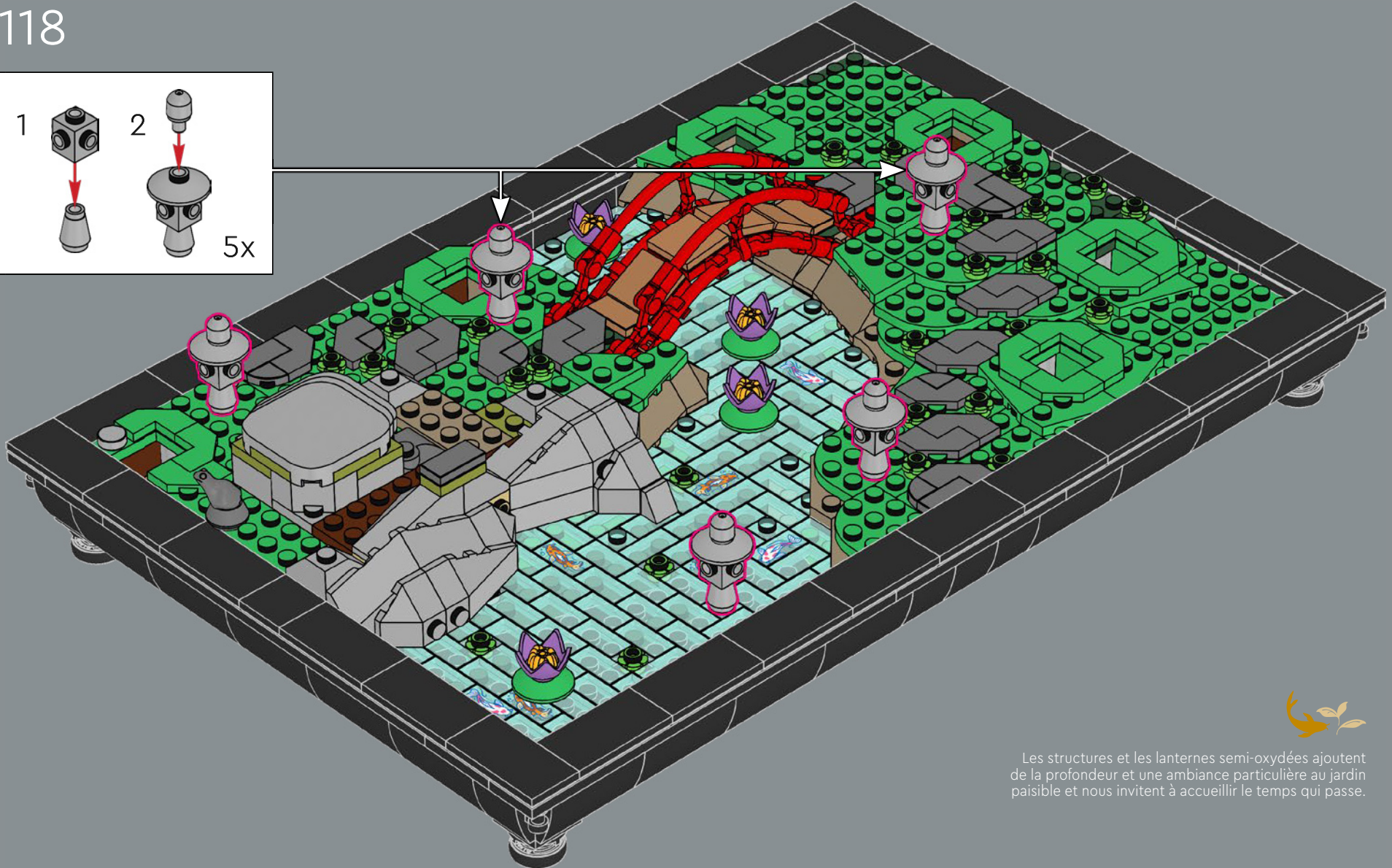
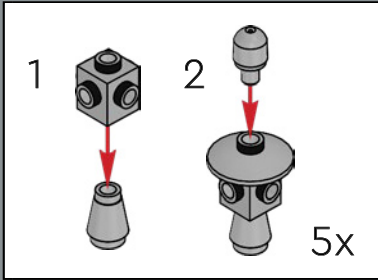

Les structures et les lanternes semi-oxydées ajoutent de la profondeur et une ambiance particulière au jardin paisible et nous invitent à accueillir le temps qui passe.

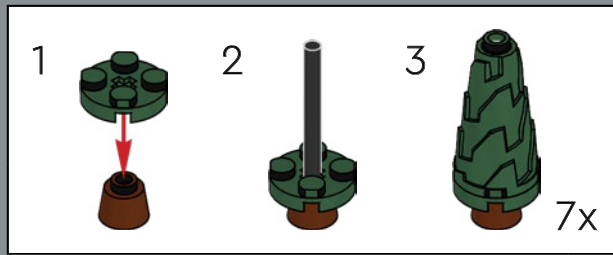
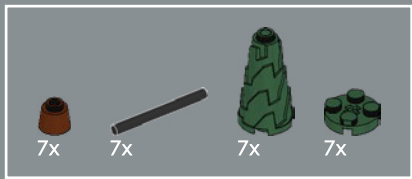

119



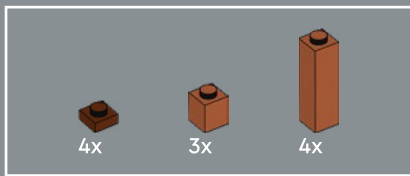

120

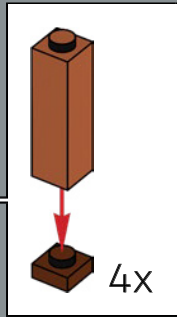
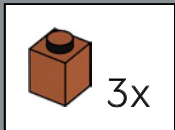

121



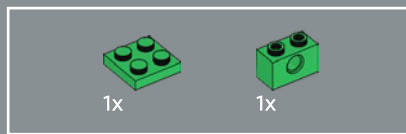

122

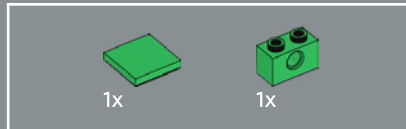
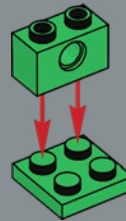

123

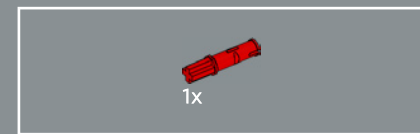
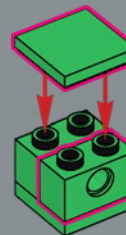

124

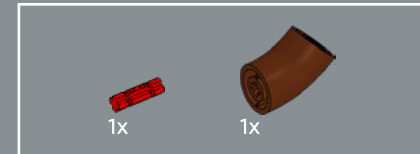
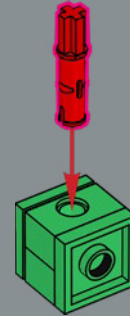

125

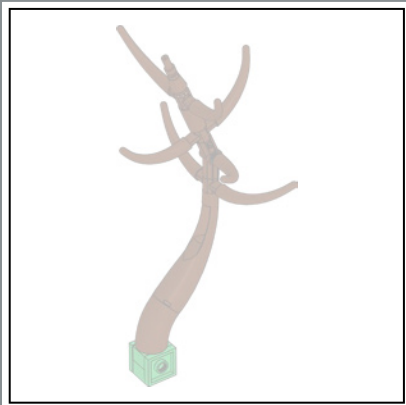
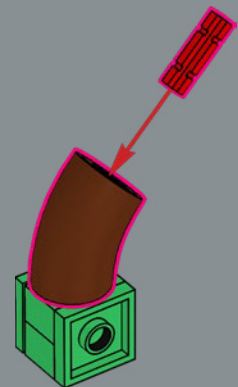

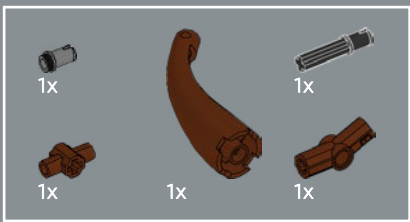

126

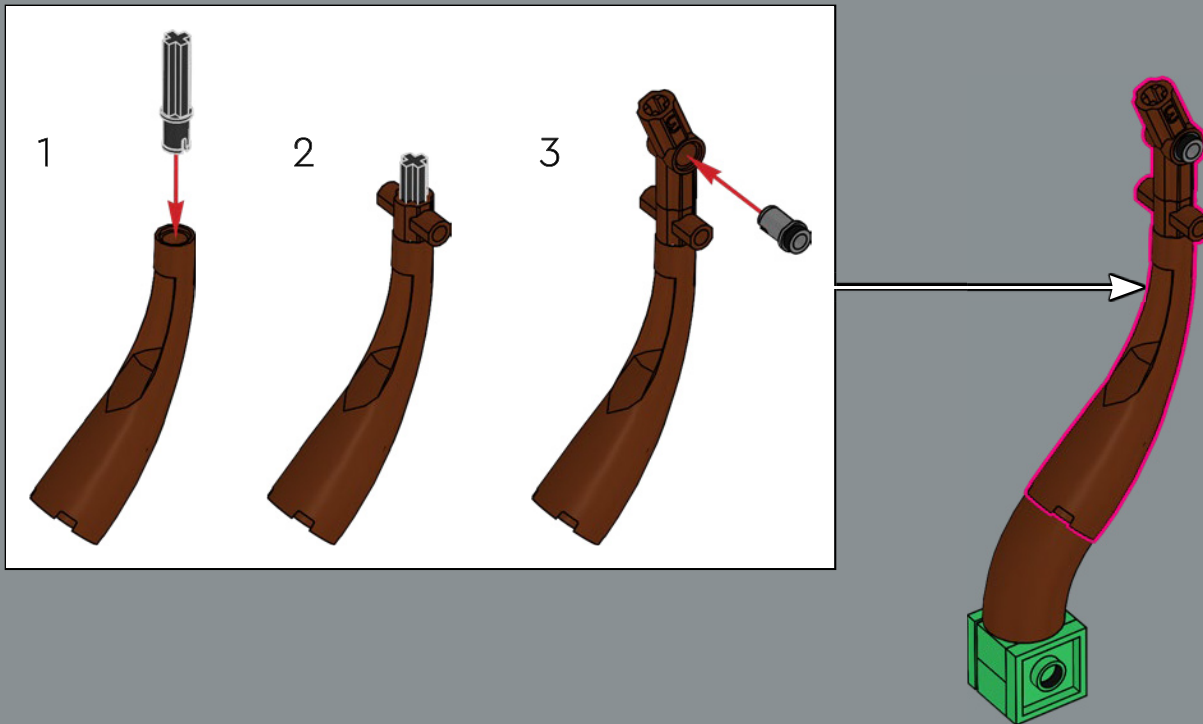

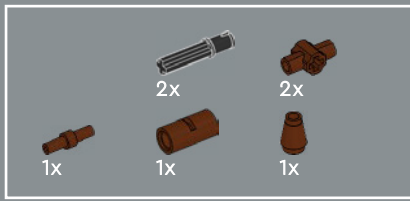

127

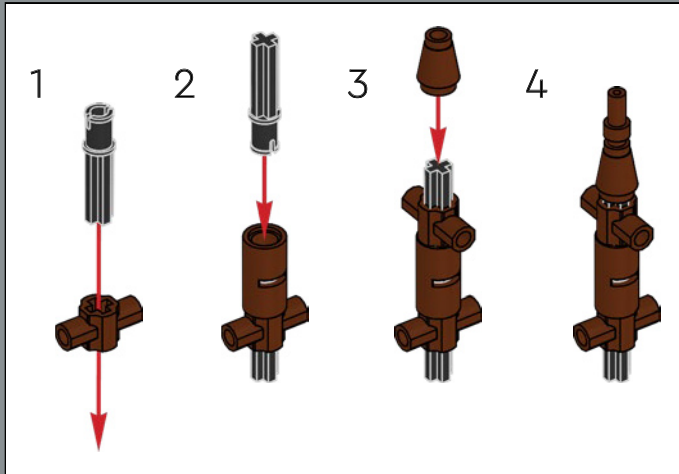

128





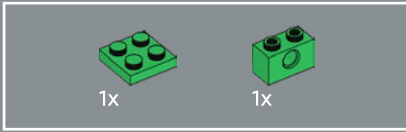
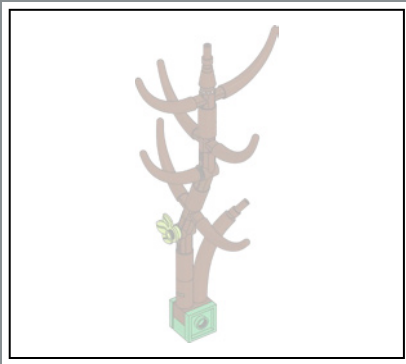

130

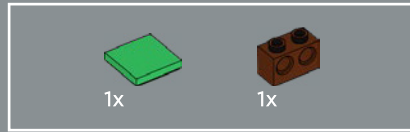
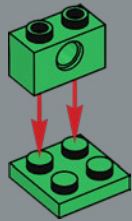

131

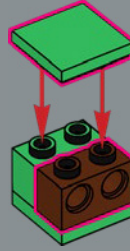

132

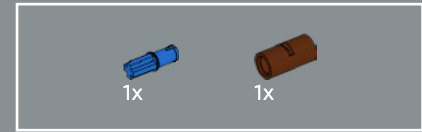
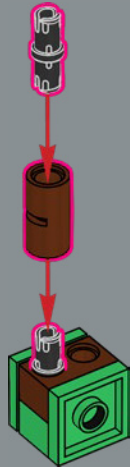

133

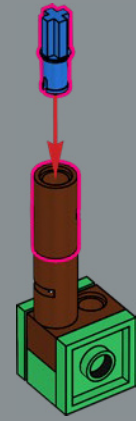

134

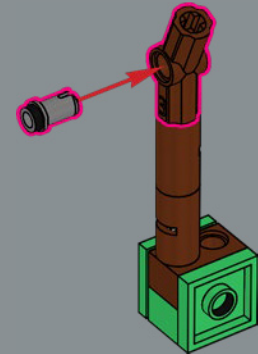

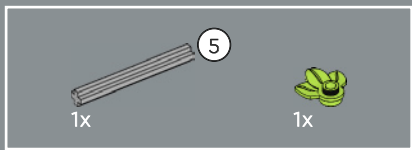

135

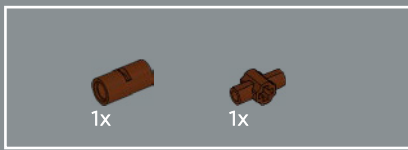
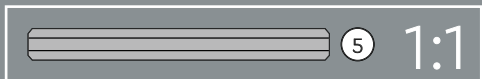

136

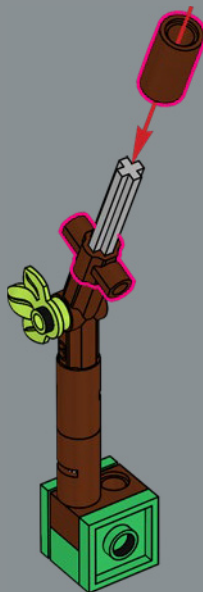

137



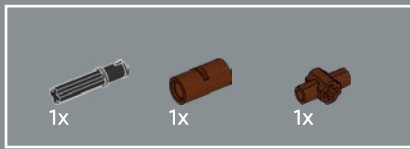

138

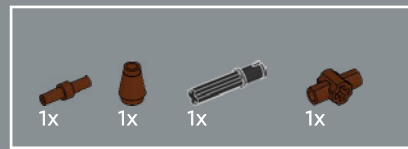
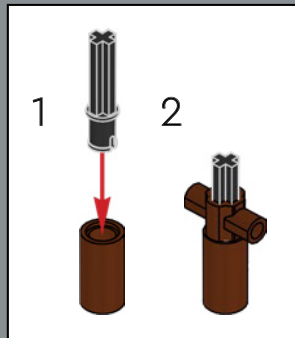

139

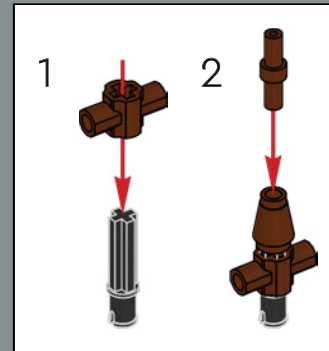

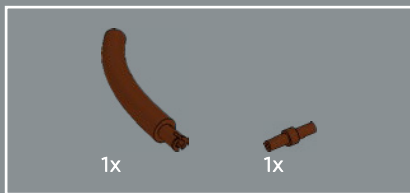

140

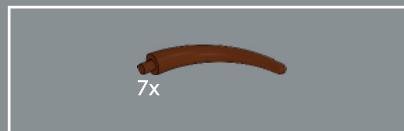
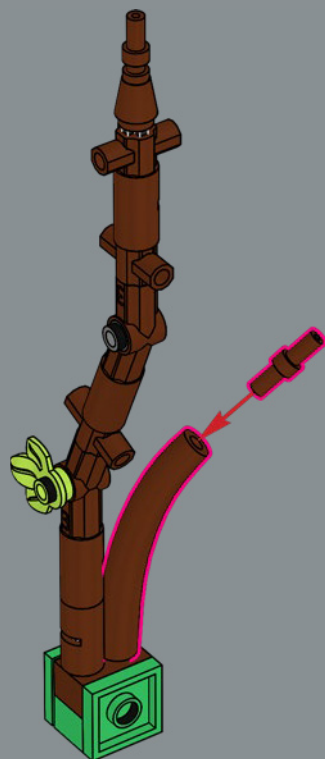

141

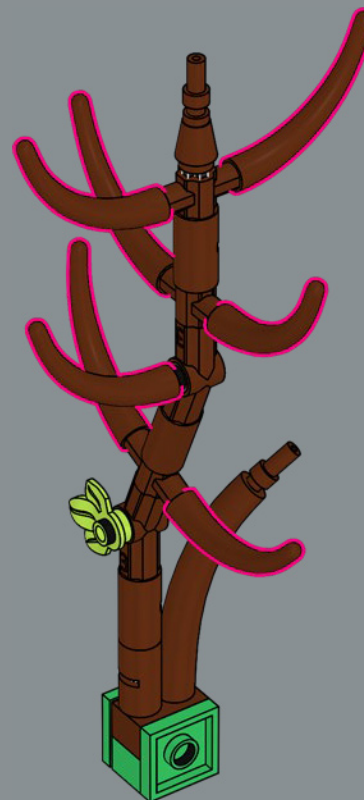

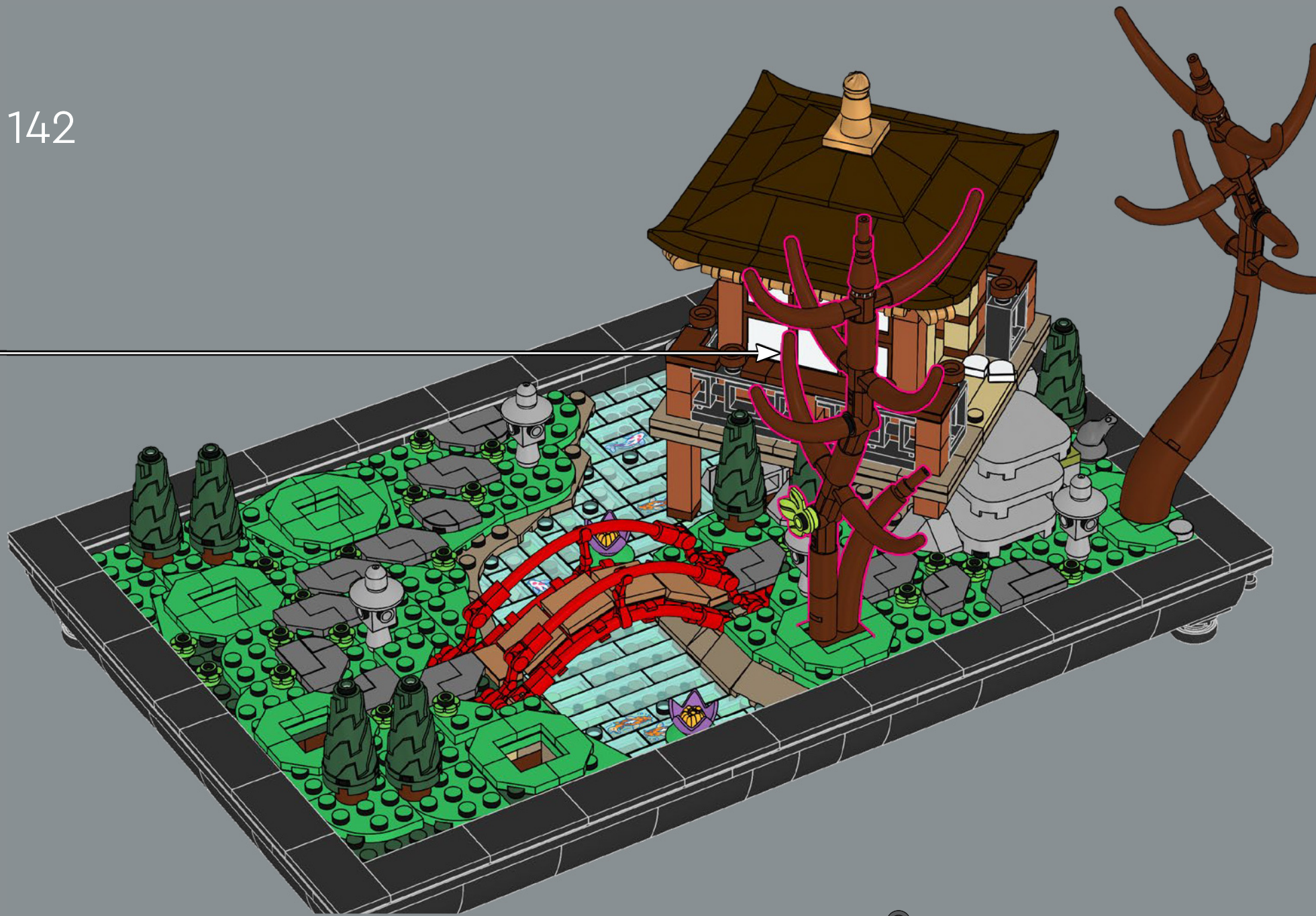

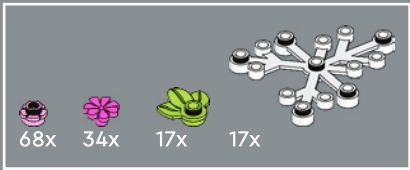

143

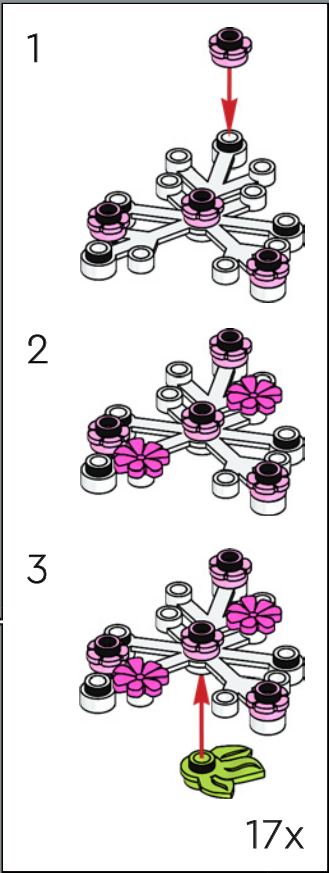

L'équilibre des différents éléments, comme l'eau, les plantes choisies avec soin et les roches variées, contribue à créer une ambiance calme dans votre jardin.

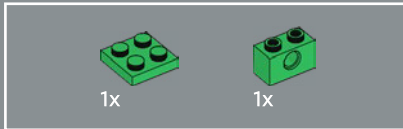
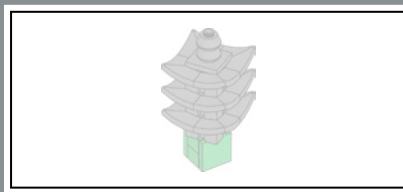

144

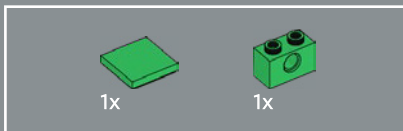
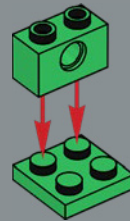

145

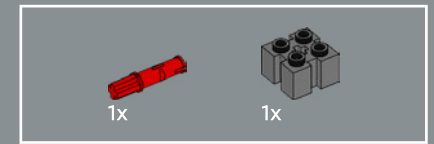
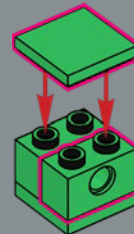

146

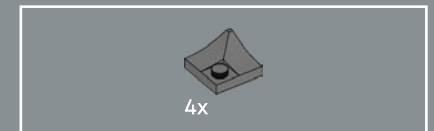
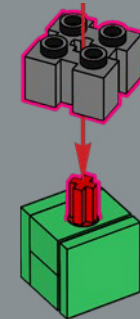

147

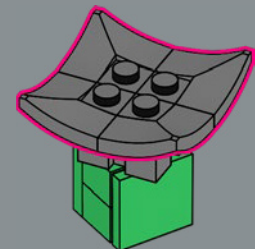

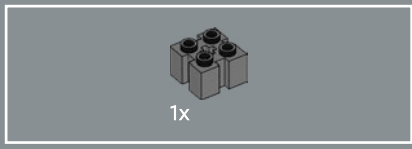

148

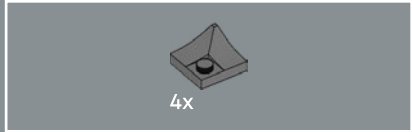
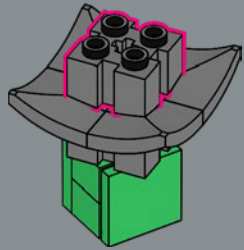

149

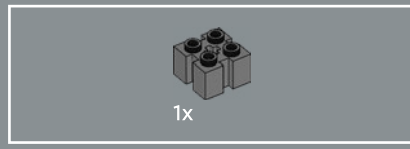
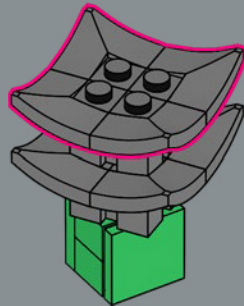

150

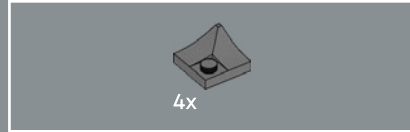
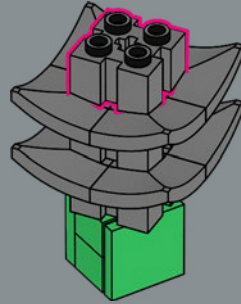

151

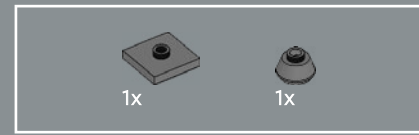
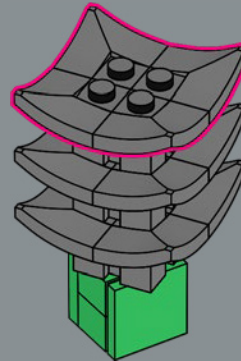

152

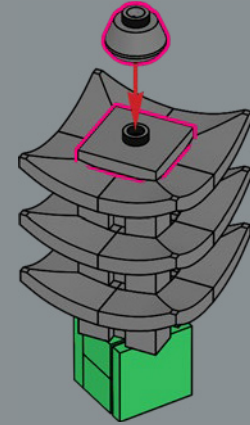

153

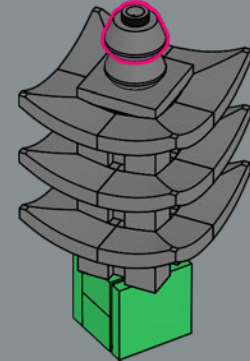

154

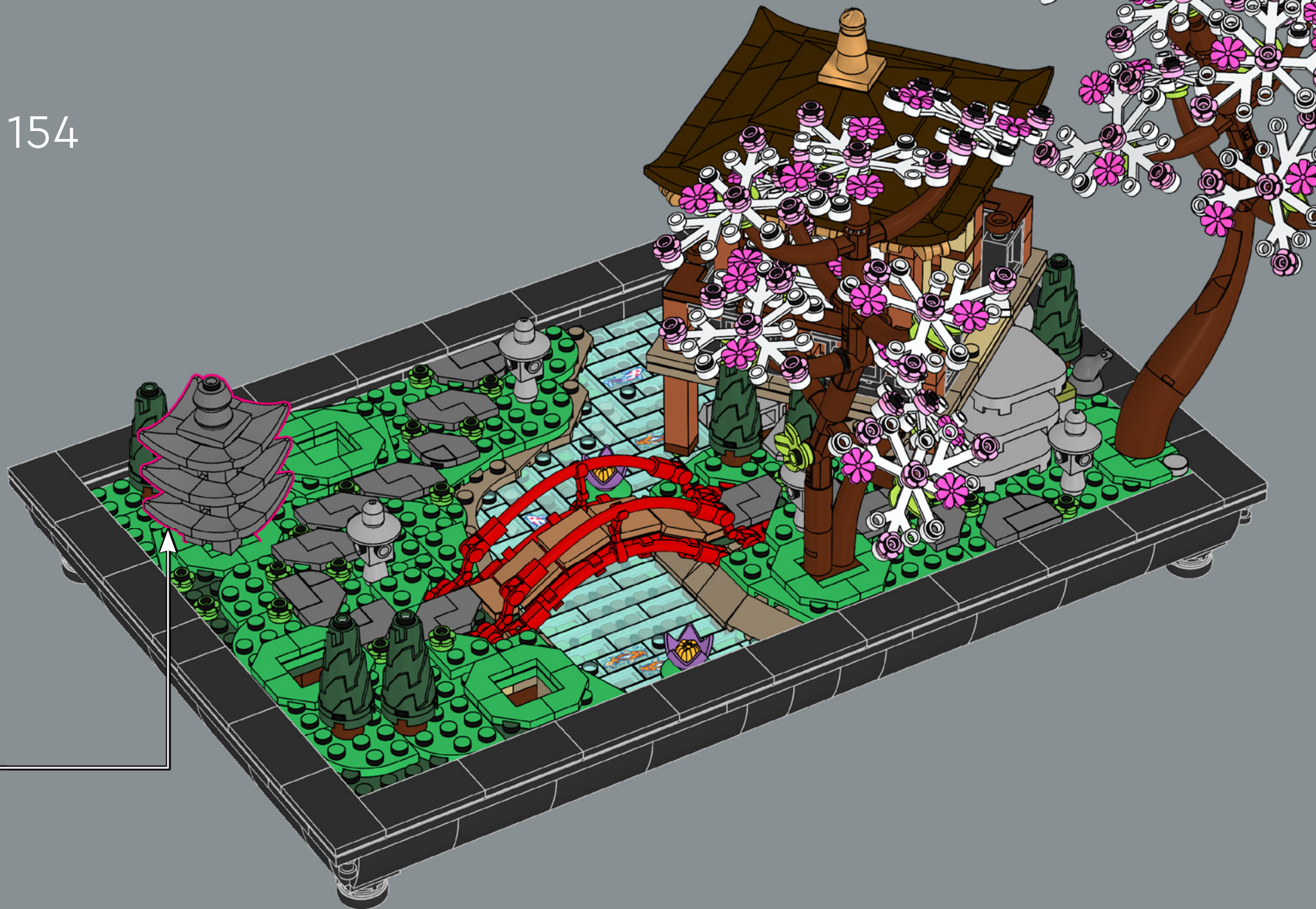

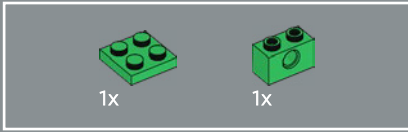
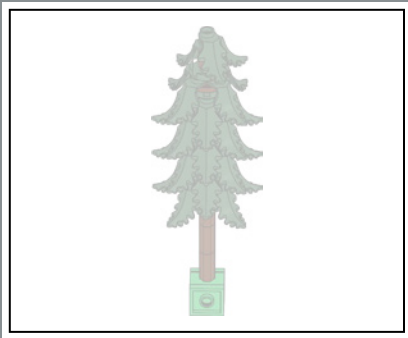

155

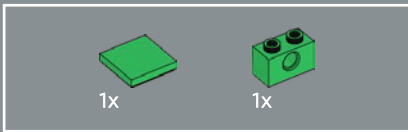
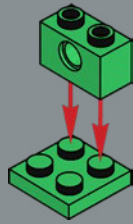

156

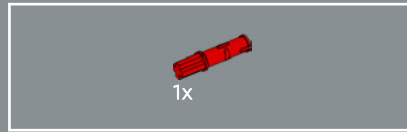
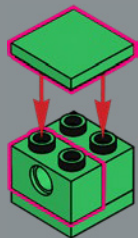

157

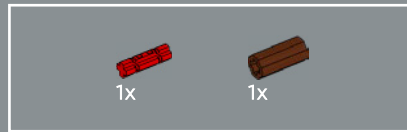
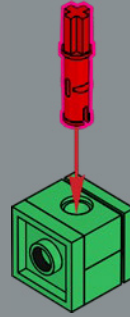

158

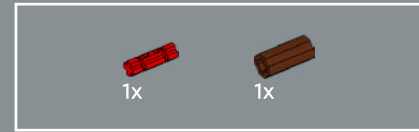
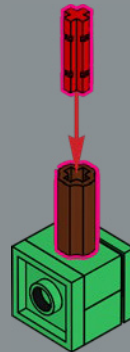

159

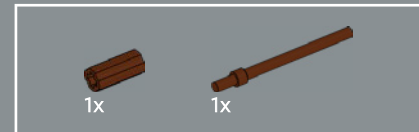
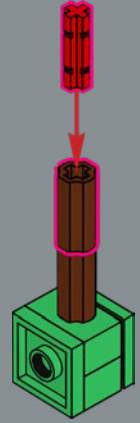

160

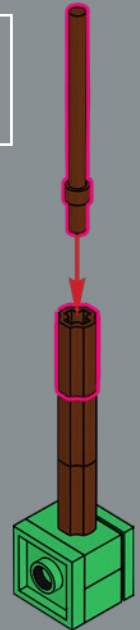



161

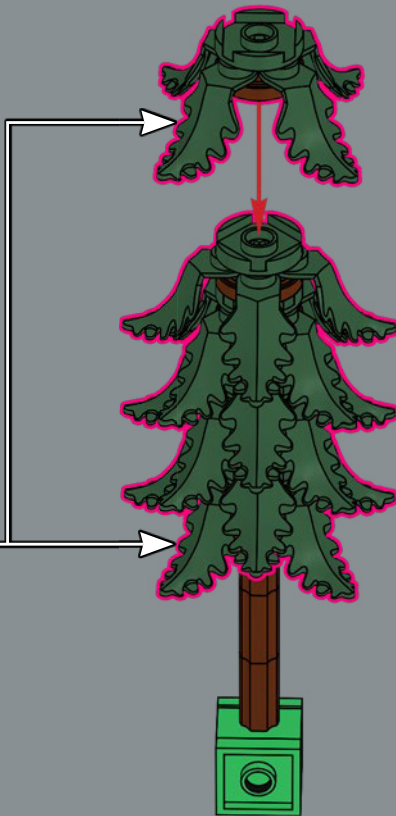

162

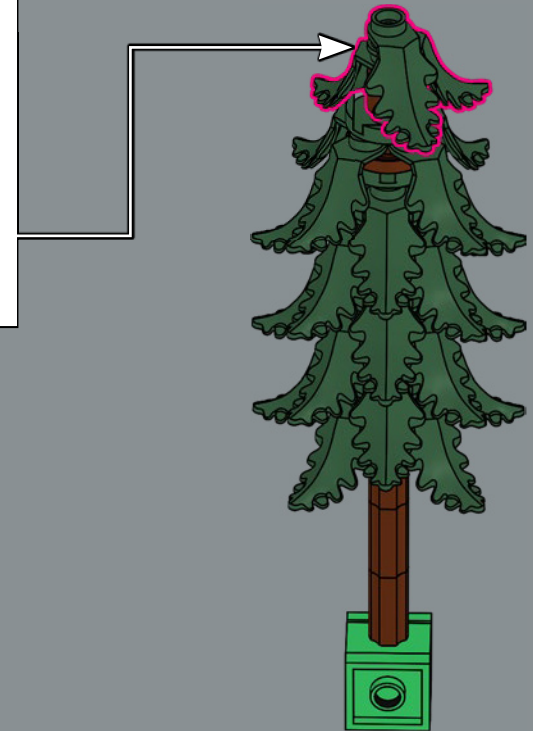
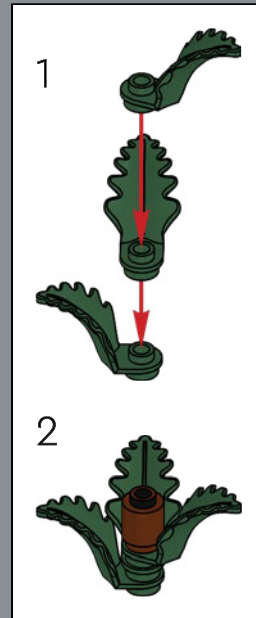



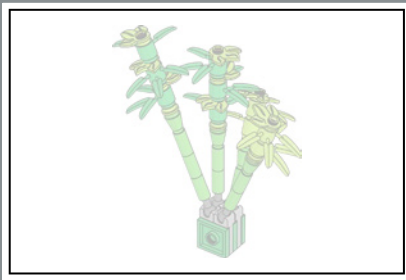

164

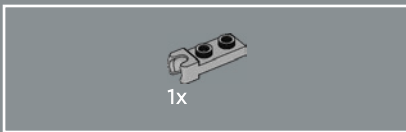
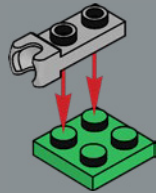

165

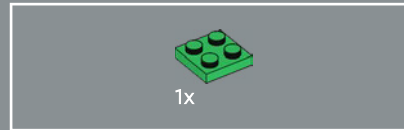
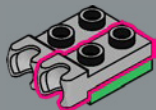

166

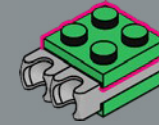

167

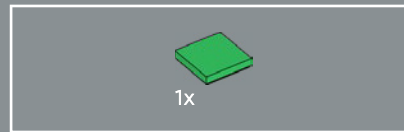
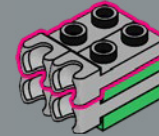

168

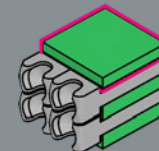



169

1



2

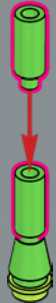

3



4



5

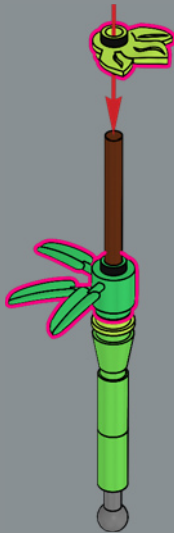

6

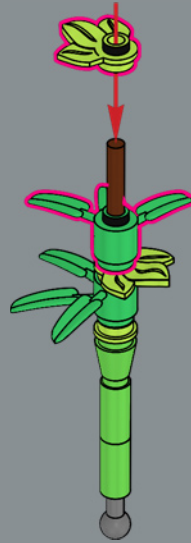

7

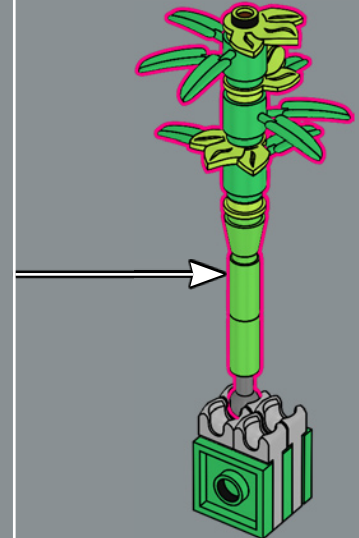
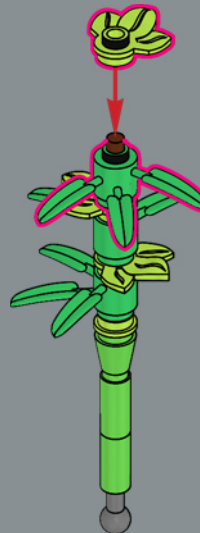



170

1

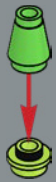

2

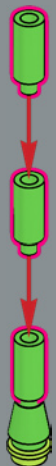

3



4



5

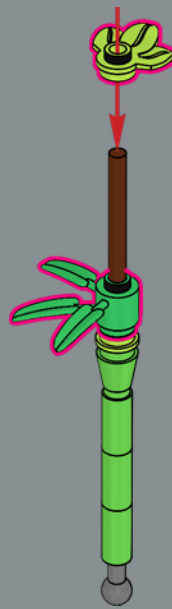

6

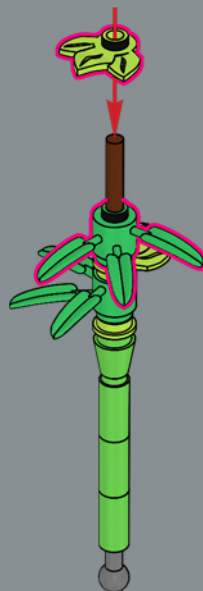

7

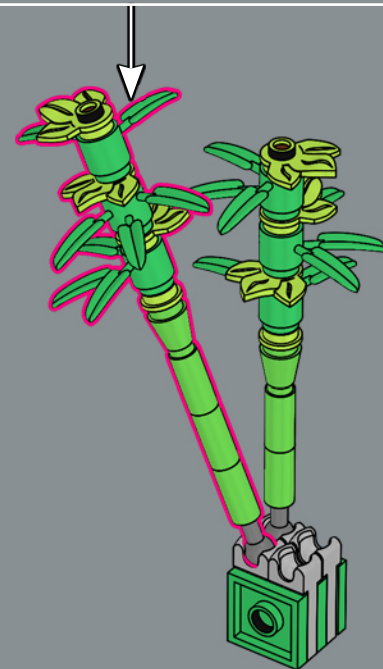

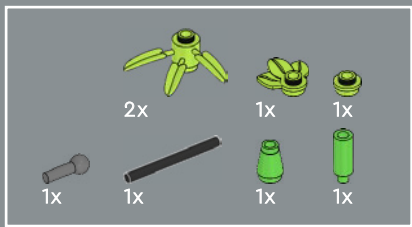

171

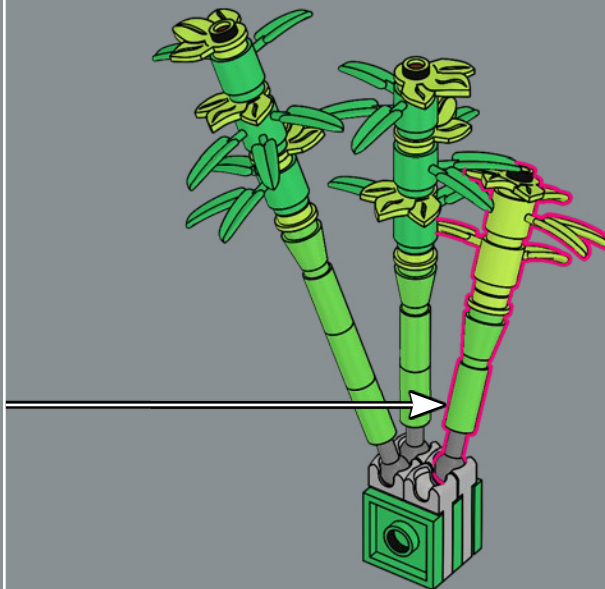
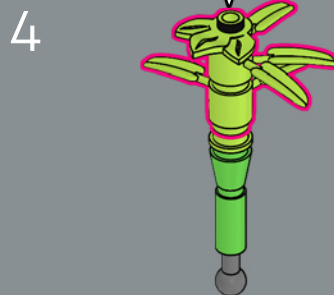
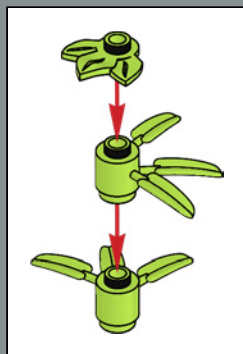
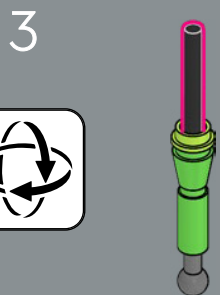
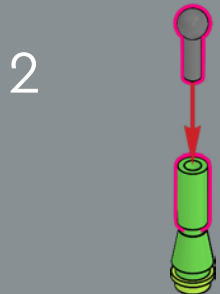
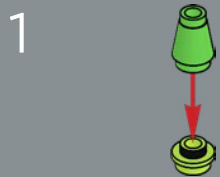

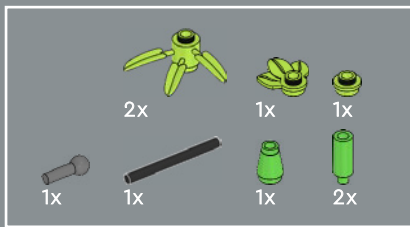

172

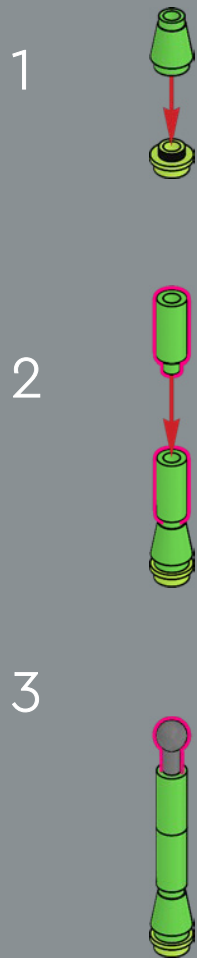

4

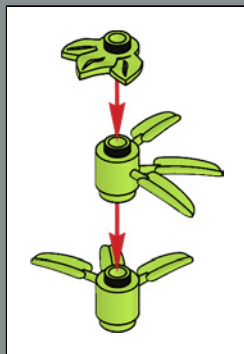

5

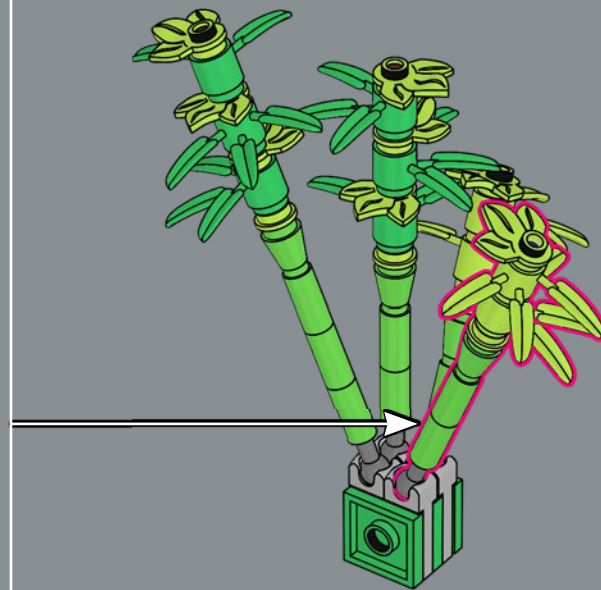
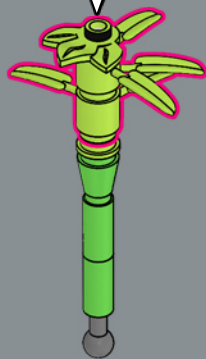



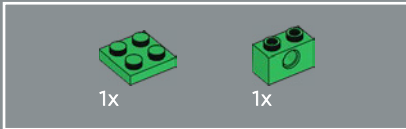

174

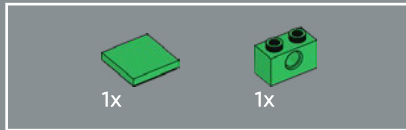
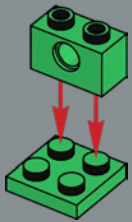

175

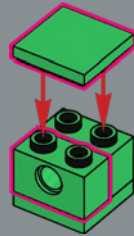

176

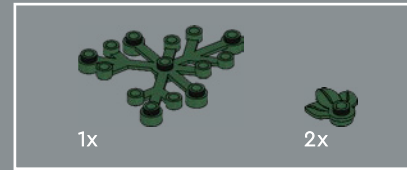
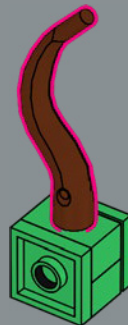

177

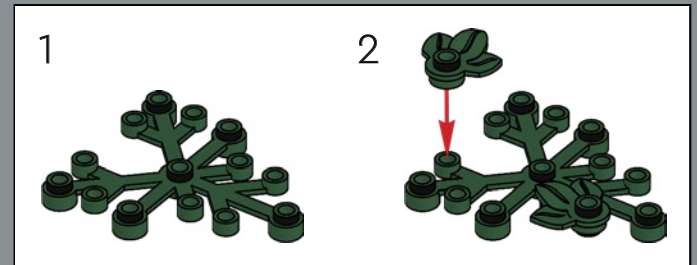

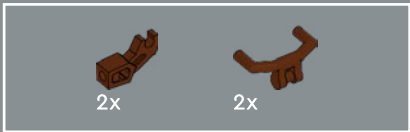

178

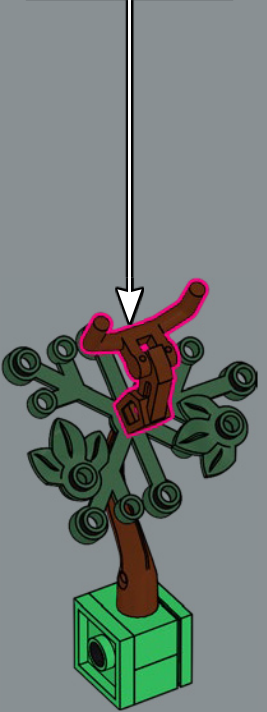
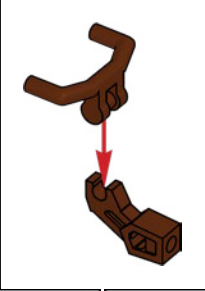

179

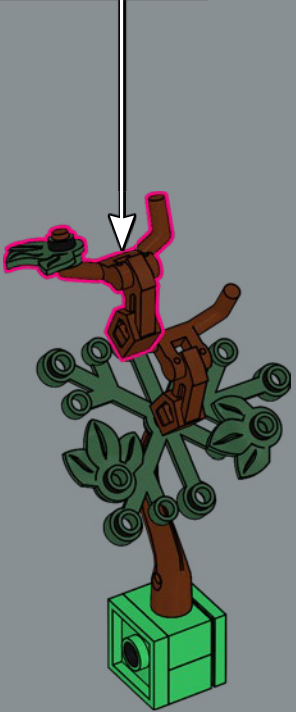
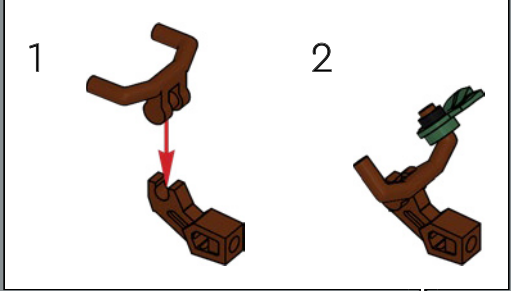

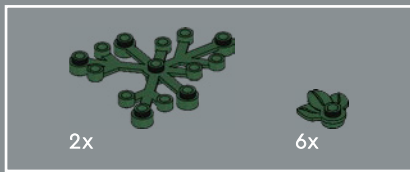

180

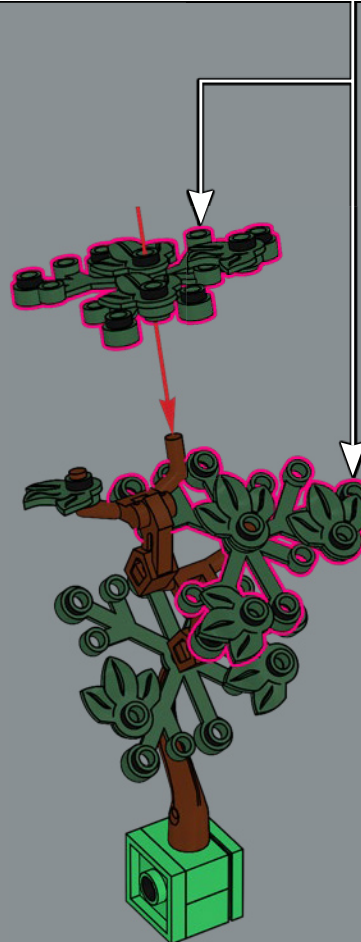
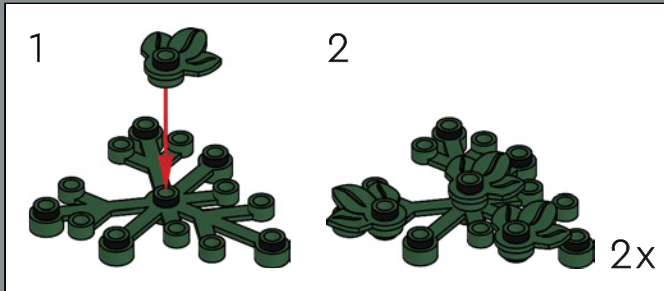



Envie d'ajouter votre touche personnelle à votre modèle ?
Laissez-vous inspirer par les cinq principes des jardins paisibles :
un enclos, l'équilibre, des paysages empruntés, le symbolisme
et l'asymétrie.

1x 4206482	8x 6456644	1x 6284070	2x 6250591	13x 4621947	25x 6252043	4x 6040126	2x 6284583	14x 6035029
1x 6456641	8x 6313120	2x 6279875	2x 6198979	10x 4621946	3x 6435012	7x 4528604	4x 6190251	1x 6328333
1x 6286492	4x 4515365	4x 4515368	18x 6256077	4x 4567908	6x 6459216	6x 6092591	26x 6286831	1x 6328333
2x 6055783	6x 6370686	4x 4180536	17x 6266969	4x 6311453	102x 6251295	15x 6126075	4x 6175572	31x 6447541
4x 4113915	3x 4142865	2x 6382697	8x 6328327	10x 6062166	5x 6252049	1x 6331865	9x 6400754	7x 6167130
4x 6057517	3x 6209519	3x 302326	1x 302428	6x 6270003	5x 302124	1x 6388214	7x 6167129	7x 6461425
3x 6214334	3x 300121	6x 302226	17x 302328	4x 6331100	5x 6253273	4x 6184880	3x 6331861	16x 6013975
4x 6257600	4x 6456646	2x 306826	23x 6385275	29x 6206150	1x 6253273	3x 6331861	2x 6390053	2x 6240030
4x 6294227	30x 4162443	4x 302126	7x 302228	8x 302128	8x 6397875	1x 6331863	7x 4650244	1x 6411592
1x 6294227	10x 6053077	8x 302026	6x 4107762	2x 379528	2x 6092602	1x 4247145	2x 4586057	3x 6416003
4x 4112982	10x 4516843	30x 4560182	9x 6230235	1x 303428	2x 6288614	2x 6038637	2x 4267874	3x 6266967
7x 4544139	5x 6089119	26x 4587844	1x 4109674	3x 383228	1x 6426644	2x 4267874	1x 6328338	4x 6456642
9x 4113988	10x 6252373	2x 303426	7x 4181135	3x 383228	2x 6264069	1x 6328338	4x 4245566	1x 6240515
1x 4125217	6x 6195092	11x 428226	3x 4143953	3x 6398657	3x 6114515	2x 6302995	1x 6240515	
	9x 6116604							

- 1x 4211183
- 3x 4211288
- 4x 4221744
- 1x 6151461
- 14x 4211190
- 5x 4216945
- 1x 4211214
- 2x 4225715
- 3x 6258989

- 1x 6348057
- 2x 4529242
- 7x 6173143
- 7x 6102360
- 3x 6451002
- 3x 4531751
- 2x 6276868
- 18x 6382102
- 1x 6326087
- 1x 6383996
- 1x 6327811

- 9x 6186673
- 12x 4211257
- 4x 6221608
- 2x 6327818
- 5x 6173132
- 3x 6261388
- 5x 4211200
- 3x 4211194
- 6x 6459423
- 3x 6170468
- 1x 6292952
- 14x 6372430
- 1x 6070442
- 8x 4211247

- 8x 4550325
- 5x 4211387
- 5x 4211511
- 3x 4651063
- 1x 4526932
- 1x 4521921
- 1x 4515374
- 8x 6034676
- 1x 6013497
- 1x 6315580
- 2x 4180418
- 1x 6315579

- 1x 4180408
- 1x 6401023
- 1x 4211397
- 1x 4211549
- 1x 4211639
- 5x 4211512
- 2x 4211400
- 2x 4598522
- 2x 4620130

5

- 5x 6284071
- 5x 6212288
- 5x 4529241
- 4x 4211353
- 4x 6043639
- 3x 6354325

- 3x 6395635
- 4x 6364352
- 7x 6199549
- 3x 6340333
- 1x 6171103
- 1x 4218696
- 1x 6126083
- 4x 4211052
- 21x 6177079
- 3x 6236949
- 12x 6447212
- 1x 4211100
- 1x 6106191
- 2x 4210678
- 1x 4211137

- 8x 6016483
- 34x 6206151
- 68x 6212501
- 1x 6186383
- 4x 6212377
- 16x 6279731
- 1x 6190252
- 2x 6173139
- 1x 6050916

- 8x 6456639
- 4x 6456643
- 4x 6456663
- 16x 6347604
- 2x 6021997
- 10x 6102990
- 4x 6347304
- 1x 6363146
- 4x 6456640



LEGO.com/service



YOU COULD WIN



YOU COULD WIN

Your feedback will help shape the future development of this product series.

Visit:

DU KÖNNTEST GEWINNEN

Dein Feedback trägt zur Weiterentwicklung dieser Produktreihe bei.

Geh auf:

VOUS POURRIEZ GAGNER

Vos commentaires nous aideront à concevoir les futurs produits de cette gamme.

Visitez :

POTRESTI VINCERE TU

La tua opinione ci aiuterà a migliorare la creazione futura di questa linea di prodotti.

Visita:

PUEDES GANAR

Tu opinión contribuirá al futuro de esta serie de productos.

Visita:

轻松获奖

您的反馈将有助于我们在今后改进本产品系列。

请访问:

LEGO.com/productfeedback

You also have the chance to win a LEGO® set.

Terms and conditions apply.*

Außerdem hast du die Chance, ein LEGO® Set zu gewinnen.

Es gelten die Teilnahmebedingungen.*

Vous pourriez également gagner un ensemble LEGO®.

Des conditions s'appliquent.*

Hai anche la possibilità di vincere un set LEGO®.

Termini e condizioni sono applicabili.*

También tienes la oportunidad de ganar un set LEGO®.

Aplican términos y condiciones.*

您还有机会赢取乐高®套装。

条款和条件适用。*

*LEGO.com/productfeedback-terms



LEGO and the LEGO logo are trademarks of the LEGO Group.
©2023 The LEGO Group.