



Booklet available in English on
Livret disponible en français sur
Folleto disponible en español en



WE'RE MAKING OUR PACKAGING MORE SUSTAINABLE

We're transitioning from single-use plastic to paper-based packaging. As we progress, you may find a mix of paper and plastic in our boxes.

NOUS RENDONS NOS EMBALLAGES PLUS DURABLES

Nous passons des emballages en plastique à usage unique aux emballages à base de papier. Durant la transition, vous pourriez trouver un mélange de papier et de plastique dans nos boîtes.

QUEREMOS HACER MÁS SUSTENTABLES NUESTROS MATERIALES DE EMBALAJE

Estamos cambiando las bolsas de plástico desechables por bolsas con base de papel. Conforme avanzamos en este propósito, puedes encontrar una mezcla de papel y de plástico en nuestras cajas.

[LEGO.com/sustainable-packaging](https://www.lego.com/sustainable-packaging)

LEGO® VIP

- 1.** SIGN UP
INSCRIVEZ-VOUS
REGÍSTRATE

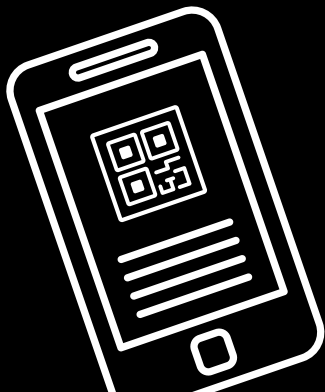

- 2.** EARN POINTS
FOR PURCHASES
GAGNEZ DES POINTS
POUR VOS ACHATS
GANA PUNTOS POR
TUS COMPRAS

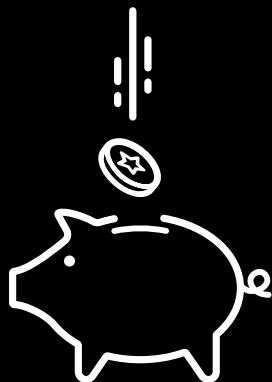

- 3.** REDEEM POINTS FOR REWARDS, EXPERIENCES,
DISCOUNTS & MORE
ÉCHANGEZ DES POINTS CONTRE DES RÉCOMPENSES,
DES EXPÉRIENCES, DES RÉDUCTIONS ET PLUS ENCORE
CANJEA PUNTOS POR RECOMPENSAS, EXPERIENCIAS,
DESCUENTOS Y MUCHO MÁS

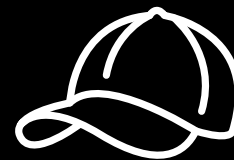
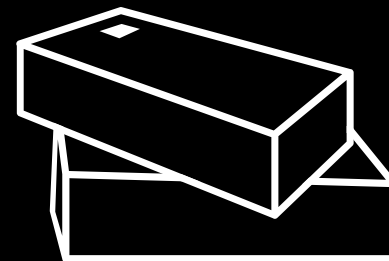
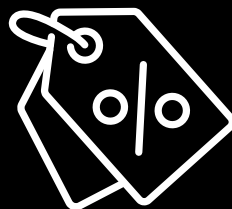



WELCOME TO RIVENDELL

20 years after the release of *The Return of the King*[™], the spectacular *The Lord of the Rings*[™] trilogy remains one of the most significant works of movie art of our time. How can you possibly choose a favorite scene or moment? In the darkest of times, Rivendell, the majestic home of the Elves, is a tranquil, flourishing haven of healing, hope, calm resolve and unification. In a pivotal meeting here, representatives of the peoples of Middle-earth forge *The Fellowship of the Ring*[™] to destroy the One Ring to Rule Them All.

BIENVENUE À RIVENDELL

Vingt ans après la sortie du film *Le Retour du roi*[™], la spectaculaire trilogie *Le Seigneur des anneaux*[™] reste l'une des œuvres d'art cinématographique les plus marquantes de notre époque. Comment pourrait-on choisir une scène ou un moment préféré ? Dans les moments les plus sombres, Rivendell, la majestueuse demeure des Elfes, est un havre tranquille et florissant de guérison, d'espoir, de calme et d'unification. Lors d'une réunion charnière, les représentants des peuples de la Terre du Milieu y forgent *la Communauté de l'Anneau*[™] afin de détruire l'Anneau unique pour les gouverner tous.

TE DAMOS LA BIENVENIDA A RIVENDEL

20 años después del lanzamiento de *El Retorno del Rey*, la espectacular trilogía de *El Señor de los Anillos* sigue siendo una de las obras más trascendentes del arte cinematográfico de nuestros días. Eso solo hace que decidirte por una escena o momento como tu favorito sea verdaderamente difícil. Incluso en los tiempos más oscuros, Rivendel, el majestuoso hogar de los elfos, es un sereno refugio de sanación, esperanza, reflexión y unificación. En una reunión decisiva celebrada en este lugar, representantes de los pueblos de la Tierra Media conformaron la Comunidad del Anillo para destruir el Anillo Único, forjado con la única finalidad de esclavizar a todos.



*The fellowship of
LEGO® Designers*

*La communauté des
concepteurs LEGO®*

*La comunidad de
diseñadores de LEGO®*

A FELLOWSHIP OF LEGO® DESIGNERS

As part of a fellowship of model, element and graphic designers from around the world, we embarked on a journey to capture the magic of this place. Using soundstage blueprints from the movies as a reference, we took some artistic liberties to combine our favorite features. This 6,000 LEGO® brick recreation of the iconic Imladris, The Last Homely House East of the Sea, is a detailed slice of Rivendell in LEGO minifigure scale, full of memorable story moments and beloved characters.

LA COMMUNAUTÉ DES CONCEPTEURS LEGO®

En tant que membres d'un groupe de concepteurs de modèles, d'éléments et de graphismes provenant du monde entier, nous avons pour mission de capturer la magie de ce lieu. Nous avons utilisé les plans du plateau d'enregistrement des films comme référence, et pris quelques libertés artistiques pour combiner nos caractéristiques préférées. Cette reconstitution en 6 000 briques LEGO® de l'emblématique Imladris, la dernière maison hospitalière à l'est de la mer, est une tranche détaillée de Rivendell à l'échelle des figurines LEGO, riche en moments mémorables et en personnages bien-aimés.

UNA COMUNIDAD DE DISEÑADORES DE LEGO®

Como una verdadera comunidad, diseñadores gráficos, de modelos y de elementos LEGO® de todos los rincones del mundo nos embarcamos en un viaje para capturar la magia de este lugar. Nos basamos en los planos de entorno utilizados en las películas, aunque también nos tomamos algunas libertades artísticas con el fin de combinar nuestras características favoritas. Esta recreación hecha con 6000 bricks LEGO del icónico Imladris, el Último Hogar al Este del Mar, es una detallada porción de Rivendell a escala de minifigura LEGO llena de memorables momentos y entrañables personajes de la historia.



CLASSIC SCENES FROM LEGO® THE LORD OF THE RINGS™

From the arrival of Gandalf the Grey™ in the Shire to the final battle against the King of the Dead on the shores of Minas Tirith, travel through some of the classic scenes from previous LEGO® *The Lord of the Rings*™ sets released in 2012-2013.



DES SCÈNES CLASSIQUES DE LEGO® LE SEIGNEUR DES ANNEAUX™

Voyagez à travers des scènes classiques de précédents ensembles LEGO® *Le Seigneur des Anneaux*™ sortis en 2012 et 2013, de l'arrivée de Gandalf le Gris™ dans la Comté à la bataille finale contre le Roi des Morts sur les rives de Minas Tirith.



ESCENAS CLÁSICAS DE EL SEÑOR DE LOS ANILLOS, INMORTALIZADAS AL ESTILO LEGO®

Desde la llegada de Gandalf el Gris a la Comarca hasta la batalla final contra el Rey de los Muertos en las riberas de Minas Tirith, revive las inolvidables escenas que reprodujeron los sets LEGO® inspirados en *El Señor de los Anillos*, lanzados entre 2012 y 2013.

9469 GANDALF™ ARRIVES

Gandalf the Grey travels to the Shire for the 111th birthday of his friend Bilbo Baggins. Here he meets young Frodo Baggins, and the adventure begins.

9469 L'ARRIVÉE DE GANDALF™

Gandalf le Gris se rend dans la Comté pour le 111^e anniversaire de son ami Bilbon Sacquet. Il y rencontre le jeune Frodon Sacquet, et l'aventure commence.

9469 LA LLEGADA DE GANDALF™

Gandalf el Gris viaja hasta la Comarca para celebrar el 111 cumpleaños de su viejo amigo Bilbo Bolsón. Es aquí donde se reúne con el joven Frodo Bolsón, ¡y la aventura comienza!

79006 THE COUNCIL OF ELROND

The people of Middle-earth have been summoned to Rivendell for The Council of Elrond. Here they will determine the fate of the One Ring.

79006 LE CONSEIL D'ELROND

Les habitants de la Terre du Milieu ont été convoqués à Rivendell pour le conseil d'Elrond. Ils y détermineront le sort de l'Anneau unique.

79006 EL CONCILIO DE ELROND

Los pueblos de la Tierra Media son convocados a visitar Rivendel para participar en el Concilio de Elrond. Entre todos, aquí determinarán el destino del Anillo Único.



9473 THE MINES OF MORIA™

The heroic Fellowship of the Ring faces evil Moria orcs and a giant cave troll in Balin's Tomb in the bone-chilling, abandoned Mines of Moria.

9473 LES MINES DE LA MORIA™

L'héroïque Communauté de l'Anneau affronte les méchantes orques de la Moria et un énorme troll des cavernes dans la tombe de Balin, dans les effroyables mines abandonnées de la Moria.

9473 LAS MINAS DE MORIA™

La heroica Comunidad del Anillo se enfrenta a malvados orcos y un gigantesco trol de las cavernas cerca de la tumba de Balin, en las espeluznantes minas abandonadas de Moria.



9474 THE BATTLE OF HELM'S DEEP™

The walled fortress at Helm's Deep and the people of Rohan are under attack by Saruman's barbaric Uruk-hai army.

9474 LA BATAILLE DU GOUFFRE DE HELM™

La forteresse fortifiée du gouffre de Helm et le peuple du Rohan sont attaqués par l'armée barbare d'Uruk-hai de Saruman.

9474 LA BATALLA DEL ABISMO DE HELM

La fortaleza amurallada del Abismo de Helm y las gentes de Rohan están bajo el asedio del brutal ejército de guerreros Uruk-hai de Saruman.



10237 THE TOWER OF ORTHANC

The biggest LEGO® The Lord of the Rings™ set at the time of its release (with 2,357 parts) features six floors with iconic minifigure characters and scenes.

10237 LA TOUR D'ORTHANC

Le plus grand ensemble LEGO® Le Seigneur des Anneaux™ au moment de sa sortie (avec 2 357 pièces) comprend six étages avec des personnages et des scènes de figurines emblématiques.

10237 LA TORRE DE ORTHANC

El más grande de los sets LEGO® El Señor de los Anillos en el momento de su lanzamiento (con 2357 piezas) tiene un total de seis niveles y montones de personajes en formato de minifigura y escenas representativas de la saga.



79008 PIRATE SHIP AMBUSH

Sauron's Mordor orcs prepare to greet their allies aboard the pirate ship, only to face Aragorn, Gimli, Legolas and the Army of the Dead instead.

79008 L'EMBUSCADE DU BATEAU PIRATE

Les orques du Mordor de Sauron se préparent à accueillir leurs alliés à bord du bateau pirate, mais ils doivent affronter Aragorn, Gimli, Legolas et l'Armée des Morts.

79008 EMBOSCADA EN EL BARCO PIRATA

Los orcos de Mordor, comandados por Sauron, se preparan para dar la bienvenida a los aliados que llegan a bordo del barco pirata. ¡Cuál será su sorpresa cuando se den cuenta de que solo encontrarán a Aragorn, Gimli, Legolas y los soldados del Rey de los Muertos!



THE TOWER

During his stay at Rivendell, Bilbo completes his book *There and Back Again* at his desk in the Tower. A secret hiding place at the Tower's base is just big enough to conceal a fugitive or keep the One Ring away from prying eyes.



LA TOUR

Pendant son séjour à Rivendell, Bilbo termine son livre *Histoire d'un aller et retour* à son bureau dans la Tour. Une cachette secrète à la base de la Tour est juste assez grande pour dissimuler un fugitif ou garder l'Anneau unique loin des regards indiscrets.



LA TORRE

Durante su estancia en Rivendel, Bilbo termina su libro *Historia de una ida y de una vuelta* en su escritorio de la Torre. Hay un escondite secreto en la base de la Torre, apenas lo suficientemente grande para ocultar a un fugitivo o mantener el Anillo Único alejado de miradas entrometidas.



Frodo features dual-molded legs to show his bare feet, a signature trait of Hobbits of the Shire. He also bears the One Ring, brought to Rivendell for the council to decide its fate.

Frodon présente des jambes à double moulage pour montrer ses pieds nus, un trait caractéristique des Hobbits de la Comté. Il porte également l'Anneau unique, amené à Rivendell pour que le conseil décide de son sort.

Frodo tiene piernas moldeadas en dos partes que revelan sus pies descalzos, un rasgo distintivo de los hobbits de la Comarca. Además, lleva consigo el Anillo Único hacia Rivendel para que su destino se decida en el Concilio.

Bilbo features a new 2-sided head decoration, including the frightening face he briefly reveals as he tries to take the Ring from Frodo.

Bilbo présente une nouvelle décoration de tête à 2 faces, notamment le visage effrayant qu'il révèle brièvement lorsqu'il tente de prendre l'Anneau à Frodon.

Bilbo cuenta con una novedosa cabeza con 2 lados decorados, uno de los cuales tiene la aterradora expresión que muestra momentáneamente cuando trata de quitarle el anillo a Frodo.

BILBO BAGGINS
BILBON SACQUET
BILBO BOLSÓN

FRODO BAGGINS
FRODON SACQUET
FRODO BOLSÓN



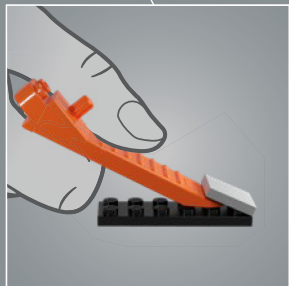
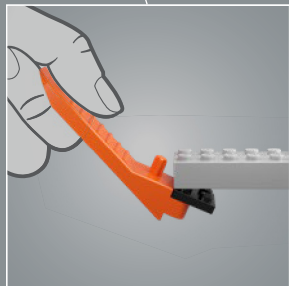
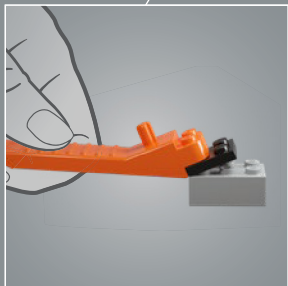
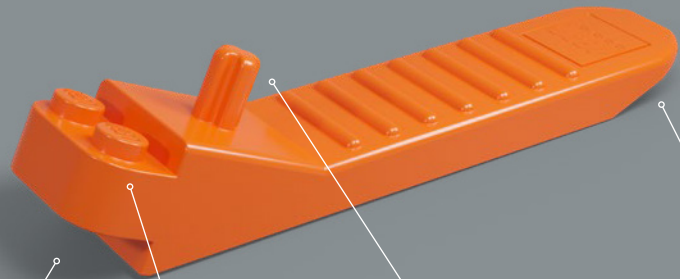

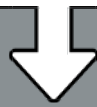

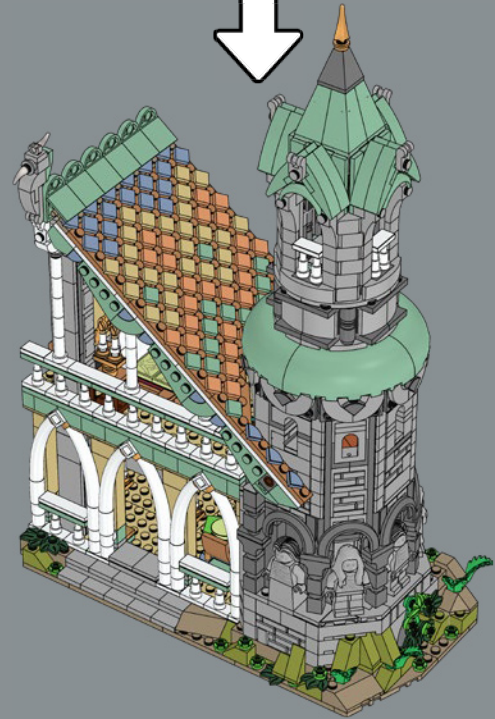

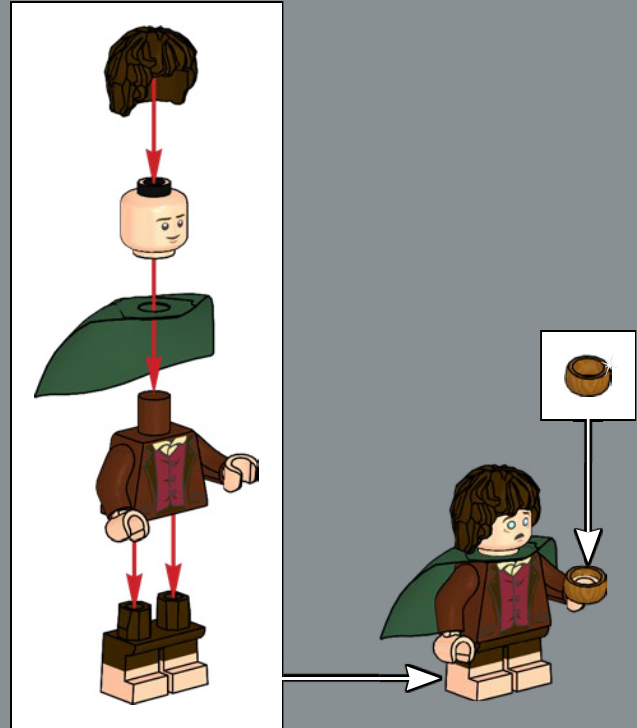
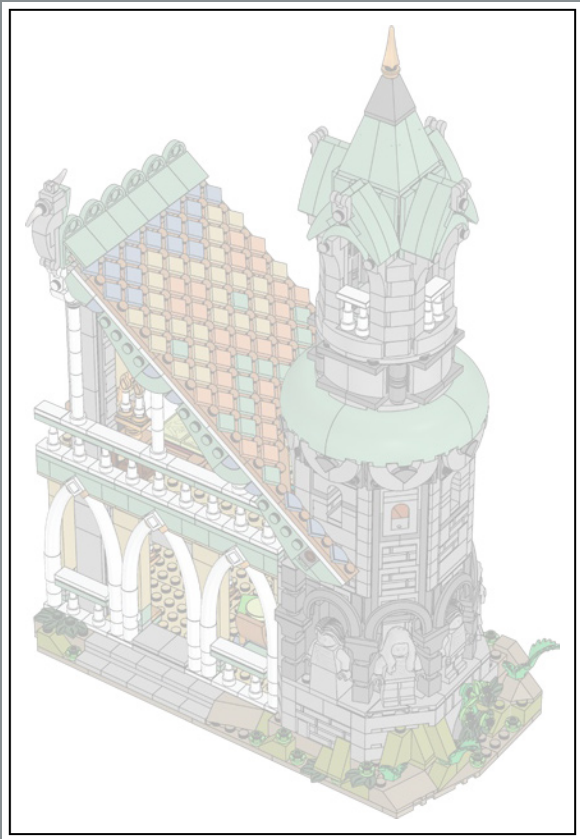

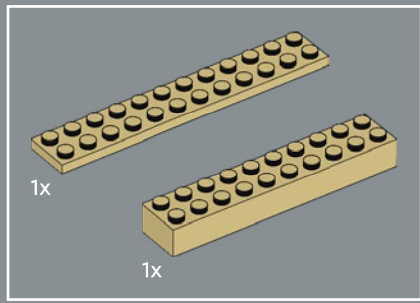

1

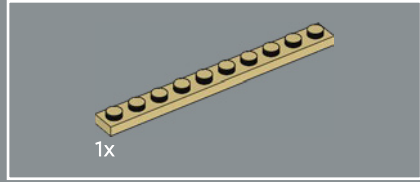
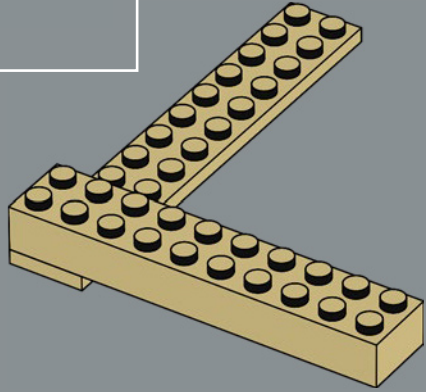

2

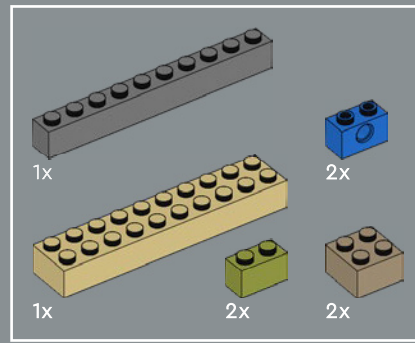
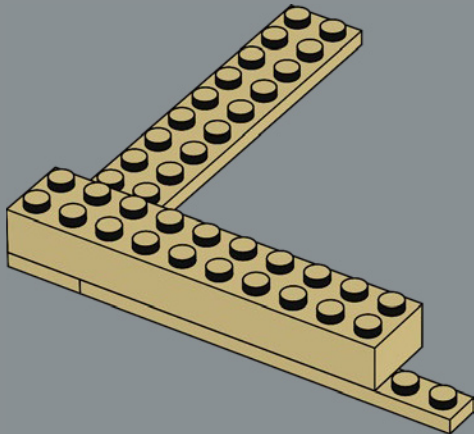

3

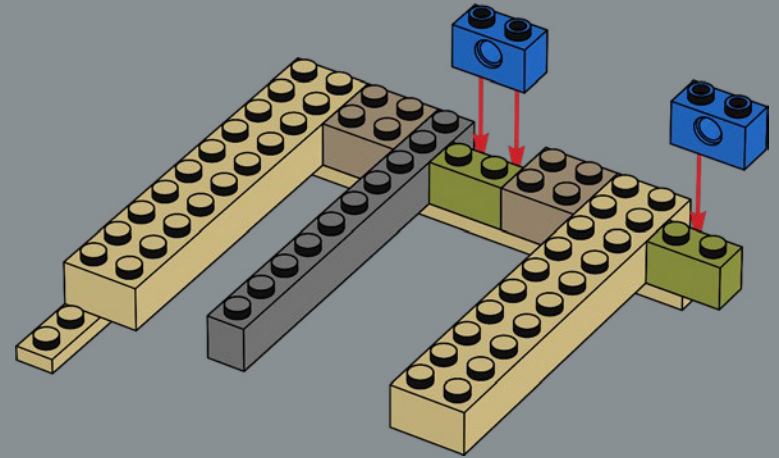

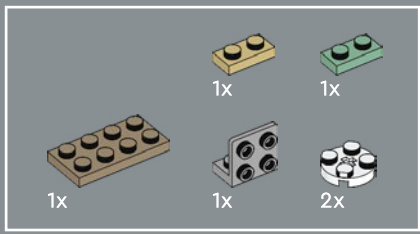

4

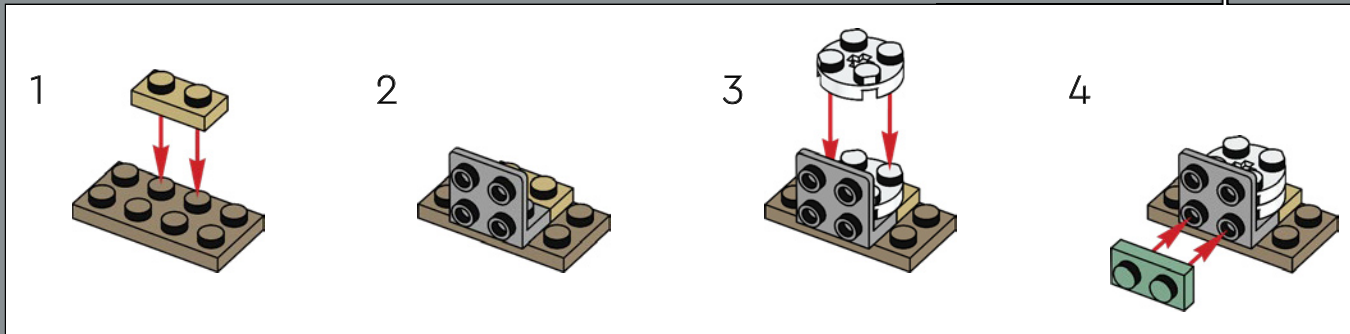
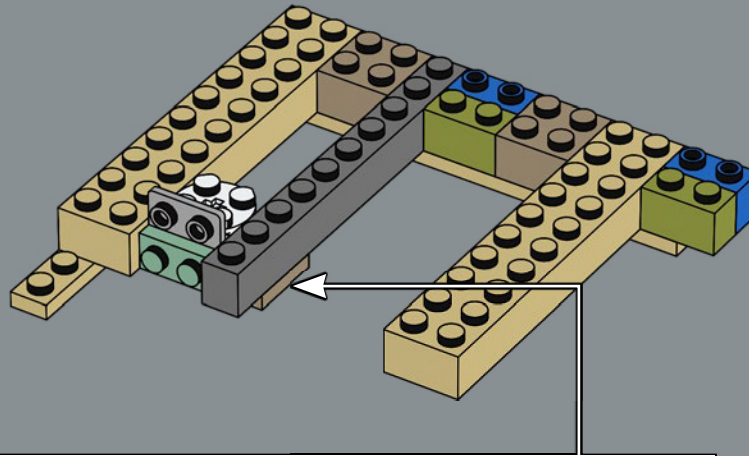

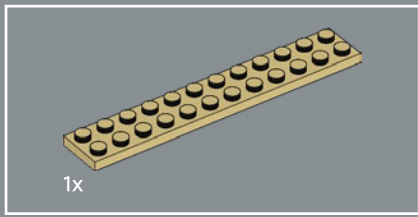

5

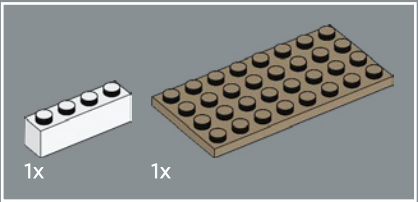
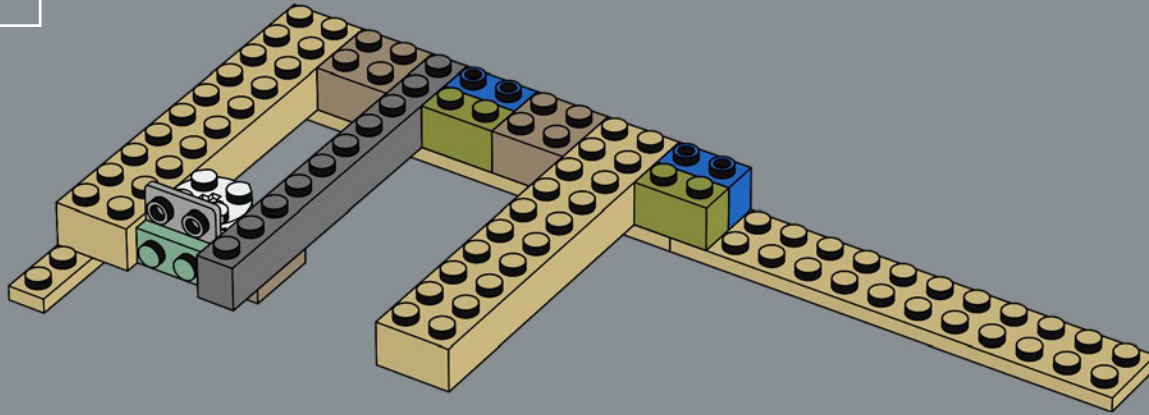

6

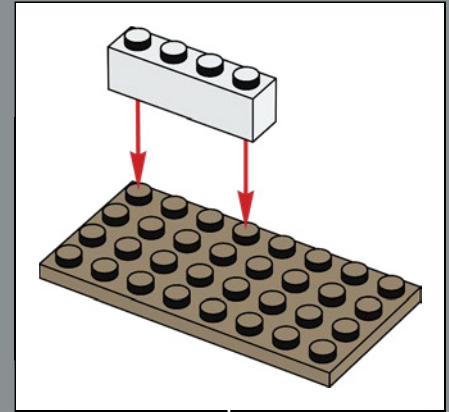
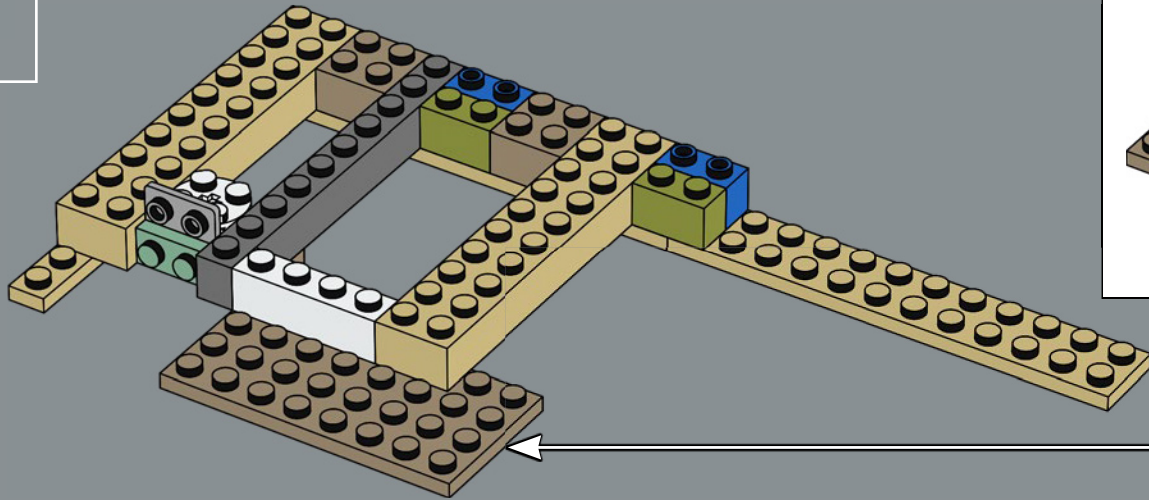

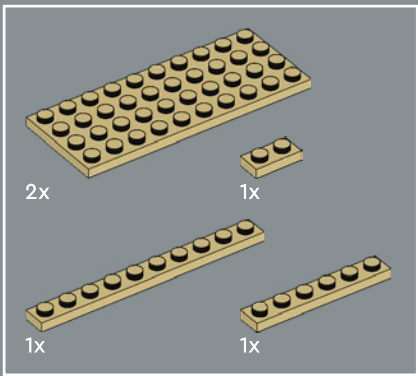

7

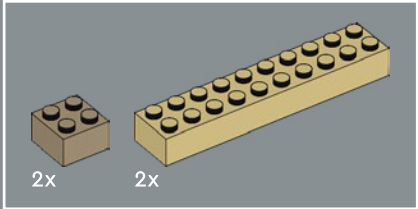
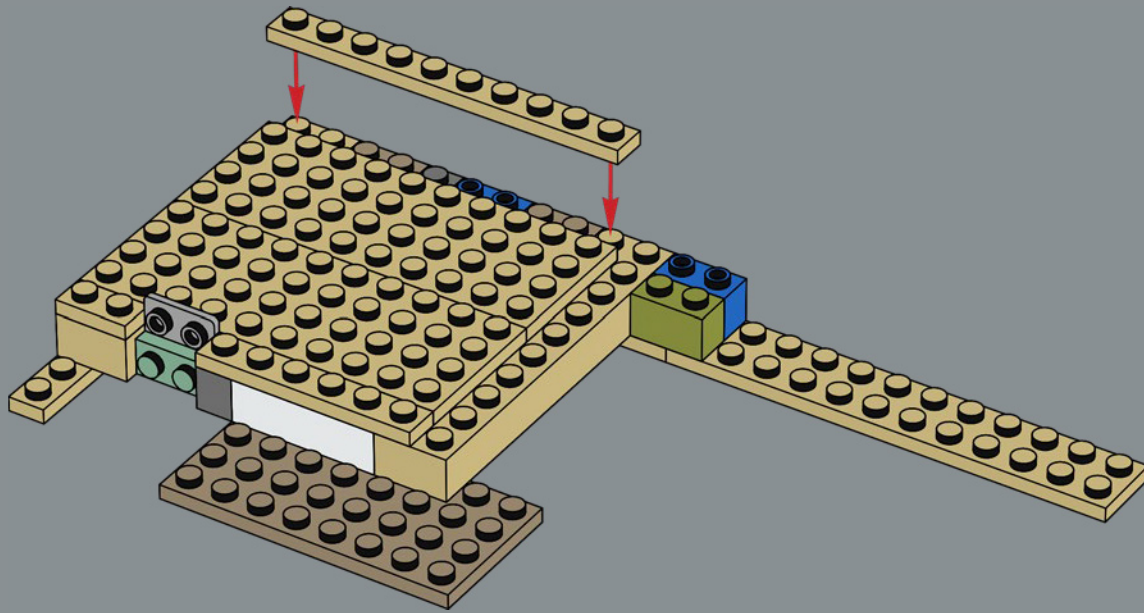

8

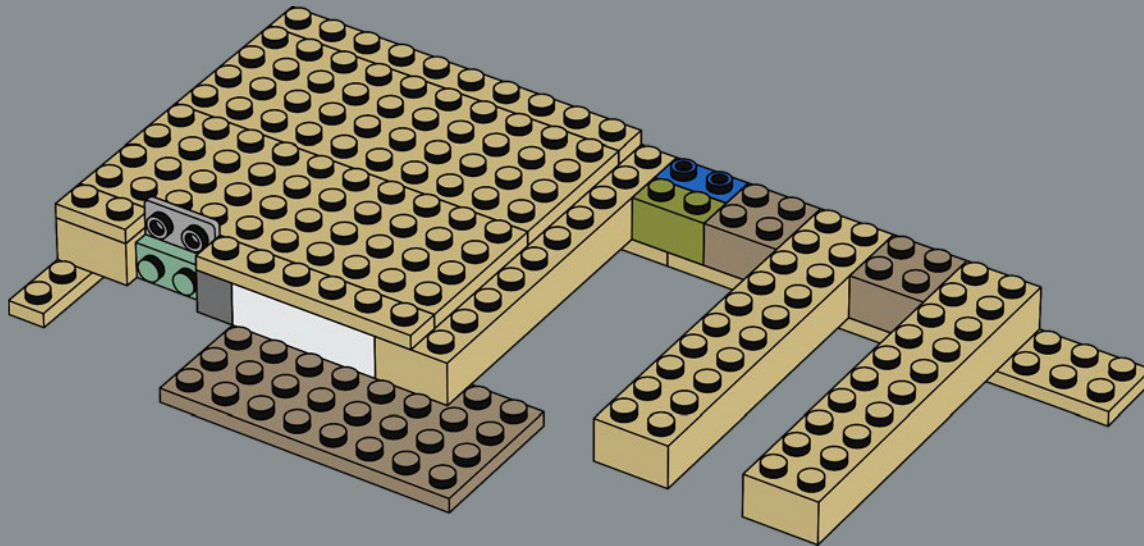

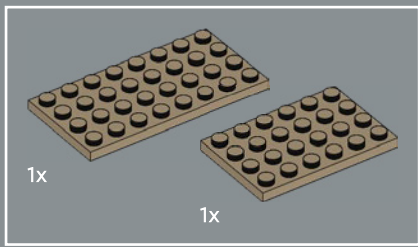

9

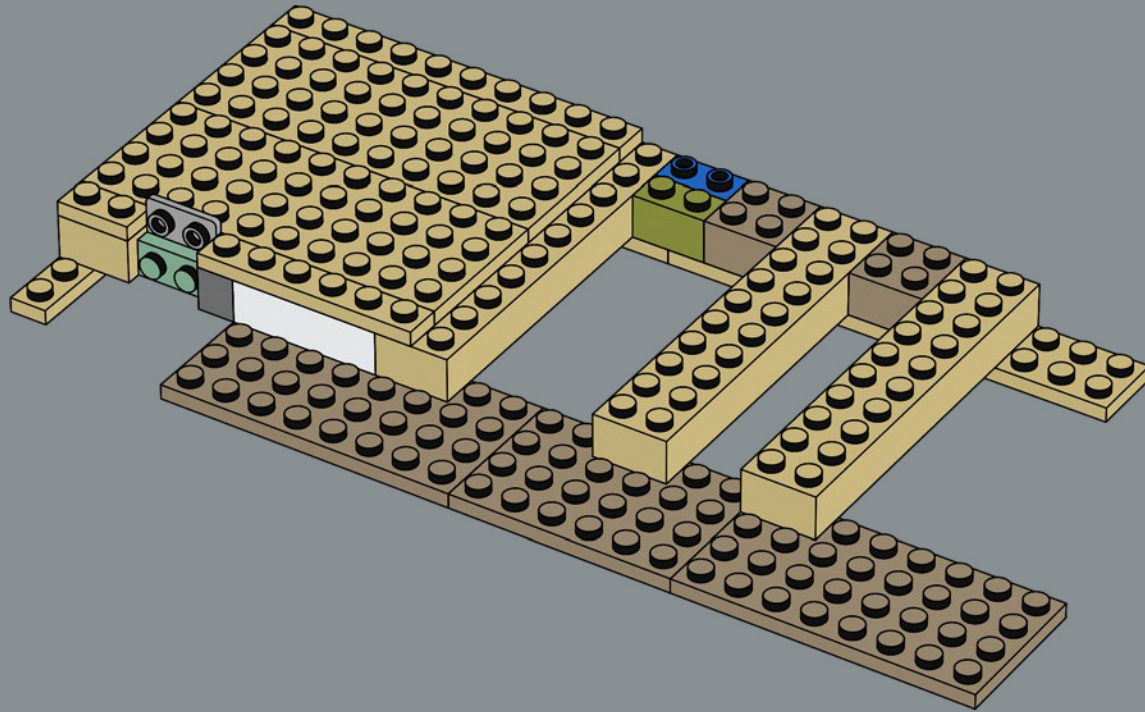

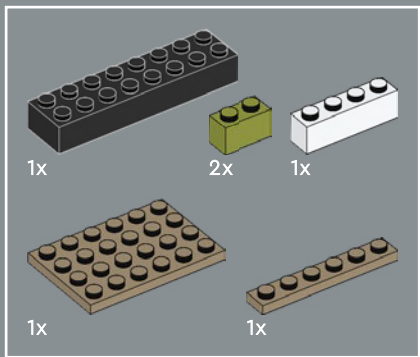

10

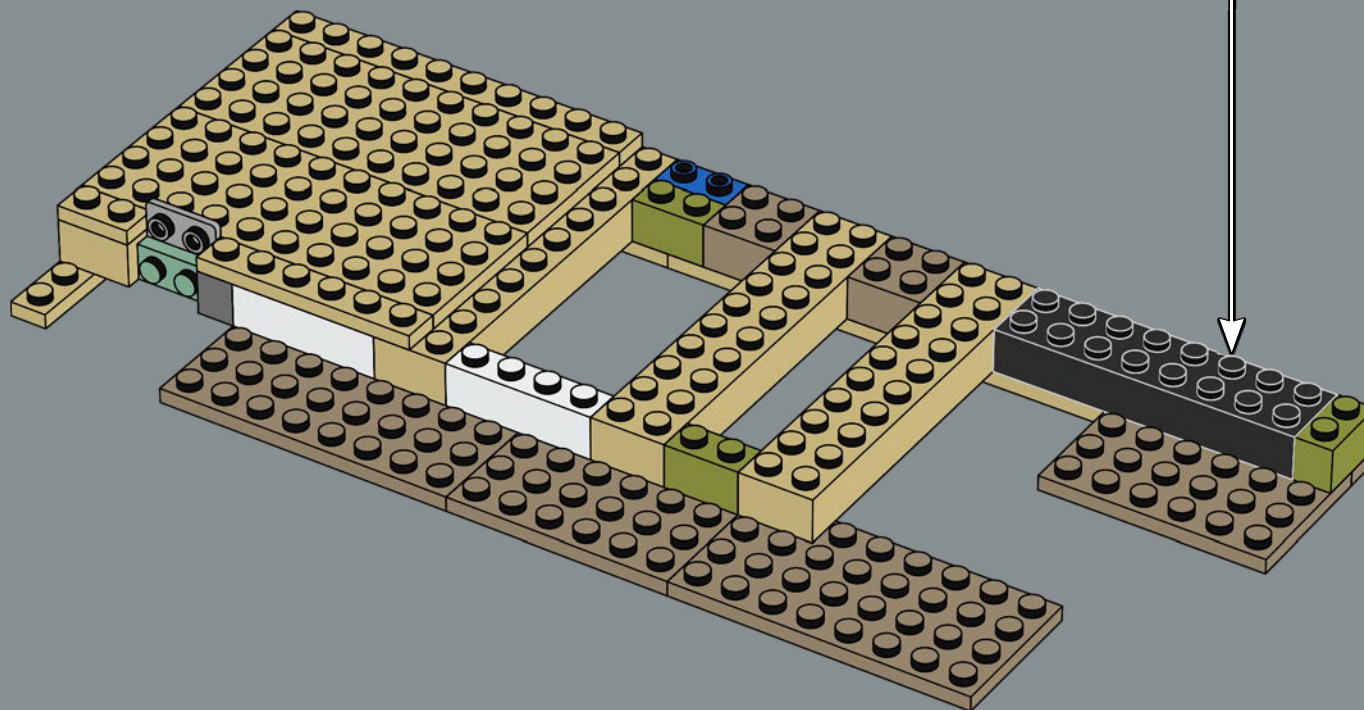
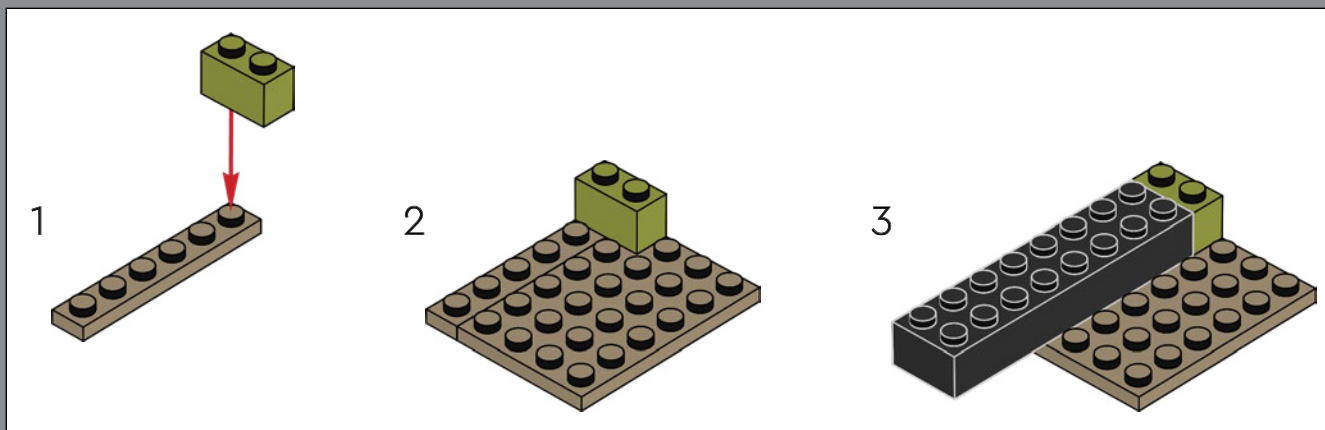

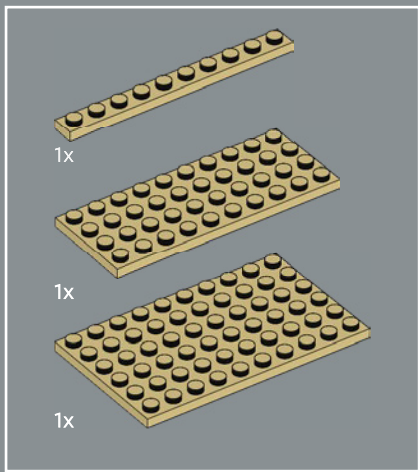

11

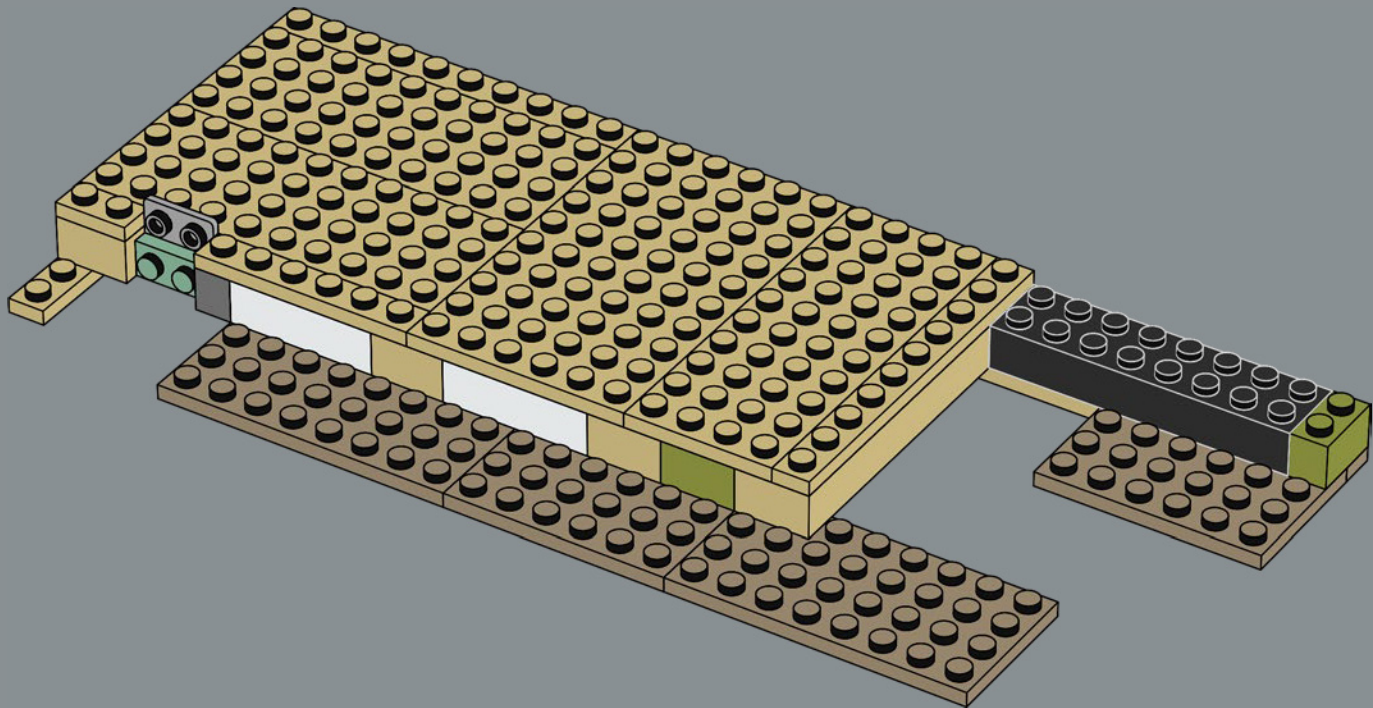

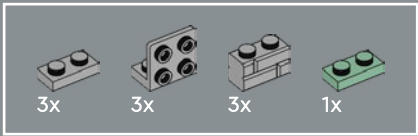

12

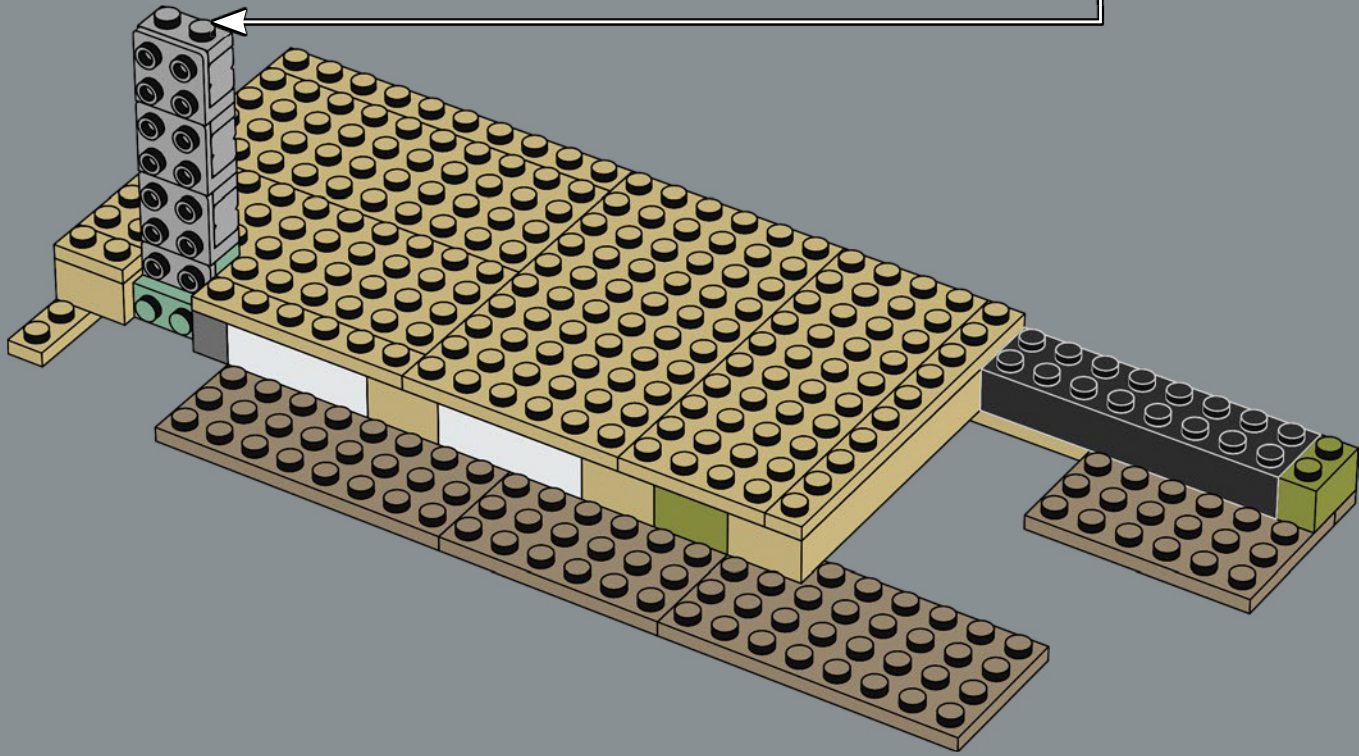
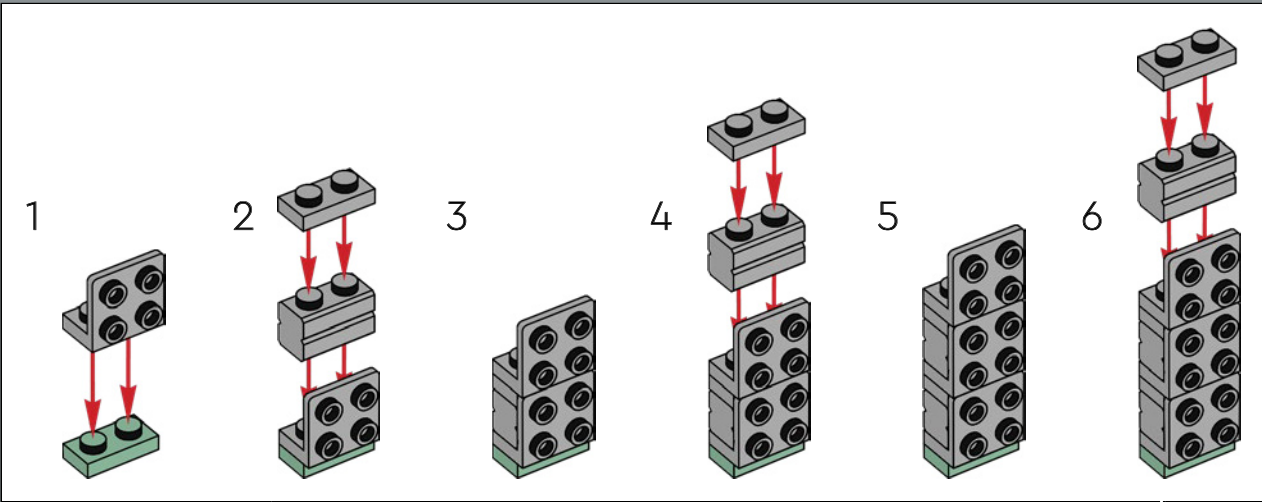

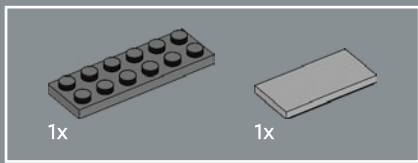

13

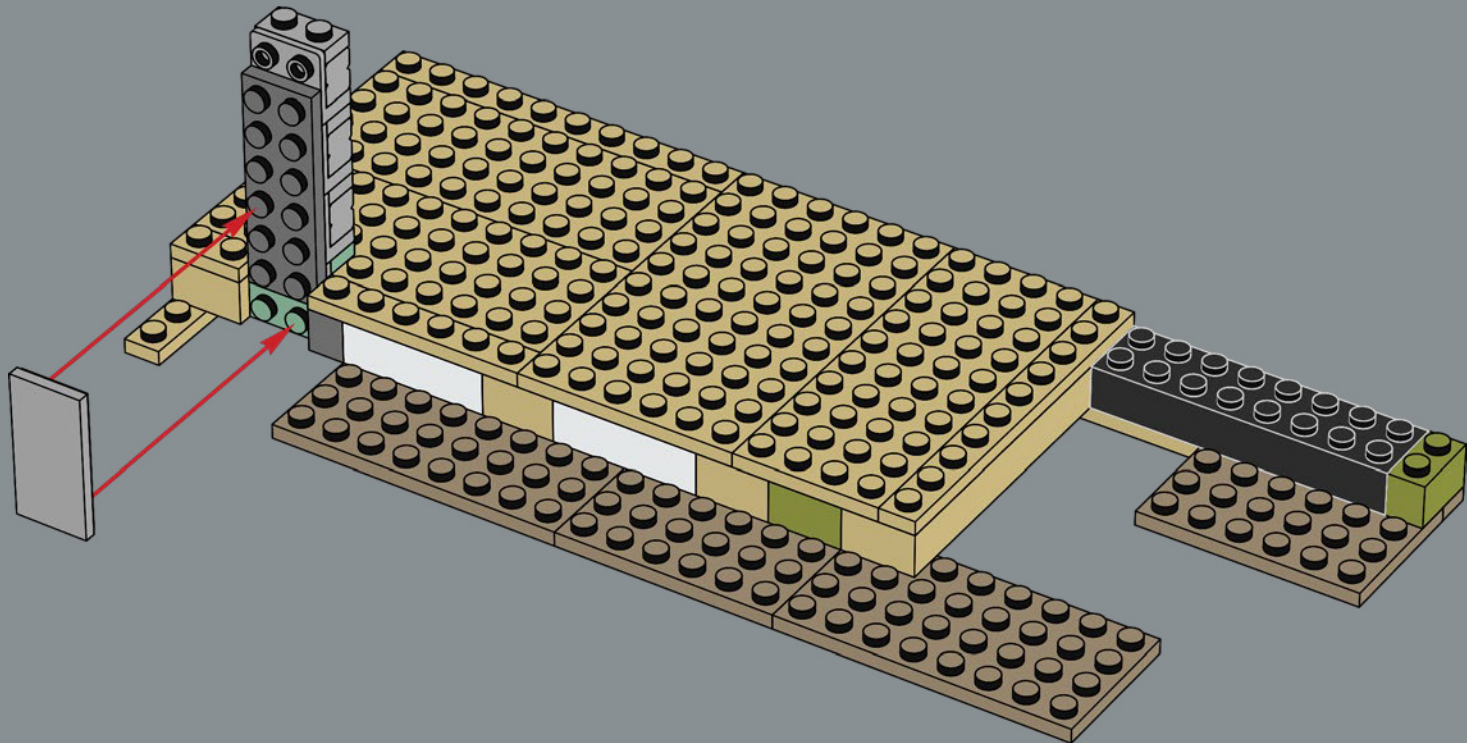

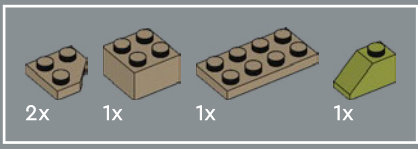

14

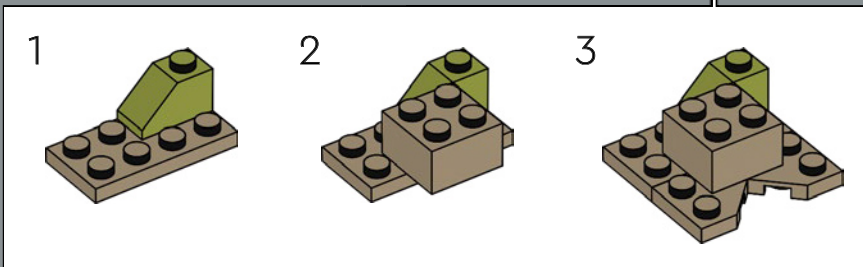
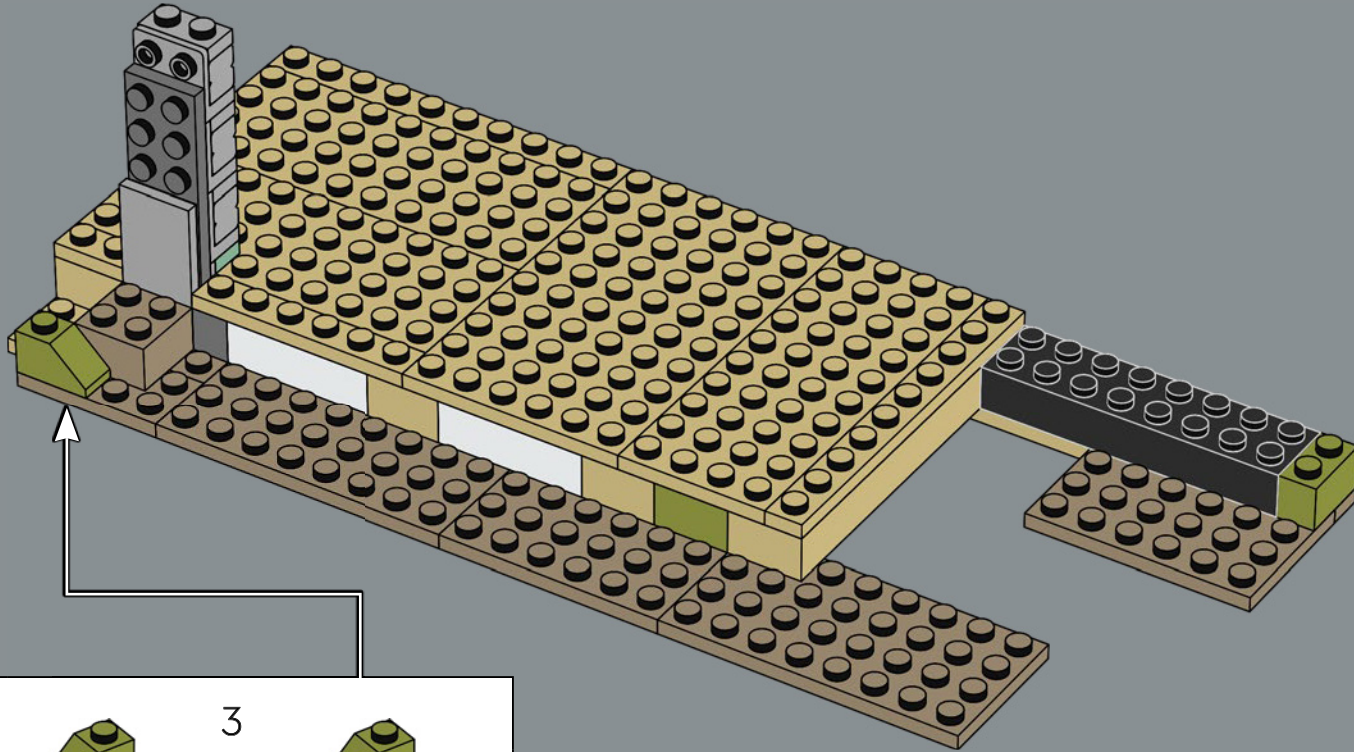

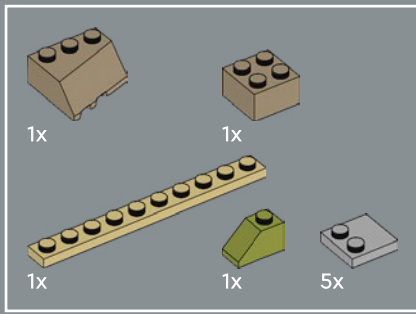

15

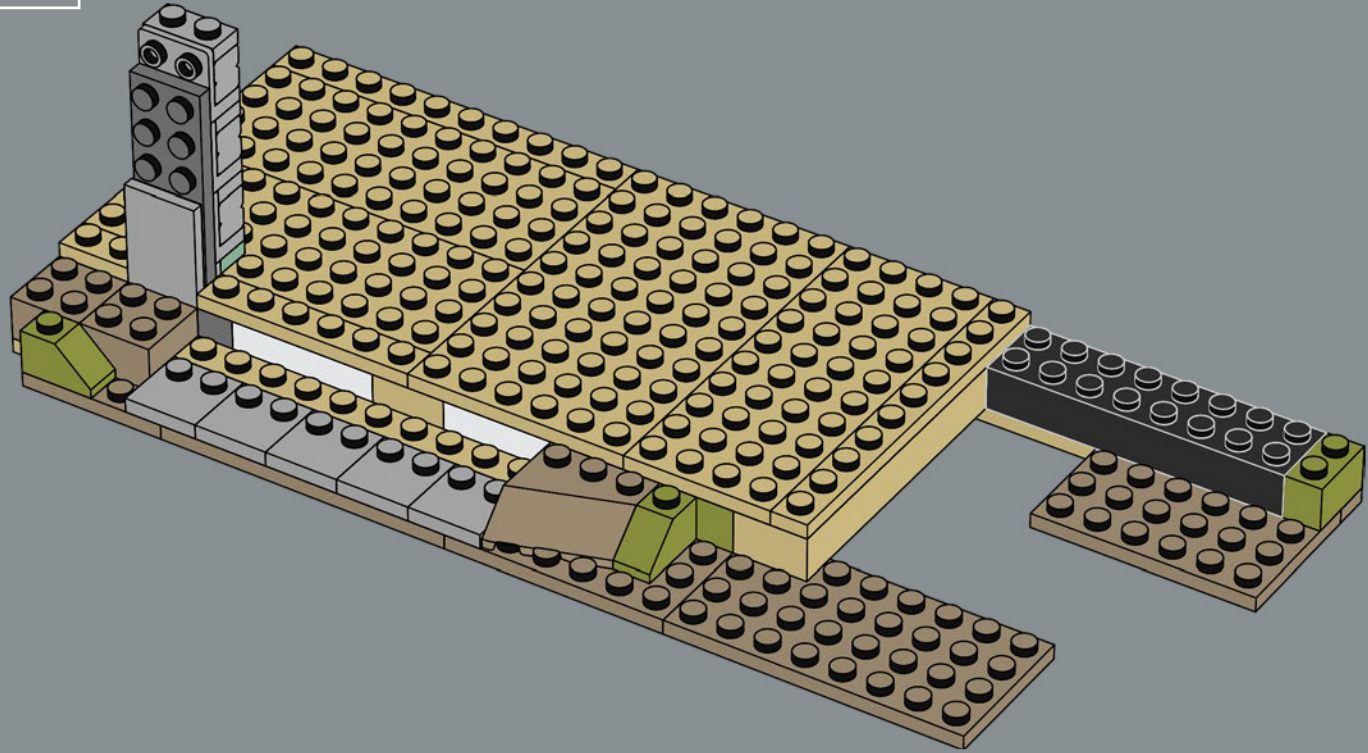

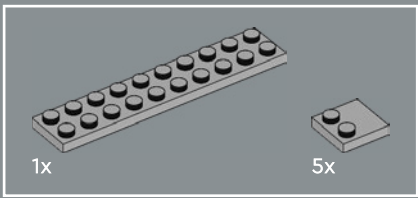

16

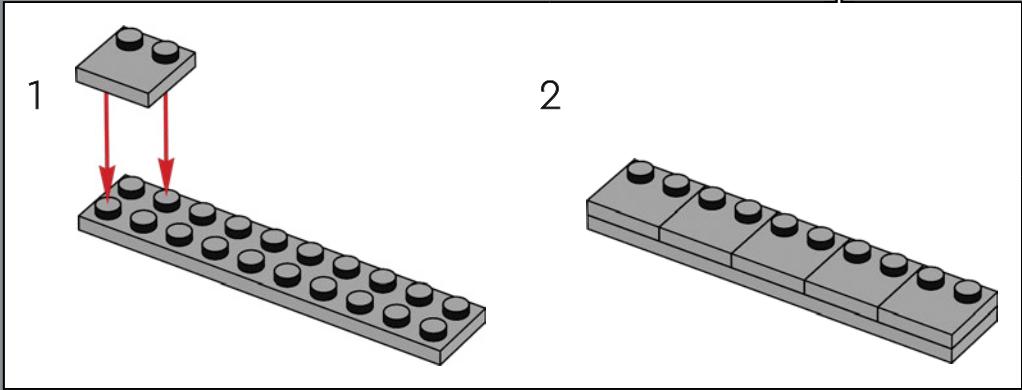
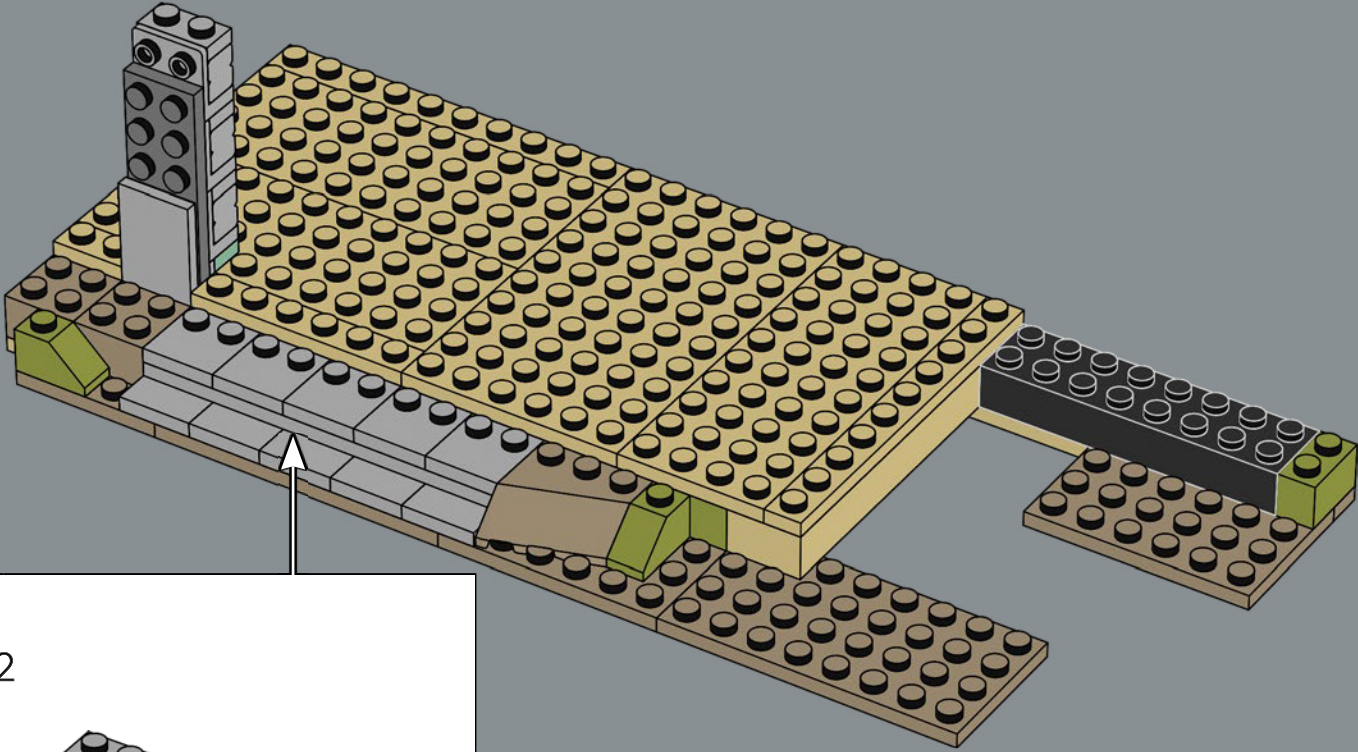

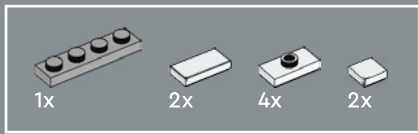

17

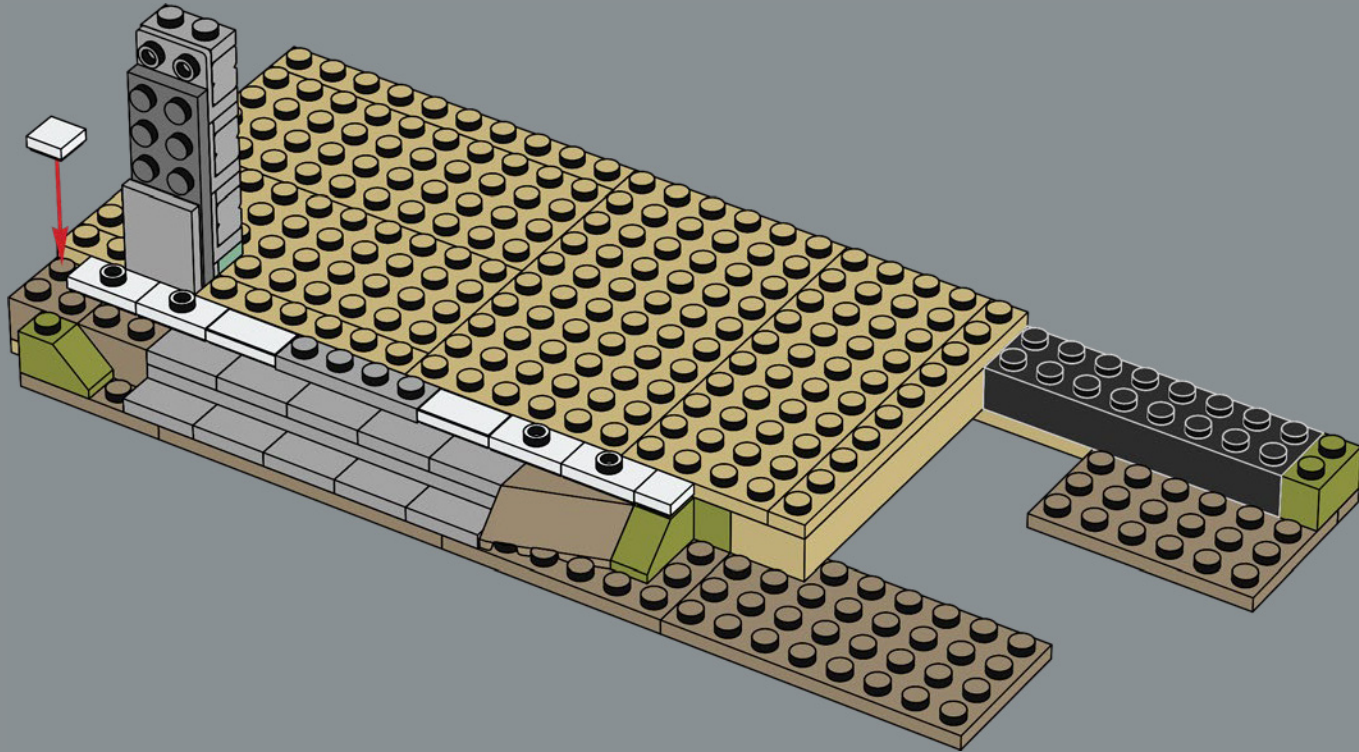

1x  2x 

18

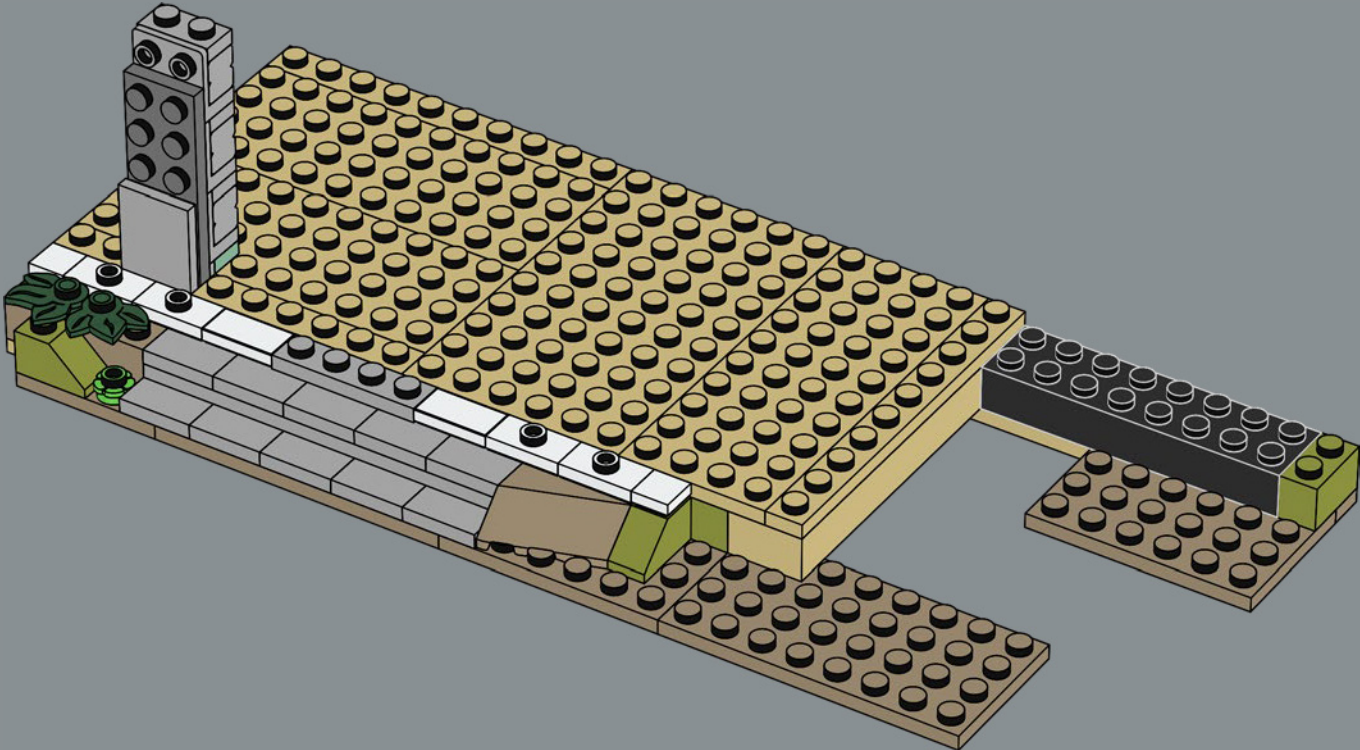

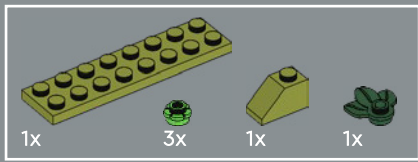

19

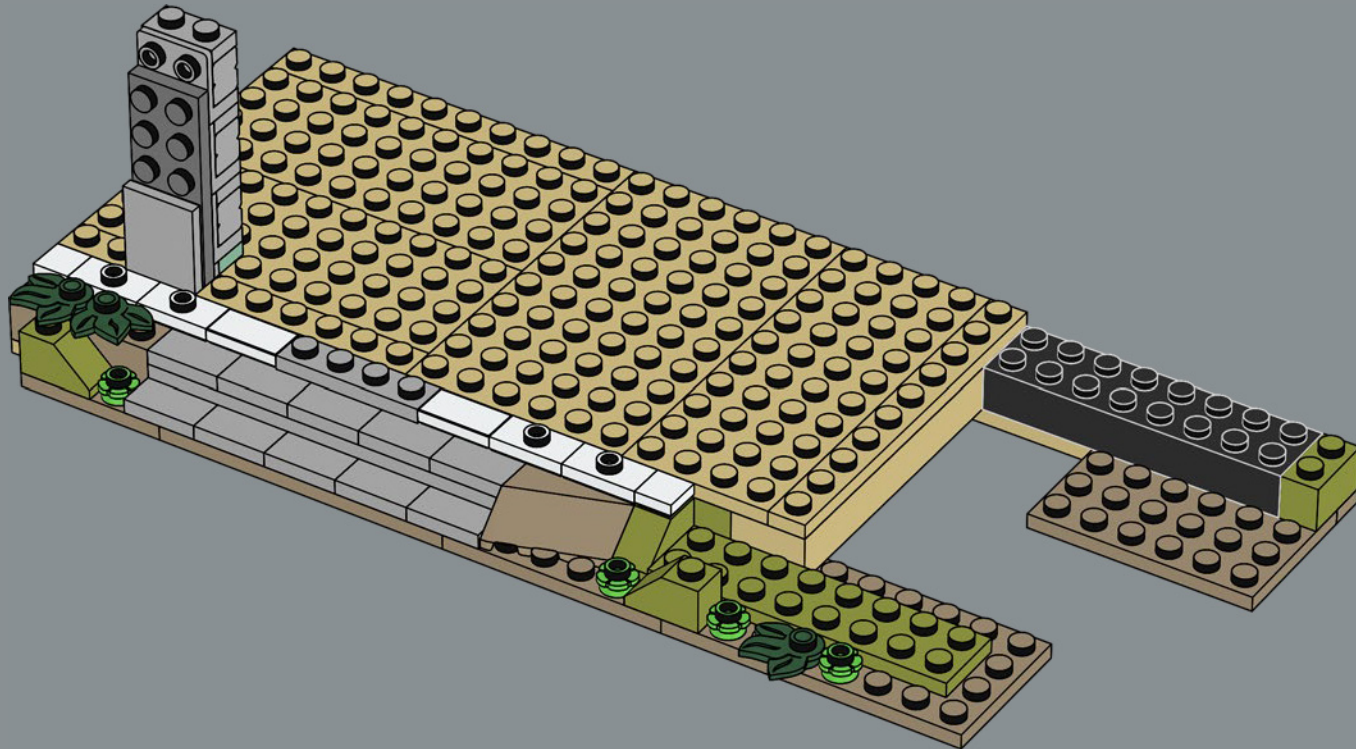

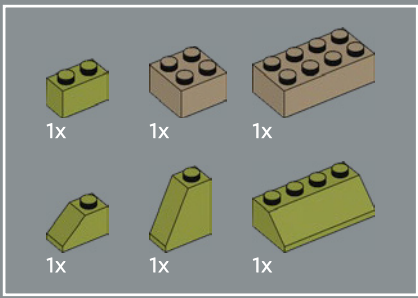

20

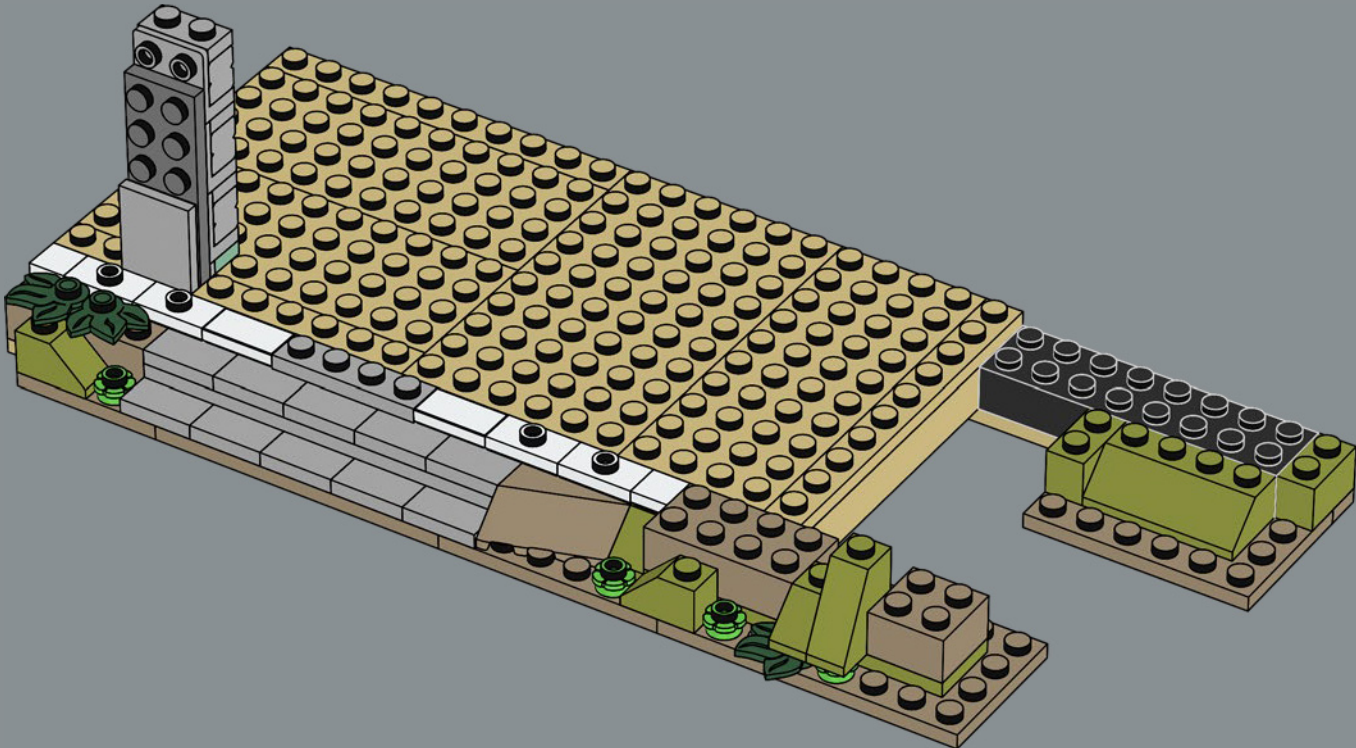

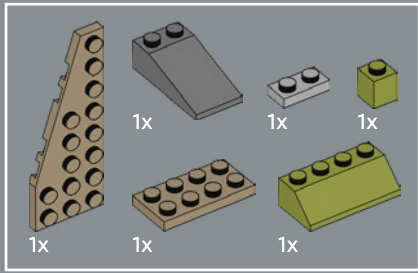

21

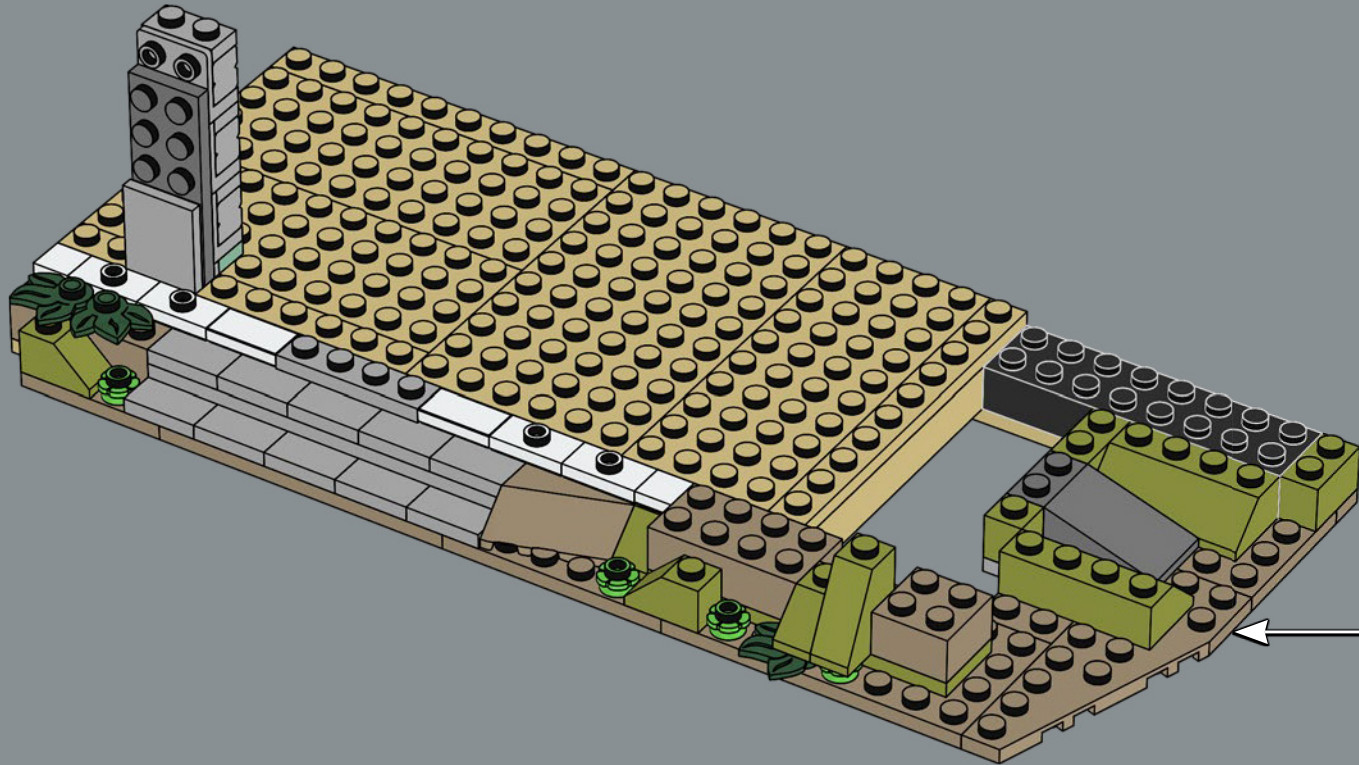
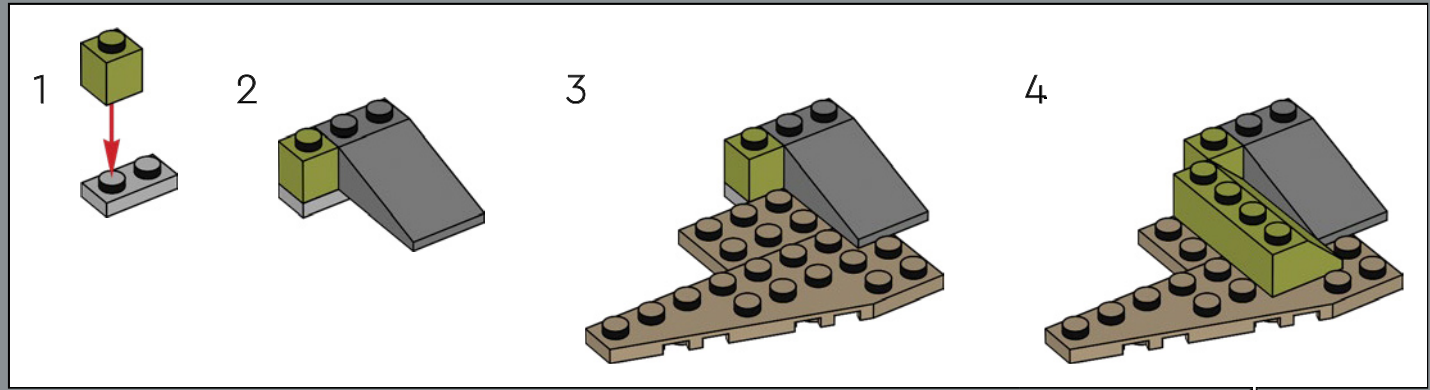

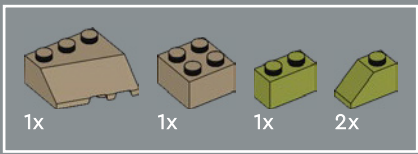

22

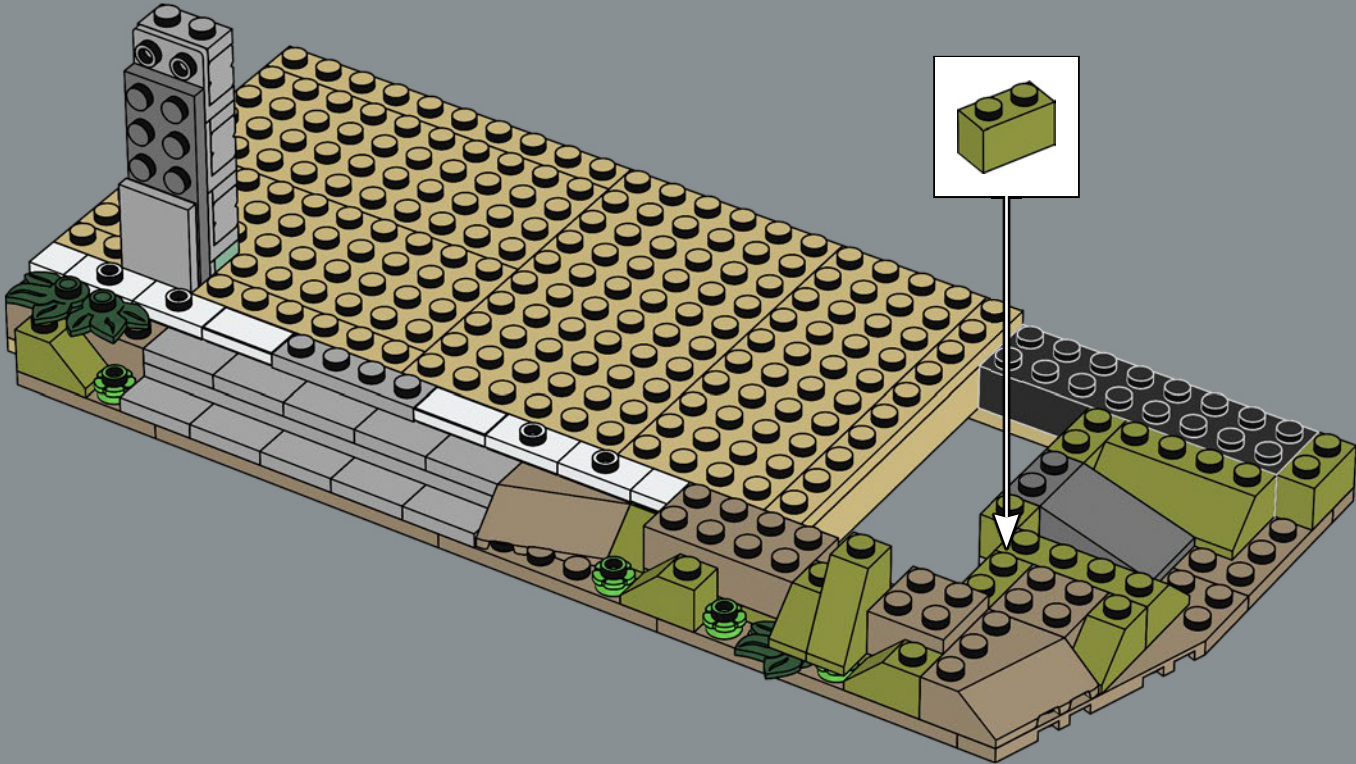

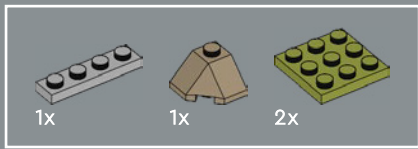

23

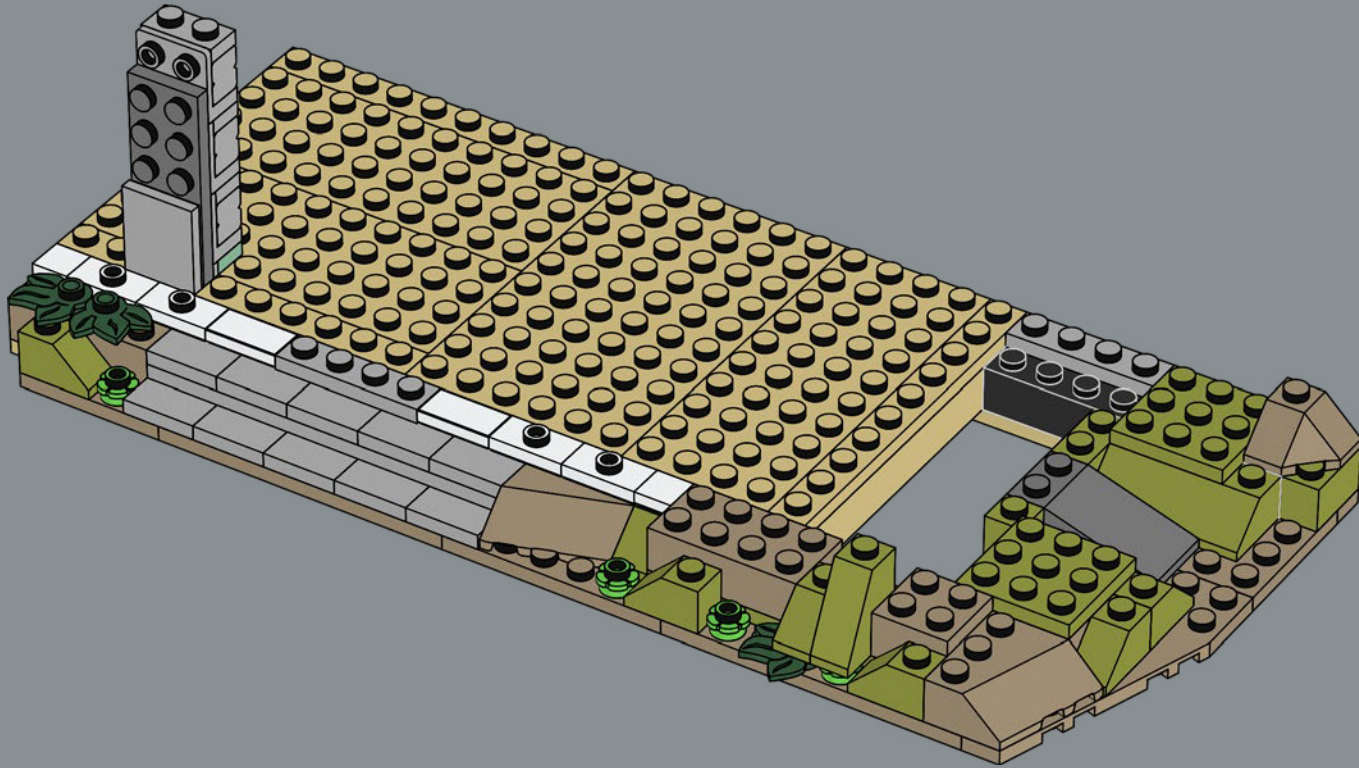

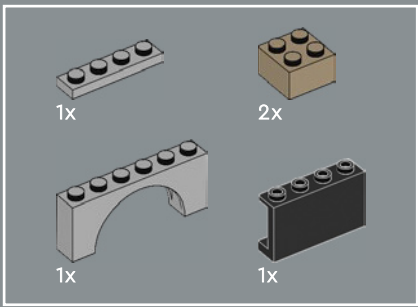

24

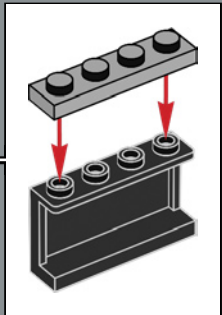
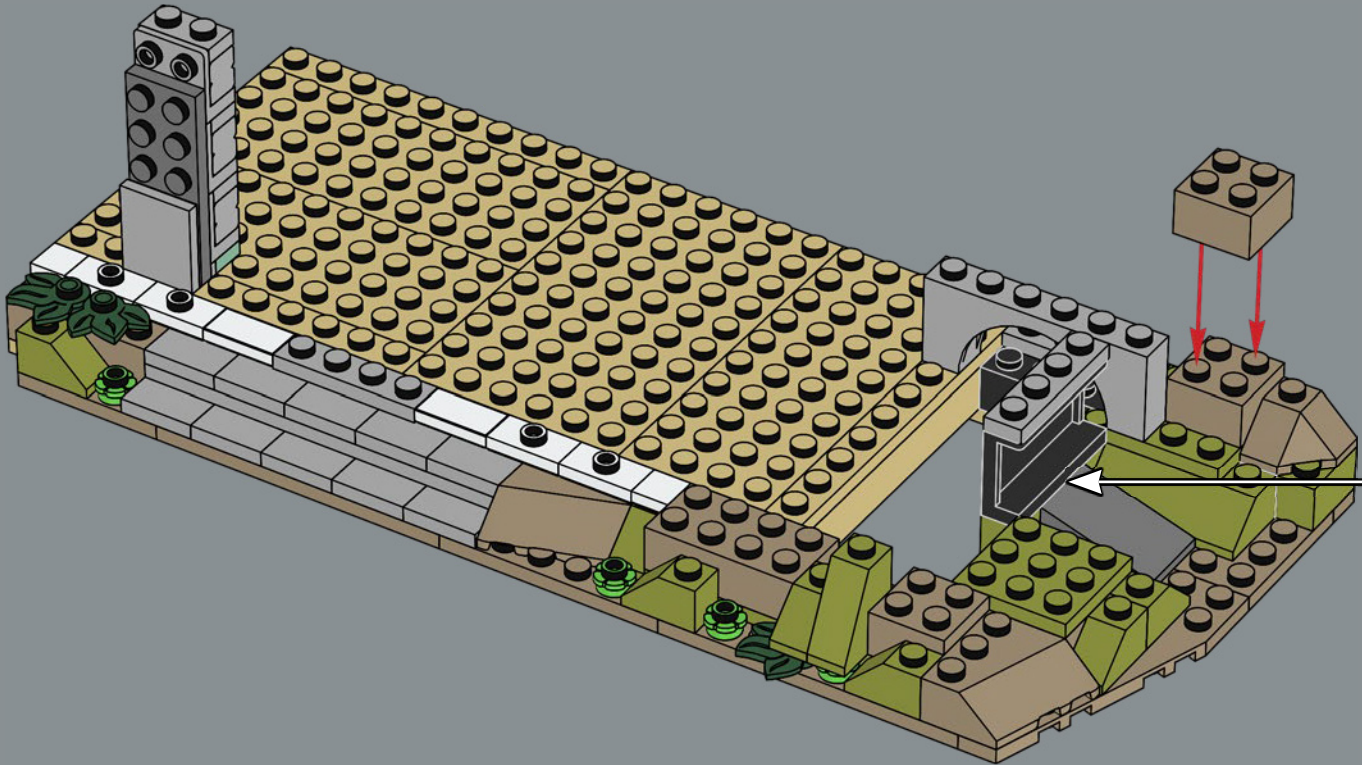

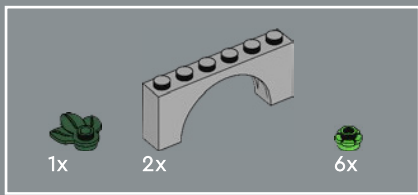

25

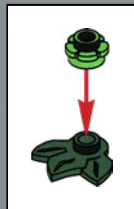
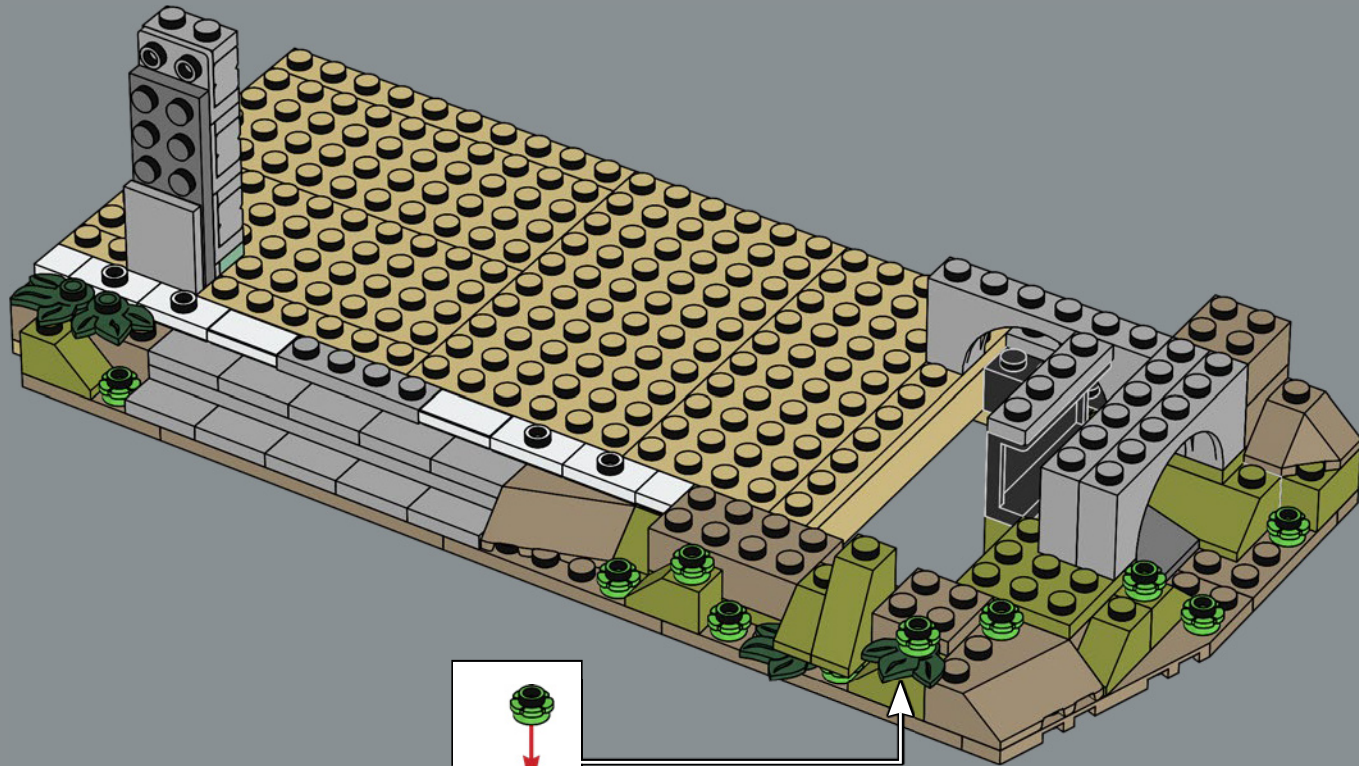

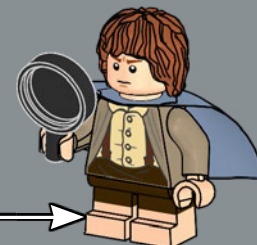
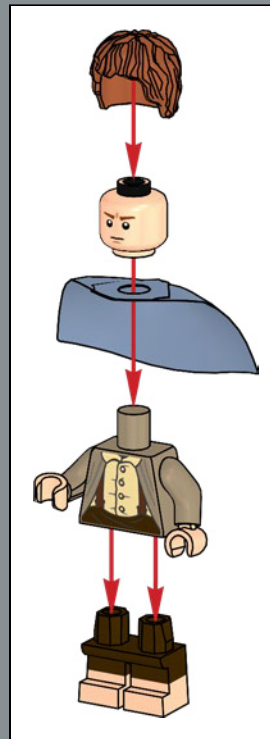
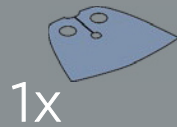
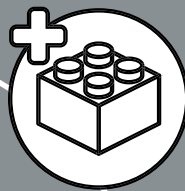

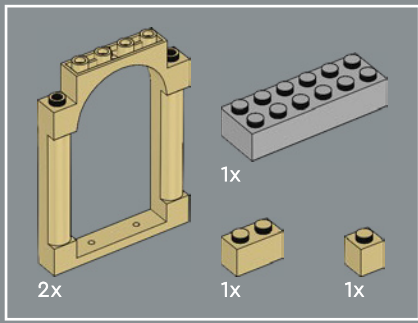

26

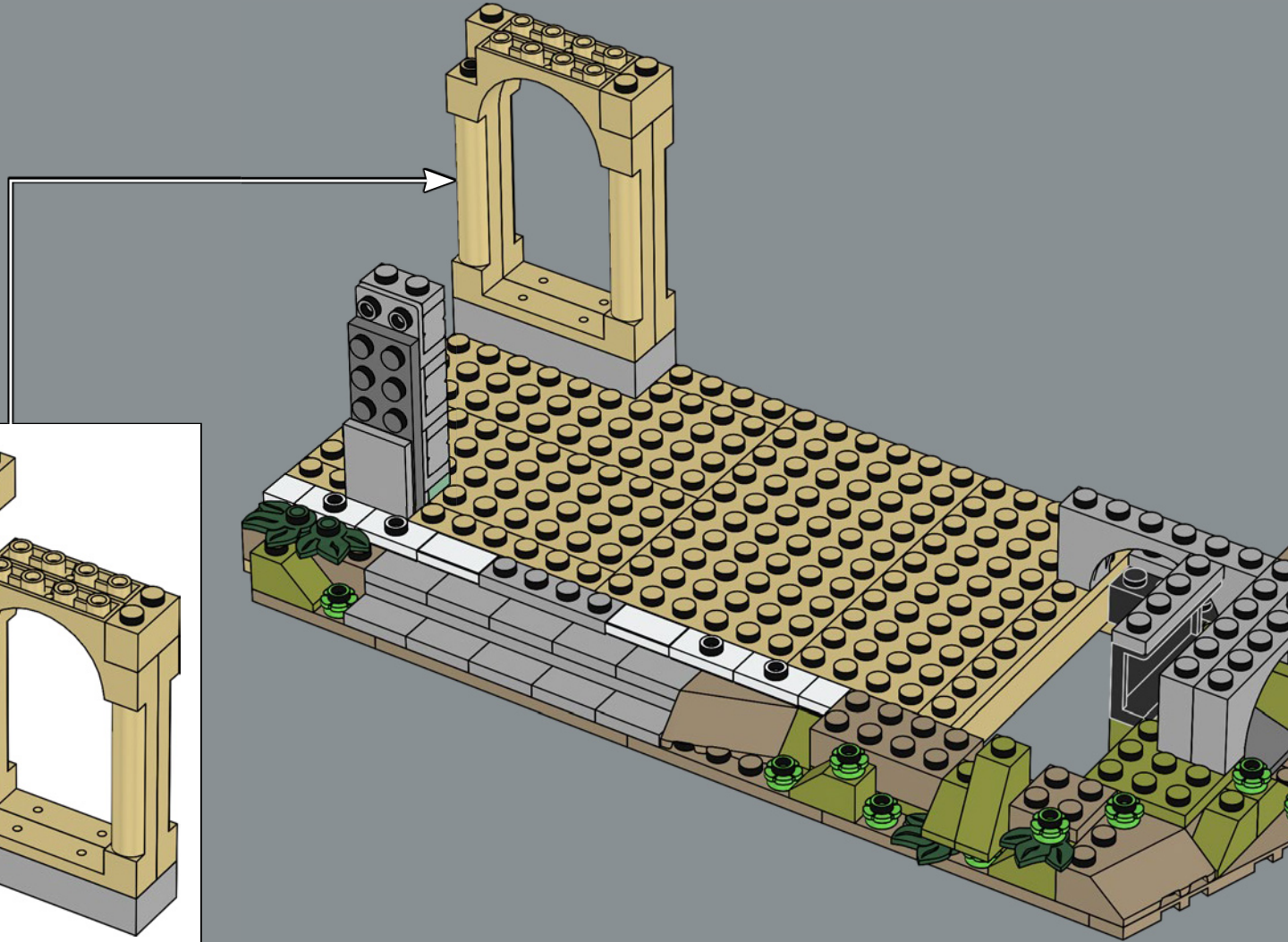
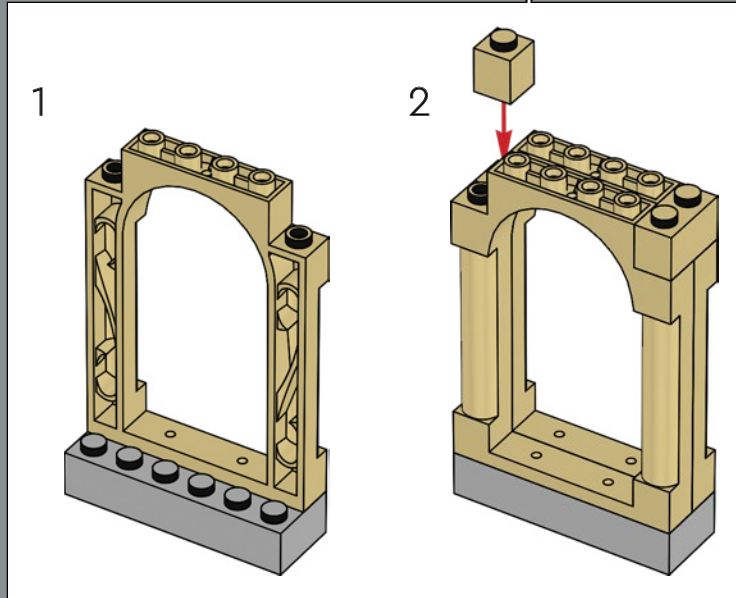

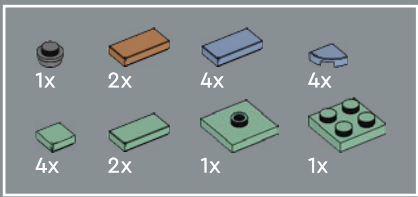

27

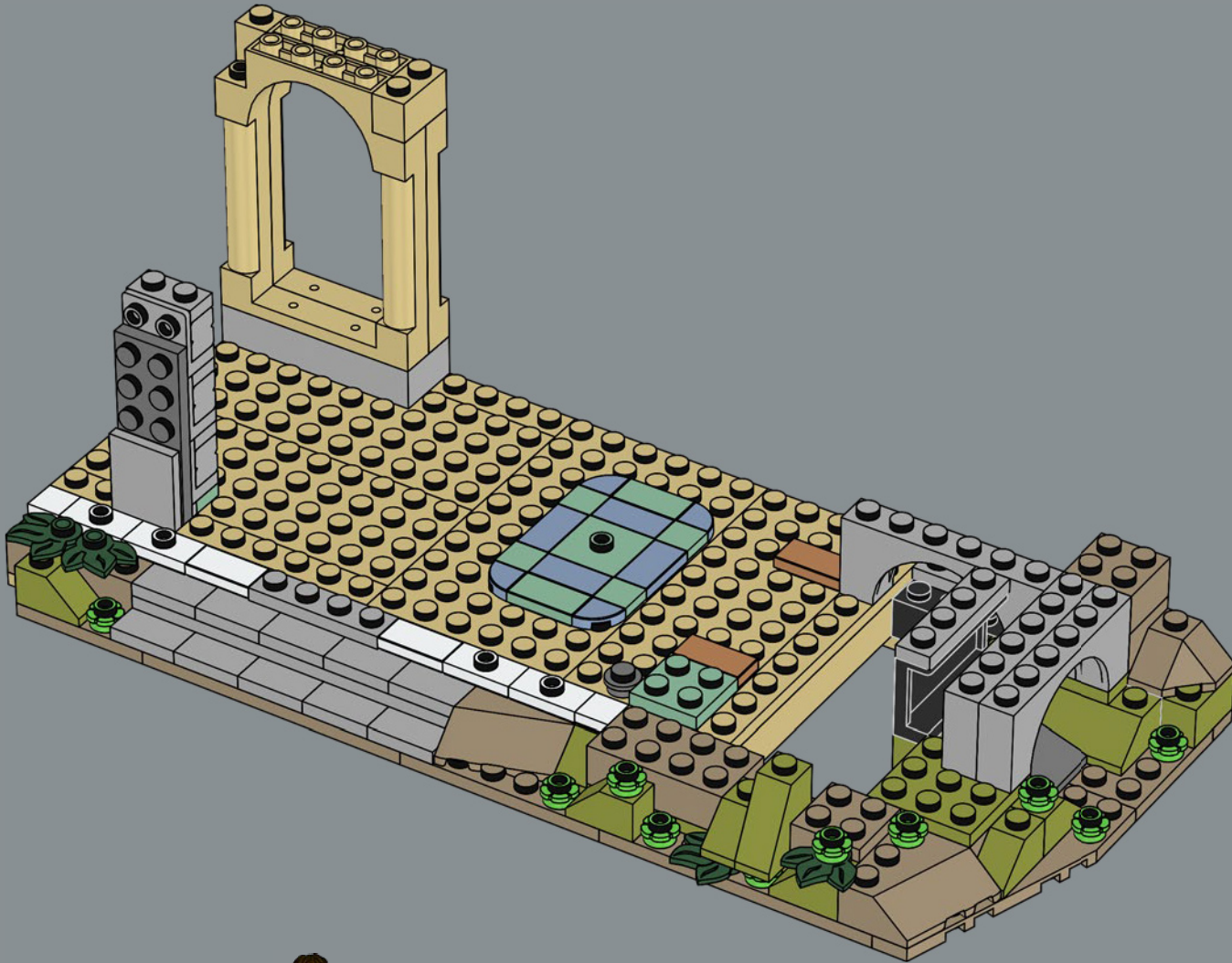

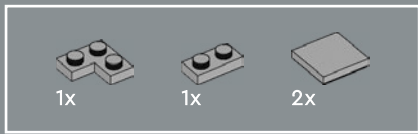

28

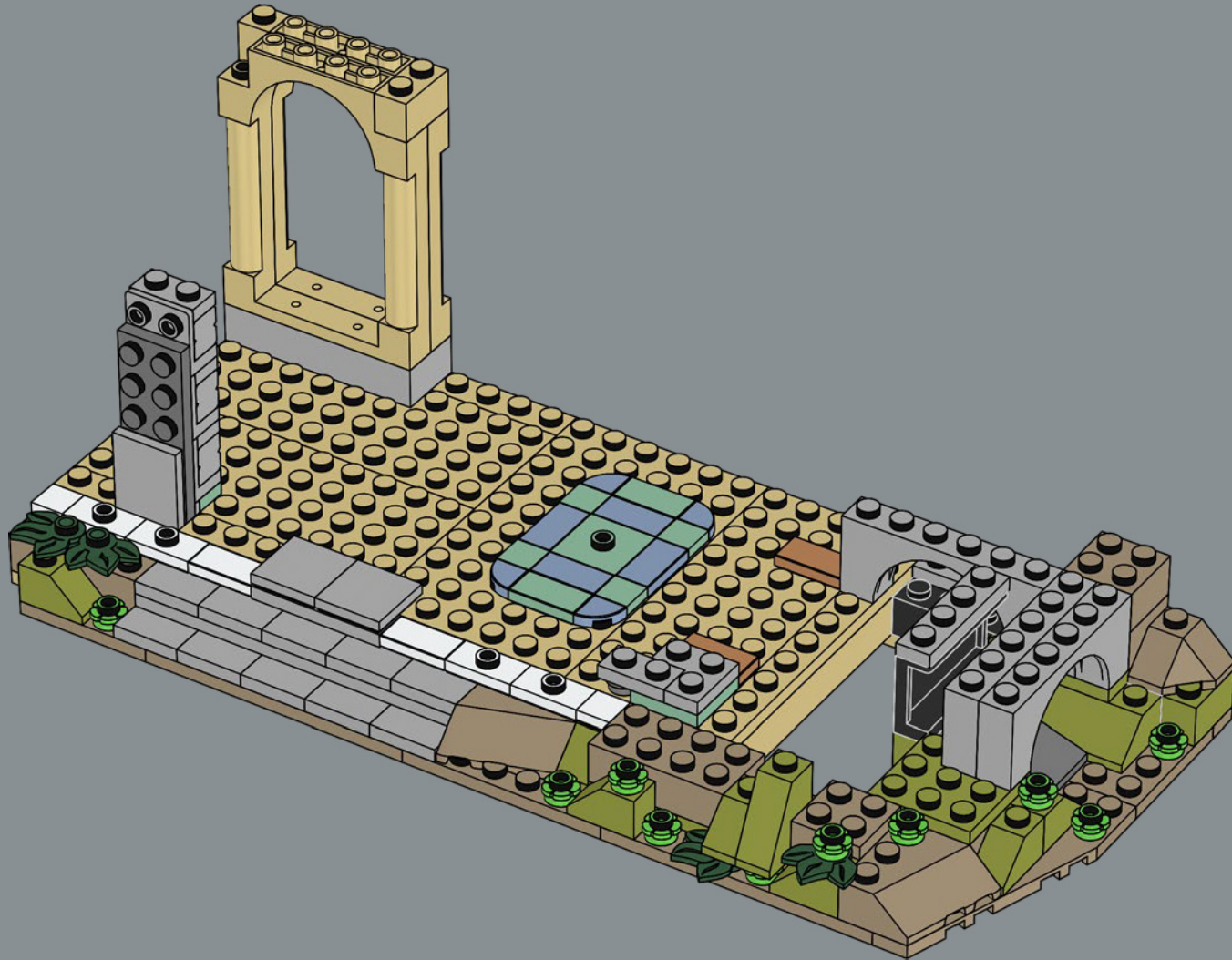



2x

29

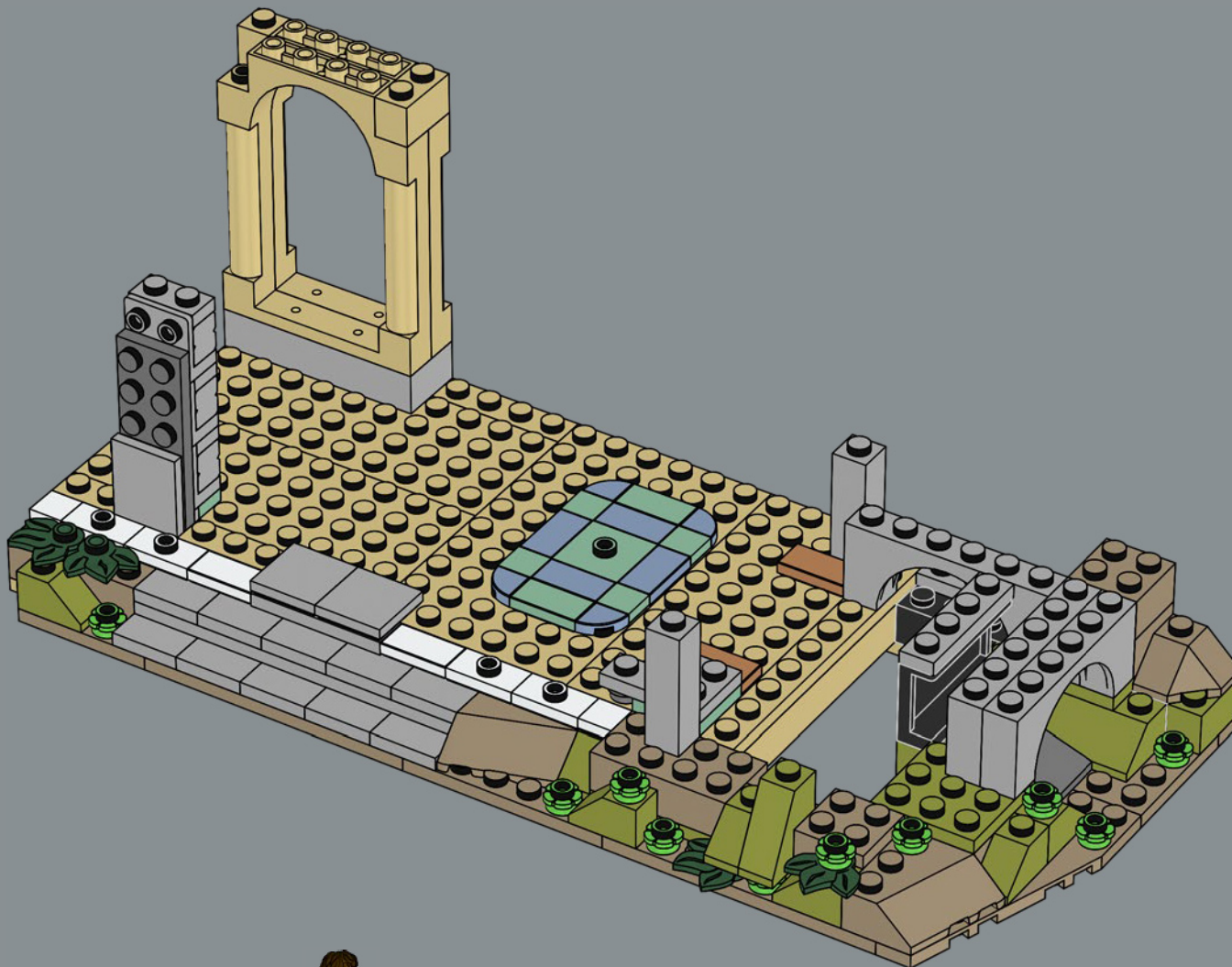

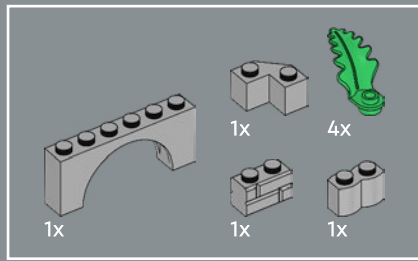

30

The fern element is a new design introduced in 2023. It's seen here for the first time, and there are 34 in this model!

L'élément de fougère est une nouvelle pièce introduite en 2023. On le voit ici pour la première fois, et ce modèle en compte 34 !

El nuevo diseño del elemento que representa un helecho se introdujo en 2023. Esta es nuestra primera oportunidad de verlo en un set (¡el modelo tiene 34 de ellos!).

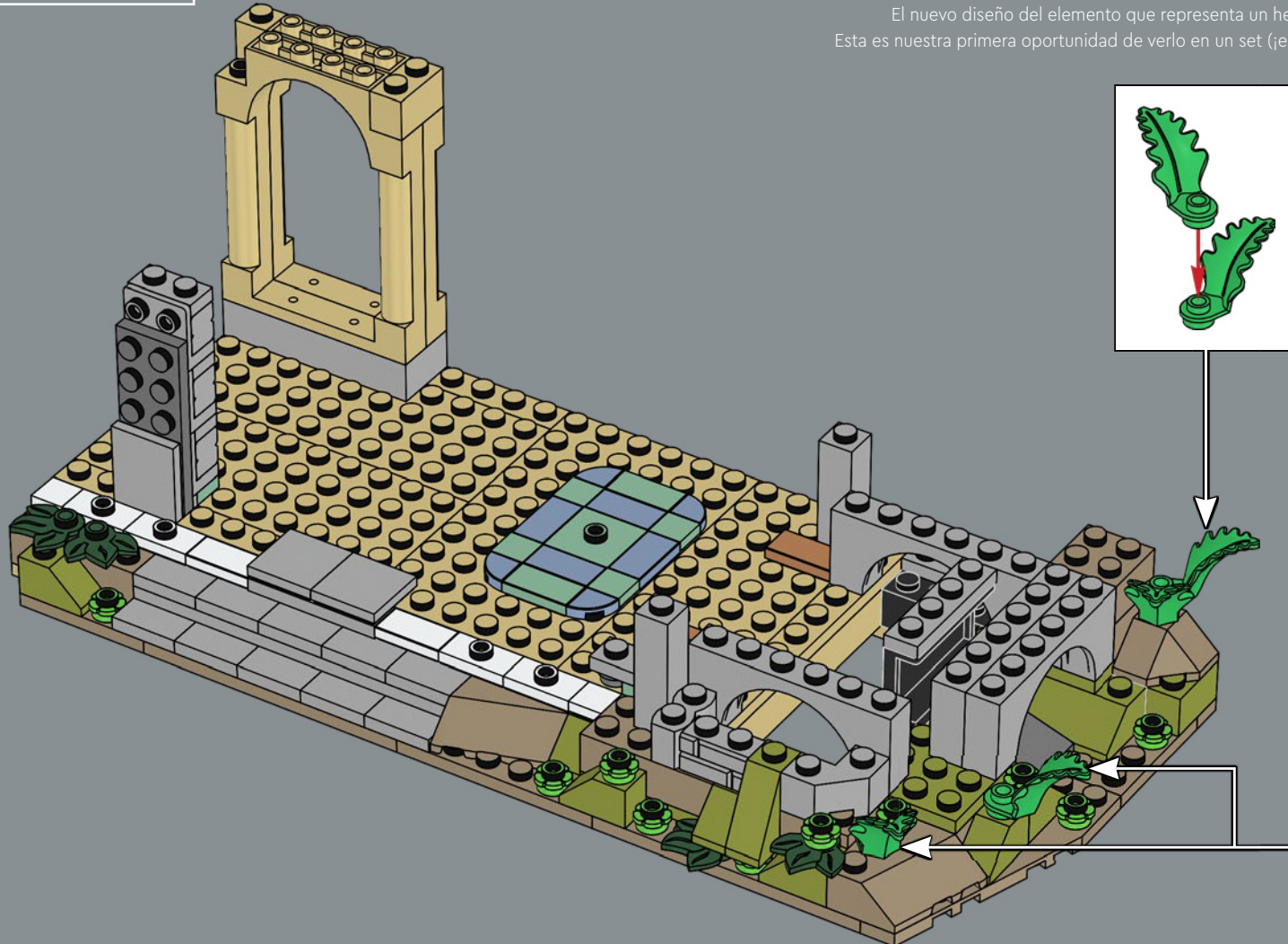

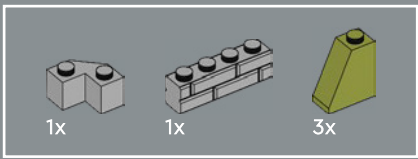

31

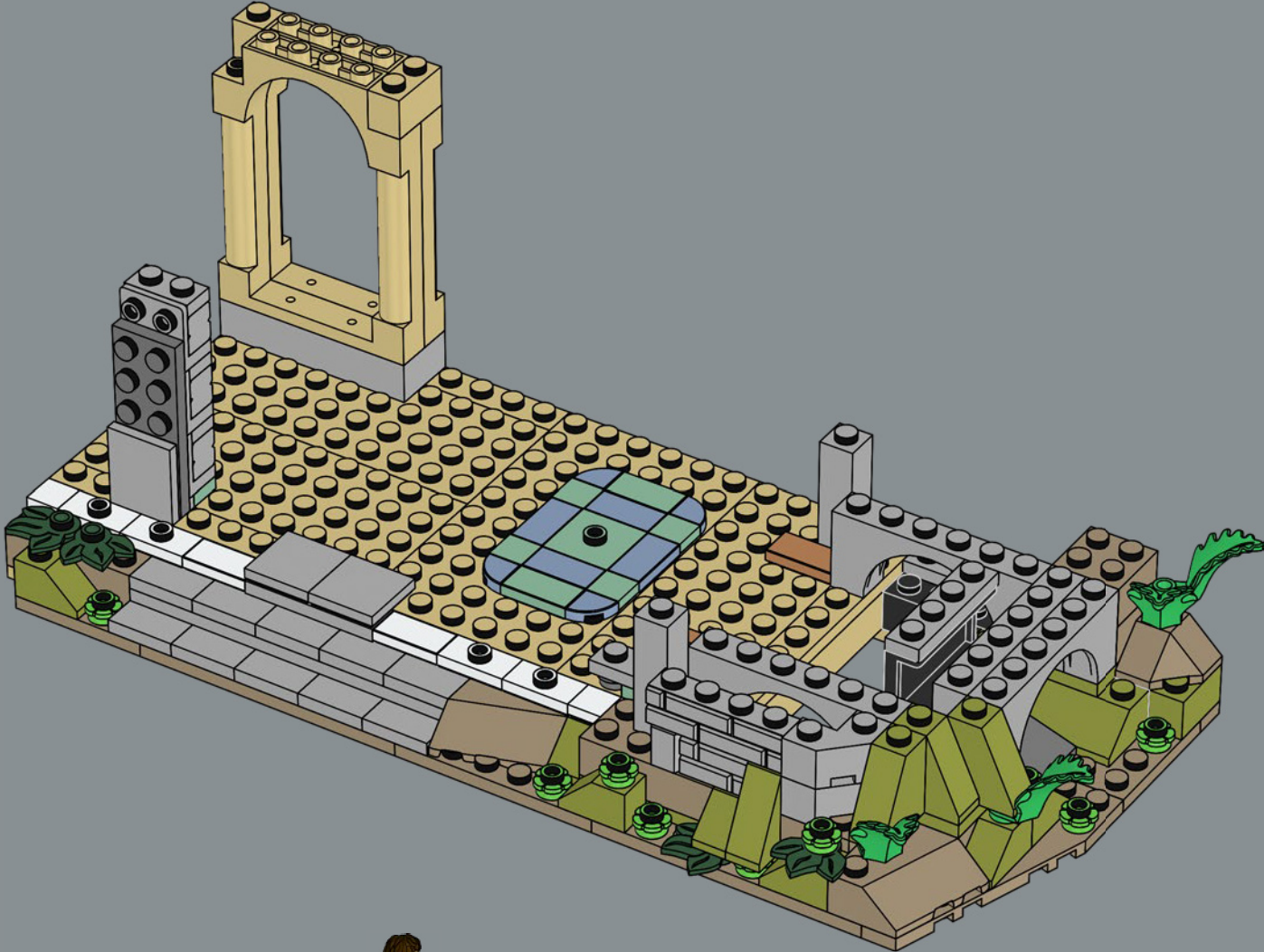

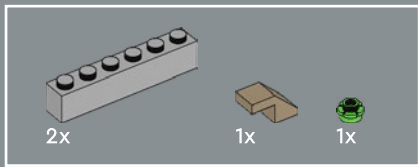

32

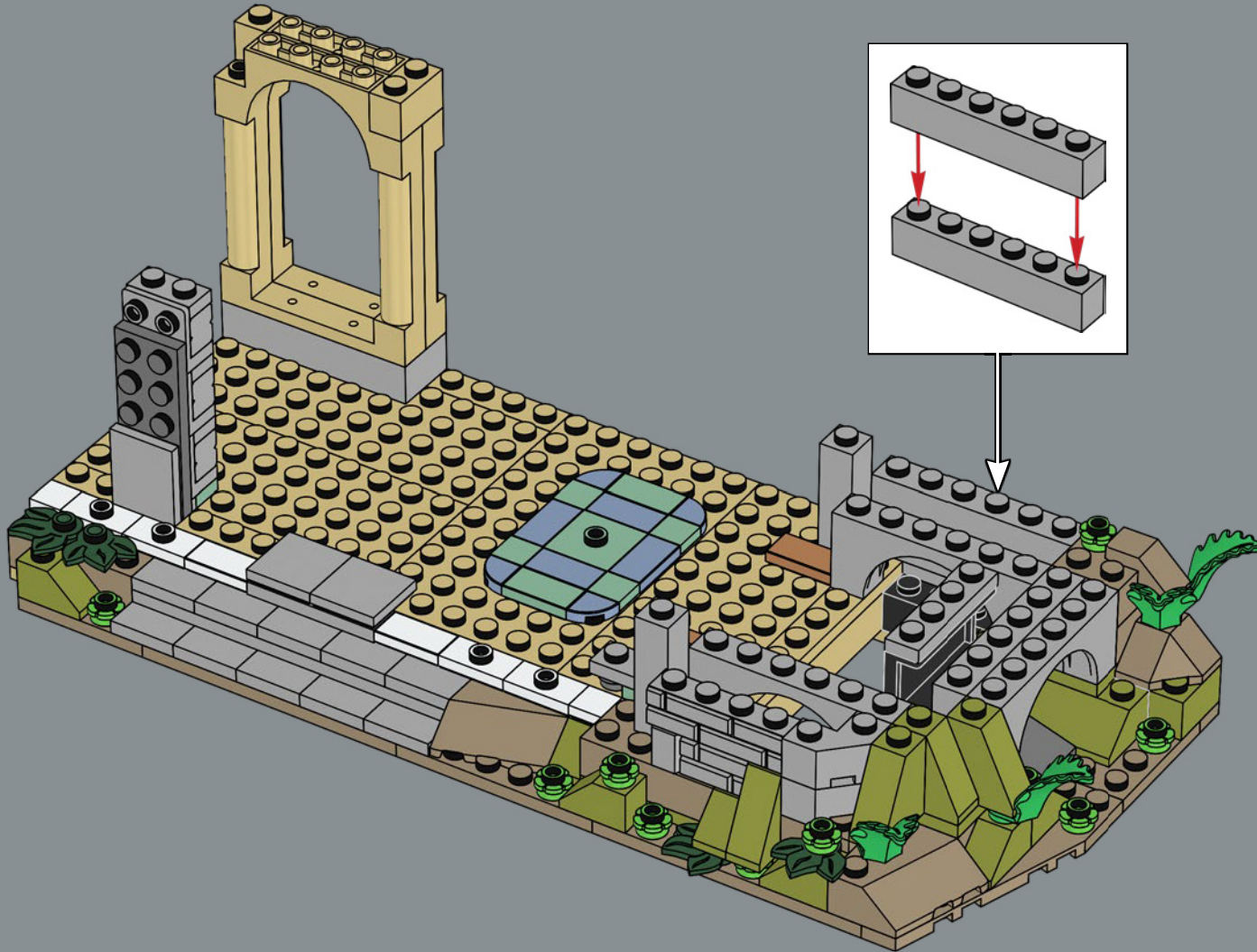

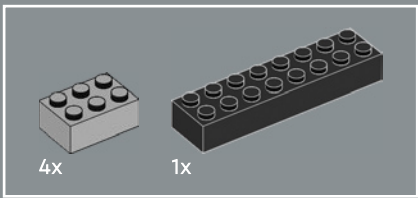

33

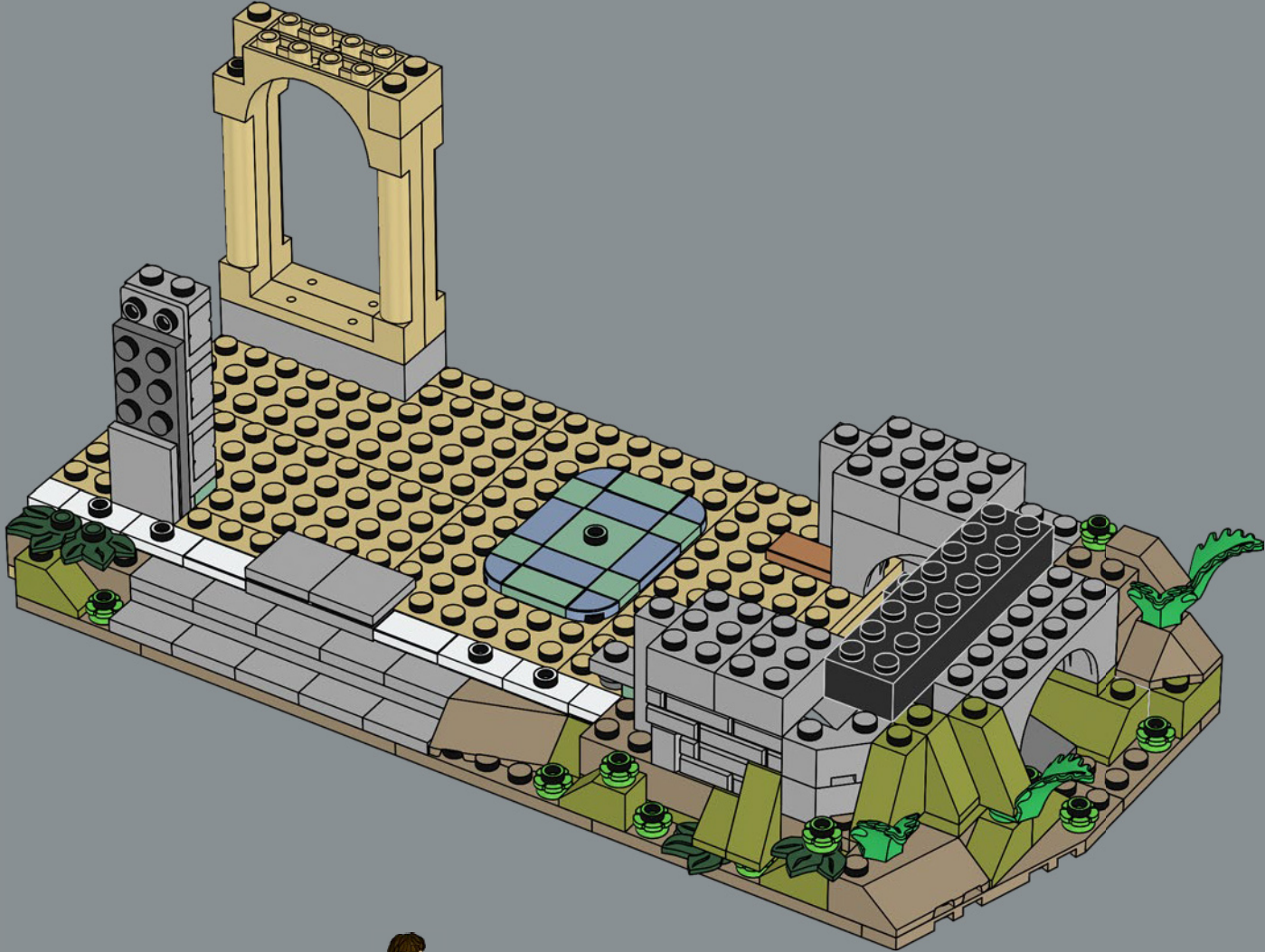

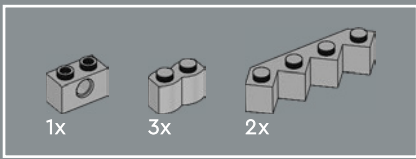

34

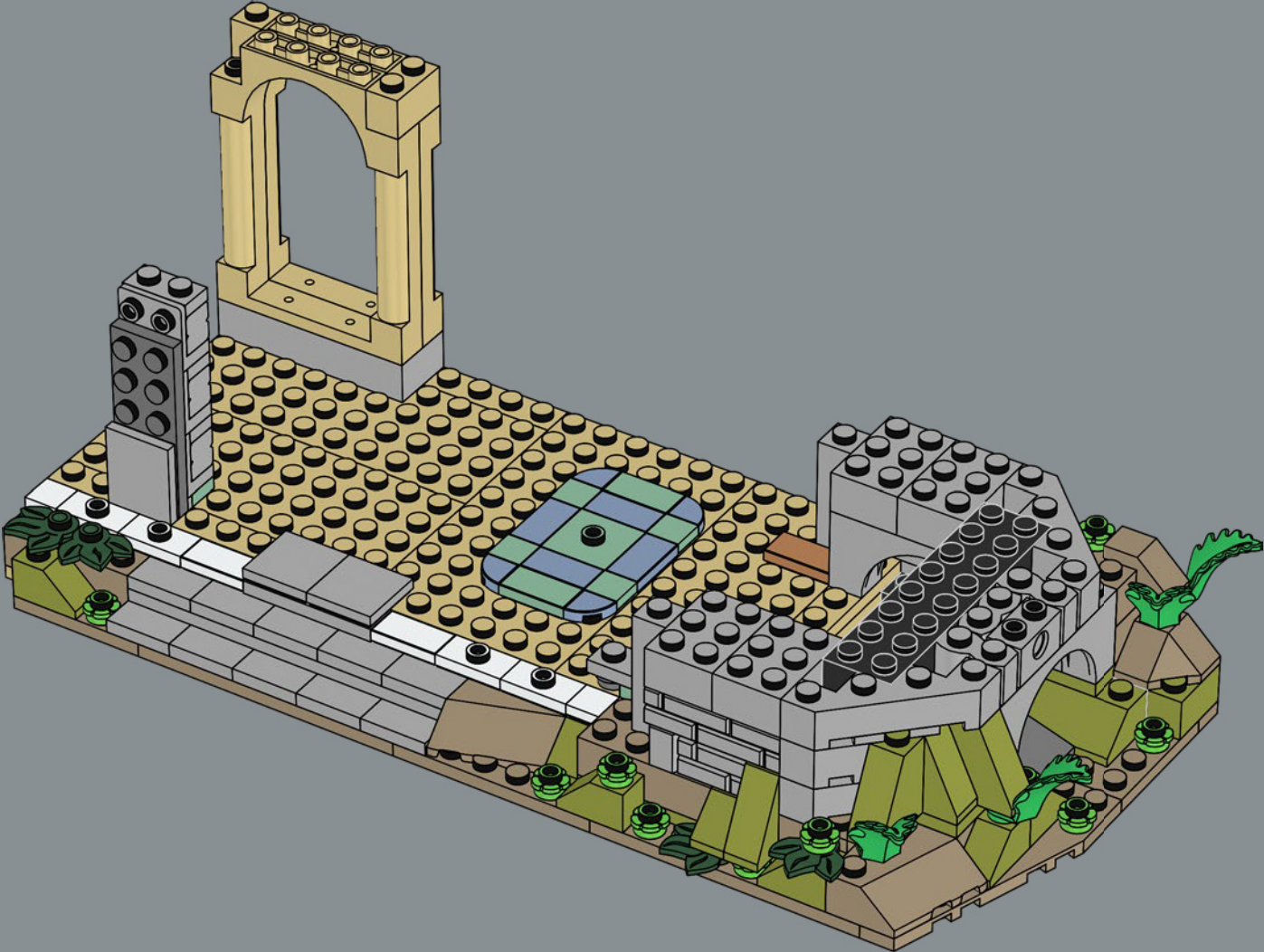

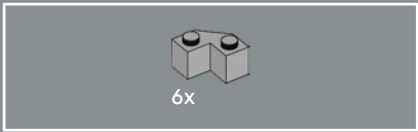

35

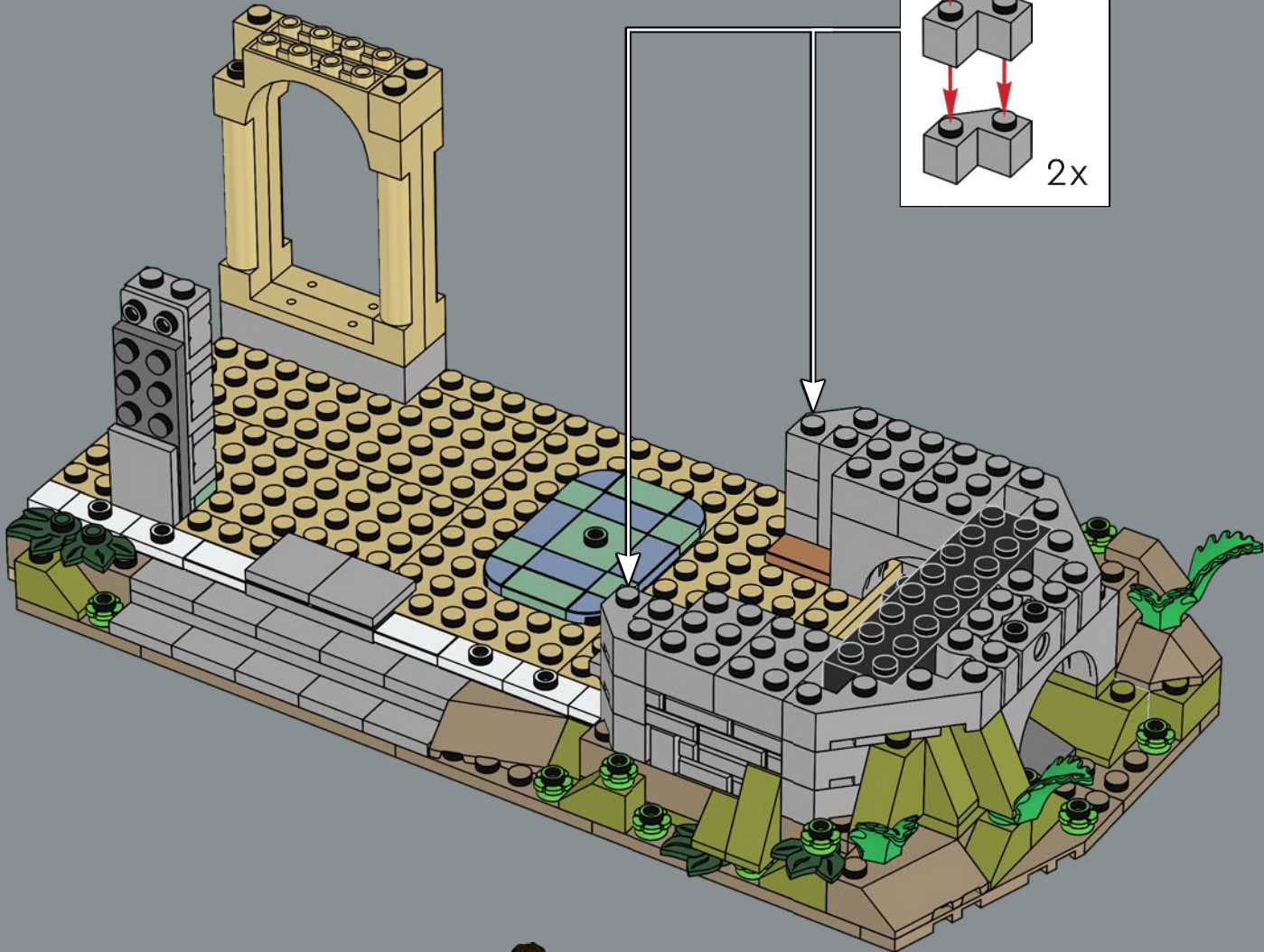
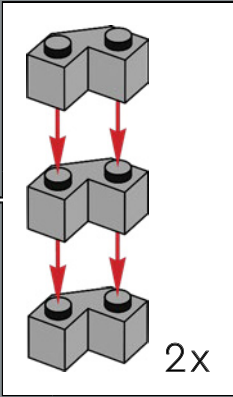

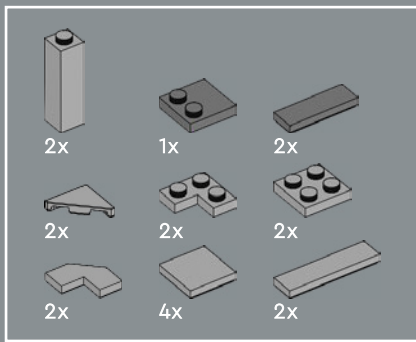

36

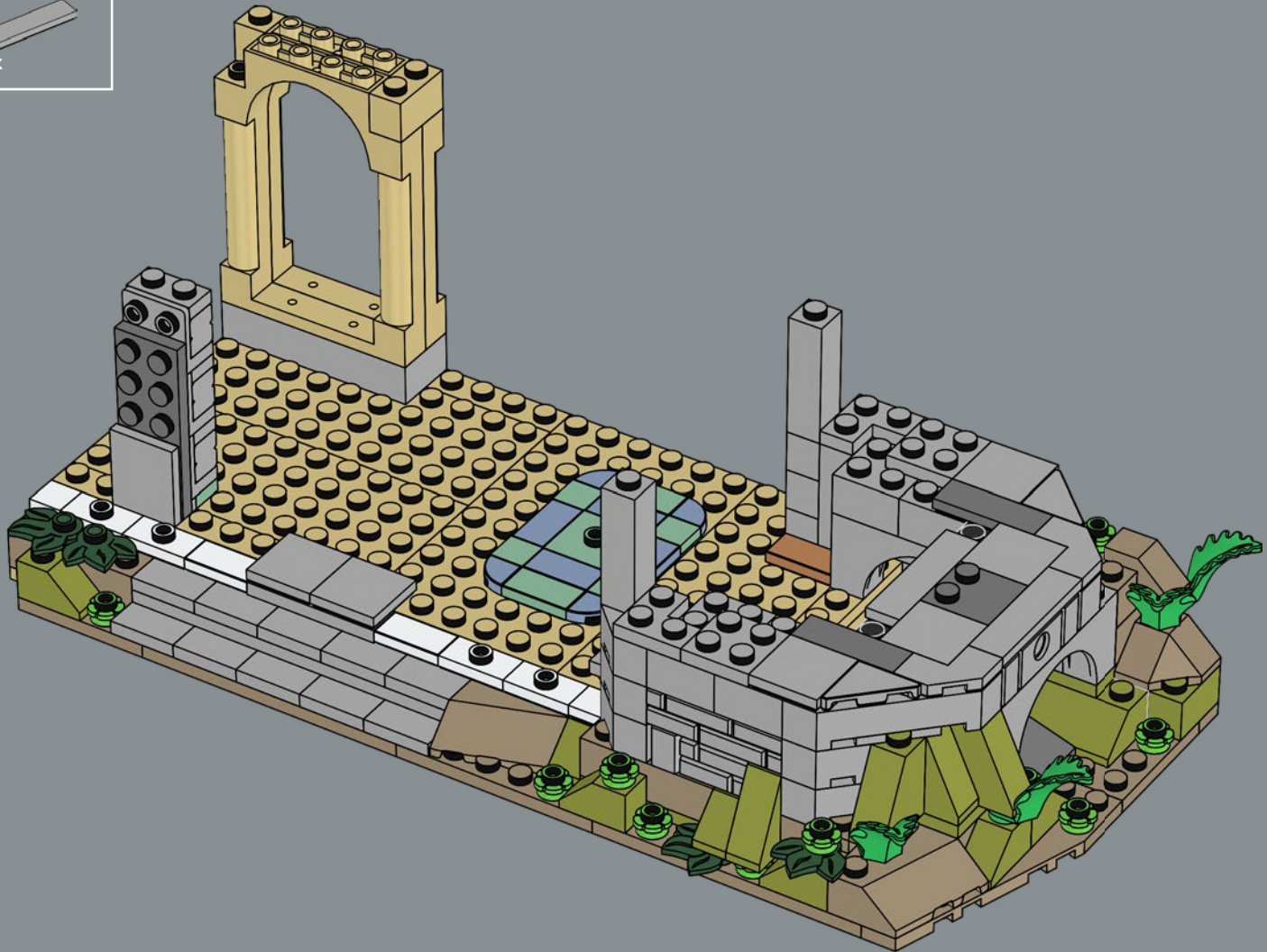

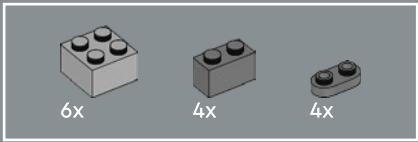

37

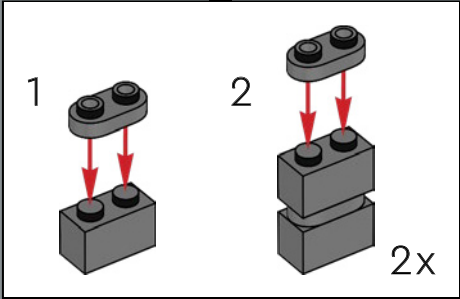
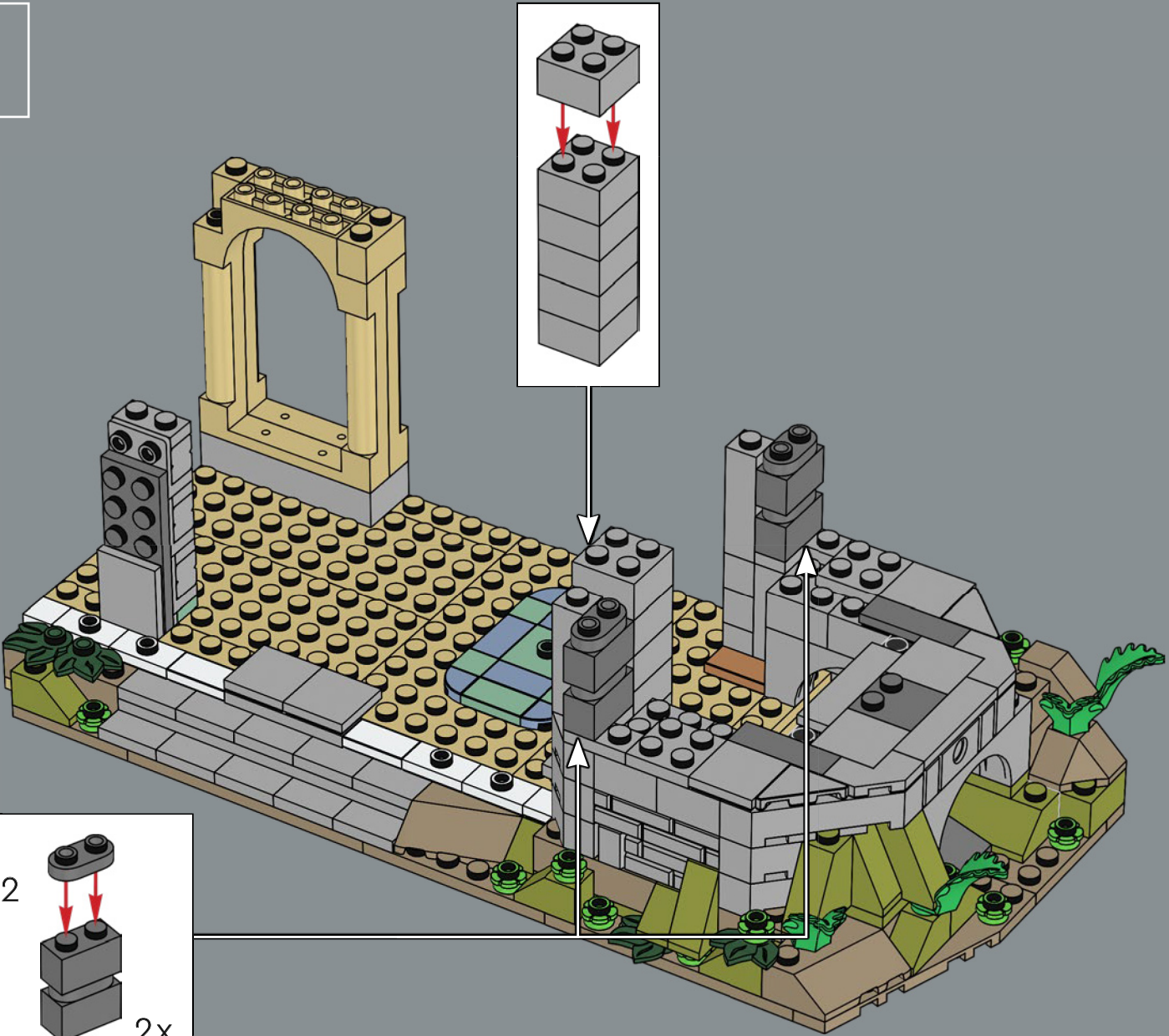

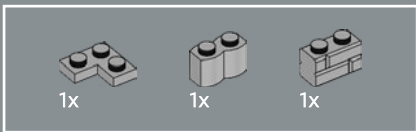

38

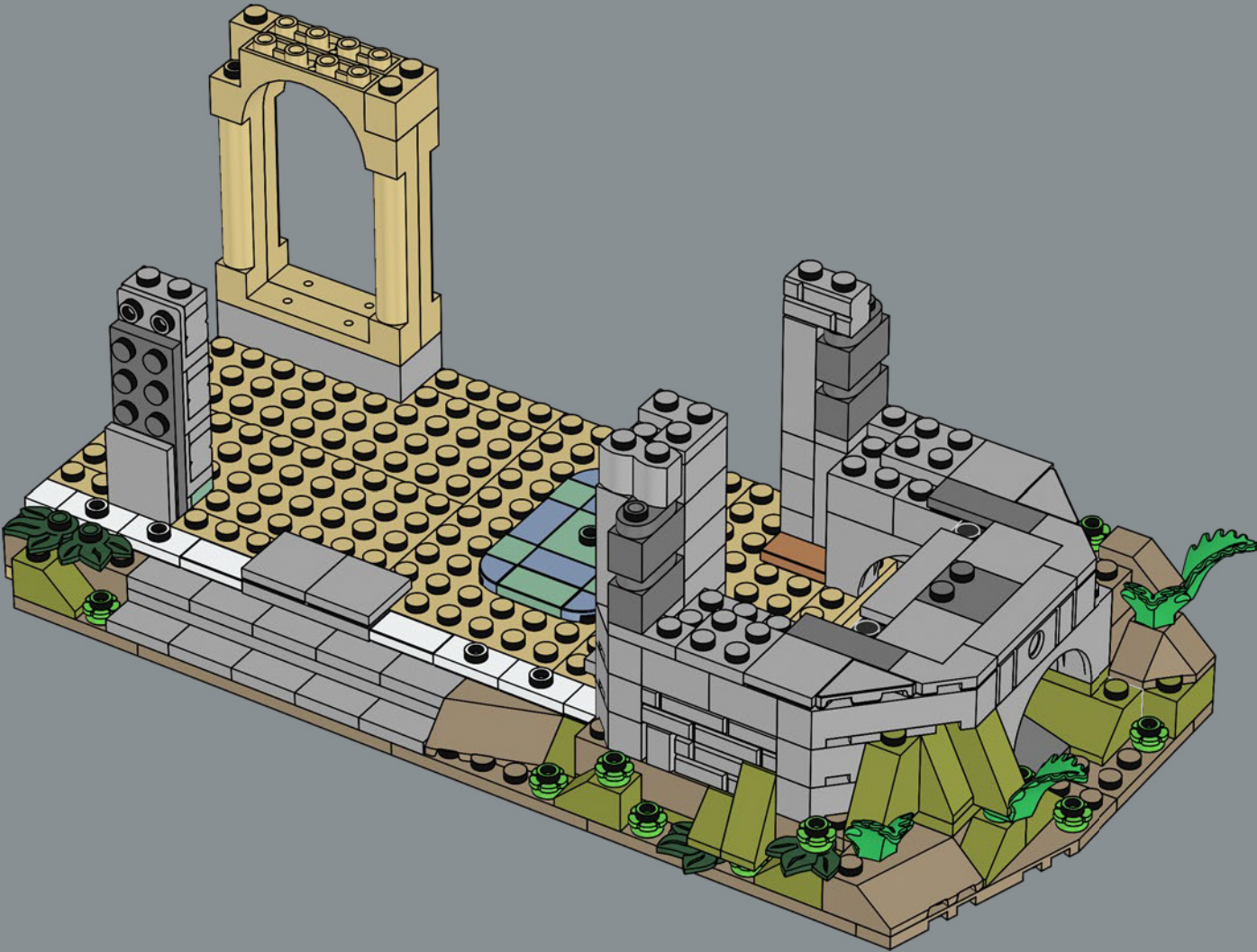



39

This hidey-hole for Samwise Gamgee was one of the final features added to the model.

Cette cachette pour Samsagace Gamegie était l'une des dernières caractéristiques ajoutées au modèle.

Este escondite para Samsagaz Gamyi fue de las últimas características que se incorporaron al modelo.

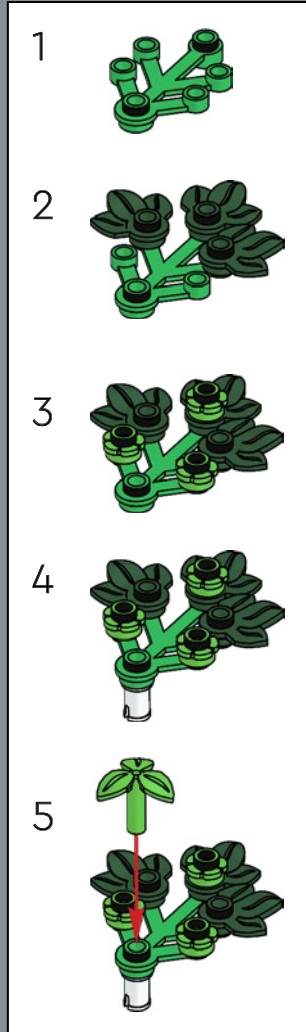

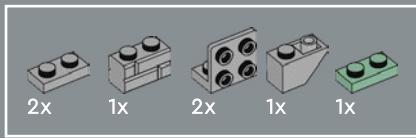

40

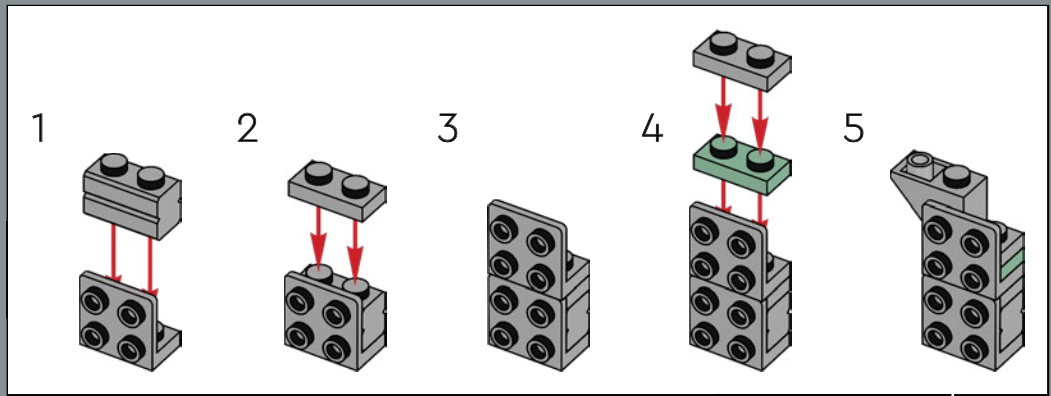
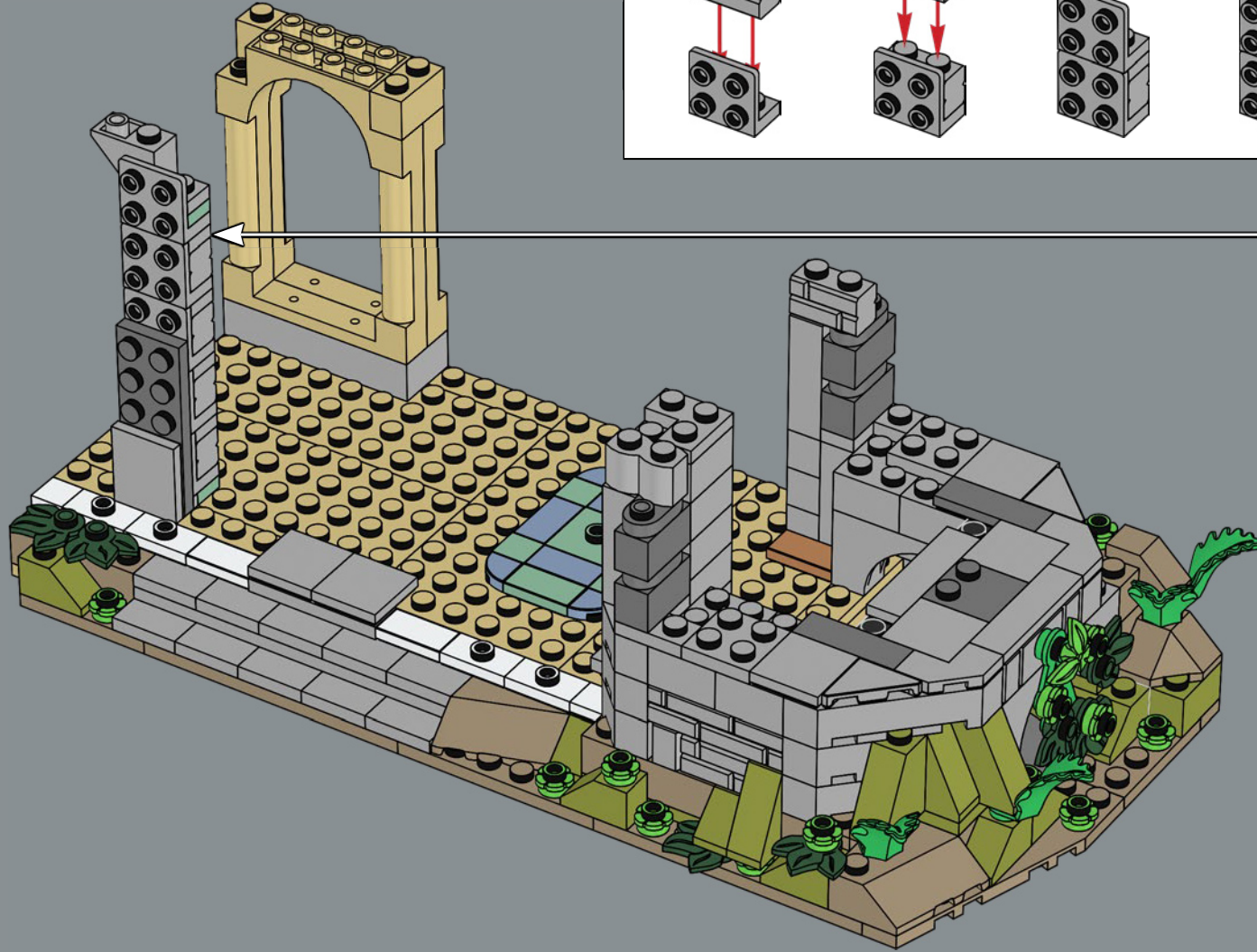

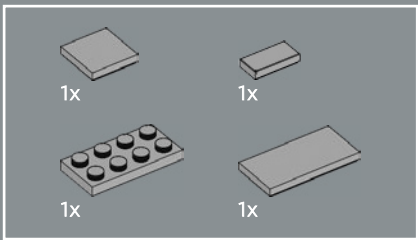

41

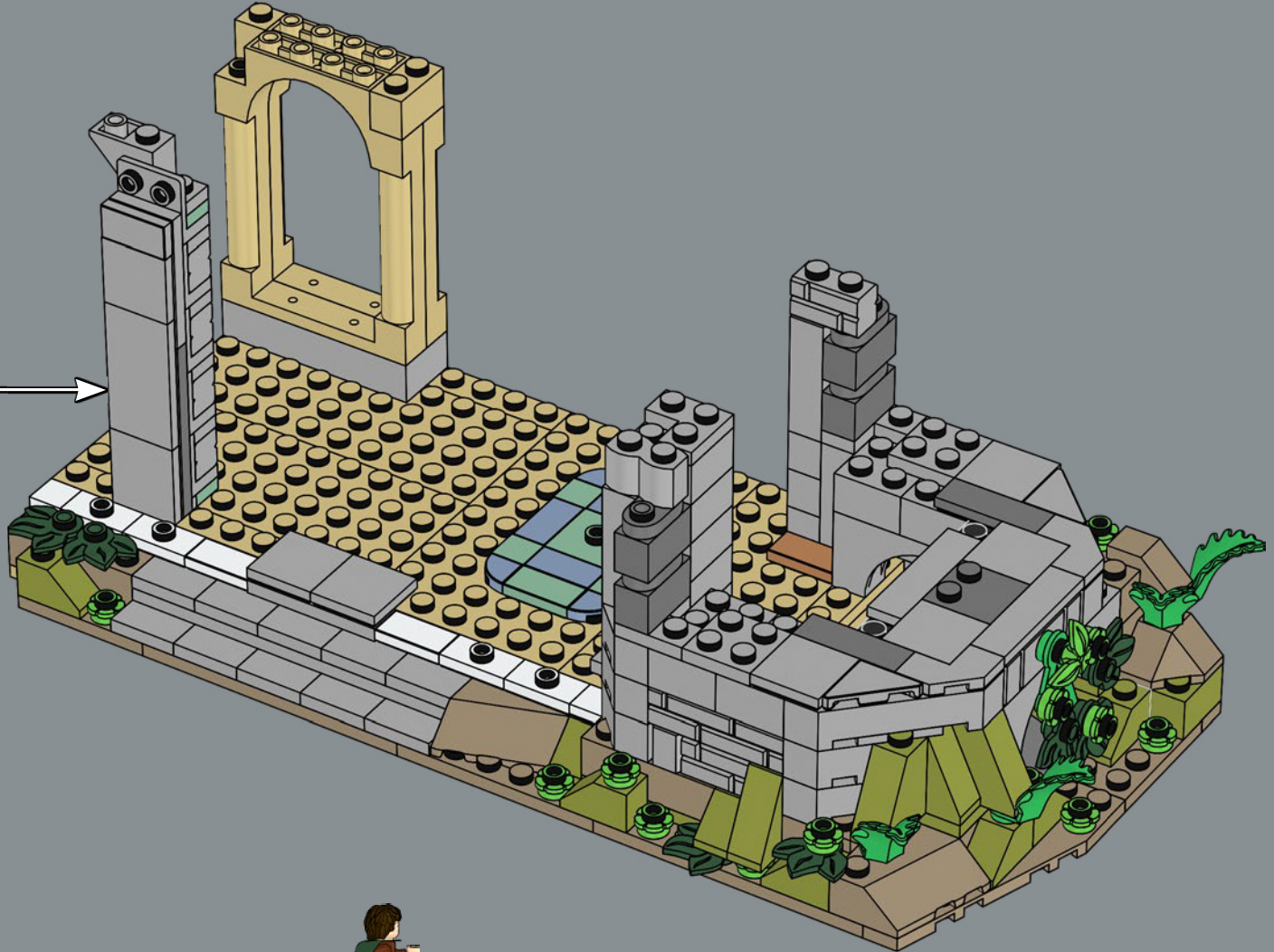
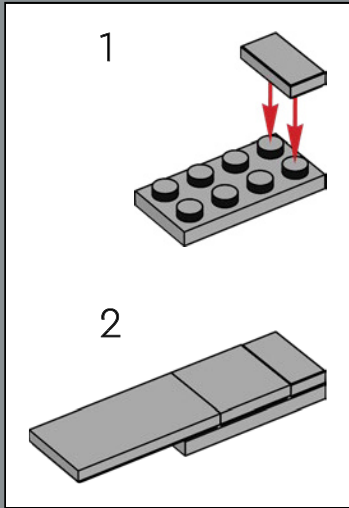

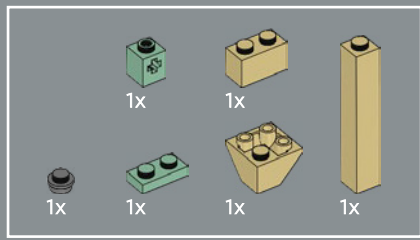

42

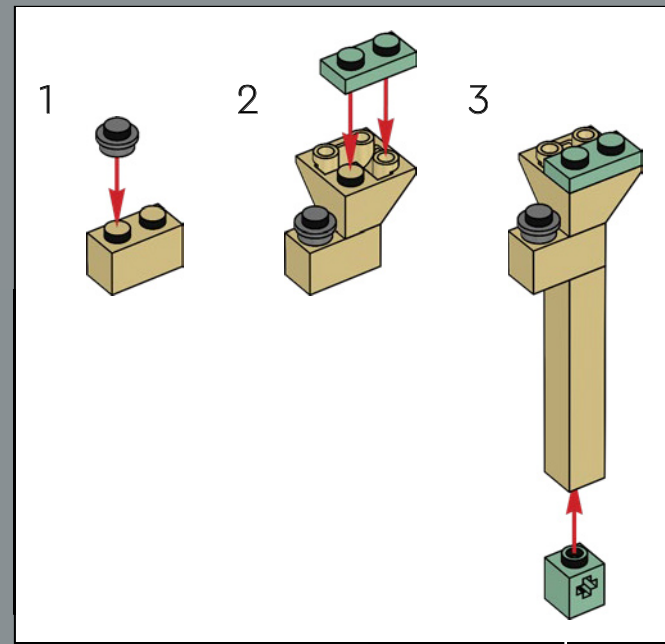
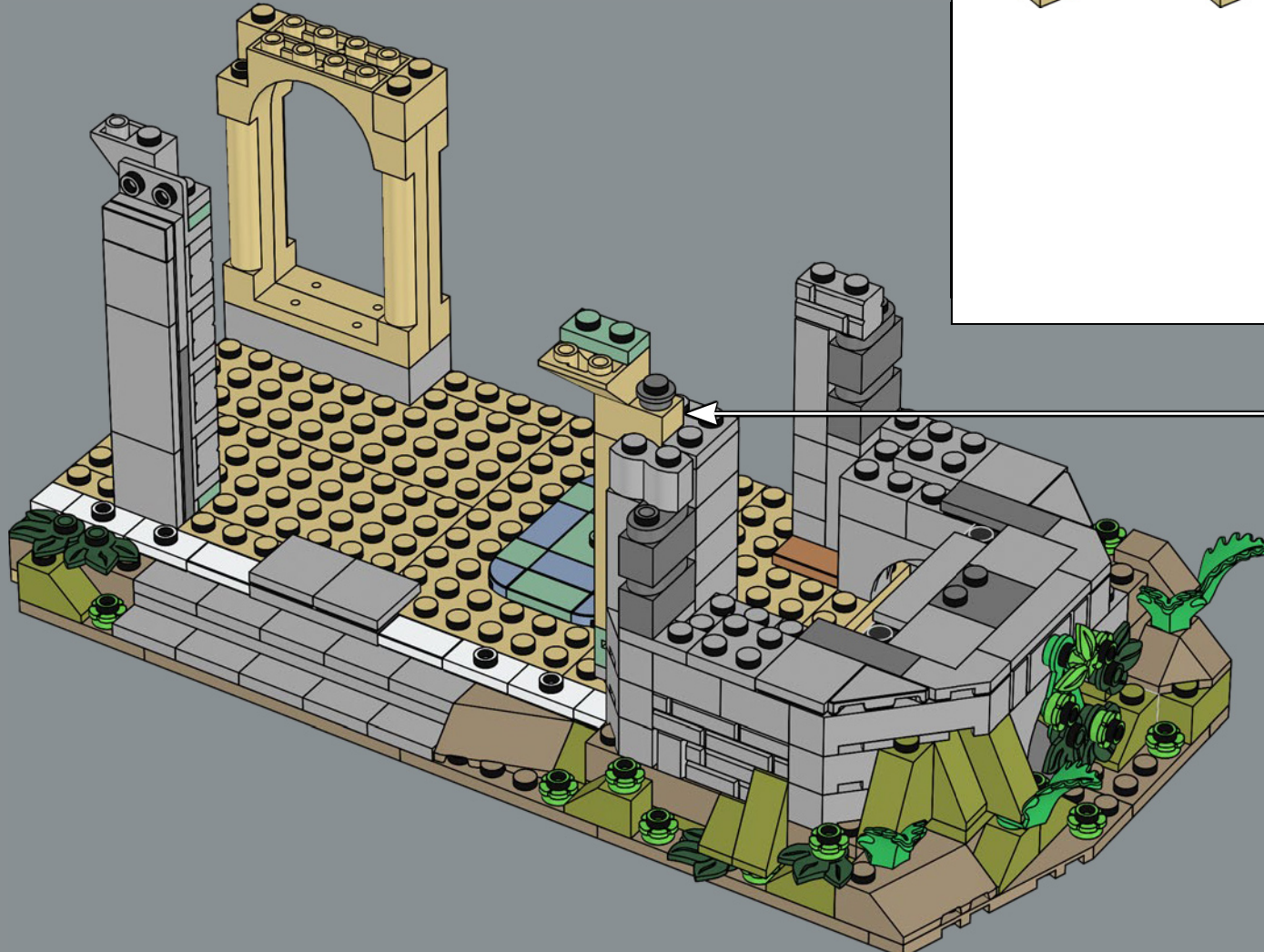

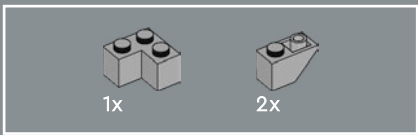

43

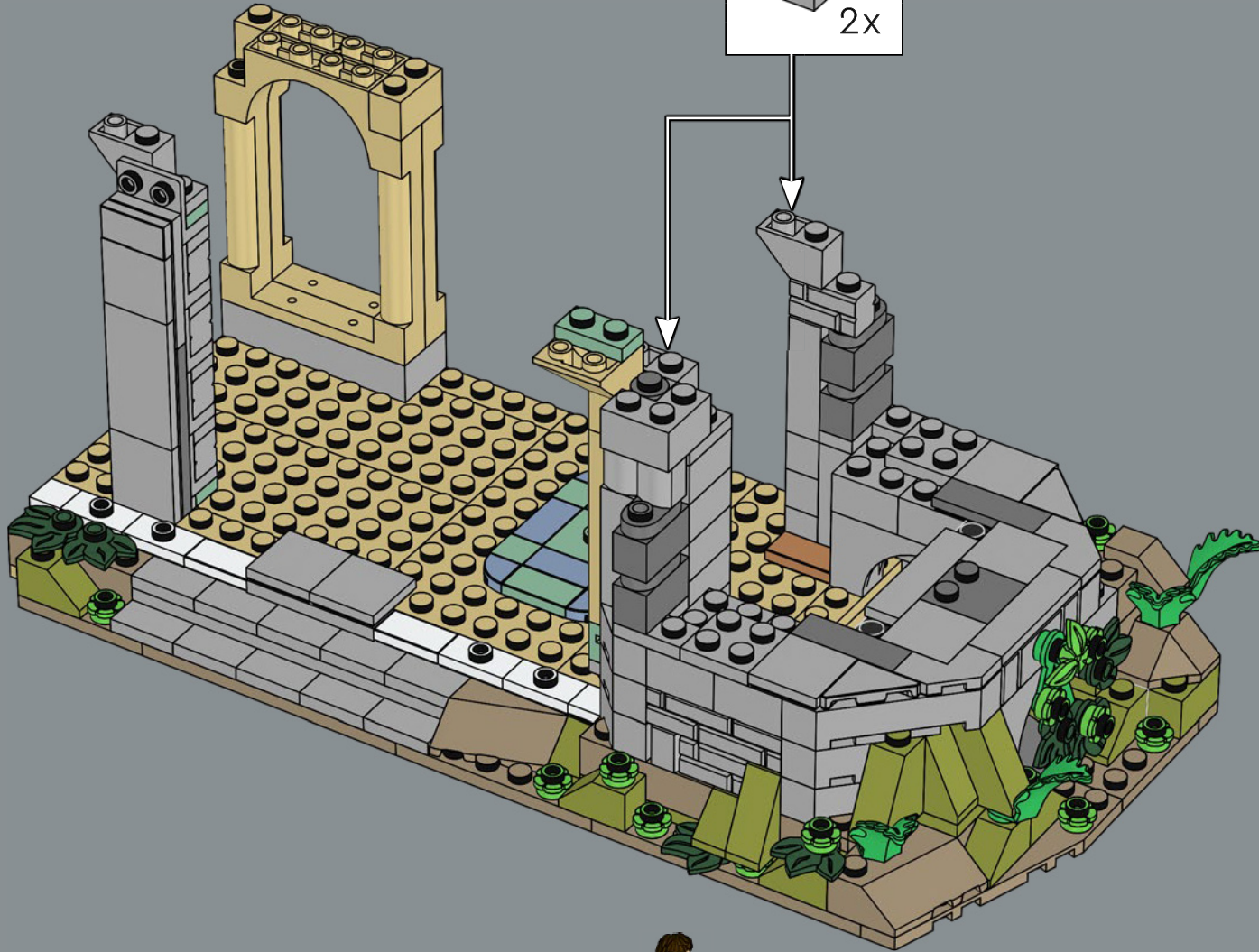
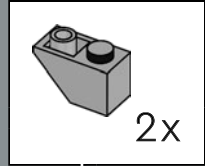

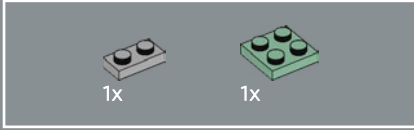
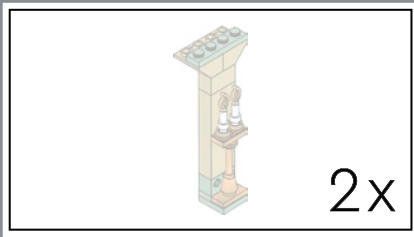

44

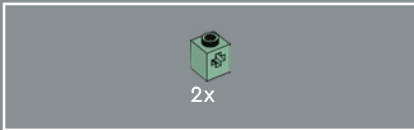
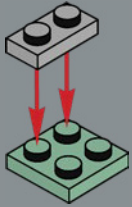

45

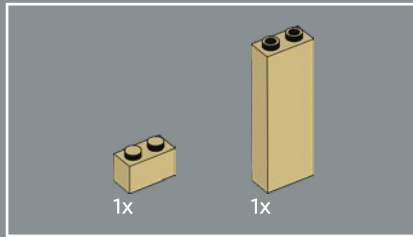
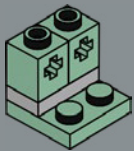

46

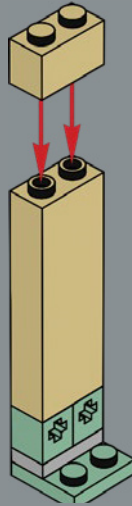

47

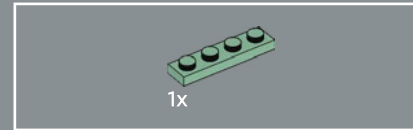
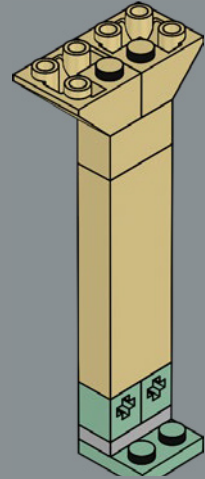

48

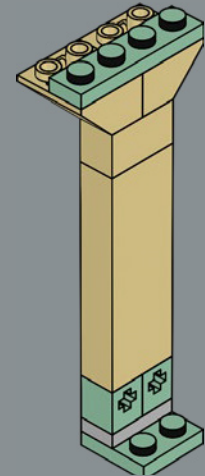

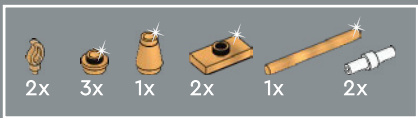

49

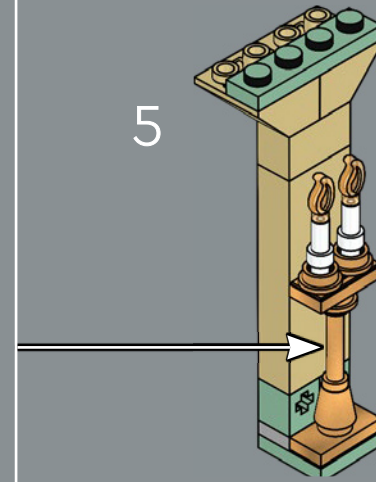
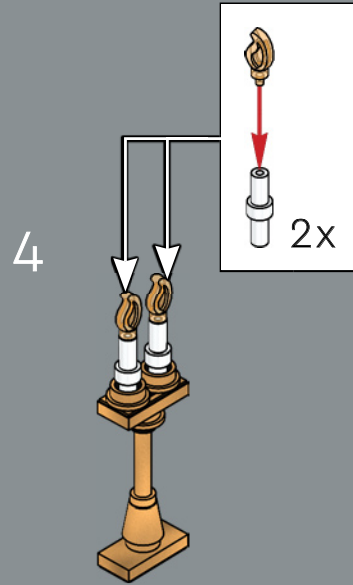
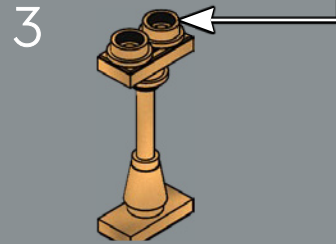
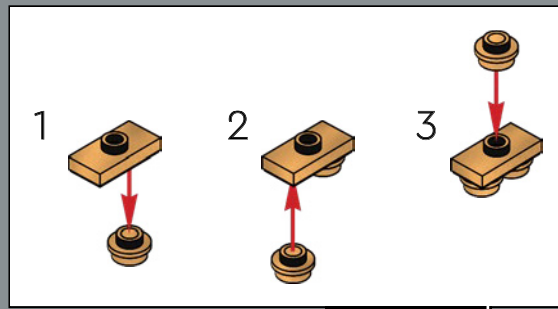
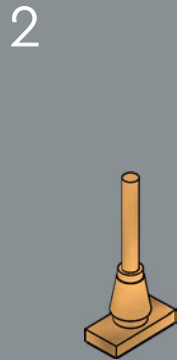
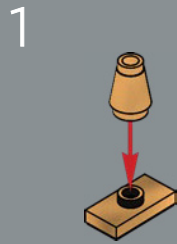

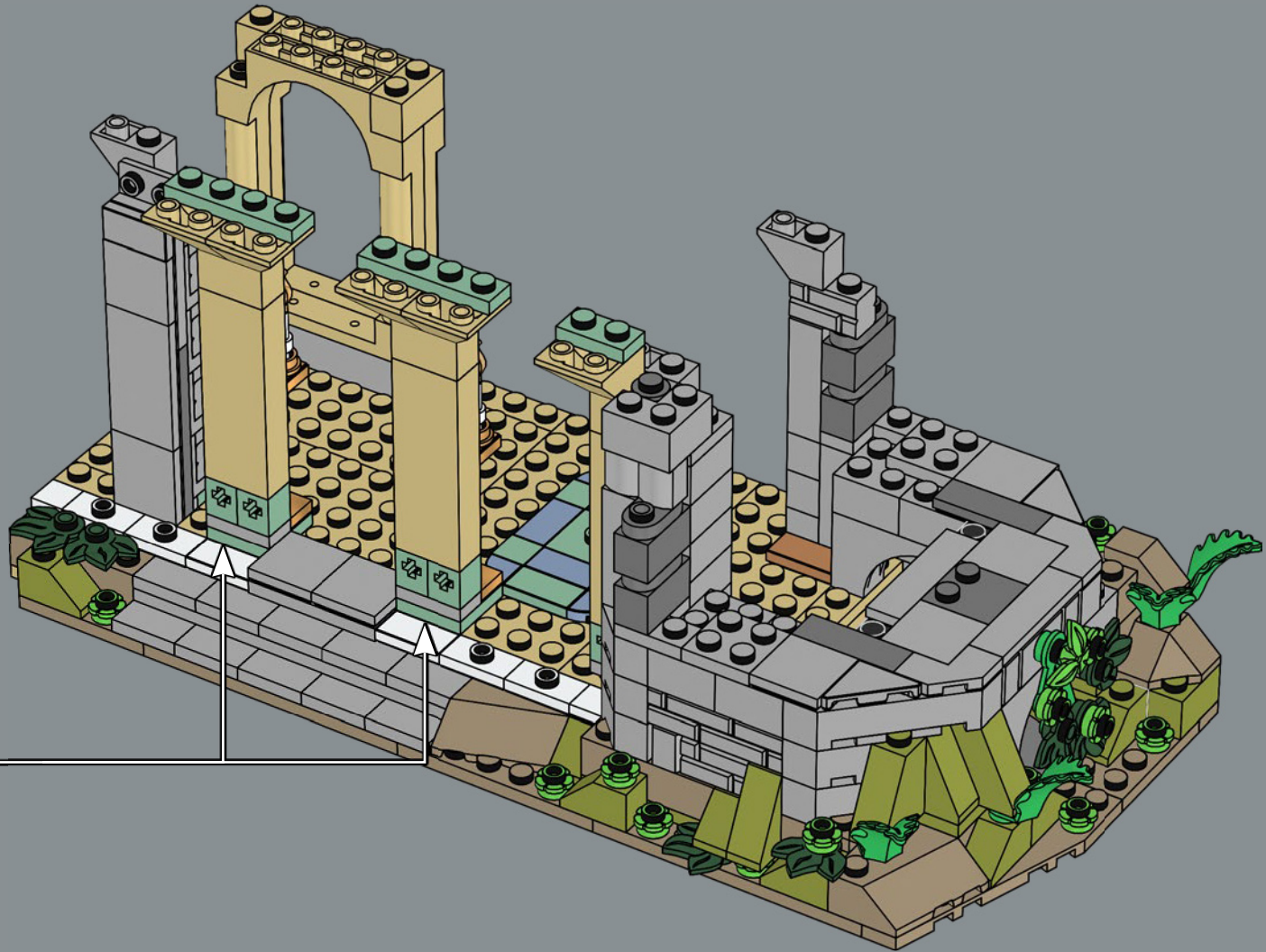

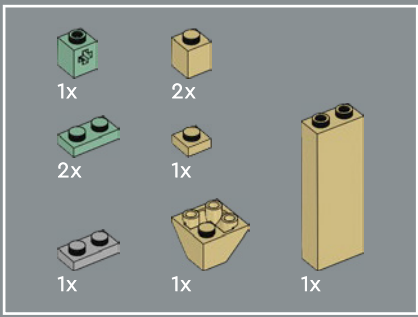

50

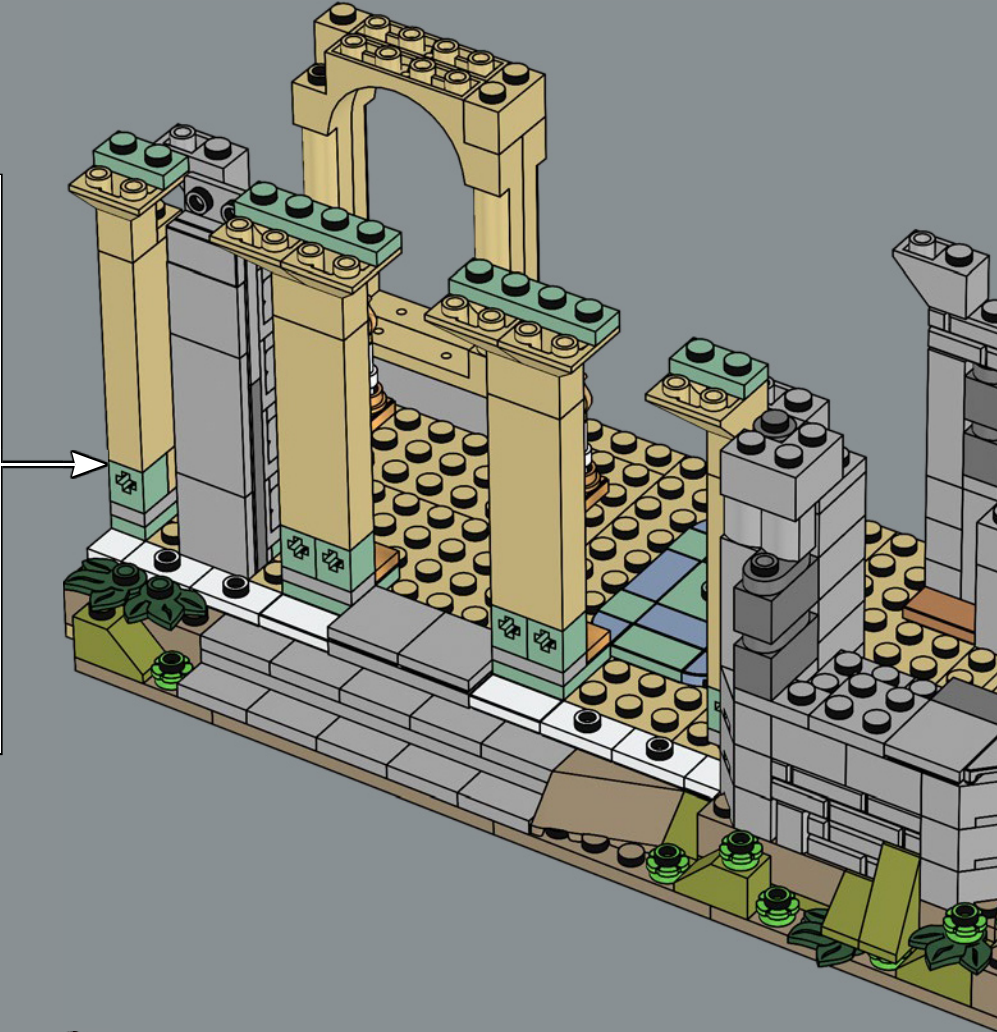
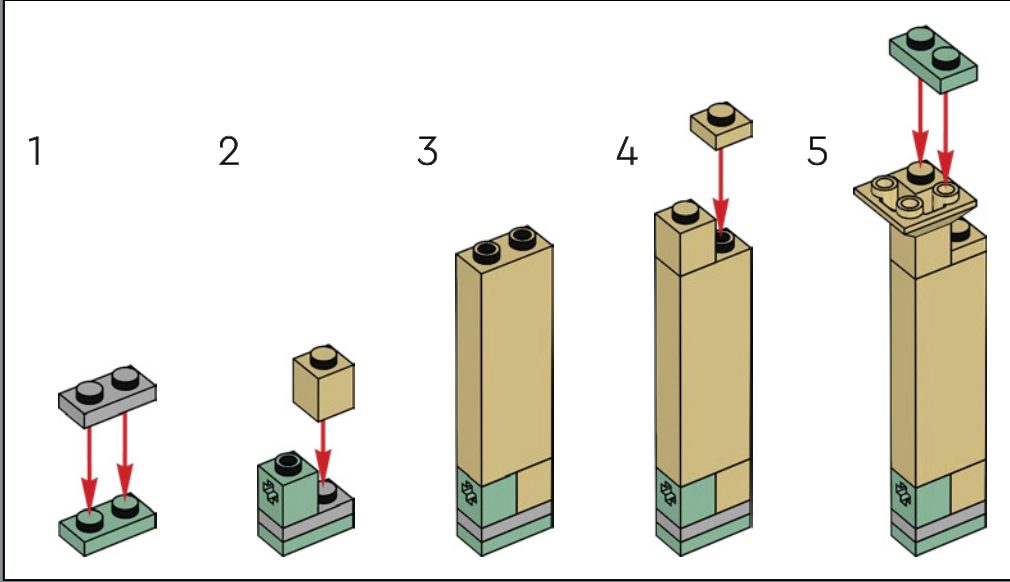

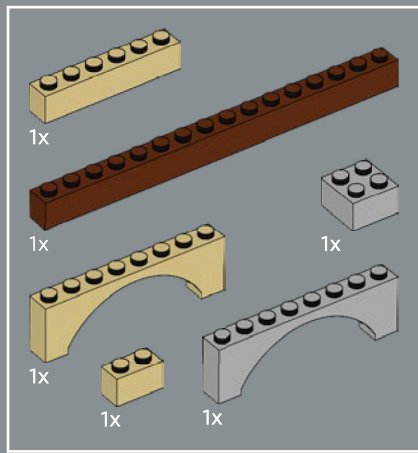

51

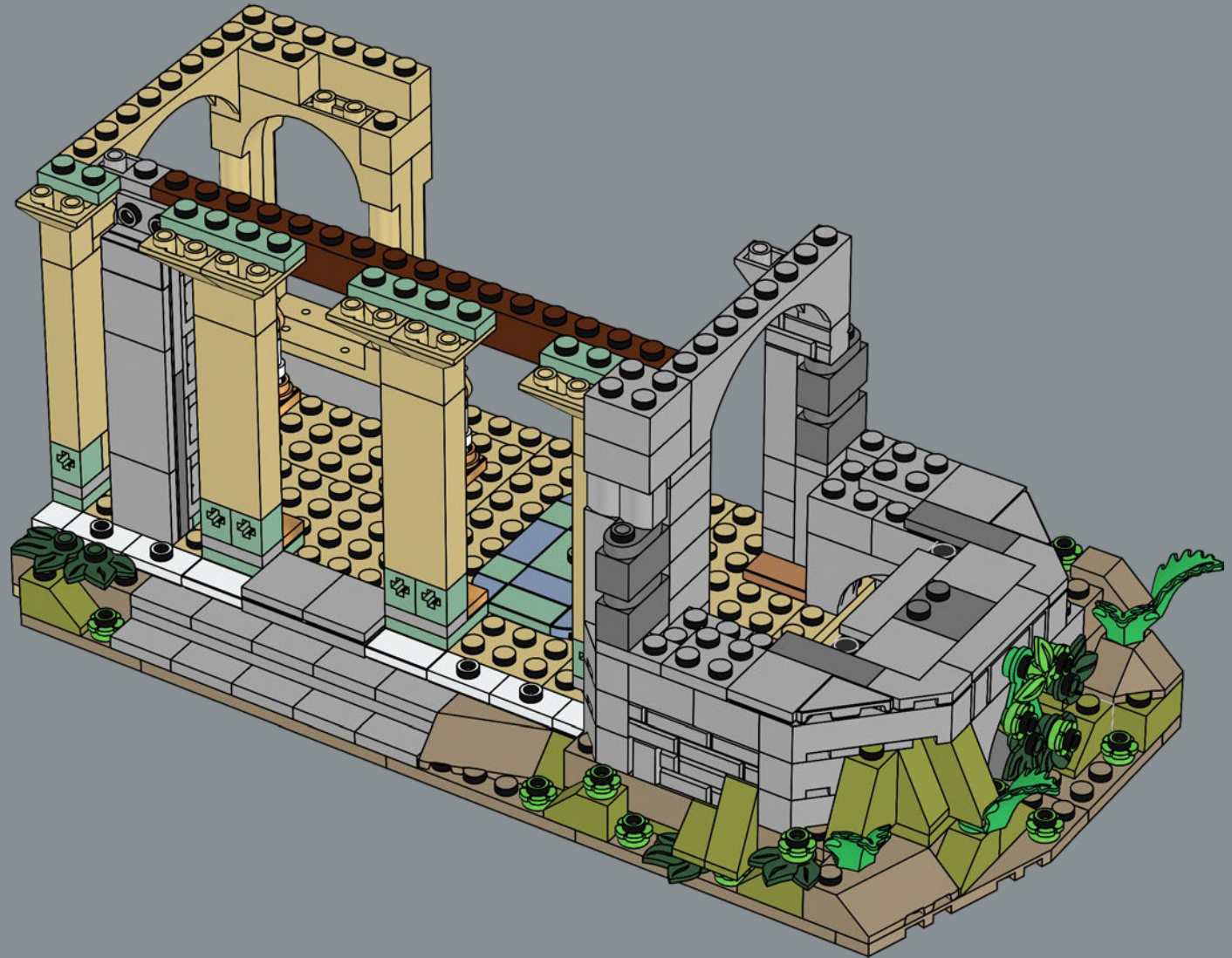

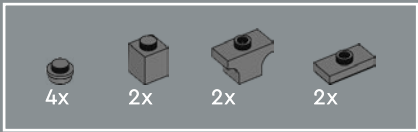

52

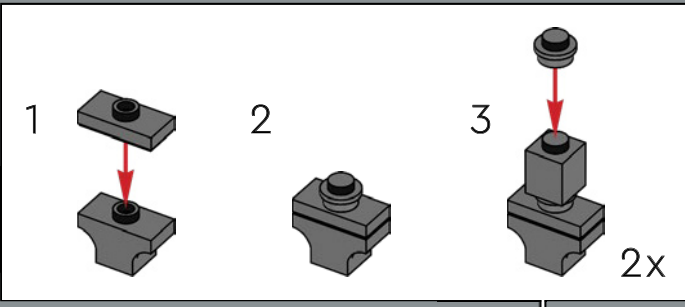
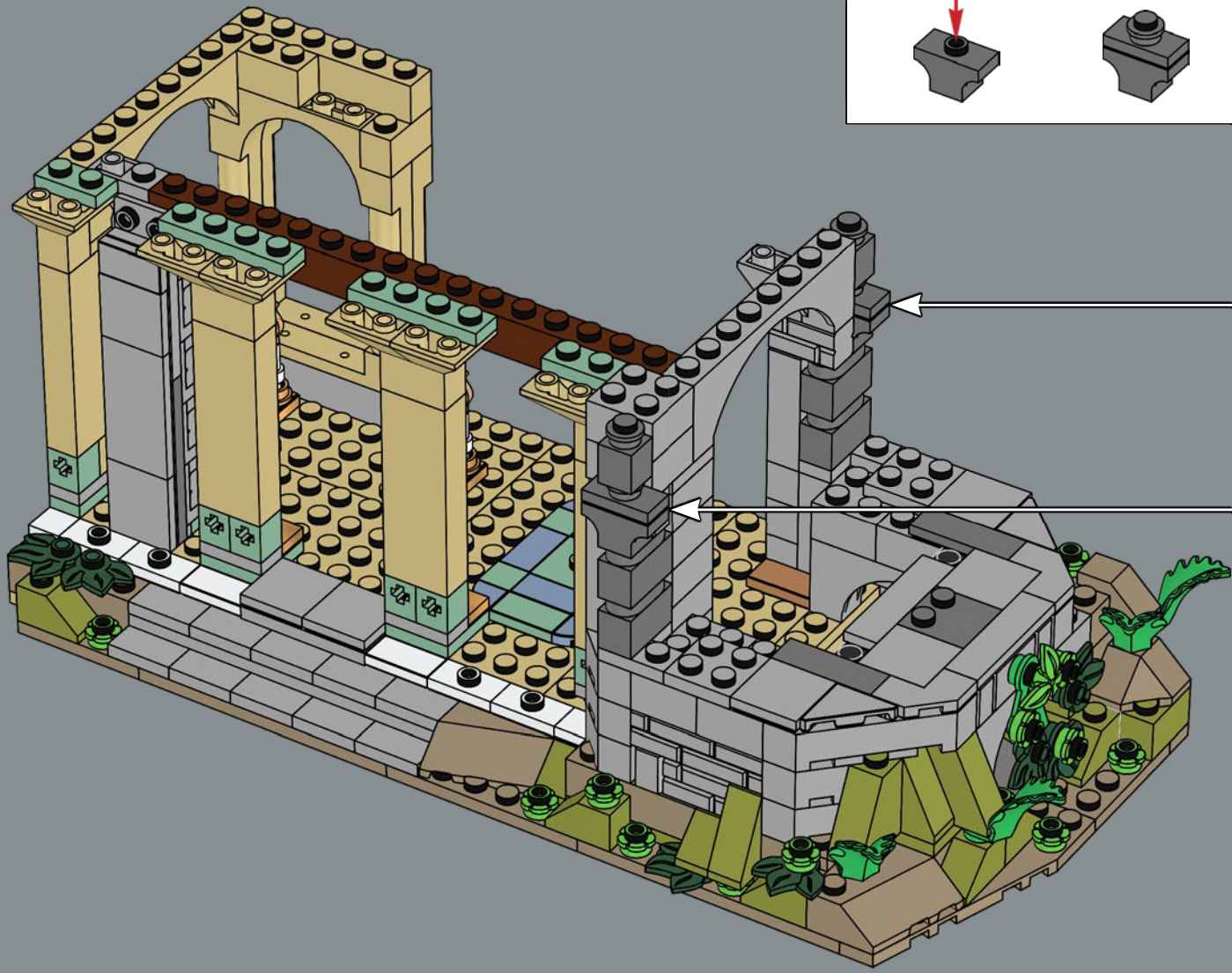

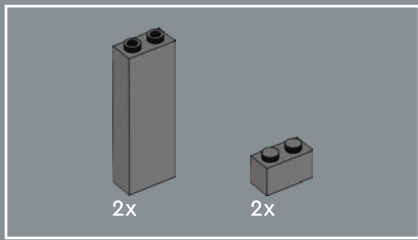

53

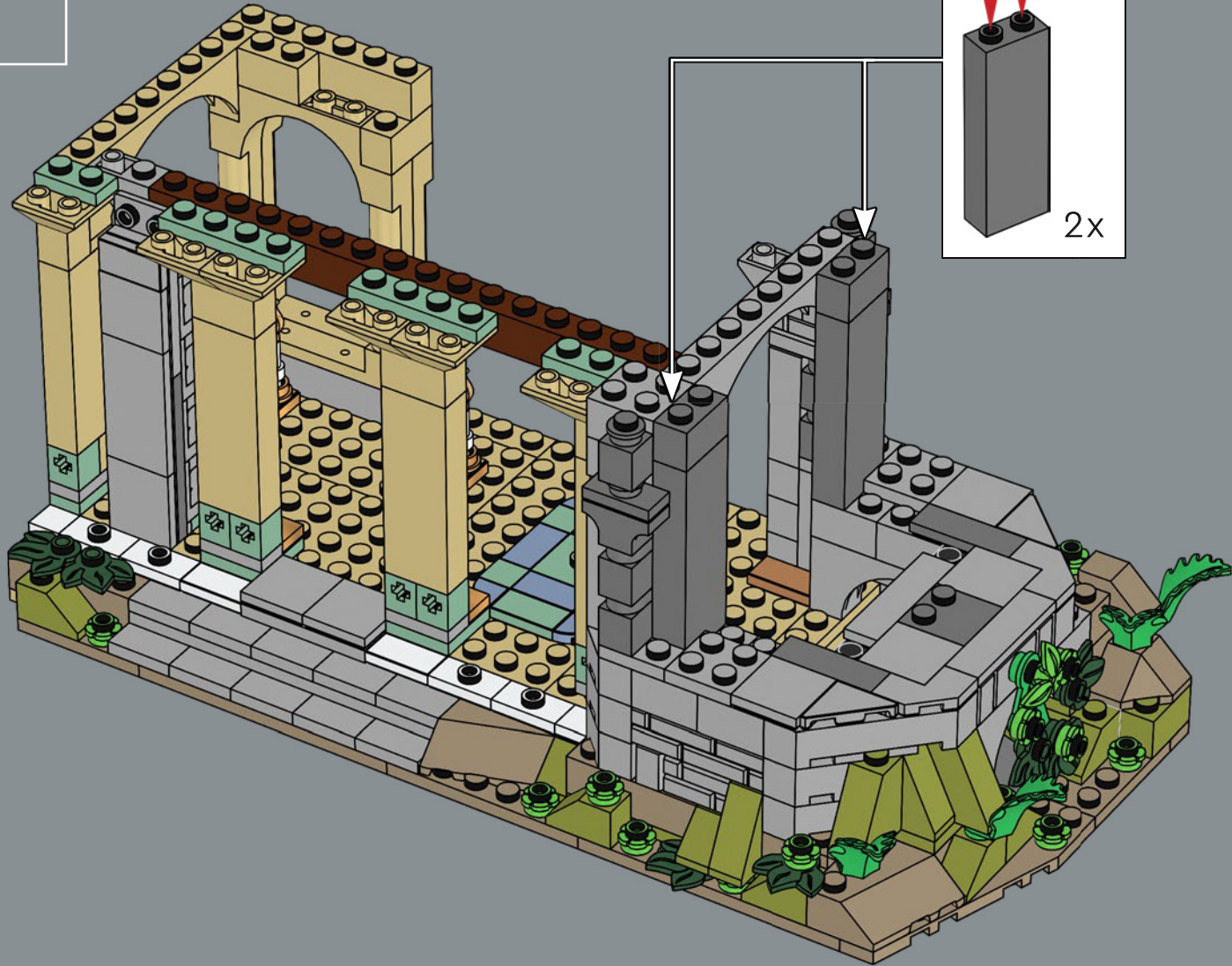



4x

54

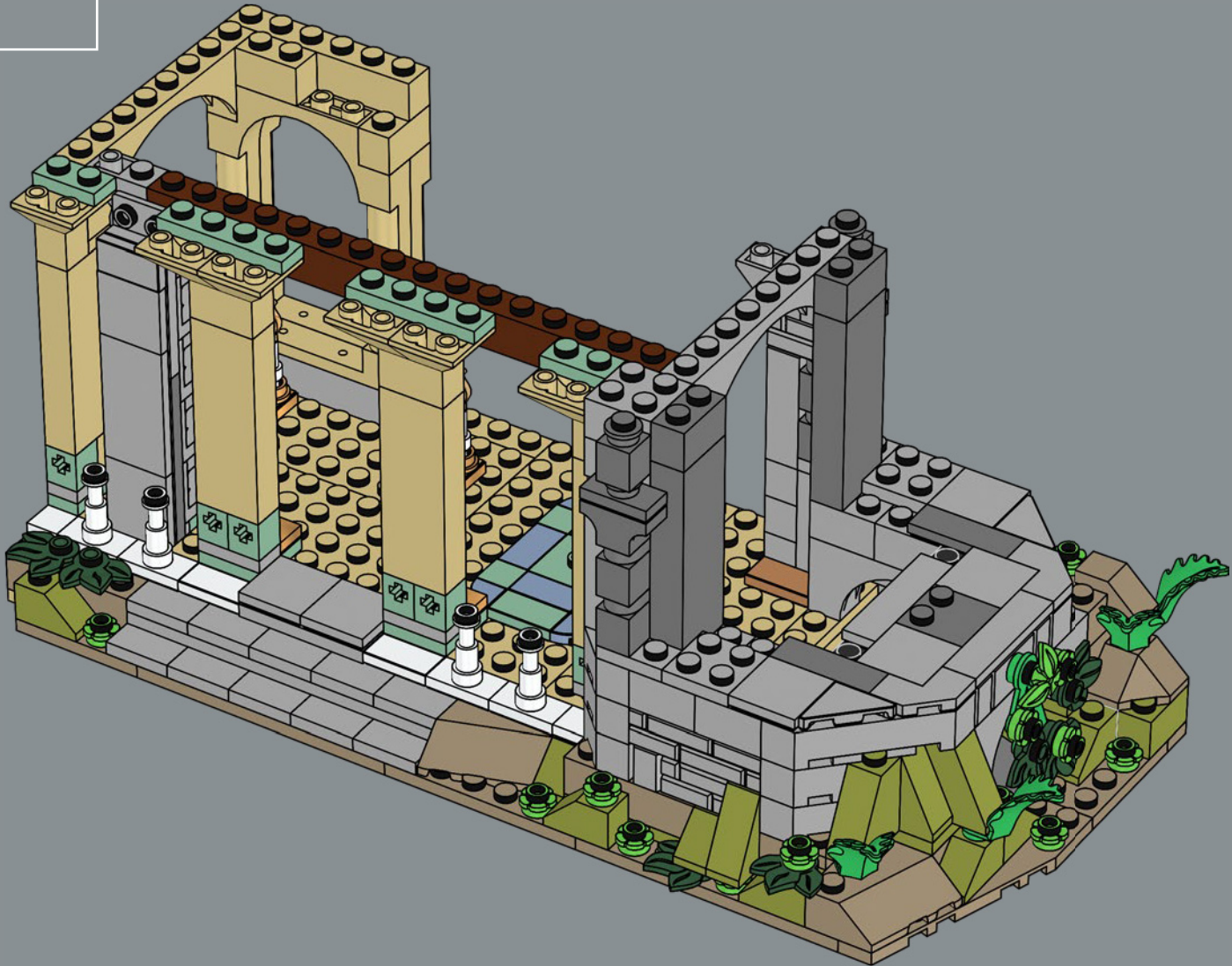

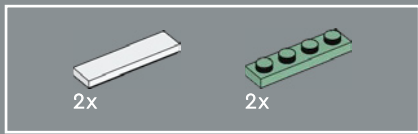

55

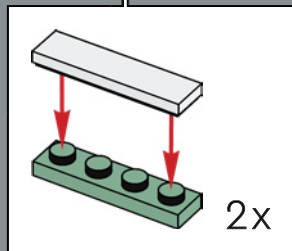
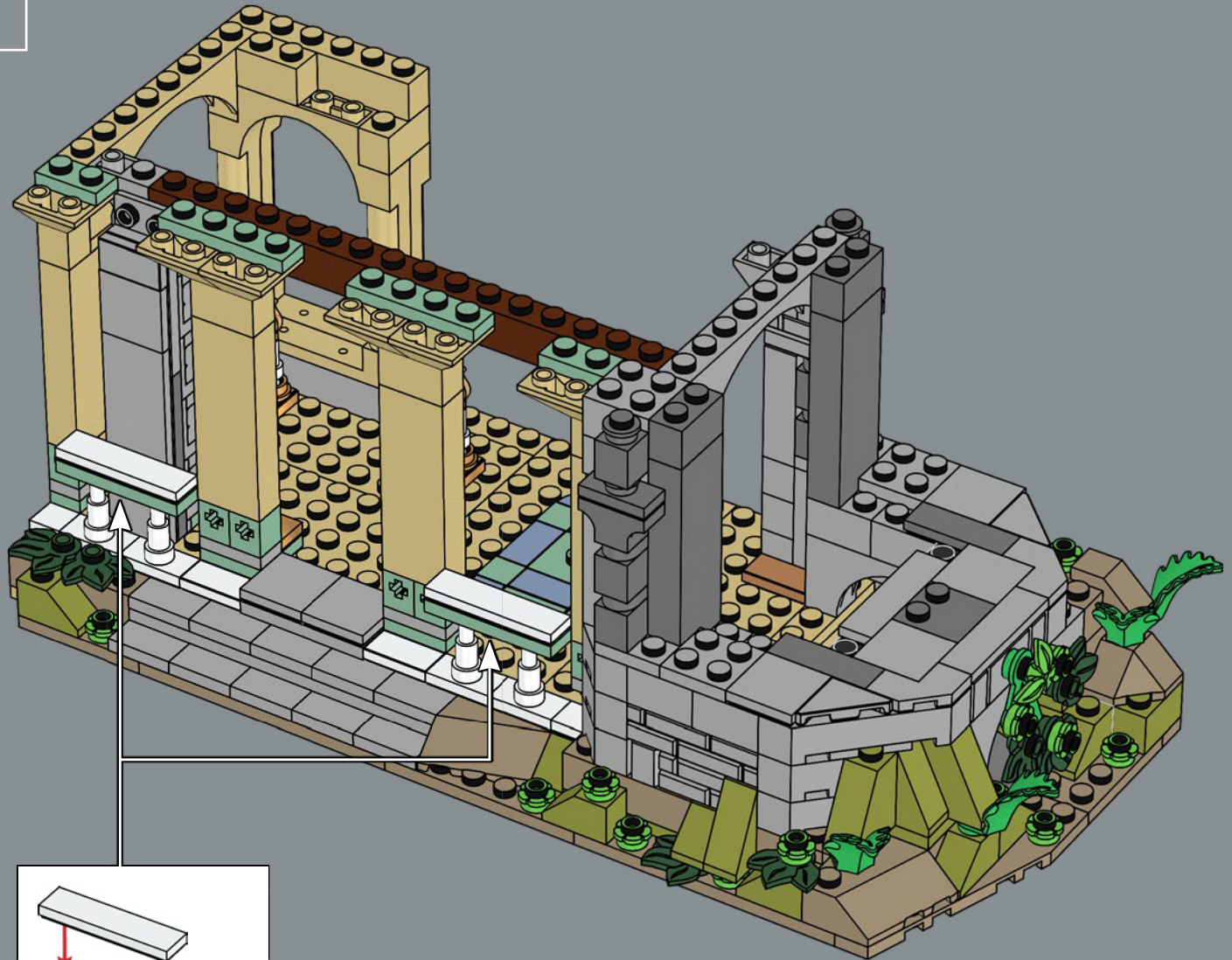

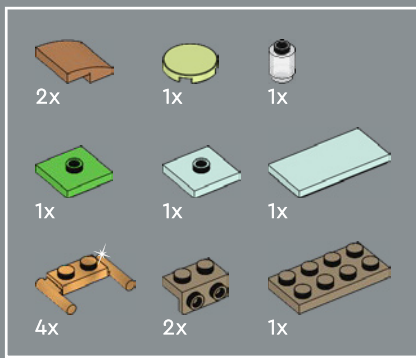

56

1



2

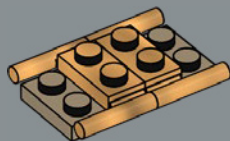

3

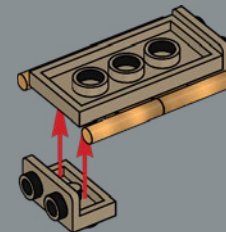

4

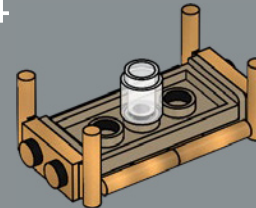

5

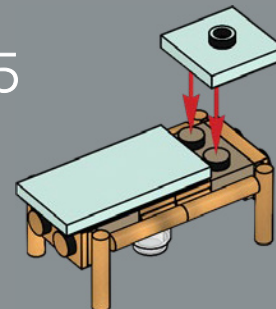

6

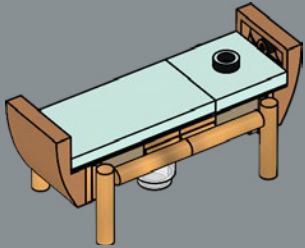

7

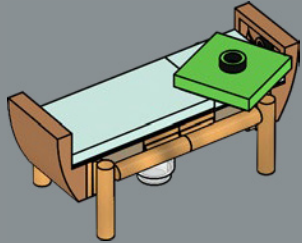

8

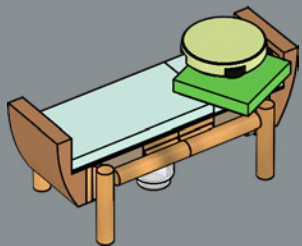

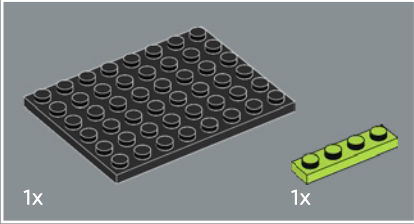
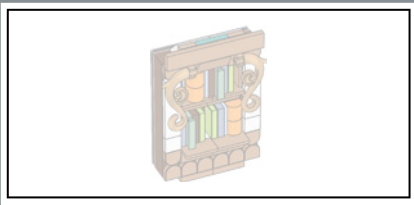

57

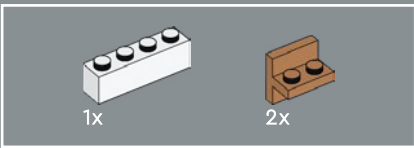
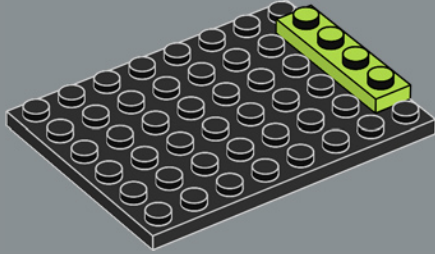

58

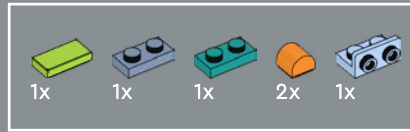
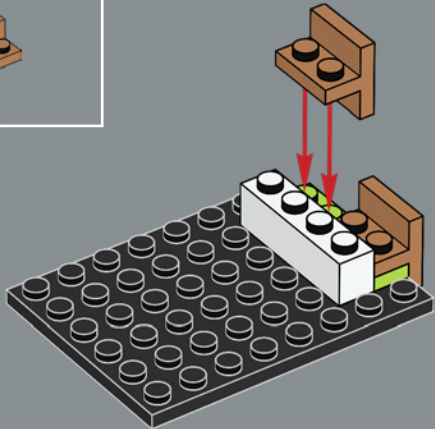

59

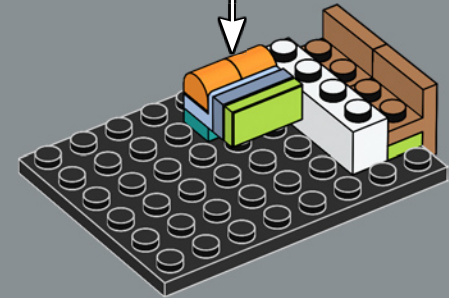
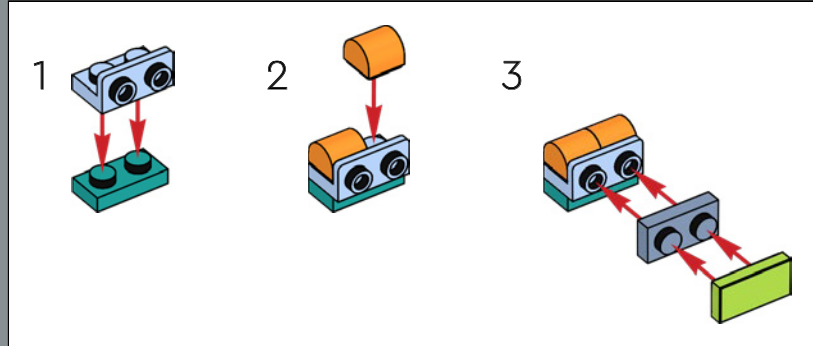

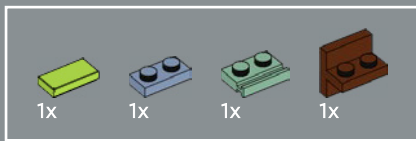

60

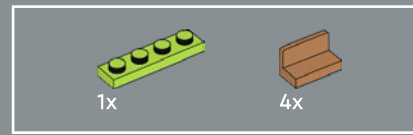
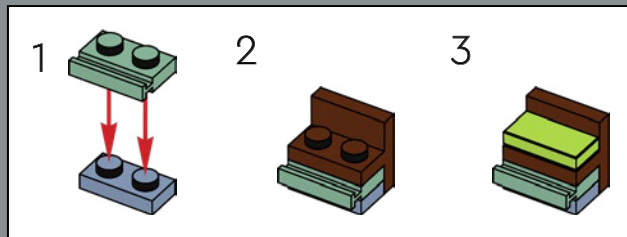

61

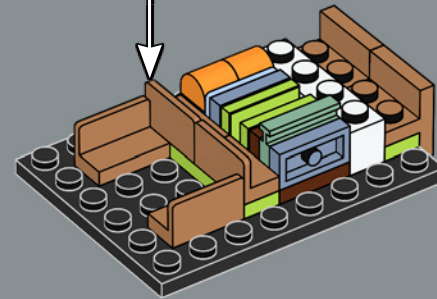
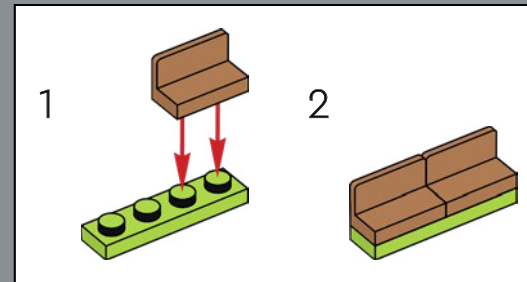

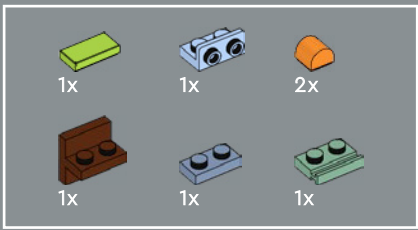

62

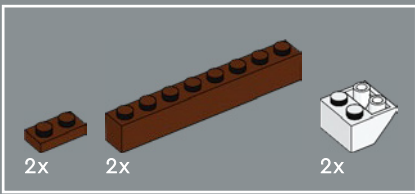
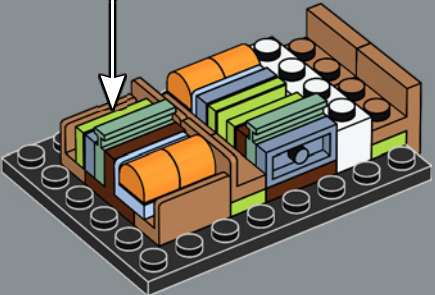
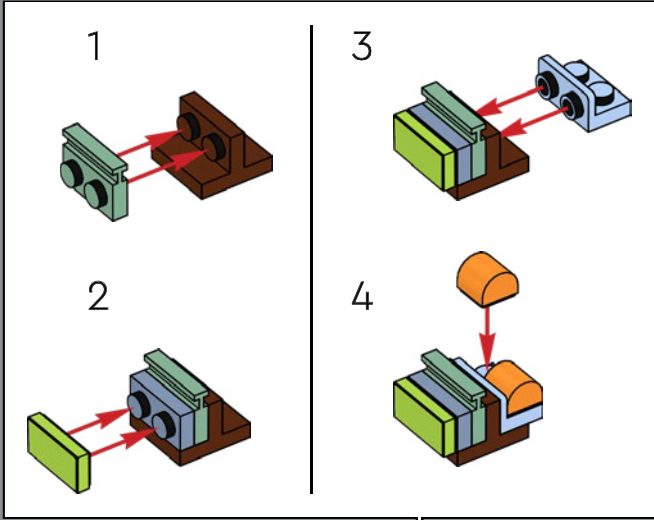

63

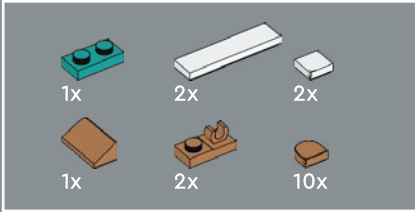
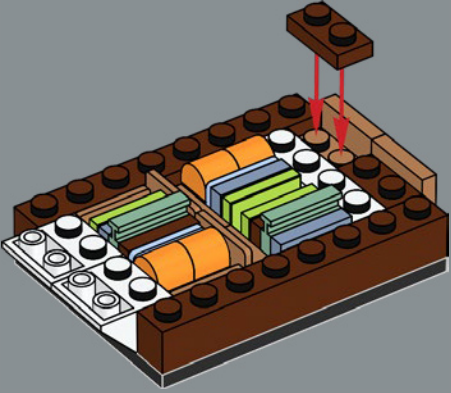

64

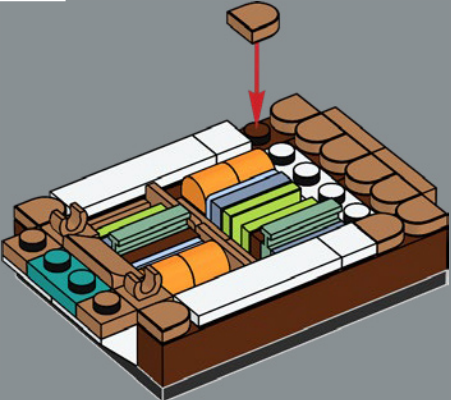

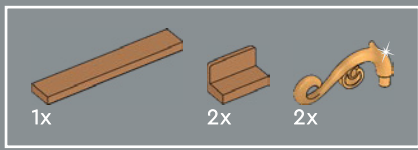

65

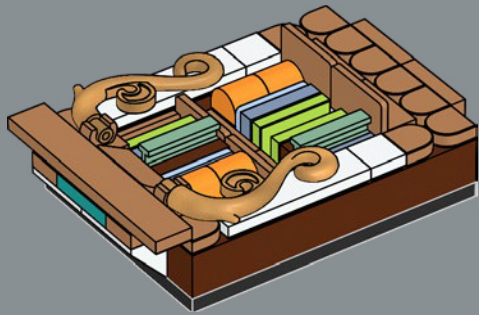

66

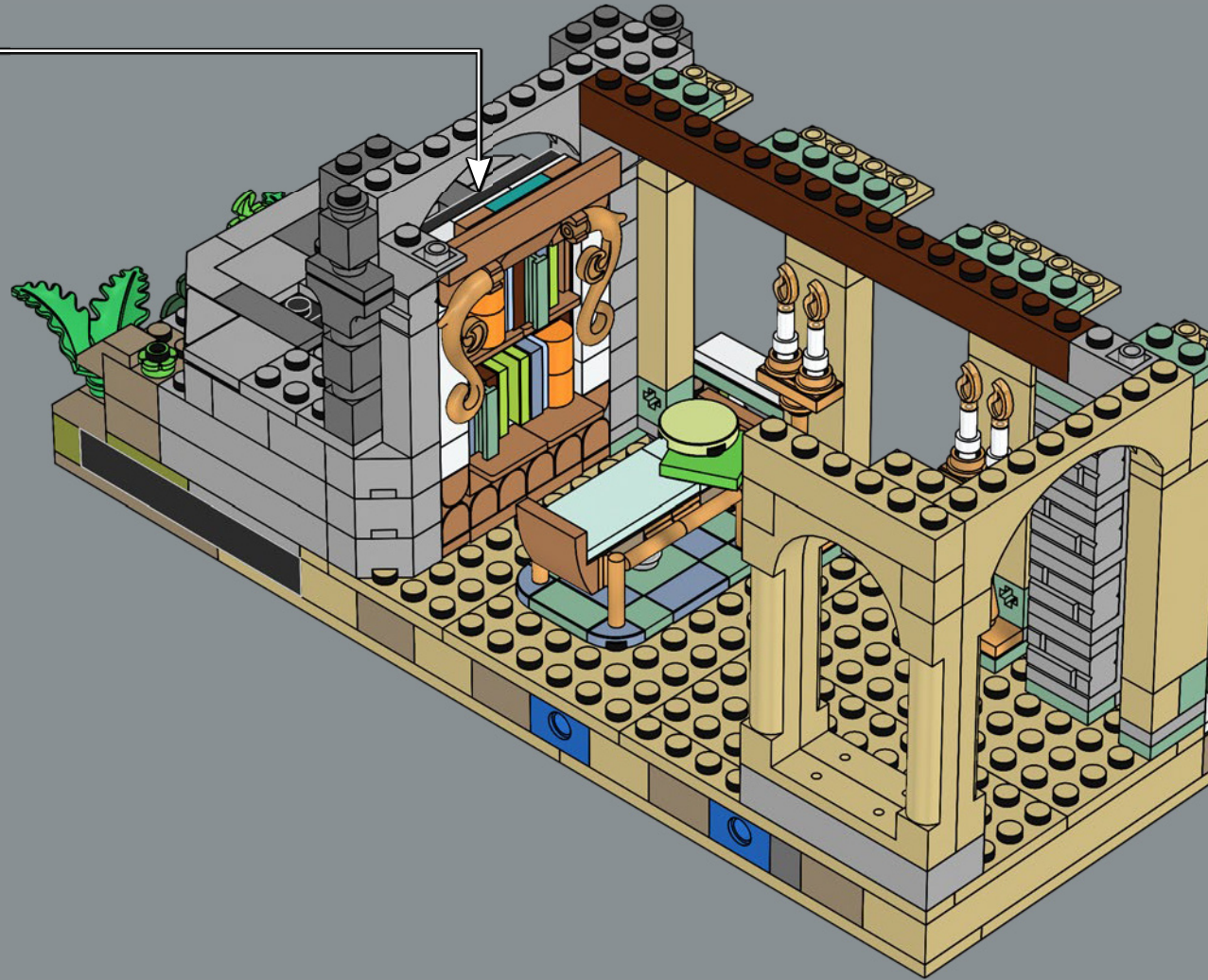

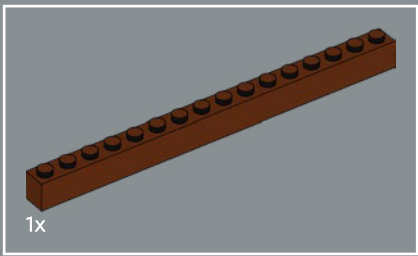

67



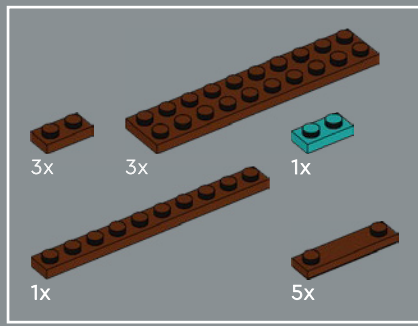

68

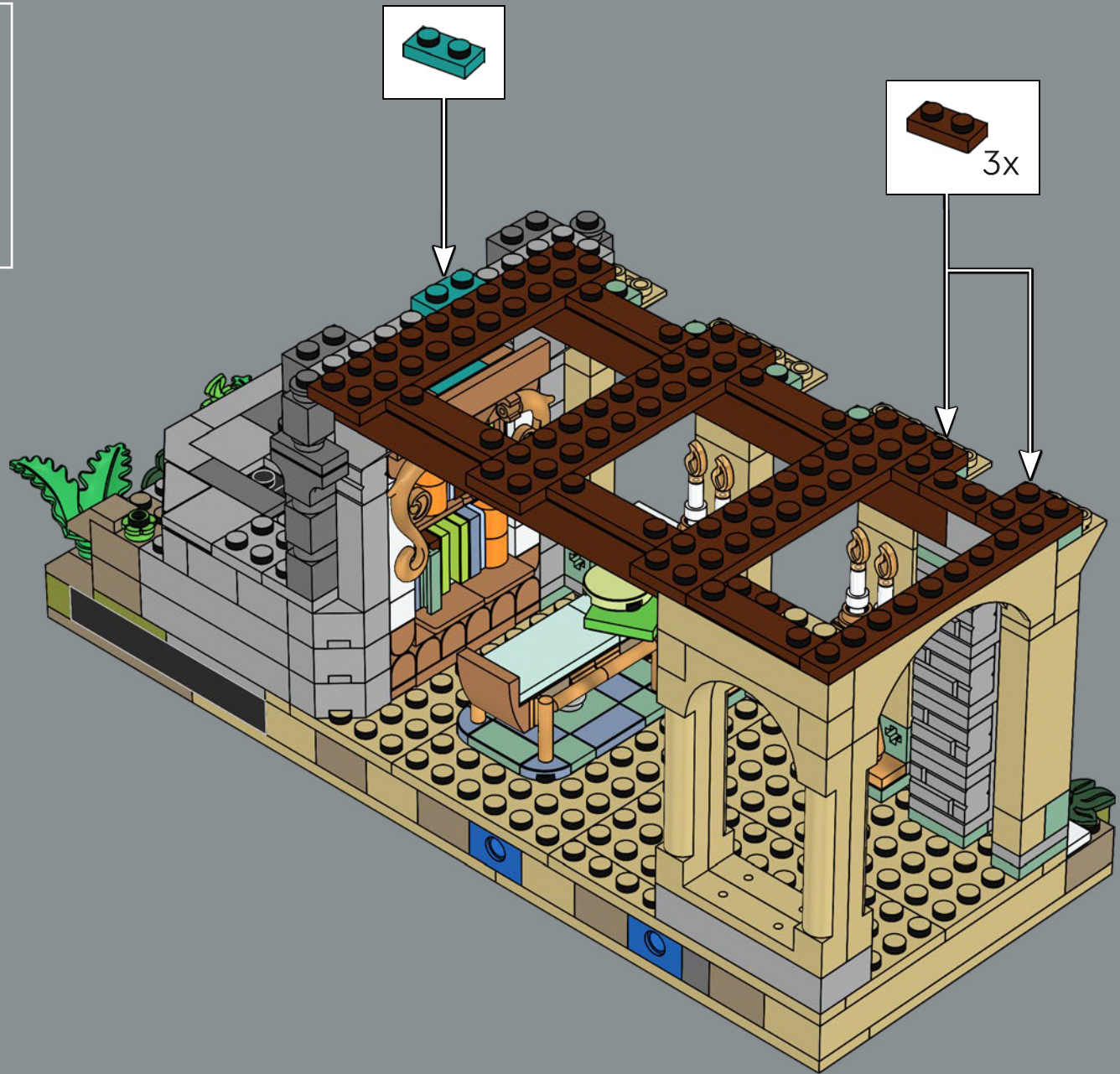

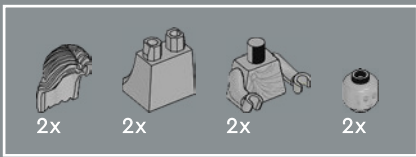

69

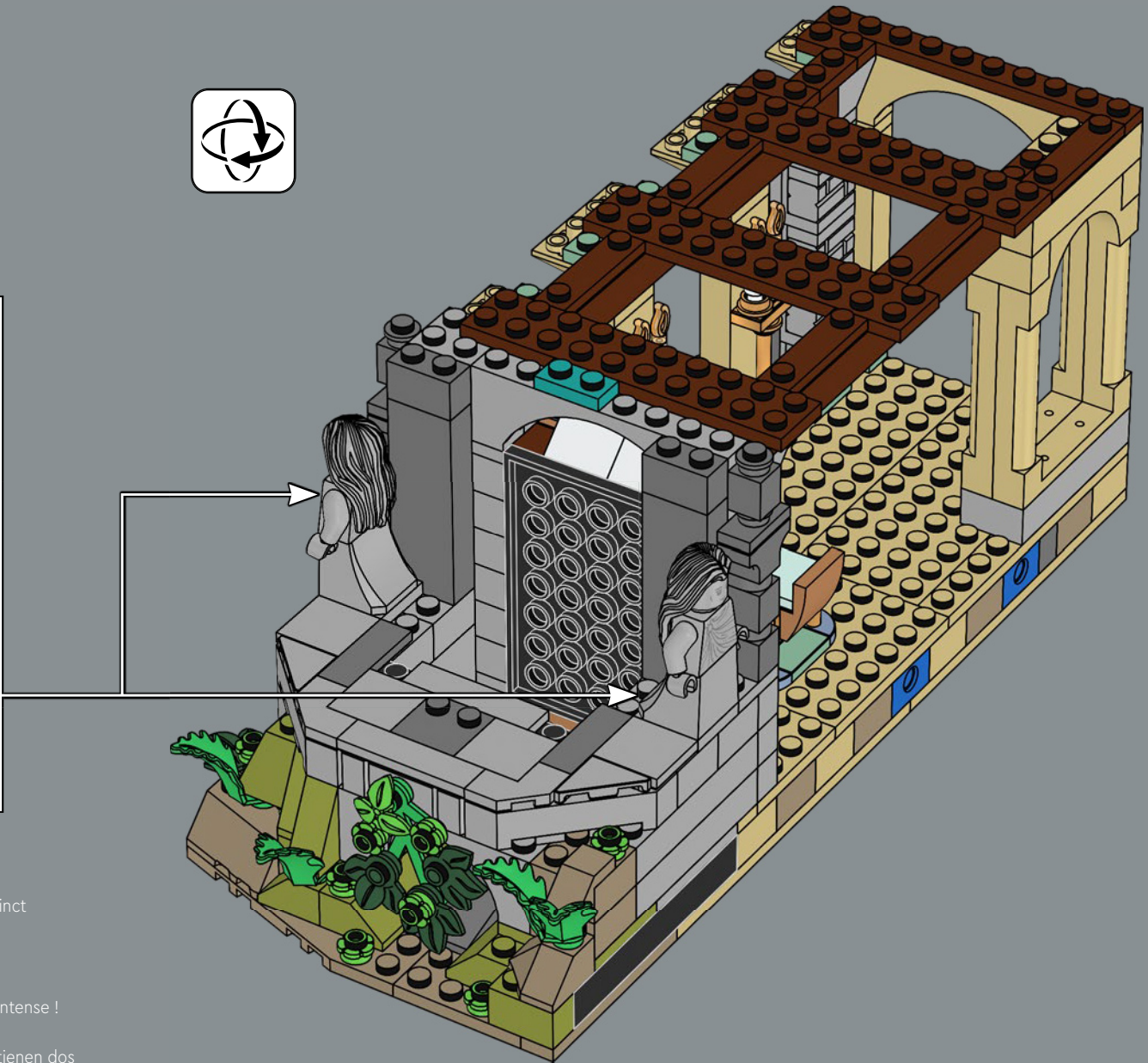
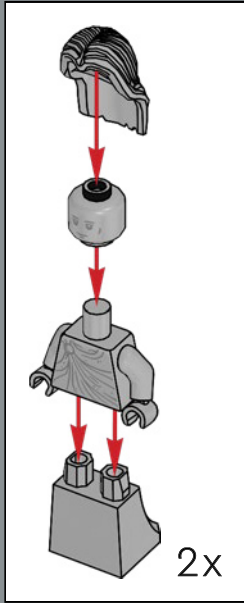

The new head decorations for the statues feature two distinct expressions: stone-faced and a hard stare!

Les nouvelles têtes décorées des statues présentent deux expressions distinctes : un visage de marbre et un regard intense !

Las nuevas decoraciones para las cabezas de las estatuas tienen dos expresiones distintas: una de roca fría, y la otra con una mirada feroz!





70

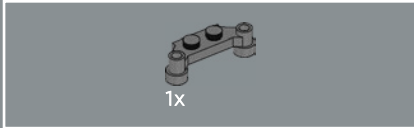
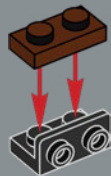

71

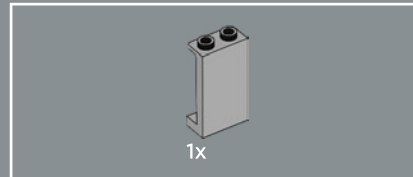
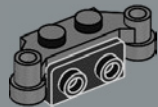

72

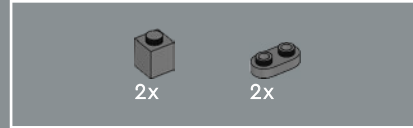
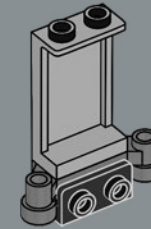

73

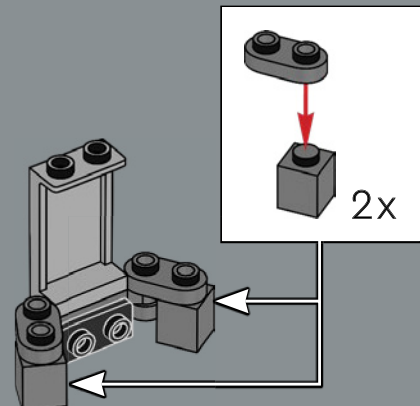



2x

74

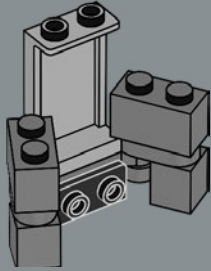

2x

75

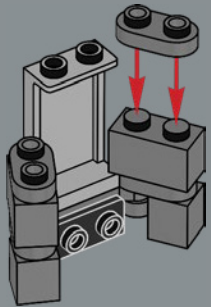

2x



2x

76

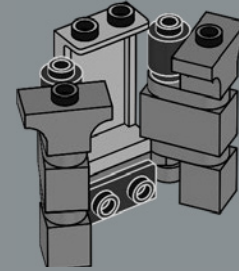

1x

77

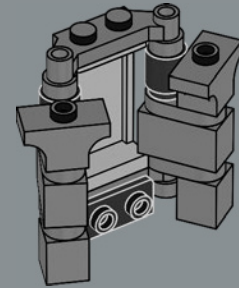

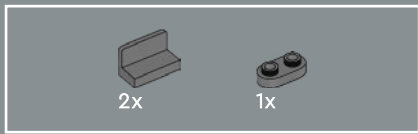

78

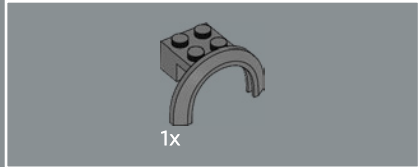
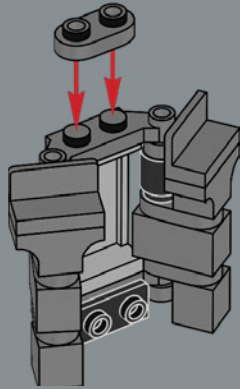

79

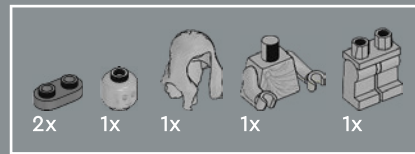
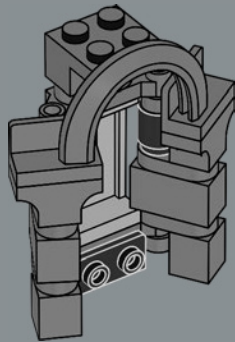

80

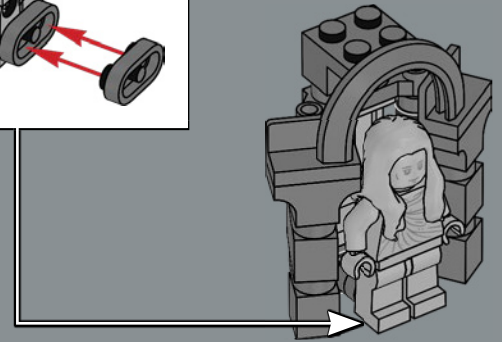
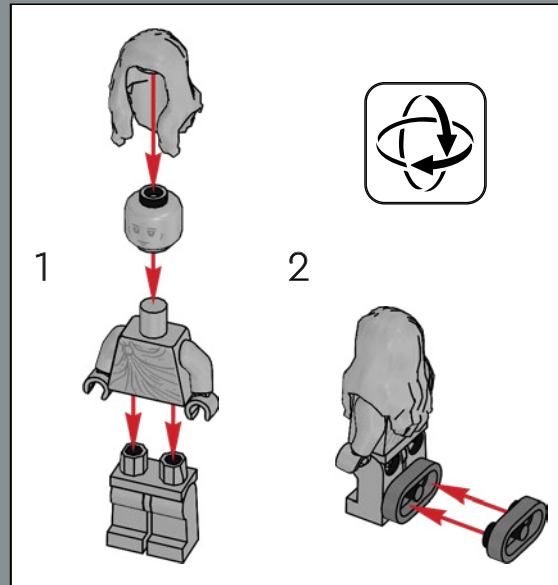



1x

81

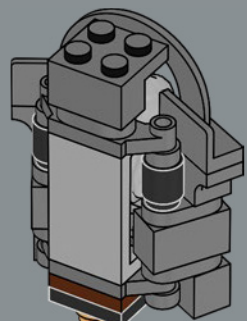

2x



82

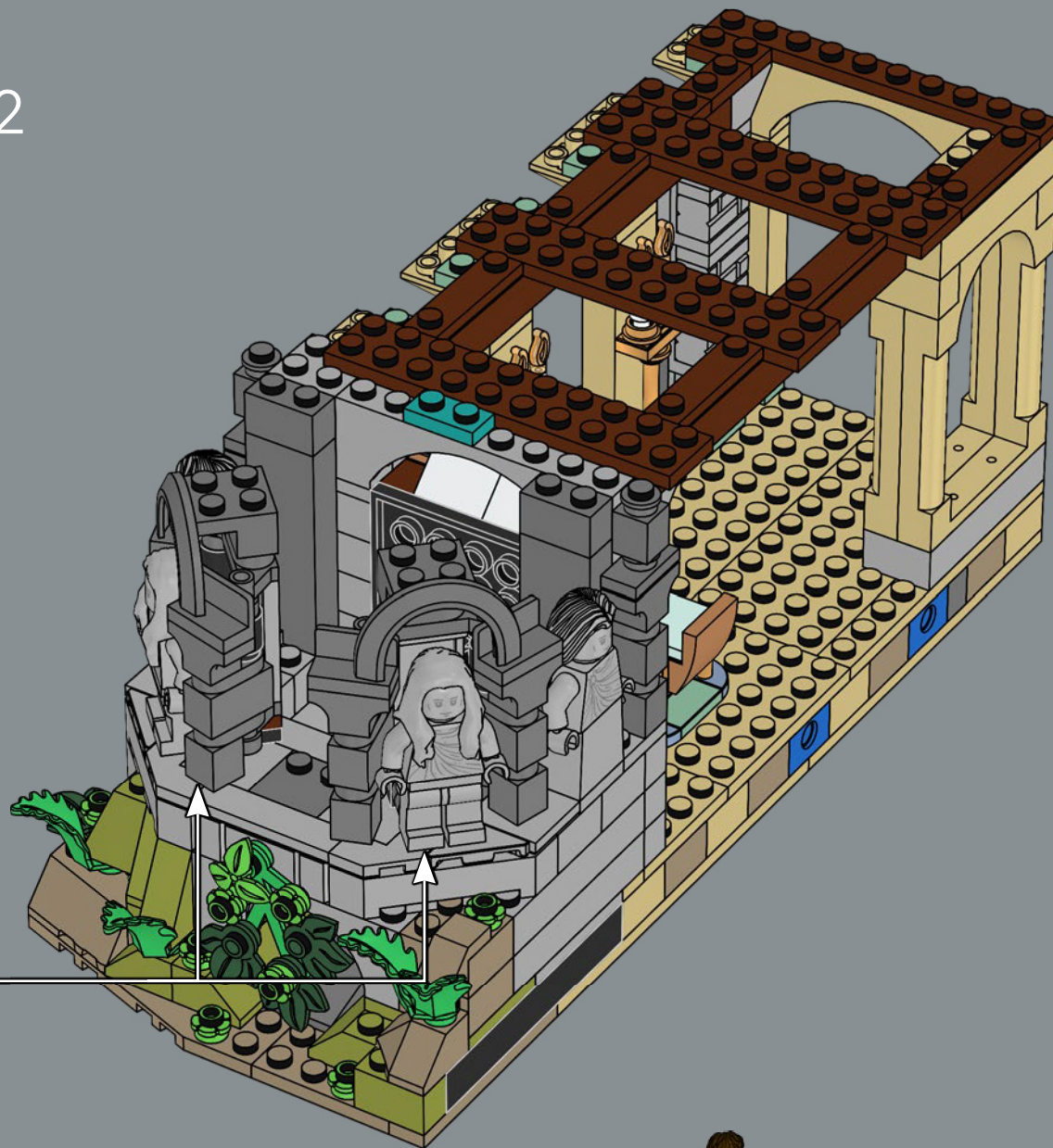

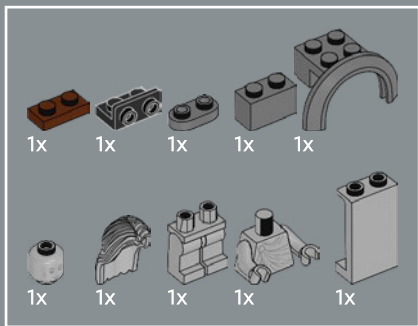

83

1

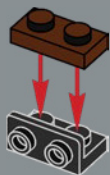

2

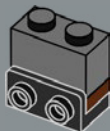

3

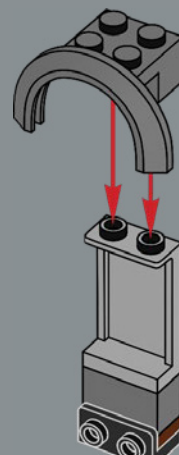

4

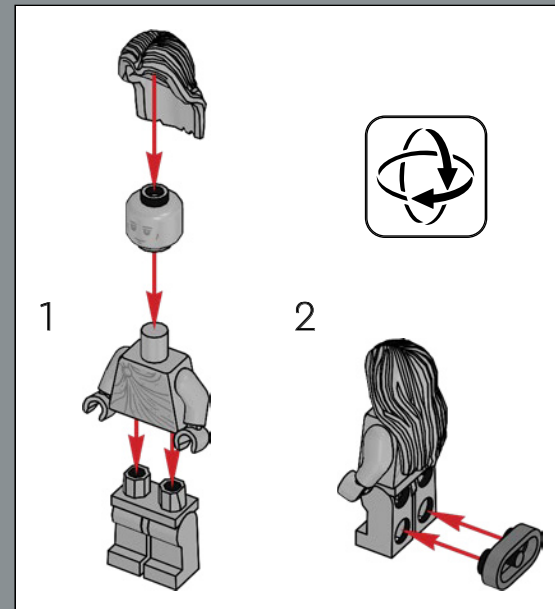

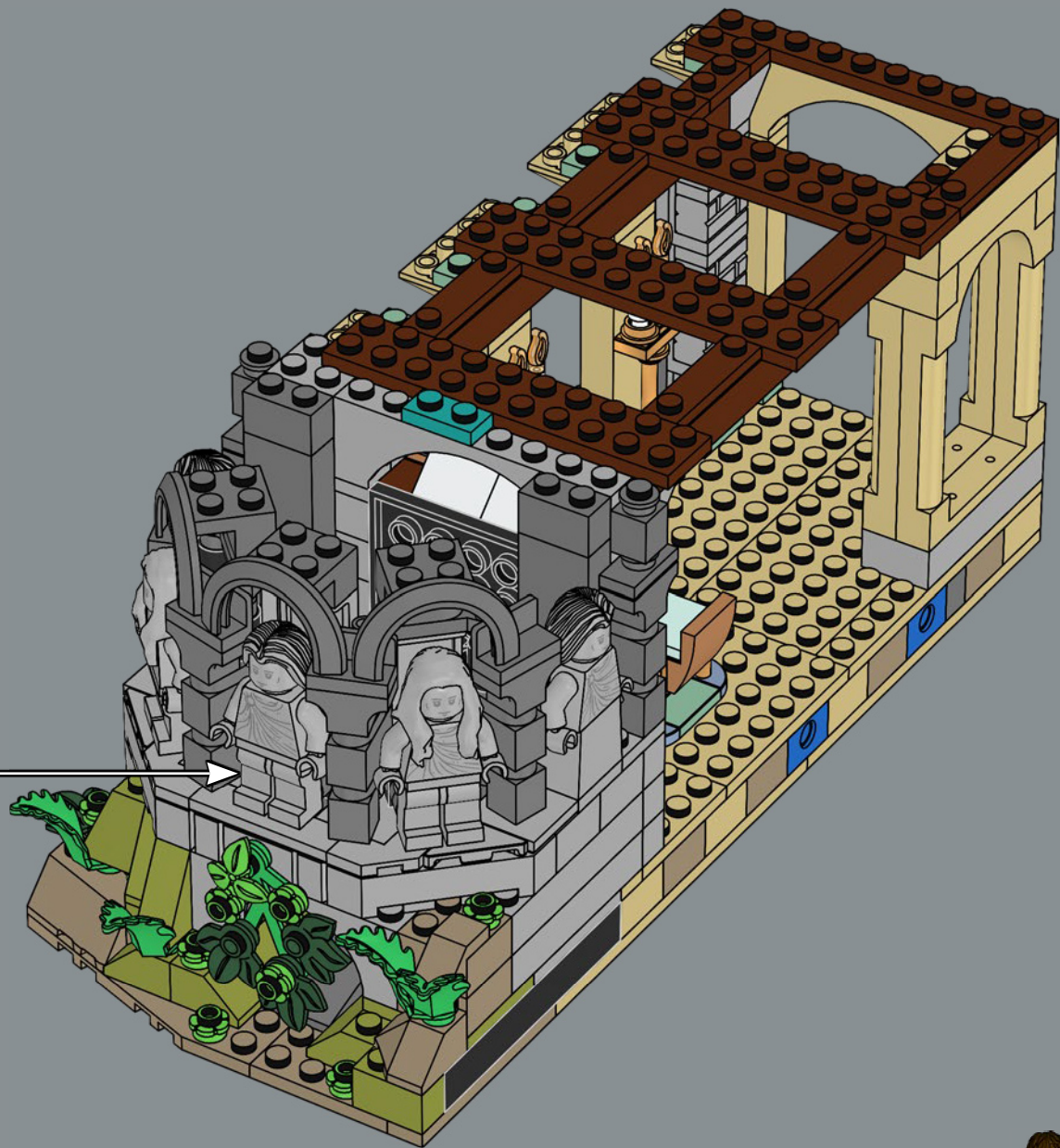

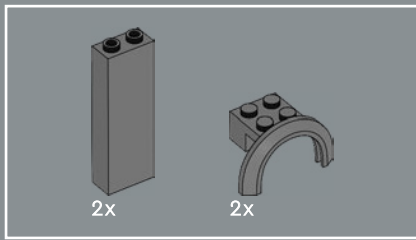

84

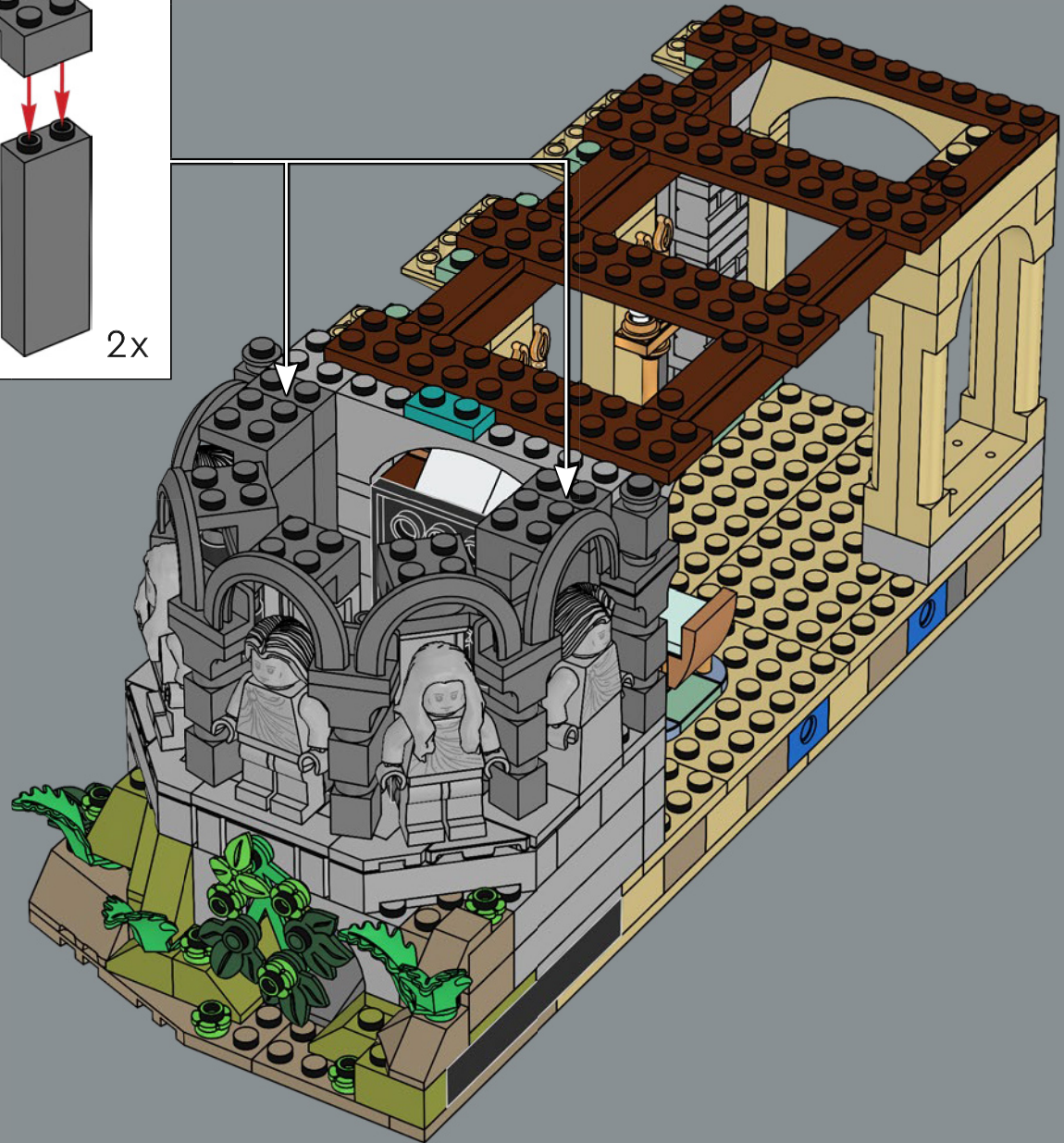
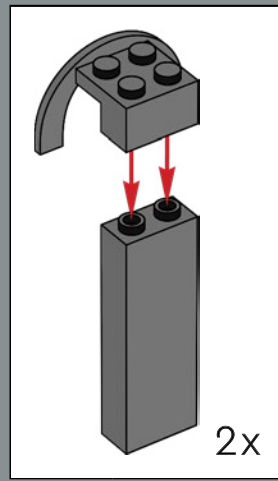

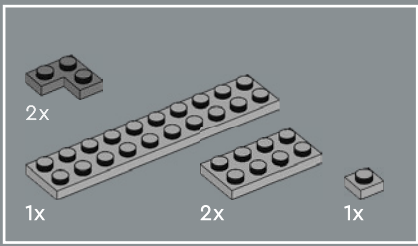

85

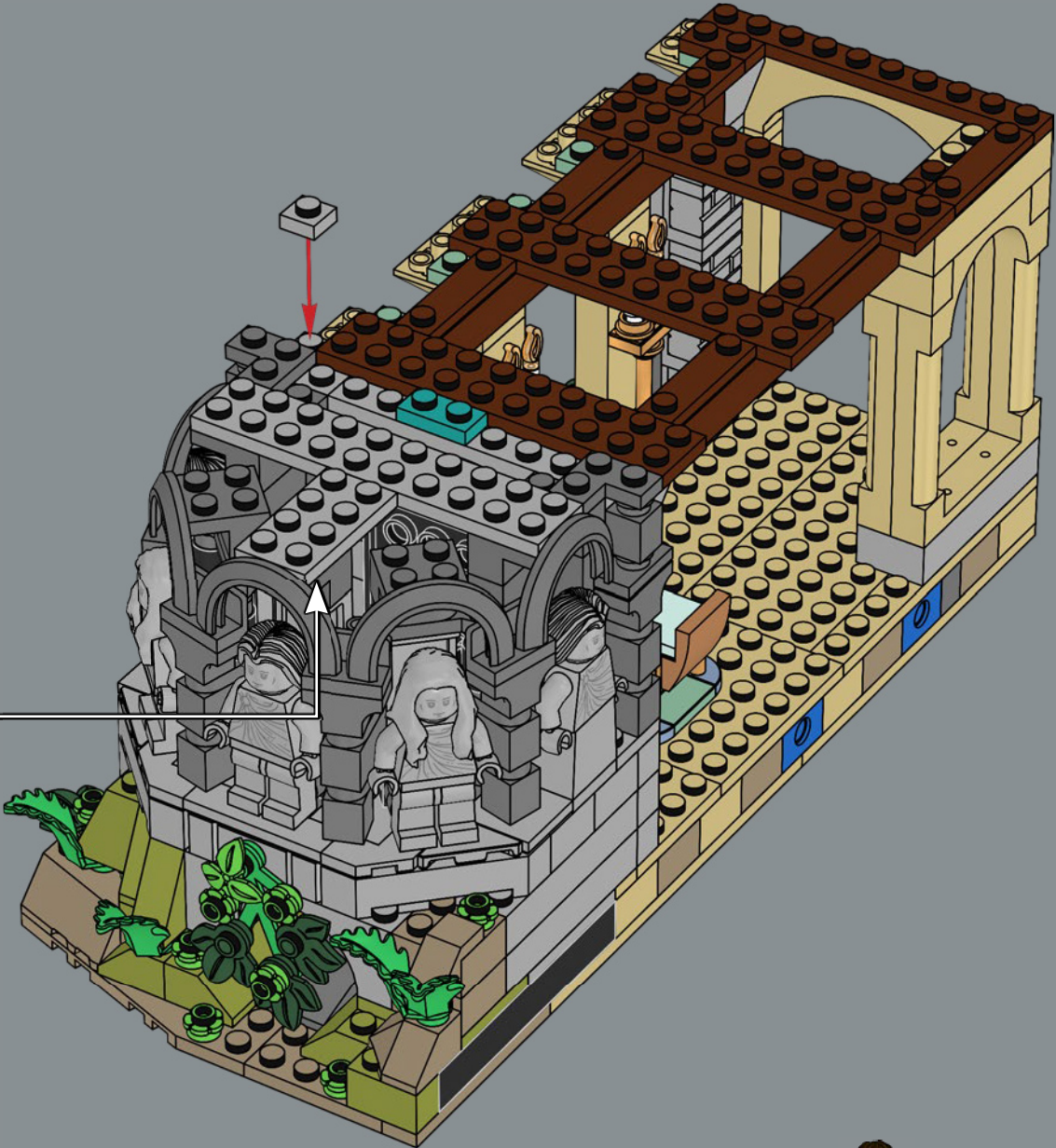
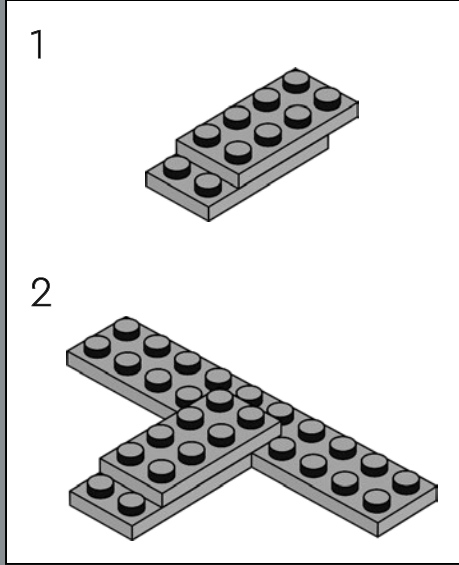

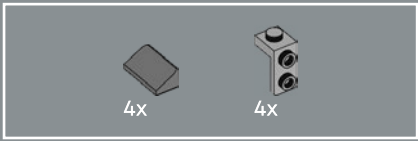

86

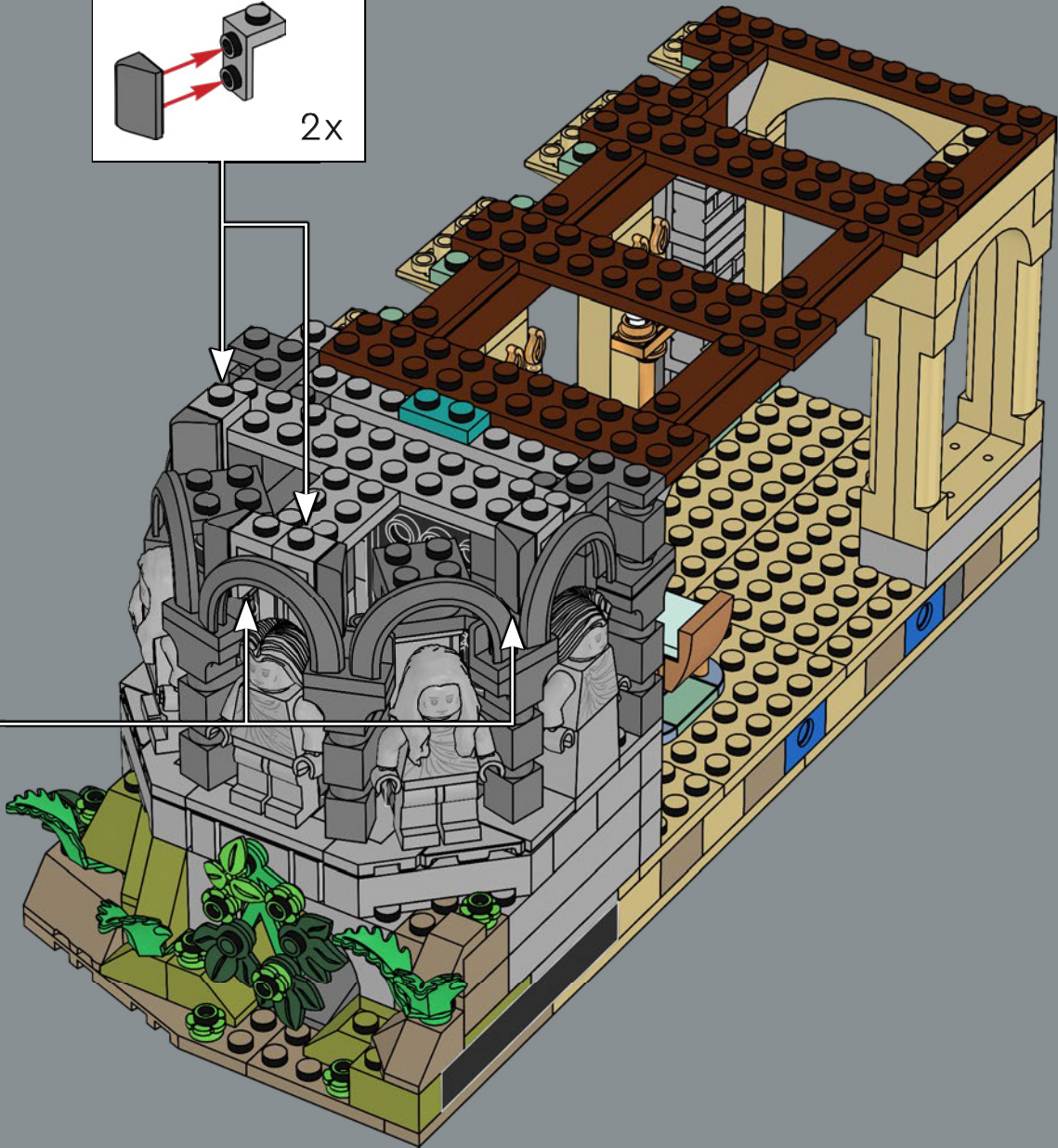
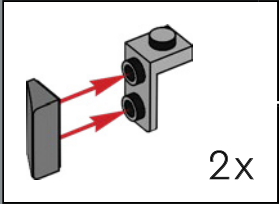
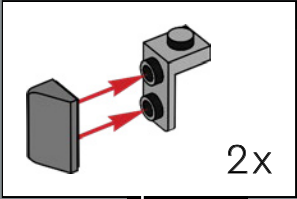

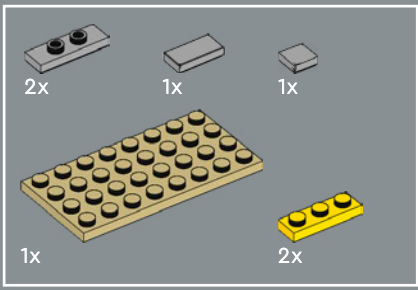

87



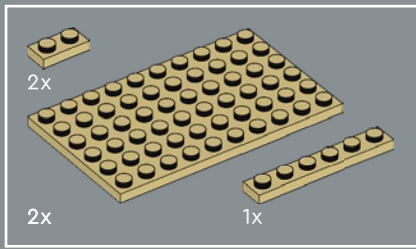

88



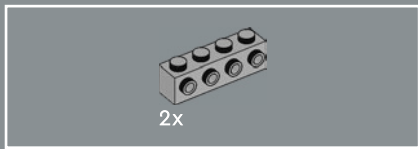

92

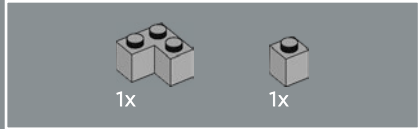
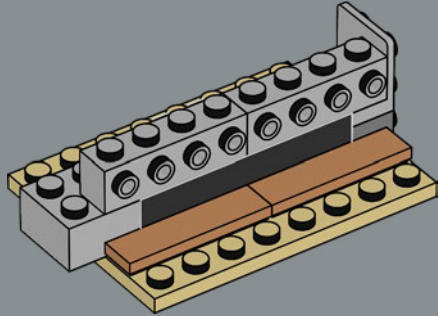

93

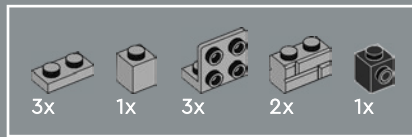
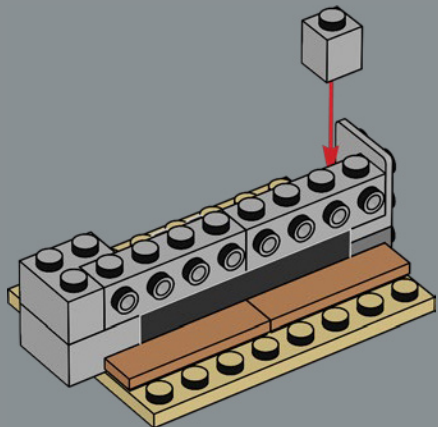

94

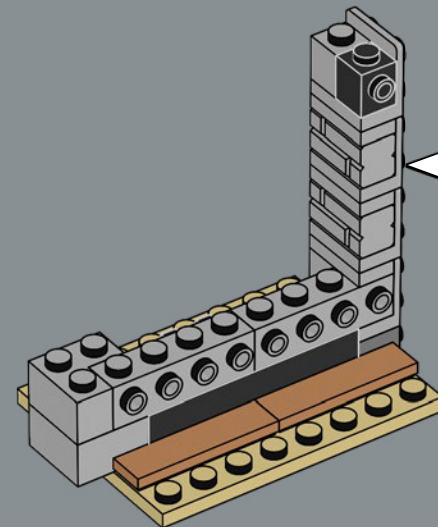
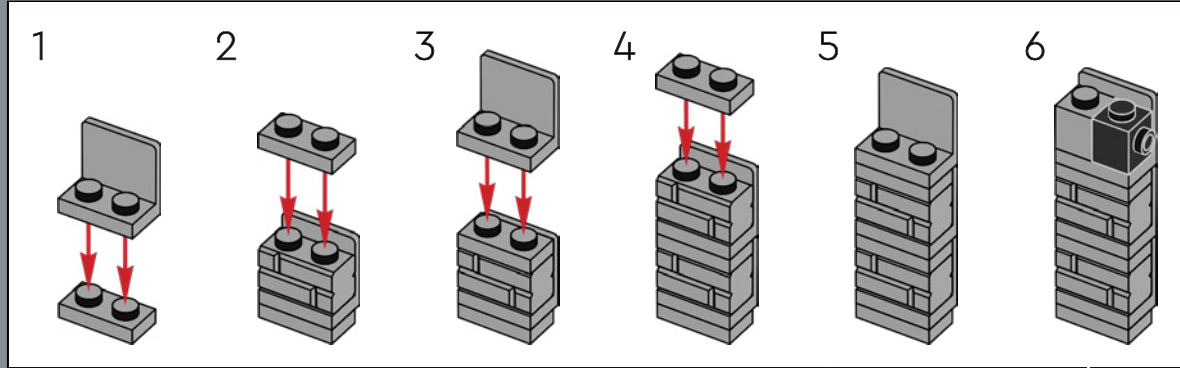

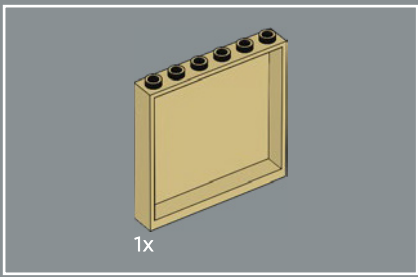

95

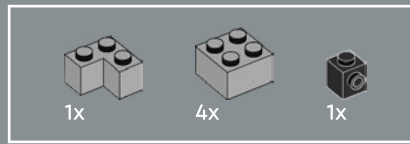
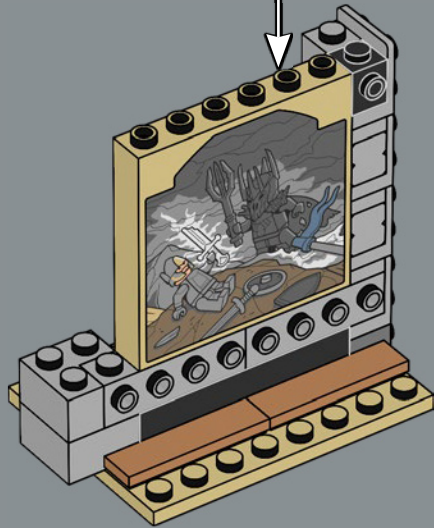
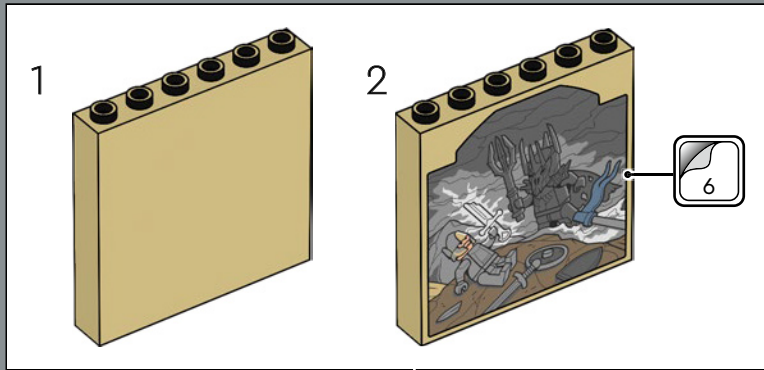

96

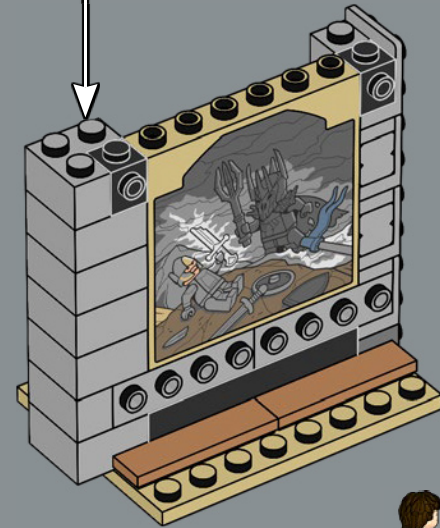
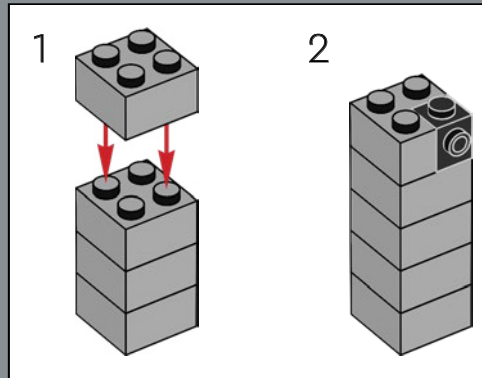

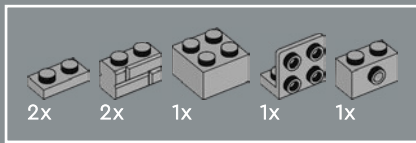

97

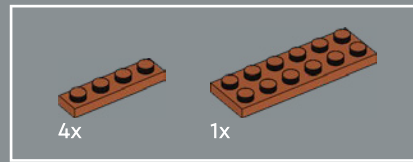
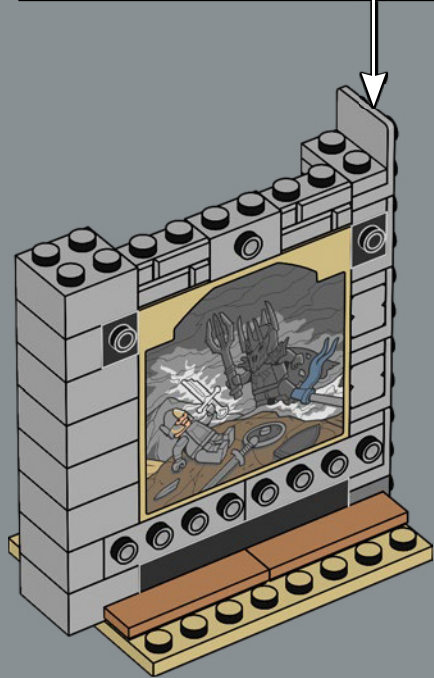
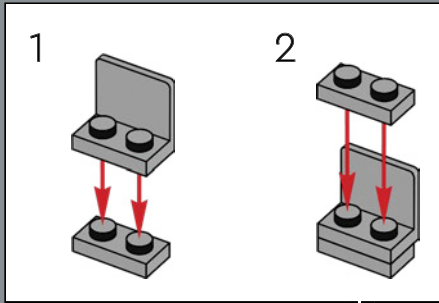

98

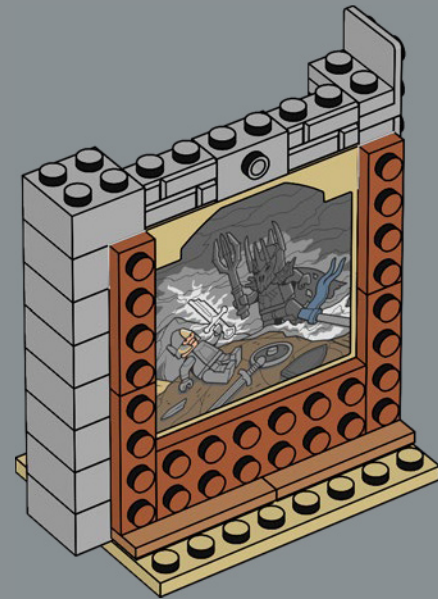

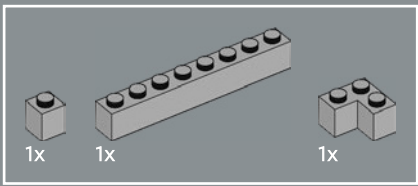

99

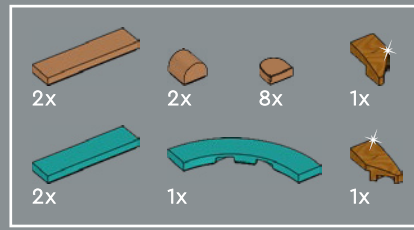
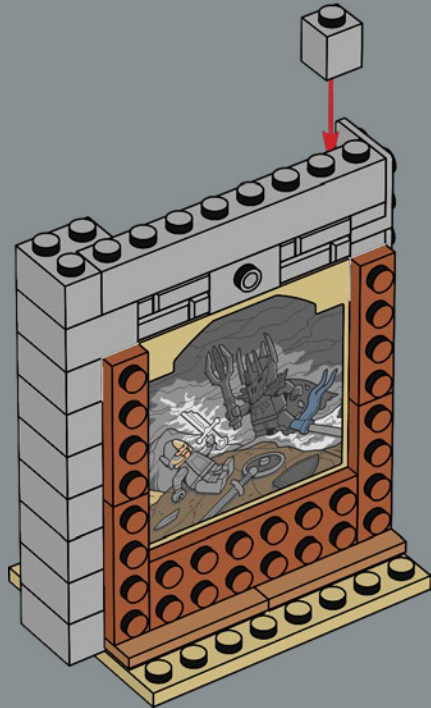

100

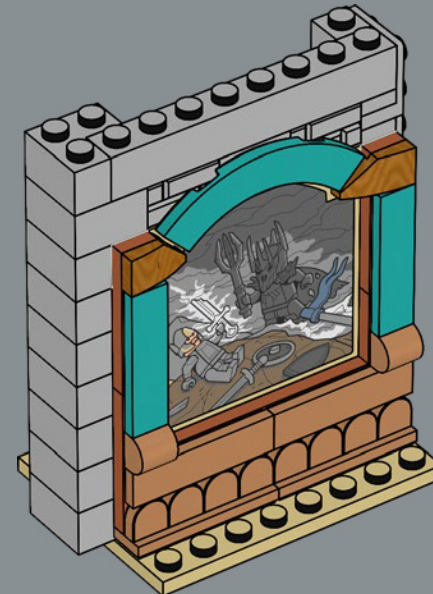

The Destruction of Sauron translated into the LEGO® universe features the newly designed Narsil hilt element and a gorgeous teal frame.

La destruction de Sauron transposée dans l'univers LEGO® présente le nouvel élément de la garde Narsil et un magnifique cadre bleu sarcelle.

La Destrucción de Sauron llevada al universo LEGO® incluye un elemento rediseñado que representa la empuñadura de Narsil y un vistoso marco azulado.



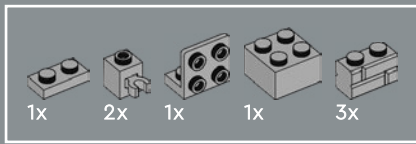

101

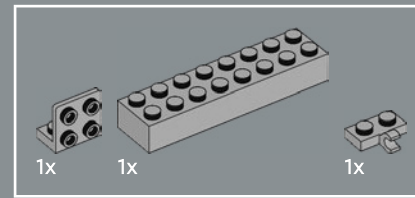
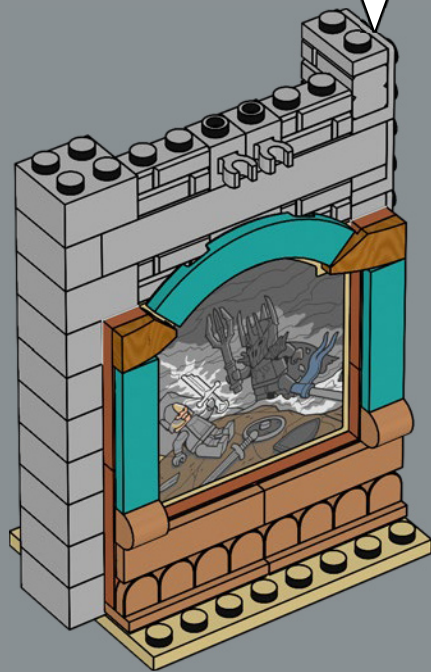
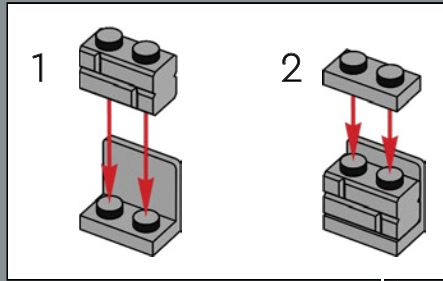

102

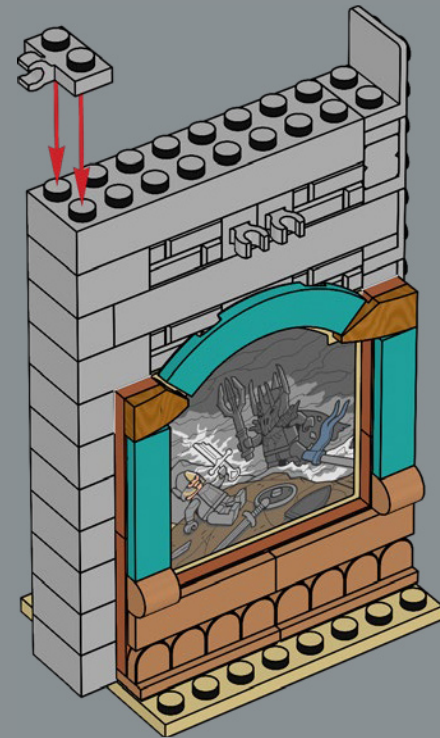

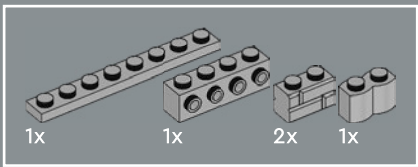

103

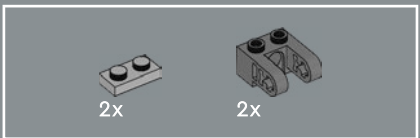
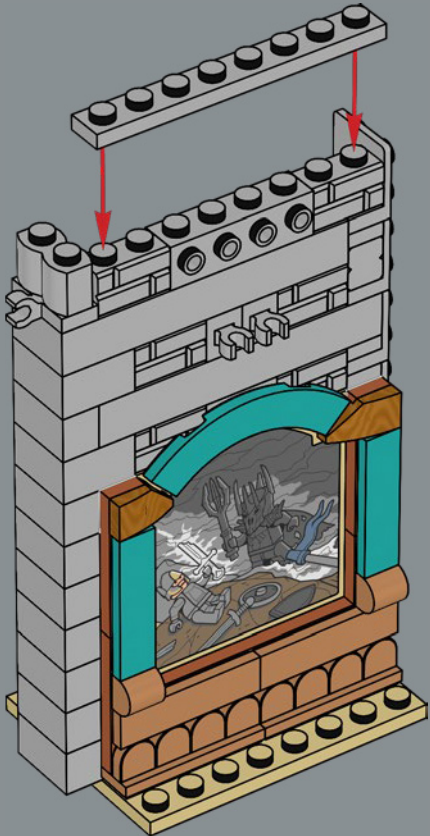

104

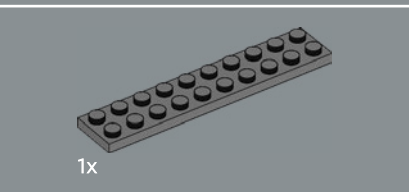
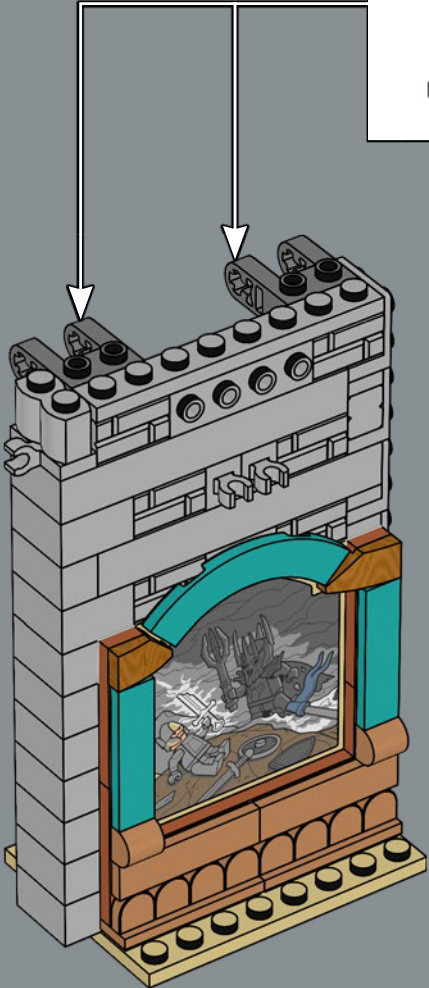
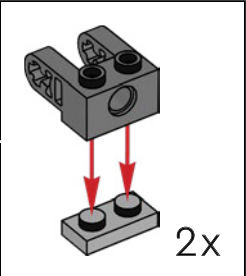

105





106



107

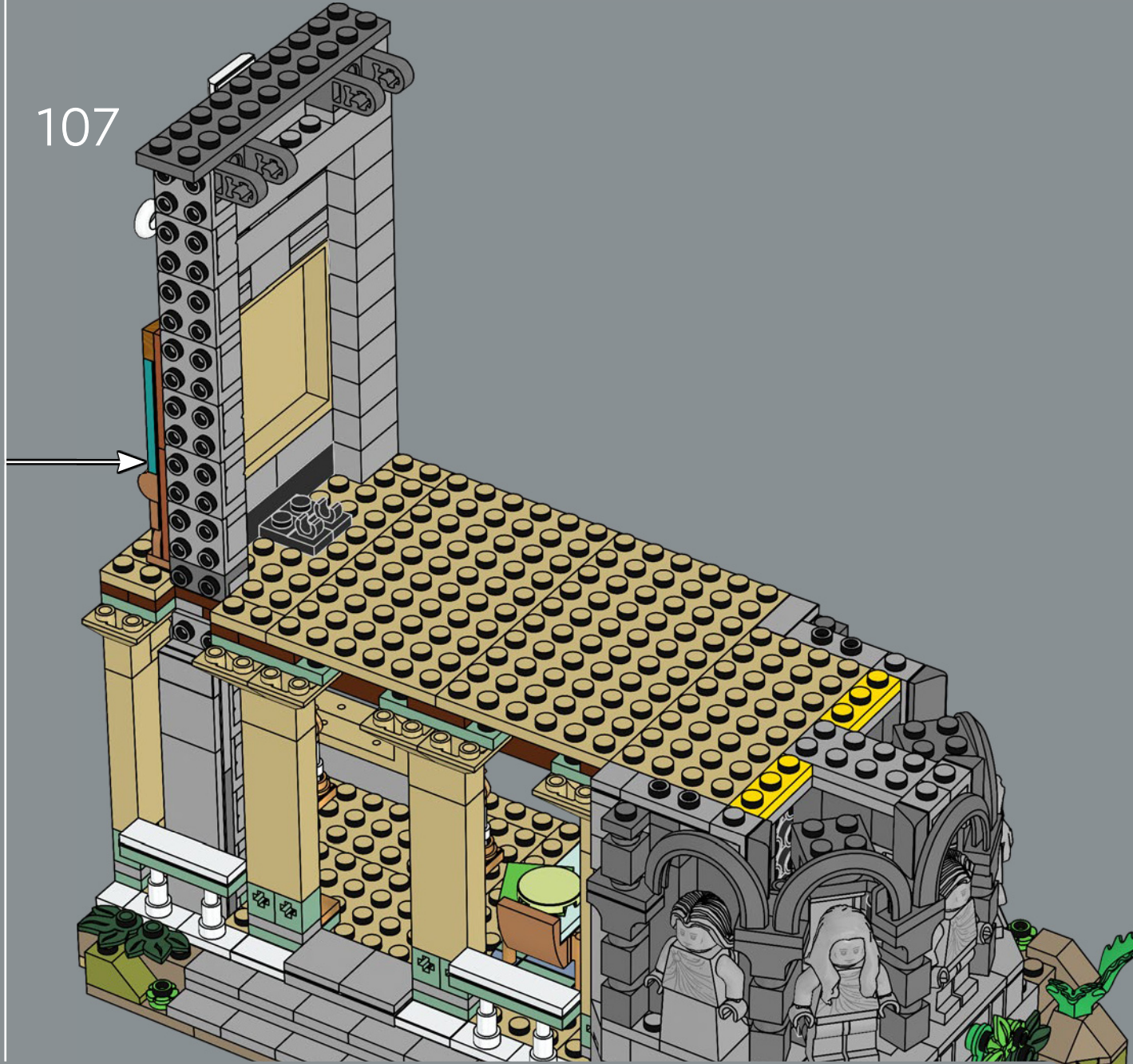

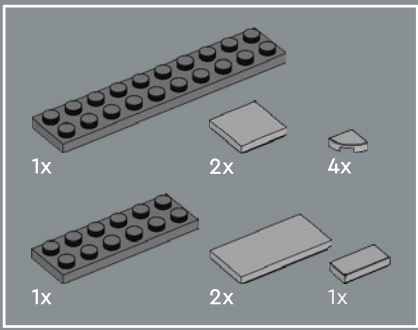

108

1

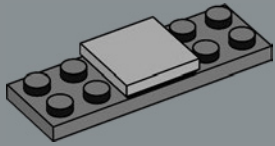

2

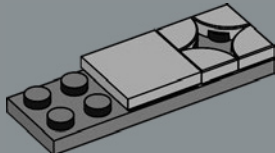

3

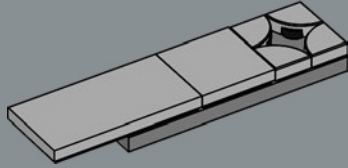

4

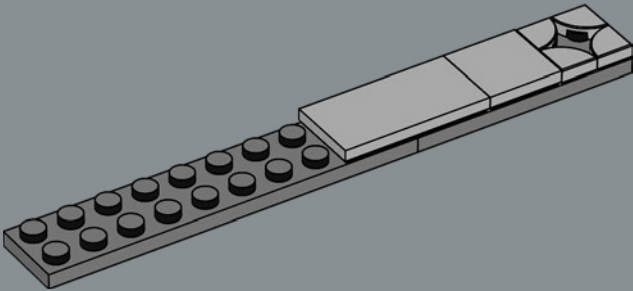

5

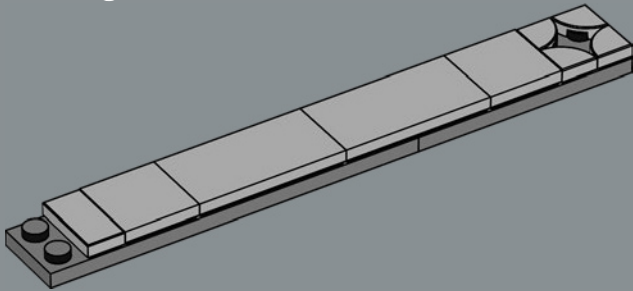

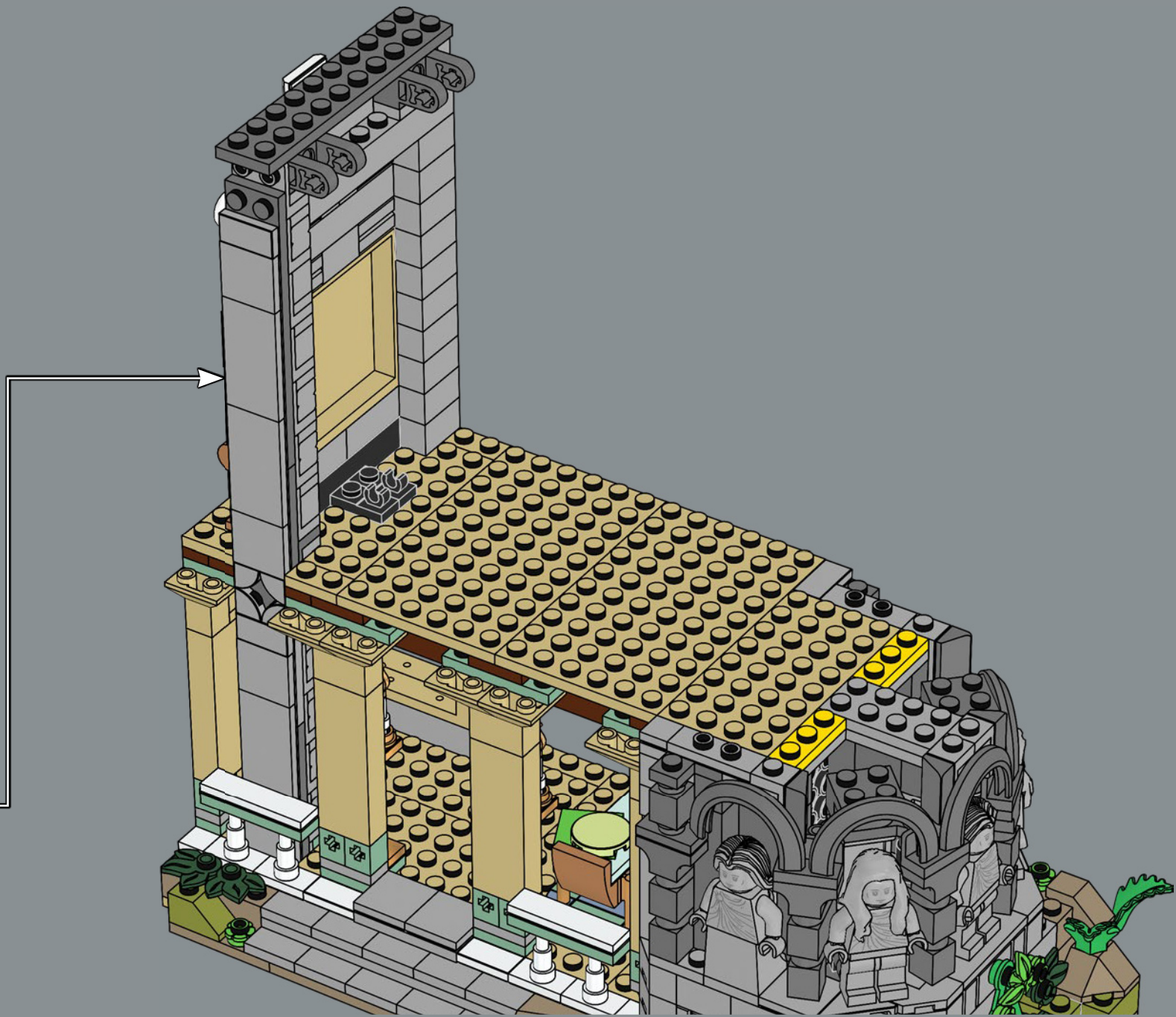

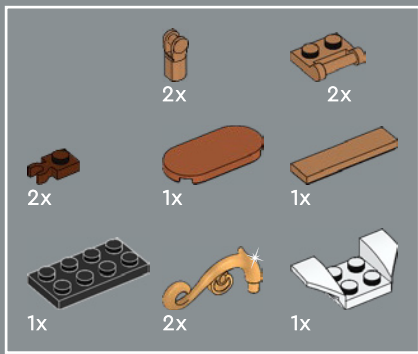

109

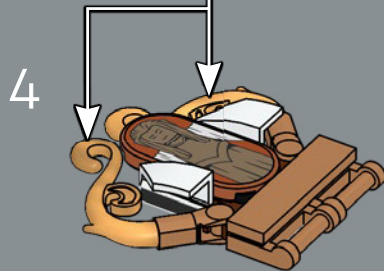
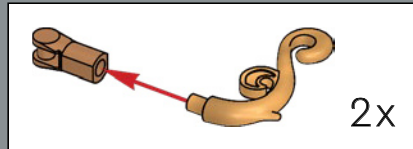
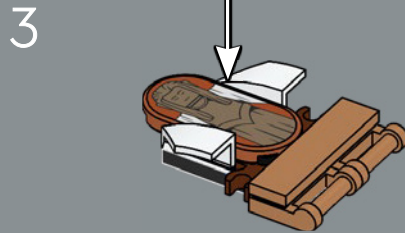
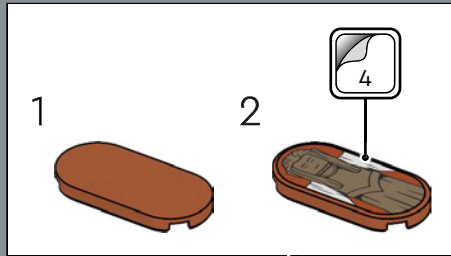
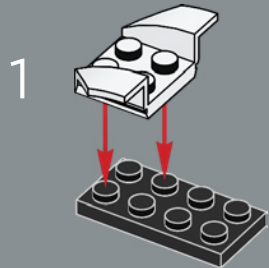

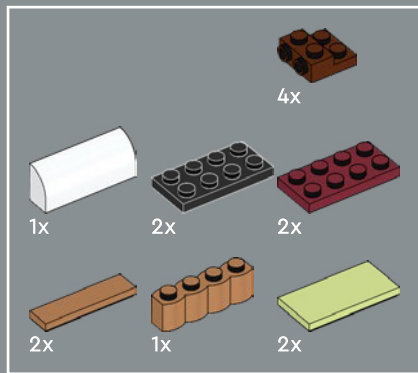

110

1

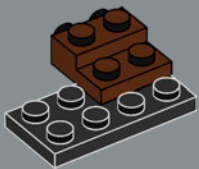

2

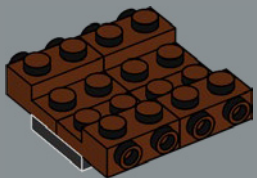

3

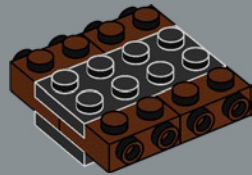

4



5

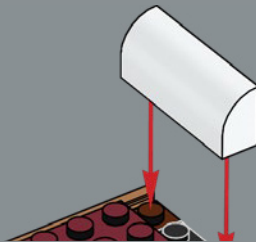

6

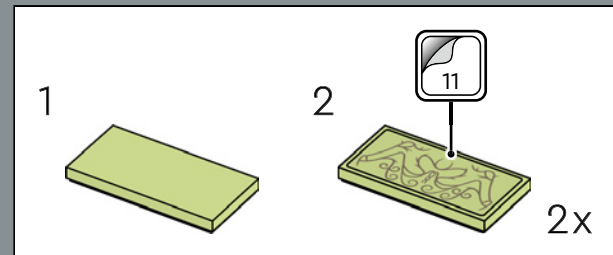
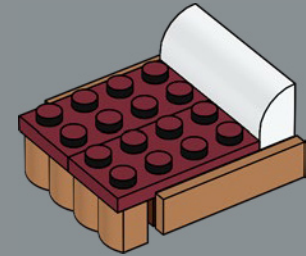

7

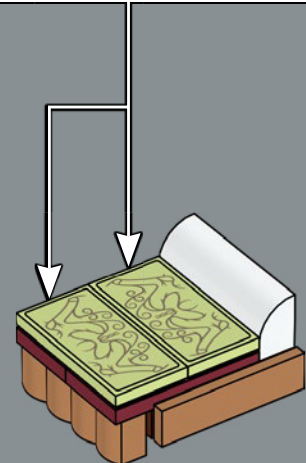

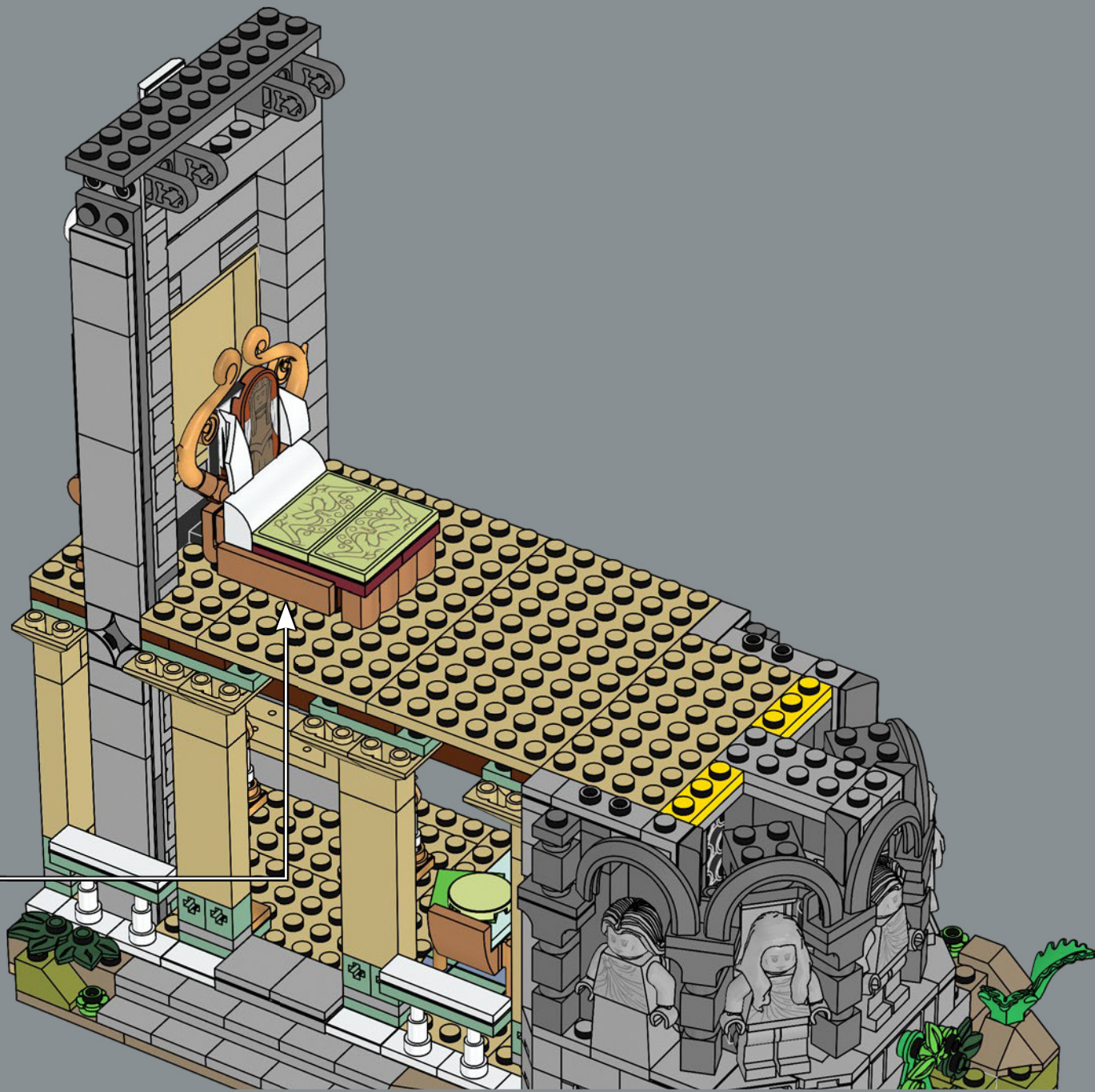



111

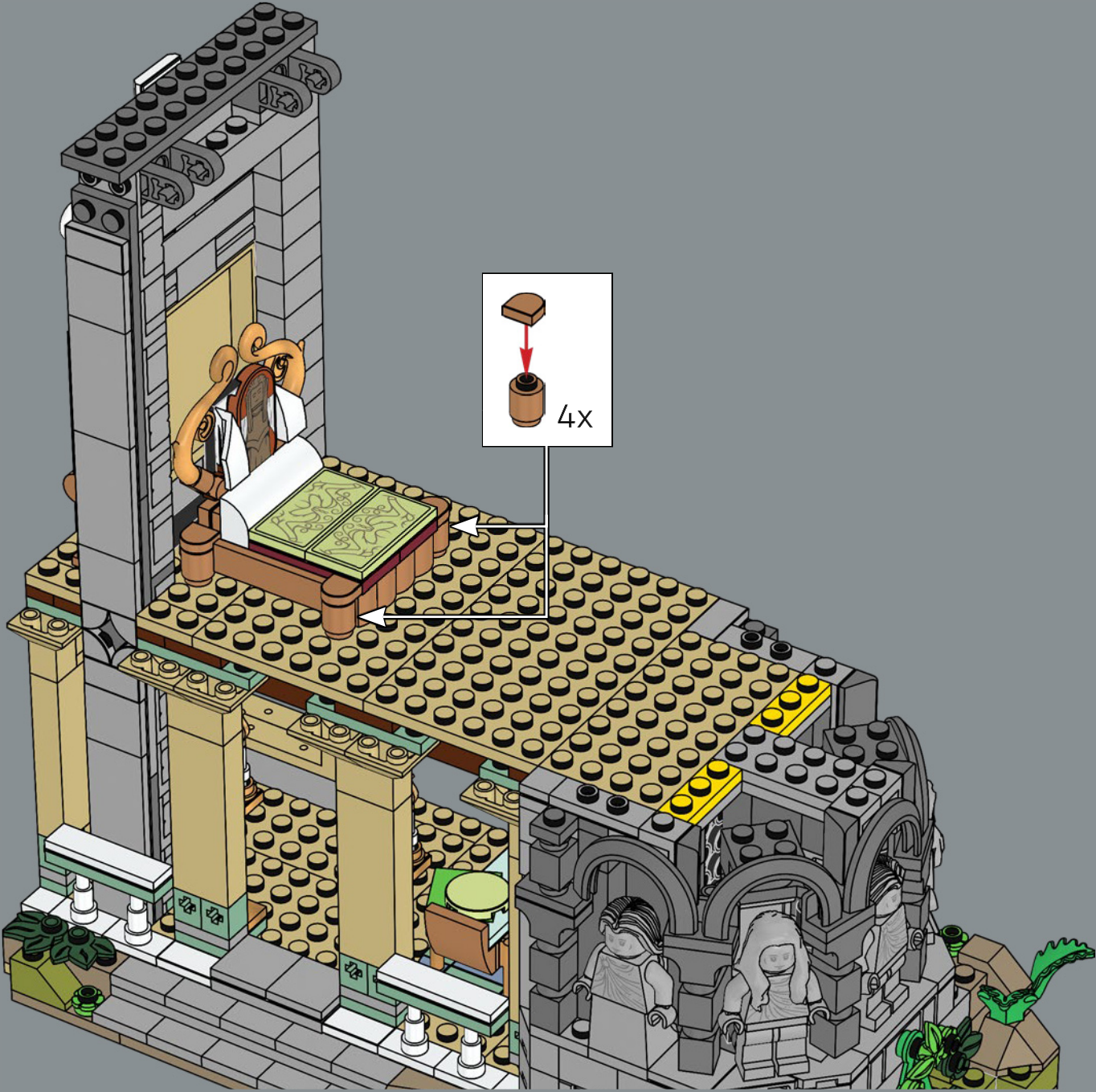

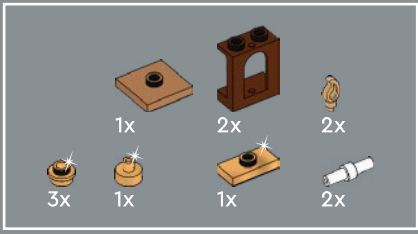

112

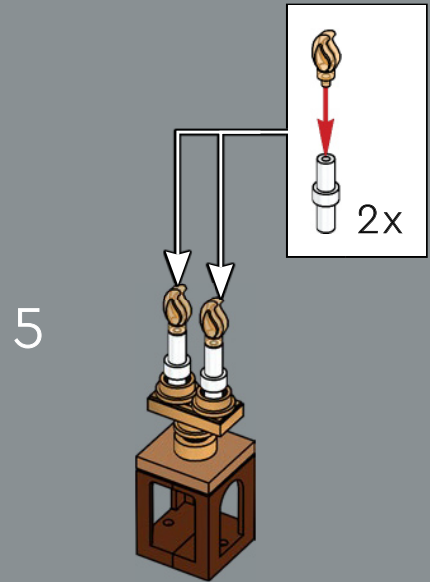
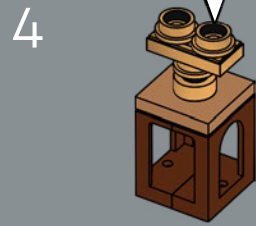
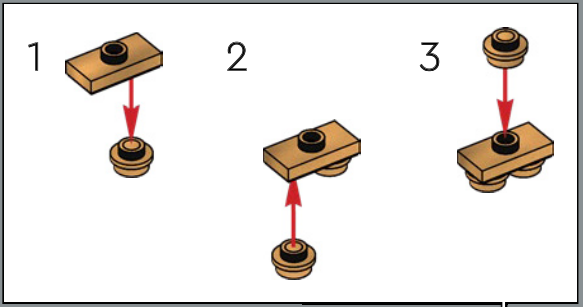
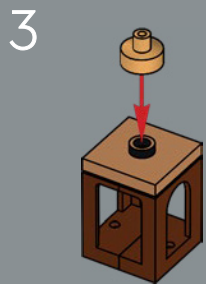
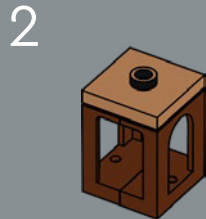
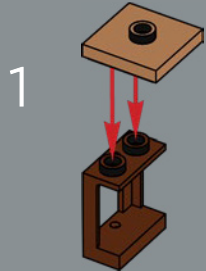

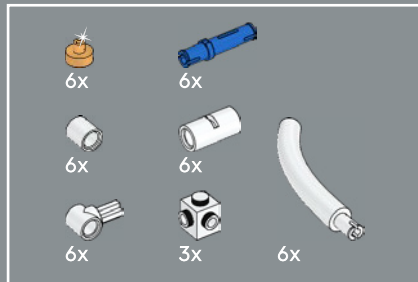
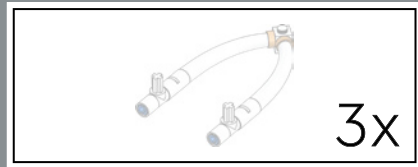

113

1



2

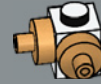

3

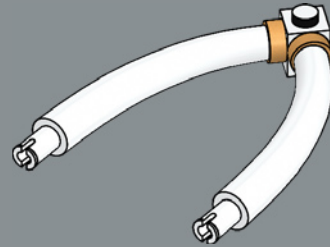

4

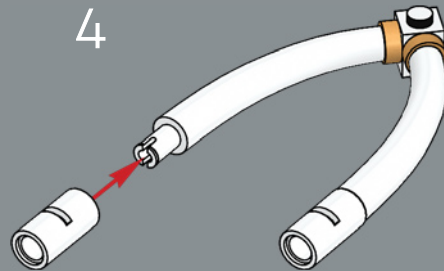

5

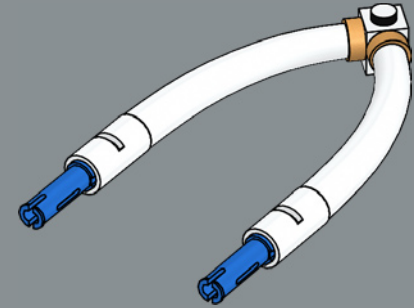

6

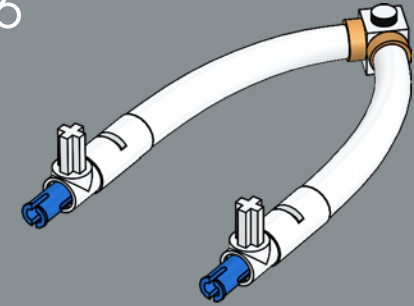

7

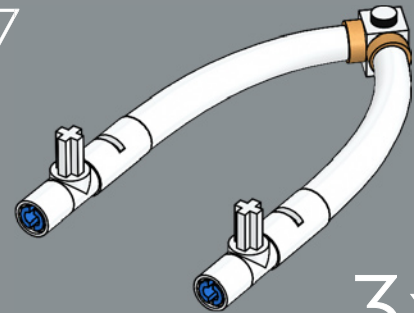

3x





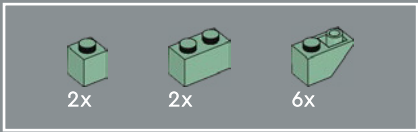

114



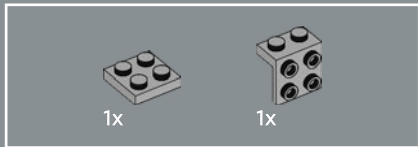
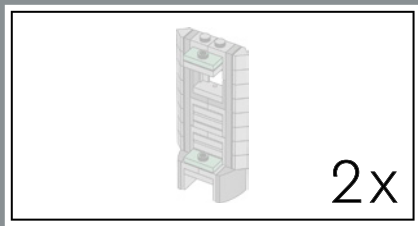

115

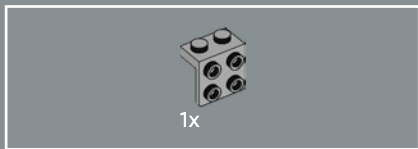
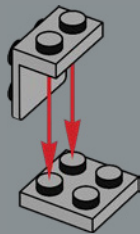

116

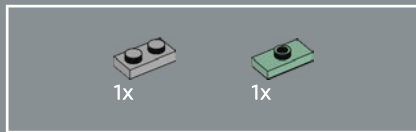
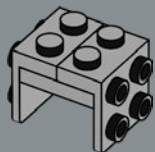

117

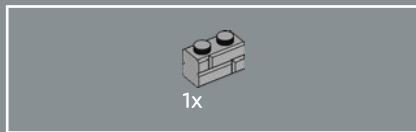
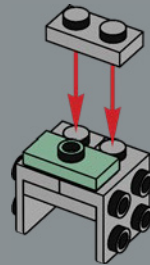

118

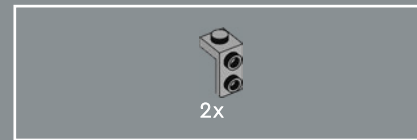
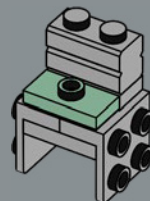

119

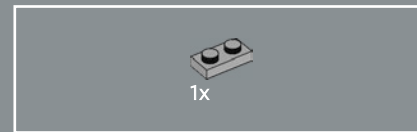
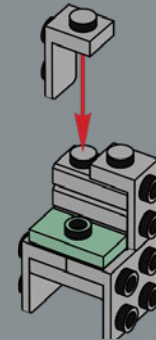

120

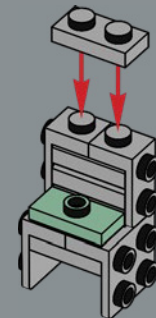

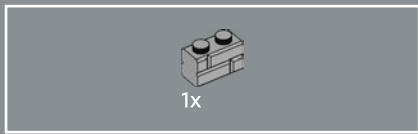

121

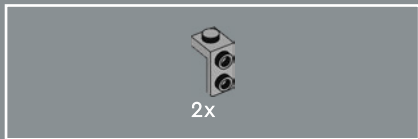
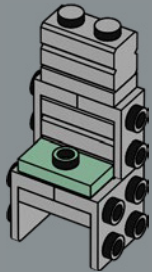

122

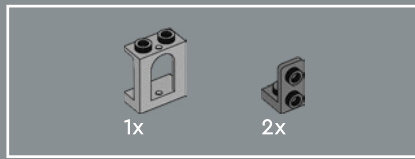
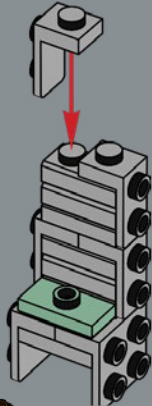

123

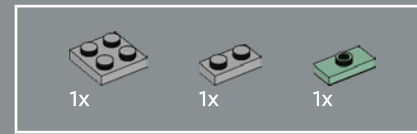
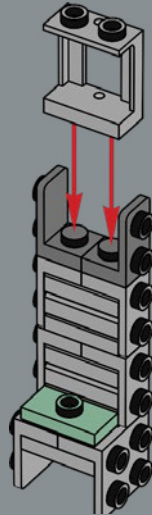

124

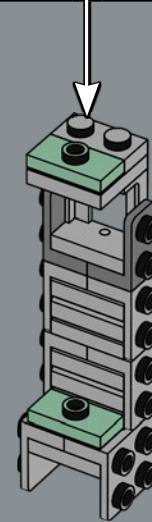
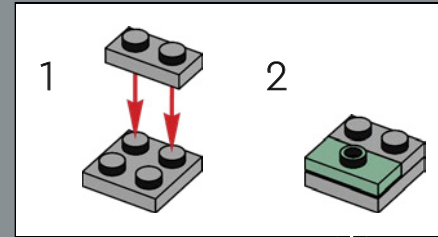



2x

125

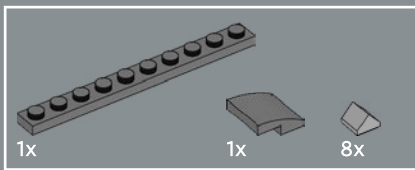
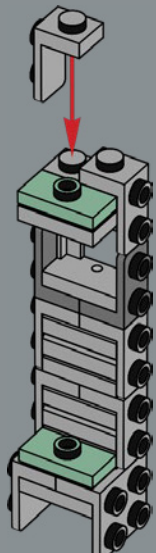

126

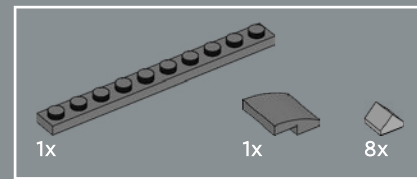
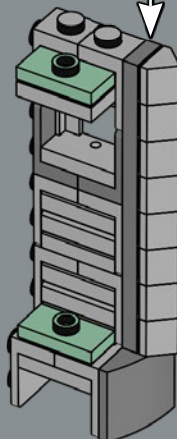
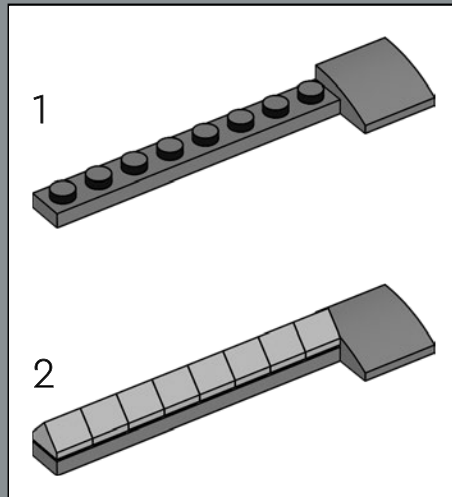

127

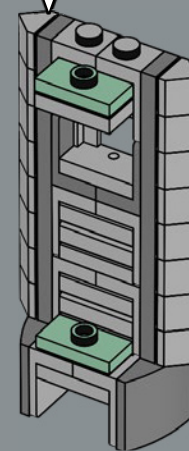
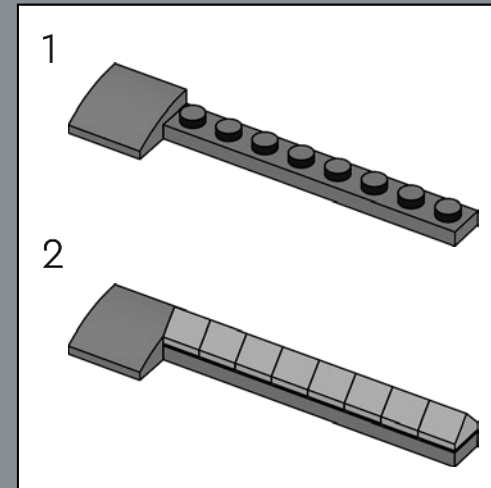

2x

128



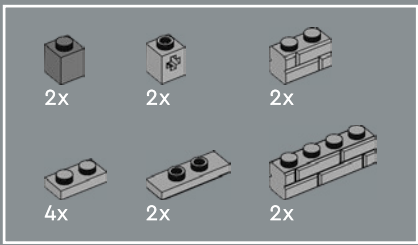

129

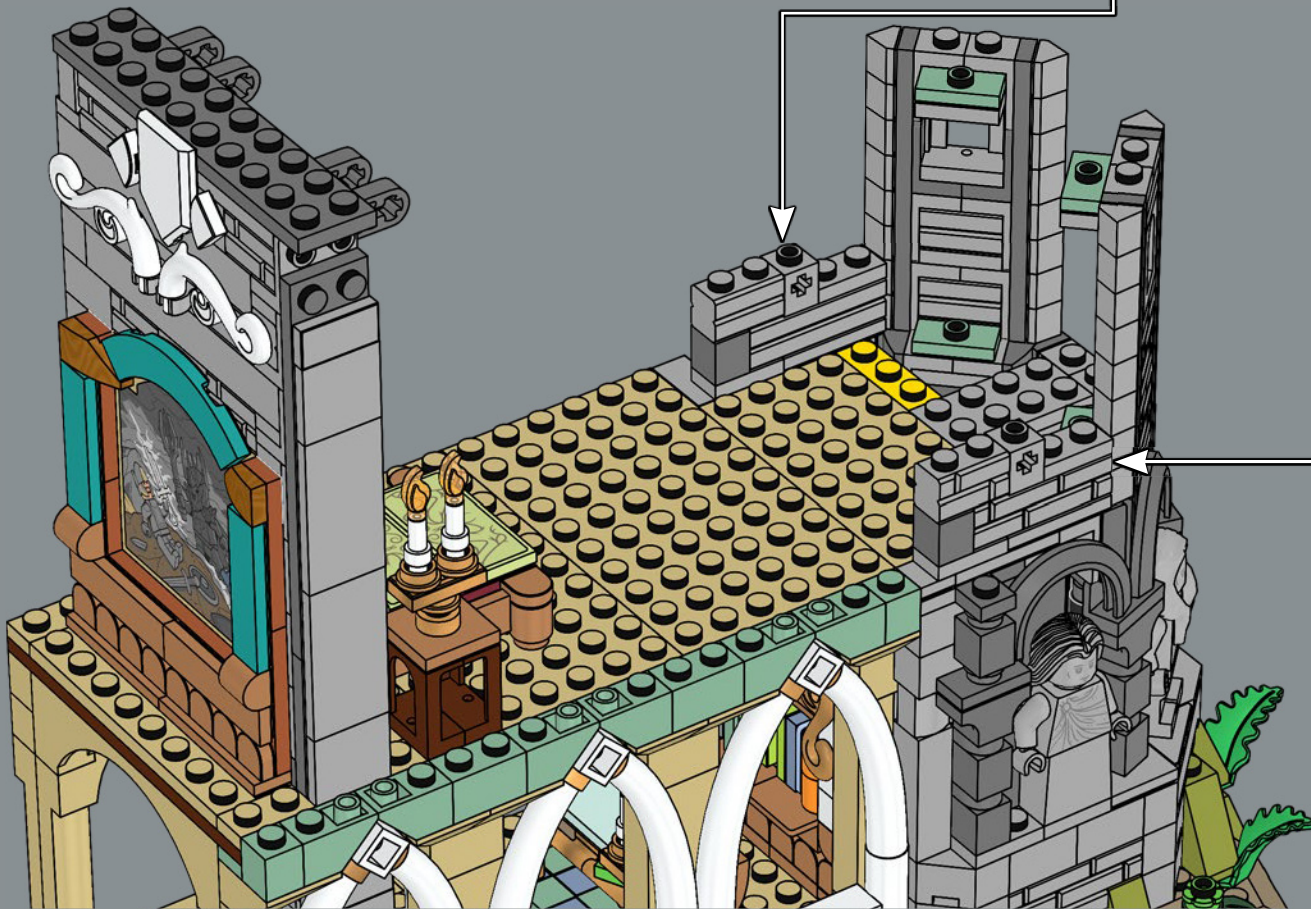
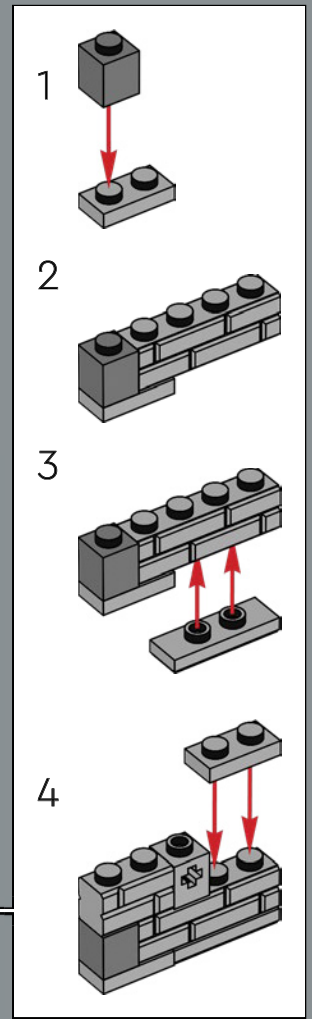
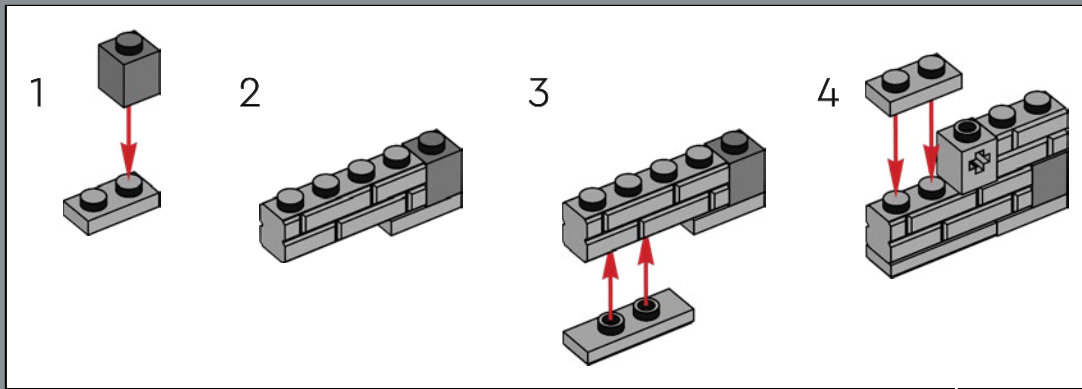

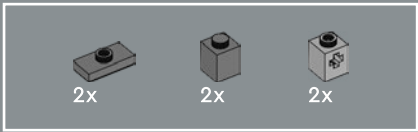

130

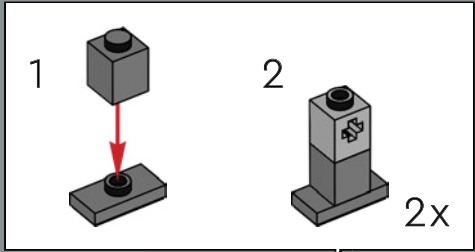

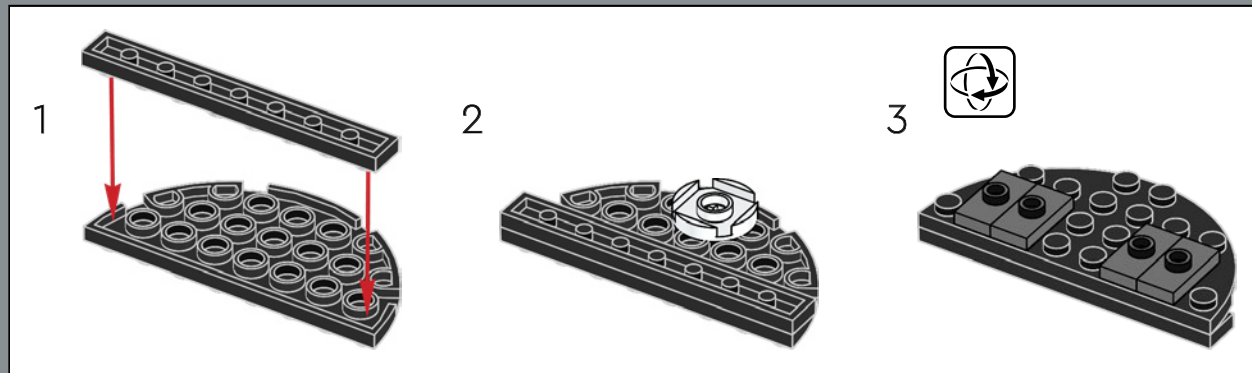
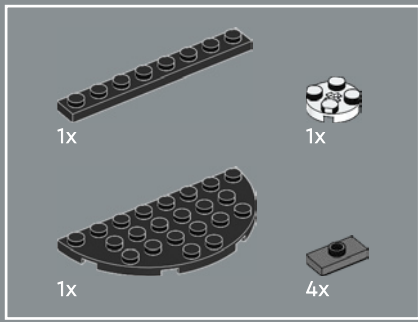

131

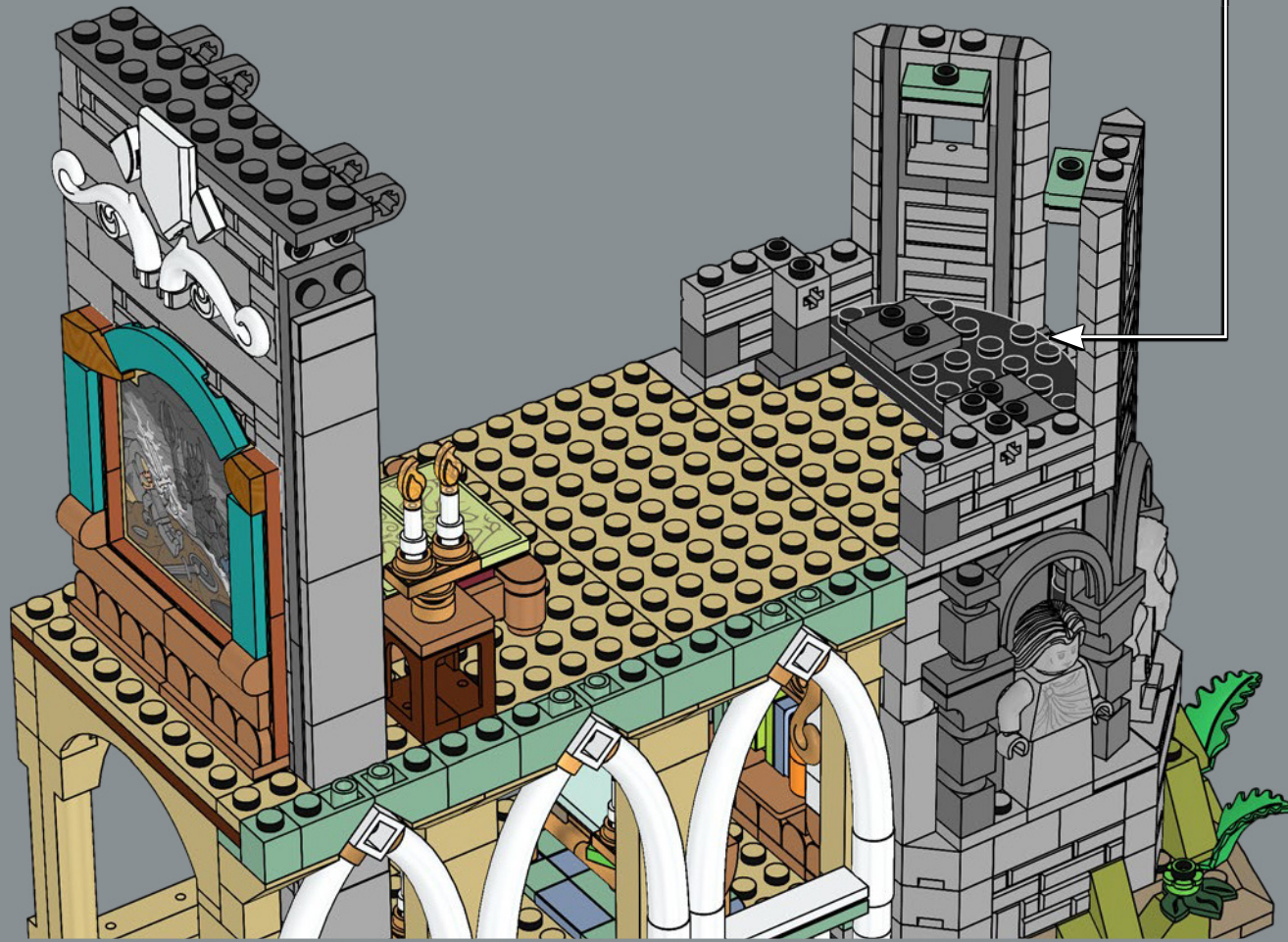

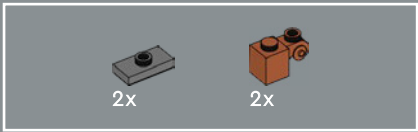

132

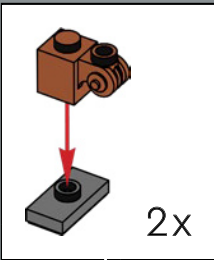

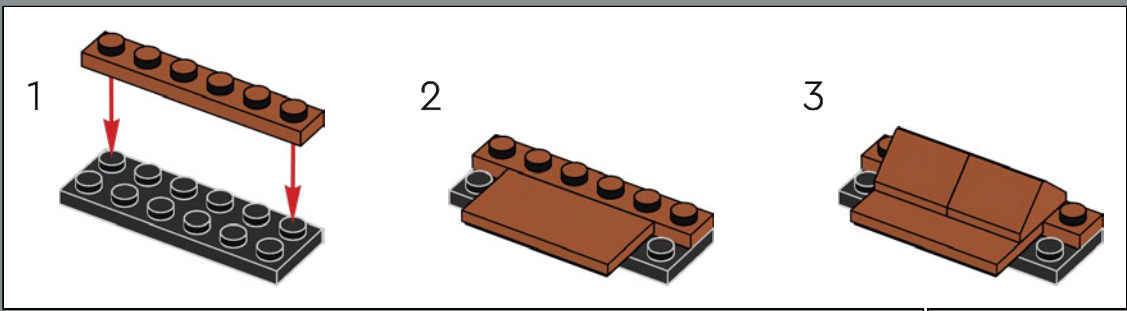
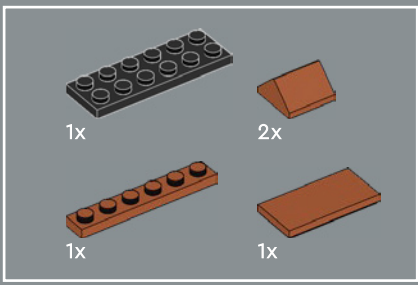

133



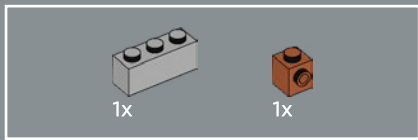

134

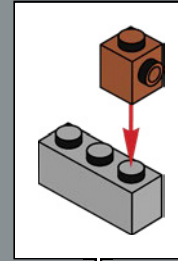

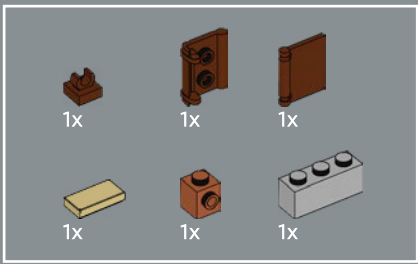

135



Not only is this a great location to write a book, but this desk also provides critical structural stability for the roof and tower that will be attached later.

Non seulement c'est un endroit idéal pour écrire un livre, mais ce bureau fournit également une stabilité structurelle essentielle pour le toit et la tour qui seront fixés plus tard.

Además de ser un fantástico lugar para escribir un libro, este escritorio proporciona estabilidad estructural al techo y la Torre, que se colocarán después.

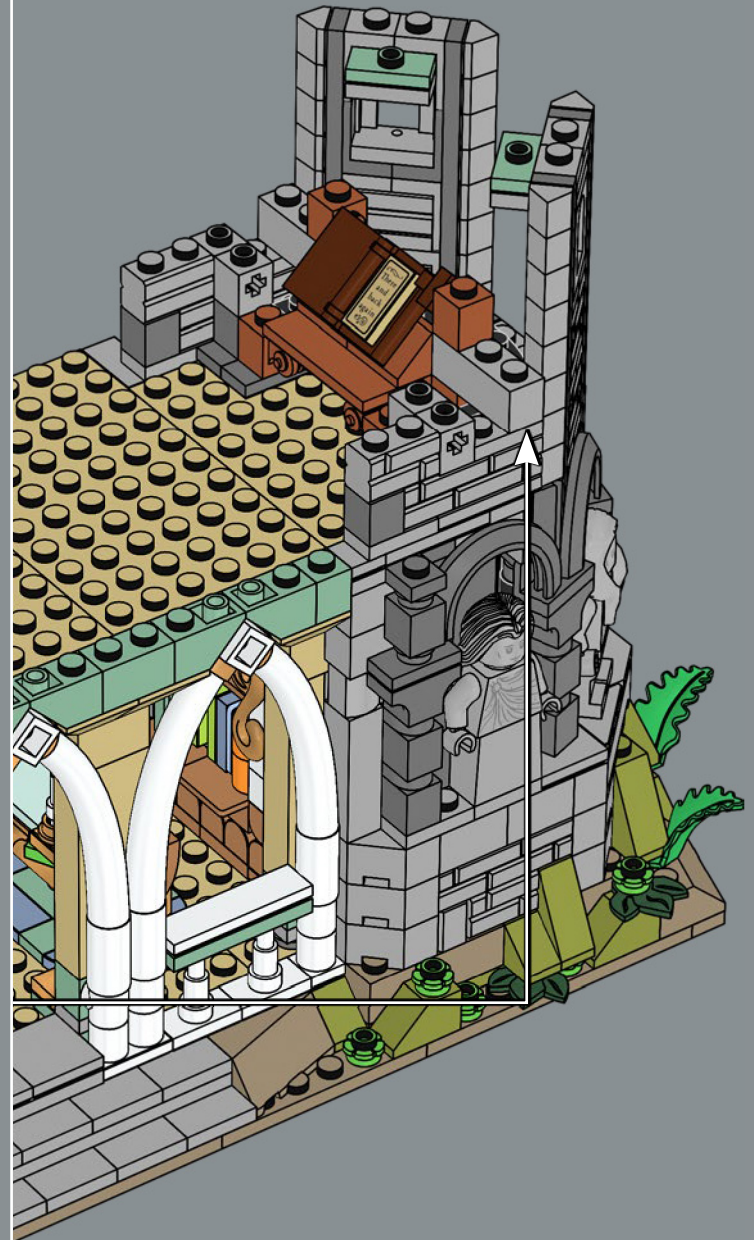
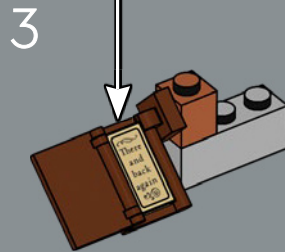
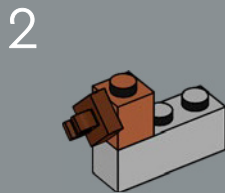
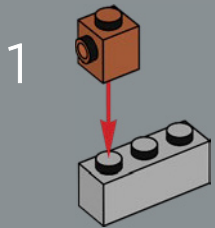
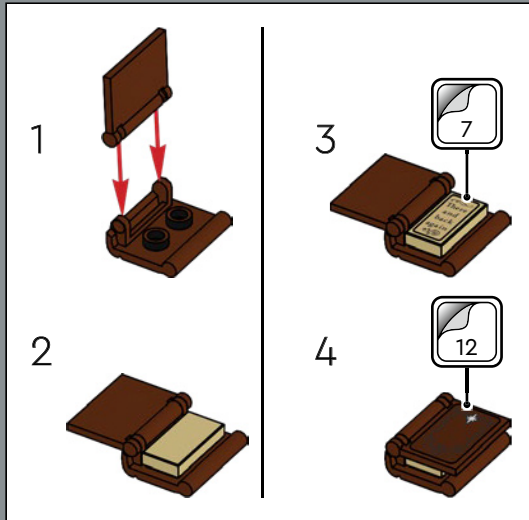

-  2x
-  1x
-  2x
-  1x
-  2x
-  2x
-  1x

136

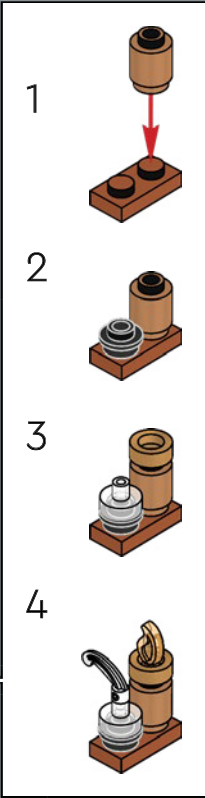
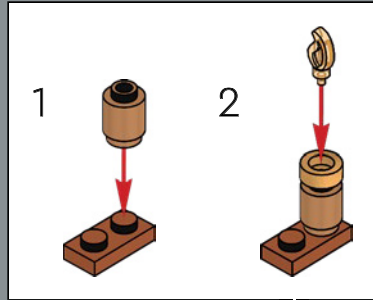

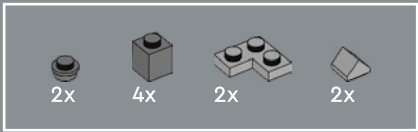

137

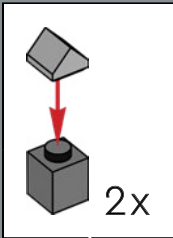



This is the first time in a LEGO® model we get to meet 111+-year-old Bilbo. Don't let him see the Ring or he might get a bit too excited!

C'est la première fois dans un modèle LEGO® que nous pouvons rencontrer un Bilbon âgé de plus de 111 ans. Ne le laissez pas voir l'Anneau ou il pourrait devenir un peu trop agité !

Esta es la primera vez que podemos encontrar una versión de Bilbo con más de 111 años en un set LEGO®. No dejes que vea el anillo, ¡o podría emocionarse demasiado!

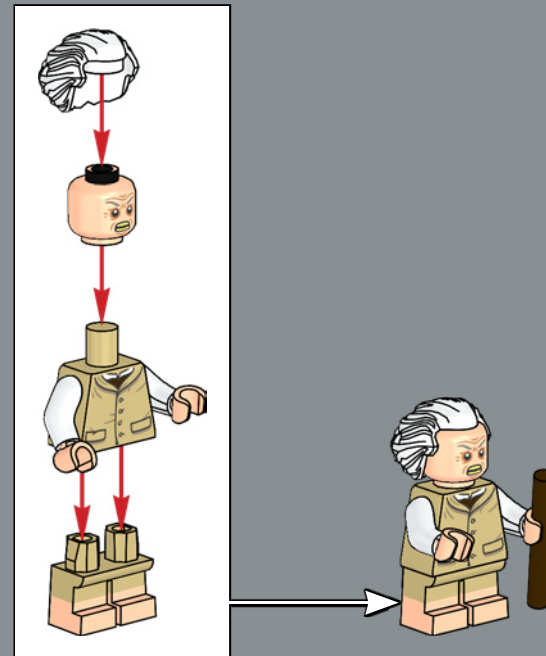

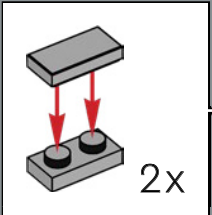
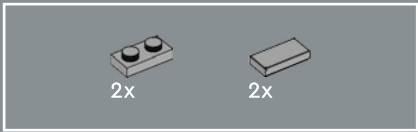

138



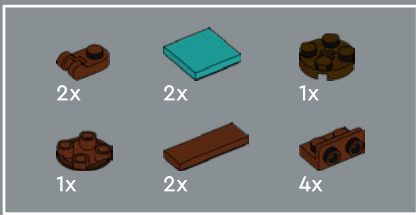

139

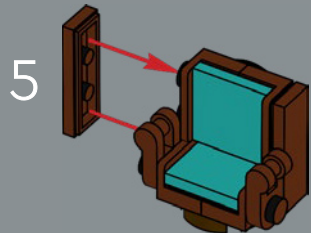
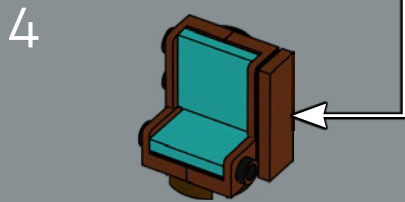
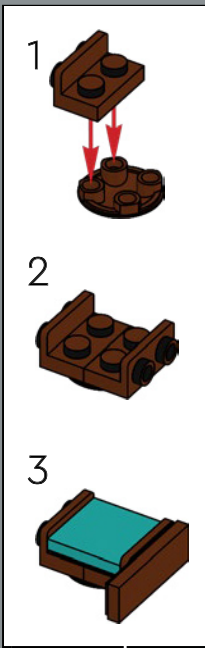
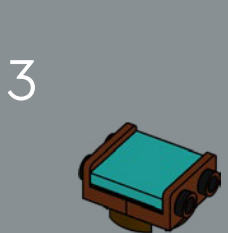
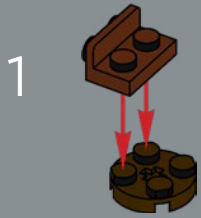

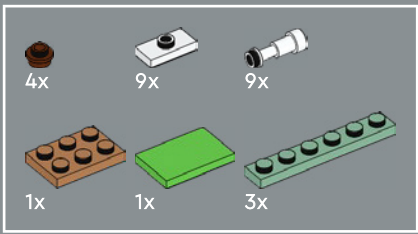

140

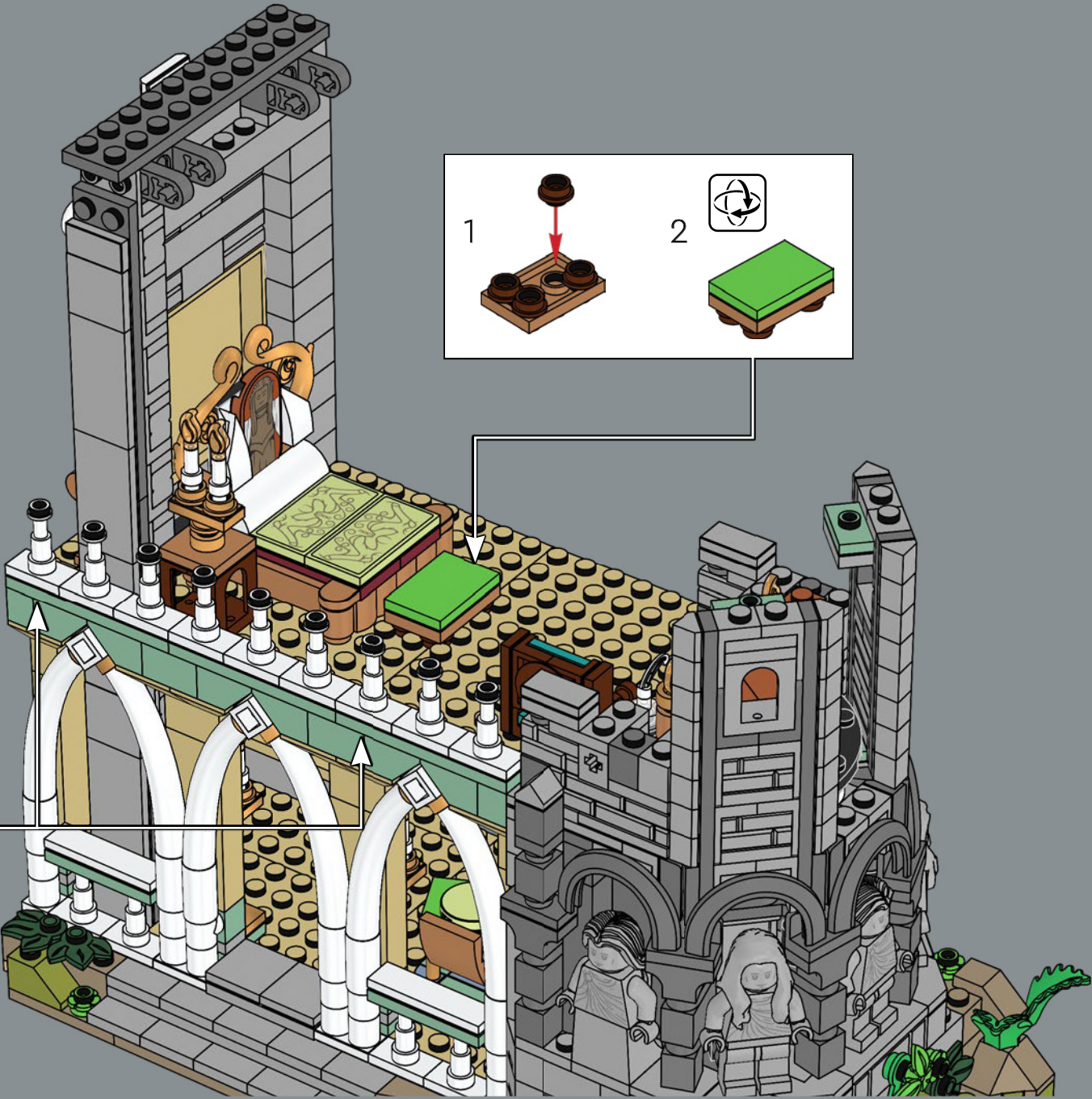
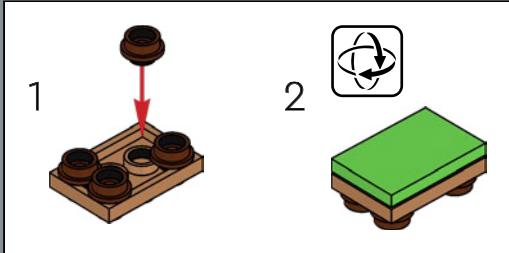
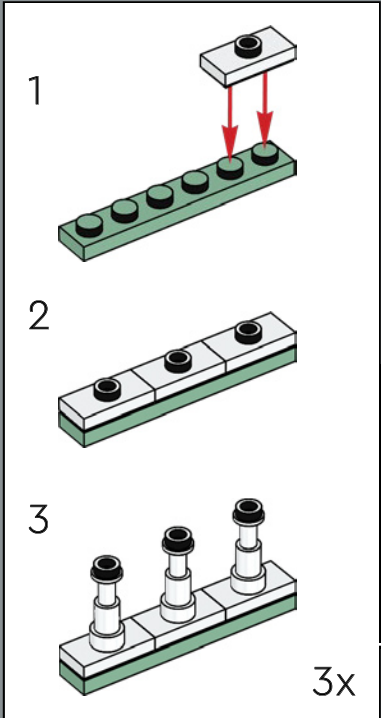

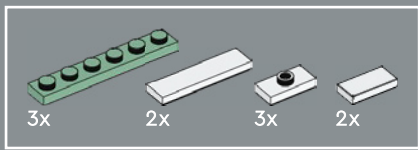

141

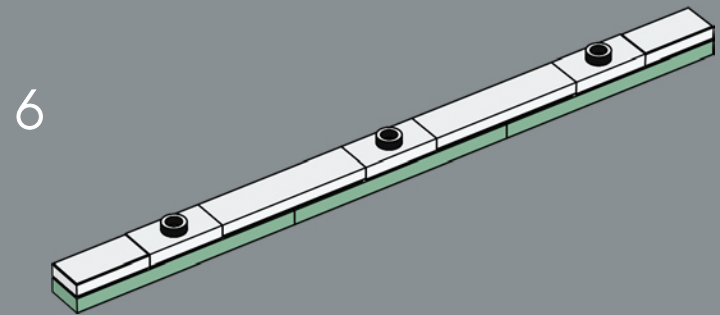
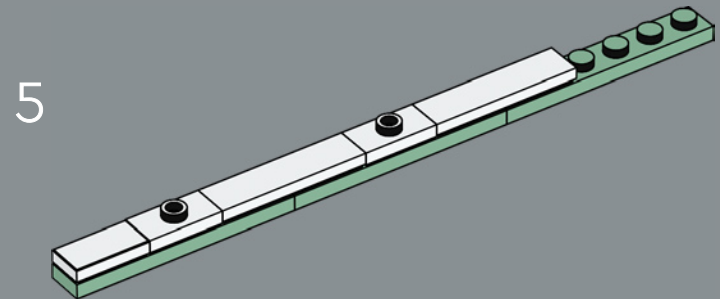
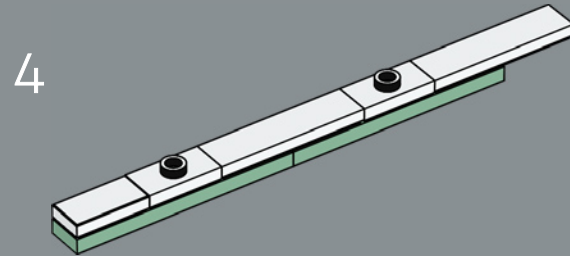
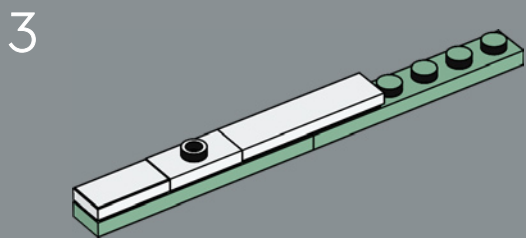
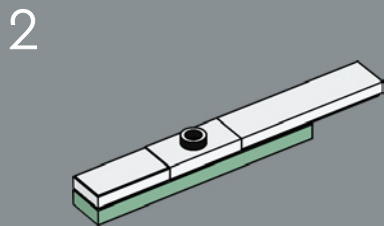
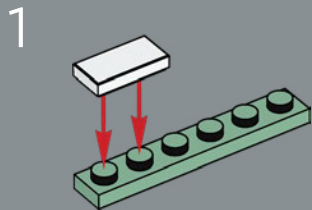



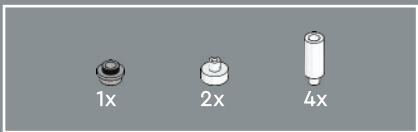

142

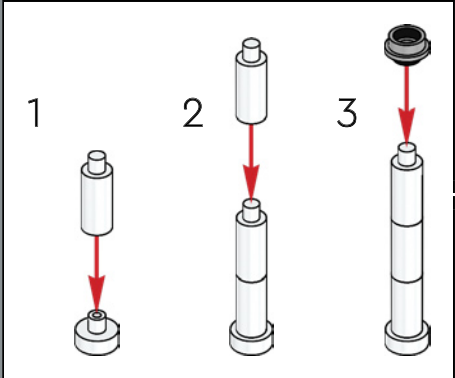

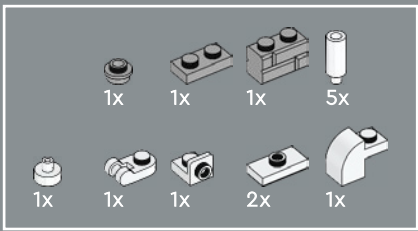

143

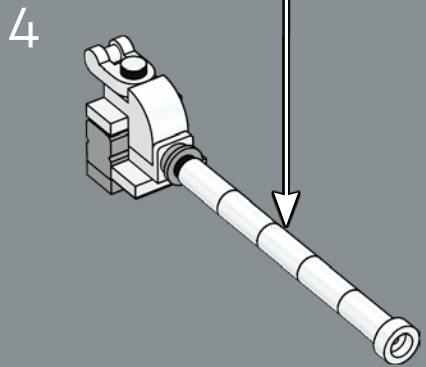
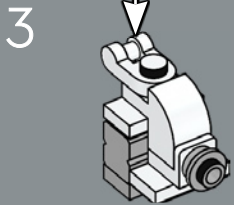
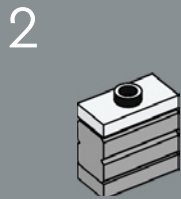
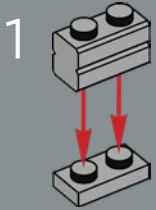
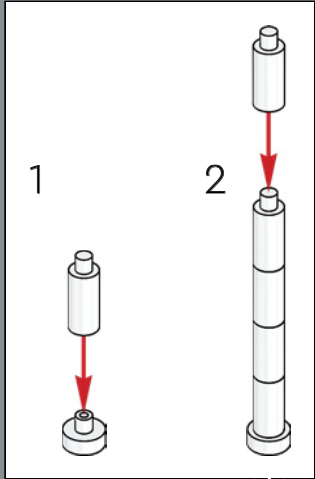
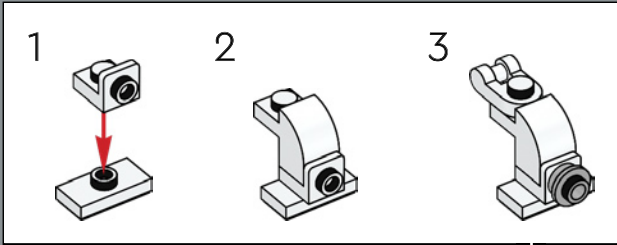



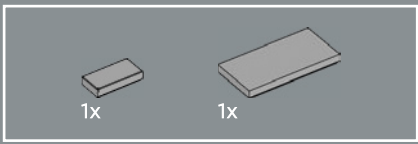

144



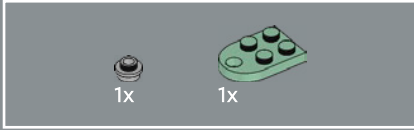
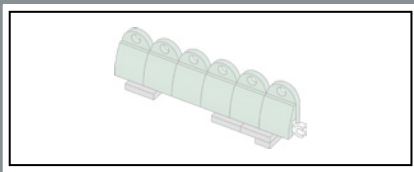

145

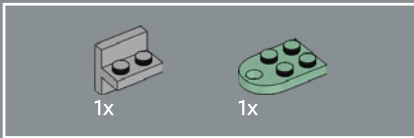
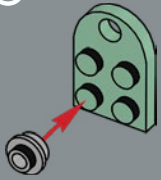

146

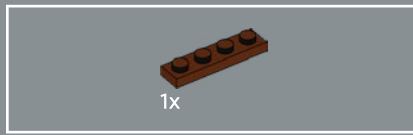
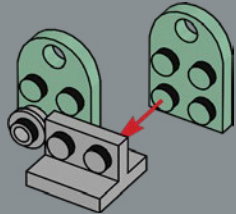

147

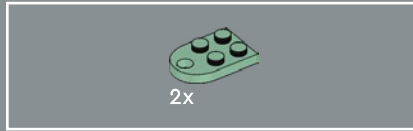
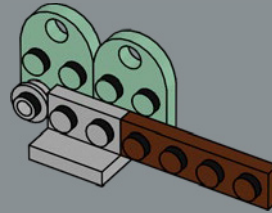

148

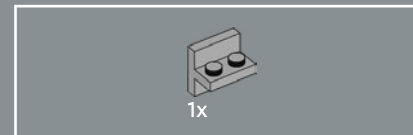
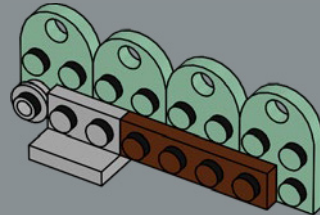

149

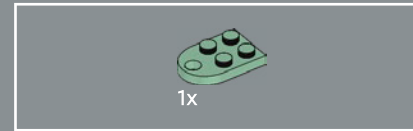
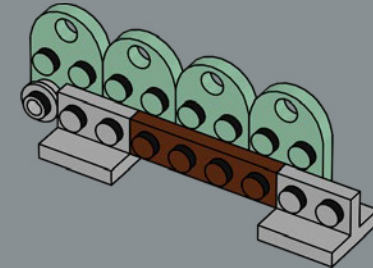

150

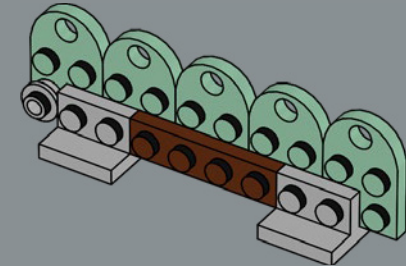



1x

151

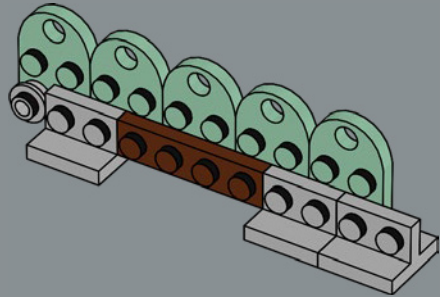

1x



1x

152

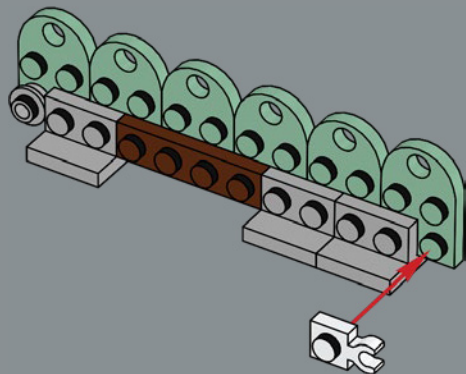

6x

153

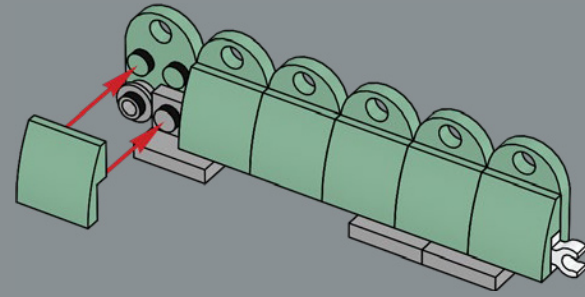

1x

154

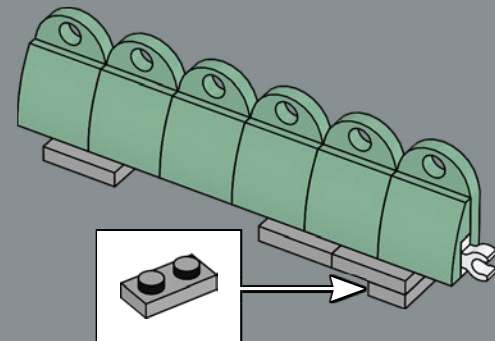

155



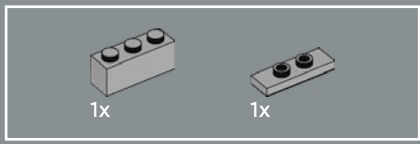

156

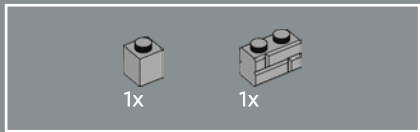
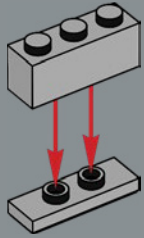

157

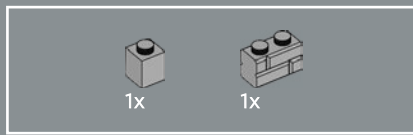
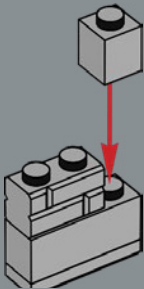

158

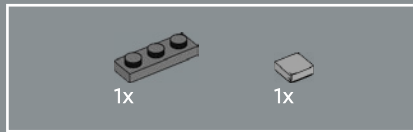
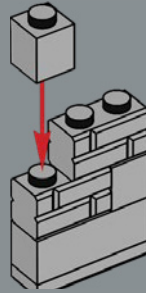

159

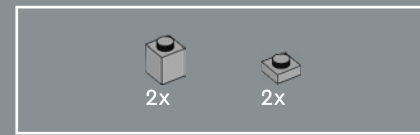
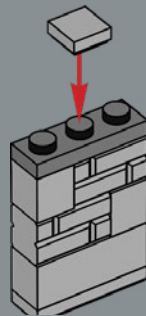

160

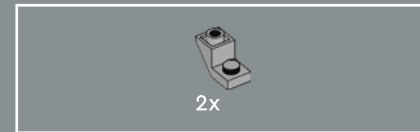
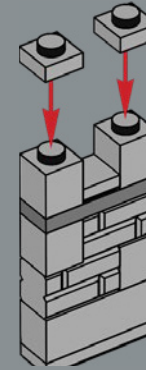

161

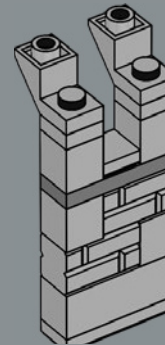

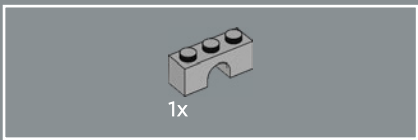

162

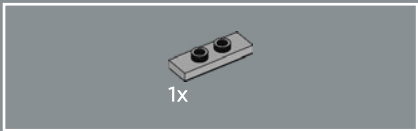
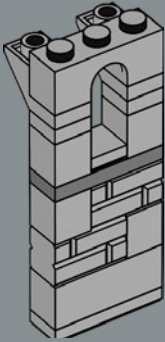

163

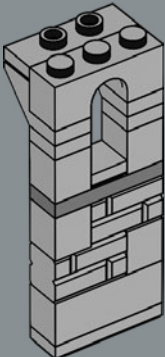

164

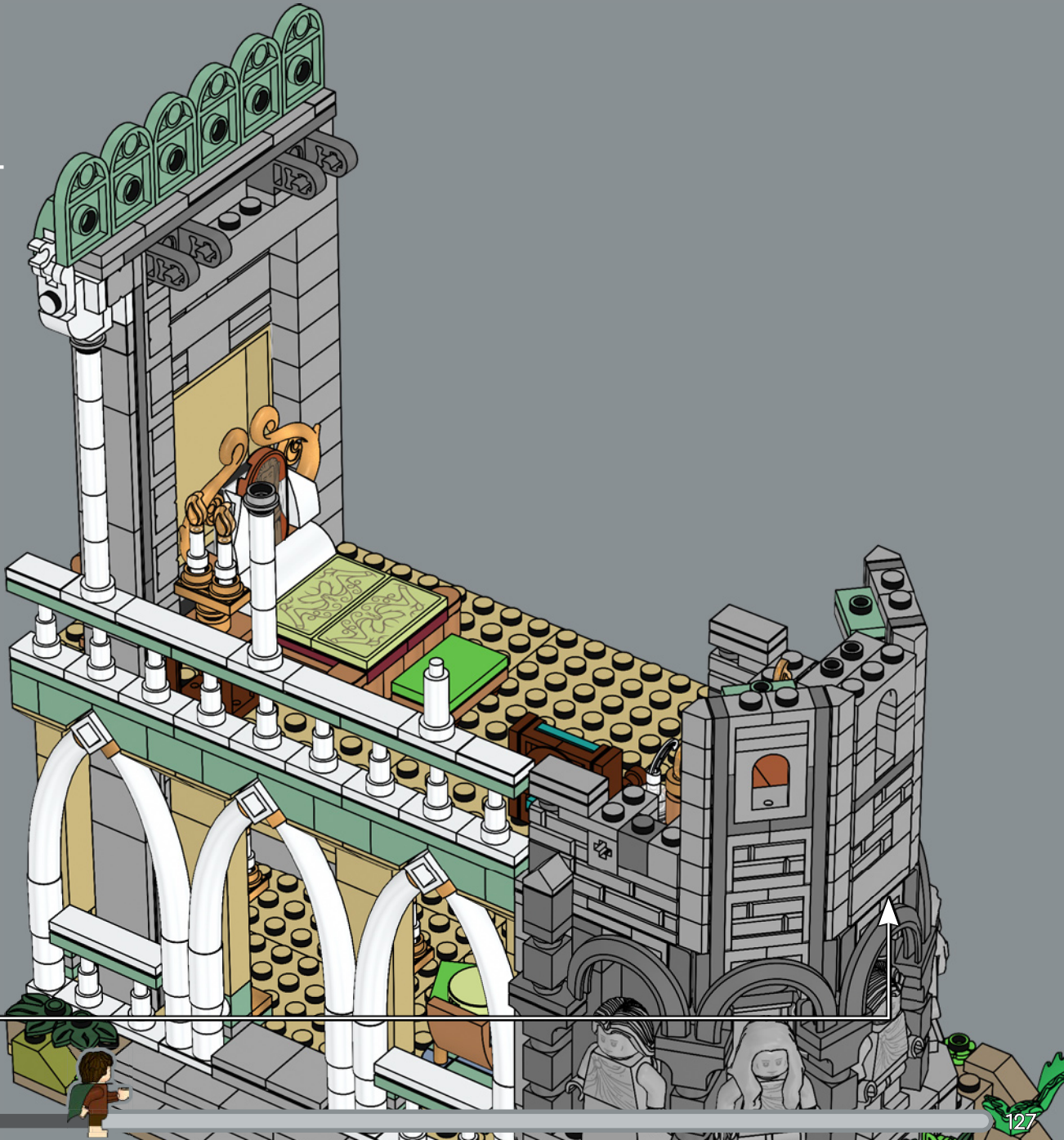

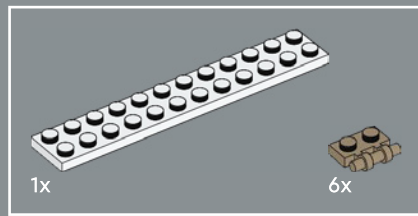

165

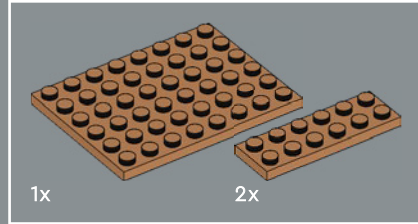
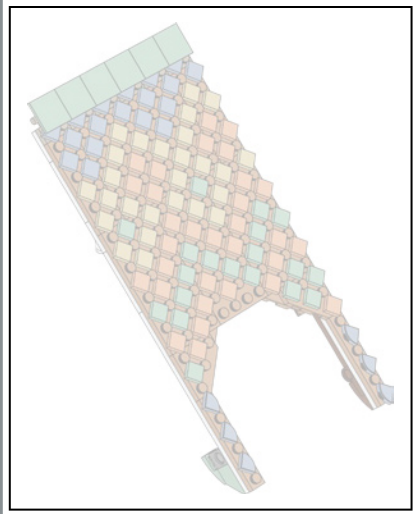
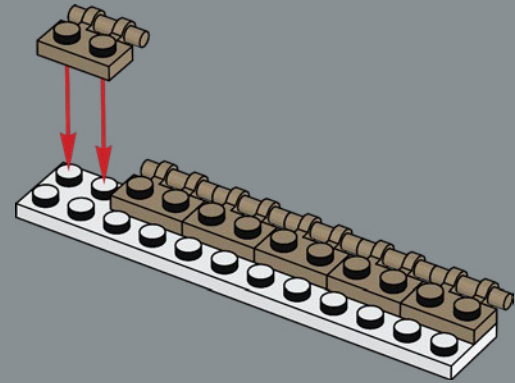

166

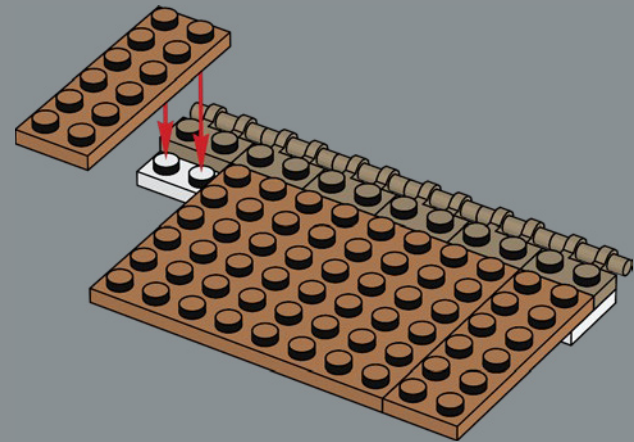

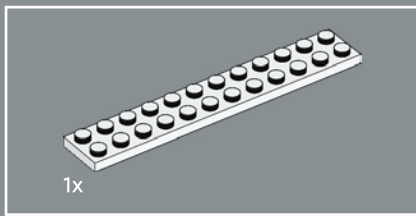

167

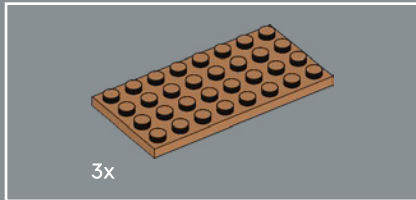
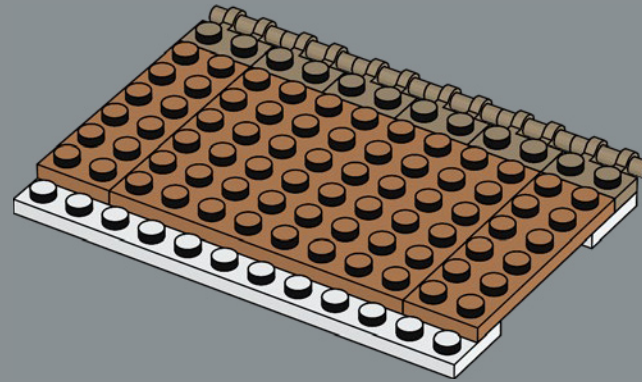

168



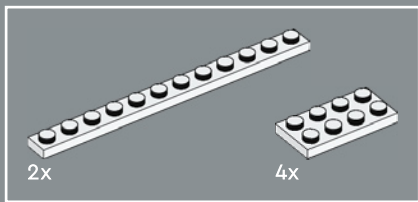

169

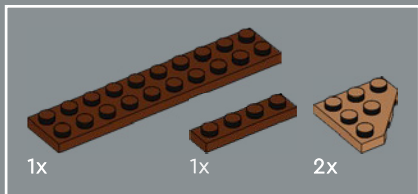
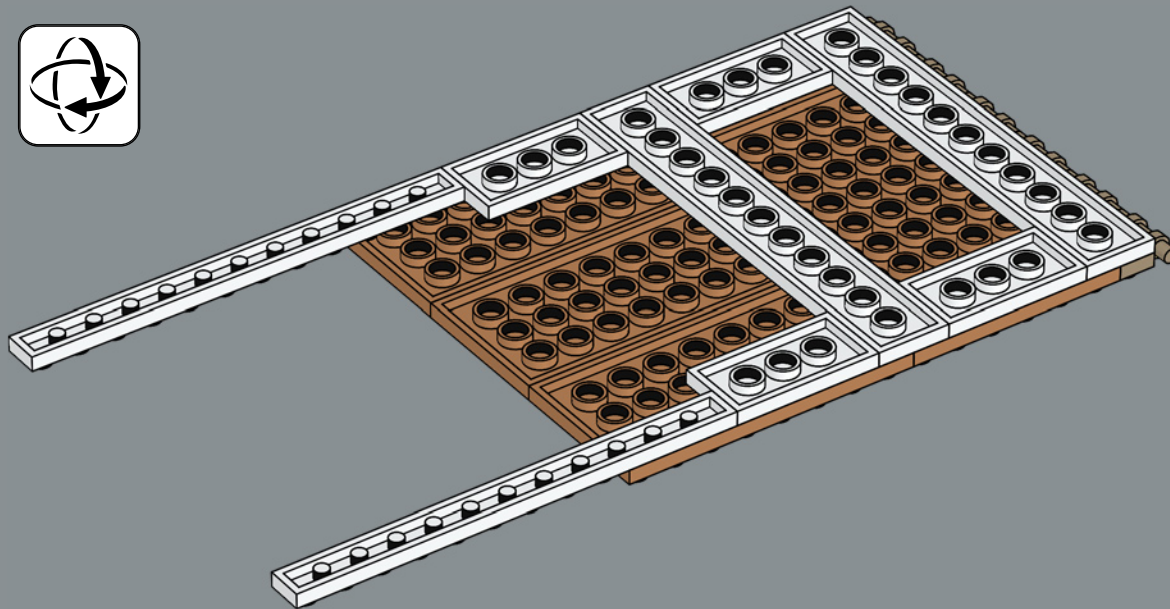

170

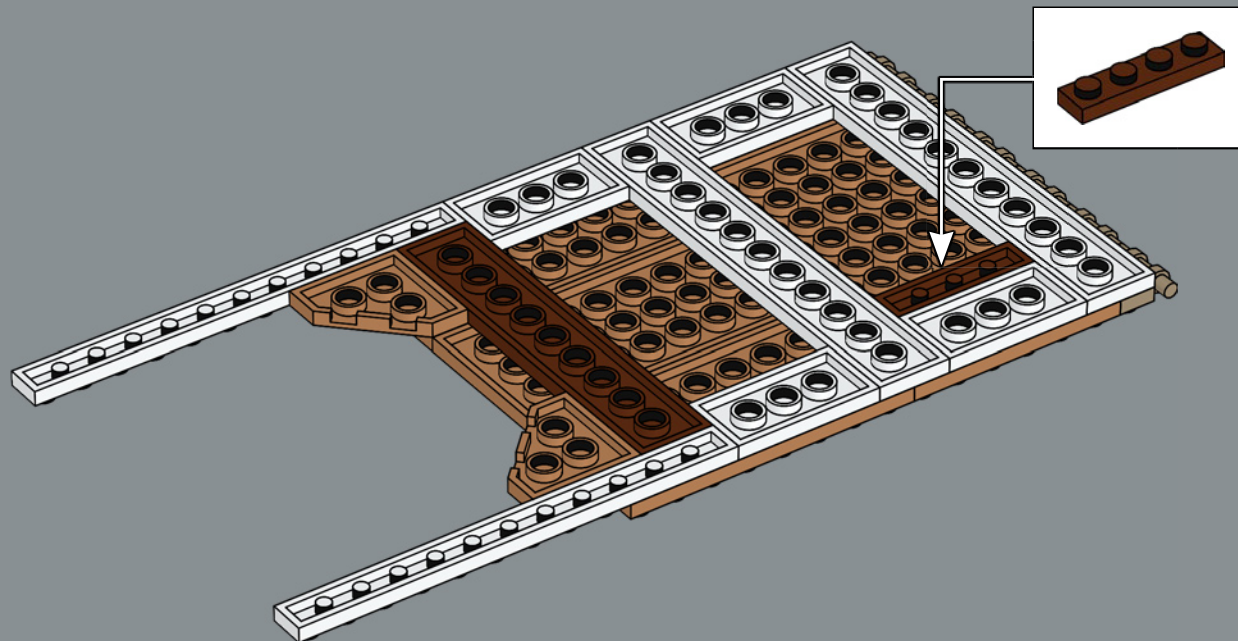

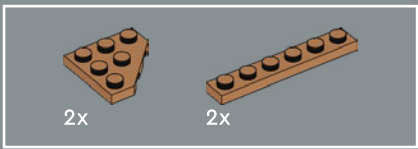

171

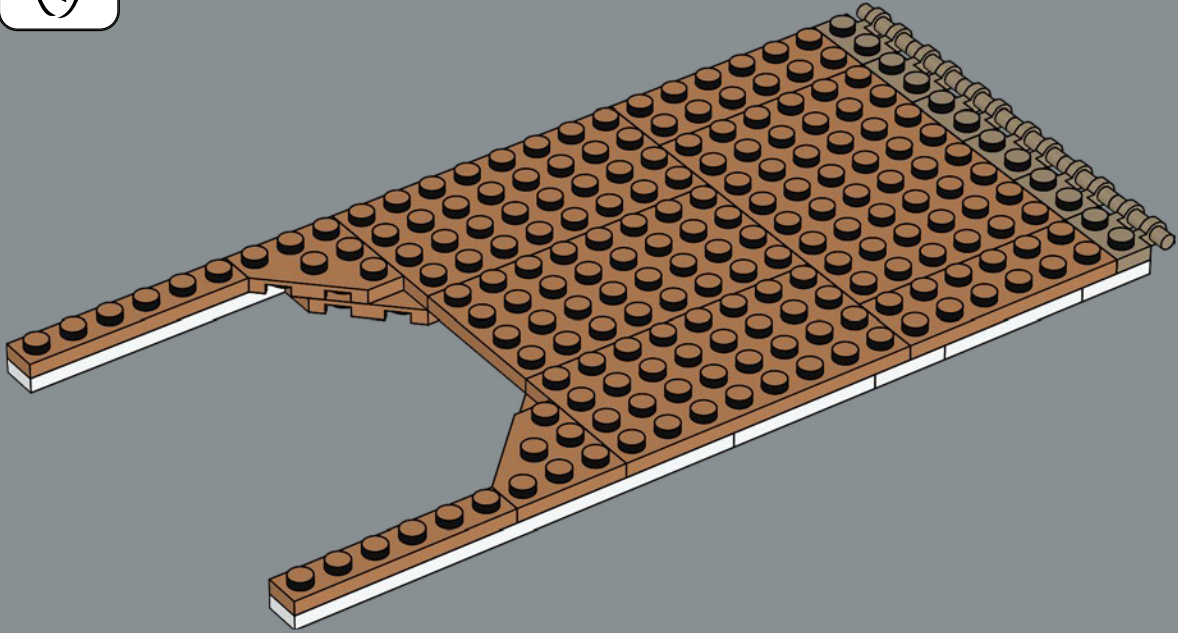



18x



172

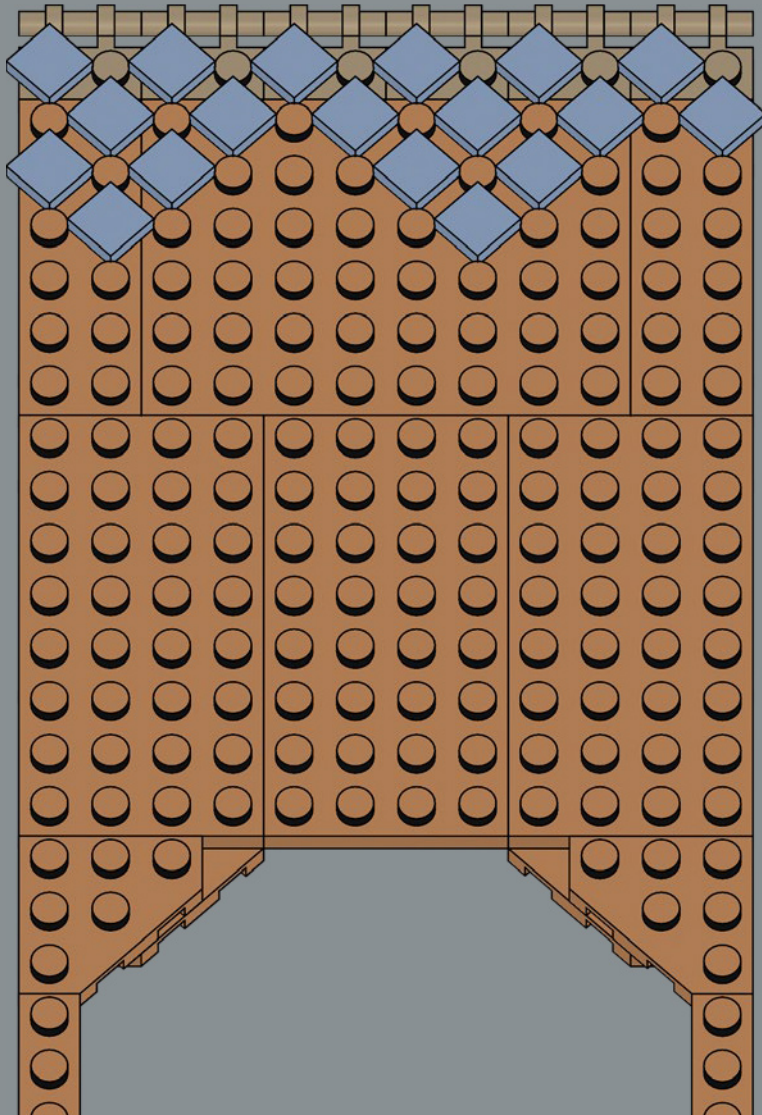

12x



8x

173

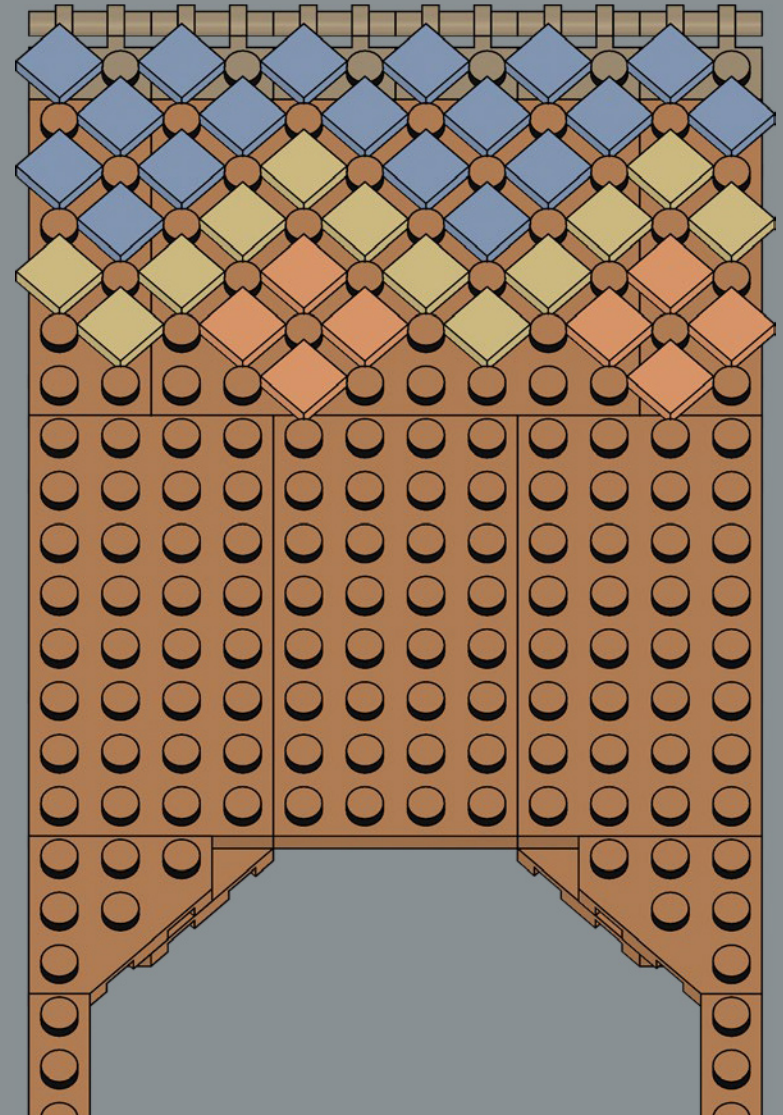

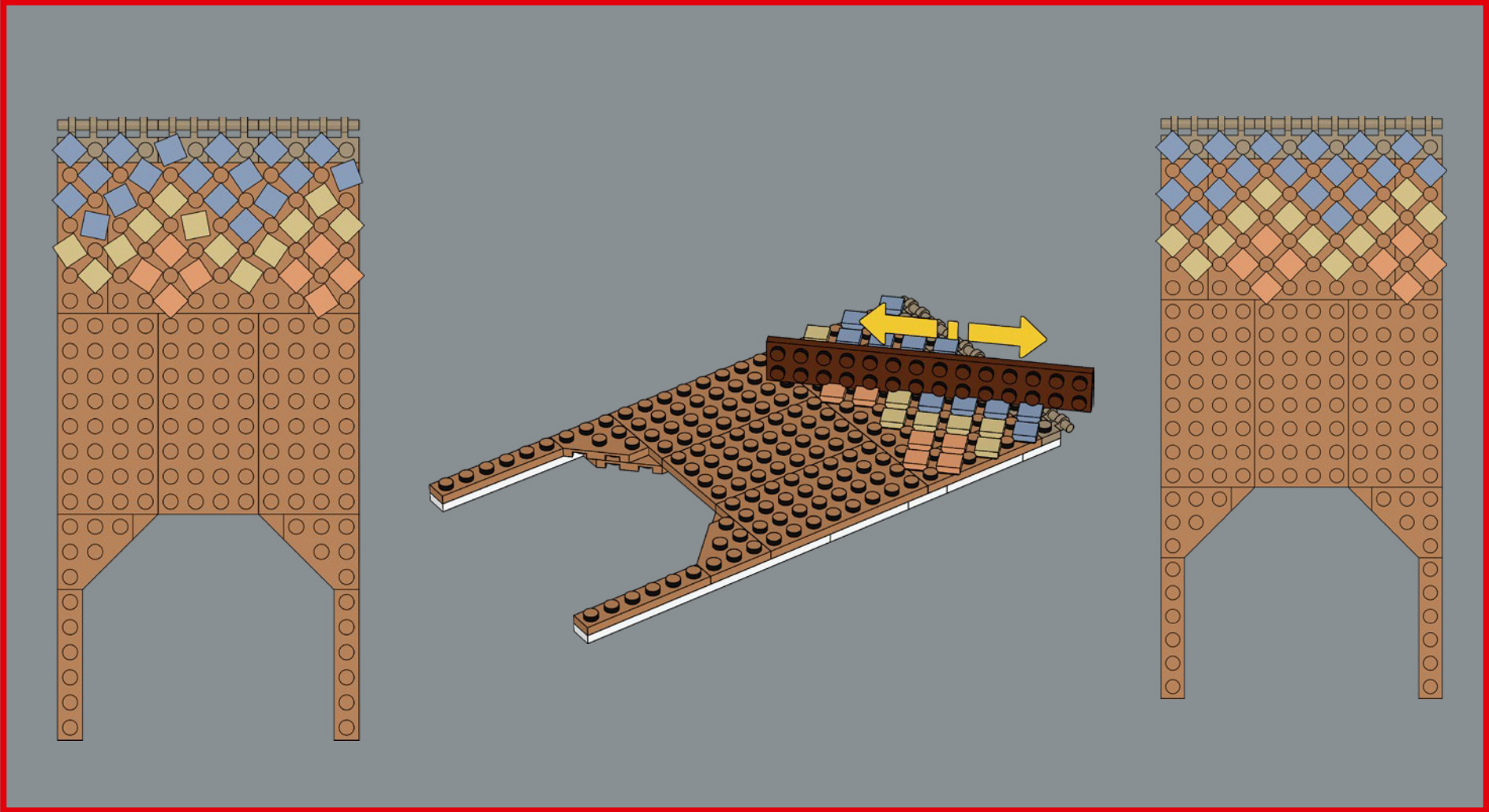



174

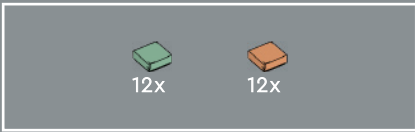
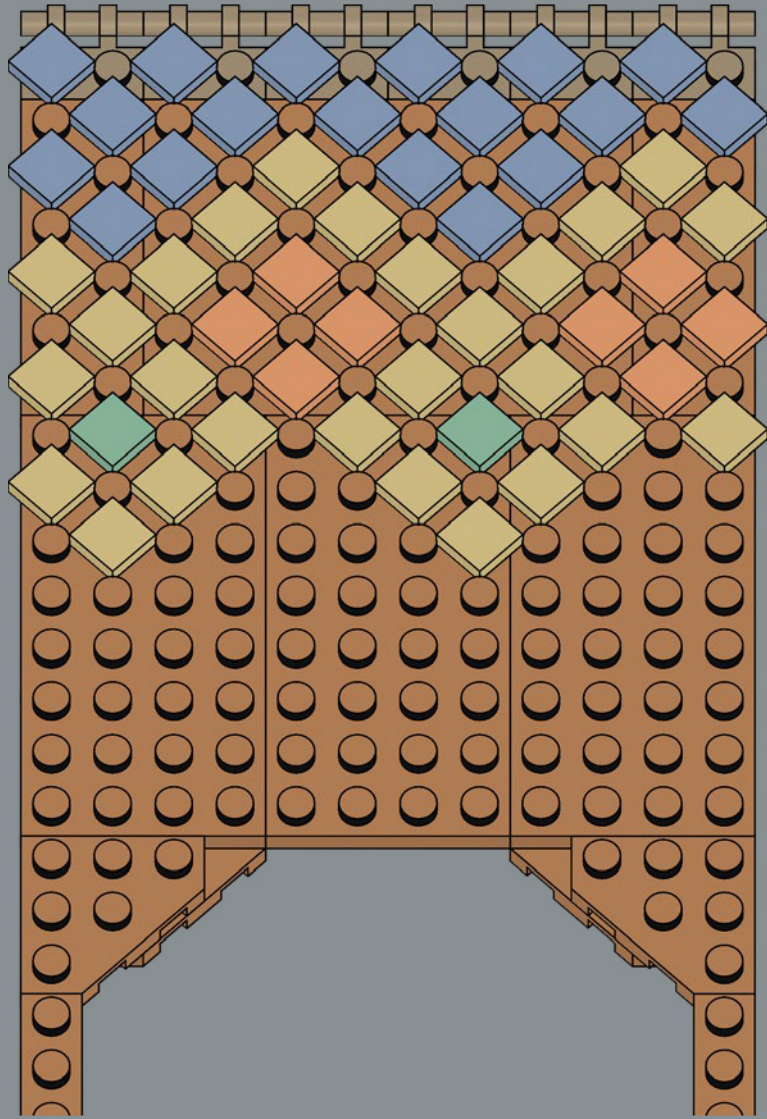

175

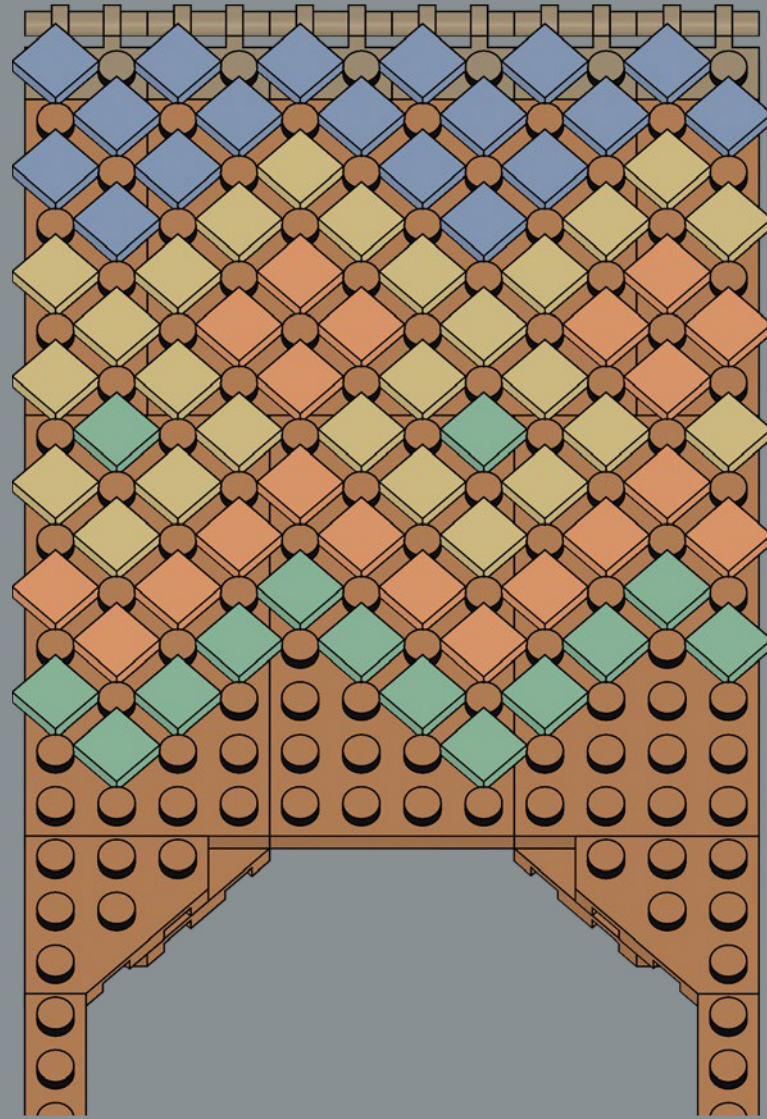



176

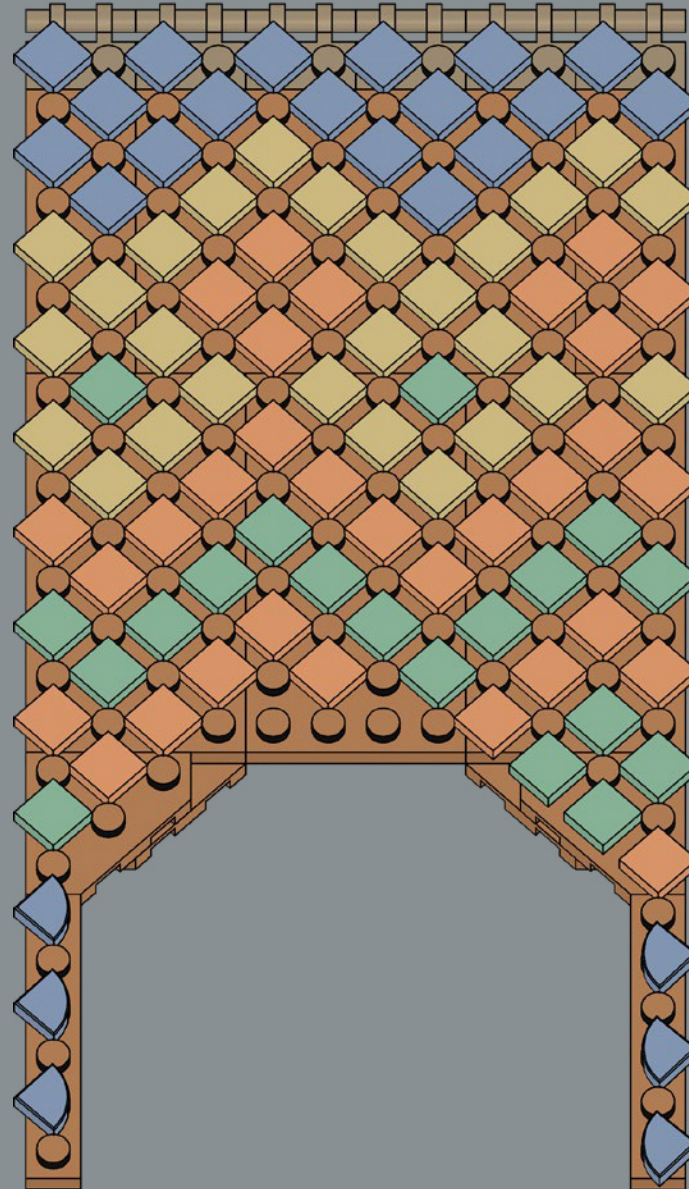

Each of the 94 1×1 tiles of the roof should be mounted at a 45-degree angle. Running a long plate or tile through the grooves once the parts are in place is a great way to align them all.

Chacune des 94 tuiles 1×1 du toit doit être posée à un angle de 45 degrés. Passer une longue plaque ou tuile dans les rainures une fois que les pièces sont en place est un excellent moyen de toutes les aligner.

Cada una de las 94 cubiertas 1×1 del techo debe colocarse en un ángulo de 45 grados. Pasar una placa o cubierta larga por las ranuras una vez que las piezas están colocadas en su lugar es una fantástica manera de alinearlas.





6x

177

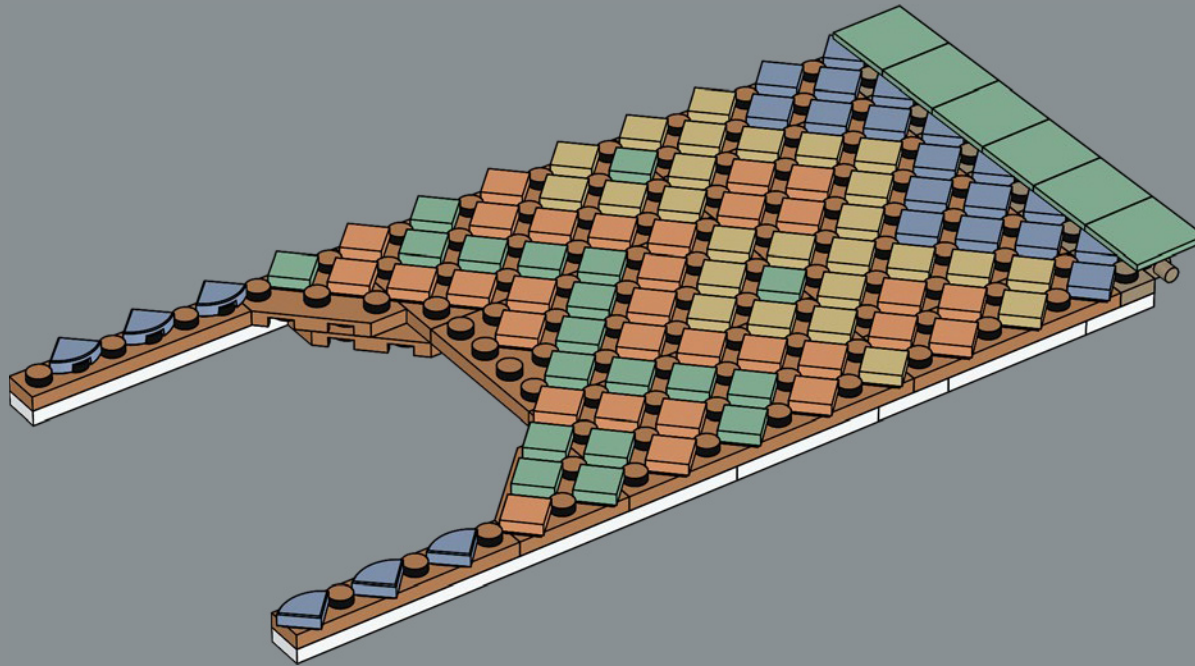

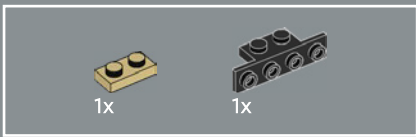

178

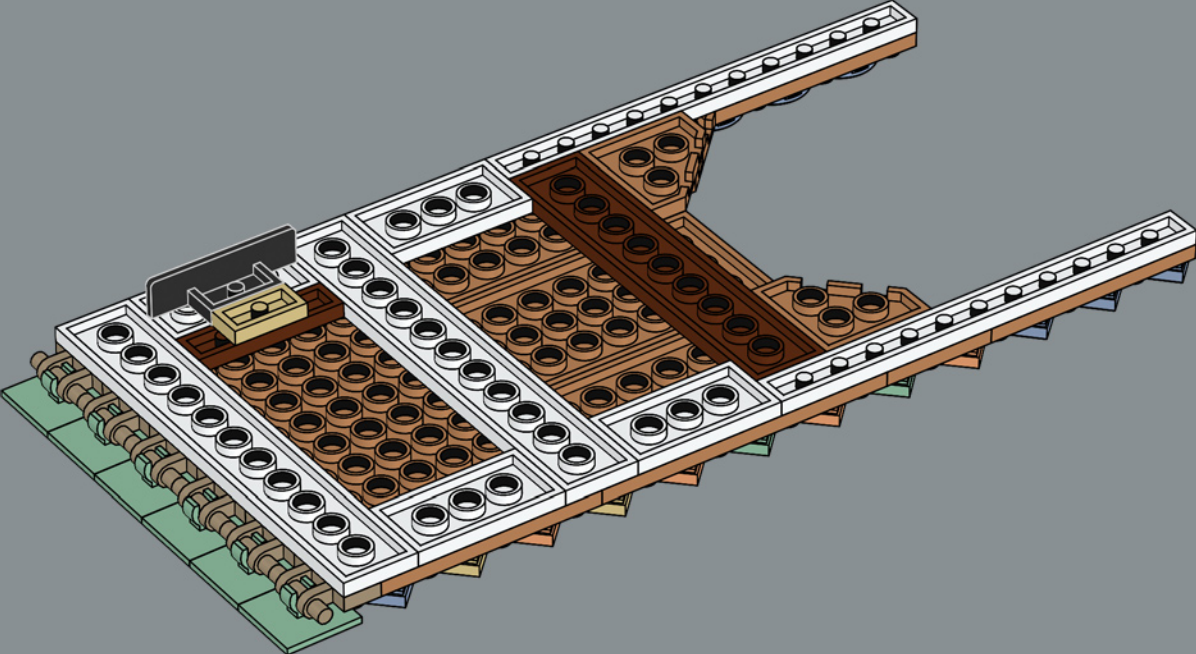



179

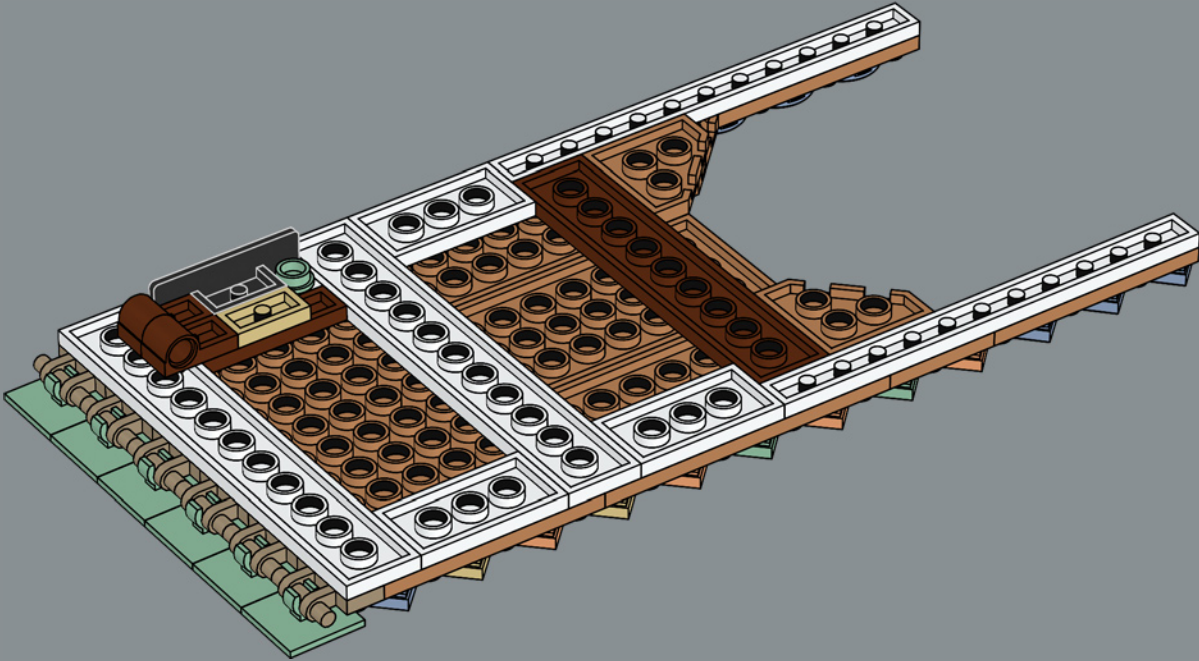

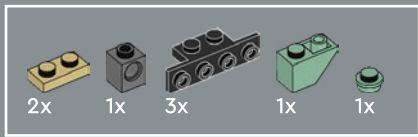

180

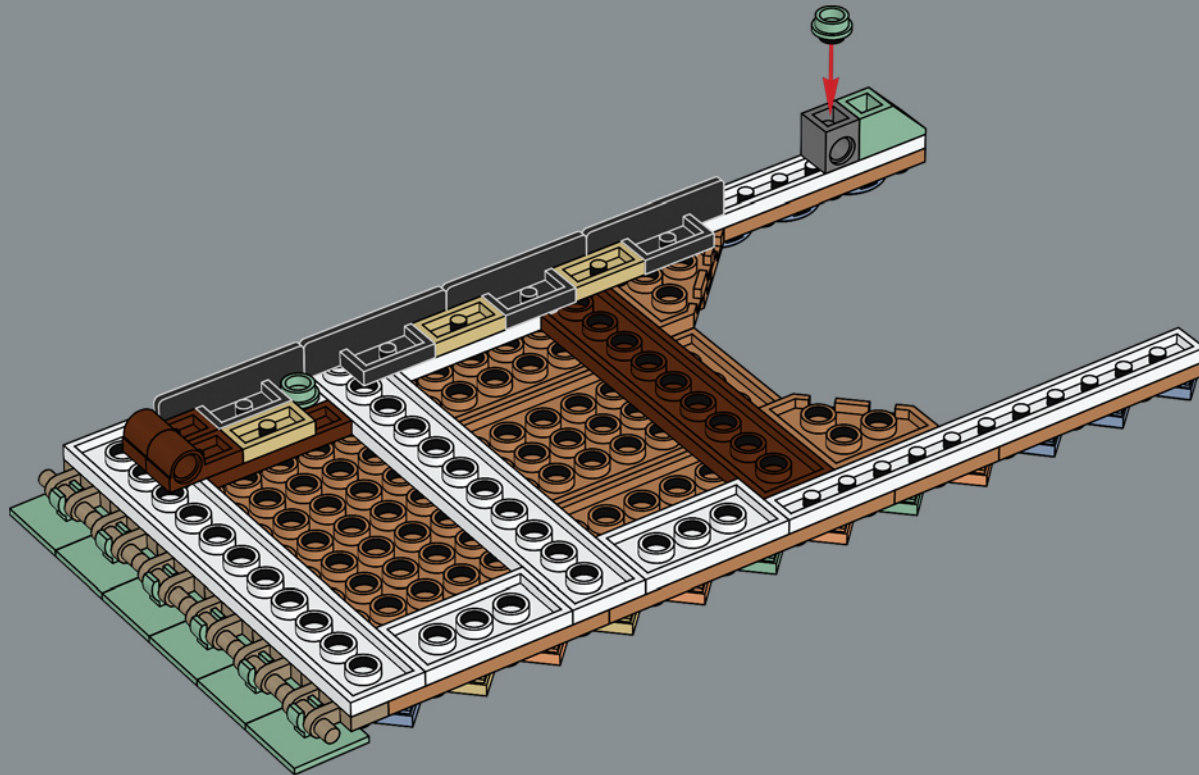

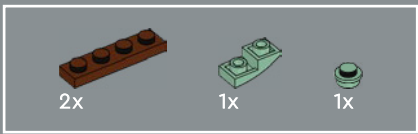

181

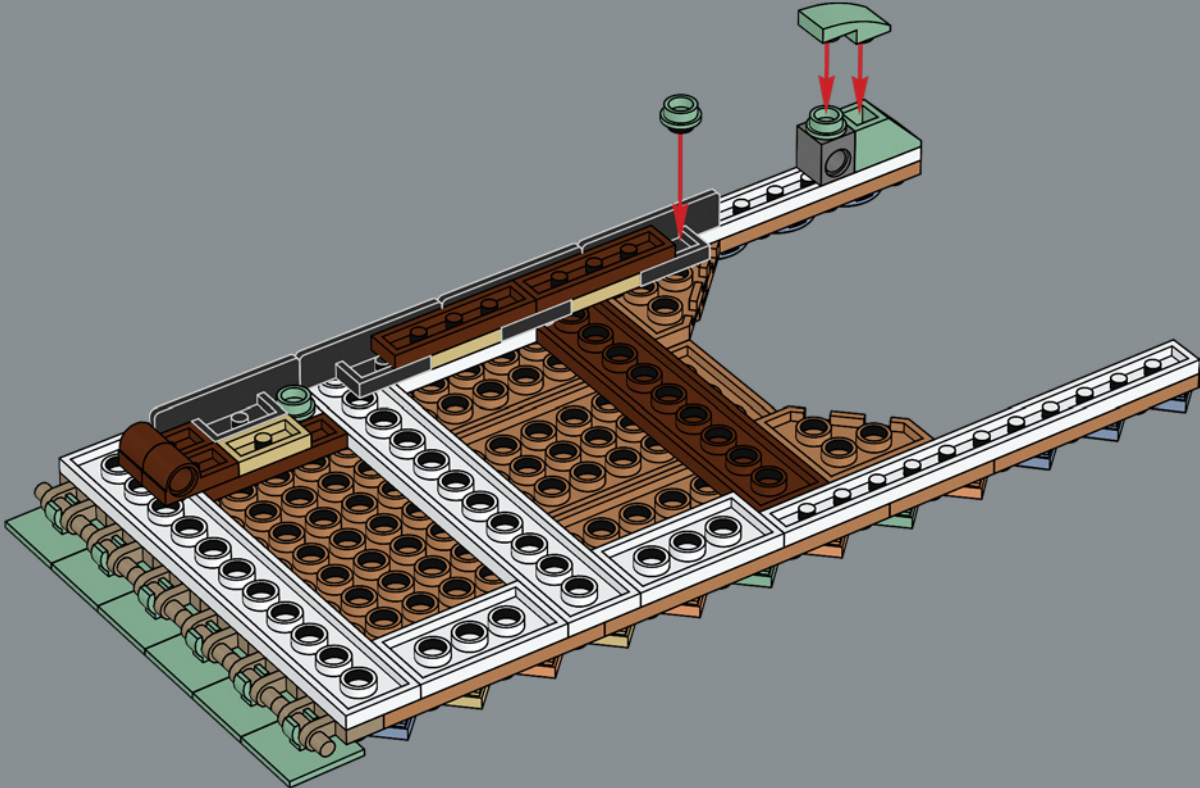

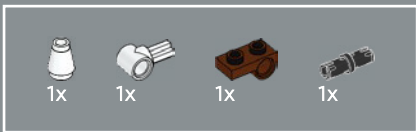

182

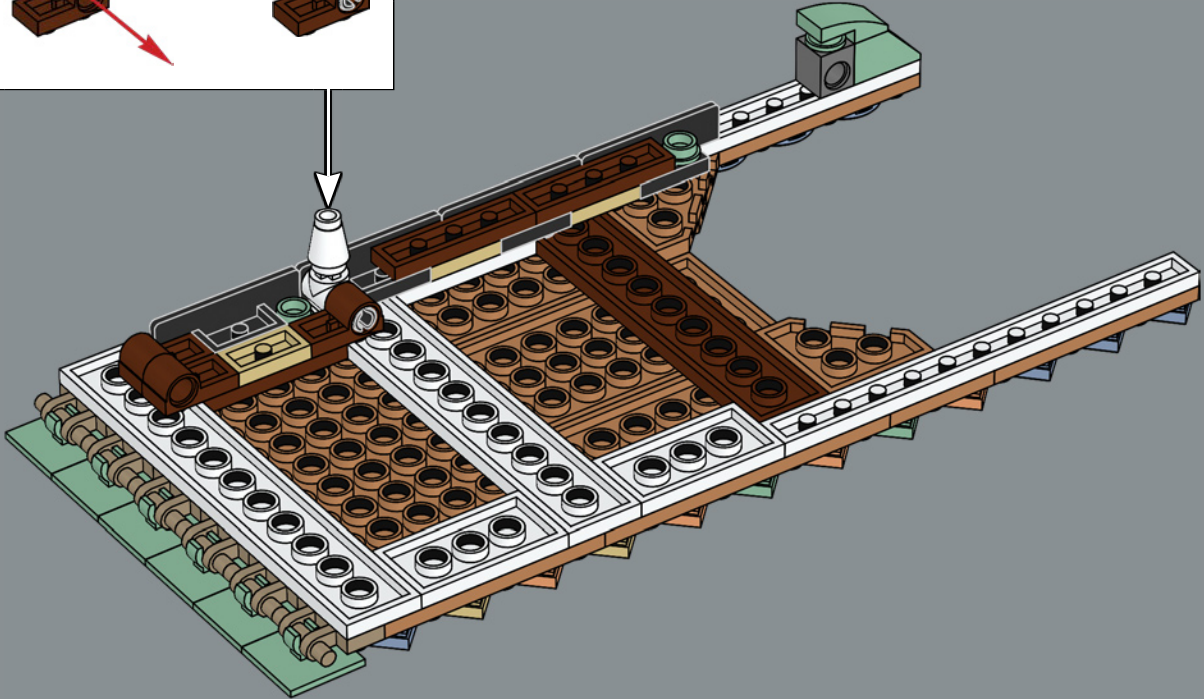
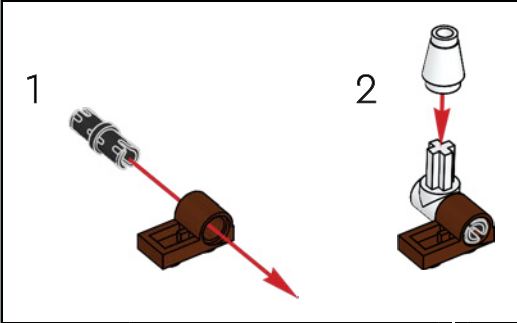

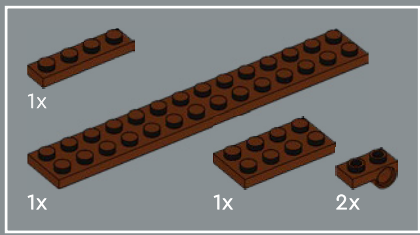

183

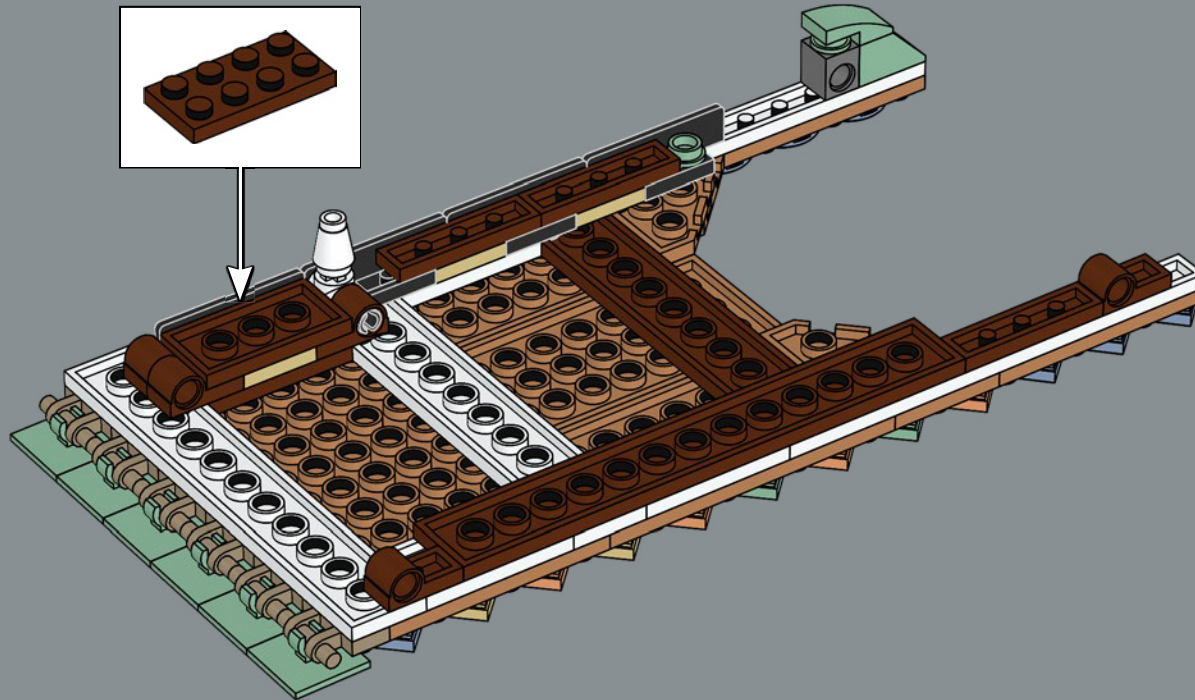

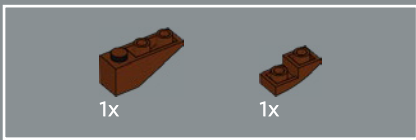

184

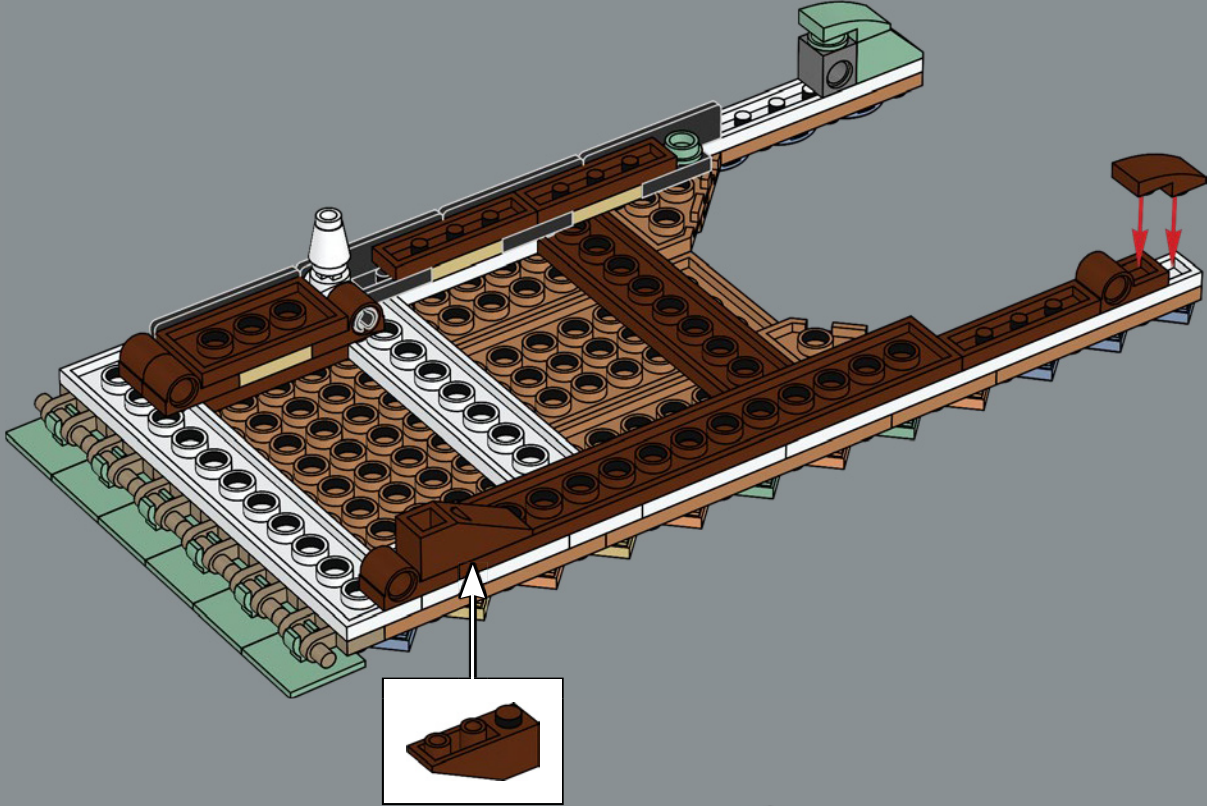

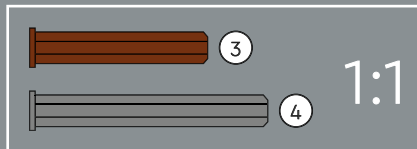
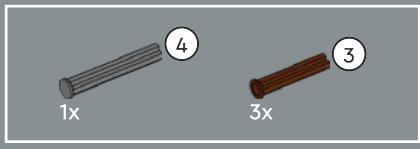

185

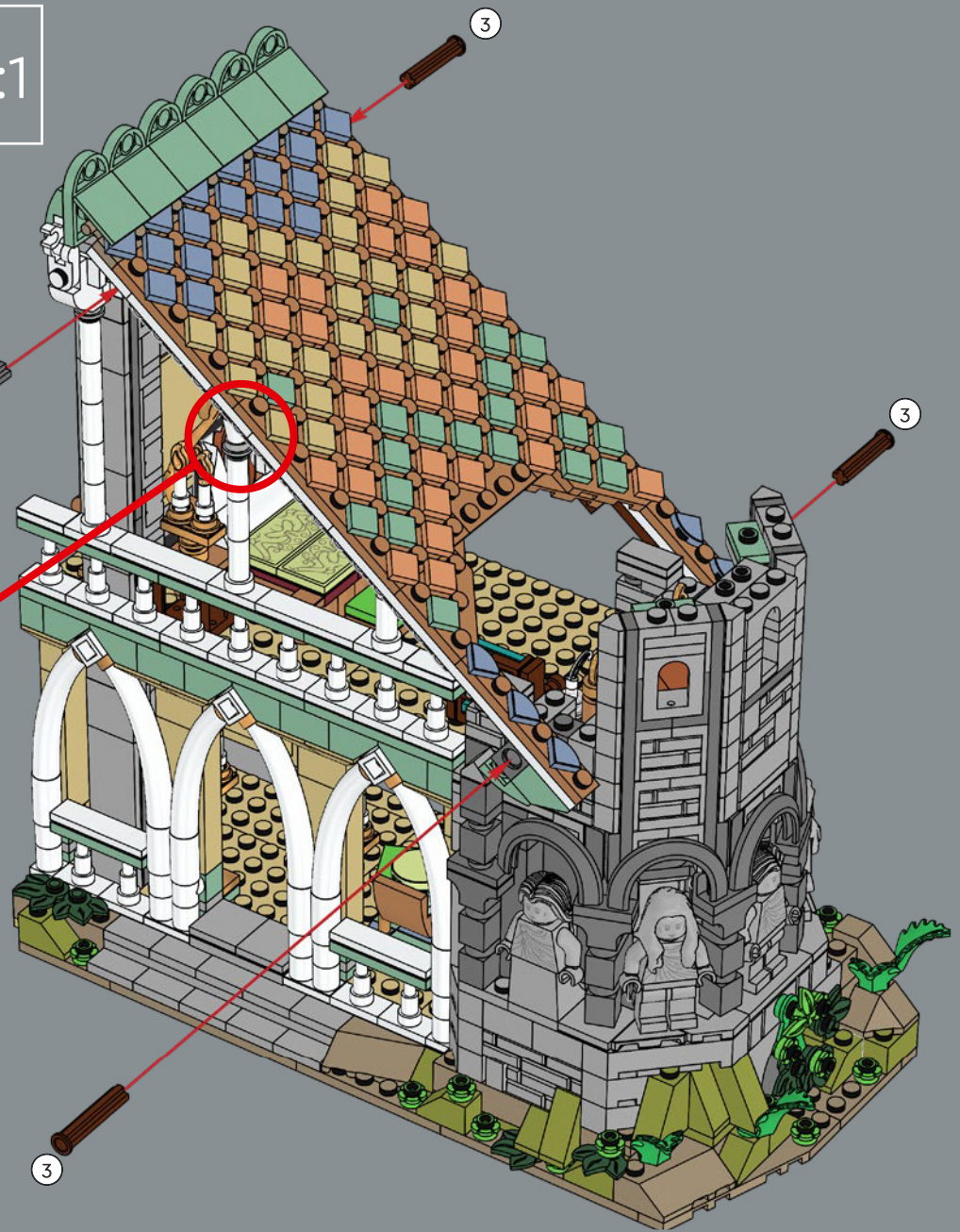
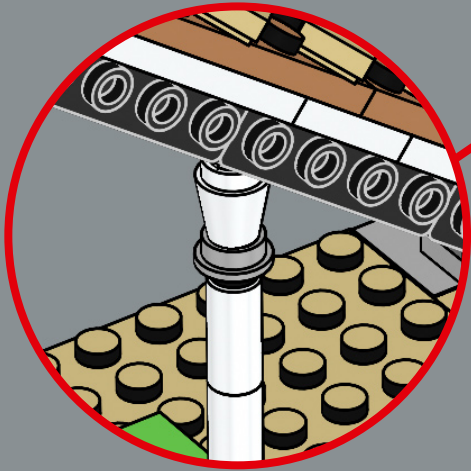
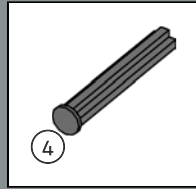

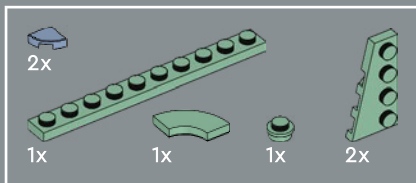

186

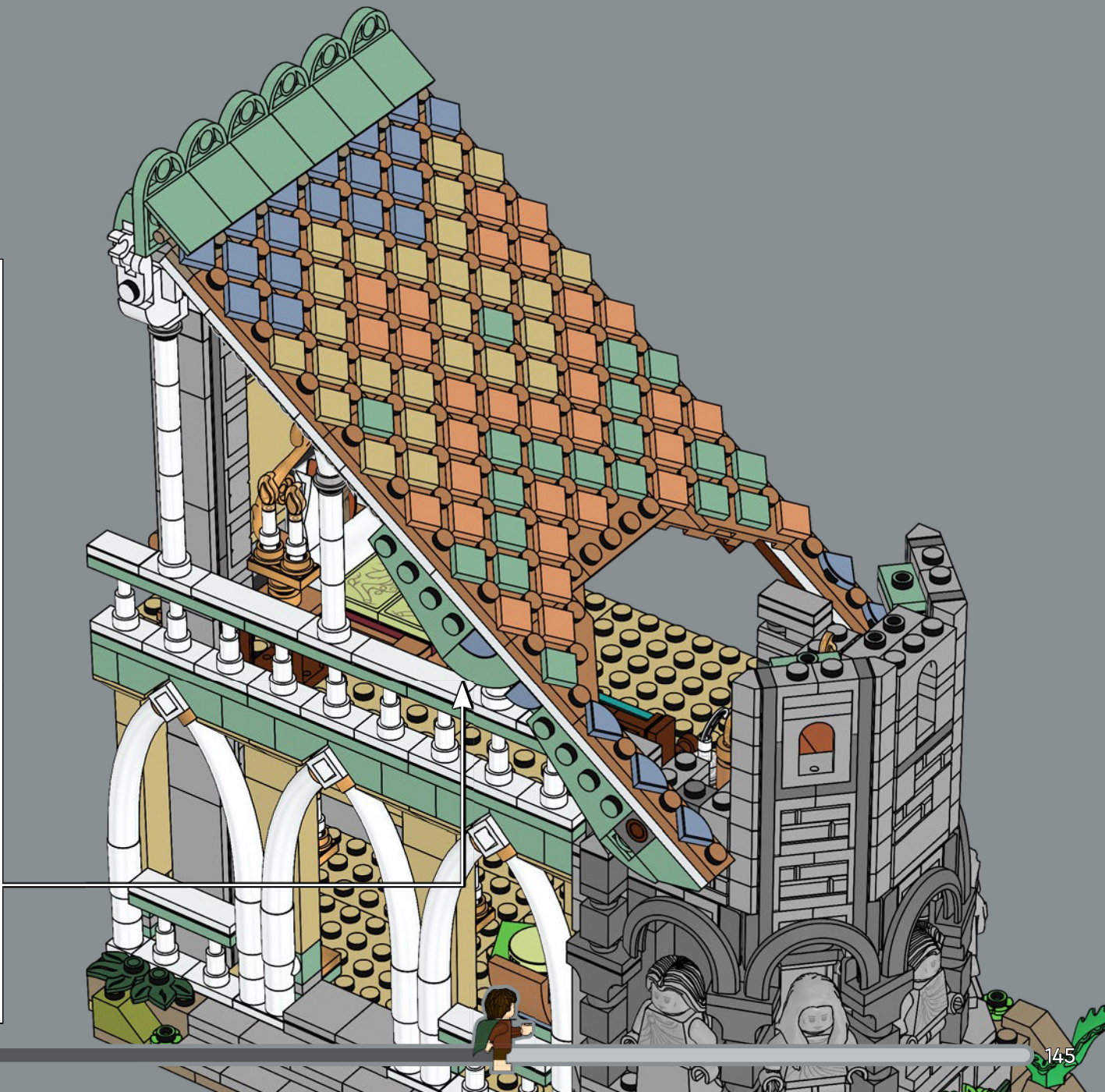
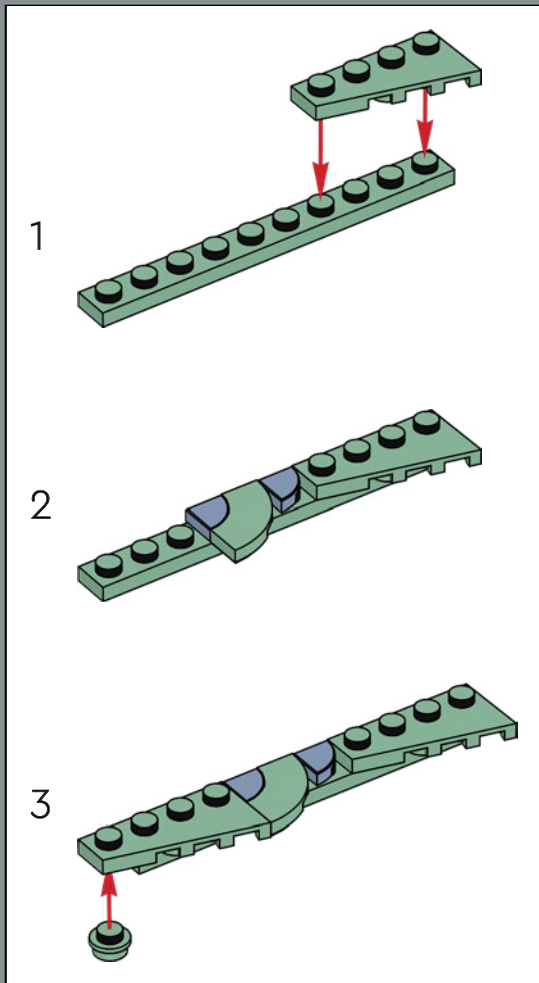

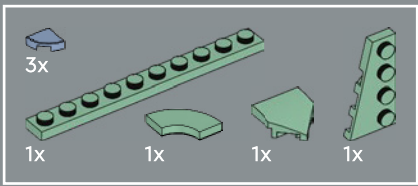

187

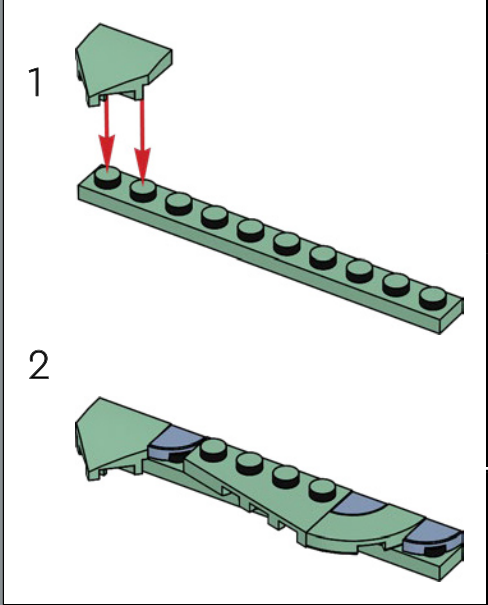

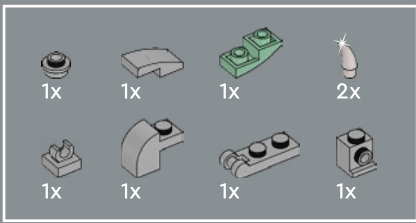

188

1

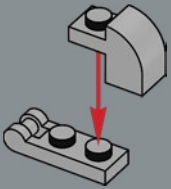

2

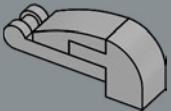

3

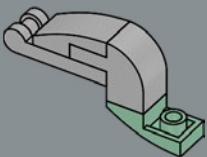

4

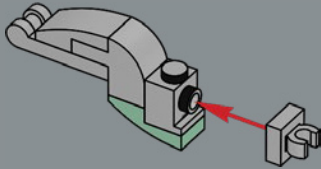

5

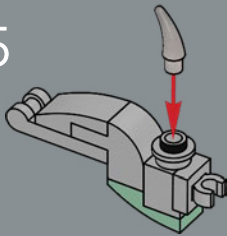

6

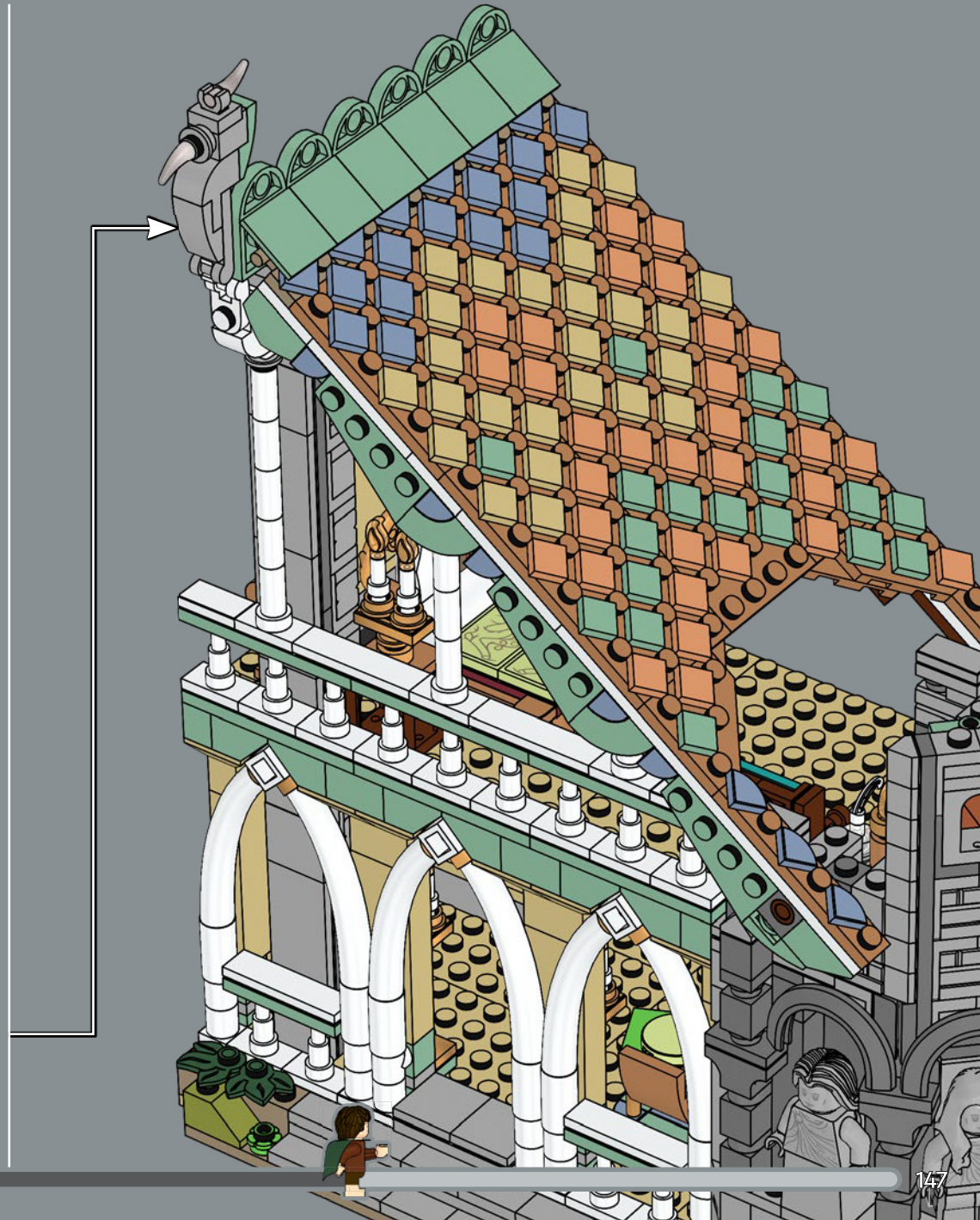
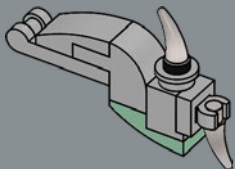

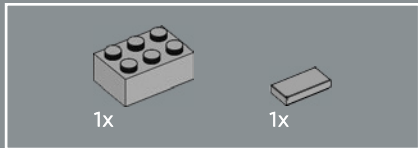

189

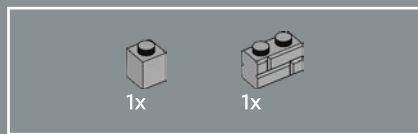
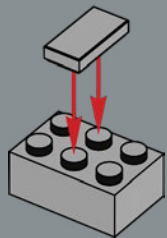

190

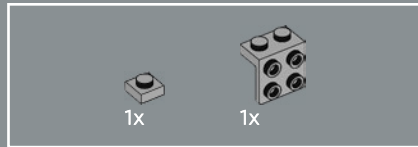
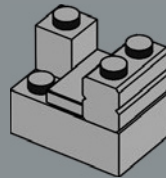

191

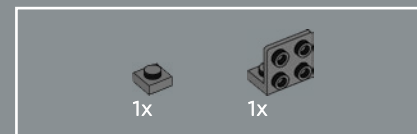
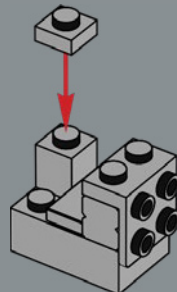

192

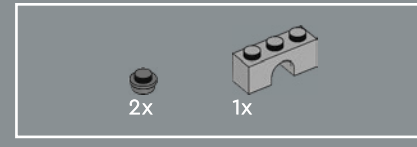
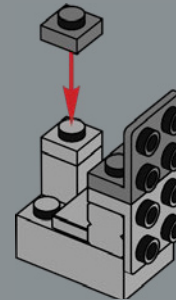

193

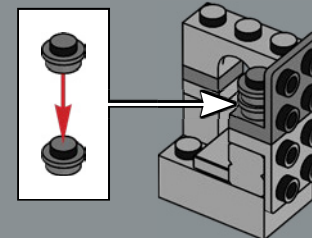

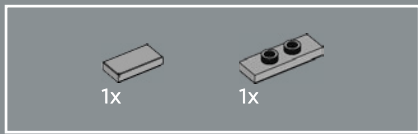

194

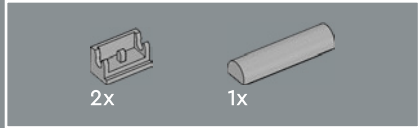
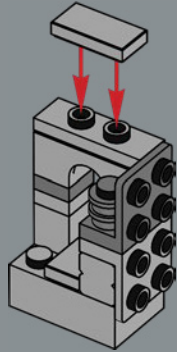

195

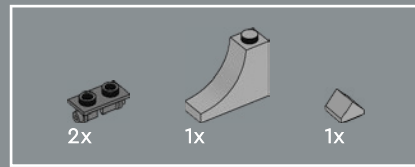
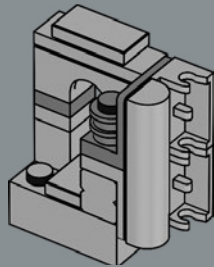

196

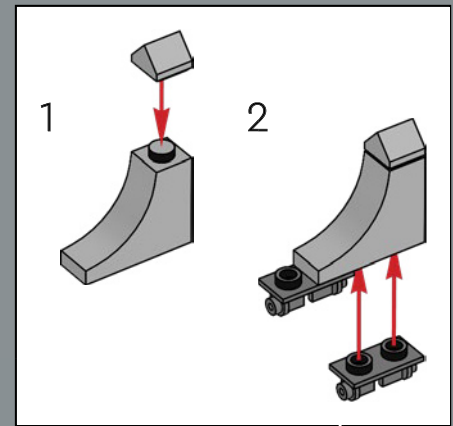
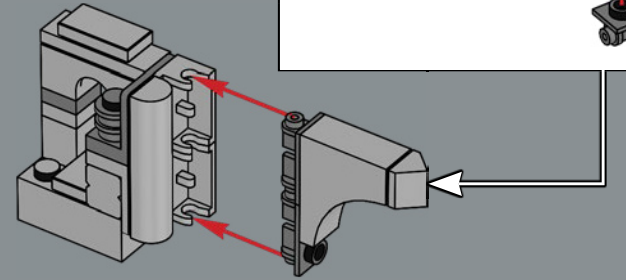

197

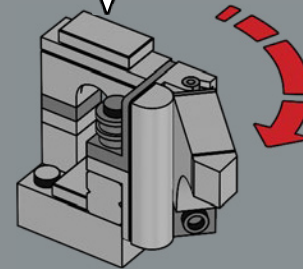



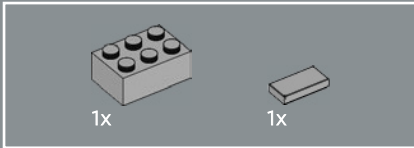
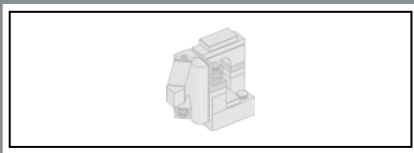

199

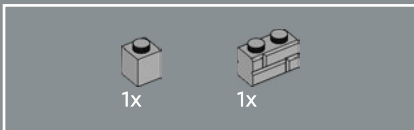
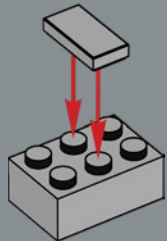

200

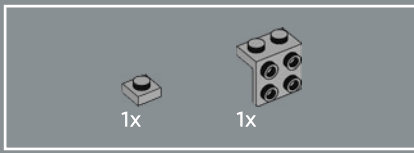
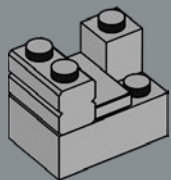

201

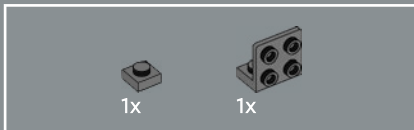
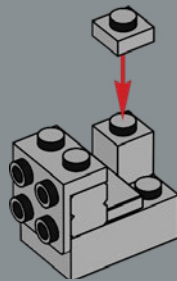

202

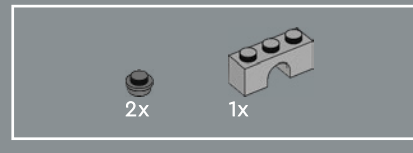
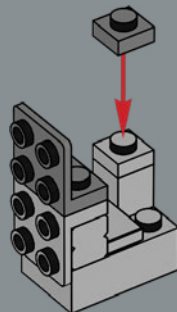

203

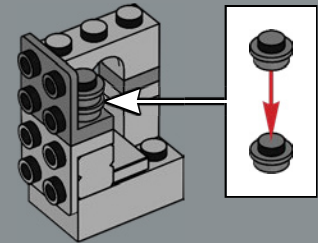

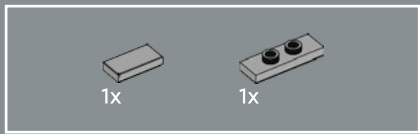

204

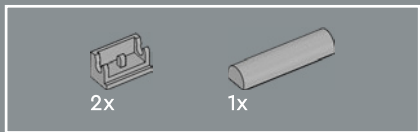
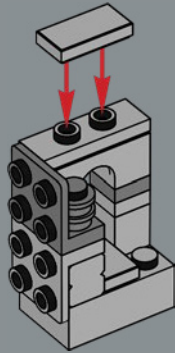

205

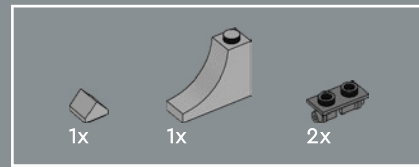
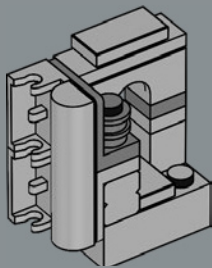

206

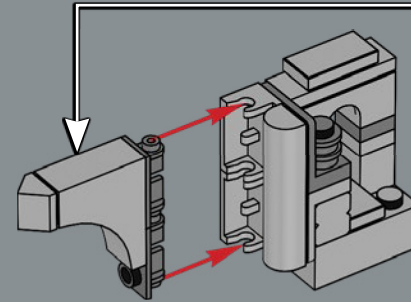
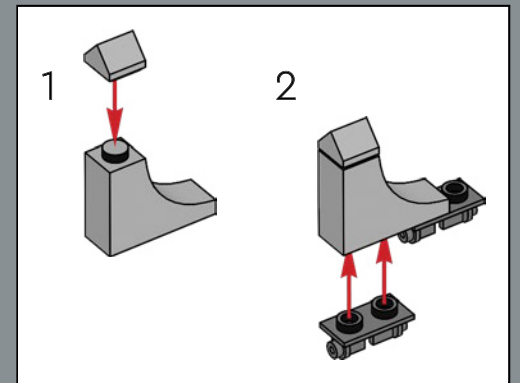

207

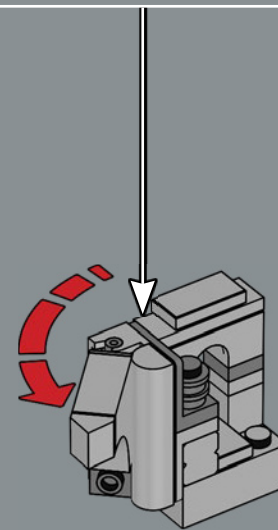

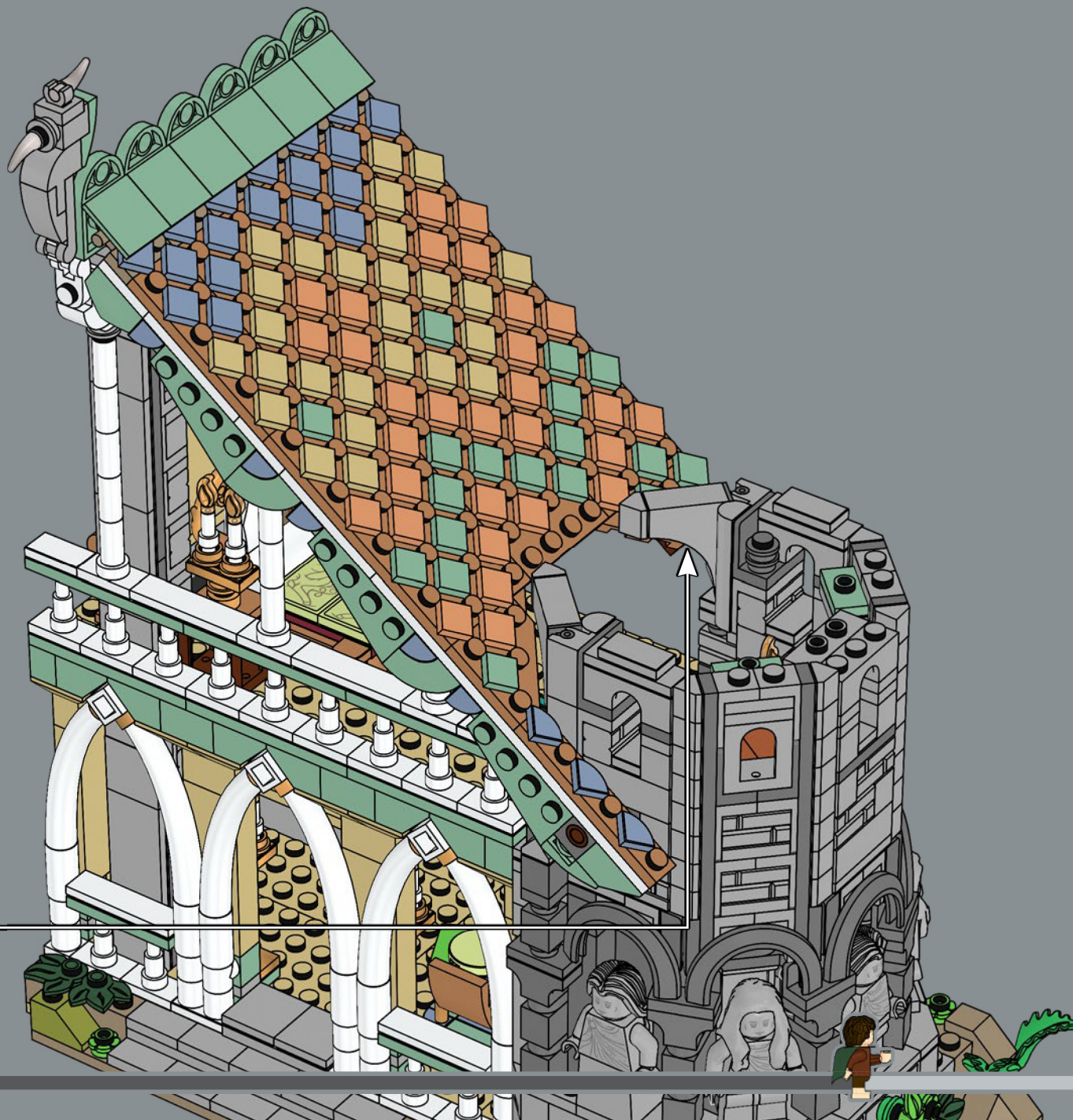

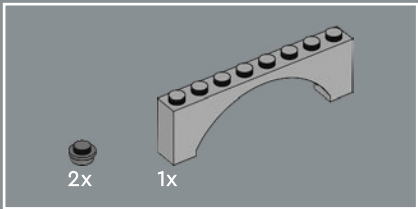

209

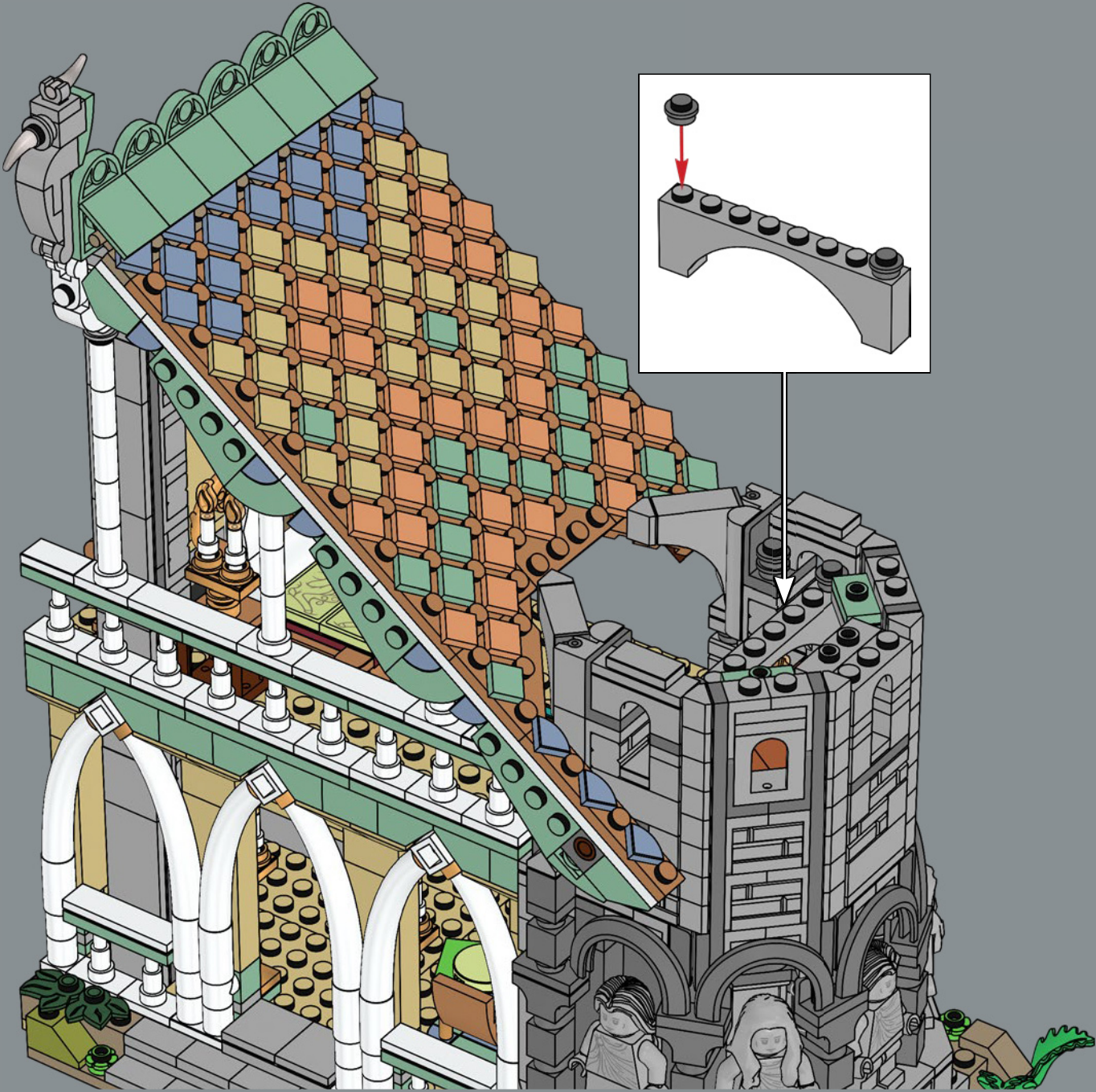

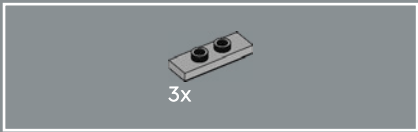

210

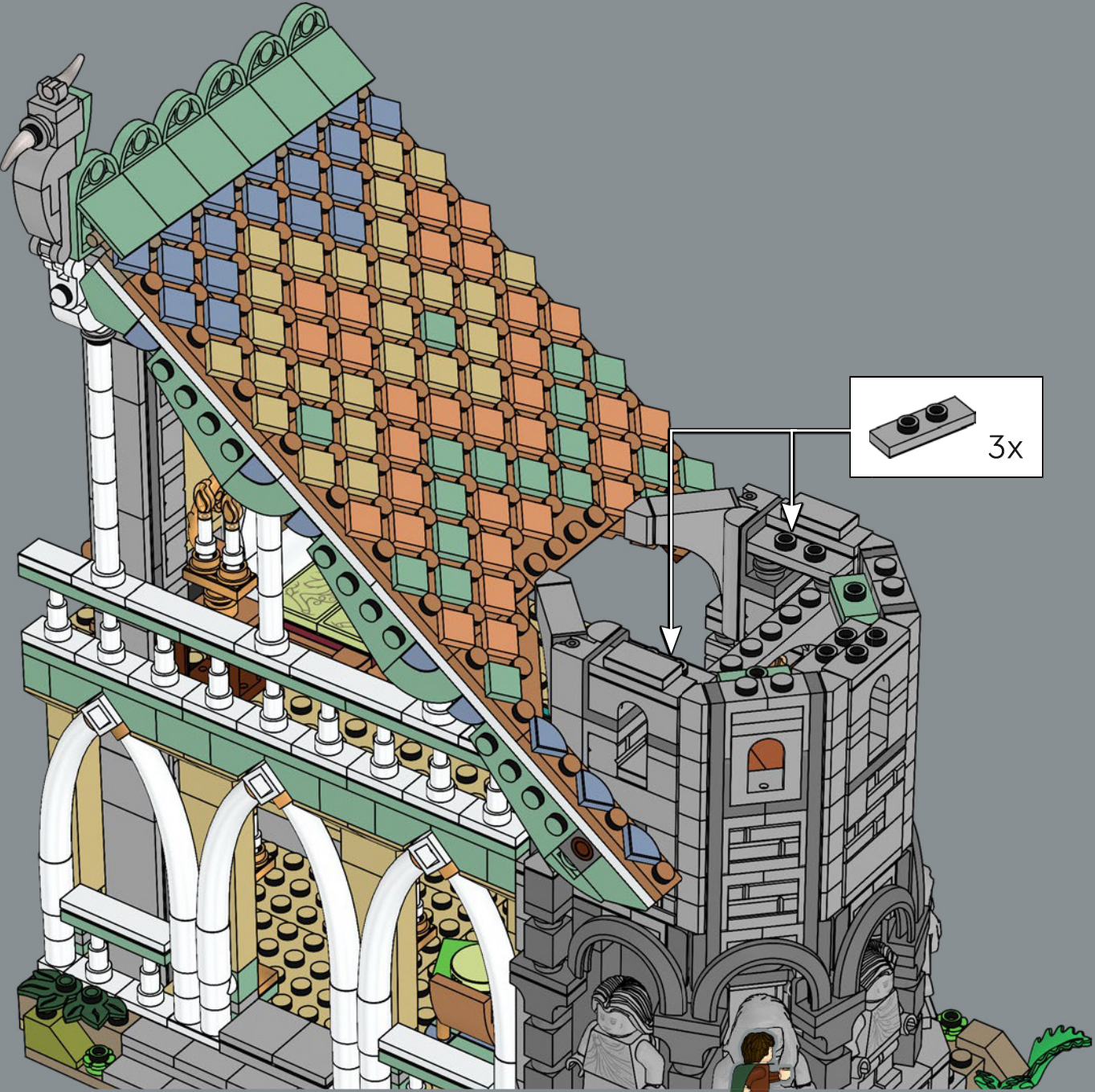



211

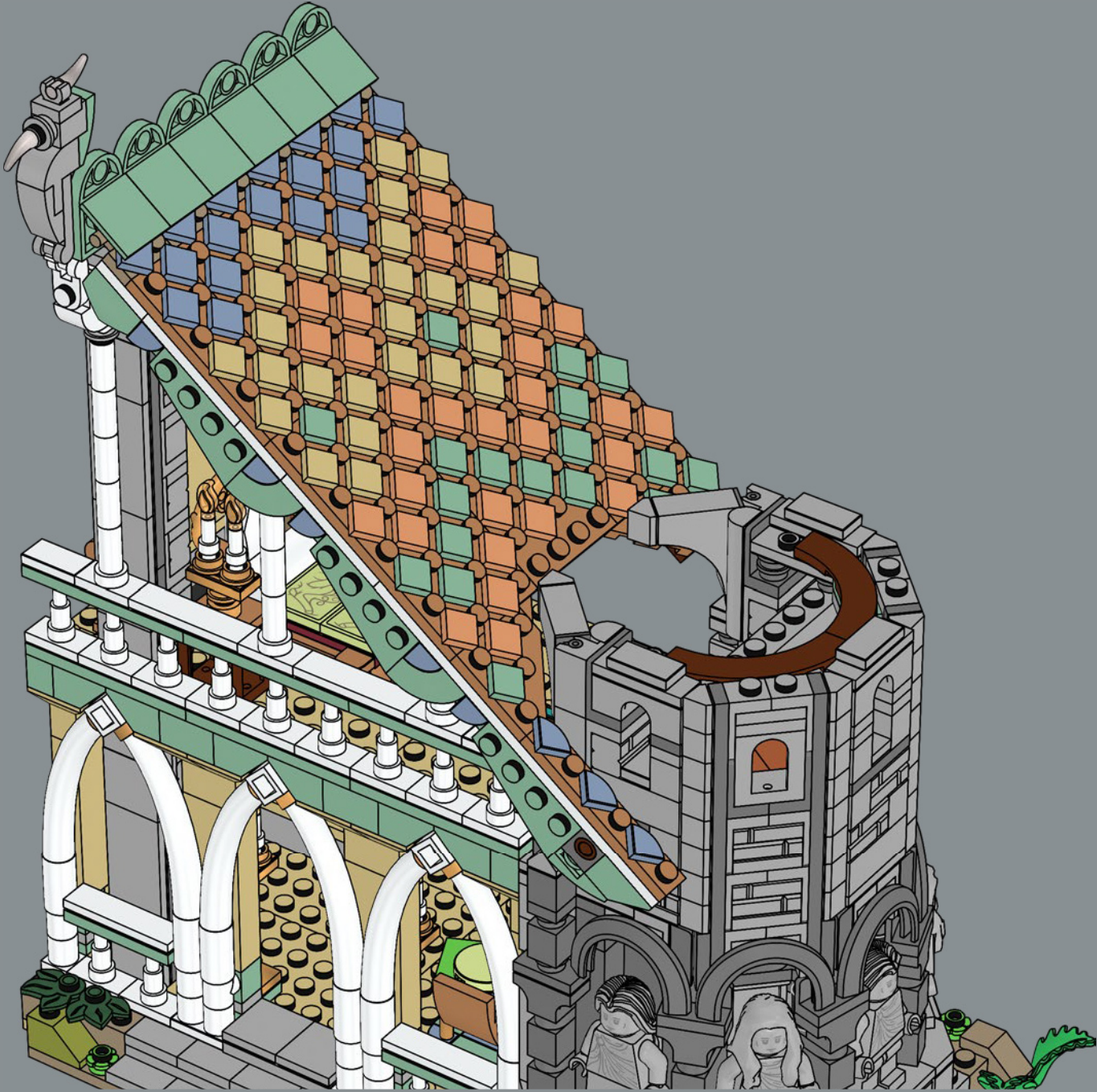

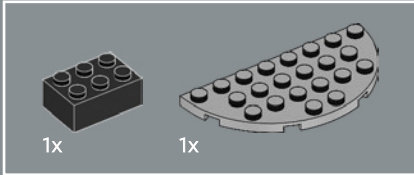
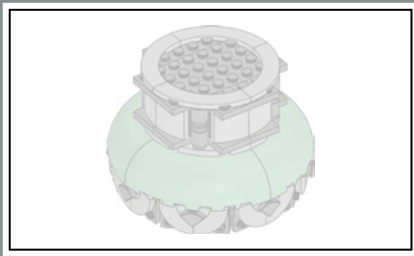

212

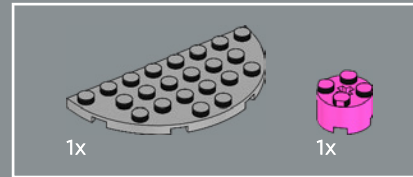
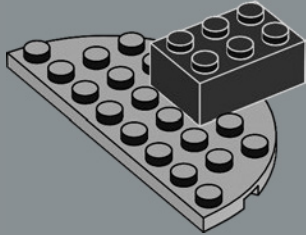

213

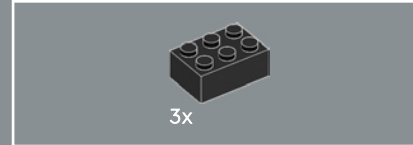
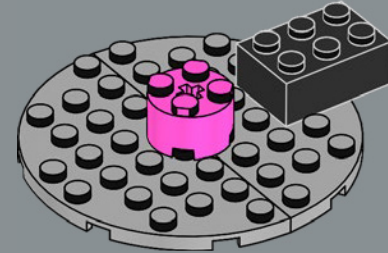

214

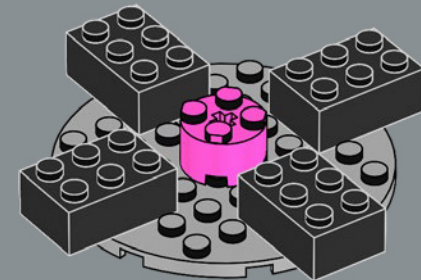

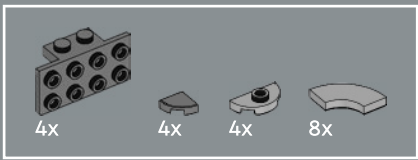

215

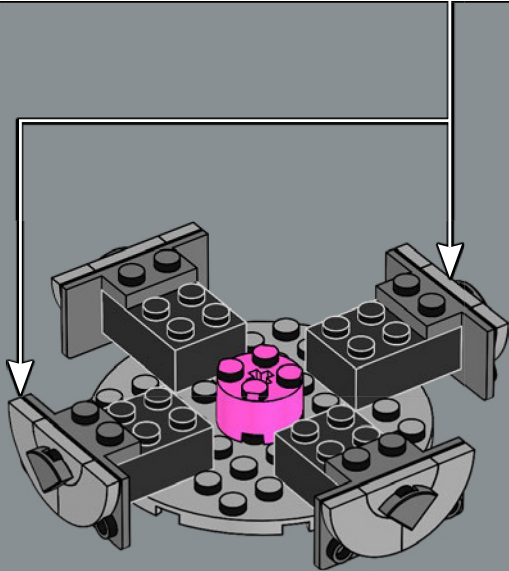
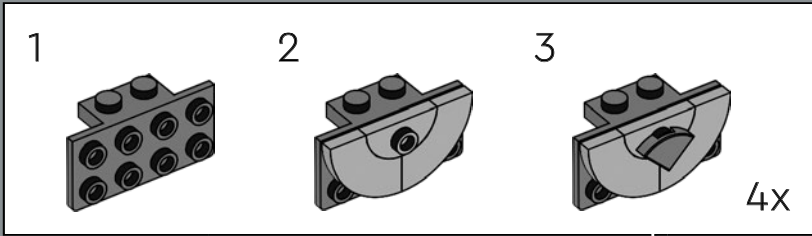

216

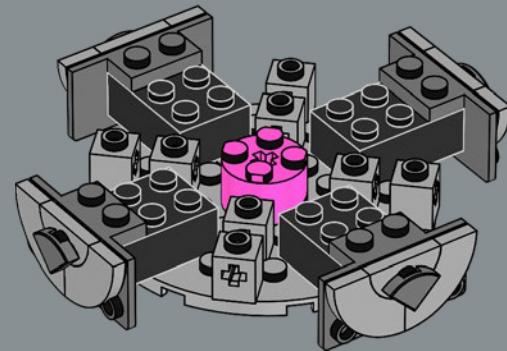

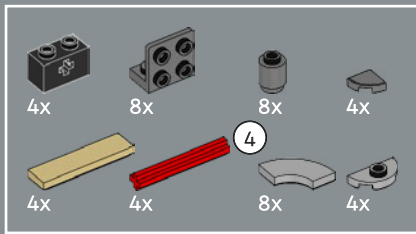

217

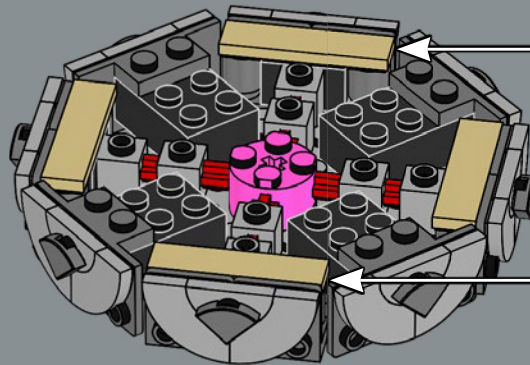
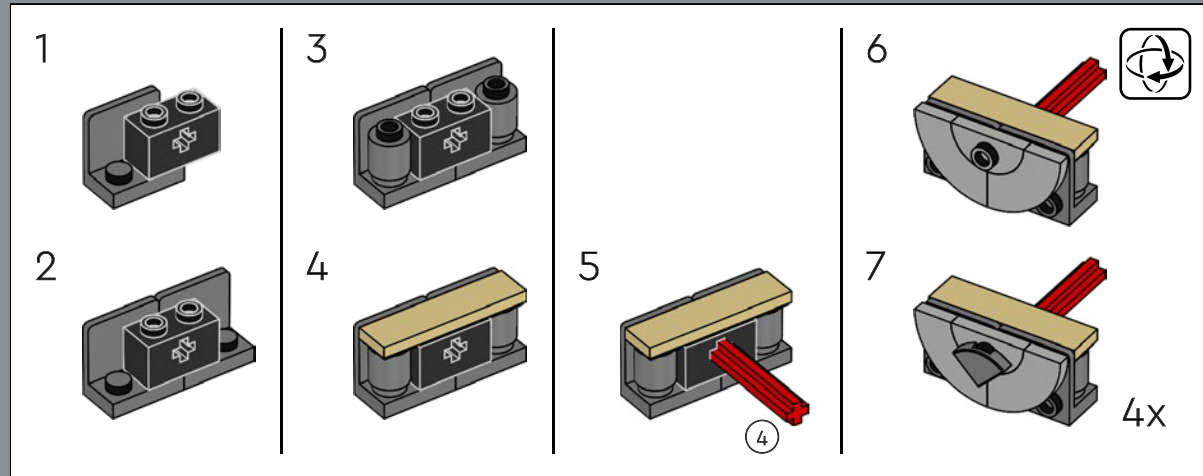

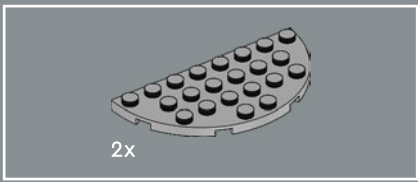

218

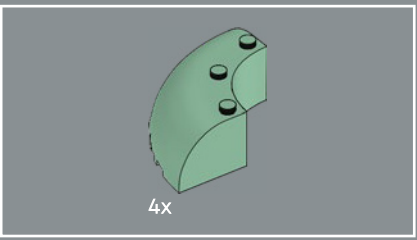
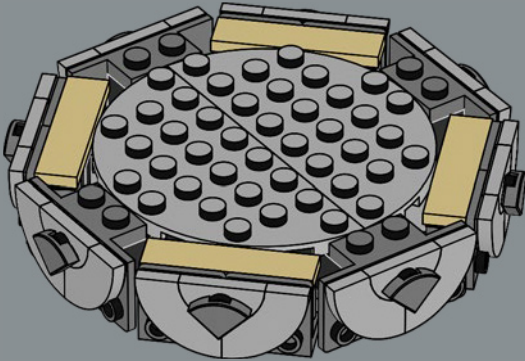

219

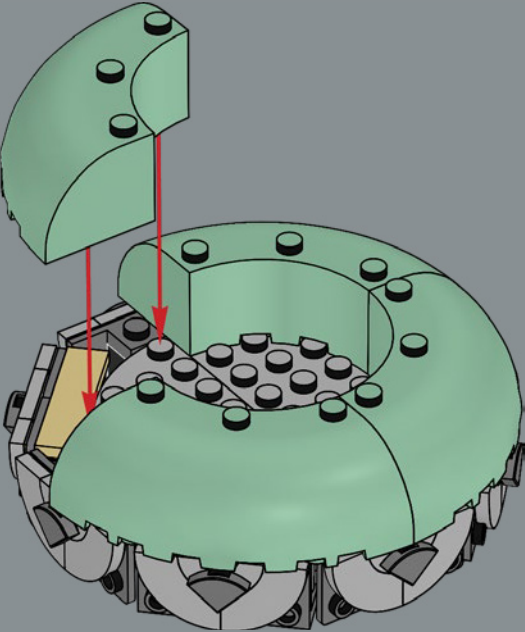

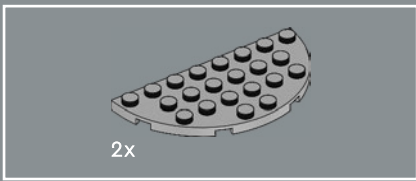

220

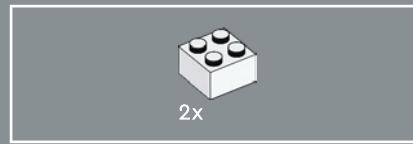
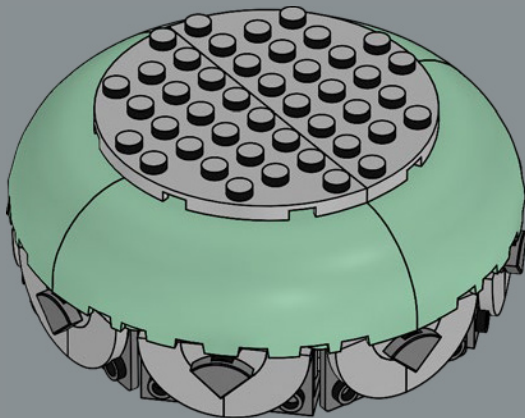

221

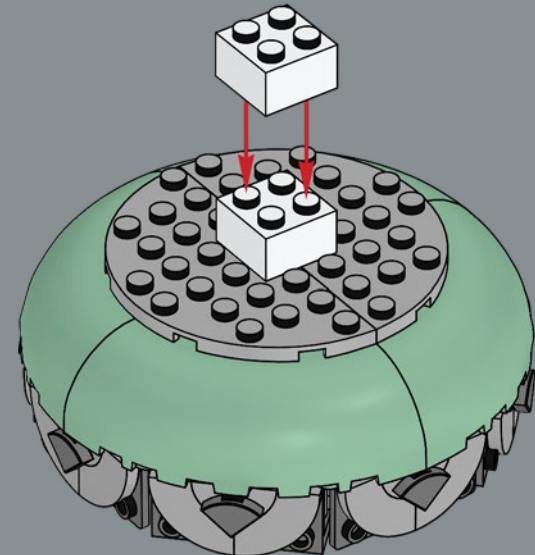

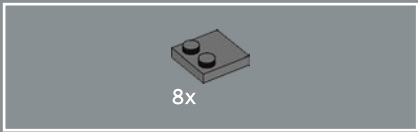

222

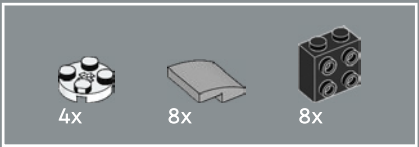
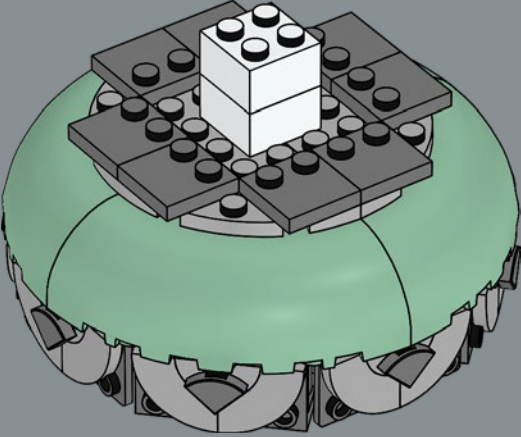

223

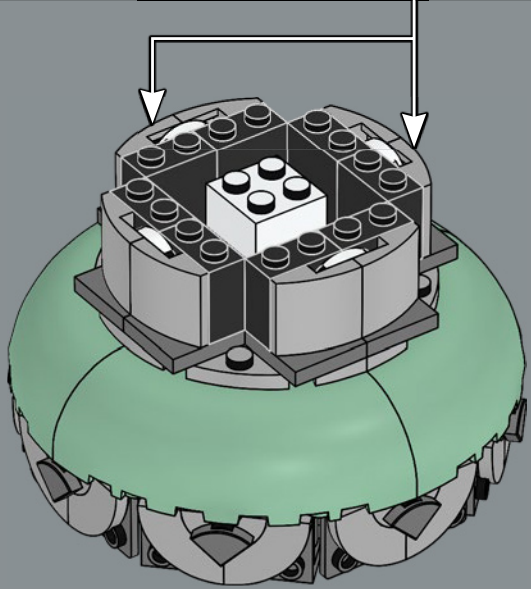
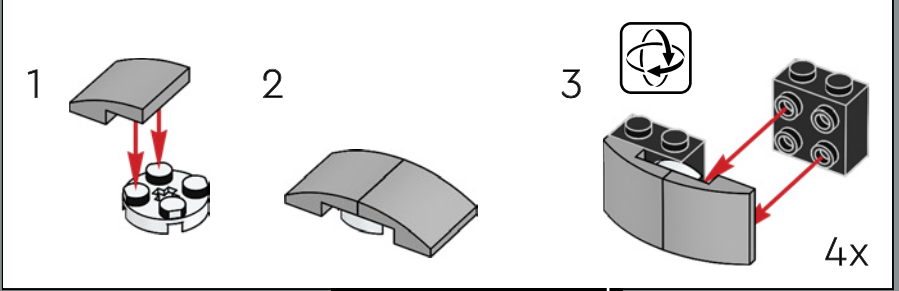

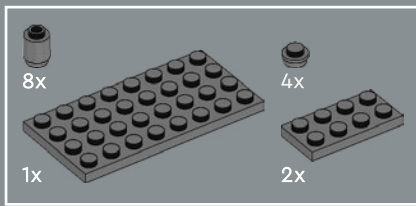

224

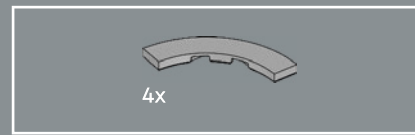
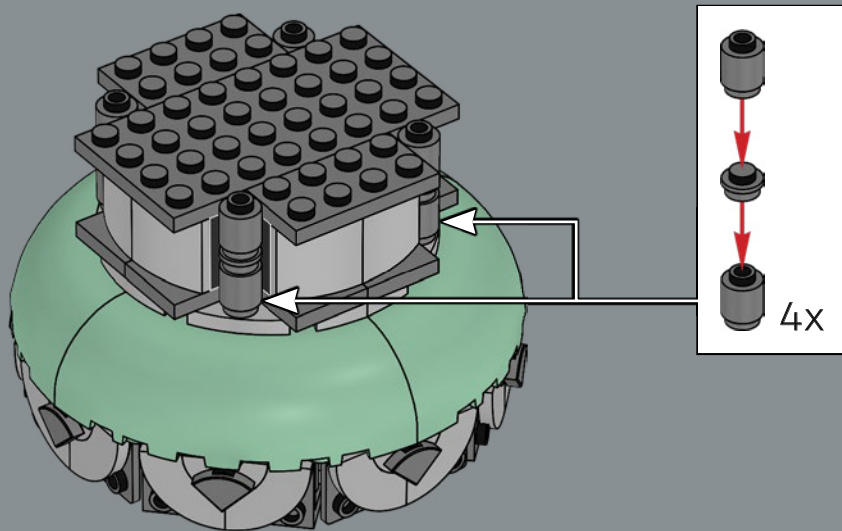

225

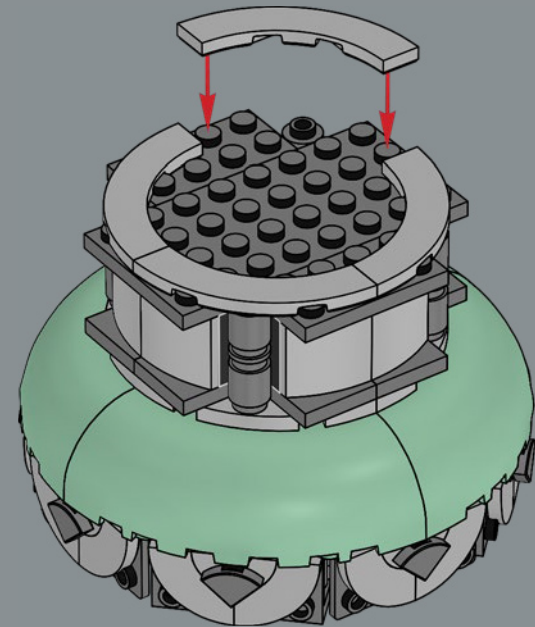



The tower roof is designed to be removable so you can peek in on Bilbo's writing progress.

Le toit de la tour est conçu pour être amovible et permettre de suivre l'écriture de Bilbon.

El techo de la Torre está diseñado para ser removible con el fin de que puedas observar cómo avanza Bilbo en la escritura de su libro.

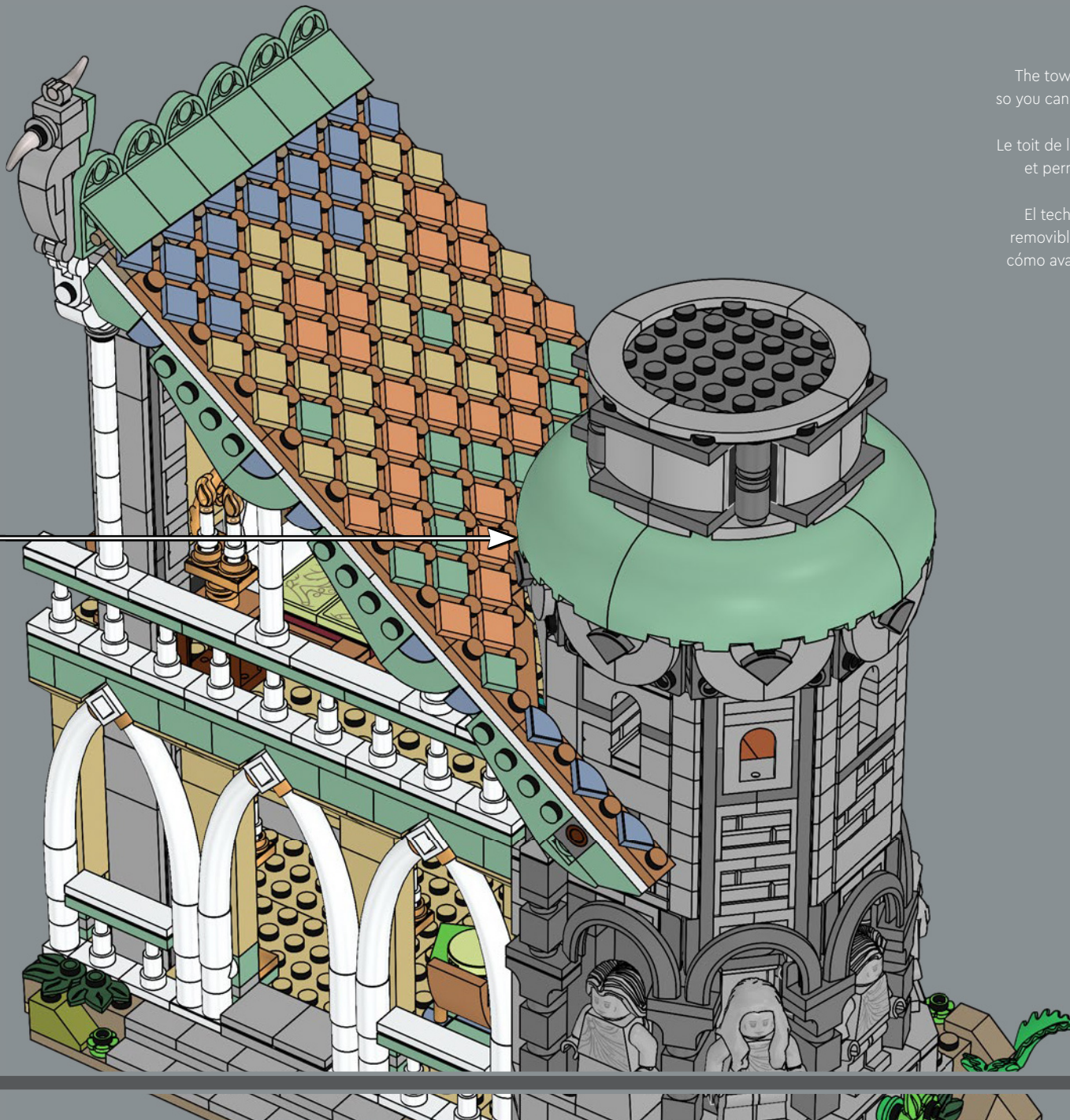

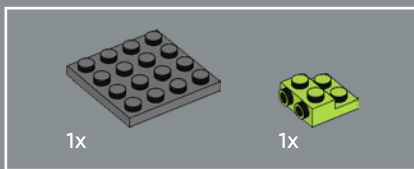

227

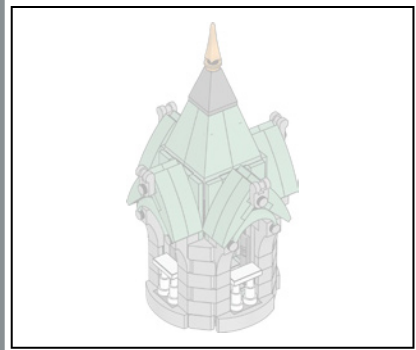
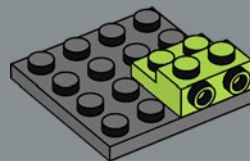

228

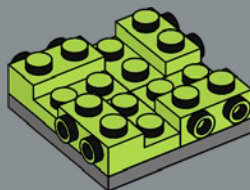

229

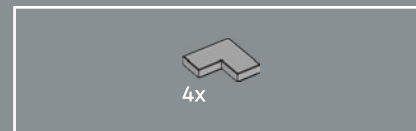
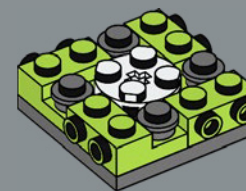

230

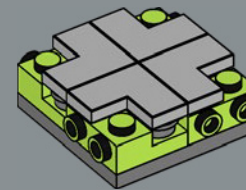



4x

231

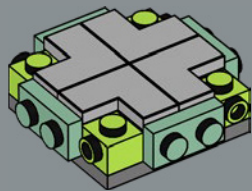

4x

8x

8x

4x

232

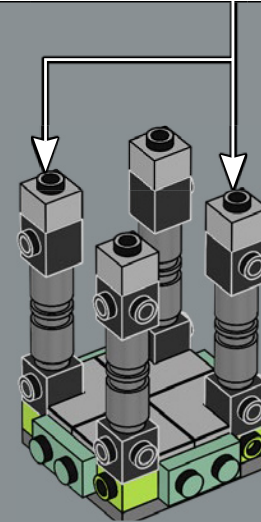
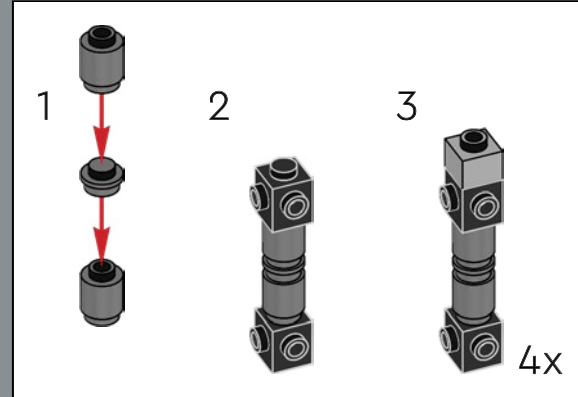

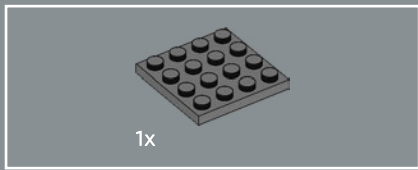

233

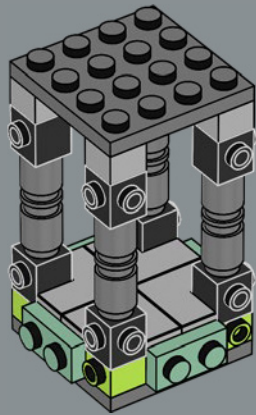

234

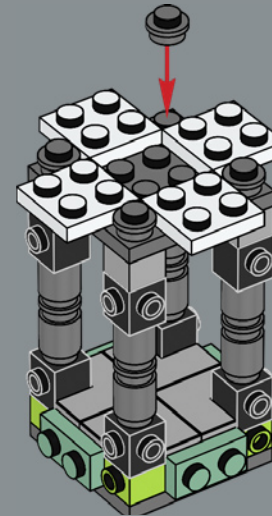

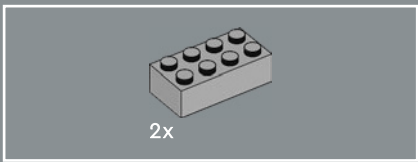

235

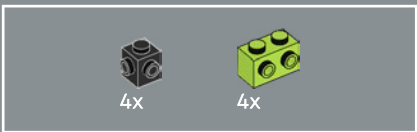
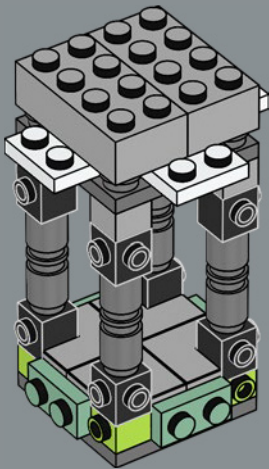

236

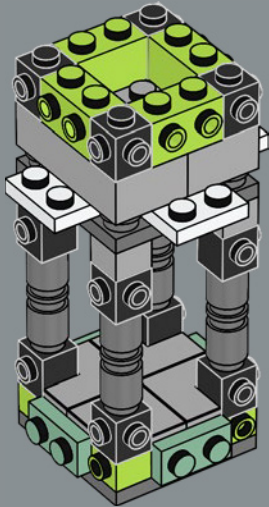

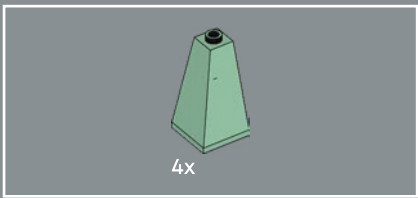

237

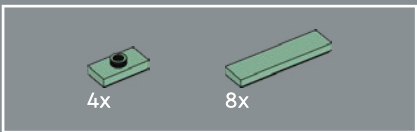
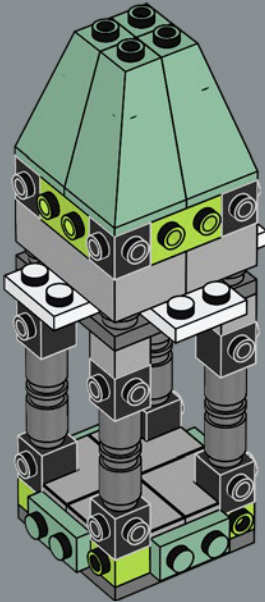

238

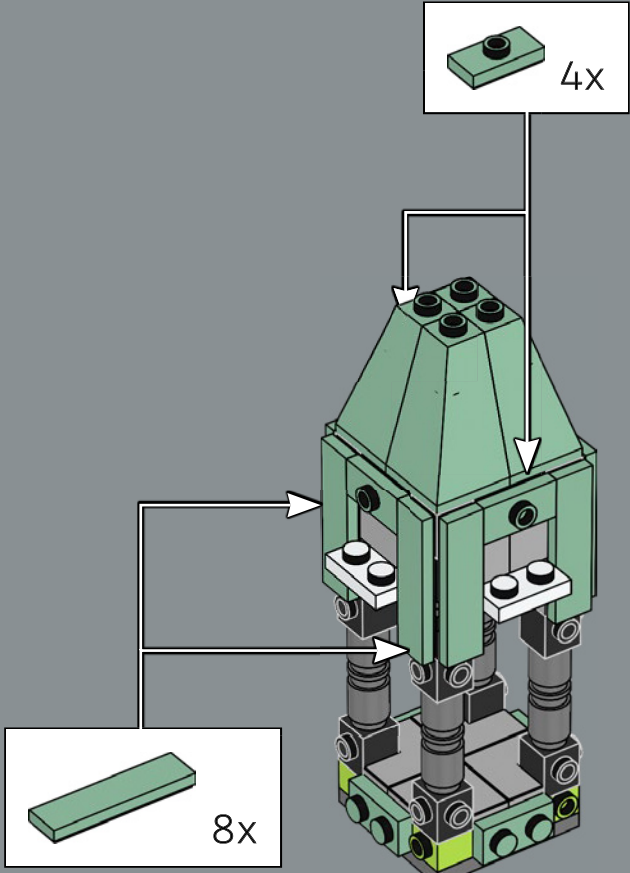

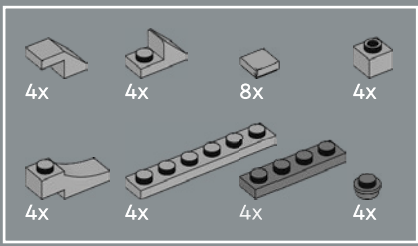

239

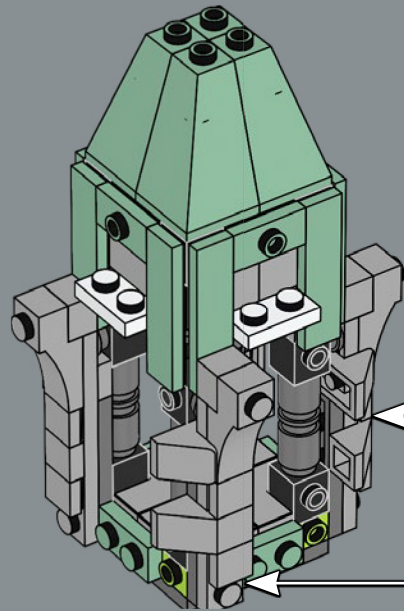
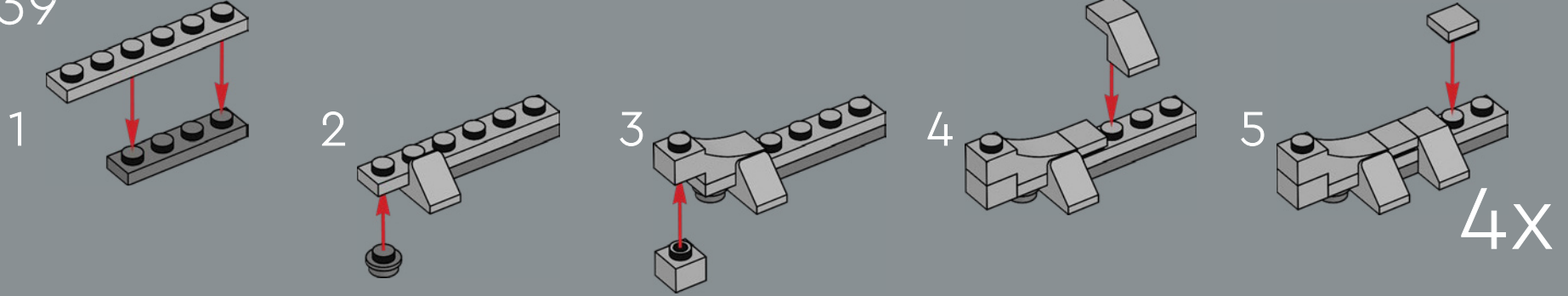

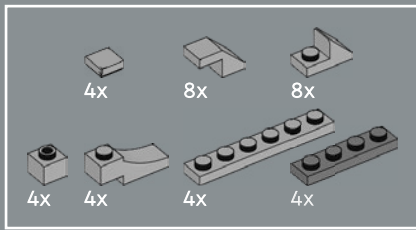

240

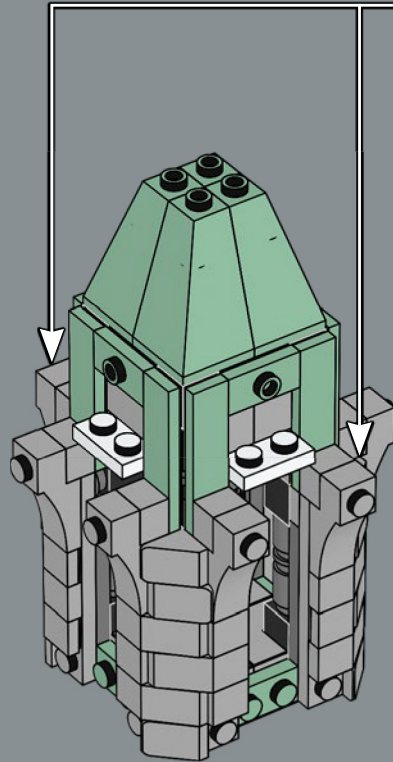
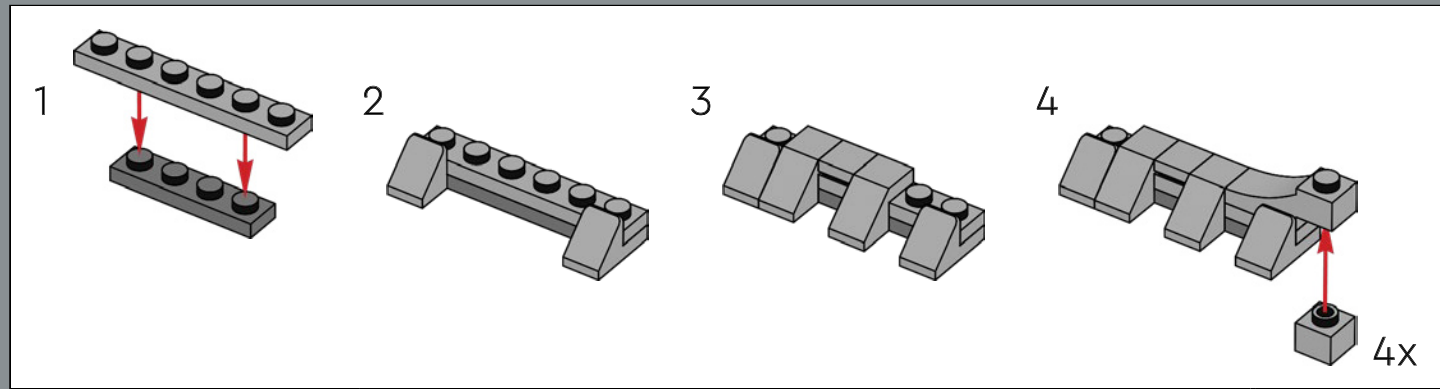



241

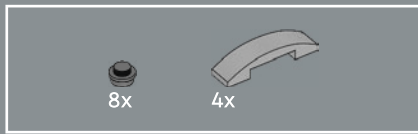
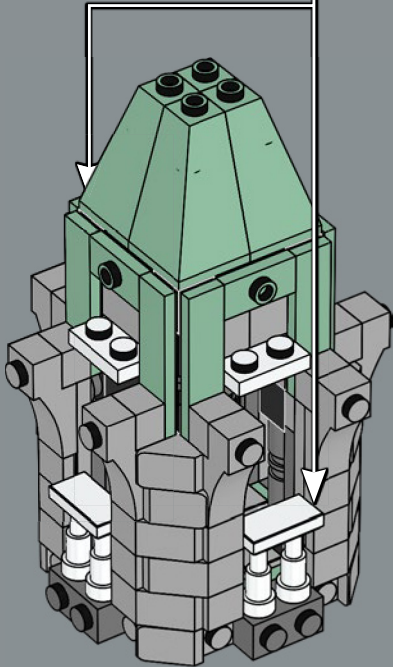
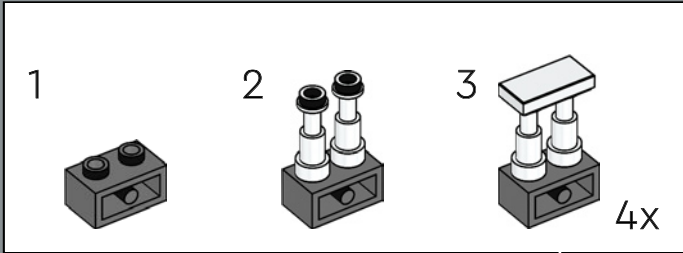

242

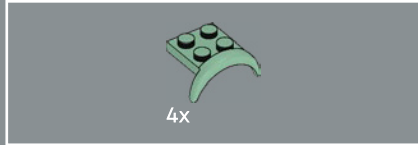
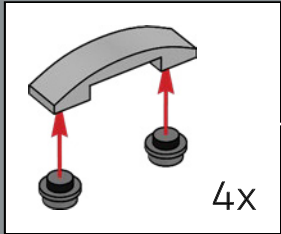

243



The green element used as the top of this window arch was originally developed as a wheel arch for a car.

L'élément vert utilisé comme sommet de cet arc de fenêtre a été conçu à l'origine comme un passage de roue pour une voiture.

El elemento verde utilizado en la parte superior de este arco de ventana se diseñó originalmente como un arco para la rueda de un automóvil.

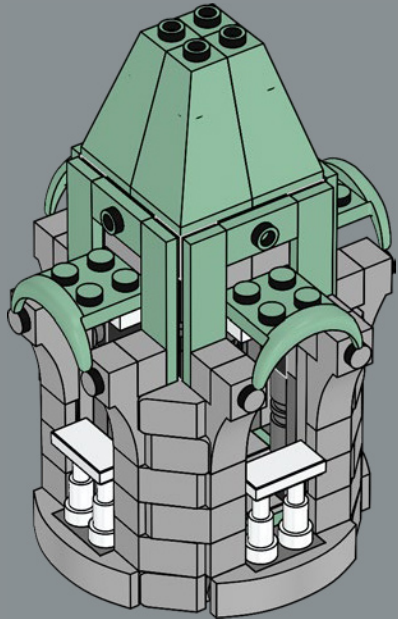
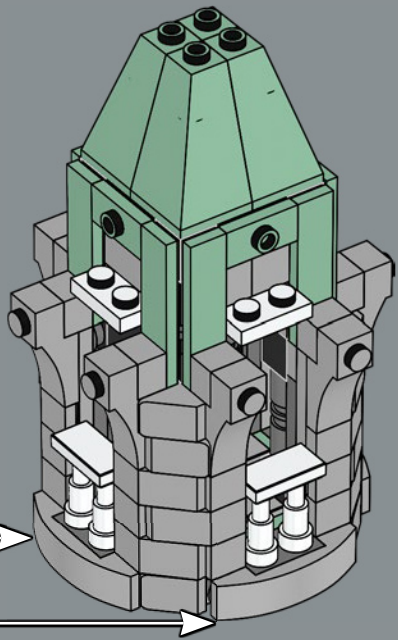

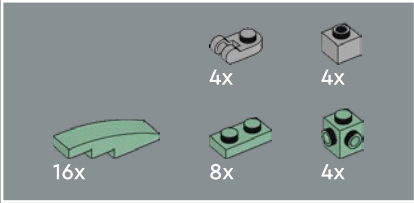

244

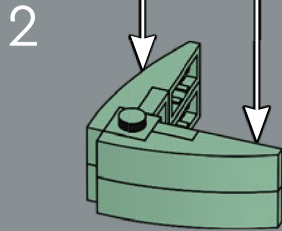
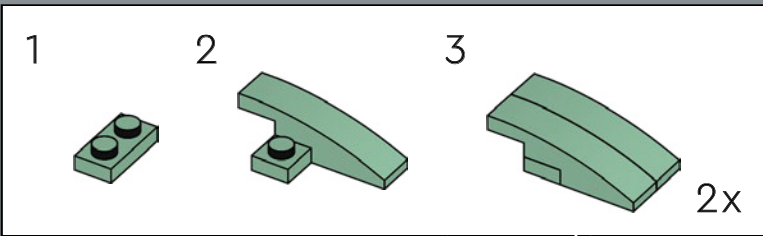
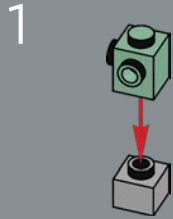

3

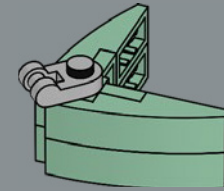

4x

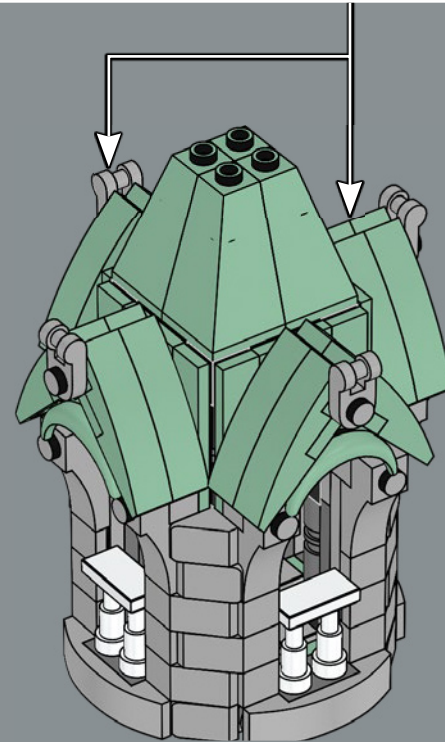



245

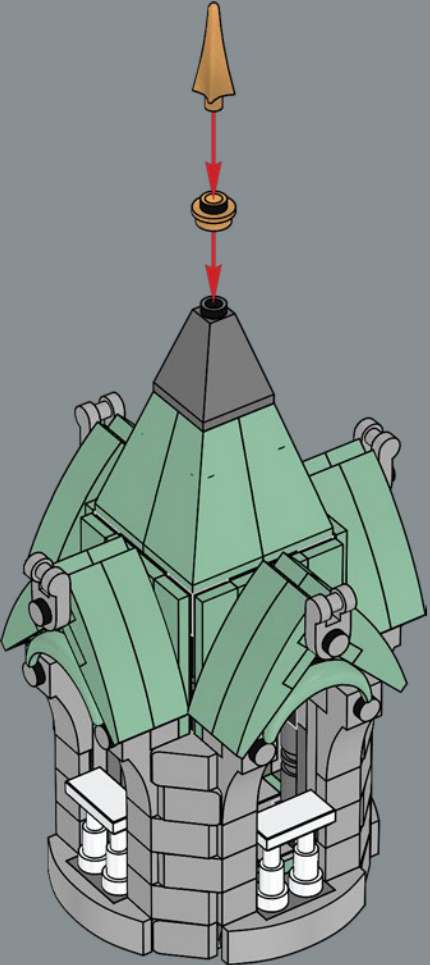

246

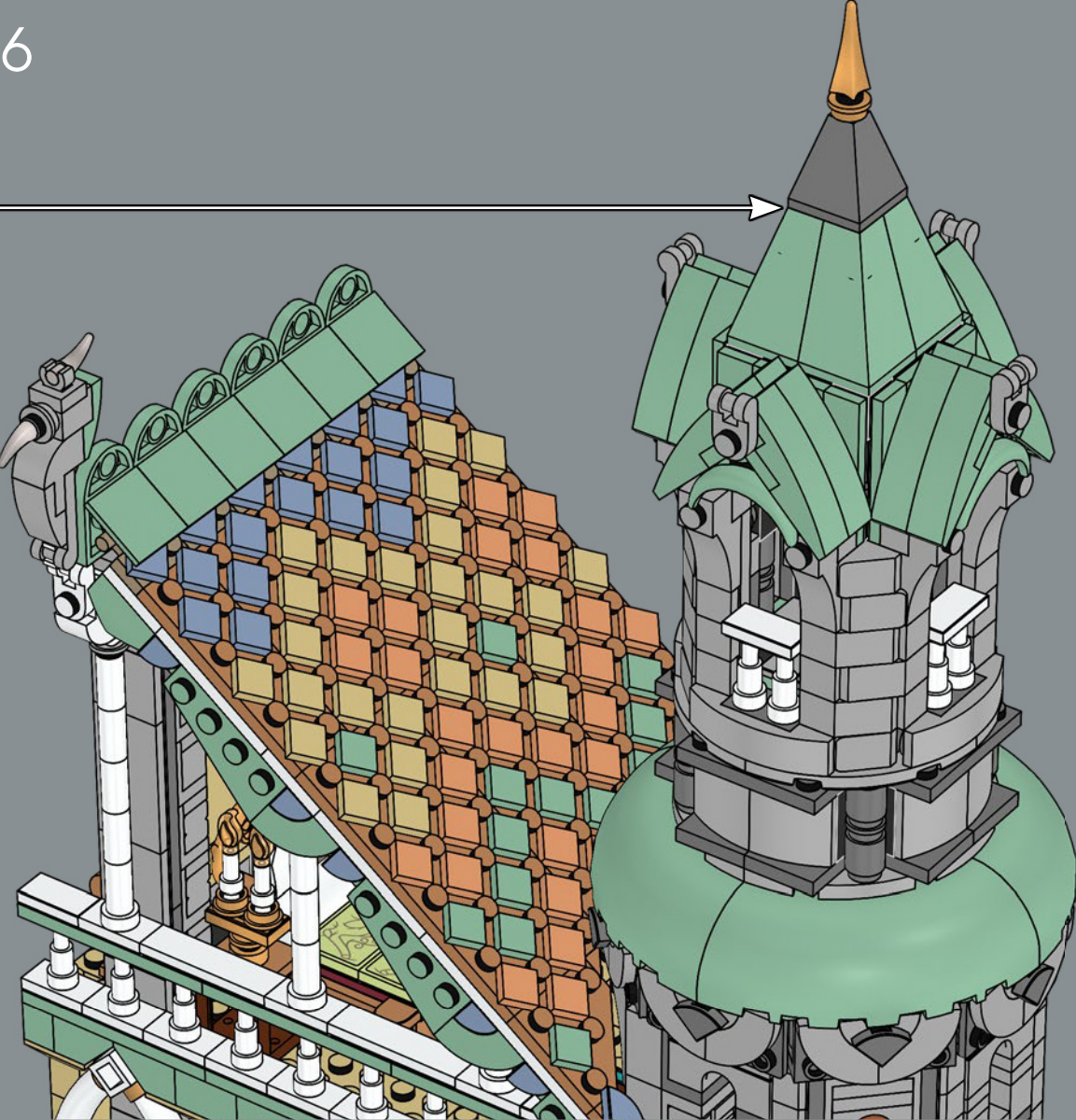

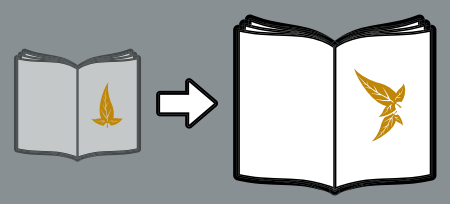

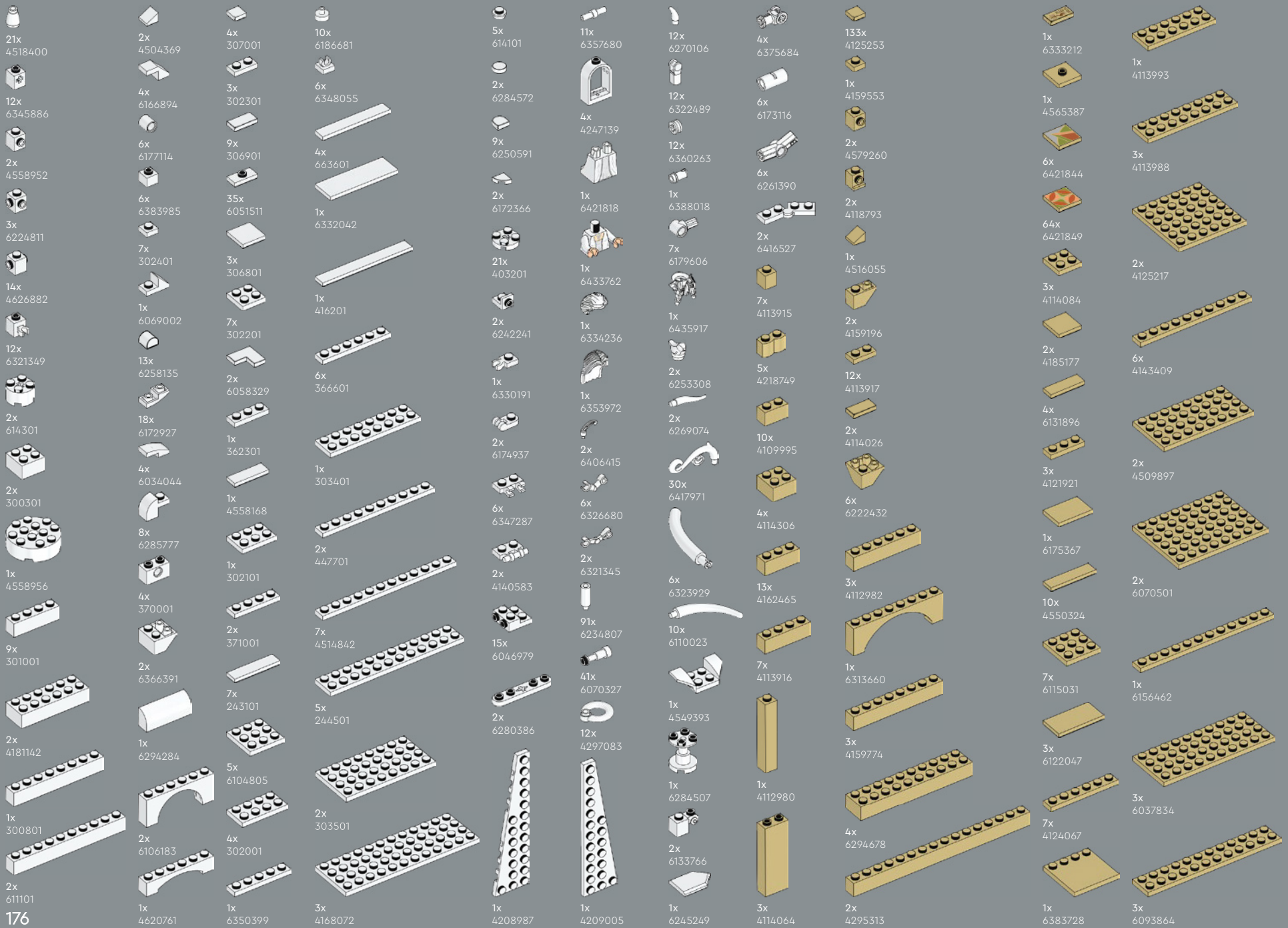

5x
4666579

2x
6145570

1x
6236914

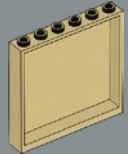

1x
4512688

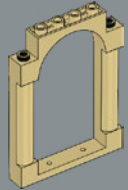

4x
6273864

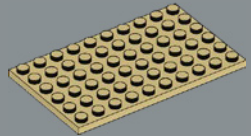

3x
4624185

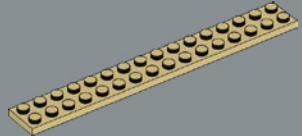

4x
6030980

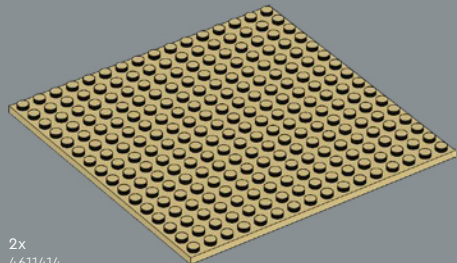

2x
4611414

1x
6310249

1x
6433765

3x
6429962

7x
6421843

1x
306921

2x
6347308

1x
6187620

1x
6001806

1x
6066342

2x
6378120

18x
4142865

1x
6209519

5x
243121

5x
6129995

1x
6330584

130x
6419170

2x
6330418

2x
614323

2x
370023

2x
302323

2x
302123

1x
4206482

9x
6299413

4x
300823

1x
235724

2x
362324

1x
302024

2x
300224

2x
300224

1x
300824

3x
6330584

6x
614124

72x
6286830

1x
346024

2x
6130008

2x
4558954

2x
6228987

4x
407026

19x
300226

1x
300926

1x
4181144

9x
6037390

2x
611226

6x
614124

72x
6286830

1x
346024

2x
6130008

5

1x
4529236

4x
306226

1x
4504382

2x
6265091

4x
6170566

12x
6187572

1x
4214559

8x
473326

20x
6275806

5x
6138173

4x
6178922

1x
6039347

3x
302026

2x
366626

3x
379526

3x
6186675

1x
6335388

1x
6330189

2x
6347310

1x
6338799

3x
6020193

1x
6016172

2x
6250020

2x
6313191

7x
346026

1x
395826

1x
6115117

4x
6401209

1x
303626

5x
6001494

1x
6168646

40x
614126

1x
474026

2x
6195325

10x
6052126

1x
452826

6x
6371584

6x
6116604

1x
6267045

6x
6168620

2x
6280168

1x
4558209

1x
6115117

4x
6401209

1x
6133200

1x
452226

1x
4189009

1x
6315887

3x
6278152

5x
6279875

8x
6280097

6x
4512363

5x
6390386

2x
6227901

1x
6315573

1x
6283610

1x
4517986

1x
6399780

6x
302128

1x
6299492

1x
6321770

1x
6171101

15x
6229130

2x
6331100

46x
6206150

4x
4119479

15x
6182261

1x
6235080

34x
6411022

16x
6268814

2x
6389695

1x
6406357

5x
6395814

1x
6293826

2x
6266964

4





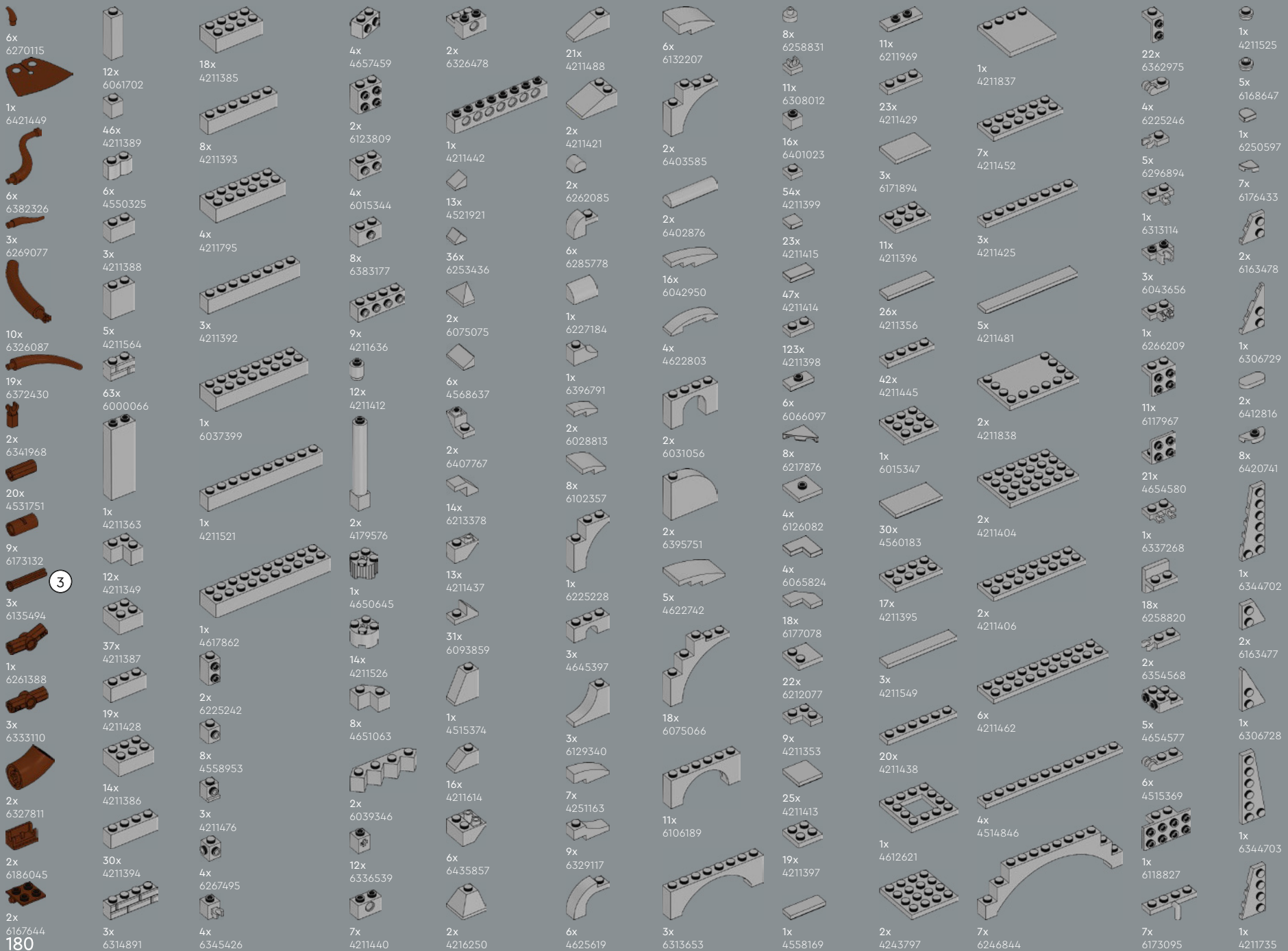

3



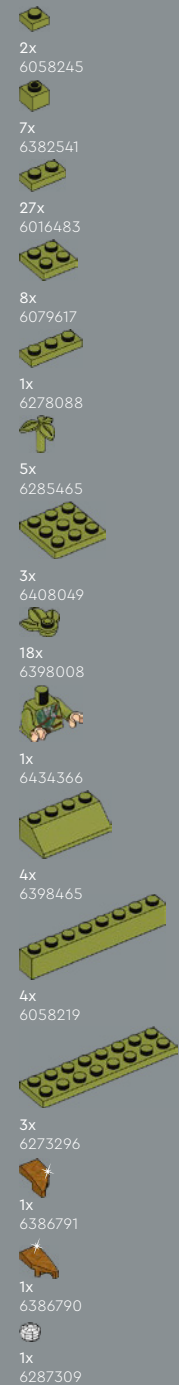
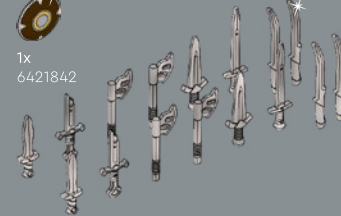
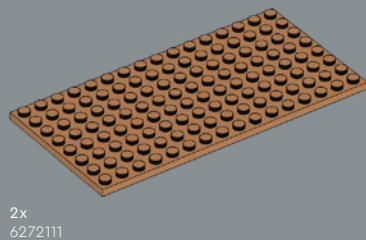

LEGO.com/service



YOU COULD WIN



YOU COULD WIN

Your feedback will help shape the future development of this product series.

Visit:

DU KÖNNTEST GEWINNEN

Dein Feedback trägt zur Weiterentwicklung dieser Produktreihe bei.

Geh auf:

VOUS POURRIEZ GAGNER

Vos commentaires nous aideront à concevoir les futurs produits de cette gamme.

Visitez :

POTRESTI VINCERE TU

La tua opinione ci aiuterà a migliorare la creazione futura di questa linea di prodotti.

Visita:

PUEDES GANAR

Tu opinión contribuirá al futuro de esta serie de productos.

Visita:

轻松获奖

您的反馈将有助于我们在今后改进本产品系列。

请访问:

LEGO.com/productfeedback

You also have the chance to win a LEGO® set.

Terms and conditions apply.*

Außerdem hast du die Chance, ein LEGO® Set zu gewinnen.

Es gelten die Teilnahmebedingungen.*

Vous pourriez également gagner un ensemble LEGO®.

Des conditions s'appliquent.*

Hai anche la possibilità di vincere un set LEGO®.

Termini e condizioni sono applicabili.*

También tienes la oportunidad de ganar un set LEGO®.

Aplican términos y condiciones.*

您还有机会赢取乐高®套装。

条款和条件适用。*

*[LEGO.com/productfeedback-terms](https://www.lego.com/productfeedback-terms)

LEGO and the LEGO logo are trademarks of the/son des marques de commerce du/son marcas registradas de LEGO Group. ©2023 The LEGO Group.

© 2023 New Line Productions, Inc. All rights reserved. The Lord of the Rings: The Fellowship of the Ring, The Lord of the Rings: The Two Towers, The Lord of the Rings: The Return of the King and the names of the characters, items, events and places therein are trademarks of The Saul Zaentz Company d/b/a Middle-earth Enterprises under license to New Line Productions, Inc. (s23)

