



THE COUNCIL RING

The Council ring and surrounding halls blend naturally into the foothills of the Misty Mountains. They hold a wealth of Middle-earth history, from Elrond's throne and study with artifacts and paintings to the shards of Narsil.



LA SALLE DU CONSEIL

La salle du Conseil et les espaces environnants se fondent naturellement dans les contreforts des Monts Brumeux. Ils renferment une mine d'informations sur l'histoire de la Terre du Milieu, depuis le trône d'Elrond jusqu'aux fragments de Narsil, en passant par les artefacts et les peintures.

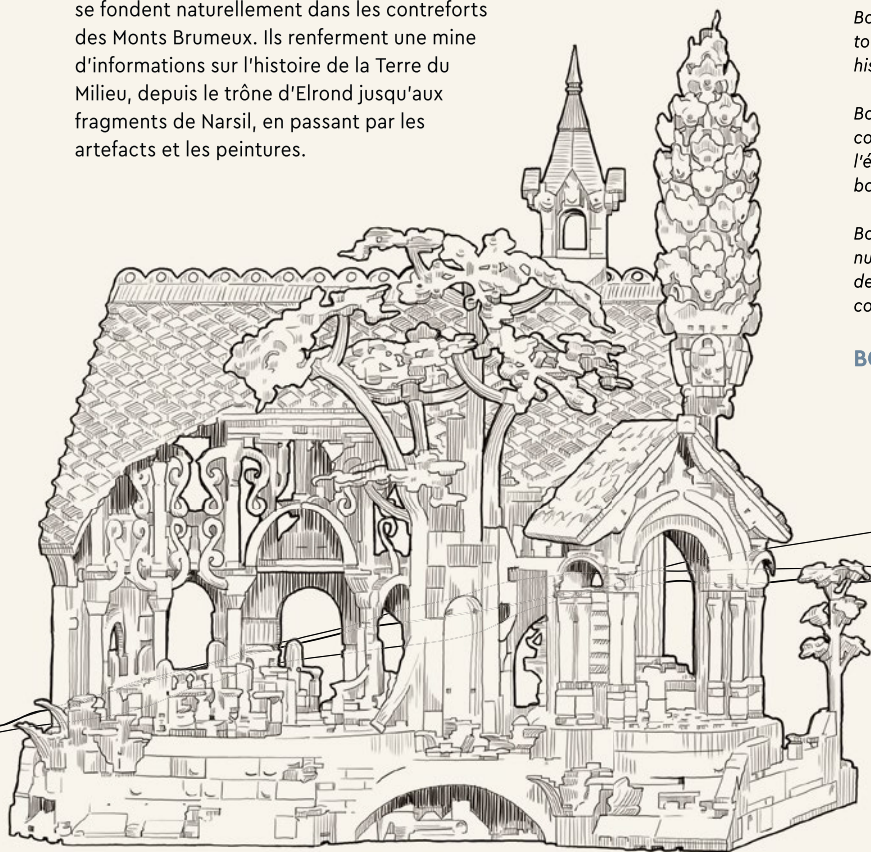

EL FORO DEL CONCILIO

El foro del concilio y los salones que lo rodean se funden naturalmente con las faldas de las Montañas Nubladas. Este lugar está repleto de objetos con valor histórico para la Tierra Media, desde el trono de Elrond y su estudio lleno de artefactos y pinturas hasta los fragmentos de la espada Narsil.

Boromir features a new sword design to represent the Sword of Gondor and his trusty round battle shield.

Boromir présente une nouvelle conception d'épée pour représenter l'épée de Gondor, ainsi que son fidèle bouclier rond de combat.

Boromir tiene una espada con un nuevo diseño que representa la Espada de Gondor y su confiable escudo de combate.

BOROMIR



Elrond has a newly designed, dual-molded wig element with distinct colors used for the ears and hair.

Elrond possède un nouvel élément de perruque à double moulage, avec des couleurs distinctes pour les oreilles et les cheveux.

Elrond lleva puesta una nueva peluca moldeada en dos partes, con distintos colores para las orejas y el cabello.

ELROND

MERRY AND PIPPIN MERRY ET PIPPIN MERRY Y PIPPIN



Merry and Pippin wear their traveling outfits and cloaks. Like Frodo, they have dual-molded legs that show their bare feet.

Merry et Pippin portent leur tenue de voyage et leur cape. Comme Frodon, ils ont des jambes à double moulage qui montrent leurs pieds nus.

Merry y Pippin visten ropa de viaje y capas. Al igual que Frodo, tienen piernas moldeadas en dos partes que revelan sus pies descalzos.

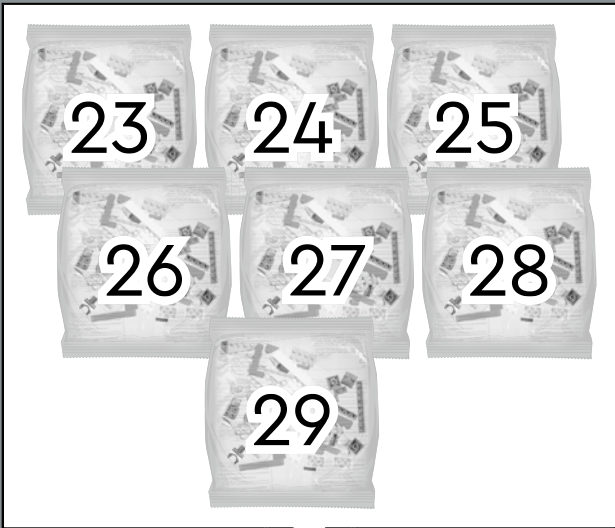

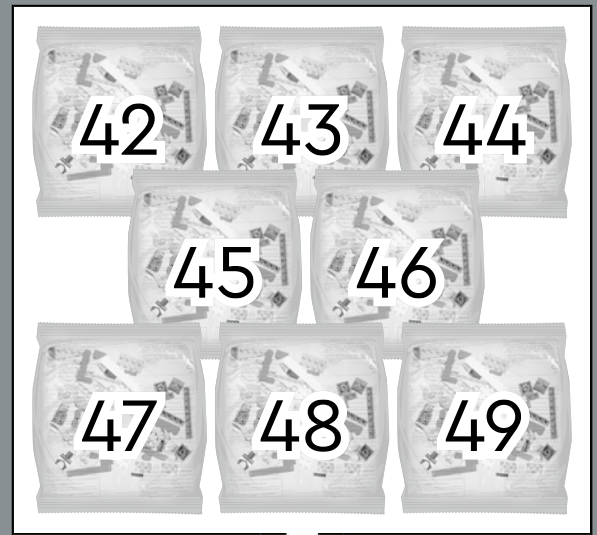
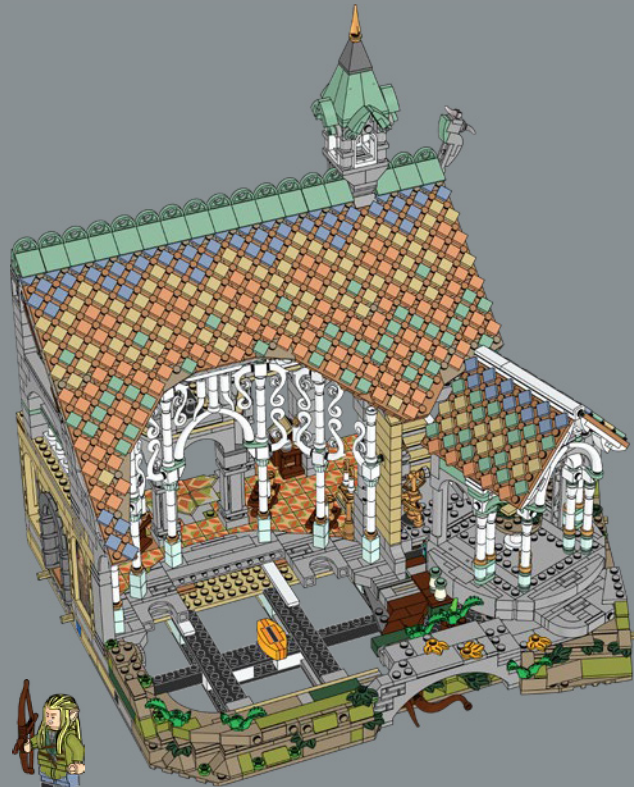

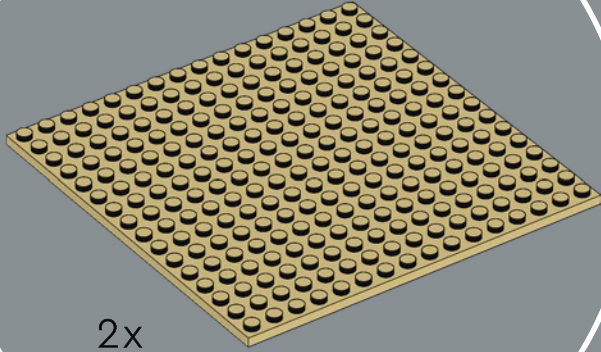
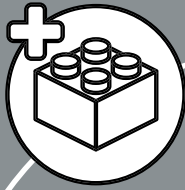

2x

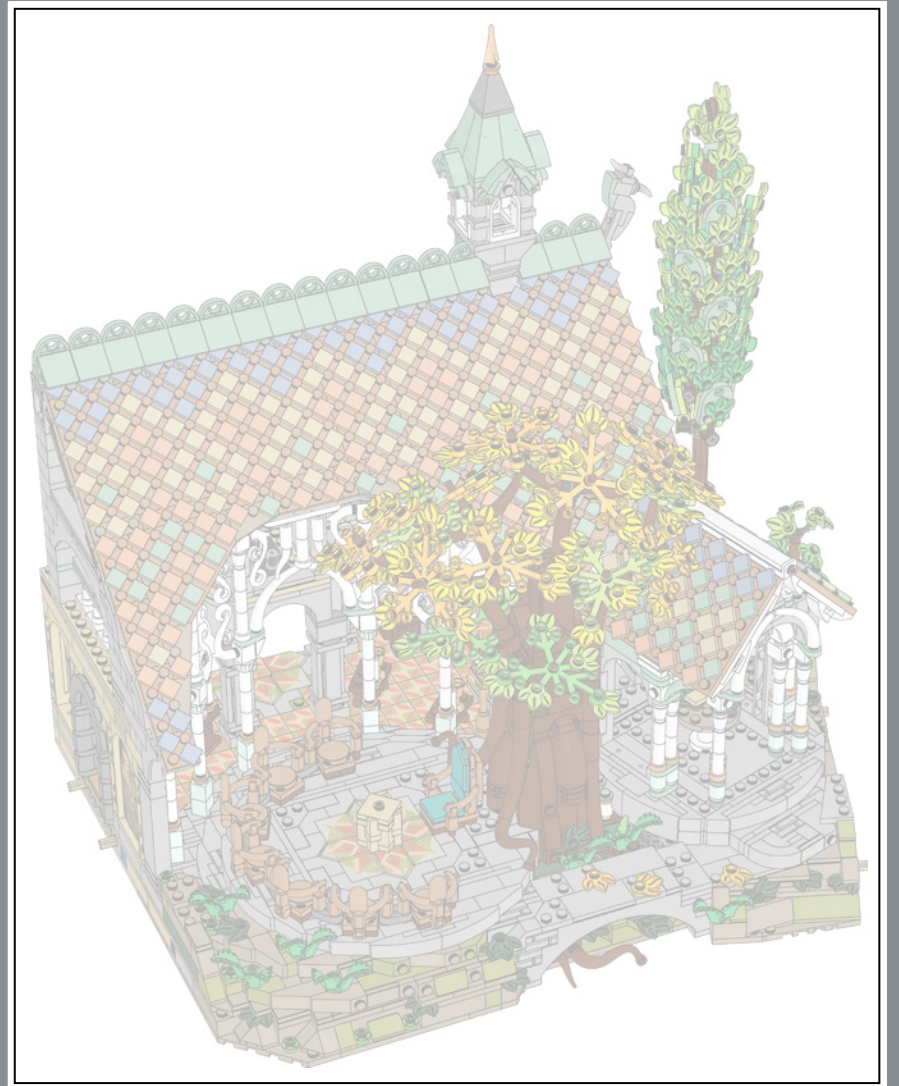

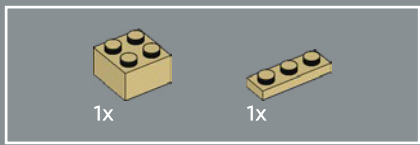

1

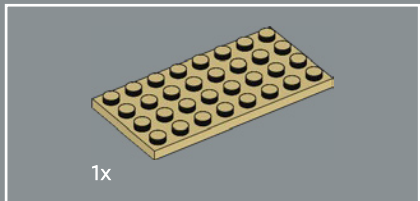
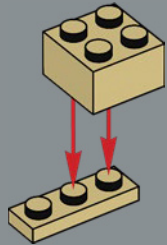

2

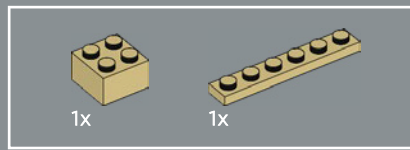
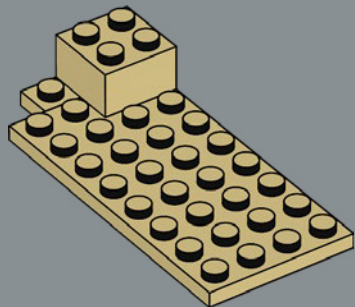

3

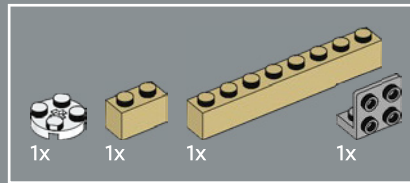
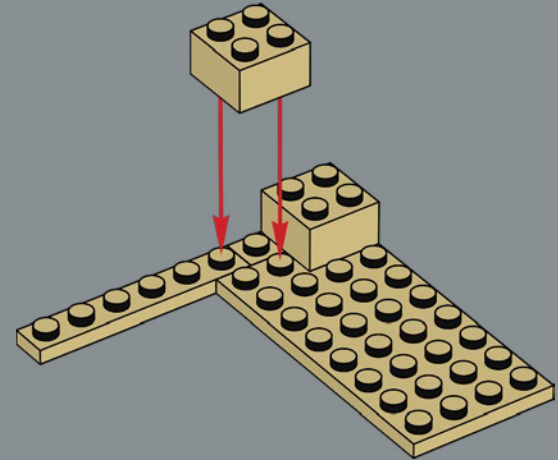

4

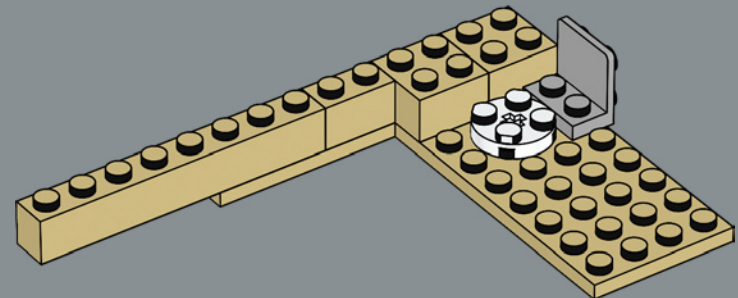

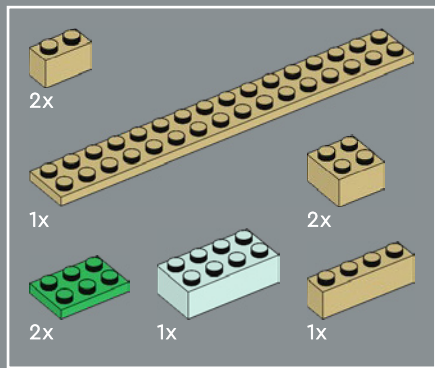

5

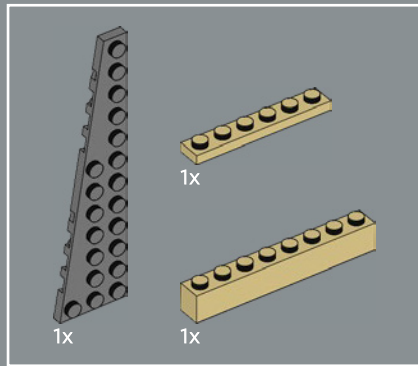
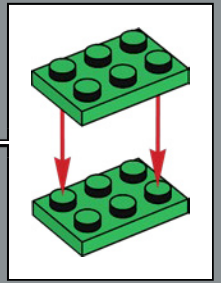
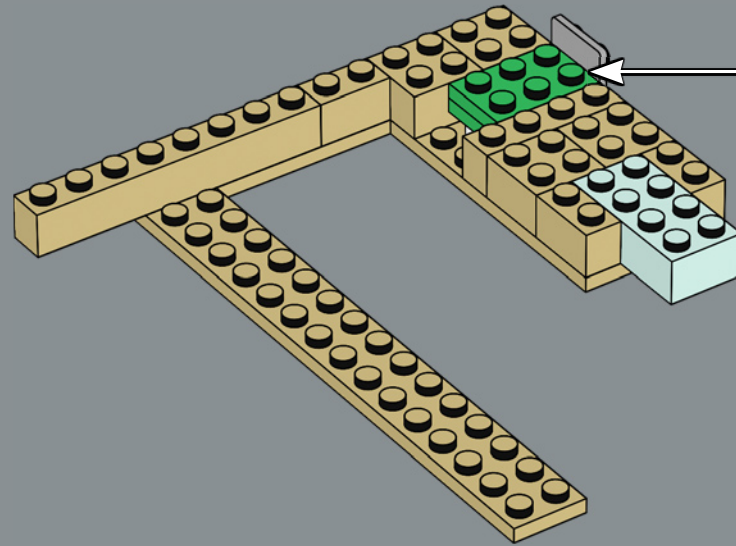

6

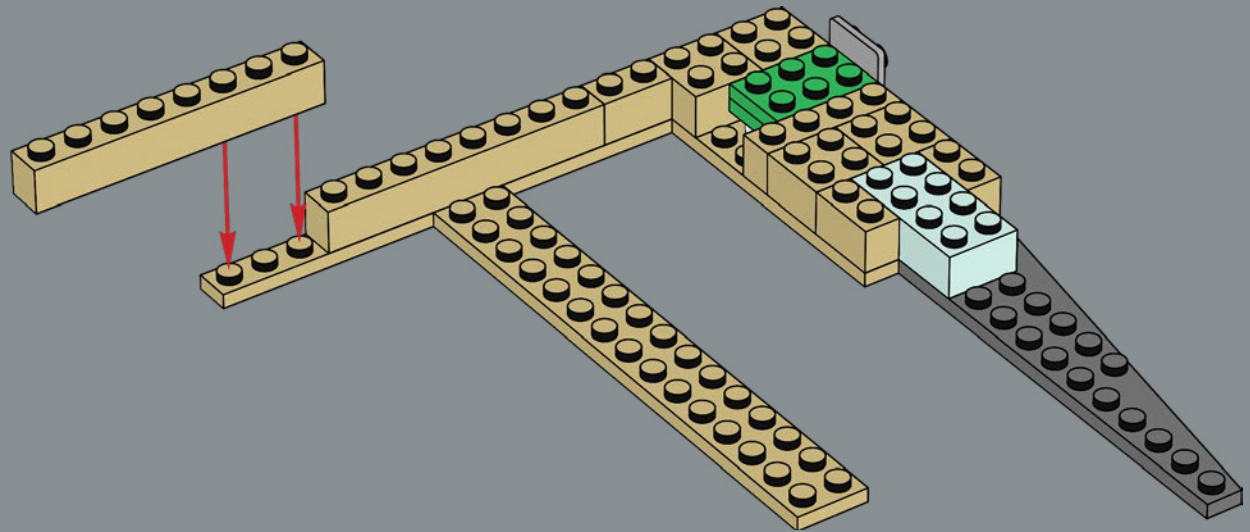

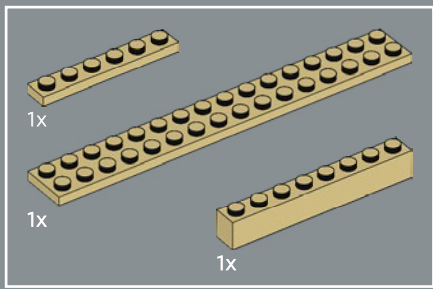

7

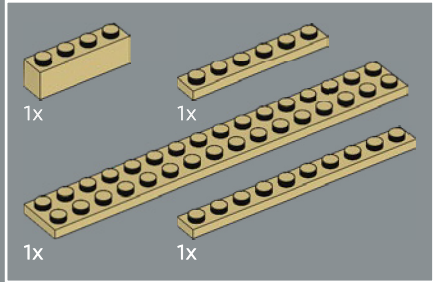
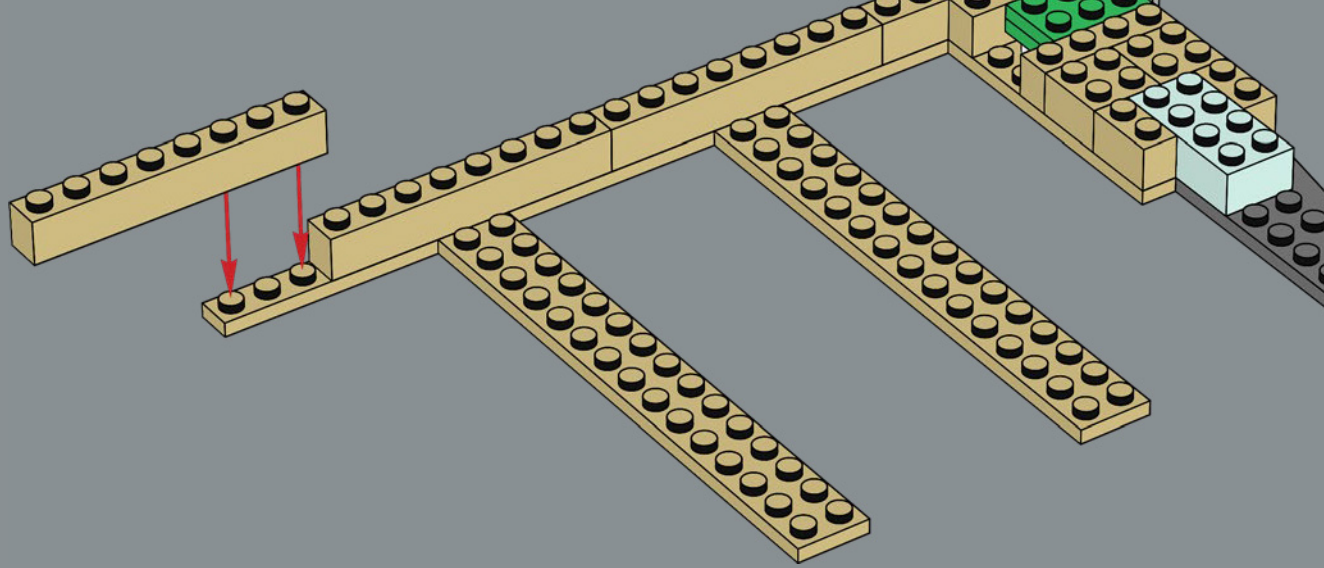

8

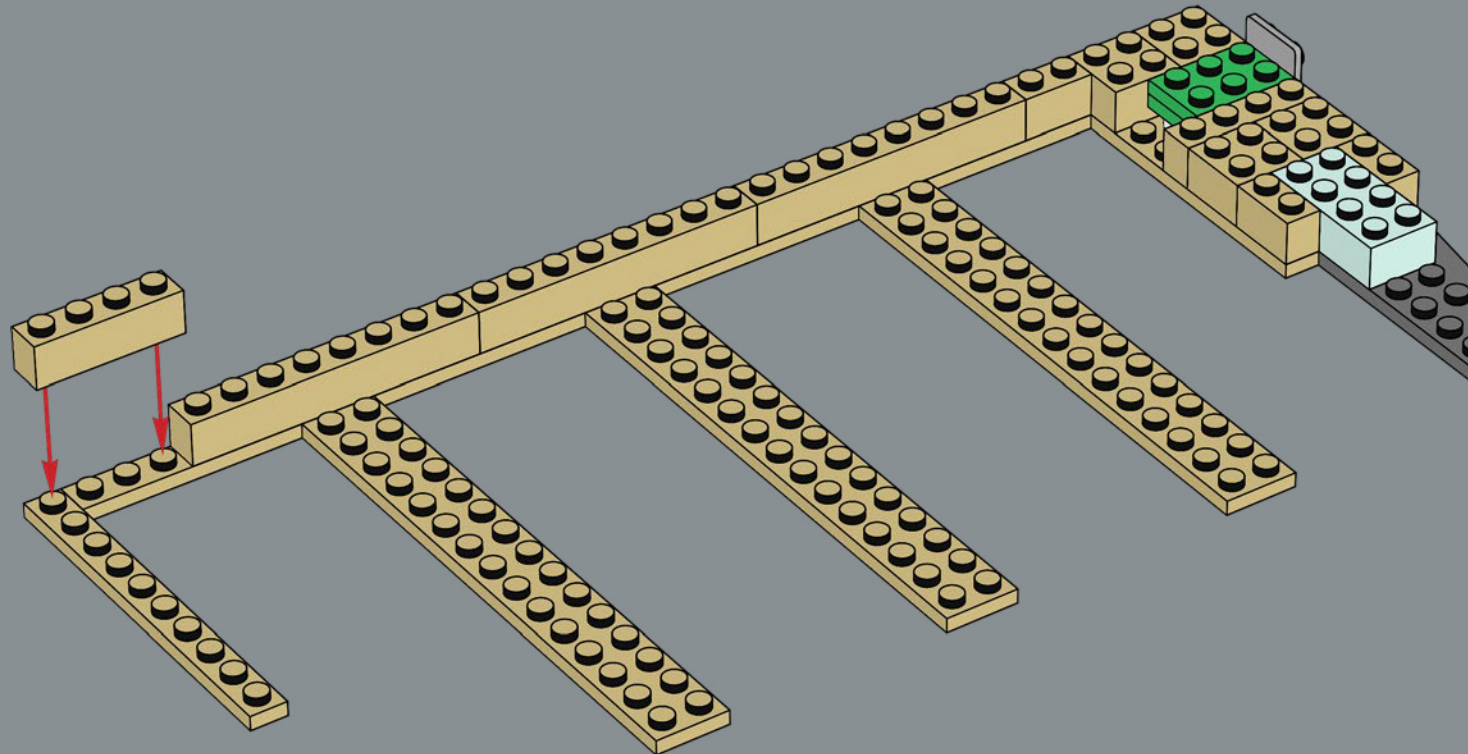

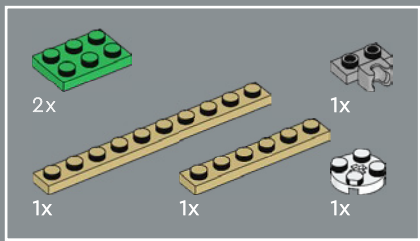

10

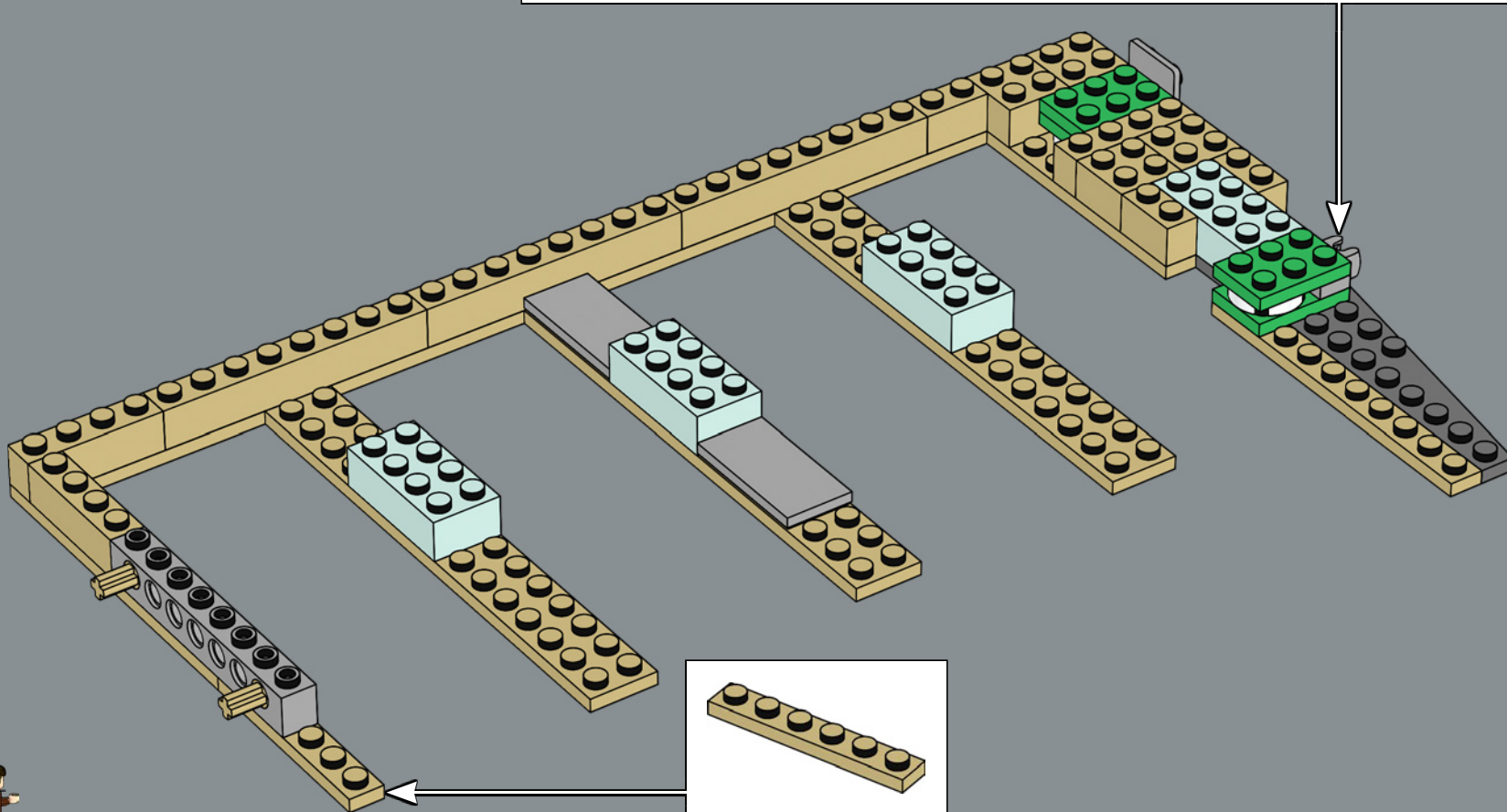
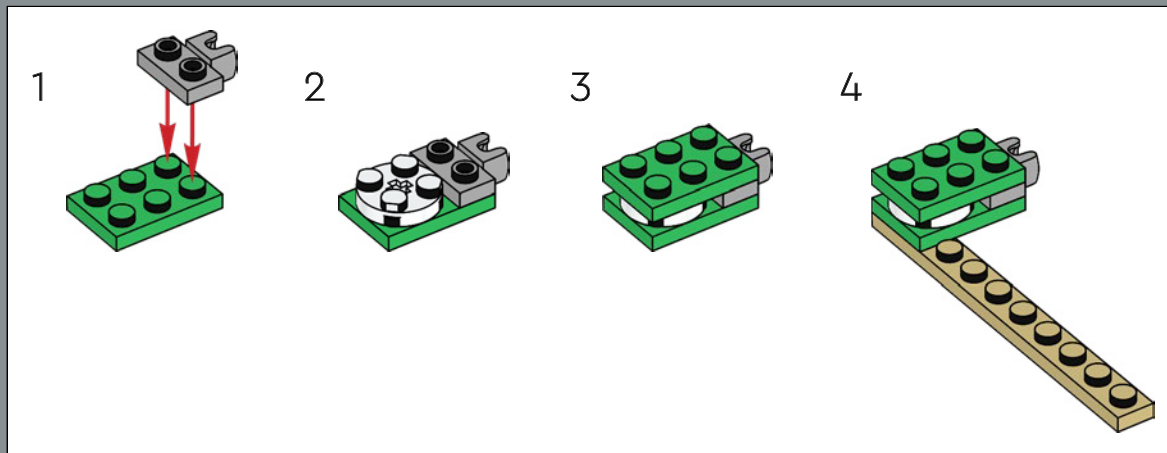

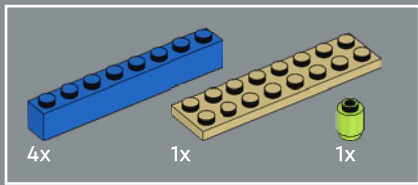

11

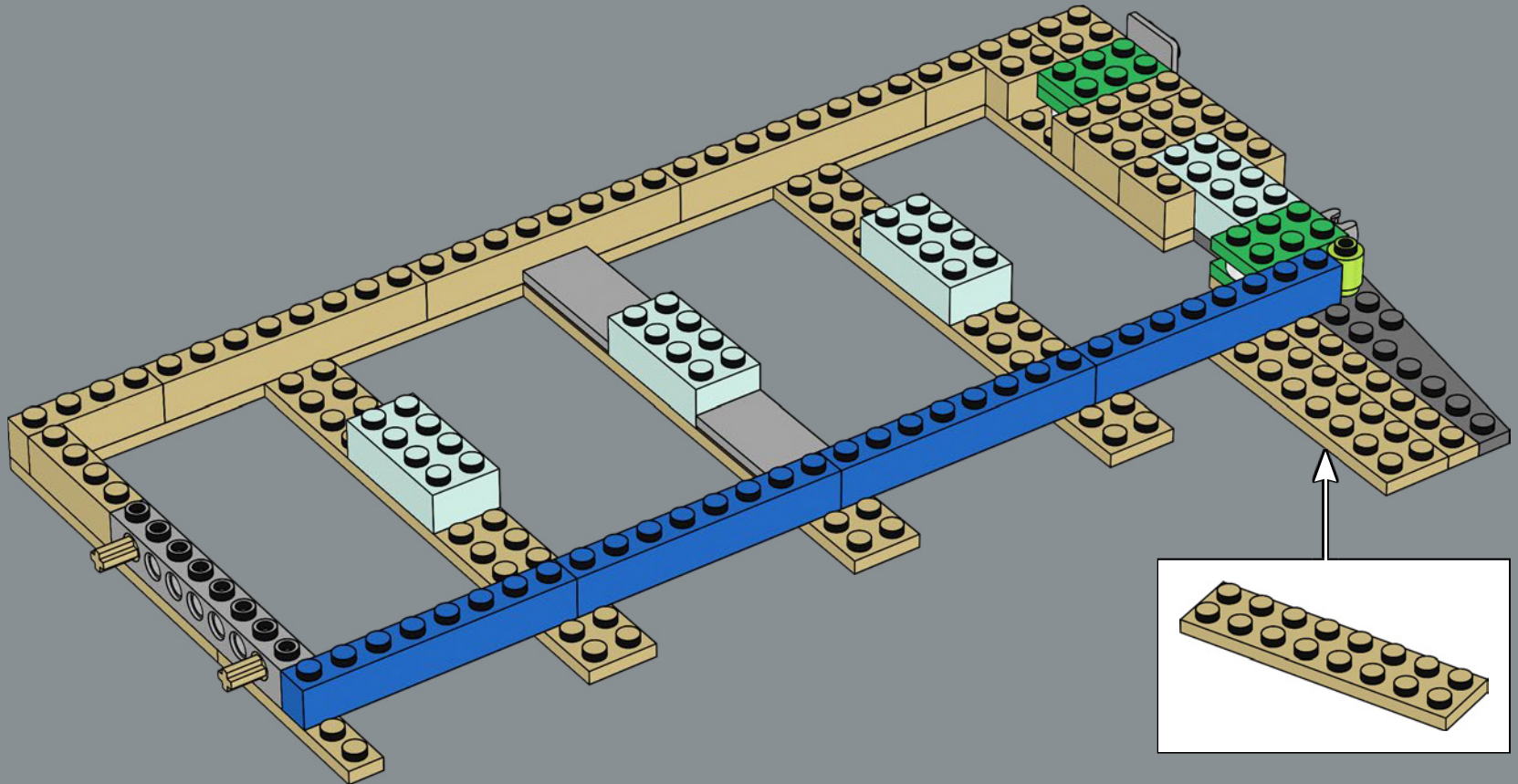

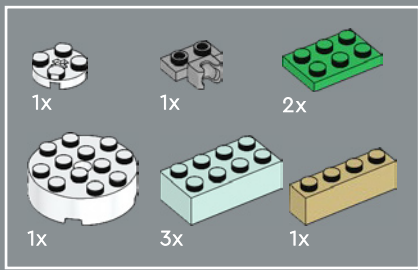

13

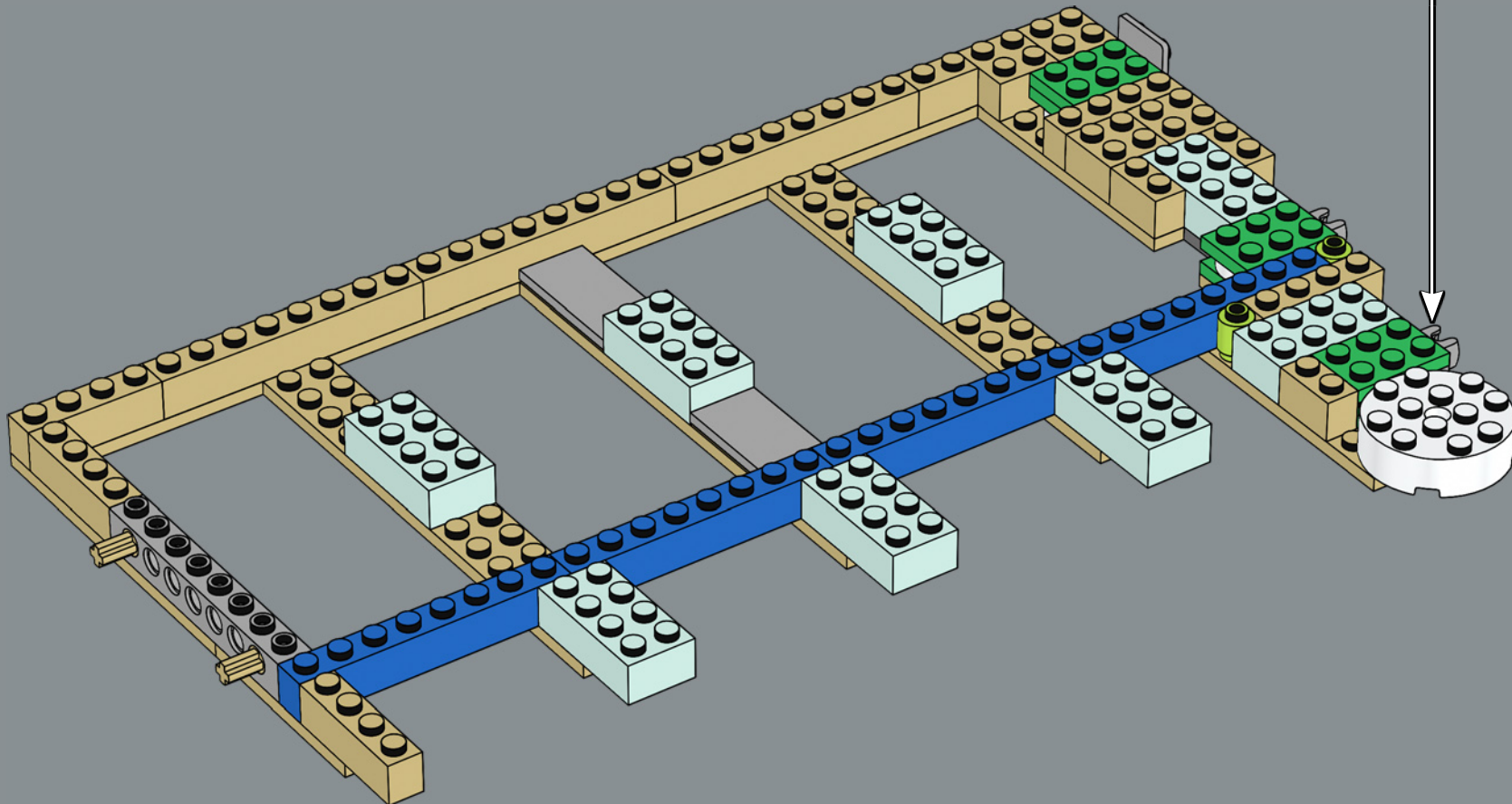
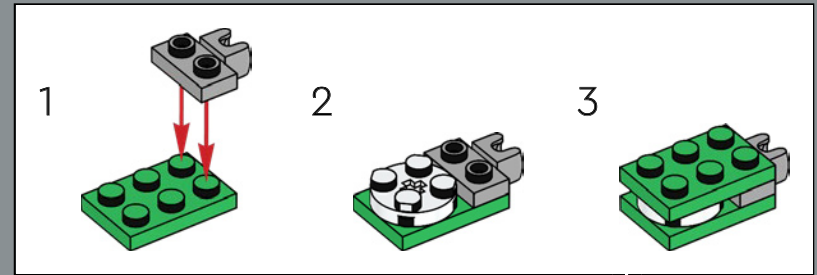

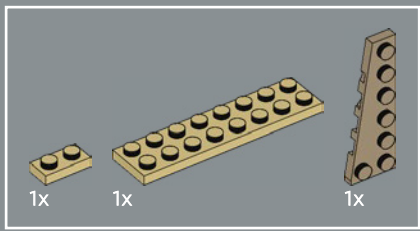

14

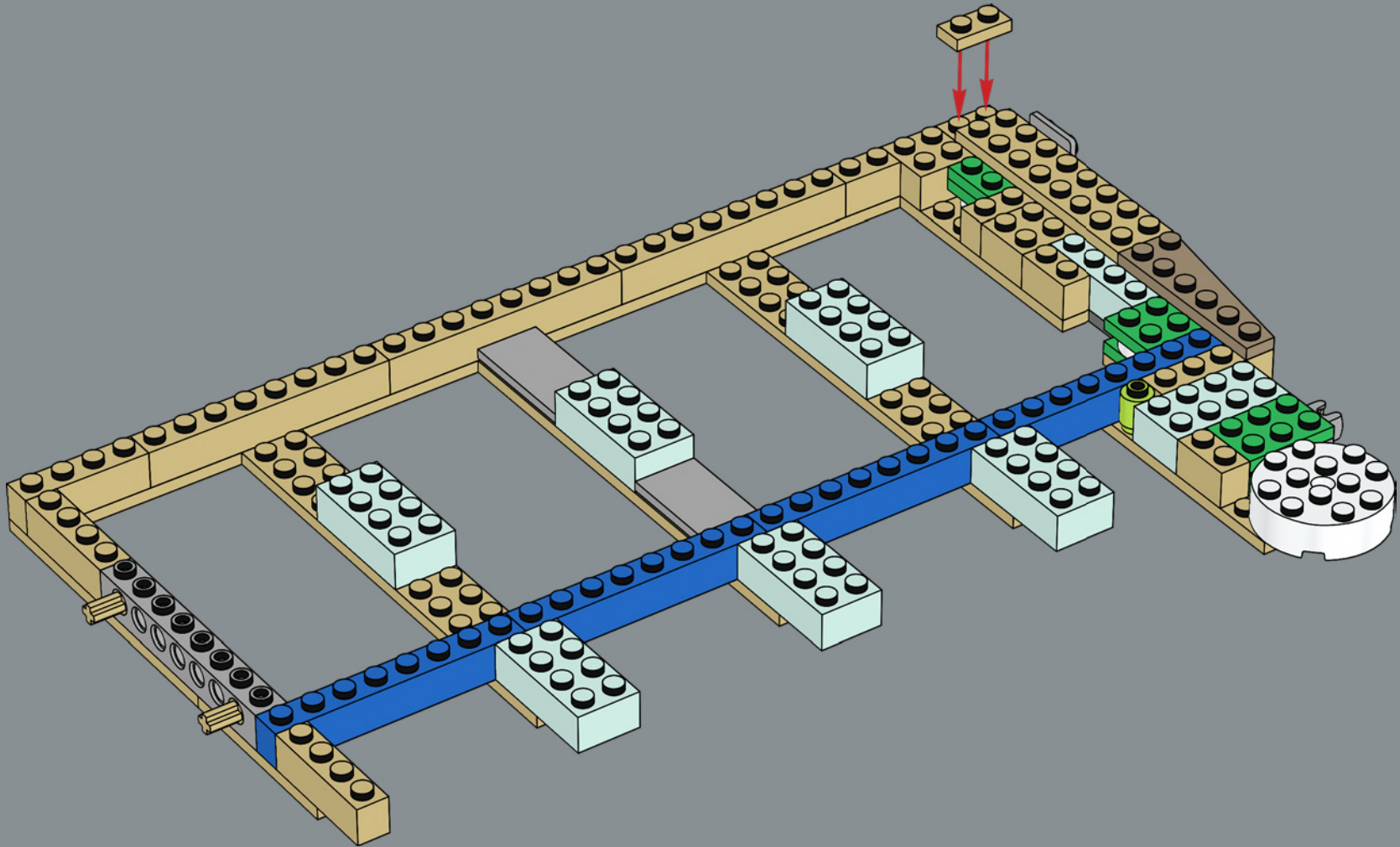

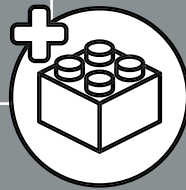
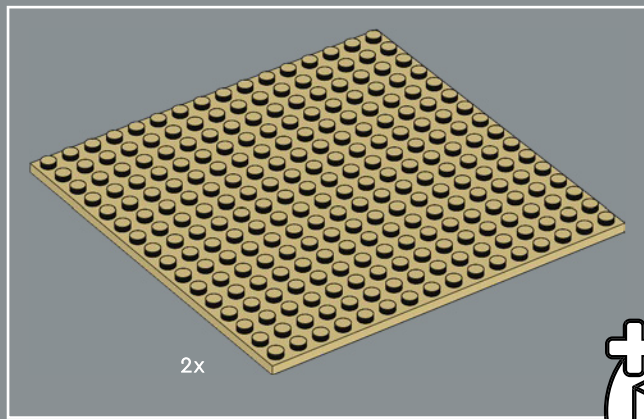

15

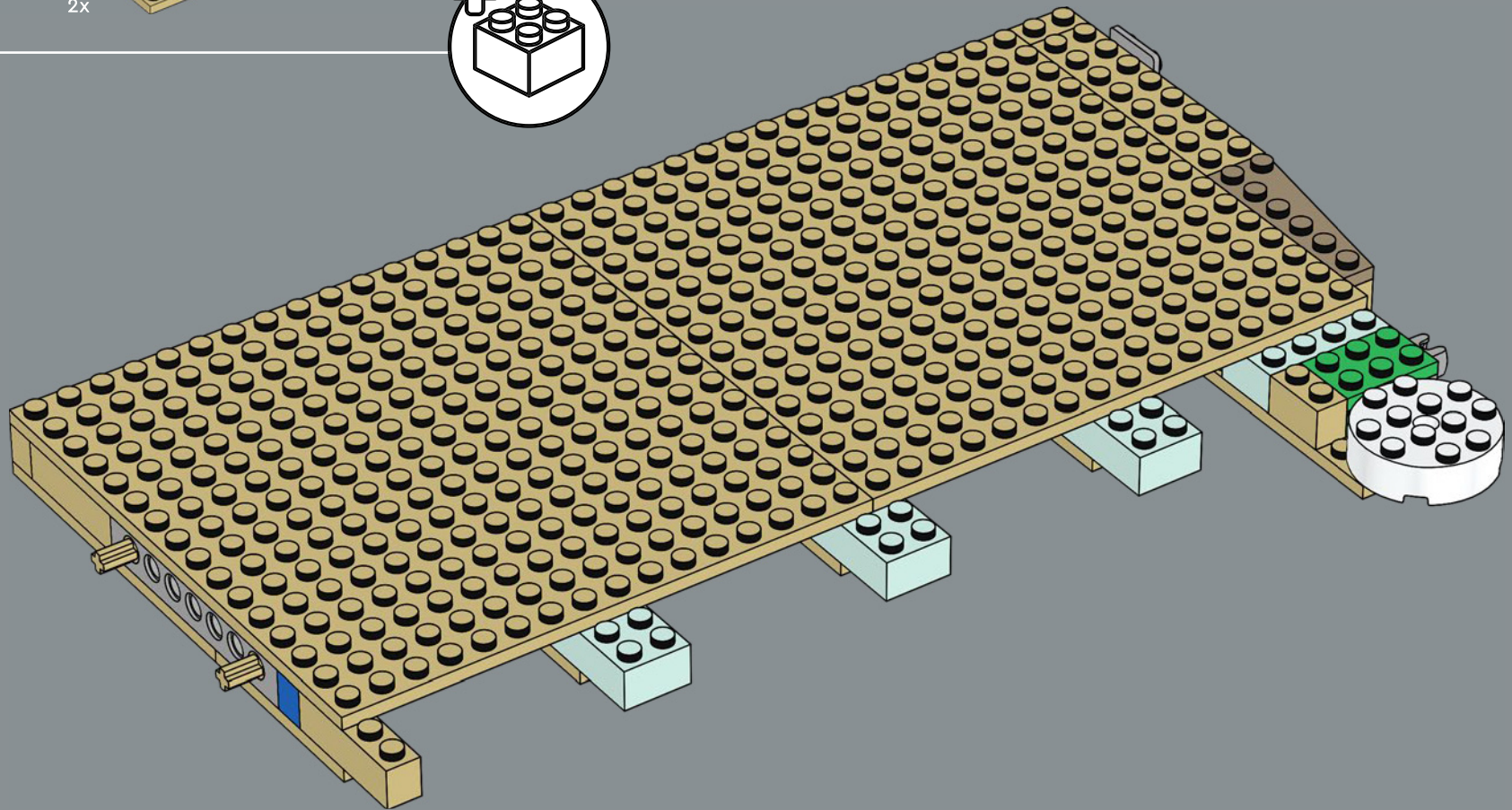

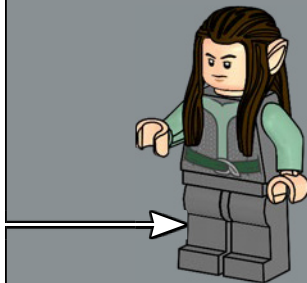
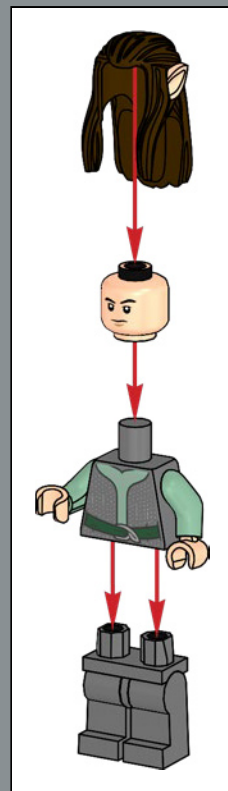

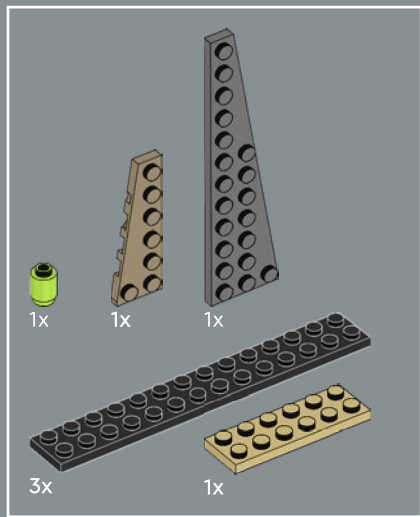

16

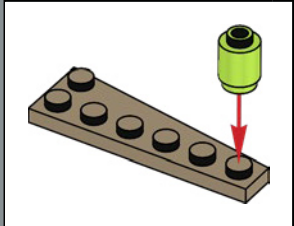
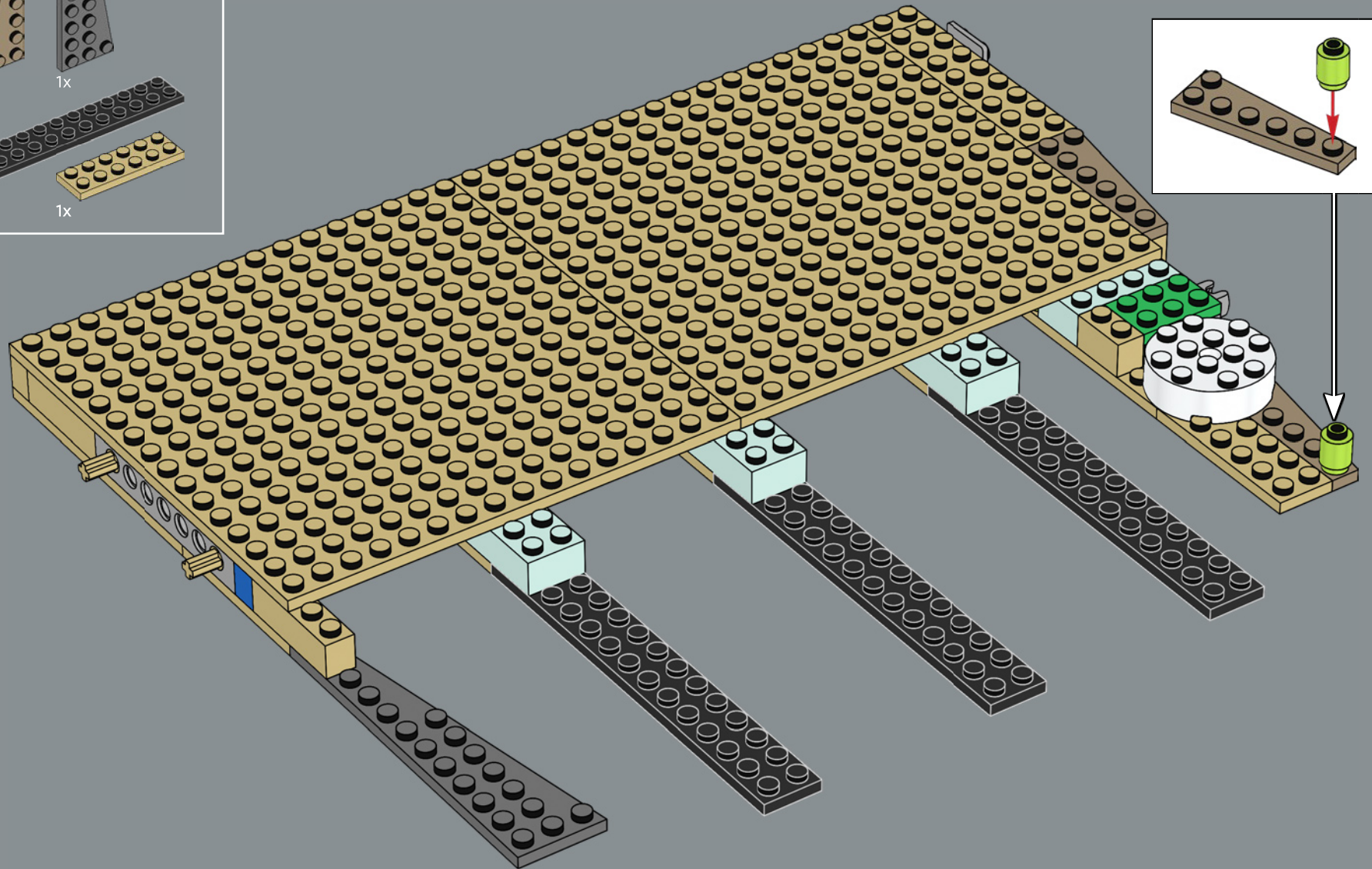

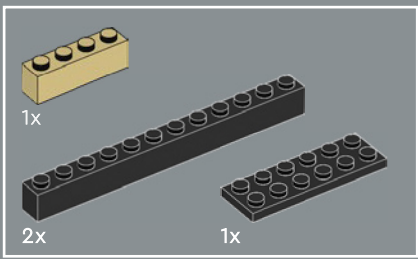

17

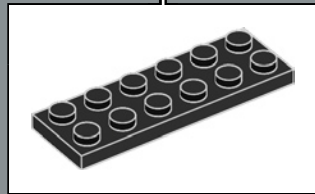
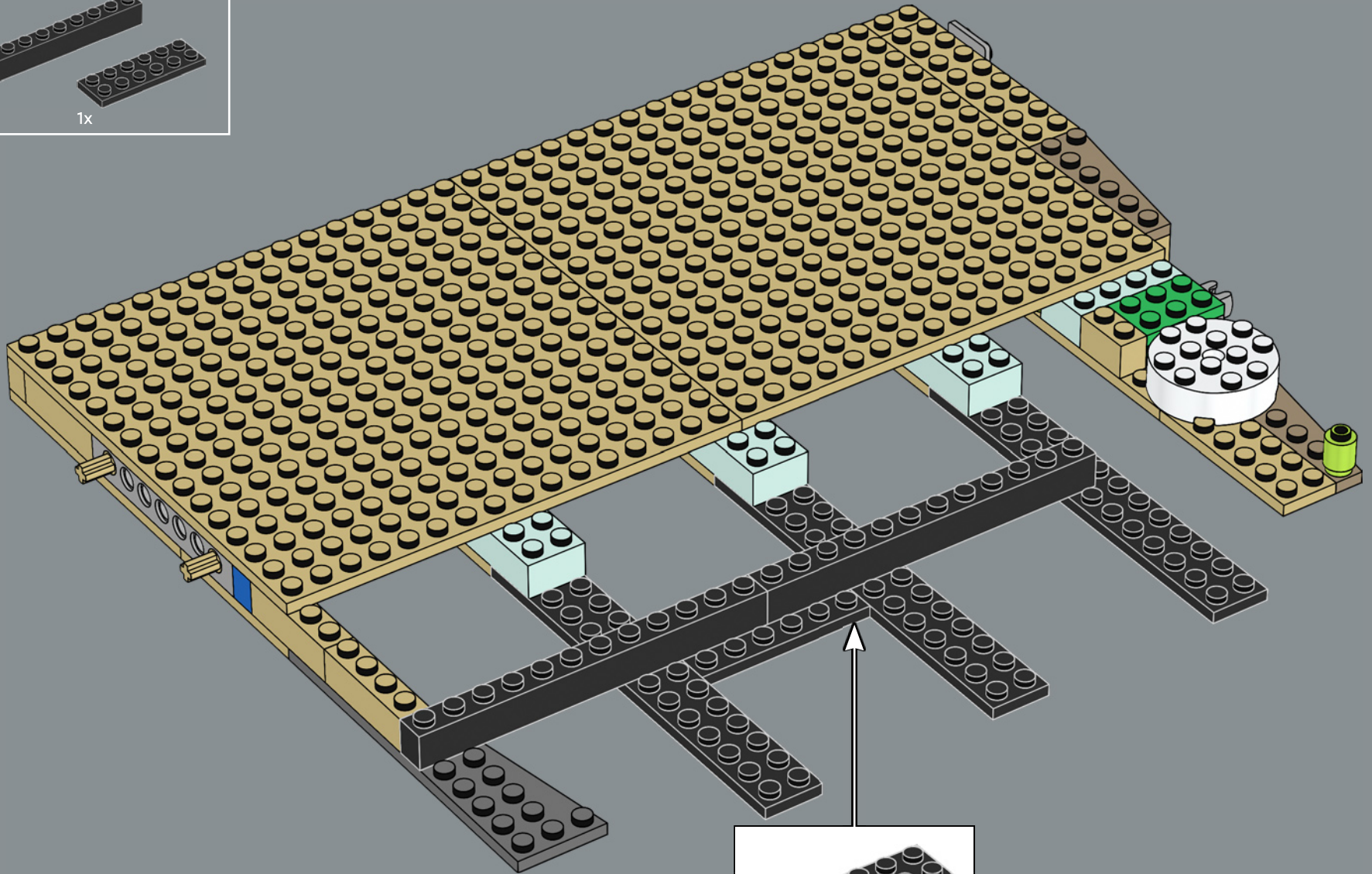

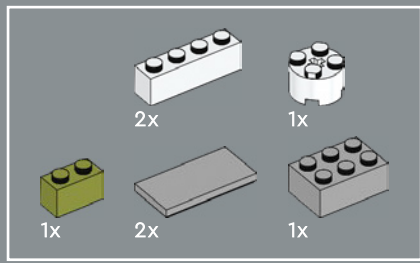

18

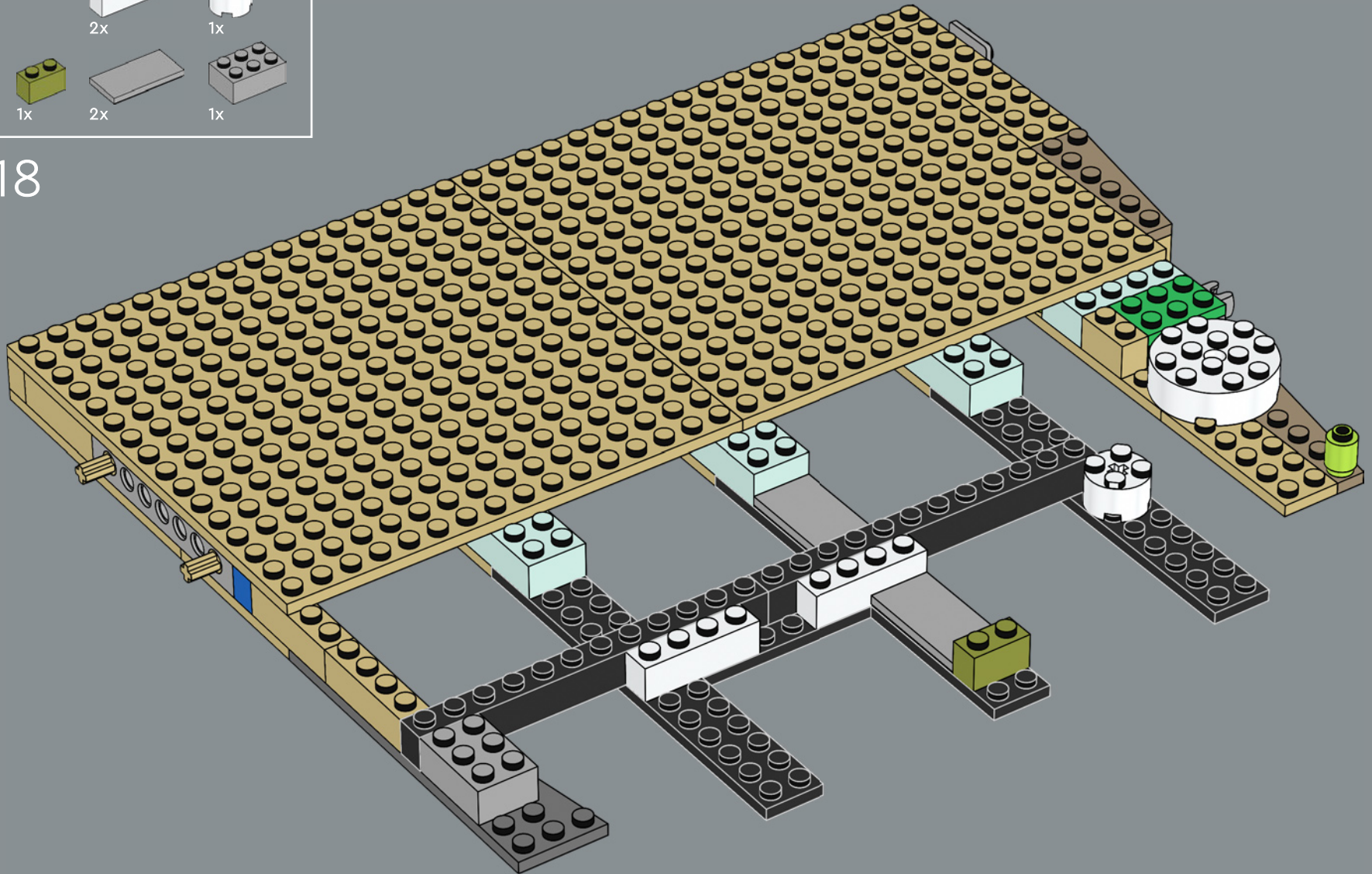

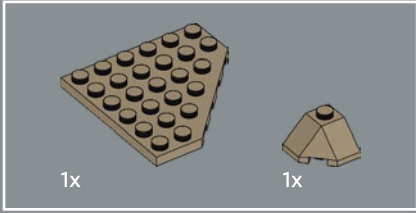
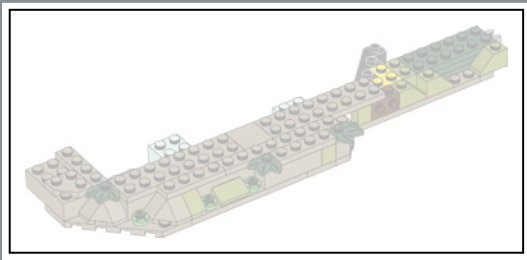

20

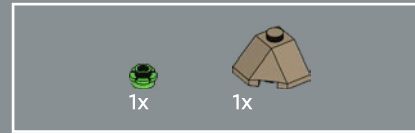
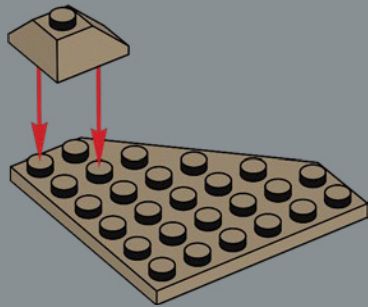

21

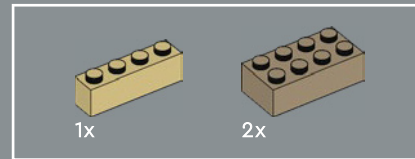
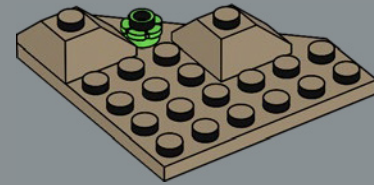

22

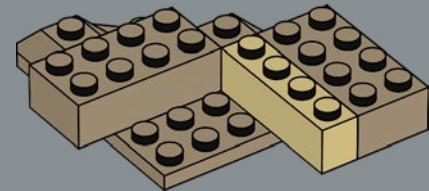

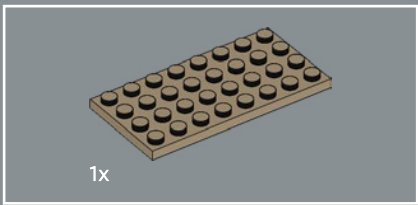

23

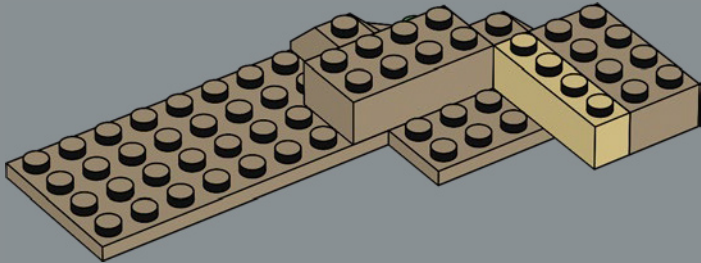

24

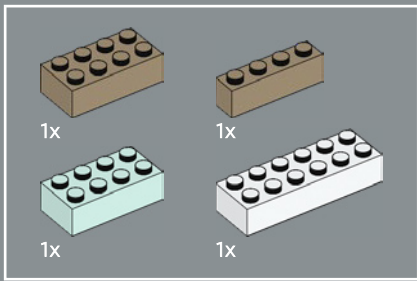
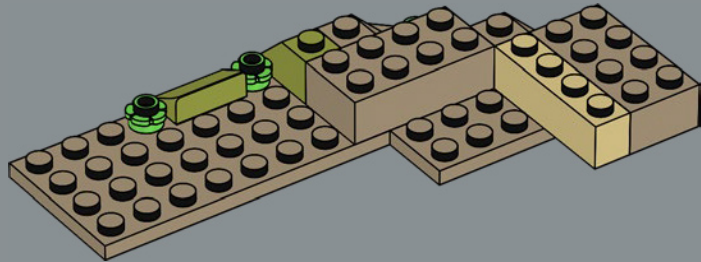

25

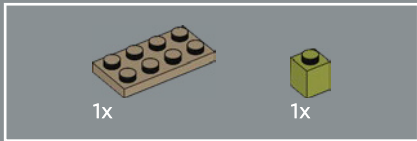
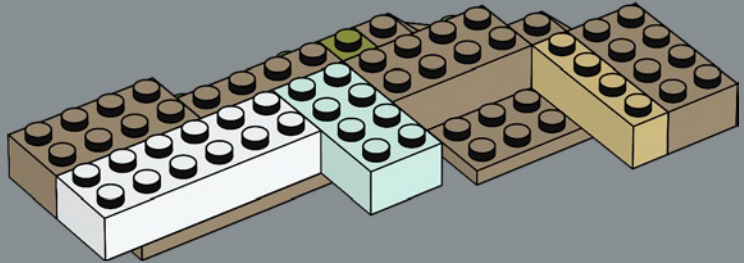

26

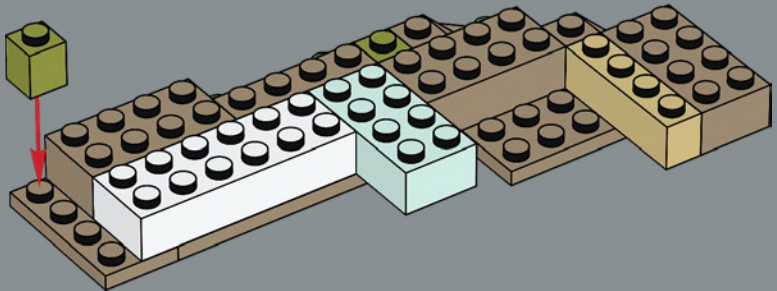

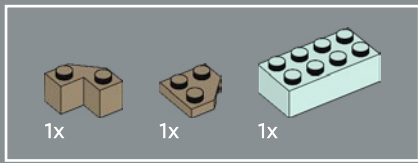

27

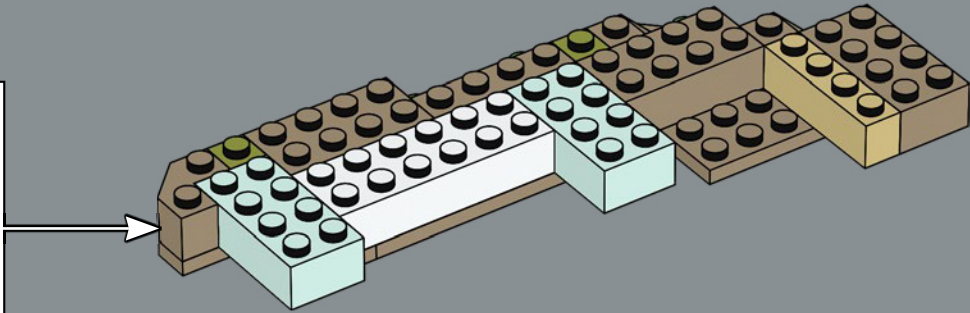
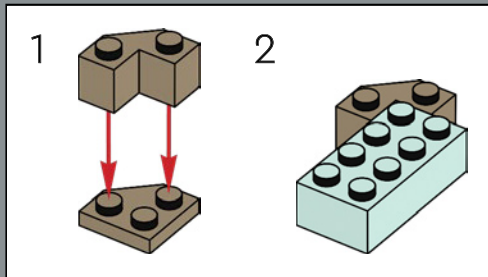

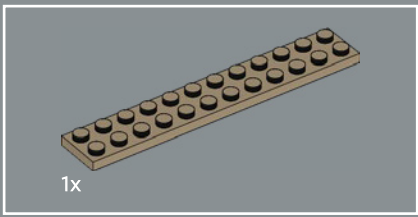

28

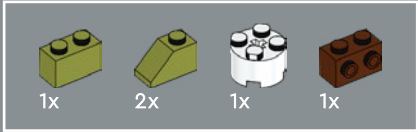
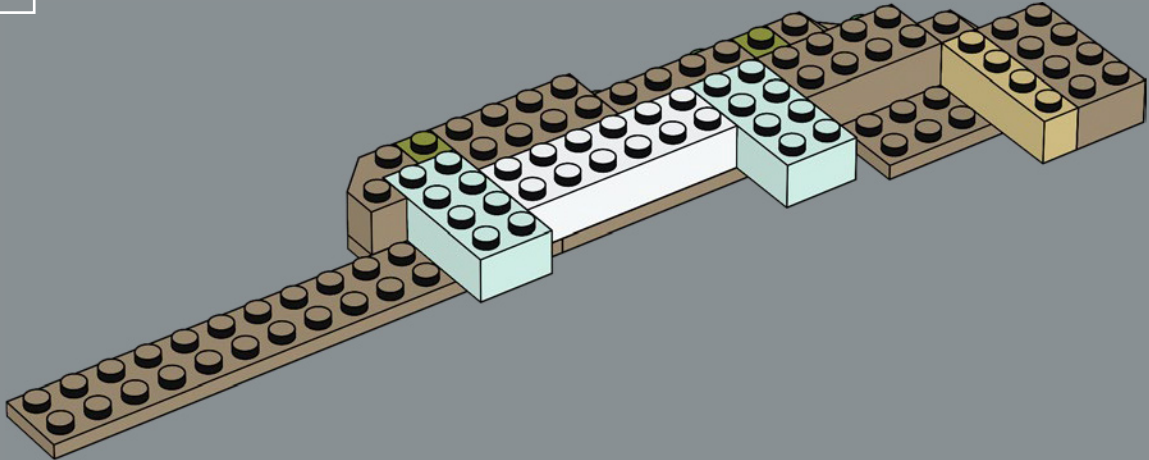

29

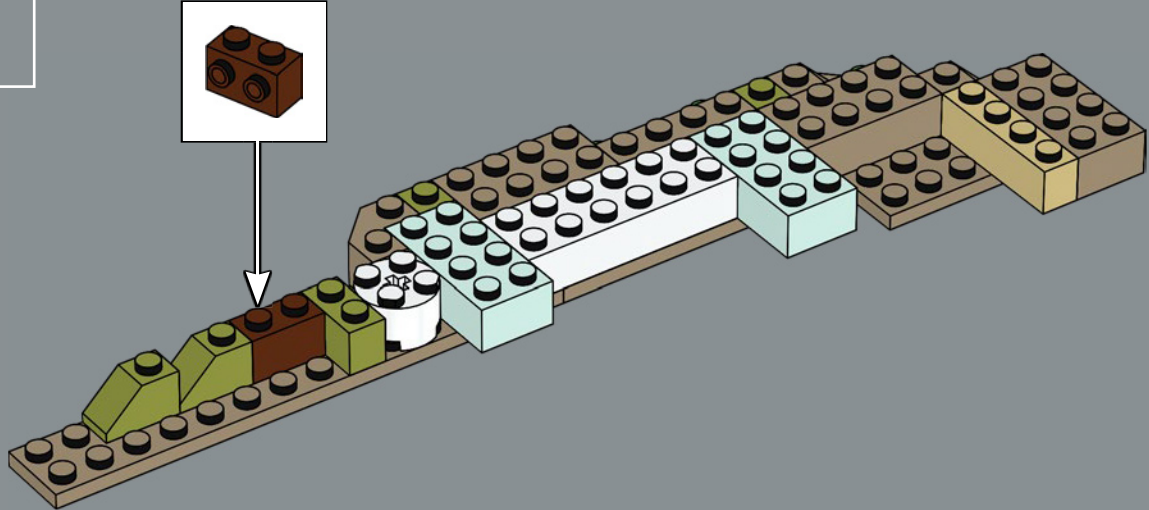

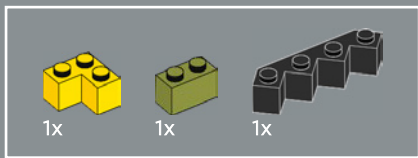

30

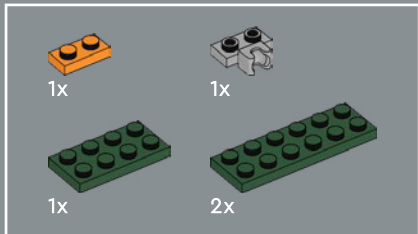
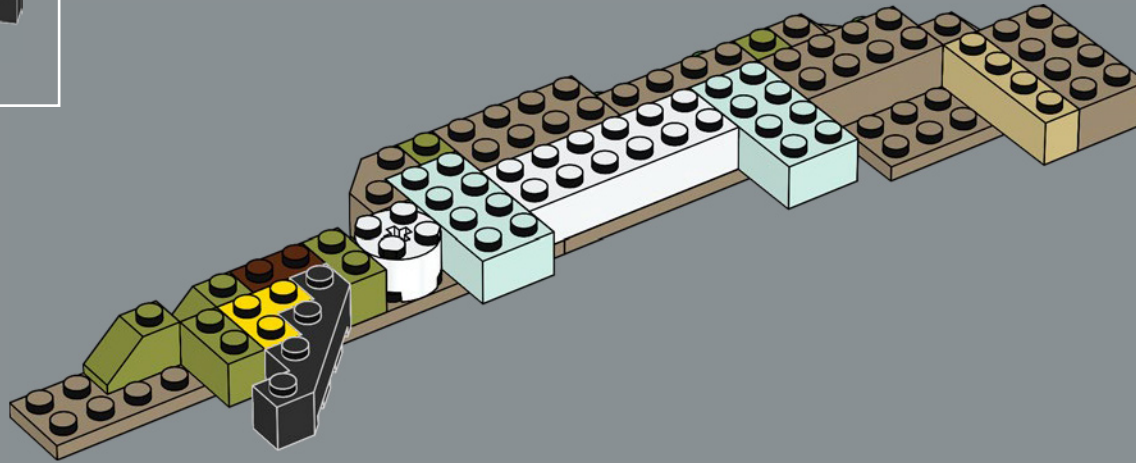

31

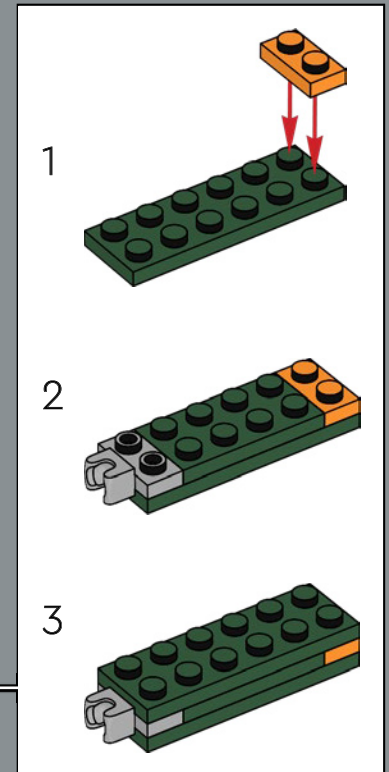
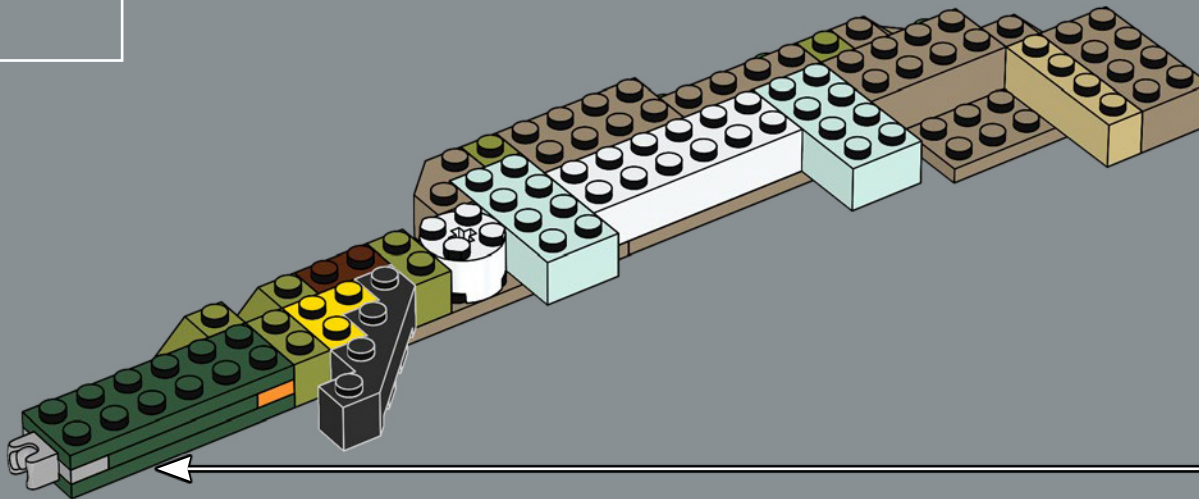

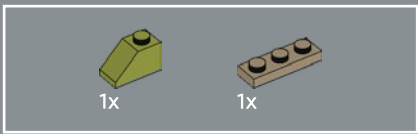

32

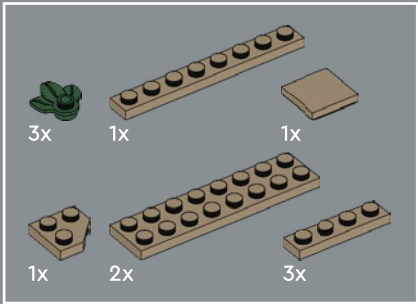
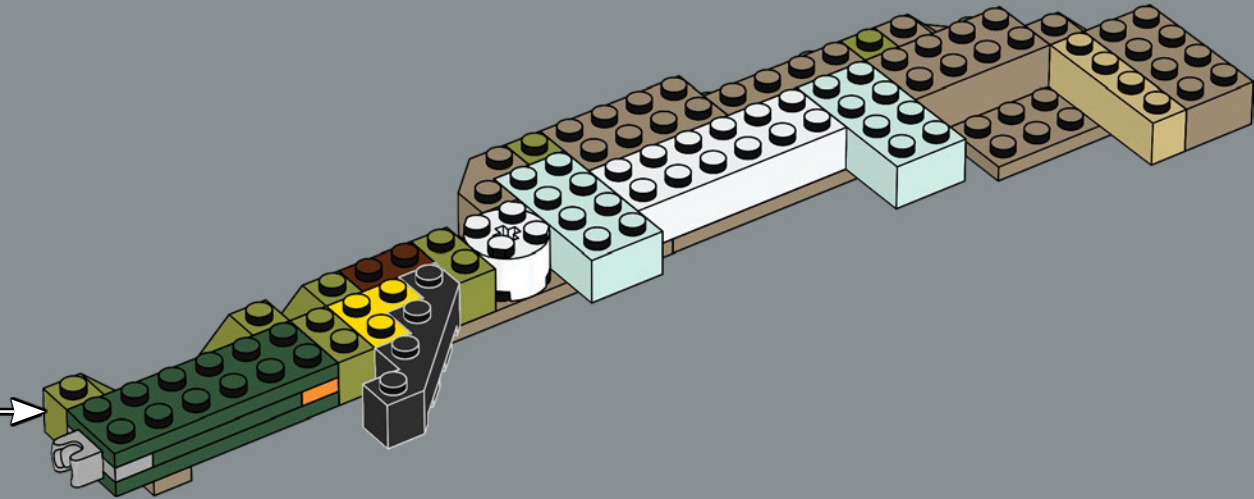
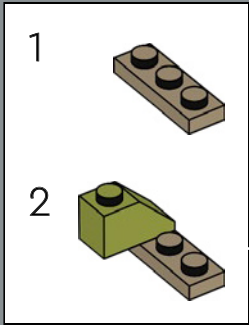

33



34

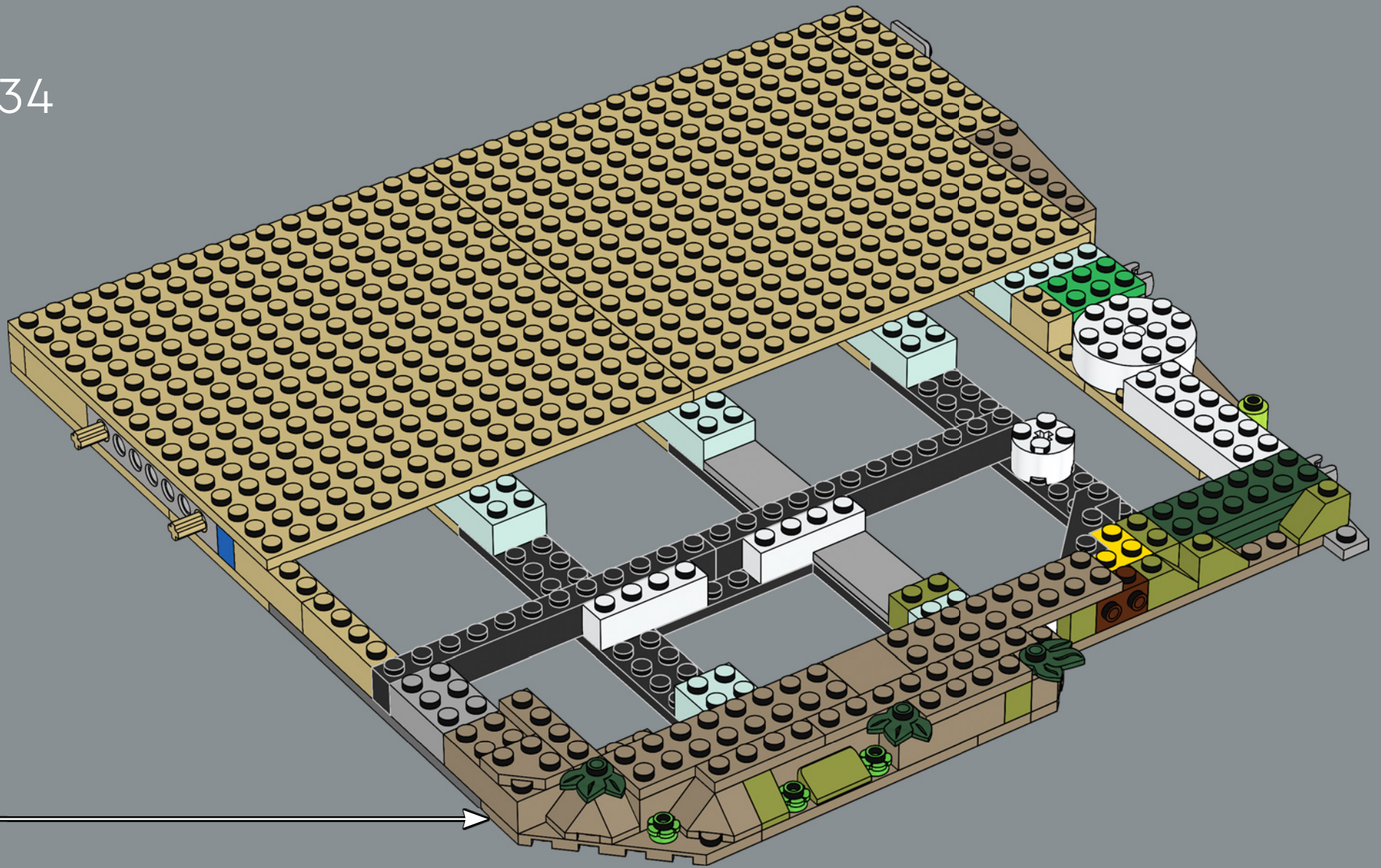

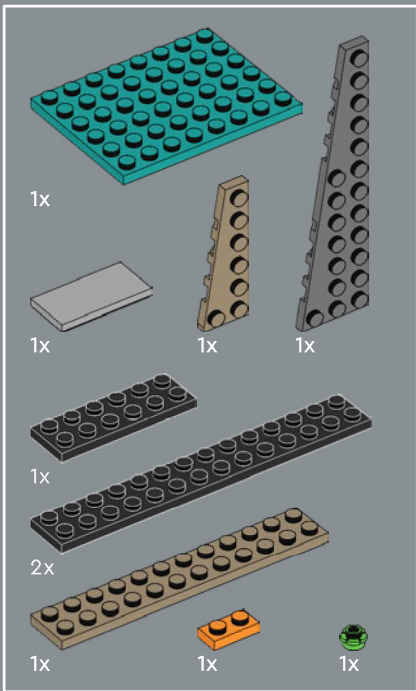

35

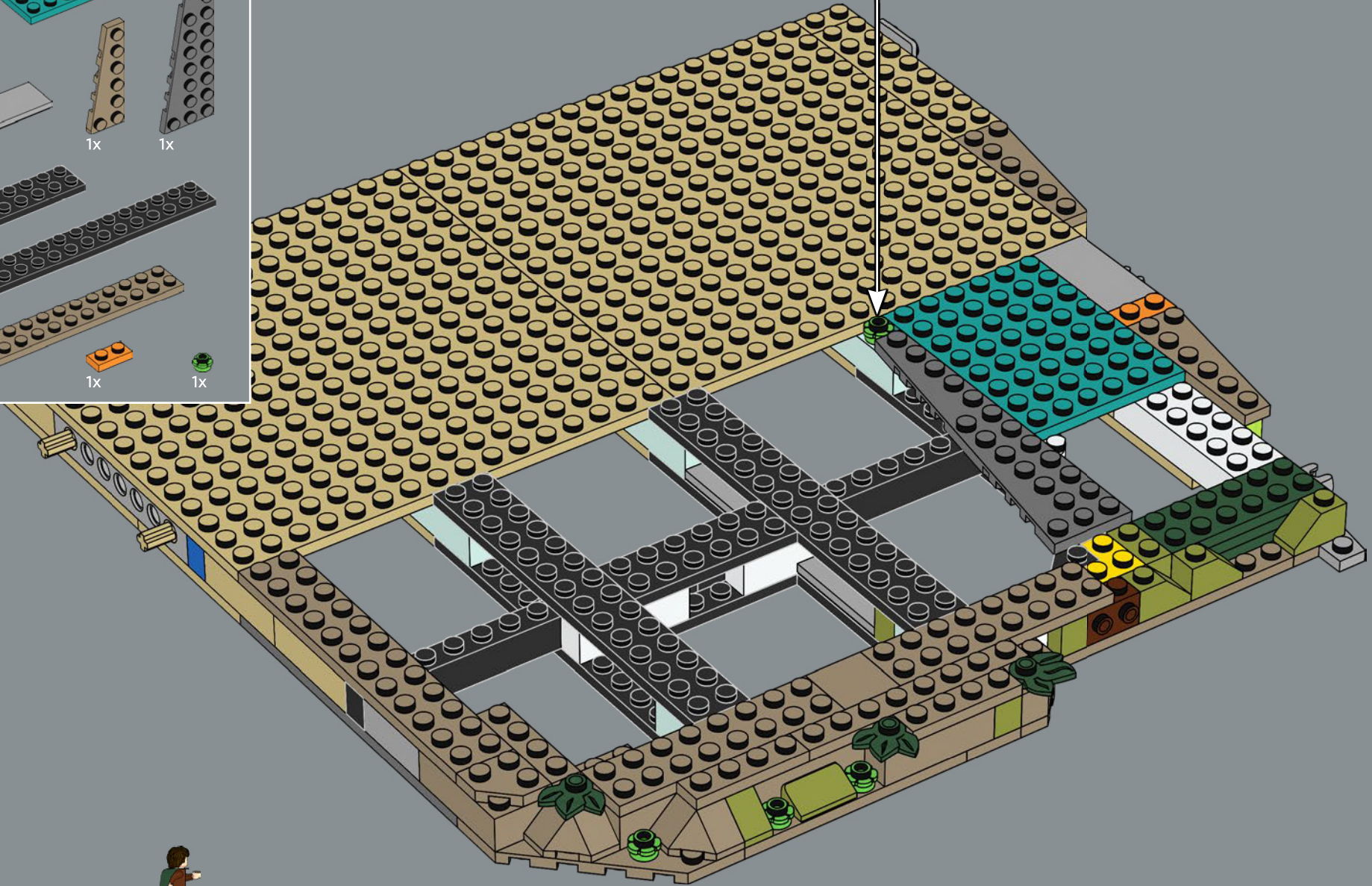

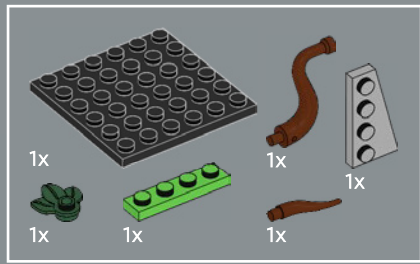

36

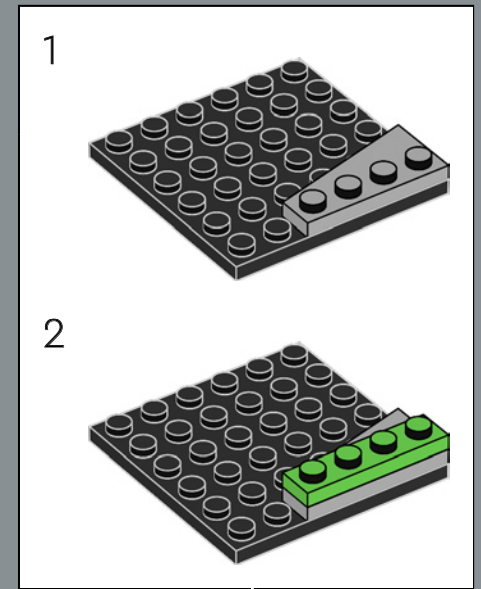

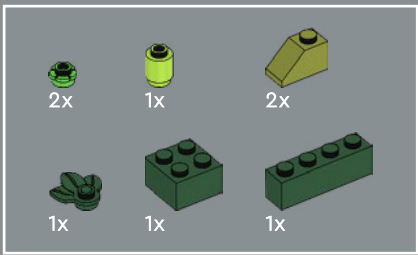

37

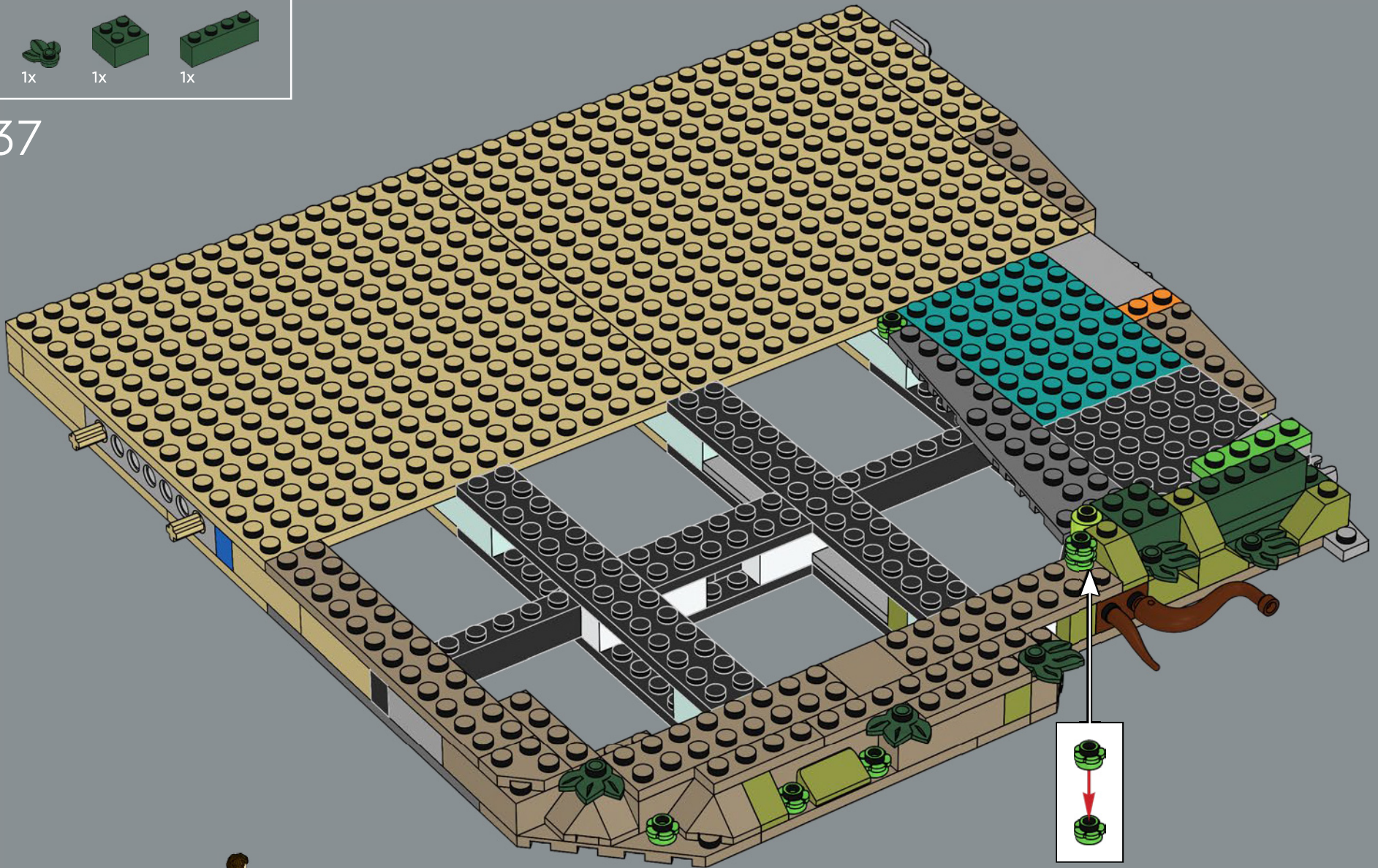

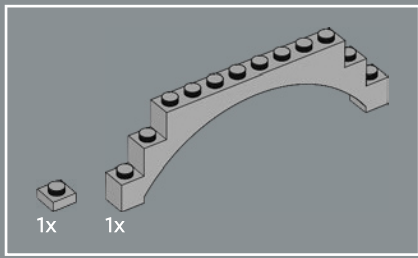

38

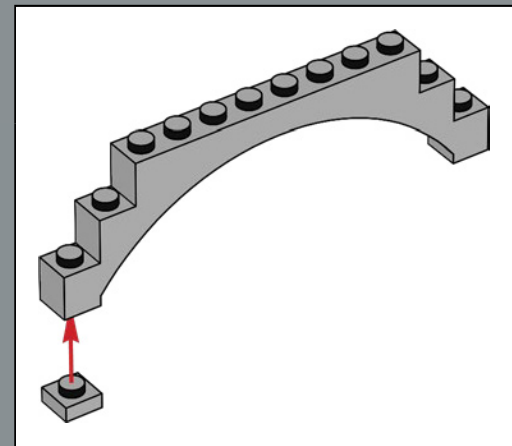
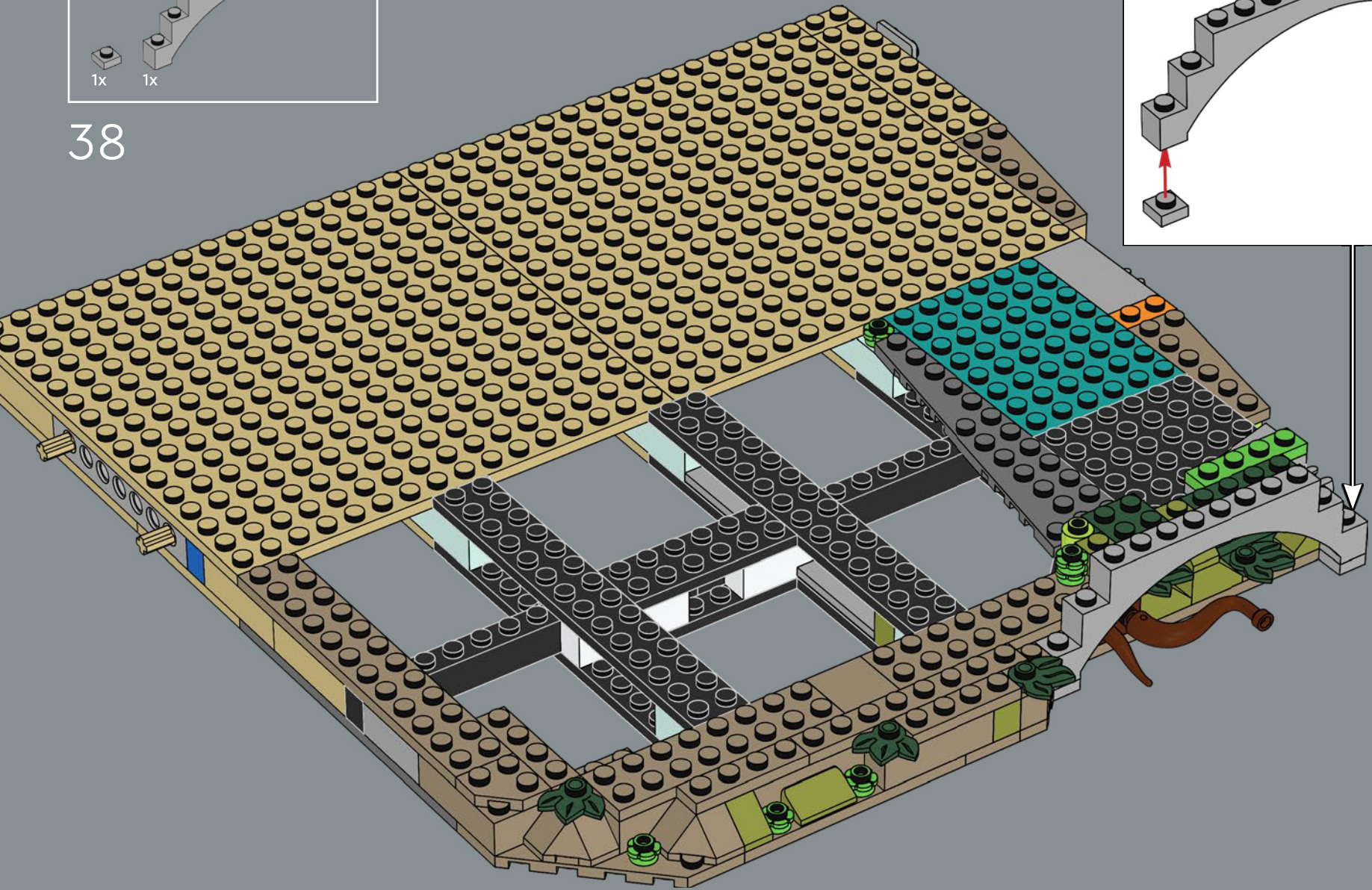

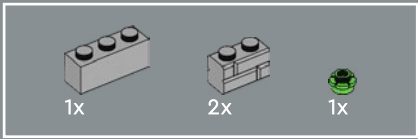

39

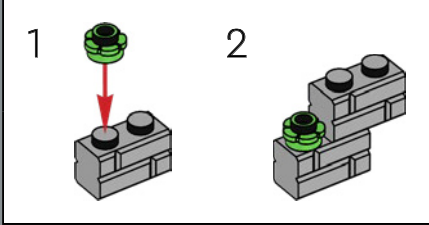
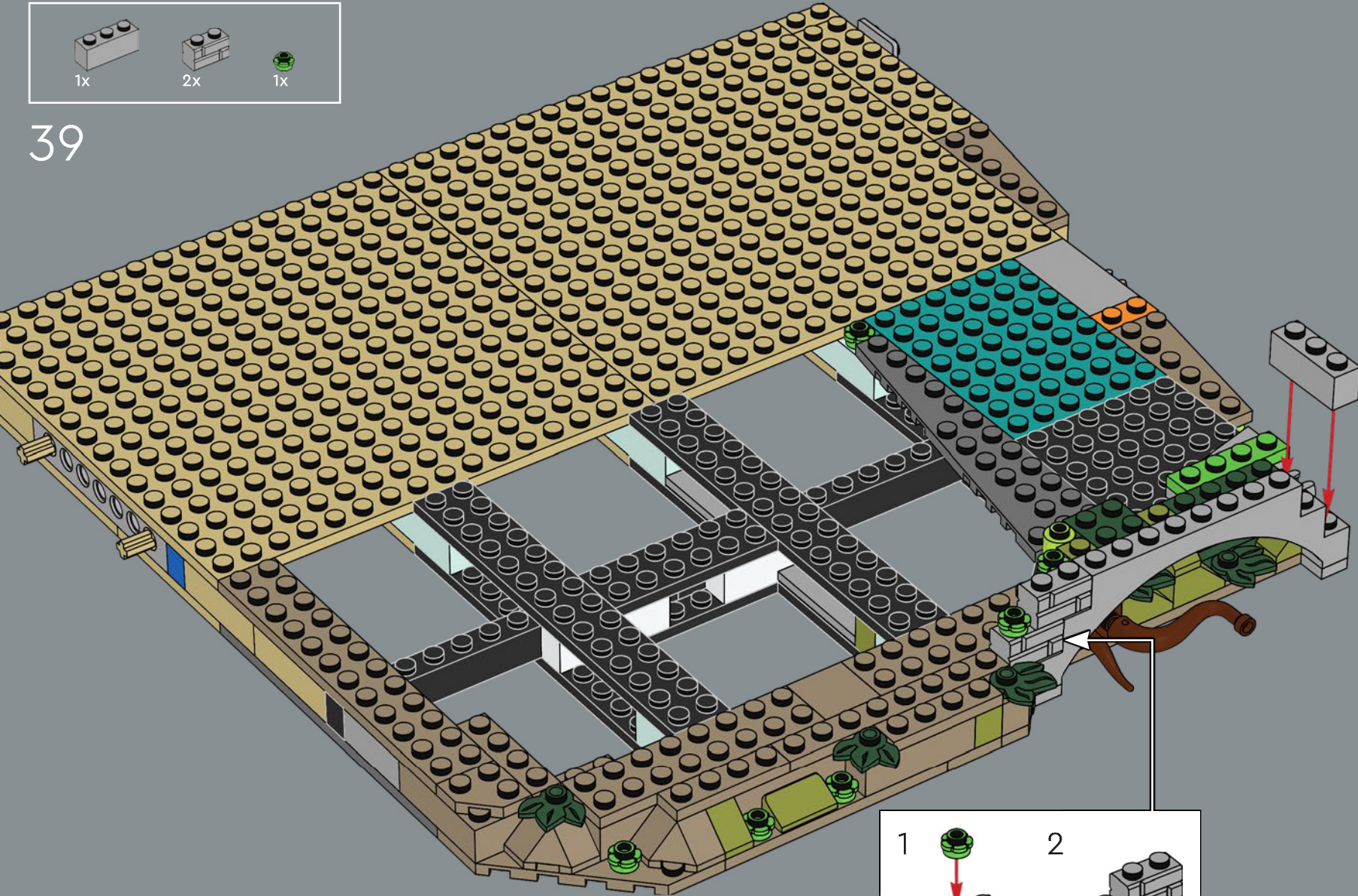

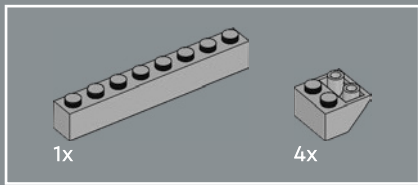

40

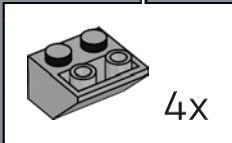
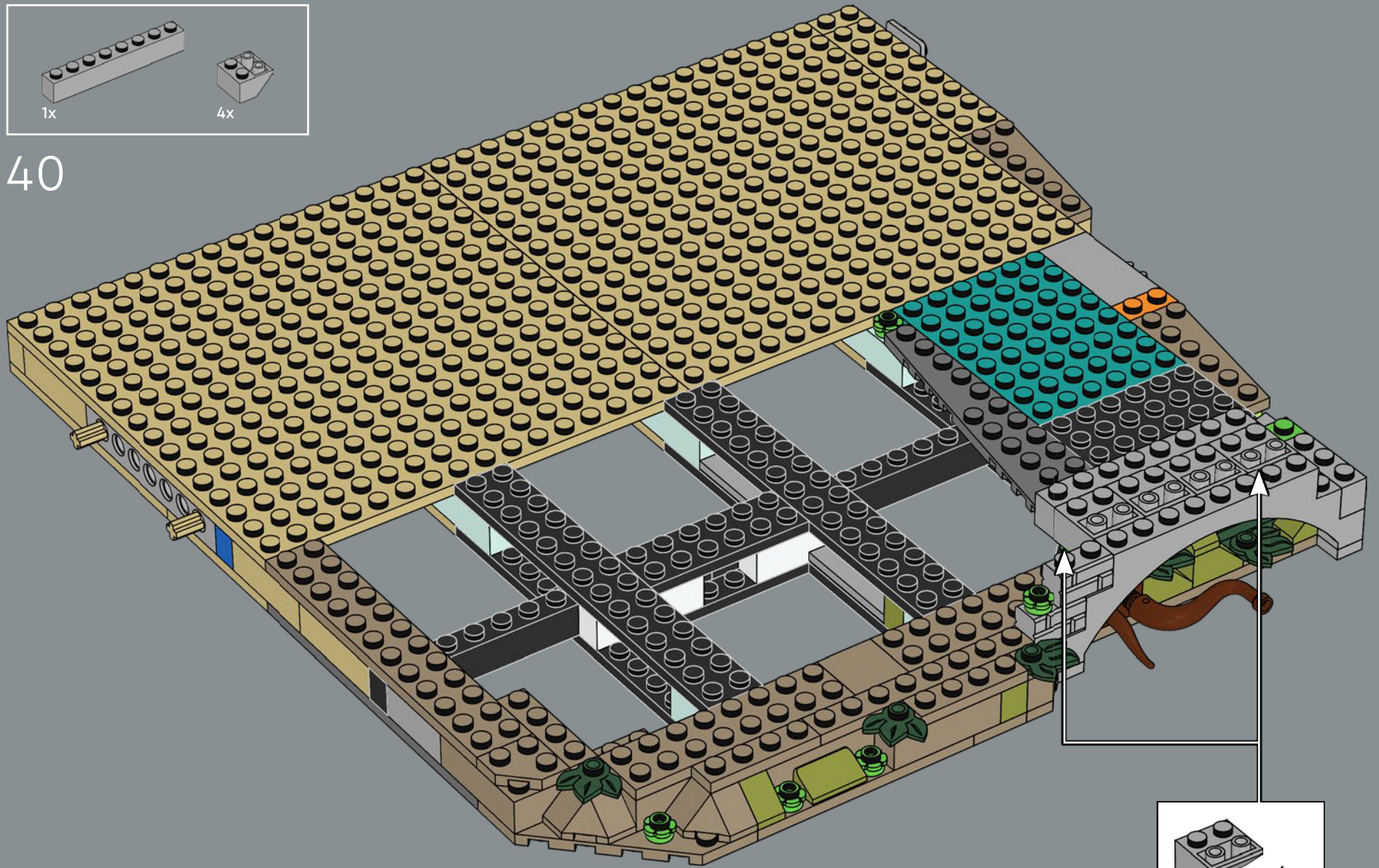

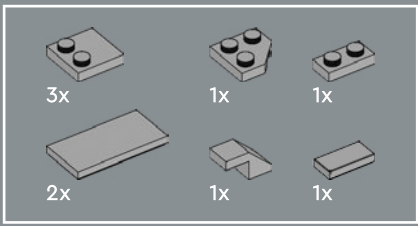

41



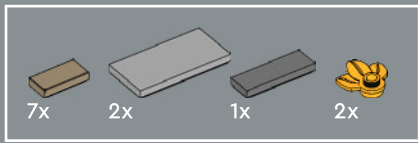

42

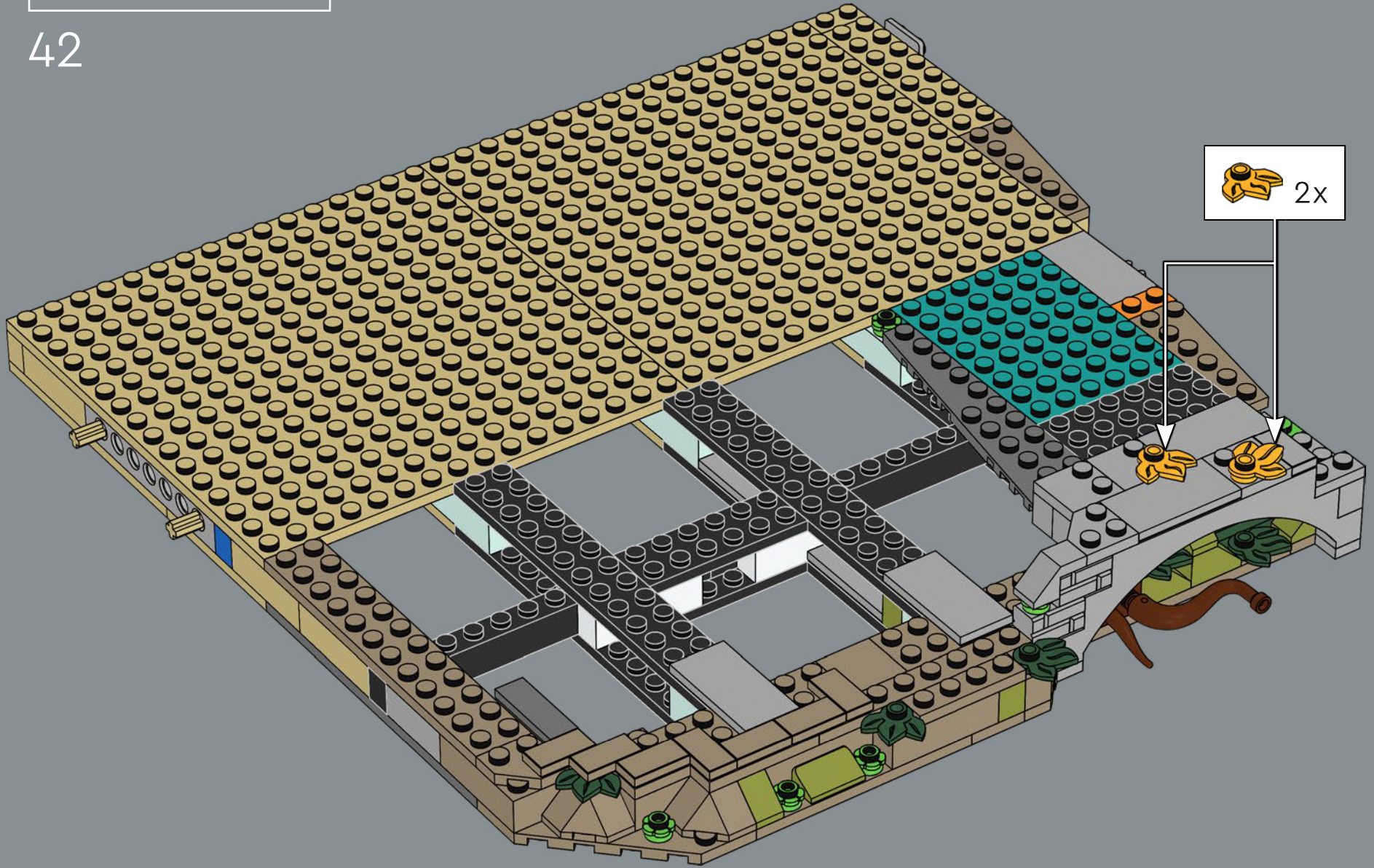



The new floor tile is included 64 times, enough to decorate an entire 16×16 plate.

La nouvelle tuile de sol est incluse 64 fois, ce qui suffit à recouvrir une plaque de 16×16.

Se incluyen 64 unidades de la nueva cubierta para pisos: ¡suficientes para decorar una placa 16×16 entera!

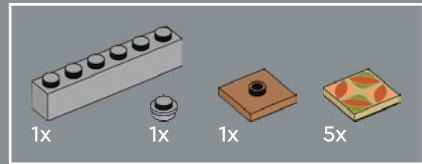

43

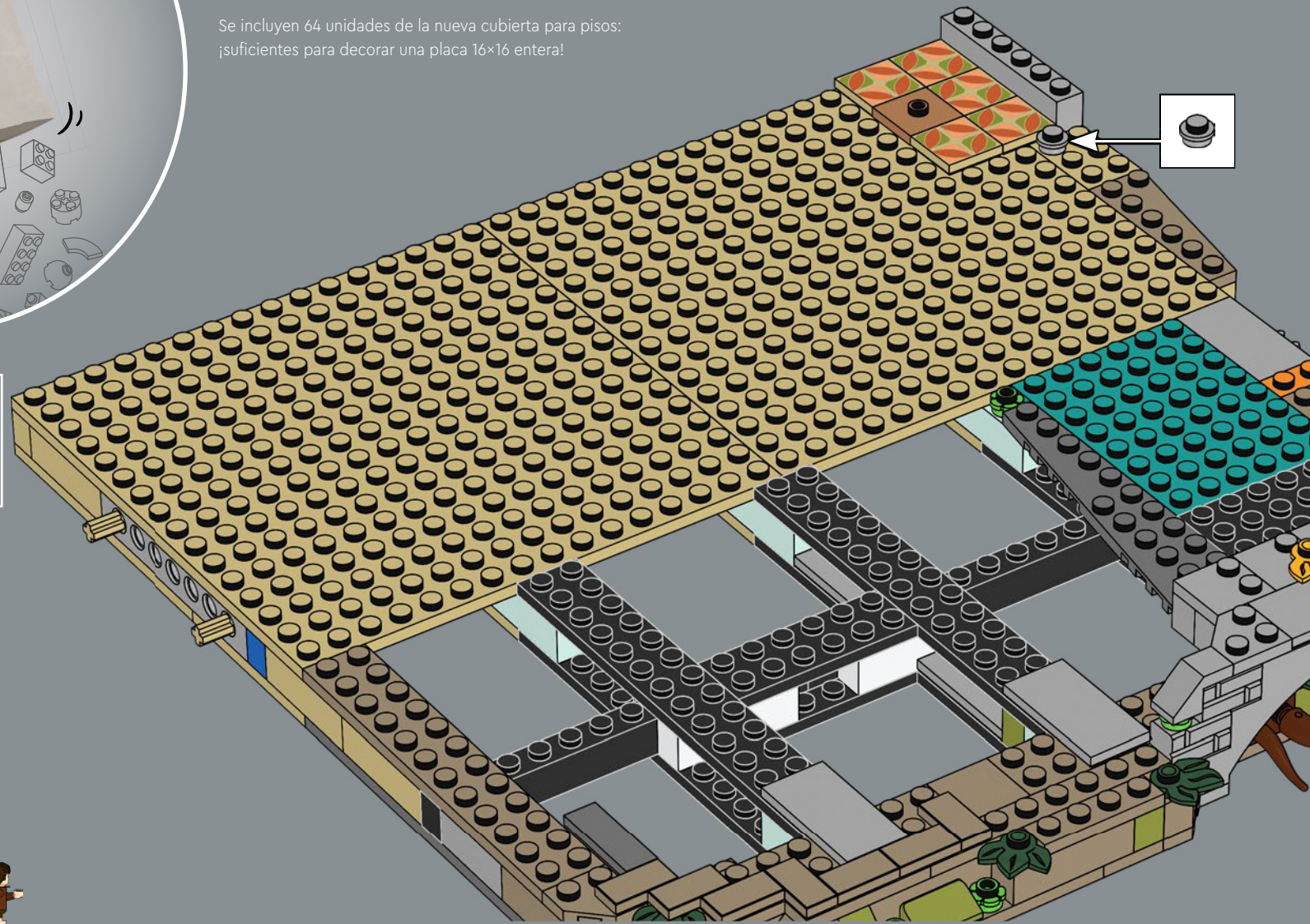



44

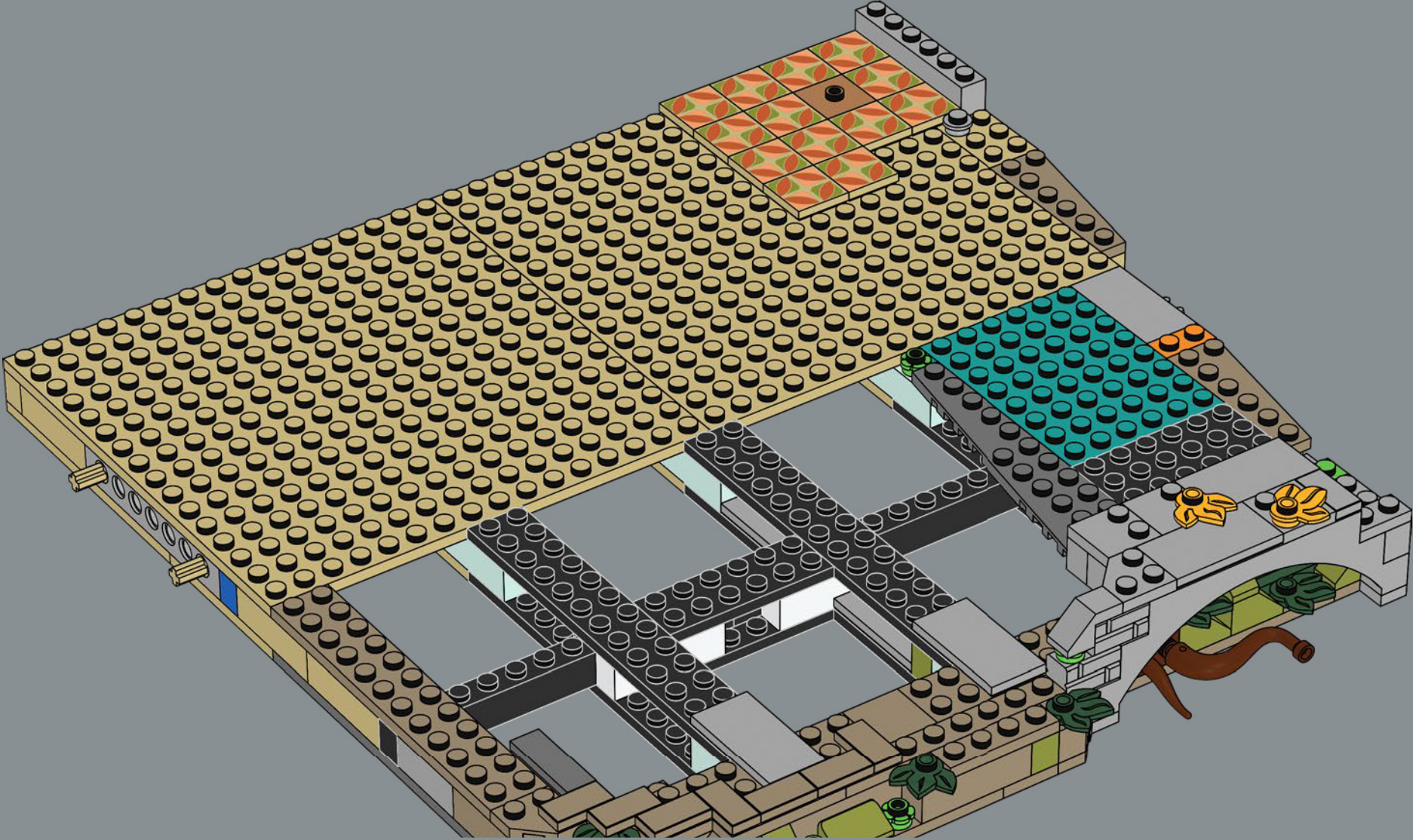

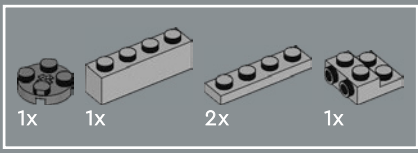

45

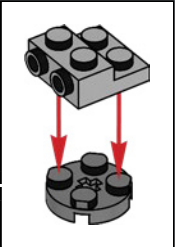
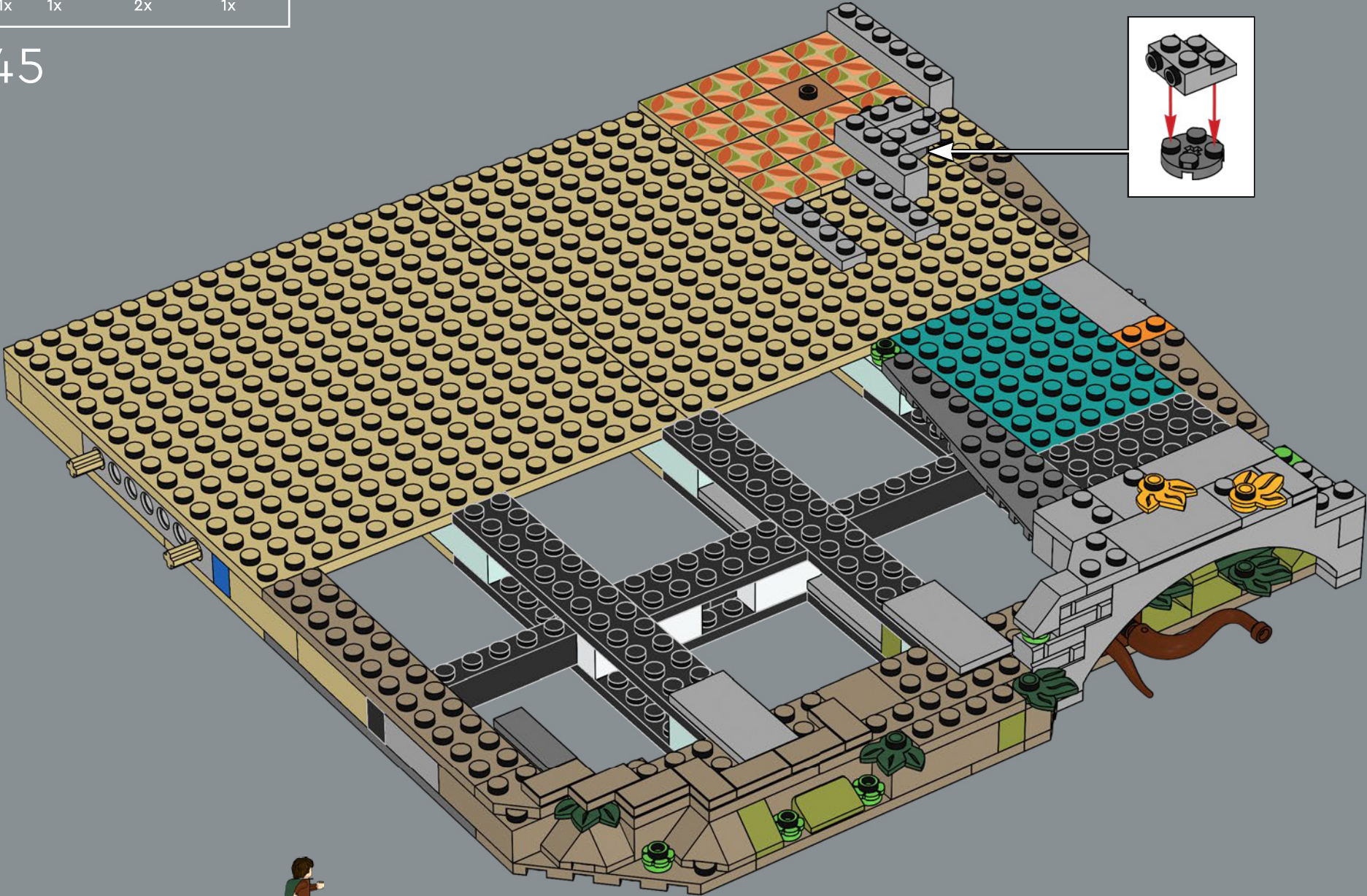

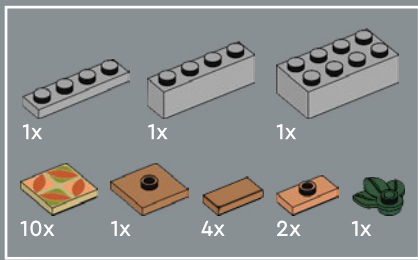

46

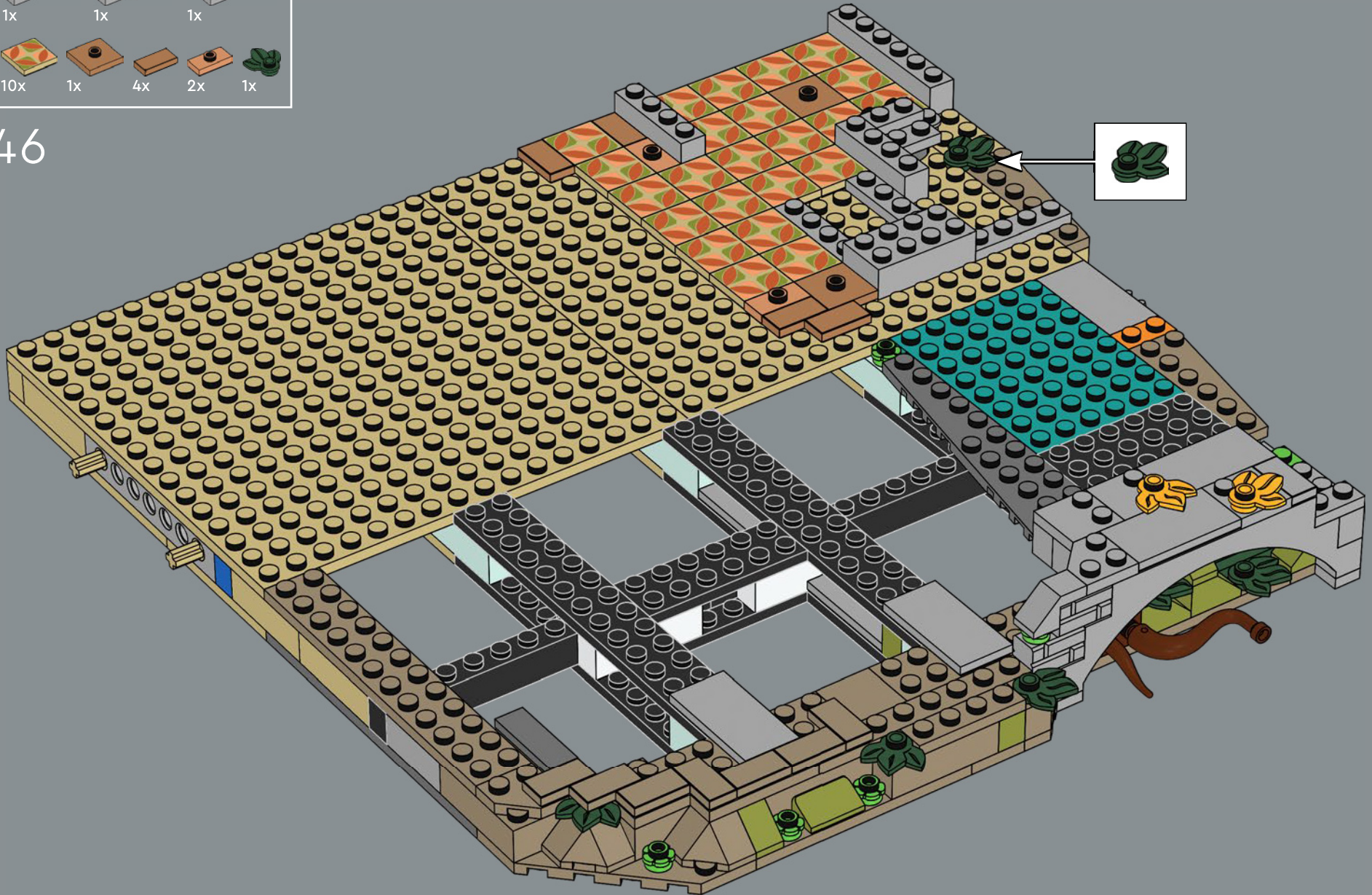

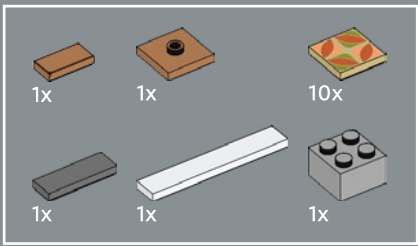

47



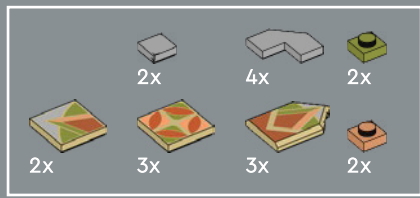

48



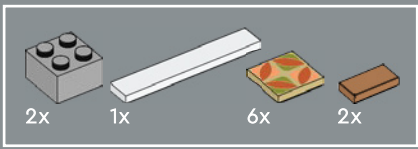

49



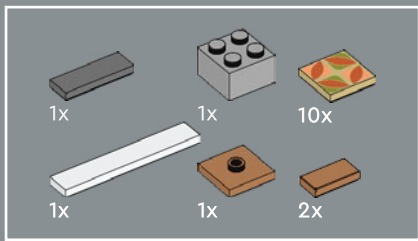

50

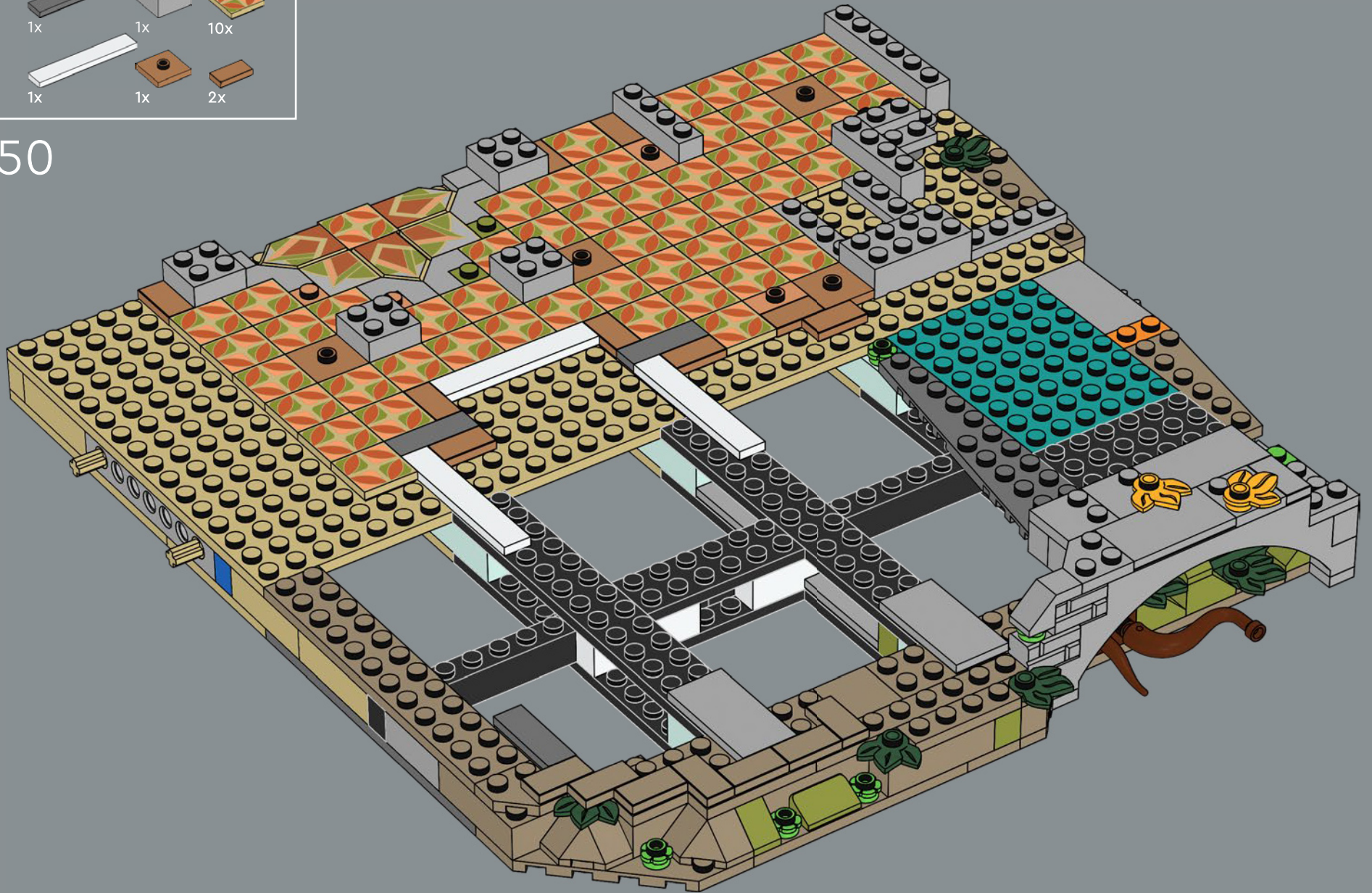

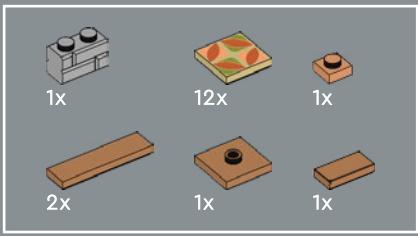

51

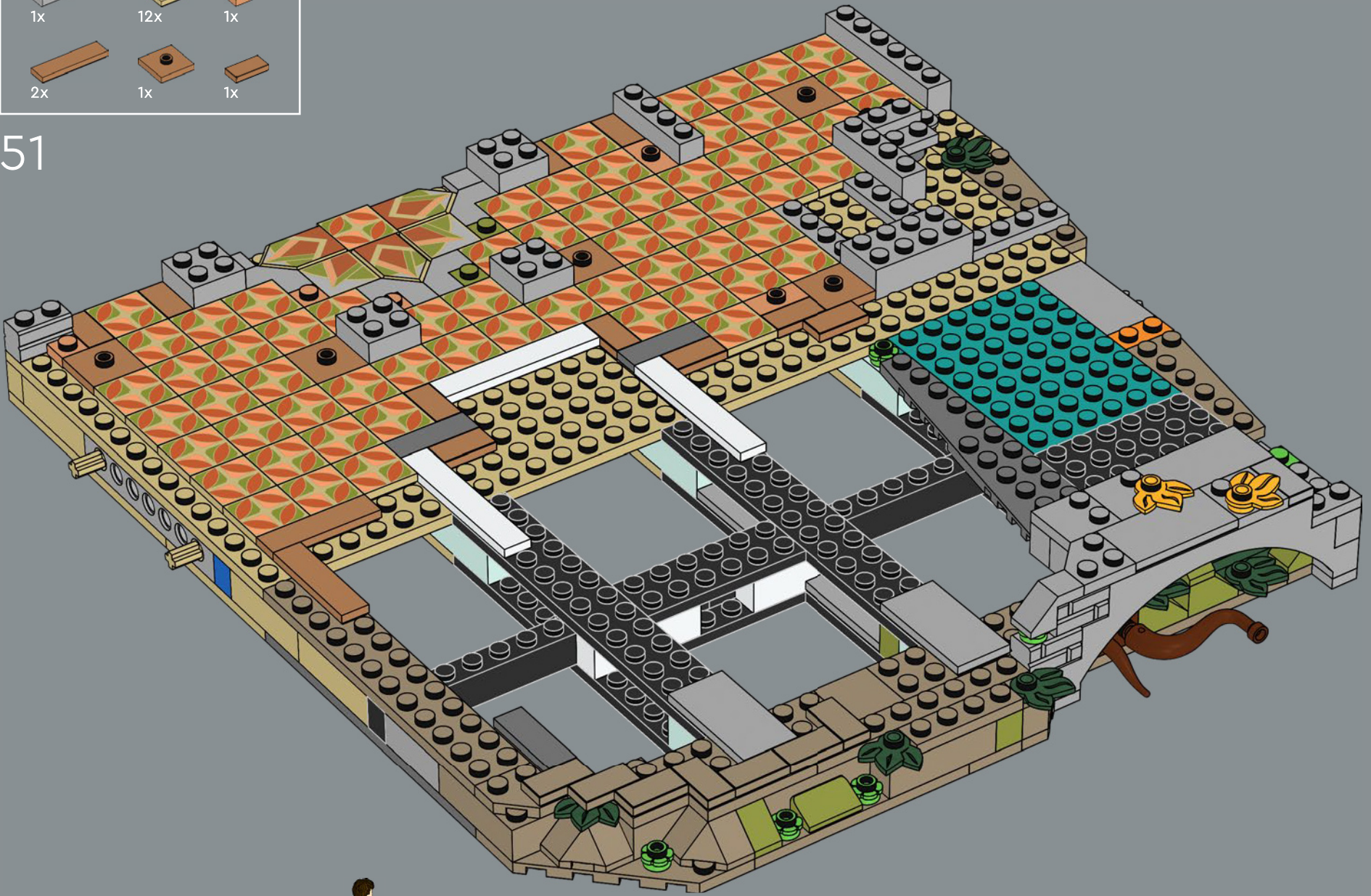

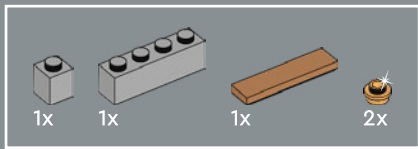

52



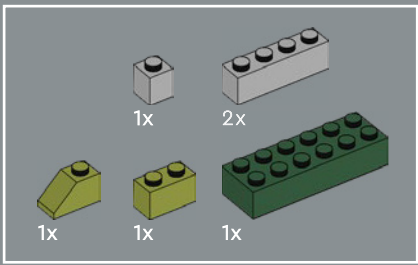

53

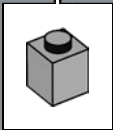
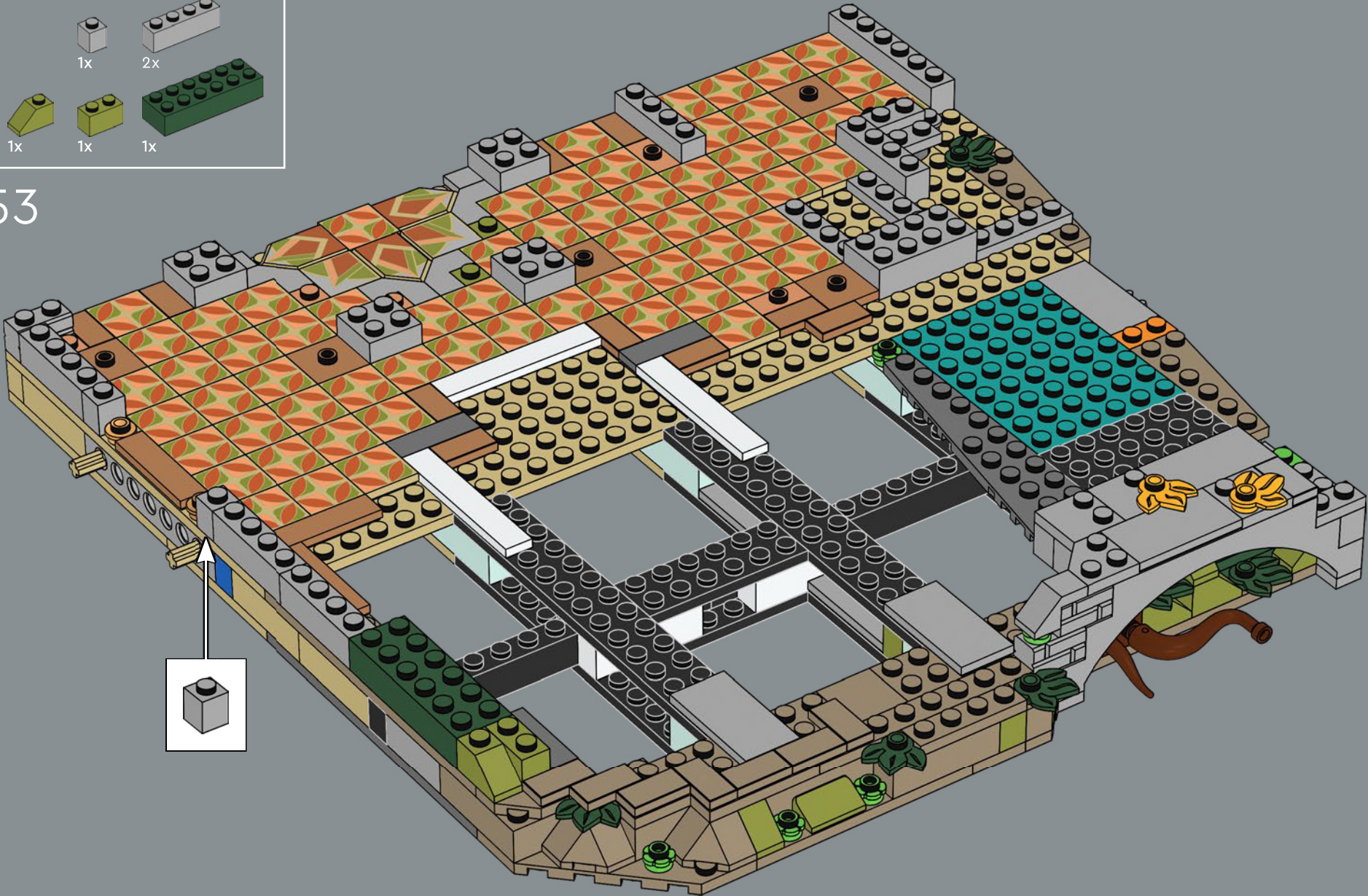

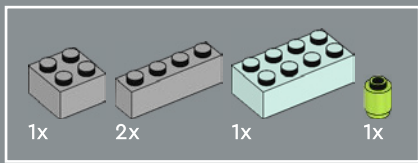

54



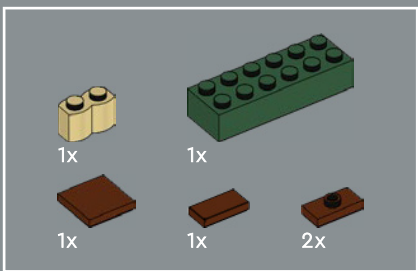

55

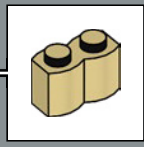
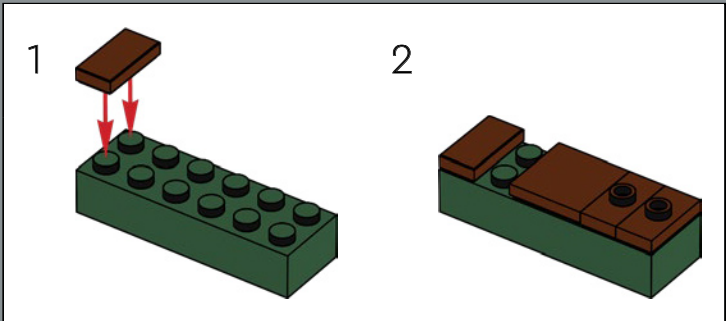
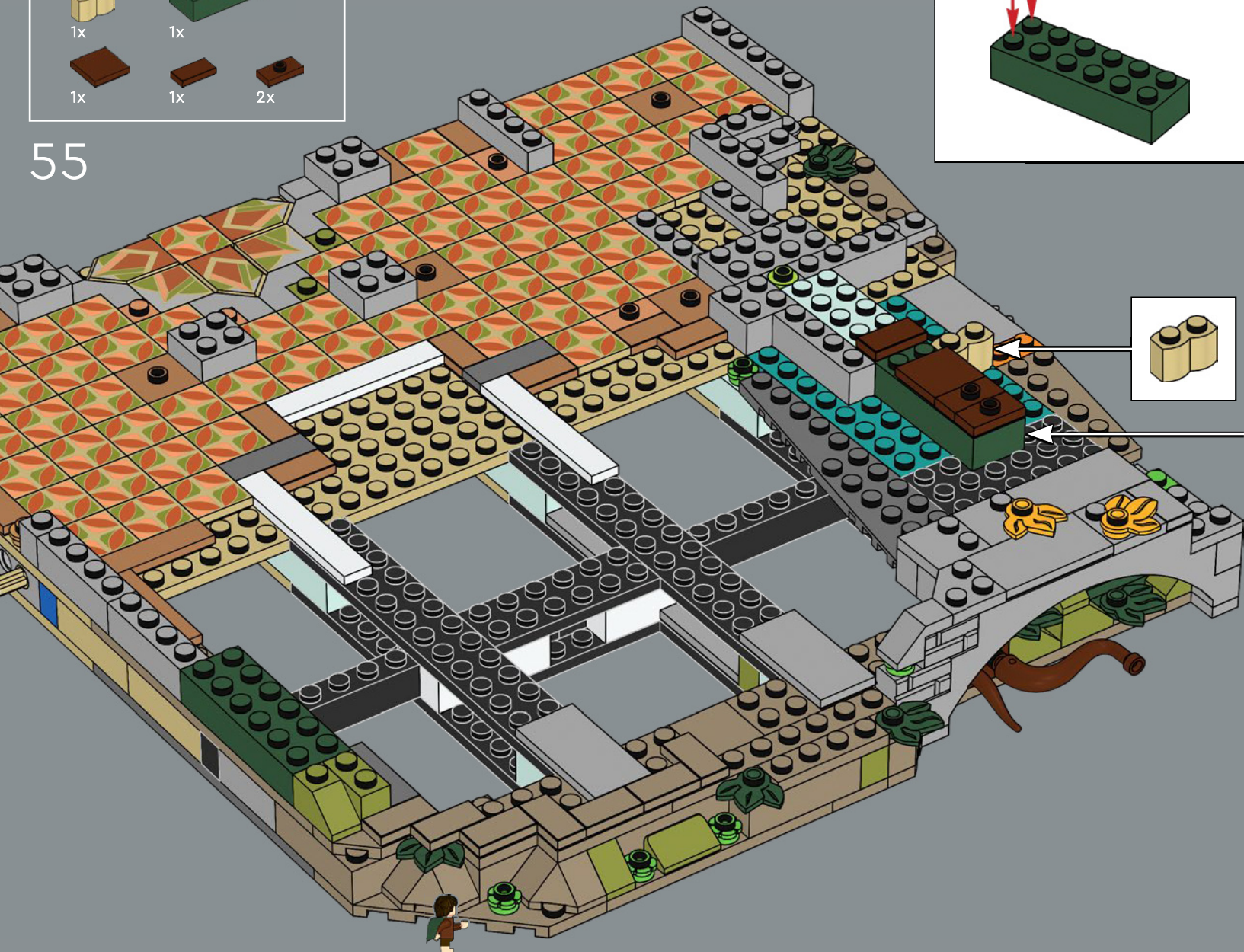

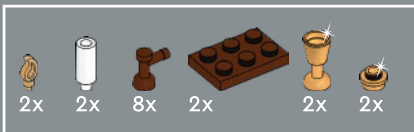

56

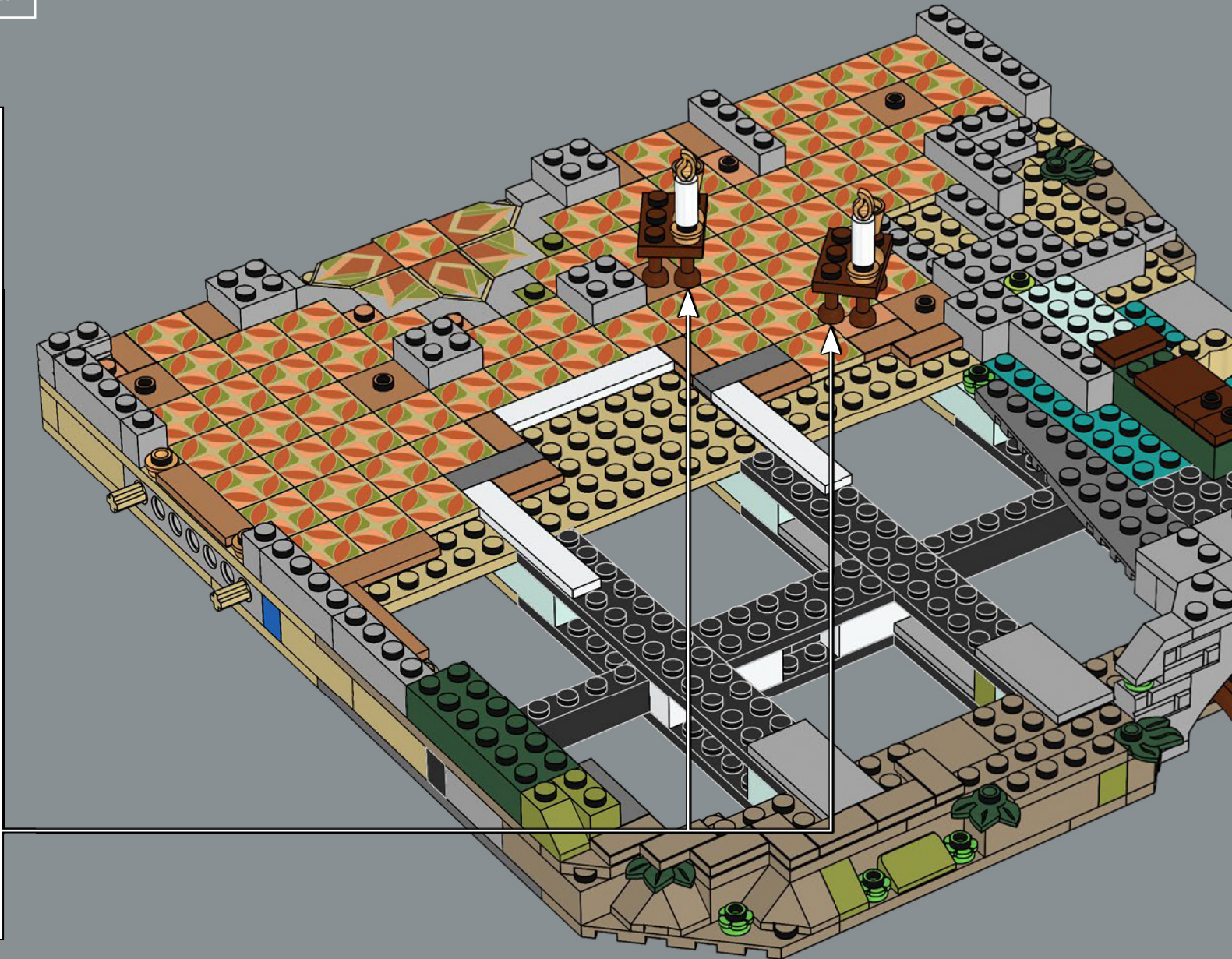

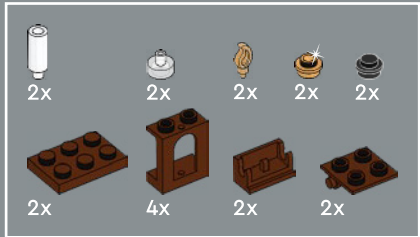

57

1

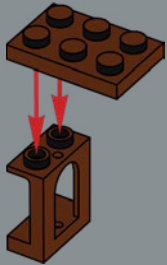

2



3



4



5

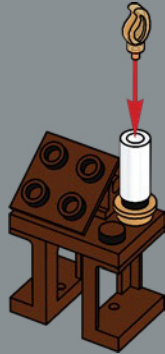

6

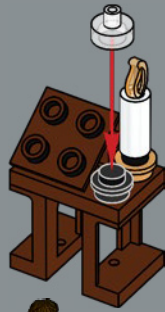

2x



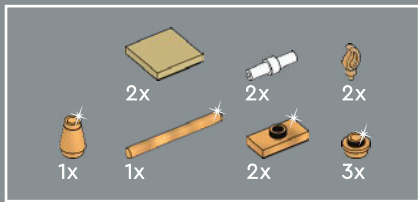

58

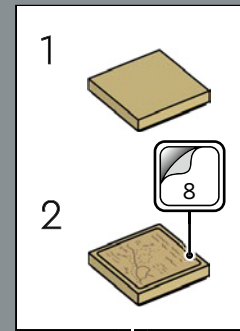
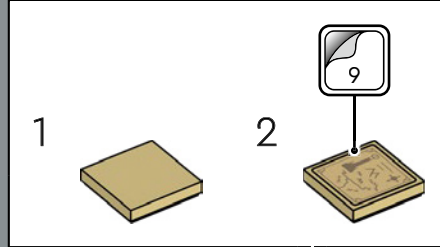
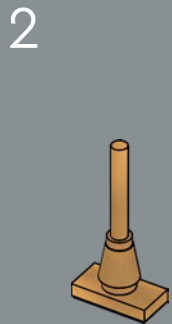
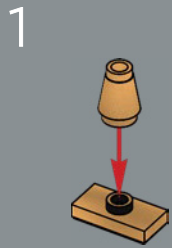
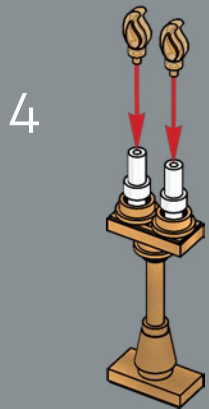
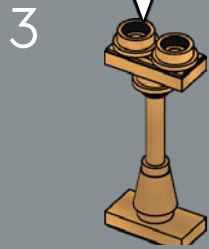
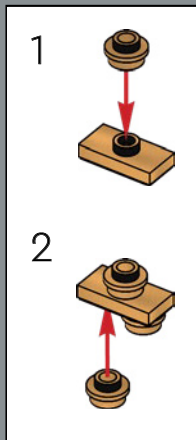

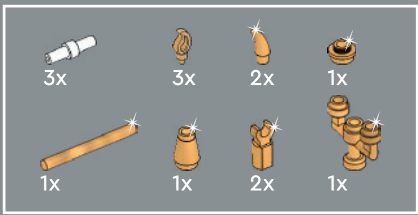

59

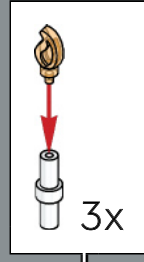
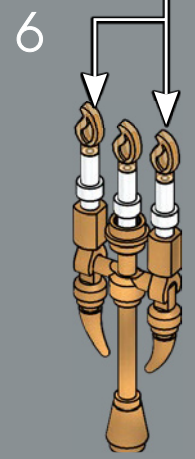
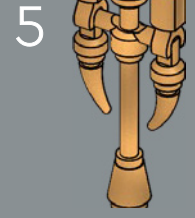
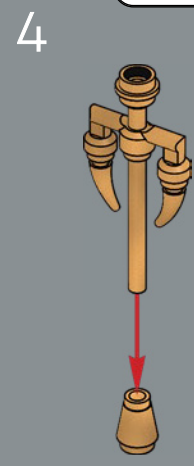
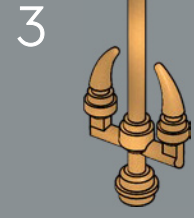
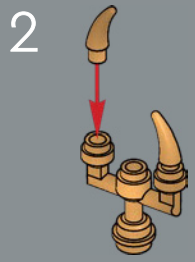
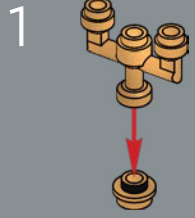

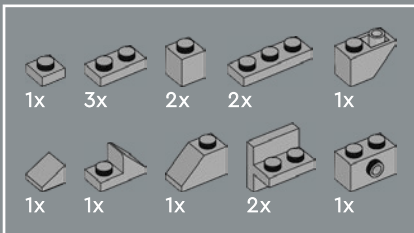
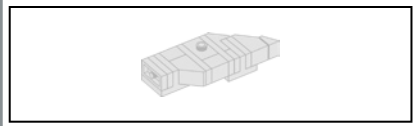

60

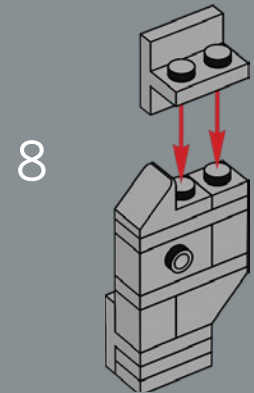
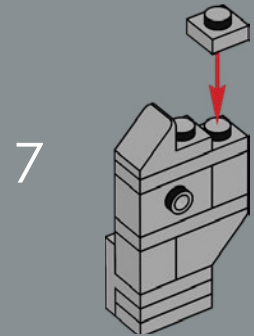
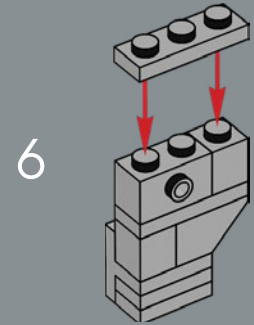
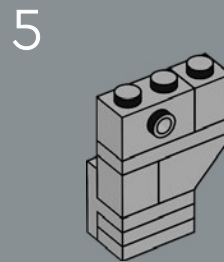
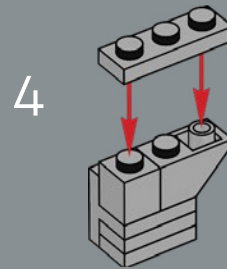
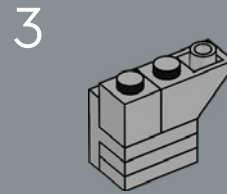
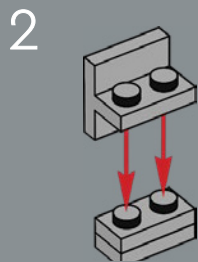
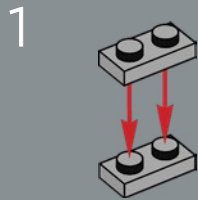

9

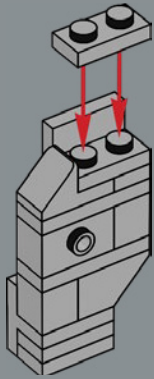

10

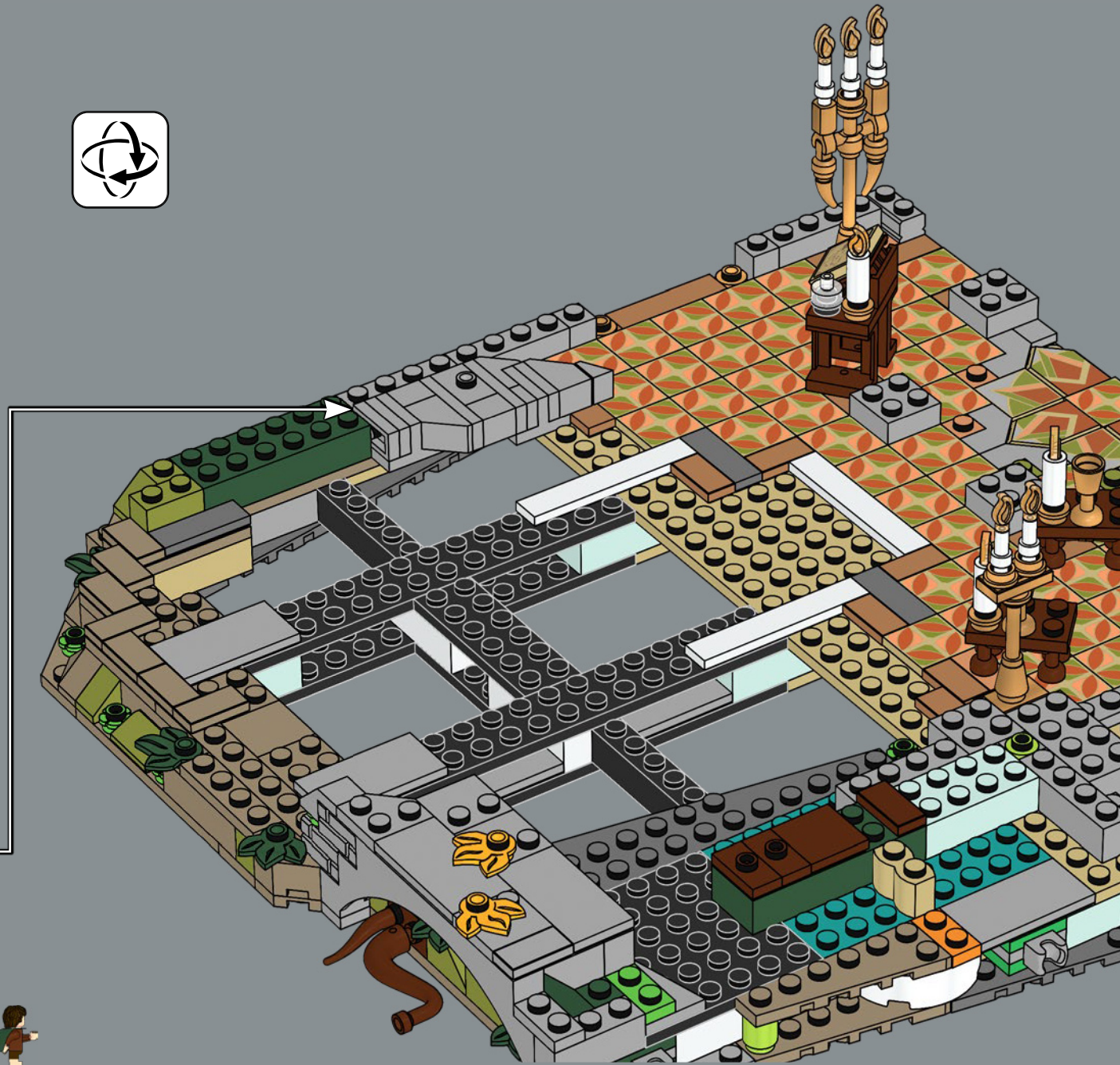
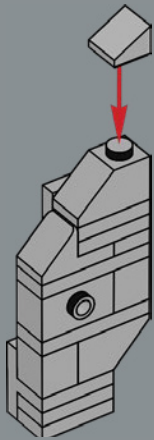

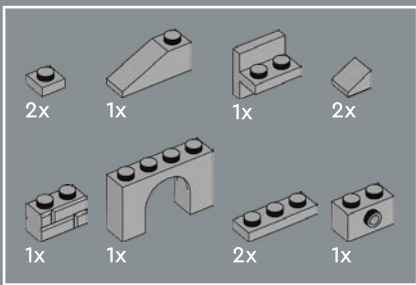

61

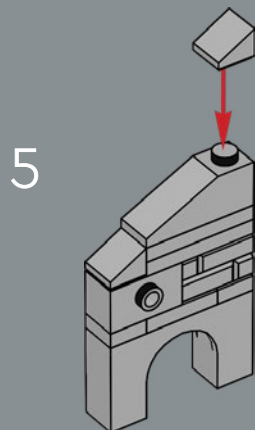
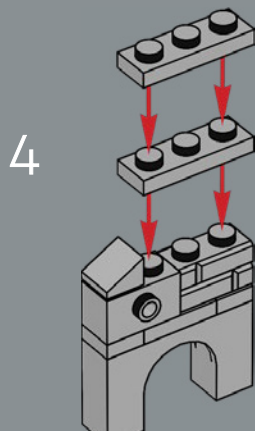
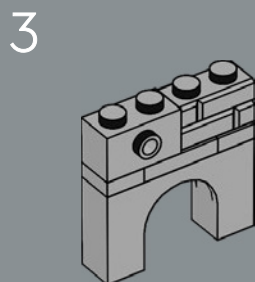
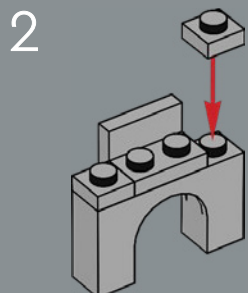
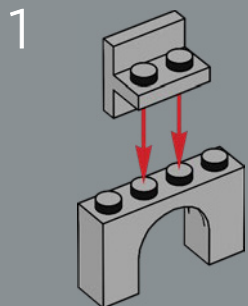

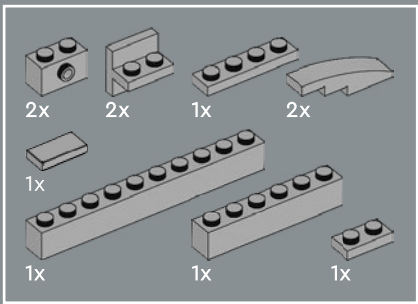

62

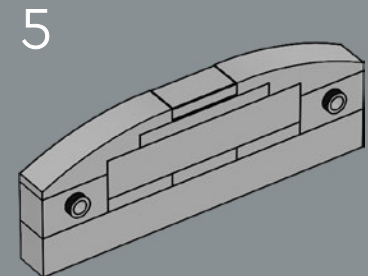
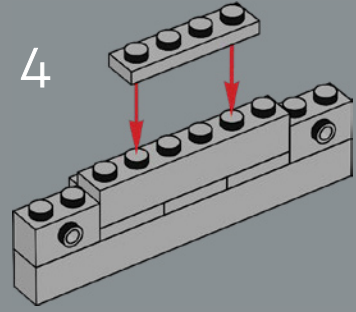
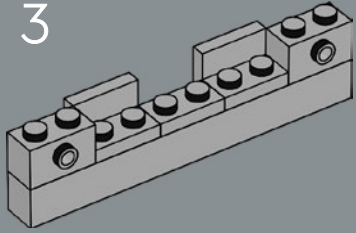
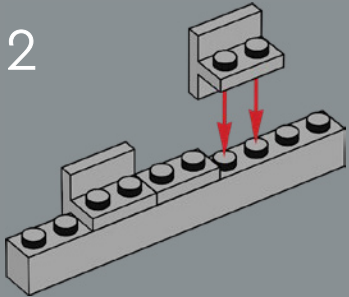
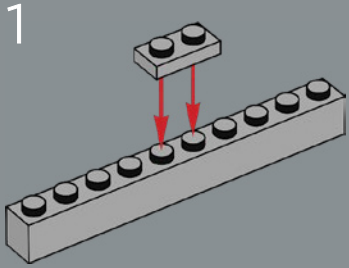

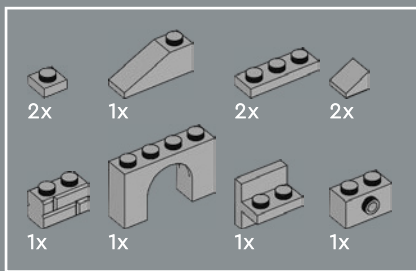

63

1

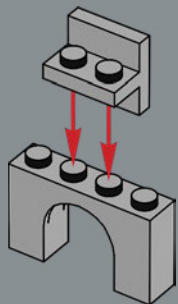

2

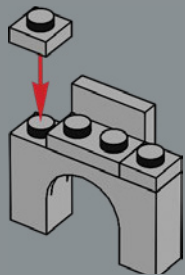

3

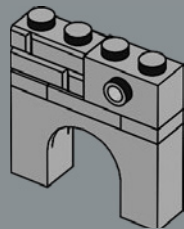

4

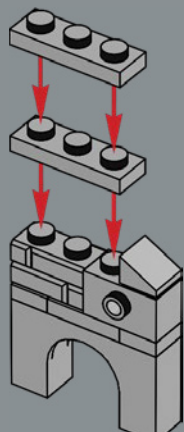

5

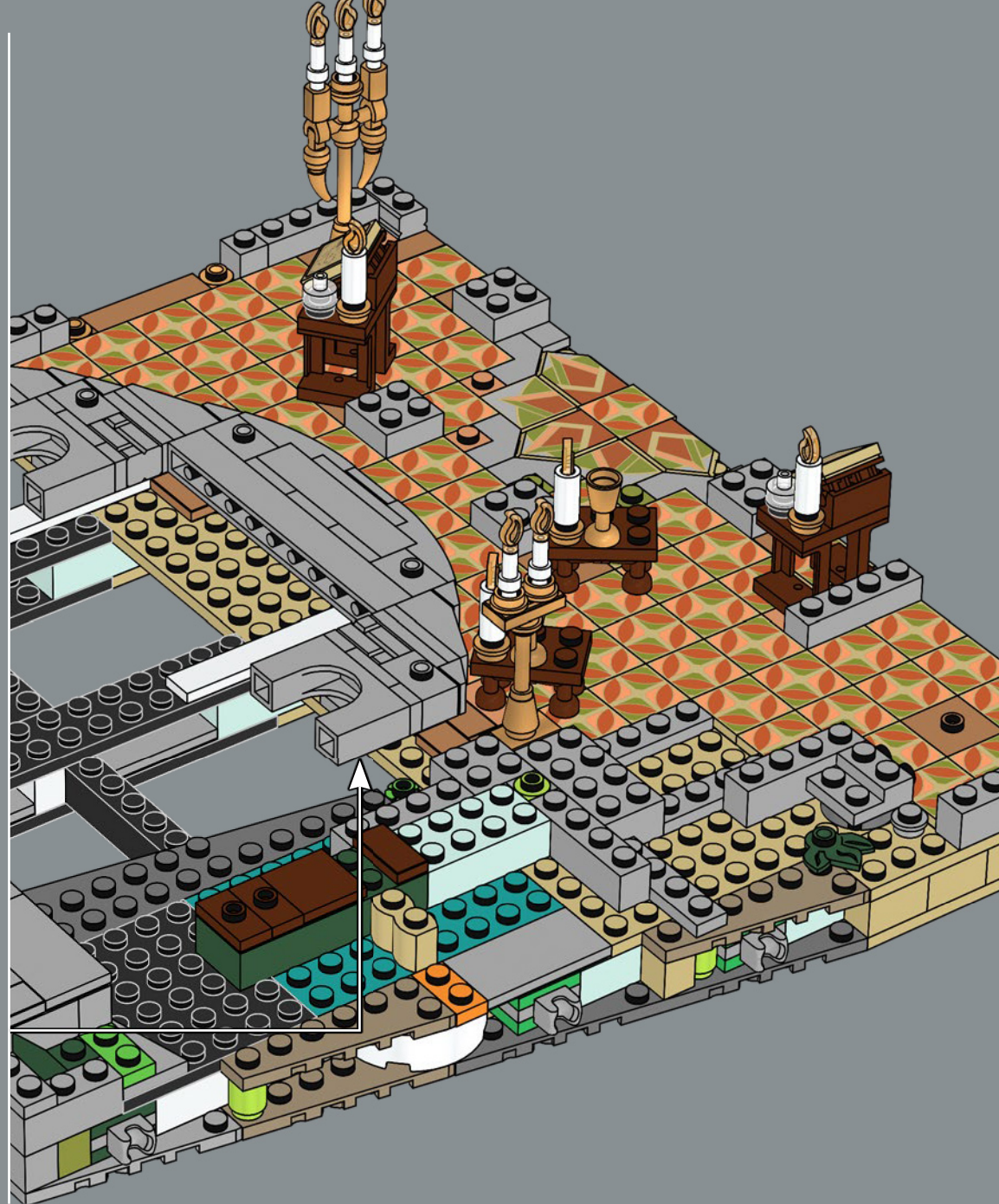
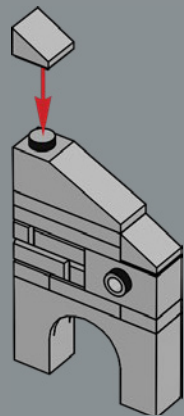

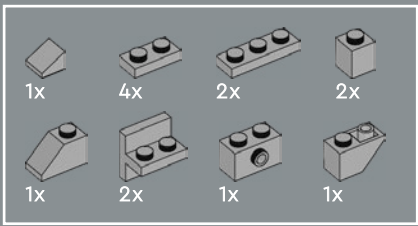

64

1

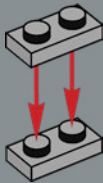

2

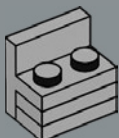

3

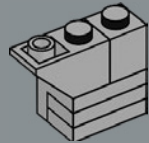

4

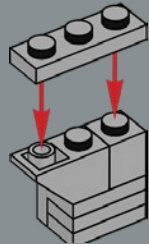

5

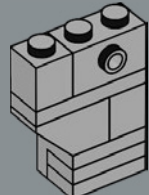

6

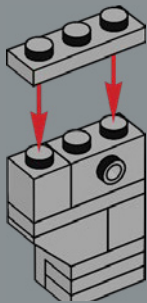

7

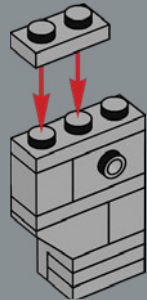

8

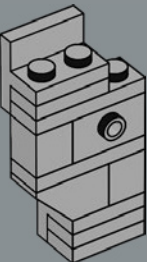

9

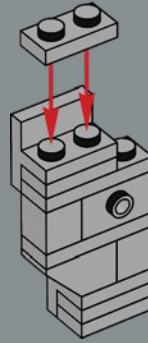

10

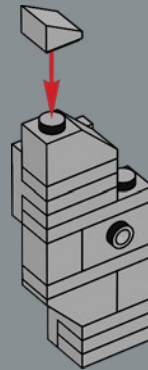



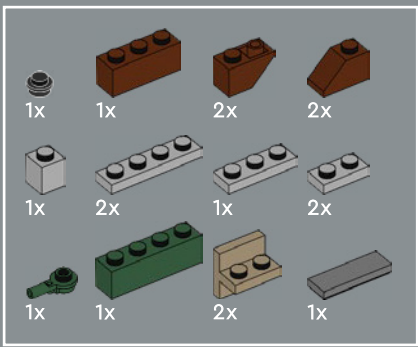

65

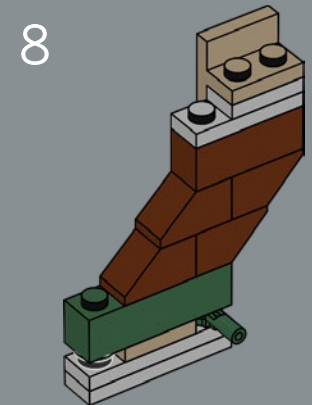
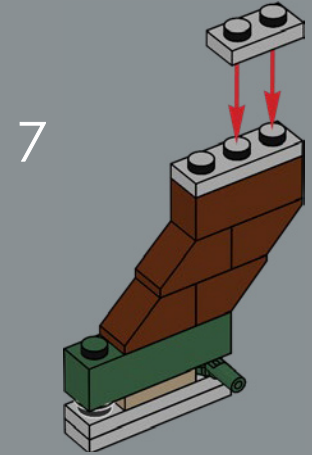
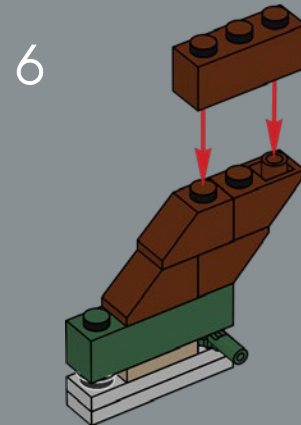
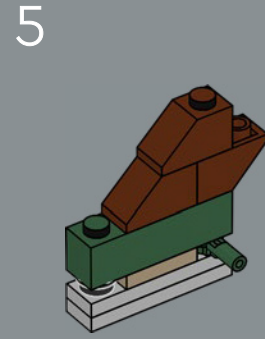
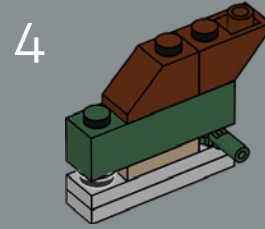
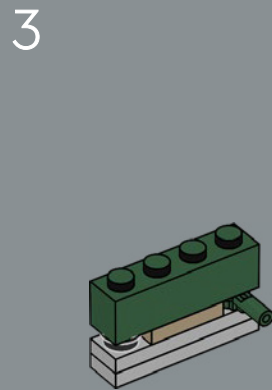
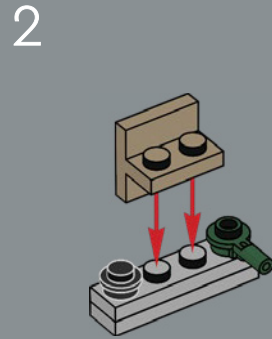
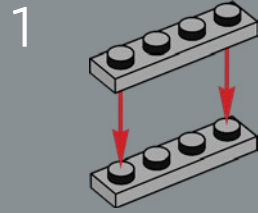

9

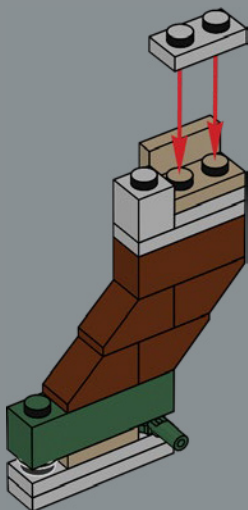

10

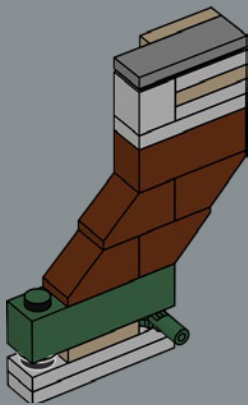



66

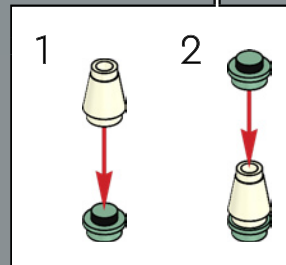
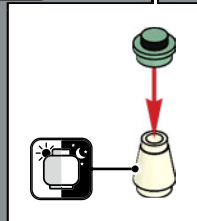
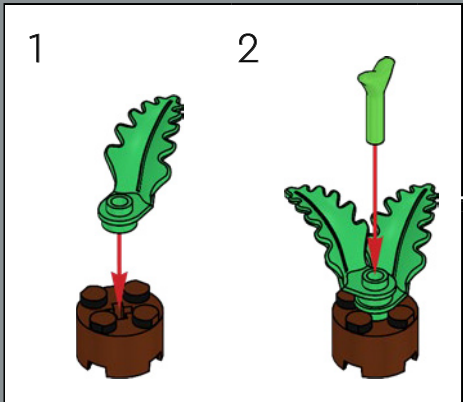
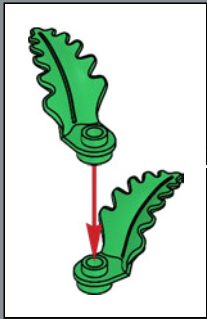

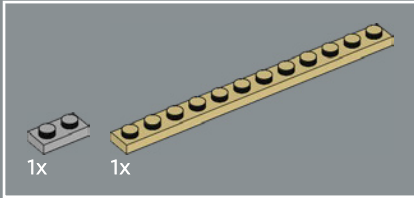
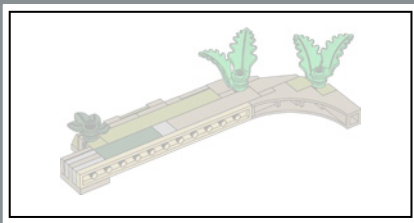

67

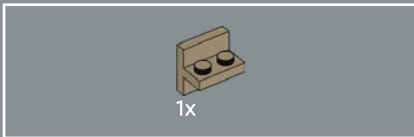
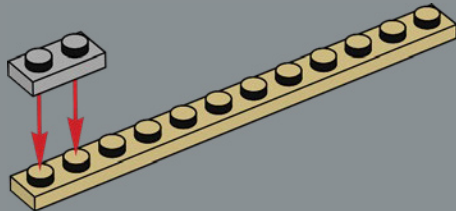

68

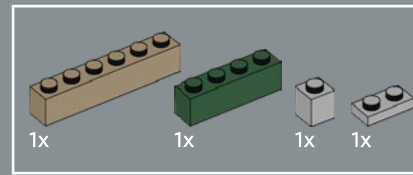
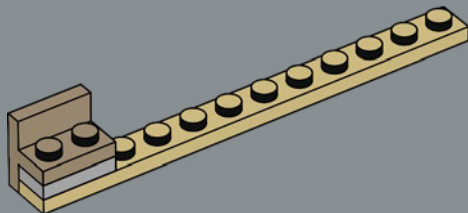

69

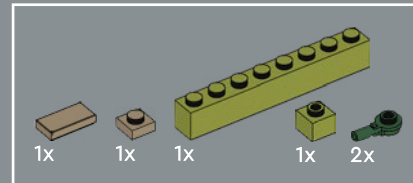
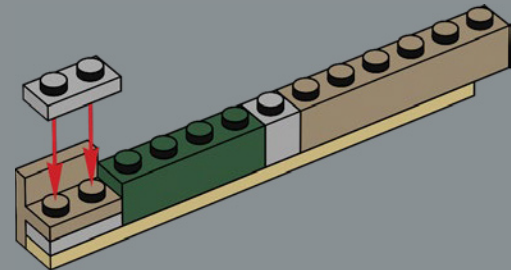

70

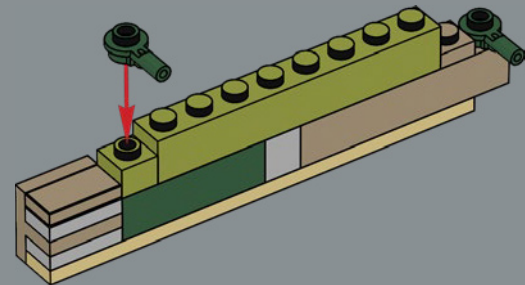

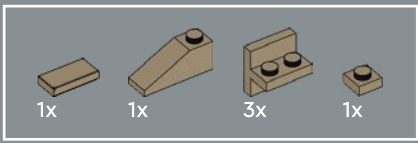

71

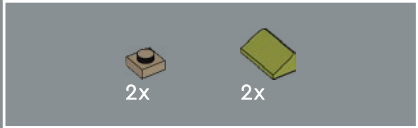
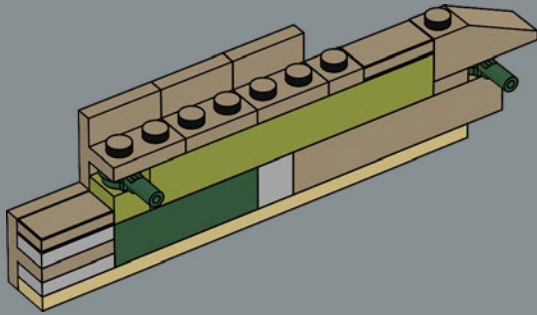

72

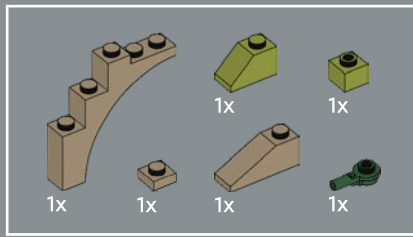
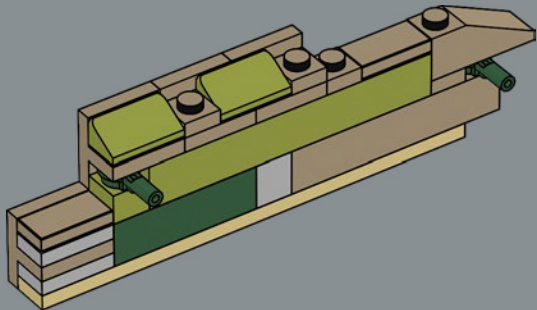

73

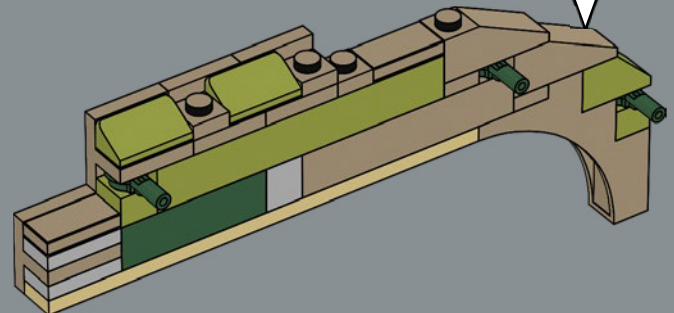
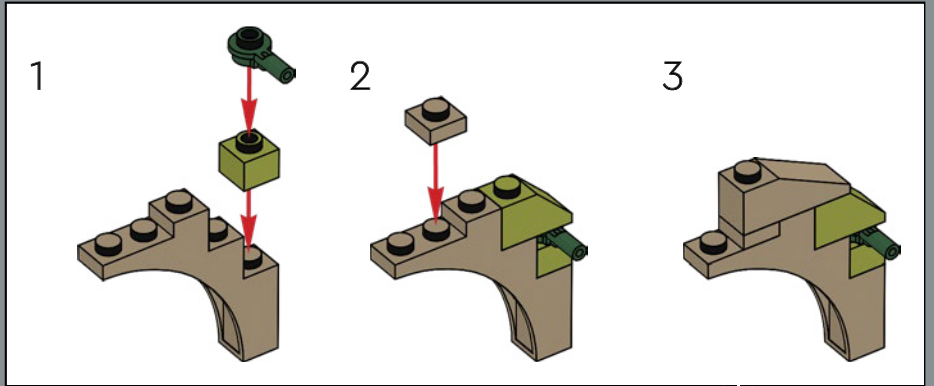



74

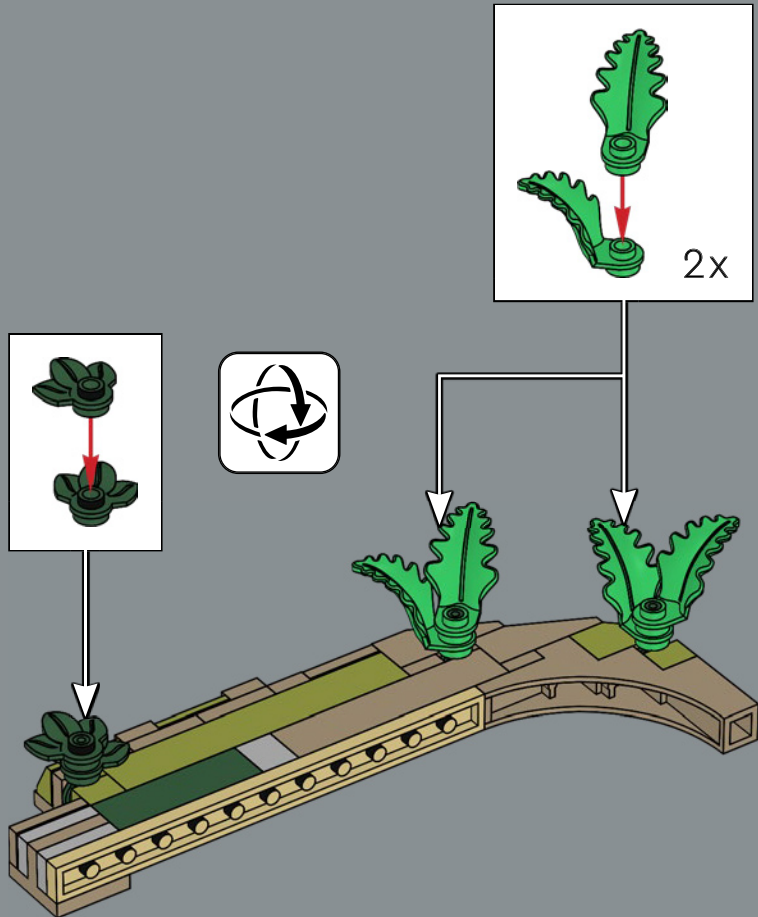

75



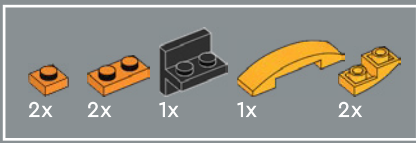

This build provides support for the central plinth of the council platform - it's always keeping an EYE on the Ring . . .

Cette construction sert de support à la plinthe centrale de la plateforme du conseil : elle garde toujours un ŒIL sur l'Anneau...

Este conjunto da soporte al pedestal central de la plataforma del concilio. ¡El anillo no puede desaparecer en ningún momento!

76

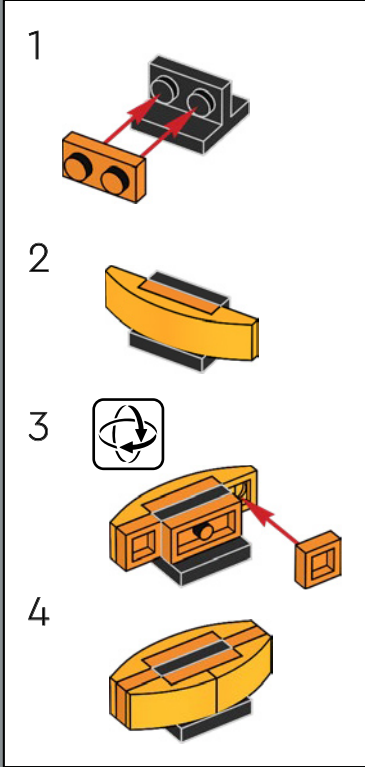

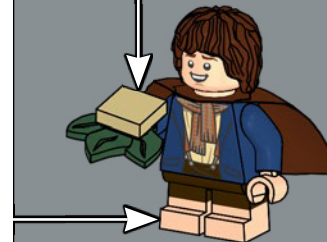
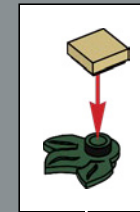
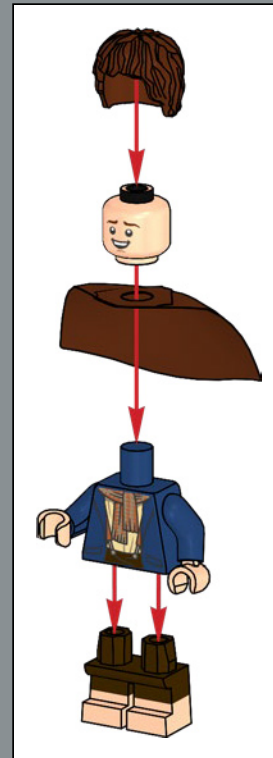
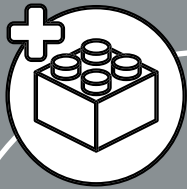

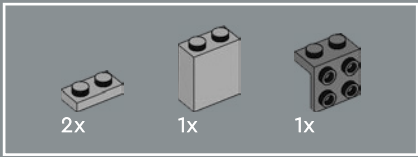

77



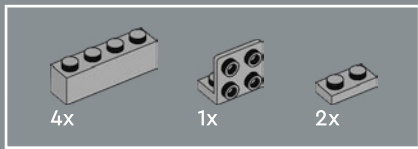

78

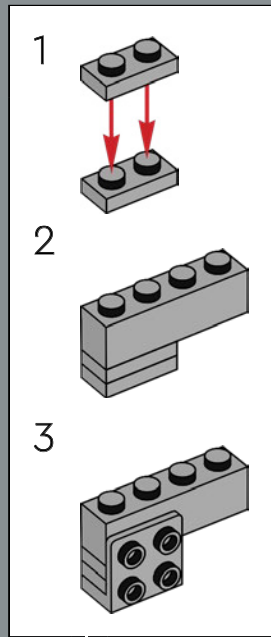
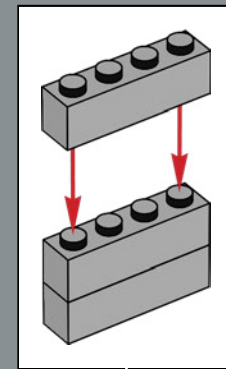

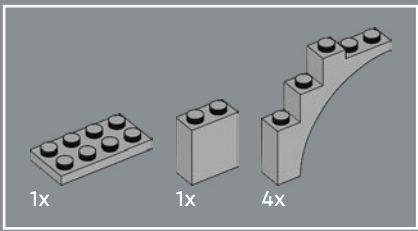

79

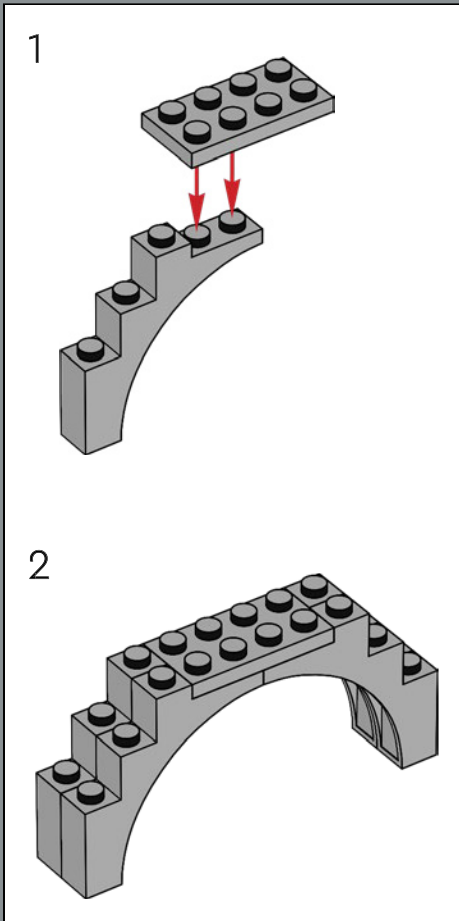
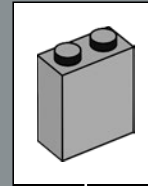

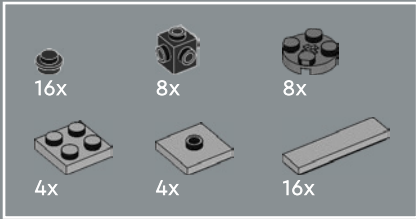

80

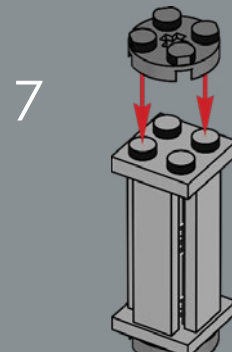
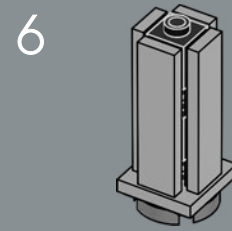
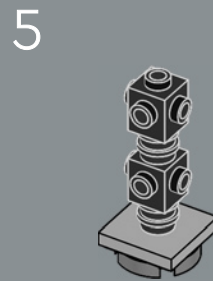
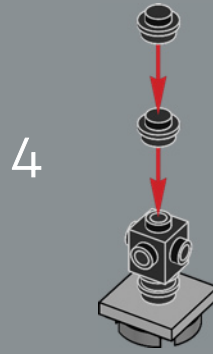
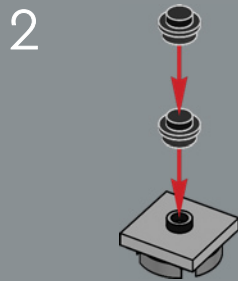
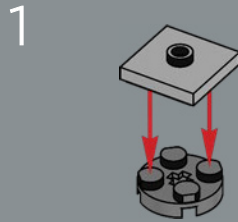

4x



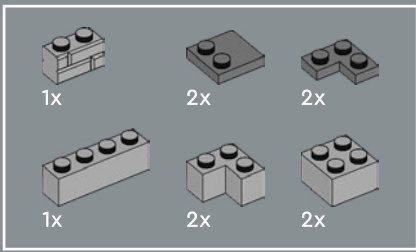

81

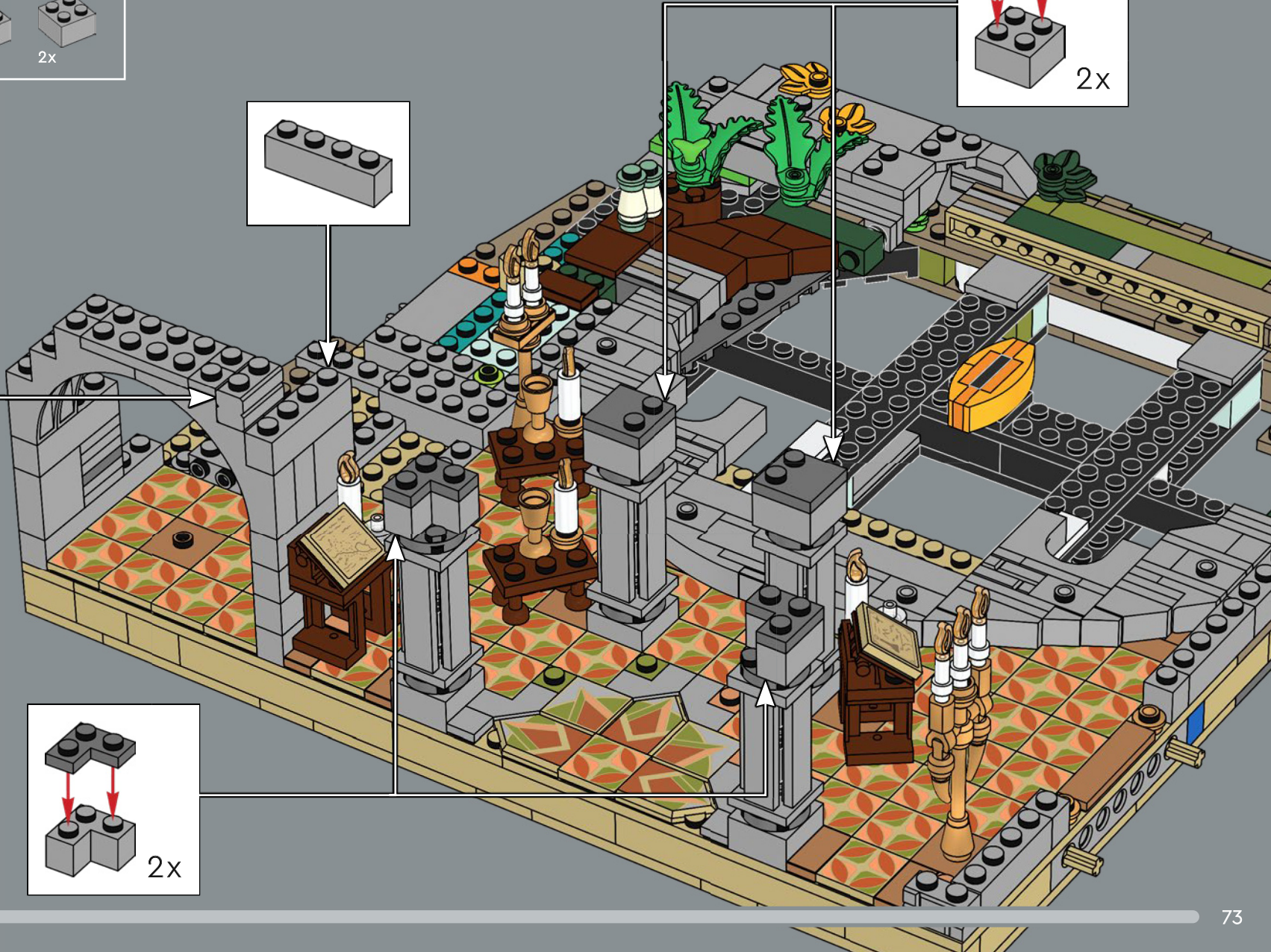
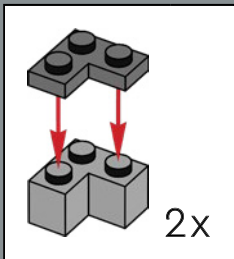
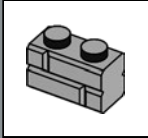
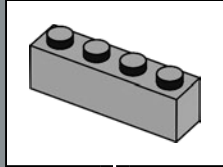
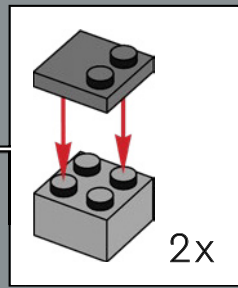

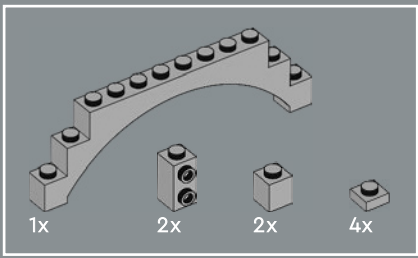

82

1

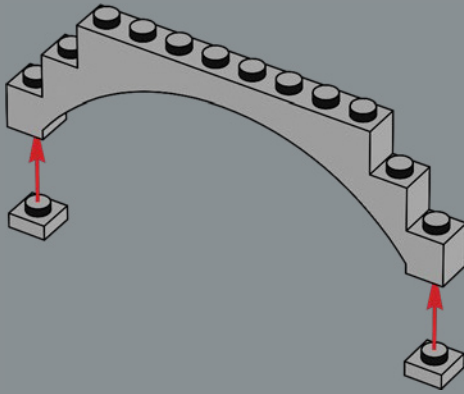

2

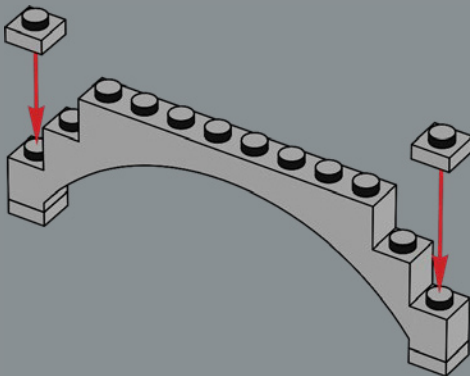

3

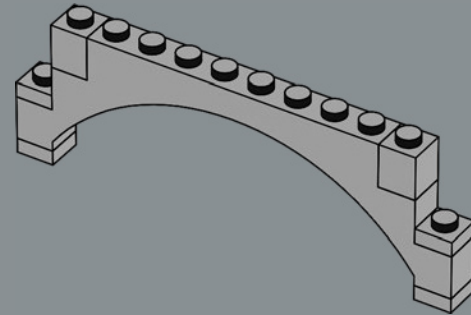

4

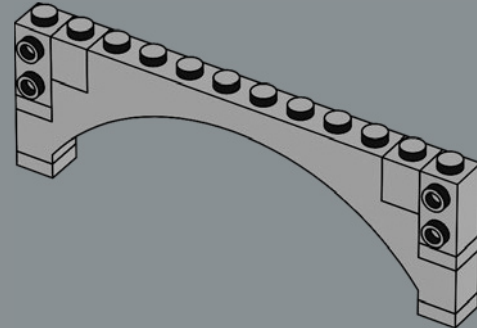



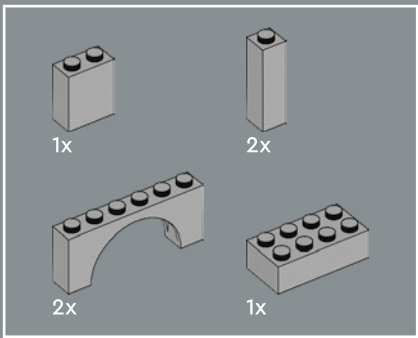

83

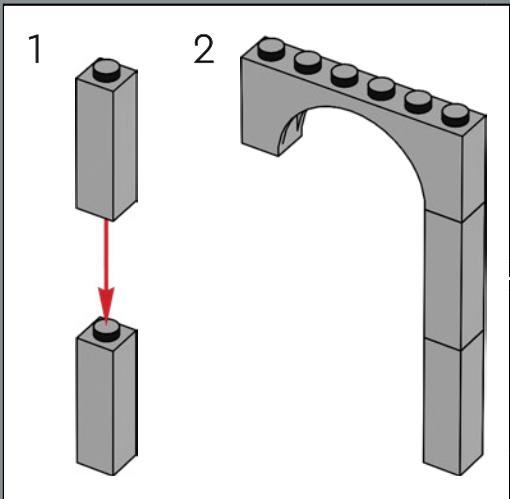

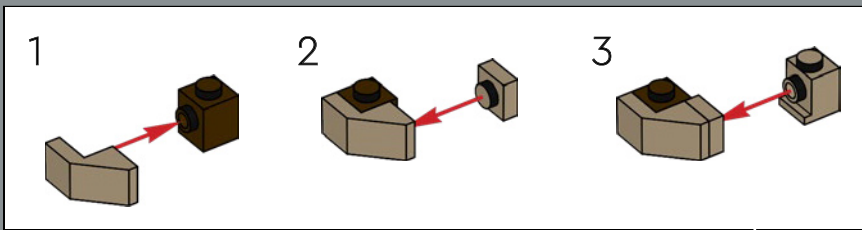
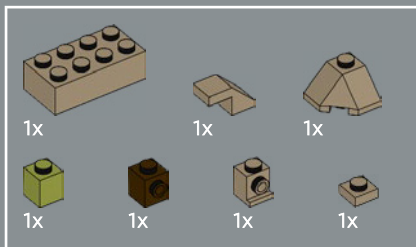

84

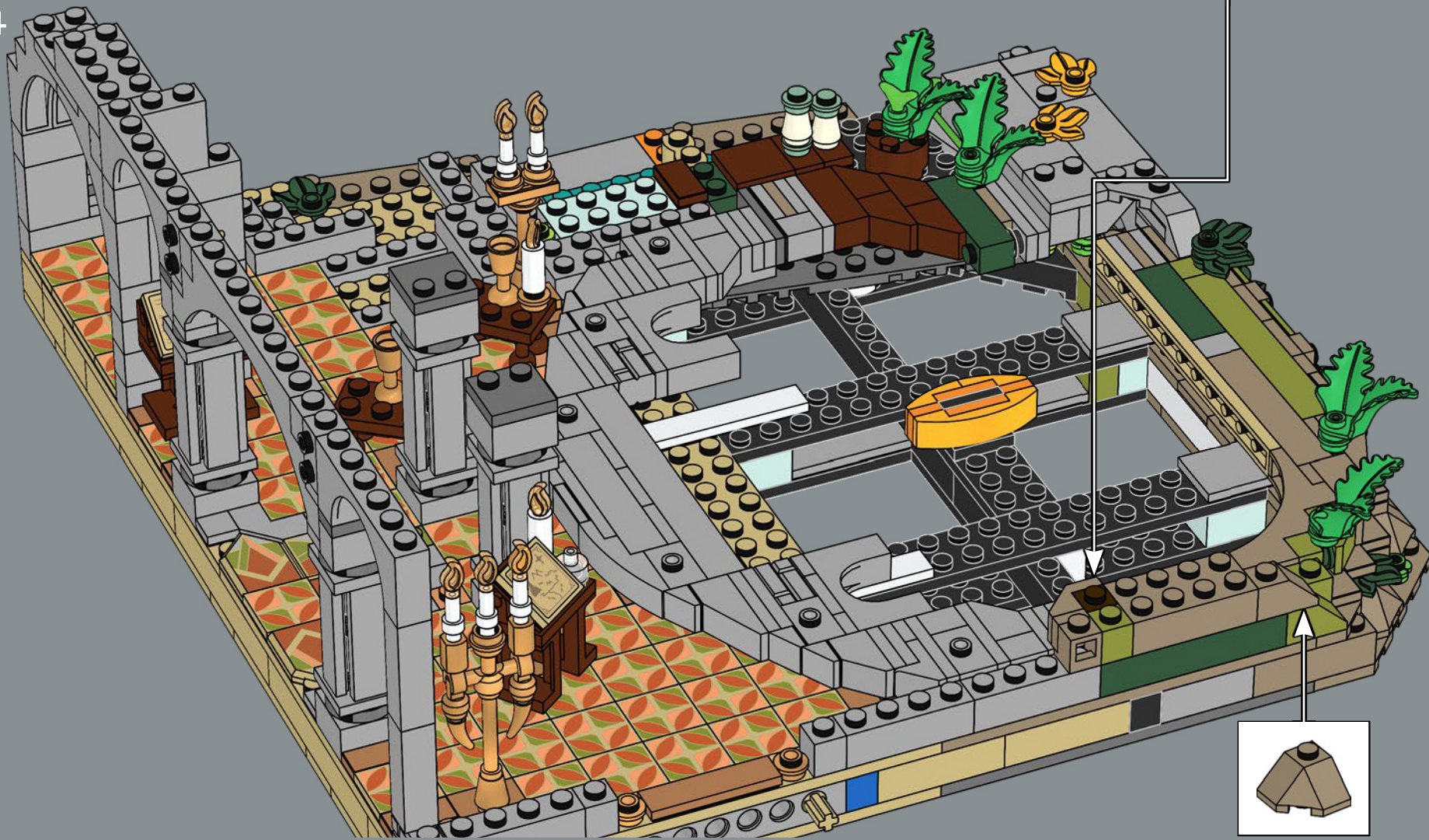

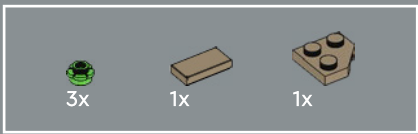

85

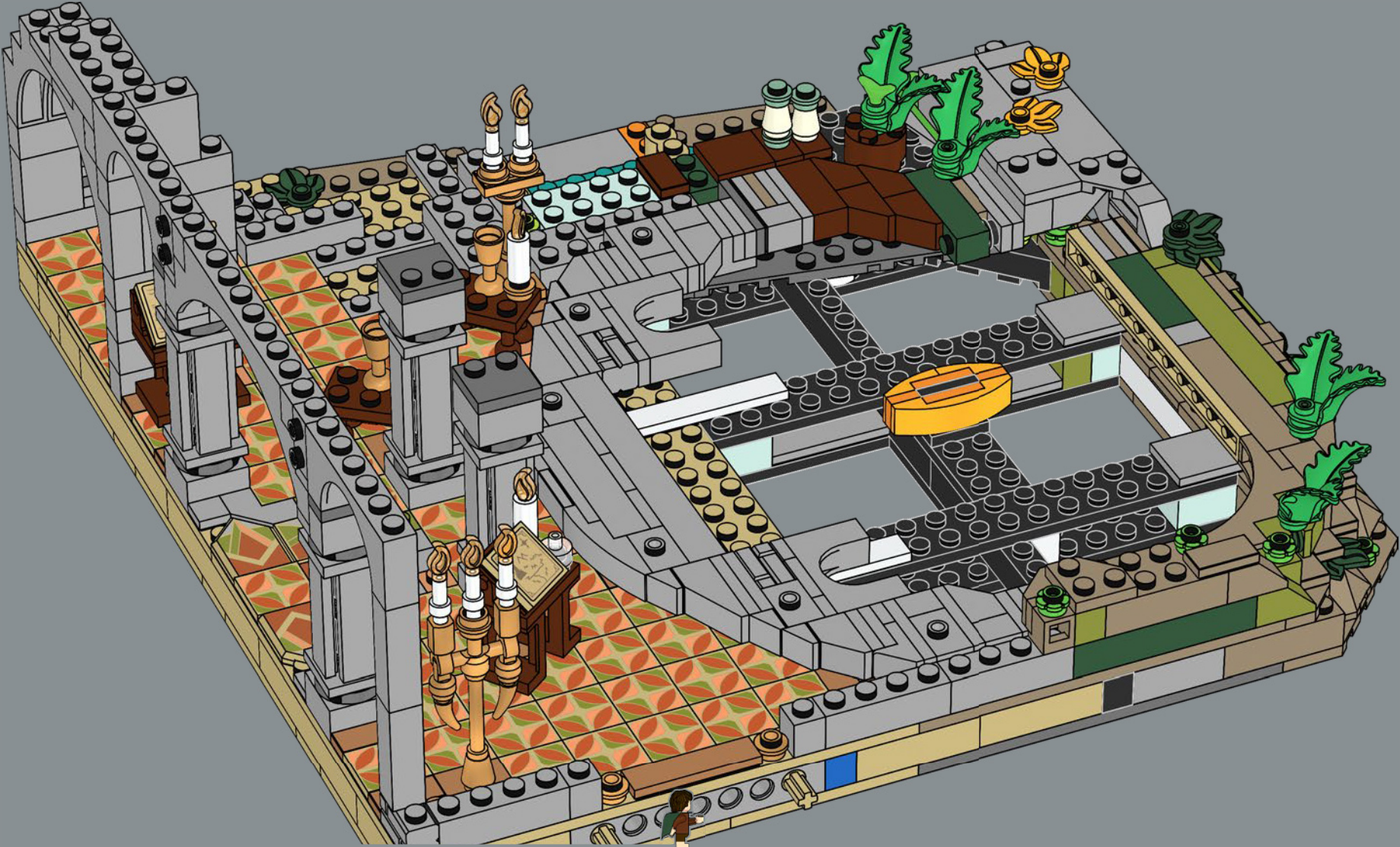

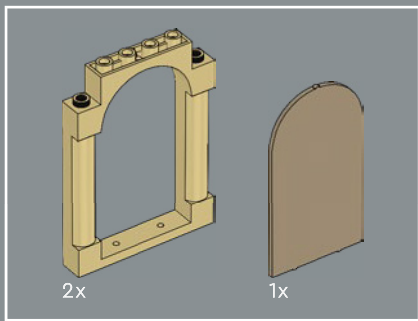

86

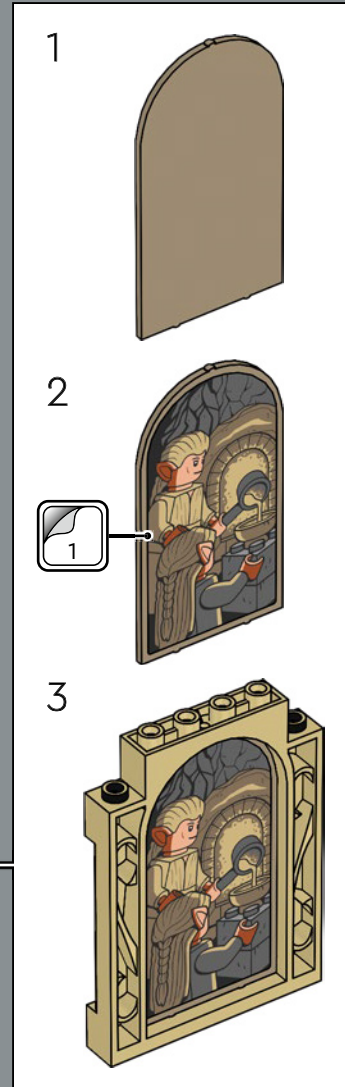

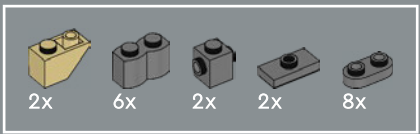

87

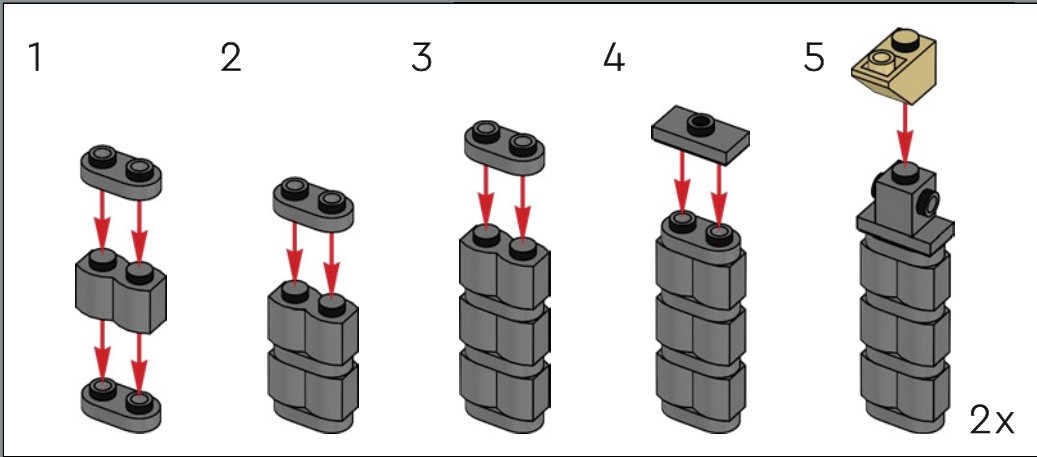

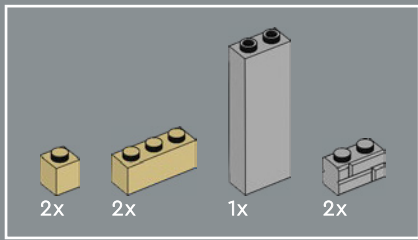

88

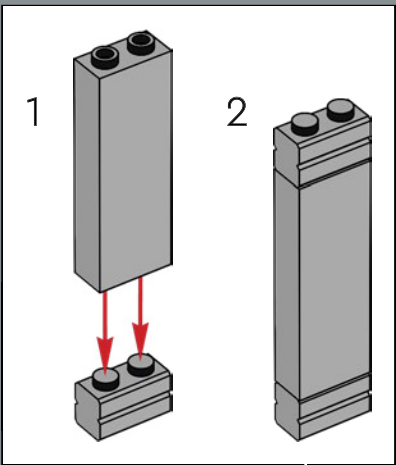

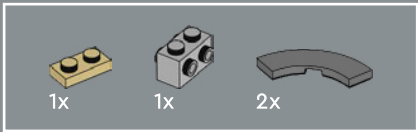

89

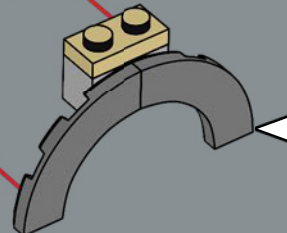
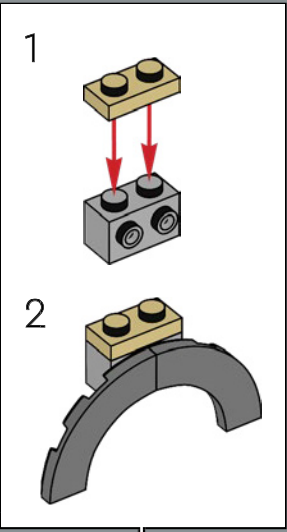

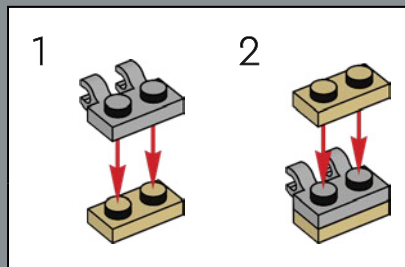
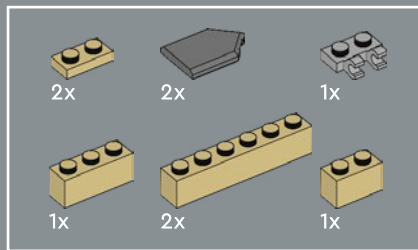

90



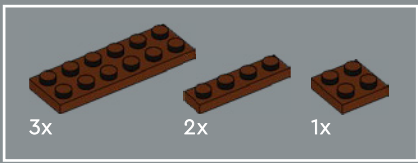

91



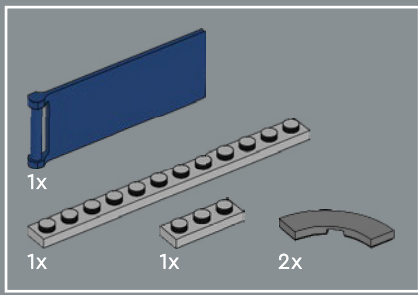

92

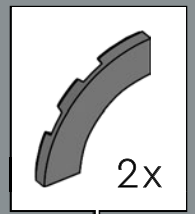
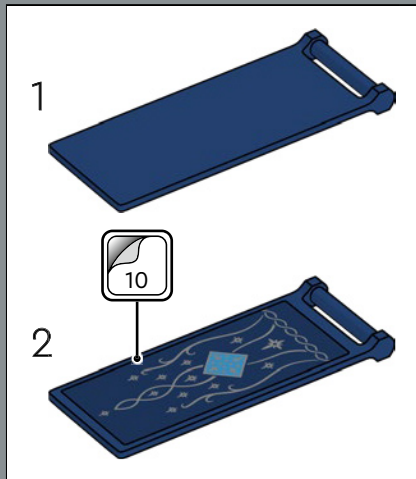



4x

93

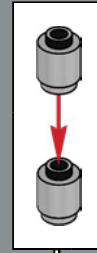

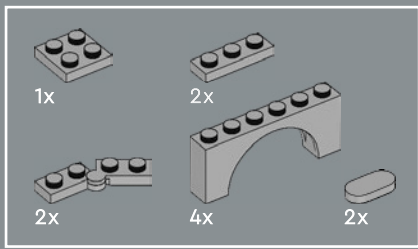

94

1

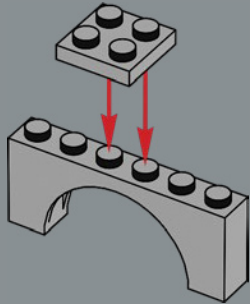

2

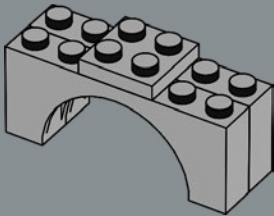

3

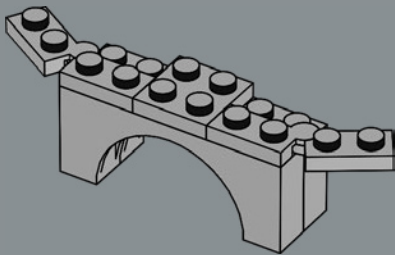

4

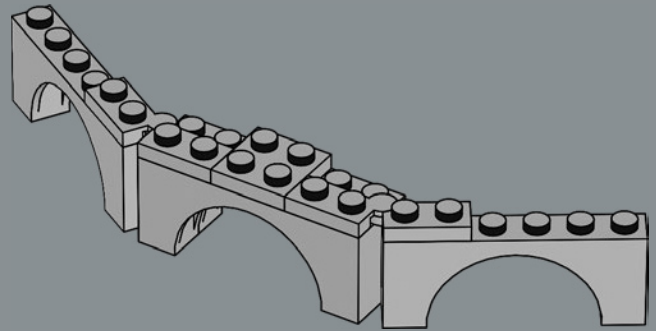

5

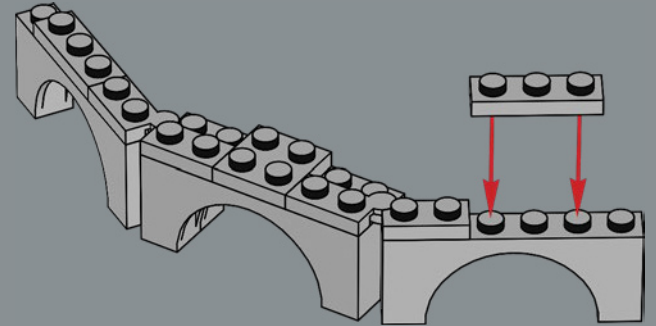

6

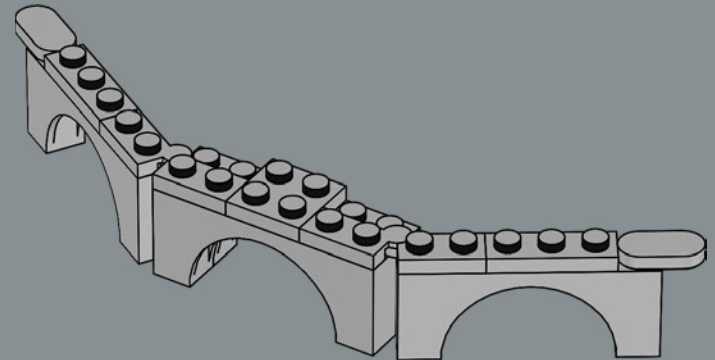



The triangles for this upper part are a technique we call Pythagorean pairs, where two dissimilar triangles share the same length hypotenuse.

Les triangles de cette partie supérieure sont répartis selon une technique appelée les paires pythagoriciennes, où deux triangles différents partagent la même hypoténuse.

Los triángulos de la parte superior se forman mediante una técnica que llamamos *pares pitagóricos*, donde dos triángulos desiguales comparten una hipotenusa de la misma longitud.





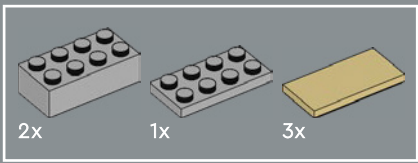

95

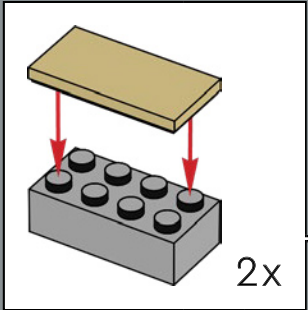
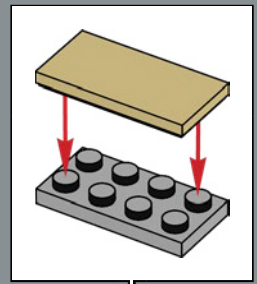

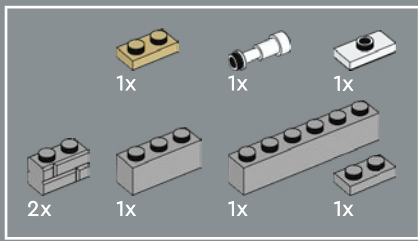

96

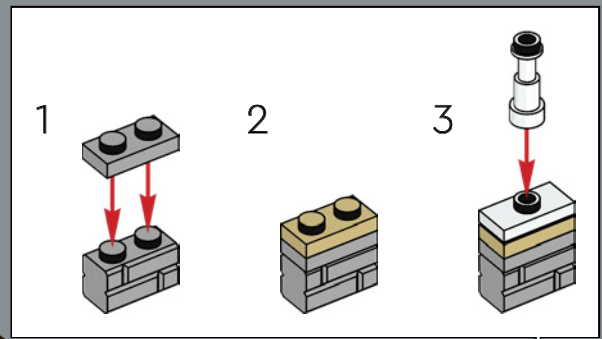

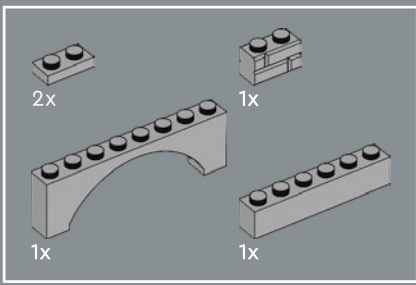



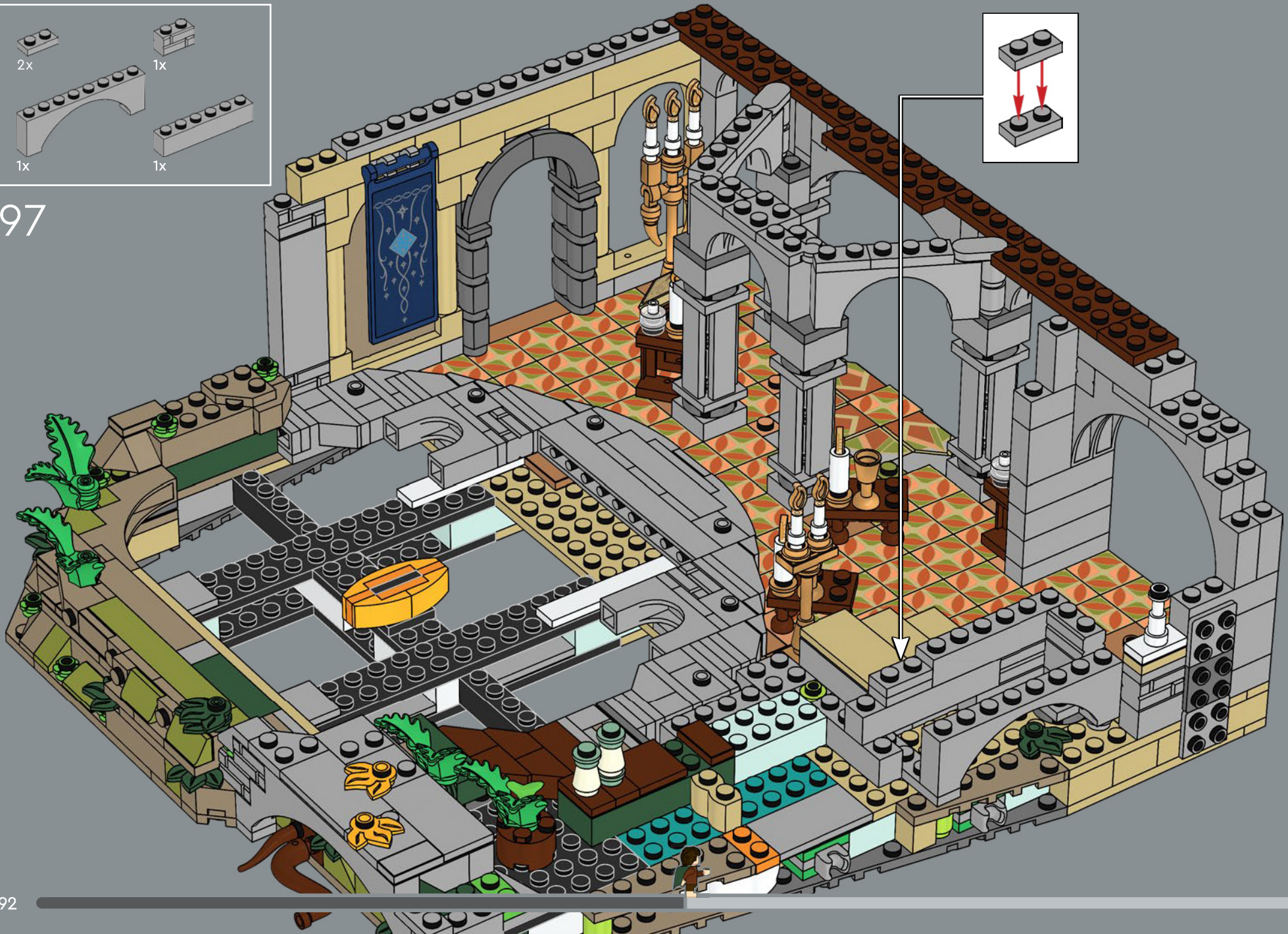
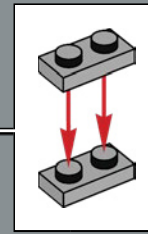

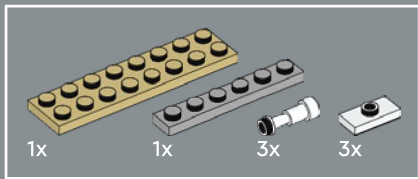

97

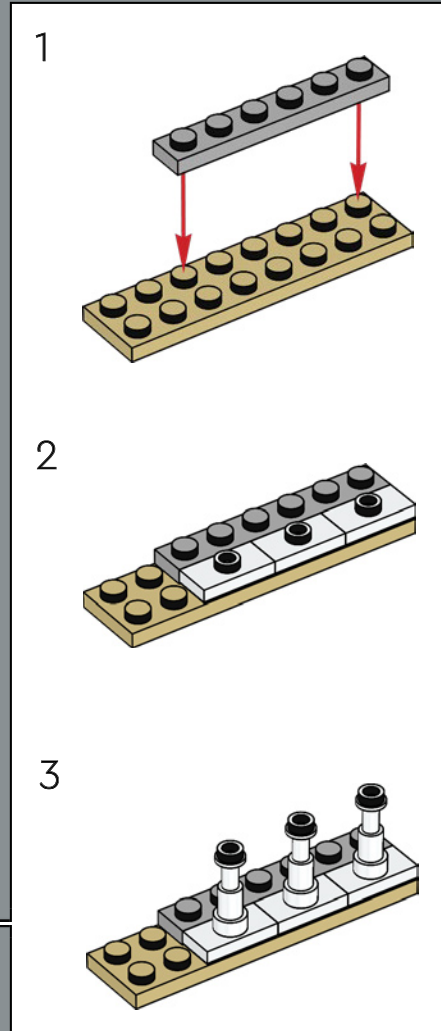



98



- 2x 
- 1x 
- 1x 
- 3x 
- 1x 
- 1x 

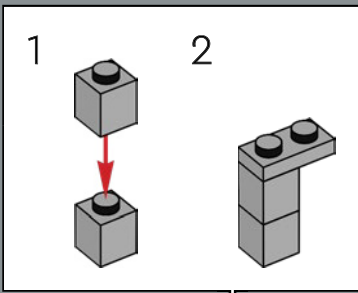

99

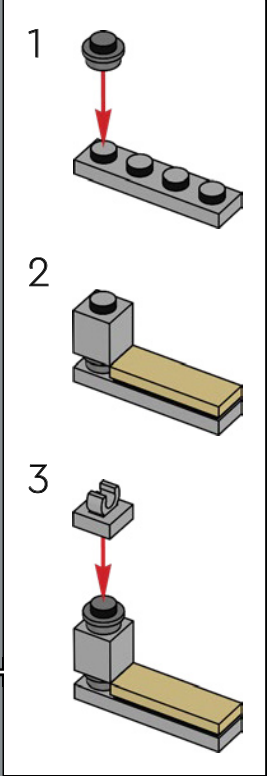

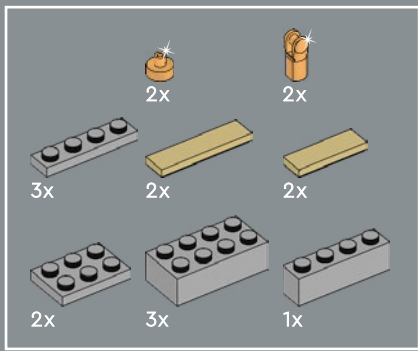

100

1

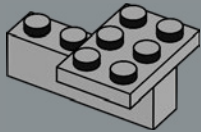

2

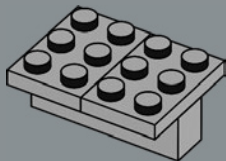

3

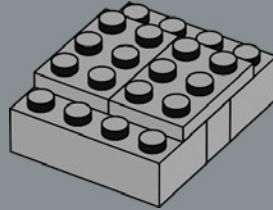

4

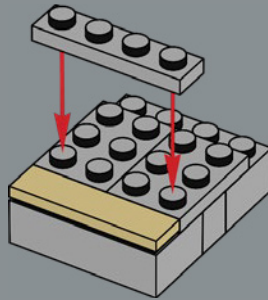

5

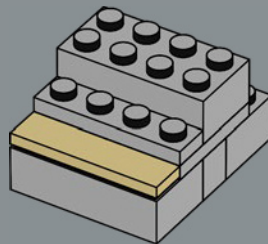

6

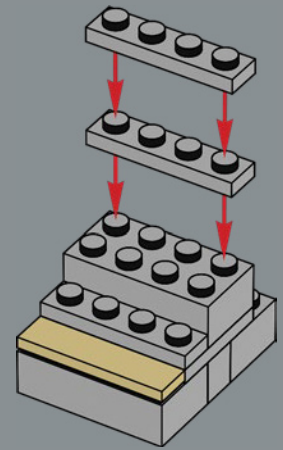

7

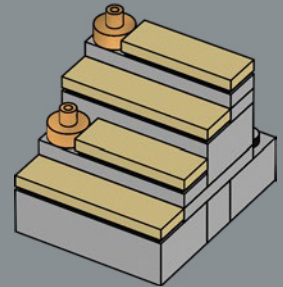

8

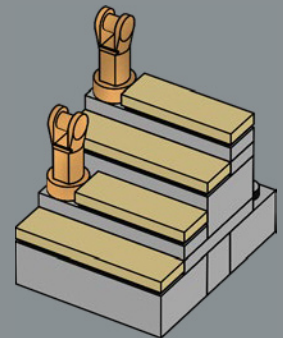



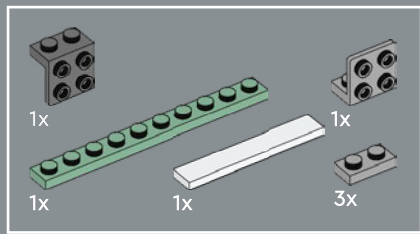

101

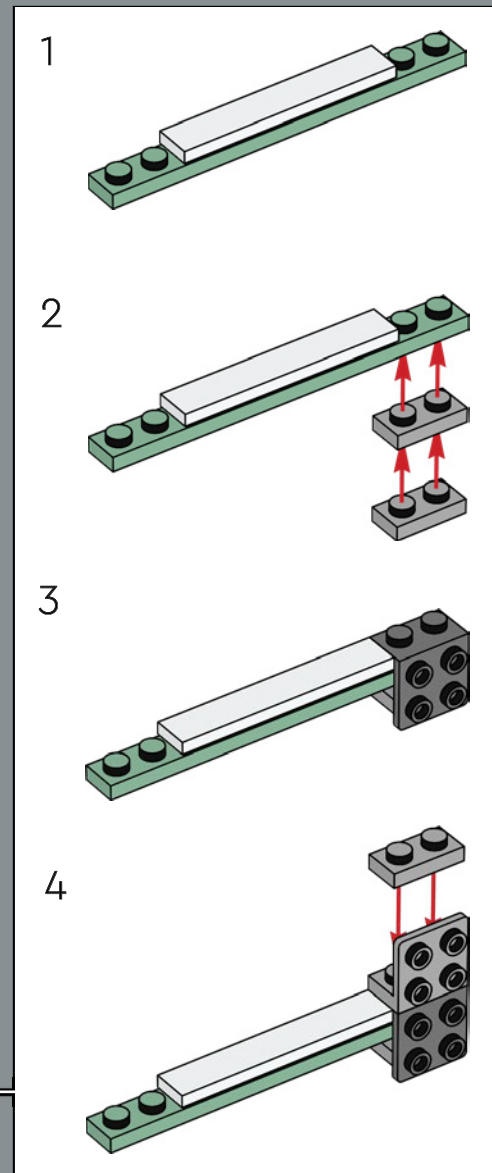

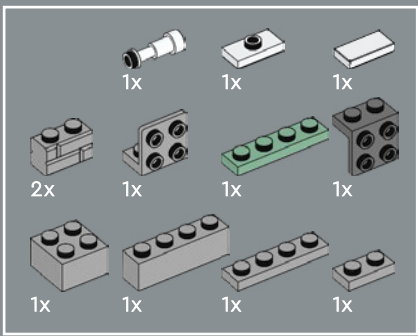

102

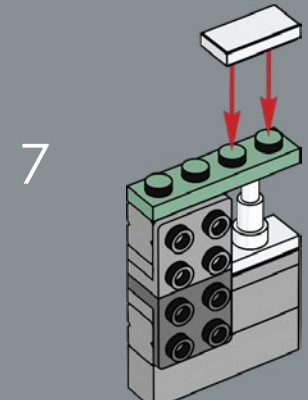
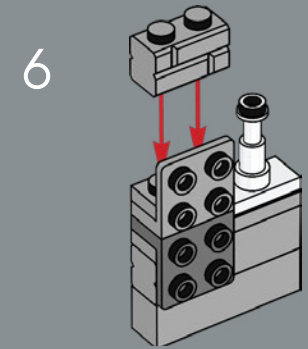
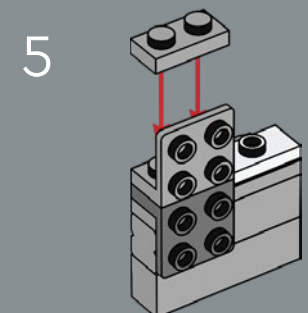
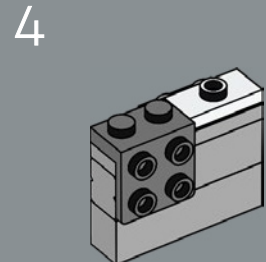
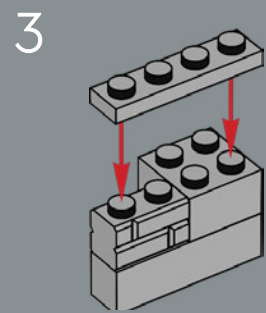
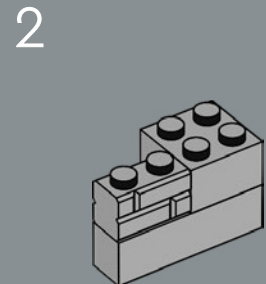
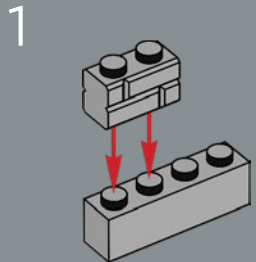



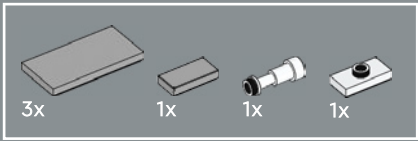

103

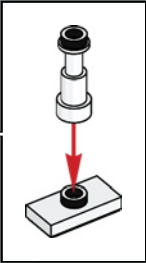

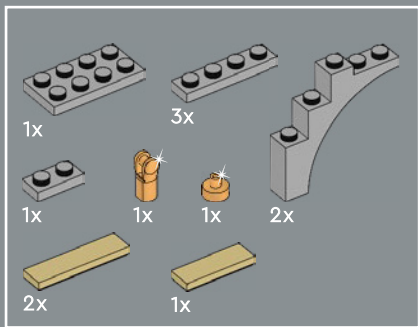

104

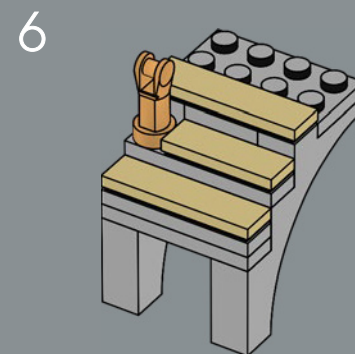
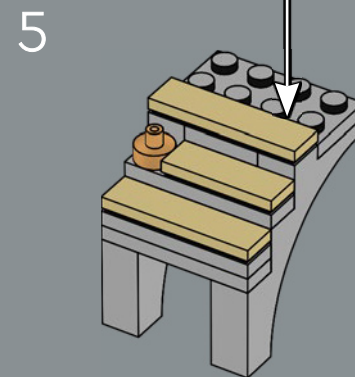
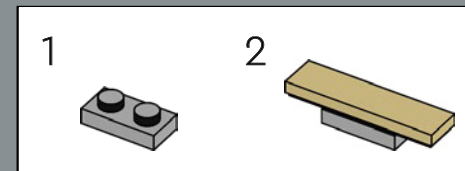
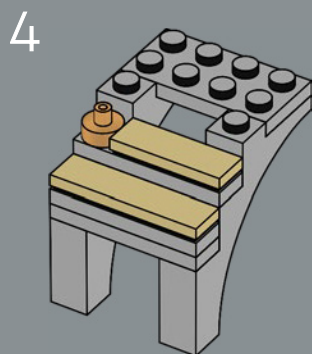
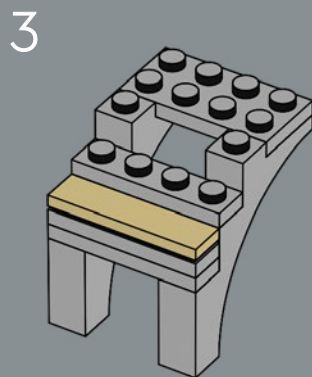
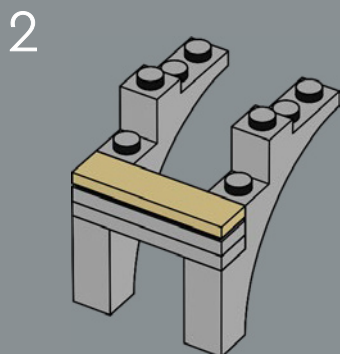
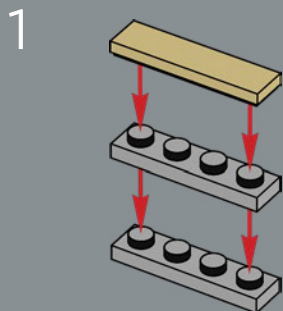



These stairs have a handrail for safety, so no studs are needed!

Ces escaliers sont munis d'une main courante; ainsi, pas besoin de tenons de sécurité !

Estas escaleras tienen un pasamanos de seguridad, así que no se necesitan espigas!



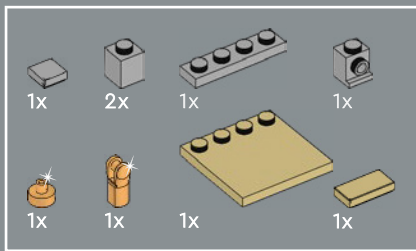

105

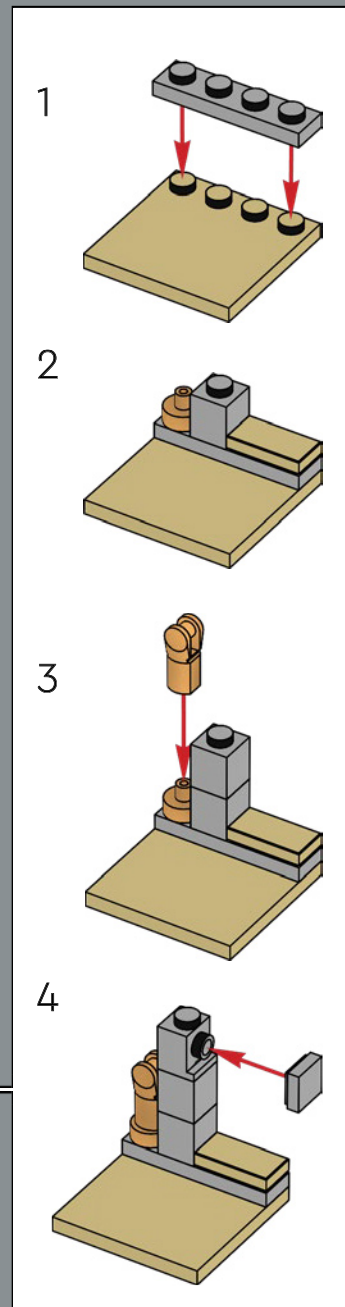
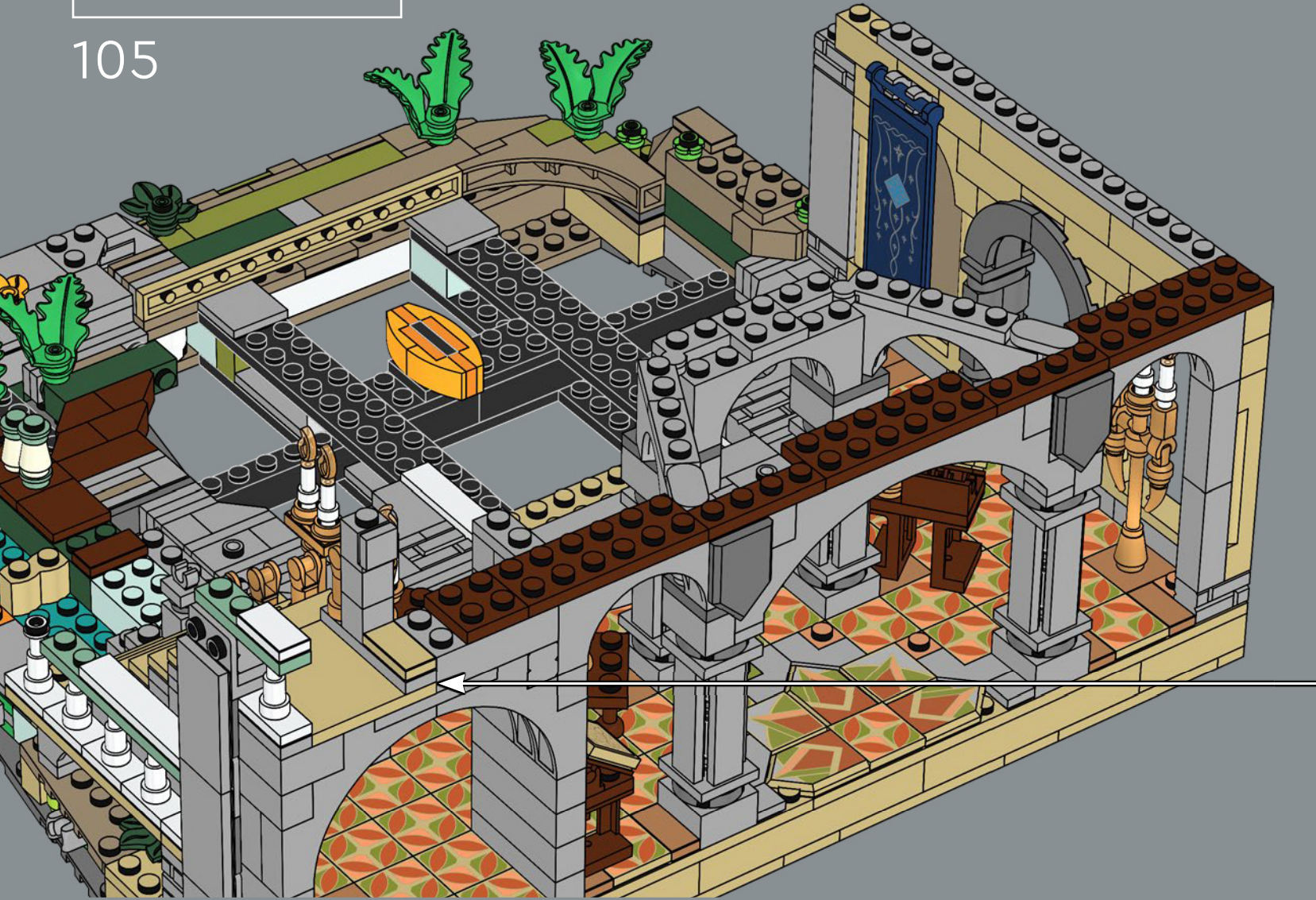

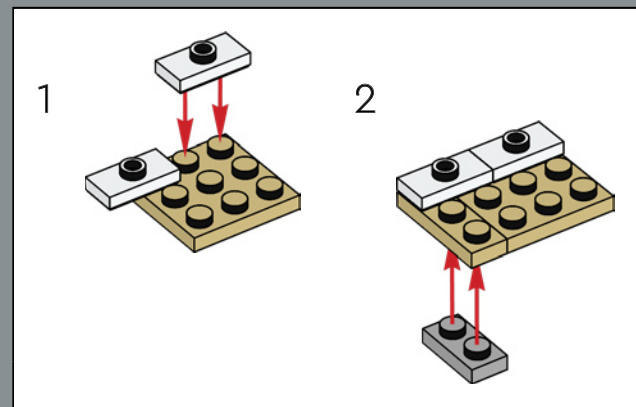
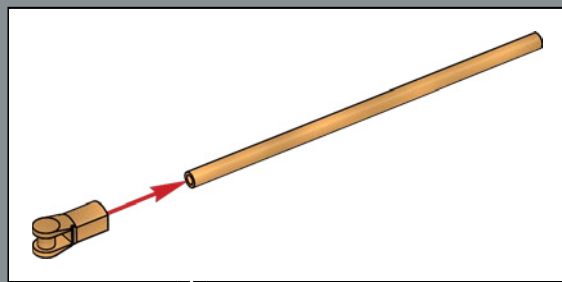
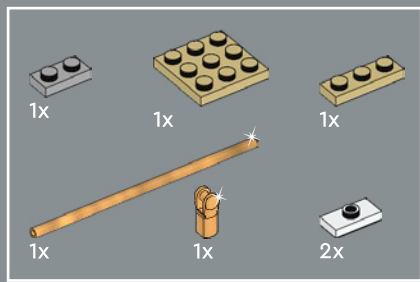

106



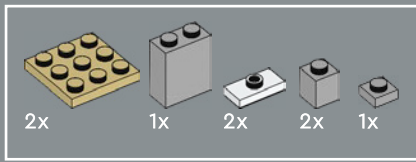

107

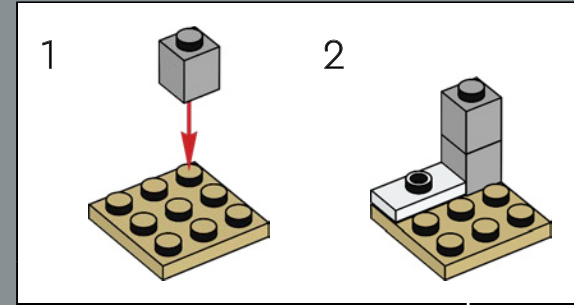
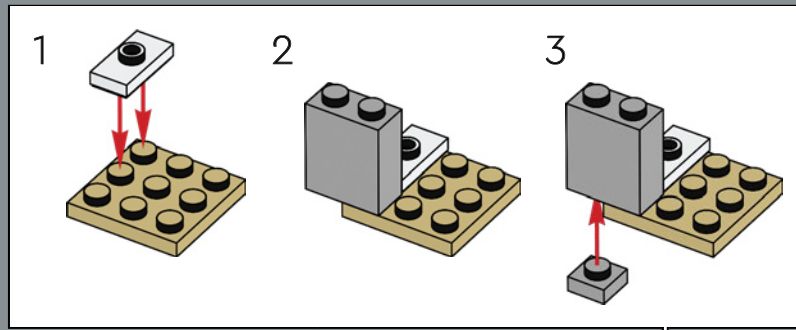

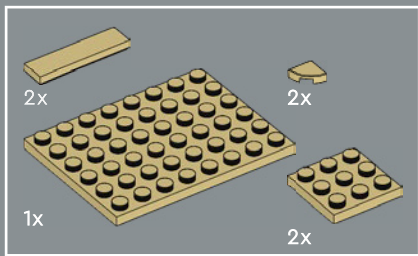

108



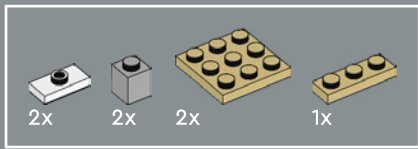

109

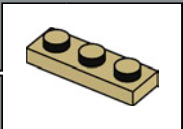
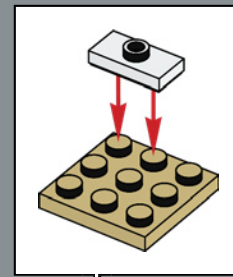
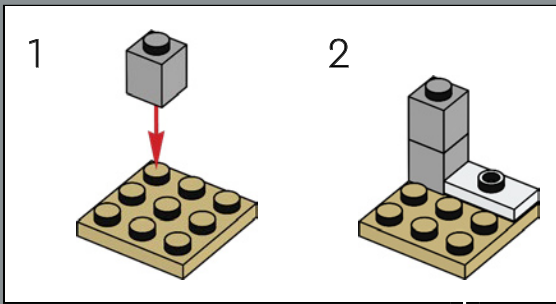

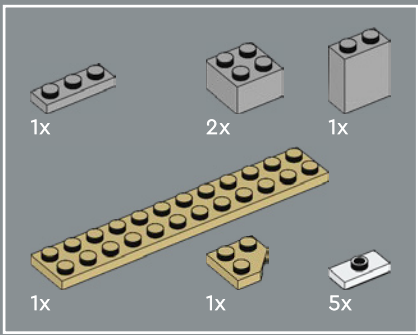

110

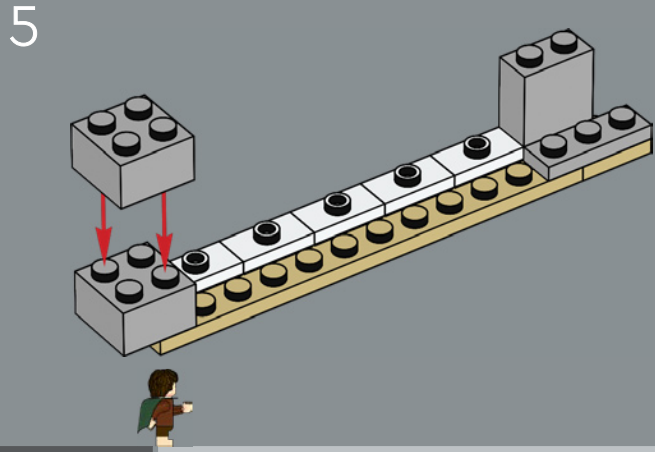
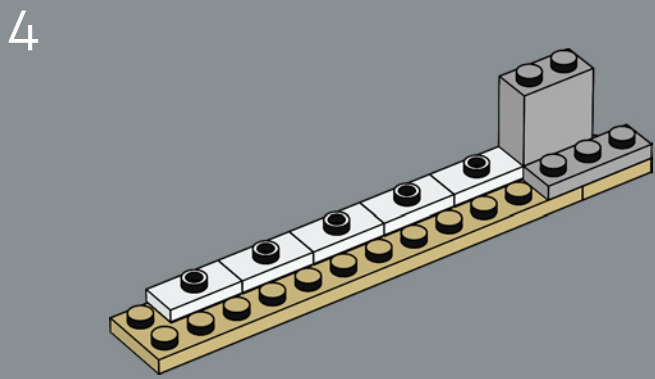
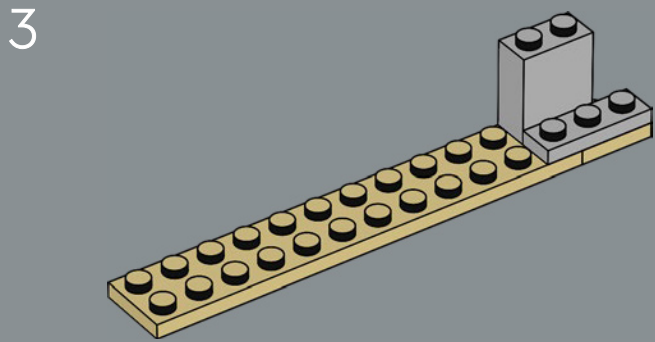
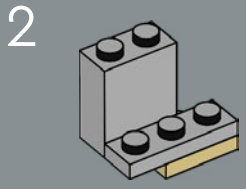
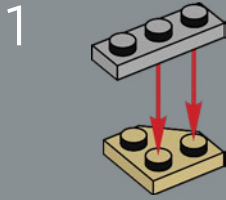



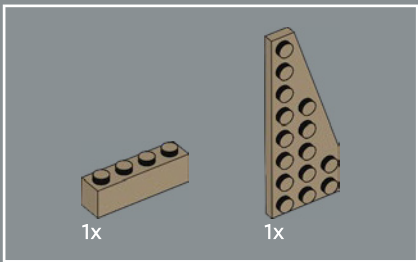
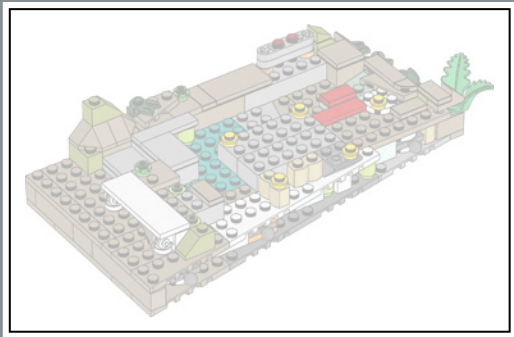

111

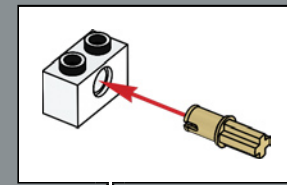
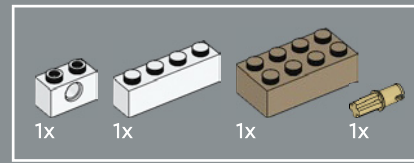
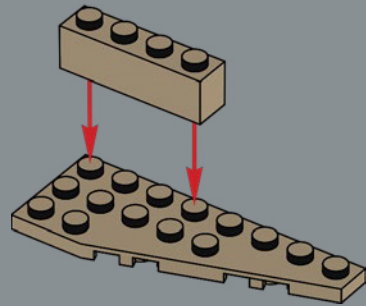

112

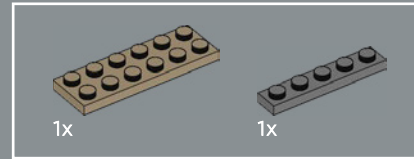
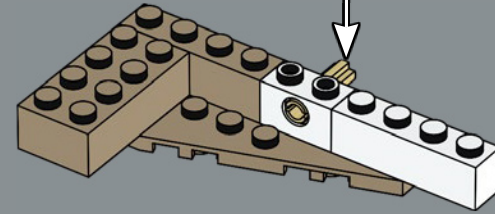

113

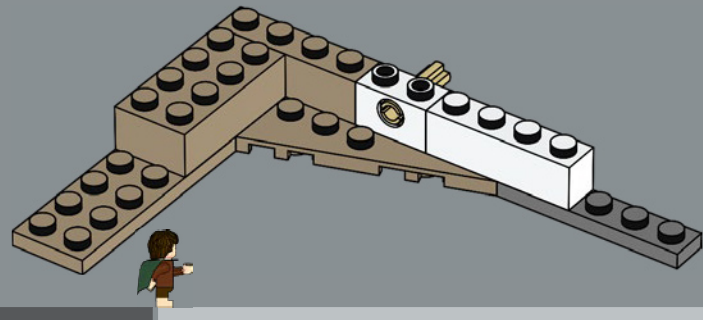

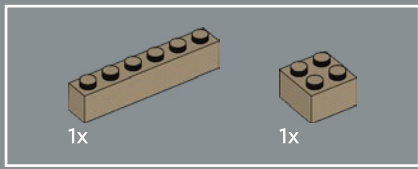

114

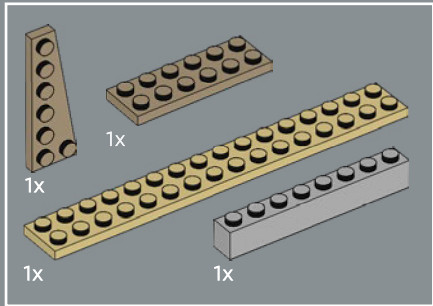
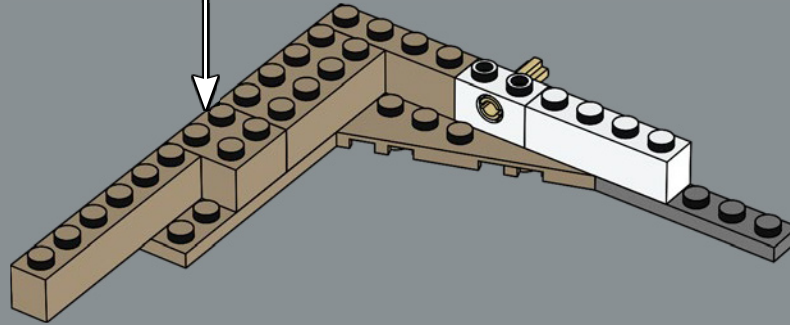
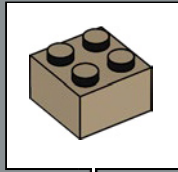

115

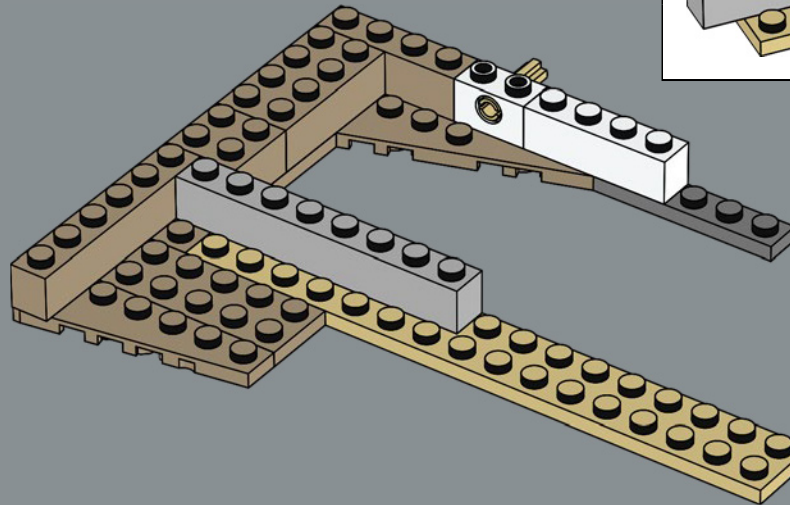
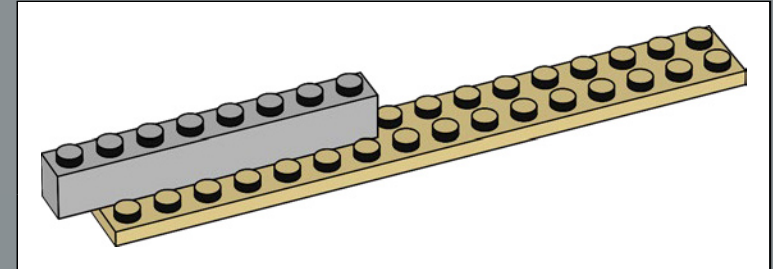

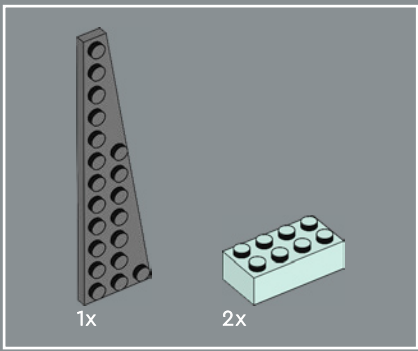

116

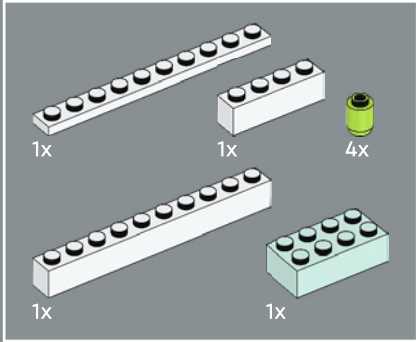
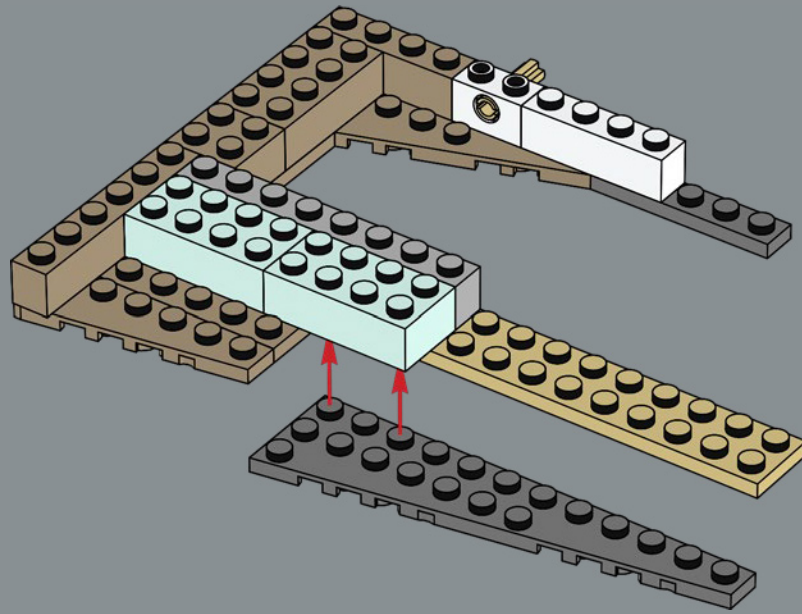

117

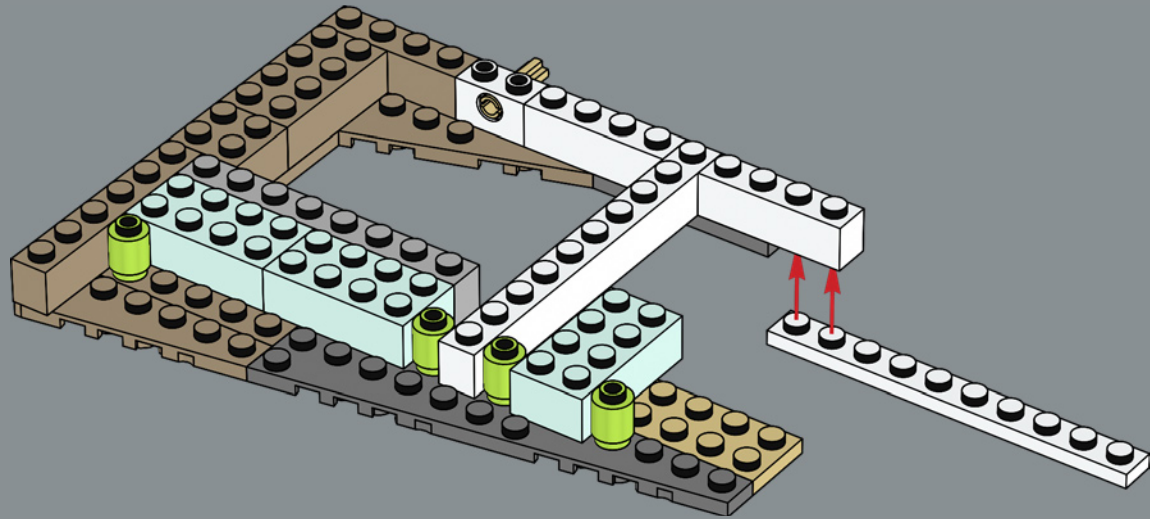

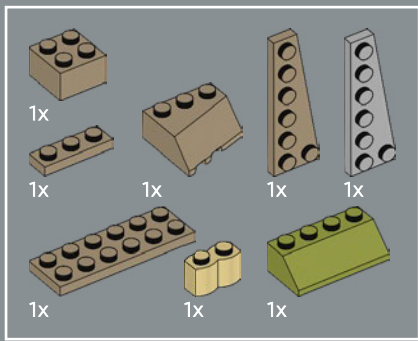

118

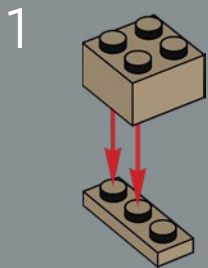

2

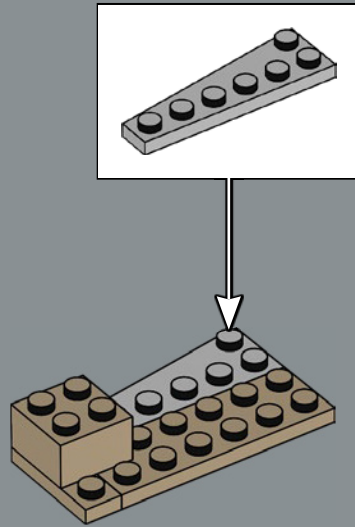

3

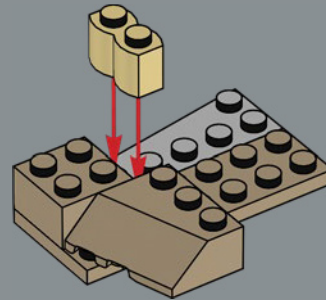

4

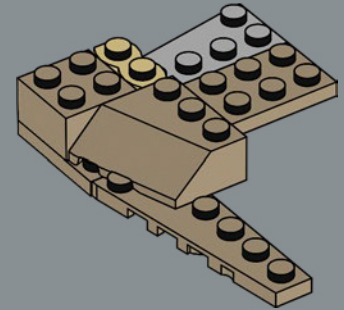

5

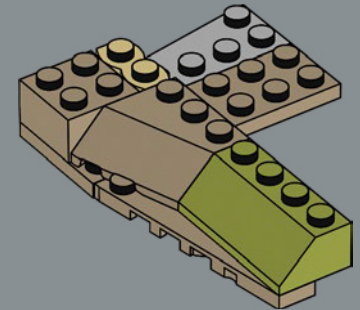

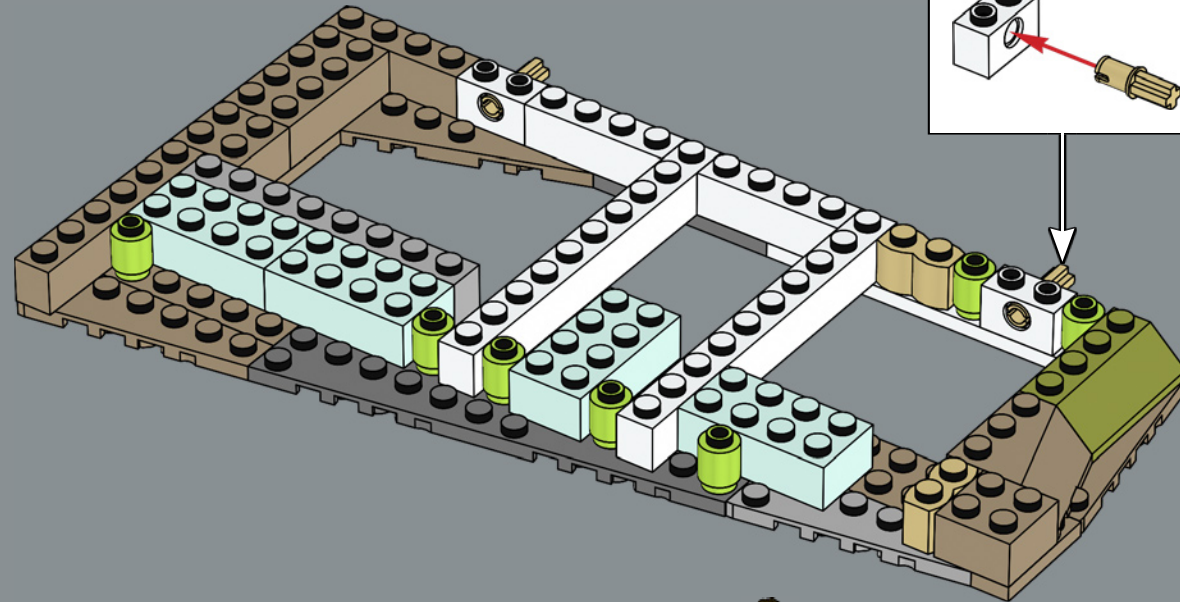
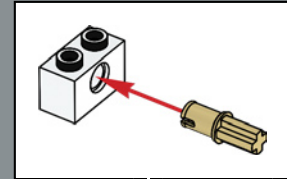
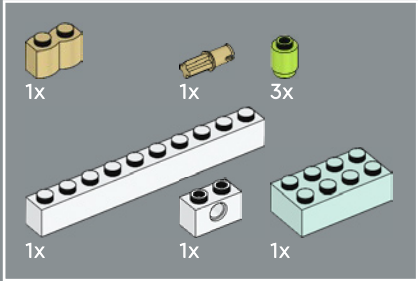
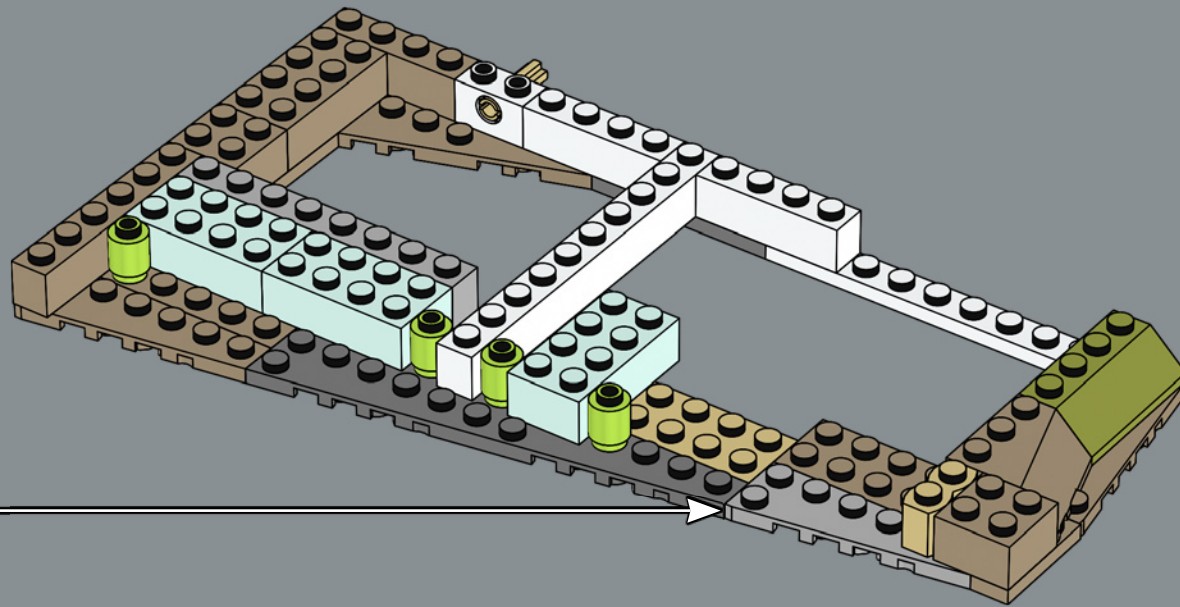

119



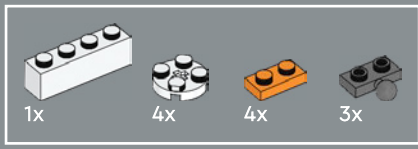

120

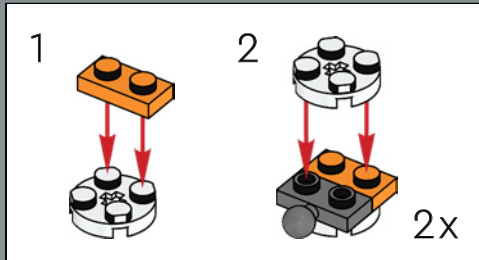
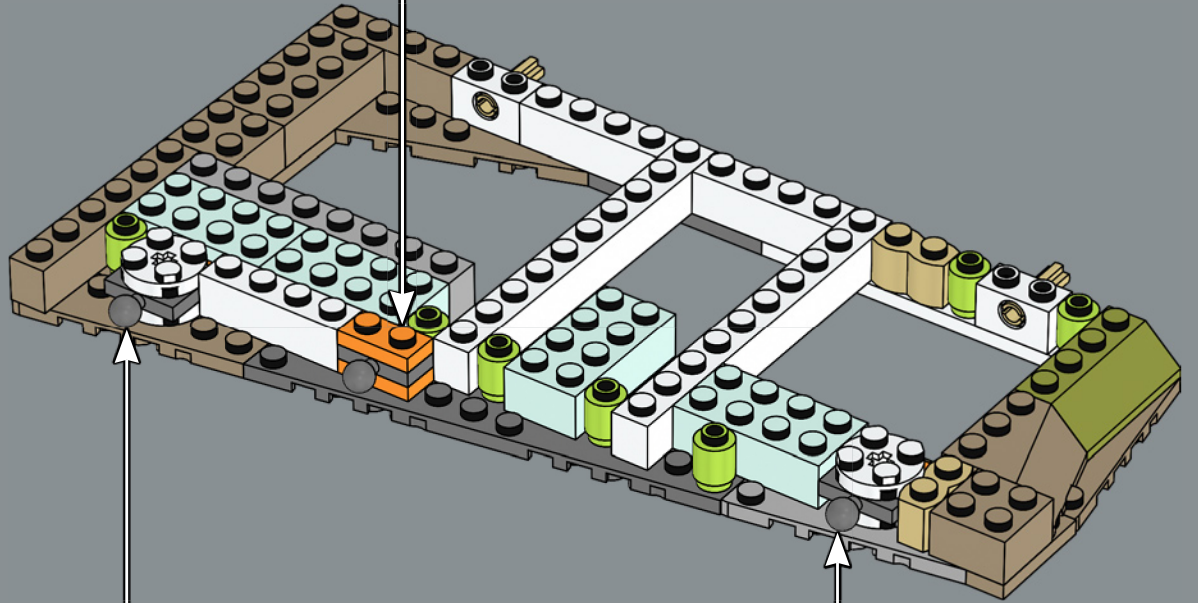
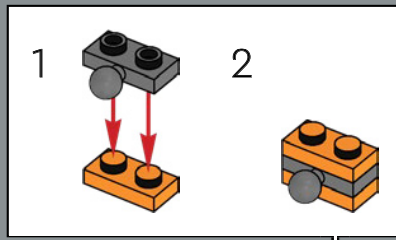

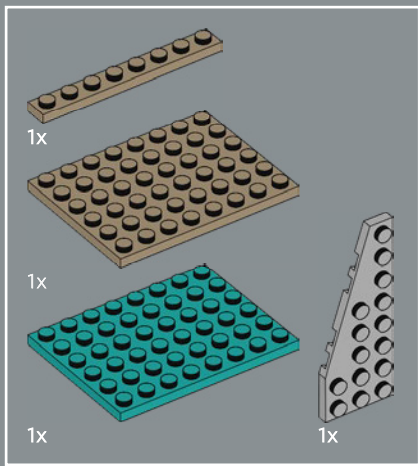

121

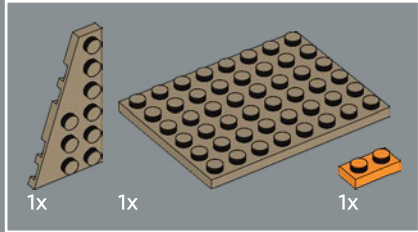
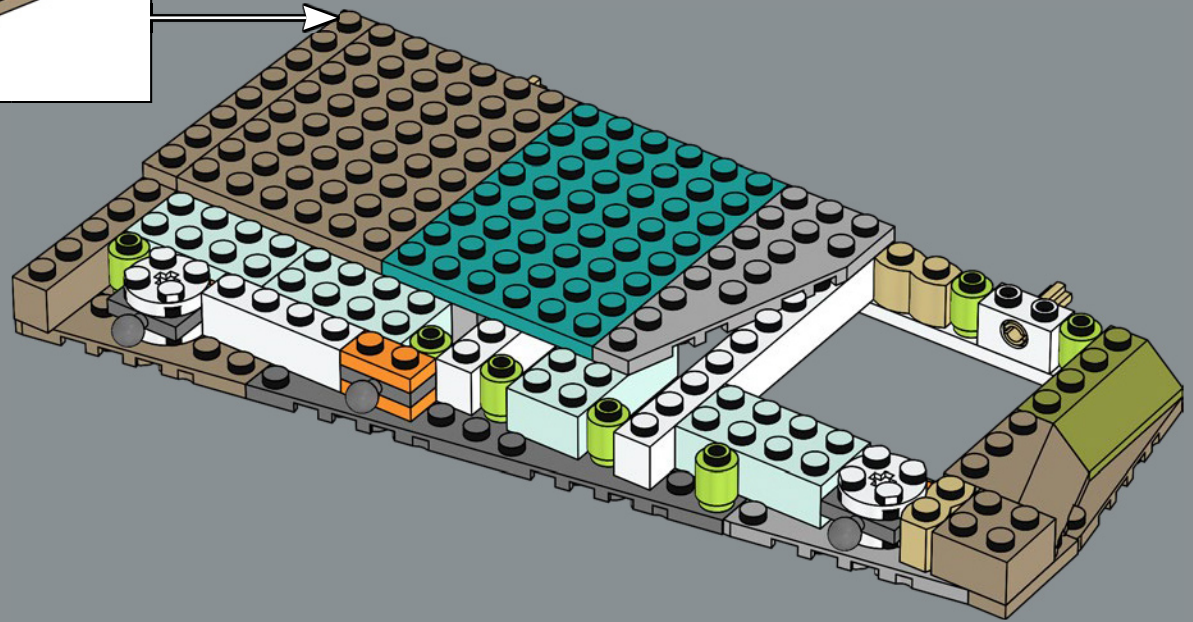
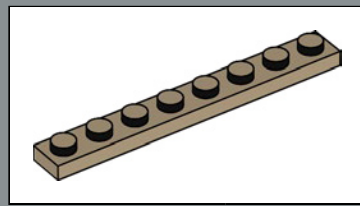

122

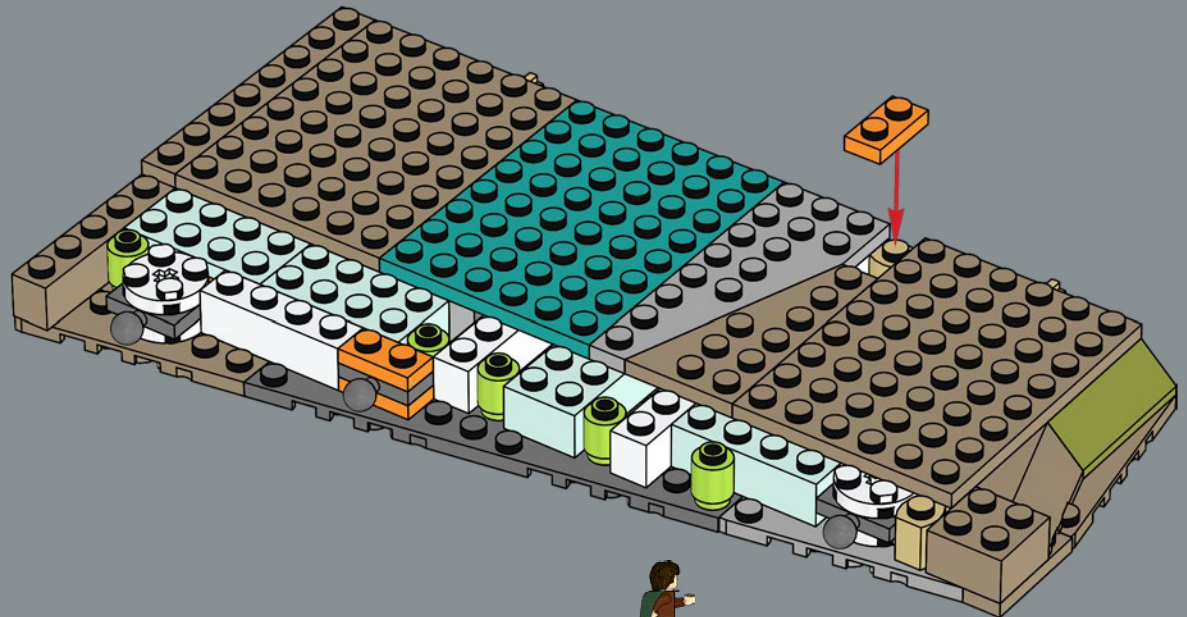

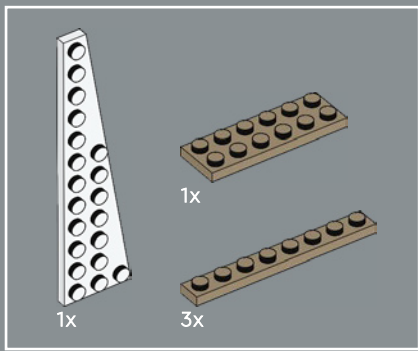

123

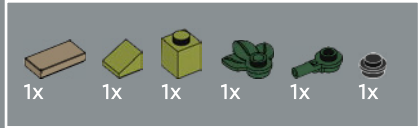
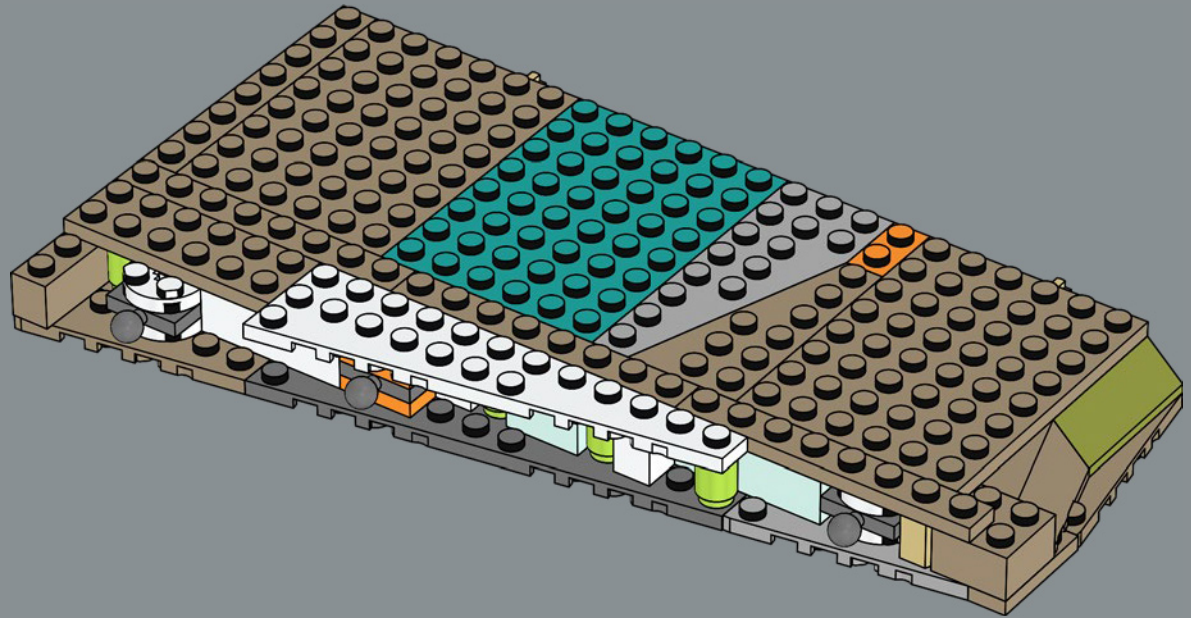

124

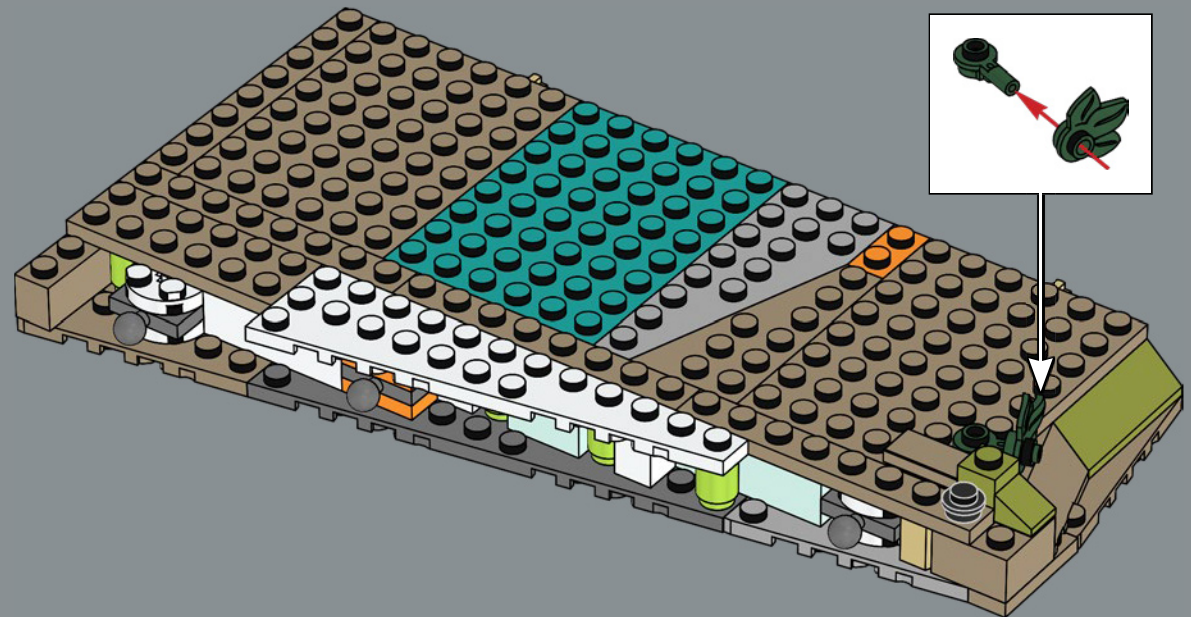

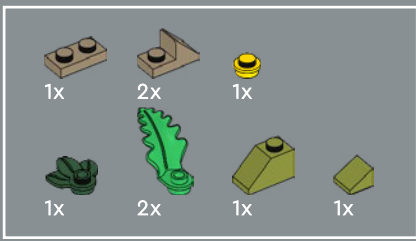

125



This build has everything, triangles, teal, ferns and matched wedge plates!

Cette construction a tout : des triangles, du bleu sarcelle, des fougères et des plaques en forme de coin assorties !

Este modelo tiene de todo: triángulos, color azulado, helechos, ¡e incluso placas de cuña que se complementan!

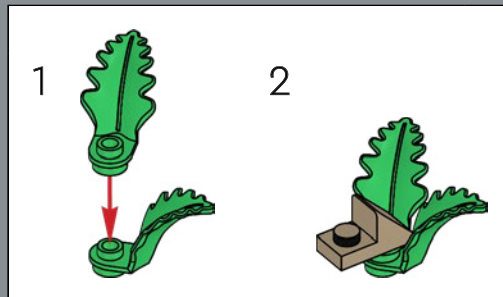
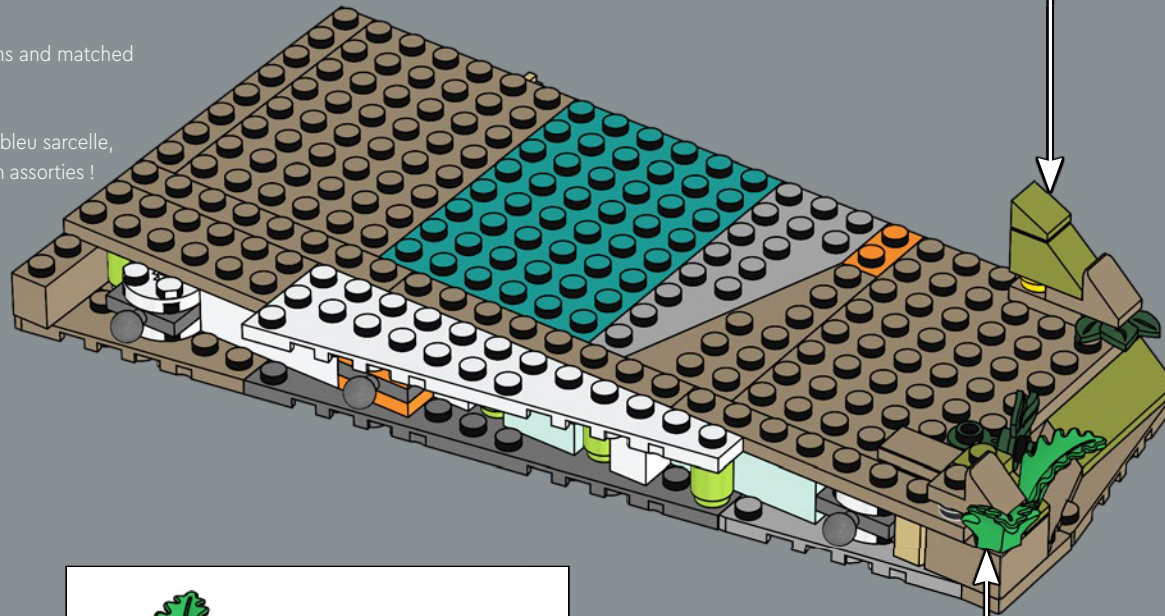
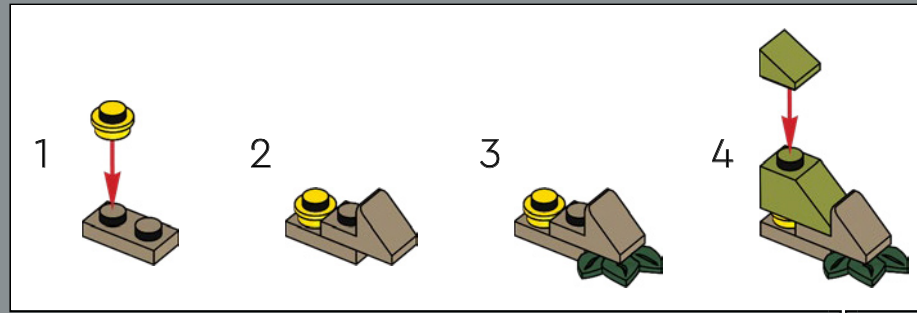

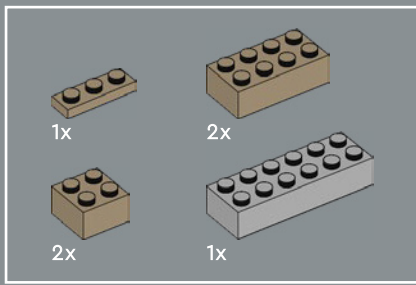

126

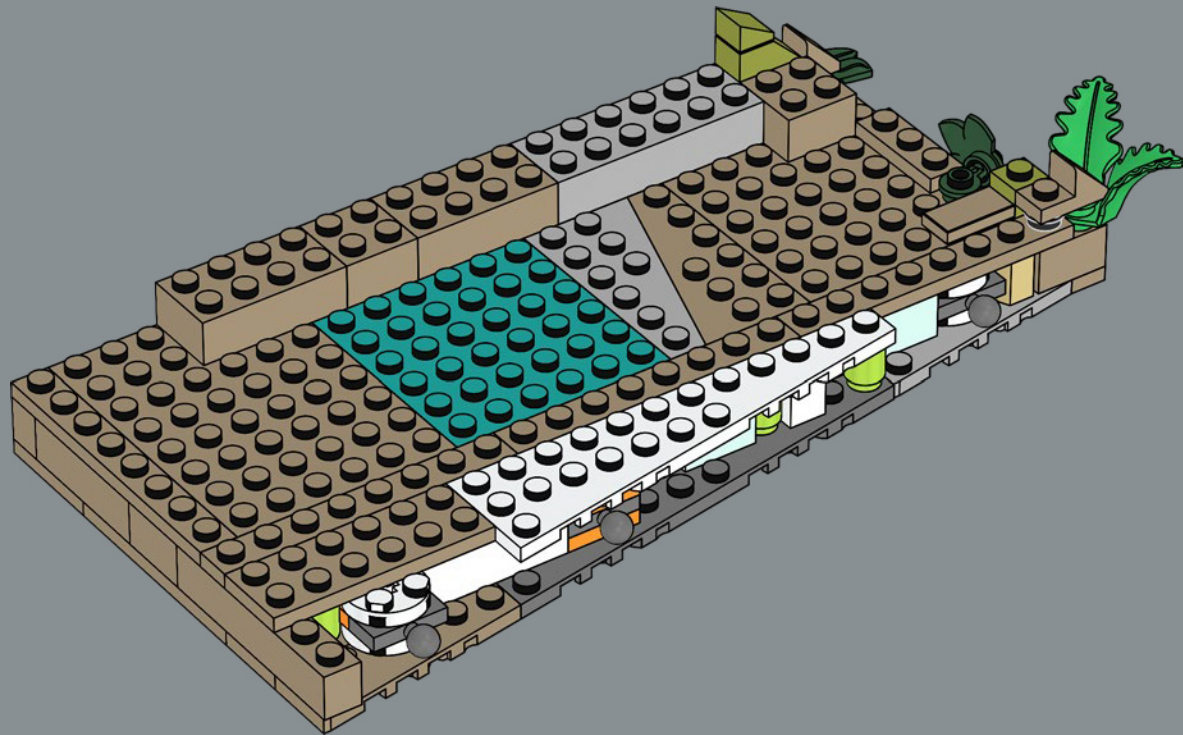

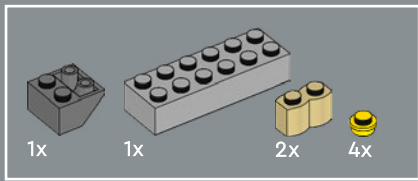

128

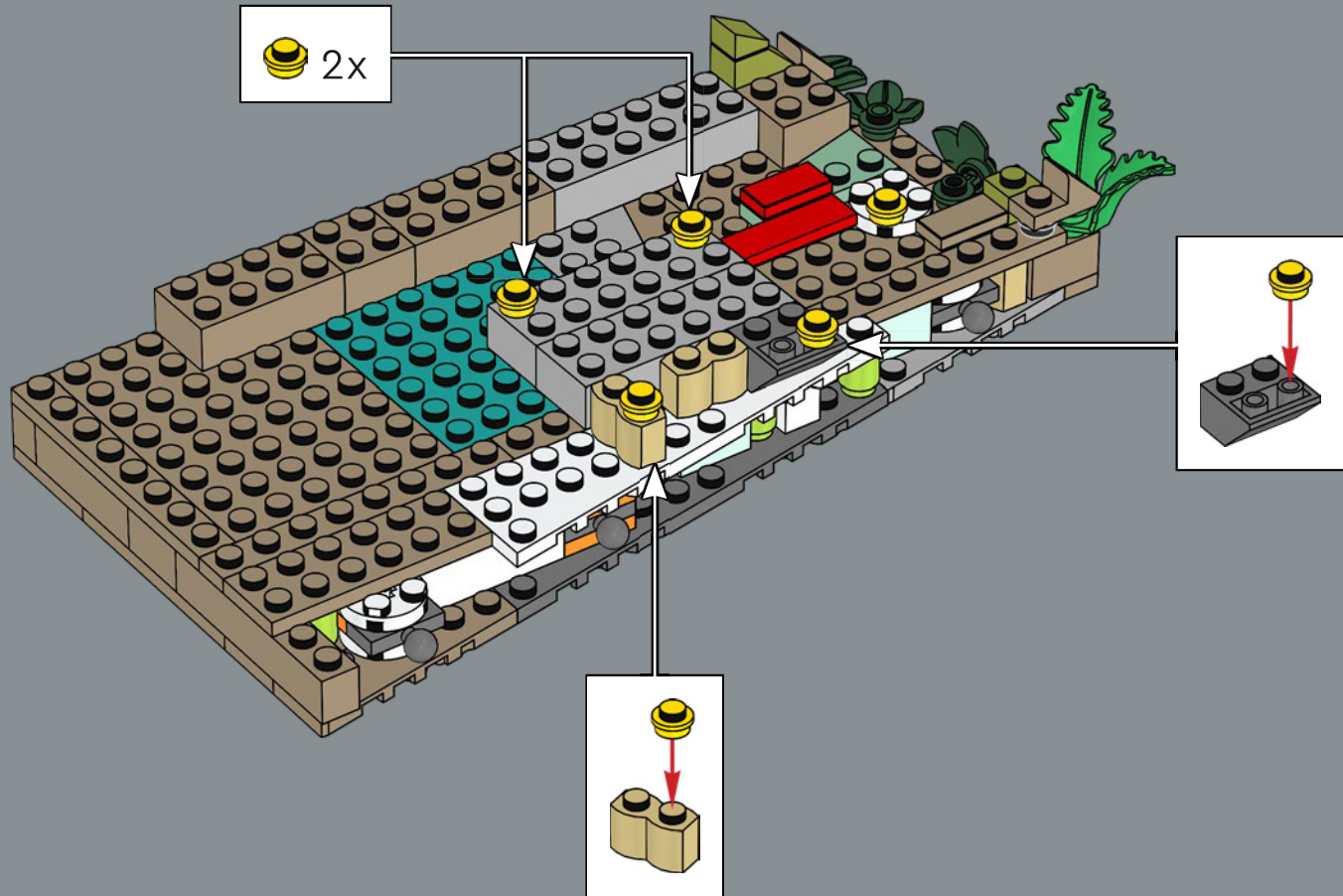

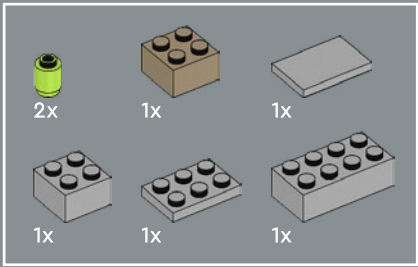

129

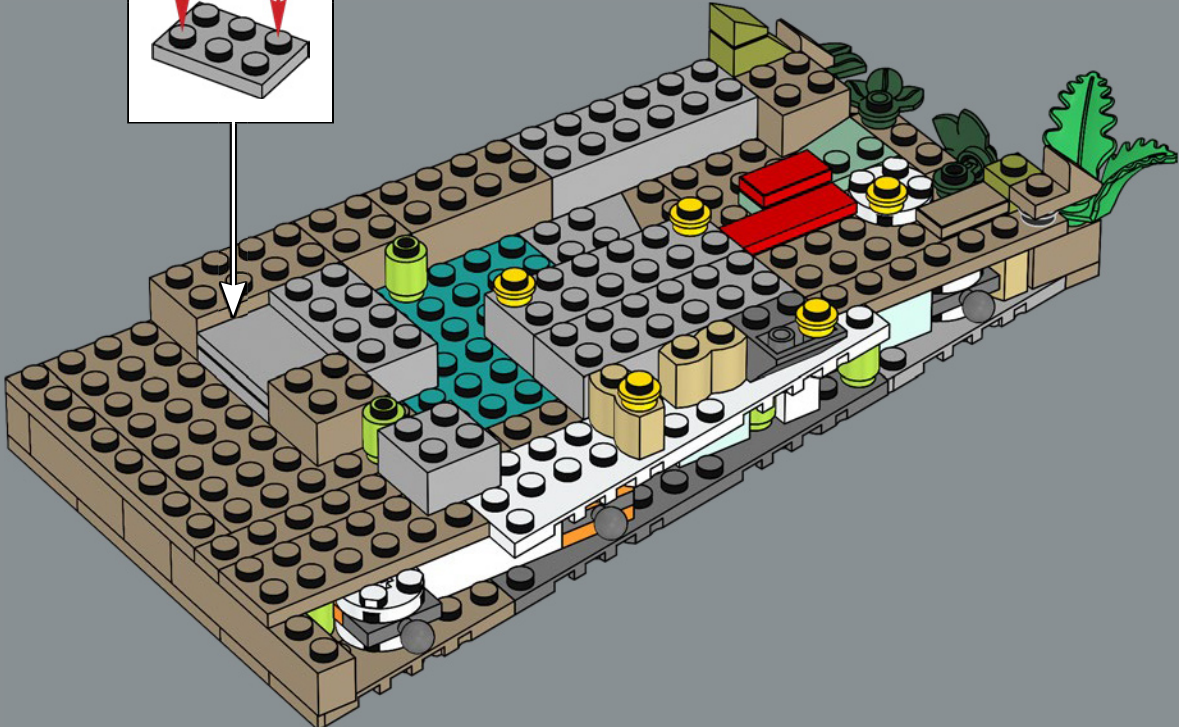
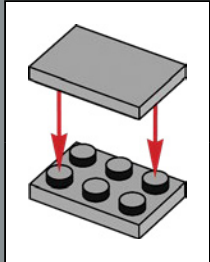

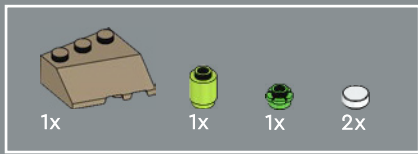

130



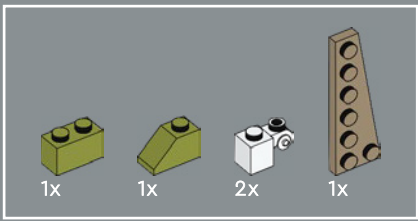

131

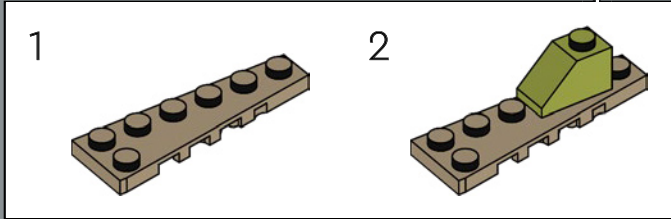
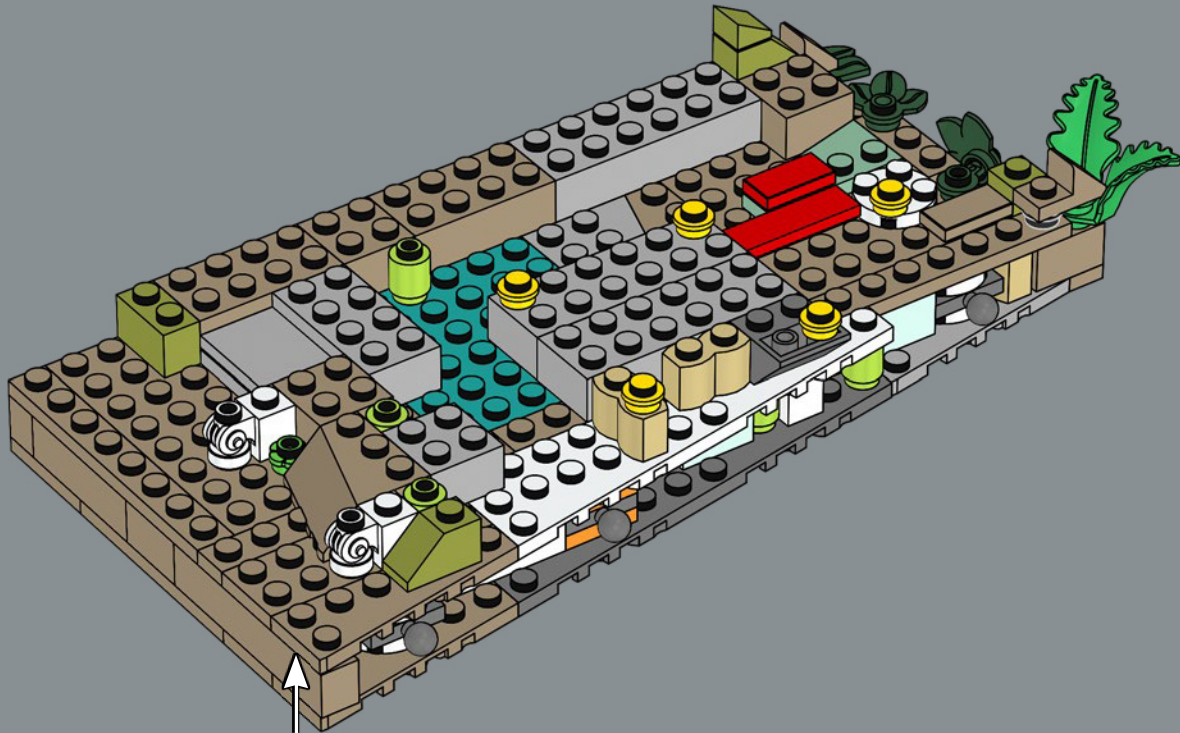

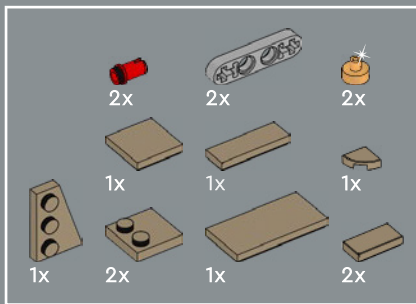

132

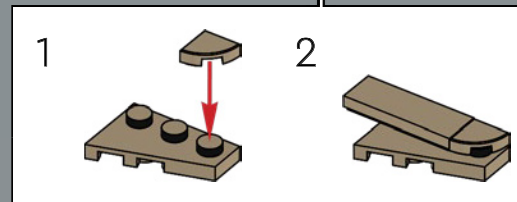
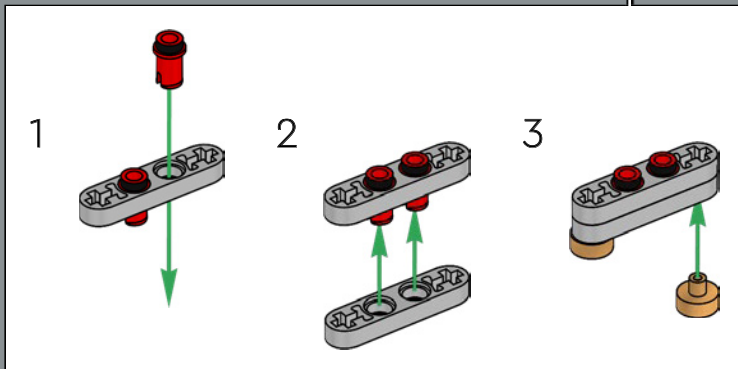
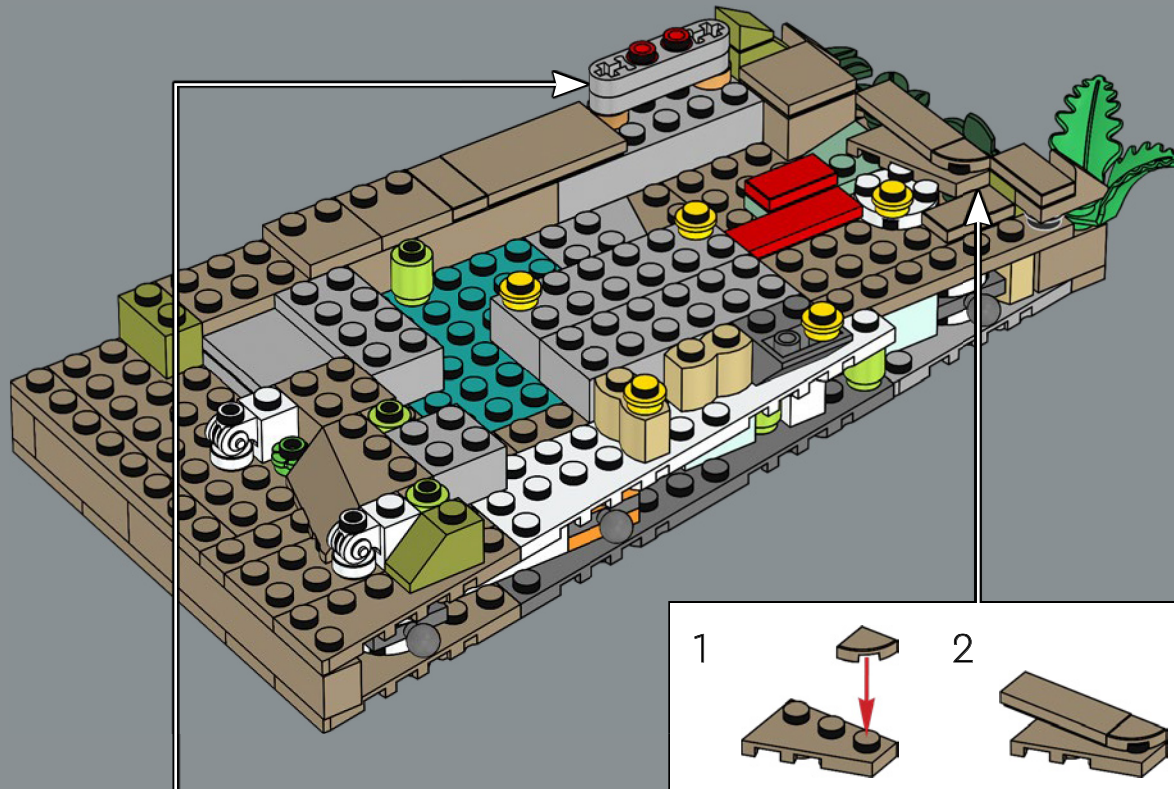

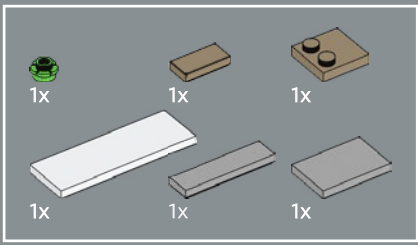

133

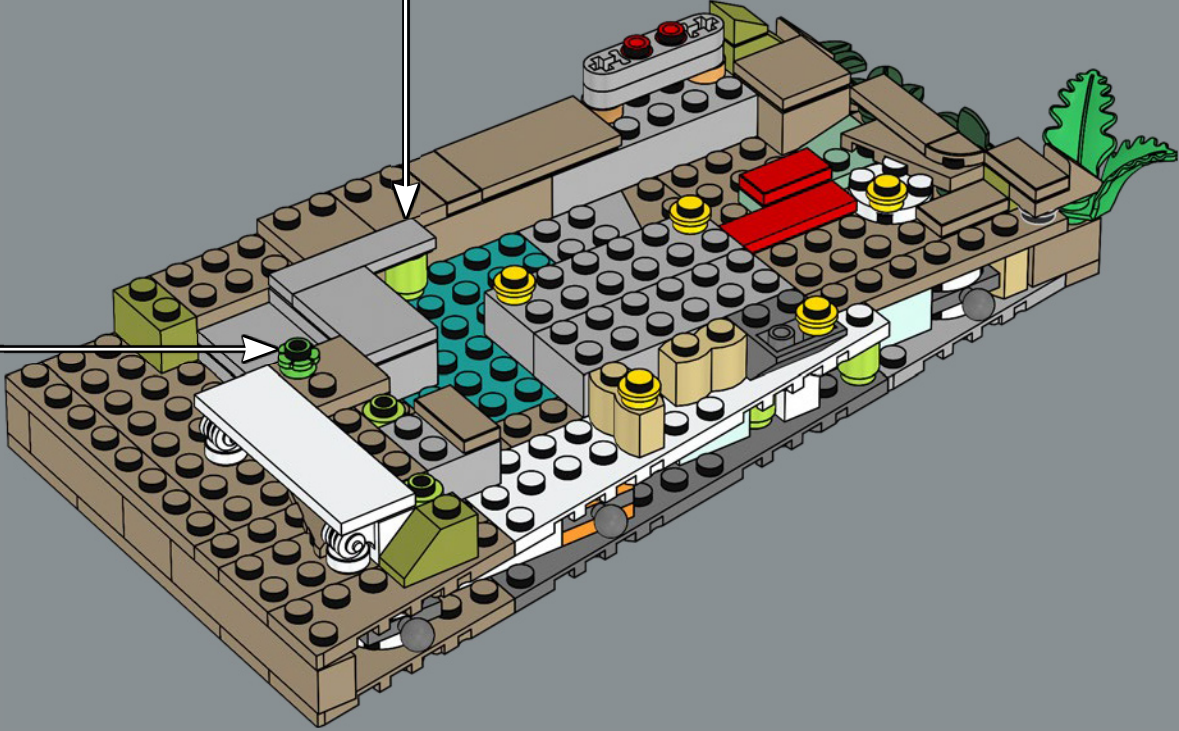
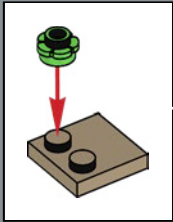
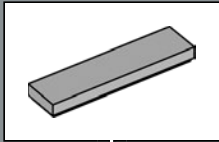

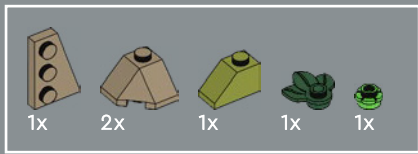

134

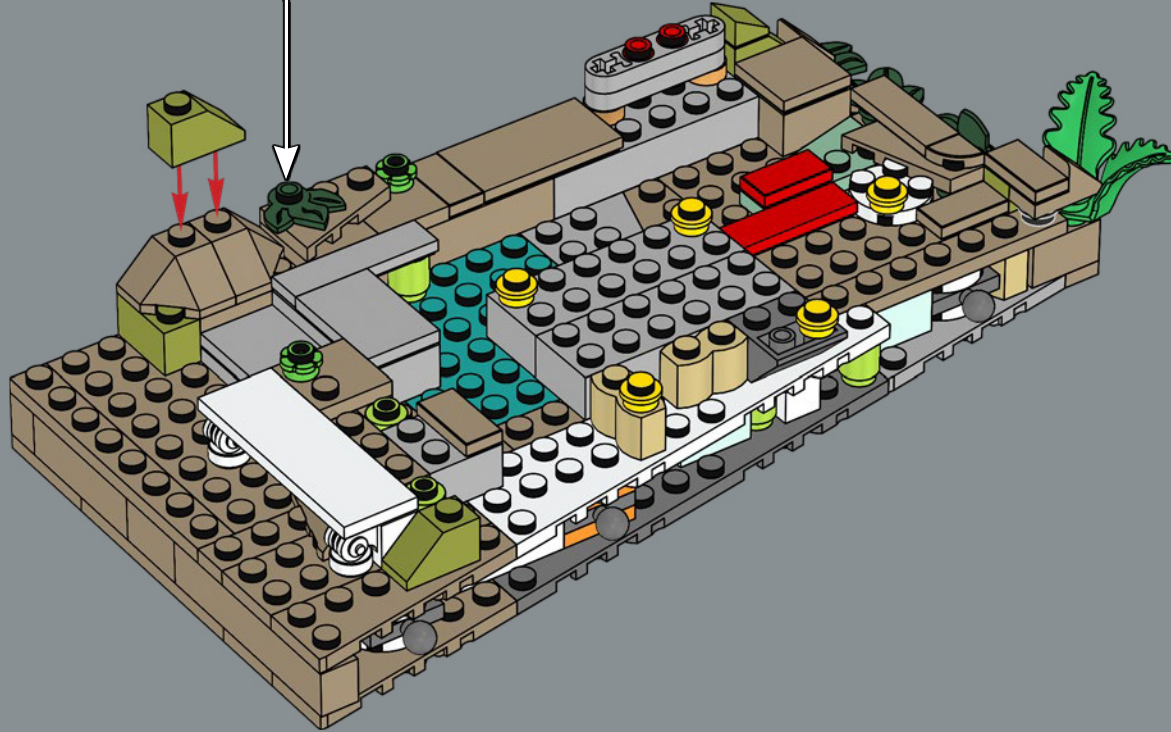
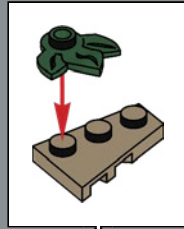



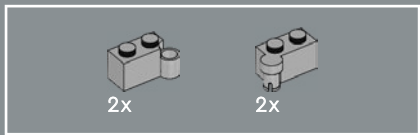

136

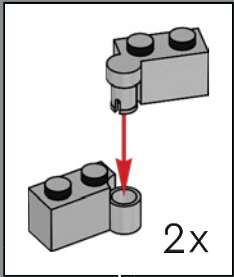

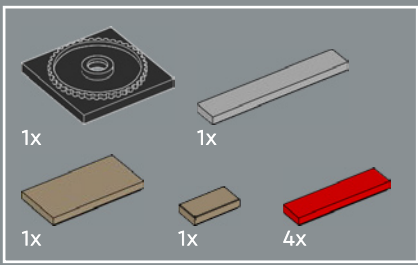

137



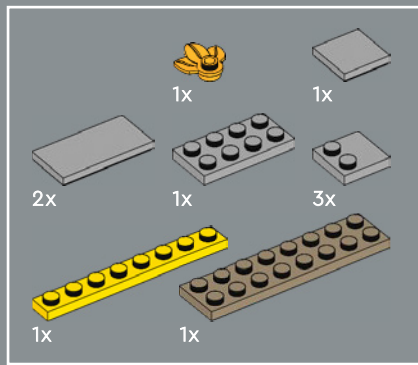

138

1

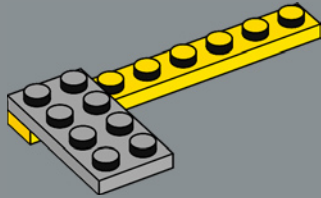

2

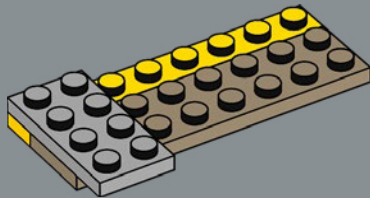

3

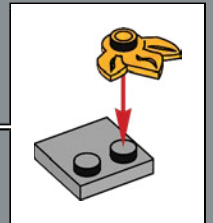
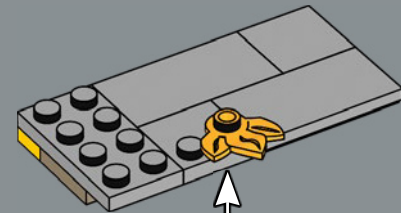

4

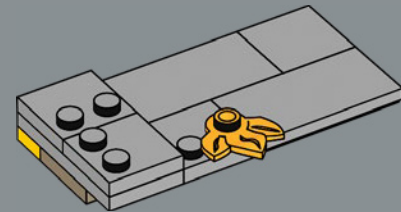



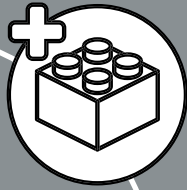

1x

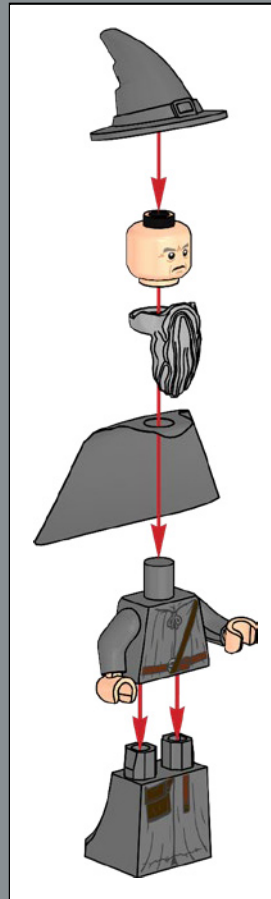
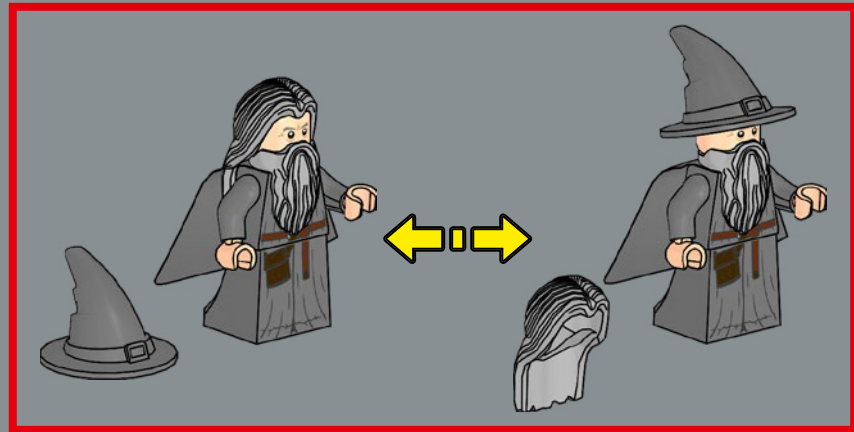

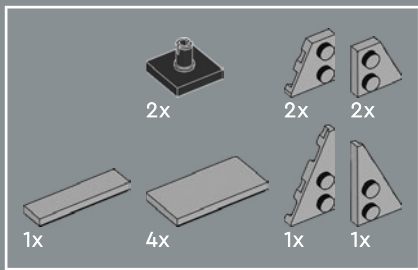

139





140



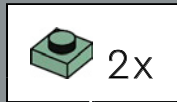
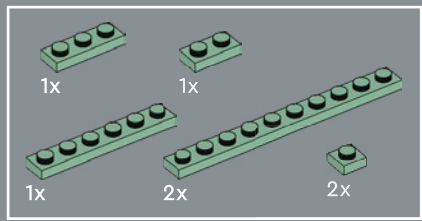

141

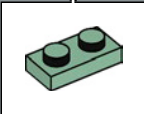

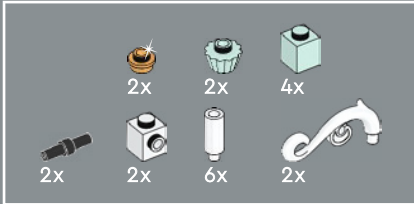
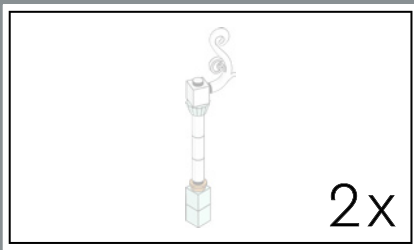

142

This Elven architectural column detail is also sometimes used as a cupcake in other sets.

Le détail de la colonne architecturale elfique est aussi parfois utilisé comme petit gâteau dans d'autres ensembles.

Los elementos que adornan esta columna arquitectónica élfica representan *cupcakes* en otros sets.

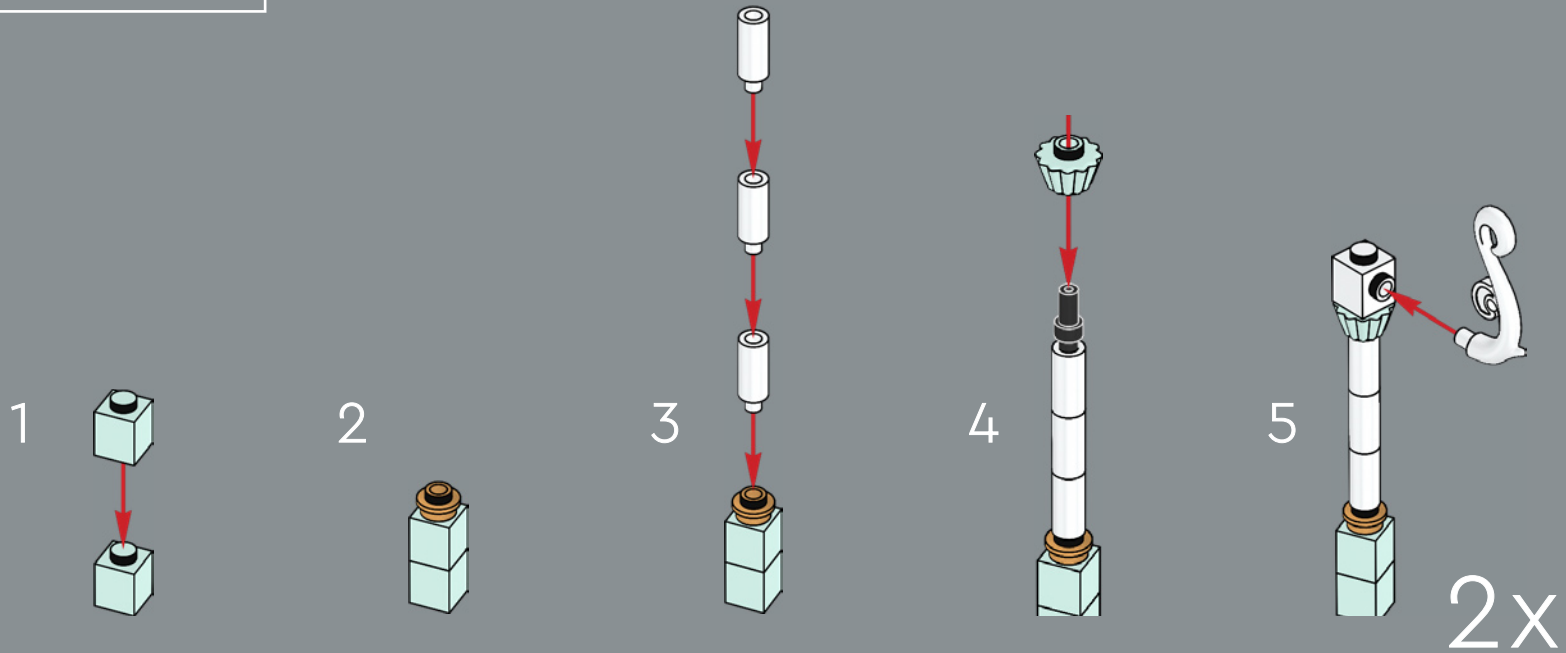



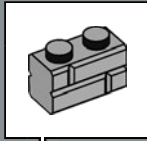
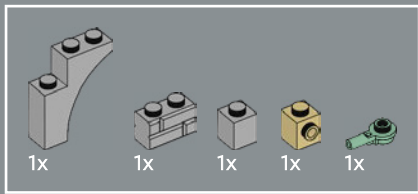

143

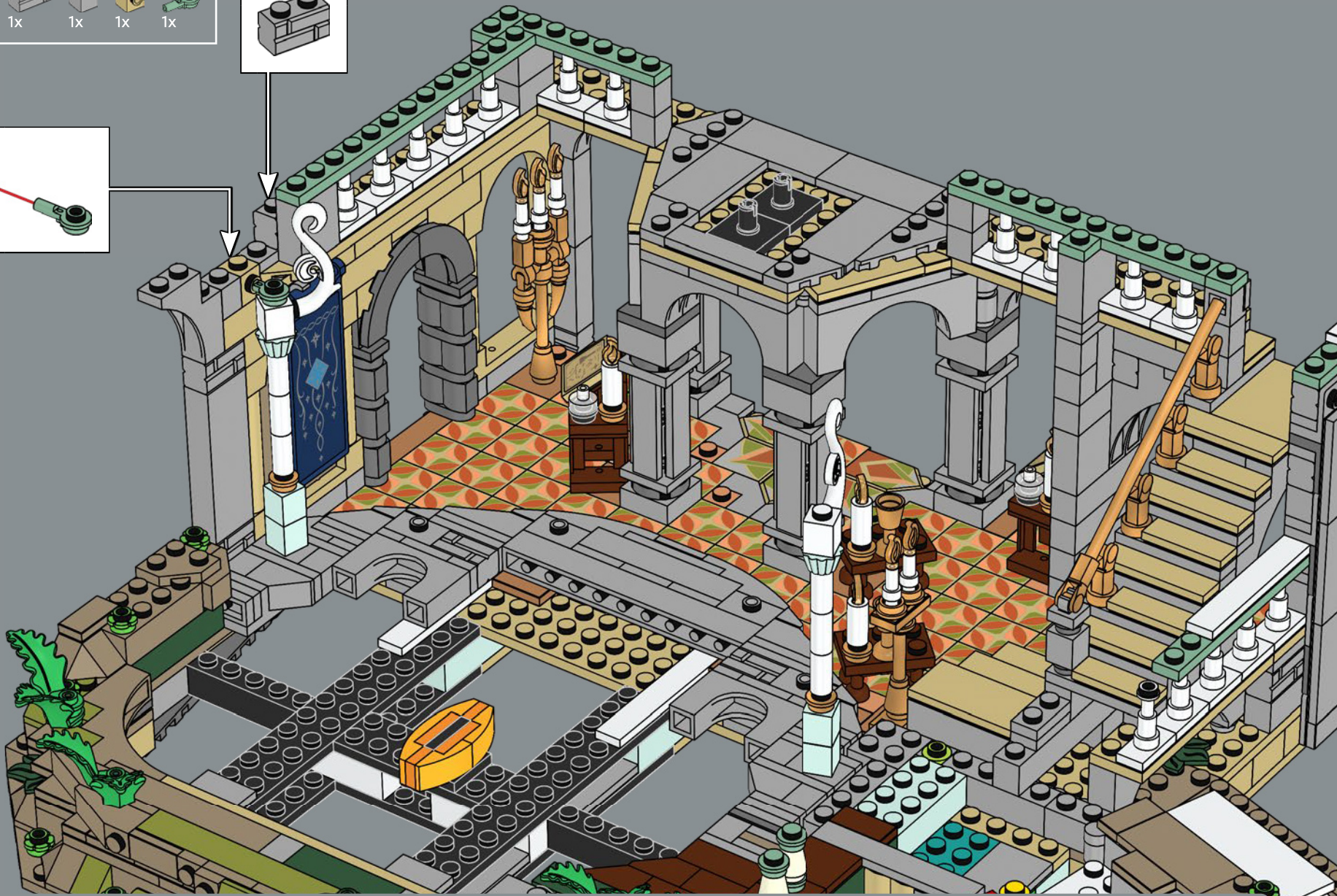
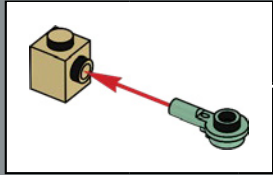

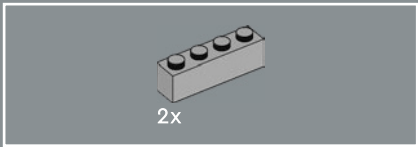

144



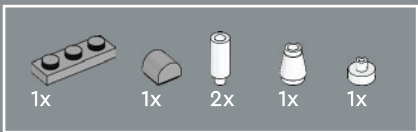

145

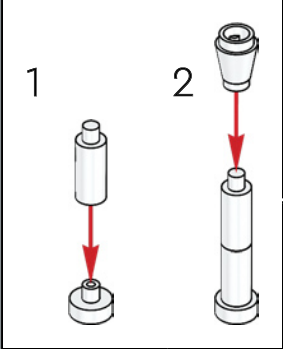
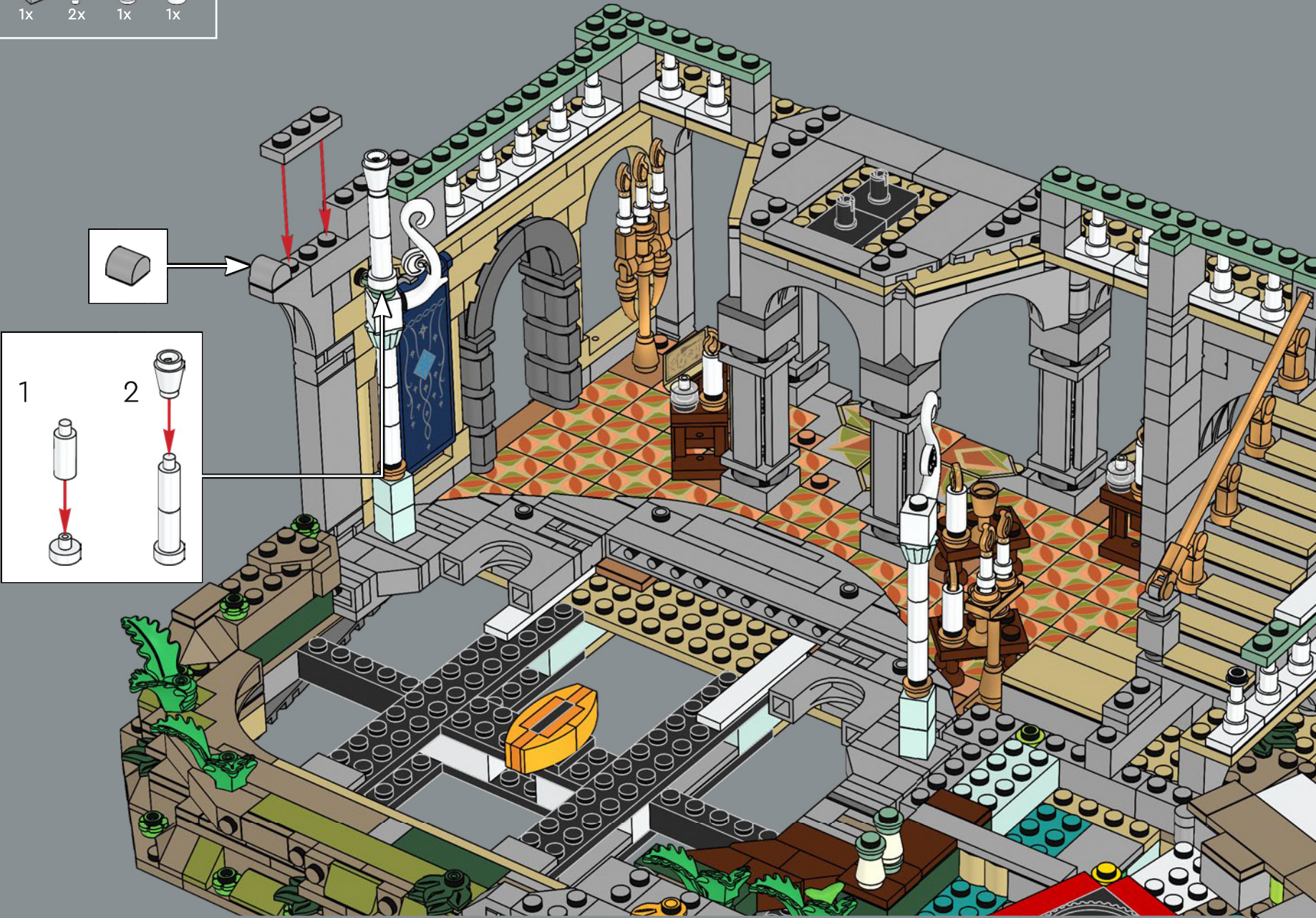

146

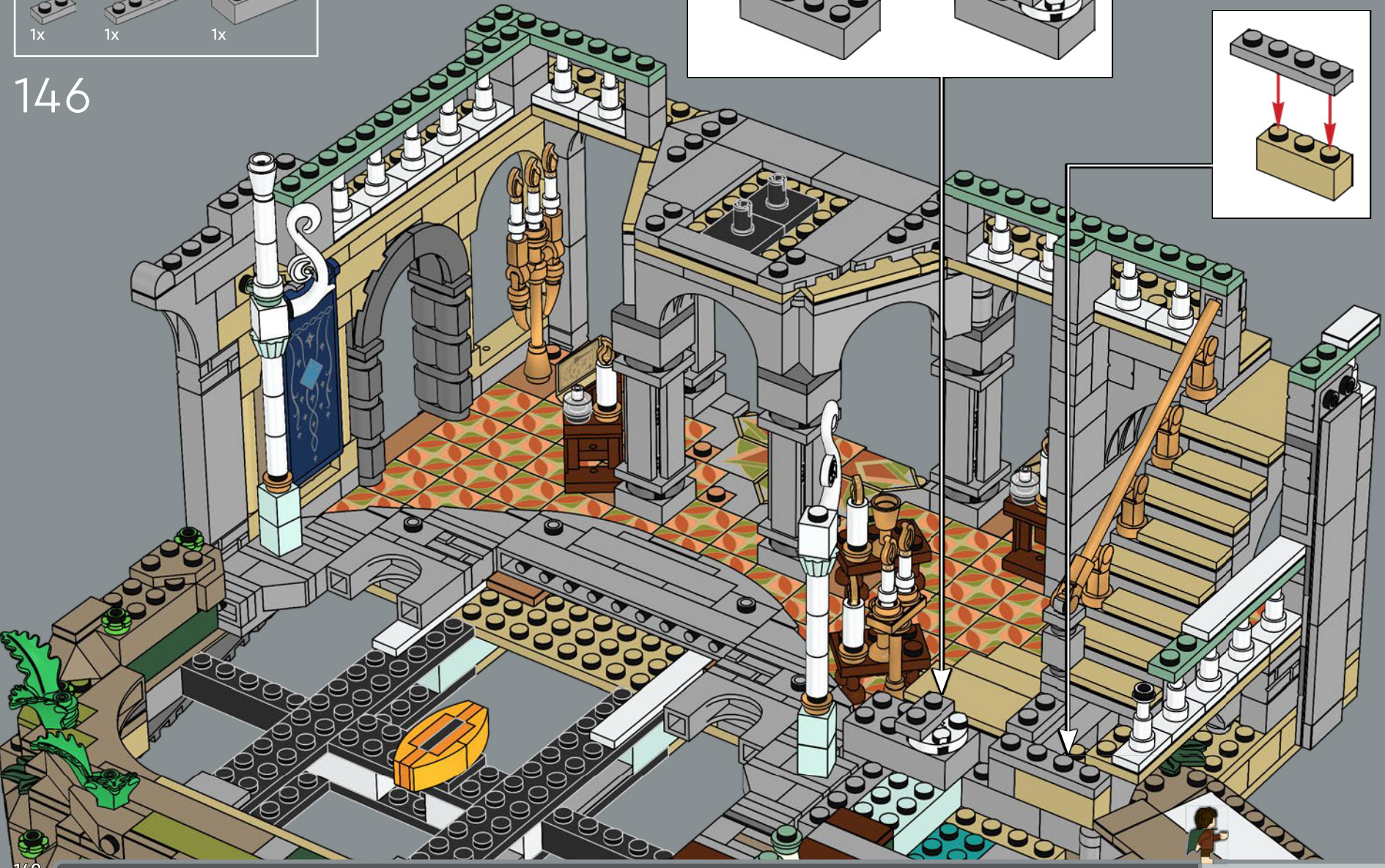
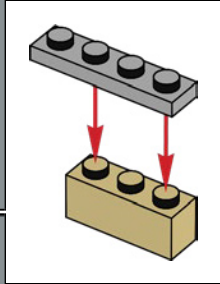
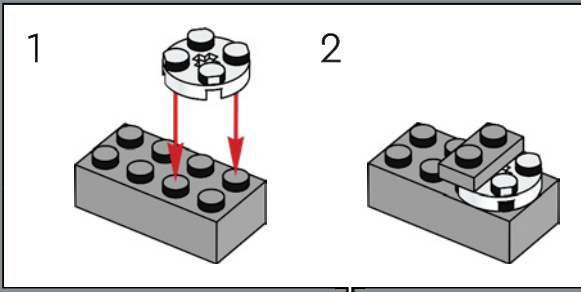
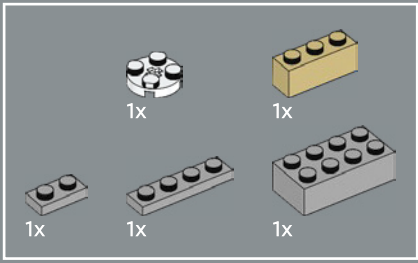

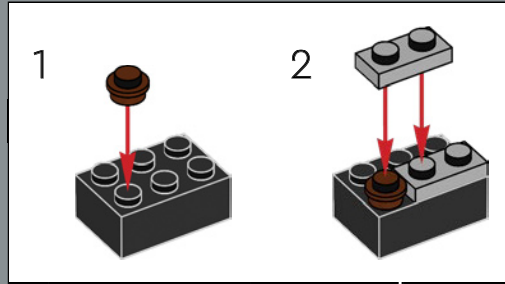
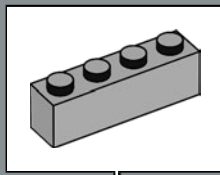
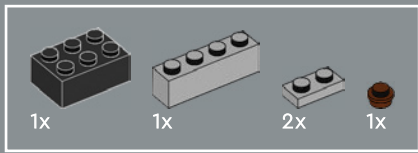

147

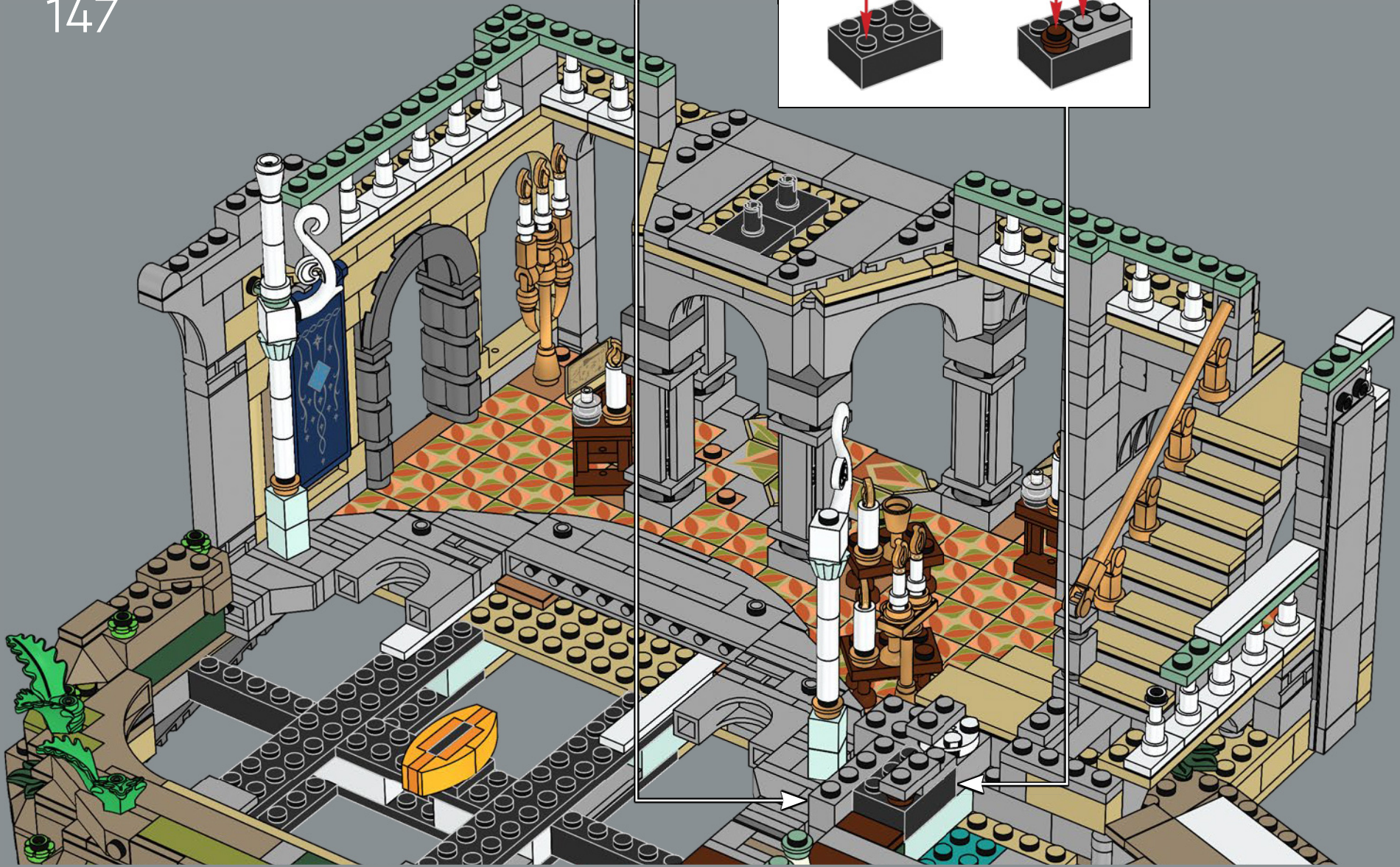

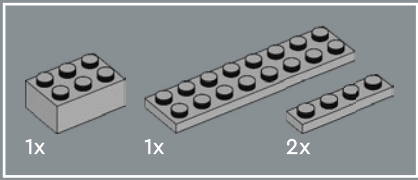

148

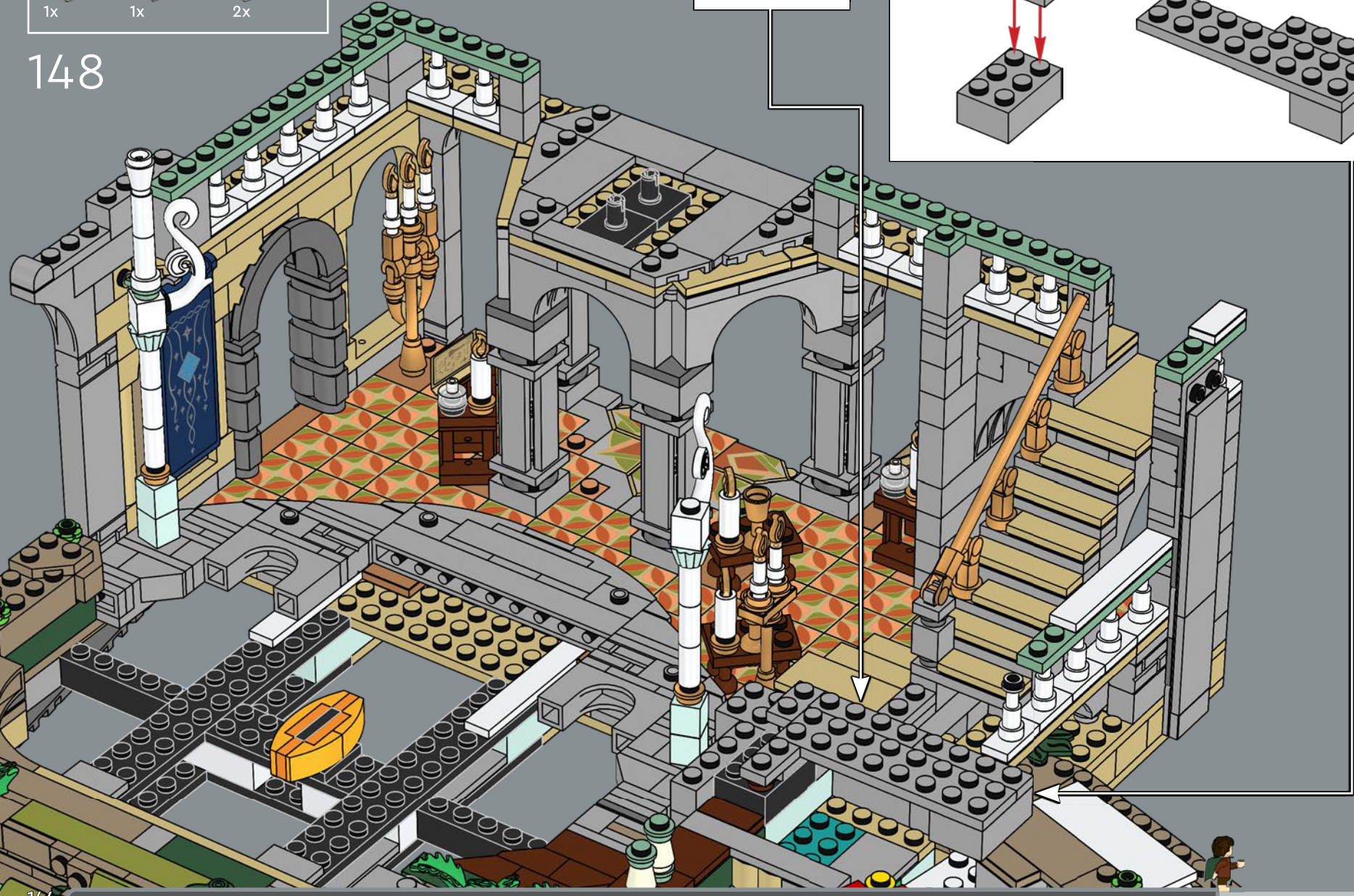
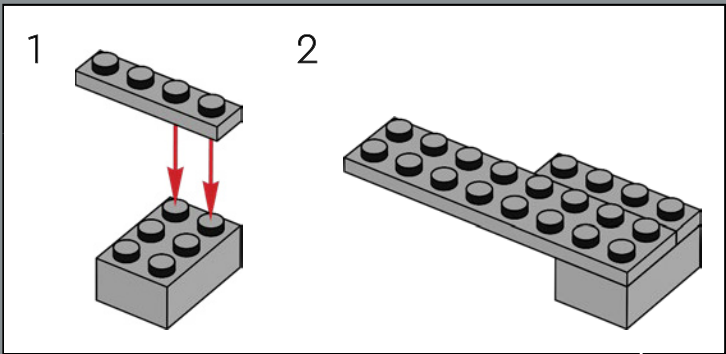
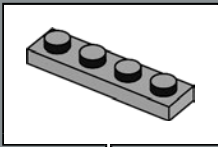

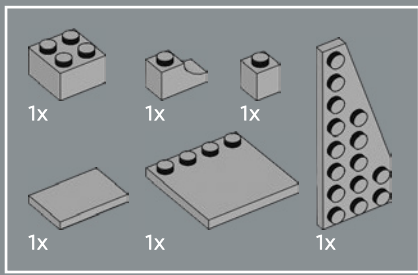

149



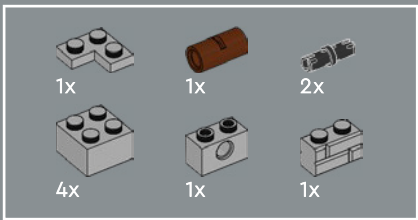

150

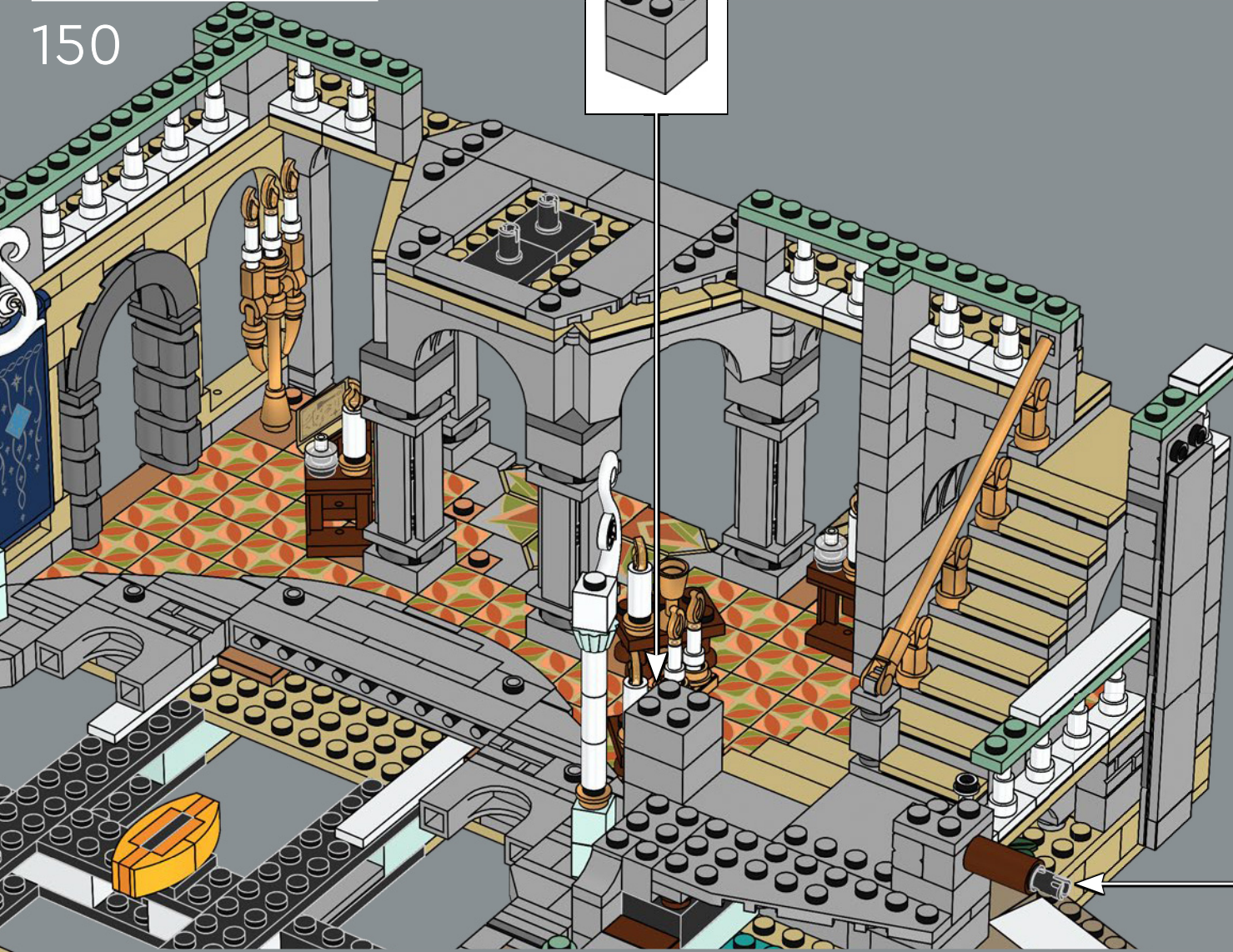
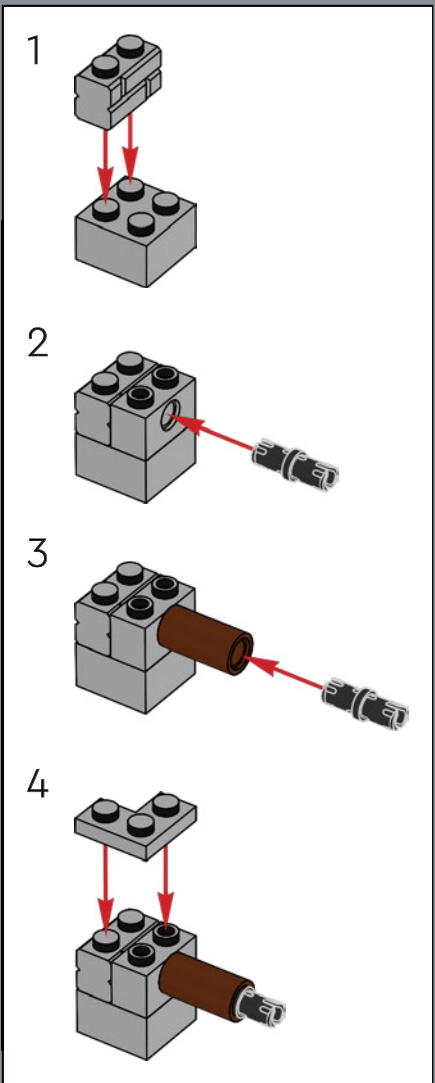
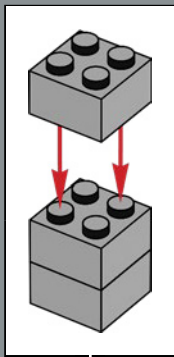

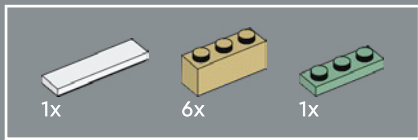

151

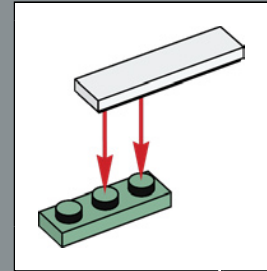
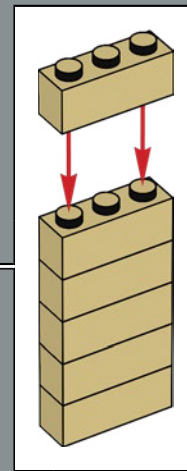



14x

152



2x

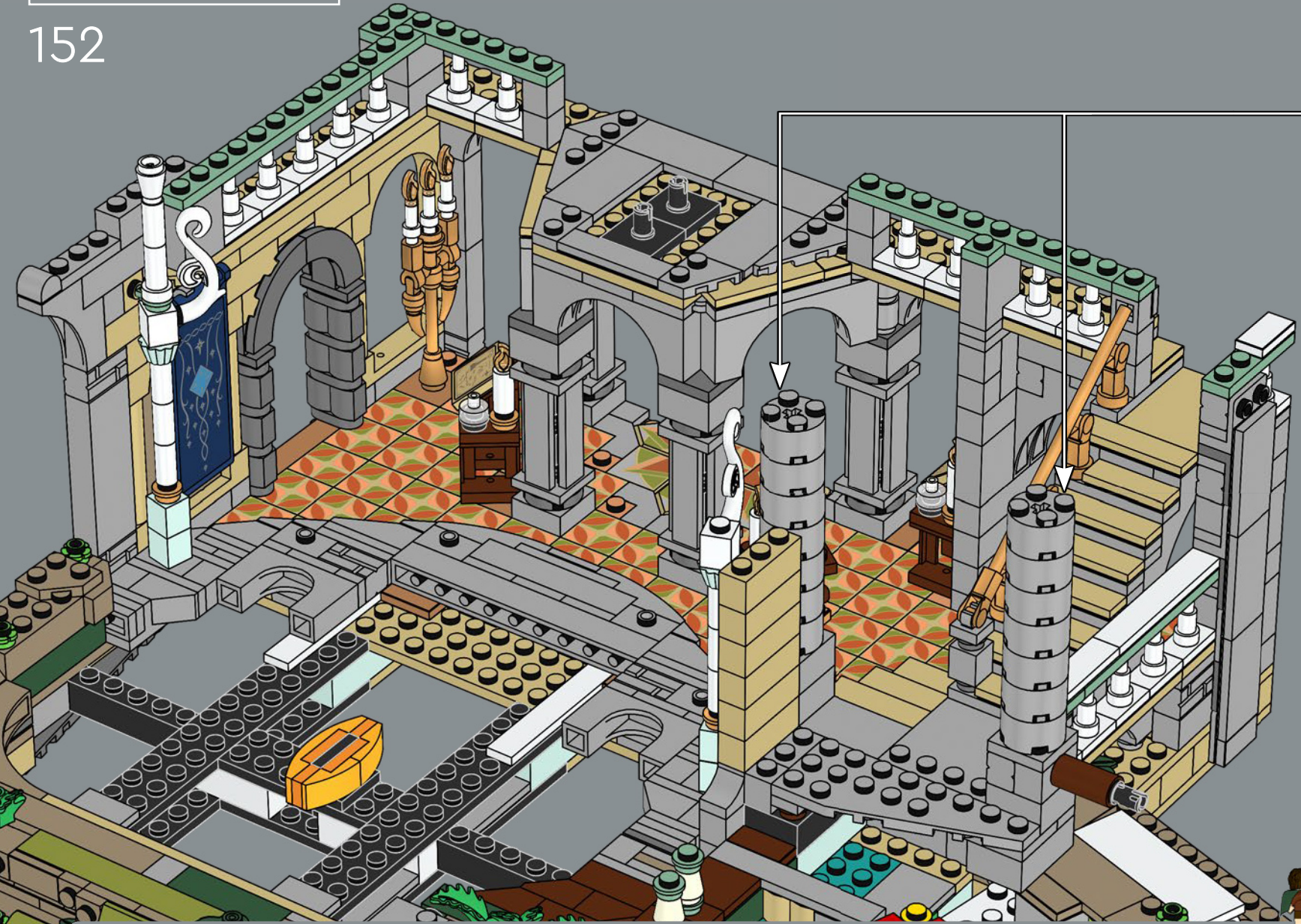

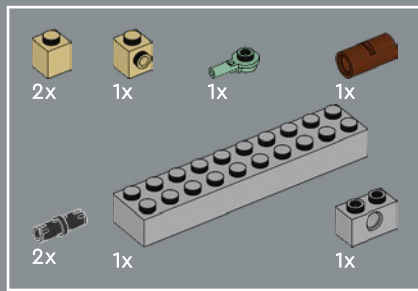

153

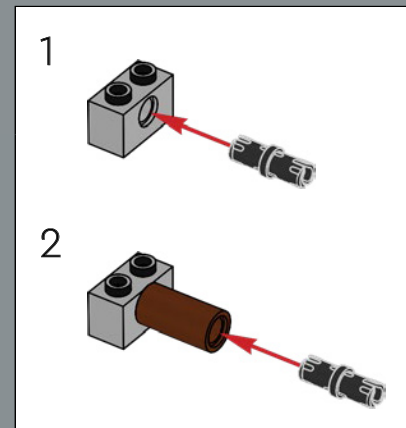
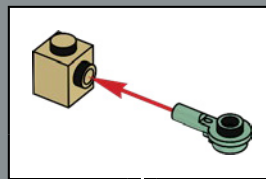

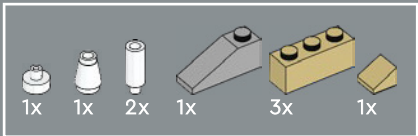

154

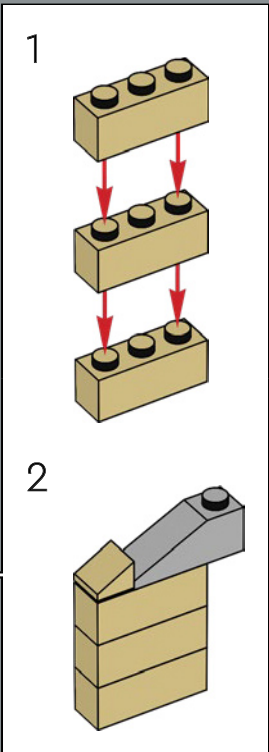
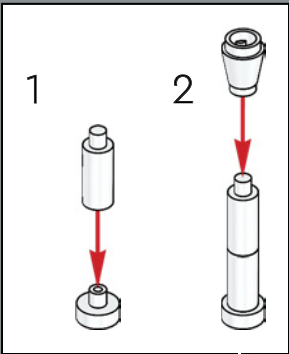

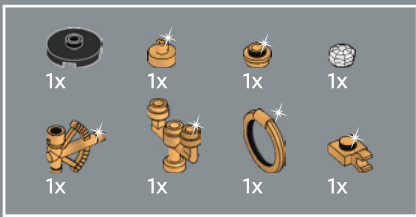

155

1

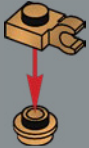

2



3

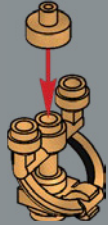

4

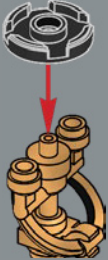

5

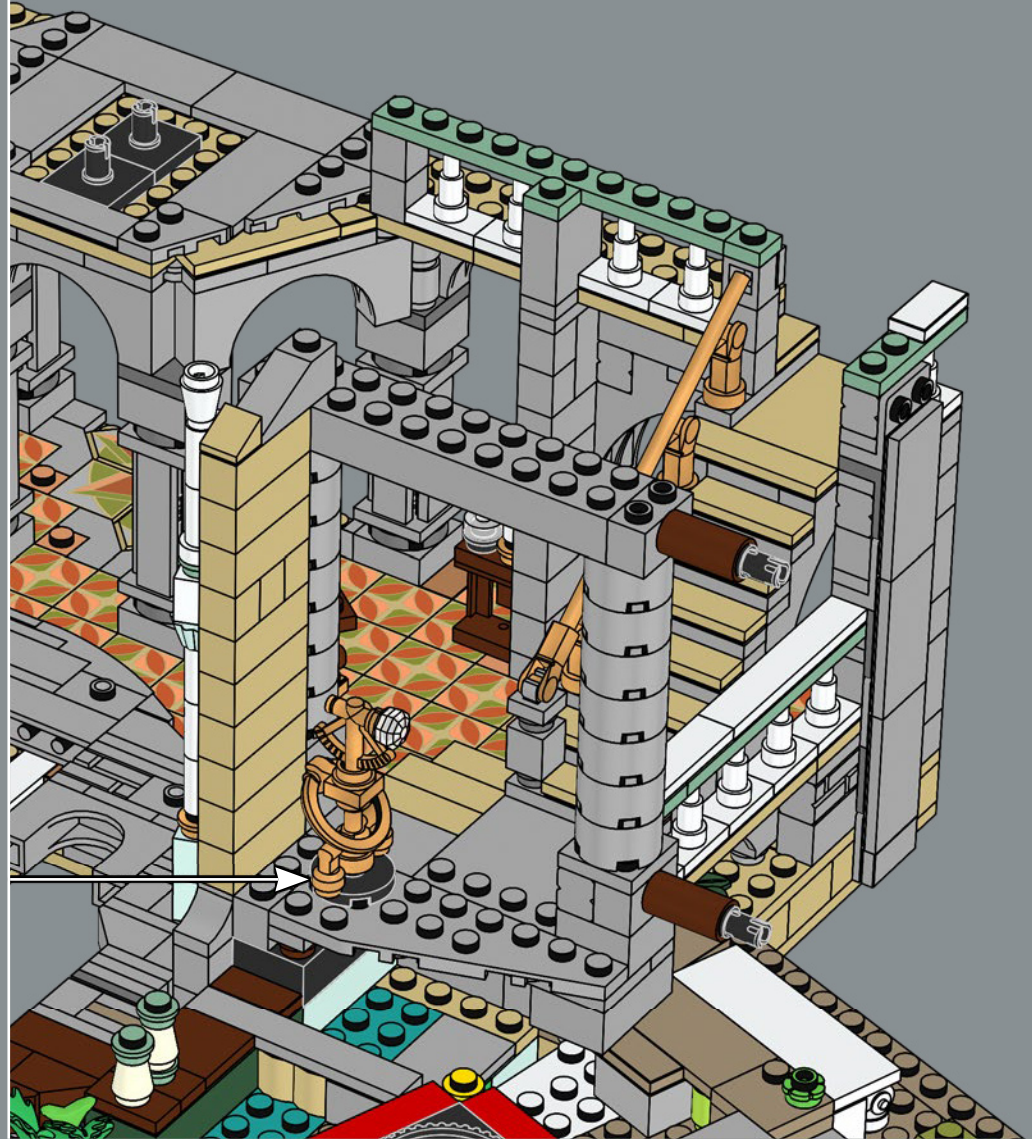
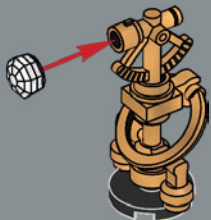



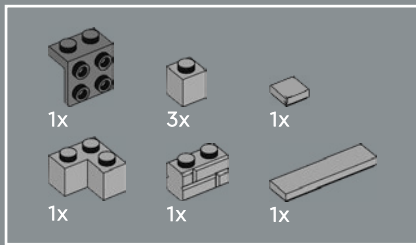

156

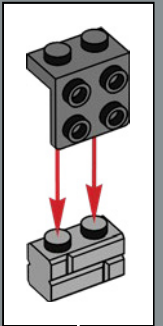

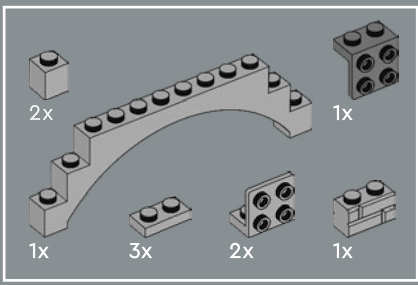

157

1

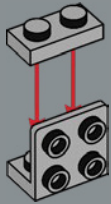

2

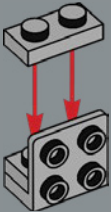

3

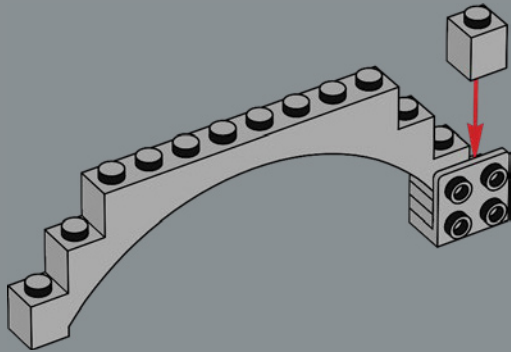

4

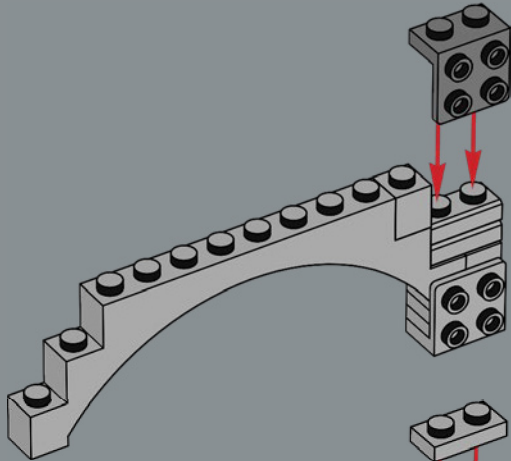

5

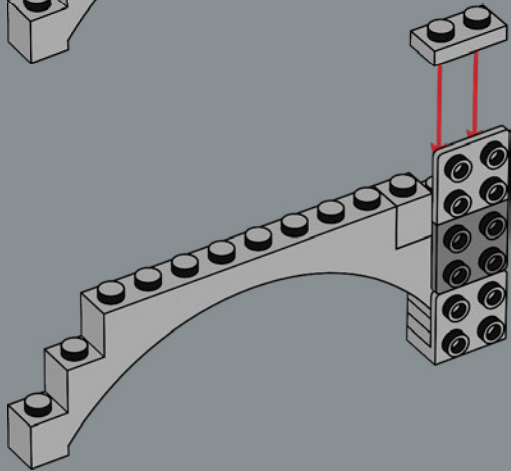



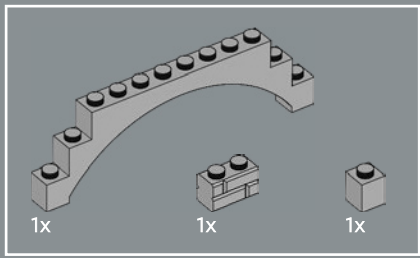

158

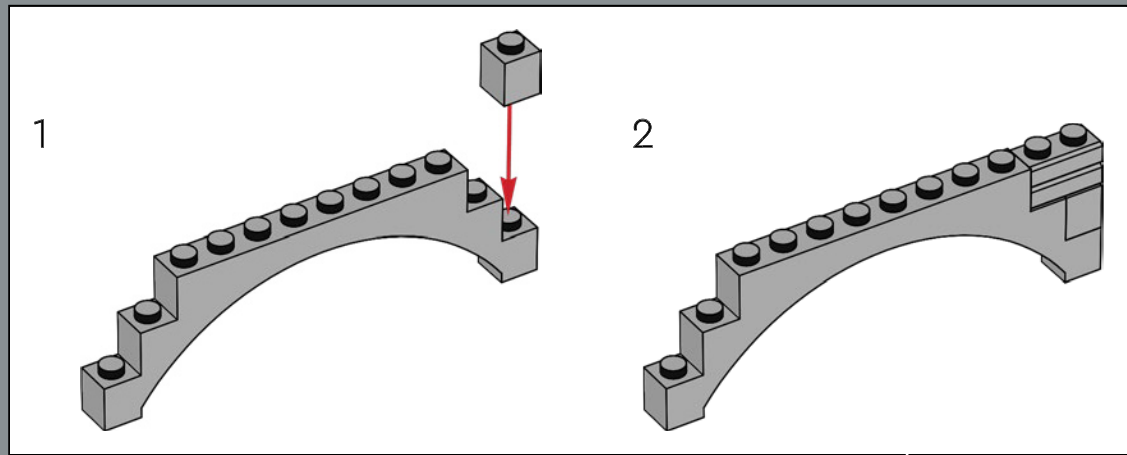

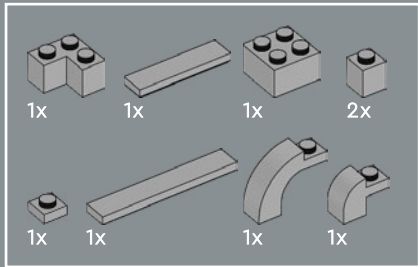

159

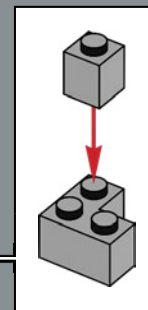
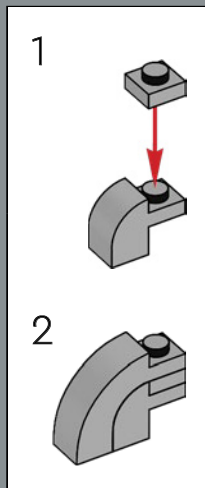

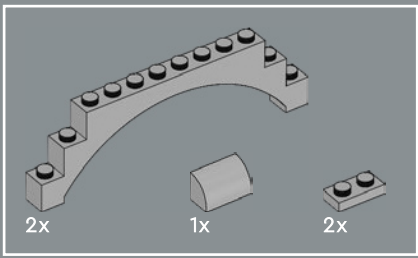

160

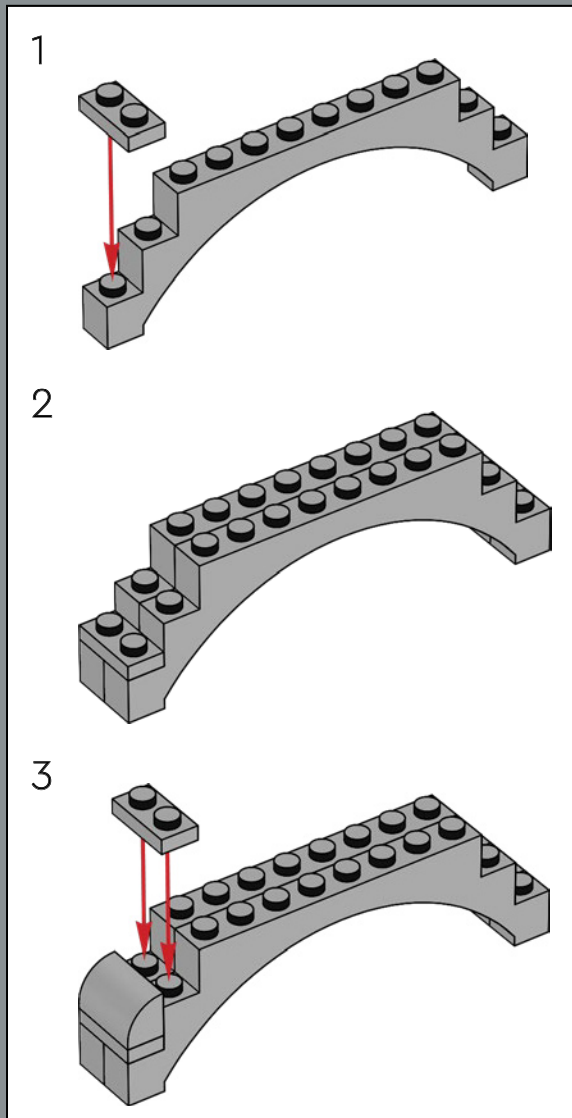

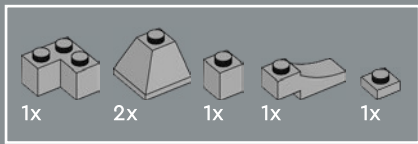

161

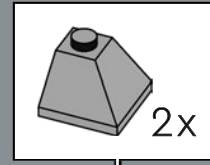
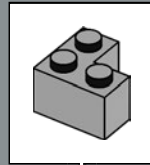
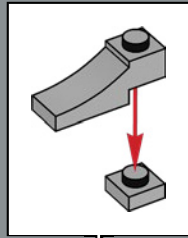

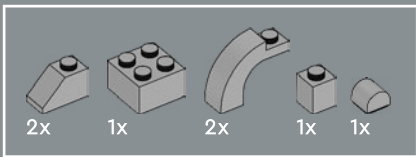

162

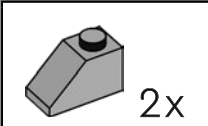
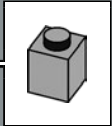

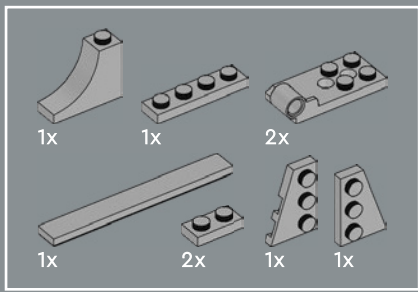

163

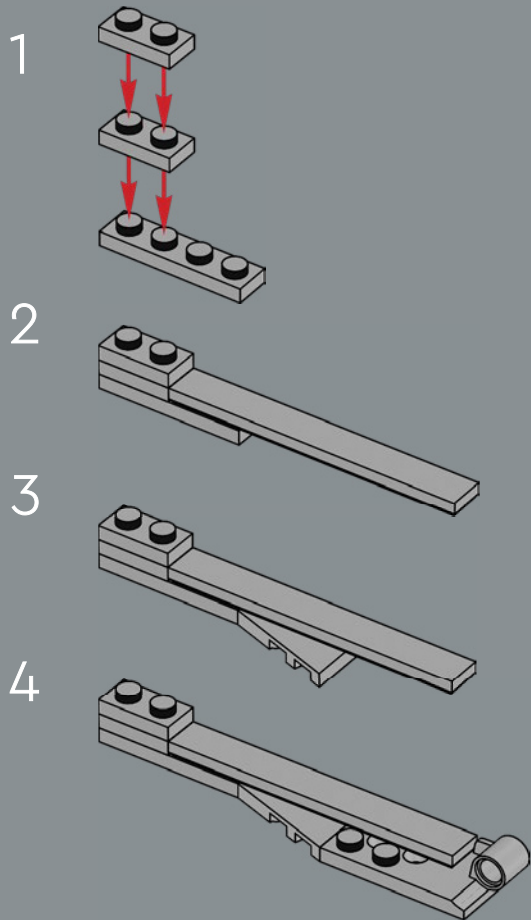

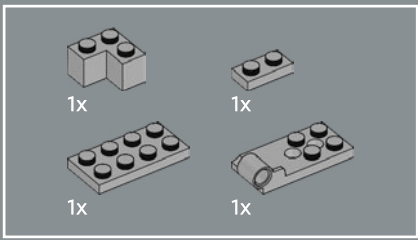

164



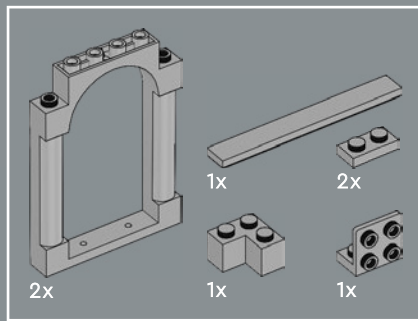

165

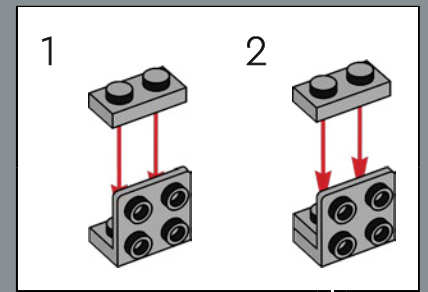

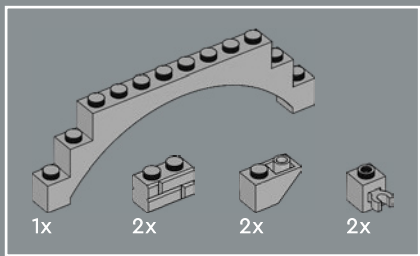

166

1

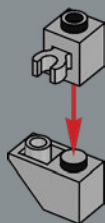

2

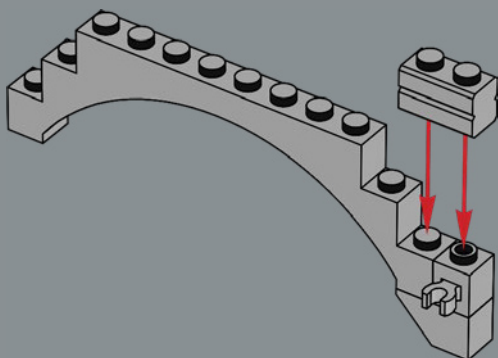

3

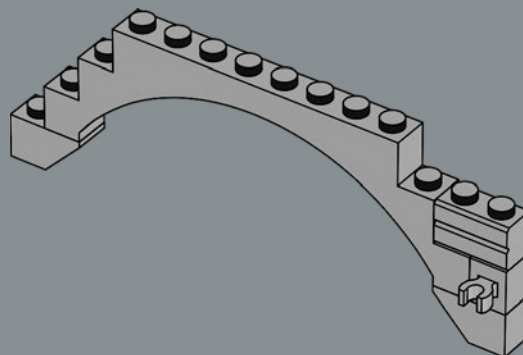

4

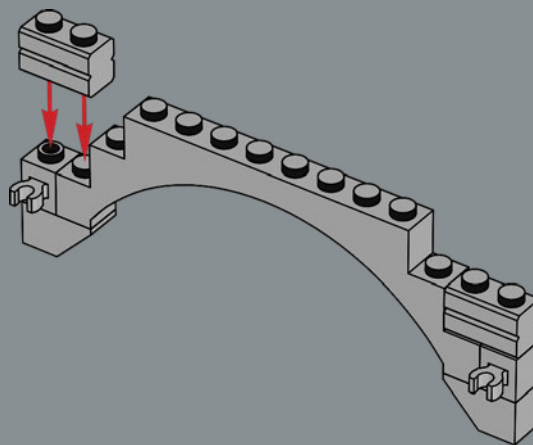

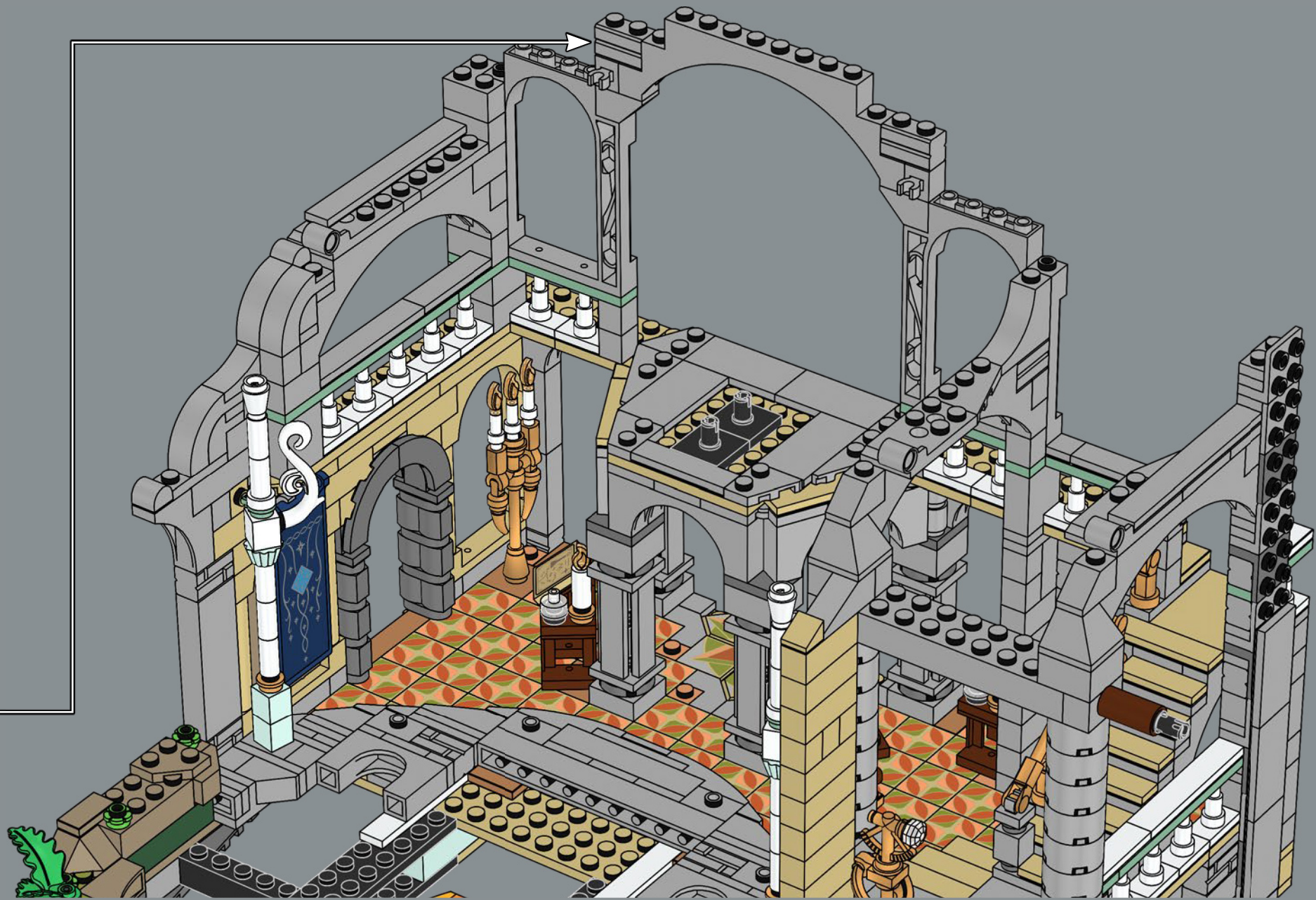

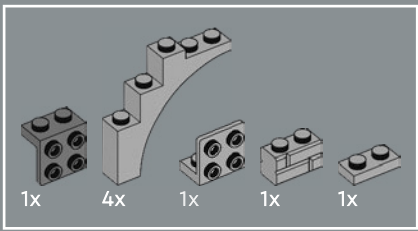

167

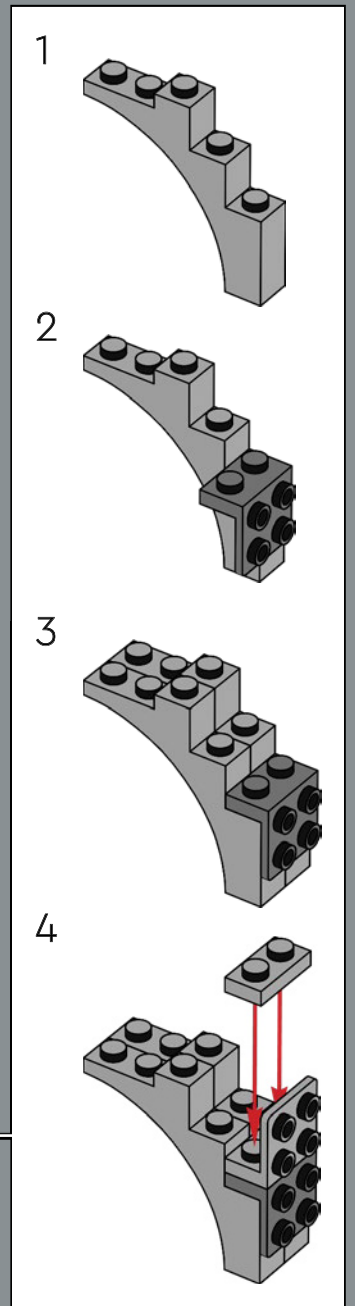
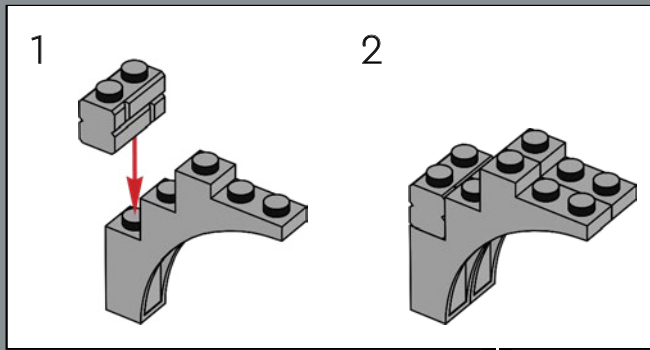

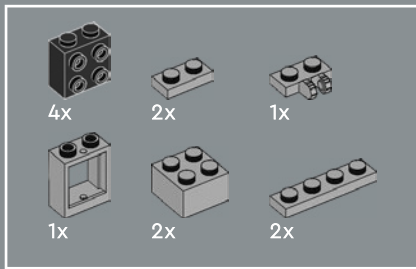

168

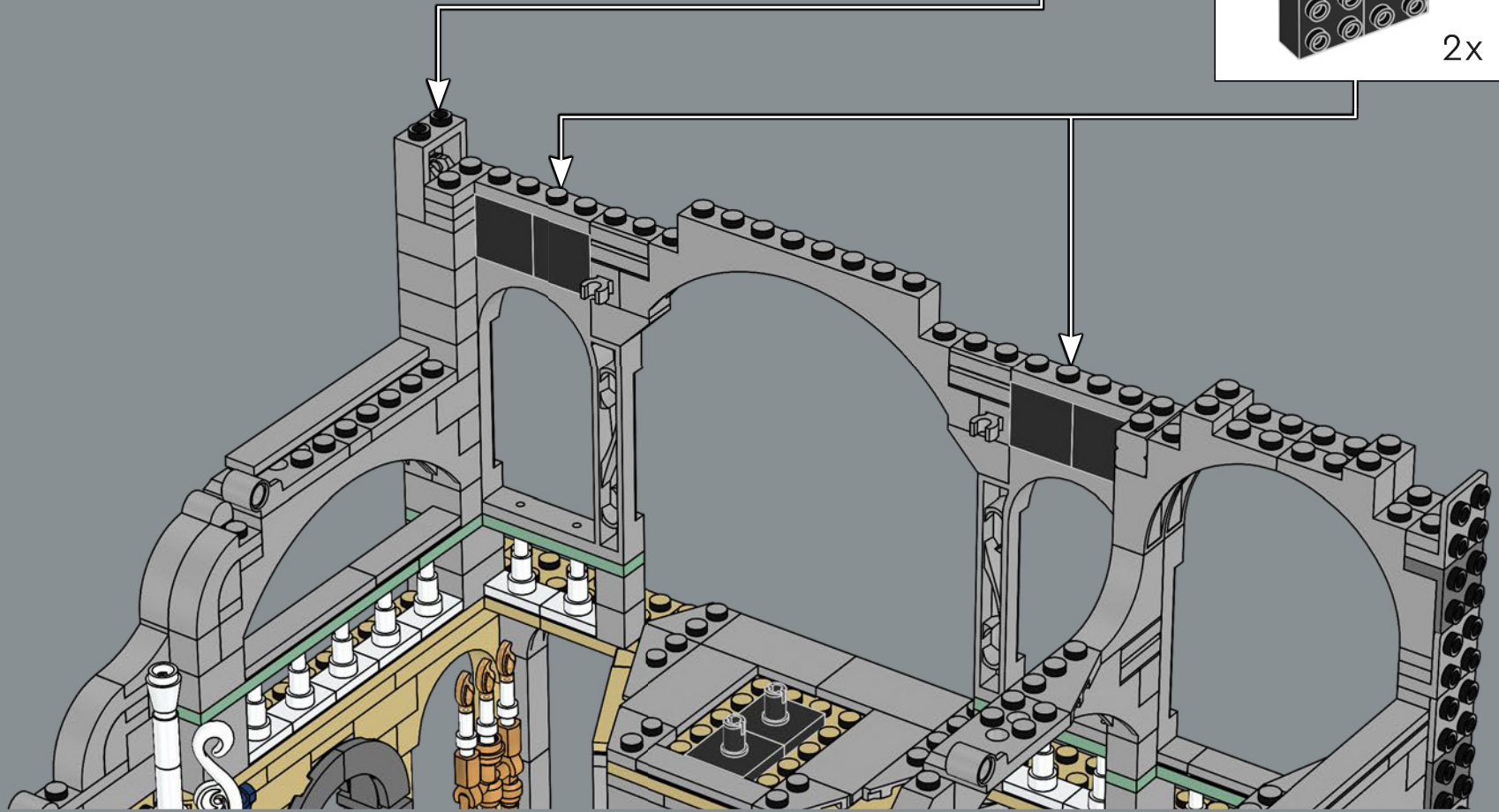
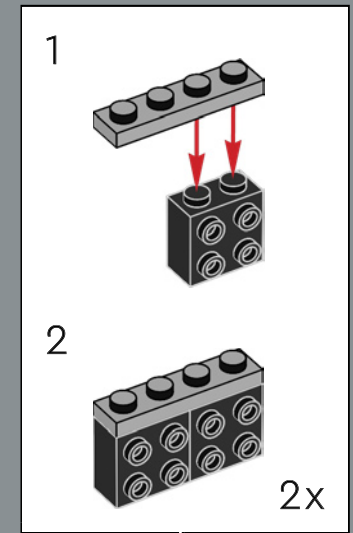
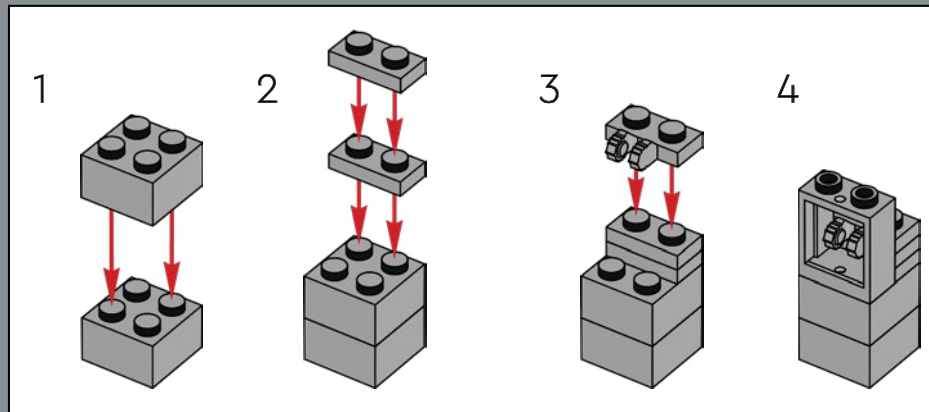

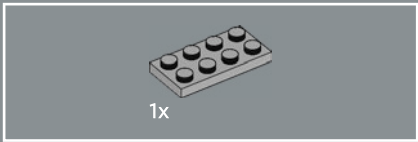

169

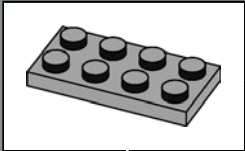

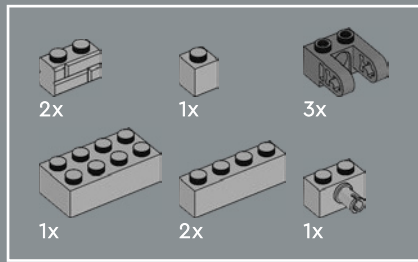

170

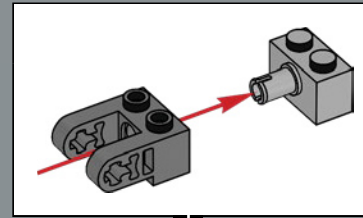

The snap connection on the 2×4 hinge bases is positioned so that it is exactly 10 modules away from the upper cross-axle holes.

La connexion par encliquetage sur les bases de charnière 2×4 est positionnée de manière à être exactement à 10 modules des trous de l'axe transversal supérieur.

La distancia que hay entre la conexión a presión de las bases 2×4 articuladas y los orificios de los ejes transversales superiores es de, exactamente, 10 módulos.

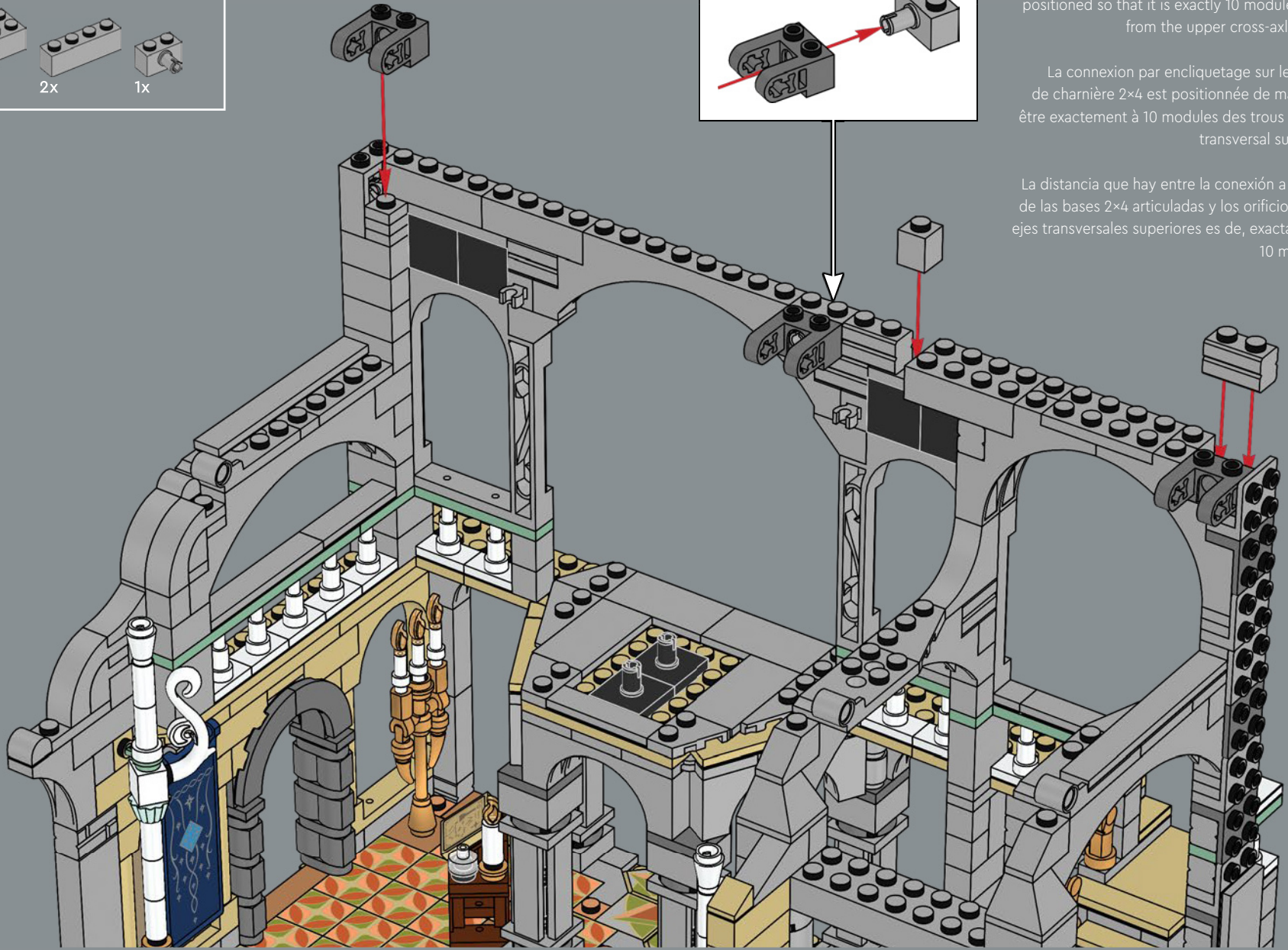

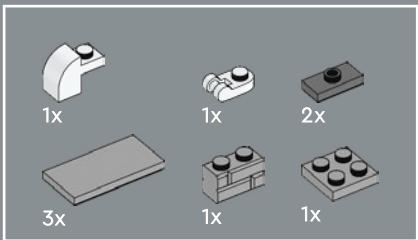

171

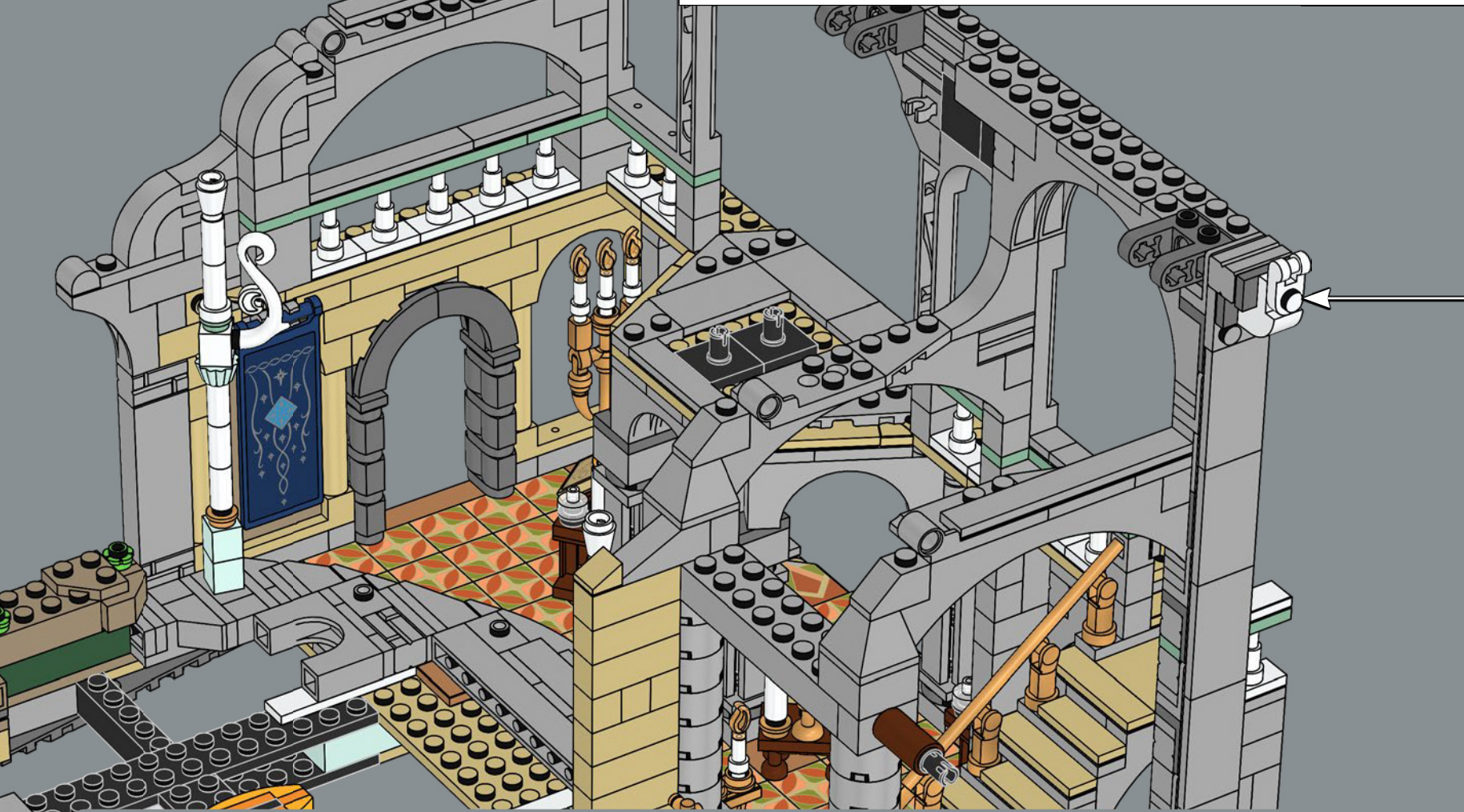
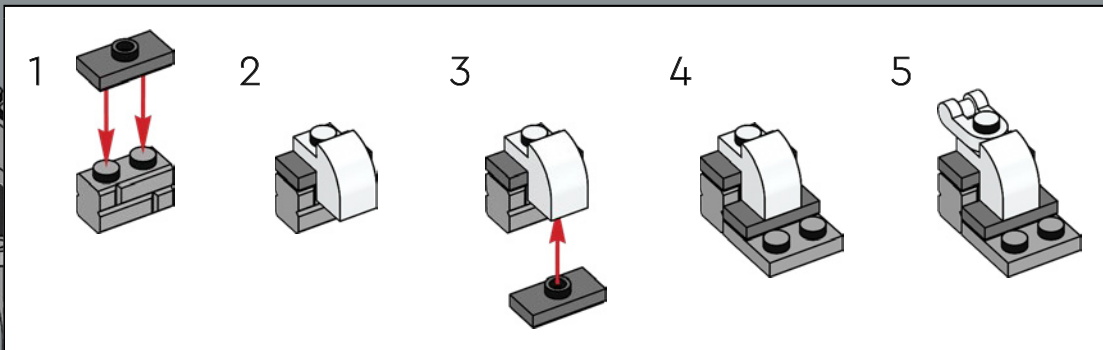

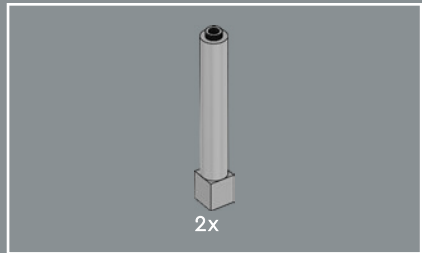

172

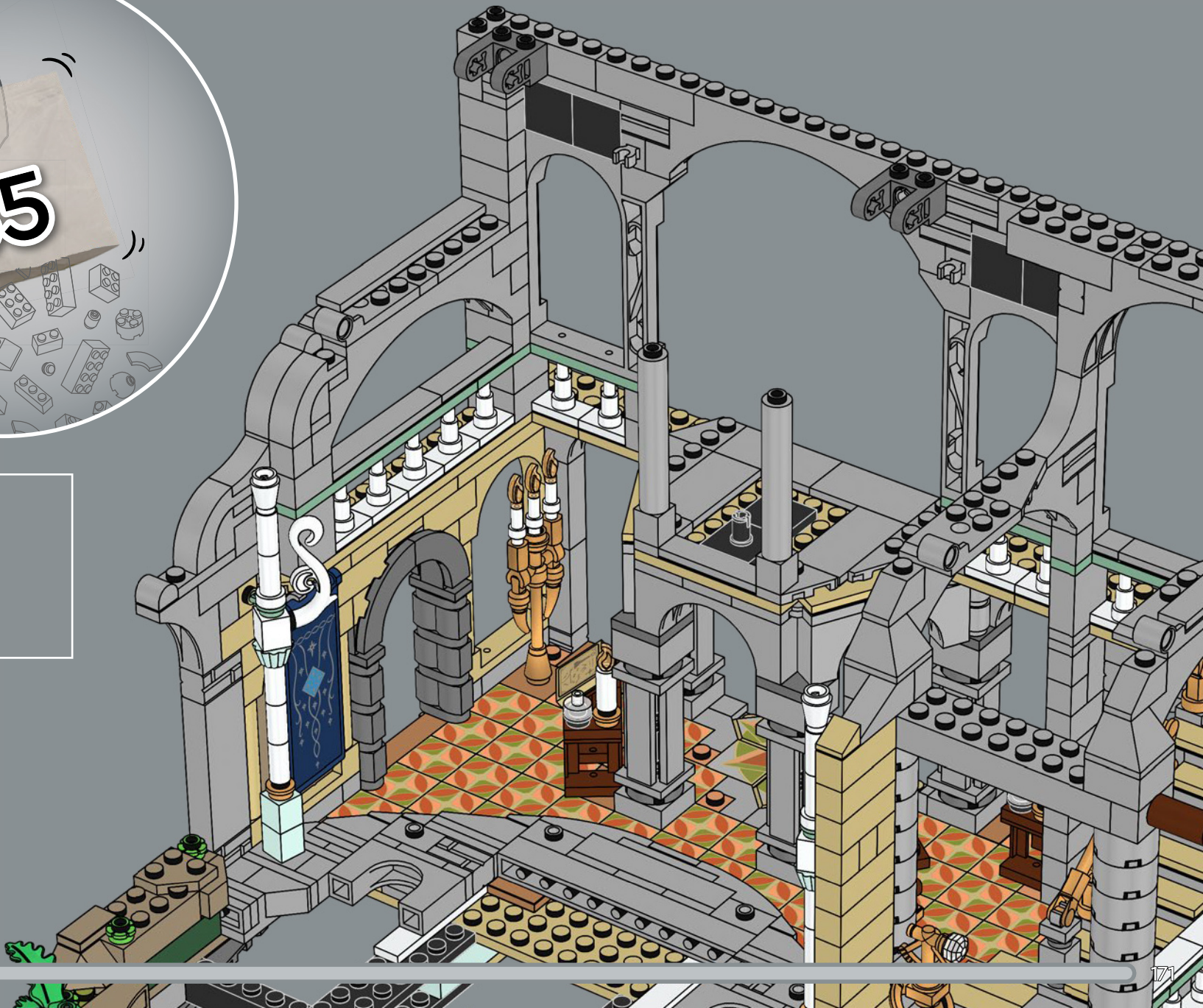

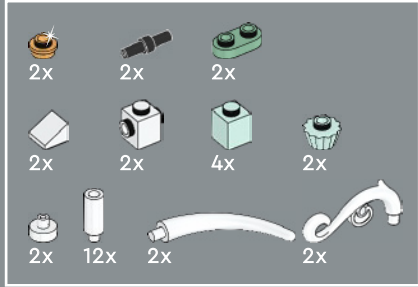
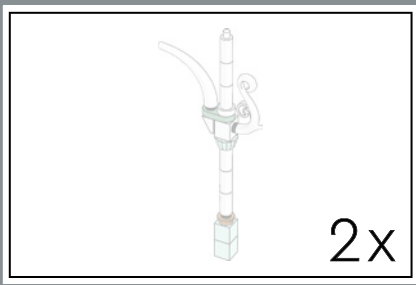

173

1



2



3



4





The detail element used here was originally developed as a magic effect for LEGO® Elves characters in 2017.

L'élément de détail utilisé ici a été initialement développé comme un effet magique pour les Elfes LEGO® en 2017.

El elemento utilizado aquí como decoración se desarrolló originalmente en 2017 como un artefacto mágico para un personaje LEGO® Elves.

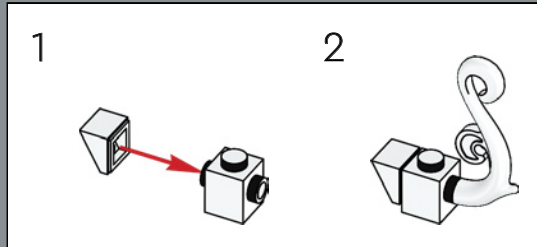

5

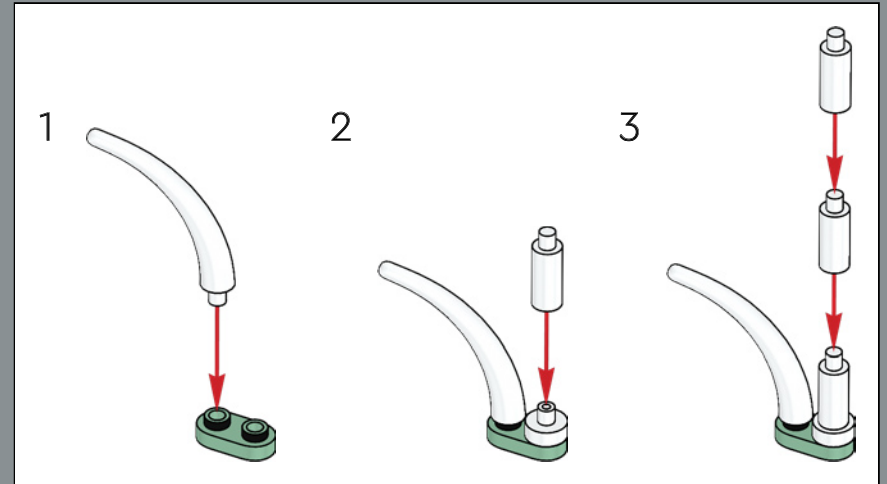
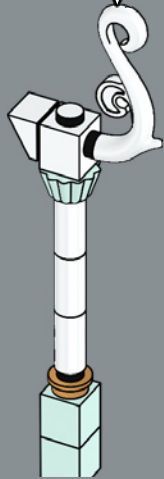

6

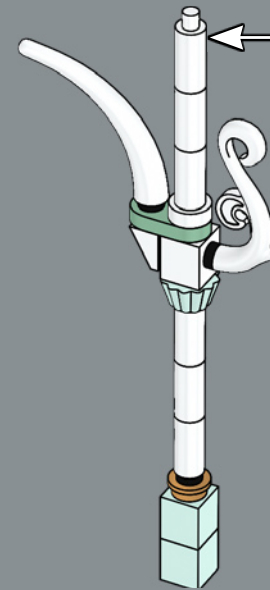

2x



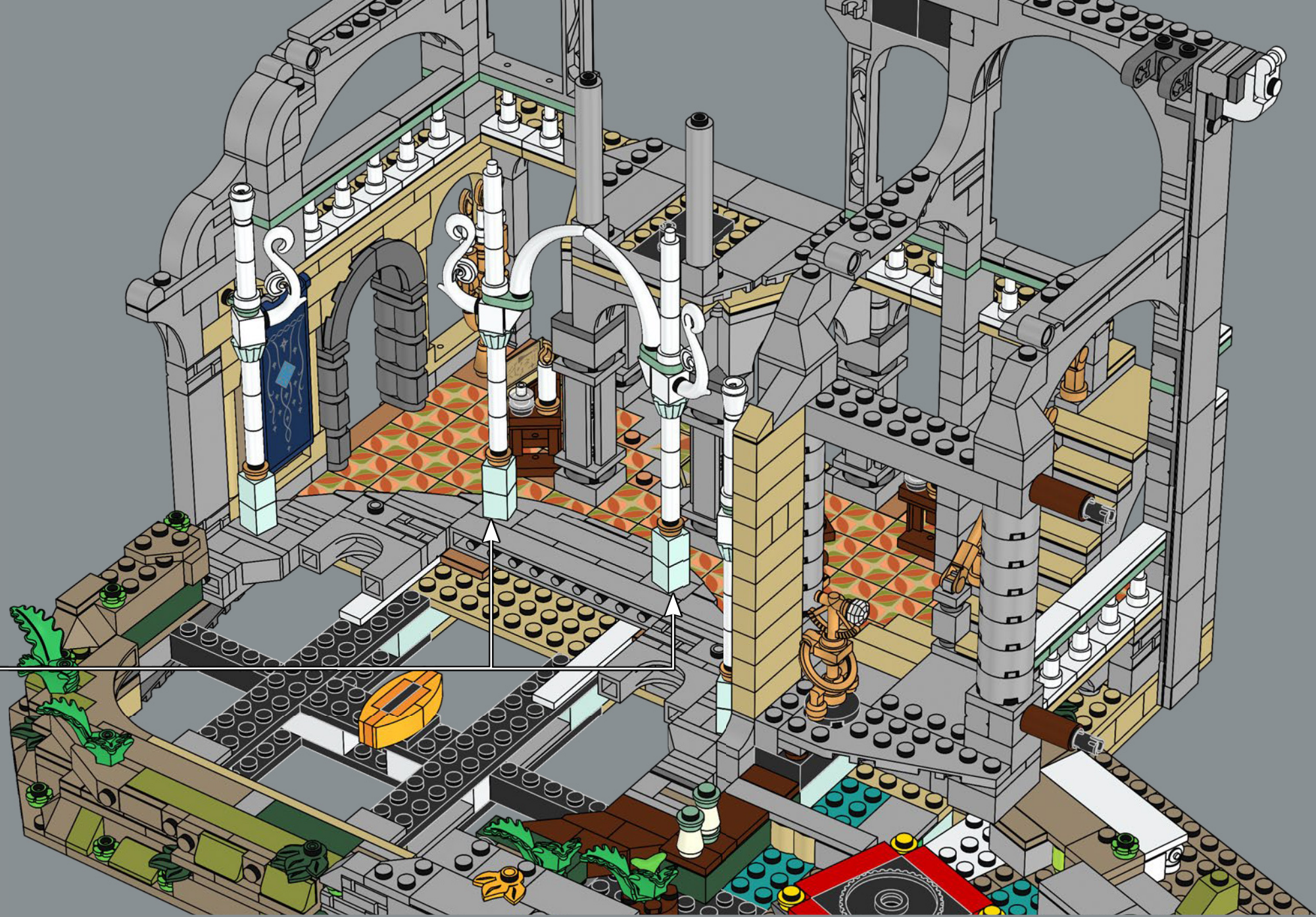

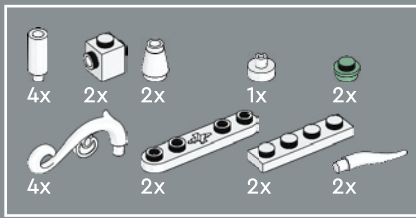

174

1

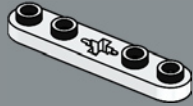

2

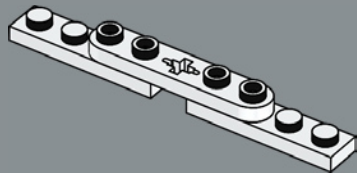

3

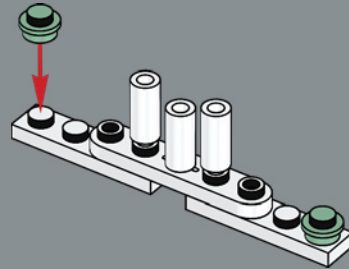

4

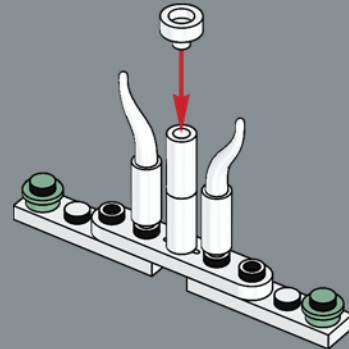

5

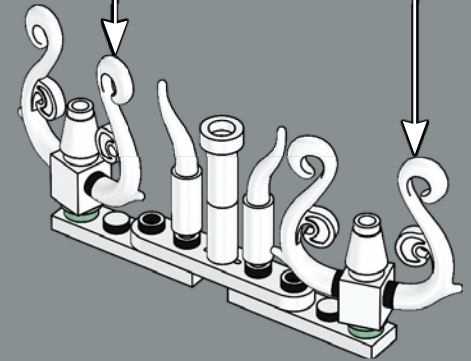

6

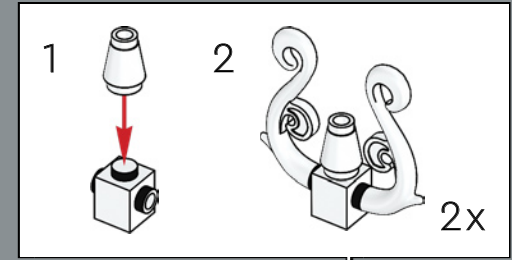
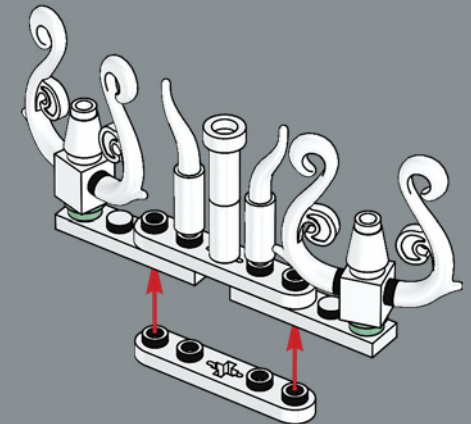

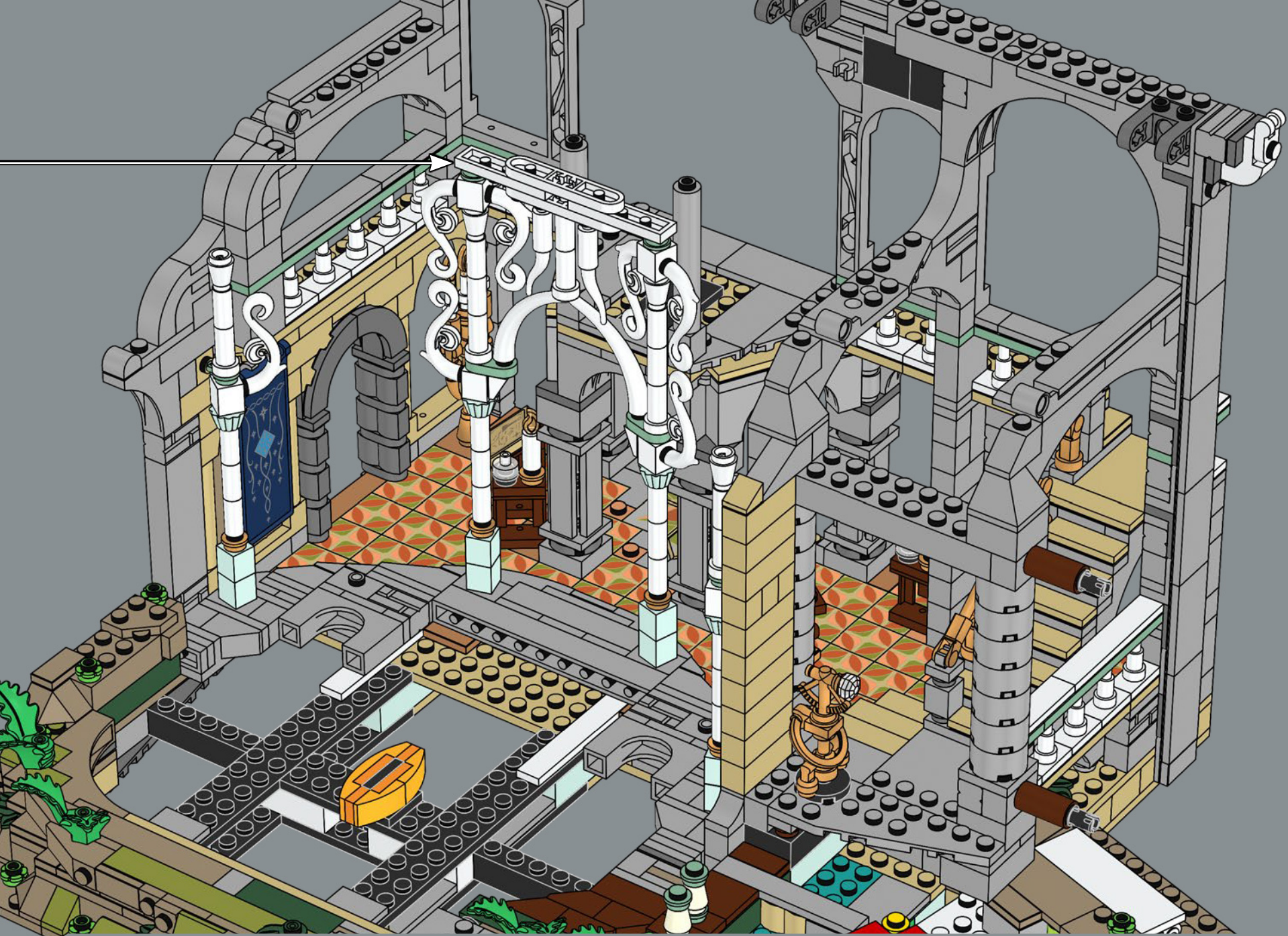

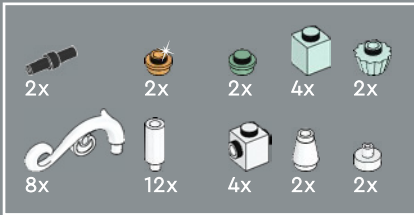
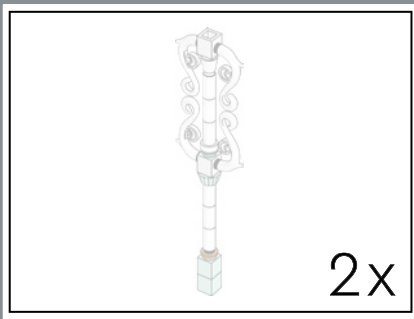

175

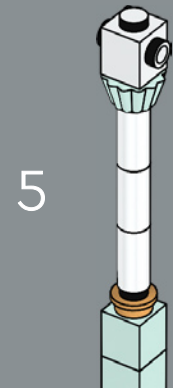
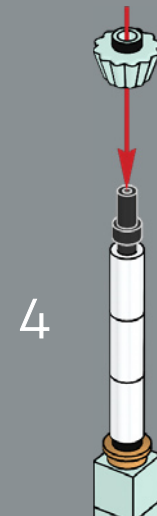
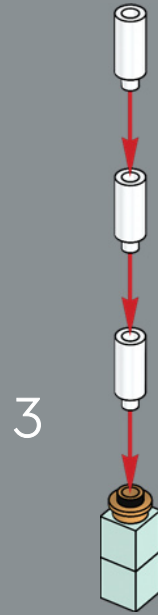
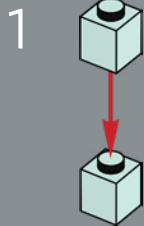

6

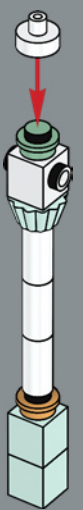

7

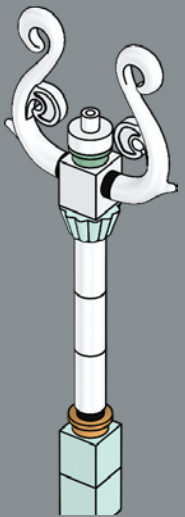

8

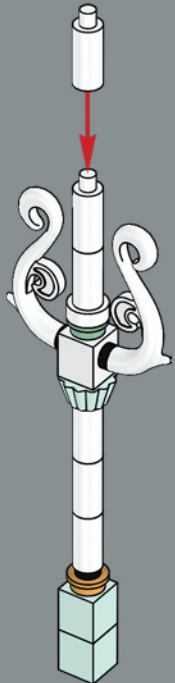

9

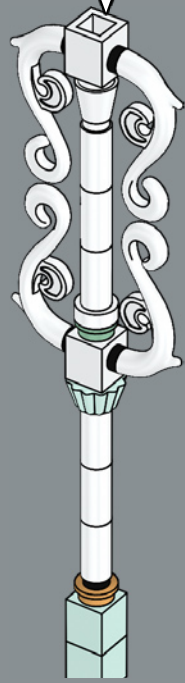

2x

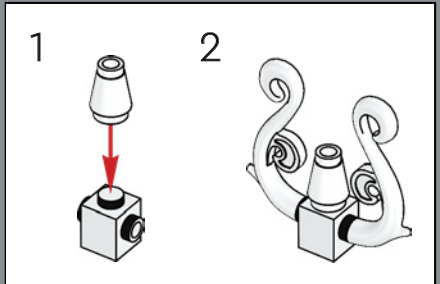



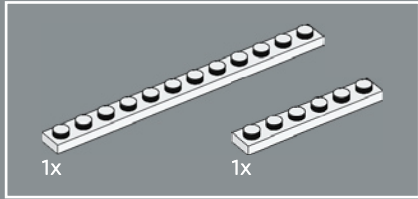
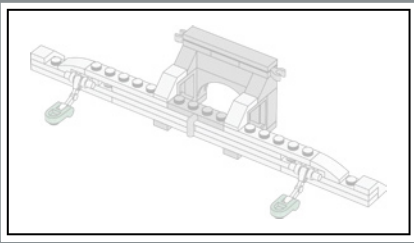

176

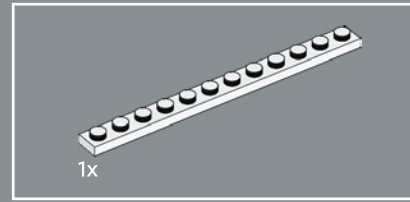
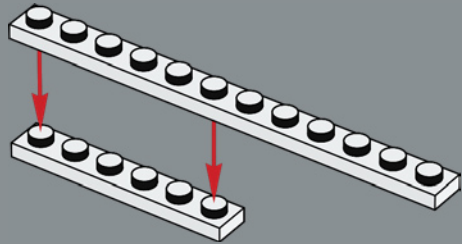

177

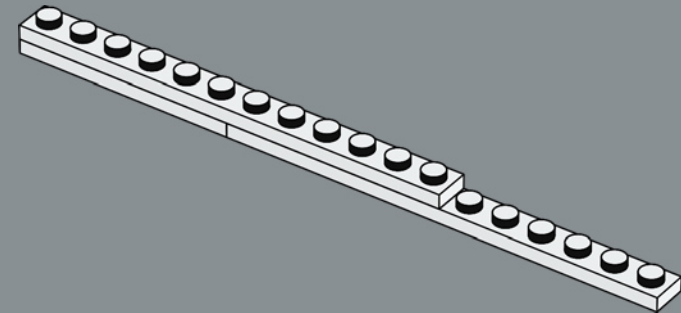

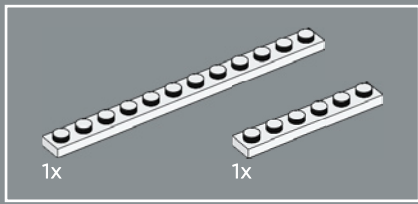

178

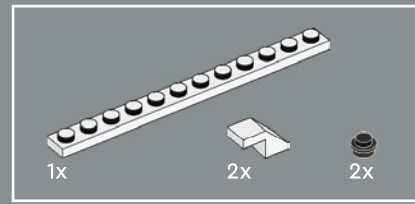
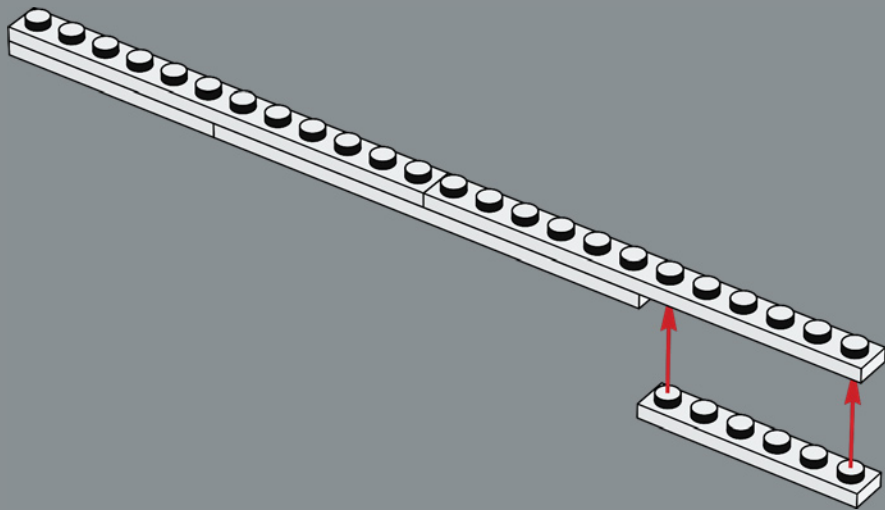

179

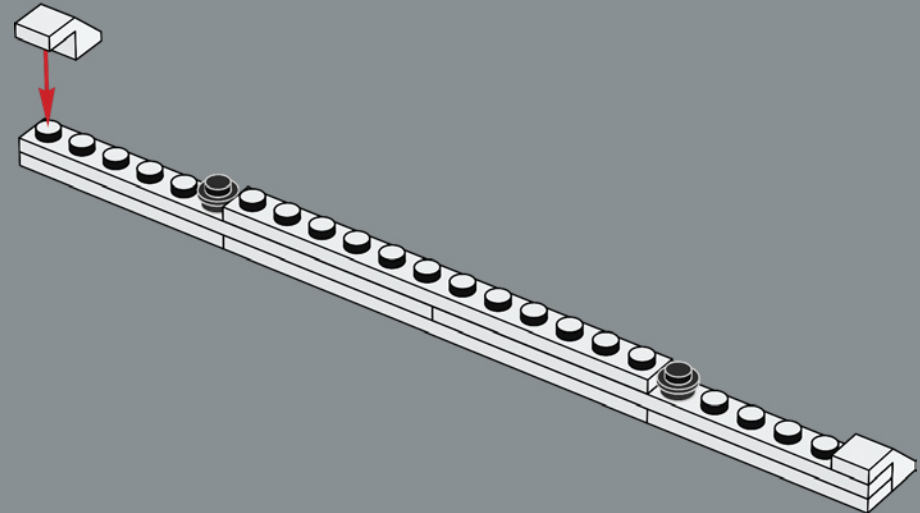



180

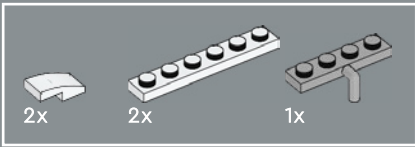
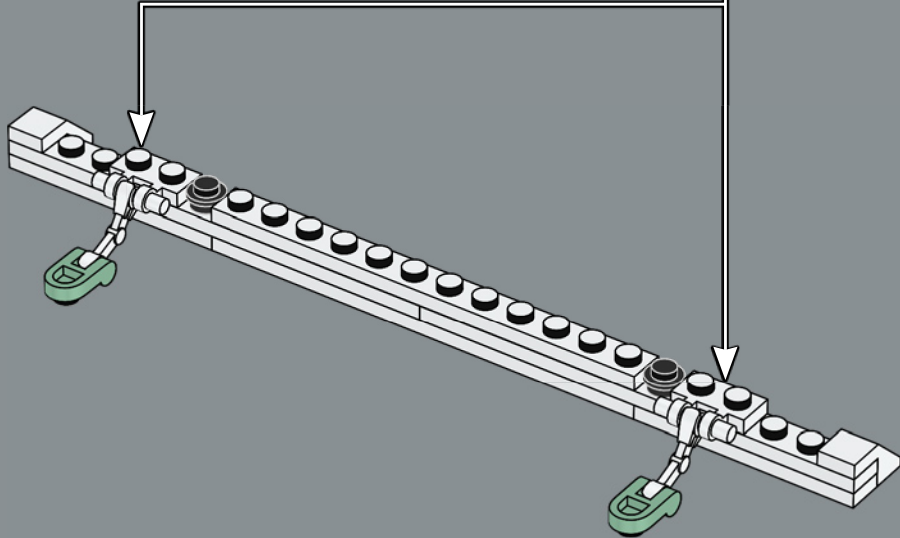
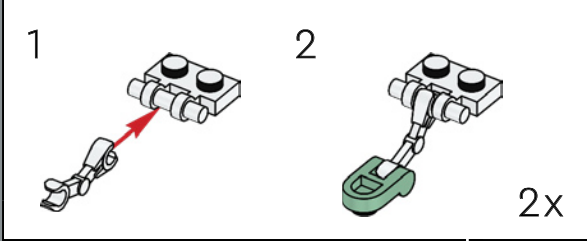

181

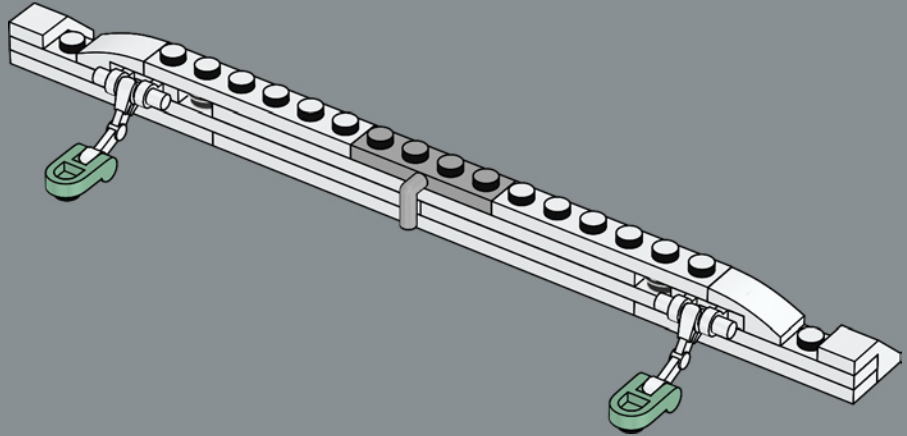

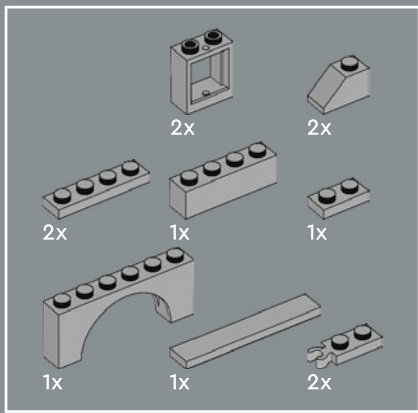

182

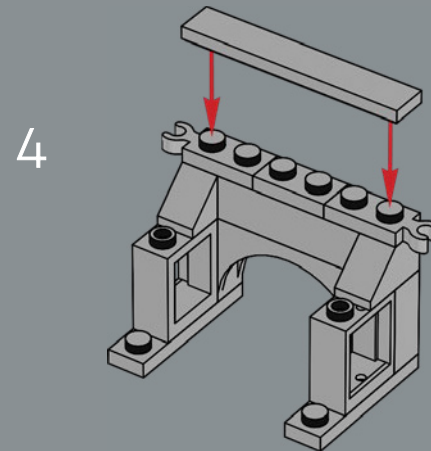
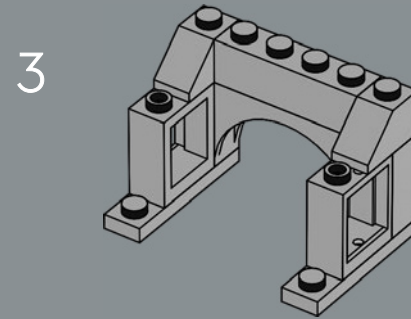
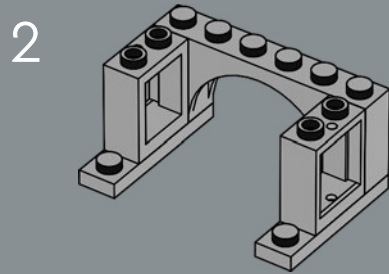
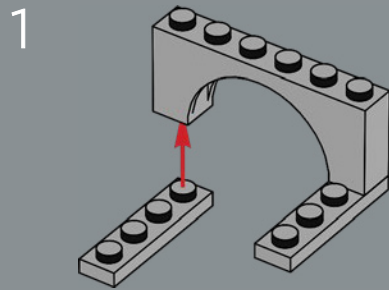

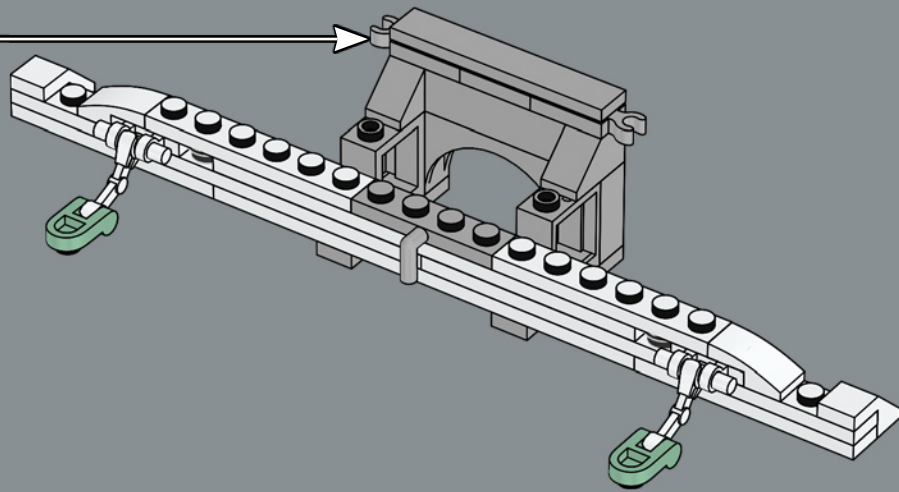

2x

183

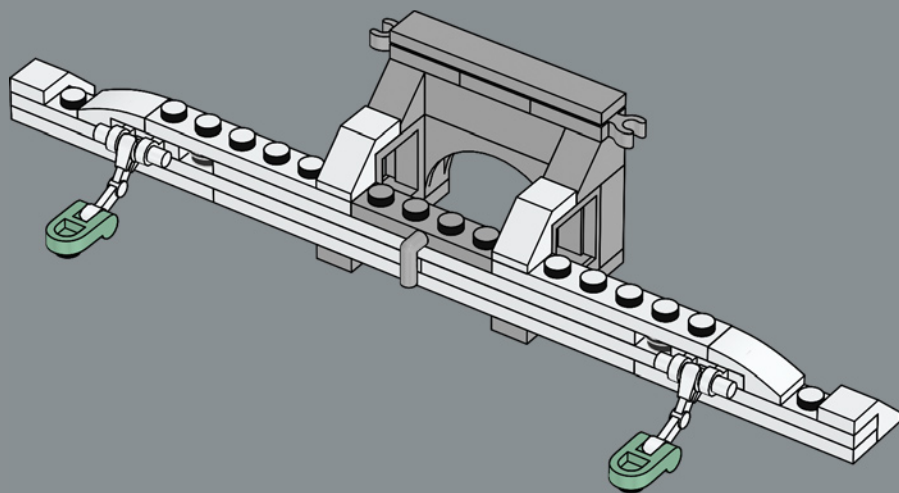

184

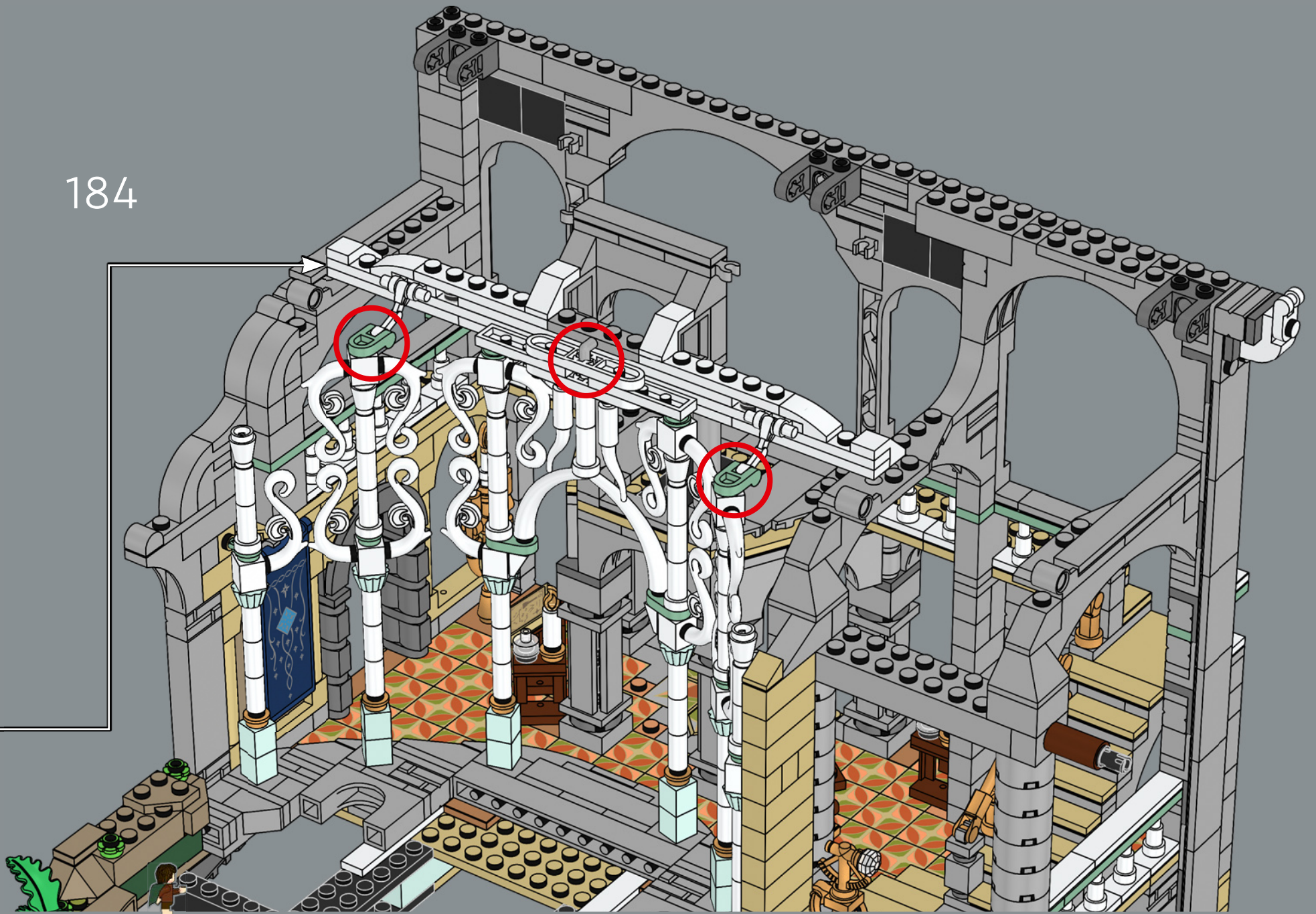

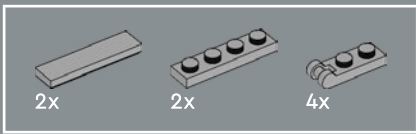

185

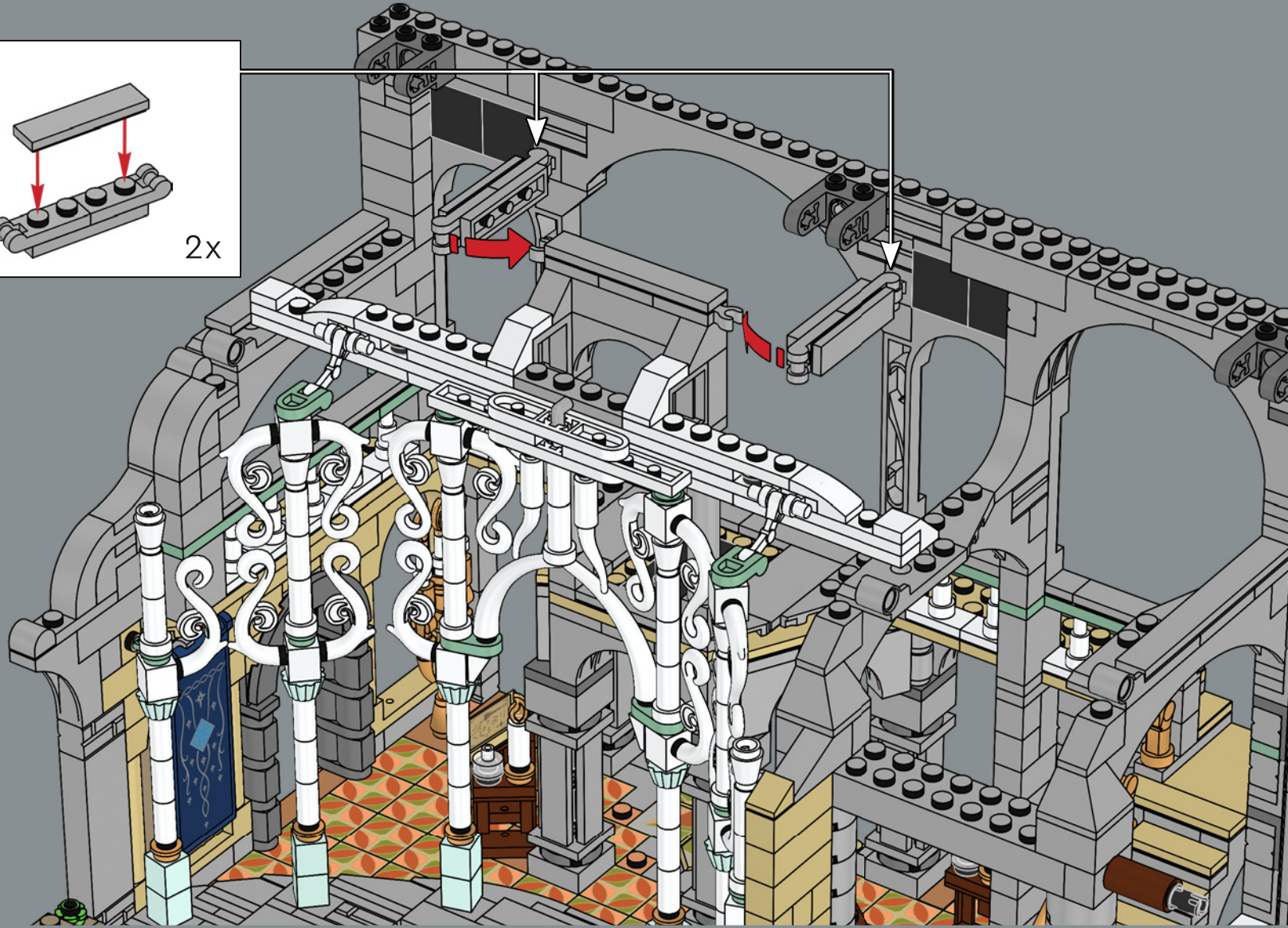
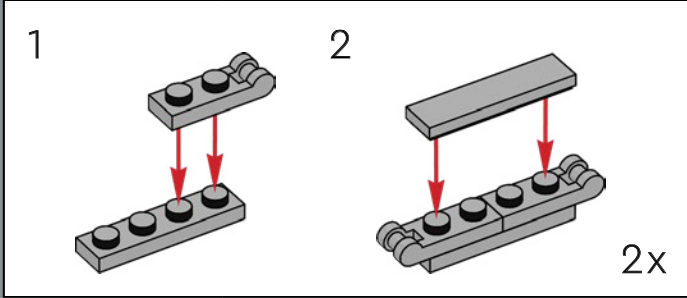

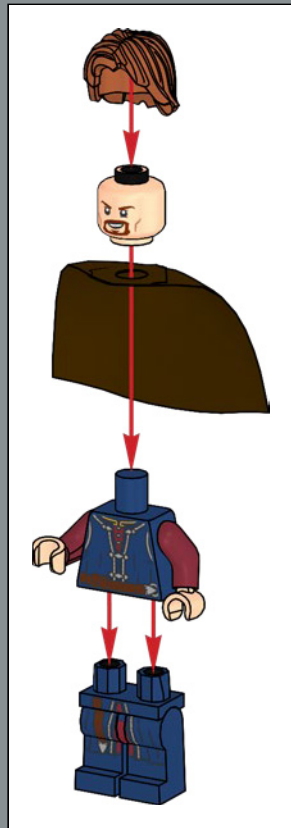
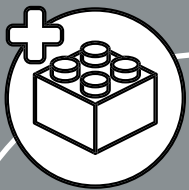

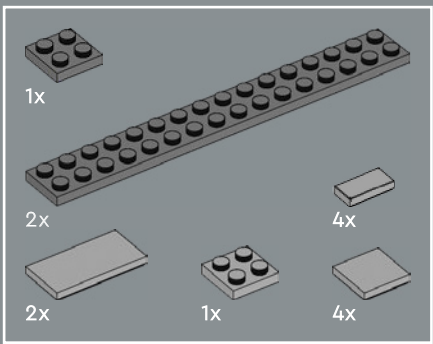

186

1

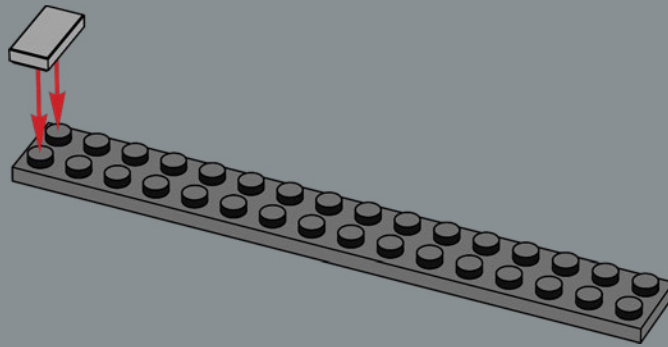

2

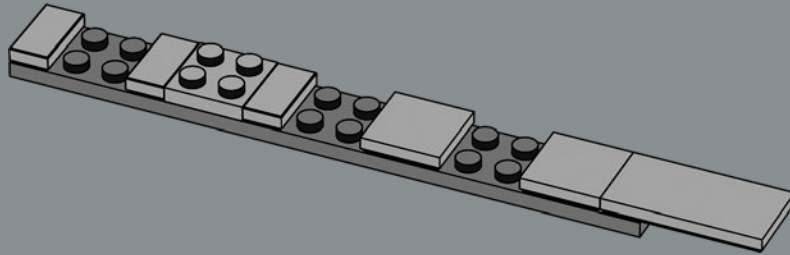

3

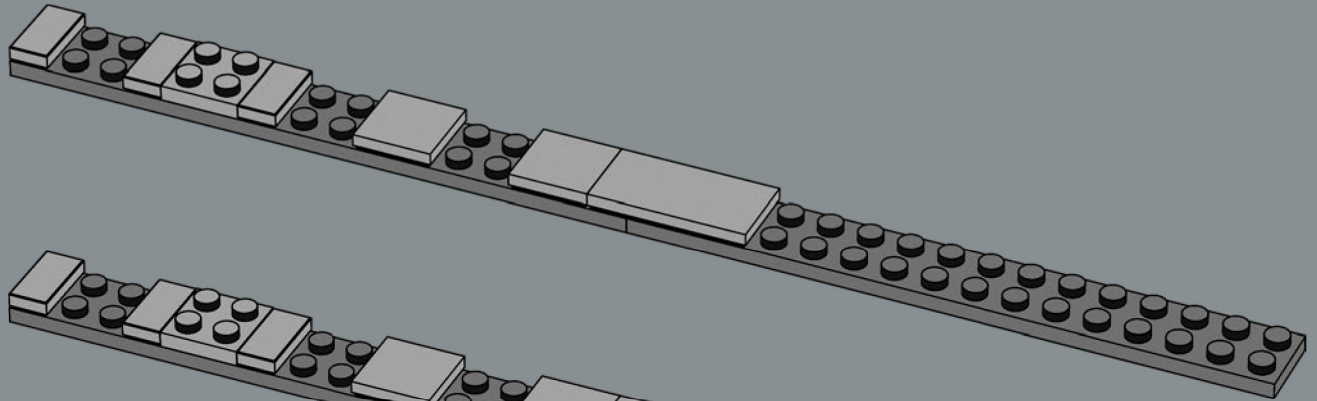

4

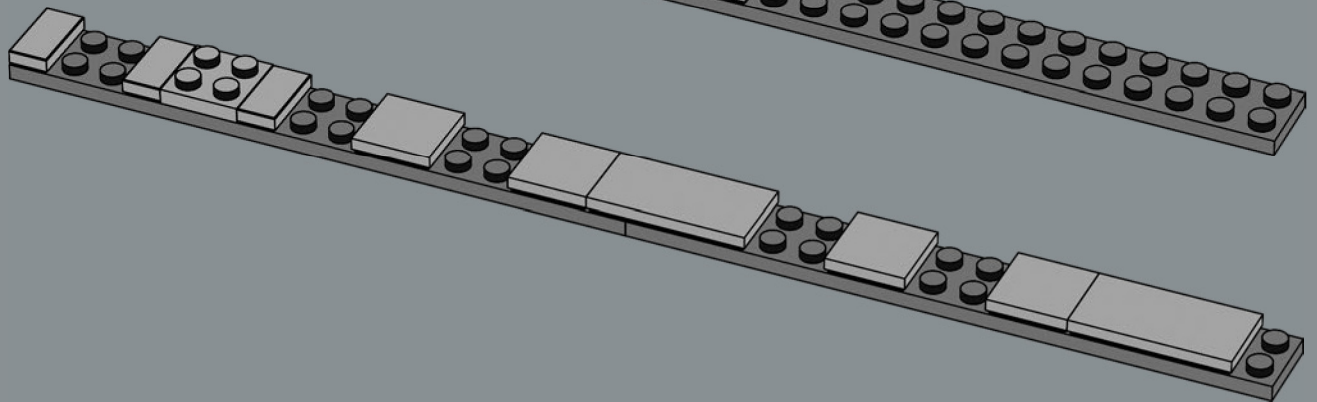

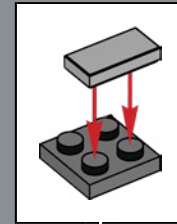

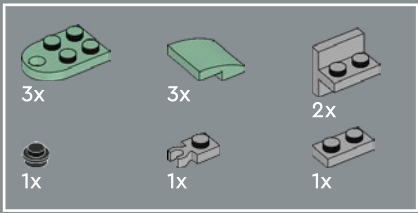

187

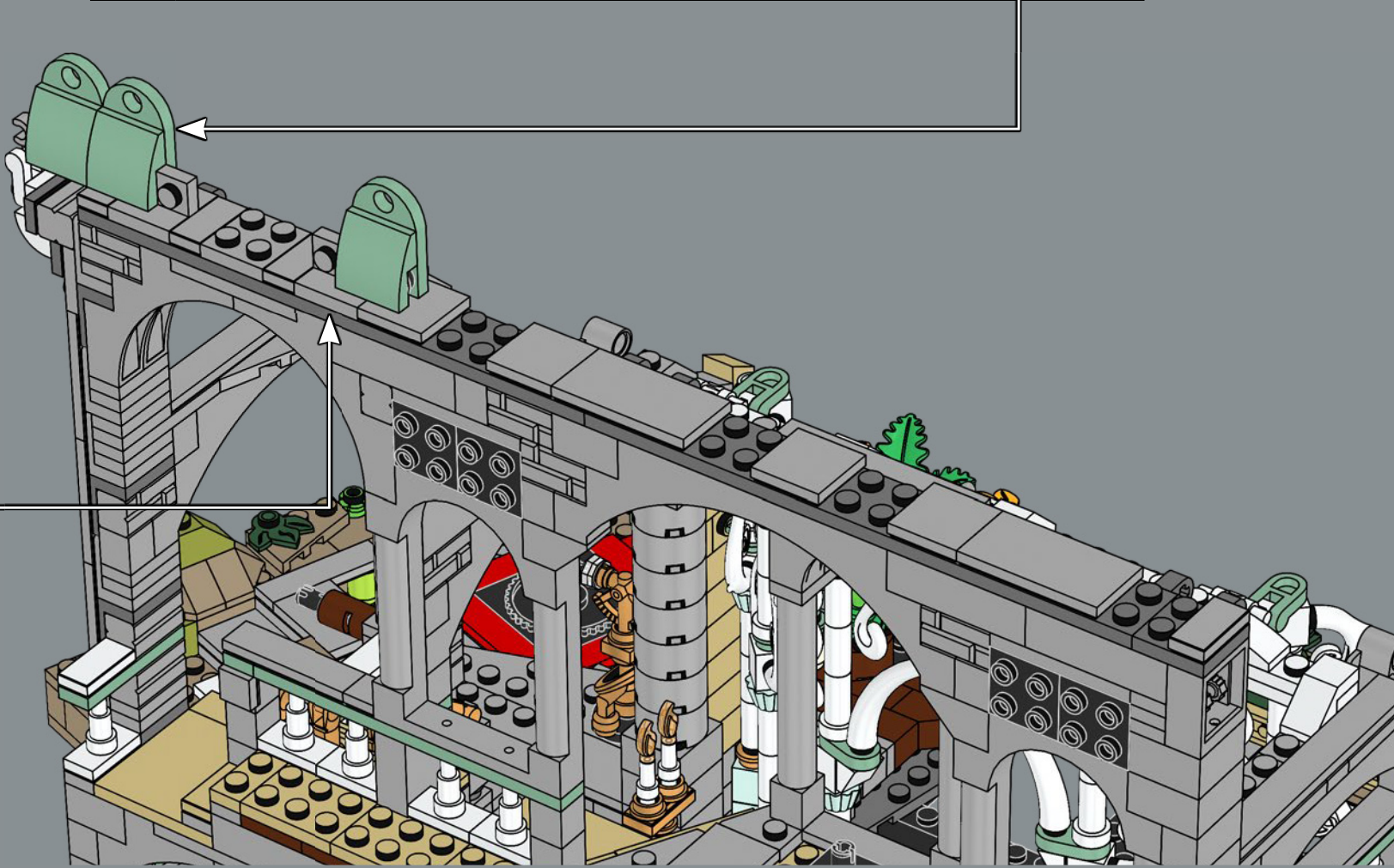
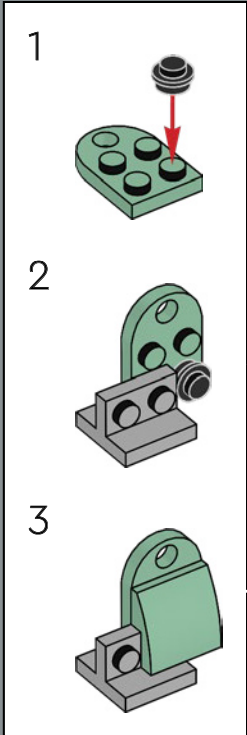
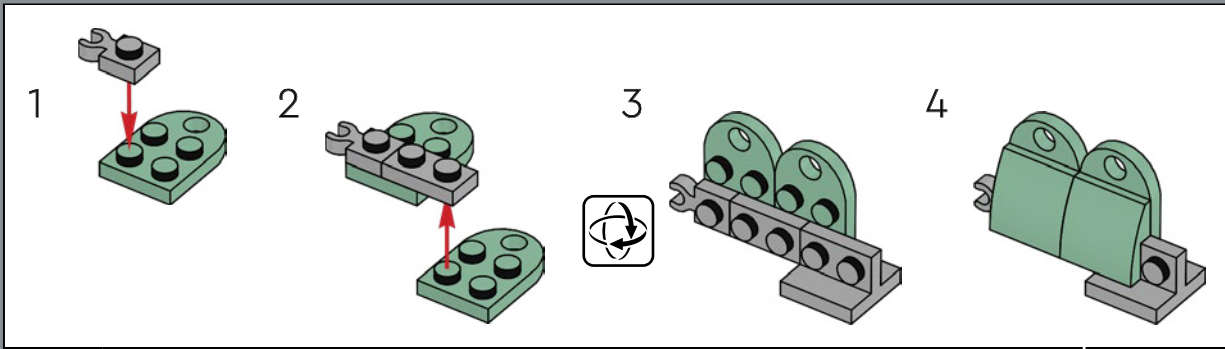

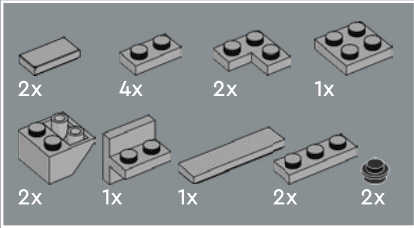
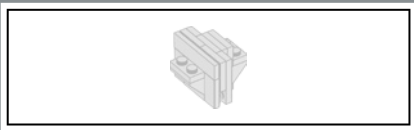

188

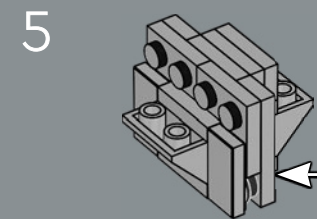
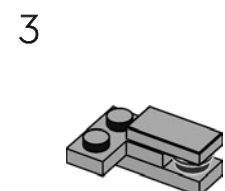
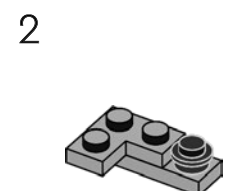
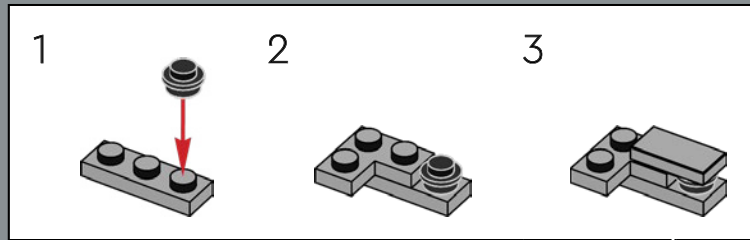
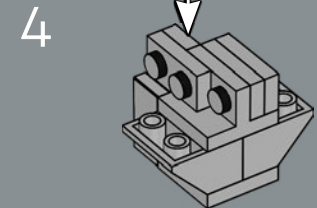
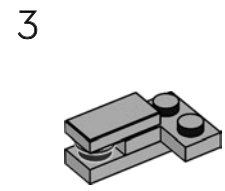
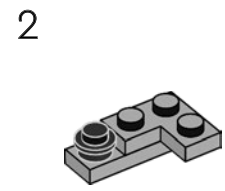
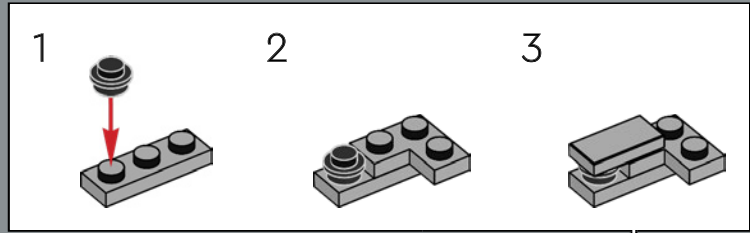
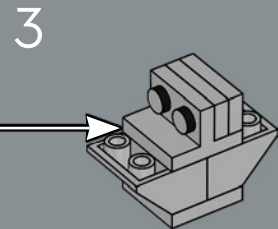
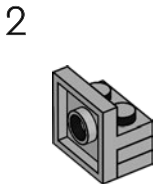
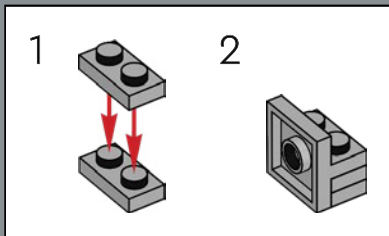
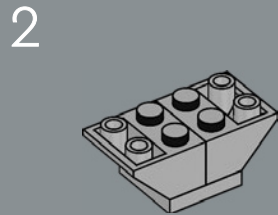
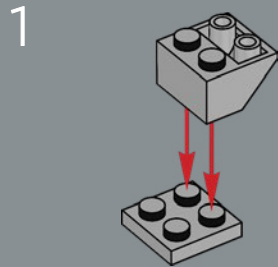

6

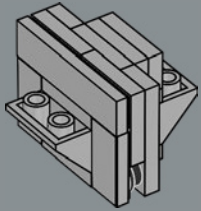

7

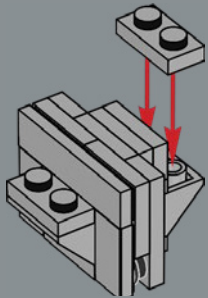

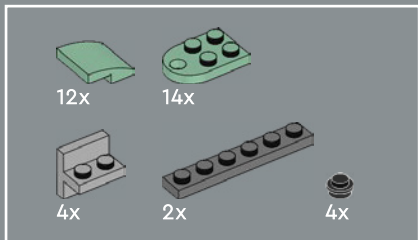

189

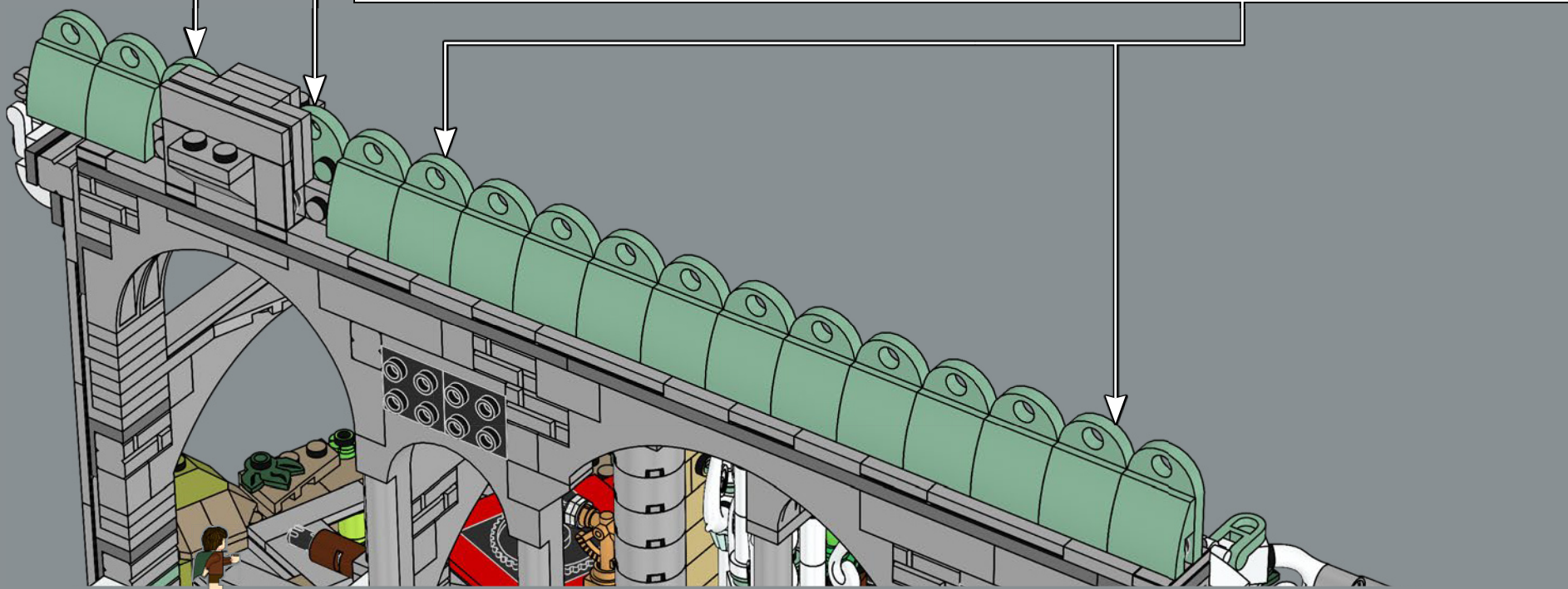
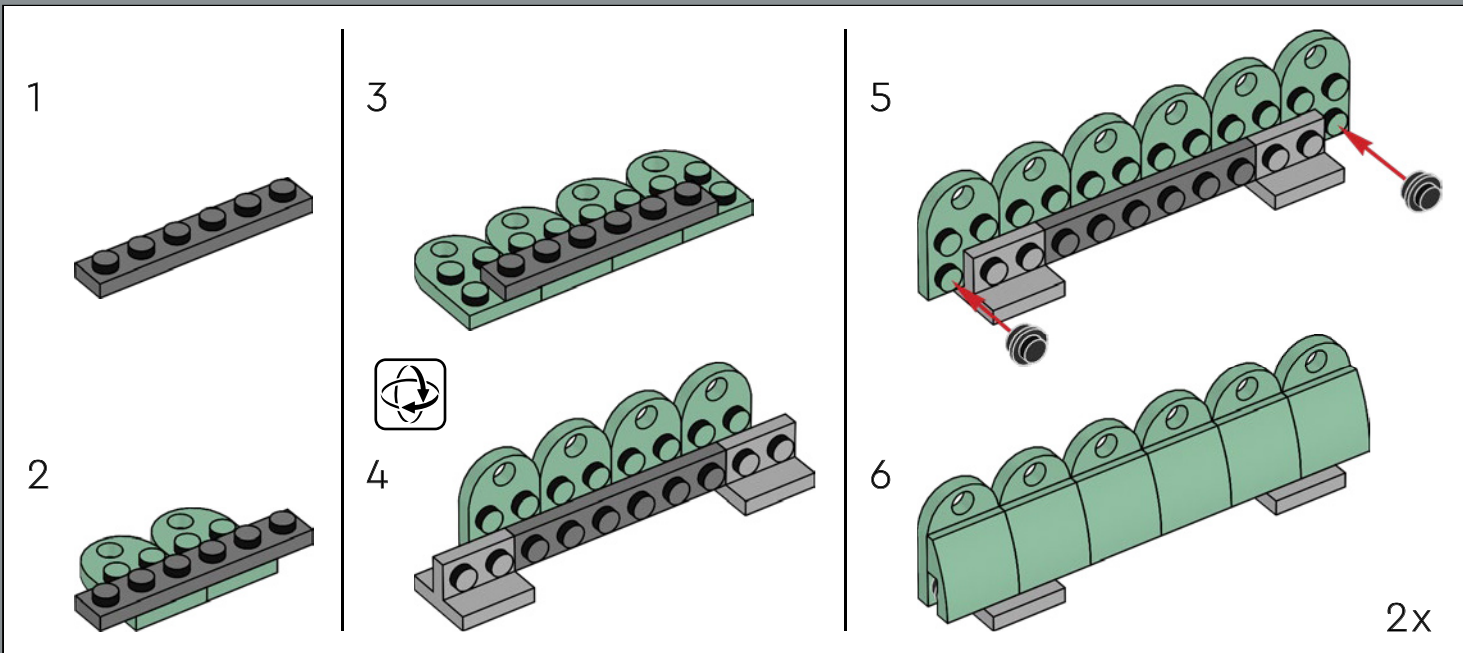
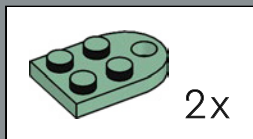



2x

190



2x

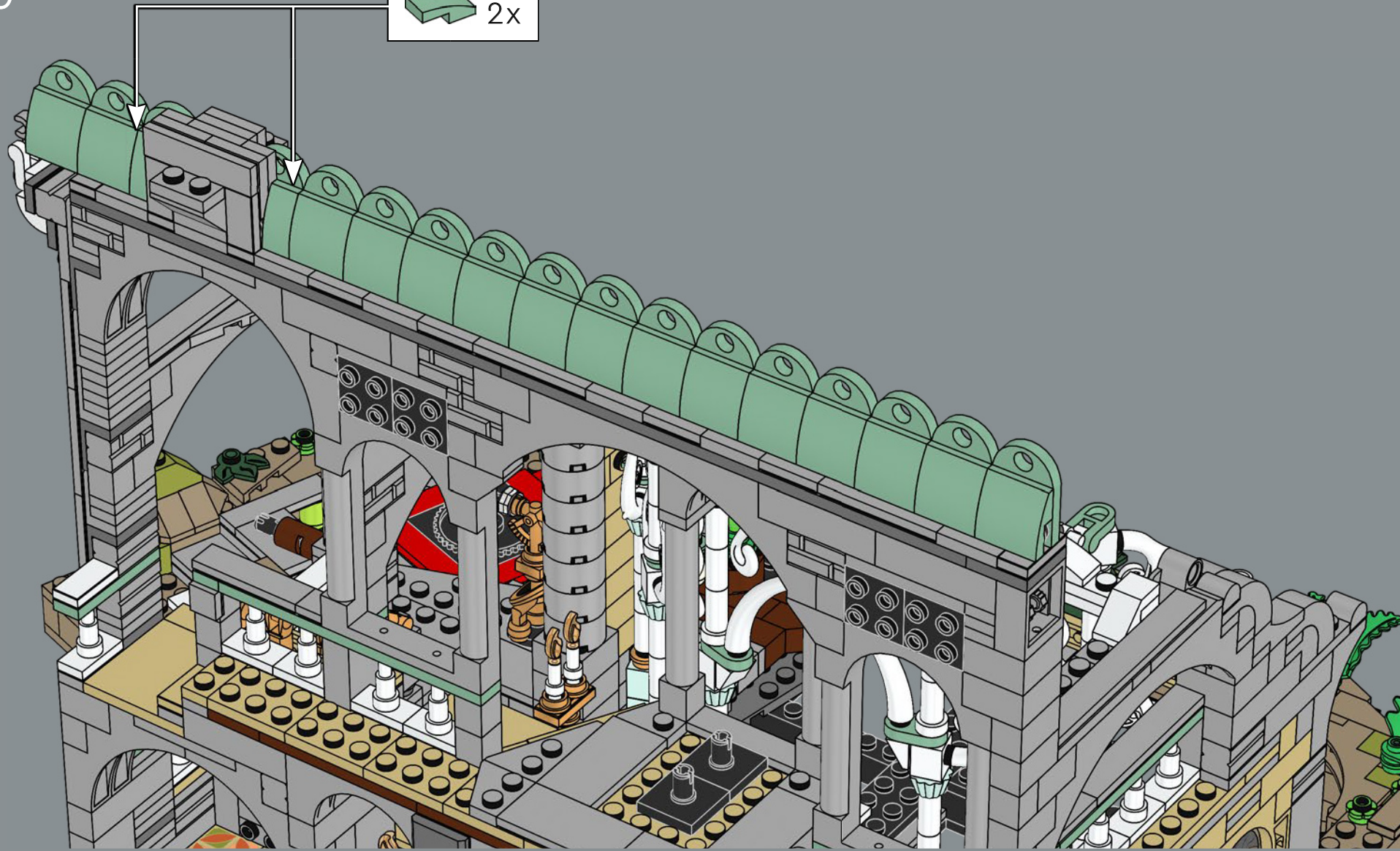

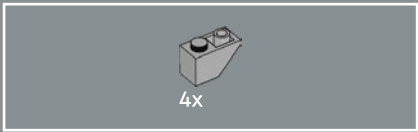

191



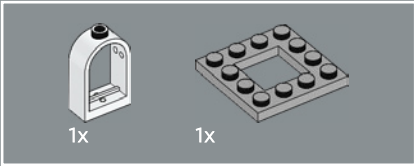
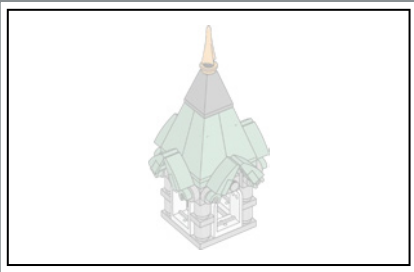

192

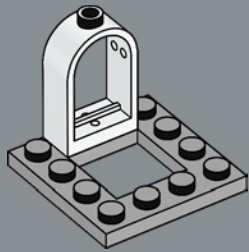

193

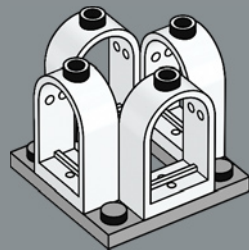

194

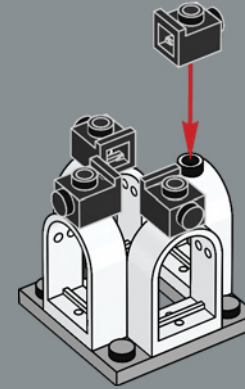

195

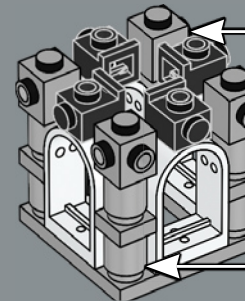
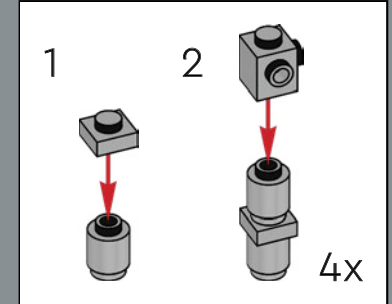

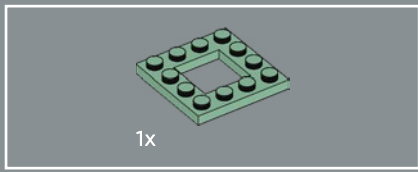

196

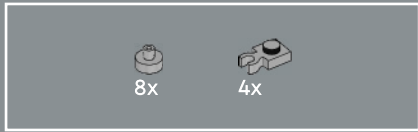
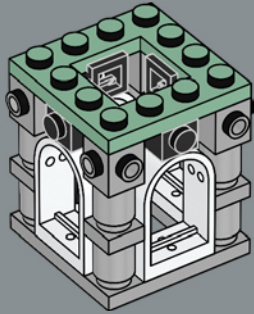

197

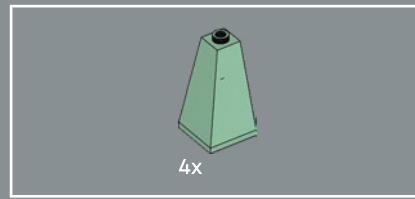
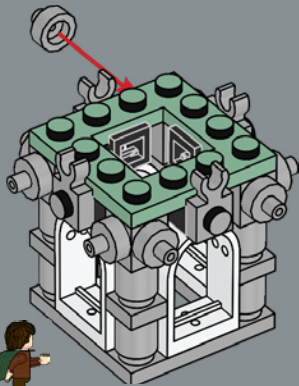

198

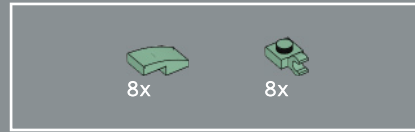
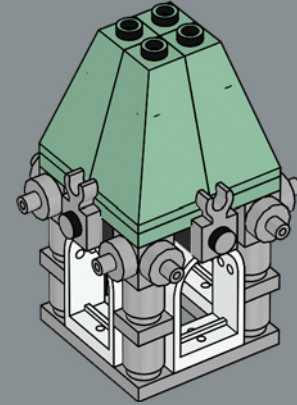

199

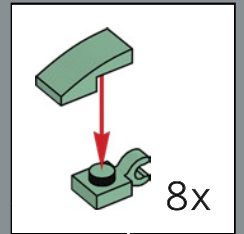
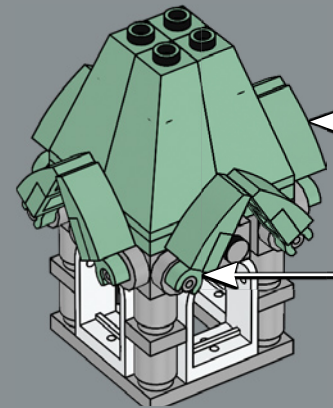



200

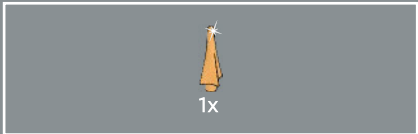
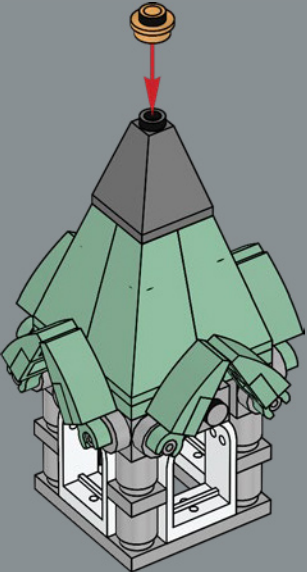

201

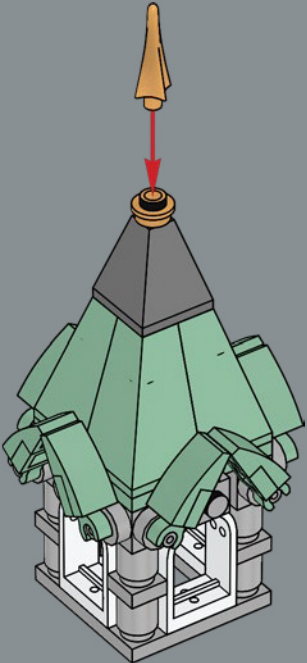

202

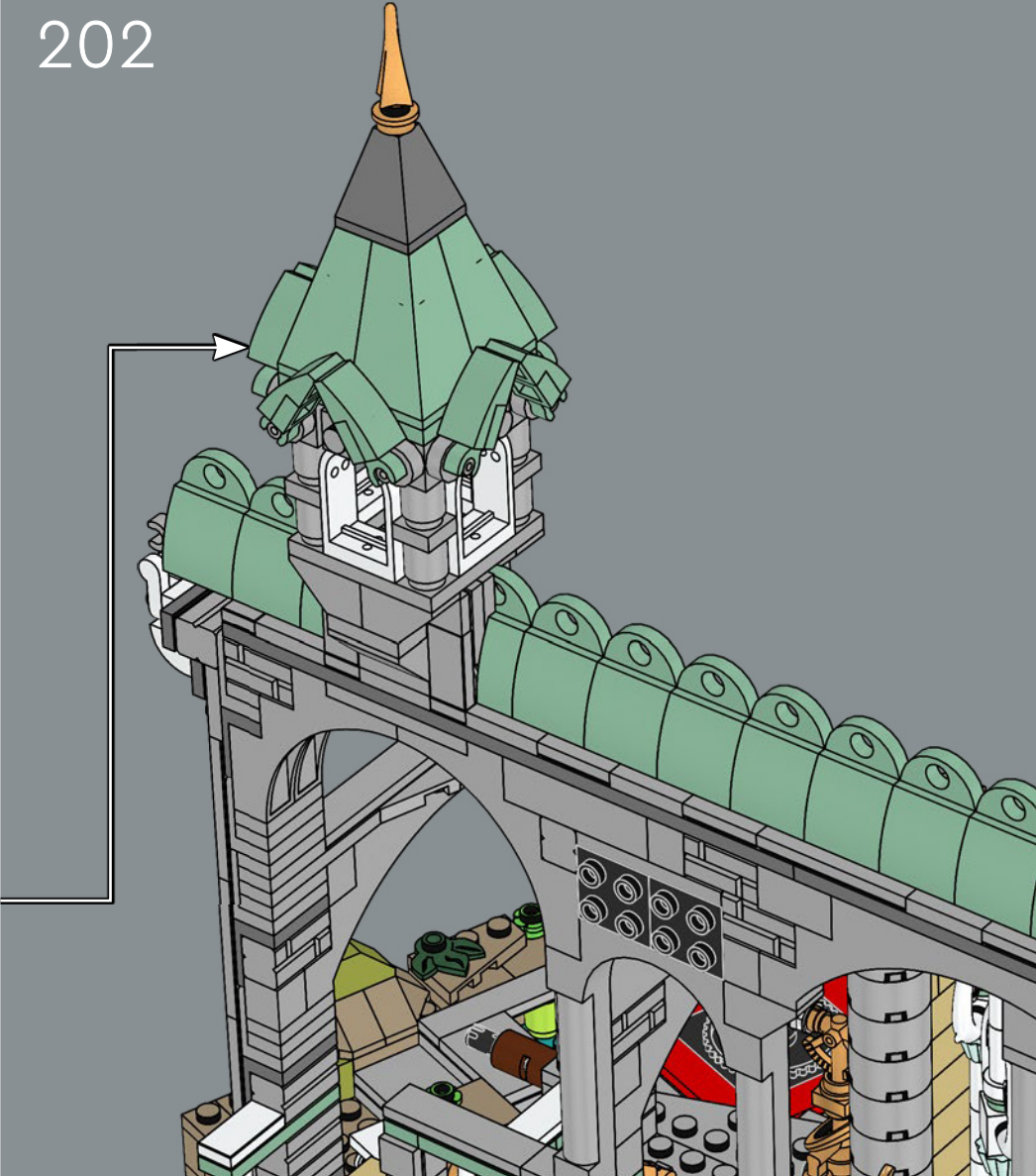

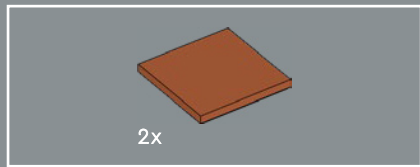

203

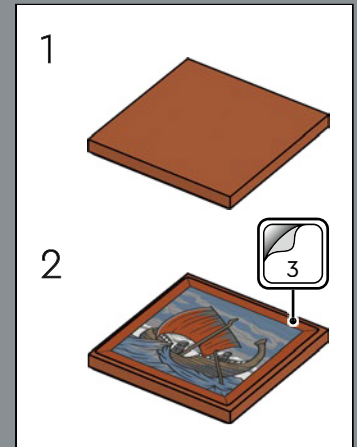
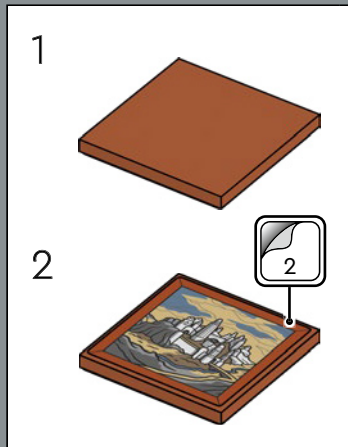

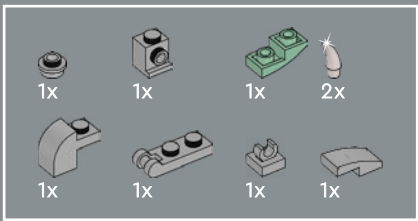

204

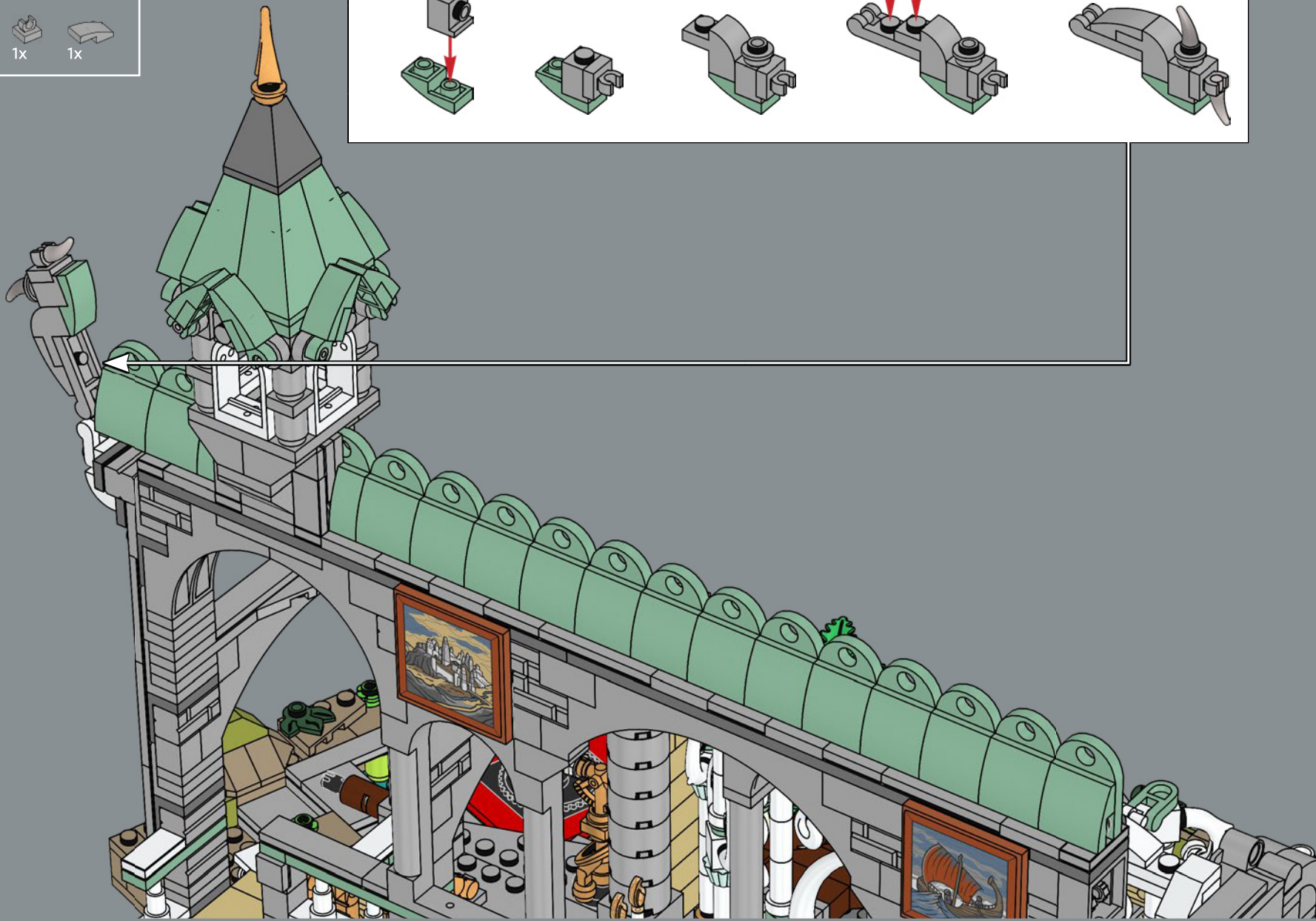
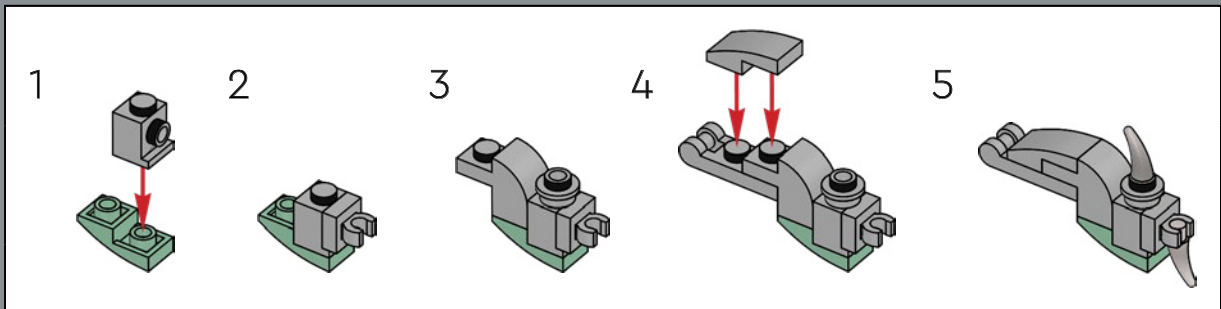

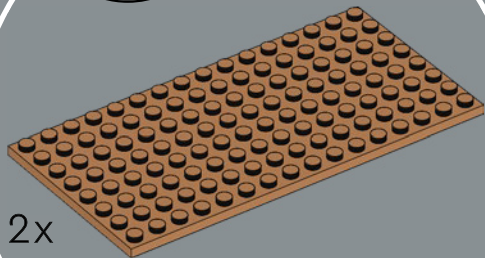
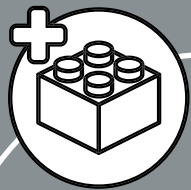

2x

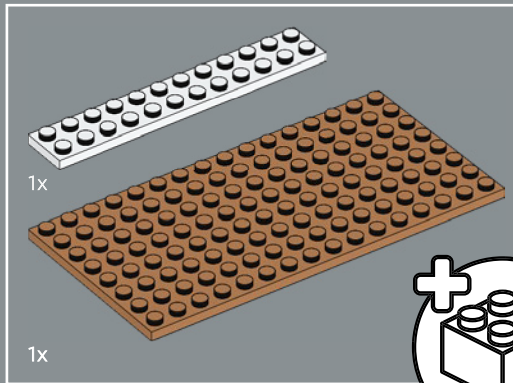
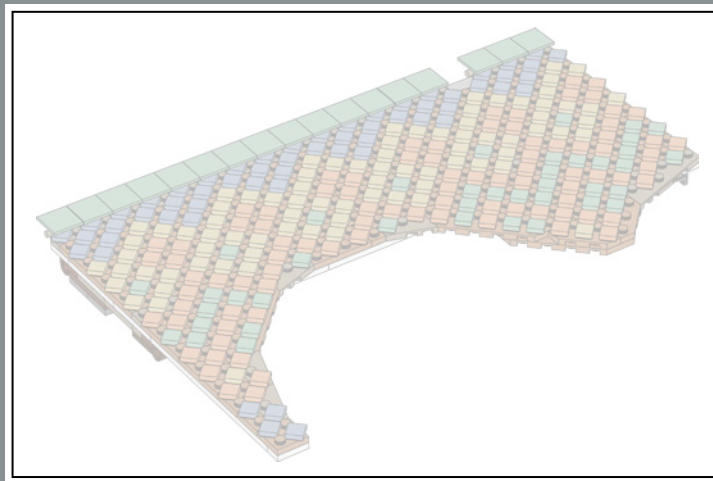

1x

1x

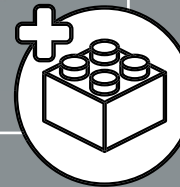

205

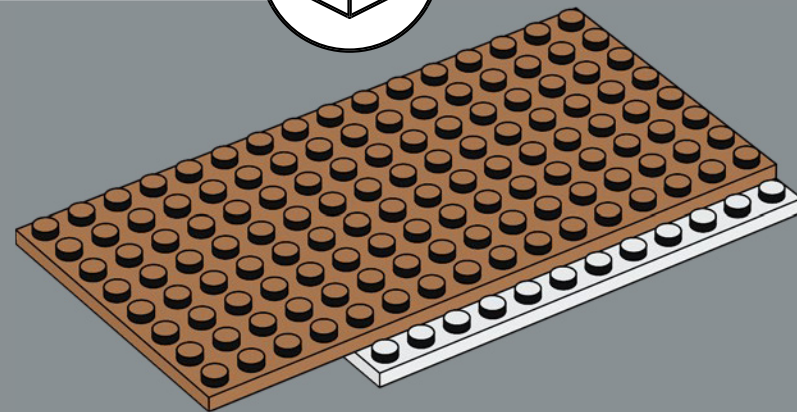

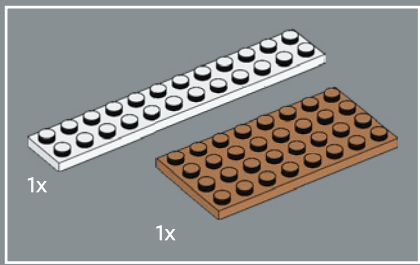

206

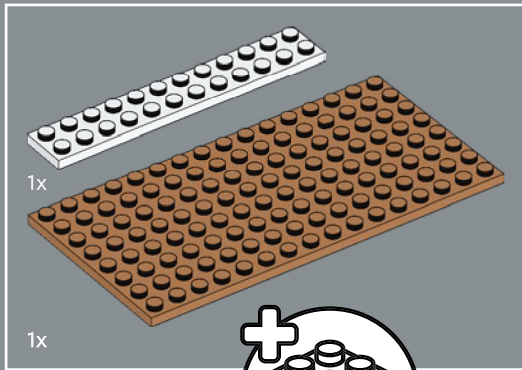
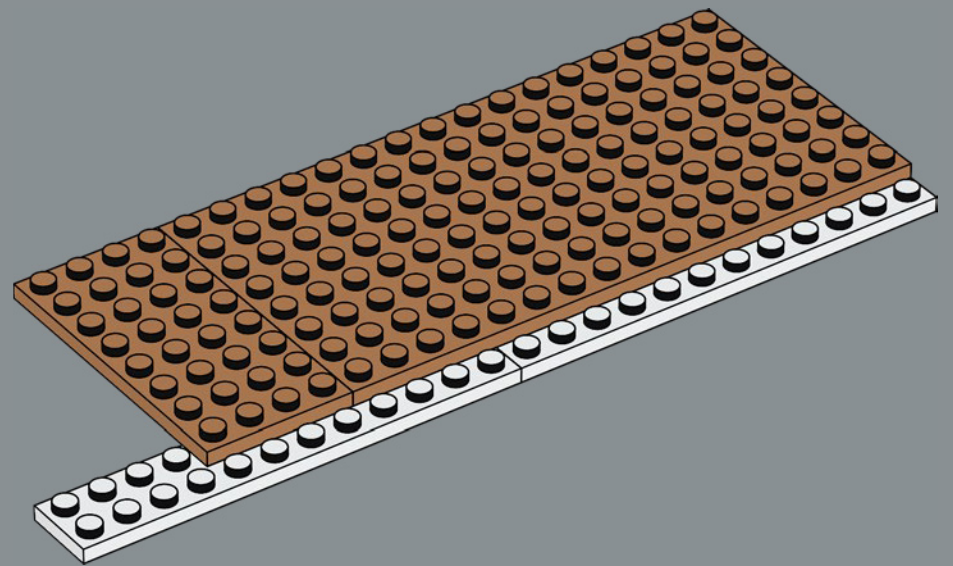

207

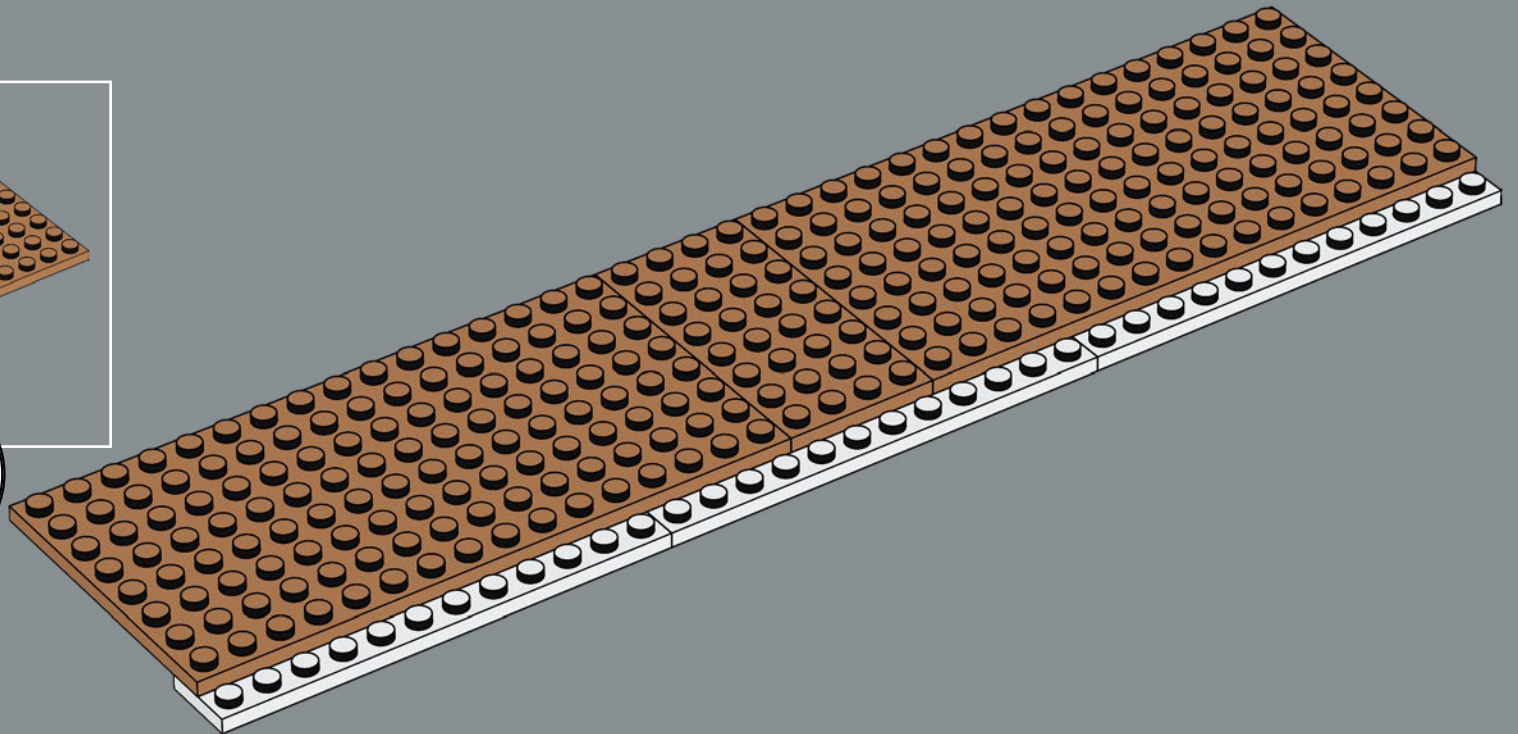
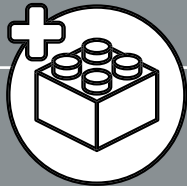



208

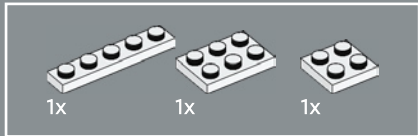
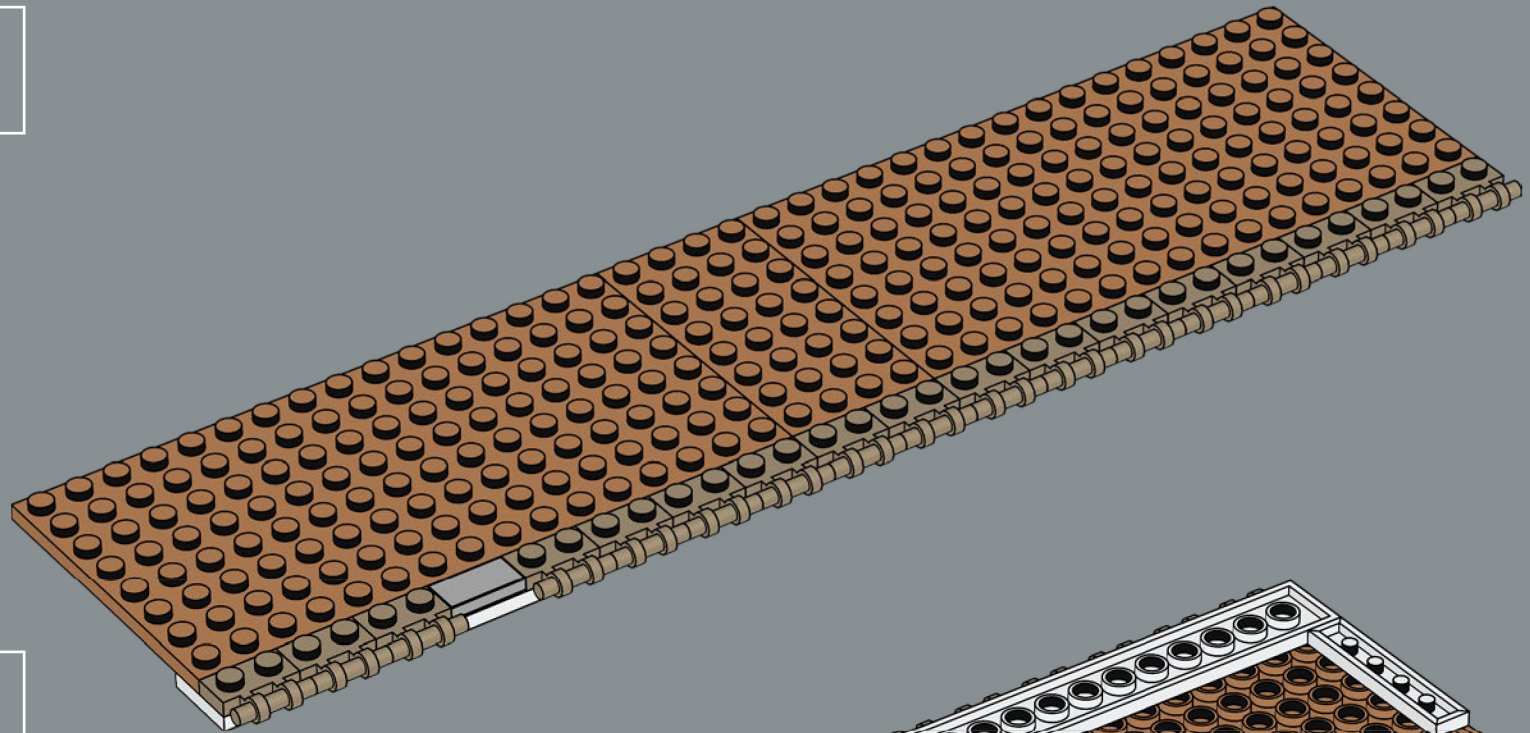

209

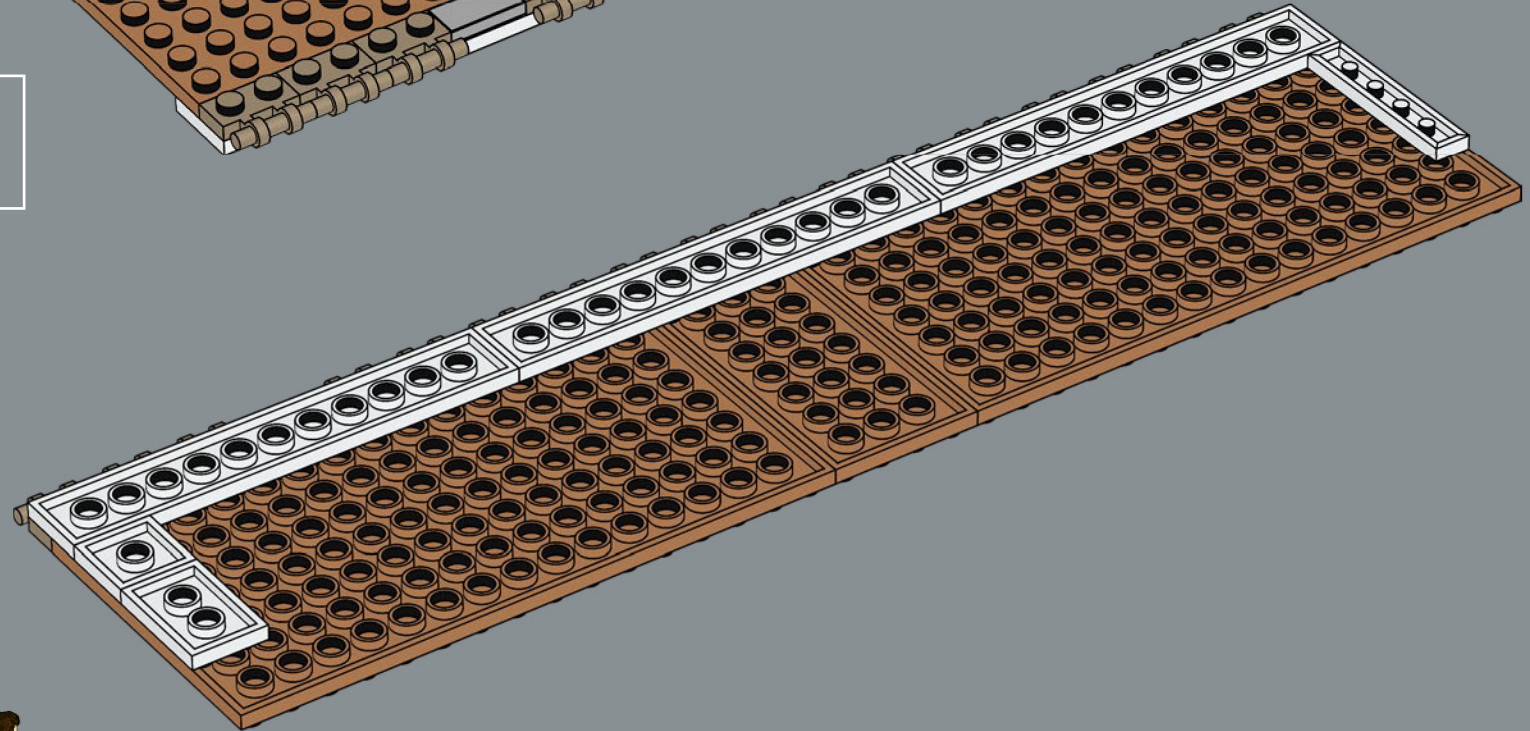

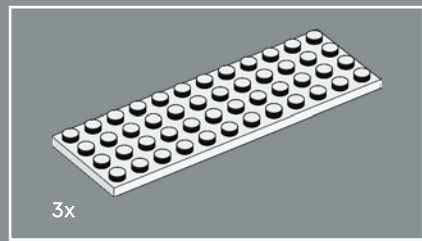

210

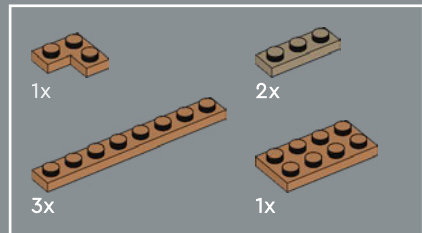
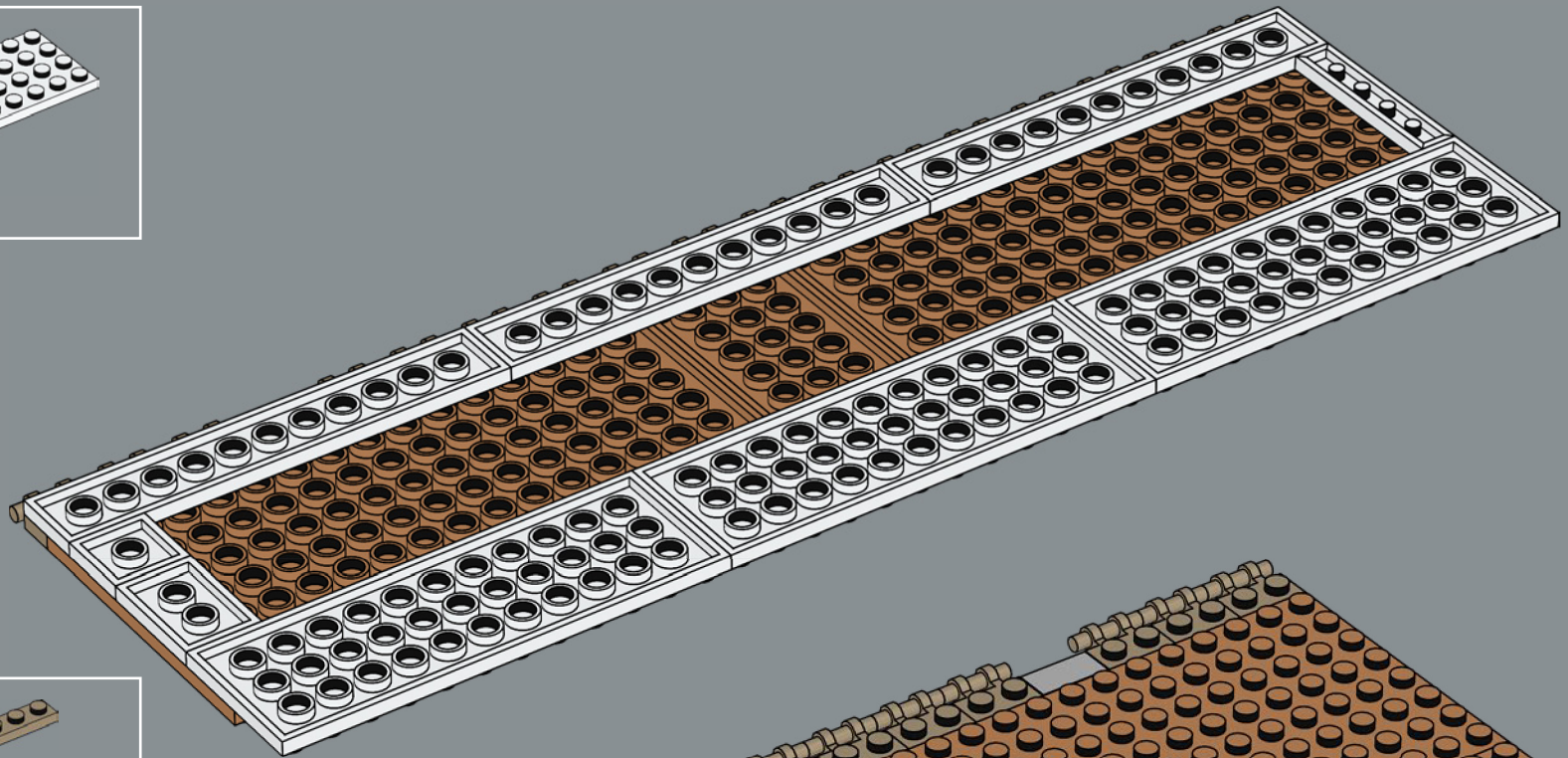

211

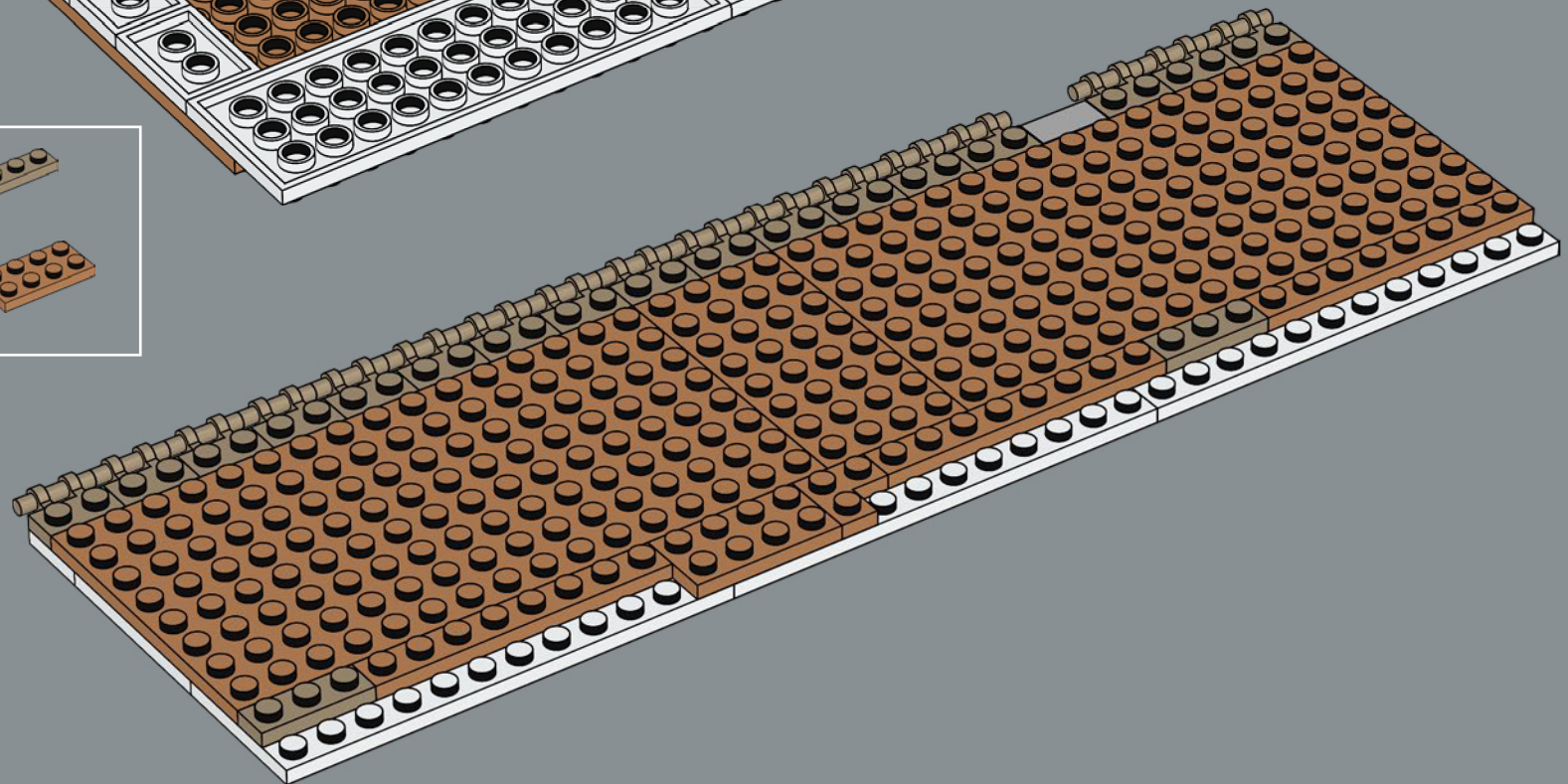

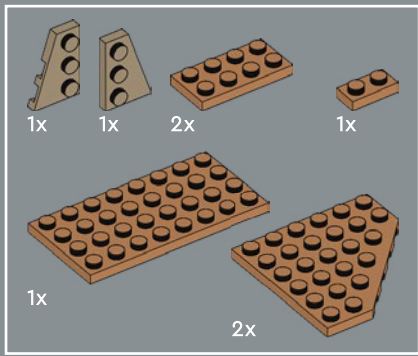

212

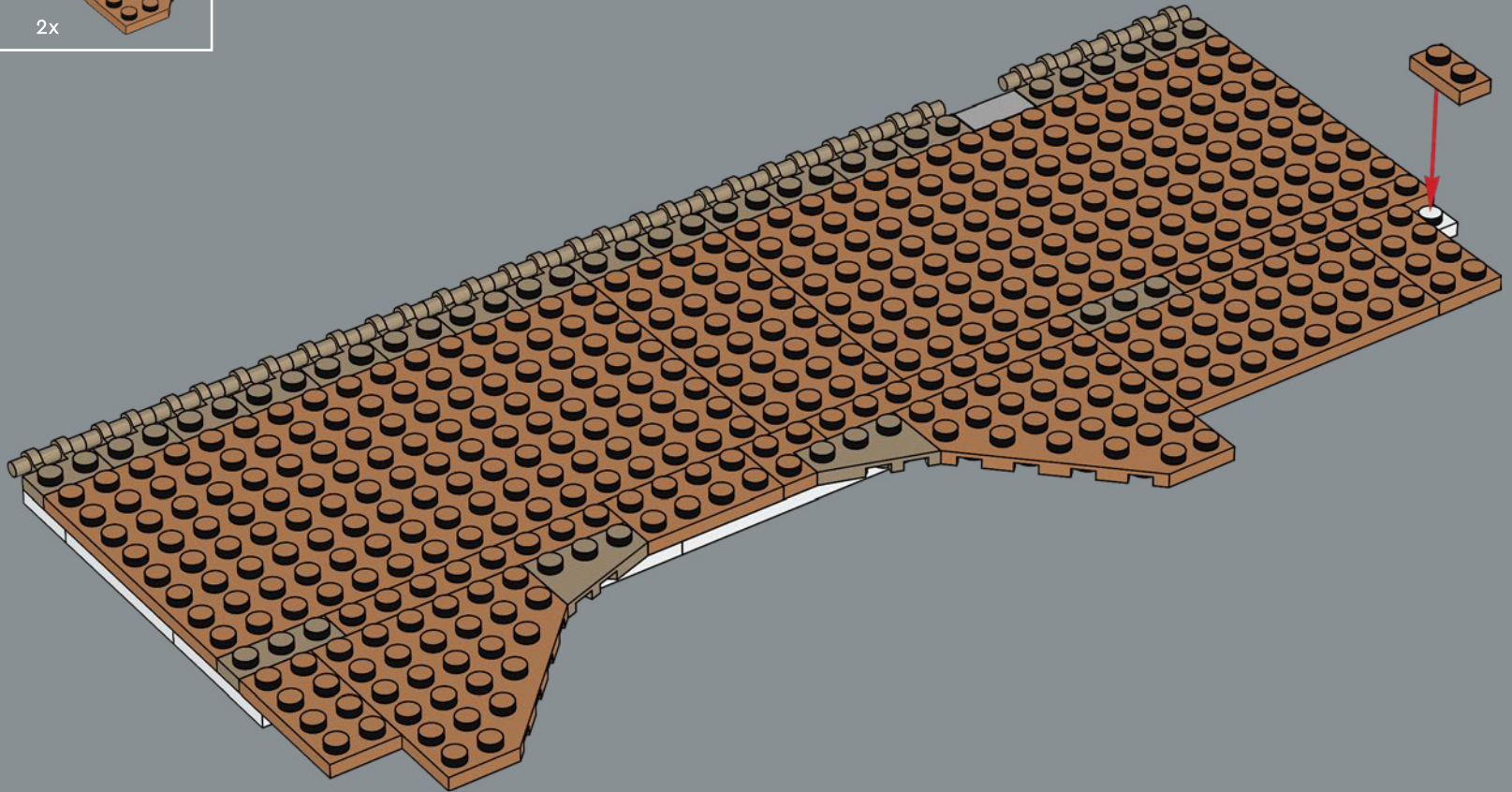

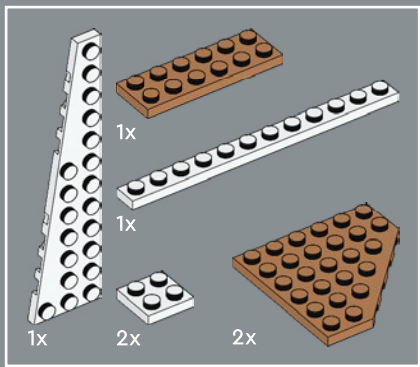

213

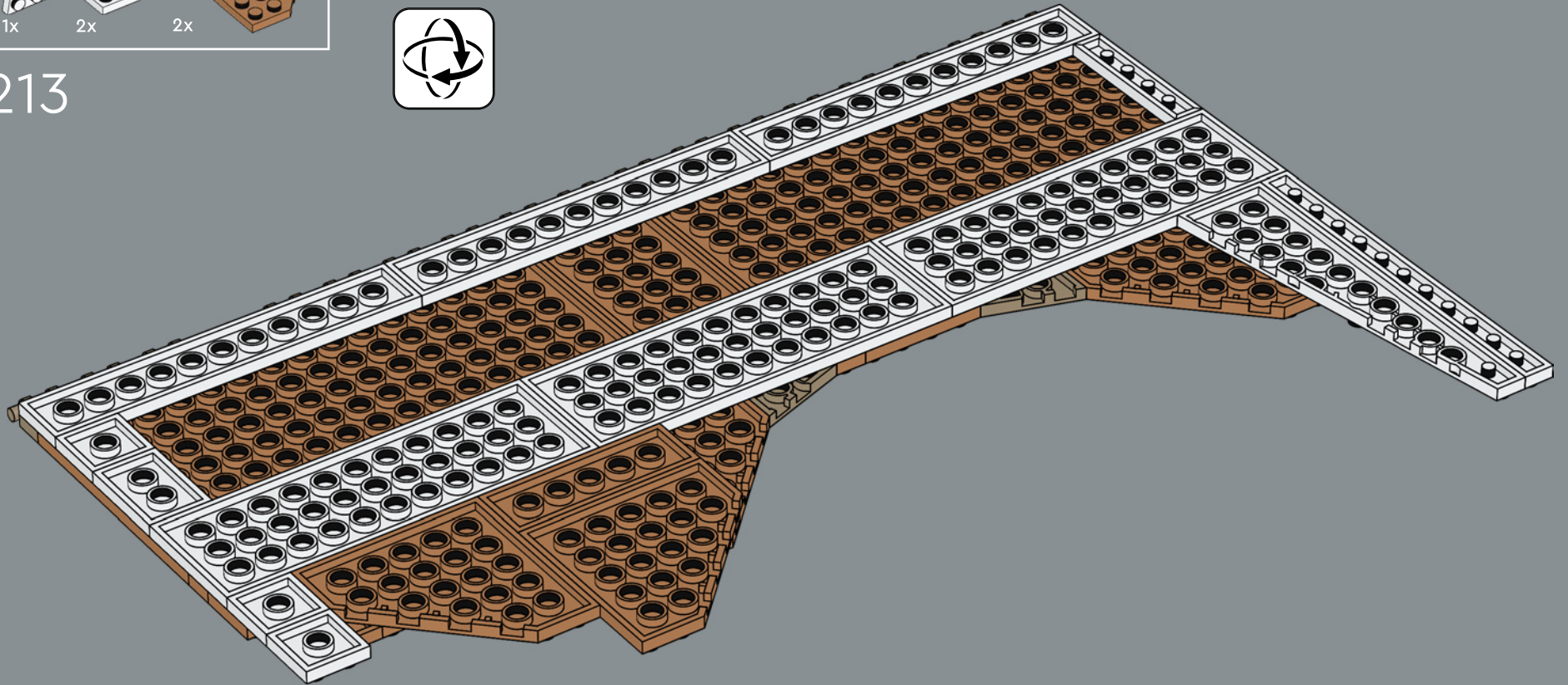

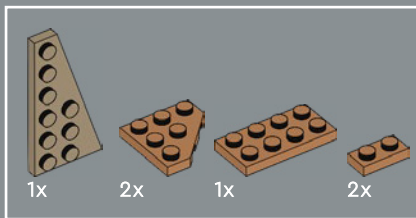

214

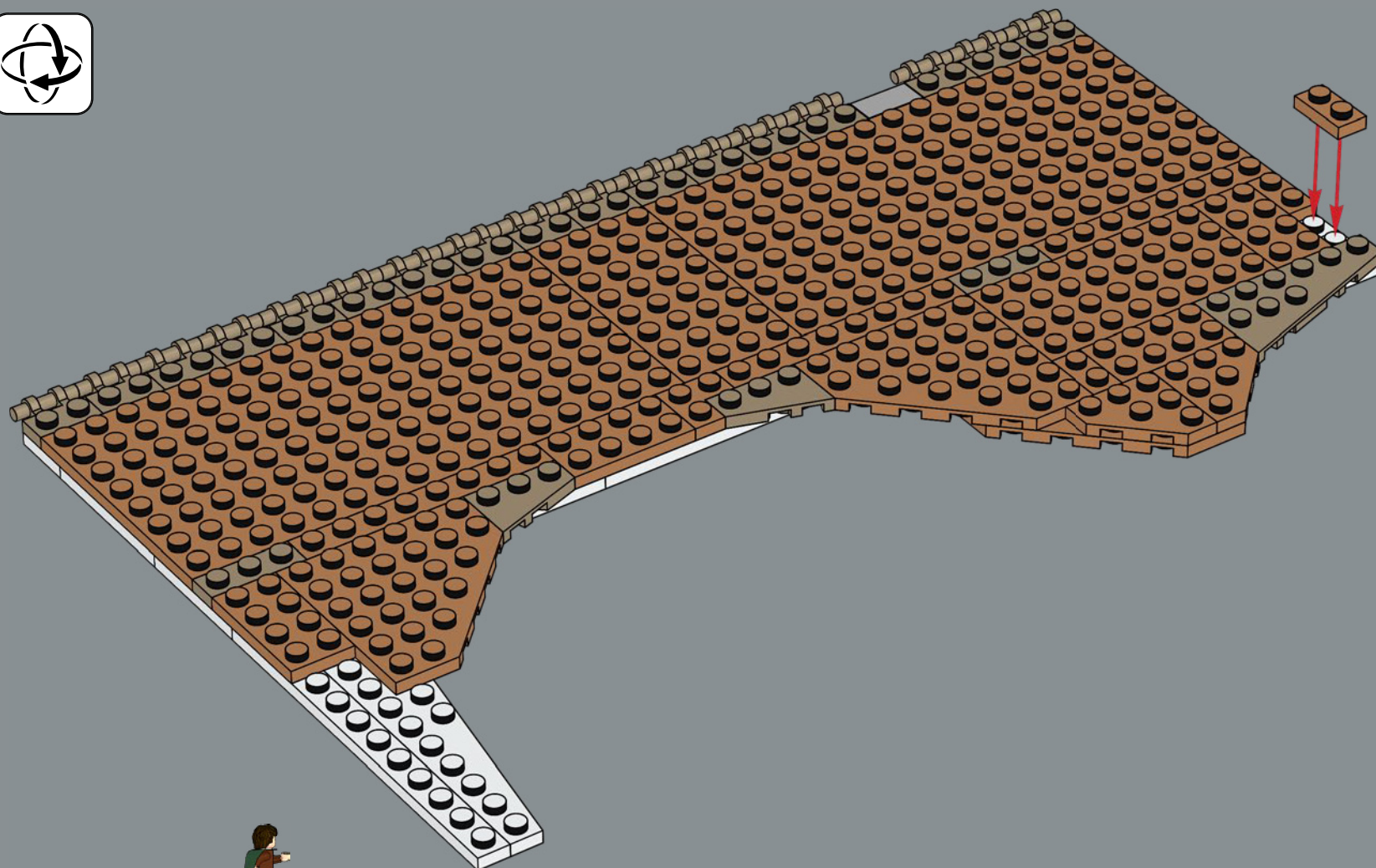

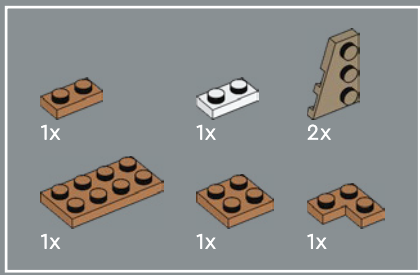

215

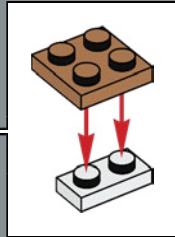
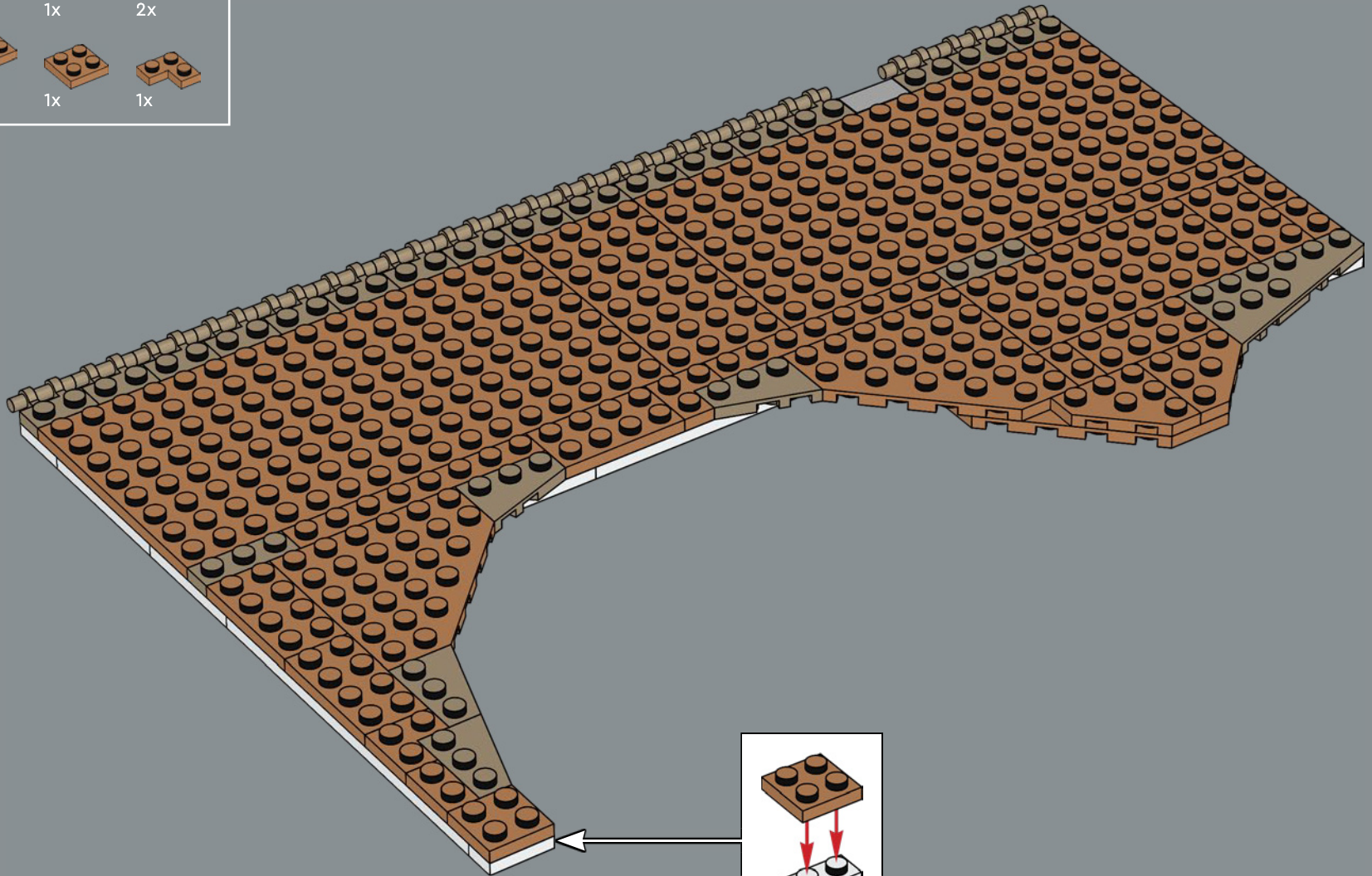

53x

216

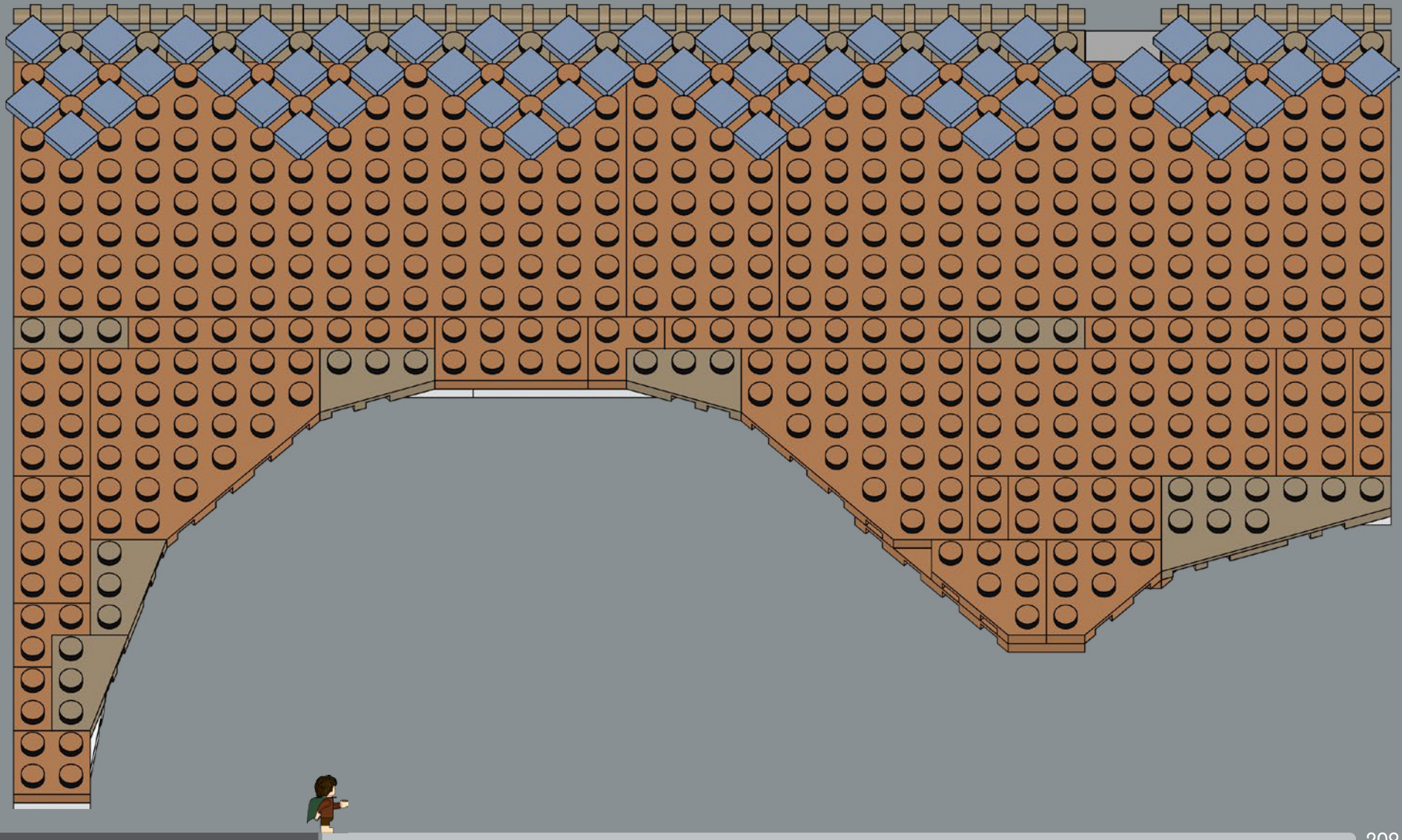

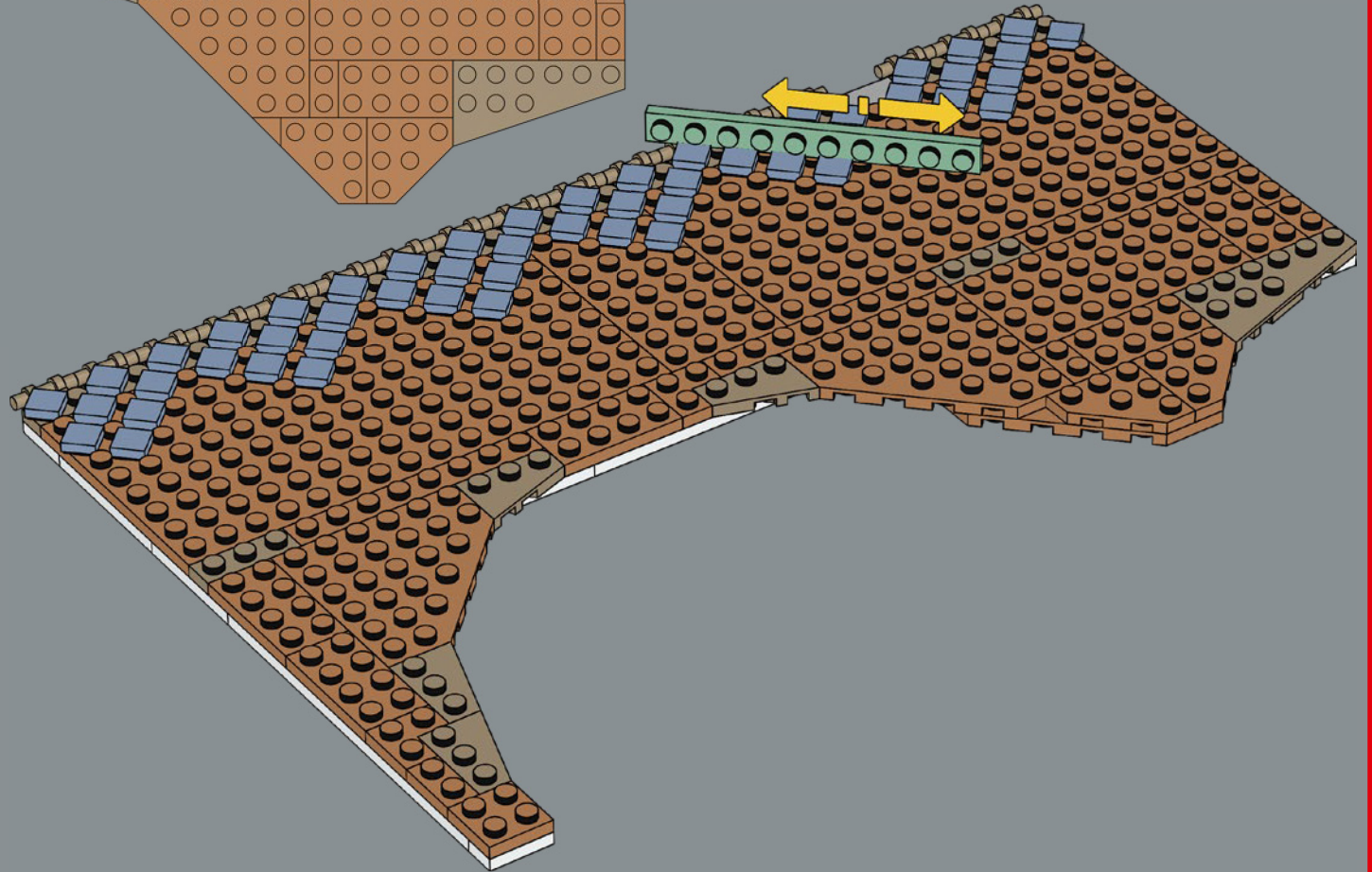
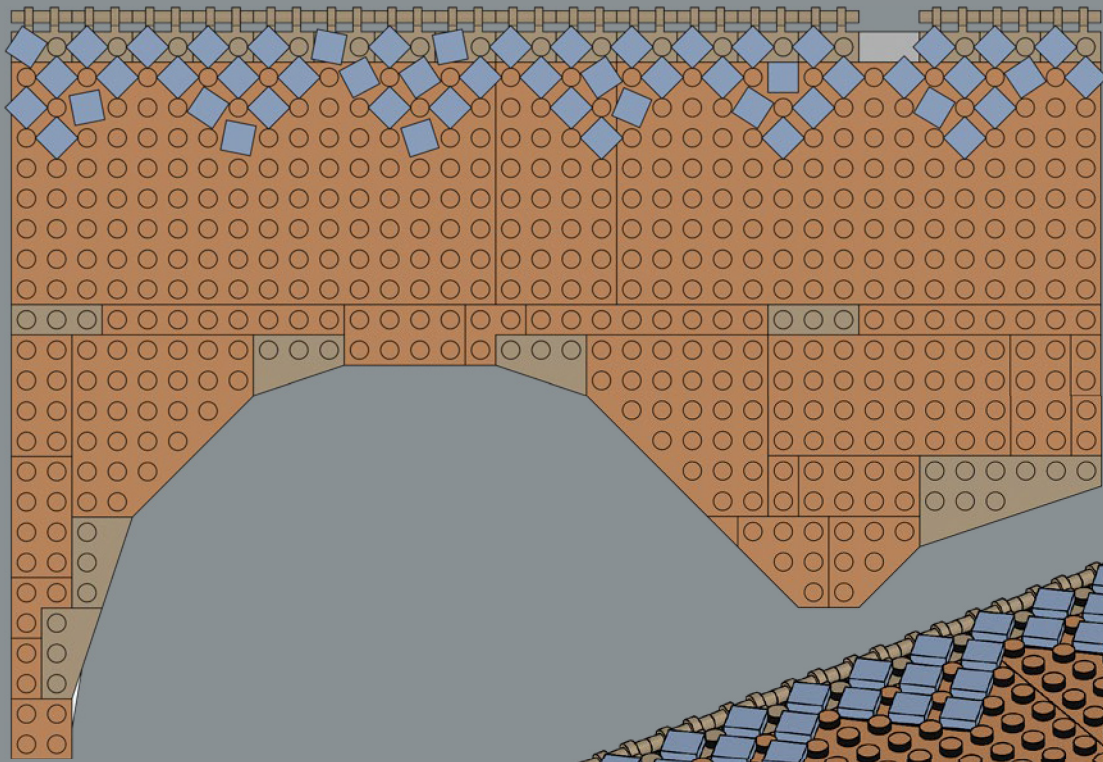

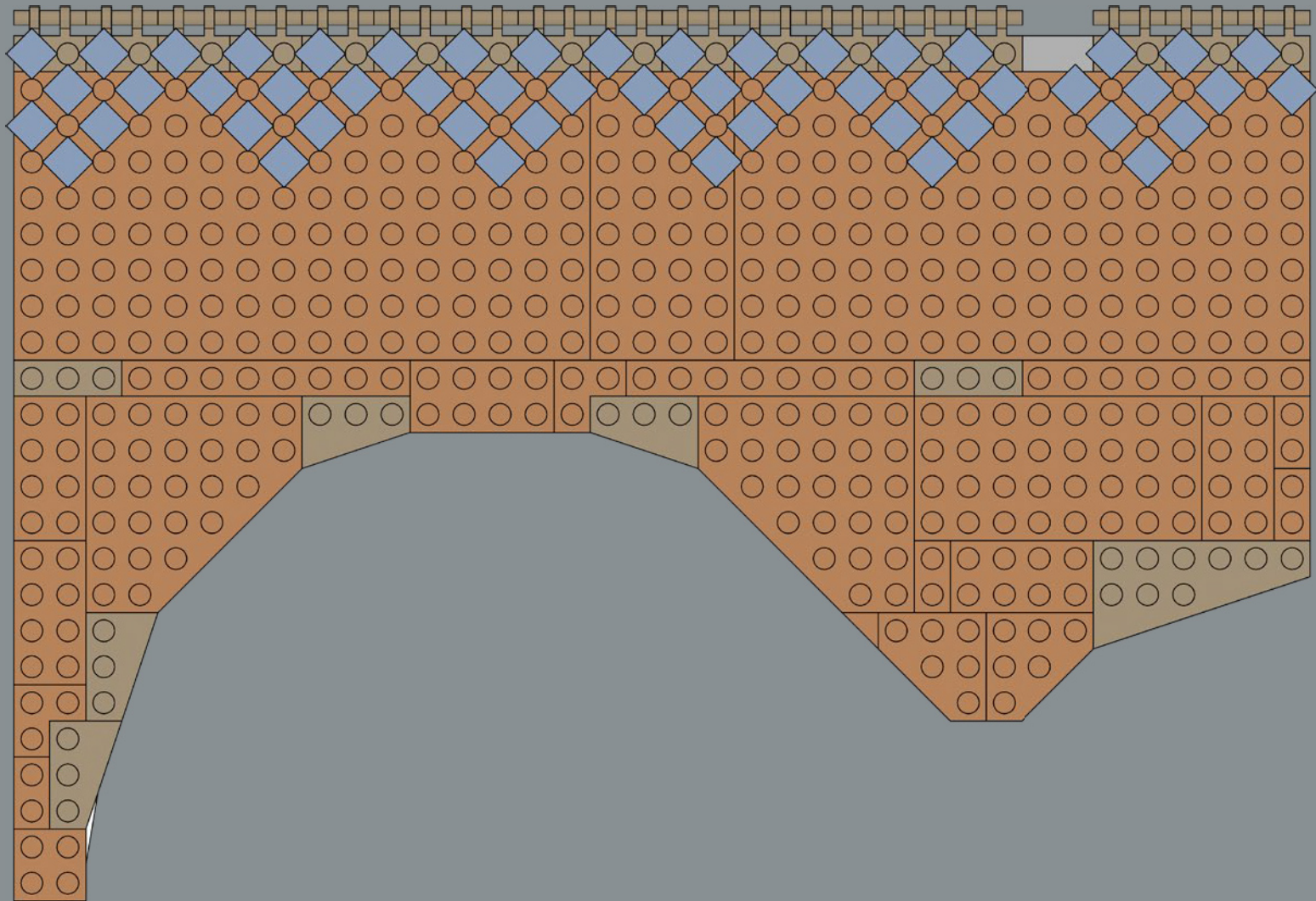

36x 24x

217

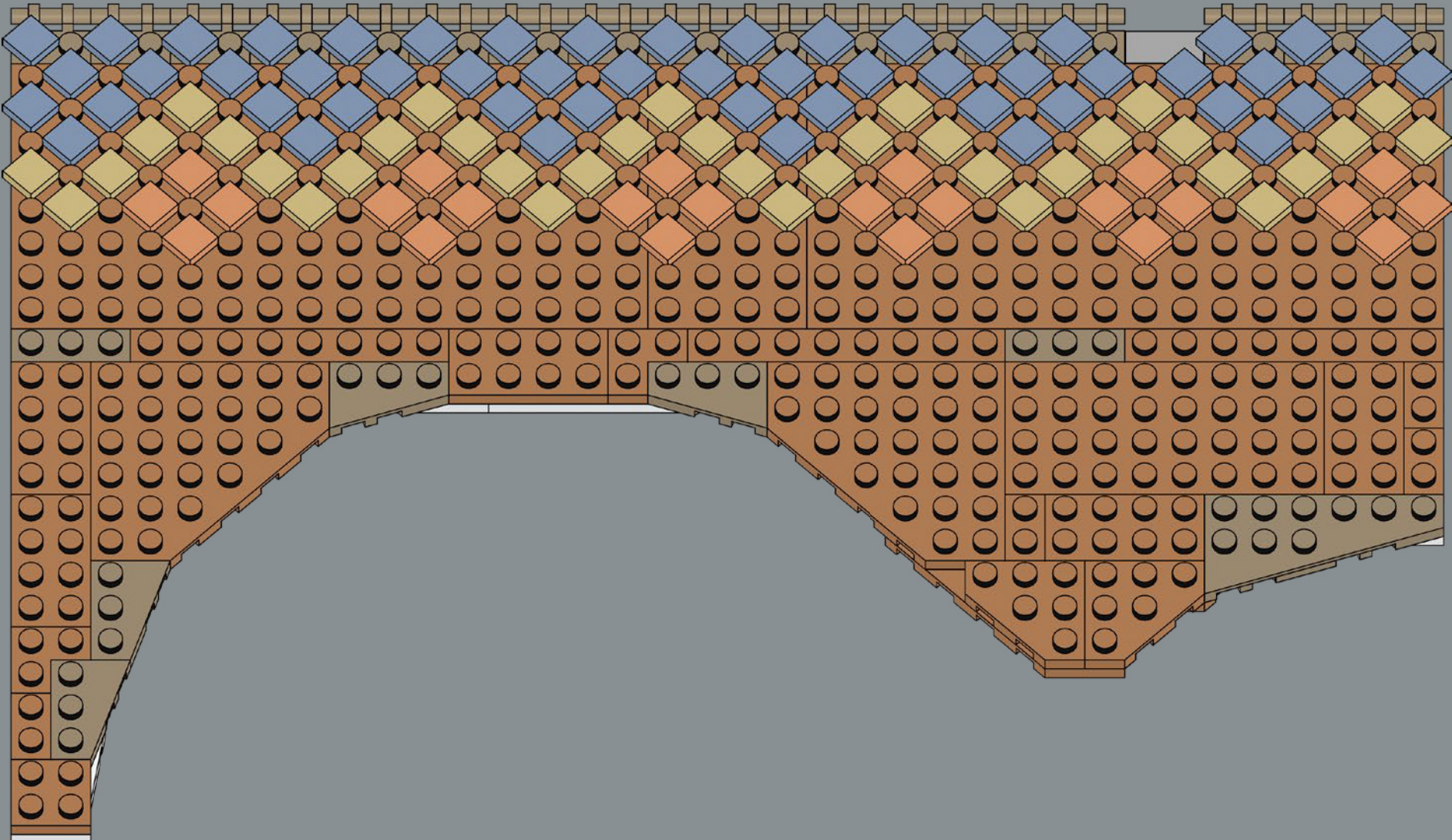

42x 6x 35x

218

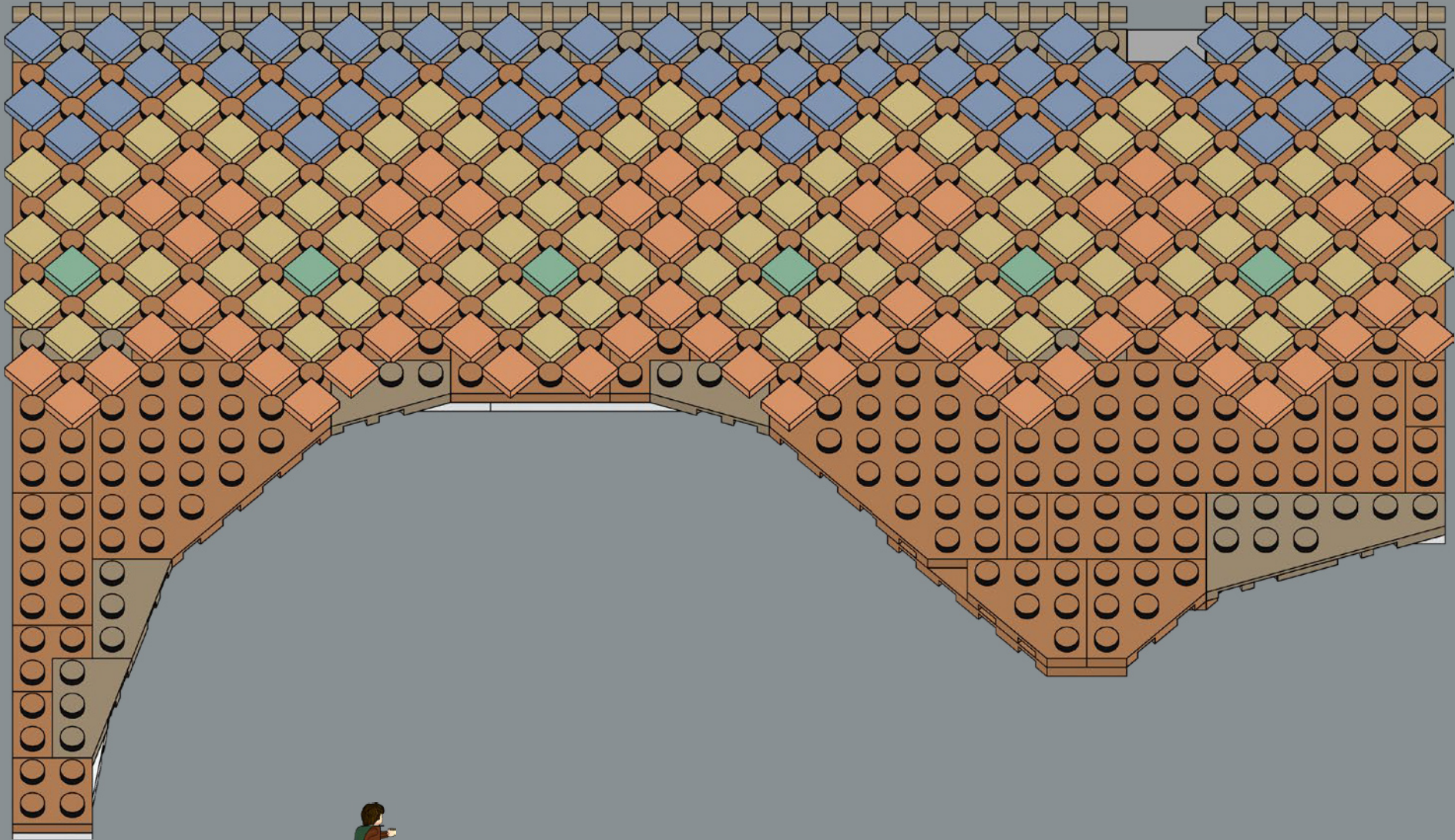

2x 4x 34x 30x

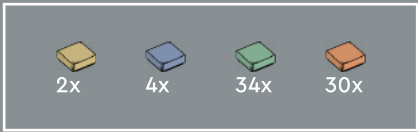

219

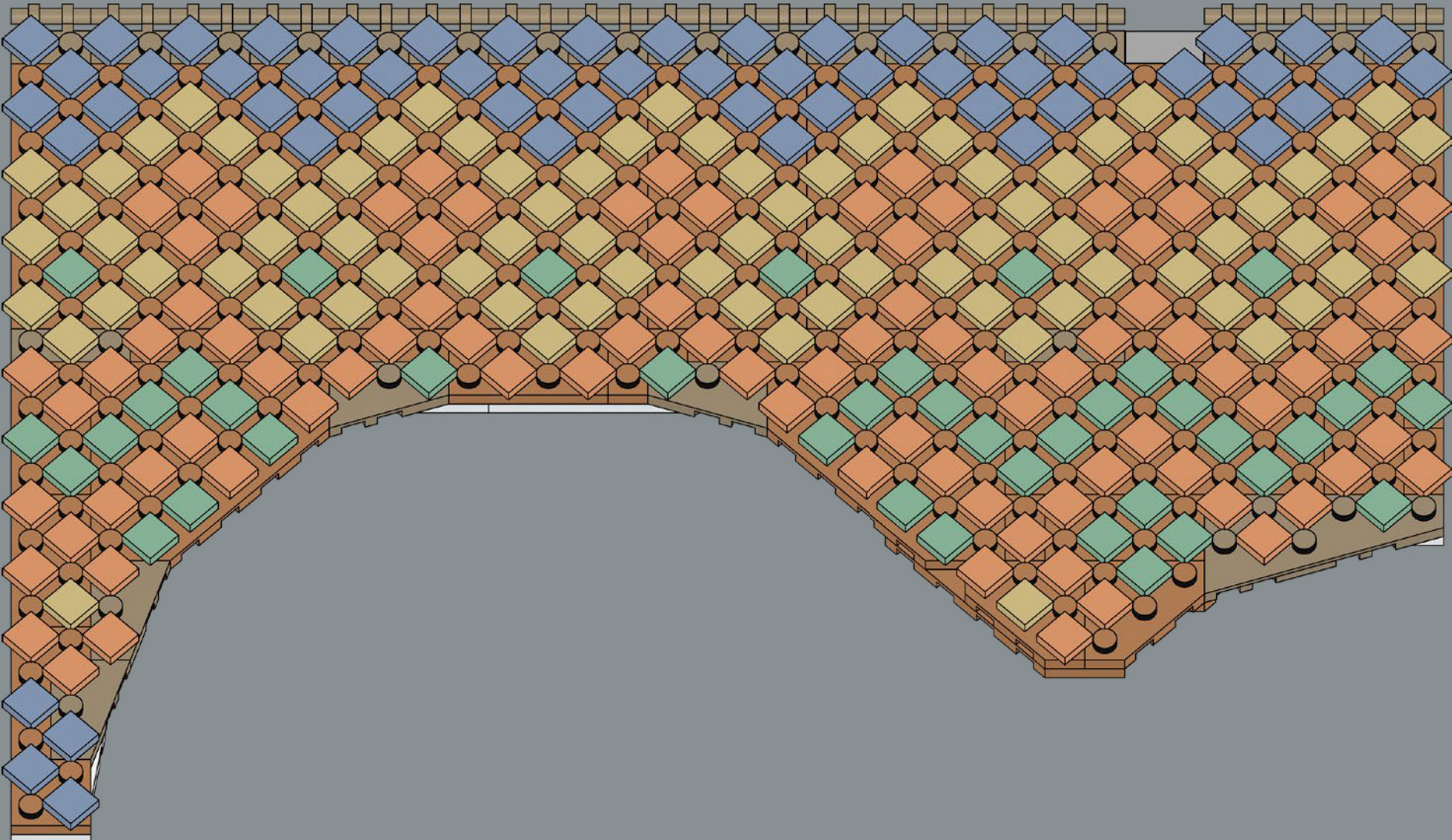



220

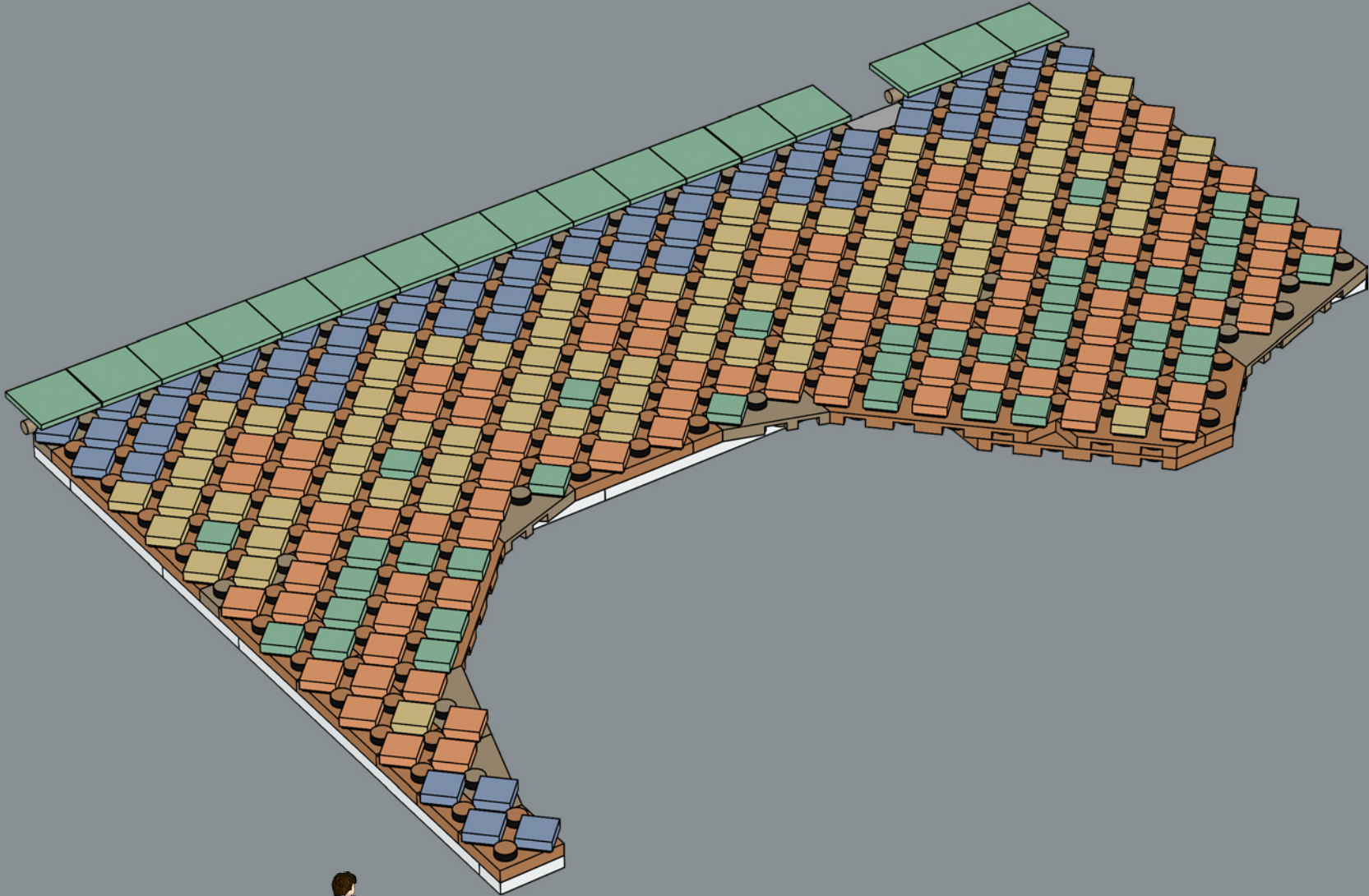

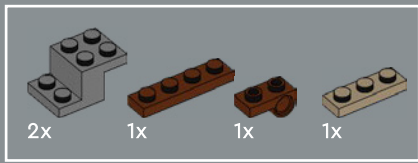

221

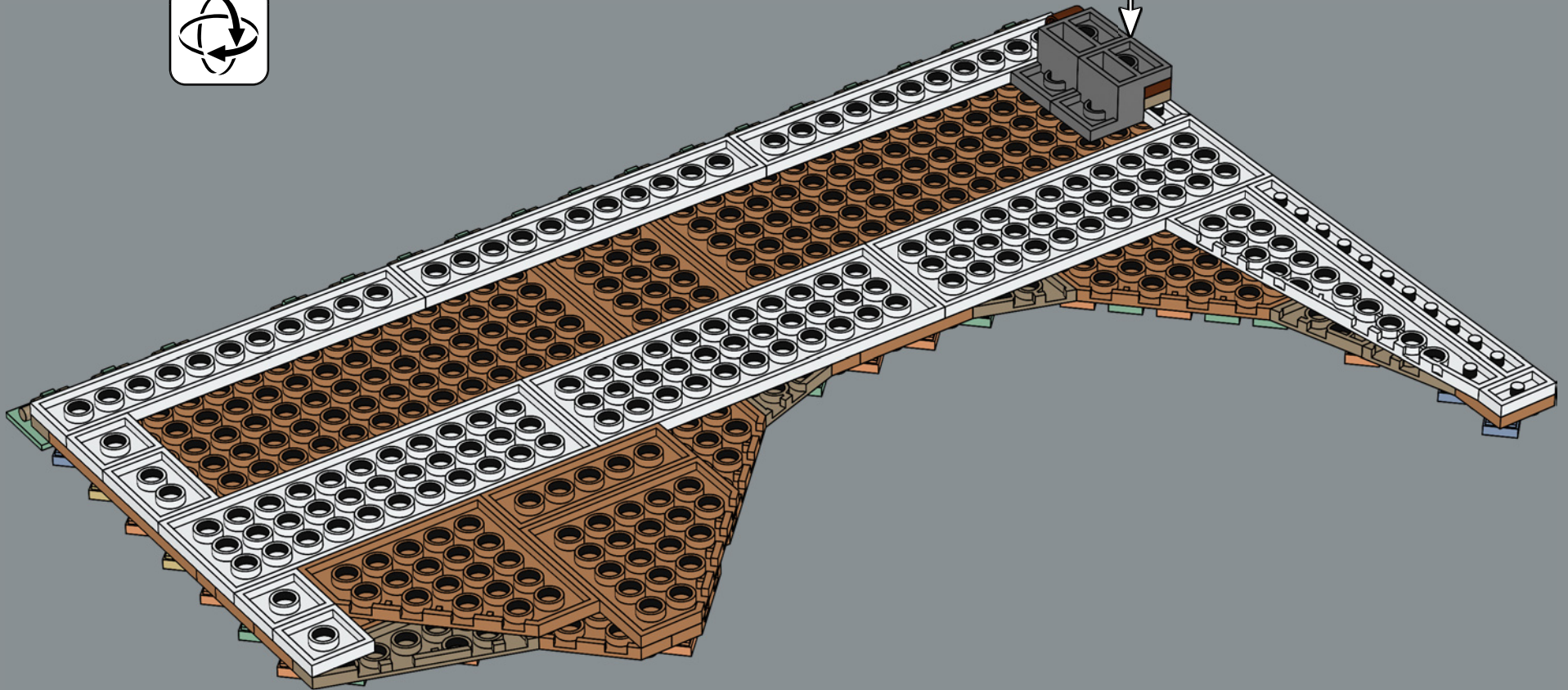
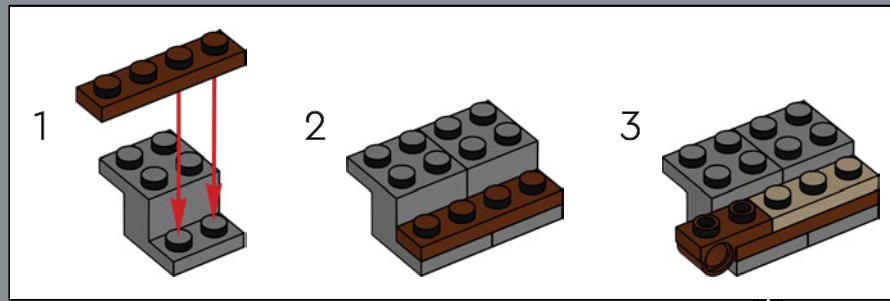

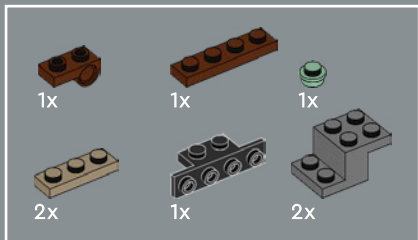

222

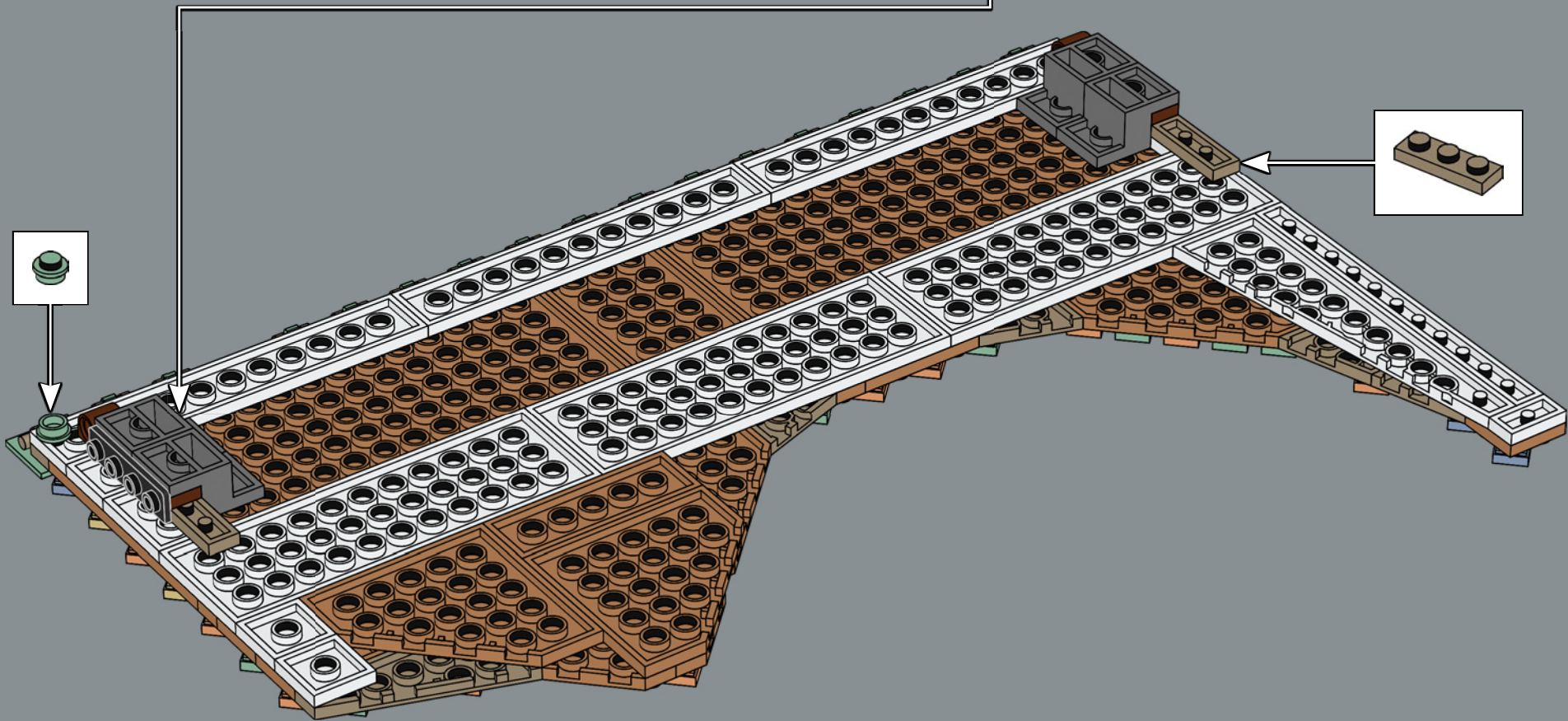
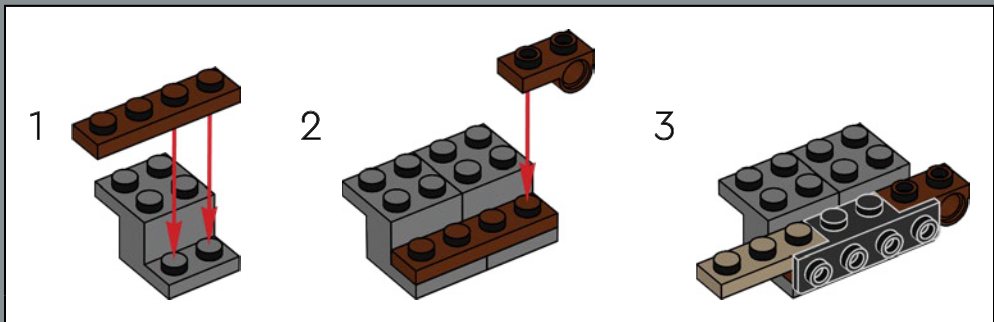

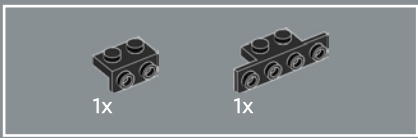

223

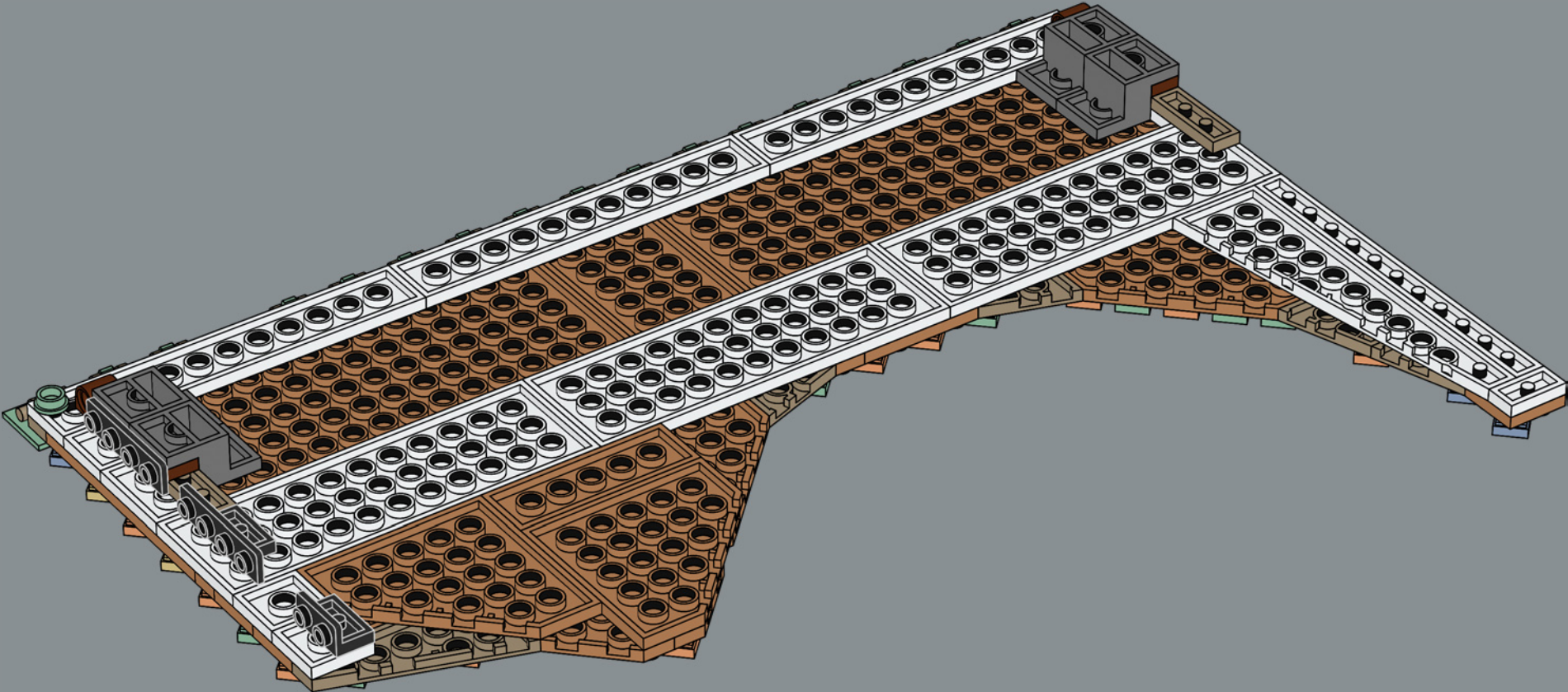

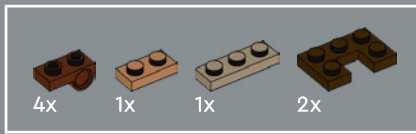

224

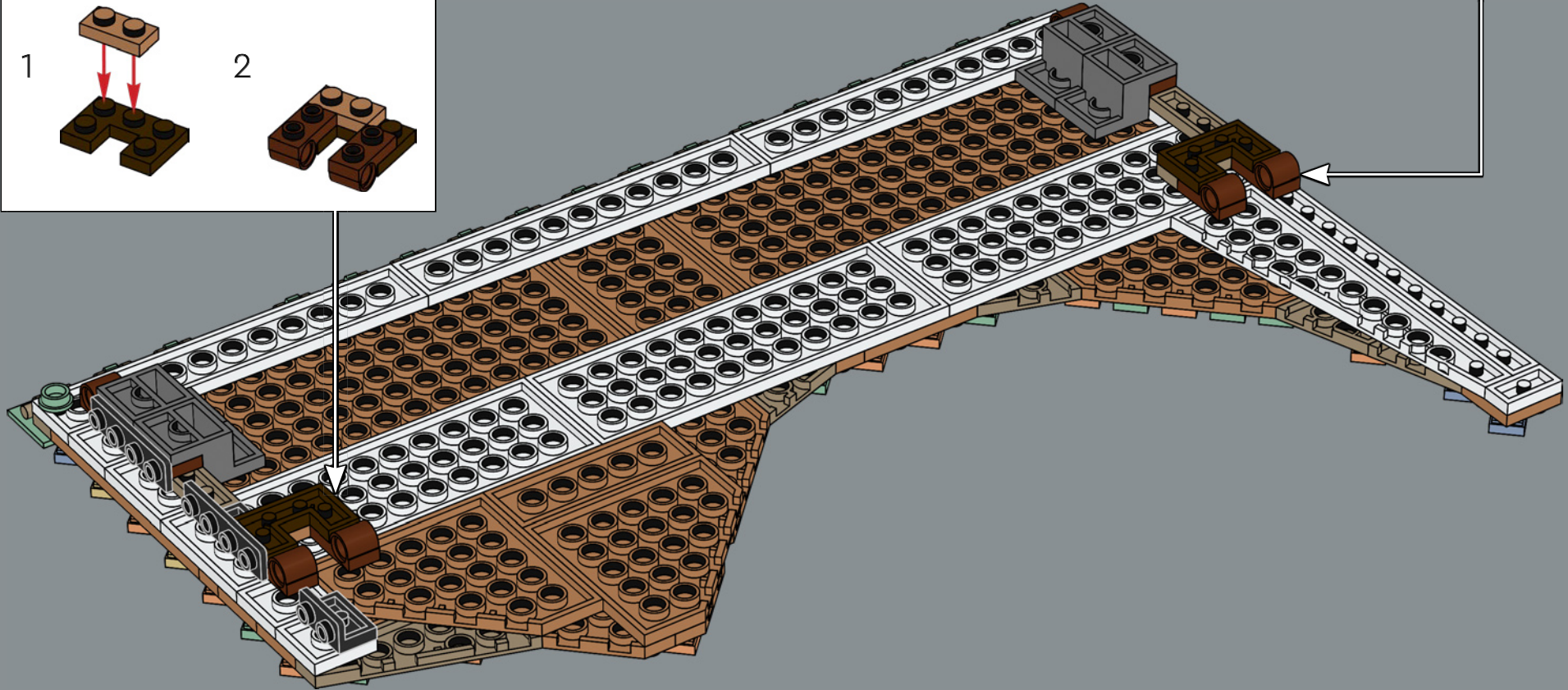
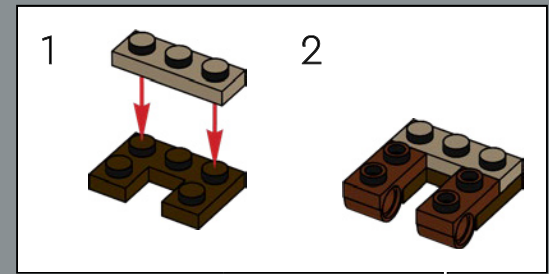
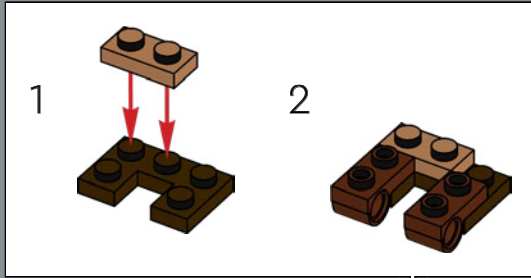

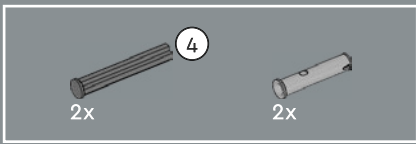

225

The roof is attached using a 3-4-5 Triangle. It provides a lot of structural stability to the model once it is attached at all four anchor points.

Le toit est fixé à l'aide d'un triangle 3-4-5. Il assure une grande stabilité structurelle au modèle une fois qu'il est fixé aux quatre points d'ancrage.

El techo se fija usando un triángulo 3-4-5. Una vez que se conecta con los cuatro puntos de anclaje, proporciona una gran estabilidad estructural al modelo.

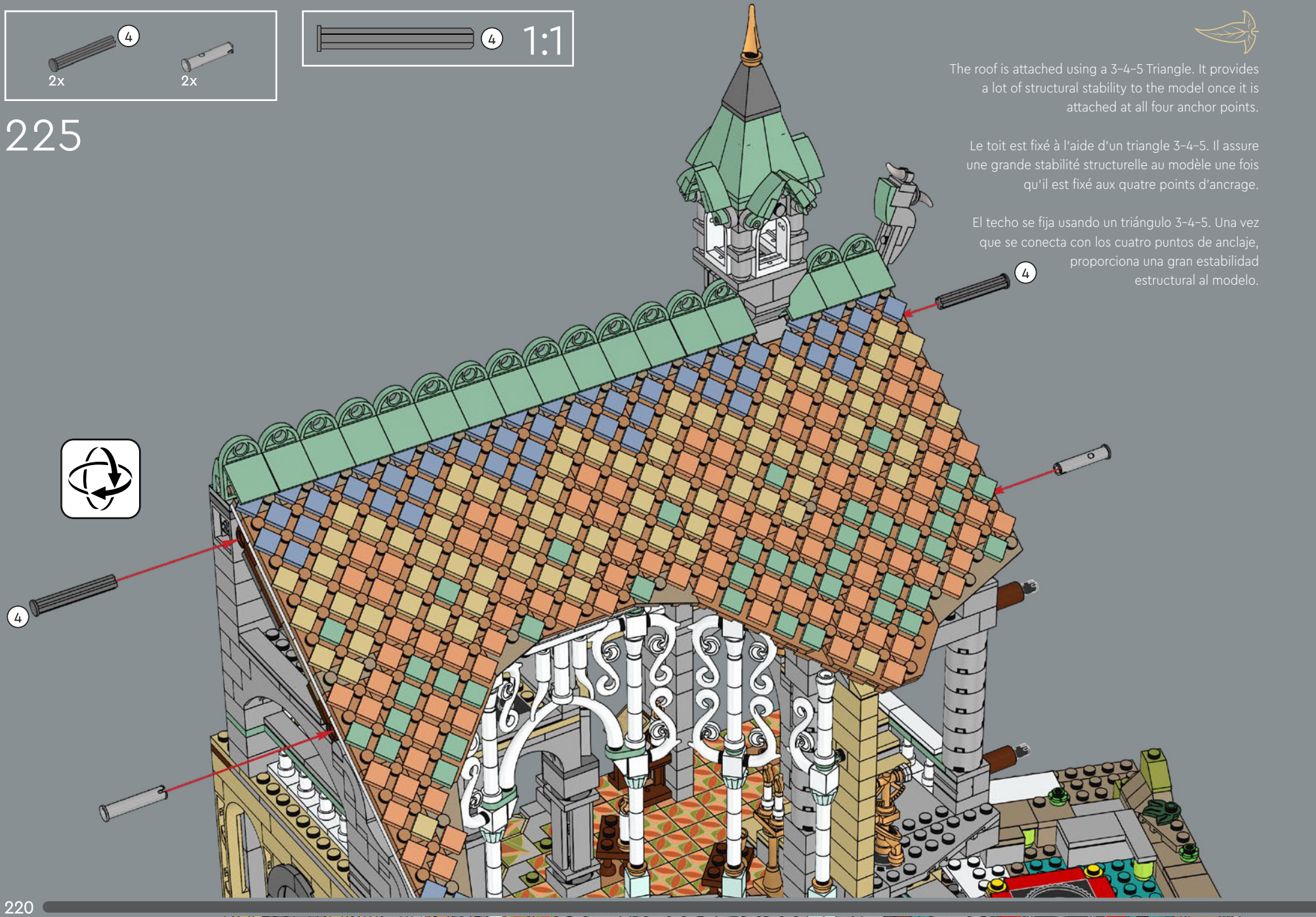

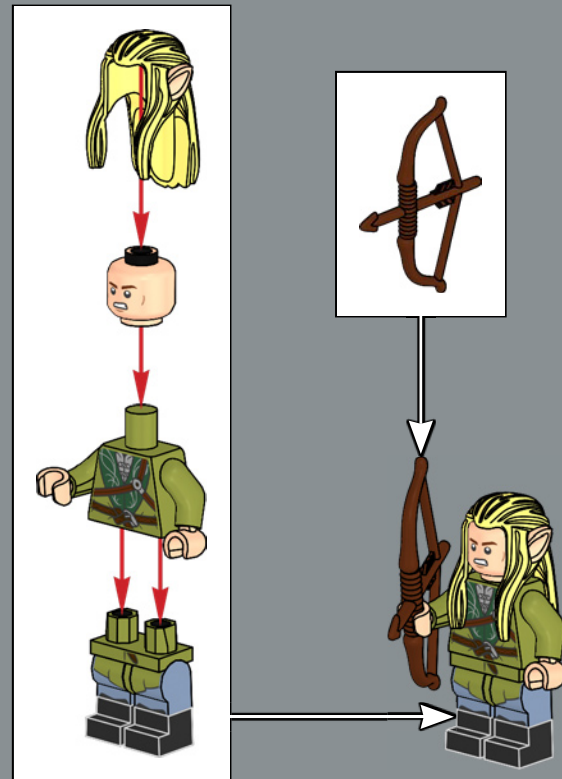

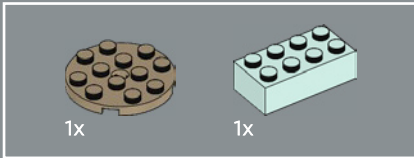
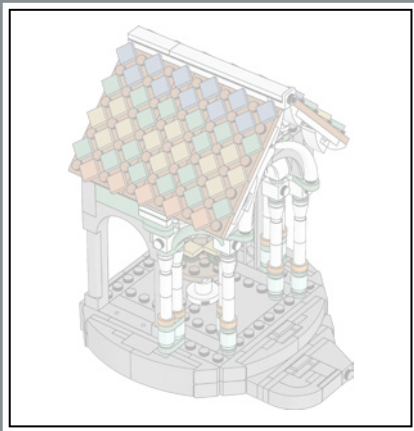

227

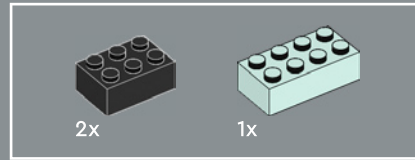
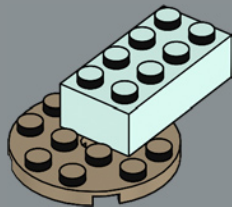

228

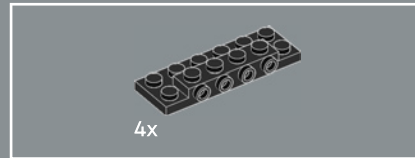
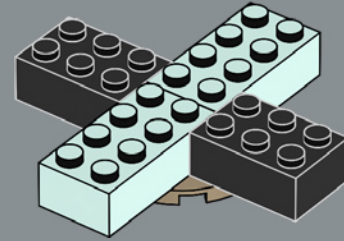

229

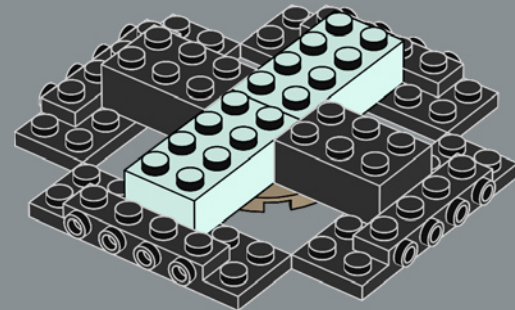

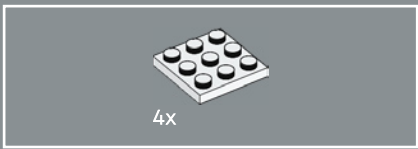

230

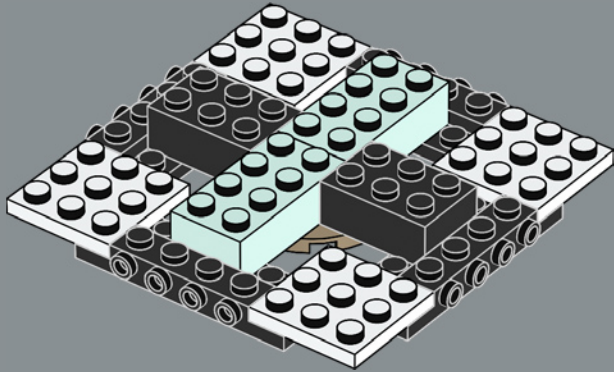

231

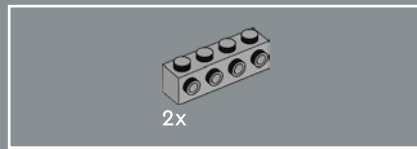
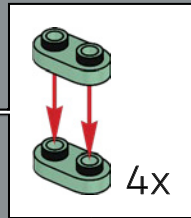
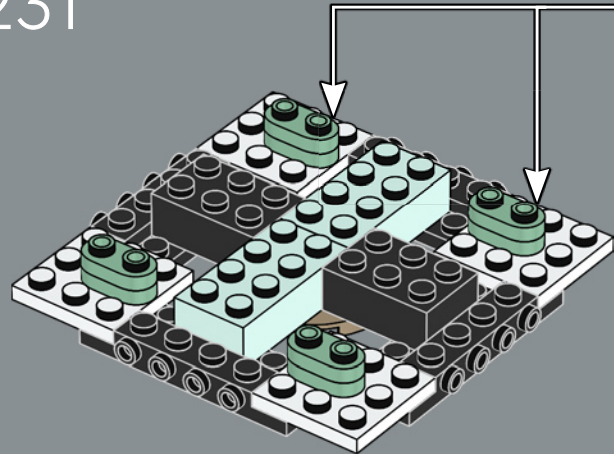

232

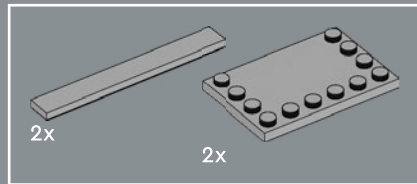
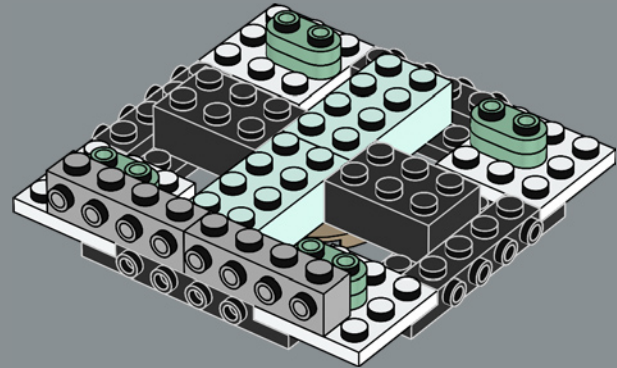

233

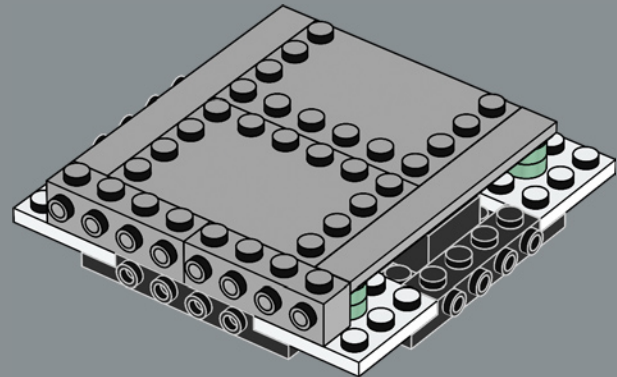

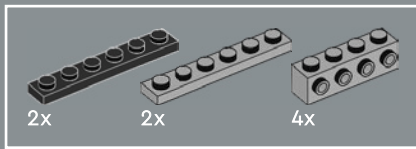

234

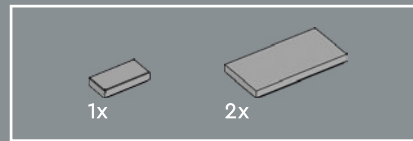
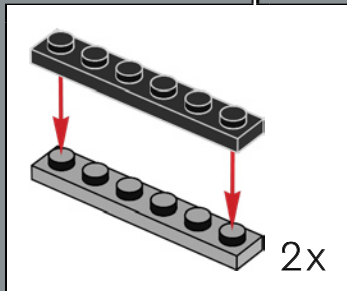
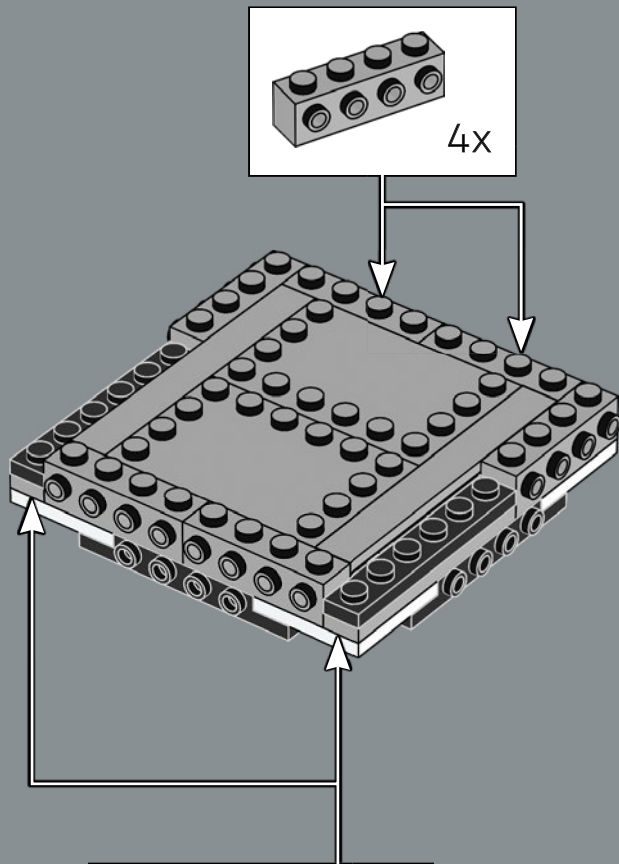

235

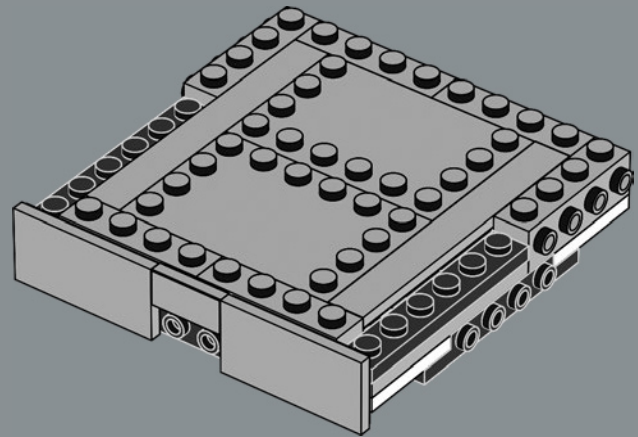

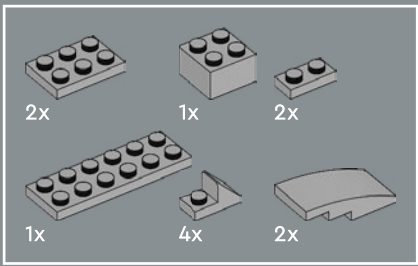

236

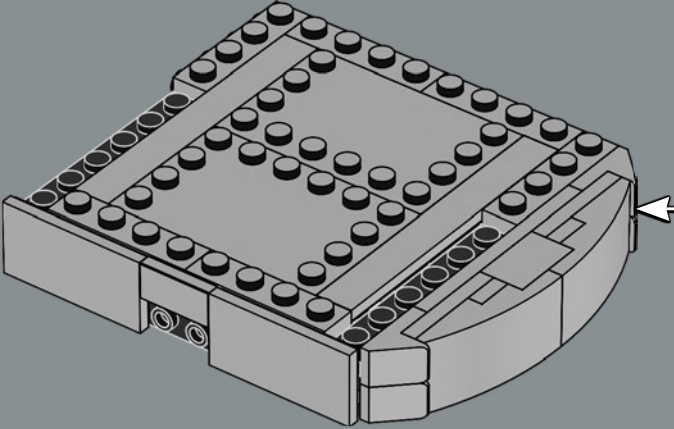
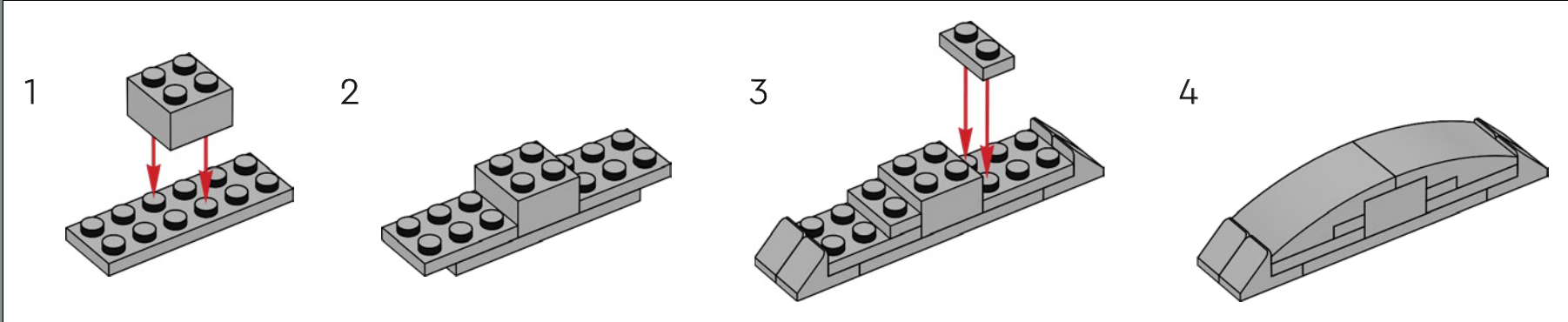

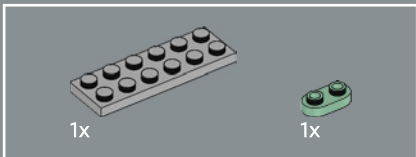
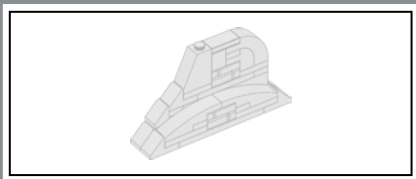

238

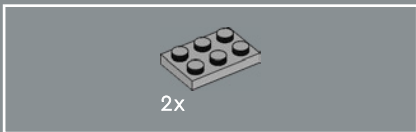
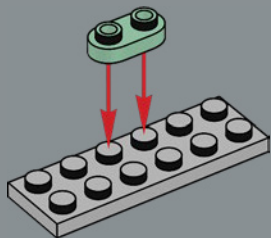

239

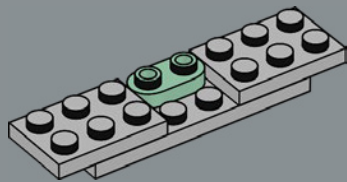

240

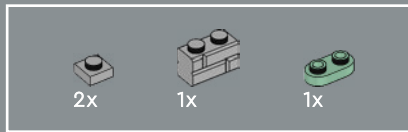
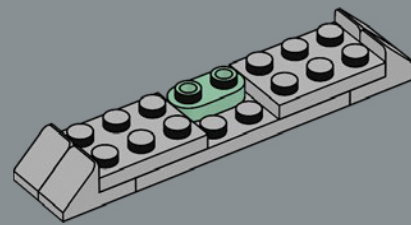

241

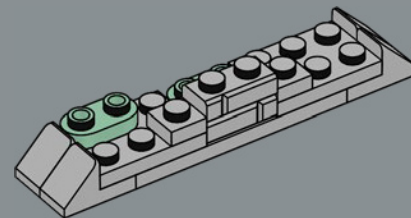

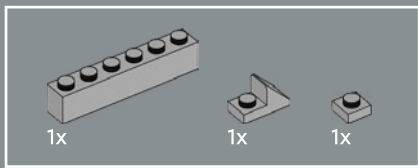

242

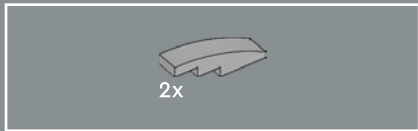
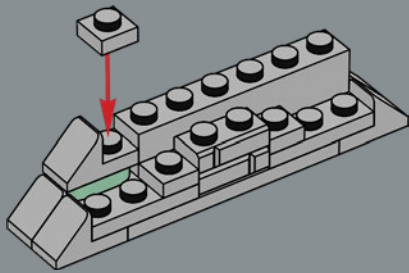

243

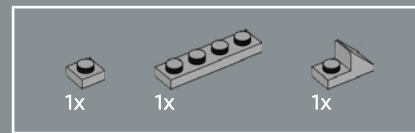
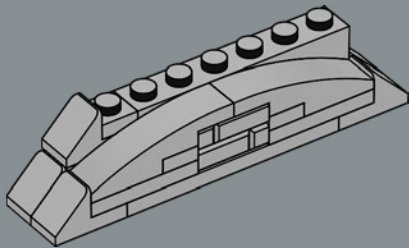

244

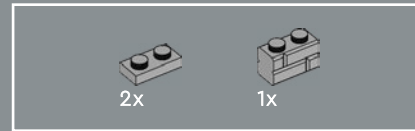
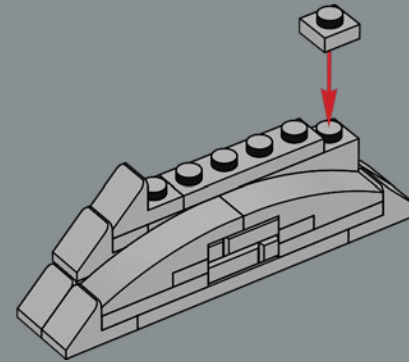

245

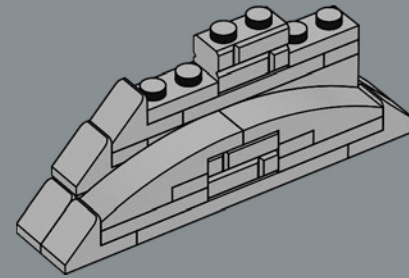

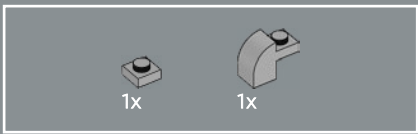

246

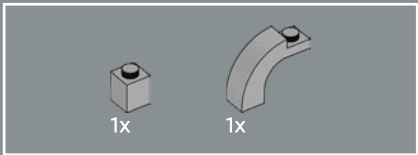
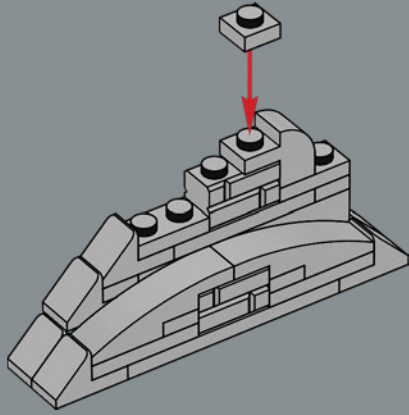

247

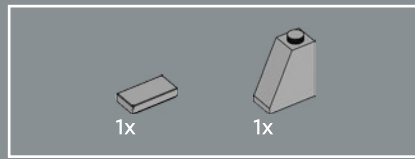
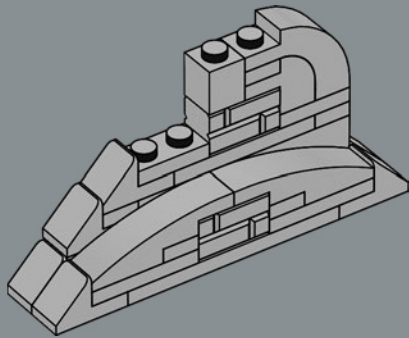

248

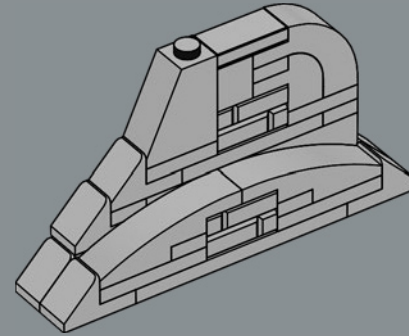

249

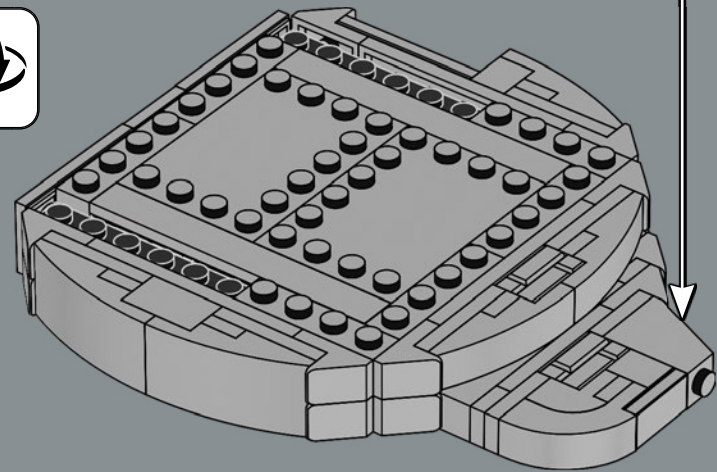

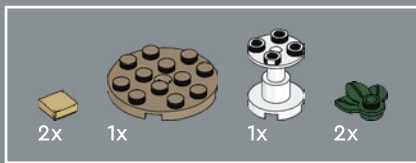

250

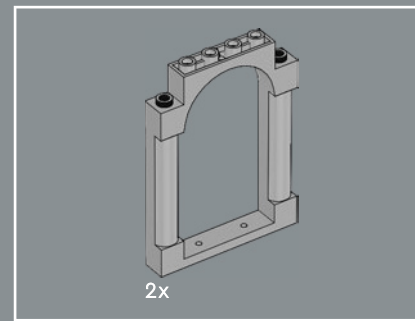
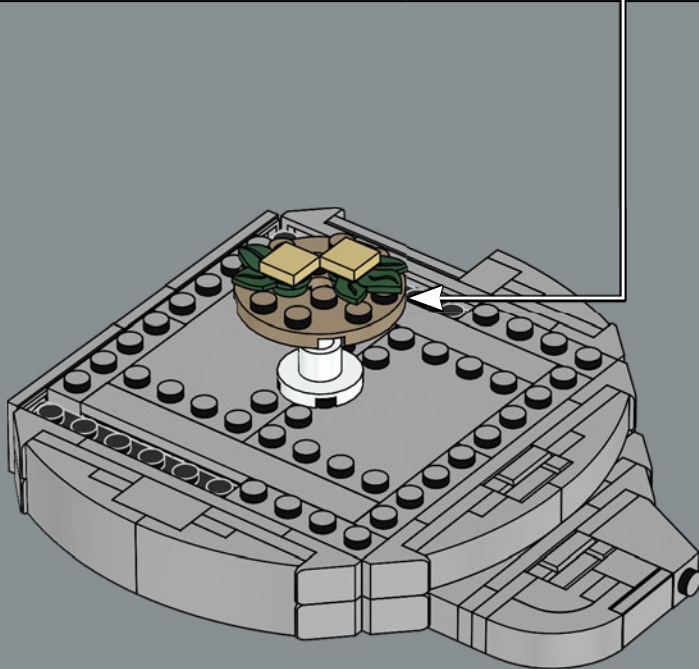
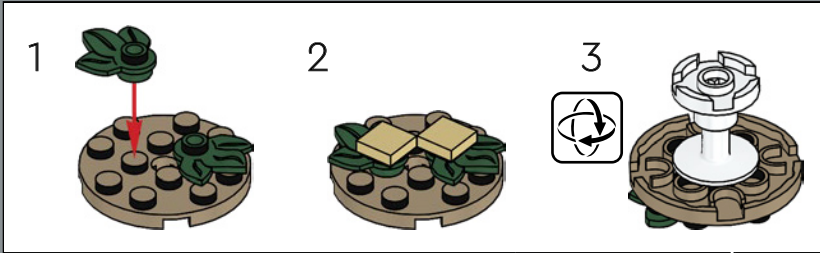

251

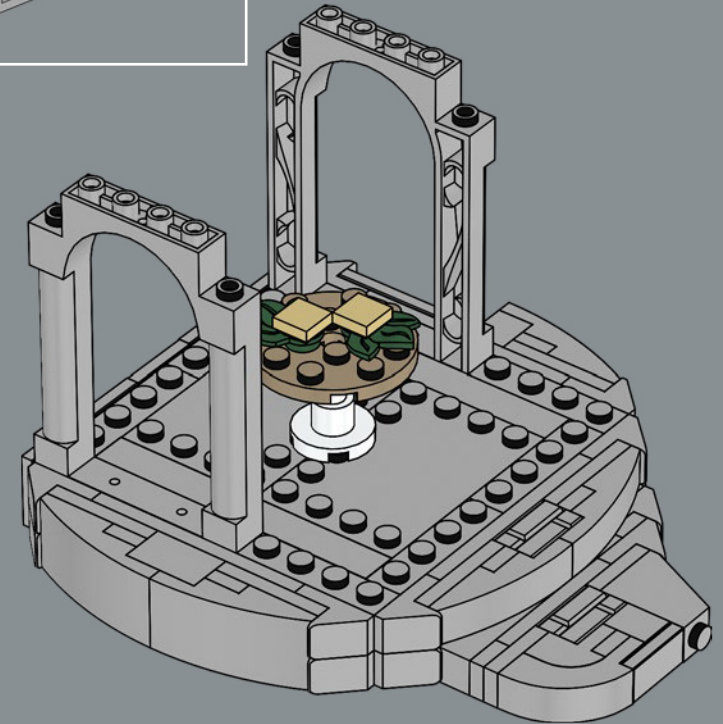

Lembas Bread! A single 1x1 tile can keep a minifigure fed for . . . a while?

Du pain lembas ! Une simple tuile 1x1 peut nourrir une figurine pendant... un moment ?

¡Pan de Lembas! Una sola cubierta 1x1 puede alimentar a una minifigura por... ¿un rato?



252

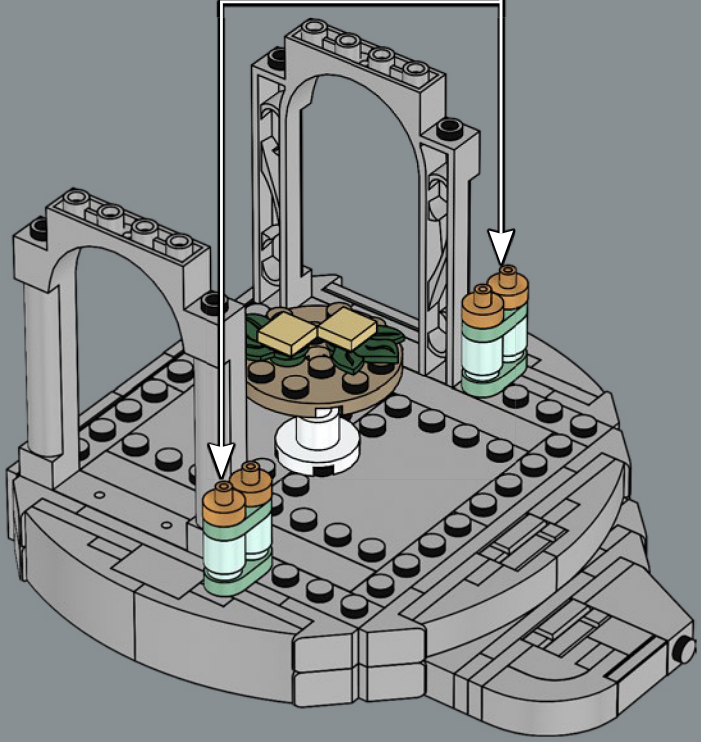
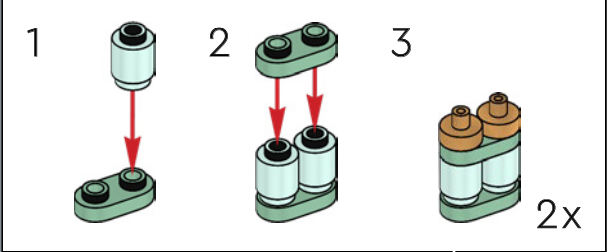

253

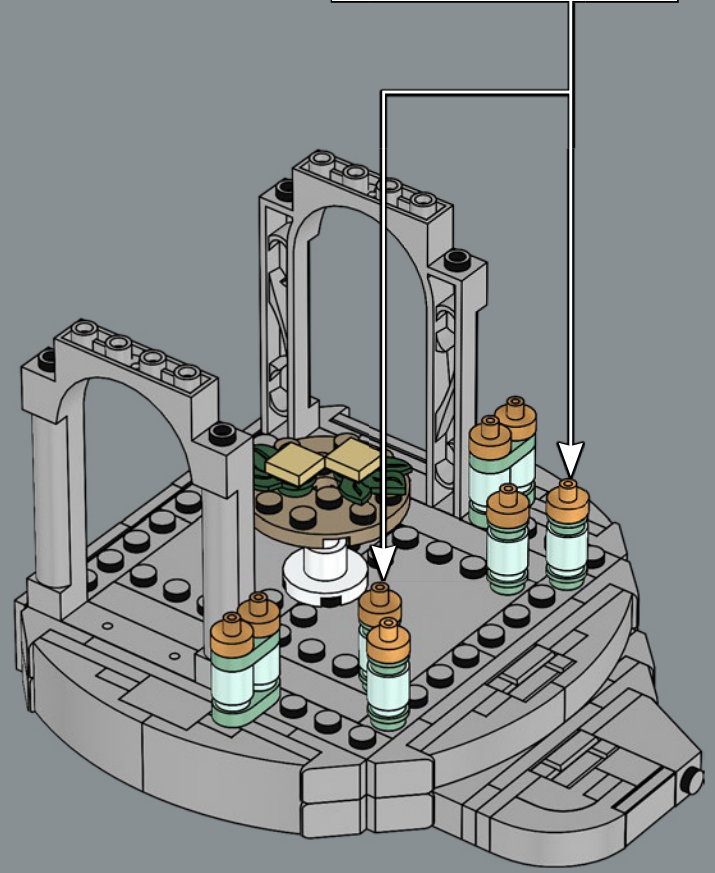
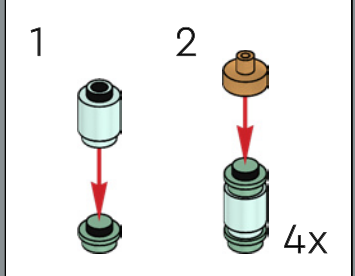

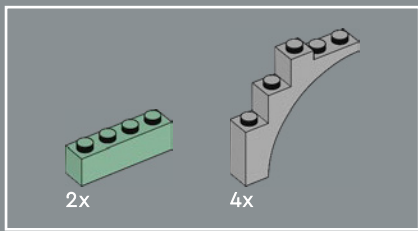

254

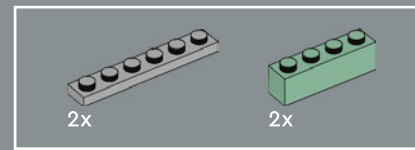
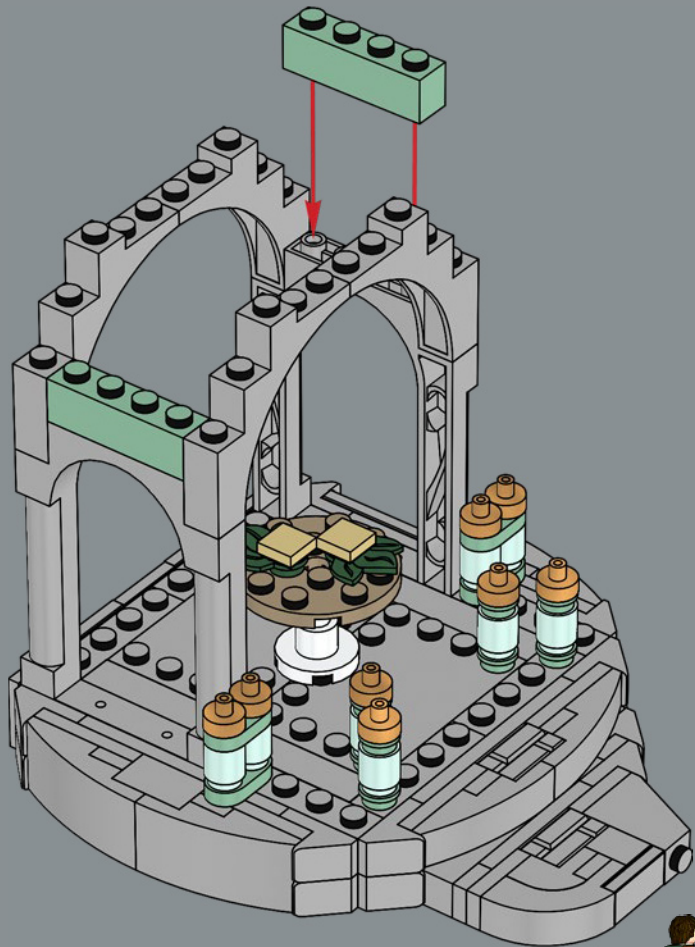

255

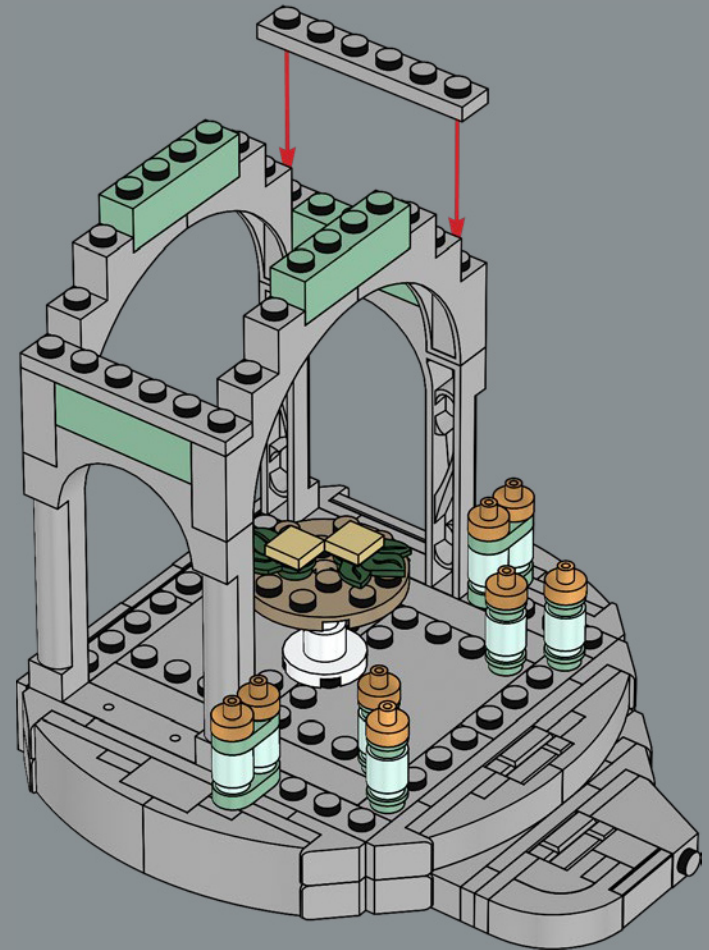

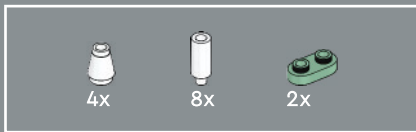

256

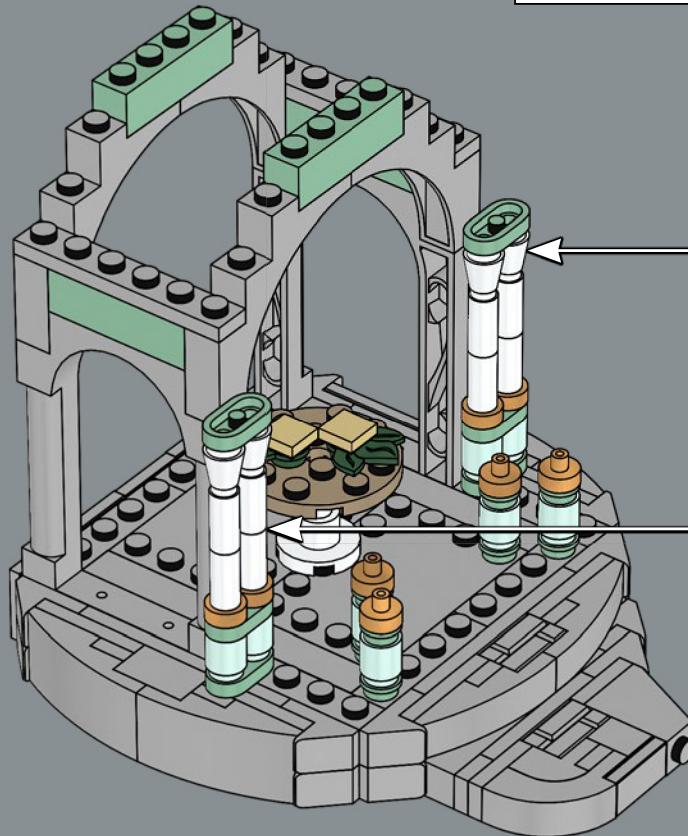
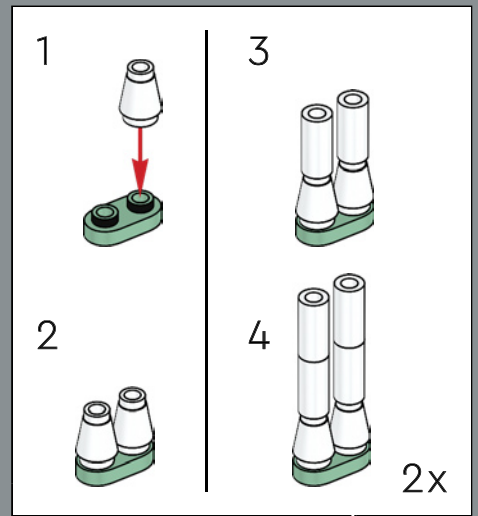

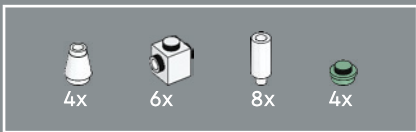

257

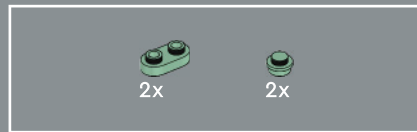
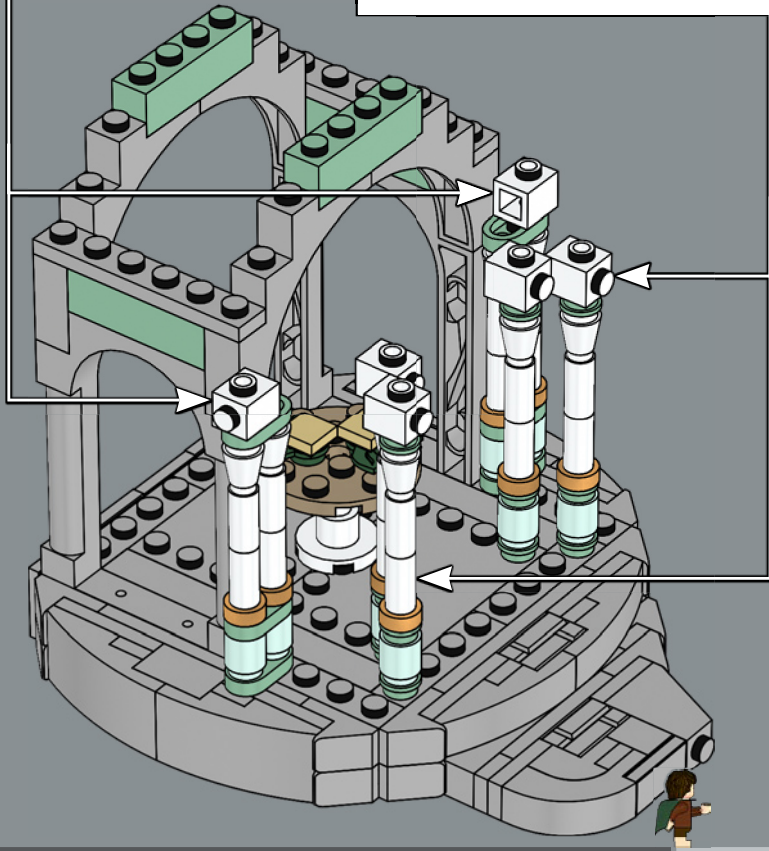
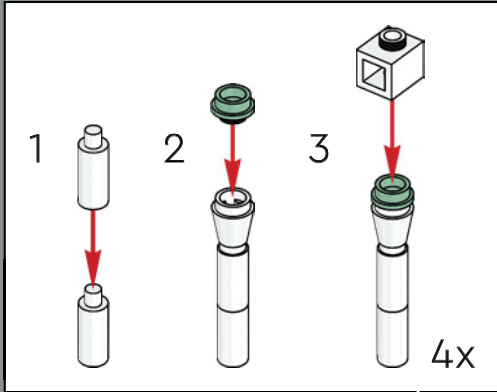
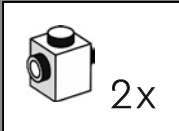

258

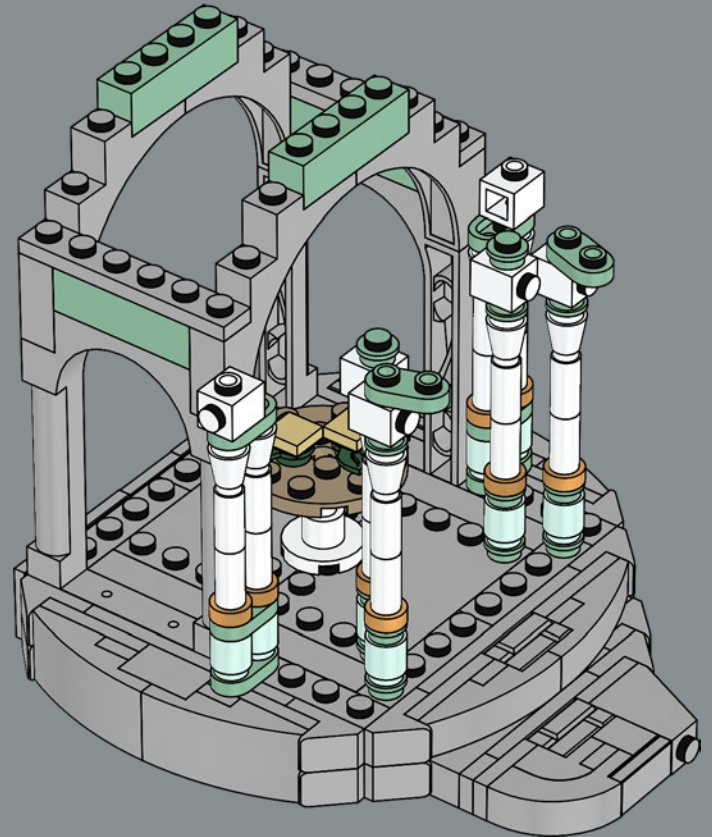

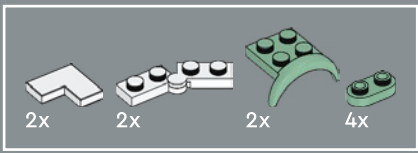

259

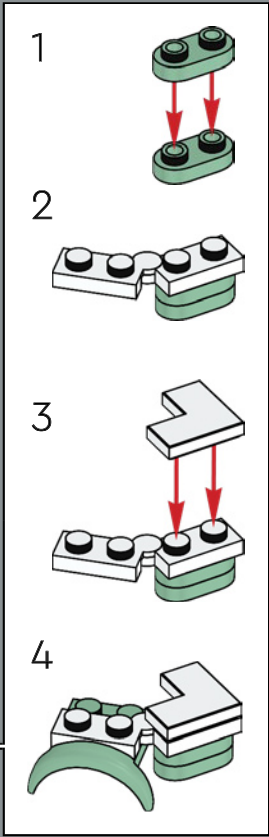
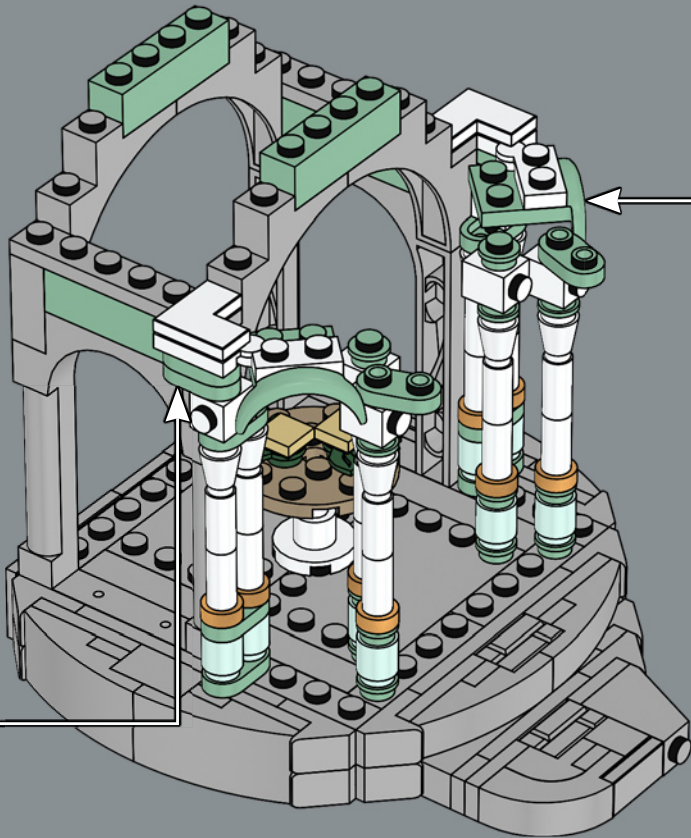
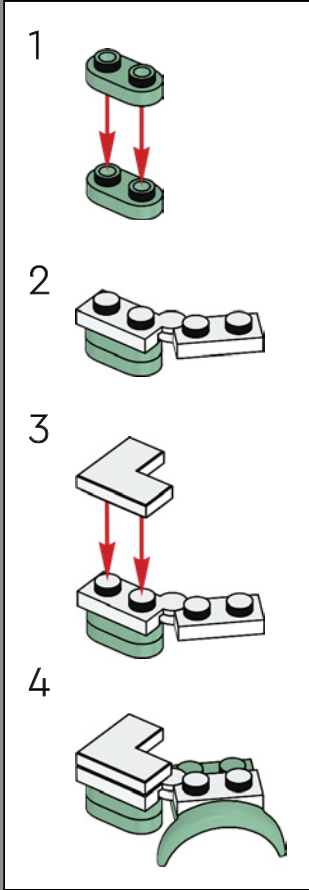

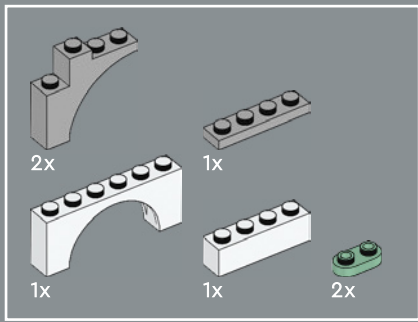

260

1

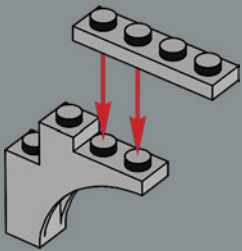

2

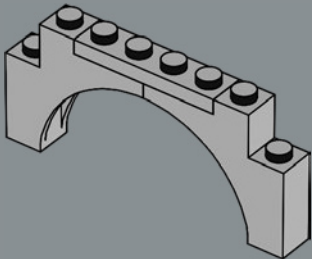

3

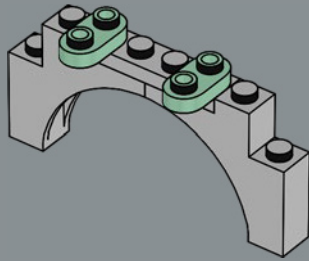

4

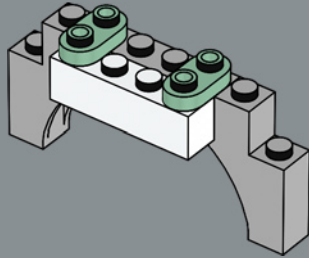

5

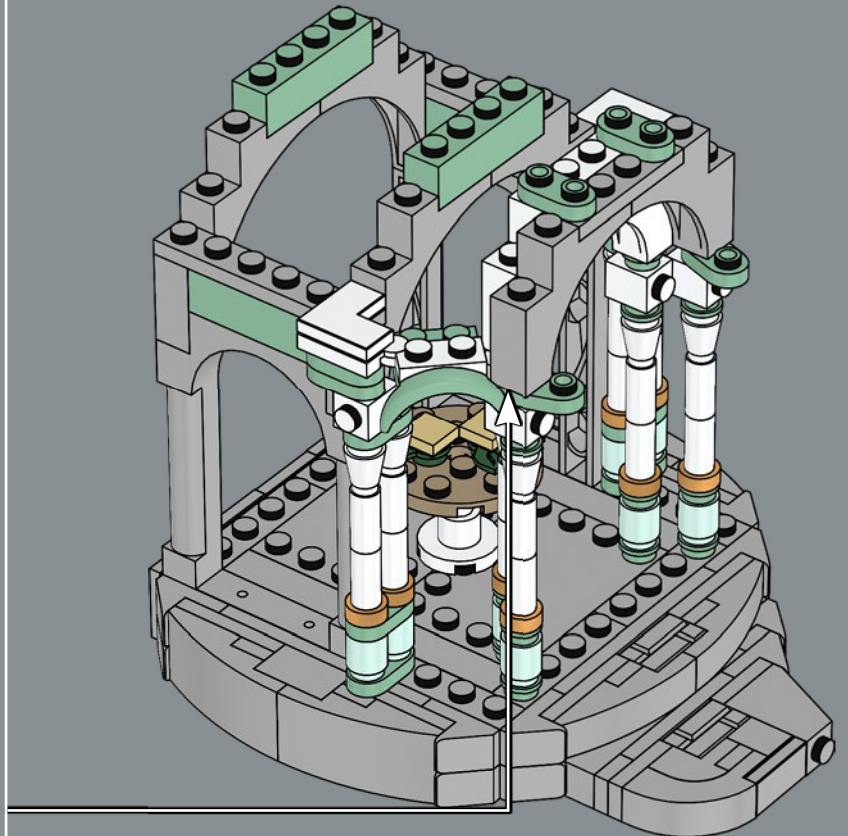
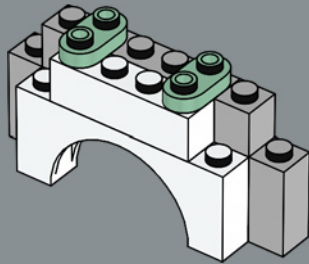

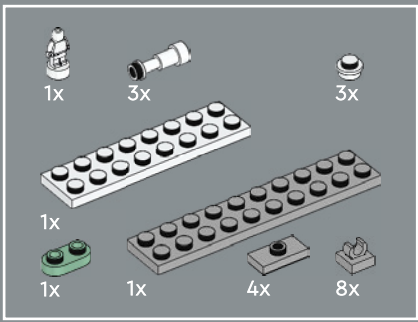

261

1

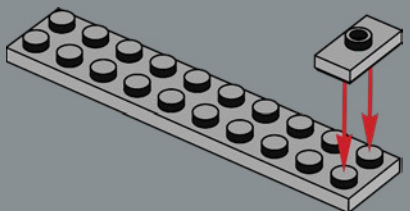

2

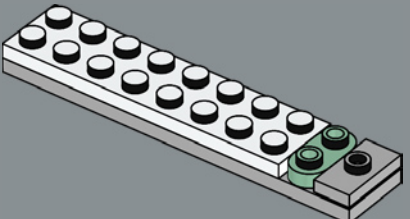

3

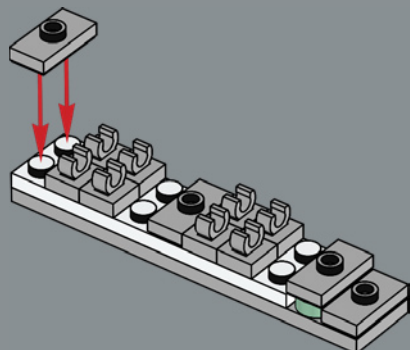

4

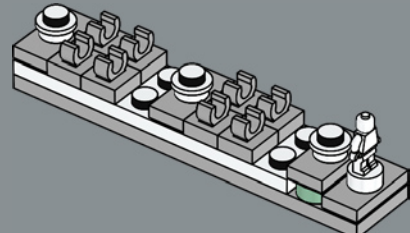

5

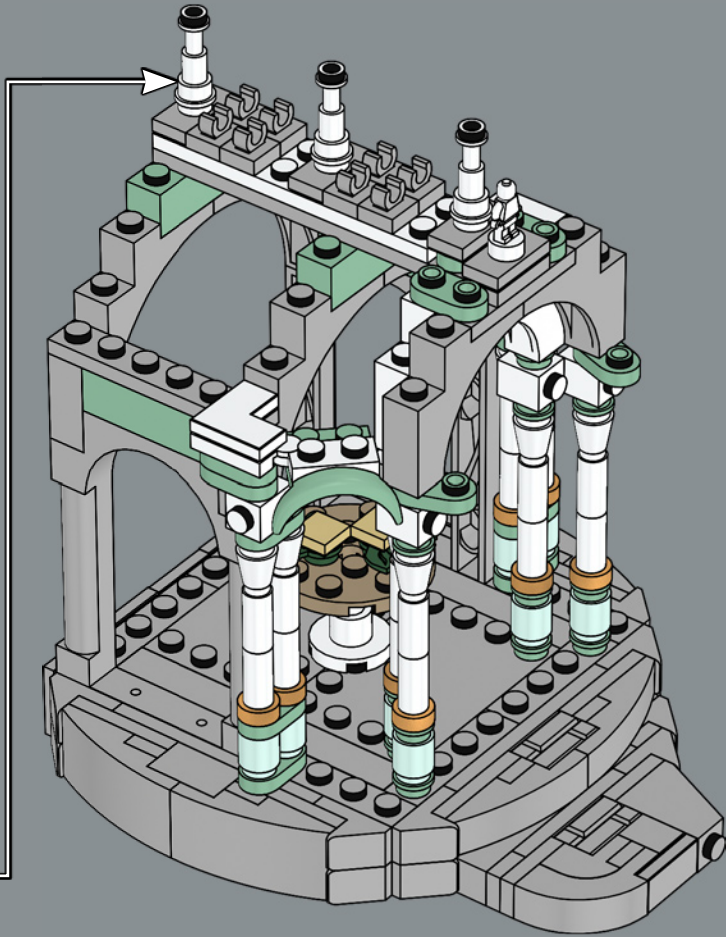
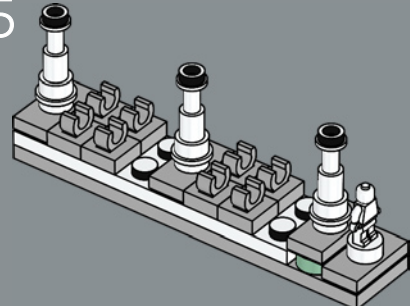

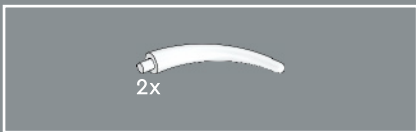

262

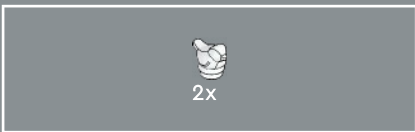
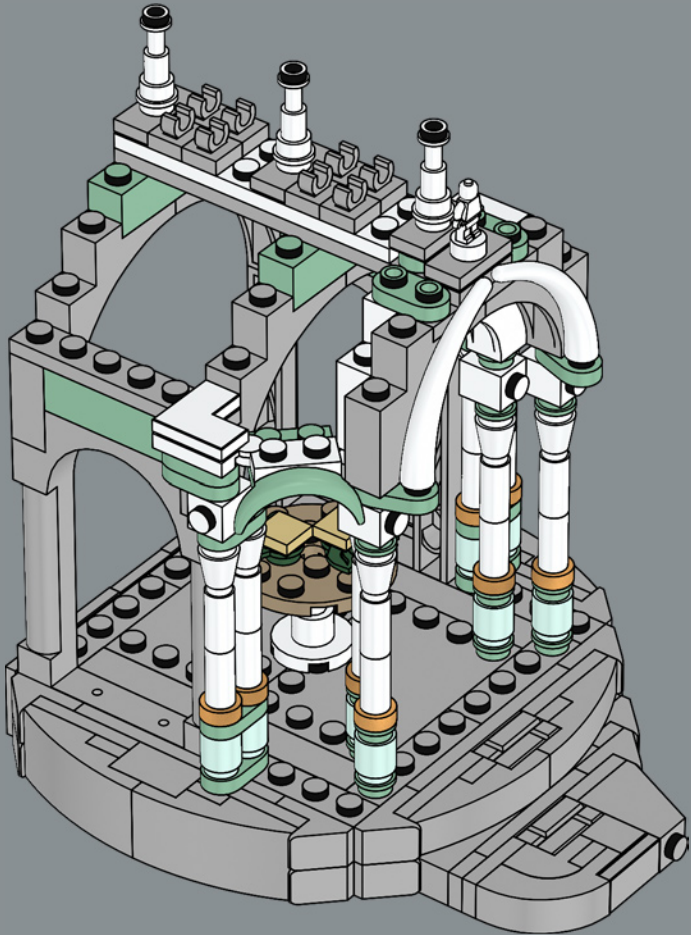

263

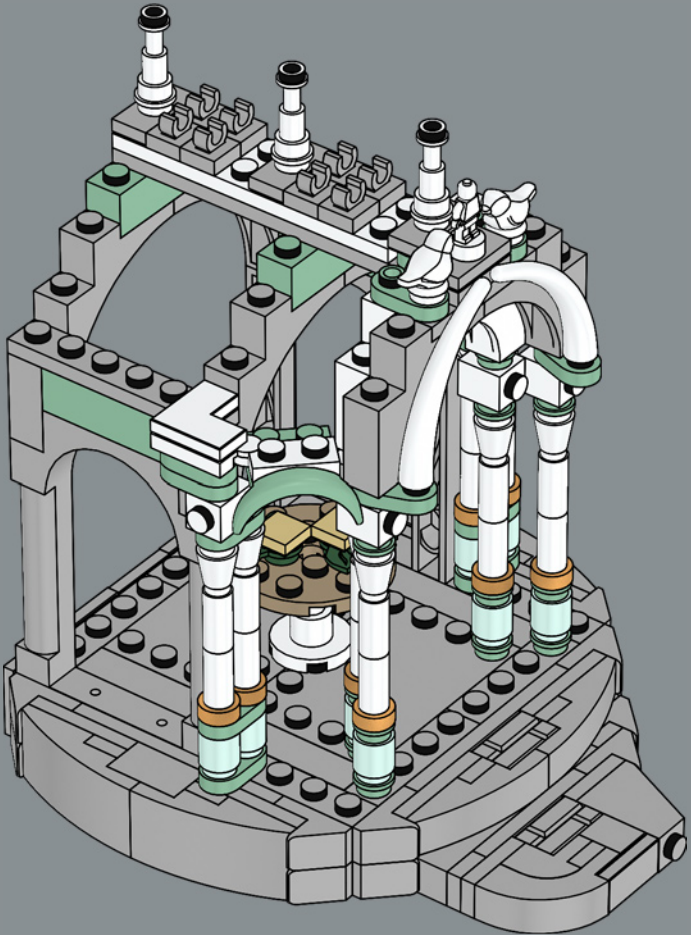

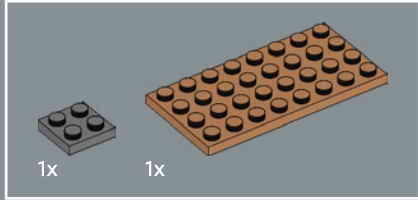
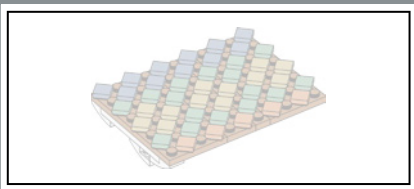

264

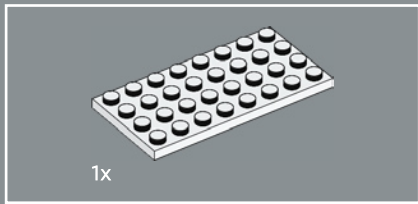

265

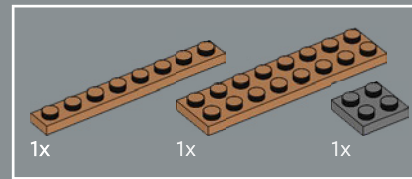

266

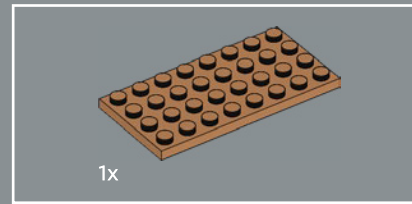
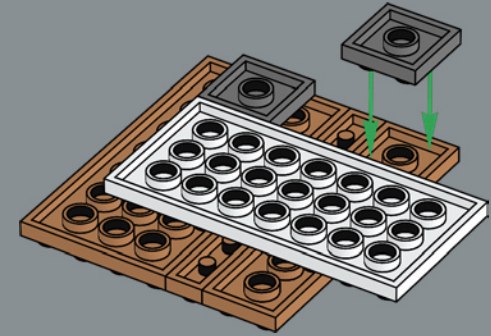

267

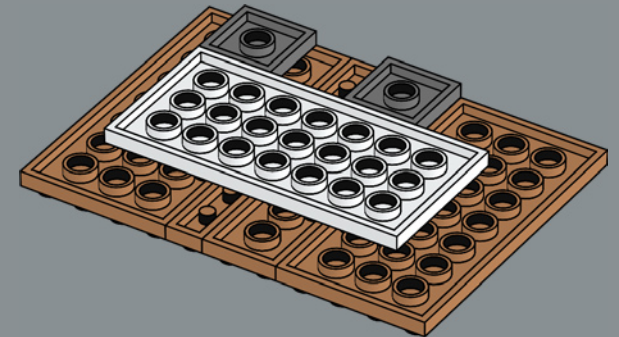

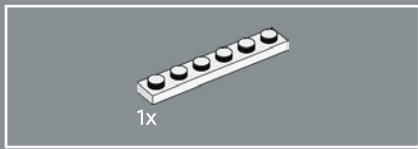

268

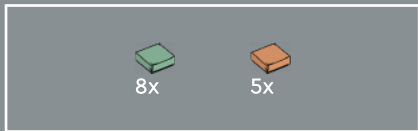
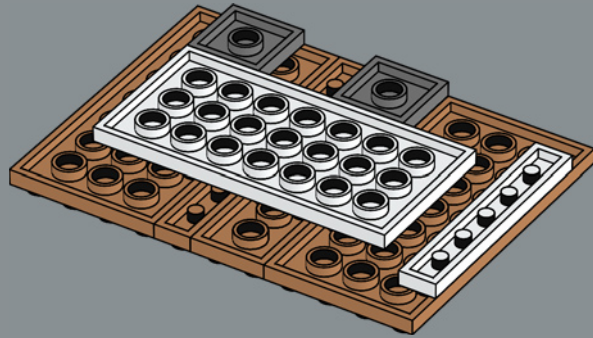

269

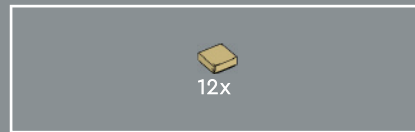
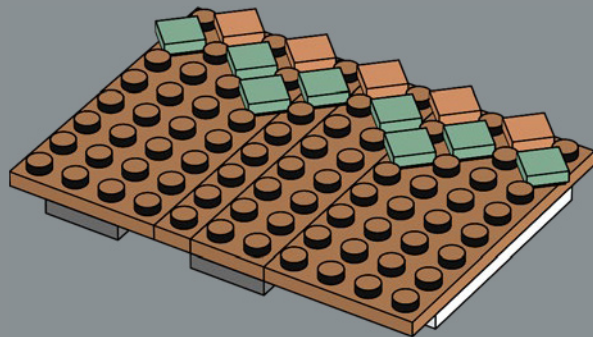

270

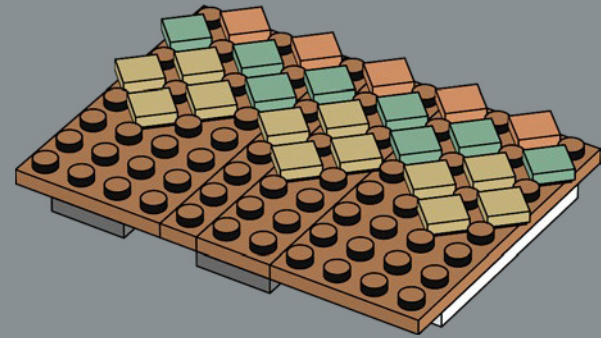

271

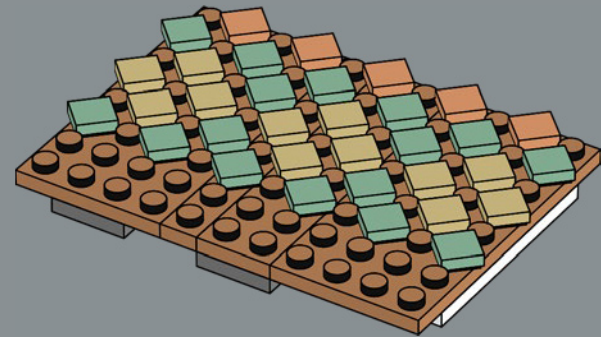

11x

272

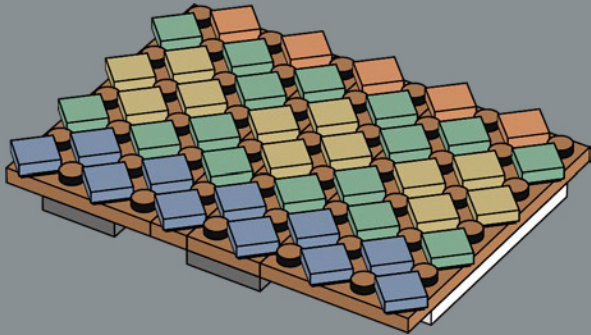

1x

3x

2x

273

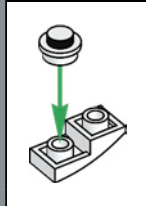
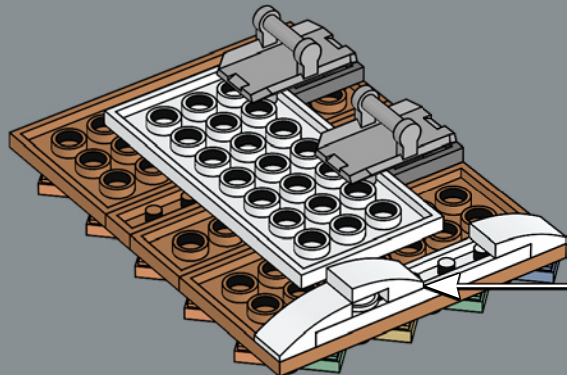

274

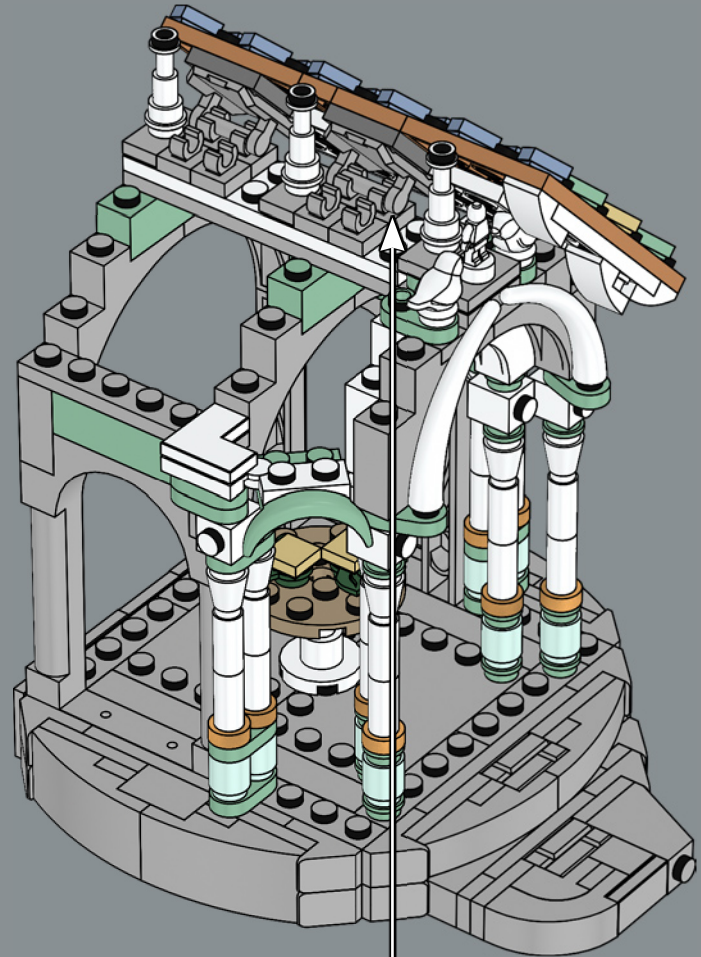

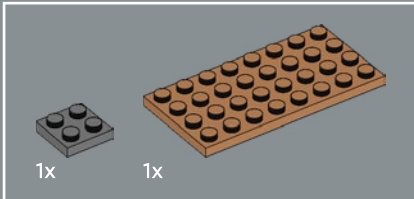
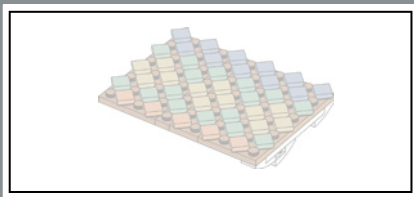

275

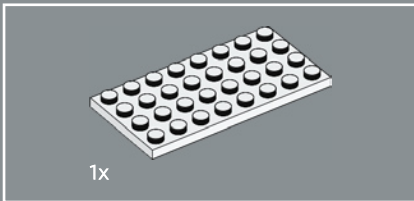
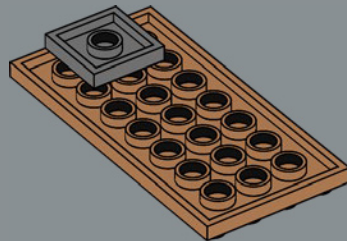

276

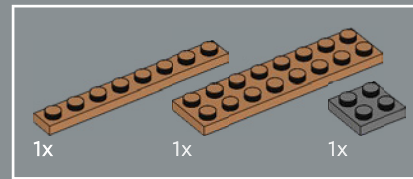
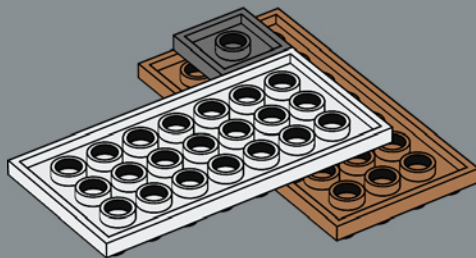

277

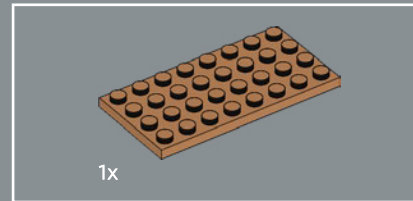
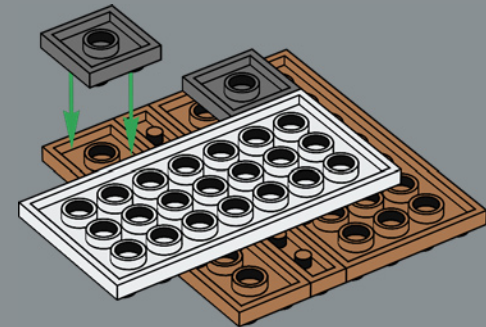

278

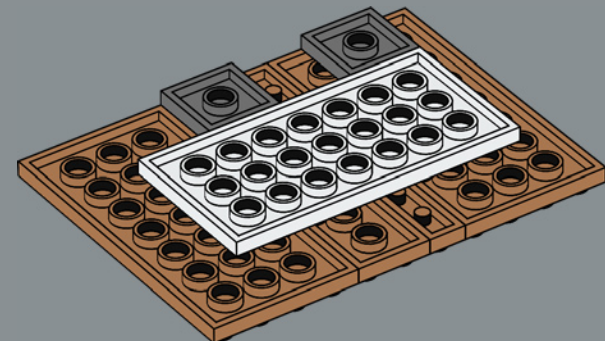

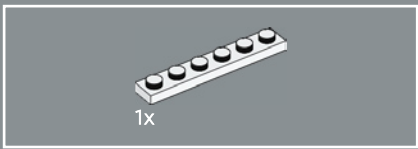

279

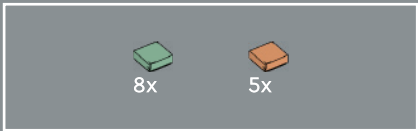
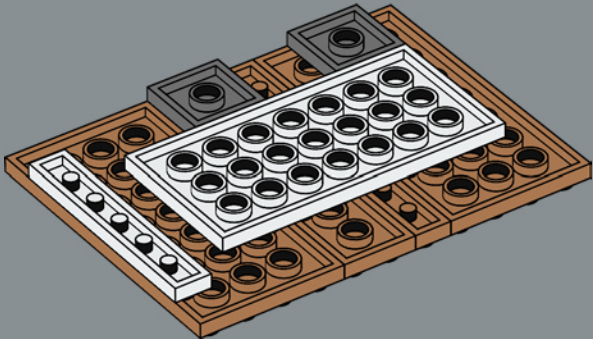

280

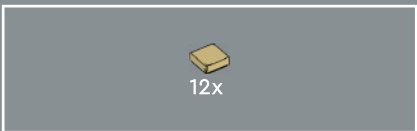
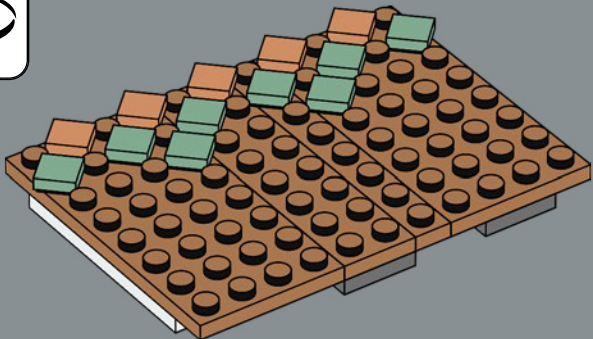

281

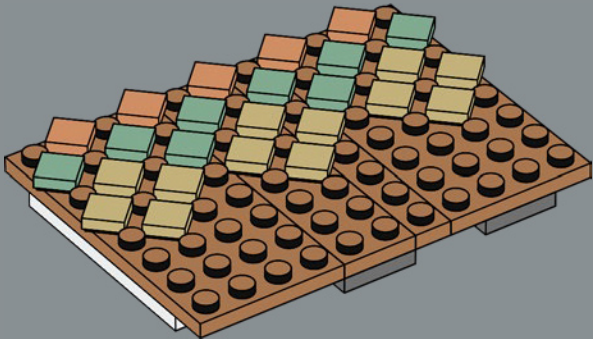

282

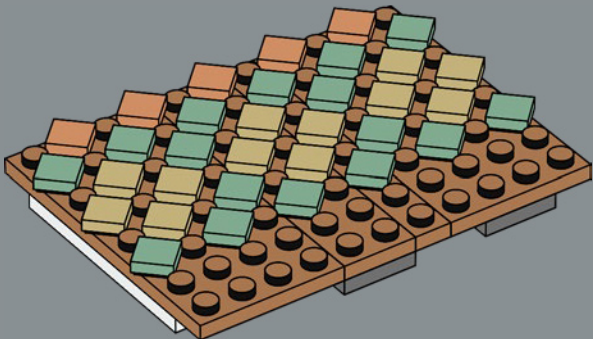



283

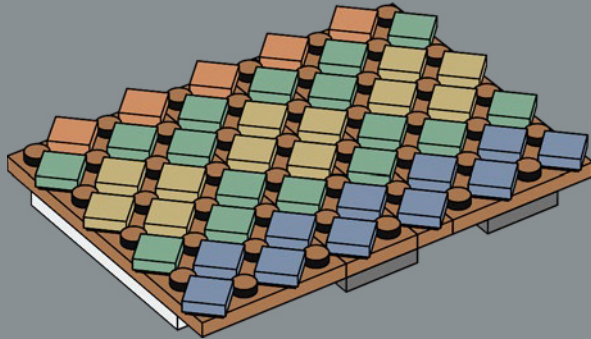

284

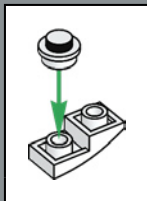
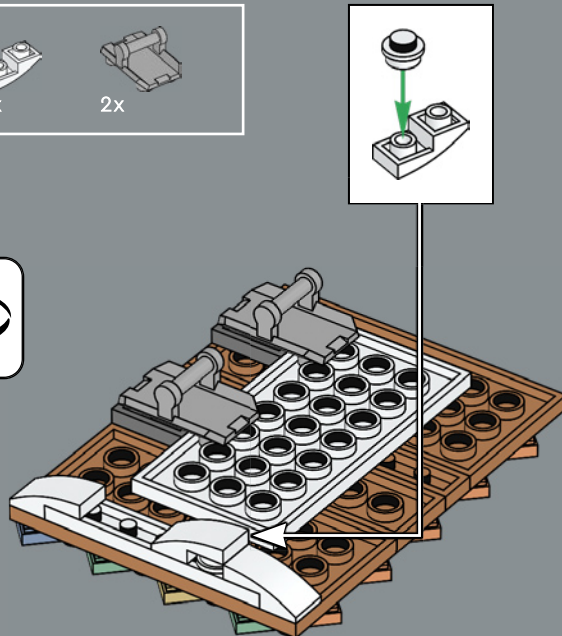

285

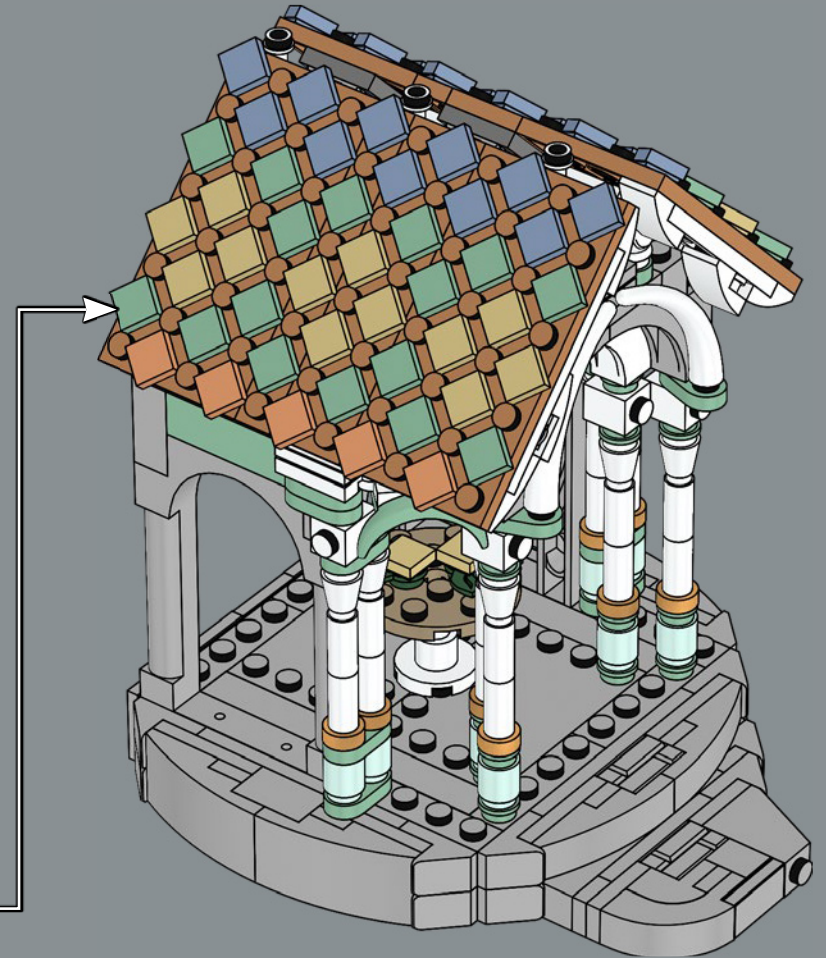

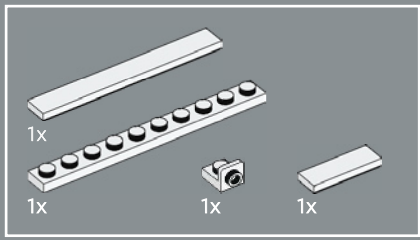

286

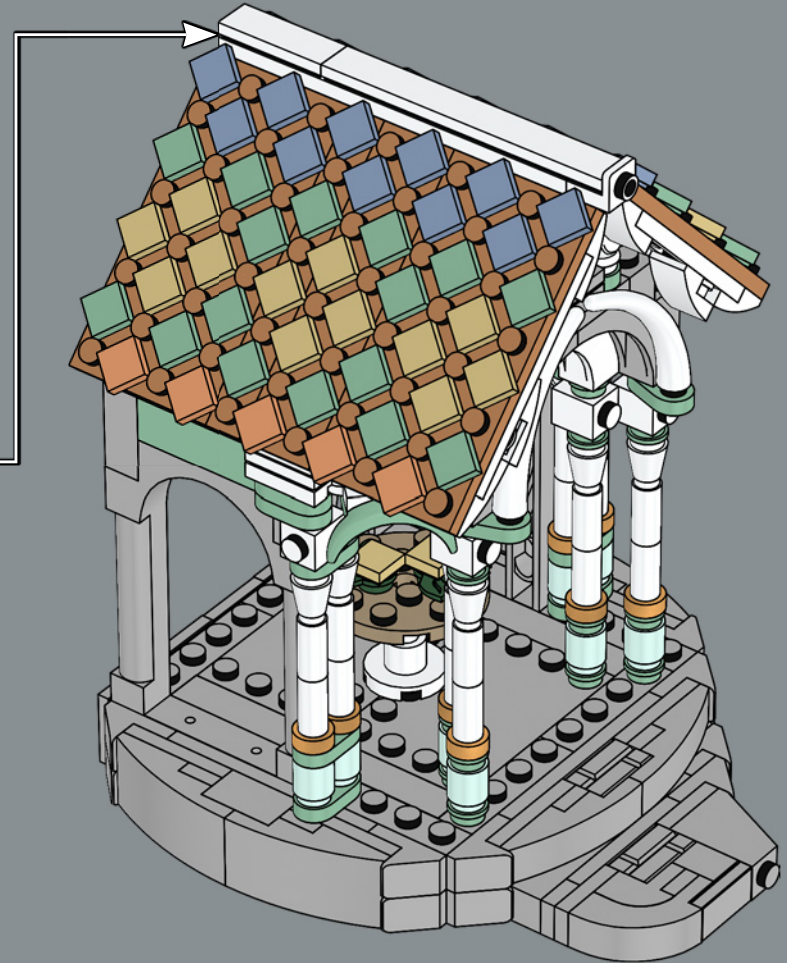
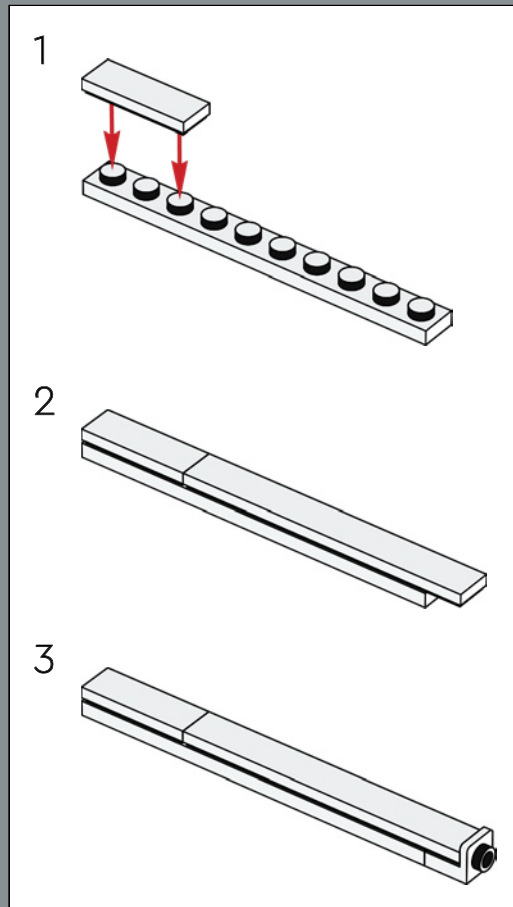



1x

288

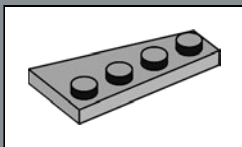

This plate is attached so it will line up perfectly with the bridge later.

Cette plaque est fixée de façon à s'aligner parfaitement avec le pont plus tard.

Esta placa debe colocarse de forma que, posteriormente, quede perfectamente alineada con el puente.

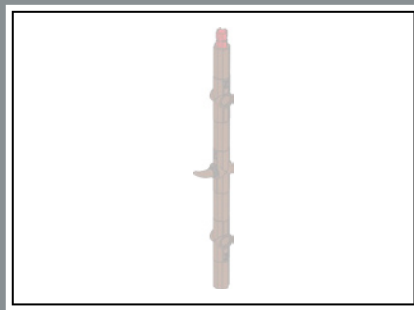

289

1



2



3



4

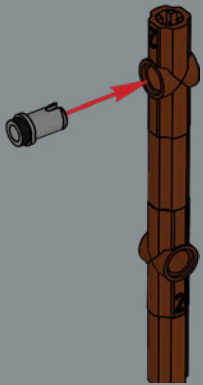

5

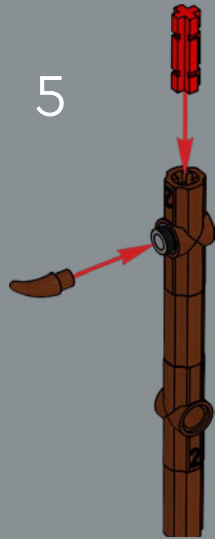

6



7



8



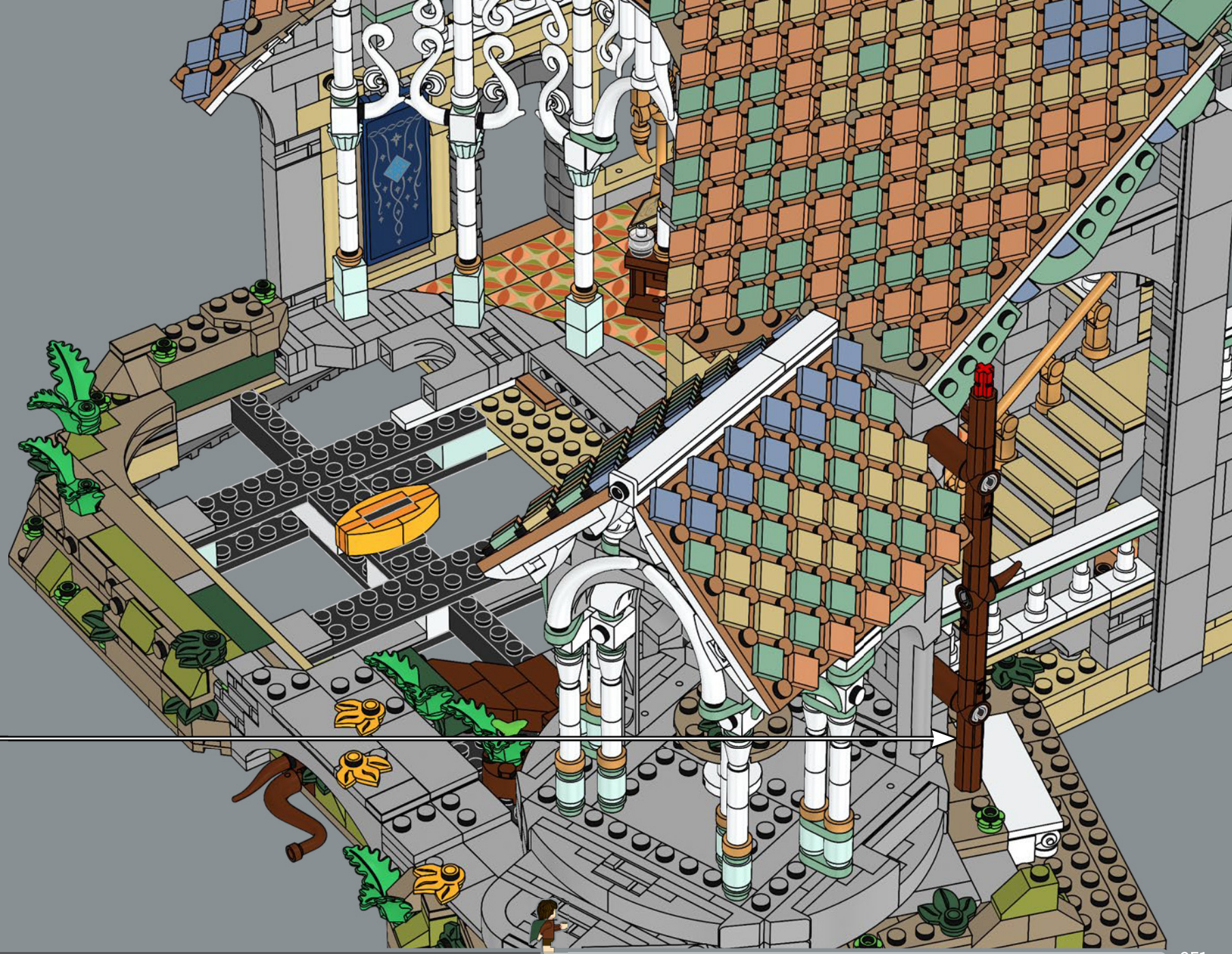

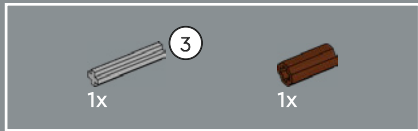
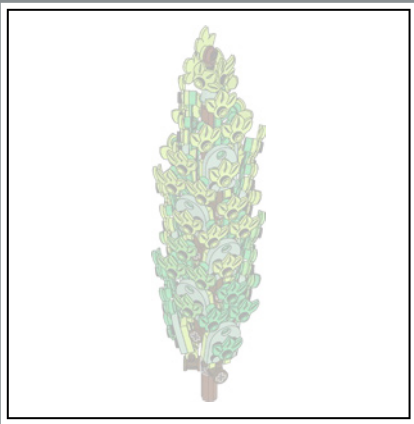

290



291

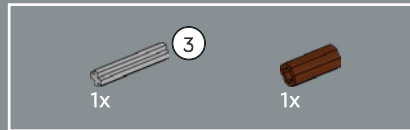
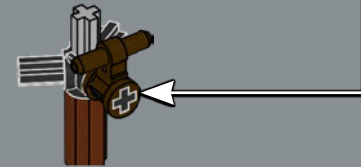
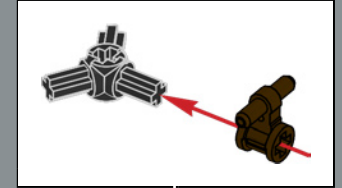
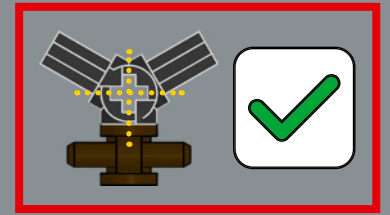

292

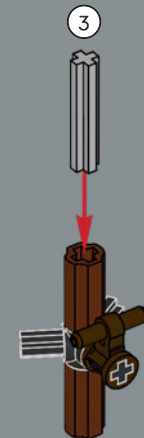

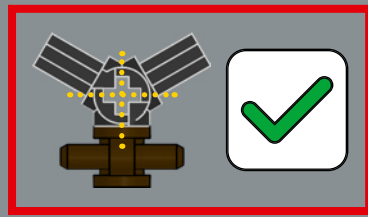

293

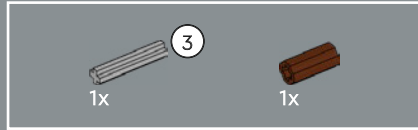
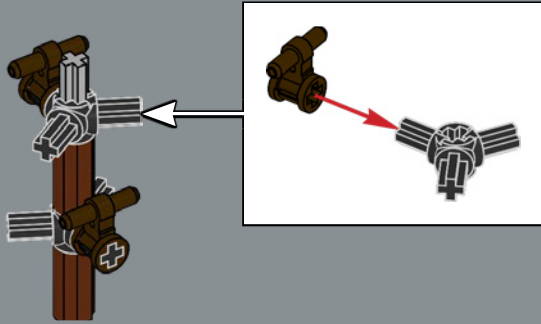

294

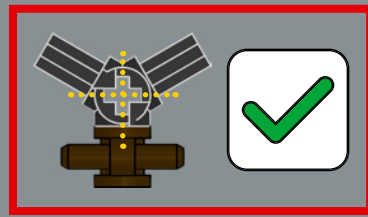
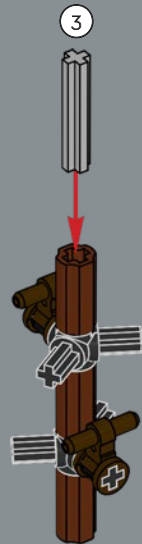

295

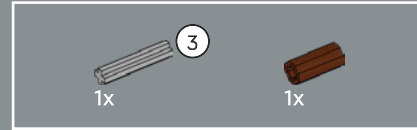
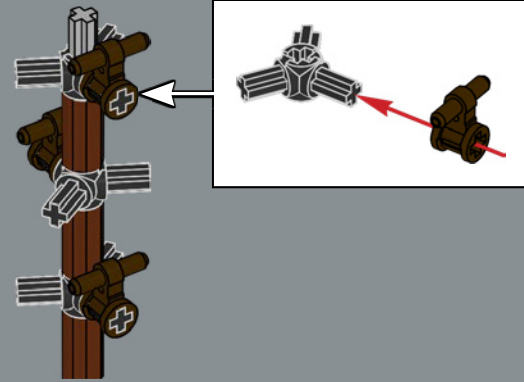

296





297

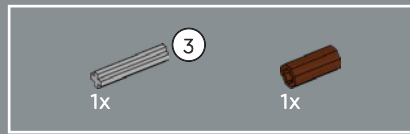
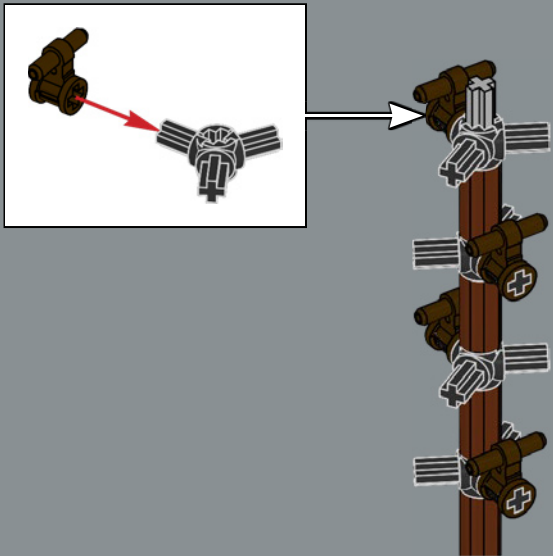
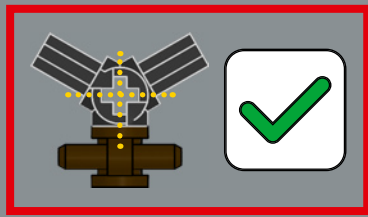

298





299

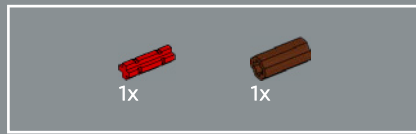
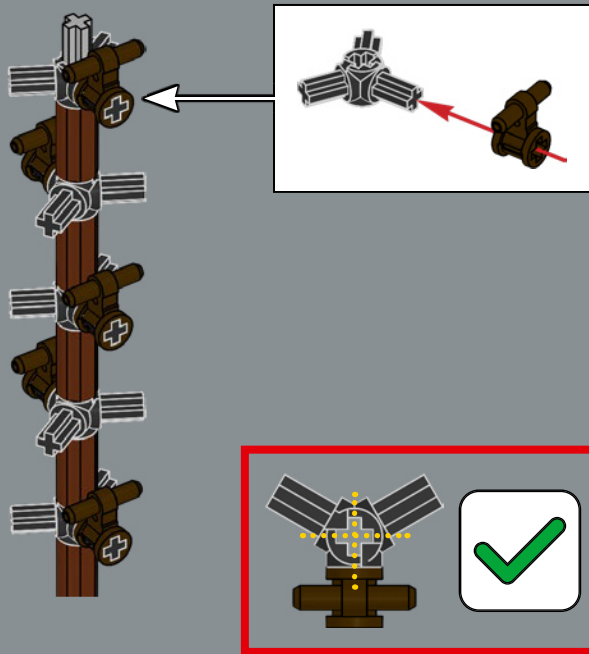

300

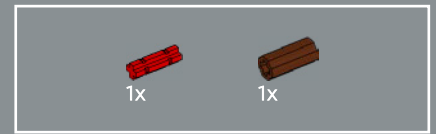

301



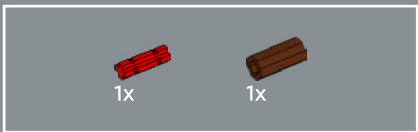

302



303



304

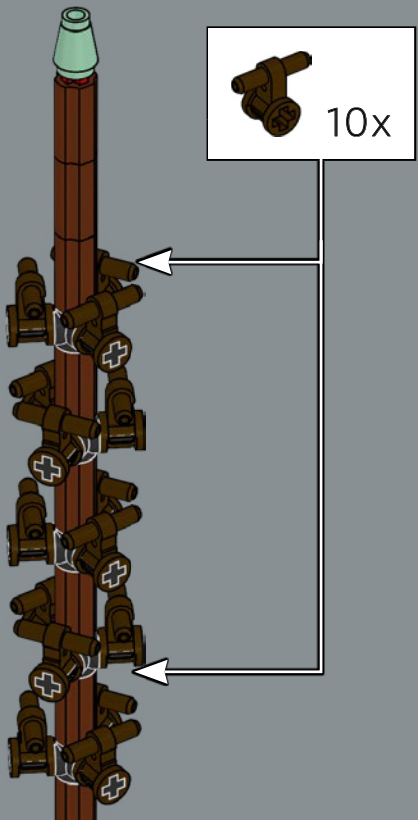



305

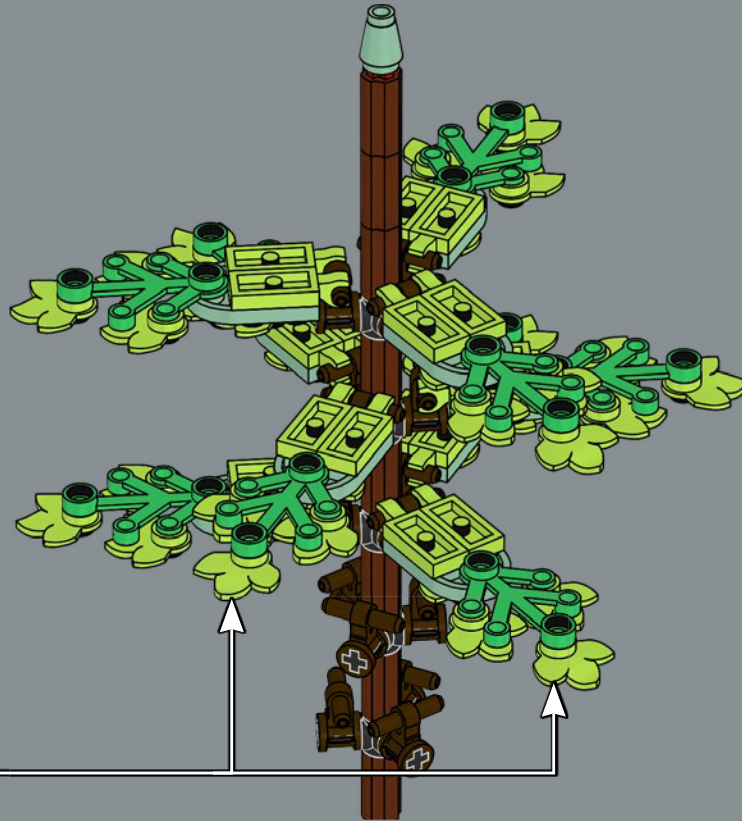
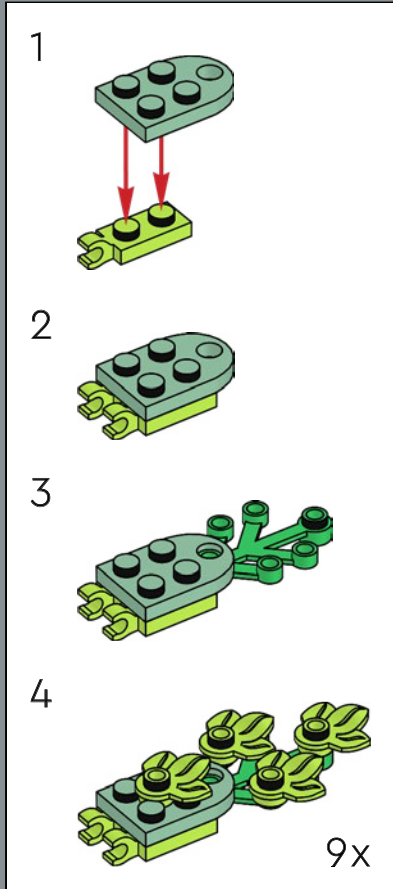

306

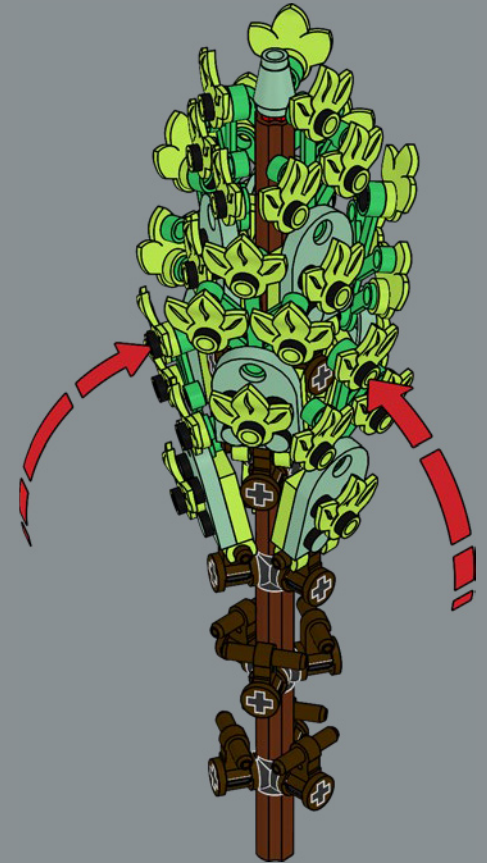

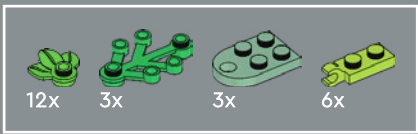

307

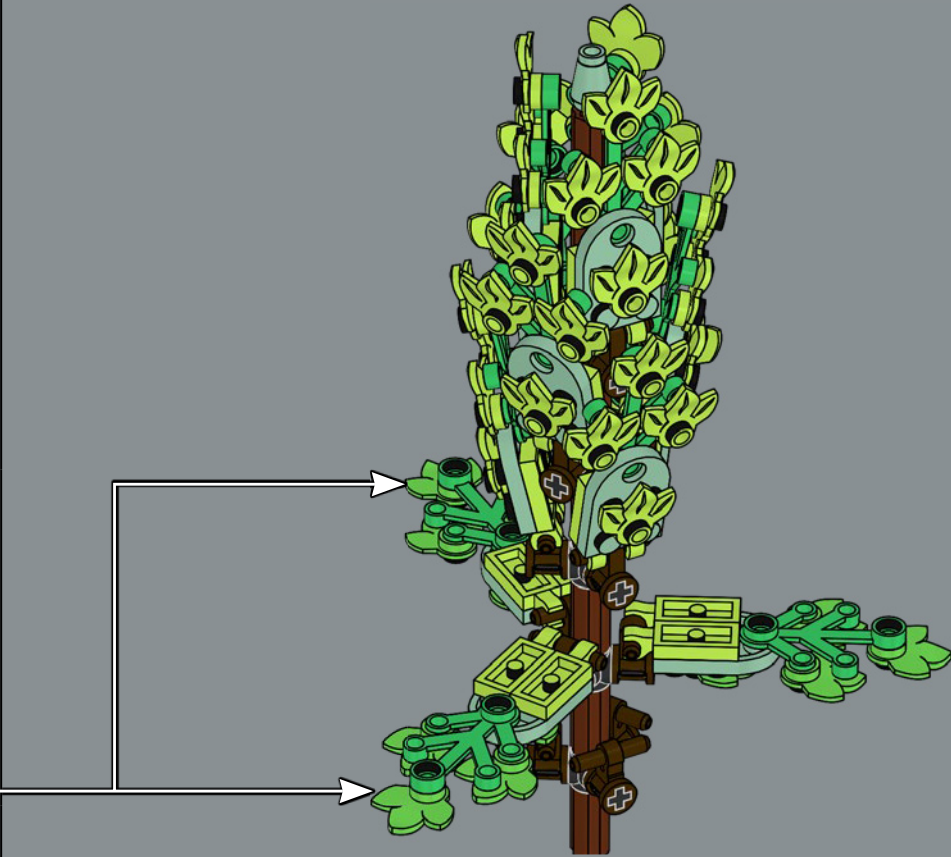
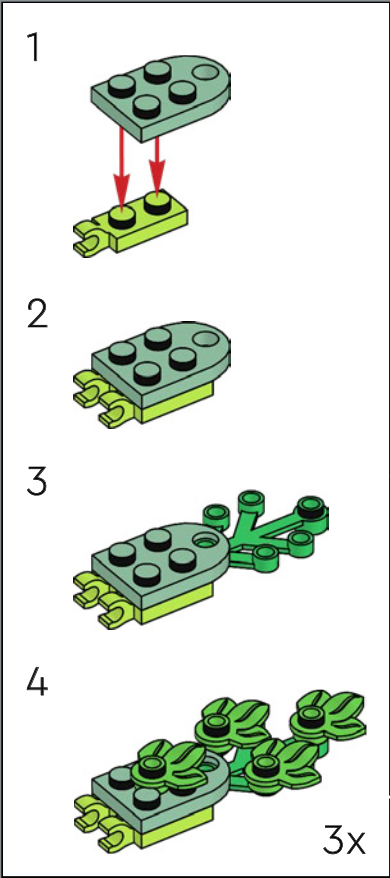

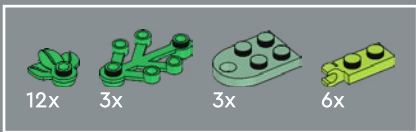

308

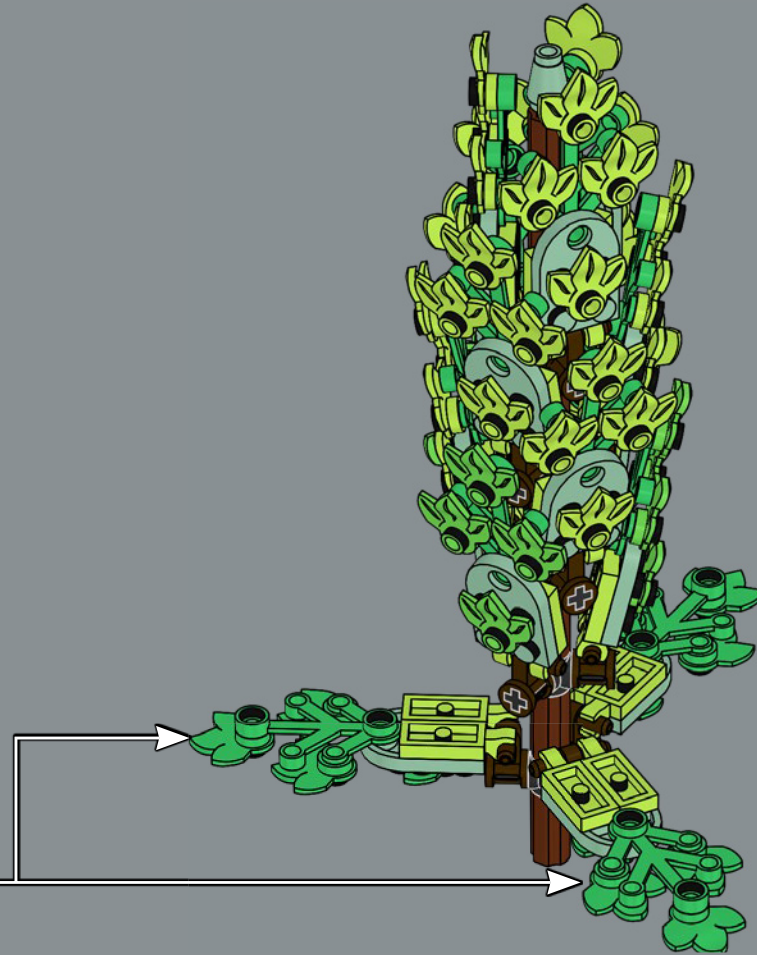
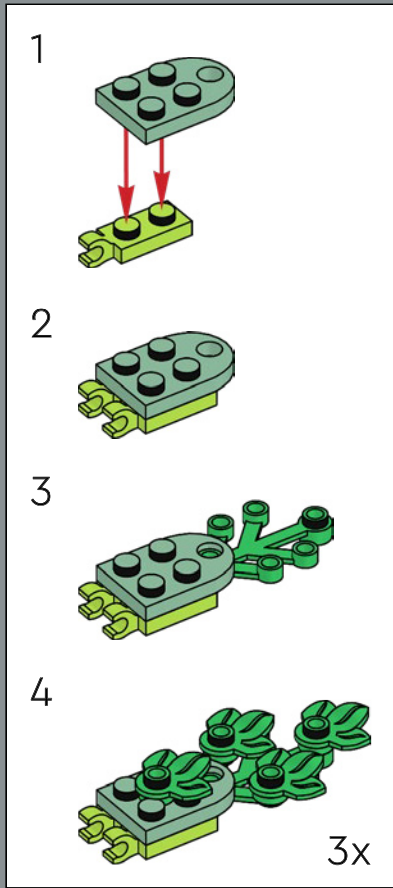



309

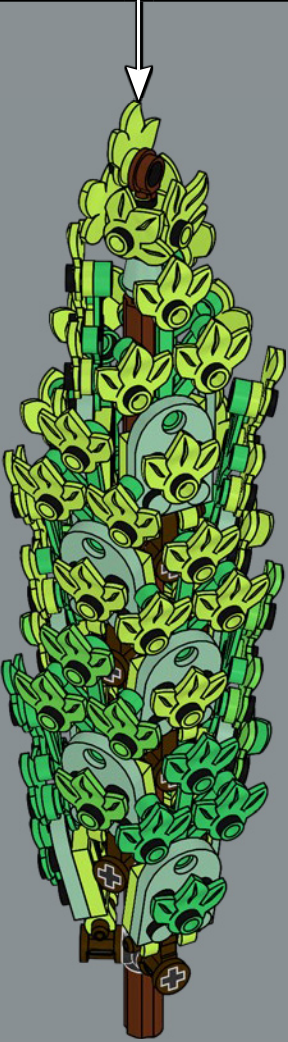
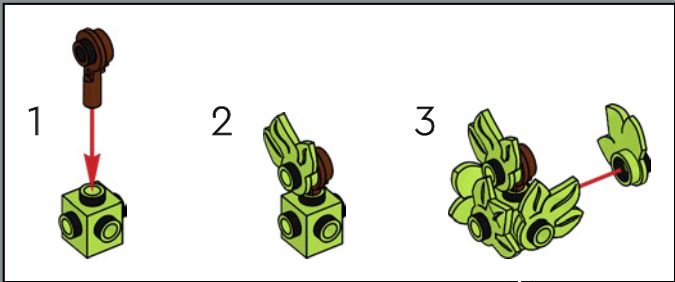

310



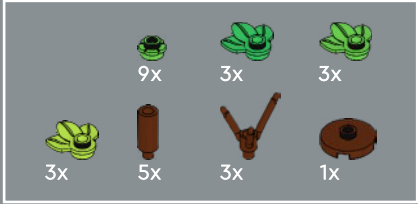
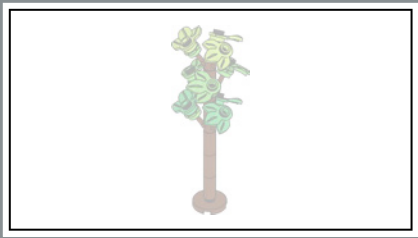

311

1



2

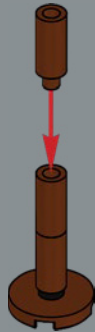

3

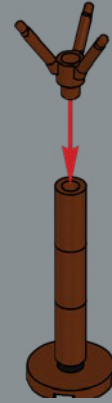

4



5



6

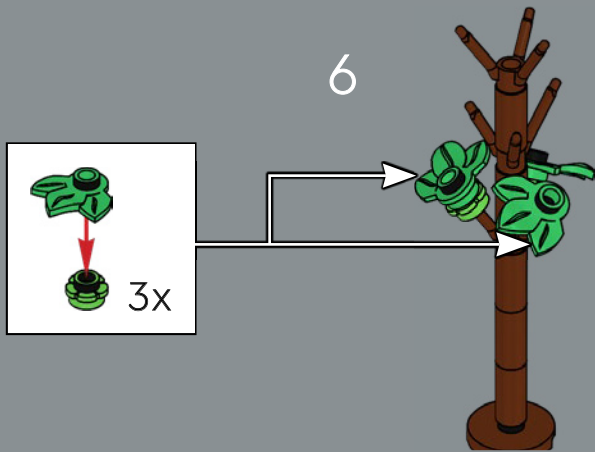

7

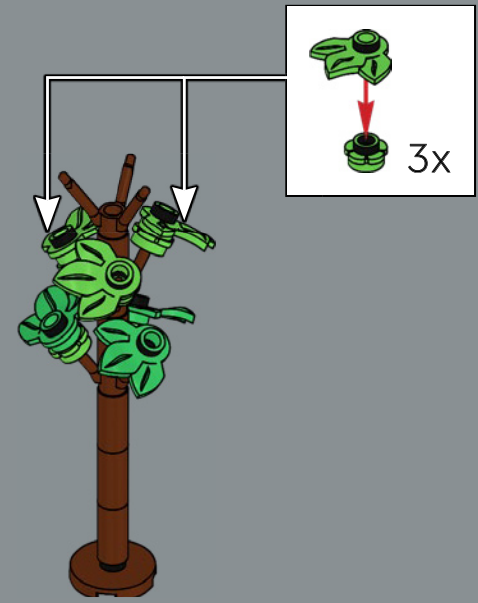

8

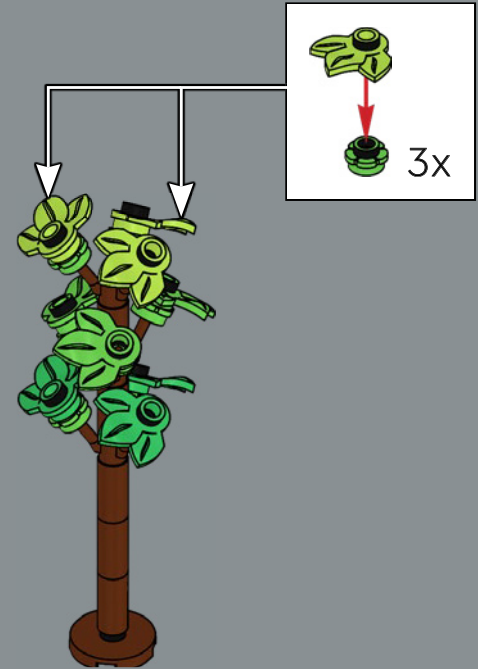

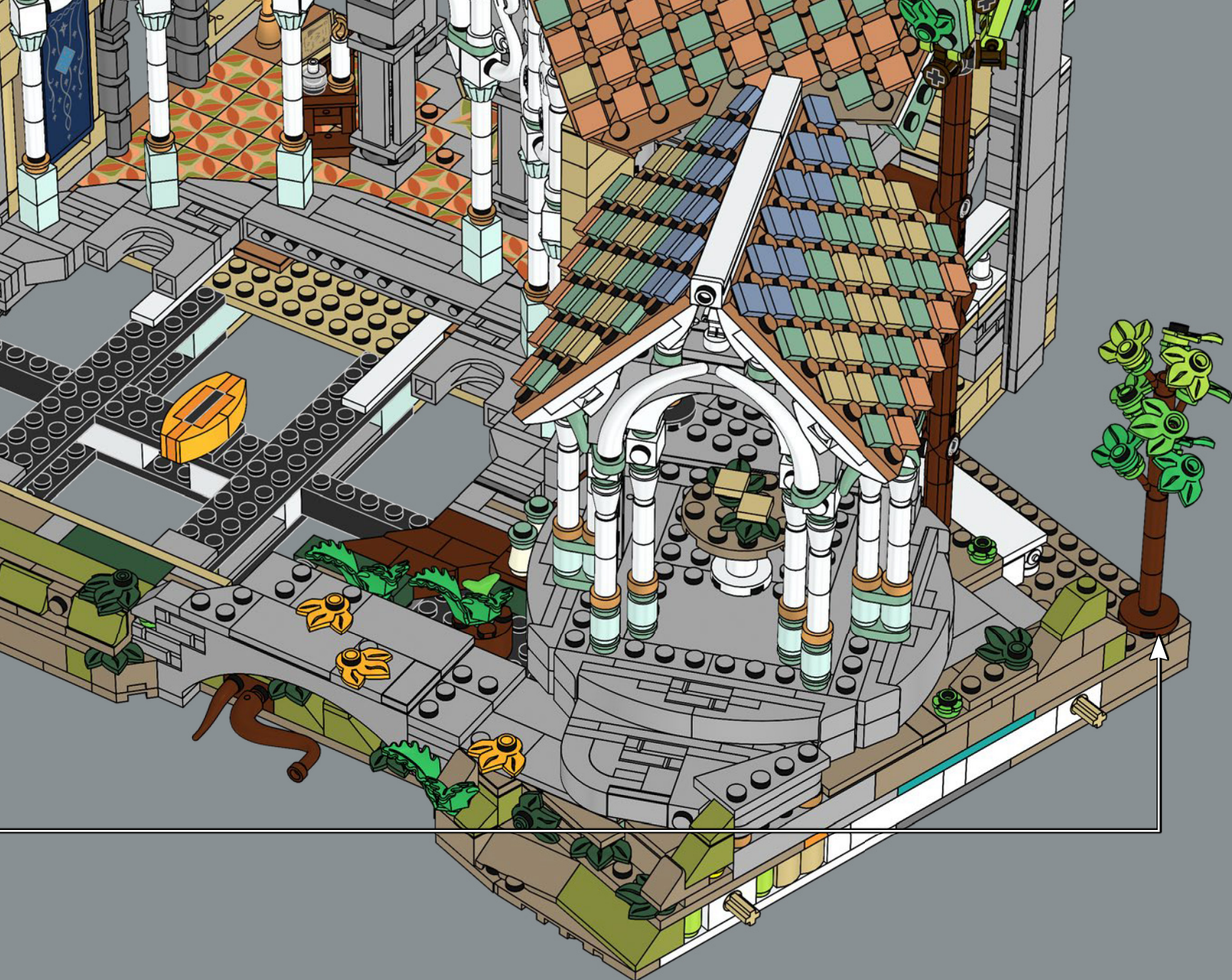

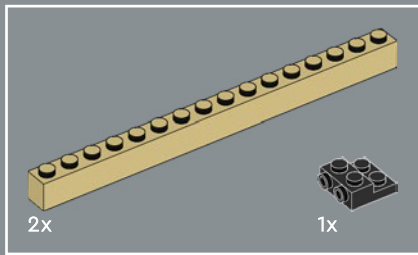

312

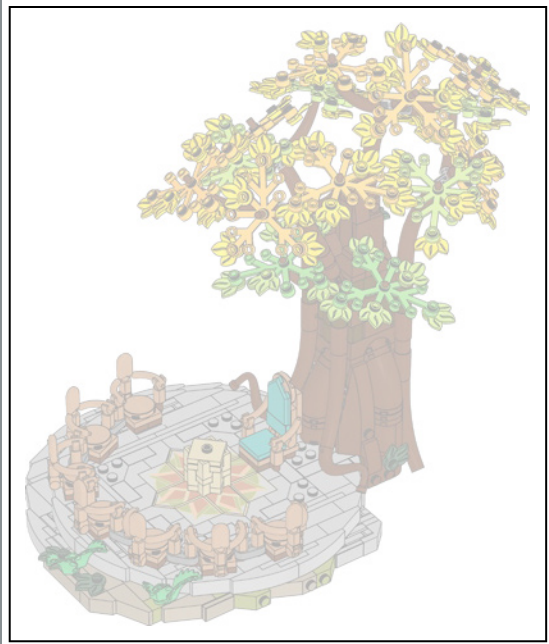
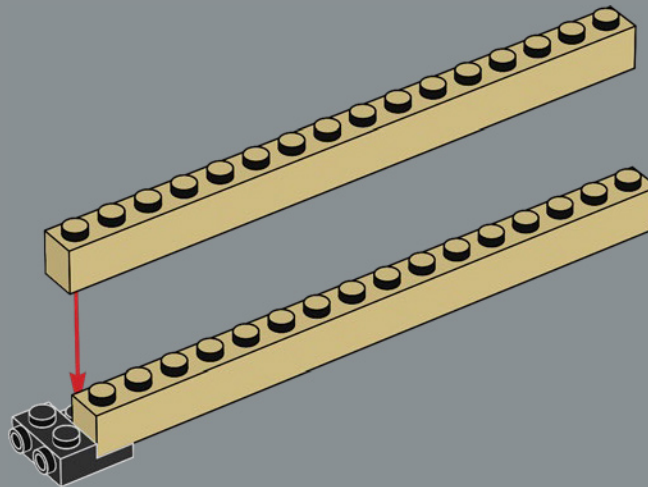

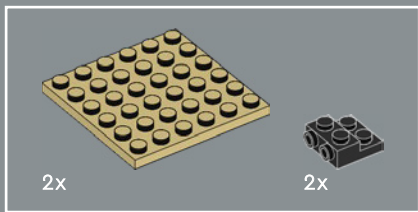

313

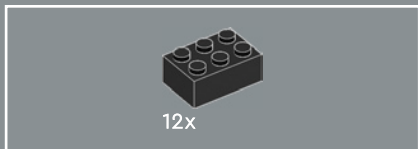
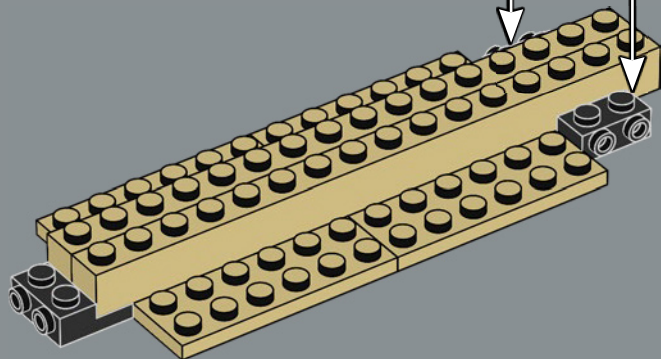
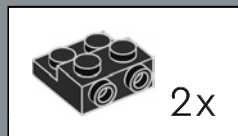

314

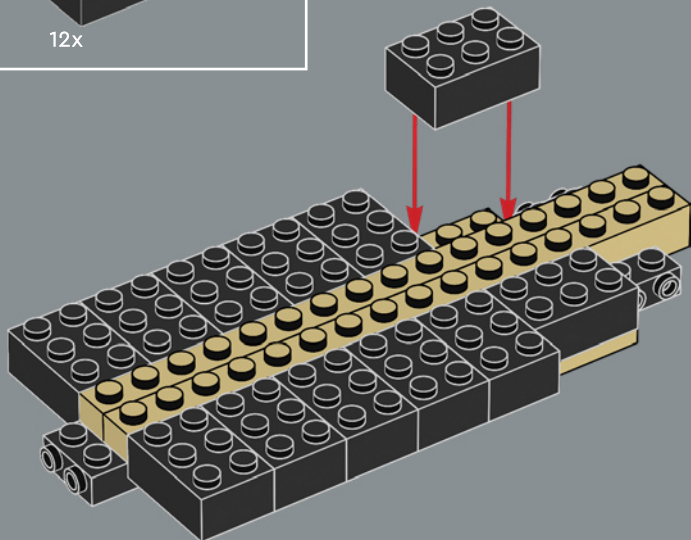

315

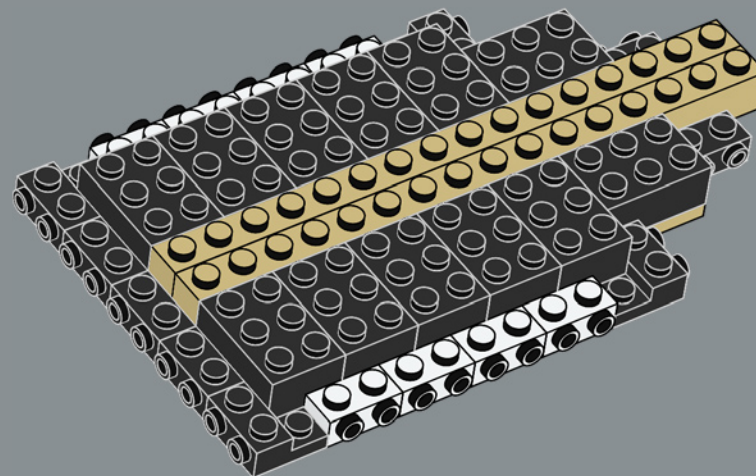

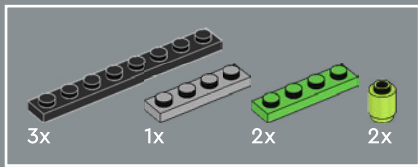

316

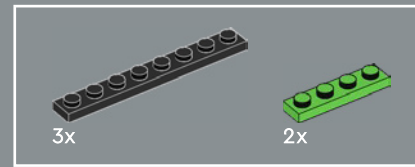
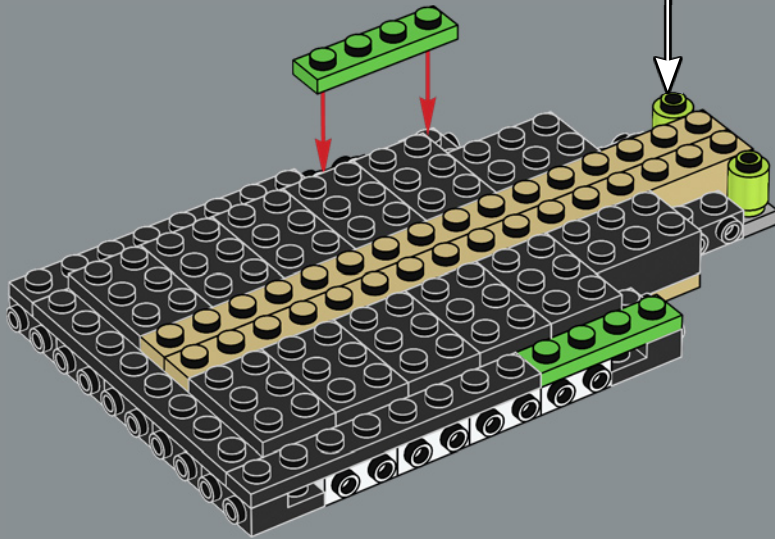
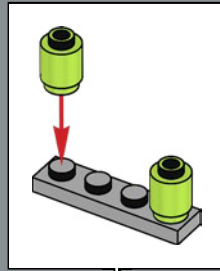

317

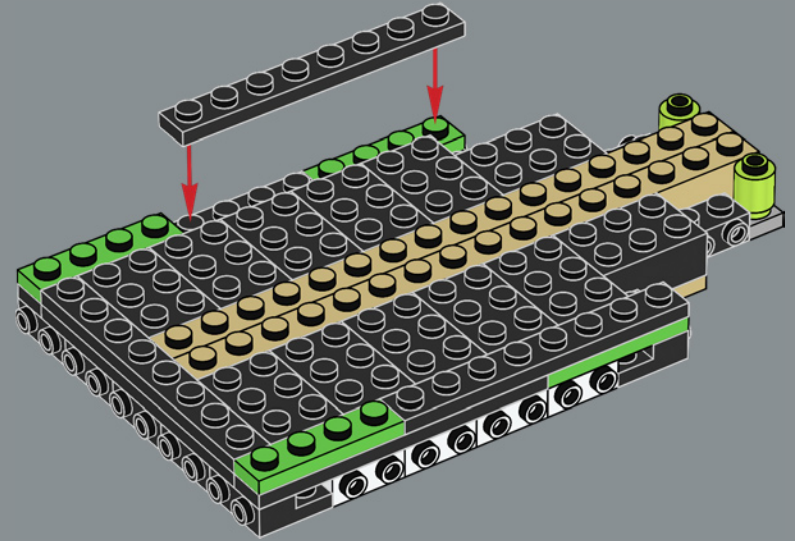

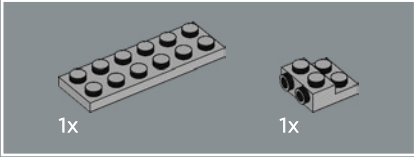
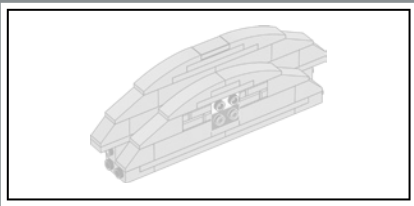

318

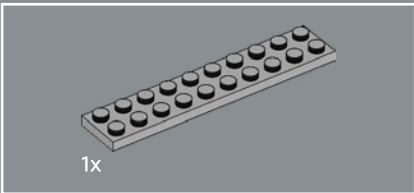
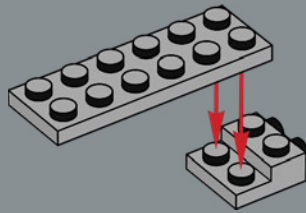

319

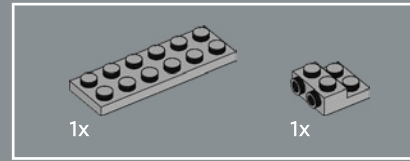
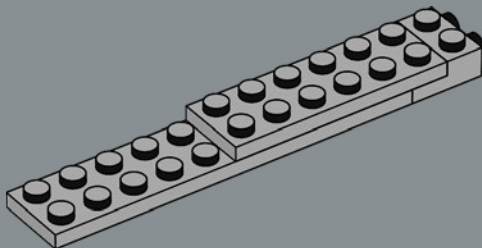

320

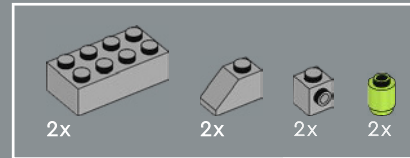
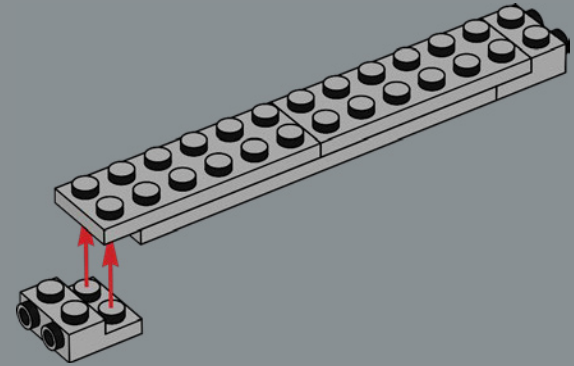

321

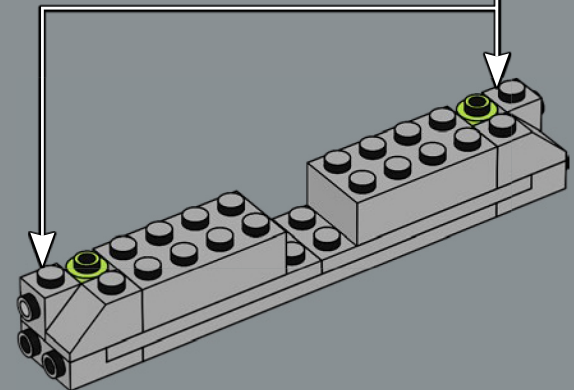
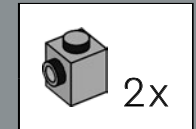

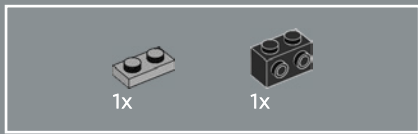

322

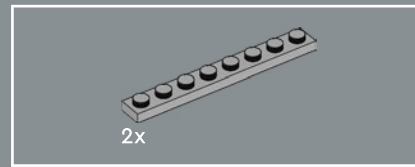
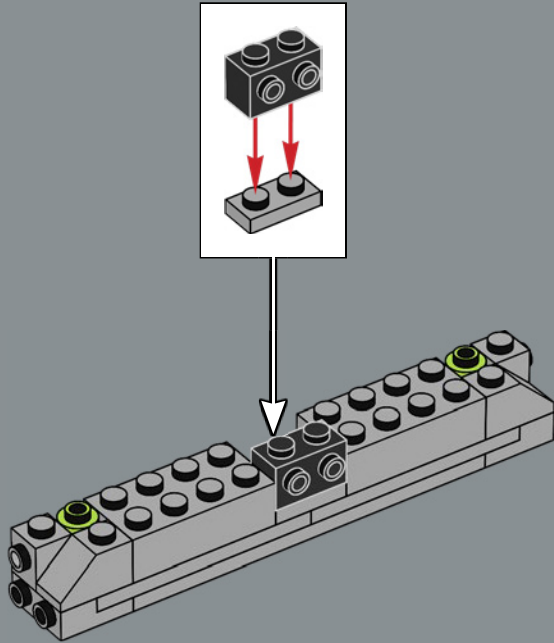

323

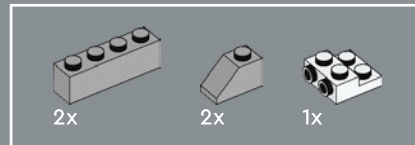
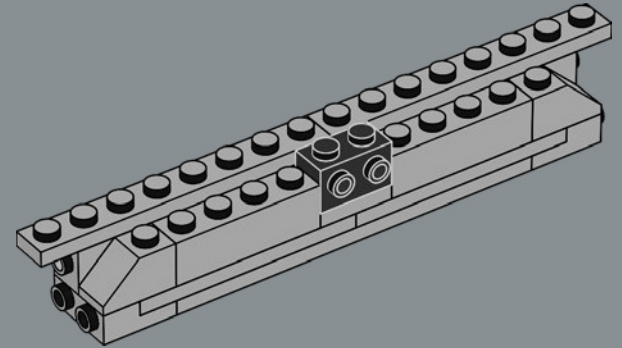

324

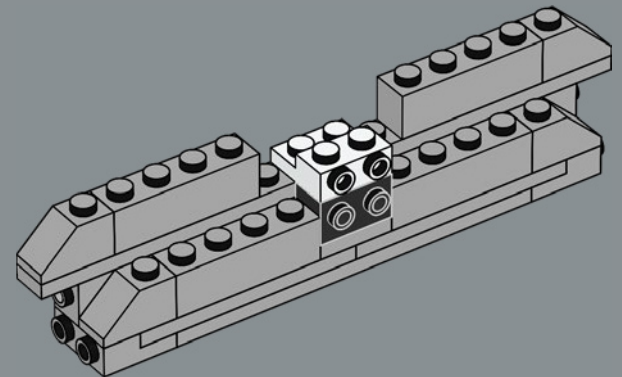

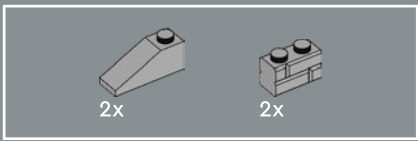

325

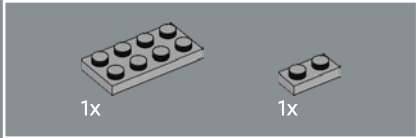
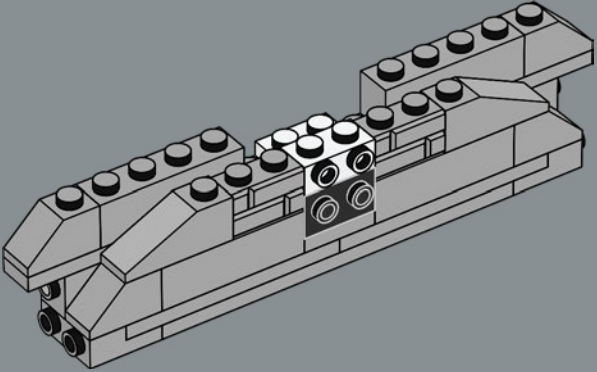

326

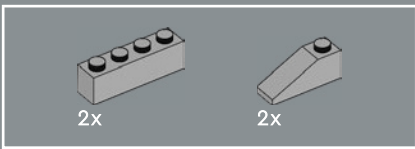
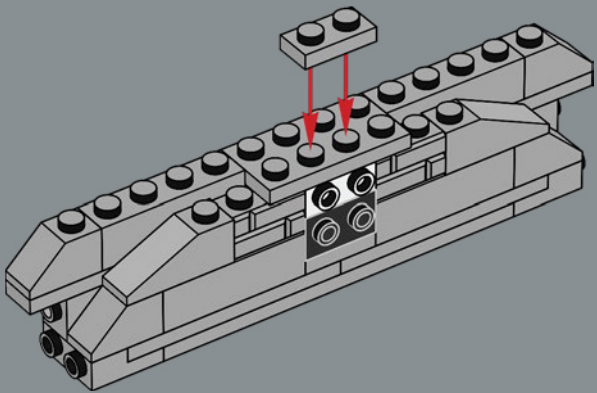

327

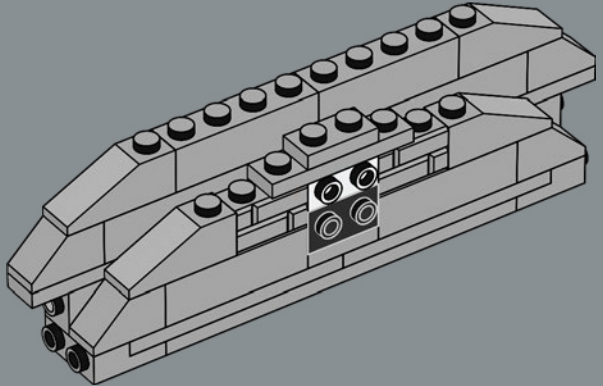

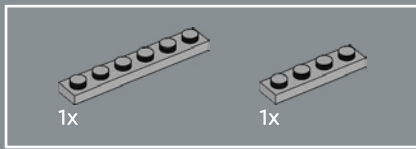

328

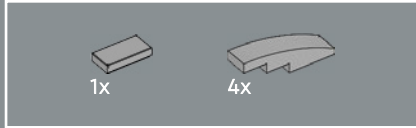
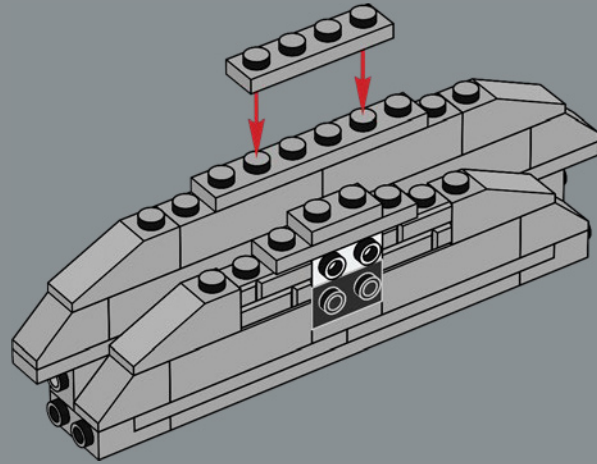

329

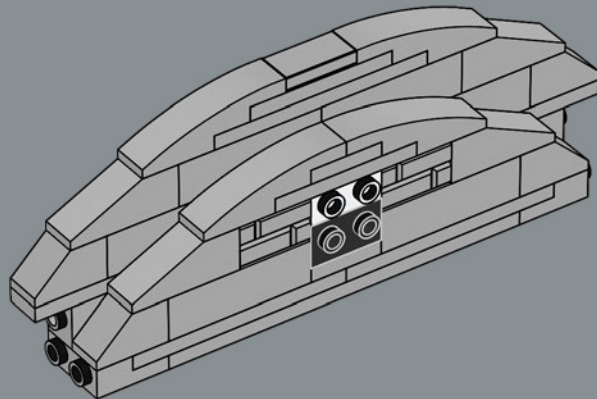

330



This base is designed with strong sideways locks so the entire council section can be removed from the model as its own display.

Cette base est conçue avec de solides verrous latéraux, de sorte que toute la section du conseil peut être retirée du modèle pour être exposée séparément.

Esta base está diseñada con fijaciones laterales fuertes para que sea posible quitar la sección del concilio completa y exhibirla por separado.

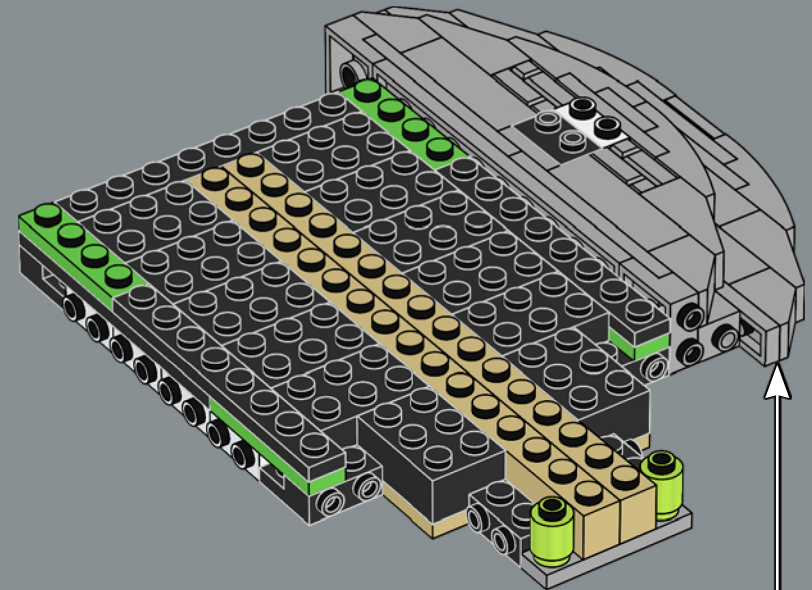

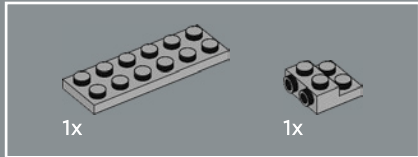
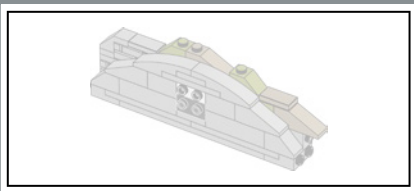

331

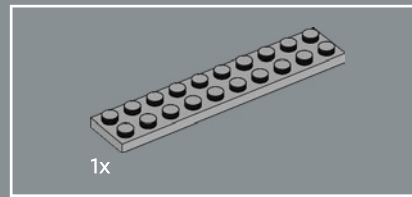
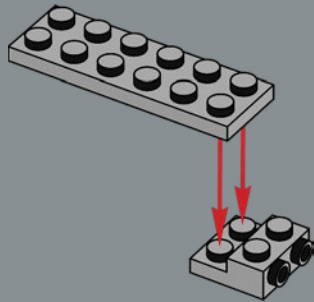

332

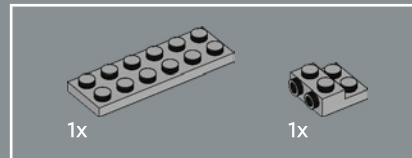
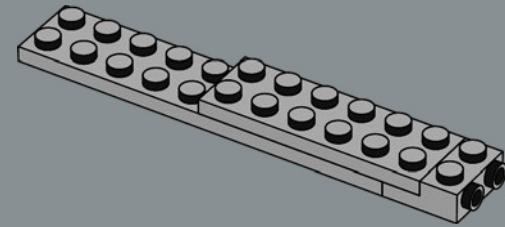

333

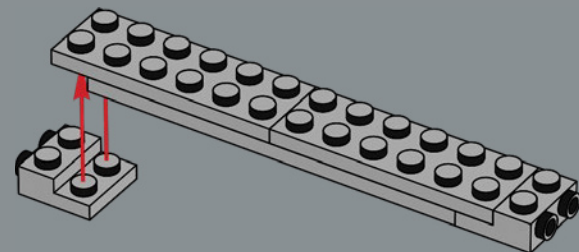

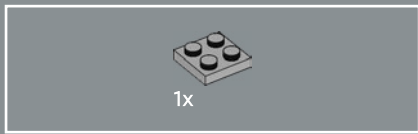

334

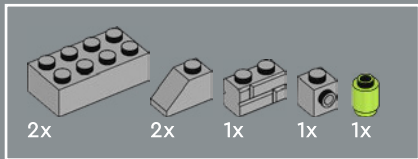
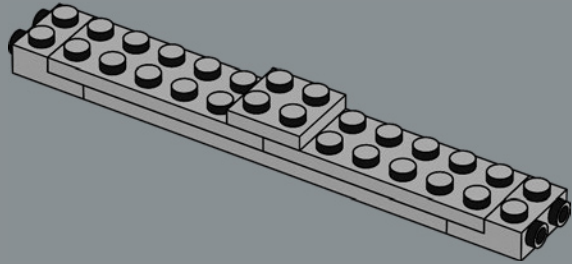

335

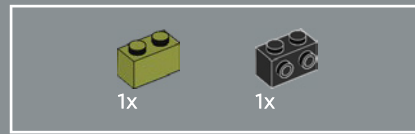
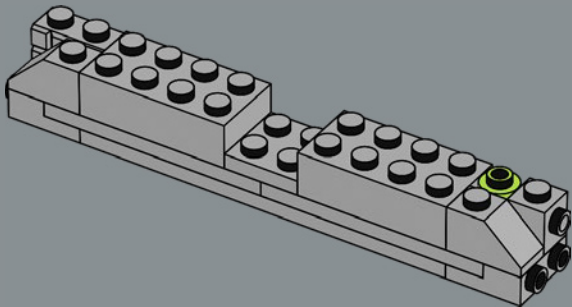

336

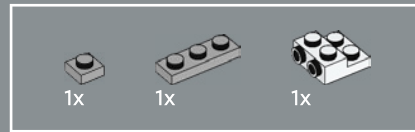
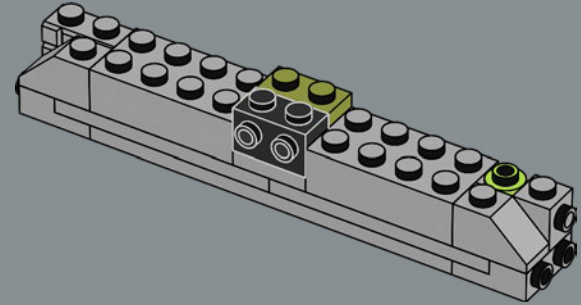

337

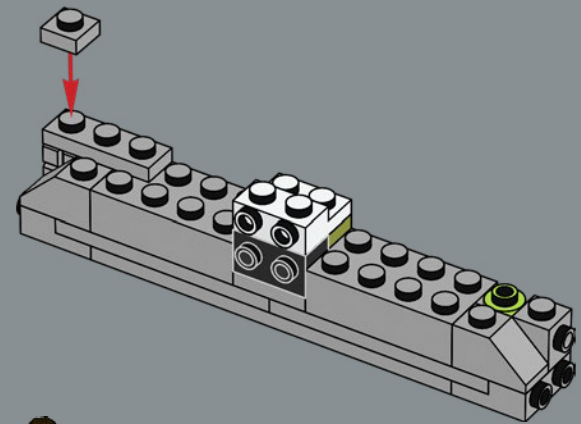

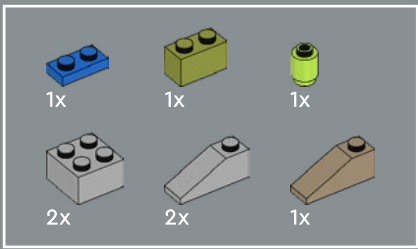

338

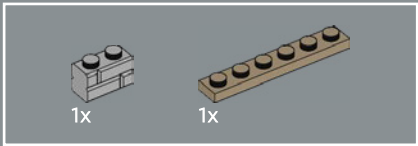
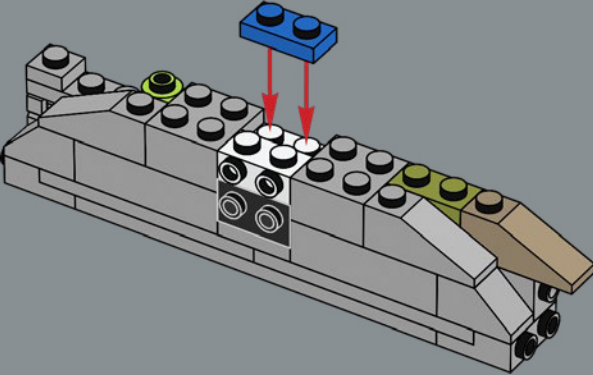

339

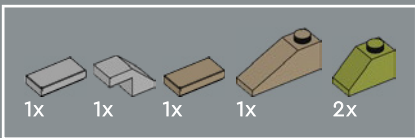
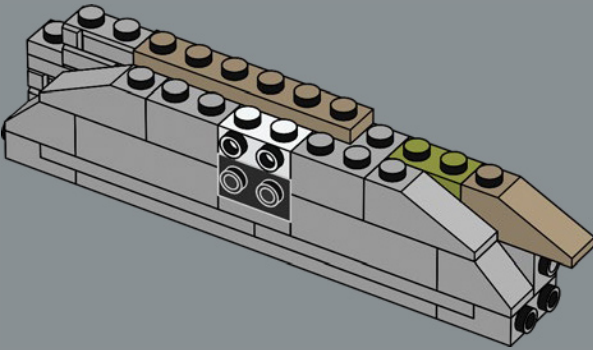

340

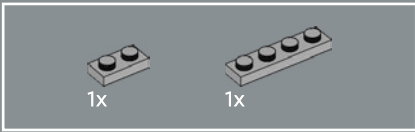
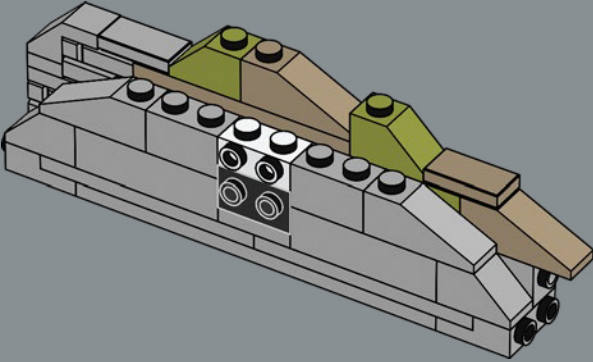

341

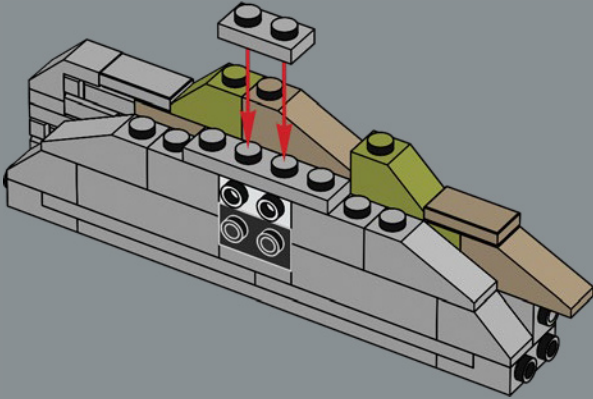

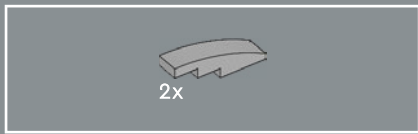

342

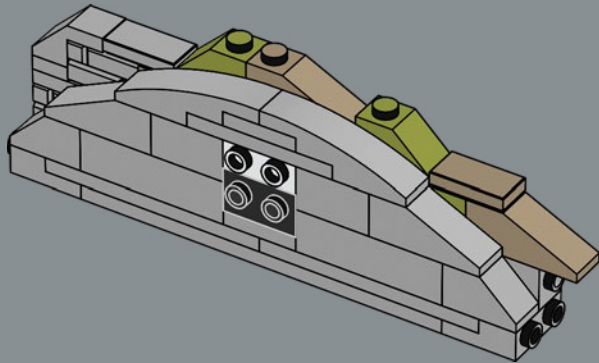

343

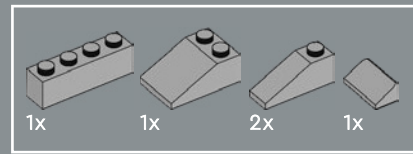
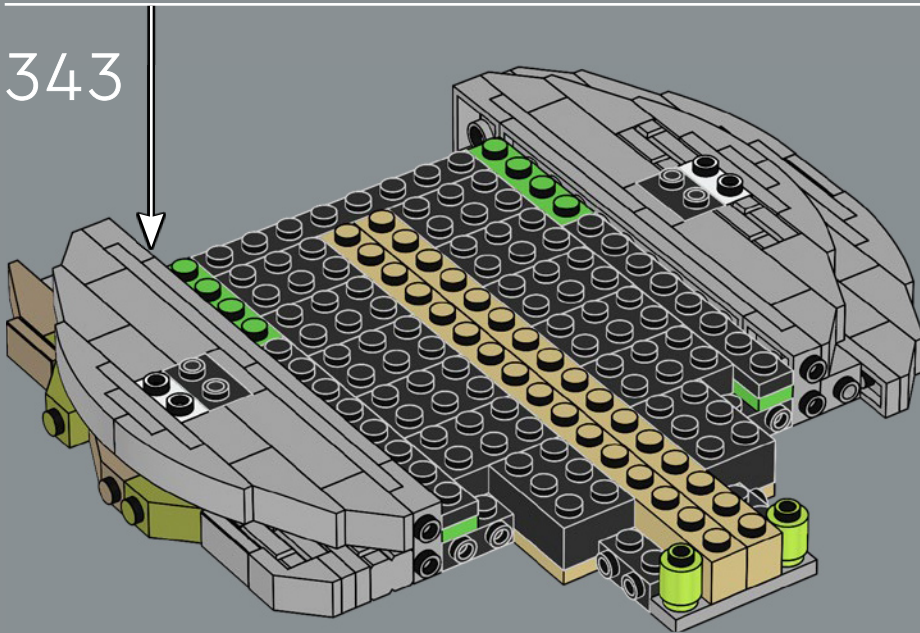

344

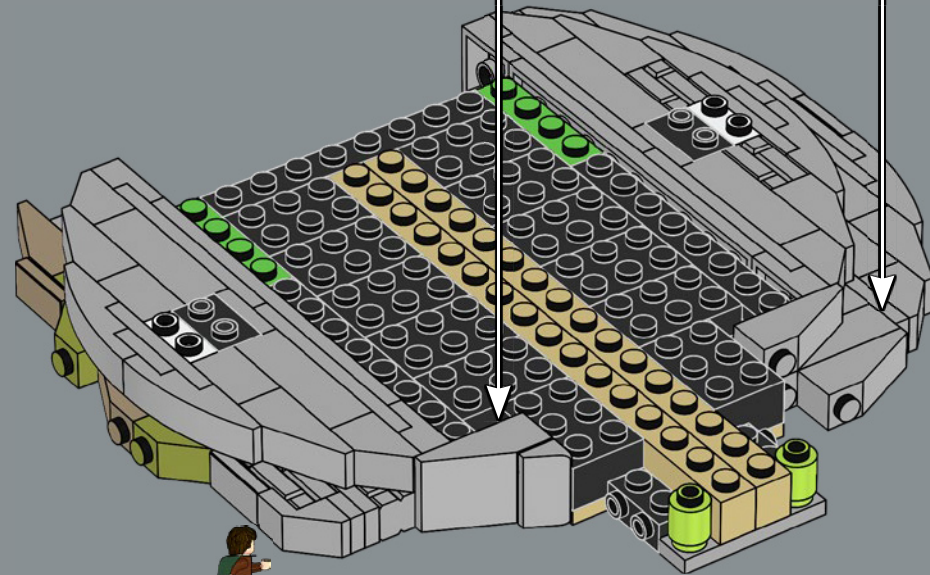
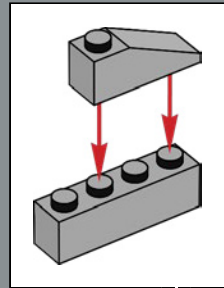
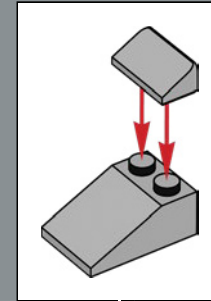

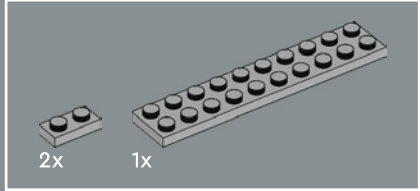
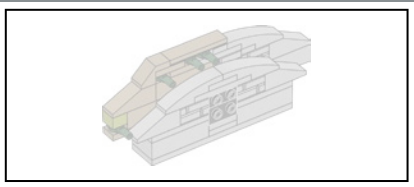

345

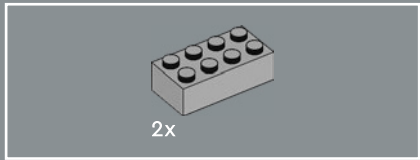
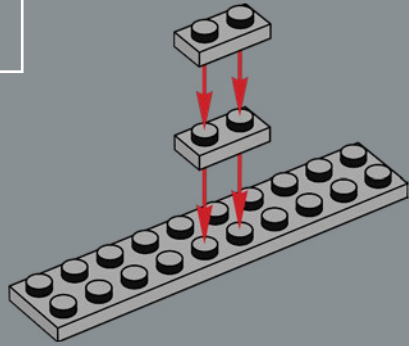

346

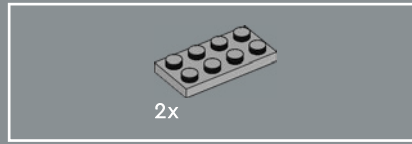
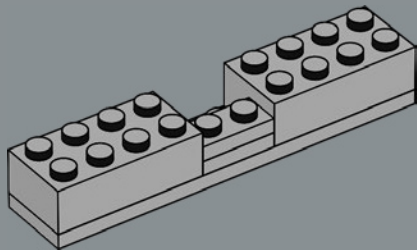

347

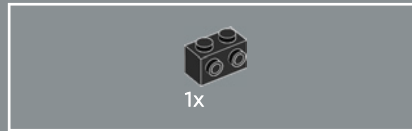
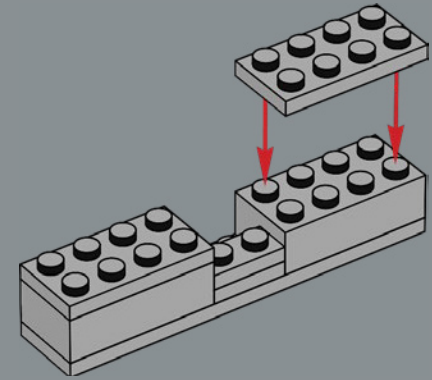

348

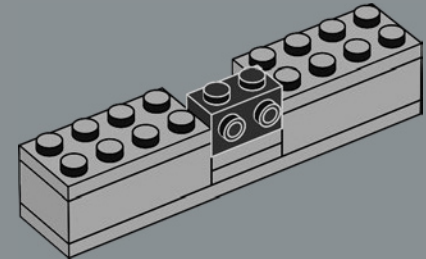

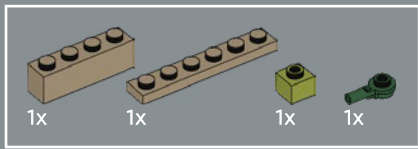

349

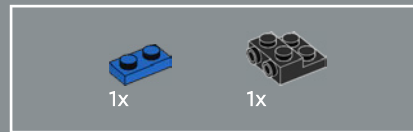
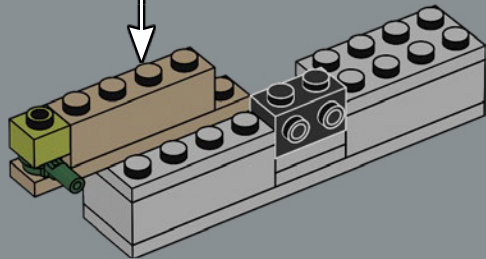
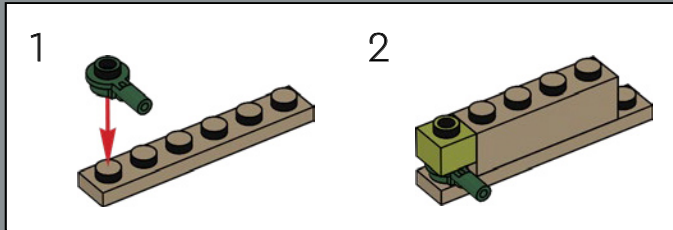

350

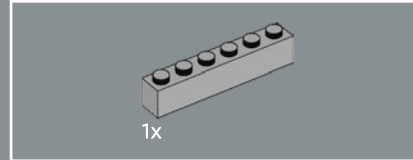
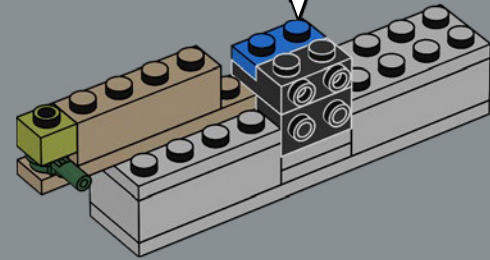
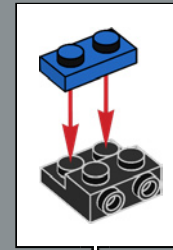

351

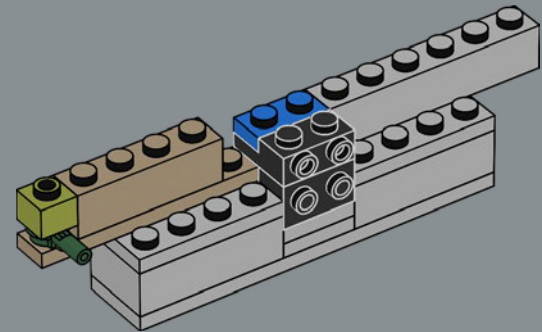

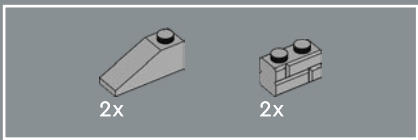

352

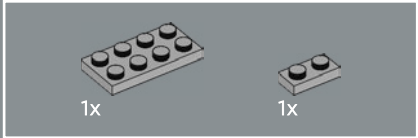
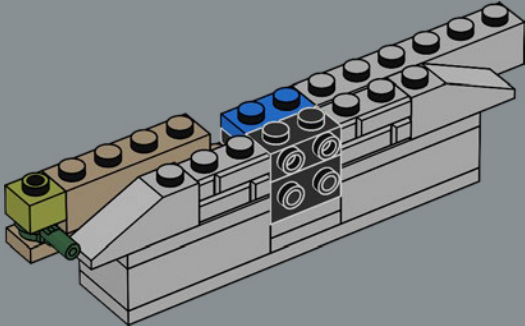

353

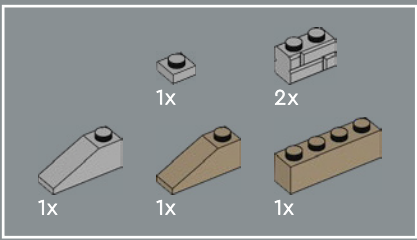
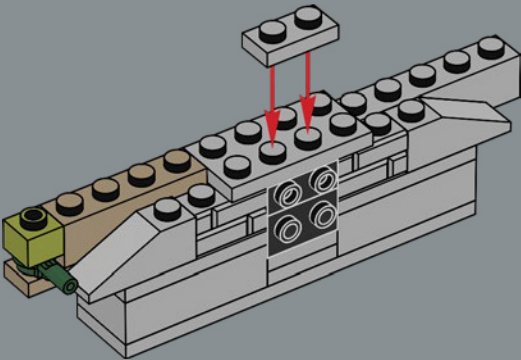

354

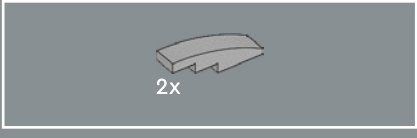
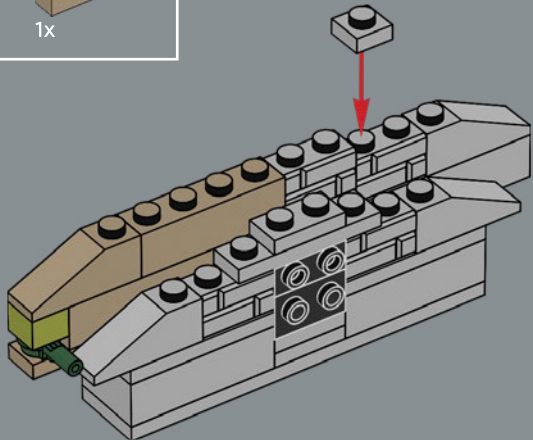

355

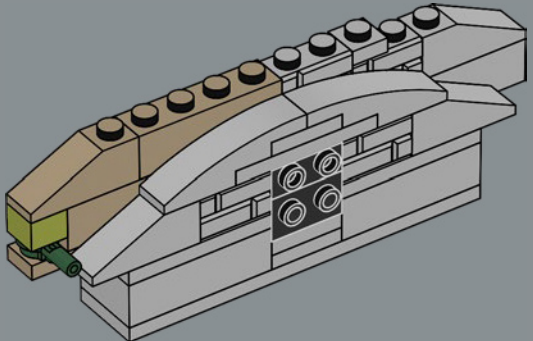

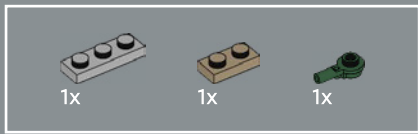

356

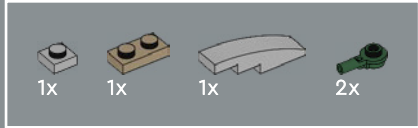
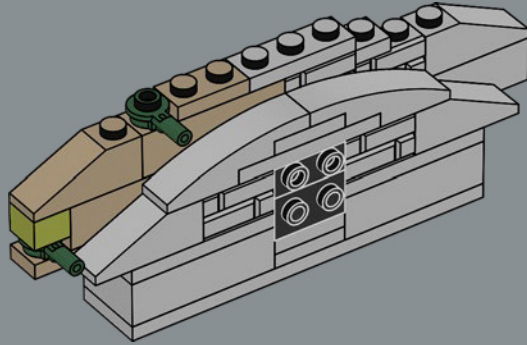

357

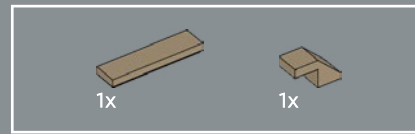
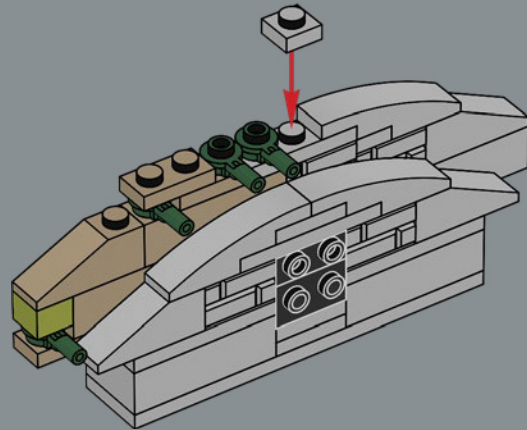

358

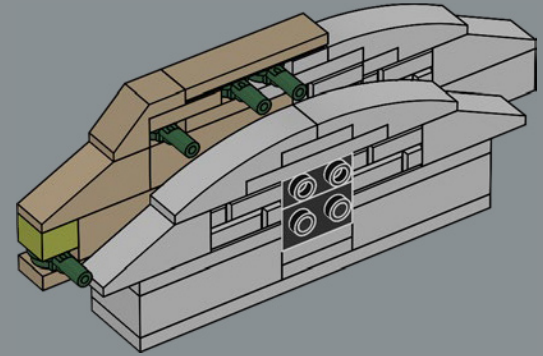

359

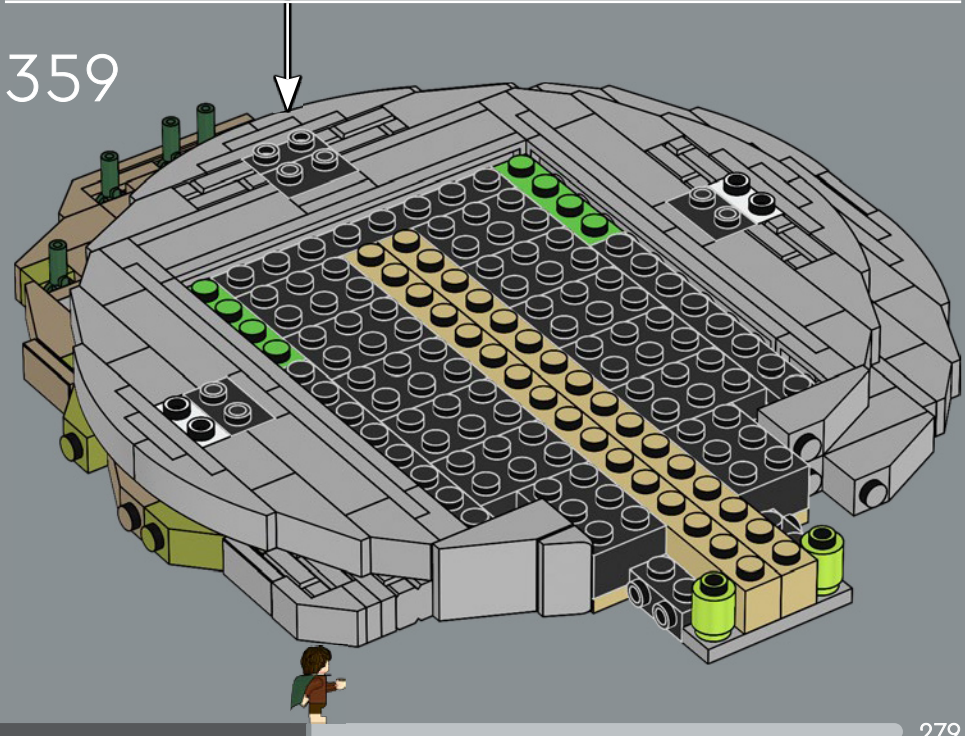



360

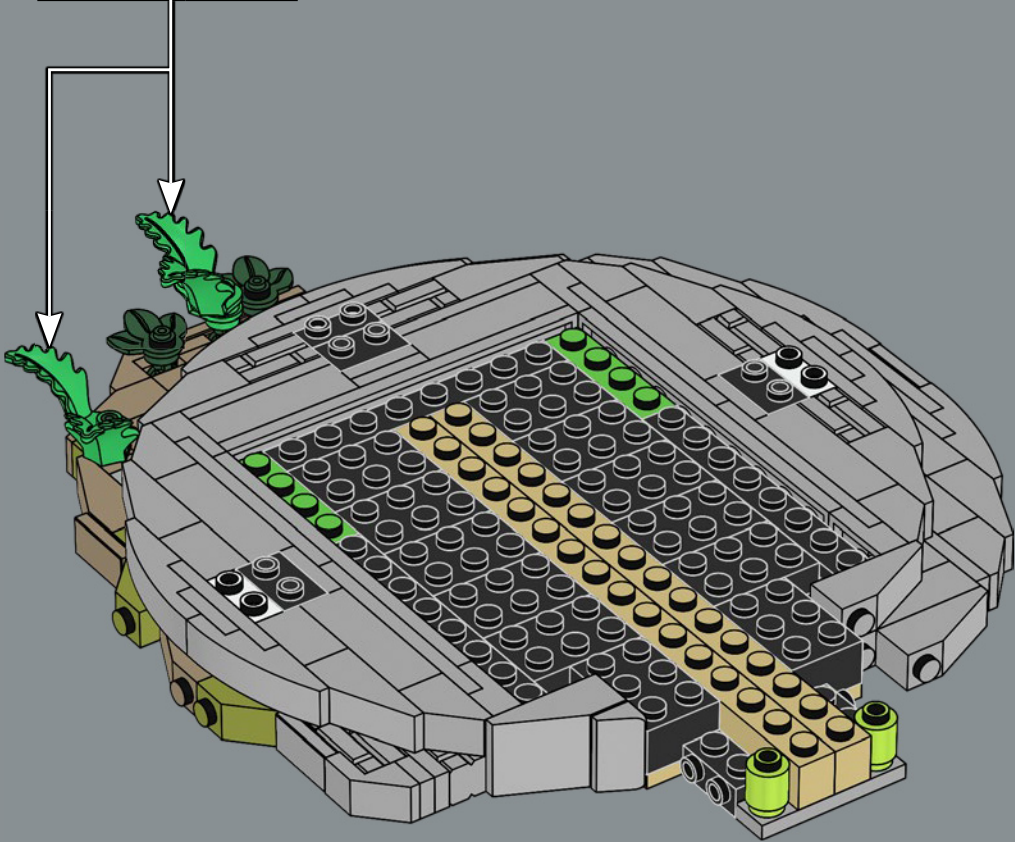
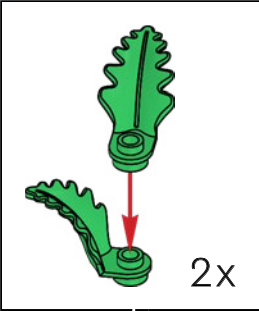

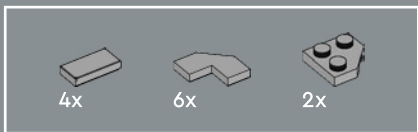

361

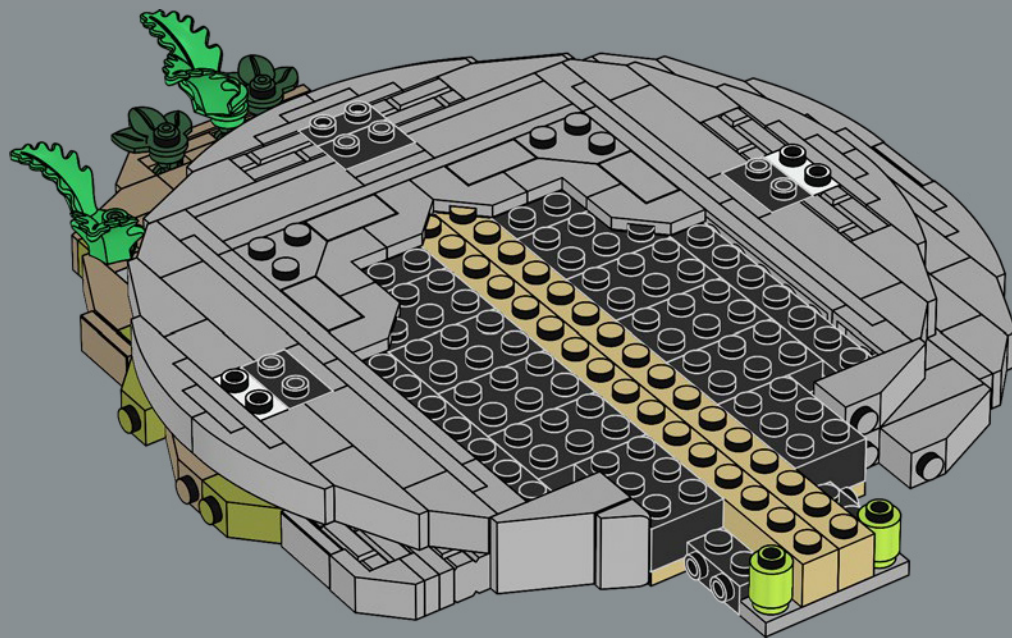

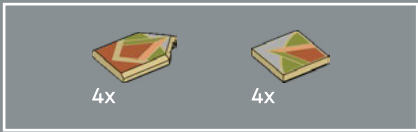

362

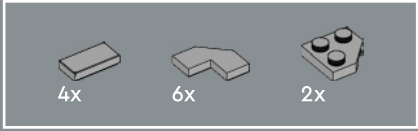
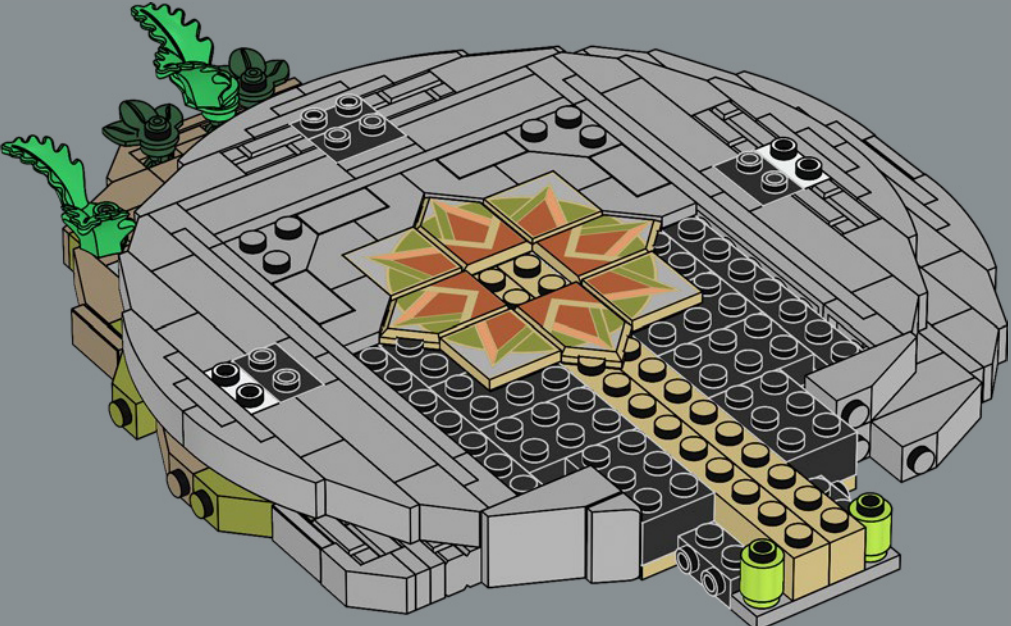

363

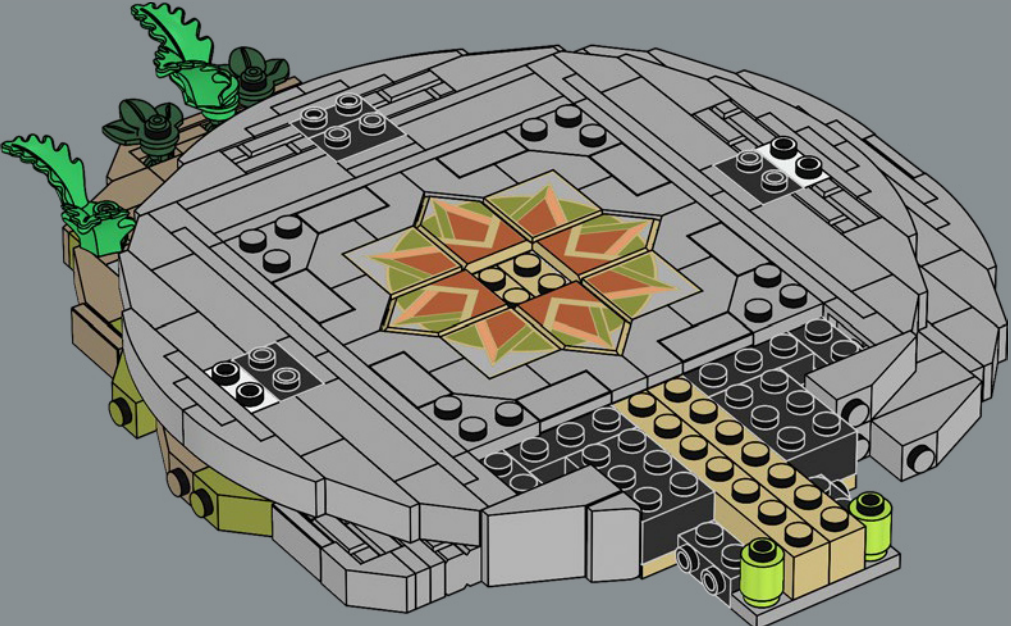

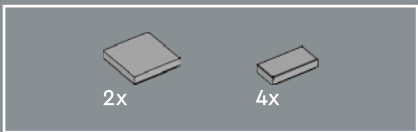

364

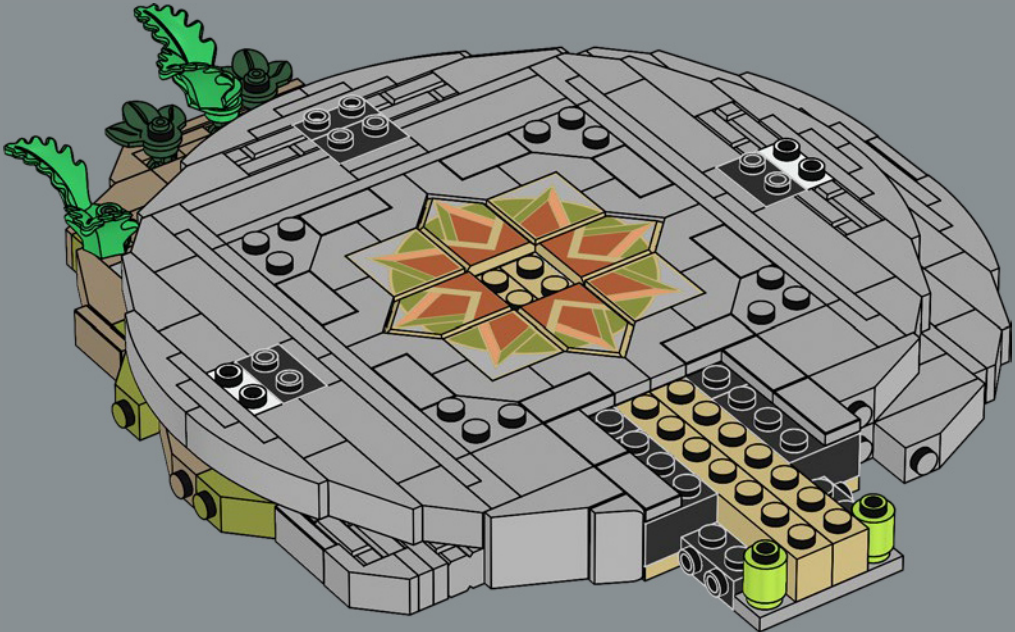

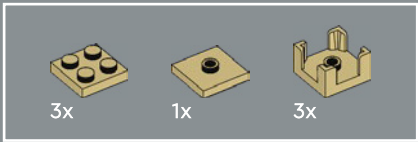

365

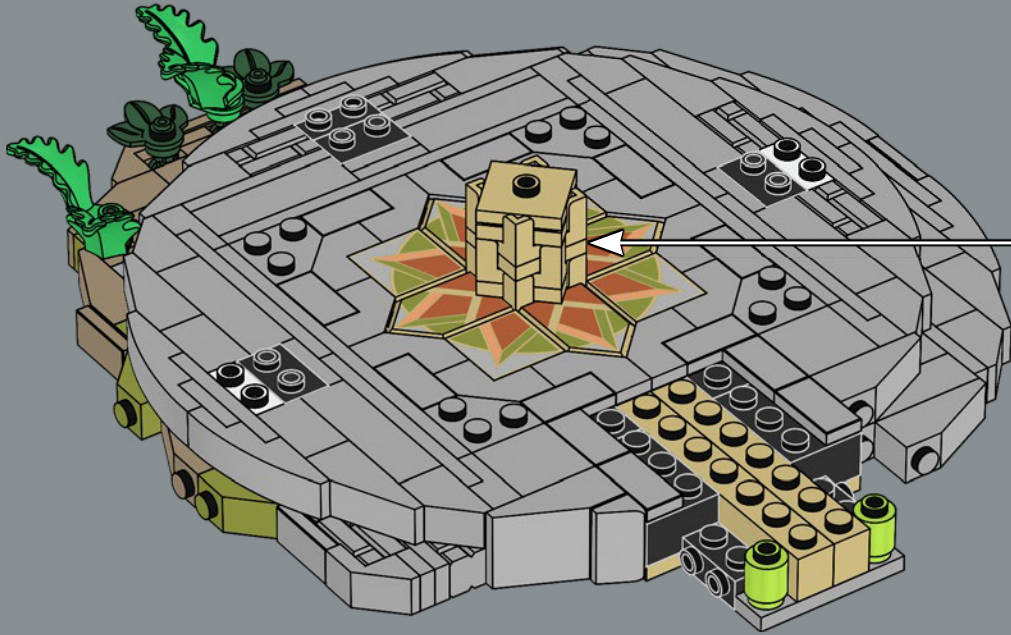
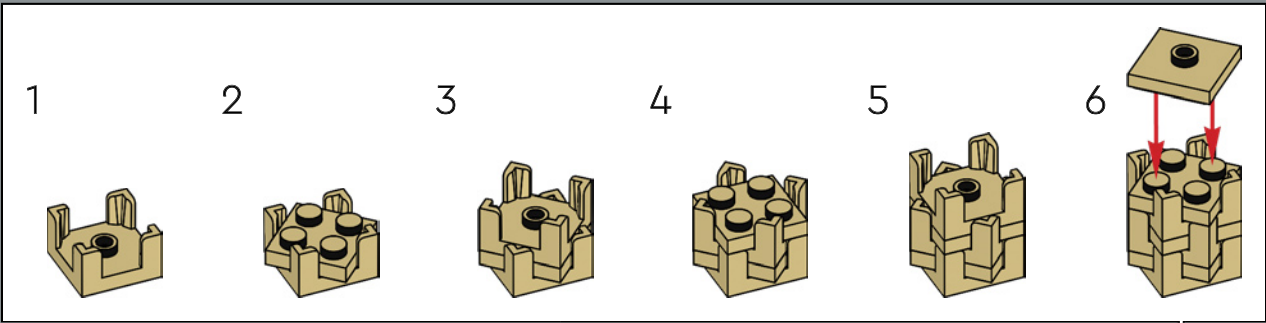

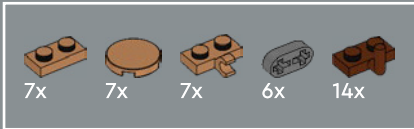
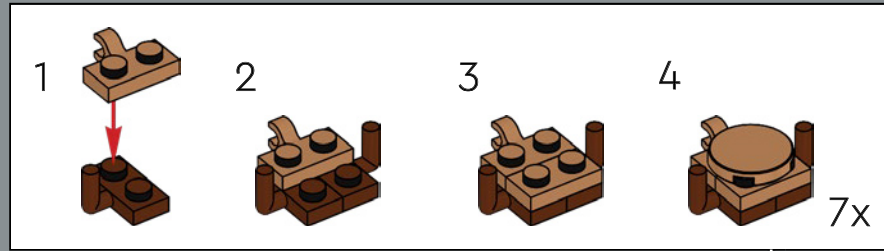
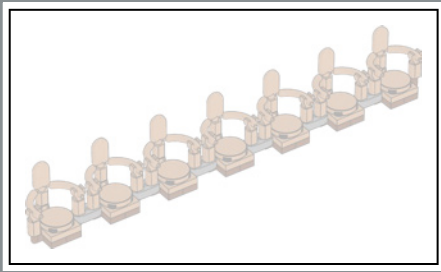

366

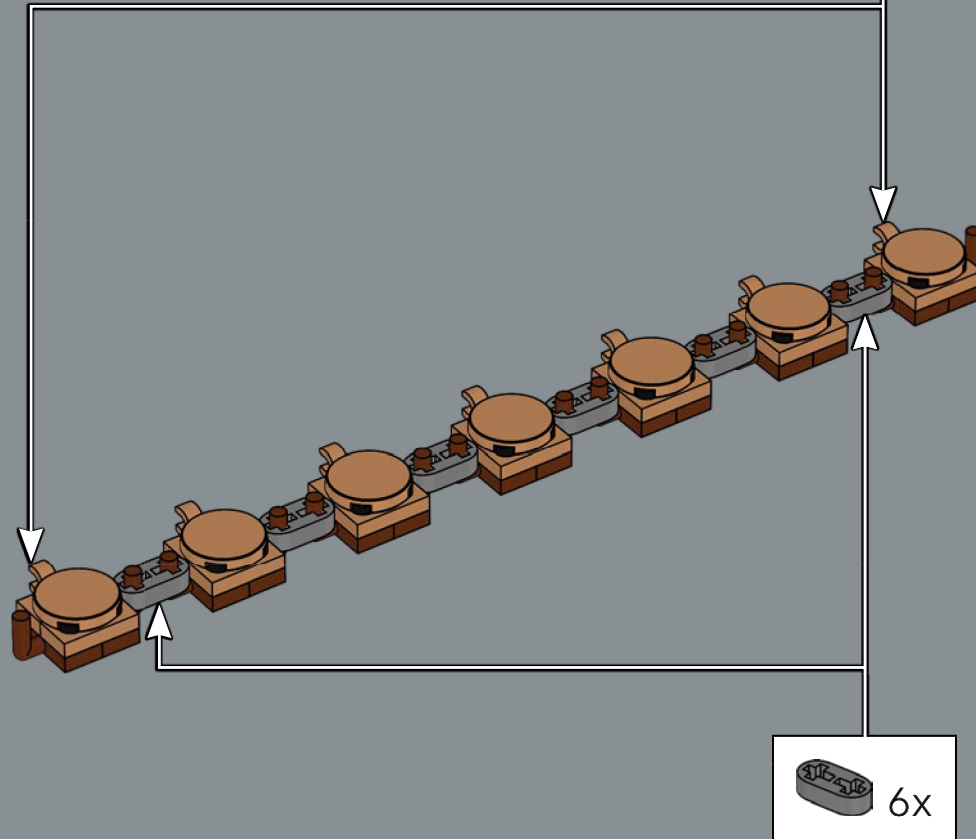



14x

367

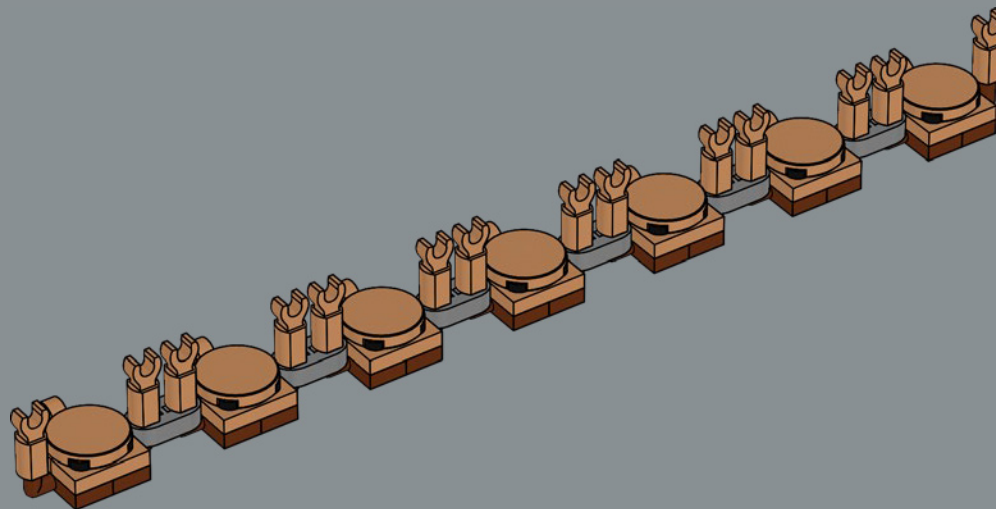

14x

368

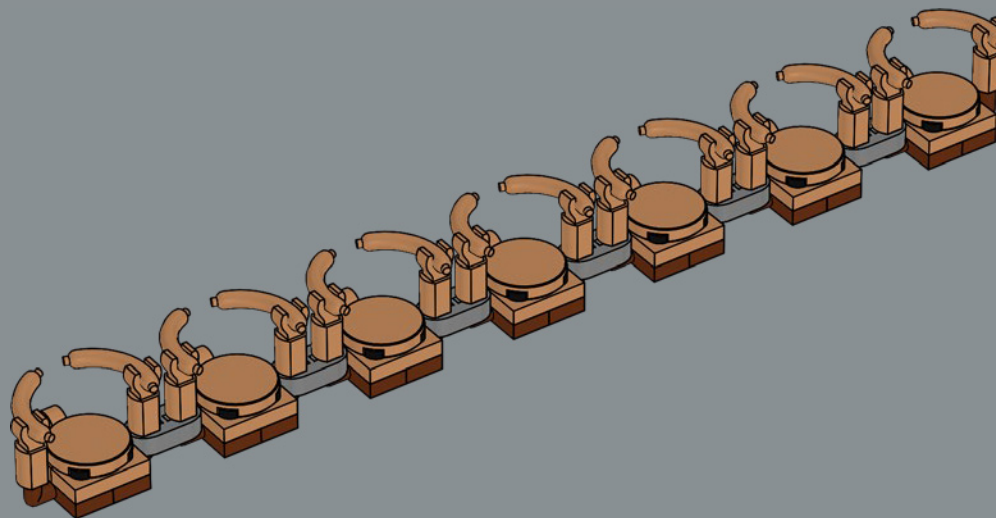

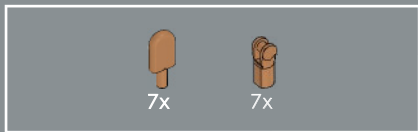

369

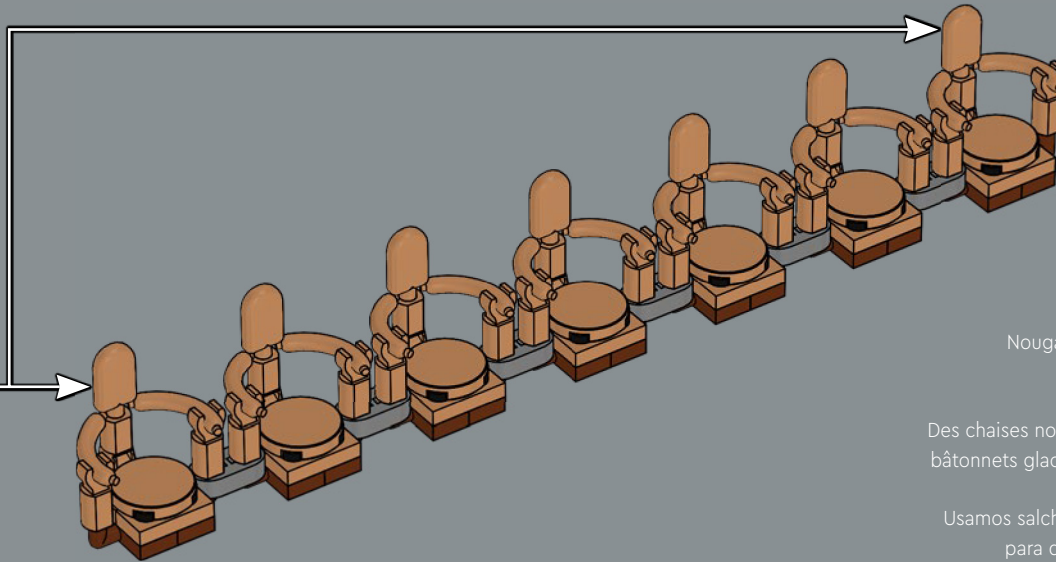
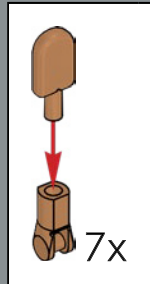

Nougat chairs built with hotdogs and popsicles;
we might have been hungry that day...

Des chaises nougat construites avec des hot-dogs et des
bâtonnets glacés; nous avions peut-être faim ce jour-là...

Usamos salchichas y paletas heladas de color caramelo
para dar forma a los asientos. Tal vez estábamos
hambrientos ese día...

370

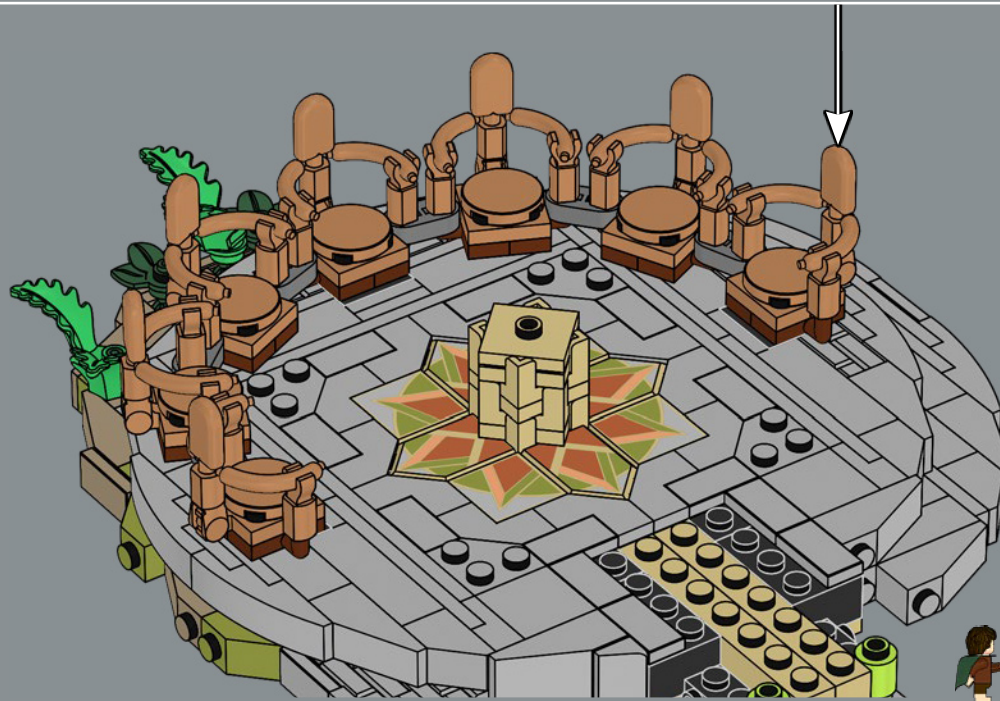

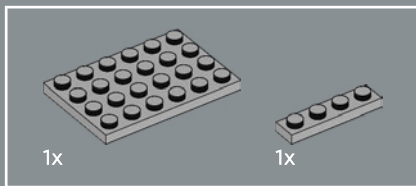

371

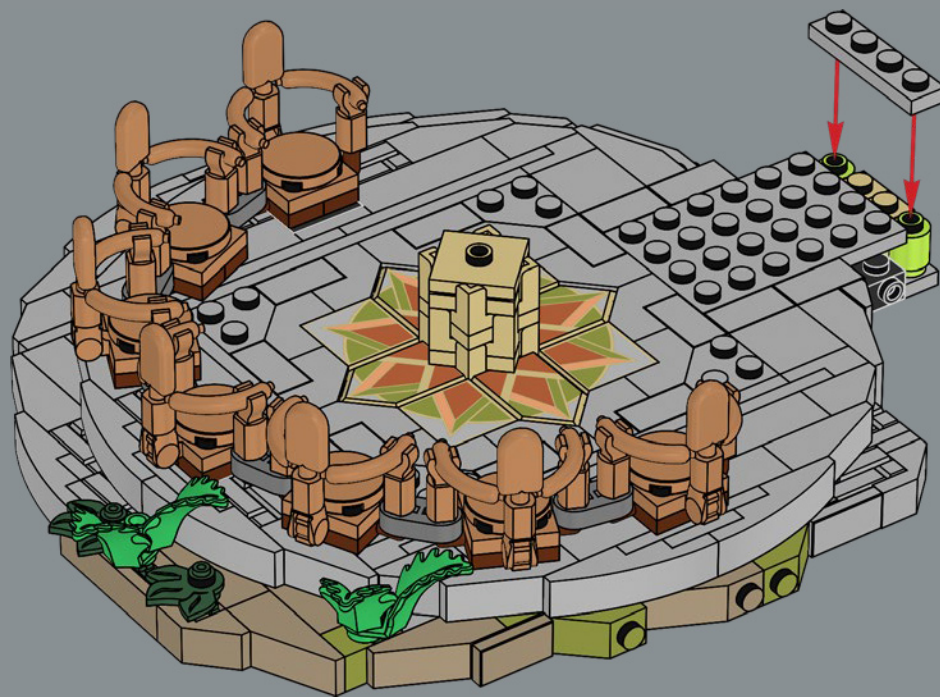
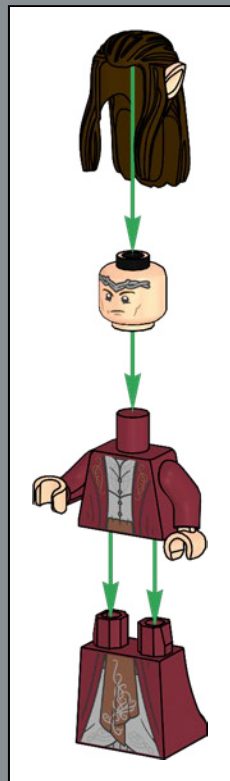

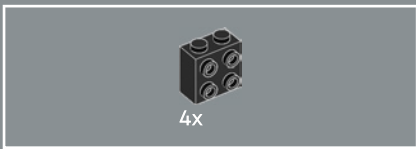

372

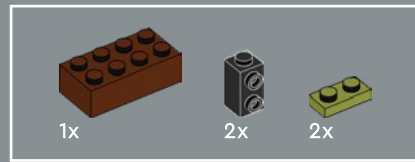
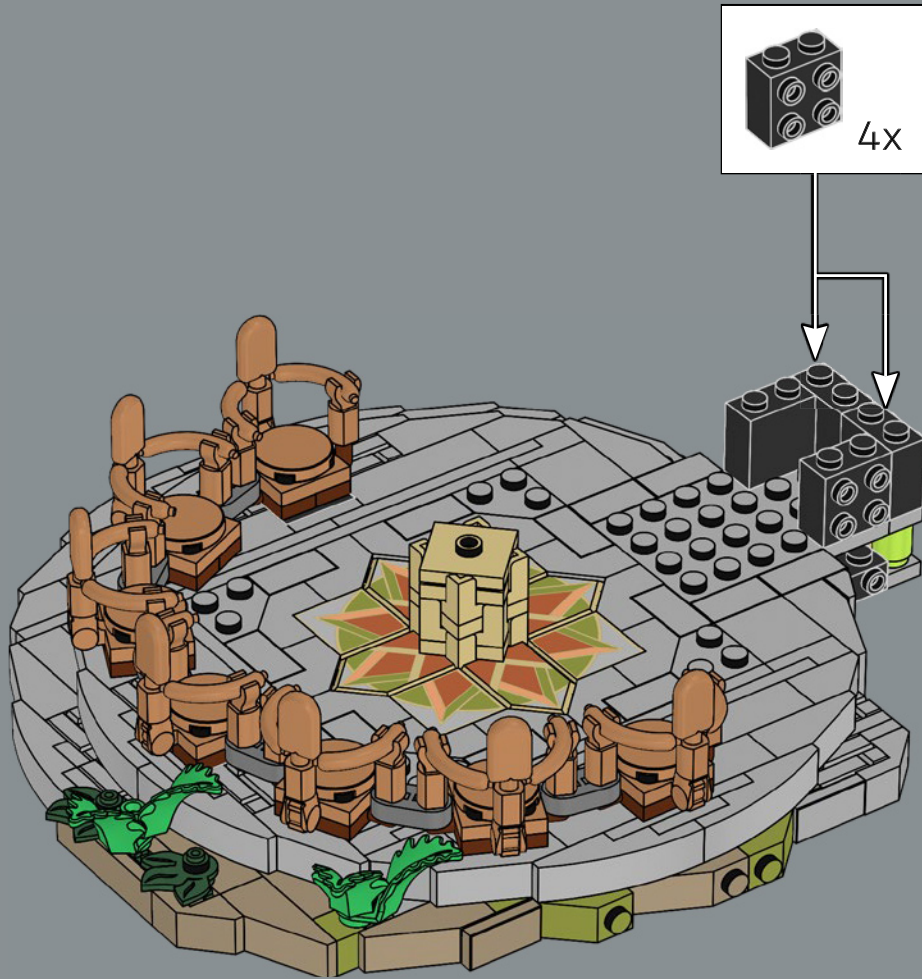

373

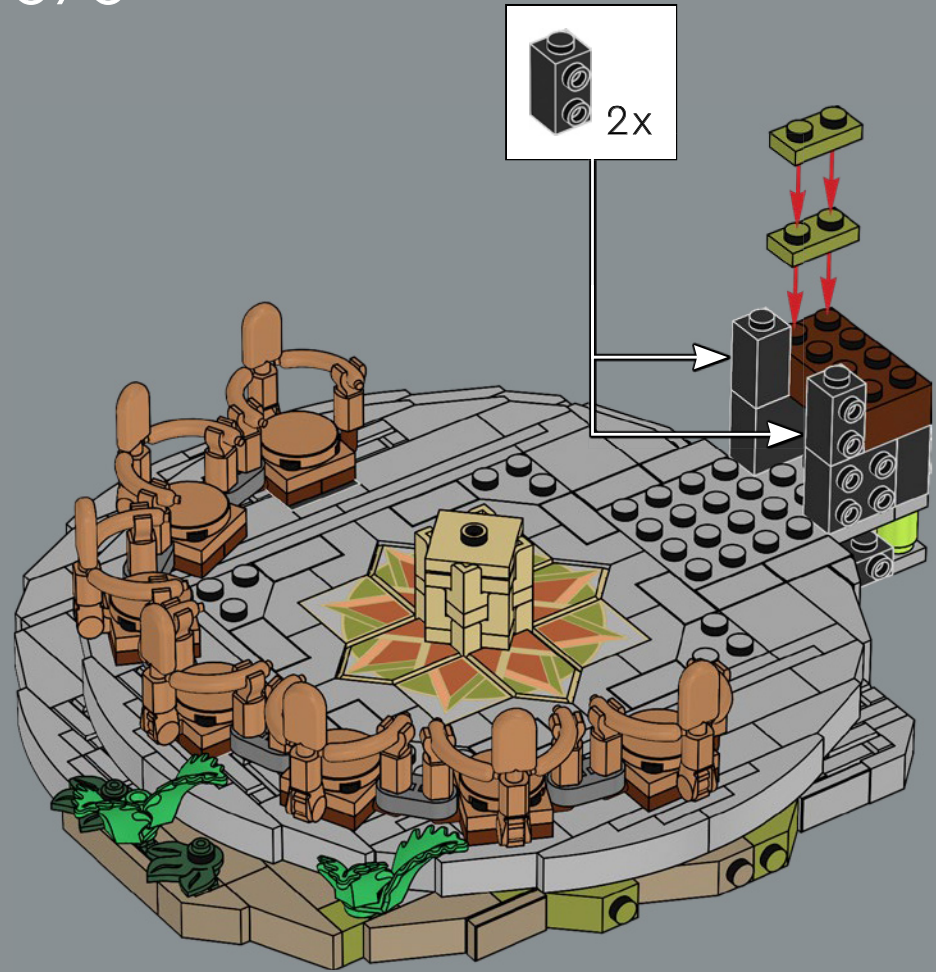

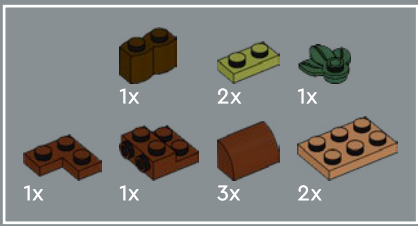

374

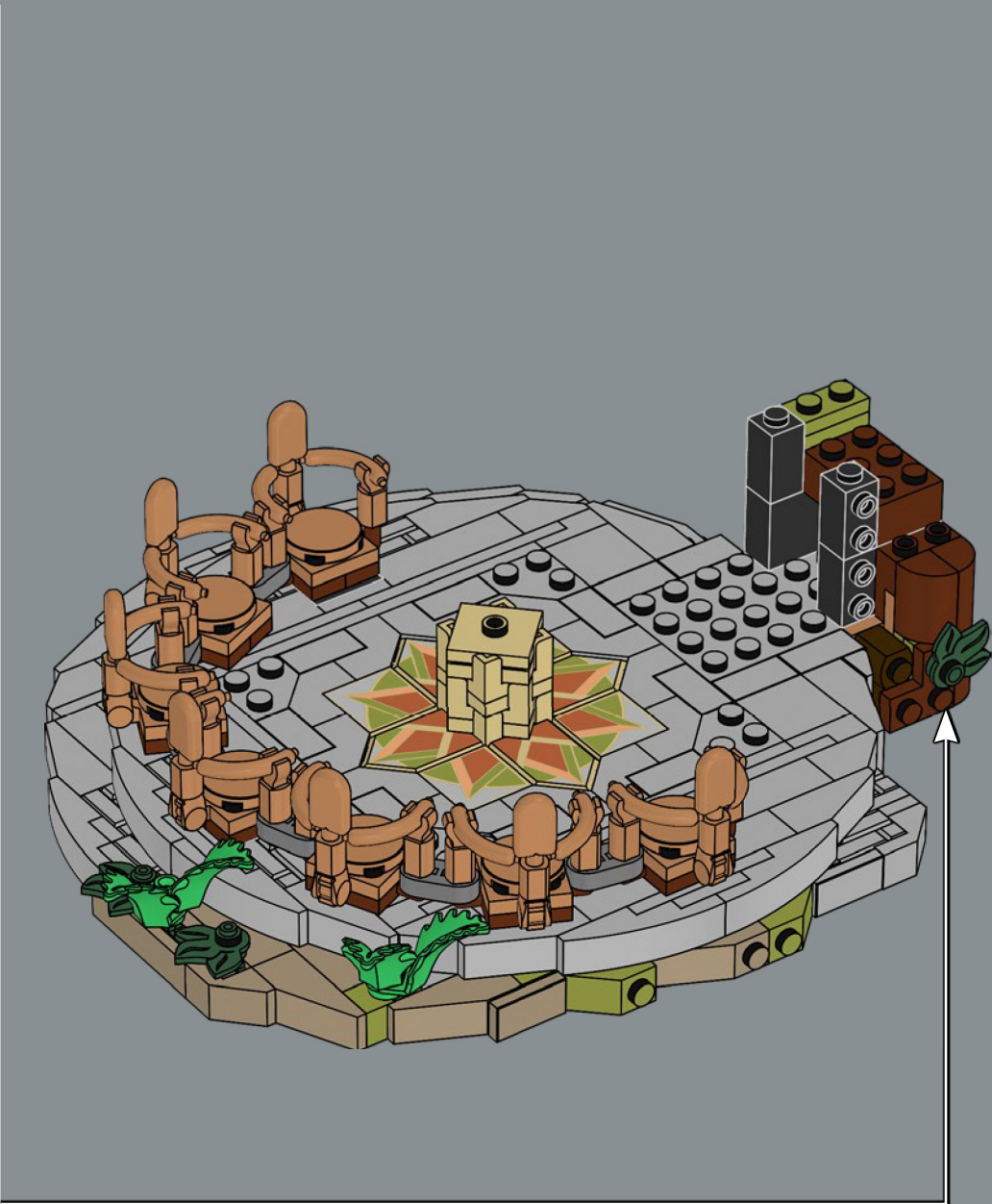
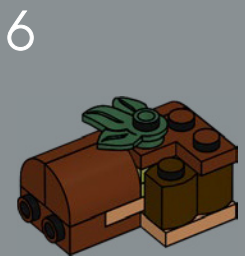
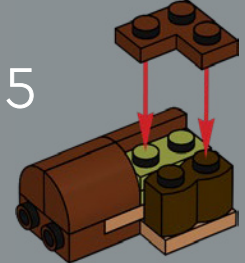
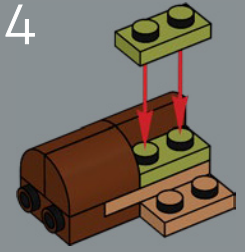
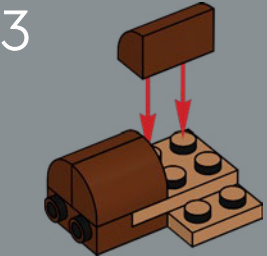
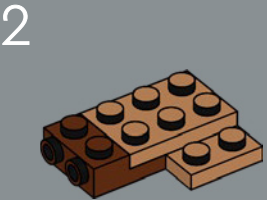
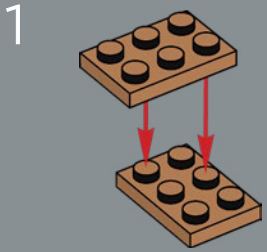

		
2x	2x	1x

375

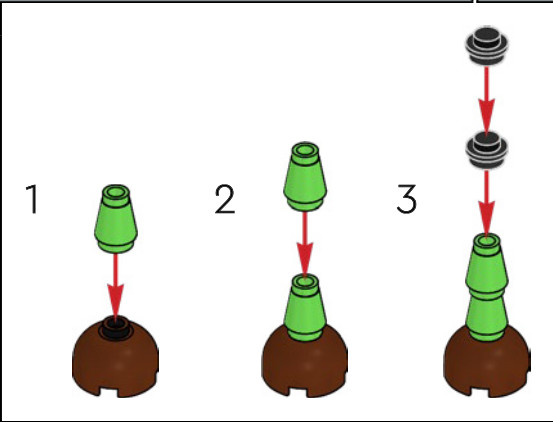
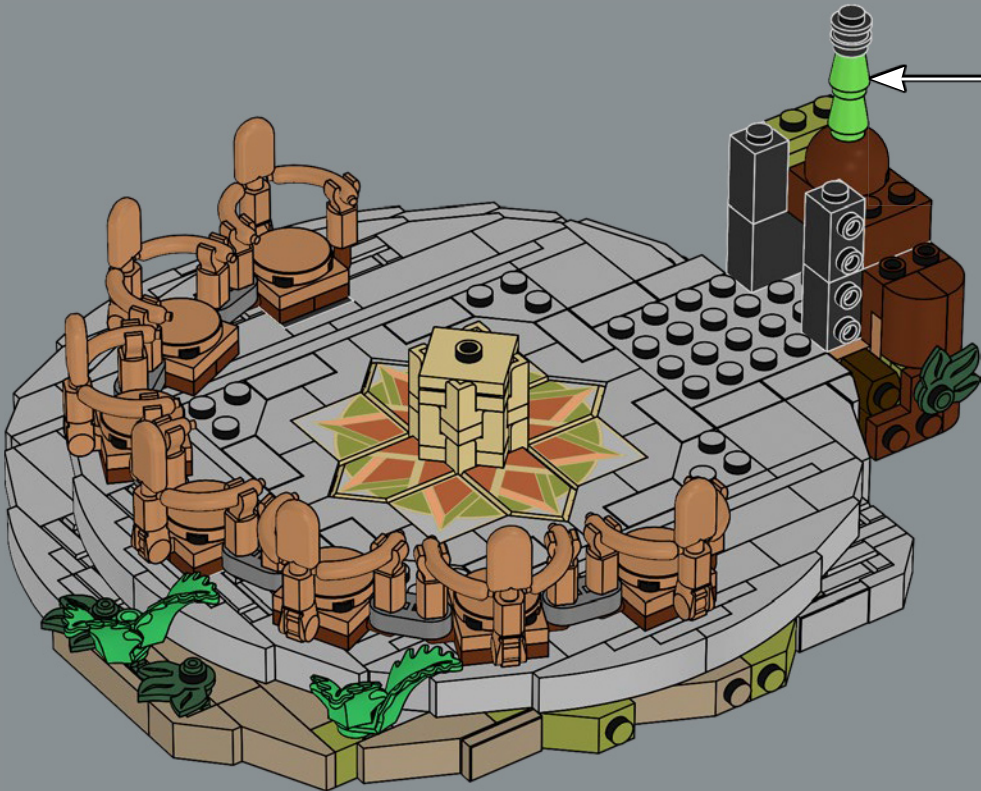

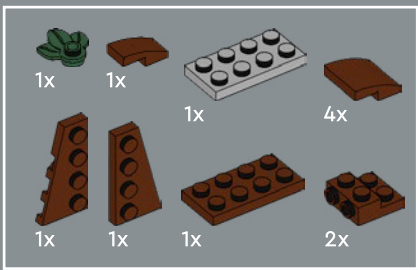

376

1



2

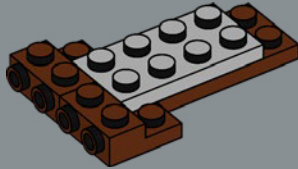

3

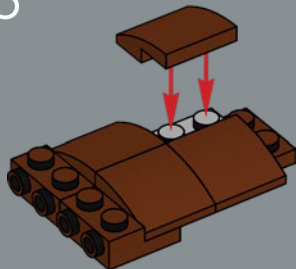

4

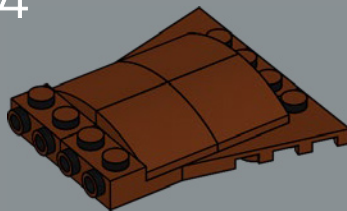

5

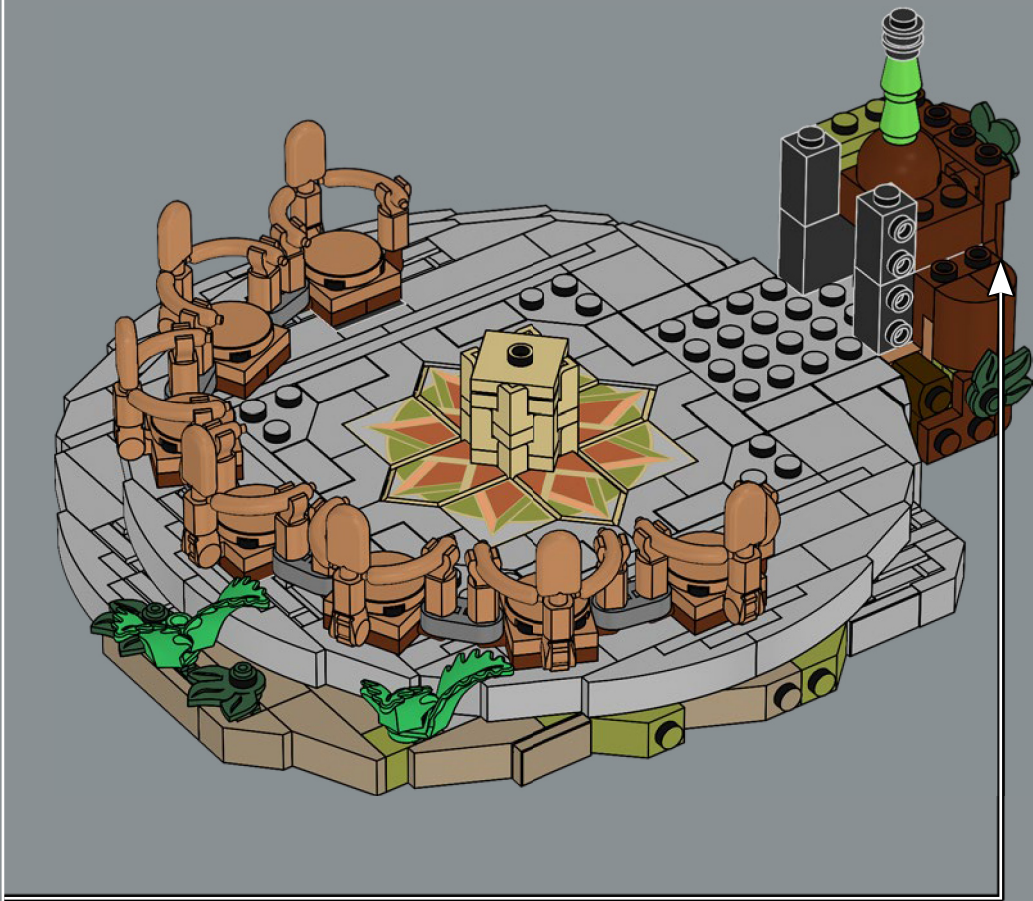
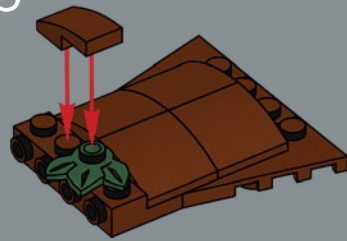

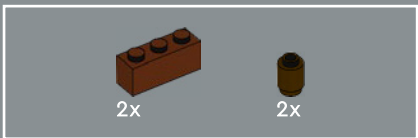

377

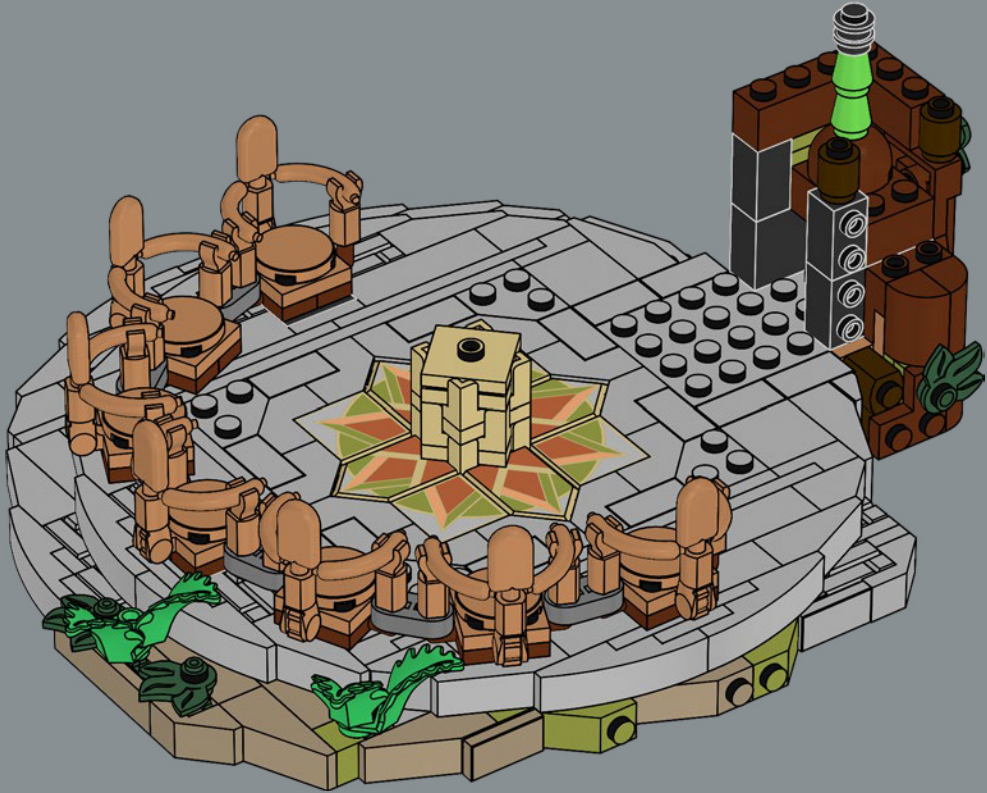

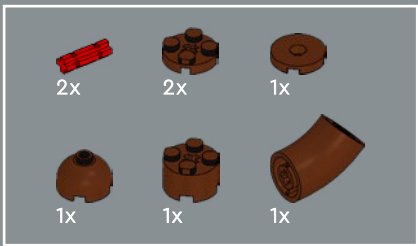

378

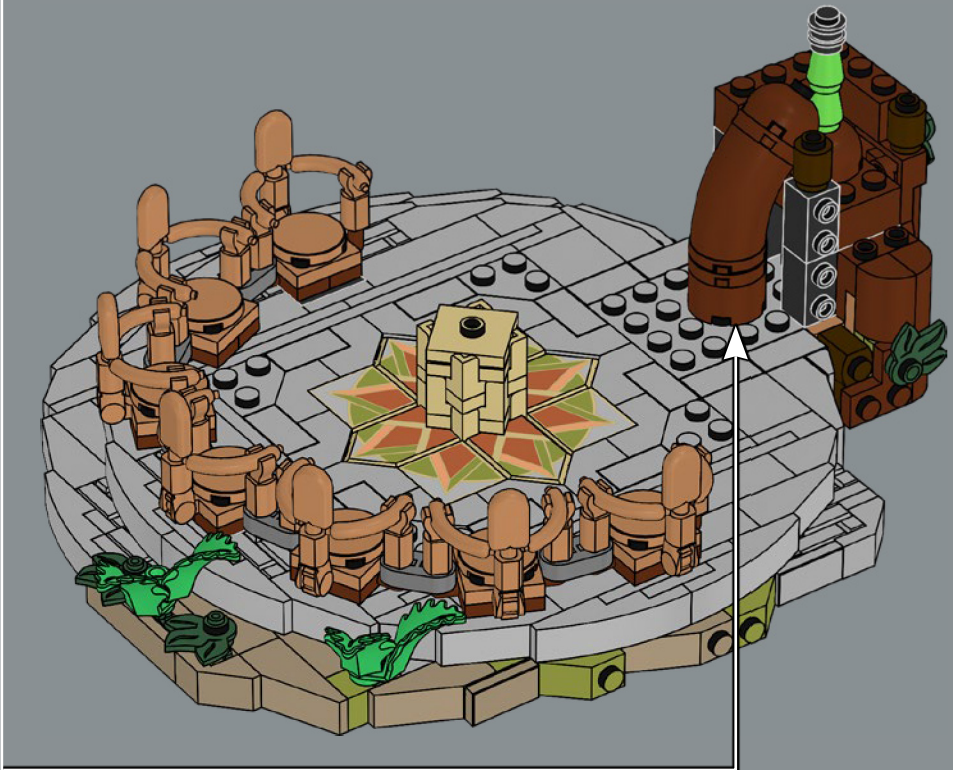
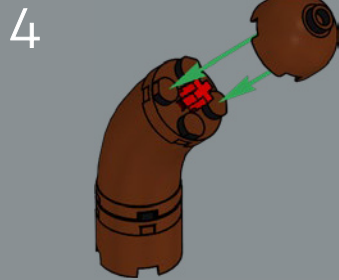
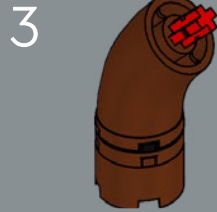
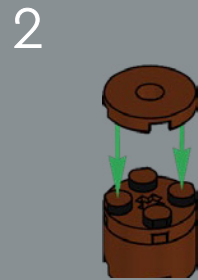
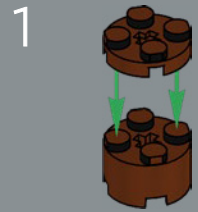
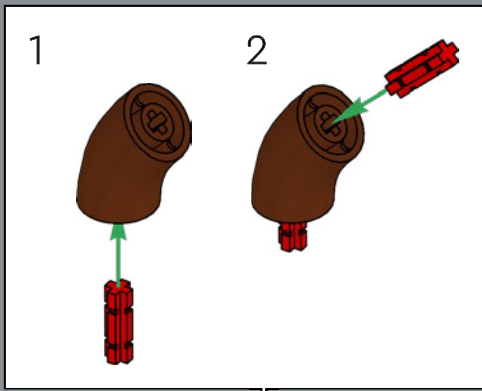

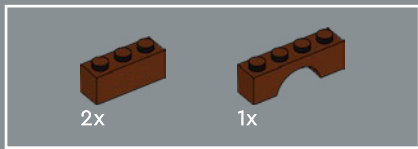

379

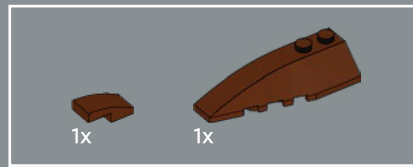
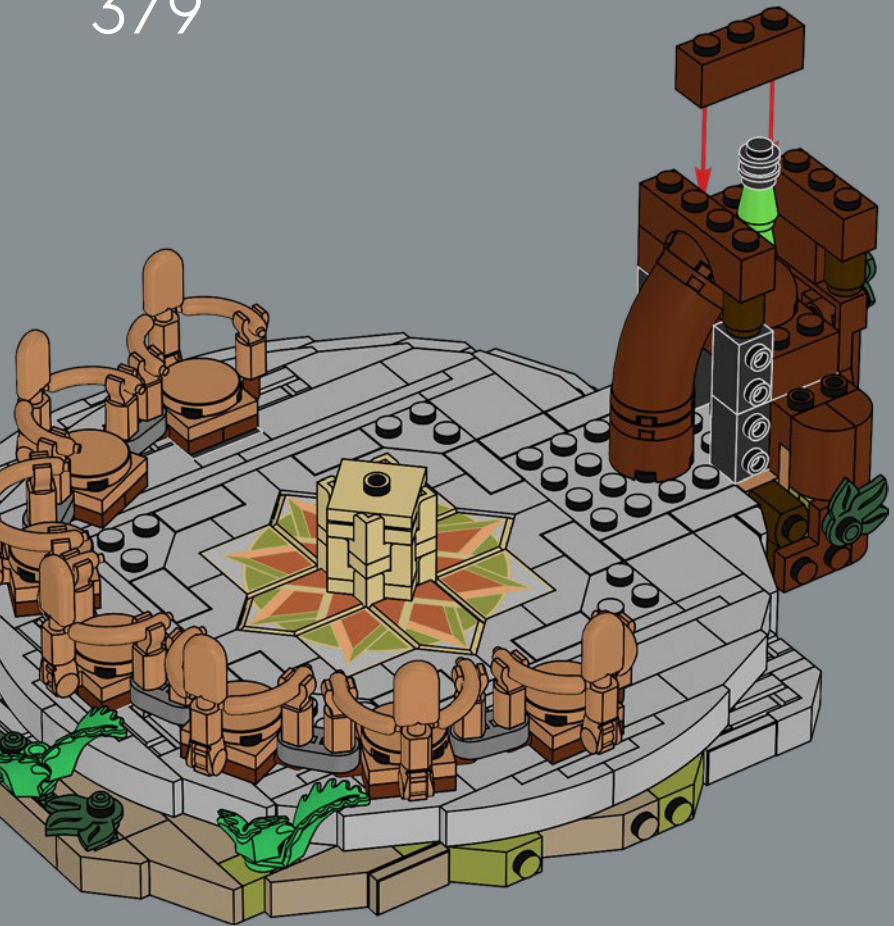

380

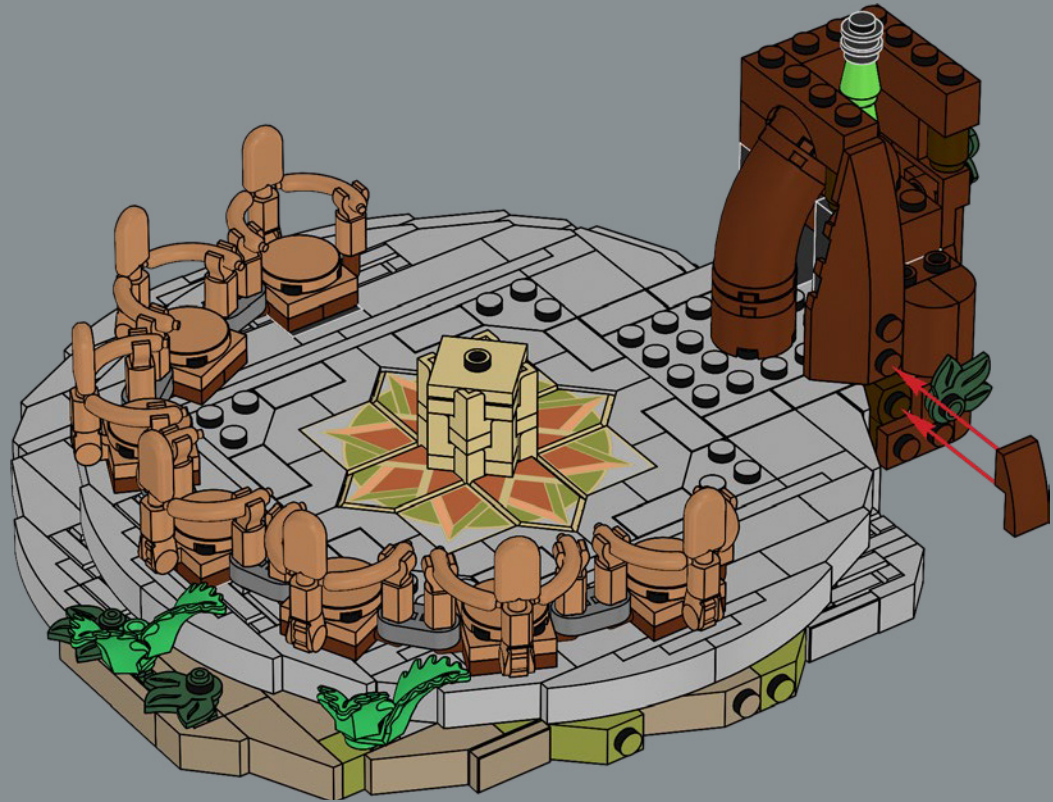

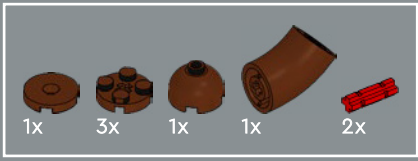

381

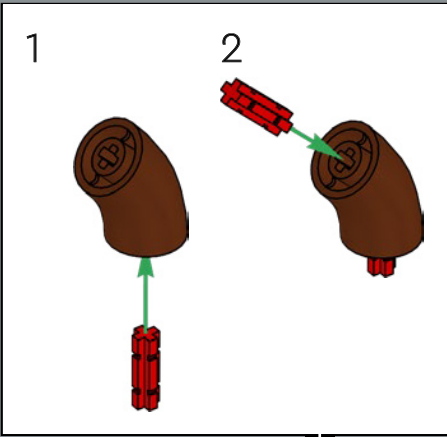

1

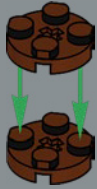

2



3



4

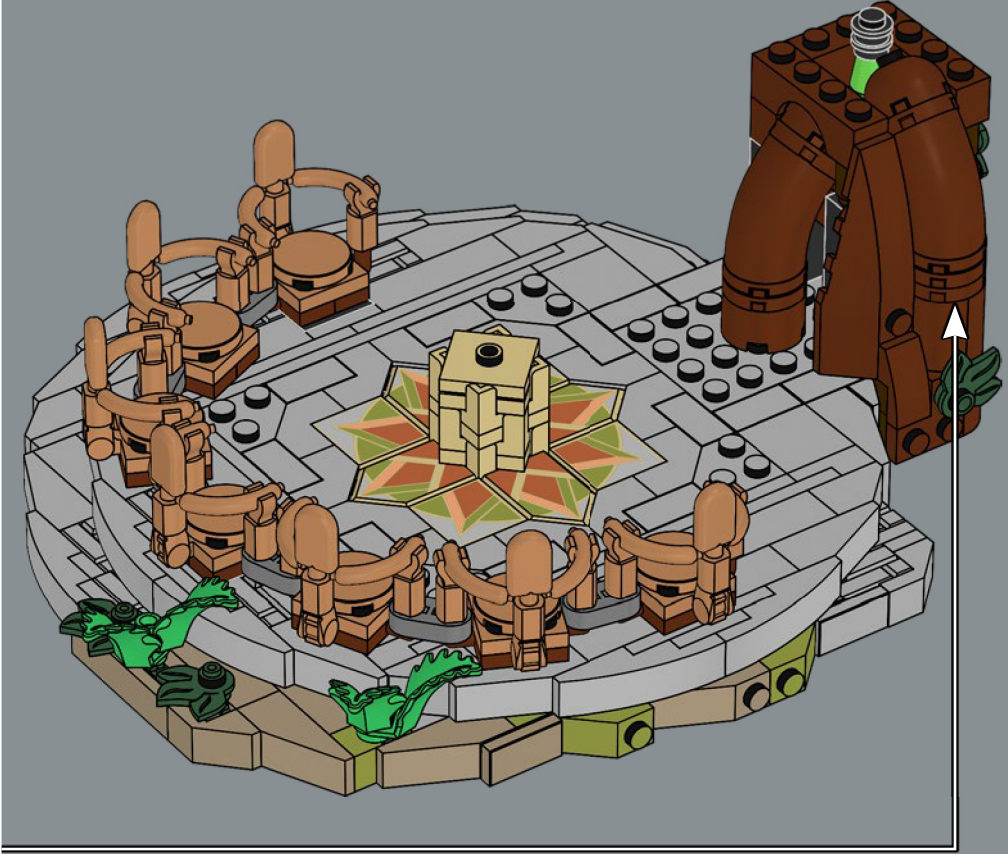
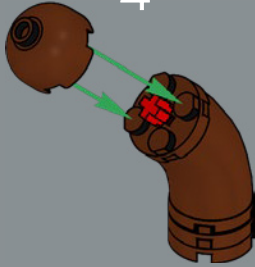

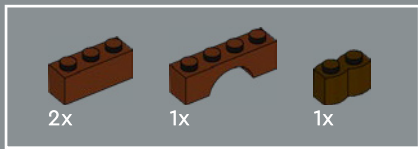

382

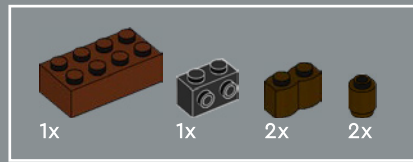
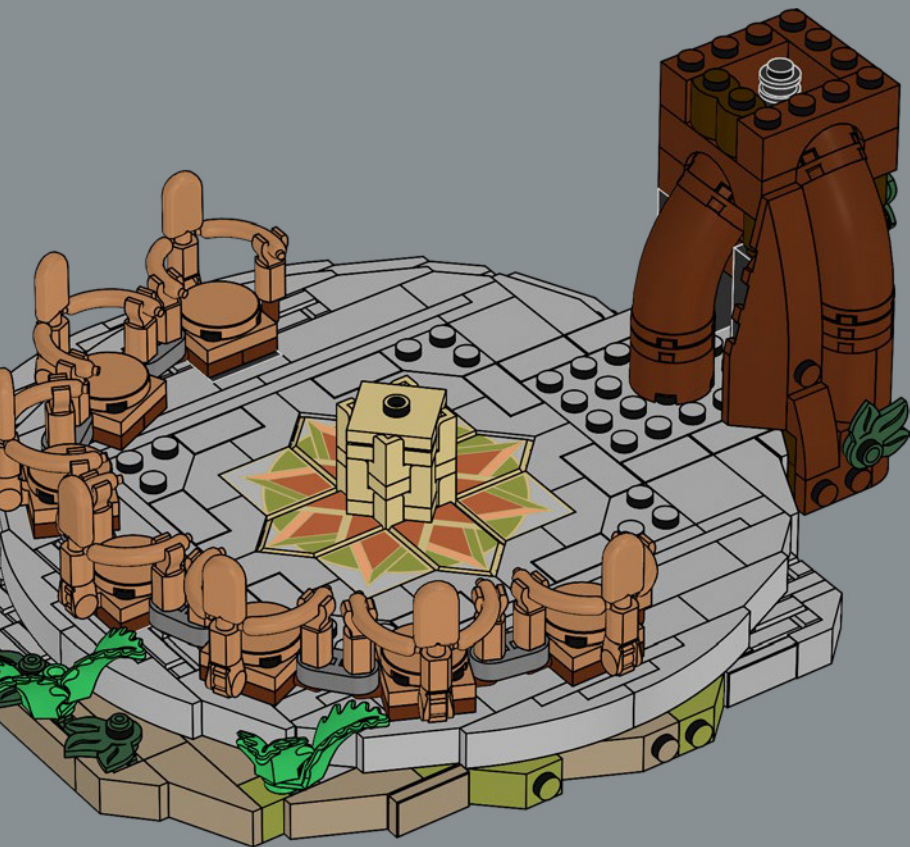

383

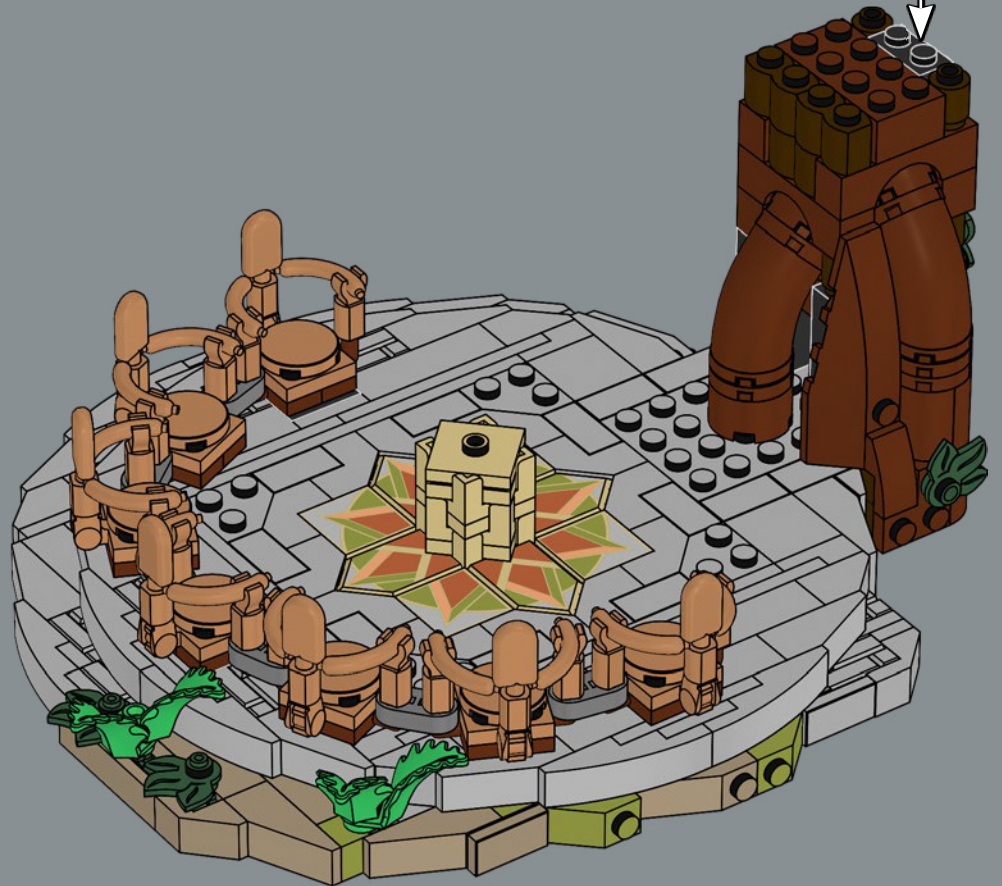

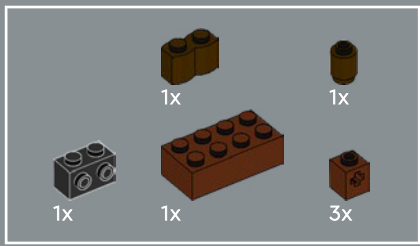

384

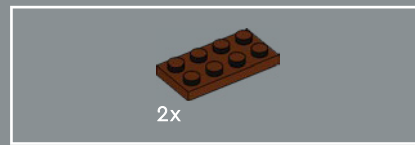
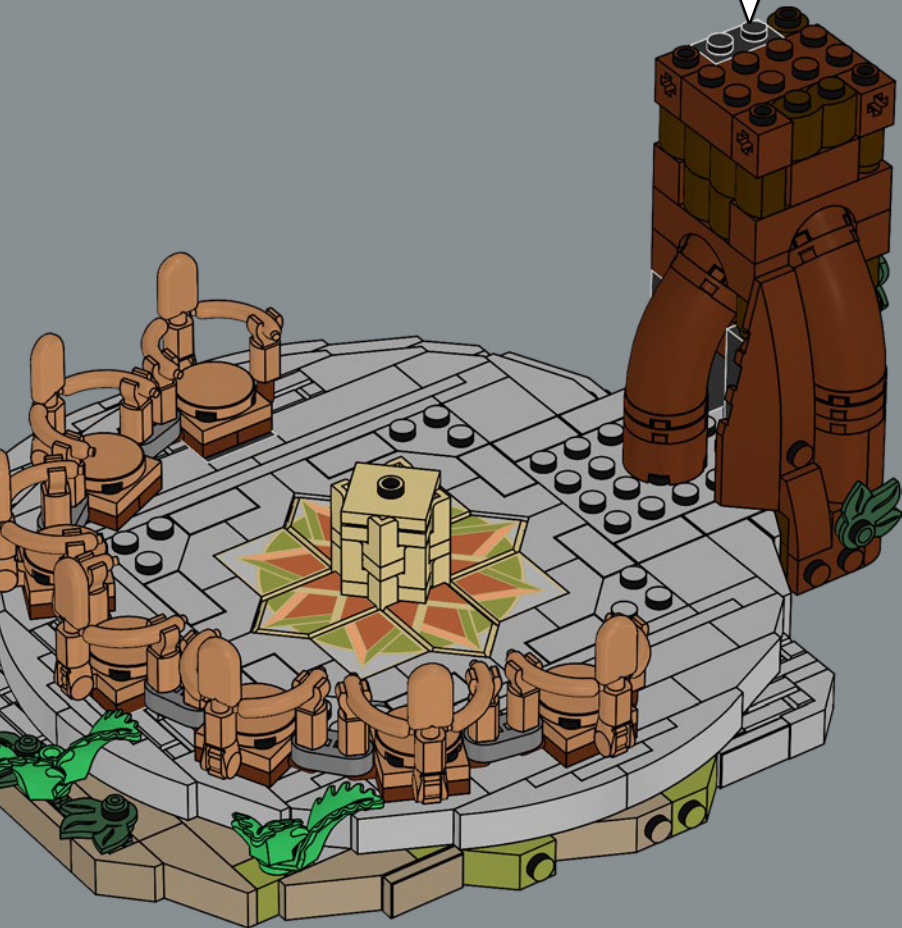
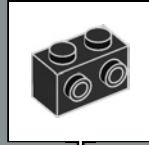

385





386

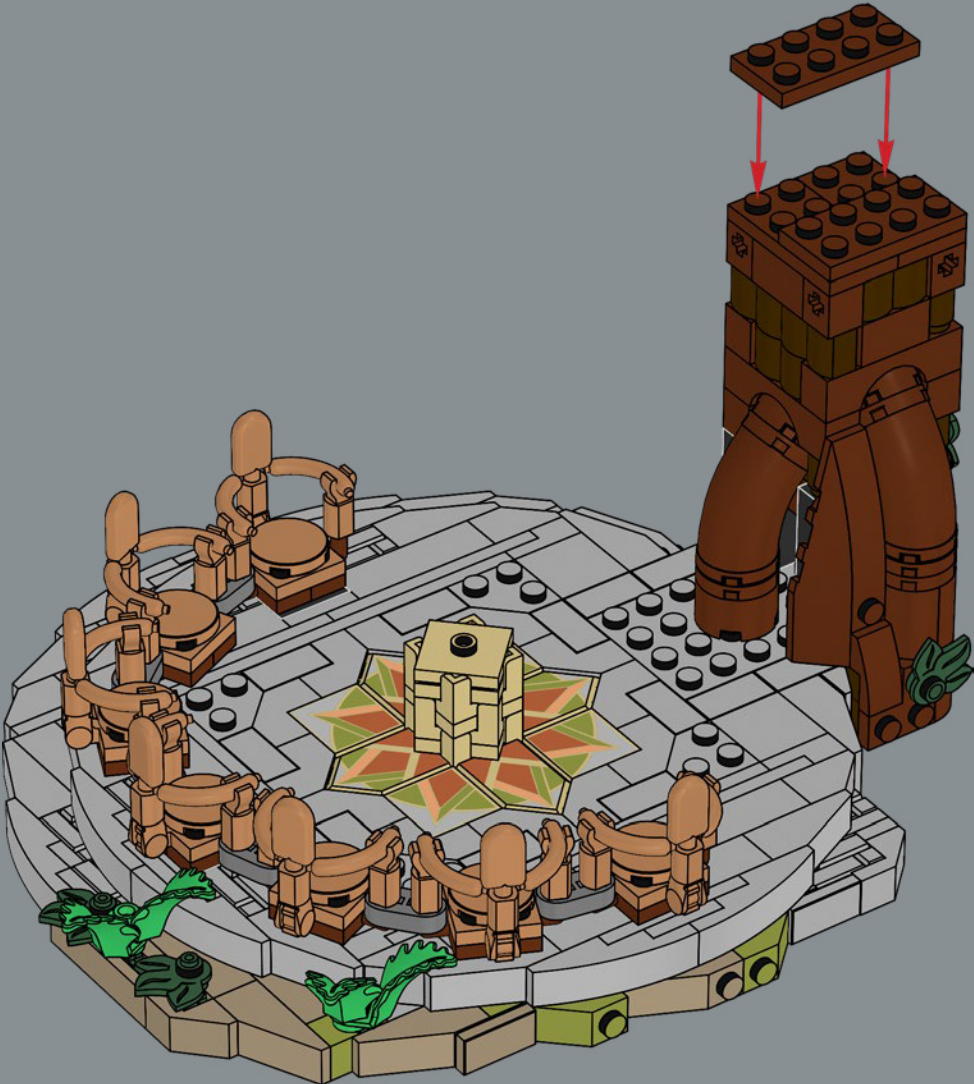

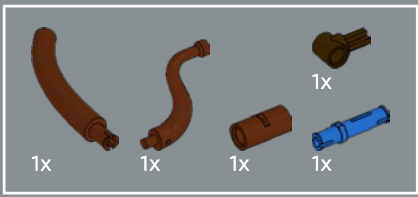

387

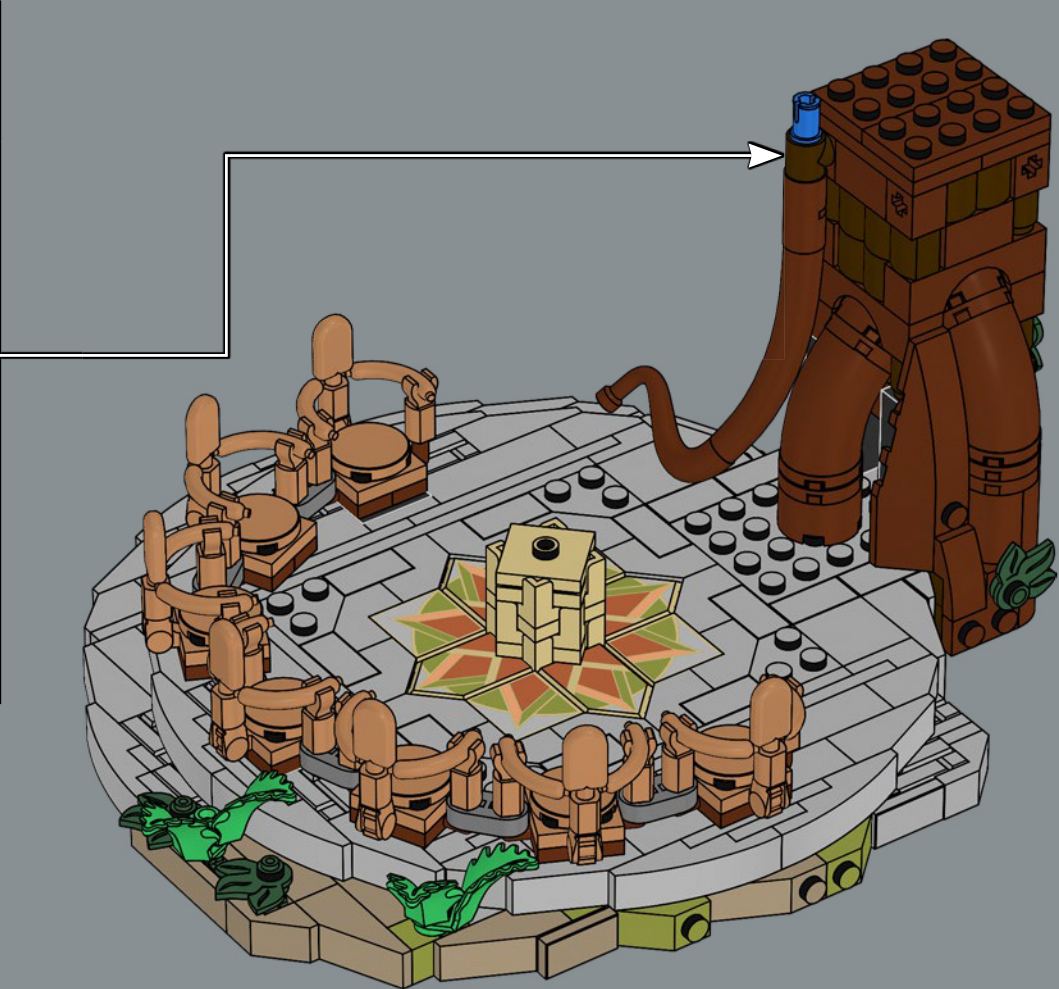
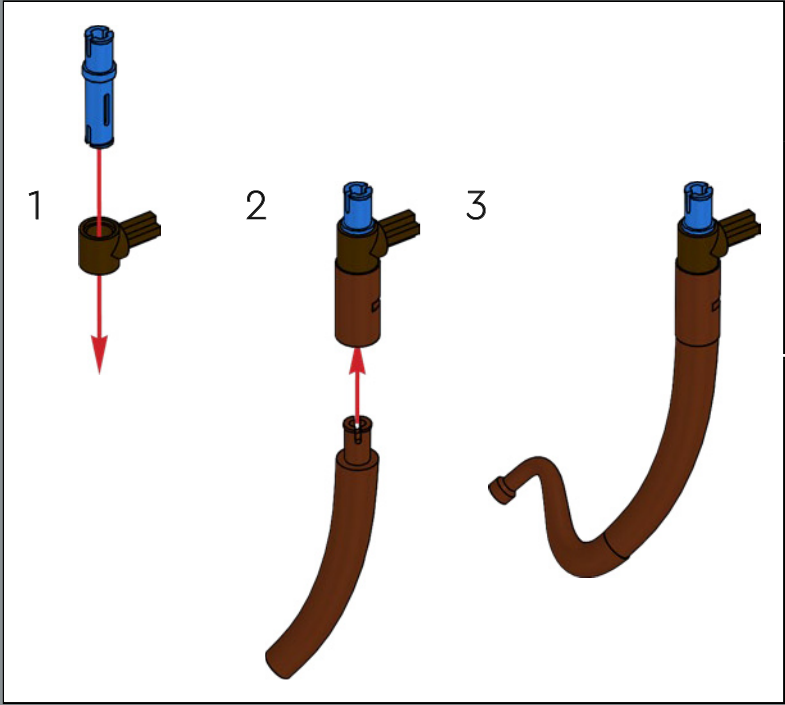

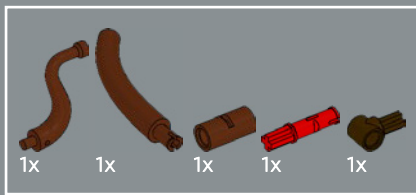

388

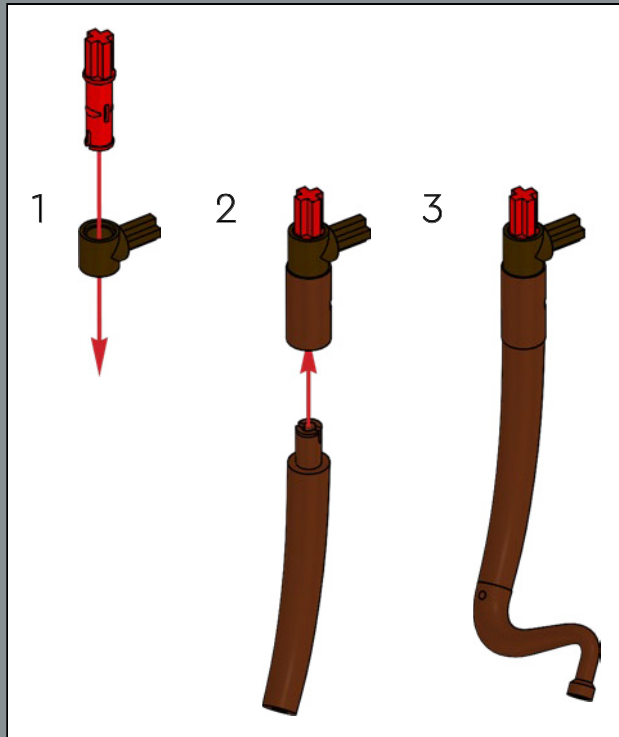

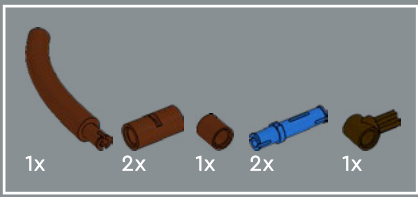

389

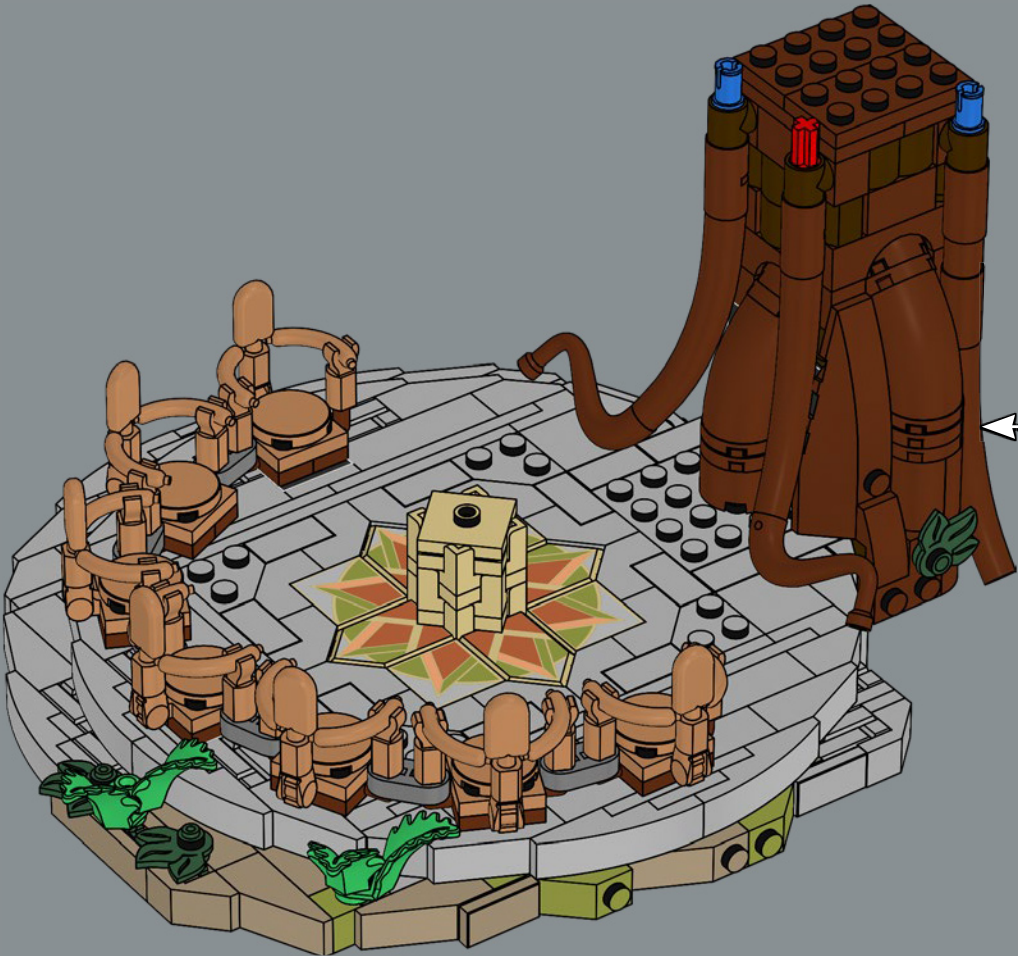
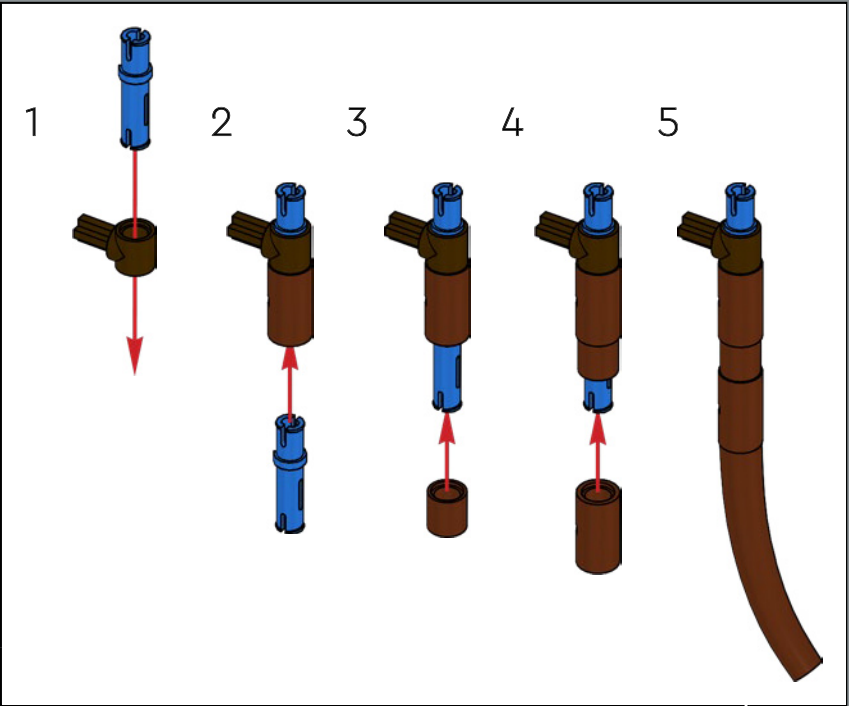

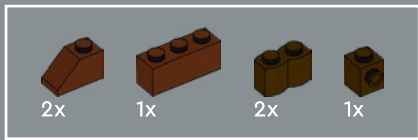

390



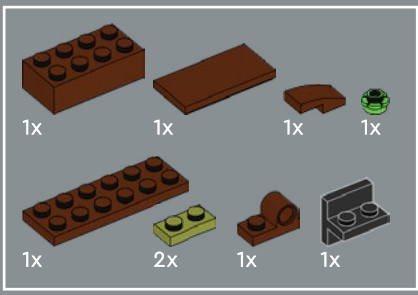

391

1

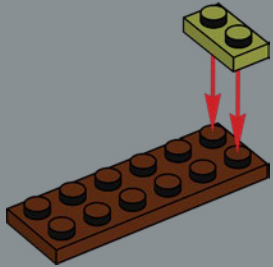

2

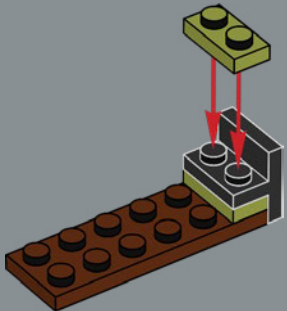

3

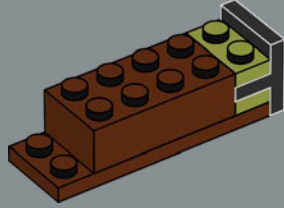

4

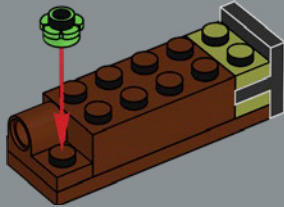

5

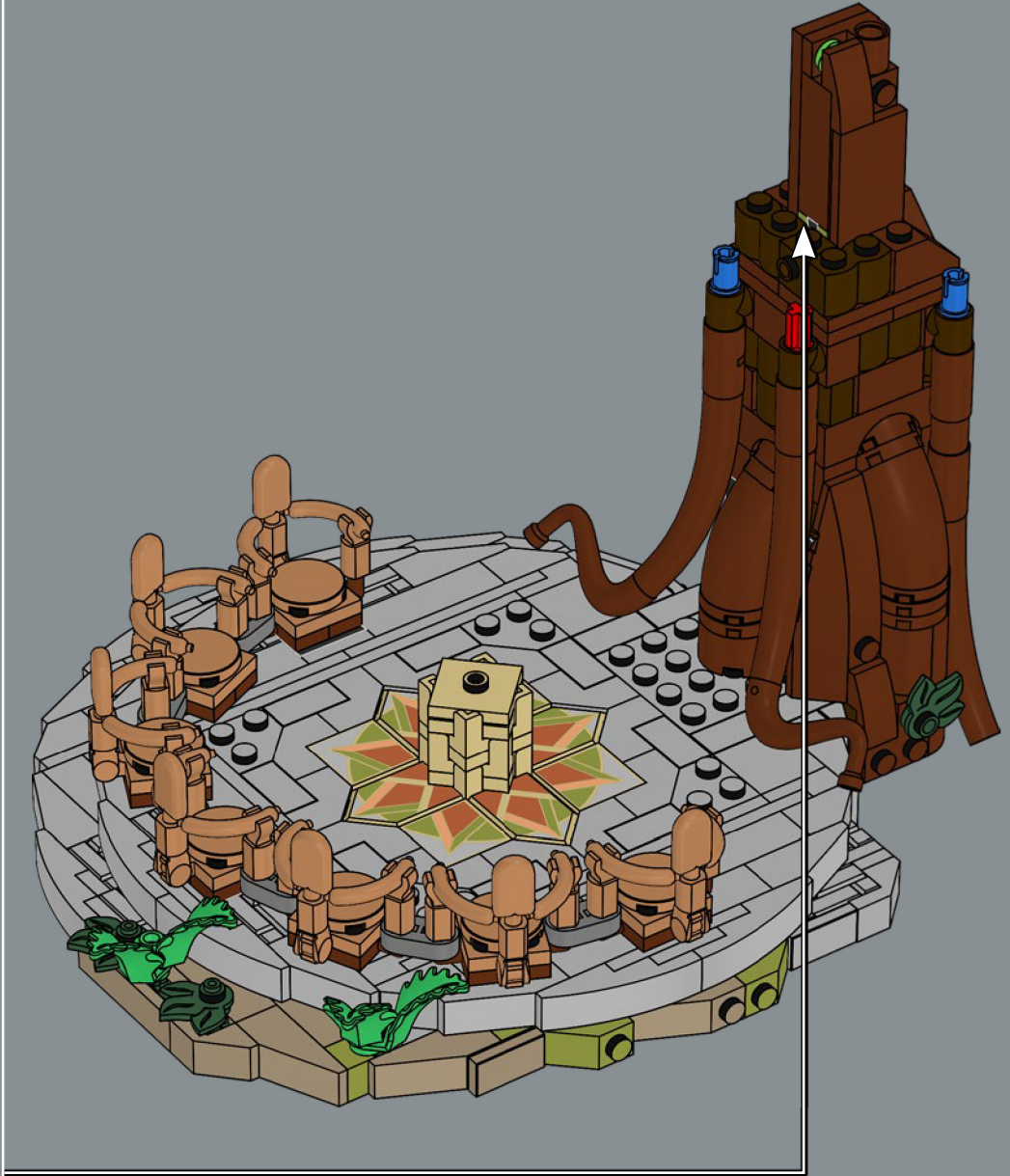
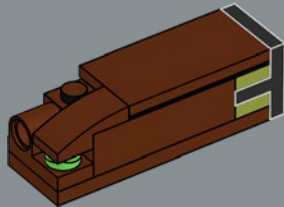

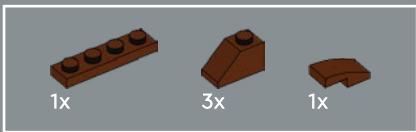

392

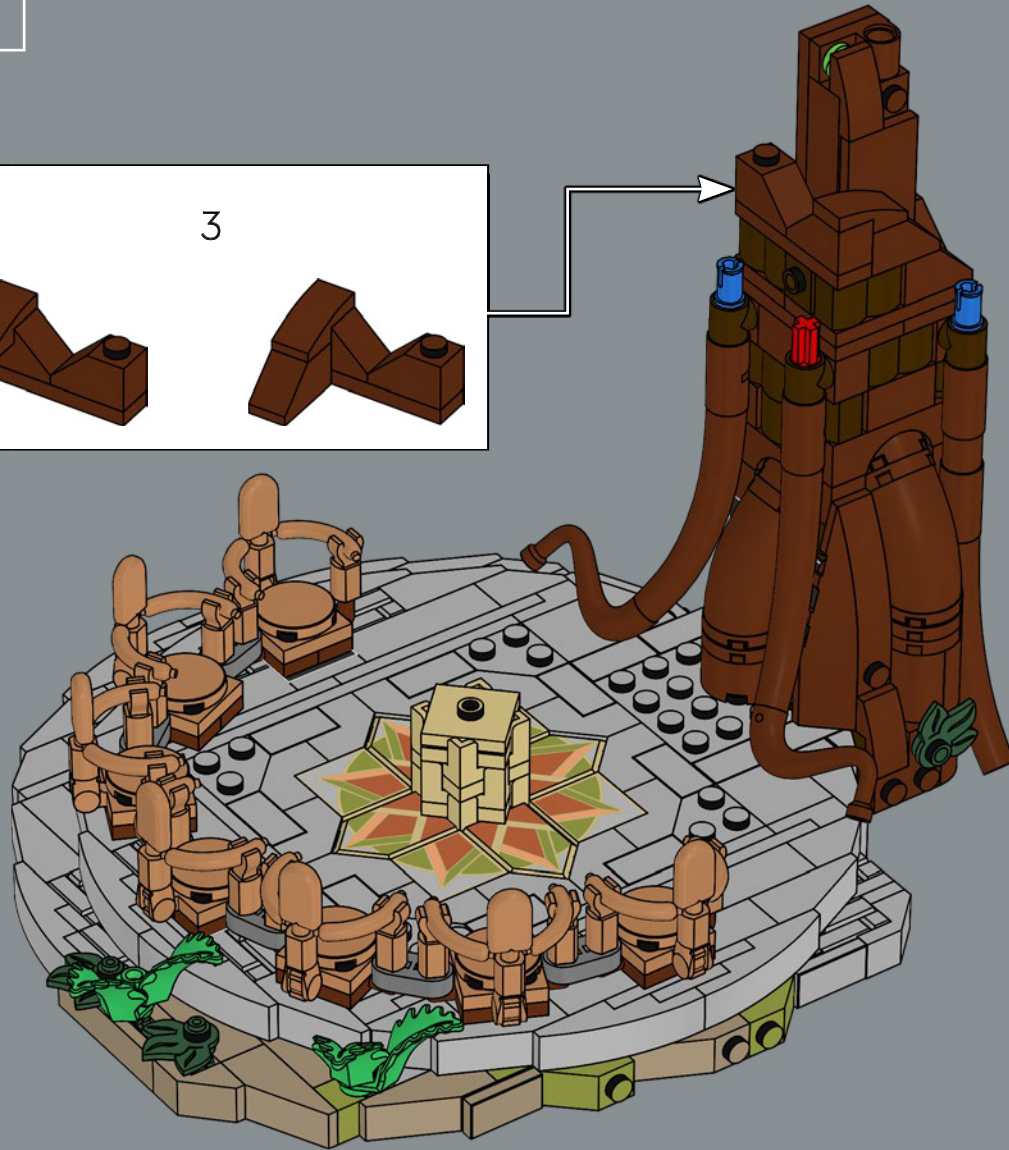
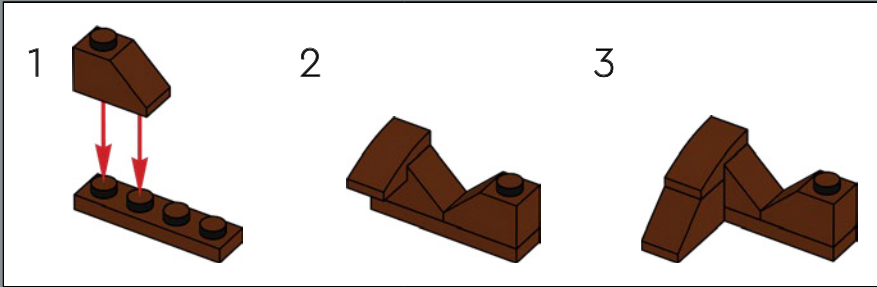

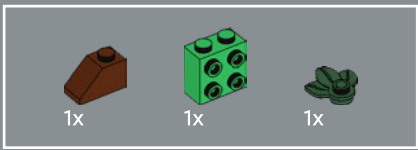

393

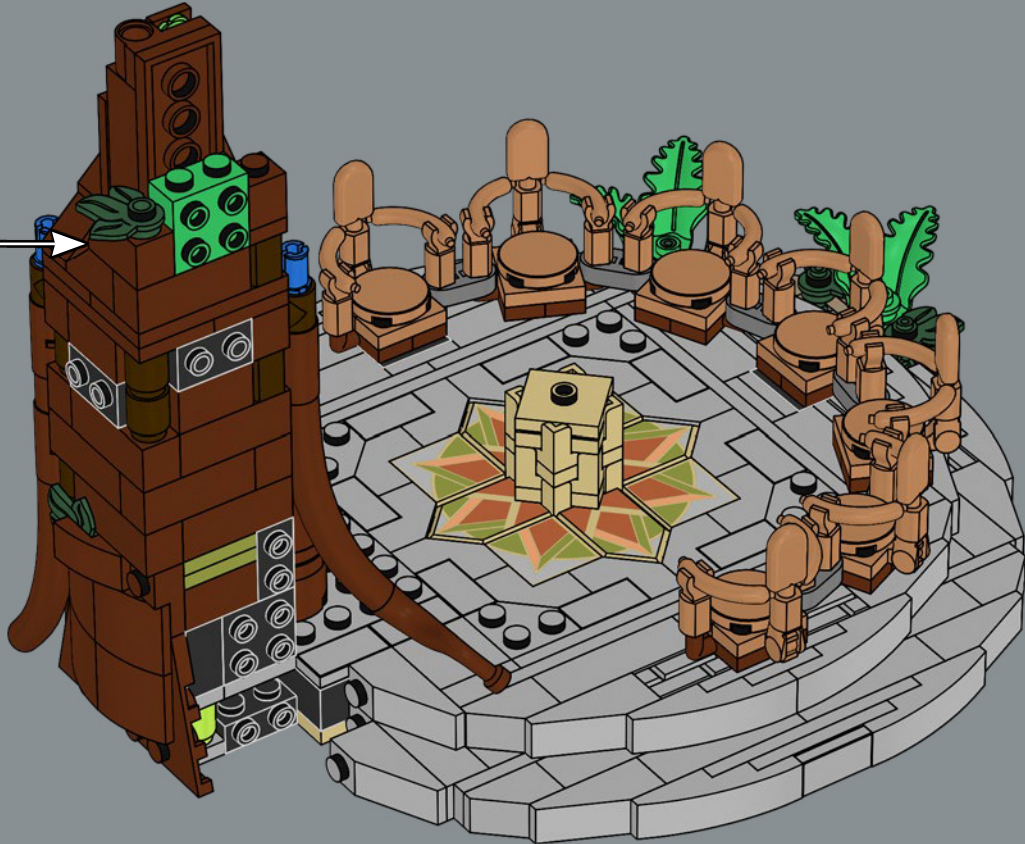
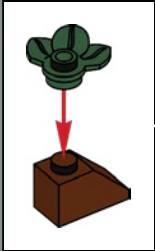

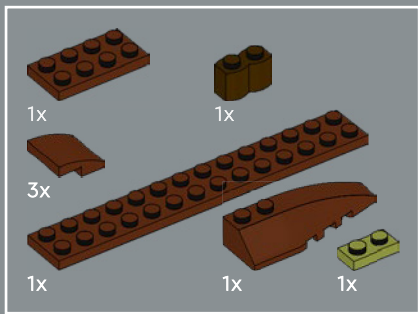

394

1

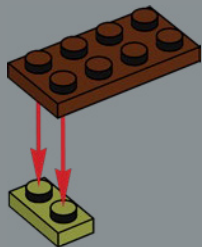

2

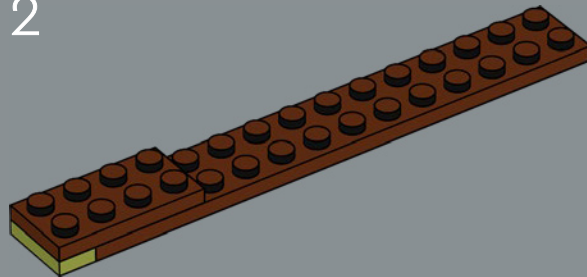

3

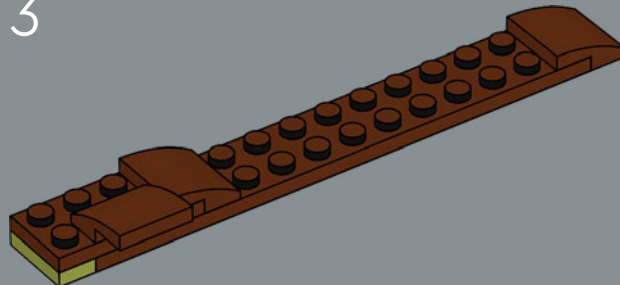

4

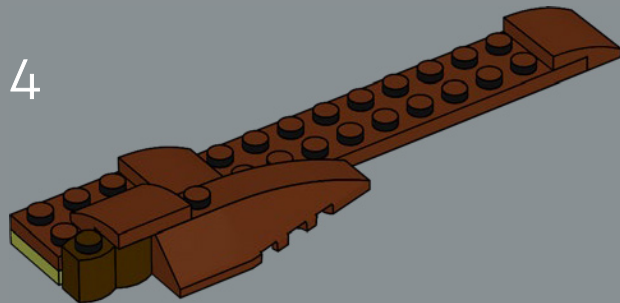



395

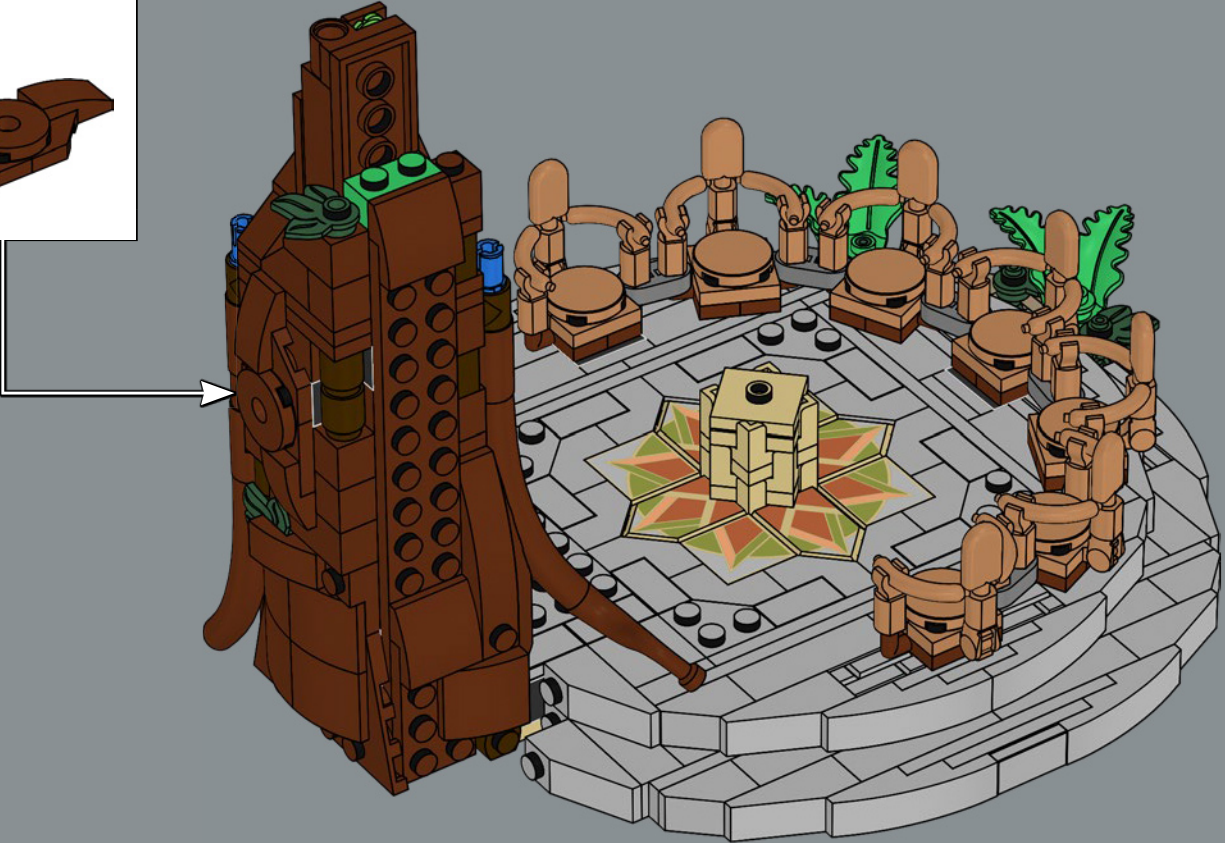
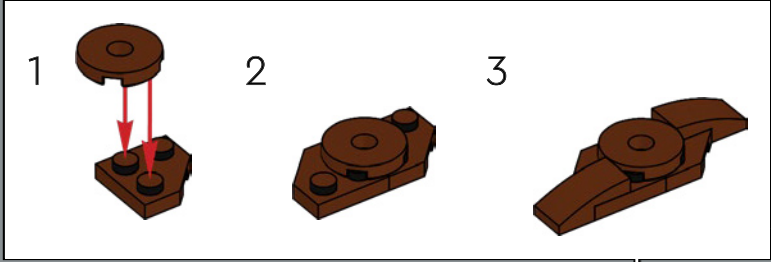

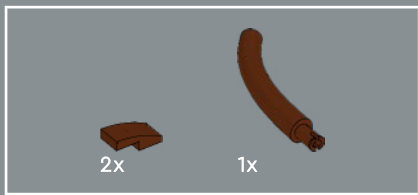

396

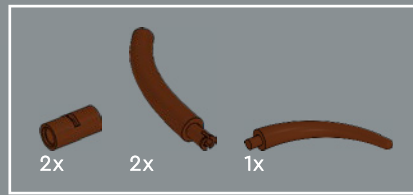
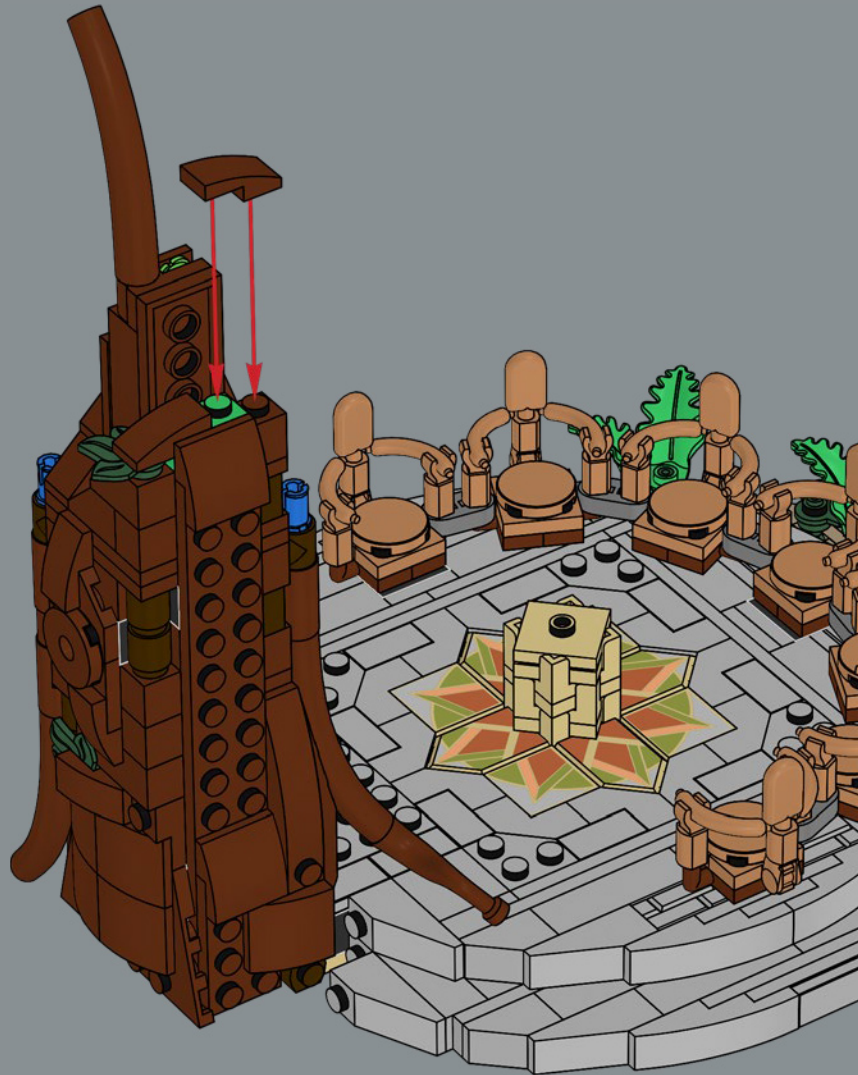

397

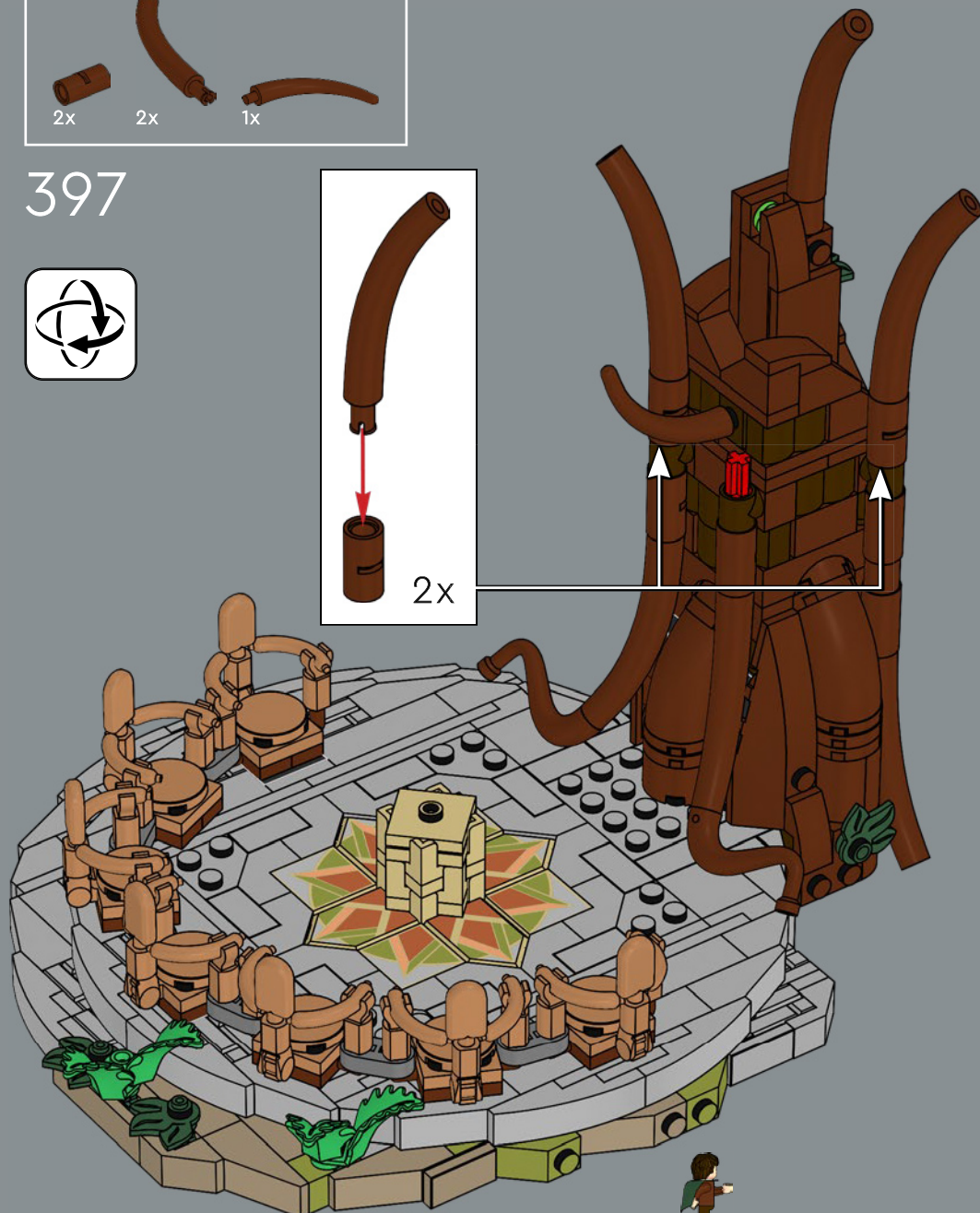
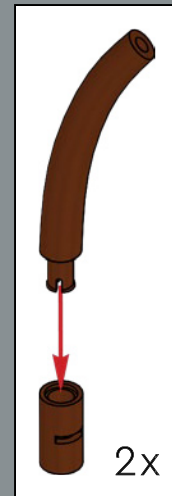

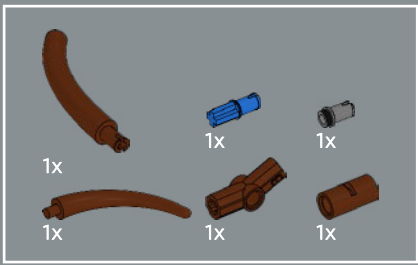

398

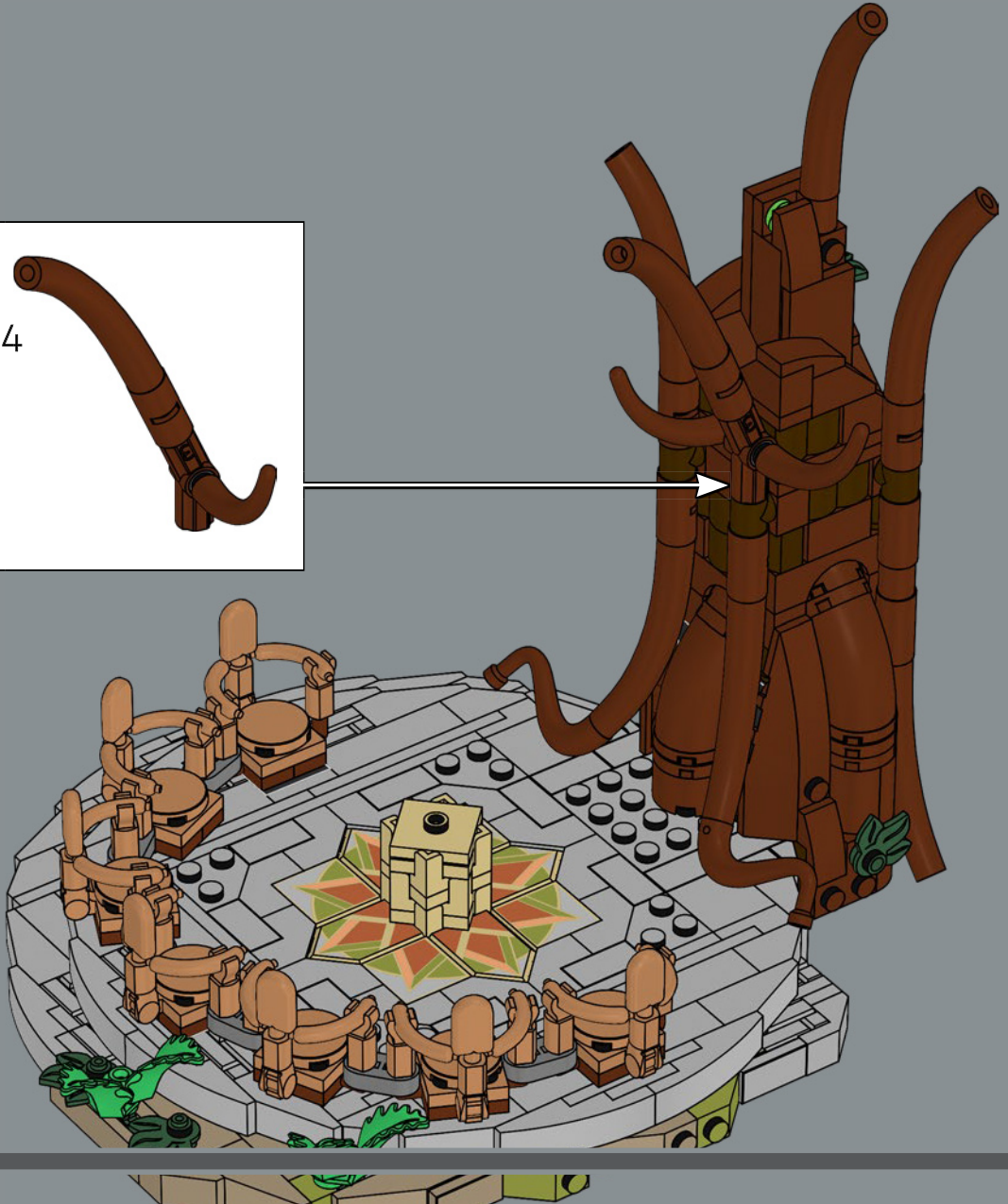
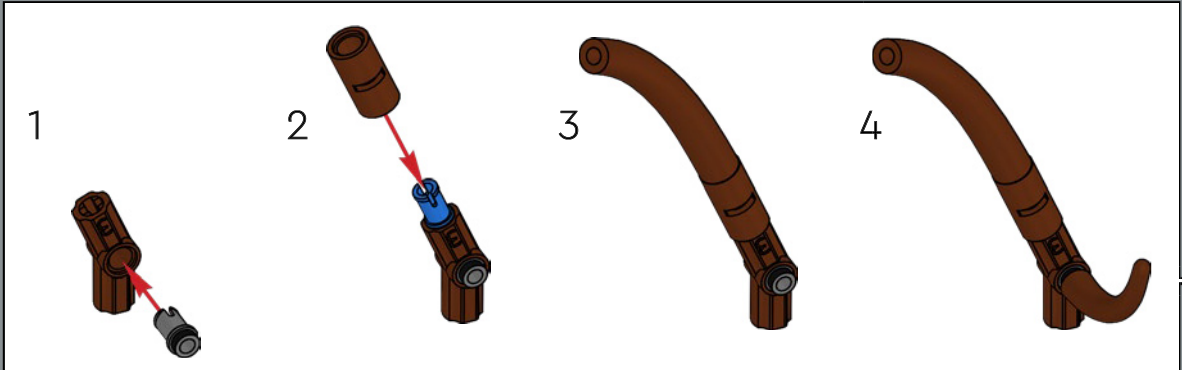

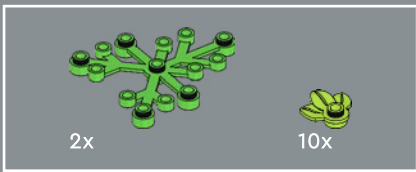

399

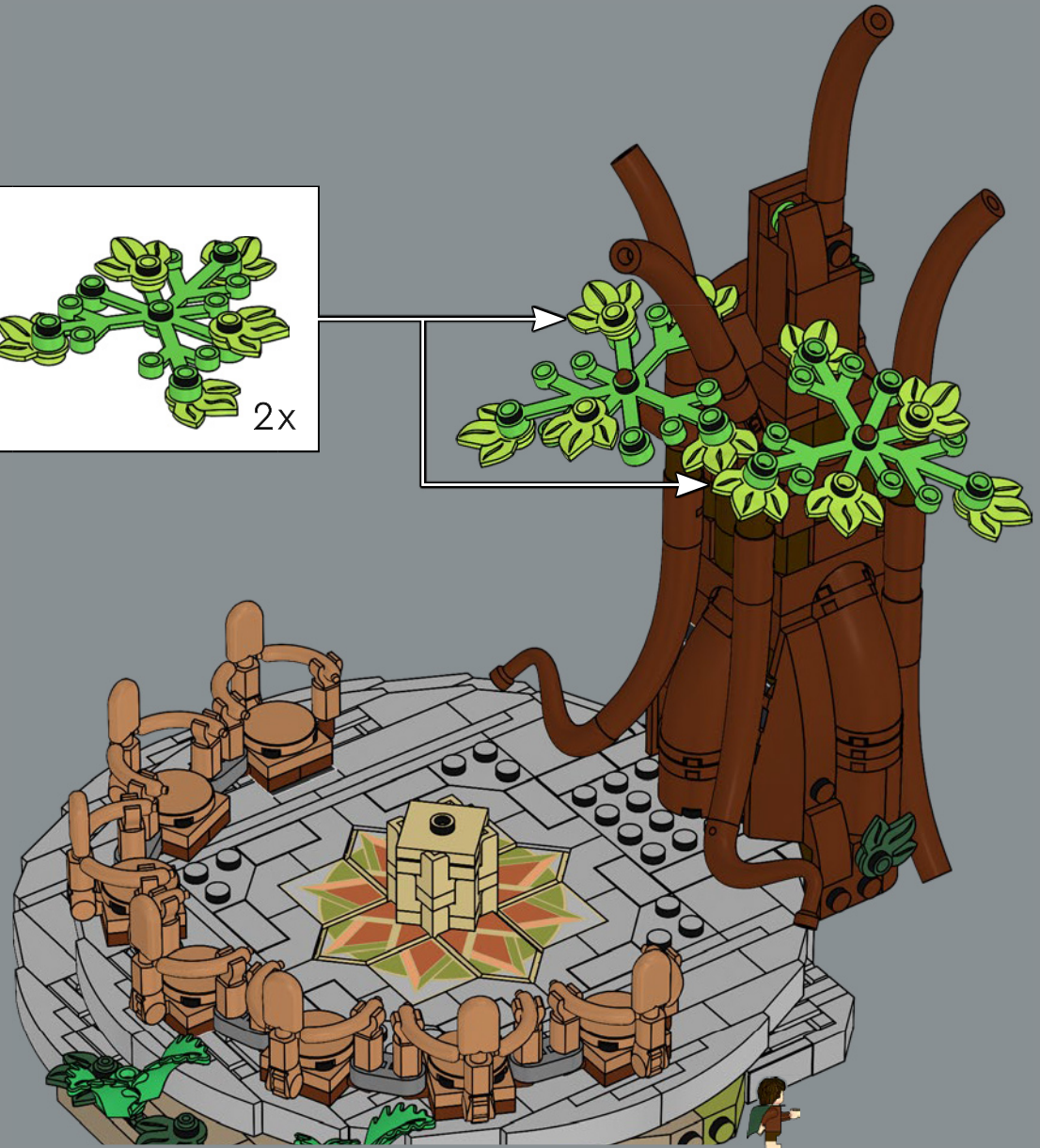
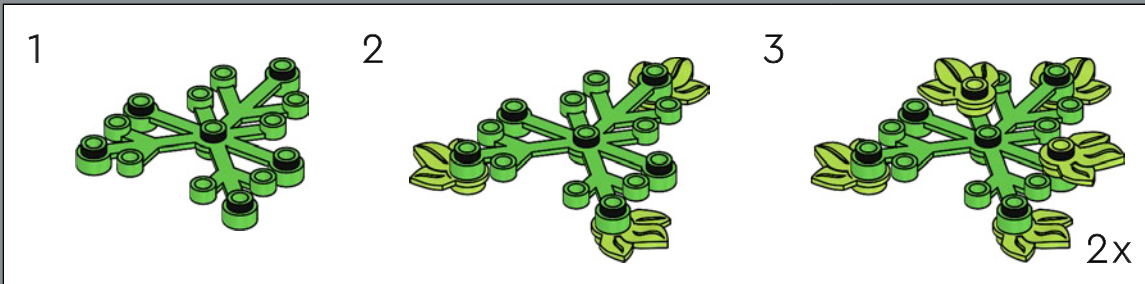



More teal pieces? We really did give Elrond the best chair.

Plus de pièces bleu sarcelle ? Nous avons vraiment réservé
la meilleure chaise à Elrond.

¿Más piezas azuladas? Es un hecho que le dimos el mejor
asiento a Elrond.



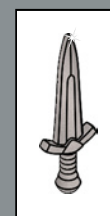
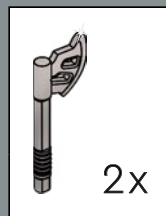
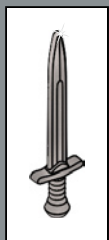
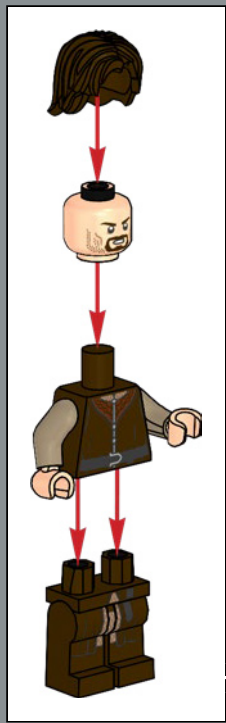
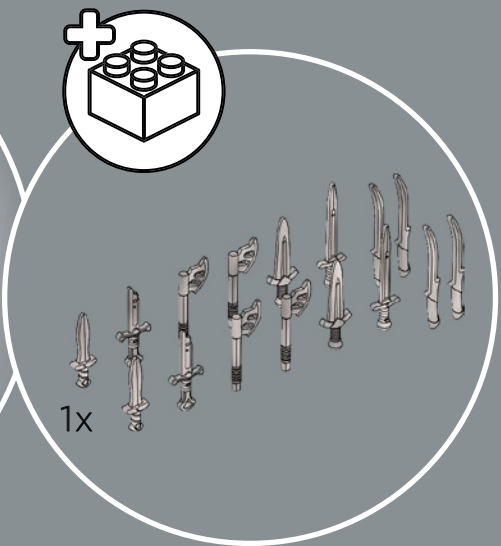

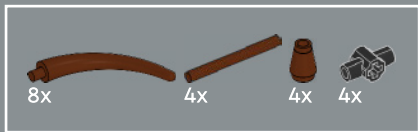

401

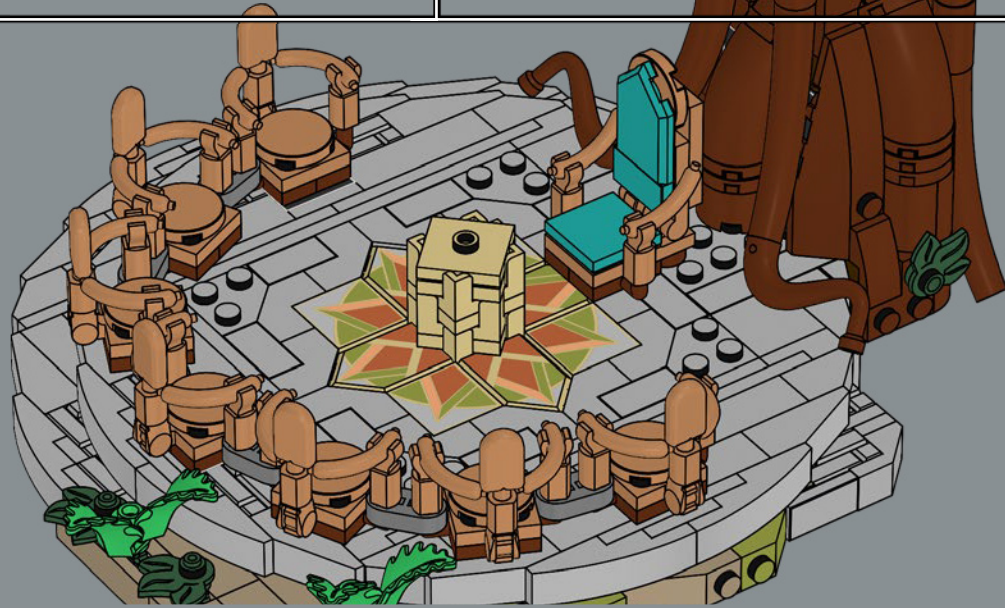
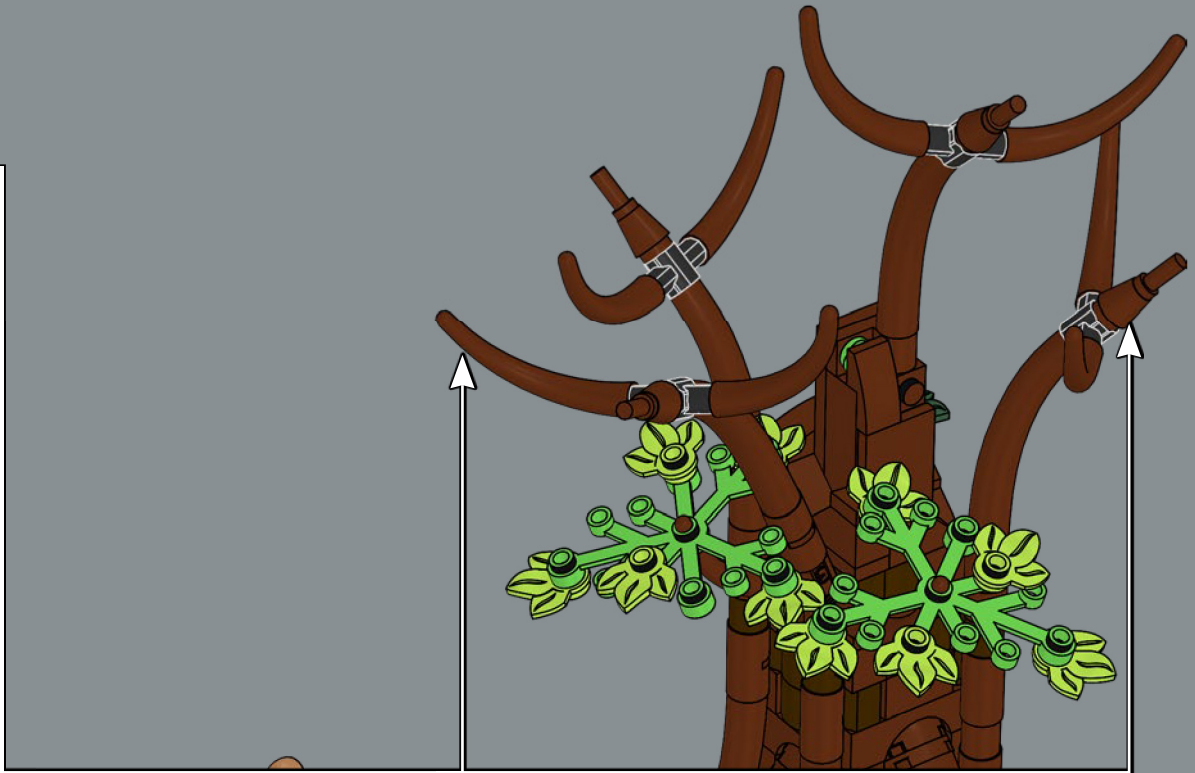
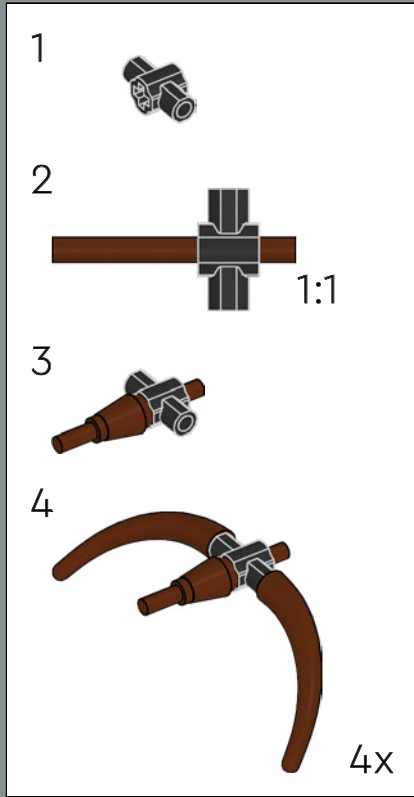

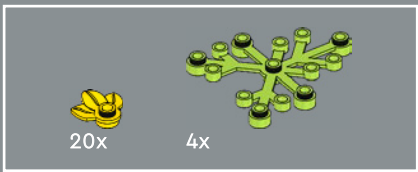

402

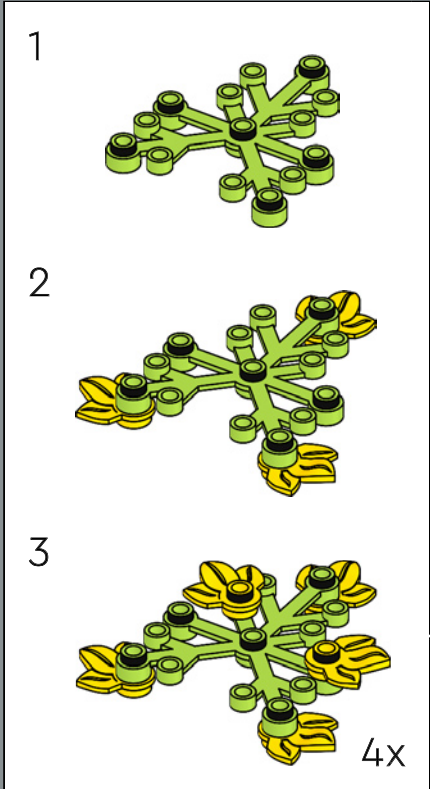

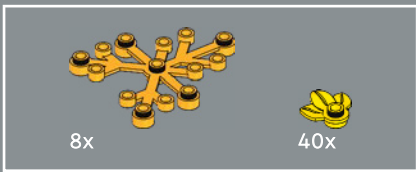

403

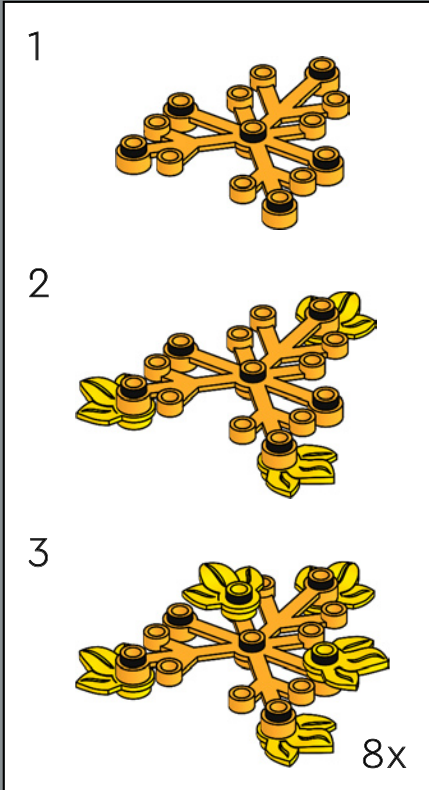



405



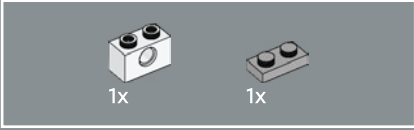
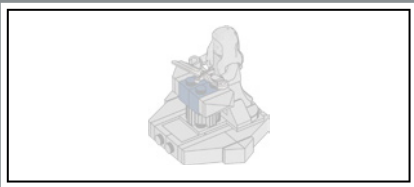

406

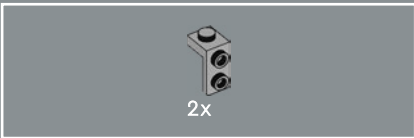
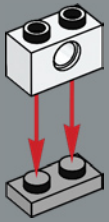

407

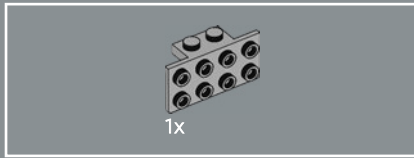
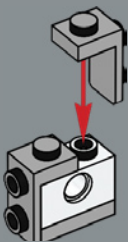

408

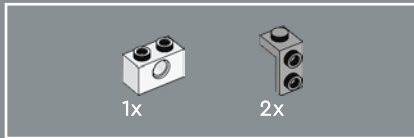
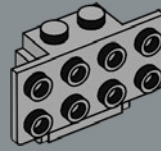

409

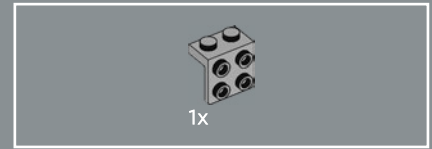
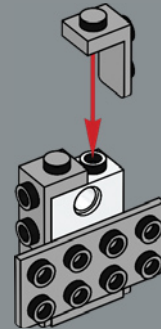

410

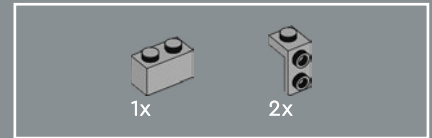
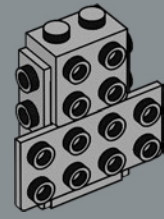

411

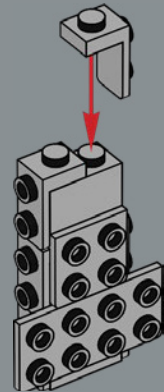

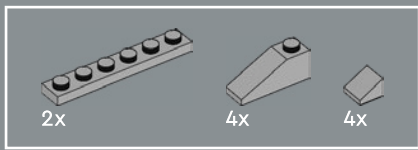

412

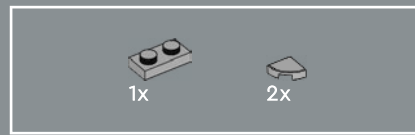
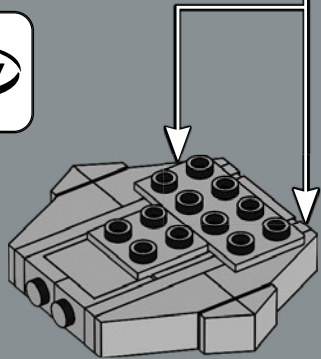
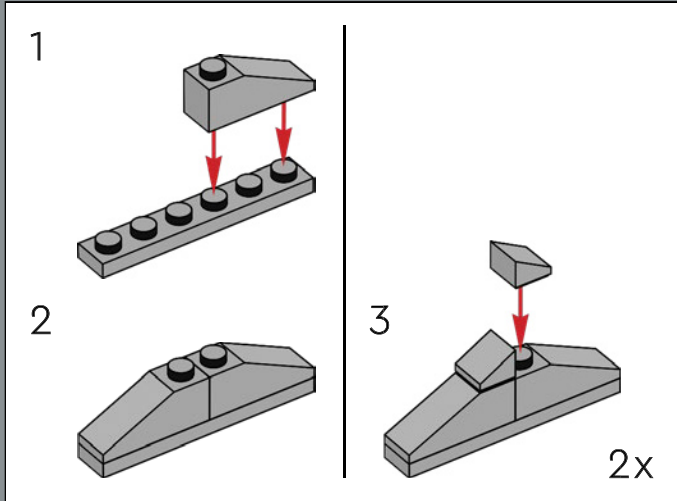

413

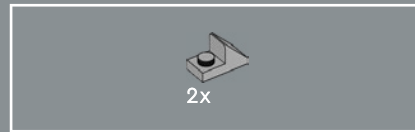
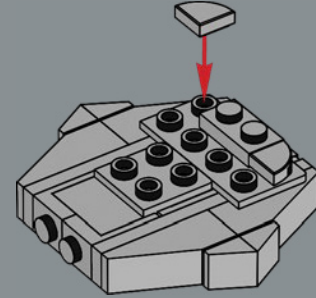

414

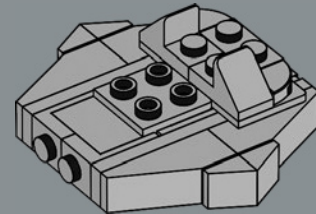



1x

415

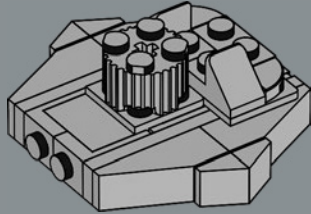

2x



2x



2x

416

1

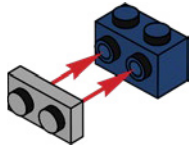

2

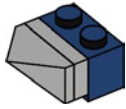

2x

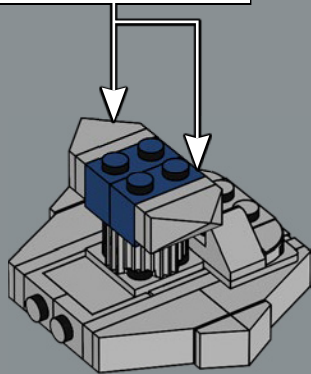

1x

1x

1x

1x

1x

417

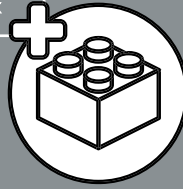

1

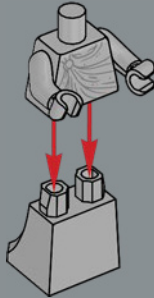

2

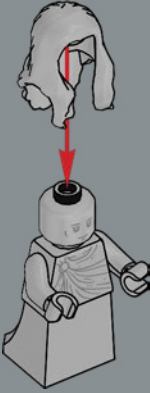

3

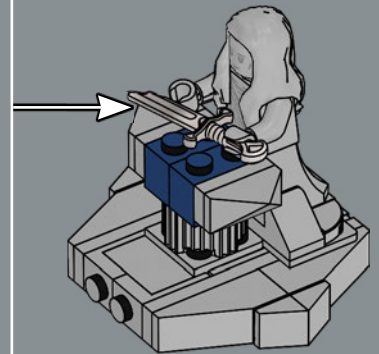

418



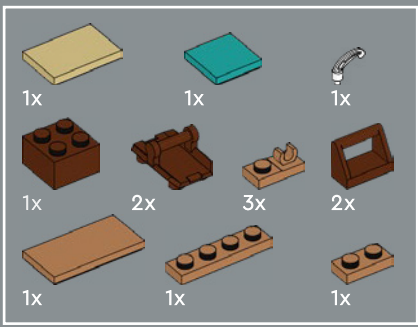

419

3

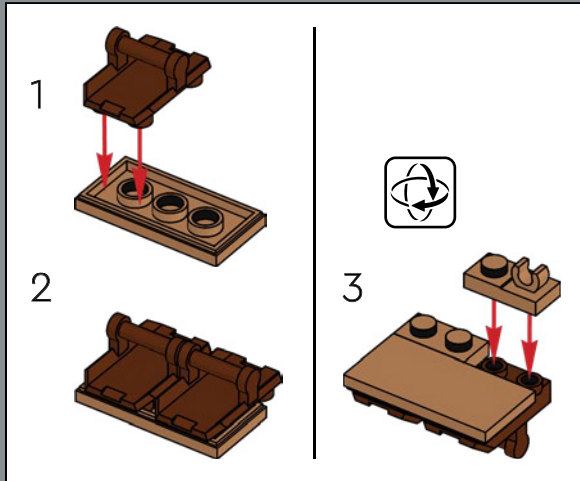
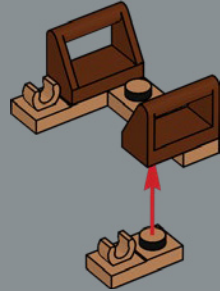

4

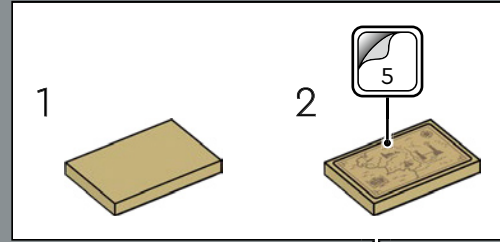
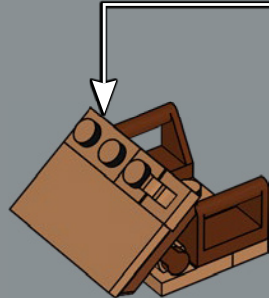

6

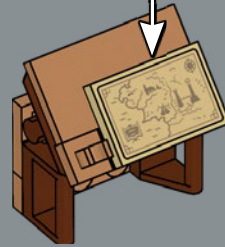

5

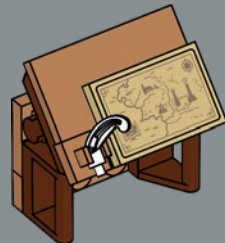

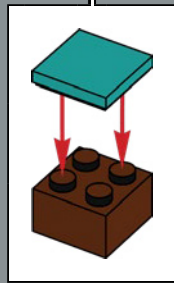

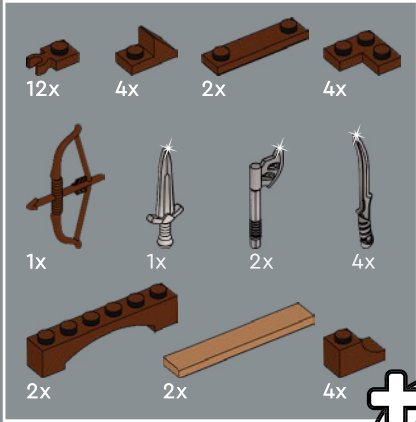
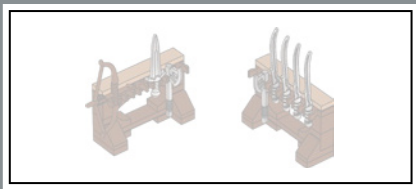

420

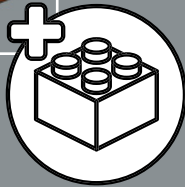

1

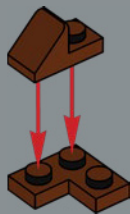

2

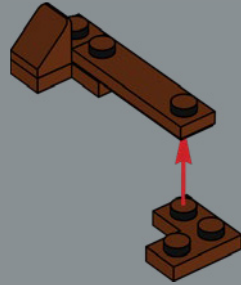

3

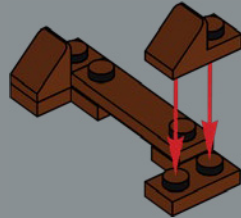

4

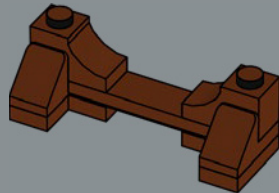

5

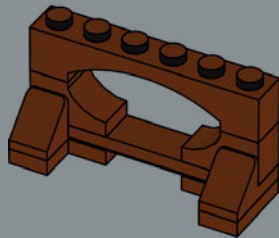

6

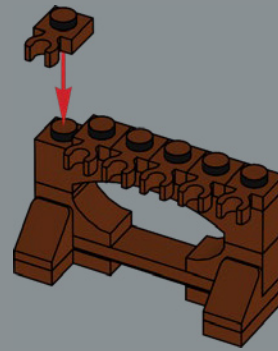

7

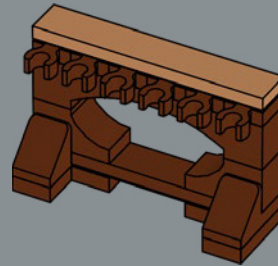

2x

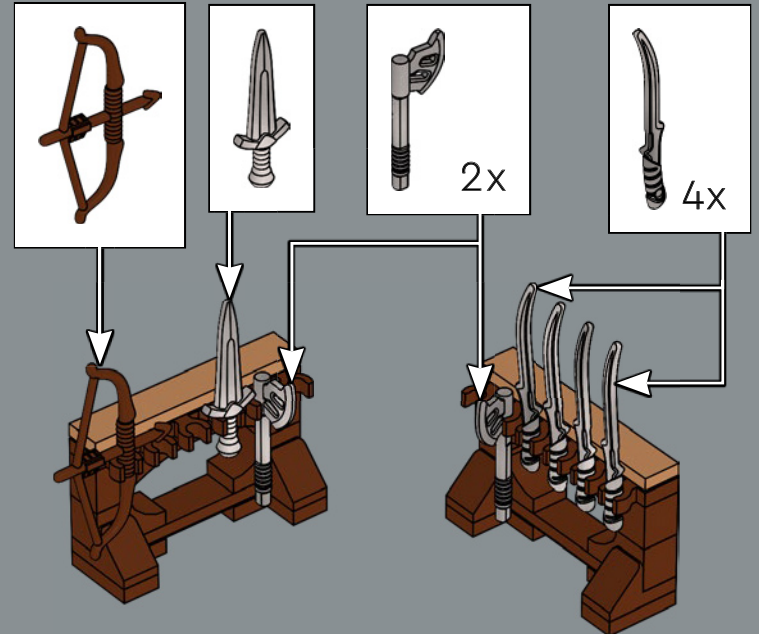



These racks can store all the extra weapons when not in use.
They fit nicely inside the armory by the forge.

Ces supports permettent de stocker toutes les armes supplémentaires lorsqu'elles ne sont pas utilisées. Ils s'intègrent bien dans l'armurerie près de la forge.

Estos soportes pueden mantener ordenadas las armas adicionales cuando no se usan. Caben perfectamente en el interior de la armería que está al lado de la forja.



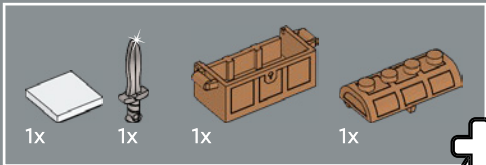

422

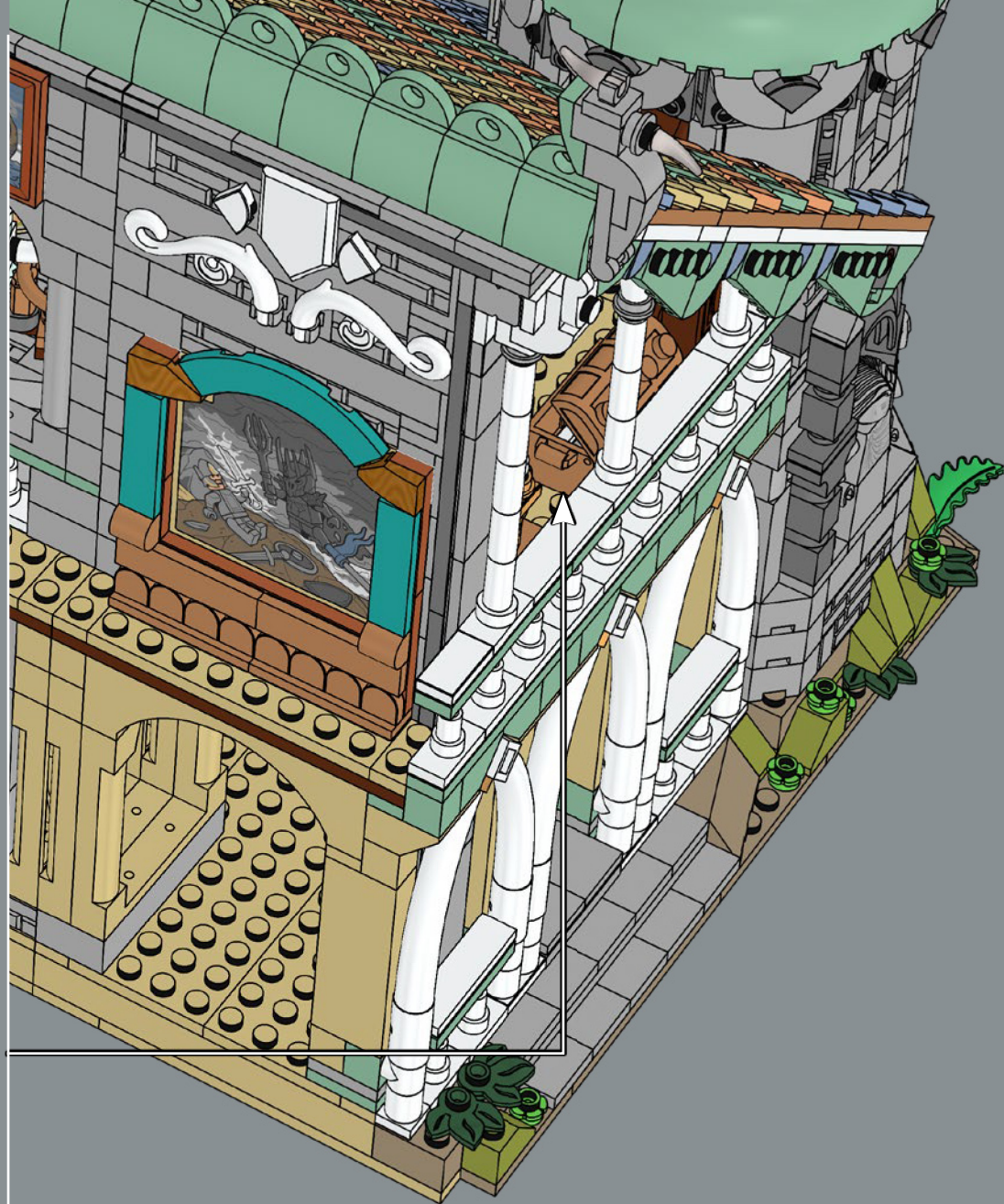
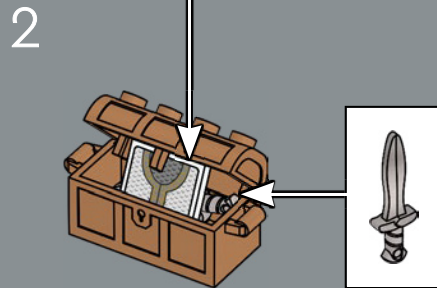
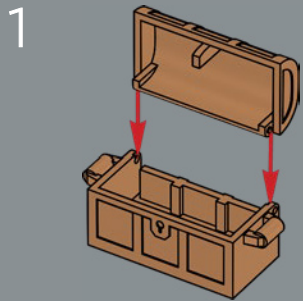
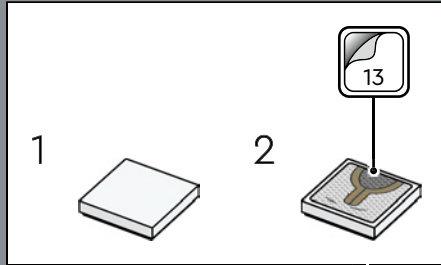
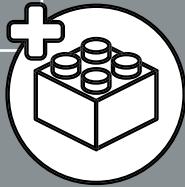

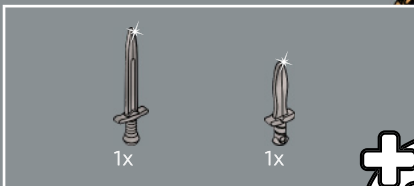

423

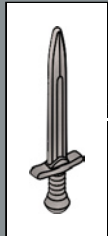

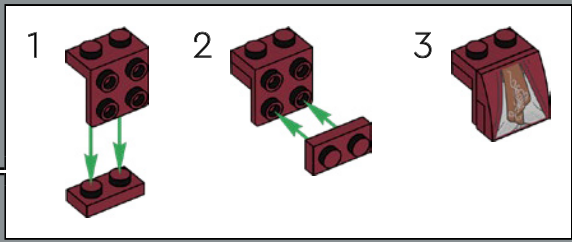
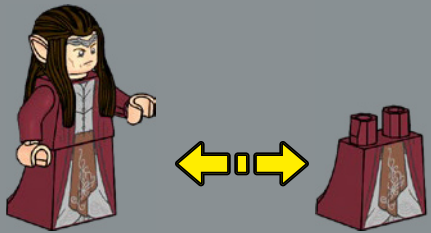
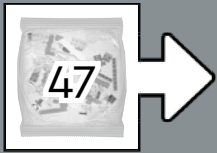
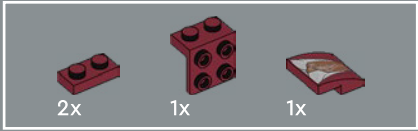
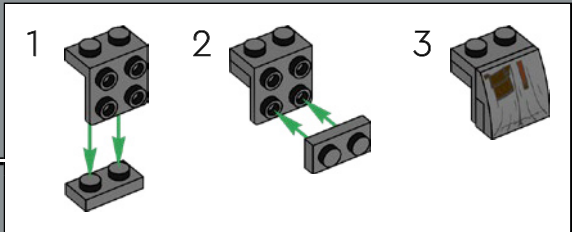
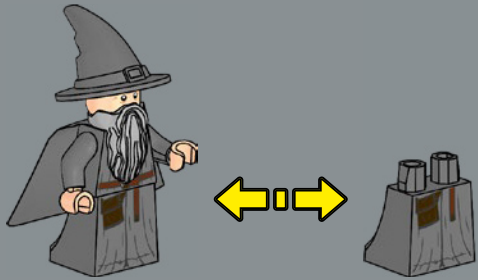
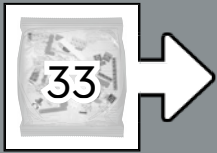
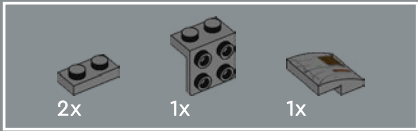
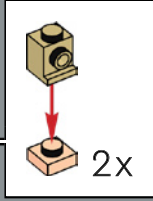
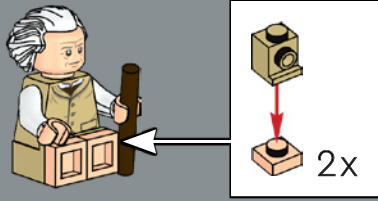
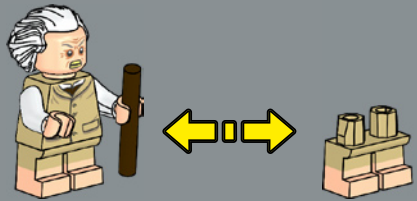
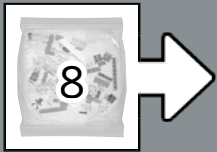
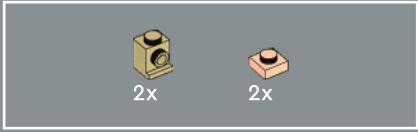
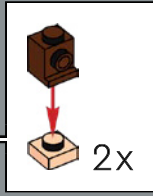
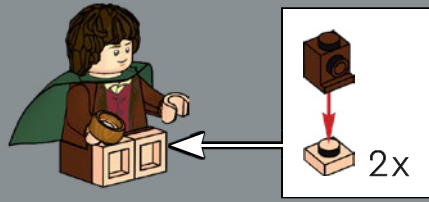
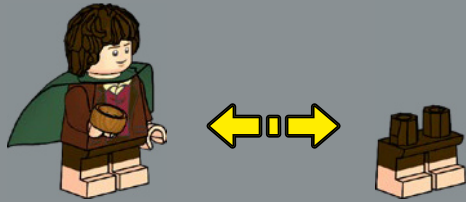
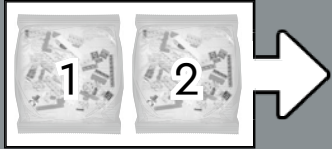
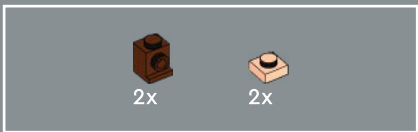



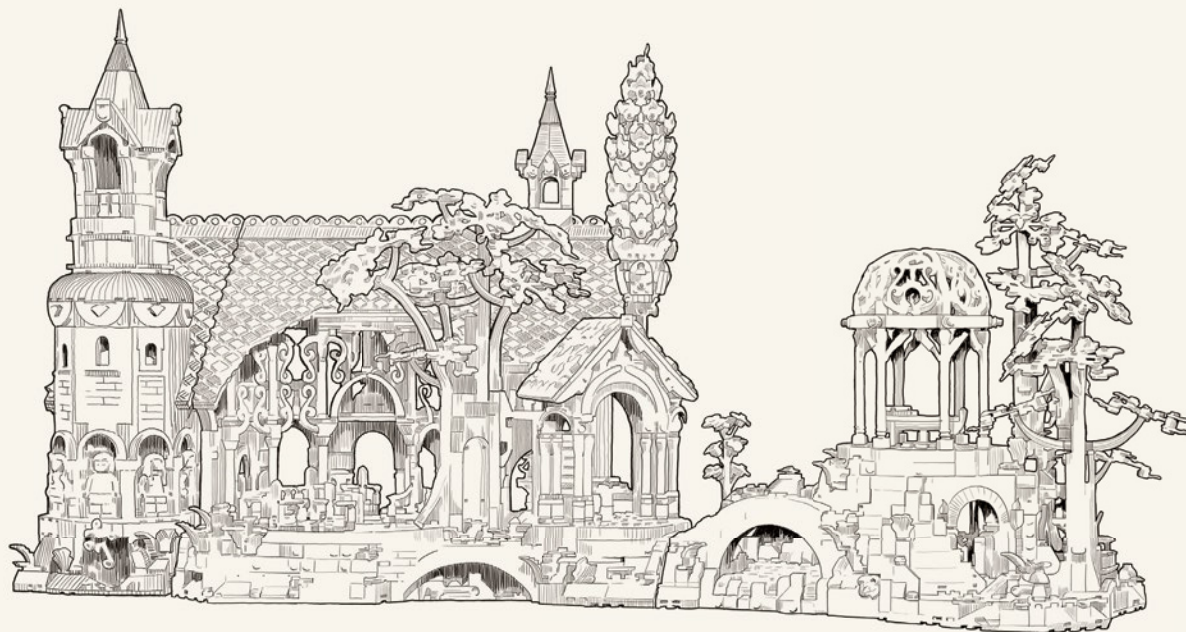

LEGO and the LEGO logo are trademarks of the/son des marques de commerce du/son marcas registradas de LEGO Group. ©2023 The LEGO Group. 6455639

© 2023 New Line Productions, Inc. All rights reserved. The Lord of the Rings: The Fellowship of the Ring, The Lord of the Rings: The Two Towers, The Lord of the Rings: The Return of the King and the names of the characters, items, events and places therein are trademarks of The Saul Zaentz Company d/b/a Middle-earth Enterprises under license to New Line Productions, Inc. (s23)