

2

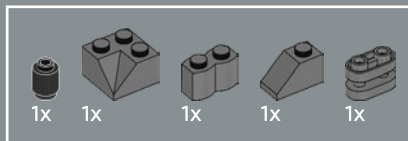

3

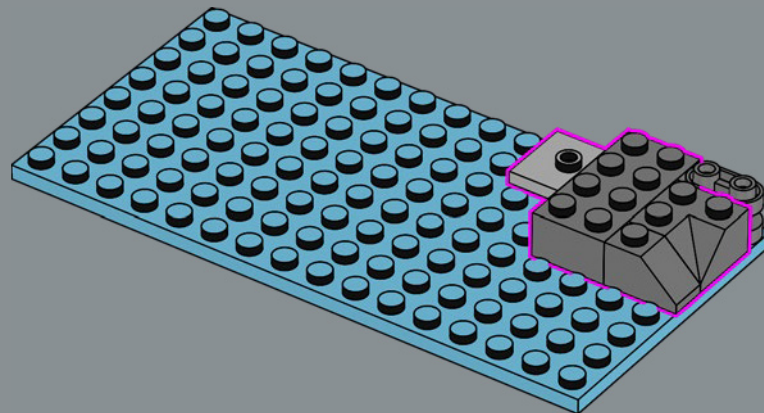

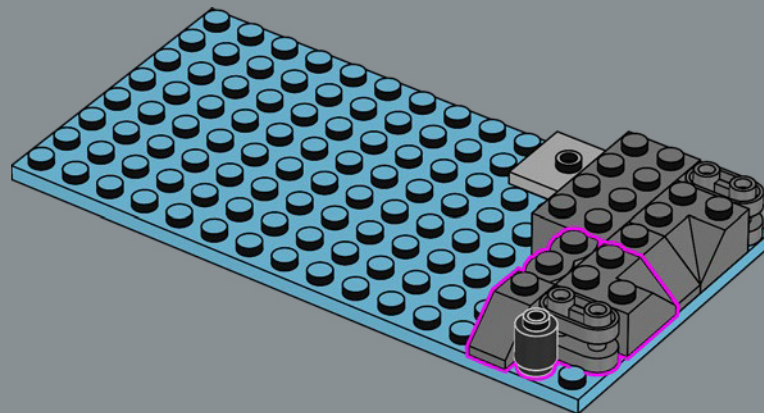
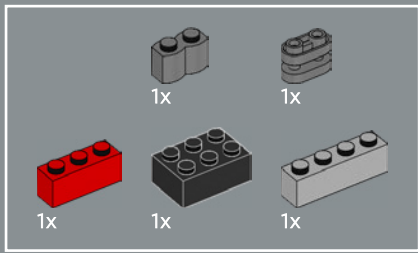

4

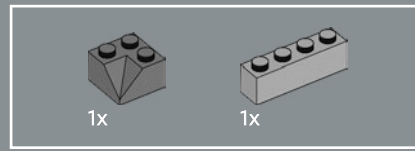
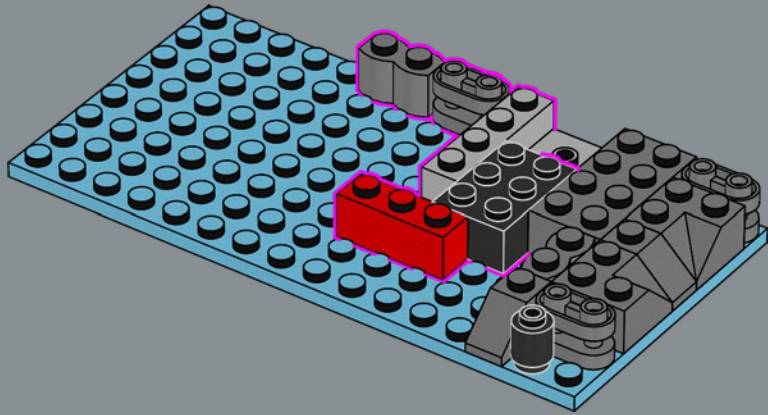

5

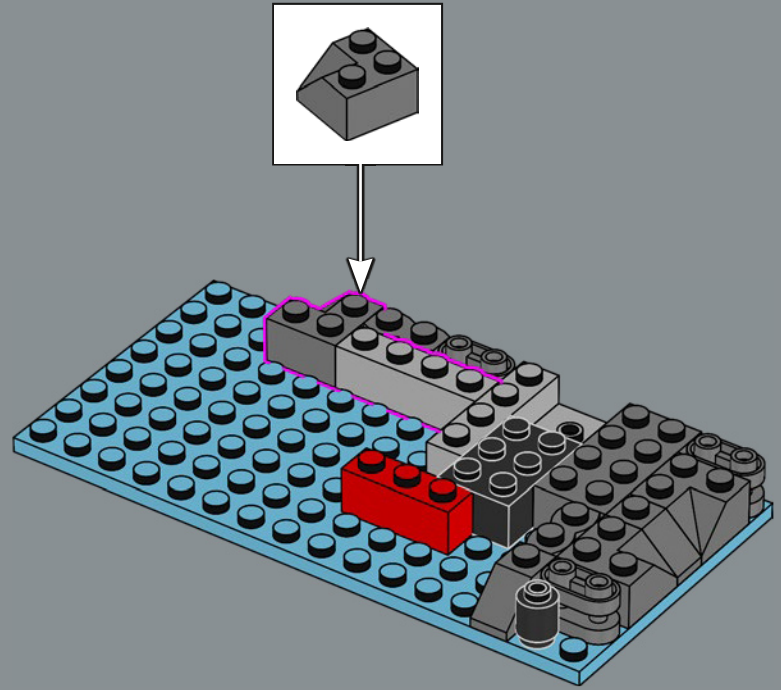

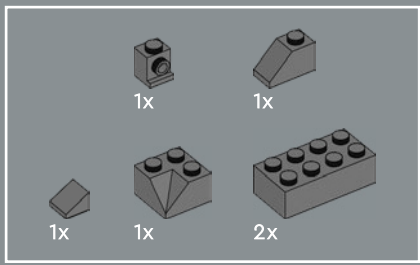

6

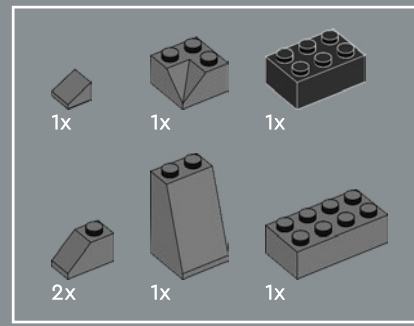
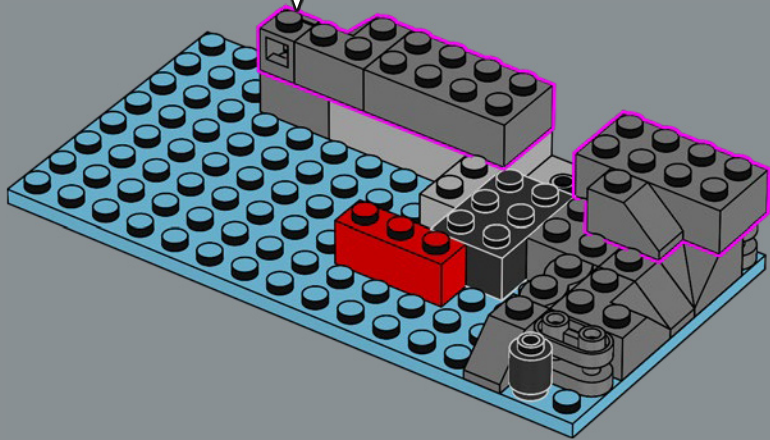
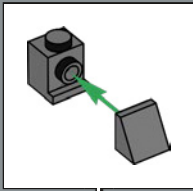

7

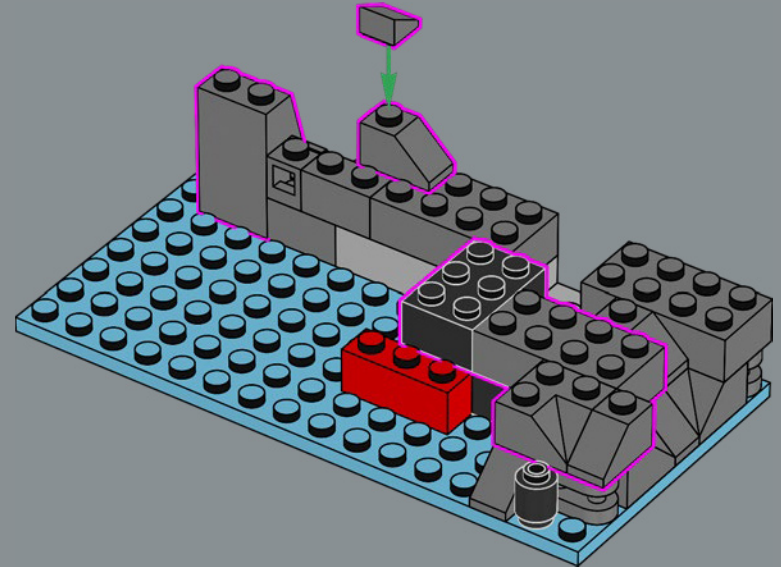

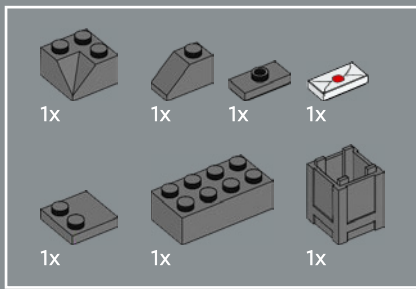

8

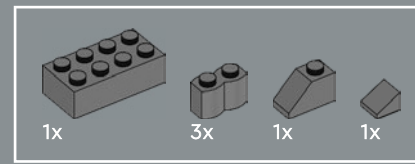
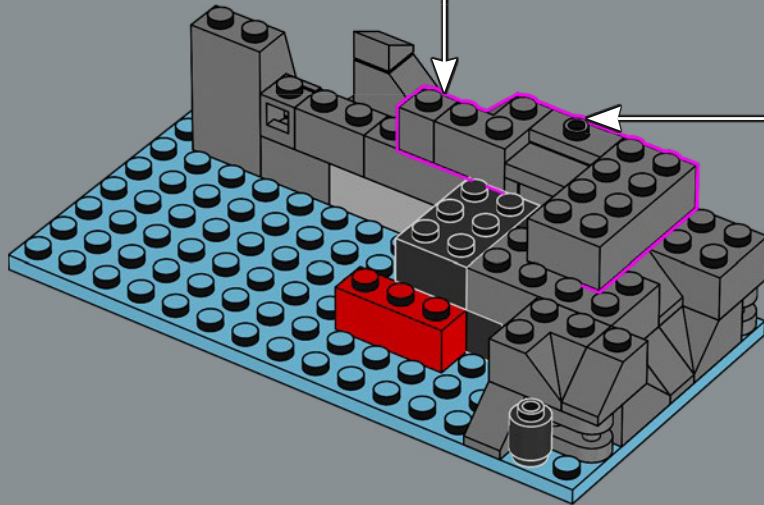
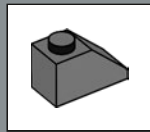
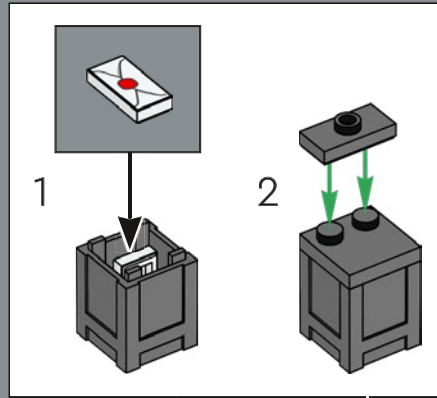

9

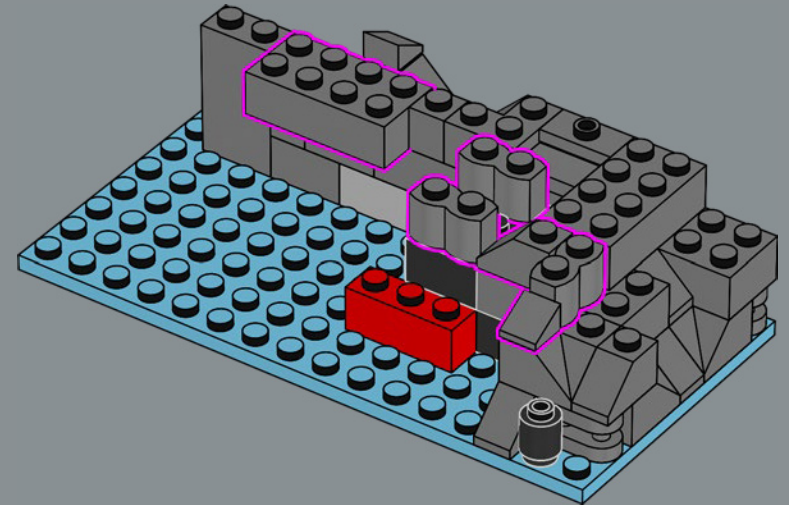

Une lettre cachée ? De qui peut-elle bien être ?
Qui peut résoudre ce mystère ?

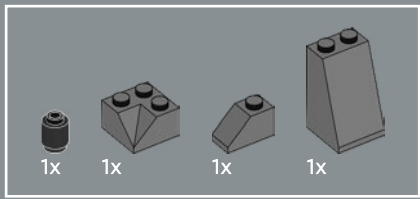

10

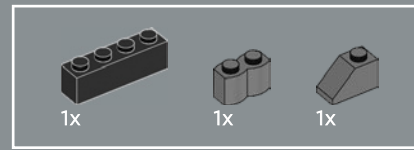
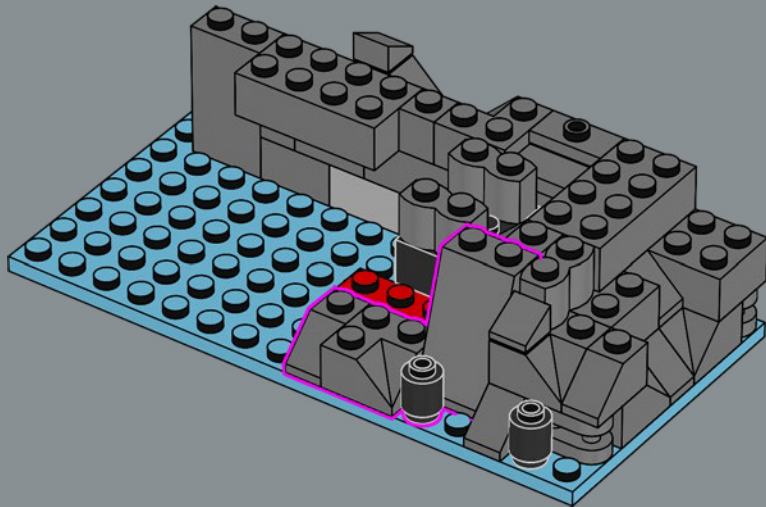

11

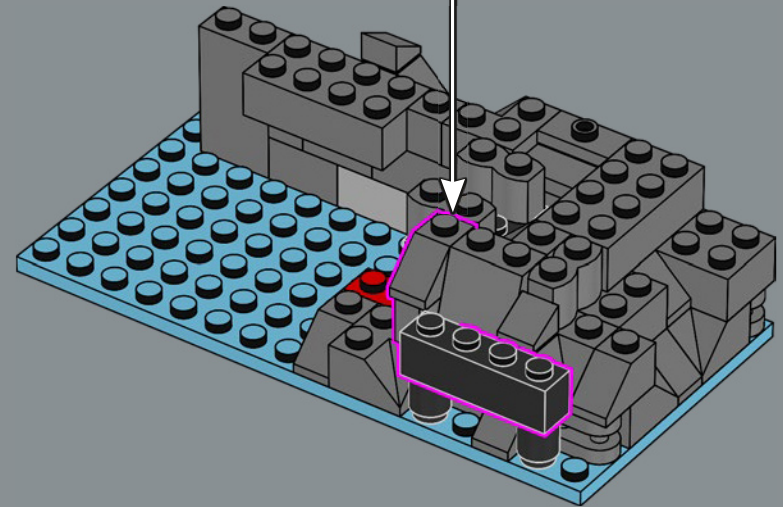
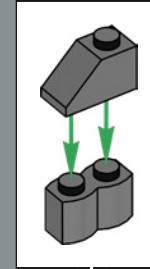

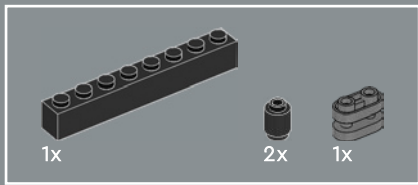

12

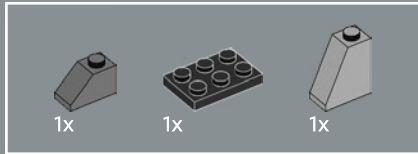
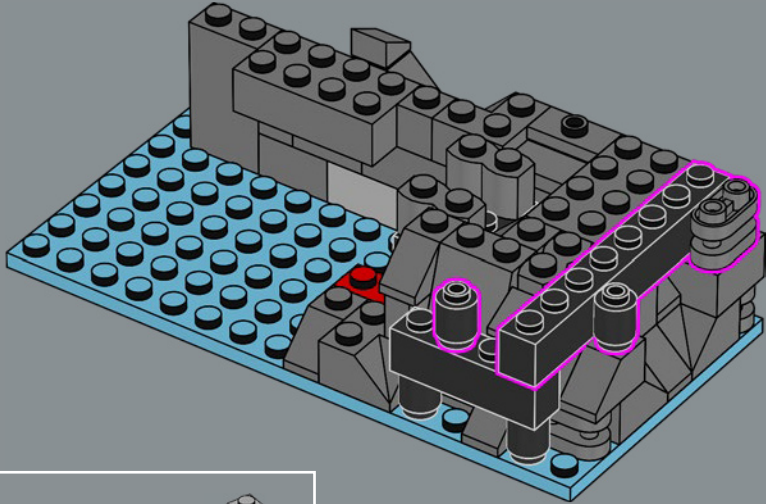

13

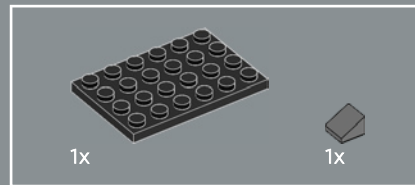
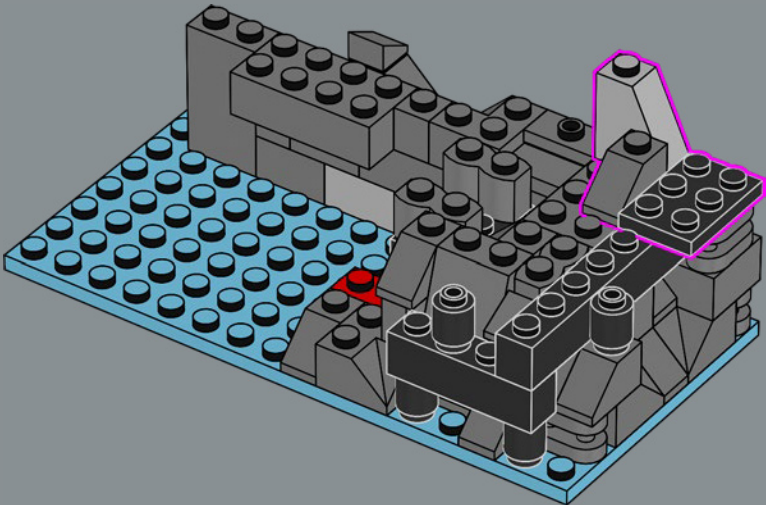

14

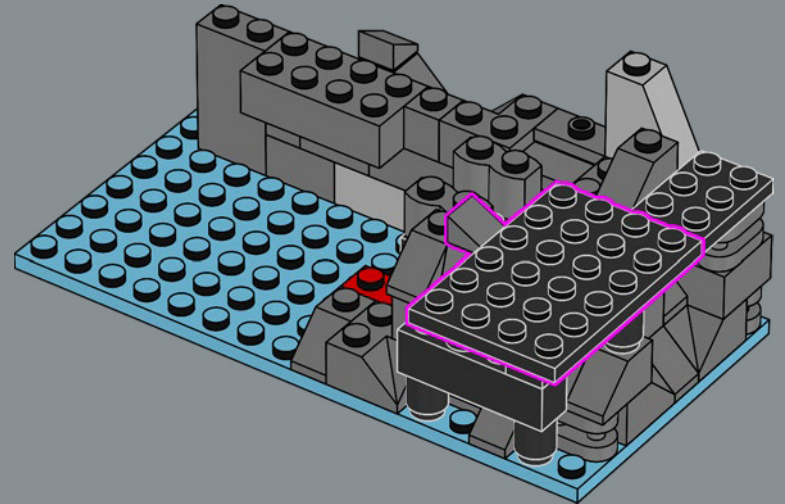

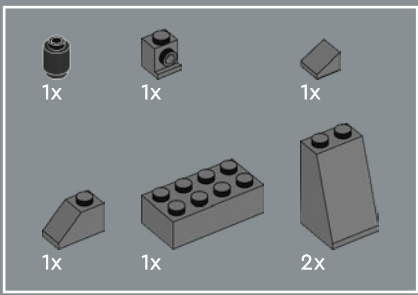

15

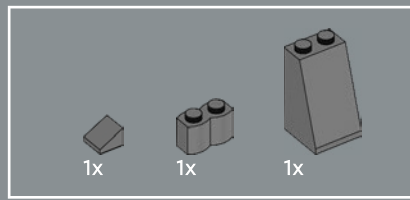
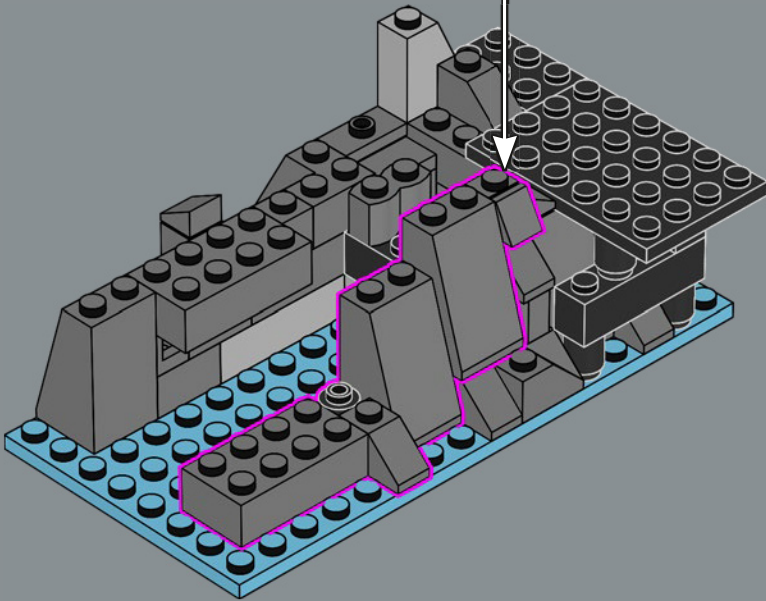
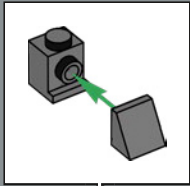

16

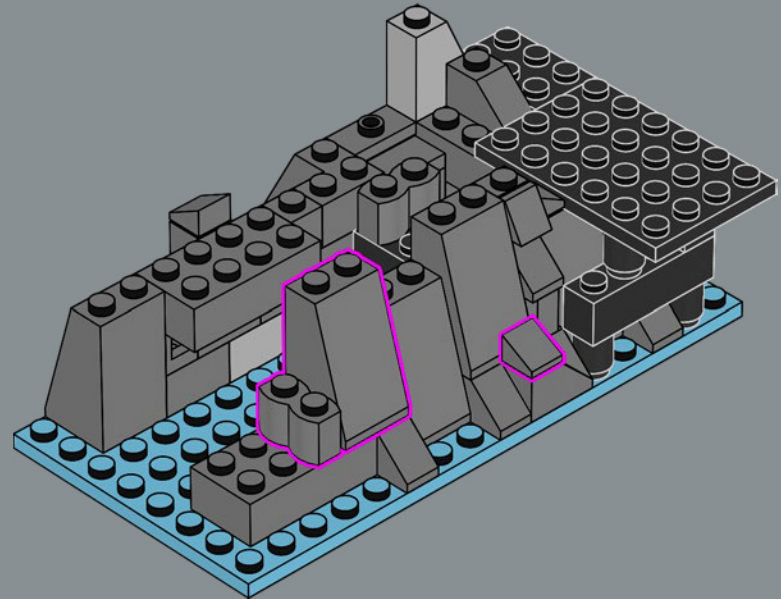

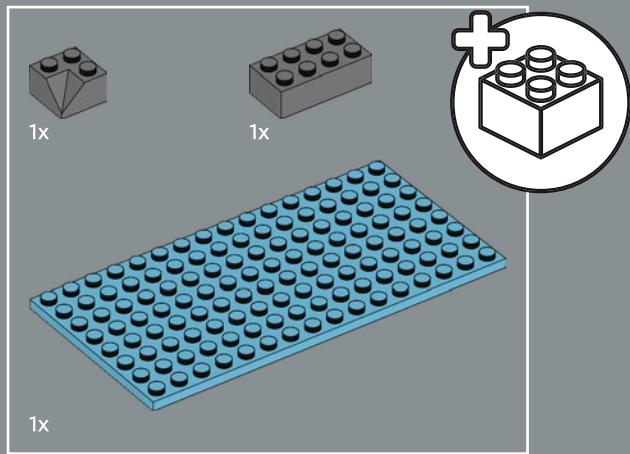

17

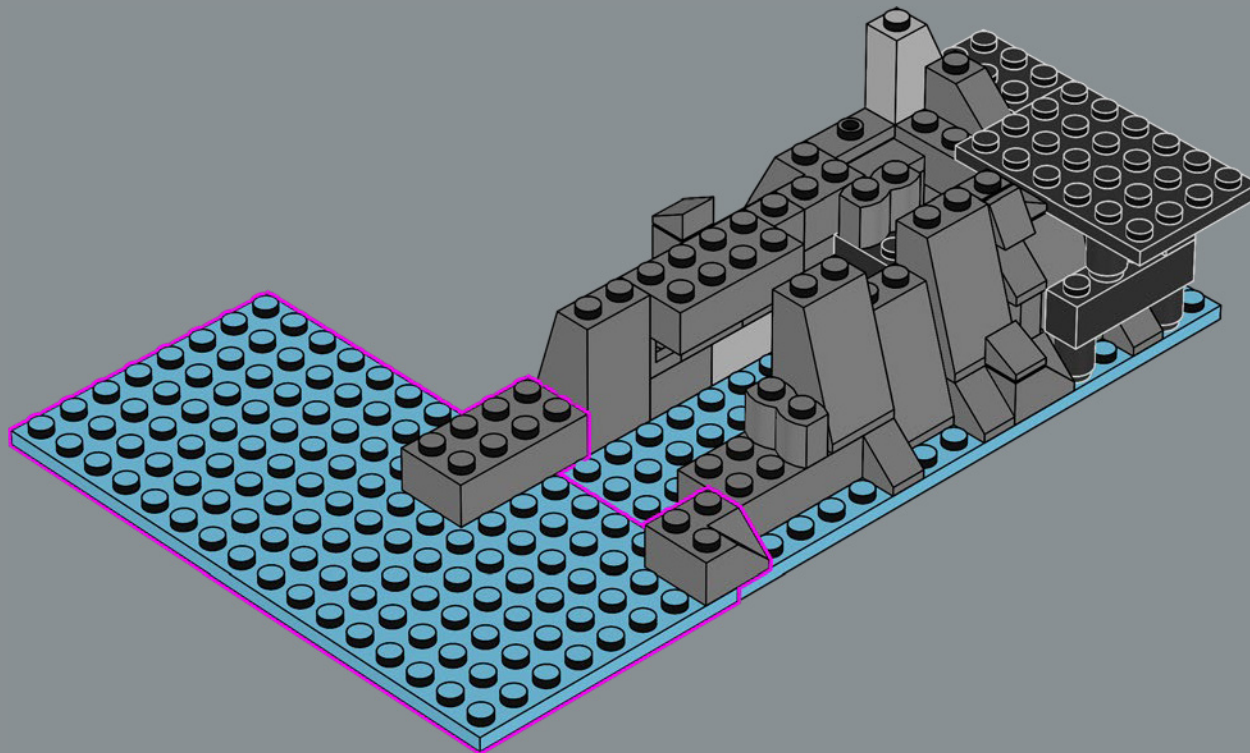

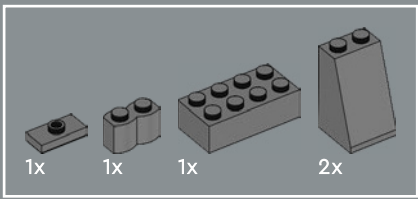

18

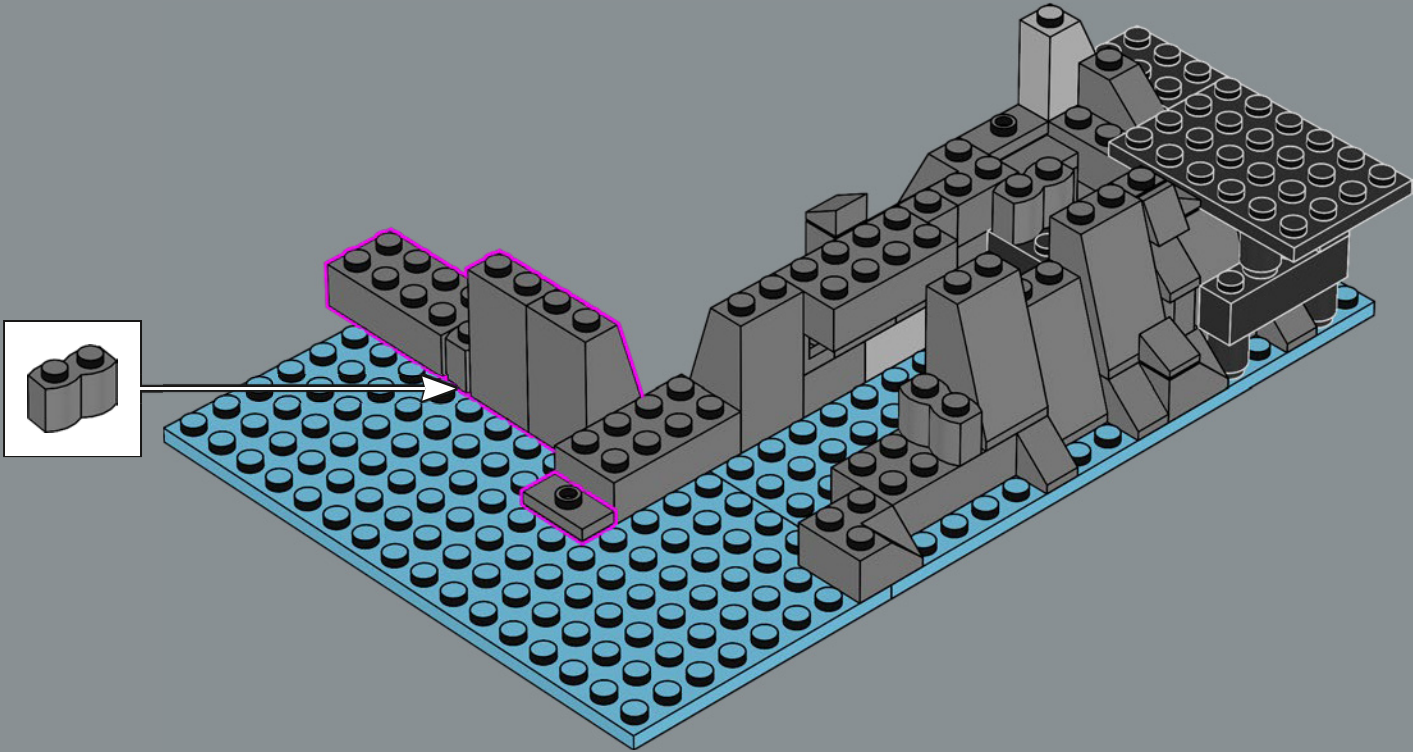

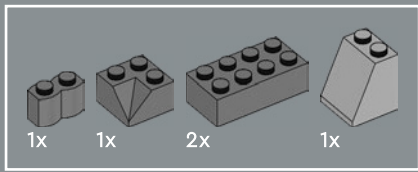

19

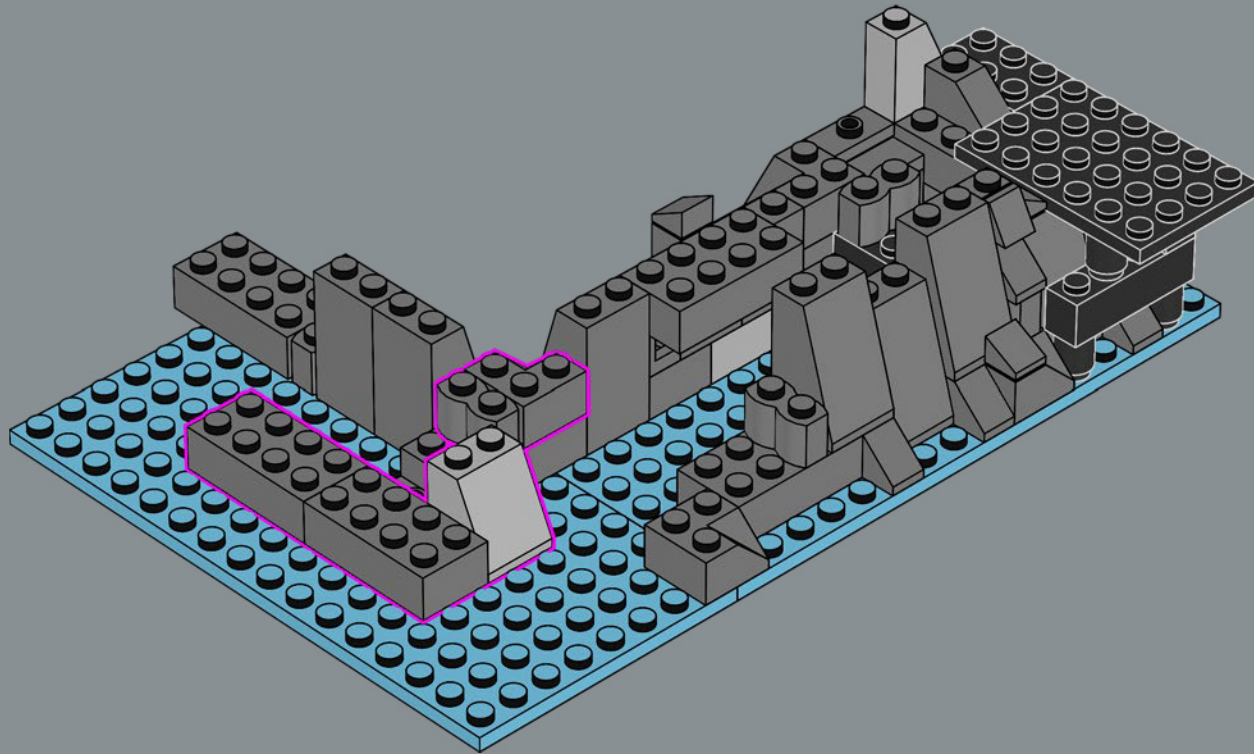

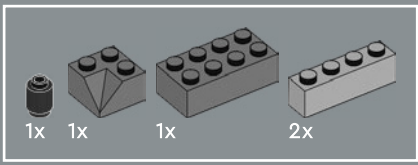

20

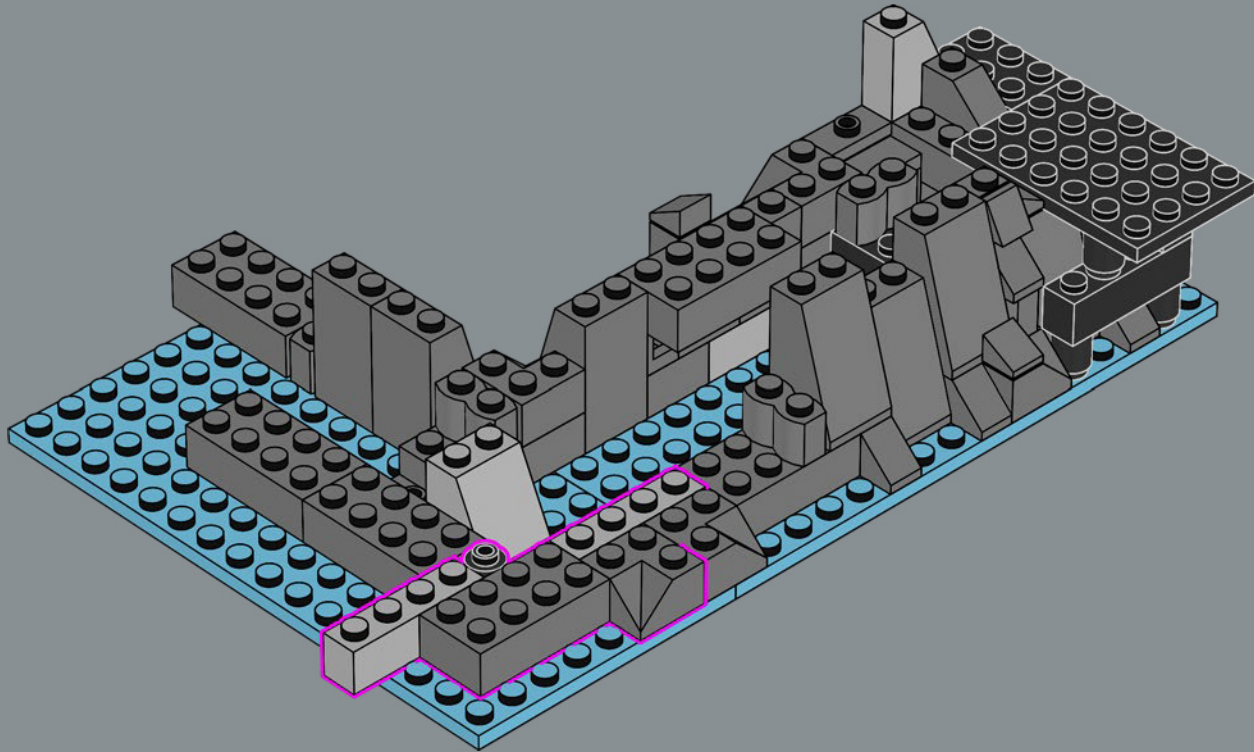

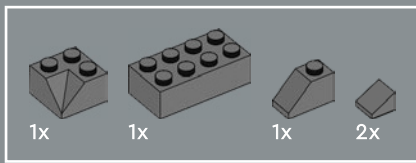

21

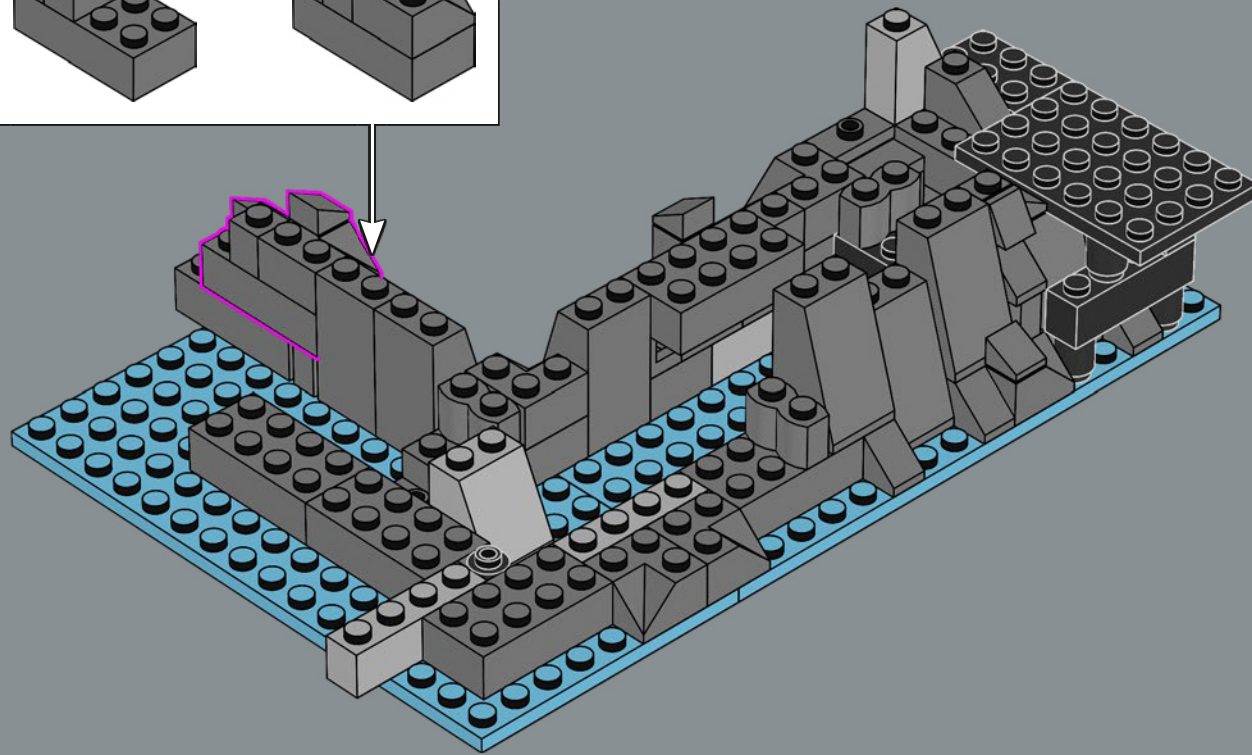
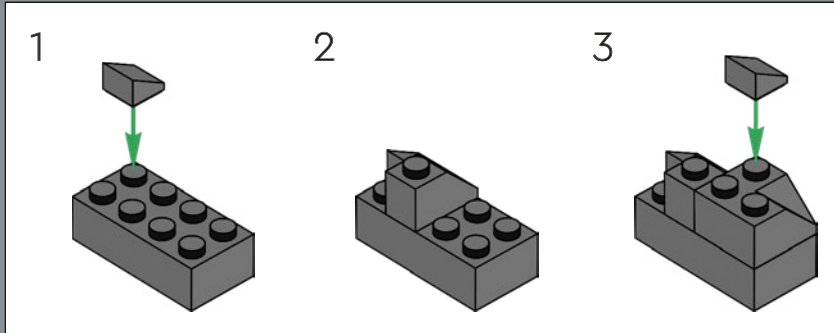

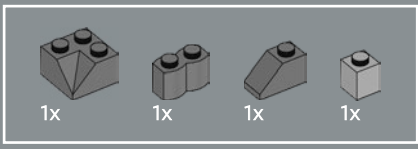

22

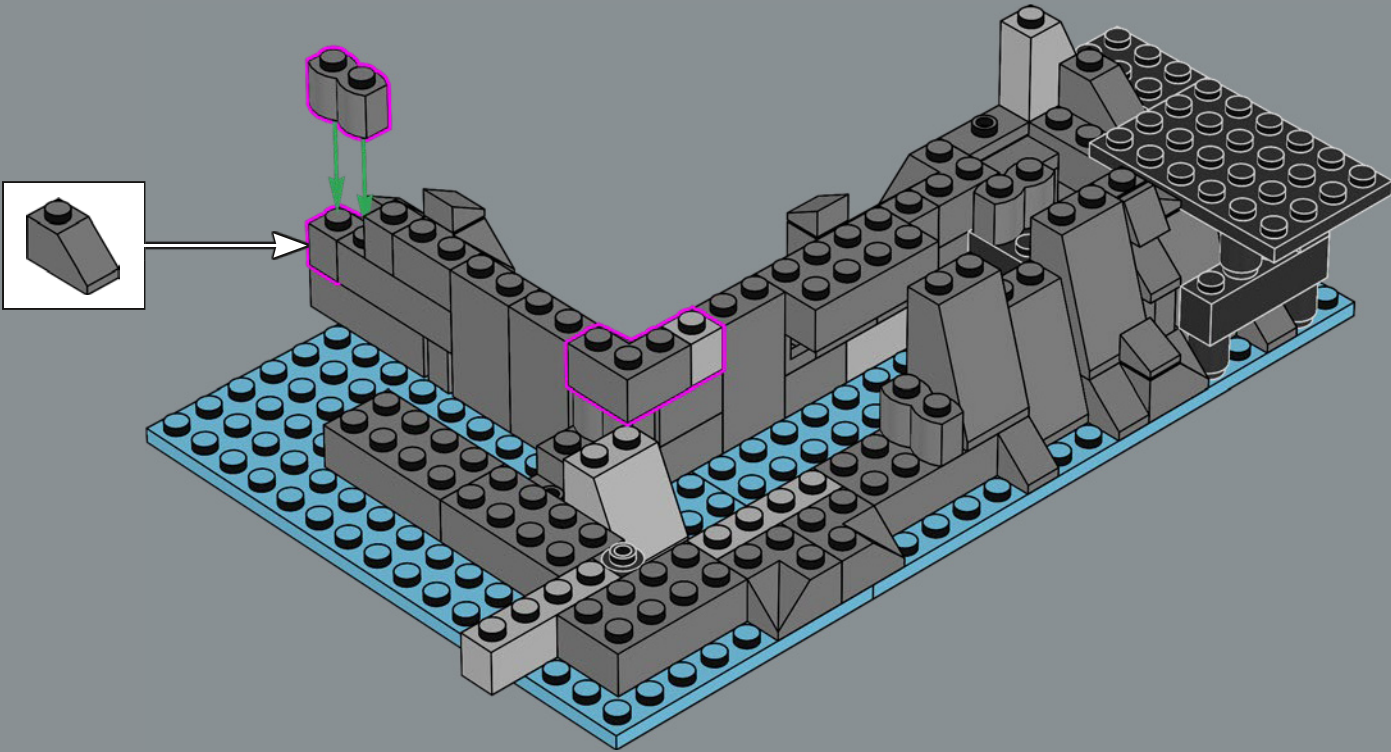

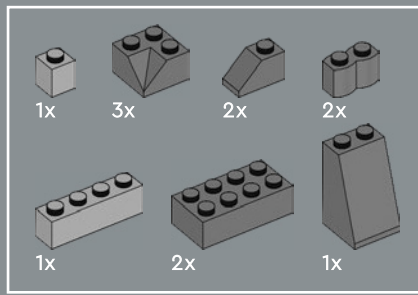

23

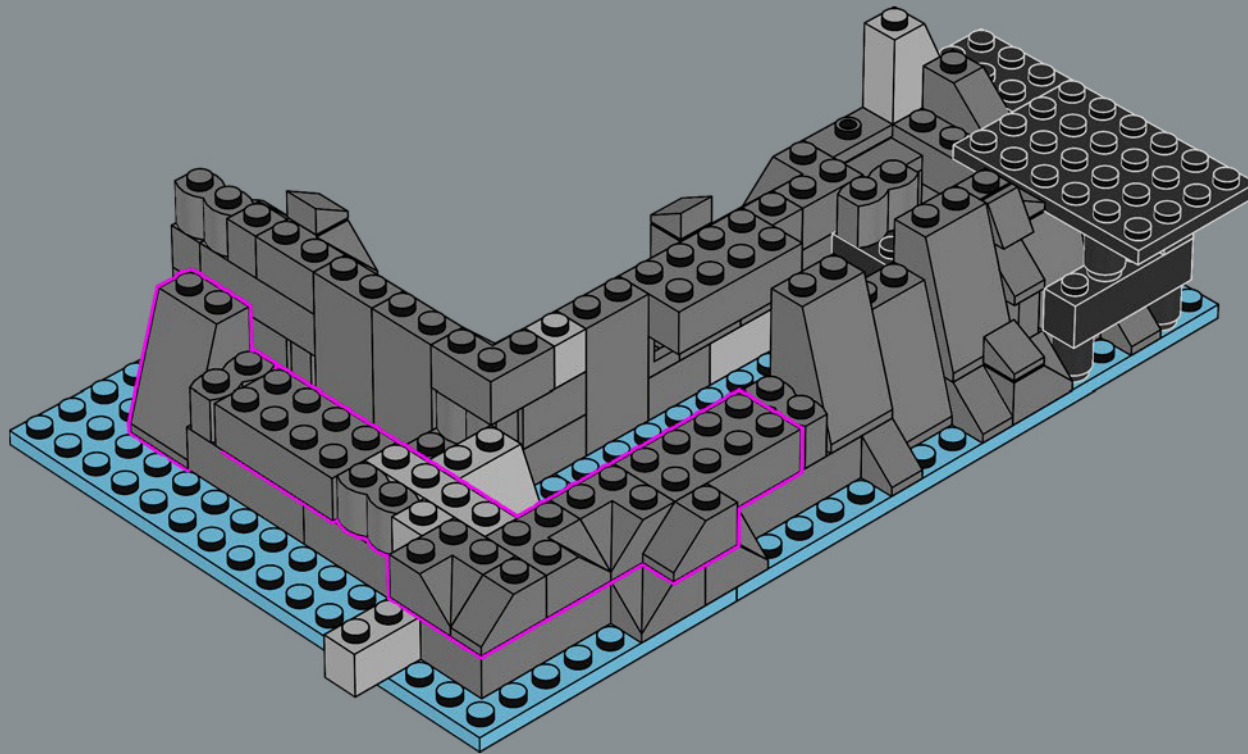

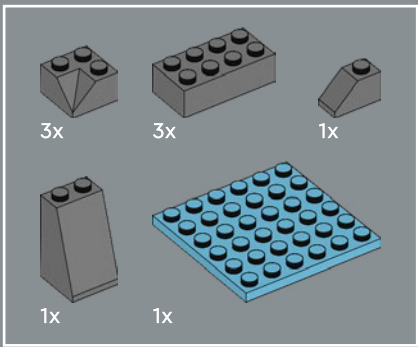

24

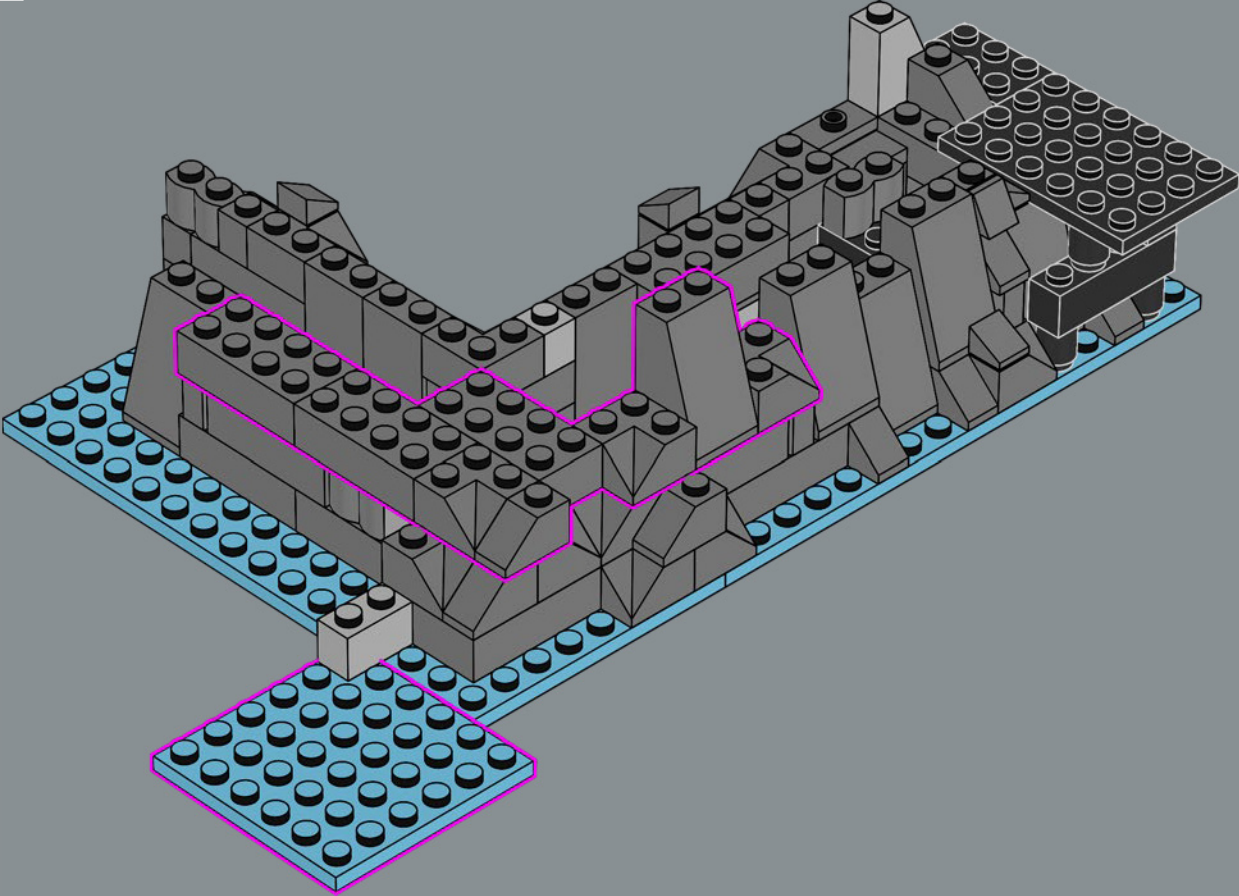

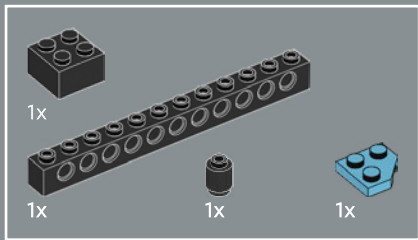

25

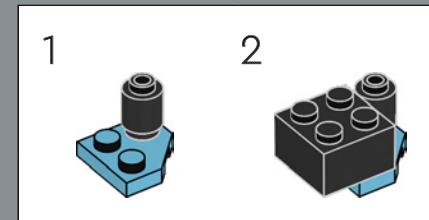
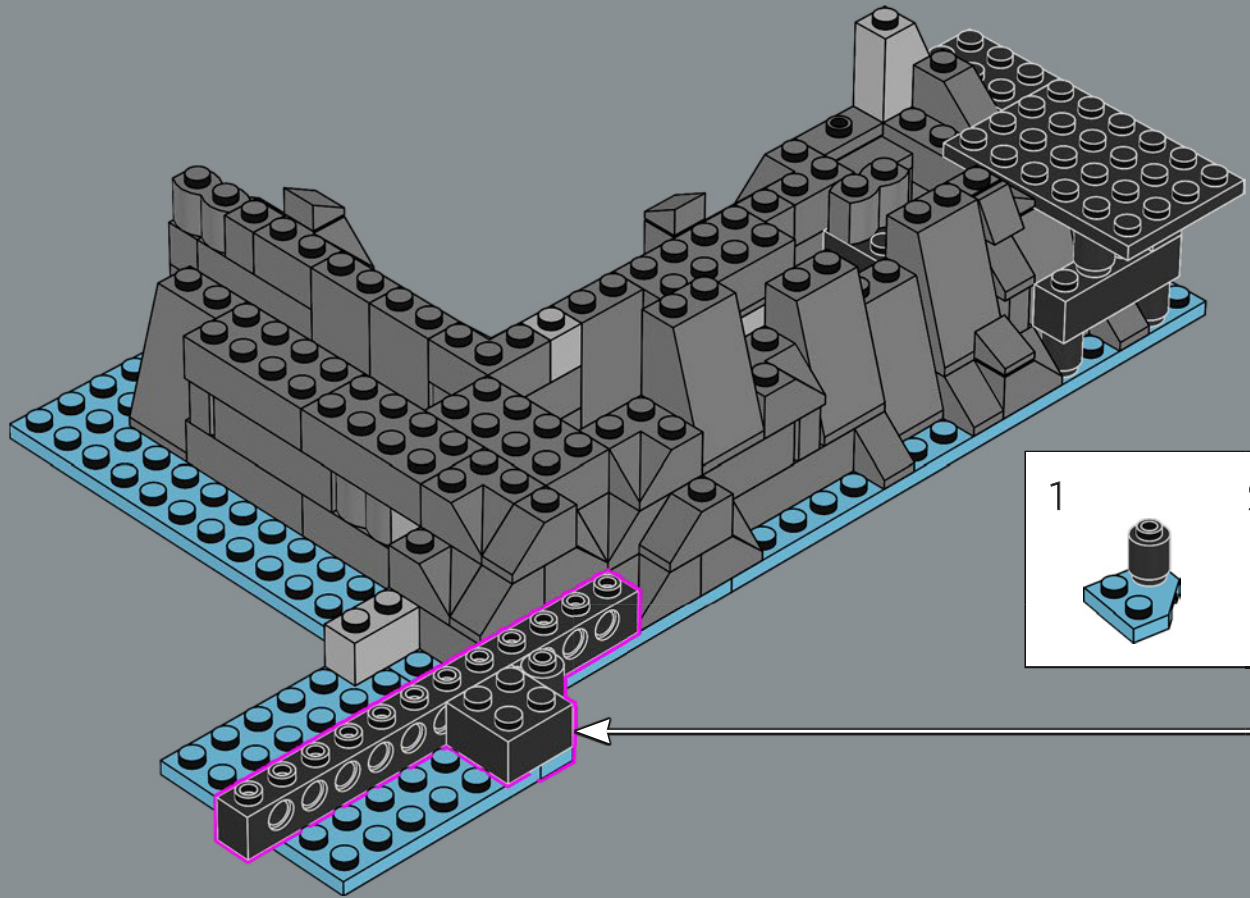

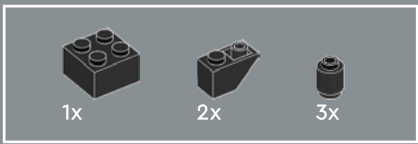

26

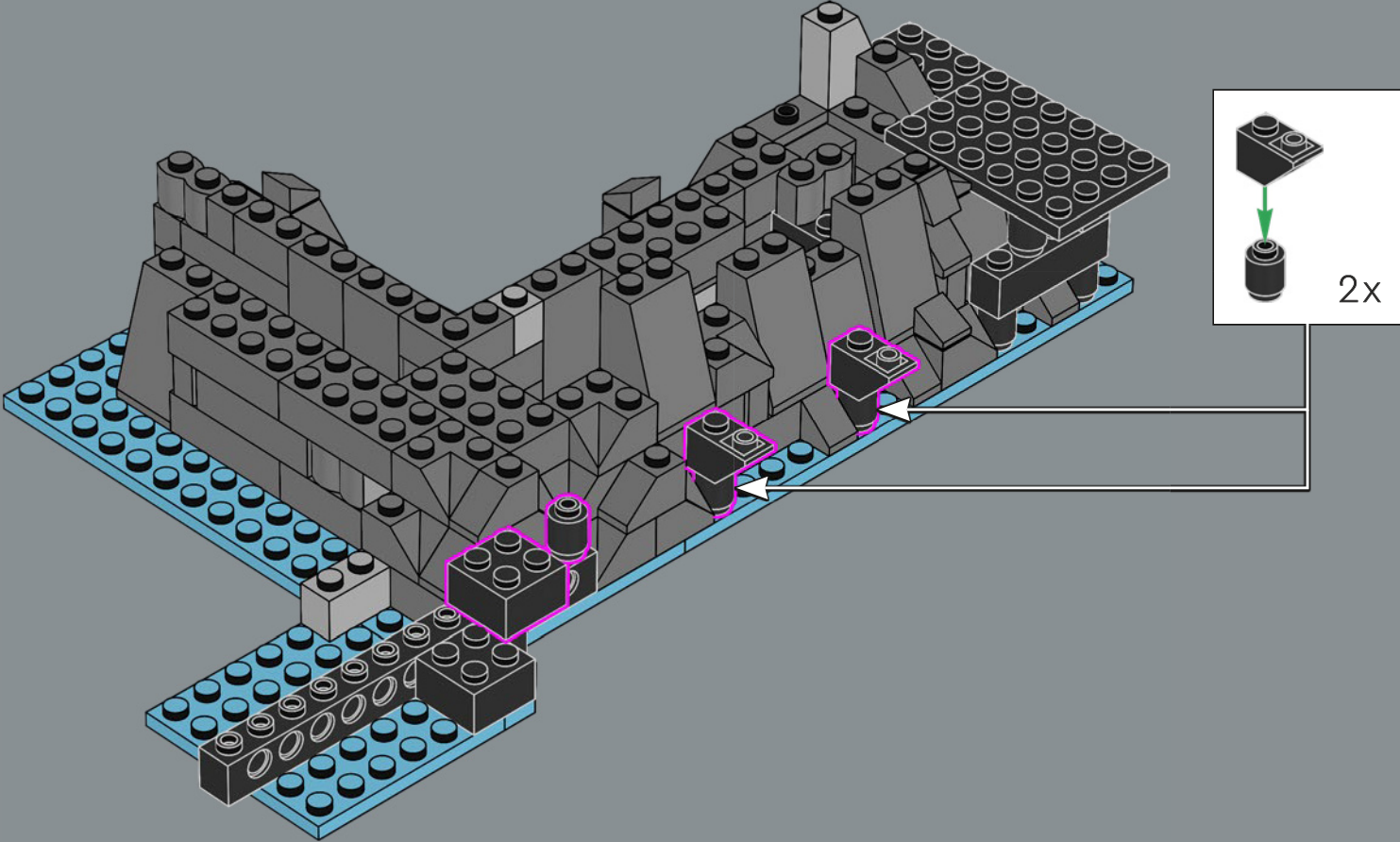

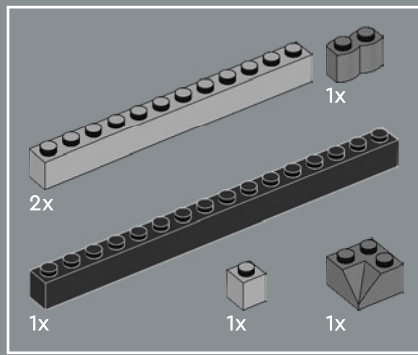

27

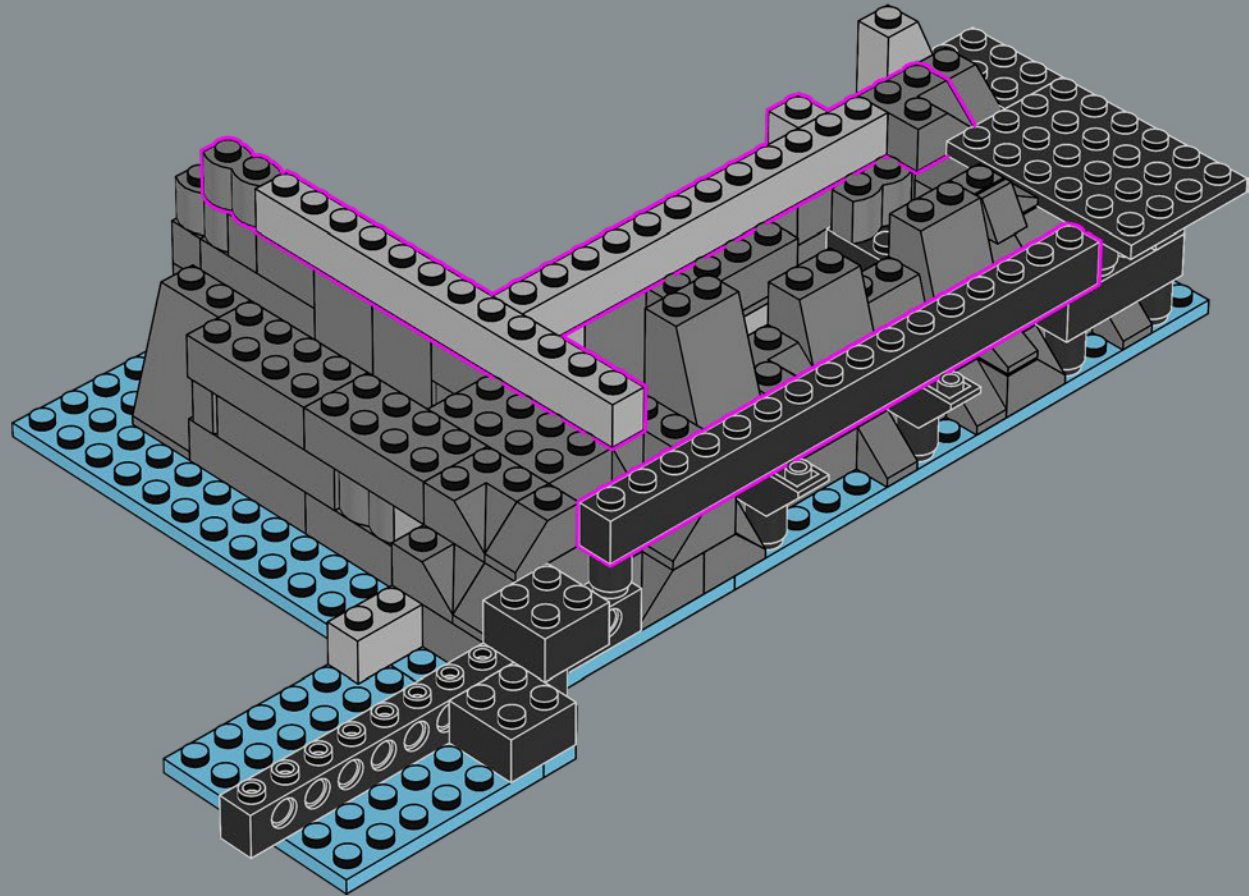

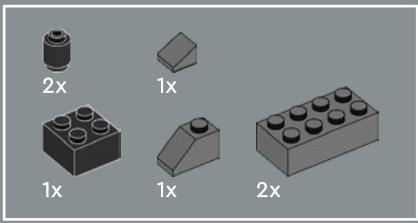

28

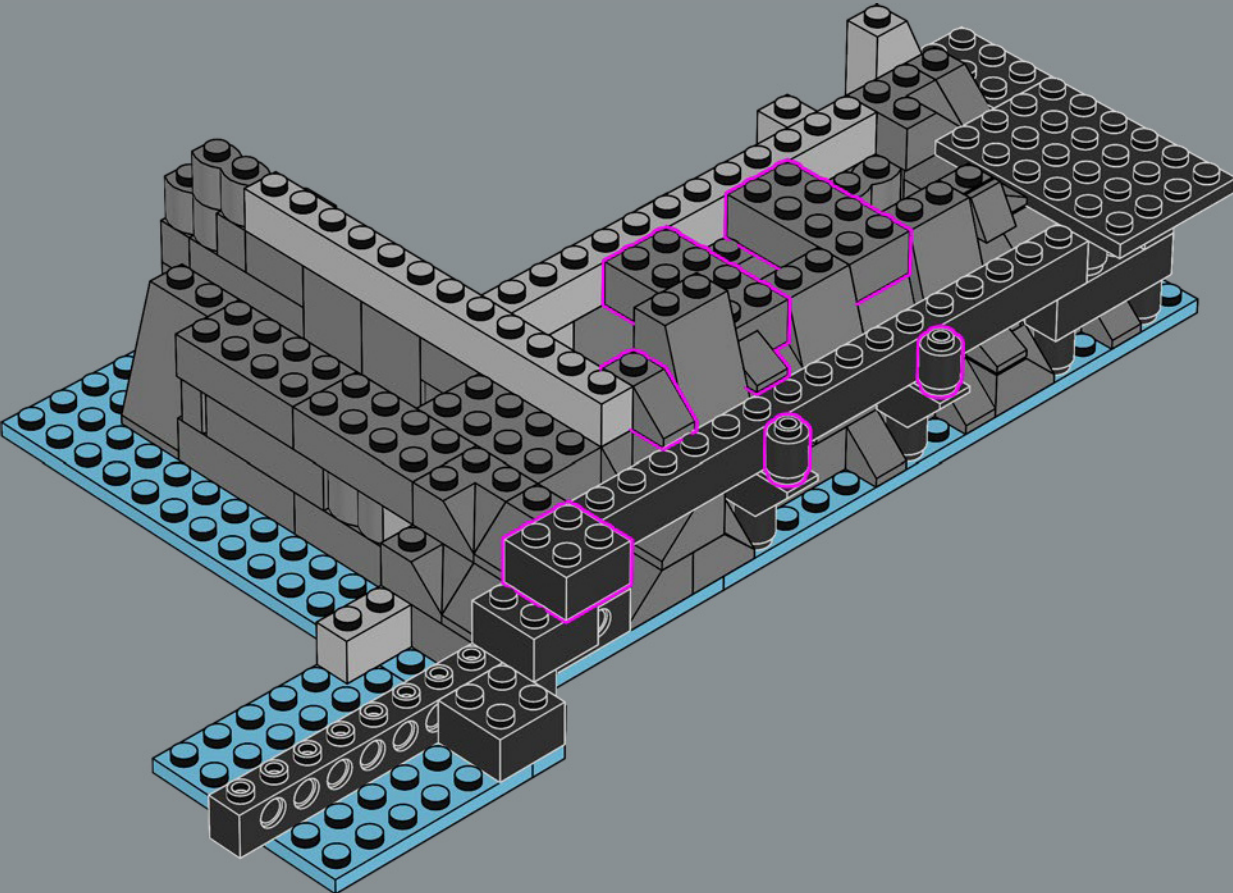

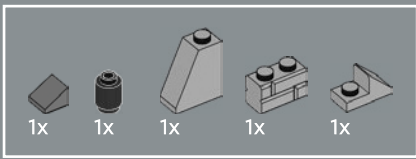

29

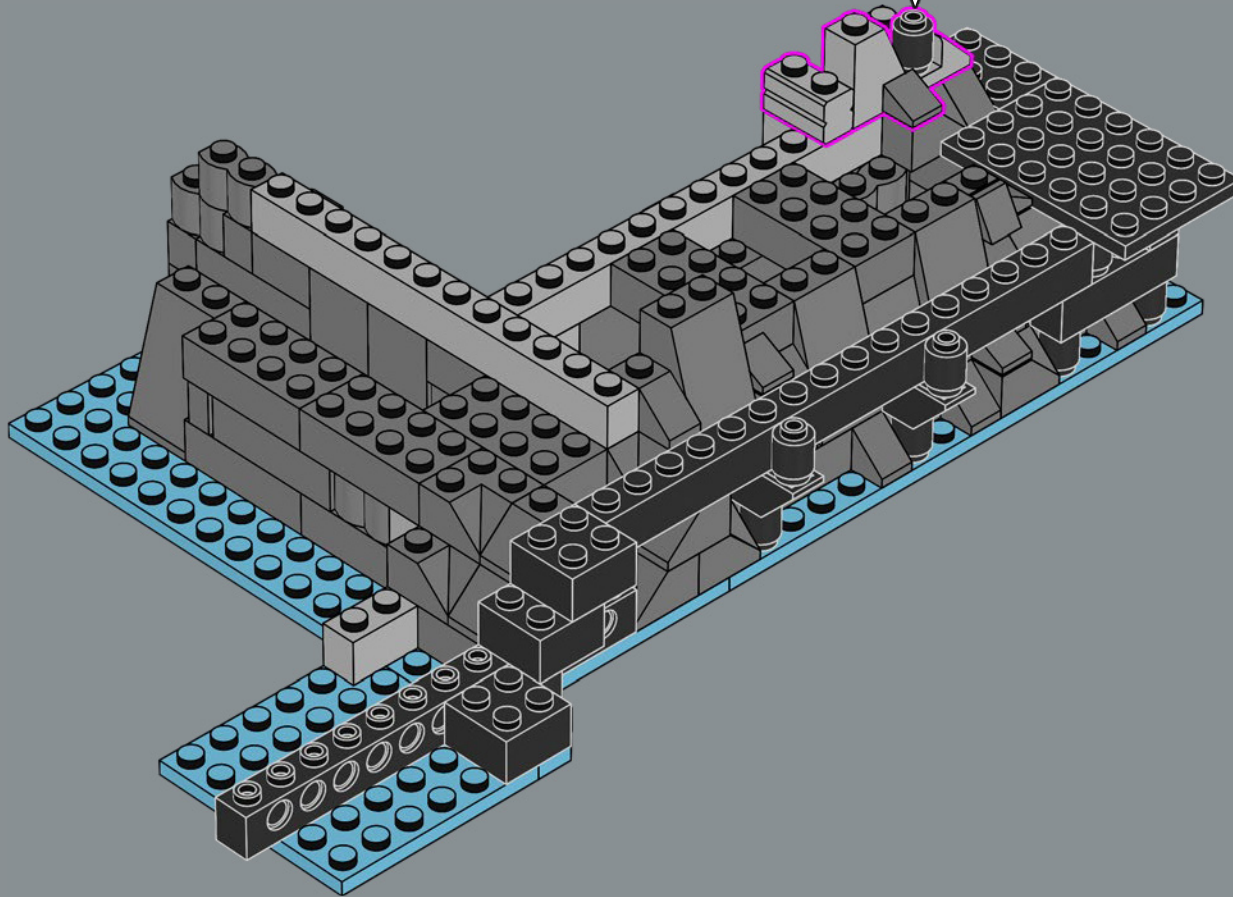
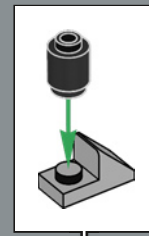

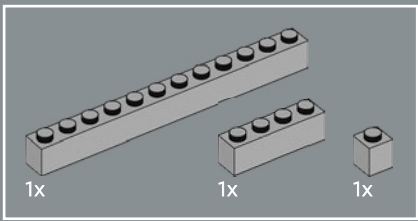

30

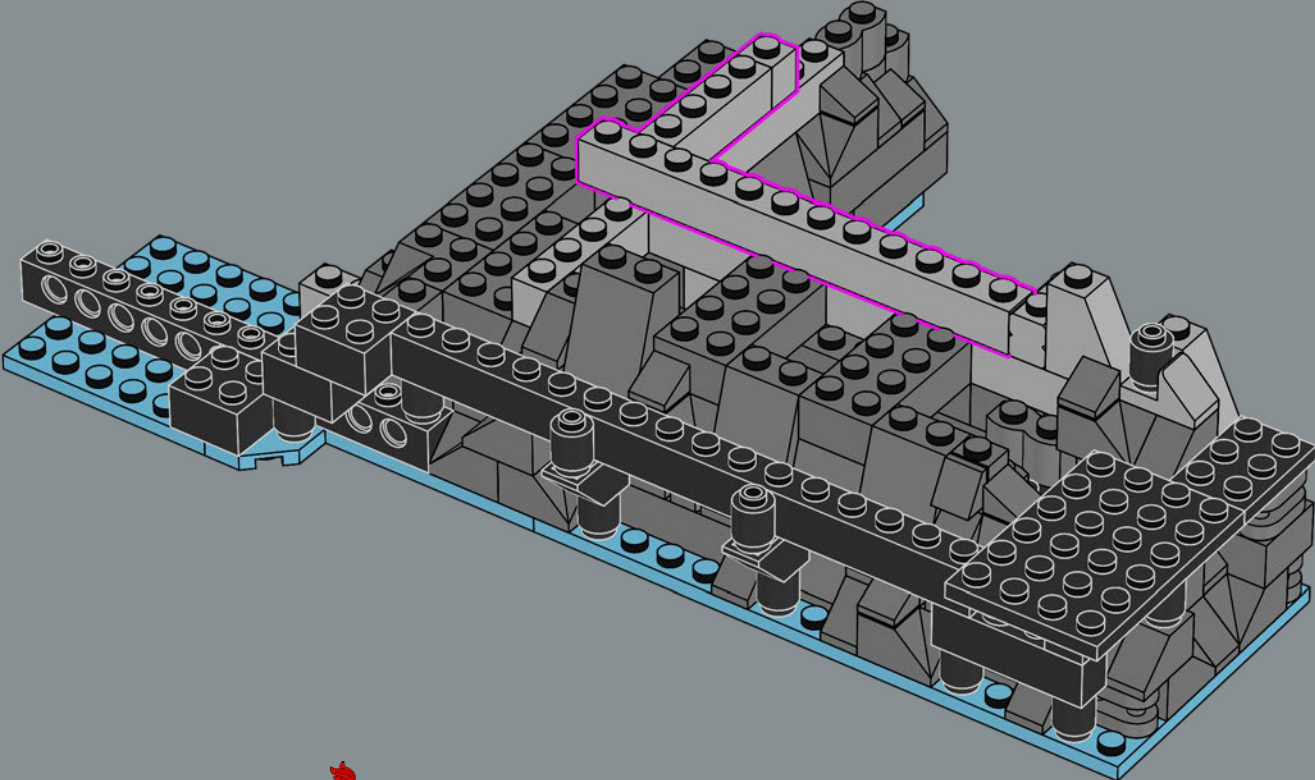

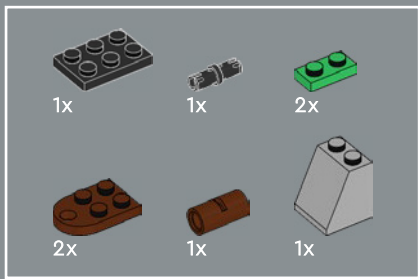

31

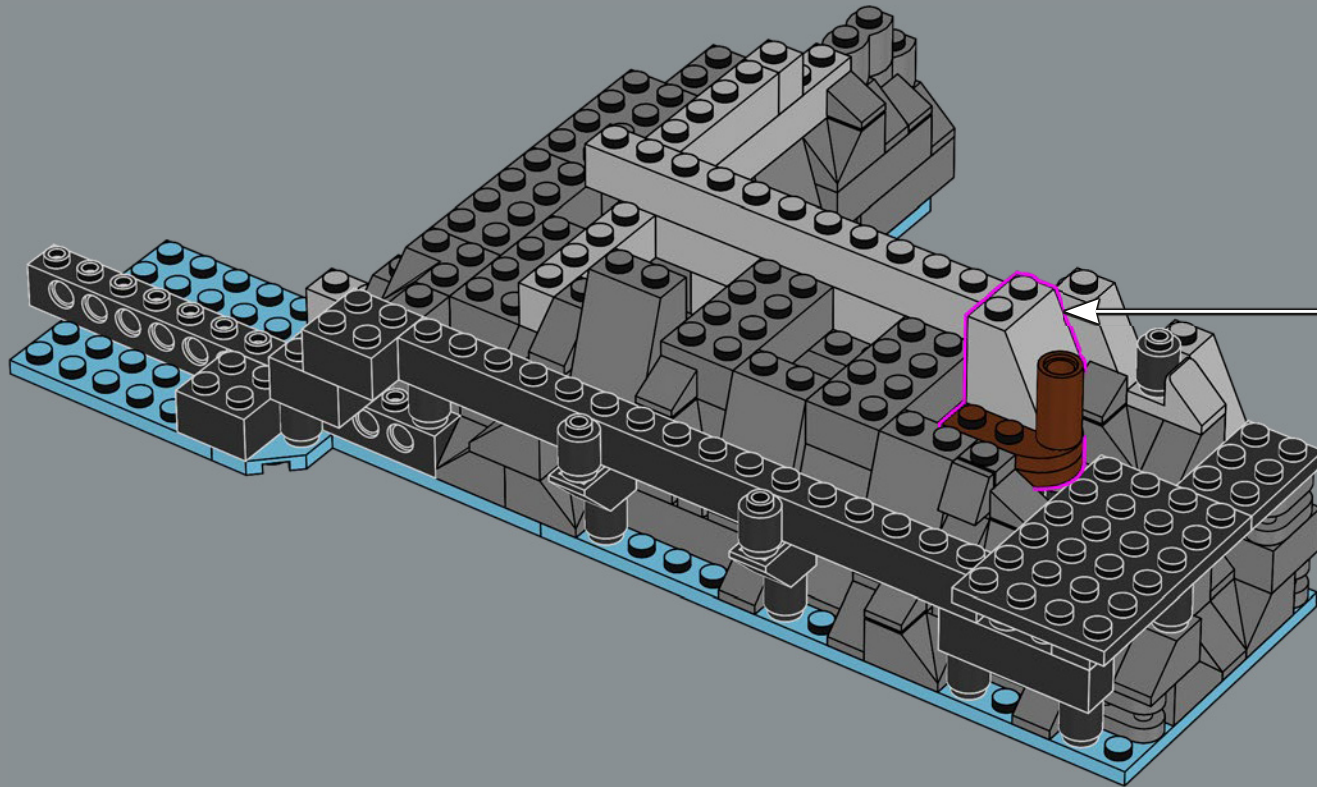
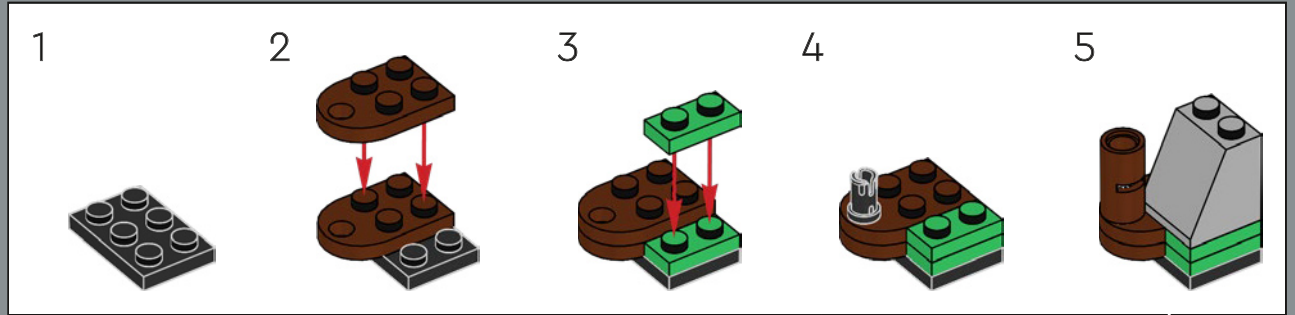

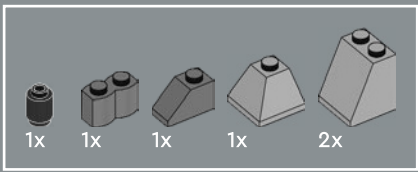

32

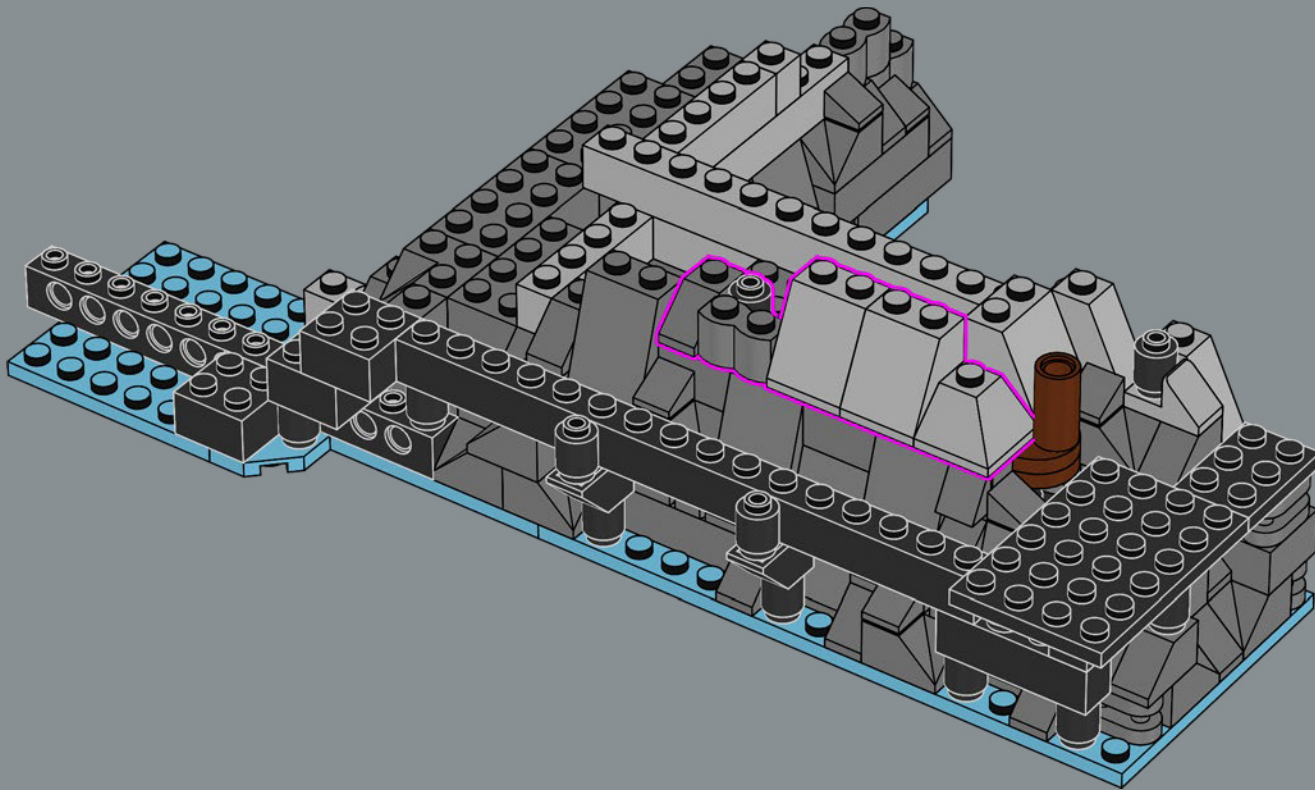

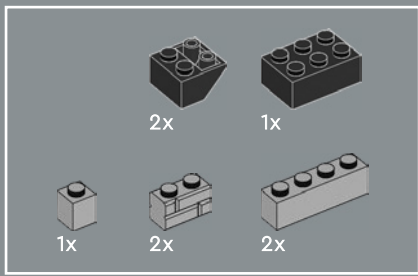

33

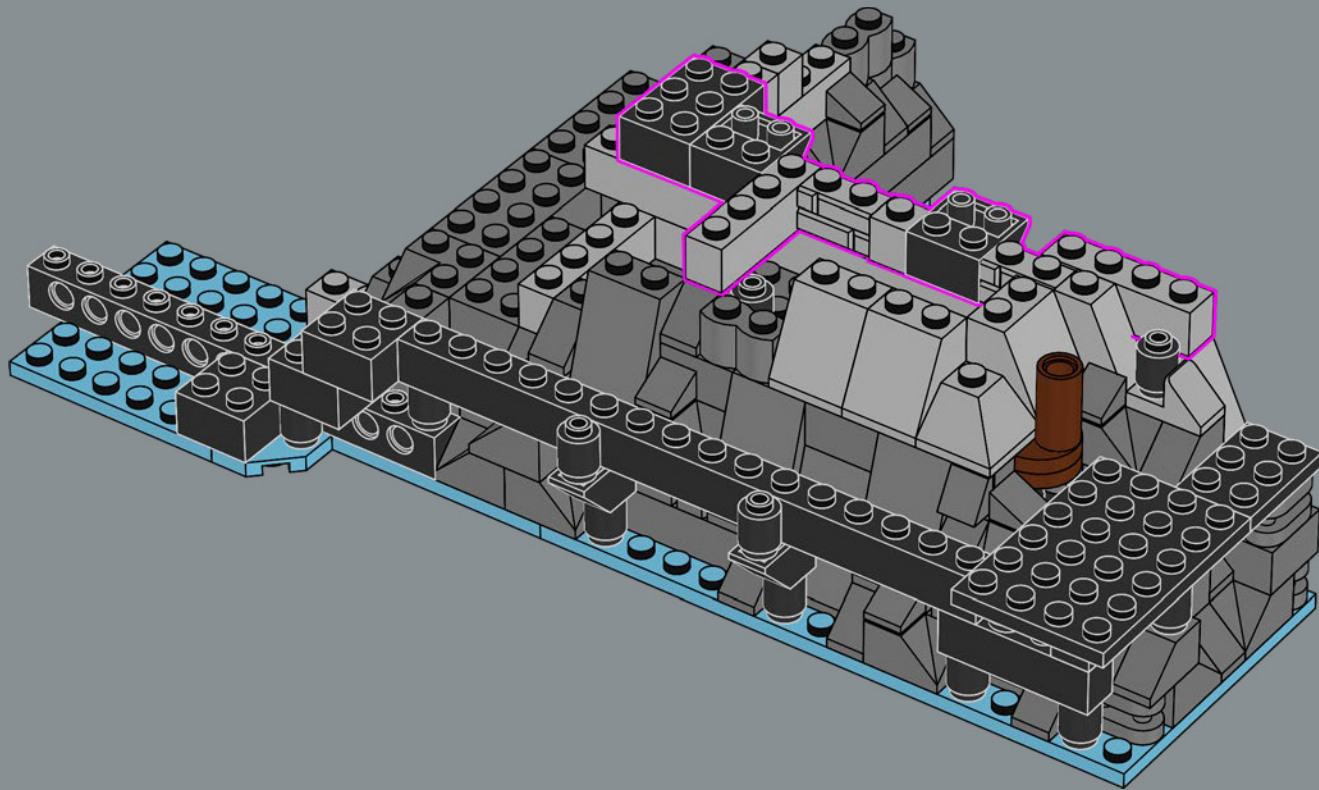

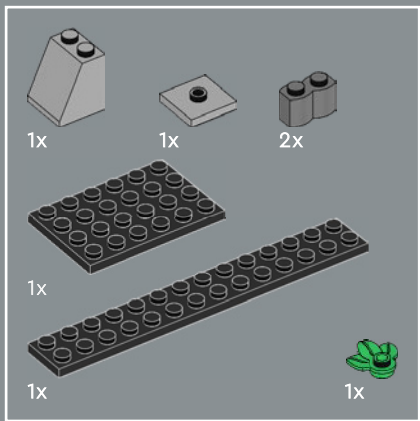

34

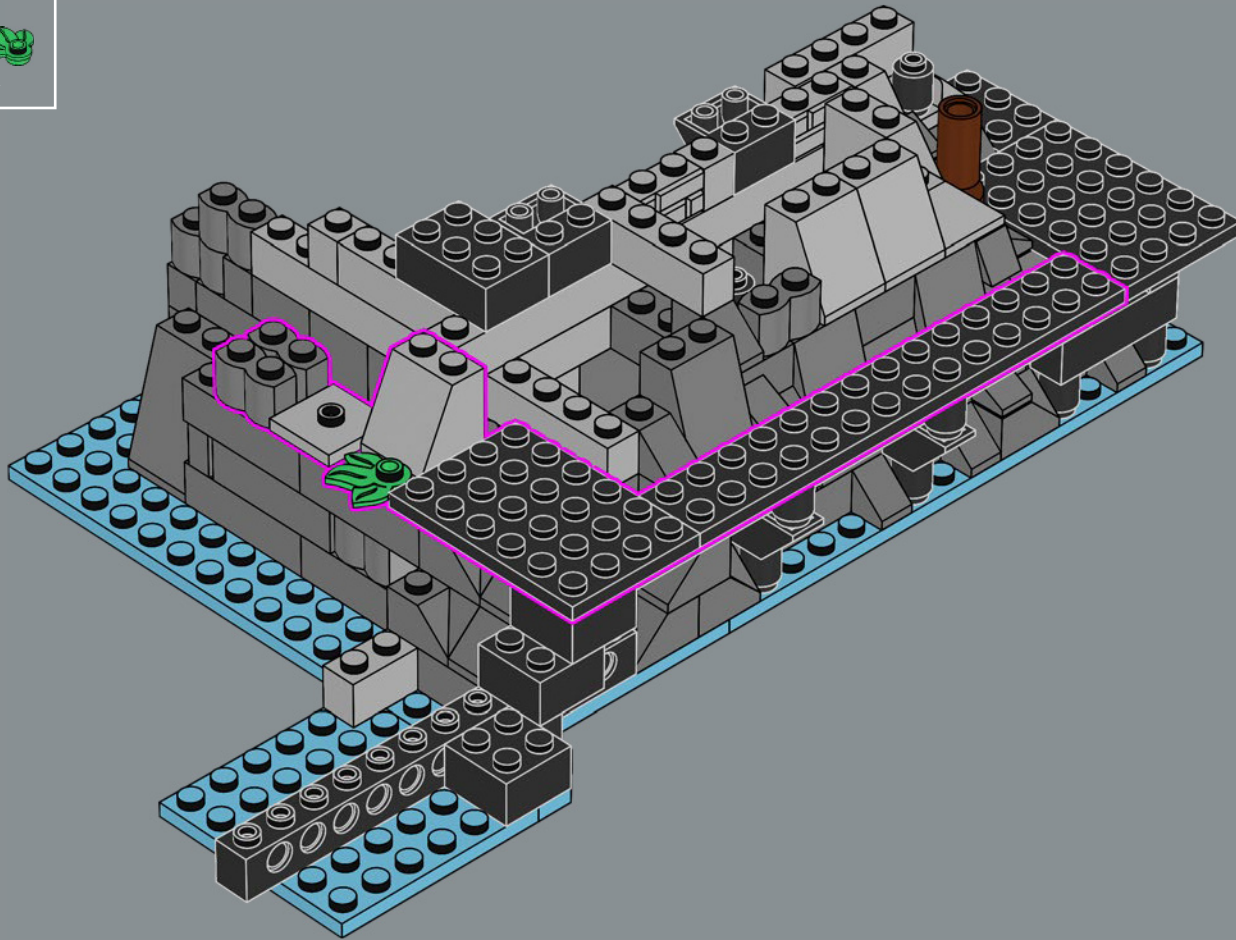

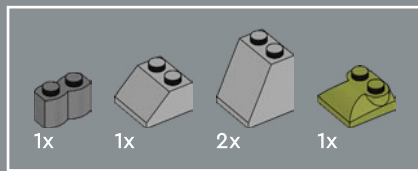

35

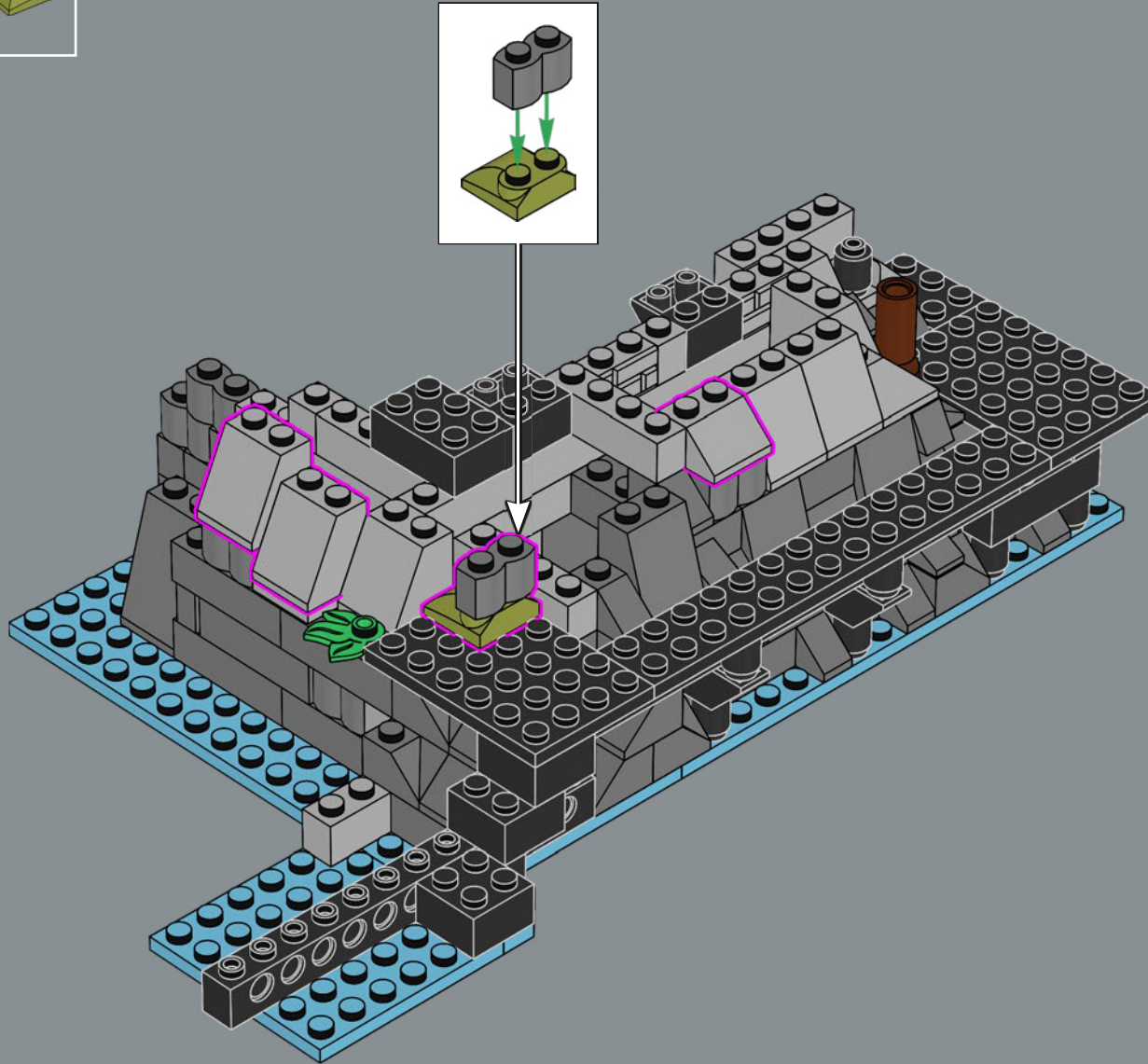

- 4x 
- 1x 
- 1x 

36

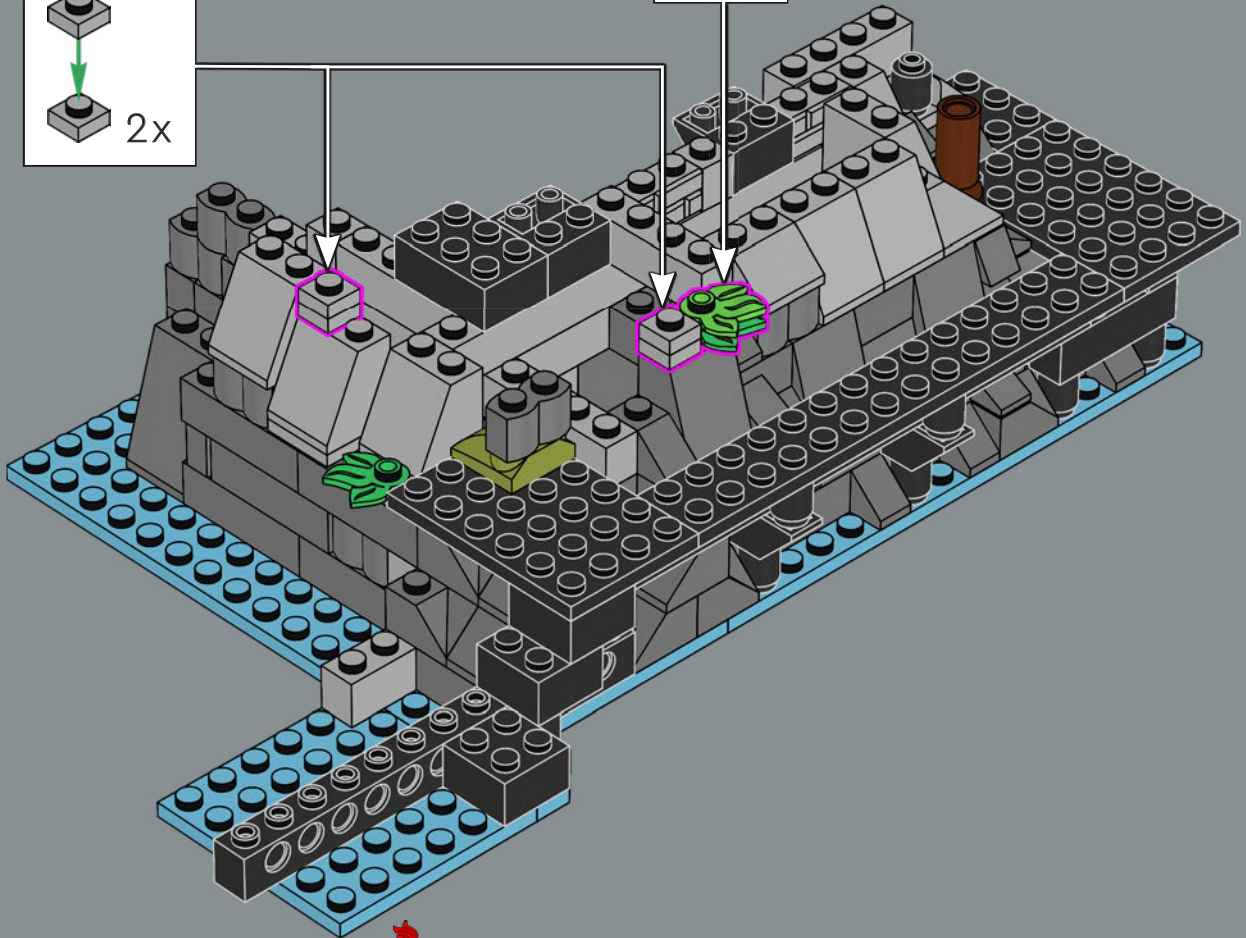
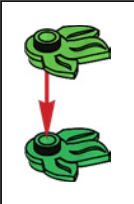
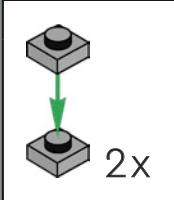

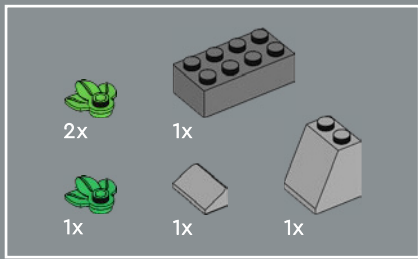

37

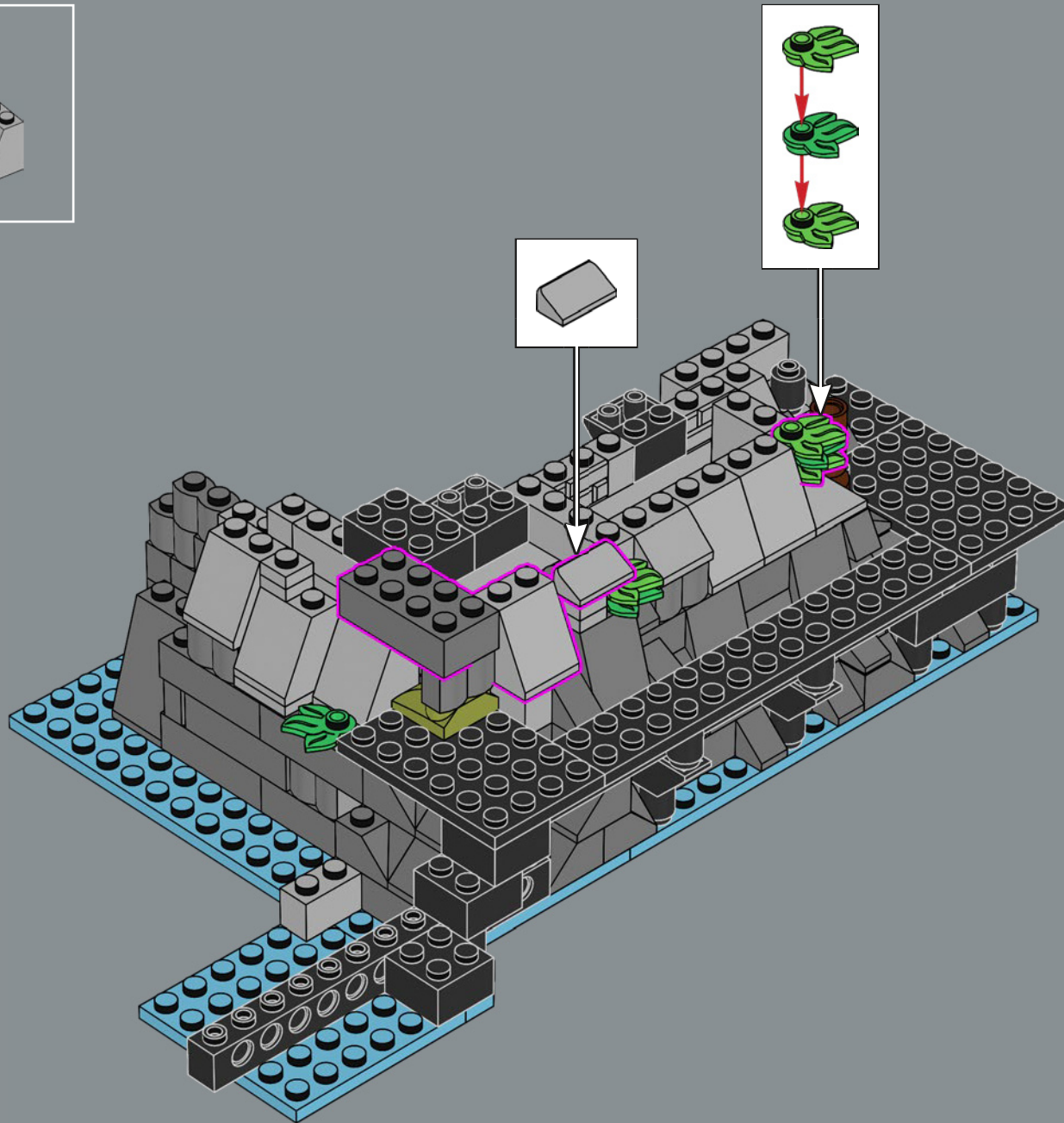

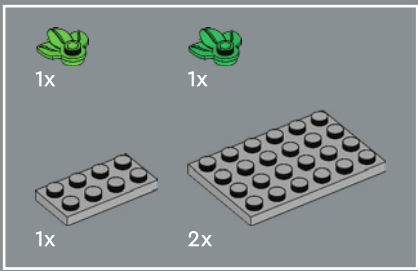

38

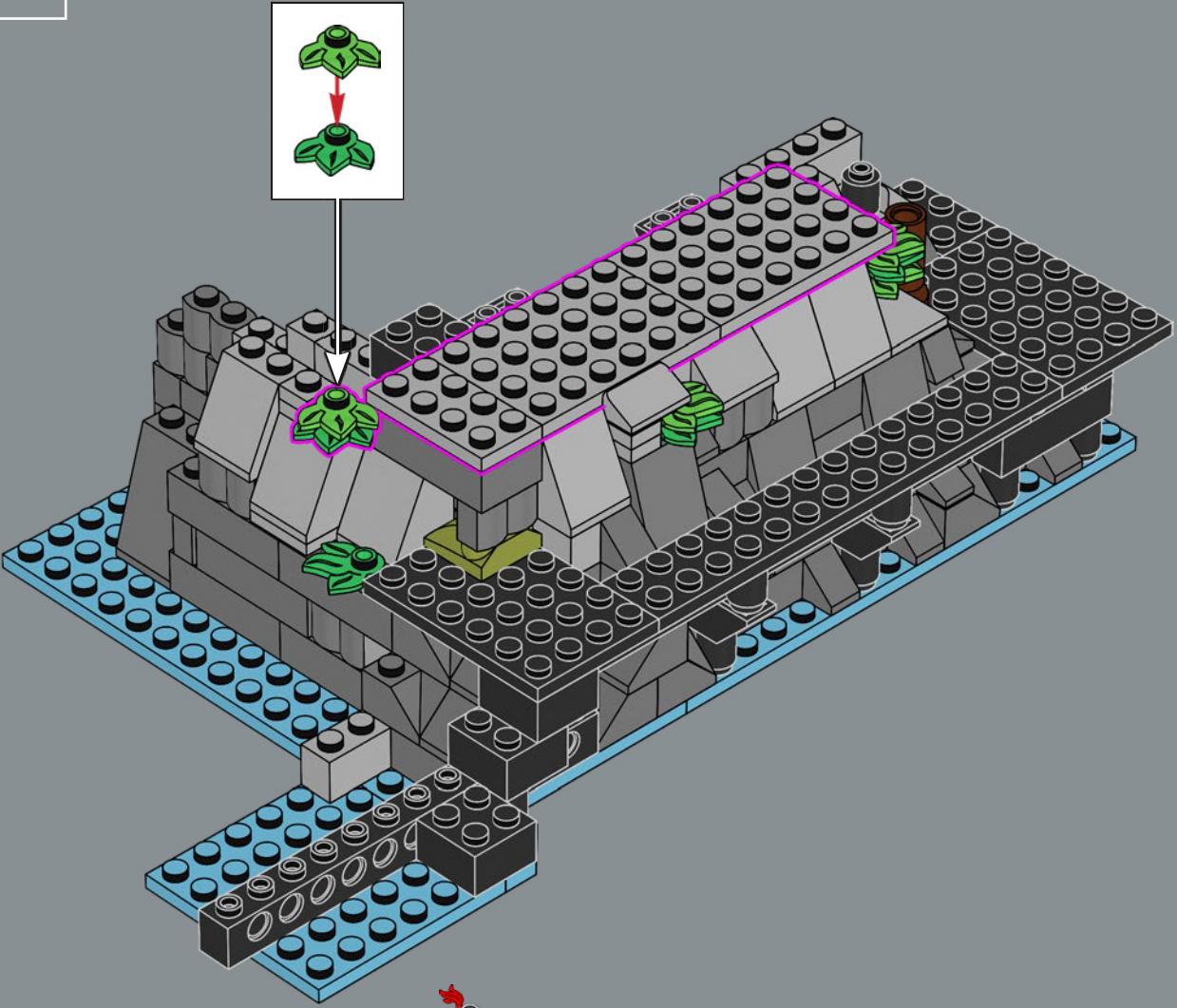

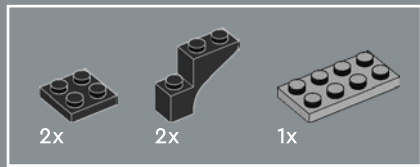

39

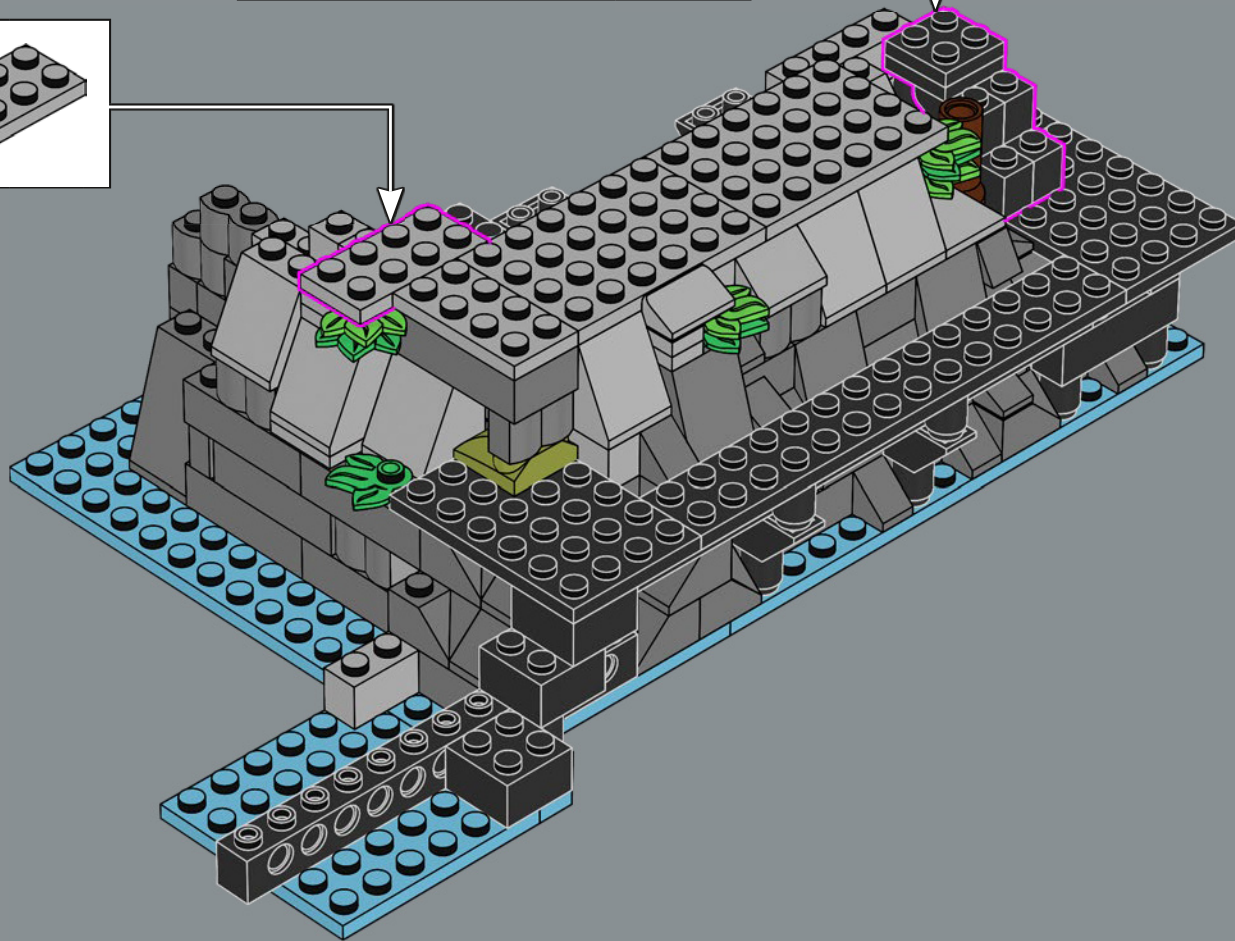
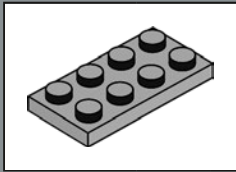
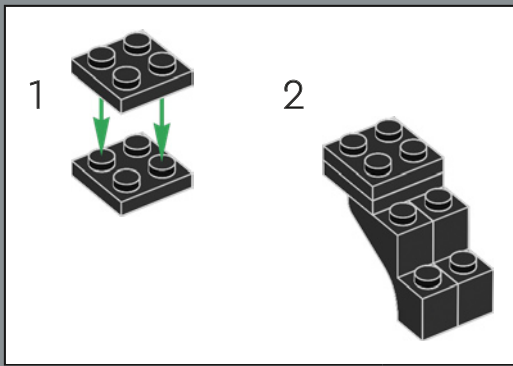

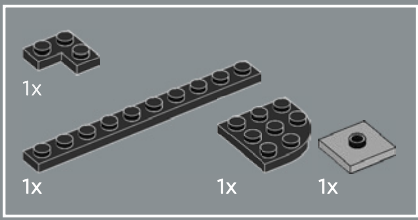

40

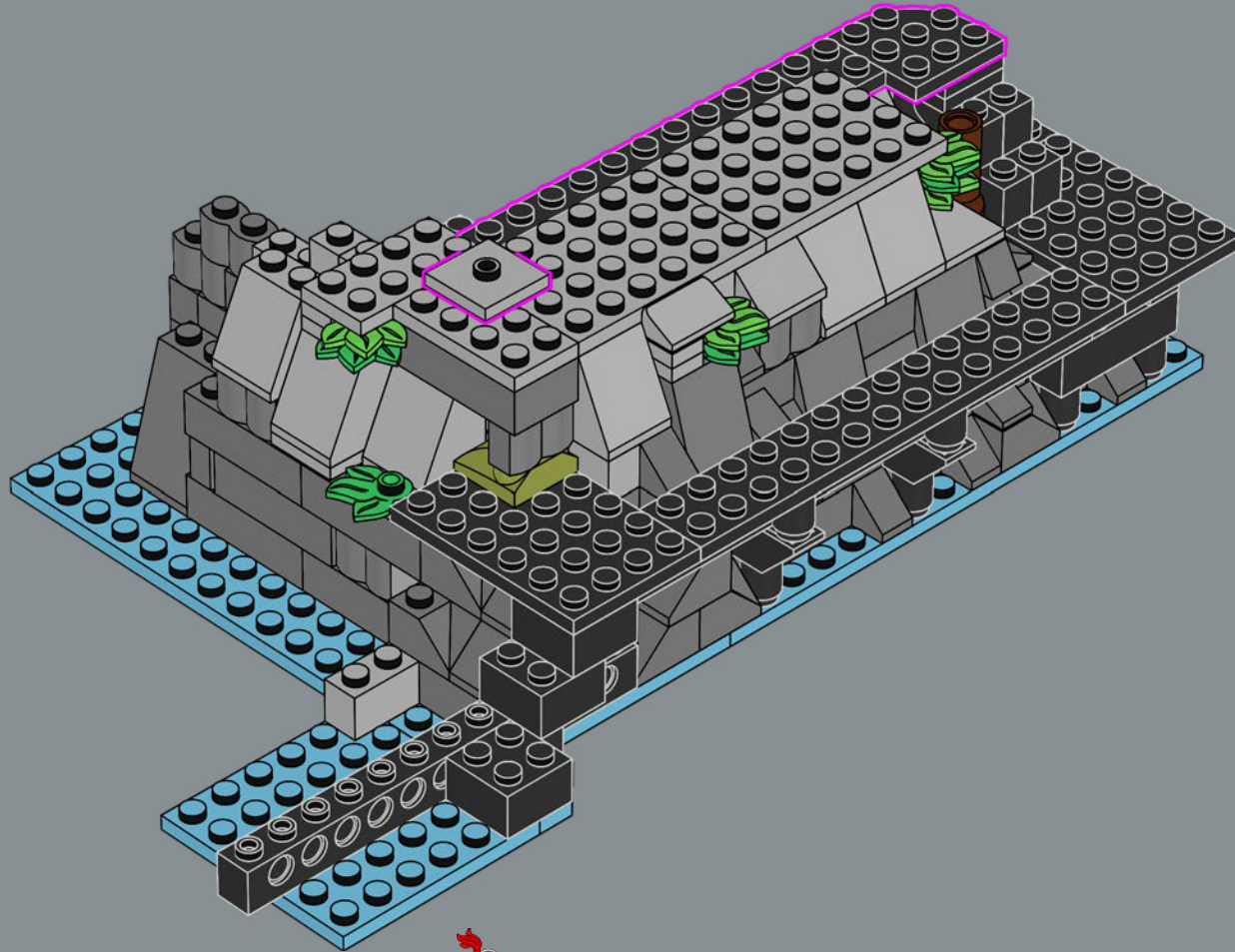

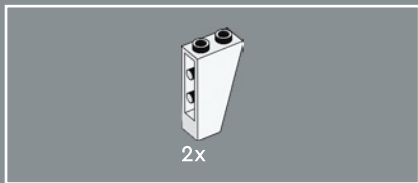

41

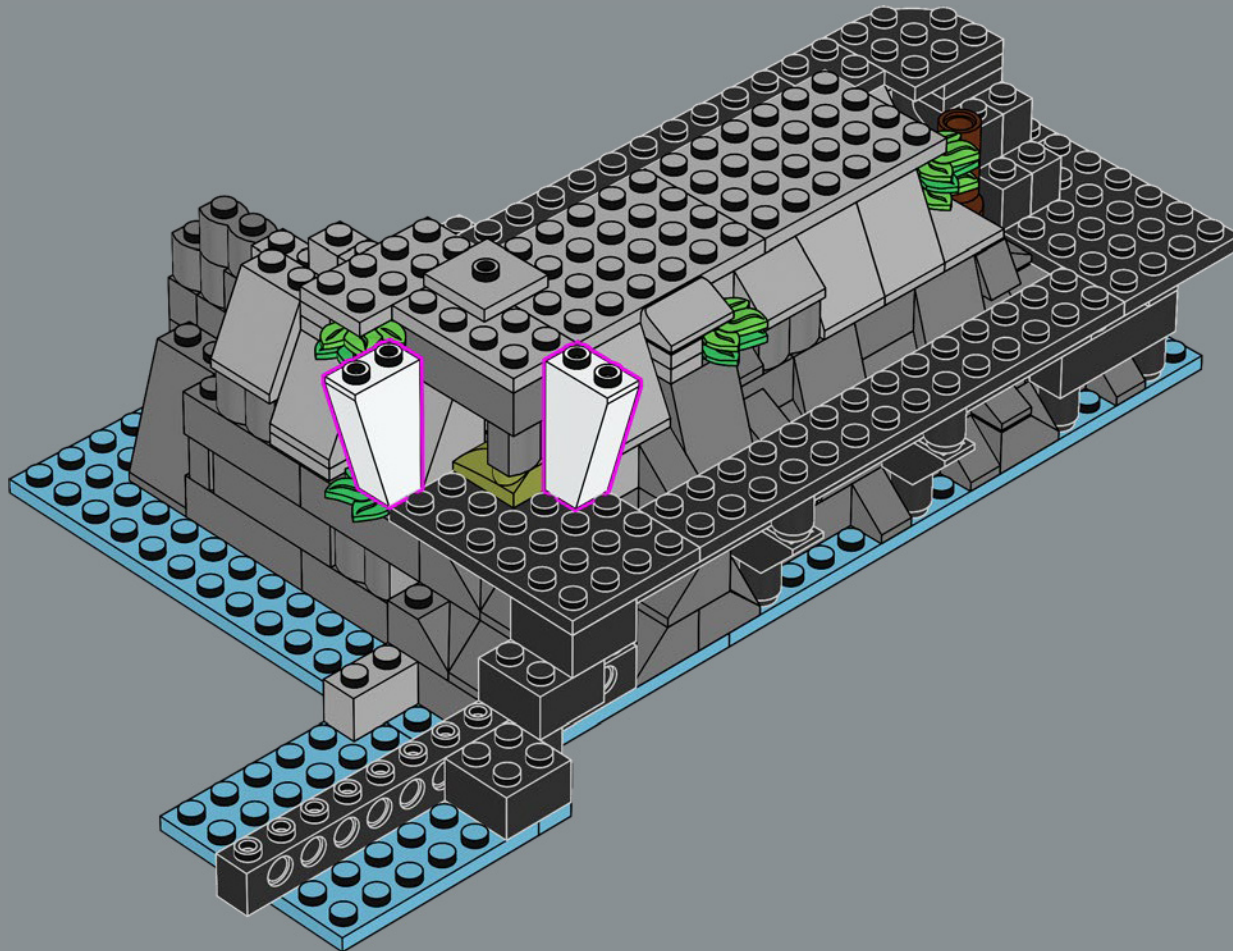

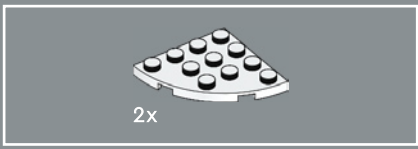

42

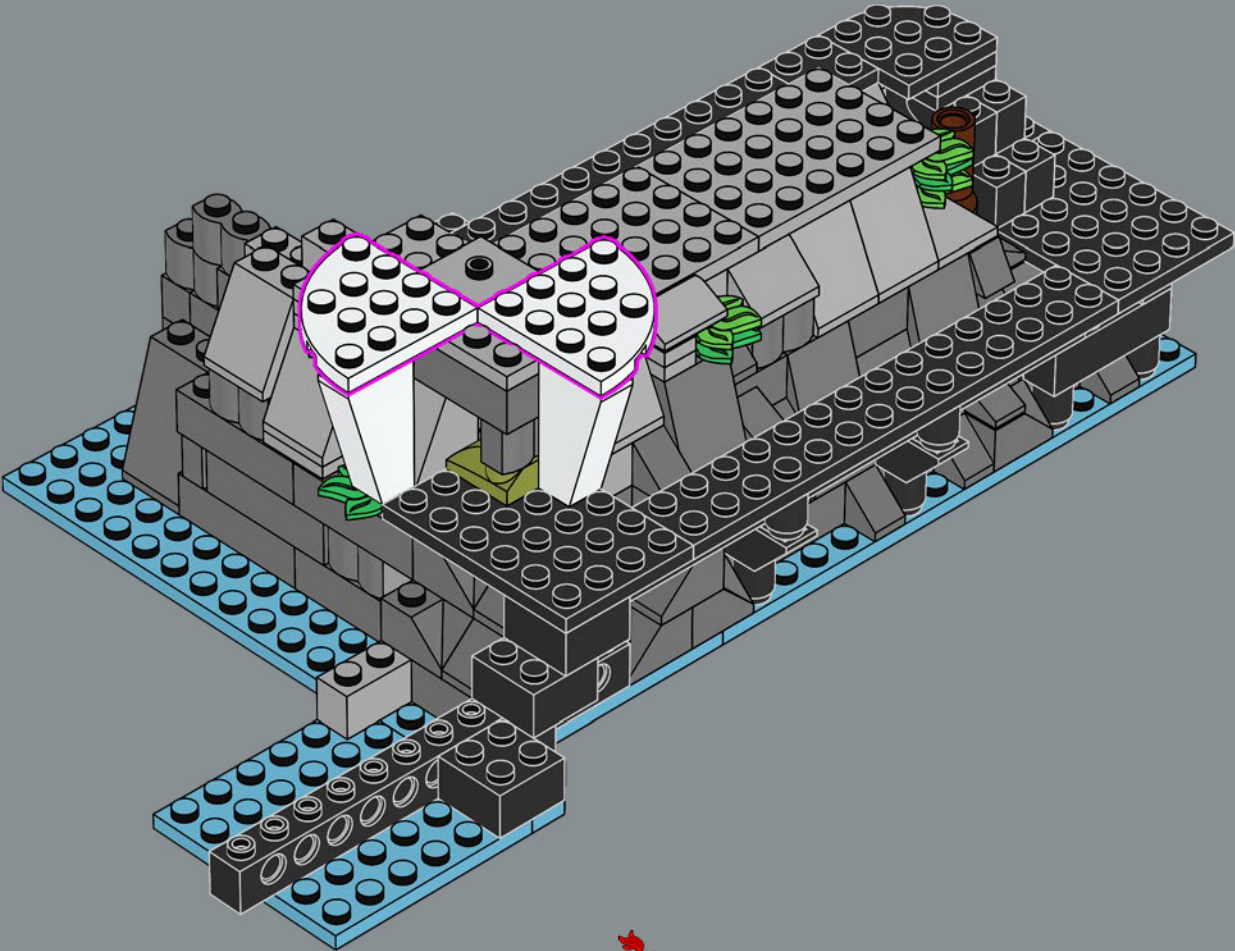

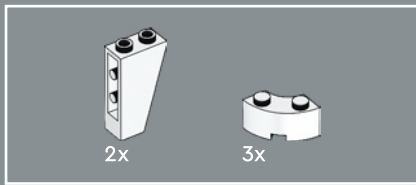

43

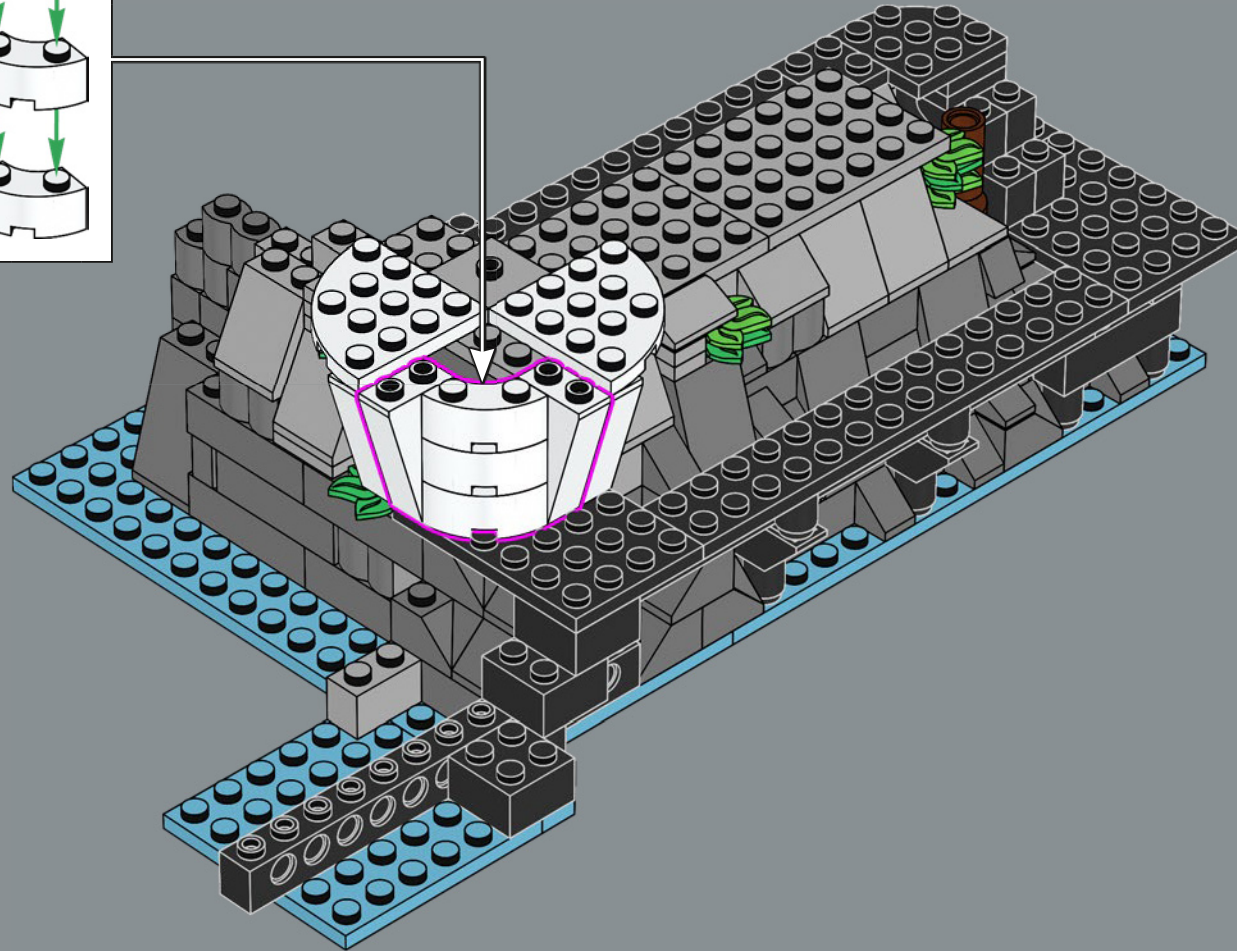
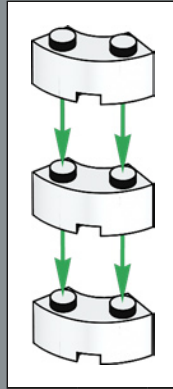



44

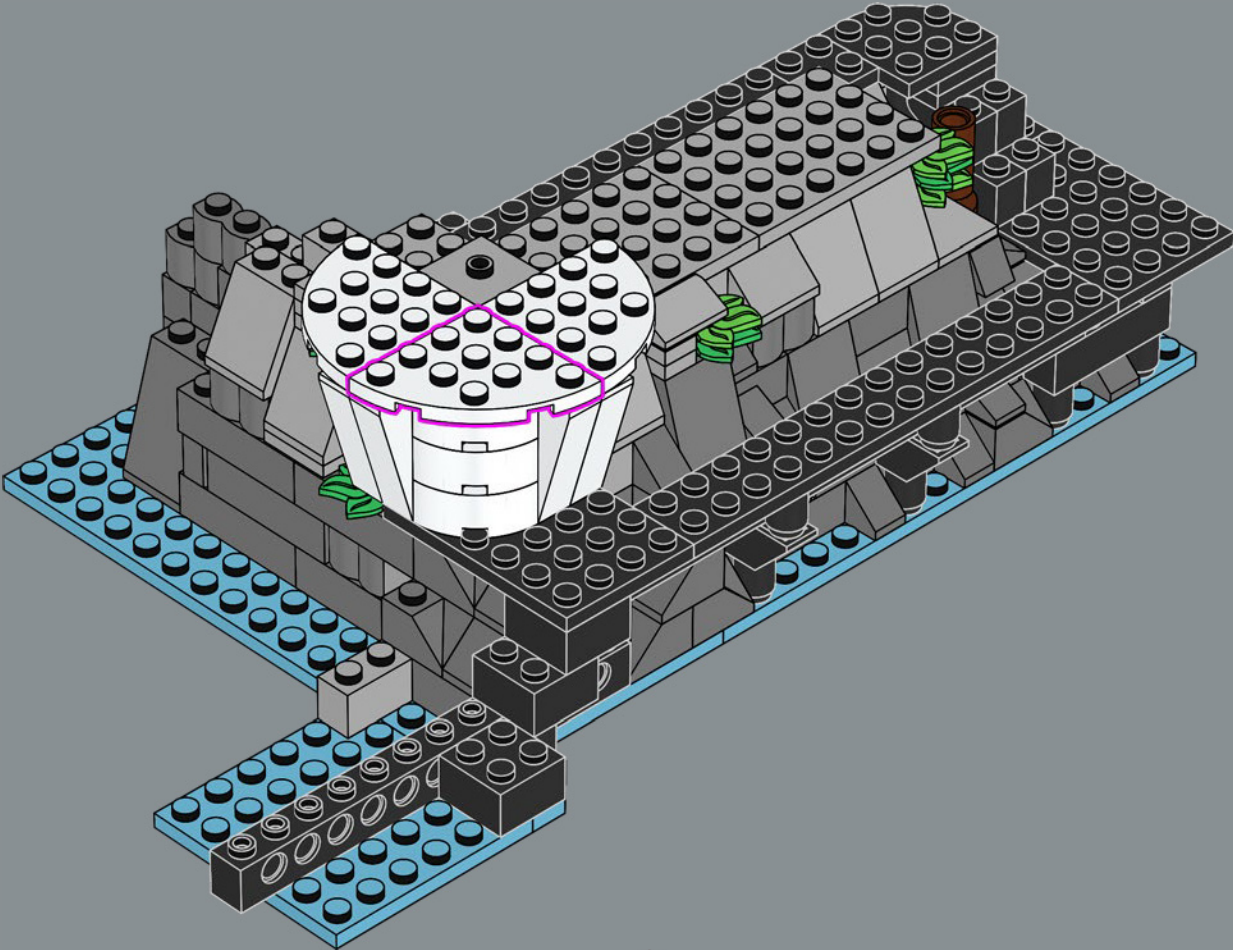

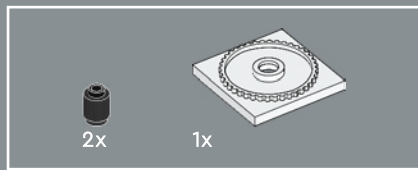

45

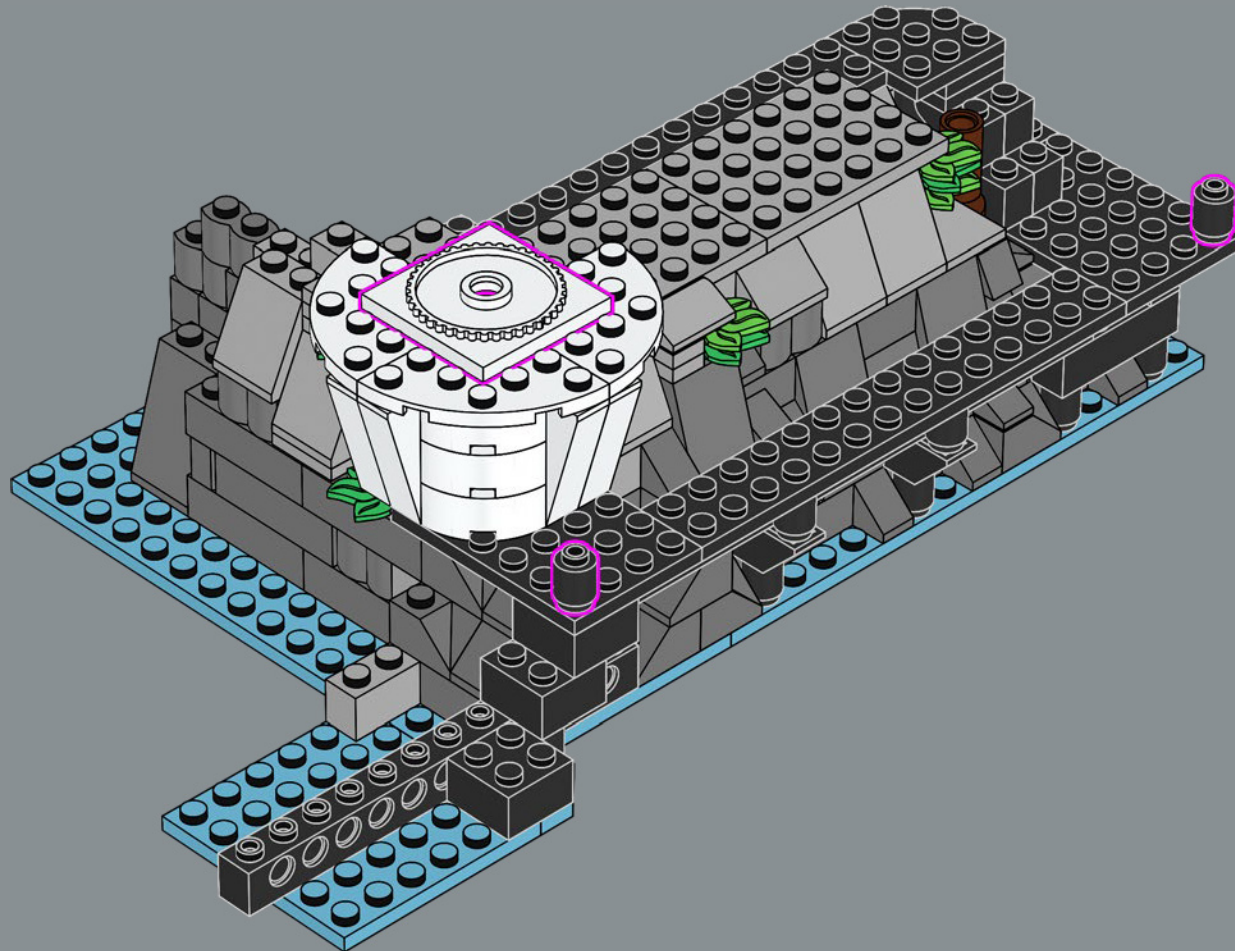

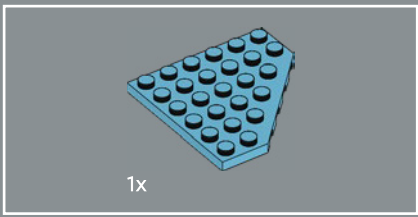

46

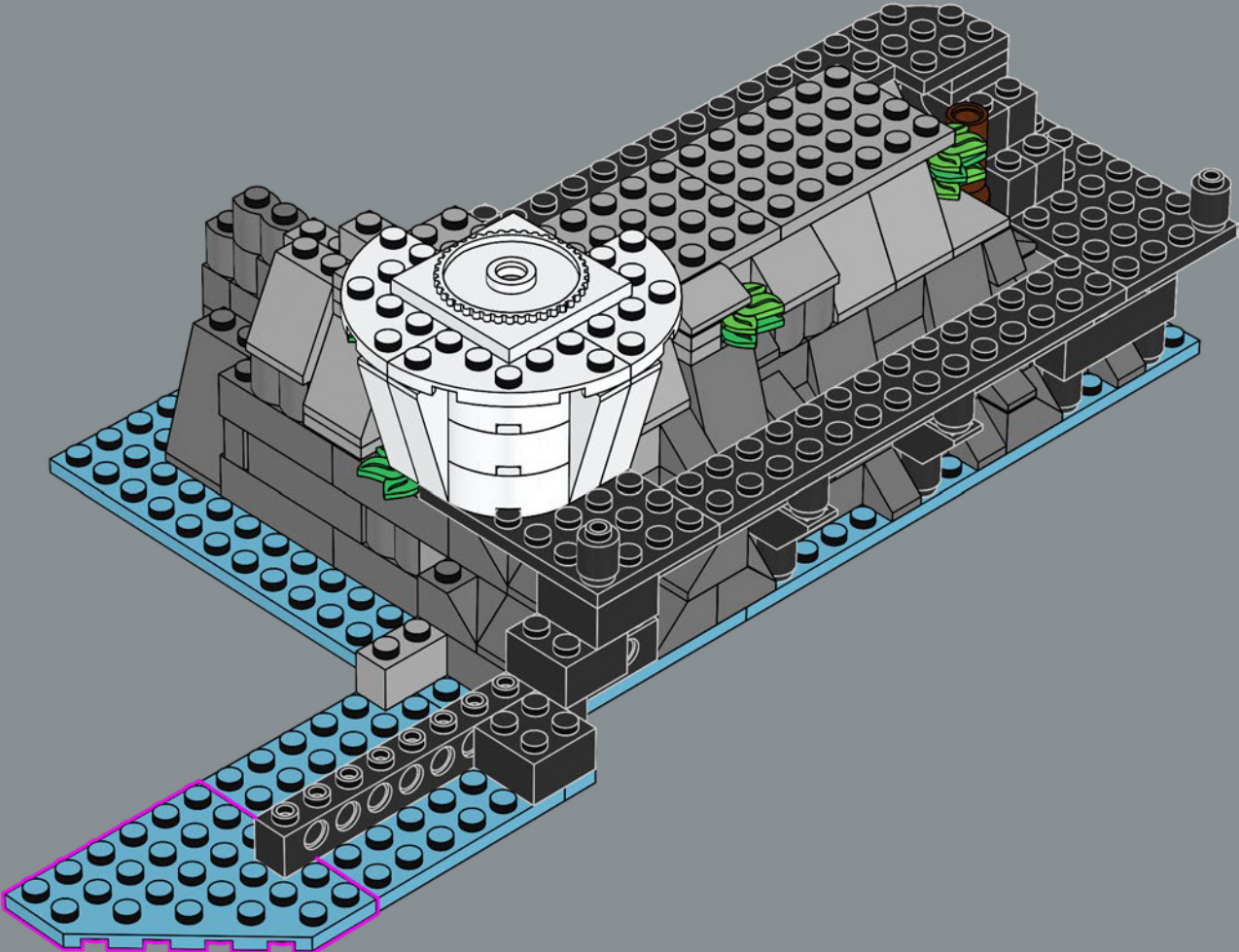

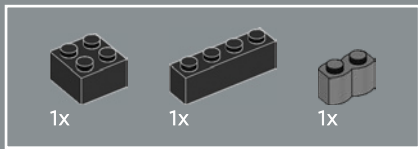

47

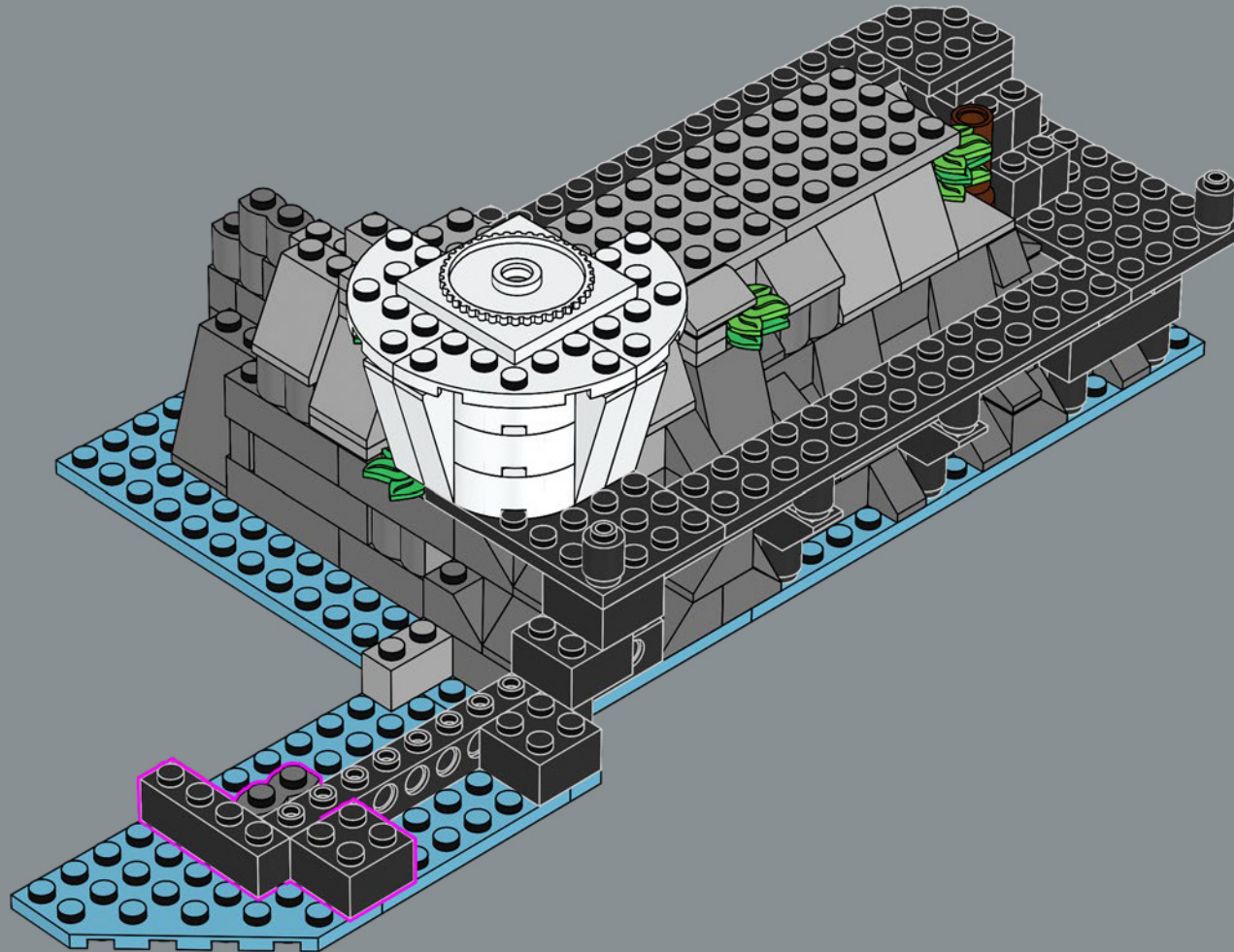

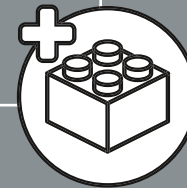
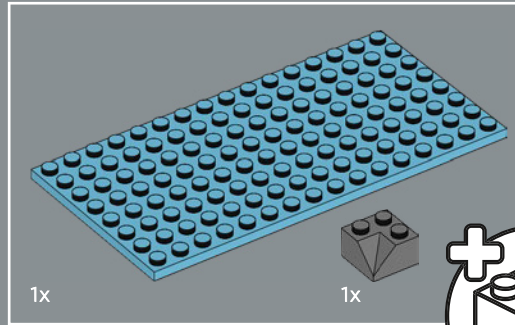
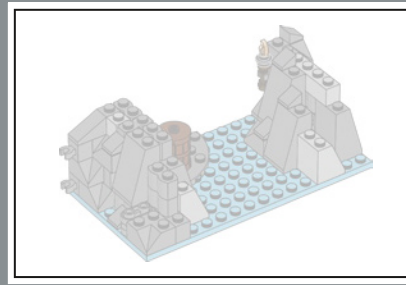
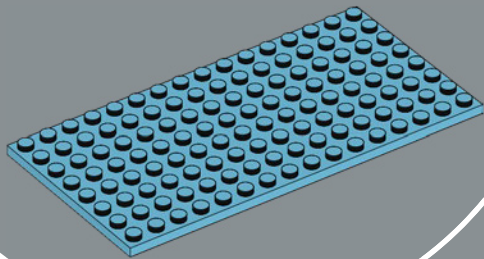
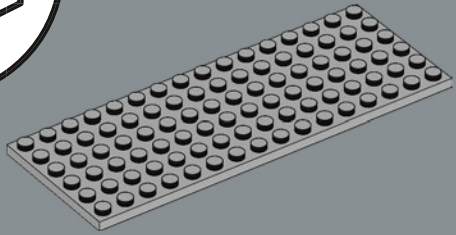
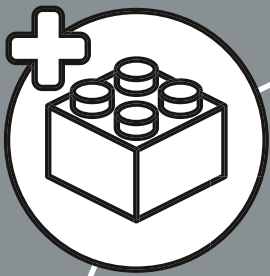

48

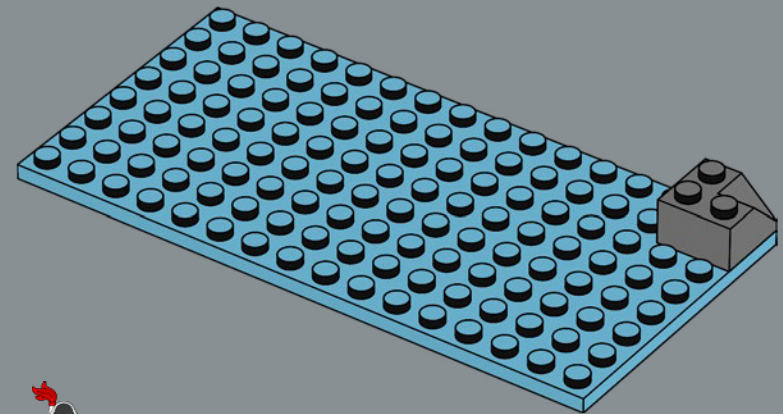



49

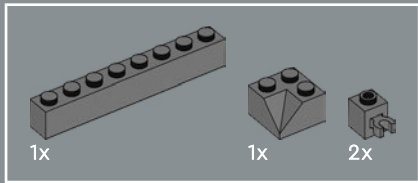
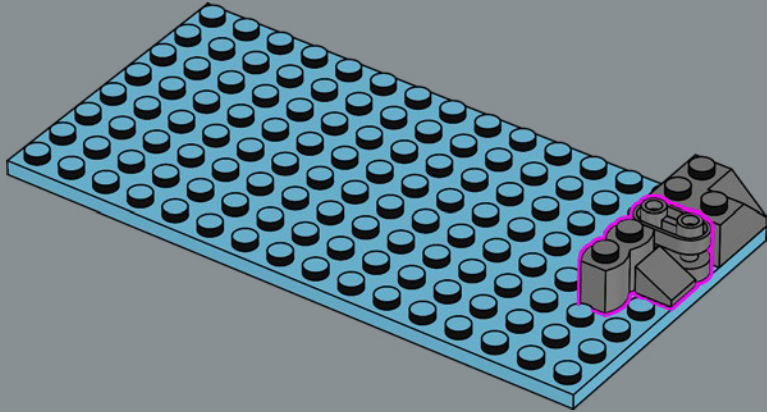

50

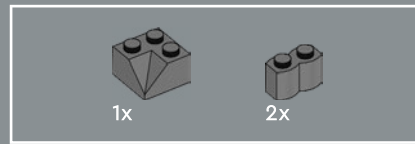
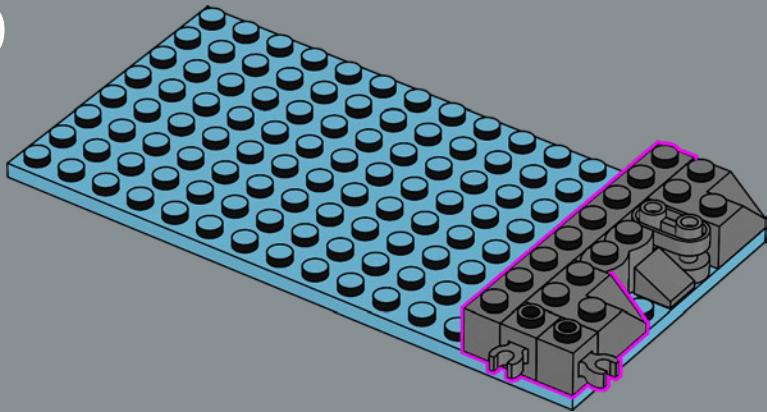

51

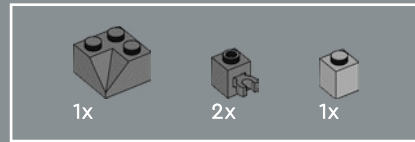
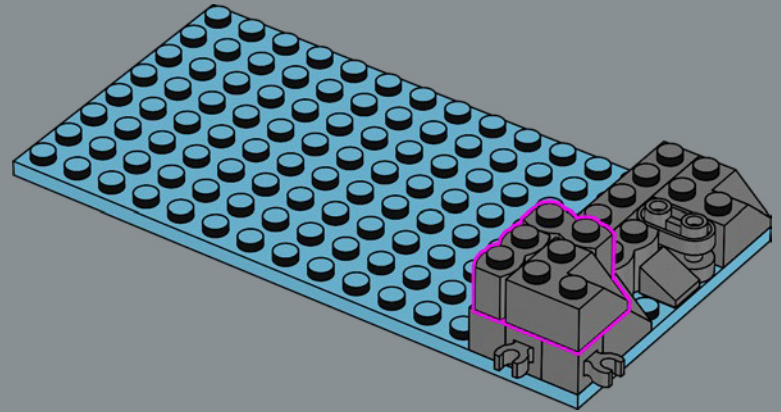

52

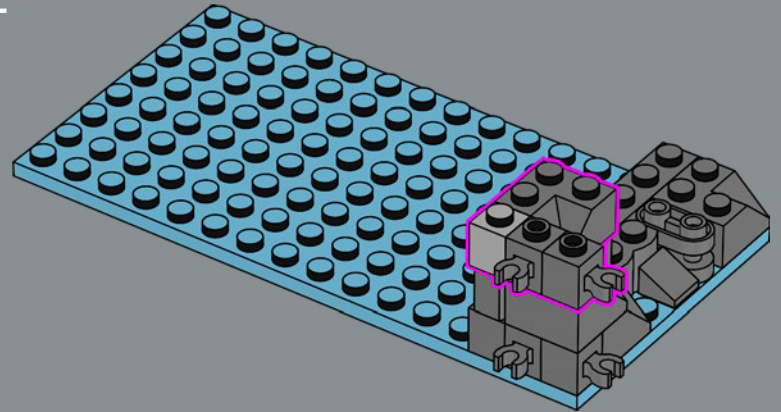

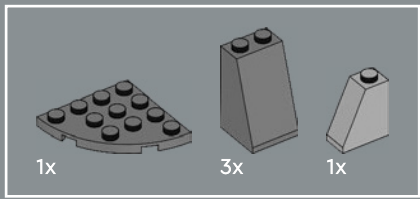

53

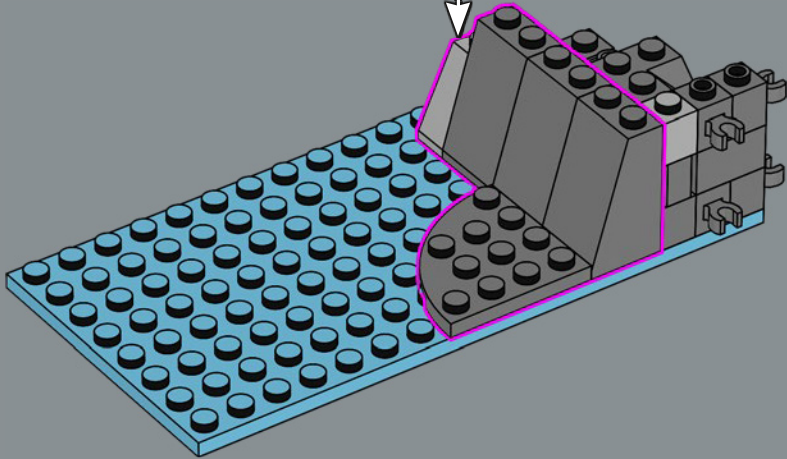
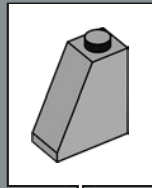

54

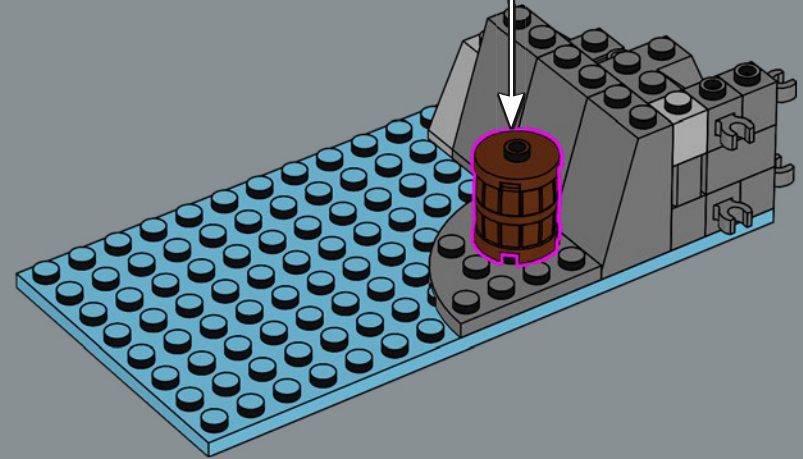
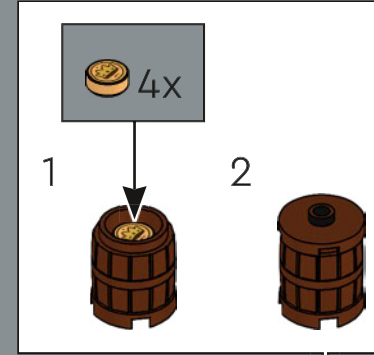

Les doublons d'or sont rangés en sécurité là où personne ne peut les trouver.



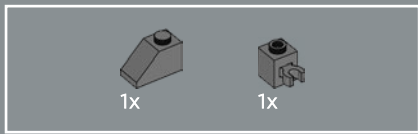

55

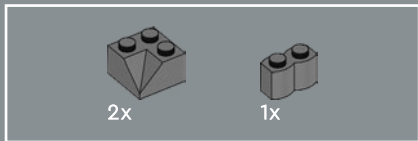
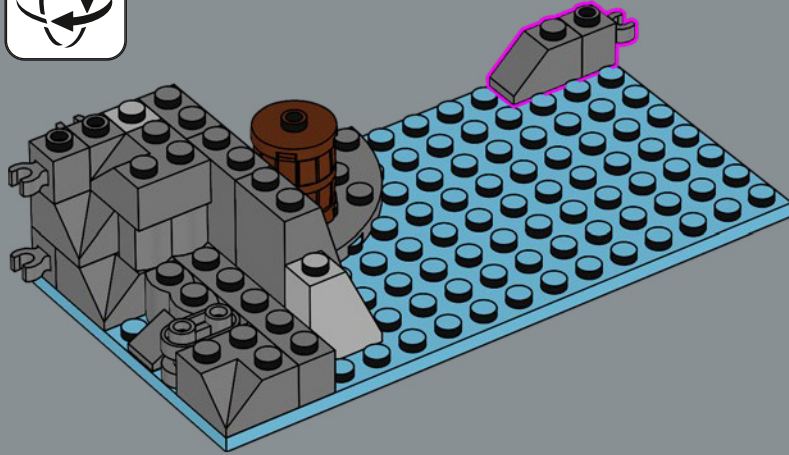

56

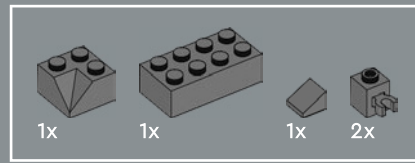
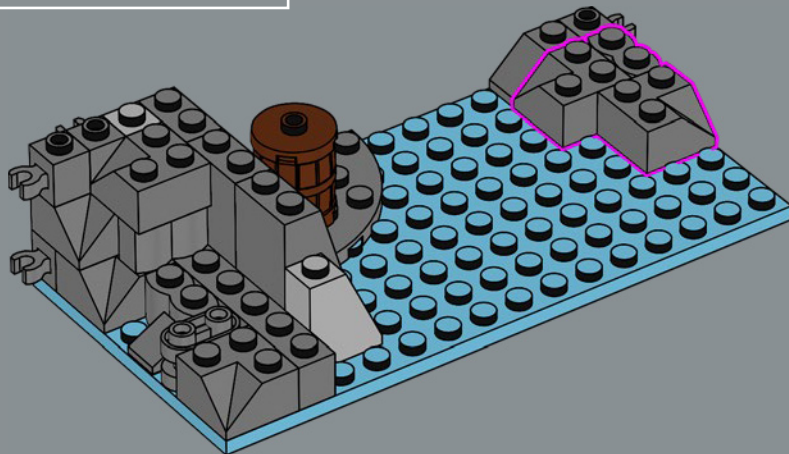

57

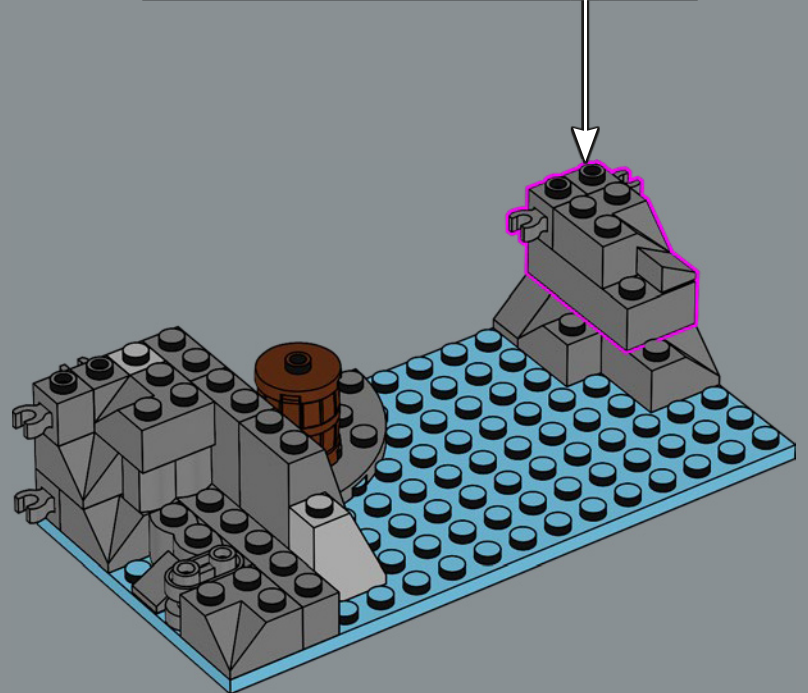
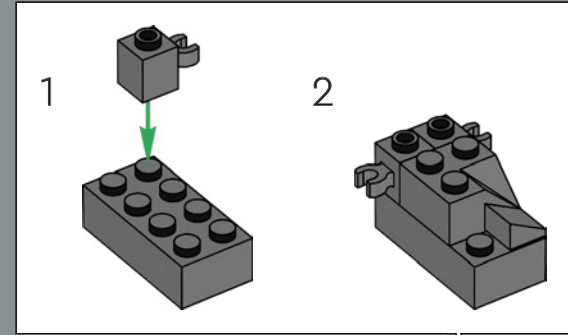

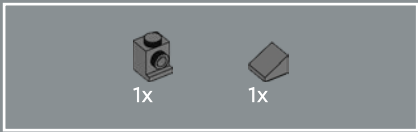

58

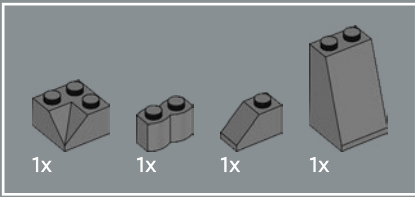
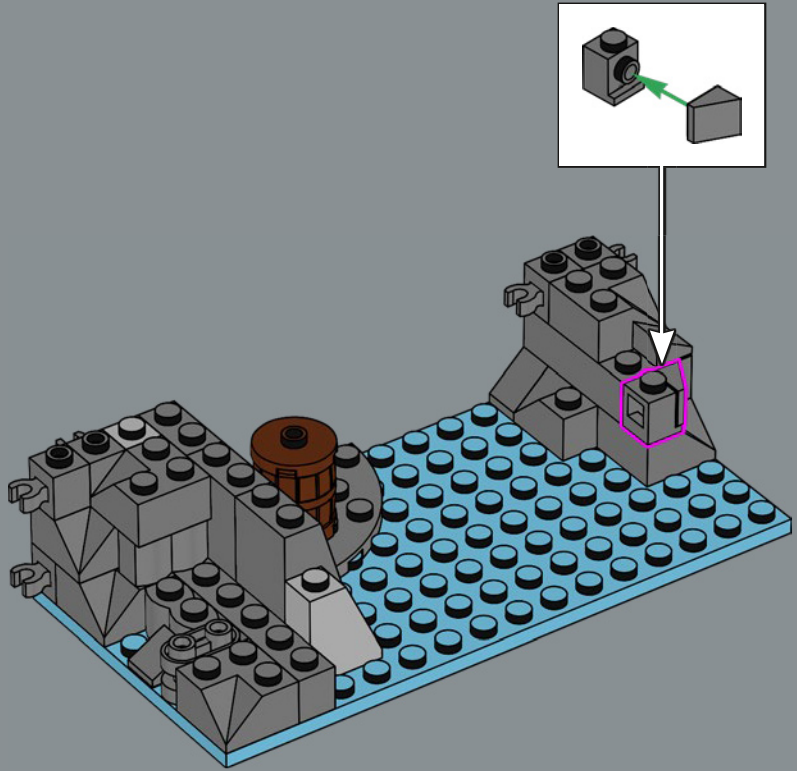
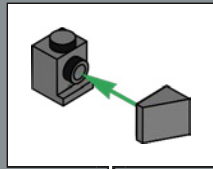

59

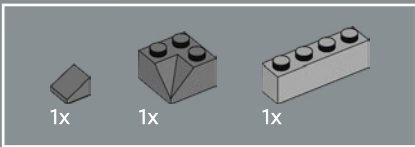
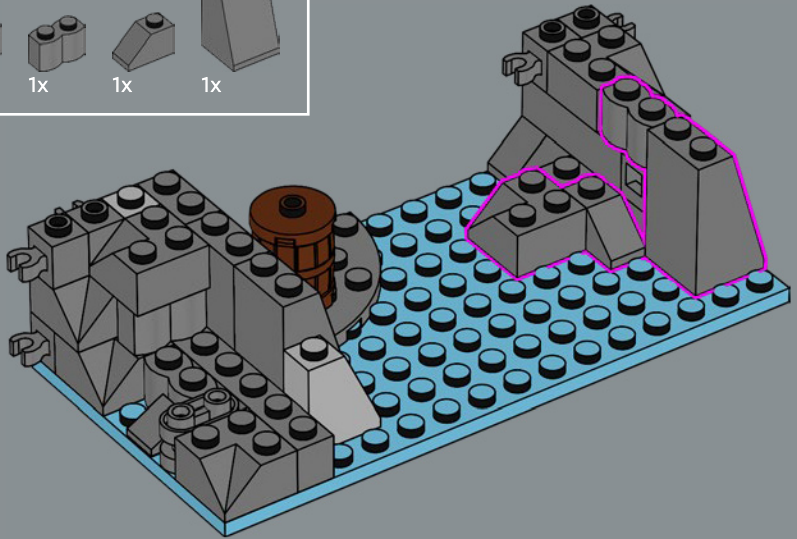

60

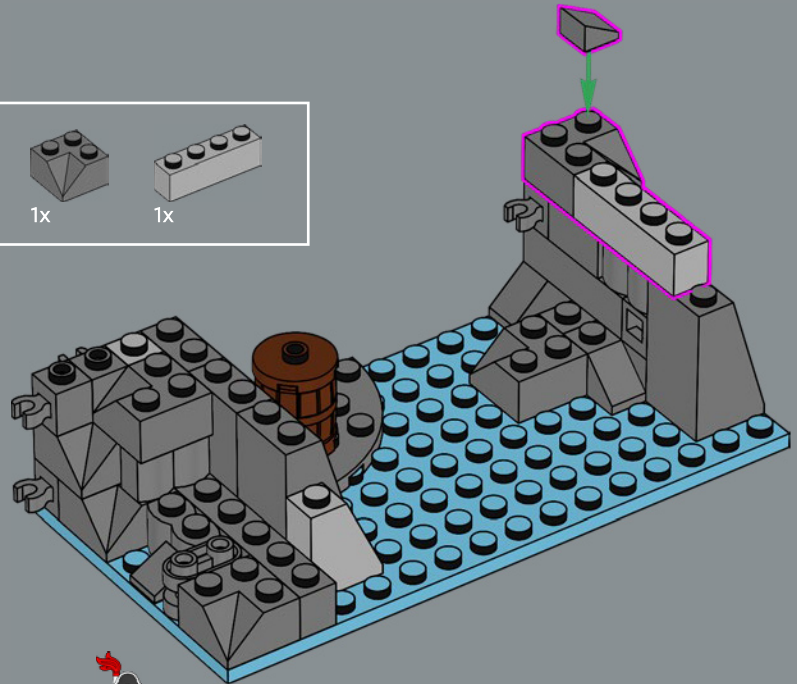

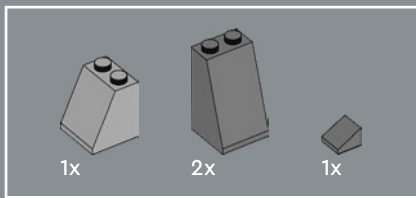

61

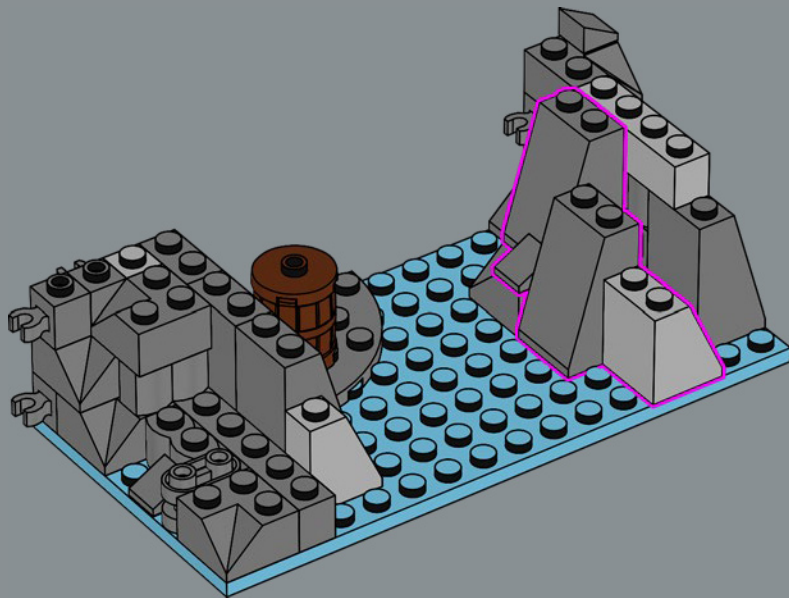

62

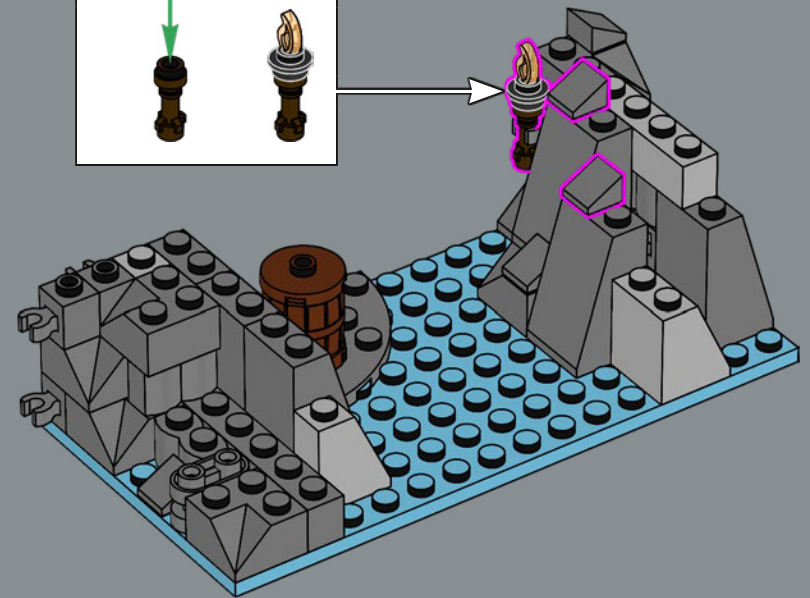
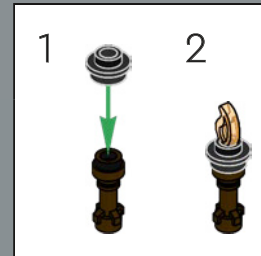

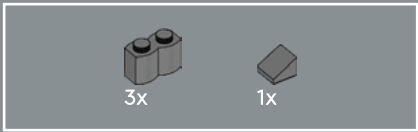

63

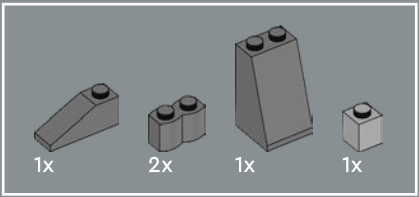
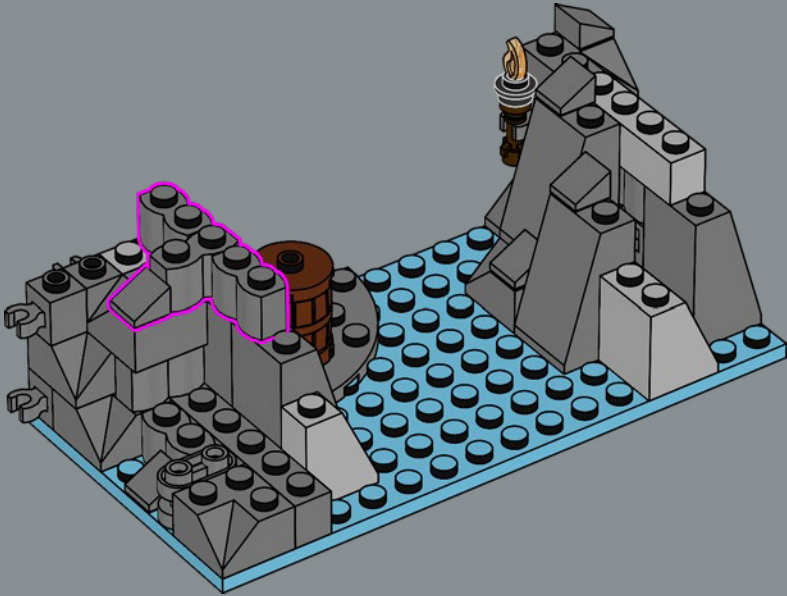

64

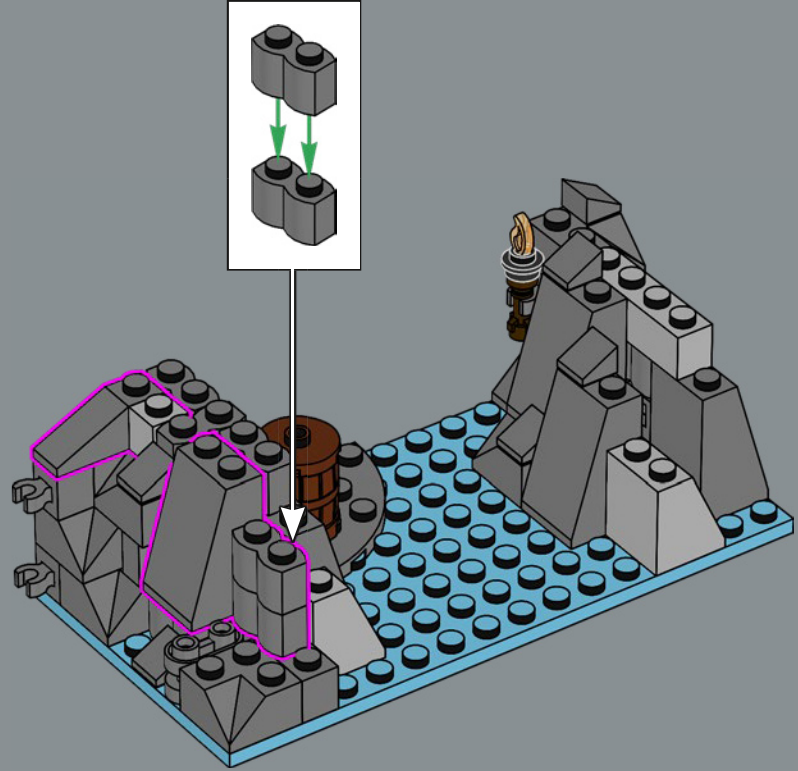

65

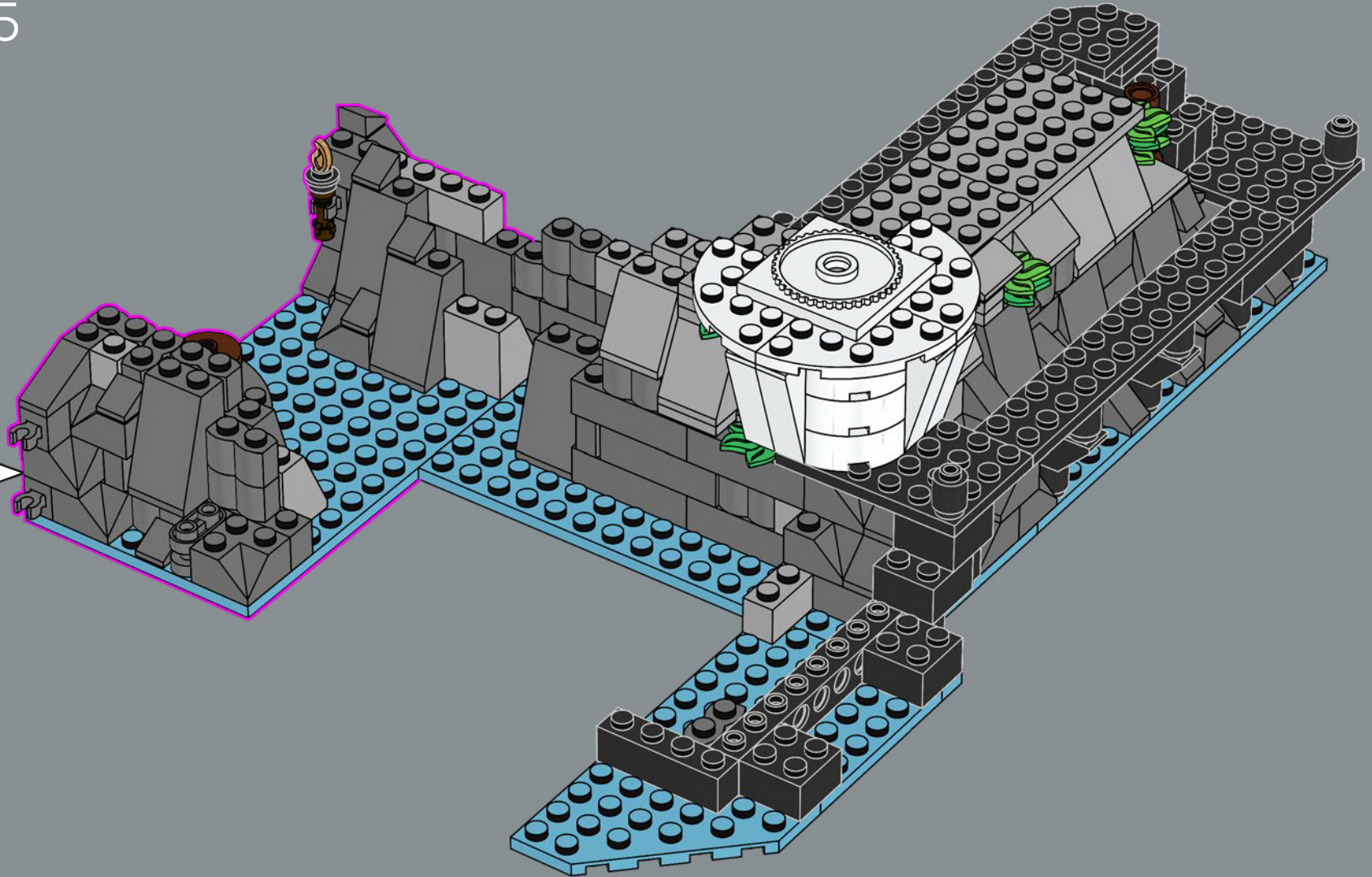

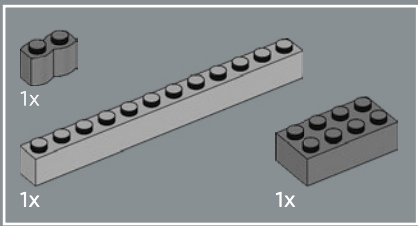

66

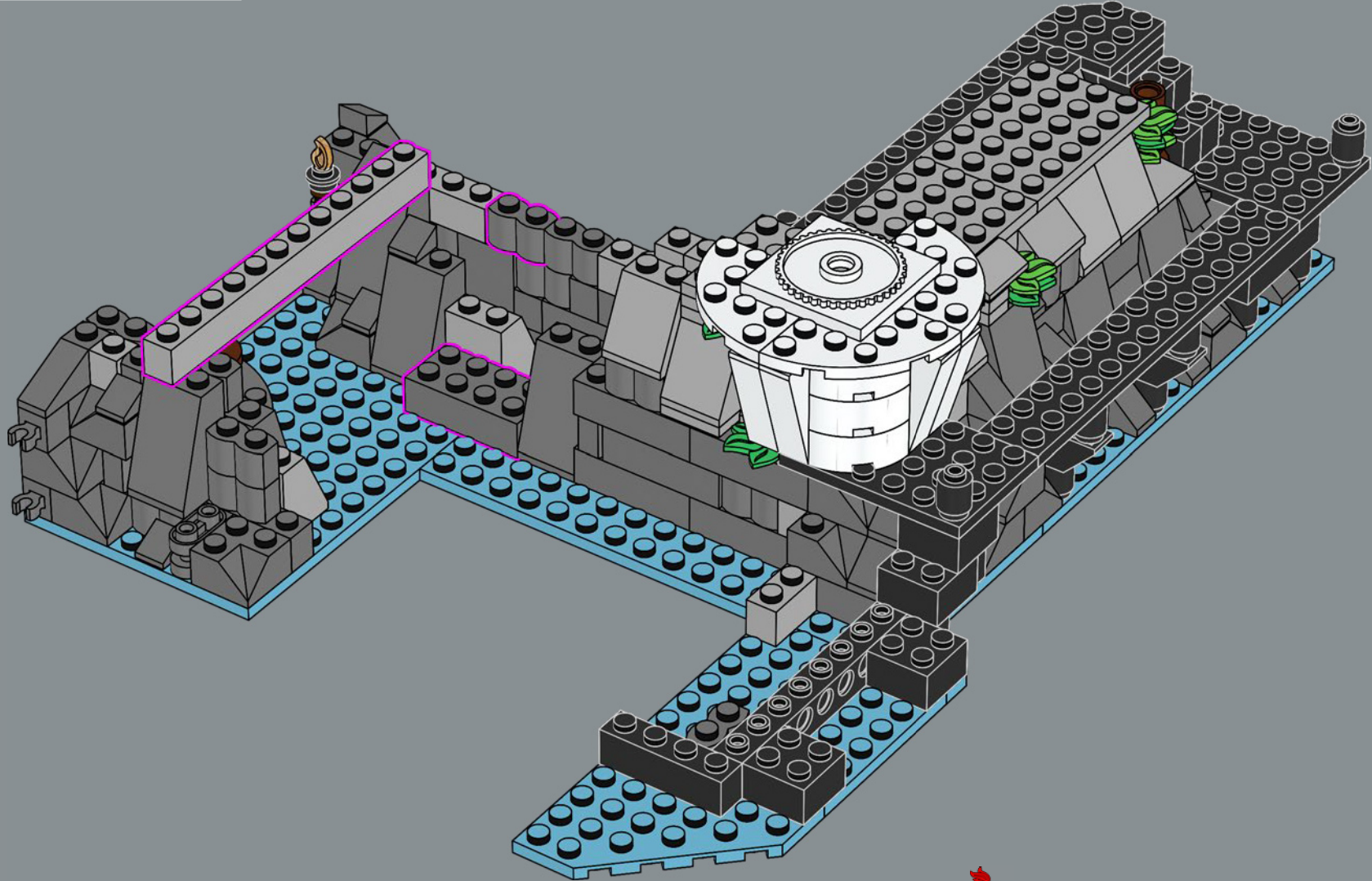

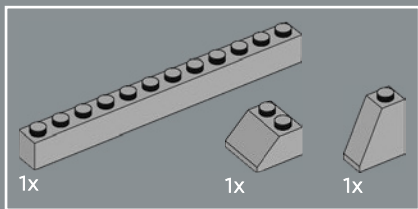

67

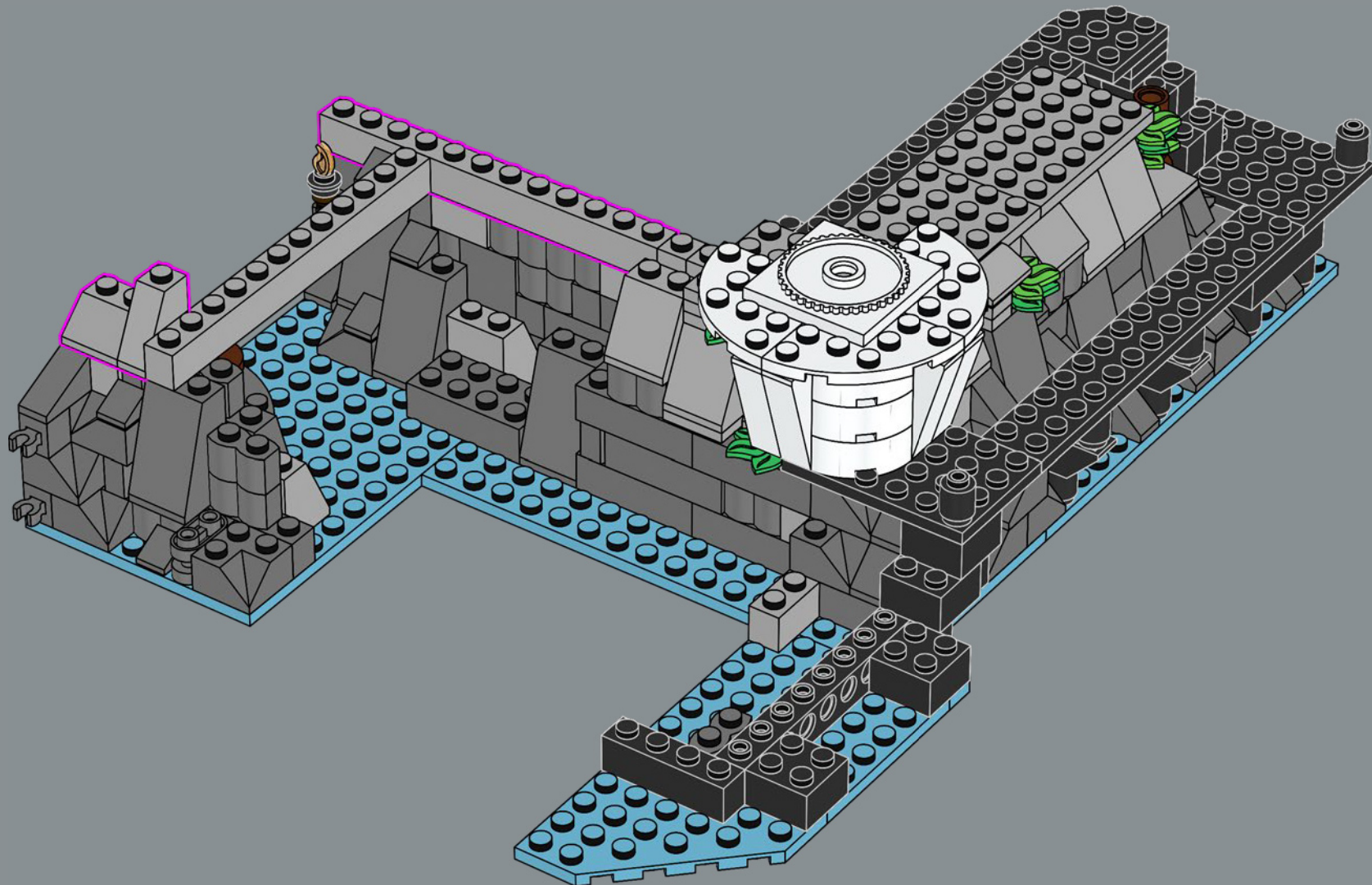

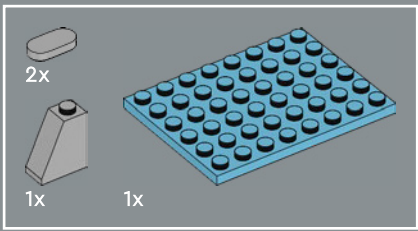

68

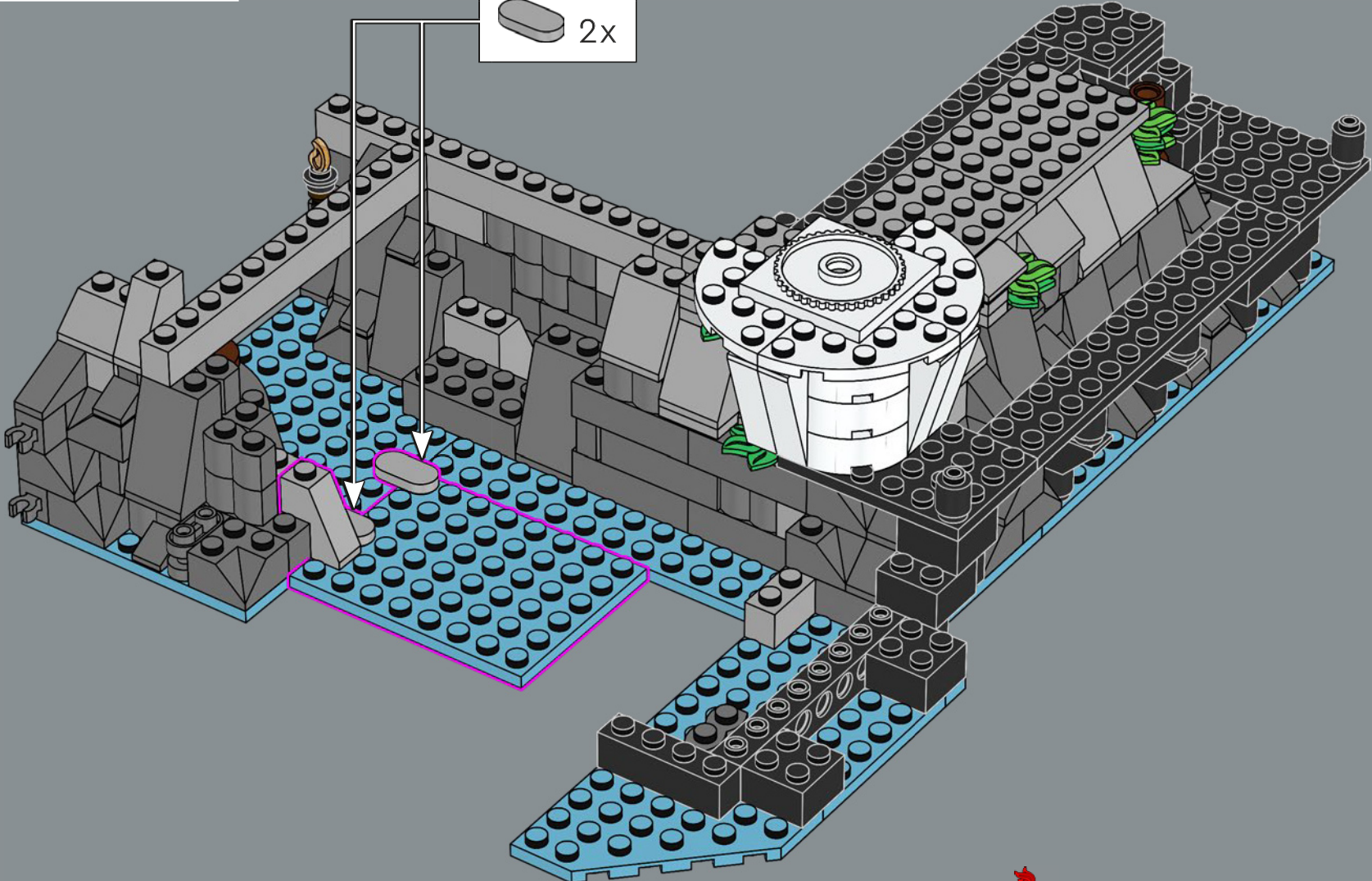

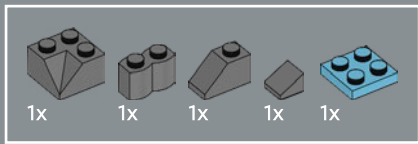

69

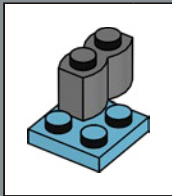
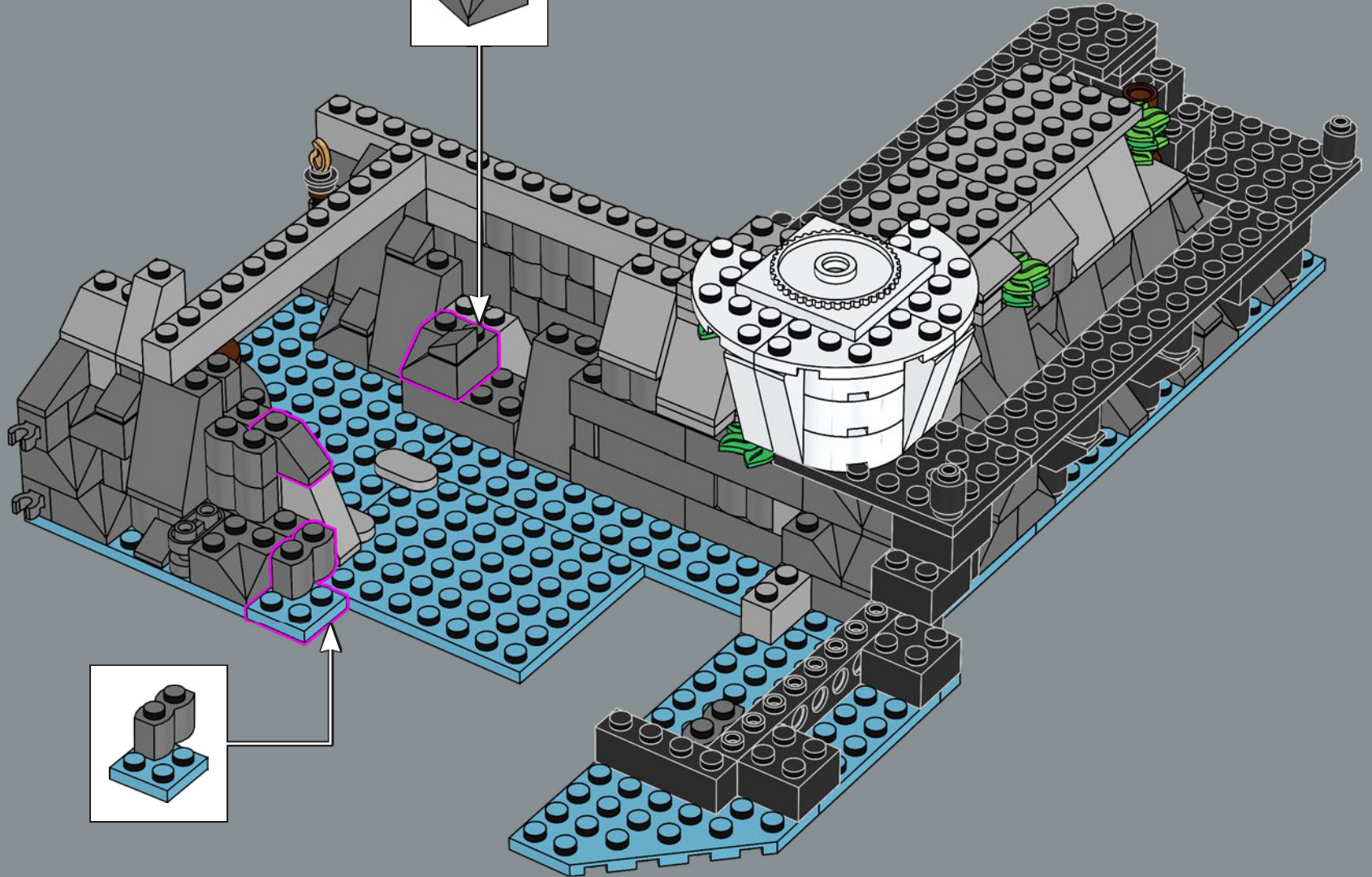
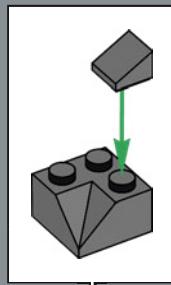

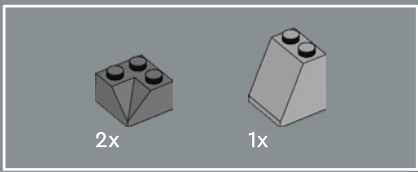

70

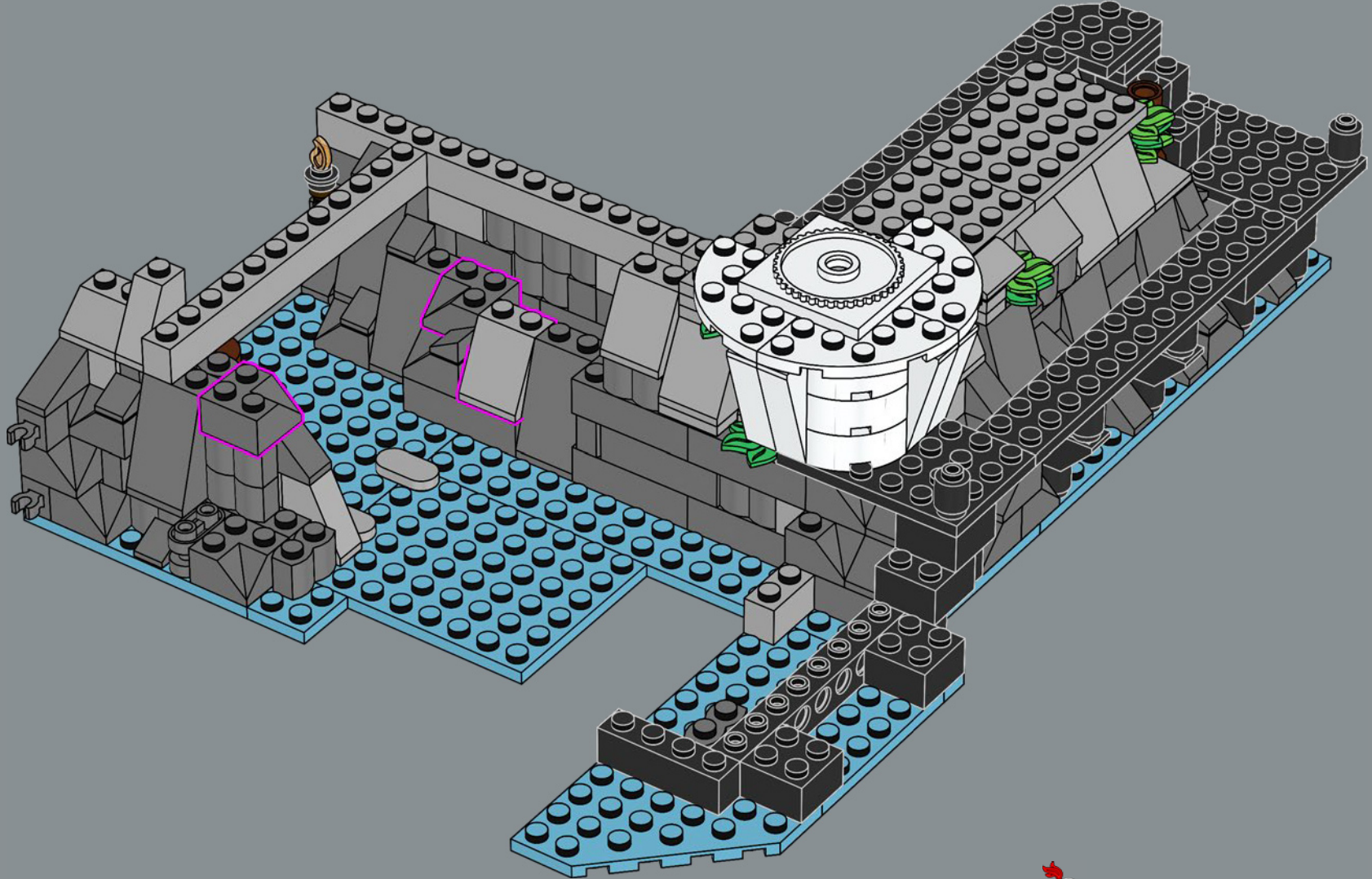

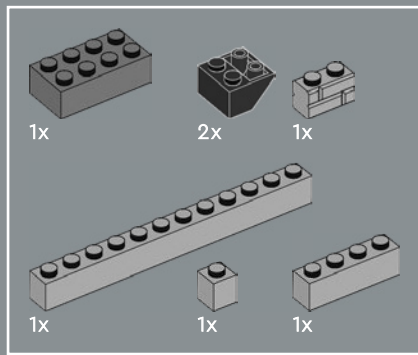

71

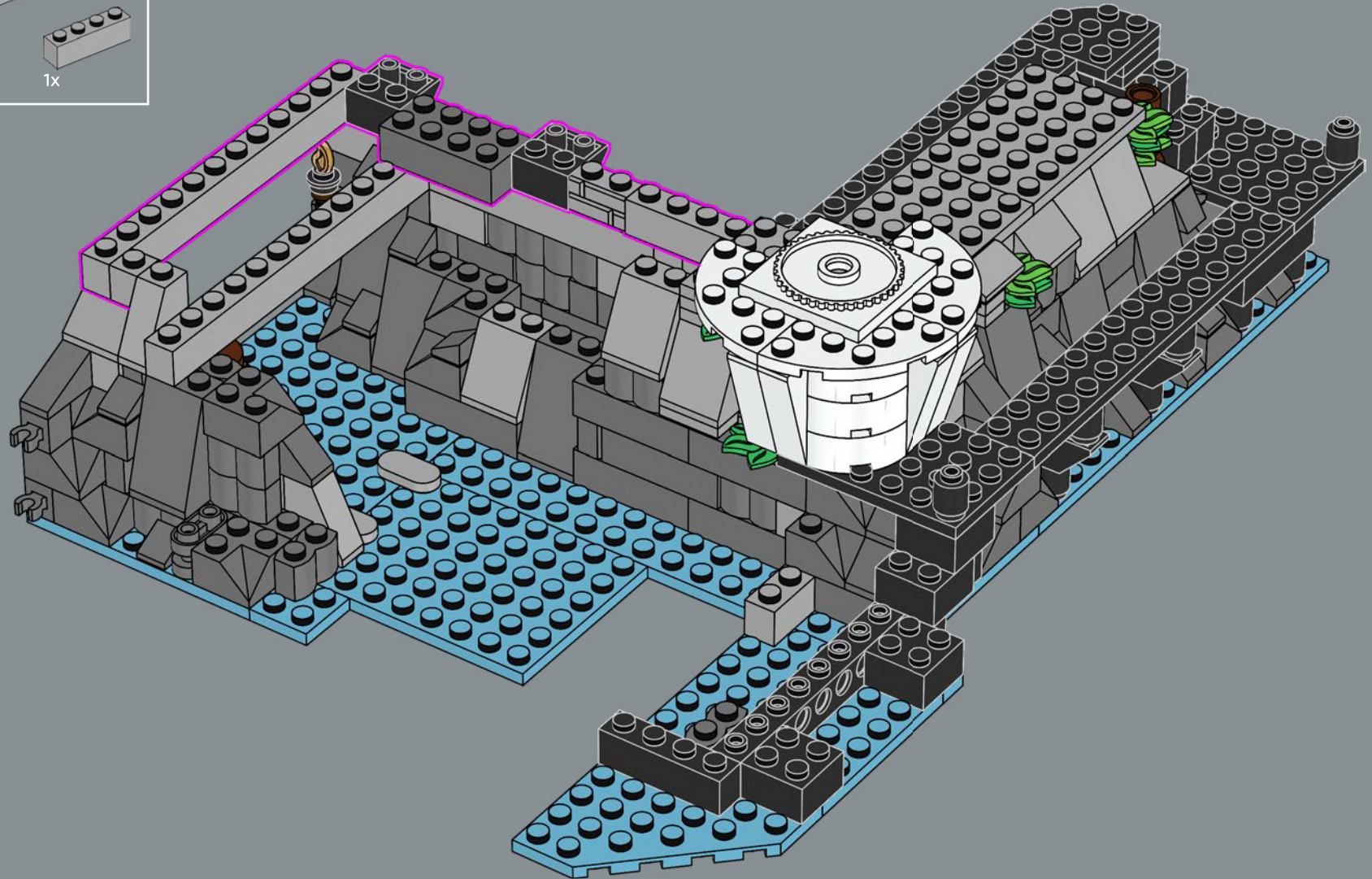

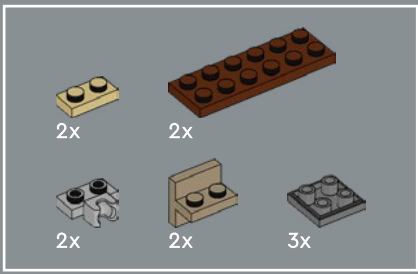

72

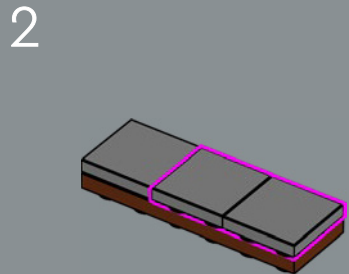
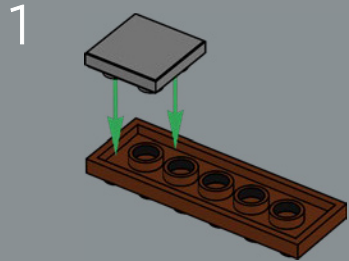

3

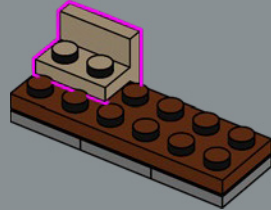

4

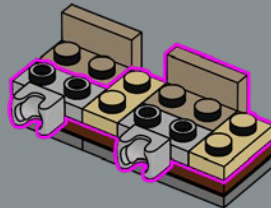

5

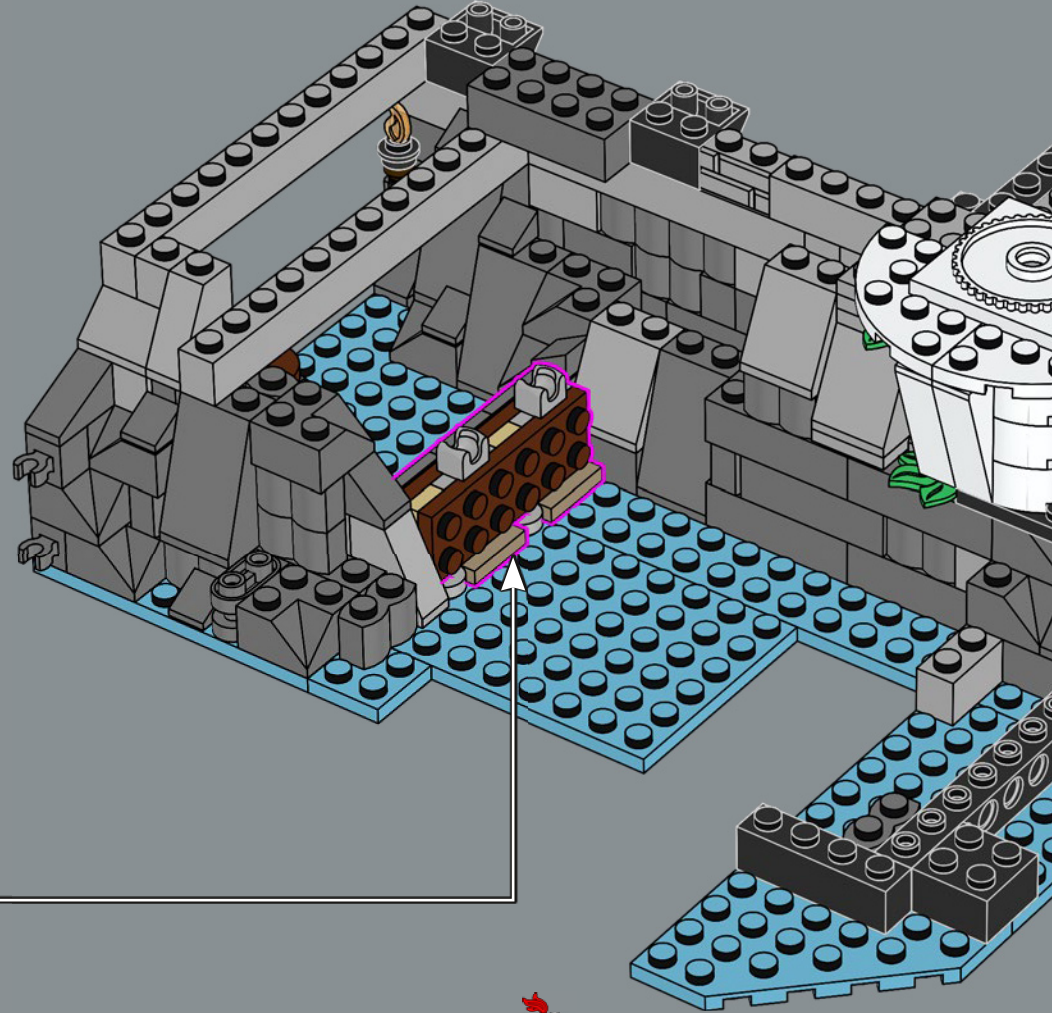
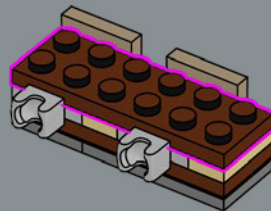

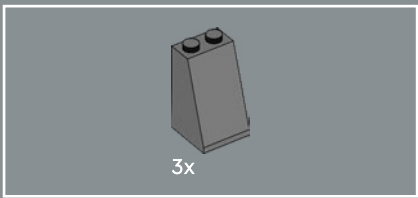

73

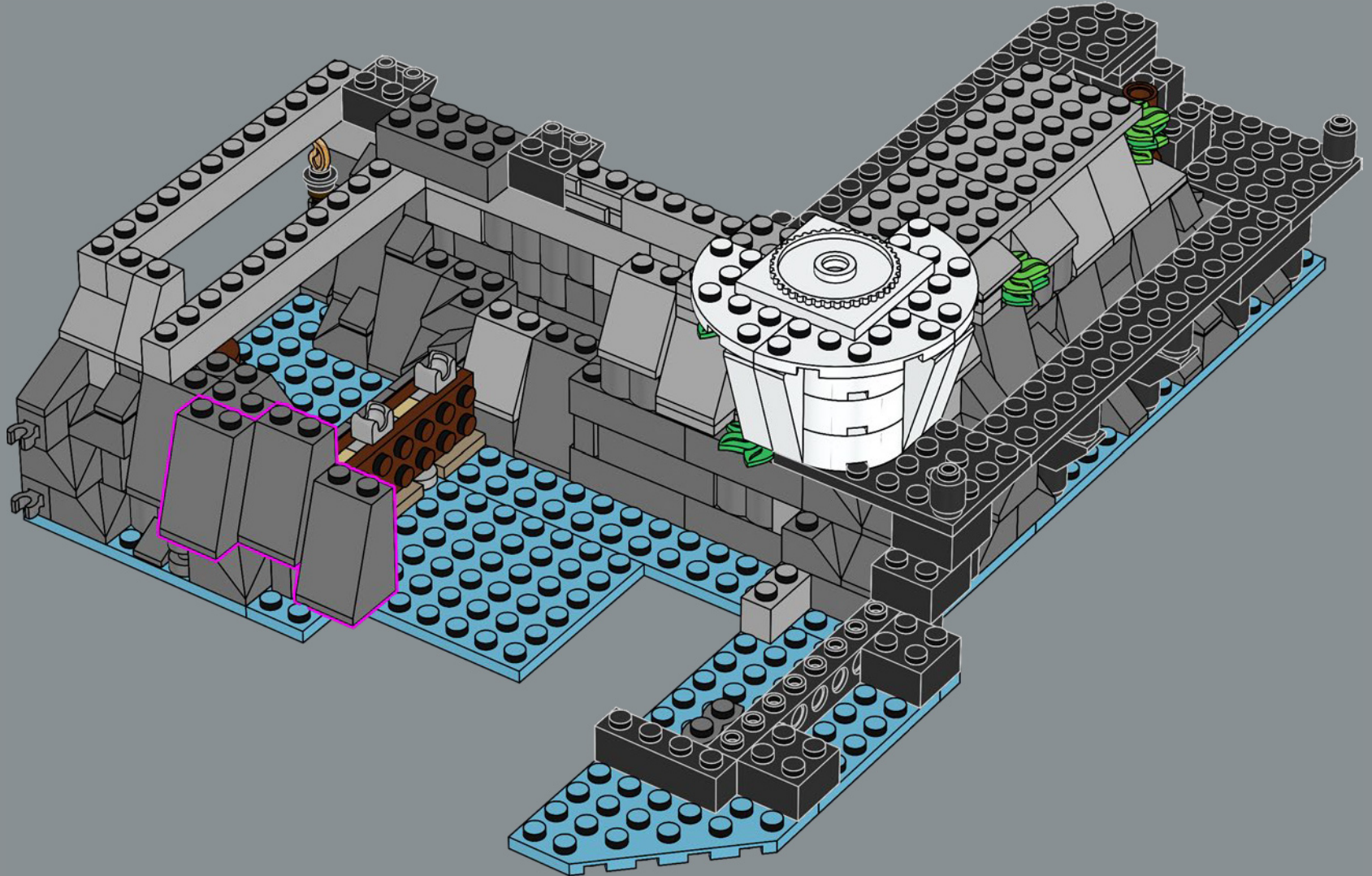

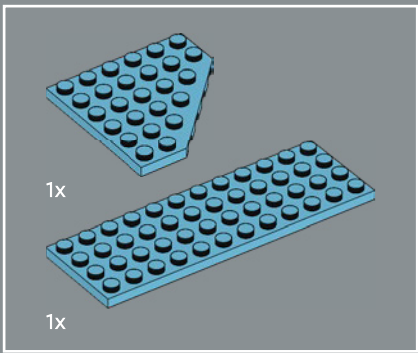

74

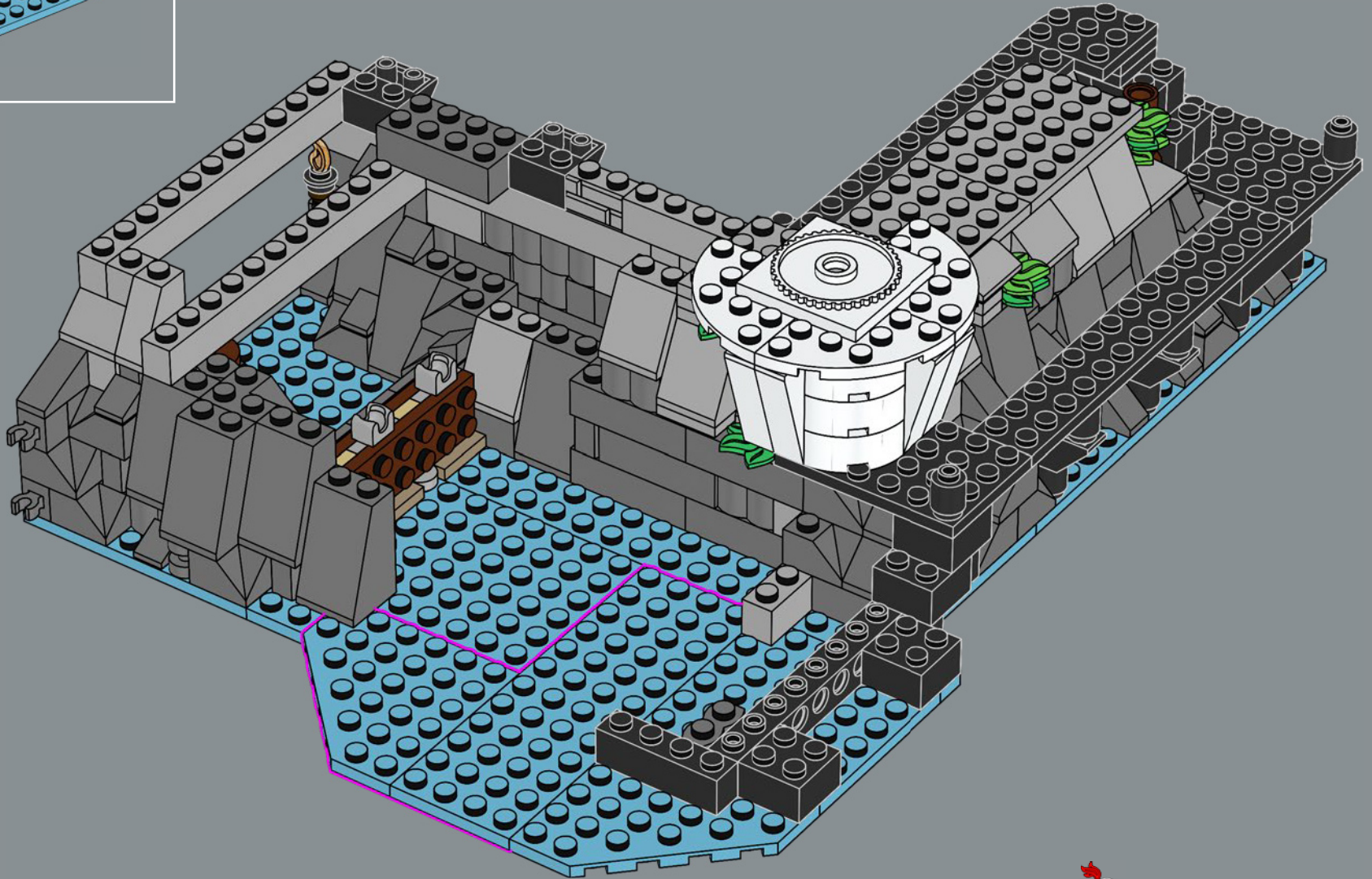

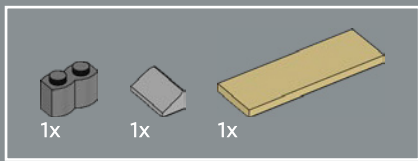

75

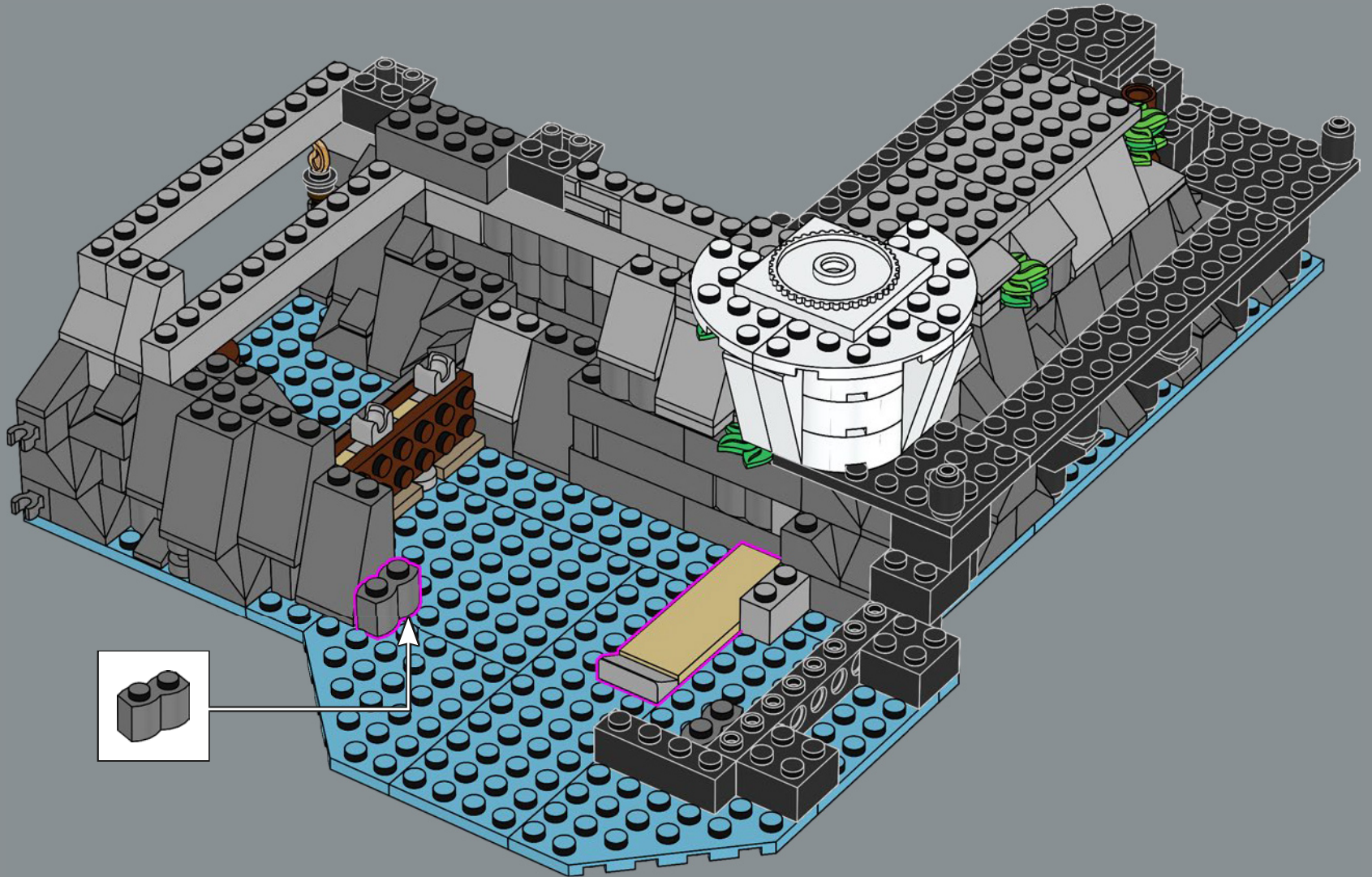

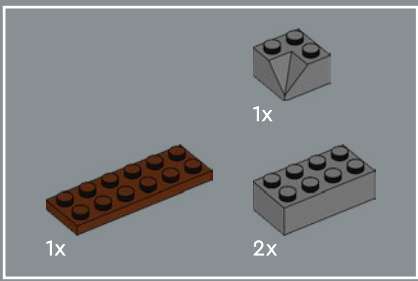

76

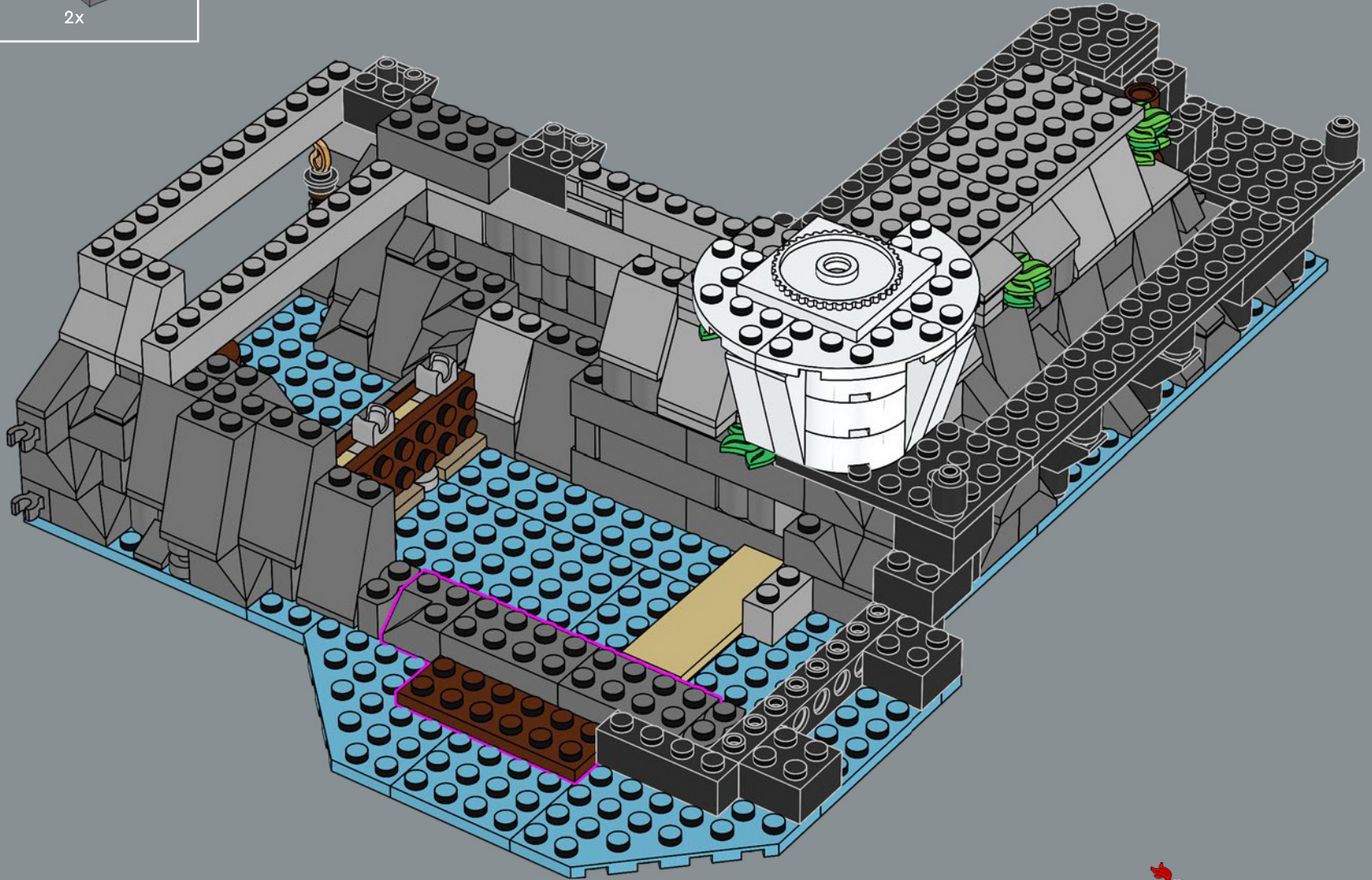

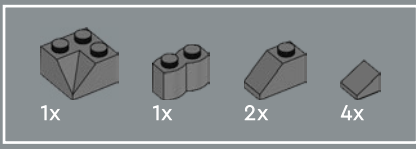

77

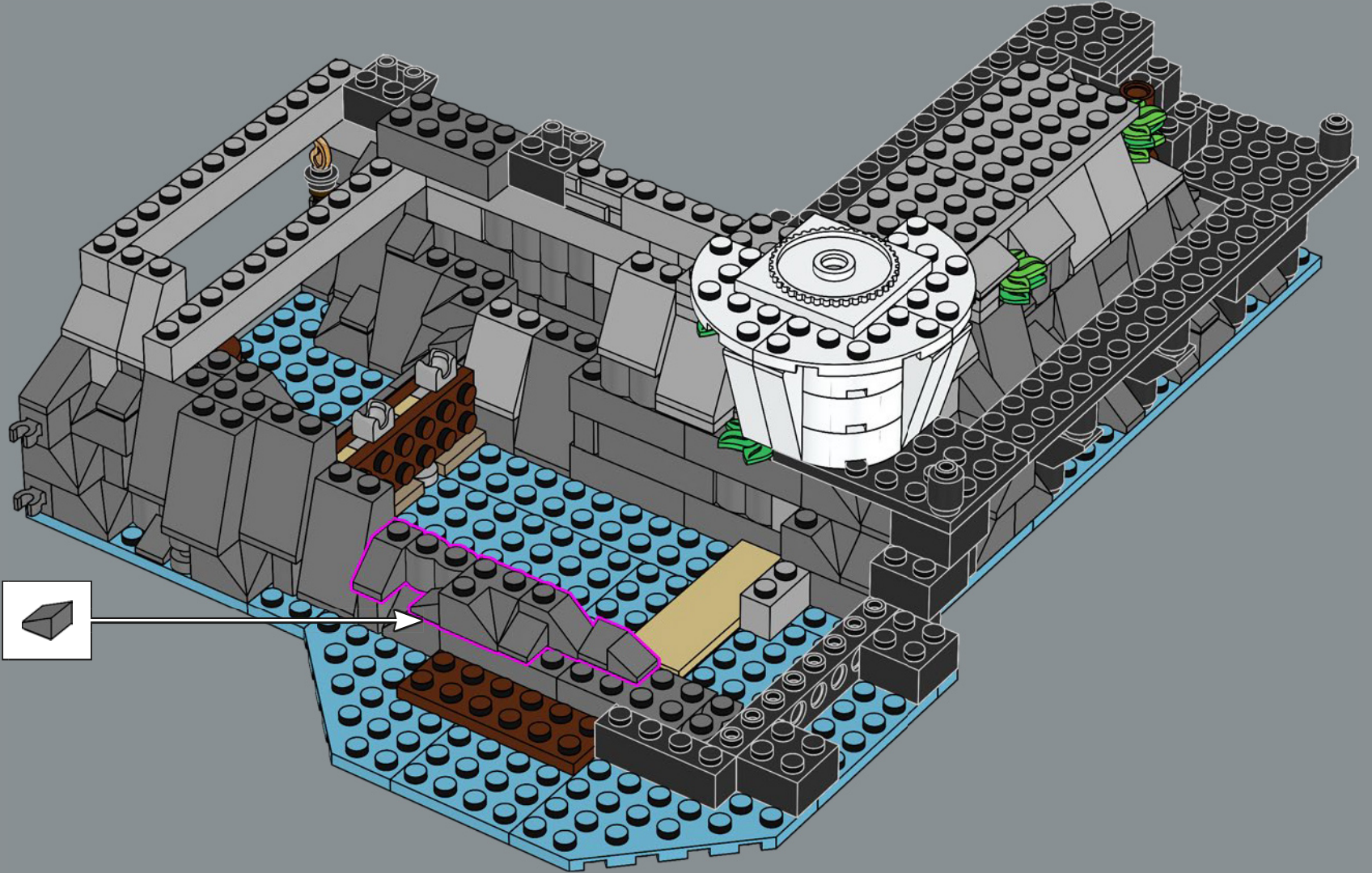

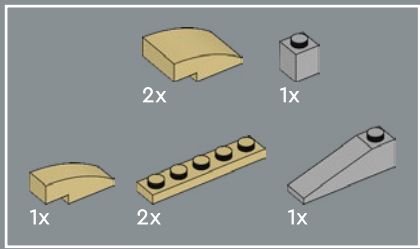

78

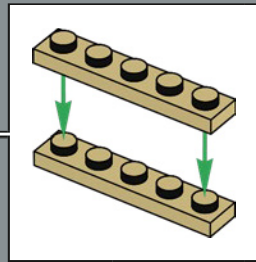
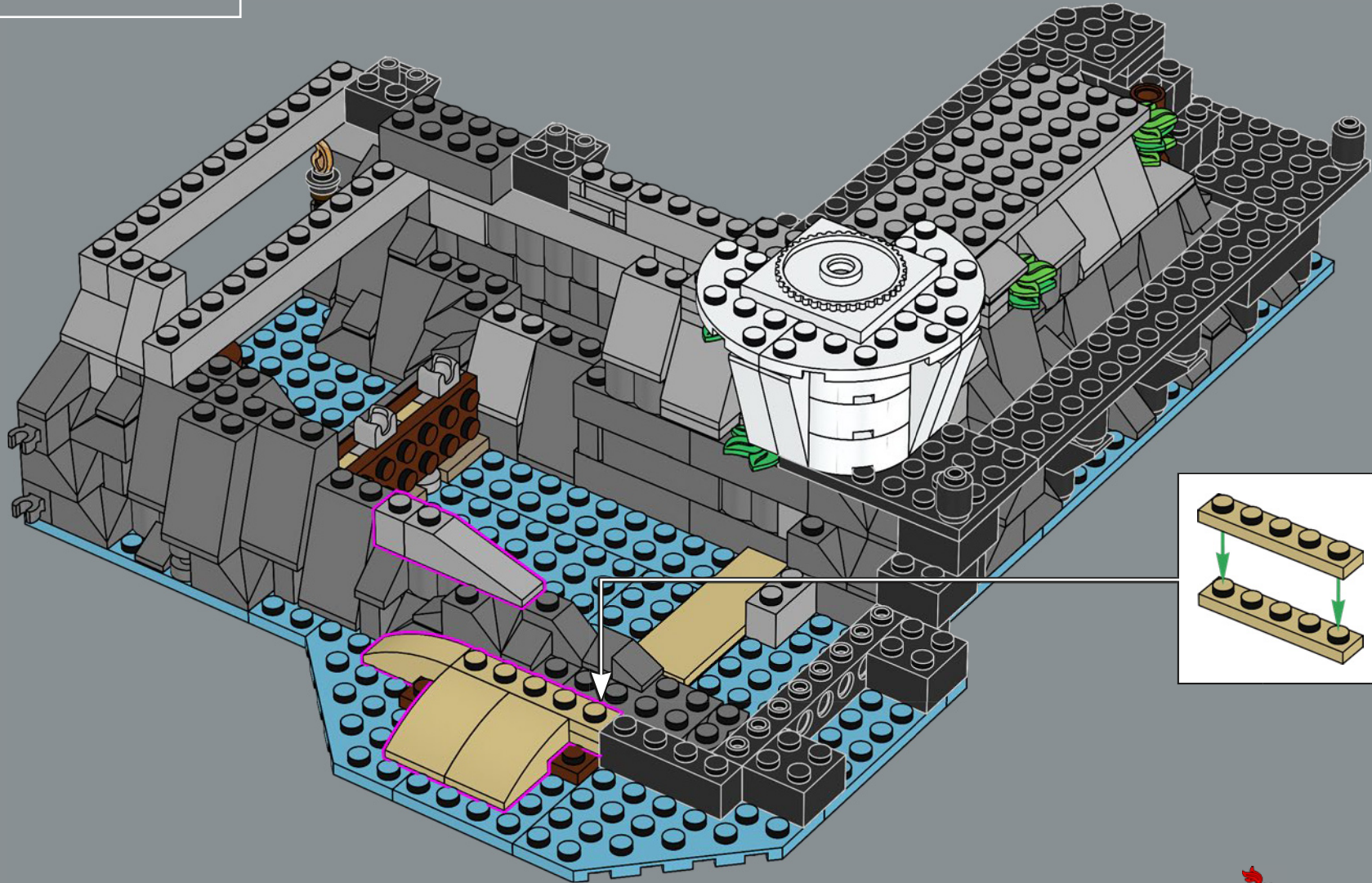

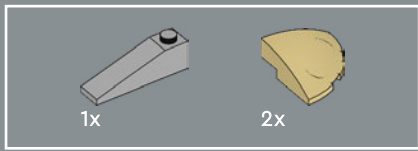

79

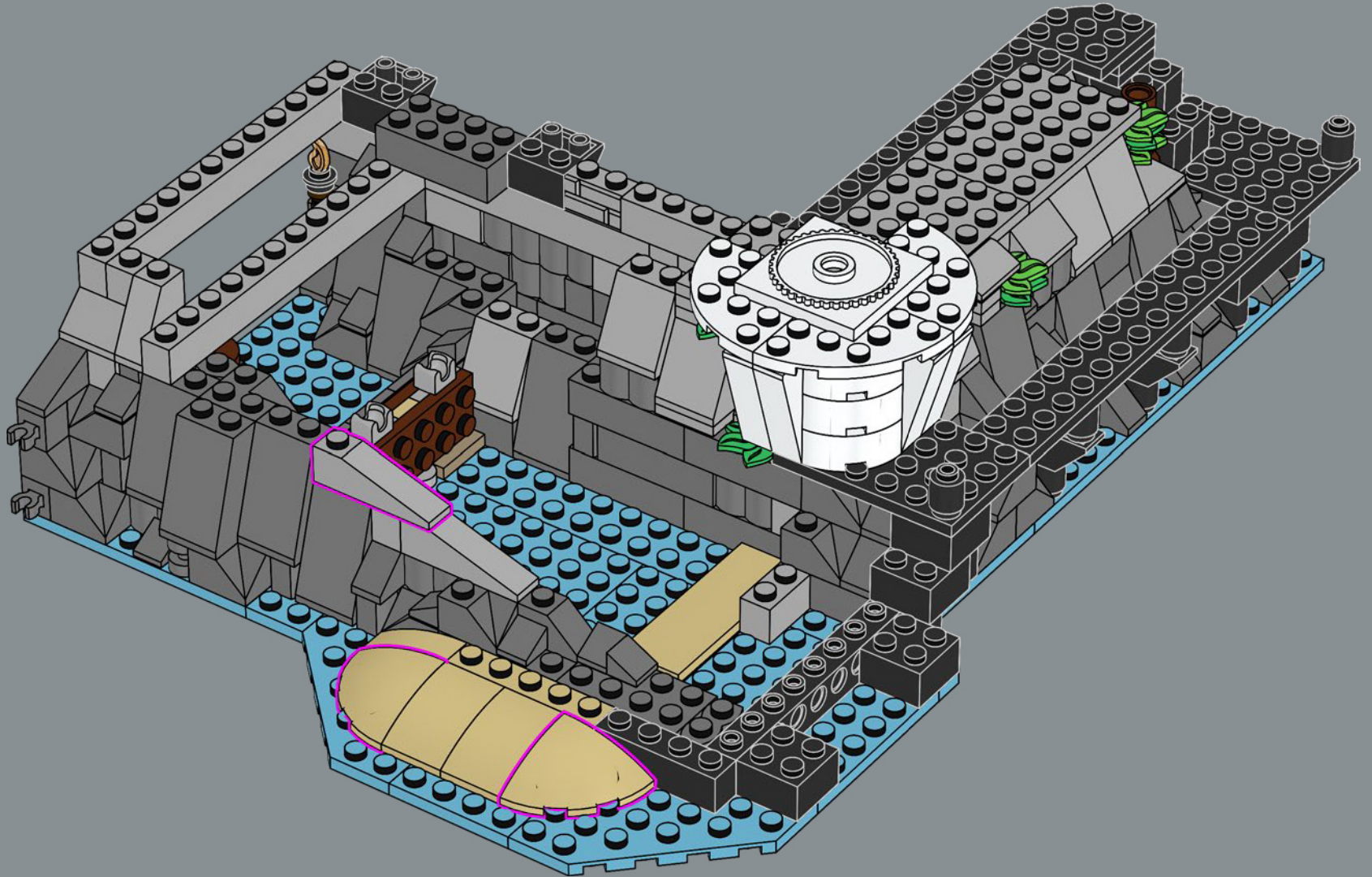

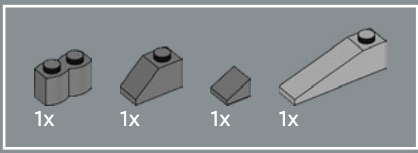

80

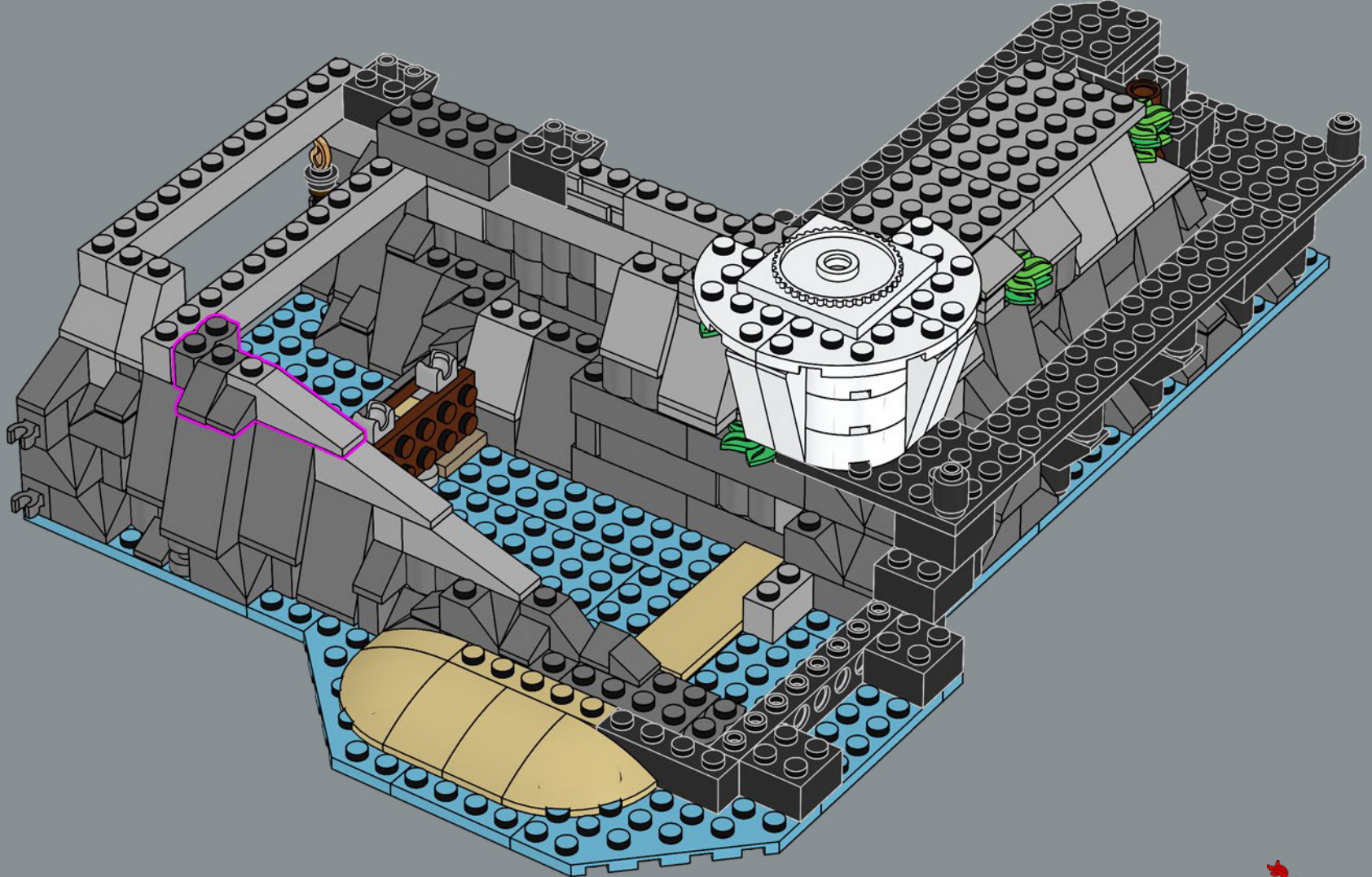

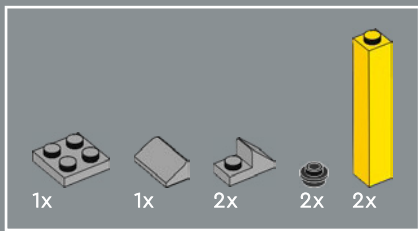

81

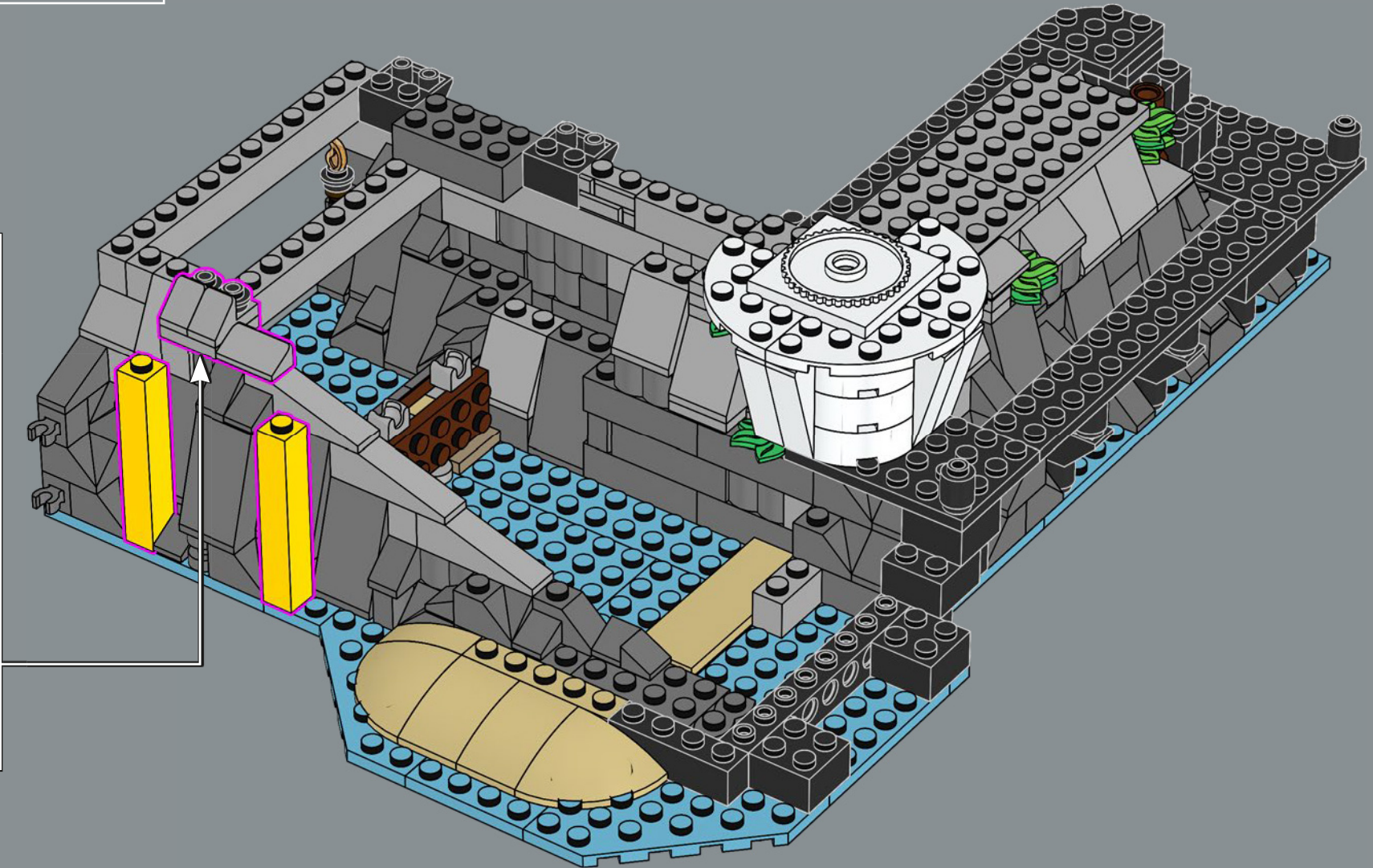
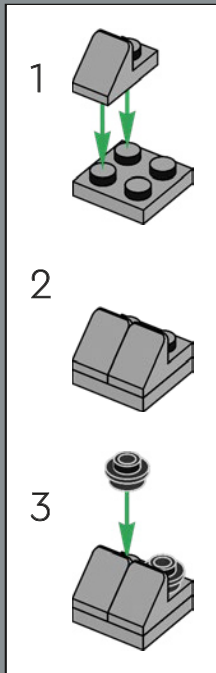

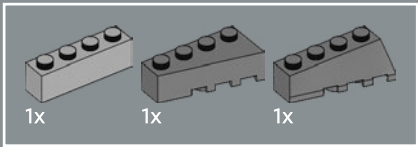

82

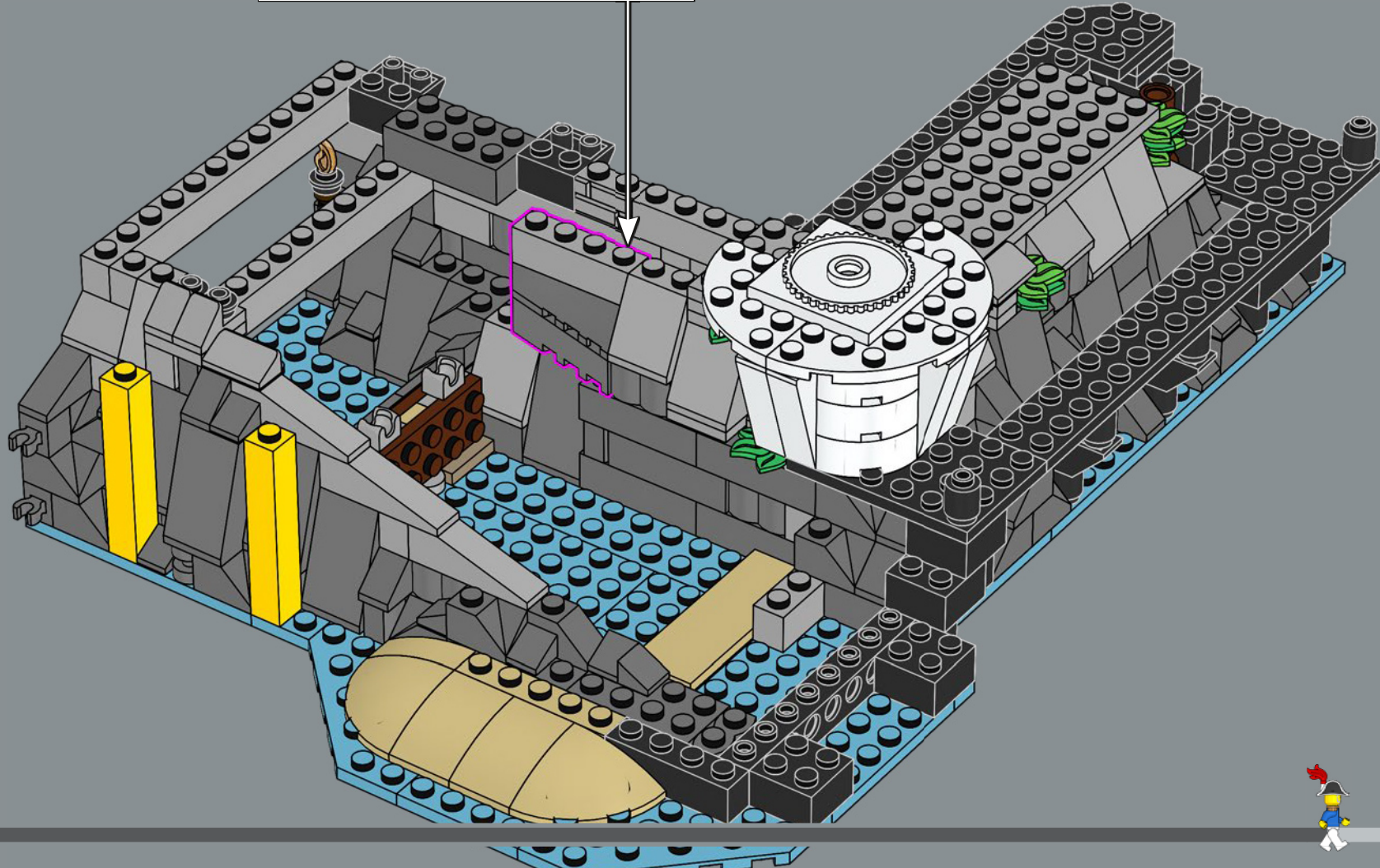
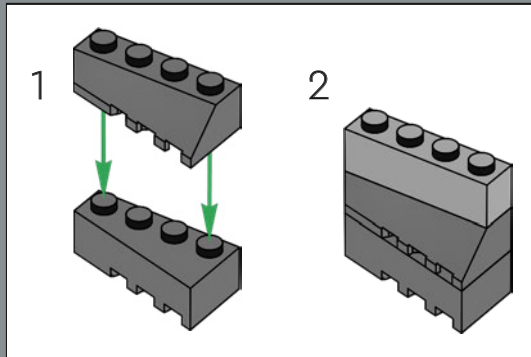

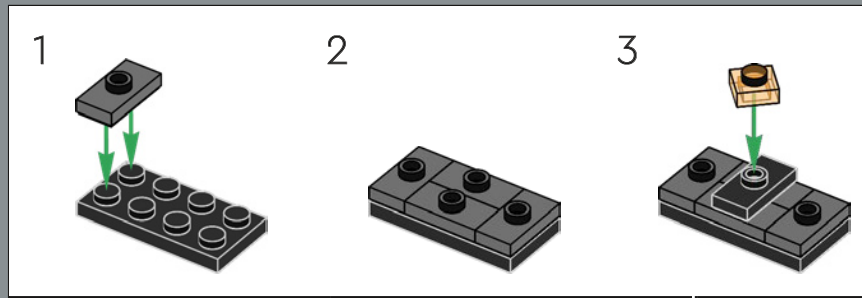
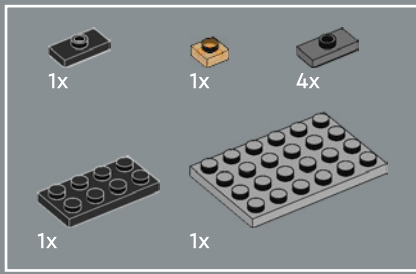

83

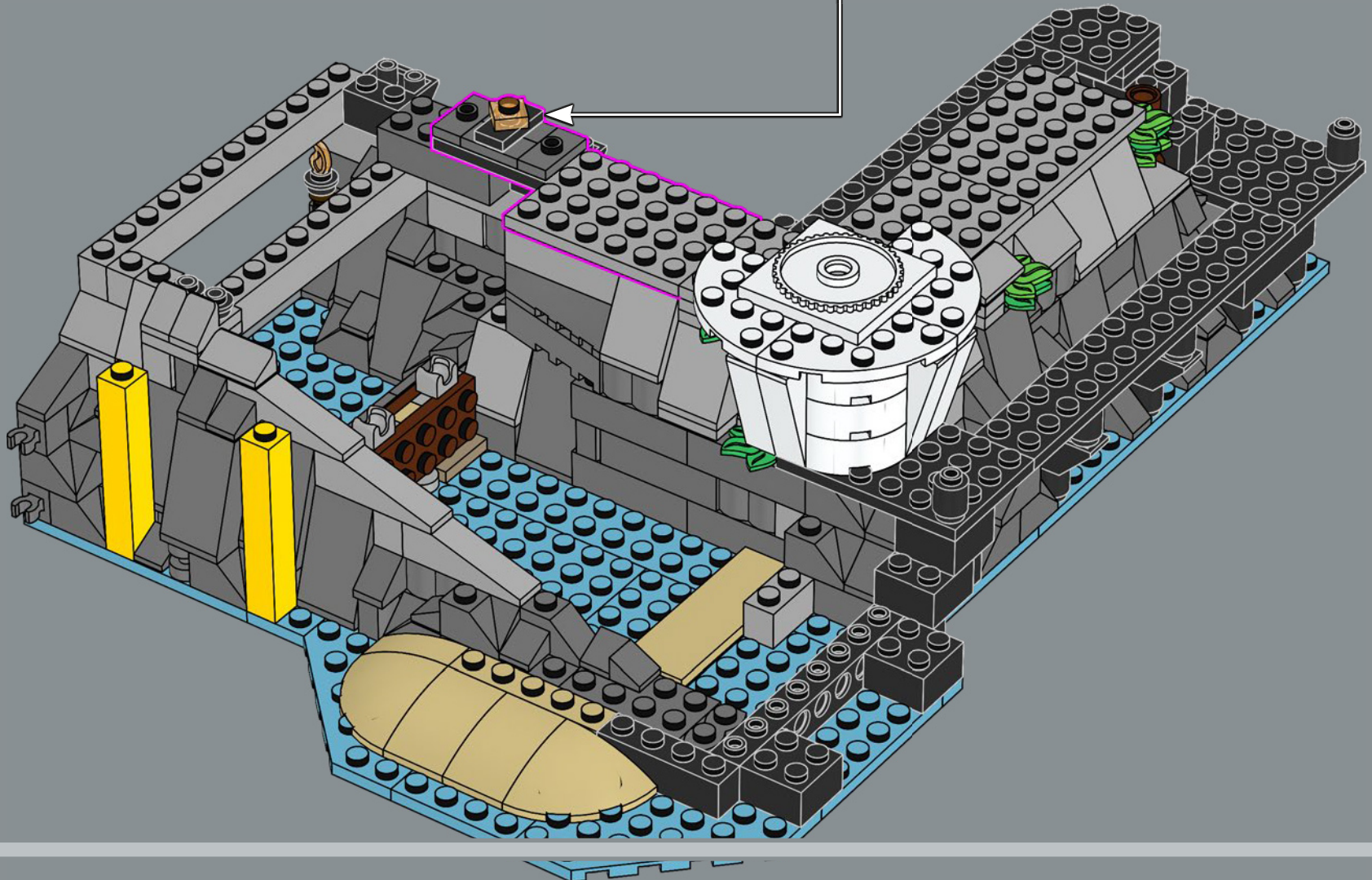

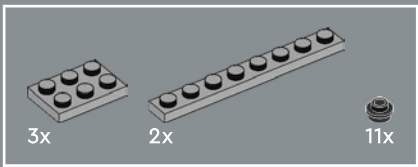

84

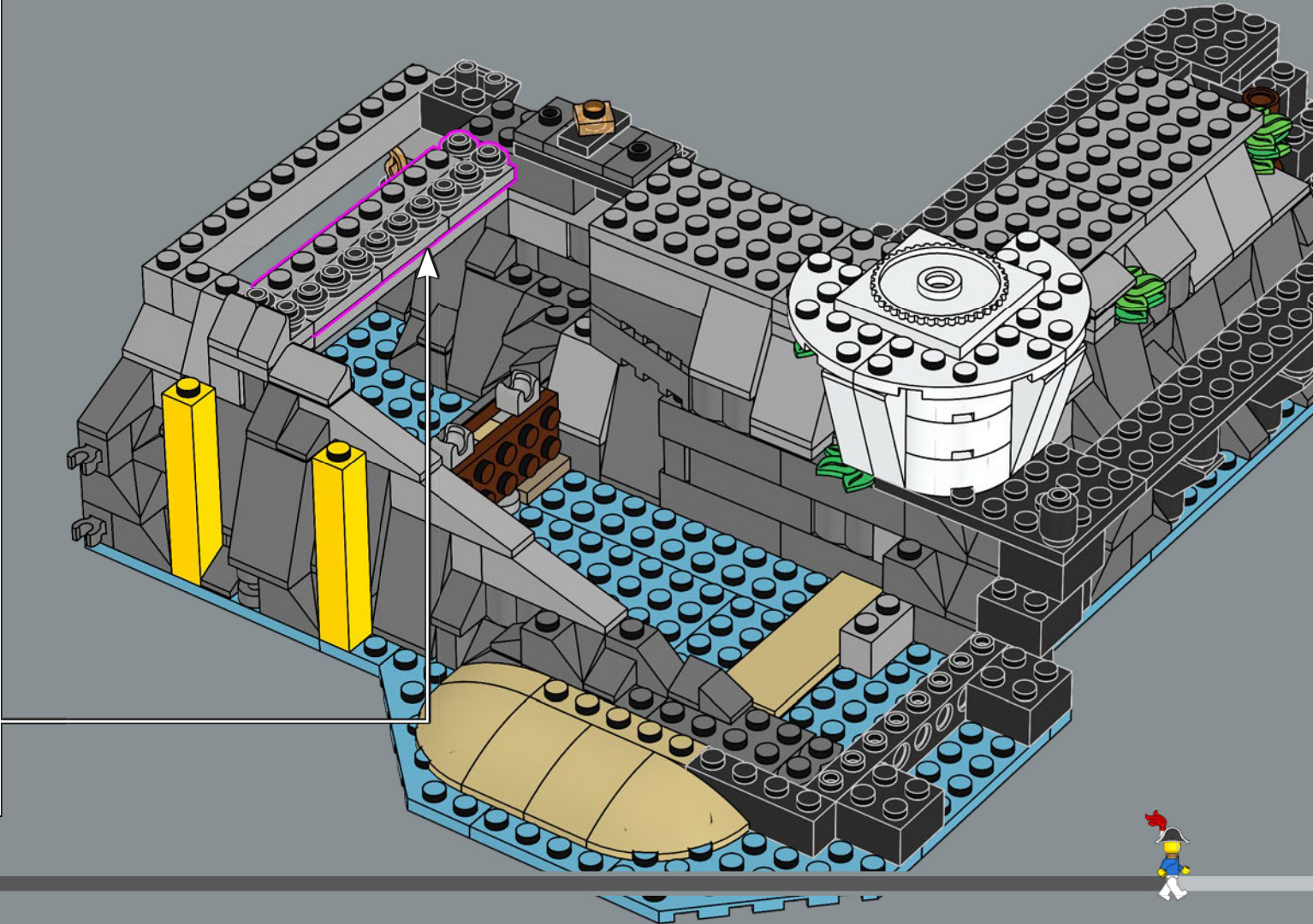
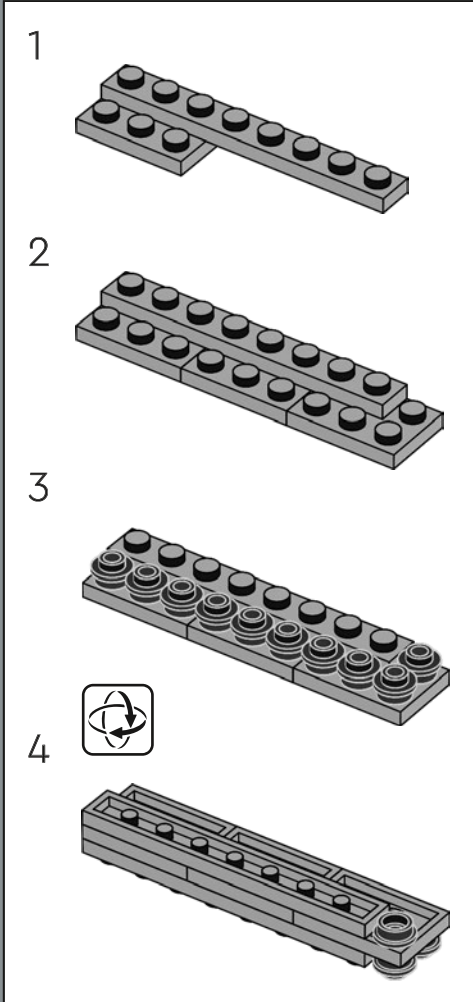

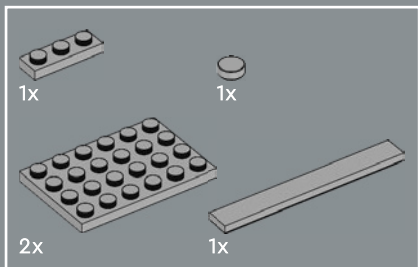

85

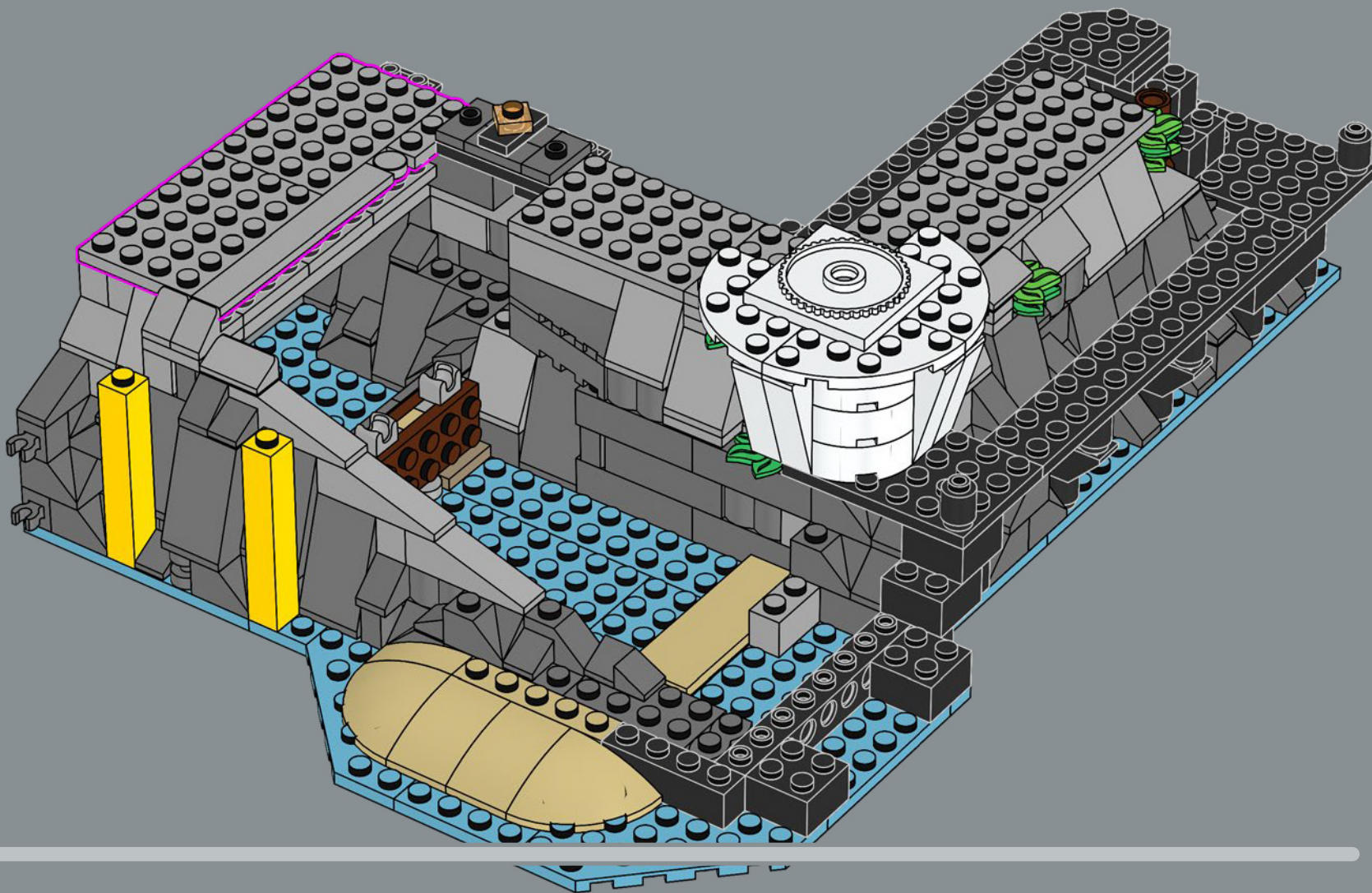

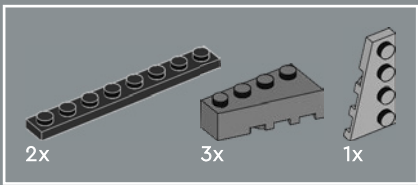

86

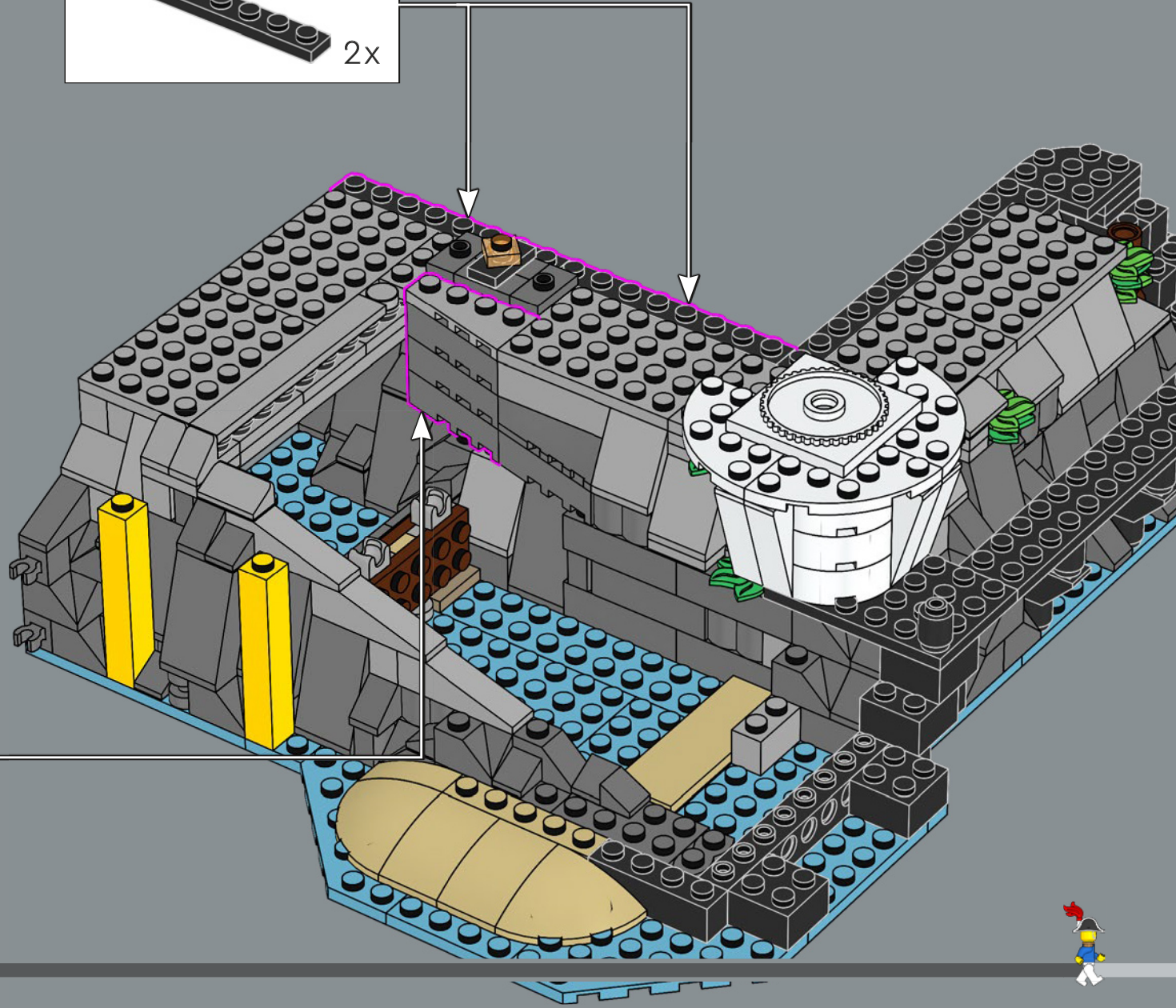
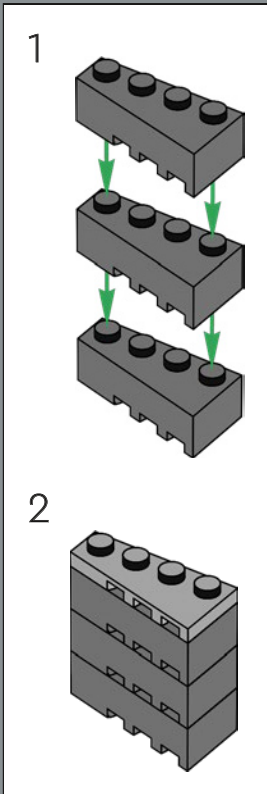
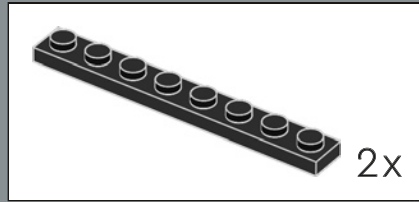

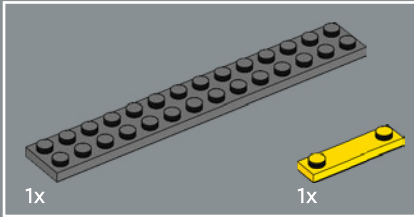
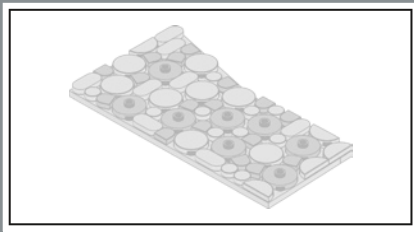

87

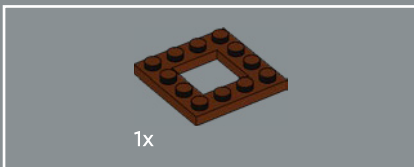
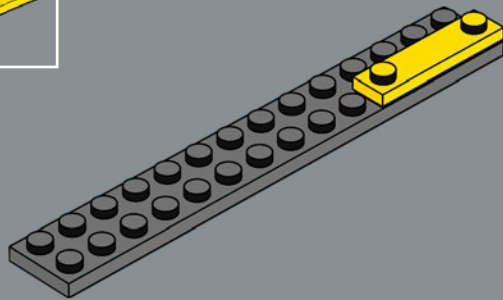

88

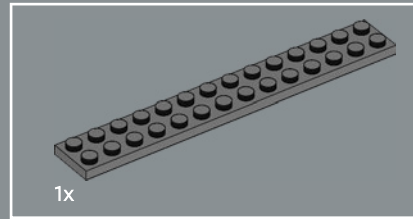
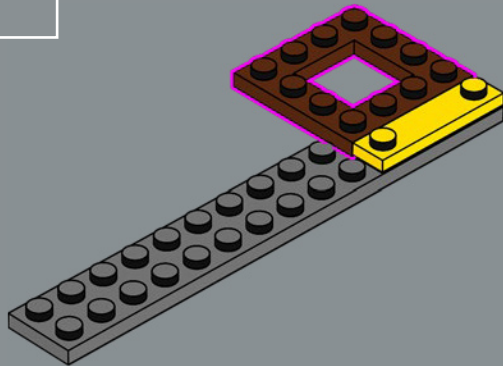

89

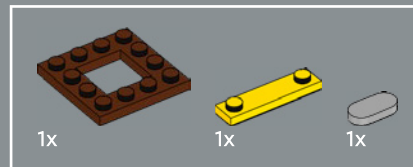
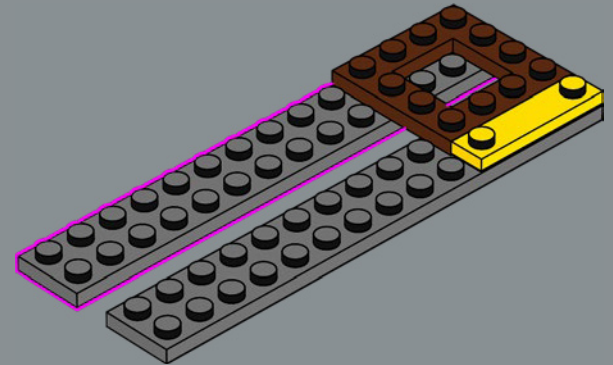

90

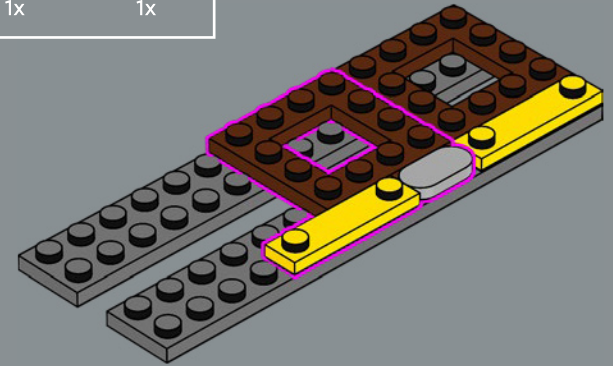

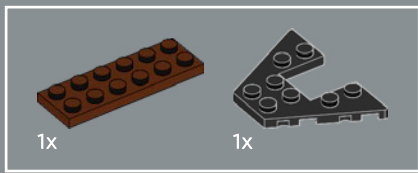

91

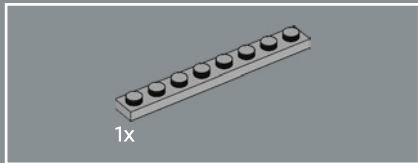
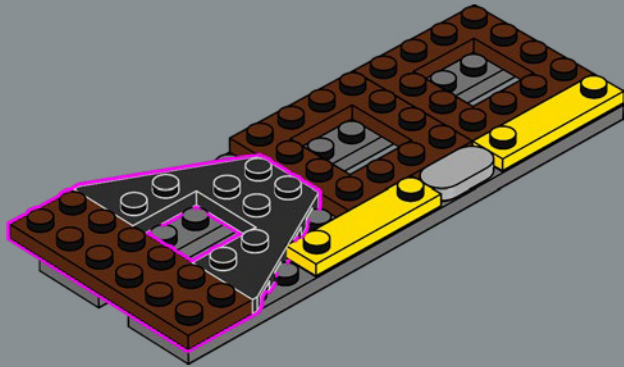

92

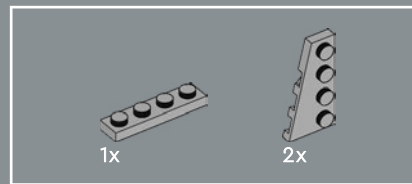
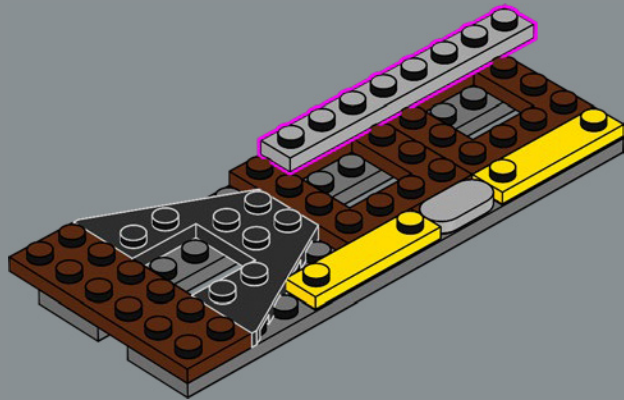

93

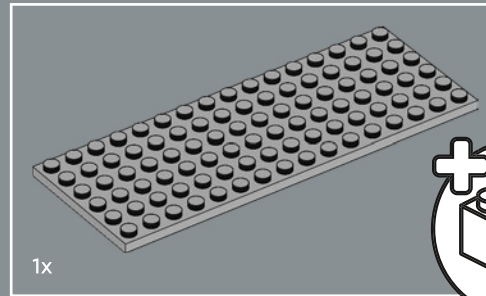
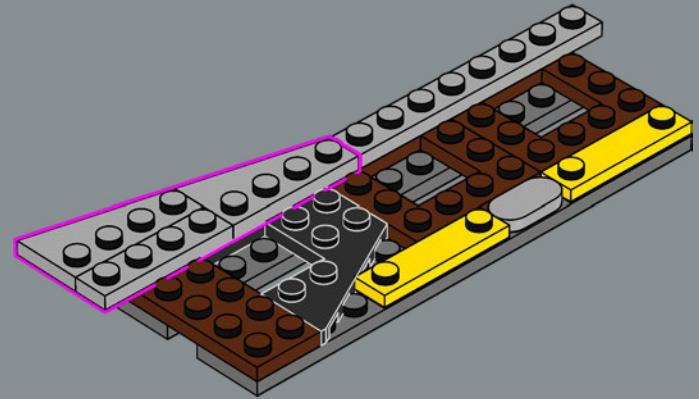

94

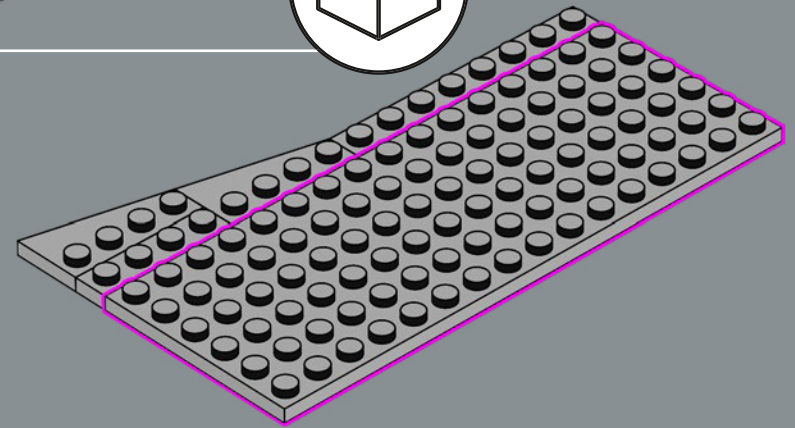

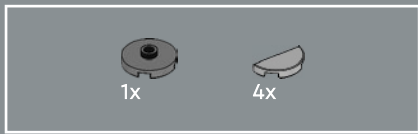

95

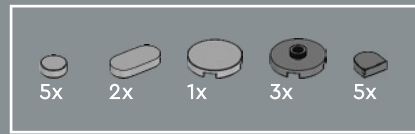
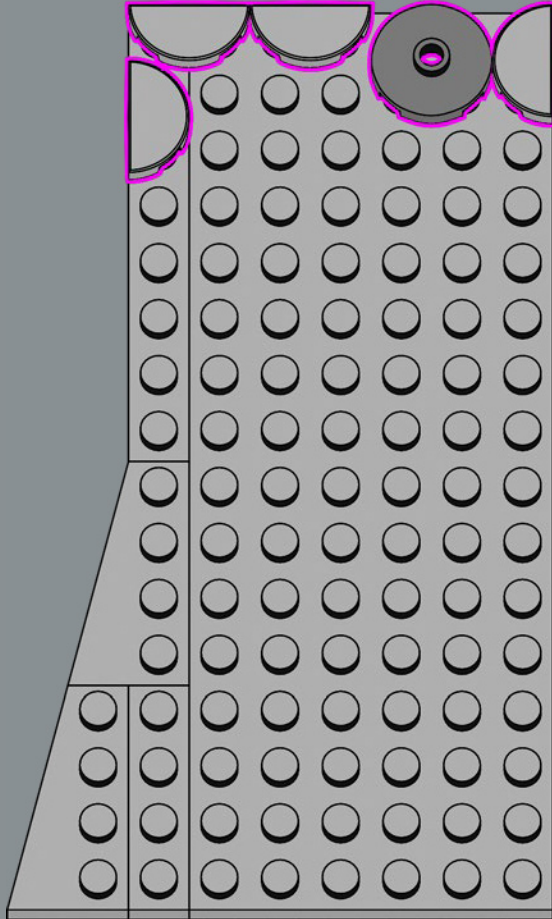

96

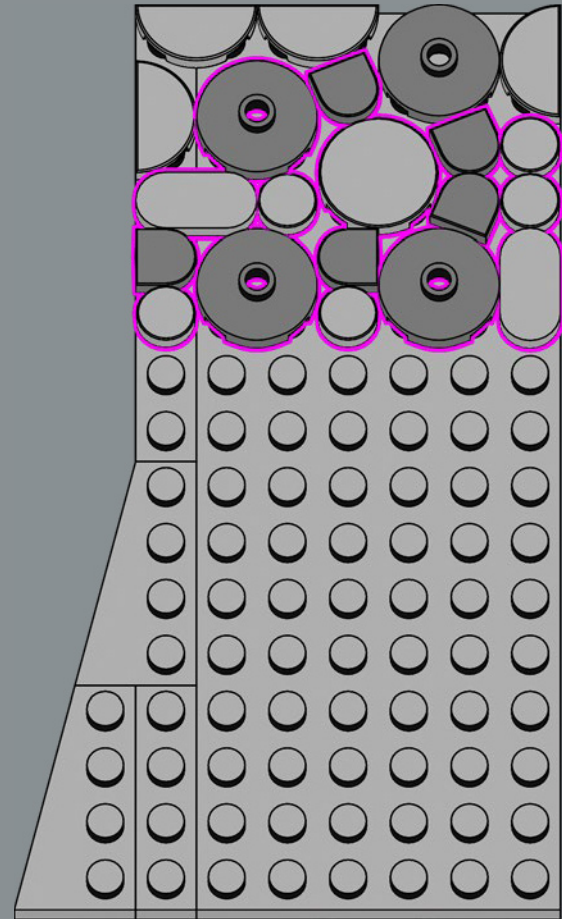

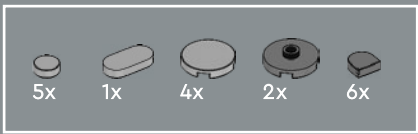

97

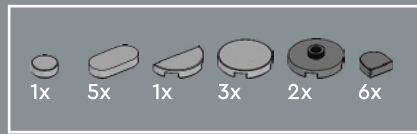
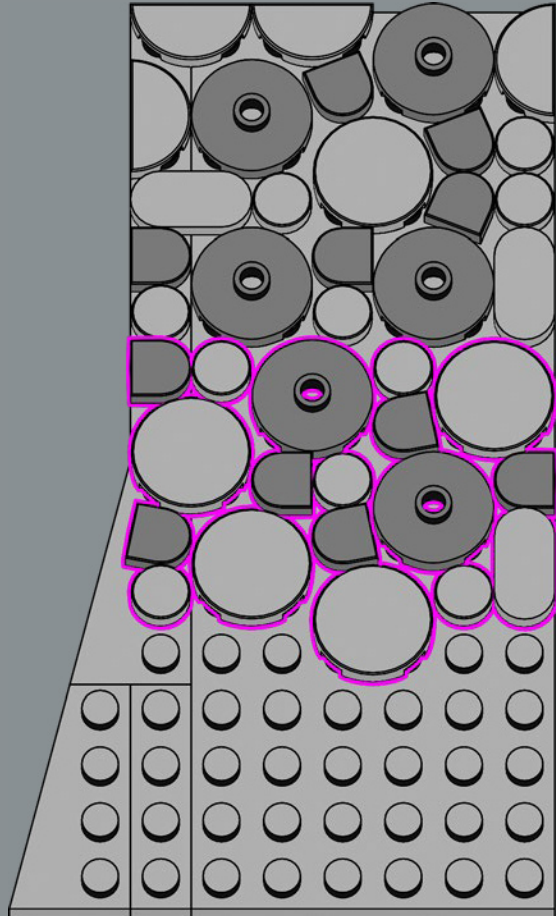

98

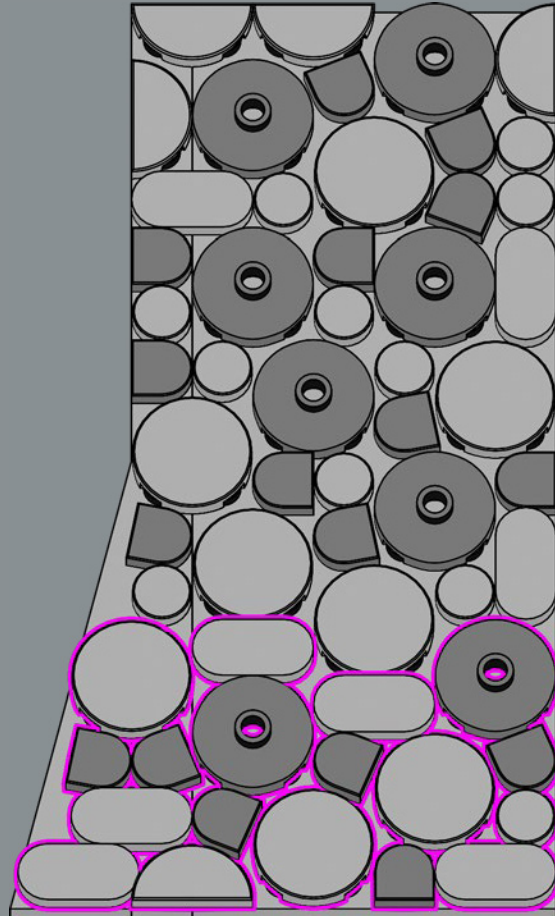

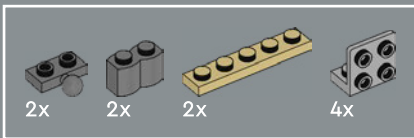

99

1

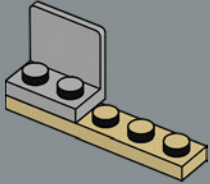

2

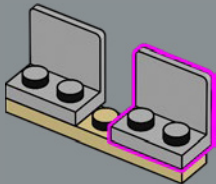

3

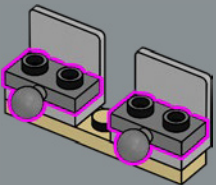

4

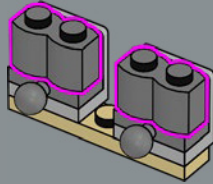

5

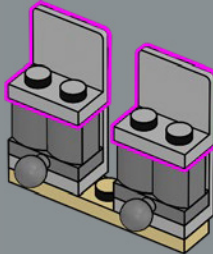

6

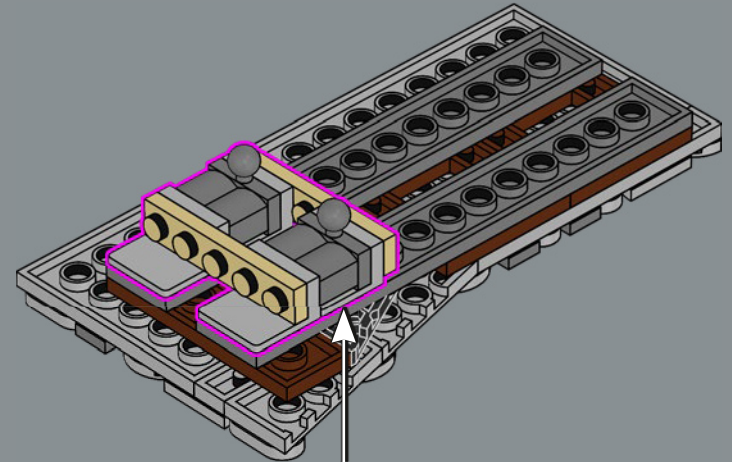
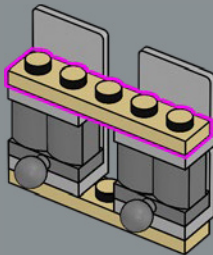



La rampe originale, qui était imprimée, est maintenant pavée.

100

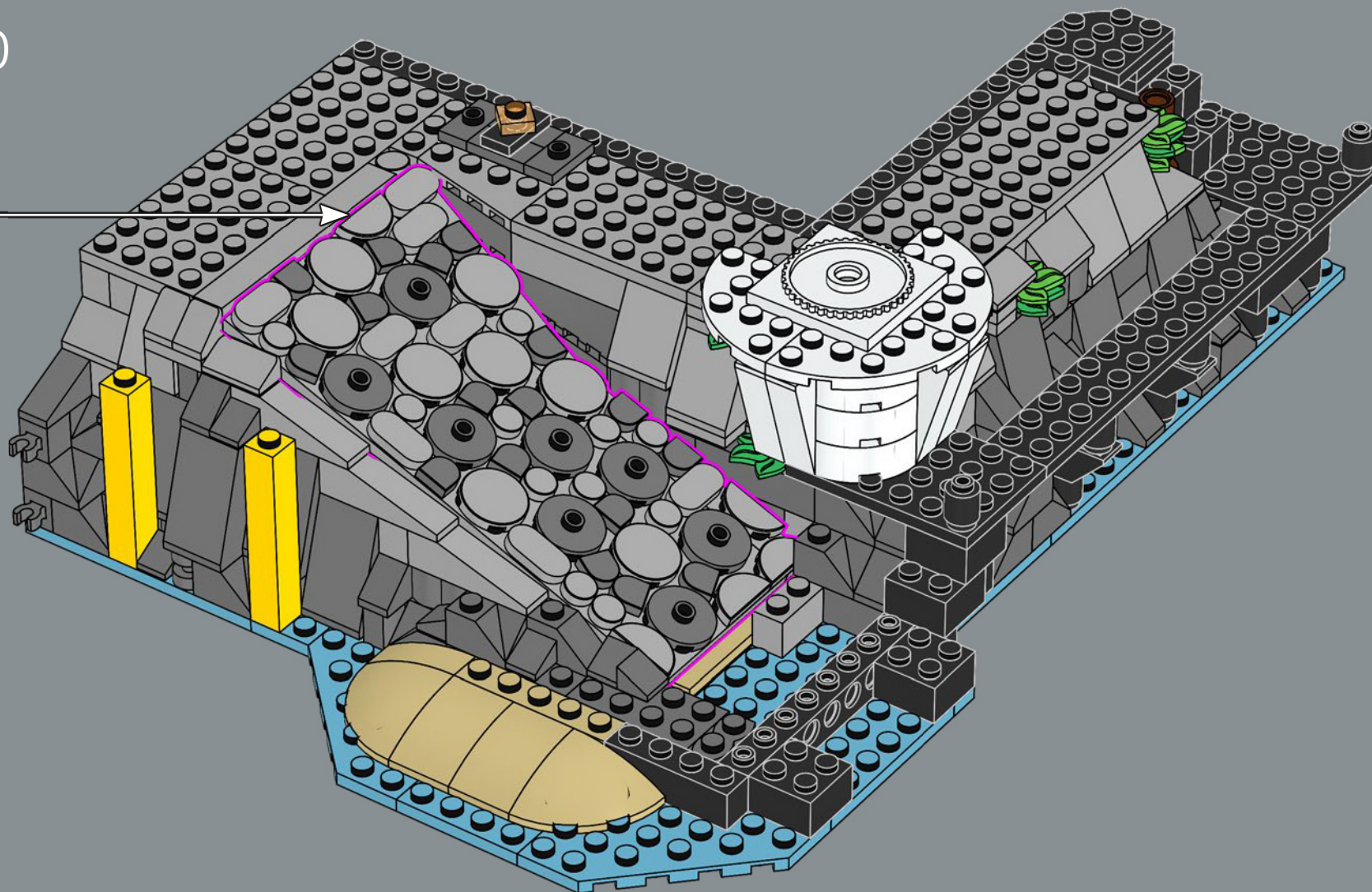
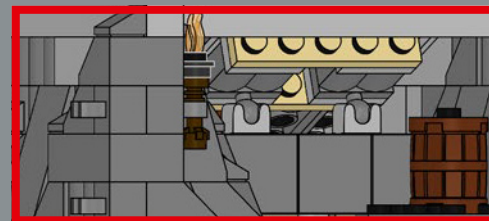

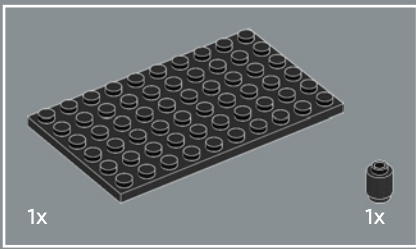

101

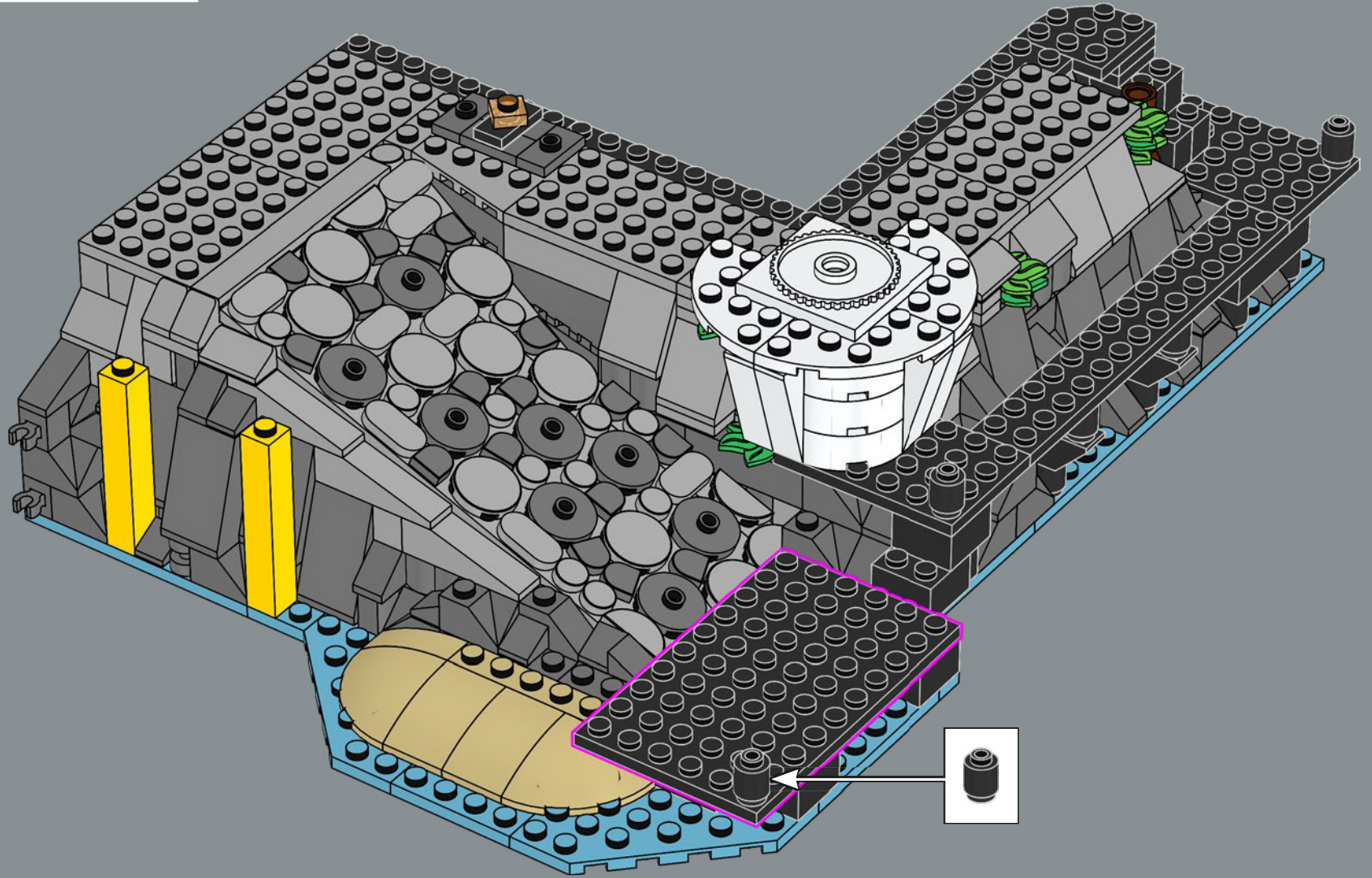

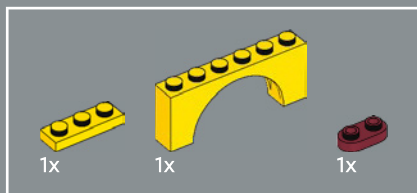

102

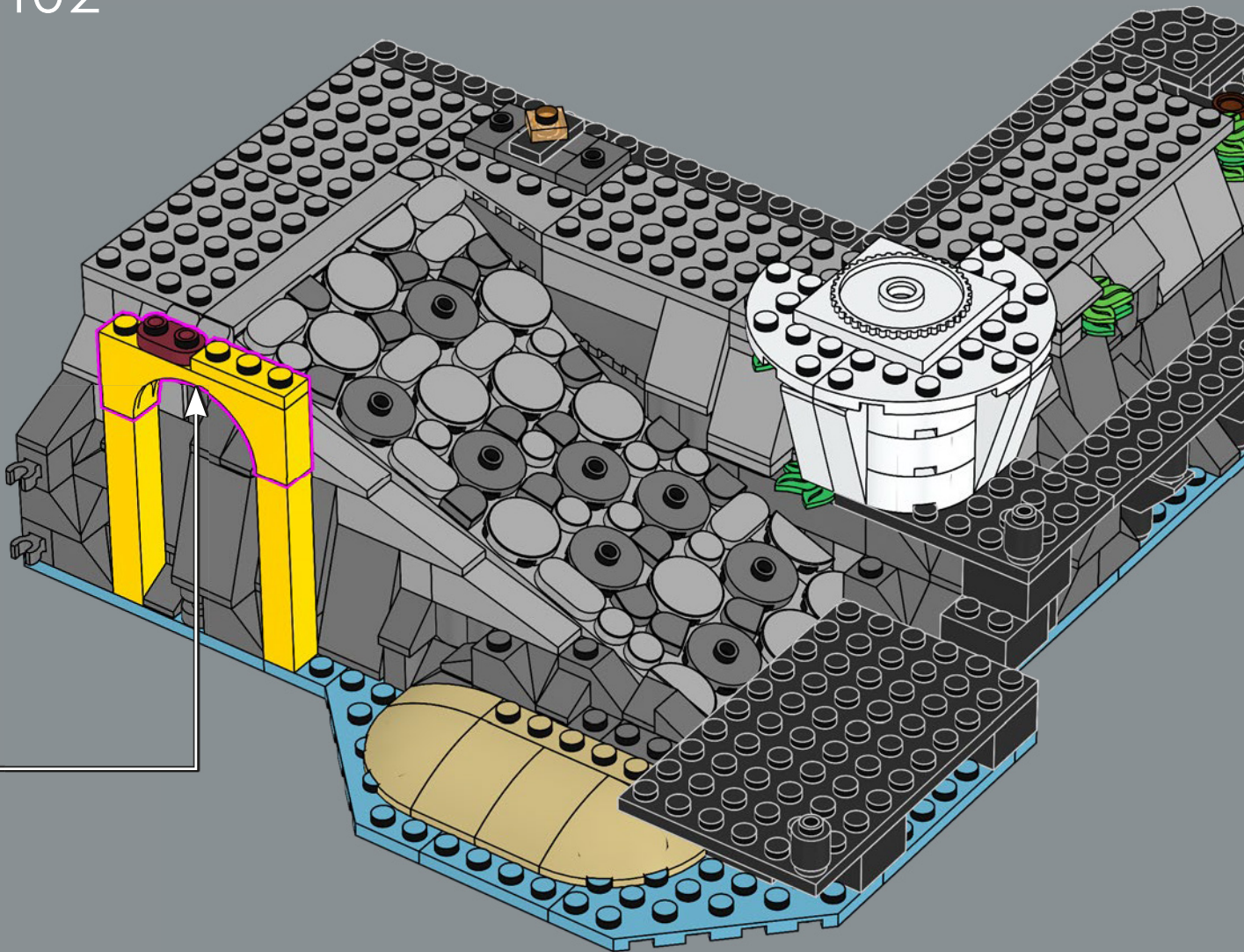
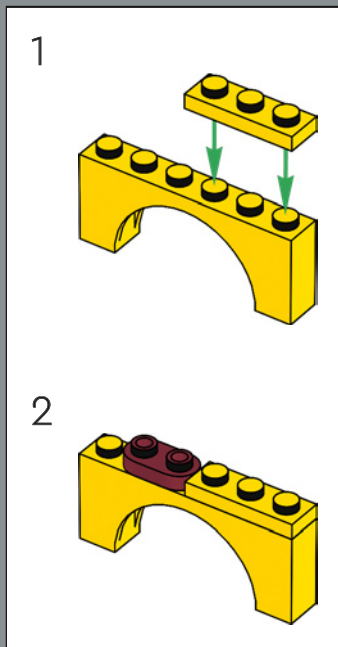

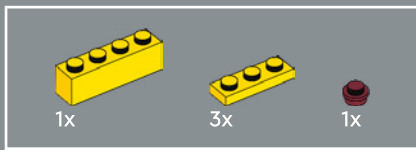

103

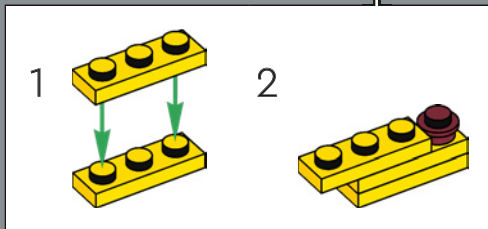
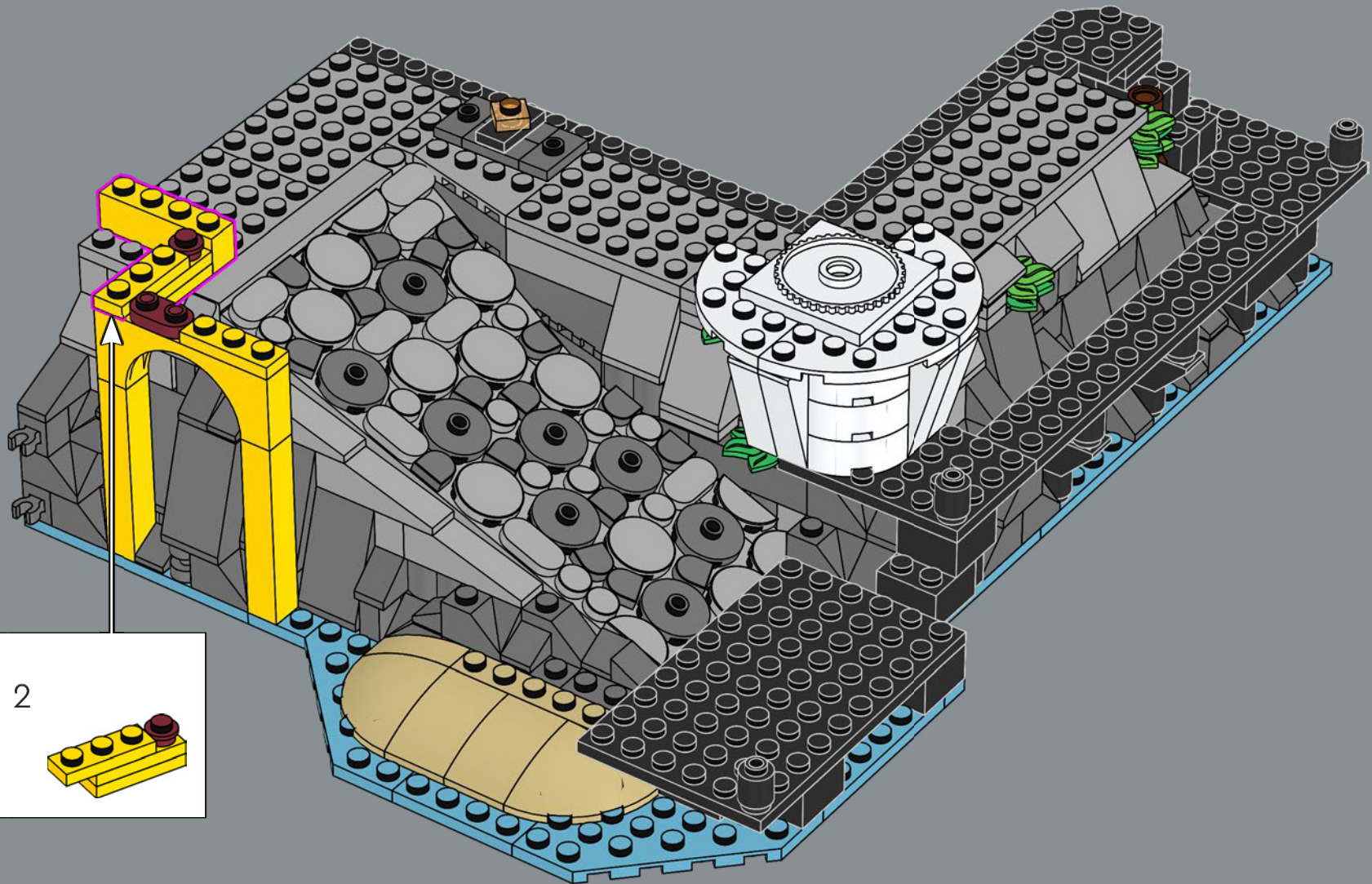

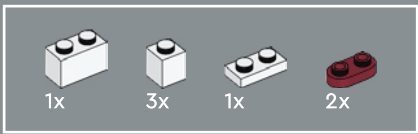

104

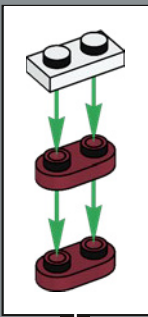

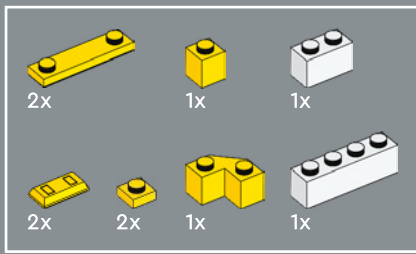

105



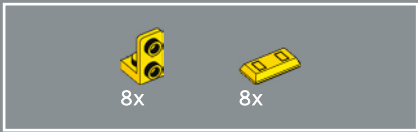

106

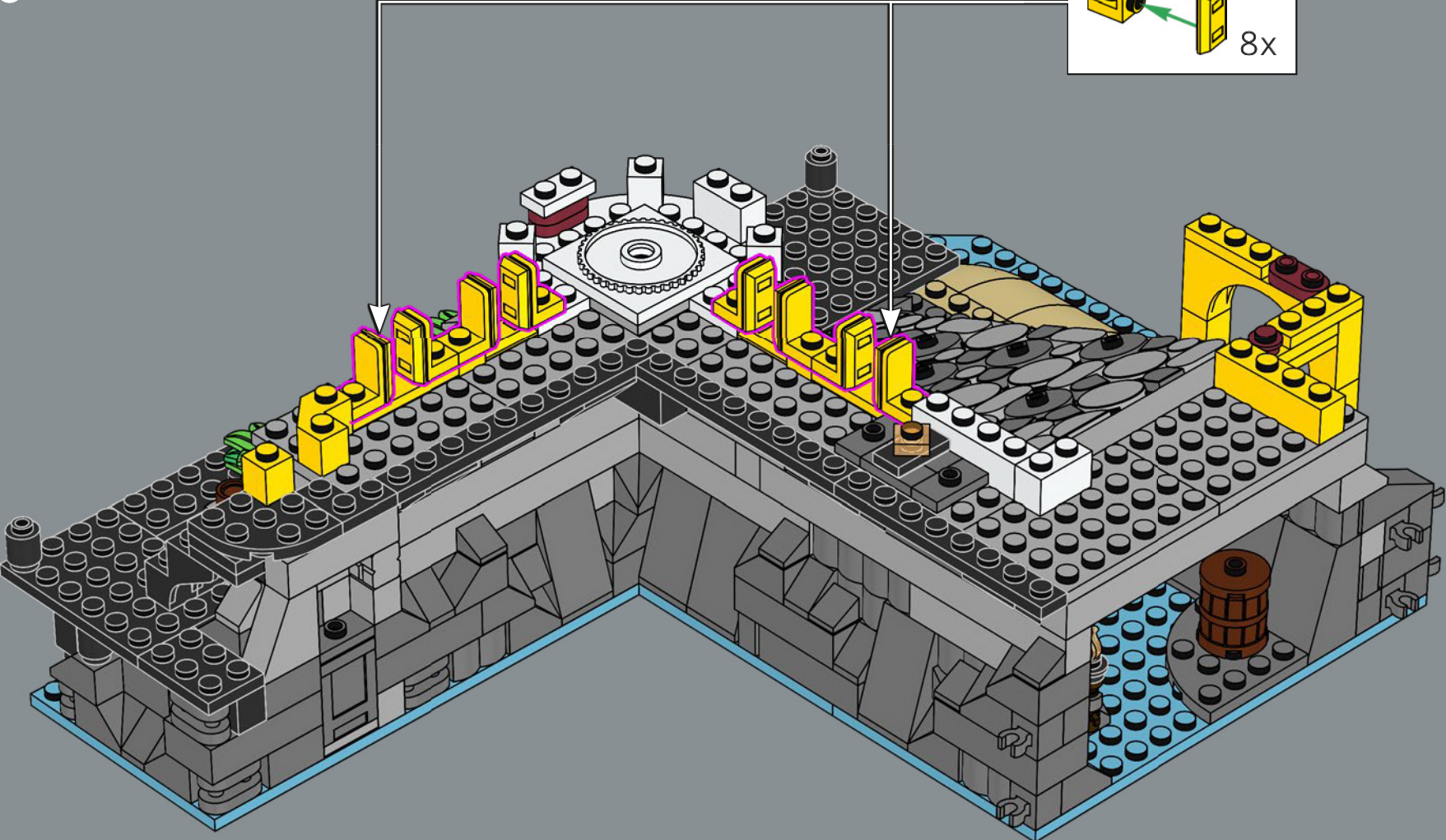
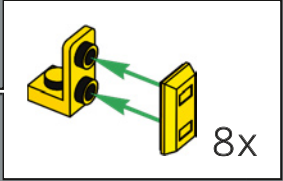

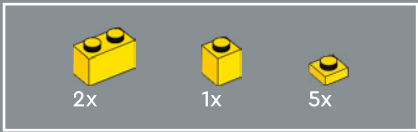

107

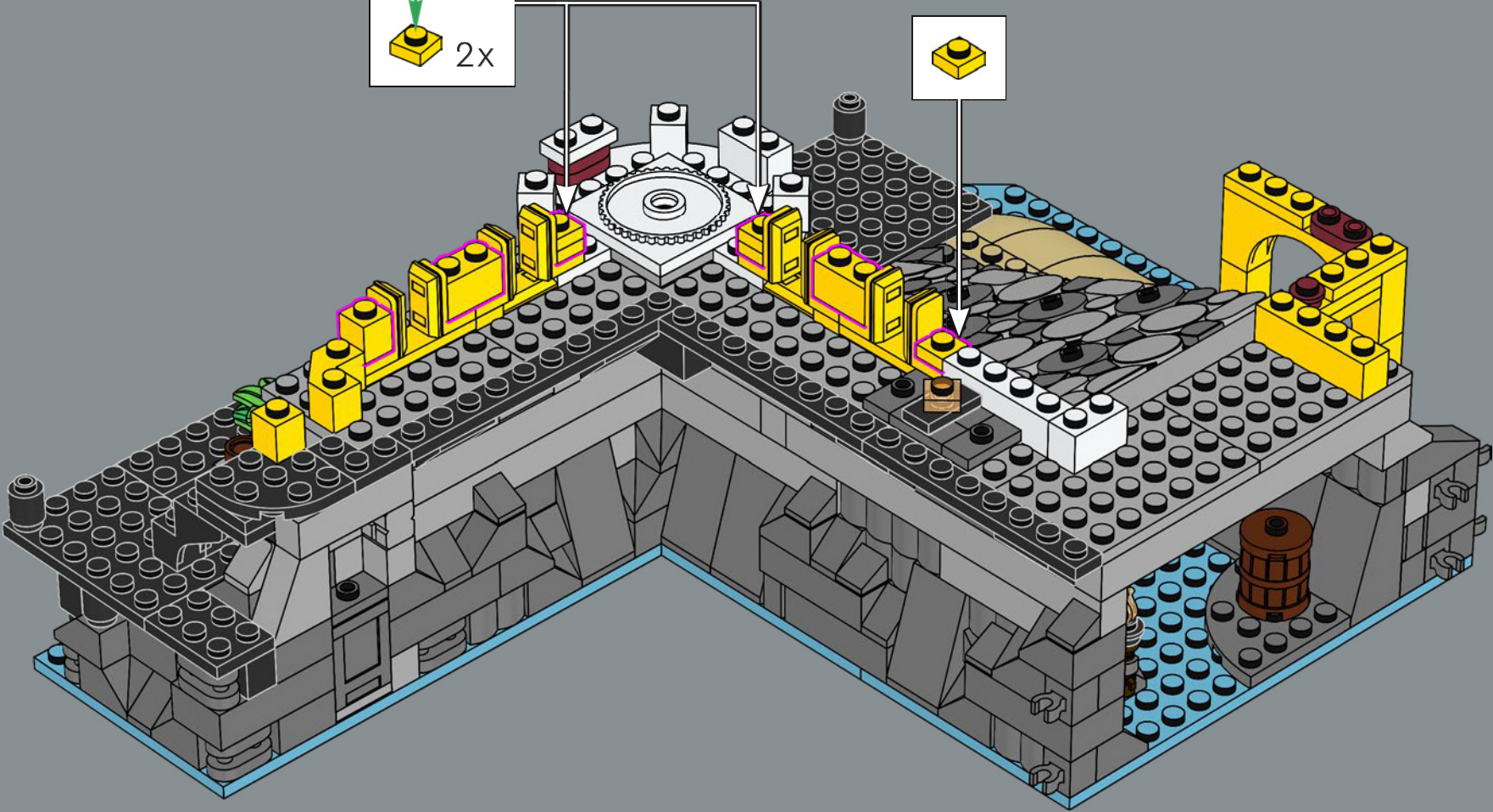
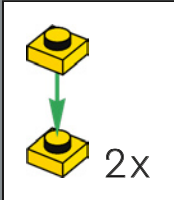



108

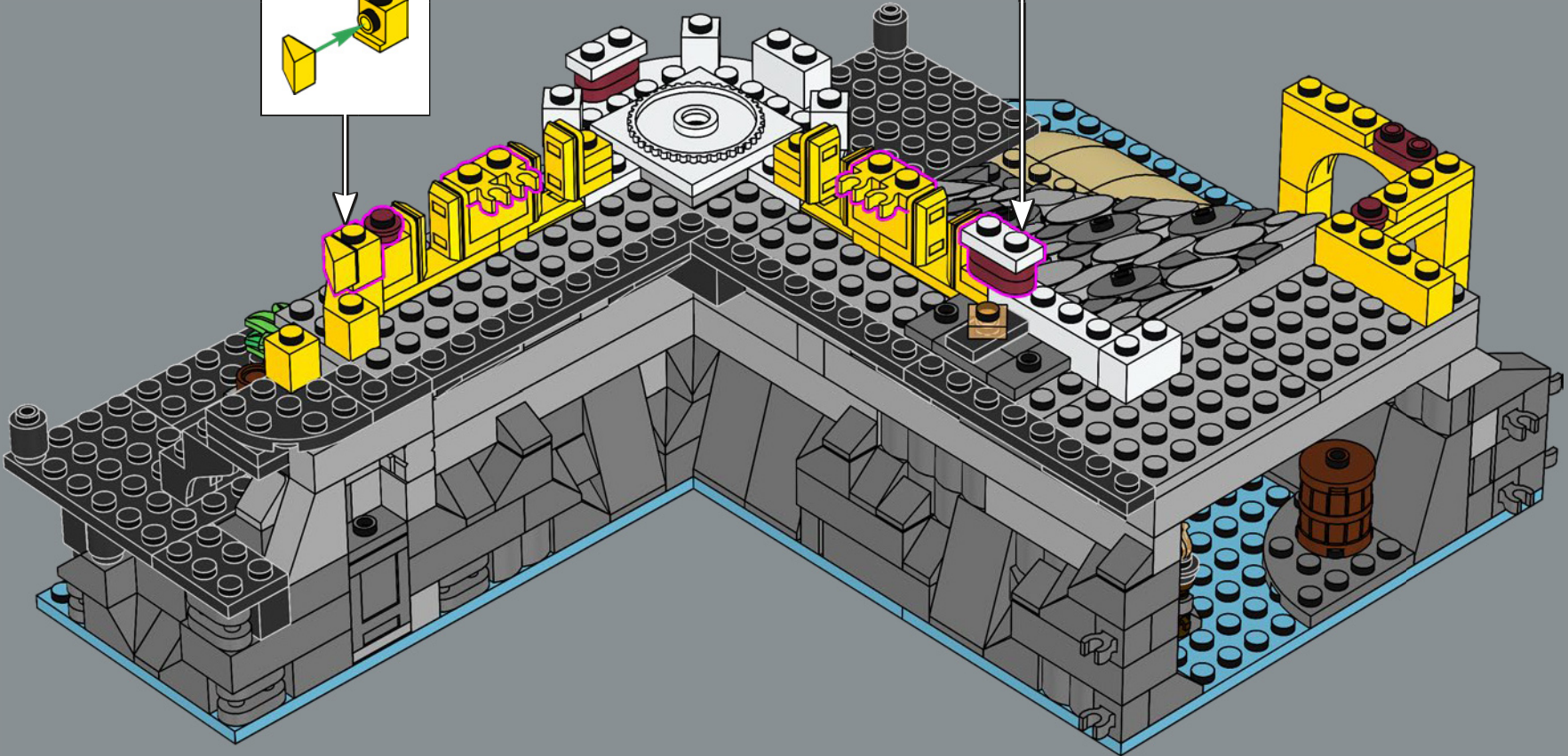
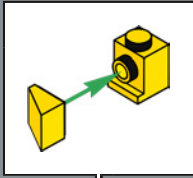
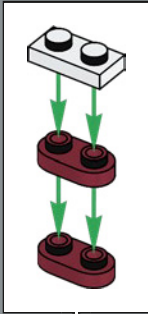

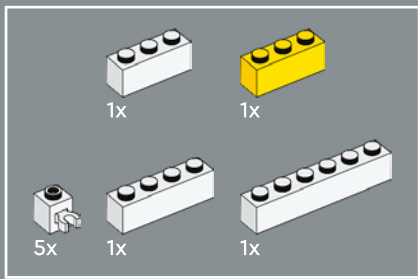

109

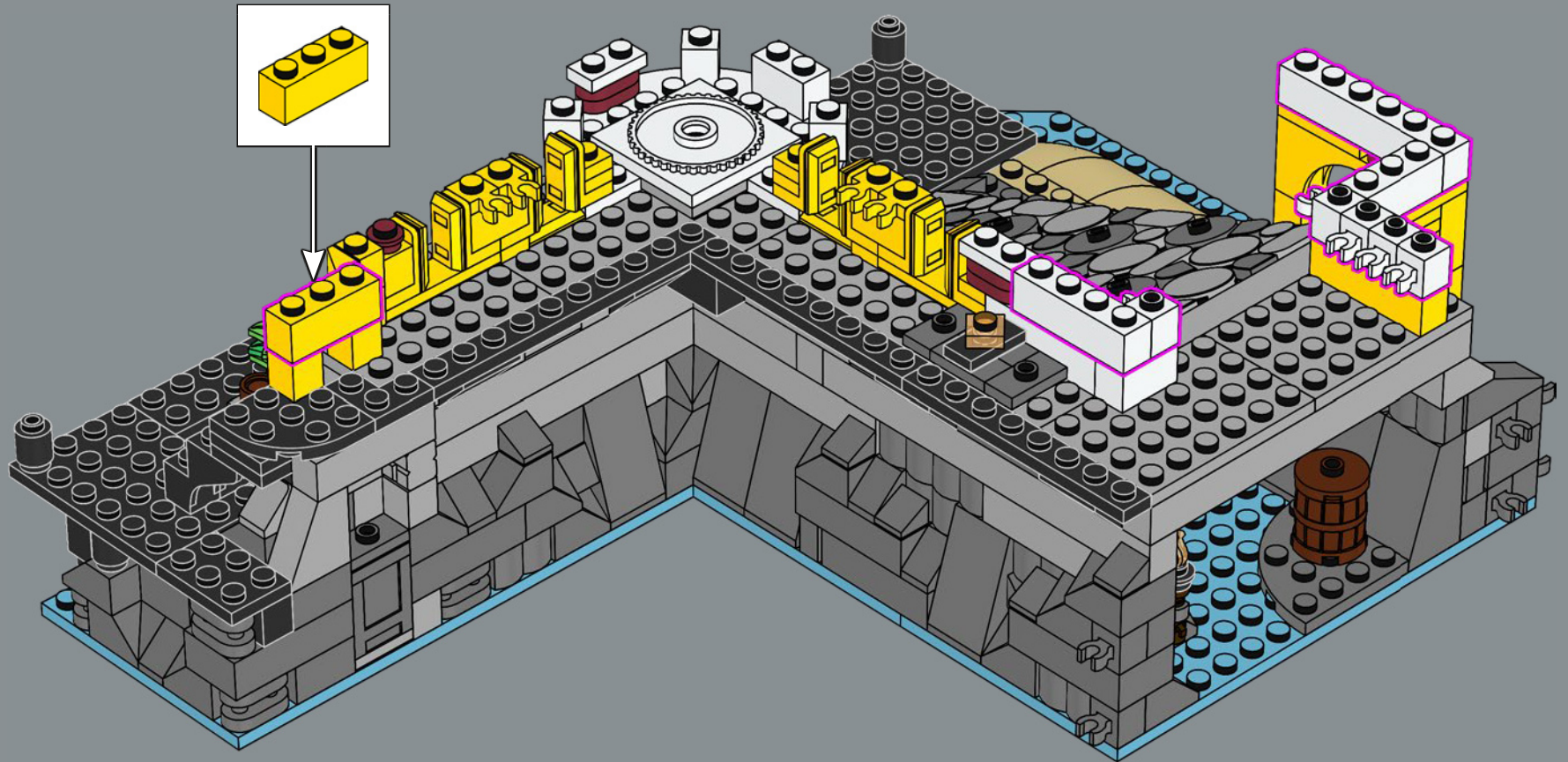

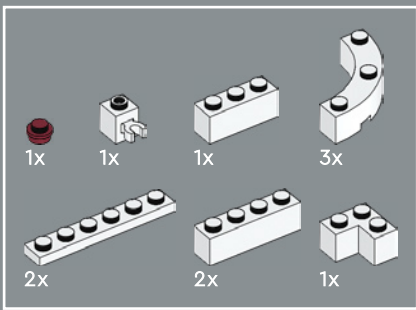

110

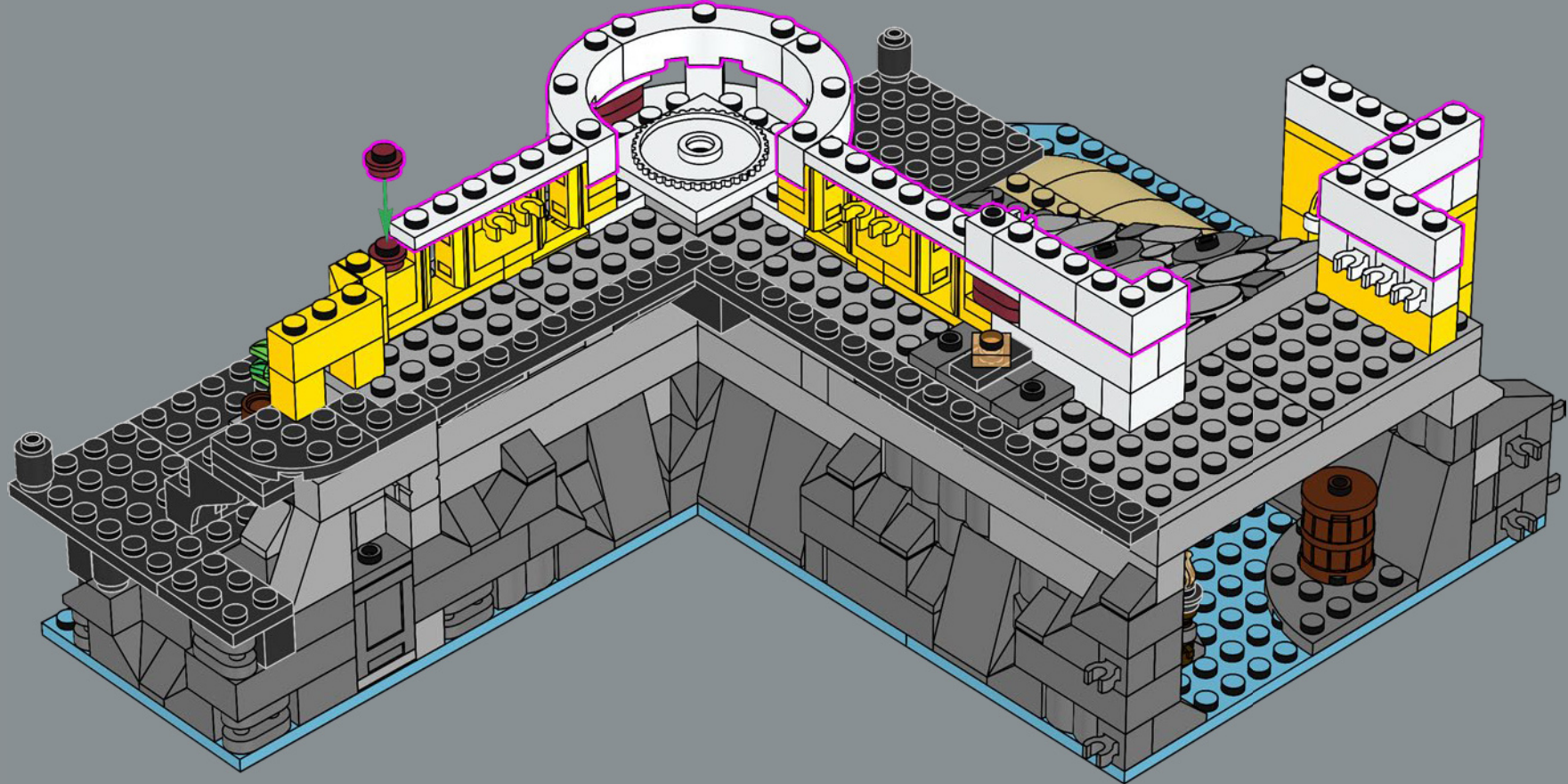

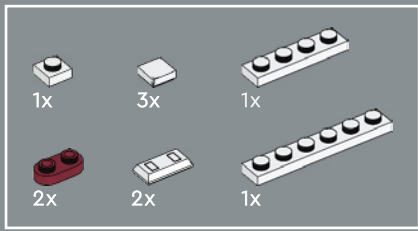

111

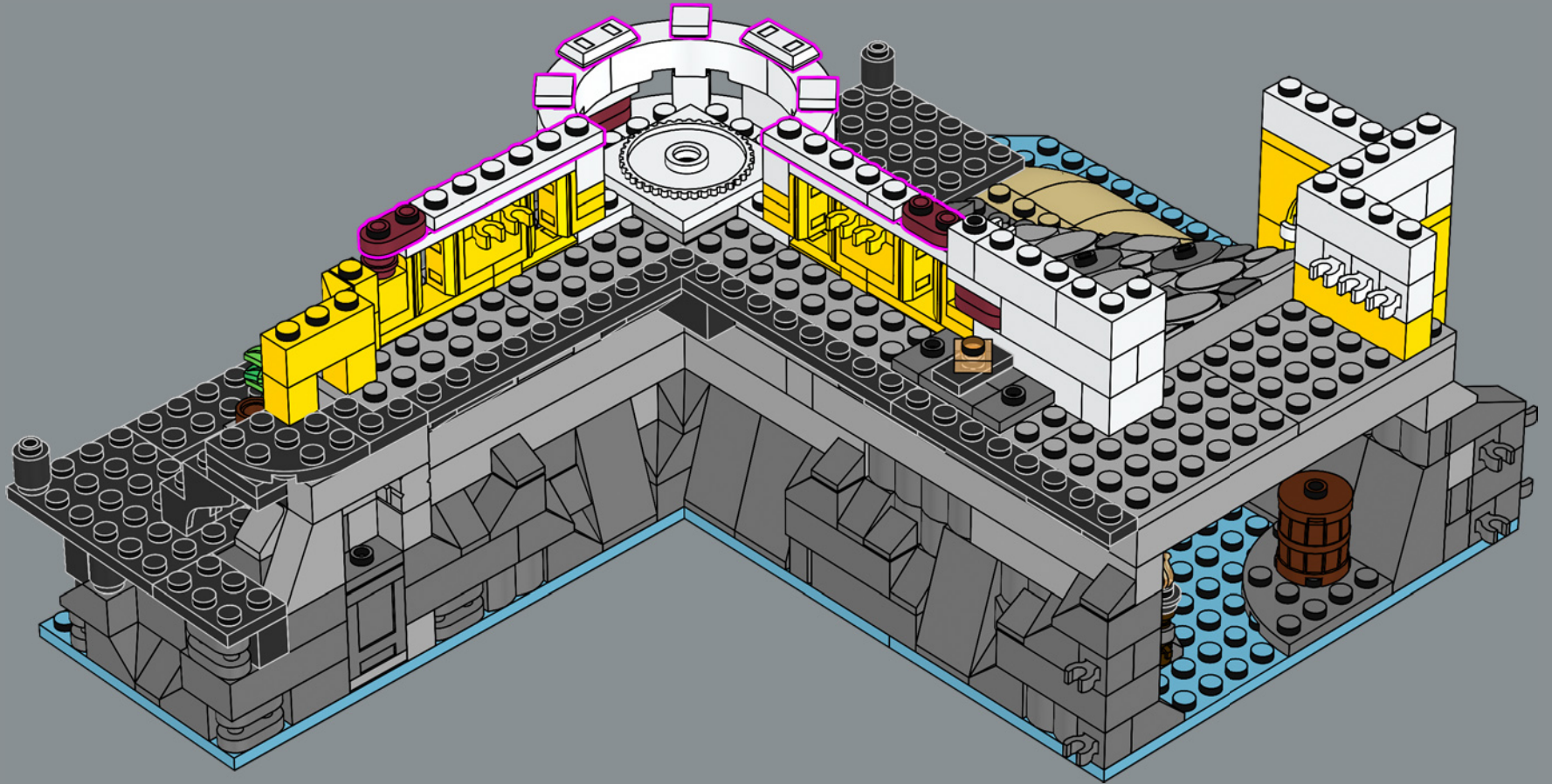

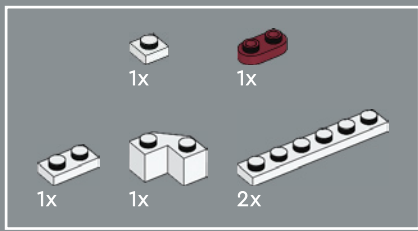

112

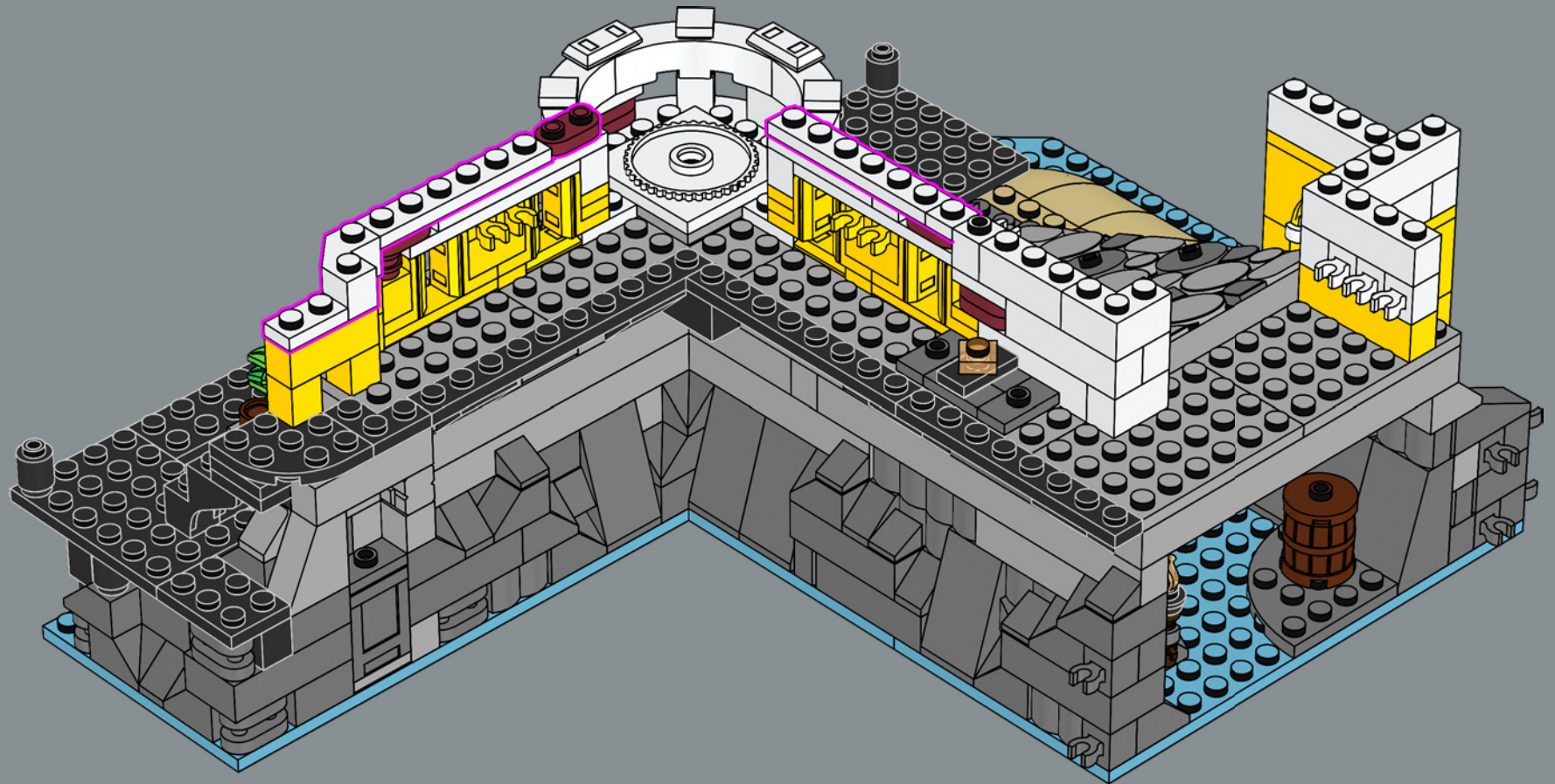

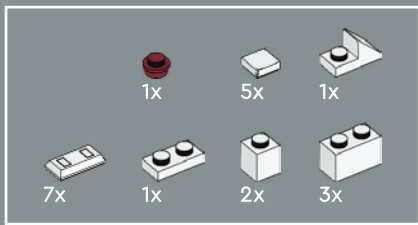

113

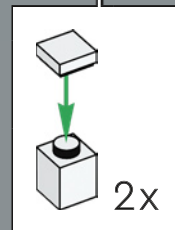
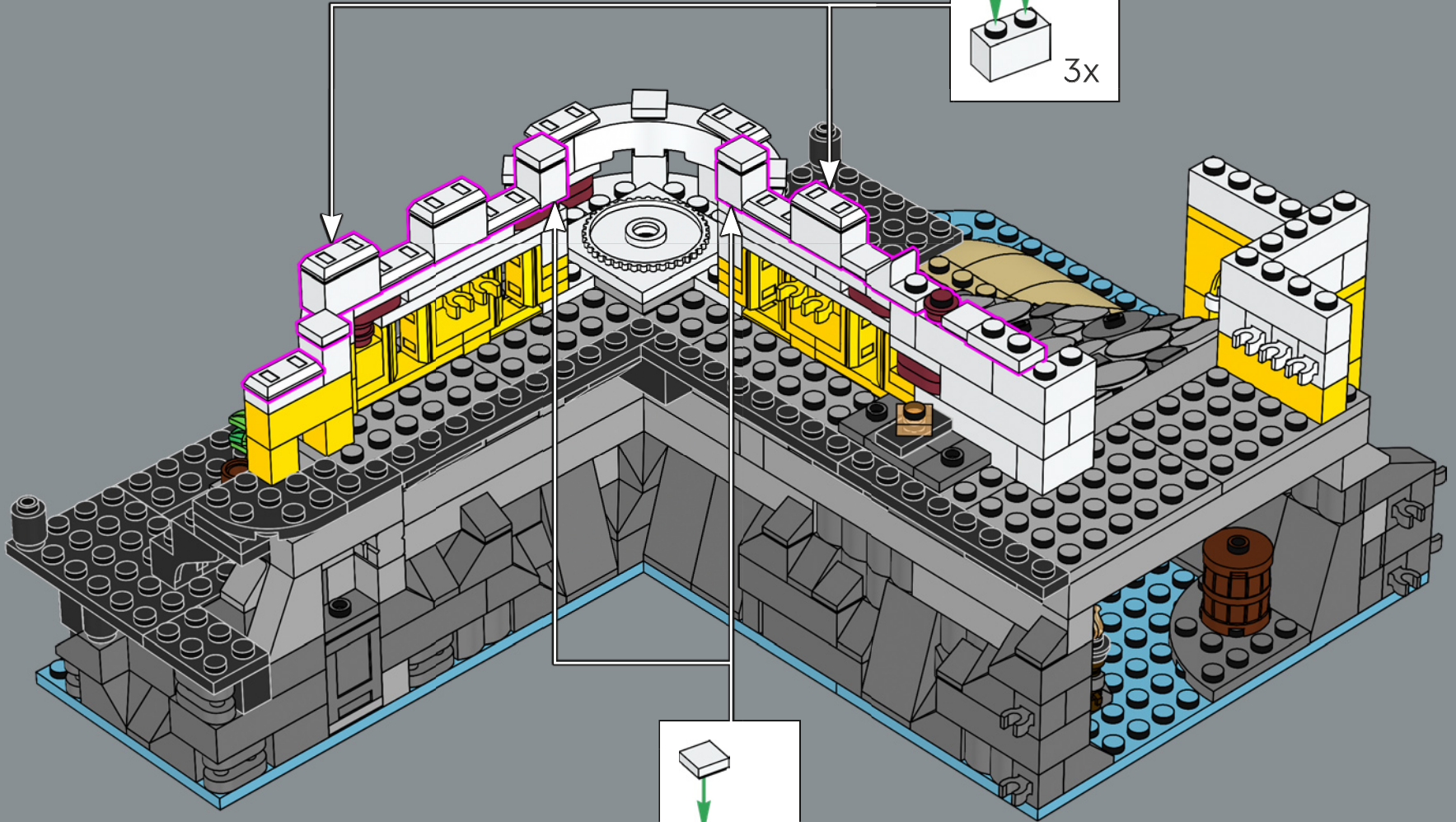
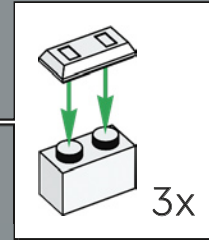

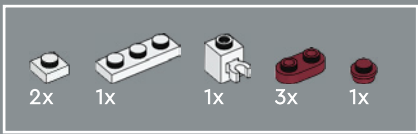

114

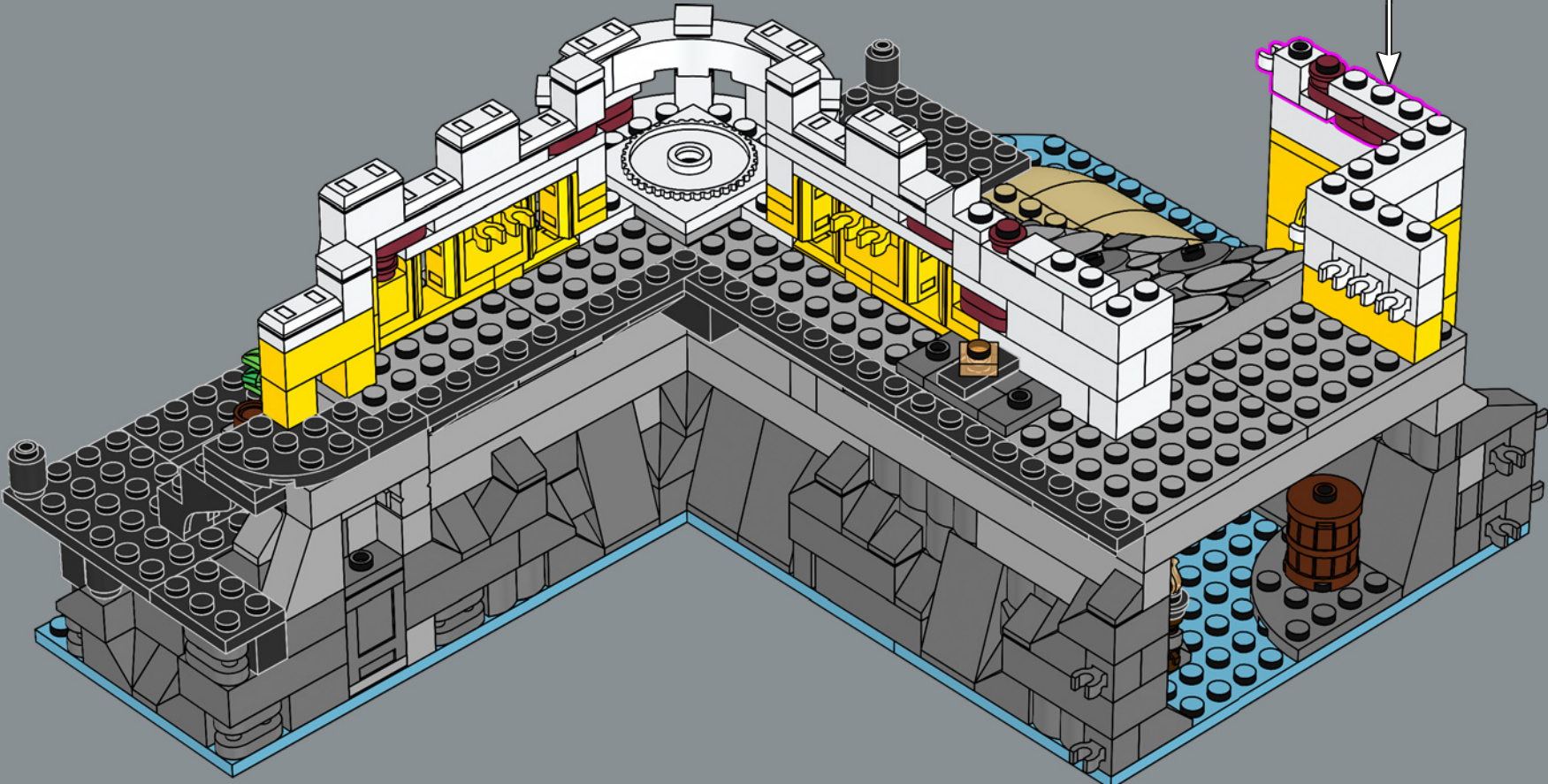
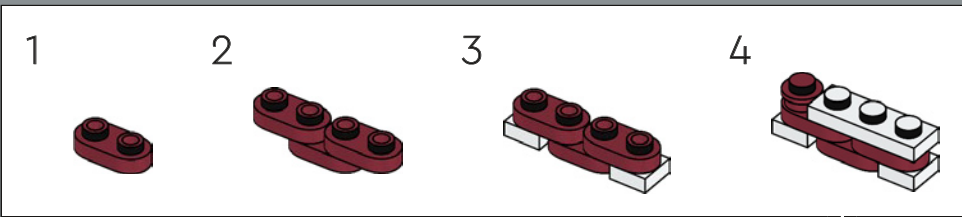

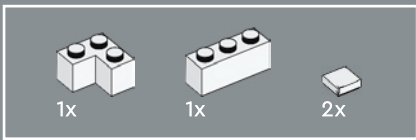

115

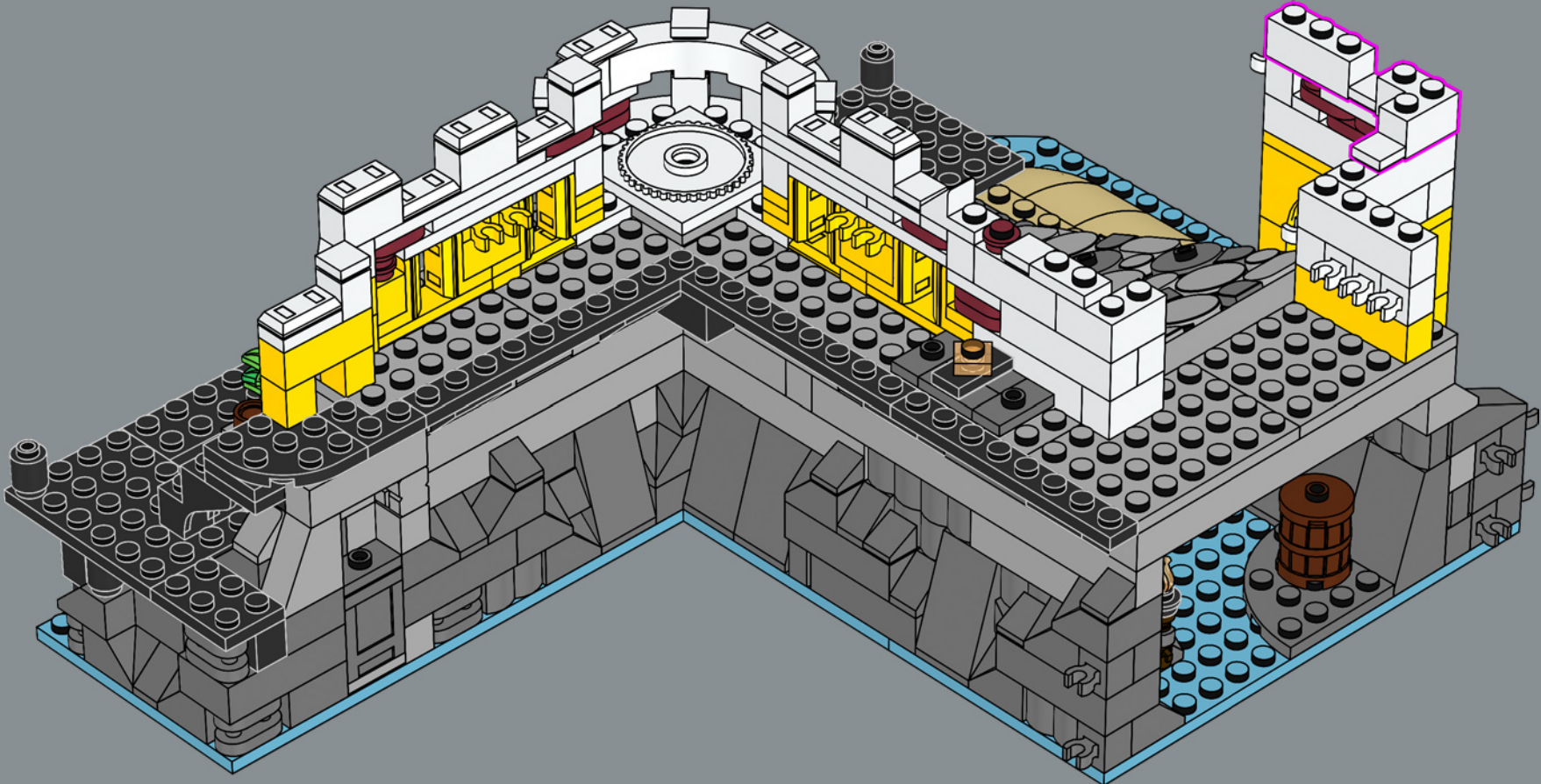

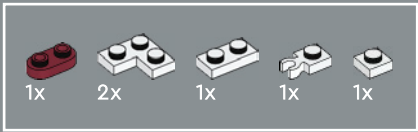

116

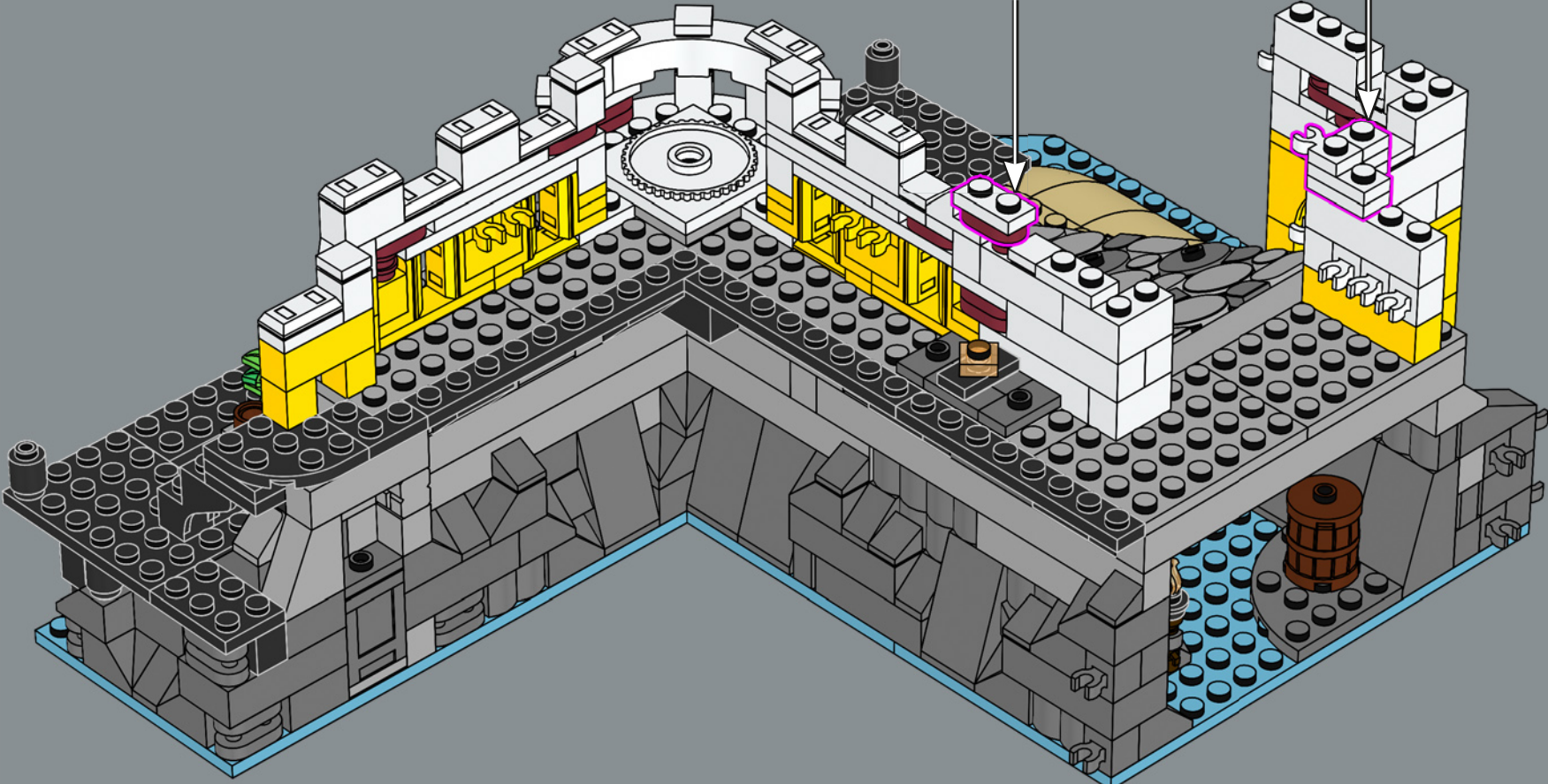
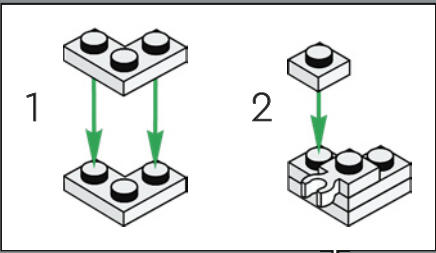
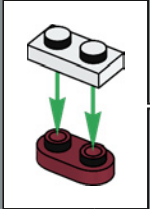



117

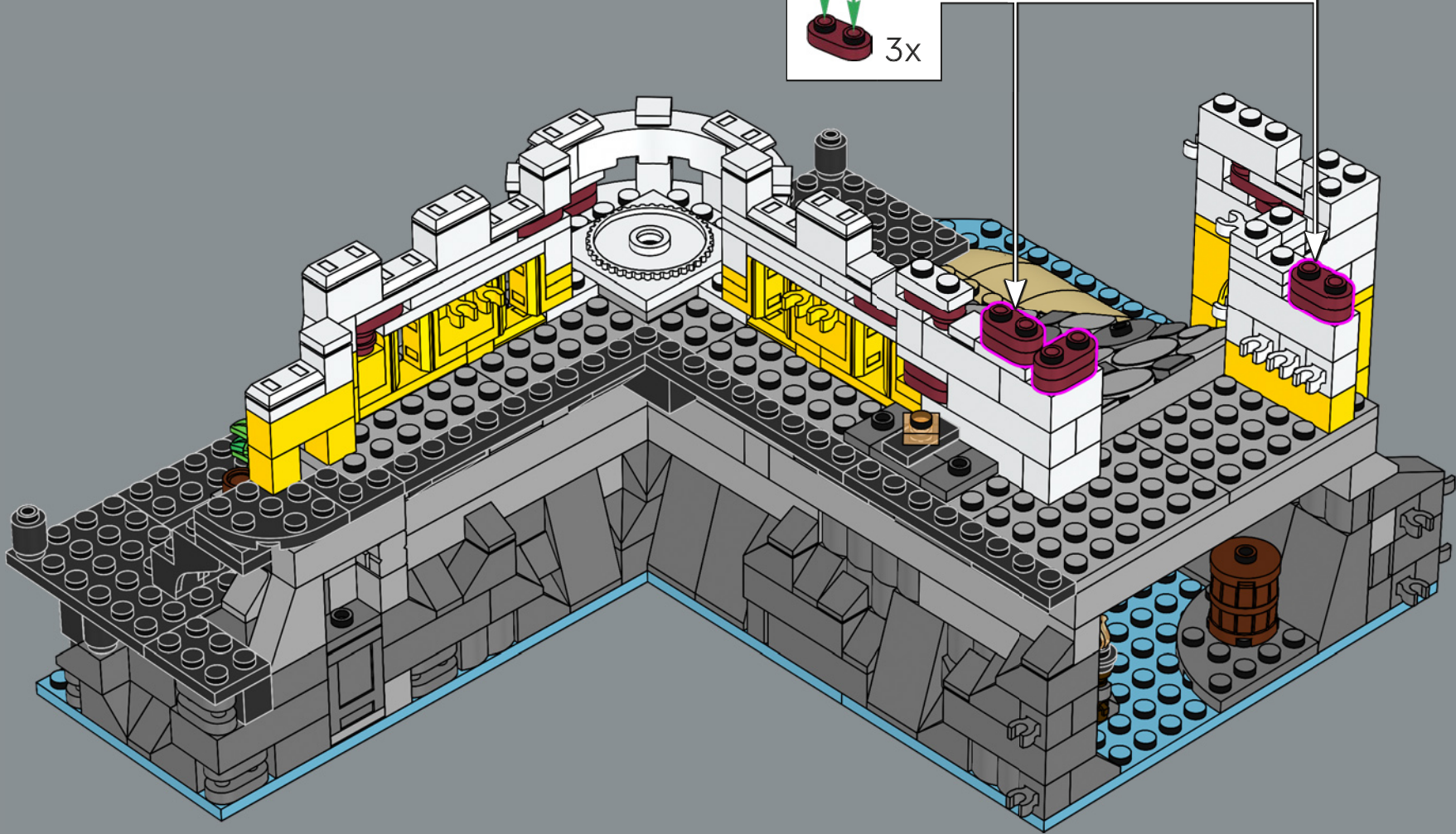
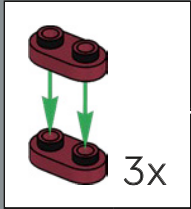

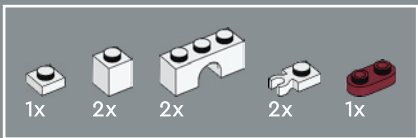

118

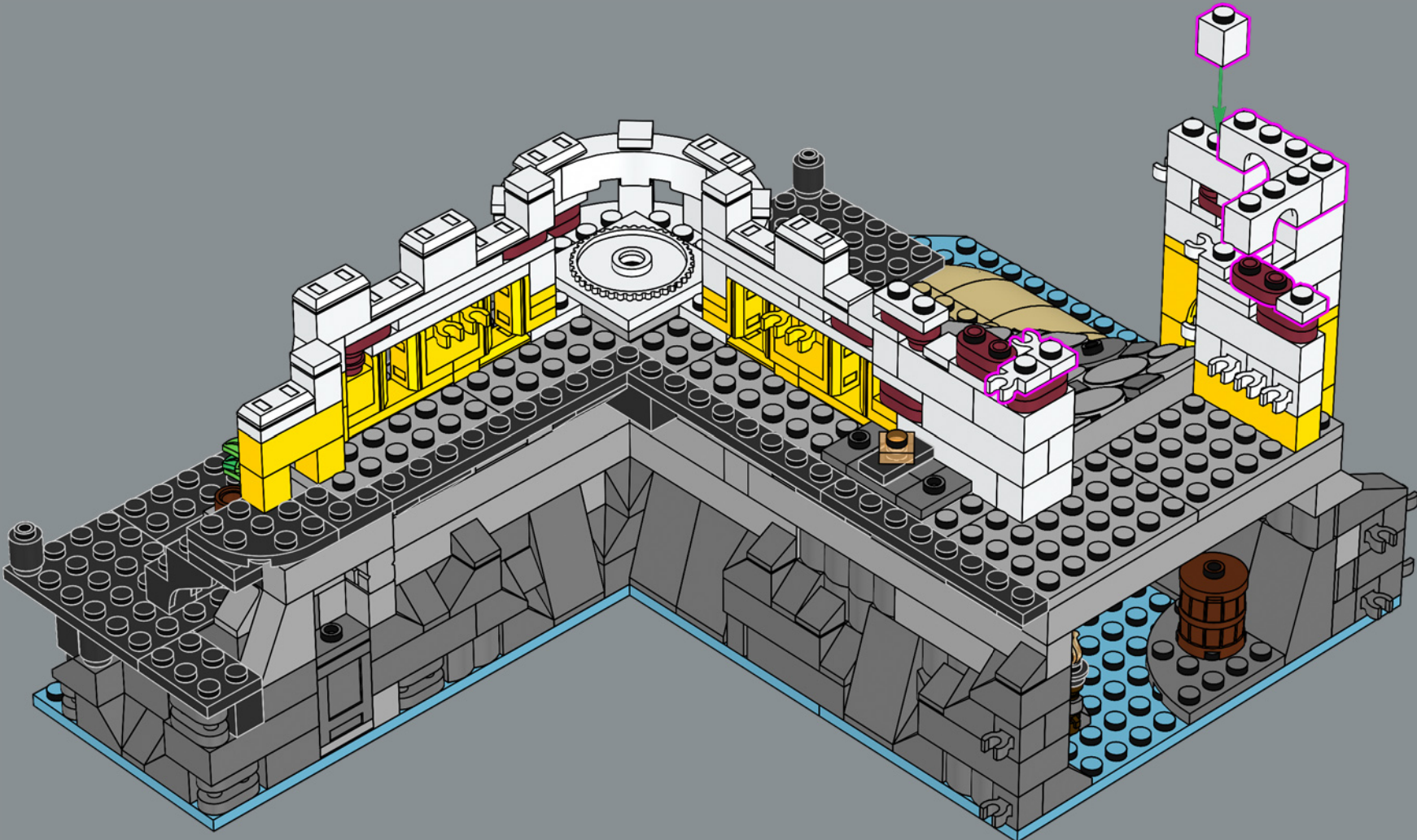

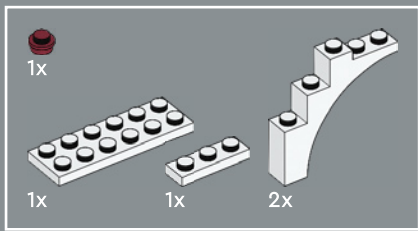

119

1

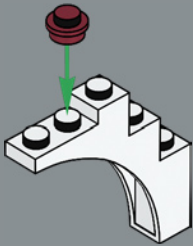

2

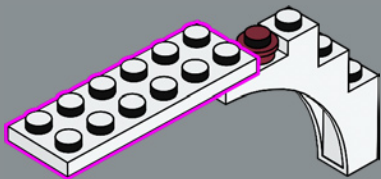

3

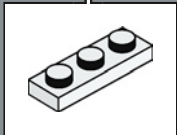
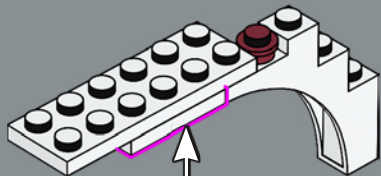

4

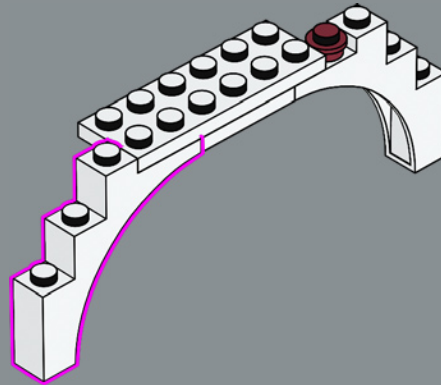

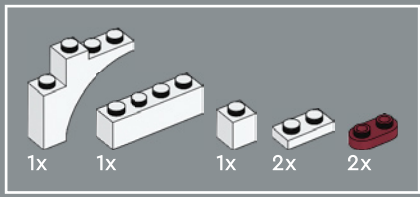

120

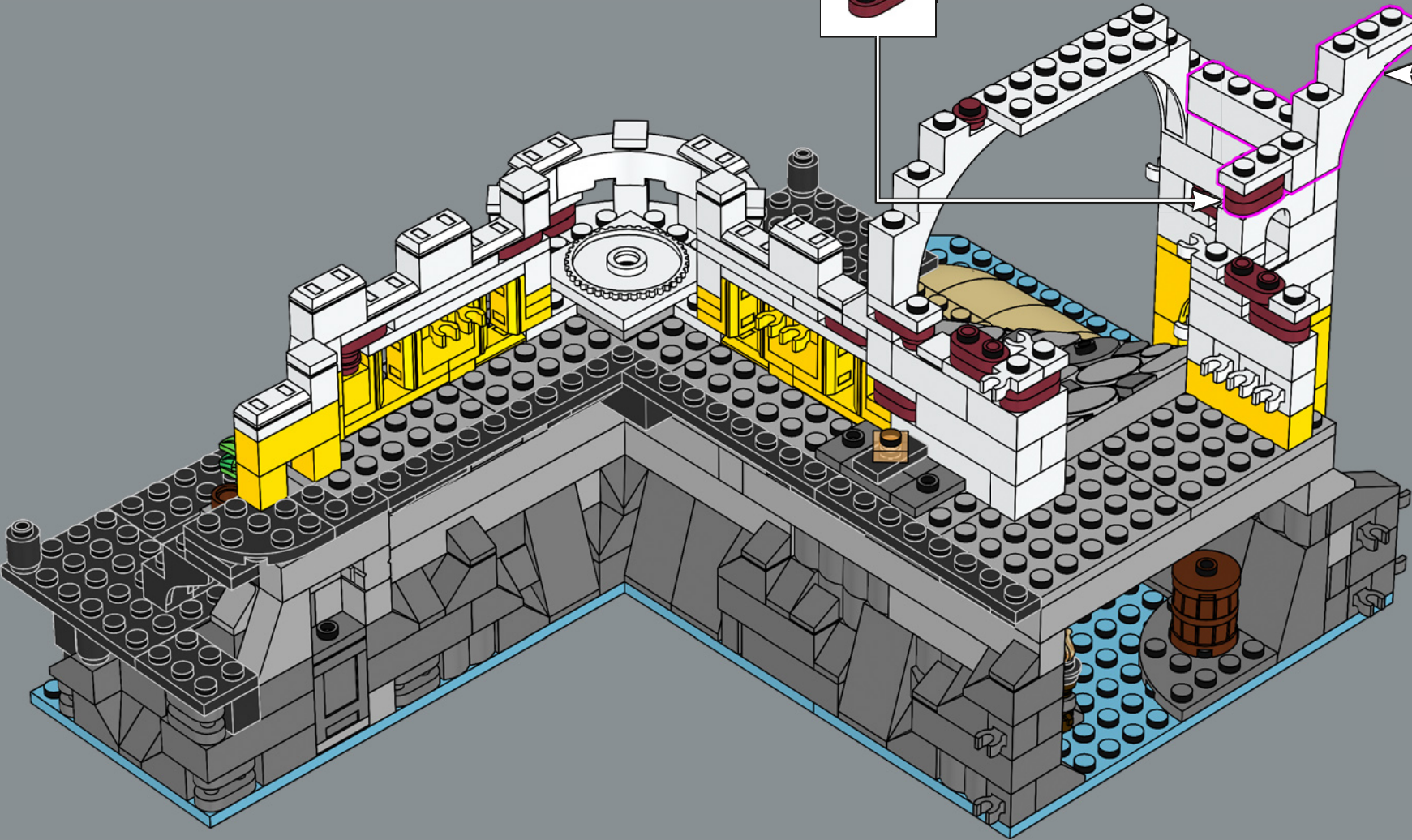
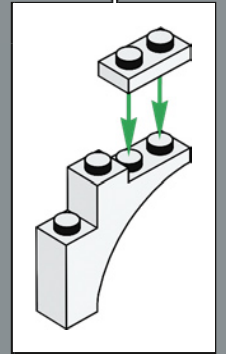
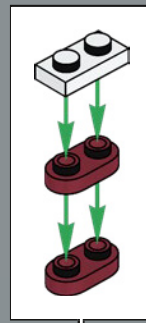

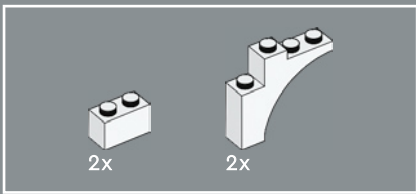

121

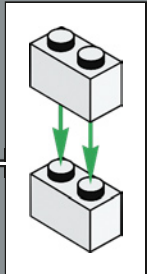
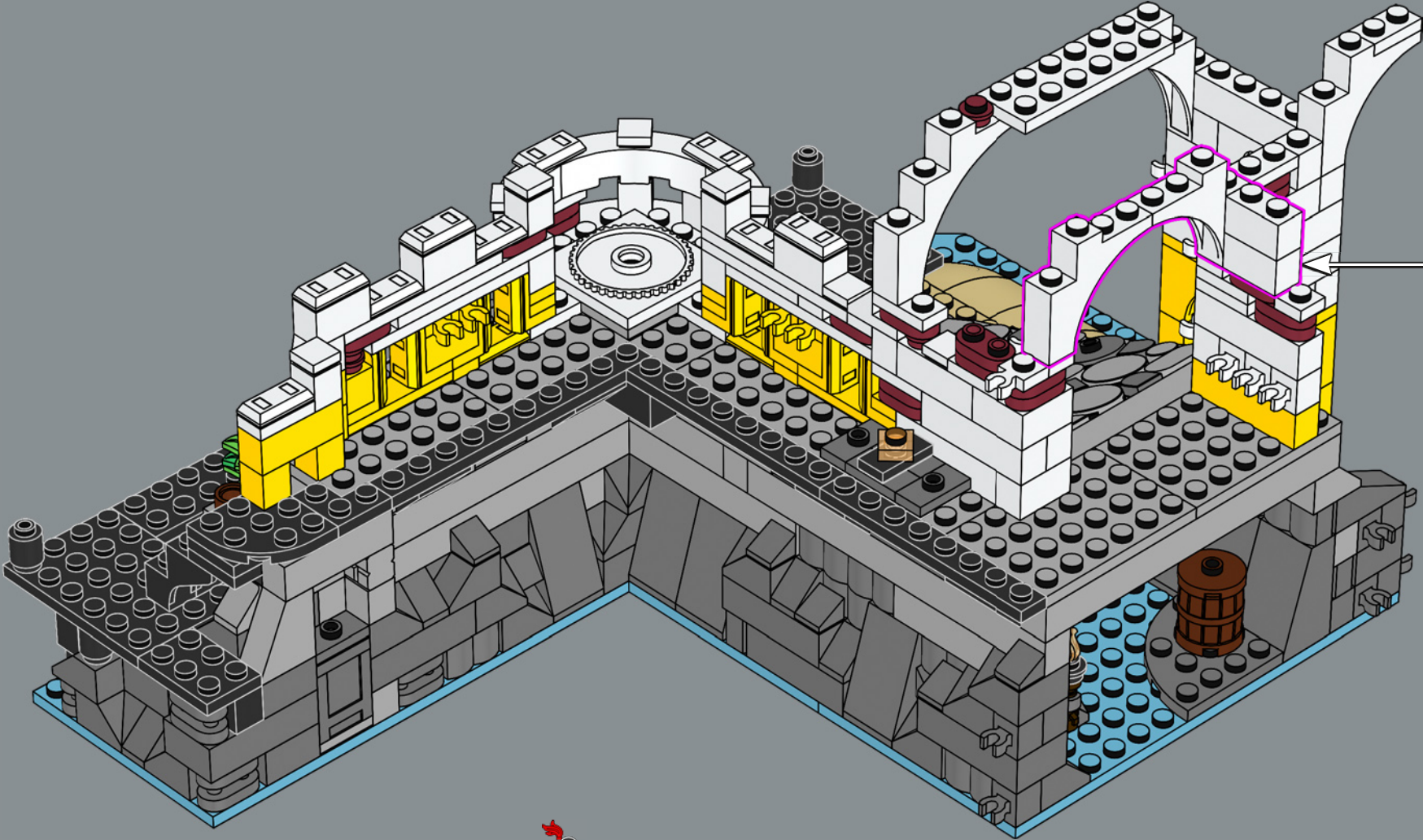

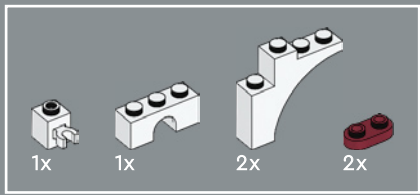

122

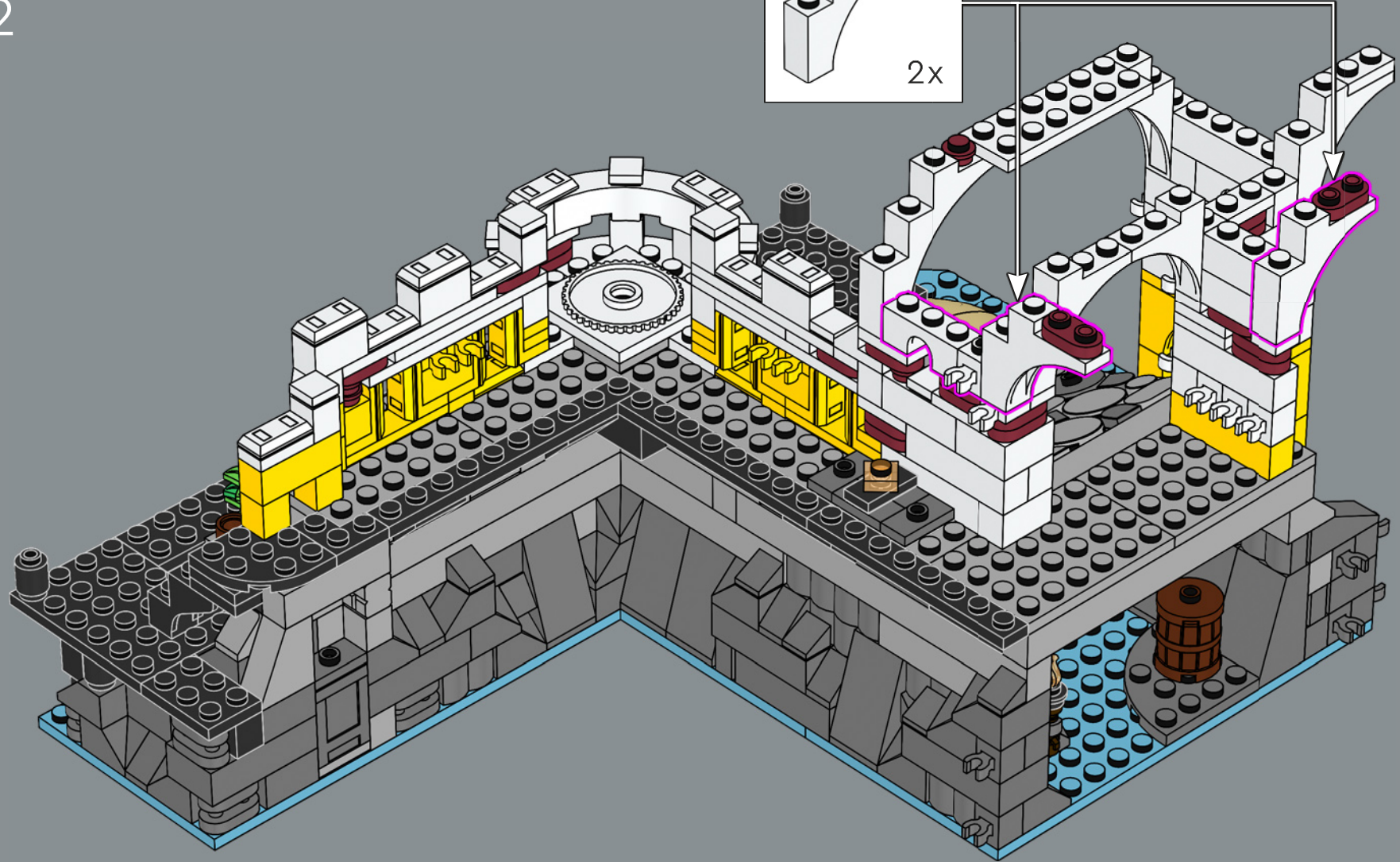
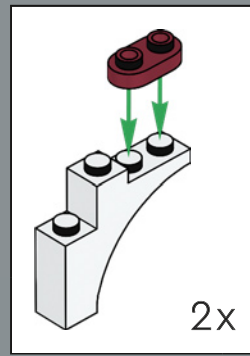



123

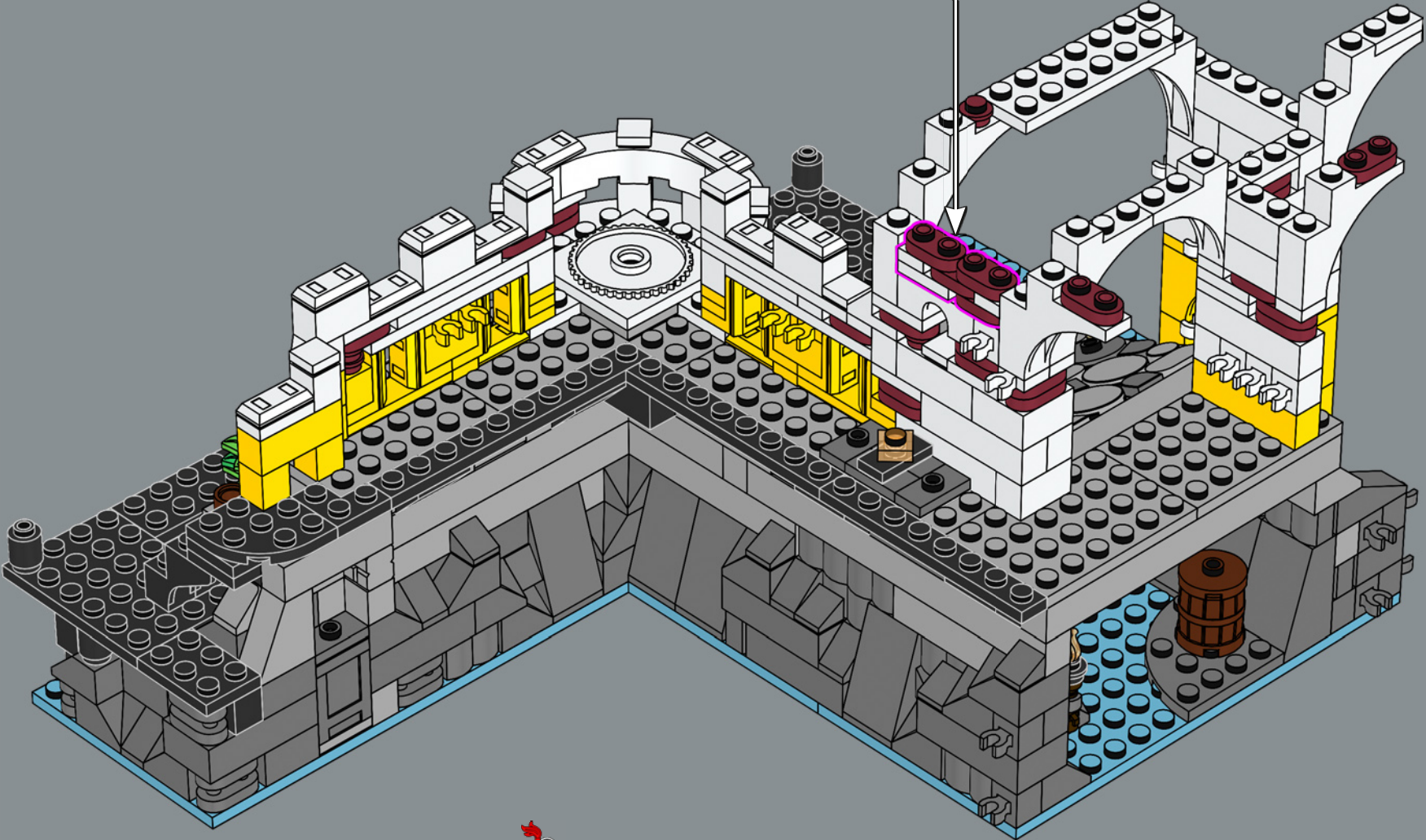
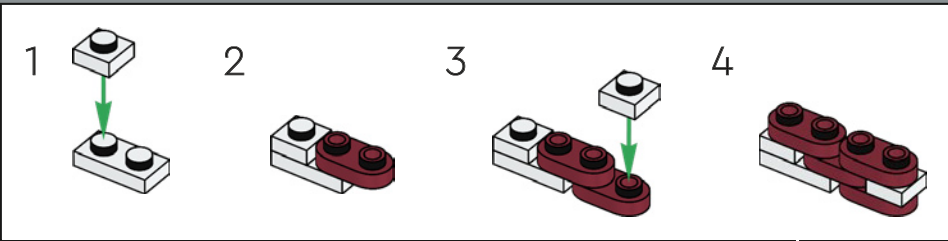

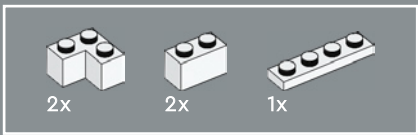

124

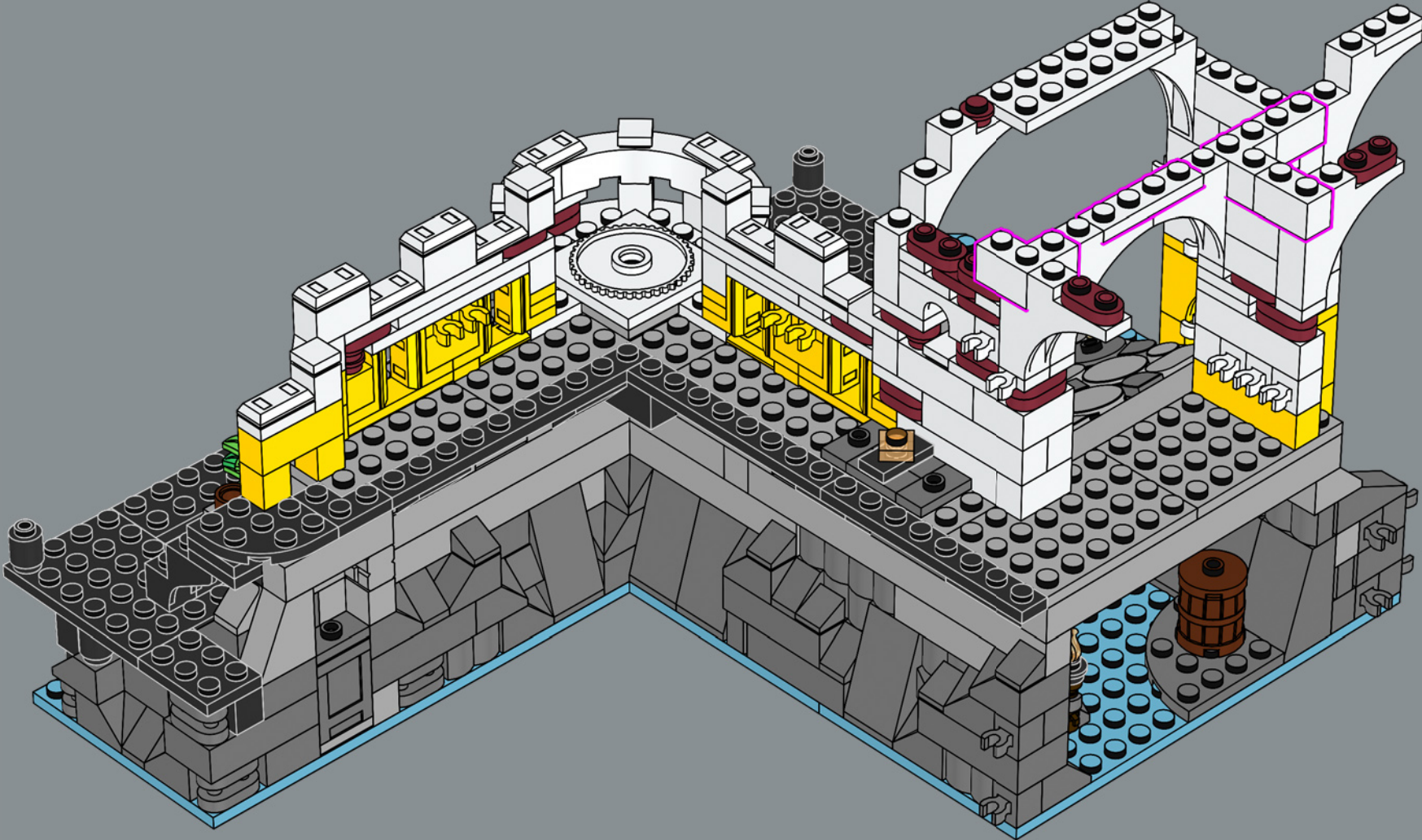

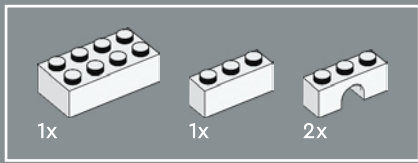

125

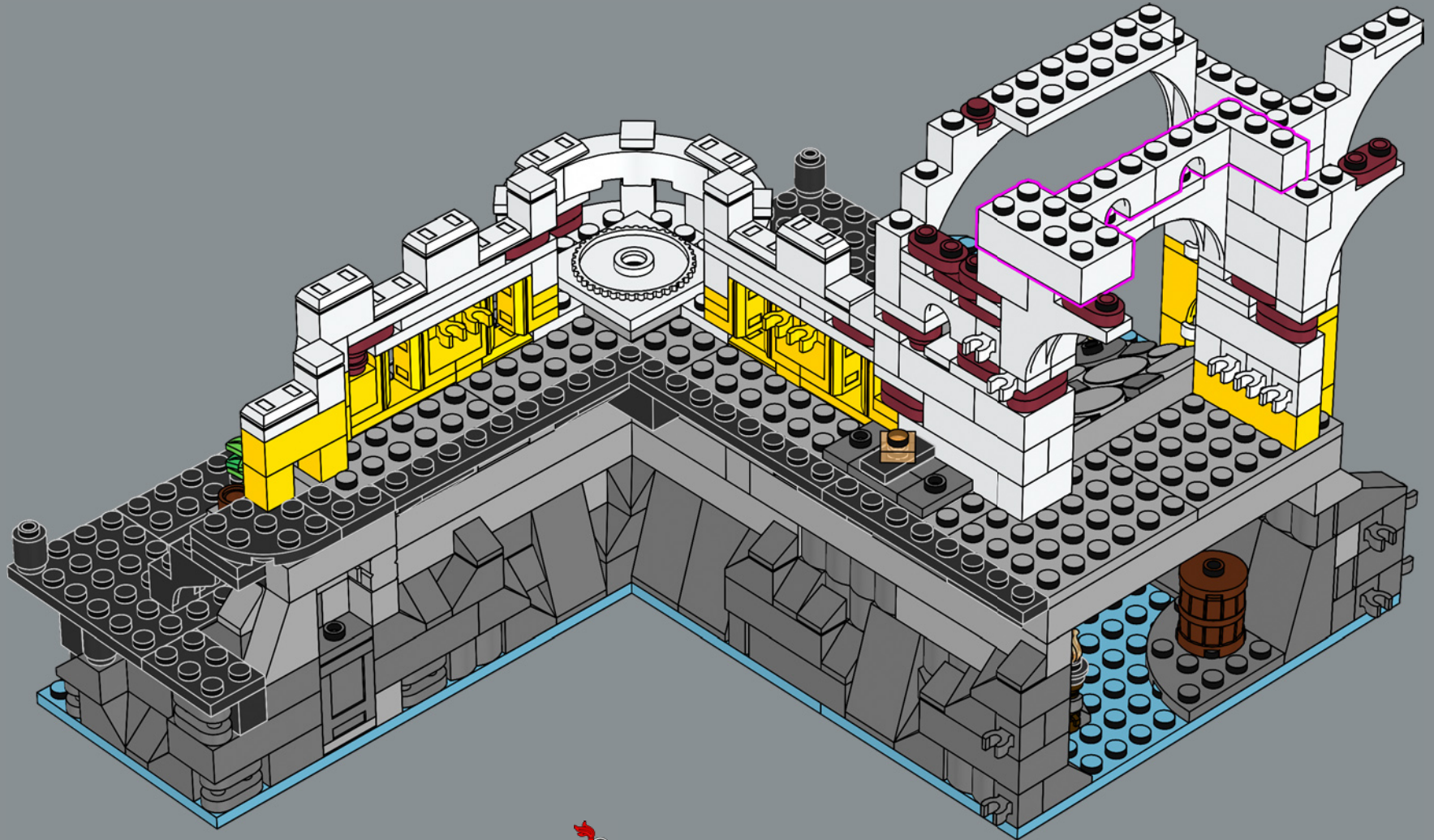

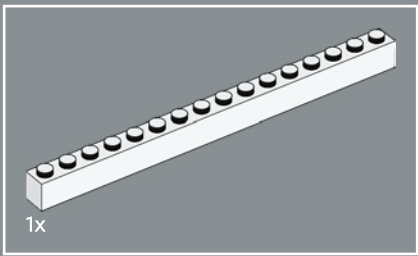

126

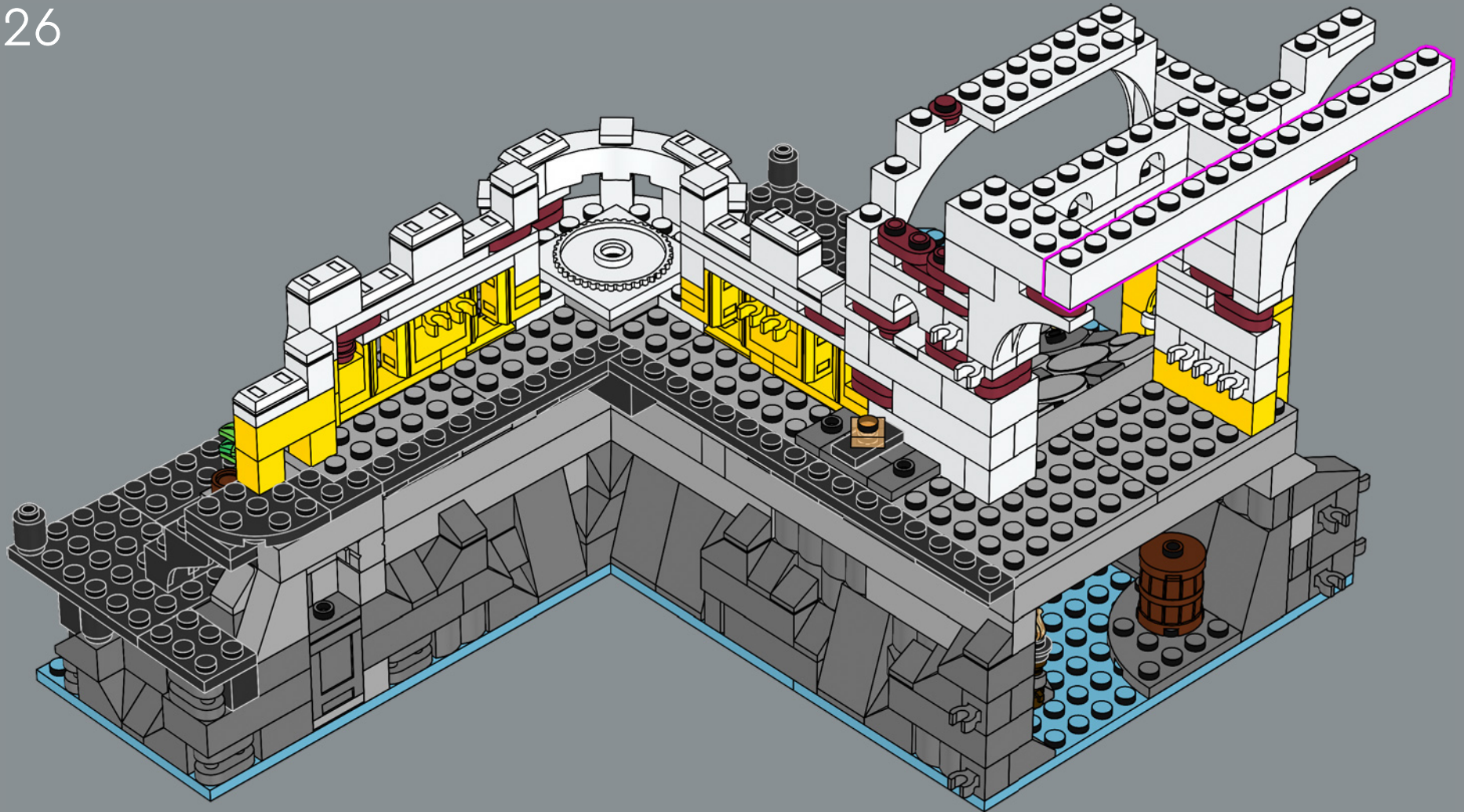

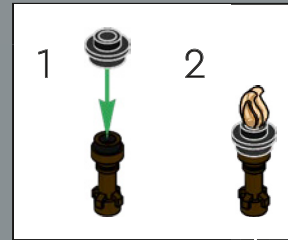
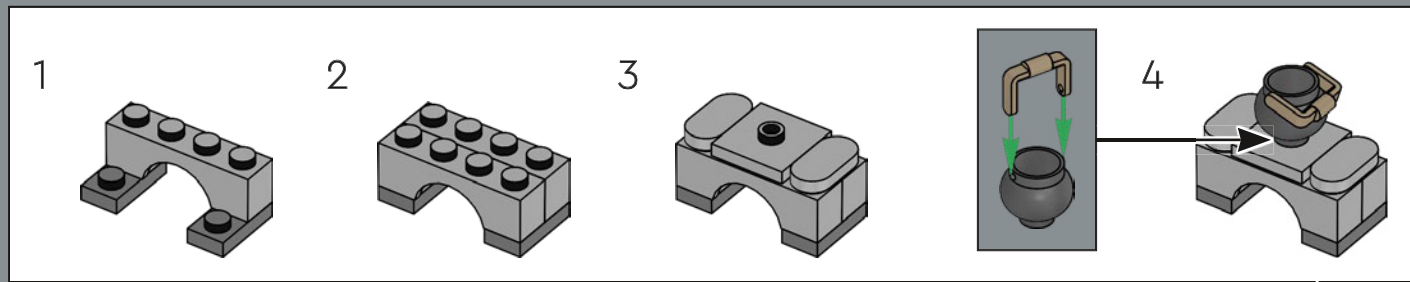
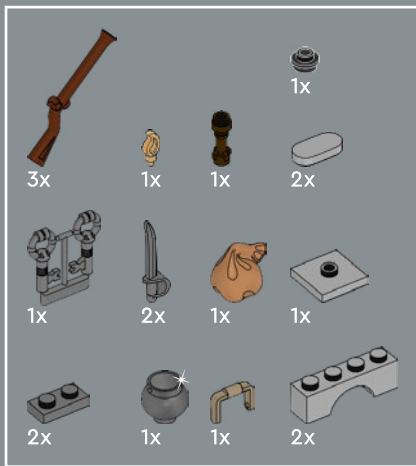

127



Les marins, les pirates et les gardes doivent tous manger ! Qu'y a-t-il au menu ? Du poisson ? Des noix de coco ? Des bananes plantain ?



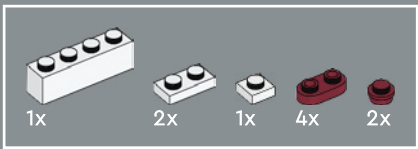

128

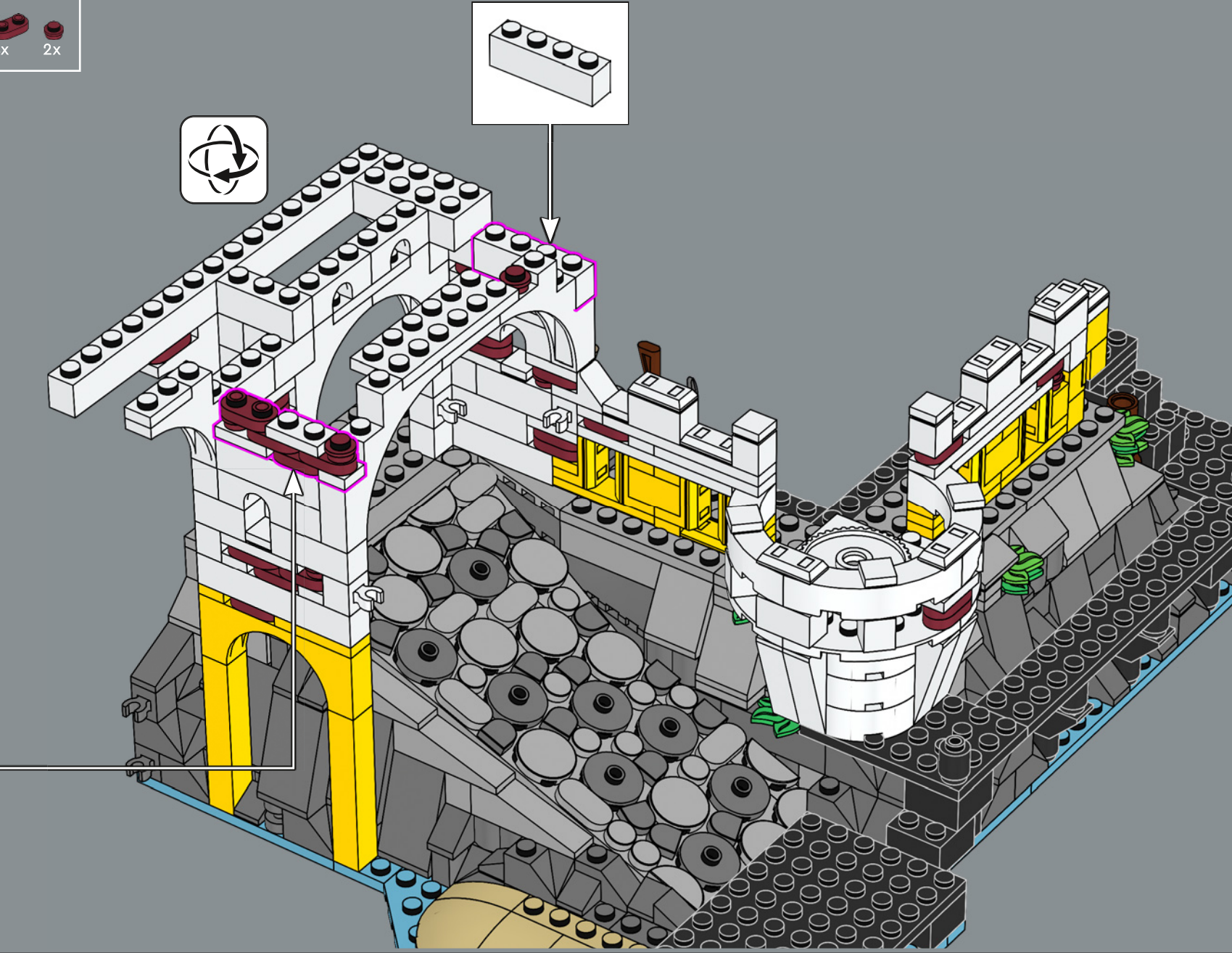
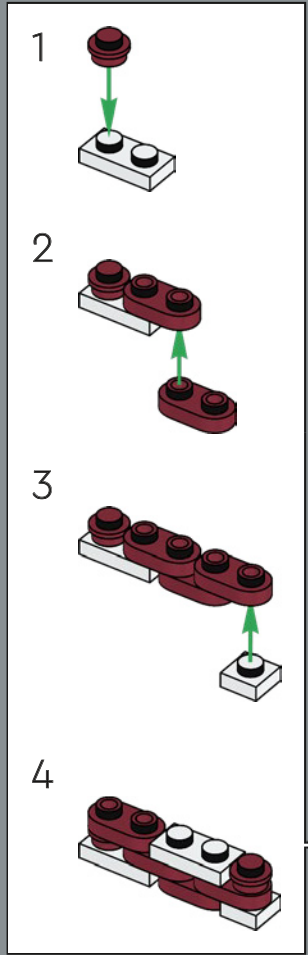
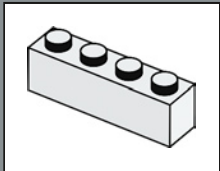

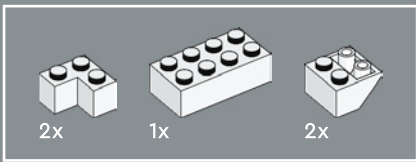

129

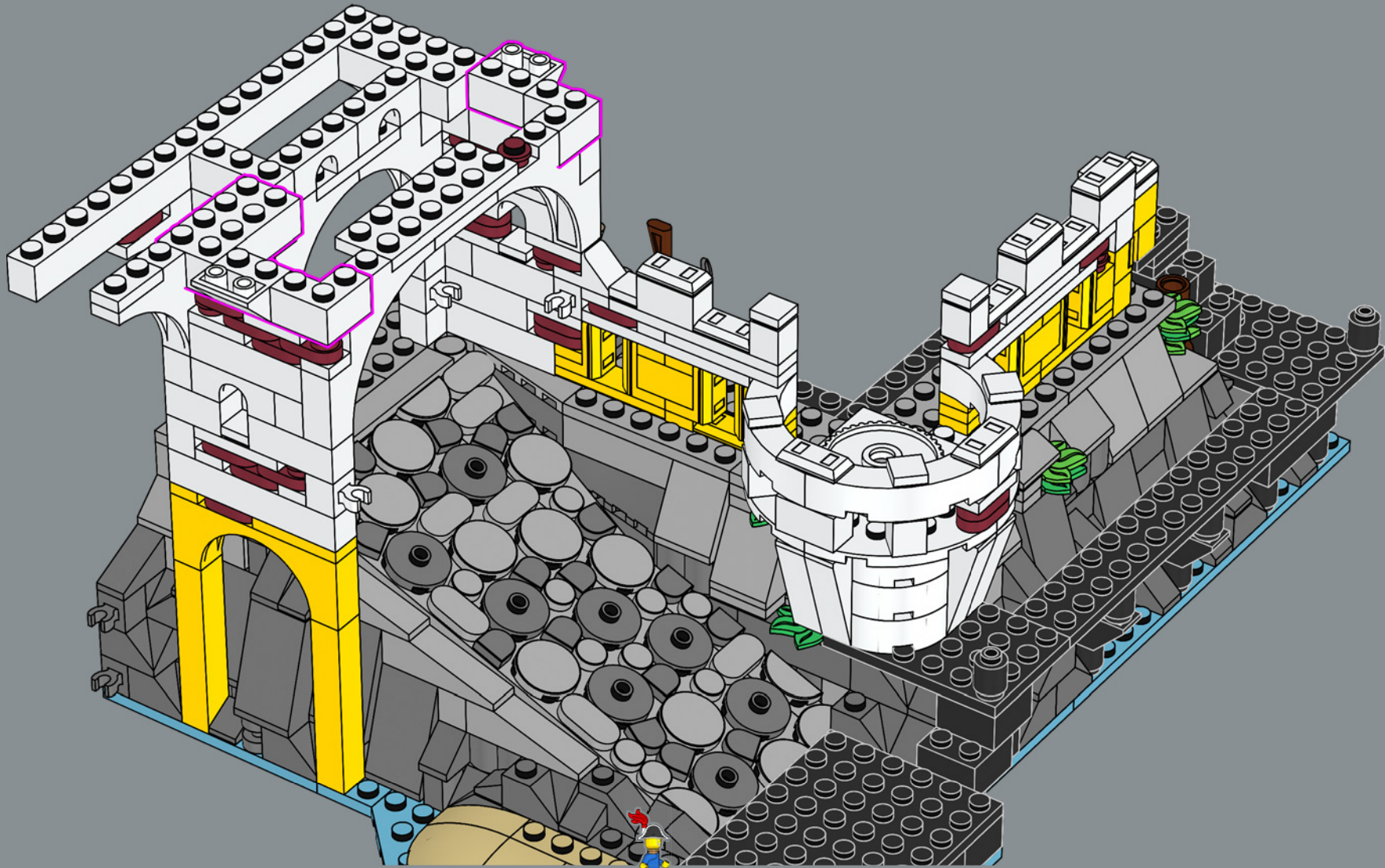

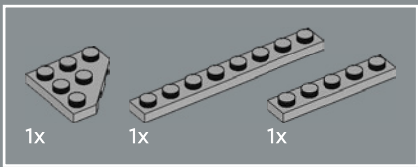

130

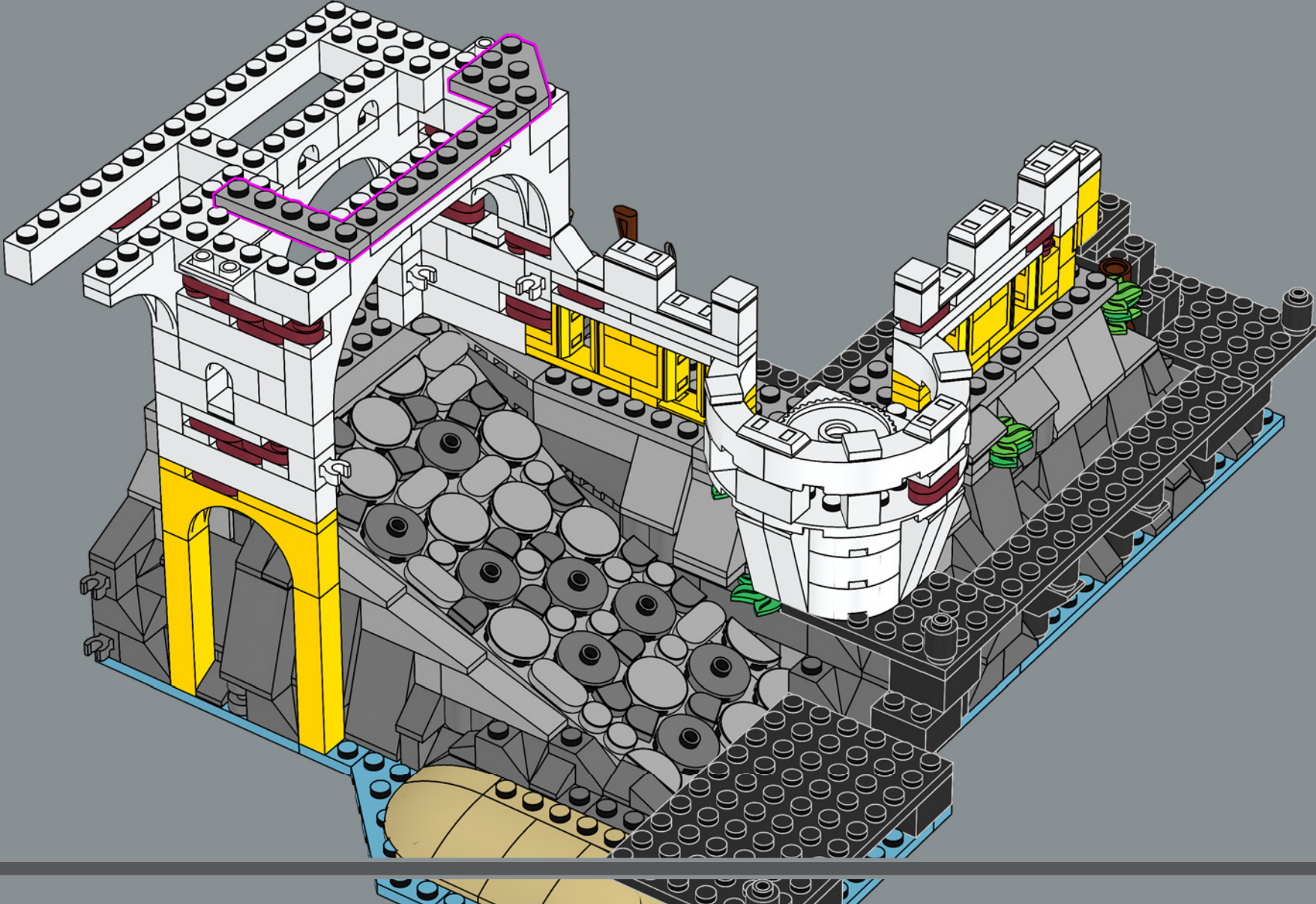

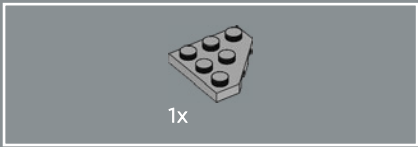

131

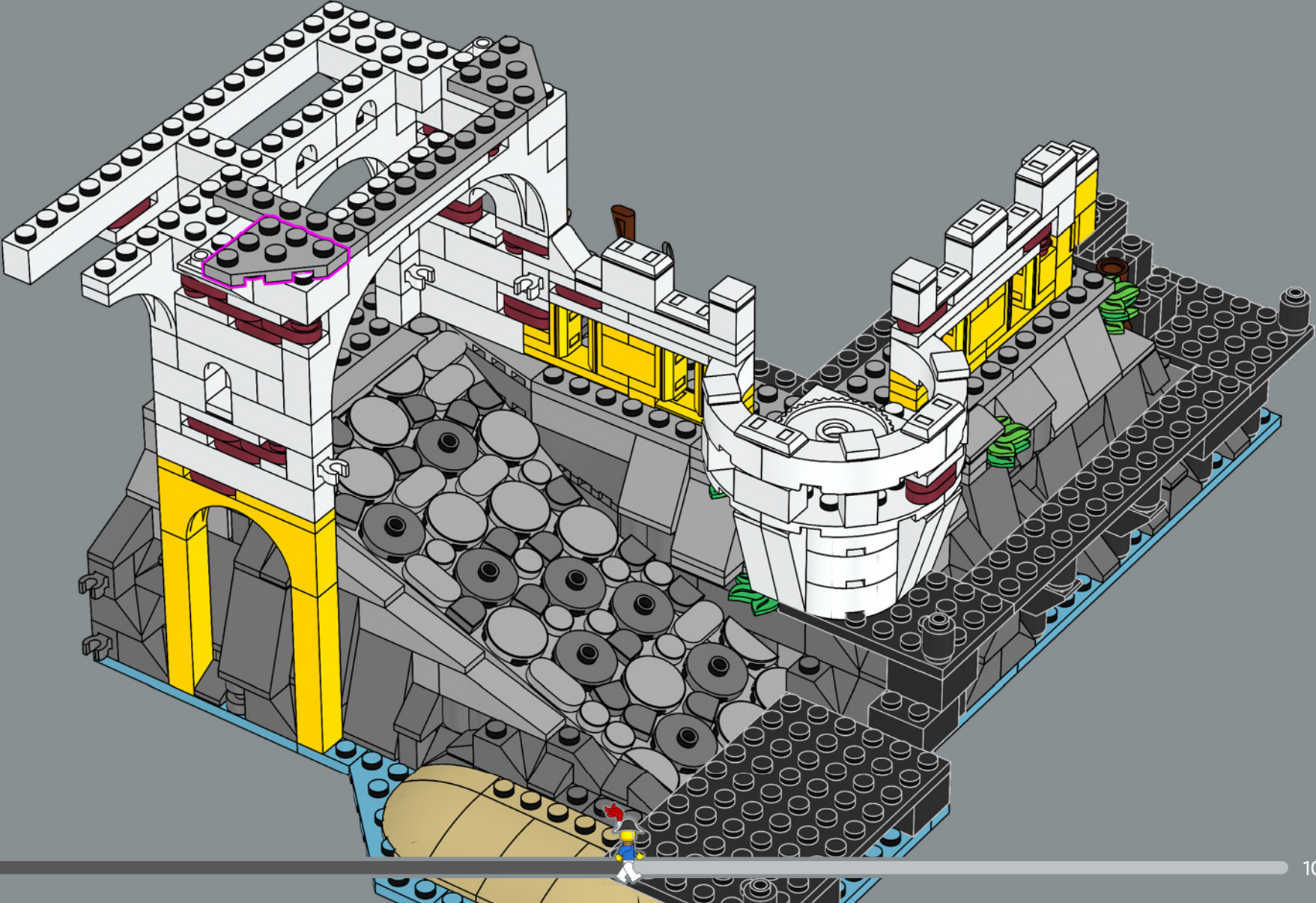



132

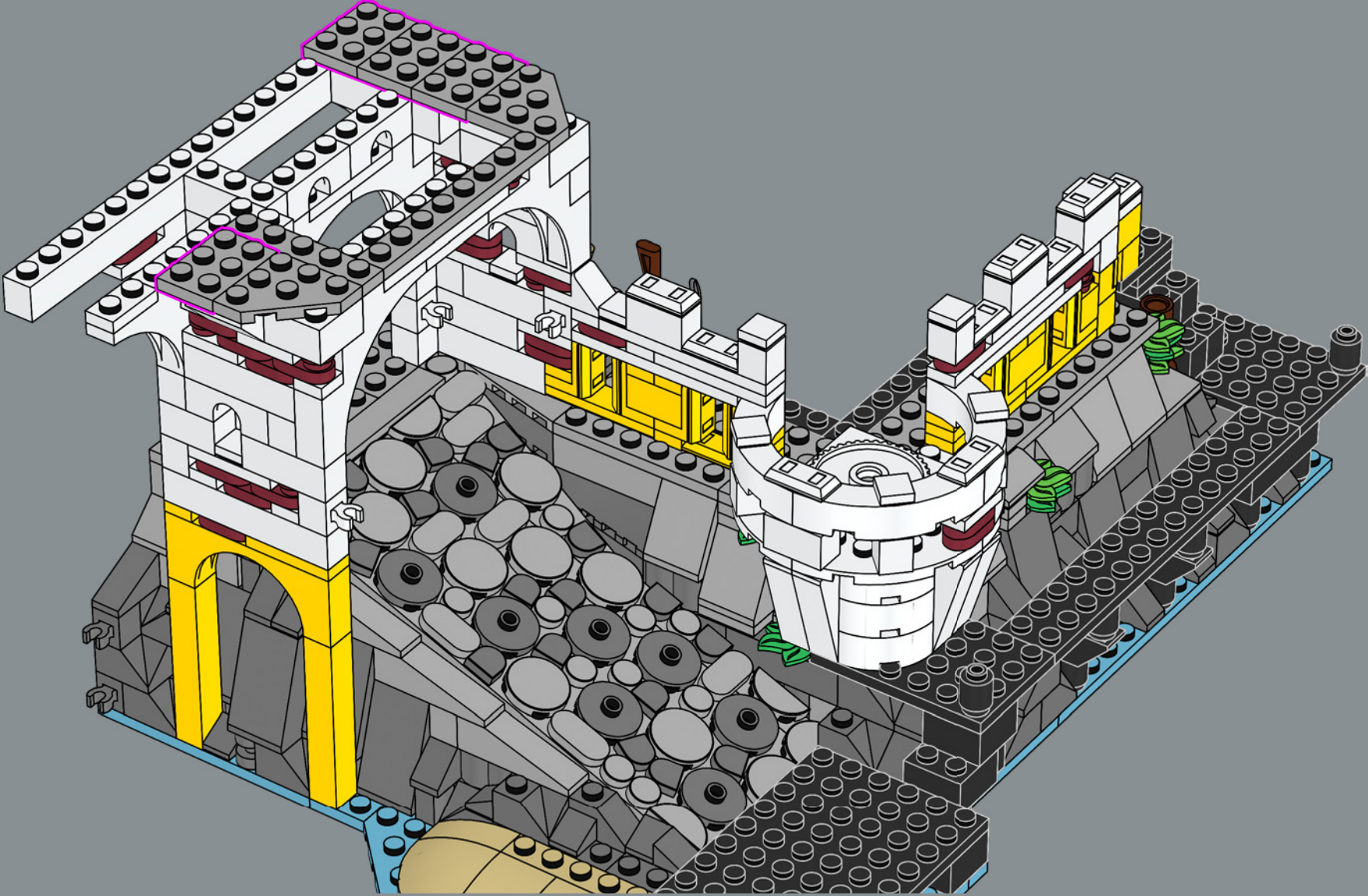

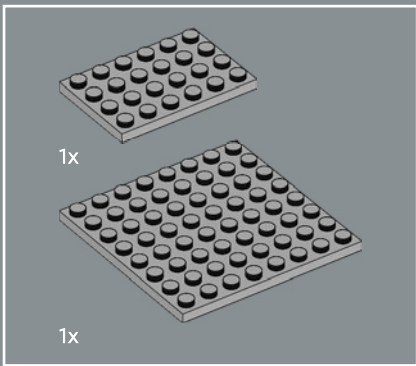

133

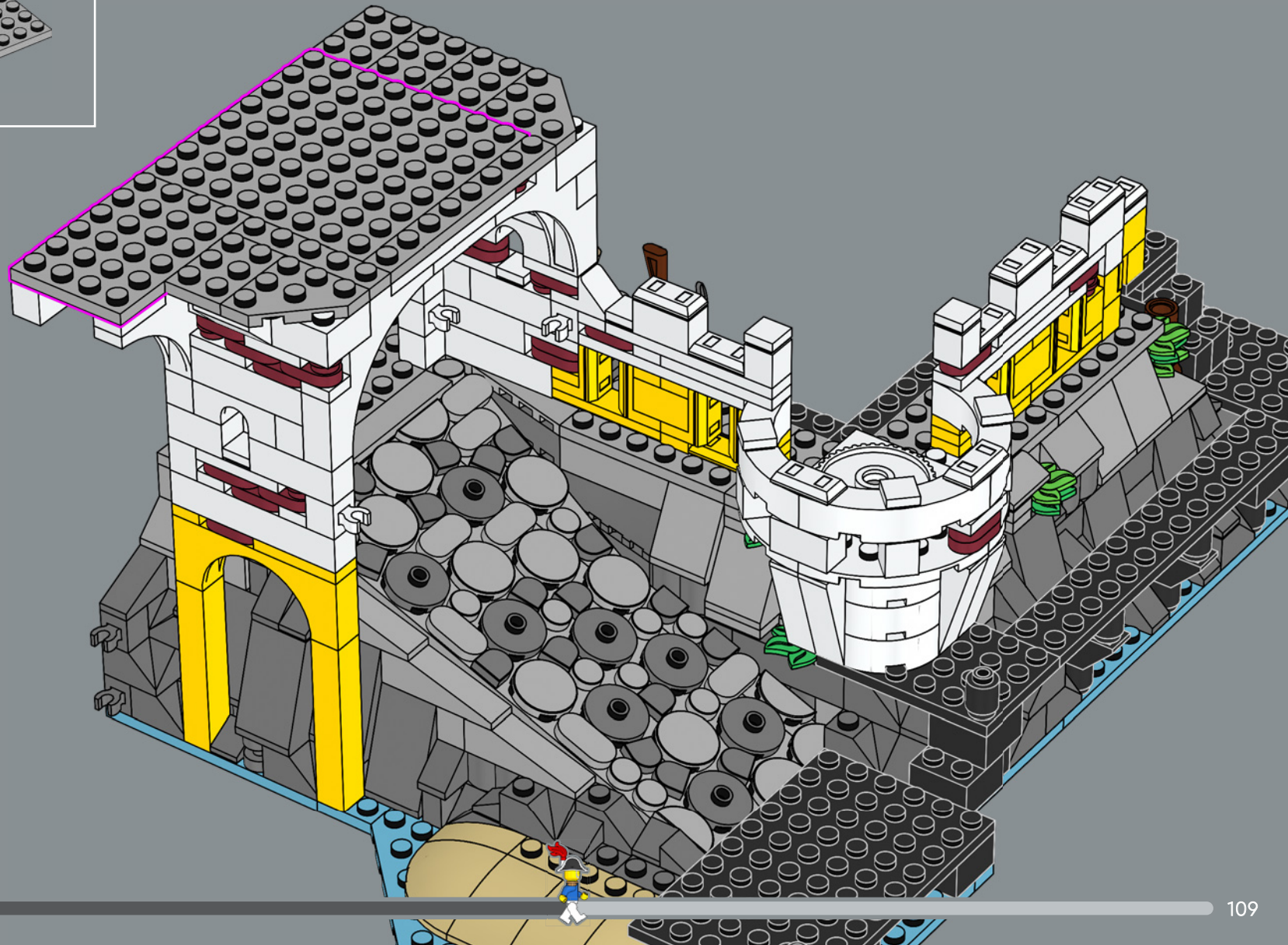

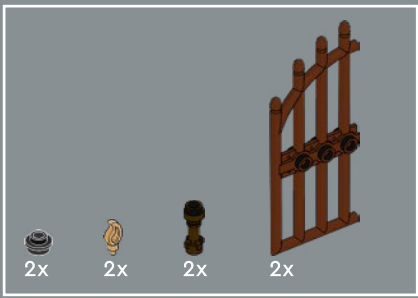

134

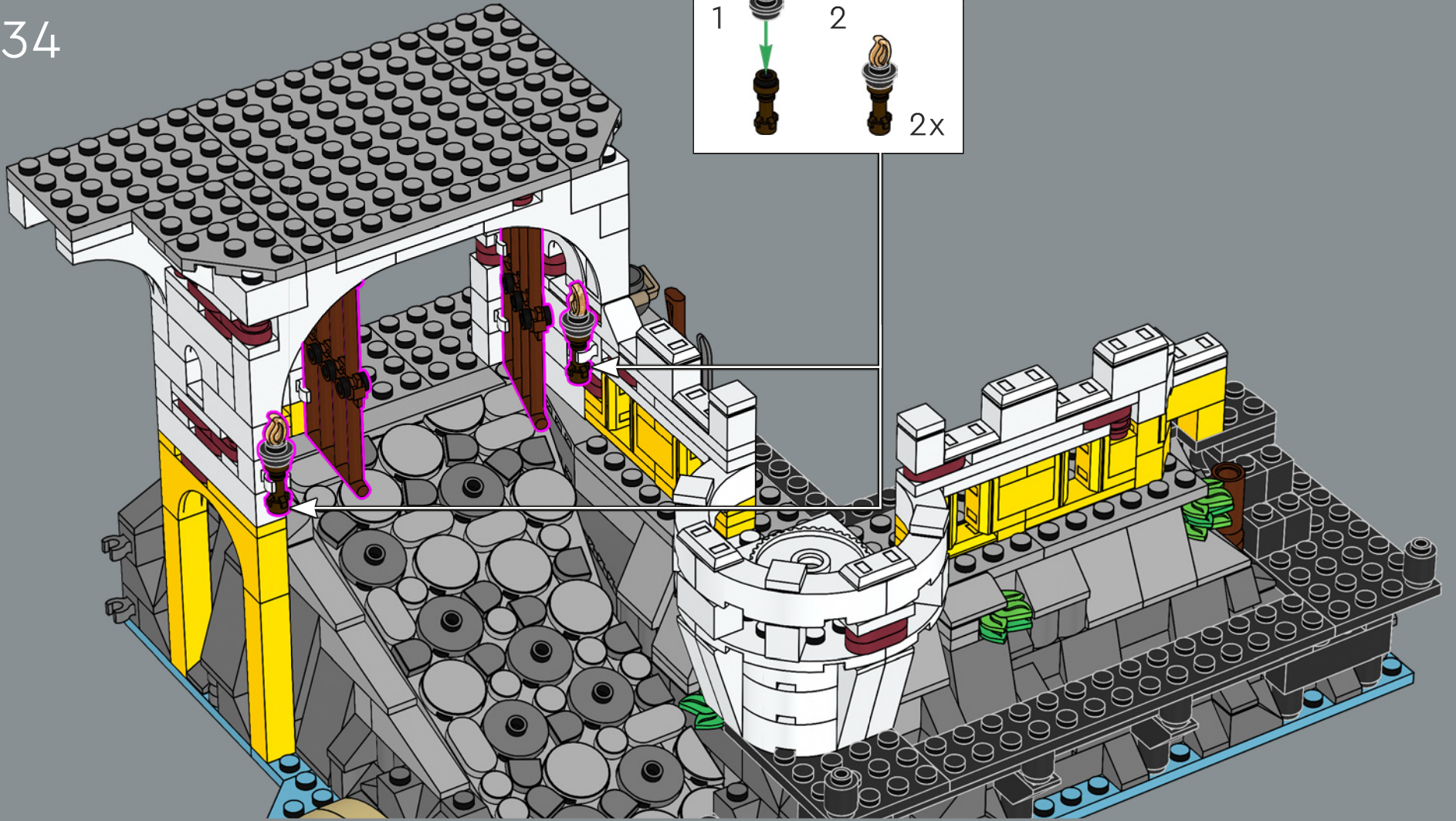
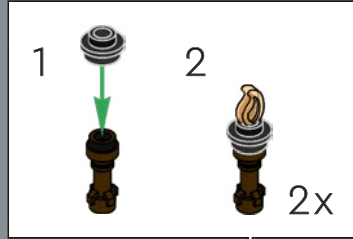

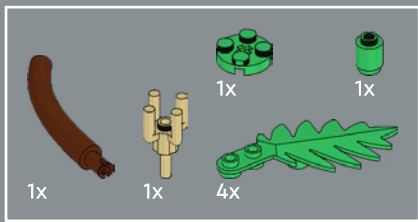

135

1

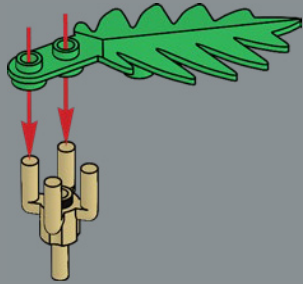

2

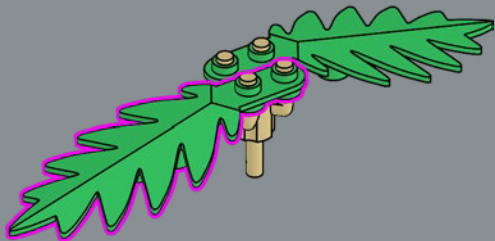

3



4



5



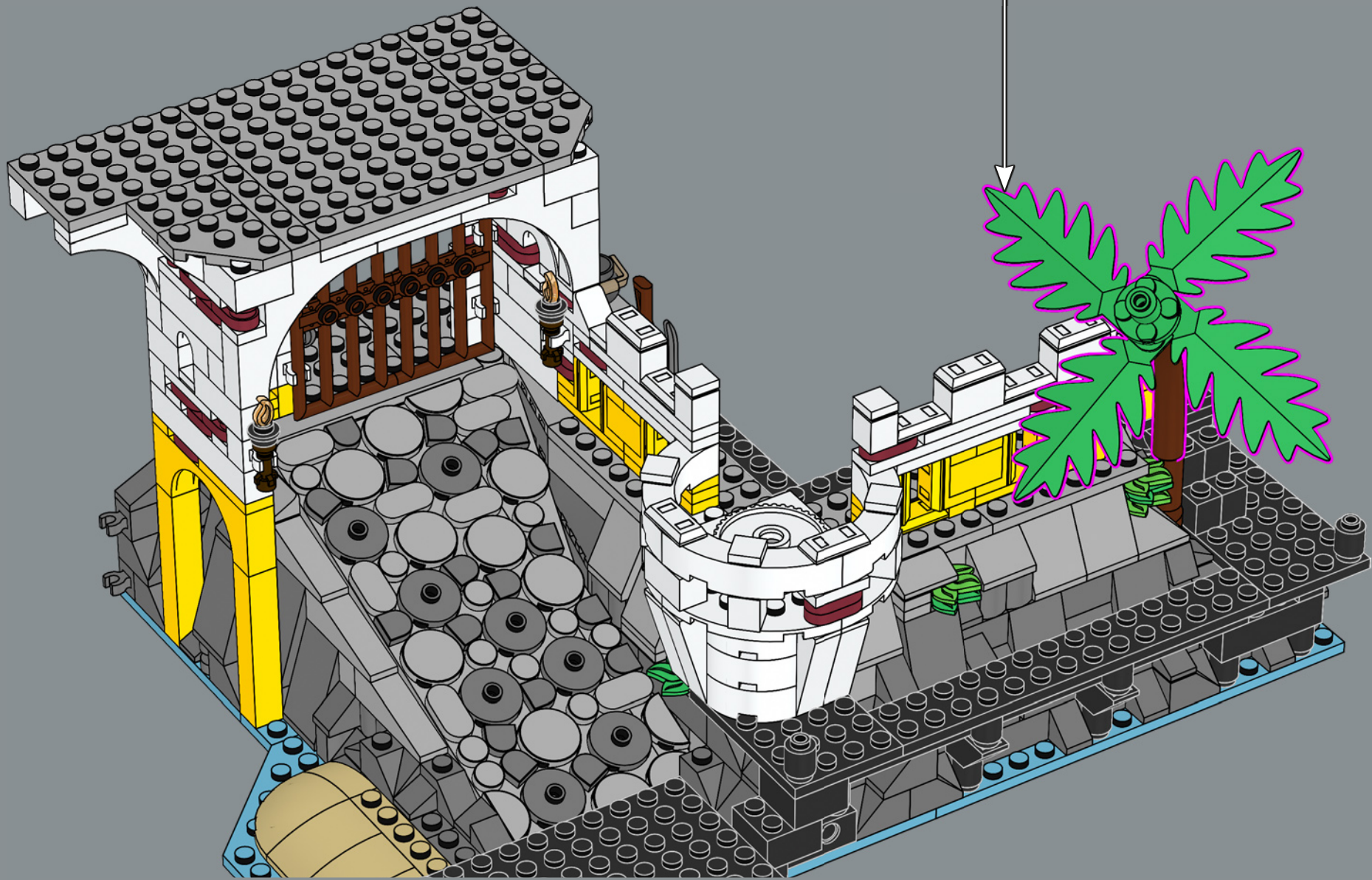

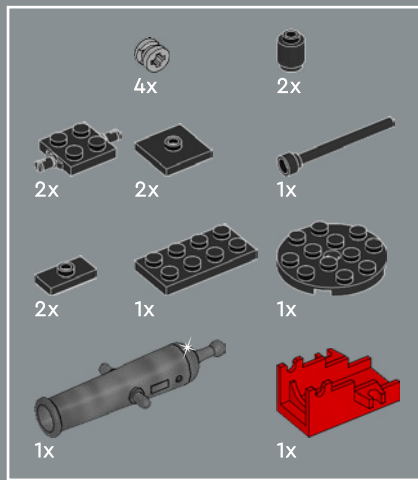

136

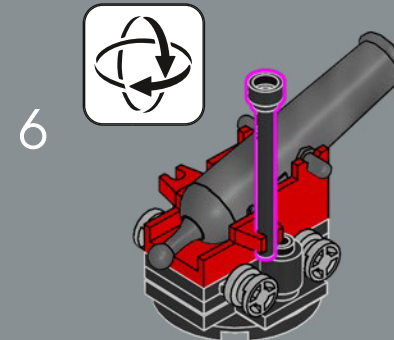
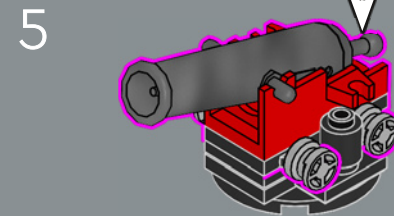
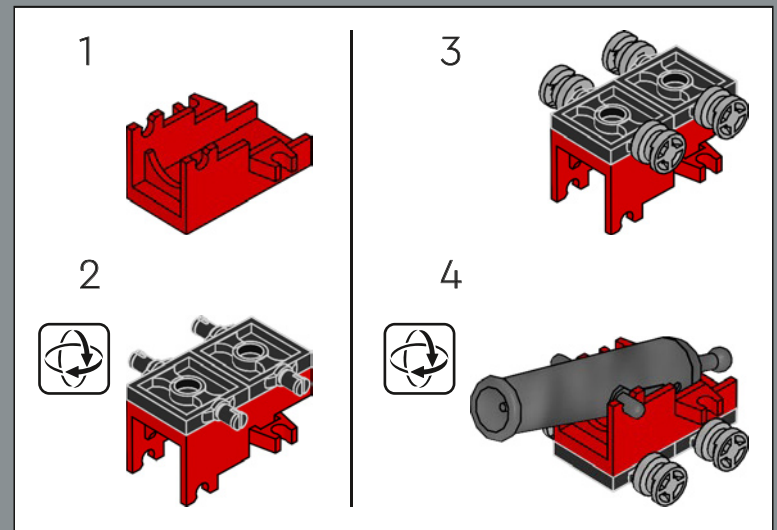
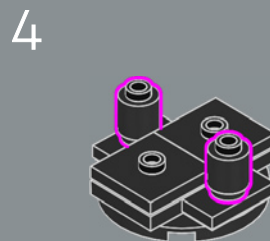
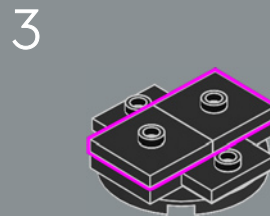
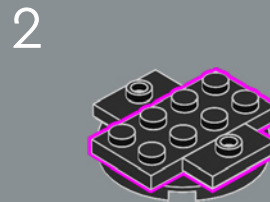
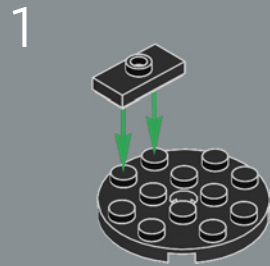

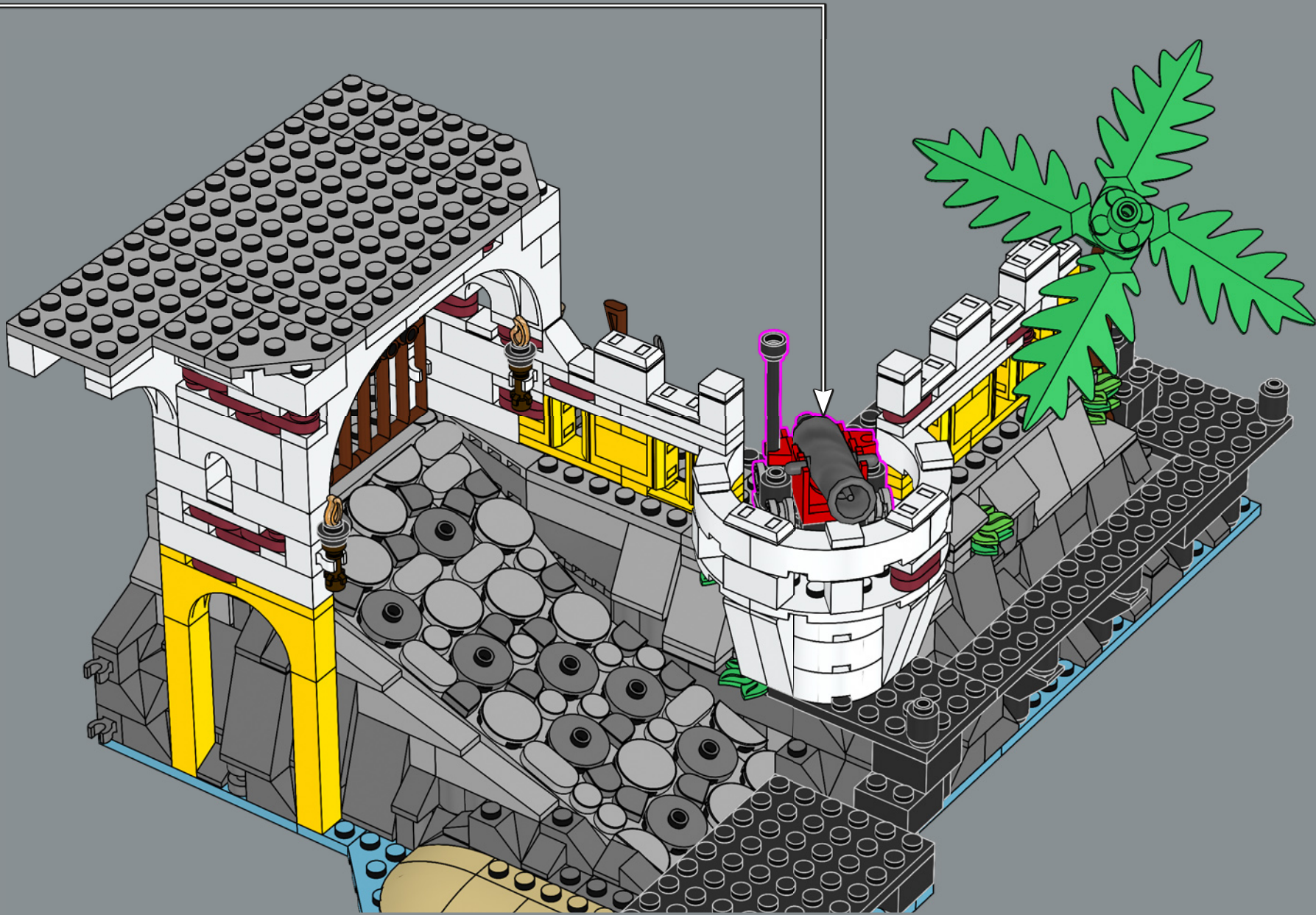

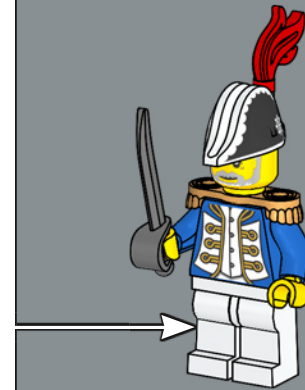
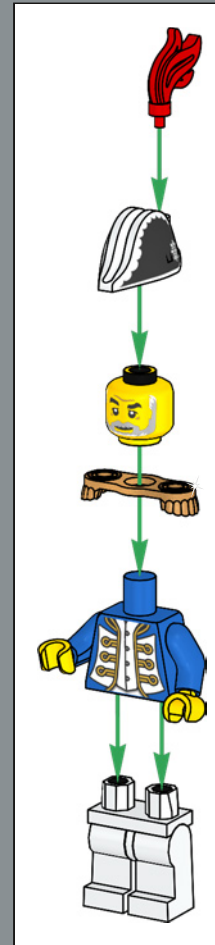



137

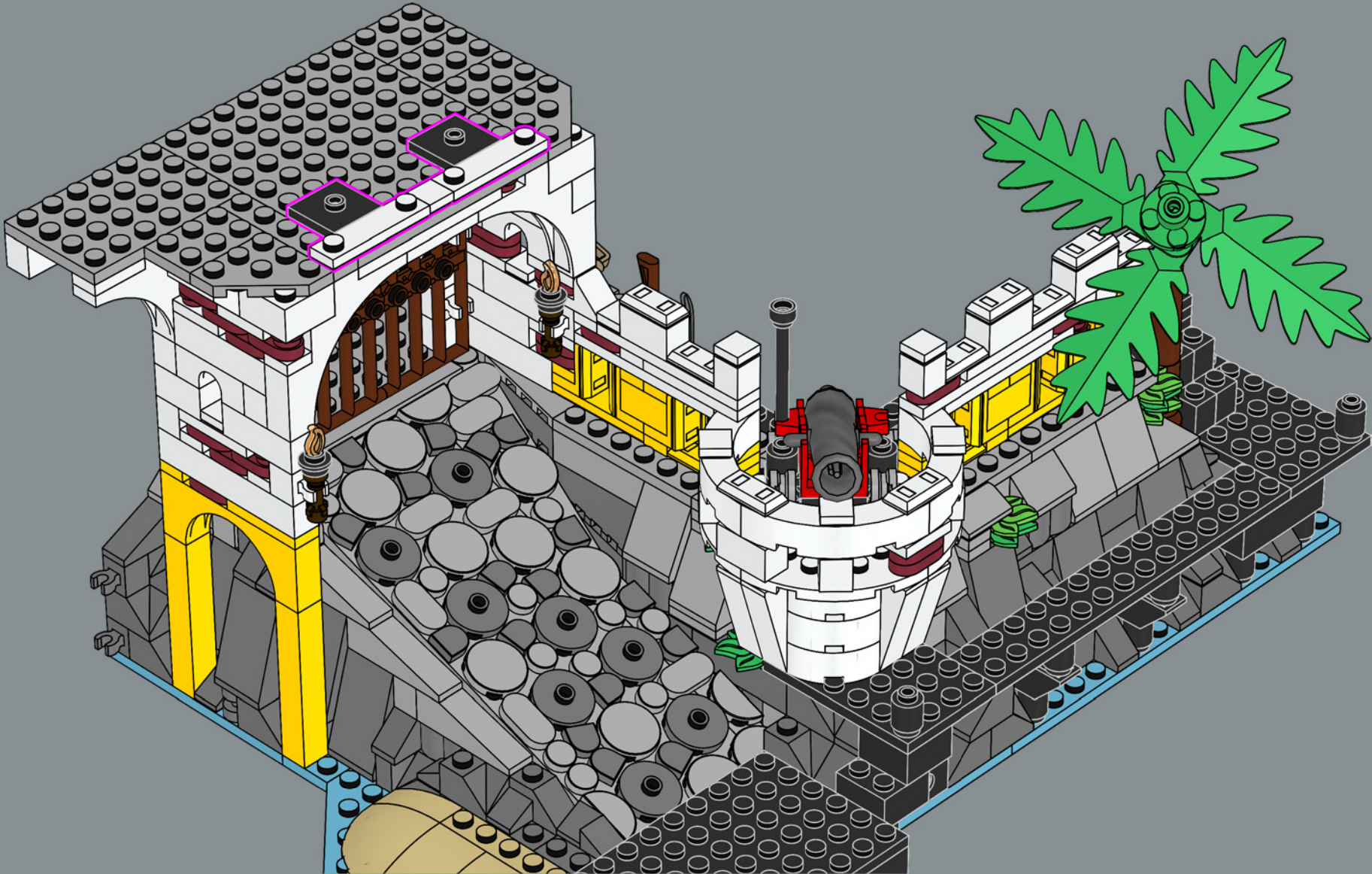

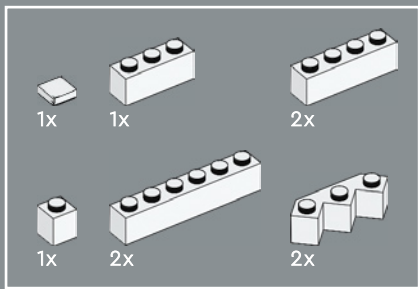

138



1x 5x 1x

139



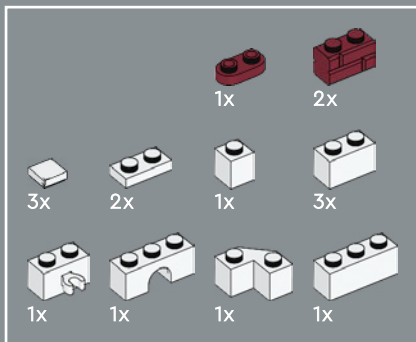

140

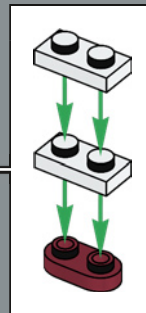

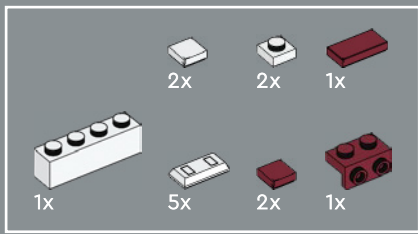

141

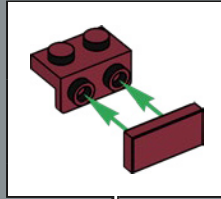



142

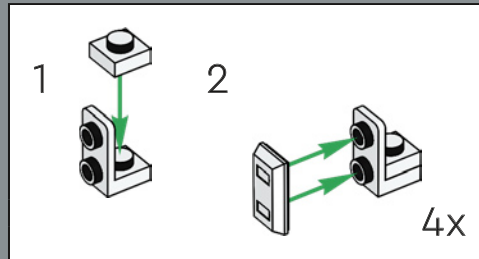



143

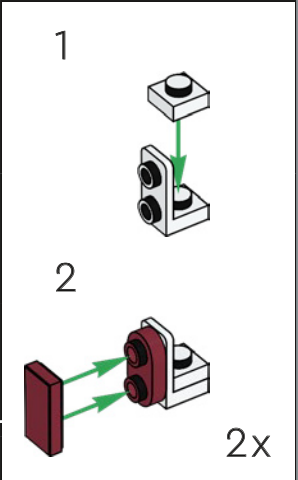

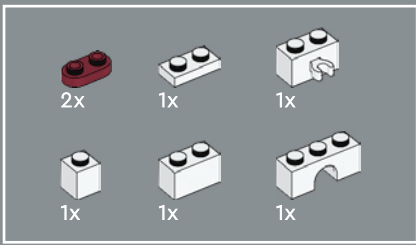

144



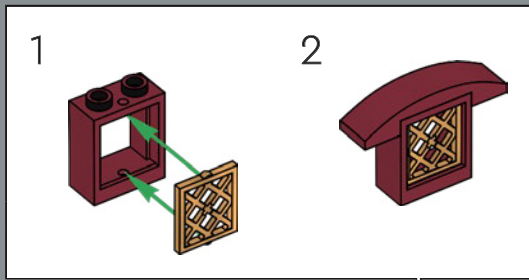
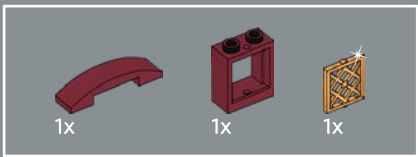

145



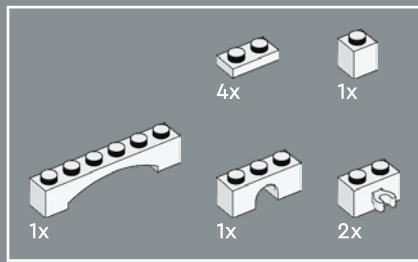

146

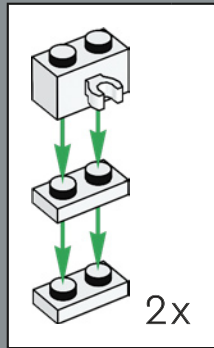

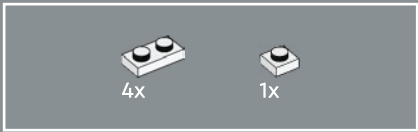

147



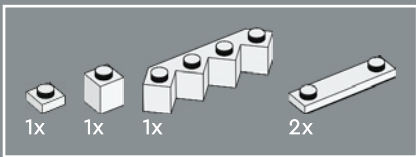

148



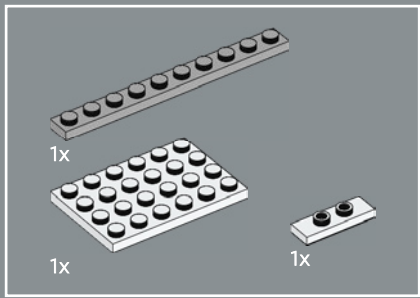

149

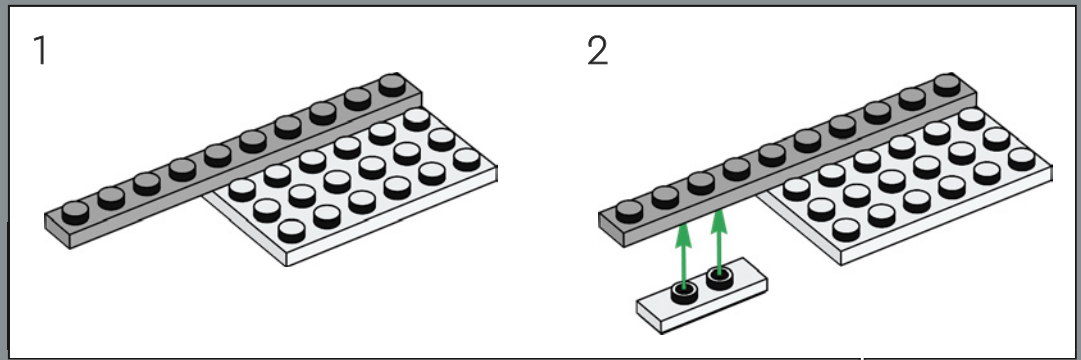

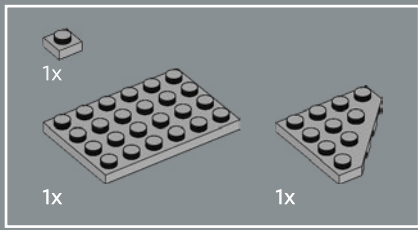

150



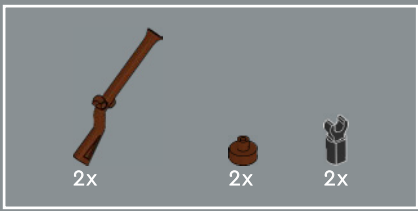

151

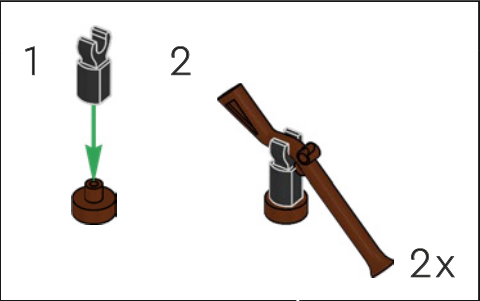

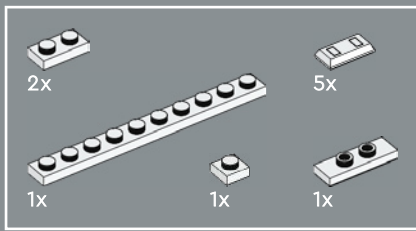

152

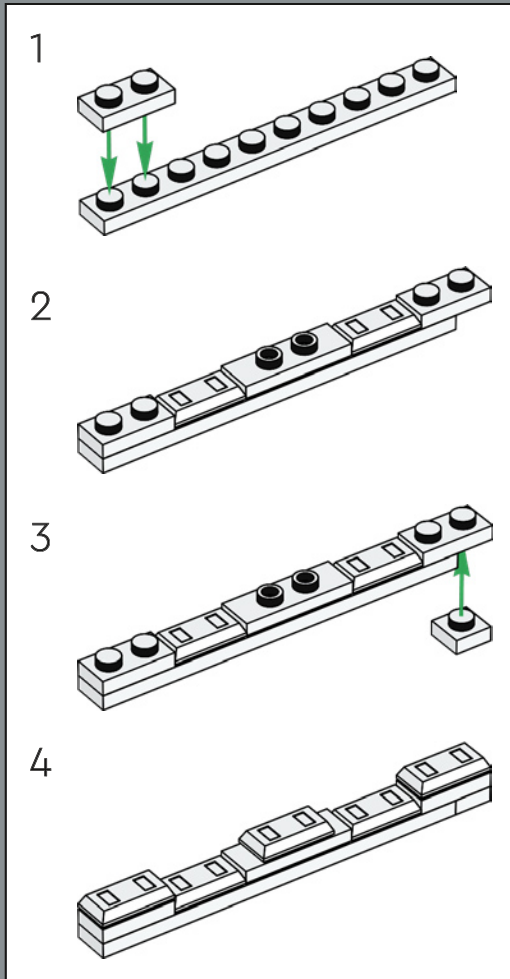

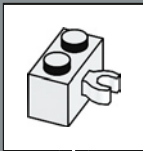
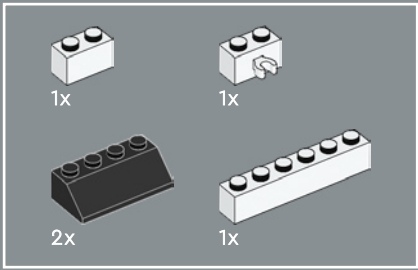

153



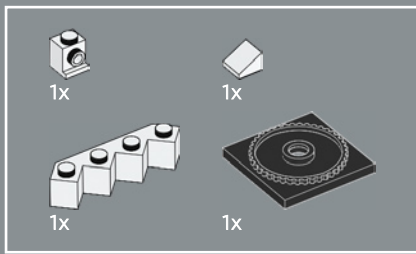

154



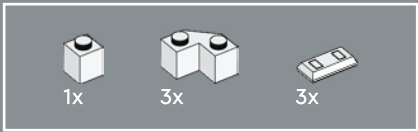

155





156



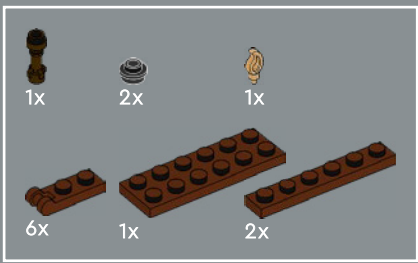

157

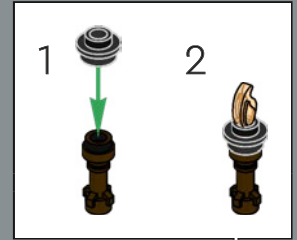
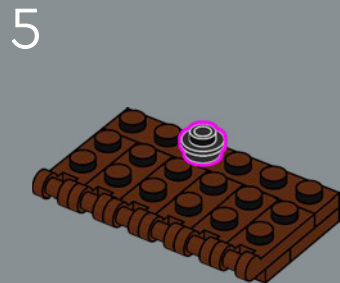
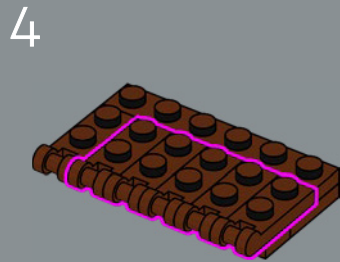
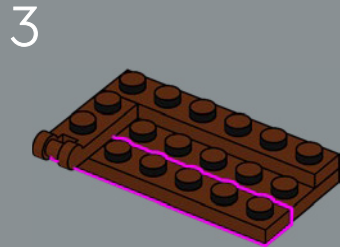
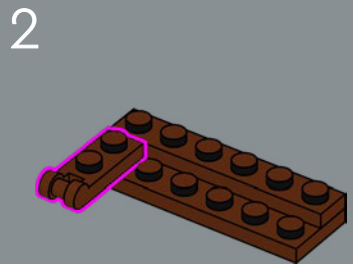
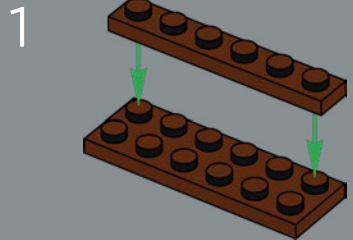



Dans son bureau, le gouverneur conserve ses biens les plus précieux et ses documents importants.

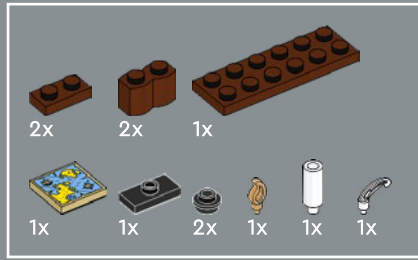

158

1

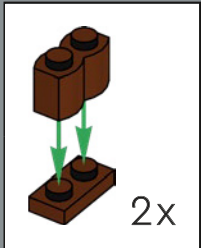
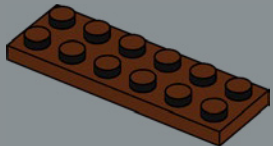

2

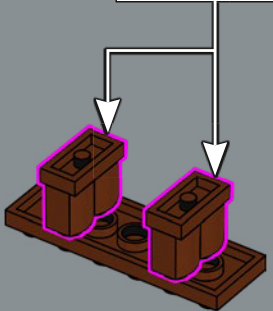

3

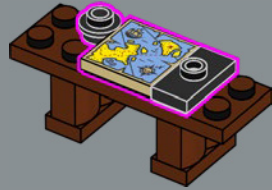

4

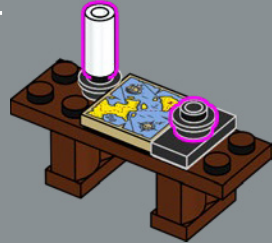

5



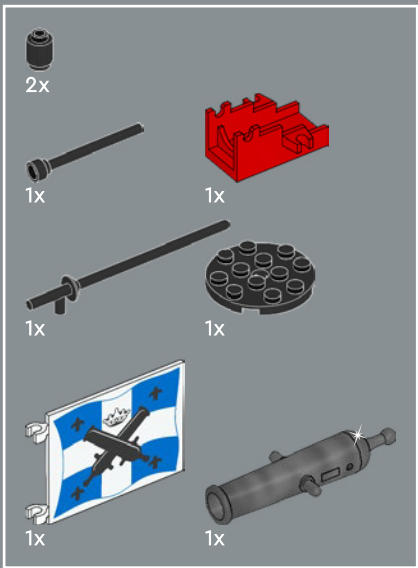

159

1



2

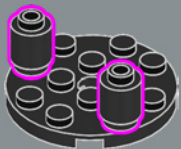

3

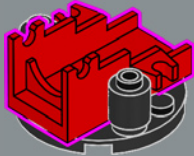

4

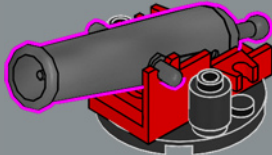

5

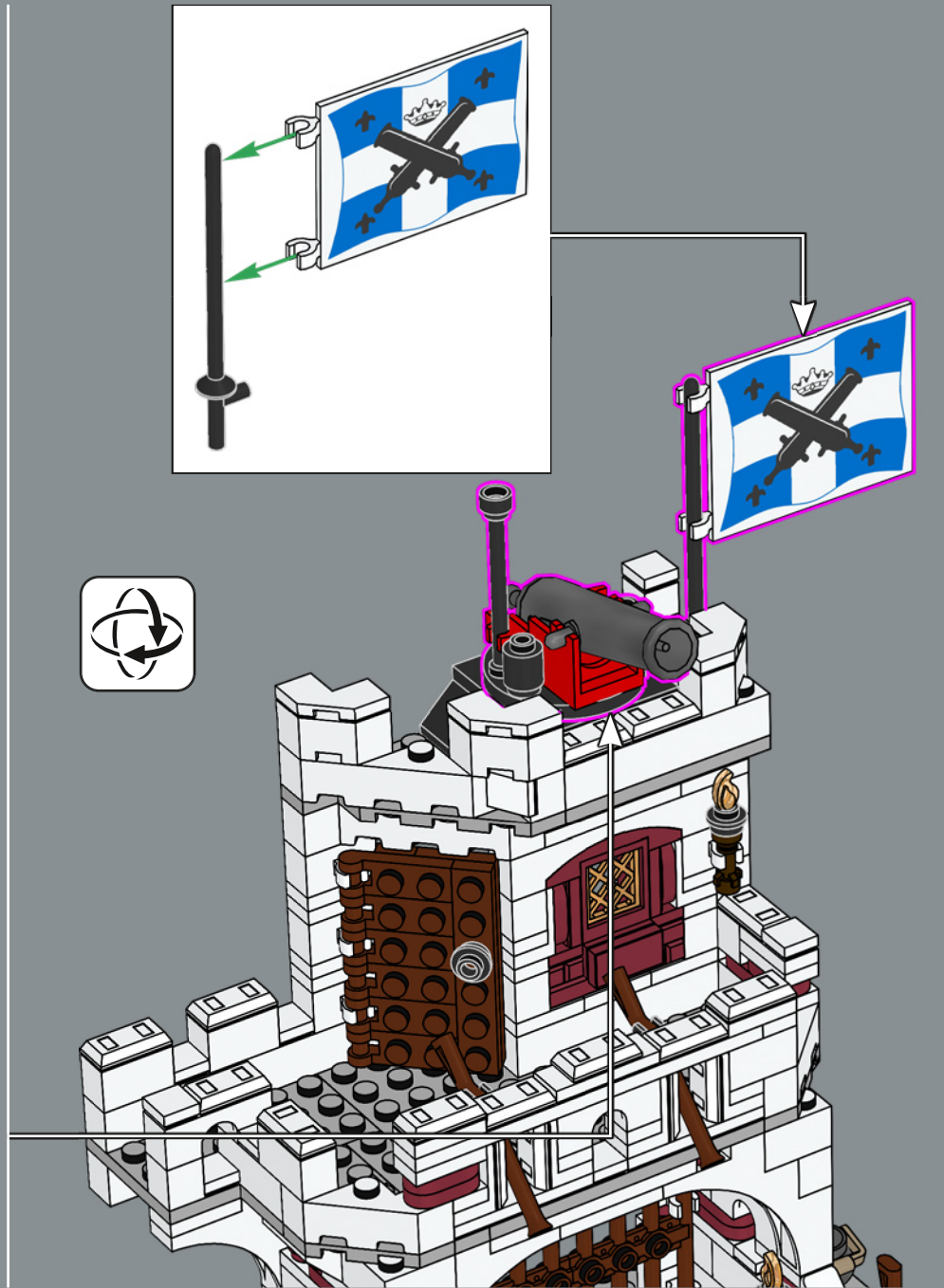
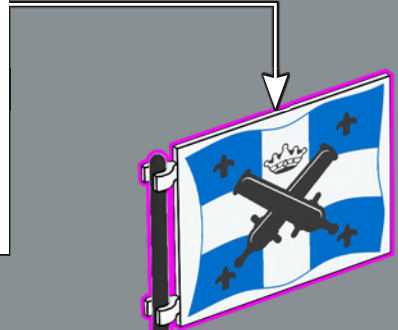
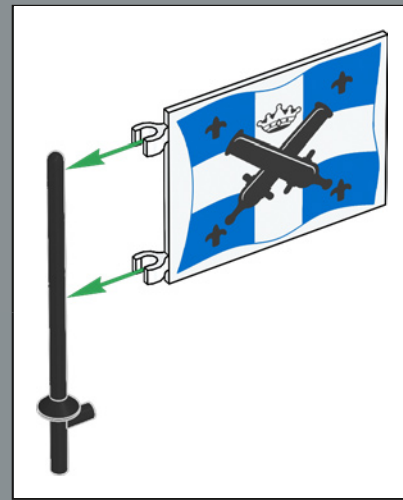
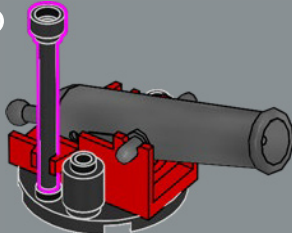





LEGO and the LEGO logo are trademarks of the LEGO Group.
©2023 The LEGO Group.