





PLANTES CARNIVORES

▣ Ces plantes ont élaboré les moyens les plus astucieux d'attirer et de piéger leurs proies. Avec différents types de pièges et d'autres dispositifs curieux, ces créations captivantes apparaissent presque comme des hybrides entre la faune et la flore. Plus de 600 espèces différentes connues peuvent engloutir un véritable buffet d'animaux candides, depuis les insectes et les larves jusqu'aux crustacés et même aux petits mammifères !



DIONÉE ATTRAPE-MOUCHE

Originaires de Caroline du Nord et de Caroline du Sud aux États-Unis.



PETITE ROSÉE

Originaires du sud-est des États-Unis.



**PLANTE TROMPETTE
JAUNE**

Originaires du sud-est des États-Unis.



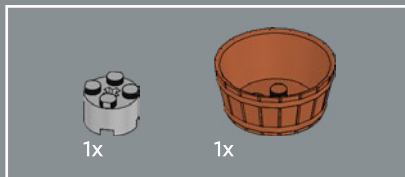

1

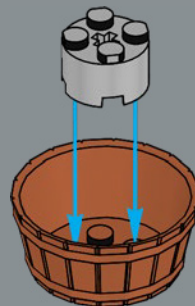

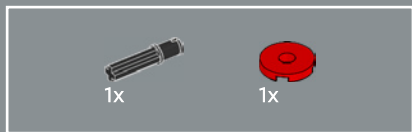

2

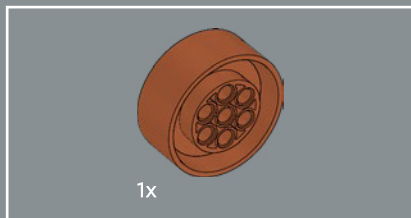
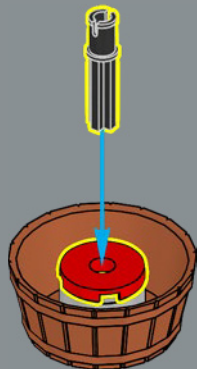

3

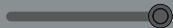
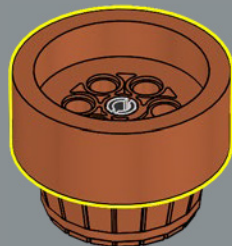



4

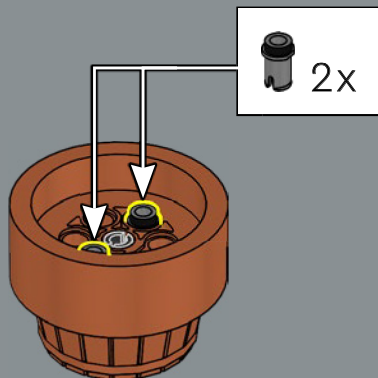

5

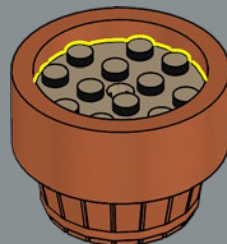

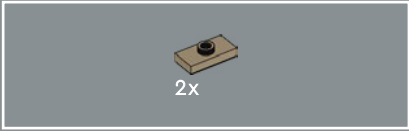

6

La dionée attrape-mouches est dotée de poils capteurs entourant ses deux feuilles qui déclenchent son piège. Lorsqu'un insecte touche les poils, les mâchoires se referment et la proie est capturée à l'intérieur.

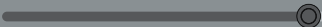
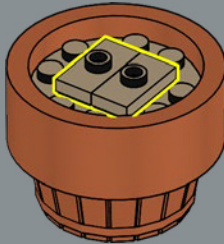



7



8





2x

9

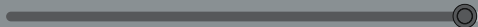

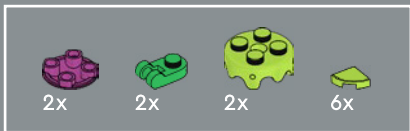

10

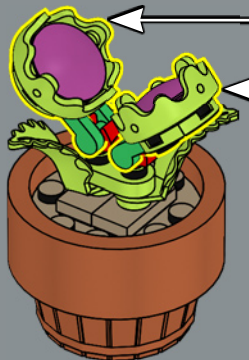
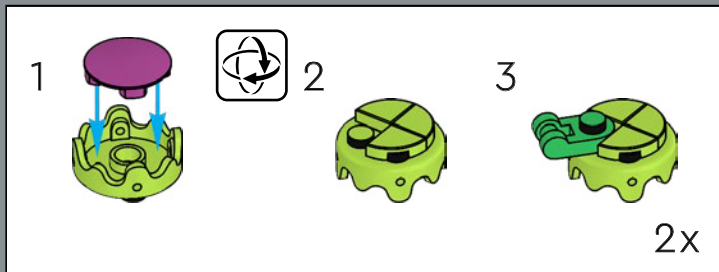

Cet élément utilisé pour les mâchoires de la dionée ne vous rappelle-t-il rien ? L'élément a été conçu à l'origine comme glaçage pour un gâteau. C'est la première fois qu'il est utilisé en vert clair.

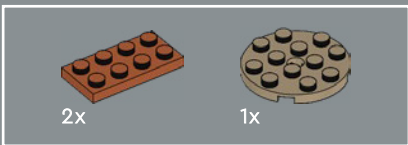
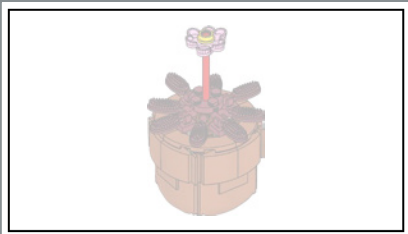

1

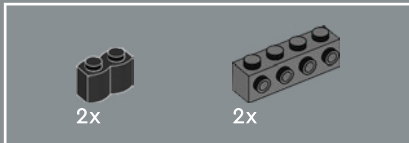
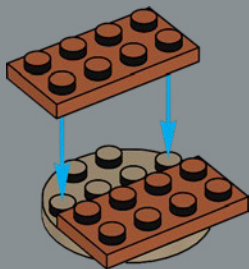

2

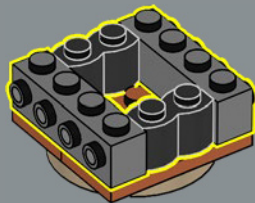

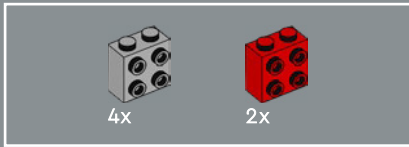

3

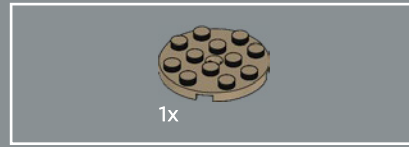
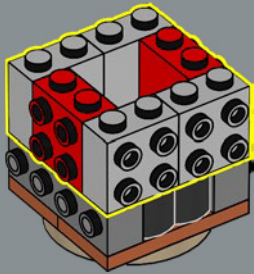

4

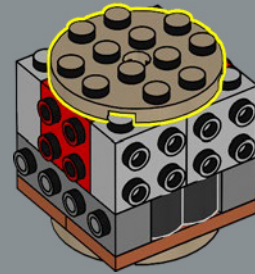

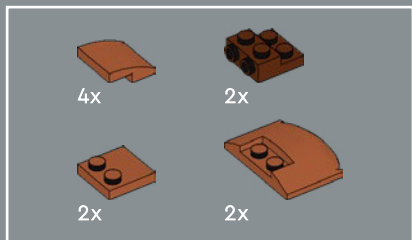

5

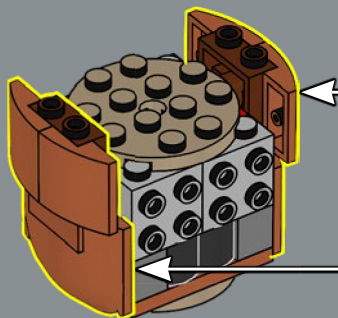
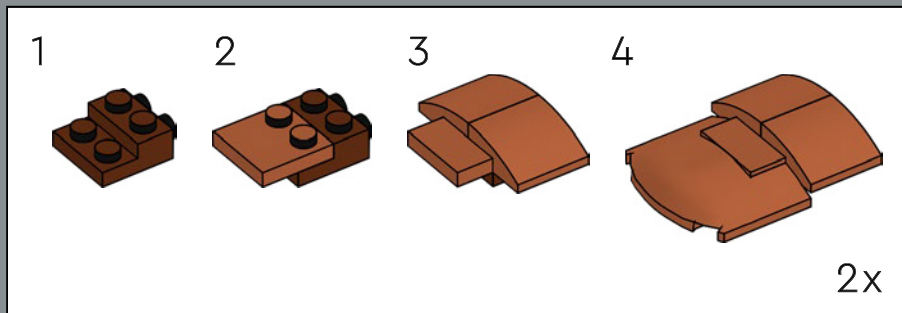

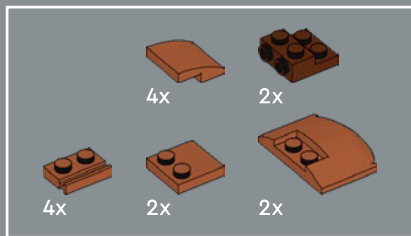

6

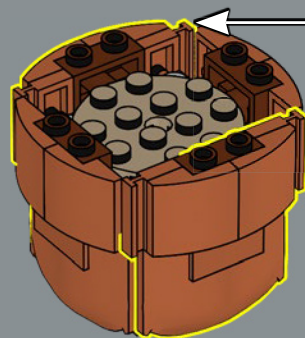
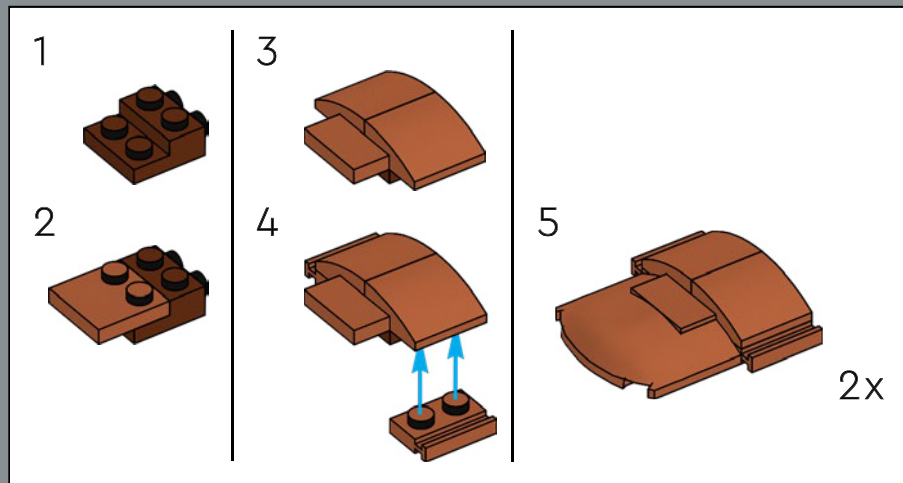

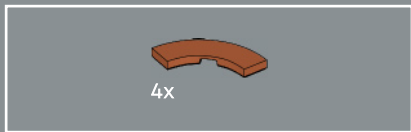

7

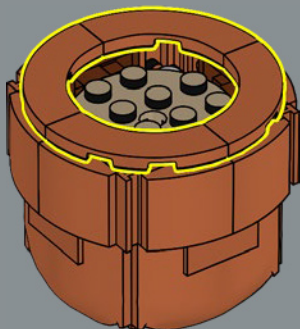

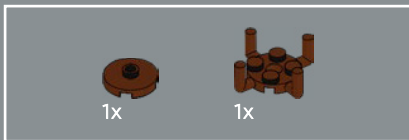

8

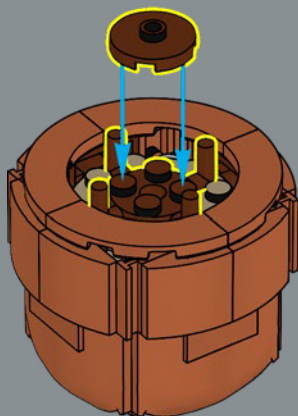

Cette plante carnivore se sert de milliers de minuscules poils, chacun étant muni d'une perle de liquide collant, pour piéger sa proie. Une fois l'insecte collé aux feuilles, celles-ci s'enroulent autour du petit insecte peu méfiant.



1x



1x

9



1x

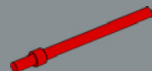

1x

10





11

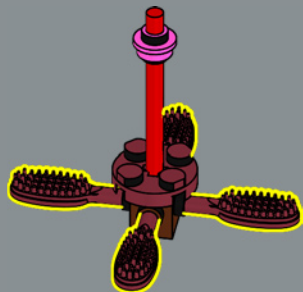

12

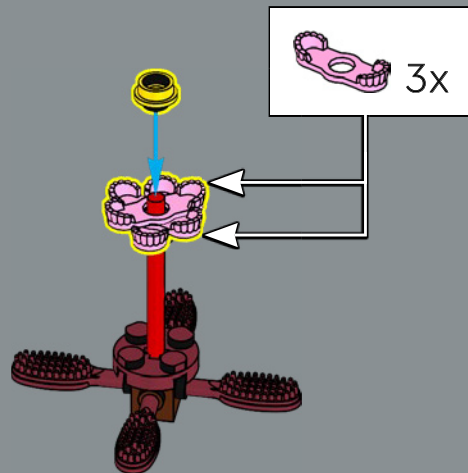

Les épaulettes roses font office de feuilles de la petite rosée, une première dans cette couleur. Si vous avez une minifigurine LEGO® Capitaine Barbe Rouge, vous pouvez la transformer en Capitaine Barbe Rose.

13

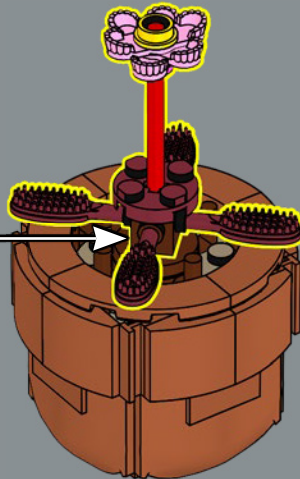

Est-ce bien vrai ? Oui, ce sont bien des petites brosse à cheveux LEGO®.

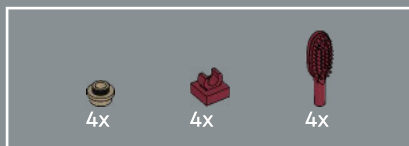

14

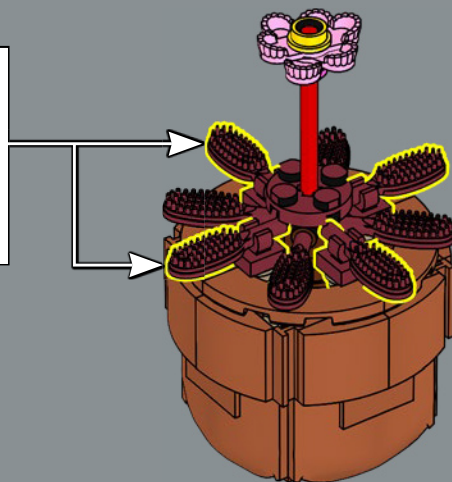
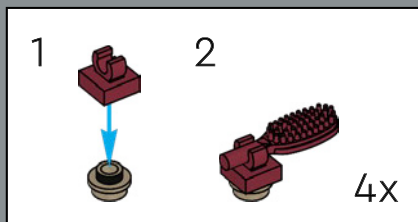

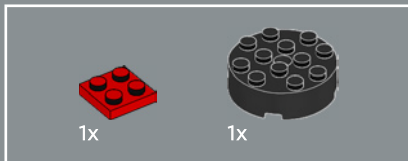
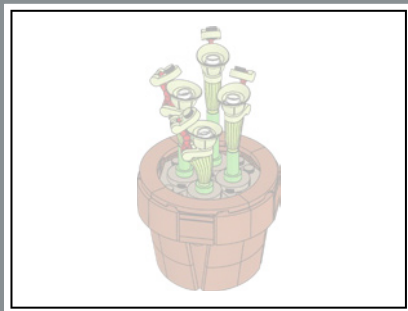

1

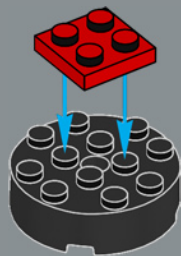



2

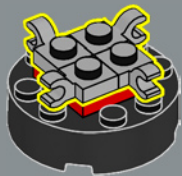

3

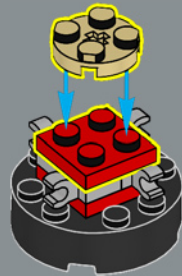

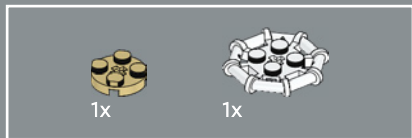

4



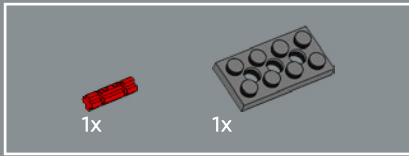

5

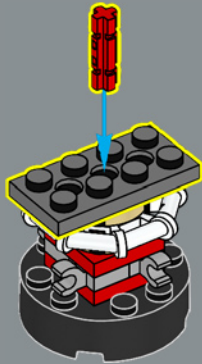

6





7

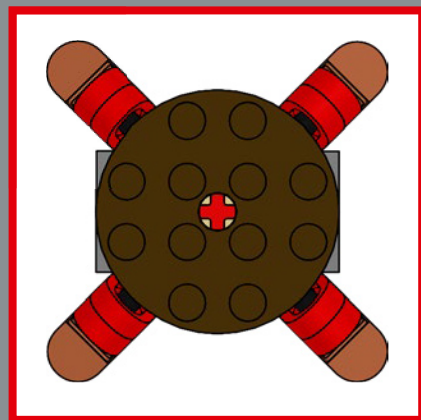
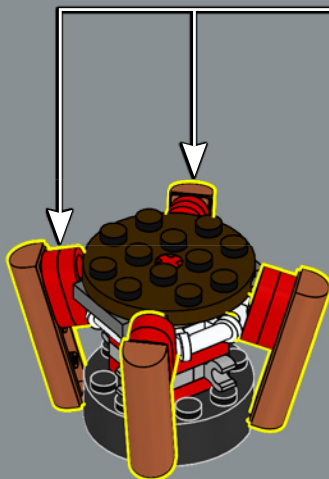
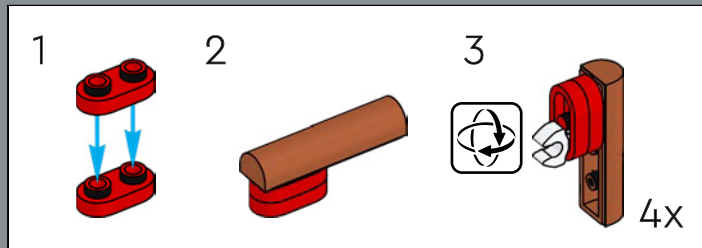

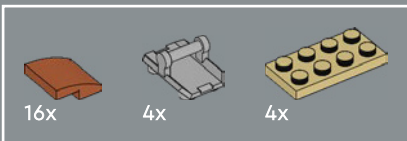

8

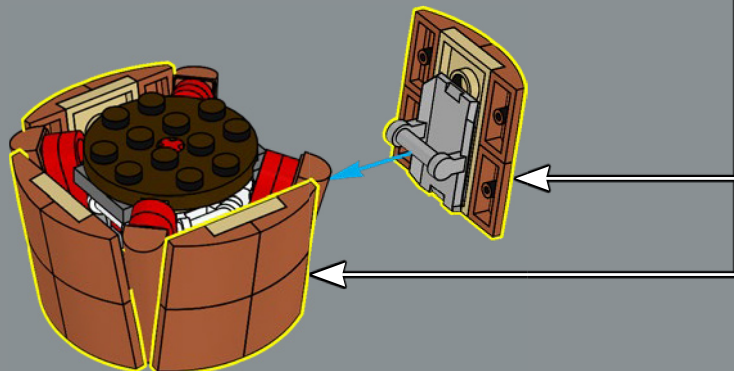
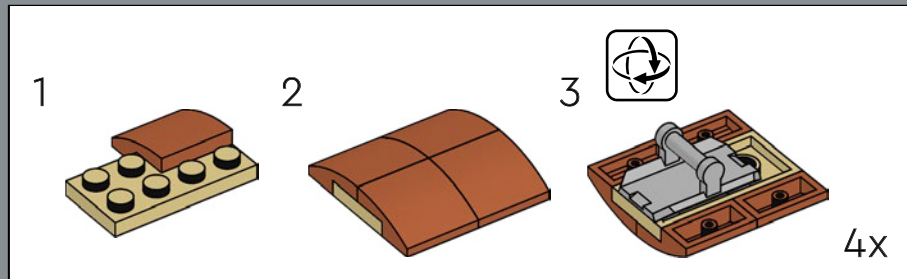

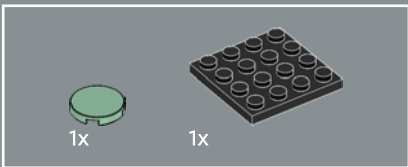
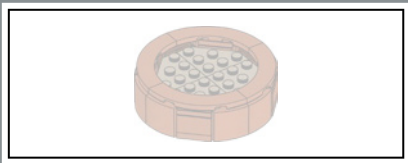

9

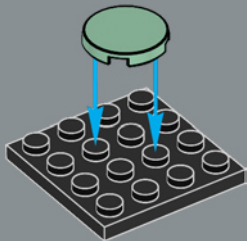



10

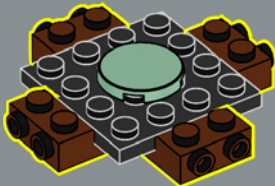

11

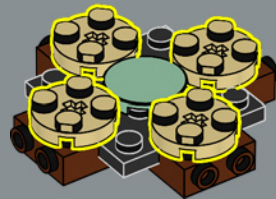



12

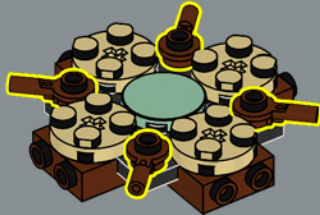

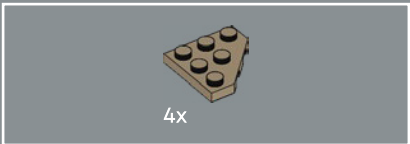

13

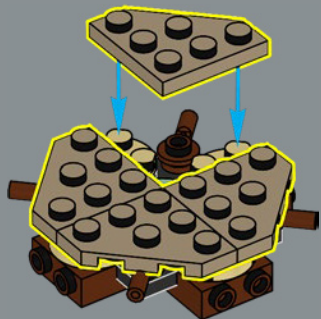



14

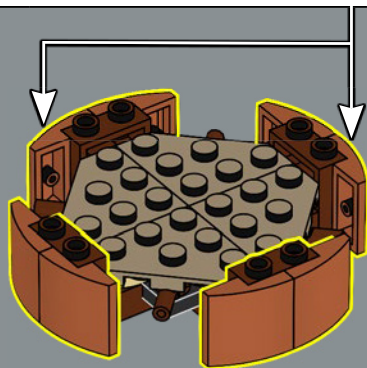
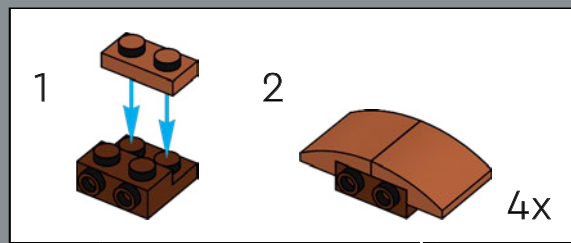



15

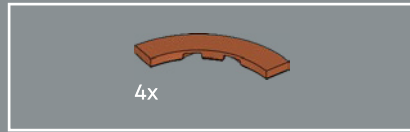
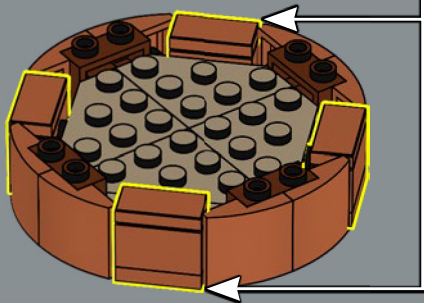
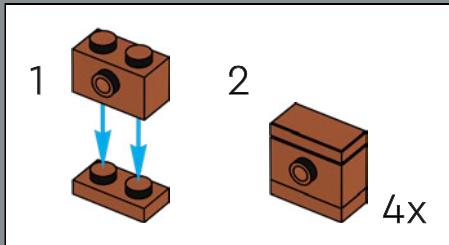

16

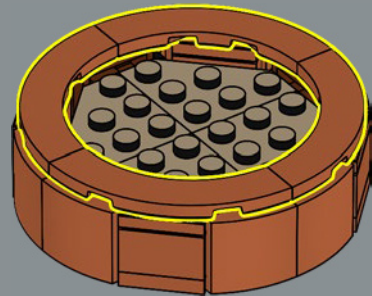

17

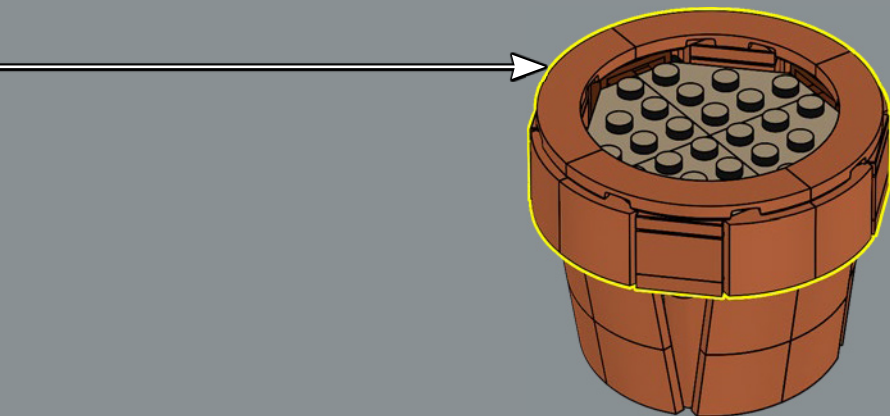

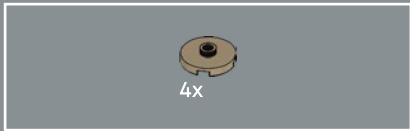

18

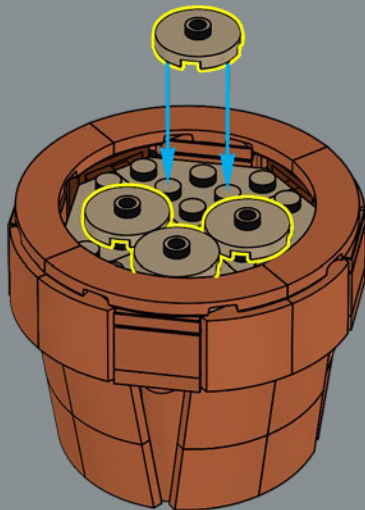



4x

19

Rien de plus rafraîchissant qu'un pichet rempli d'enzymes digestives ! Les coupes de ces plantes sont remplies de sucres digestifs qui décomposent les malheureux insectes qui y tombent.

Pour éviter les déclenchements intempestifs, deux poils capteurs doivent être déclenchés avant que le piège ne se referme.

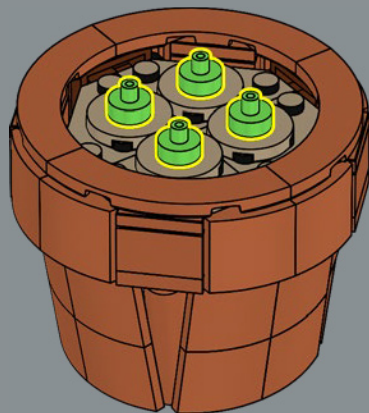



20

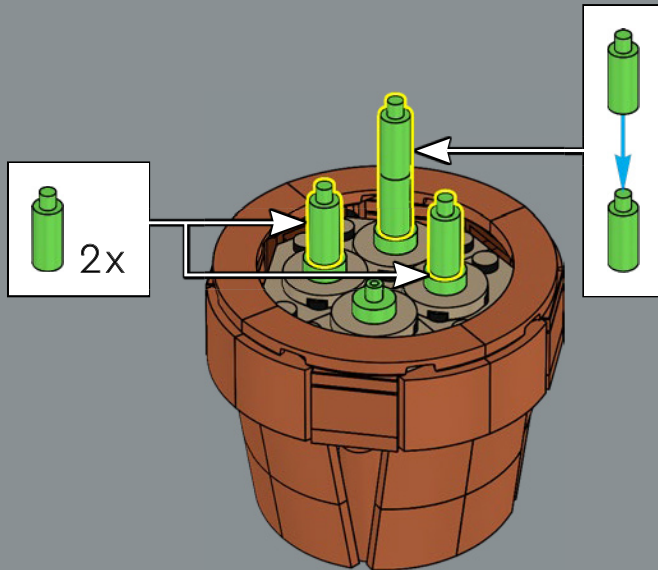



4x



4x



8x



4x



4x



4x

21

1

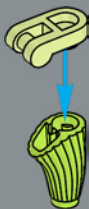

2



3



4



4x

Alerte éléments intéressante : ces plantes trompette sont dotées d'un casque d'explorateur vert printemps vif pour l'ouverture de la trompette et d'une tête à balai vert clair pour la tige.

Étonnamment, la feuille qui pousse au-dessus de la trompette ne peut pas bouger ni sceller la plante. En revanche, elle empêche la pluie de pénétrer et de diluer le liquide que la plante contient.

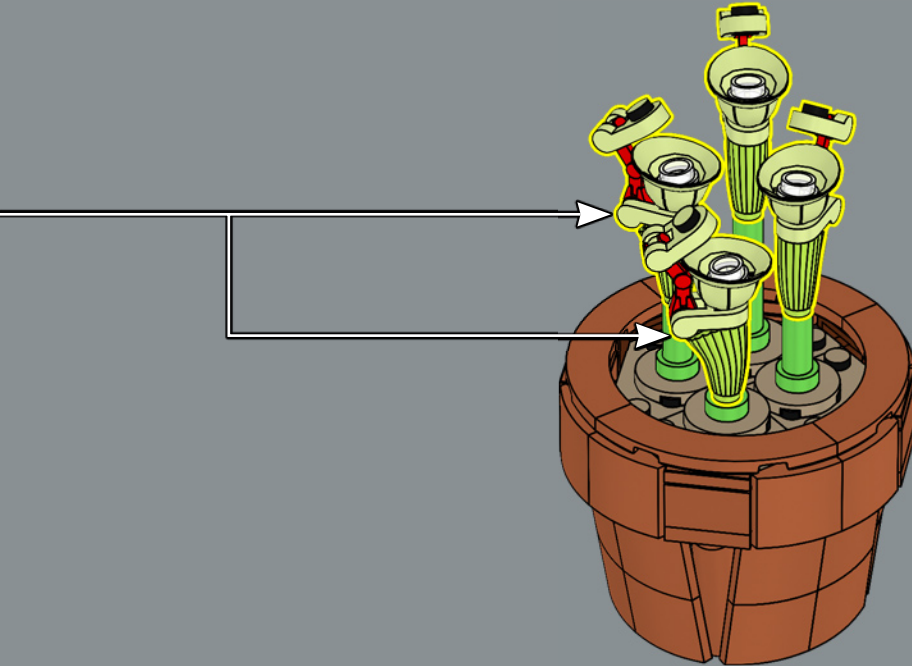



LEGO and the LEGO logo are trademarks of the LEGO Group. ©2024 The LEGO Group. 6494682