



building
bigger
thinking™



WARNING: CHOKING HAZARD.
Toy contains small parts and a small ball.
Not for children under 3 years.

10404

LEGO

building
bigge
thinking™



Did you know your
imagination is bigger
than a grown-up?

Savais-tu que ton
imagination est plus grande
que celle des adultes ?

¿Sabías que tienes más
imaginación que los
adultos?

it's true! you can

think of anything...

all you need to do is **build it**

c'est vrai !

tu peux **imaginer tout ce que tu veux...**

et t'amuser à **le construire**

¡es cierto!

puedes **imaginar cualquier cosa...**

lo único que tienes que hacer es **construir**



For **60 years**
LEGO® bricks have
inspired **creativity**

Depuis **60 ans**,
les briques LEGO®
stimulent la **créativité**

Los bricks LEGO®
llevan más de **60**
años fomentando la
creatividad

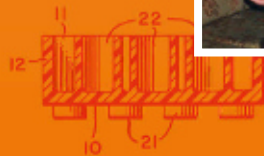



This box is
designed to inspire
bigger thinking in
generations to come

Cette boîte est
conçue pour inspirer les
générations futures à
voir plus grand

Esta caja está
diseñada para inspirar
a las próximas
generaciones a
pensar en grande

Easy Building
Construction facile
Construcción fácil

Medium Building
Construction intermédiaire
Construcción intermedia

Advanced Building
Construction avancée
Construcción avanzada

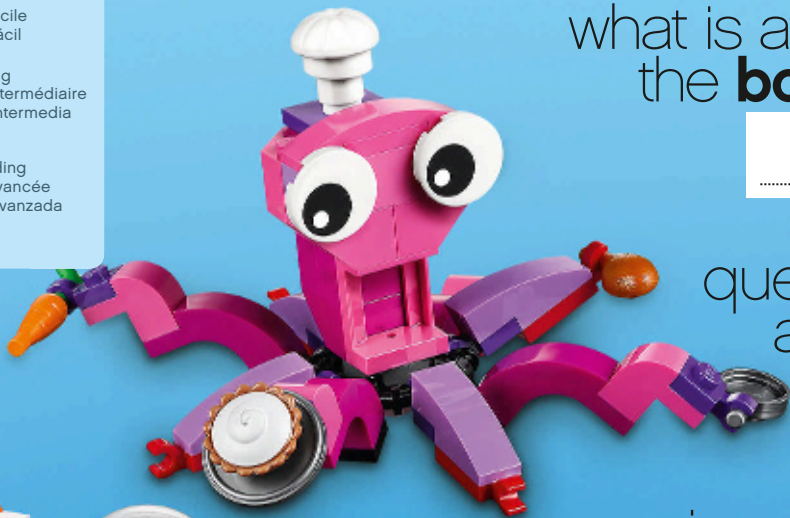

what is at
the **bottom** of the

?

que trouve-t-on
au **fond** de

?



Page/Página **16**

¿qué hay en
el **fondo** de

?



Page/Página **28**

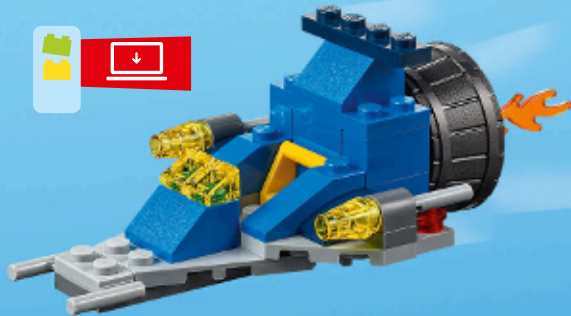

Page/Página 44



Page/Página 8

 [LEGO.com/biggerthinking](https://www.lego.com/biggerthinking)



AVERTISSEMENT : RISQUE D'ÉTOUFFEMENT.
Le jouet contient des petites pièces ainsi qu'une petite boule.
Il ne convient pas aux enfants de moins de 3 ans.



ADVERTENCIA: PELIGRO DE ASFIXIA.
Juguete que contiene partes pequeñas y una pelota pequeña.
No recomendado para niños menores de 3 años.

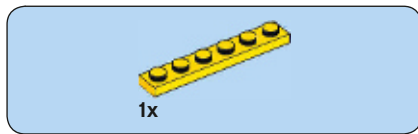

1

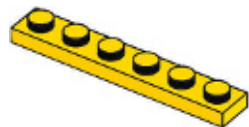



1x

2

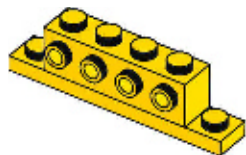

2x



1x

3

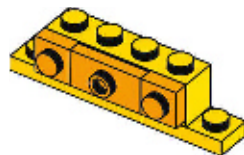



3x

4

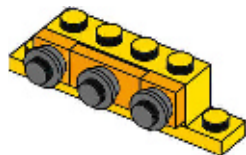



3x

5

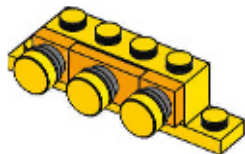

2x

6

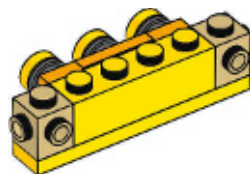
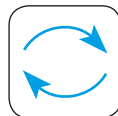

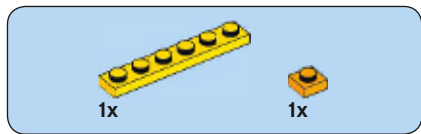

7

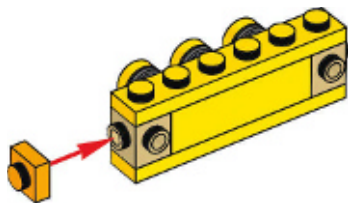

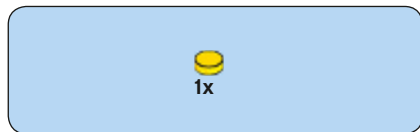

8

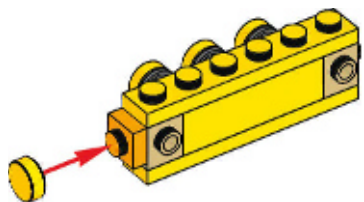

9

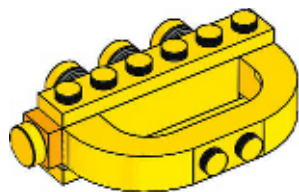



10

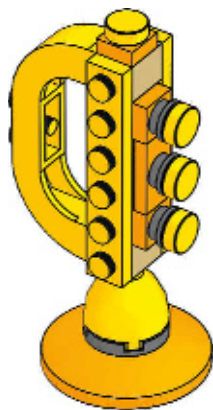
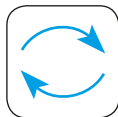

which

.....

is playing
the **trumpet?**



quels

.....

jouent de la
trompette ?



¿qué

.....

está tocando la
trompeta?



Upload your build at / Télécharge ta construction sur / Carga tu modelo en





1x



1x

1

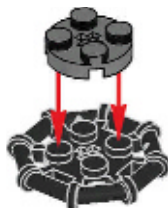
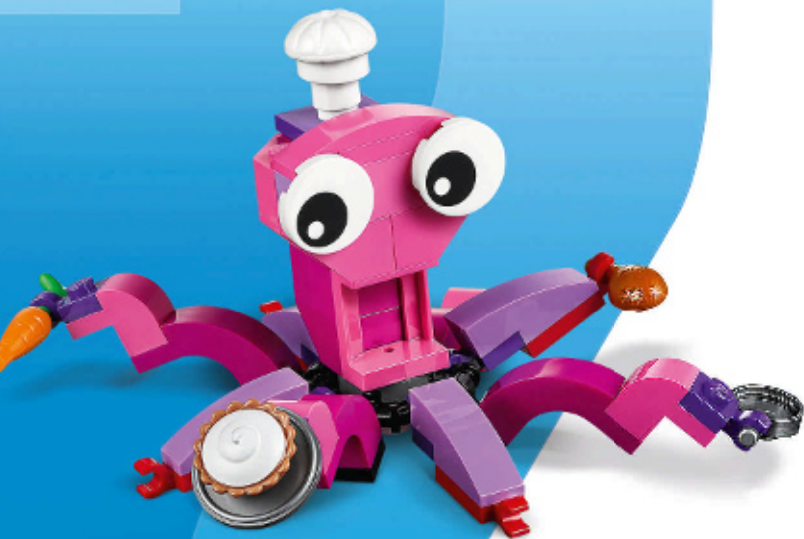

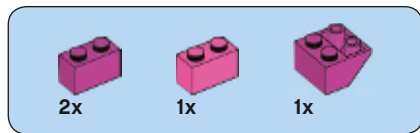

2

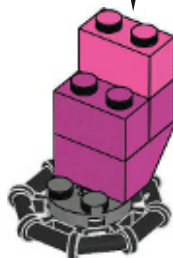
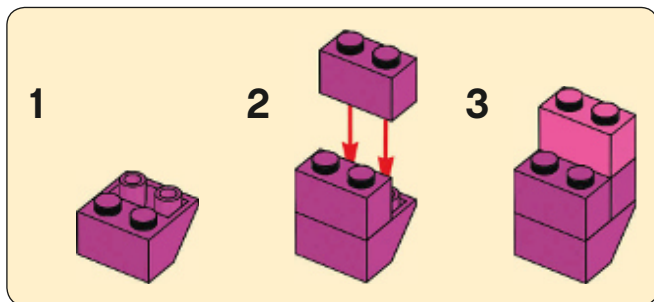



1x

3





4x

4

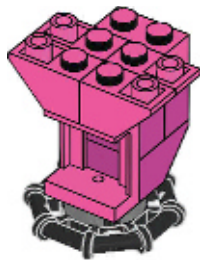

1x

5

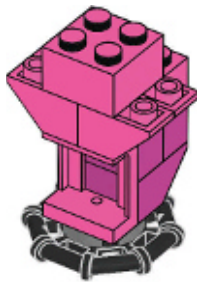



2x

6

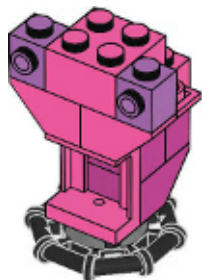



2x

7

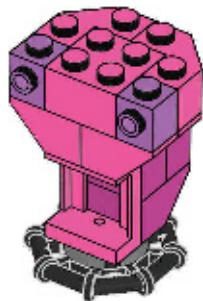

1x



1x

8

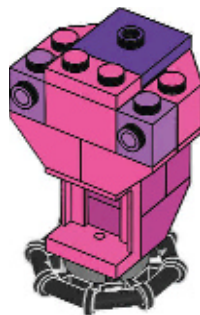



2x



1x

9

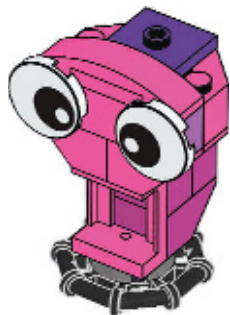

1x

10

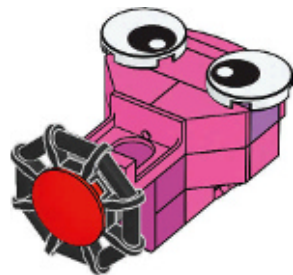
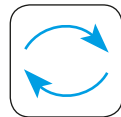

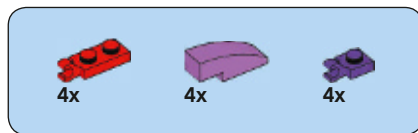

11

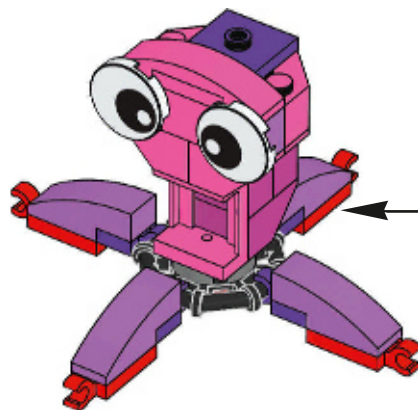
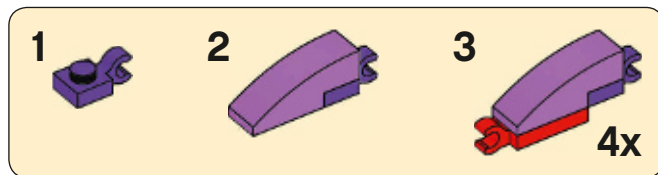
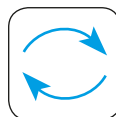

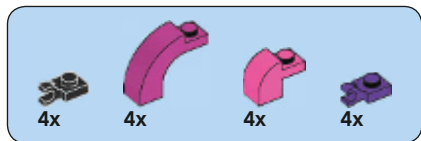

12

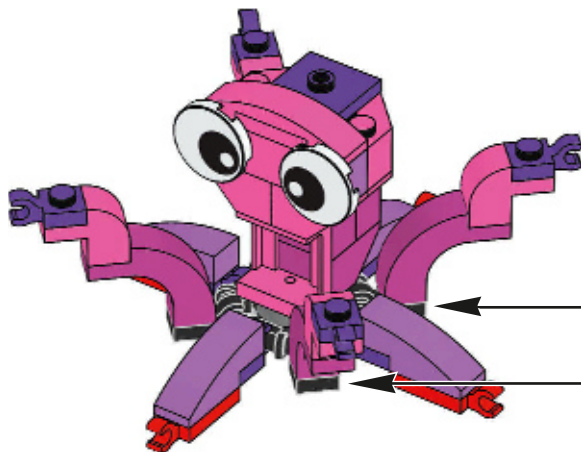
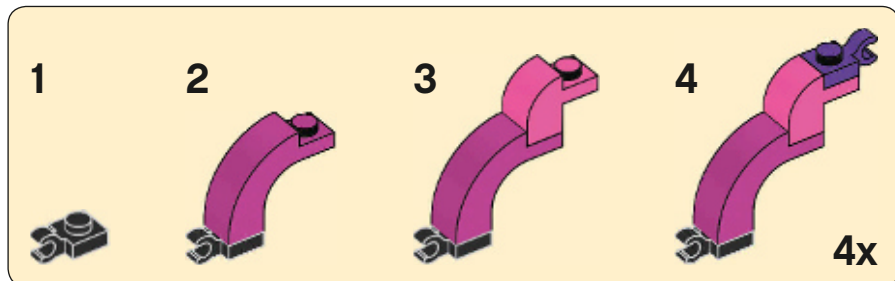



1x



1x

13

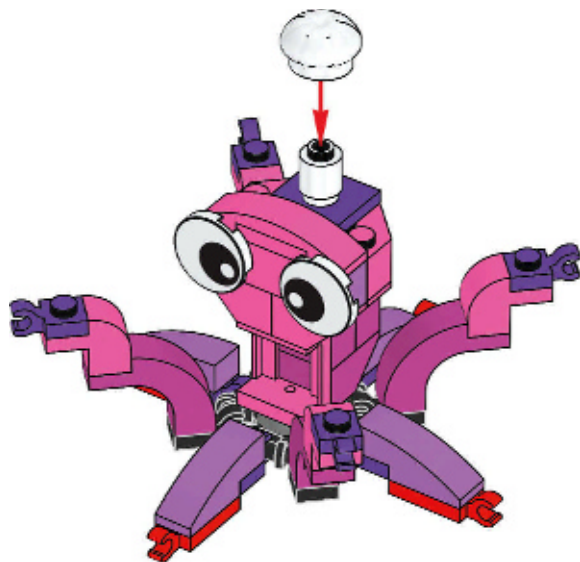

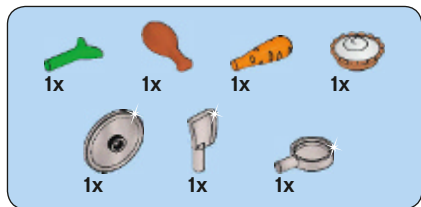

14

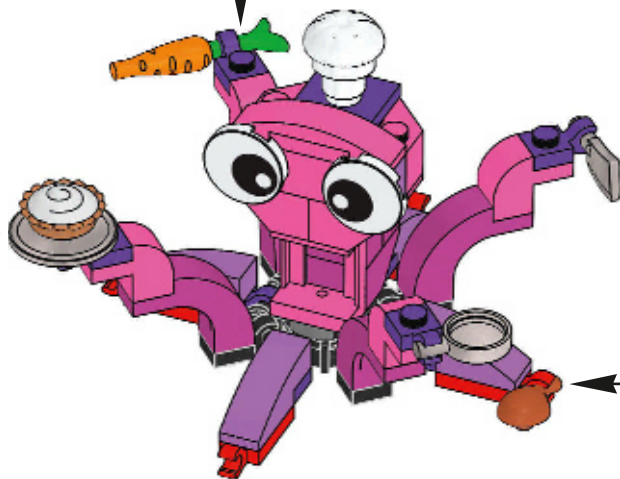
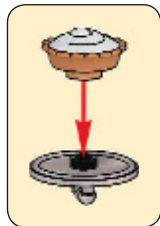
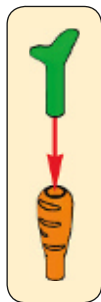

who is the

.....



running away
from?

que fuit

..... ?



¿de qué
está huyendo

..... ?

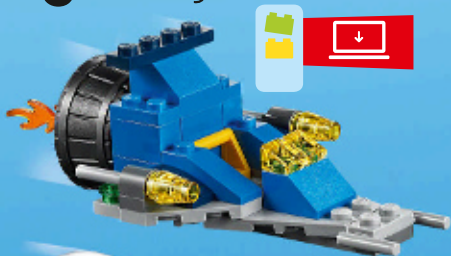

Upload your build at / Télécharge ta construction sur / Carga tu modelo en



LEGO.com/biggerthinking



1



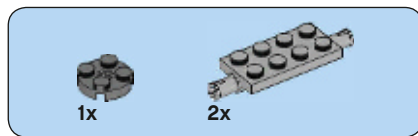

2

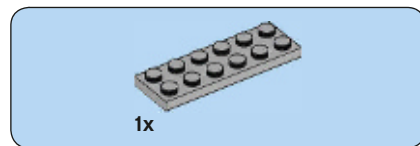
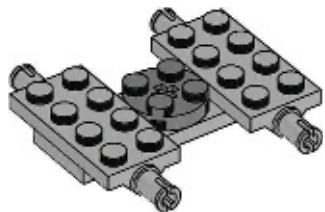

3

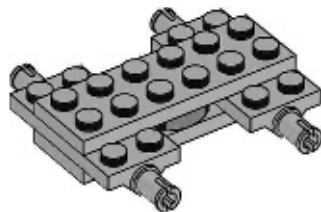



4

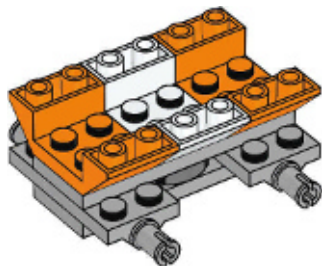

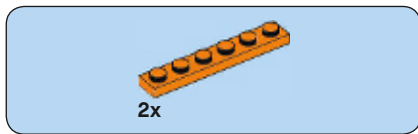

5

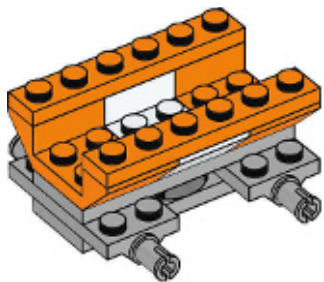

6

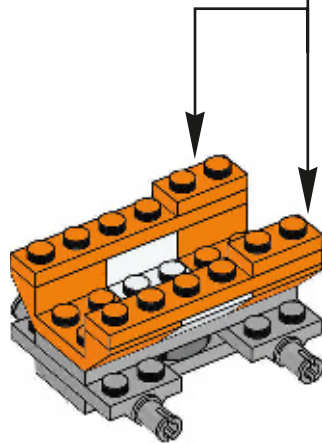
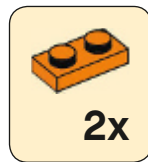



7

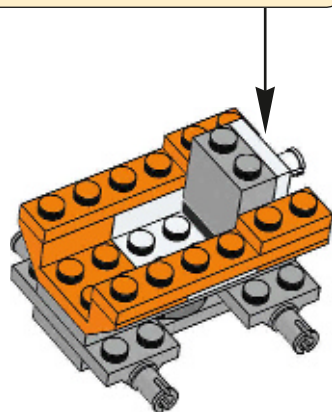
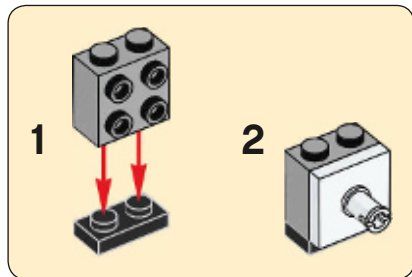



4x

8

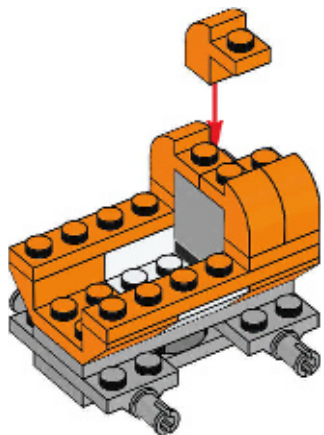

1x

9

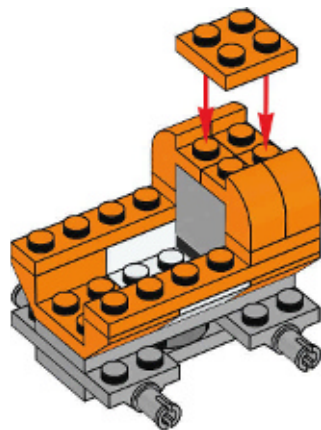



2x



1x

10

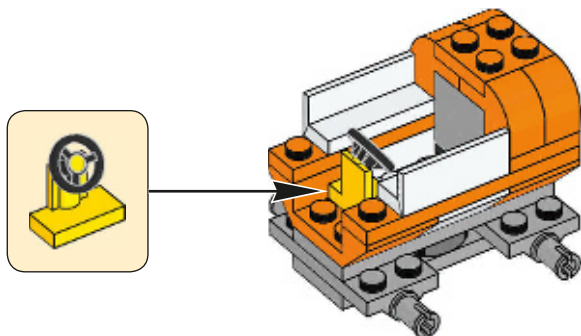



1x

11

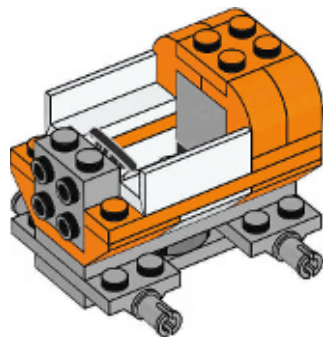

2x

12

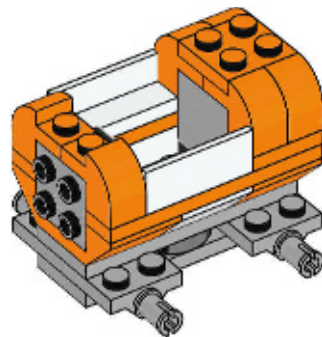



2x

13

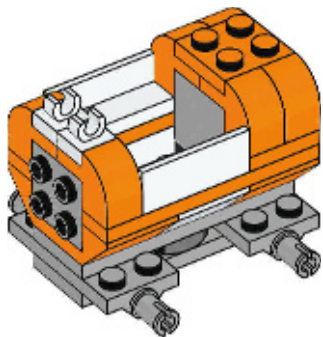

1x

14

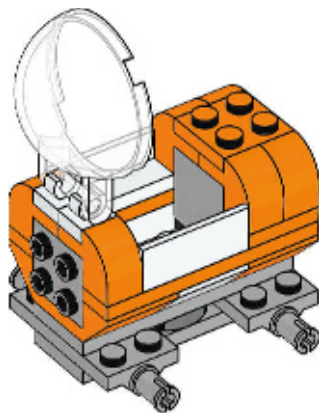



15

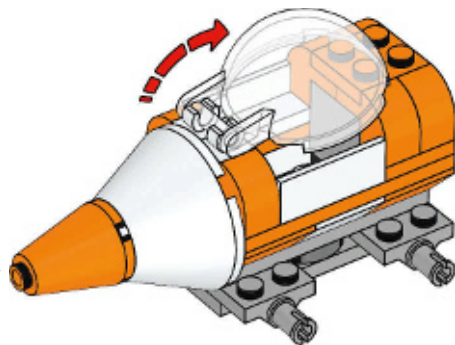
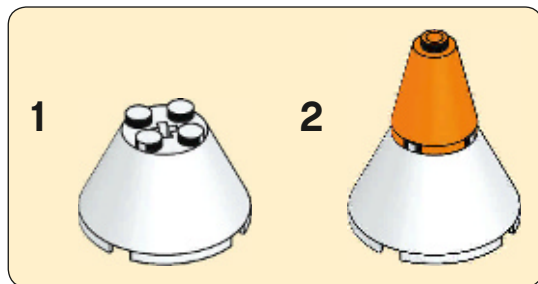



1x

16





1x

17



4x

18





4x

19



40



1x



1x

20

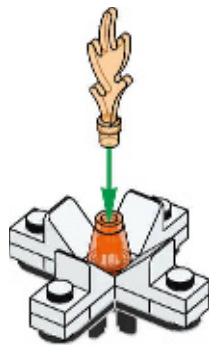



4x



4x

21

1



2



4x

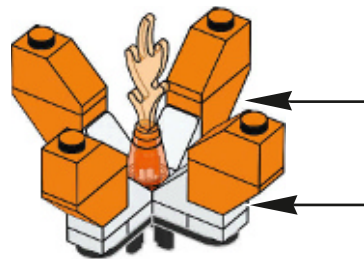

22

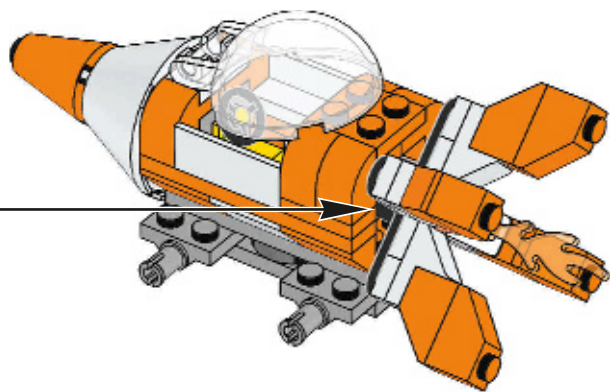



23

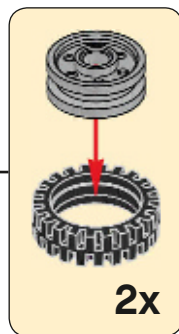
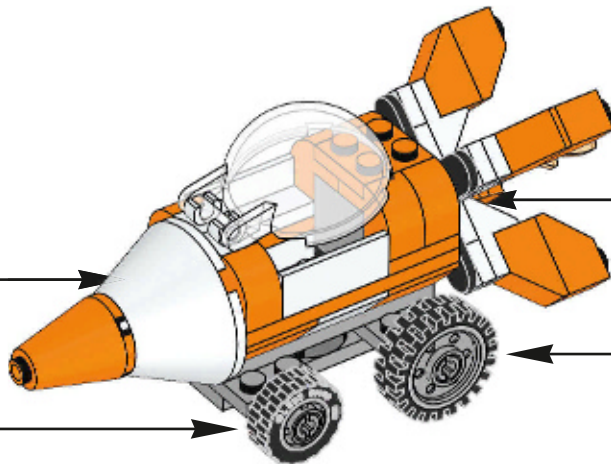
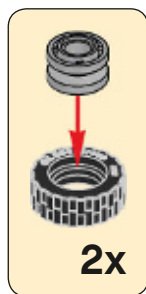



1x

1





1x

2



1x

3





1x

4



2x

5



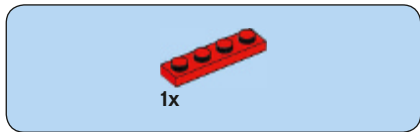

6



7

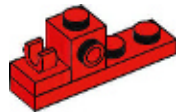



2x

8

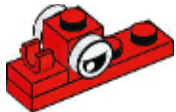

1x

9



10



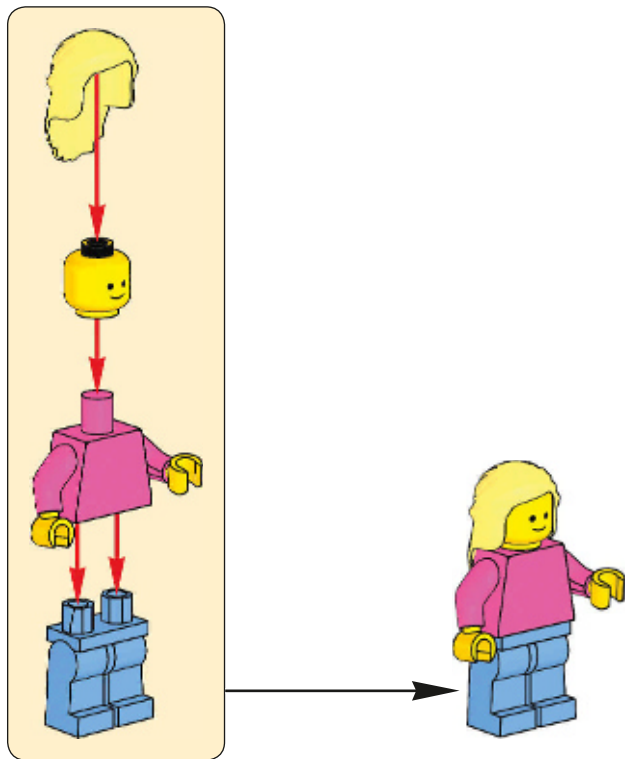

what is the

.....



protecting?

que protège

.....



¿qué protege

.....



Upload your build at / Télécharge ta construction sur / Carga tu modelo en



 LEGO.com/biggerthinking

LEGO Friends











































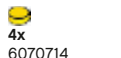











































LEGO CLASSIC



LEGO CITY



 4x 306201	 2x 6099412	 2x 4162465	 2x 4278275		 4x 300123	 4x 302324	 2x 6234162	 1x 452226
 2x 6097402	 1x 6108662	 2x 4598467	 1x 9342	 1x 303221	 2x 366623	 4x 300324	 2x 4181143	 1x 400626
 4x 6099548	 1x 6218943	 2x 4113233	 4x 300421	 4x 300523	 2x 366623	 2x 4247771	 2x 4181143	 1x 6018805
 4x 302401	 1x 6218943	 2x 4113233	 4x 4534648	 4x 614323	 1x 4275815	 2x 4247771	 1x 6231761	 1x 247926
 4x 6054551	 2x 4173943	 2x 6106187	 2x 6160161	 8x 300423	 2x 9336	 2x 366624	 6x 4517925	 1x 6127159
 1x 6174310	 2x 6057517	 2x 6072998	 2x 449521	 1x 6141932	 4x 300524	 4x 301024	 2x 302326	 6x 4107736
 2x 6060734	 4x 6175968	 2x 407021	 1x 389921	 2x 303923	 1x 389924	 2x 4164073	 4x 4617848	 4x 300328
 4x 6069002	 4x 6029889	 2x 6030266	 2x 371021	 4x 428623	 2x 6145704	 2x 300124	 1x 6170814	 4x 303928
 1x 246001	 8x 6148265	 1x 4298617	 4x 300121	 2x 302023	 1x 9553	 2x 300124	 4x 4541455	 4x 4106356
 2x 6139694					 1x 243224			

 4x 6109752	 1x 4613756	 1x 4499885	 1x 6047056	 2x 4159007	 2x 6094069	 4x 4245570	 4x 6102975	 2x 6206249
 2x 6070756	 4x 6125776	 1x 4228126	 4x 4504371	 4x 4153826	 2x 6172932	 2x 6055241	 2x 6055086	 2x 6000066
 4x 6036238	 8x 4623598	 4x 4567332	 2x 6062601	 4x 4118827	 4x 4502089	 4x 4609925	 4x 4211190	 4x 4642934
 4x 6154879	 4x 4619514	 4x 4260942	 6x 6112356	 4x 418827	 4x 4504374	 4x 4609925	 4x 4211225	 2x 4520320
 4x 6206150	 1x 4119479	 2x 6124858	 4x 6136553	 4x 418827	 4x 4264569	 2x 4539060	 2x 4538252	 2x 4211429
 1x 4626724	 1x 4529755	 2x 4540865	 4x 4616279	 4x 4177932	 2x 6094143	 2x 4539071	 1x 4597642	 4x 4651063
 1x 6106160	 1x 4278013	 4x 611647	 4x 4177932	 1x 6103249	 4x 6073026	 4x 4262655	 1x 4597642	 4x 6123809
54		 2x 3005748	 4x 4121967	 2x 4279734	 2x 6153589	 4x 4261397	 2x 6044706	 4x 6123809
		 2x 3005748	 4x 4121967	 8x 4164022	 2x 6175295	 4x 4211150	 2x 4211452	 1x 4211748



1x
4258273



1x
4258275



4x
4211387



4x
6044729



4x
4211436



2x
4211363



4x
4211572



2x
4529241



2x
4558953



4x
4211758



2x
4533772



2x
4211357



1x
4599496



2x
4211718



2x
4211464



2x
4211394



2x
4211394



2x
4515351



2x
4211361



2x
6209682



6x
4519195



2x
6172860



4x
6030472



1x
4243668



2x
6122504



4x
6073040



4x
6133823



1x
6003002



2x
6019987



3x
4210633



4x
4211042



2x
6055313



2x
4632574



2x
4211088



2x
4211104



1x
4535833



4x
6057387



4x
4622743



2x
6160819



4x
4621545



4x
6056413



2x
6231517



2x
6212978



2x
4517992



4x
6052345



2x
4520632



4x
6022083



1x
4550924



2x
6126086



4x
4653960



2x
6133818



4x
6052345



8x
6173790



3x
3005741



1x
6160341



2x
4538950



1x
6019608



1x
6197966



1x
6153590



1x
4624615



1x
6037507



1x
6076677



1x
6076604



1x
4611885



2x
4632100



2x
6064049

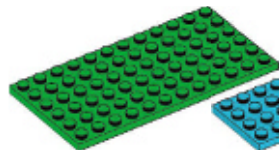

1x
4541414

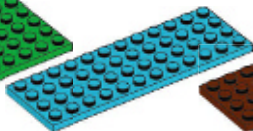

1x
6056270



1x
4271874



2x
303428

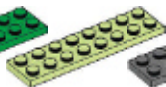

2x
6216968



2x
4210997

Customer Service

Kundenservice

Service Consommateurs

Servicio Al Consumidor

LEGO.com/service or dial



: 00800 5346 5555

: 1-800-422-5346

WIN

GO TO WWW.LEGO.COM/PRODUCTFEEDBACK AND
GIVE US YOUR SHORT **FEEDBACK** ABOUT THIS
LEGO® SET FOR A CHANCE TO WIN
A COOL LEGO PRIZE.

Terms & Conditions apply

LEGO.com/productfeedback



GEWINNE

Erzähle uns auf
www.LEGO.com/productfeedback

etwas über die Erfahrungen, die du mit
diesem LEGO® Set gemacht hast, und
sichere dir die Chance auf einen coolen
LEGO Preis!

Es gelten die Teilnahmebedingungen

GAGNE

Rends-toi sur
www.LEGO.com/productfeedback

et donne-nous quelques commentaires sur
ce produit LEGO® pour avoir une chance
de gagner un prix LEGO !

Voir Conditions Générales

GANAN

Visita
www.LEGO.com/productfeedback

y envíanos tu opinión acerca de este set
LEGO®. ¡Participarás en el sorteo de un
premio LEGO!

Términos y Condiciones aplicables

获取奖品

登录
www.LEGO.com/productfeedback

给出关于此乐高®套装的简短反馈，
就有机会获得炫酷乐高奖品

《条款及条件》适用