

10497

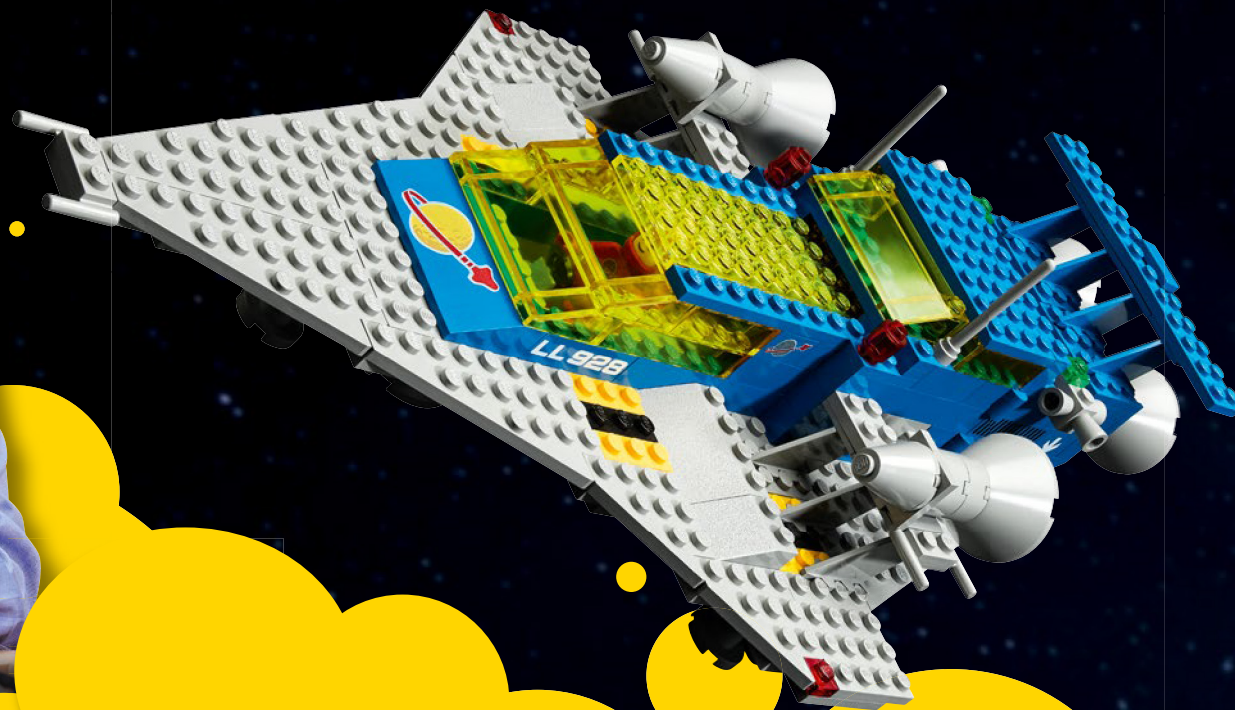



Kjeld Kirk Kristiansen è il nipote del fondatore del LEGO Group, Ole Kirk Kristiansen, ed era alla guida dell'azienda quando la serie Spazio fu lanciata nel 1979.



MESSAGGIO DI KJELD

Tra la fine degli anni '50 e l'inizio degli anni '60, quando ero ragazzo, ero molto interessato alla cosiddetta "Corsa allo spazio" e costruii una base missilistica ispirata al Centro spaziale statunitense di Cape Canaveral. Quando fu lanciato nel 1979, il set Galaxy Explorer diventò rapidamente uno dei miei preferiti. Mi piaceva in particolare lo scomparto nascosto nella parte posteriore, dove si trovava il buggy lunare: era una caratteristica attraente, quasi segreta. E poi, ovviamente, c'erano gli astronauti LEGO®! Questo modello per il 90° anniversario mi riporta alla mente ricordi felici e trasporta davvero il *Galaxy Explorer* nel 21° secolo.

Kjeld Kirk Kristiansen

UN CLASSICO RIVISITATO

Nell'ambito delle celebrazioni per il 90° anniversario del Gruppo LEGO®, abbiamo scelto di rivisitare uno dei più famosi set spaziali LEGO mai lanciati. Riportare in vita un modello molto amato dal passato richiede sempre un'attenta considerazione, ma il nostro obiettivo era creare una versione più grande e dettagliata del *Galaxy Explorer*, pur rendendo omaggio a tutti gli aspetti magici del modello originale. Mi auguro che vi divertirete a costruire questa nuova classica navicella spaziale LEGO!



90
years
of play

LEGO FUTURION, 1979

90 anni di gioco

Nel 2022, per celebrare i 90 anni del LEGO Group, abbiamo chiesto ai fan di votare i classici temi LEGO che desideravano fossero rivisitati con un set speciale per l'anniversario. Decine di migliaia di fan hanno preso parte al sondaggio e Classic Space è stato uno dei chiari vincitori!

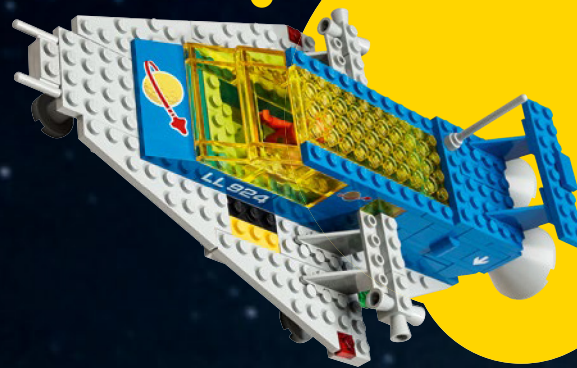

I set 924 Space Cruiser e 918 One Man Spaceship erano simili nel design ma più piccoli del possente Galaxy Explorer 928/497.



IL VIAGGIO NELLO SPAZIO

I set LEGO® a tema spaziale si sono sempre rivelati immensamente popolari e per molti fan un'astronave LEGO in mattoncini è stato spesso il loro primo viaggio in un nuovo mondo di spazio e fantascienza.

Lanciato nel 1979, l'iconico set Galaxy Explorer 928/497 includeva un'astronave futuristica, un piccolo rover spaziale, una base lunare con torre e piattaforma di atterraggio e, soprattutto, 4 delle prime minifigure di astronauta spaziale nei colori rosso e bianco!

Quello che ora conosciamo come Classic Space è cresciuto come tema e nel decennio successivo gli space cruiser sarebbero diventati più dettagliati, e le basi lunari, i buggy lunari e i robot ancora più avanzati. Seguirono rapidamente altri sottotemi, come Futuron (1987), Blacktron (1987) e Polizia Spaziale (1989), che introdussero accessori come monorotaie e set intercambiabili più complessi, universi narrativi più intricati e personaggi e minifigure più distintivi.

1978-1984



La minifigure dell'astronauta, introdotta in questi anni, è un vero elemento rivoluzionario. Originariamente prodotta solo in rosso e bianco, diventa presto disponibile anche in blu, giallo e nero.

1987

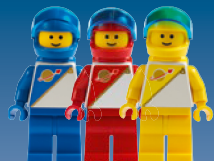

Il design dell'uniforme viene aggiornato con una cerniera incrociata dall'anca alla spalla, oltre a un casco ridisegnato con una visiera blu trasparente.

1993



Il sottotema spaziale degli anni '90, il Pianeta di ghiaccio, ha ora una versione alternativa, in cui la metà del pianeta nel classico logo è congelata.

2009



Questa iconica "statua" dell'astronauta appare solo in un singolo set della Polizia Spaziale.

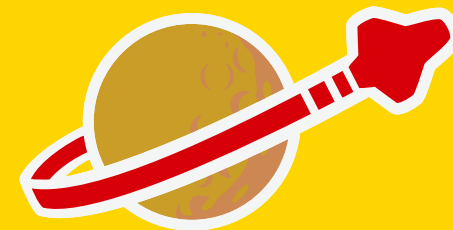

Ogni elemento del tema originale Classic Space recava l'iconico e tanto amato logo LEGO® Space, con la sua navicella spaziale rossa in orbita intorno a una luna.

2014



Forse l'astronauta LEGO più famoso di tutti, Benny di *LEGO Movie*, indossa un logo spaziale logoro e un casco incrinato.

2014



Un nuovo astronauta in uniforme verde appare nel set 21109 LEGO Ideas - Esoscheletro.

2019



Lenny, il primo astronauta rosa, si unisce alla squadra spaziale di Benny in *The LEGO Movie 2* insieme a Kenny e Jenny.

2020



Un esclusivo astronauta arancione è incluso nel libro *LEGO Minifigure: A Visual History*.

2021



La Serie 21 delle Minifigure contiene il Poliziotto spaziale con un logo spaziale classico sulla tuta e anche un busto Futuron.

2022



Gli astronauti in questo set aggiornato del Galaxy Explorer sono copie quasi esatte degli originali del 1979.



"SIN DA QUANDO HO INIZIATO A PROGETTARE
MODELLI LEGO® NEL 2012, HO SEMPRE SOGNATO
DI CREARE UNA VERSIONE AGGIORNATA DEL
GALAXY EXPLORER".

MICHAEL PSIAKI



Michael ha anche progettato due astronavi più piccole,
costruibili usando gli stessi mattoncini inclusi in questo set.
Questi veicoli spaziali sono ispirati ai set 924 e 918. Le istruzioni
per questi modelli alternativi sono disponibili online all'indirizzo:
LEGO.com/buildinginstructions



Il designer non ha potuto fare a meno di aggiungere un'altra caratteristica personale al modello aggiornato. Il piccolo robot non era nel set originale. È apparso per la prima volta nel set 6809 nel 1987.



IL DESIGN TEAM

Ho iniziato a lavorare a una versione aggiornata di questo set abbastanza presto nella mia carriera di designer LEGO®, intorno all'inverno 2013. L'astronave ha attraversato diverse fasi di modifiche e ritocchi prima di diventare il modello di oggi. Inizialmente, ho costruito versioni un po' lontane dal modello originale, ma poi, nella fase di perfezionamento, l'astronave è diventata sempre più simile al primo prototipo, con alcuni interessanti aggiornamenti. Una delle grandi decisioni è stata quella di rendere il modello 1,5 volte più grande dell'originale. Volevamo dare l'impressione che il Galaxy Explorer fosse ora cresciuto, proprio come i fan della

prima astronave. E poiché la navicella è più grande, abbiamo potuto inserire tutti e 4 gli astronauti nella cabina di pilotaggio, invece di uno solo. Abbiamo anche costruito una porta stagna tra il compartimento dell'equipaggio e il compartimento del rover, in modo che gli astronauti fossero protetti anche quando i portelloni posteriori erano aperti. L'aggiunta del carrello di atterraggio retrattile conferisce all'astronave un profilo molto più aerodinamico quando naviga nello spazio!

Michael Psiaki, LEGO® Design Master

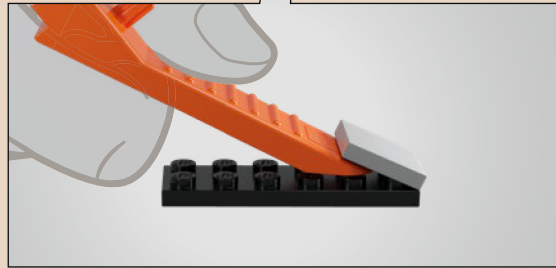
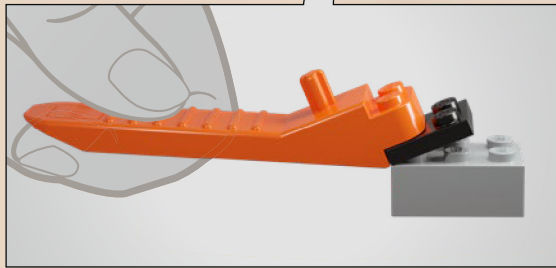
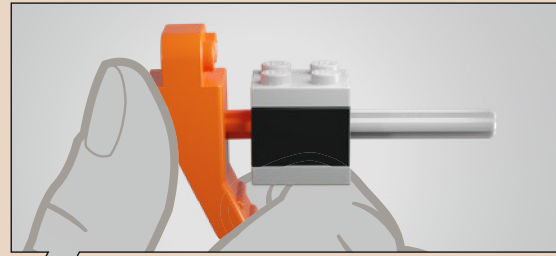
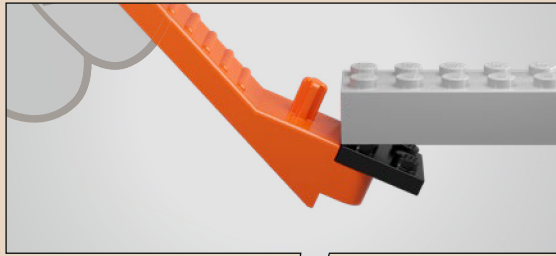

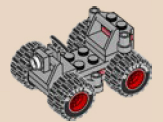
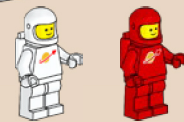
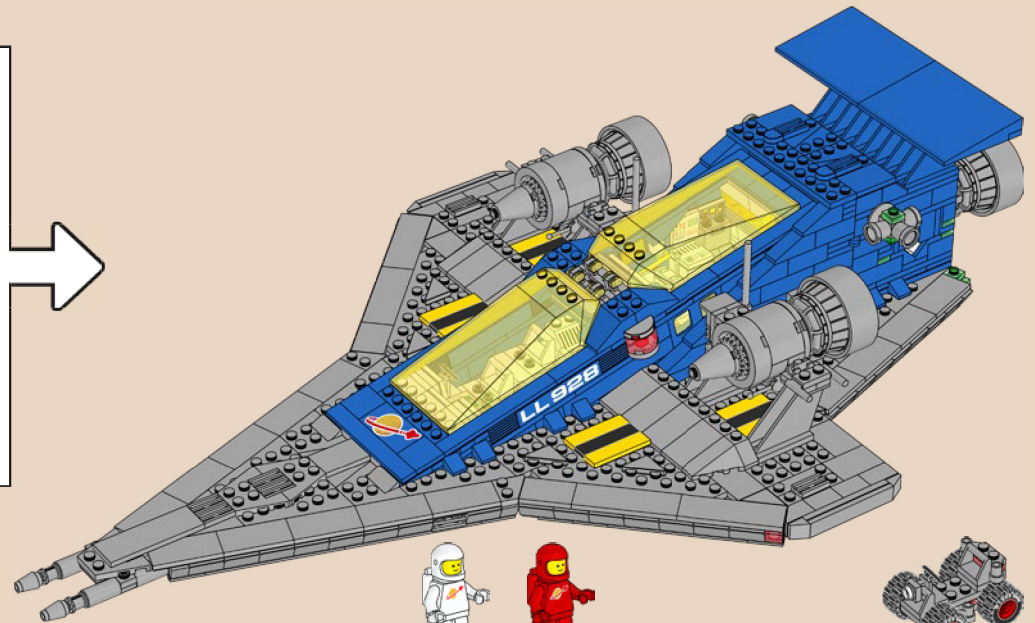
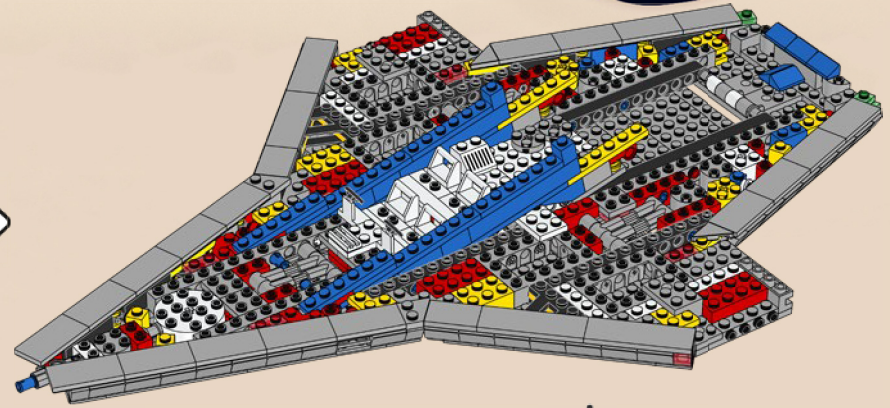

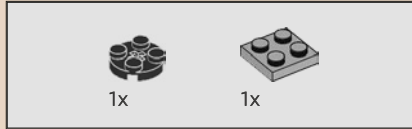
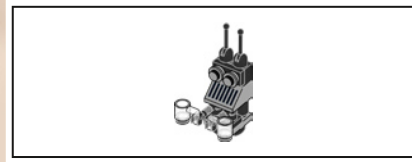
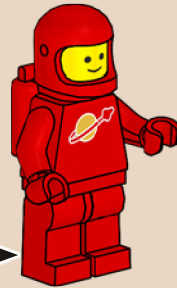
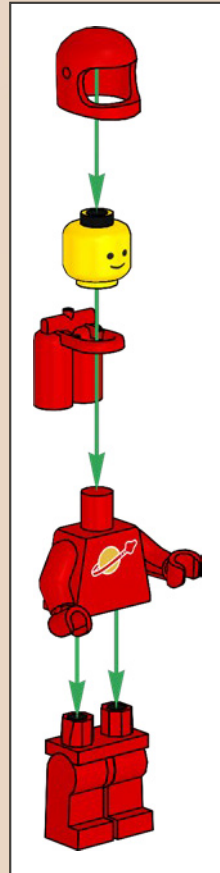

1

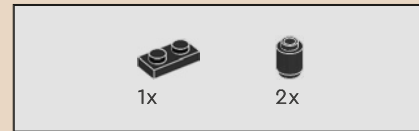
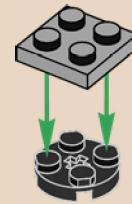

2

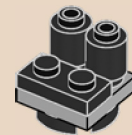

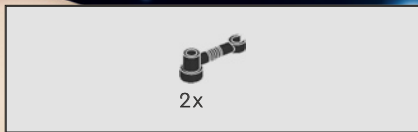

3

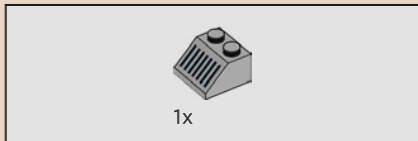
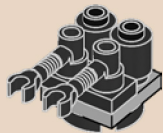

4

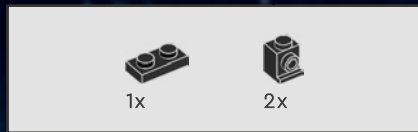
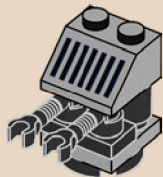

5

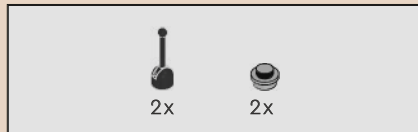
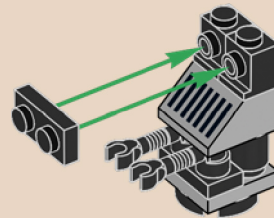

6

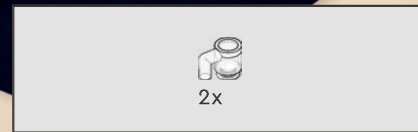
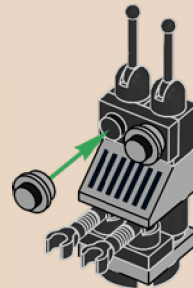

7

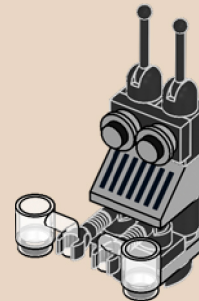

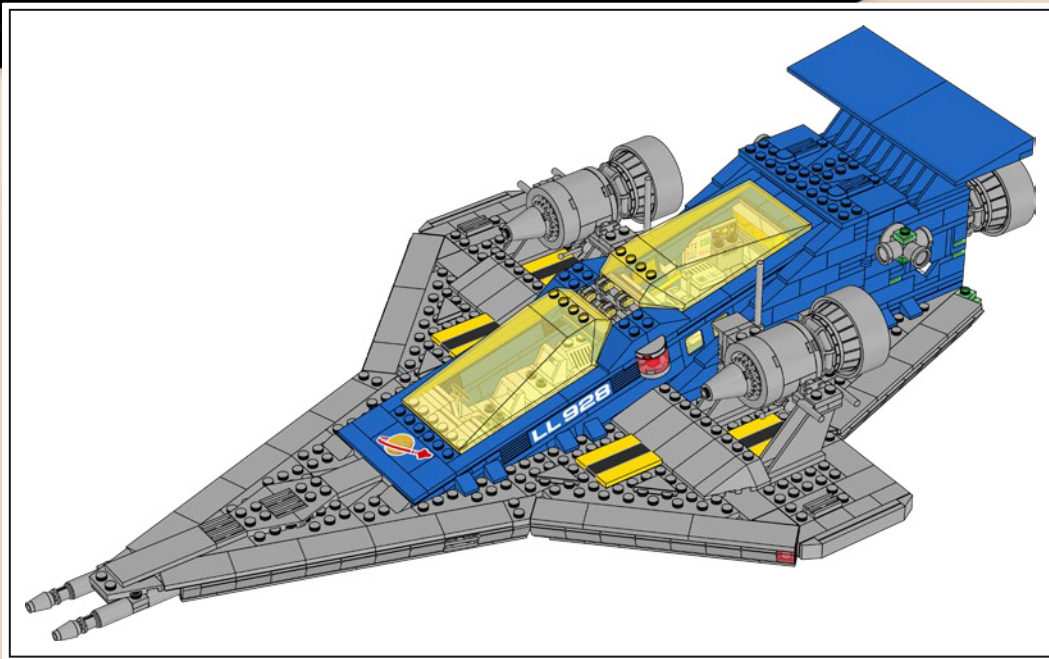

2

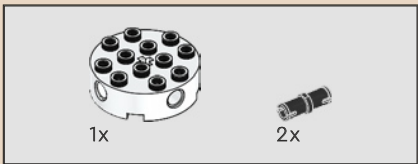

1

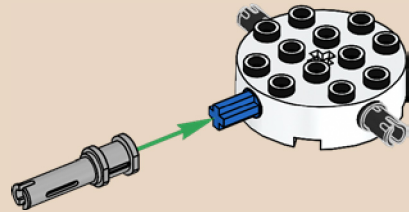
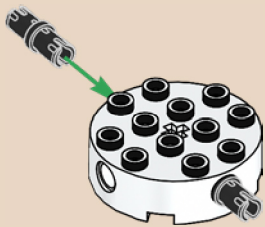



3

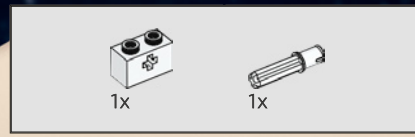
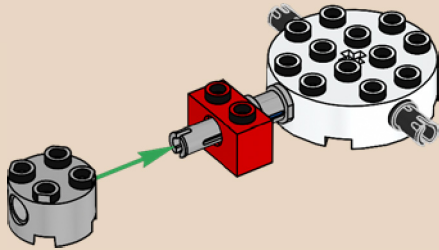

4

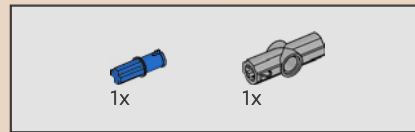
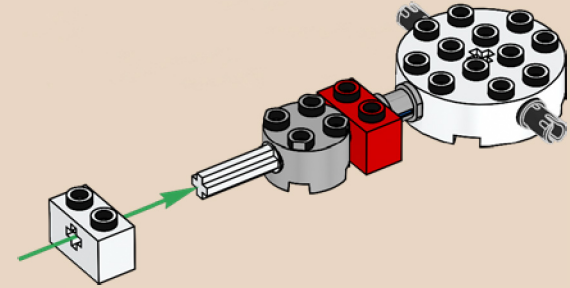

5

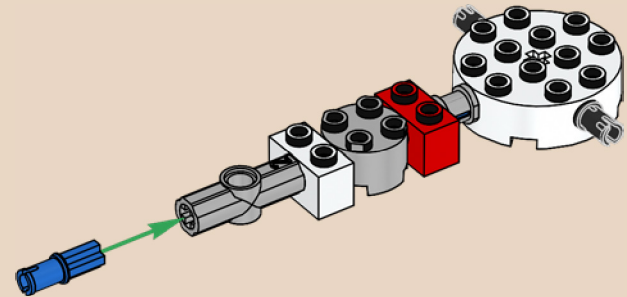

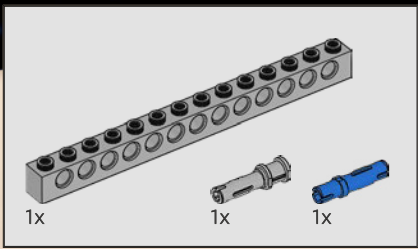

6

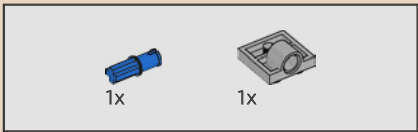
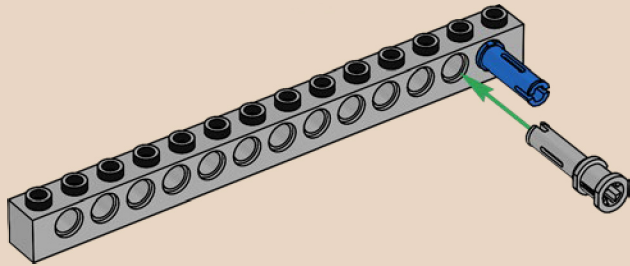

7

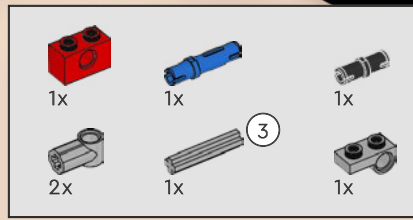
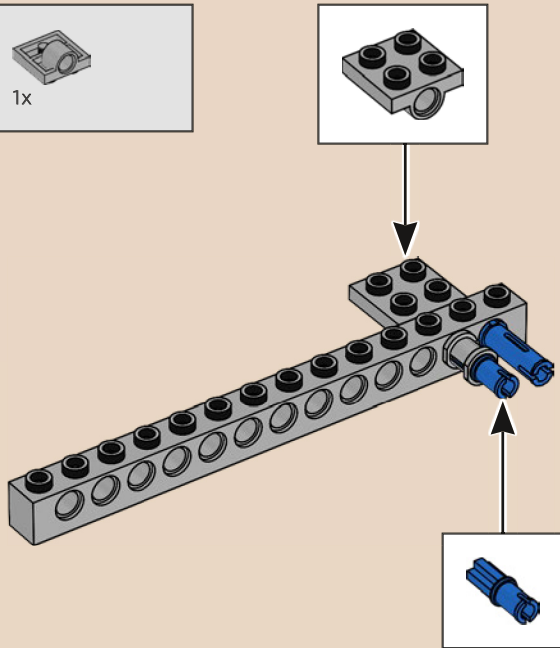

8

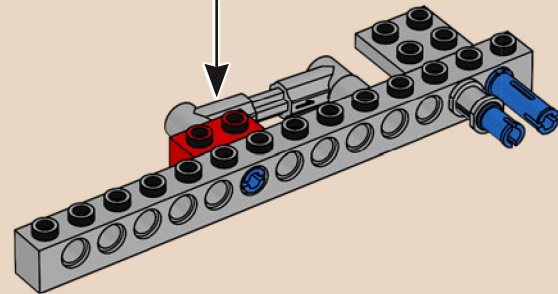
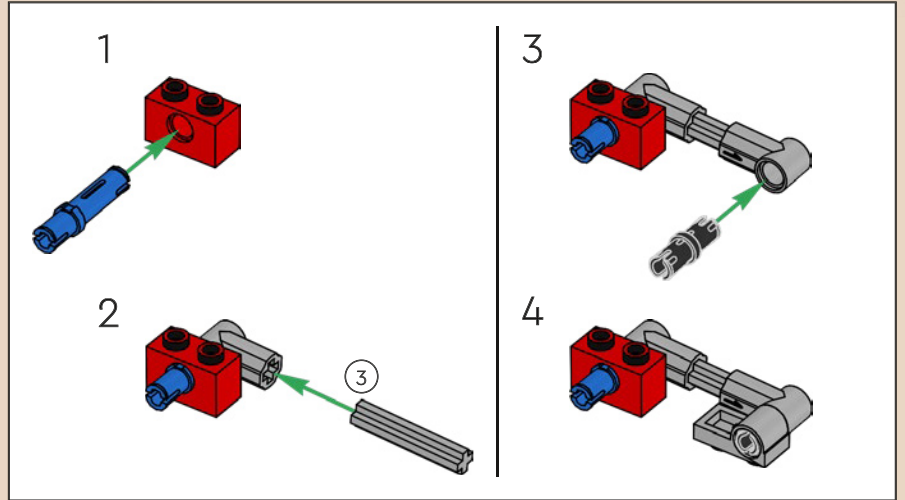

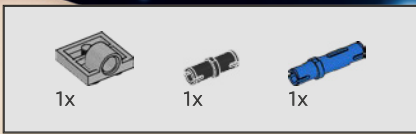

9

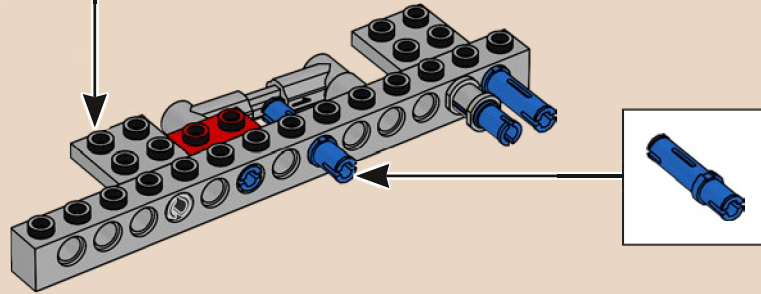
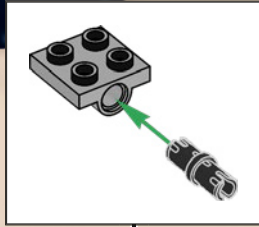

10

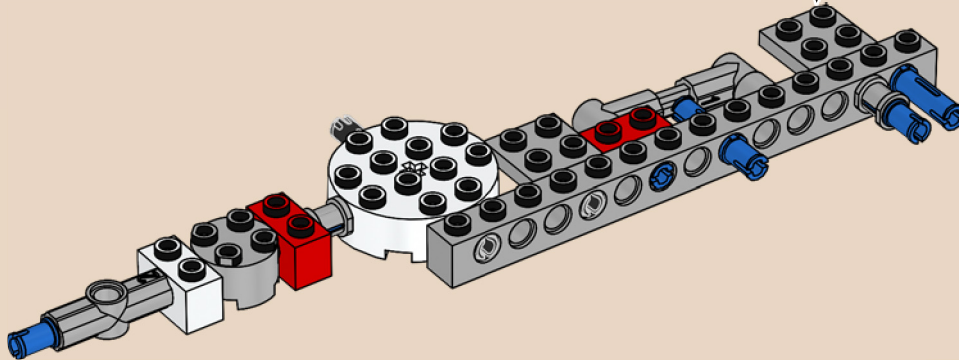

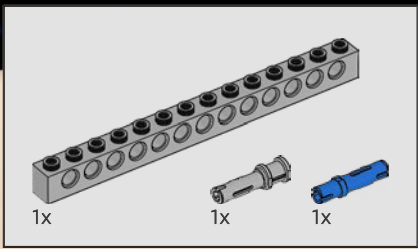

11

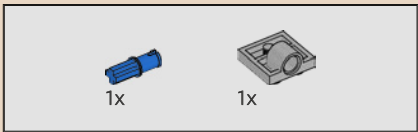
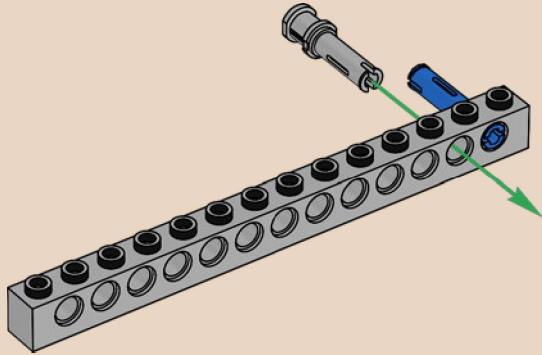

12

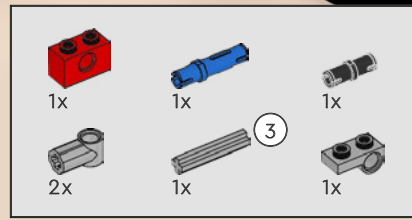
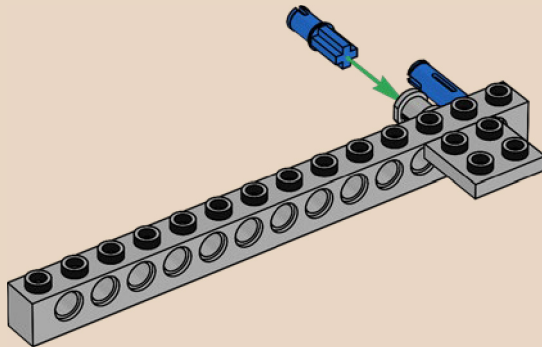

13

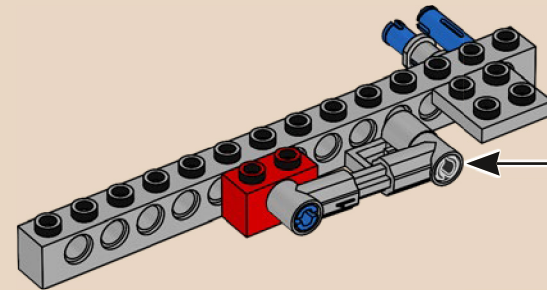
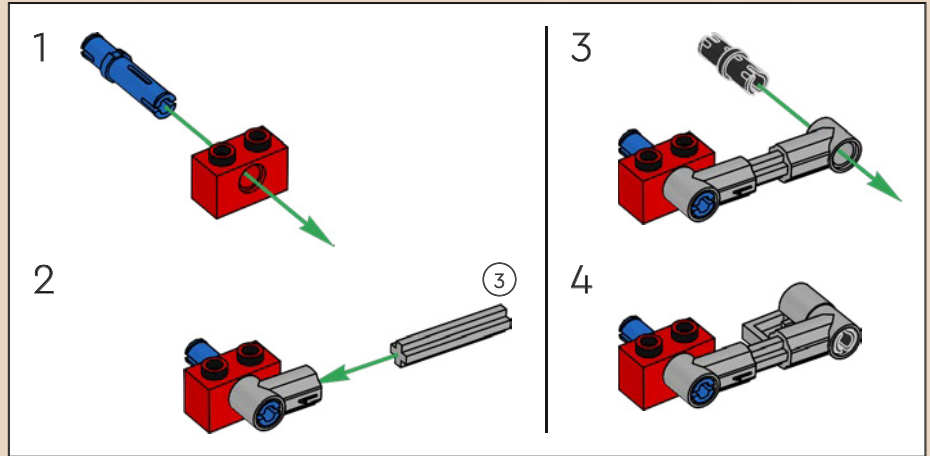

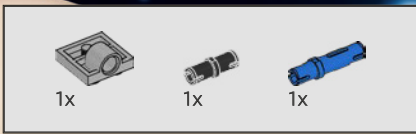

14

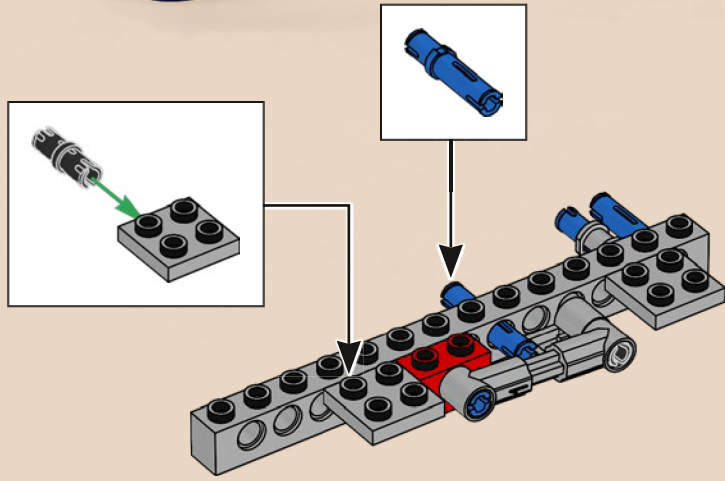

15

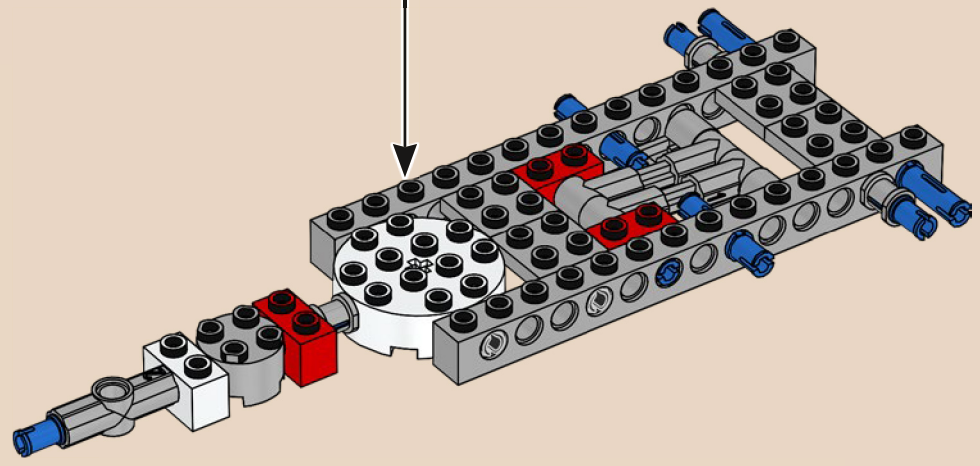



16

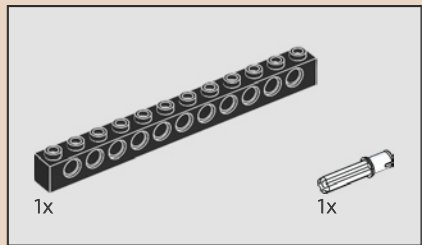
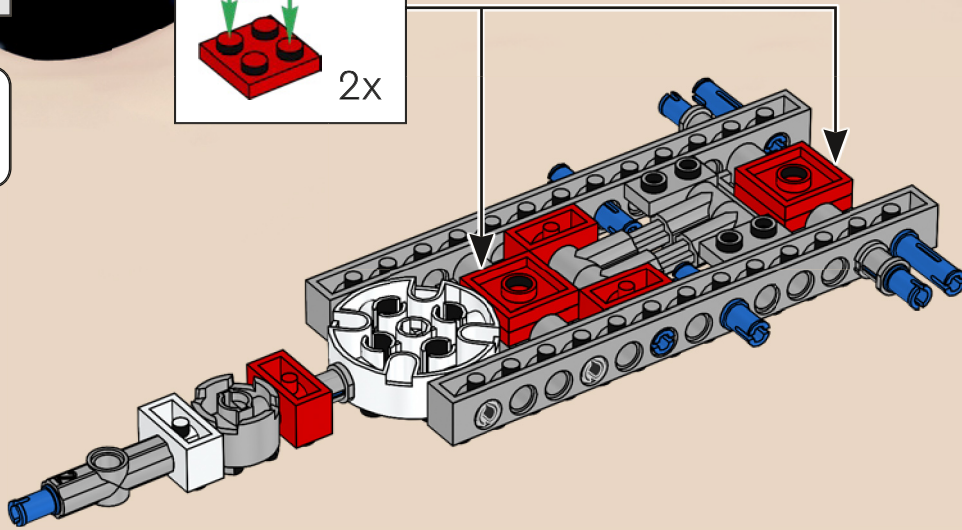
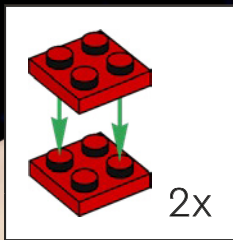

17

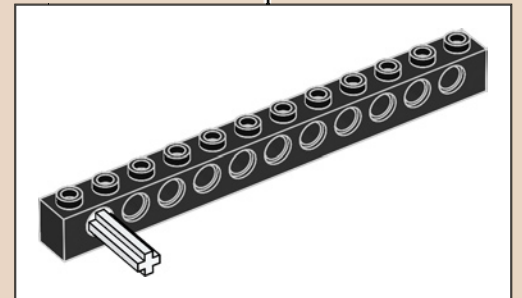
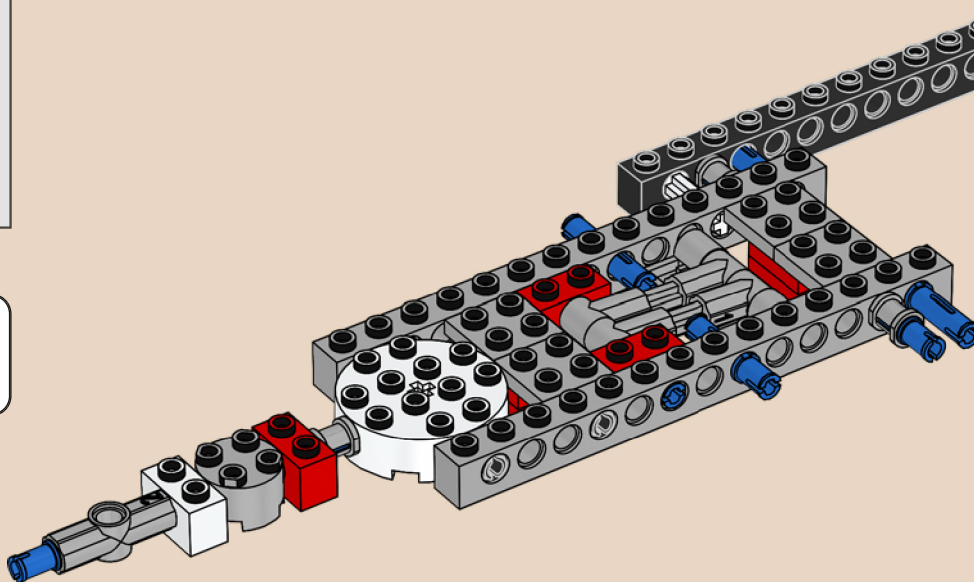

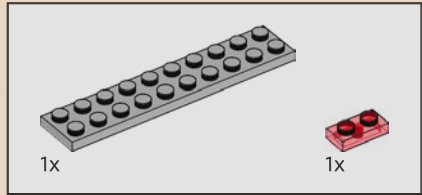
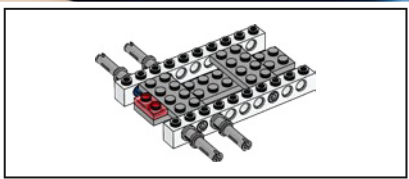

18

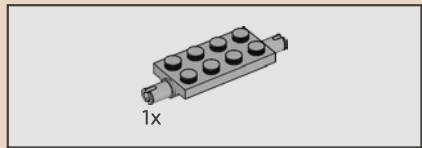
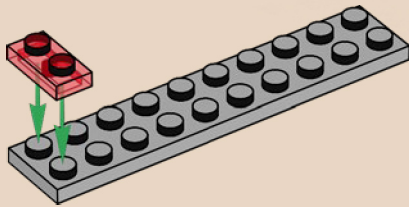

19

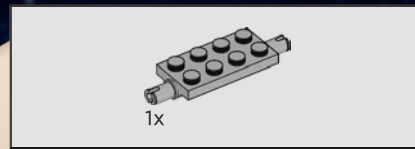
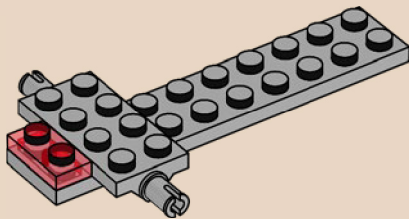

20

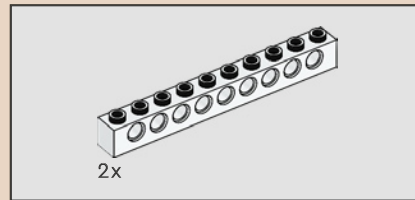
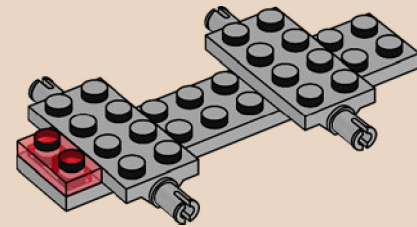

21

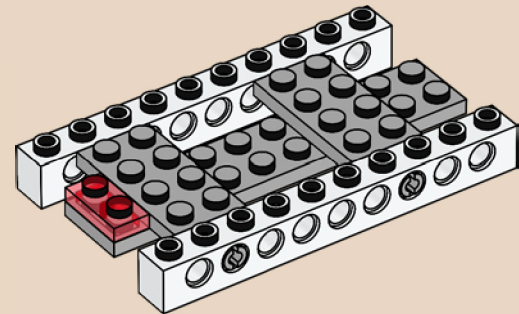

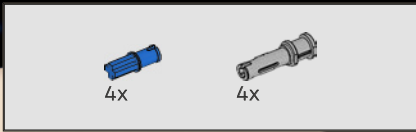

22

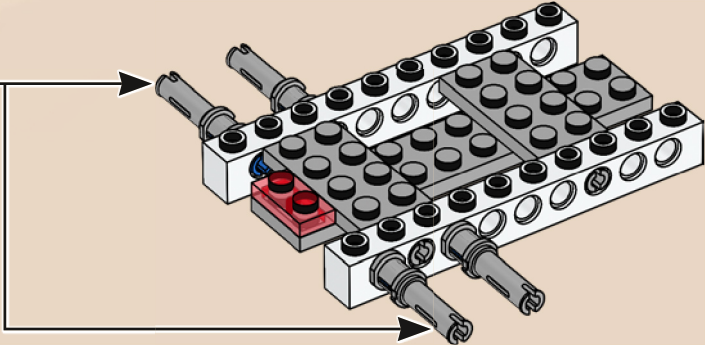
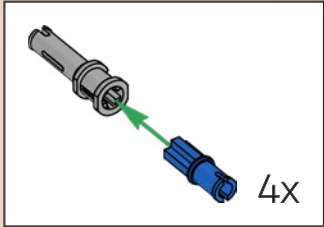

23

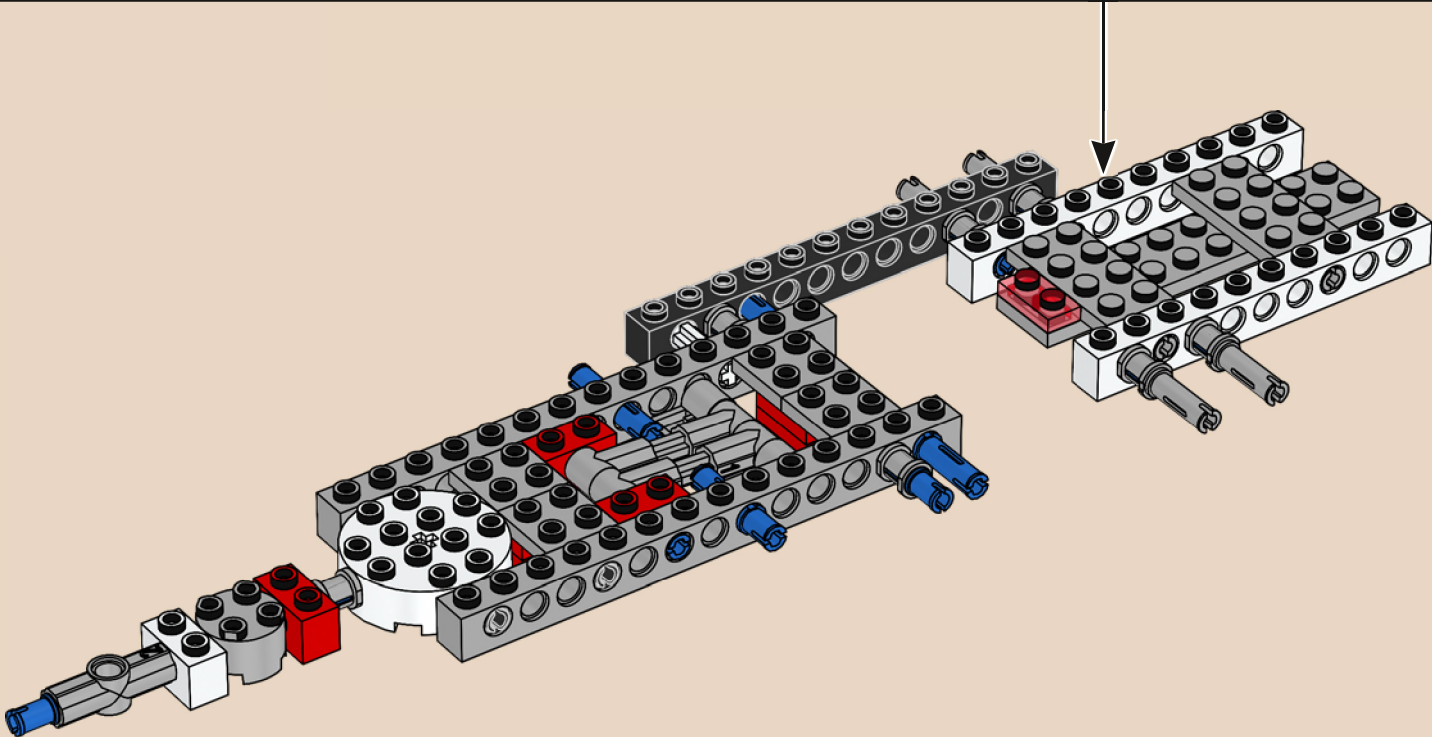

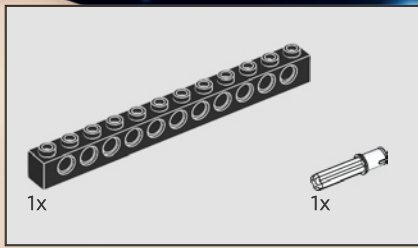

24

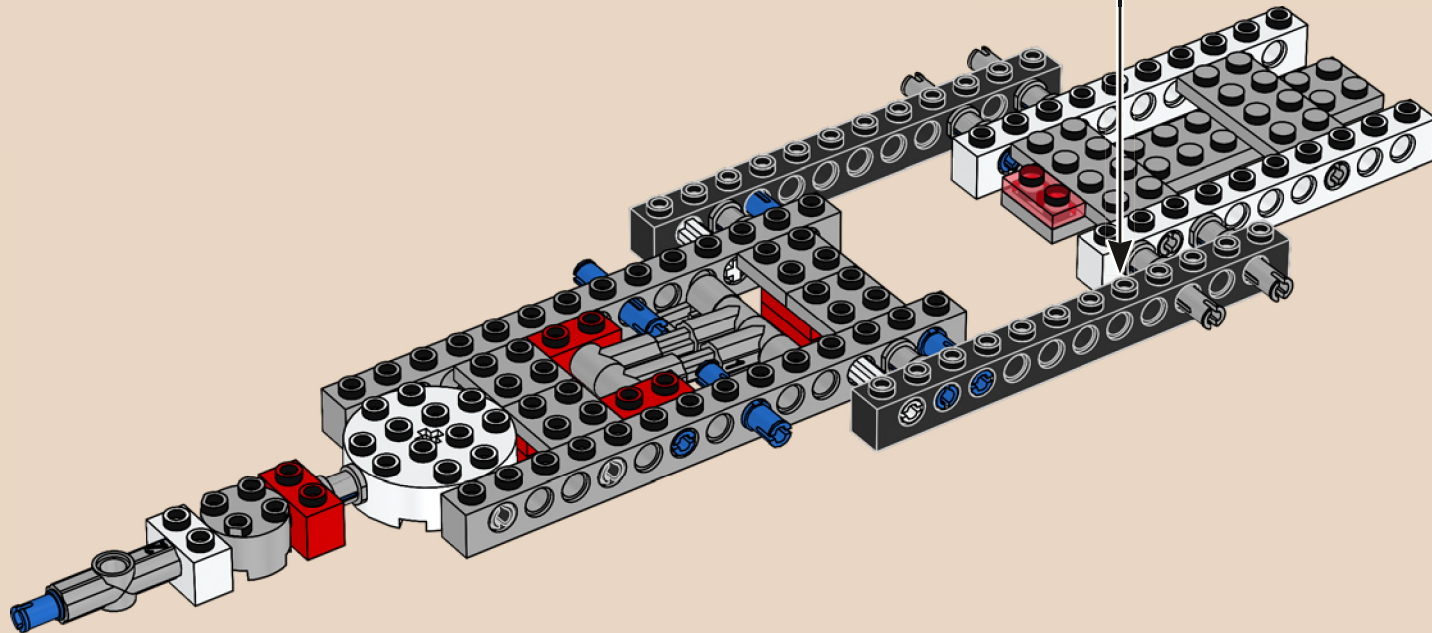
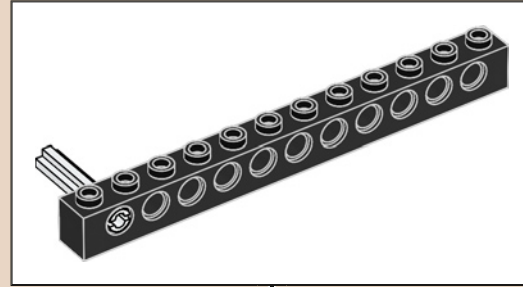

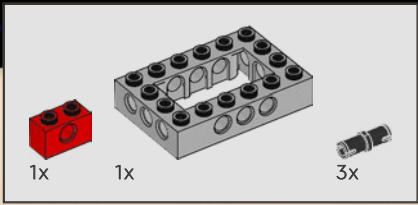

25

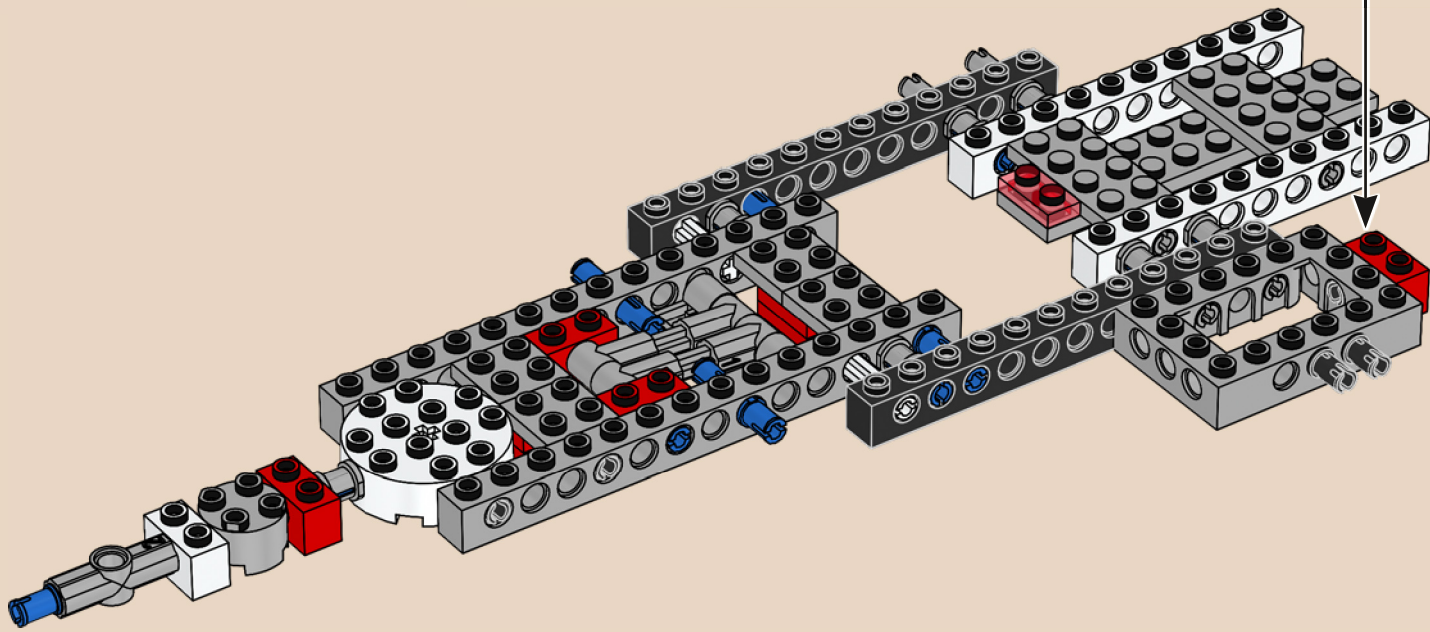
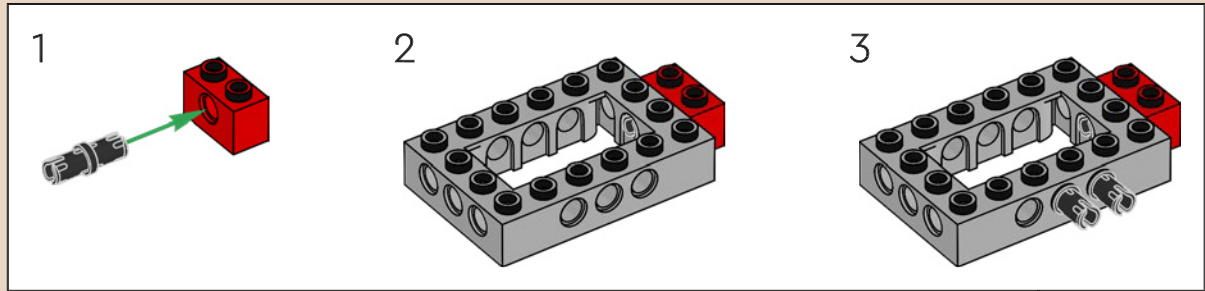

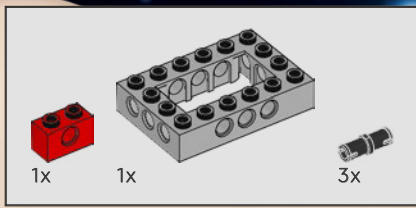

26

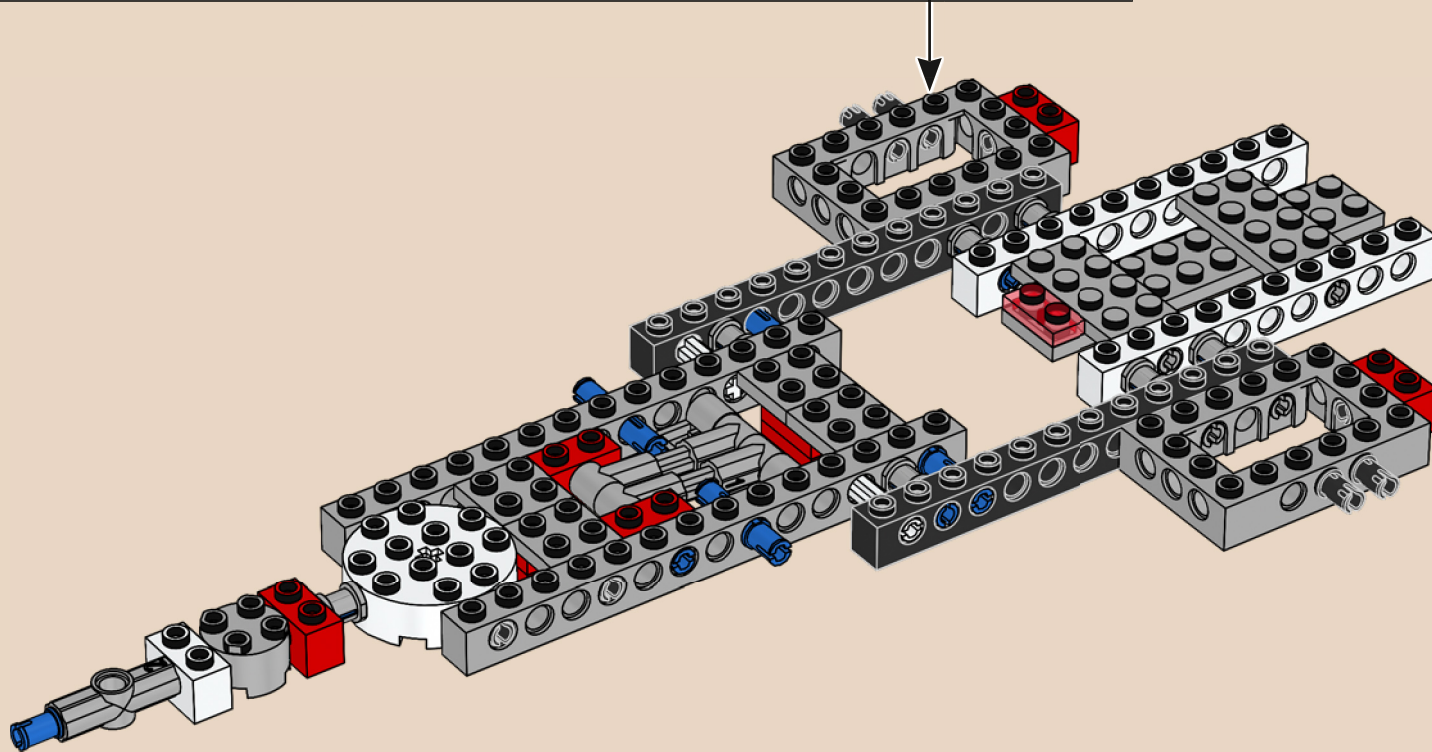
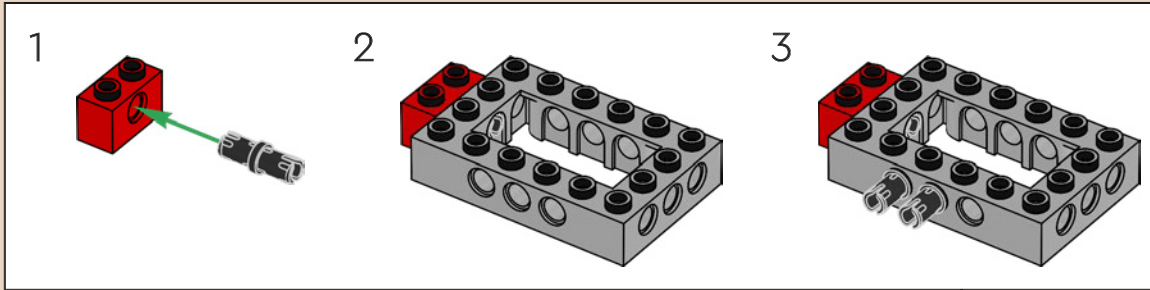

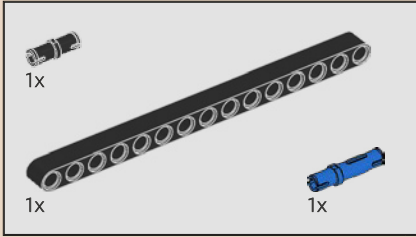
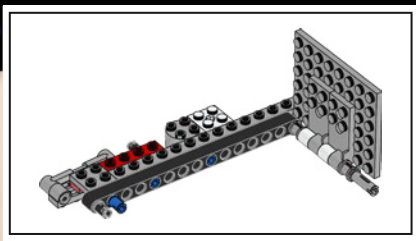

27

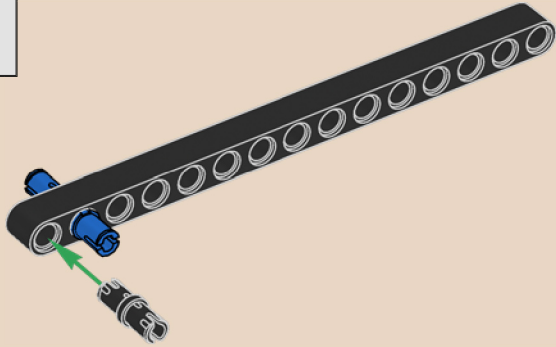

28

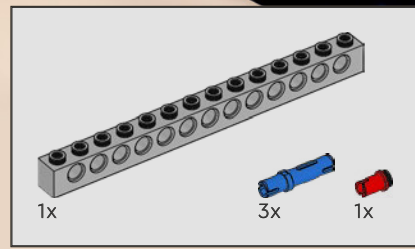
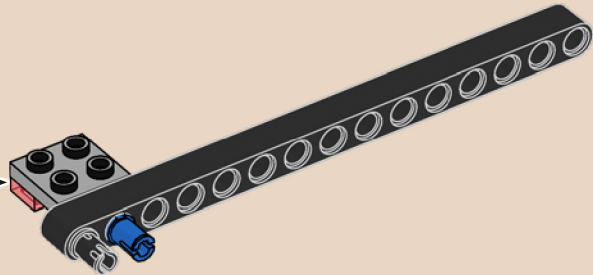
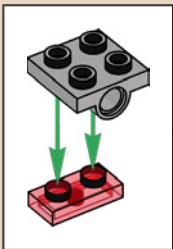

29

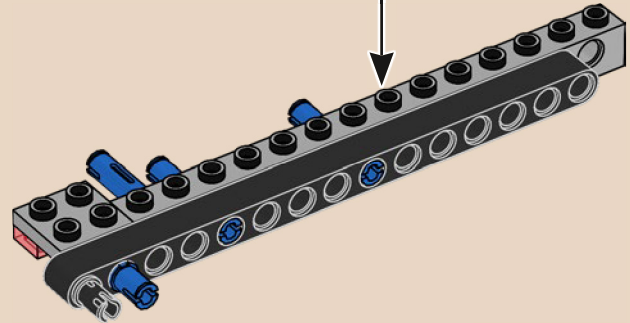
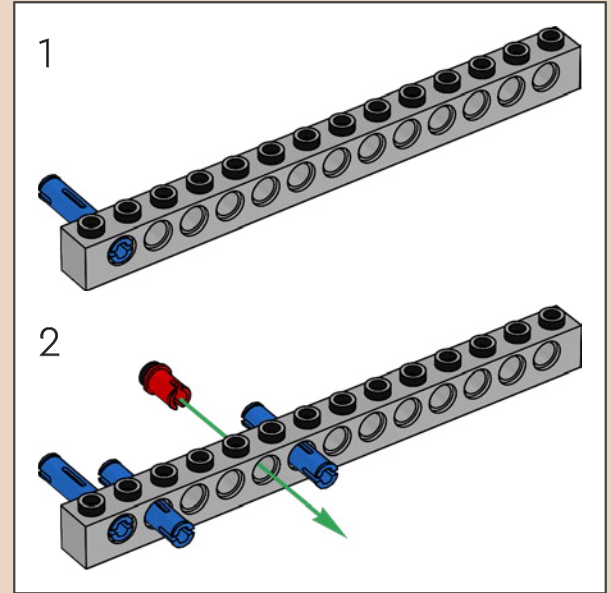



30

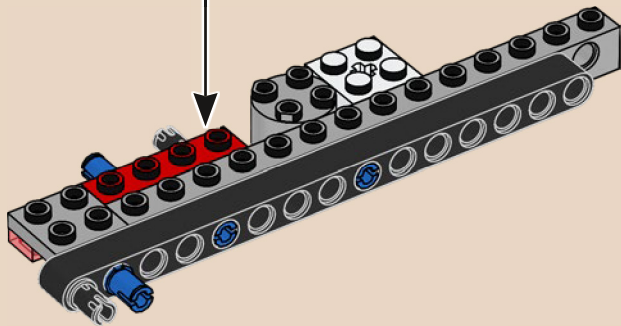
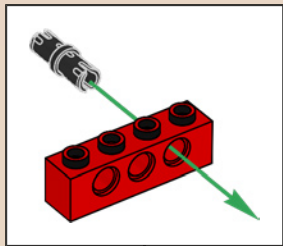

31

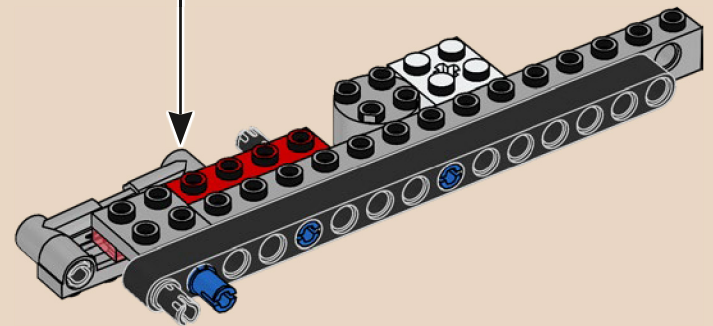
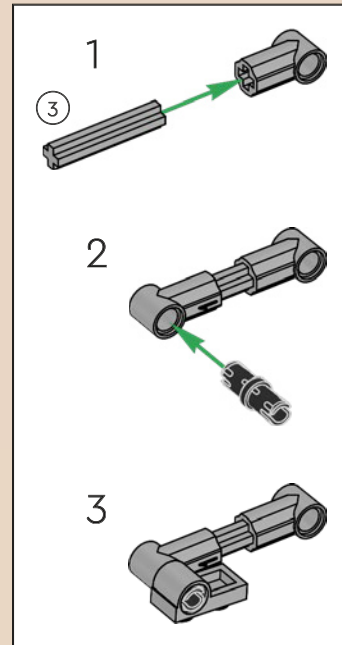
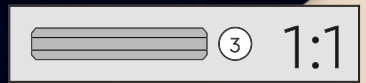

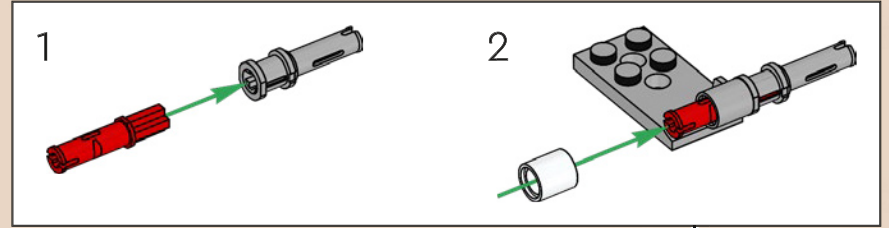
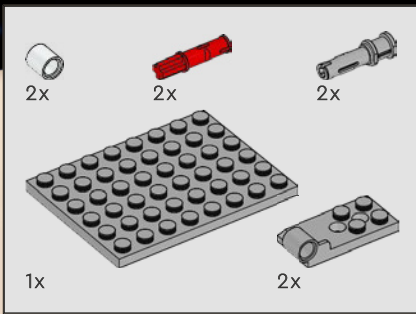

32

1

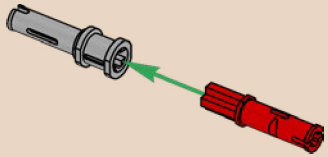

2

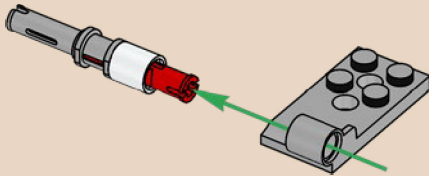

3

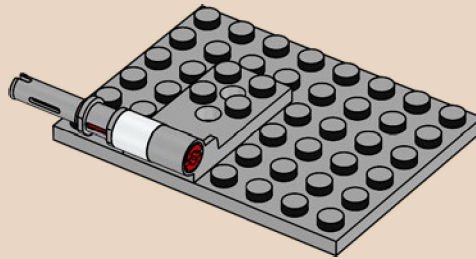

4

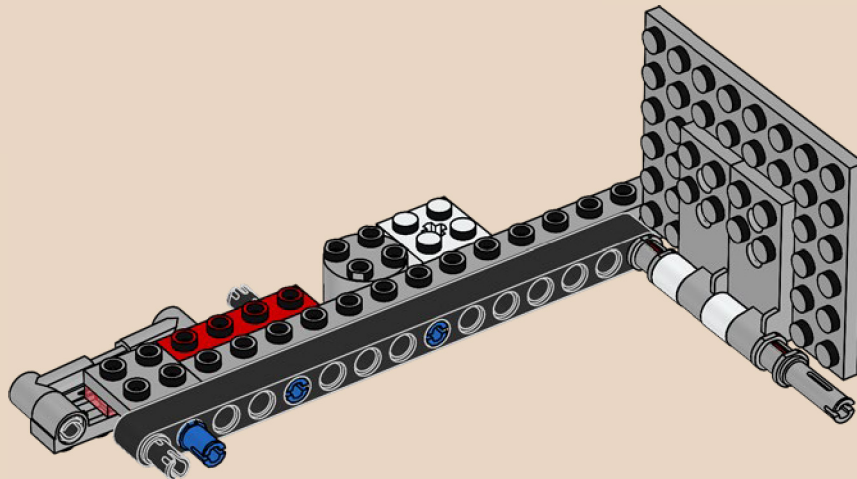
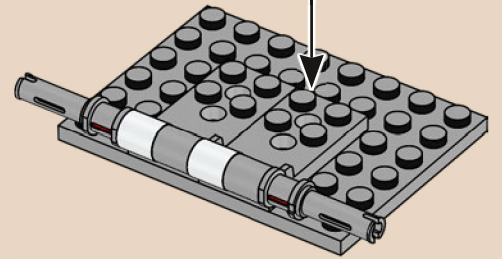

33

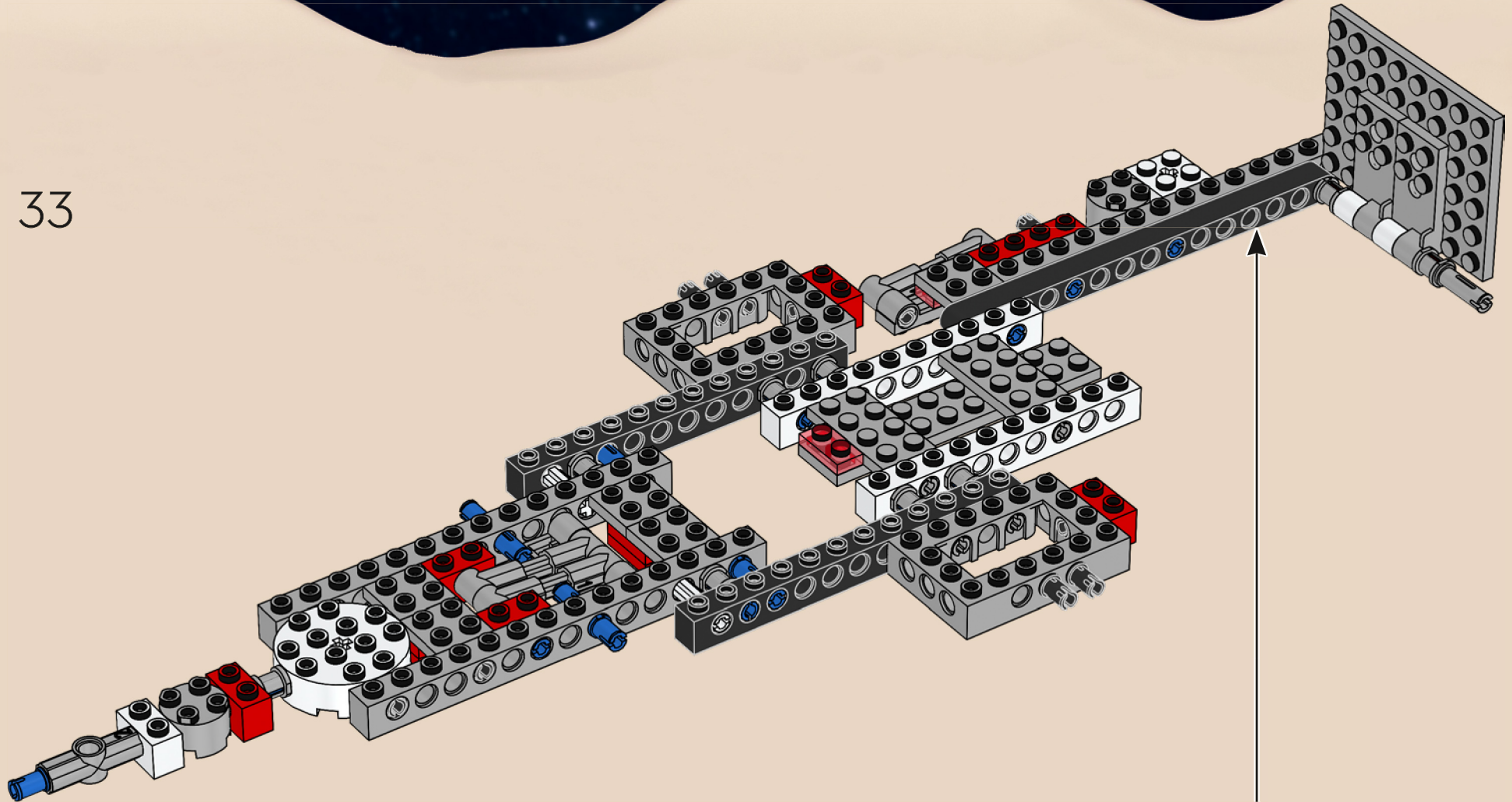

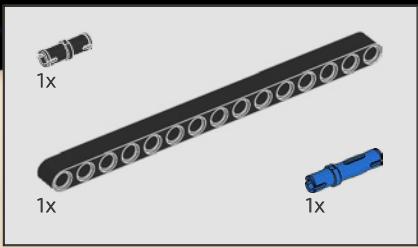

34

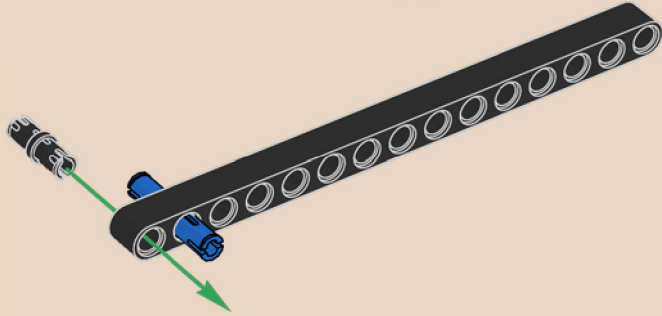

35

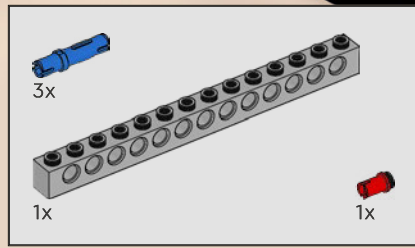
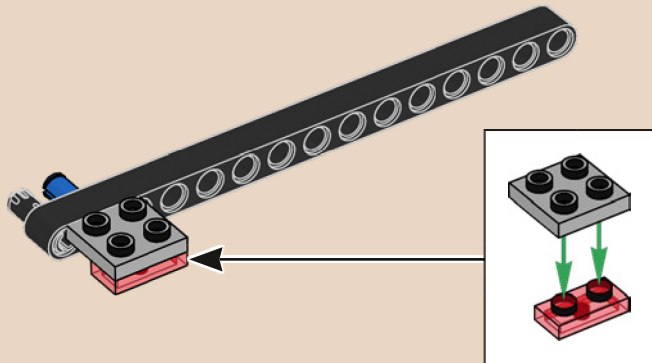

36

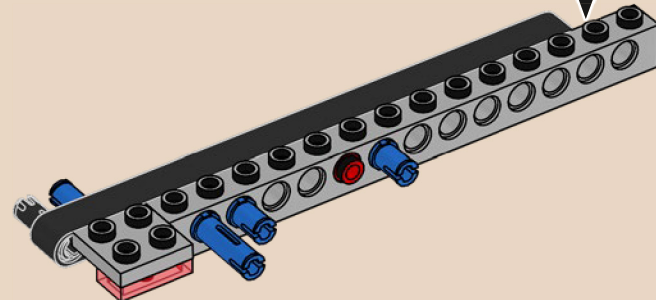
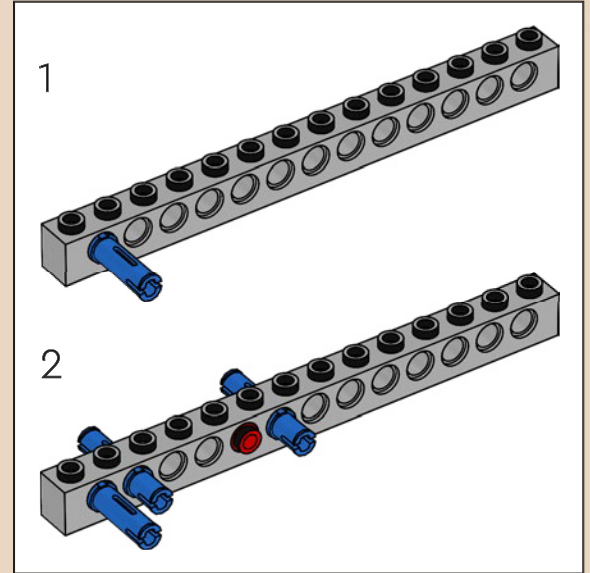

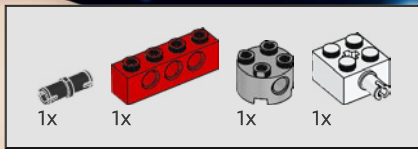

37

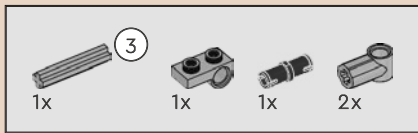
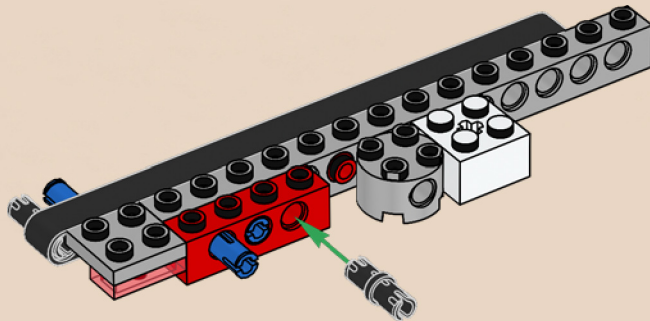

38

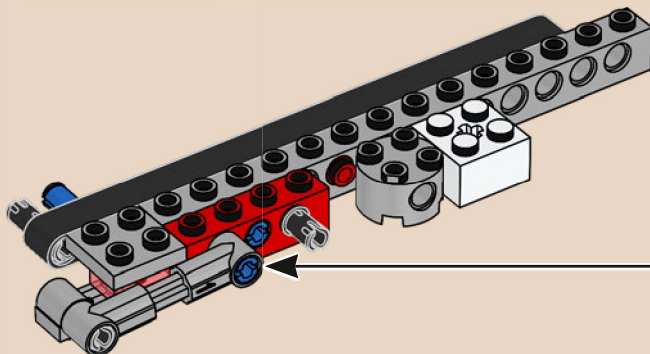
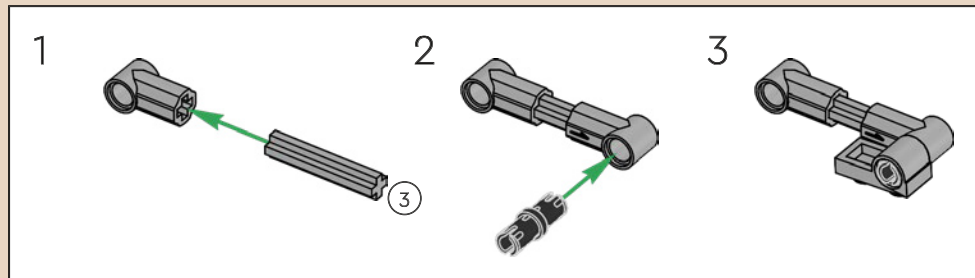

39

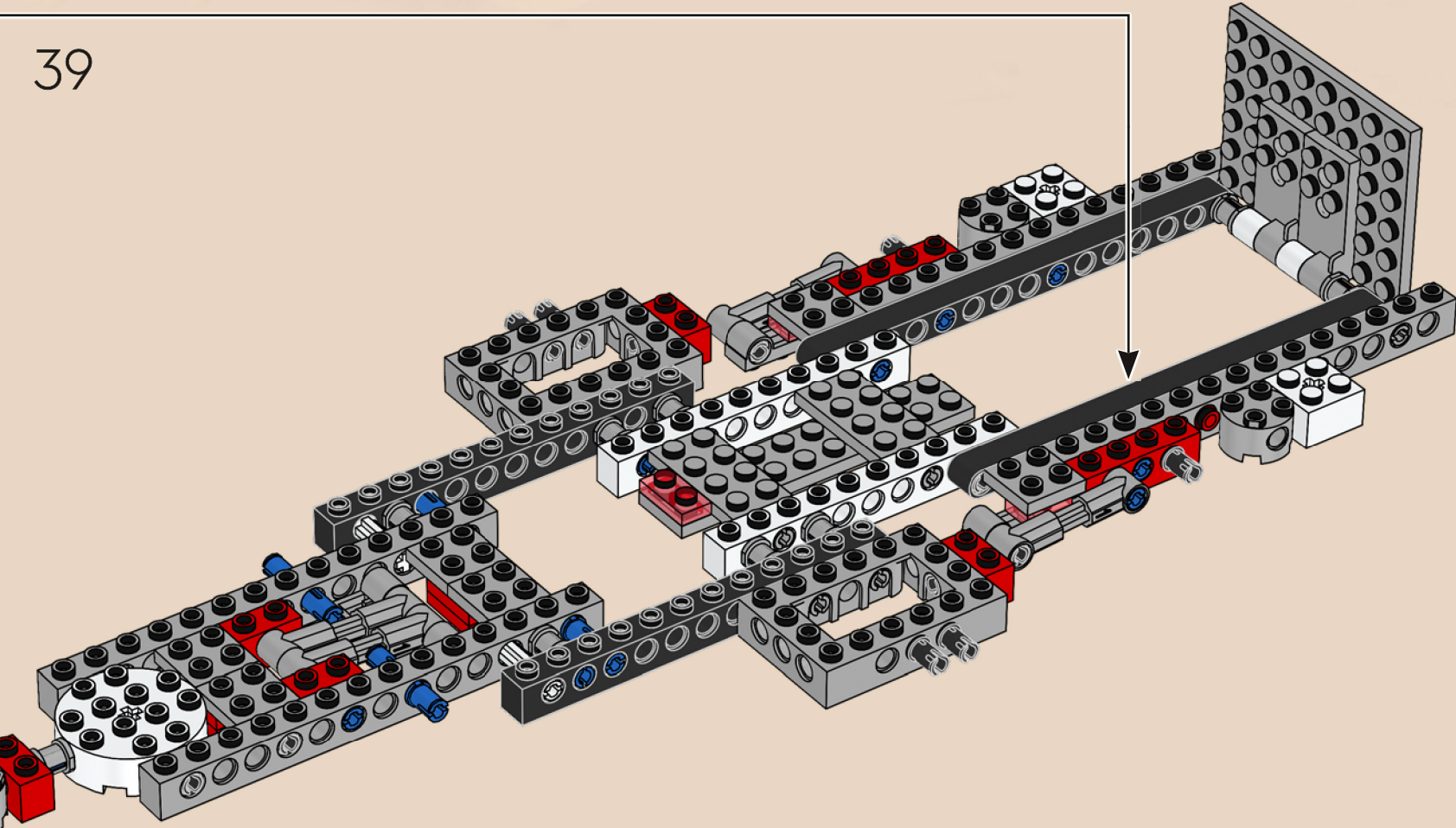

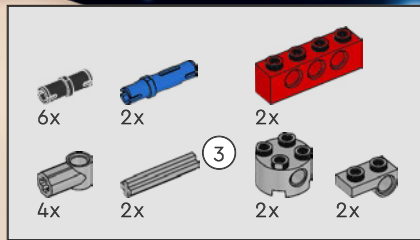

40

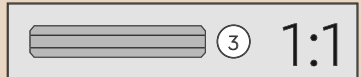
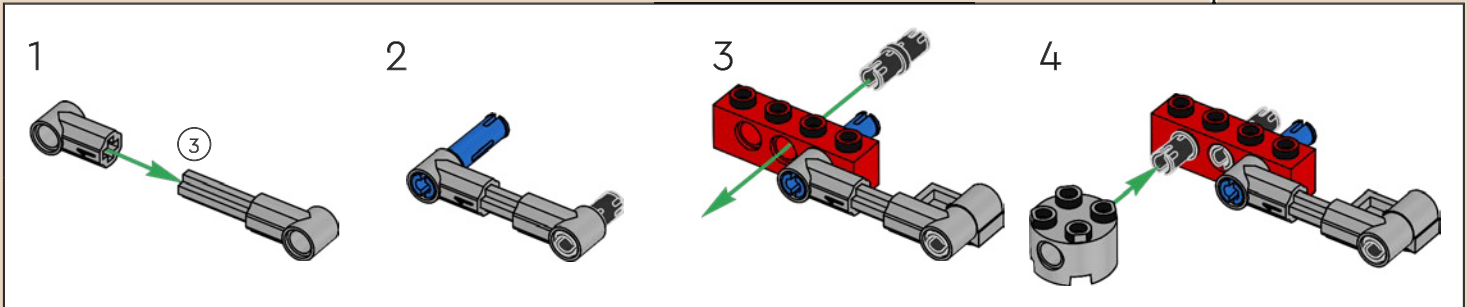
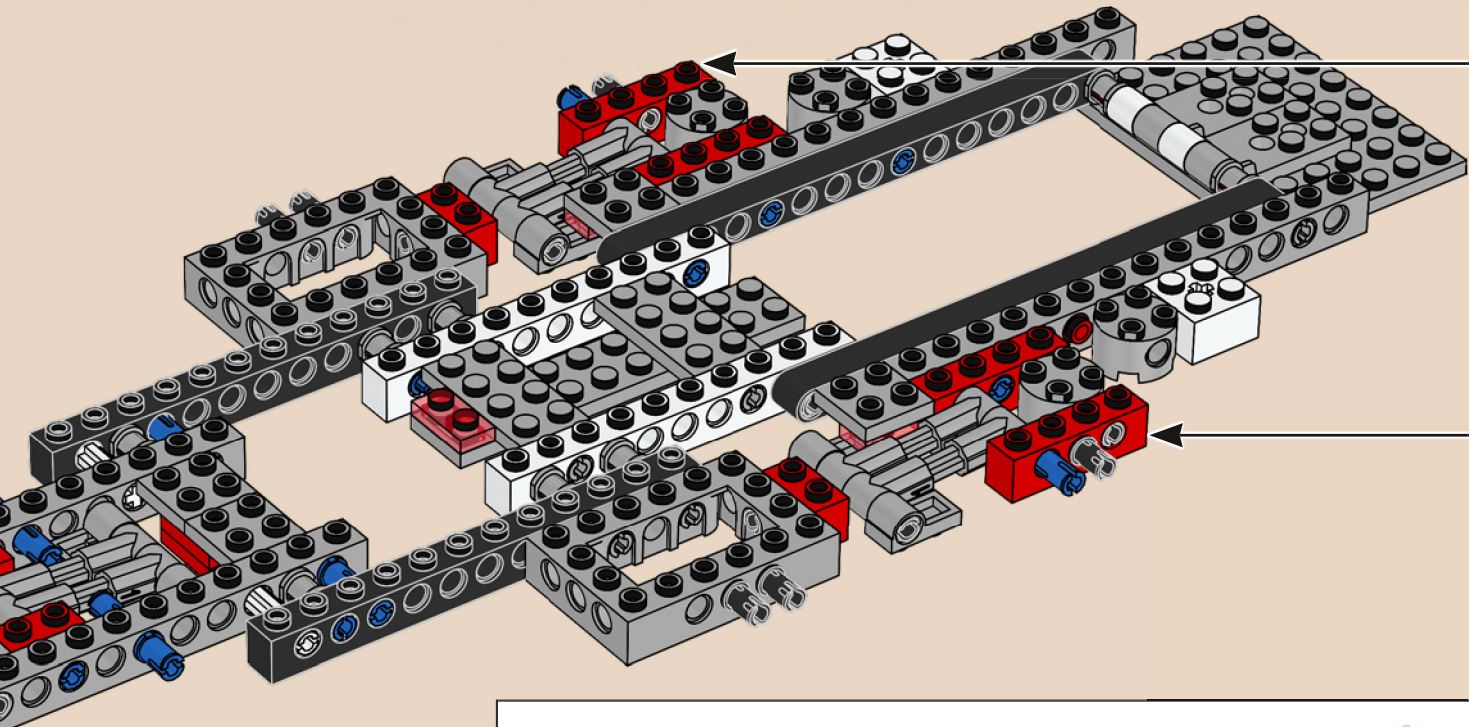
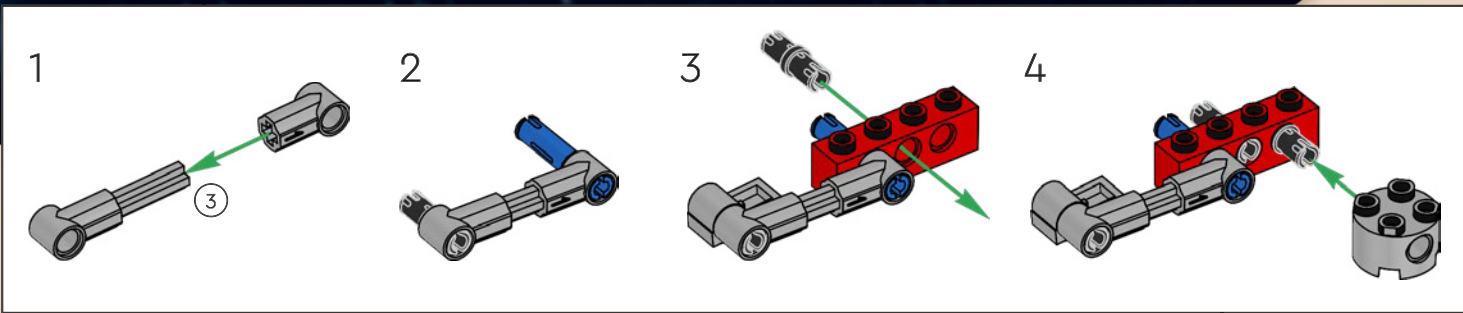

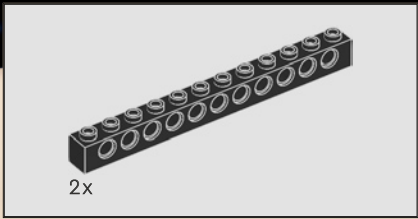

41

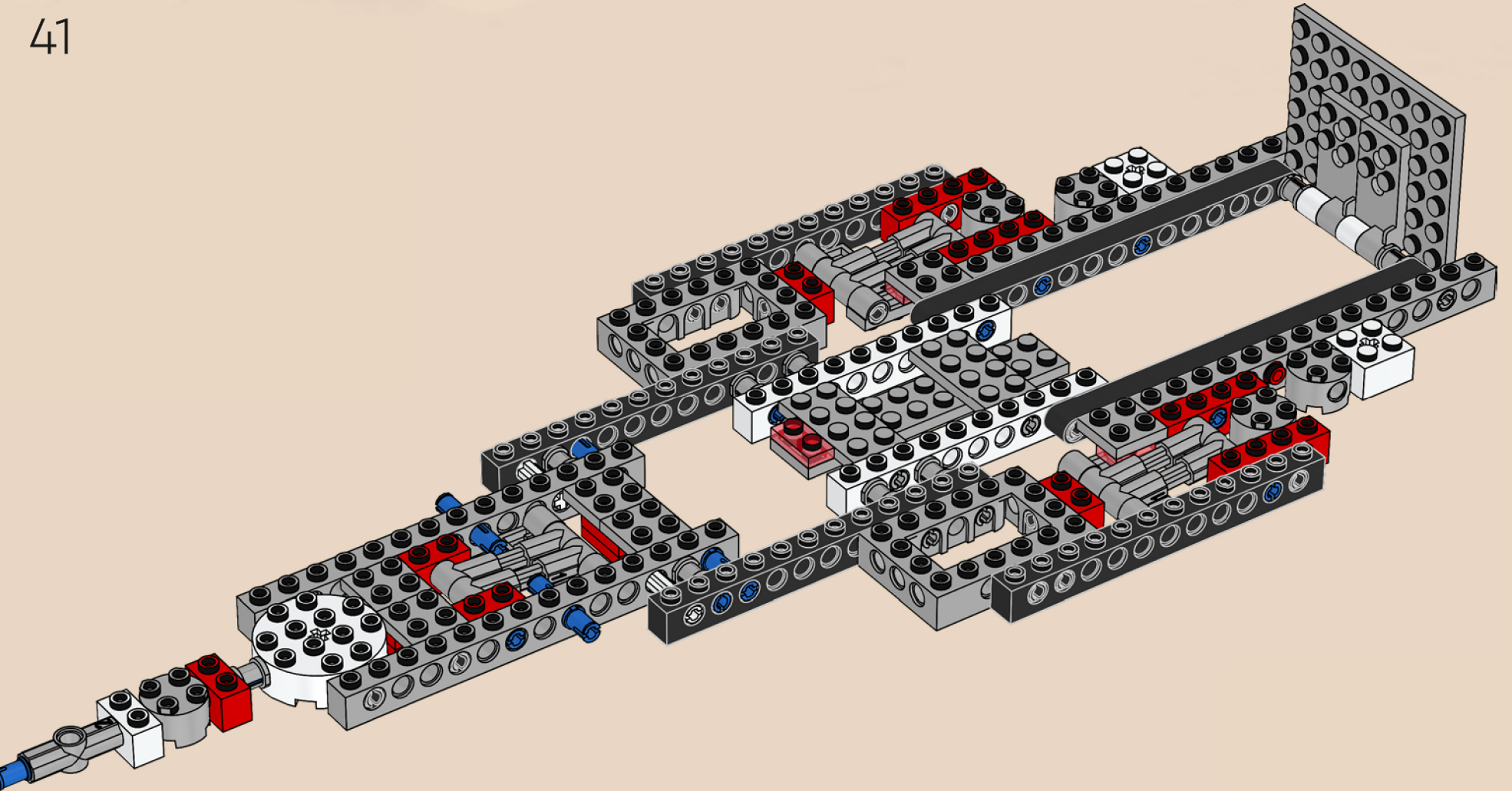

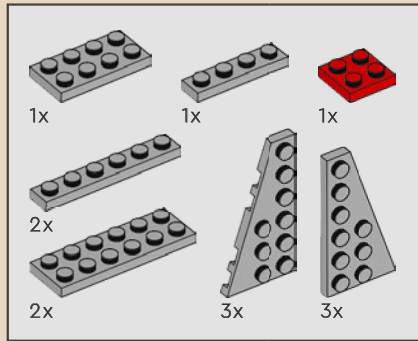

42

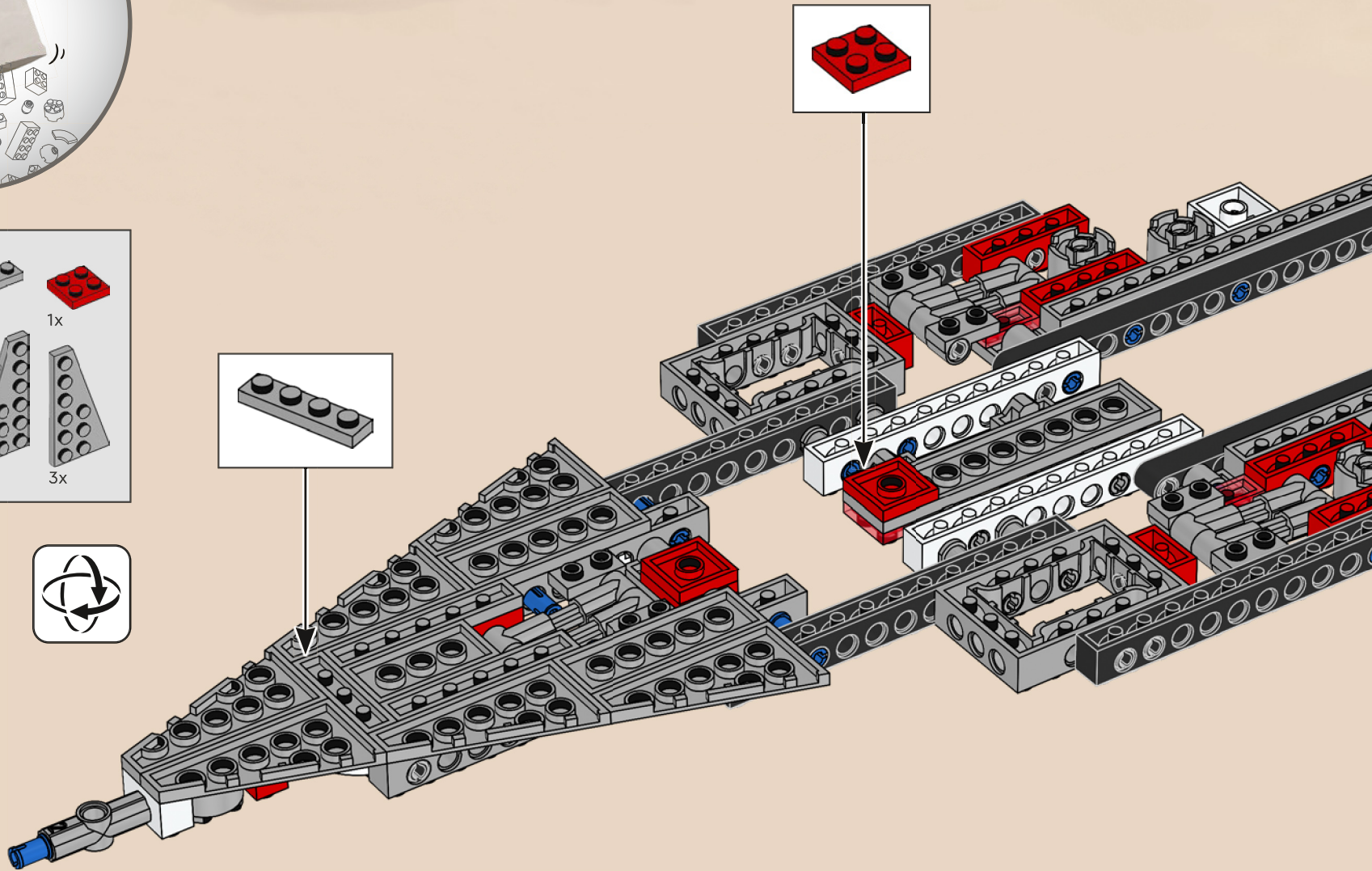

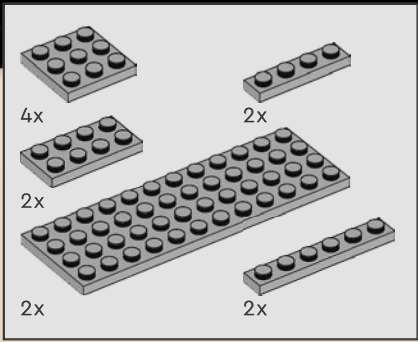

43

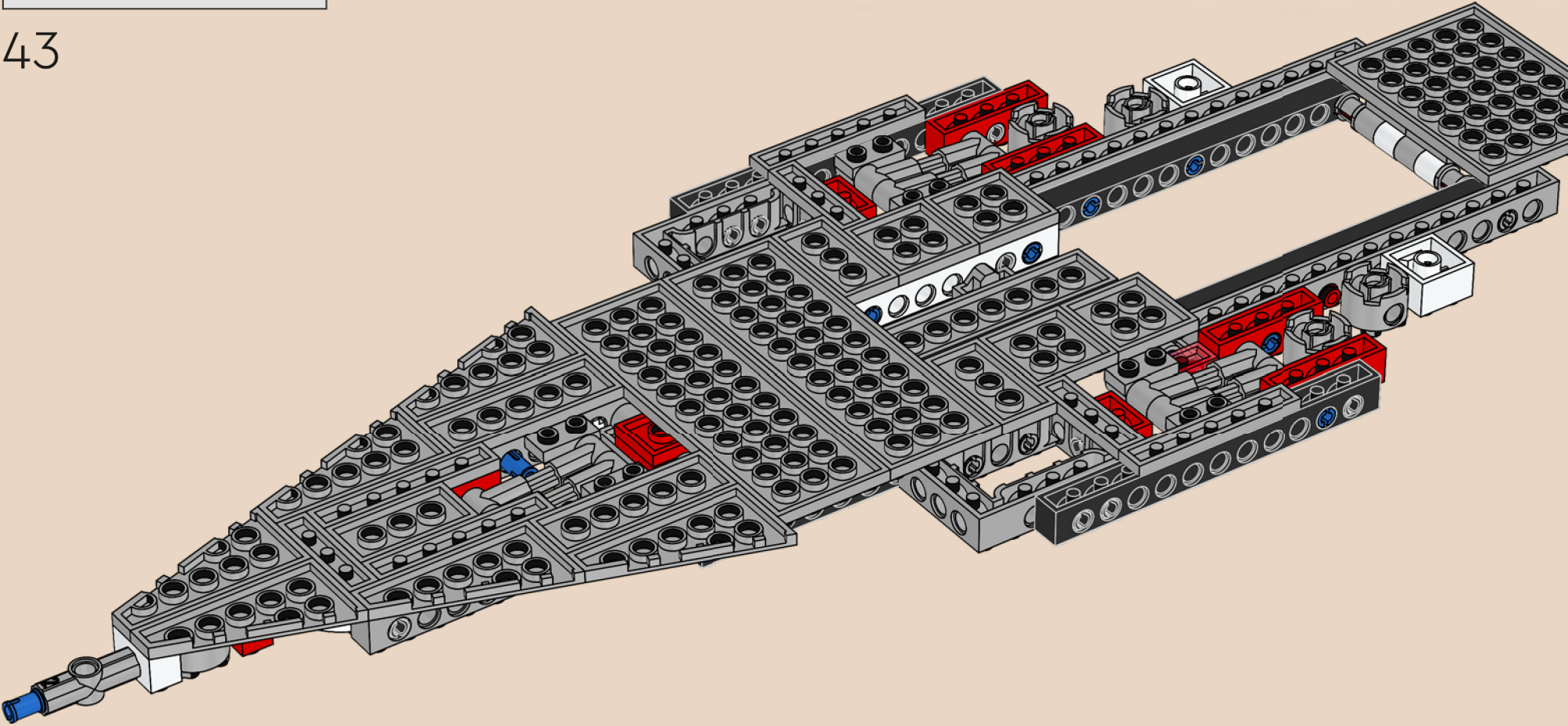

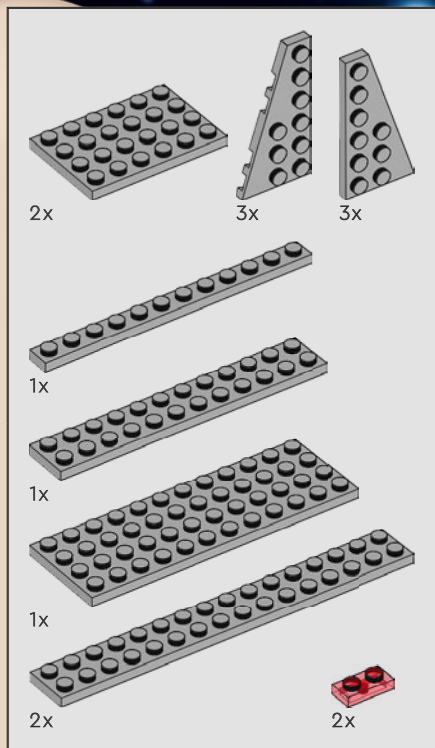

44

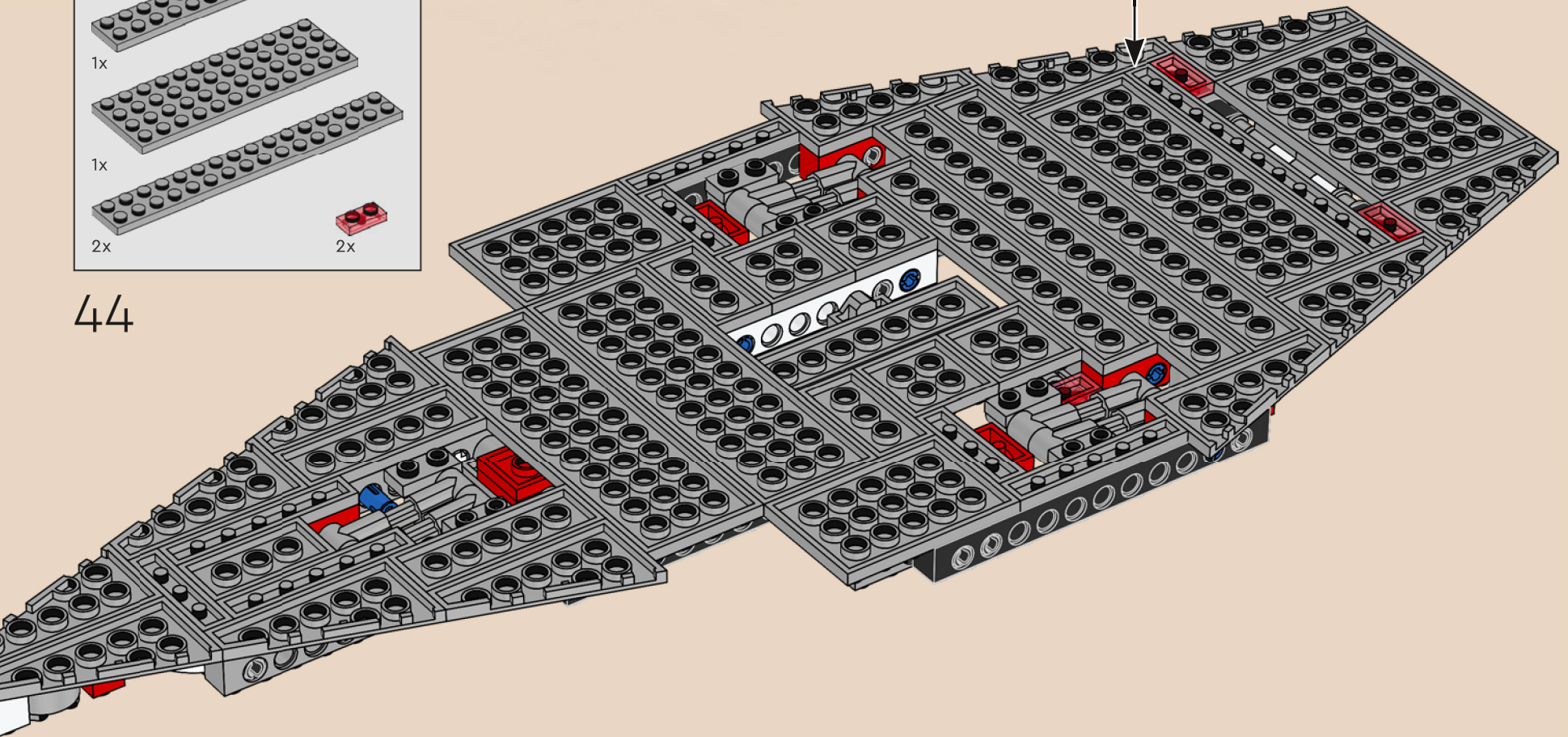
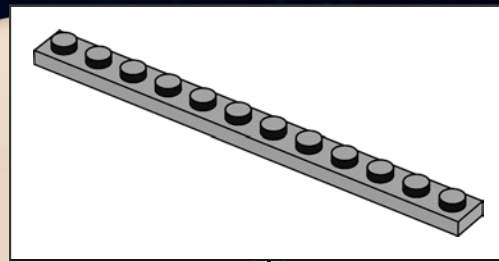

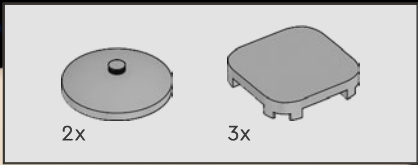

45

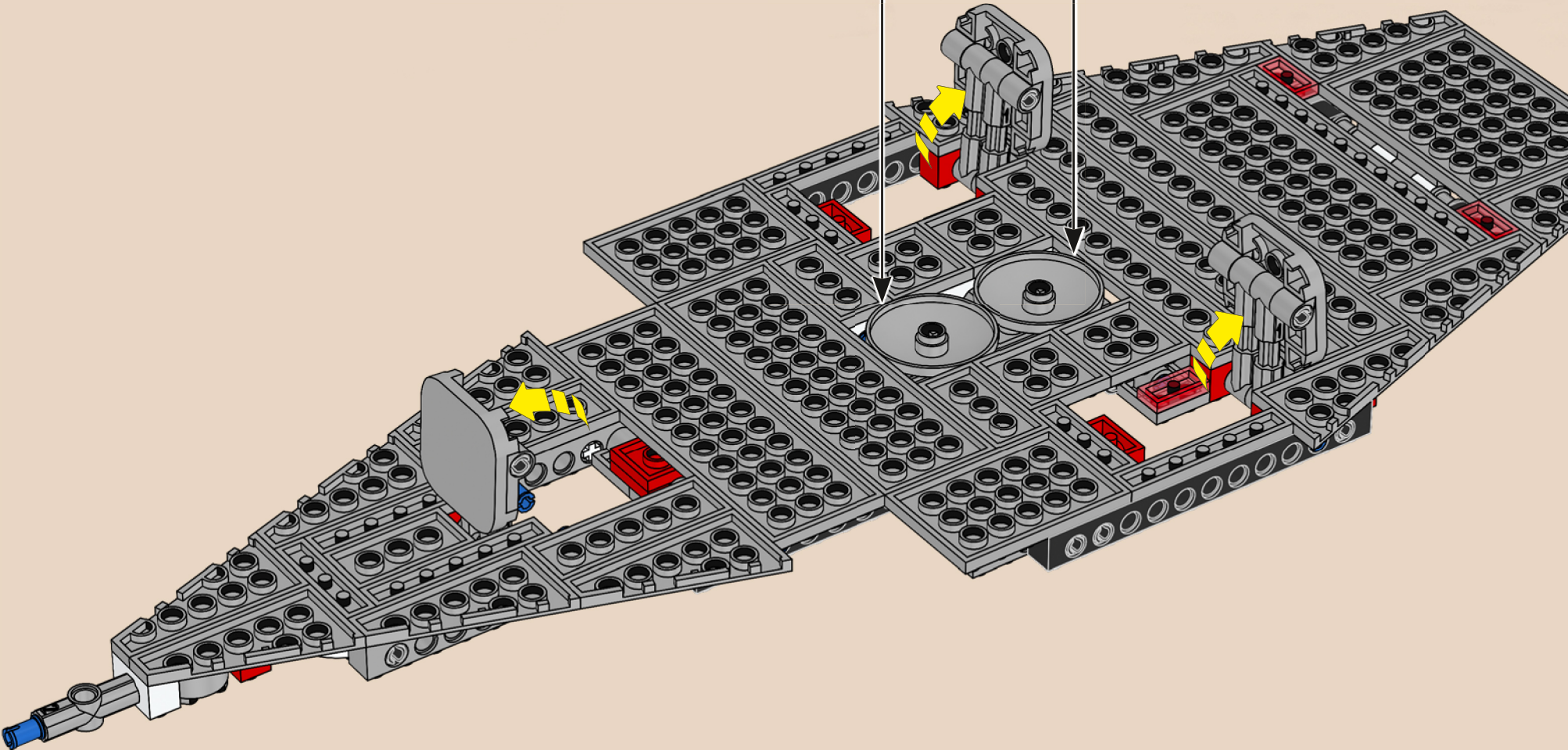
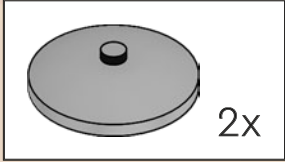

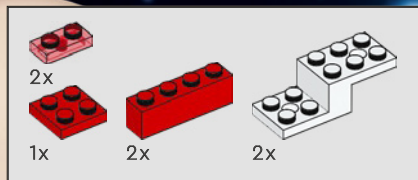

46

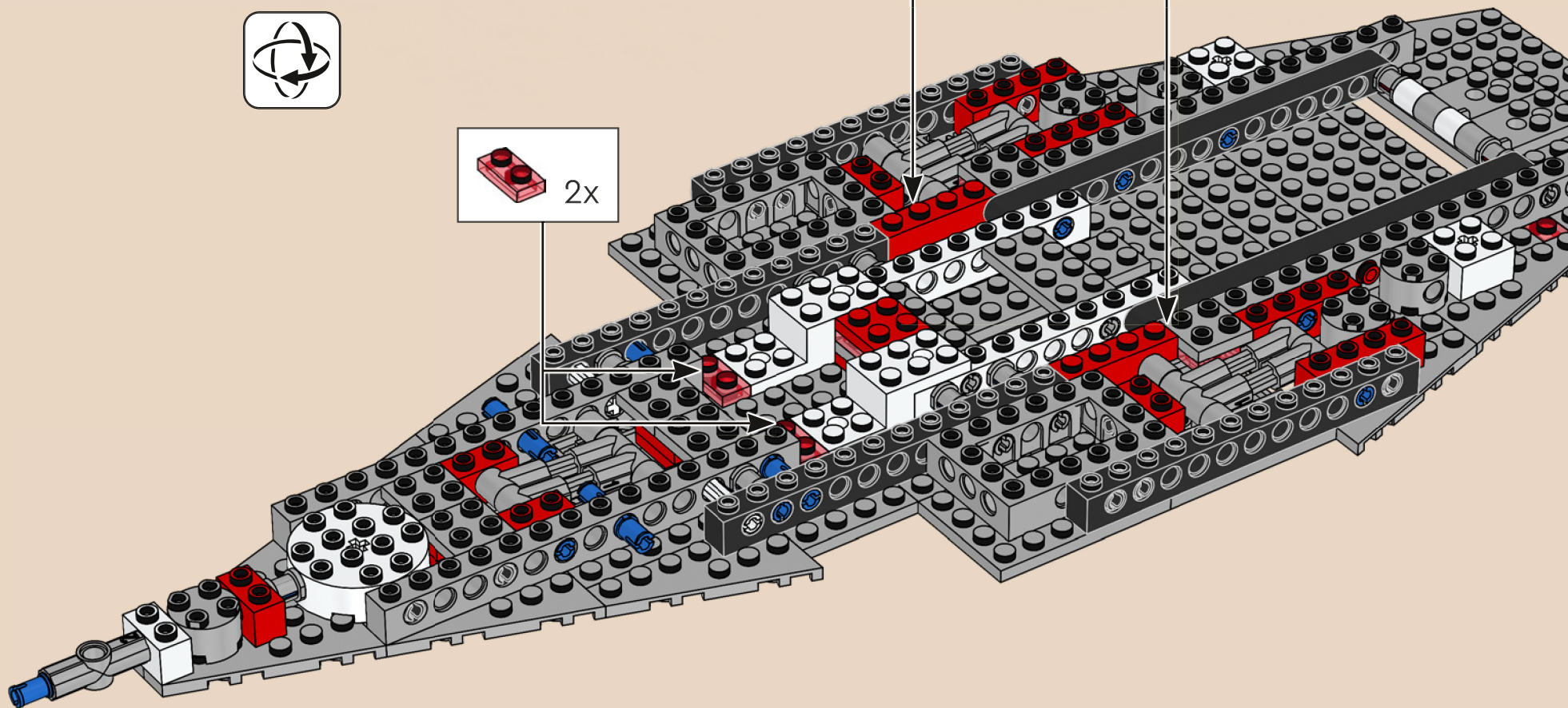
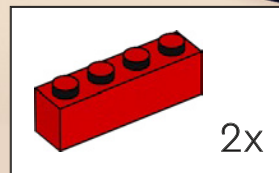

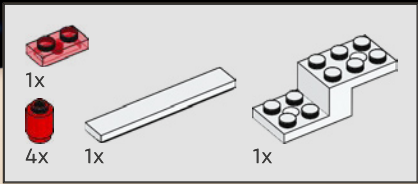

47

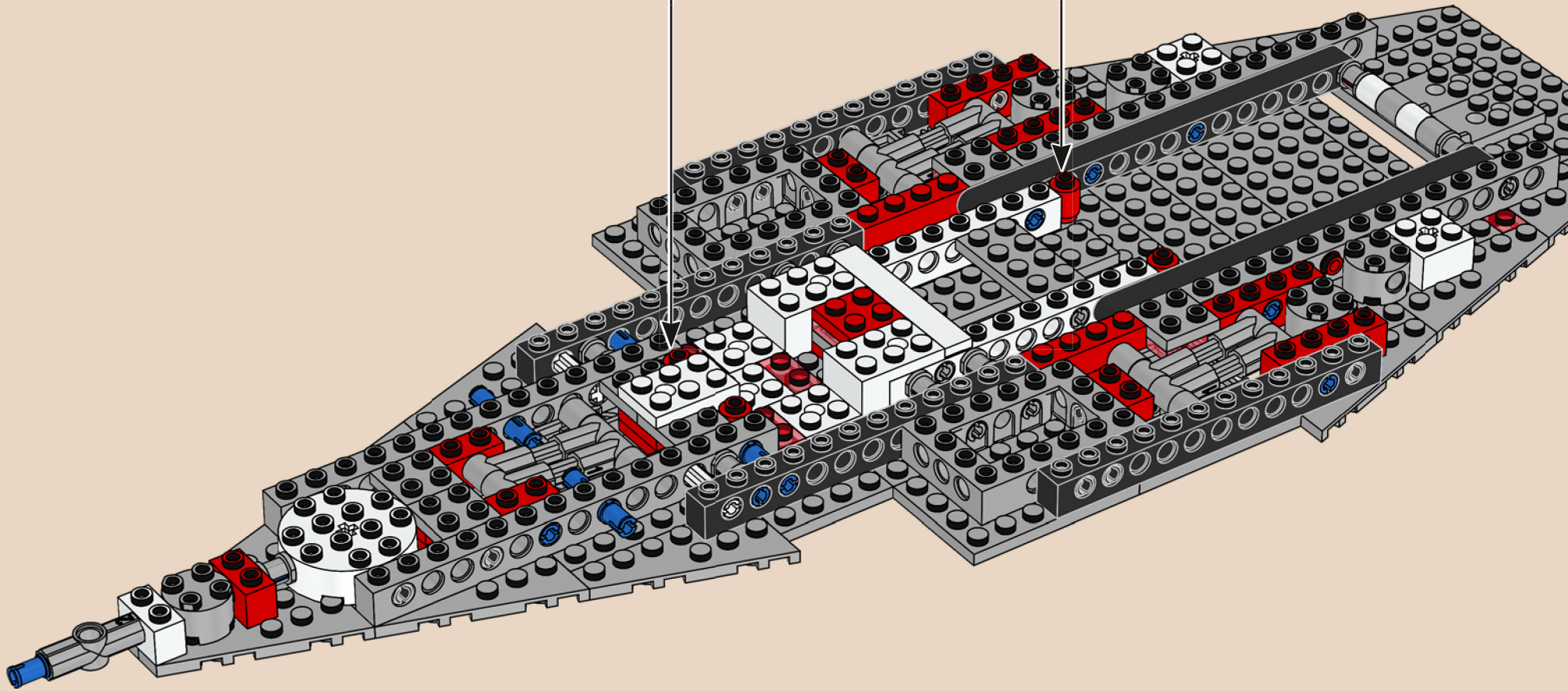
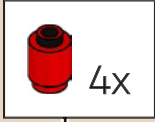

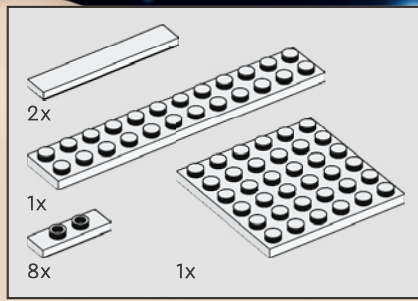

48

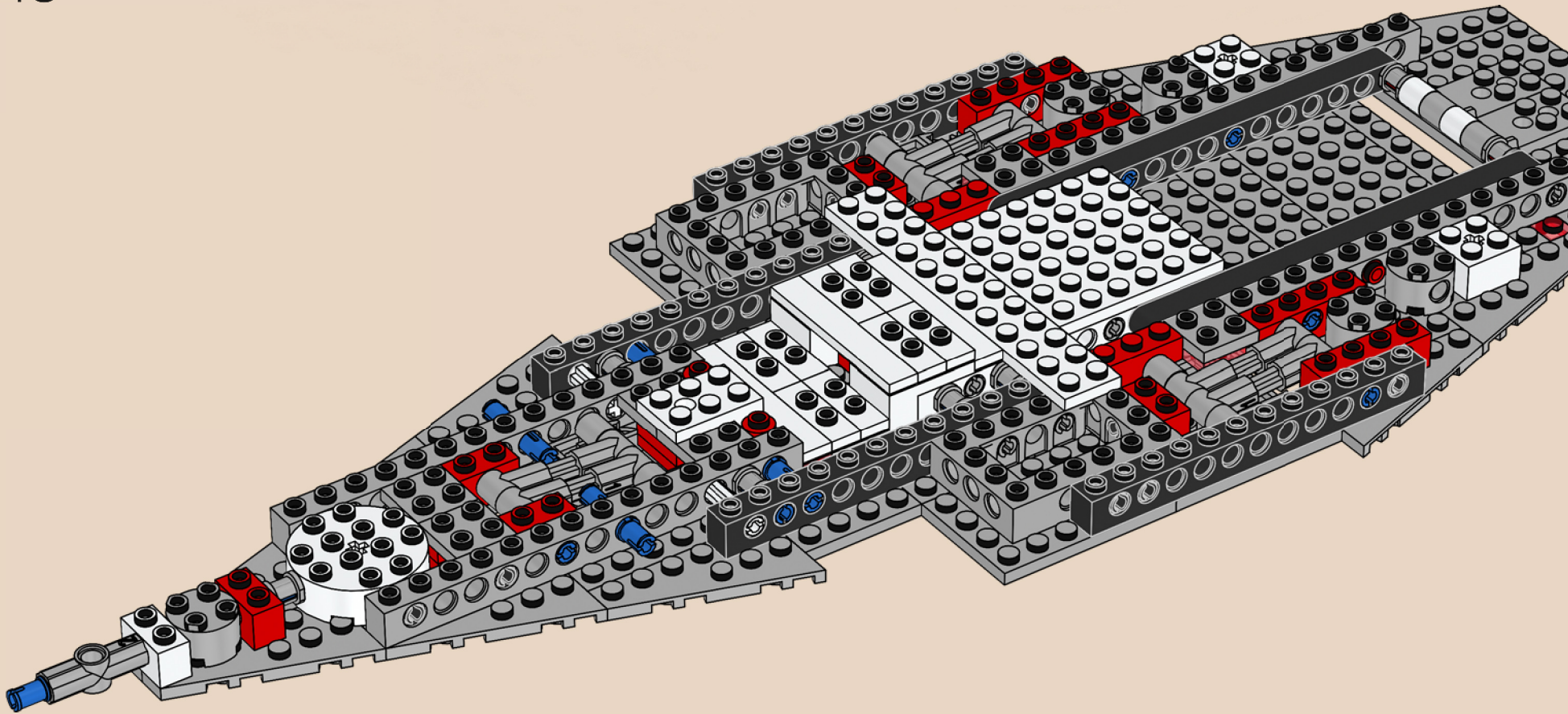

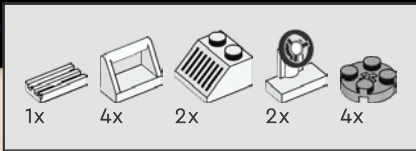

49

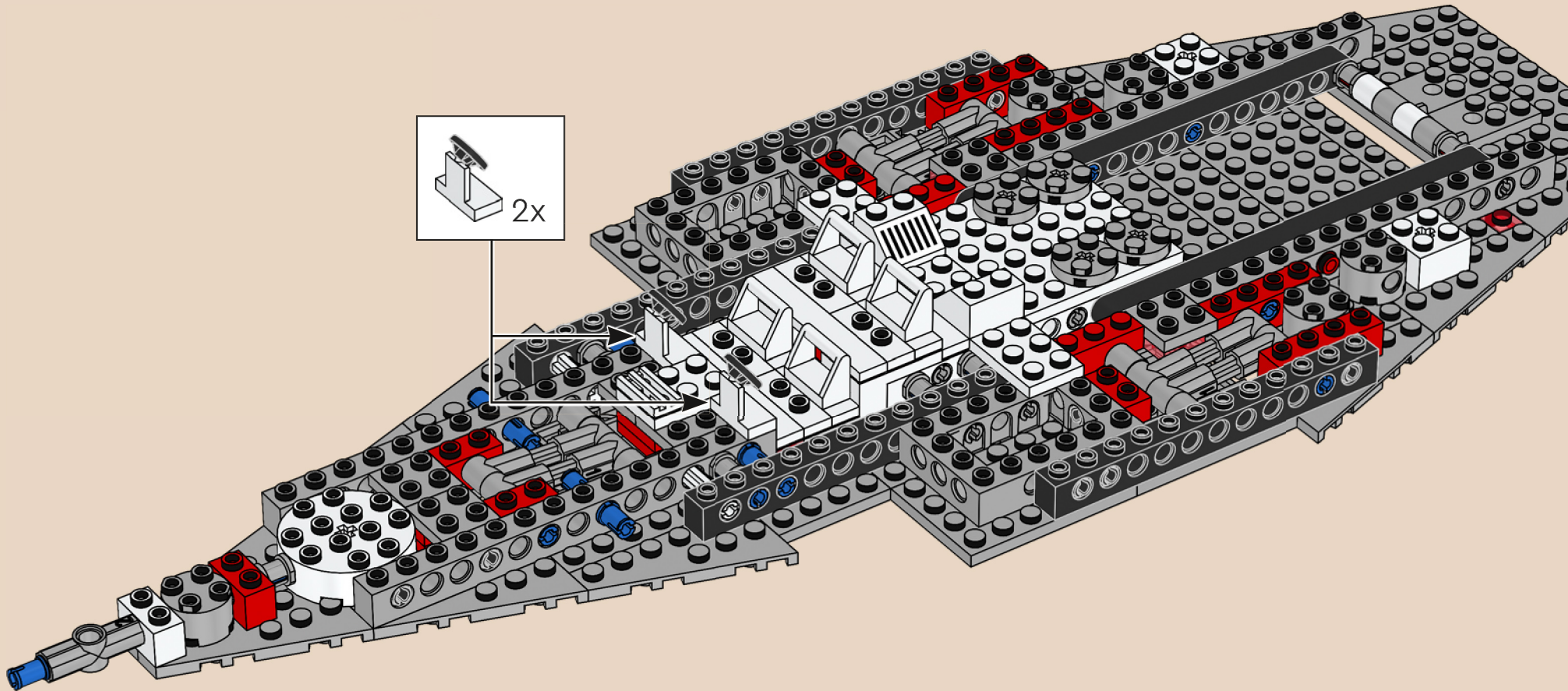

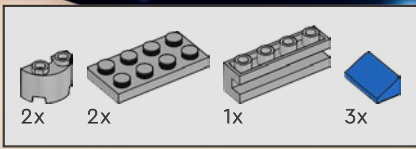

50

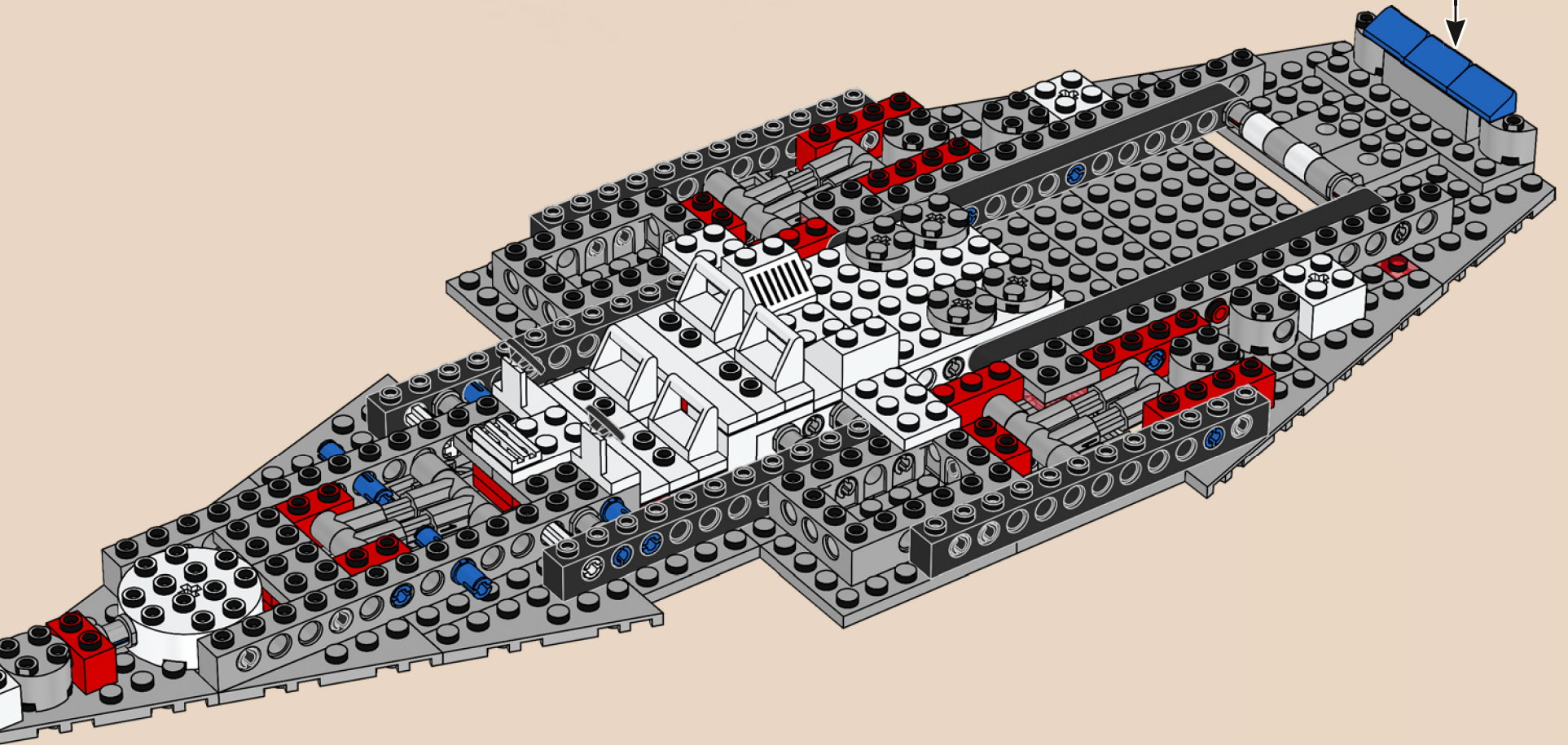
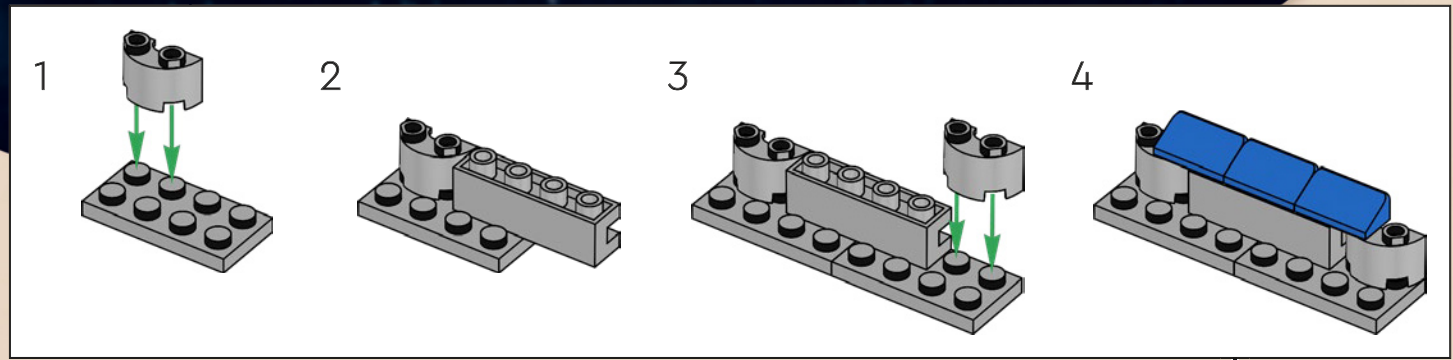

4x 2x 2x

4x

51

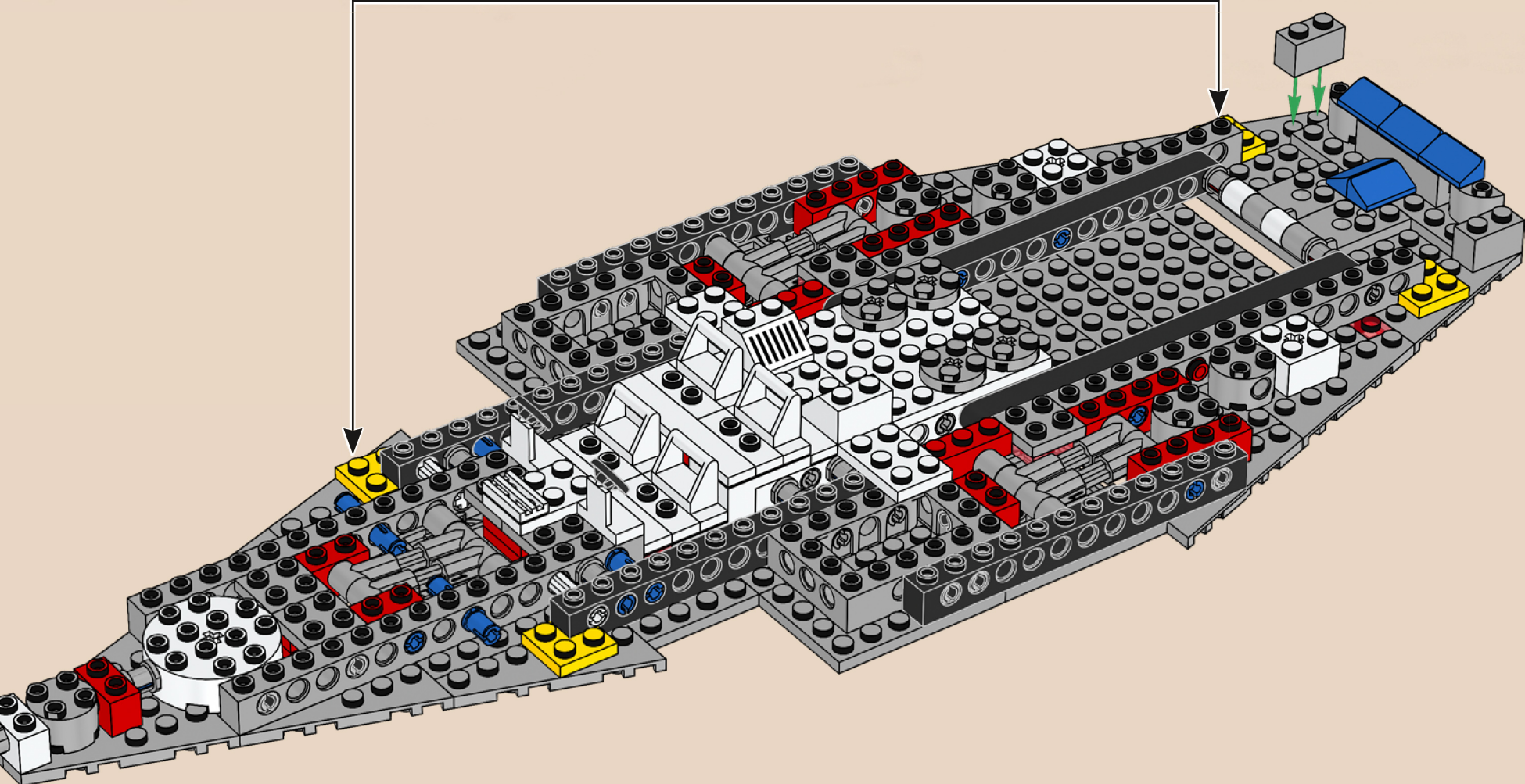

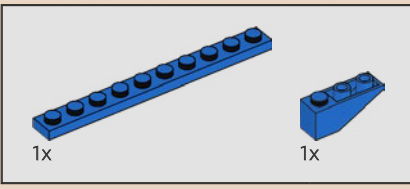
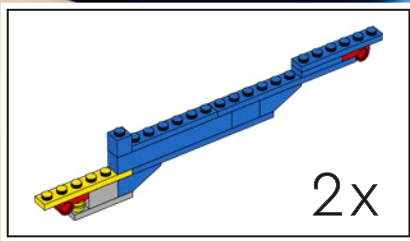

52

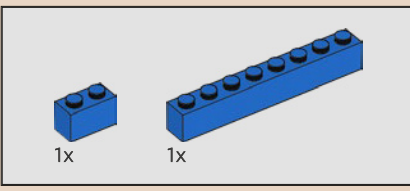
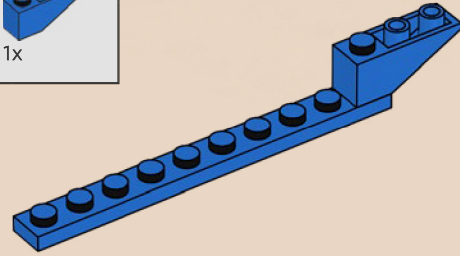

53

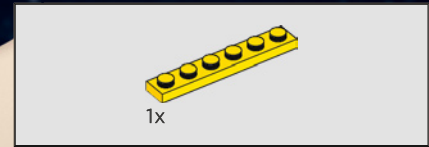
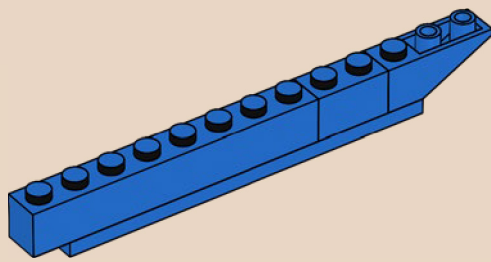

54

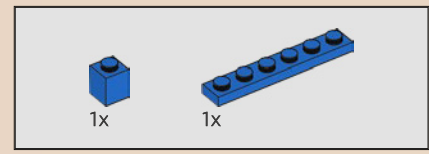
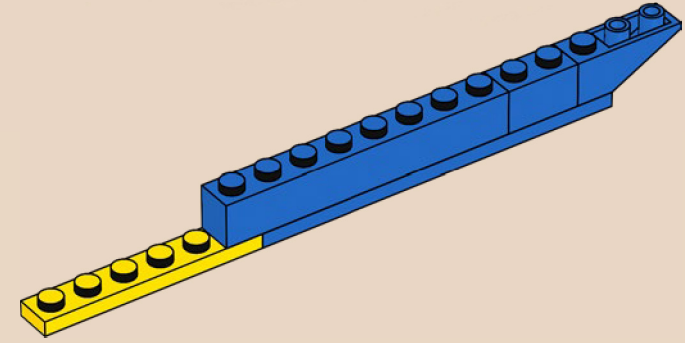

55

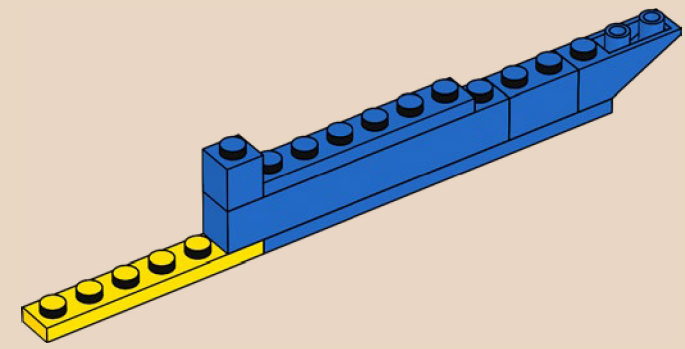

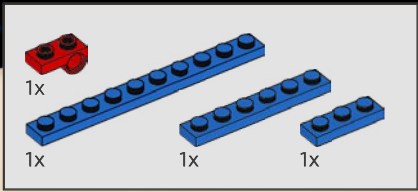

56

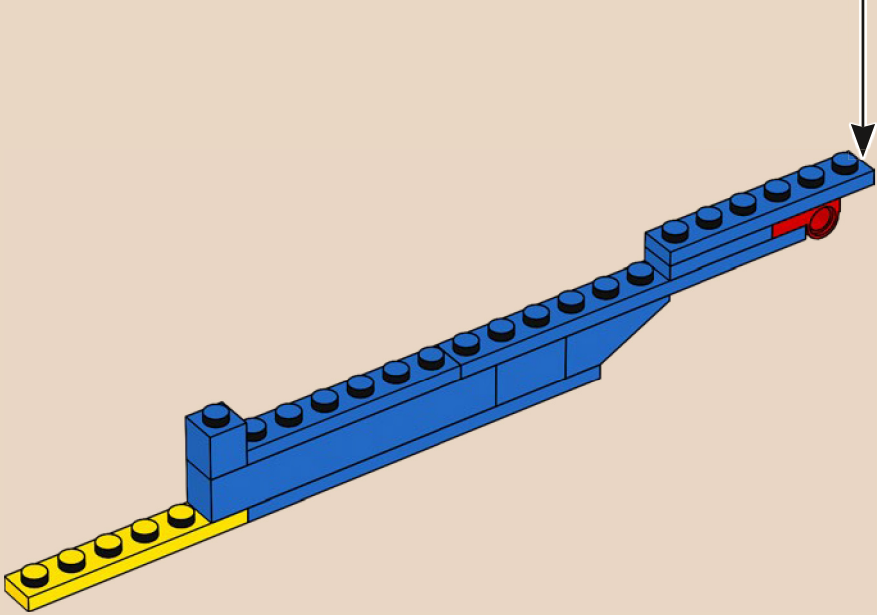
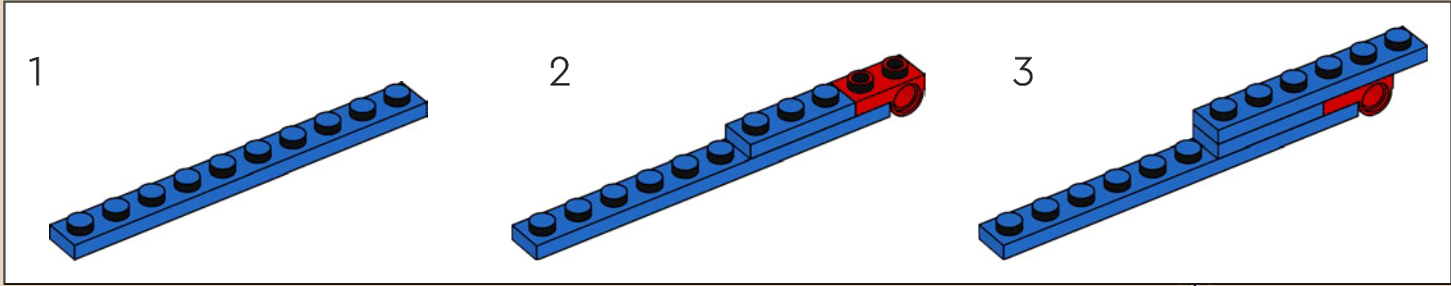



57

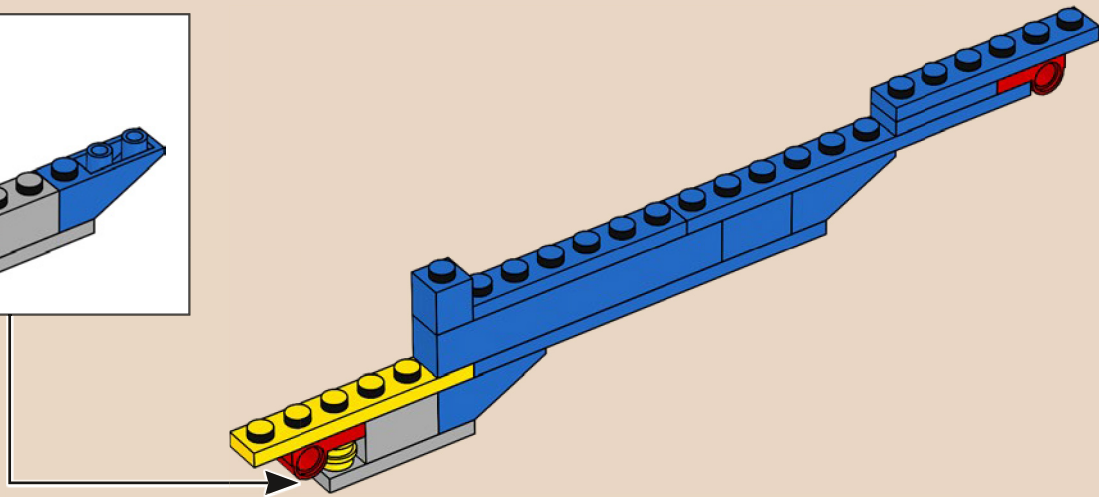
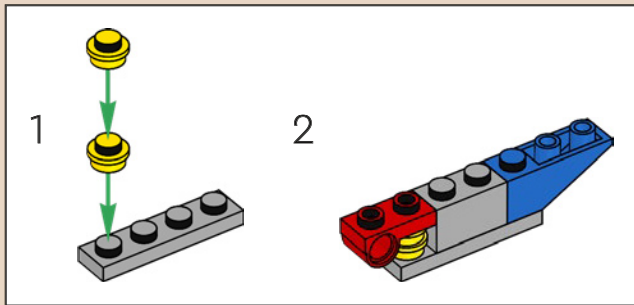

2x

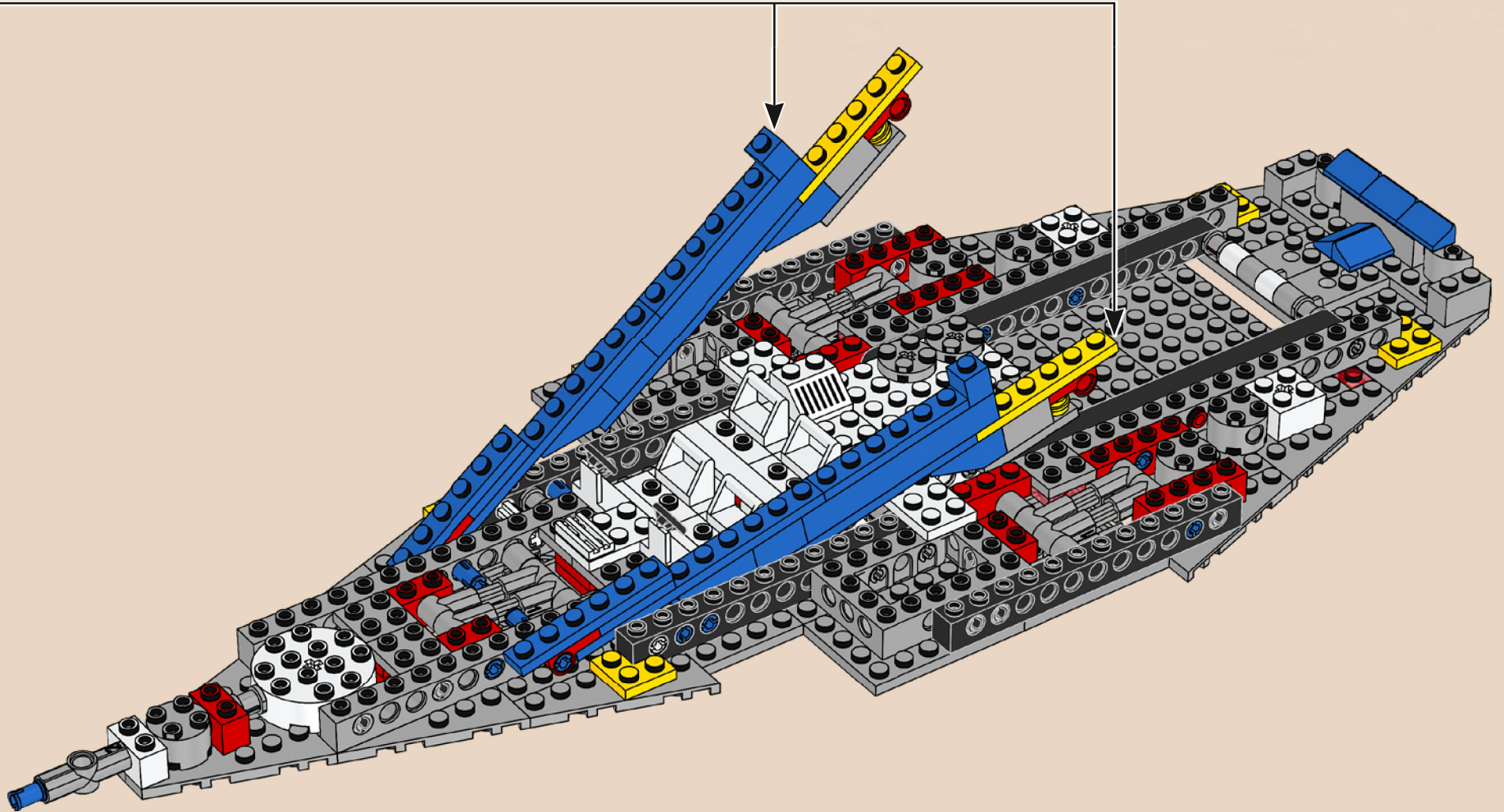



59

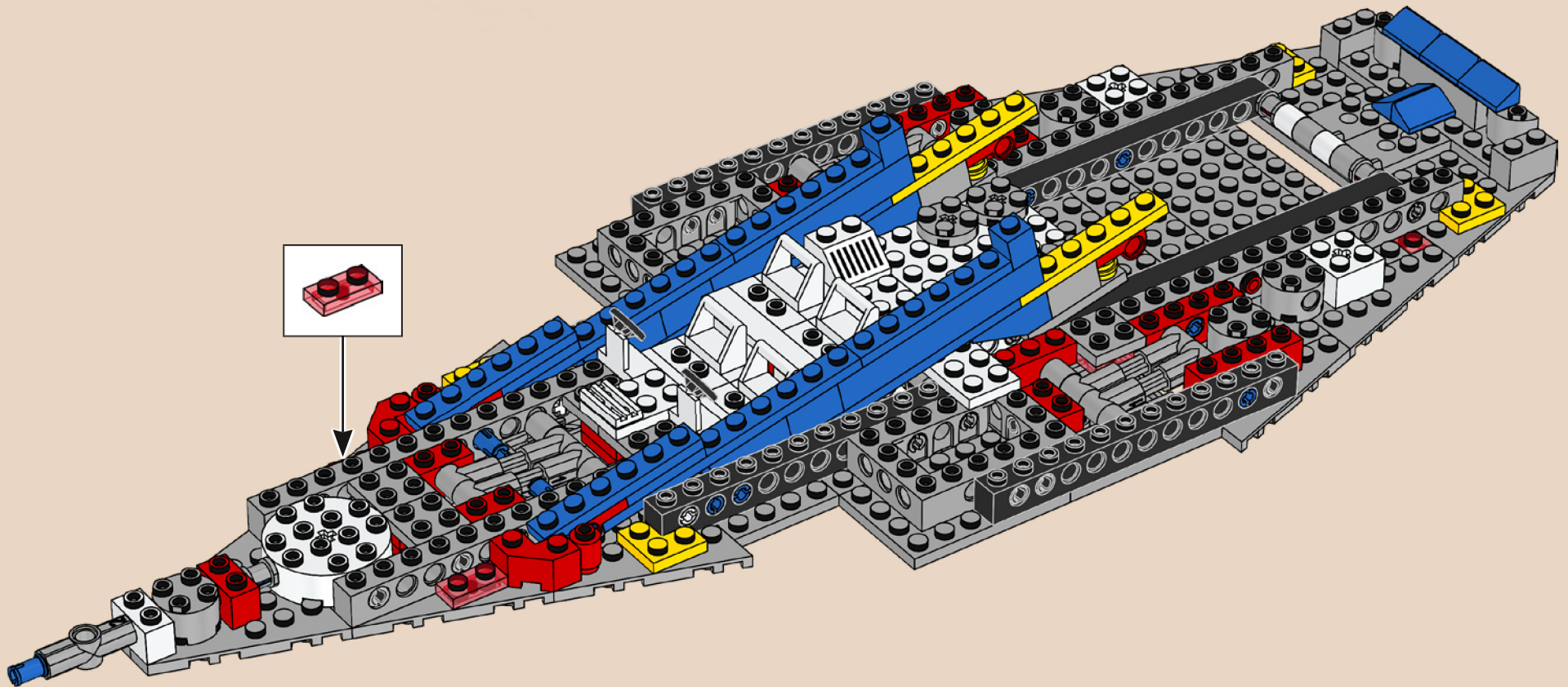

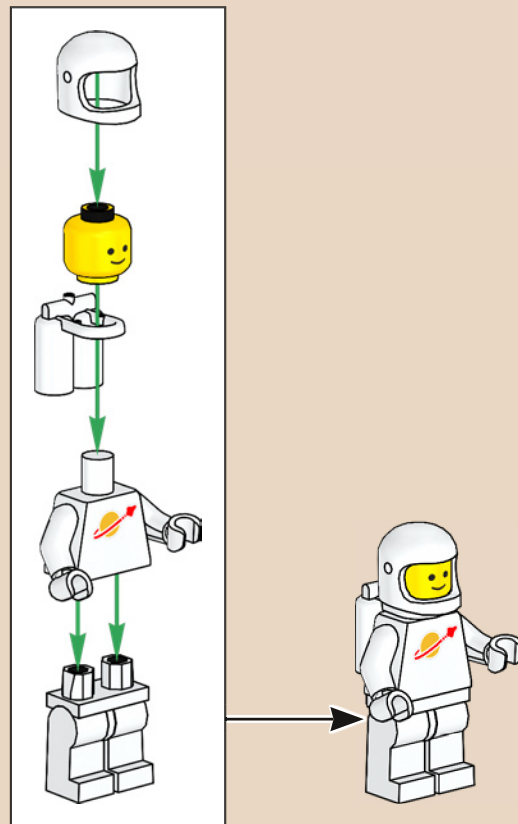

Il modello presenta gli stessi 4 astronauti del set originale, ma i loro caschi sono stati leggermente modificati e ora sono dotati di un sottogola più robusto!

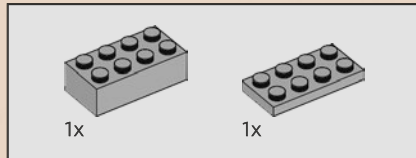
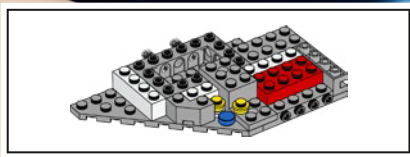

60

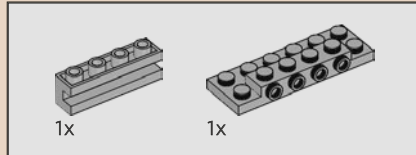
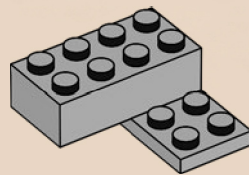

61

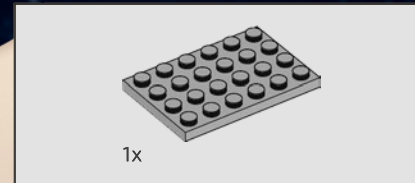
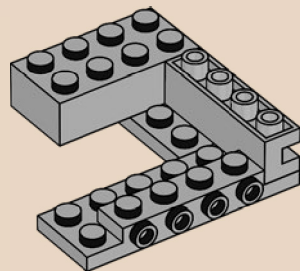

62

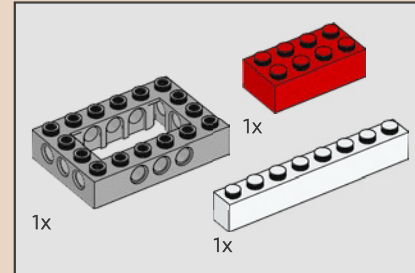
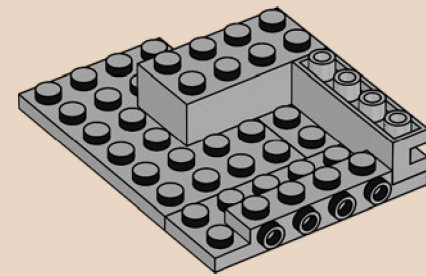

63

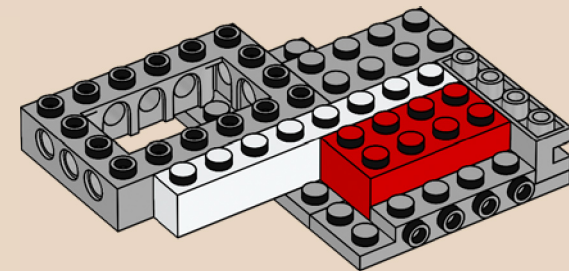

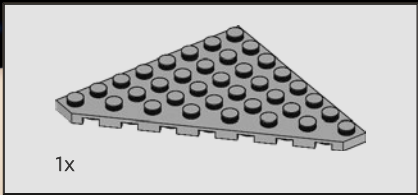

64

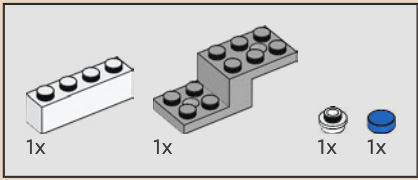
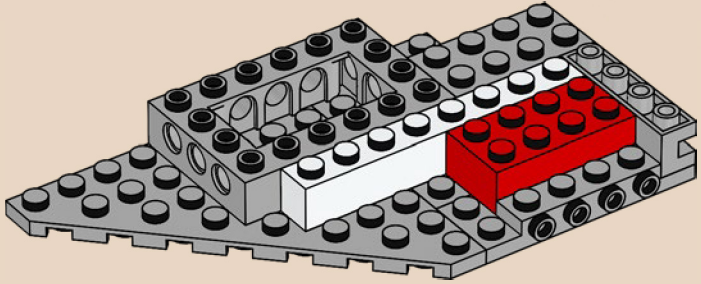

65

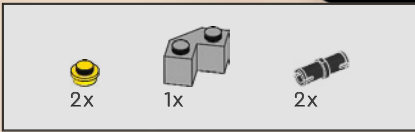
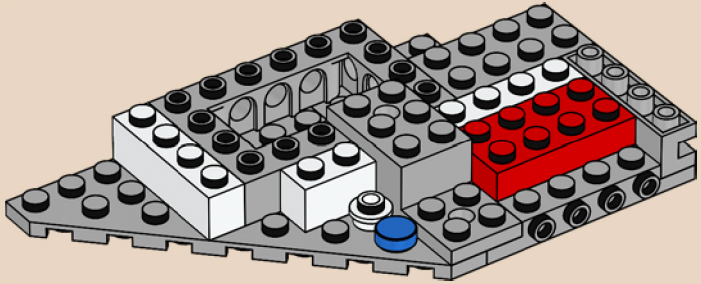

66

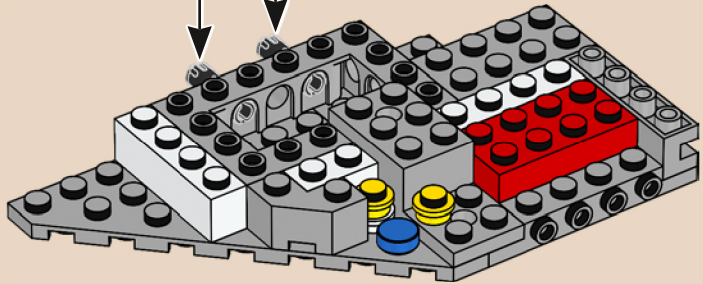

67

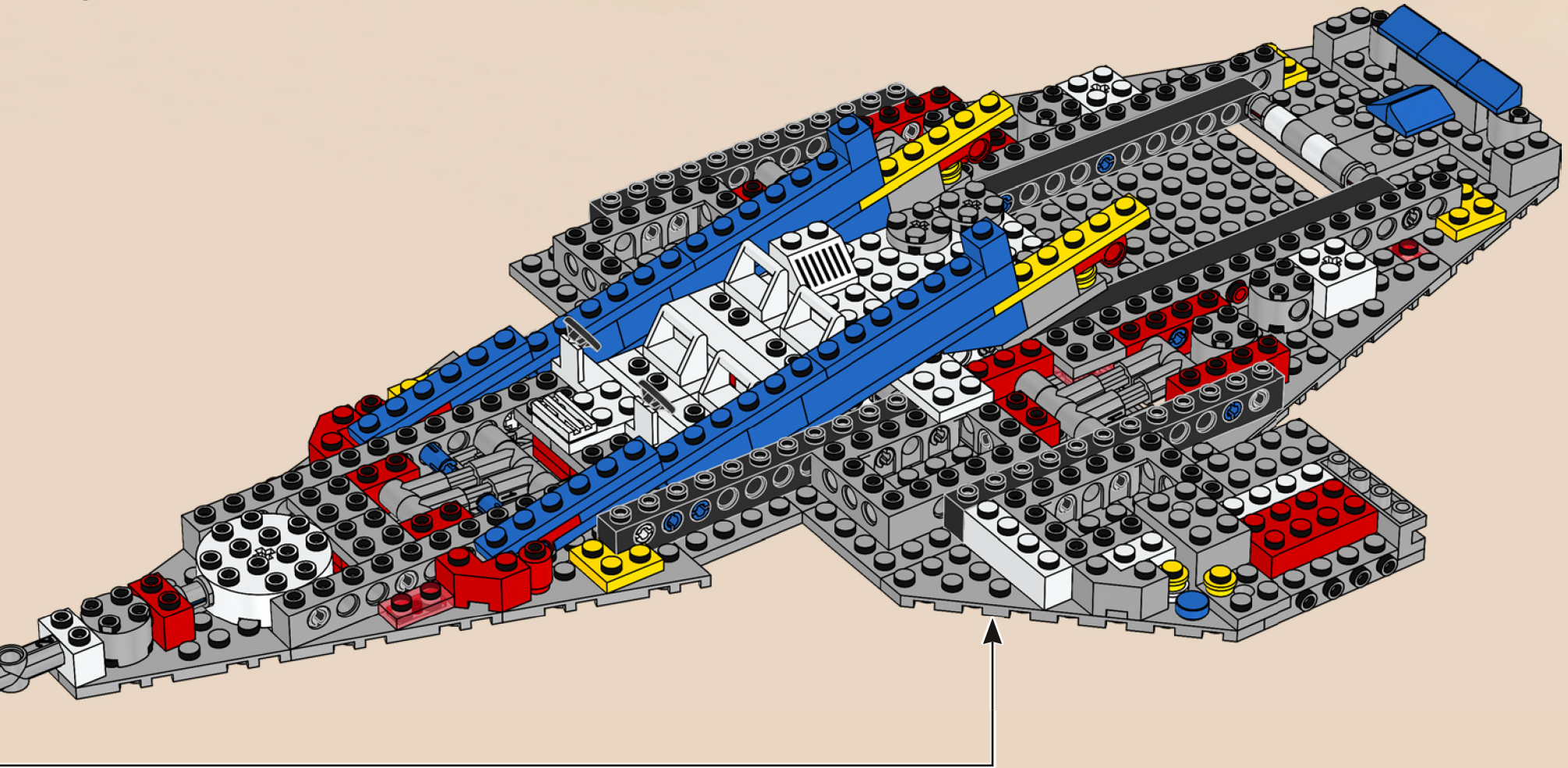

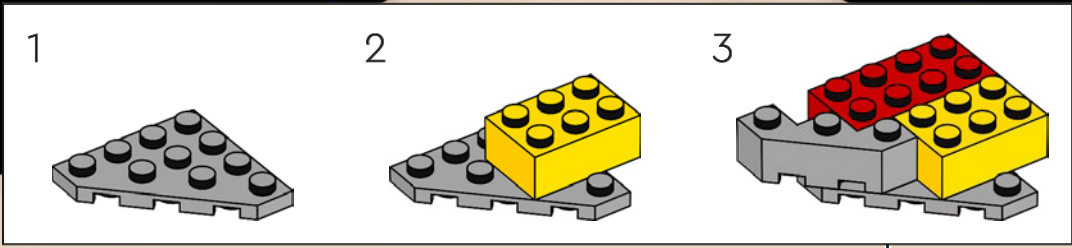
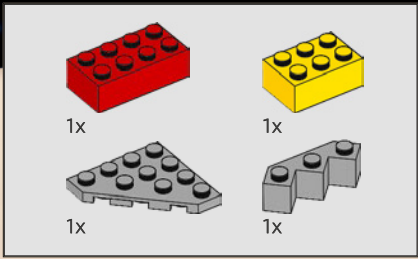

68

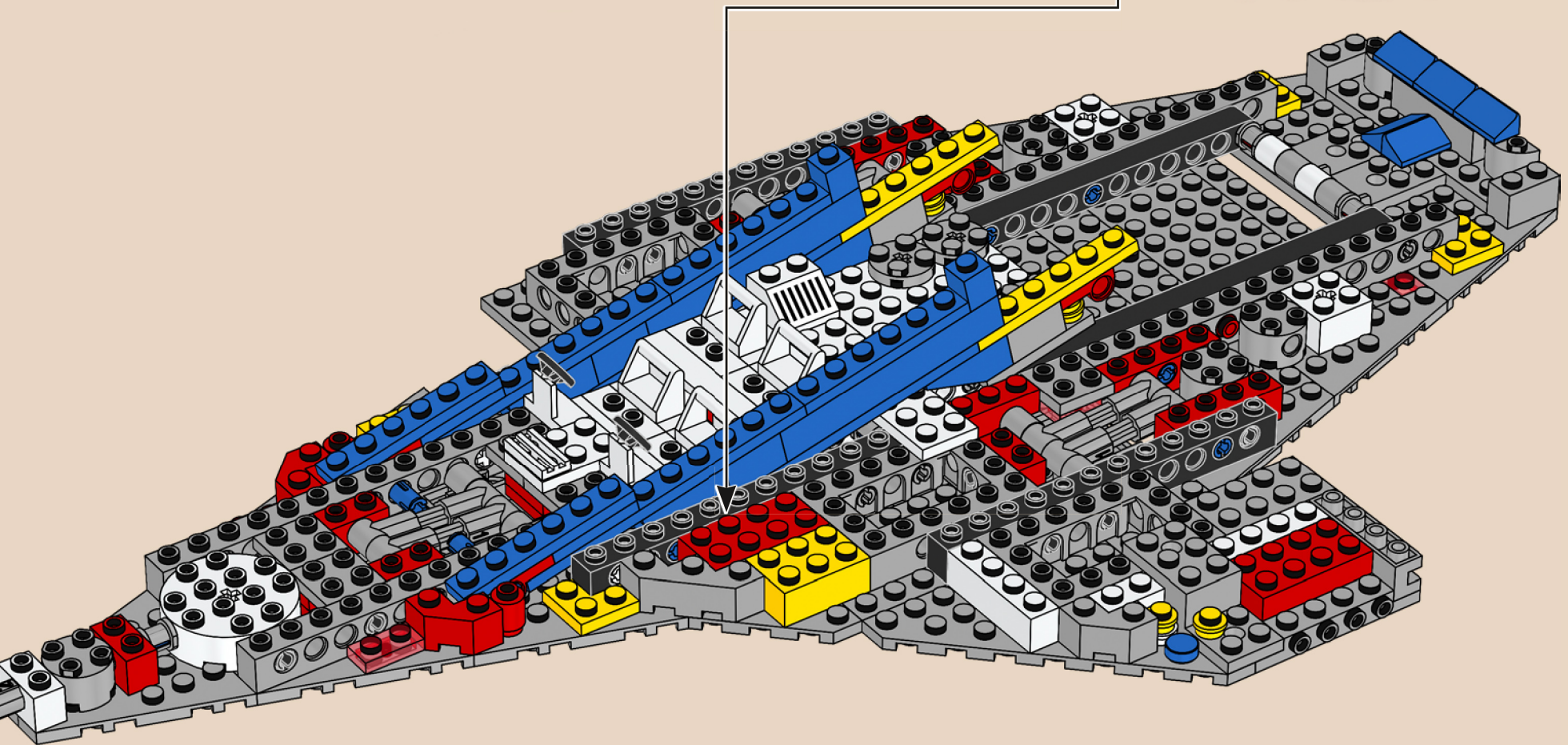

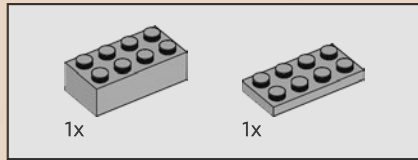
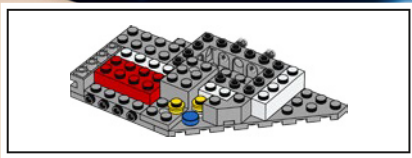

69

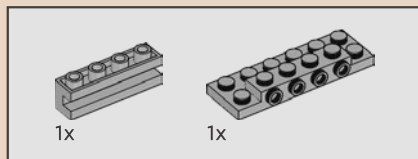
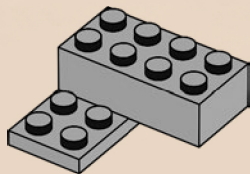

70

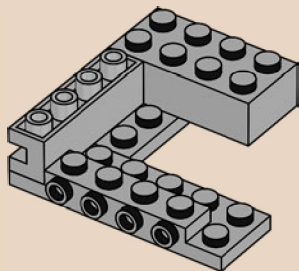

71

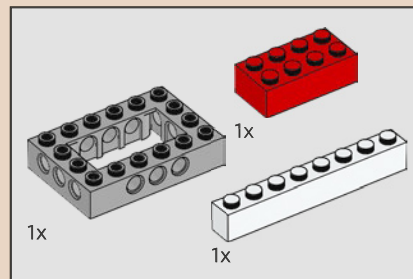
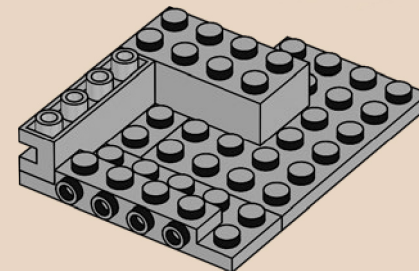

72

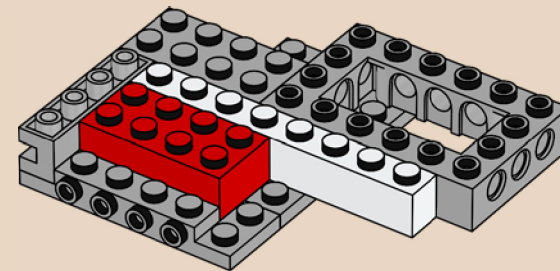

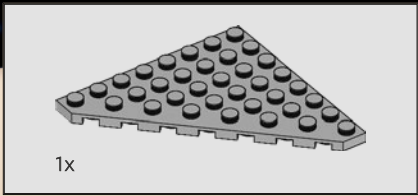

73

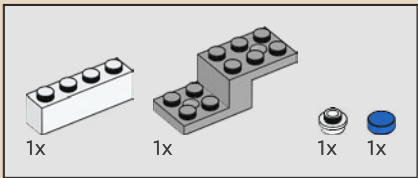
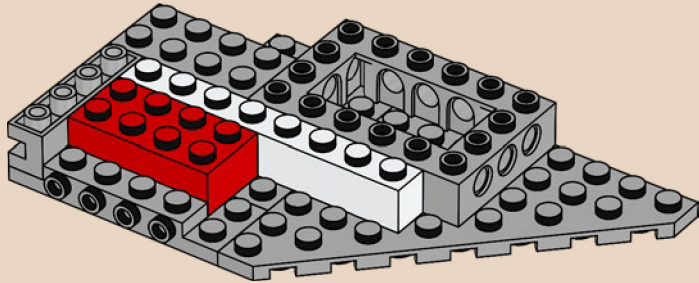

74

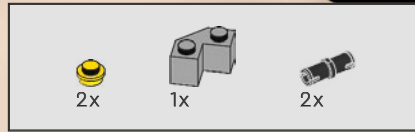
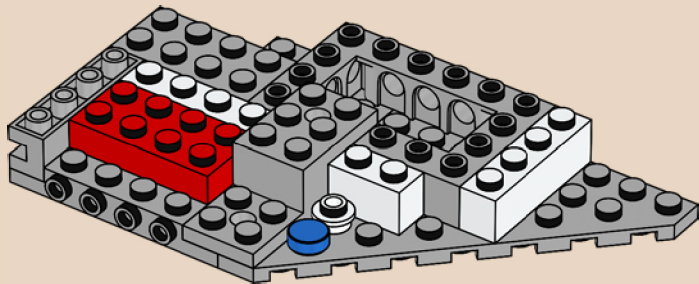

75

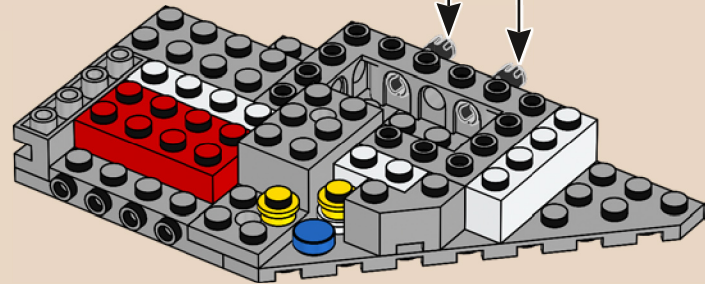
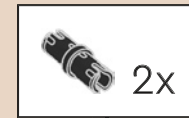

76

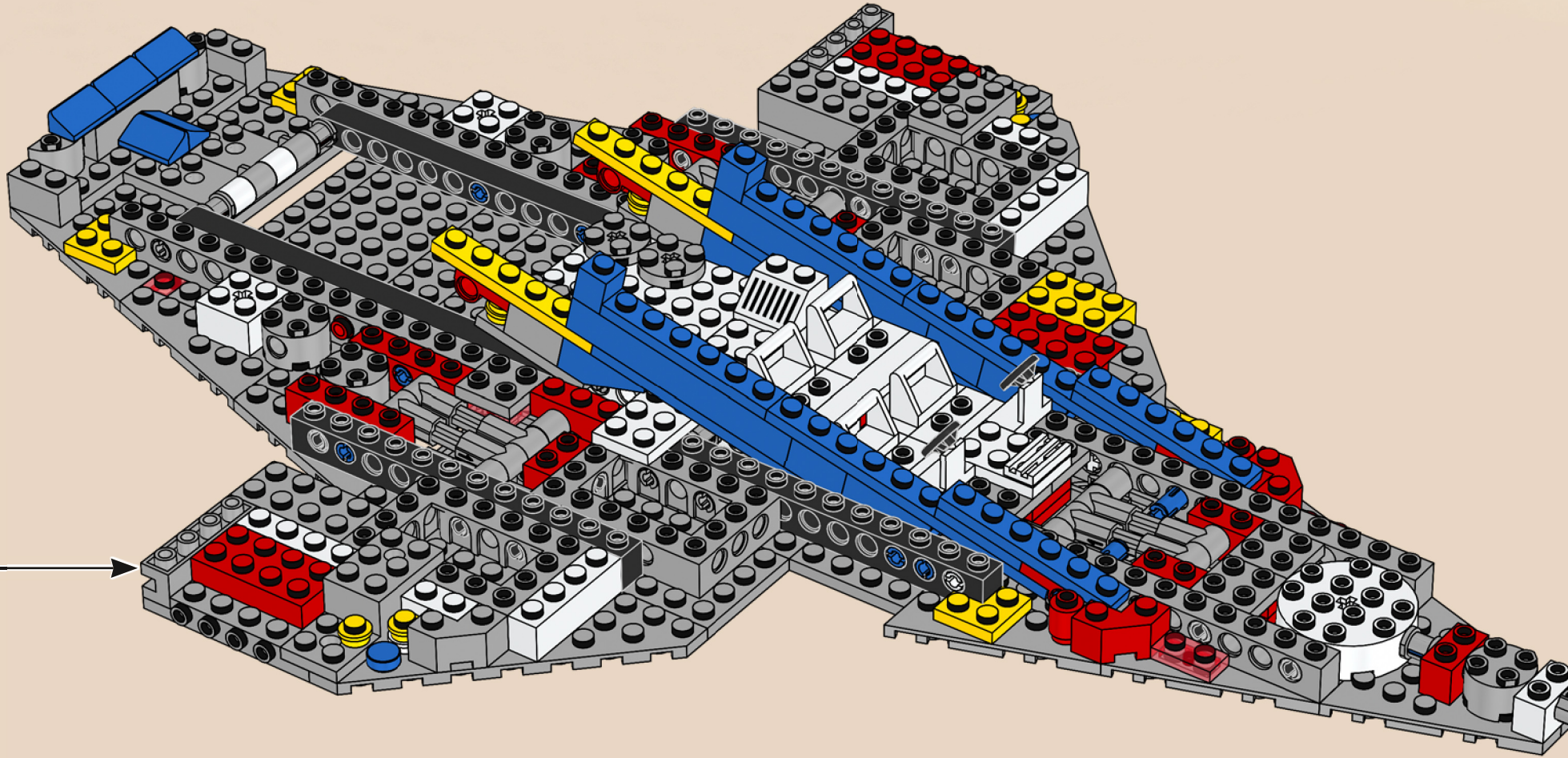

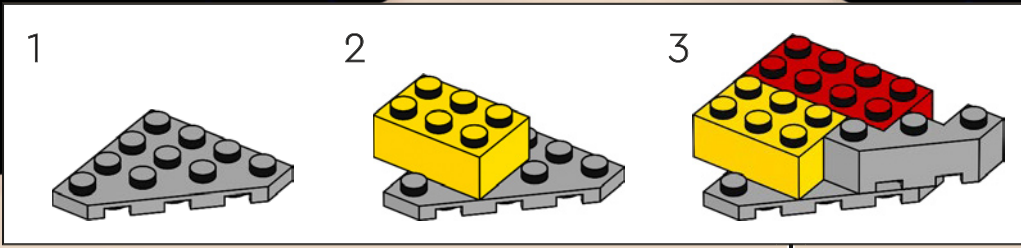
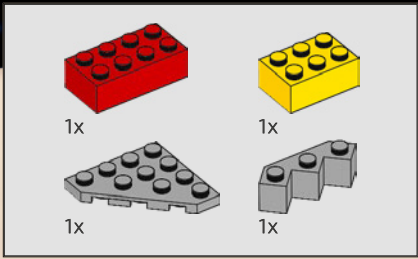

77

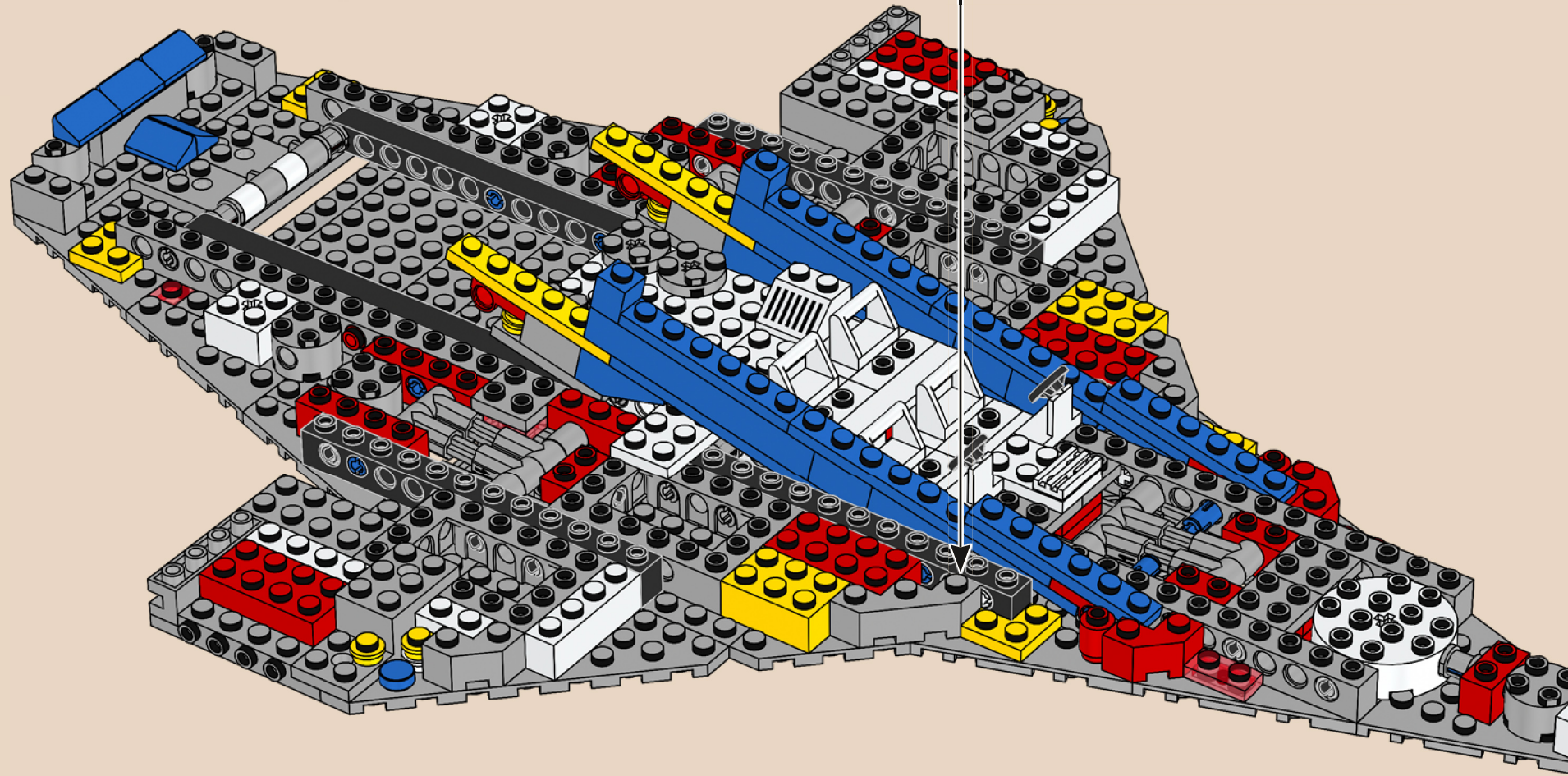



78



La palette dei colori di questa navicella spaziale comprende solo i colori disponibili nel 1979 quando fu lanciato il prodotto originale, ad eccezione del colore 194, grigio pietra medio.

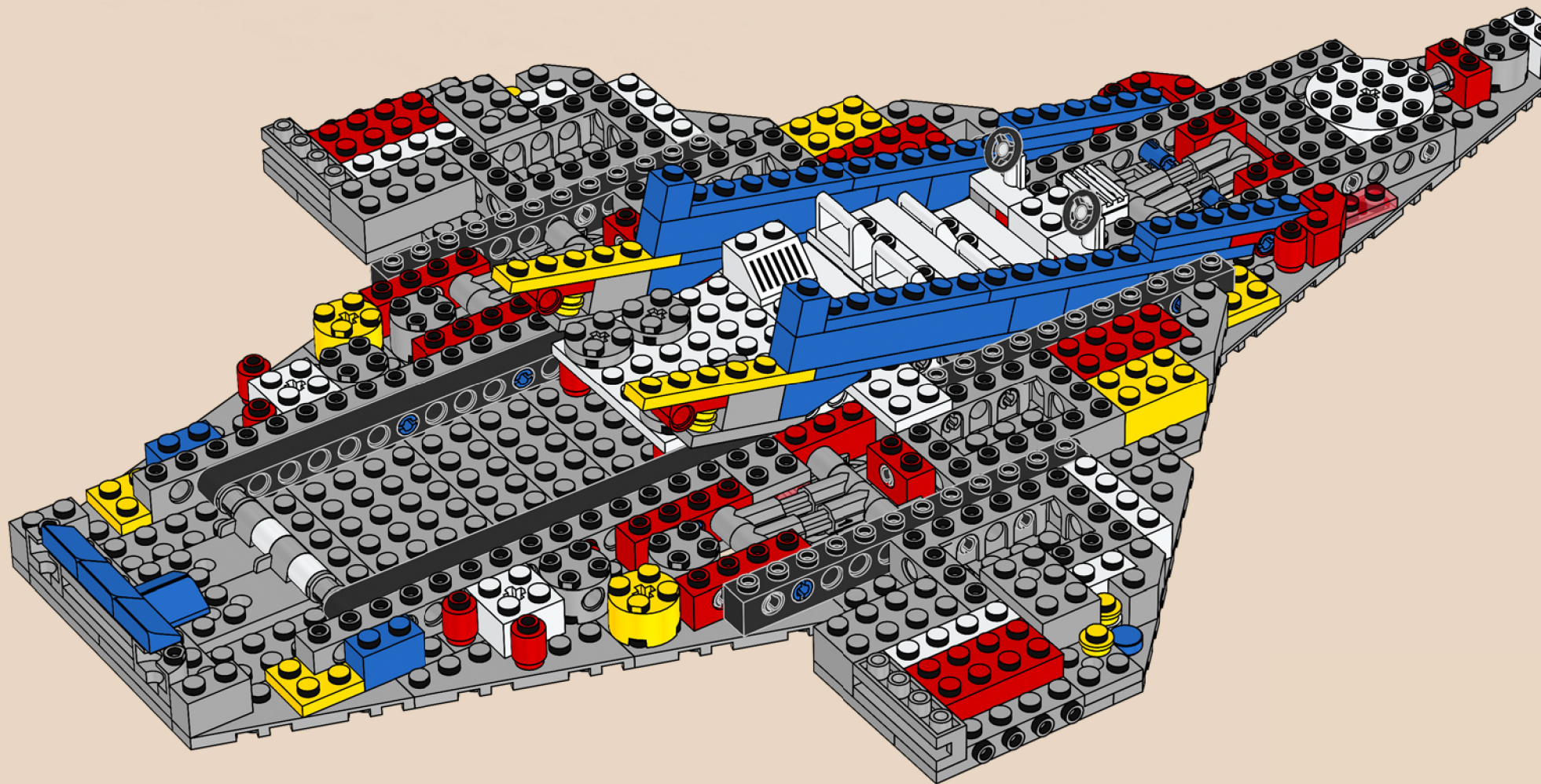

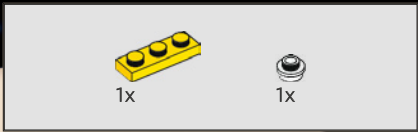

79

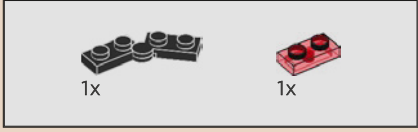
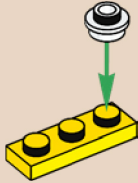

80

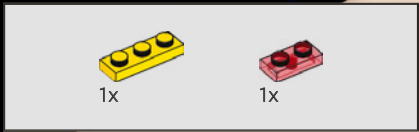
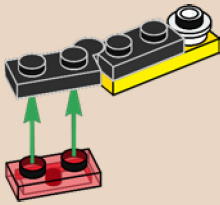

81

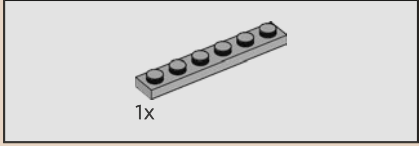
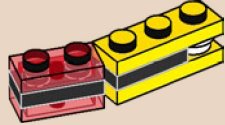

82

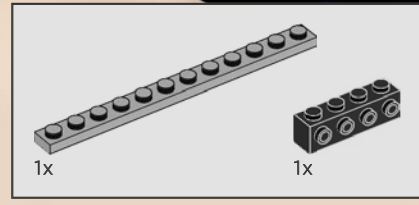

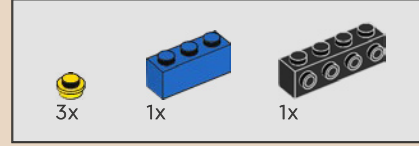
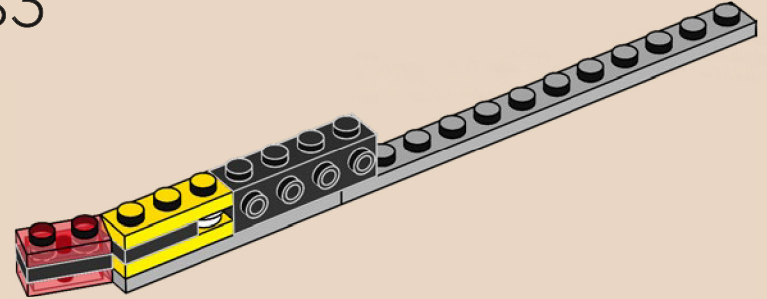

83

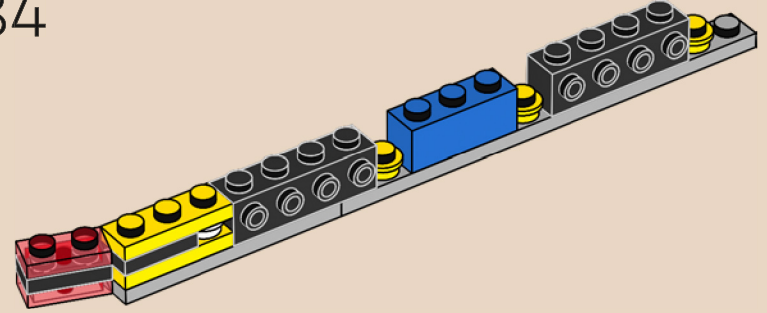

84



1x  2x 

85

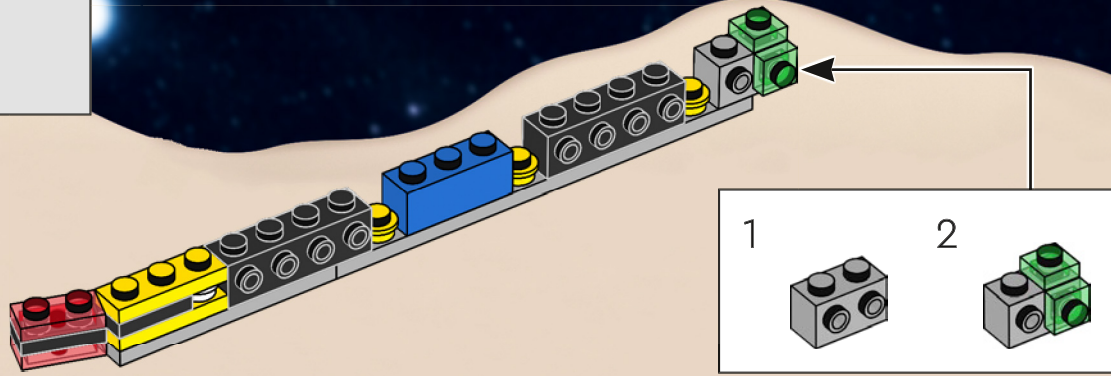

86

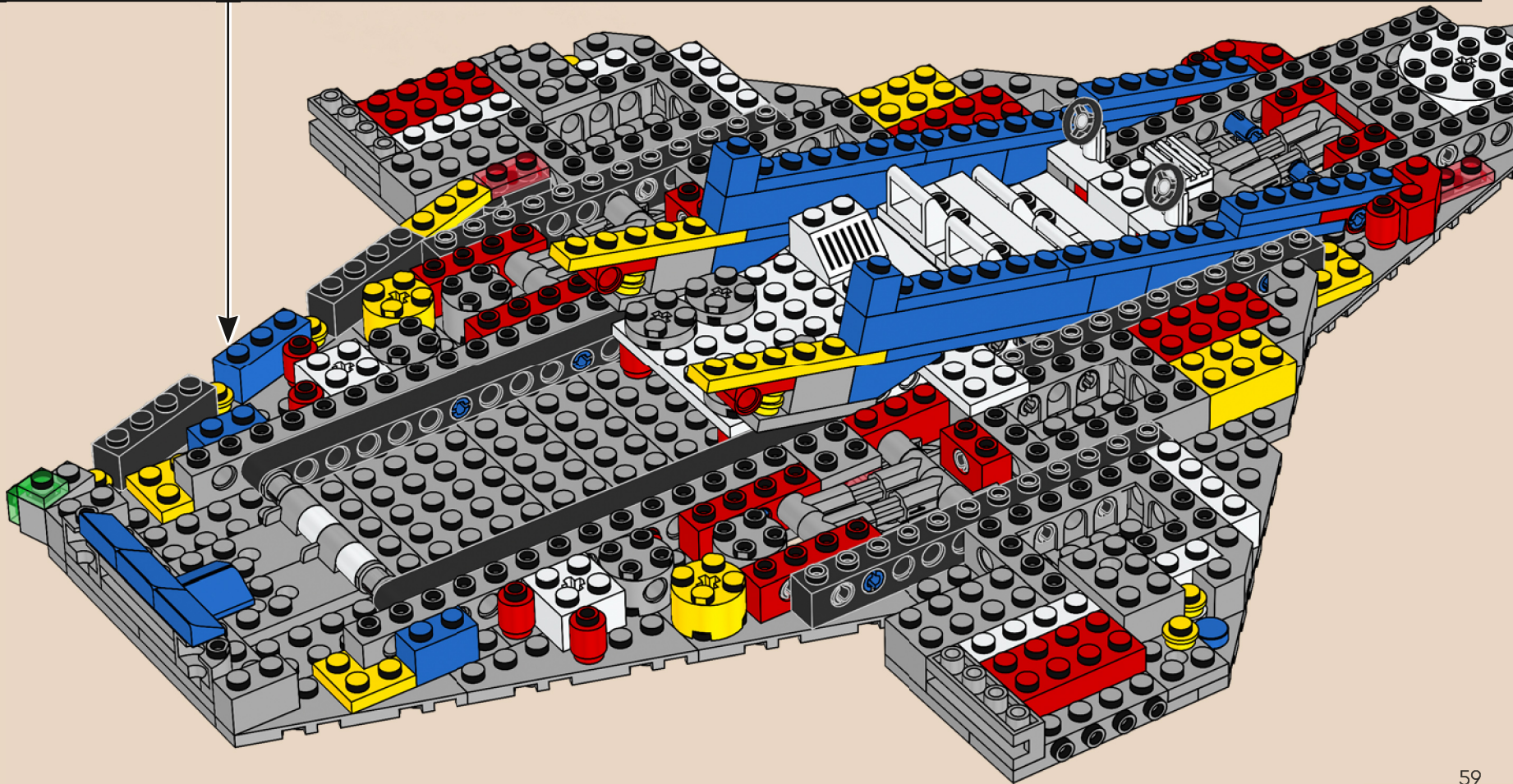

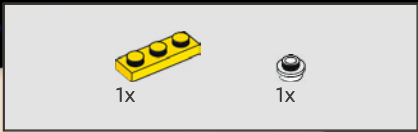

87

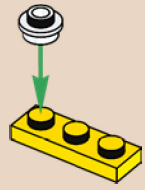

88

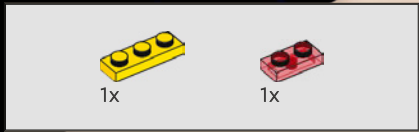
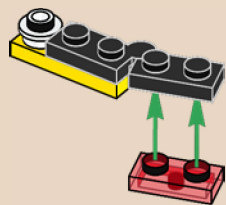

89

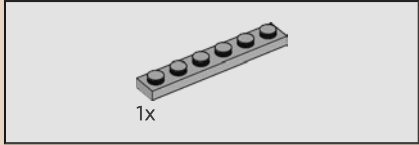
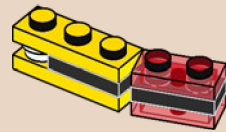

90

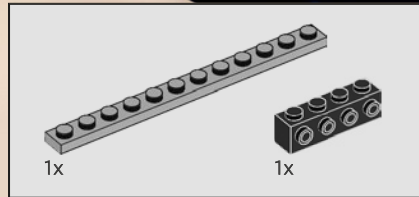
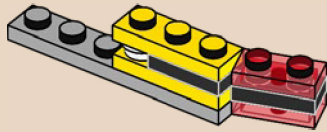

91

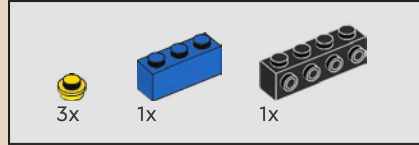
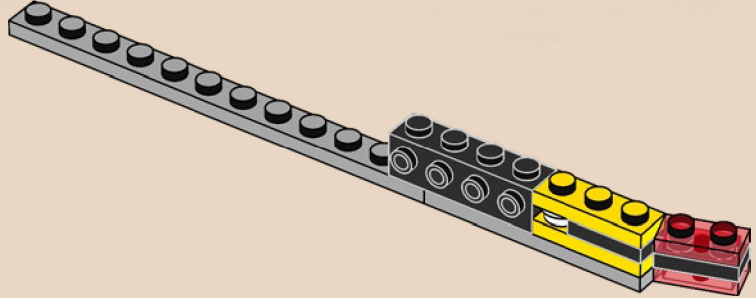

92

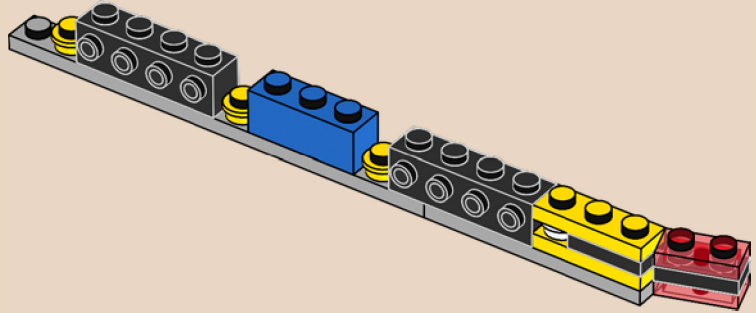

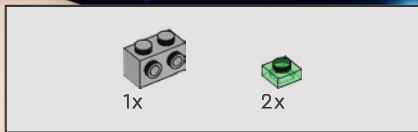

93

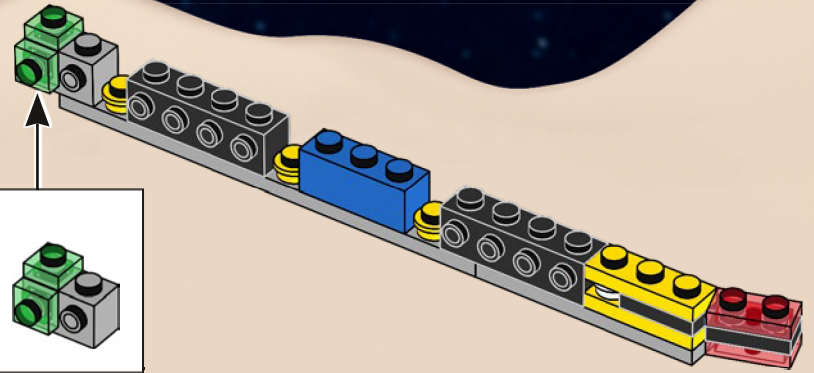
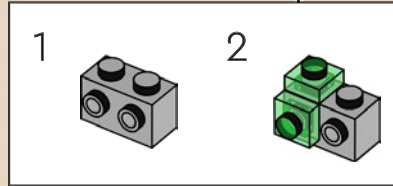

94

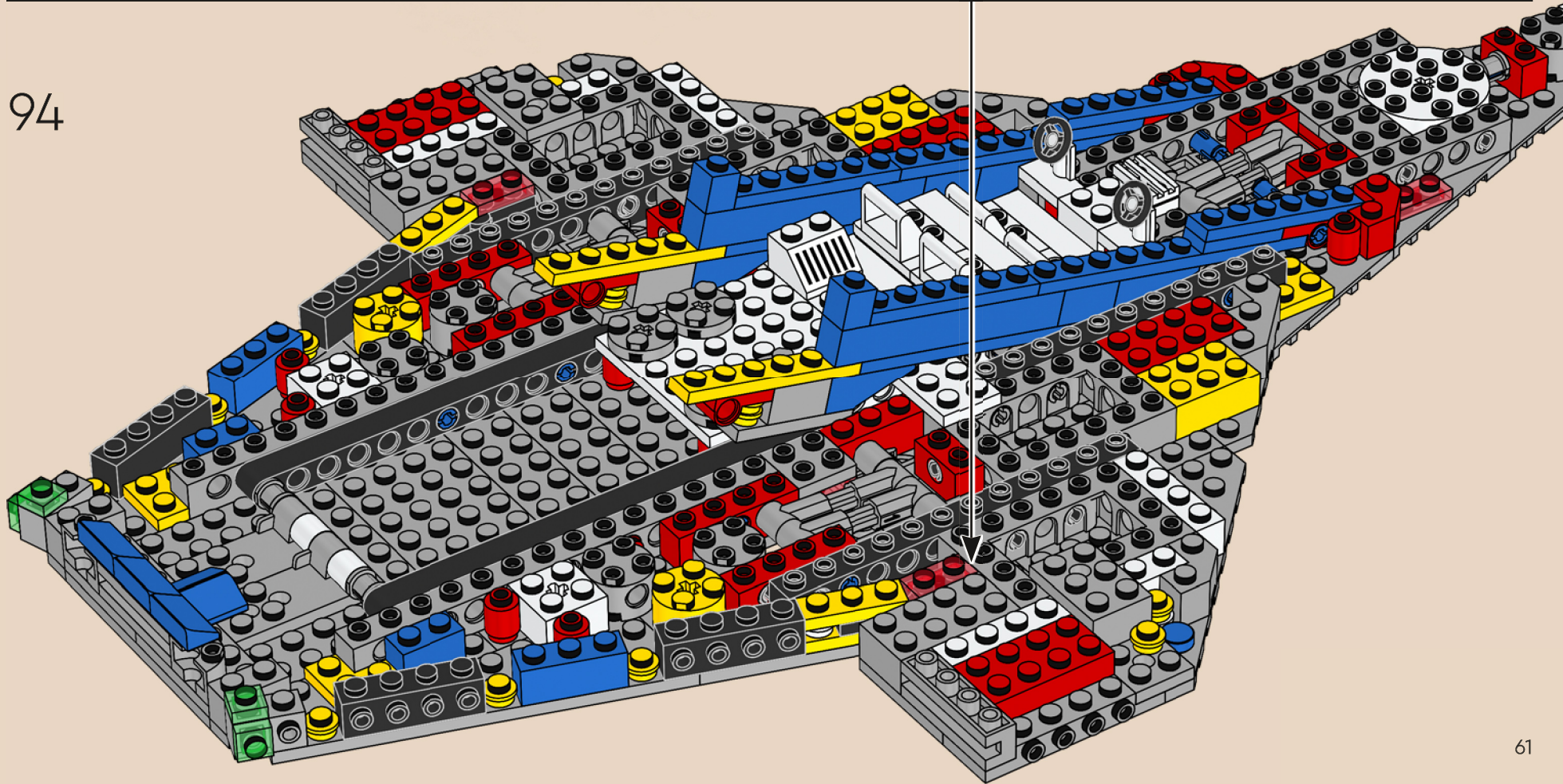

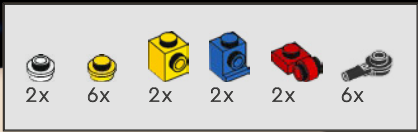

95

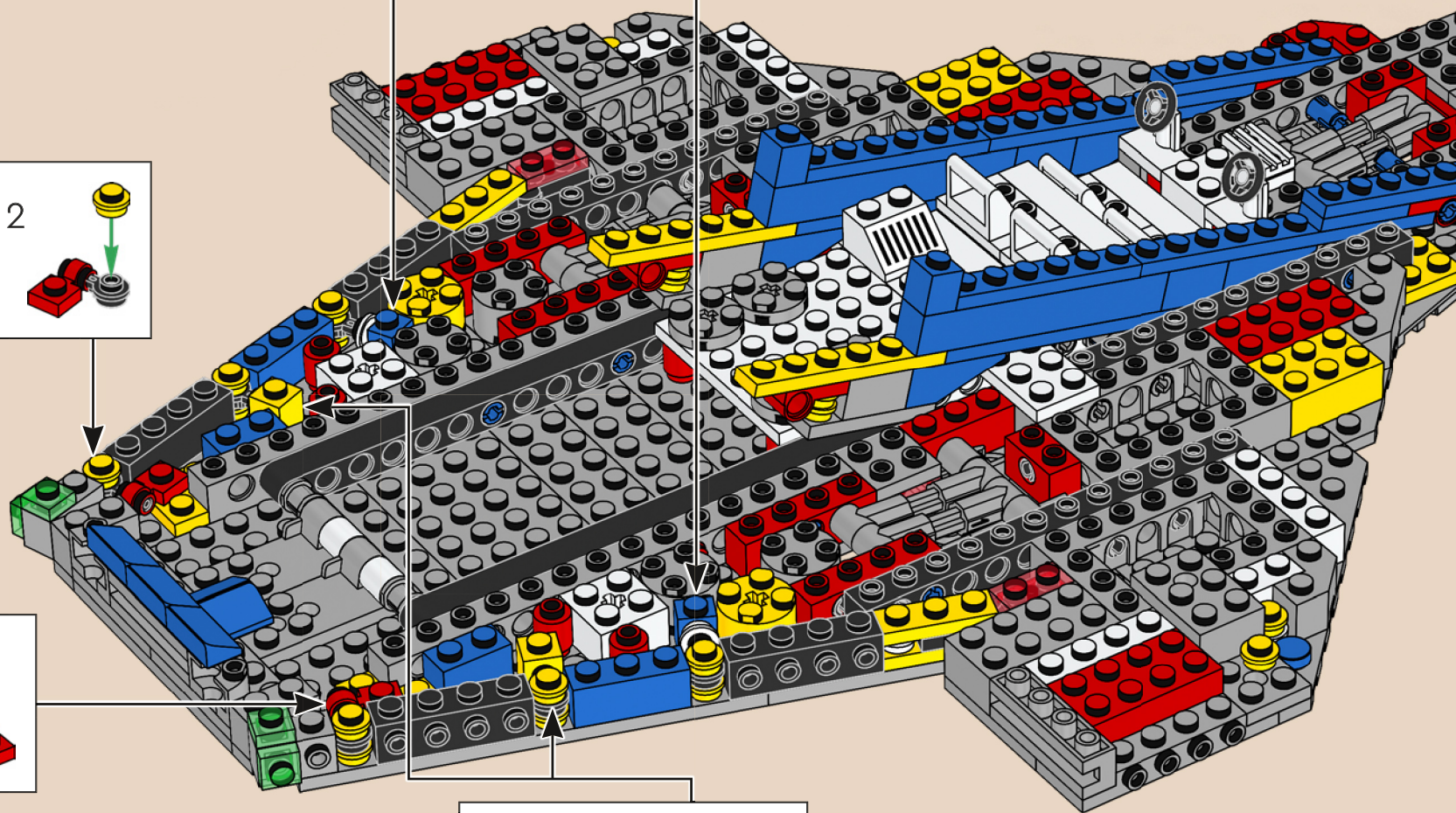
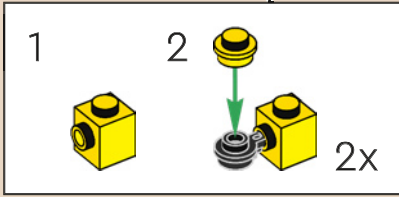
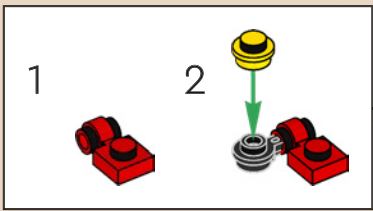
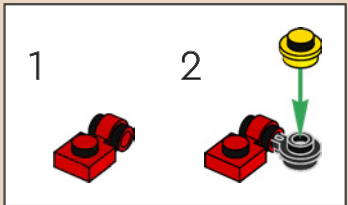
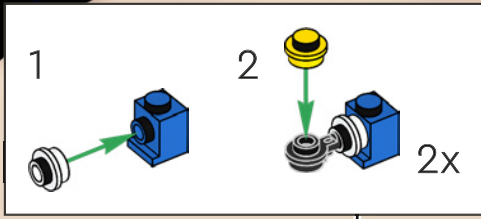

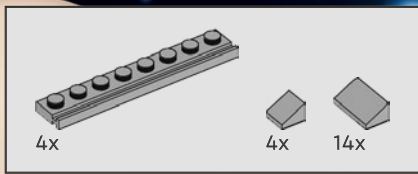

96

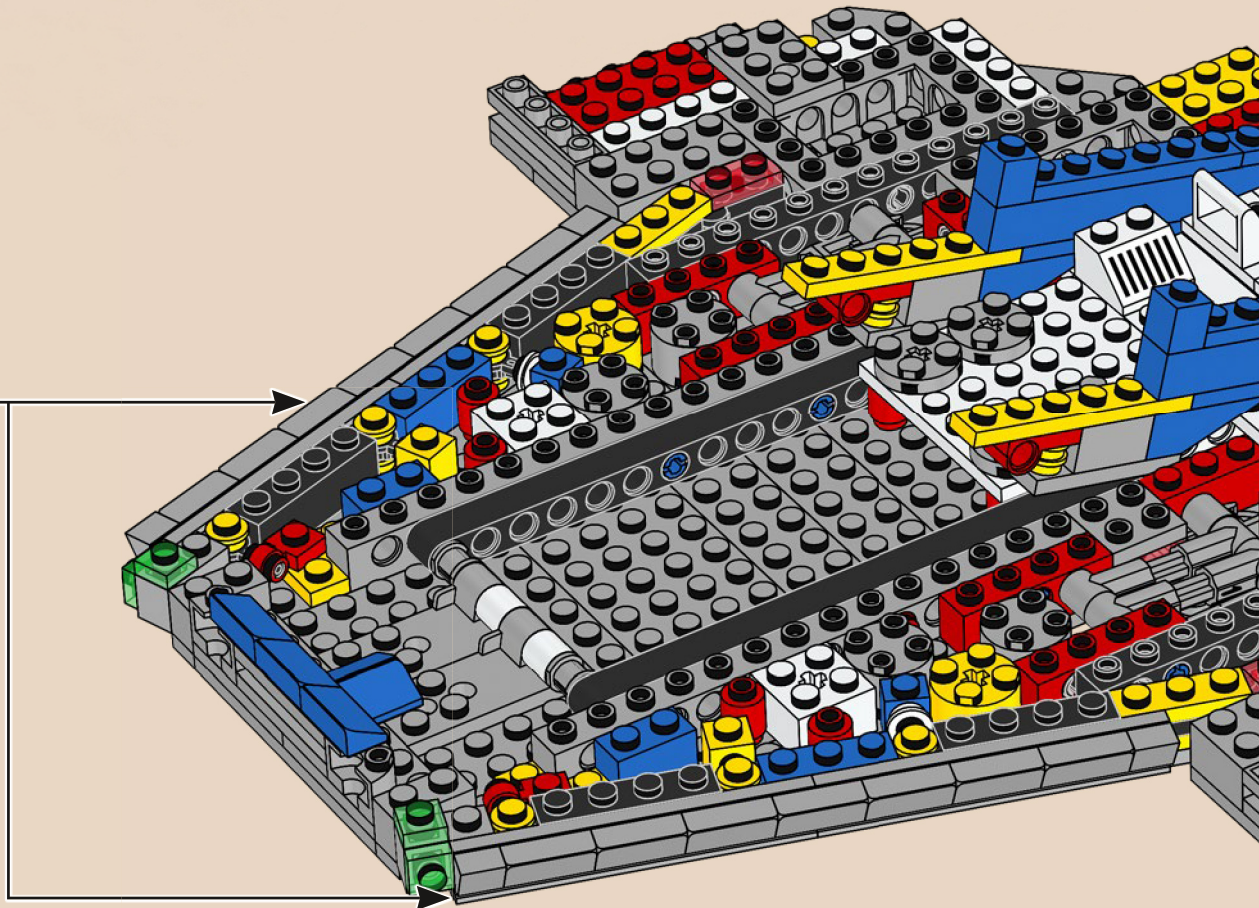
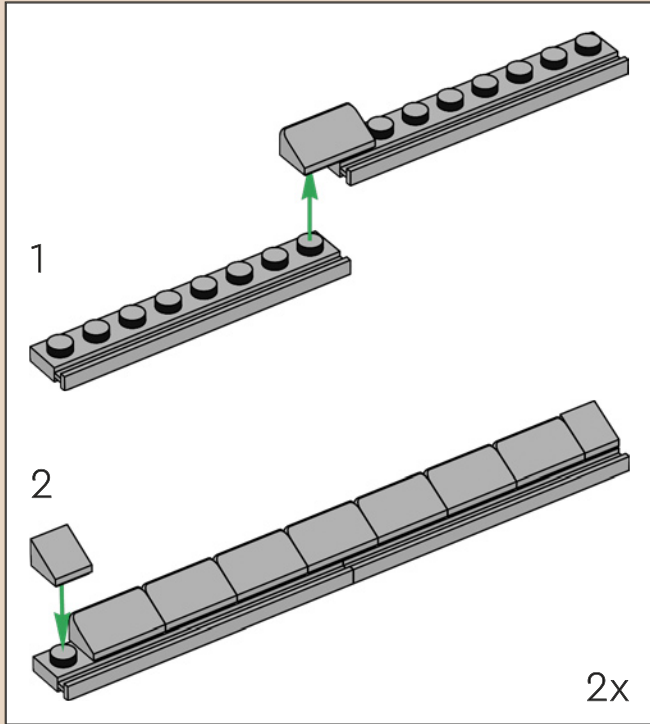

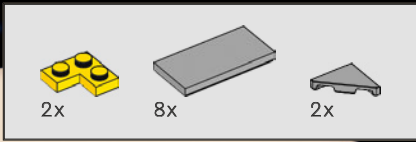

97

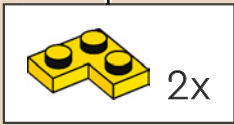
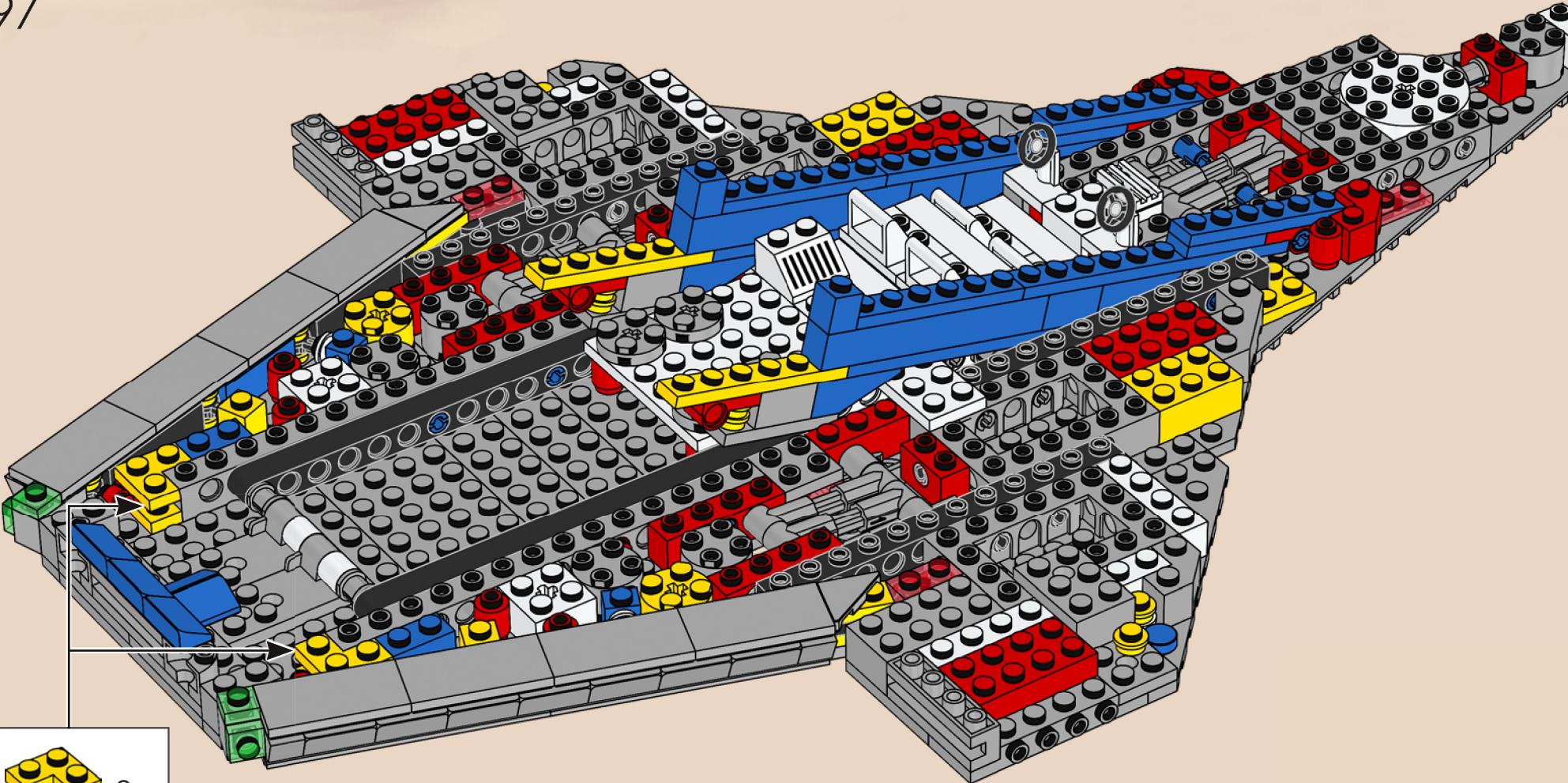

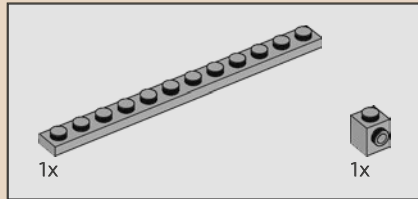
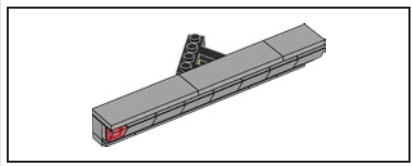

98

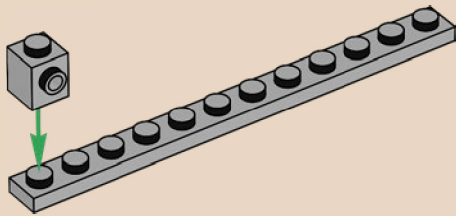

99

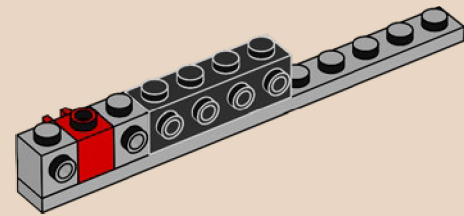

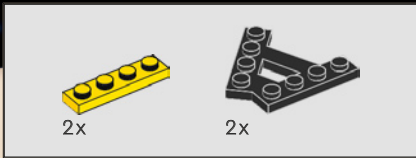

100

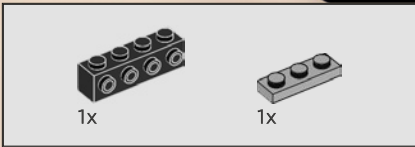
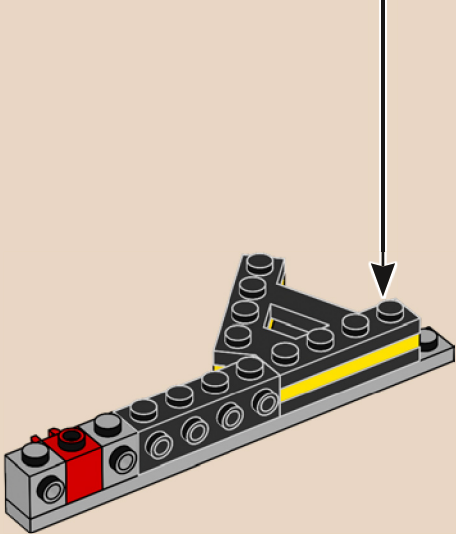
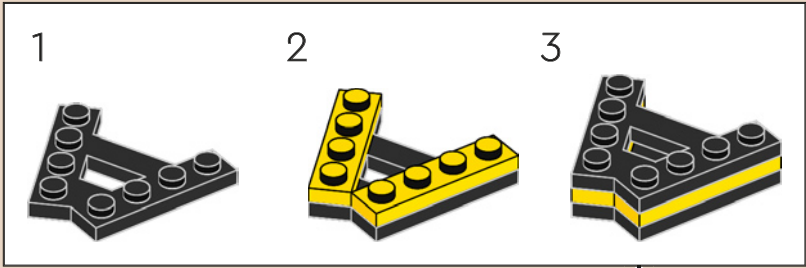

101

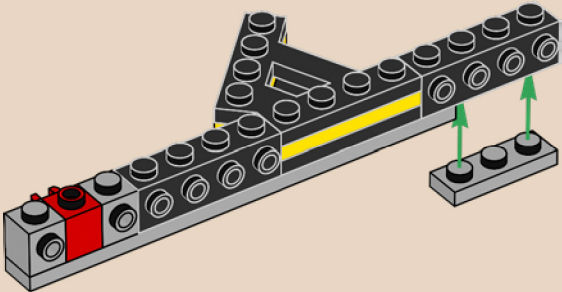

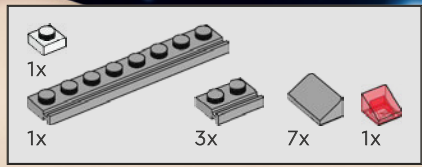

102

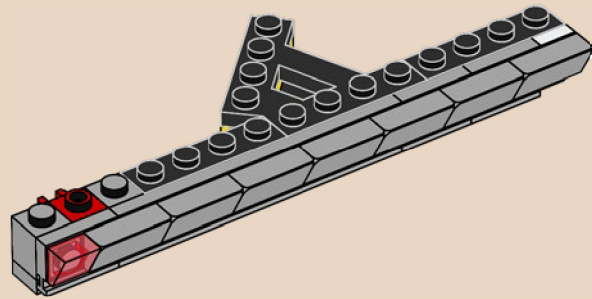
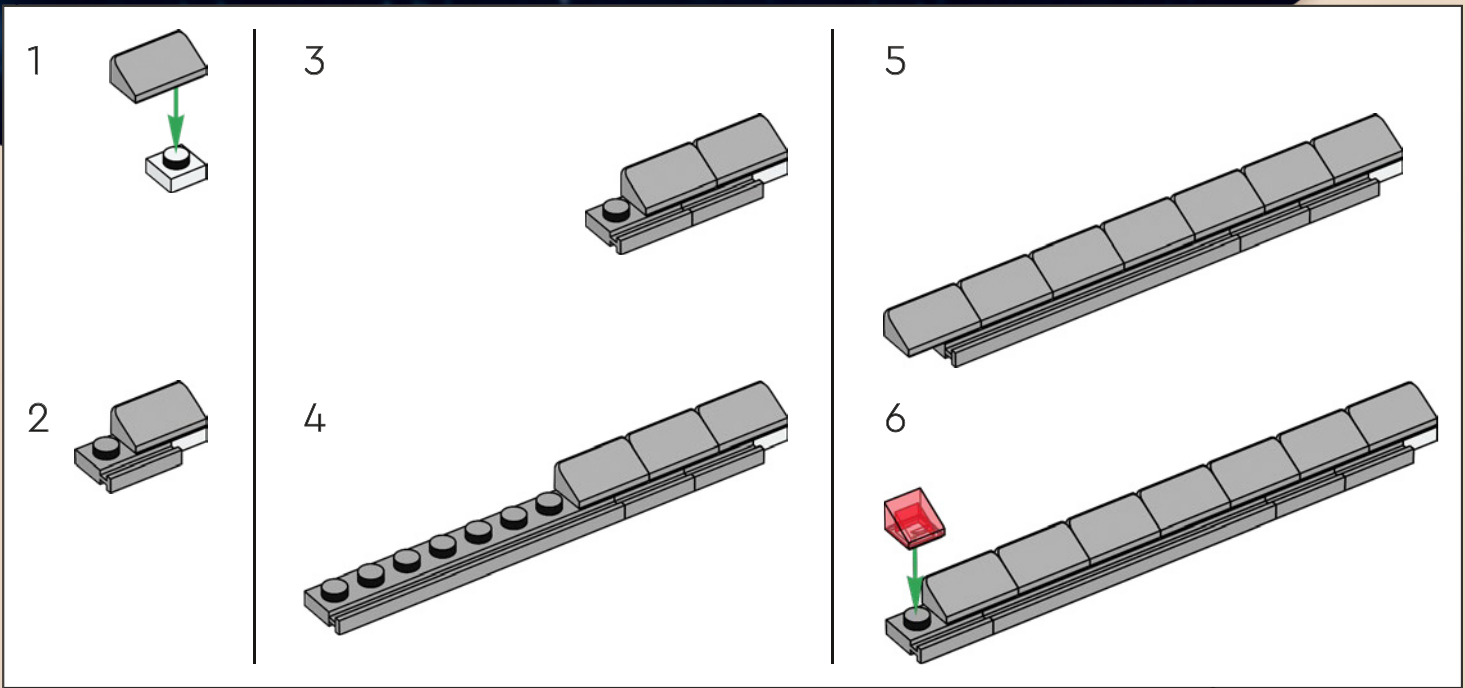

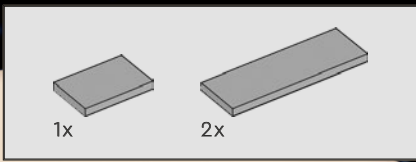

103

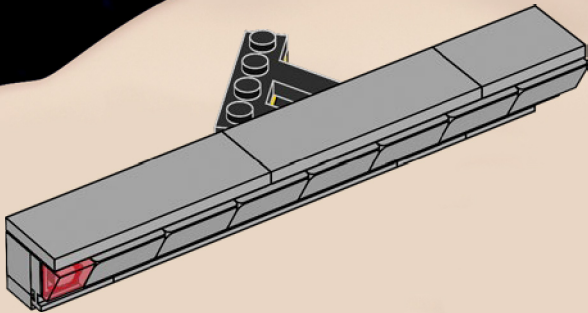

104

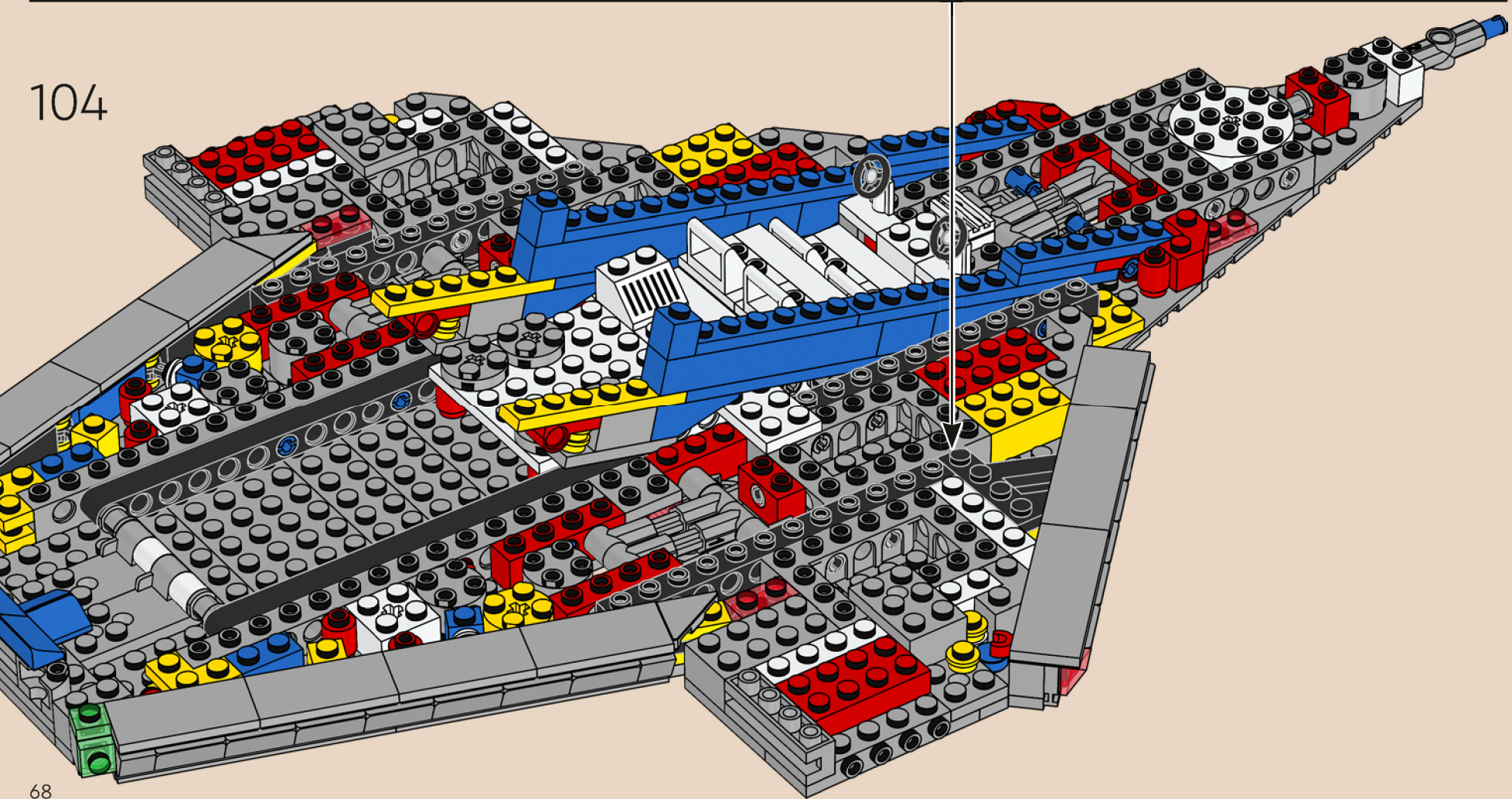

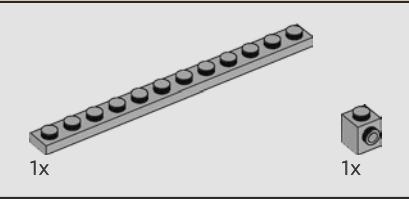
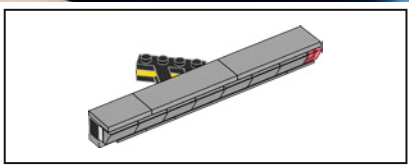

105

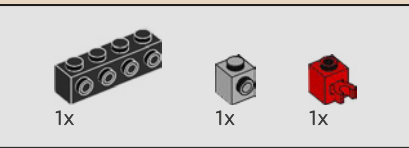
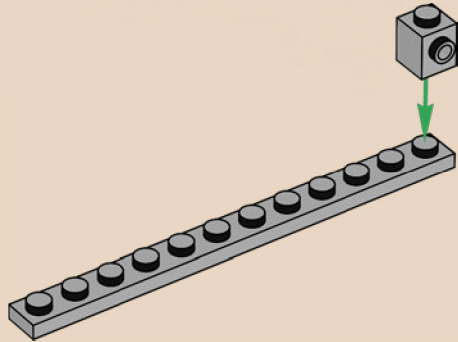

106

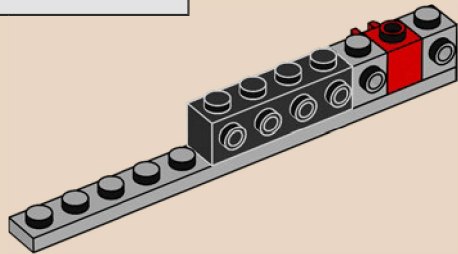

107

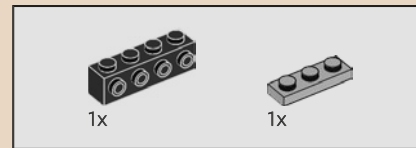
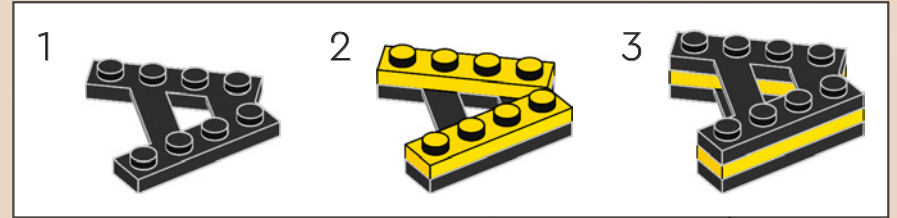

108

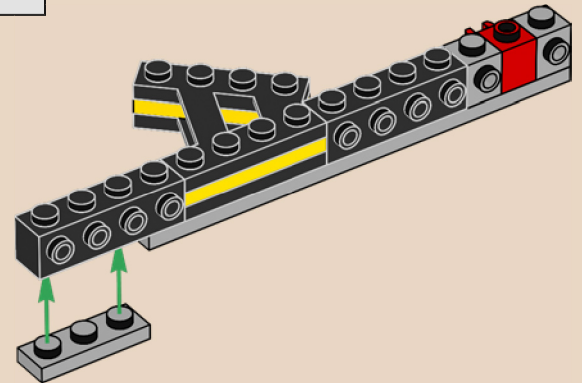

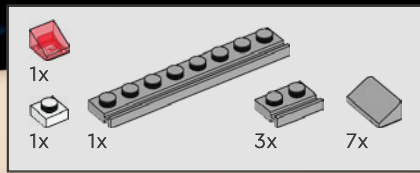

109

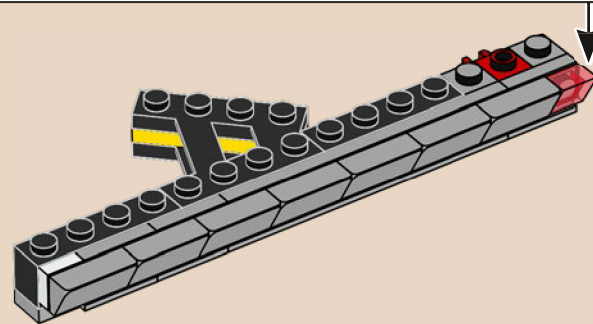
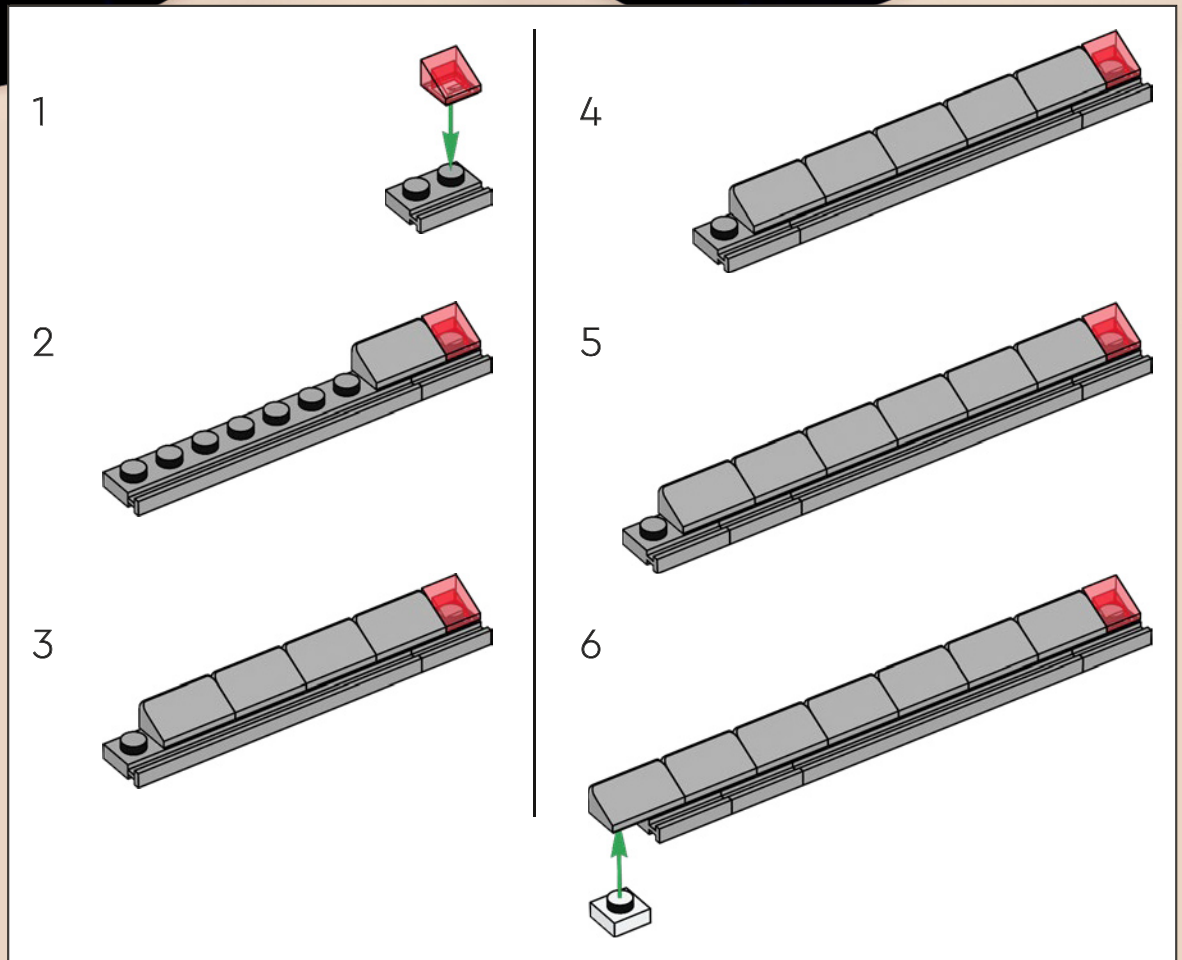

Le luci di navigazione rosse e verdi sul modello originale non erano posizionate tradizionalmente (luci rosse sul lato sinistro, luci verdi a destra). Invece, le luci rosse sono più in avanti e quelle verdi più indietro. In questo nuovo modello, le luci sono nella stessa posizione.

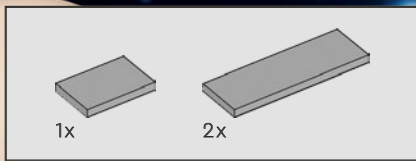

110

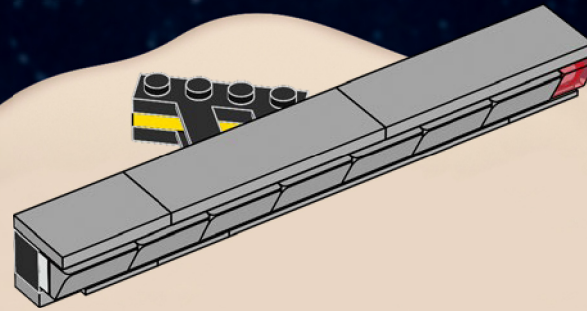

111

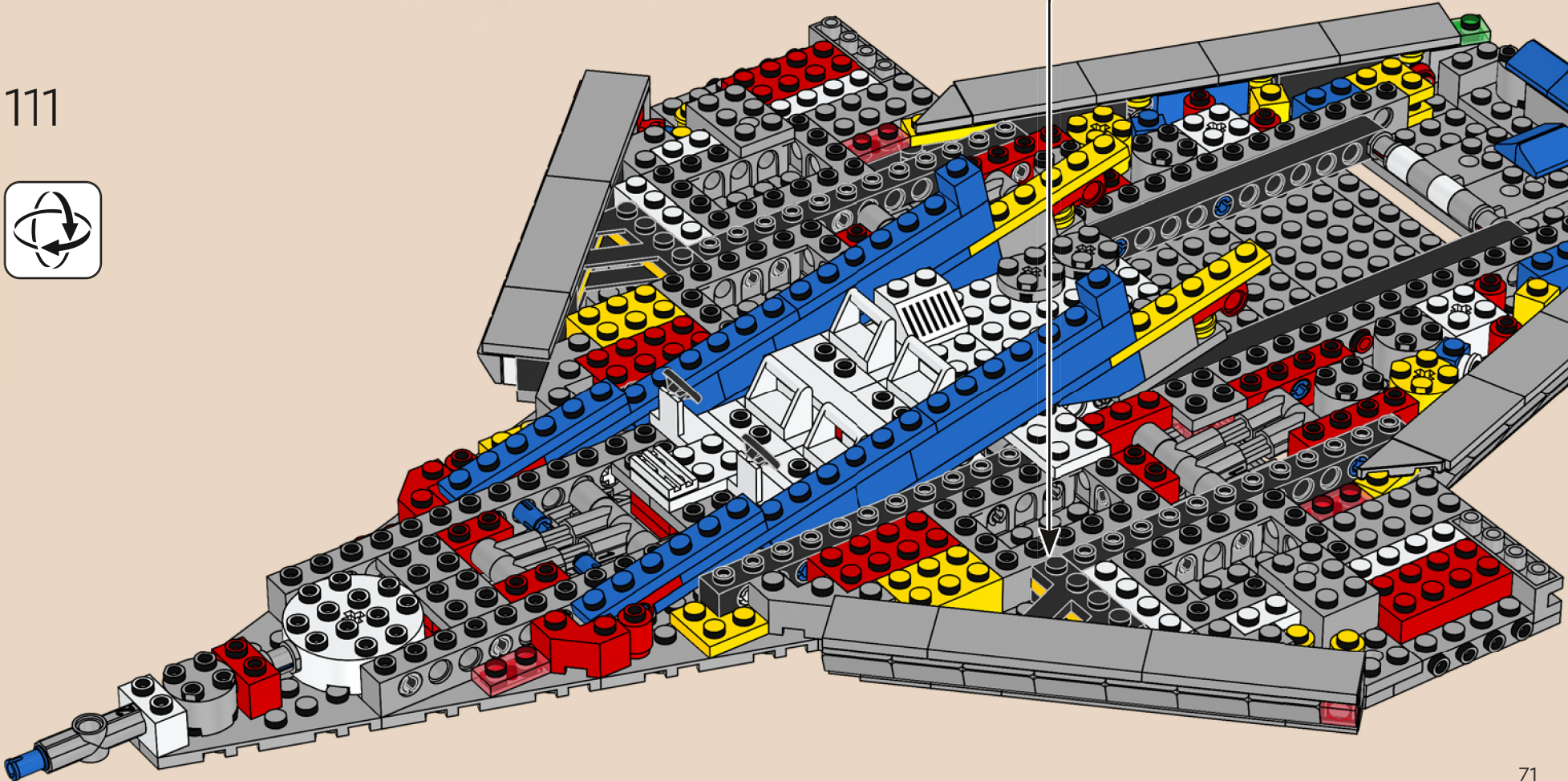

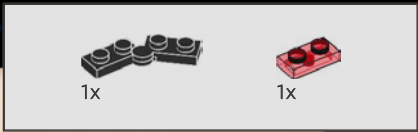

112

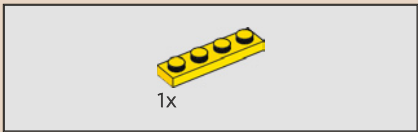
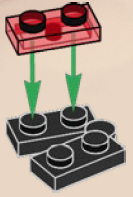

113

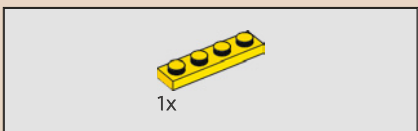
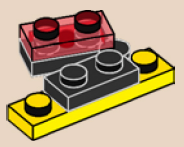

114

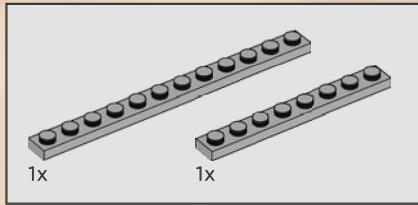
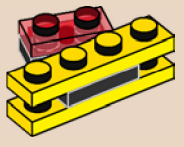

115

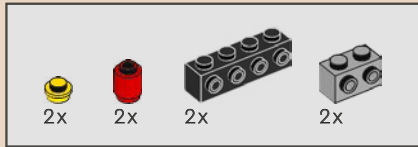
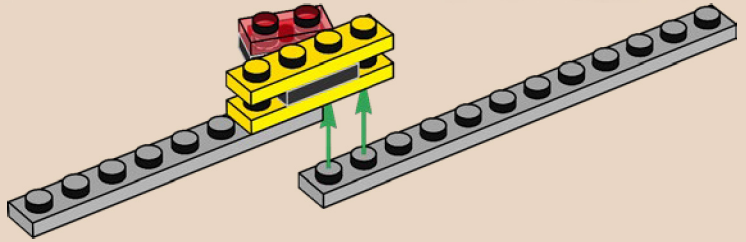



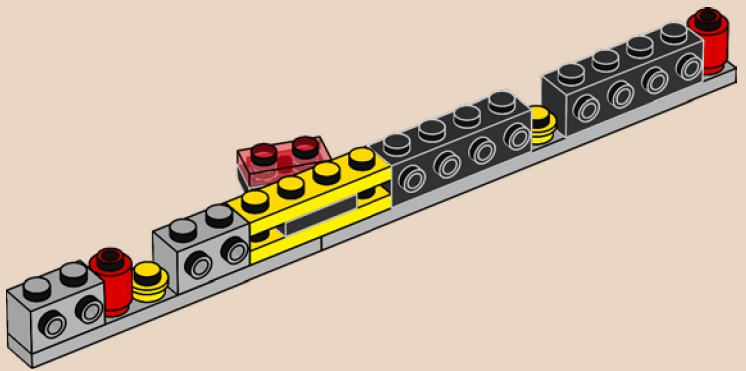

116

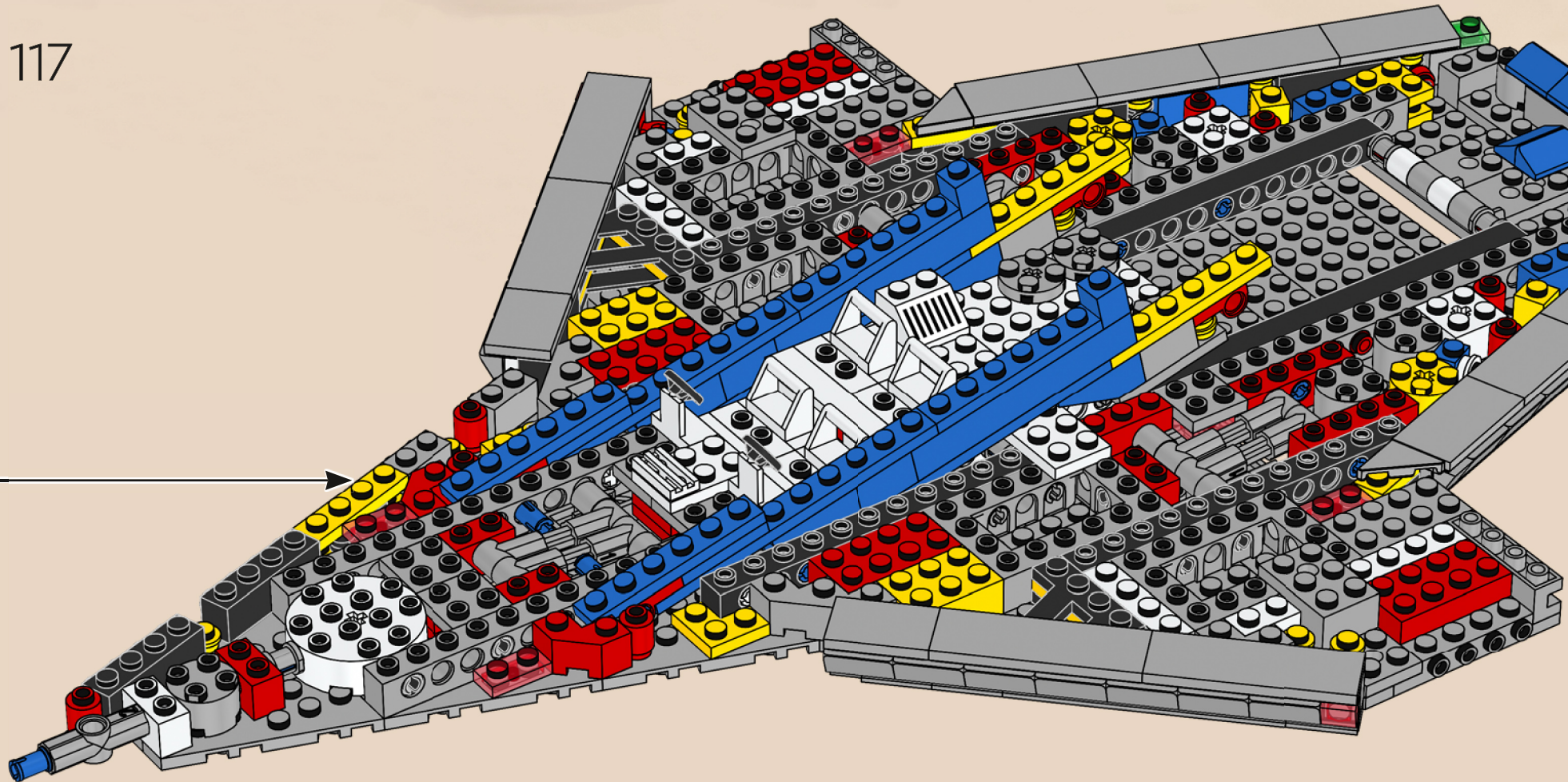

117



- 
2x
- 
1x
- 
2x
- 
1x

118

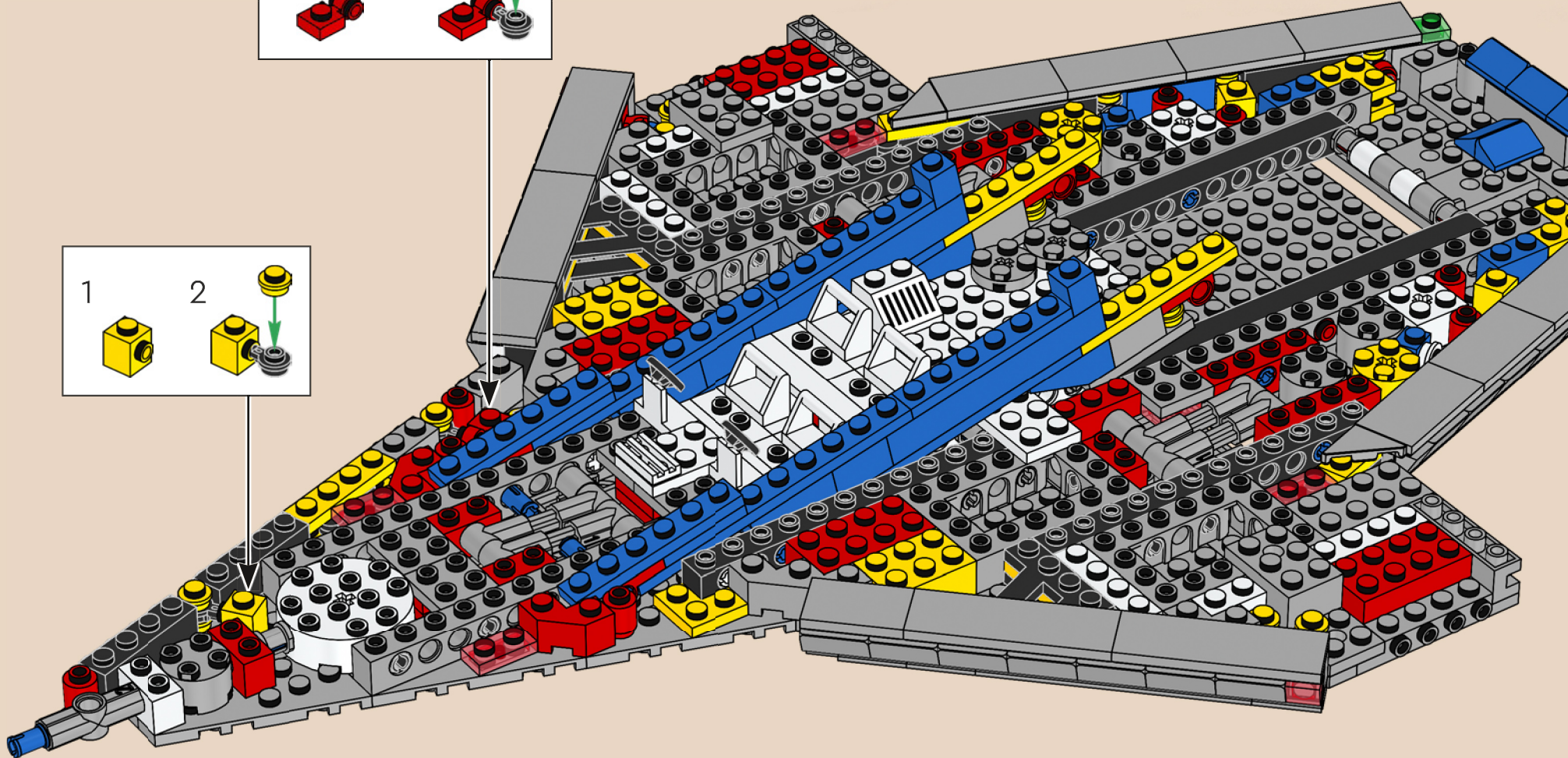
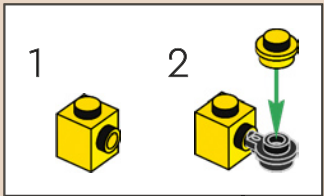
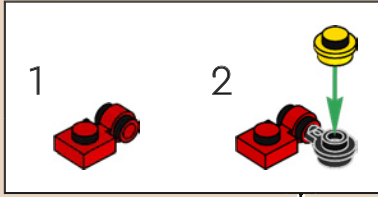

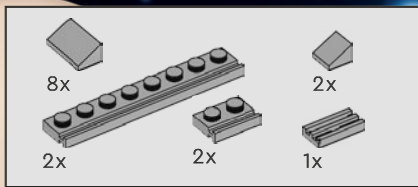

119

1

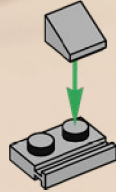

2

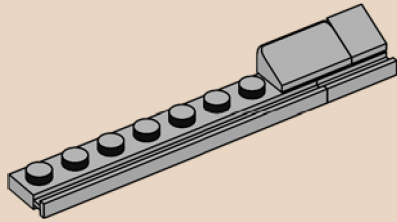

3

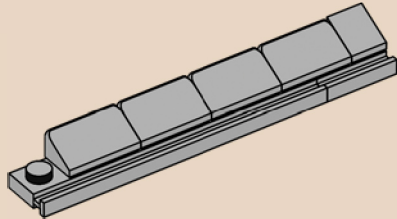

4

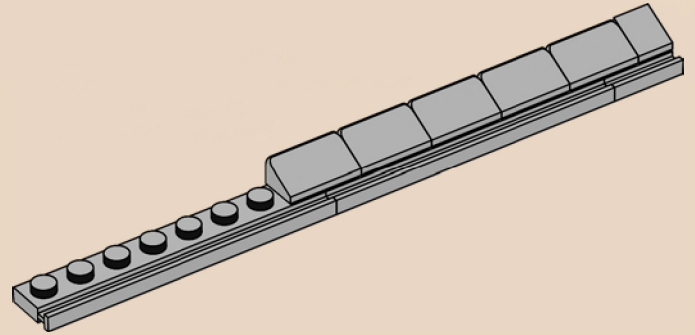

5

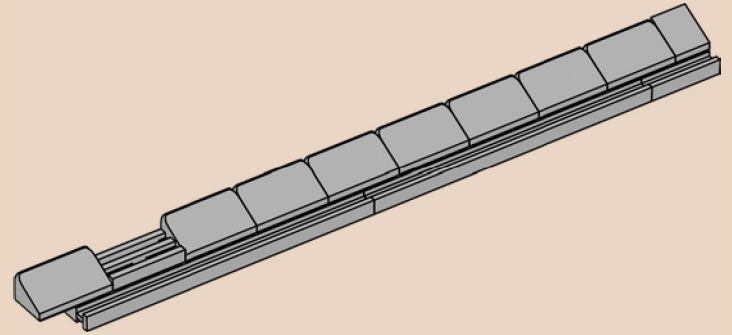

6

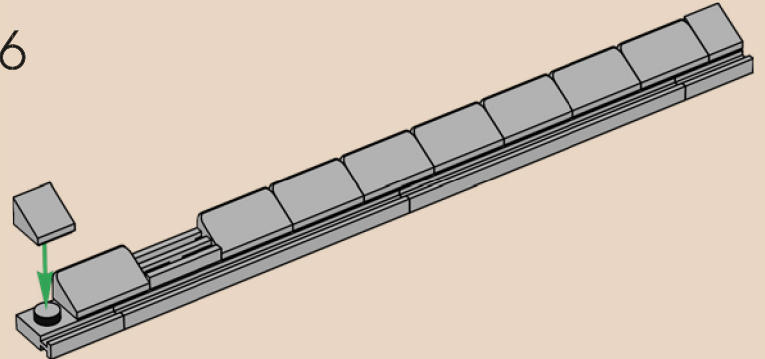

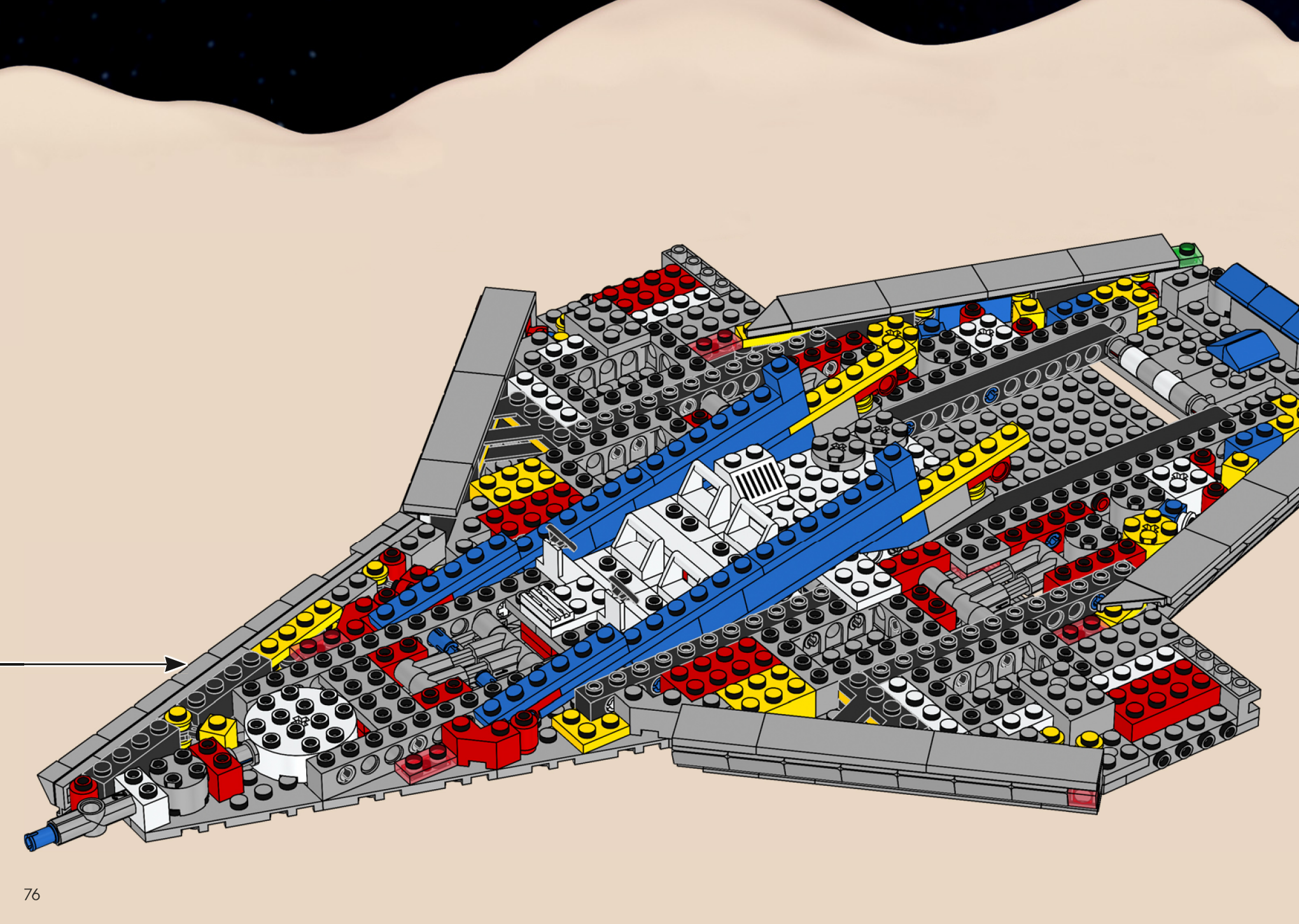

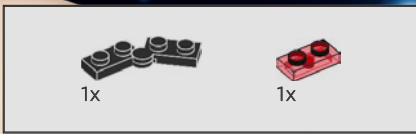

120

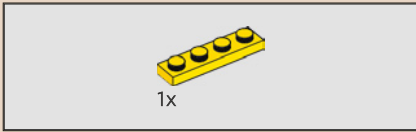
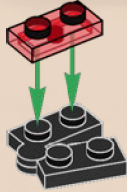

121

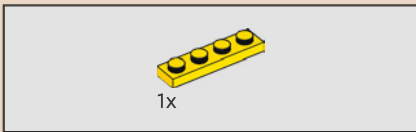
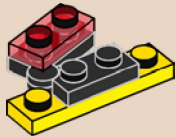

122

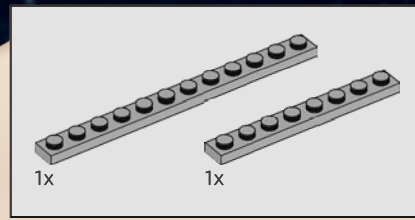
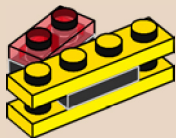



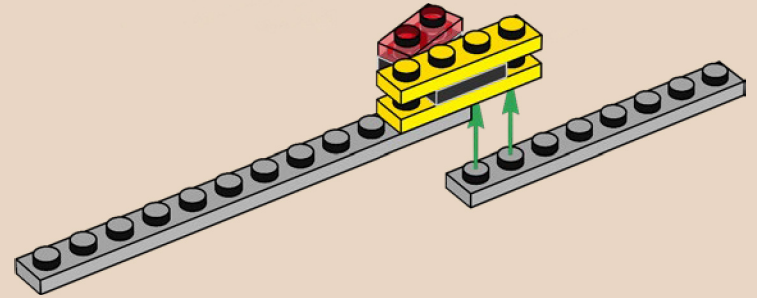

123

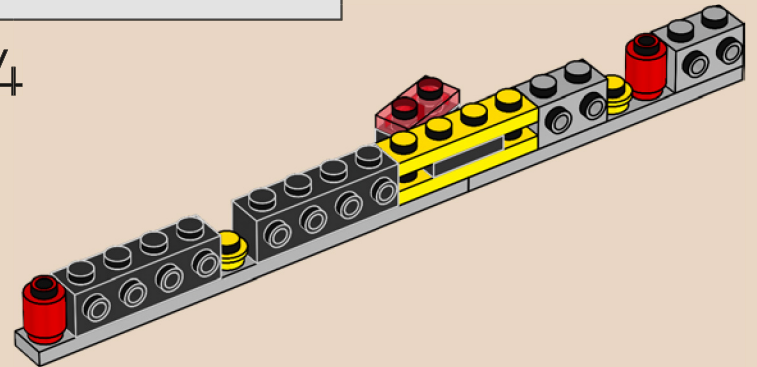

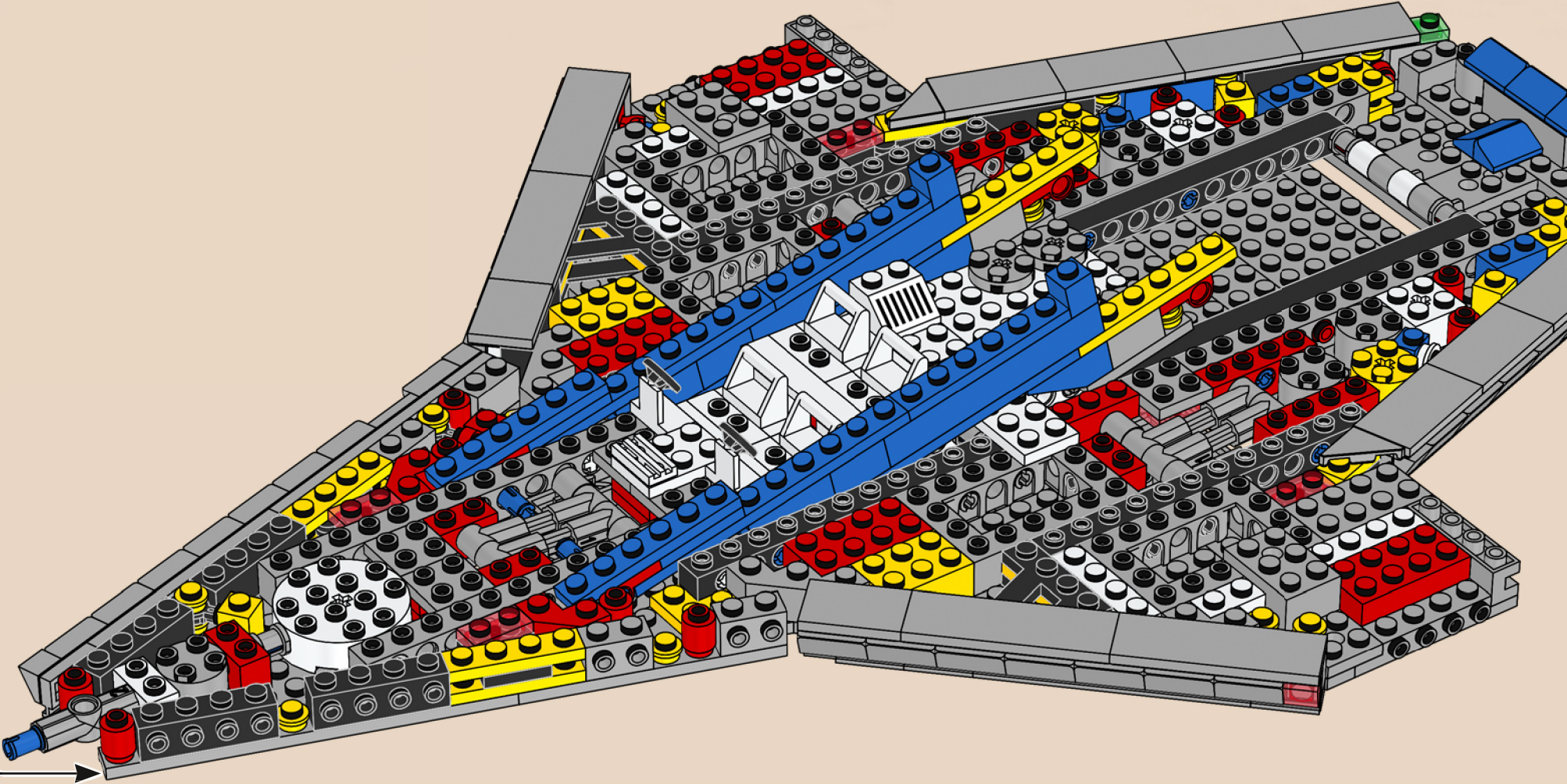
124





			
2x	1x	1x	2x

126

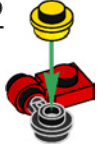
1	2
	

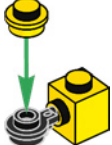
1	2
	

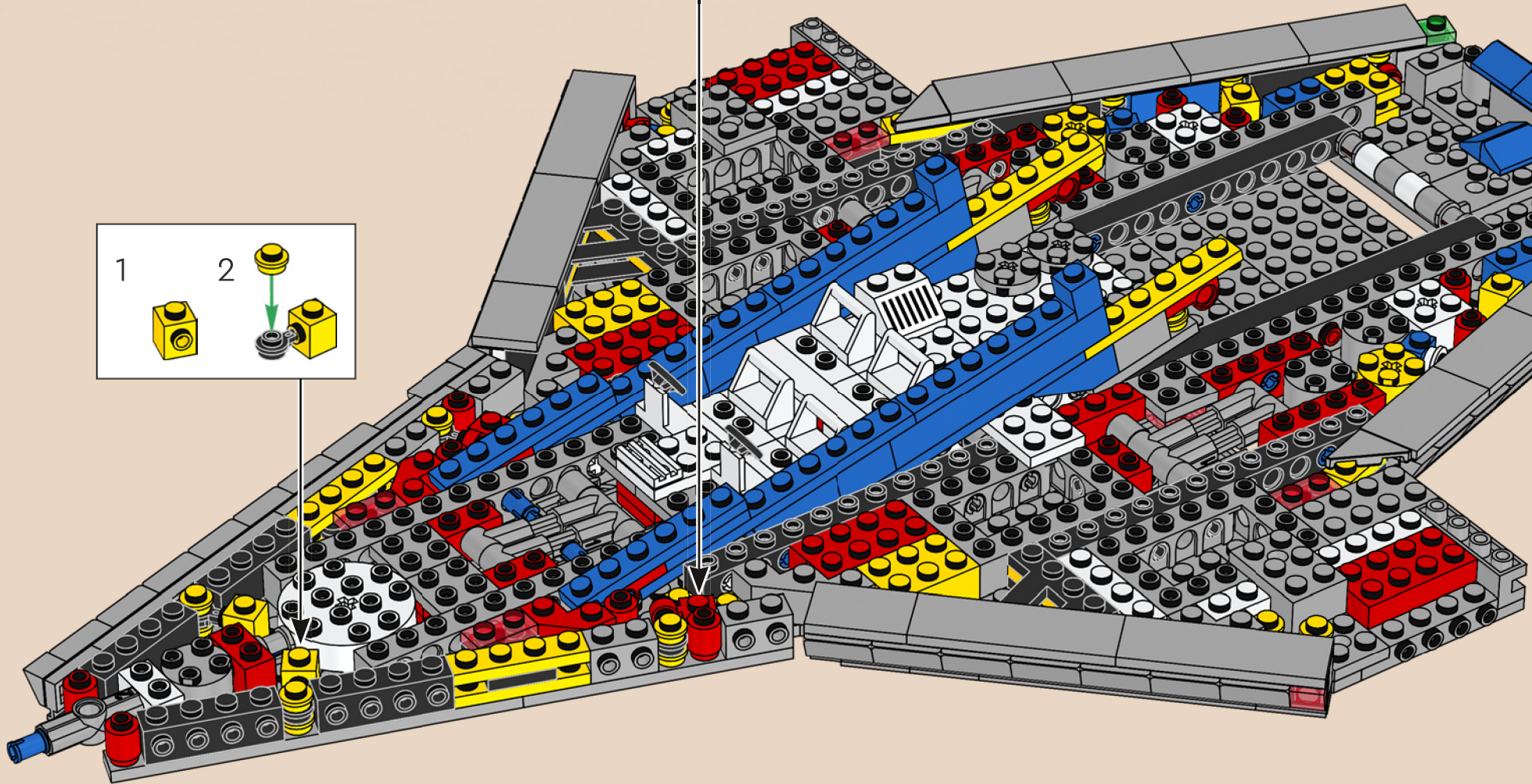

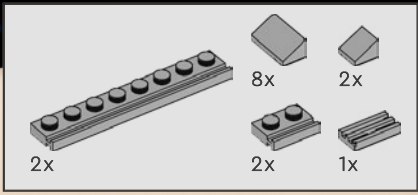

127

1

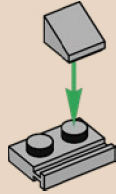

2

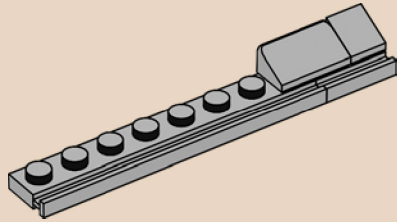

3

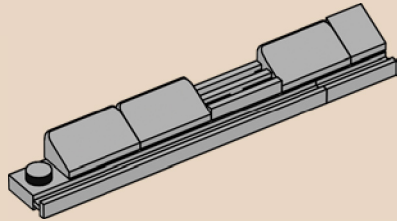

4

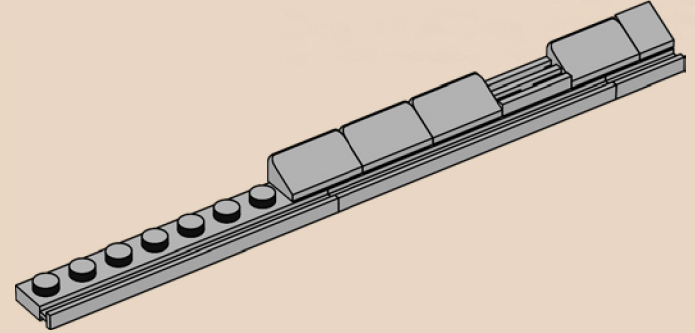

5

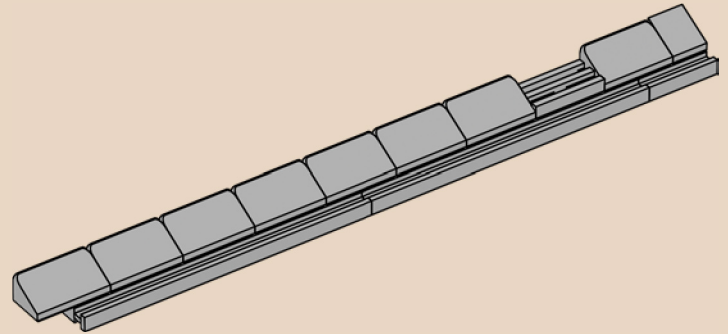

6

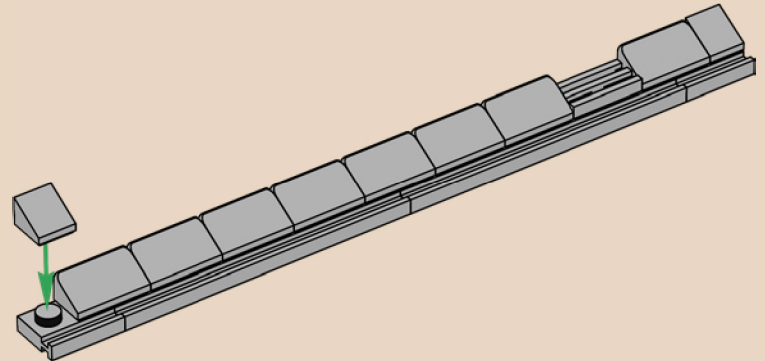

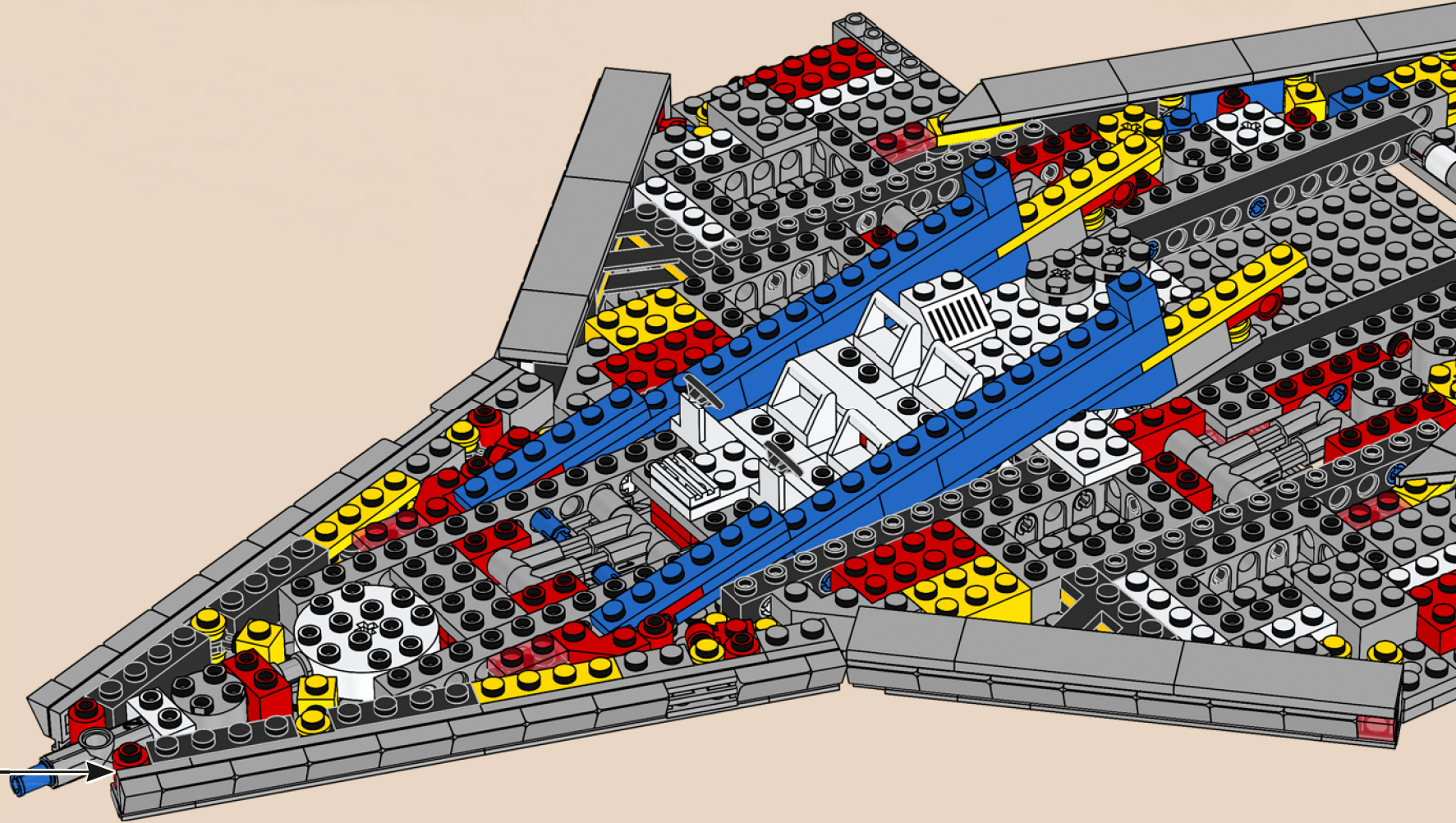

4x 1x 1x

4x

128

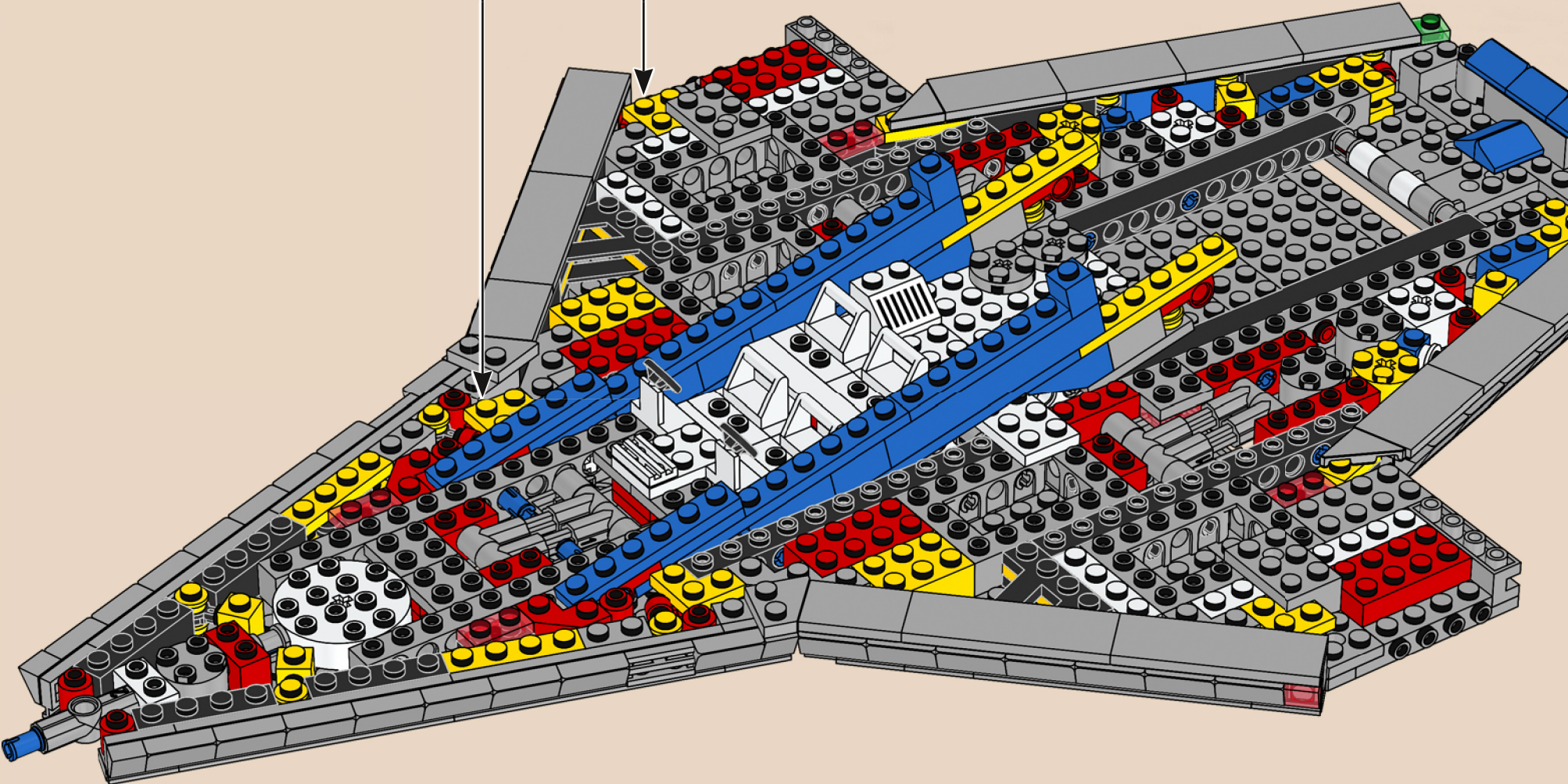

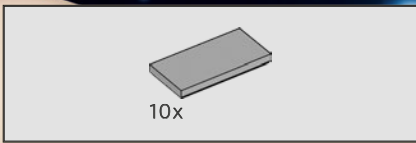

129

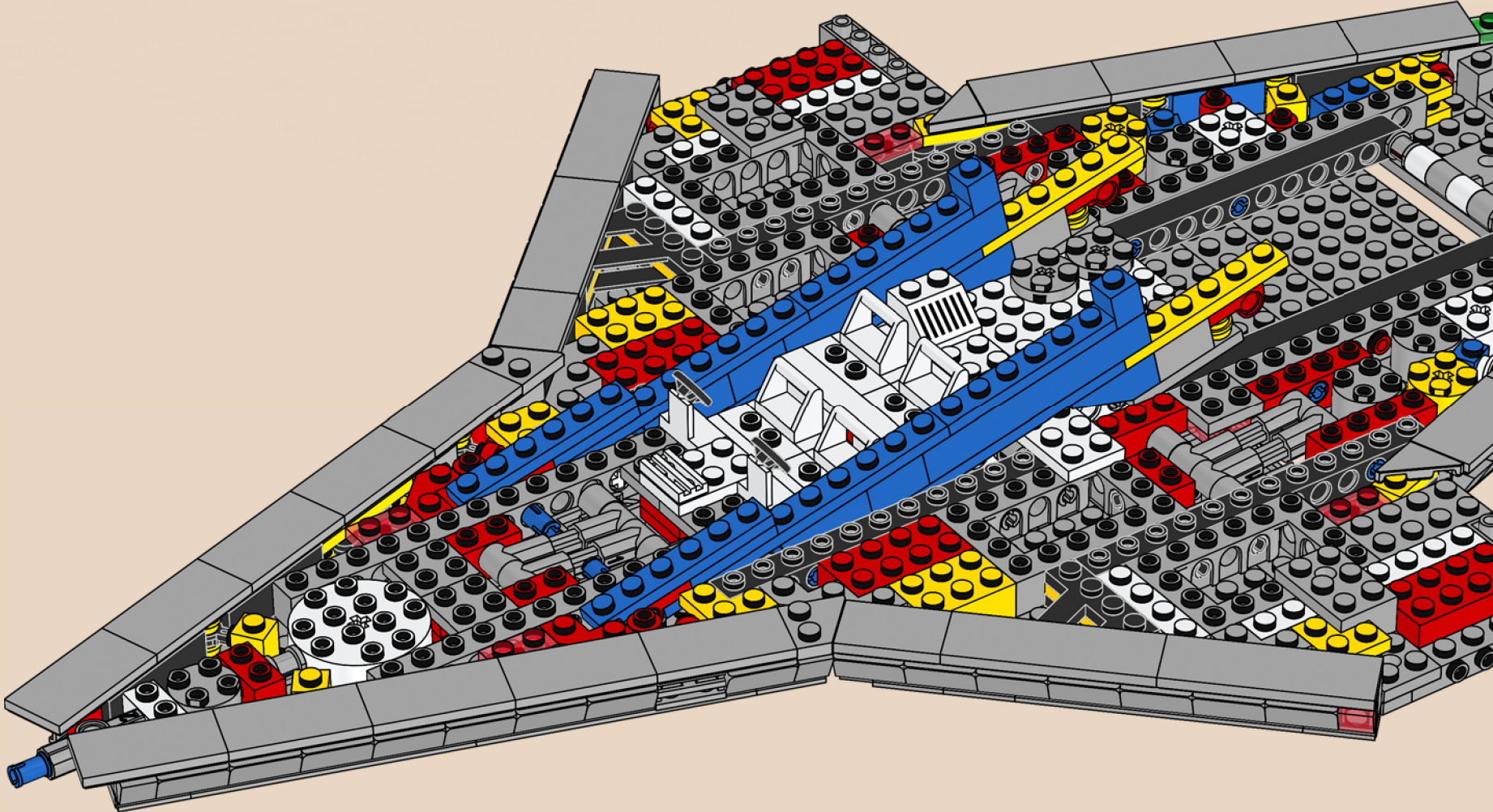

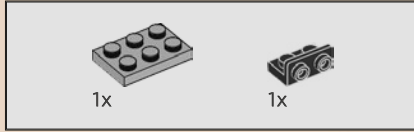
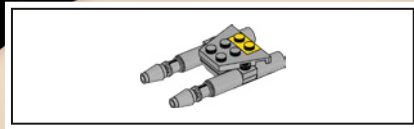
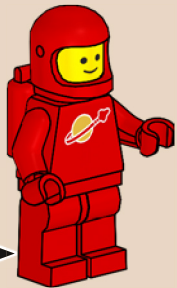
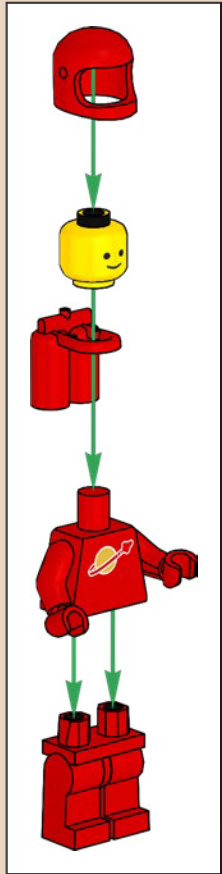

130

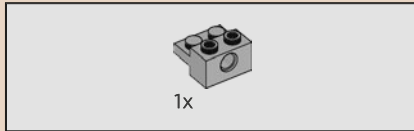
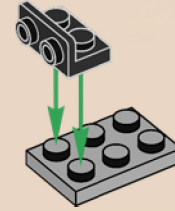

131

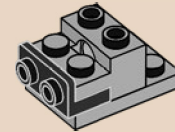

132

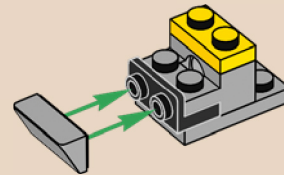



133

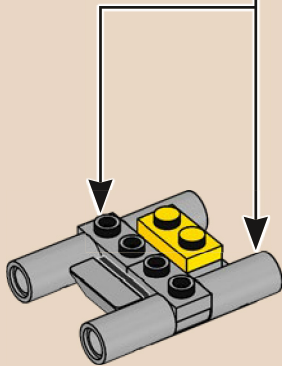
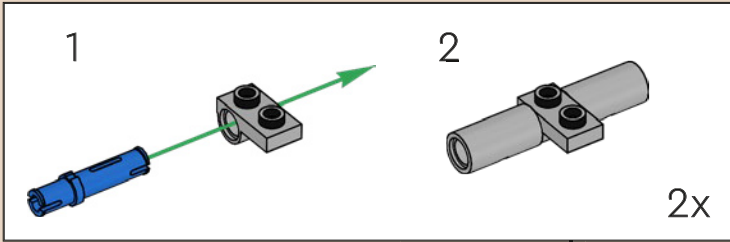

134

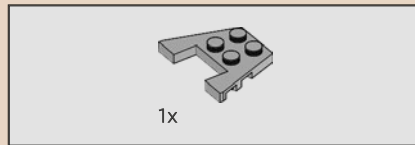
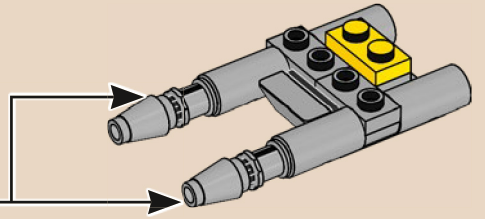
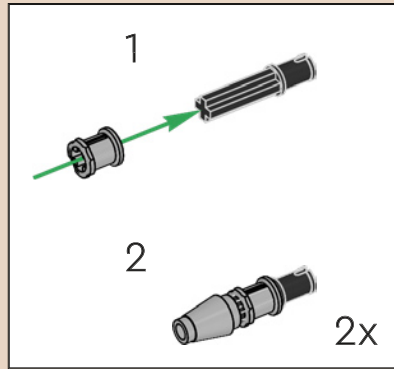

135

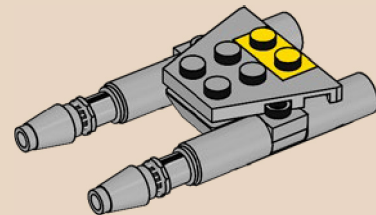

136

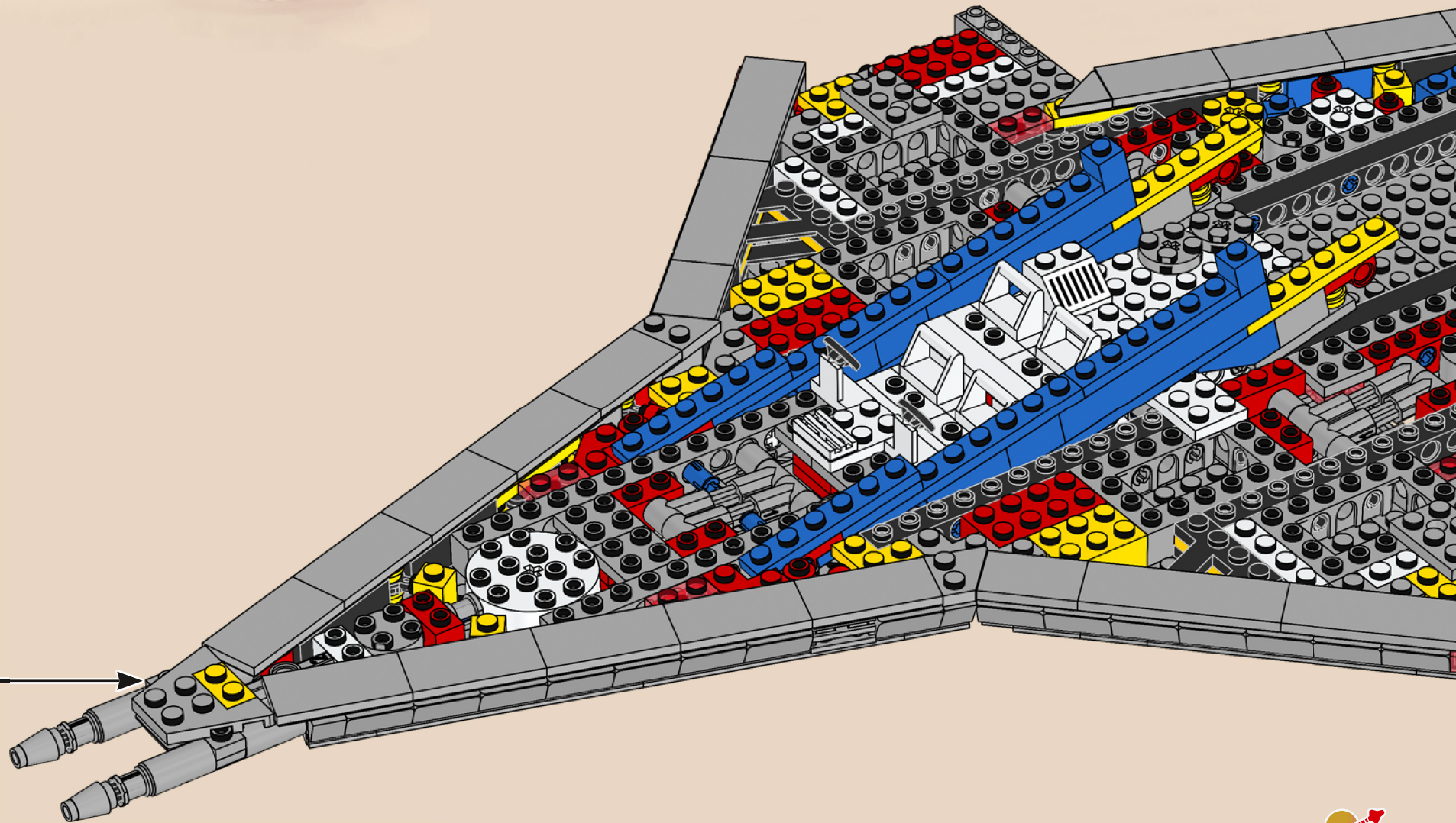

Il numero del set 10497 è un omaggio al numero del set utilizzato per la versione americana del set originale Galaxy Explorer, 497.

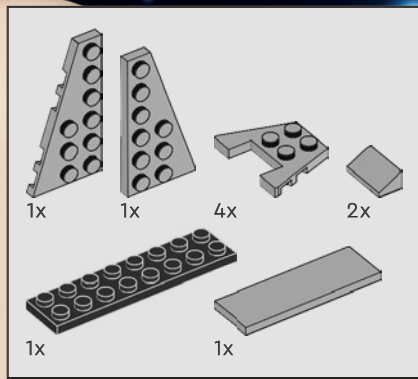

137

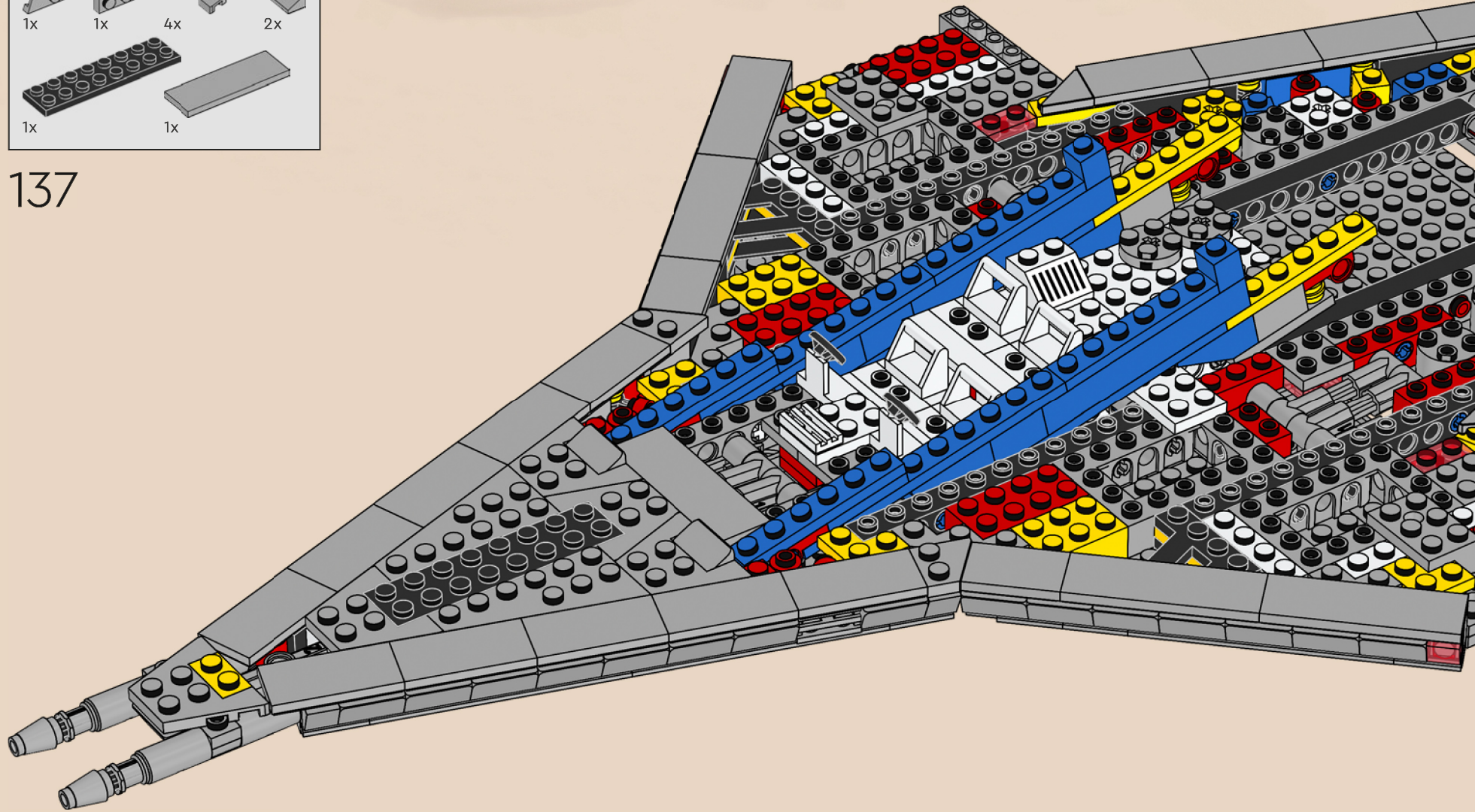

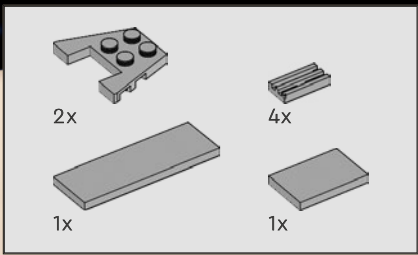

138

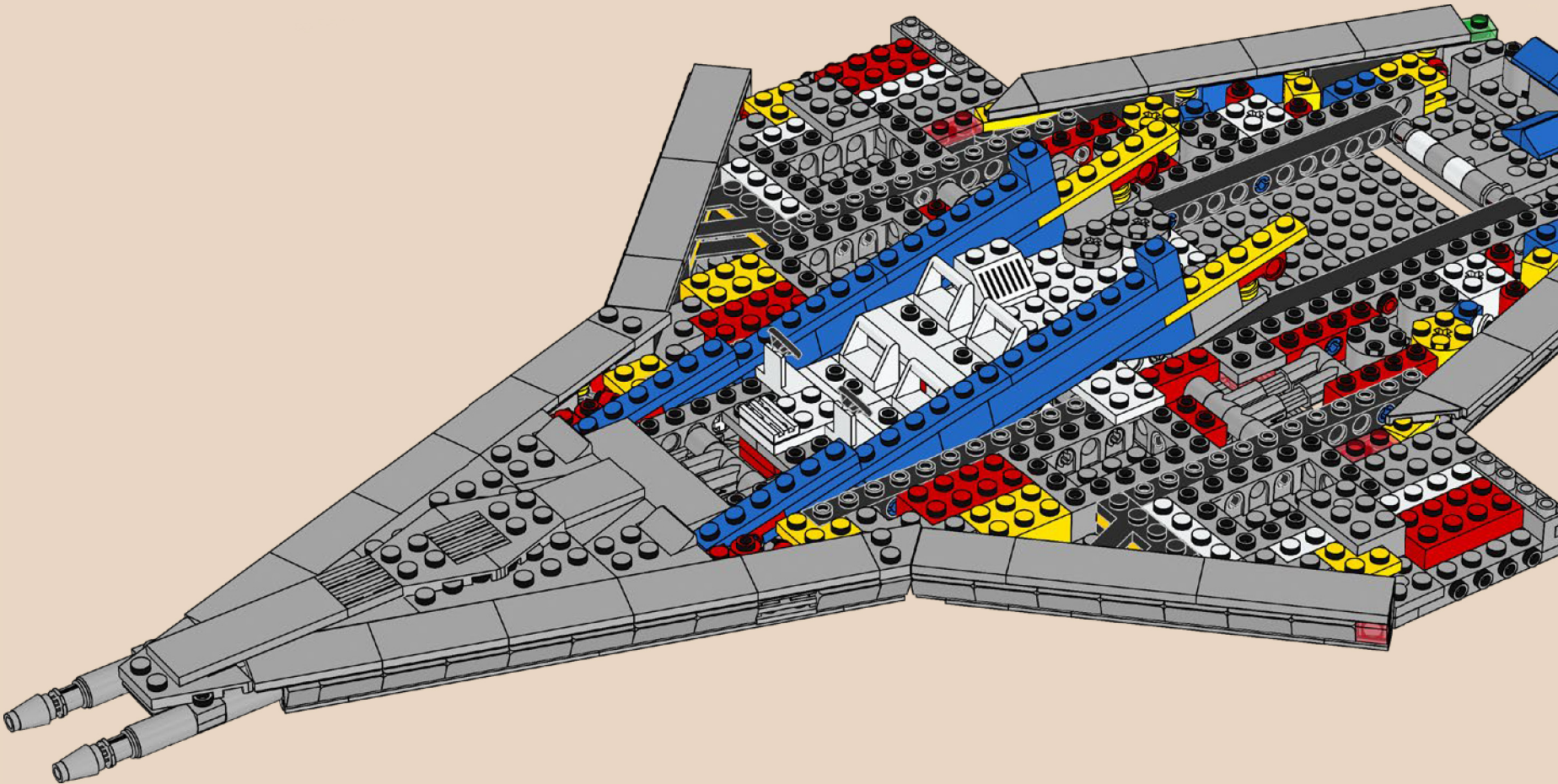

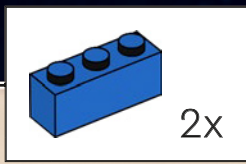
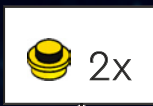
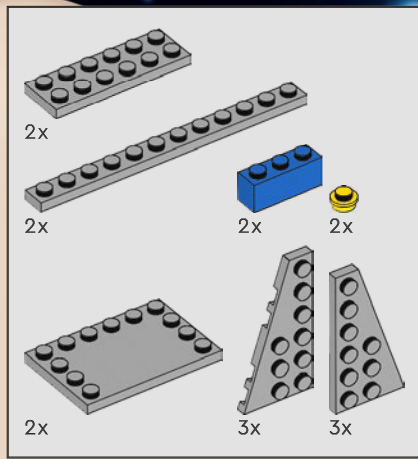

139

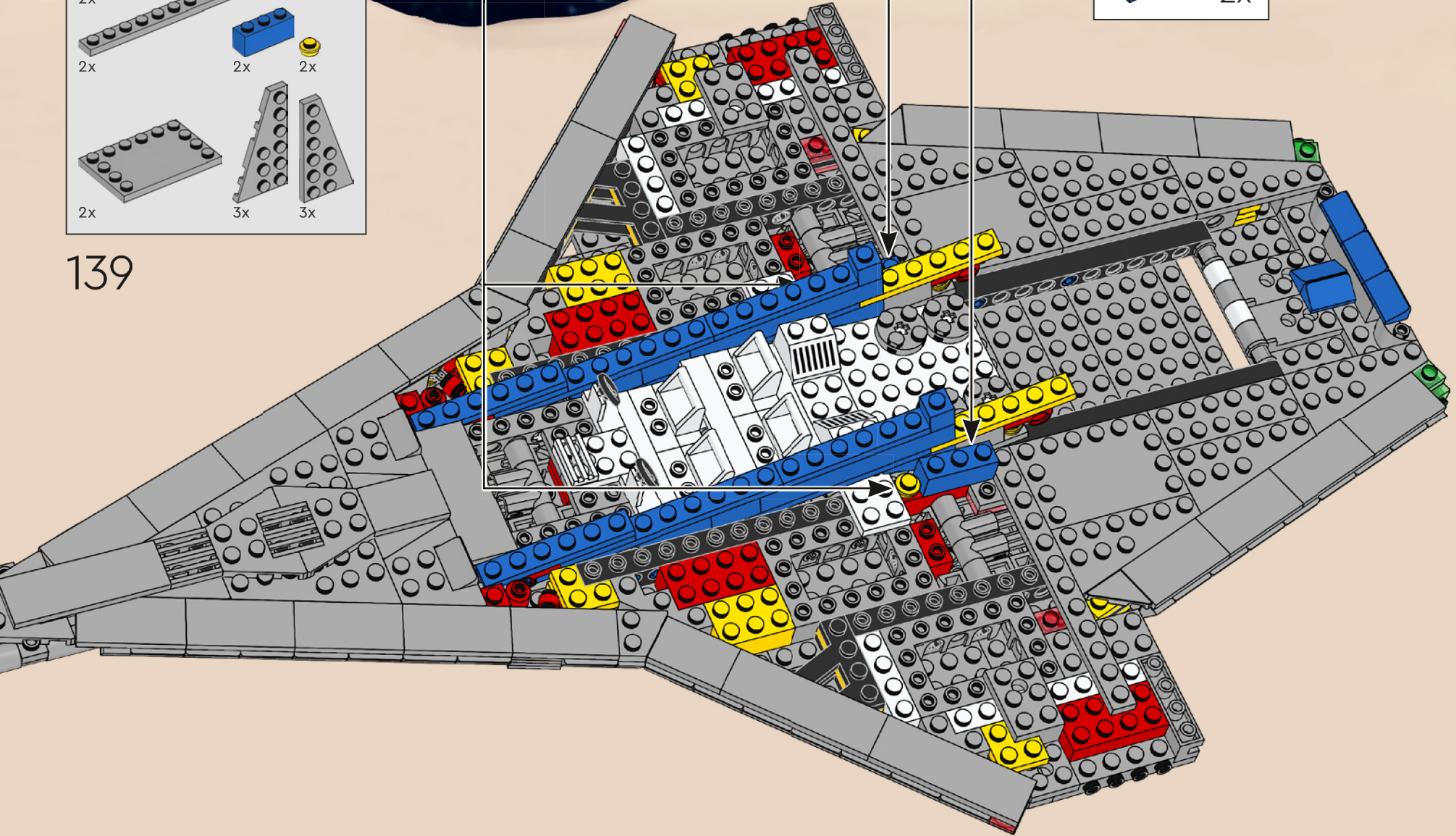

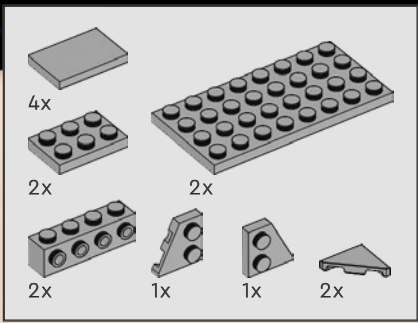

140

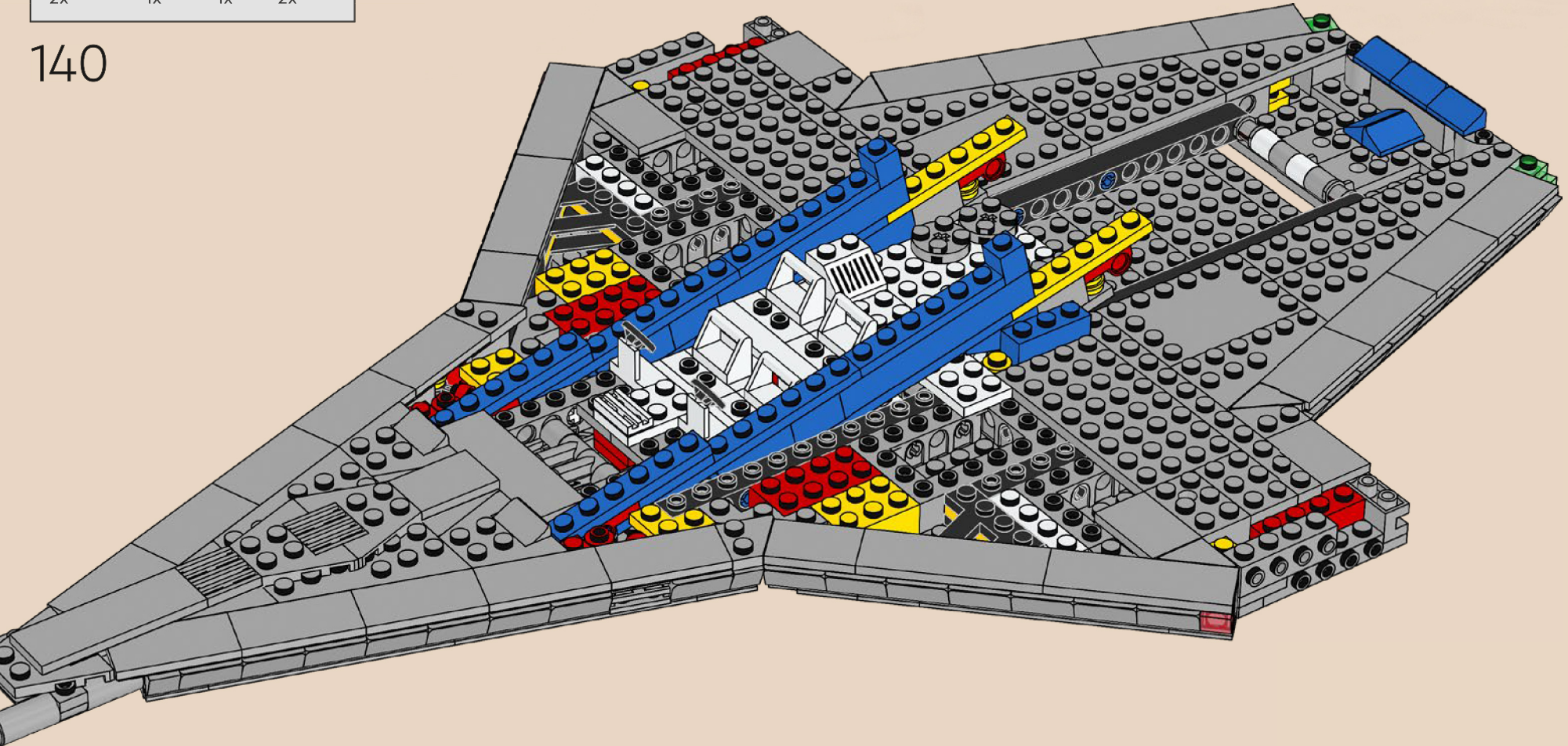

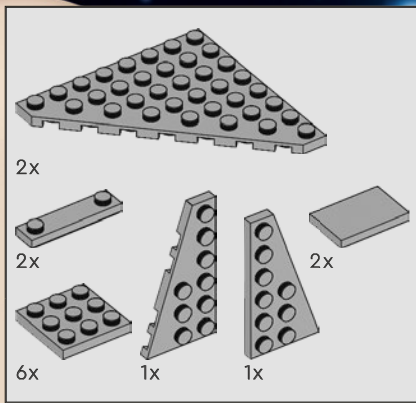

141

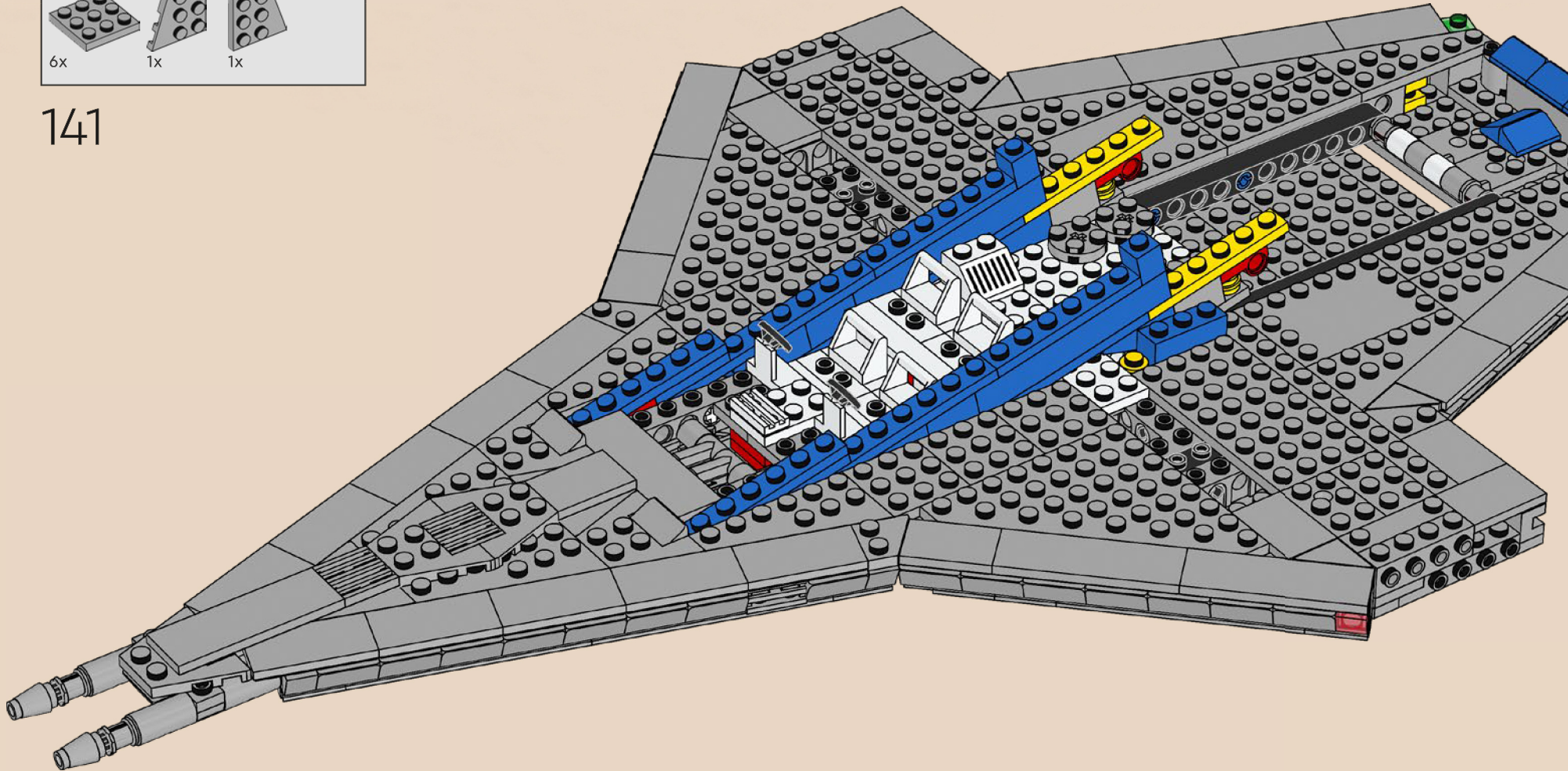

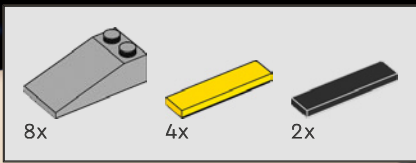

142

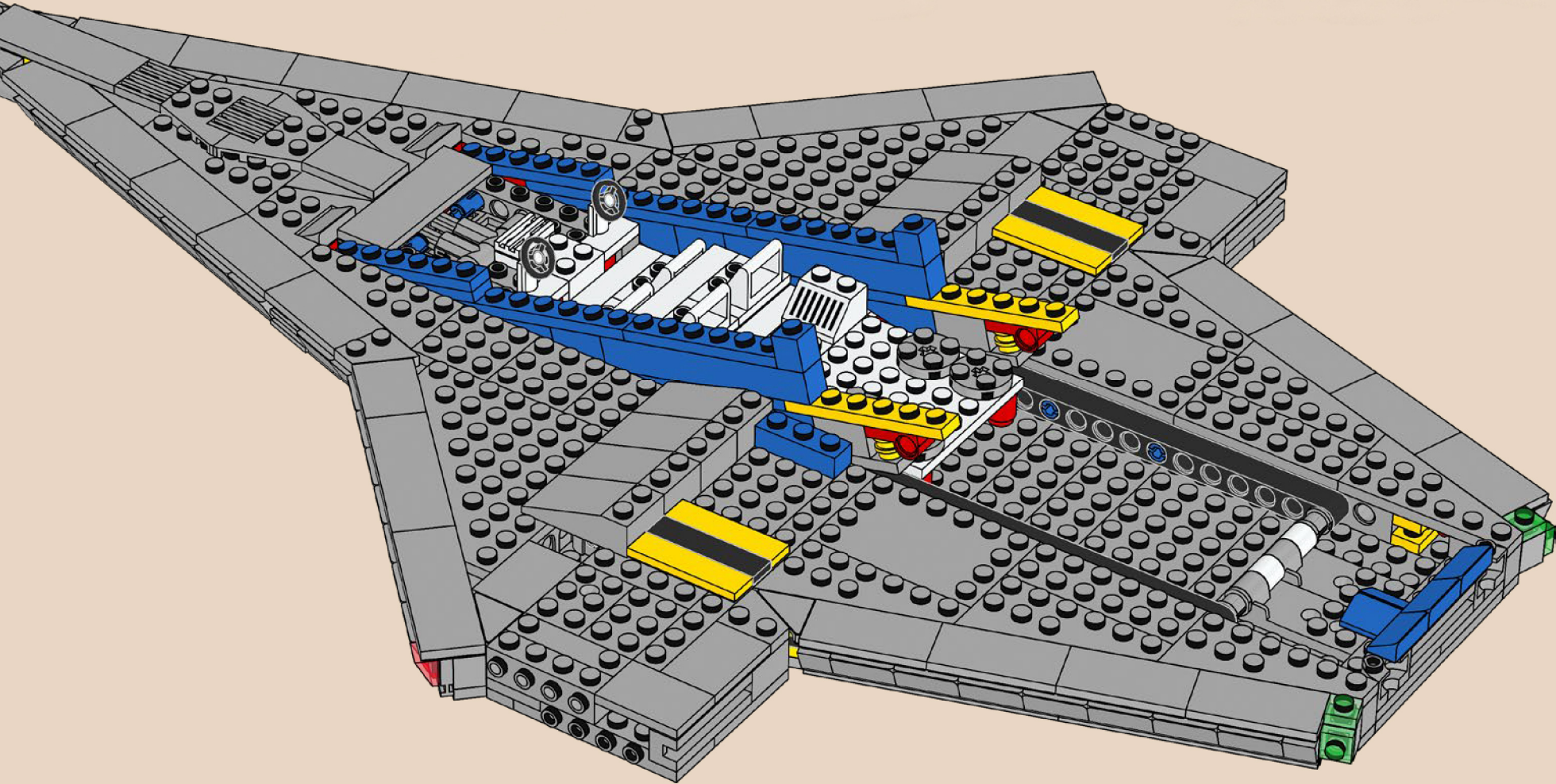

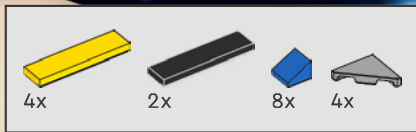

143

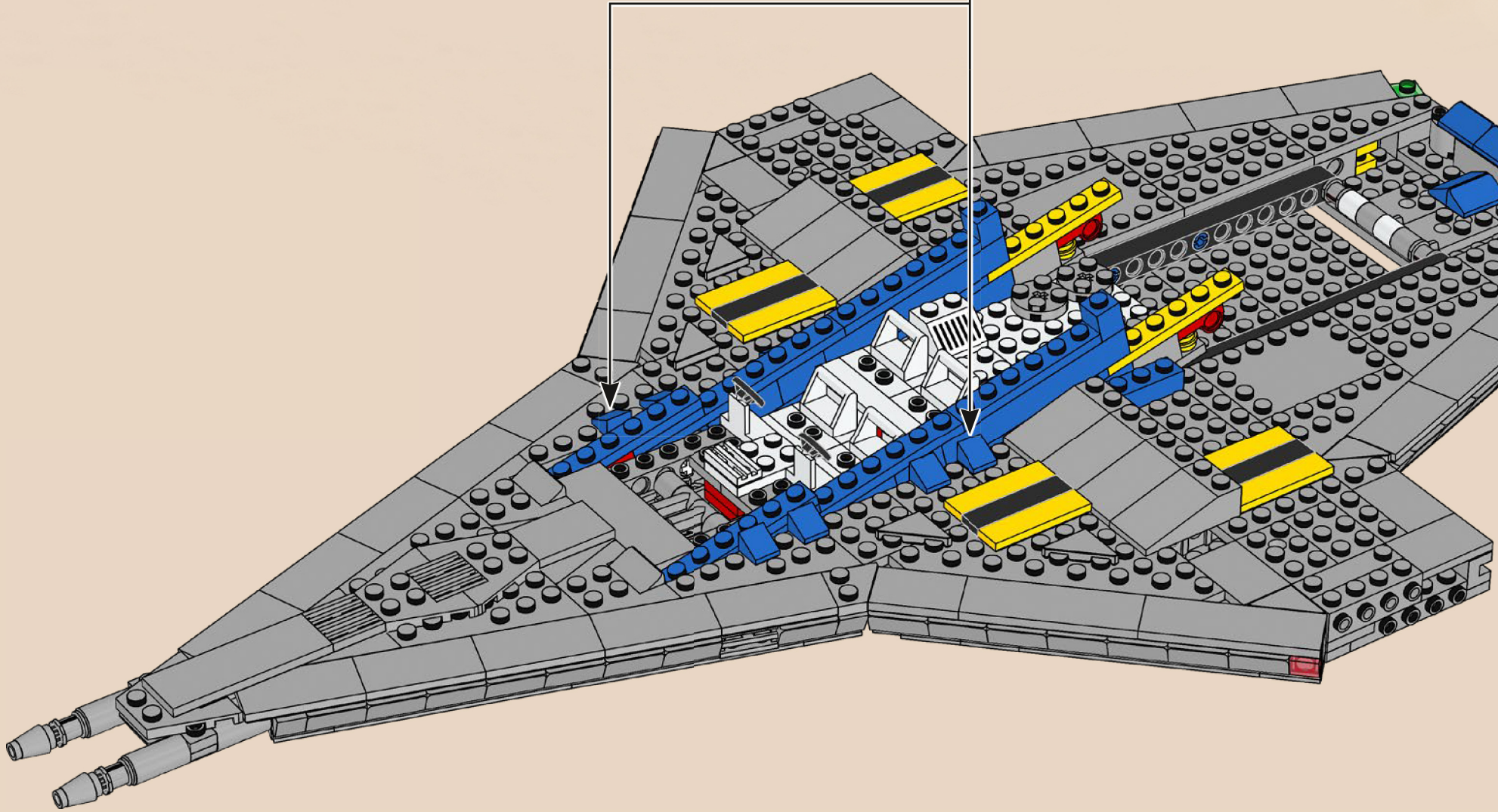

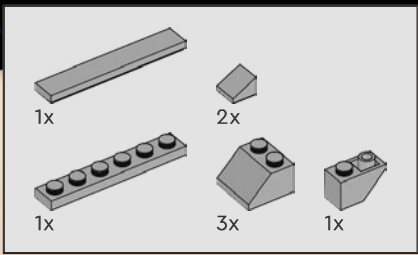

144

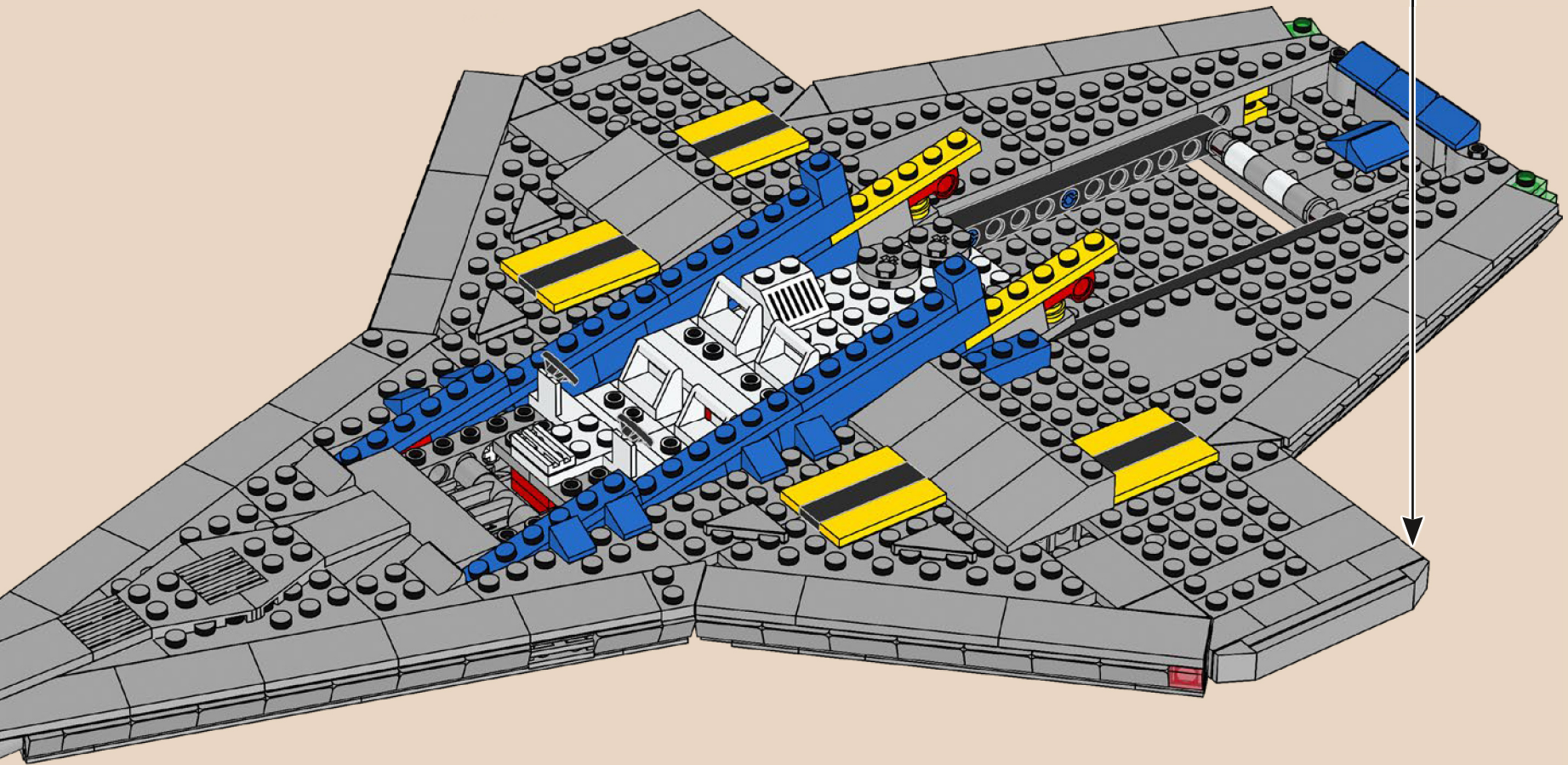
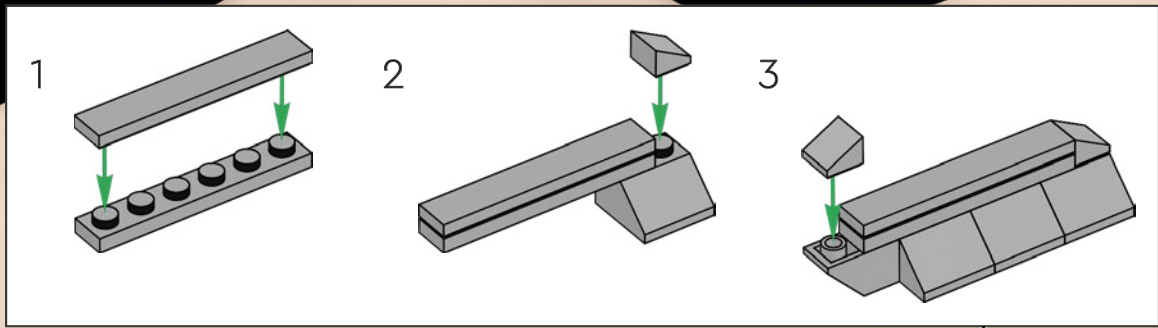

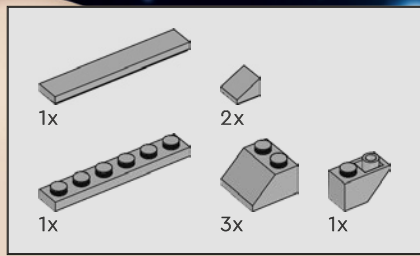

145

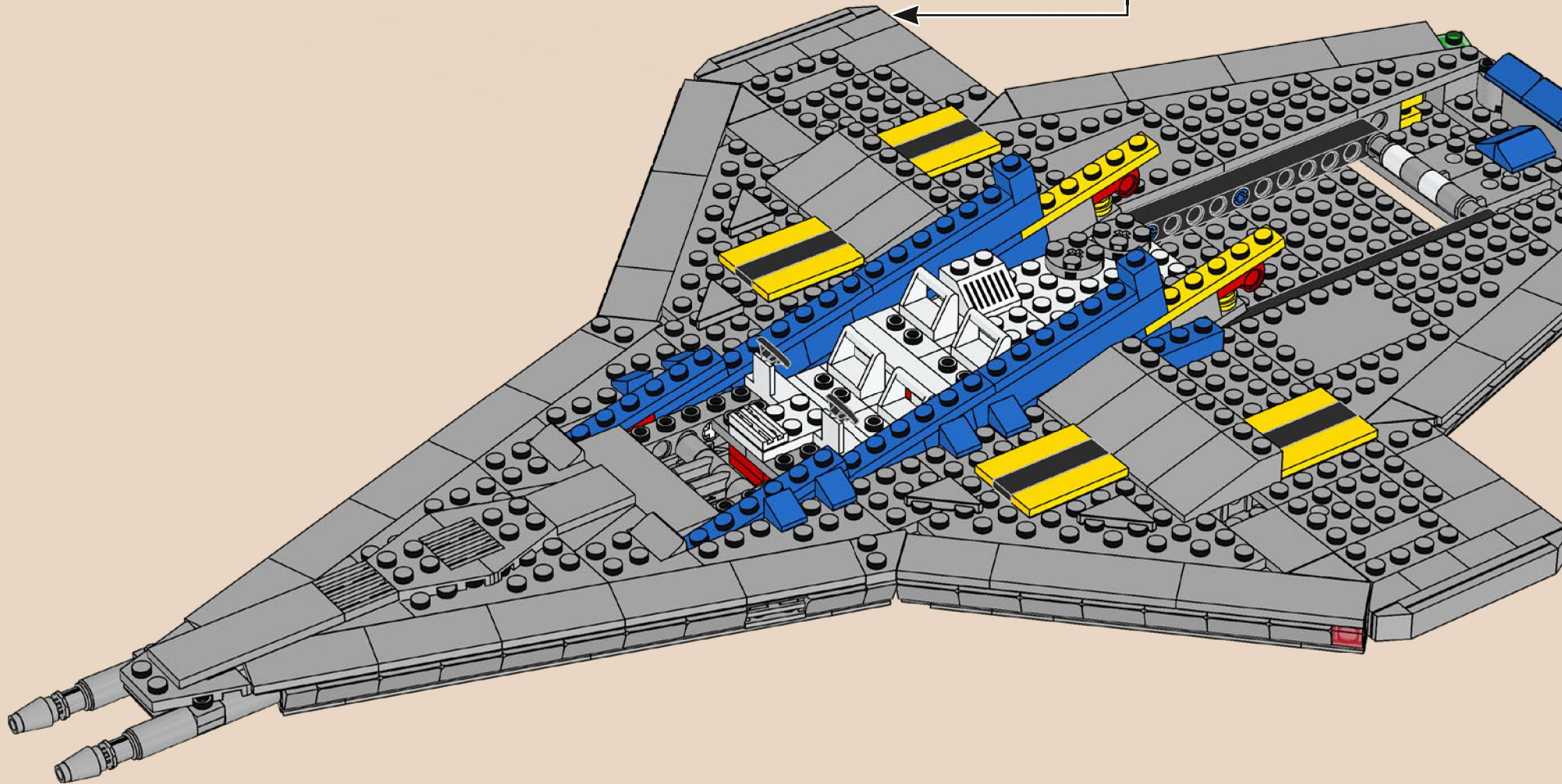
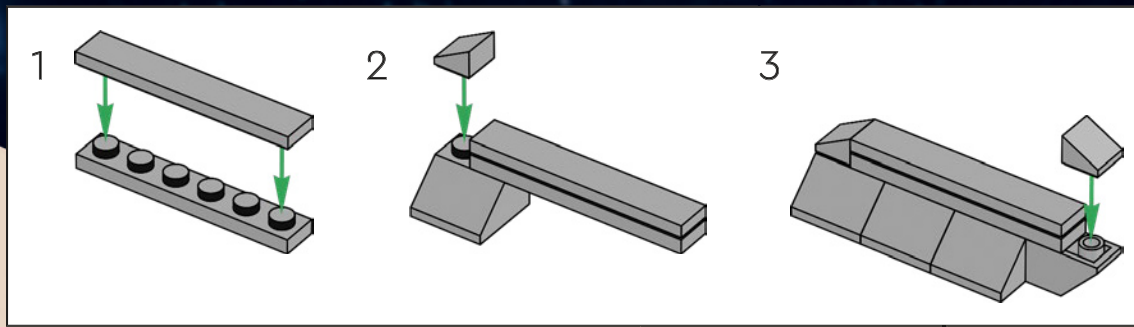

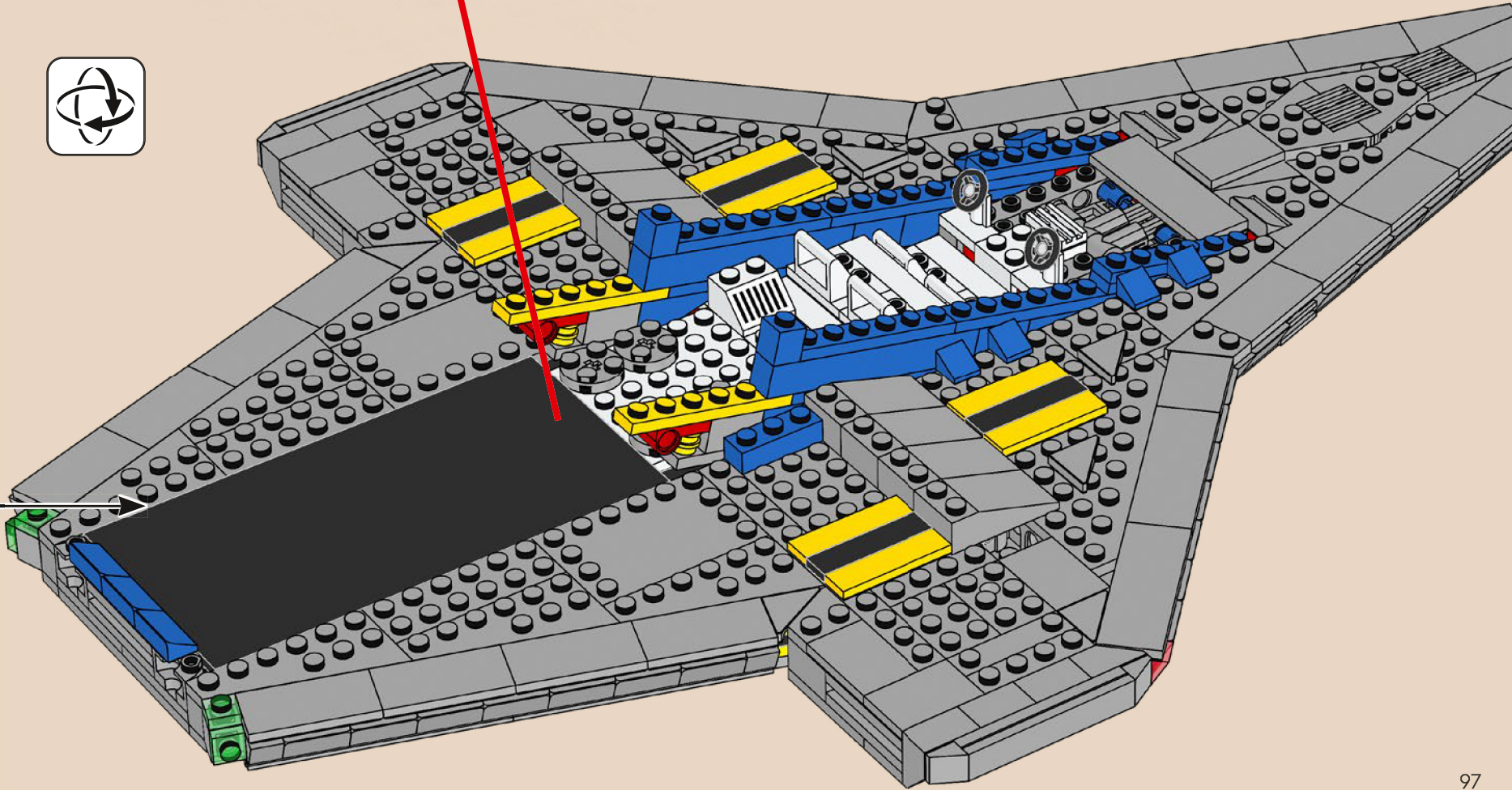
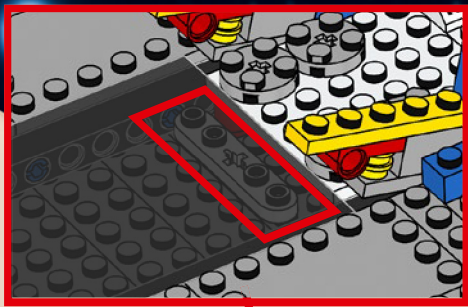

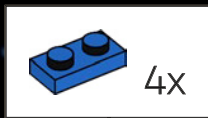
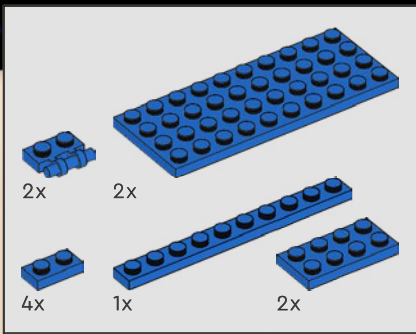

147

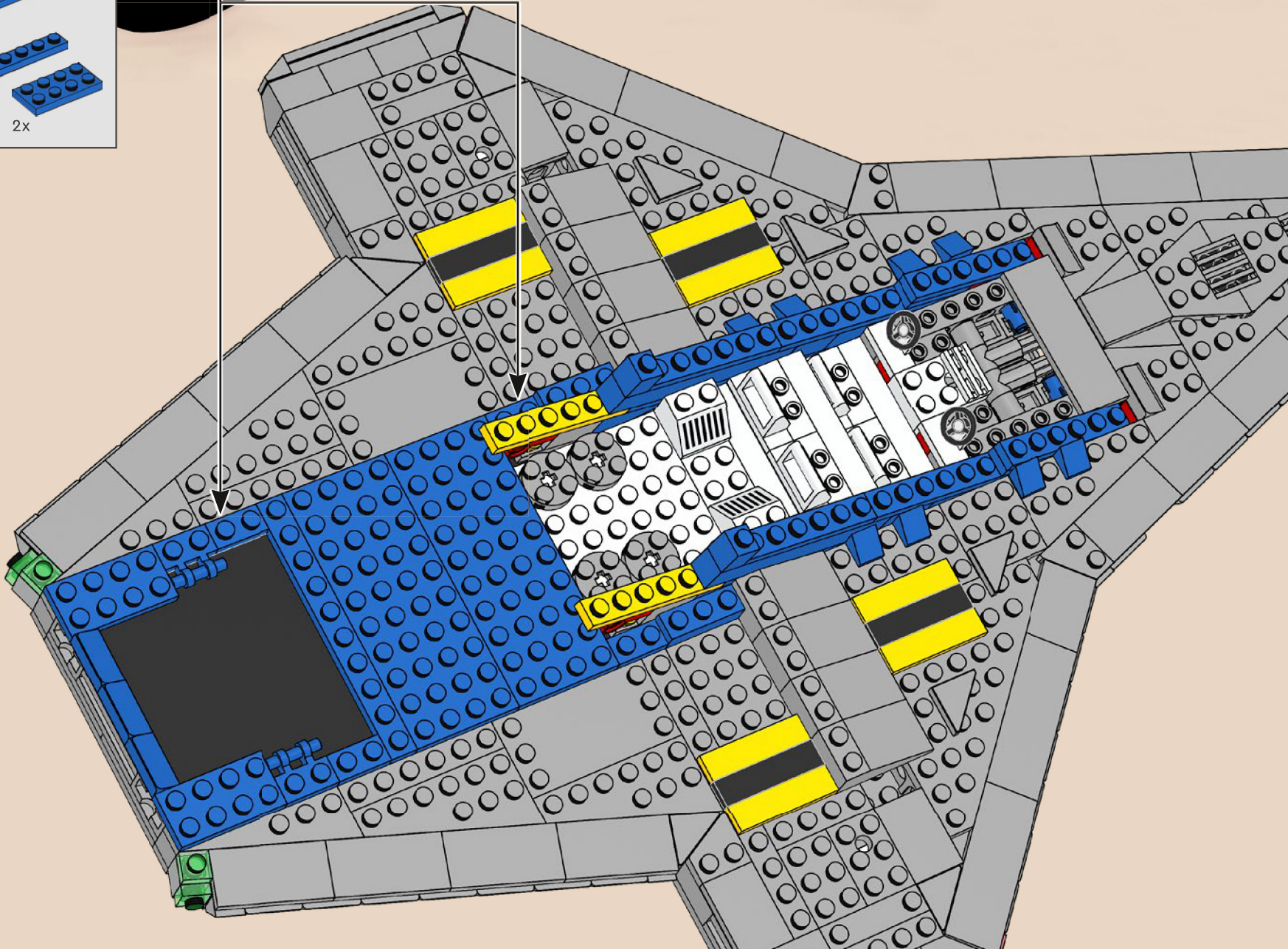

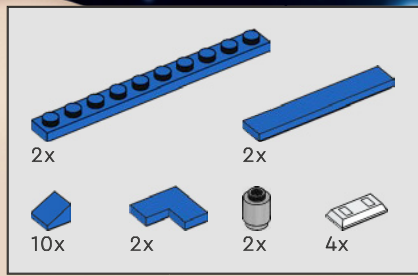

148

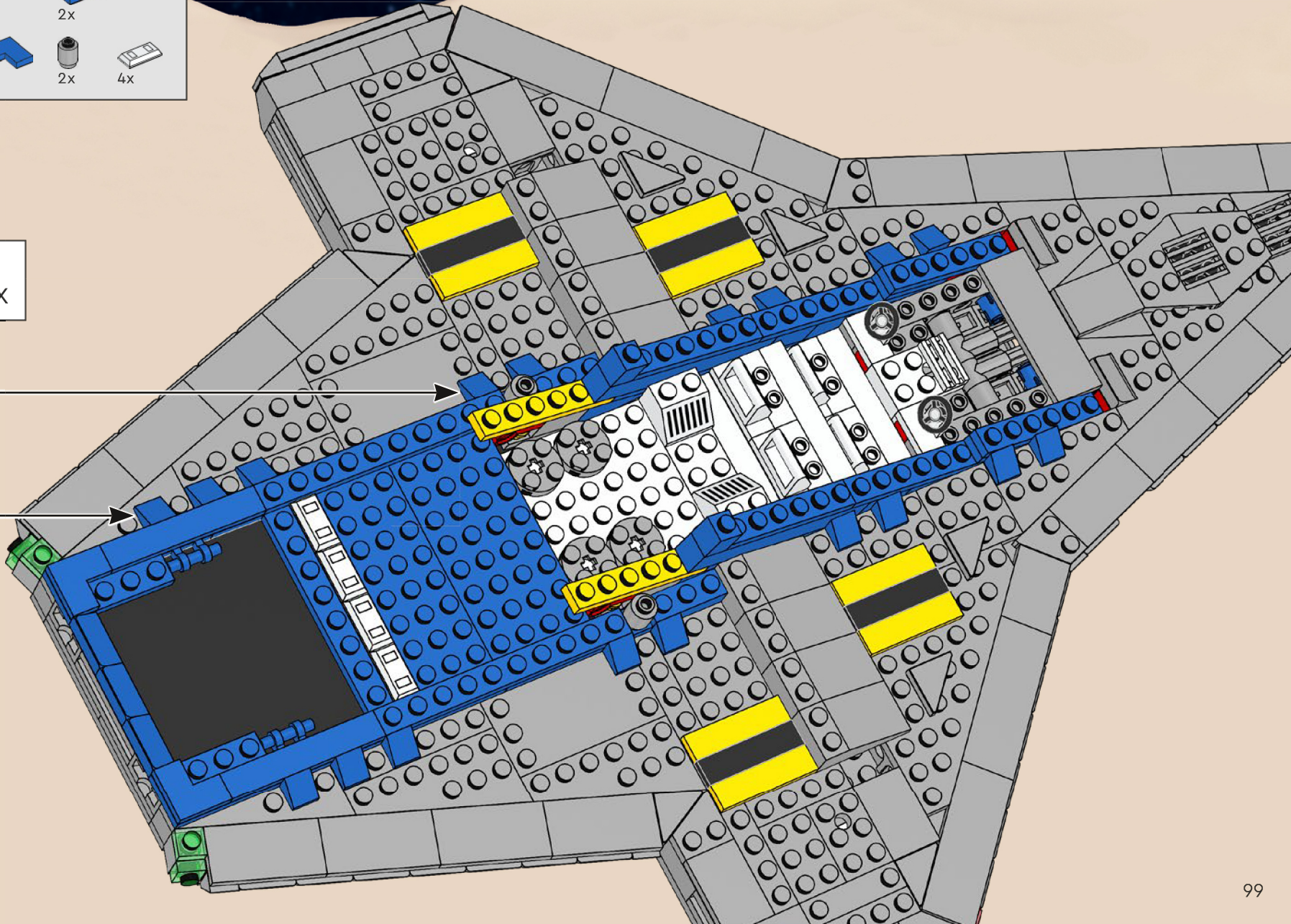

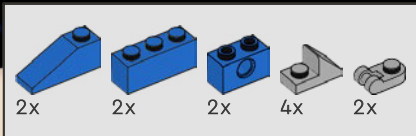

149

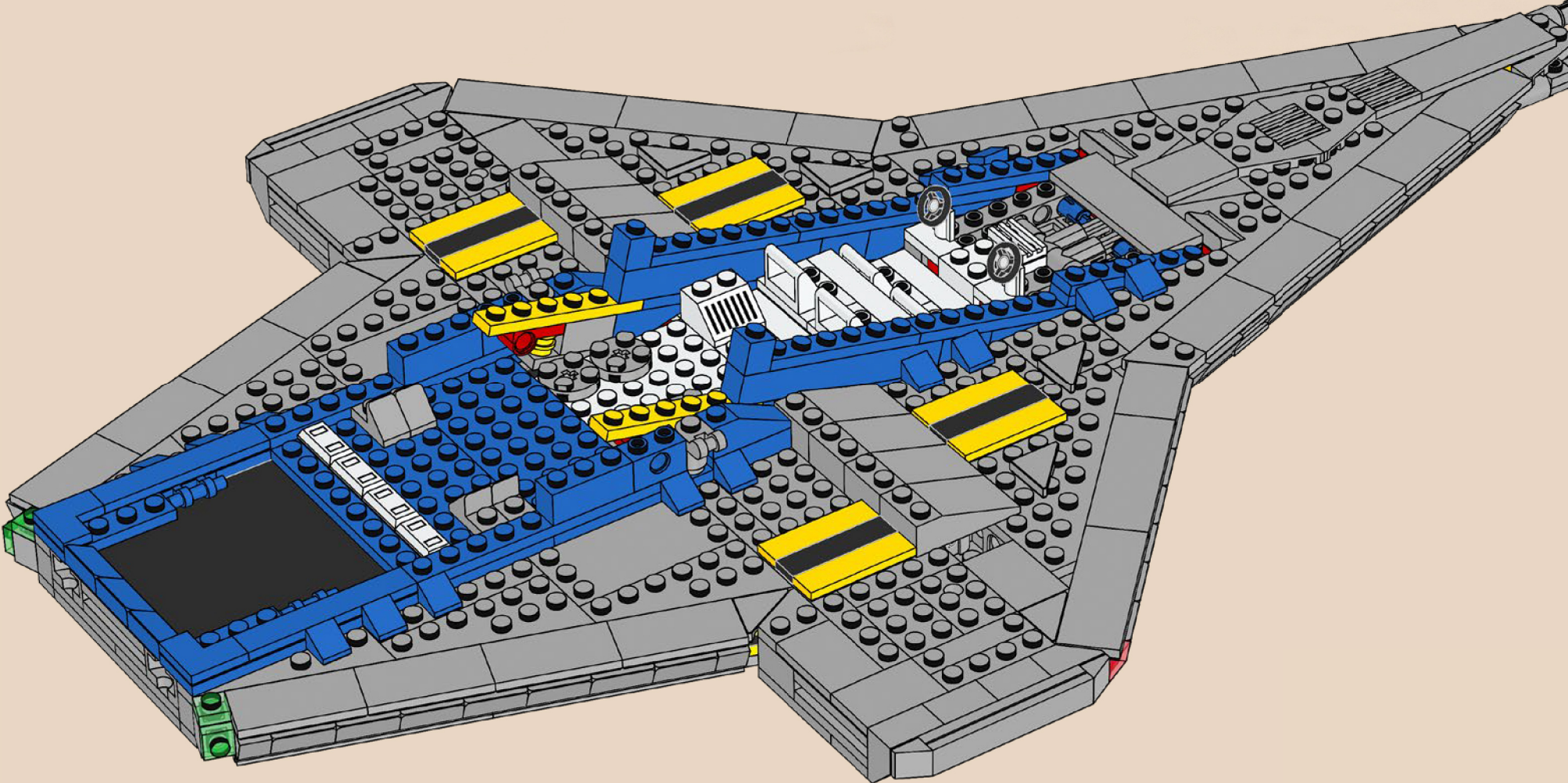

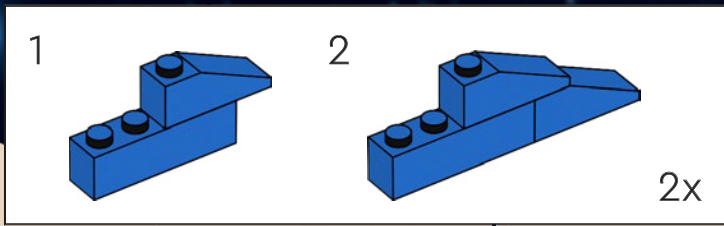
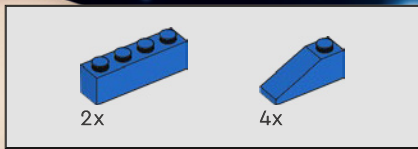

150

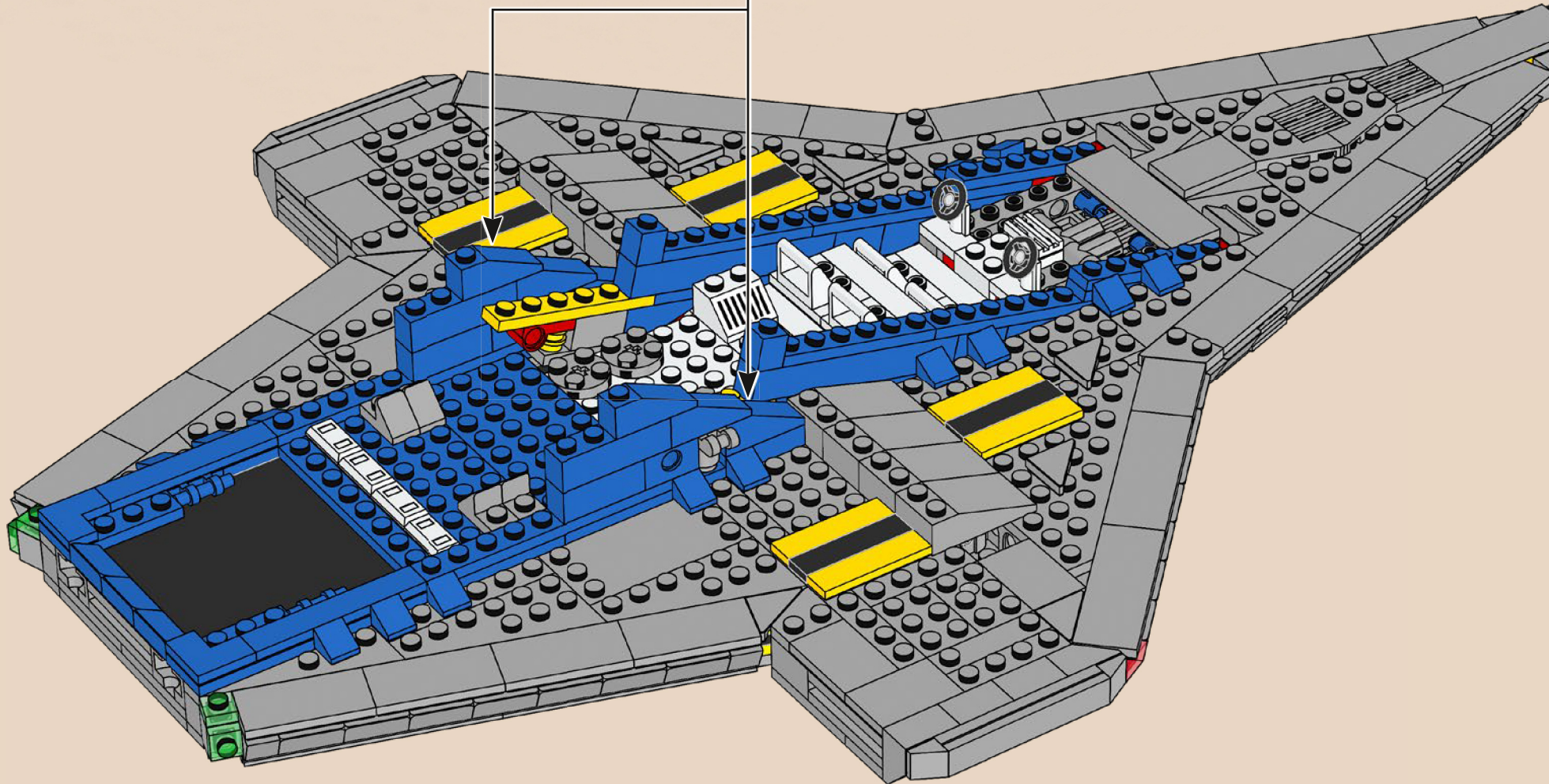

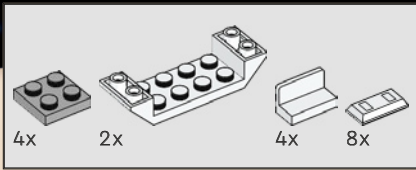

151

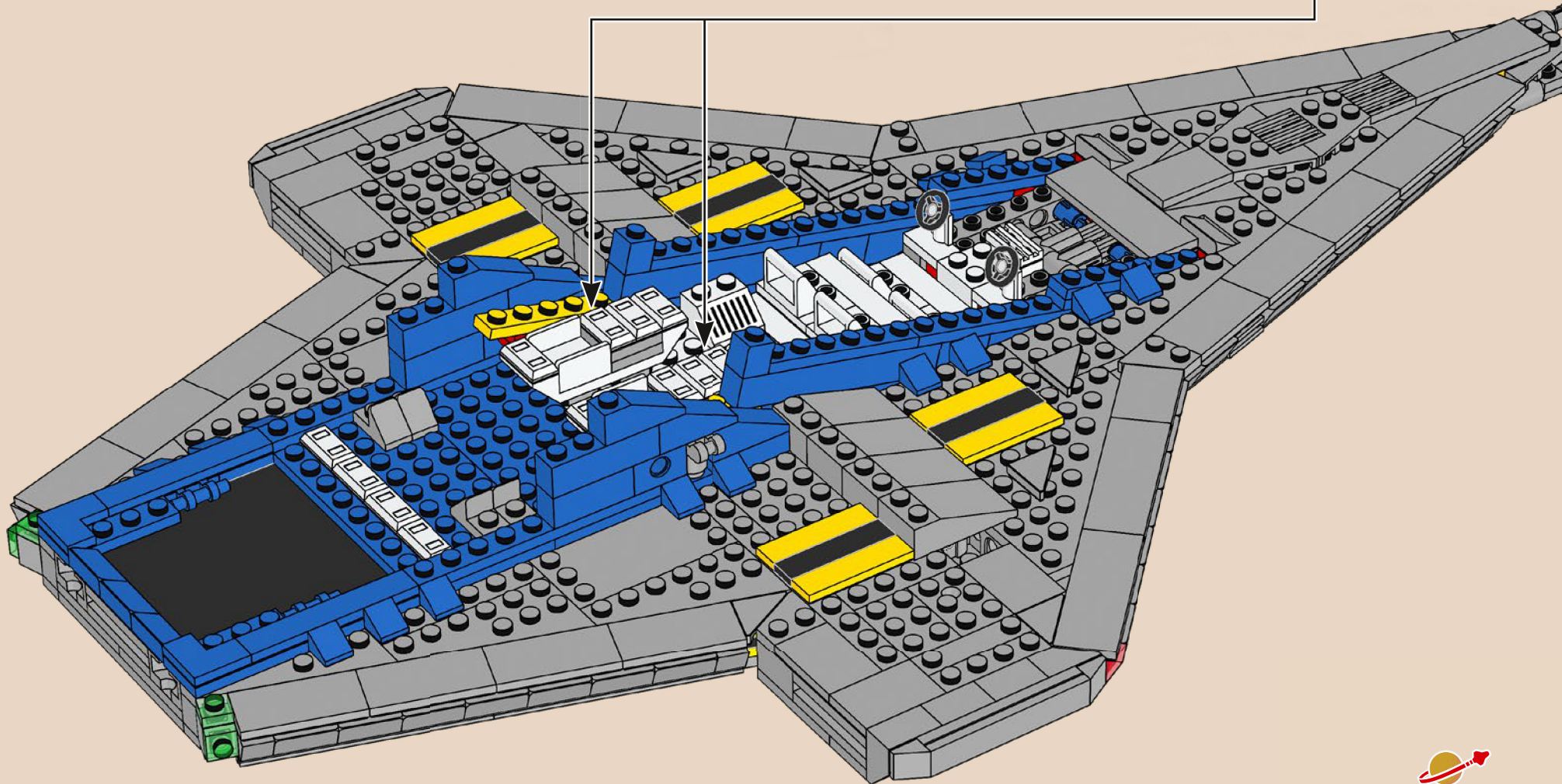
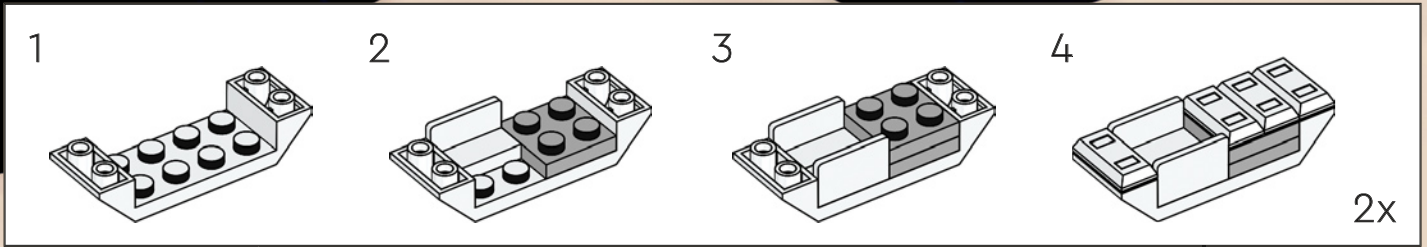

I letti degli astronauti sono progettati in modo che l'equipaggio possa sdraiarsi senza dover rimuovere le bombole d'aria.

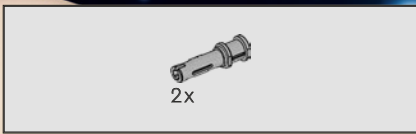

152

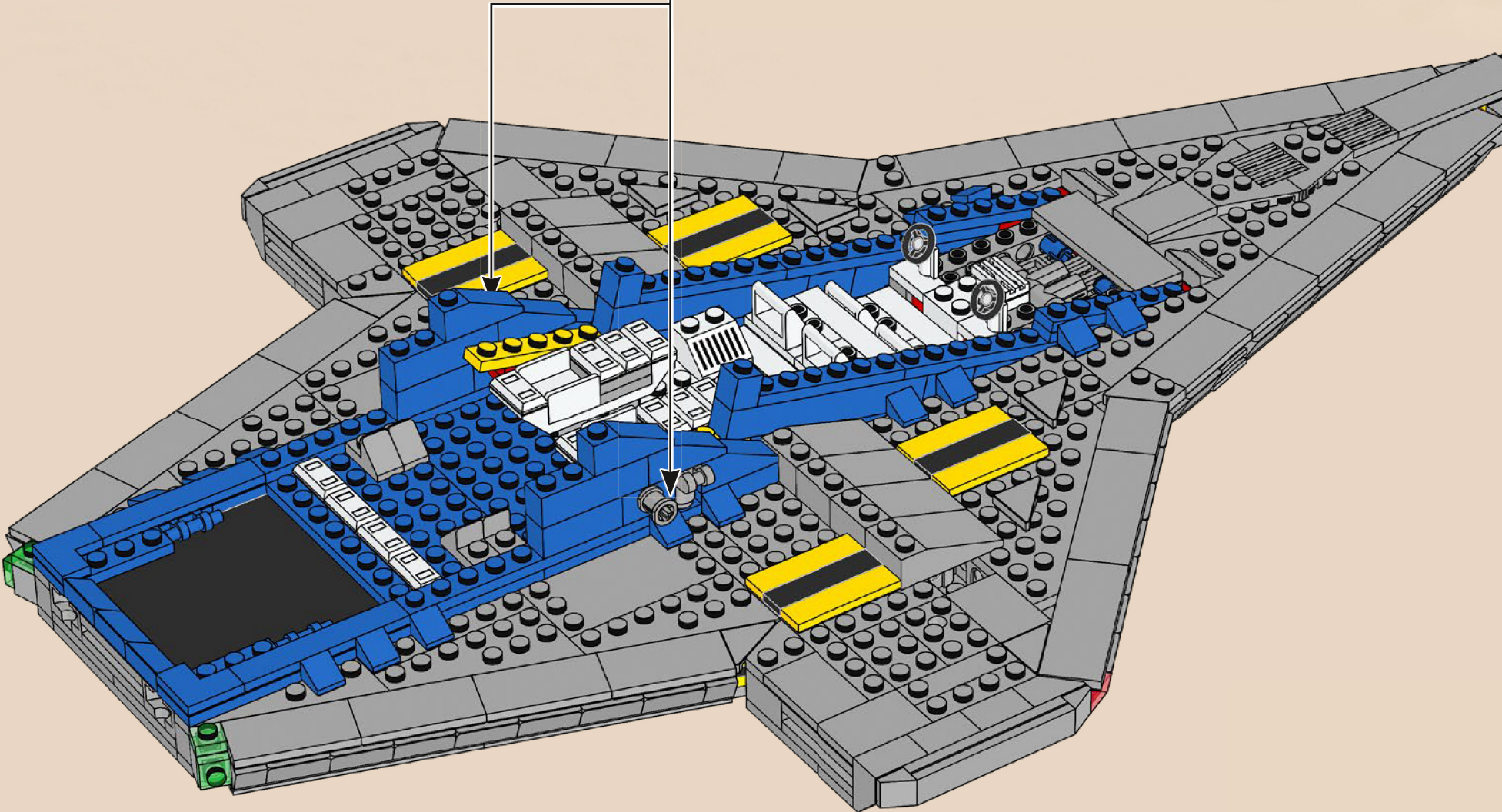

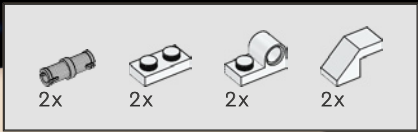

153

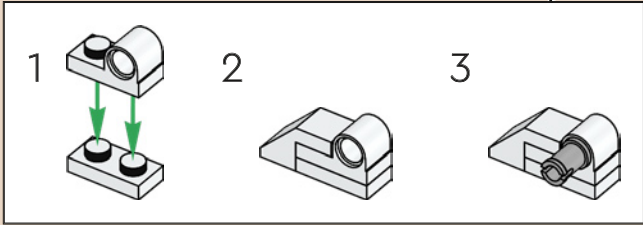
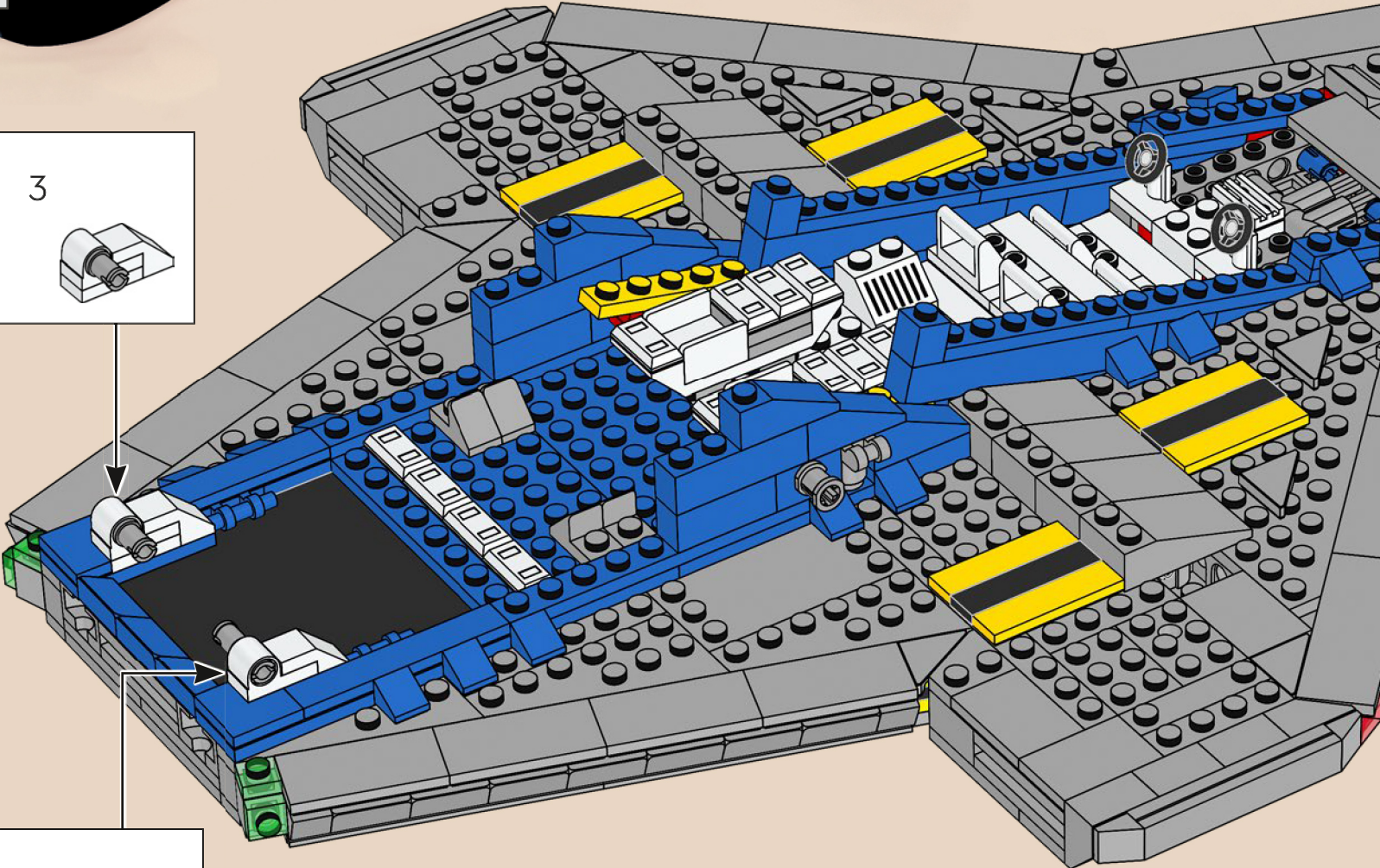
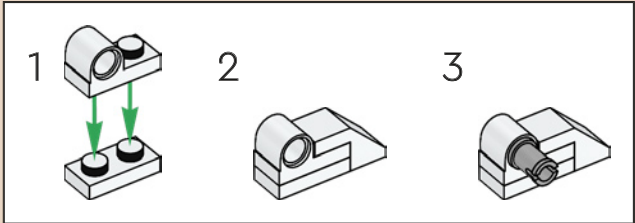

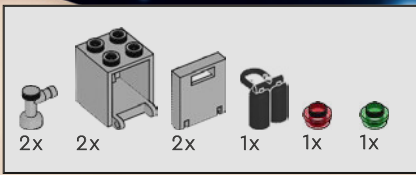

154

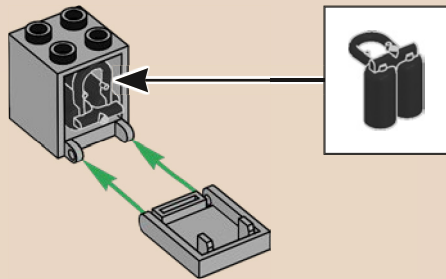
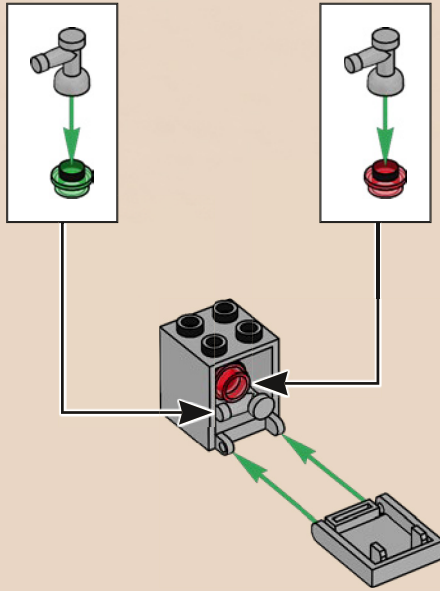

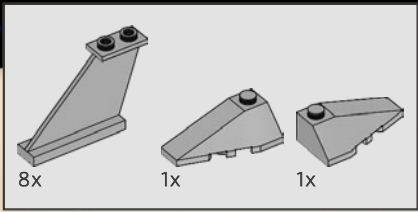

155

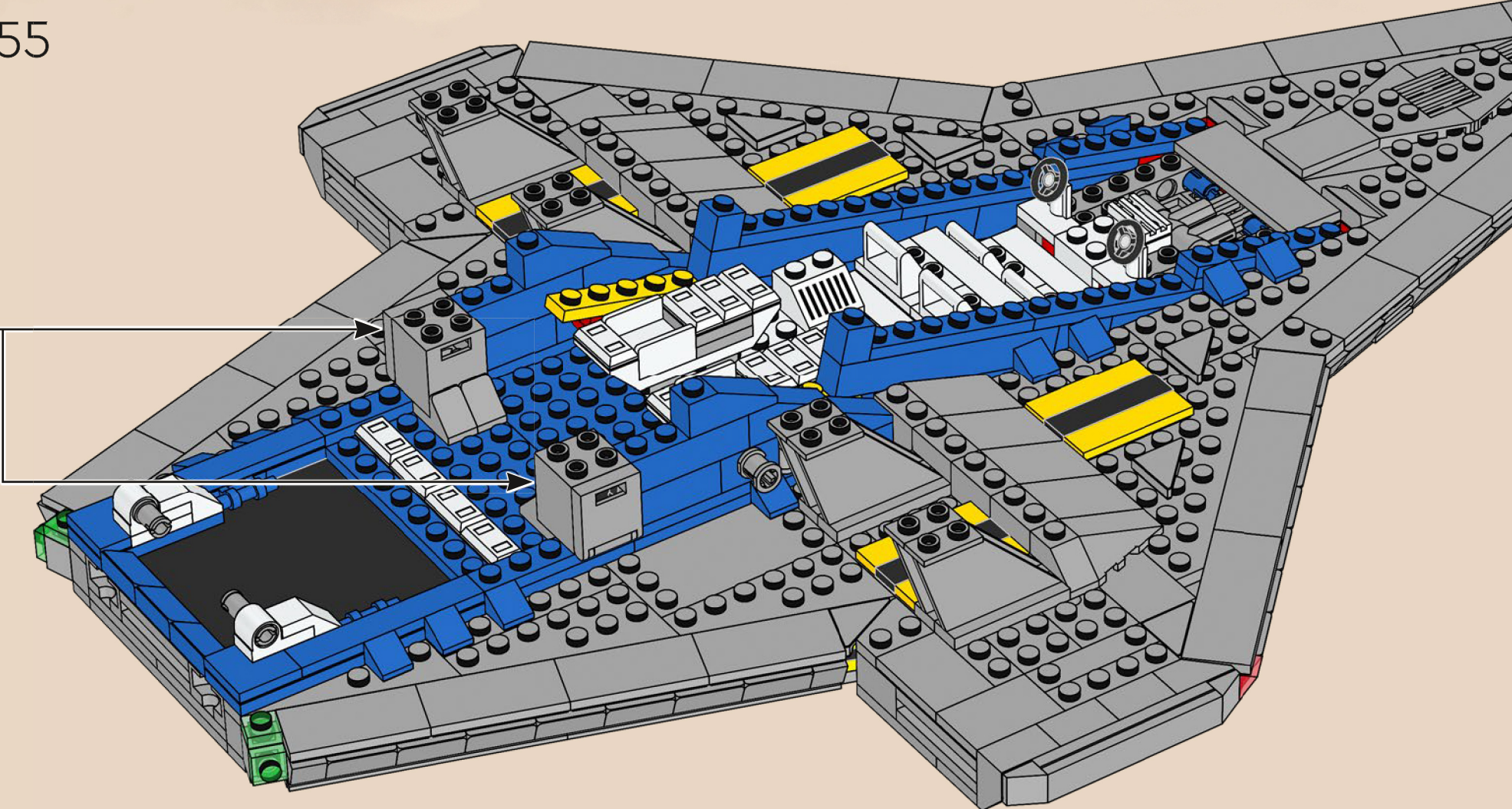



8x

156

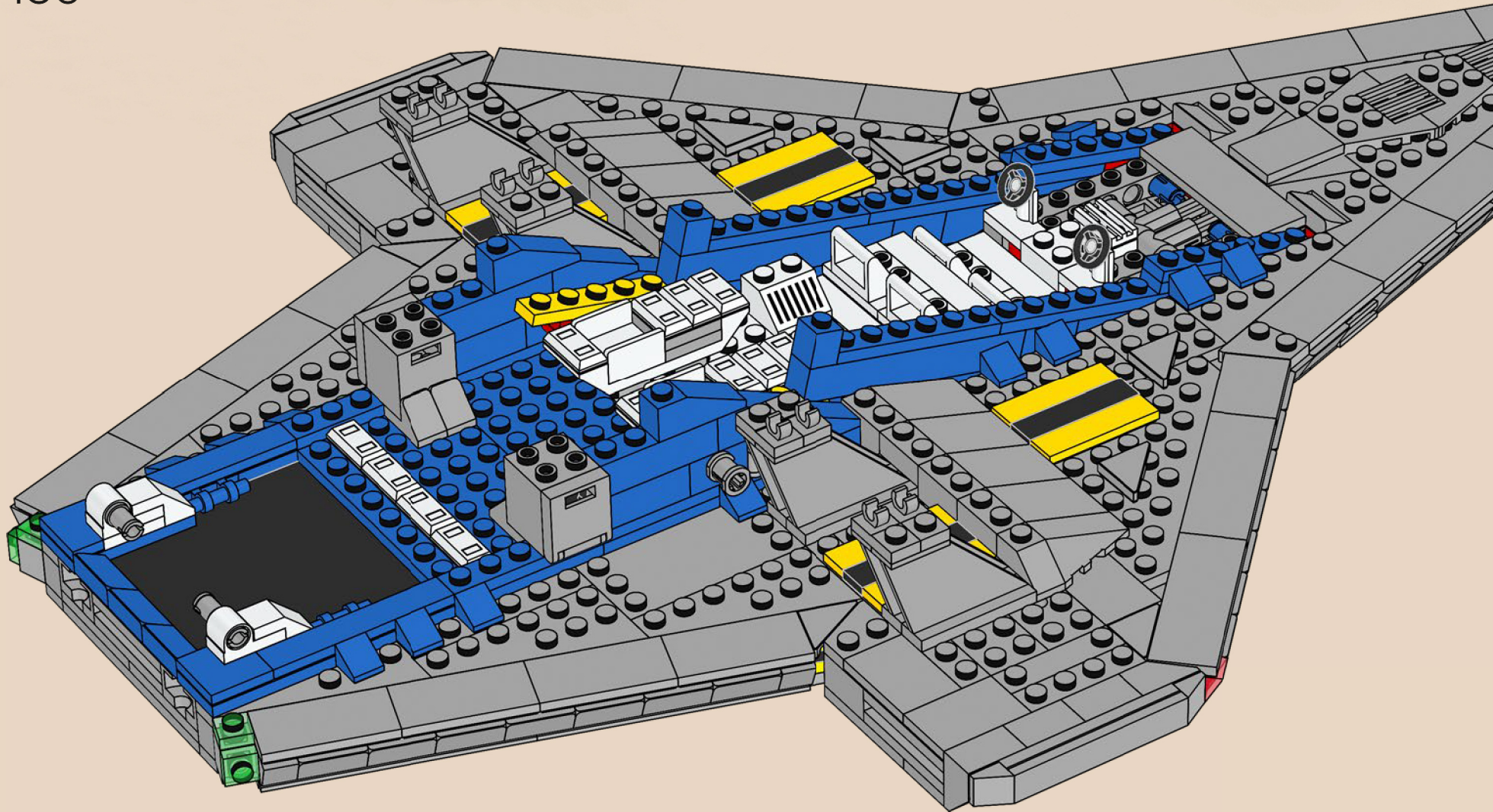

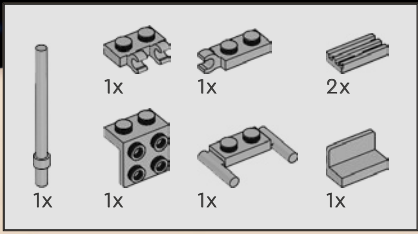

157

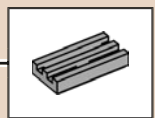
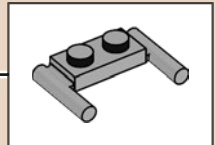
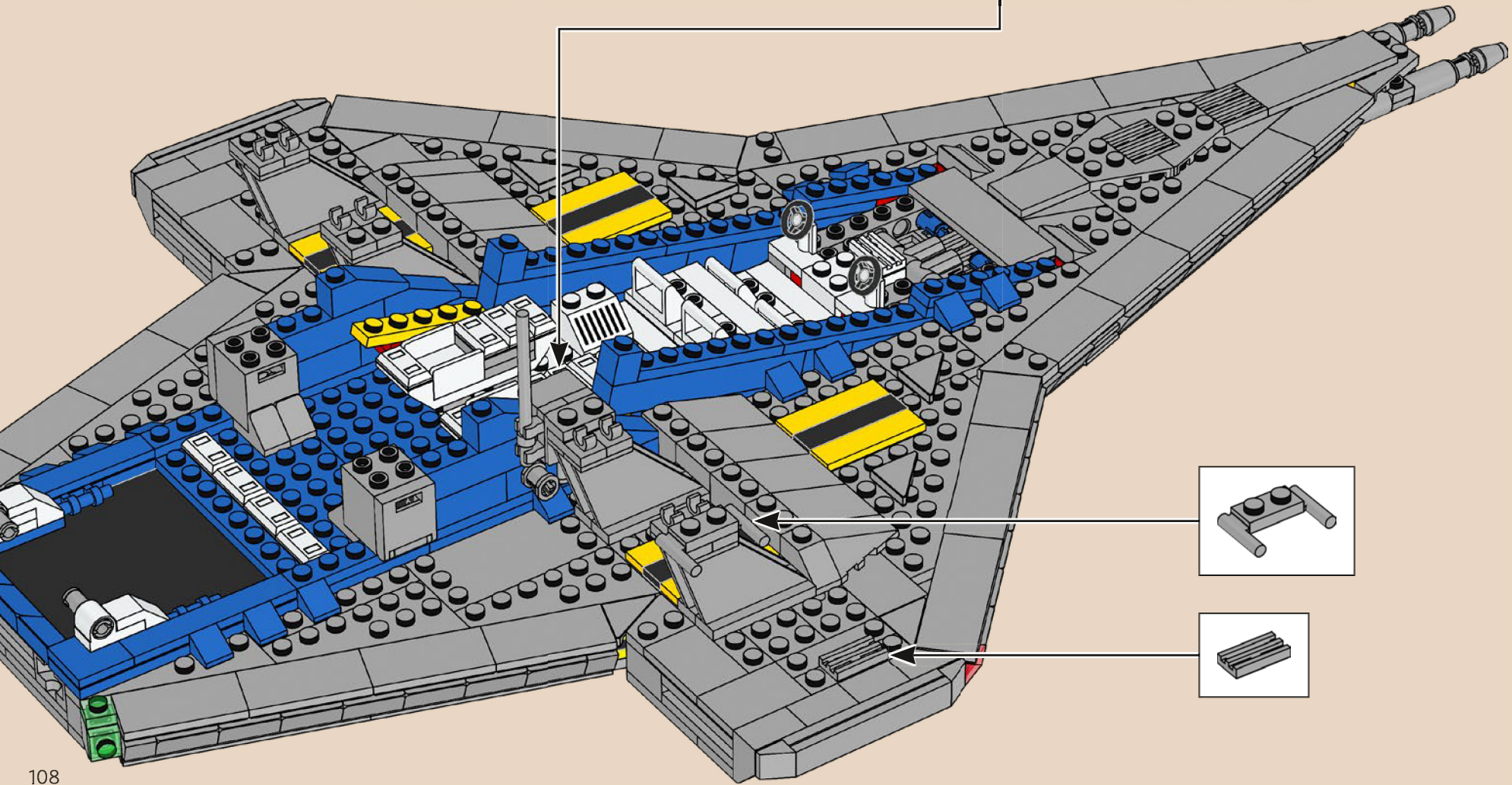
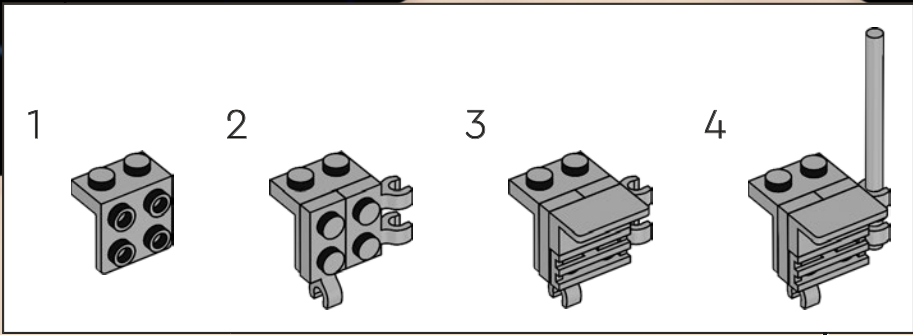

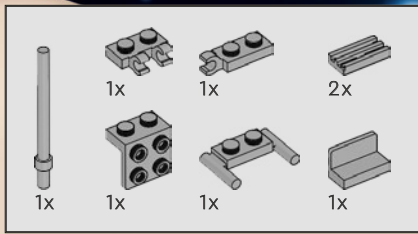

158

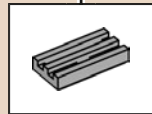
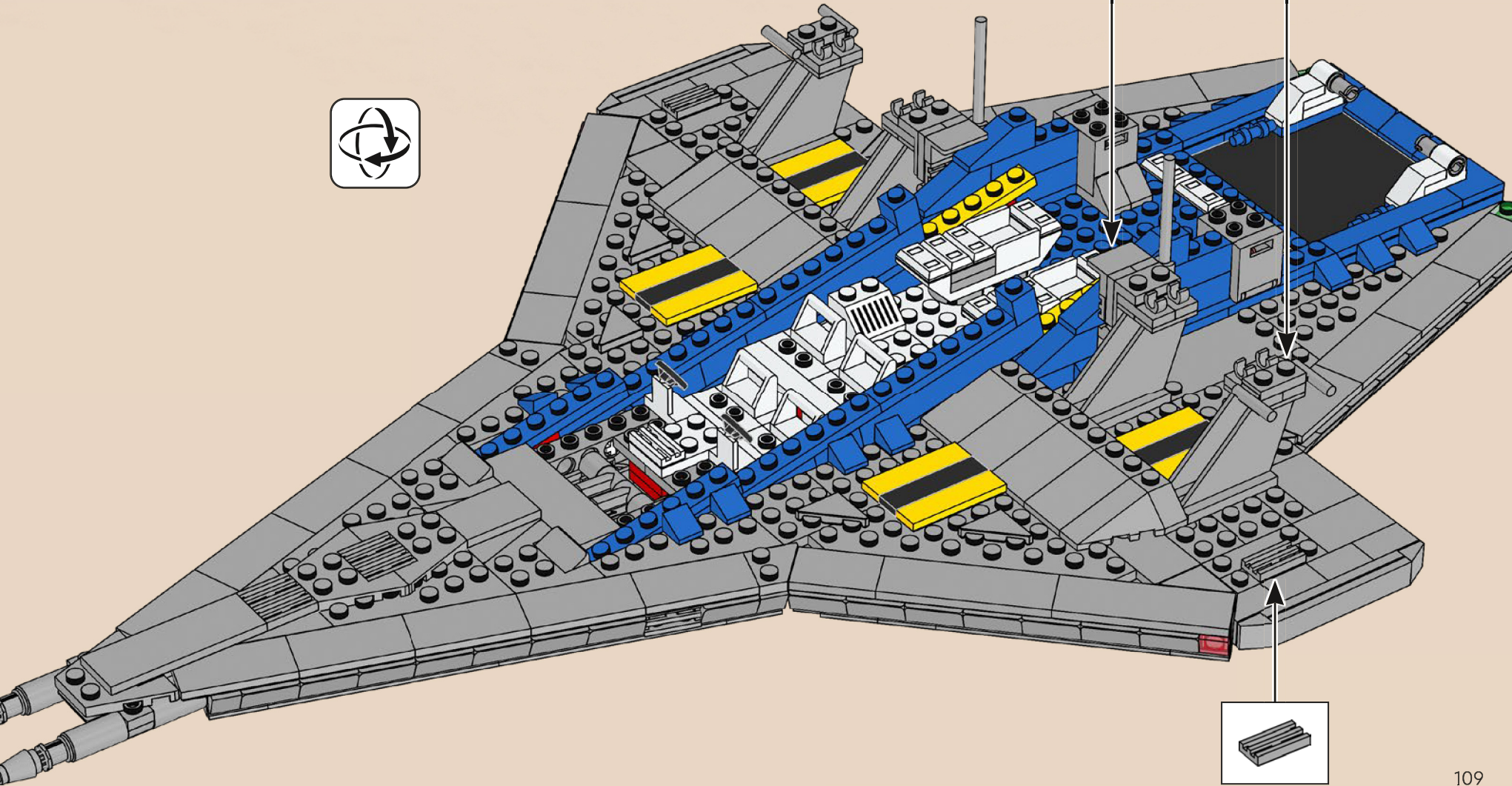
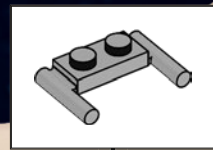
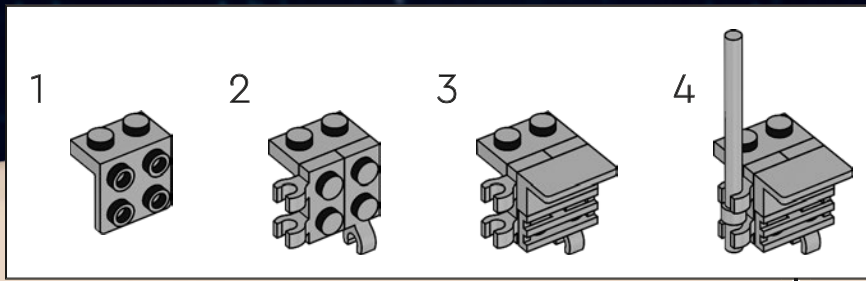

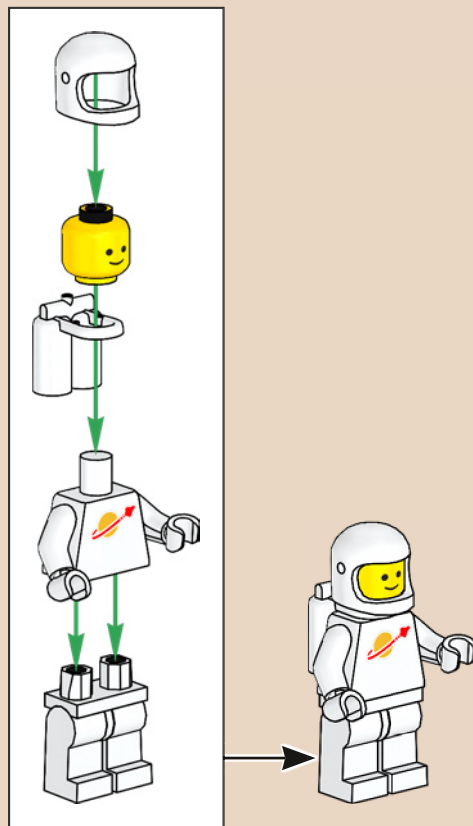

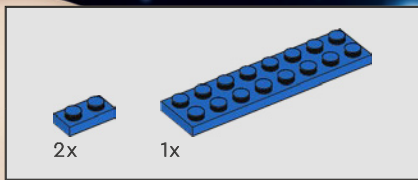

159

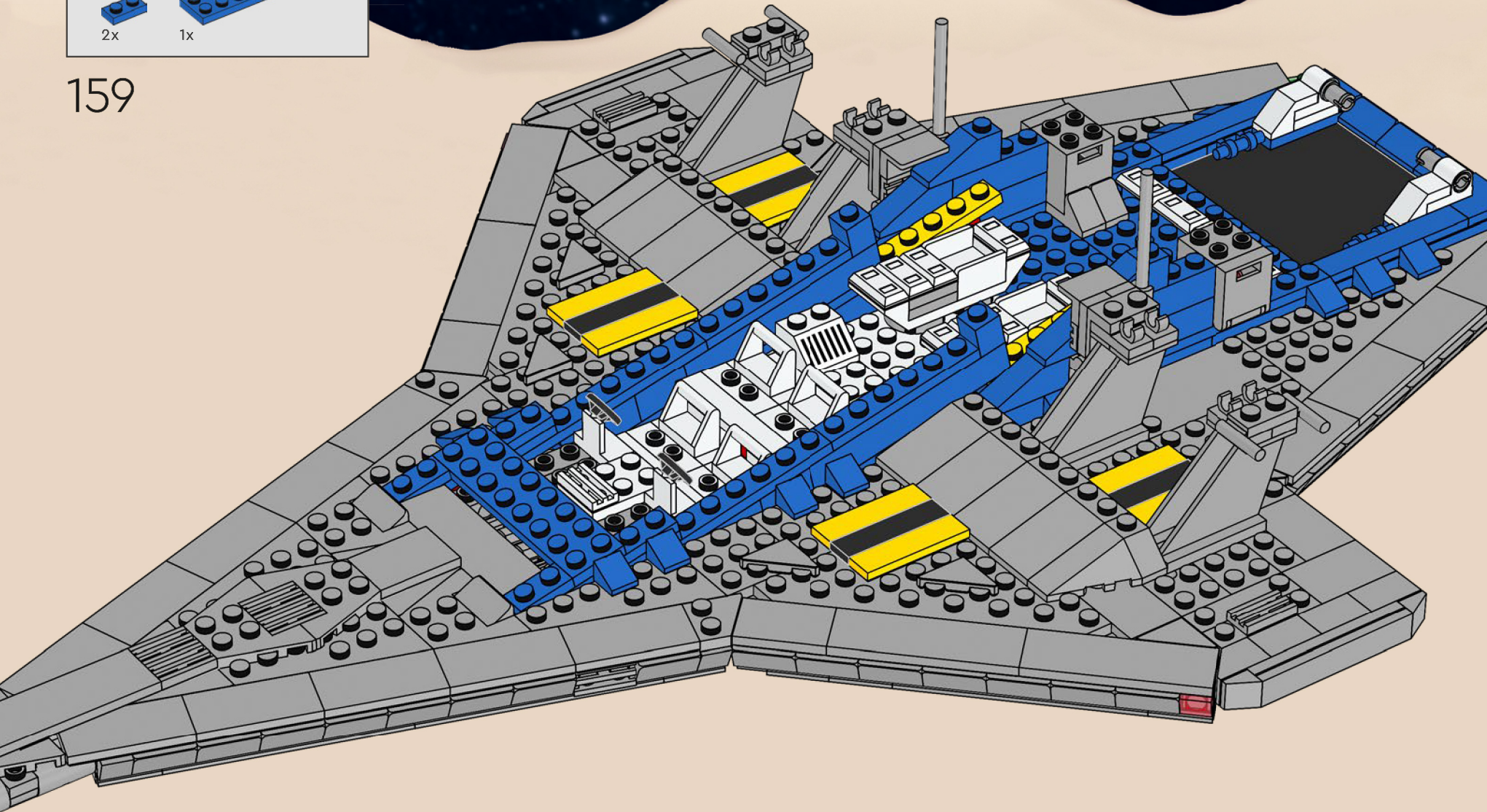

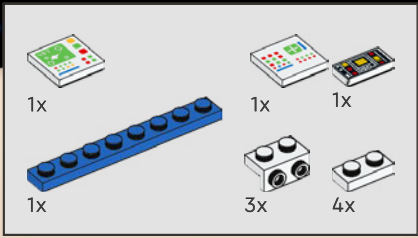

160

1

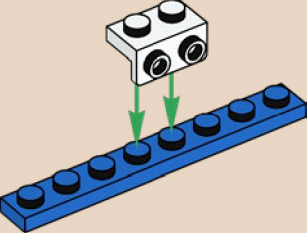

2

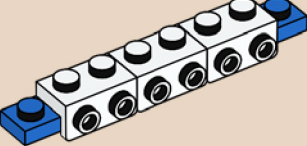

3

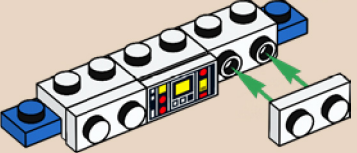

4

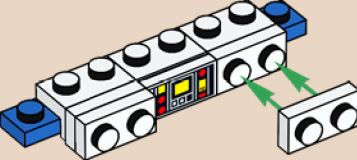

5

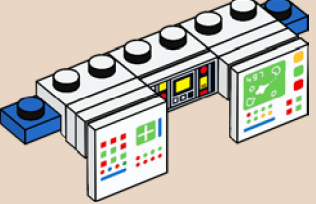



Il pilota del set originale utilizzava un unico volante per controllare l'astronave. La versione aggiornata ha anche comandi aggiornati: DUE volanti!

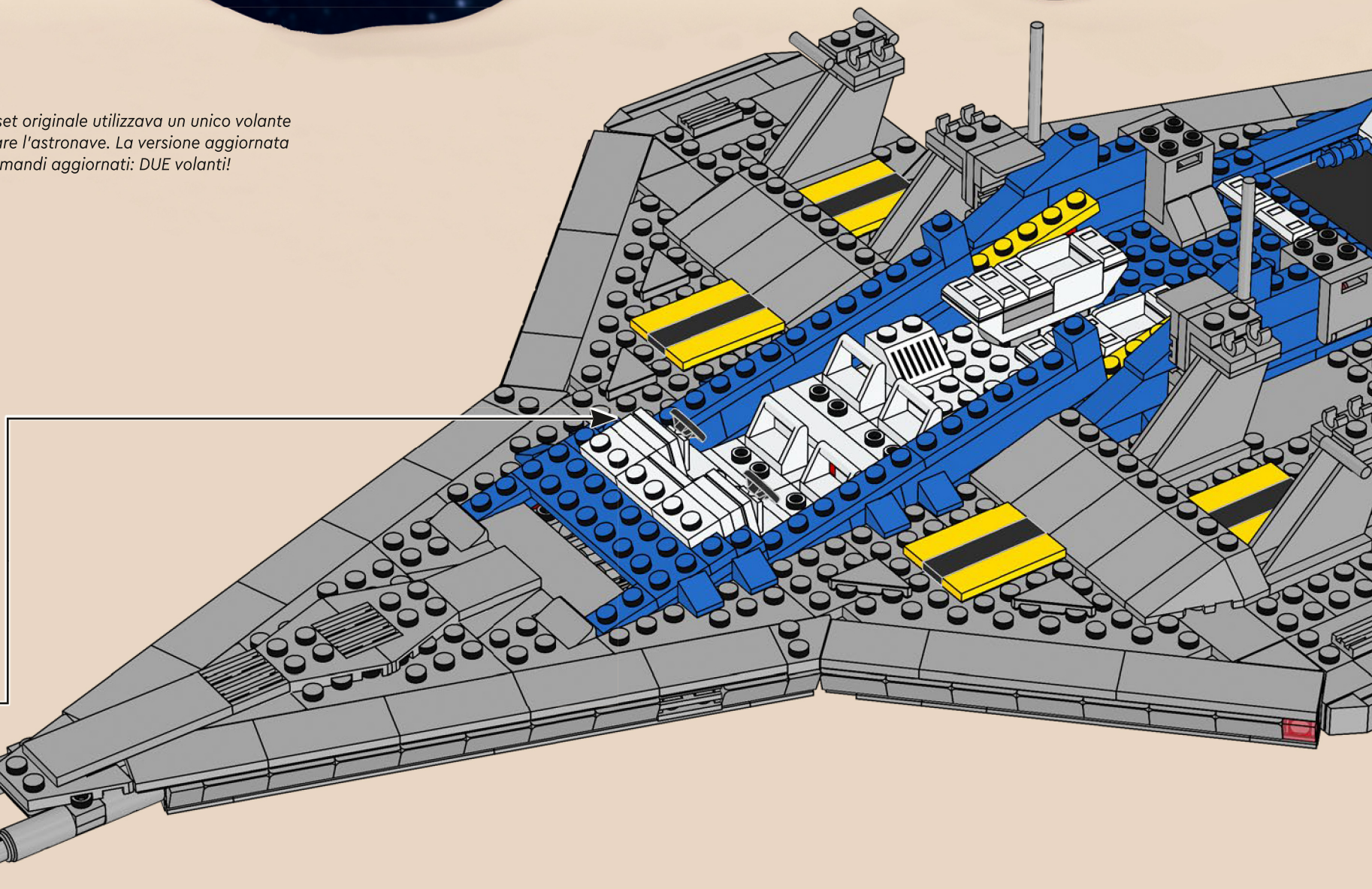

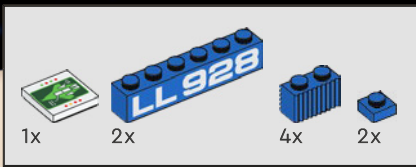

161



Il Galaxy Explorer originale era dotato dell'elemento designatore LL 928 stampato su un mattoncino 1x4. Sulla versione moderna della nave, LL 928 è stampato su un mattoncino più grande del 50%, l'1x6.

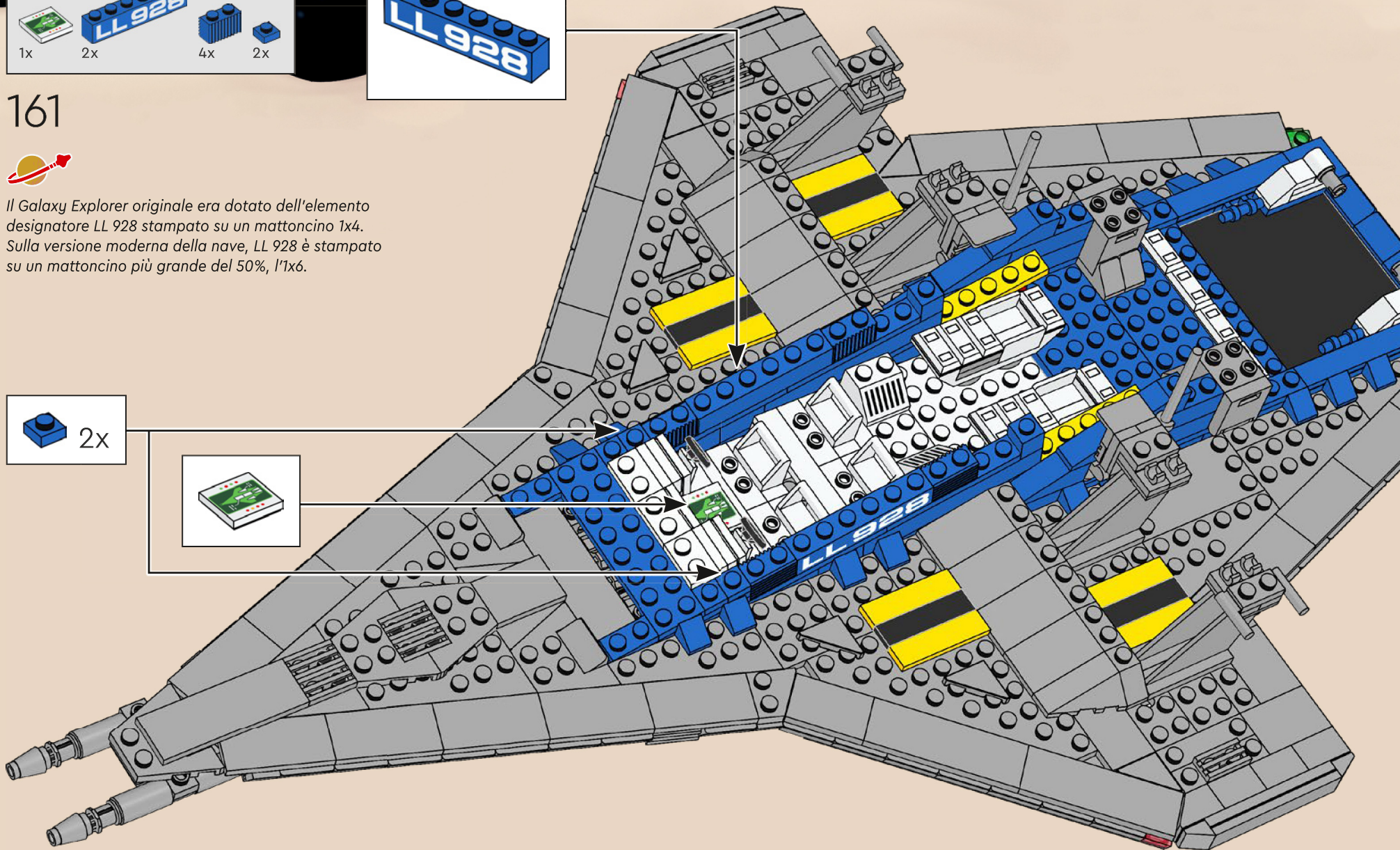

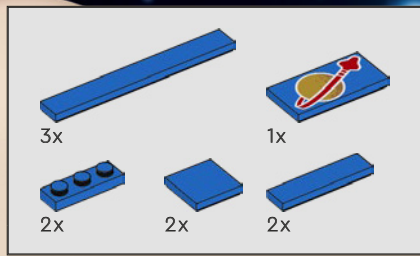

162

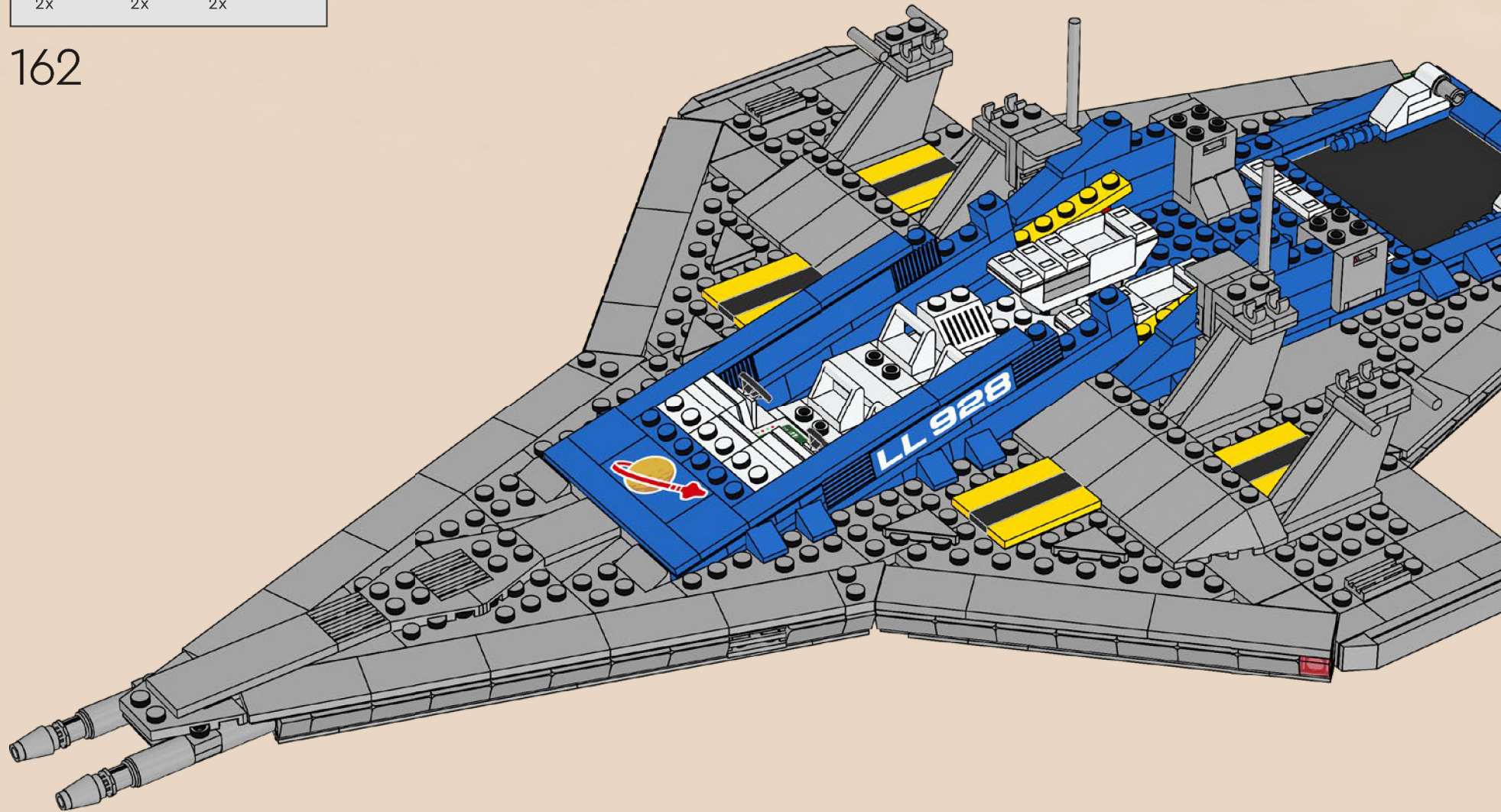

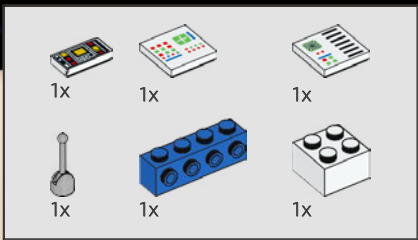

163

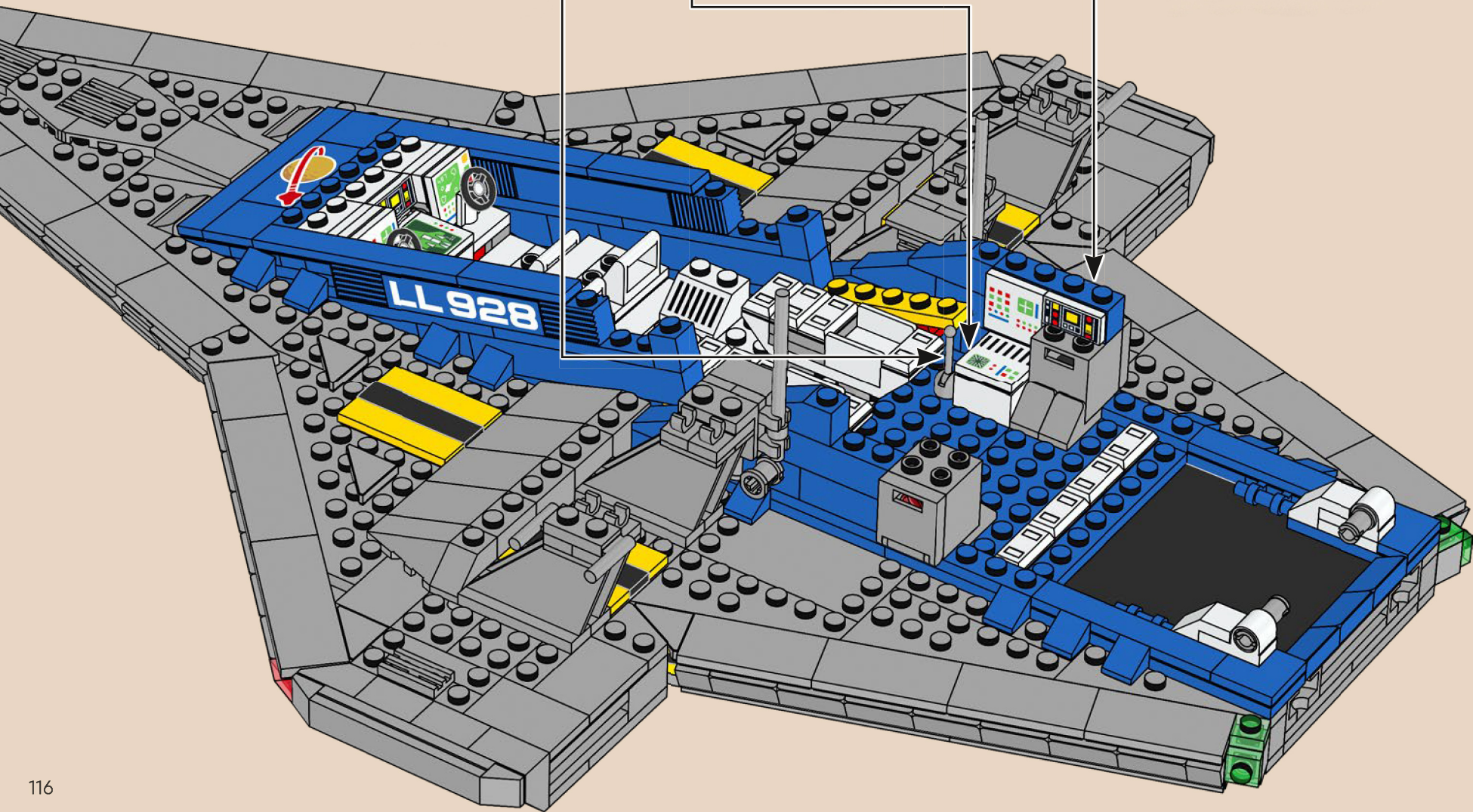
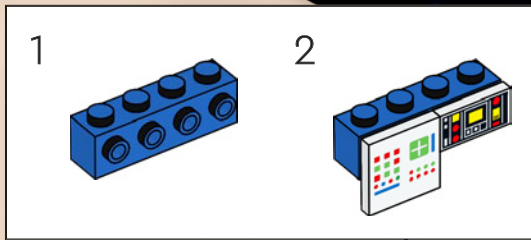
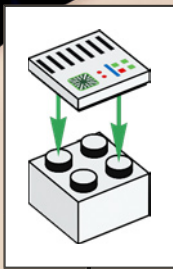
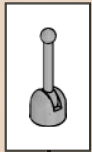

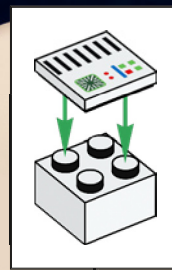
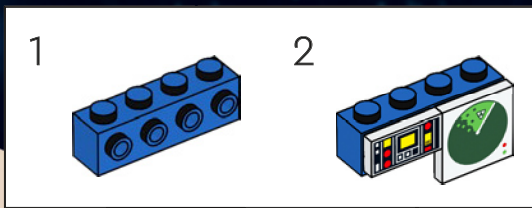
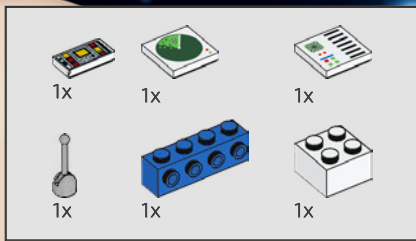

164

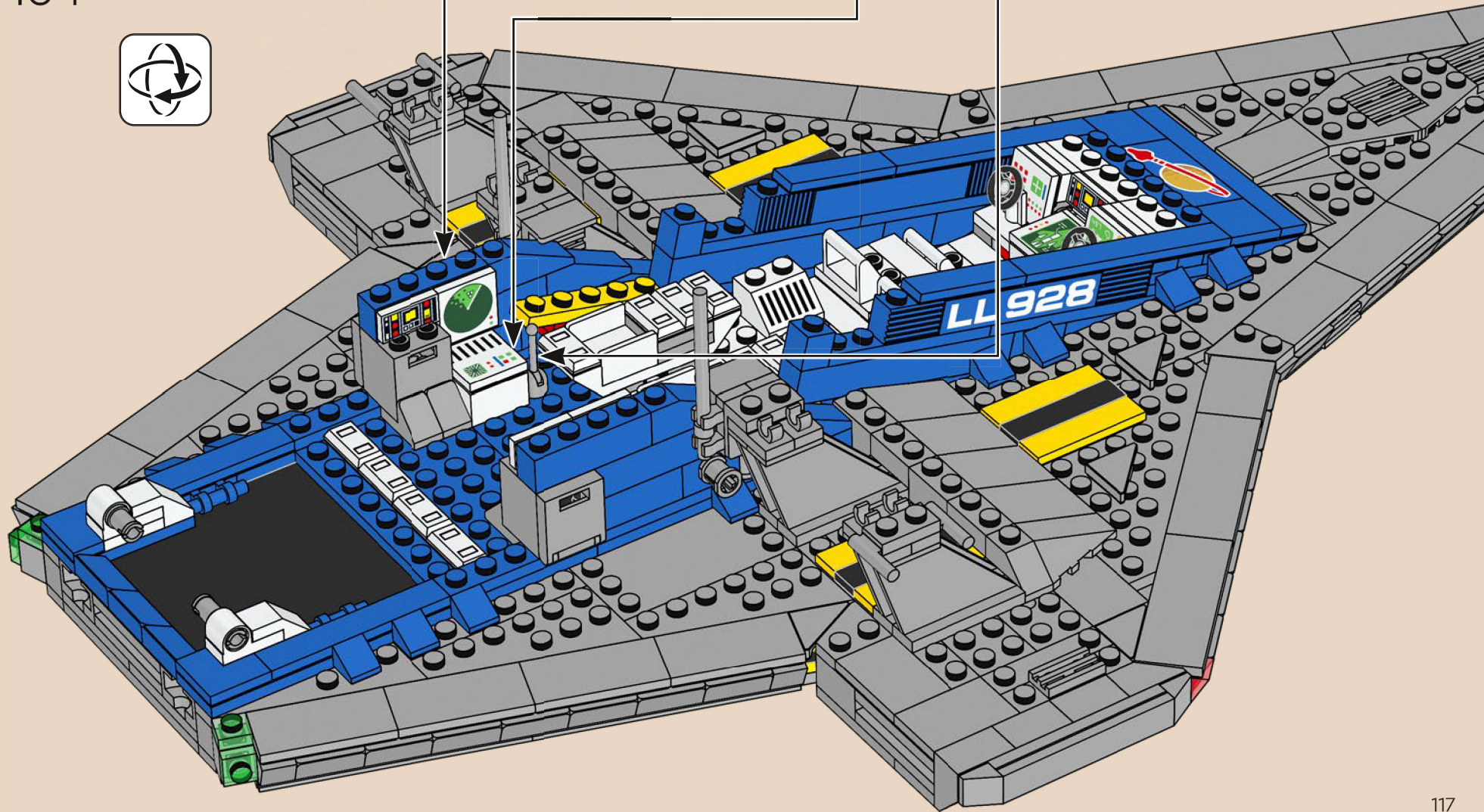

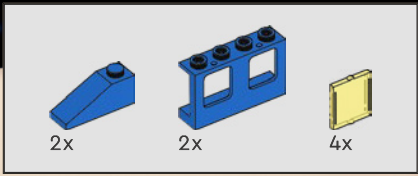

165

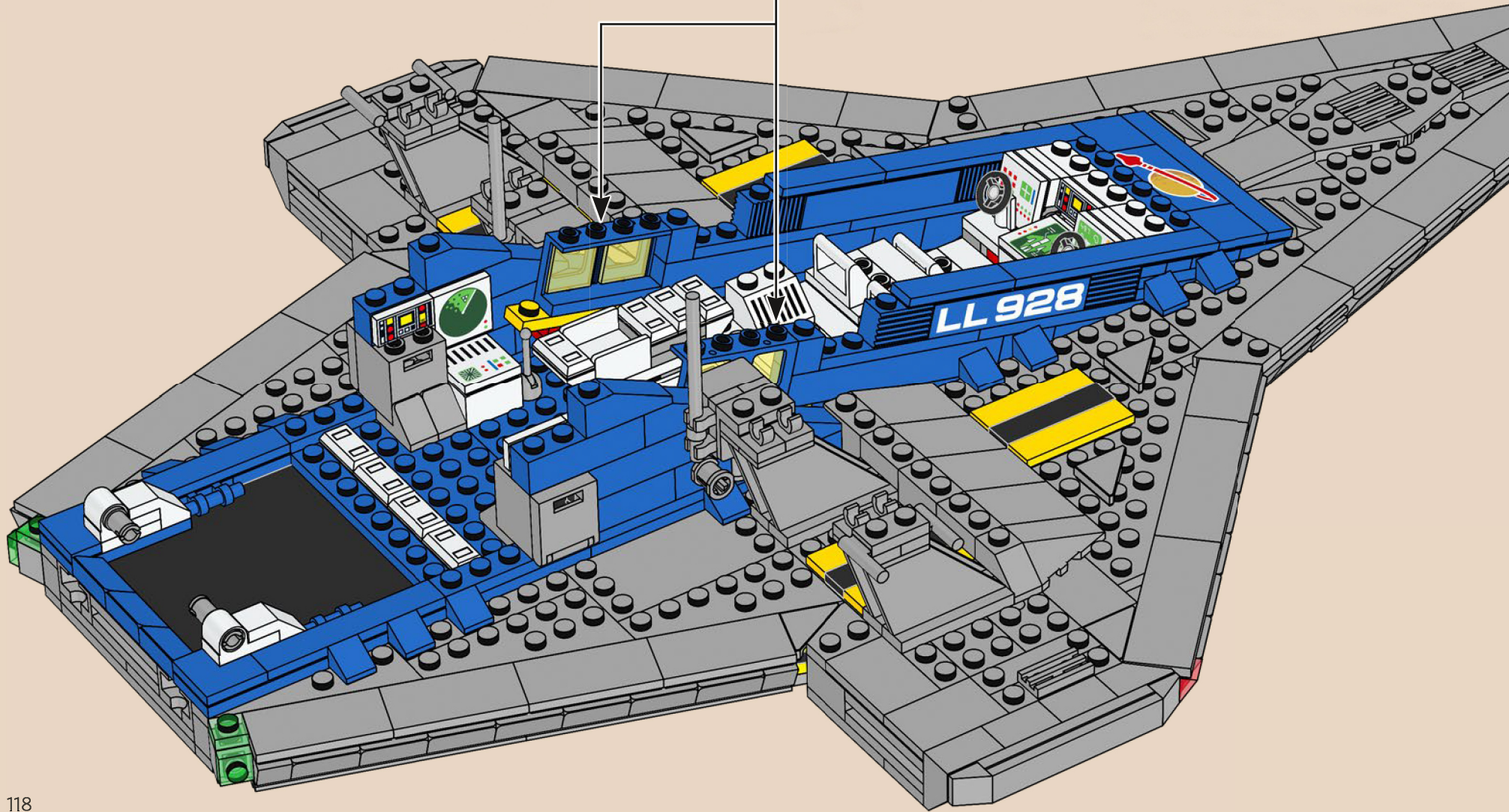
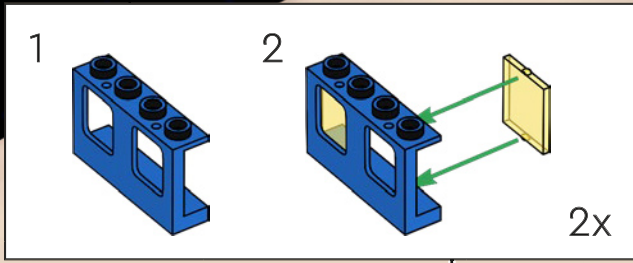

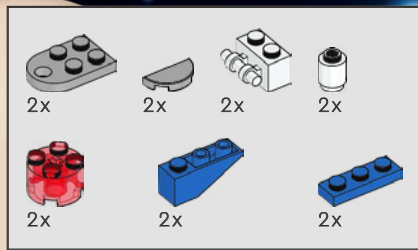

166

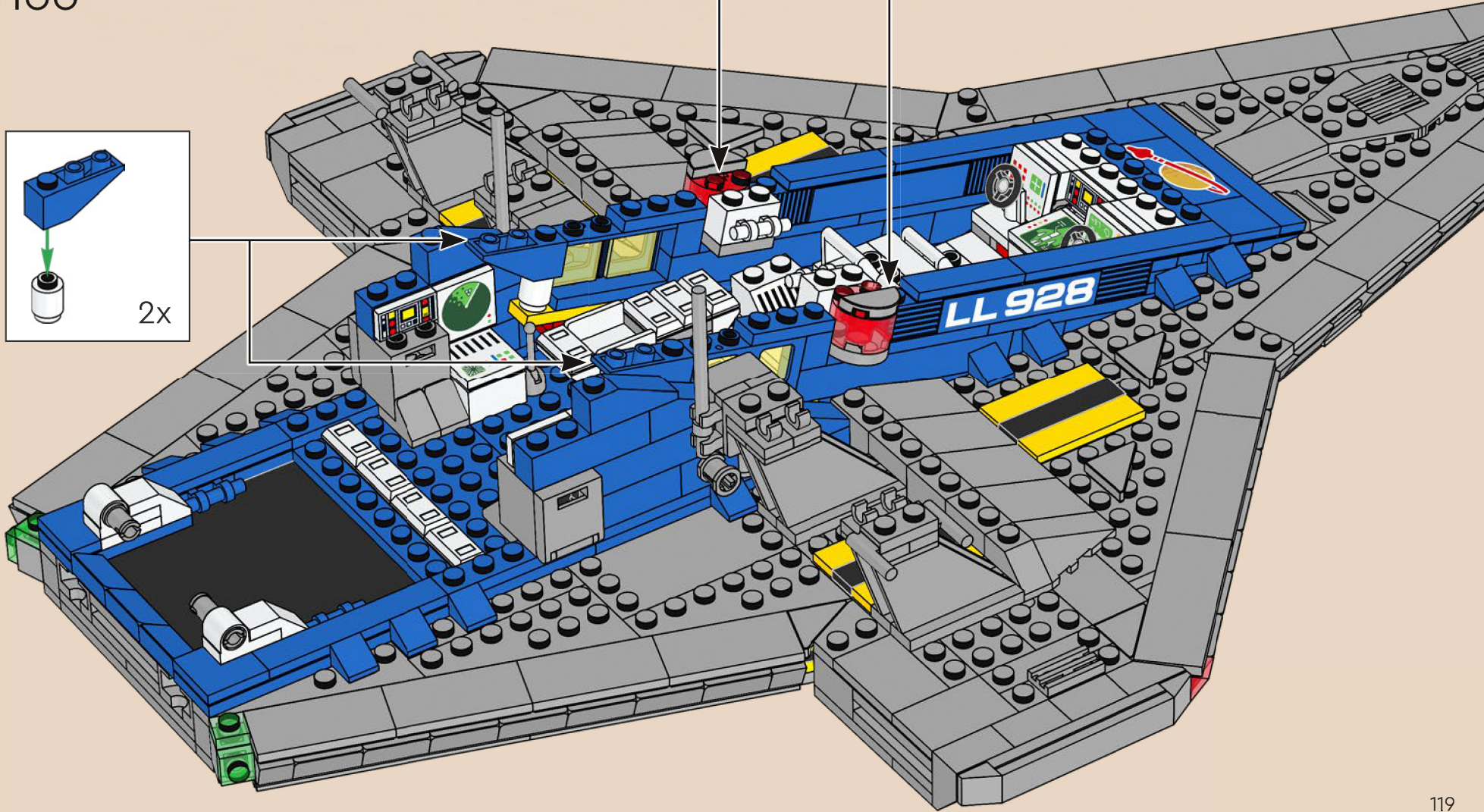
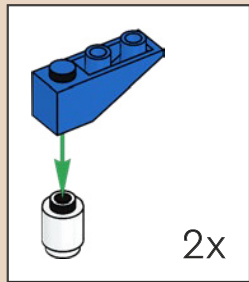

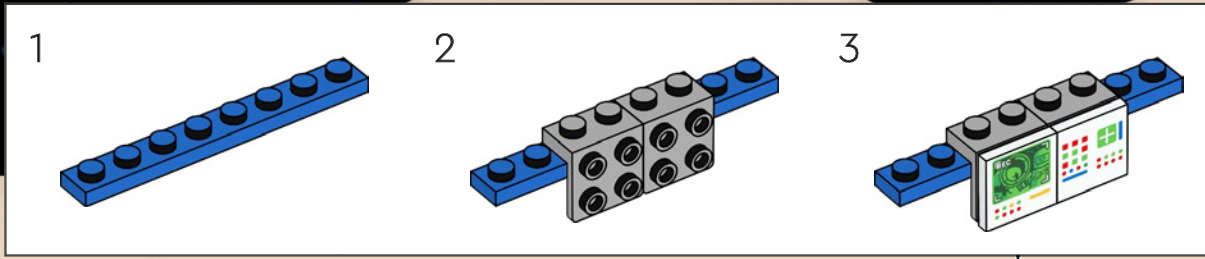
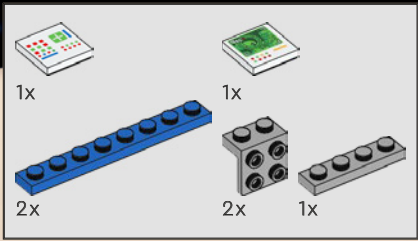

167

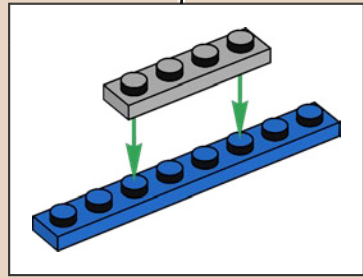
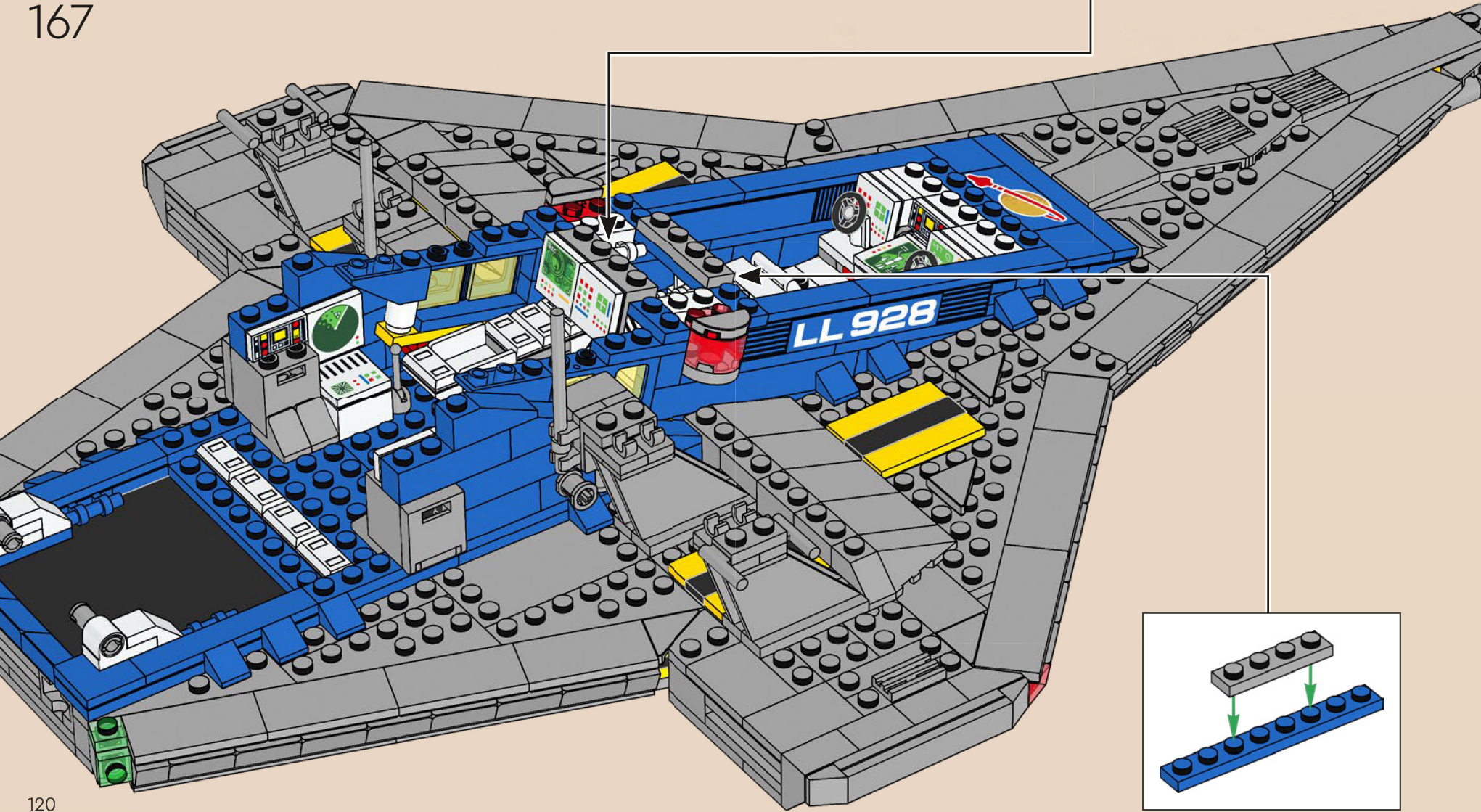

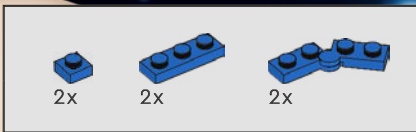

168

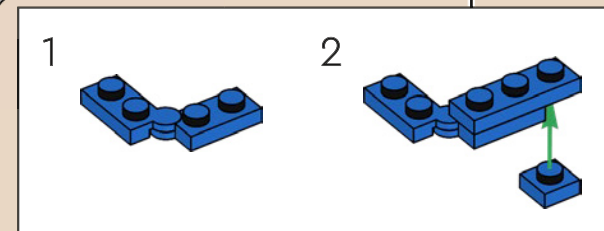
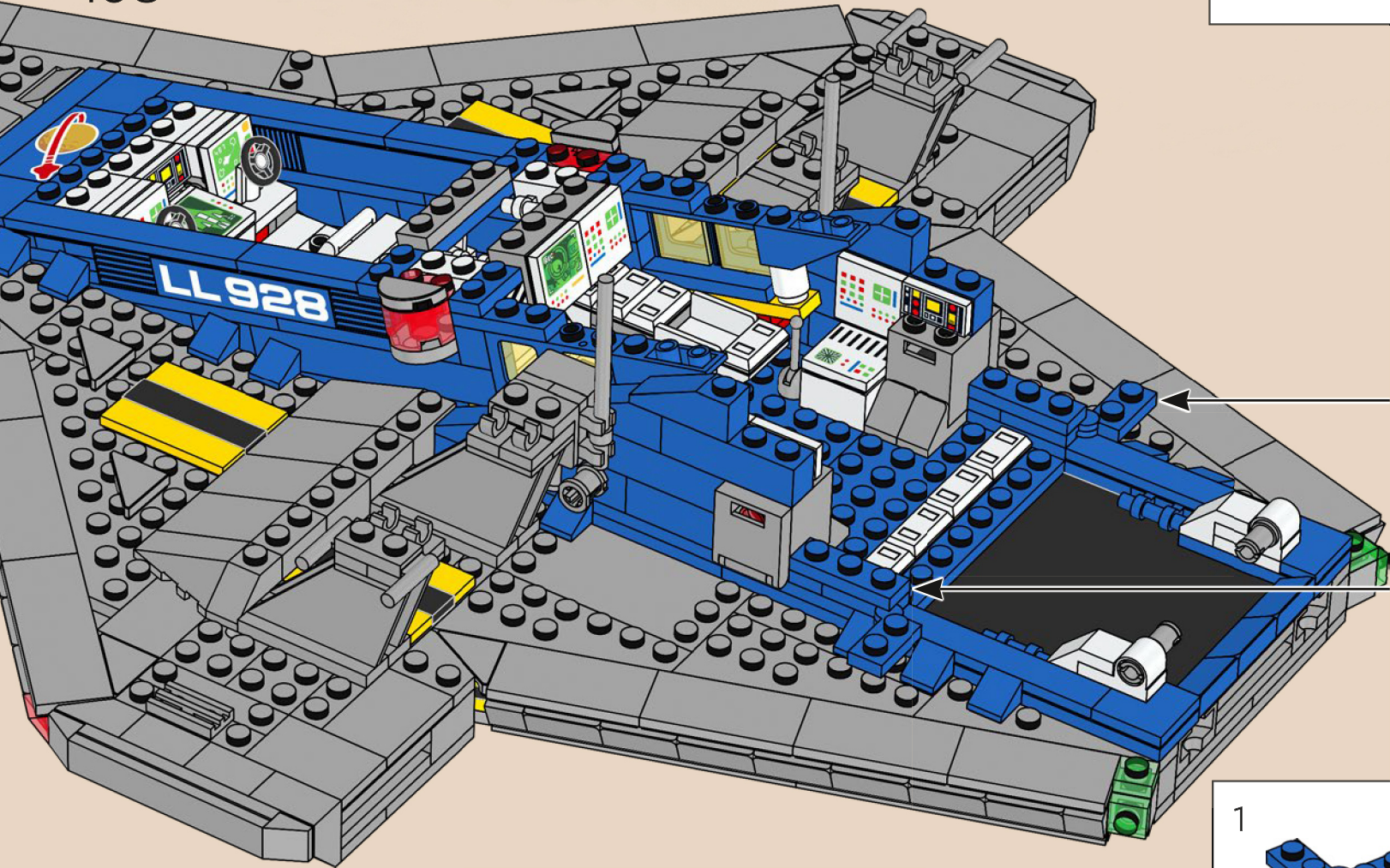
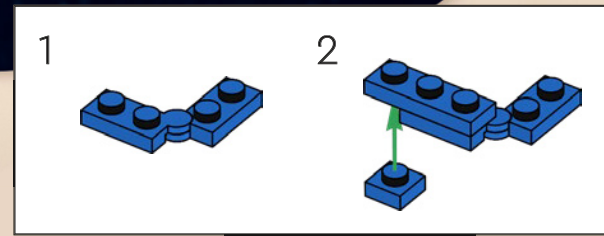

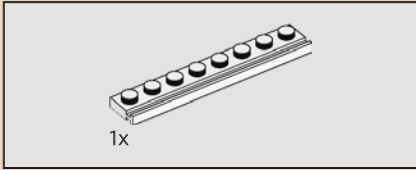
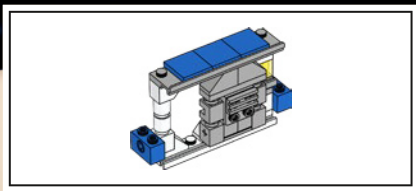

169

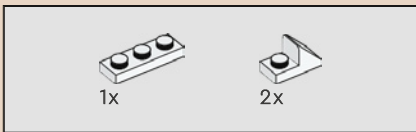
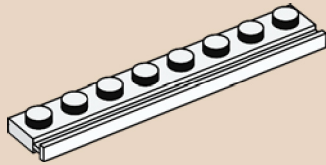

170

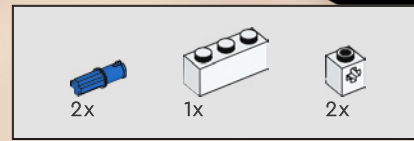
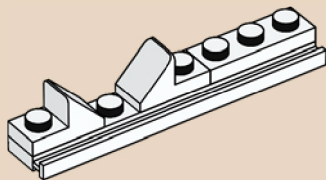

171

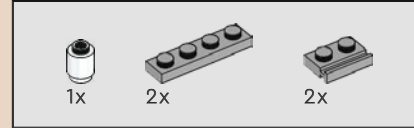
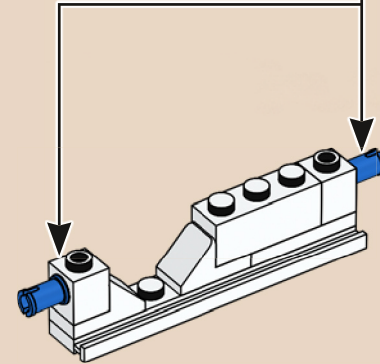
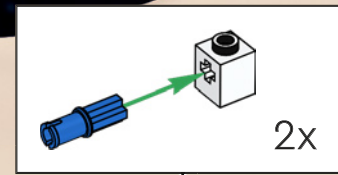

172

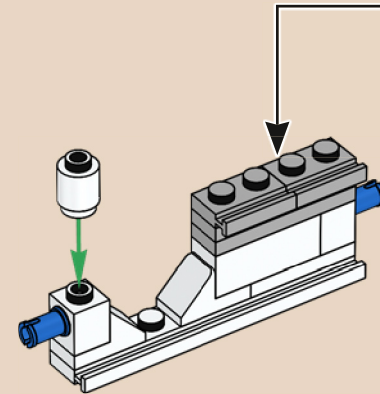
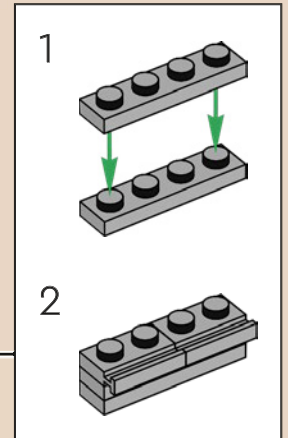



1x



2x

173

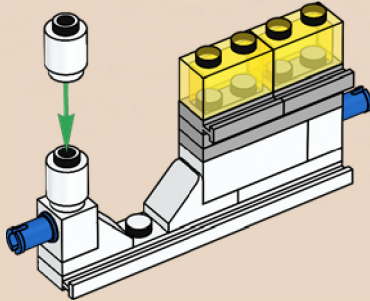

1x



2x

174

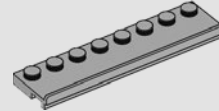
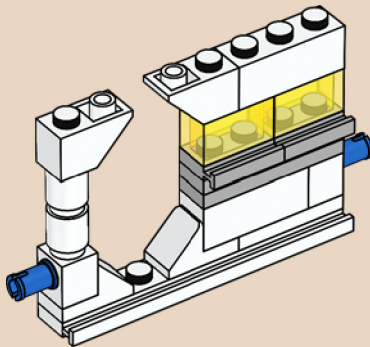

1x

175

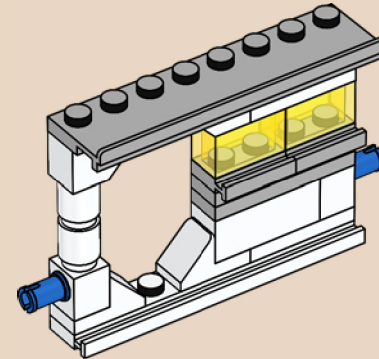

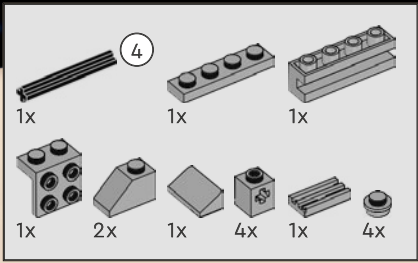

176

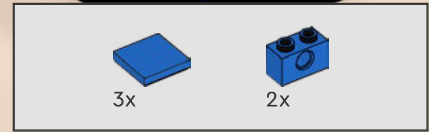
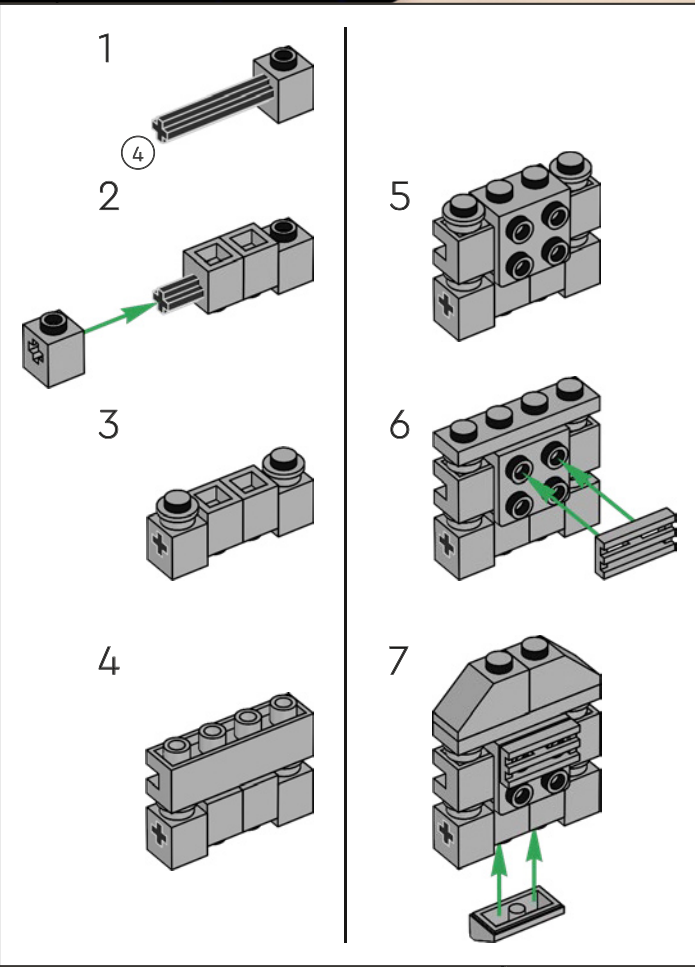
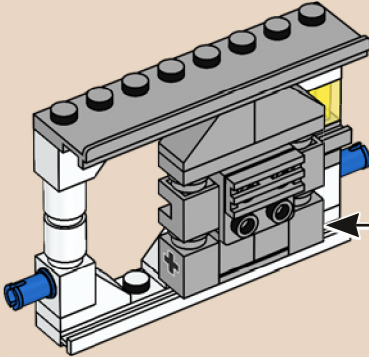

177

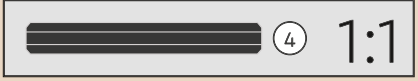
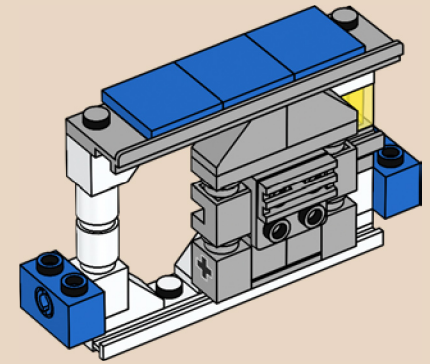

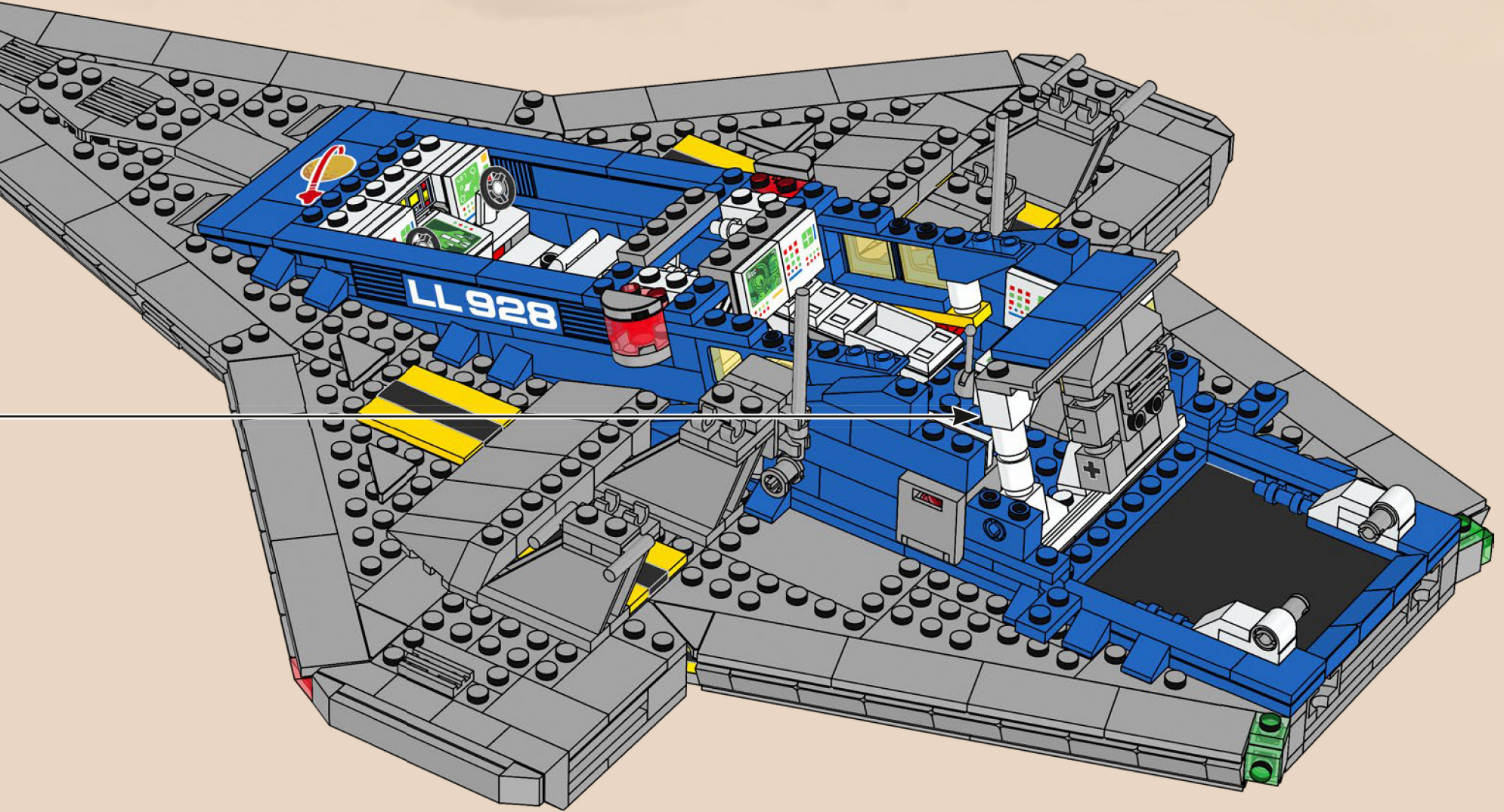

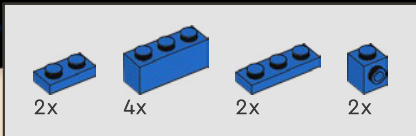

179

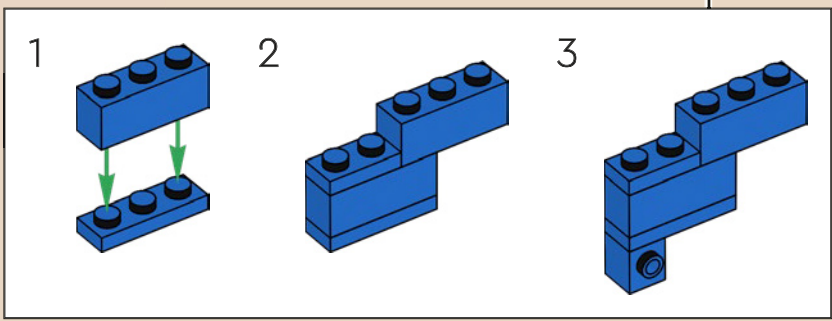
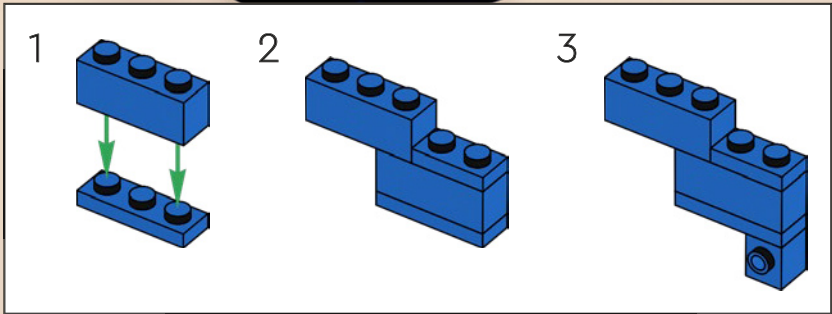
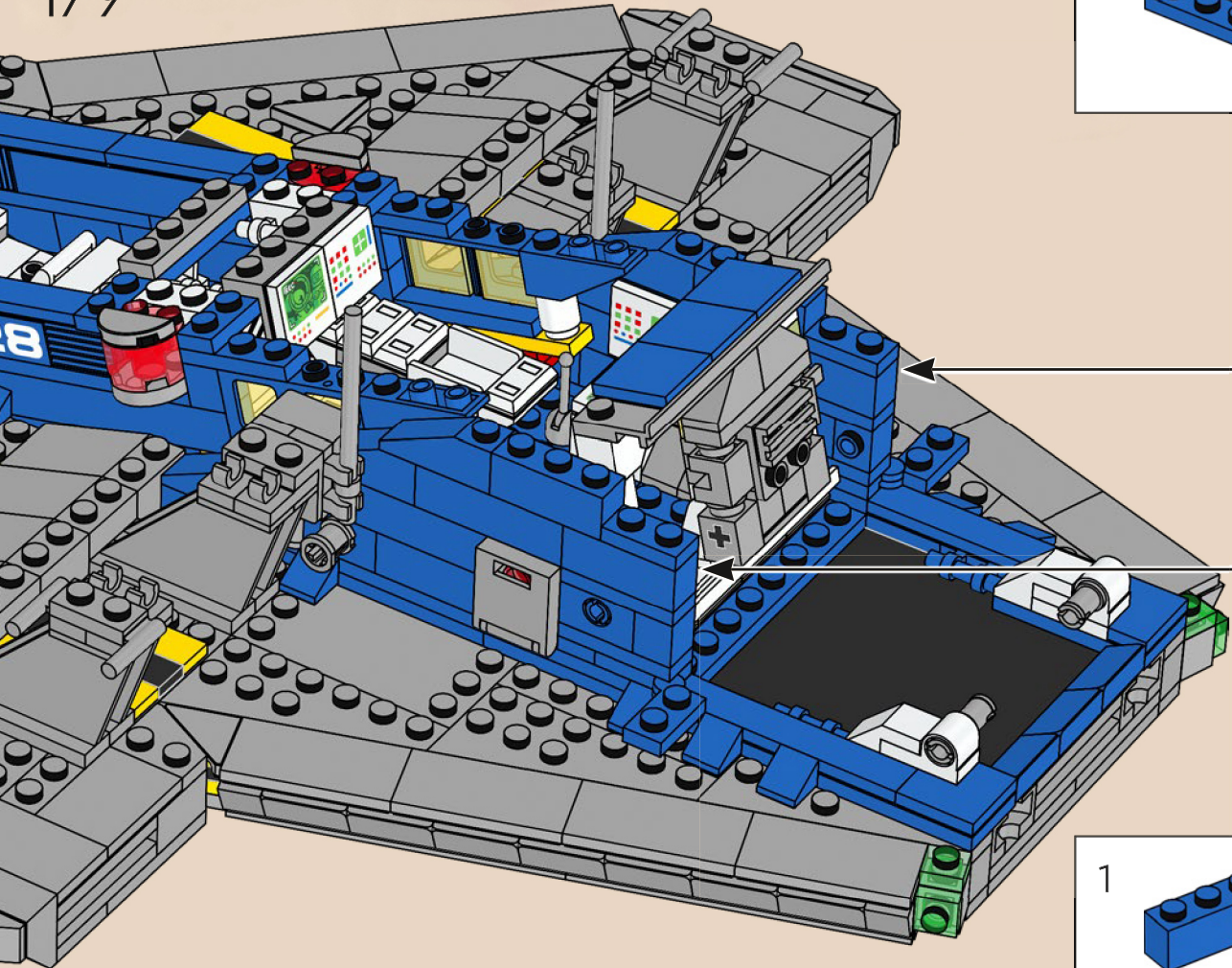

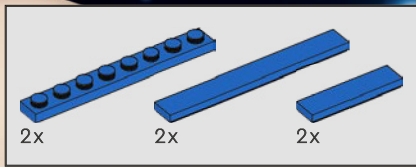

180

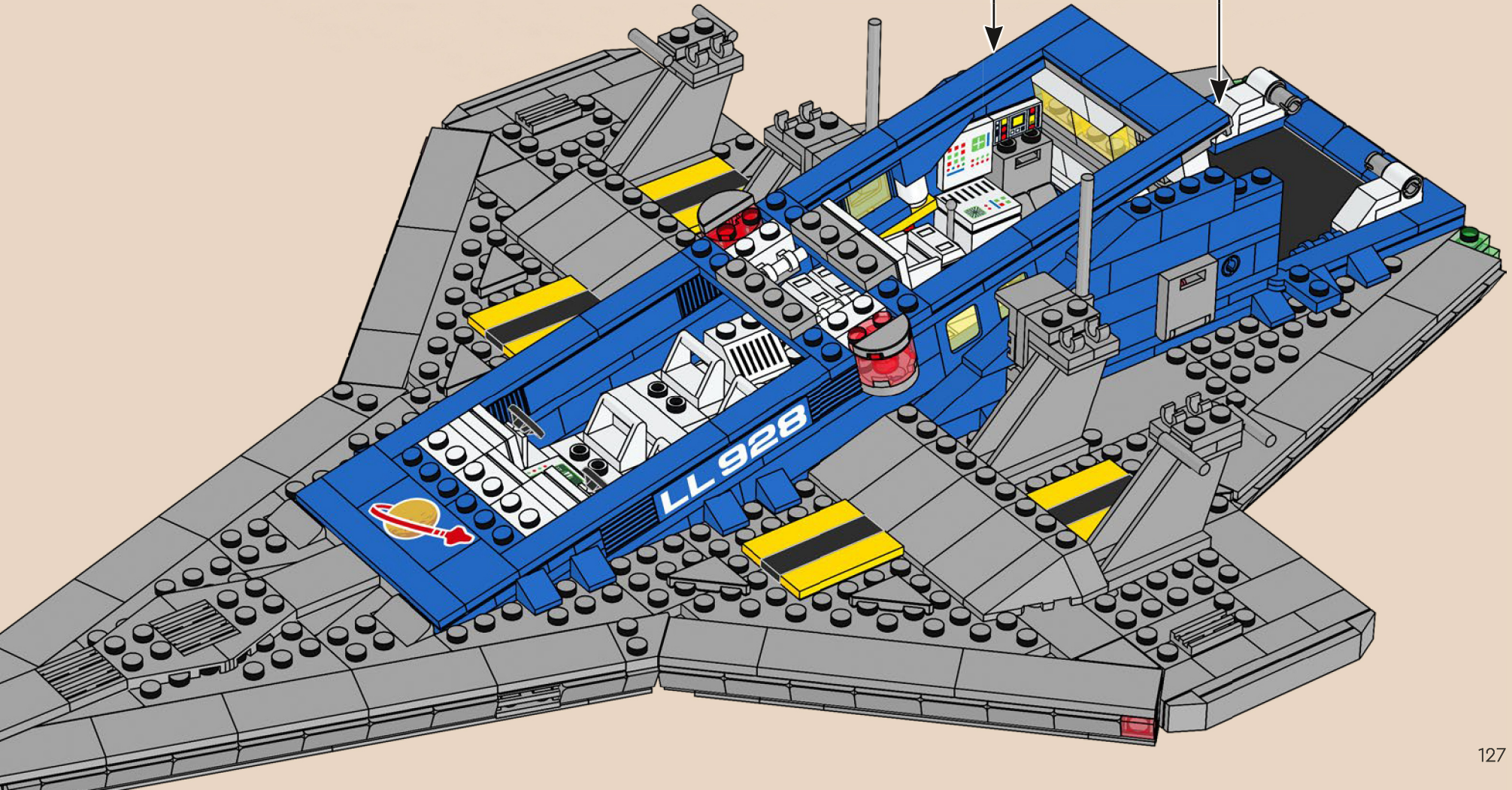
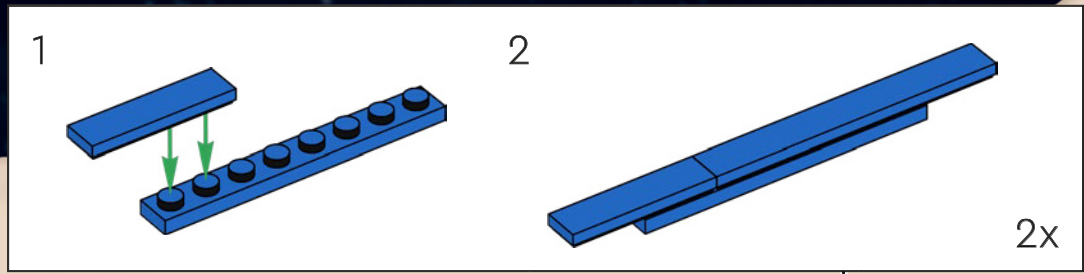

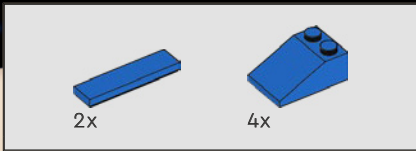

181

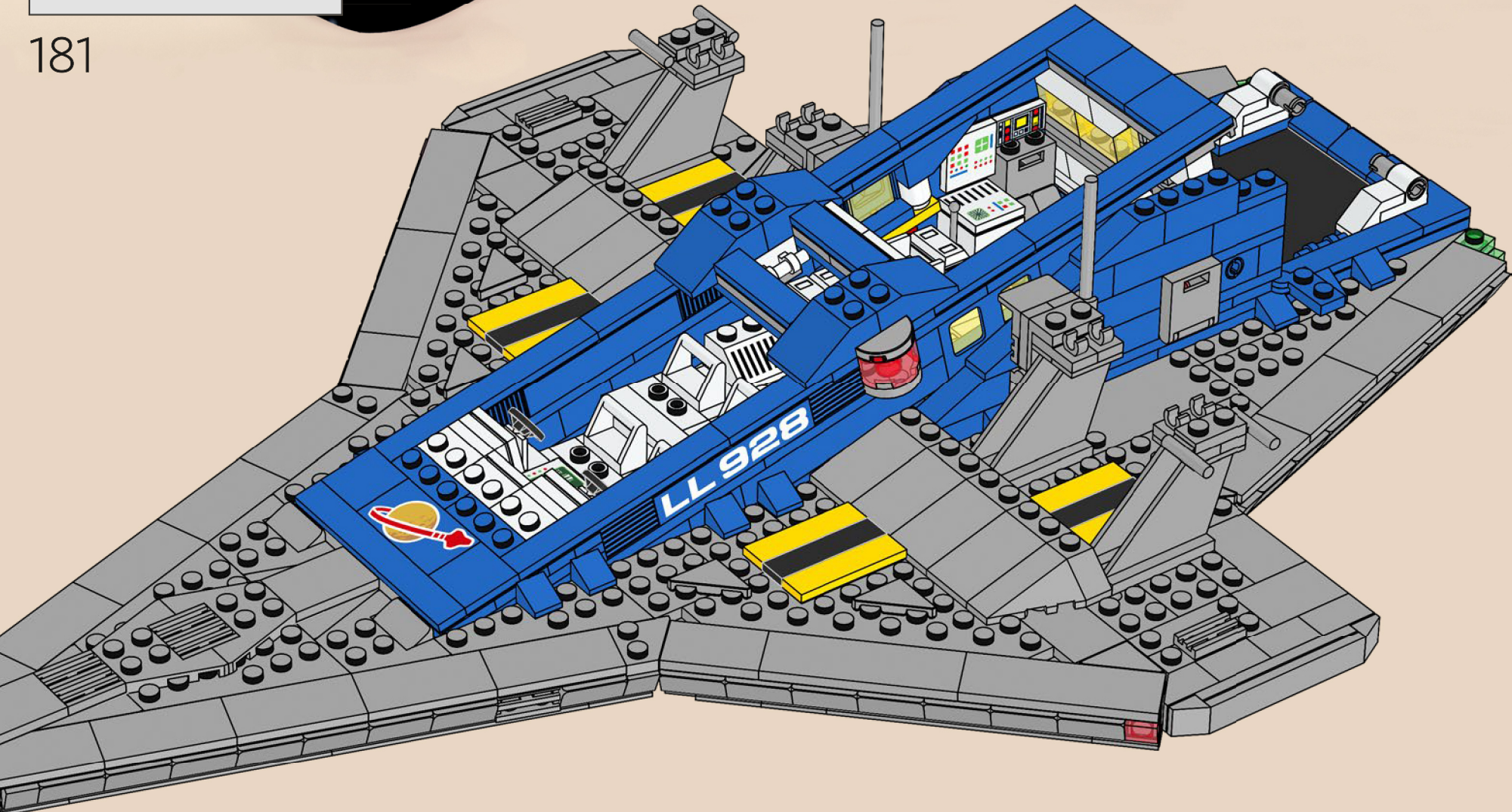

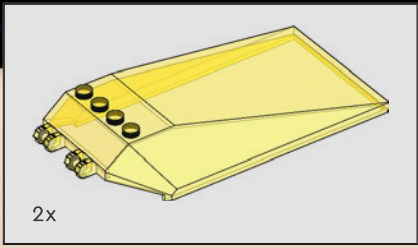

183

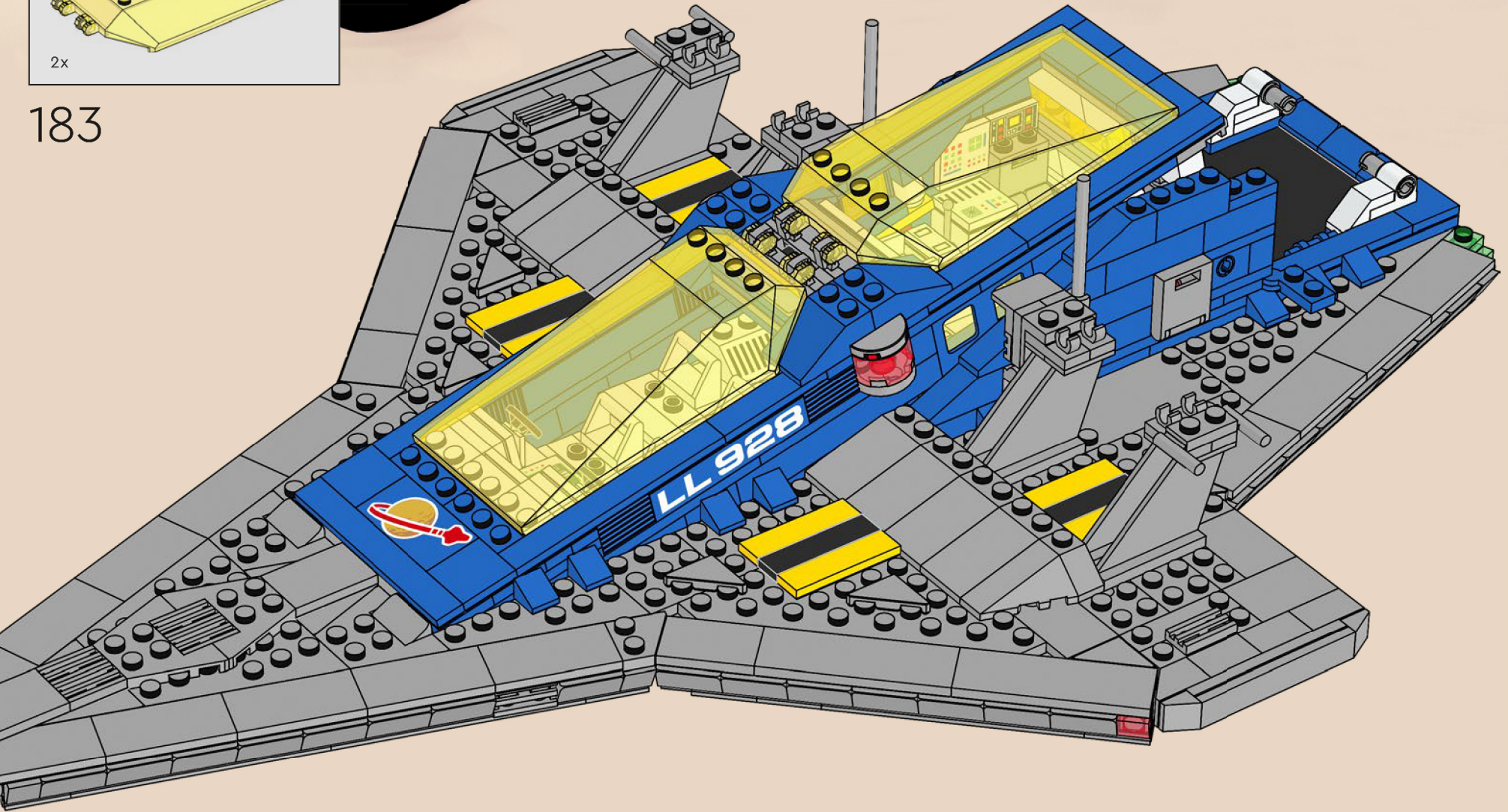

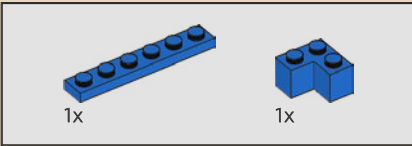
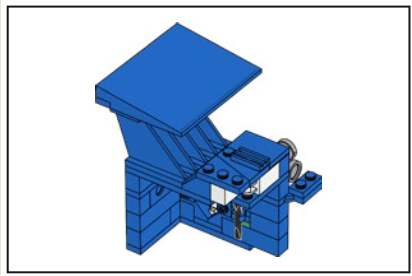

184

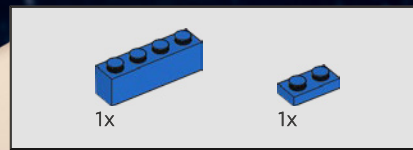
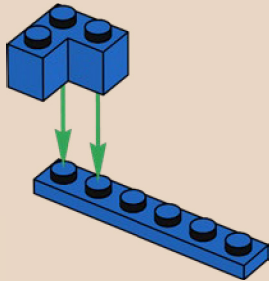

185

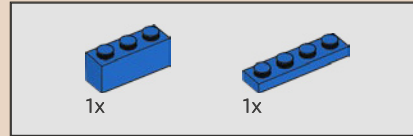
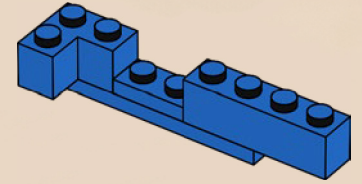

186

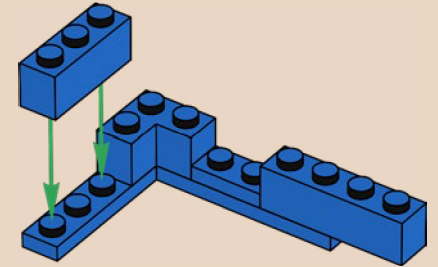

187

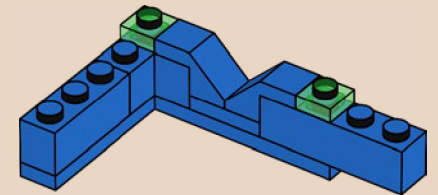

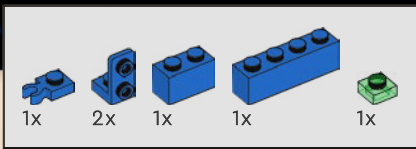

188

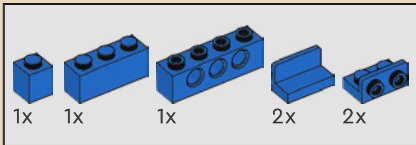
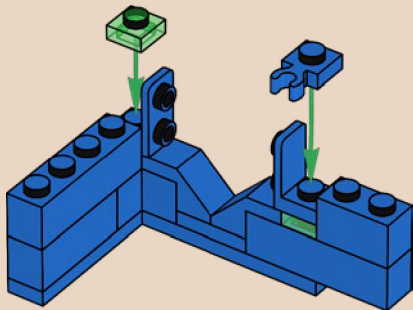

189

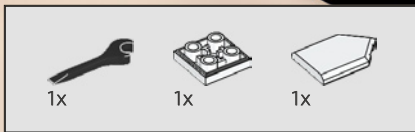
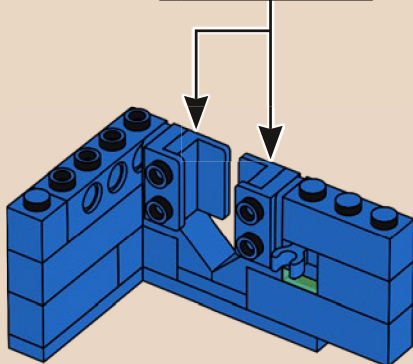
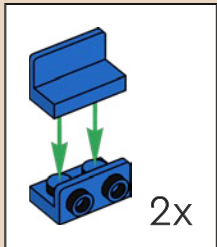

190

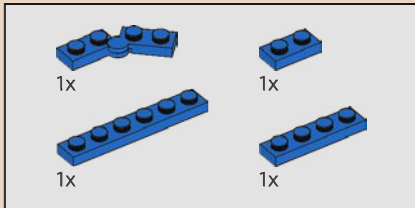
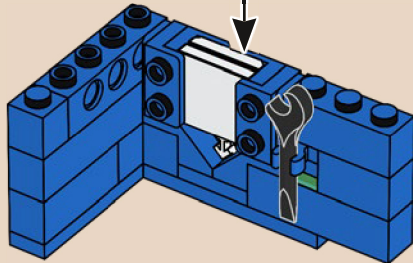
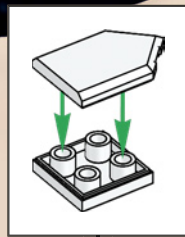

191

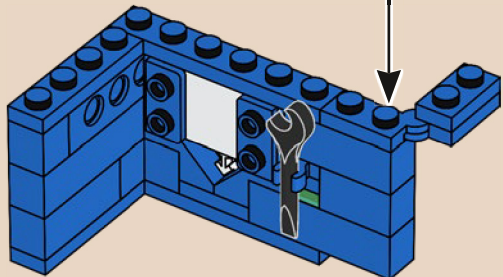
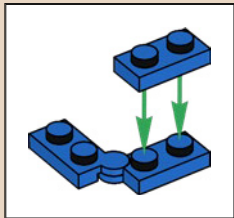

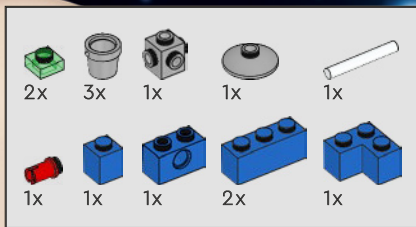

192

1

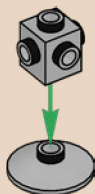

2



3

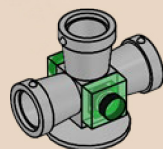

4

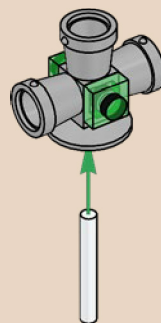

5

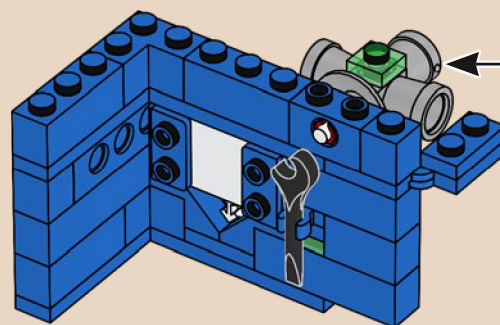
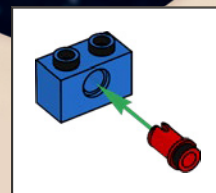
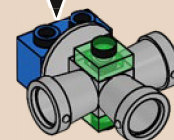

Sul modello originale, la decorazione della freccia era stampata su un mattoncino 1x2. La freccia in questo modello è stata realizzata con lo scudo di un set LEGO® NEXO KNIGHTS.

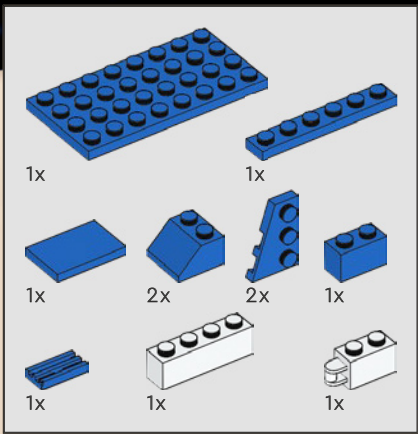

193

1

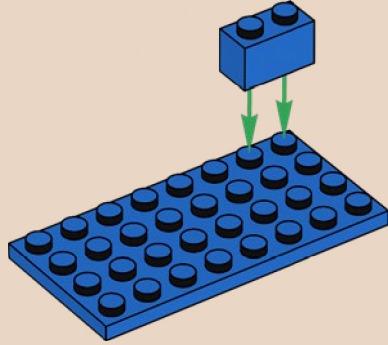

2

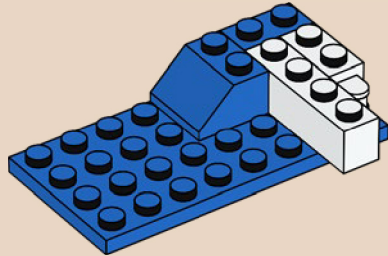

3

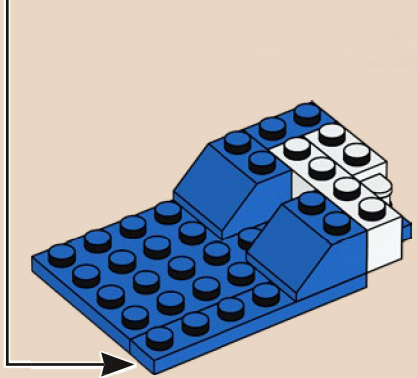
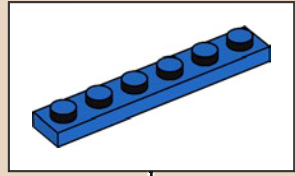

4

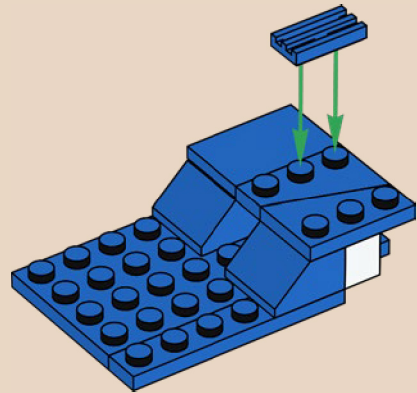

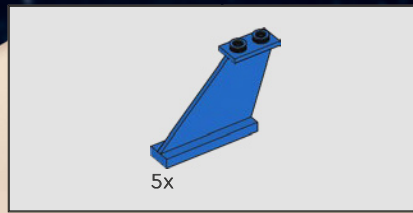

194

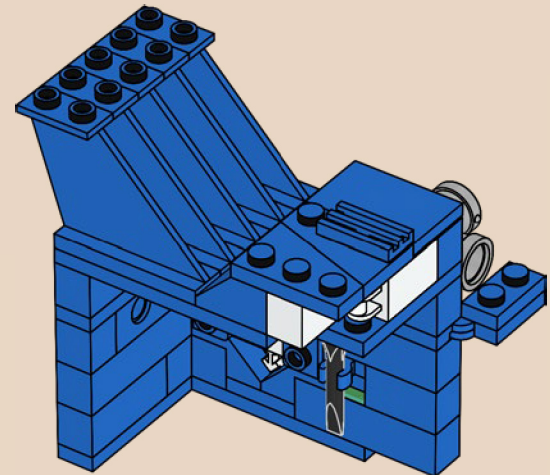
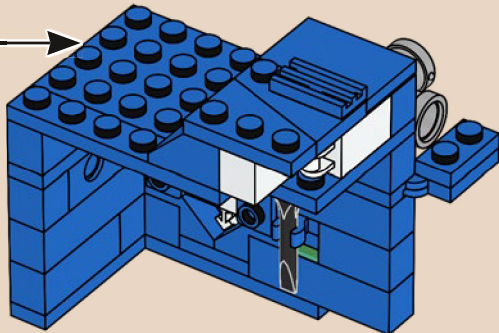

*Il walkie-talkie e la chiave inglese
erano gli strumenti usati dagli
astronauti anche nel set originale.*

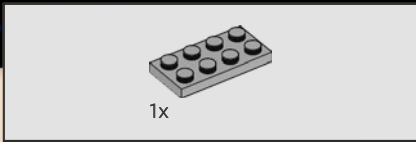

195

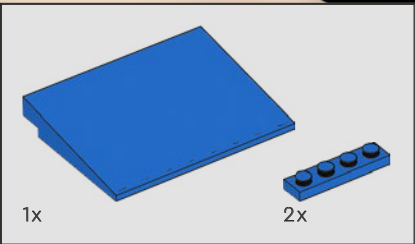
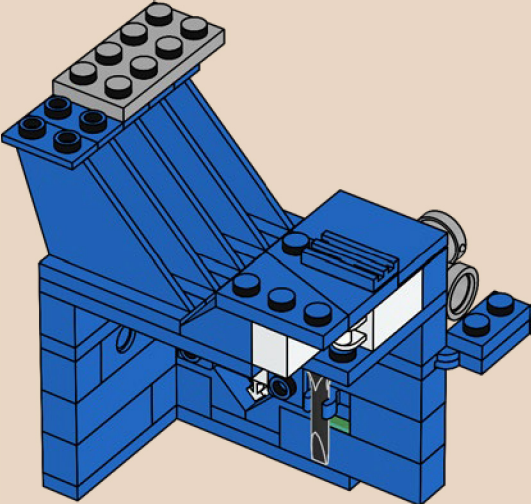

196

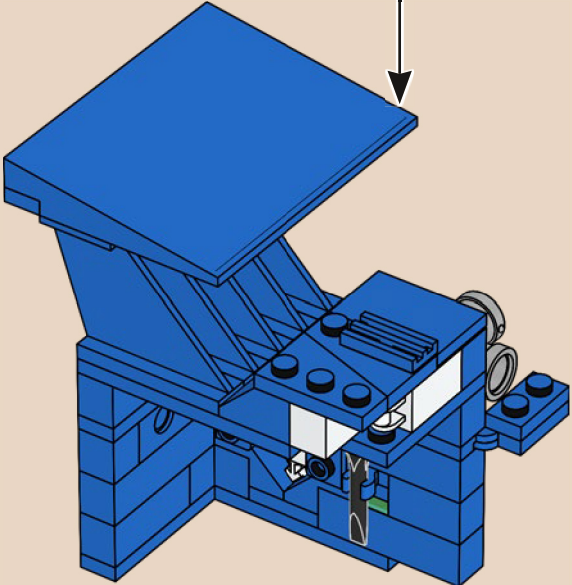
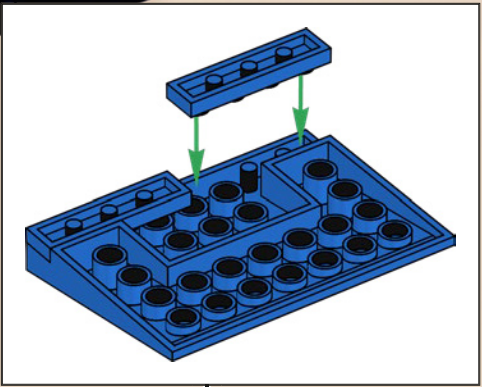

197

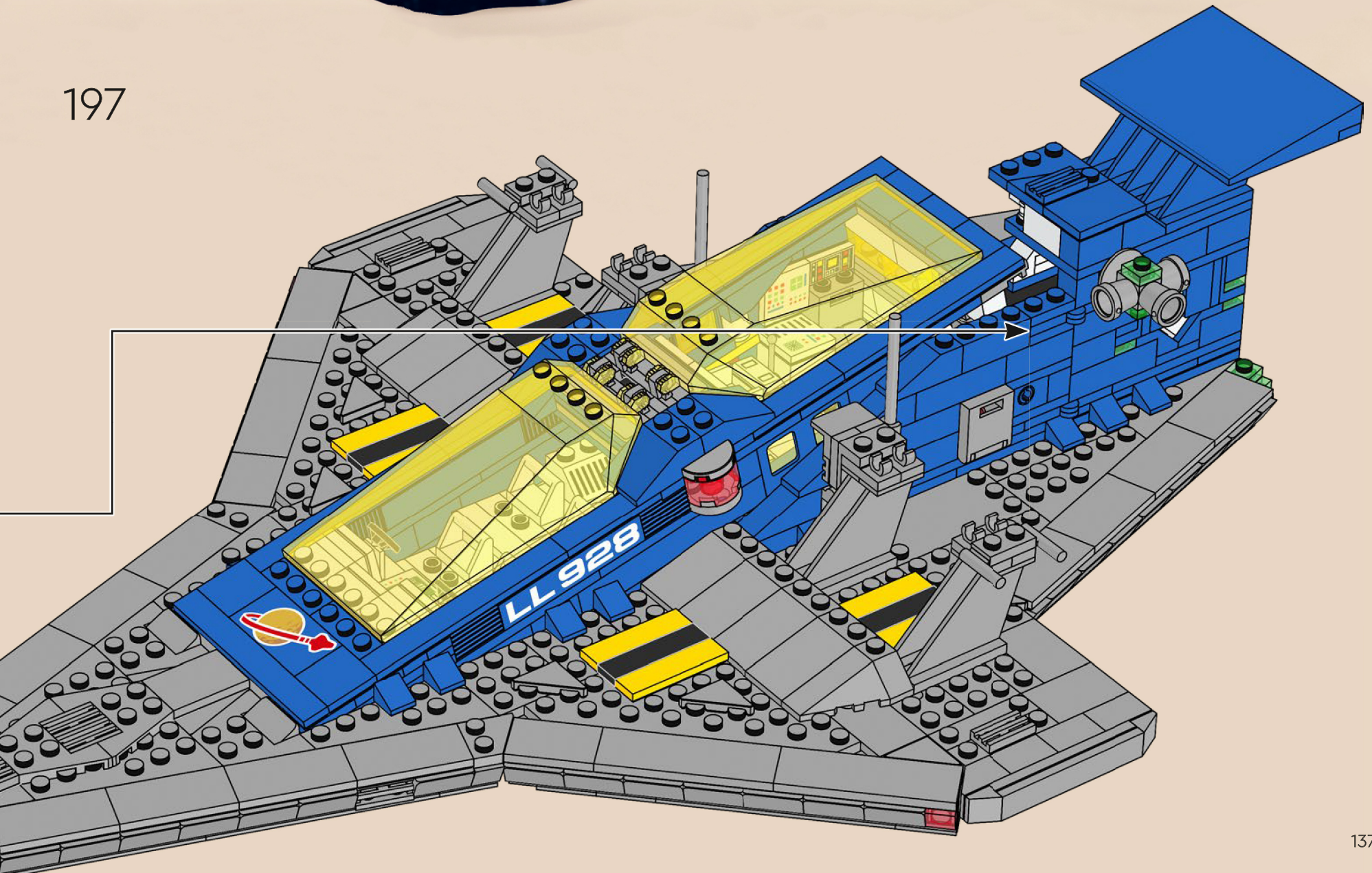

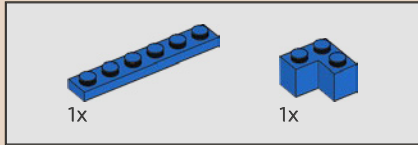
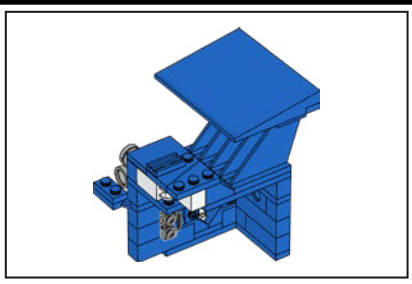

198

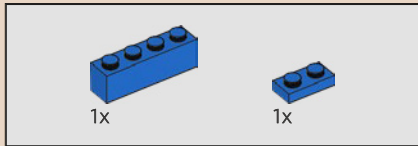
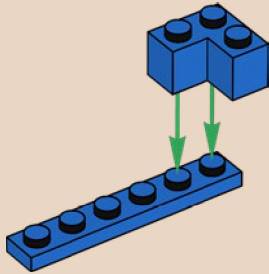

199

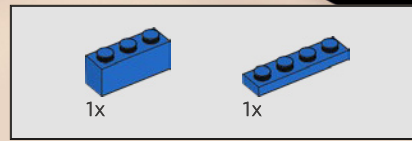
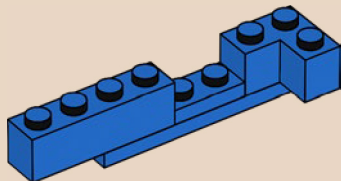

200

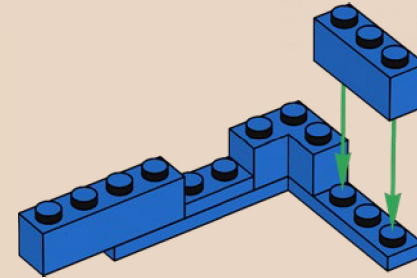

201

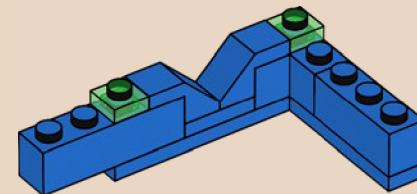

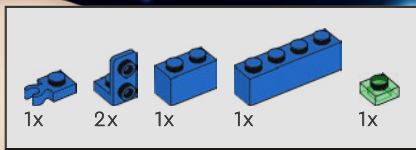

202

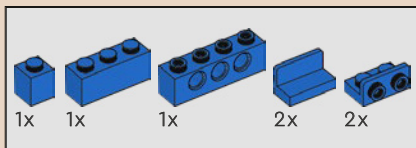
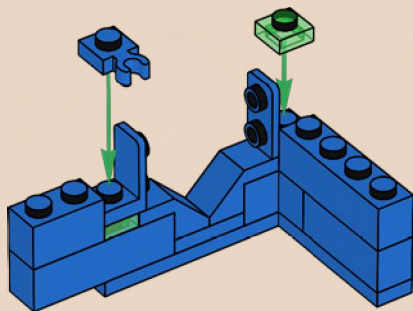

203

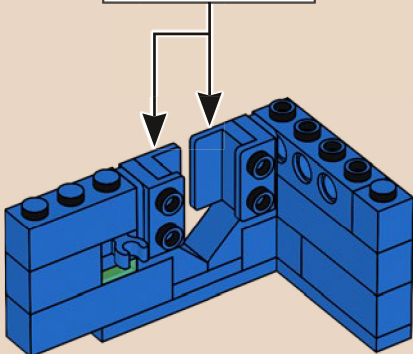
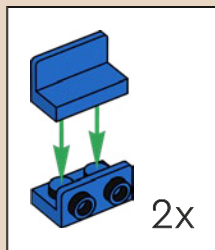

204

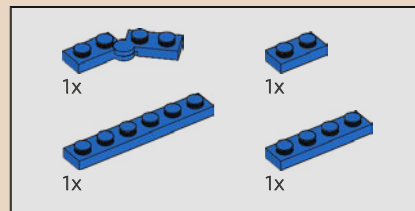
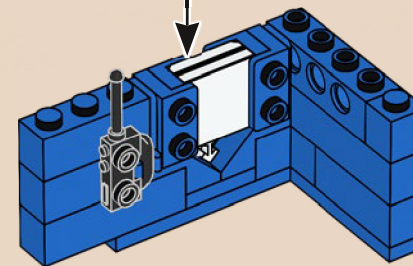
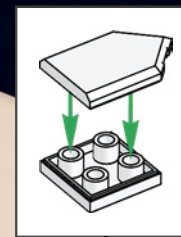

205

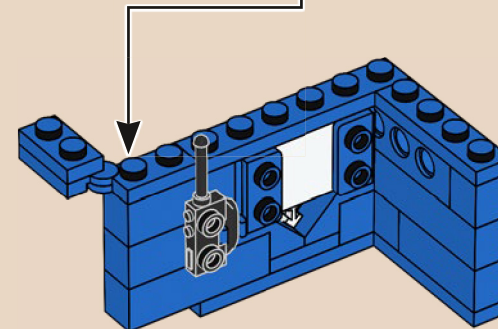
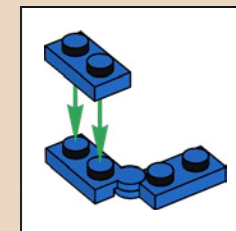

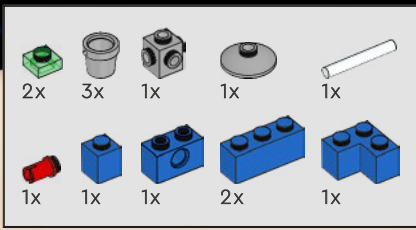

206

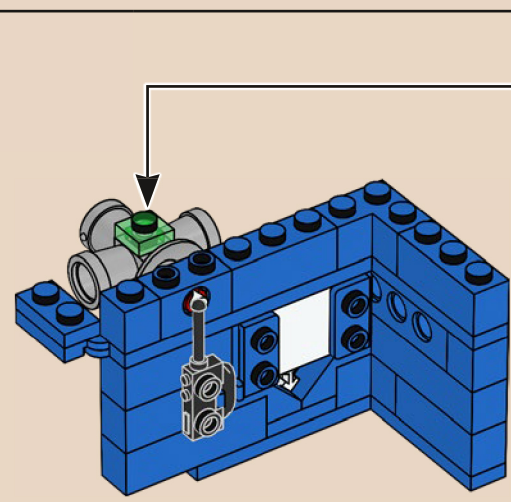
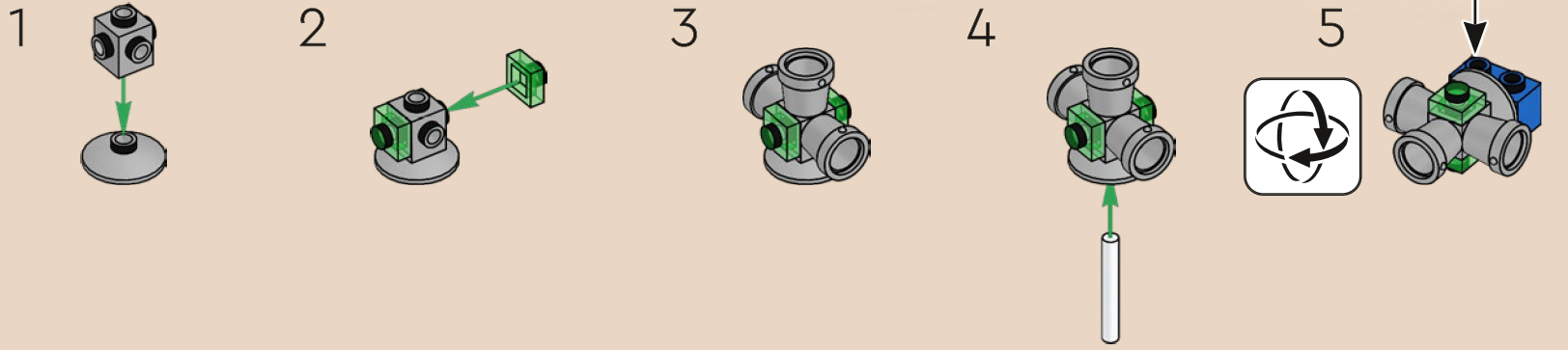

I propulsori del modello originale erano stati costruiti utilizzando un unico elemento. Questi propulsori più grandi sono stati costruiti utilizzando secchi di vernice, introdotti per la prima volta nel tema del Castello del 2011.

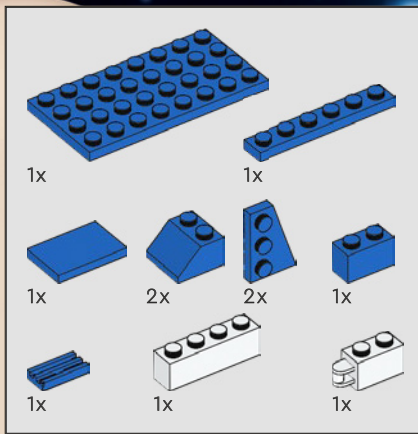

207

1

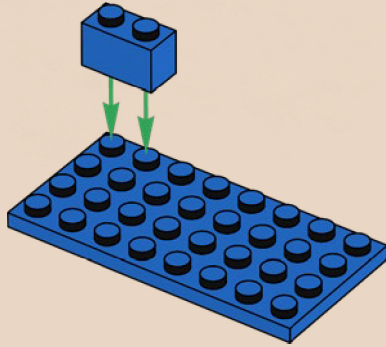

2

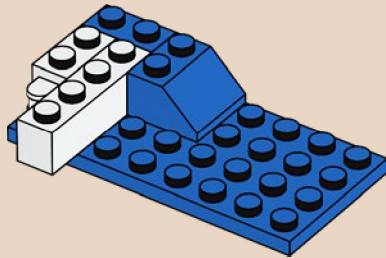

3

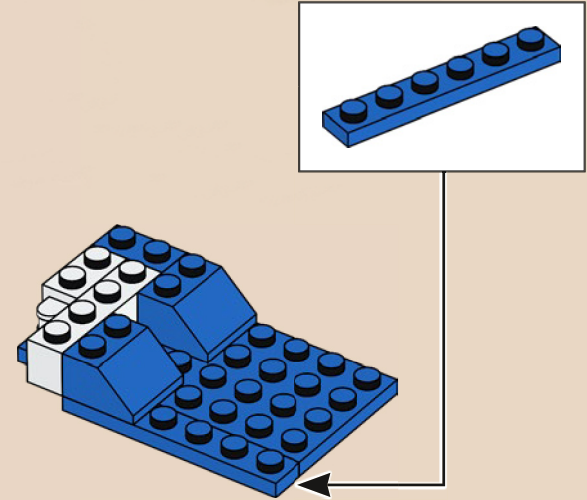

4

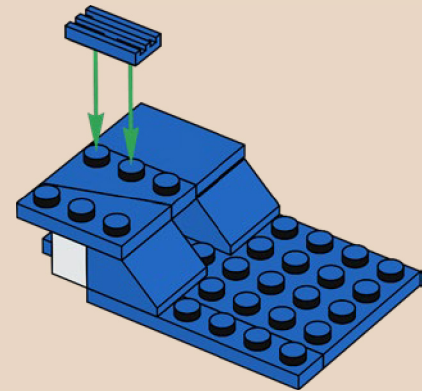

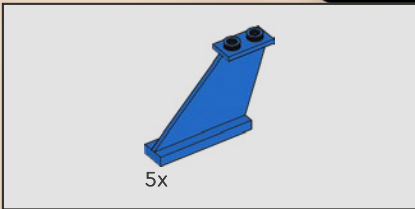

208

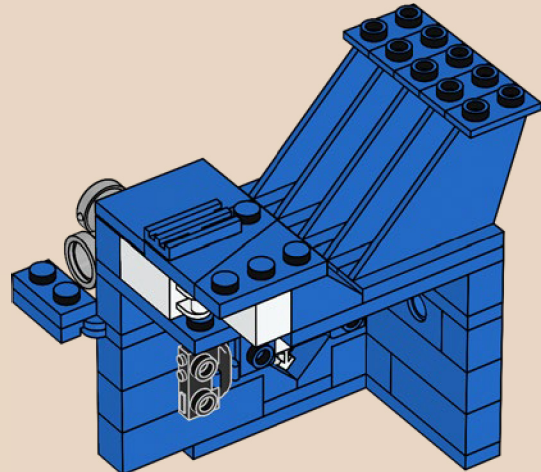
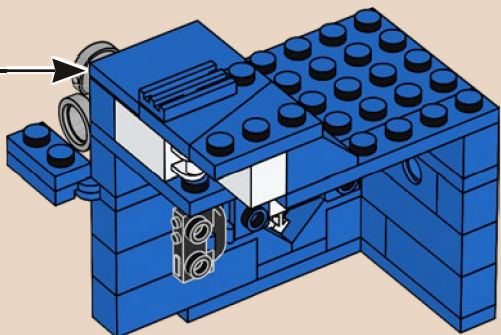



209

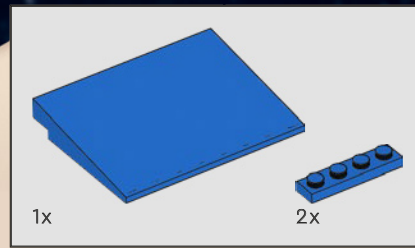
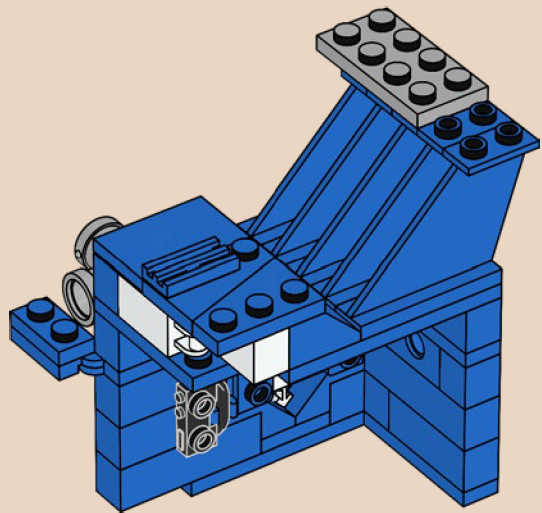

210

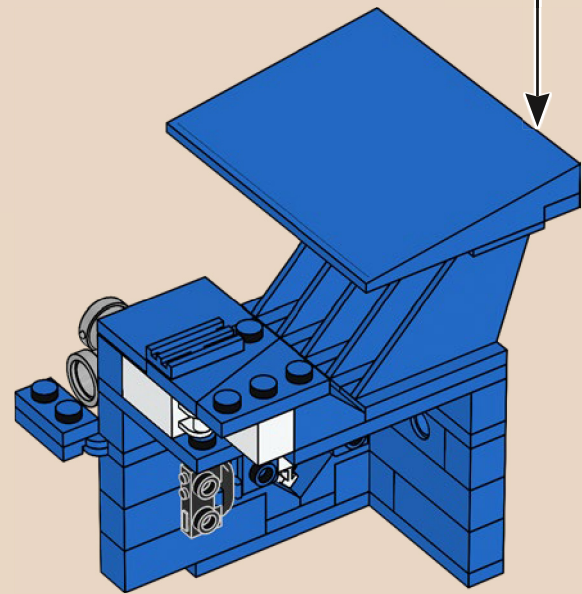
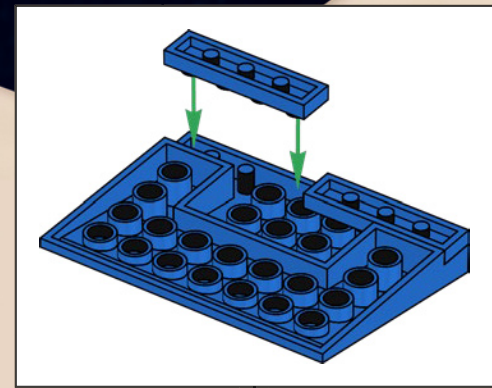

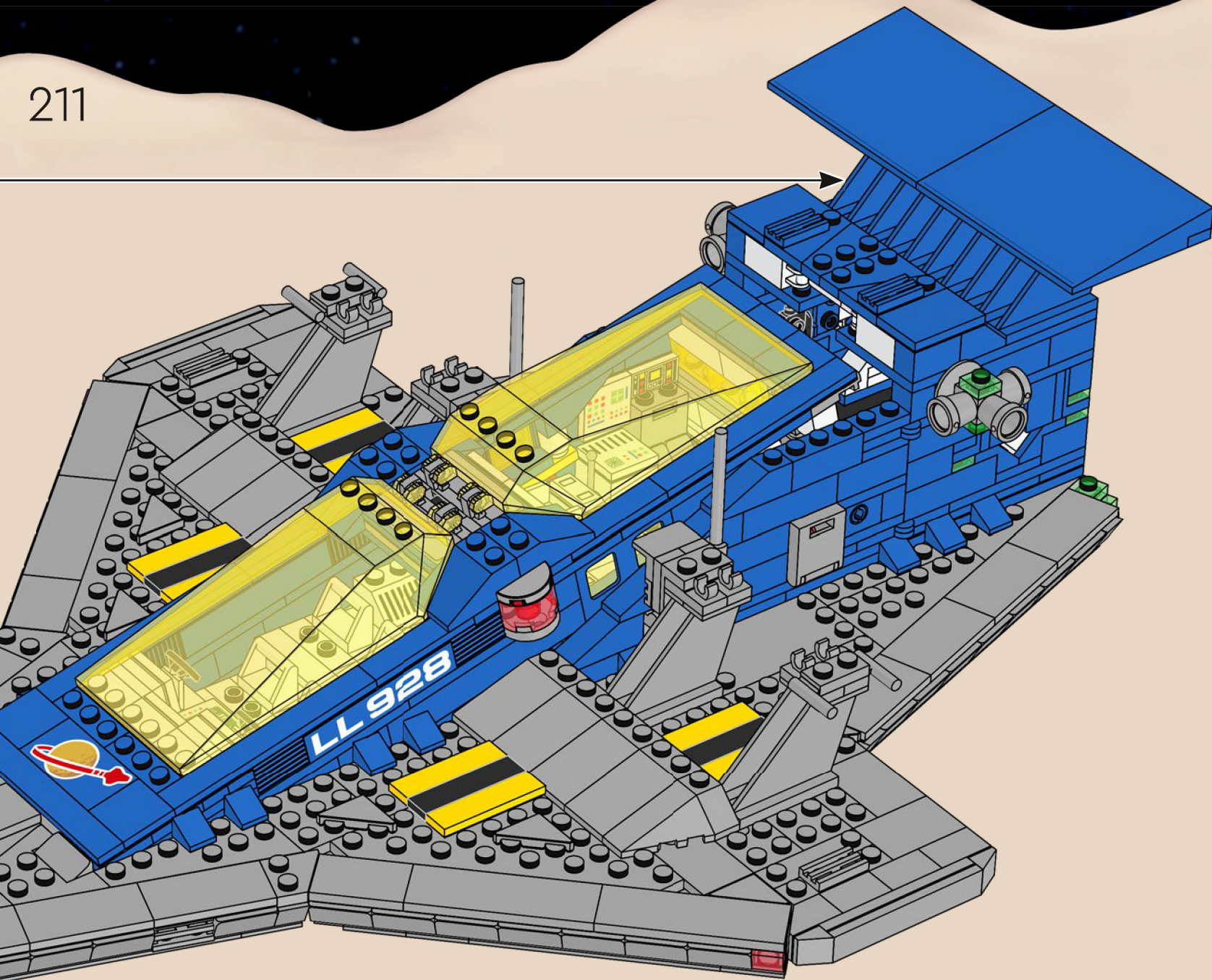

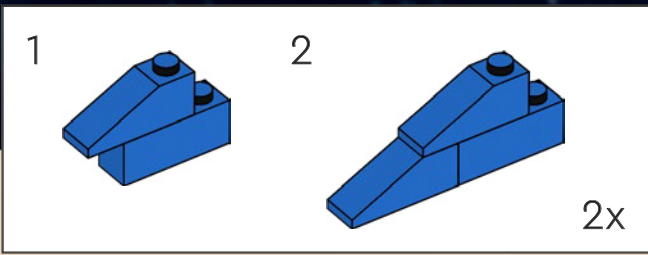
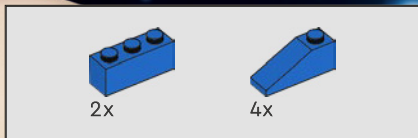

212

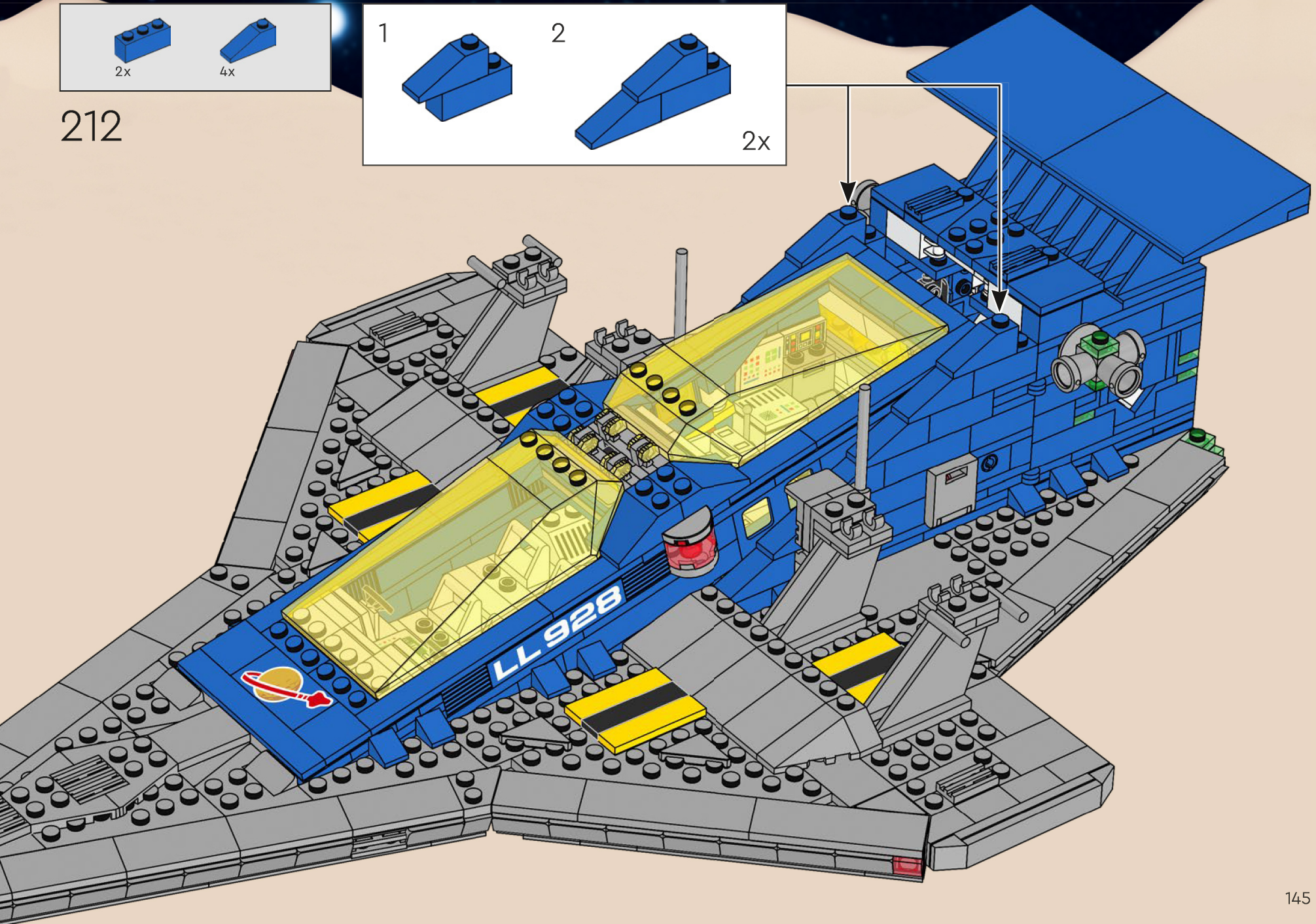

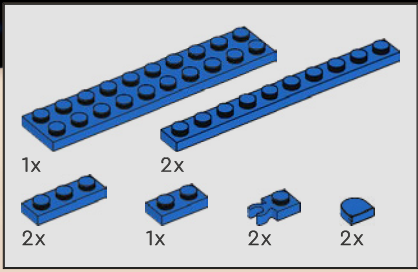

213

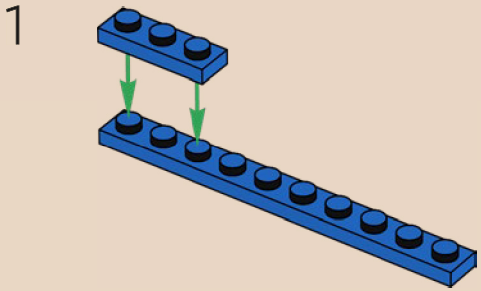

2

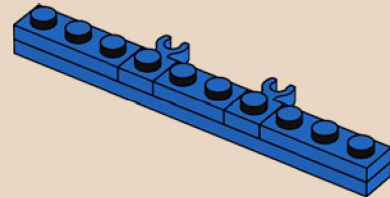

3

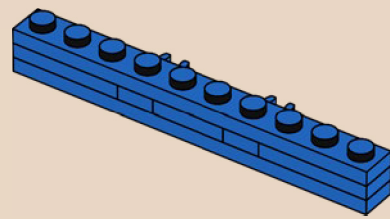

4

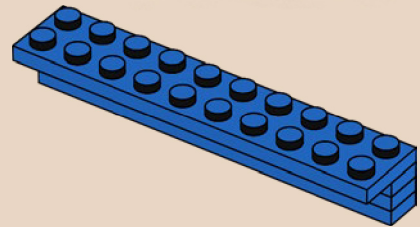

5

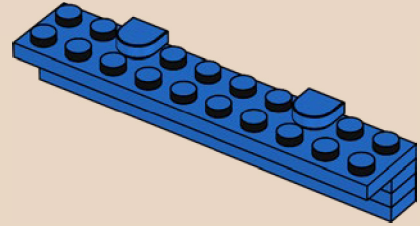

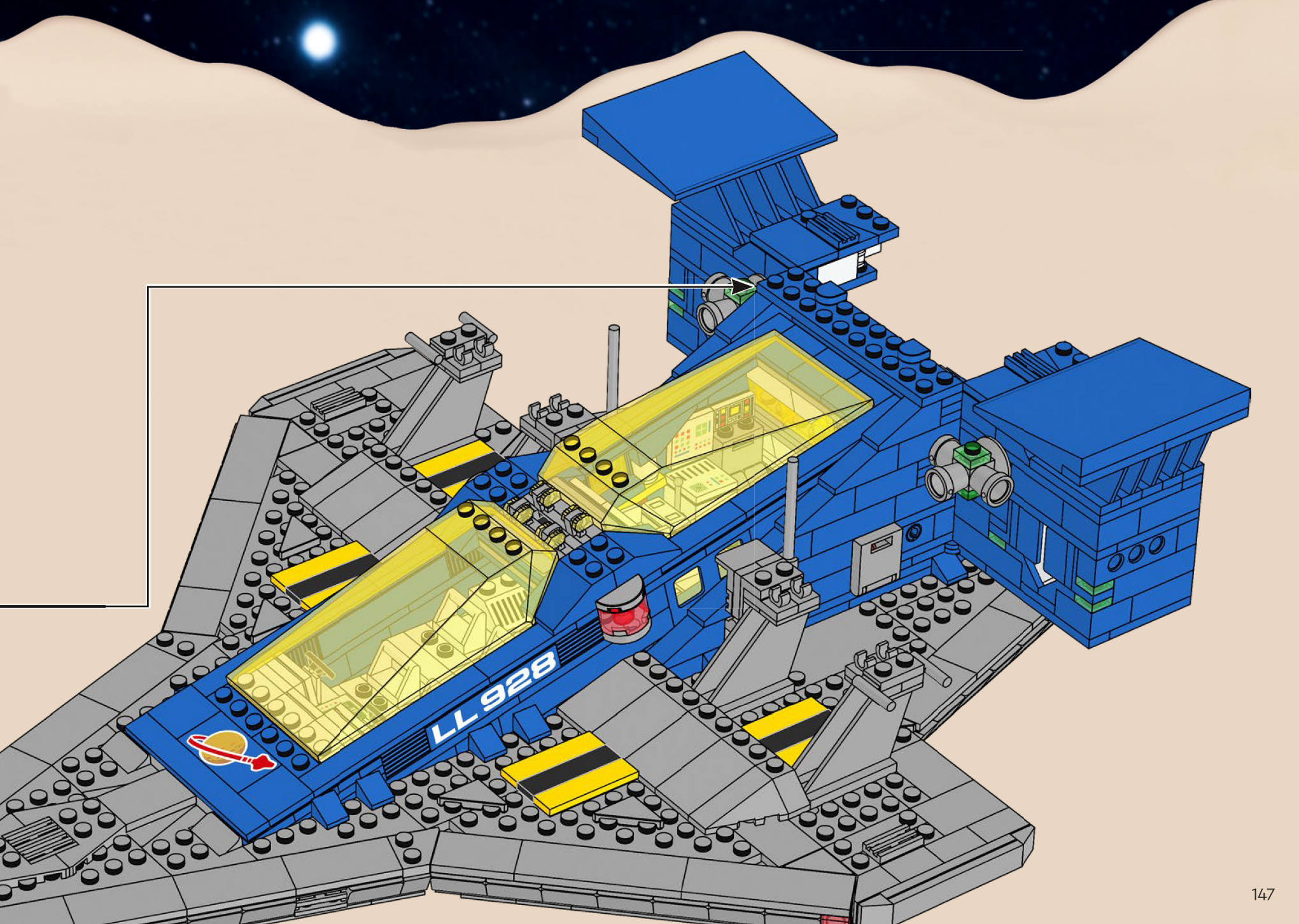

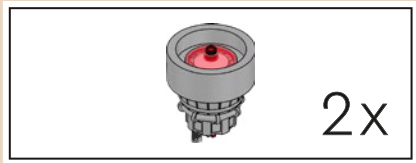

214

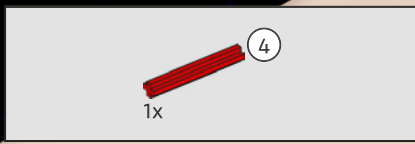
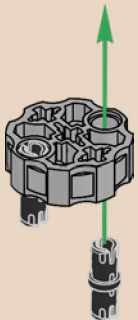

215

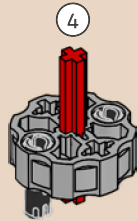

216

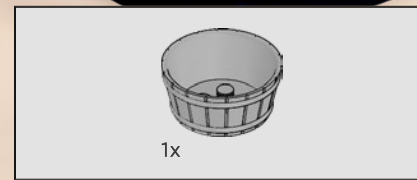
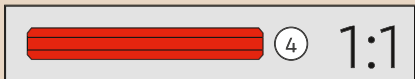
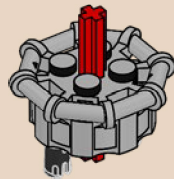

217

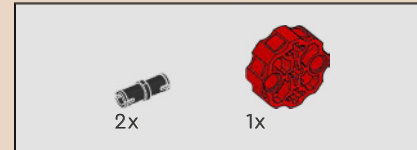
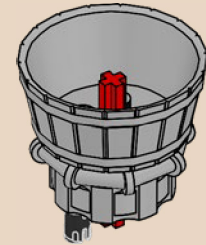

218

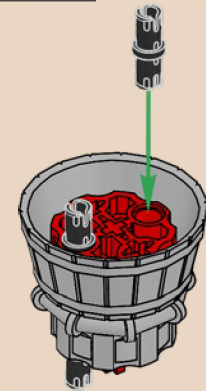



219

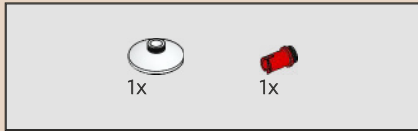
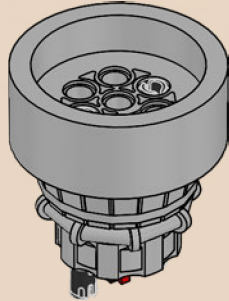

220

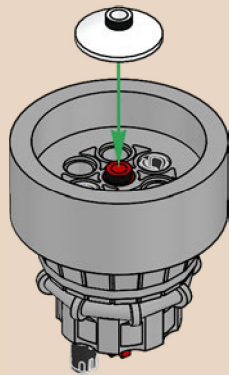

221

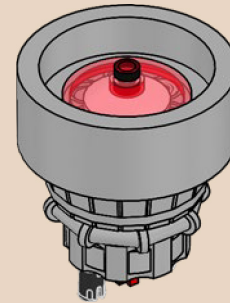

2x

222

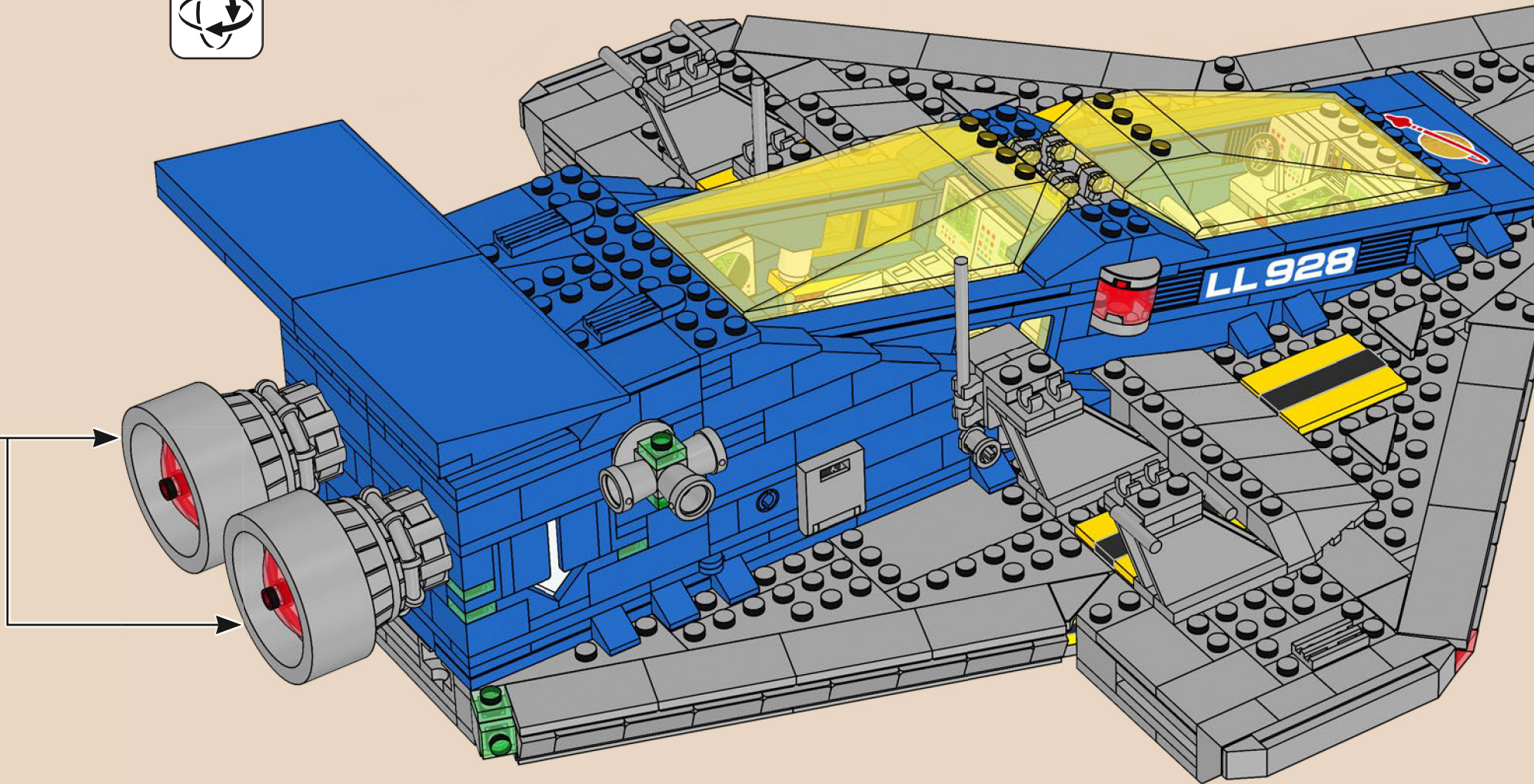

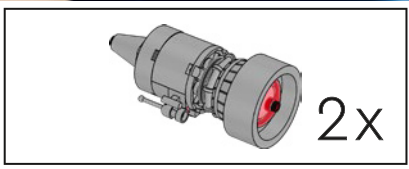

223

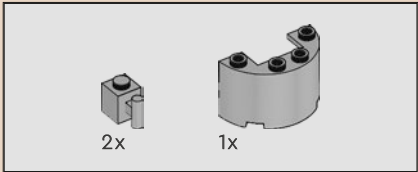
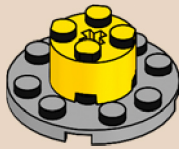

224

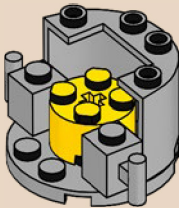

225

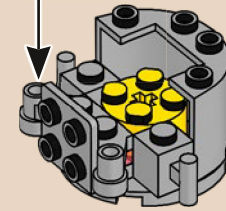
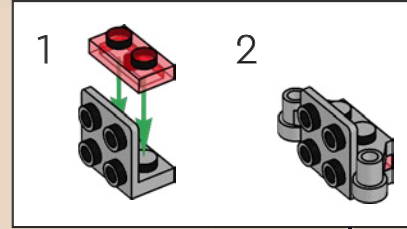

226

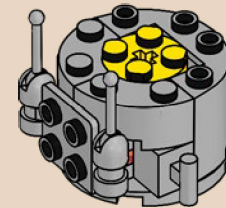

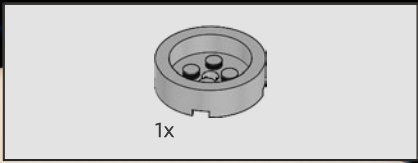

227

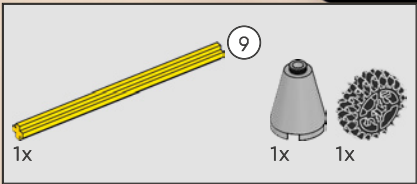
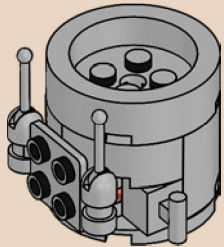

228

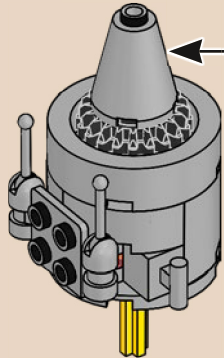
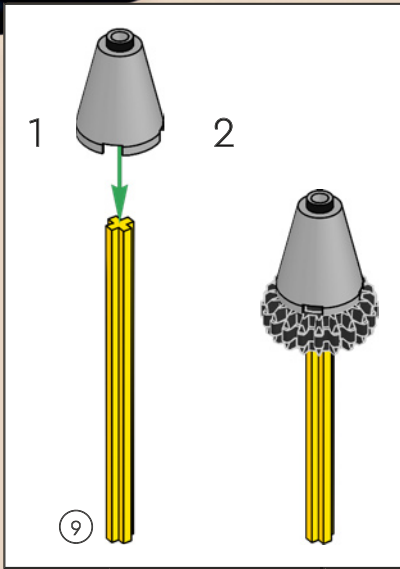

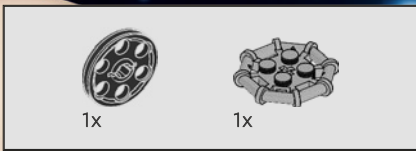

229

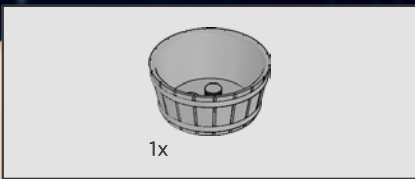
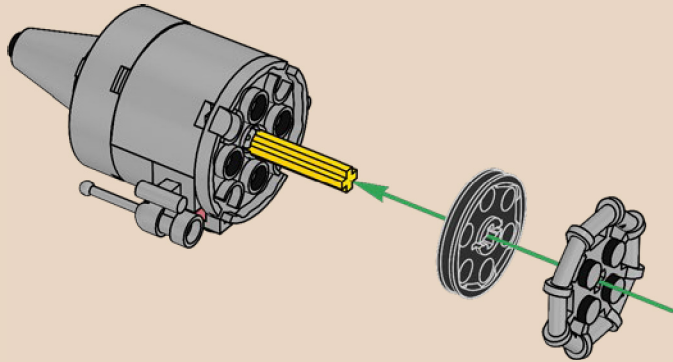

230

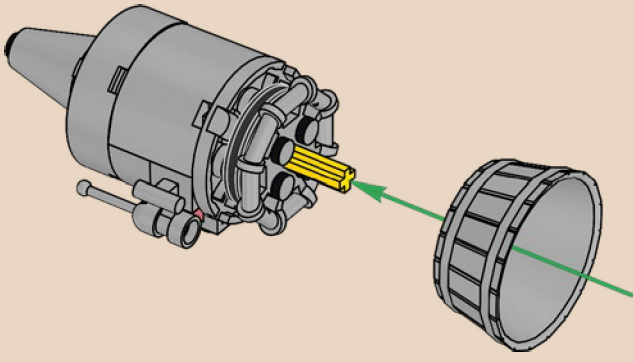

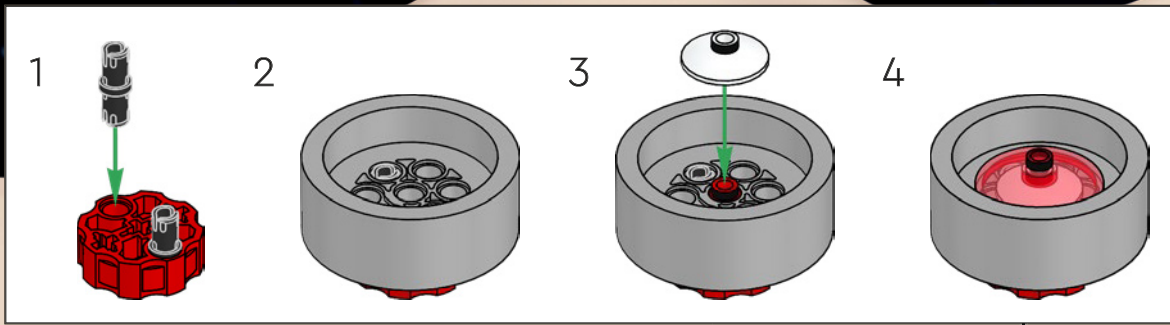
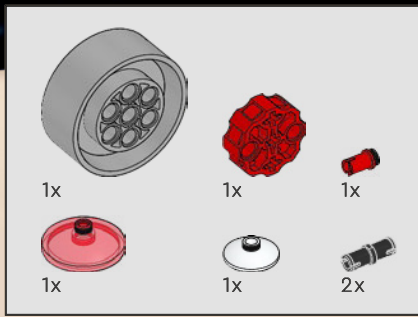

231

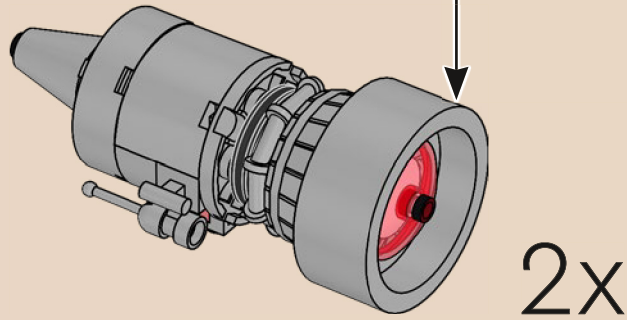



232

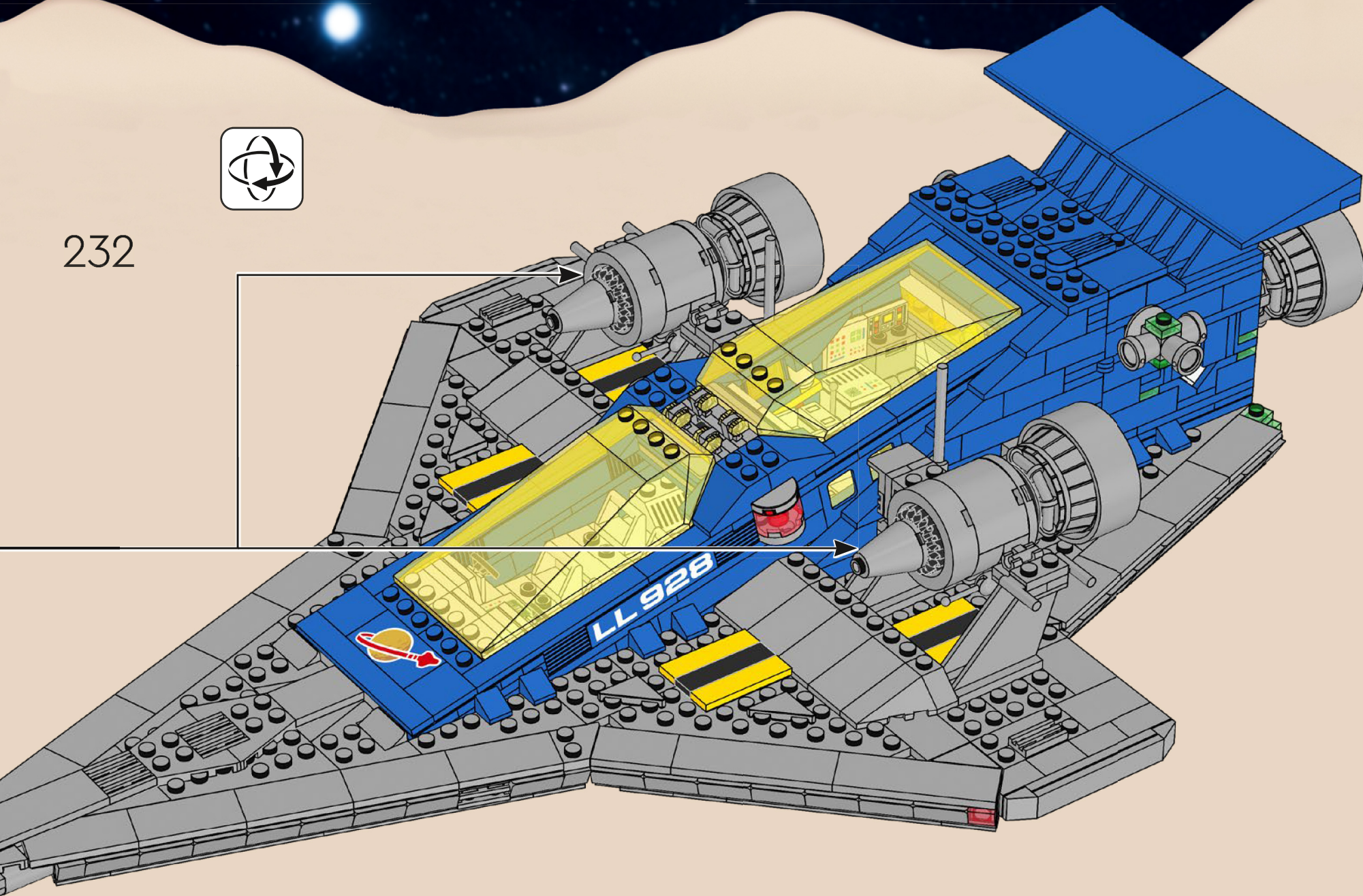

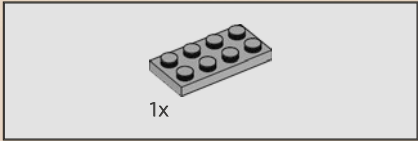
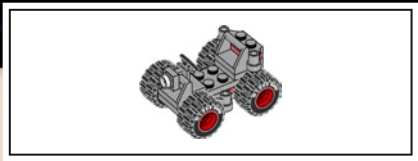

1

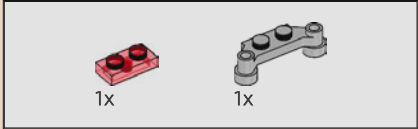

2

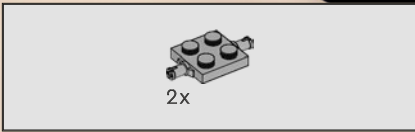
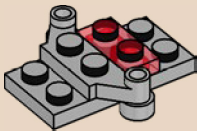

3

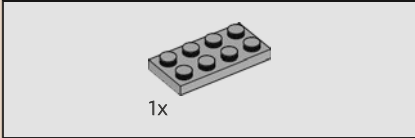
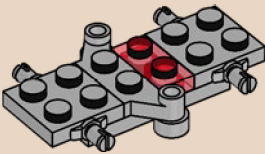

4

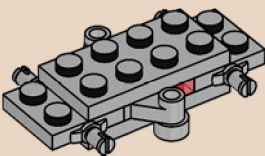

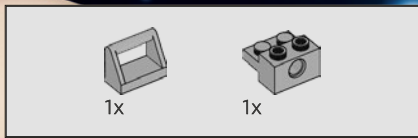

5

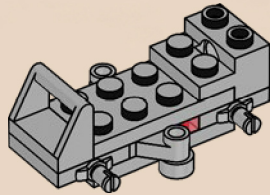

6

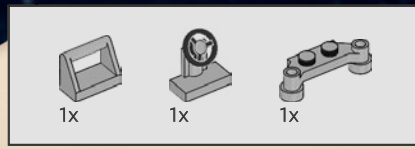
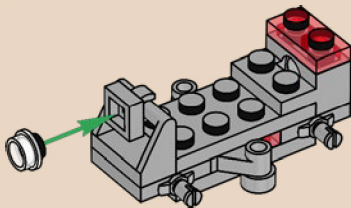

7

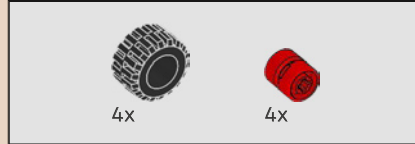
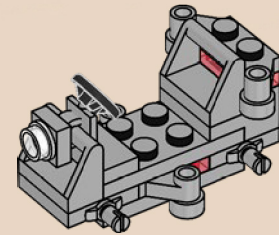

8

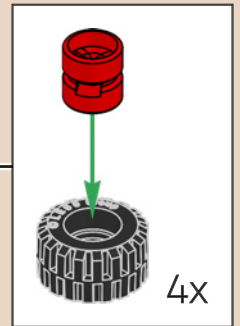
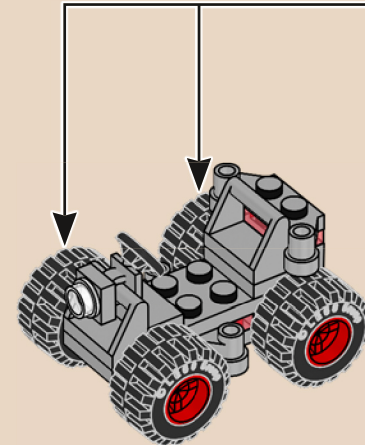

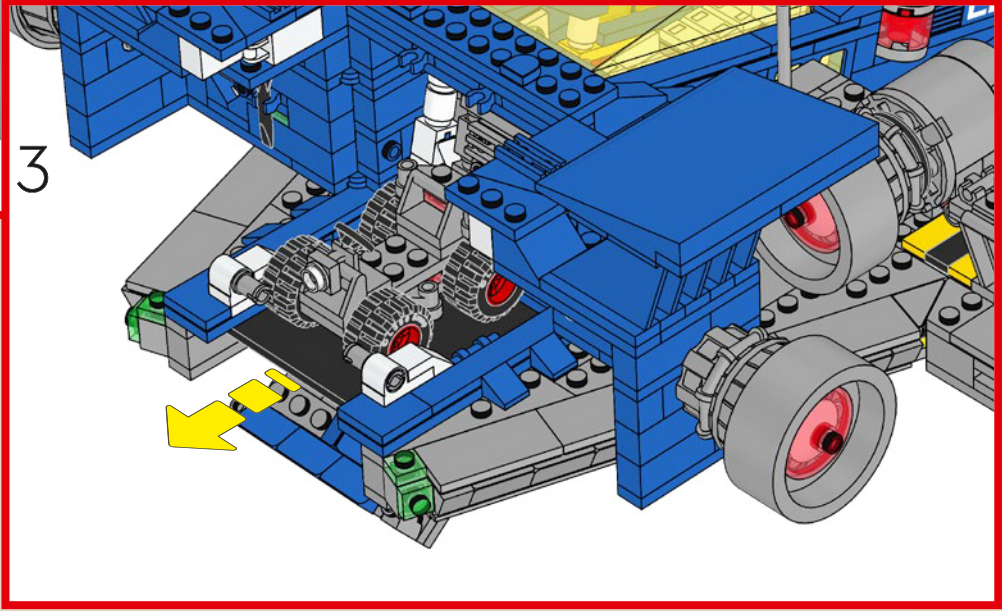
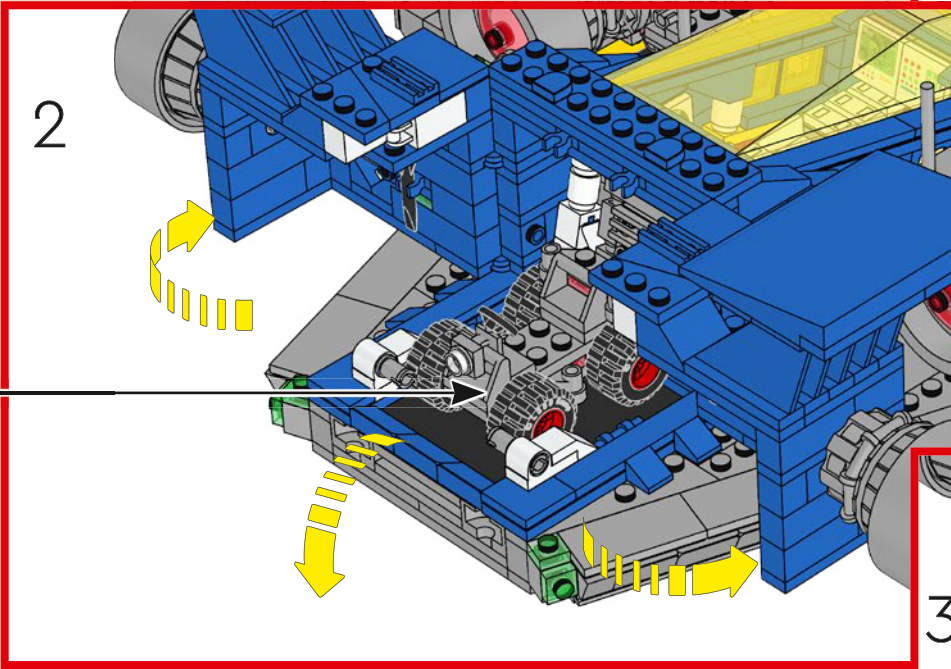
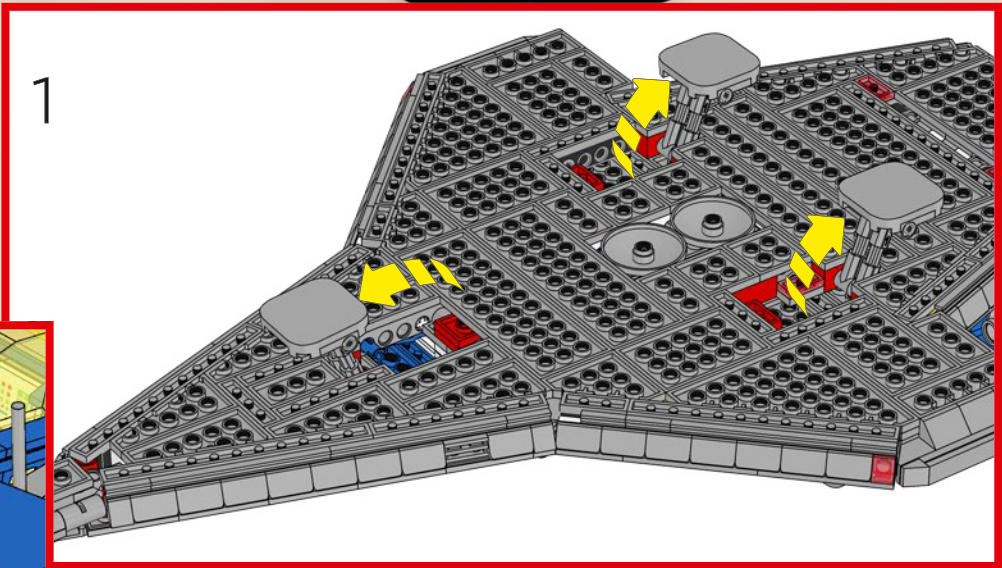

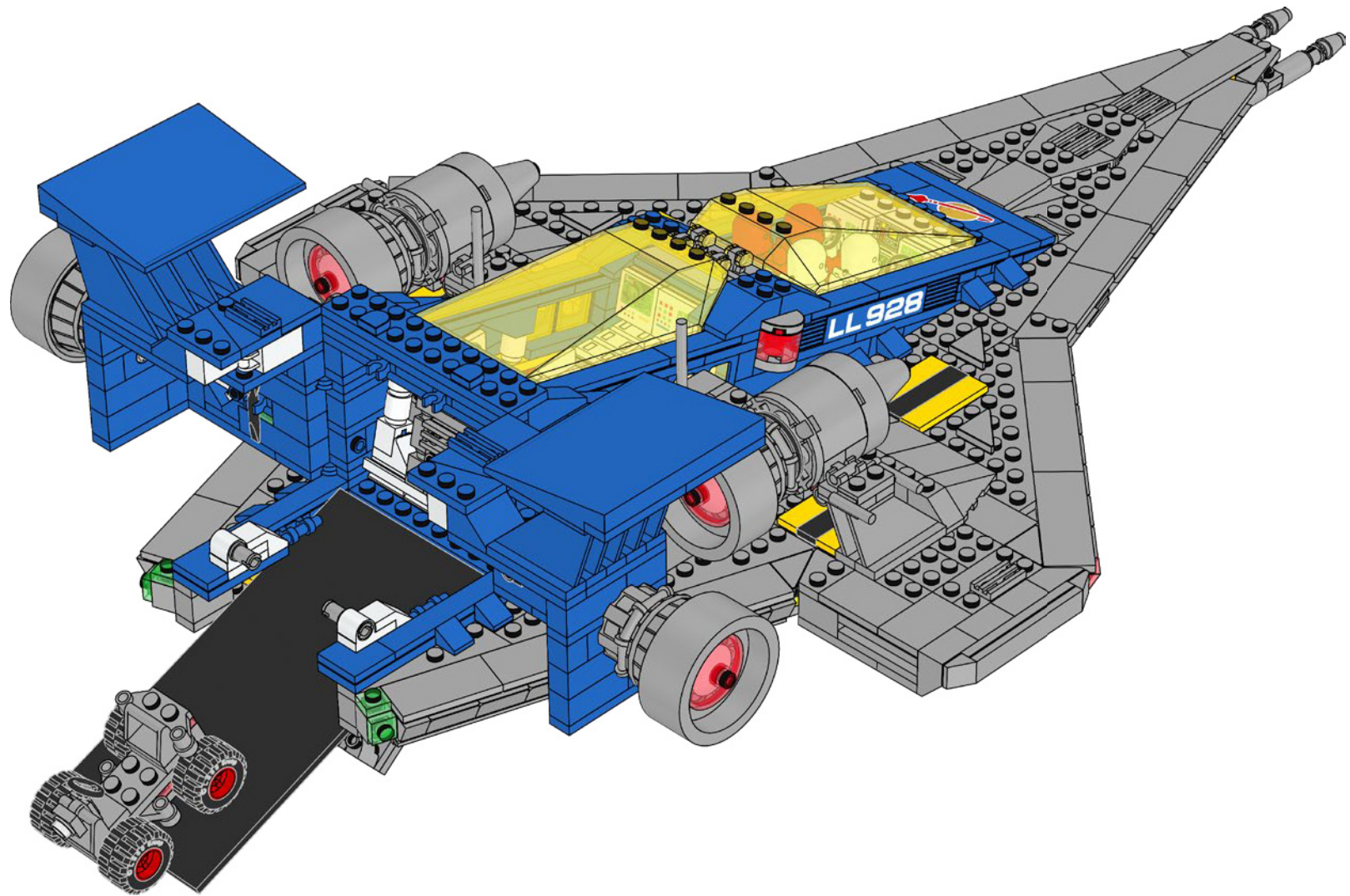

- 4x 306201
- 6x 6168642
- 2x 6177114
- 2x 302401
- 2x 6345886
- 2x 6390834
- 2x 6268849
- 4x 474001
- 4x 243201
- 2x 6069002
- 12x 6210076
- 3x 6304928
- 2x 366501
- 4x 6146215
- 1x 241201

- 6x 302301
- 2x 6057414
- 1x 6178921
- 2x 6166894
- 3x 6018774
- 2x 4140626
- 2x 6198933
- 3x 6289797
- 2x 6013866
- 2x 300301
- 2x 6403936
- 2x 6271990
- 2x 6245249
- 8x 6195371

- 2x 362201
- 1x 362301
- 2x 6396335
- 2x 9327
- 4x 301001
- 1x 4203583
- 1x 6280386
- 3x 6053026
- 2x 6093526
- 2x 6131572
- 2x 300801
- 1x 4501853

- 1x 4144012
- 2x 273001
- 1x 244501
- 3x 663601
- 1x 6428484
- 3x 6428480
- 1x 6428481
- 1x 6428482
- 2x 6428485
- 1x 6428487
- 2x 6345429
- 2x 6390835
- 4x 6281994
- 4x 6207482

- 5x 370021
- 4x 6168634
- 2x 4581525
- 6x 302221
- 2x 6209519
- 4x 6313596
- 2x 6396330
- 2x 9342
- 2x 6129995
- 4x 370121
- 2x 301021
- 4x 300121
- 14x 306221
- 8x 6378120
- 2x 6390833

- 6x 300523
- 2x 4583862
- 18x 4504380
- 2x 407023
- 4x 6344218
- 4x 6352221
- 2x 4498156
- 2x 4498155
- 5x 4651236
- 10x 4206482
- 4x 6289241
- 8x 300423
- 6x 370023
- 2x 241223
- 13x 302323

- 4x 6228601
- 4x 6146218
- 4x 6133721
- 2x 4140586
- 18x 6299413
- 5x 306823
- 4x 4558606
- 4x 303923
- 2x 6129747
- 20x 362223
- 6x 6372038
- 12x 362323
- 2x 6284575
- 2x 6268862
- 4x 302423
- 2x 6196596

- 4x 6294307
- 6x 243123
- 2x 4212411
- 2x 370123
- 8x 371023
- 6x 301023
- 2x 6207688
- 2x 302023
- 1x 6302718
- 10x 6254953
- 12x 428623
- 4x 6416505
- 2x 4118785
- 2x 6323429

10x
366623

5x
346023

5x
416223

2x
300823

1x
303423

9x
447723

2x
303523

1x
383223

2x
6337084

2x
303023

30x
614124

4x
9336

4x
4624985

6x
614324

1x
302324

10x
242024

4x
362324

2x
300224

8x
371024

8x
243124

2x
366624

2x
6130010

2x
73587

2x
306226

2x
407026

1x
6268852

2x
6281993

10x
6196548

40x
6279875

1x
403226

1x
4226995

2x
9551

2x
302326

1x
6020193

2x
4141580

2x
6346535

2x
6323668

1x
6170545

4x
4568644

2x
6089119

1x
400626

1x
370526

4x
6416444

4x
6054852

1x
303426

4x
389526

2x
4542573

1x
4603646

12x
4162443

4x
243126

1x
6240030

2x
6238856

1x
6208450

2x
6245252

2x
6334501

20x
6240212

4x
6273482

4x
6315923

2x
6244907

2x
6390837

1x
6240515

1x
6240221

14x
6252046

2x
6170418

2x
4211412

2x
4529241

6x
4211525

2x
6275844

6x
6057487

2x
4211503

4x
6336539

4x
4558953

12x
4521921

4x
6170569

2x
4211511

2x
6225246

1x
6308012

2x
6163477

2x
6163478

2x
6311384

2x
6296894

2x
4211492

12x
6296859

4x
6173127

48x
4568637

4x
4211475

2x
6404367

2x
4211512

2x
4211807

5x
6372076

4x
6093859

9

4

15

- 8x 6326078
- 2x 4211614
- 2x 4651063
- 8x 6168633
- 11x 4211350
- 2x 4211357
- 6x 6015344
- 2x 6146223
- 4x 4211388
- 2x 4211437
- 2x 4654580
- 2x 6337268
- 12x 4211568
- 8x 6217876
- 2x 6319336
- 11x 4282786
- 11x 4282789
- 5x 4211397
- 2x 6326478

- 6x 6045988
- 4x 4567448
- 1x 6316961
- 6x 4211815
- 11x 6321747
- 2x 4211491
- 1x 6346487
- 2x 6186129
- 2x 4211429
- 2x 6408022
- 2x 4211419
- 4x 6302648

3

- 2x 4211718
- 3x 4211396
- 9x 6171894
- 2x 4211464
- 2x 6249550
- 4x 6397889
- 2x 6071299
- 9x 4211445
- 4x 4211613
- 2x 4211636
- 2x 6257593

- 1x 4180418
- 2x 6276045
- 2x 4515351
- 2x 4211664
- 2x 6303438
- 7x 6170521
- 10x 6015347
- 4x 6262086
- 11x 4211395
- 2x 6258903
- 18x 4560183
- 1x 4180408

- 2x 4211385
- 8x 4509915
- 8x 6390838
- 3x 6354325
- 2x 6028811
- 2x 6408542
- 4x 6303442
- 8x 4211438
- 2x 4211549
- 2x 4160560
- 2x 6102575

- 4x 4211452
- 1x 4211462
- 6x 6318584
- 2x 4211425
- 4x 4211716
- 2x 4211838
- 4x 4211404
- 10x 4211498
- 1x 4222019
- 6x 6267587
- 2x 4211407

- 2x 6408629
- 5x 6117967
- 6x 4211410
- 1x 4211408
- 9x 4514846
- 1x 4211360
- 4x 4268343
- 4x 4211705
- 3x 4211401
- 2x 4211486

Customer Service
 Kundenservice
 Service Client
 Assistenza clienti
 Atención al cliente
 Serviço de Apoio ao Consumidor
 Ügyfélszolgálat
 Klientu apkalpošanas dienests
 Serviciul pentru client
 客户服务
 コンシューマーサービス
 고객 서비스
LEGO.com/service



FEEDBACK AND WIN



FEEDBACK AND WIN

Your feedback will help shape the future development of this product series.

Please visit:

FEEDBACK UND GEWINNEN

Dein Feedback trägt zur Weiterentwicklung dieser Produktreihe bei.

Geh auf:

COMMENTEZ ET GAGNEZ

Vos commentaires nous aideront à concevoir les futurs produits de cette gamme.

Rendez-vous sur :

COMENTA Y GANA

Tu opinión nos ayudará a dar forma al desarrollo de esta serie de productos en el futuro.

Visita:

反馈有奖

您的反馈将有助于我们在今后改进本系列产品。

请访问：

[LEGO.com/productfeedback](https://www.lego.com/productfeedback)

By completing, you will automatically enter a drawing to win a LEGO® set.

Terms & Conditions apply.

Durch Ausfüllen nimmst du automatisch an der Verlosung eines LEGO® Preises teil.

Es gelten die Teilnahmebedingungen.

En envoyant vos commentaires, vous serez automatiquement inscrit(e) à un tirage au sort qui vous permettra de remporter un prix LEGO®.

Offre soumise à conditions.

Al contestar, participarás automáticamente en el sorteo y podrás ganar un set LEGO®.

Sujeto a Términos y Condiciones.

完成我们的反馈调查，即可自动进入抽奖环节，赢取乐高®套装。

适用《条款和条件》。

