

10497

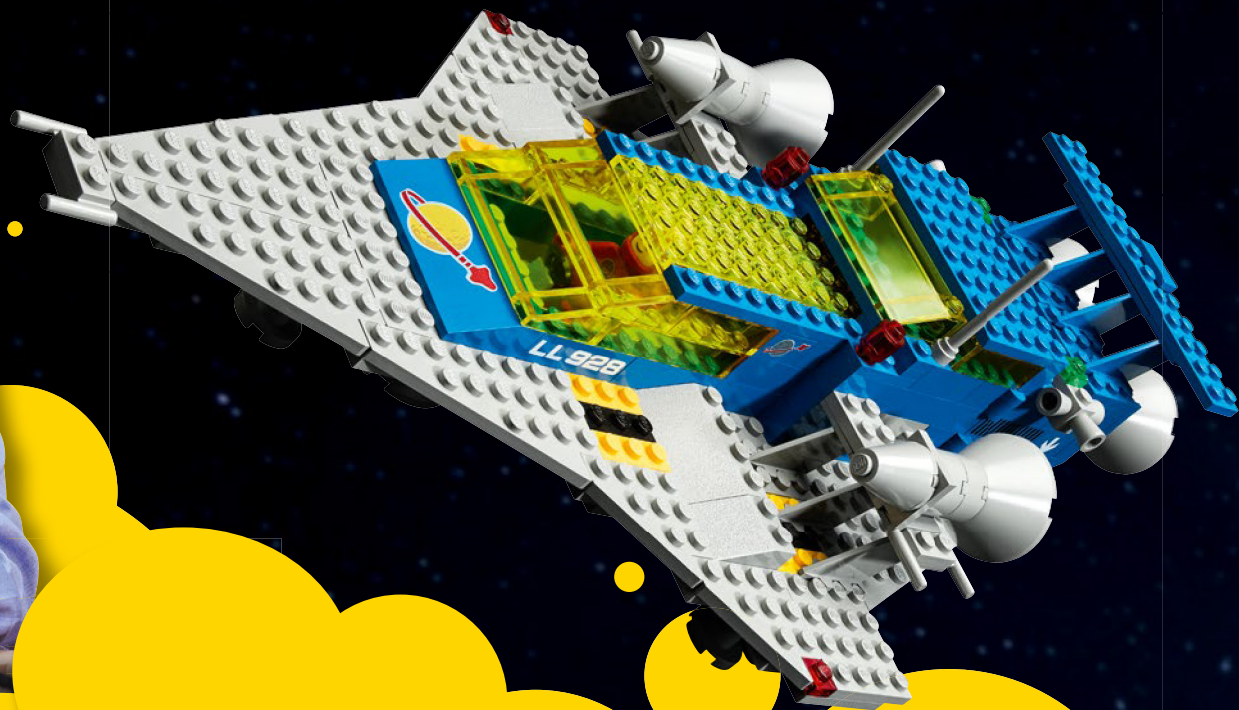



Kjeld Kirk Kristiansen 是乐高集团创始人 Ole Kirk Christiansen 的孙子，在 1979 年推出太空系列时开始领导公司。

## KJELD 寄语

在 50 年代末和 60 年代初，作为一个小男孩，我对太空竞赛非常感兴趣，受美国卡纳维拉尔角航天中心的启发，我建造了一座火箭发射基地。银河探索号 (Galaxy Explorer) 在 1979 年一推出就迅速成为我的最爱套装之一。我特别喜欢后部隐藏的隔舱，那里存放着月球探险车——这是一项不错的、几乎秘密的功能。当然，还有乐高®宇航员！这款 90 周年纪念模型带回了快乐的回忆，并真正将银河探索号带入了 21 世纪。

Kjeld Kirk Kristiansen

# 重温经典

作为乐高® 90 周年庆典的一部分，我们选择重温有史以来最具标志性的乐高太空系列套装之一。重新推出过去备受喜爱的模型总需要慎重考虑，但我们的目标是创造一款更大、更精致的银河探索号，同时仍然向原始版模型的所有神奇方面致敬。我们希望你喜欢拼搭这款全新的经典乐高宇宙飞船！

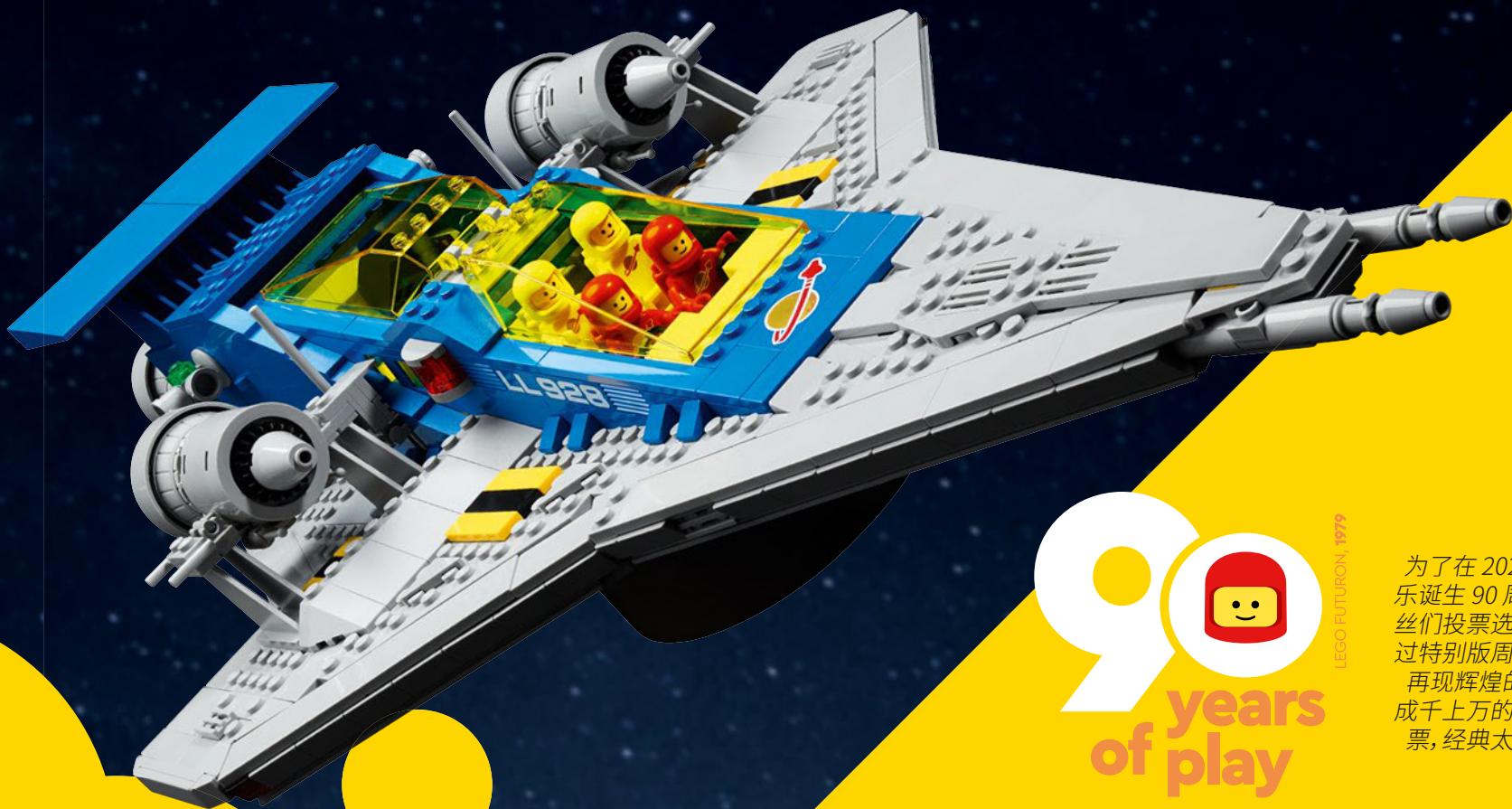

90  
years  
of play

LEGO FUTURON, 1979

## 90 年玩乐历程

为了在 2022 年庆祝乐高玩乐诞生 90 周年，我们号召粉丝们投票选出他们最希望通过特别版周年纪念套装使其再现辉煌的经典乐高主题。成千上万的粉丝们参加了投票，经典太空主题成为遥遥领先的赢家！



套装 924 太空巡洋舰 (Space Cruiser) 和 918 单人宇宙 (One Man Spaceship) 在设计上相似, 但比强大的 928/497 银河探索号要小。



## 太空之旅

太空主题的高®套装一直很受欢迎, 对于许多粉丝来说, 积木拼搭的乐高宇宙飞船通常是他们第一次探索全新的太空和科幻小说世界。

标志性的 928/497 银河探索号套装于 1979 年推出, 其包含一艘未来主义风格的宇宙飞船、一辆小型的太空探测车, 以及一座设有塔楼和着陆架的月球基地, 最重要的是, 还有 4 个第一批太空宇航员小人仔, 他们身着红色和白色服饰!

我们所熟知的“经典太空系列”已发展为一个主题, 在未来十年里, 太空巡洋舰的细节将变得更加丰富, 月球基地、月球探险车和机器人将更加先进。其他子主题也紧随其后, 如 Futuron (1987)、Blacktron (1987) 和太空警察 (Space Police, 1989), 它们引入了单轨列车和更复杂的可互换式套装, 以及更深层次的故事世界和独特定义的小人仔角色。

## 1978-1984 年



宇航员小人仔是一个开创性的元素。最初只有红色和白色，蓝色、黄色和黑色版本紧随其后。

## 1987 年

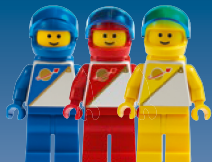

对制服设计进行了更新，加上了从臀部到肩膀的拉链，还重新设计了头盔，带有蓝色透明的遮阳板。

## 1993 年



90年代的太空主题冰冻星球 (Ice Planet) 出现了经典标识的替代版本，其中星球的一半被冰雪覆盖。

## 2009 年



这个独特的宇航员“雕像”仅在一款太空警察套装中出现过。

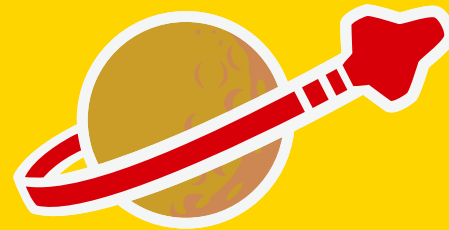

原始经典太空主题中的所有内容都带有现在备受喜爱的标志性乐高®太空标识，其中有红色宇宙飞船绕着月亮飞行。

## 2014 年



来自《乐高大电影》的本尼戴着破旧的太空标识和破裂的头盔，他也许是最著名的乐高宇航员。

## 2014 年



一名身穿绿色制服的新宇航员出现在 21109 Exo Suit 乐高创意 LEGO Ideas 套装中。

## 2019 年

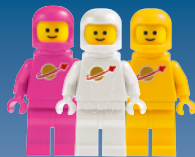

第一位粉红色宇航员 Lenny 与 Kenny 和 Jenny 一起加入了《乐高大电影 2》中的本尼太空小队。

## 2020 年



一位独家版橙色宇航员被收录在《LEGO Minifigure: A Visual History》一书中。

## 2021 年



具有收藏价值的小人仔系列 21 包含一个太空警察男孩，他拥有 Futuron 躯干，盔甲上绘有经典的太空标识。

## 2022 年



这款更新版银河探索号套装中的宇航员几乎是 1979 年原始版的精确复制。

“自从 2012 年开始设计乐高® 模型以来,我一直梦想着创造一款更新版本的银河探索号。”

MICHAEL PSIAKI



Michael 还设计了两艘较小的宇宙飞船,你可以用这款套装内含的积木拼搭它们。这些宇宙飞船的设计灵感源自套装 924 和 918。你可以访问以下网址,找到这些可选模型的说明:  
[LEGO.com/buildinginstructions](http://LEGO.com/buildinginstructions)



设计师忍不住为更新后的模型添加了一项个性化特征。最初的套装不包含这个小机器人，它于1987年首次出现在套装6809中。



## 设计团队感言

在我的乐高®设计师生涯中，我很早就开始着手这款套装的更新版本，大约在2013年冬天。从那时起，这艘飞船经历了多次迭代，才成了今天的样子。我最初设计的版本偏离原始模型较多，但随着模型的改进，我们不对使其接近原始设计，并进行了一些很酷的升级。其中一项重大决定是使它比原始模型大1.5倍。我们想给人一种感觉，就像原始版的粉丝一样，银河

探索号现在也长大了。由于飞船空间较大，因此我们可以将所有4名宇航员都安置在驾驶舱中，而不仅仅是一名宇航员。我们还在工作人员舱和太空探测车舱之间设计了一个气闸门，这样即使打开后门，宇航员也会得到保护。为飞船添加可伸缩式起落架可令其在太空中巡航时拥有更流畅的外形！

**Michael Psiaki, 乐高®资深设计师**

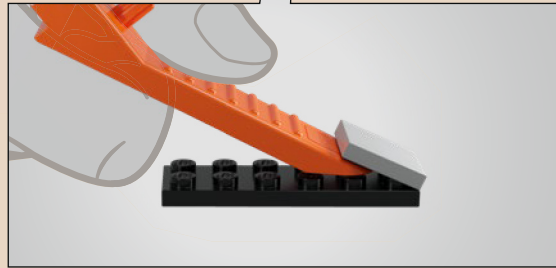
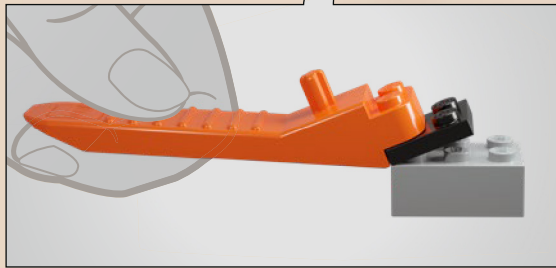
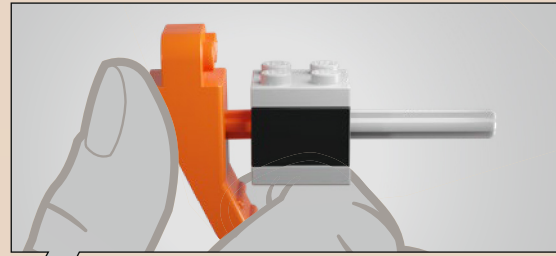
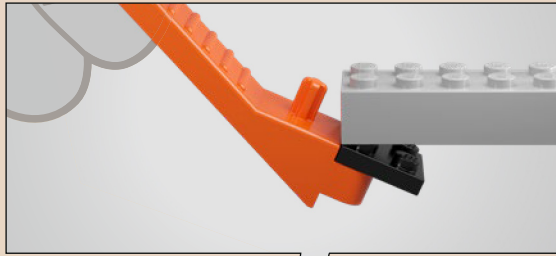



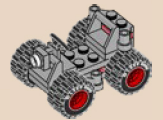
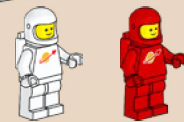
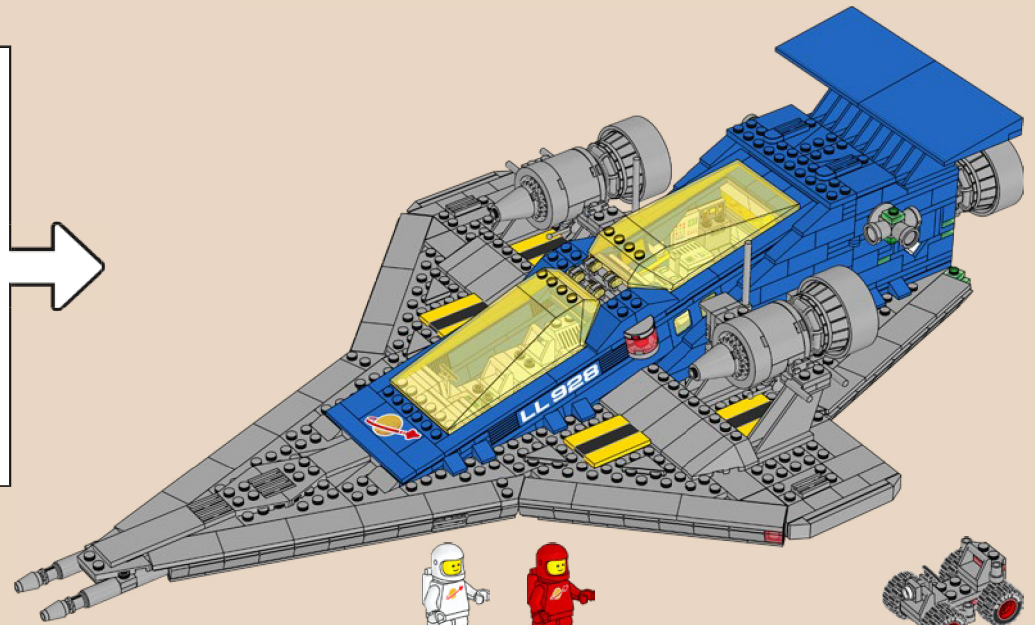
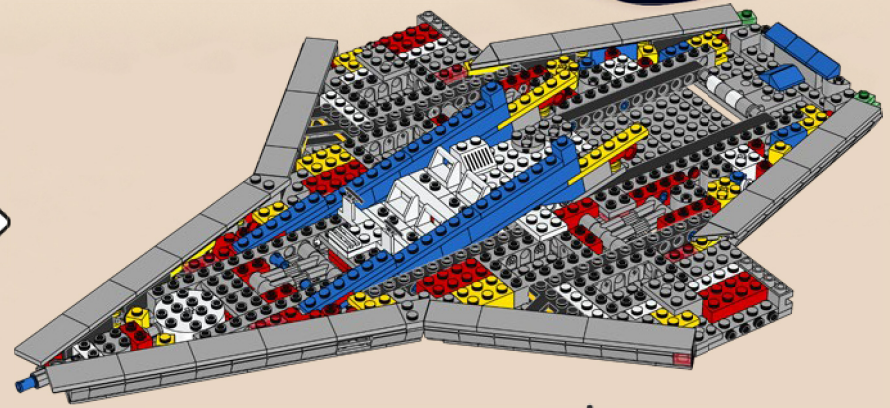

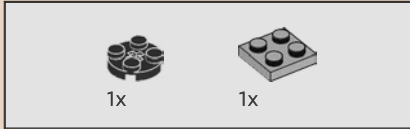
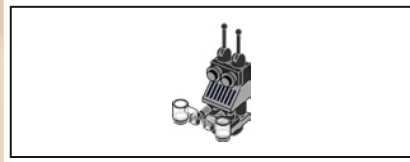
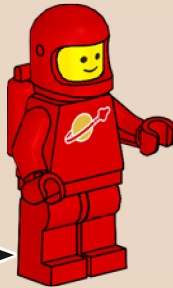
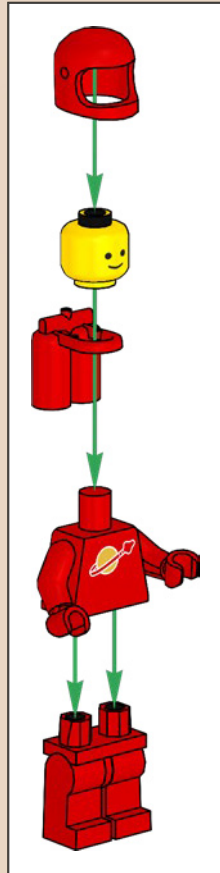

1

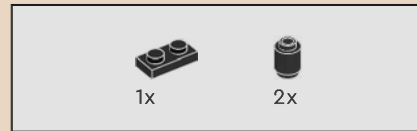
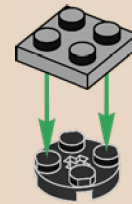

2

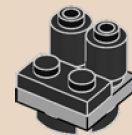

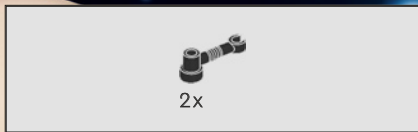

3

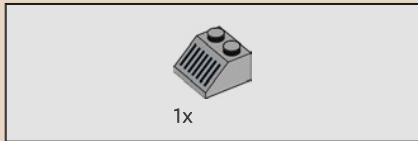
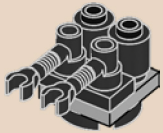

4

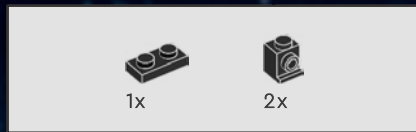
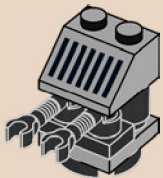

5

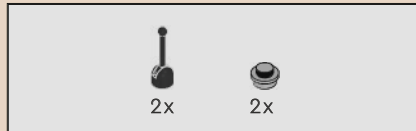
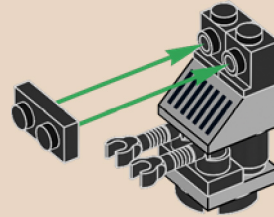

6

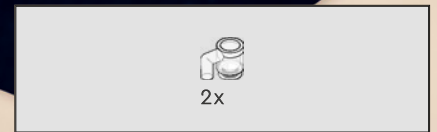
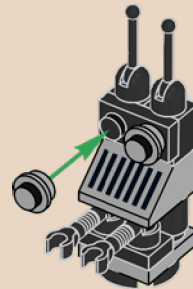

7

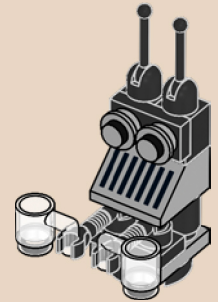

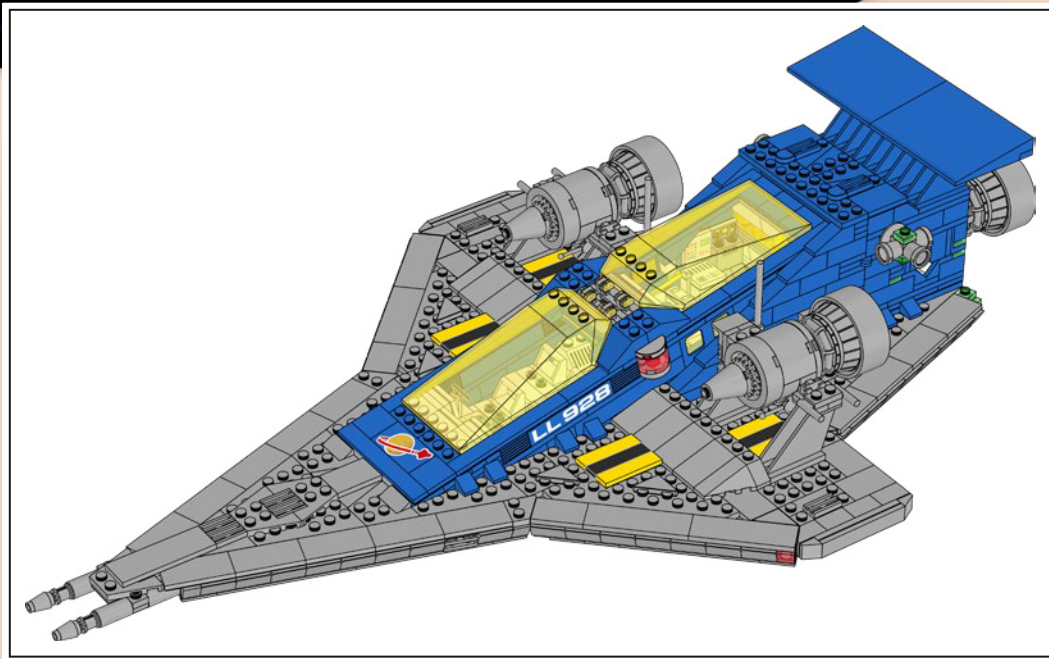

2



1

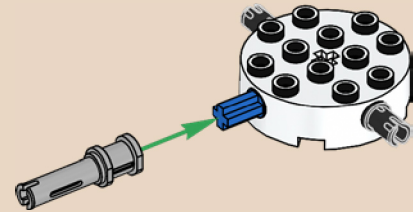
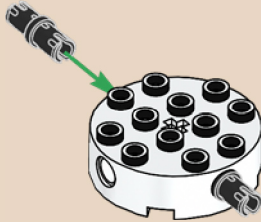



3

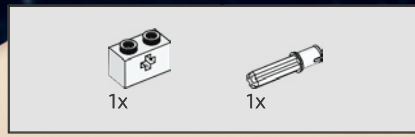
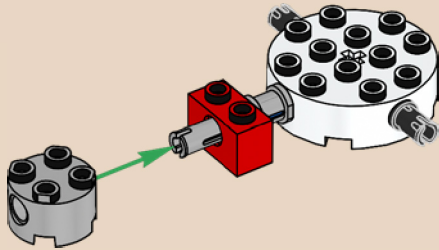

4

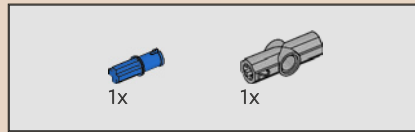
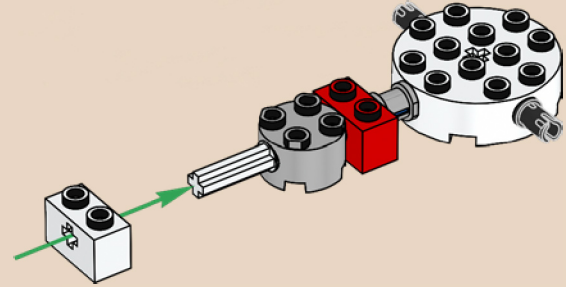

5

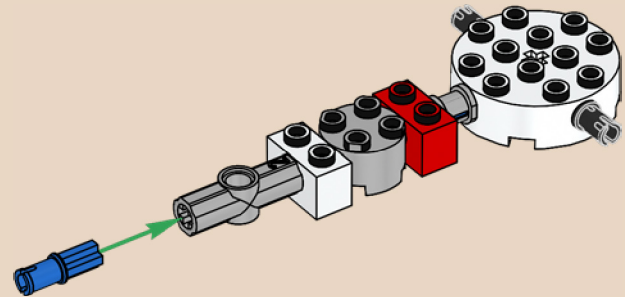

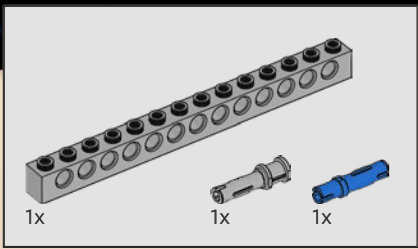

6

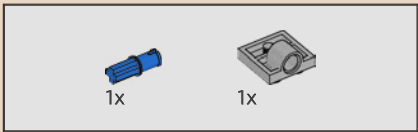
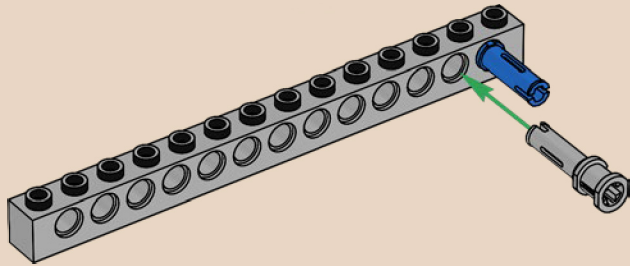

7

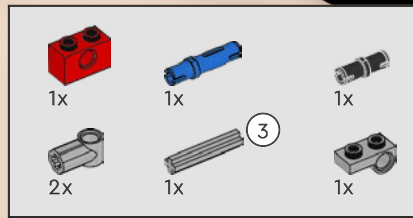
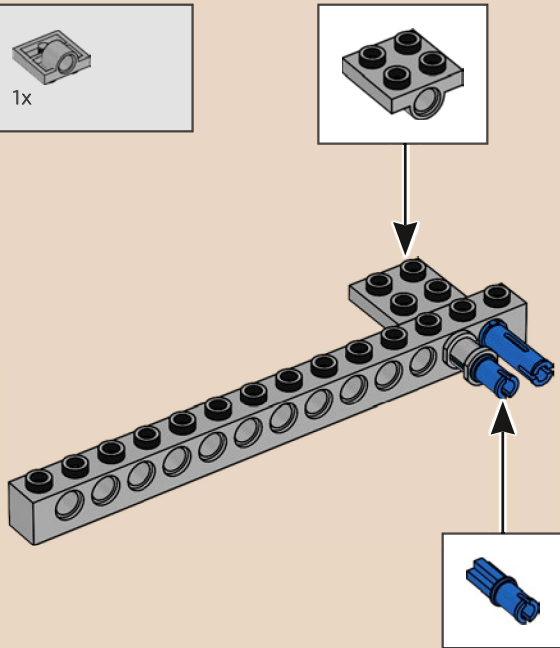

8

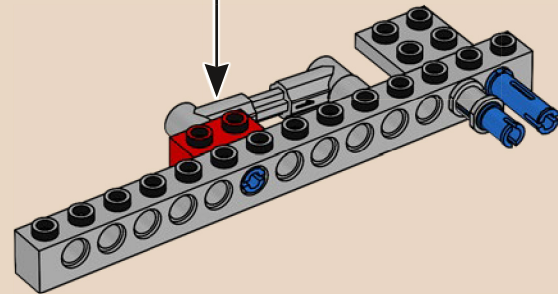
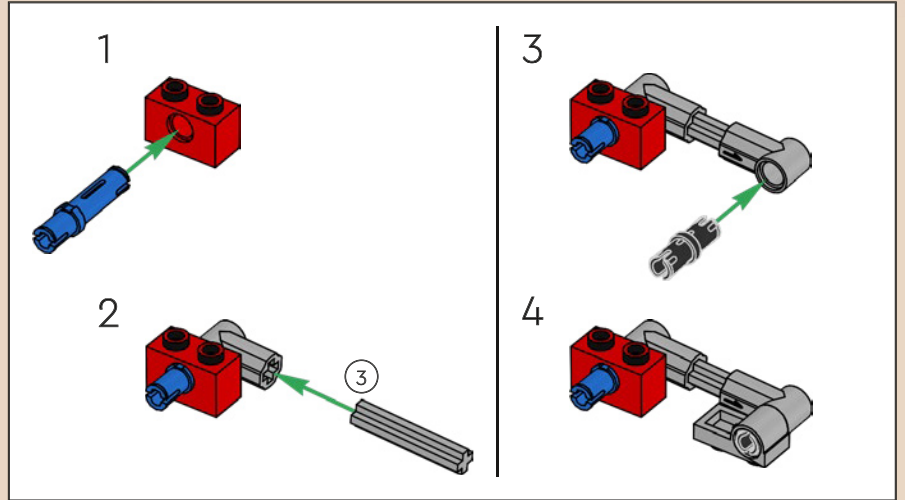

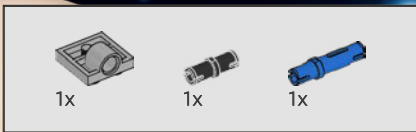

9

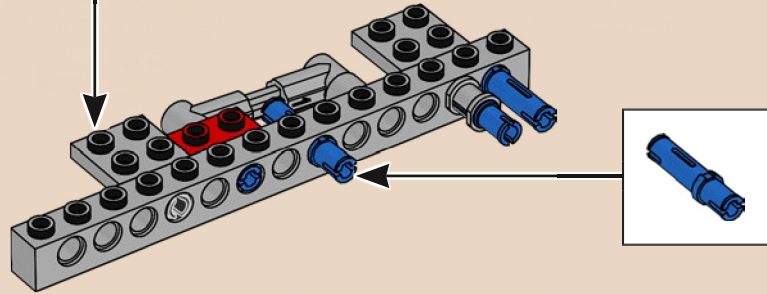
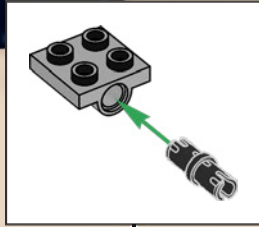

10

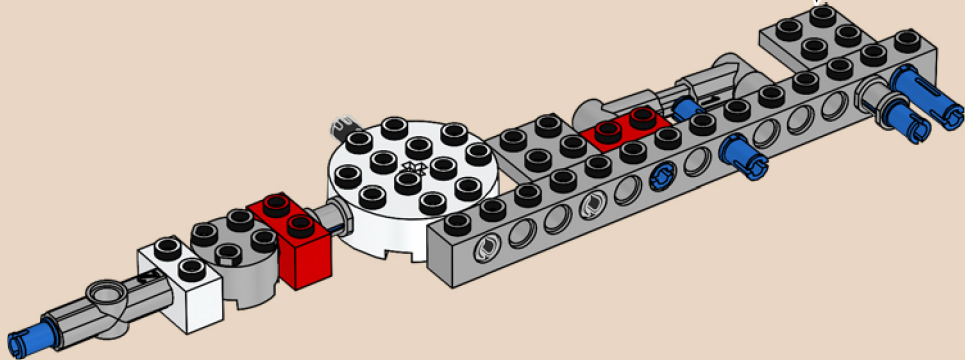

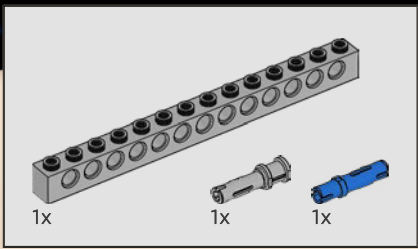

11

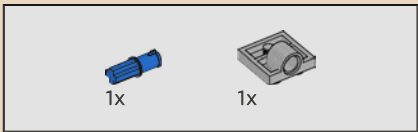
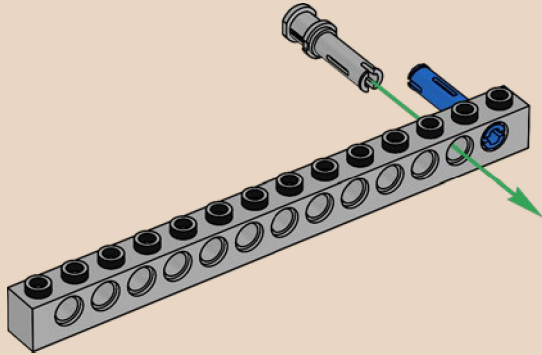

12

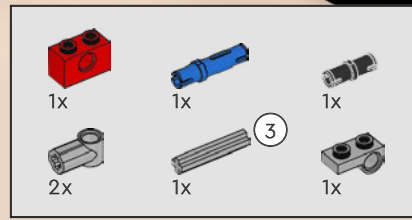
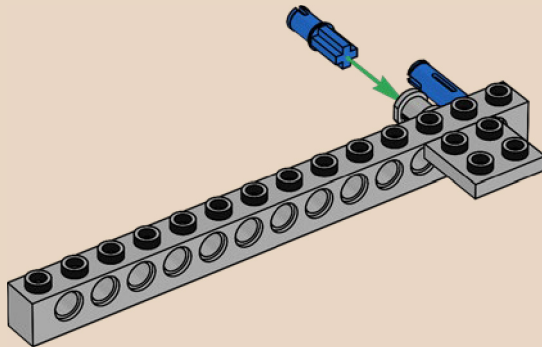

13

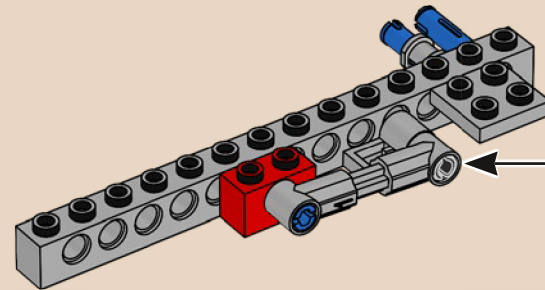
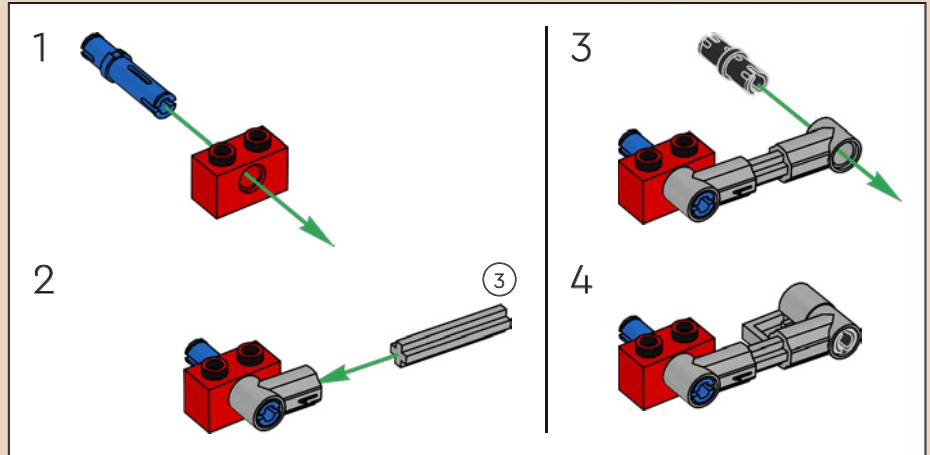



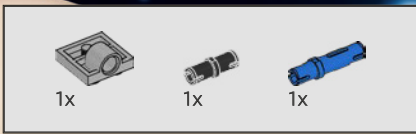

14

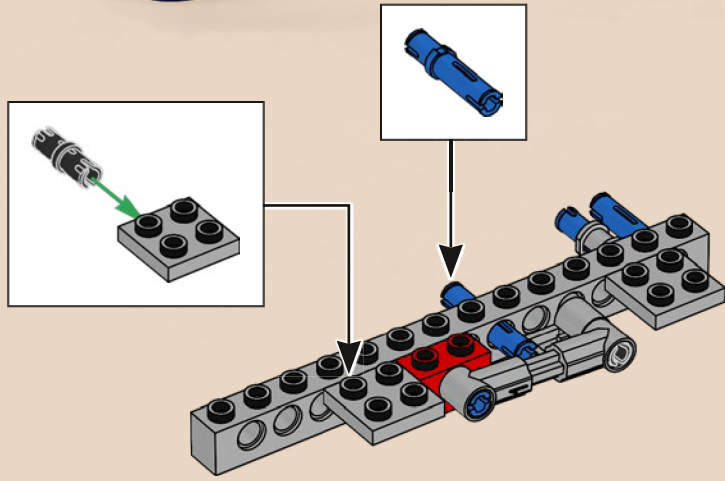

15

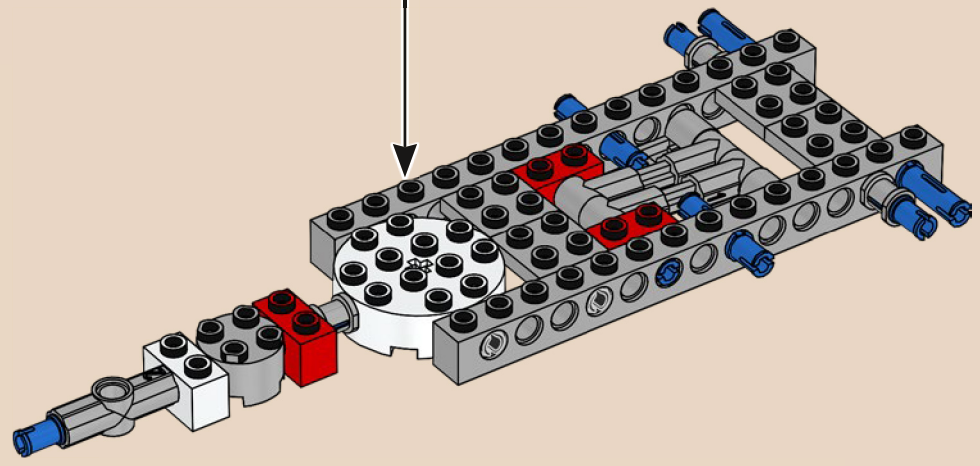



16

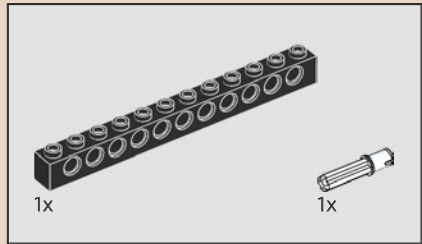
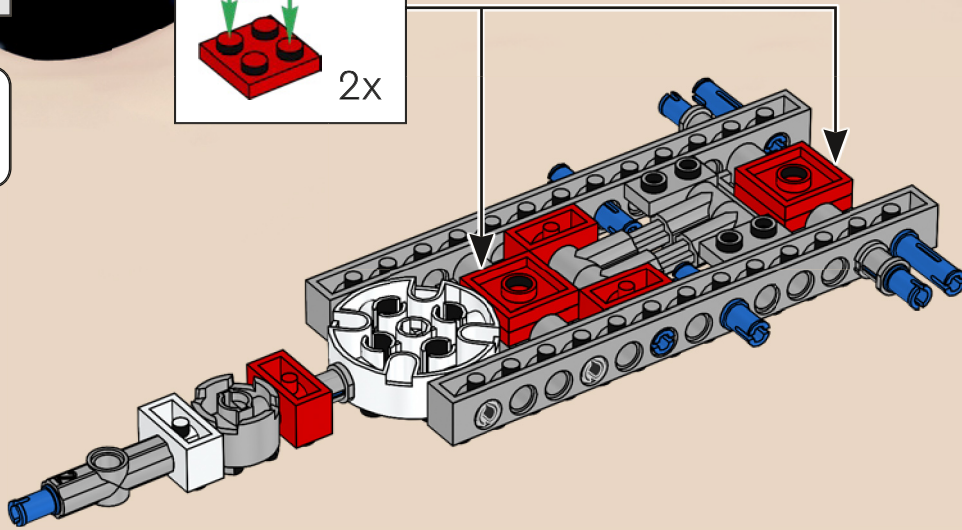
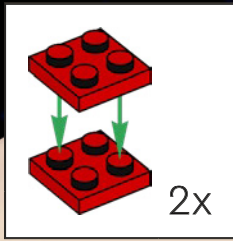

17

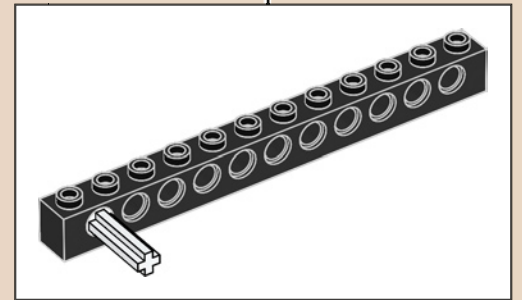
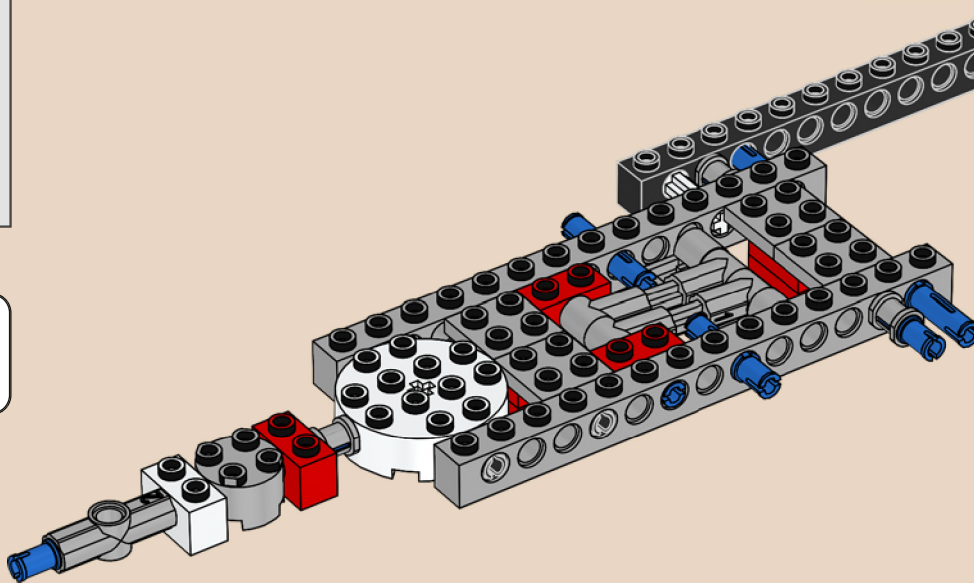

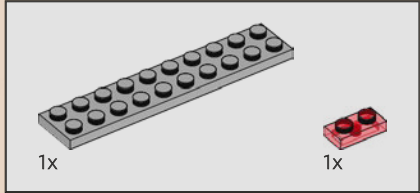
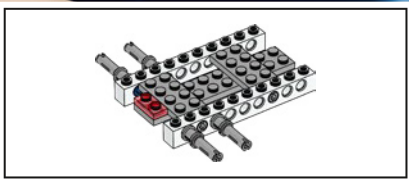

18

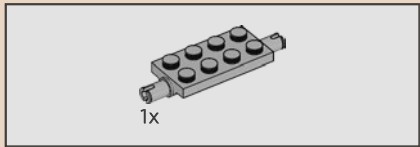
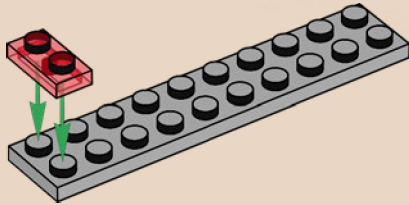

19

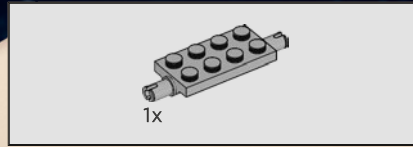
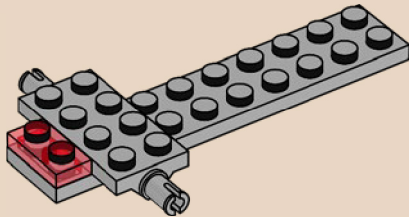

20

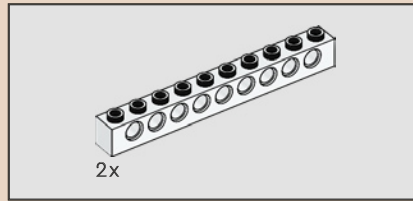
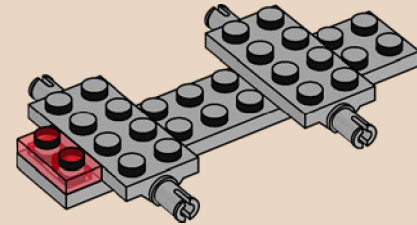

21

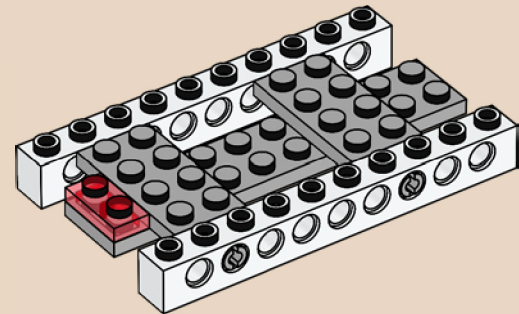

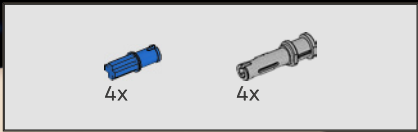

22

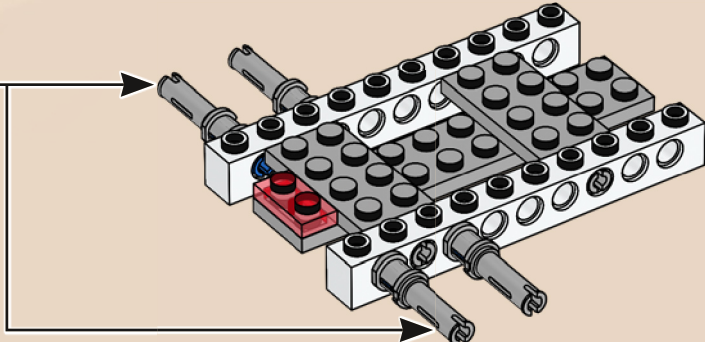
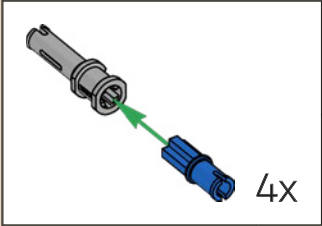

23

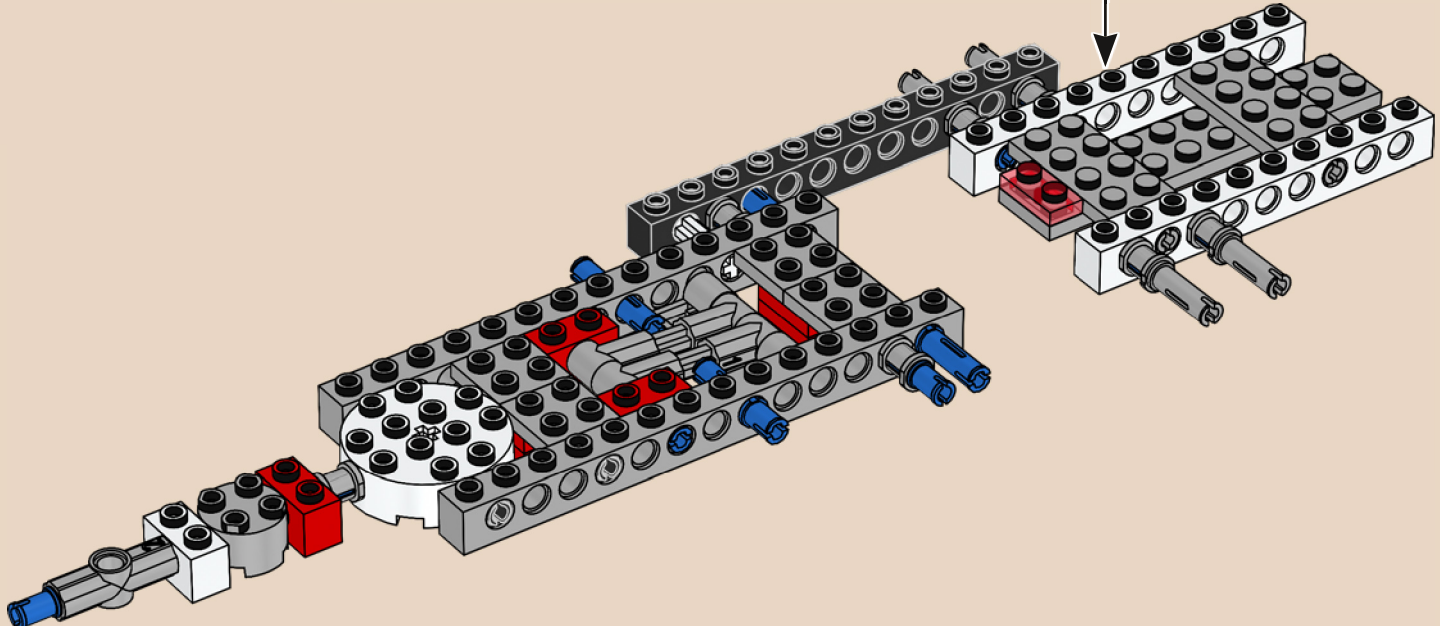

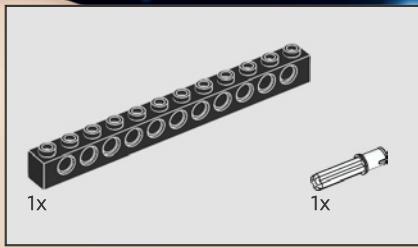

24

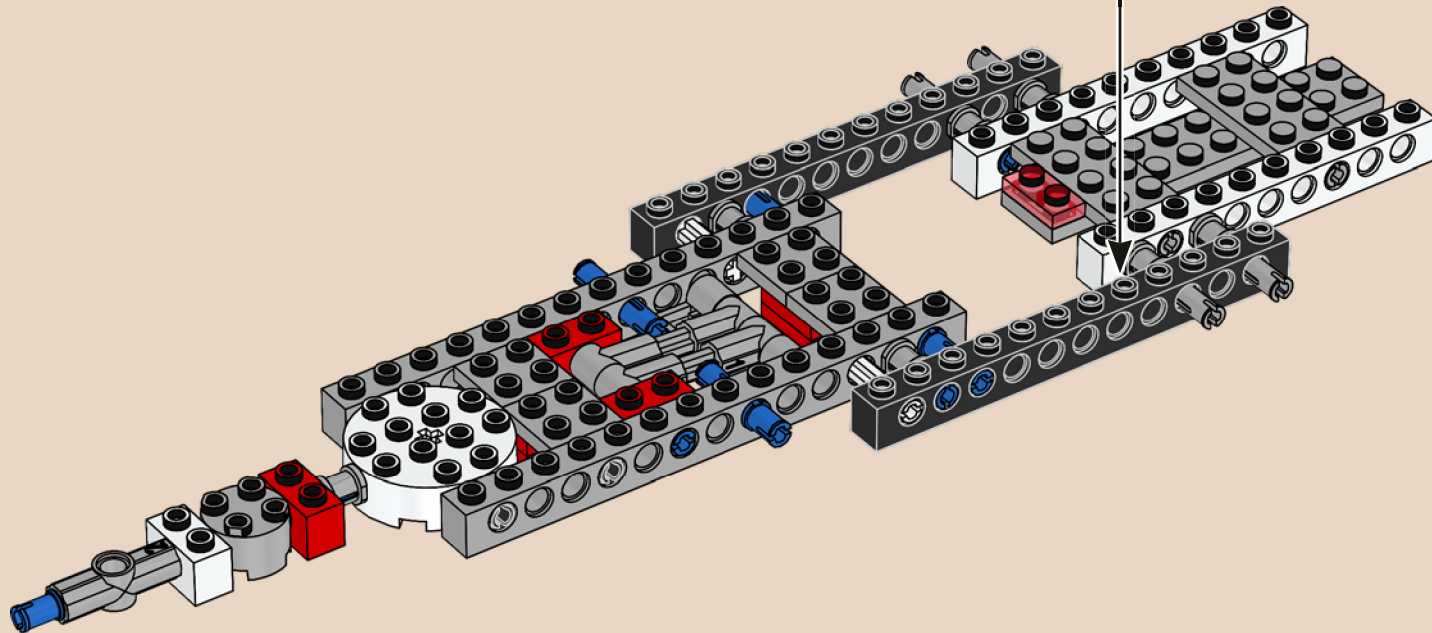
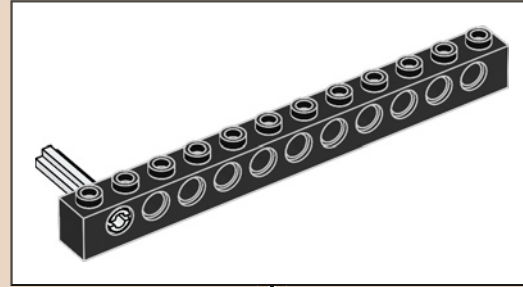

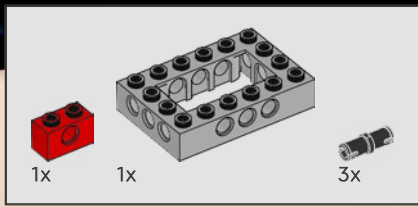

25

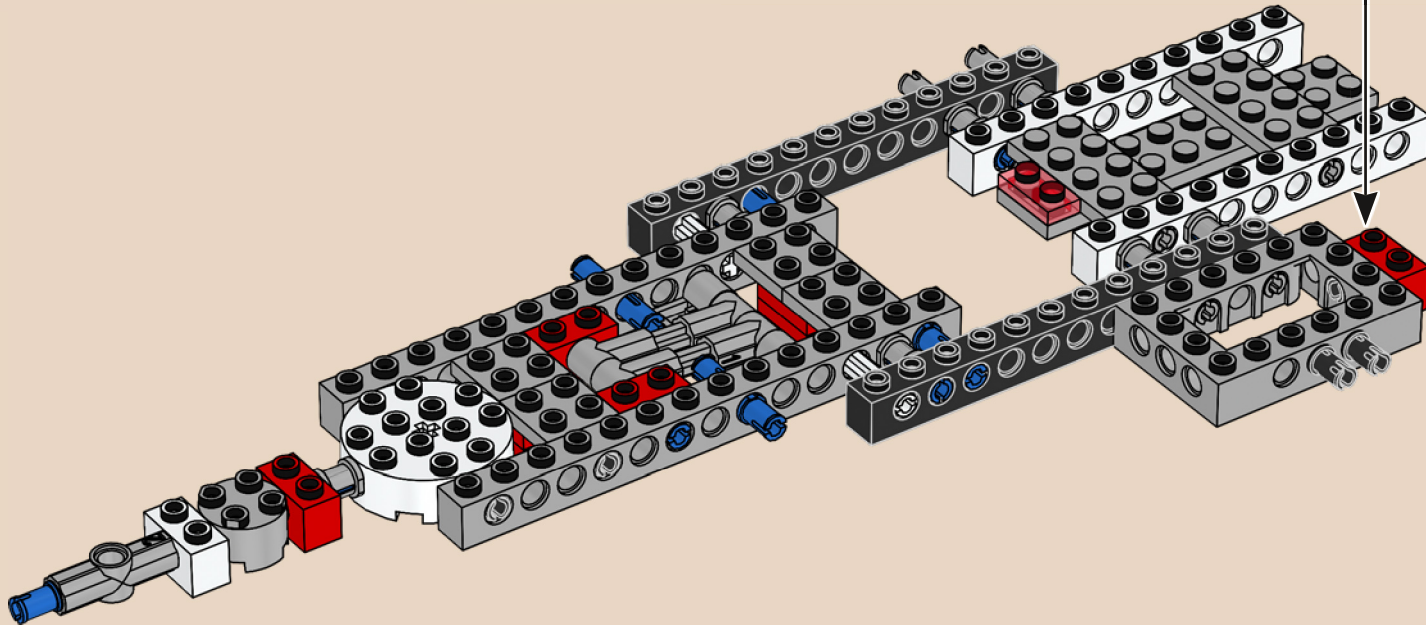
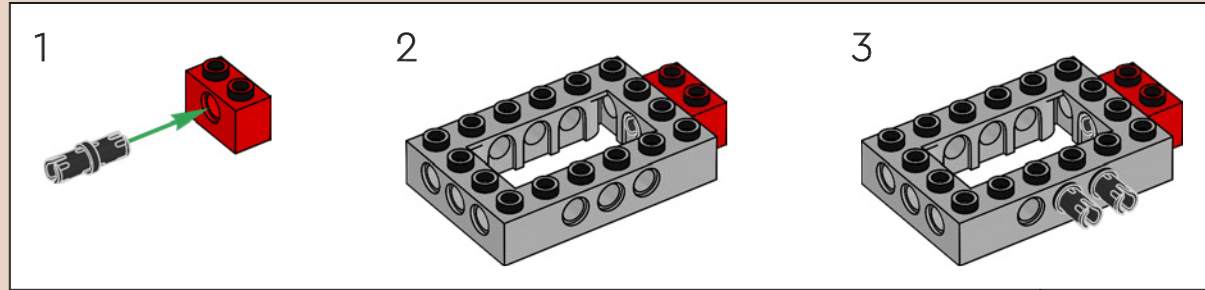

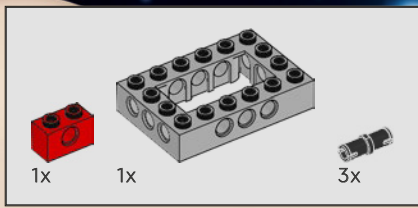

26

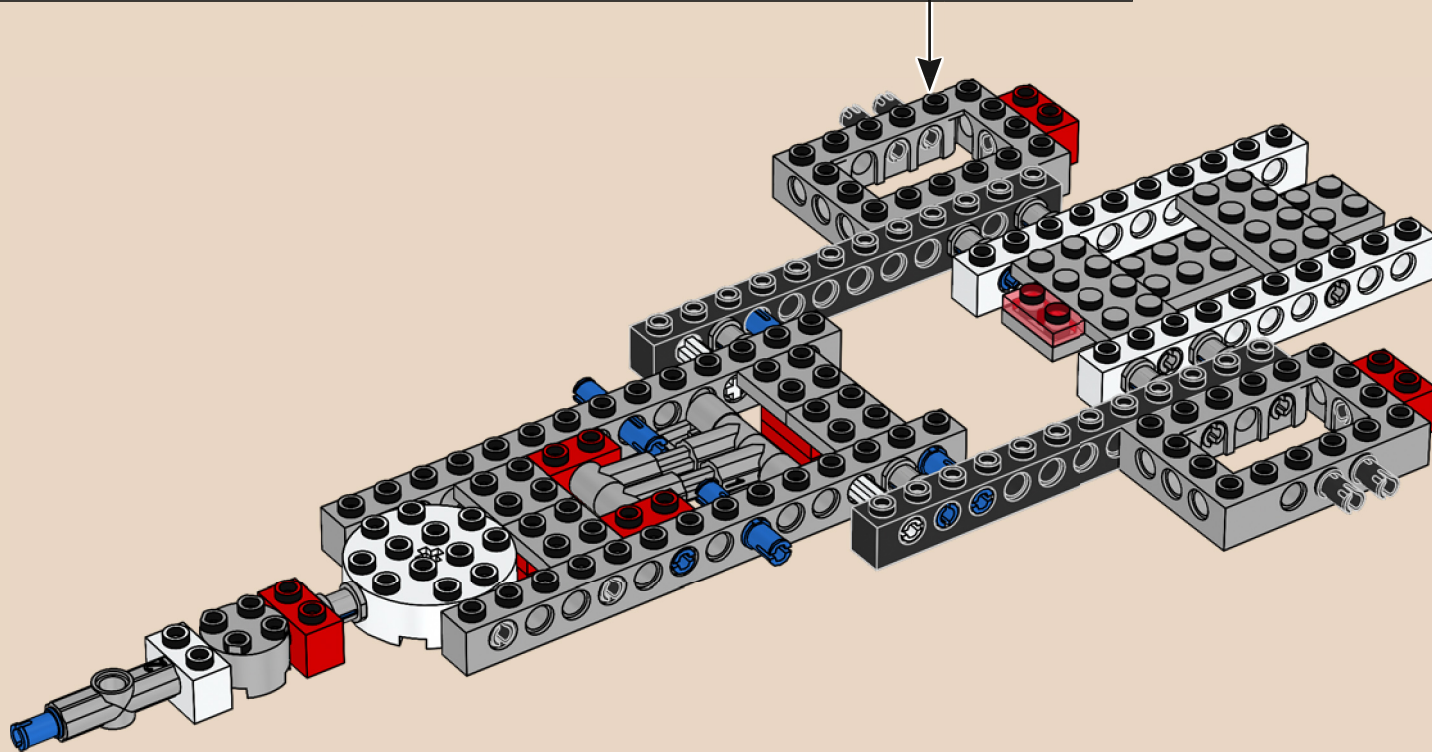
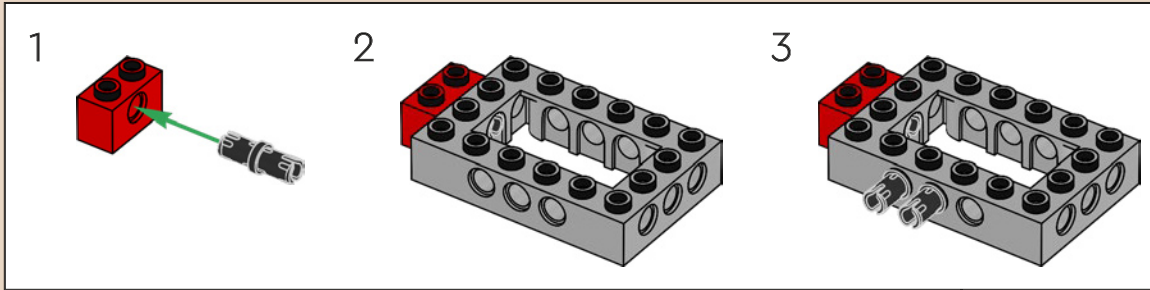

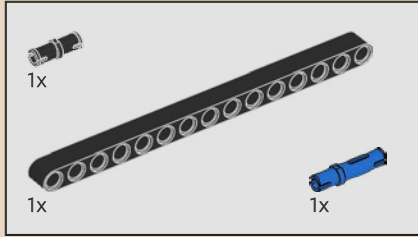
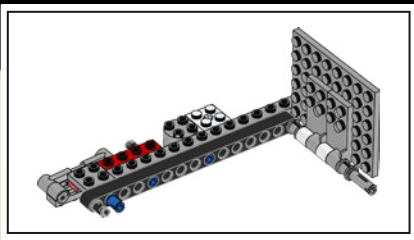

27



28

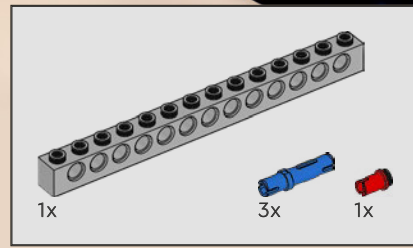
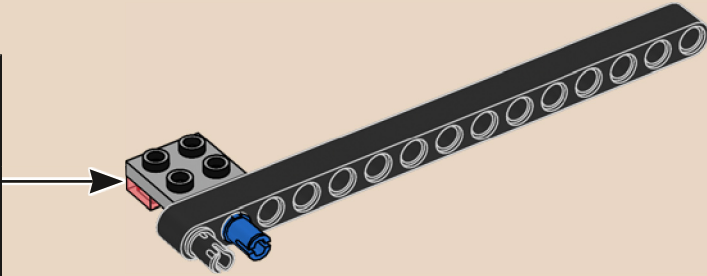
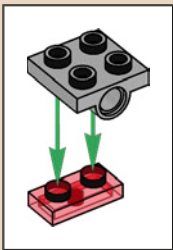

29

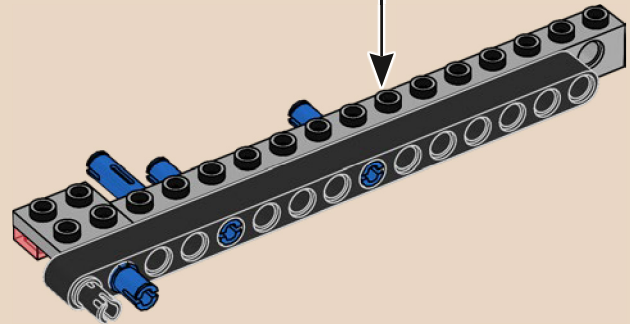
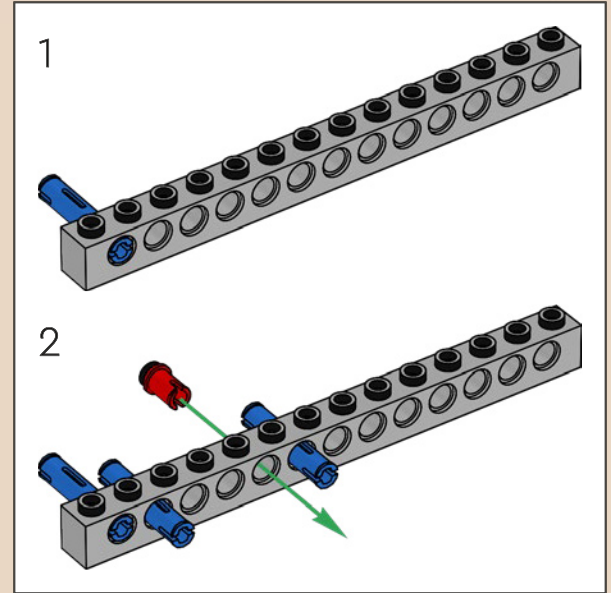





30

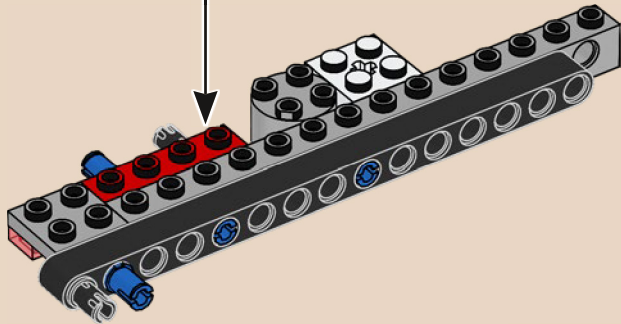
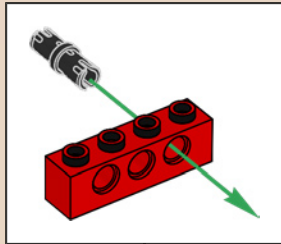

31

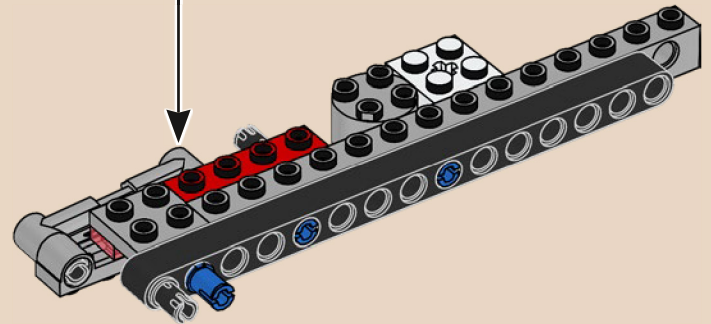
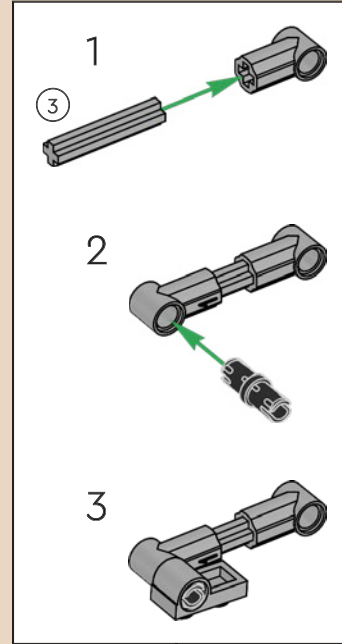
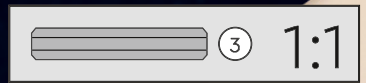

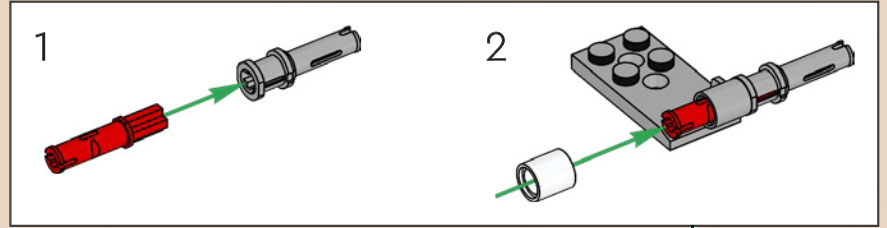
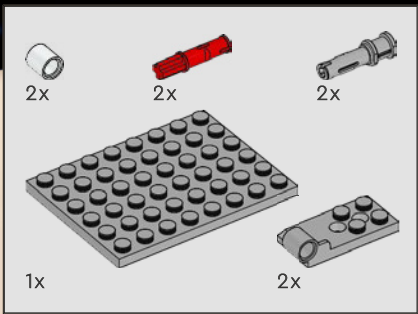

32

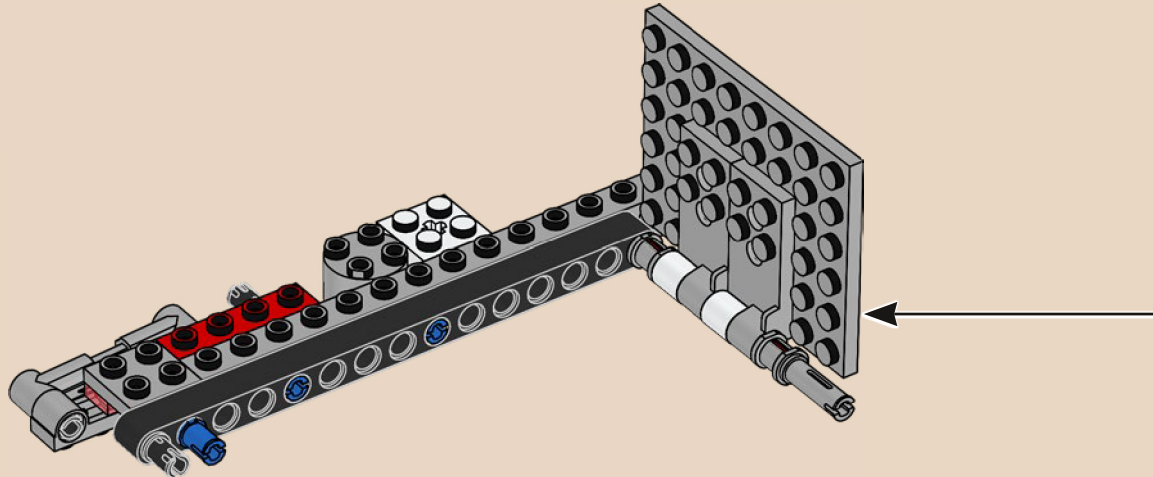
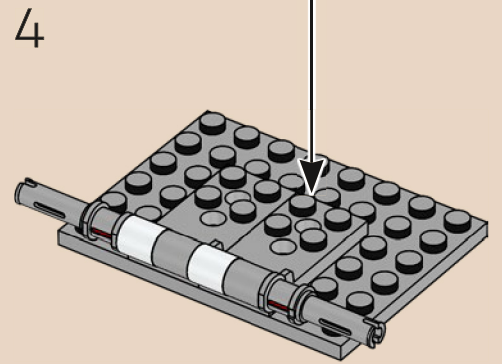
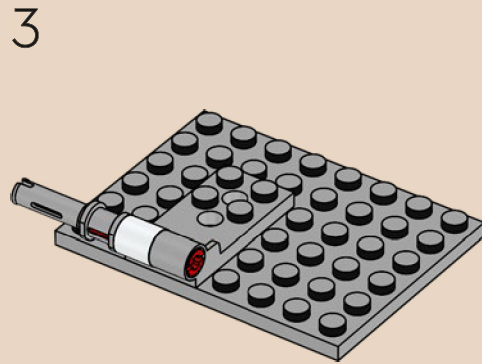
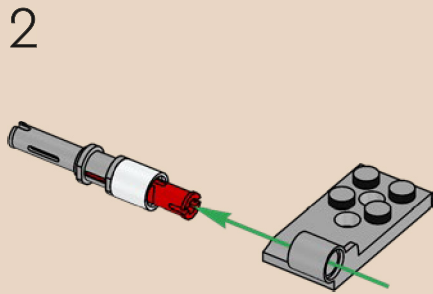
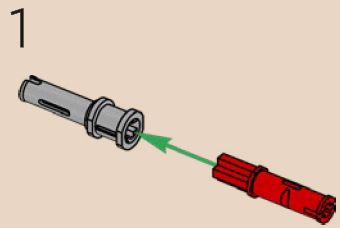

33

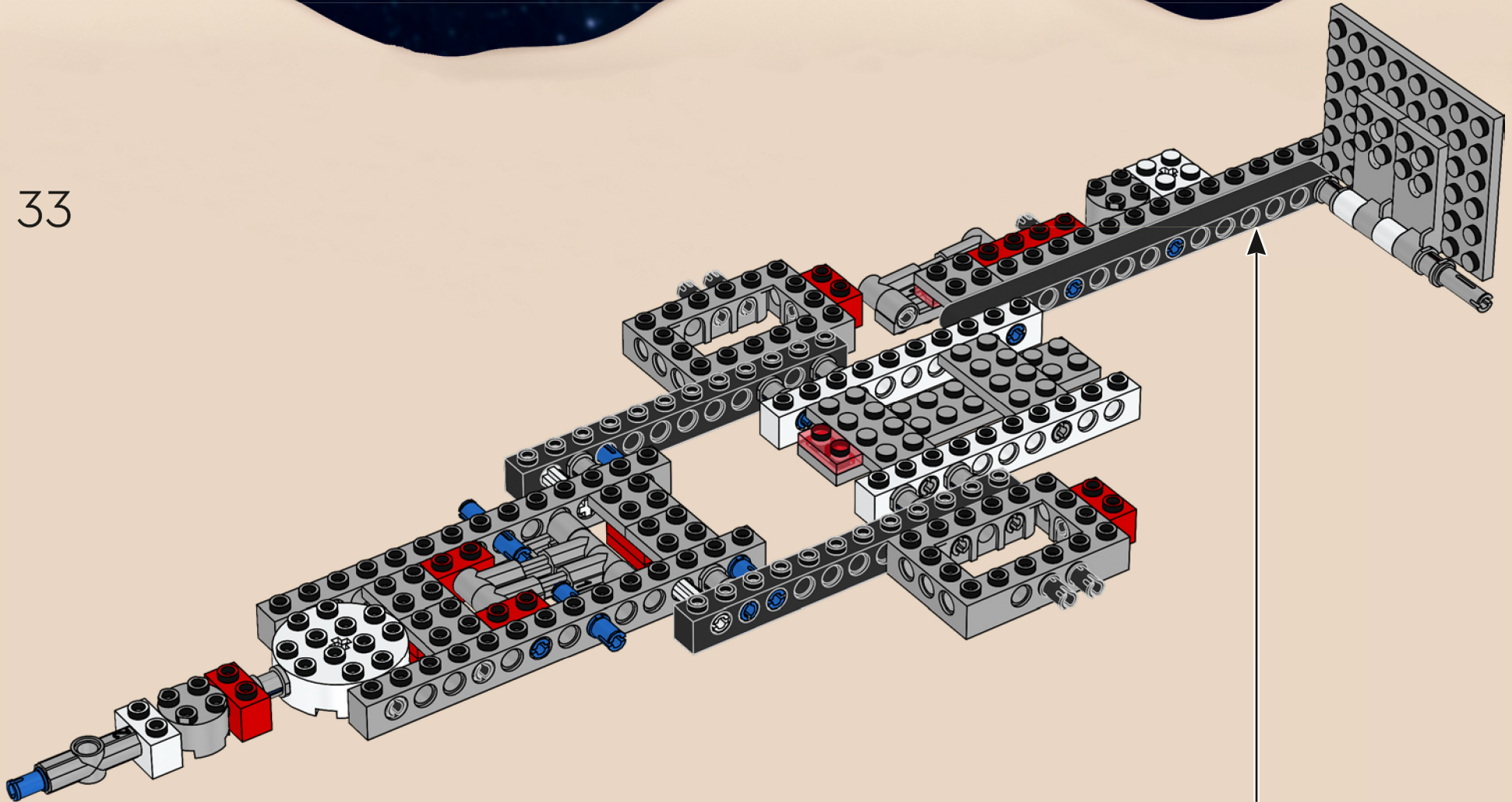

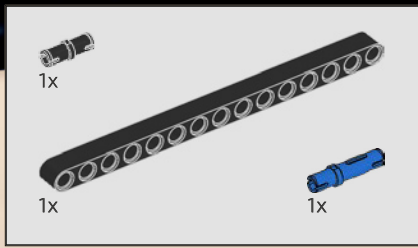

34

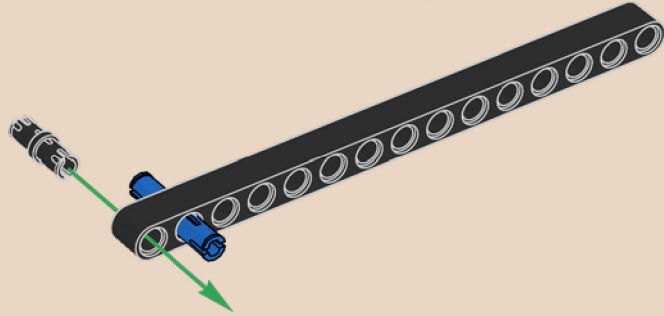

35

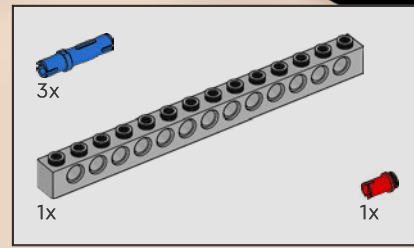
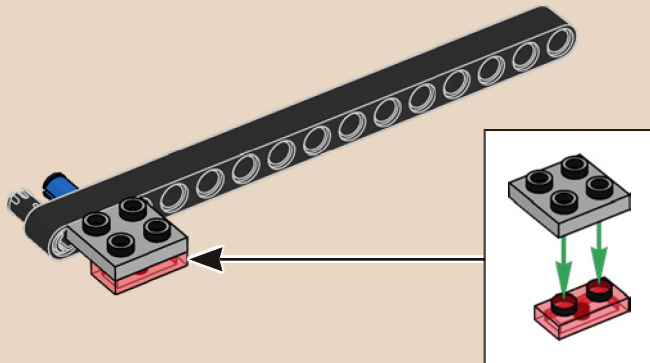

36

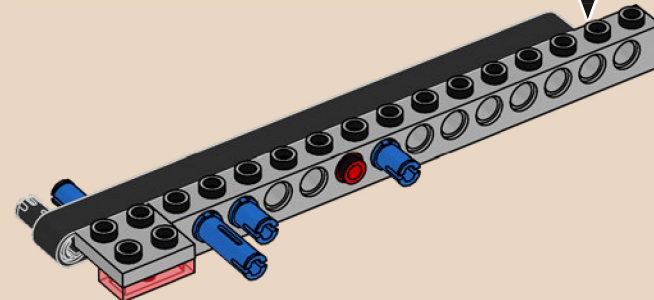
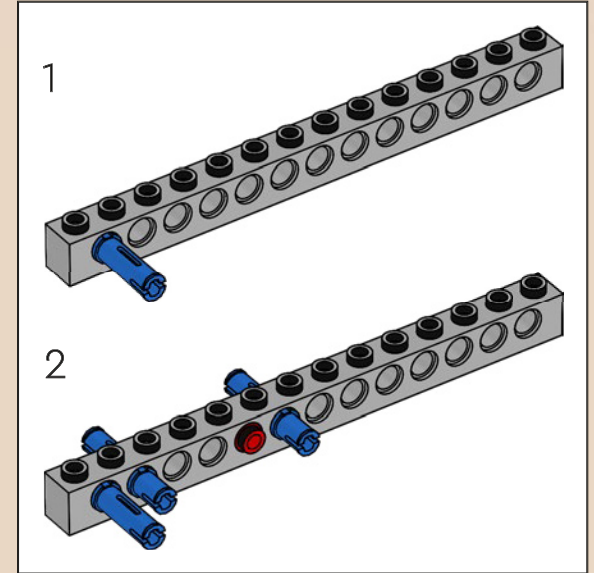

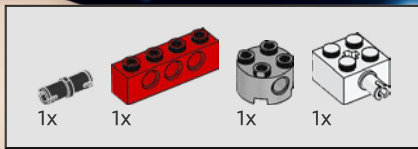

37

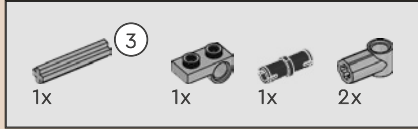
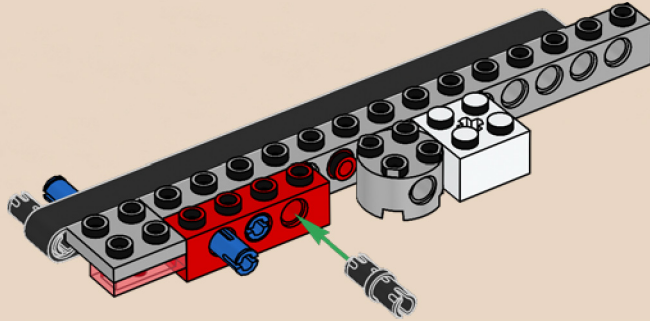

38

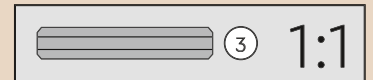
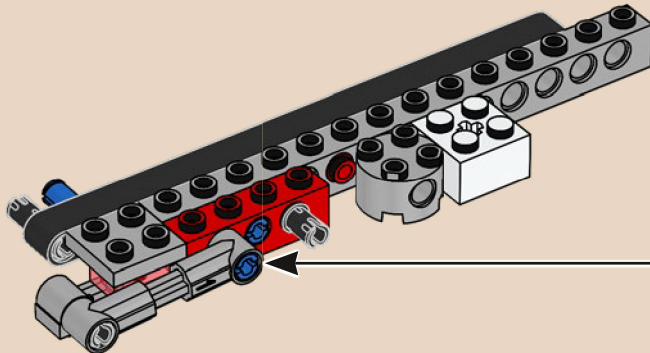
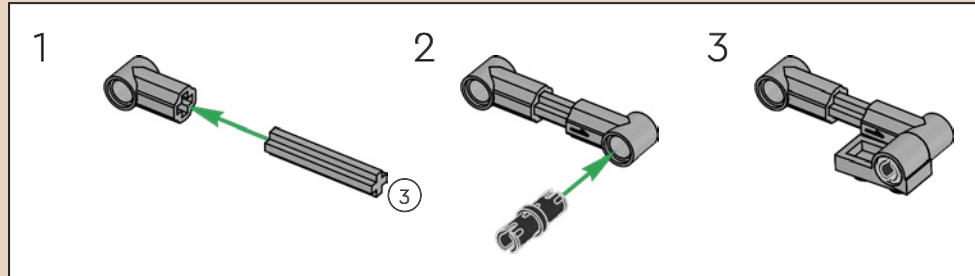

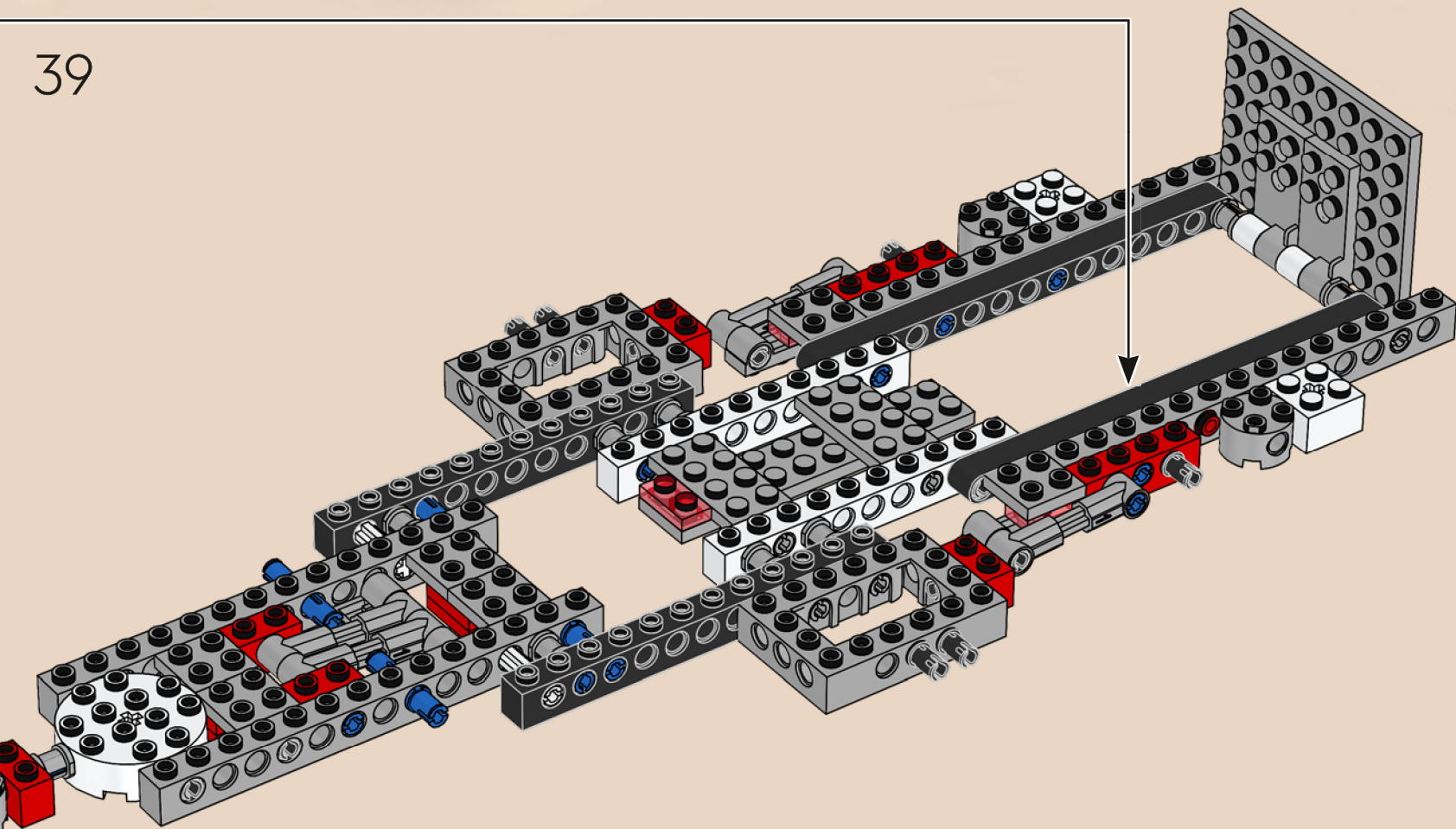

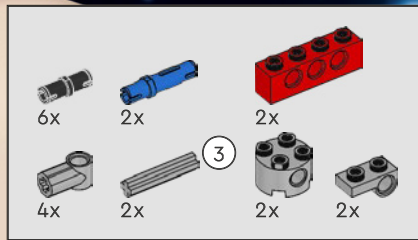

40

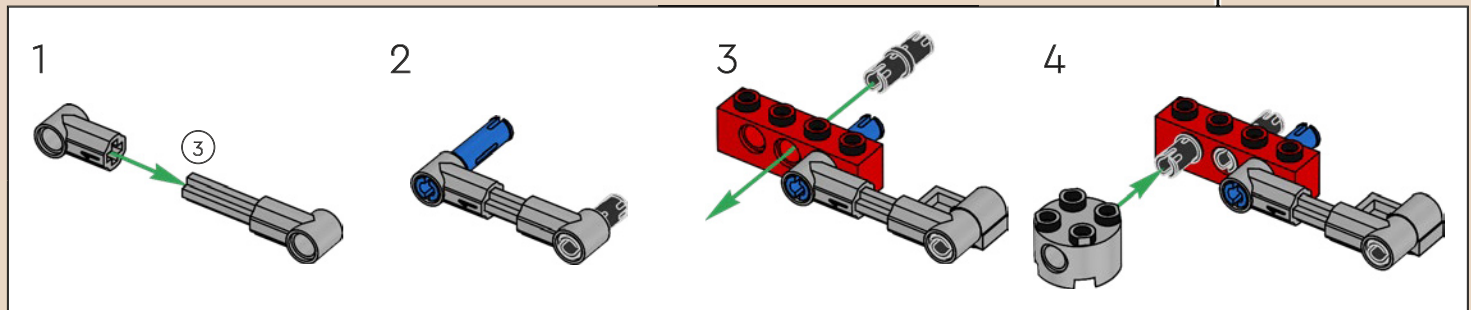
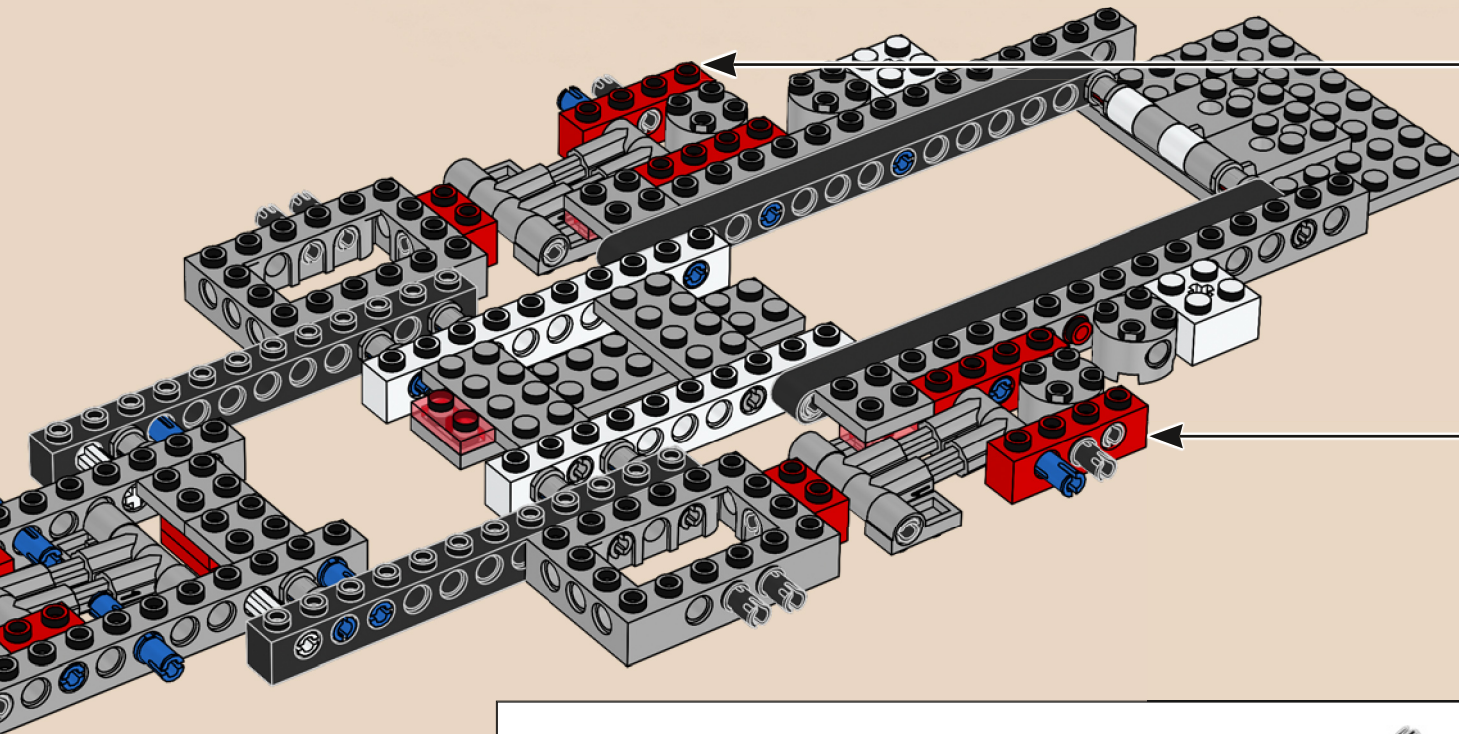
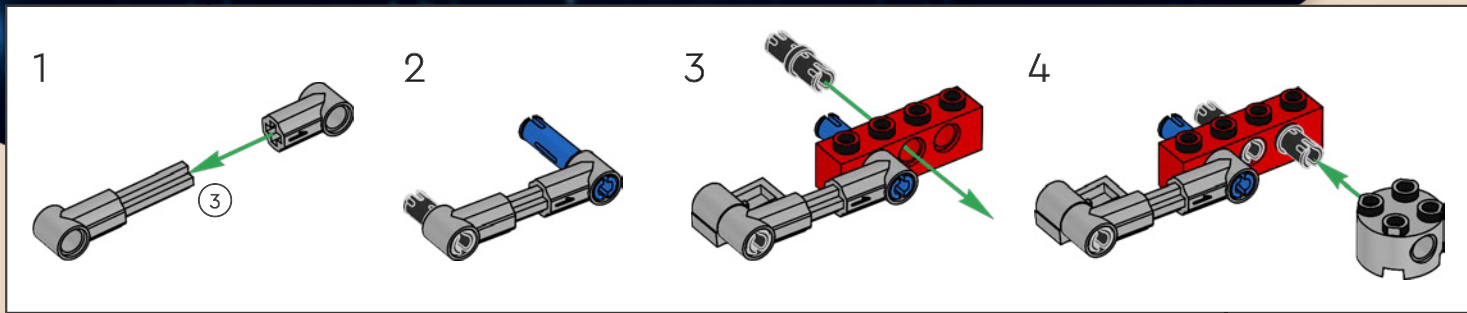

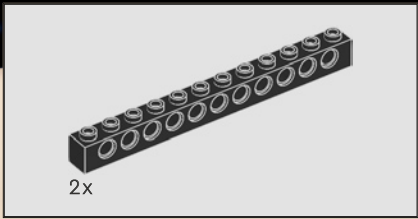

41

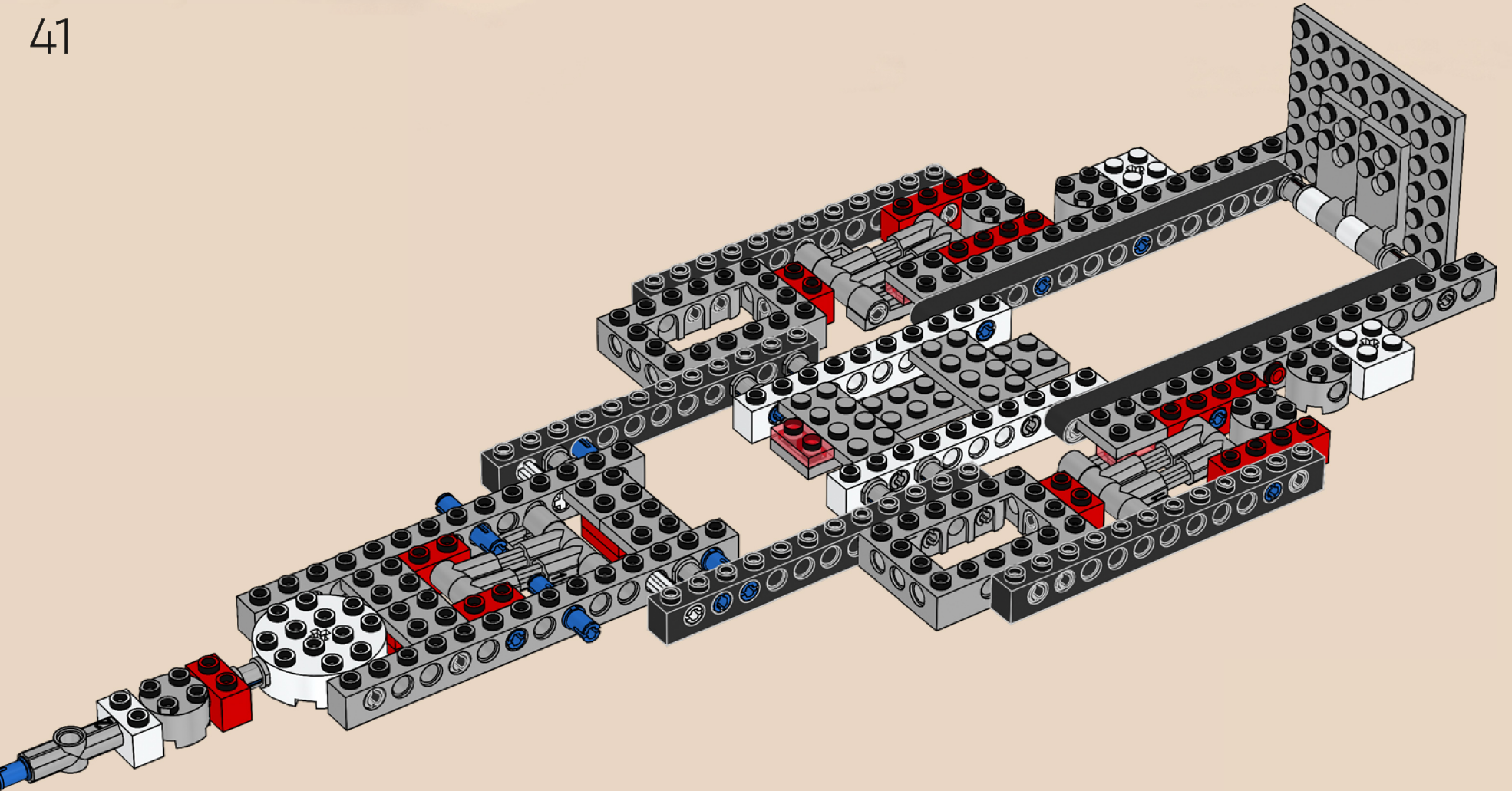



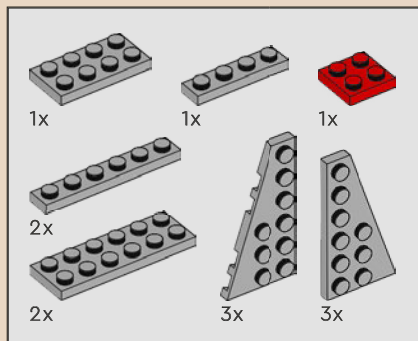

42

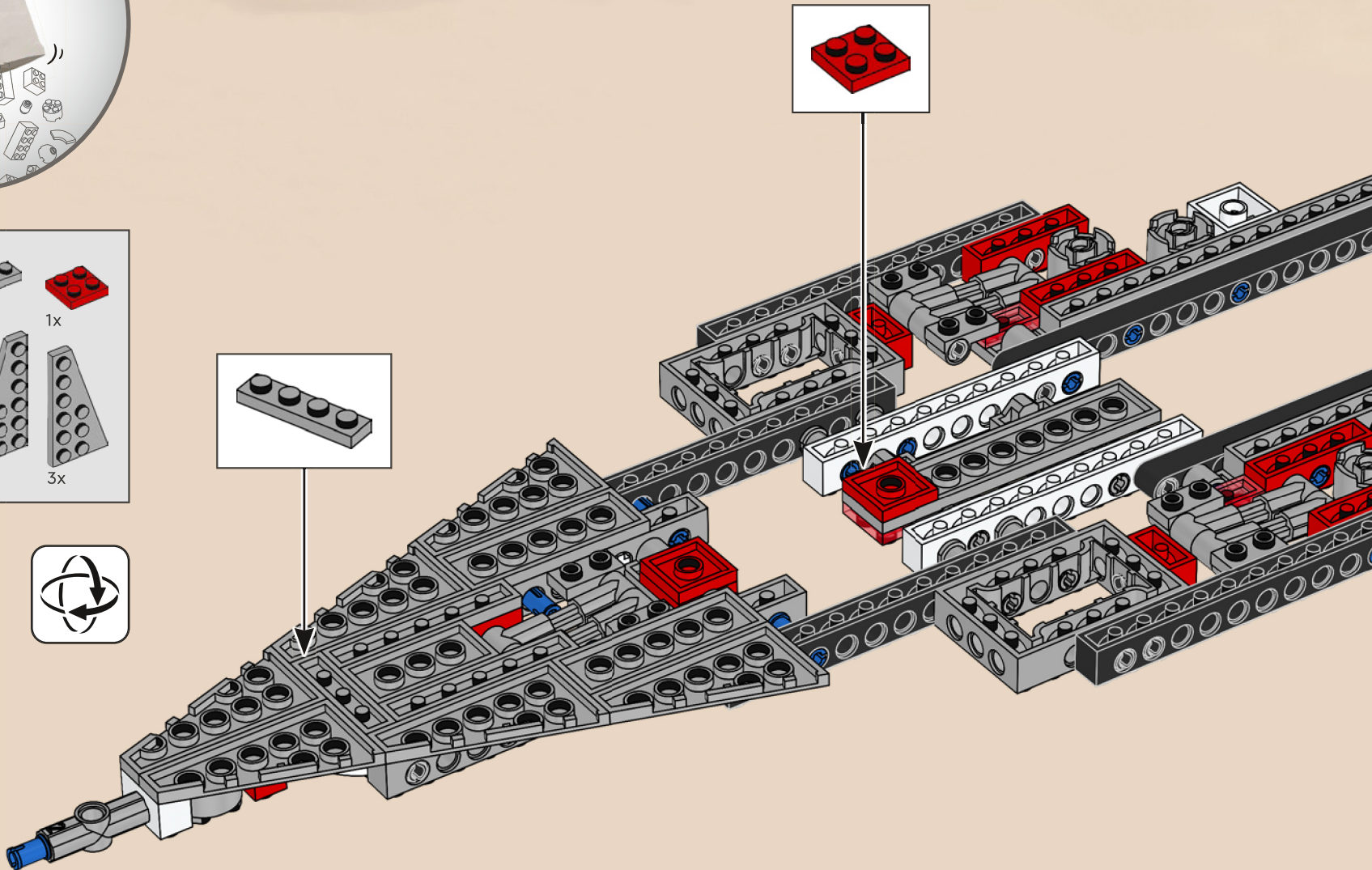

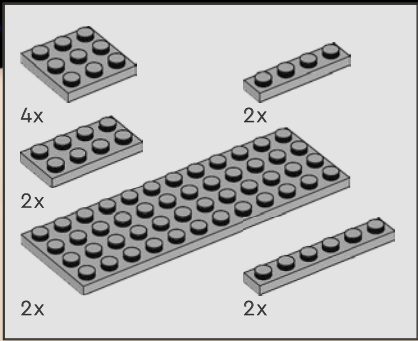

43

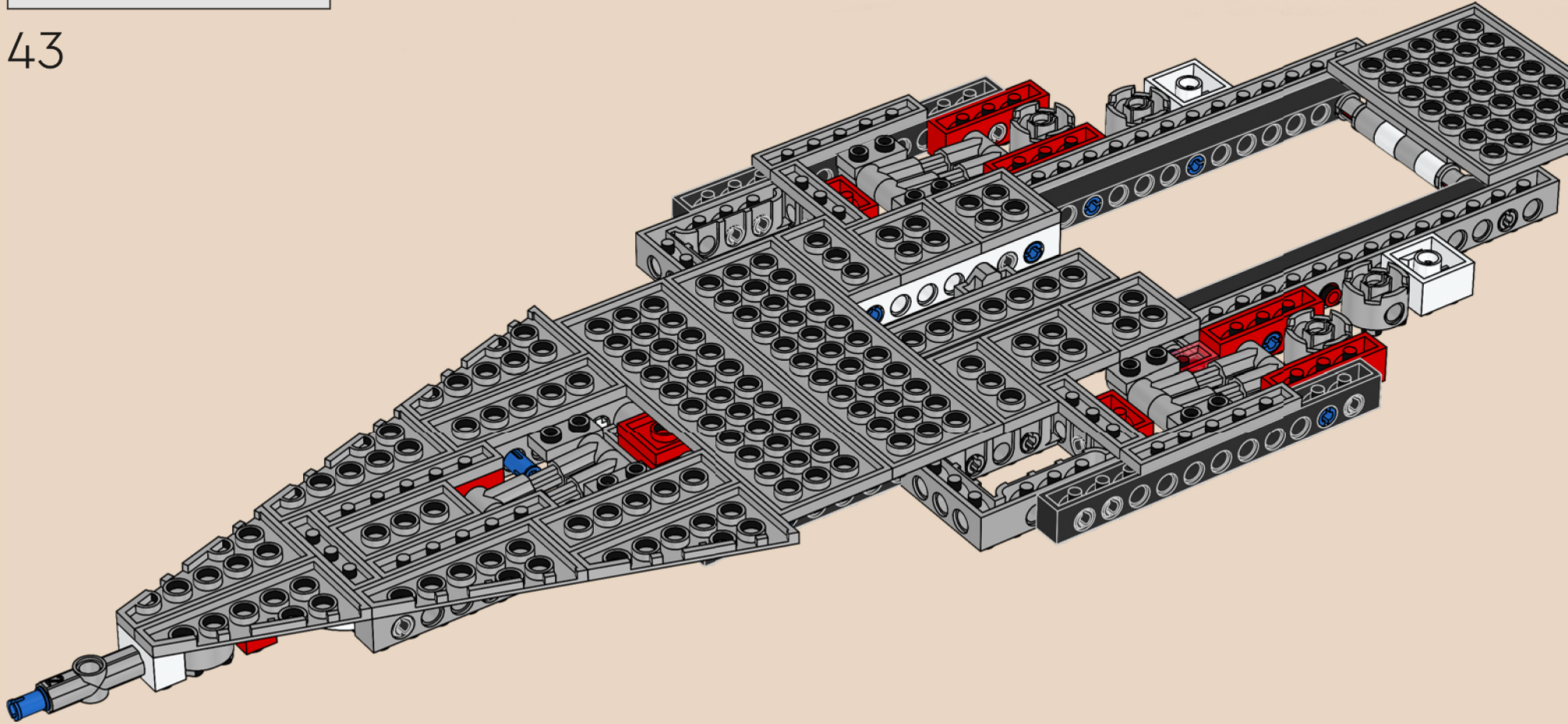

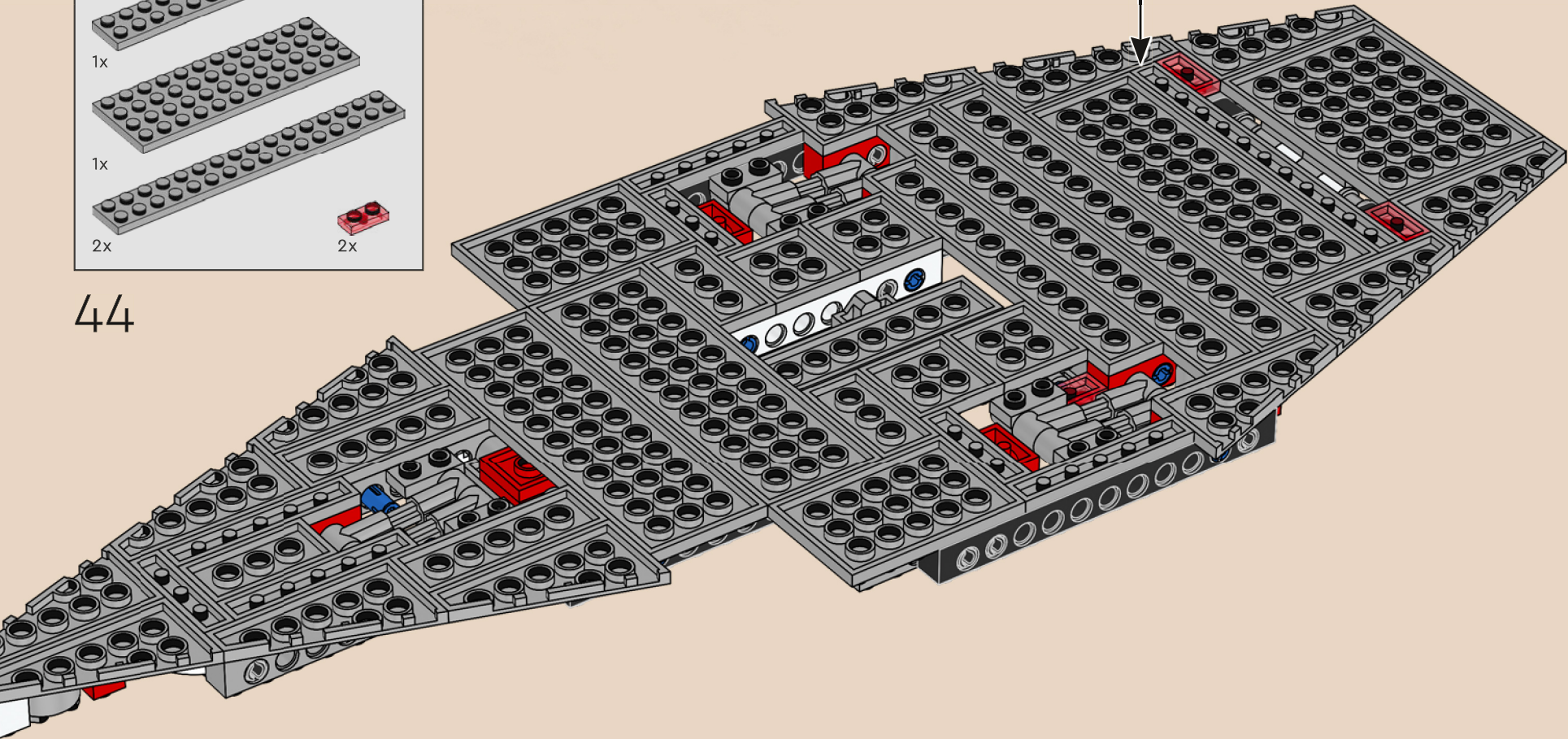
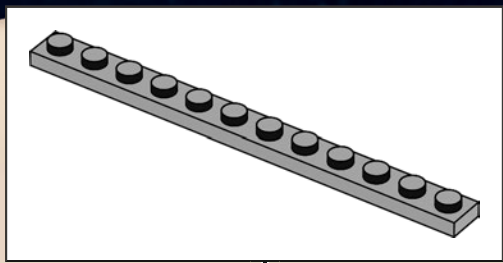
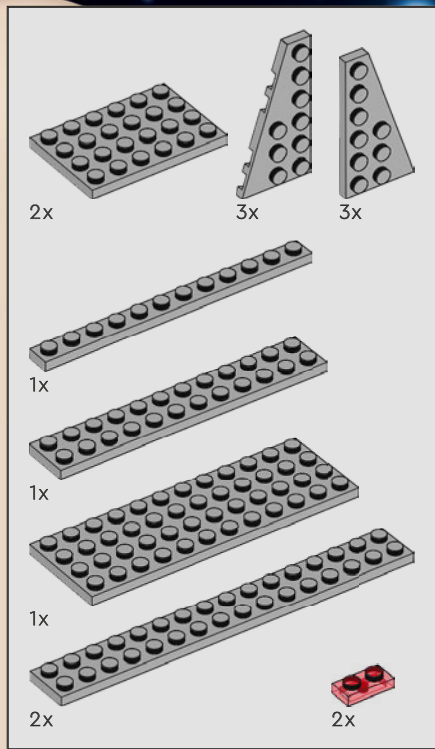

44

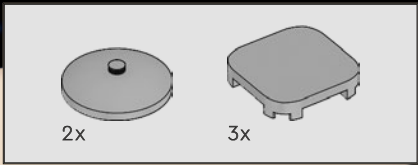

45

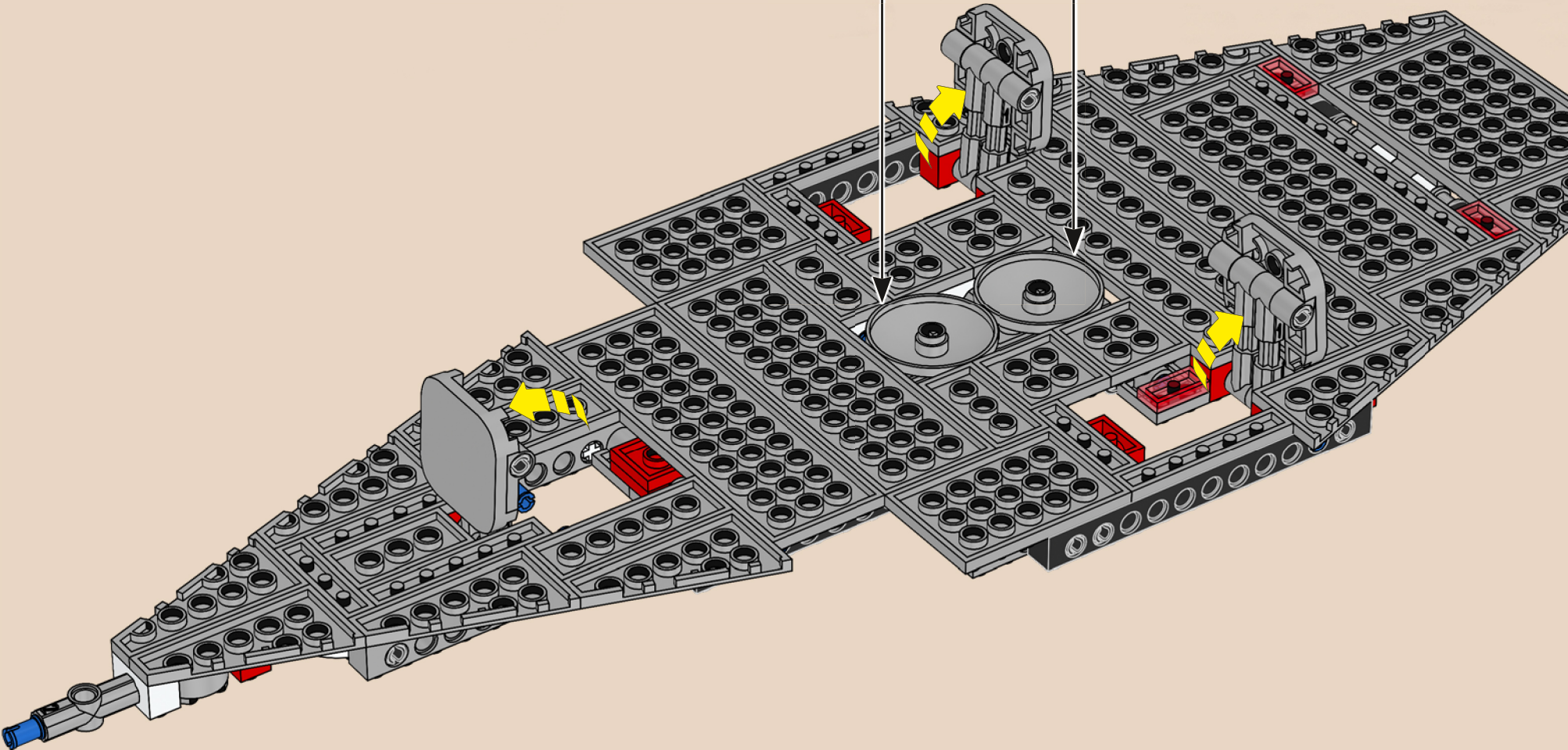
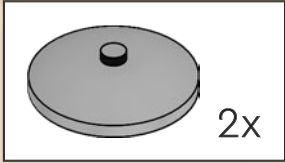

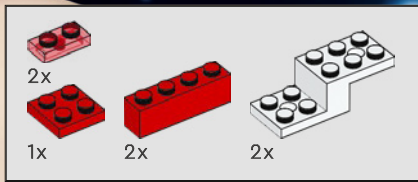

46

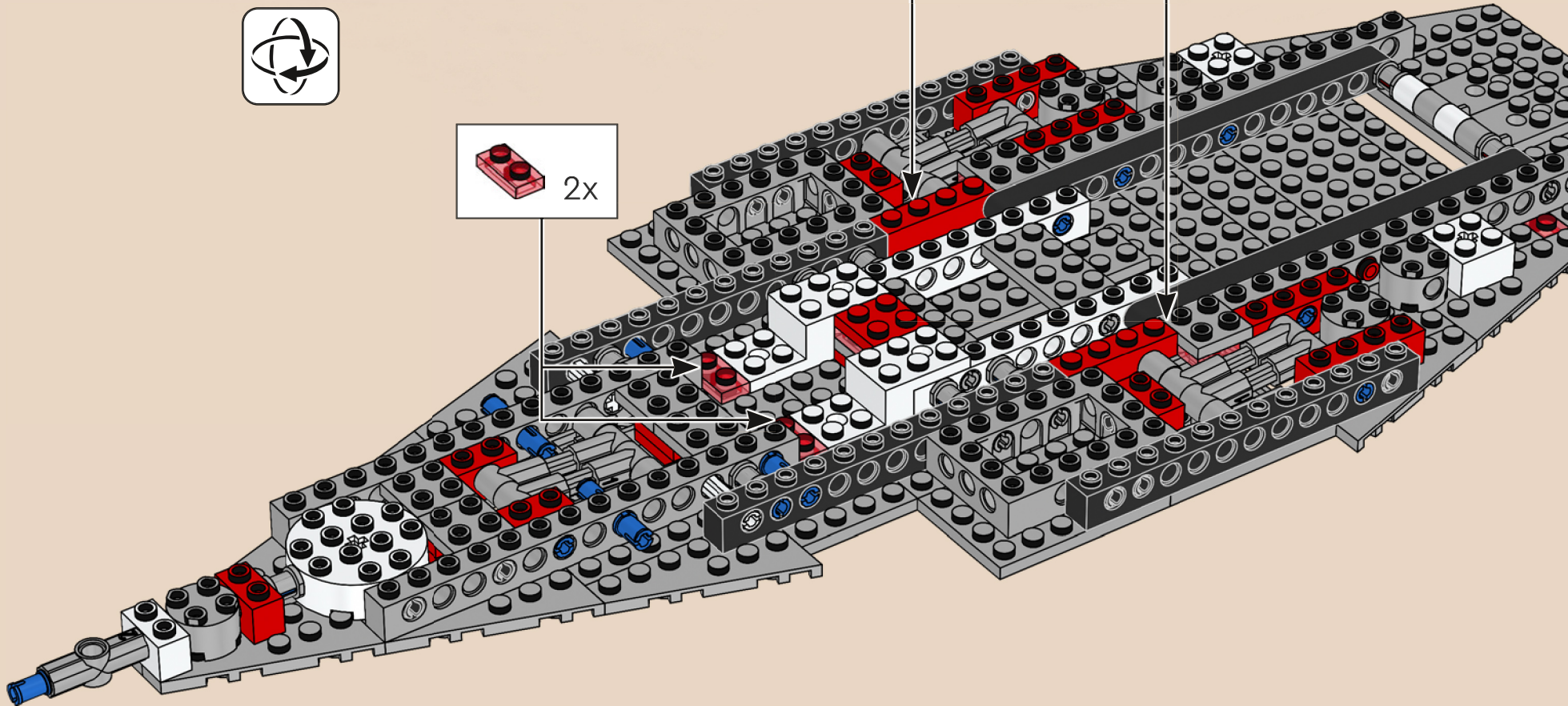
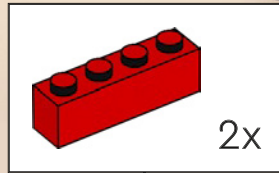

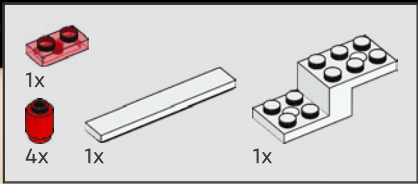

47

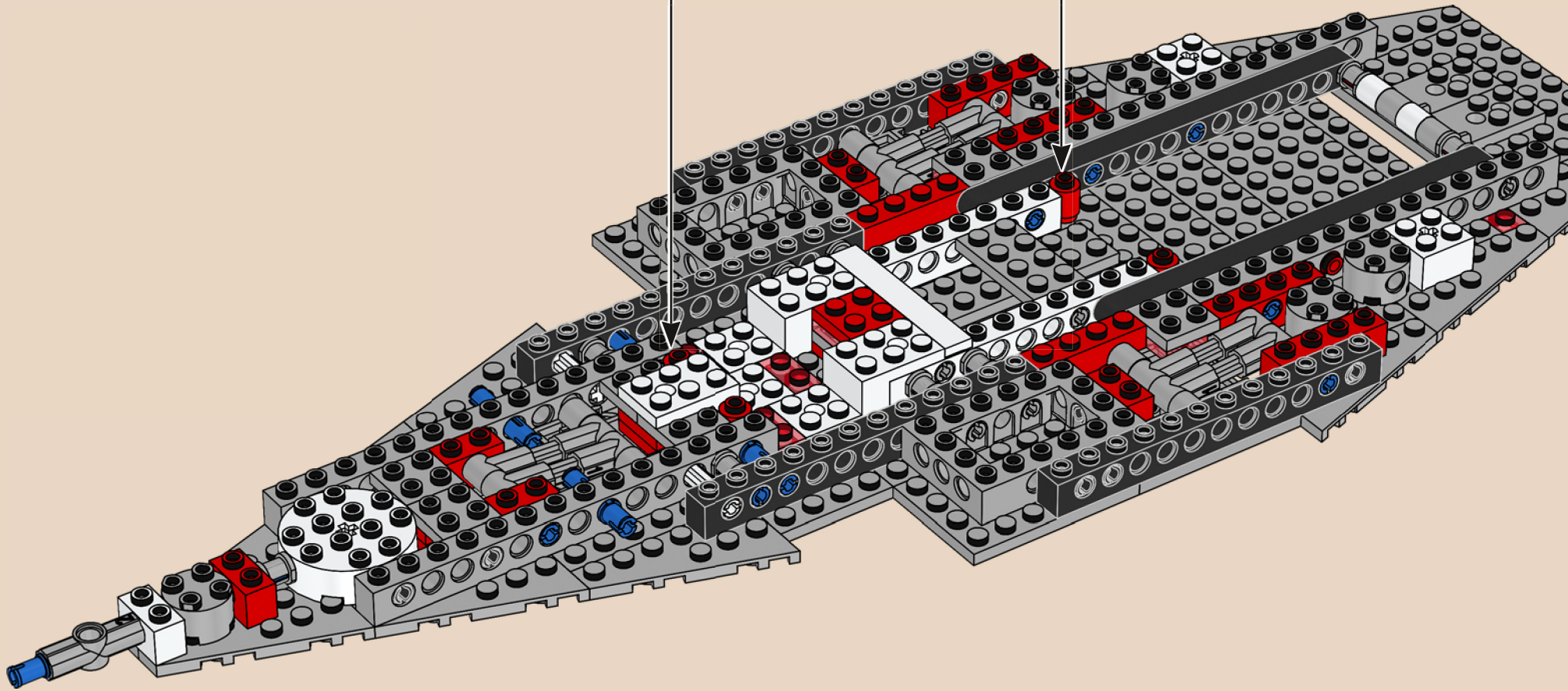

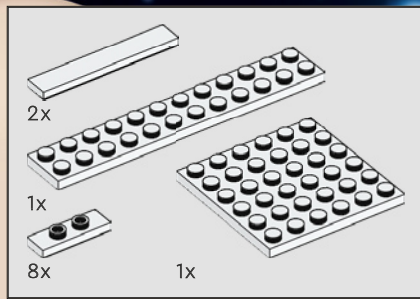

48

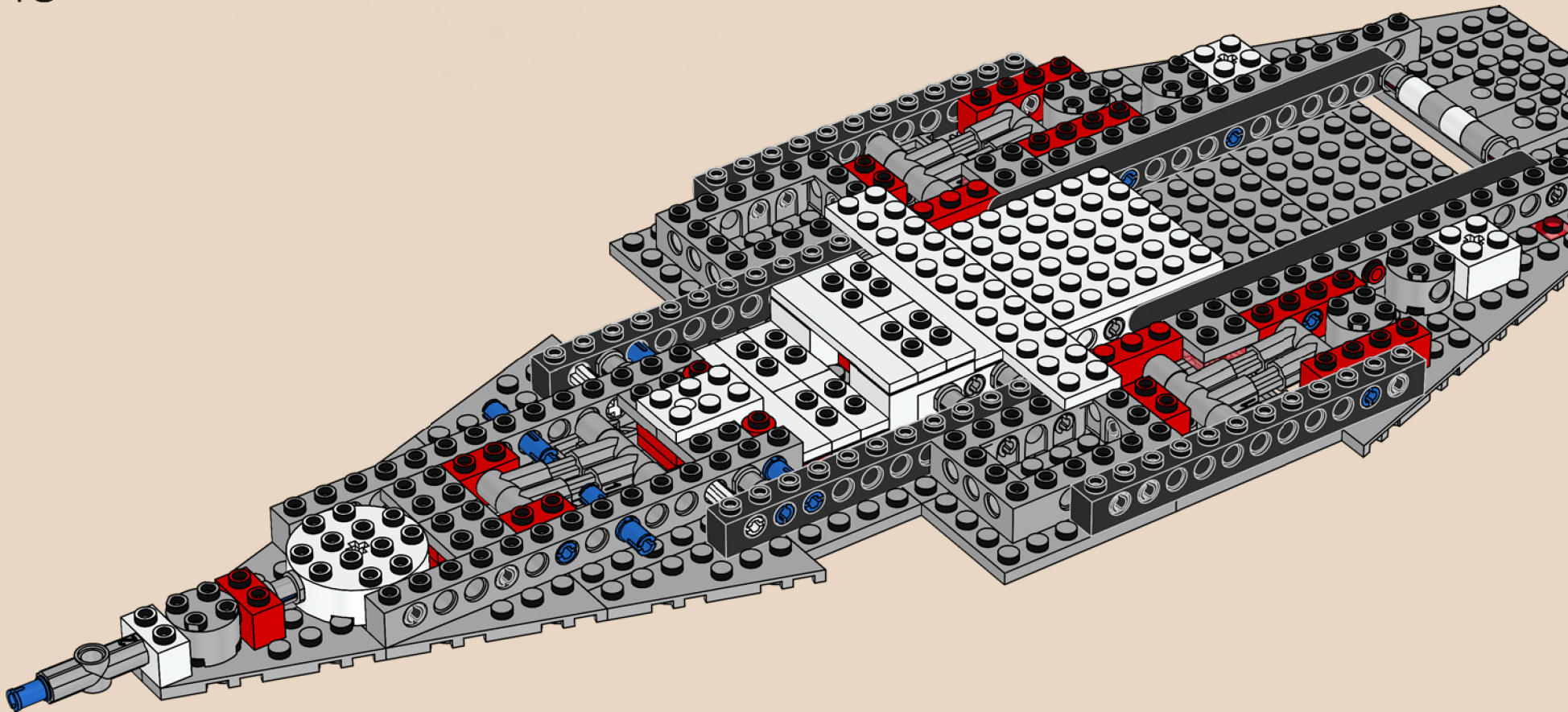



49

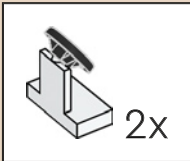
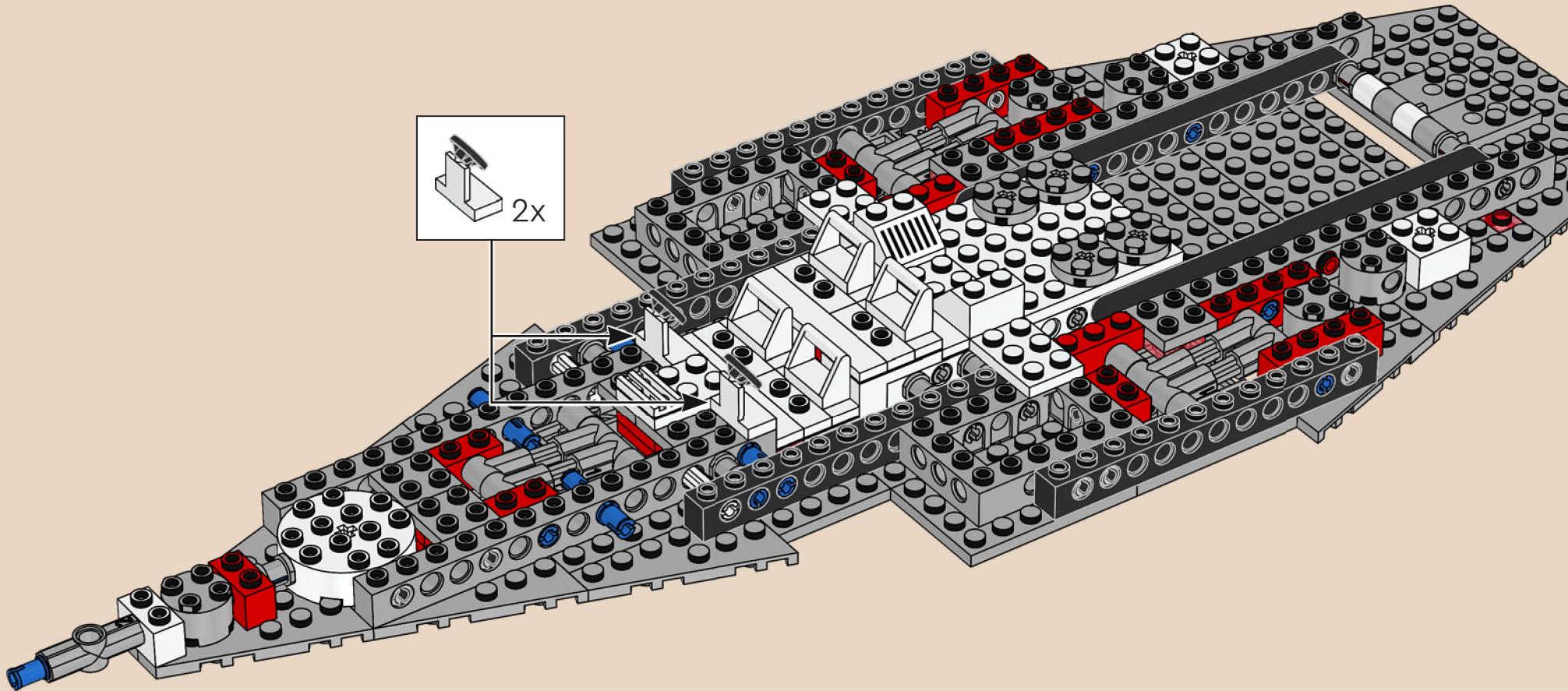

停用多年的白色呼吸器于 2019 年重新启用。



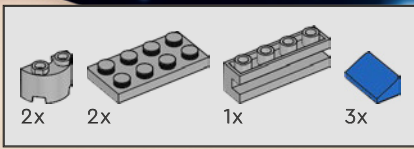

50

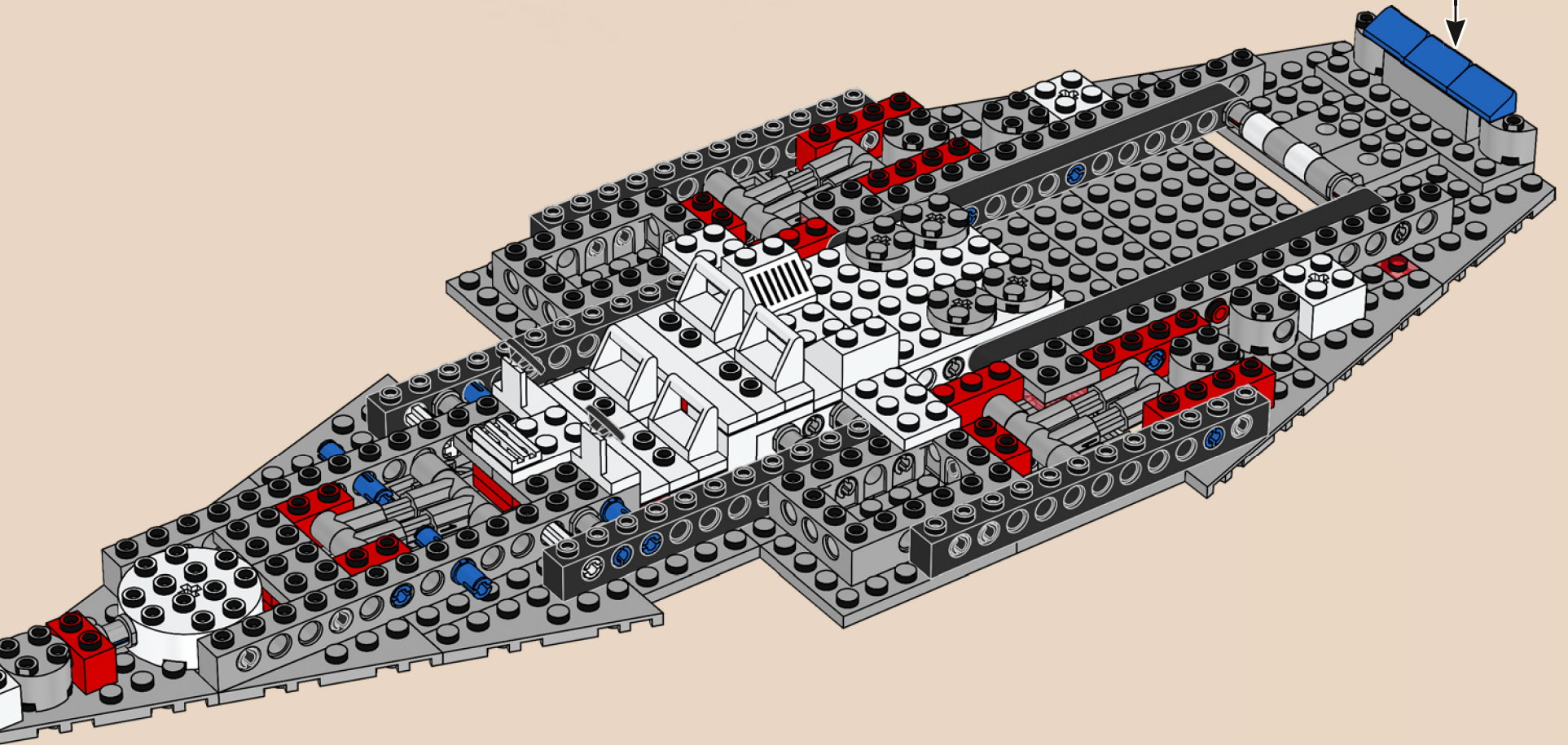
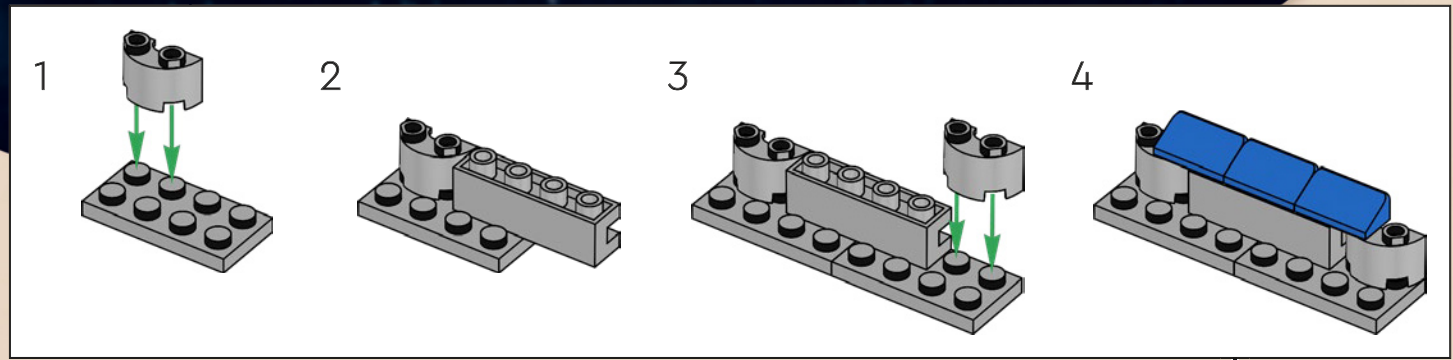

4x 2x 2x

4x

51

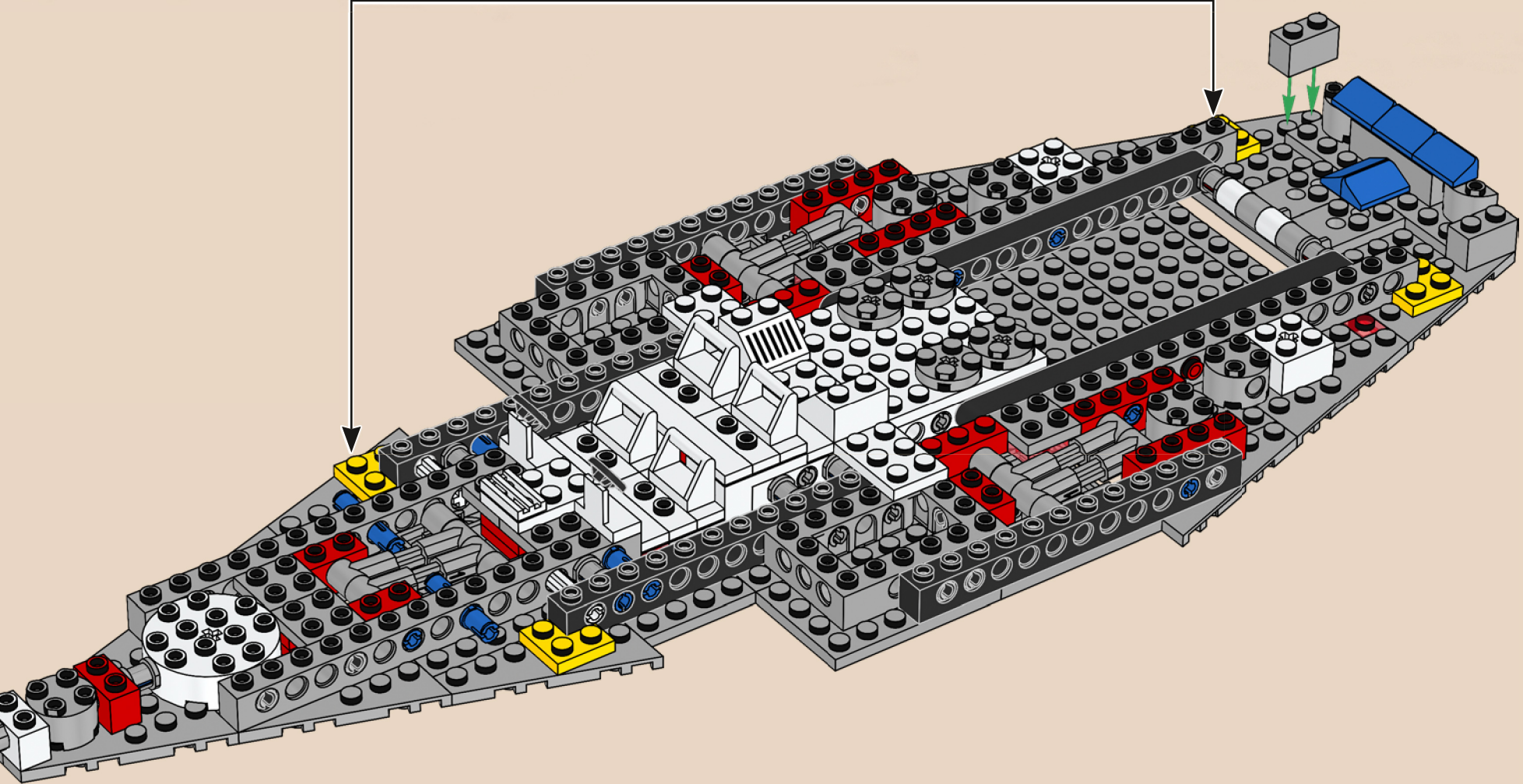

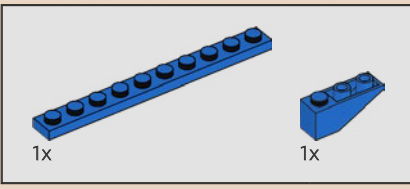
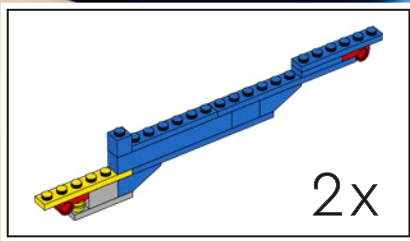

52

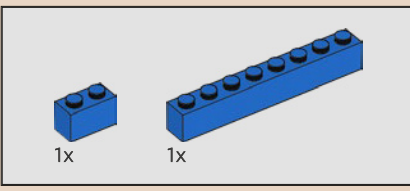
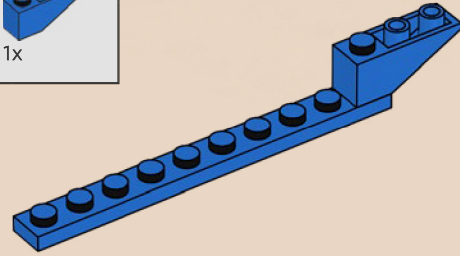

53

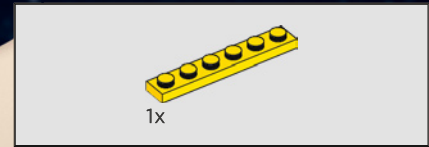
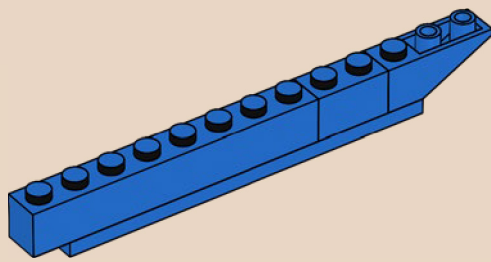

54

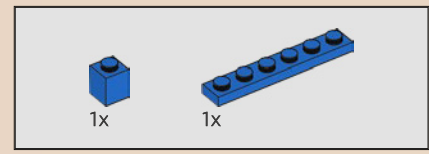
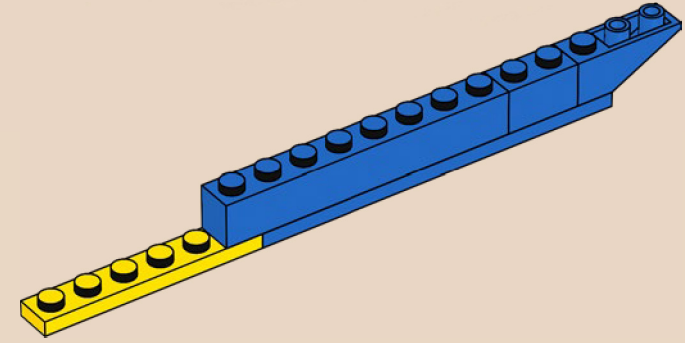

55

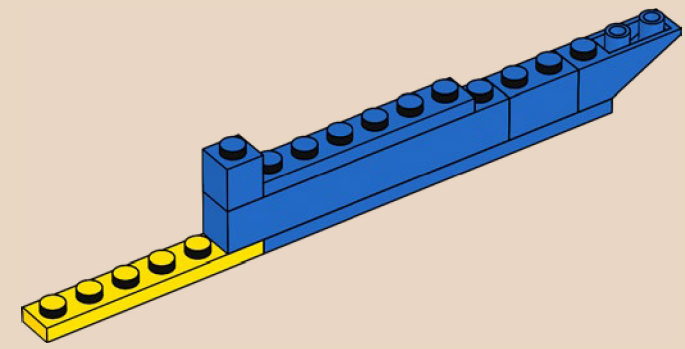

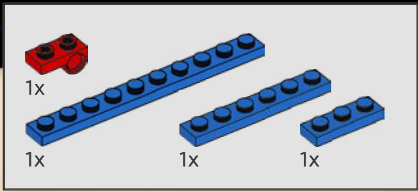

56

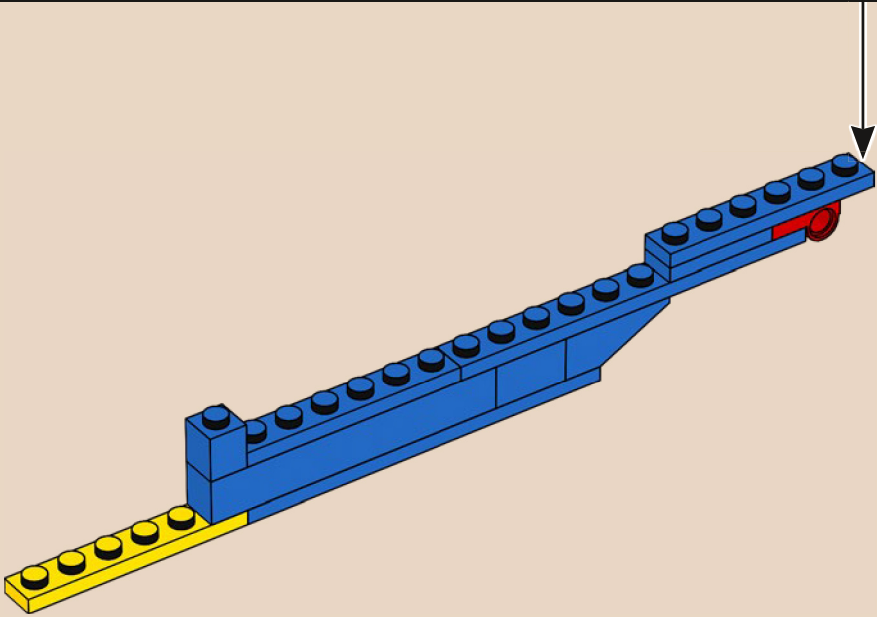
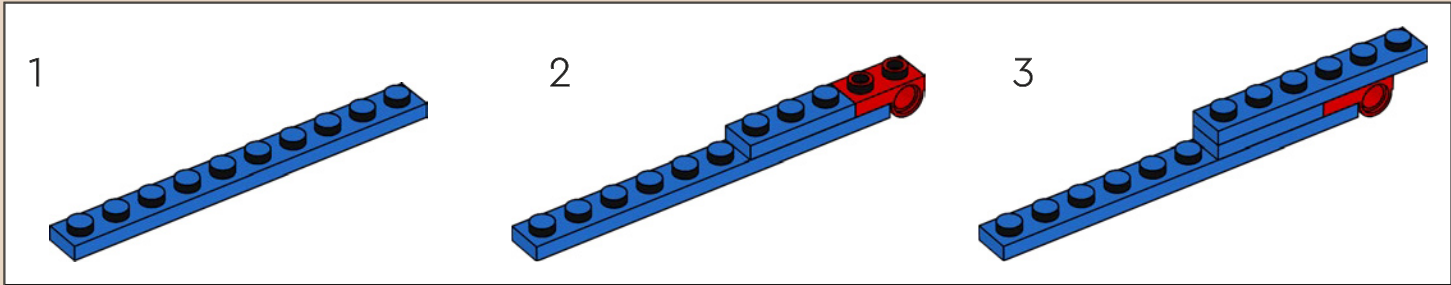



57

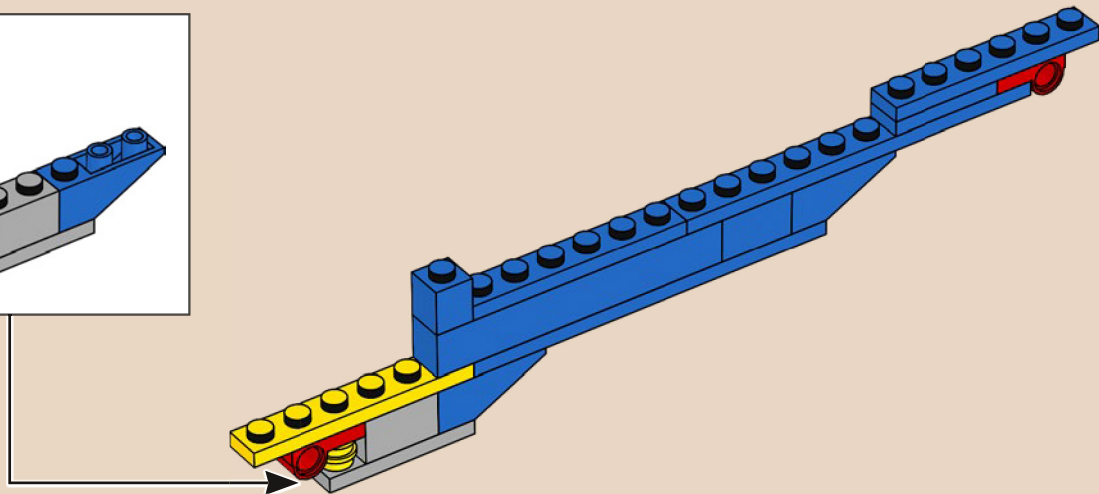
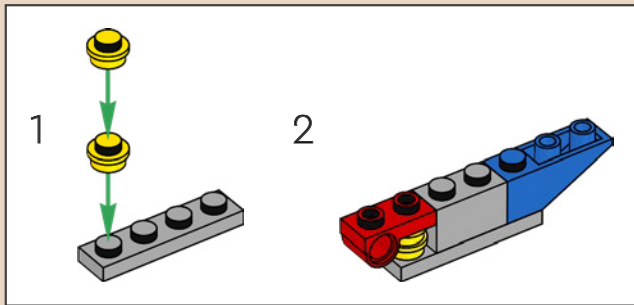

2x

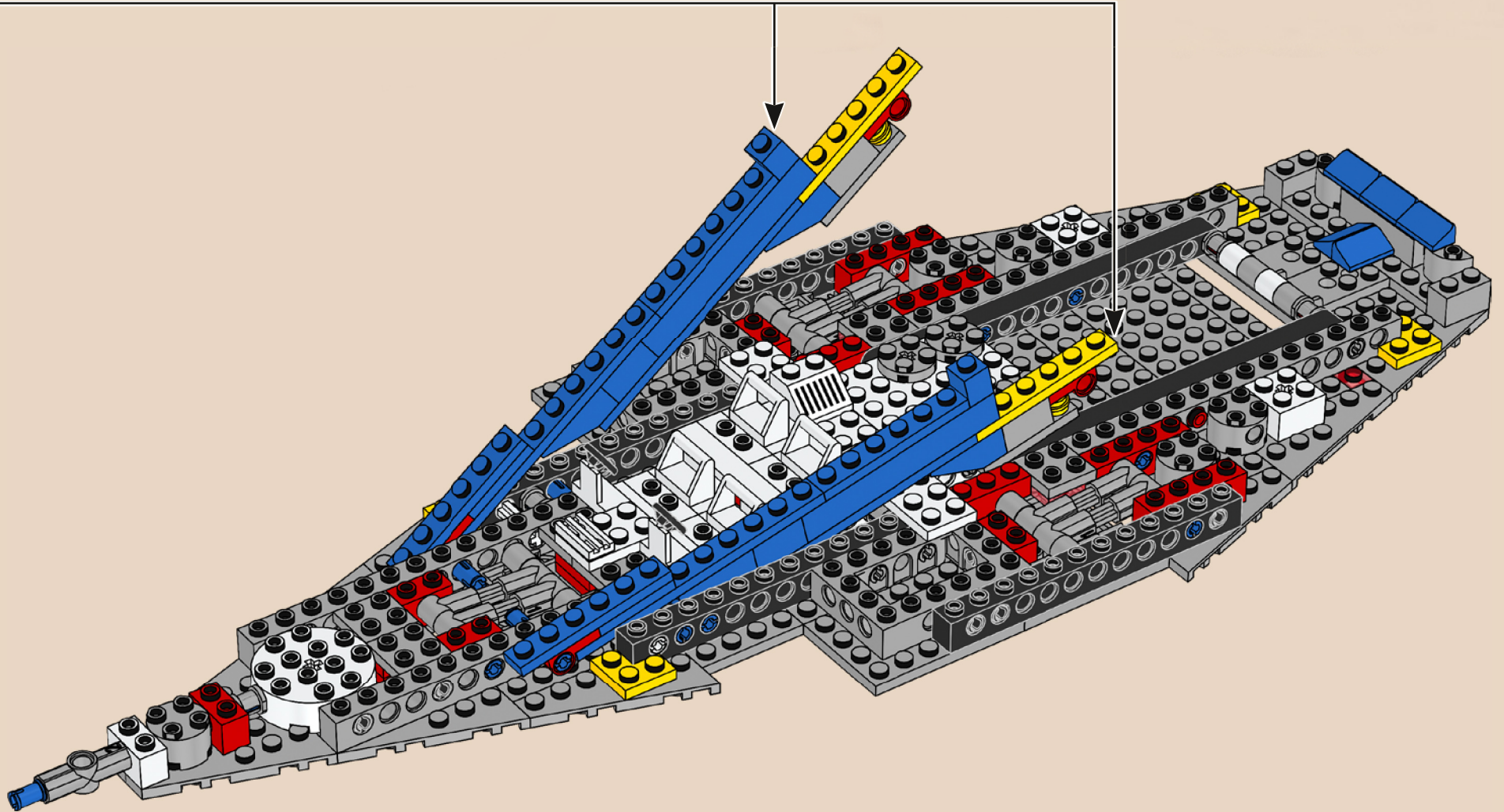



59

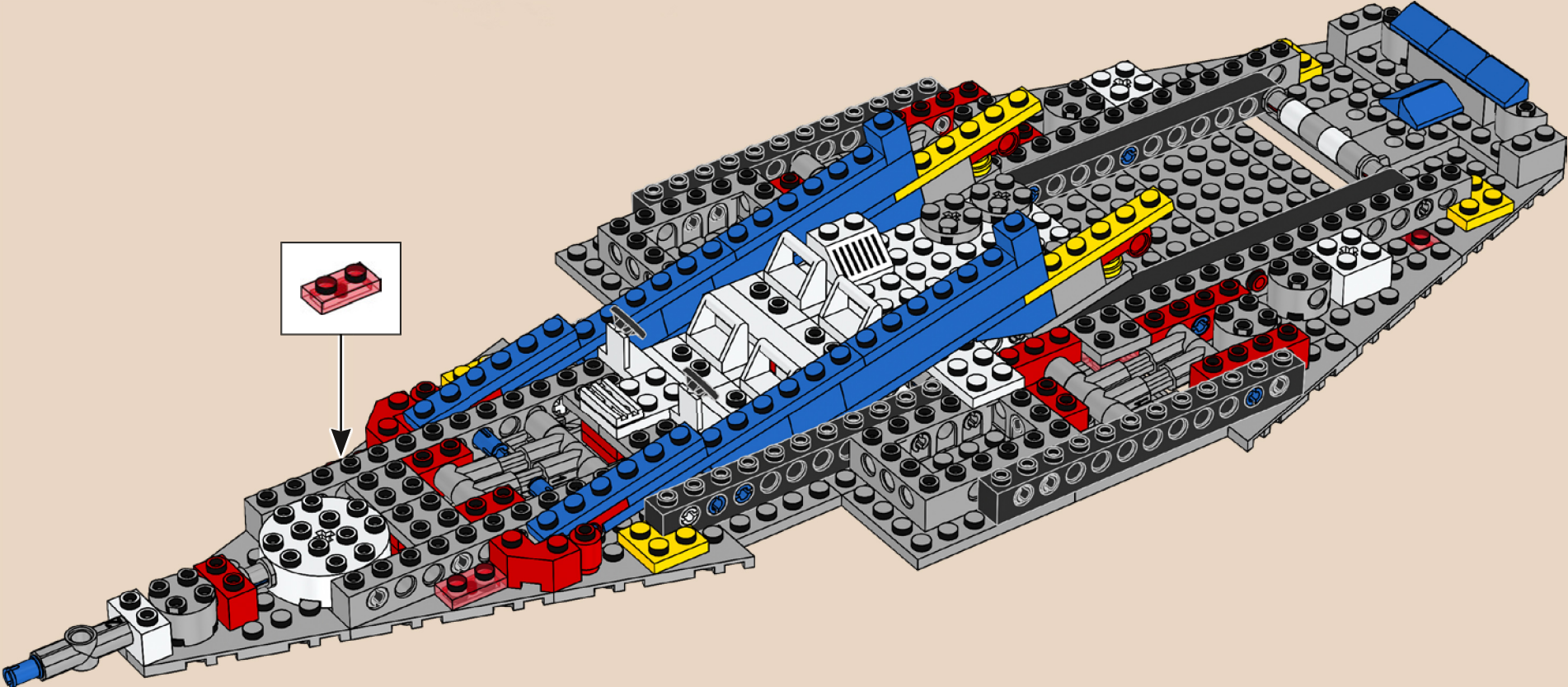

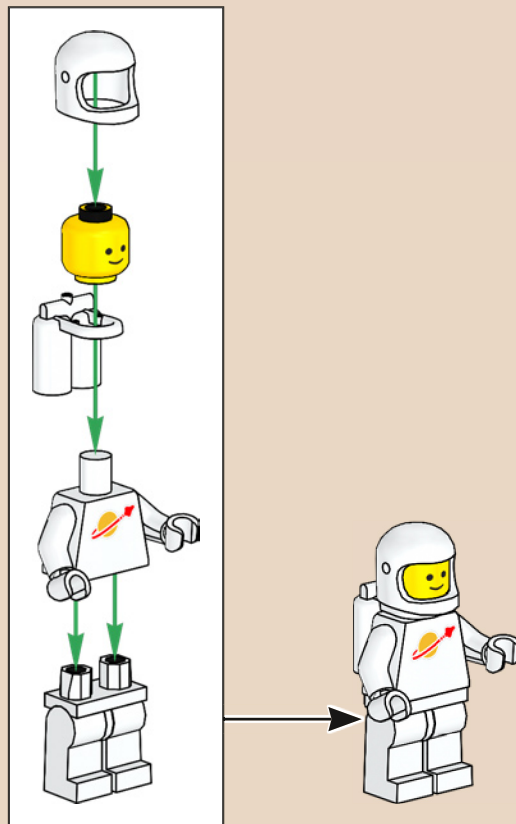

此模型包含与原始模型相同的4名宇航员，  
只是他们的头盔经过了轻微的修改，现在带  
有弹性更强的下巴带！



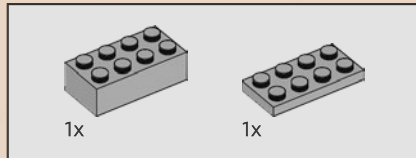
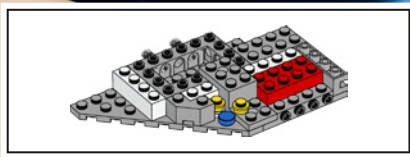

60

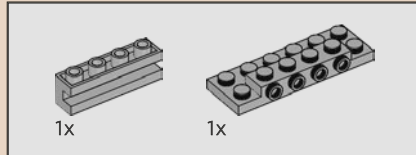
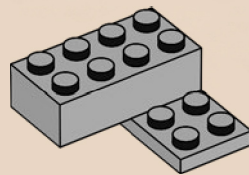

61

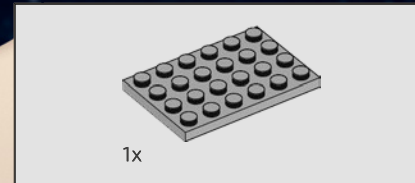
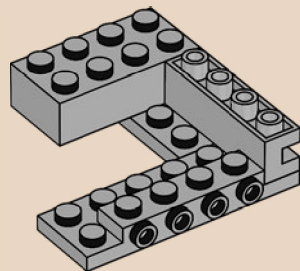

62

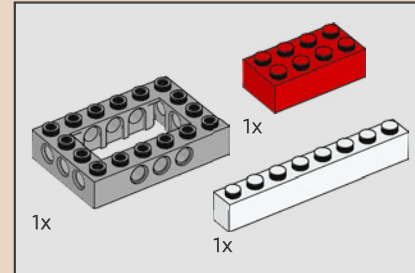
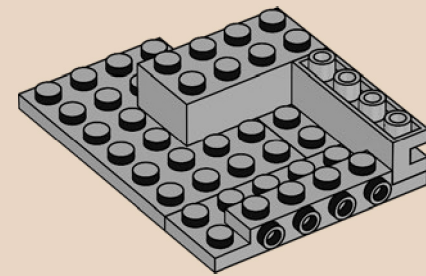

63

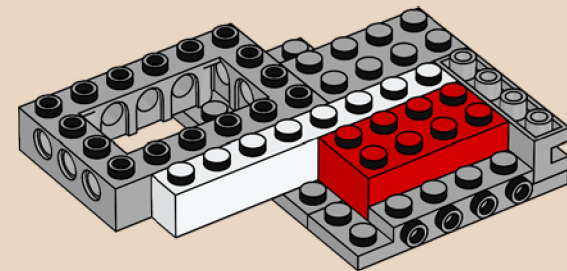

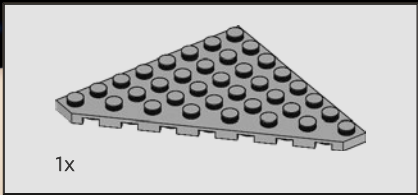

64

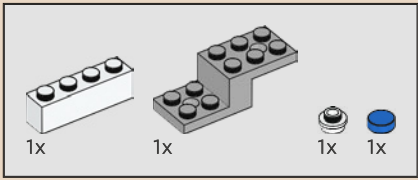
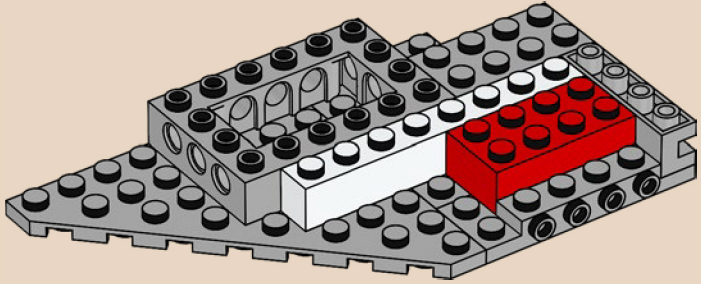

65

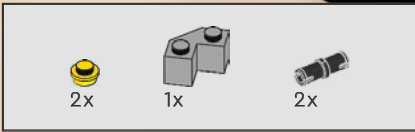
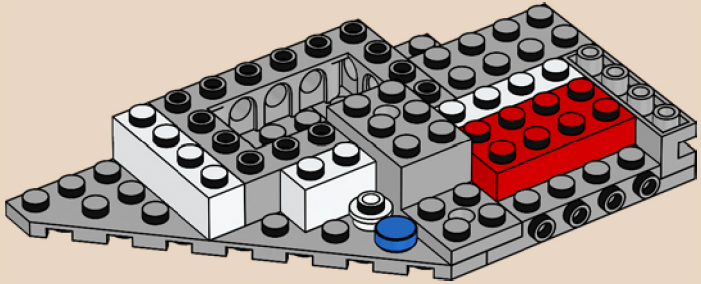

66

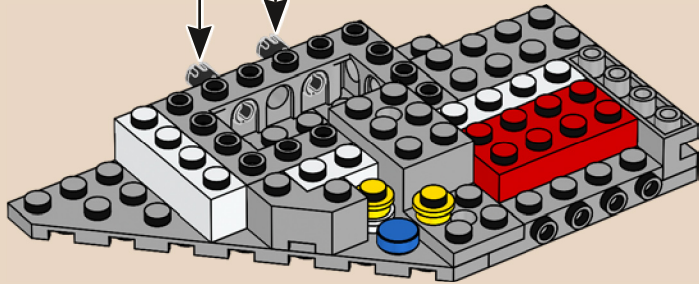

67

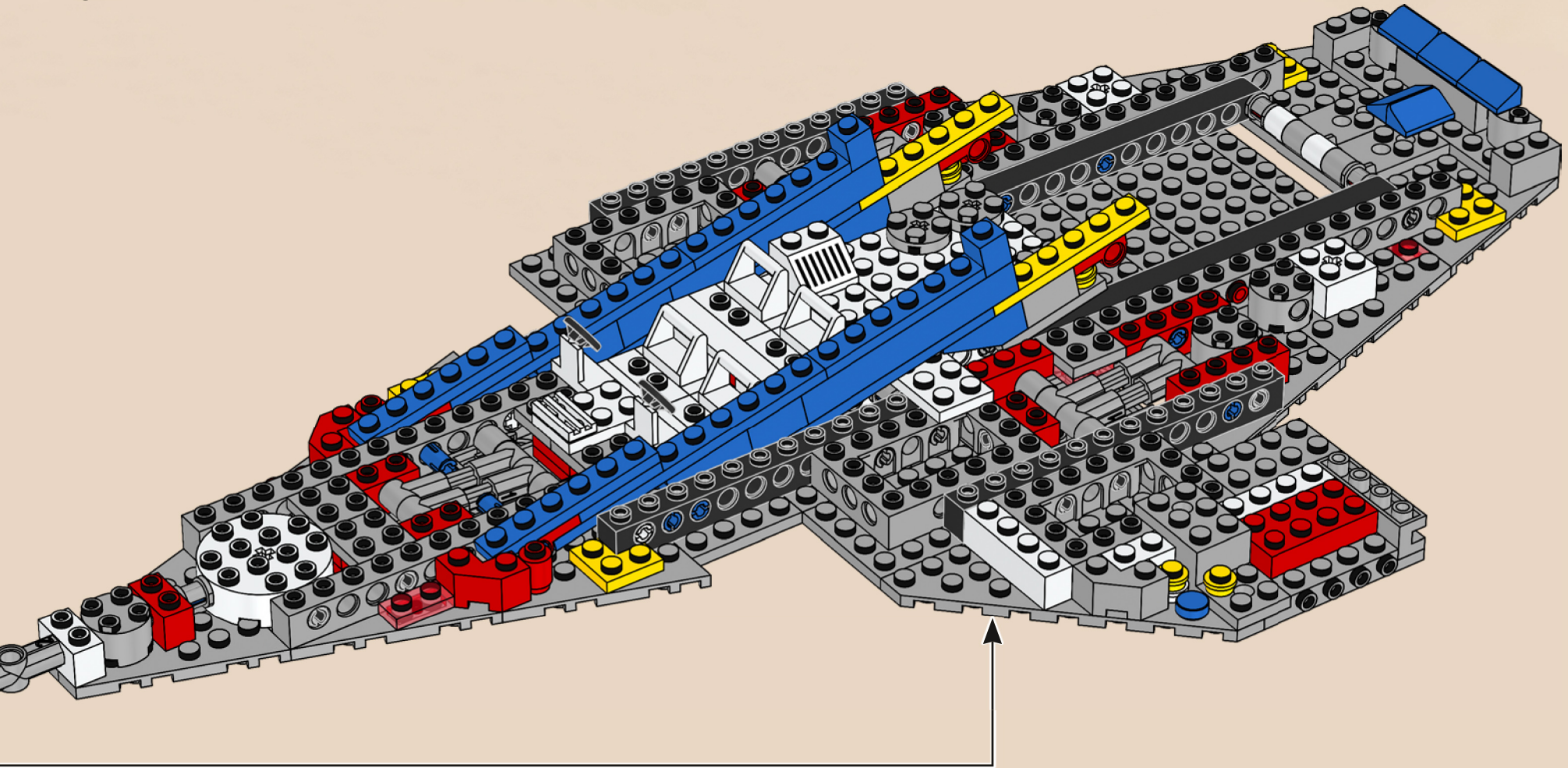

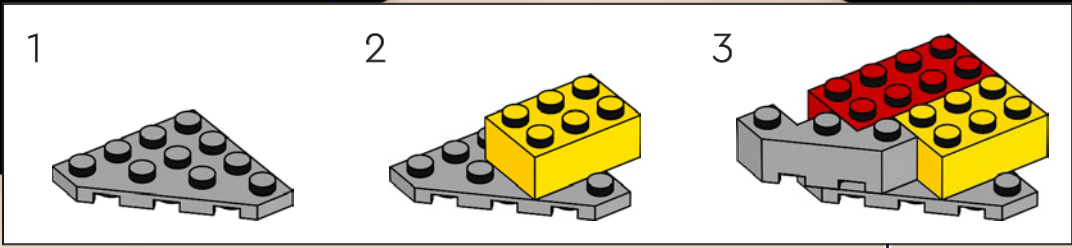
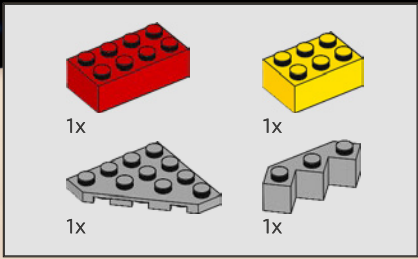

68

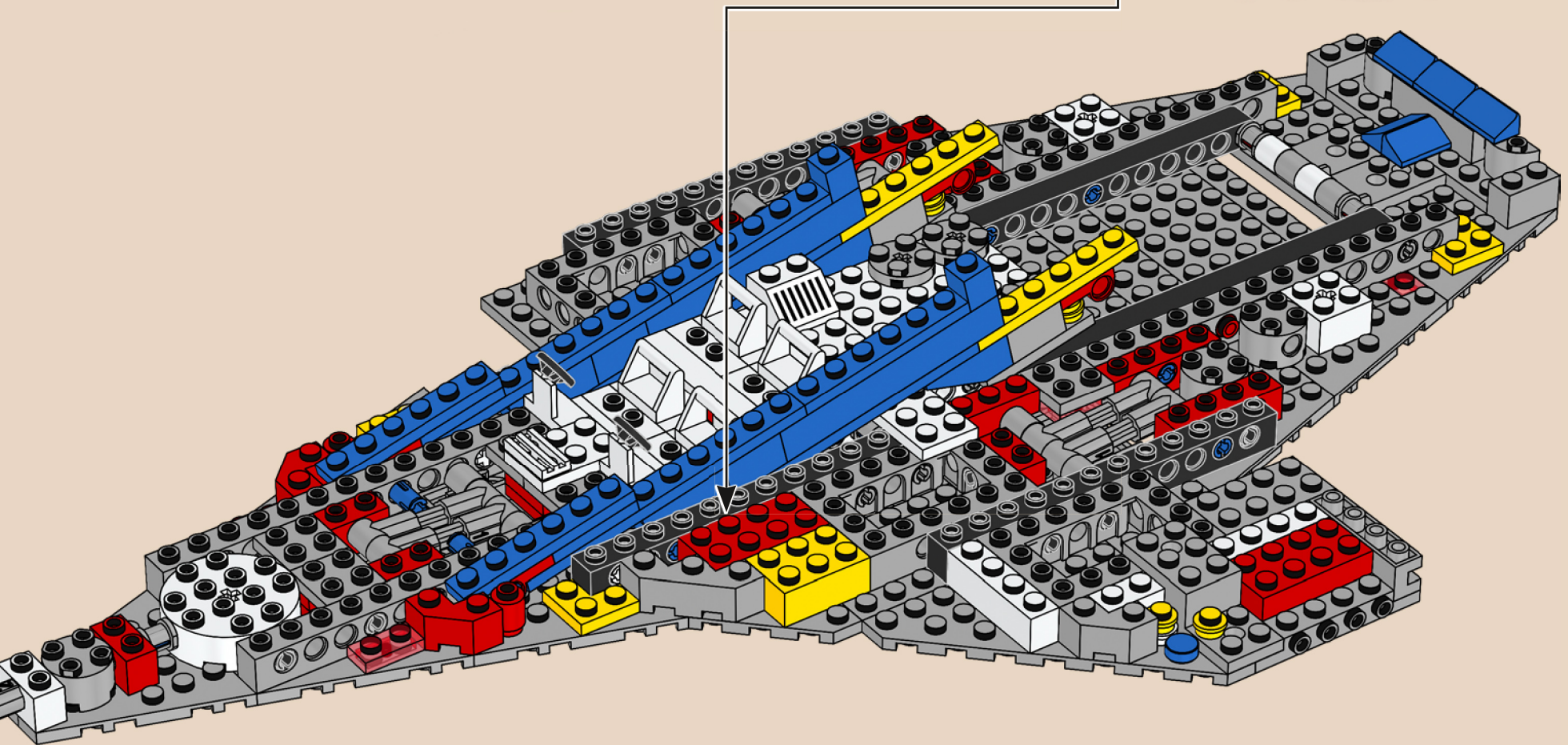

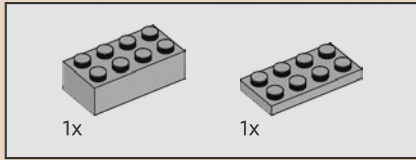
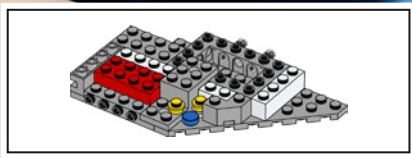

69

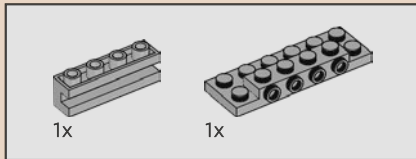
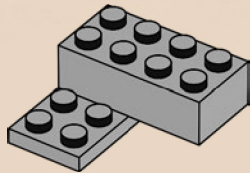

70

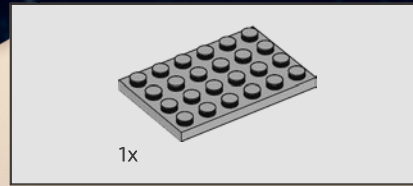
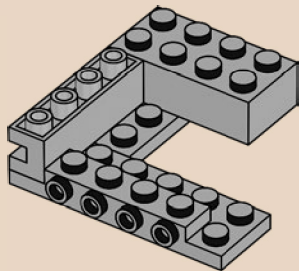

71

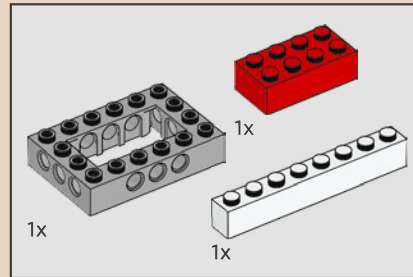
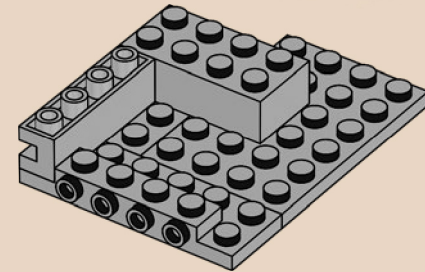

72

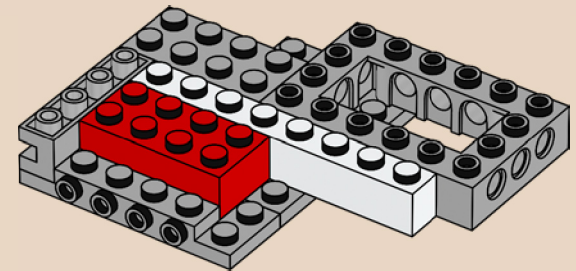

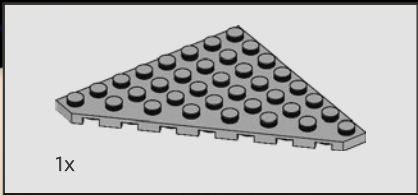

73

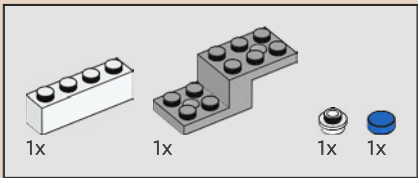
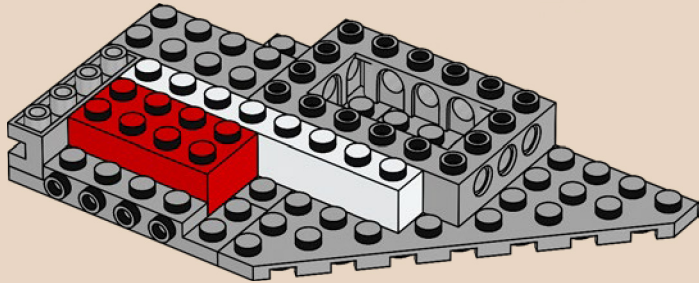

74

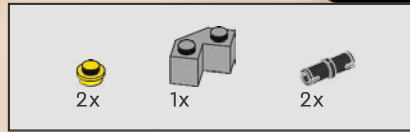
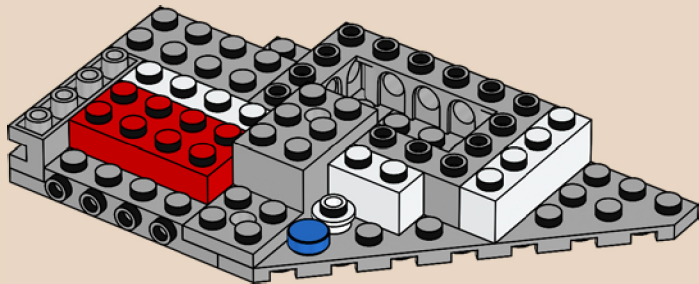

75

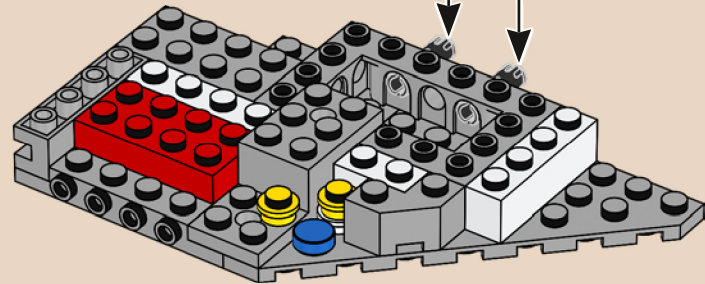
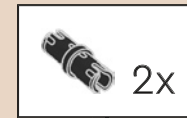

76

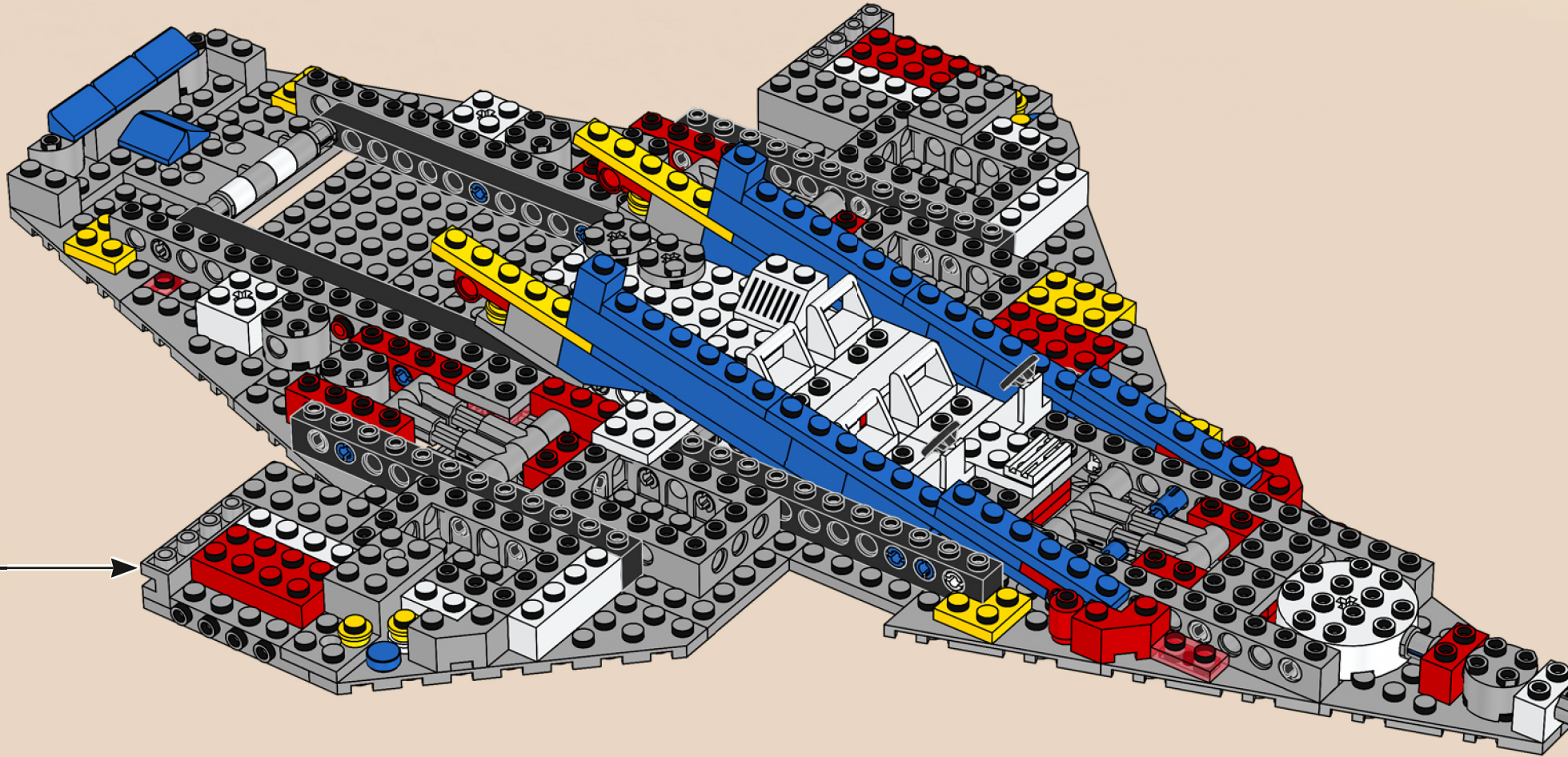

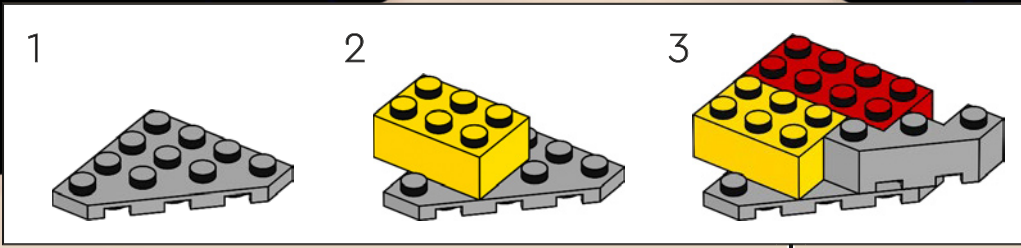
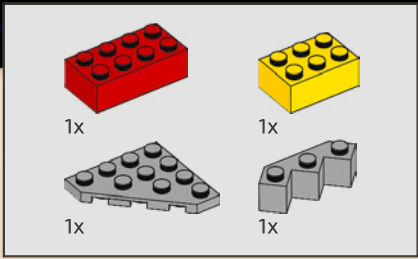

77

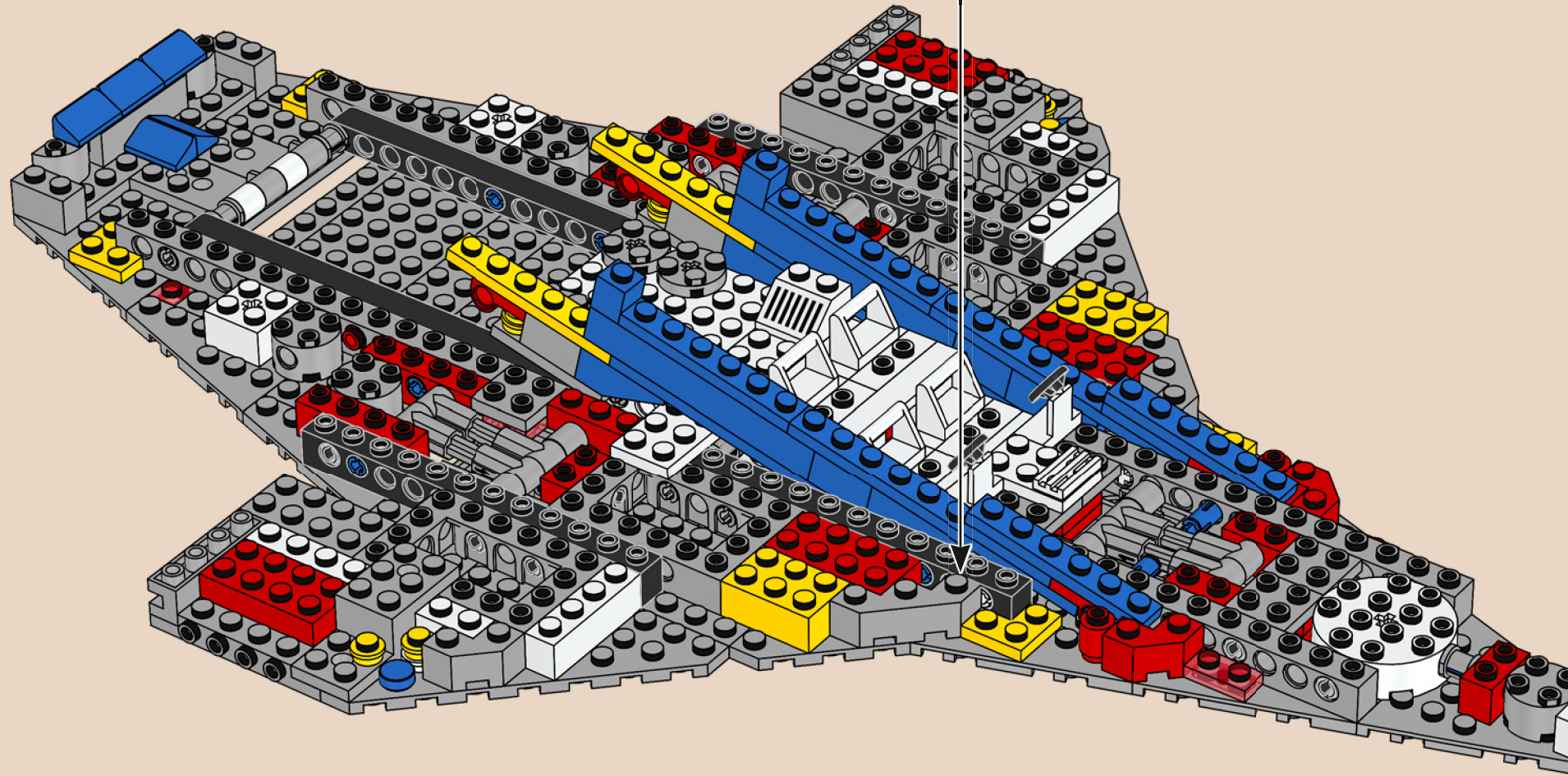





78



这艘宇宙飞船的色彩仅采用 1979 年原始产品发布时的色彩,除了色彩 194,还有中度石灰色。

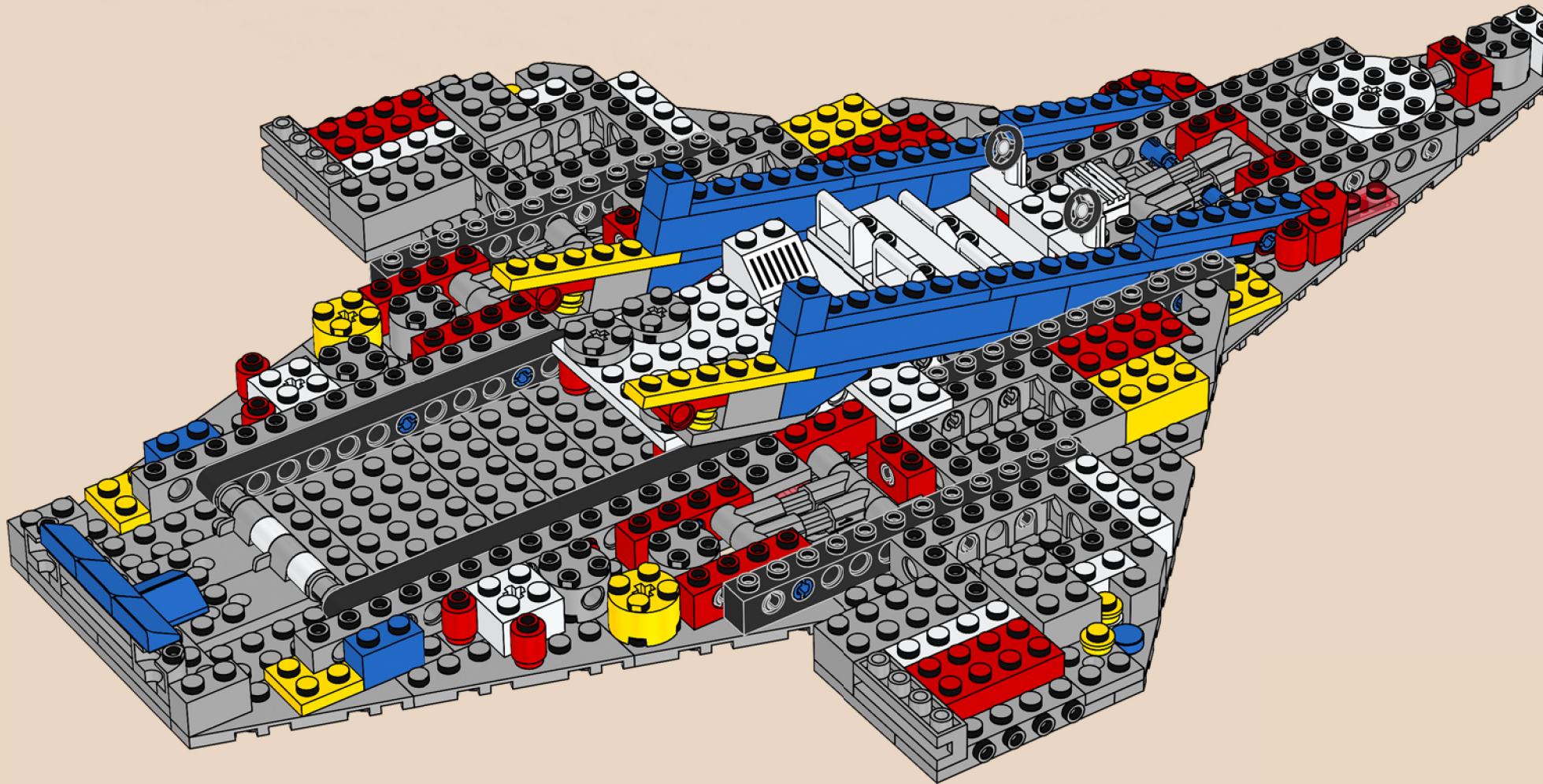

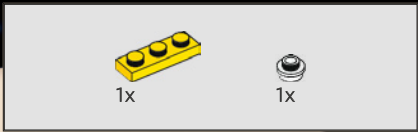

79

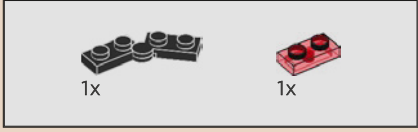
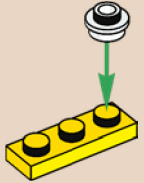

80

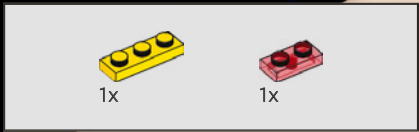
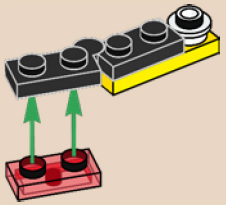

81

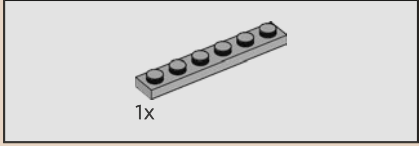
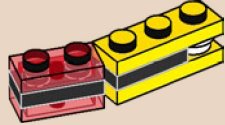

82

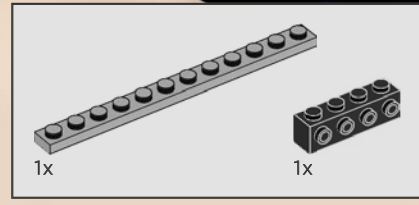

83

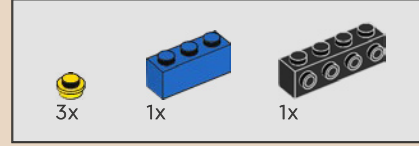
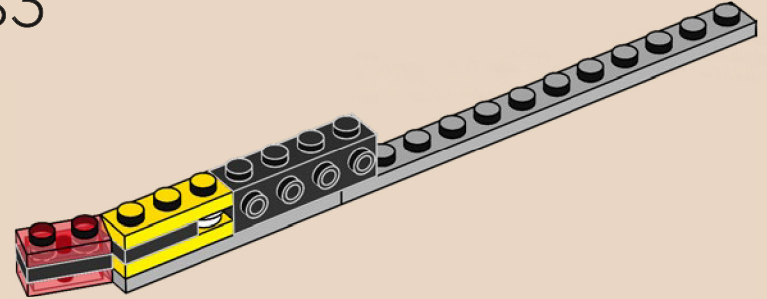

84

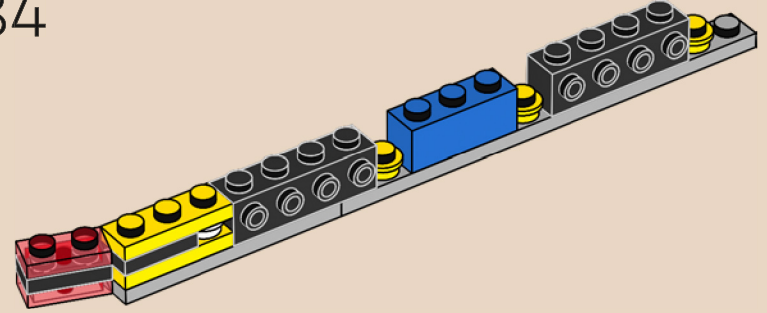

1x  2x 

85

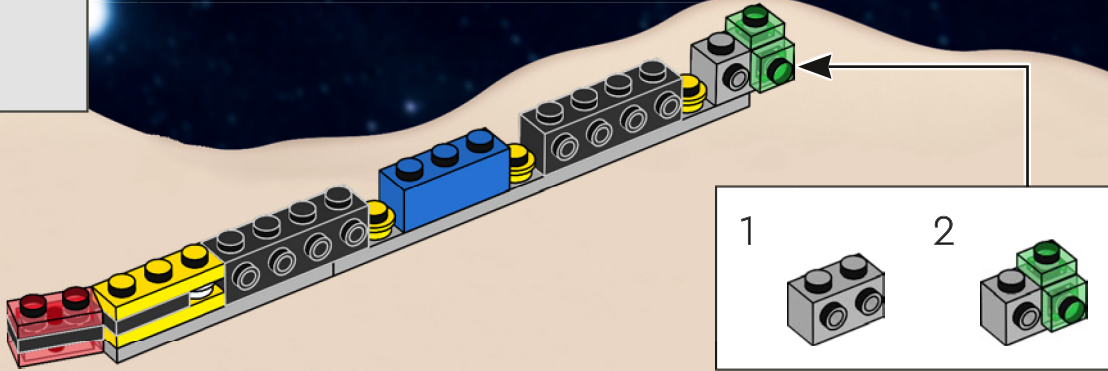

86

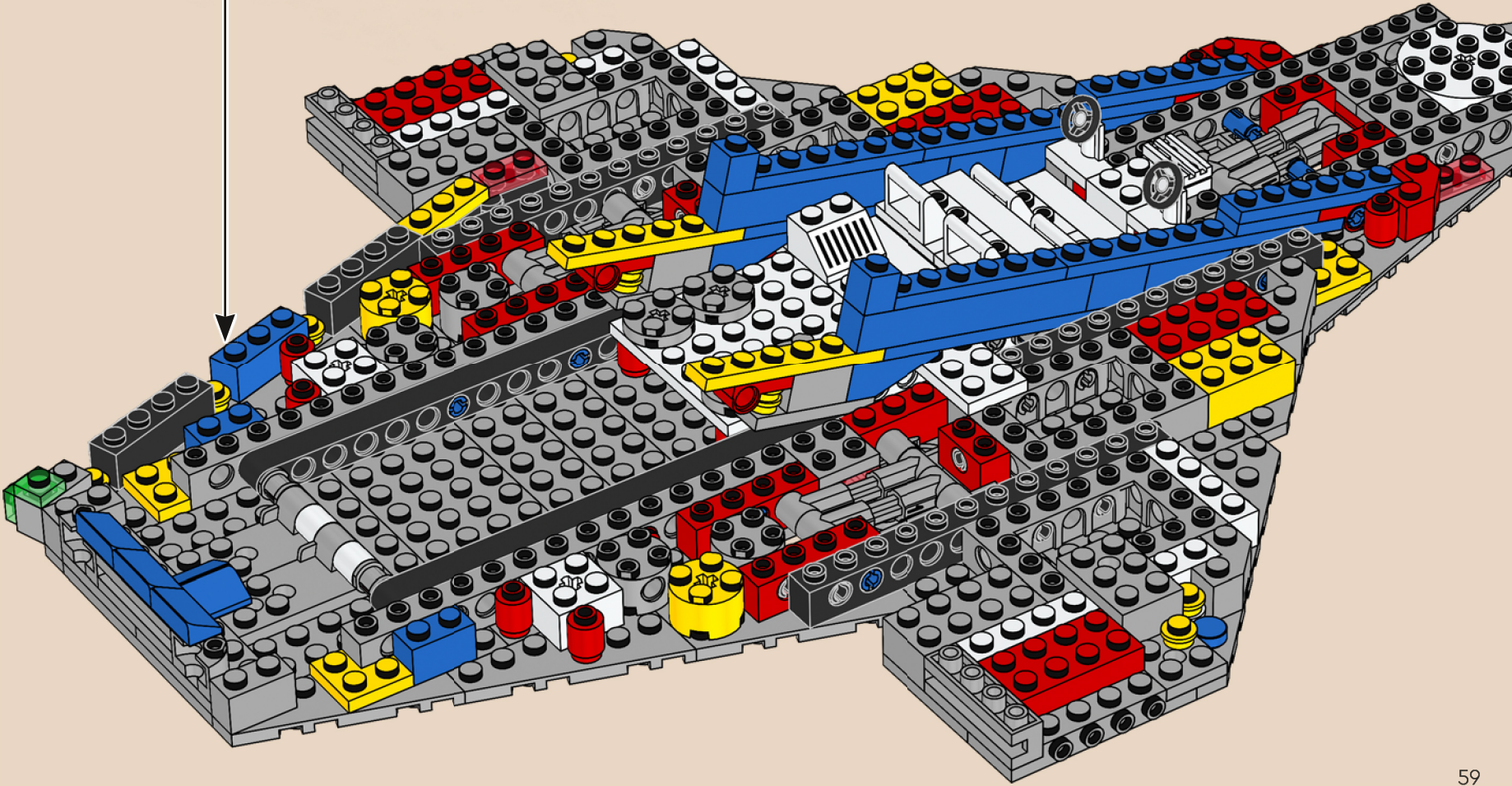

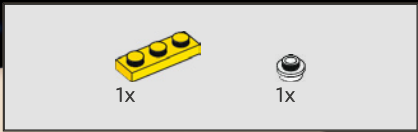

87

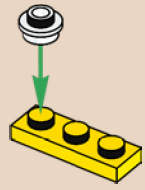

88

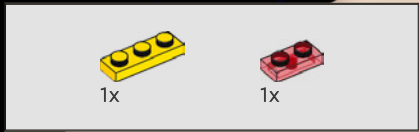
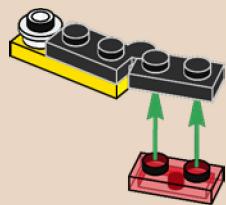

89

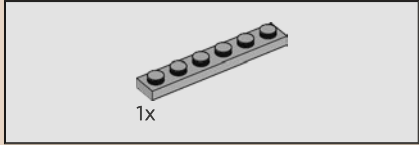
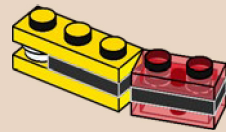

90

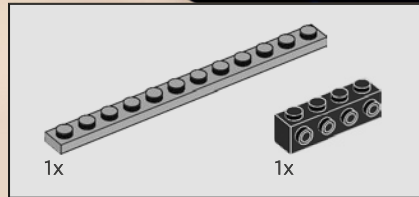
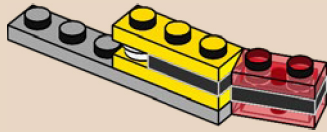

91

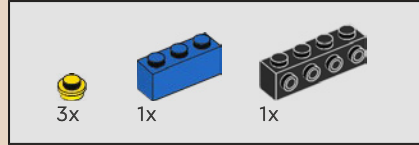
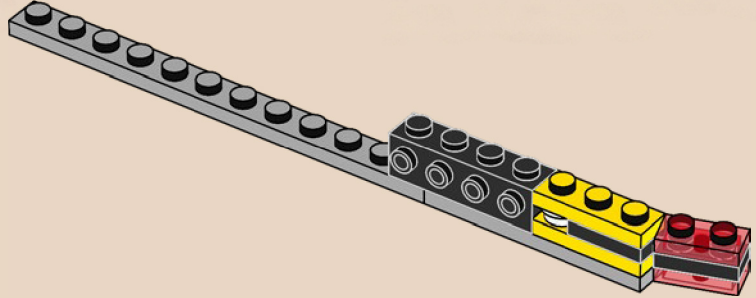

92

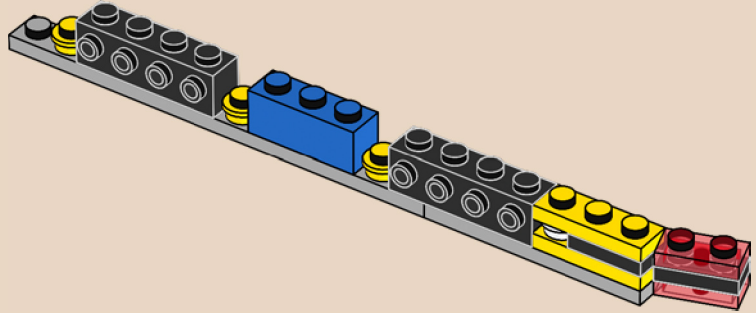

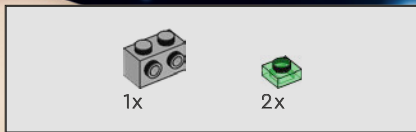



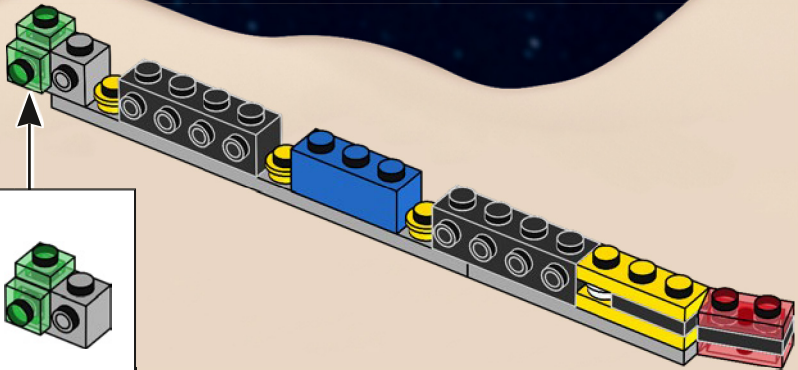
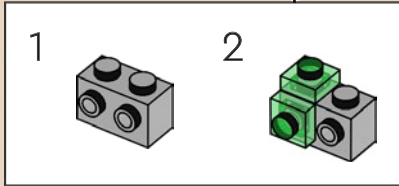

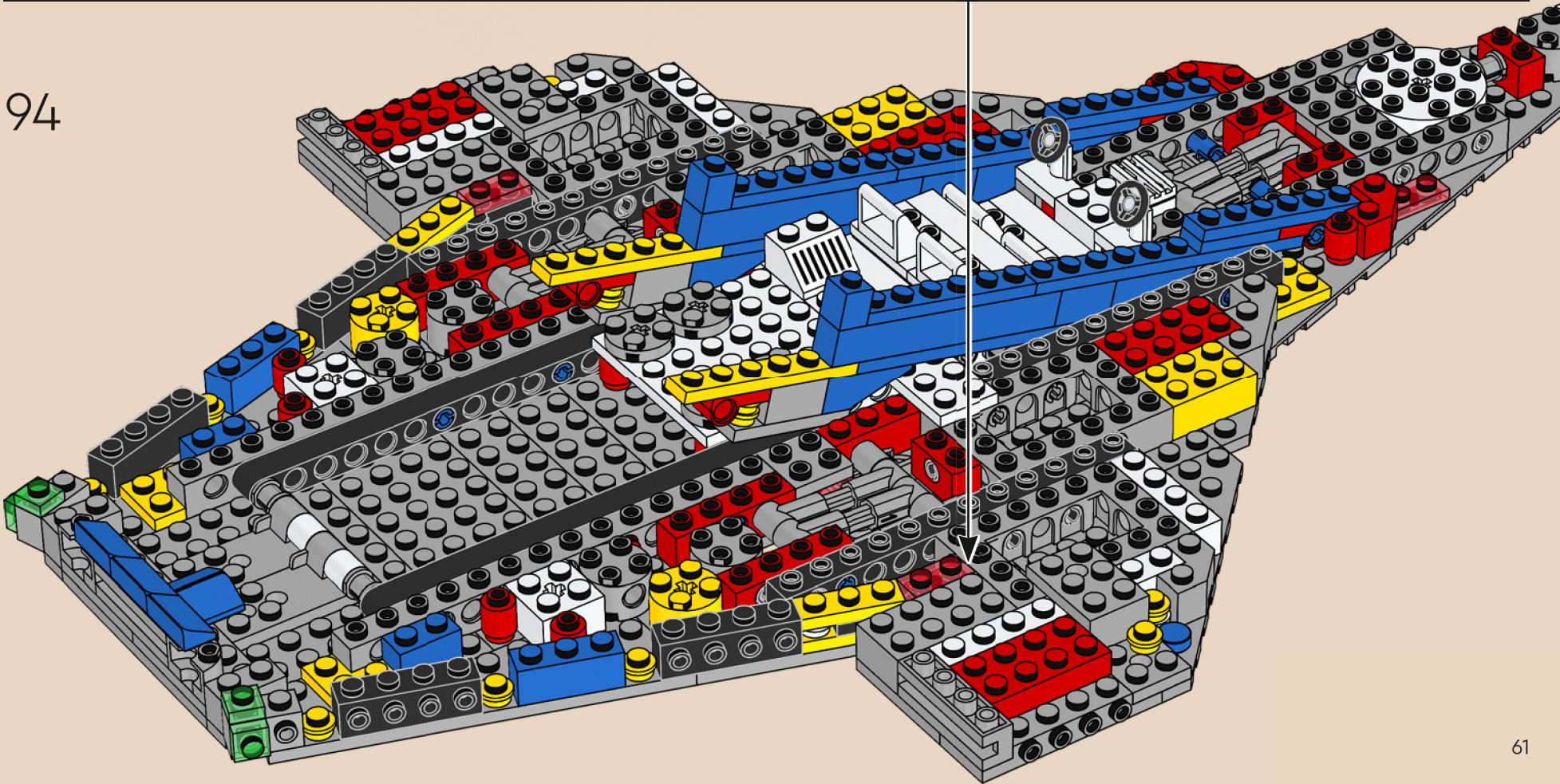

93



94



-  2x
-  6x
-  2x
-  2x
-  2x
-  6x

95

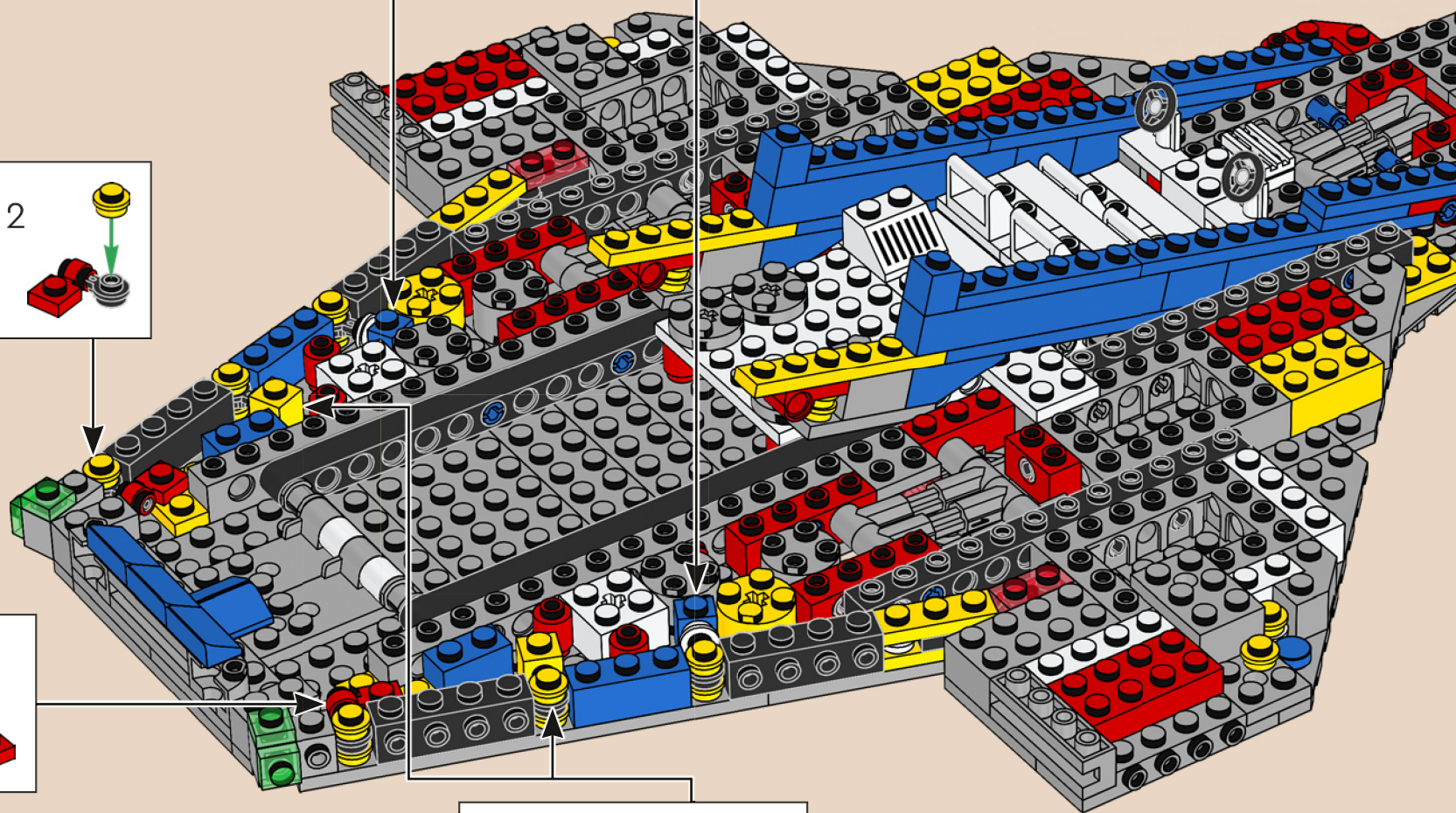
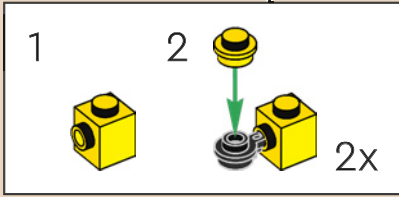
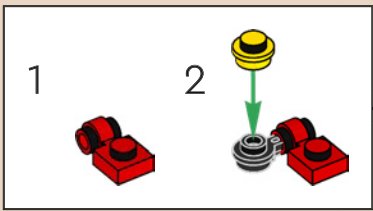
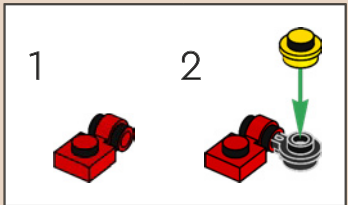
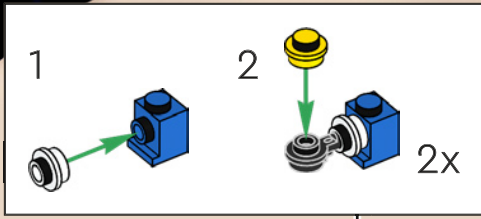

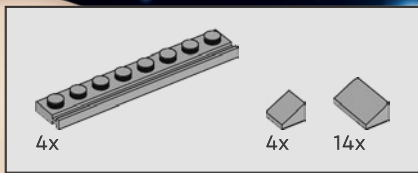

96

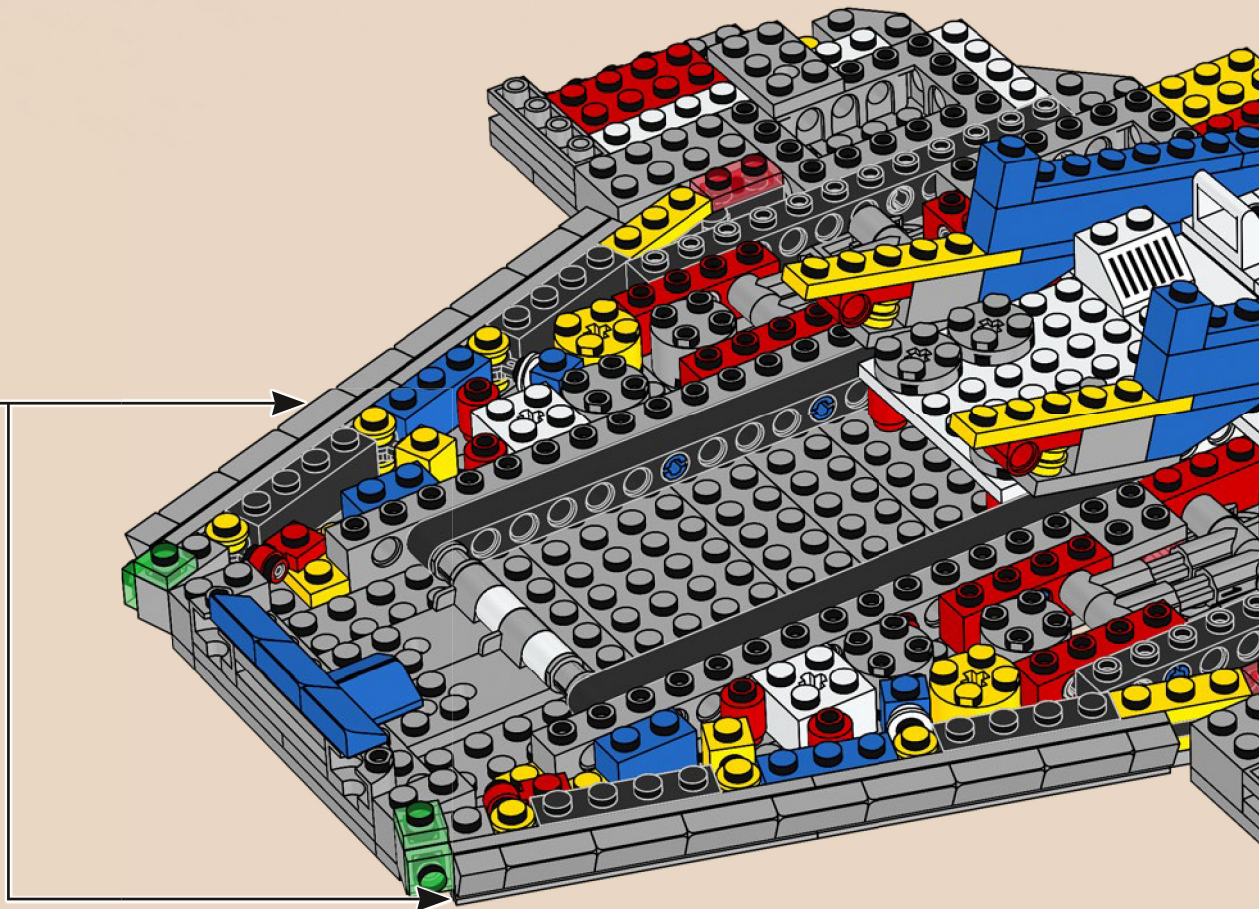
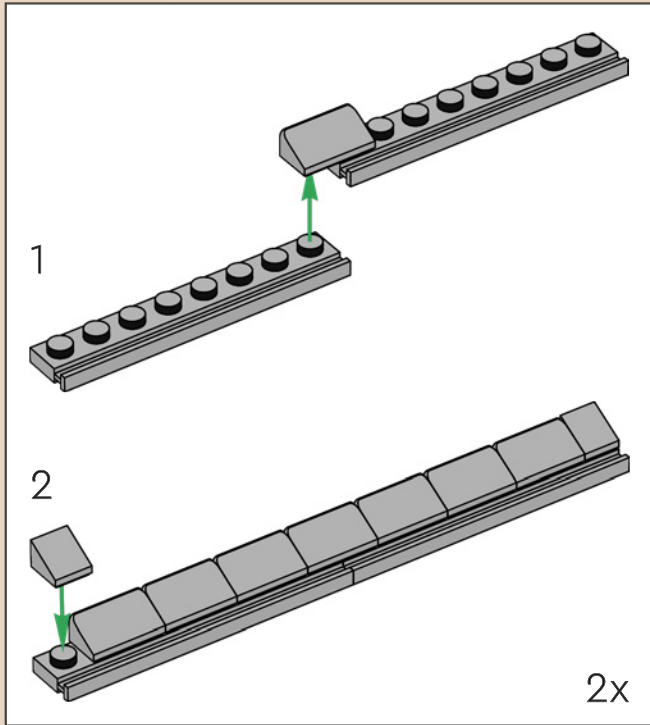

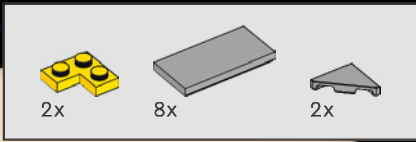

97

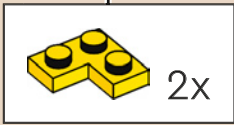
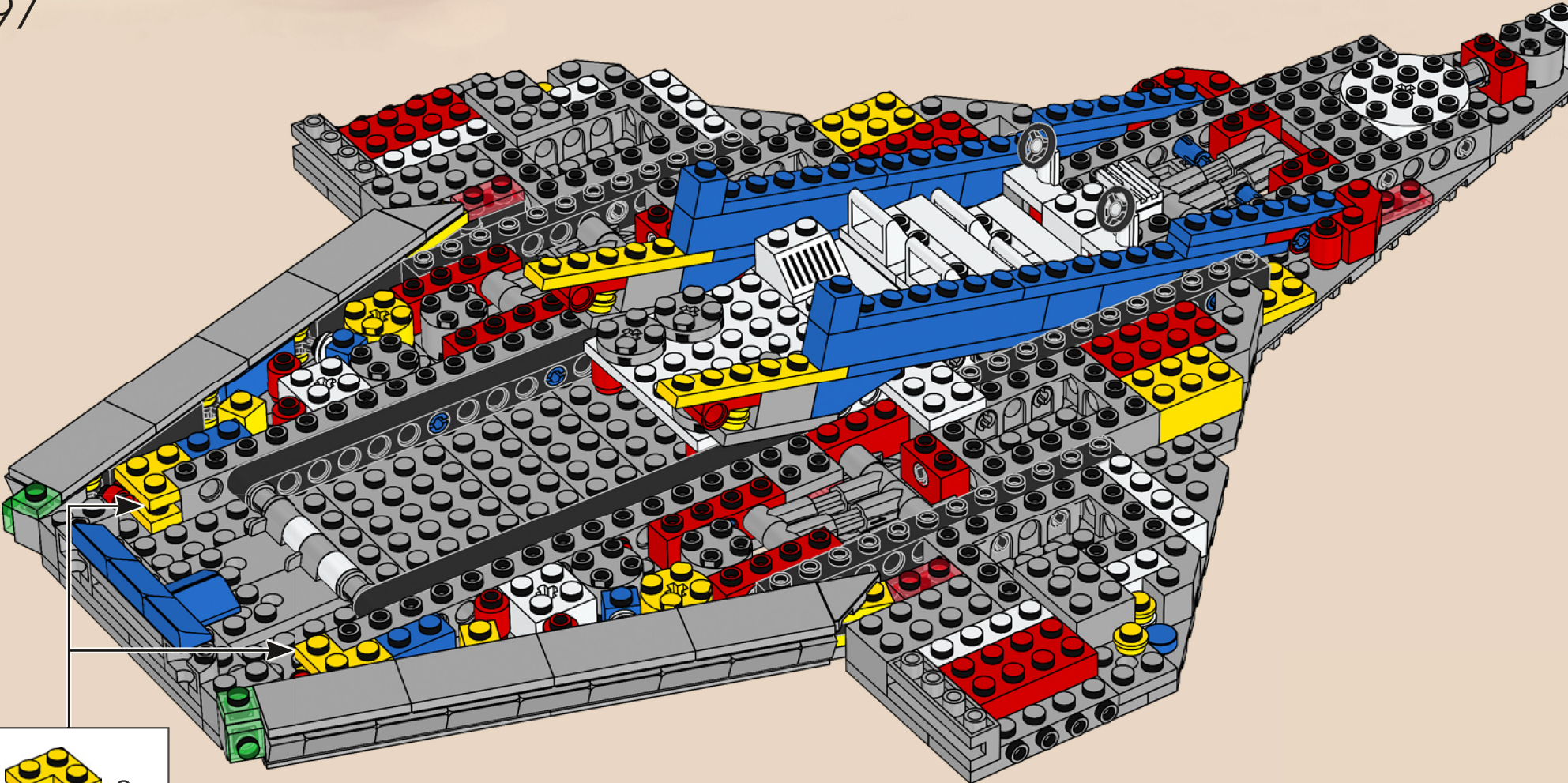



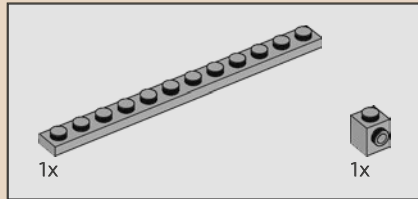
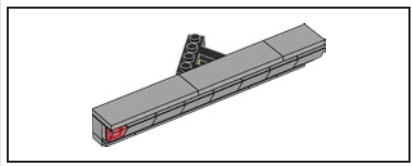

98

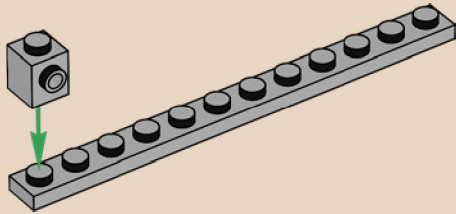

99

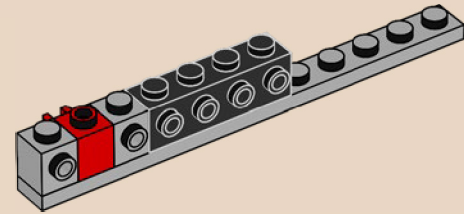

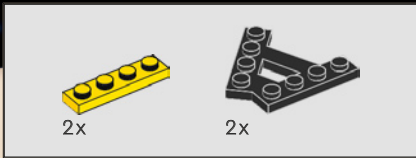

100

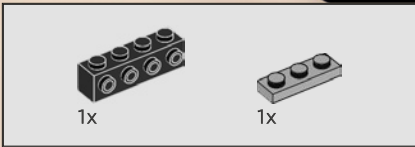
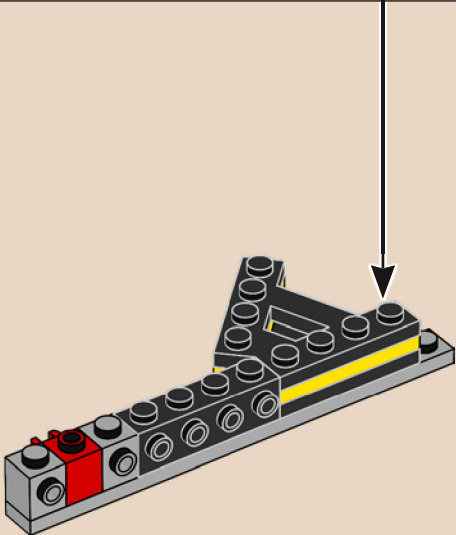
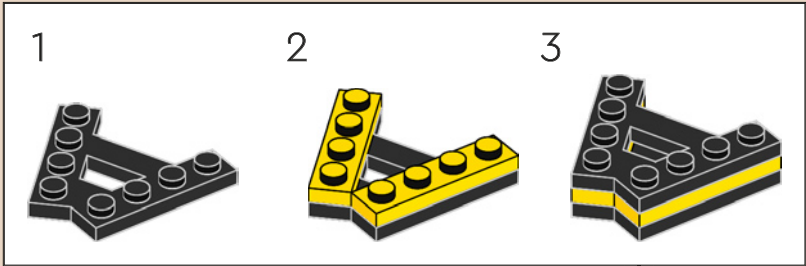

101

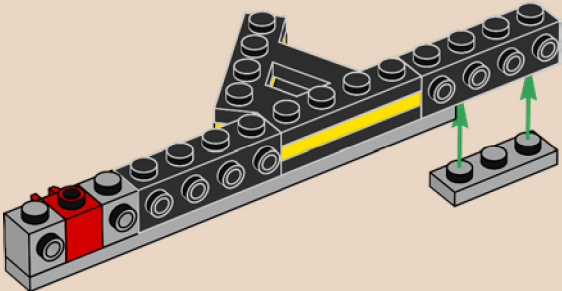

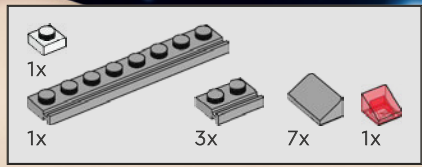

102

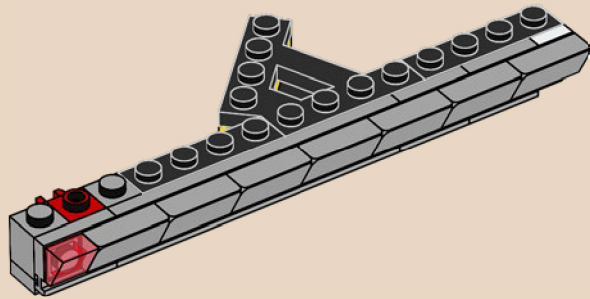
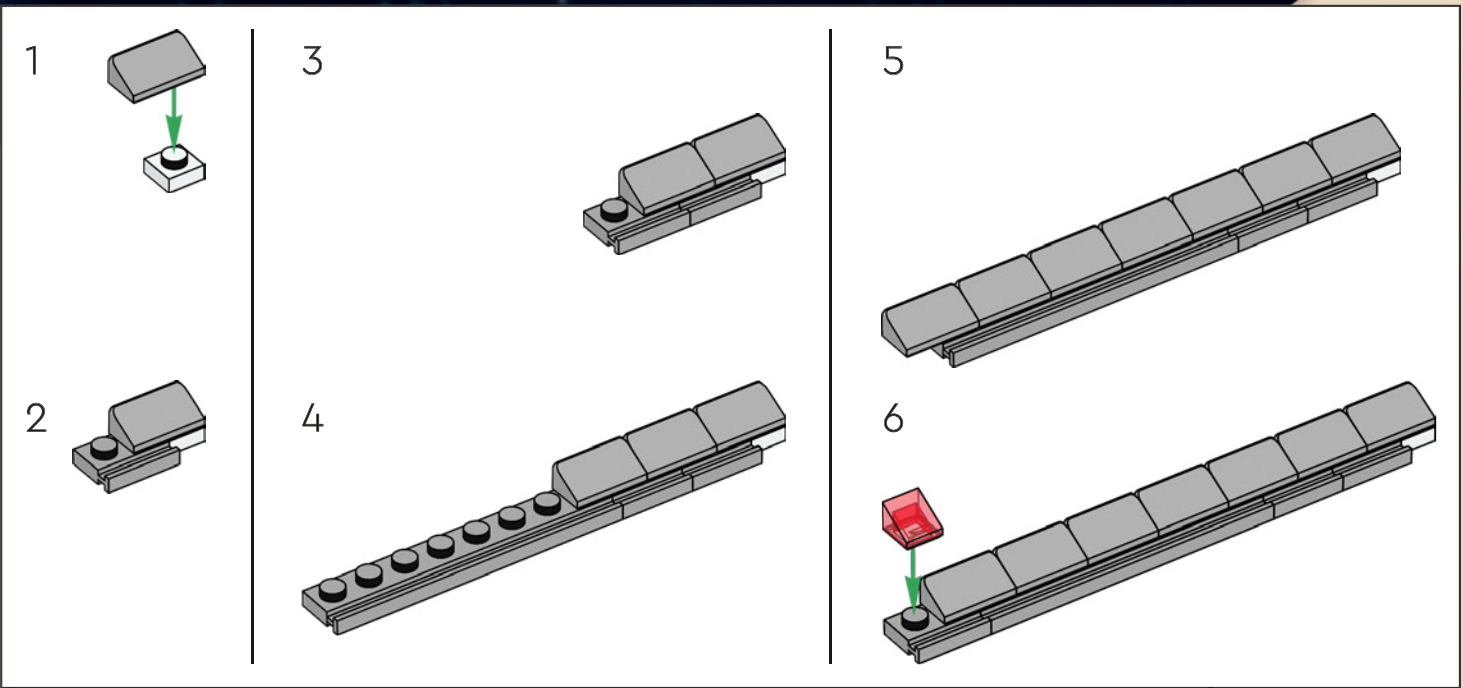

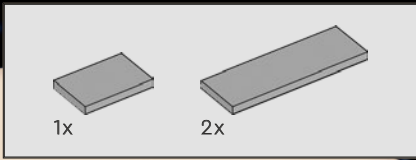

103

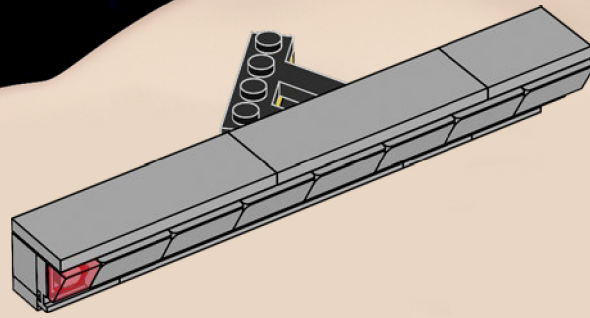

104

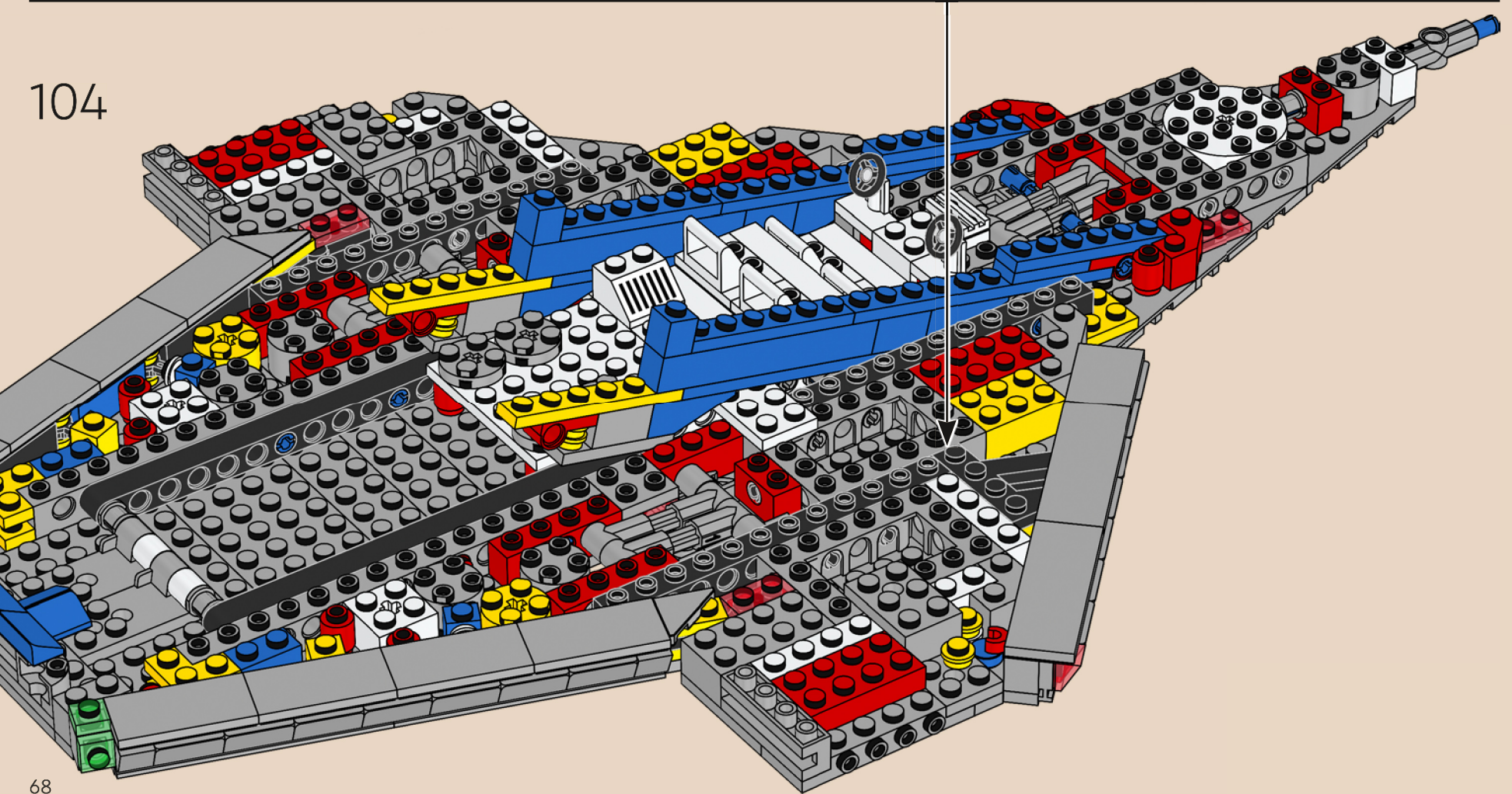

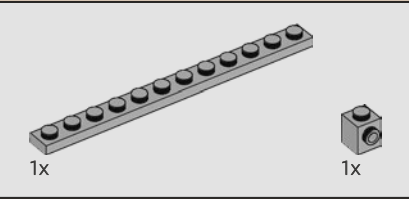
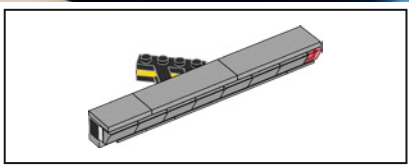

105

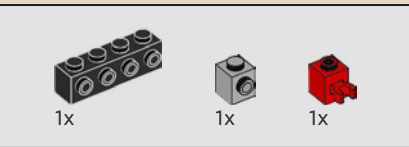
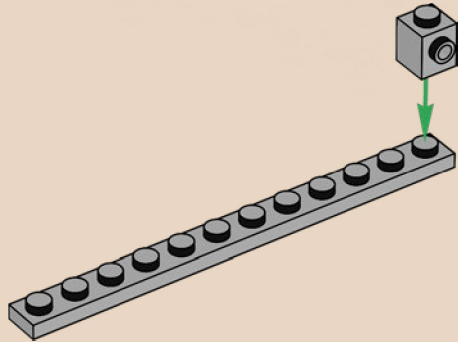

106

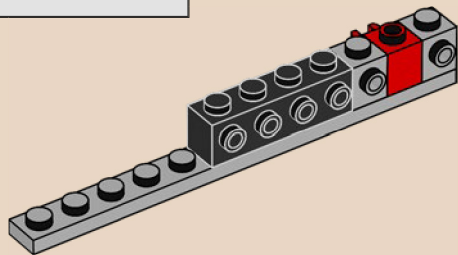

107

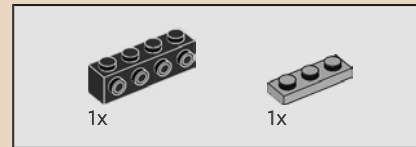
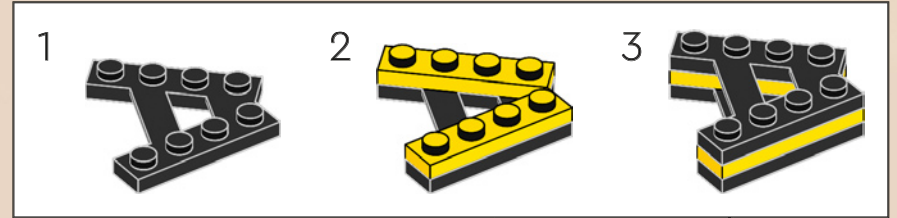

108

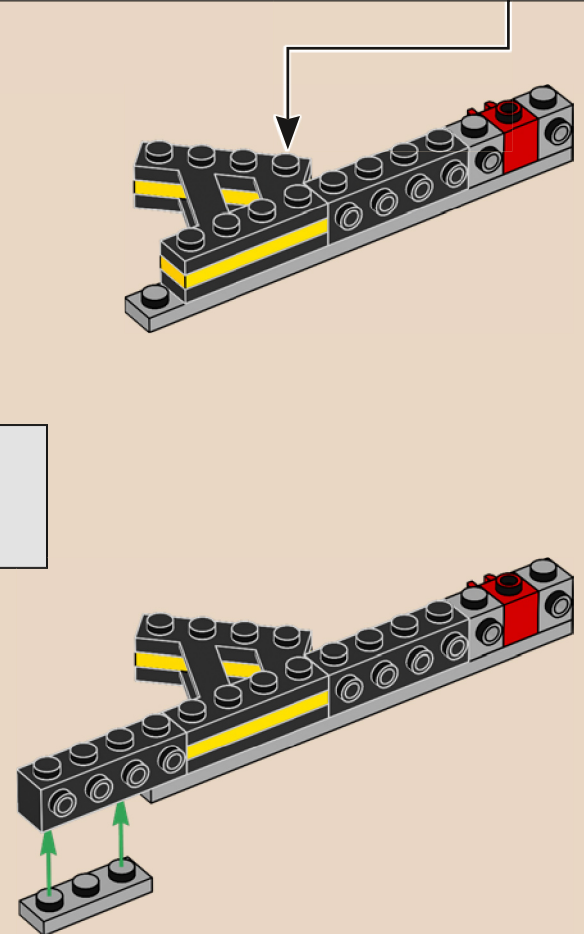

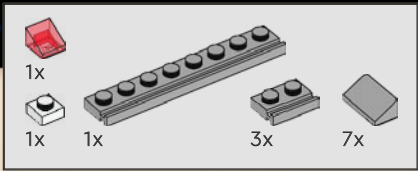

109

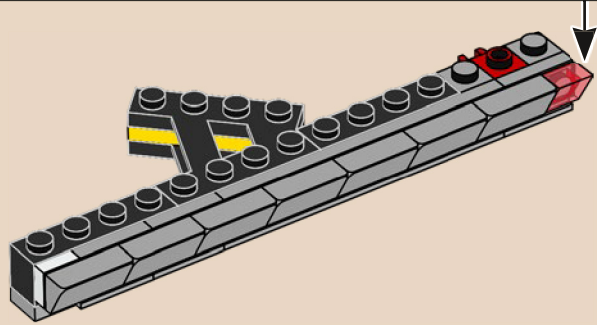
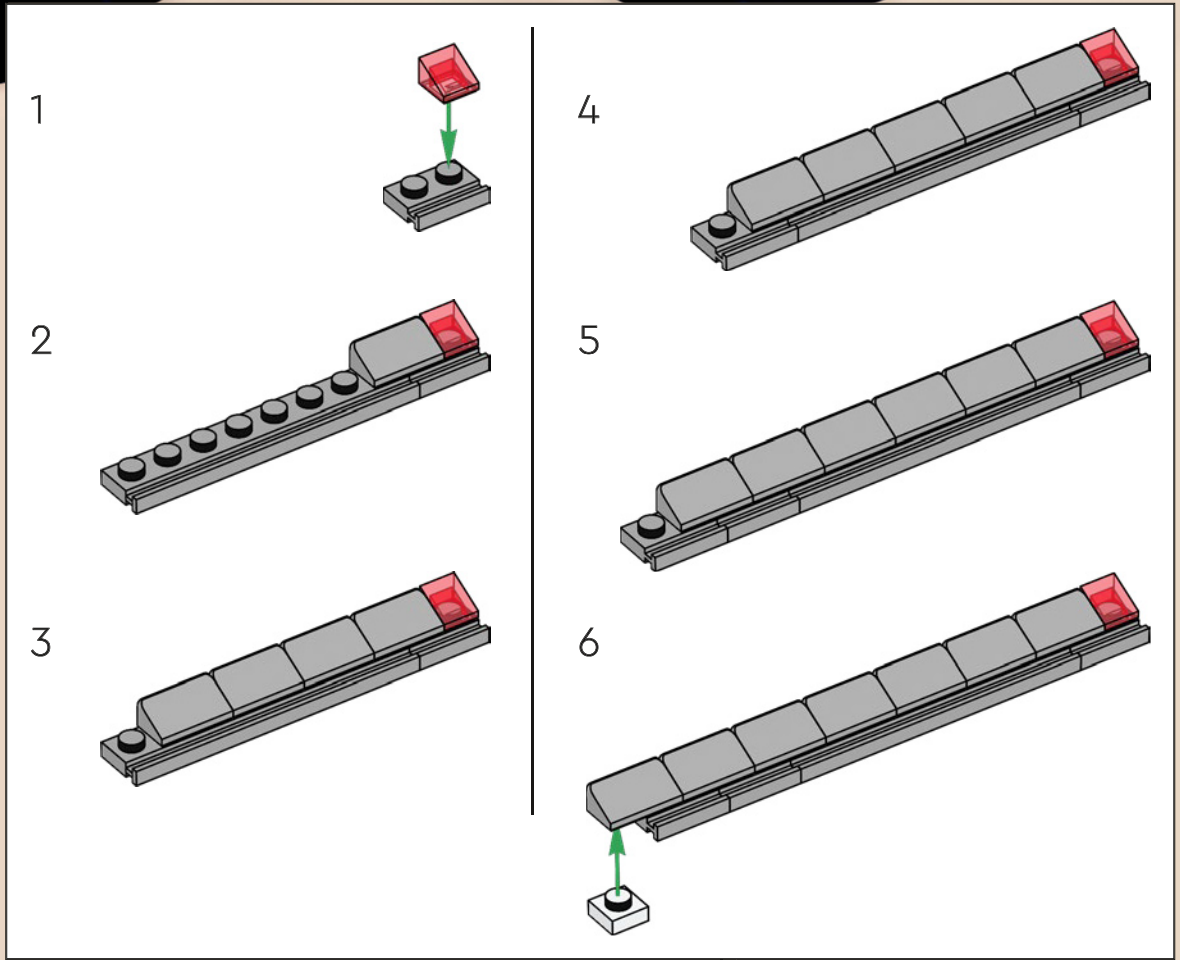

原始模型上的红色和绿色导航灯并未采用传统拼搭位置(左侧为红灯,右侧为绿灯),而是红灯朝前,绿灯朝后。此新模型保持了相同的位置。

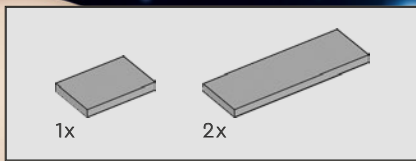

110

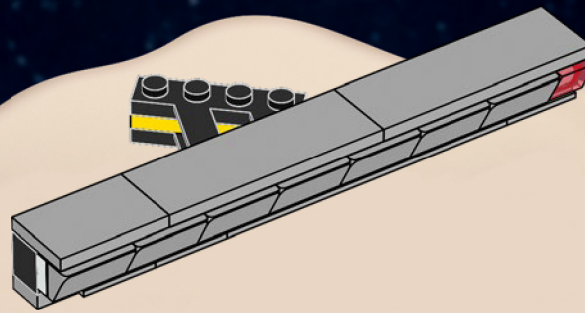

111

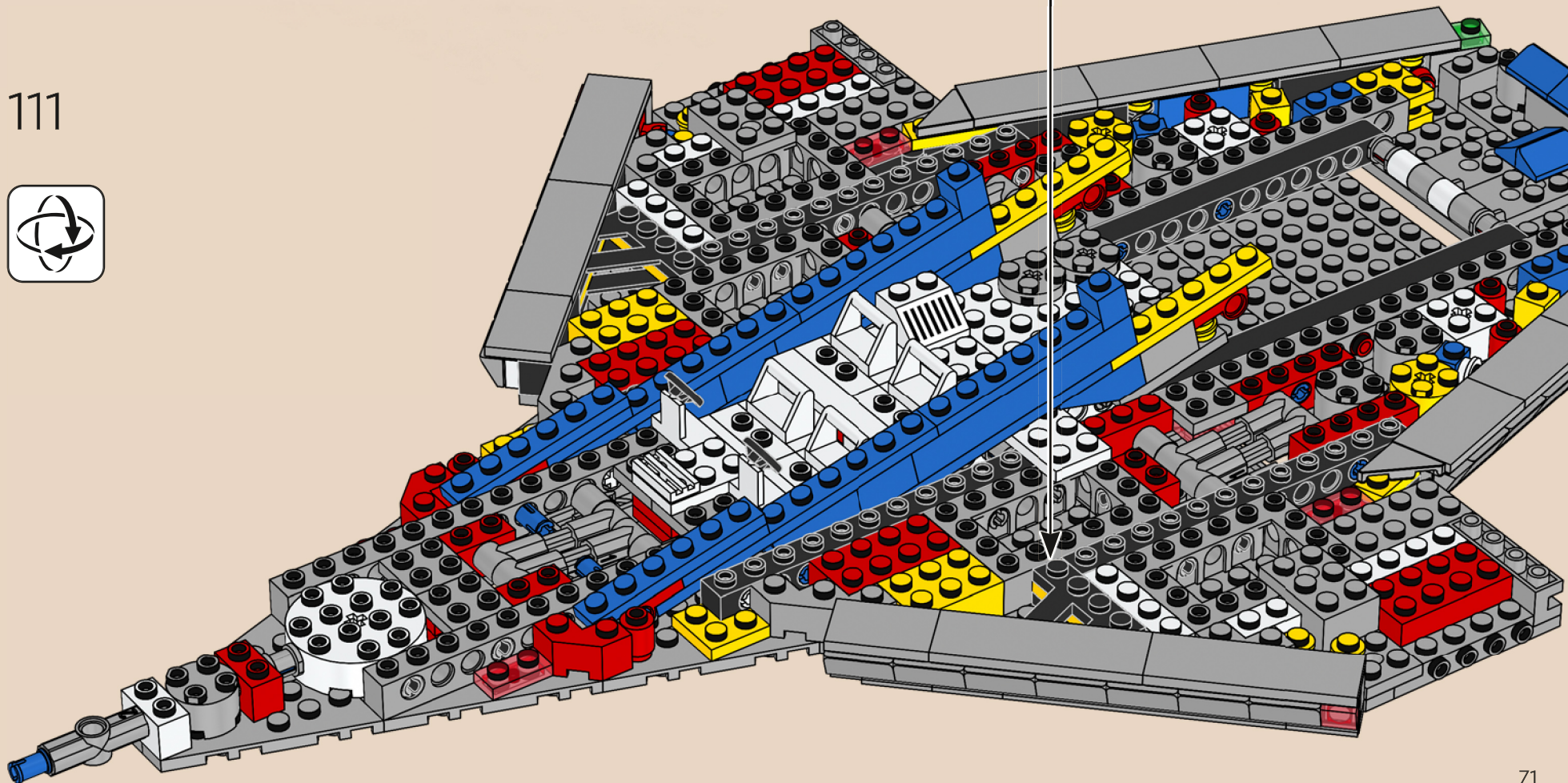

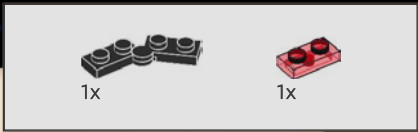

112

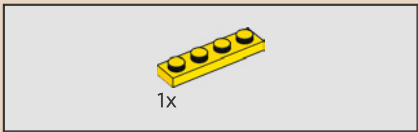
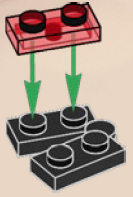

113

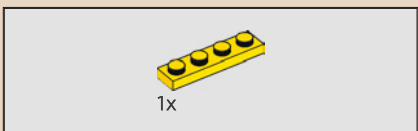
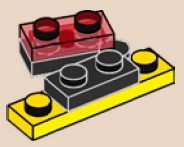

114

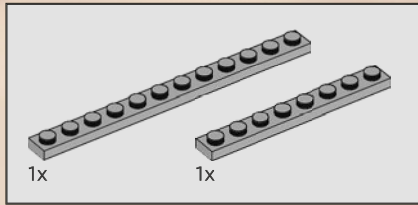
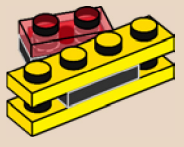

115

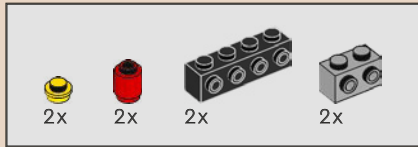
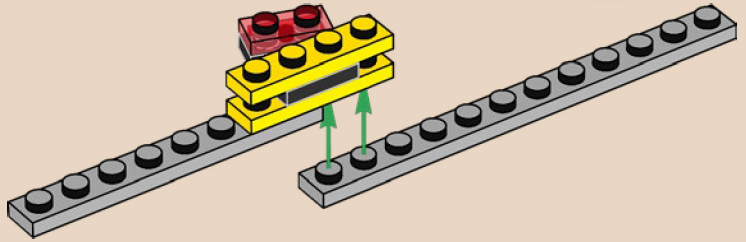



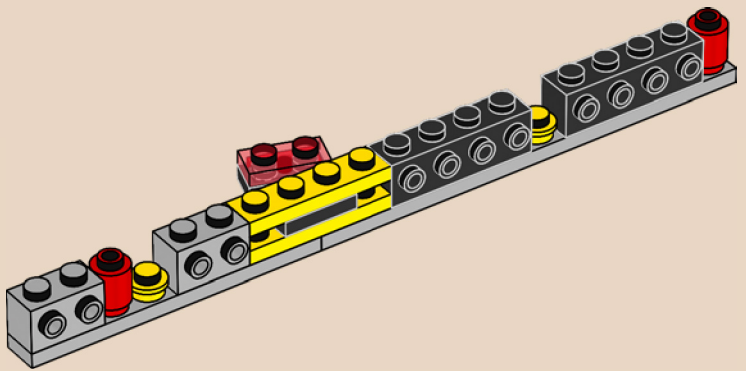

116



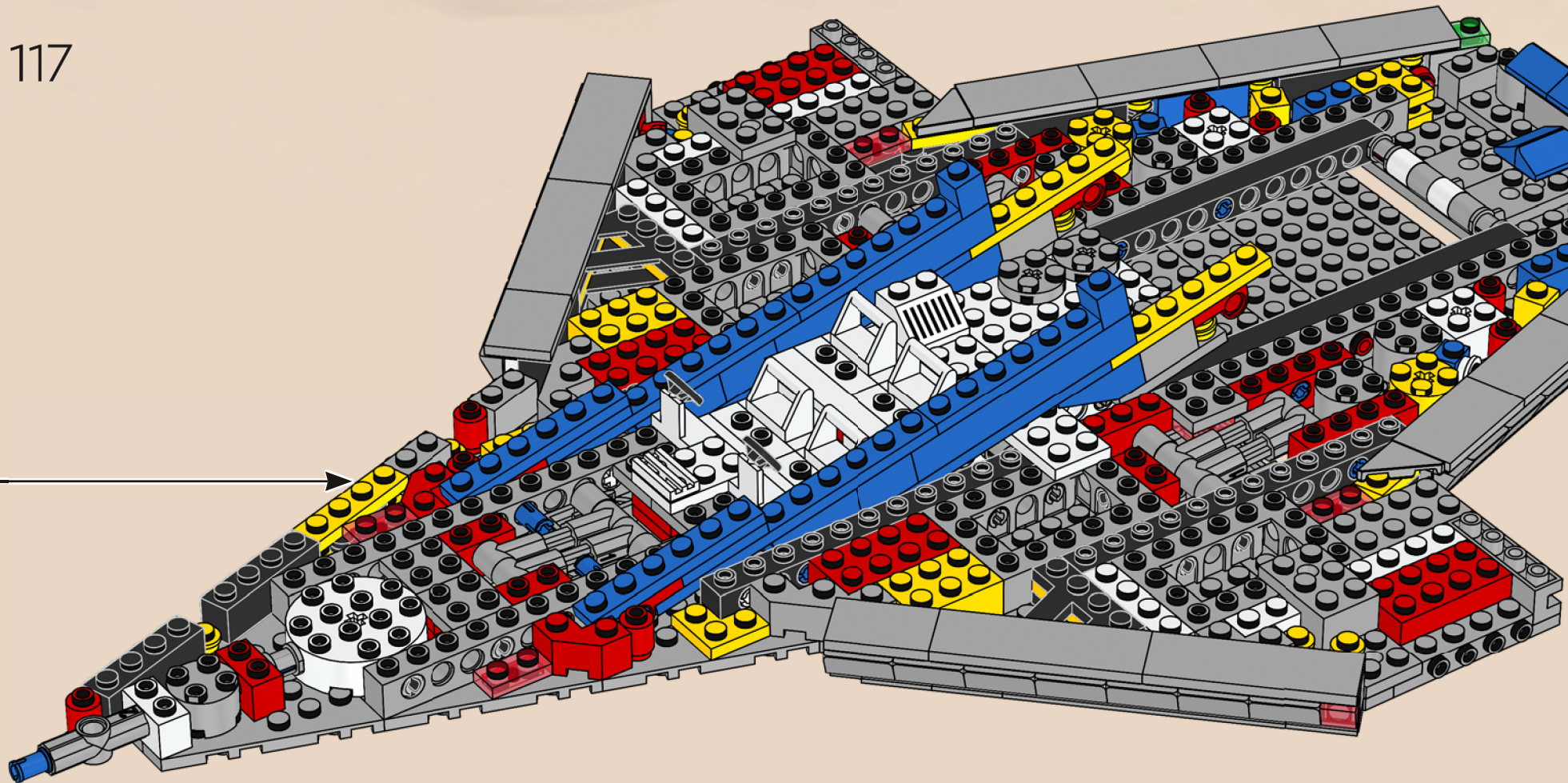



117





			
2x	1x	2x	1x

118

1 

2  

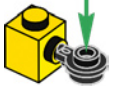
1 

2  

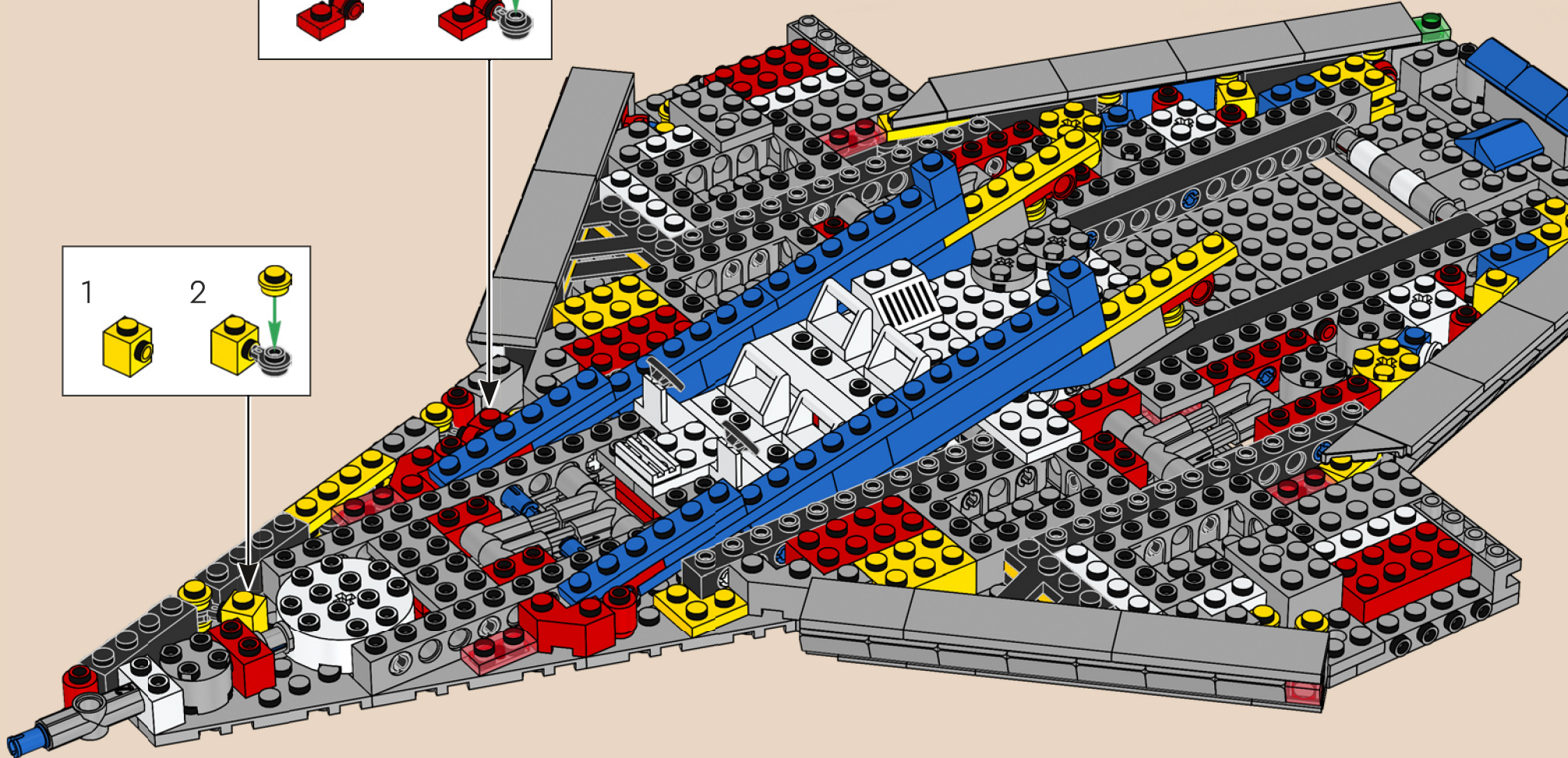

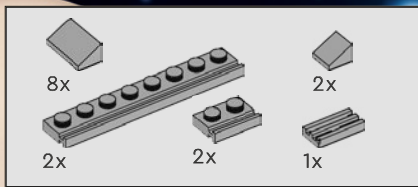

119

1

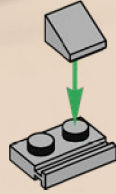

2

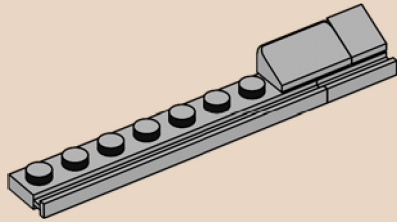

3

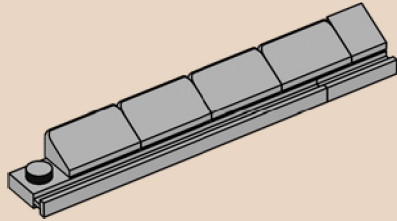

4

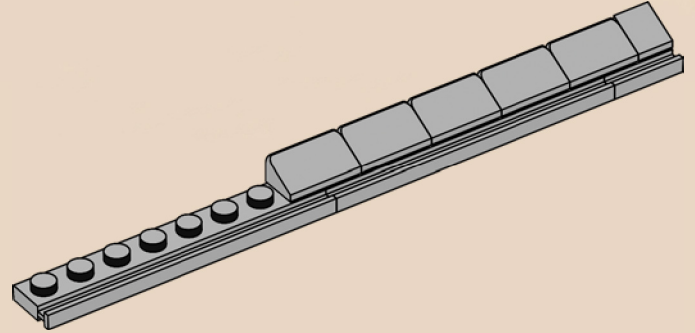

5

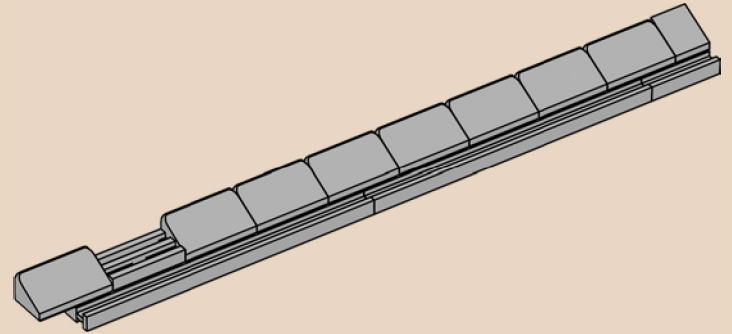

6

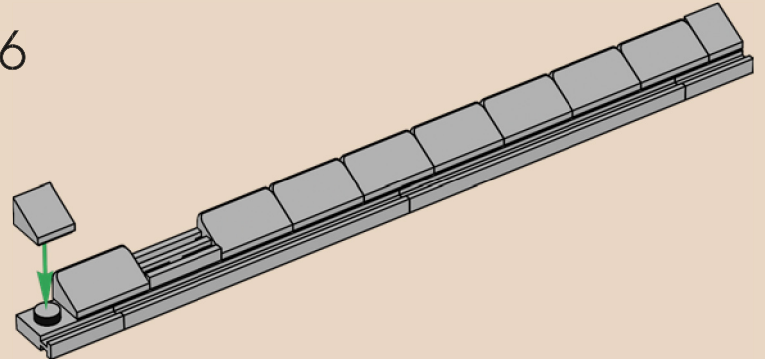

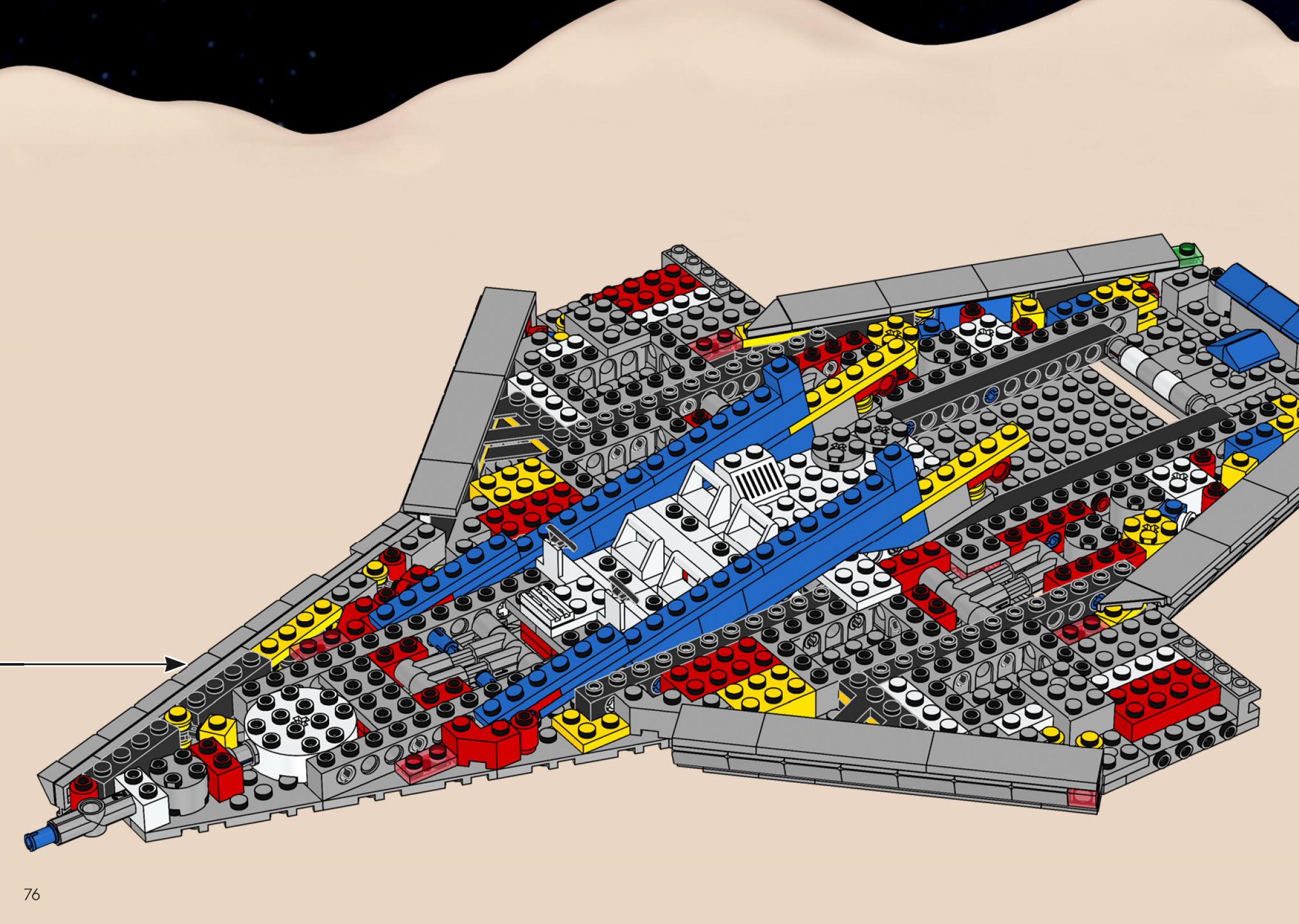

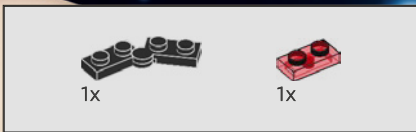

120

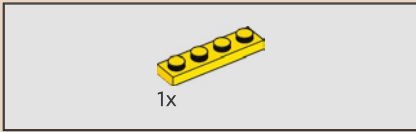
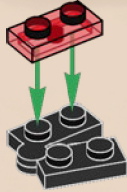

121

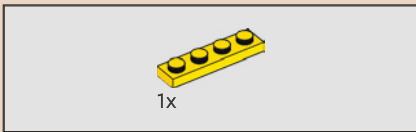
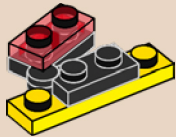

122

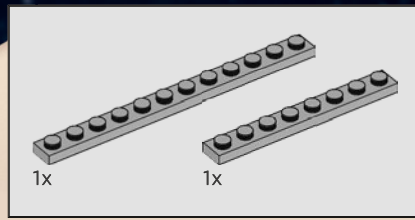
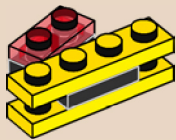



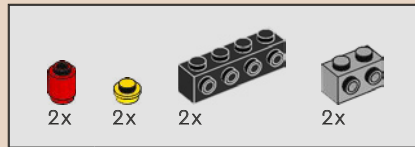
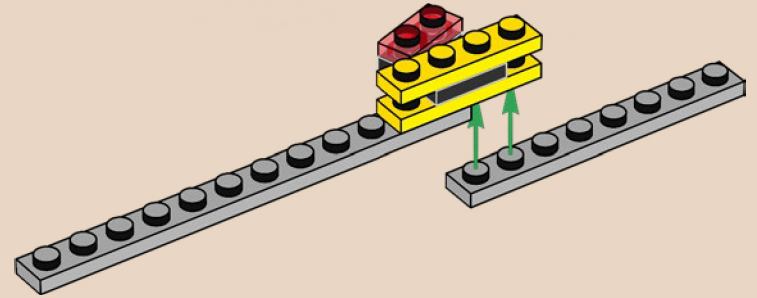

123

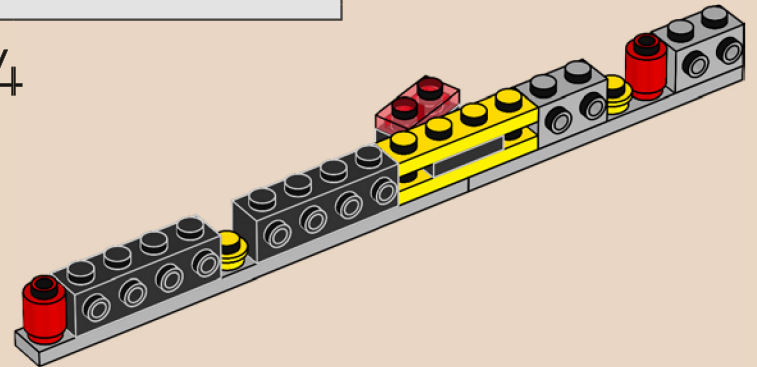

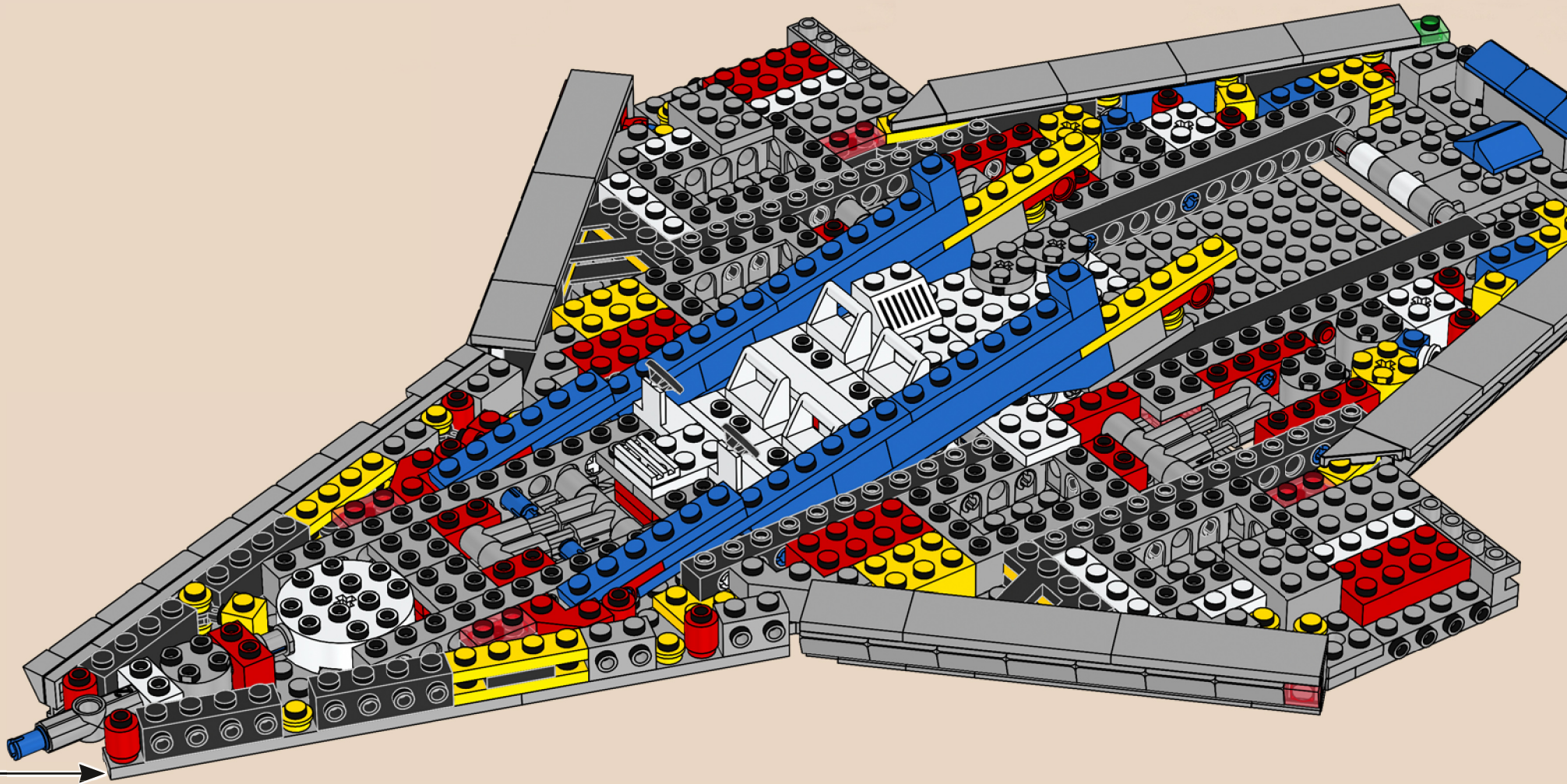

124





			
2x	1x	1x	2x

126

1	2
	

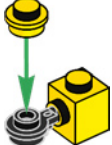
1	2
	

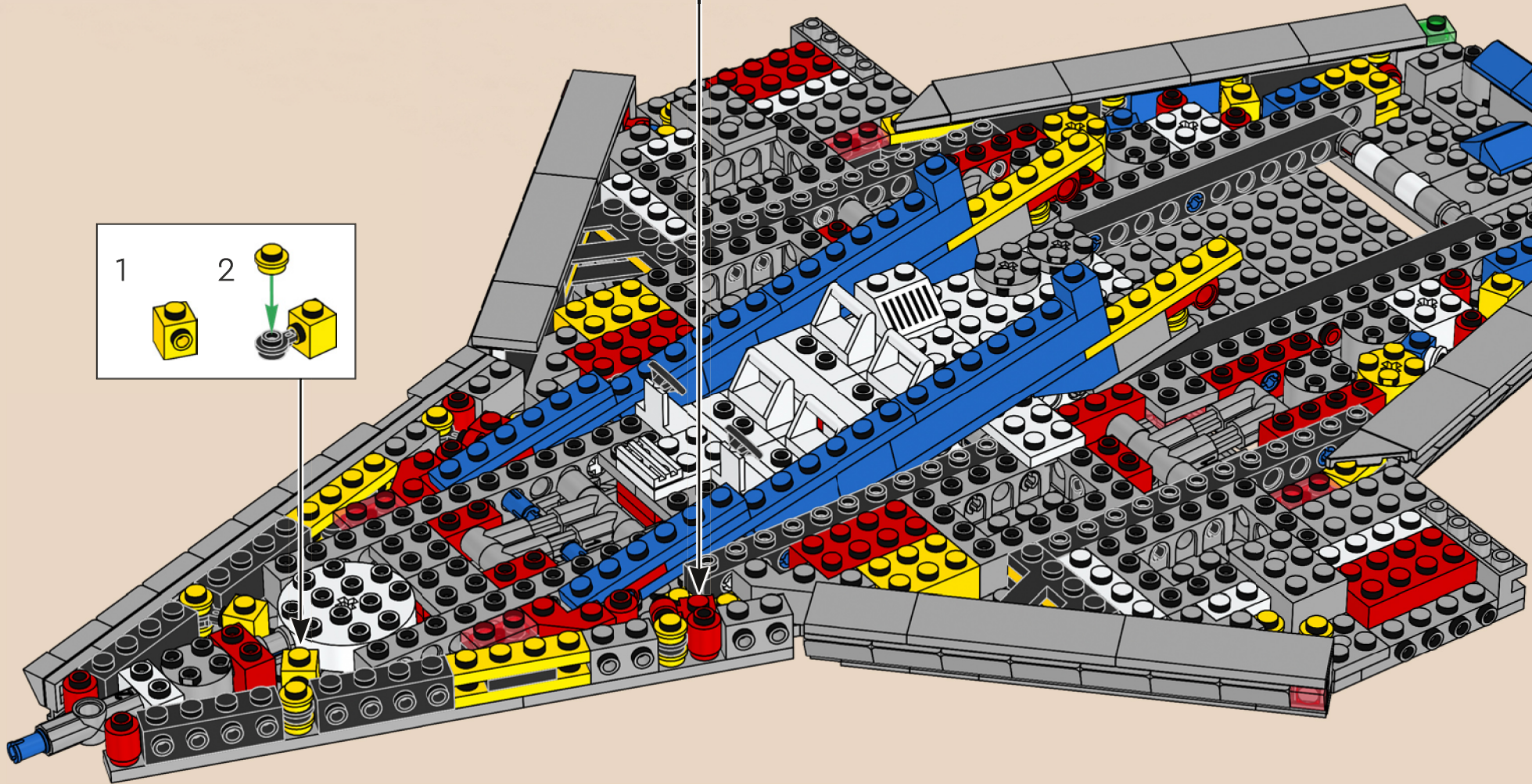

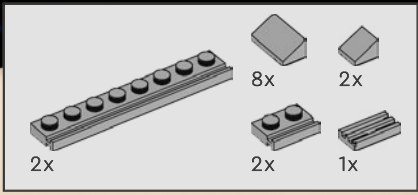

127

1

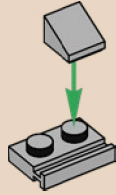

2

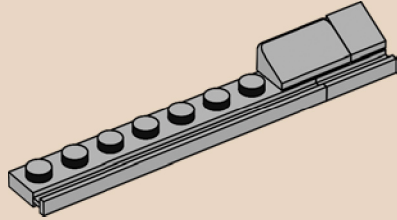

3

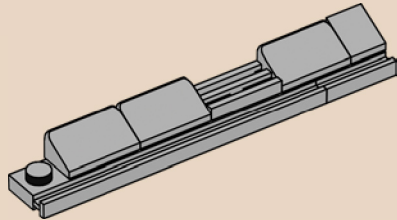

4

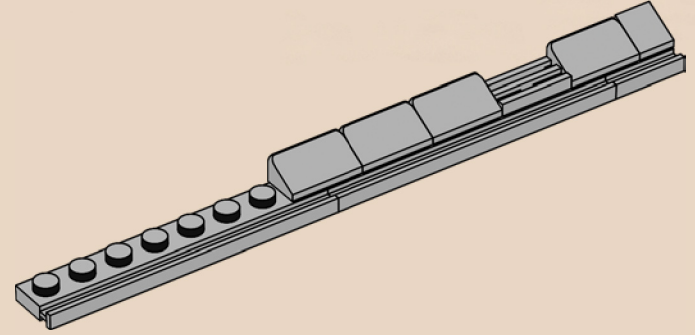

5

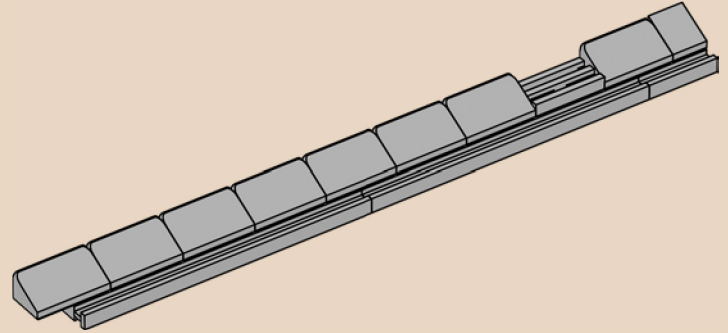

6

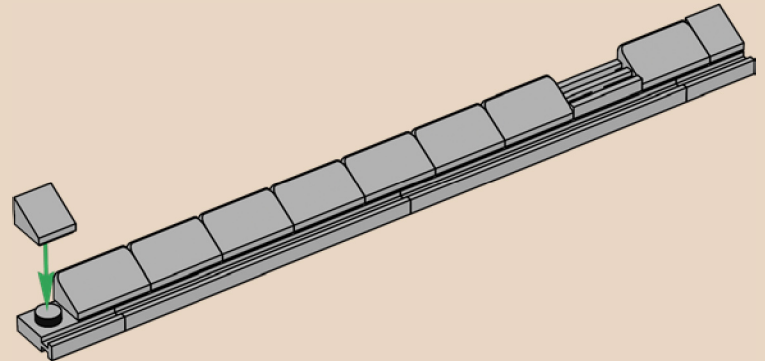



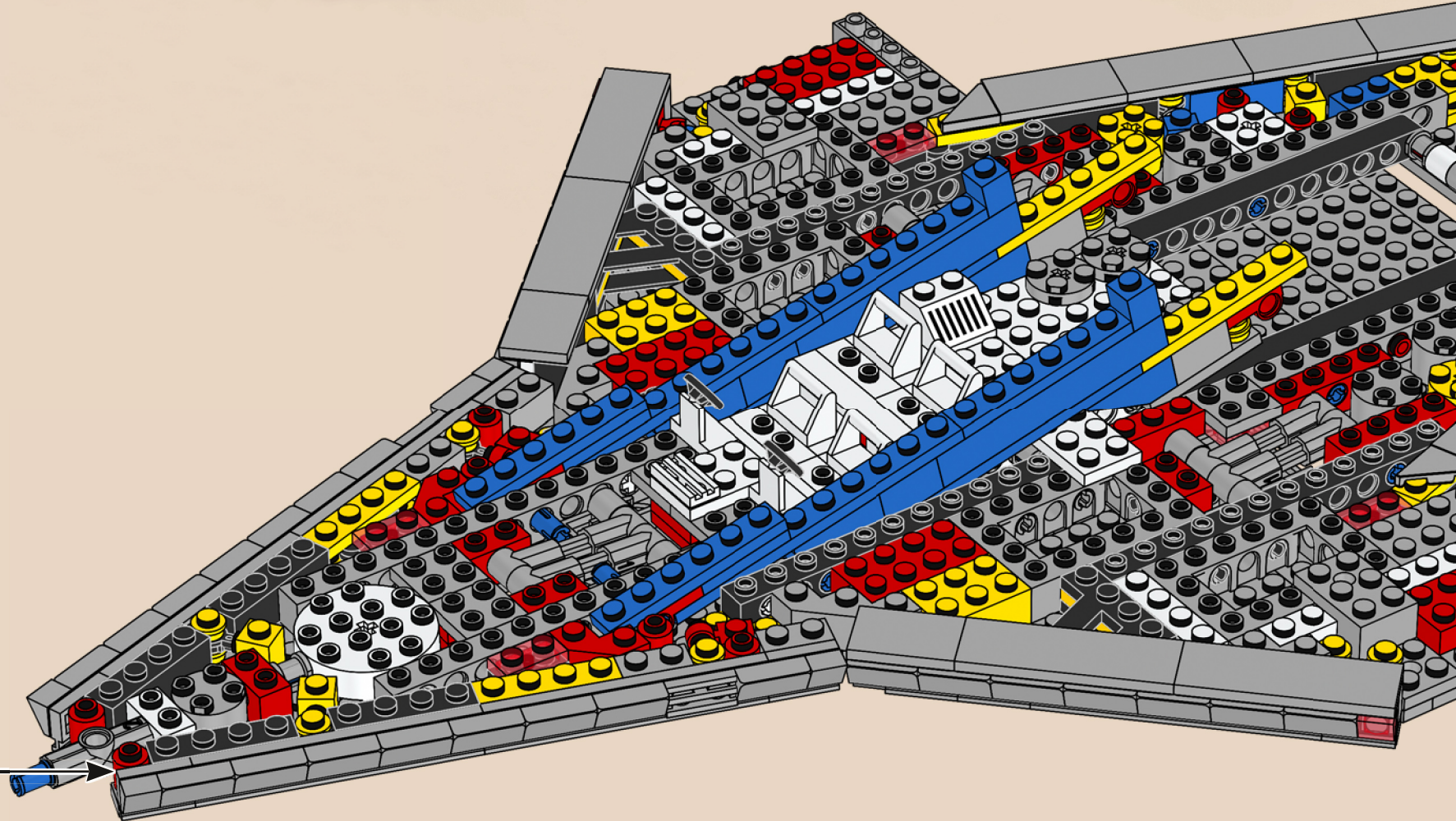

4x 1x 1x

4x

128

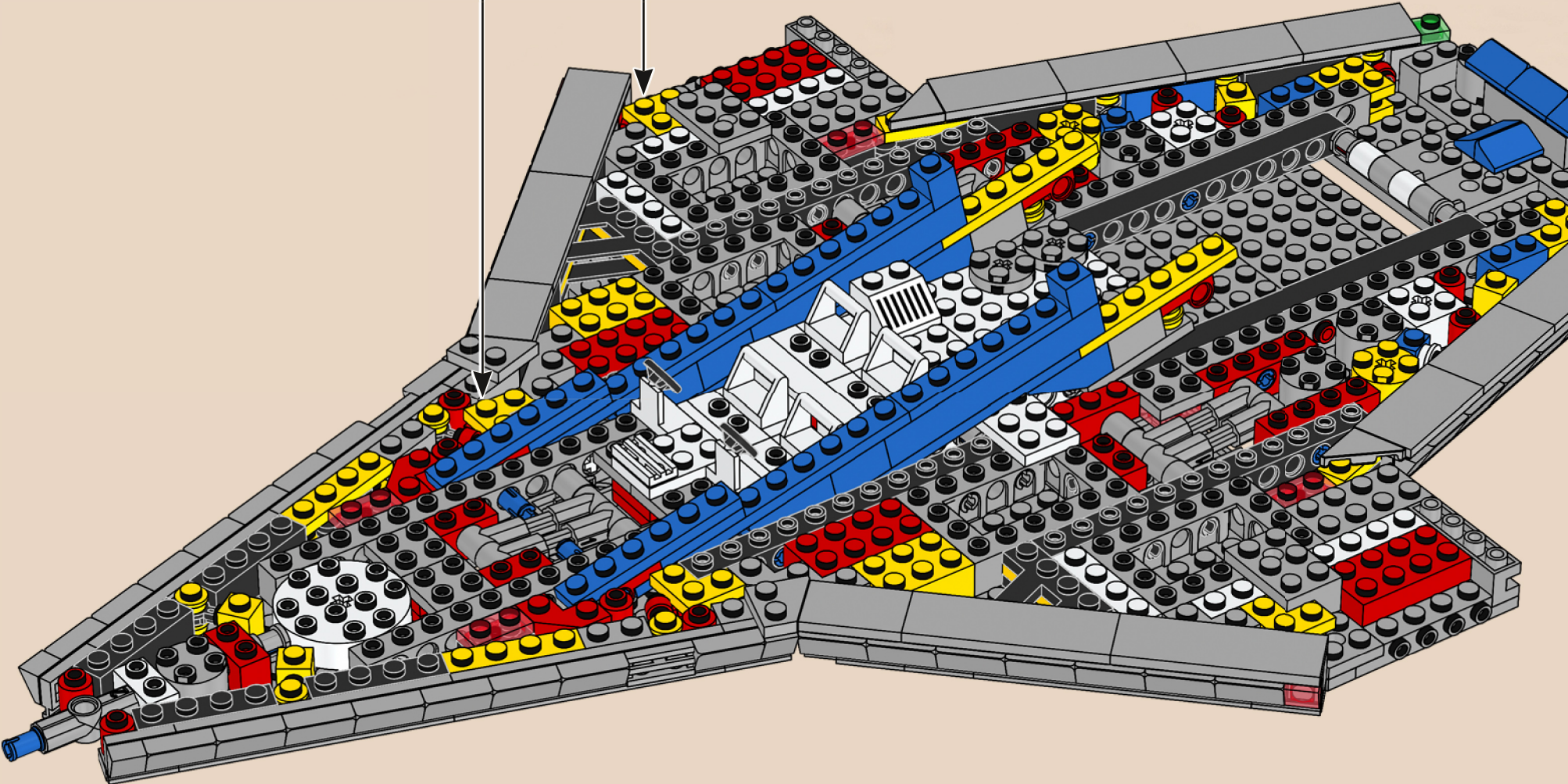

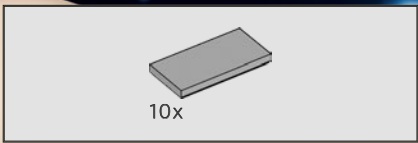

129

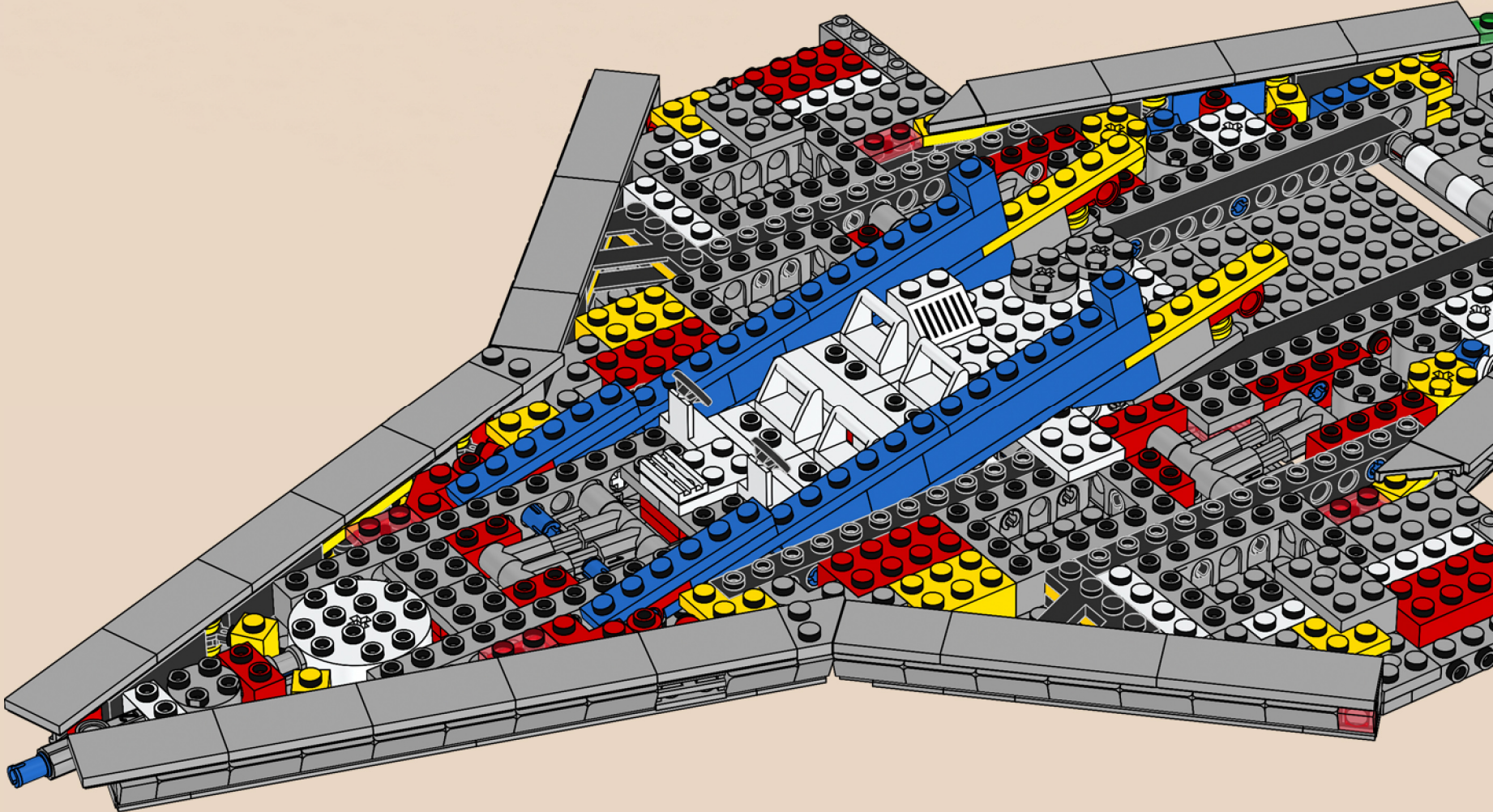

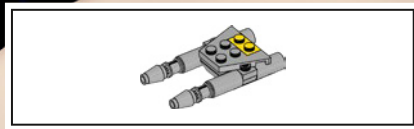
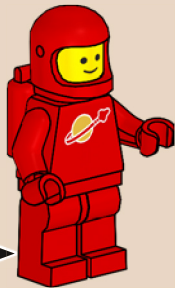
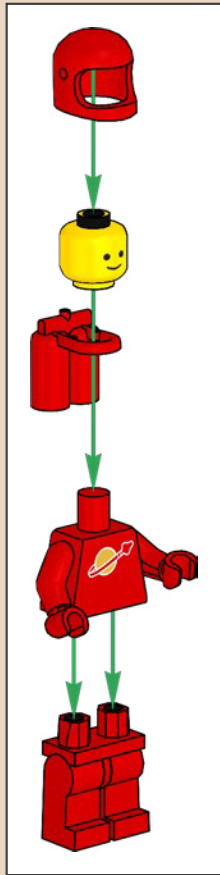

130

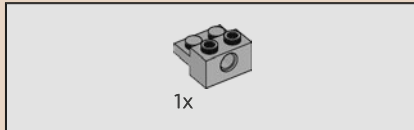
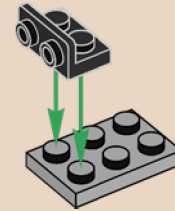

131

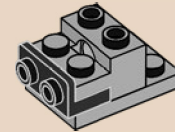

132

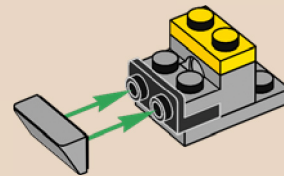



133

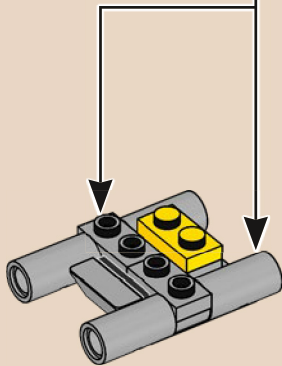
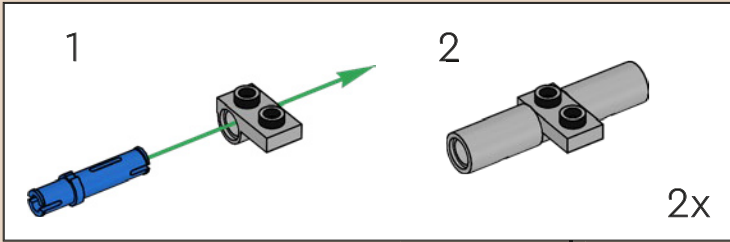

134

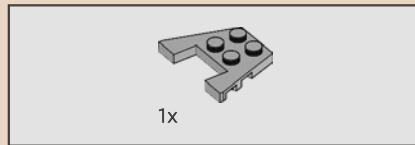
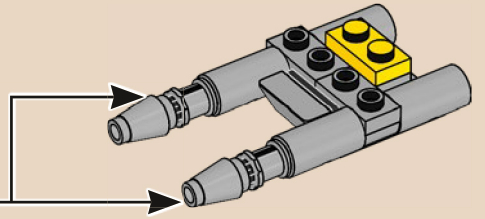
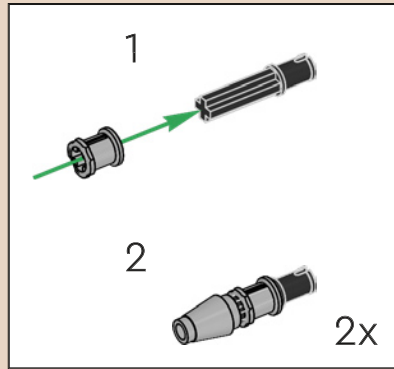

135

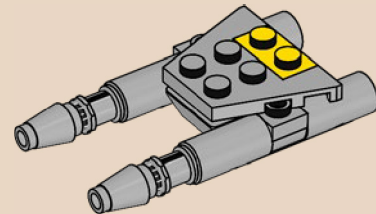

136

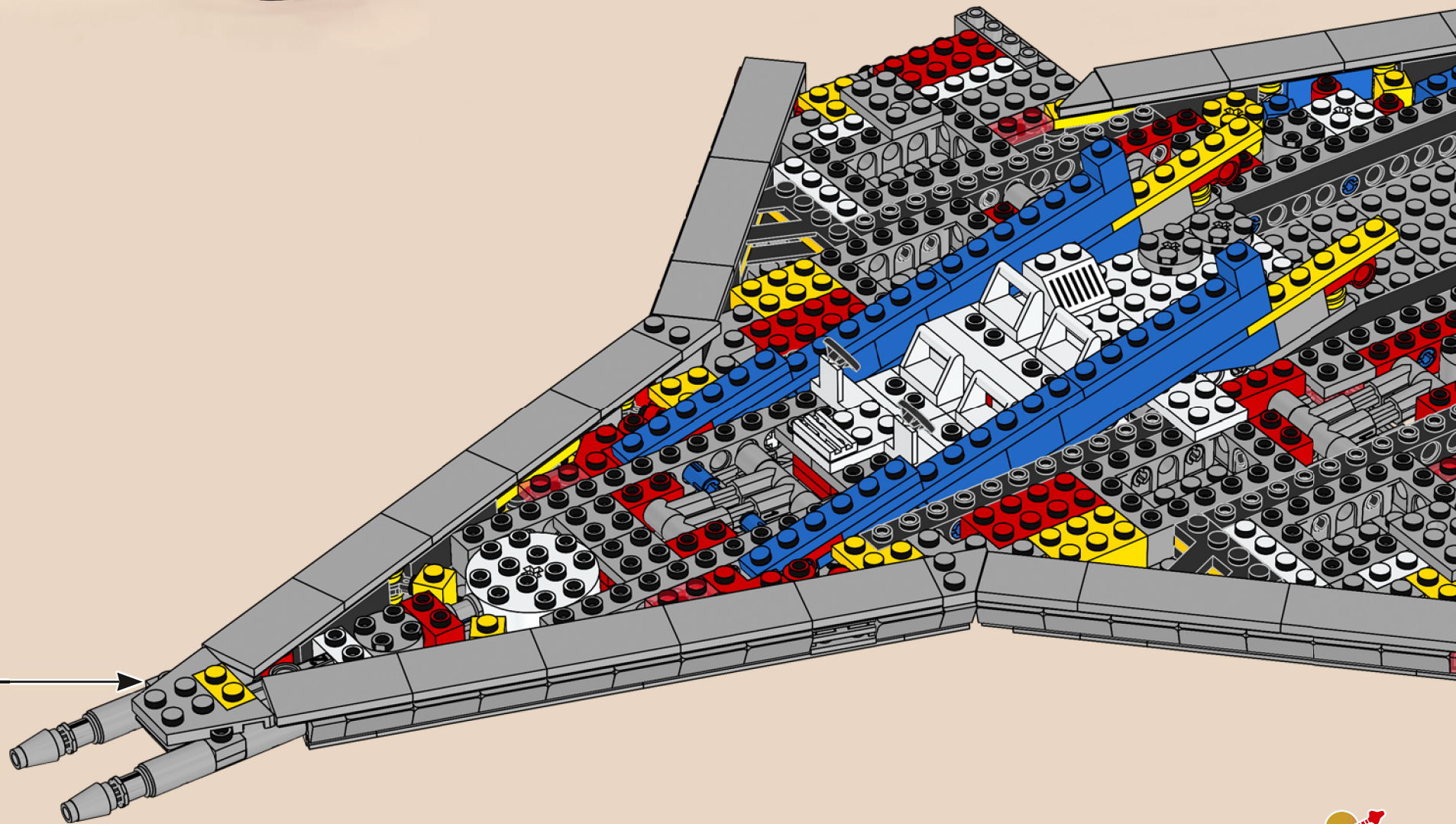

套装编号 10497 用于向原始银河探飞船  
美国版的套装编号 497 致敬。

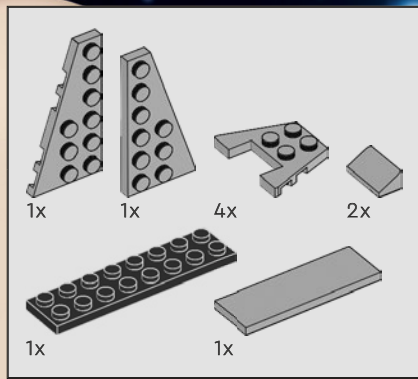

137

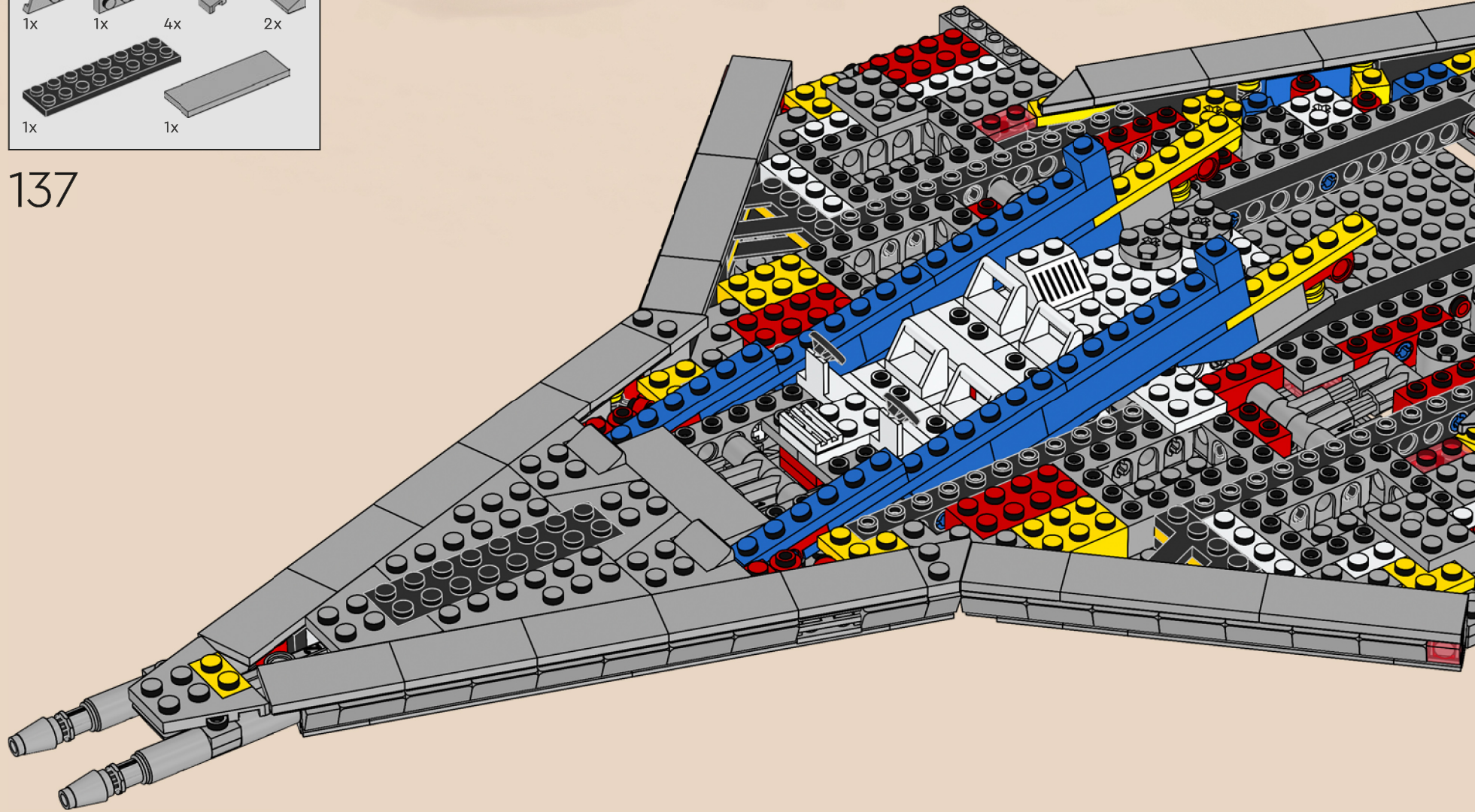

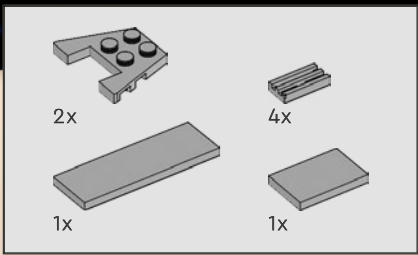

138

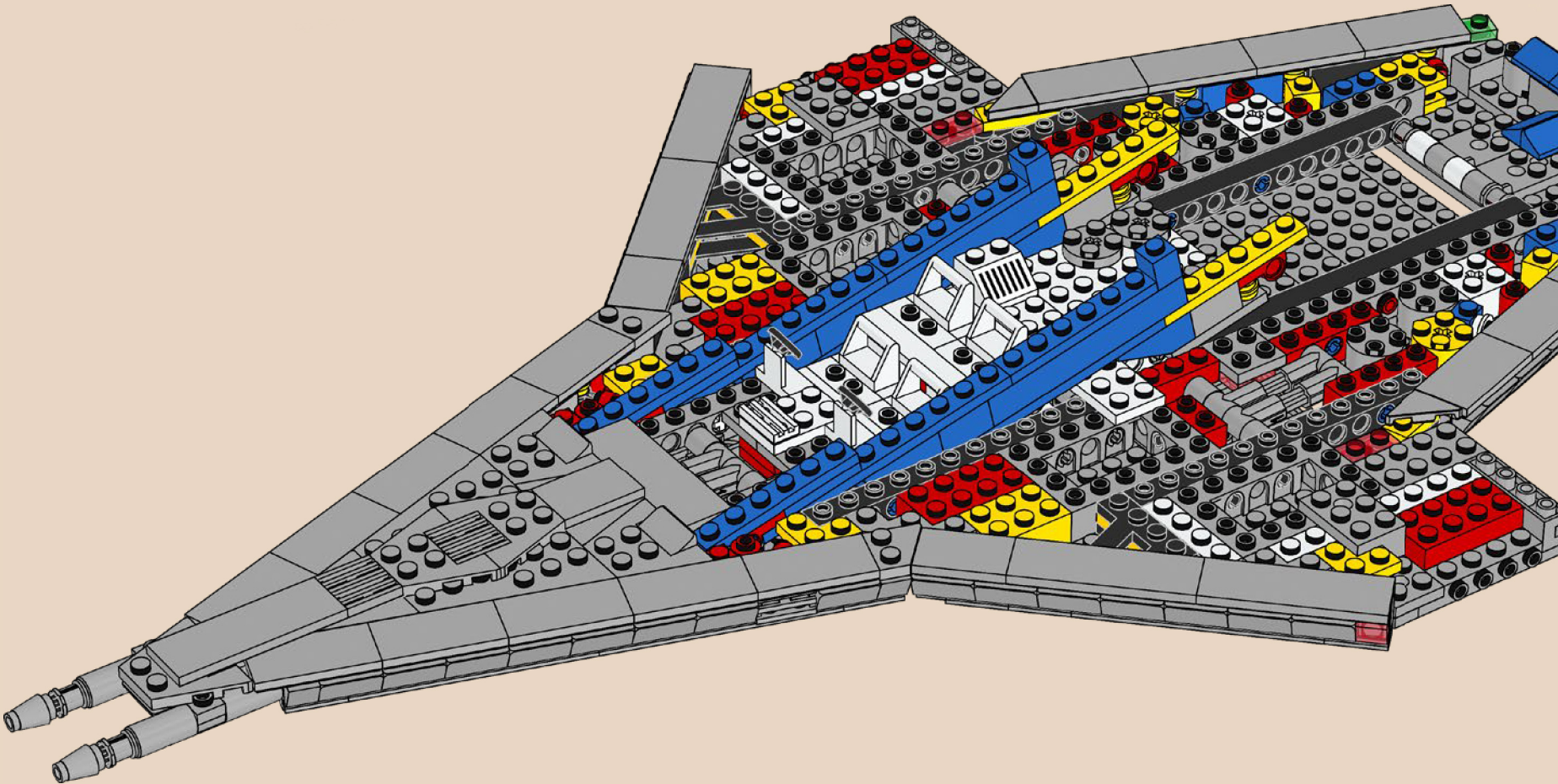



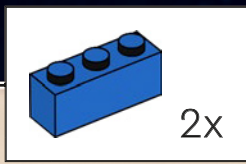
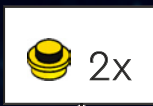
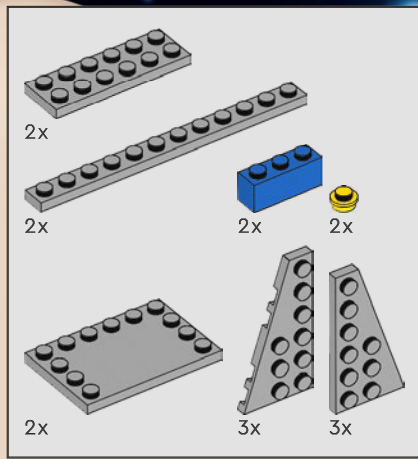

139

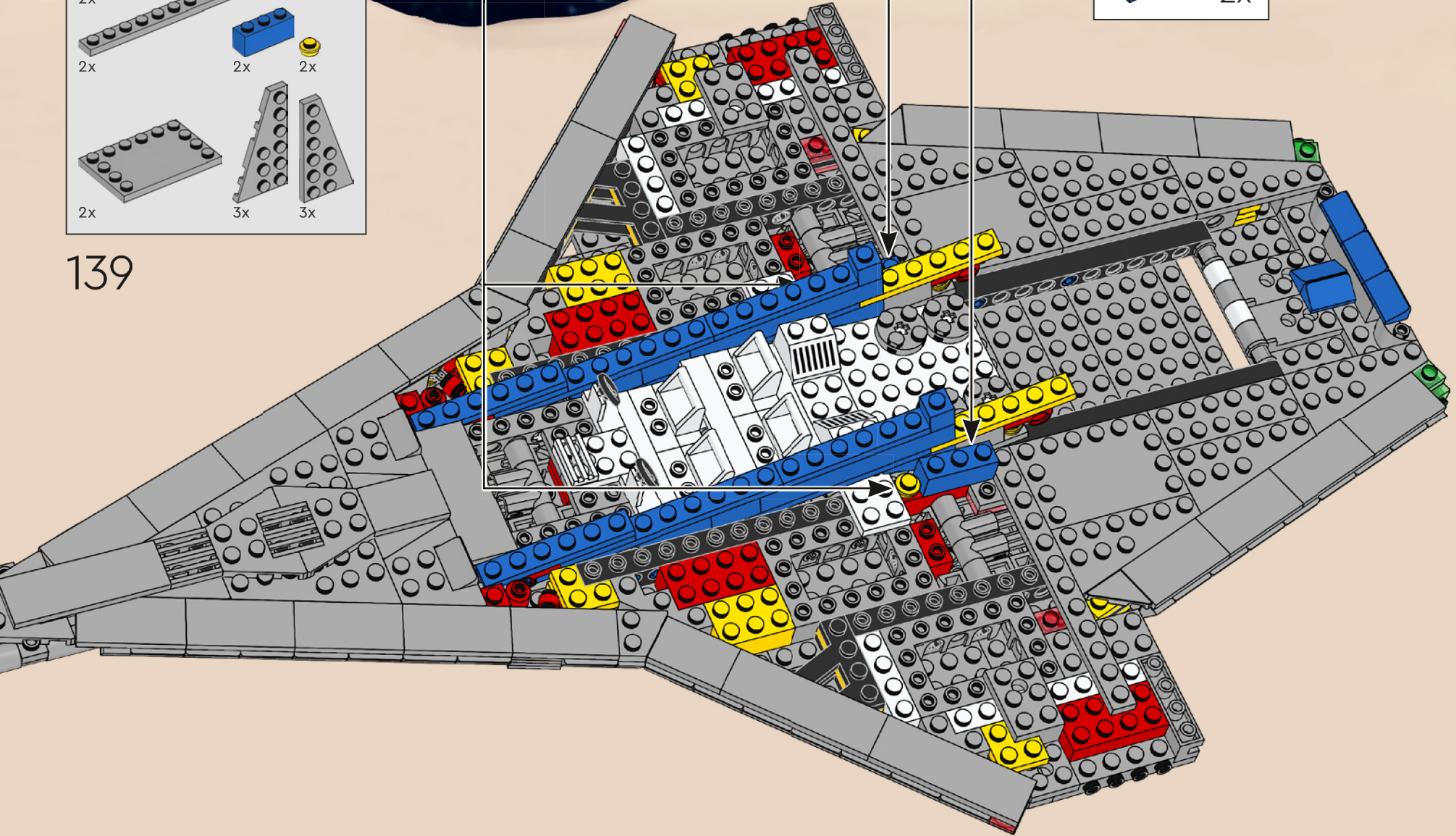

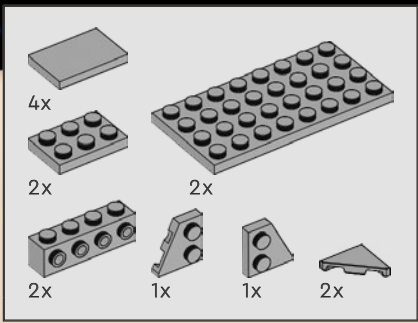

140

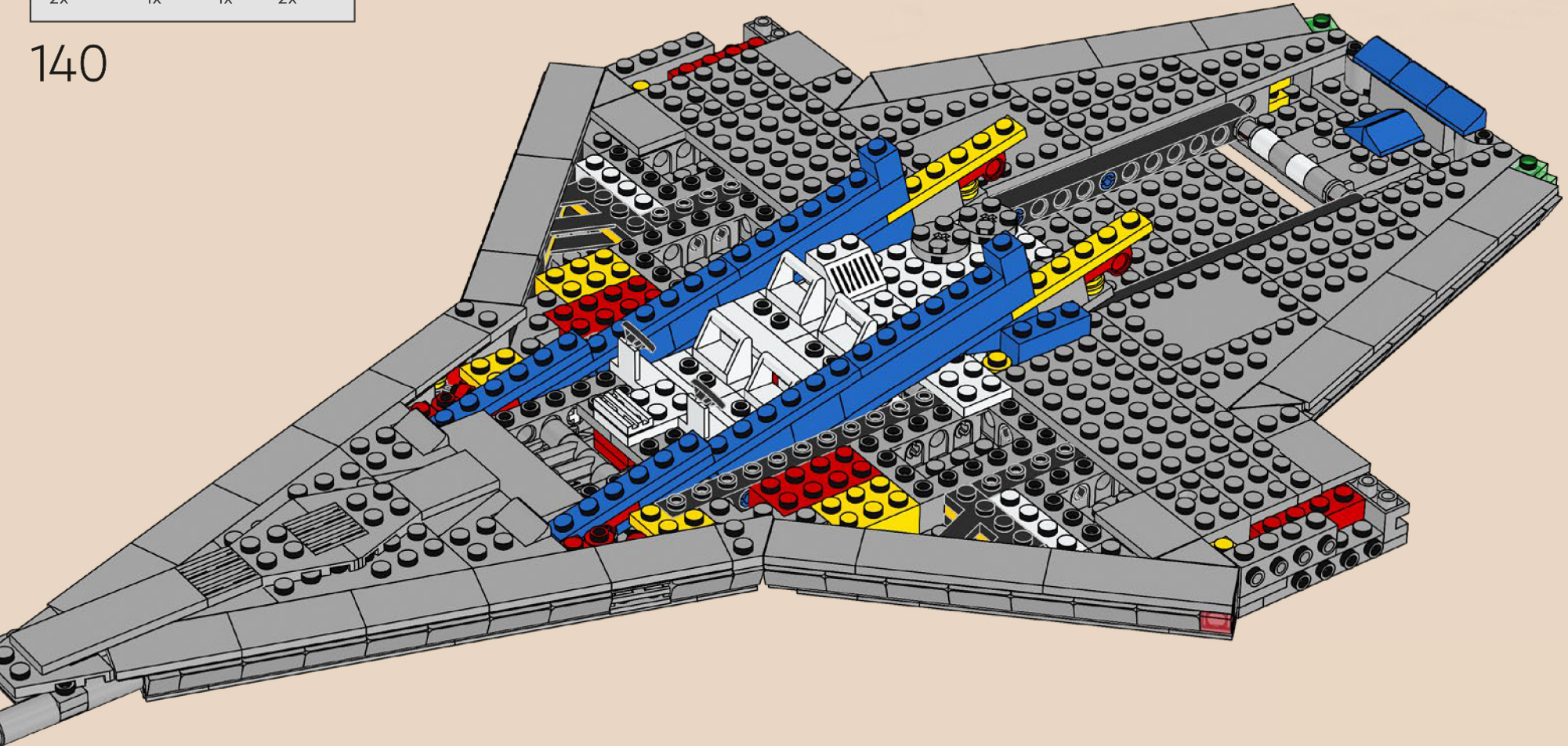

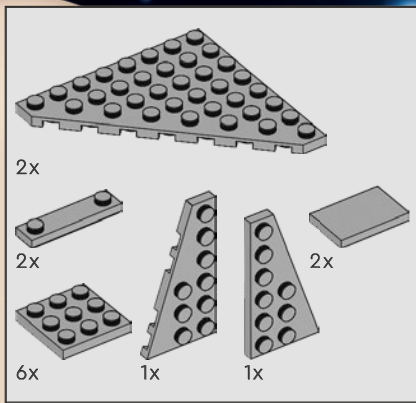

141

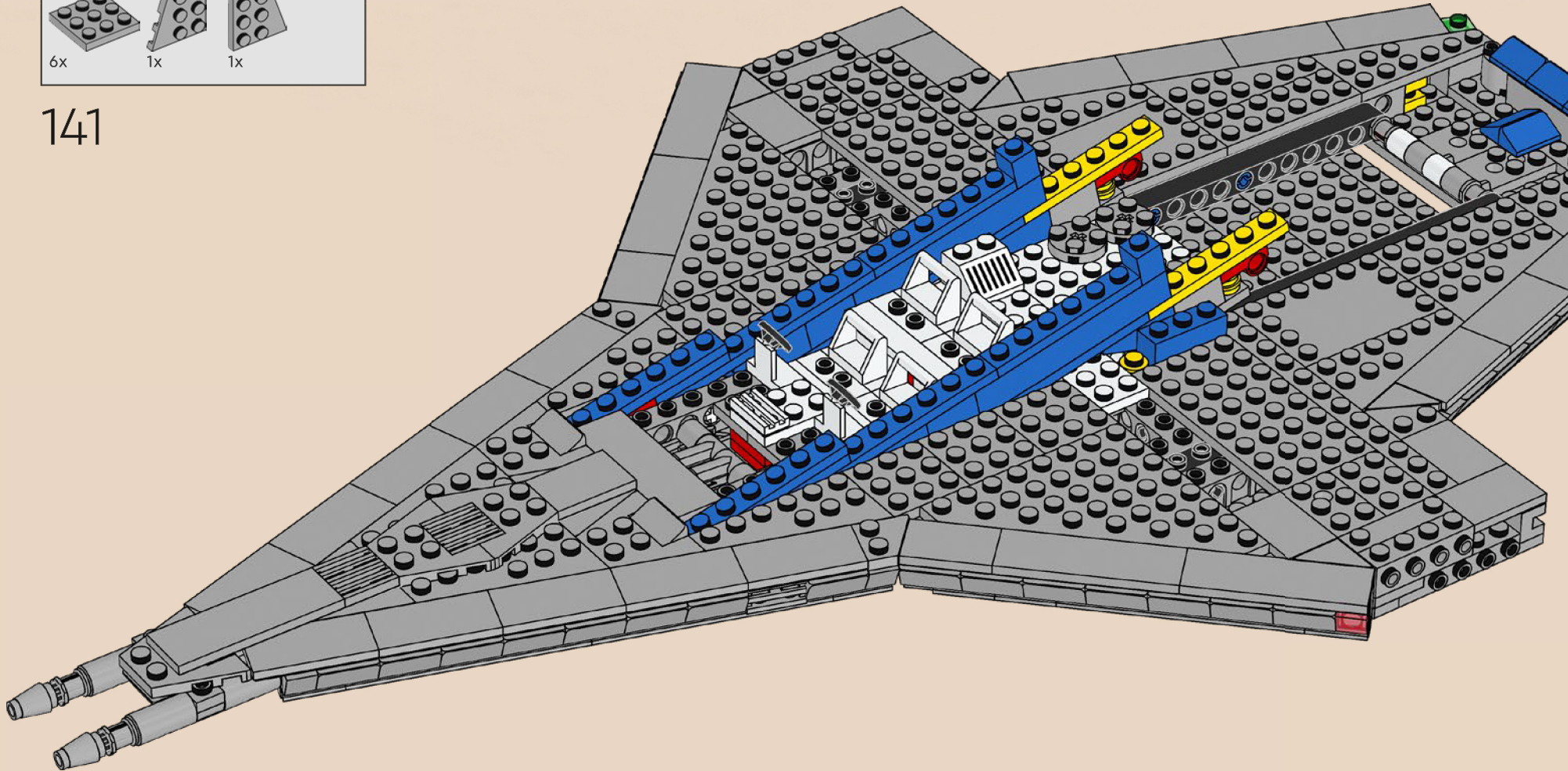

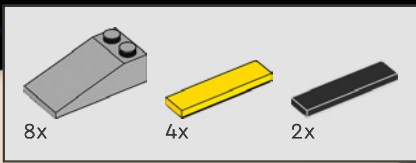

142

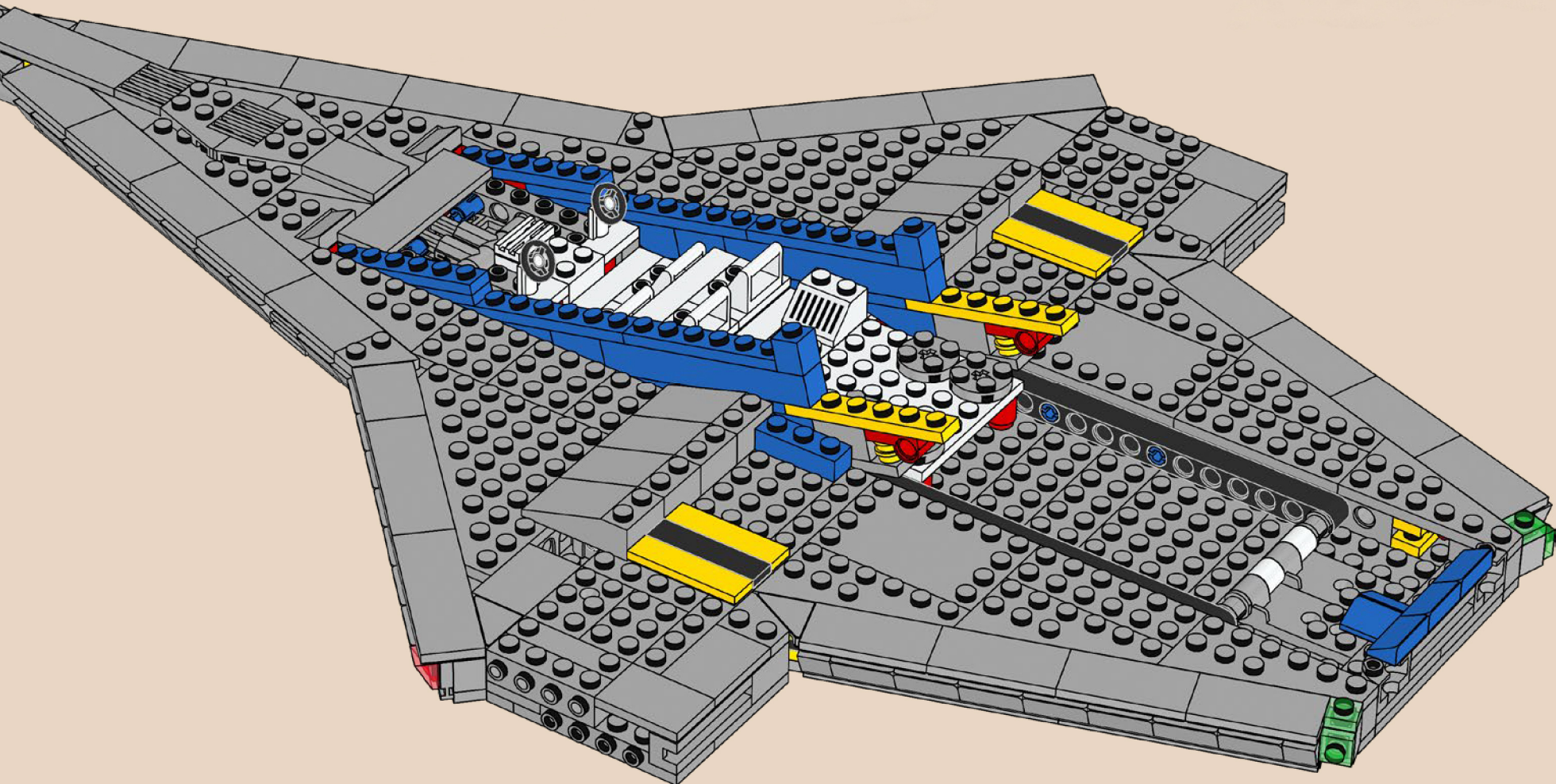

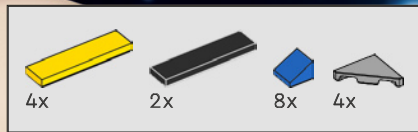

143

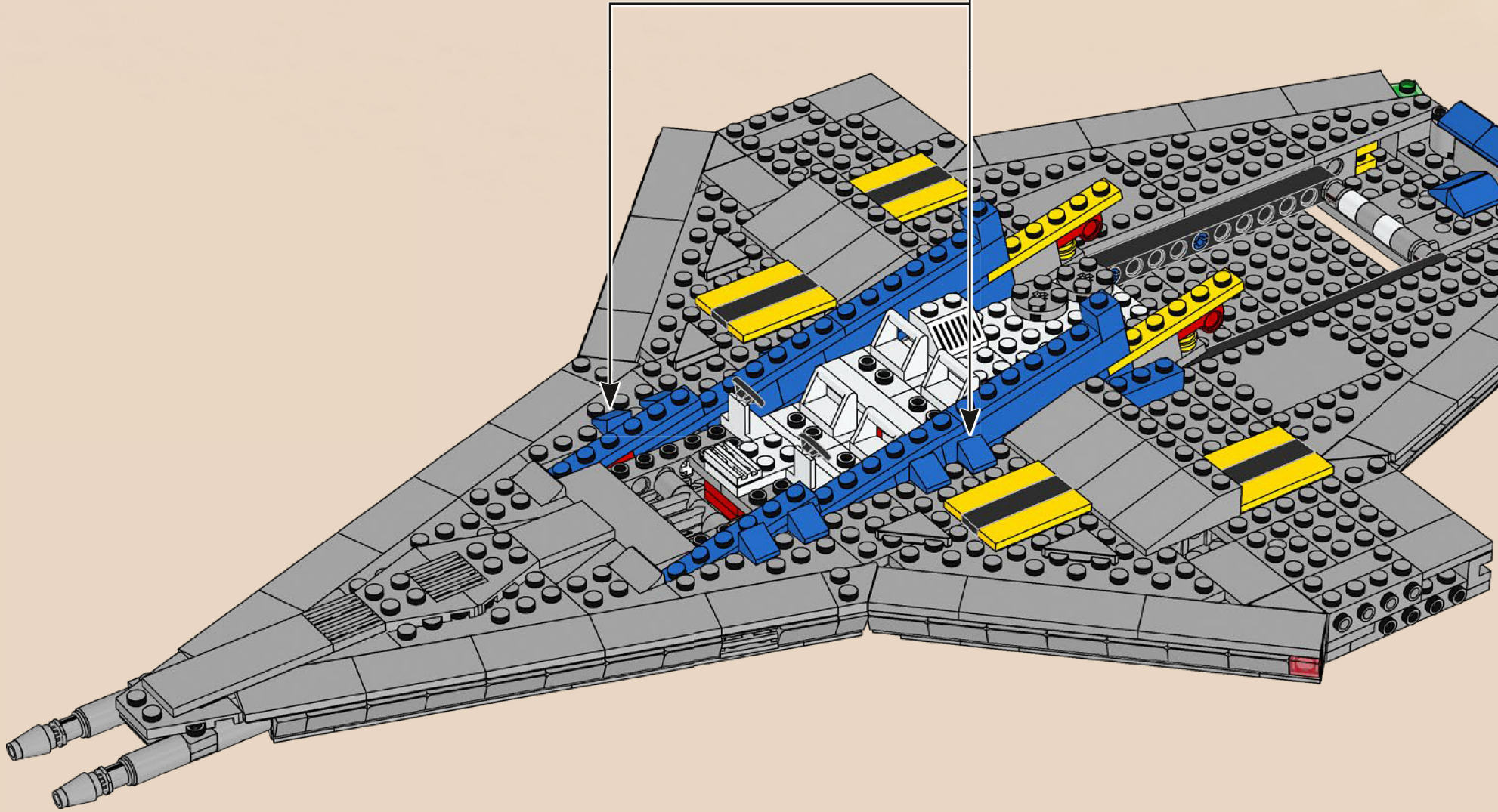

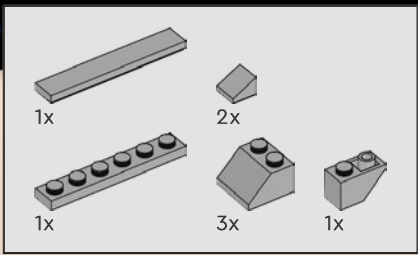

144

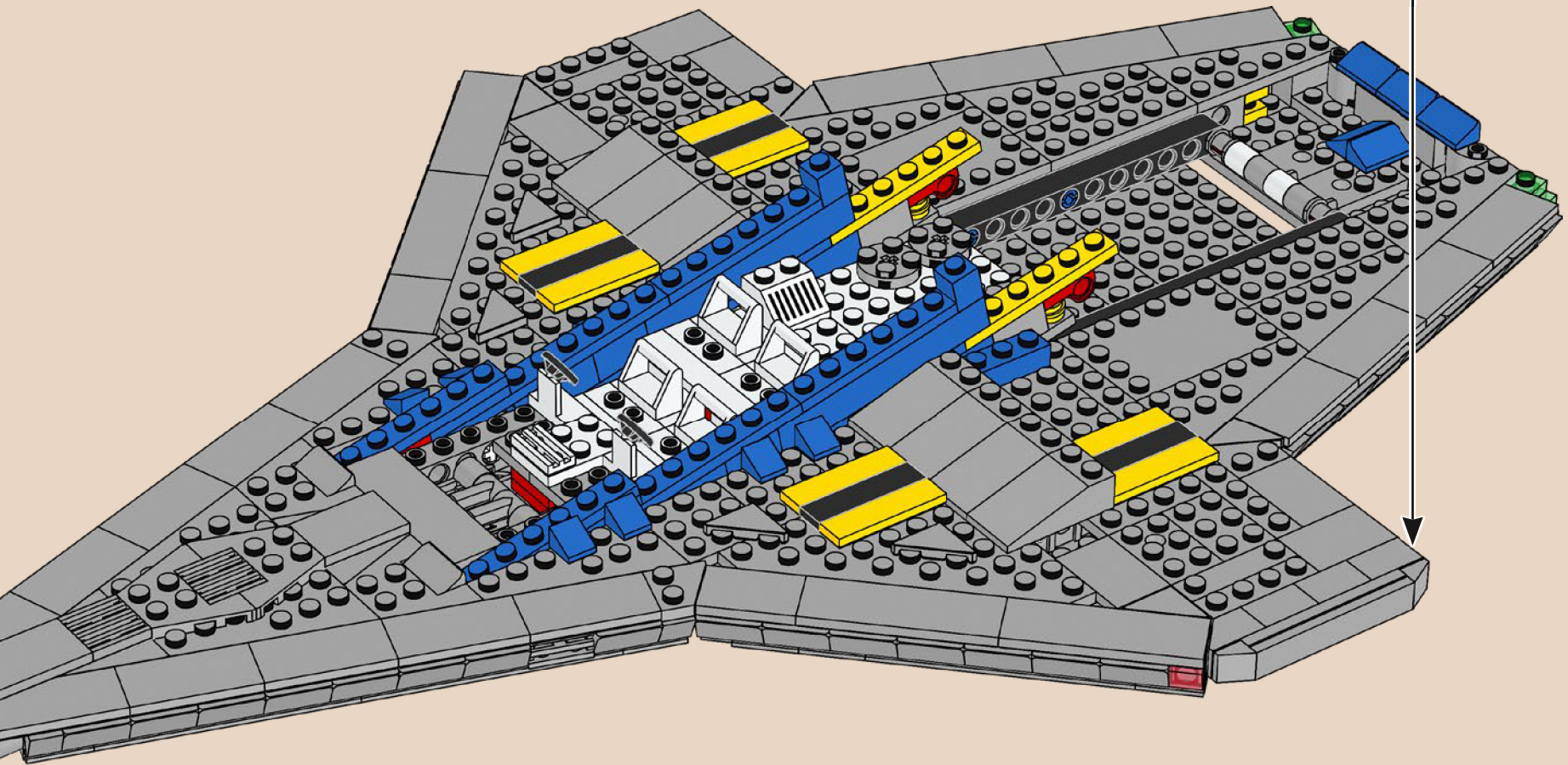
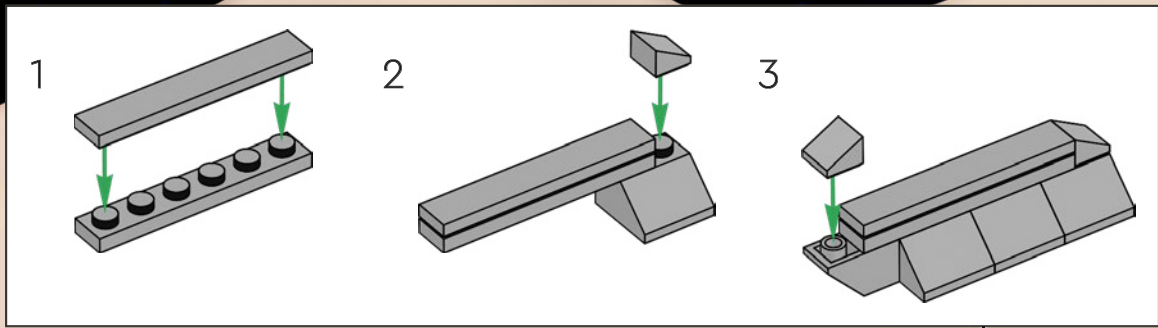

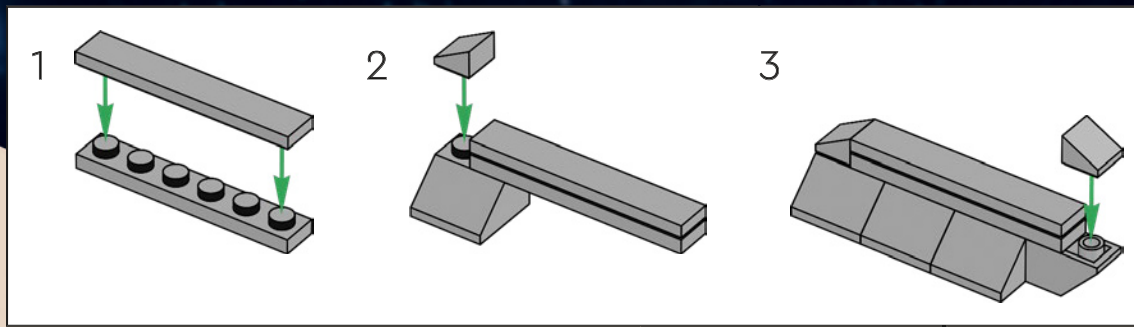
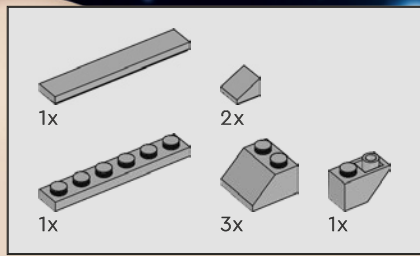

145

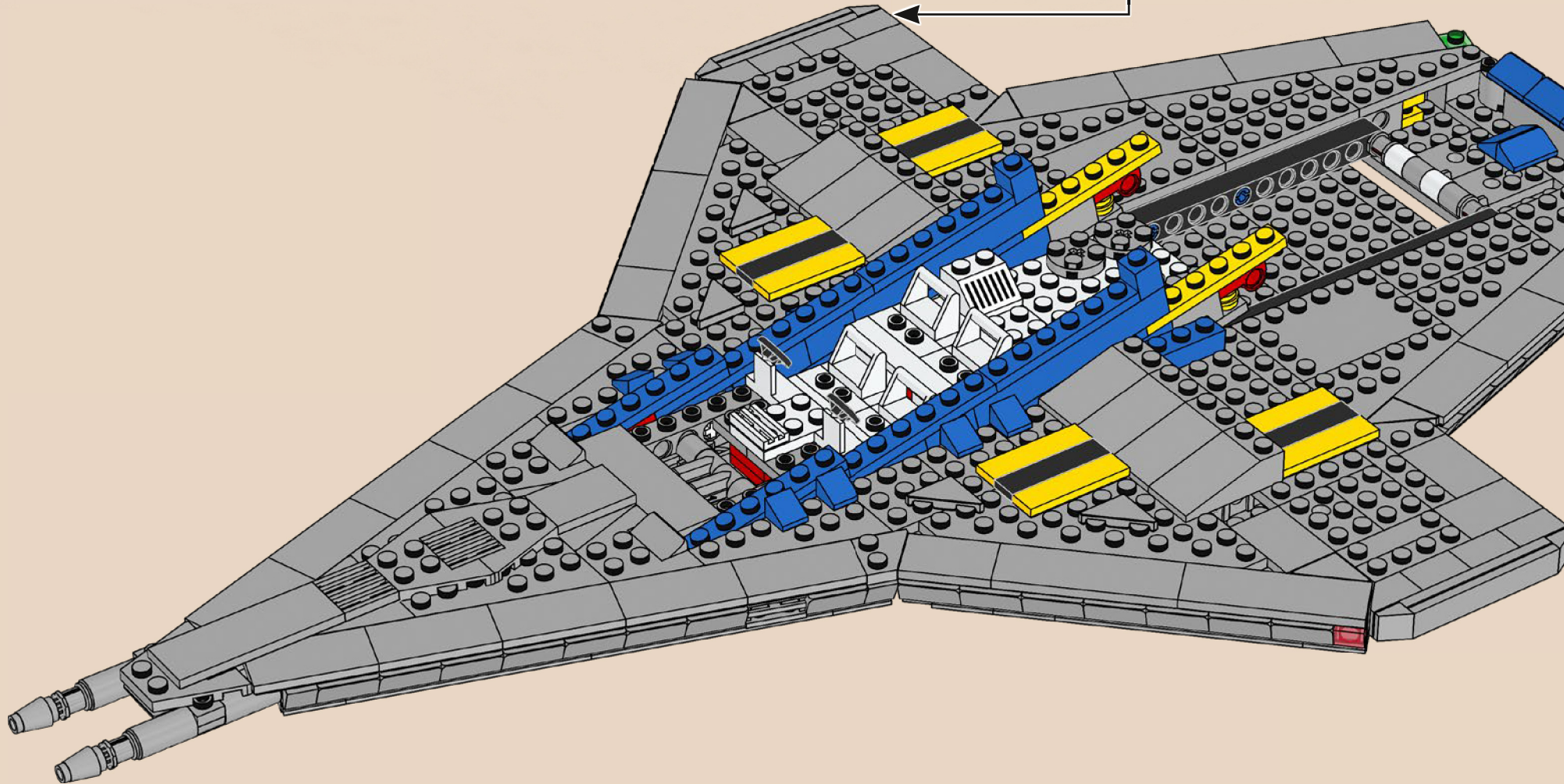

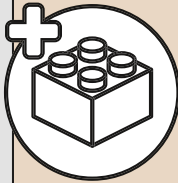
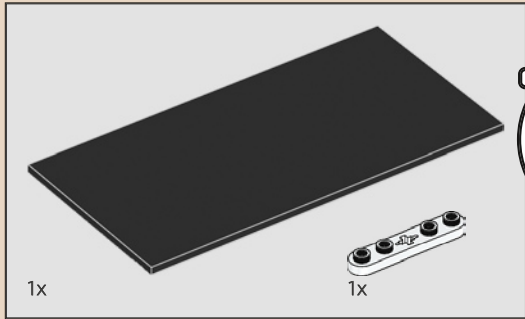
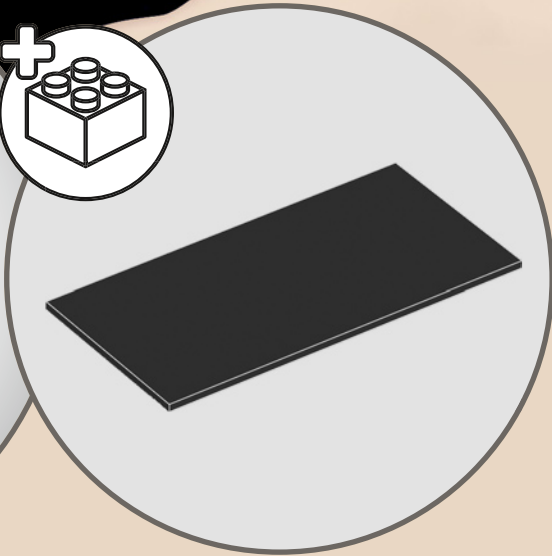
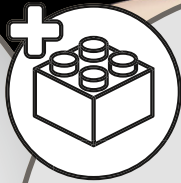
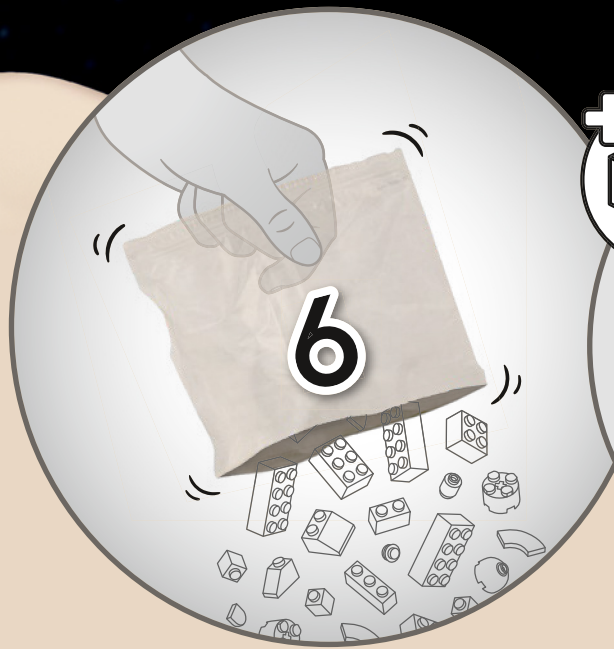

146

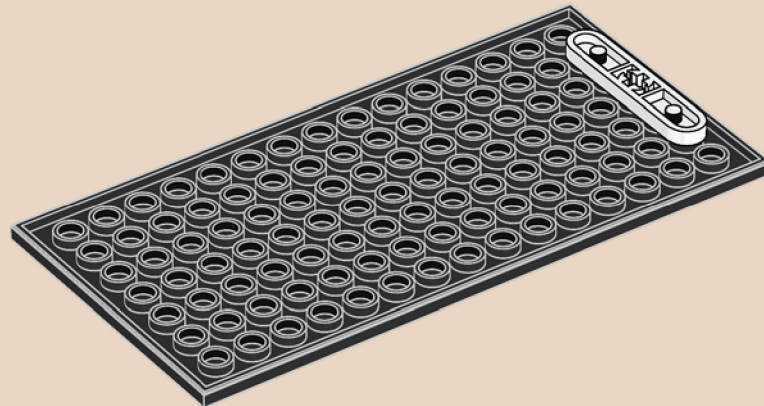



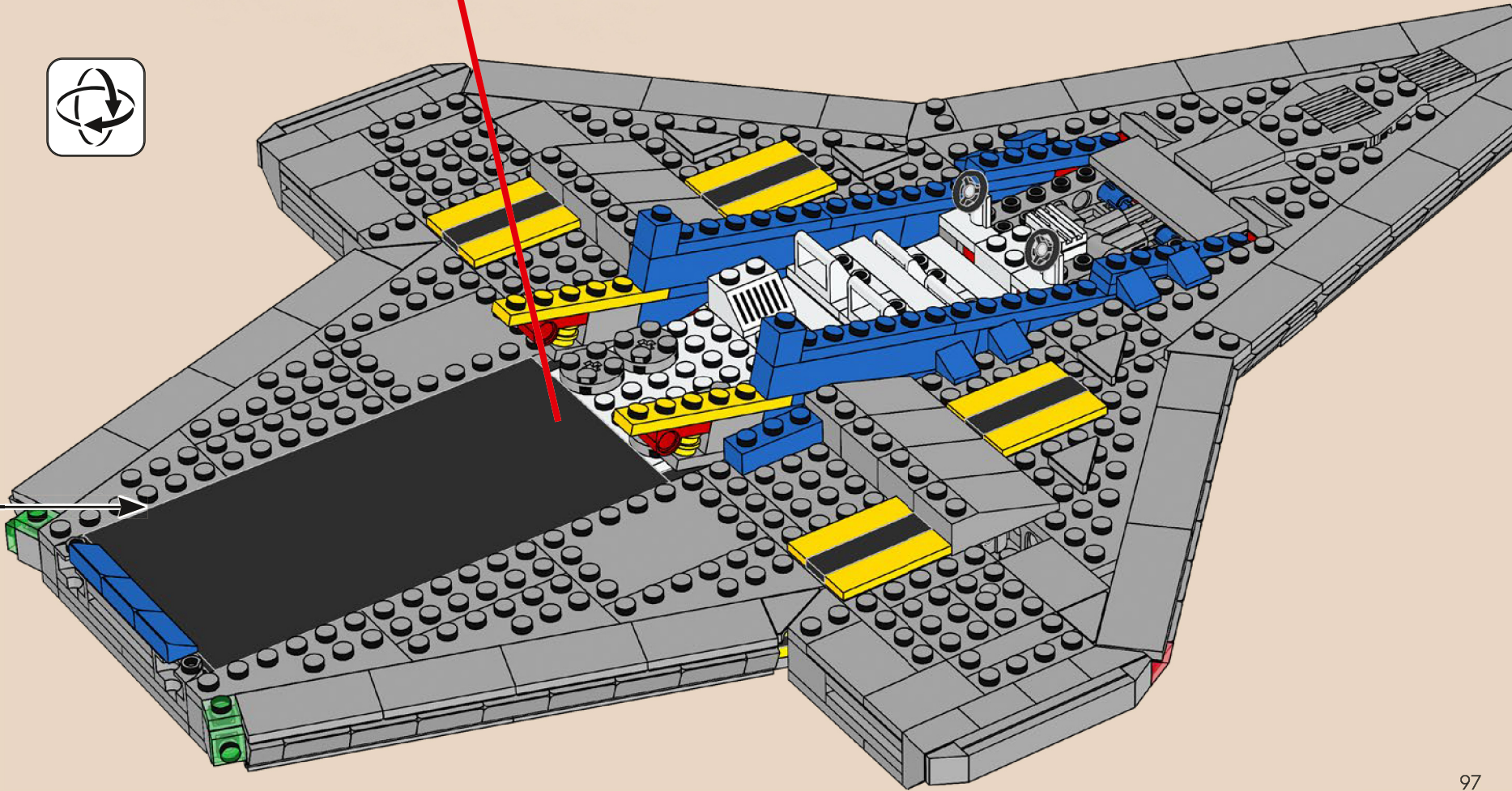
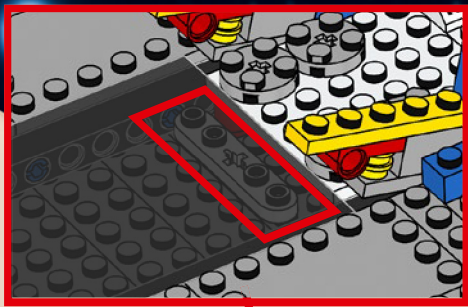

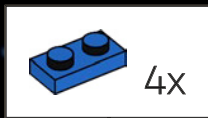
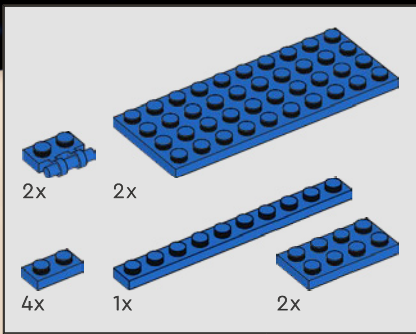

147

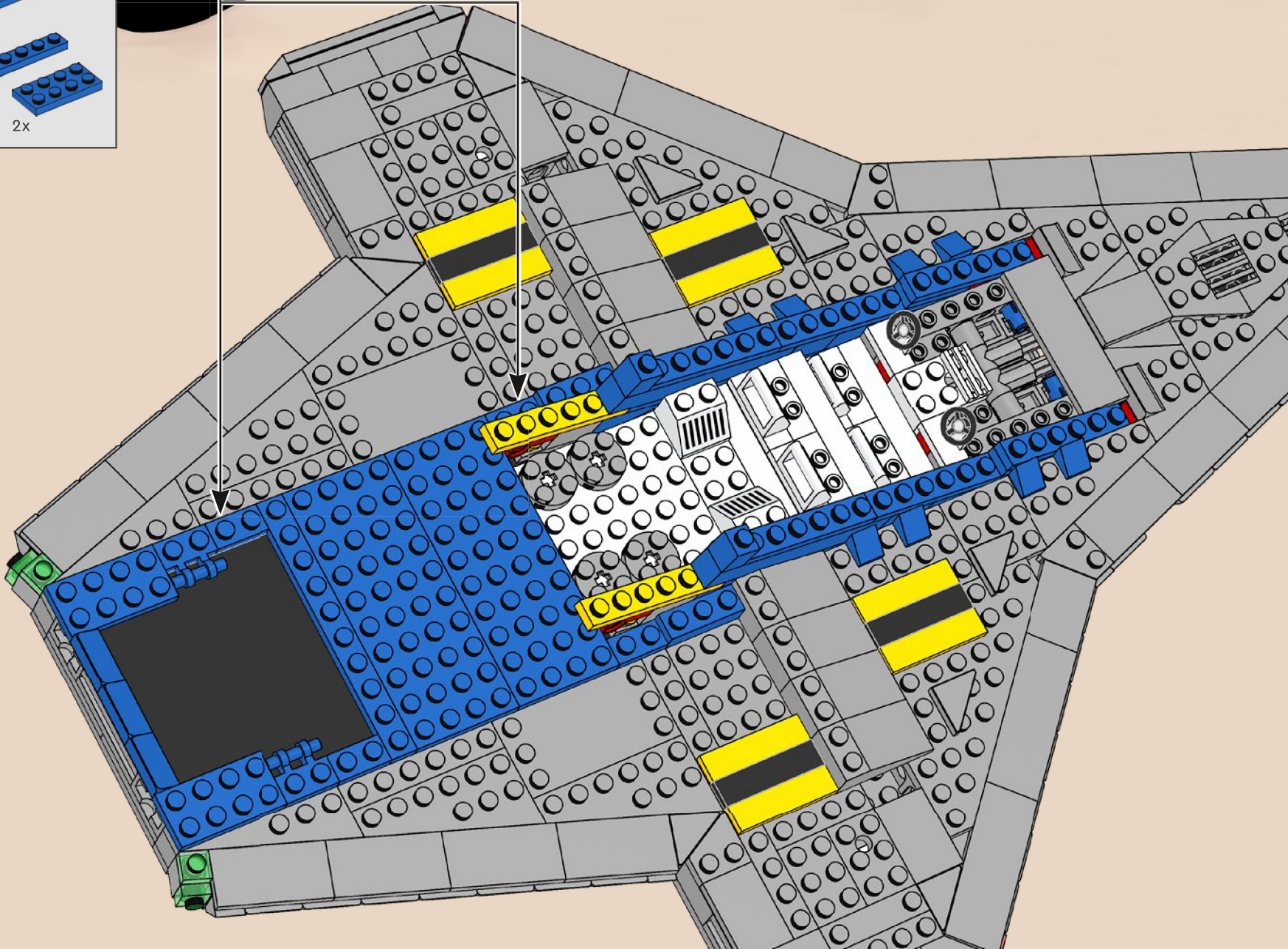

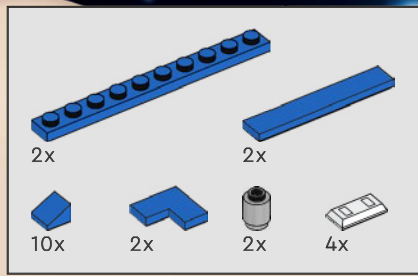

148

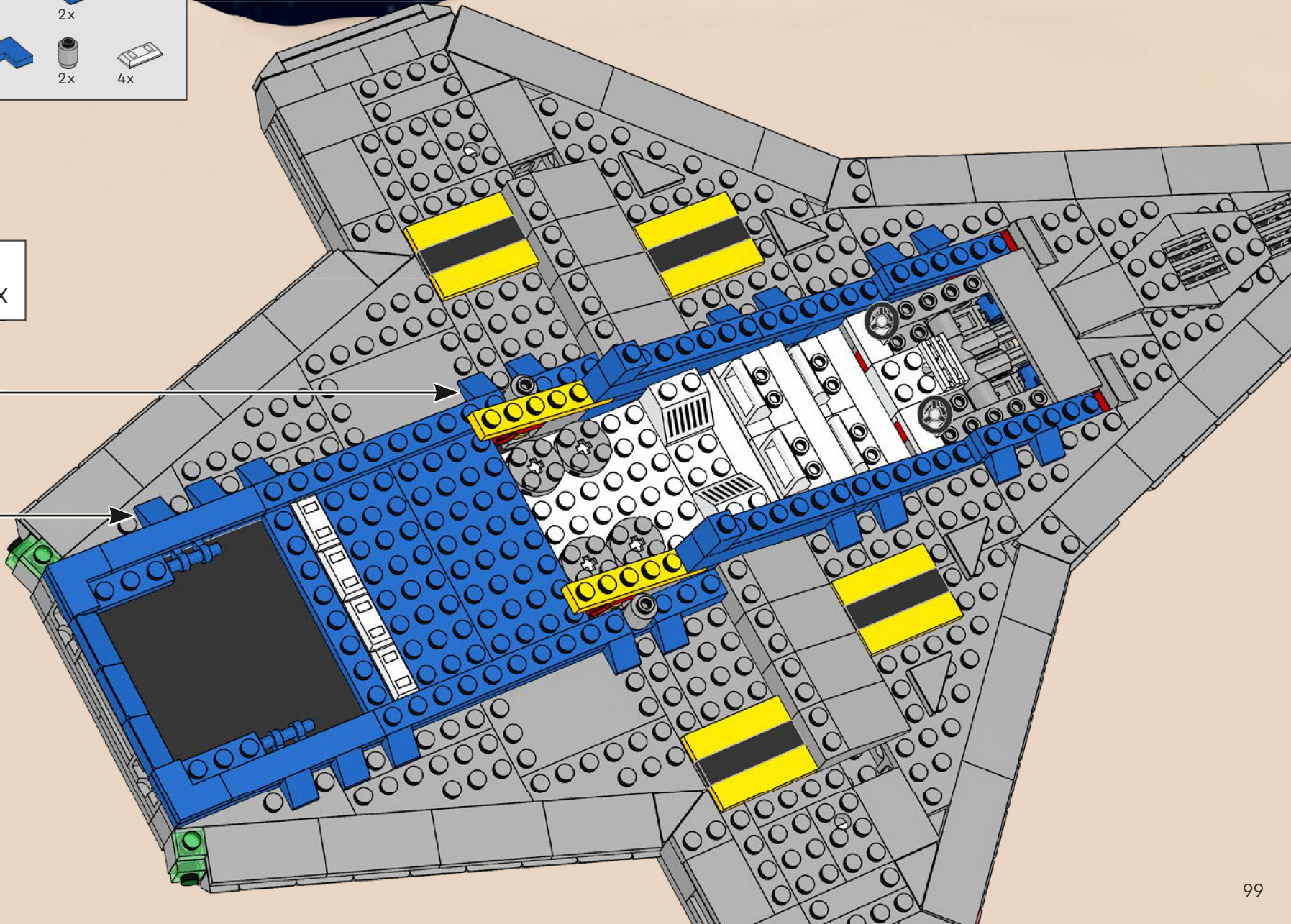
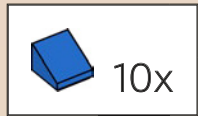

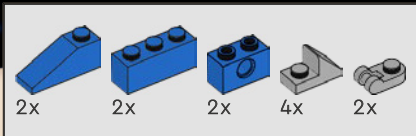

149

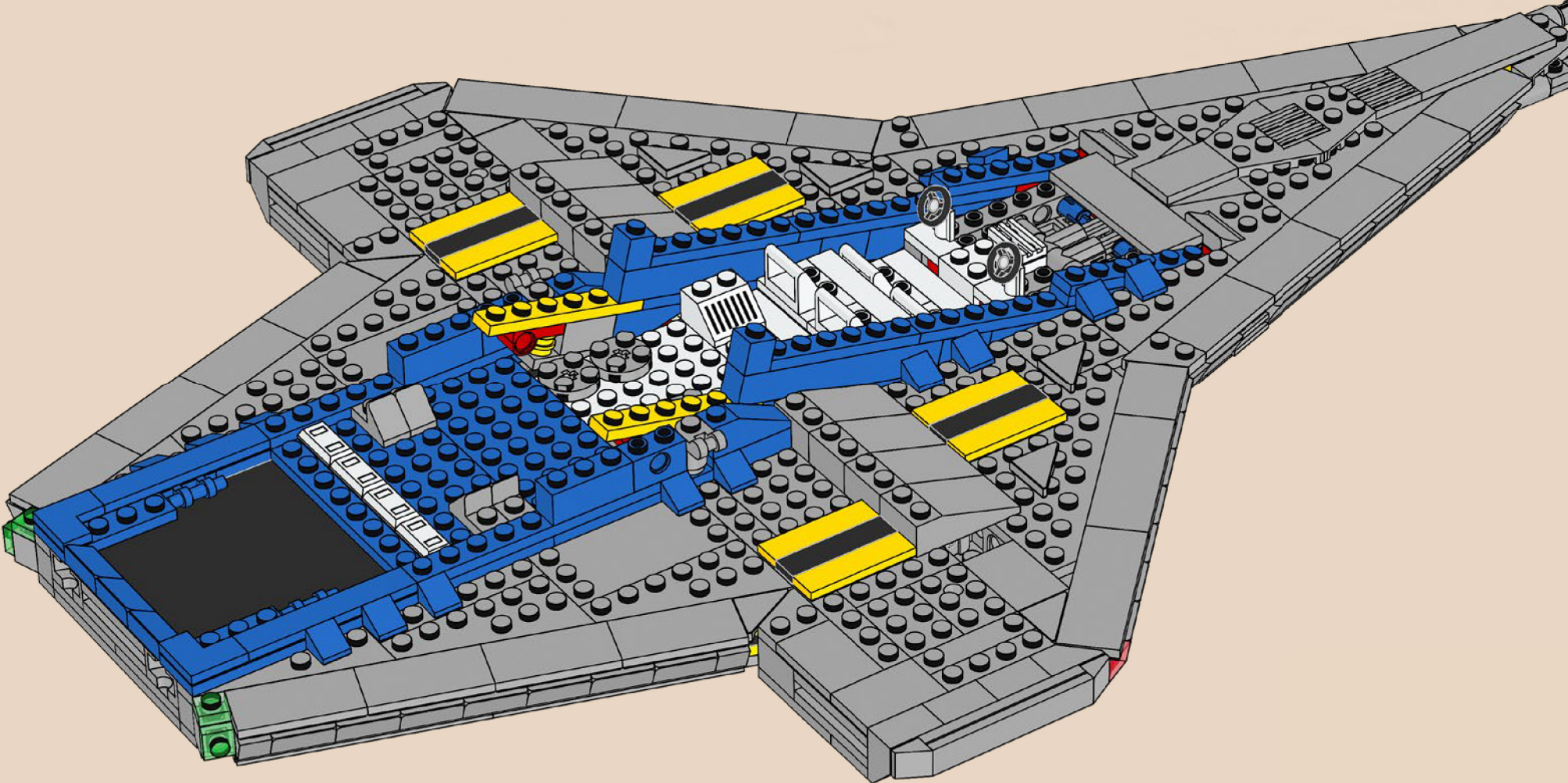

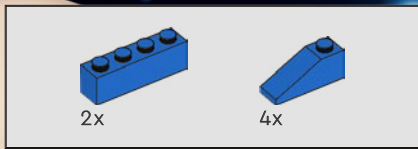

150

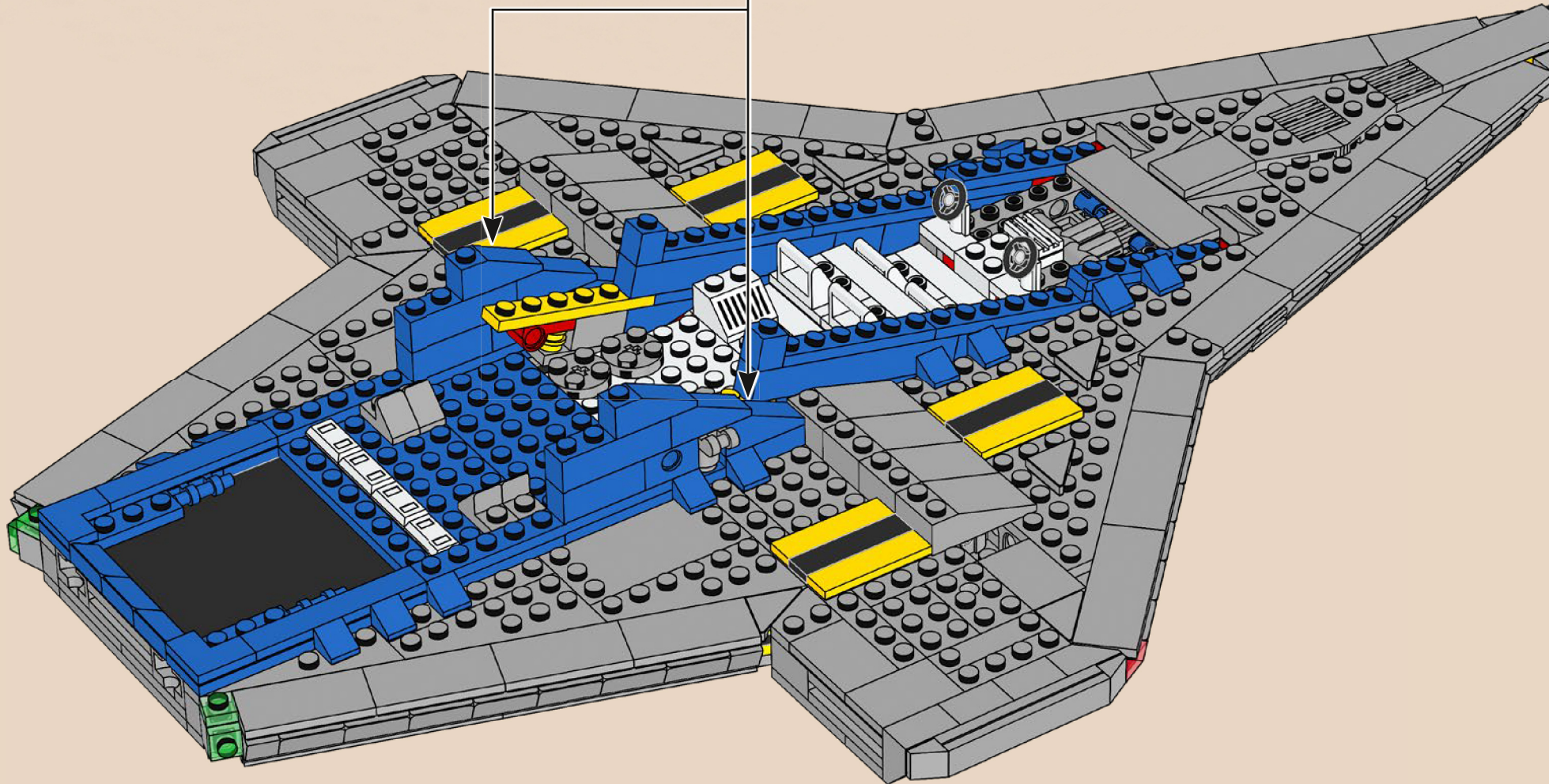
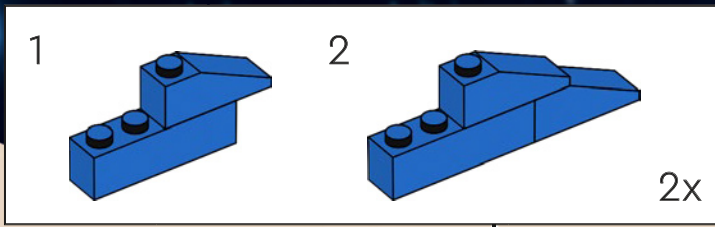

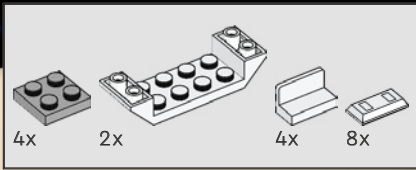

151

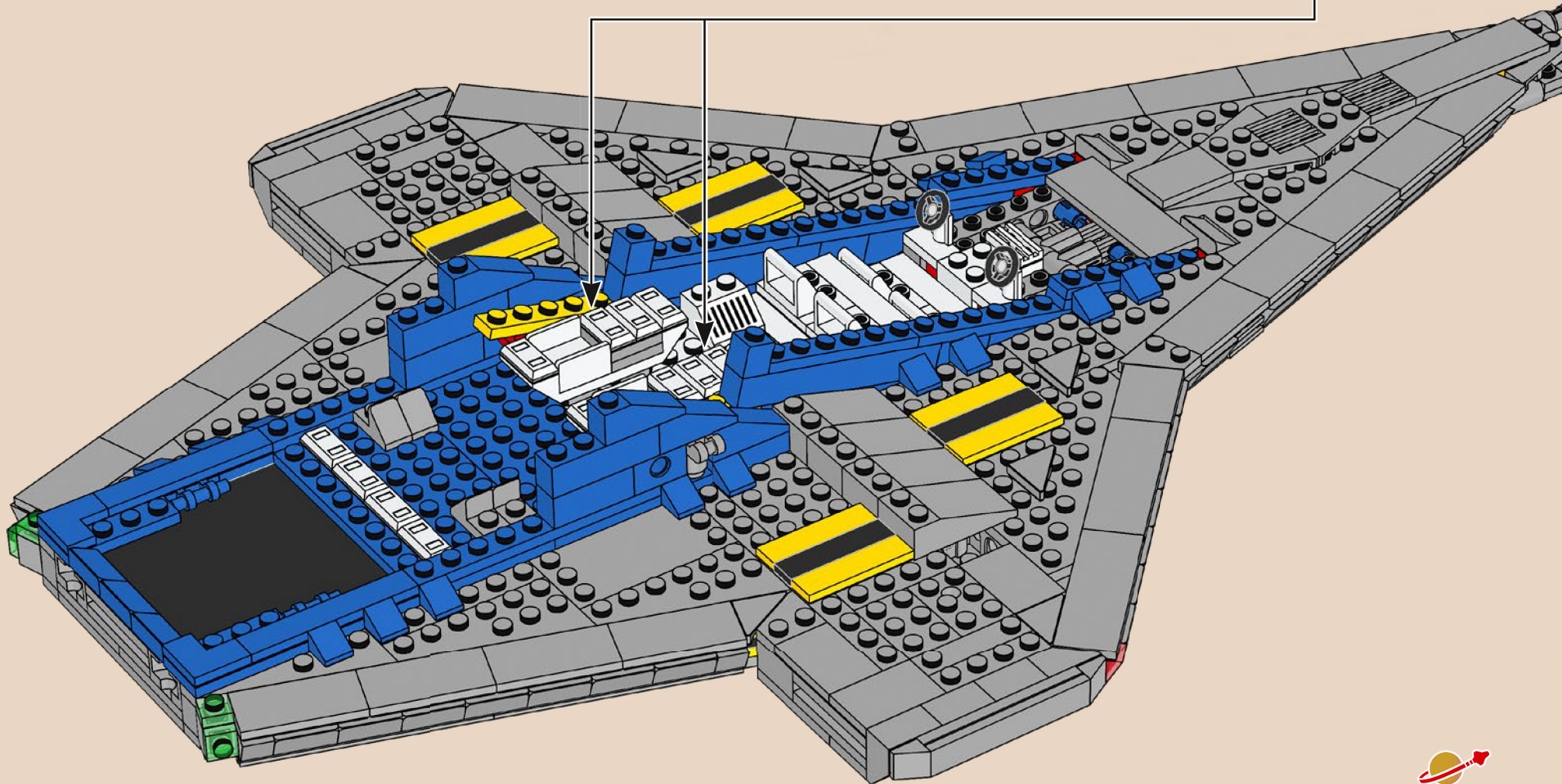
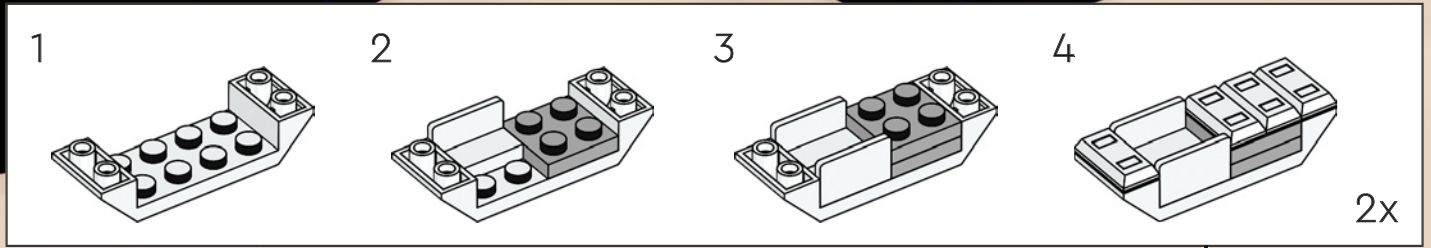

对宇航员的床铺专门进行了设计,以便他们躺下而不必取下他们的氧气罐。

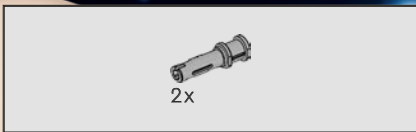

152

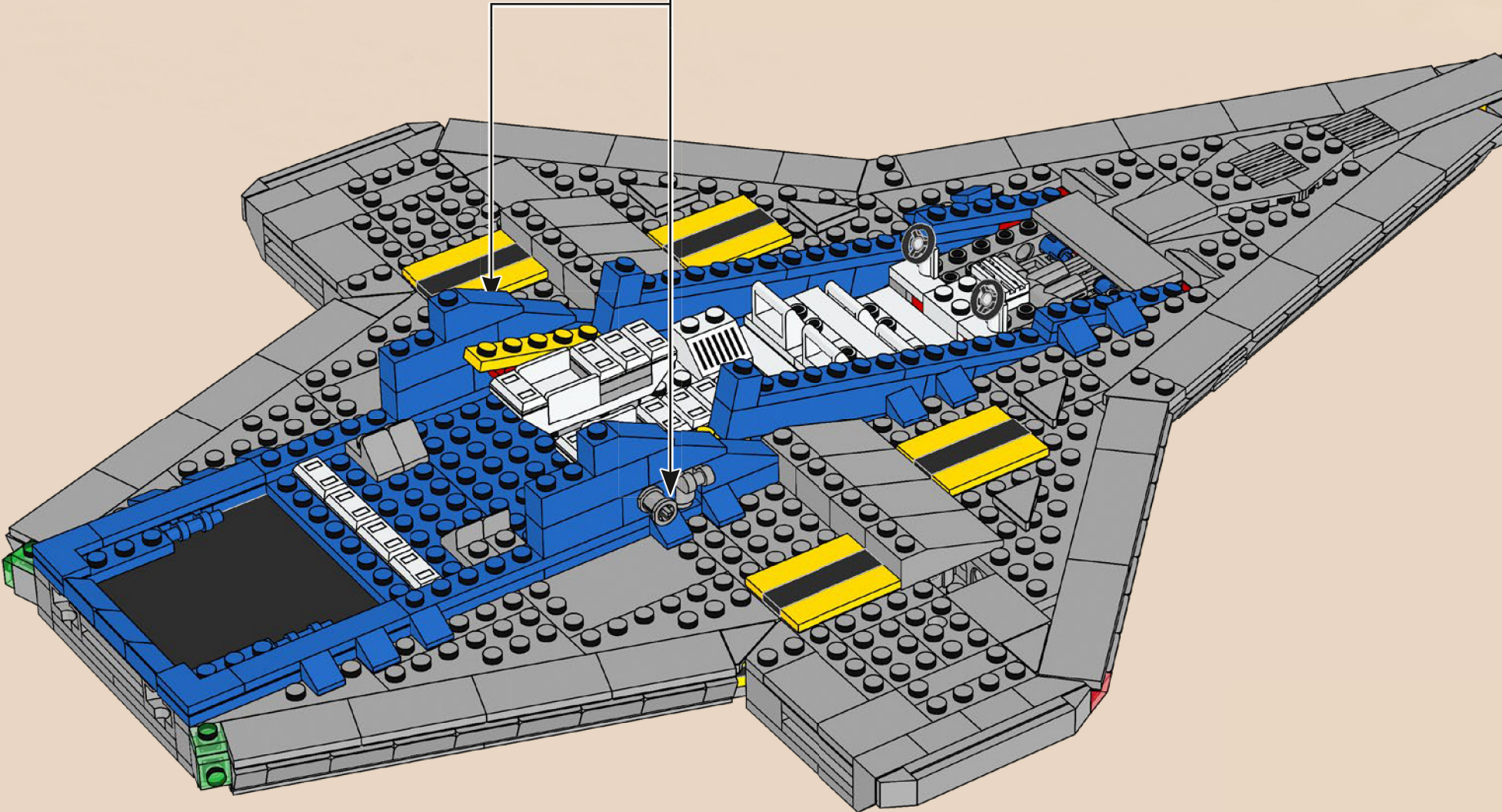

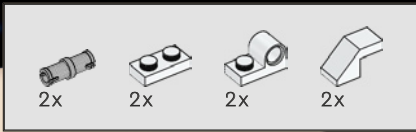

153

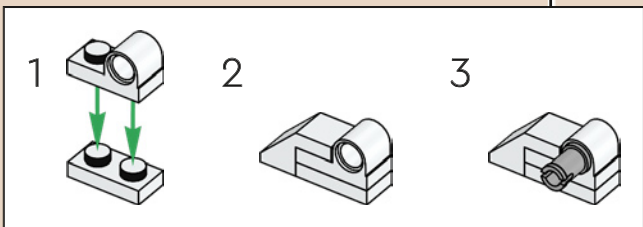
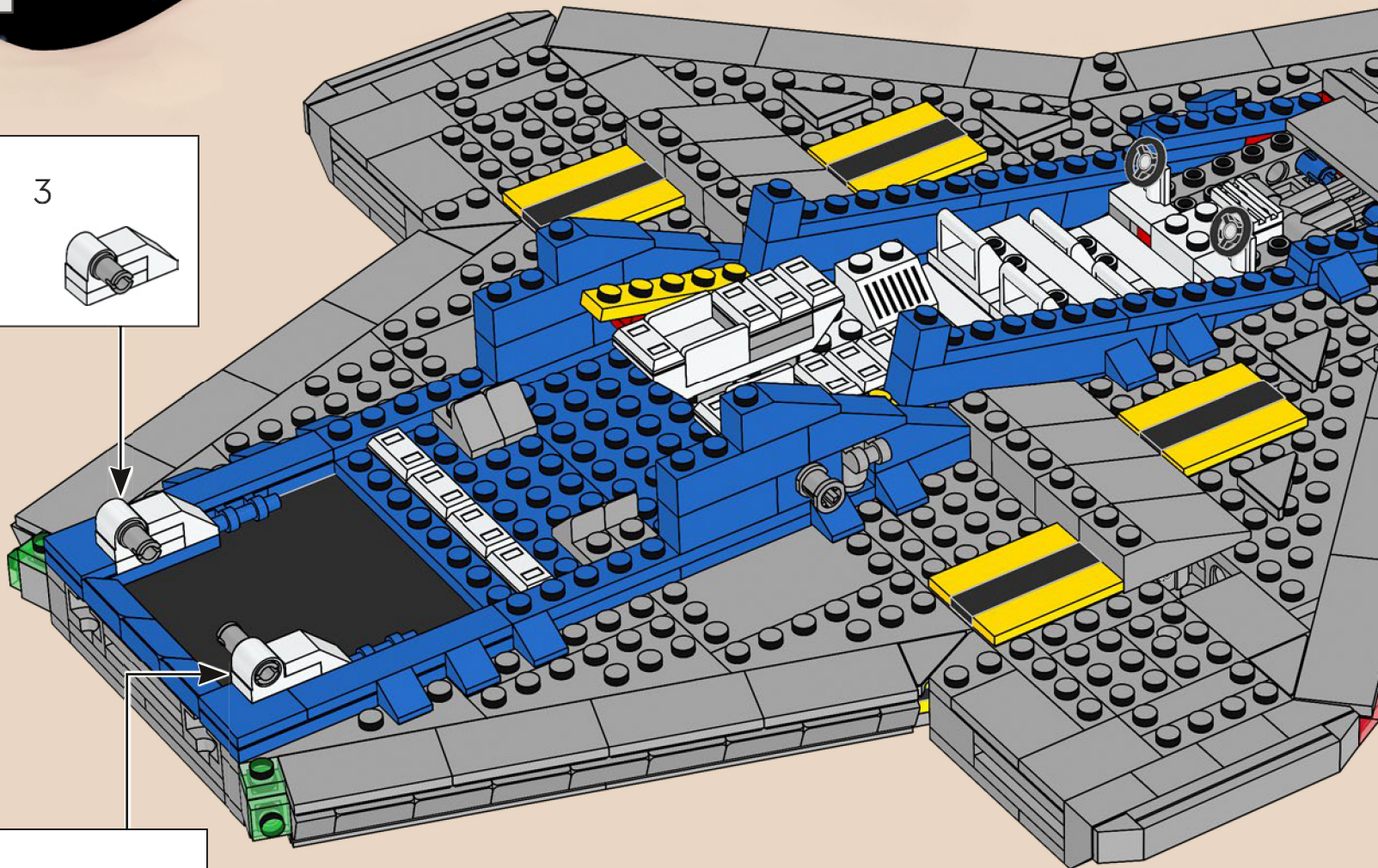
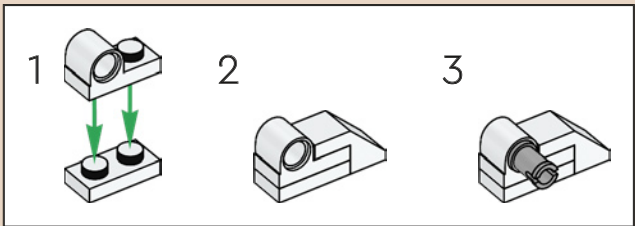



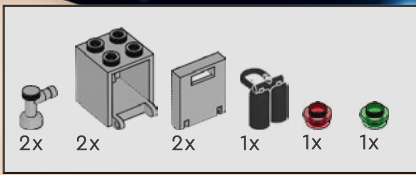

154

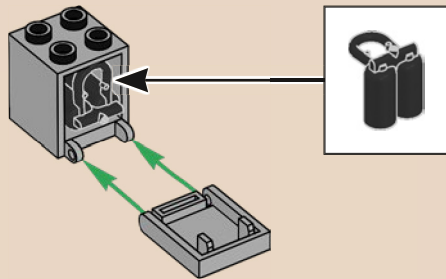
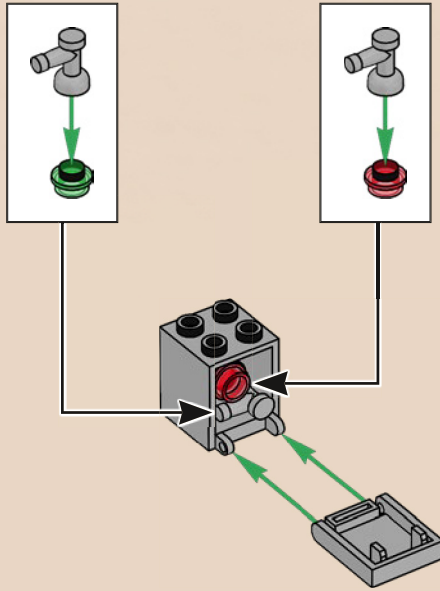

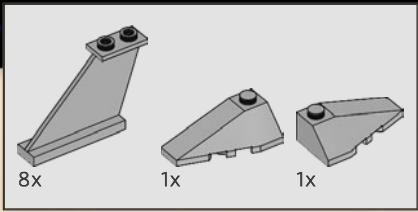

155

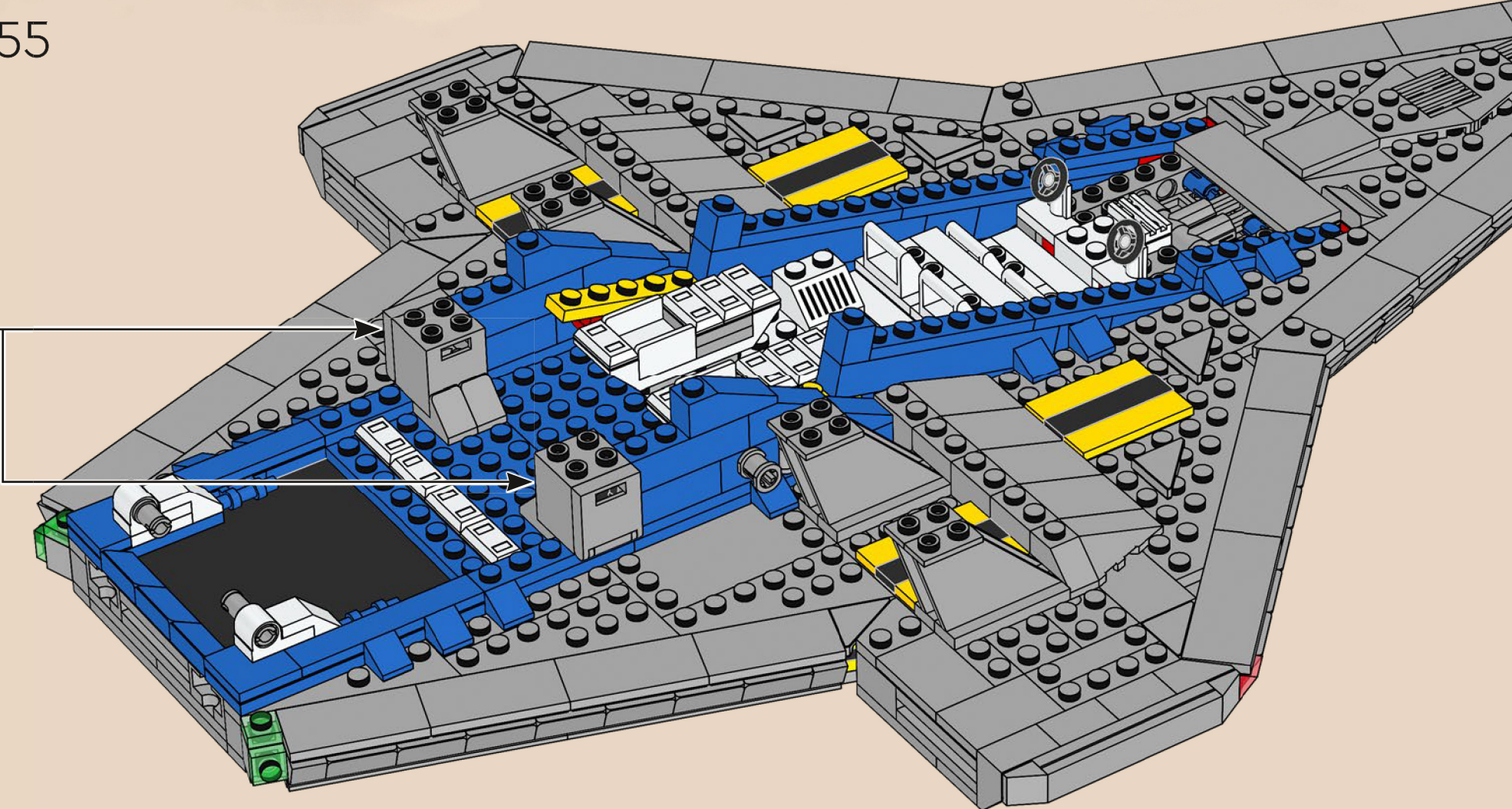



8x

156

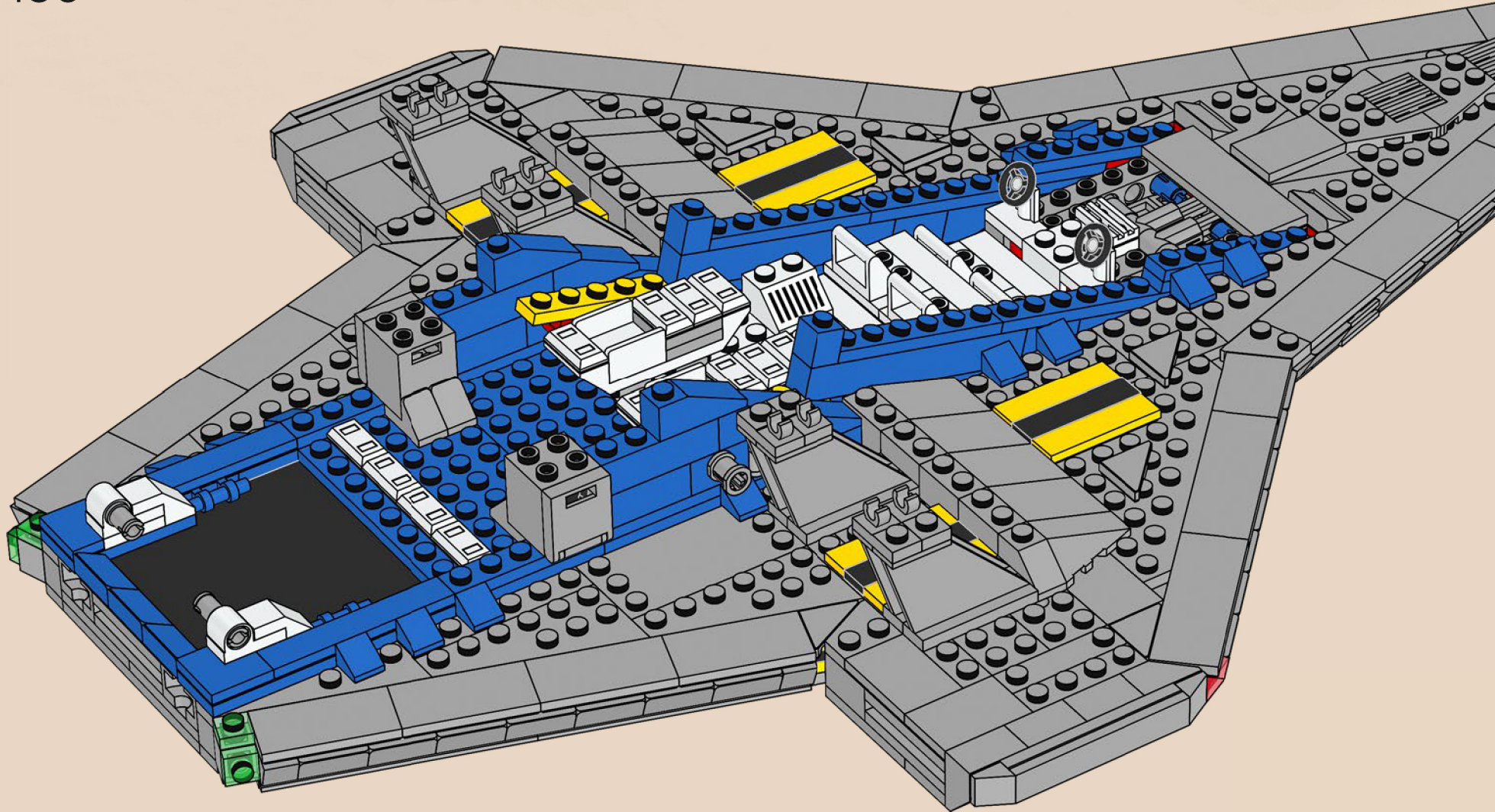

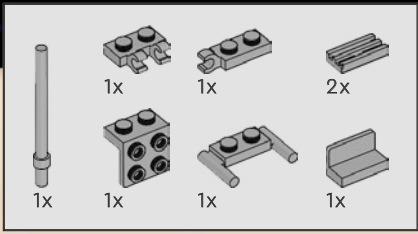

157

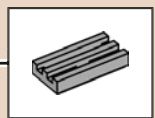
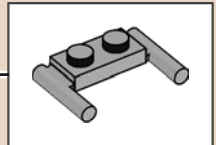
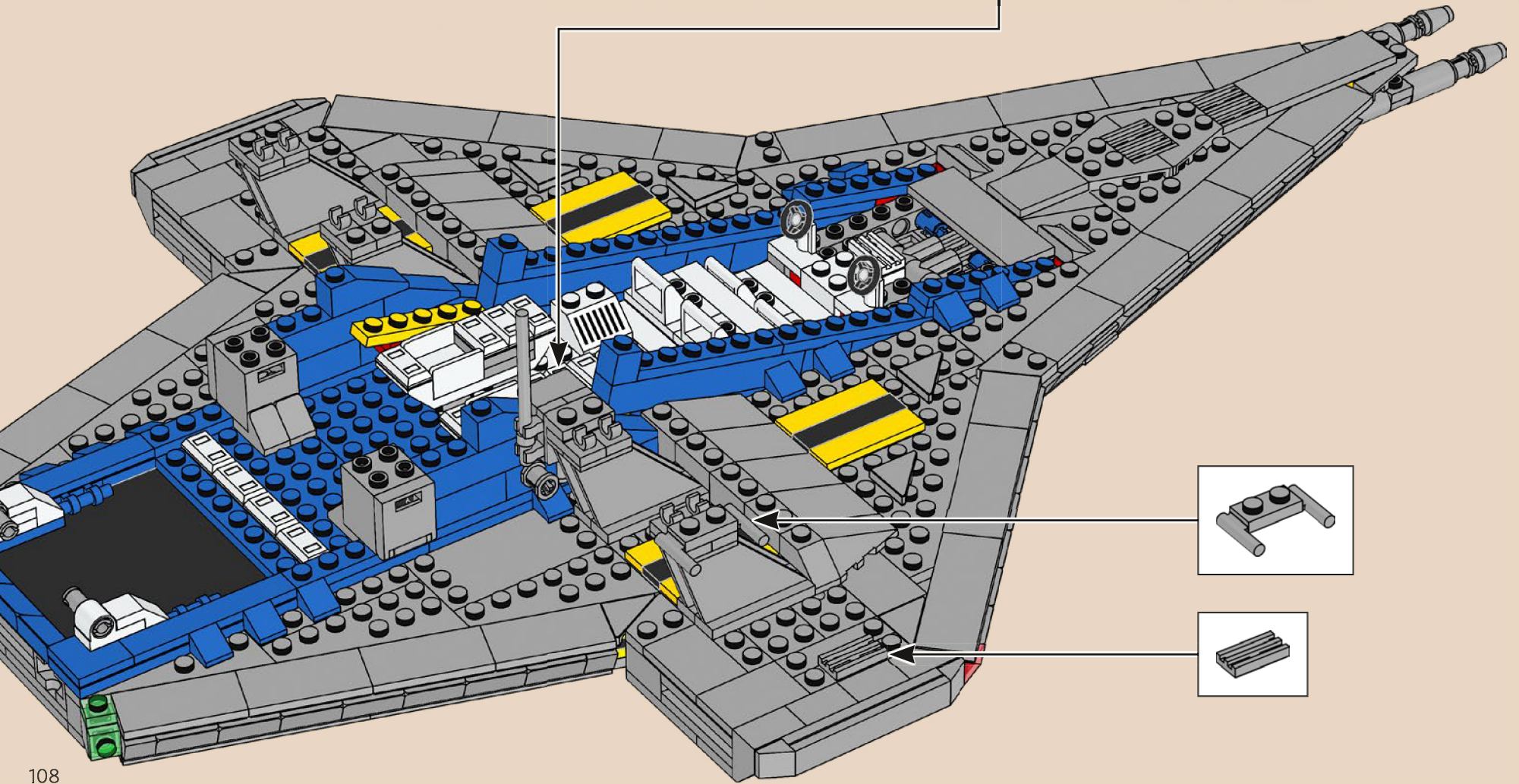
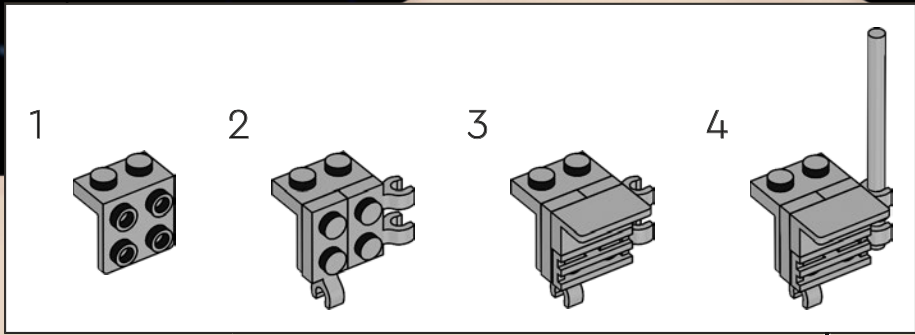

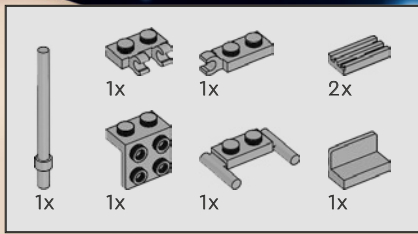

158

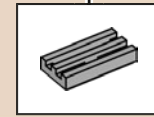
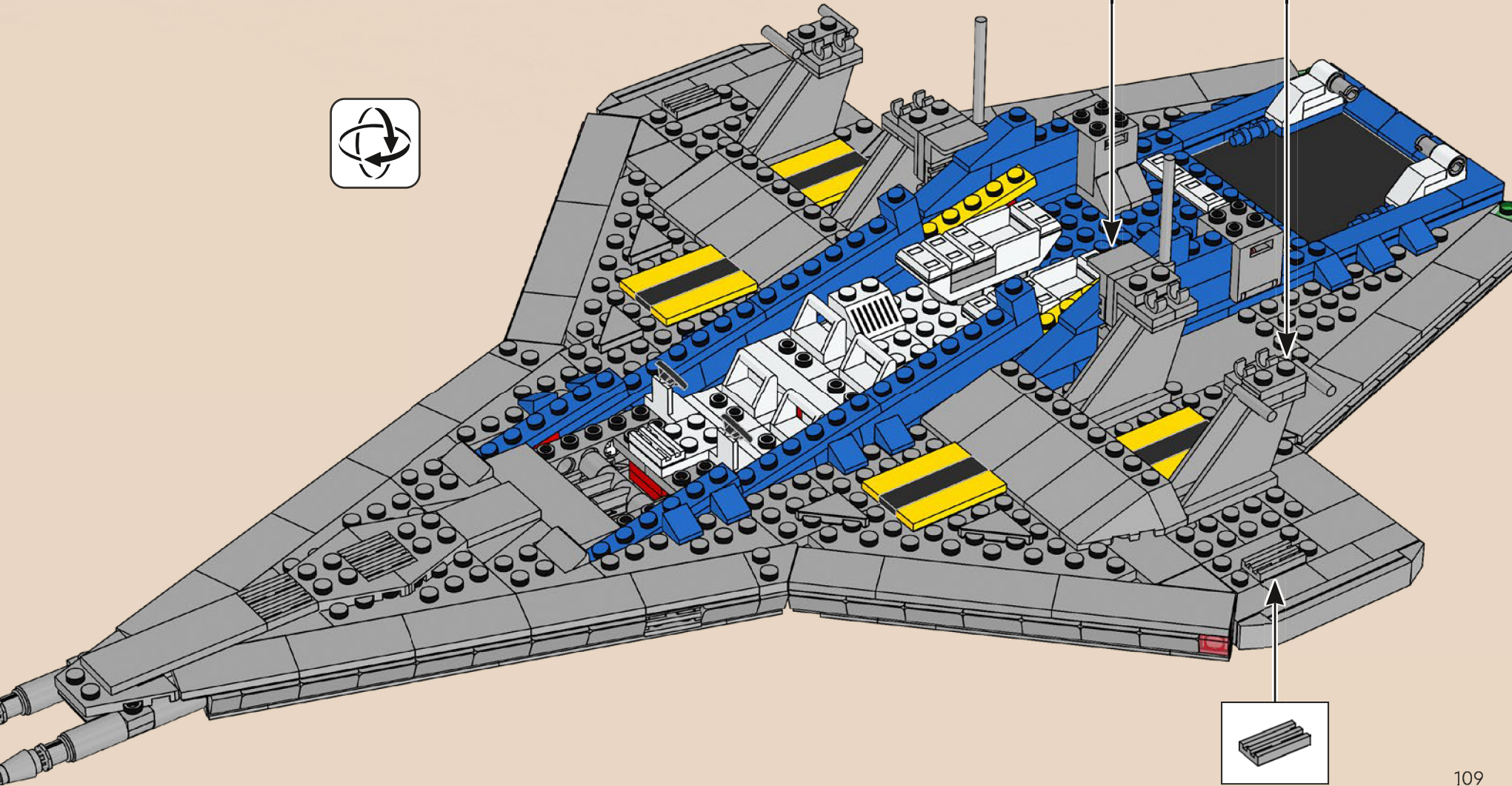
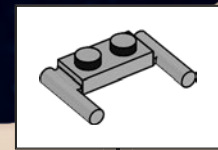
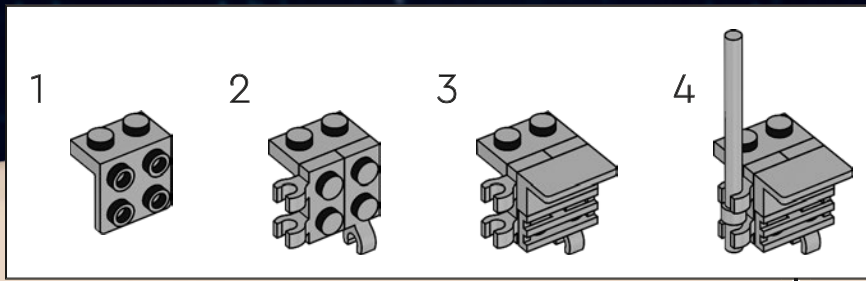

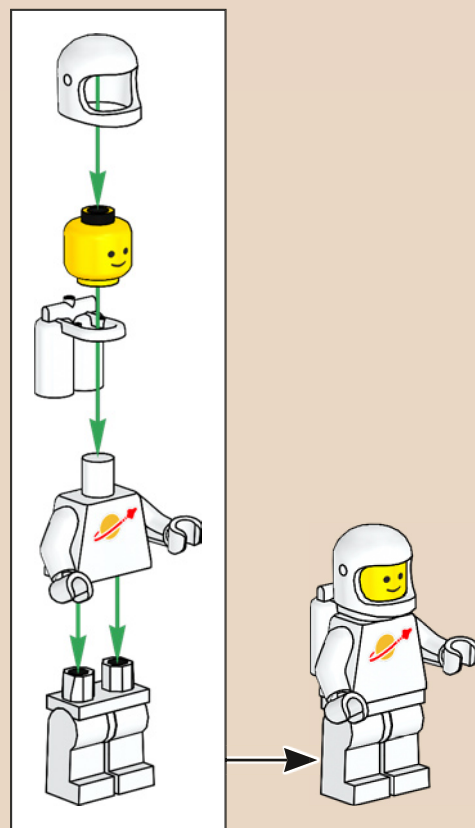

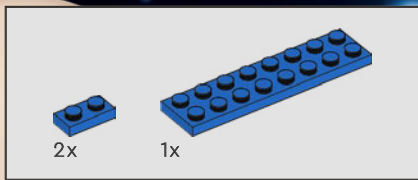

159

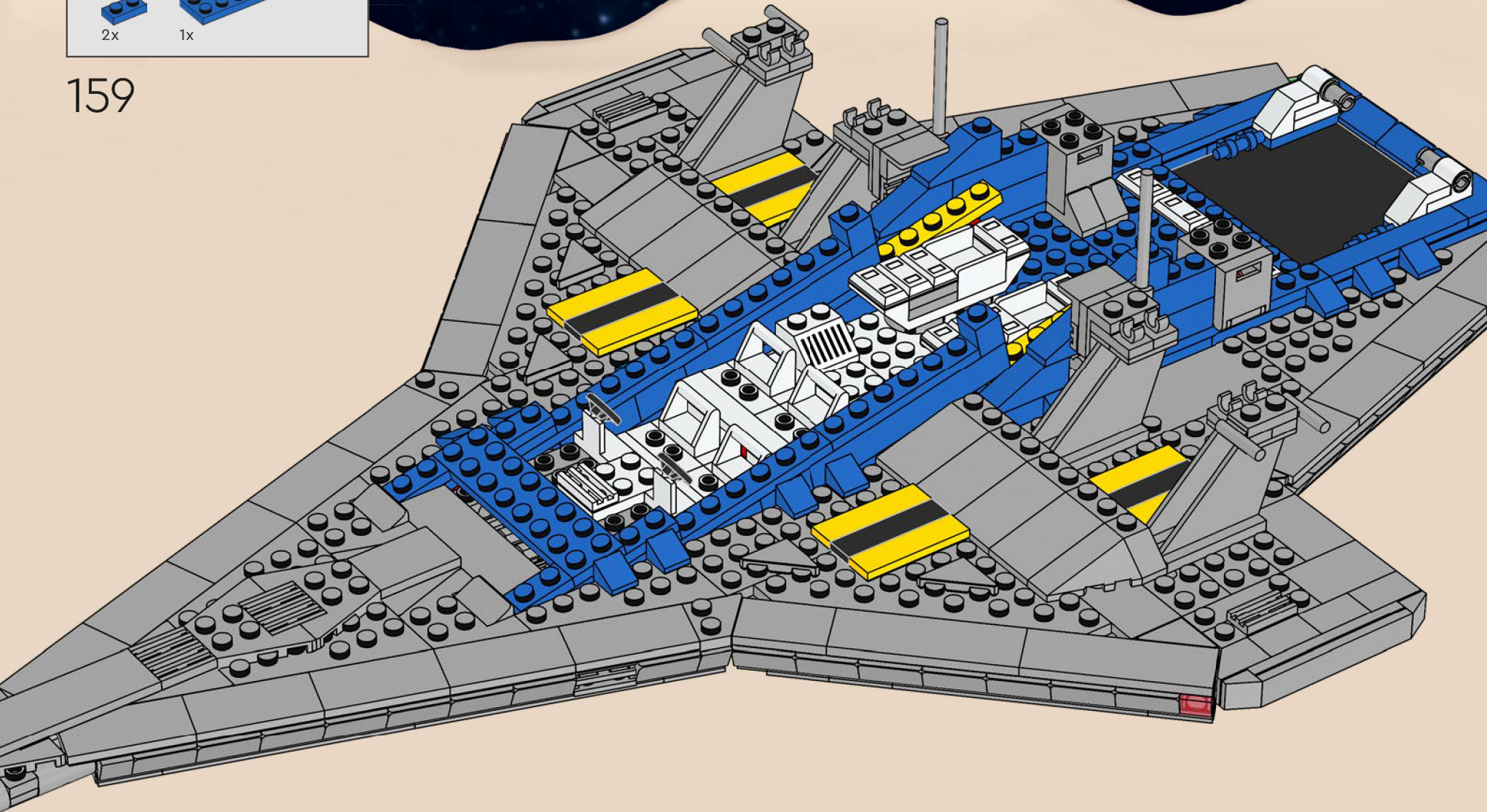

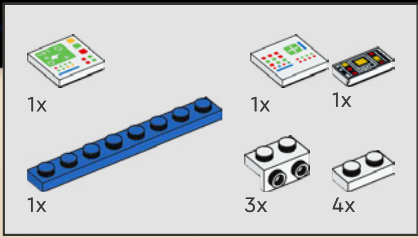

160

1

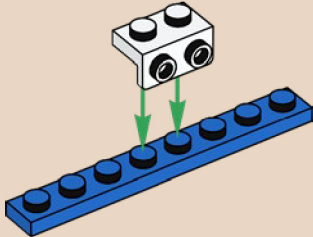

2

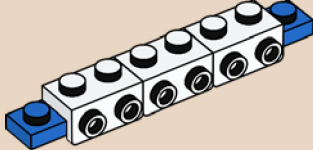

3

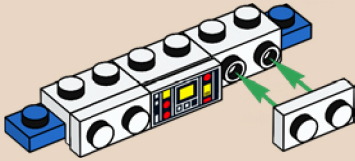

4

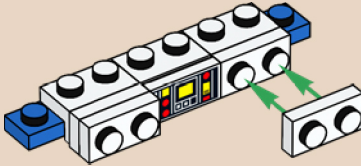

5

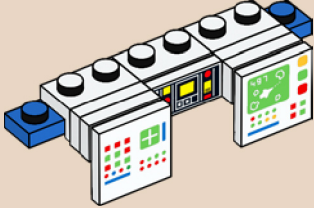





原始套装中的飞行员用单个方向盘来控制飞行器。更新后的版本还带有升级的控制系统：两个方向盘！

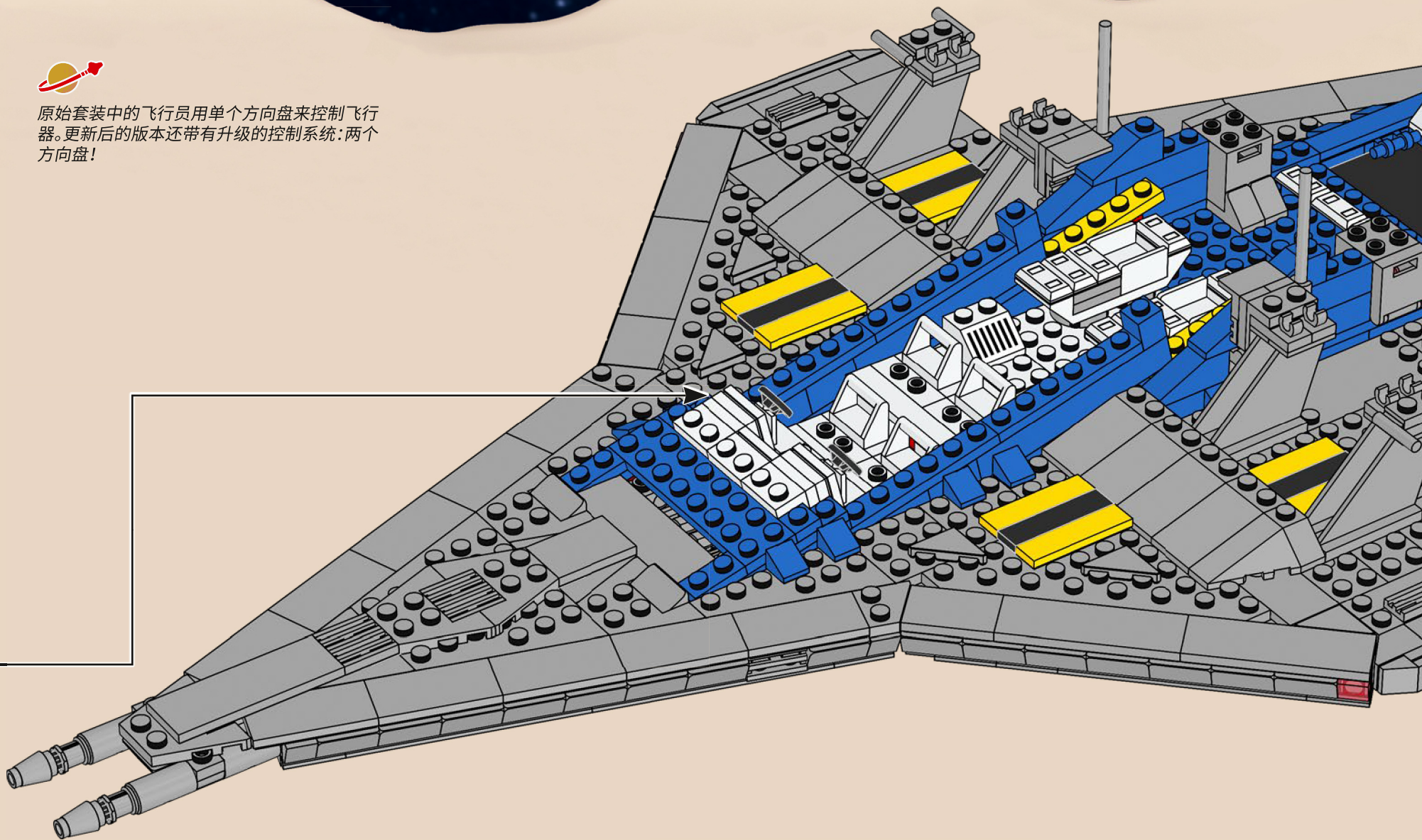

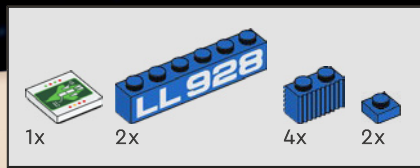

161



最初的银河探索号带有标号 LL 928, 印在 1x4 积木上。在这艘飞船的现代版本上, LL 928 印在大 50% 的积木上, 即 1x6。

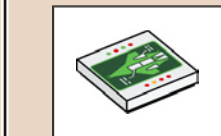

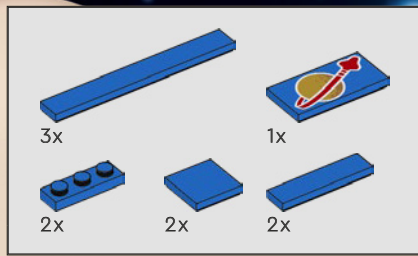

162

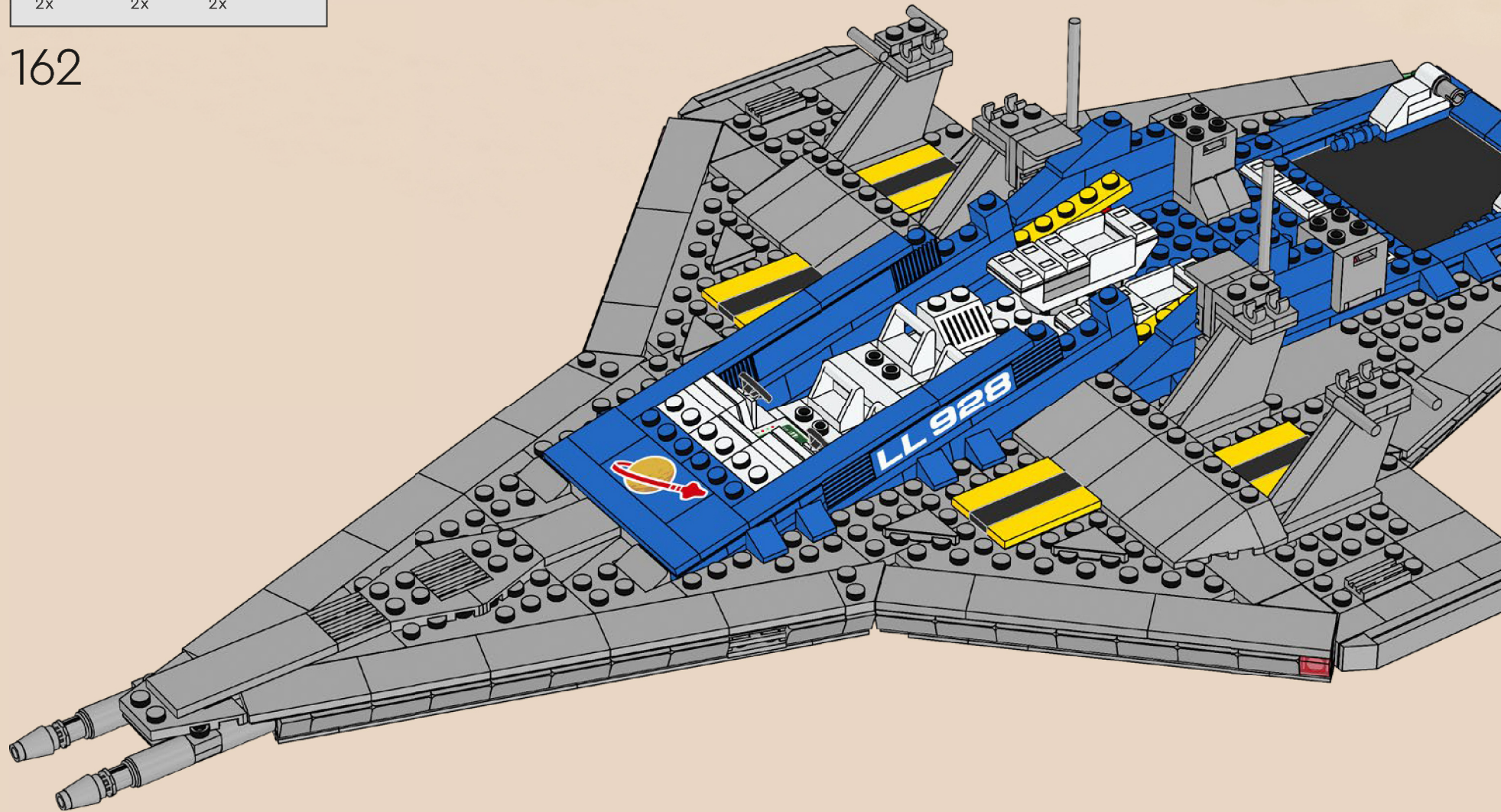

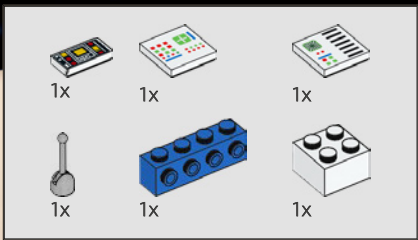

163

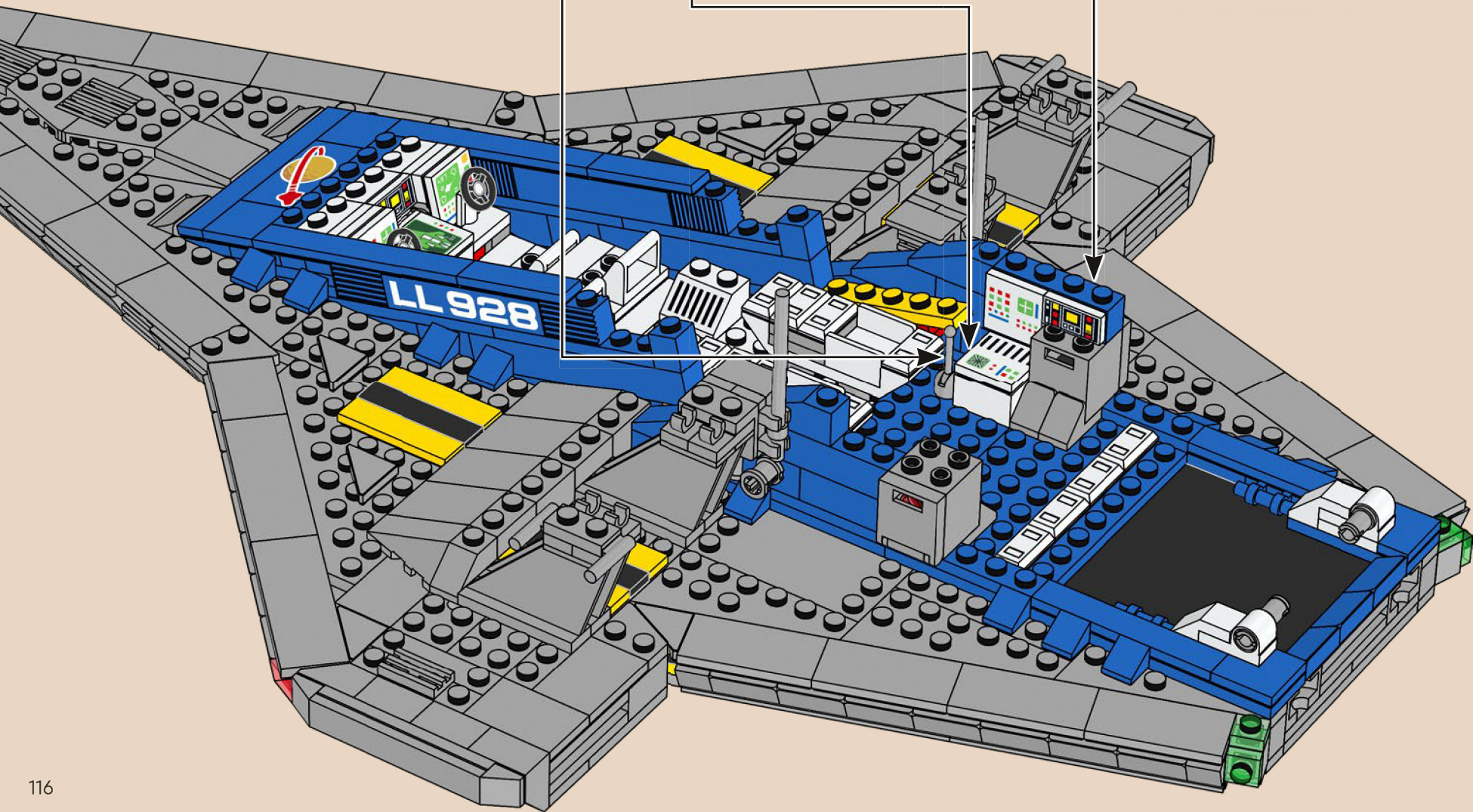
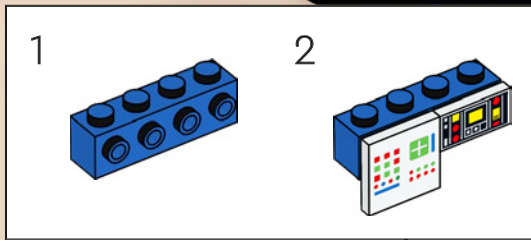
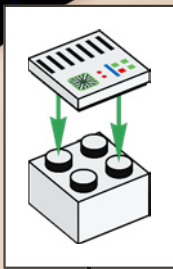
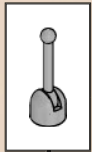

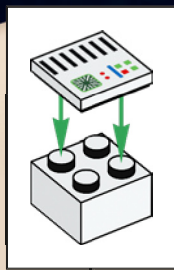
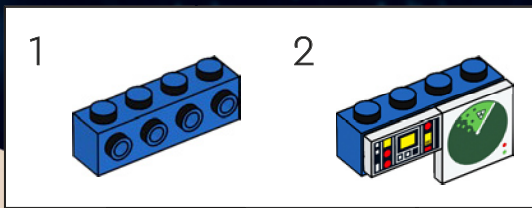
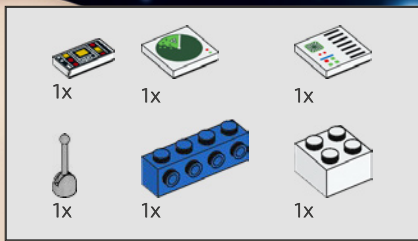

164

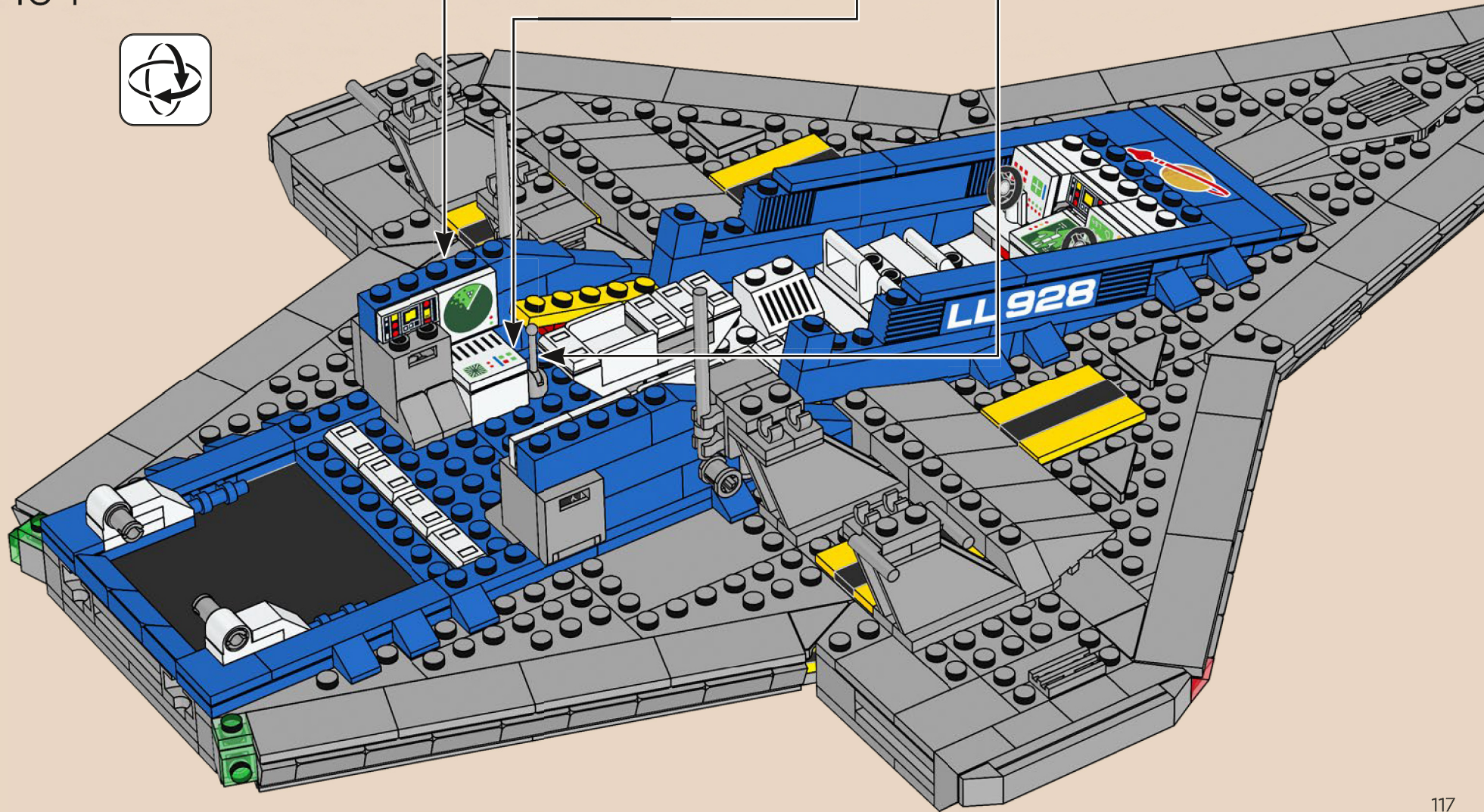

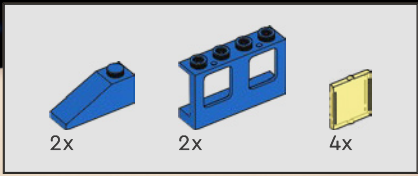

165

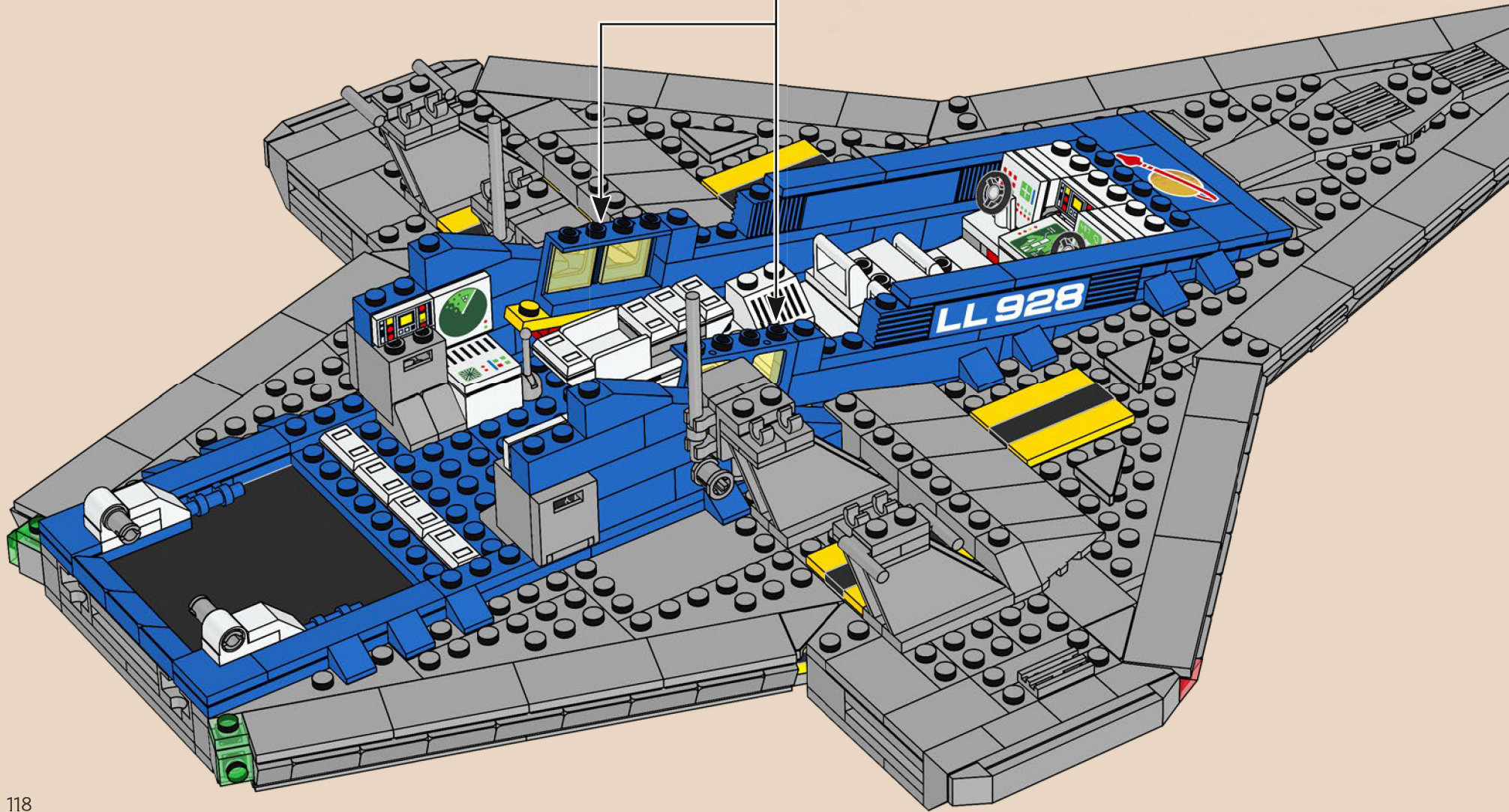
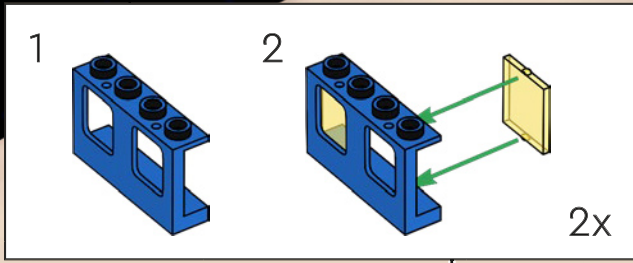

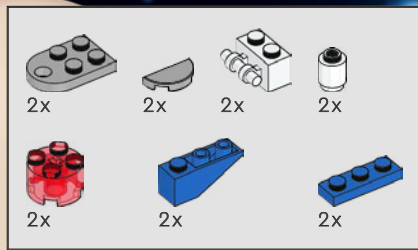

166

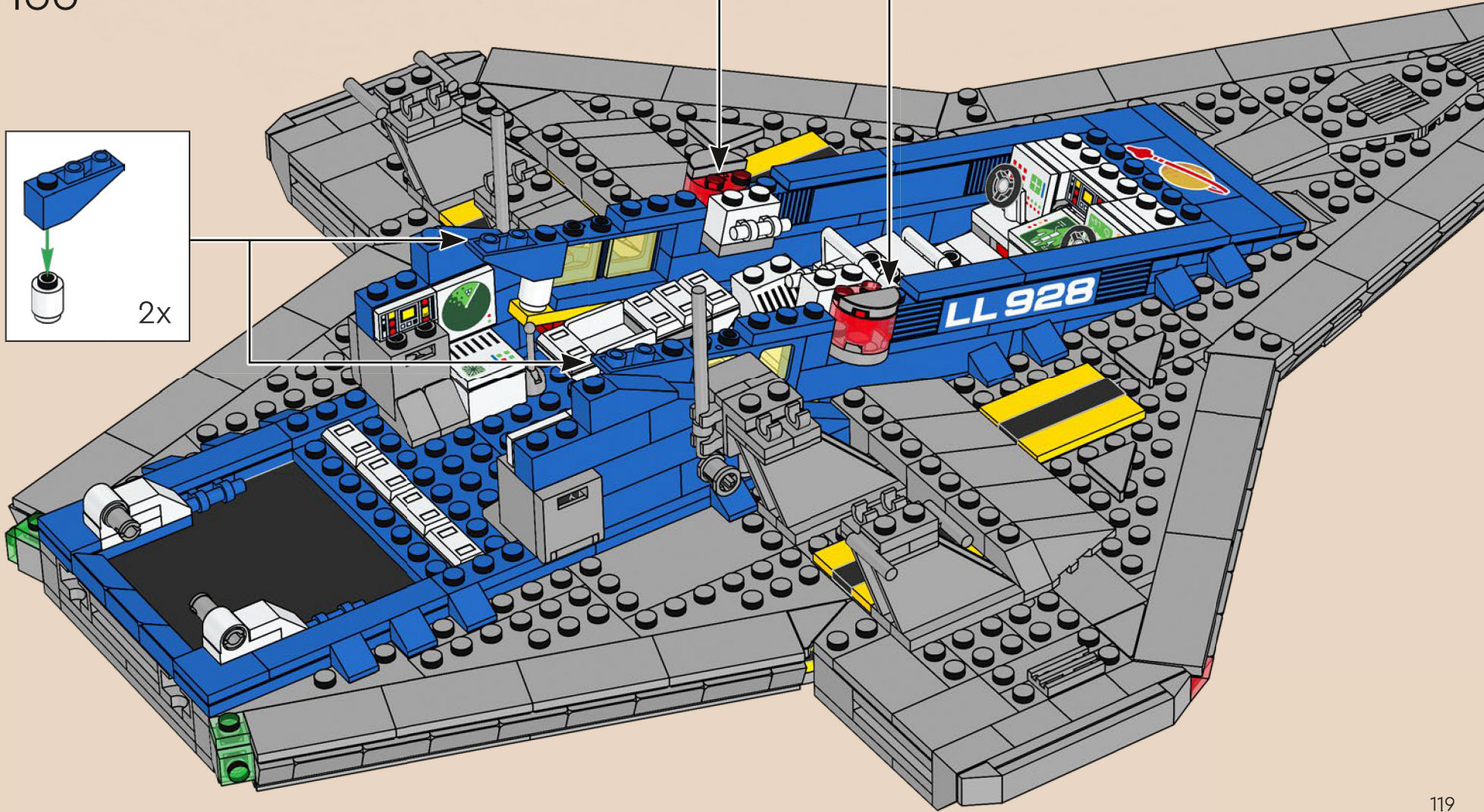
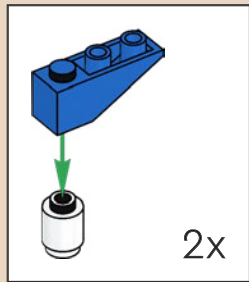

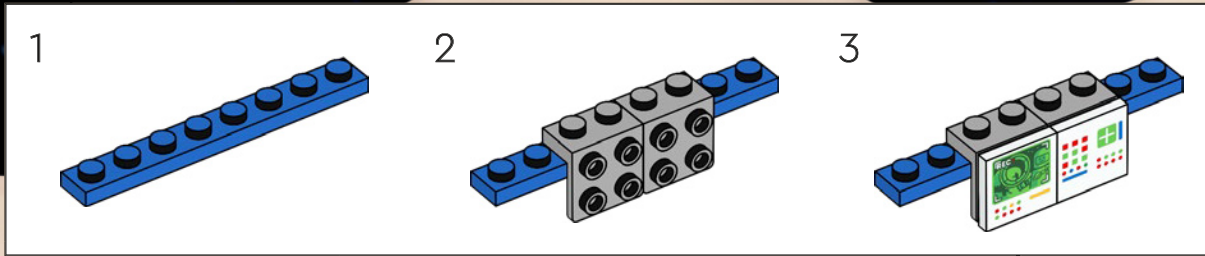
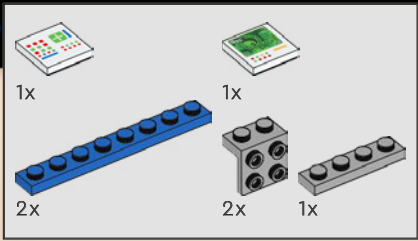

167

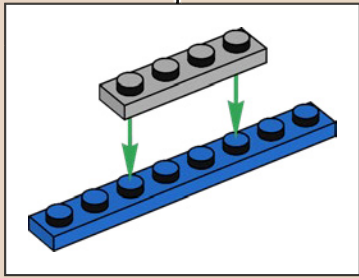
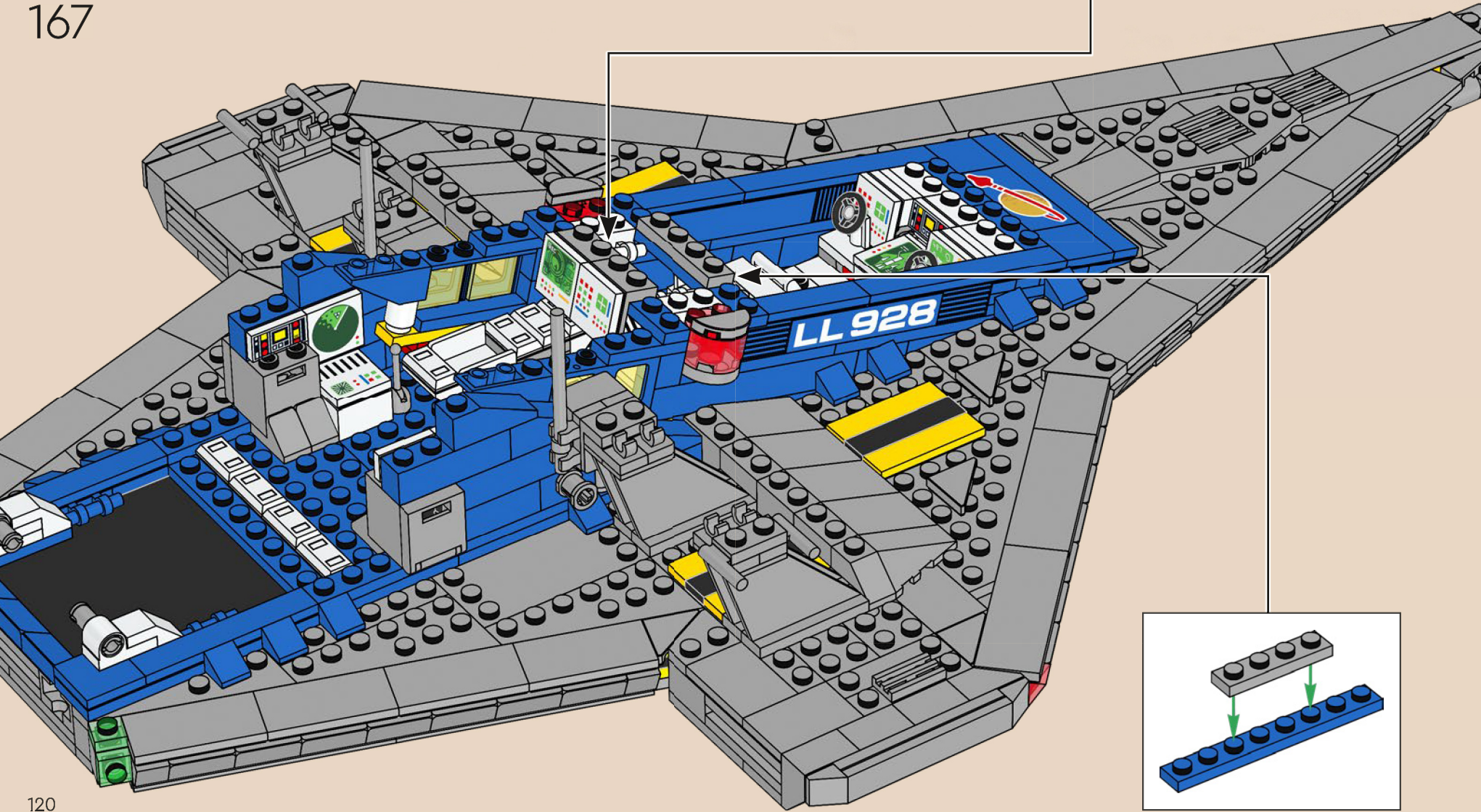



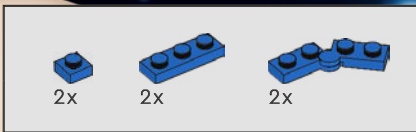

168

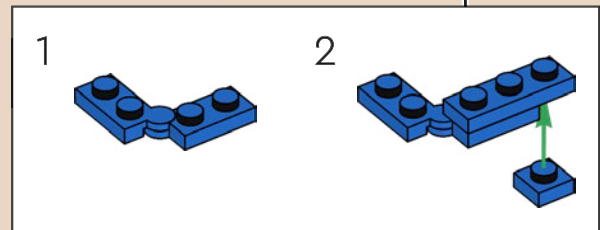
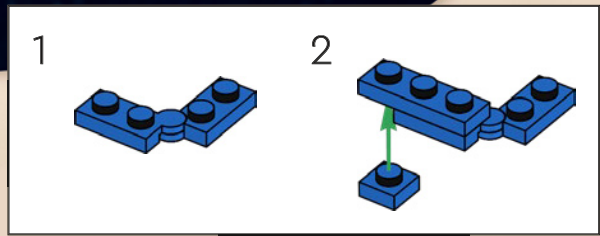
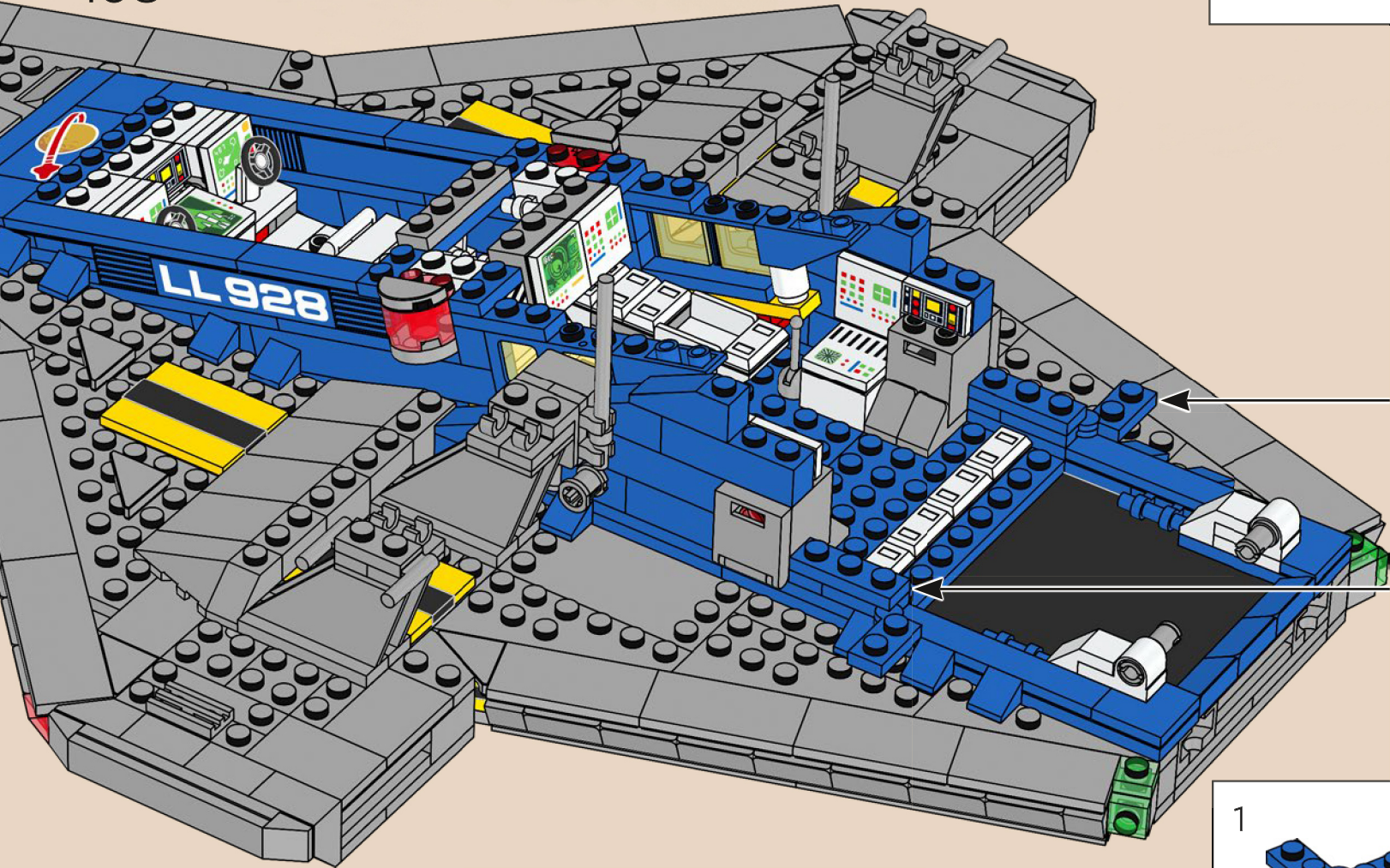

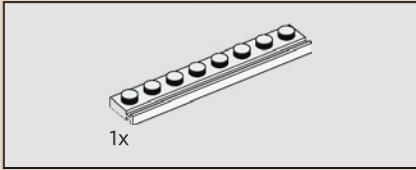
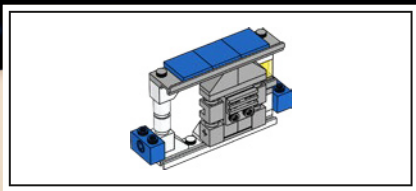

169

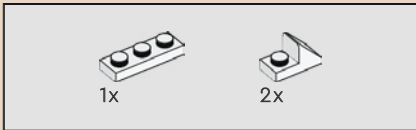
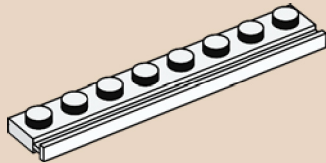

170

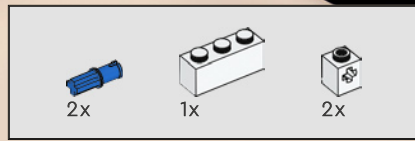
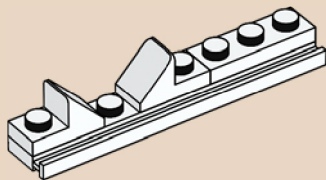

171

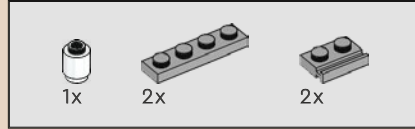
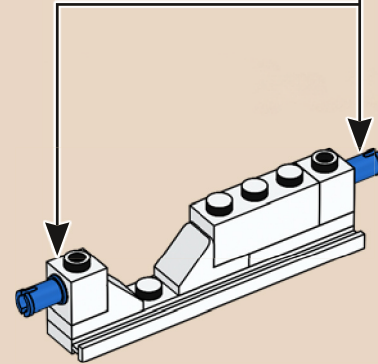
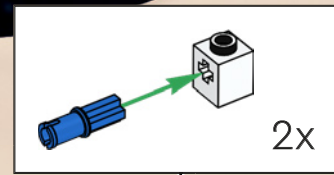

172

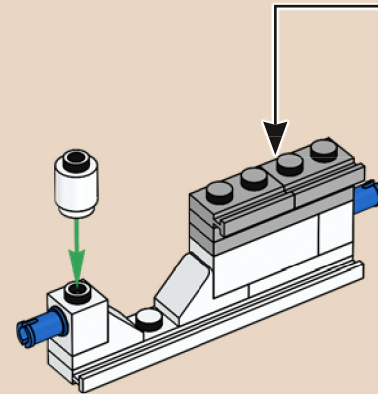
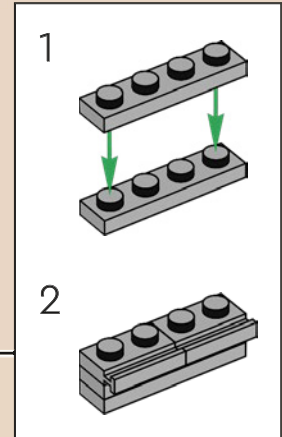



1x



2x

173

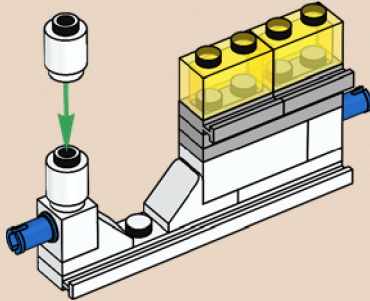

1x



2x

174

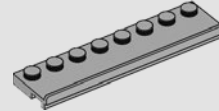
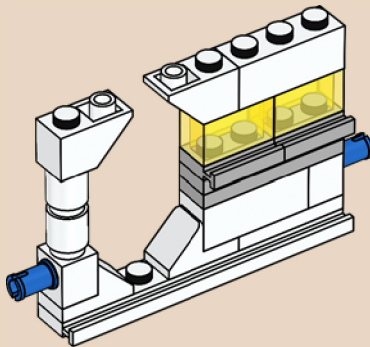

1x

175

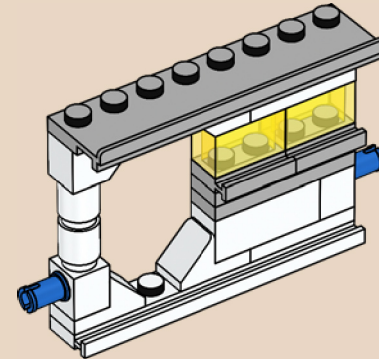

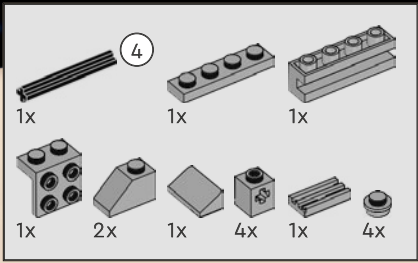

176

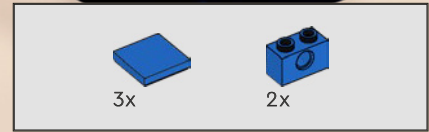
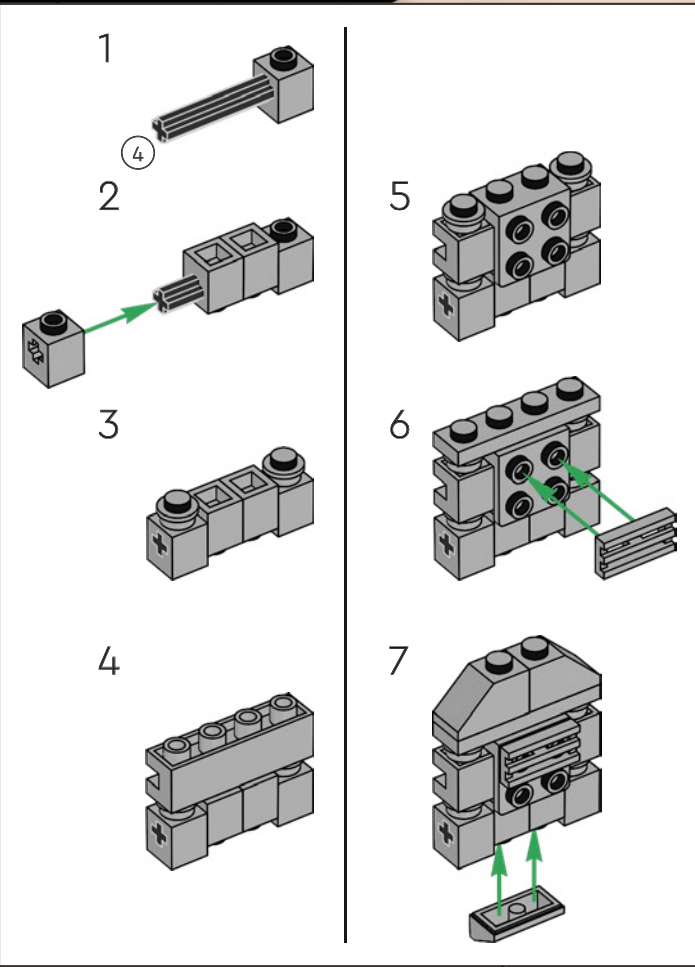
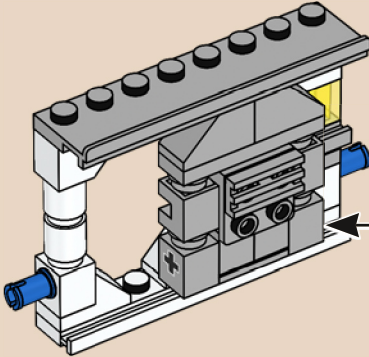

177

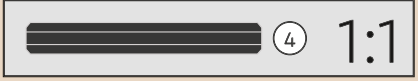
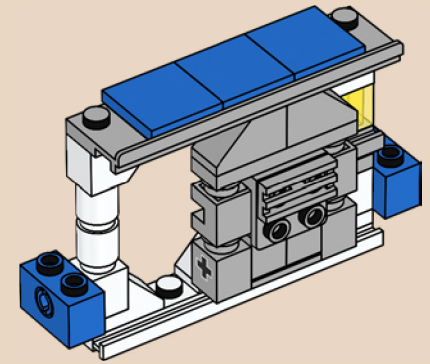

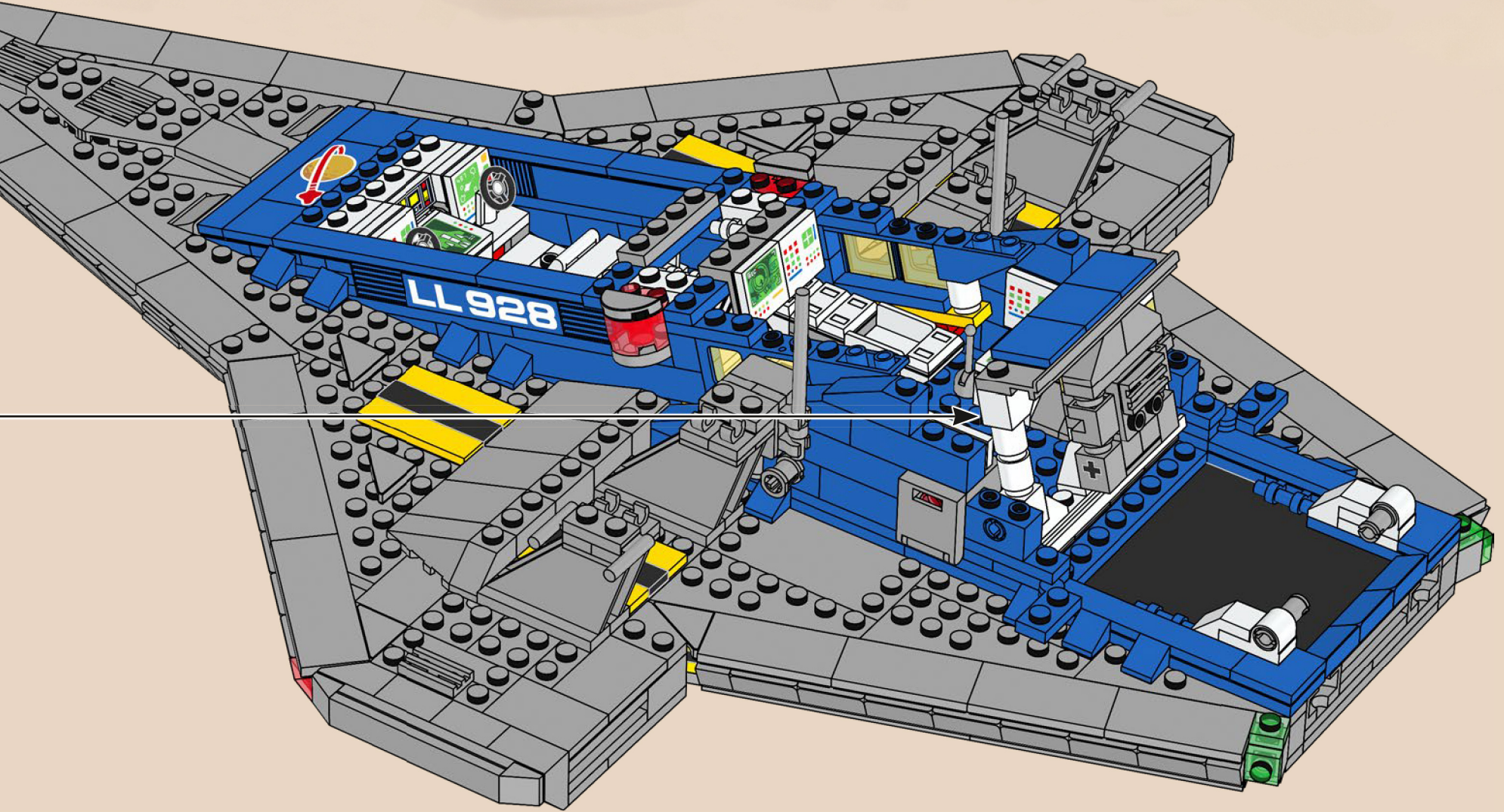

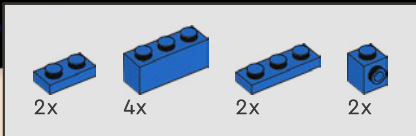

179

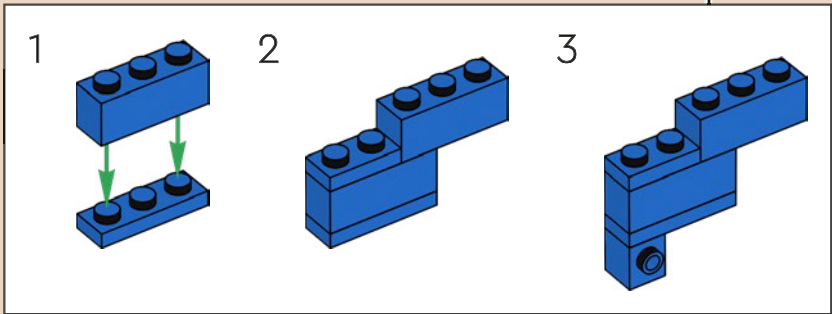
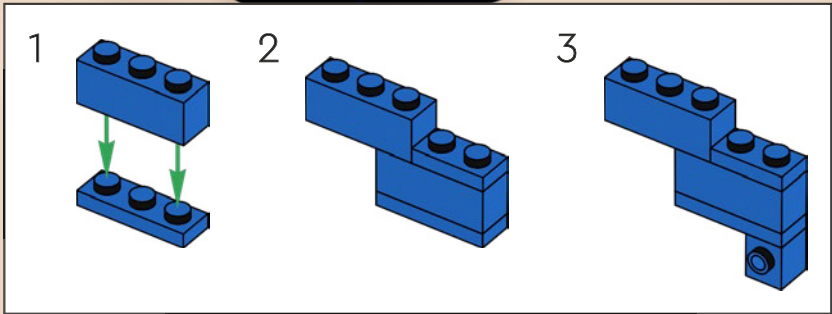
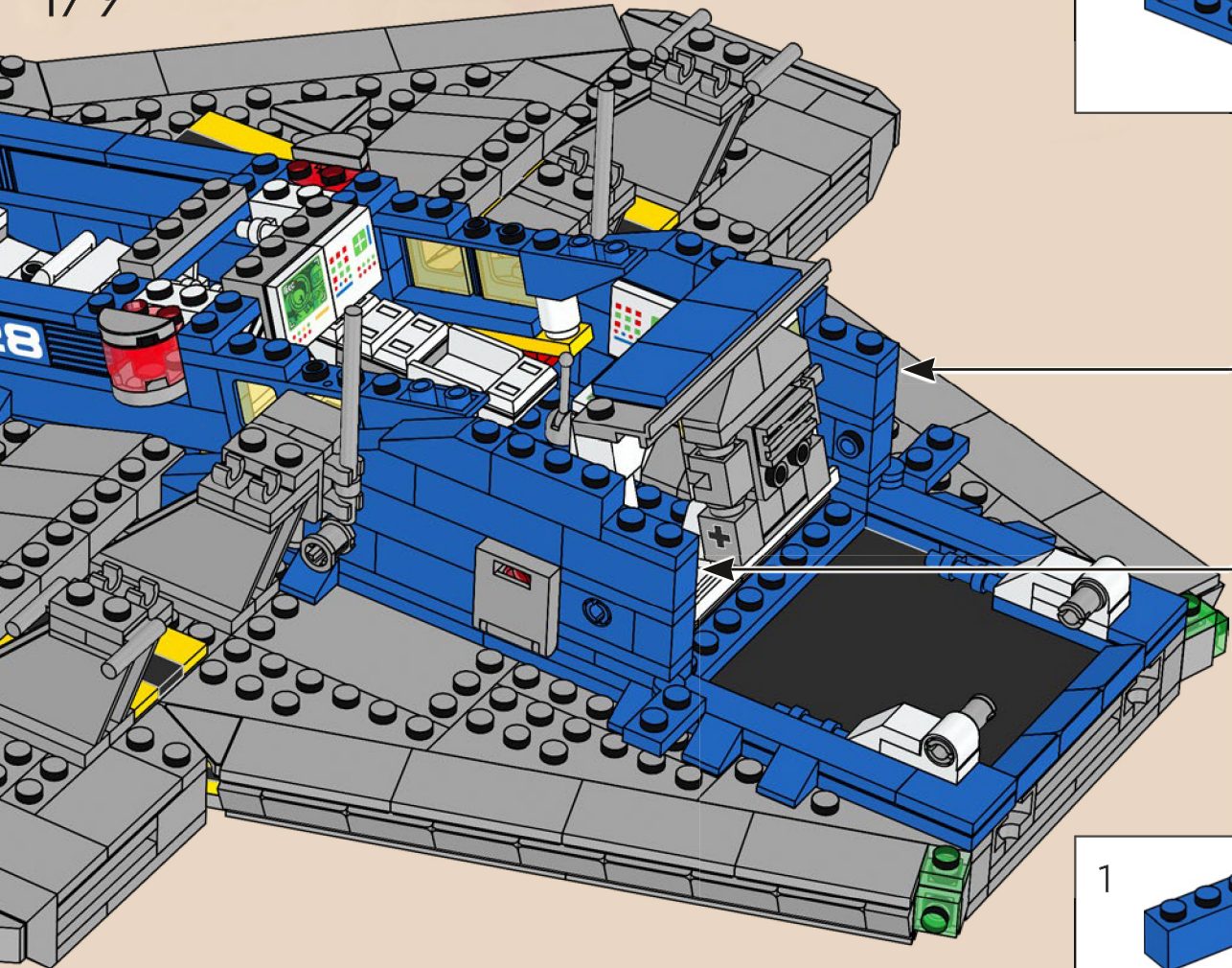

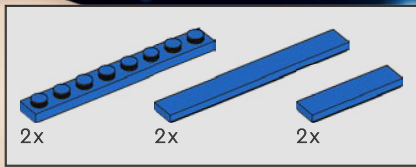

180

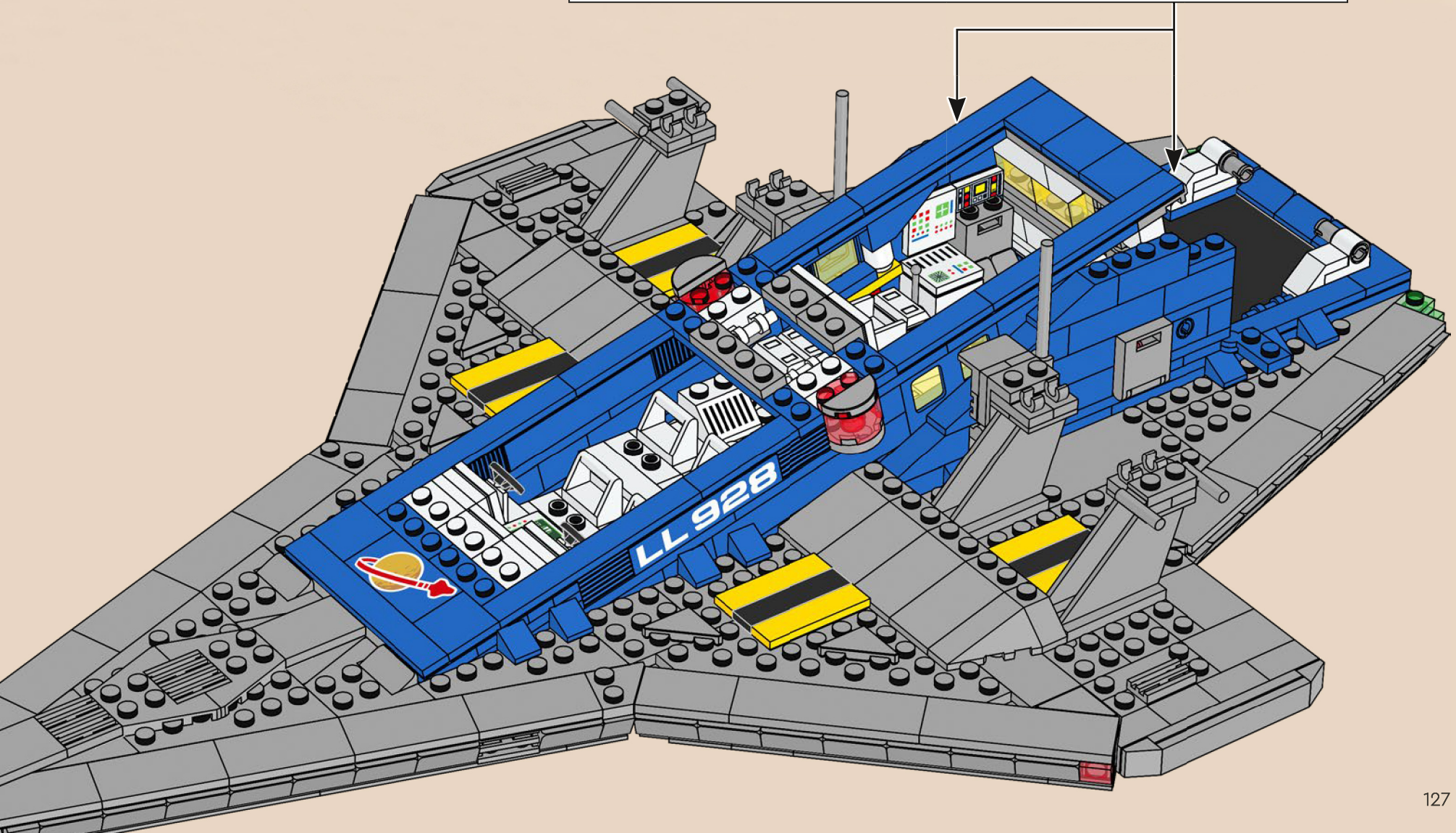
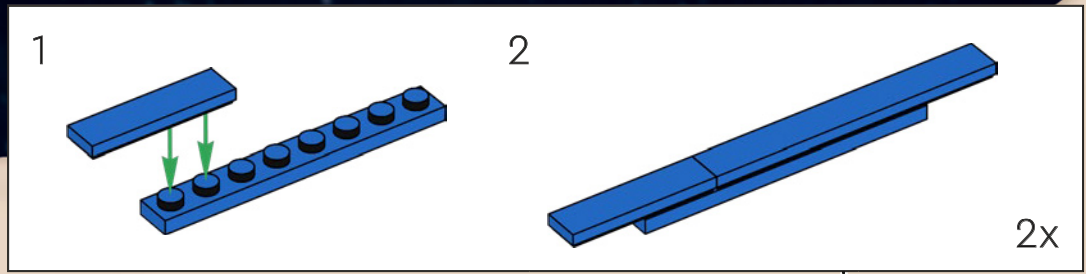

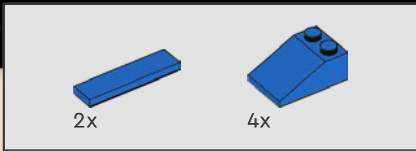

181

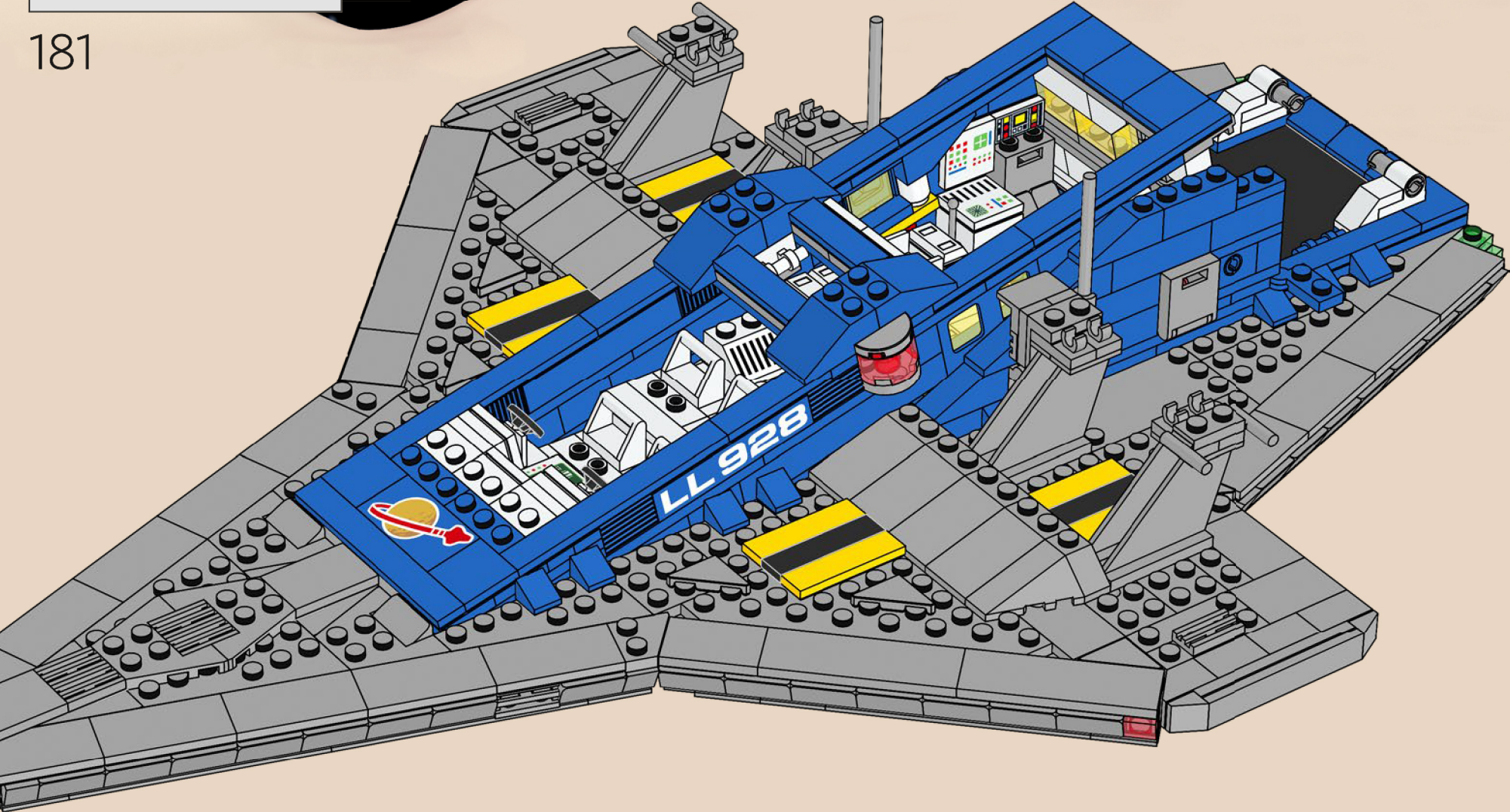



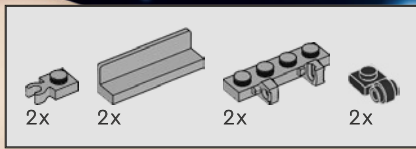

182

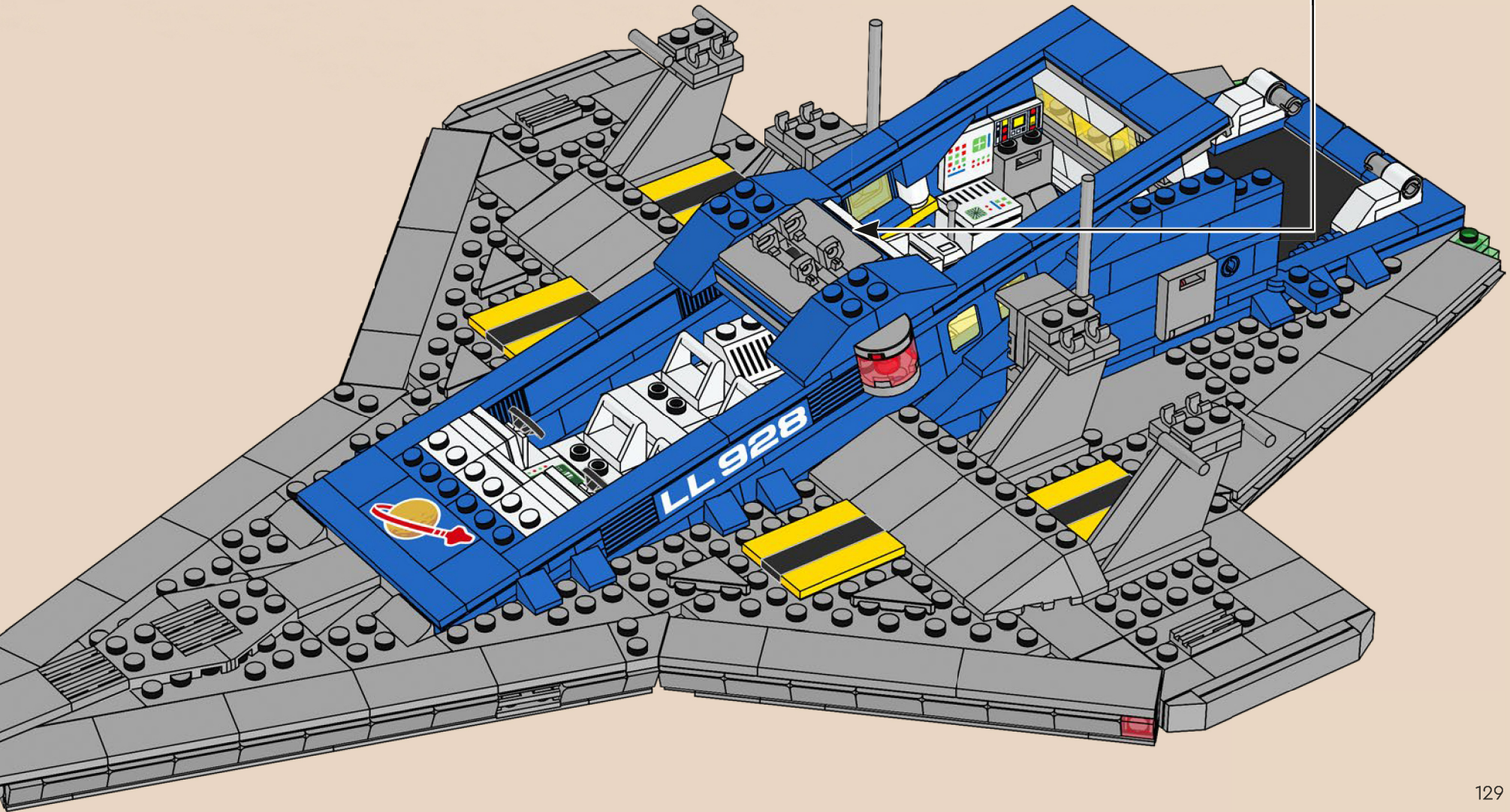
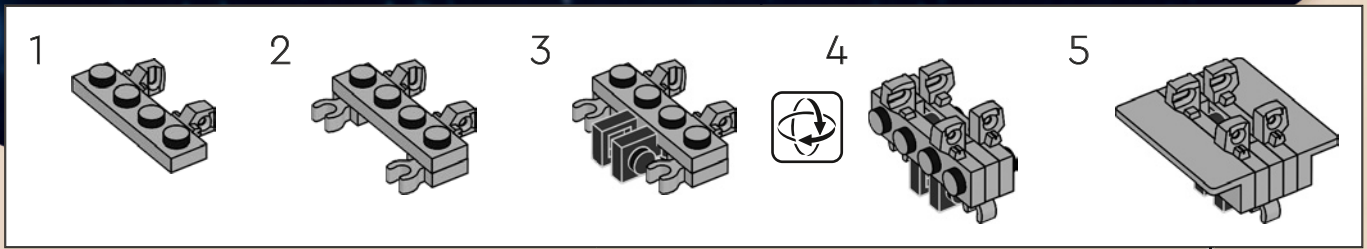

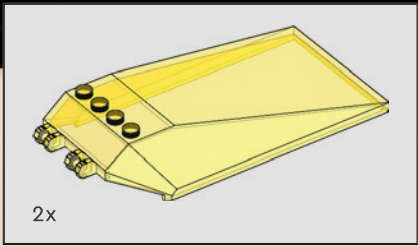

183

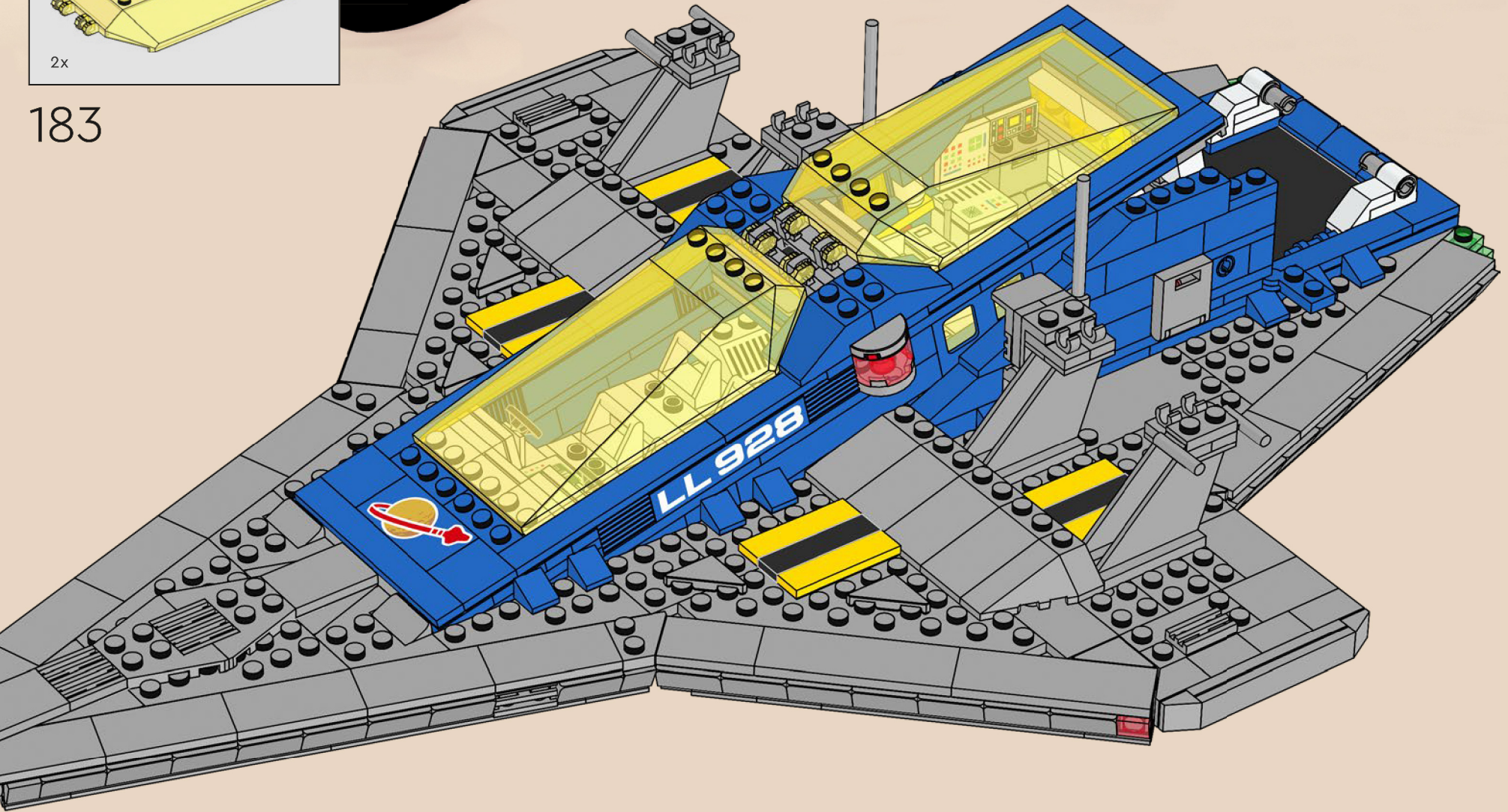

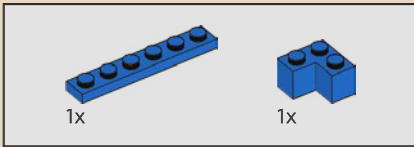
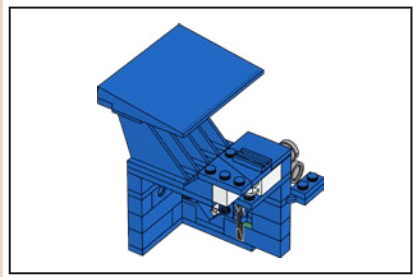

184

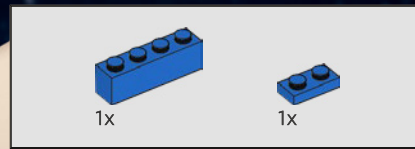
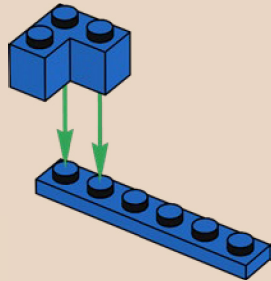

185

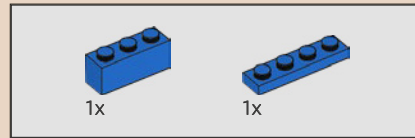
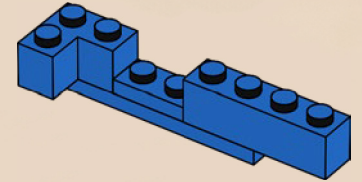

186

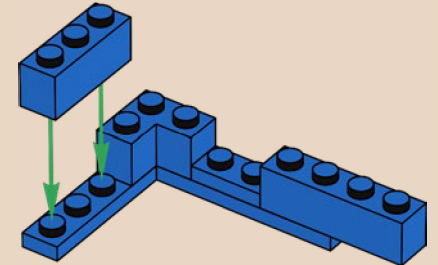

187

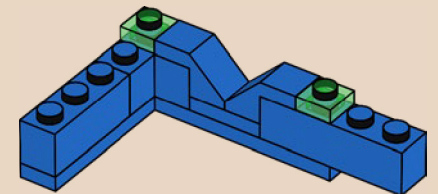

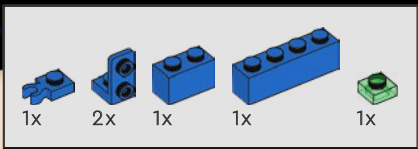

188

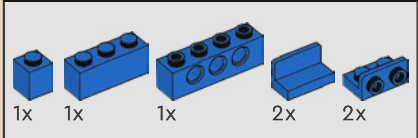
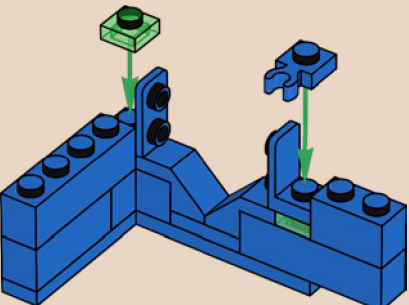

189

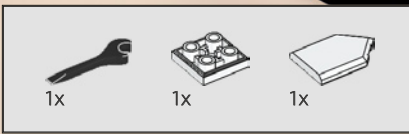
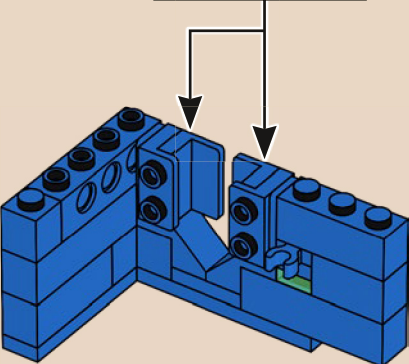
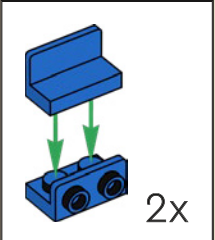

190

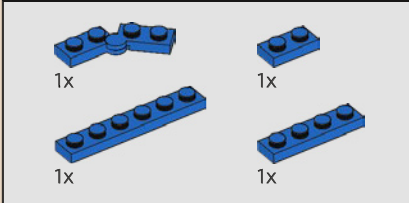
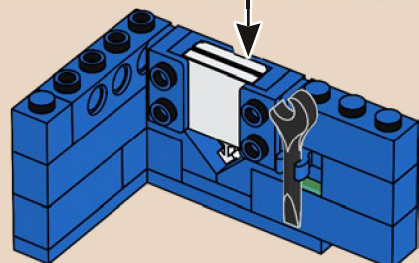
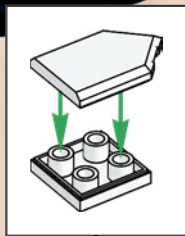

191

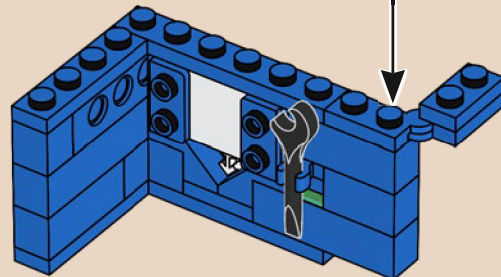
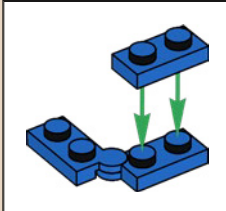

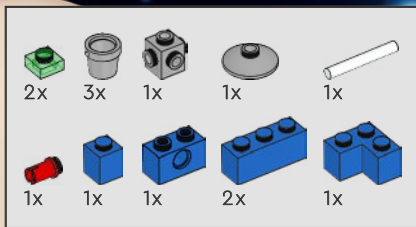

192

1

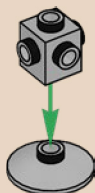

2



3

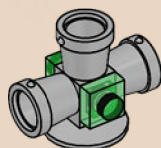

4

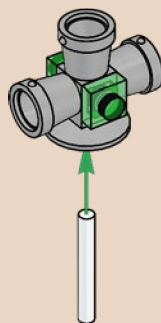

5

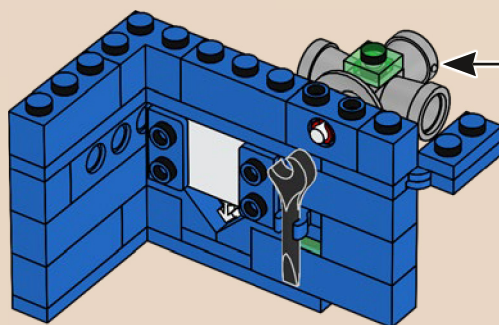
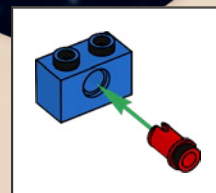
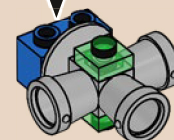

在原始模型上, 箭头装饰印在 1x2 积木上。此模型中的箭头由乐高® NEXO KNIGHTS 未来骑士团套装中的盾牌拼搭而成。

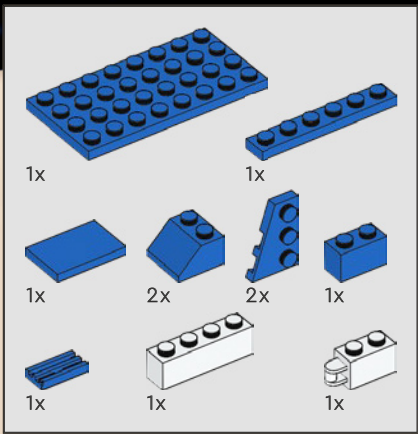

193

1

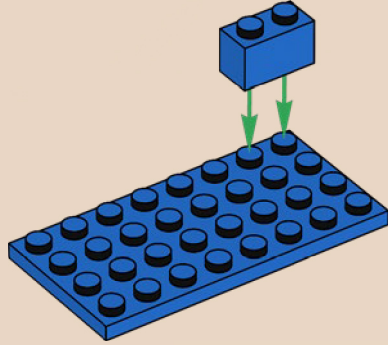

2

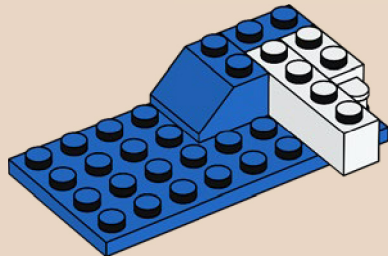

3

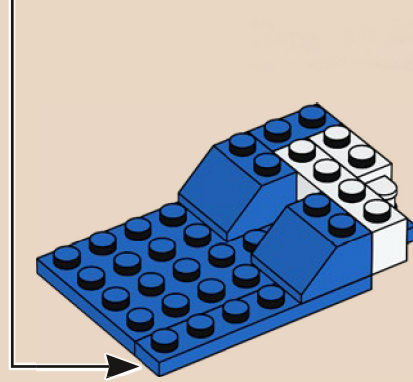
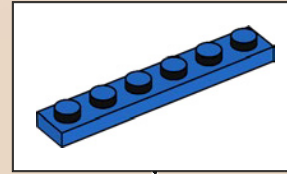

4

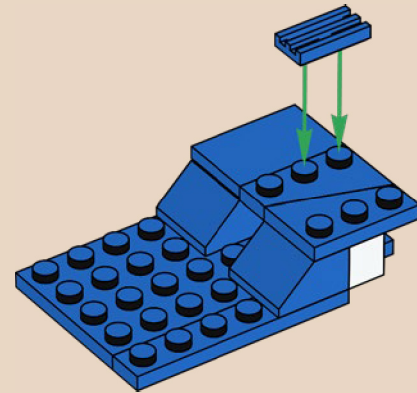

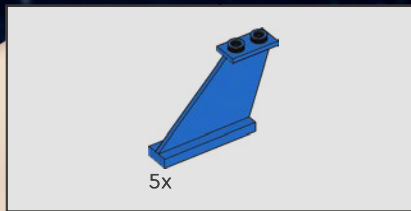

194

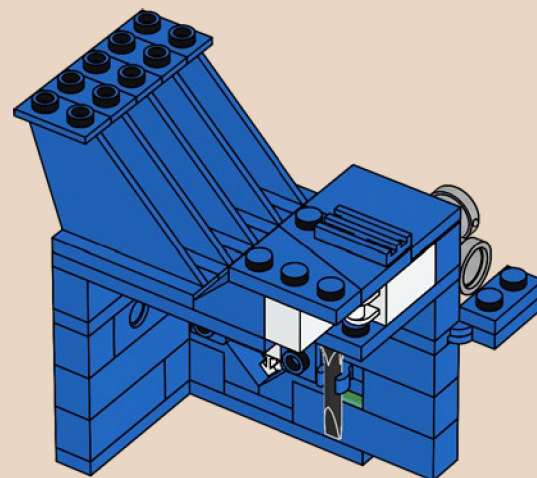
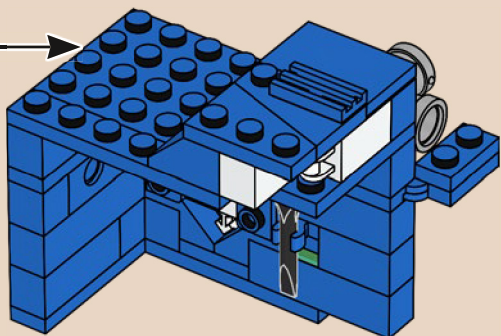

对讲机和扳手是宇航员在原始套装中使用的工具。

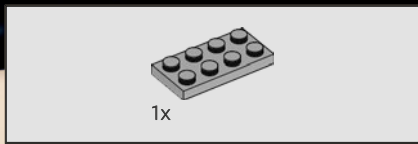

195

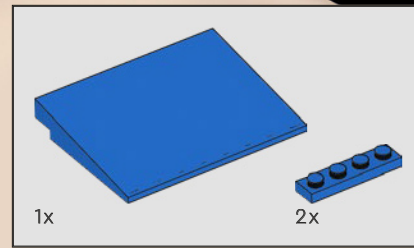
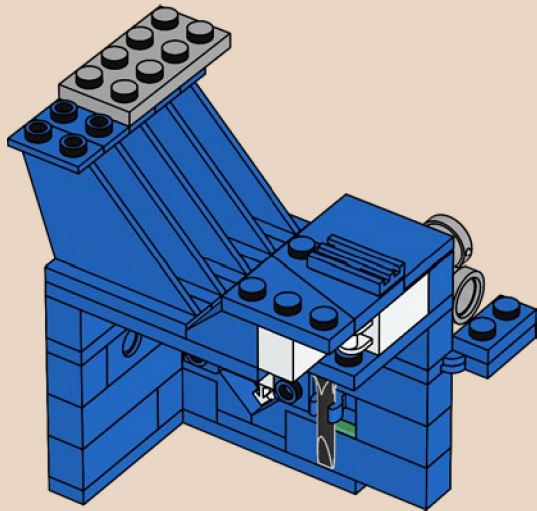

196

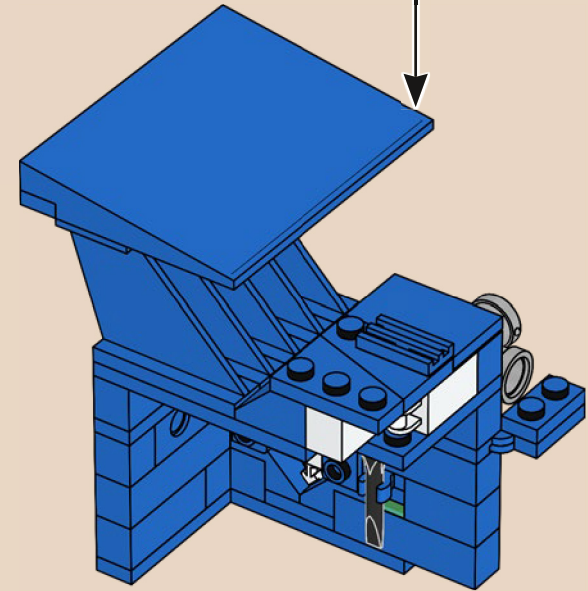
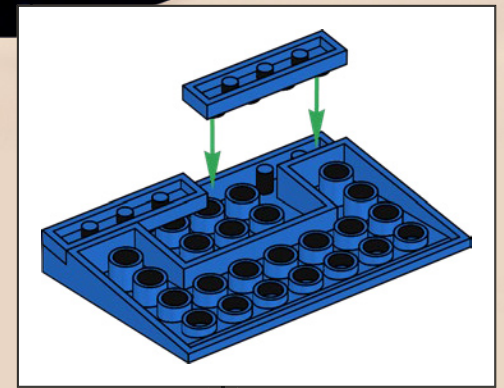



197

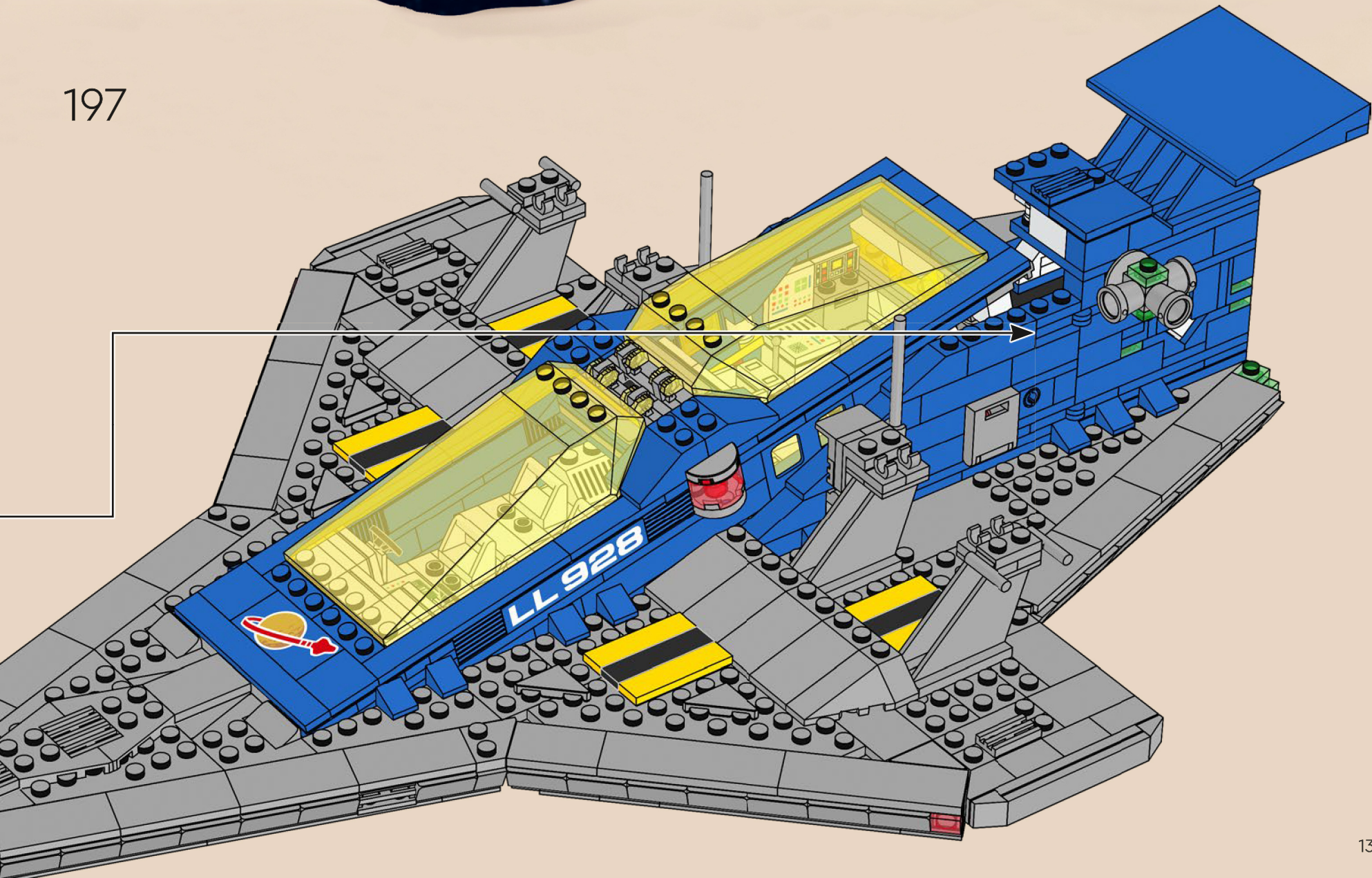

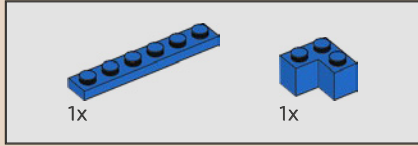
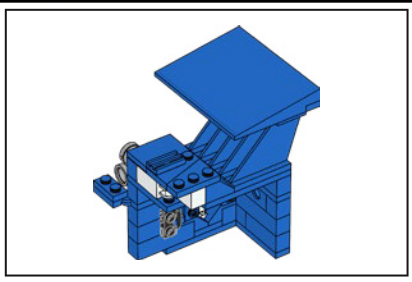

198

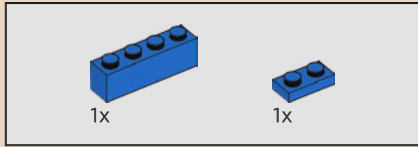
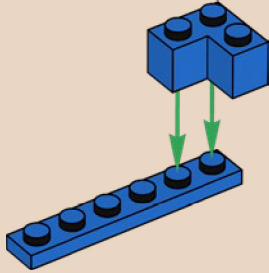

199

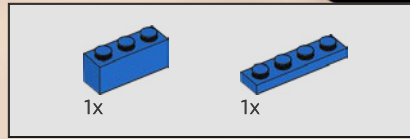
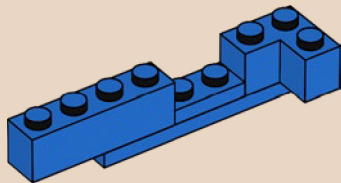

200

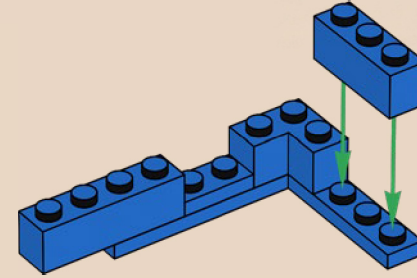

201

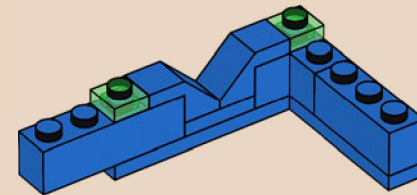

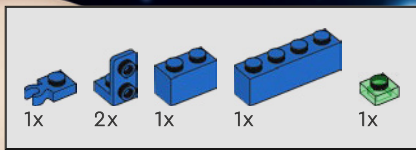

202

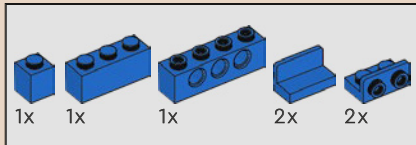
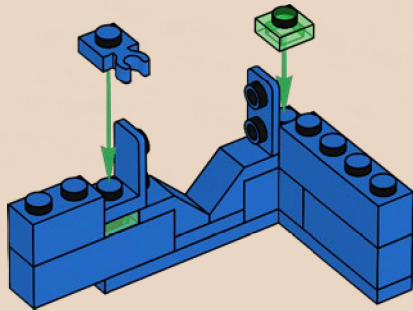

203

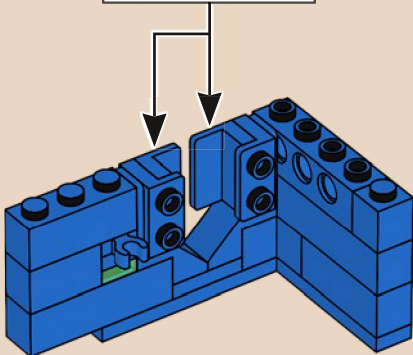
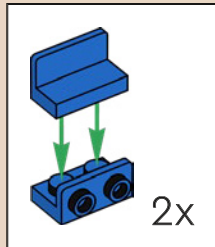

204

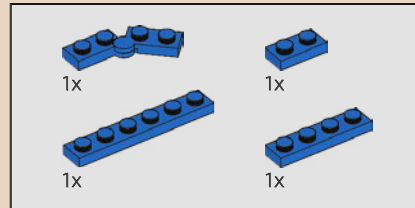
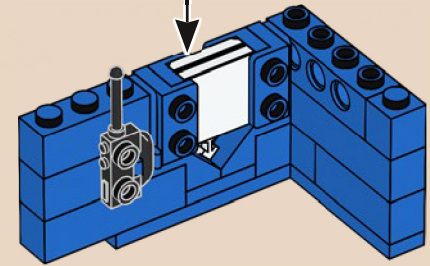
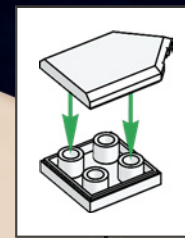

205

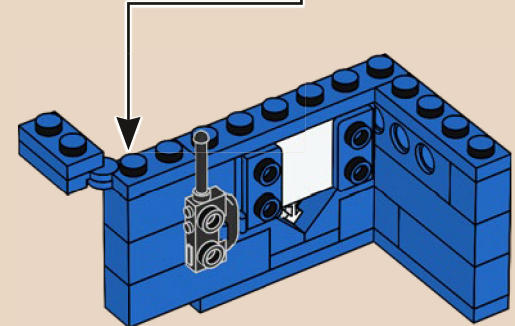
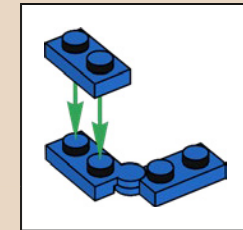

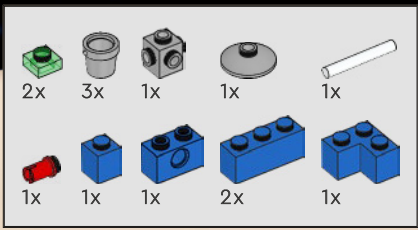

206

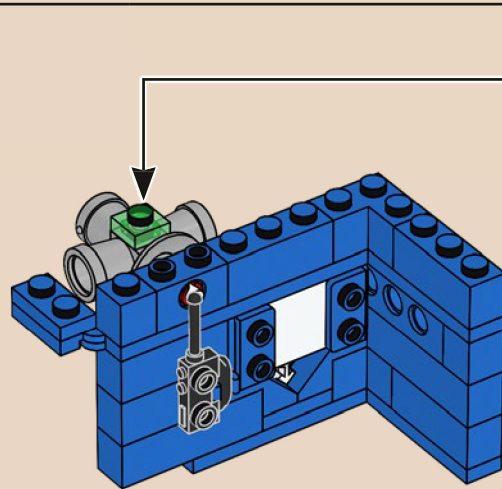
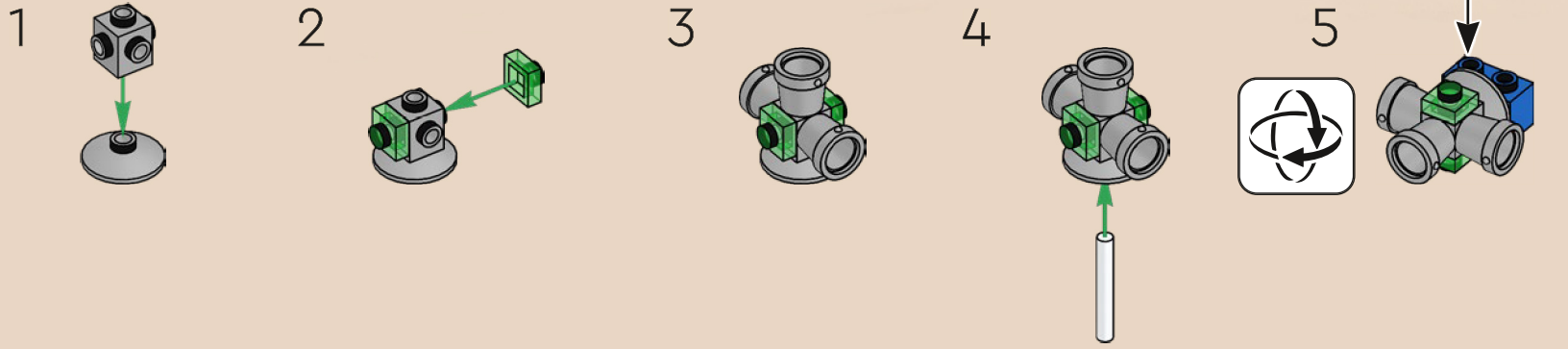

原始模型上的推进器由单个组件拼搭而成。这些较大的推进器由油漆桶拼搭而成，其首次在 2011 年的城堡主题中引入。

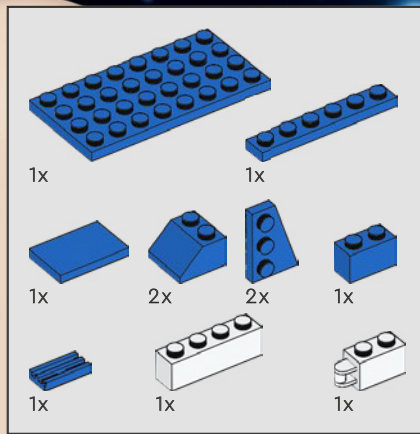

207

1

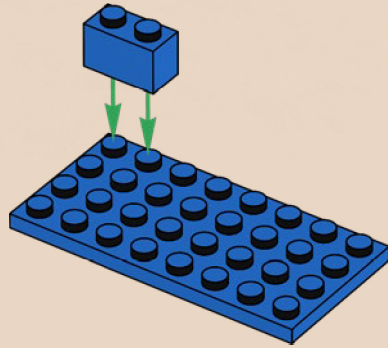

2

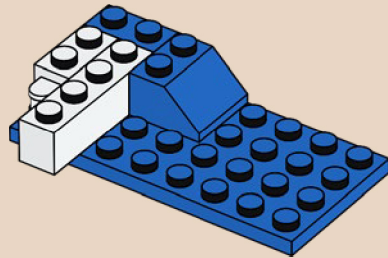

3

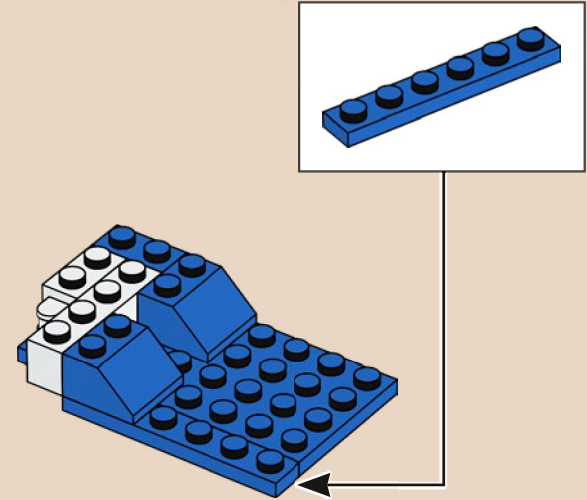

4

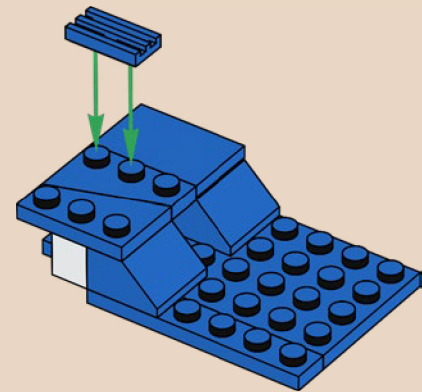

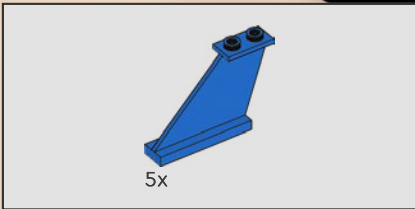

208

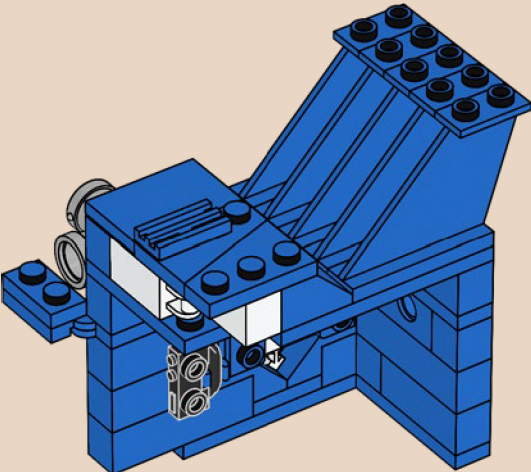
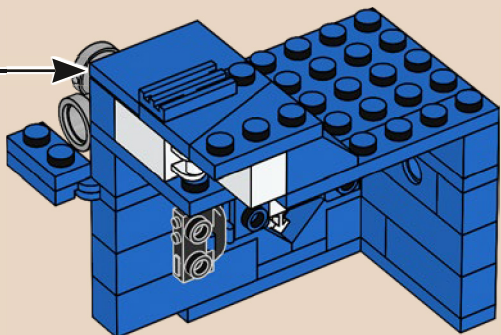

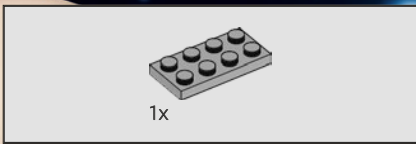

209

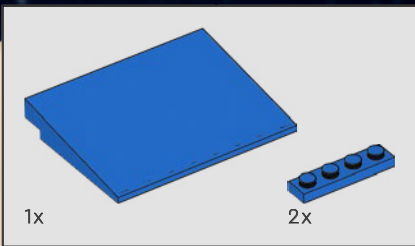
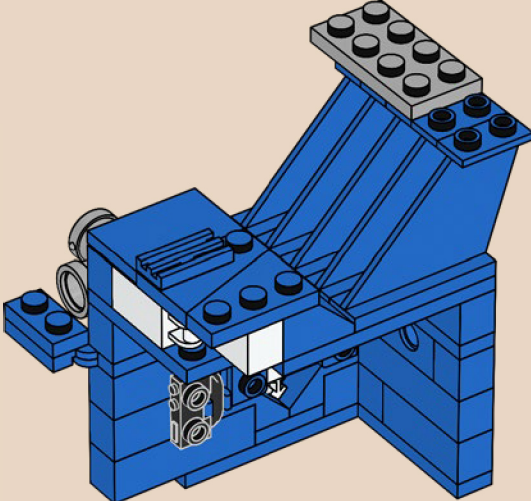

210

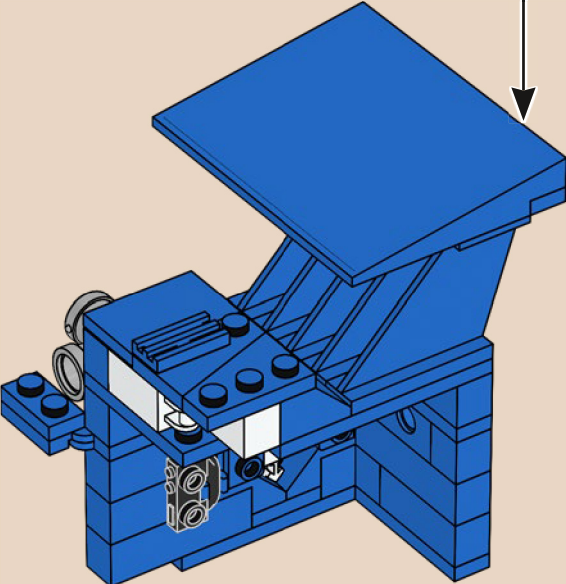
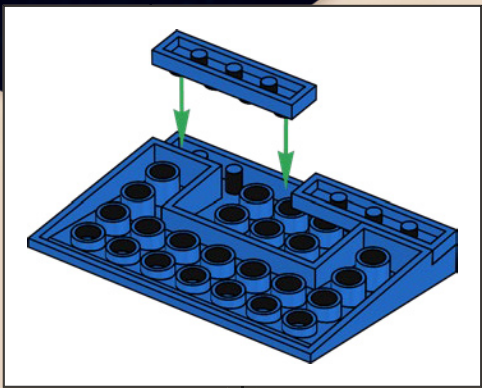

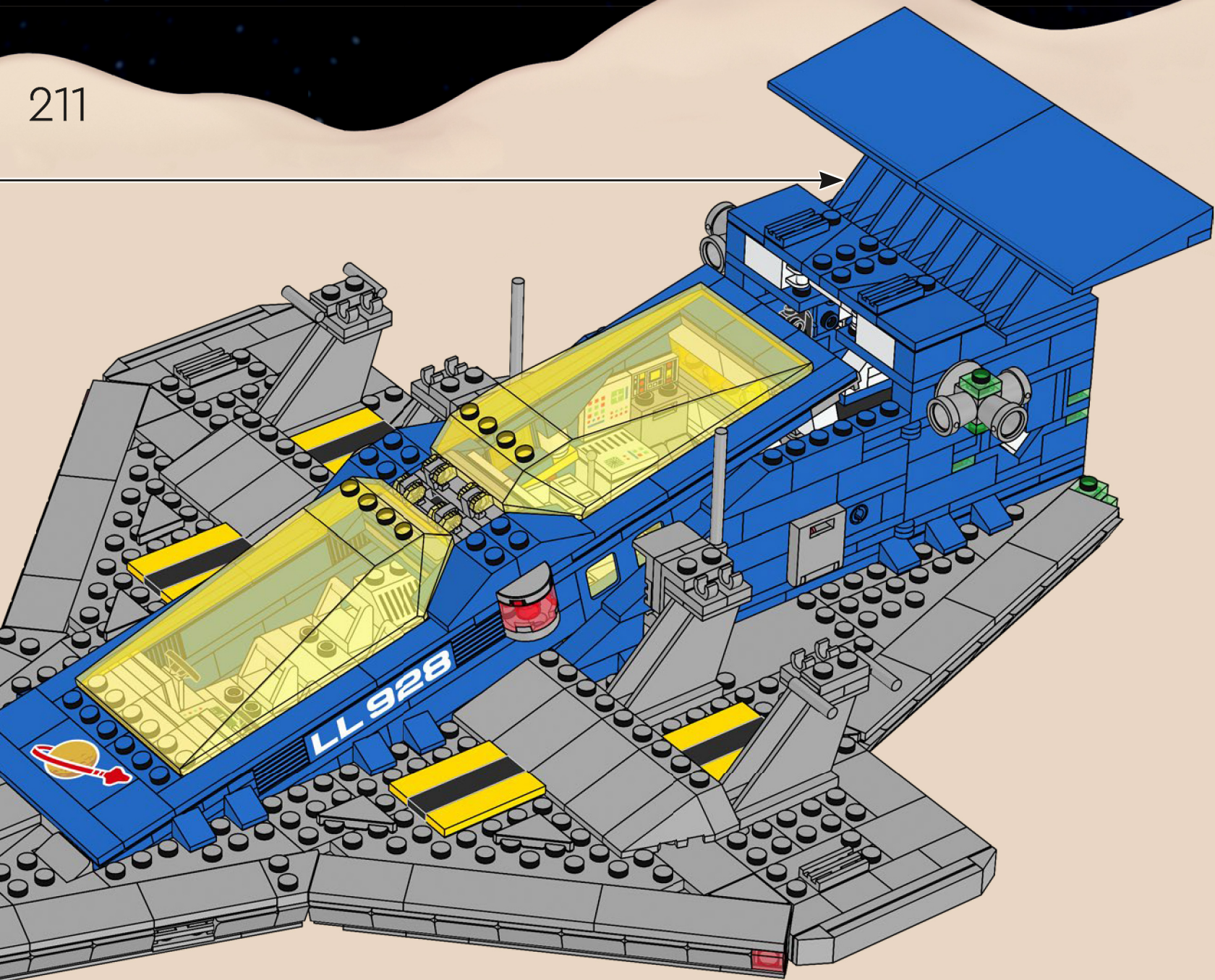



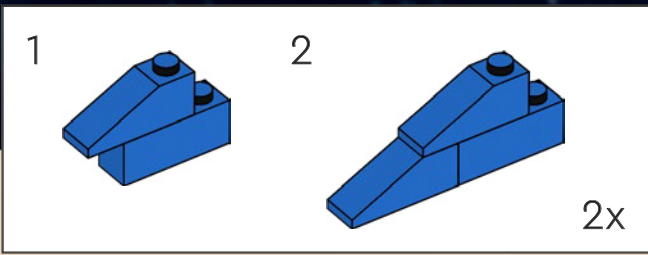
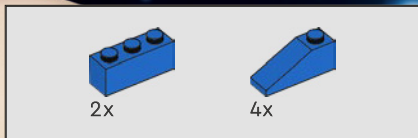

212

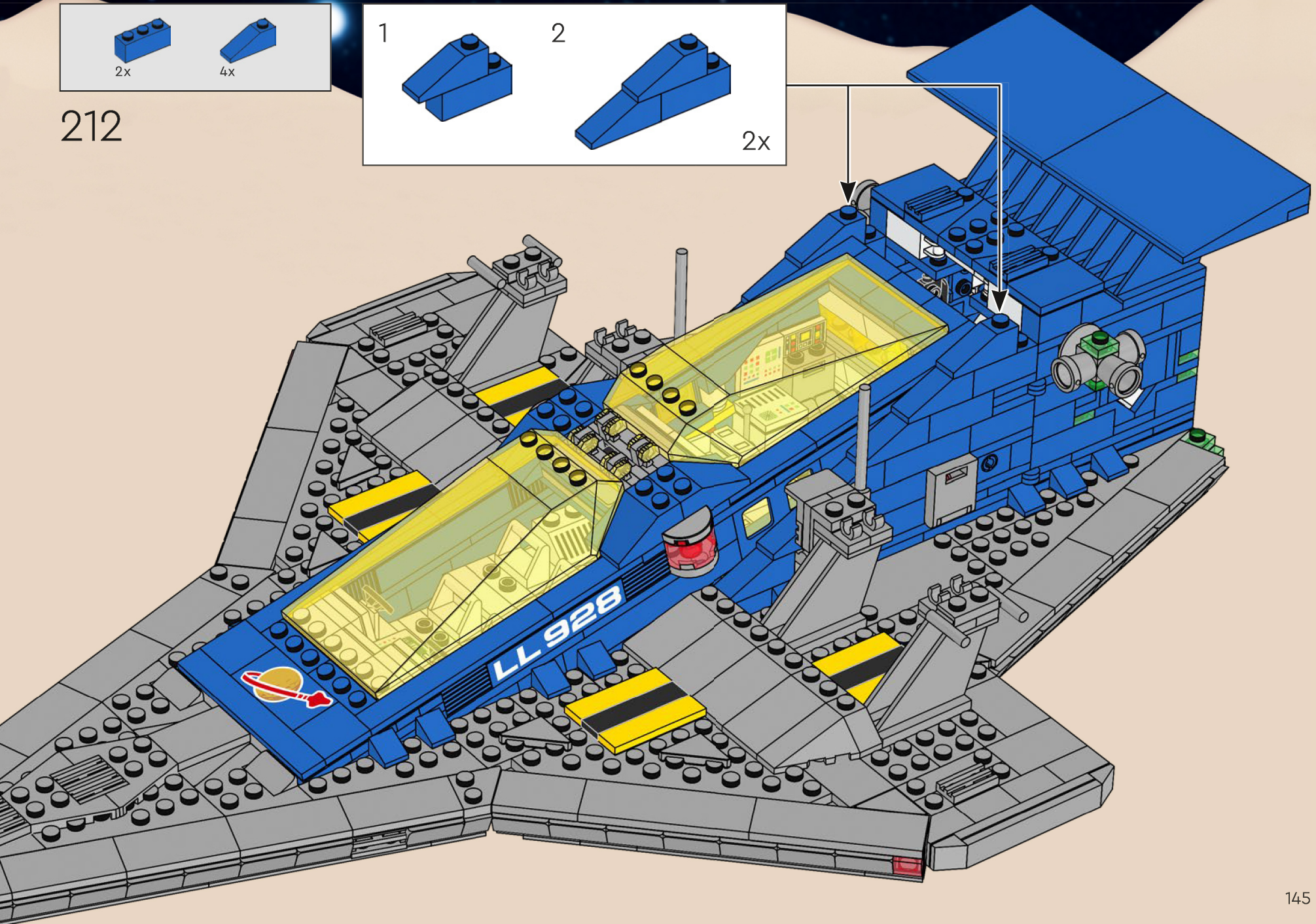

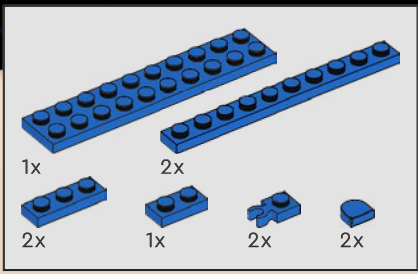

213

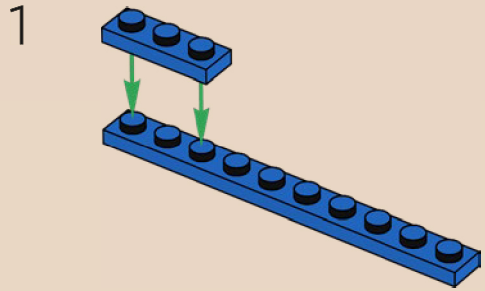

2

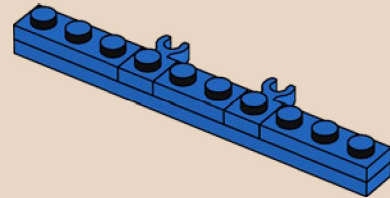

3

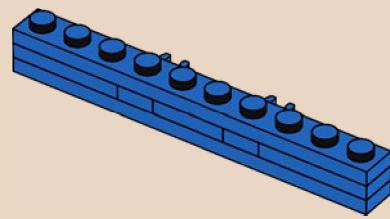

4

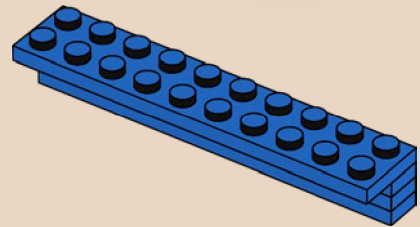

5

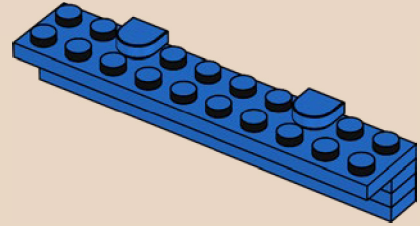

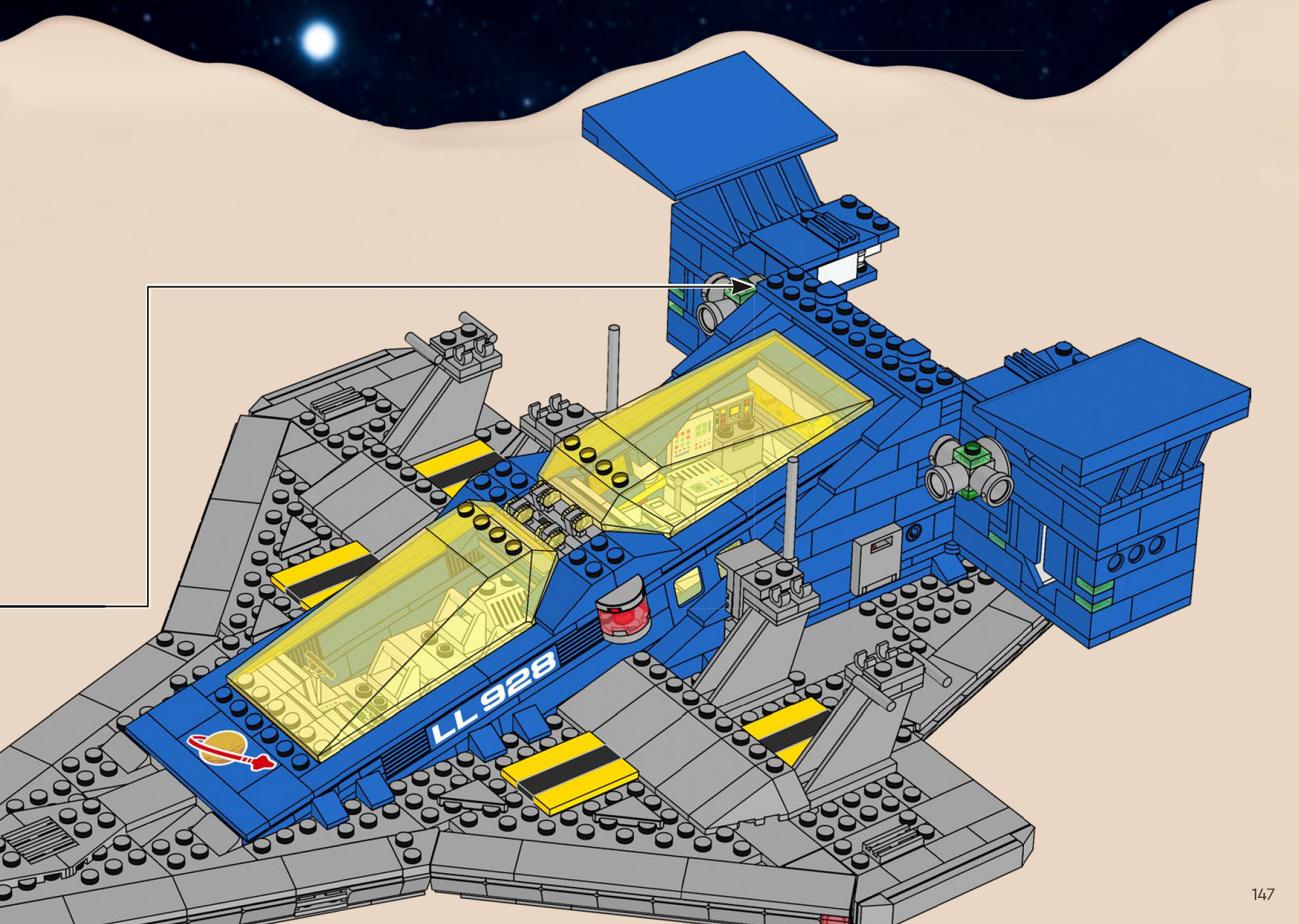

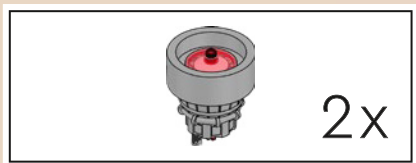
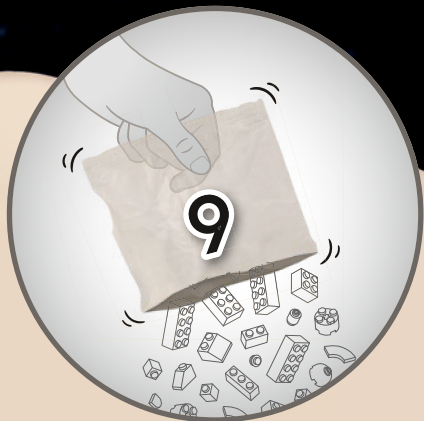

214

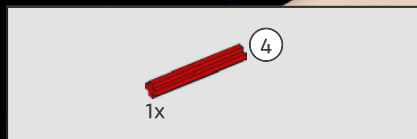
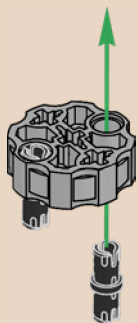

215

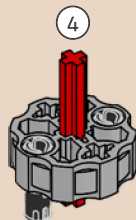

216

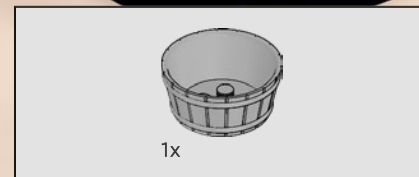
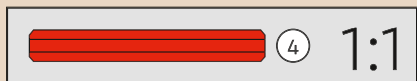
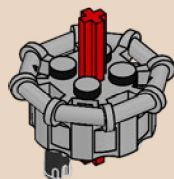

217

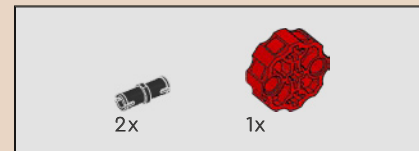
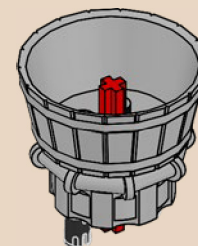

218

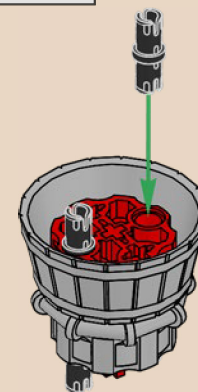



219

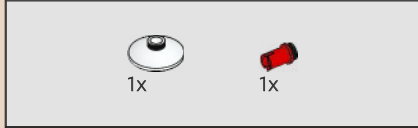
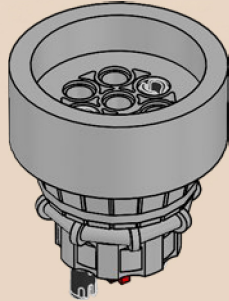

220

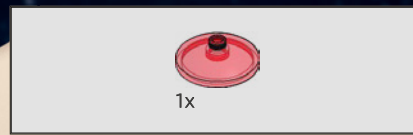
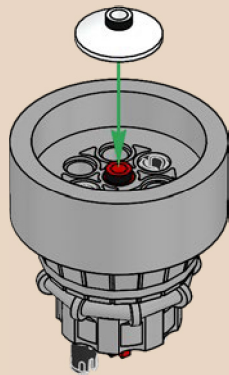

221

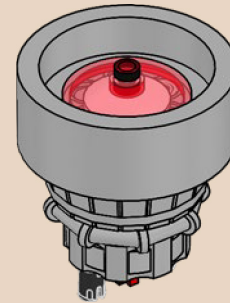

2x

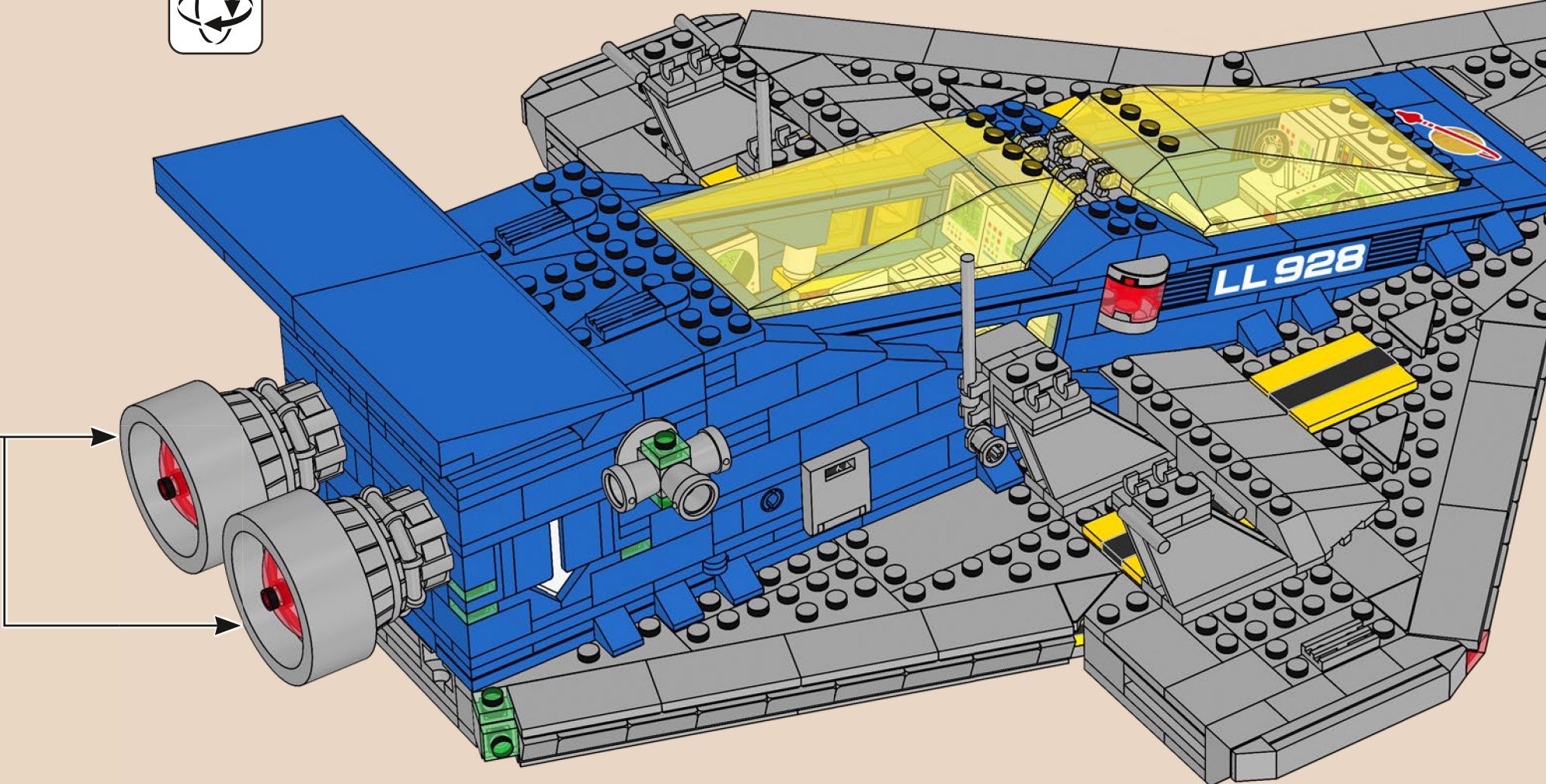

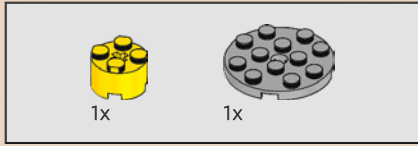
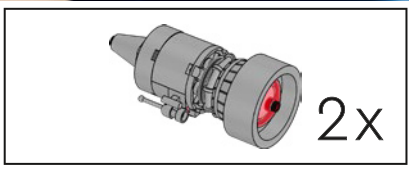

223

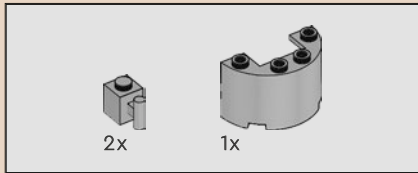
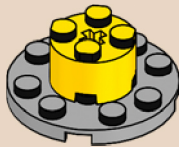

224

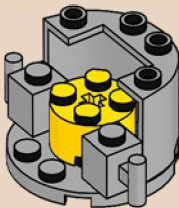

225

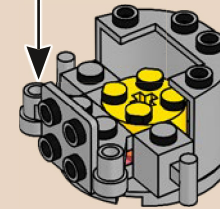
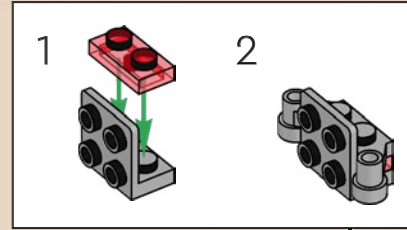

226

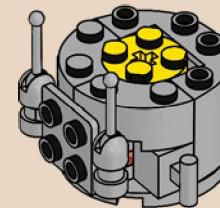

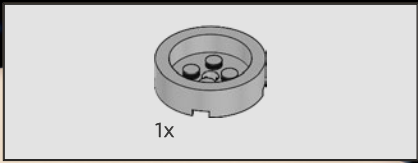

227

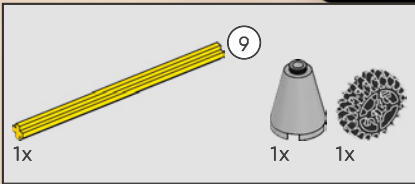
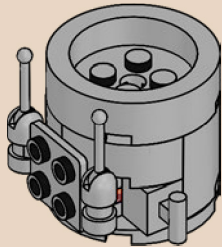

228

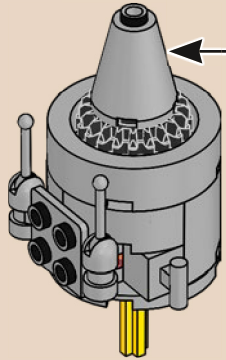
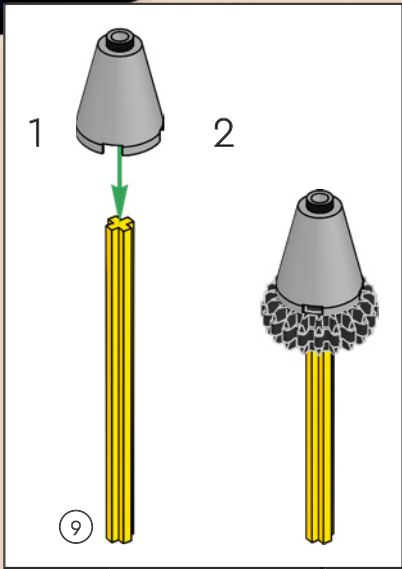



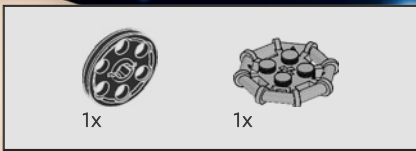

229

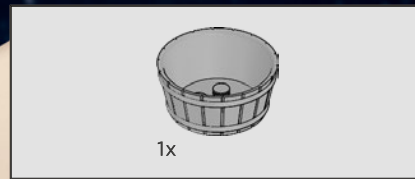
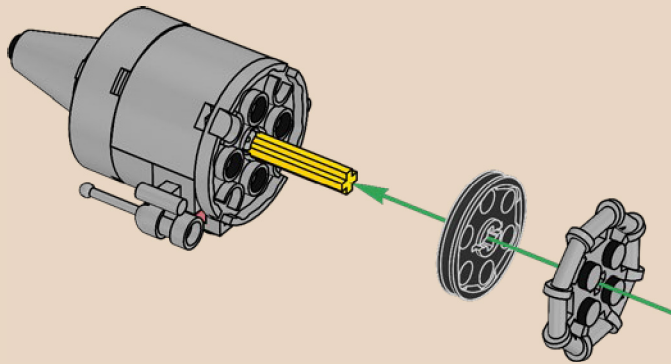

230

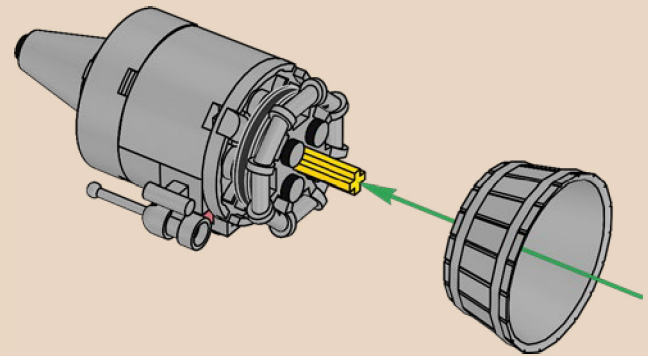

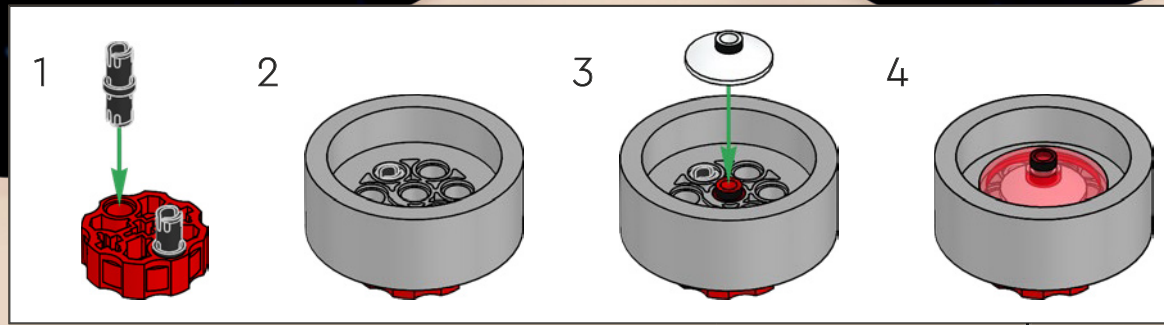
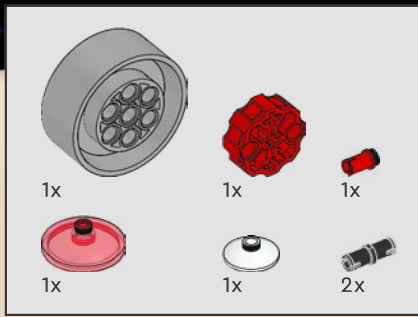

231

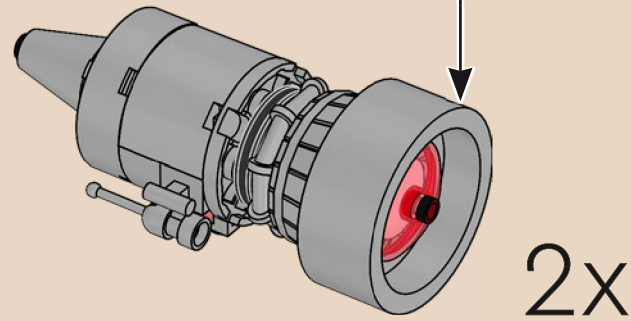

232

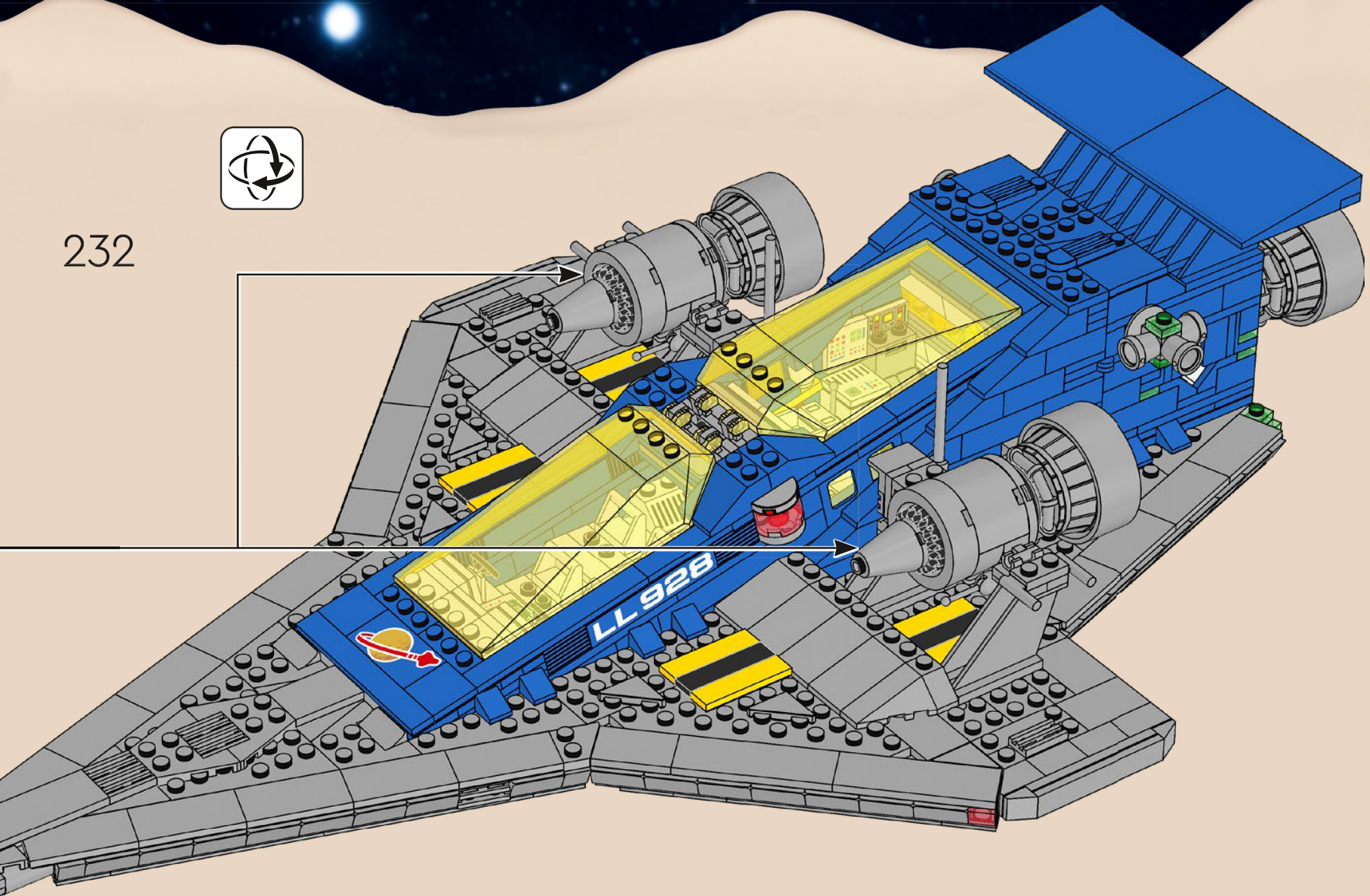

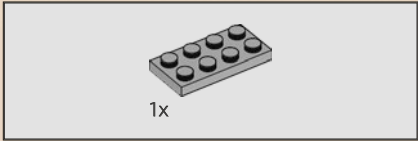
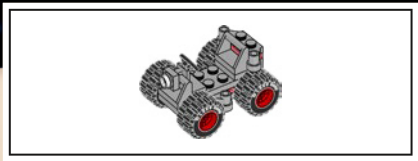

1

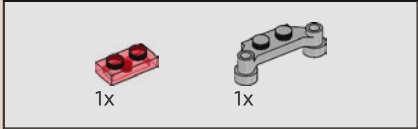

2

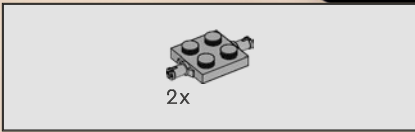
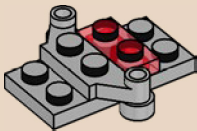

3

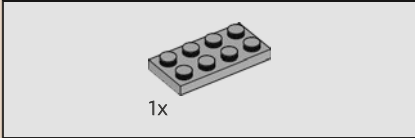
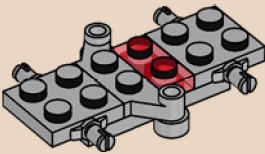

4

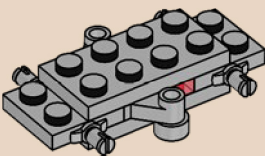

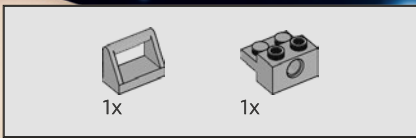

5

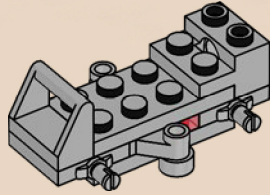

6

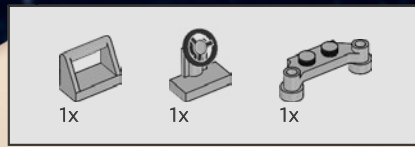
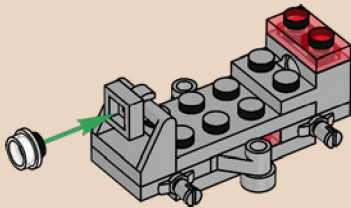

7

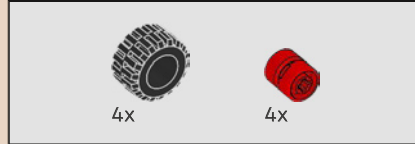
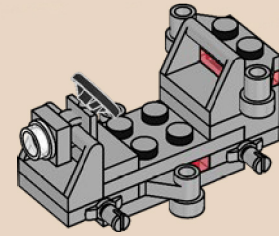

8

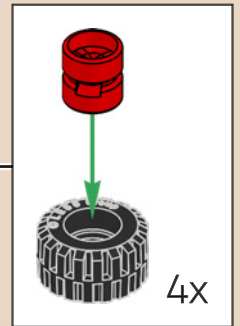
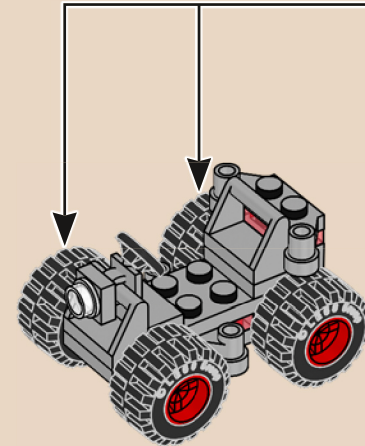

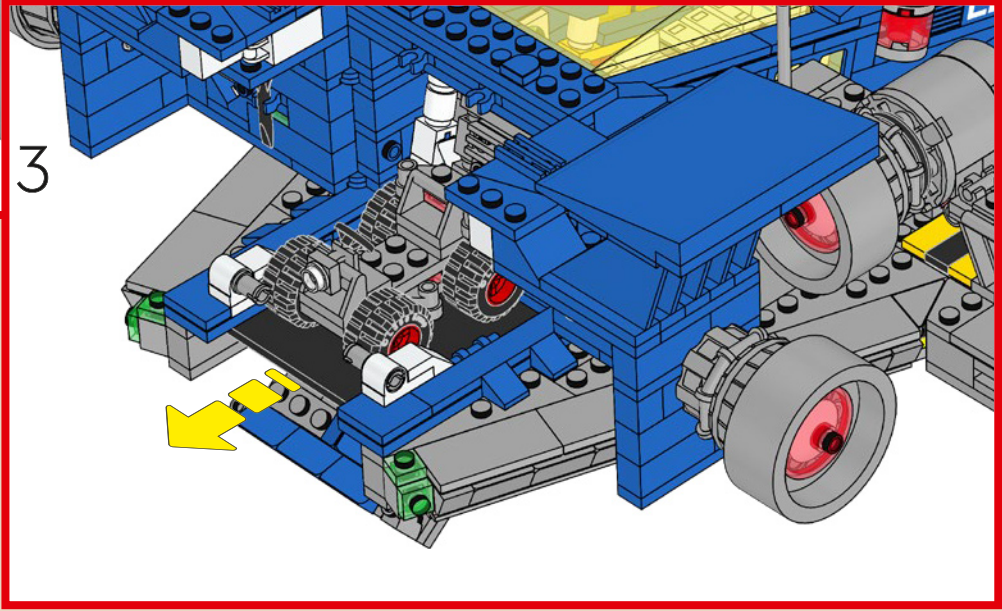
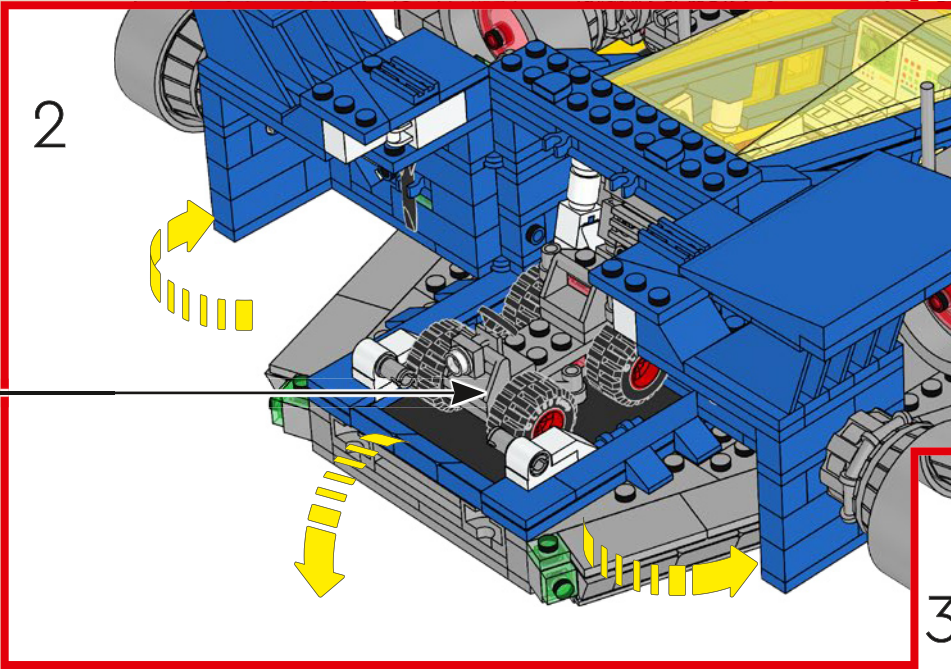
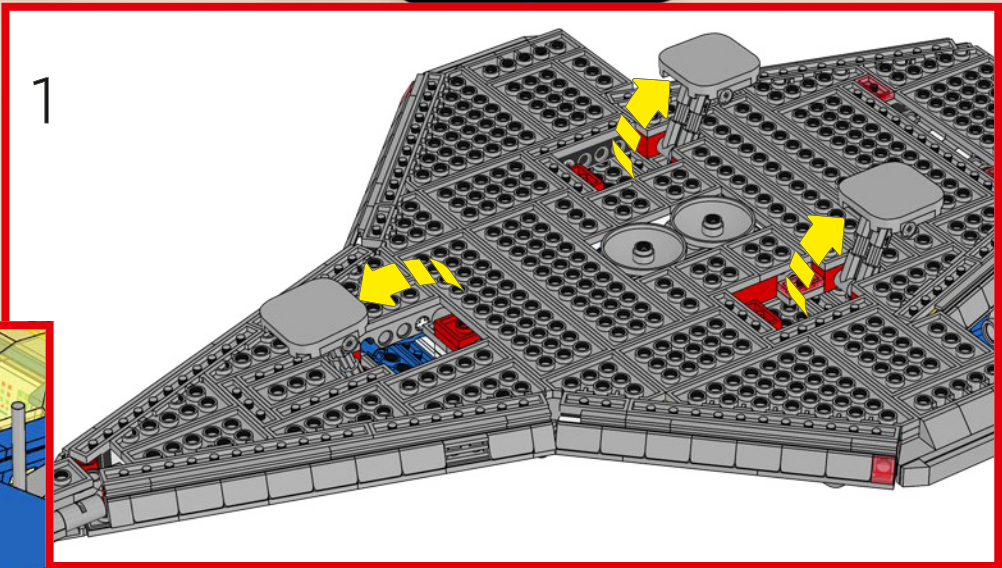

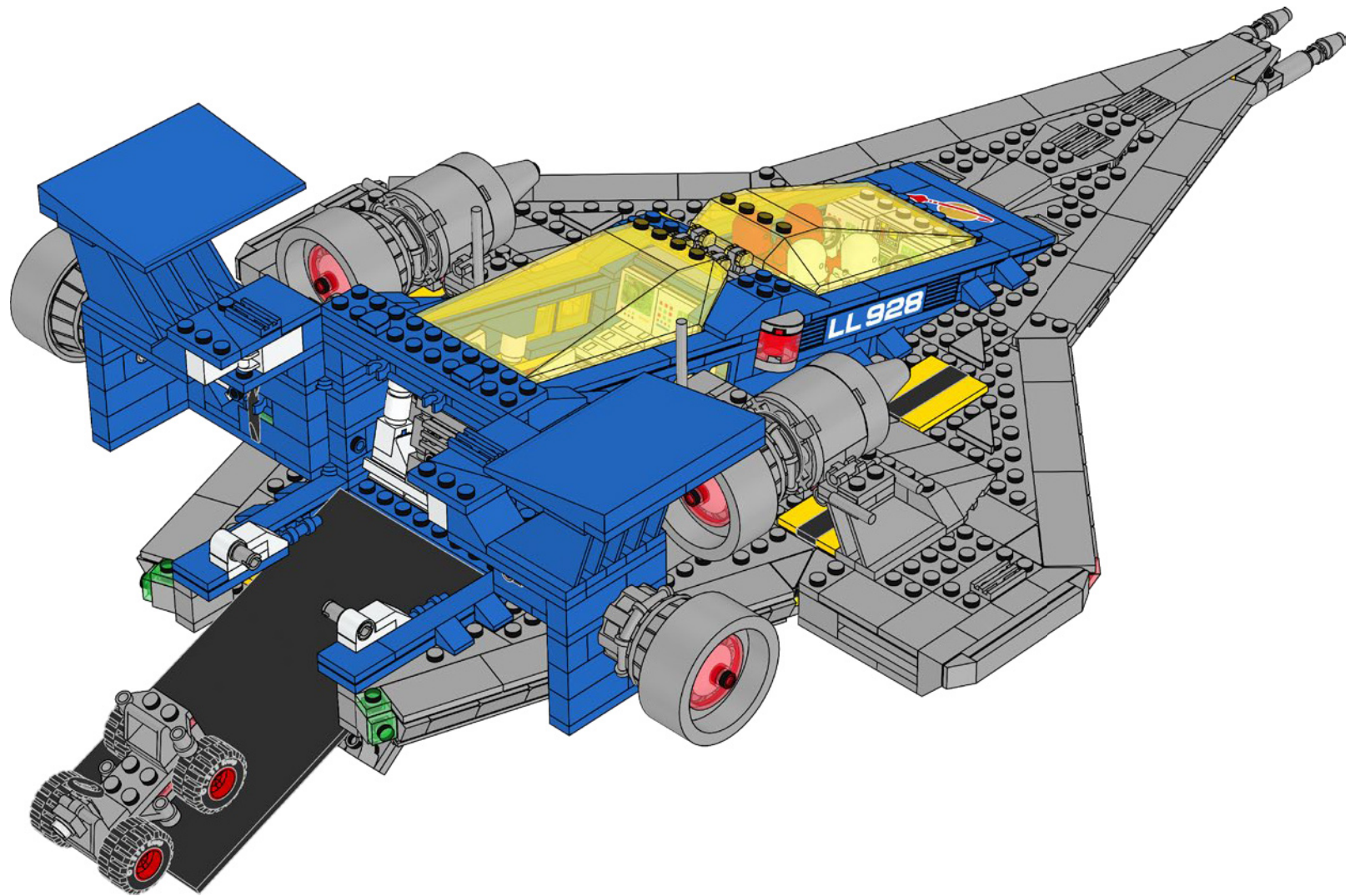

- 4x 306201
- 6x 6168642
- 2x 6177114
- 2x 302401
- 2x 6345886
- 2x 6390834
- 2x 6268849
- 4x 474001
- 4x 243201
- 2x 6069002
- 12x 6210076
- 3x 6304928
- 2x 366501
- 4x 6146215
- 1x 241201

- 6x 302301
- 2x 6057414
- 1x 6178921
- 2x 6166894
- 3x 6018774
- 2x 4140626
- 2x 6198933
- 3x 6289797
- 2x 6013866
- 2x 300301
- 2x 6403936
- 2x 6271990
- 2x 6245249
- 8x 6195371

- 2x 362201
- 1x 362301
- 2x 6396335
- 2x 9327
- 4x 301001
- 1x 4203583
- 1x 6280386
- 3x 6053026
- 2x 6093526
- 2x 6131572
- 2x 300801
- 1x 4501853

- 1x 4144012
- 2x 273001
- 1x 244501
- 3x 663601
- 1x 6428484
- 3x 6428480
- 1x 6428481
- 1x 6428482
- 2x 6428485
- 1x 6428487
- 2x 6345429
- 2x 6390835
- 4x 6281994
- 4x 6207482

- 5x 370021
- 4x 6168634
- 2x 4581525
- 6x 302221
- 2x 6209519
- 4x 6313596
- 2x 6396330
- 2x 9342
- 2x 6129995
- 4x 370121
- 2x 301021
- 4x 300121
- 14x 306221
- 8x 6378120
- 2x 6390833

- 6x 300523
- 2x 4583862
- 18x 4504380
- 2x 407023
- 4x 6344218
- 4x 6352221
- 2x 4498156
- 2x 4498155
- 5x 4651236
- 10x 4206482
- 4x 6289241
- 8x 300423
- 6x 370023
- 2x 241223
- 13x 302323

- 4x 6228601
- 4x 6146218
- 4x 6133721
- 2x 4140586
- 18x 6299413
- 5x 306823
- 4x 4558606
- 4x 303923
- 2x 6129747
- 20x 362223
- 6x 6372038
- 12x 362323
- 2x 6284575
- 2x 6268862
- 4x 302423
- 2x 6196596

- 4x 6294307
- 6x 243123
- 2x 4212411
- 2x 370123
- 8x 371023
- 6x 301023
- 2x 6207688
- 2x 302023
- 1x 6302718
- 10x 6254953
- 12x 428623
- 4x 6416505
- 2x 4118785
- 2x 6323429



10x  
366623

5x  
346023

5x  
416223

2x  
300823

1x  
303423

9x  
447723

2x  
303523

1x  
383223

2x  
6337084

2x  
303023

30x  
614124

4x  
9336

4x  
4624985

6x  
614324

1x  
302324

10x  
242024

4x  
362324

2x  
300224

8x  
371024

8x  
243124

2x  
366624

2x  
6130010

2x  
73587

2x  
306226

2x  
407026

1x  
6268852

2x  
6281993

10x  
6196548

40x  
6279875

1x  
403226

1x  
4226995

2x  
9551

2x  
302326

1x  
6020193

2x  
4141580

2x  
6346535

2x  
6323668

1x  
6170545

4x  
4568644

2x  
6089119

1x  
400626

1x  
370526

4x  
6416444

4x  
6054852

1x  
303426

4x  
389526

2x  
4542573

1x  
4603646

12x  
4162443

4x  
243126

1x  
6240030

2x  
6238856

1x  
6208450

2x  
6245252

2x  
6334501

20x  
6240212

4x  
6273482

4x  
6315923

2x  
6244907

2x  
6390837

1x  
6240515

1x  
6240221

14x  
6252046

2x  
6170418

2x  
4211412

2x  
4529241

6x  
4211525

2x  
6275844

6x  
6057487

2x  
4211503

4x  
6336539

4x  
4558953

12x  
4521921

4x  
6170569

2x  
4211511

2x  
6225246

1x  
6308012

2x  
6163477

2x  
6163478

2x  
6311384

2x  
6296894

2x  
4211492

12x  
6296859

4x  
6173127

48x  
4568637

4x  
4211475

2x  
6404367

2x  
4211512

2x  
4211807

5x  
6372076

4x  
6093859

- 8x 6326078
- 2x 4211614
- 2x 4651063
- 8x 6168633
- 11x 4211350
- 2x 4211357
- 6x 6015344
- 2x 6146223
- 4x 4211388
- 2x 4211437
- 2x 4654580
- 2x 6337268
- 12x 4211568
- 8x 6217876
- 2x 6319336
- 11x 4282786
- 11x 4282789
- 5x 4211397
- 2x 6326478
- 6x 6045988
- 4x 4567448
- 1x 6316961
- 6x 4211815
- 11x 6321747
- 2x 4211491
- 1x 6346487
- 2x 6186129
- 2x 4211429
- 2x 6408022
- 2x 4211419
- 4x 6302648



3

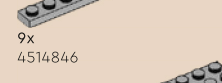
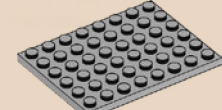
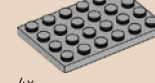
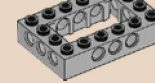
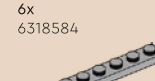
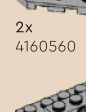
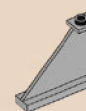

Customer Service  
 Kundenservice  
 Service Client  
 Assistenza clienti  
 Atención al cliente  
 Serviço de Apoio ao Consumidor  
 Ügyfélszolgálat  
 Klientu apkalpošanas dienests  
 Serviciul pentru client  
 客户服务  
 コンシューマーサービス  
 고객 서비스  
**LEGO.com/service**



# FEEDBACK AND WIN



## FEEDBACK AND WIN

Your feedback will help shape the future development of this product series.

Please visit:

## FEEDBACK UND GEWINNEN

Dein Feedback trägt zur Weiterentwicklung dieser Produktreihe bei.

Geh auf:

## COMMENTEZ ET GAGNEZ

Vos commentaires nous aideront à concevoir les futurs produits de cette gamme.

Rendez-vous sur :

## COMENTA Y GANA

Tu opinión nos ayudará a dar forma al desarrollo de esta serie de productos en el futuro.

Visita:

## 反馈有奖

您的反馈将有助于我们在今后改进本系列产品。

请访问：

[LEGO.com/productfeedback](https://www.lego.com/productfeedback)

By completing, you will automatically enter a drawing to win a LEGO® set.

Terms & Conditions apply.

Durch Ausfüllen nimmst du automatisch an der Verlosung eines LEGO® Preises teil.

Es gelten die Teilnahmebedingungen.

En envoyant vos commentaires, vous serez automatiquement inscrit(e) à un tirage au sort qui vous permettra de remporter un prix LEGO®.

Offre soumise à conditions.

Al contestar, participarás automáticamente en el sorteo y podrás ganar un set LEGO®.

Sujeto a Términos y Condiciones.

完成我们的反馈调查，即可自动进入抽奖环节，赢取乐高®套装。

适用《条款和条件》。

