



CLASSIC

10704



[LEGO.com/classic](https://www.lego.com/classic)



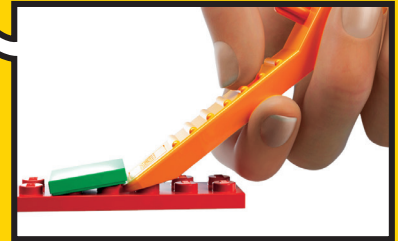
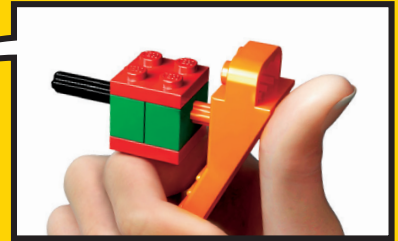
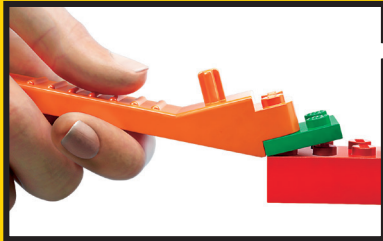

LEGO.com/brickseparator



Easy building
Einfach zu bauen
Construction facile
Construcción fácil
Construção fácil
Kezdő építőknek
简单拼砌



Medium building
Mittelschwer
Construction intermédiaire
Construcción intermedia
Construção intermédia
Gyakorló építőknek
中级拼砌



Advanced building
Fortgeschritten
Construction avancée
Construcción avanzada
Construção avançada
Tapasztalt építőknek
高级拼砌



Page/页码
6



Page/页码
18



Page/页码
14



Page/页码
26

Page/页码
38



Page/页码
56



LEGO.com/classic

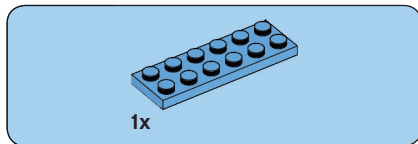

1

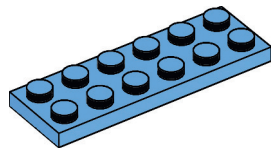

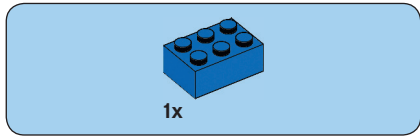

2

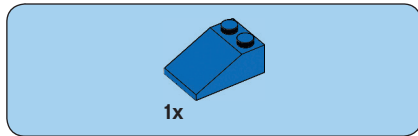
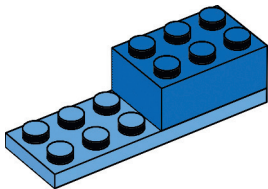

3

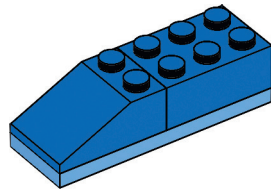



1x



1x

4

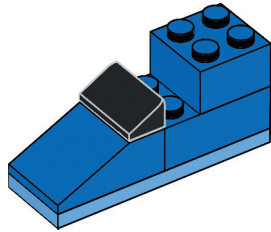

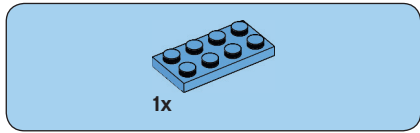

5

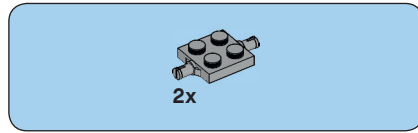
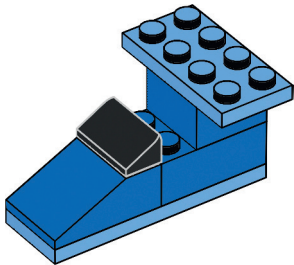

6

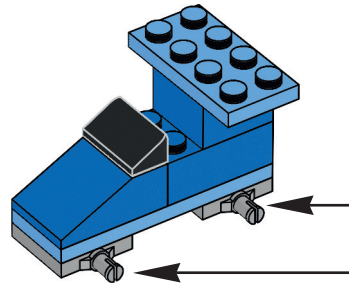
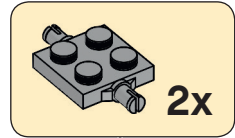



4x



4x

7



4x

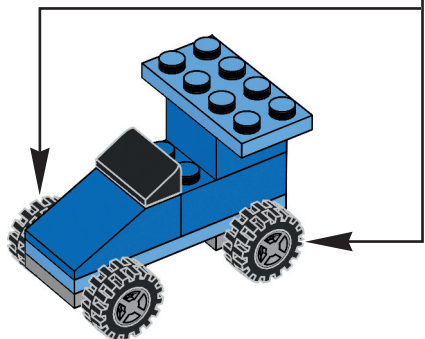

1x

8

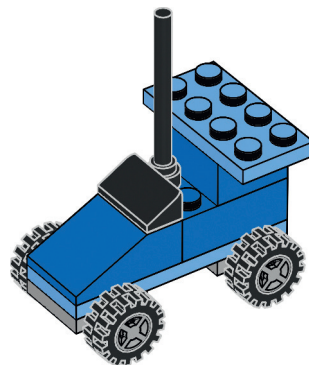

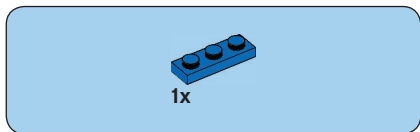
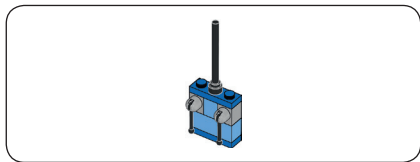

1

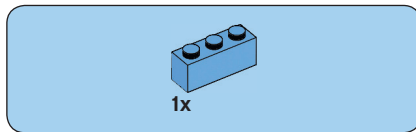
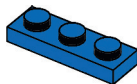

2

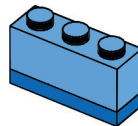



1x



2x

3

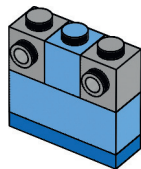

1x

4

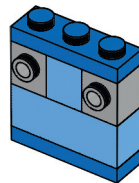

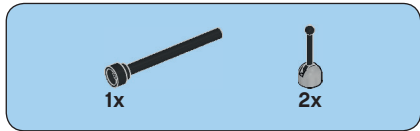

5

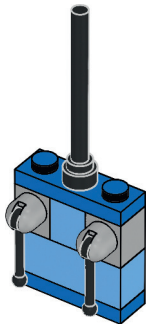

6

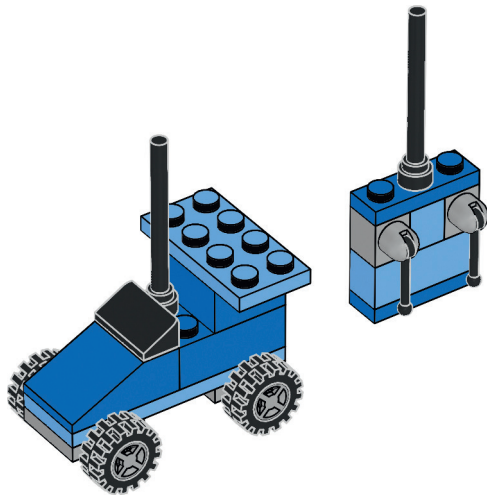

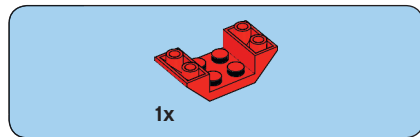

1

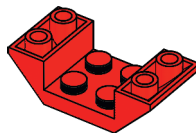

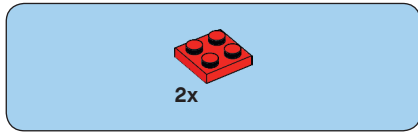

2

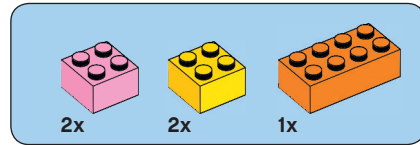
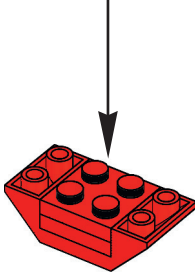
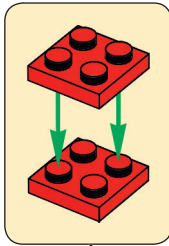

3

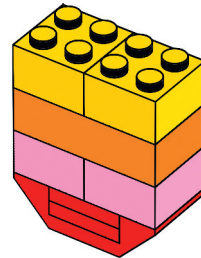

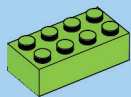

1x

4

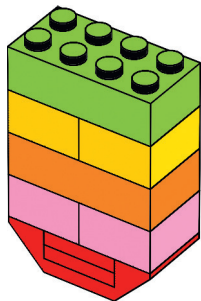

2x

5

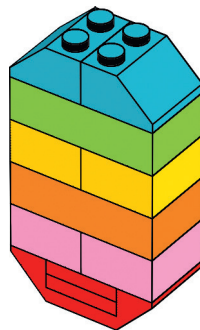



3x

6

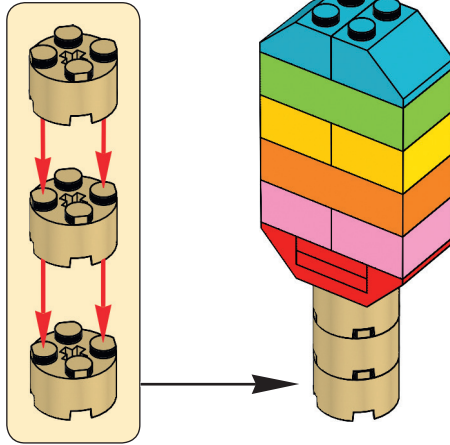

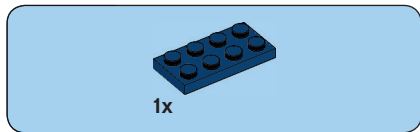

1

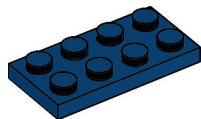

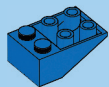

1x

2

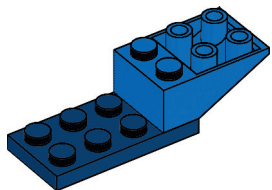

1x

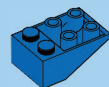

1x

3

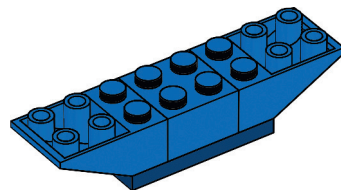

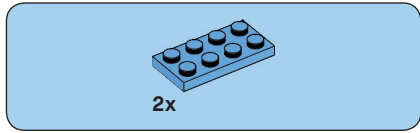

4

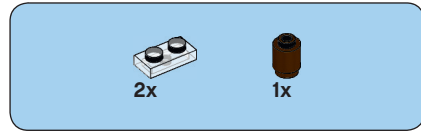
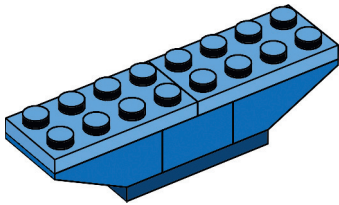

5

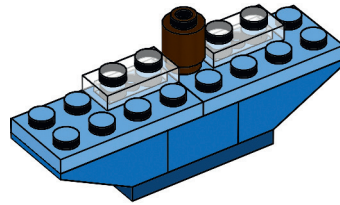

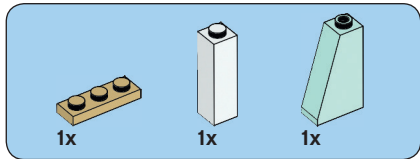
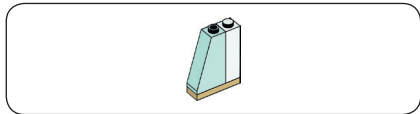

6

1

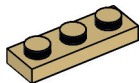

2

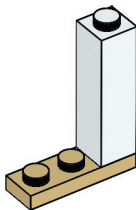

3

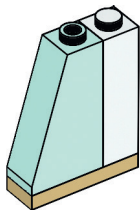

7

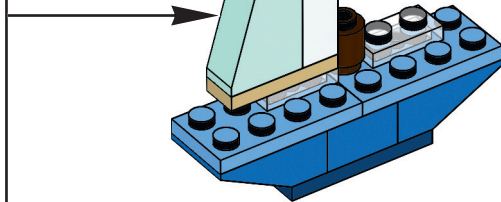



8

1



2

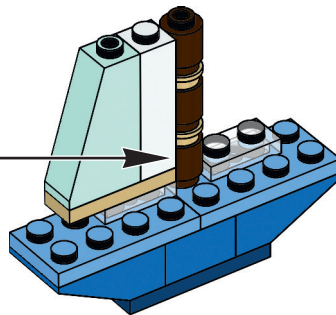

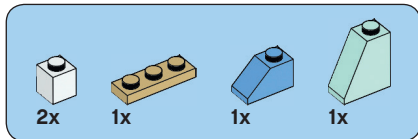
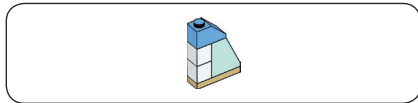

9

1

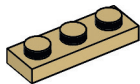

2

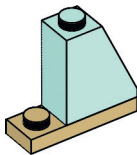

3

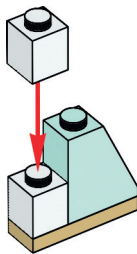

4

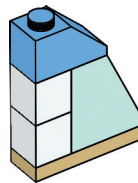

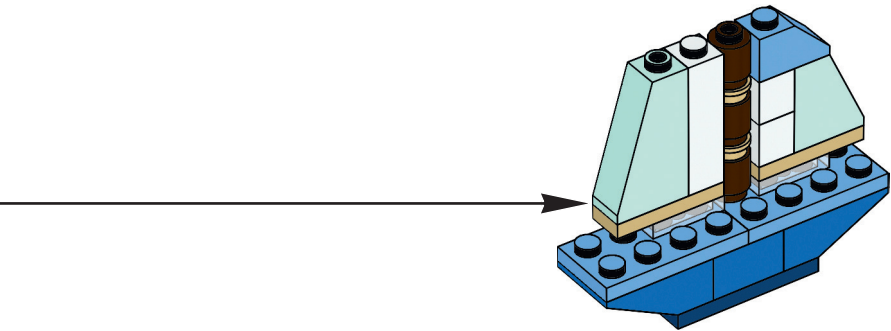

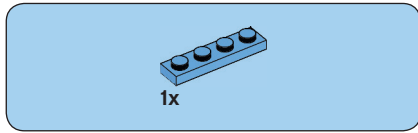

10

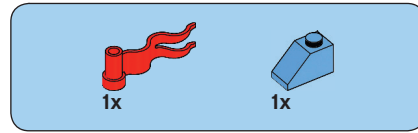
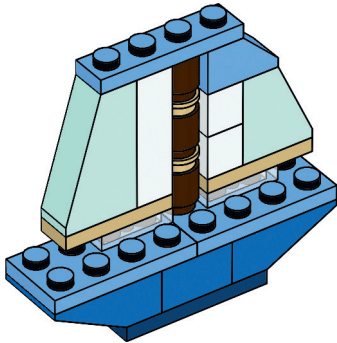

11

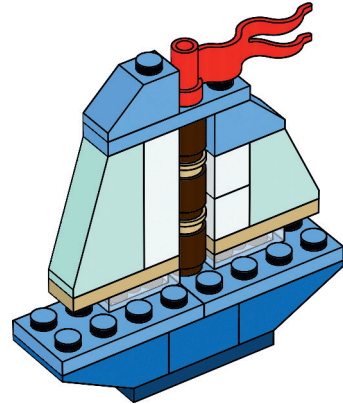

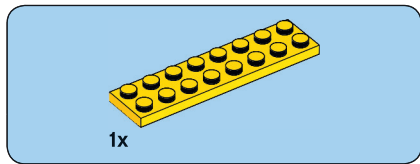

1

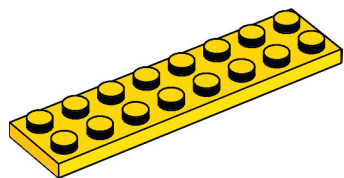

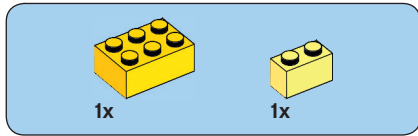

2

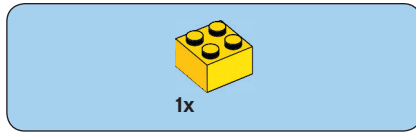
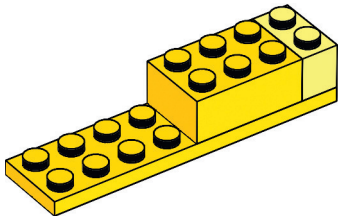

3

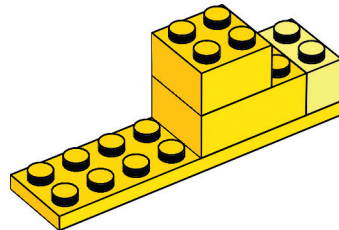



4x

4

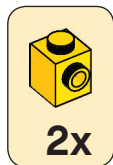

2x

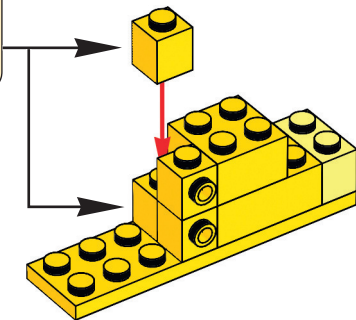

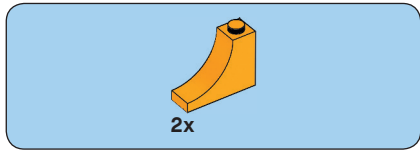

5

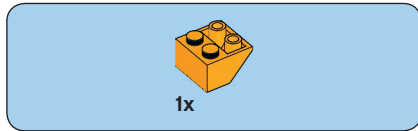
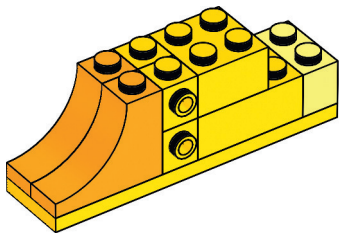

6

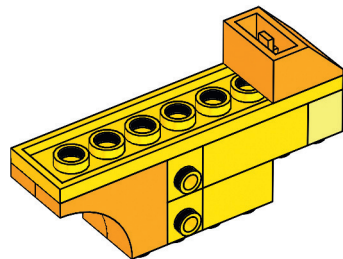
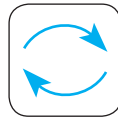

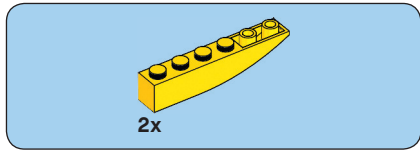

7

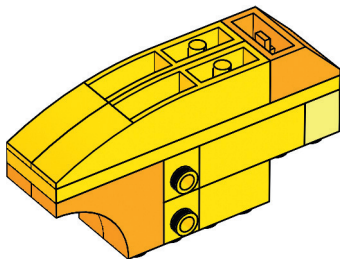

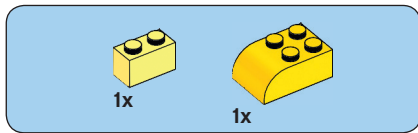

8

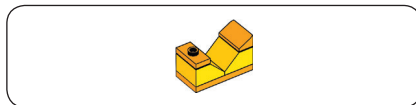
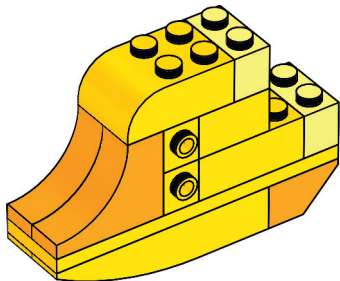
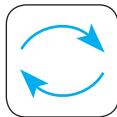

9

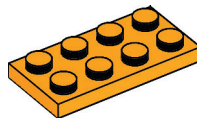
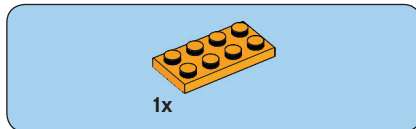



2x

10

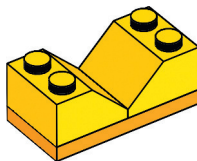

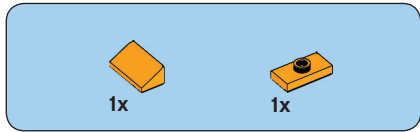

11

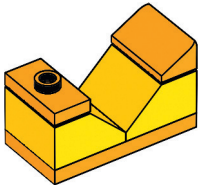

12

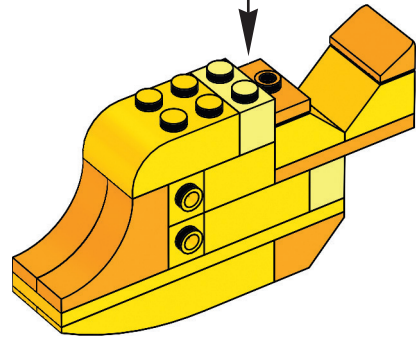



1x

13

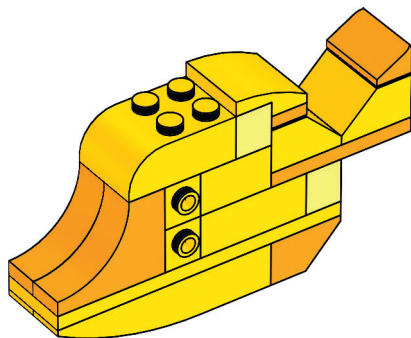

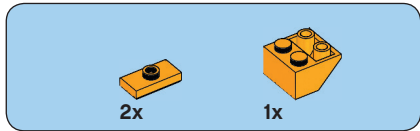

14

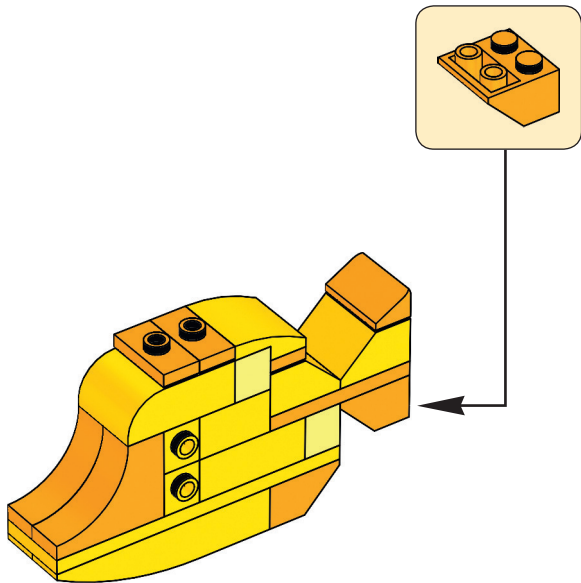



1x

15

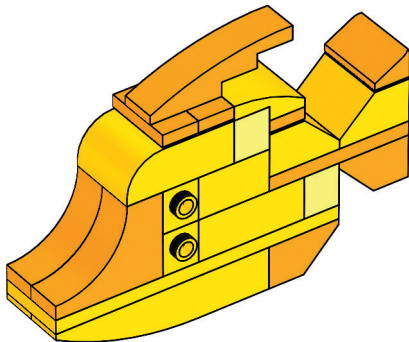



16

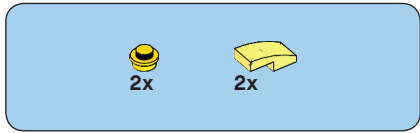
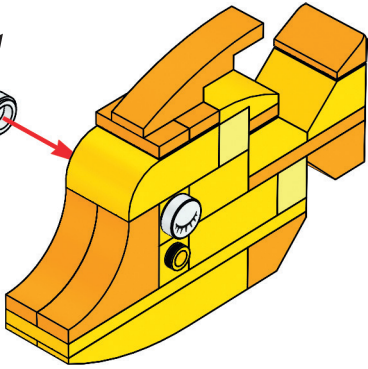

17

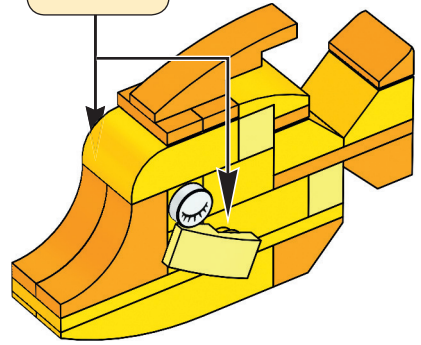
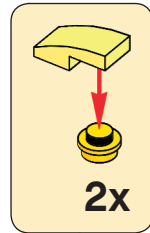

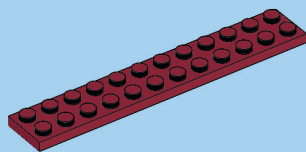

1x

1

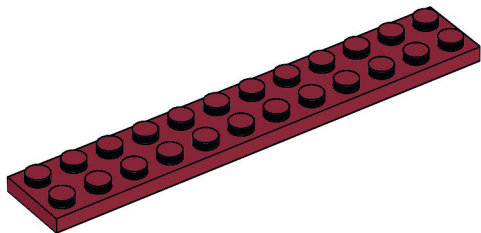



1x



1x

2

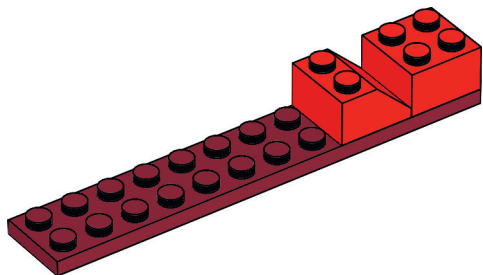

2x

3

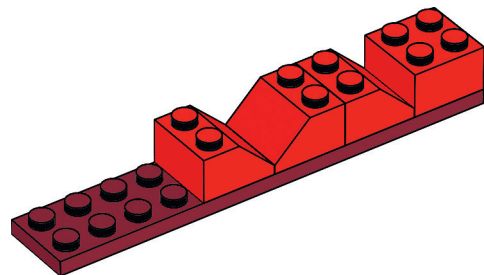

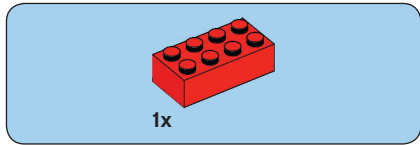

4

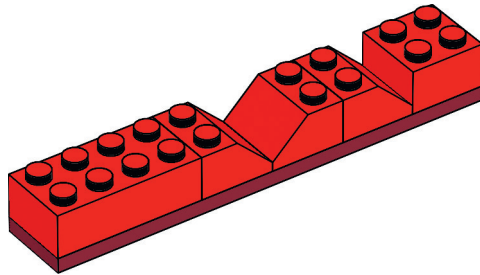

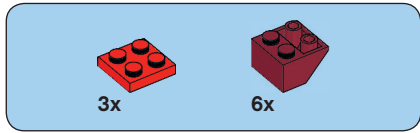

5

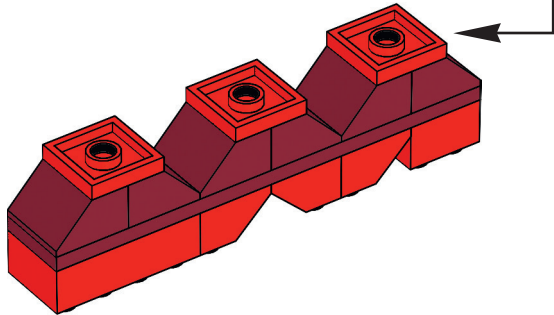
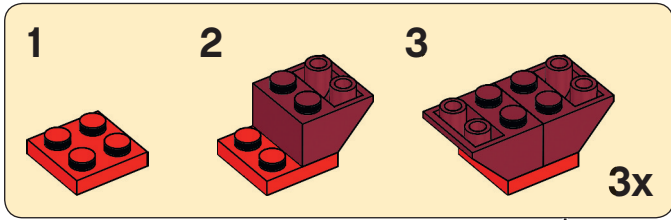

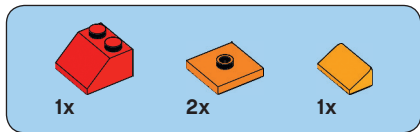

6

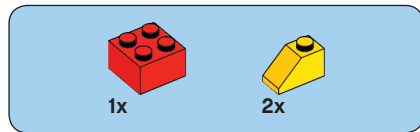
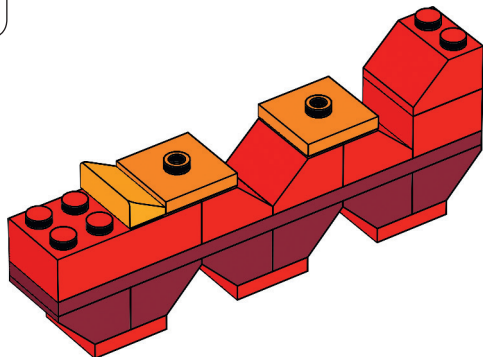
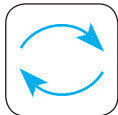

7

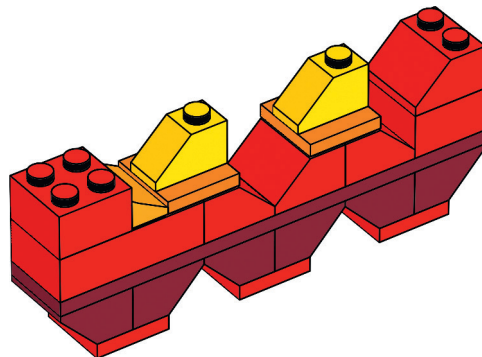

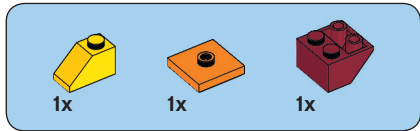

8

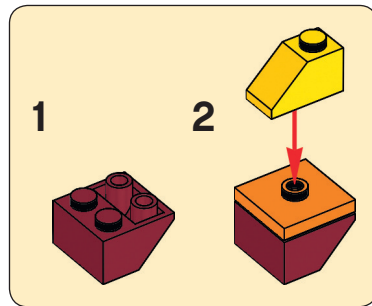
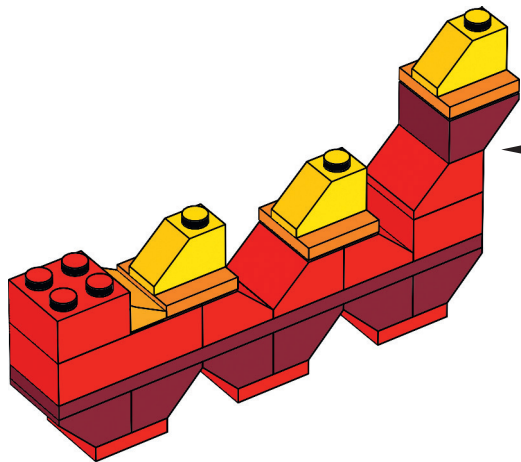

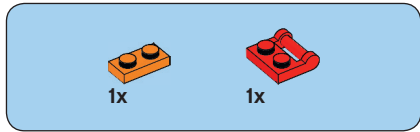

9

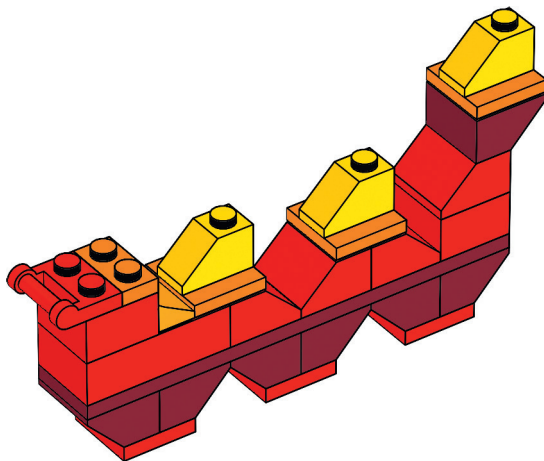



2x

10

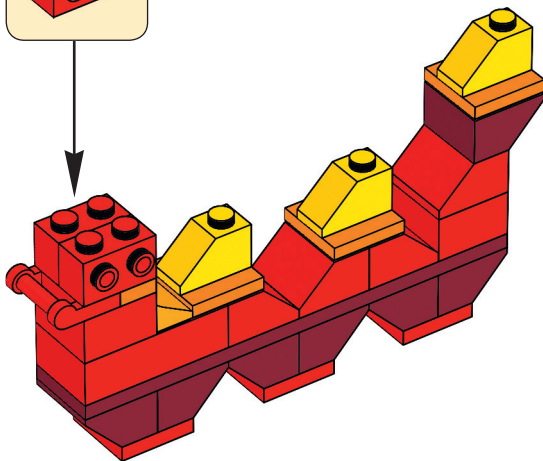
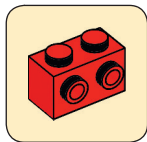

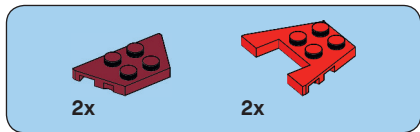

11

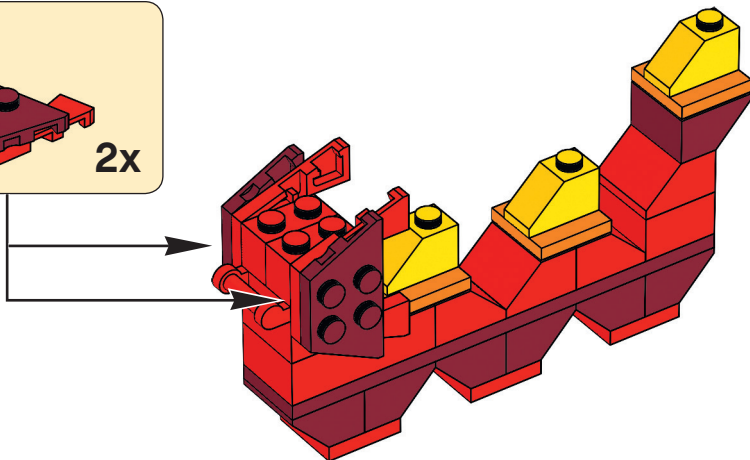
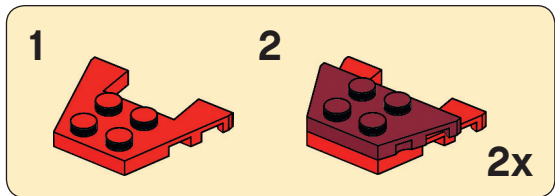

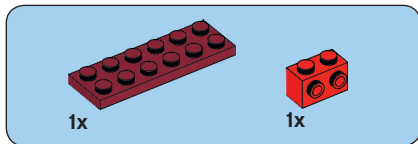
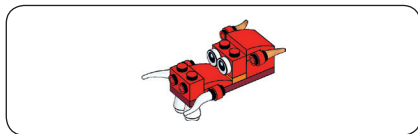

12

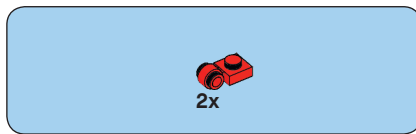
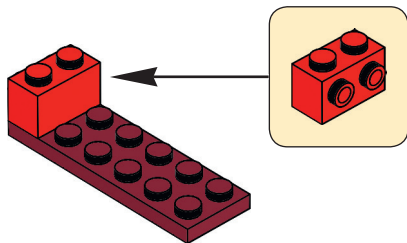

13

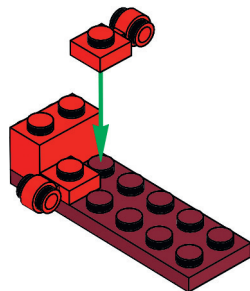



1x



1x

14

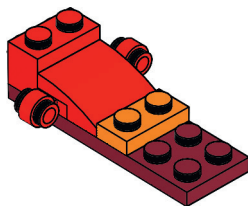



1x

15

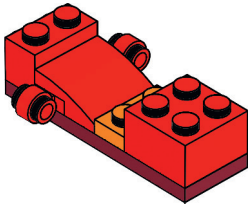

2x



1x

16

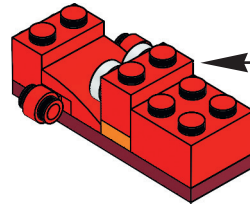
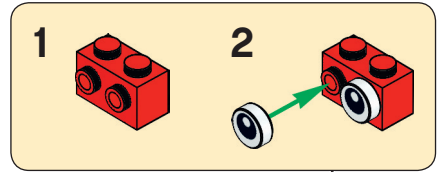



2x

17

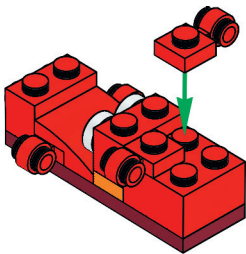

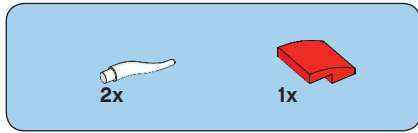

18

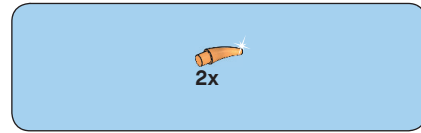
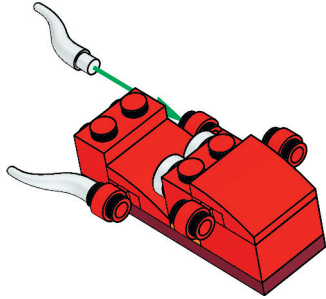

19

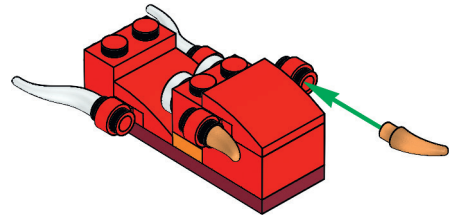



20

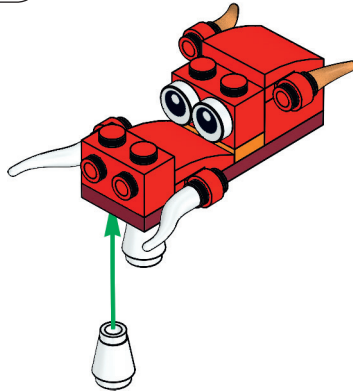
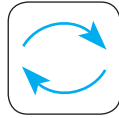

21

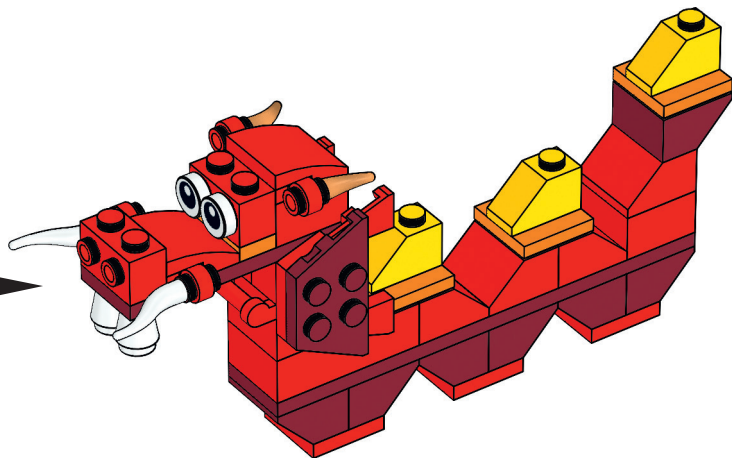

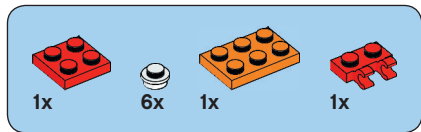

22

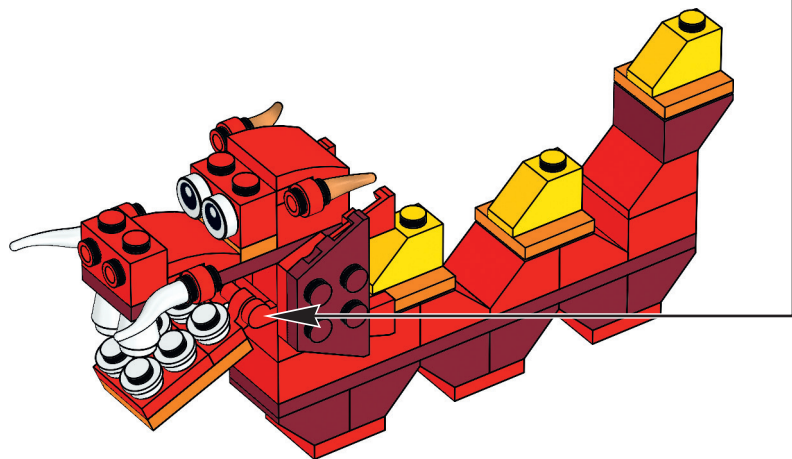
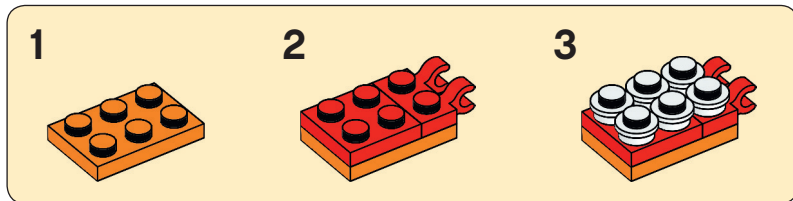



3x



3x

23

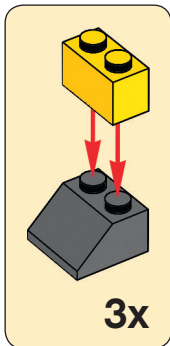
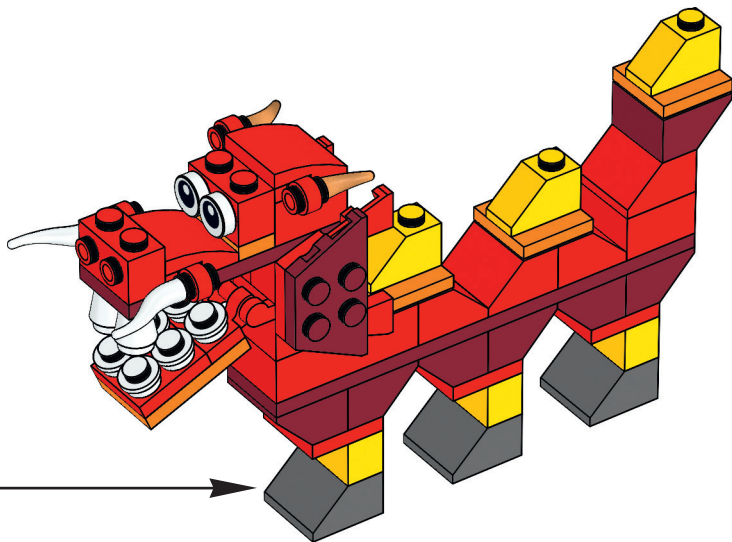

3x

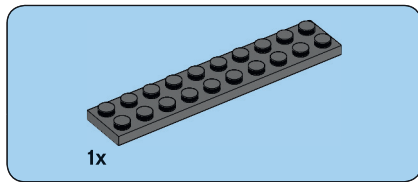

1

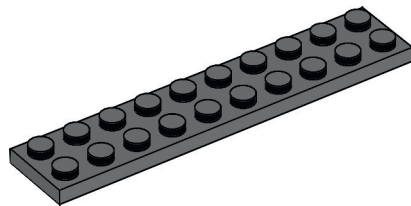

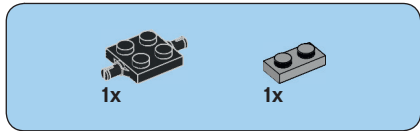

2

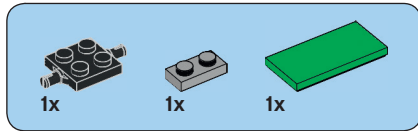
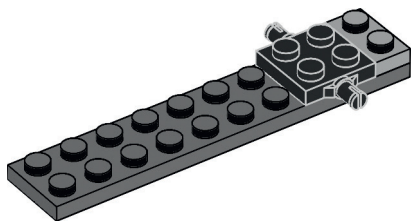

3

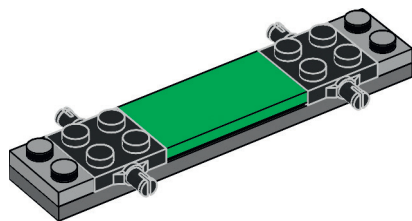

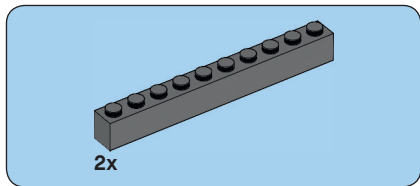

4

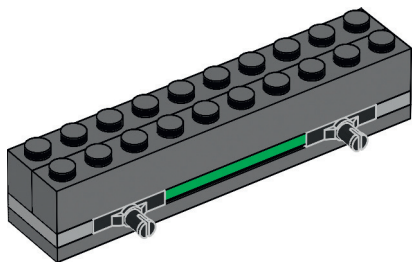

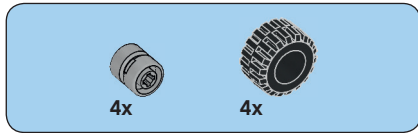

5

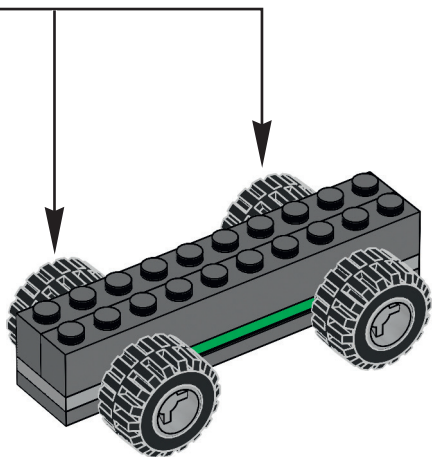
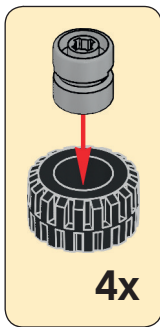

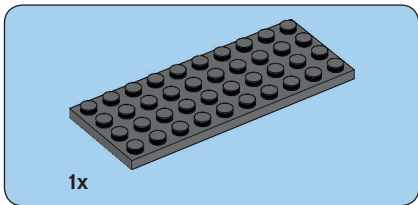

6

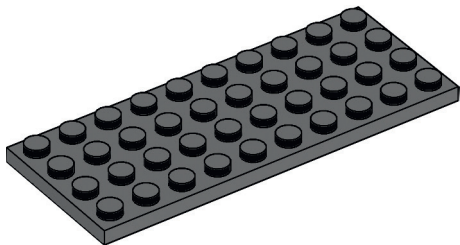

7

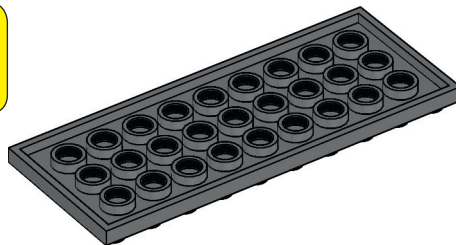



8

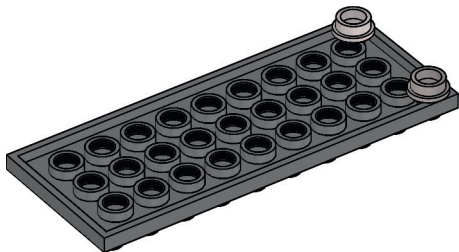

9

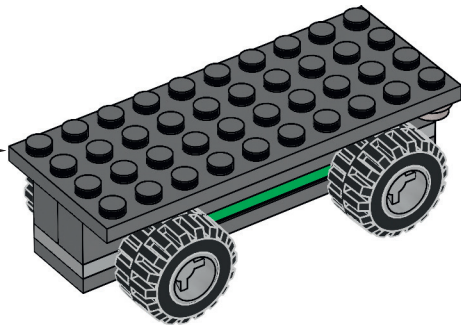



2x

10

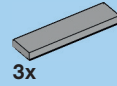
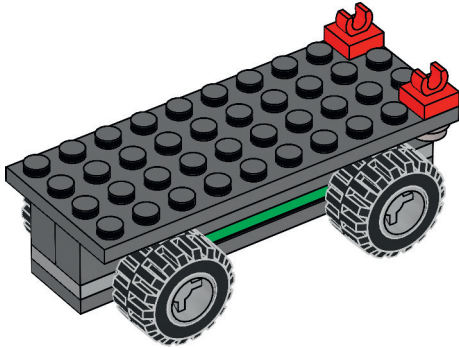

3x

11

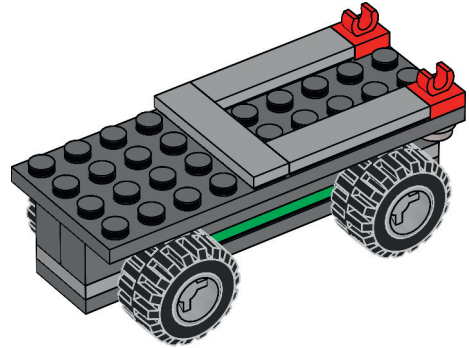

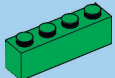

1x

12

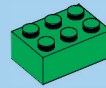
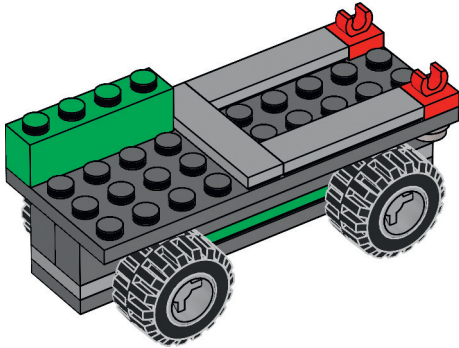

1x

13

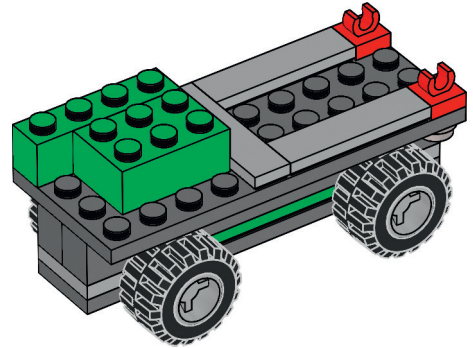

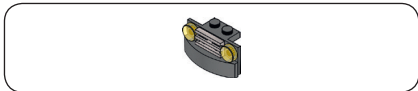

14

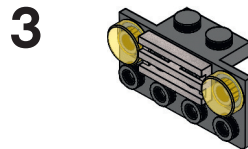
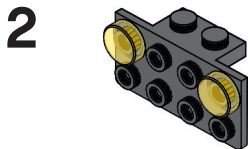
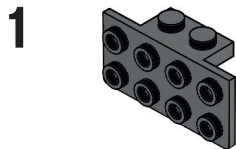

4

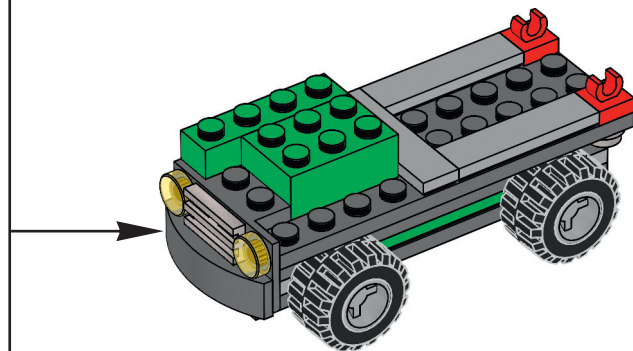
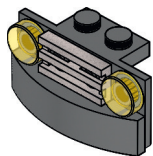



2x

15

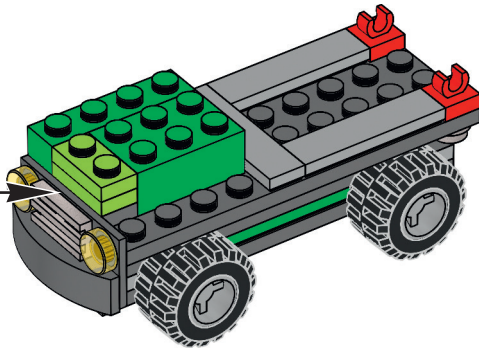
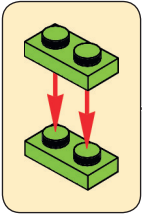

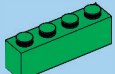

1x

16

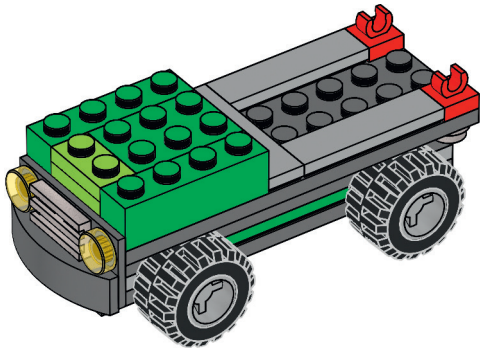

2x



1x

17

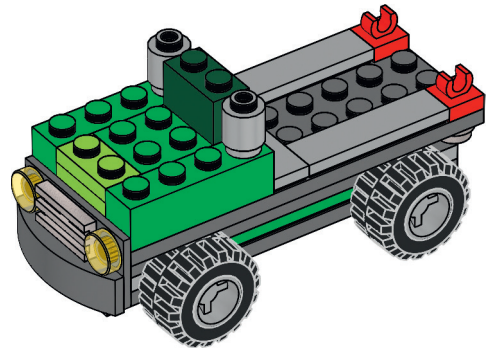

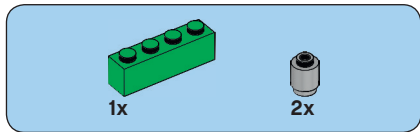

18

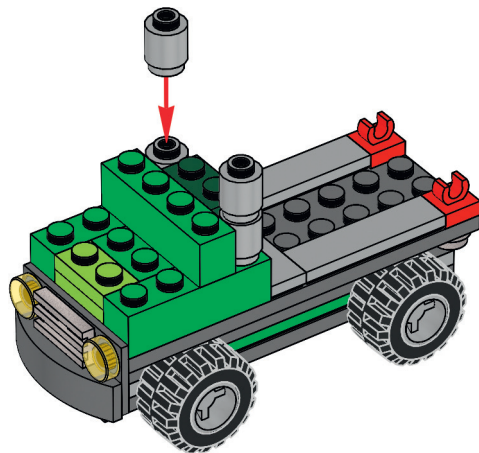



2x

19

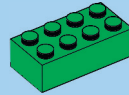
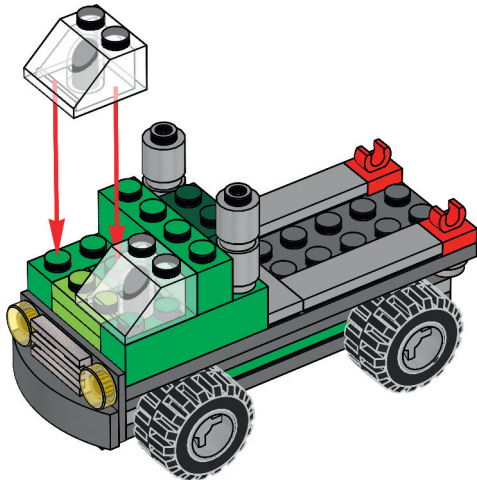

1x

20

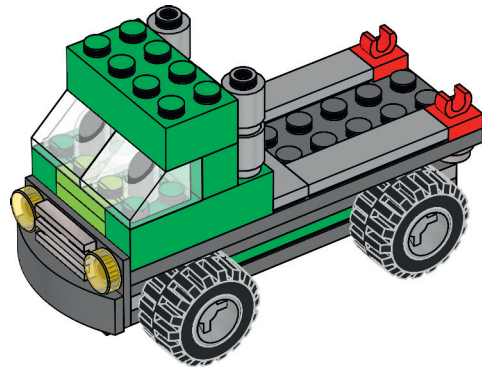

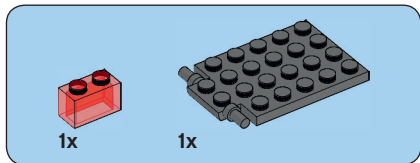
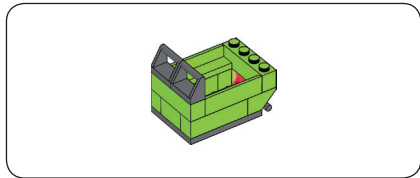

21

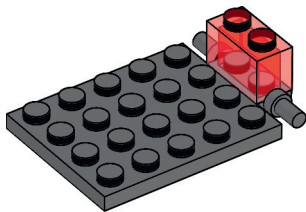



2x

22

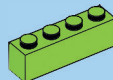
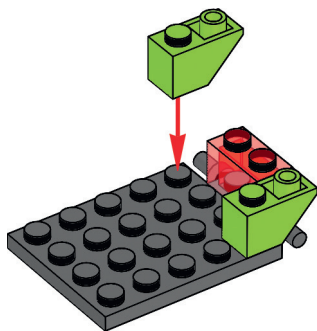

2x

23

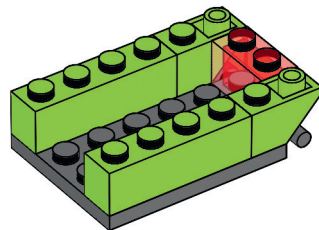



1x

24

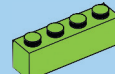
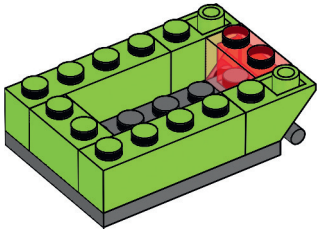

1x

25

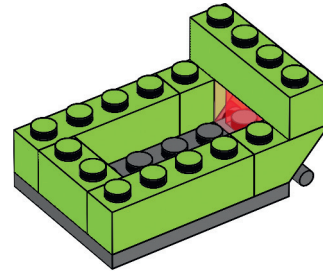

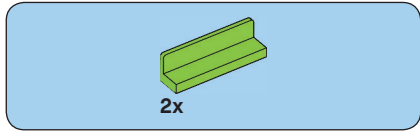

26

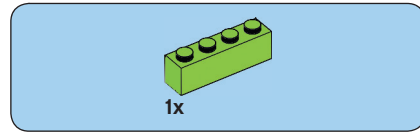
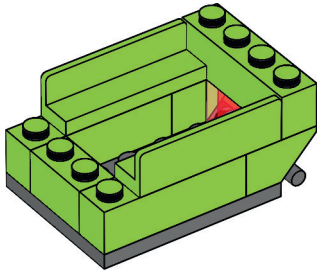

27

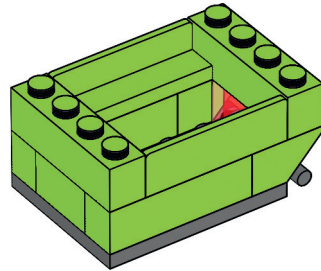



2x

28

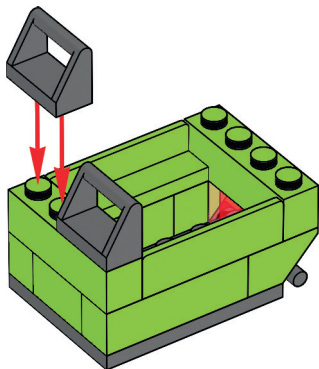

29

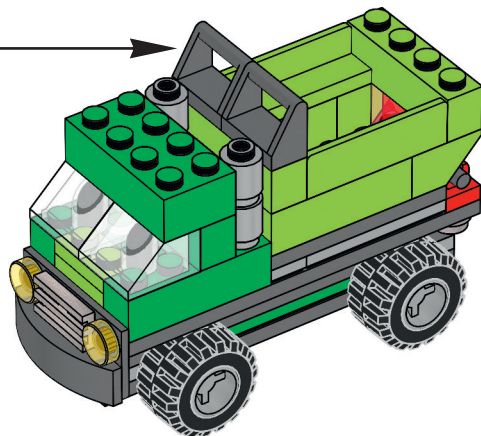



3x

30

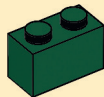

3x

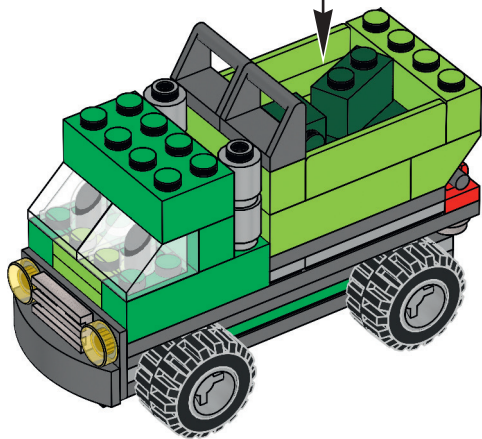

MORE IDEAS ONLINE:

WEITERE IDEEN ONLINE:
PLUS D'IDÉES EN LIGNE :
MÁS IDEAS EN INTERNET:
MAIS IDEIAS ONLINE:
ONLINE MÉG TÖBB ÖTLETET TALÁLSZ:
更多在线构思:
LEGO.COM/classic





10698



10696



10692



10699



10700



10701



31060



31054



31055

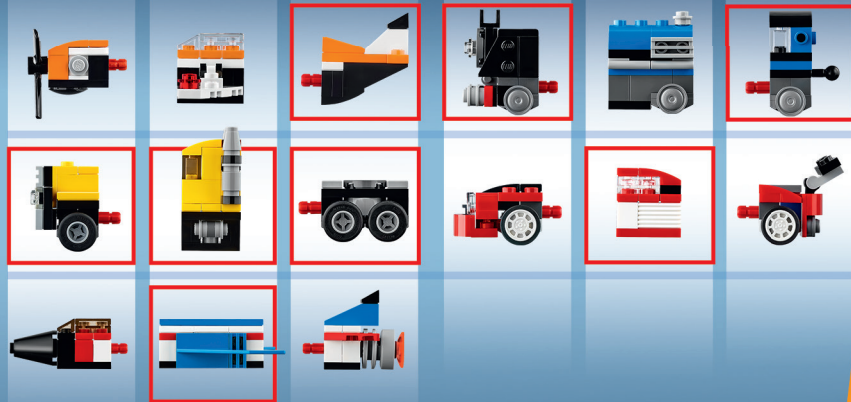



4x
4518400



6x
614101



4x
6029156



3x
6097402



3x
6099548



4x
300501



2x
6055541



2x
6097801



4x
6058177



4x
4532972



4x
300301



10x
303901



2x
4233370



4x
302101



2x
4530590

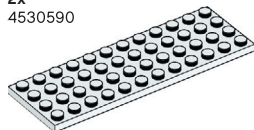

1x
4168072



4x
4121932



2x
6032360



3x
4161734



2x
4579260



4x
4125220



4x
4109995



4x
6092587



2x
6046924



4x
4114306



2x
4118866



4x
4121921



4x
4114309



2x
6139363



4x
4114319

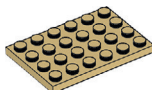

1x
4114001



2x
4113988



4x
614321



4x
6019155



2x
4556153



2x
4226876



6x
302221



4x
6105976



4x
300321



4x
303921



4x
4632572



1x
449521



2x
6170523



2x
487121



8x
300121



4x
366621





















4x
362221



4x
300521











2x
6072998

 4x
362323
 4x
4509443
 4x
300223
 4x
6141996
 4x
4649773
 4x
300123
 2x
366623
 1x
303423
 4x
300324
 4x
4529235
 3x
614123
 4x
300523
 4x
300323
 3x
614124
 4x
4624985
 8x
300424
 4x
4121965
 2x
6079007
 4x
300324

































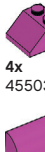



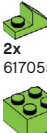





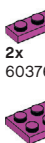









80

 4x
303924
 4x
300224
 4x
621524
 1x
4561507
 2x
6175158
 2x
4181143
 2x
303424
 2x
4221775
 2x
4504382
 4x
300526
 4x
4613162
 4x
4578677
 2x
4548180
 4x
4515373
 4x
4617848
 4x
300426

 4x
4568644
 4x
428626
 2x
460026
 1x
4530589
 2x
395726
 4x
302026
 4x
300126
 2x
292626

 4x
300528
 4x
6112266
 4x
4121969
 4x
302228
 4x
4644085
 4x
4107637
 1x
4583718
 4x
4109674

 3x
4619599
 4x
4112838
 2x
4141737
 3x
4566179
 4x
4106356
 2x
6102903
 1x
4277361

					
2x 6024020	4x 4179830	4x 4177932	4x 4527943	4x 6172869	2x 6093064
					
4x 4167842	4x 4626883	4x 6078590	4x 6030276	3x 6078932	4x 6015454
					
4x 622740	4x 6000881	4x 6013635	4x 4164037	4x 6101073	4x 6184880
					
4x 3006841	2x 4179828	4x 4153825	4x 4164022	4x 4550362	4x 4249891
					
4x 306541	4x 4650970	4x 4251969	2x 6170559	2x 6022656	4x 4528981
					
4x 6107790	2x 6101858	4x 4125278	4x 4220632	2x 6037652	2x 4540280
					
2x 4650500		4x 4153827	4x 4234716	4x 6037658	4x 6142695
					
4x 306544	1x 4654448	4x 4189007	4x 6092671	4x 6066120	4x 6142695
					
4x 3006848			4x 4165967	1x 6170921	2x 4667595

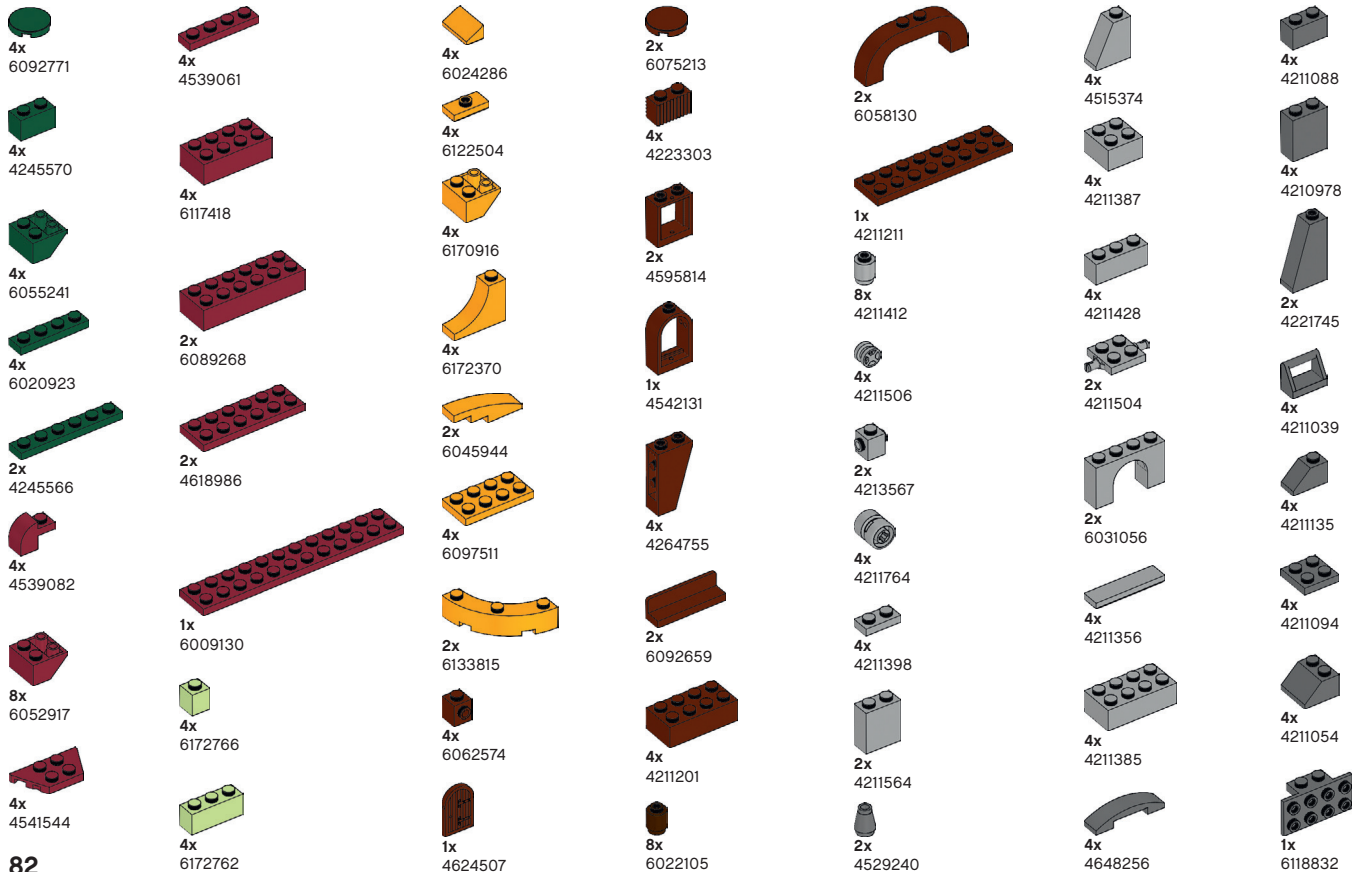

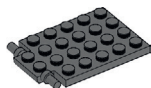

1x
4595710

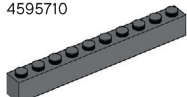

2x
4211107



1x
4210678

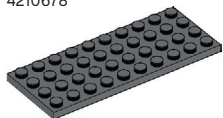

1x
4211122



2x
4618195



4x
4492224



4x
6132426



4x
6160819



4x
4621542



4x
4517993



4x
4580010



4x
4517995



4x
4550359



4x
4649743



4x
6002148



4x
6175307



4x
6022083



4x
6133822



4x
6147726



4x
6084028



2x
6097501



4x
6092604



4x
6174640



4x
6035470



4x
4626935



4x
4620909



4x
6092674



4x
4618647



4x
4655246



4x
4625032



4x
6173655



3x
6146866



4x
4625629



2x
4619653



3x
4633691



2x
4619636



4x
6136331



4x
4623598



4x
6107188



4x
6109901



4x
4619516



4x
4655173



2x
4649745



2x
6027624



4x
6163294



2x
6097055



2x
6037655



4x
6056283



4x
4651231



4x
4569382



4x
6174192



4x
4651232



Customer Service

Kundenservice

Service Consommateurs

Servicio Al Consumidor

LEGO.com/service or dial



: 00800 5346 5555

: 1-800-422-5346

WIN

GO TO WWW.LEGO.COM/PRODUCTFEEDBACK AND
GIVE US YOUR SHORT **FEEDBACK** ABOUT THIS
LEGO® SET FOR A CHANCE TO WIN
A COOL LEGO PRIZE.

Terms & Conditions apply

LEGO.com/productfeedback



GEWINNE

Erzähle uns auf
www.LEGO.com/productfeedback

etwas über die Erfahrungen, die du mit
diesem LEGO® Set gemacht hast, und
sichere dir die Chance auf einen coolen
LEGO Preis!

Es gelten die Teilnahmebedingungen

GAGNE

Rends-toi sur
www.LEGO.com/productfeedback

et donne-nous quelques commentaires sur
ce produit LEGO® pour avoir une chance
de gagner un prix LEGO !

Voir Conditions Générales

GANAN

Visita
www.LEGO.com/productfeedback

y envíanos tu opinión acerca de este set
LEGO®. ¡Participarás en el sorteo de un
premio LEGO!

Términos y Condiciones aplicables

获取奖品

登录
www.LEGO.com/productfeedback

给出关于此乐高®套装的简短反馈，
就有机会获得炫酷乐高奖品

《条款及条件》适用

LEGO and the LEGO logo are trademarks of the LEGO Group. ©2017/2018 The LEGO Group.

6259464