



**LEGO**

# JUNIORS

**EASY TO BUILD**

10754



**WARNING: CHOKING HAZARD.**  
Small parts. Not for children under 3 years.



[LEGO.com/juniors](https://www.lego.com/juniors)

**MARVEL**  
**SPIDER-MAN**





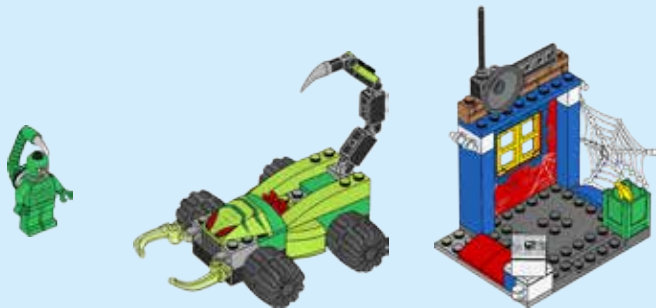
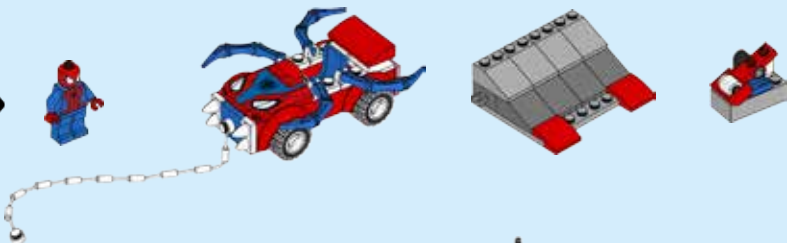

**AVERTISSEMENT : RISQUE D'ÉTOUFFEMENT.**

Contient des petites pièces. Ne convient pas aux enfants de moins de 3 ans.



**ADVERTENCIA: PELIGRO DE ASFIXIA.**

No recomendado para niños menores de 3 años. Contiene piezas pequeñas.

**FACILE À CONSTRUIRE**

**FÁCIL DE CONSTRUIR**

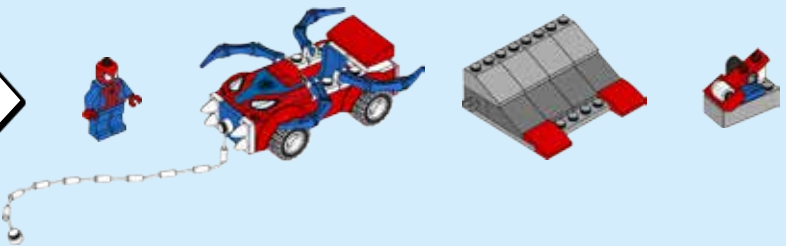
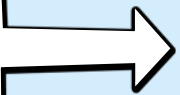

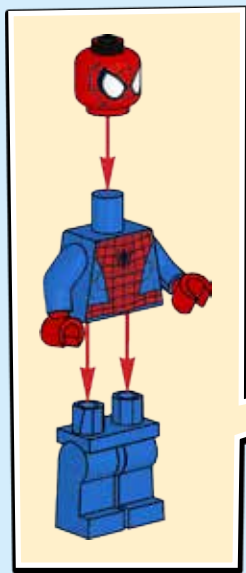



1x



4x



4x

1

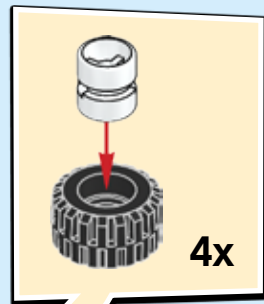
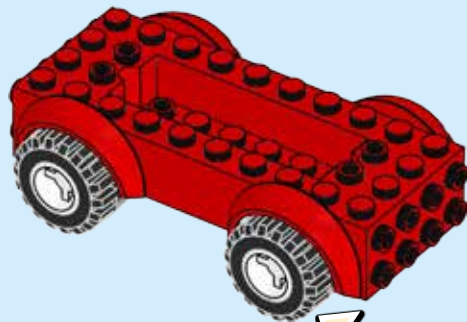

4x





2

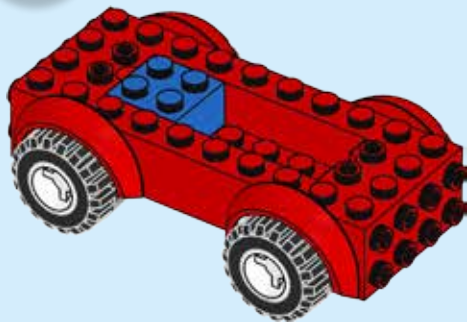

3

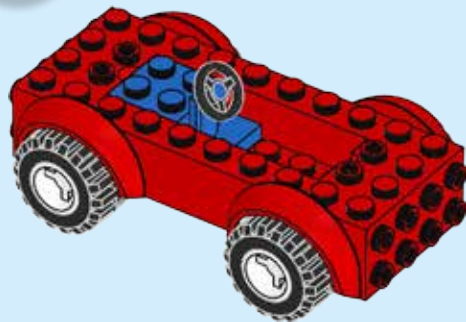



1x

4

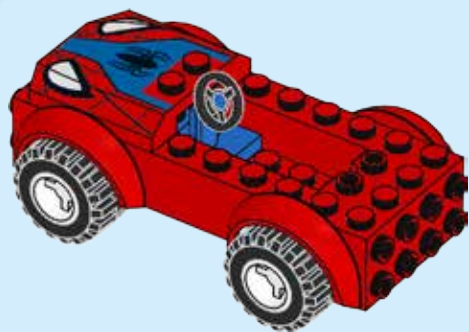



1x



4x



5

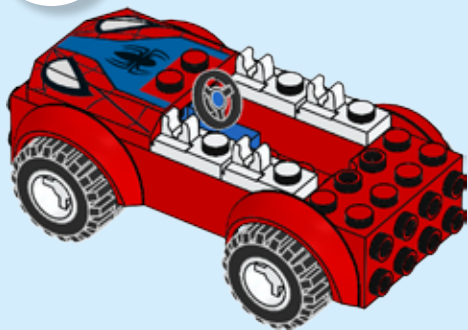

6

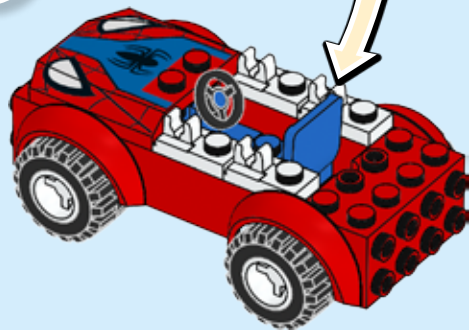



2x

7

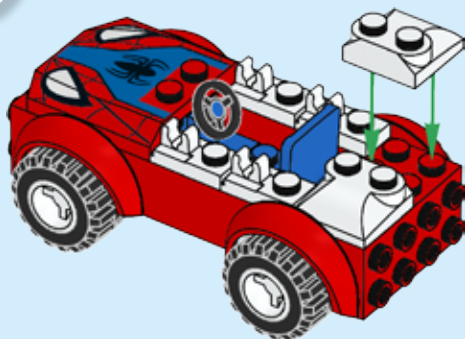



1x

1x

2x

1x

8

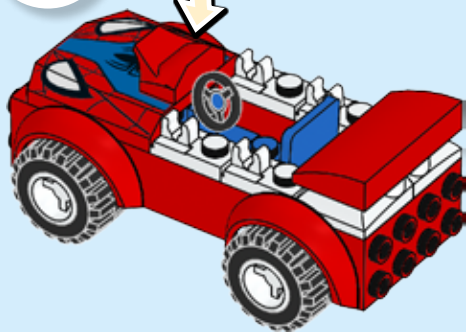

9

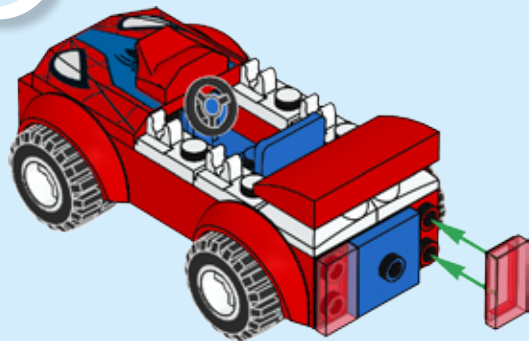



1x



2x



10

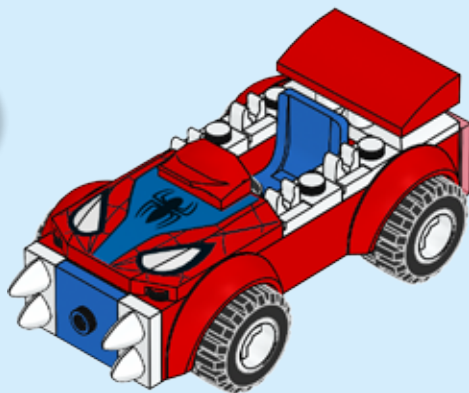

1x



4x



11

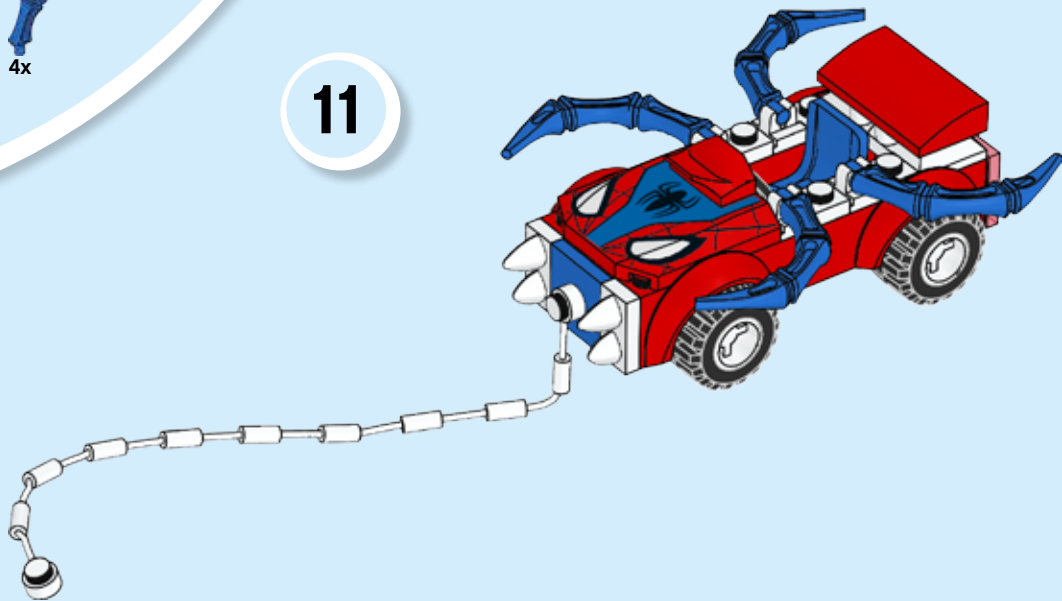

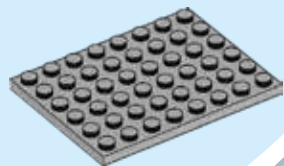

1x



1x

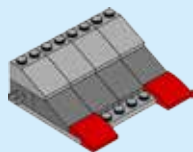

1

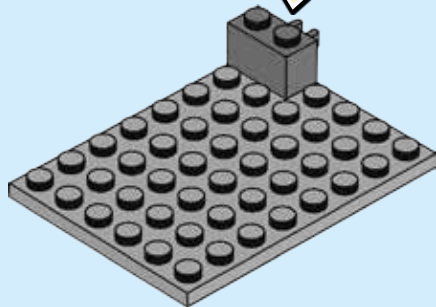
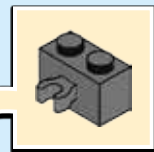





4x



1x



2x

2

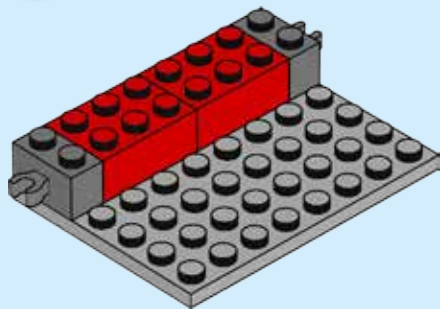

3

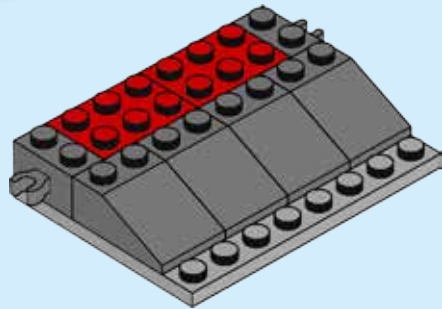



2x

4

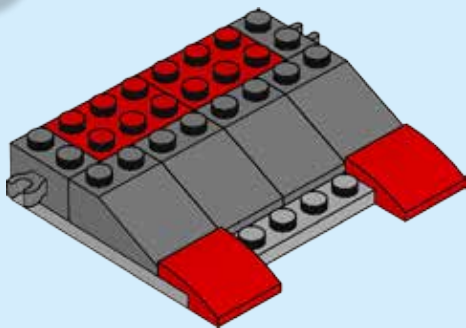



4x

5

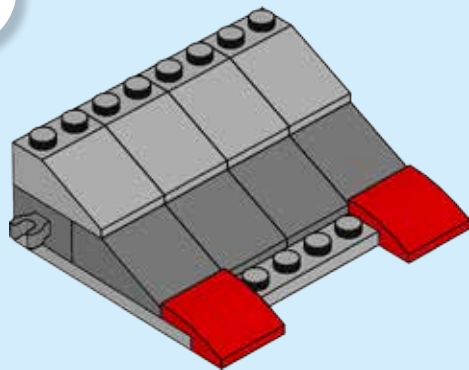

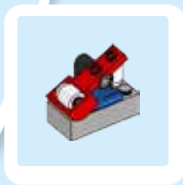
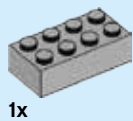

1

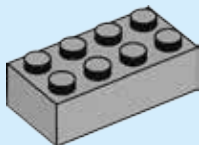

2

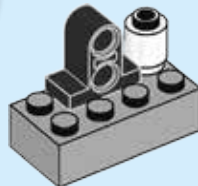





1x



1x



3

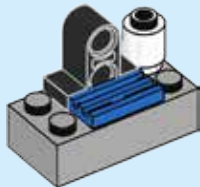

4

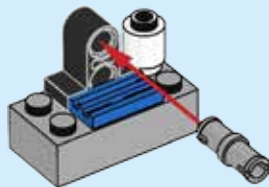



1x



1x

5

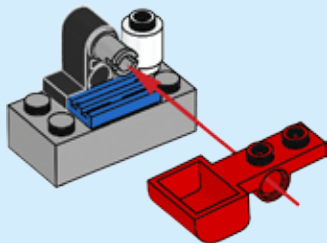

6

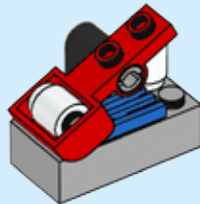

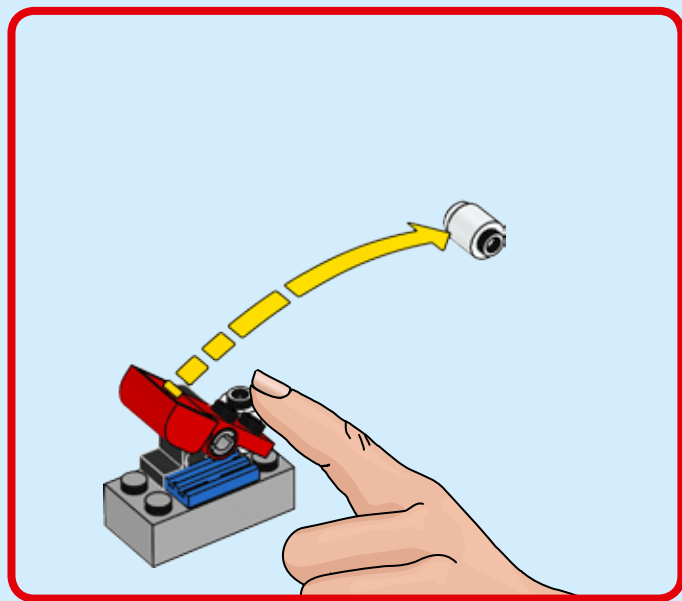



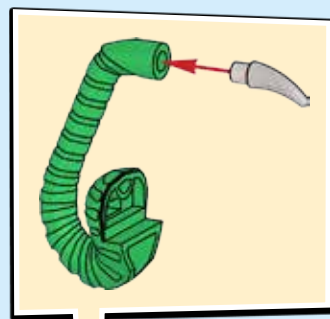
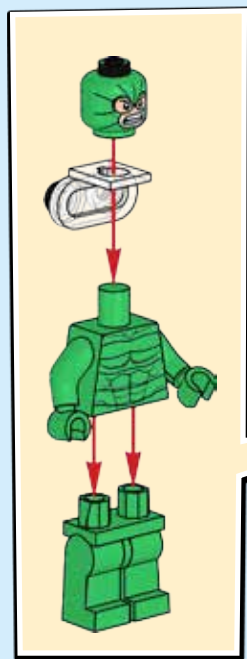
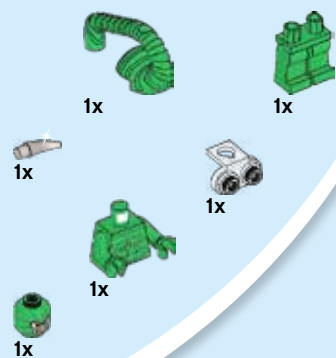

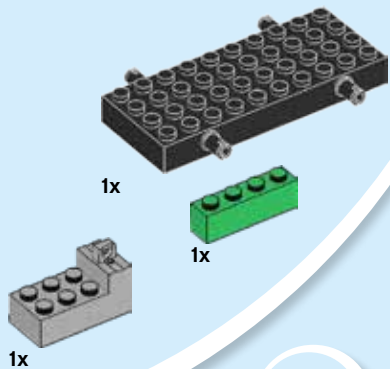

1

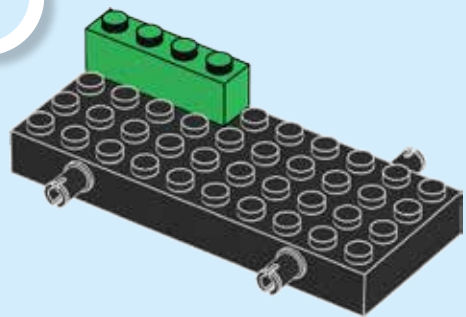

2

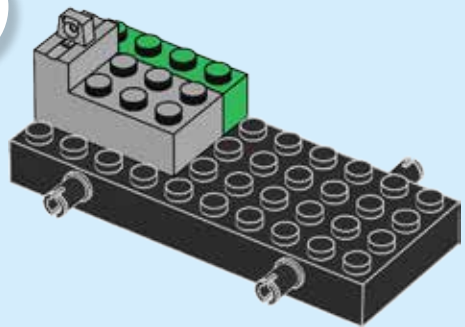



1x



2x



1x

3

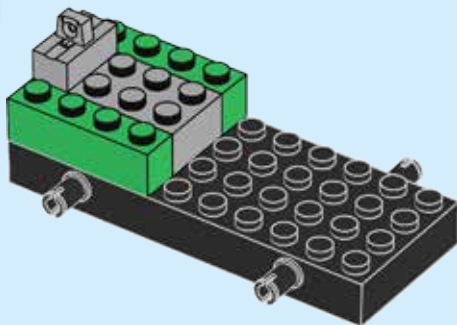

4

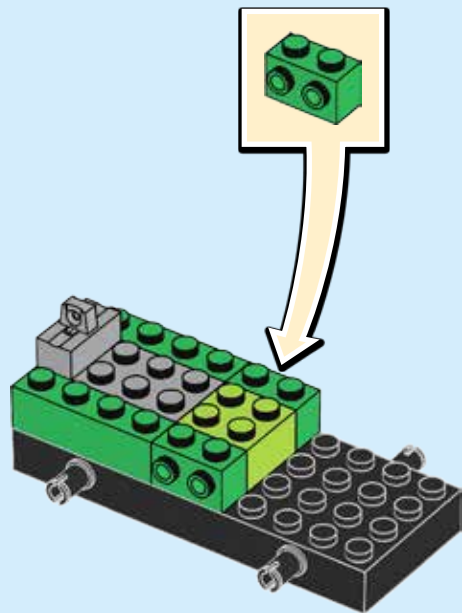



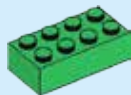

1x

5

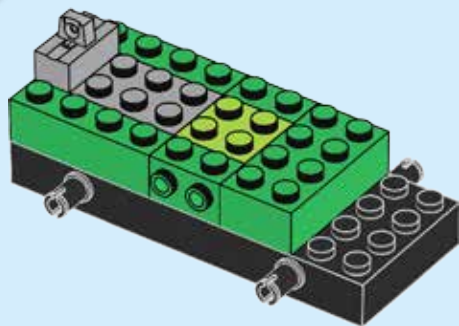



6

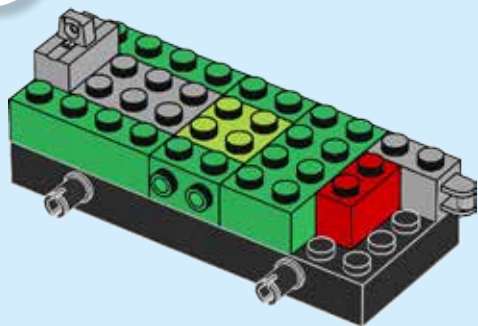

7

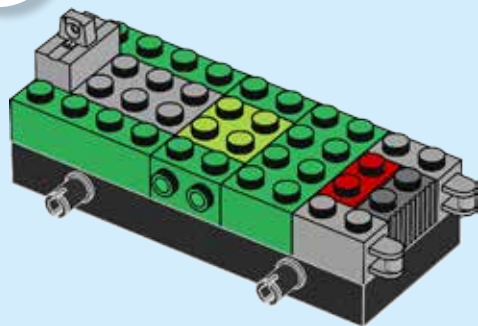

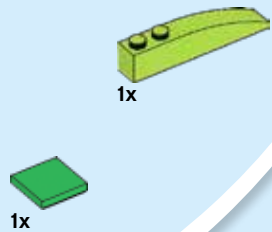

8

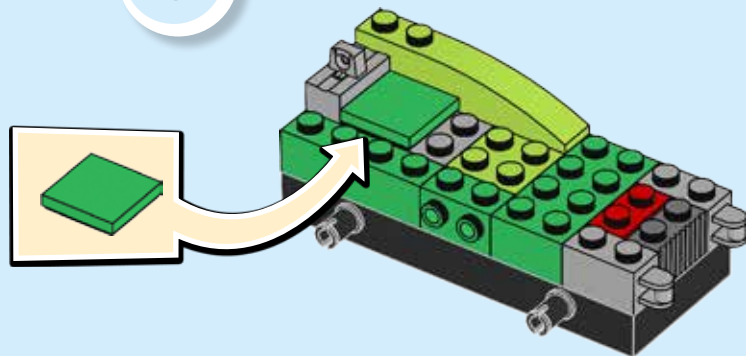



1x



9

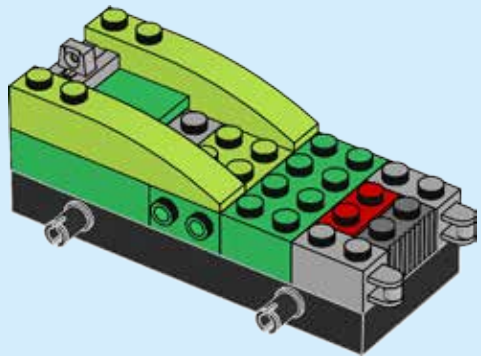



10

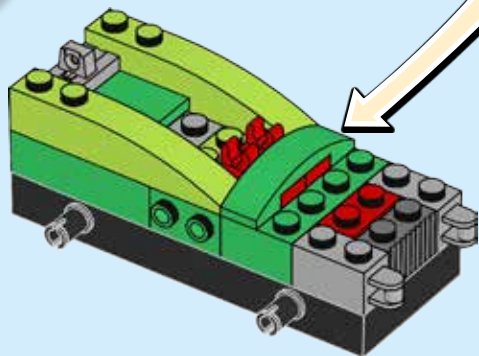
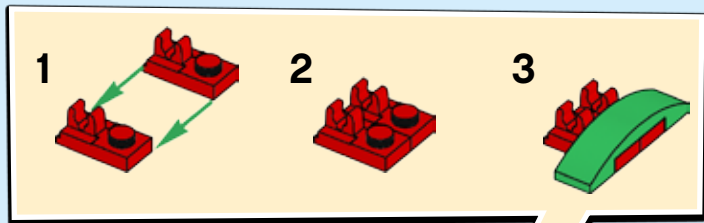



1x



1x

11

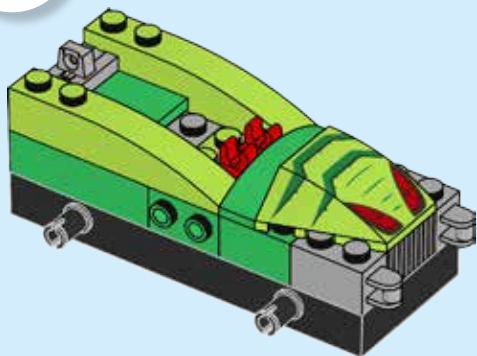

12

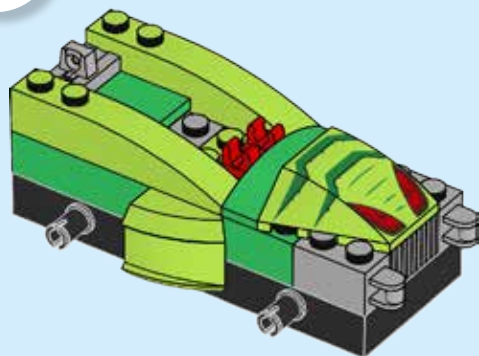



1x

13

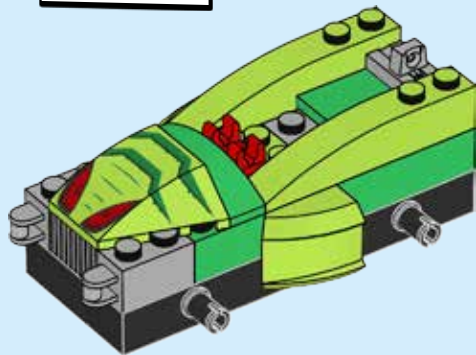



4x

14

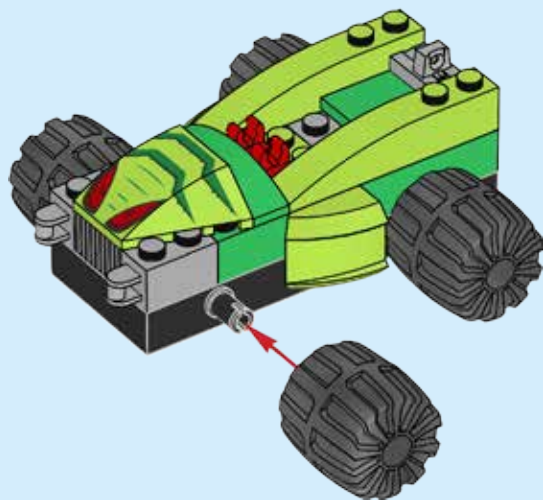





2x

15

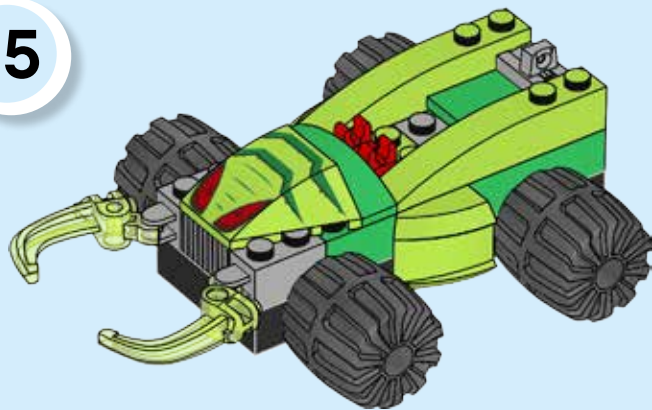



1x



1x



2x



16

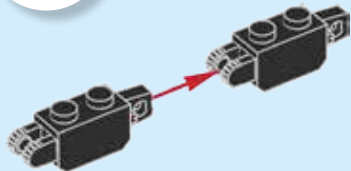

17

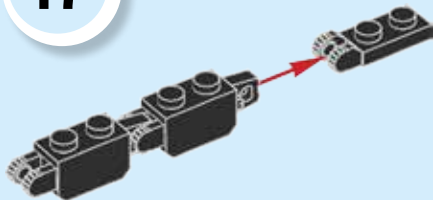

18

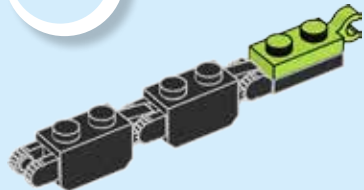



1x



1x

19

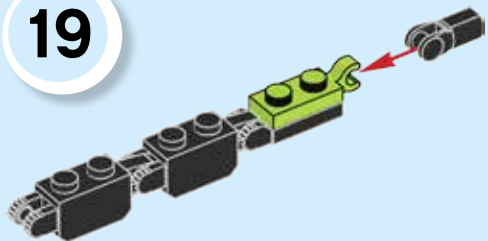

20

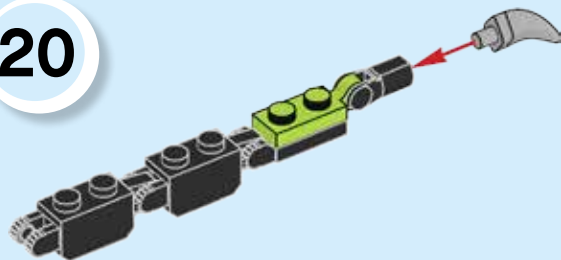

21

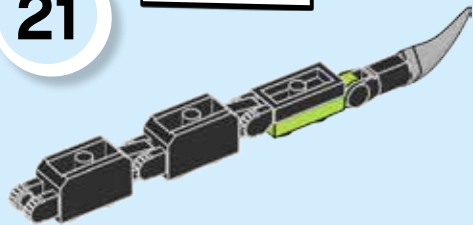

22

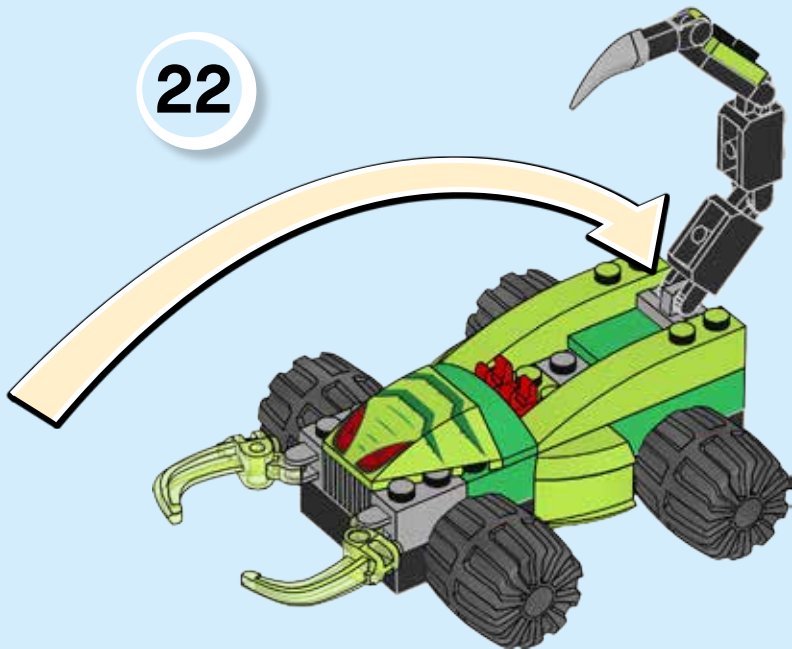

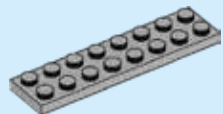

1x



1

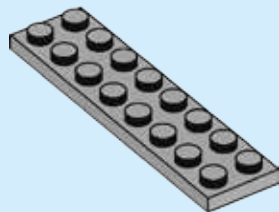

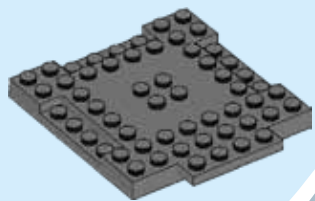

1x

2

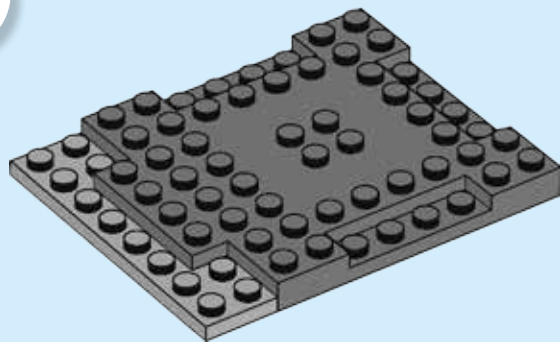



2x

3

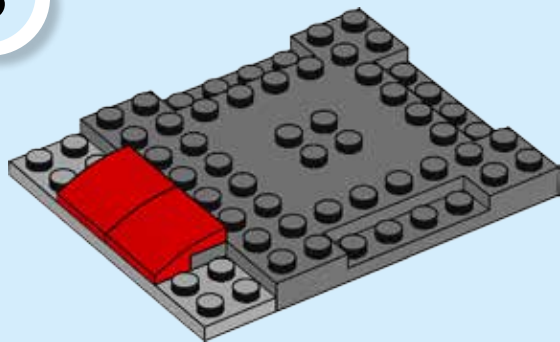



4

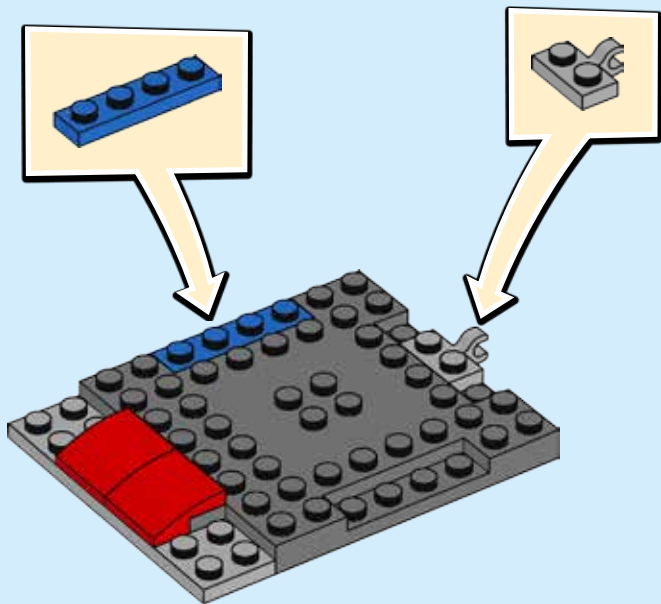





1x



5

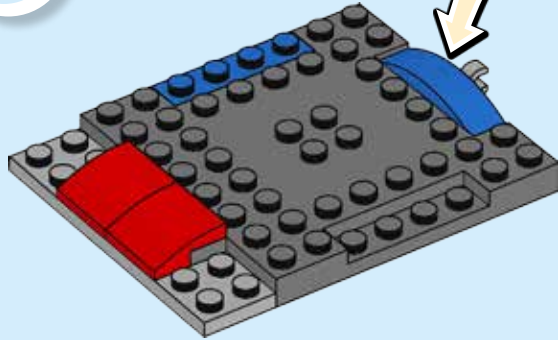
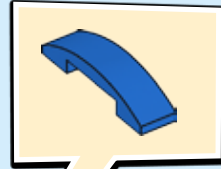



1x

6

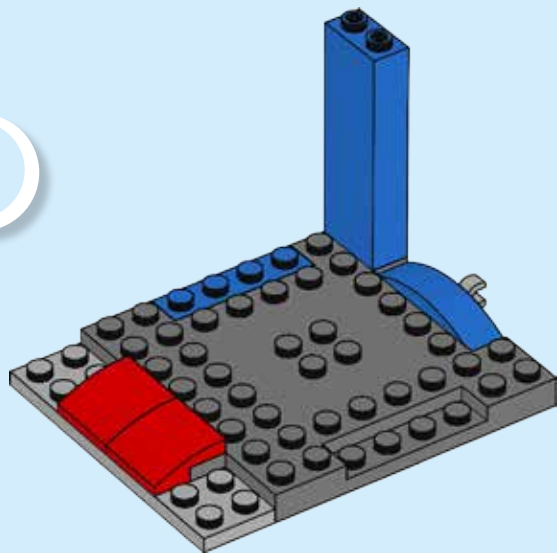



2x

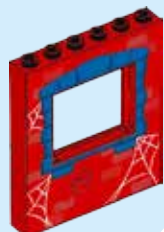

1x

1



2

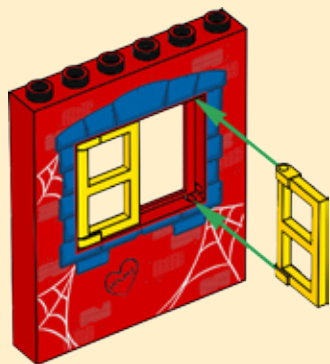

7

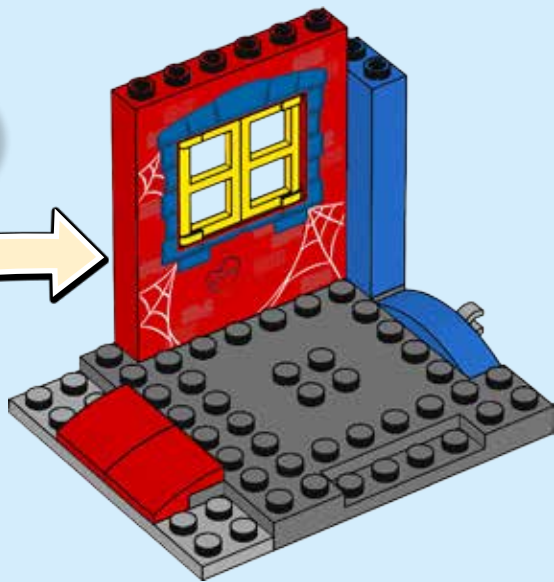



1x

8

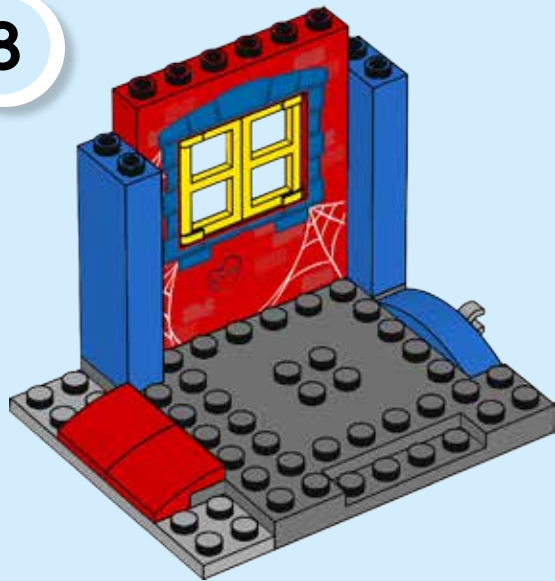



2x

9

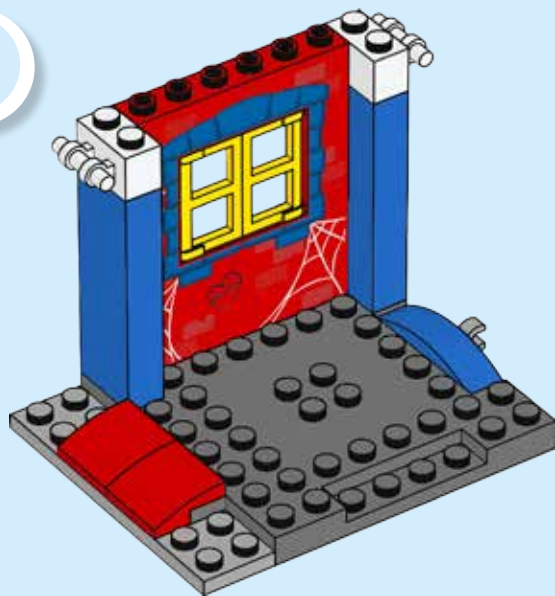

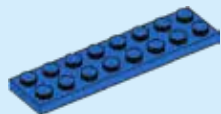

1x

10

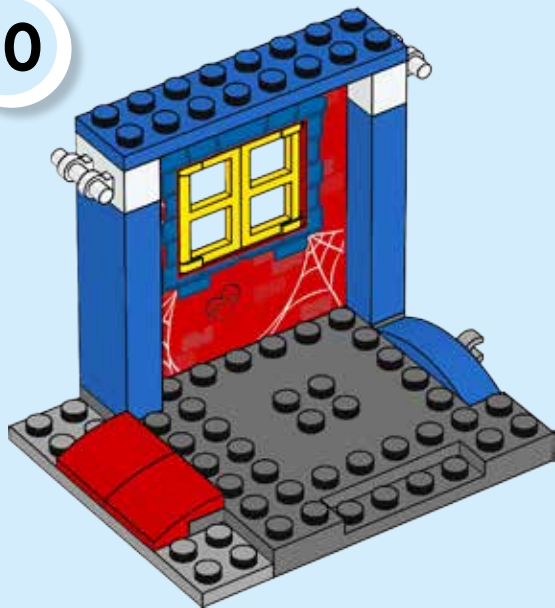

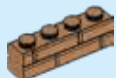

2x

11







1x



1x

12

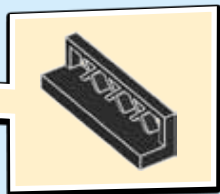



1x

13

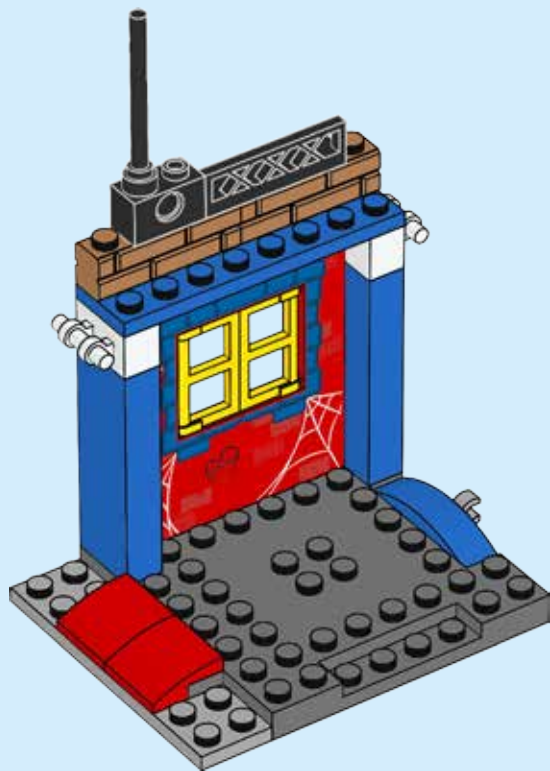



1x



14

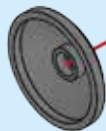

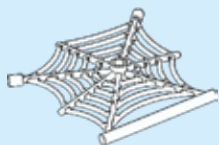

1x

15

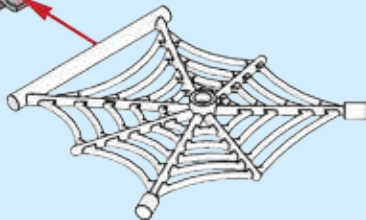



16

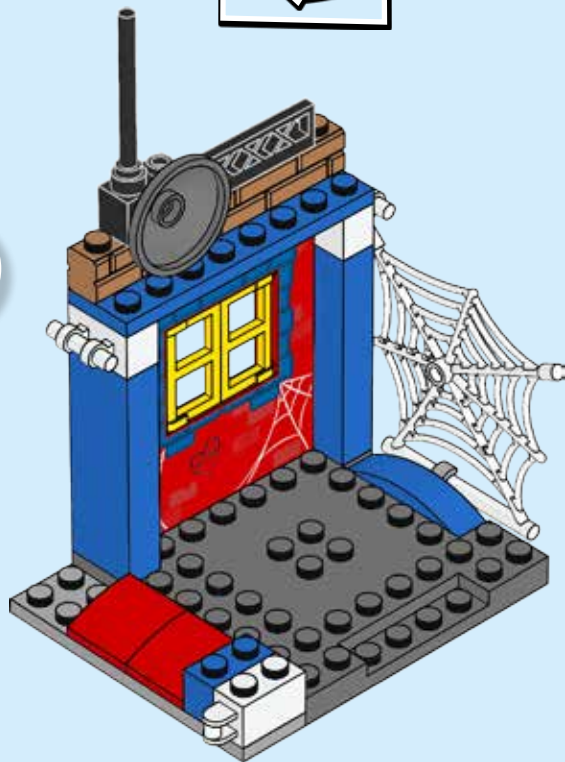



1x

17





1x



1x



1x



1x

18

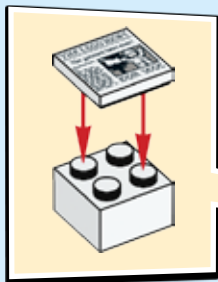

19

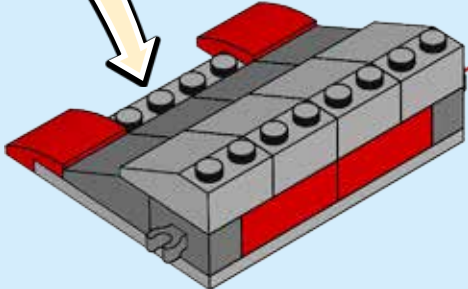
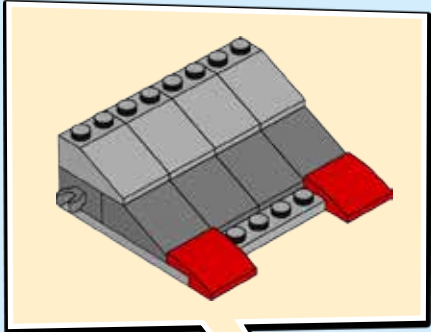





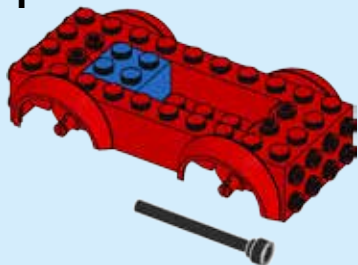
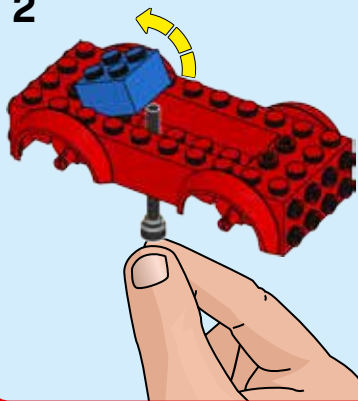

**1****2**

  
2x  
306201

  
4x  
4170457

  
2x  
6046384

  
4x  
4598527

  
2x  
4140626

  
1x  
6198933

  
1x  
6218212

  
1x  
6126046

  
2x  
4494474

  
1x  
300301

  
1x  
6006221

  
1x  
6003621

  
2x  
300221

  
1x  
4220516

  
1x  
300421

  
2x  
4597713

  
4x  
6105976

  
1x  
6004899

  
1x  
6174008

  
1x  
4597912

  
1x  
6214100

  
1x  
6214099

  
1x  
6020101

  
1x  
9341

  
1x  
241223

  
1x  
300423

  
1x  
9566

  
2x  
6055104

  
2x  
4565319

  
1x  
300323

  
1x  
407923

  
1x  
4649773

  
1x  
371023

  
4x  
6212037

  
1x  
303423

  
1x  
4114584

  
2x  
6171059



1x  
6143318



1x  
370026



1x  
4144024



4x  
4568644



1x  
4183060



2x  
4167106



1x  
4187209



1x  
395726

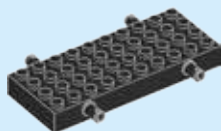

1x  
6023257



1x  
6155199



1x  
74040



2x  
6129807



1x  
4107762



1x  
4548102



1x  
6155204



1x  
6153495



1x  
6021539



2x  
4112838



1x  
4106356



2x  
4189801



1x  
6138122



1x  
4220632



2x  
6129278



1x  
6214112



2x  
6139693



1x  
4211807



1x  
6028812



2x  
6198932



1x  
6195495



4x  
4211421



1x  
6097167



1x  
4211385



1x  
4211406

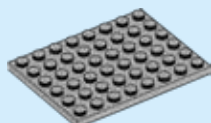

1x  
4211408



1x  
4210636



2x  
6127738



1x  
4210865



4x  
4211106



2x  
6215122



1x  
4612901



1x  
6100958



2x  
6055309



4x  
6124924



1x  
6063310



1x  
6096959

**Customer Service**

**Kundenservice**

**Service Consommateurs**

**Servicio Al Consumidor**

**LEGO.com/service or dial**



**: 00800 5346 5555**

**: 1-800-422-5346**



The fun continues!  
L'amusement continue !  
¡La diversión continúa!

6-12



DC COMICS  
**SUPER  
HEROES**



10754

4-7



76089



76091

**LEGO**  
**JUNIORS**  
EASY TO BUILD

**MARVEL**  
marvelkids.com

© 2018 MARVEL



# WIN

GO TO [WWW.LEGO.COM/PRODUCTFEEDBACK](http://WWW.LEGO.COM/PRODUCTFEEDBACK) AND  
GIVE US YOUR SHORT **FEEDBACK** ABOUT THIS  
LEGO® SET FOR A CHANCE TO WIN  
A COOL LEGO PRIZE.

Terms & Conditions apply



## [LEGO.com/productfeedback](http://LEGO.com/productfeedback)

### GEWINNE

Erzähle uns auf  
[www.LEGO.com/productfeedback](http://www.LEGO.com/productfeedback)

etwas über die Erfahrungen, die du mit  
diesem LEGO® Set gemacht hast, und  
sichere dir die Chance auf einen coolen  
LEGO Preis!

Es gelten die Teilnahmebedingungen

### GAGNE

Rends-toi sur  
[www.LEGO.com/productfeedback](http://www.LEGO.com/productfeedback)

et donne-nous quelques commentaires sur  
ce produit LEGO® pour avoir une chance  
de gagner un prix LEGO !

Voir Conditions Générales

### GANAN

Visita  
[www.LEGO.com/productfeedback](http://www.LEGO.com/productfeedback)

y envíanos tu opinión acerca de este set  
LEGO®. ¡Participarás en el sorteo de un  
premio LEGO!

Términos y Condiciones aplicables

### 获取奖品

登录  
[www.LEGO.com/productfeedback](http://www.LEGO.com/productfeedback)

给出关于此乐高®套装的简短反馈，  
就有机会获得炫酷乐高奖品

《条款及条件》适用

LEGO and the LEGO logo are trademarks of the/son des marques de commerce du/son marcas registradas de LEGO Group. ©2018 The LEGO Group.  
© 2018 MARVEL

6225147