



MARVEL  
**SPIDEY**  
and his  
**AMAZING FRIENDS**

10783



3



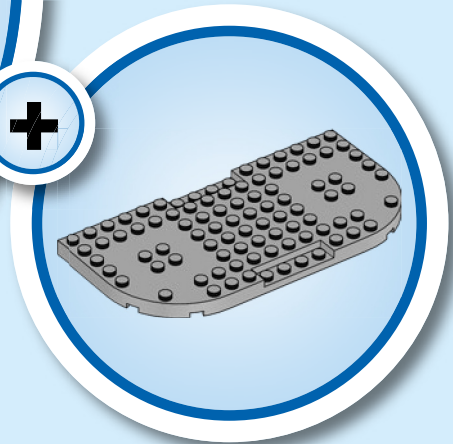

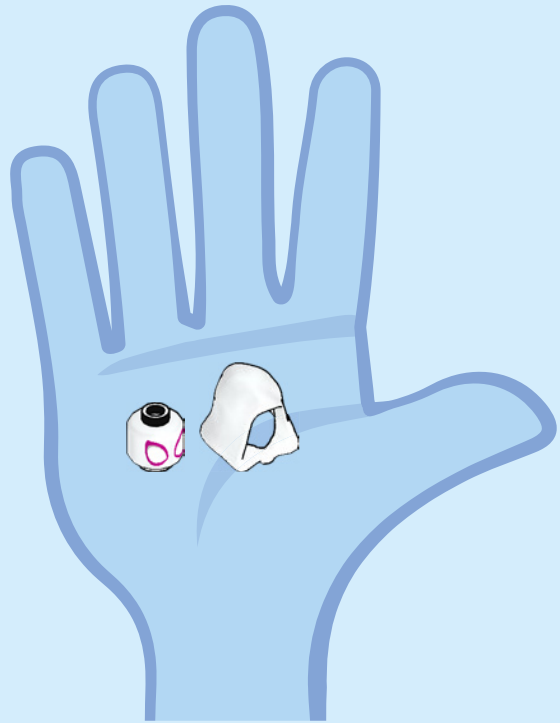
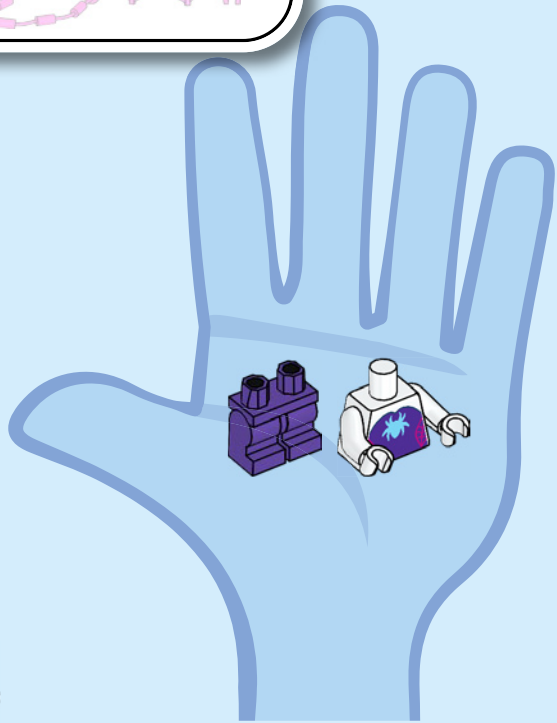
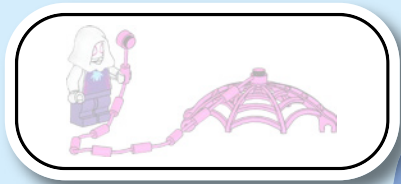

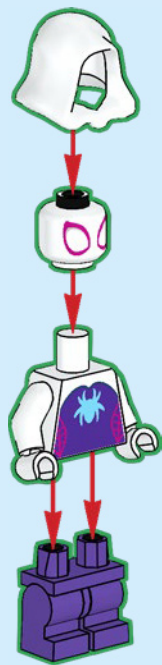

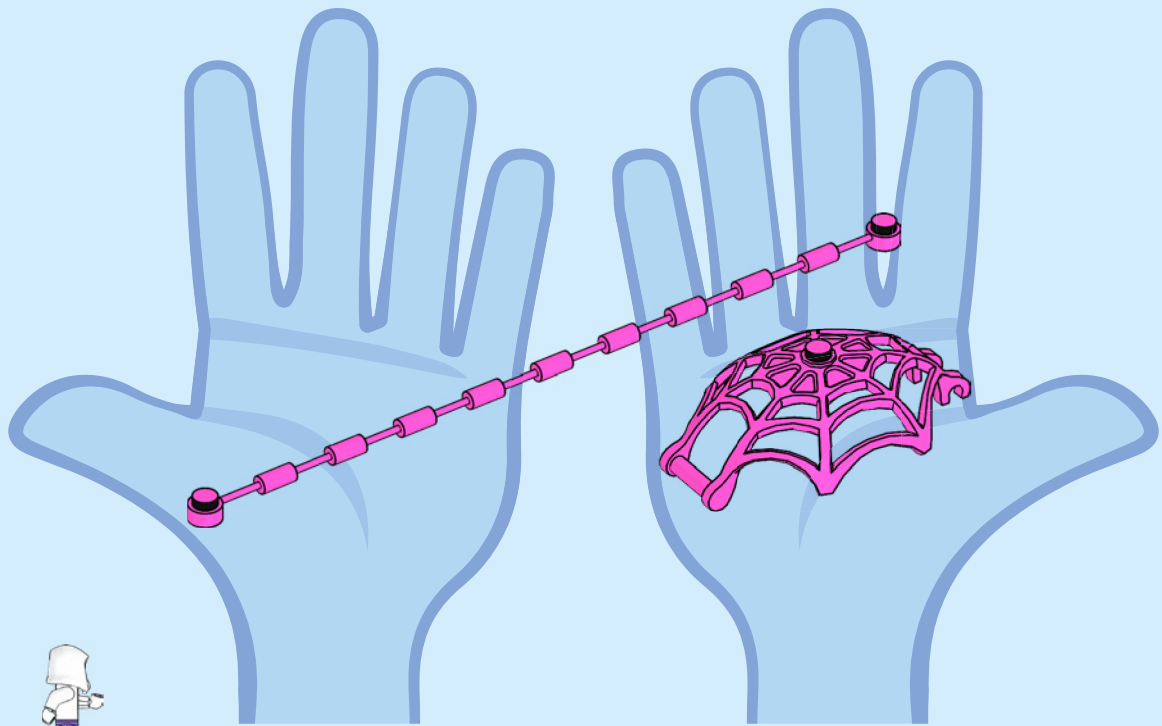

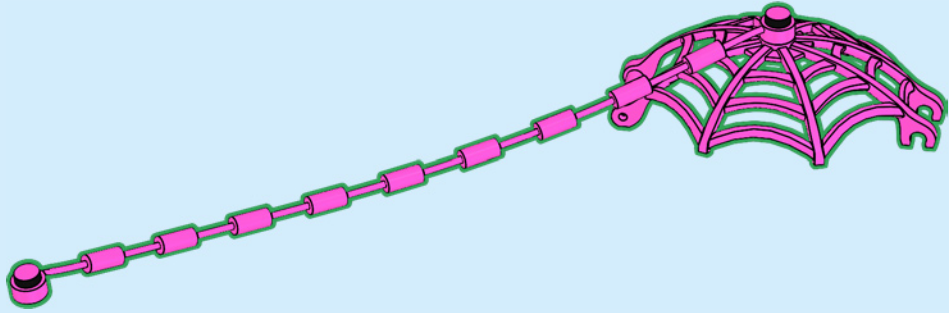

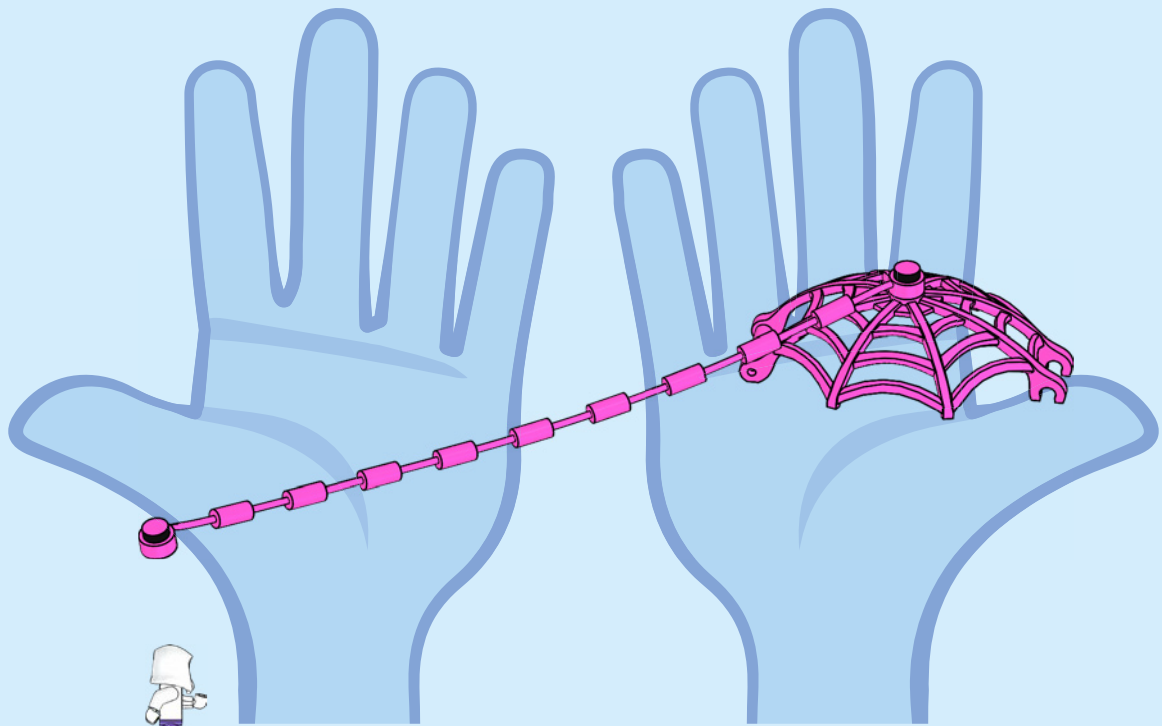





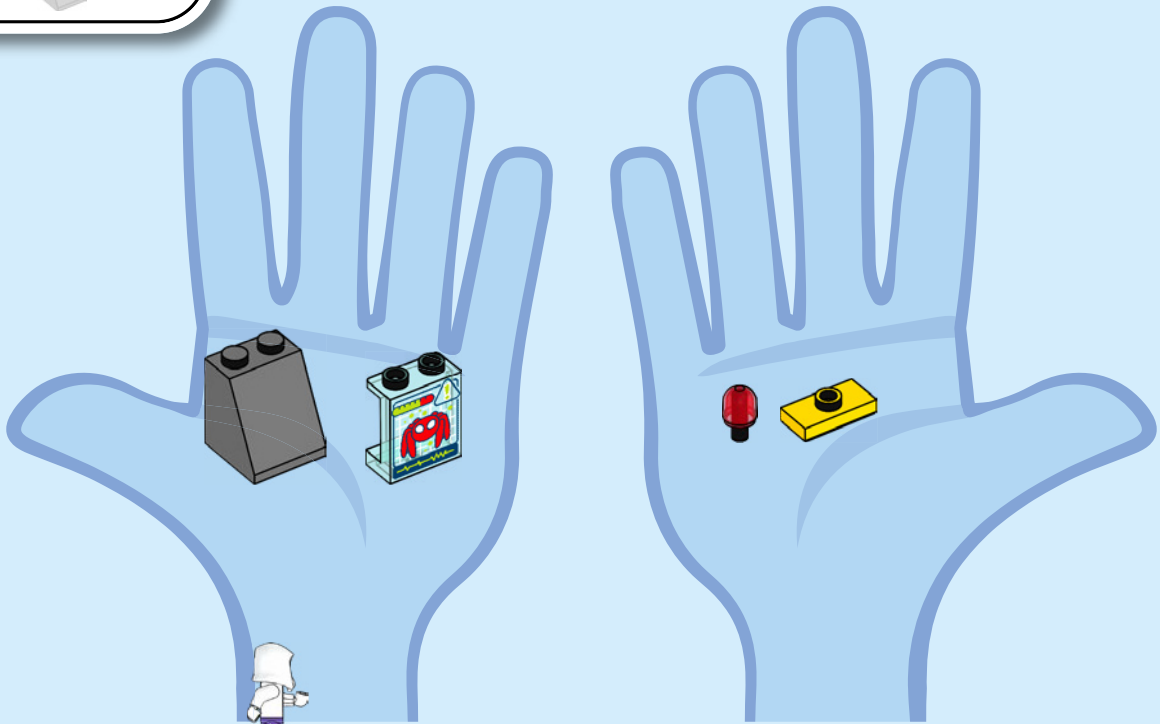

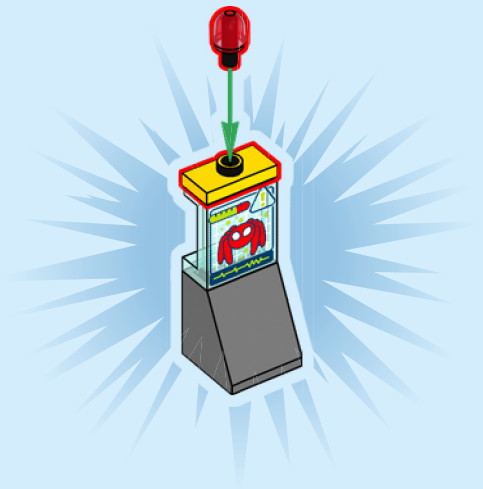

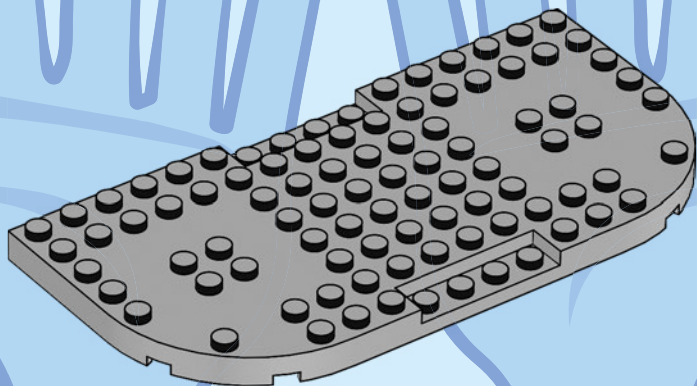

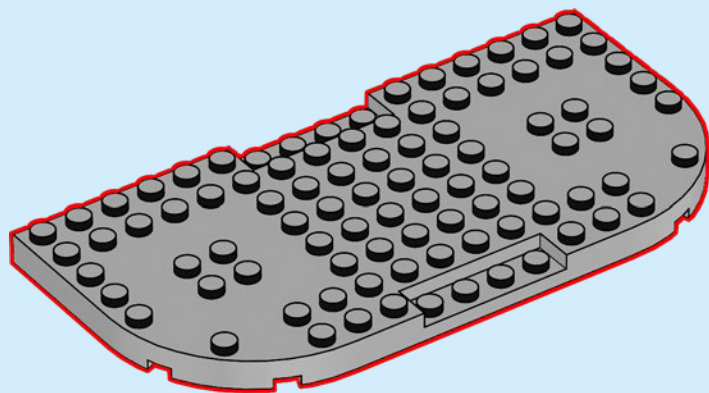

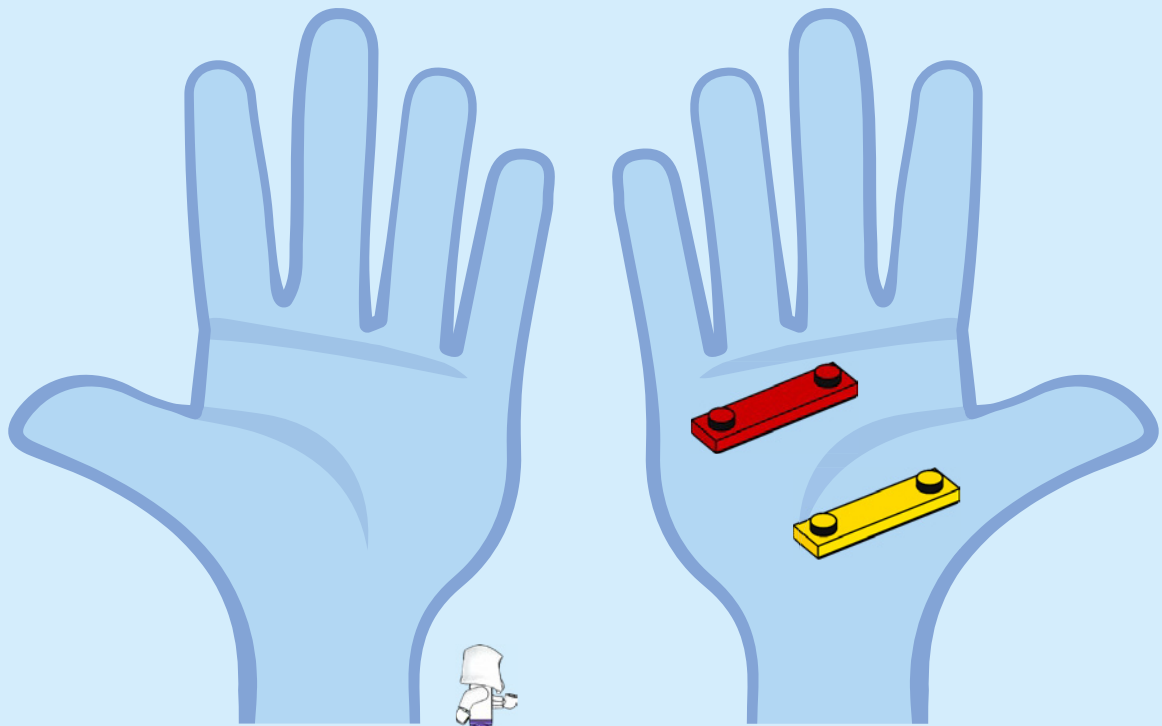

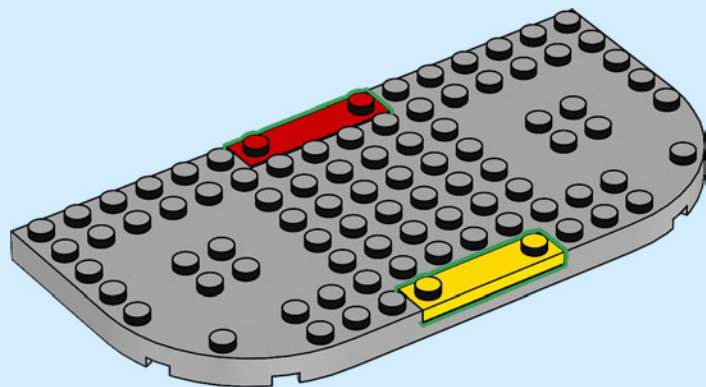

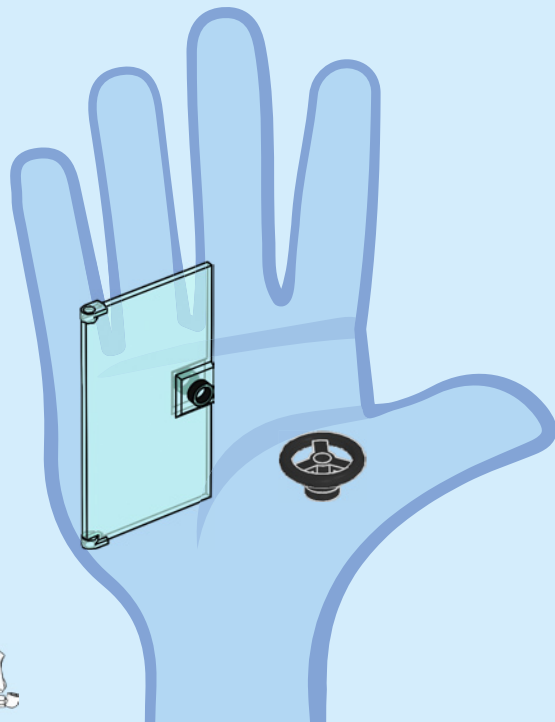
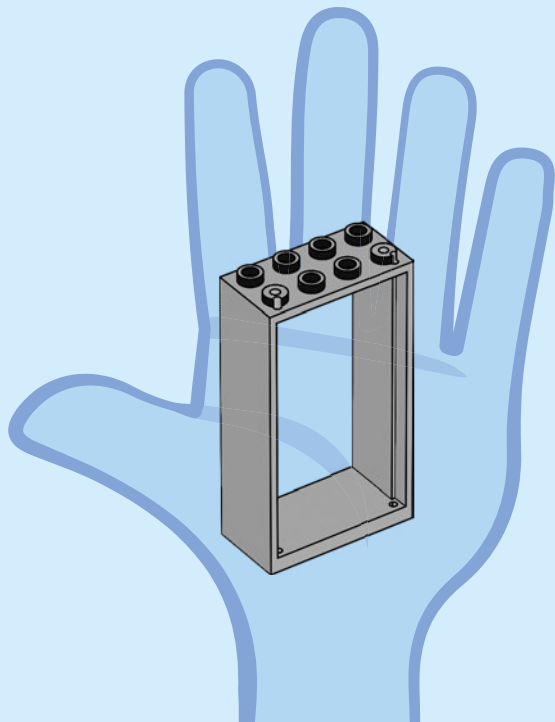



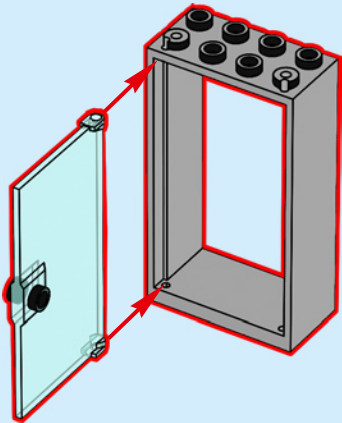

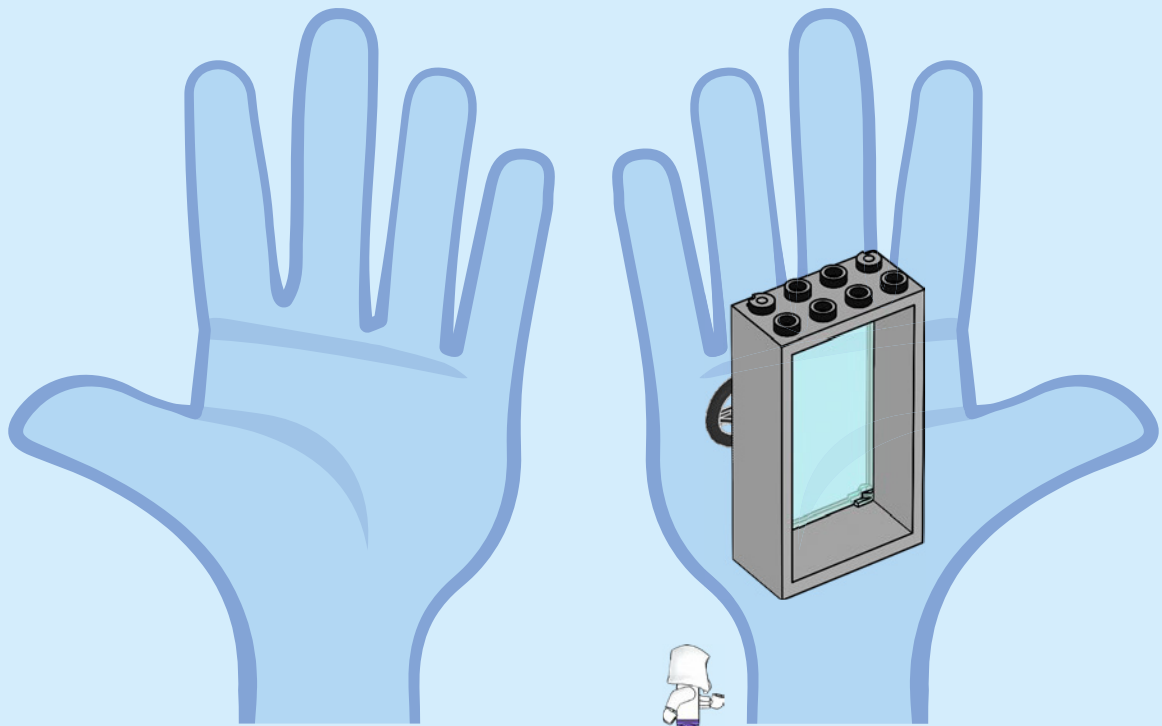

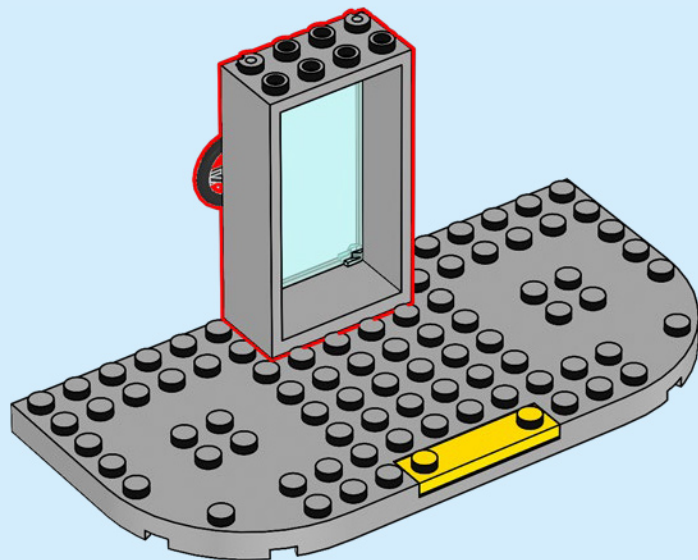

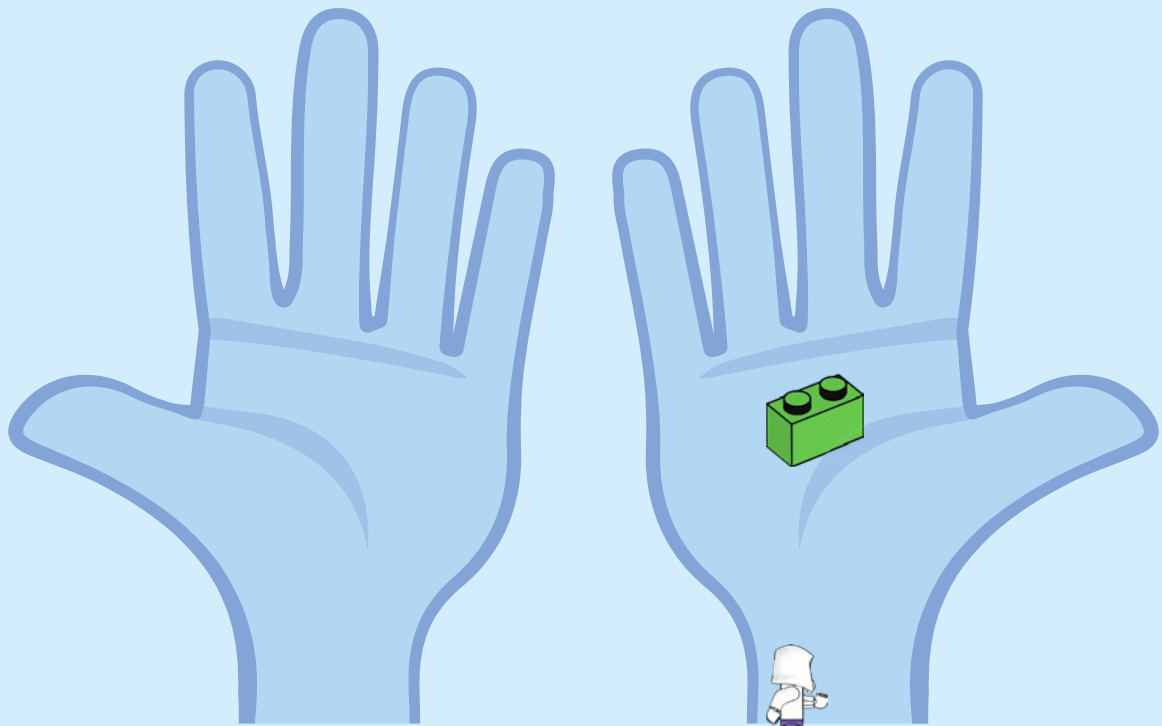

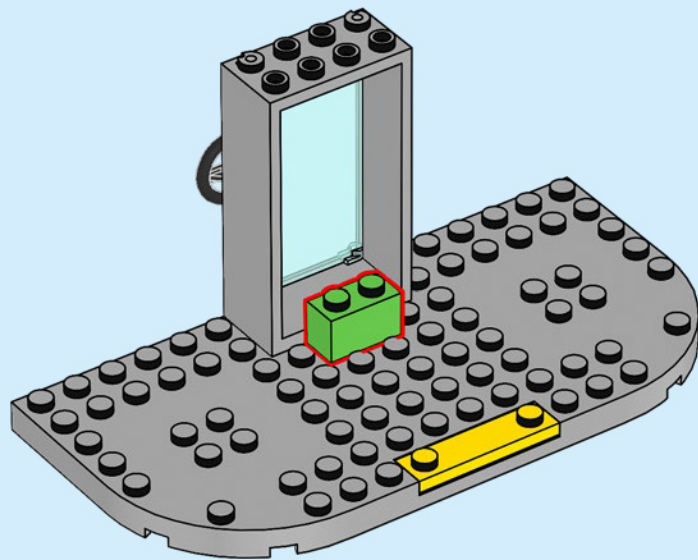

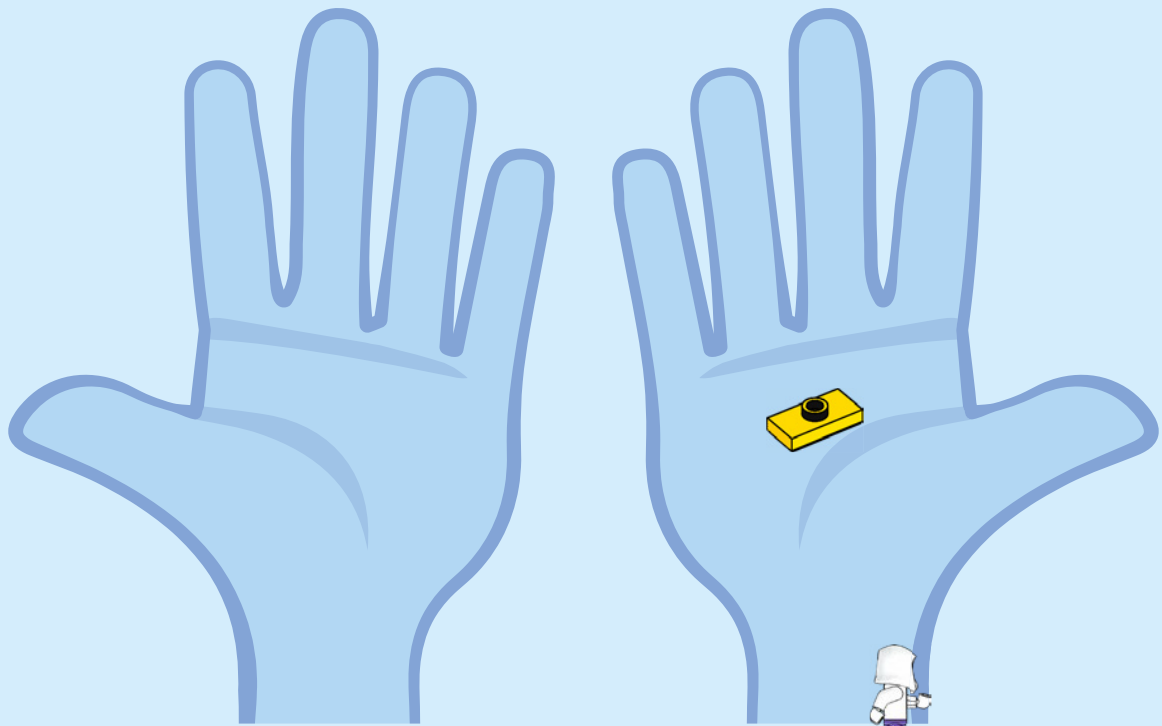

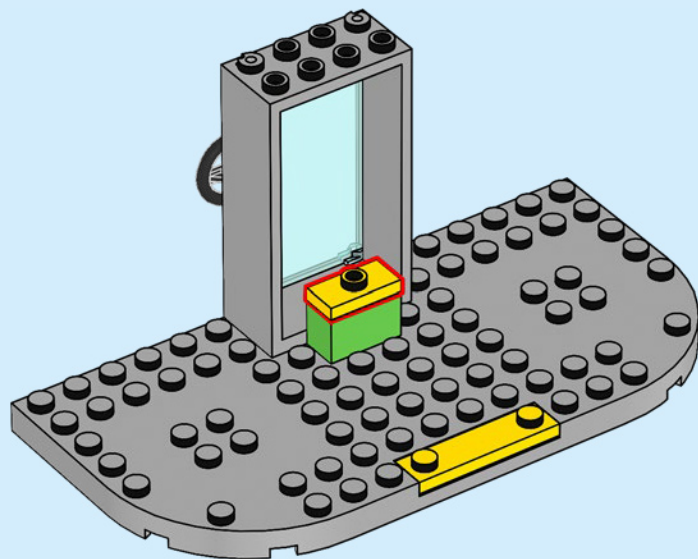

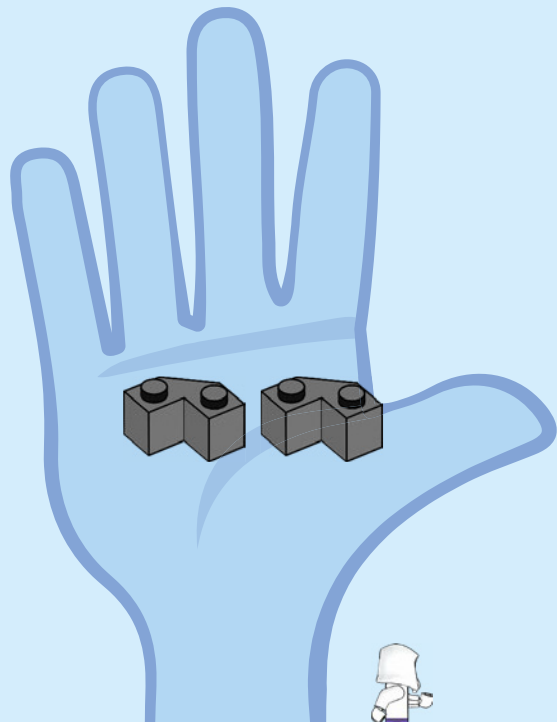
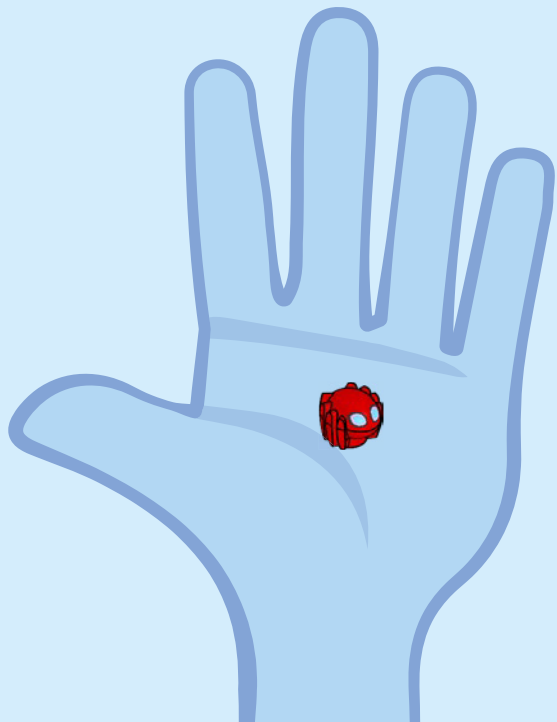



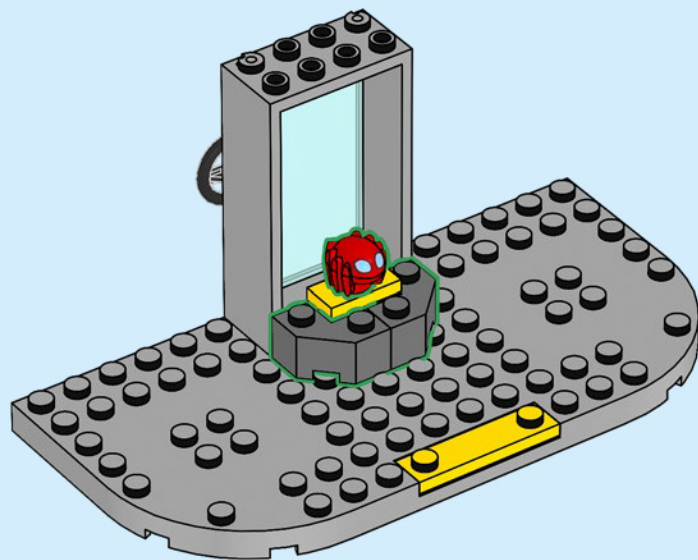

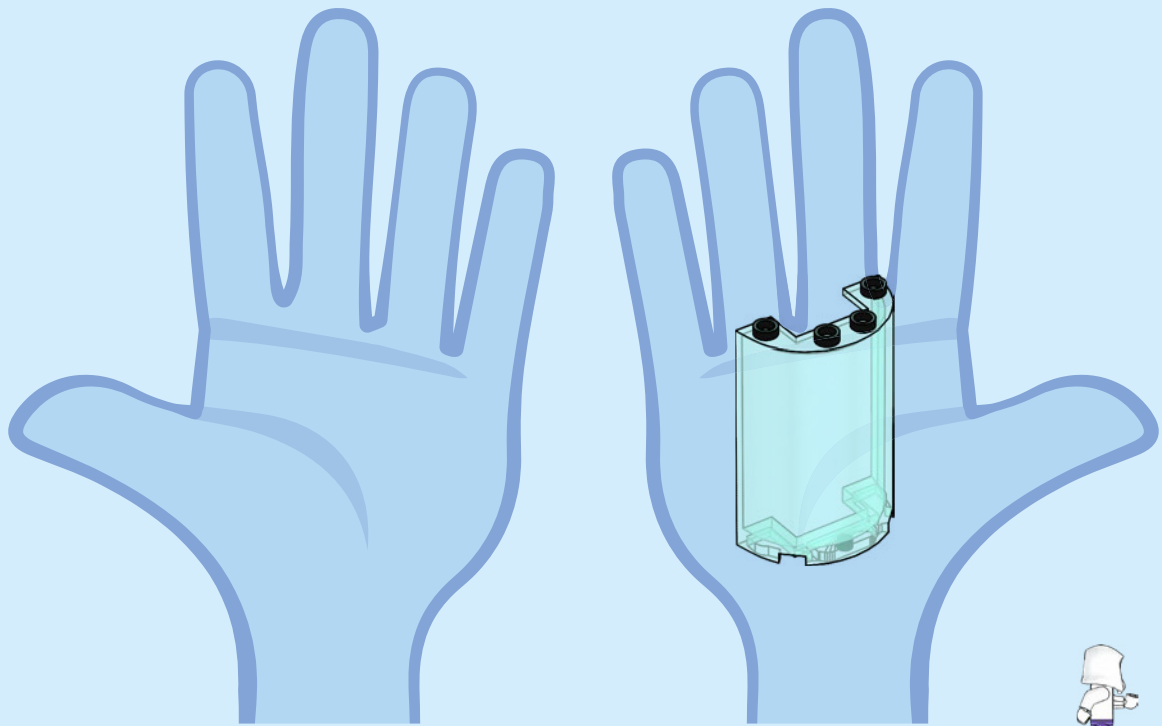

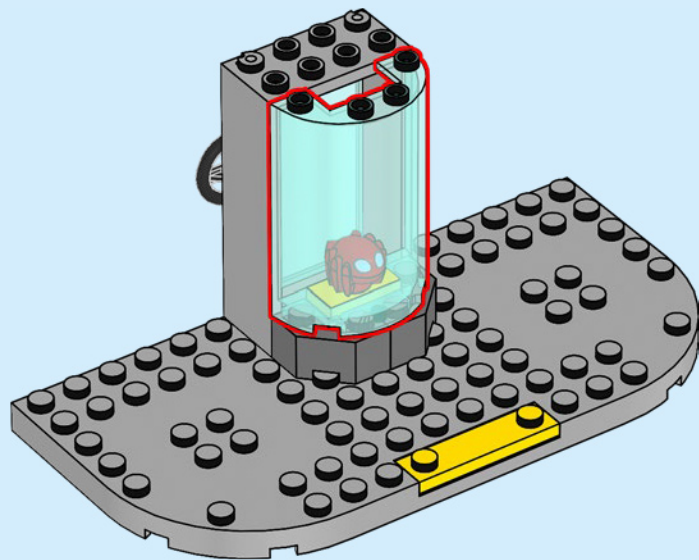

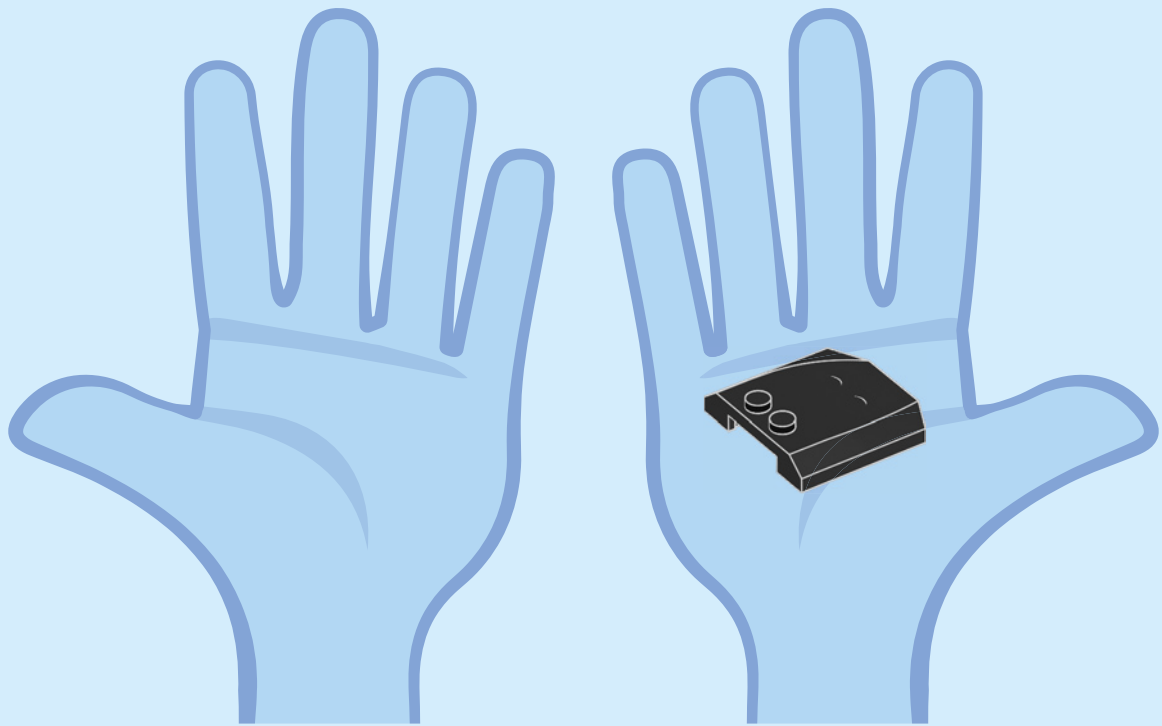

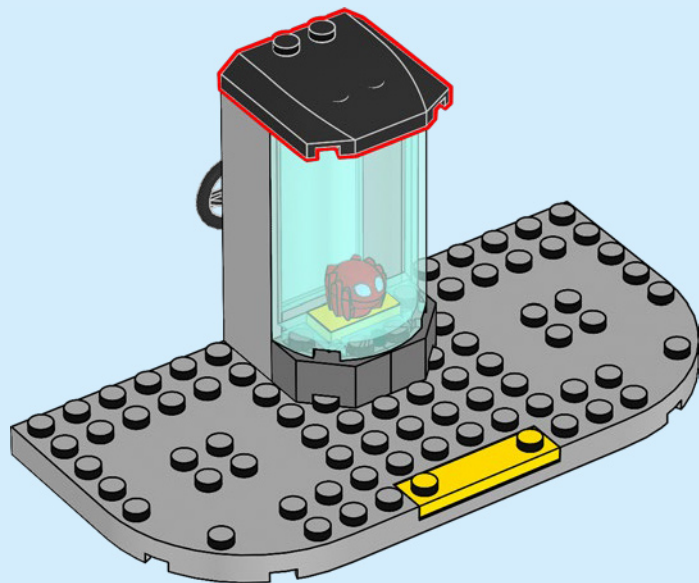

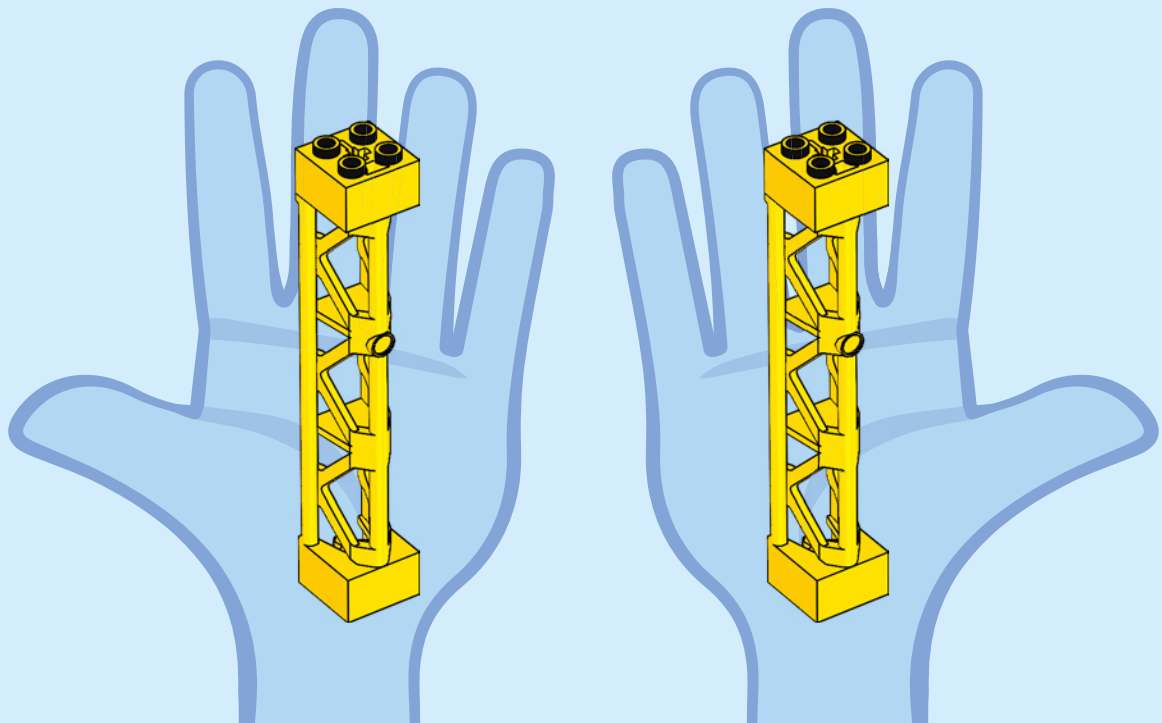

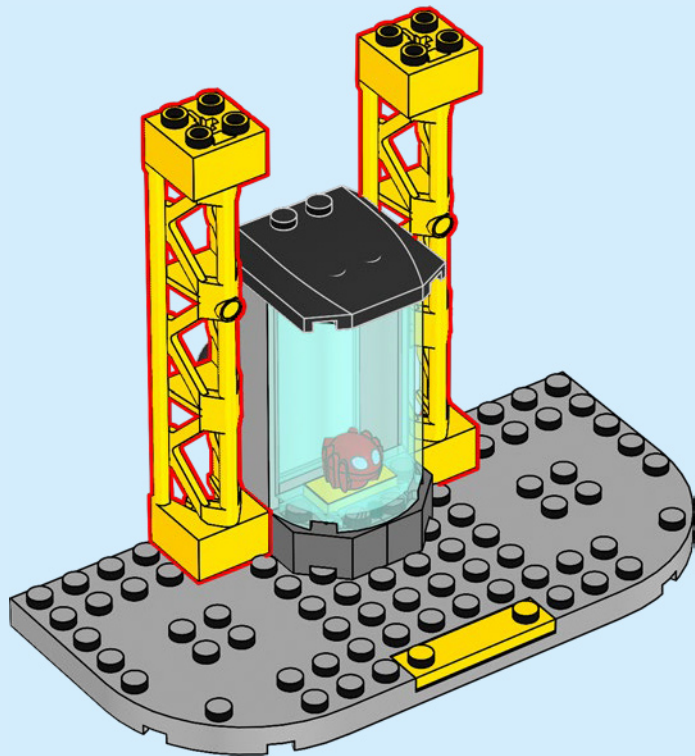

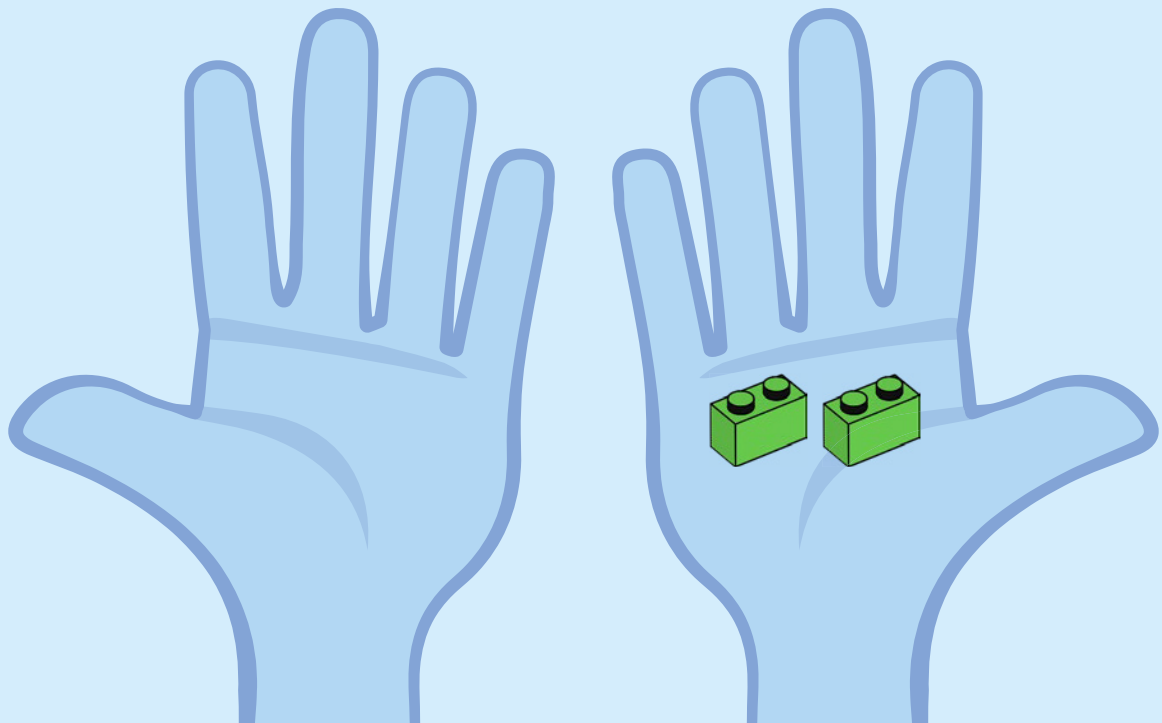



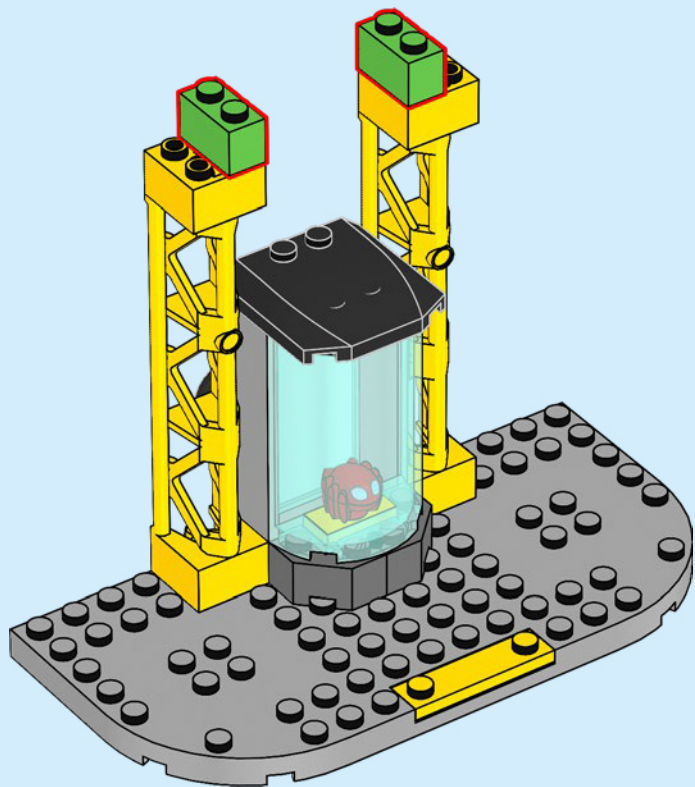

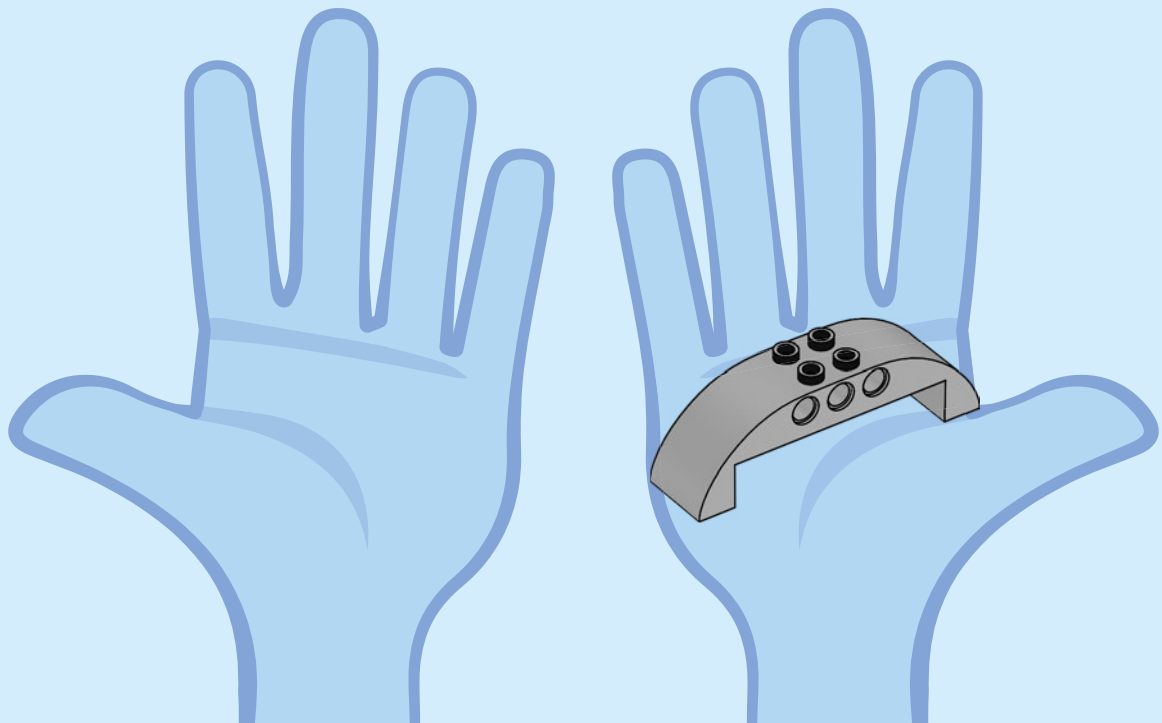

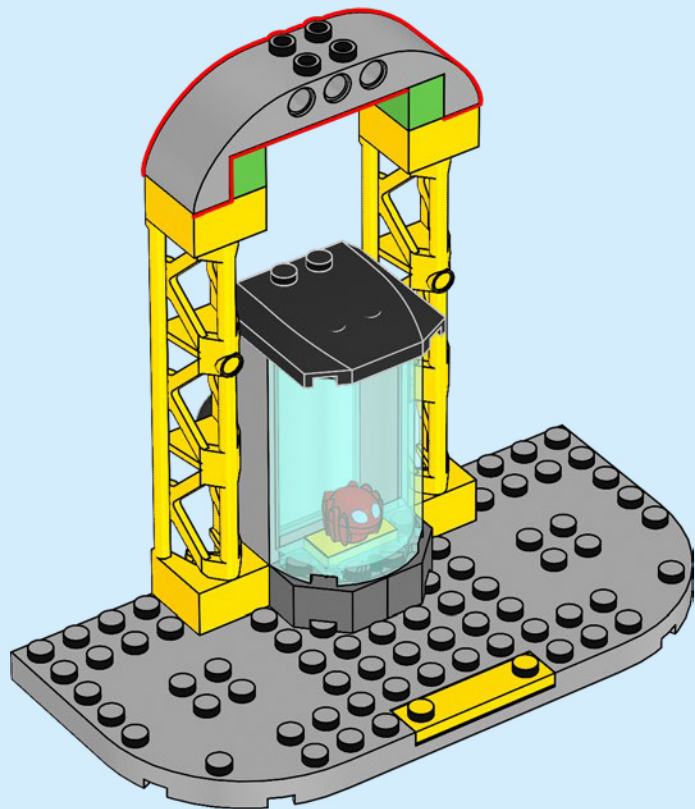

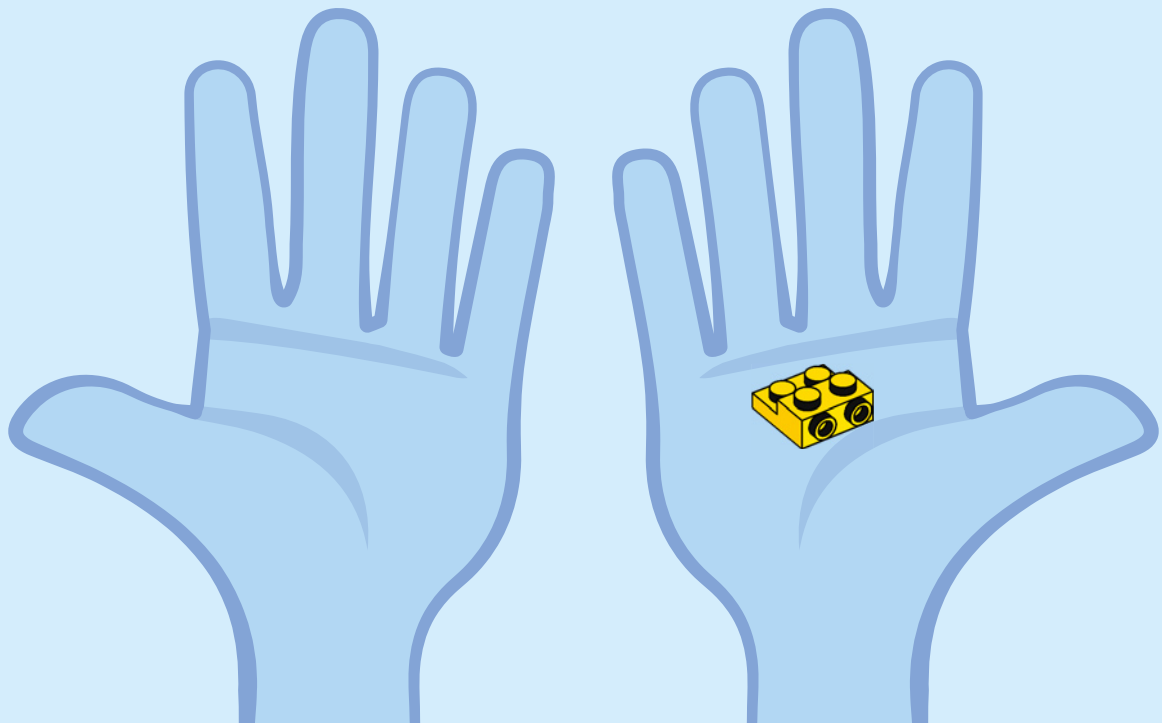

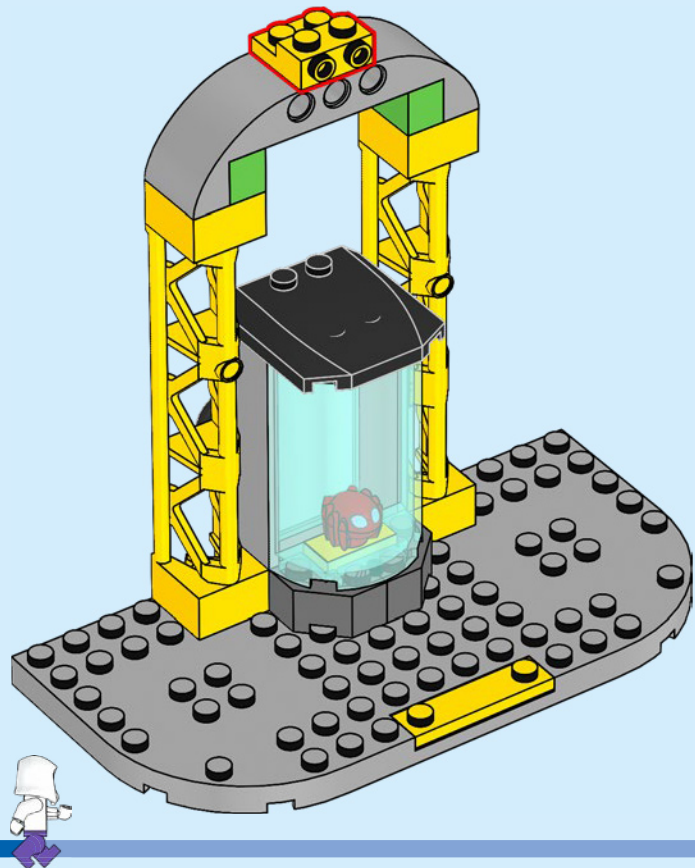

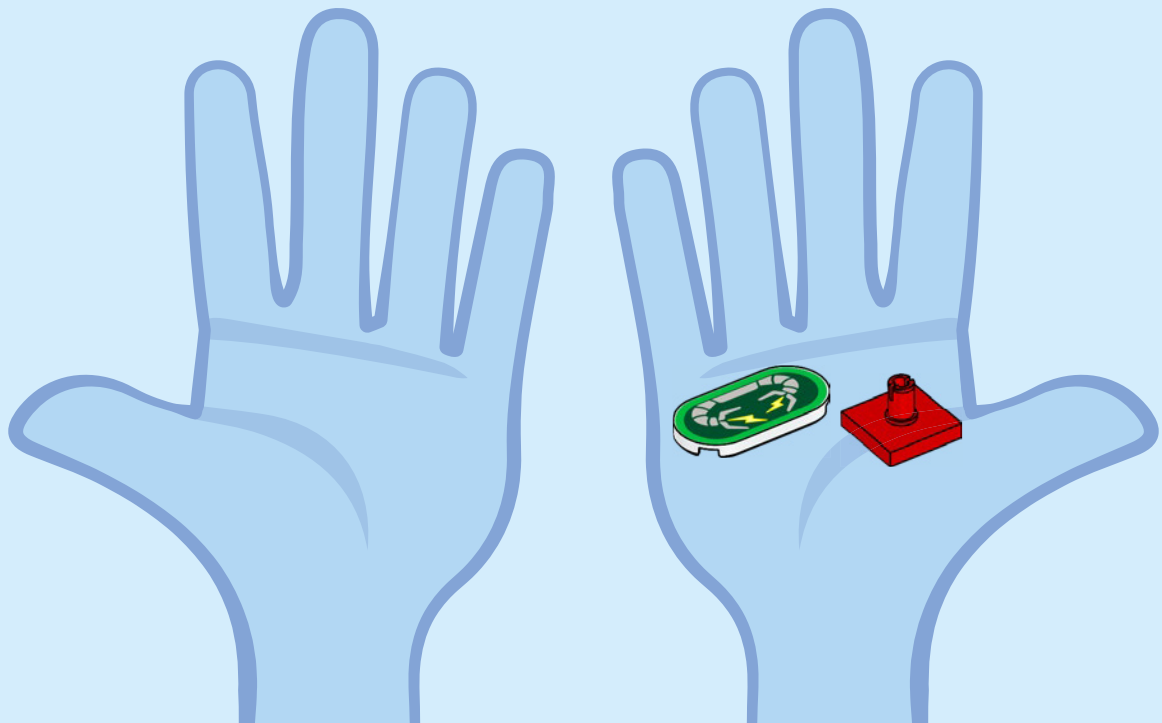

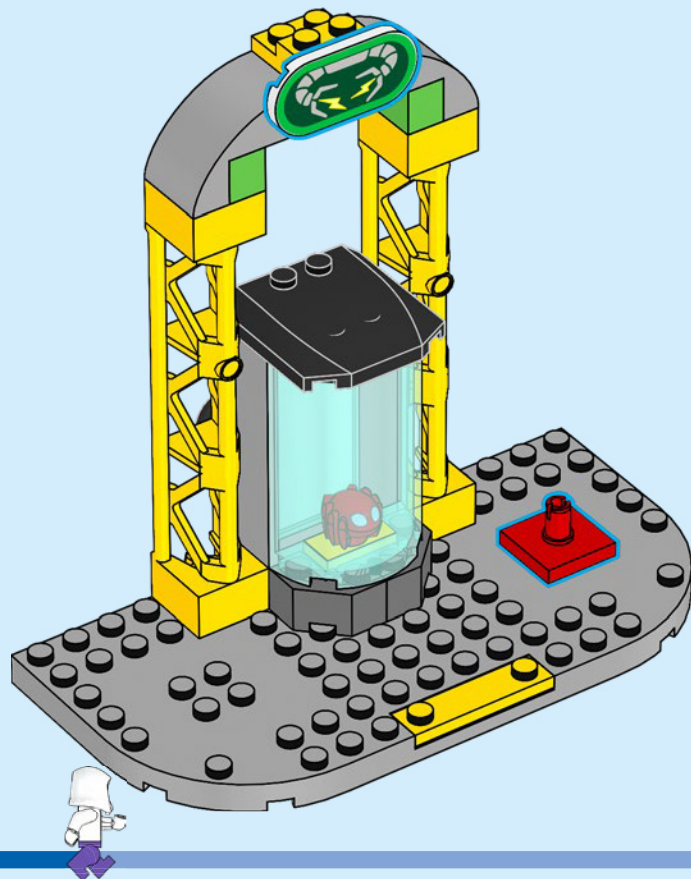

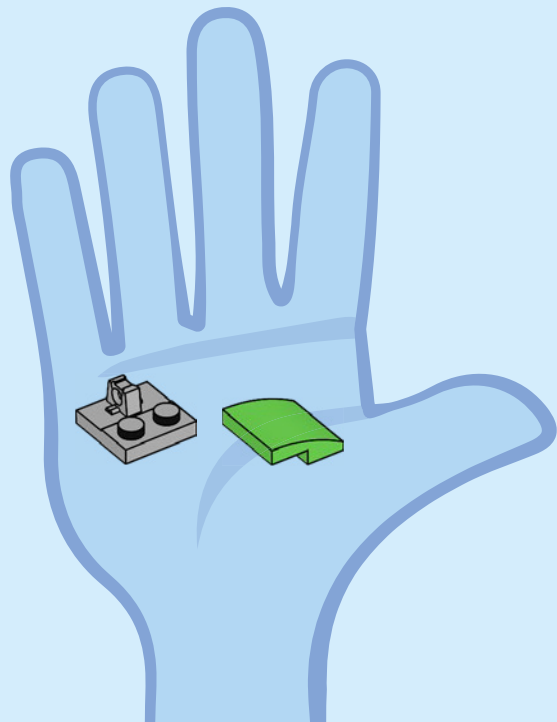
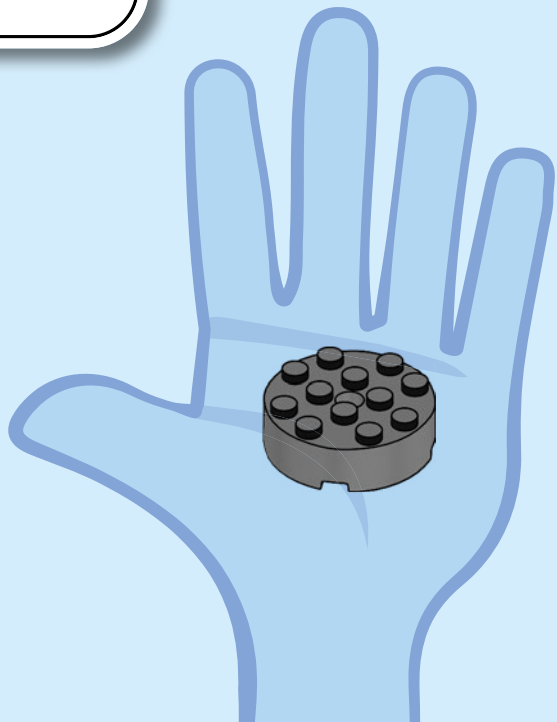



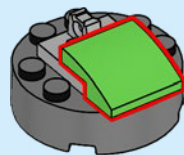
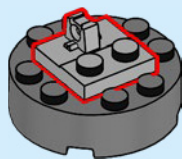

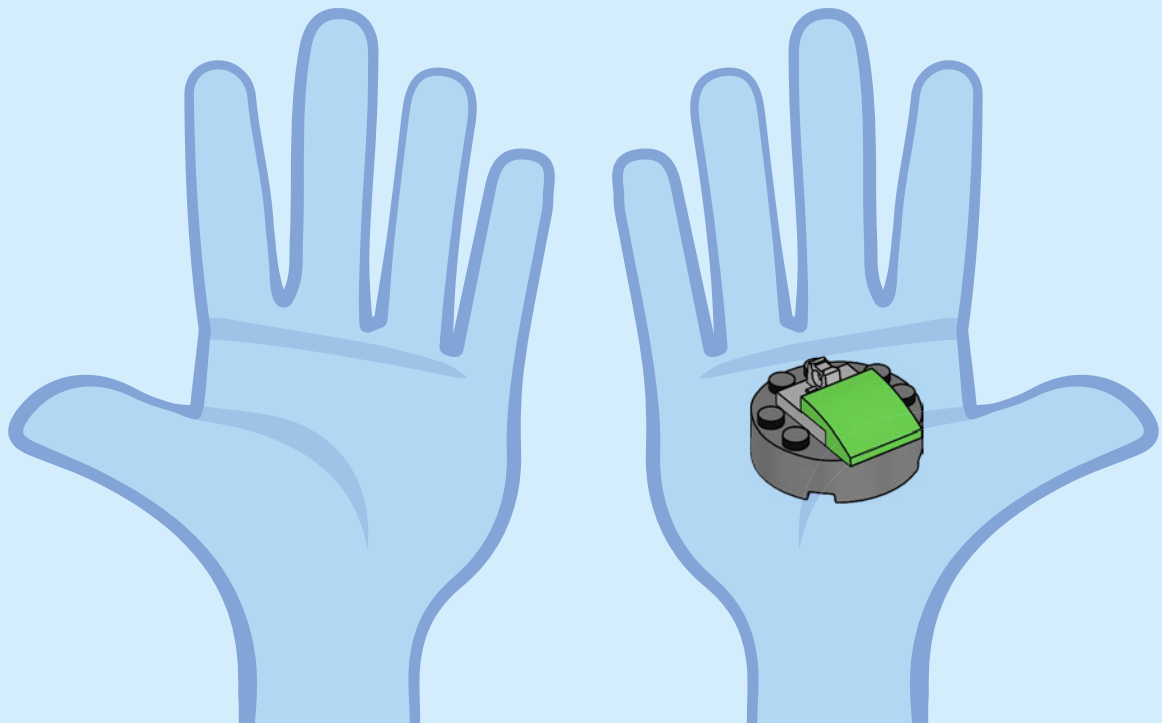

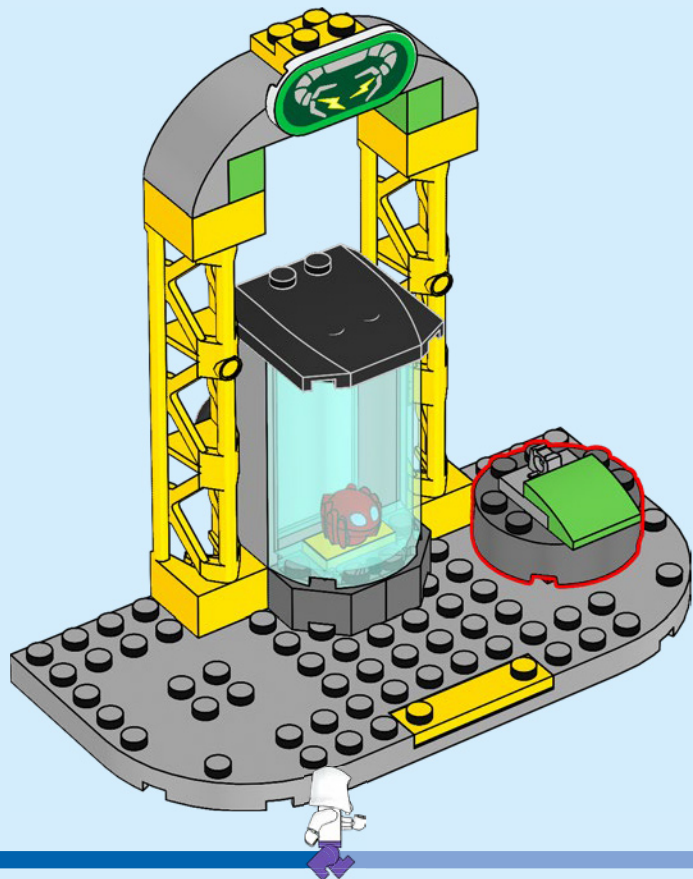

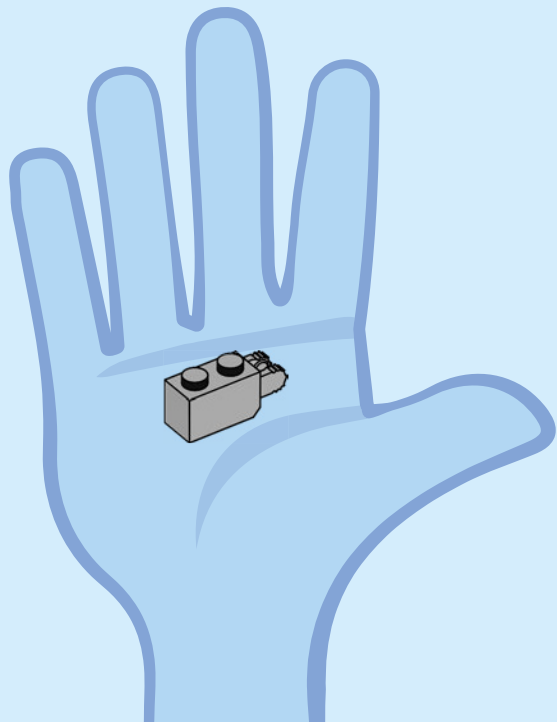
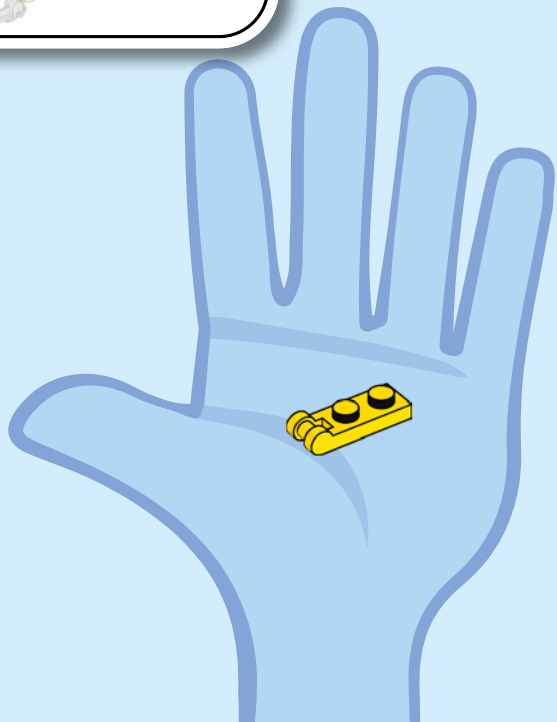
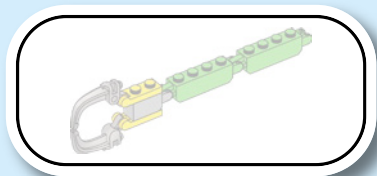

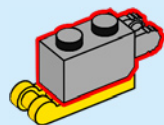

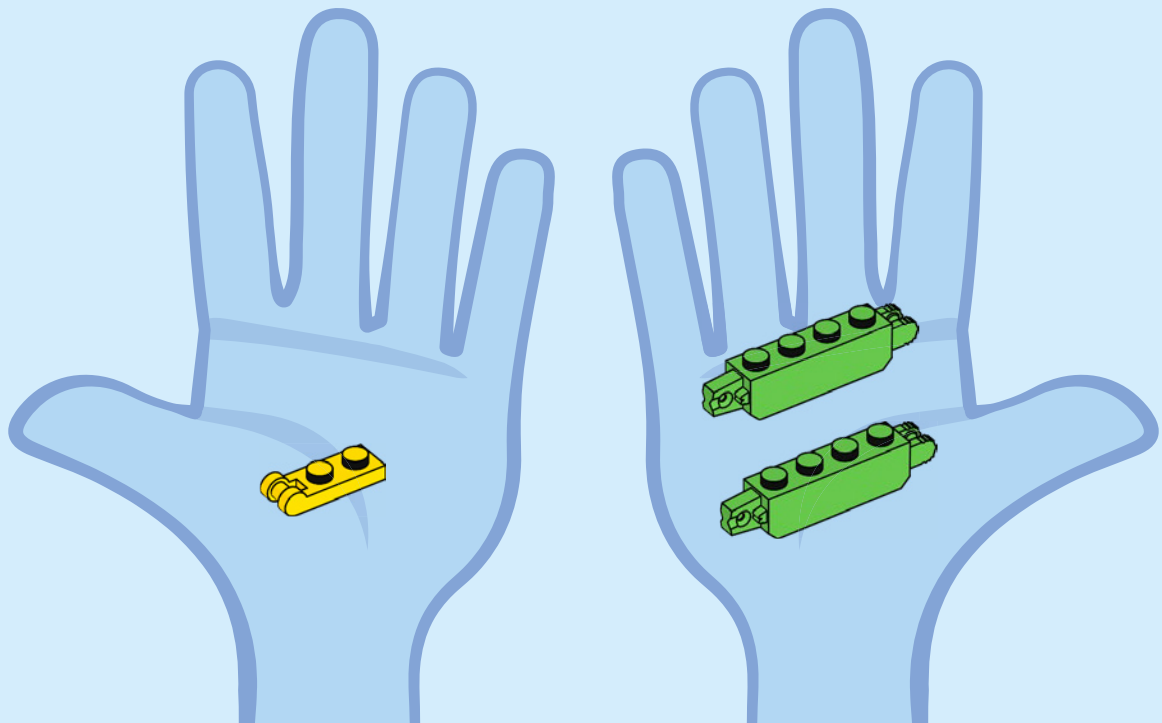

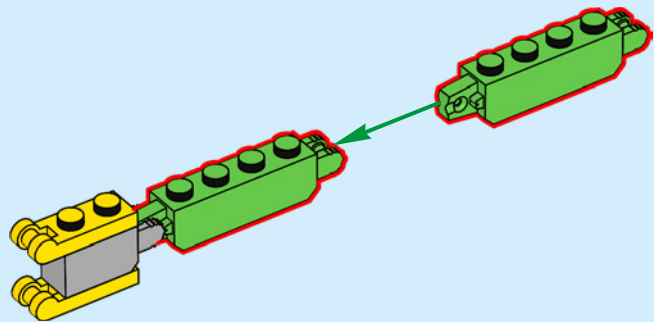
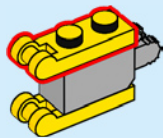

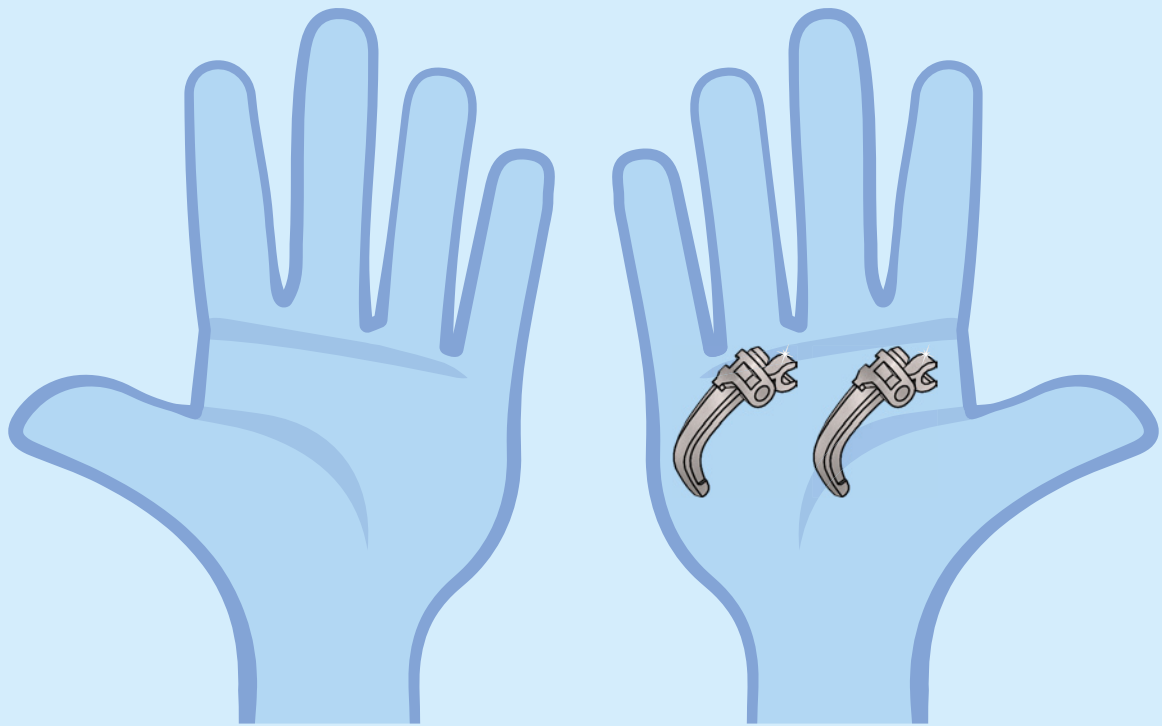



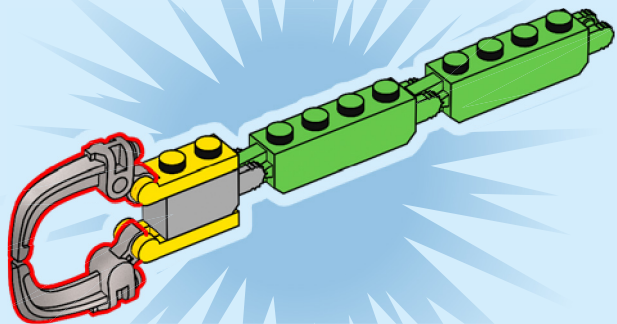

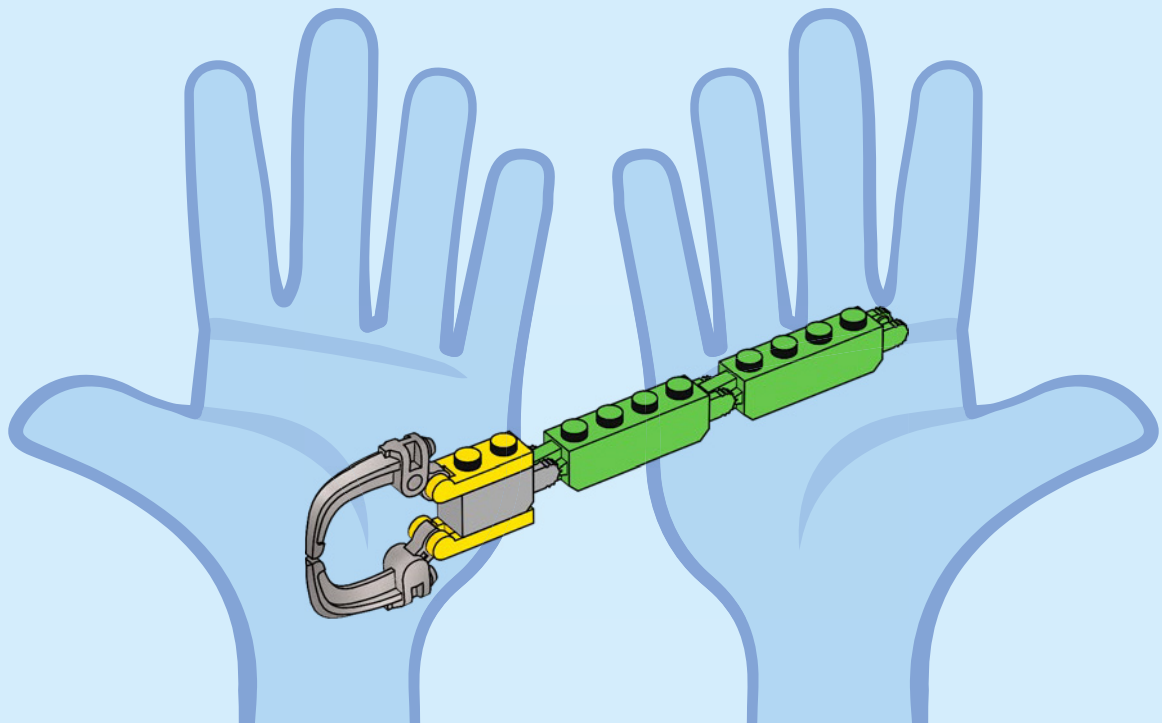

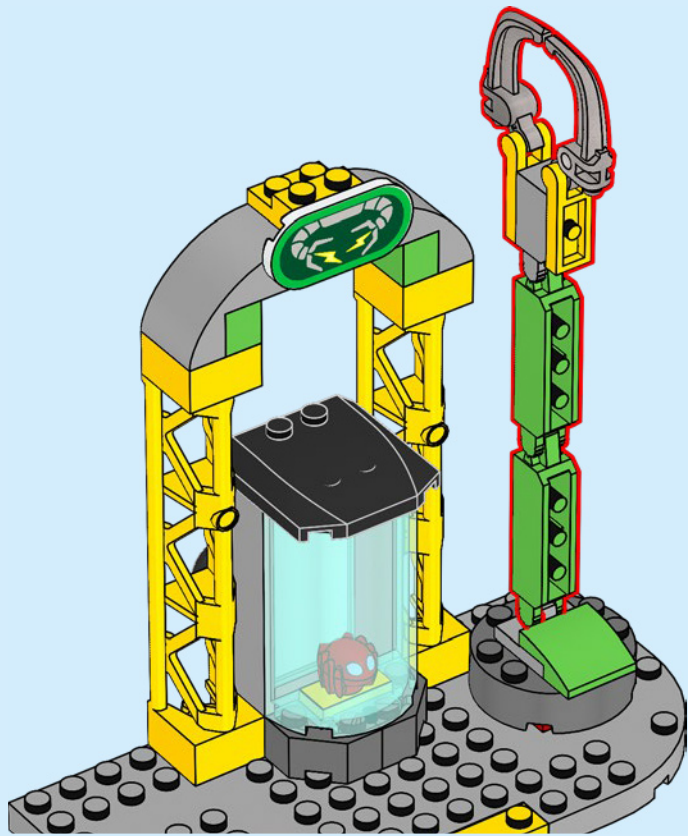

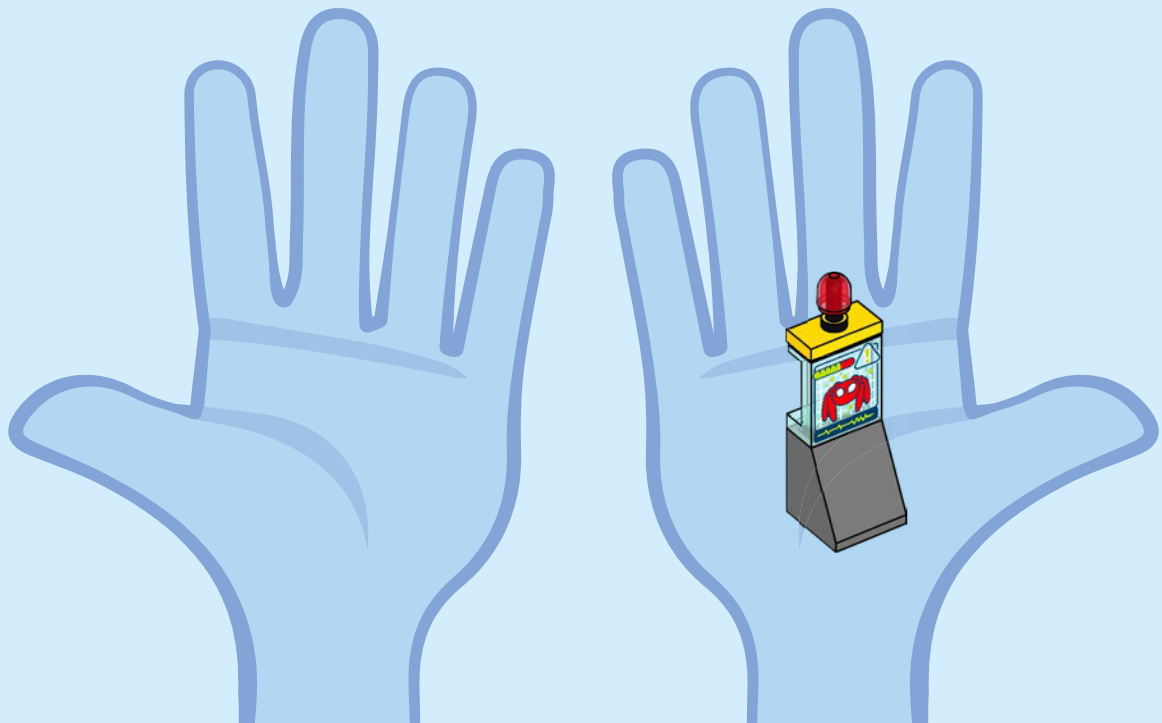

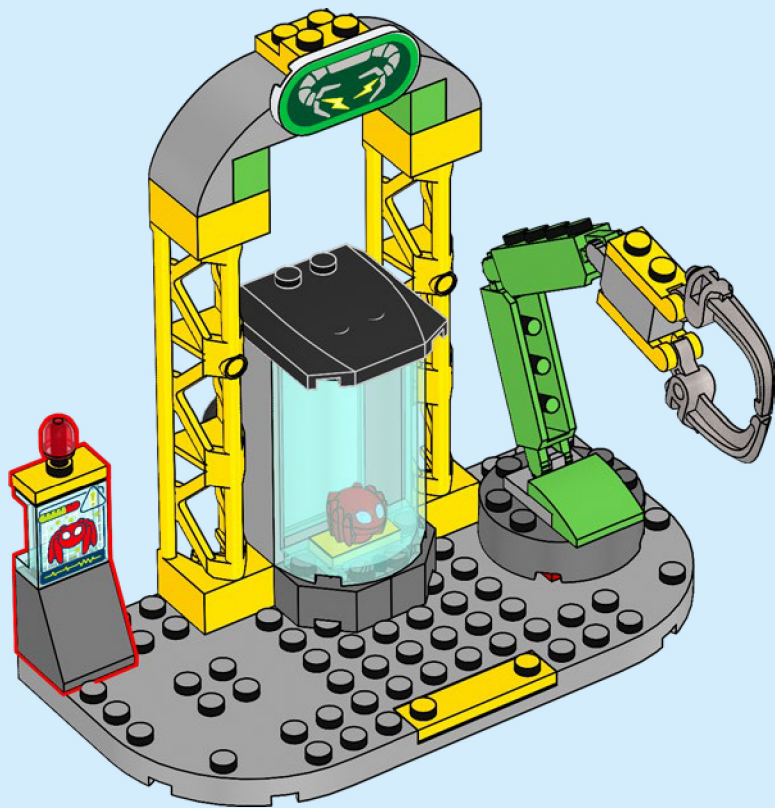

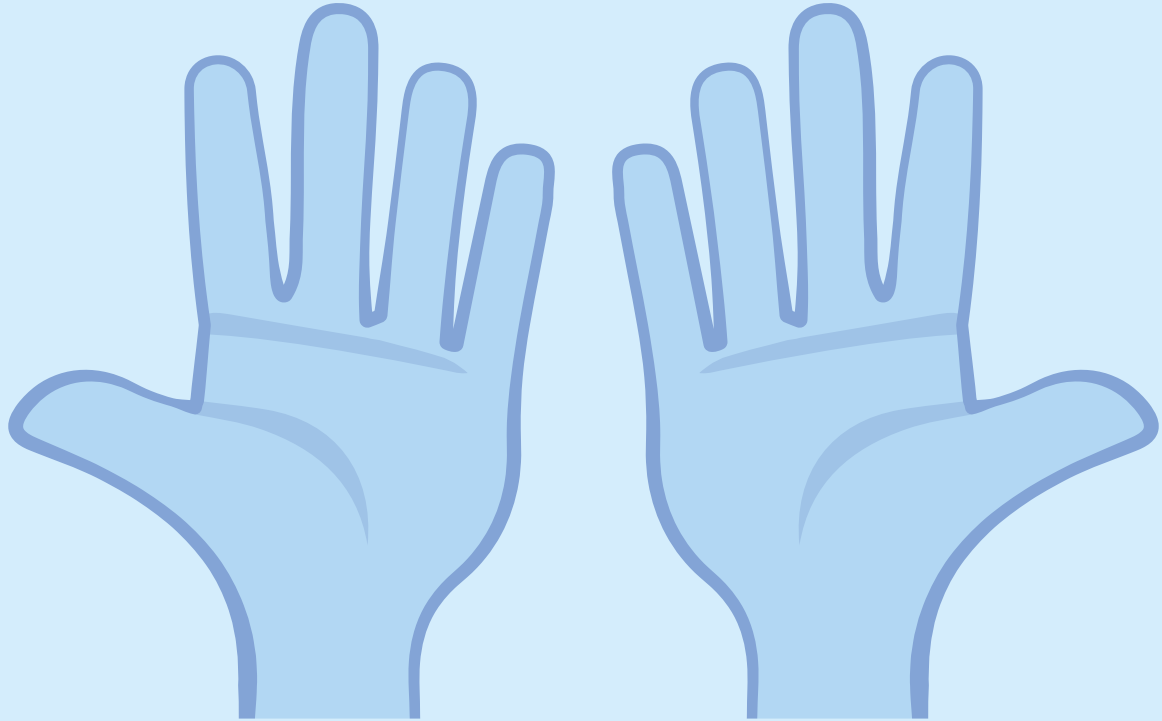

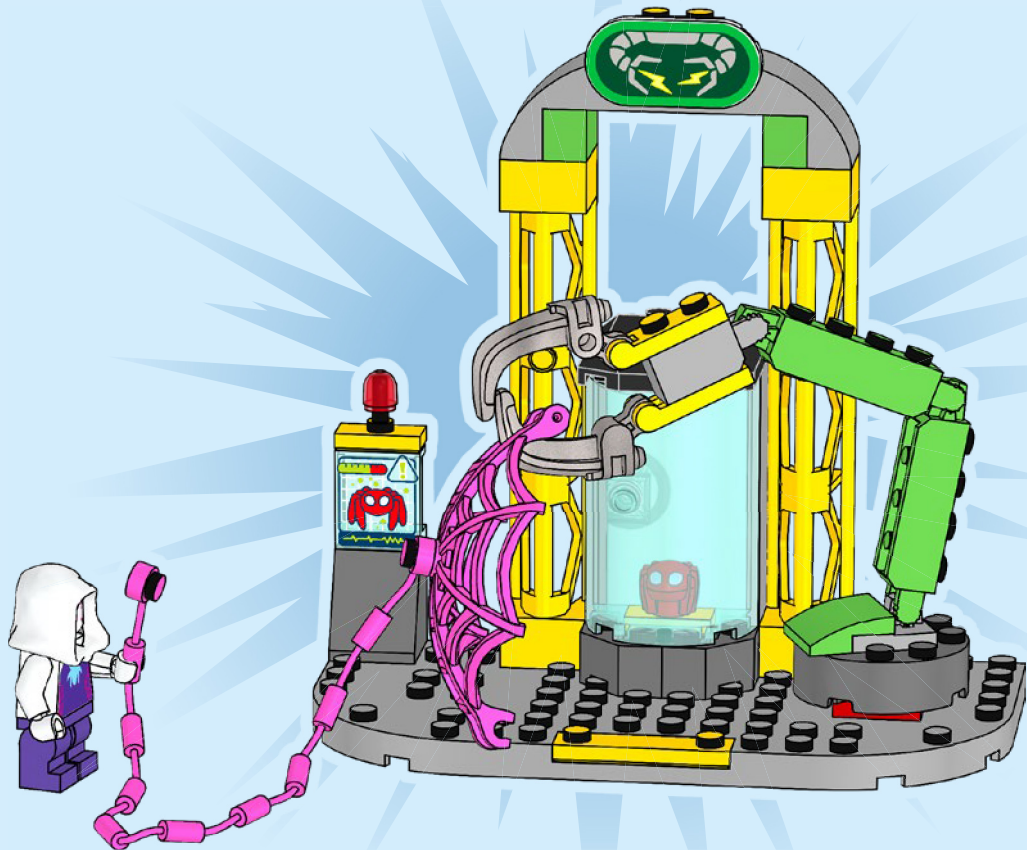



# MARVEL SPIDEY and his AMAZING FRIENDS

Disney  
Junior

10782



10781

LEGO and the LEGO logo are trademarks of the LEGO Group.  
©2022 The LEGO Group.  
© 2022 MARVEL  
6403128

10783



10784



4+