



# duplo

**FLOTTE**

**FAIT DES  
BULLES**

**FLOTA**

**HACE  
BURBUJAS**



**FLOTTES**

**MAKES AIR  
BUBBLES**

**10907**

LEGO.com/DUPLO



# duplo

FLOTTE  
FLOTA

FLOATS



10886  
Ages 1½+



10910  
Ages 2+



Ages/edades

1½



10847  
Ages 1½+





Disney  
**FROZEN**

**BRIQUE  
LUMIERE**

**LADRILLO  
LUMINOSO**

**LIGHT  
BRICK**

**10899**  
Ages 2+



© Disney



**10902**  
Ages 2+

**SON ET  
LUMIERE**  
**LUZ Y  
SONIDOS**



**10904**  
Ages 2+

**5**



**duplo**

**CONSTRUIRE ET  
CRÉER DES LIENS**

**CREATE & CONNECT**





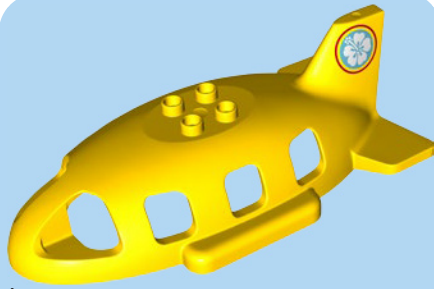

1x

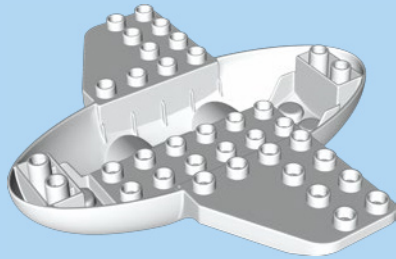

1x



1x

1x

1

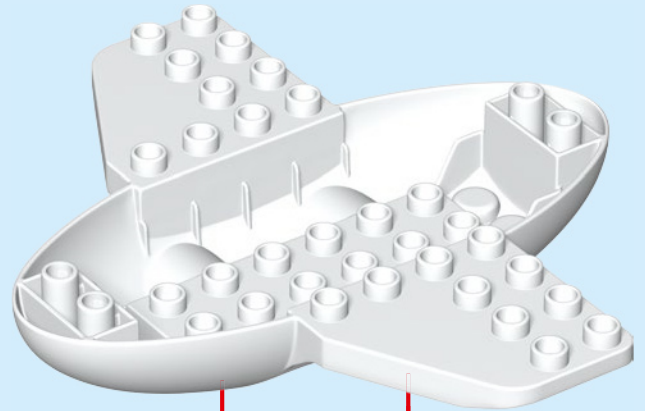

2





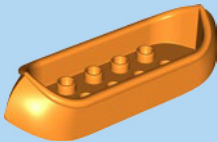

1x



1x



1x



1x



1x



1x

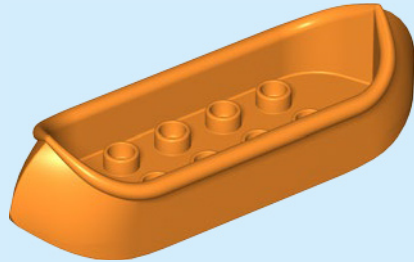

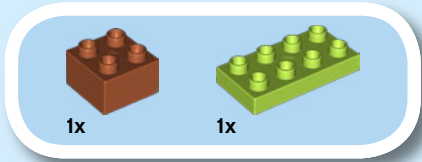

1

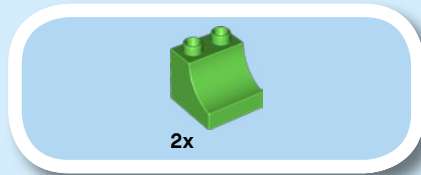
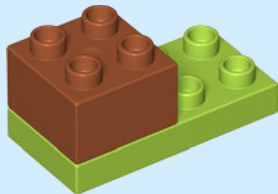

2

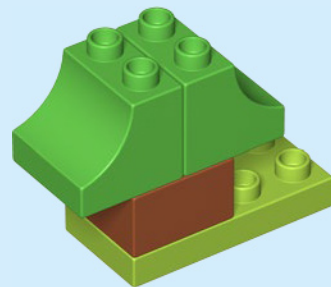



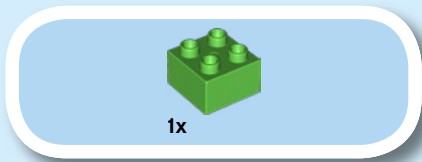

3

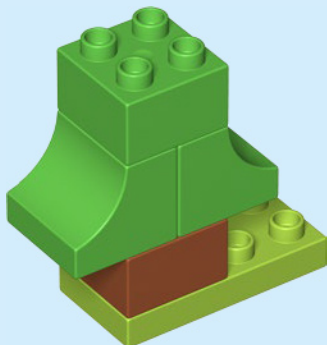

4



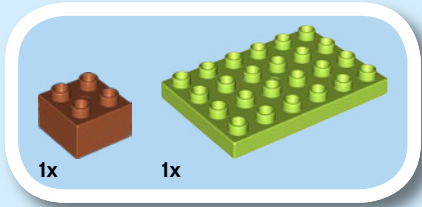

1

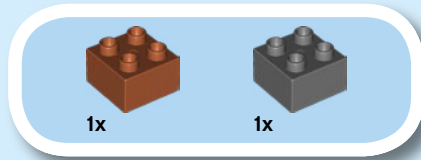
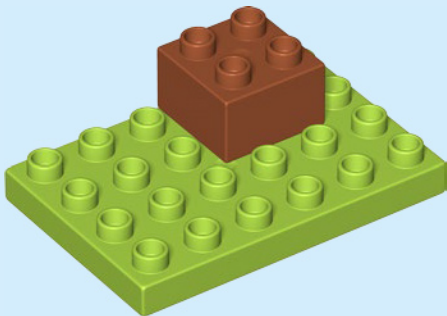

2

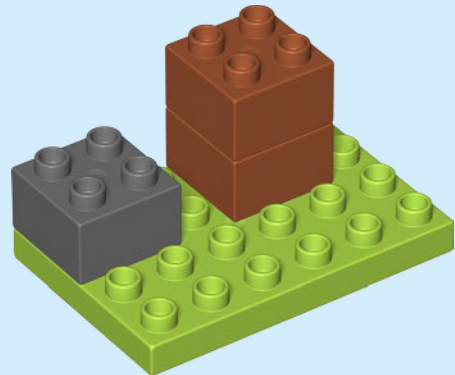



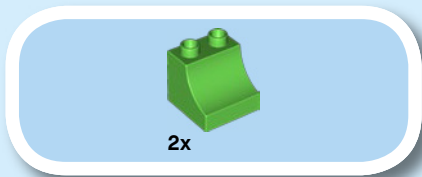

3

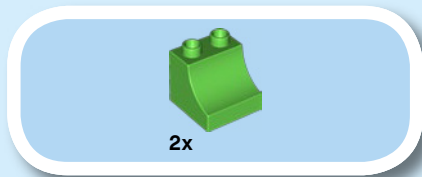
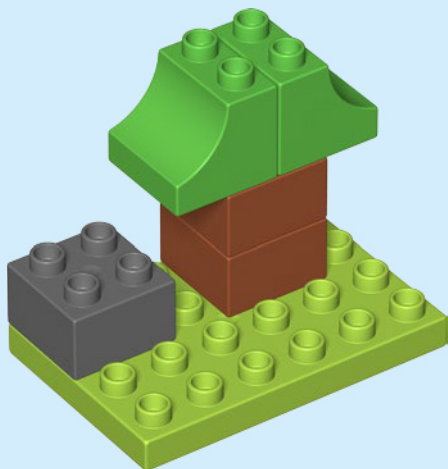

4

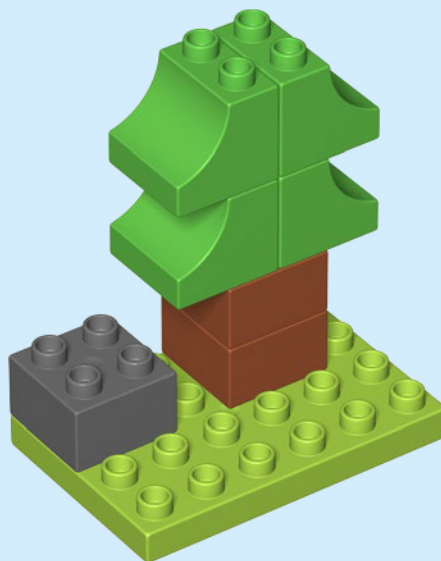

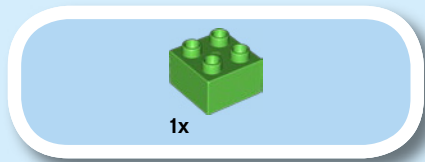

5

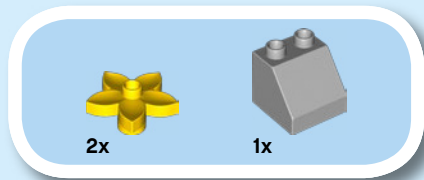
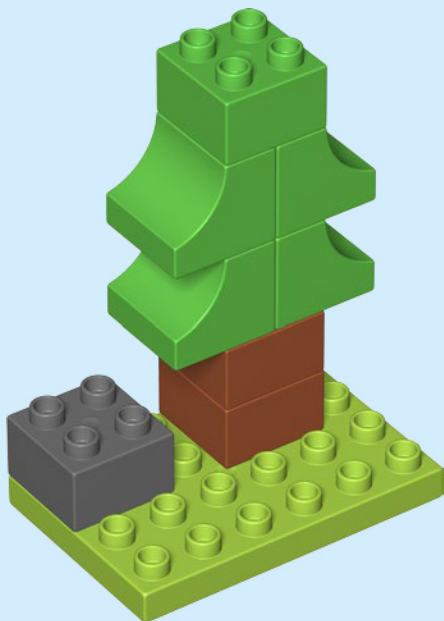

6

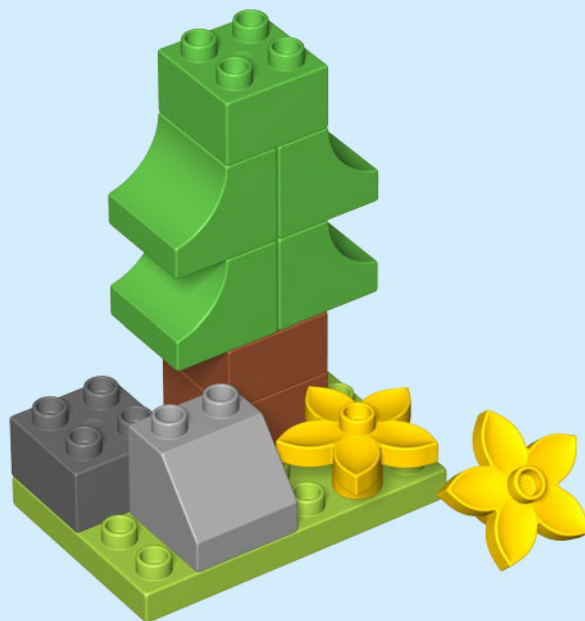



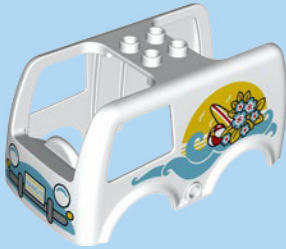

1x



1x



1x



1x



1x

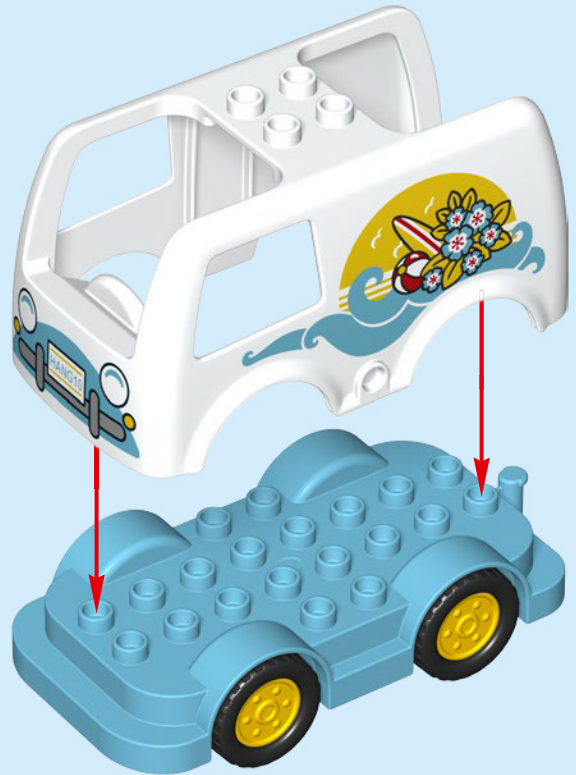

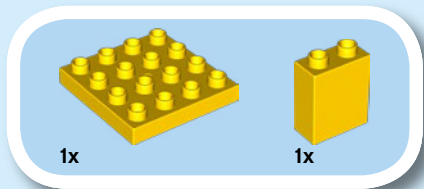
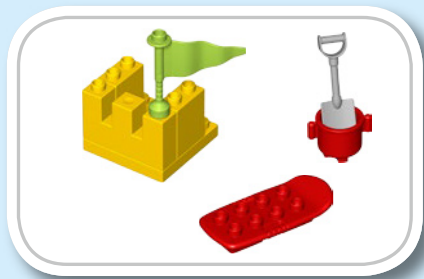

1

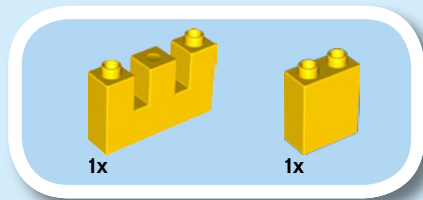
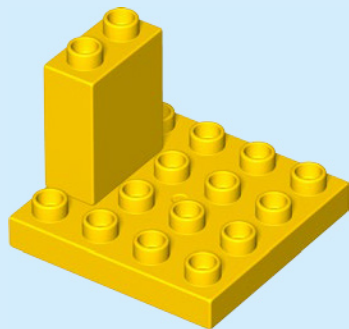

2

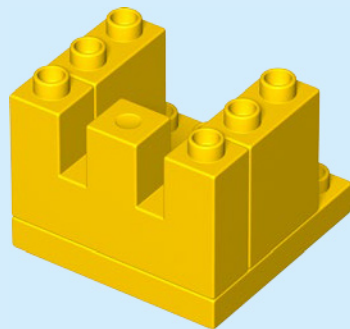

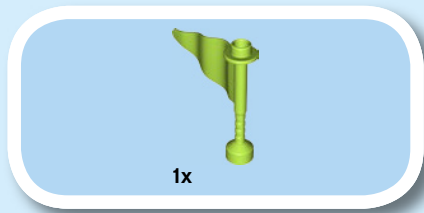

3

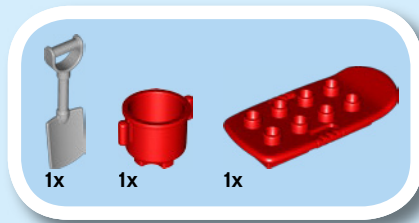
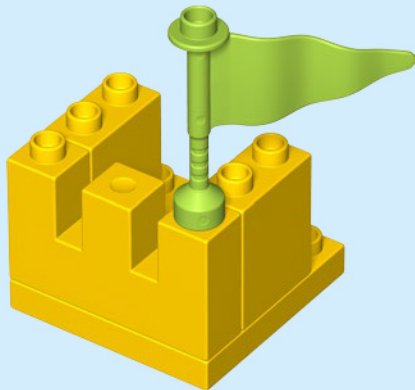

4

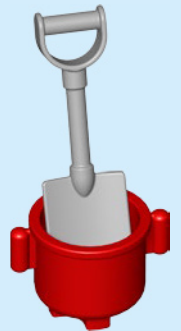
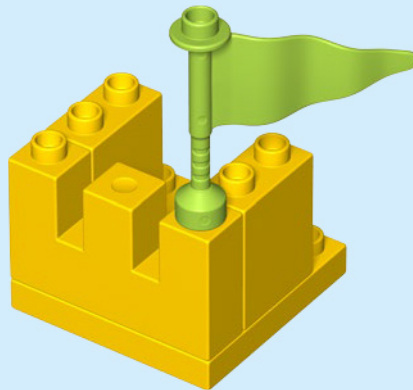



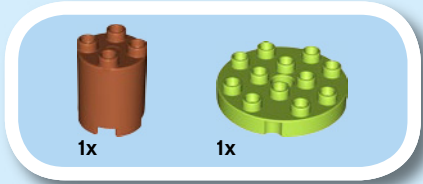

1

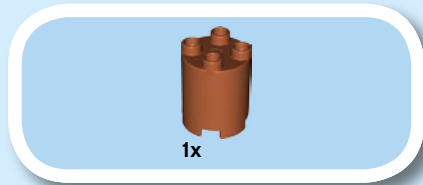
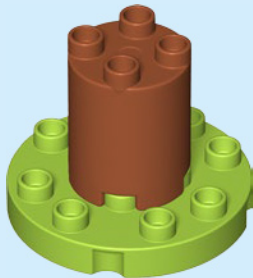

2

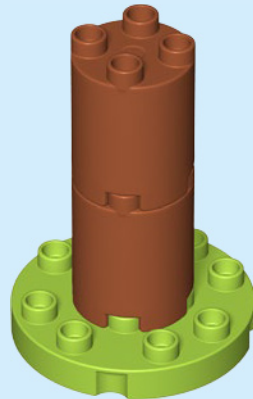

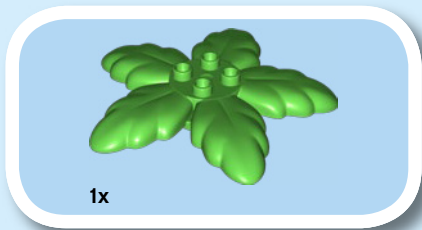

3

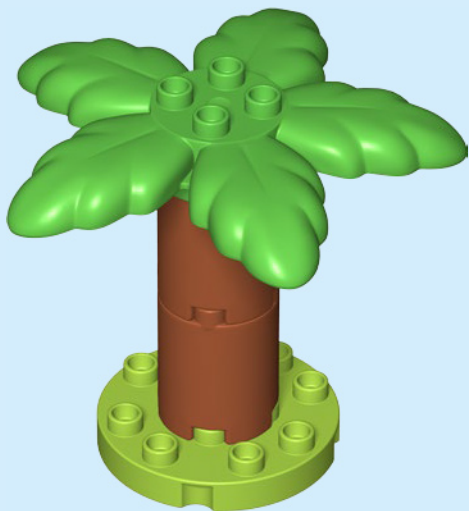

4



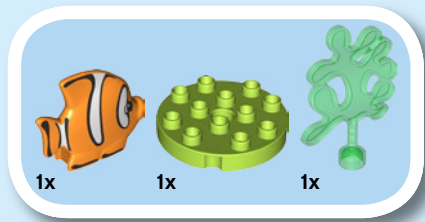

1

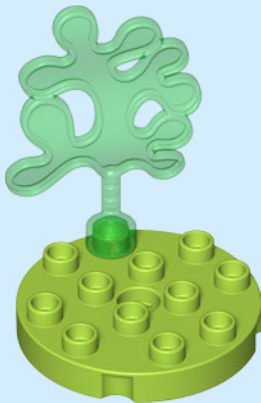

2





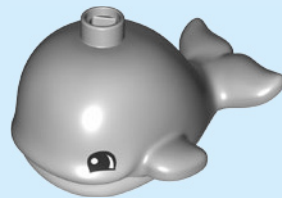
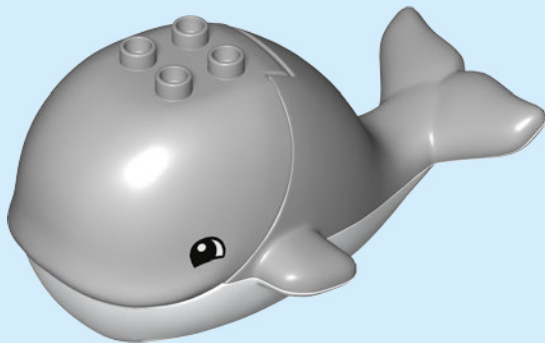
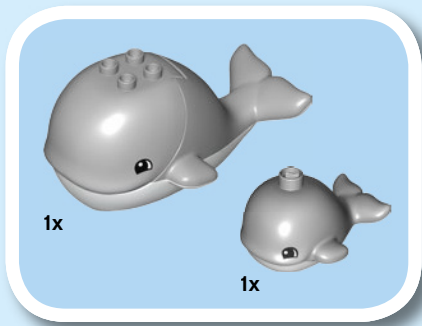

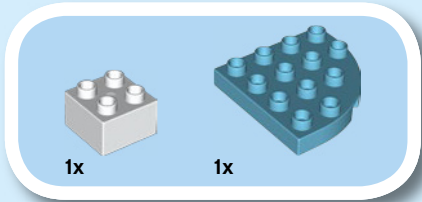

1

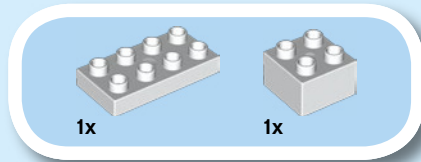
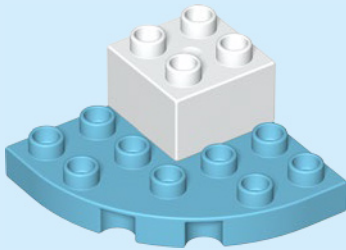

2

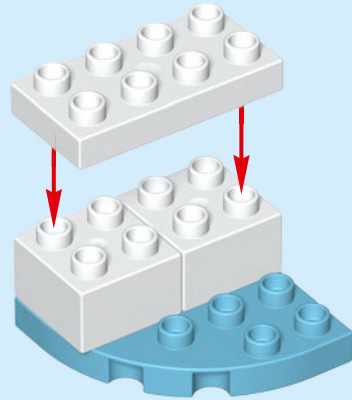

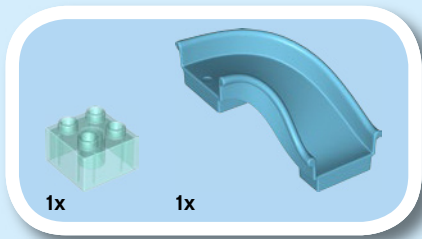

3

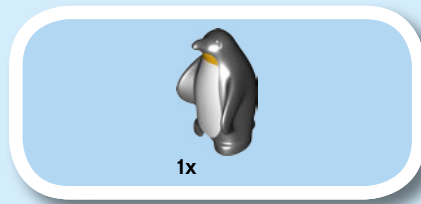
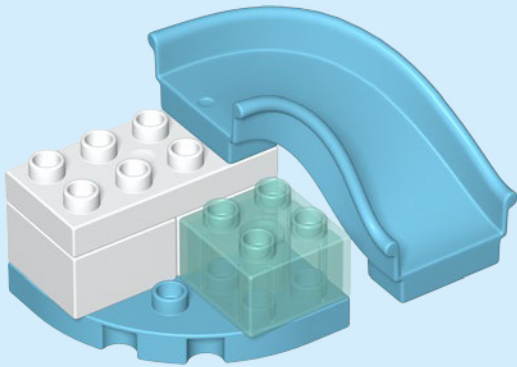

4

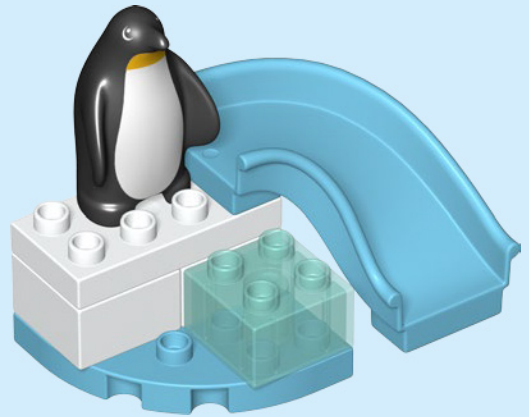





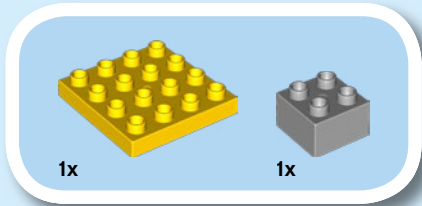
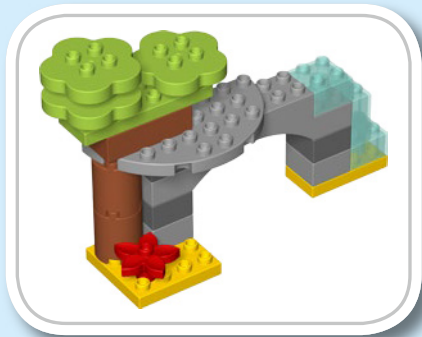

1

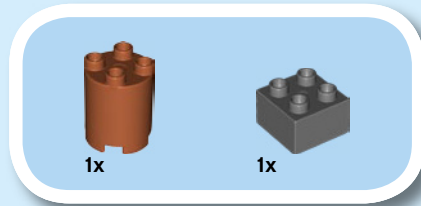
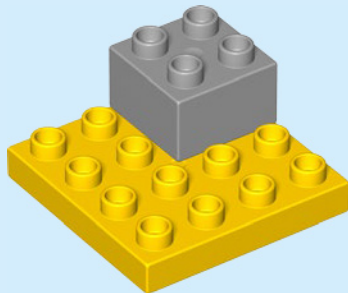

2

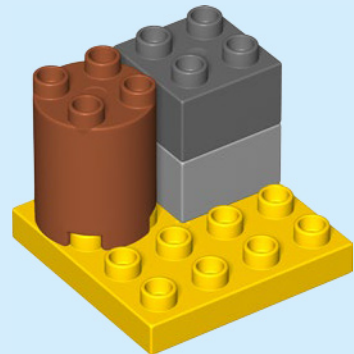

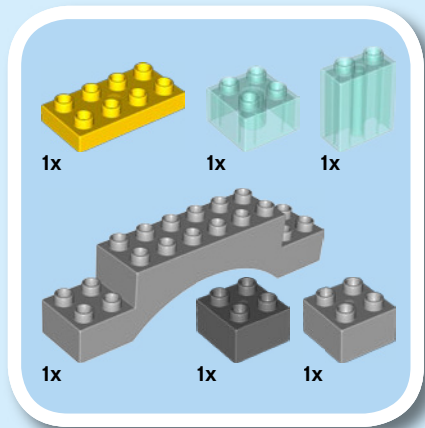

3

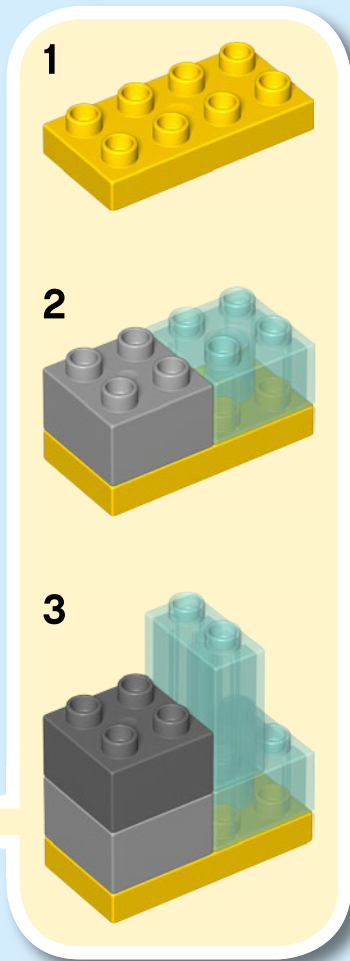
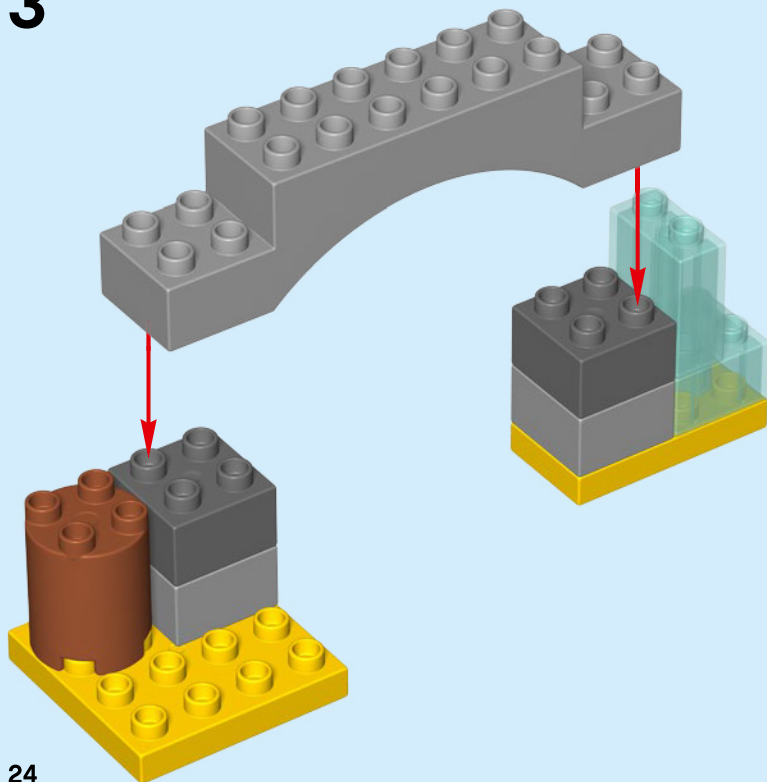

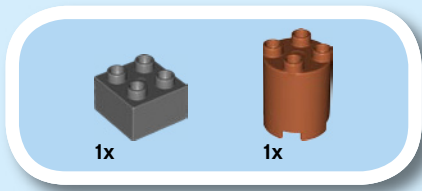

4

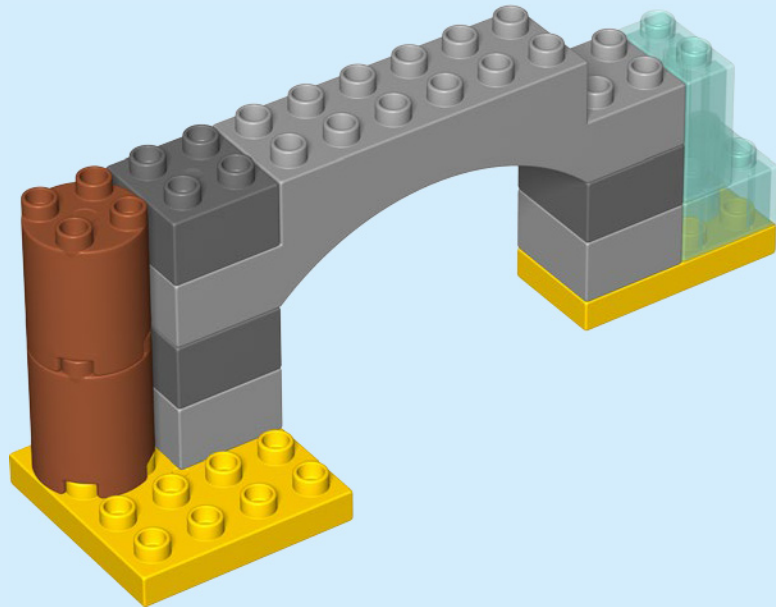

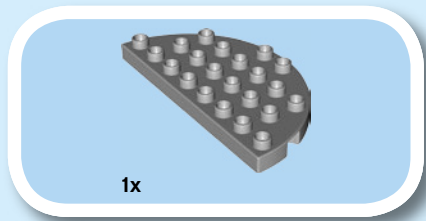

5

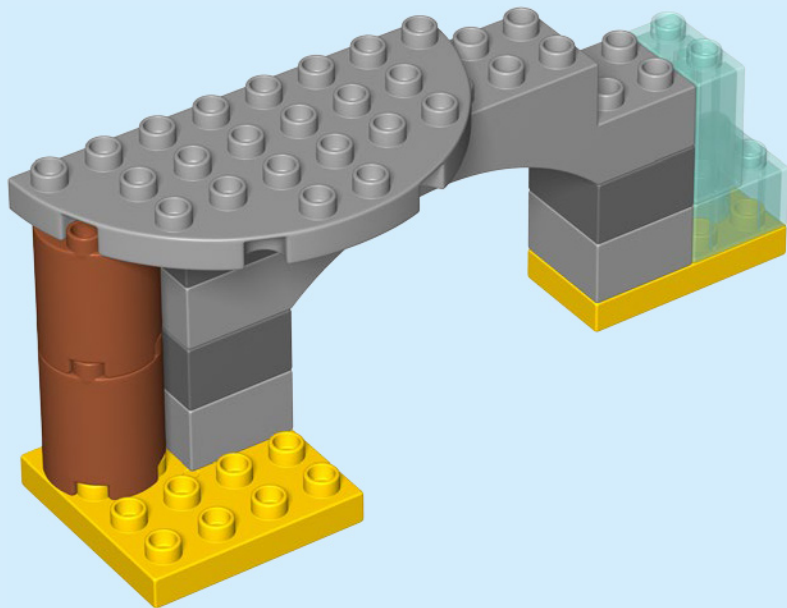



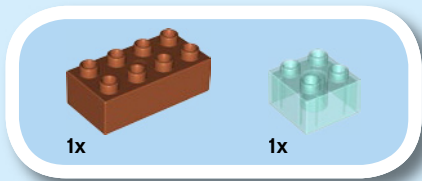

6

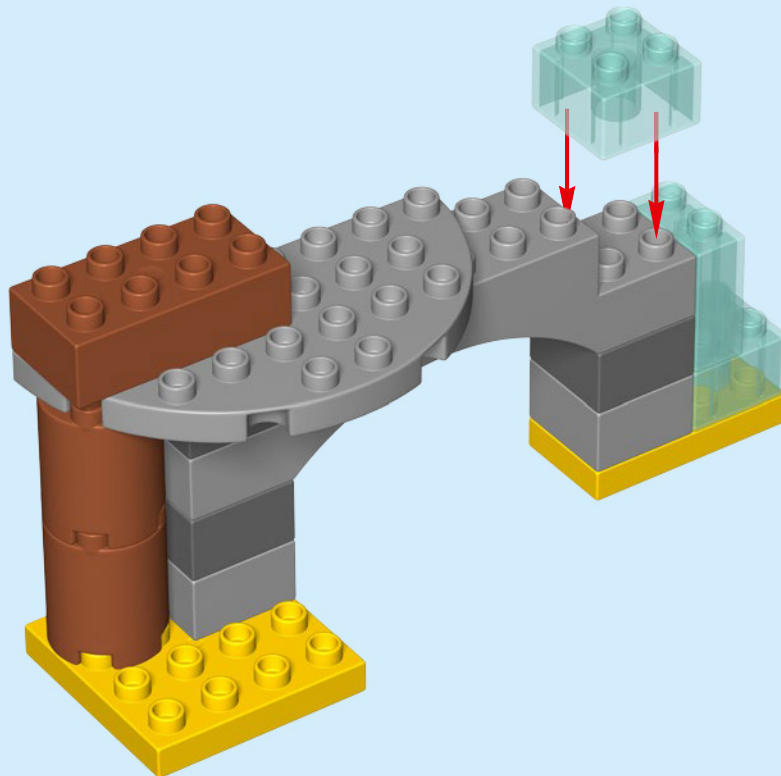

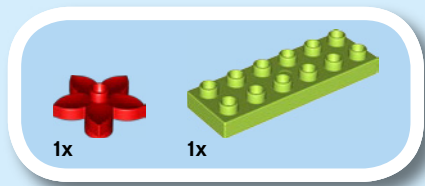

7

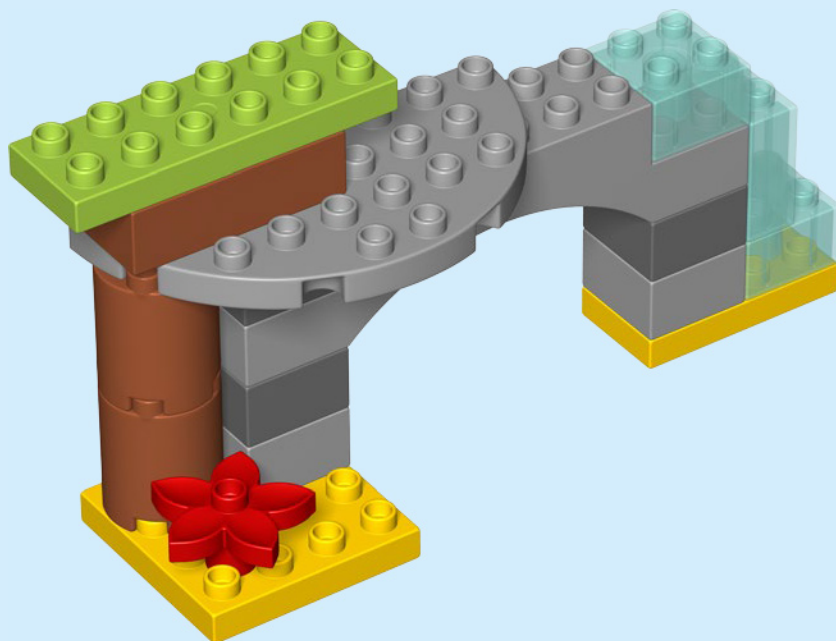

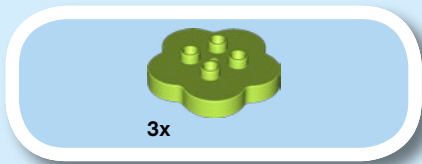

8

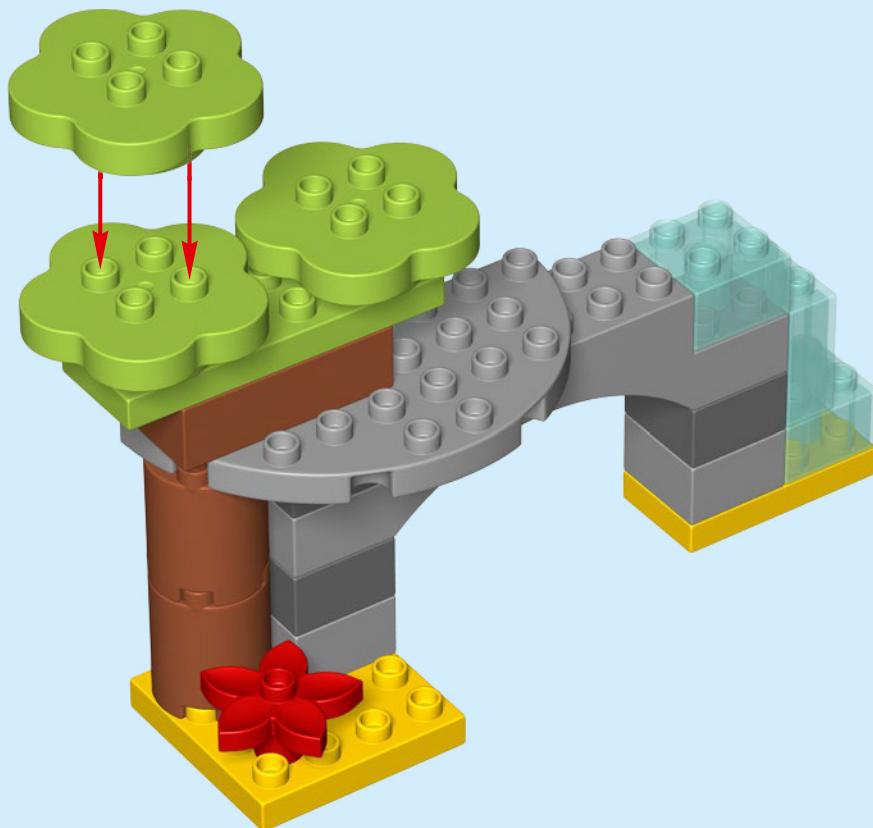

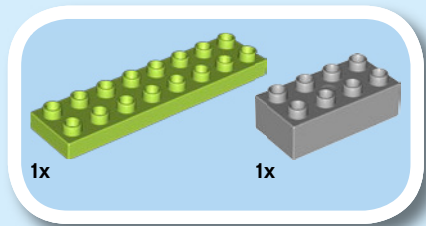

1

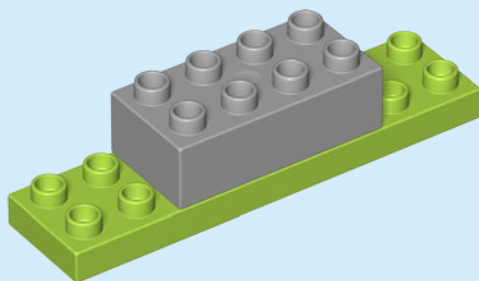

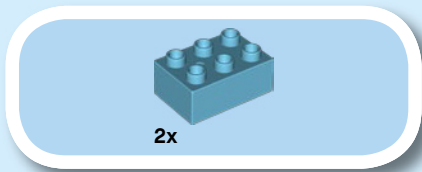

2

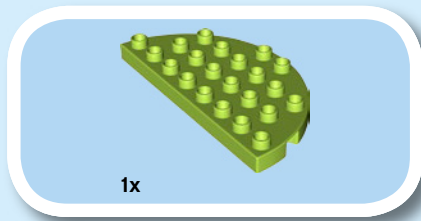
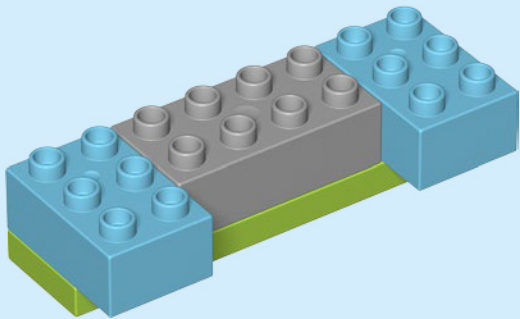

3

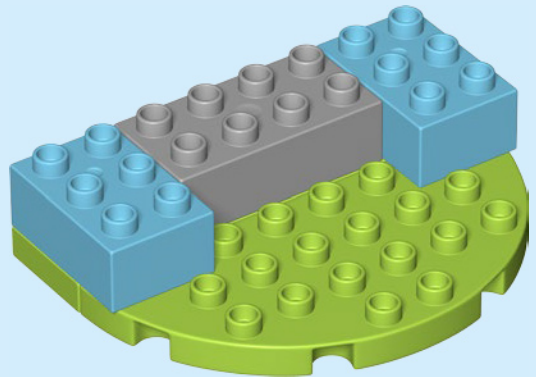



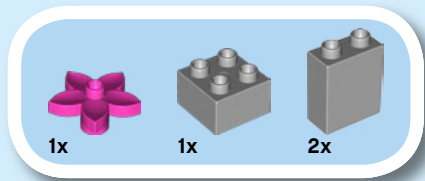

4

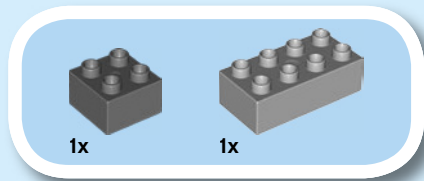

5

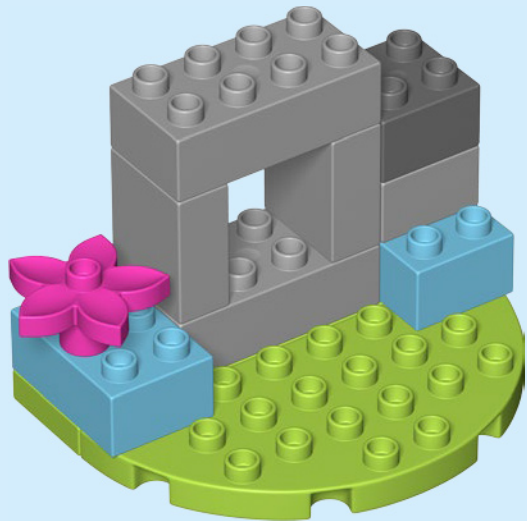
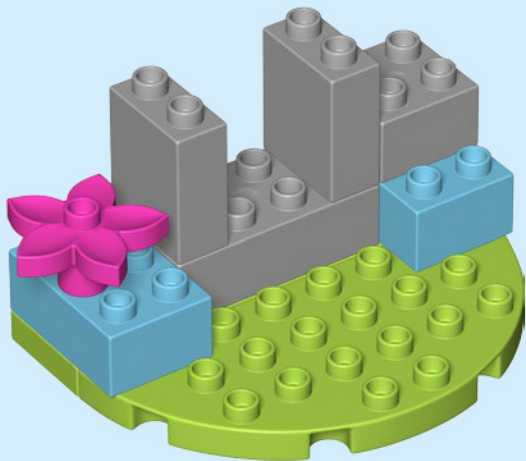

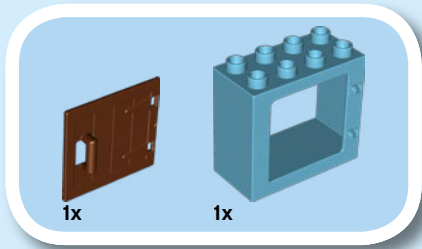

6

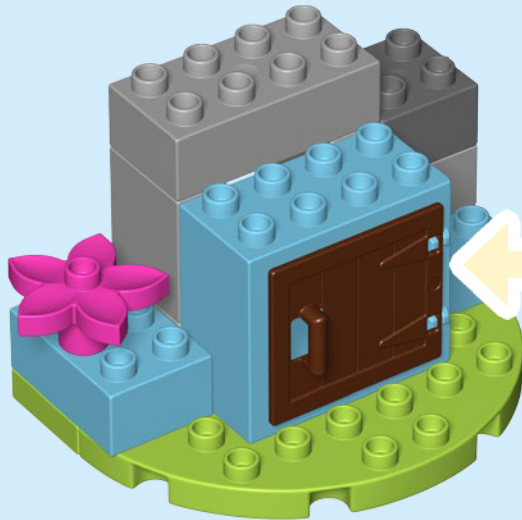
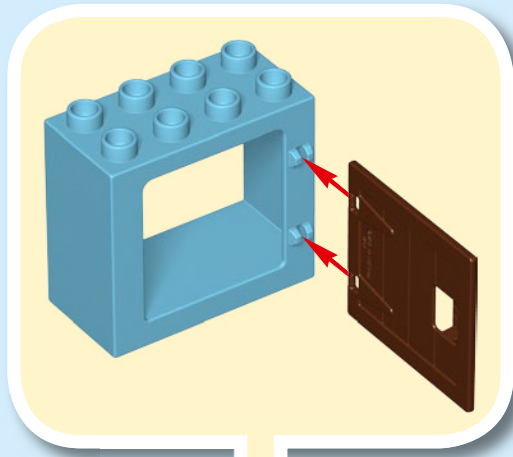



7

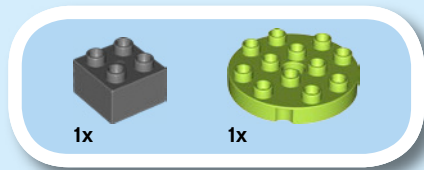
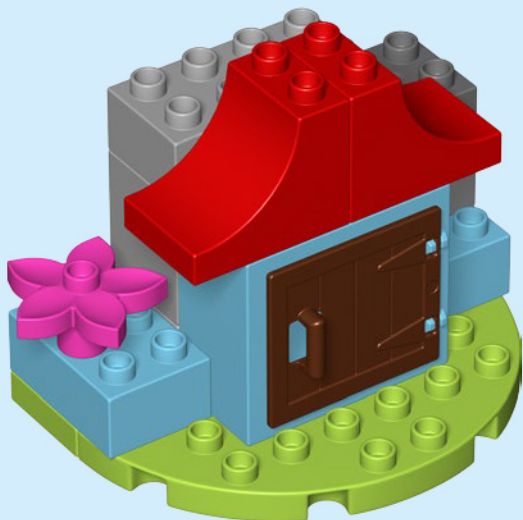

8

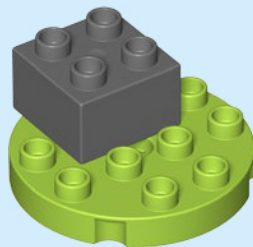

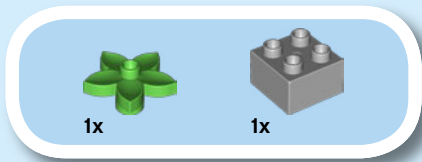

9

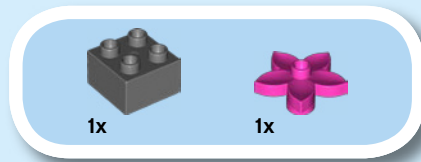
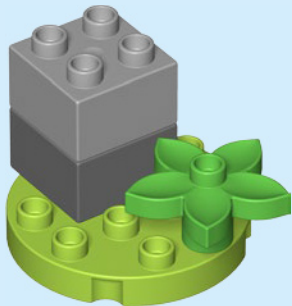

10

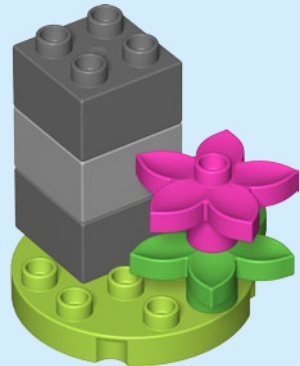

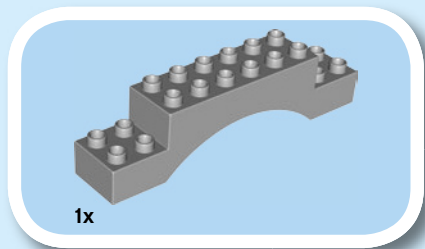

11

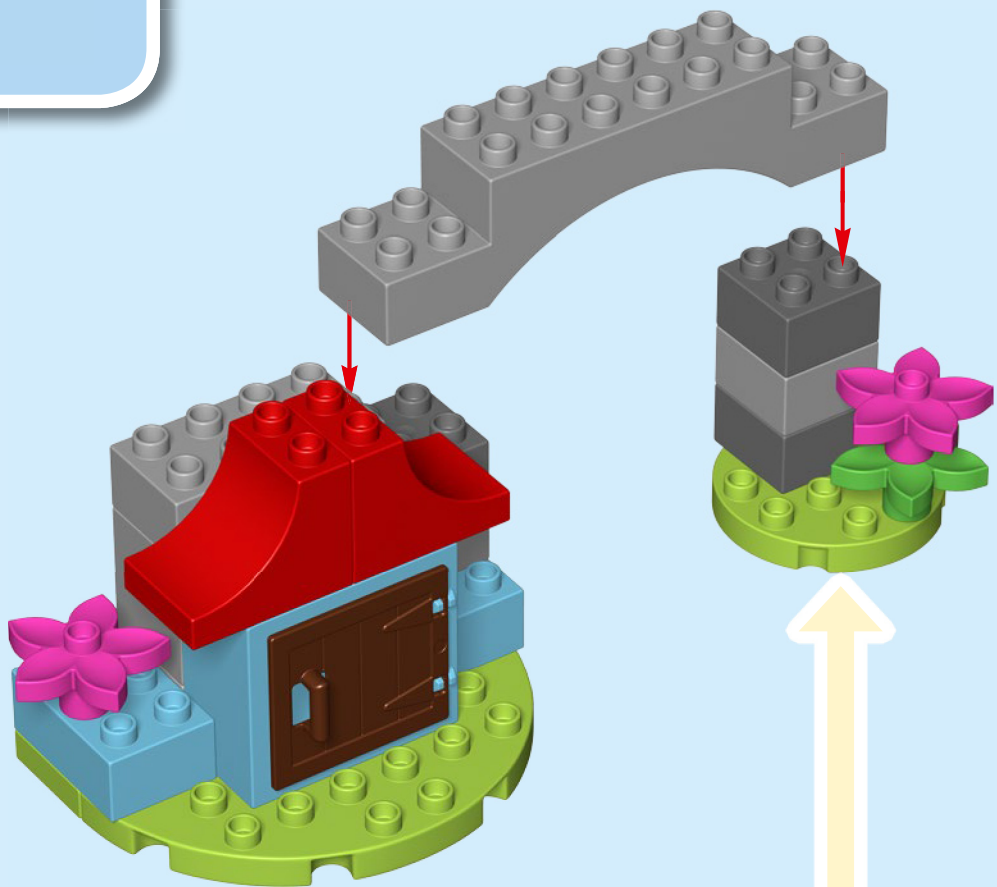



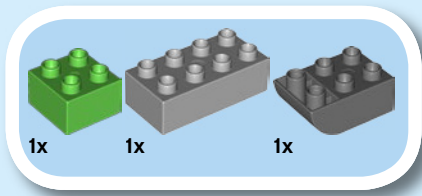

12

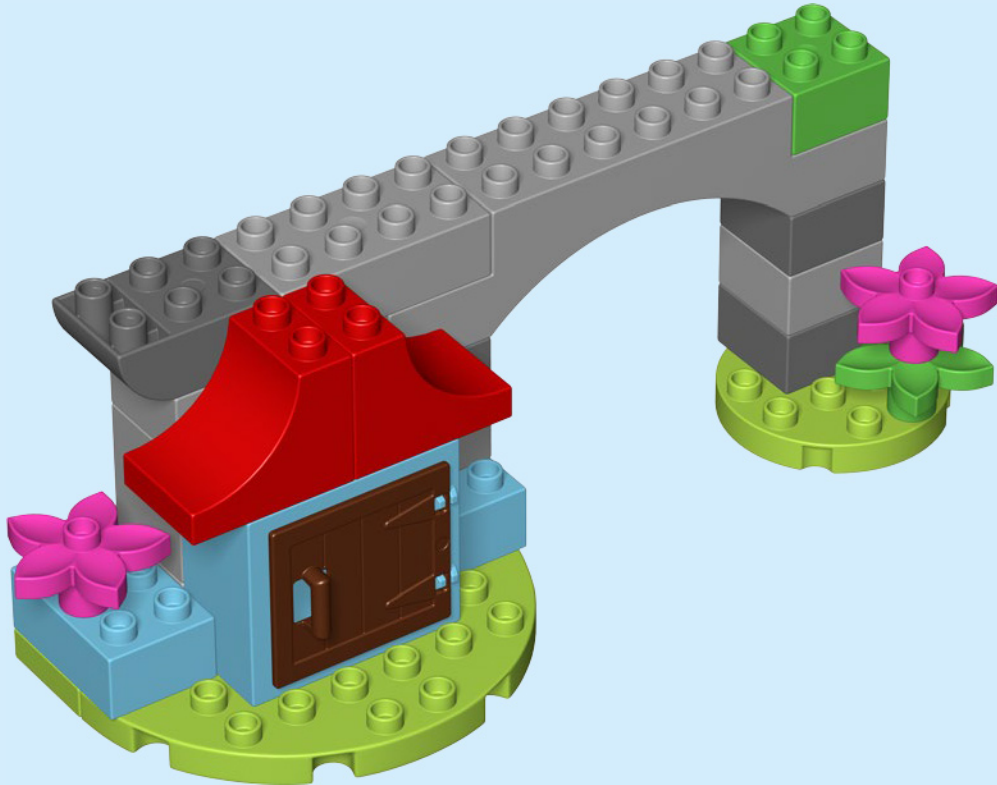

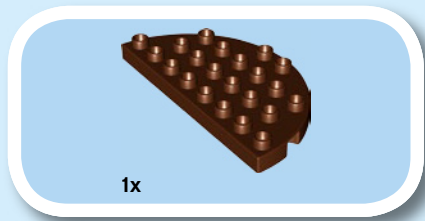

13

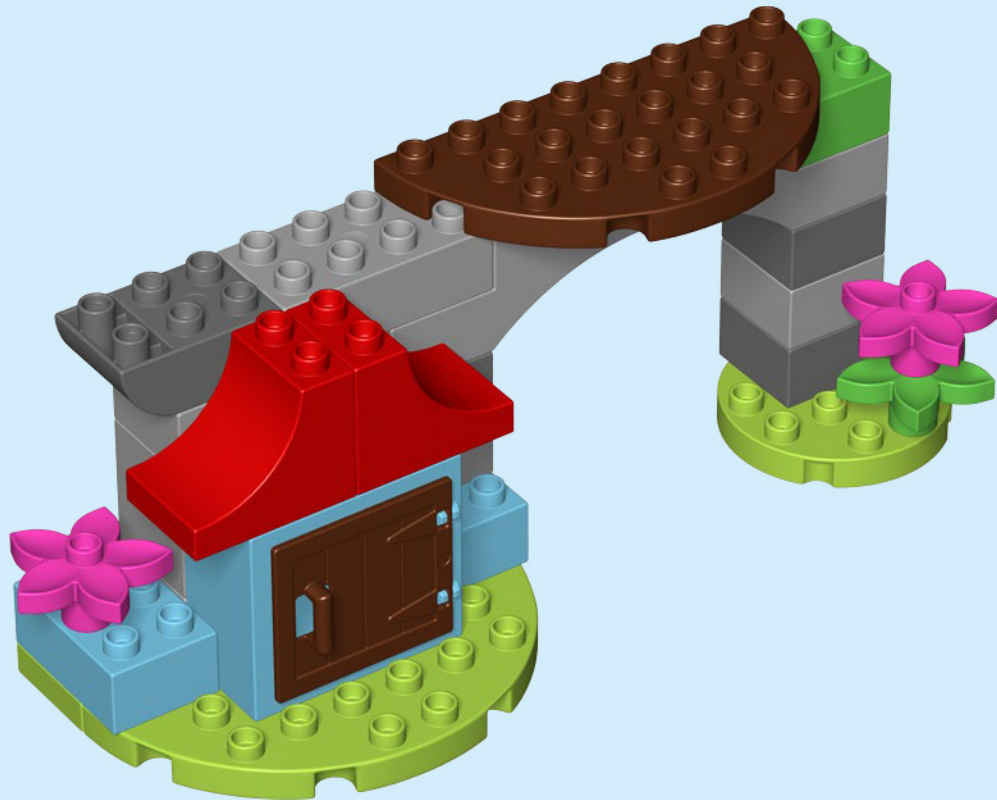

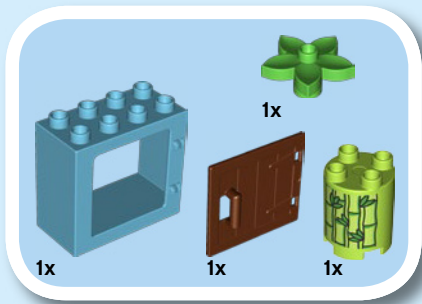

14

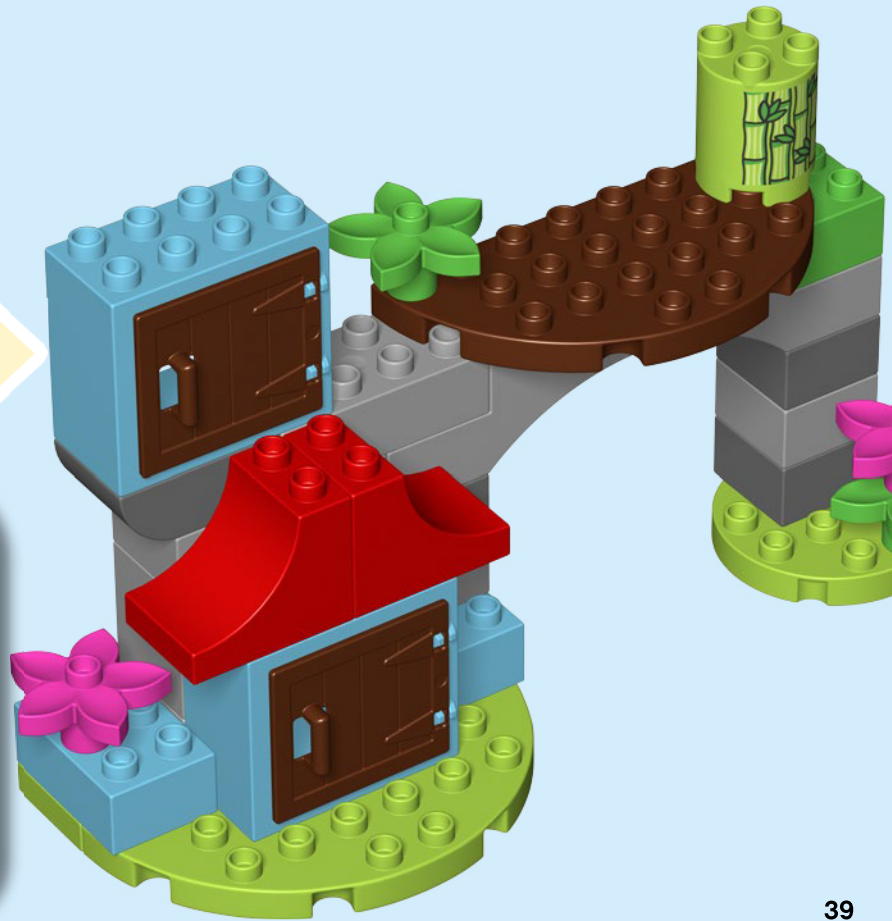
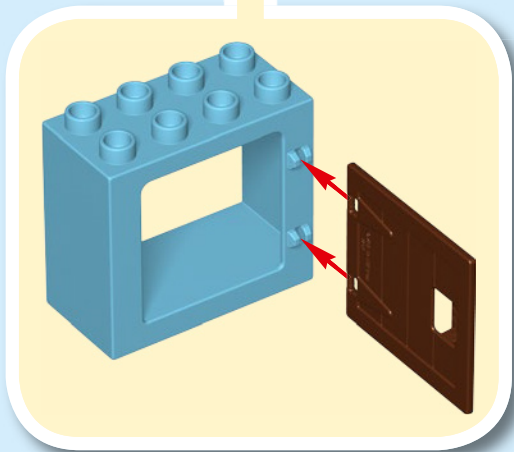

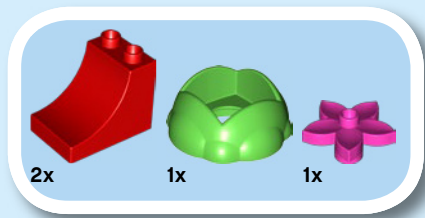

15

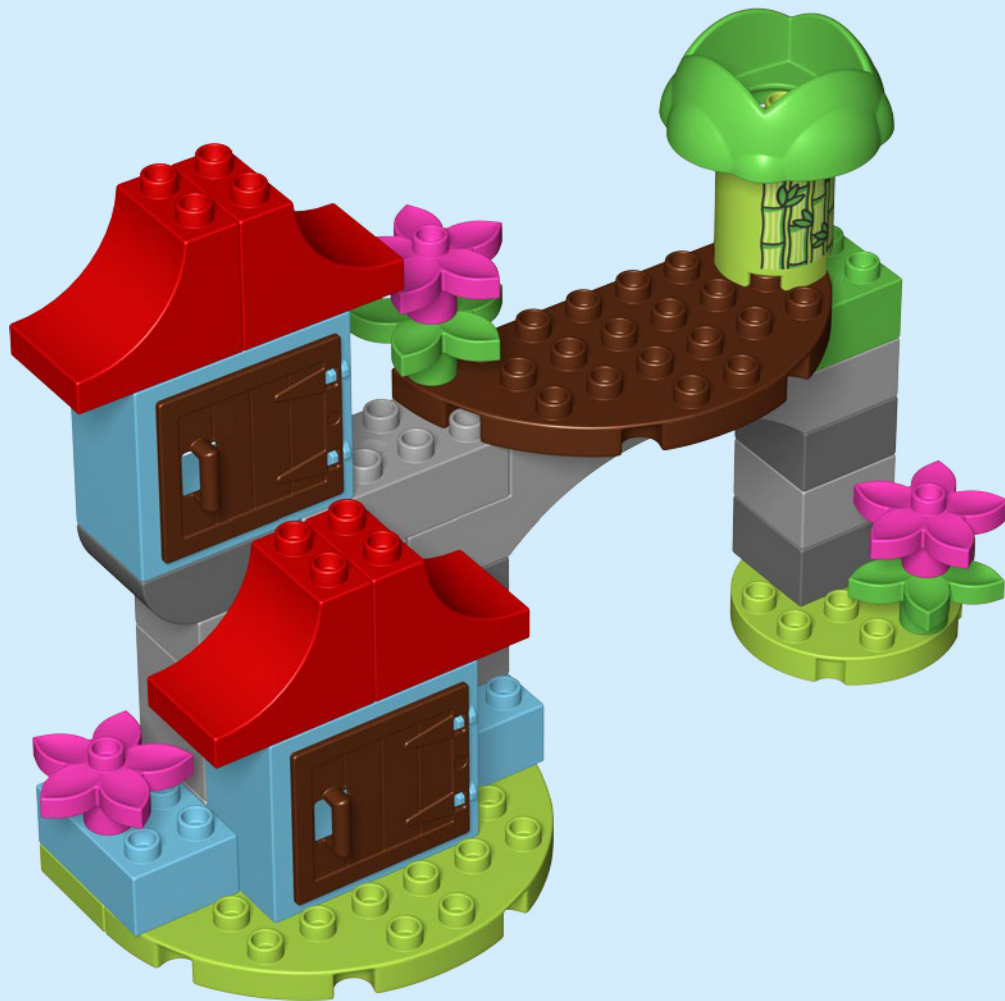

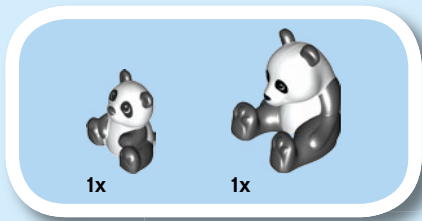

16





**LEGO**

**duplo**



**LEGO**

**duplo**



**SOCIAL &  
EMOTIONAL SKILLS**  
**APTITUDES SOCIALES  
ET ÉMOTIONNELLES**  
**HABILIDADES SOCIALES  
Y EMOCIONALES**

**IMAGINATION  
& CREATIVITY**  
**IMAGINATION  
ET CRÉATIVITÉ**  
**IMAGINACIÓN  
Y CREATIVIDAD**





# duplo

## LEGO® DUPLO® APPS APPLICATIONS



Our games are available for download for both Android and iOS.

Nos jeux peuvent être téléchargés sur les appareils Android et iOS.

Nuestros juegos están disponibles para dispositivos Android e iOS.



Customer Service  
Kundenservice  
Service Consommateurs  
Servicio Al Consumidor

LEGO.com/service or dial

					: 00800 5346 5555			
		: 1-800-422-5346						



**duplo**

**The fun continues!**  
**L'amusement continue !**  
**¡La diversión continúa!**

Ages/edades

**1½+**

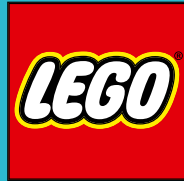

**4+**

Ages/edades



1x  
6255014

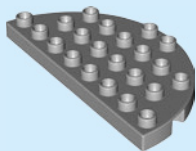

1x  
6187341

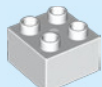

2x  
343701

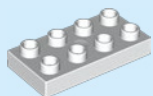

1x  
4250172

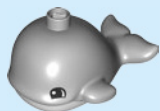

1x  
6262209

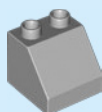

1x  
422193

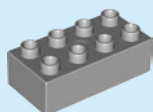

3x  
4211754

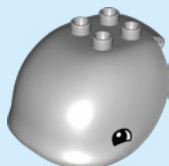

1x  
6129621

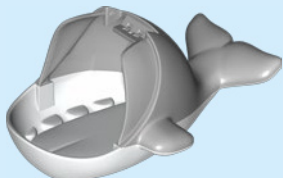

1x  
6129620

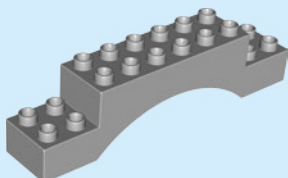

2x  
6223716

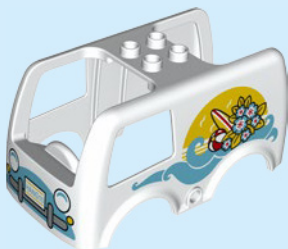

1x  
6262357

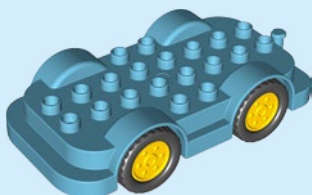

1x  
6265375

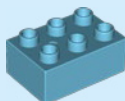

2x  
6138409

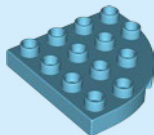

1x  
6184964

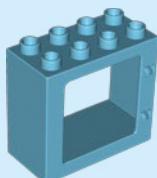

2x  
6137113

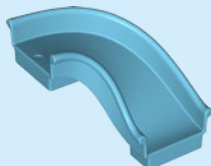

1x  
6215346

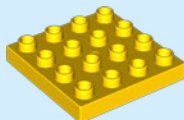

2x  
6151299

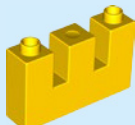

1x  
6250858

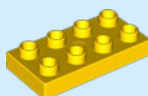

1x  
4160152



2x  
6030817



2x  
4100853



1x  
6265759



1x  
6265293



1x  
6263777



1x  
6259327



1x  
4100774

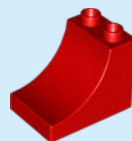

4x  
230121

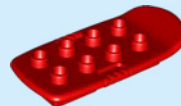

1x  
6145943



4x  
6033052



1x  
6094178



3x  
4158534



1x  
6094187



1x  
4158386



1x  
6263021

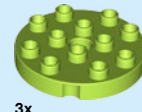

3x  
6263779

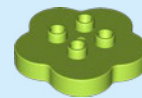

3x  
6054622

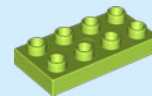

1x  
4185178

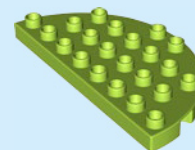

1x  
6208323

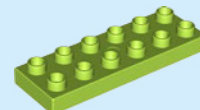

1x  
6249381

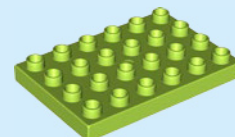

1x  
6208515

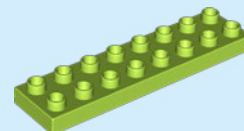

1x  
6138112





1x  
6187321



1x  
6201043



6x  
6094052



2x  
4121575



3x  
4168579

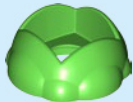

1x  
6263781

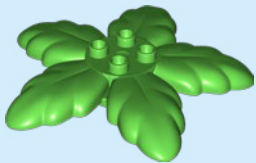

1x  
4121576

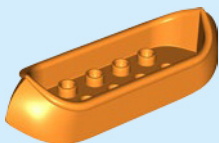

1x  
6263782



1x  
6028006



1x  
6095870

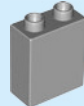

2x  
6184970

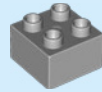

4x  
4266228



7x  
4210953



1x  
6252919



3x  
4224735



1x  
6210314

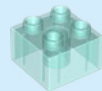

3x  
6201835



1x  
6259183



1x  
6104418



1x  
6262260

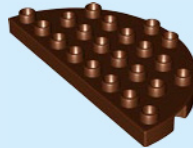

1x  
6214593



2x  
6016315



1x  
6266800



1x  
6194070



1x  
6268360



1x  
6264312



1x  
6273387



1x  
6266937



1x  
6265055



1x  
6264273



1x  
6266771



1x  
6262266



1x  
6266766



1x  
6263784

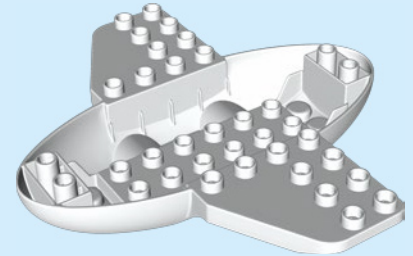

1x  
6093976

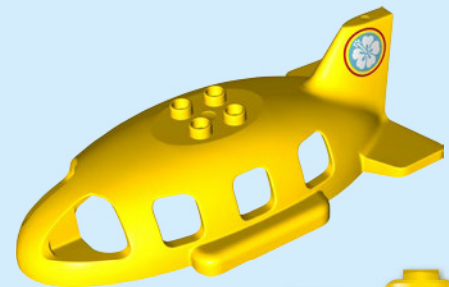

1x  
6214939

Customer Service

Kundenservice

Service Consommateurs

Servicio Al Consumidor

LEGO.com/service or dial



: 00800 5346 5555

: 1-800-422-5346



# win

Go to [www.LEGO.com/productfeedback](http://www.LEGO.com/productfeedback) and  
give us your short **feedback** about  
this LEGO® DUPLO® set for a chance  
to win a cool LEGO prize

Terms & Conditions apply



## LEGO.com/productfeedback

### GEWINNE

Erzähle uns auf  
[www.LEGO.com/productfeedback](http://www.LEGO.com/productfeedback)

etwas über die Erfahrungen, die du mit  
diesem LEGO® Set gemacht hast, und  
sichere dir die Chance auf einen coolen  
LEGO Preis!

Es gelten die Teilnahmebedingungen

### GAGNE

Rends-toi sur  
[www.LEGO.com/productfeedback](http://www.LEGO.com/productfeedback)

et donne-nous quelques commentaires  
sur ce produit LEGO® pour avoir une  
chance de gagner un prix LEGO !

Voir Conditions Générales

### GANAN

Visita  
[www.LEGO.com/productfeedback](http://www.LEGO.com/productfeedback)

y envíanos tu opinión acerca de este set  
LEGO®. ¡Participarás en el sorteo de un  
premio LEGO!

Términos y Condiciones aplicables

### 获取奖品

登录  
[www.LEGO.com/productfeedback](http://www.LEGO.com/productfeedback)

给出关于此乐高®套装的简短反馈，  
就有机会获得炫酷乐高奖品

《条款及条件》适用

LEGO, the LEGO logo, DUPLO and the DUPLO logo are trademarks of the/son des marques de commerce du/son marcas registradas de LEGO Group. ©2019 The LEGO Group.

6296225