



Architecture

21033

Chicago

Illinois, USA

Chicago

Illinois, États-Unis

Chicago

Illinois (EE.UU.)



LEGO.com/architecture/booklet

Chicago

Known as the Windy City, Chicago rises up from the shores of Lake Michigan to present the perfect image of a modern American metropolis.

As the 'Gateway to the West' and the starting point of the famous Route 66, Chicago became America's fastest growing city as the country expanded westward. It is now

the third largest city in the USA, with 77 distinct districts and a population of nearly three million people.

History and architecture have always gone hand-in-hand in Chicago. The Great Fire of 1871 forced the city to completely reinvent itself and provided the foundation for the vibrant modern skyline we see today.

["It is hopeless for the occasional visitor to try to keep up with Chicago. She outgrows his prophecies faster than he can make them."]

Mark Twain





Willis Tower™

Located in the heart of the city, the 110-story Willis Tower was completed in 1974 at a cost of \$175 million. The tower was the first to use the “bundled-tubular” construction principle, where nine independent sections were joined together to provide extra stability against Chicago’s high winds. The Willis Tower has more than 16,000 bronze-tinted windows and 28 acres (11.3 ha) of black aluminum cladding or “skin”. The Ledge, the famous glass balcony that extends from the tower’s observation deck, leaves visitors standing 1,353 ft. (412 m) in the air.



Cloud Gate

Designed by British artist Anish Kapoor, the 110-ton (99,790.3 kg) elliptical sculpture is forged from a seamless series of highly polished stainless steel plates, which reflect Chicago's famous skyline and the clouds above. Inspired by liquid mercury, the sculpture is among the largest of its kind in the world, measuring 66 ft. (20 m) long by 33 ft. (10 m) high.



© Patrick Pyszka



DuSable Bridge

The DuSable Bridge is where the famous Michigan Avenue crosses the Chicago River and is both a beautiful work of art and a great civil engineering feat. Completed in 1920, the Beaux Arts style bridge was designed to resemble the

Alexander III Bridge over the Seine in Paris. The double-deck bridge with highways on both levels opens up to allow boats to pass underneath.



The Wrigley Building™

Standing on a triangular piece of land at the northwest corner of Michigan Avenue and the Chicago River, The Wrigley Building has been an iconic part of the city's skyline for over 95 years. The Wrigley Building consists of two towers, completed in 1921 and 1924, connected by walkways at the 3rd and 14th floors. The Wrigley Building's architecture combines French Renaissance and Spanish Revival styles, but adds a unique American twist.

The Wrigley Building is clad in more than 250,000 terra cotta tiles of more than 500 unique designs. The tiles are six different colors, ranging from blue-white at the bottom to creamy white at the top, to enhance a sunlit appearance.





Big Red



This simple, rectangular International Style structure was completed in 1973 and is famous for its eye-catching red color. The 600 ft. (183 m) tall building is also renowned for using its lights and windows to display messages during festive and sporting events. A computer program is used to calculate which windows need to be activated to create the proper message.

John Hancock Center



Completed in 1970, the distinctive 100-story John Hancock Center reaches 1,127 ft. (343.5 m) into the city skyline. Named after an insurance company and original tenant, the tower is known locally in Chicago as “Big John”. A band of white lights adorn the top of the building and are visible throughout Chicago at night. The color of these lights changes to mark different holidays such as Christmas (red & green), Valentine’s Day (red & white) and St Patrick’s Day (green).



Chicago

Surnommée « ville des vents », Chicago s'élève sur les rives du lac Michigan, présentant l'image parfaite d'une métropole américaine moderne.

En tant que « porte vers l'ouest » et point de départ de la célèbre Route 66, Chicago devint la ville américaine à la croissance la plus rapide lorsque le pays commença à s'étendre vers l'ouest. C'est aujourd'hui la troisième plus

grande ville des États-Unis avec 77 districts et une population de près de 3 millions d'habitants.

L'histoire et l'architecture sont toujours allées de pair à Chicago. Le grand incendie de 1871 a contraint la ville à se réinventer complètement et a fourni la base du paysage moderne et dynamique que nous connaissons aujourd'hui.

[« Il n'y a aucun espoir pour le visiteur occasionnel de tenter d'évoluer à la cadence de Chicago. La ville accomplit ses prophéties plus vite qu'il ne peut les énoncer. »]

Mark Twain





La tour Willis™

Située au cœur de la ville, la tour Willis, haute de 110 étages, a été achevée en 1974 et a coûté 175 millions de dollars. Cette tour a été la première à utiliser le principe de « construction tubulaire groupée ». Neuf sections indépendantes ont été reliées entre elles pour garantir une stabilité supplémentaire contre les vents forts de Chicago. La tour Willis compte plus de 16 000 fenêtres teintées de bronze et 11,3 ha de parement ou « habillage » en aluminium noir. Le Ledge, célèbre balcon en verre qui s'étend depuis la plate-forme d'observation de la tour, permet aux visiteurs de se tenir à 412 mètres dans les airs.



La Cloud Gate

Créée par l'artiste britannique Anish Kapoor, cette structure elliptique de 99 790,3 kg est forgée dans une série de plaques d'acier inoxydable hautement polies qui reflètent le célèbre paysage de Chicago et les nuages au-dessus. Inspirée par le mercure liquide, cette sculpture figure parmi les plus grandes de ce genre au monde, mesurant 20 mètres de long et 10 mètres de haut.



© Patrick Pyszka





Le pont DuSable

Le pont DuSable est l'endroit où la célèbre avenue Michigan traverse la rivière Chicago. Il constitue une superbe œuvre d'art et une grande réussite de génie civil. Terminé en 1920, ce pont de style Beaux-Arts fut conçu de façon à ressembler

au pont Alexandre III sur la Seine, à Paris. Le pont compte deux étages avec des routes sur les deux niveaux et s'ouvre pour permettre aux bateaux de passer dessous.



Le Wrigley Building™

Situé sur un terrain triangulaire au coin nord-ouest de l'avenue Michigan et de la rivière Chicago, le Wrigley Building est un emblème dans le paysage de la ville depuis plus de 95 ans. Le Wrigley Building est composé de deux tours, terminées en 1921 et en 1924, reliées par des passerelles aux 3^e et 14^e étages. L'architecture du Wrigley Building combine la Renaissance française et le Renouveau espagnol, mais ajoute une touche américaine unique.

Le Wrigley Building est revêtu de plus de 250 000 plaques en terre cuite avec plus de 500 motifs uniques. Les plaques sont de six teintes différentes allant du blanc bleuté dans le bas au blanc cassé dans le haut, pour renforcer l'effet de luminosité.





Big Red



Cette structure simple et rectangulaire de style international fut terminée en 1973. Elle est célèbre pour sa couleur rouge distinctive. La tour de 183 m de haut est aussi célèbre pour utiliser ses lumières et ses fenêtres afin de transmettre des messages pendant les événements festifs et sportifs. Un programme informatique calcule quelles fenêtres doivent être illuminées pour créer le message voulu.

John Hancock Center



Terminé en 1970, le John Hancock Center, très caractéristique, s'élève à 343,5 m dans le paysage de la ville. Baptisée du nom de la compagnie d'assurance qui l'occupait à l'origine, cette tour est connue localement à Chicago sous le nom de « Big John ». Une bande de lumières blanches orne le haut du bâtiment et est visible dans tout Chicago la nuit. La couleur de ces lumières change pour marquer différentes fêtes telles que Noël (rouge et vert), la Saint-Valentin (rouge et blanc) ou la Saint-Patrick (vert).



Chicago

Chicago, conocida como «la ciudad del viento», se alza a orillas del lago Michigan y representa el paradigma moderno de la metrópoli americana.

Como puerta de entrada a la mitad occidental de Estados Unidos y punto de partida de la famosa Ruta 66, Chicago se convirtió en la ciudad de más rápido crecimiento a medida que el país se expandía hacia el oeste. En la actualidad, es

la tercera ciudad más grande de Estados Unidos, con 77 distritos diferentes y una población de casi tres millones de habitantes.

La historia y la arquitectura han ido siempre de la mano en Chicago. El Gran Incendio de 1871 obligó a la ciudad a reinventarse por completo, y fue la base del moderno y vibrante horizonte que hoy conocemos.

[*«Para el visitante ocasional, es imposible tratar de seguir el ritmo de Chicago. Es una ciudad que cumple sus profecías antes de que las formule».*]

Mark Twain





Torre Willis Tower™

Ubicada en el corazón de la ciudad, esta torre de 110 plantas fue completada en 1974 y su coste fue de 175 millones de dólares. Fue la primera en aplicar el principio de construcción de «agrupamiento tubular», al reunir nueve secciones independientes para proporcionar estabilidad adicional frente a los fuertes vientos de Chicago. En la torre Willis Tower hay más de 16.000 ventanas tintadas en bronce y 113.000 m² de revestimiento o «piel» de aluminio negro. The Ledge, el famoso balcón acristalado que sobresale del mirador de la torre, permite a los visitantes contemplar 412 m de altura a sus pies.



Cloud Gate

Diseñada por el artista británico Anish Kapoor, esta escultura elíptica de 99.790,3 kg está forjada a partir de una serie de planchas de acero inoxidable extremadamente pulido, soldadas de forma imperceptible para reflejar el famoso horizonte de Chicago y las nubes que lo sobrevuelan. Inspirada en el mercurio líquido, se trata de una de las esculturas más grandes del mundo de su clase, con 20 m de longitud y 10 m de altura.



© Patrick Pyszka





Puente DuSable

El Puente DuSable es el lugar por el que la popular avenida Michigan cruza el río Chicago y representa tanto una bella obra de arte como un gran logro de la ingeniería civil. Completado en 1920, este puente, de estilo Beaux Arts, se

diseñó a semejanza del Puente Alejandro III sobre el río Sena, en París. Su doble cubierta, con calzada en ambos niveles, se abre para permitir el paso de las embarcaciones.



Edificio Wrigley

Alzándose en un terreno triangular situado en el extremo noroccidental de la avenida Michigan, junto al río Chicago, el edificio Wrigley ha sido una emblemática pieza del horizonte de la ciudad durante más de 95 años. Consta de dos torres, completadas en 1921 y 1924, conectadas por pasarelas en las plantas 3 y 14. La arquitectura del edificio Wrigley combina el estilo renacentista francés con la arquitectura neocolonial española, pero incorpora un singular toque estadounidense.

El edificio Wrigley está cubierto por más de 250.000 baldosas de terracota con más de 500 diseños distintos. Las baldosas poseen seis colores diferentes que van desde el blanco-azul de la base hasta el blanco crema de la parte superior para potenciar la sensación de encontrarse iluminadas por el sol.





Edificio Big Red



Esta sencilla estructura de estilo internacional se completó en 1973 y es famosa por su llamativo color rojo. Con sus 183 m de altura, su popularidad también se debe al uso de las luces y las ventanas para mostrar mensajes durante los acontecimientos festivos y deportivos. Un programa de computadora se encarga de calcular qué ventanas se deben activar para crear el mensaje deseado.

Centro John Hancock



Completado en 1970, este destacado edificio de 100 plantas alcanza los 343,5 m de altura en el horizonte de la ciudad. Bautizado con el nombre de la aseguradora que fue su inquilino original, los habitantes de Chicago conocen la torre como «Big John». La parte superior del edificio está adornada por una franja de luces blancas que son visibles en todo Chicago por la noche. El color de estas luces cambia para señalar distintos días festivos: la Navidad (rojo y verde); el Día de San Valentín (rojo y blanco); y el Día de San Patricio (verde).



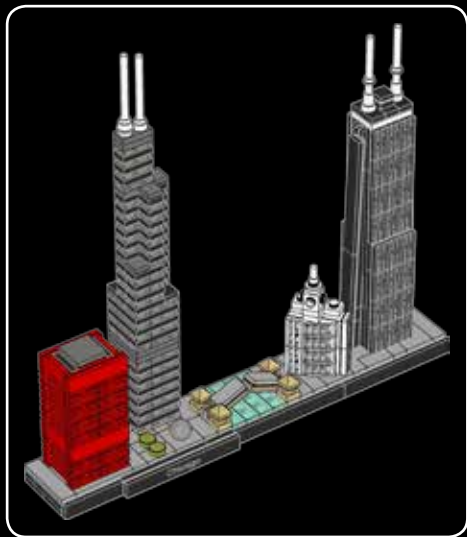

1x

1

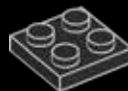



2

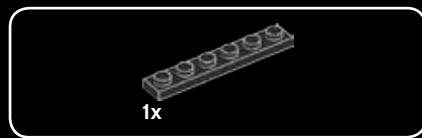
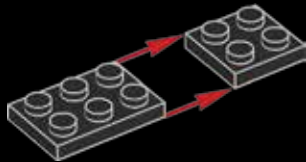

3

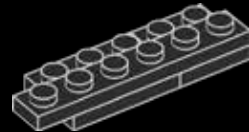



4

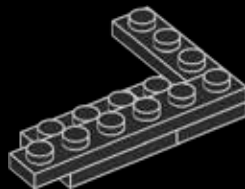



5

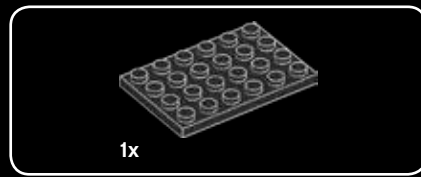
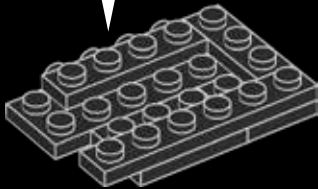
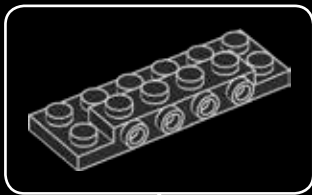

6

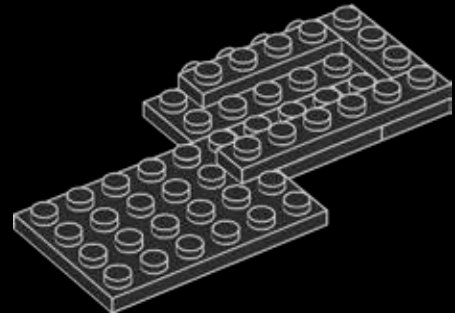



1x

7

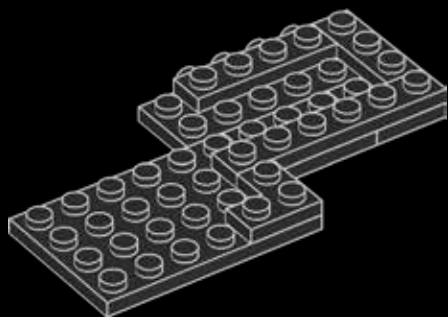

1x

8

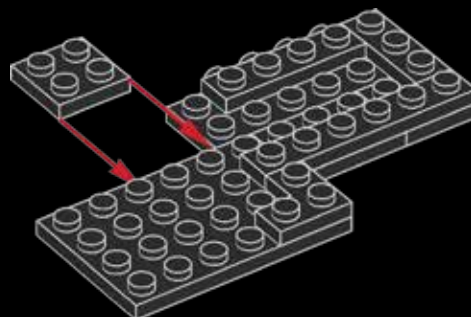



9

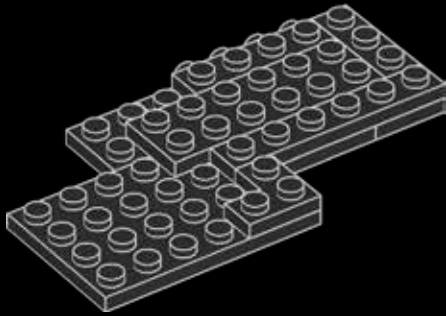

10

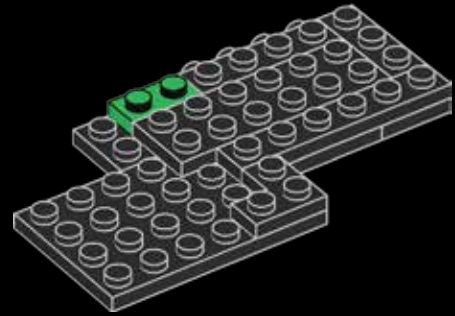



1x

11

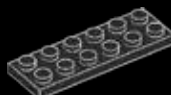
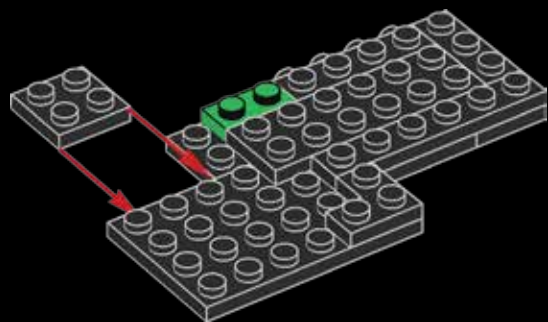

1x

12

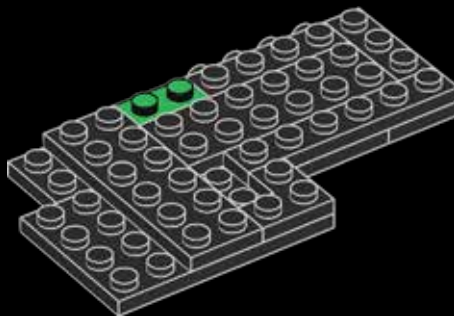



13

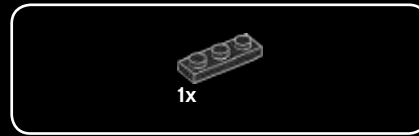
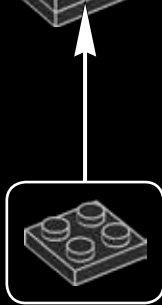
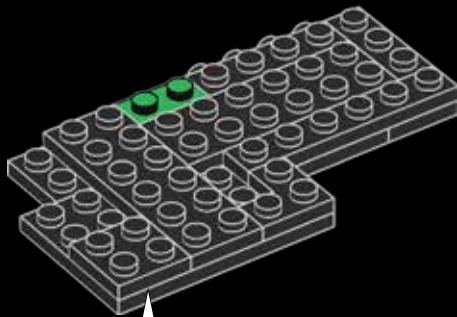

14

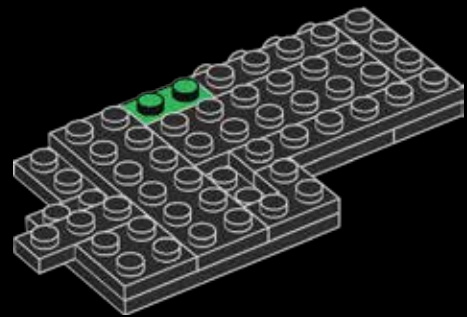

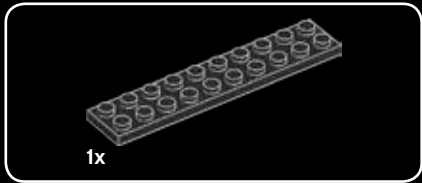

15

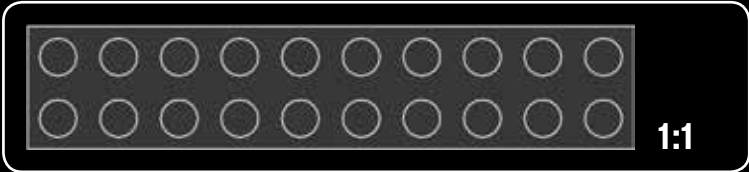
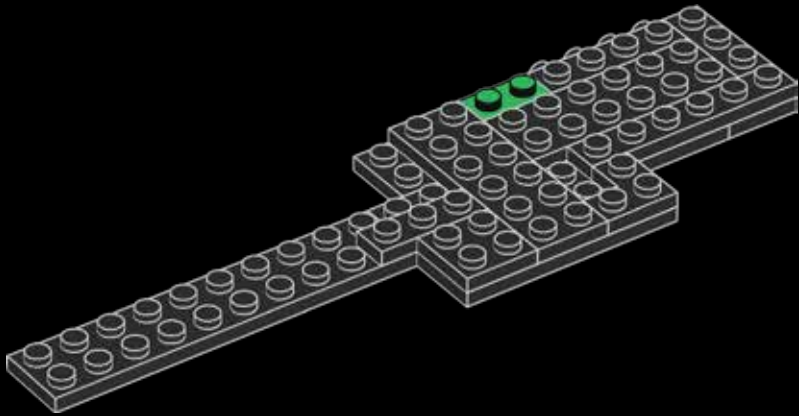

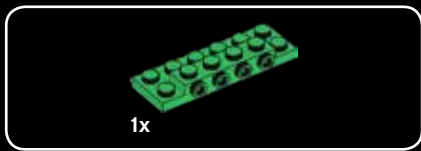

16

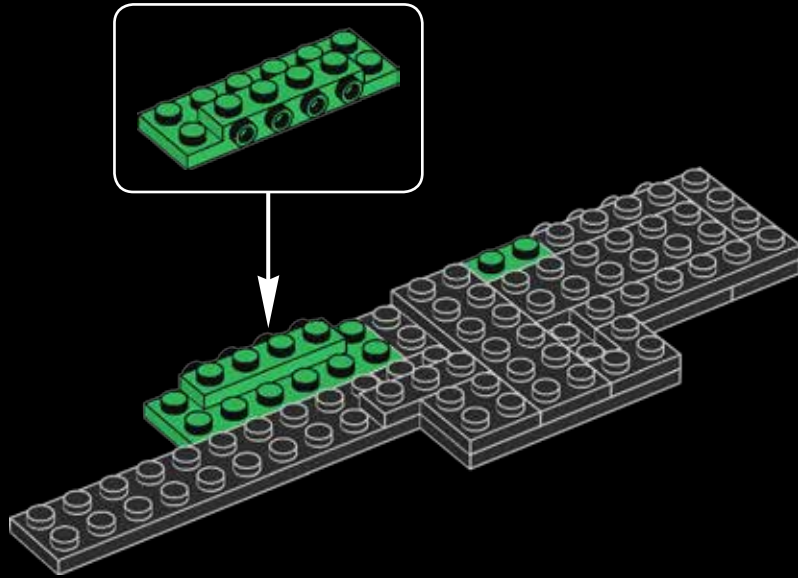

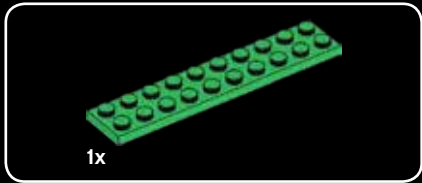

17

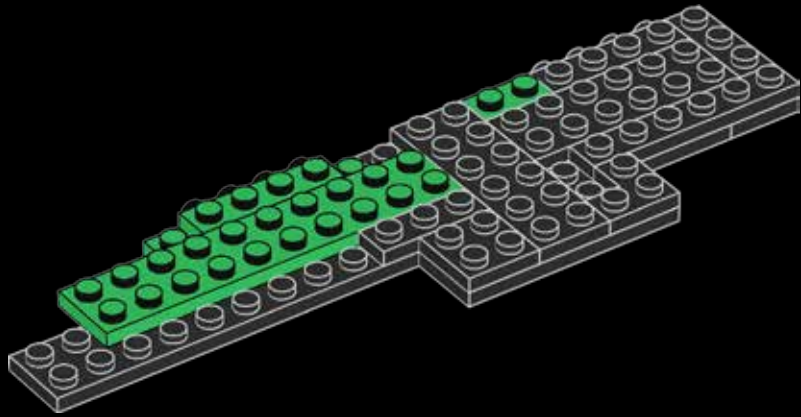



18

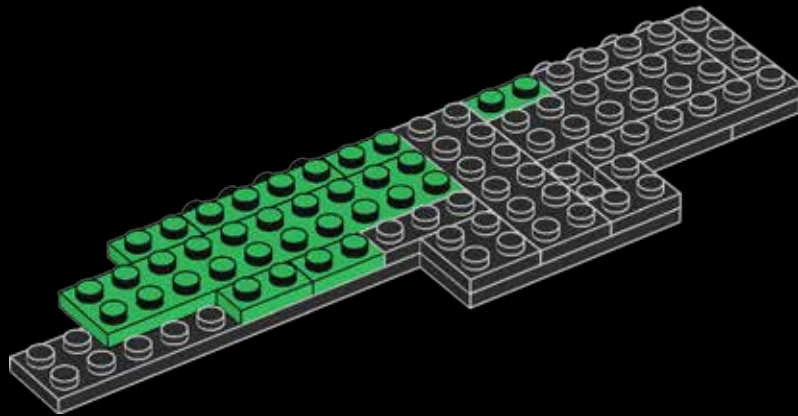



1x

19

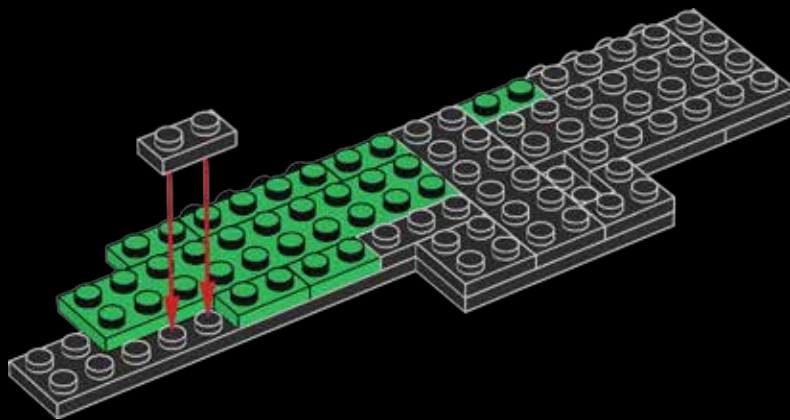



20

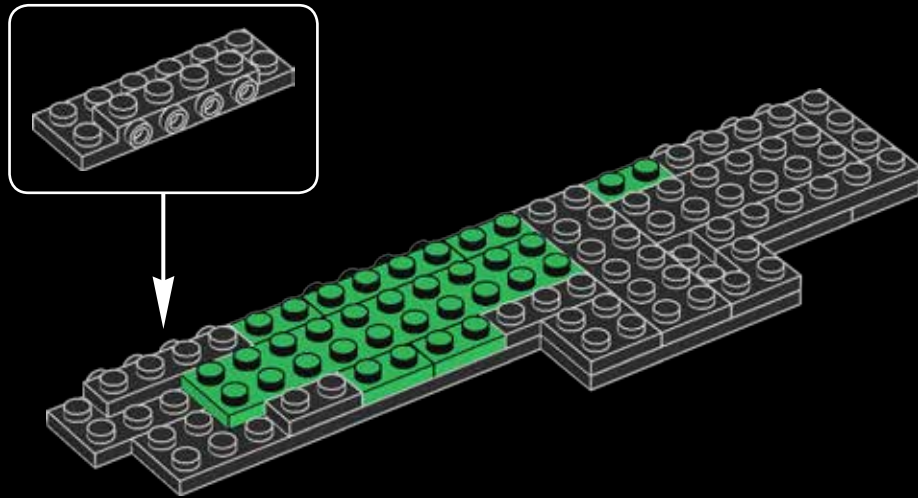



1x

21

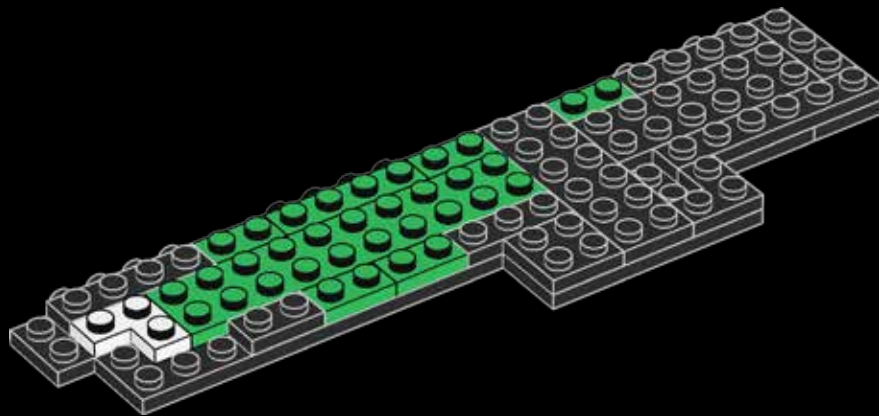



22

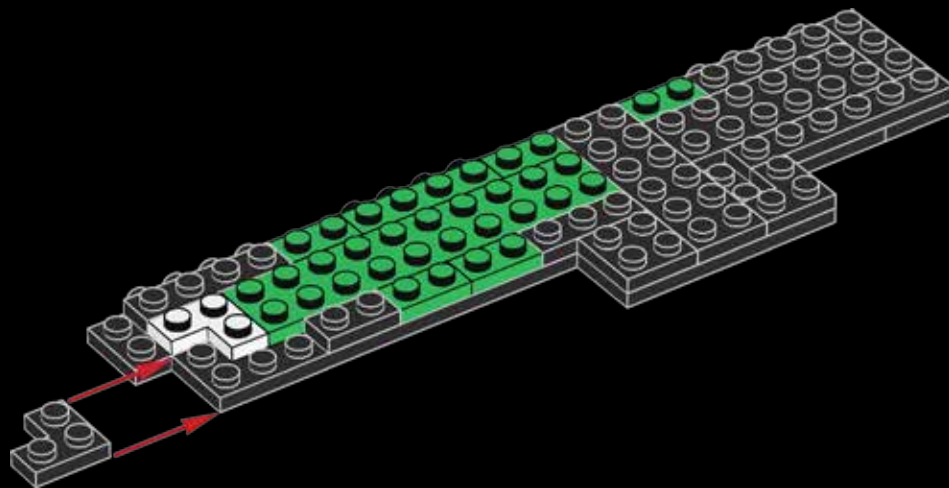

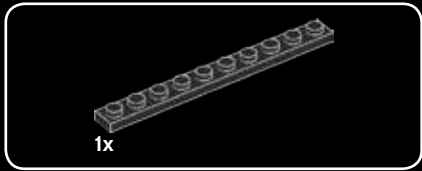

23

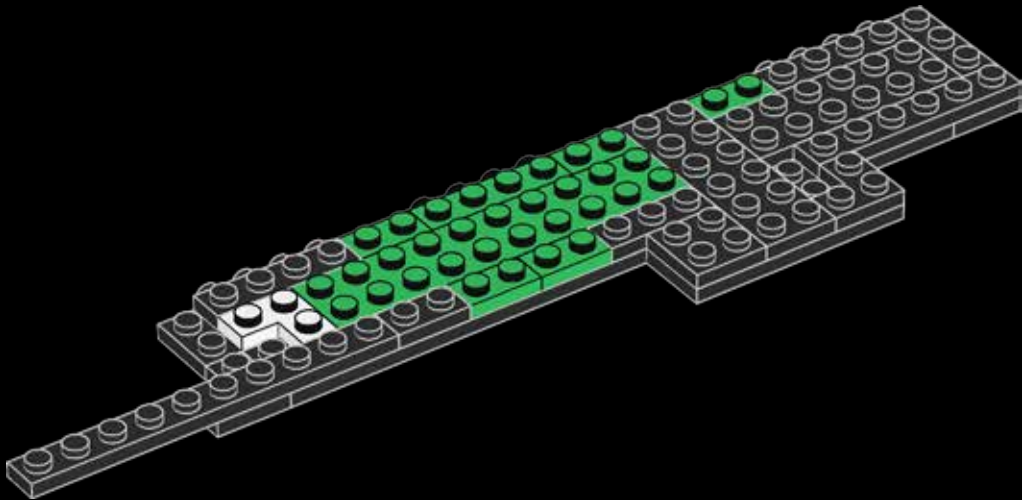



24

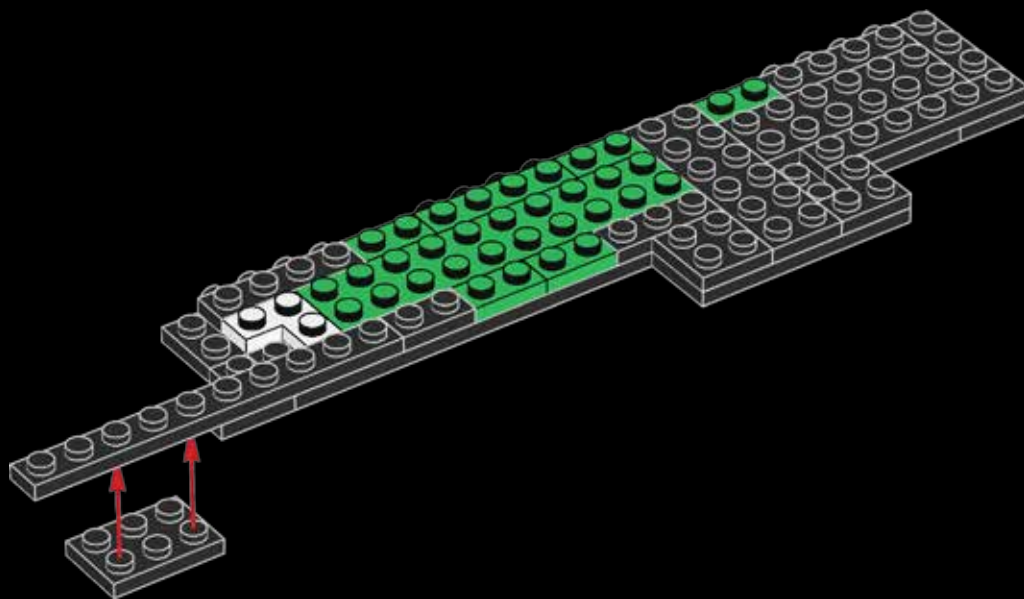



1x

25

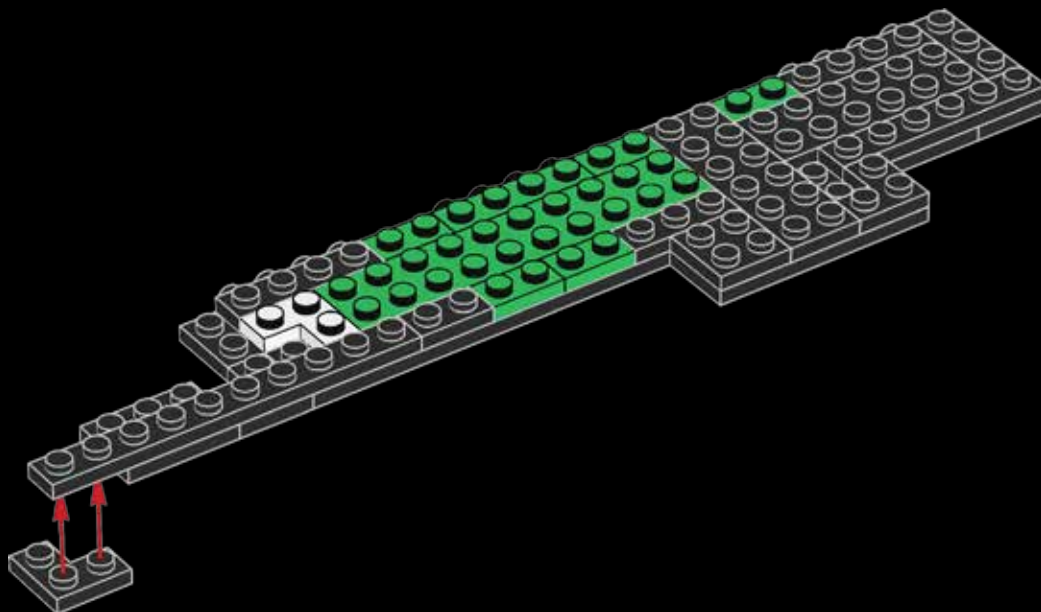



26

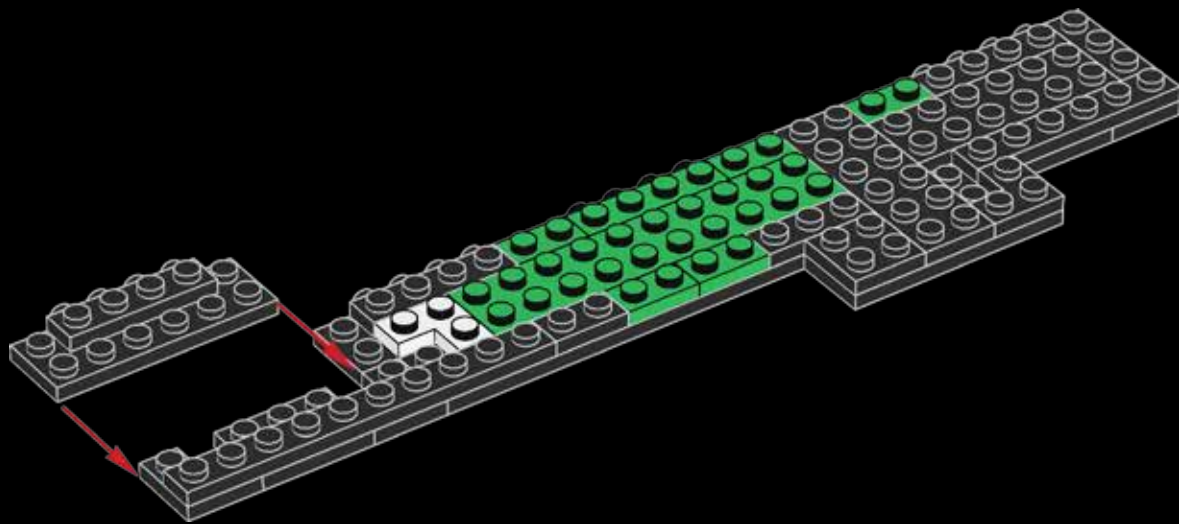



1x

27

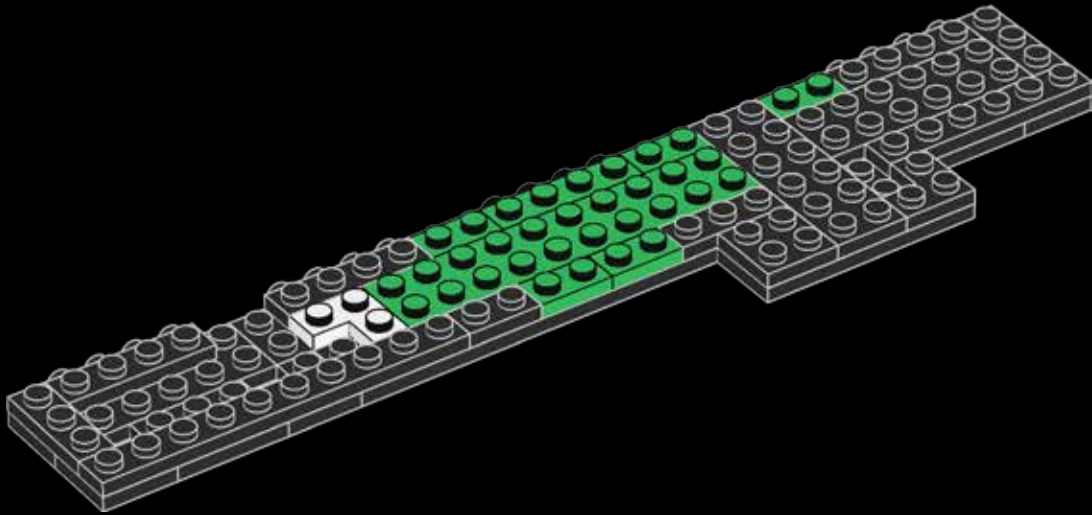



28

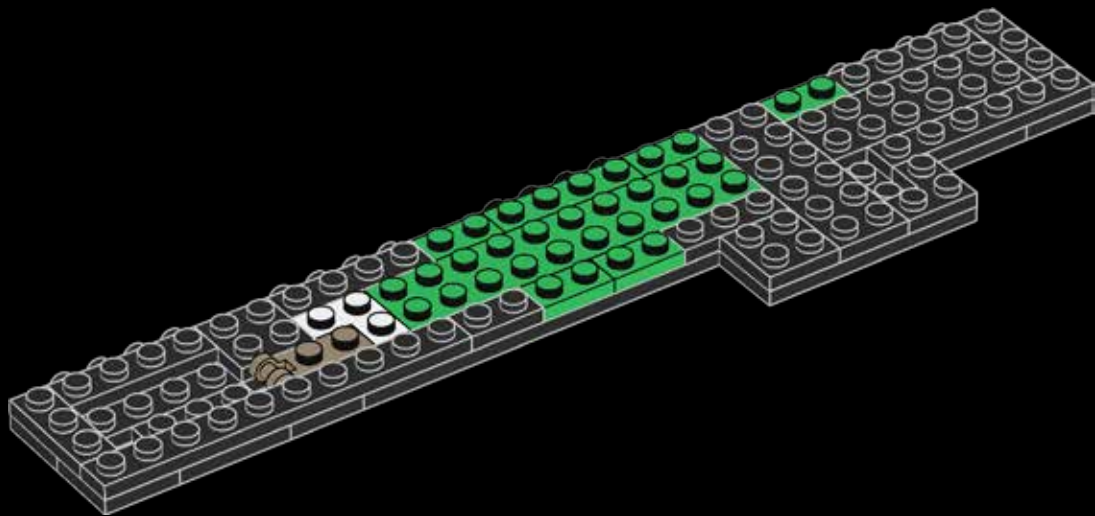



29

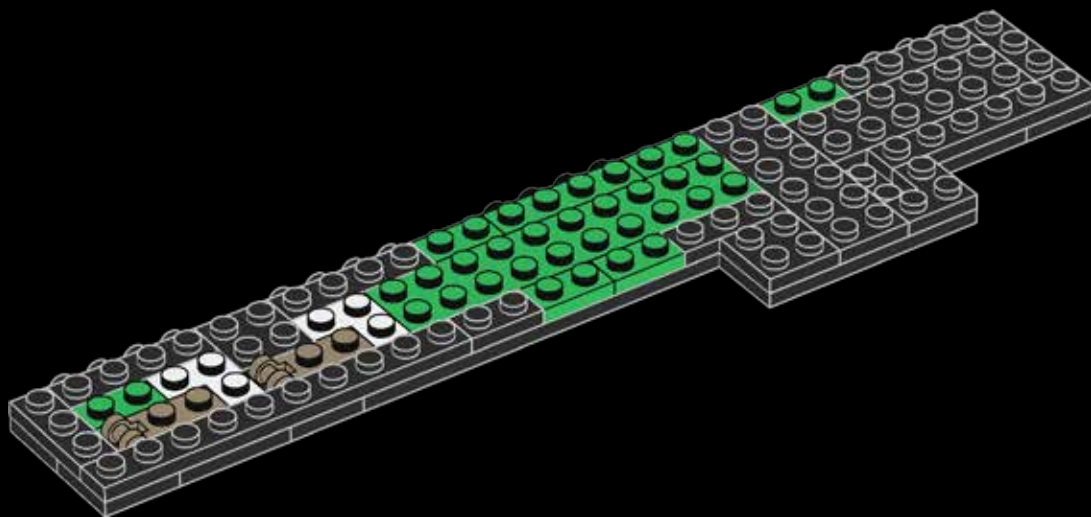

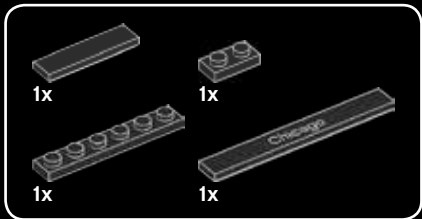

30

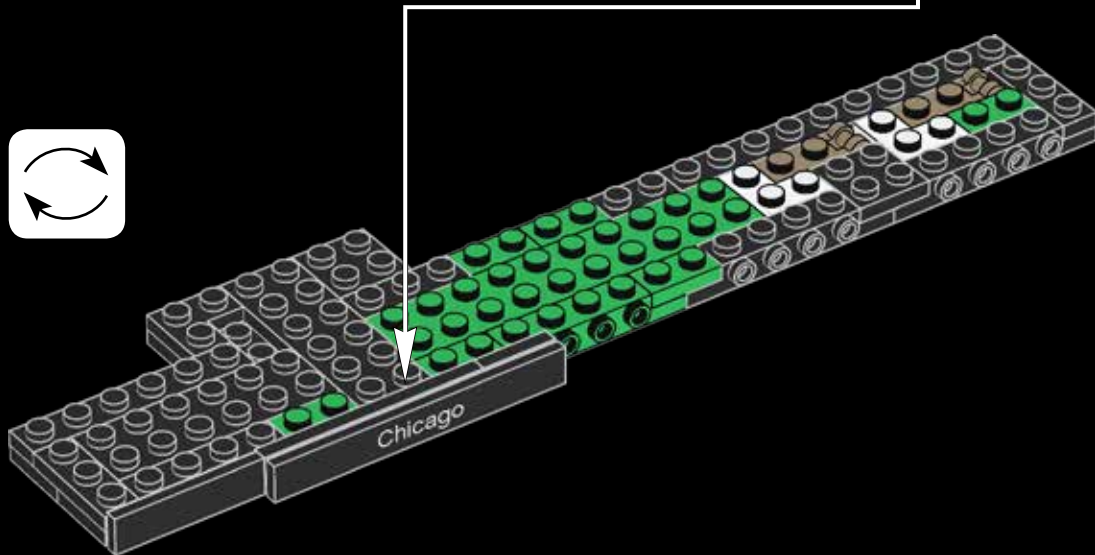
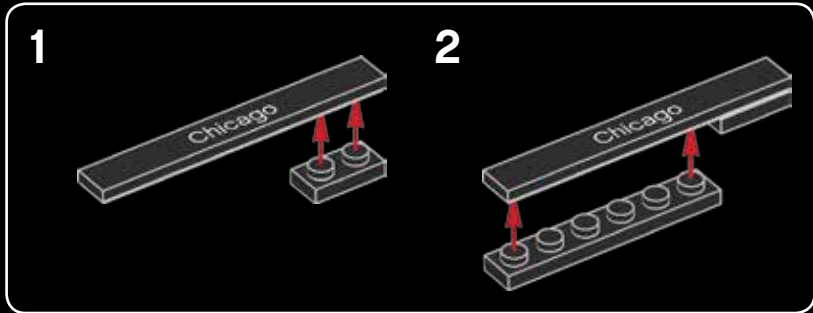

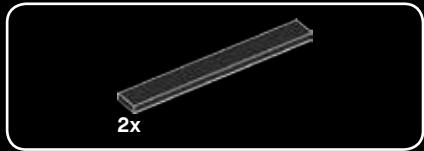

31

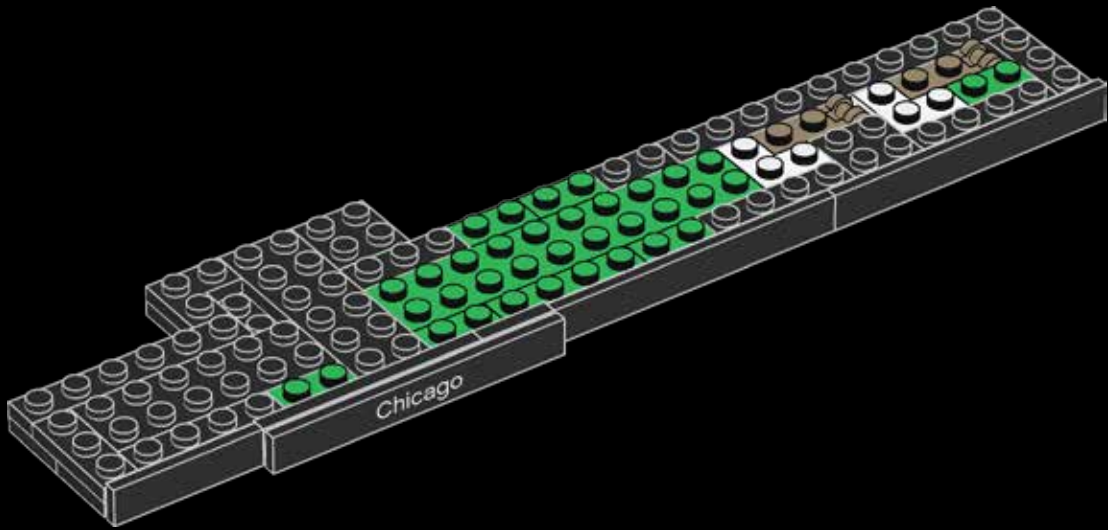

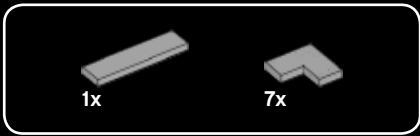

32

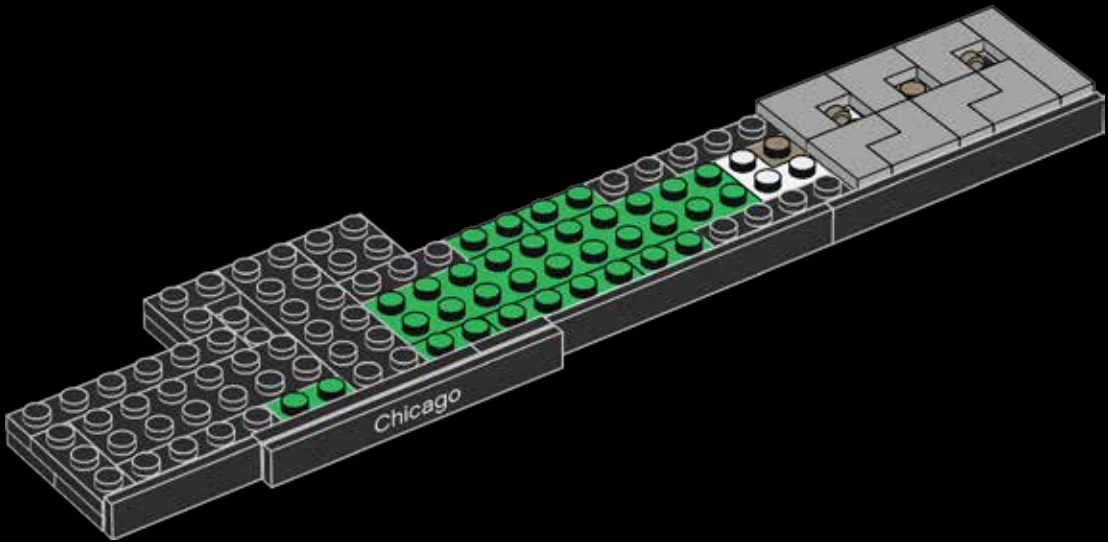

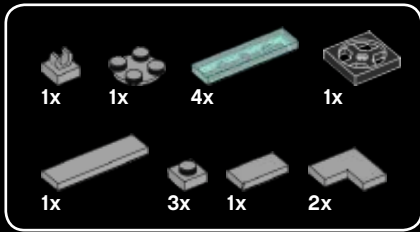

33

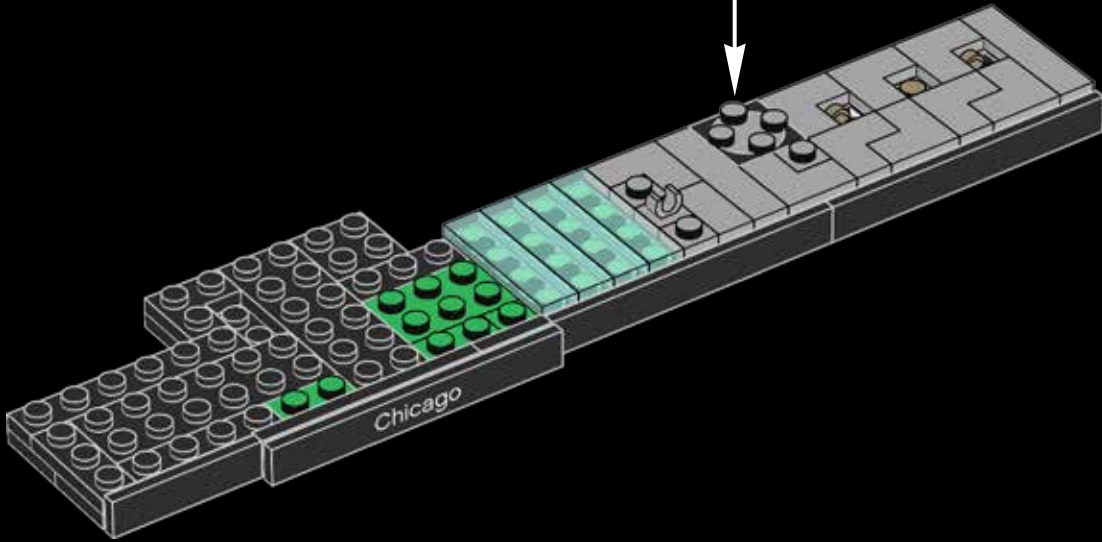
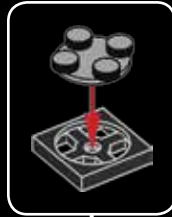

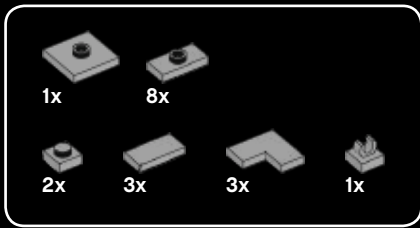

34

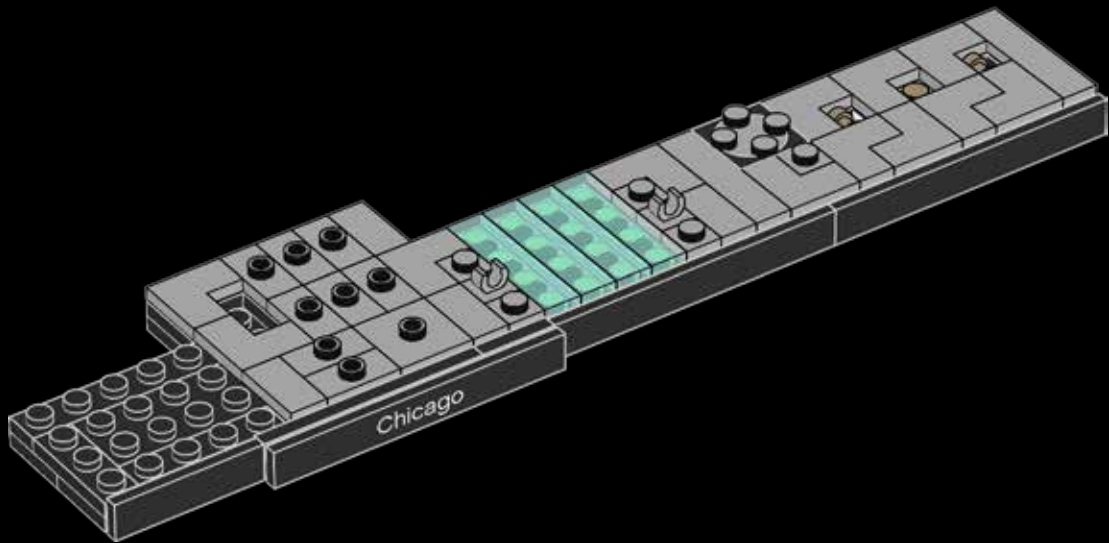

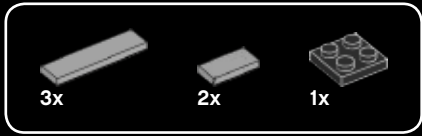

35

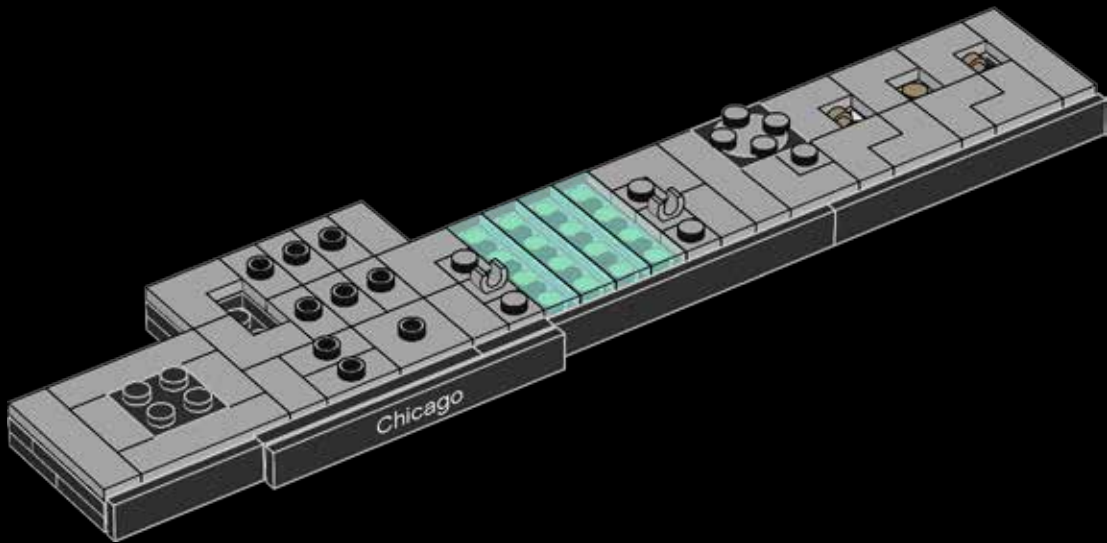

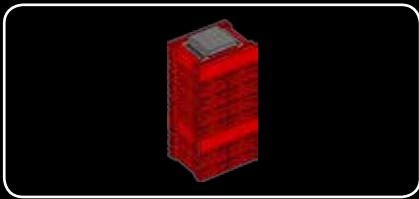

1x

36

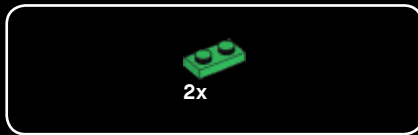

2x

37

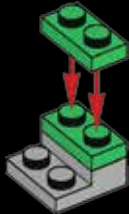

1x

38



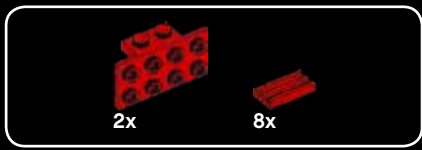

39

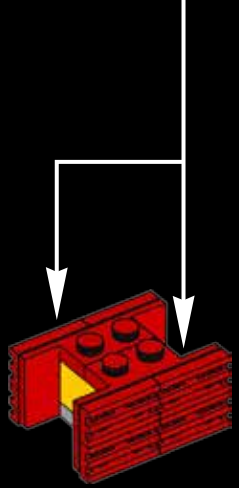
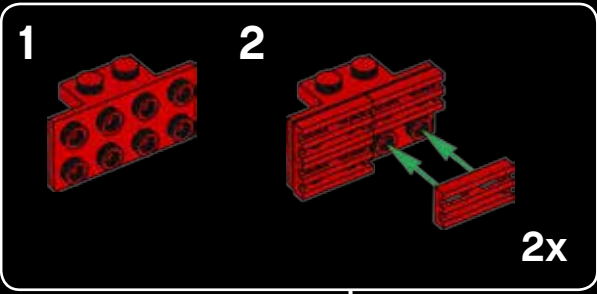

40

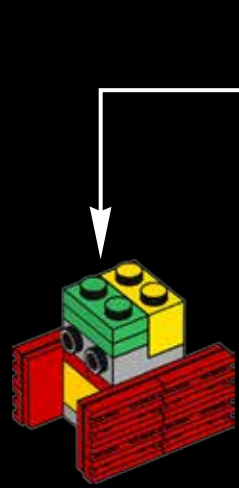
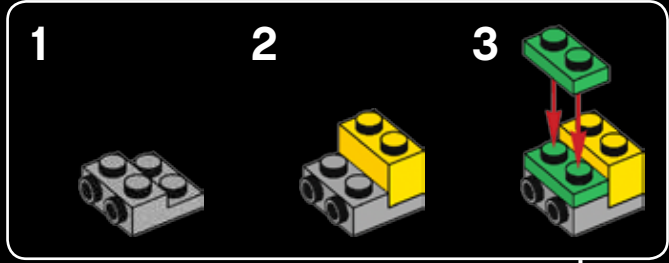

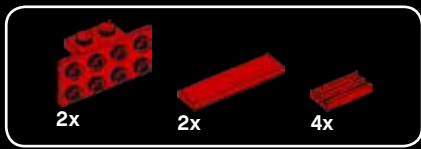

41

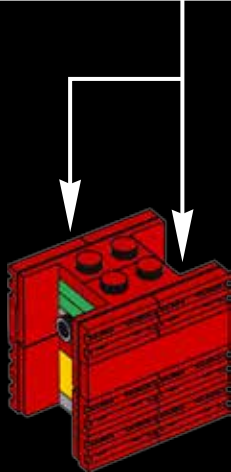
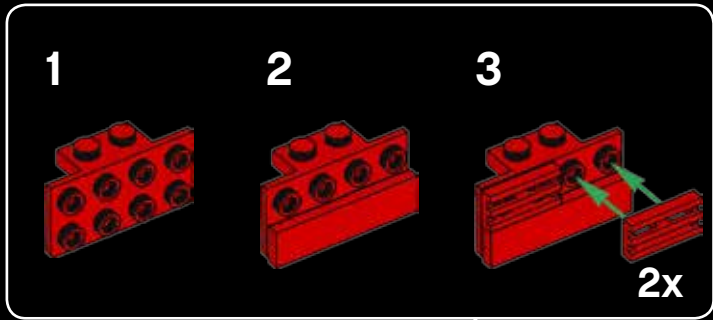

42

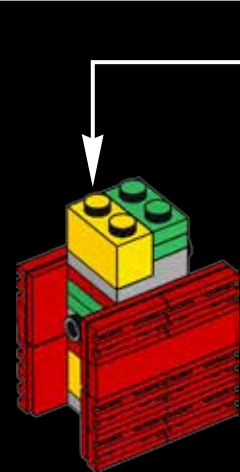
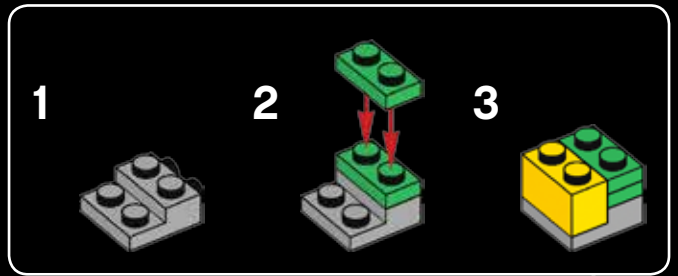

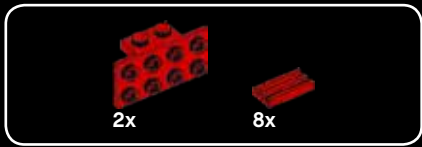

43

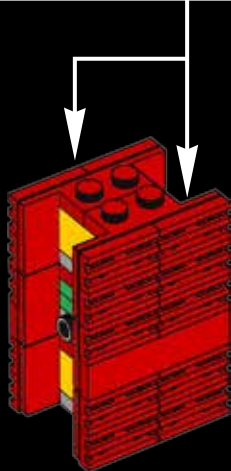
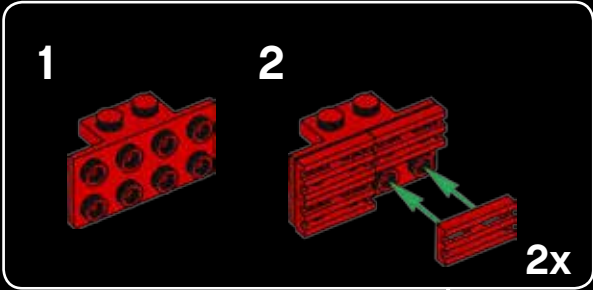

44

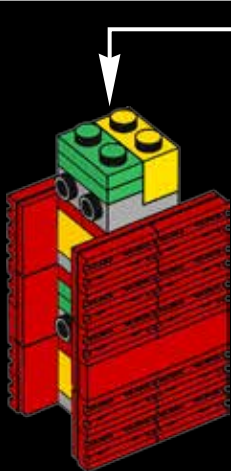
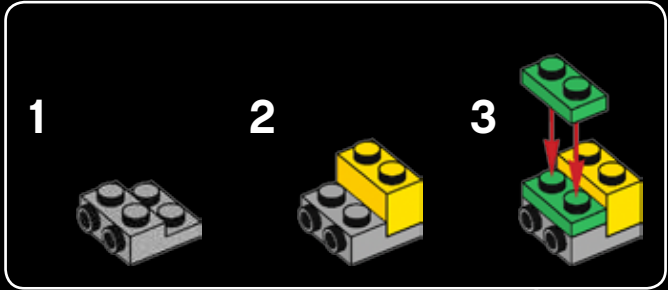

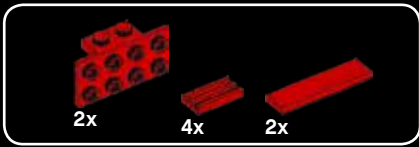

45

With only 44 stories, Big Red is not a massive structure by Chicago standards.

Avec seulement 44 étages, le Big Red n'est pas une structure massive selon les normes de Chicago.

Con sólo 44 plantas, el edificio Big Red no es una estructura gigantesca para los estándares de Chicago.

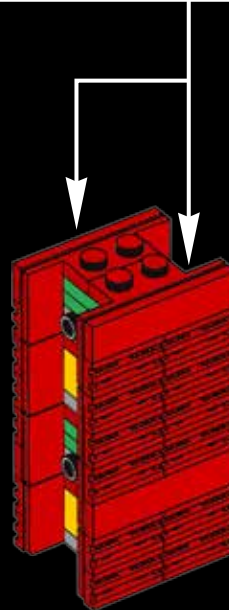
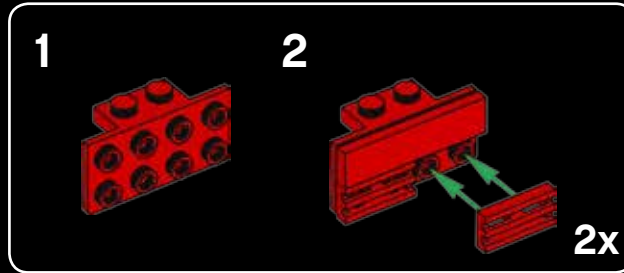

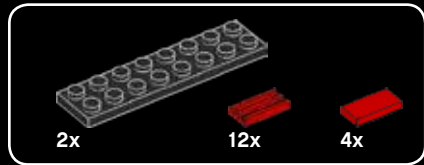

46

1

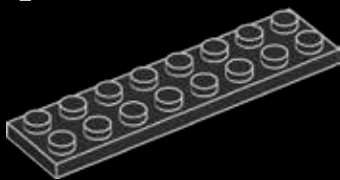

2

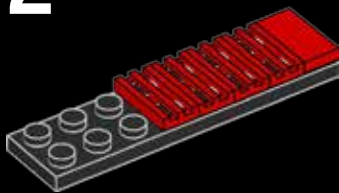

3

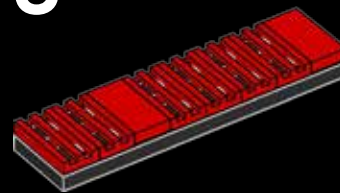

2x

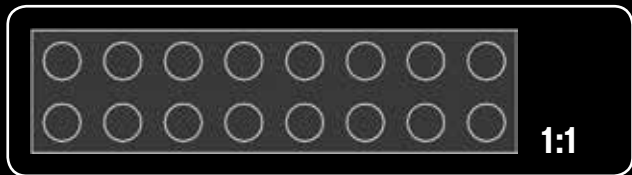

The total floor area of the building is
1,299,990 sq. ft. (120,773 m²)

La surface au sol totale de l'immeuble
est de 120 773 m².

Posee una superficie total de
120.773 m².

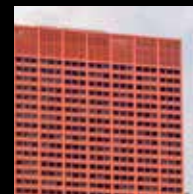

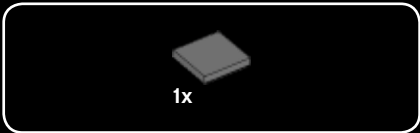

47

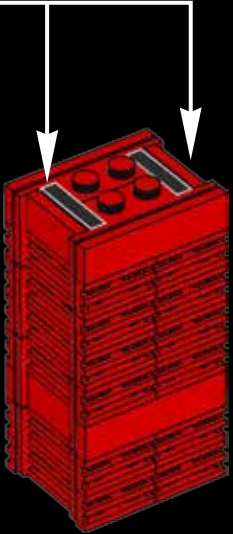

48

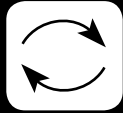

The sculpture was assembled in California and sailed through the Panama Canal and St Lawrence Seaway to Chicago.

La sculpture a été assemblée en Californie et est arrivée à Chicago par le canal de Panama et la voie maritime du Saint-Laurent.

Esta escultura se ensambló en California y navegó a través del canal de Panamá y la vía marítima del San Lorenzo hasta Chicago.



© Patrick Pyska

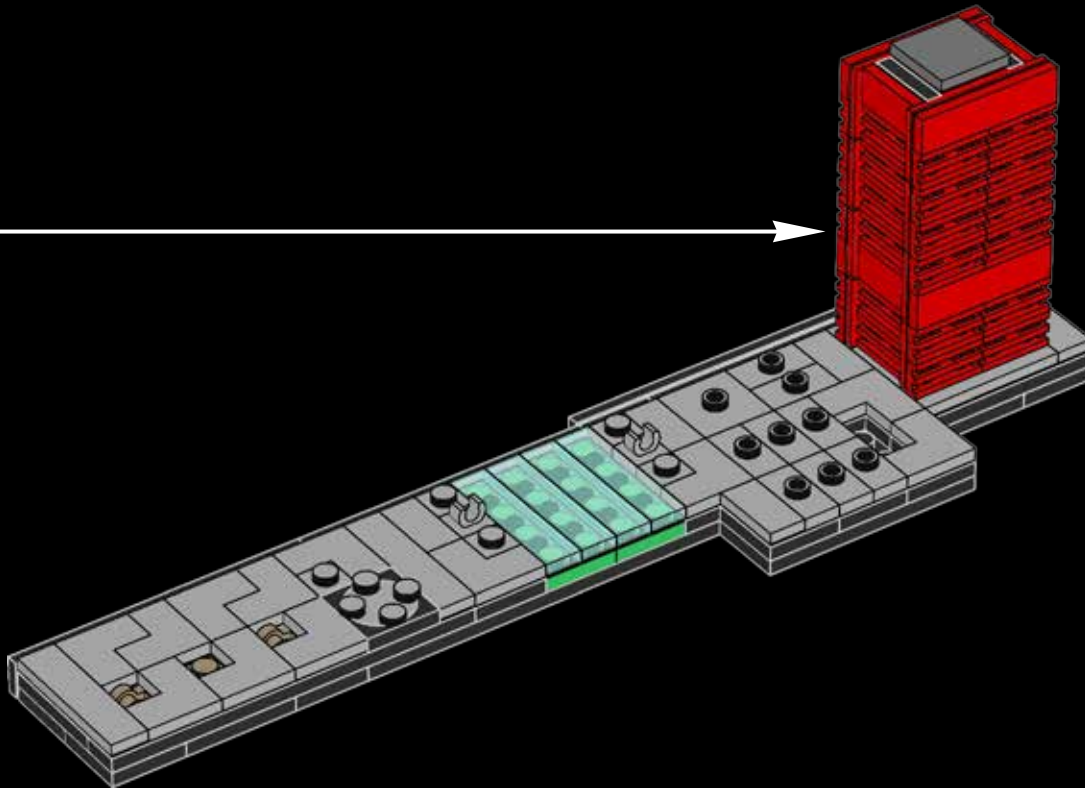

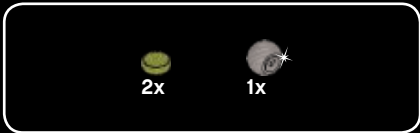

49

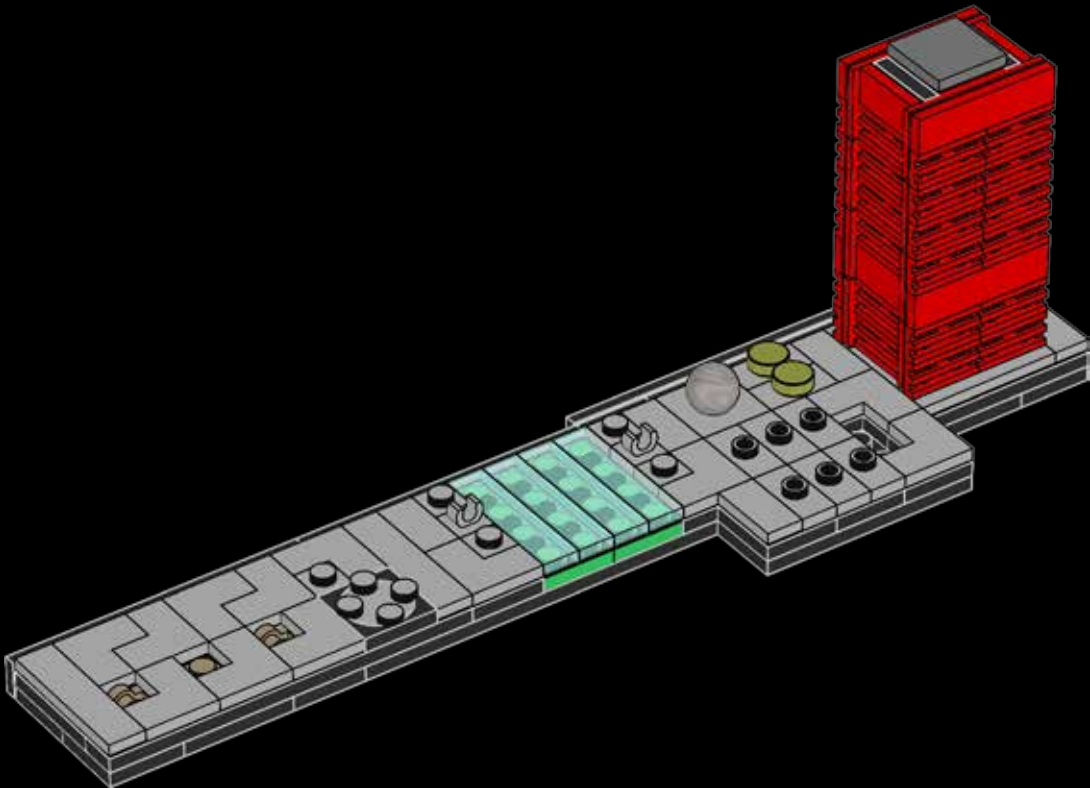

The entire sculpture is cleaned and washed twice a year with 40 US gallons (150 liters) of liquid detergent.

La totalité de la sculpture est nettoyée et lavée deux fois par an avec 150 litres de détergent liquide.

La escultura entera se limpia y lava con 150 litros de detergente líquido dos veces al año.



© Patrick Pyszka

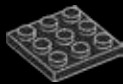

1x

50

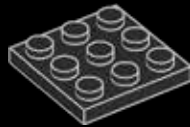

4x

51

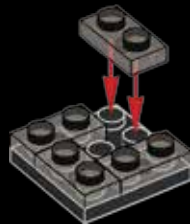

52

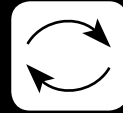

1x

53



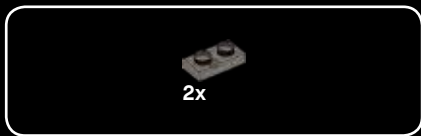

54



55

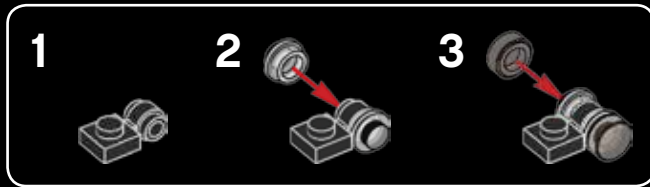

56



57

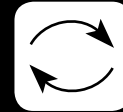

58

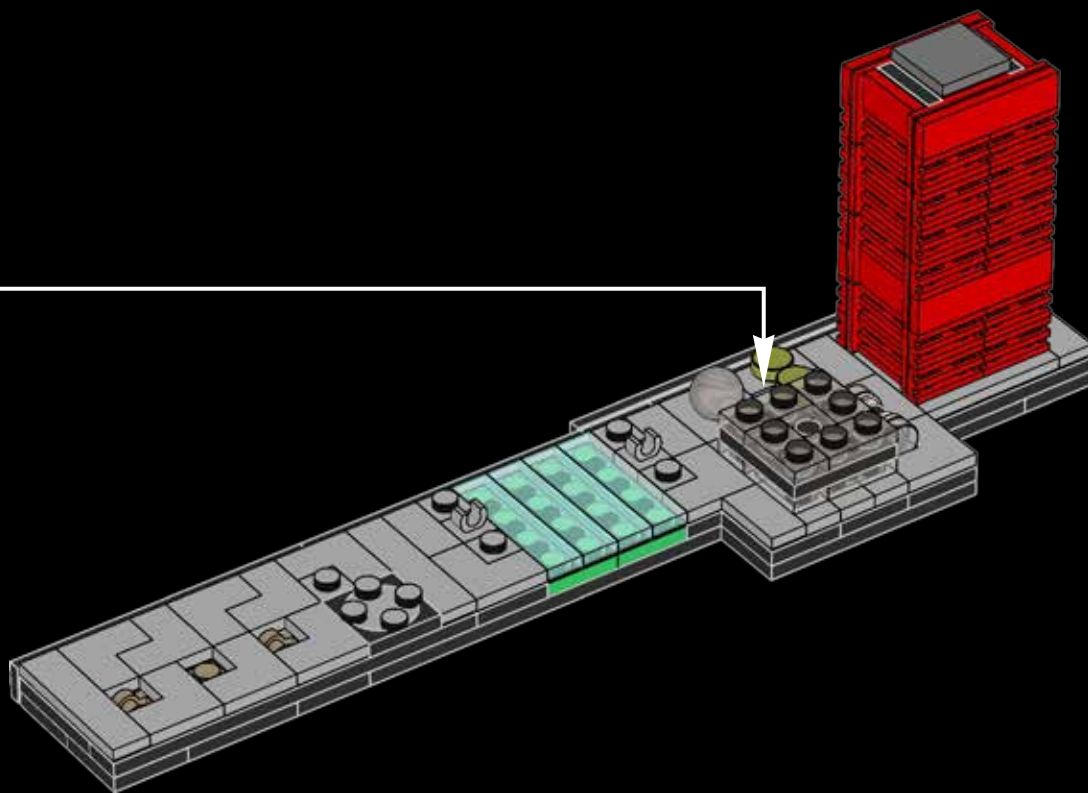

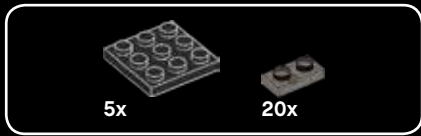

59

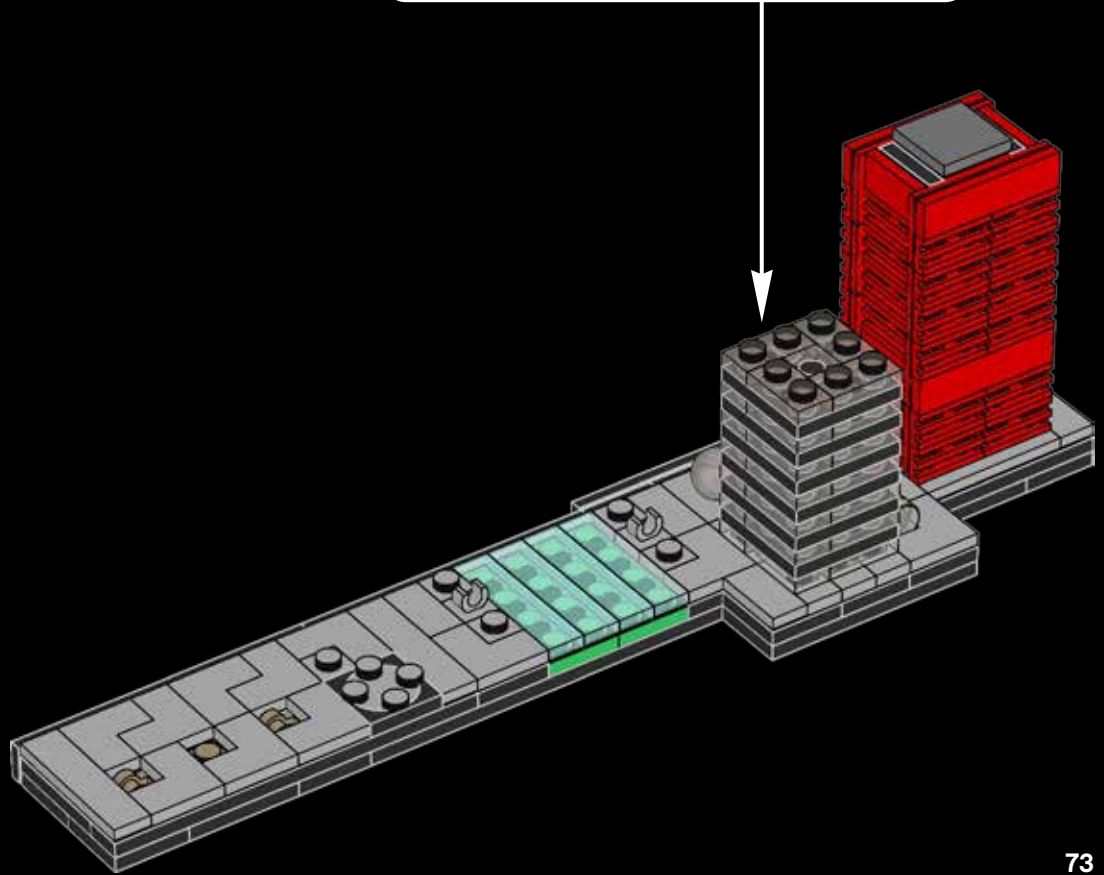
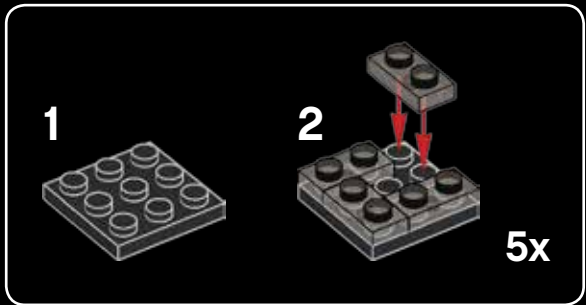



1x

60

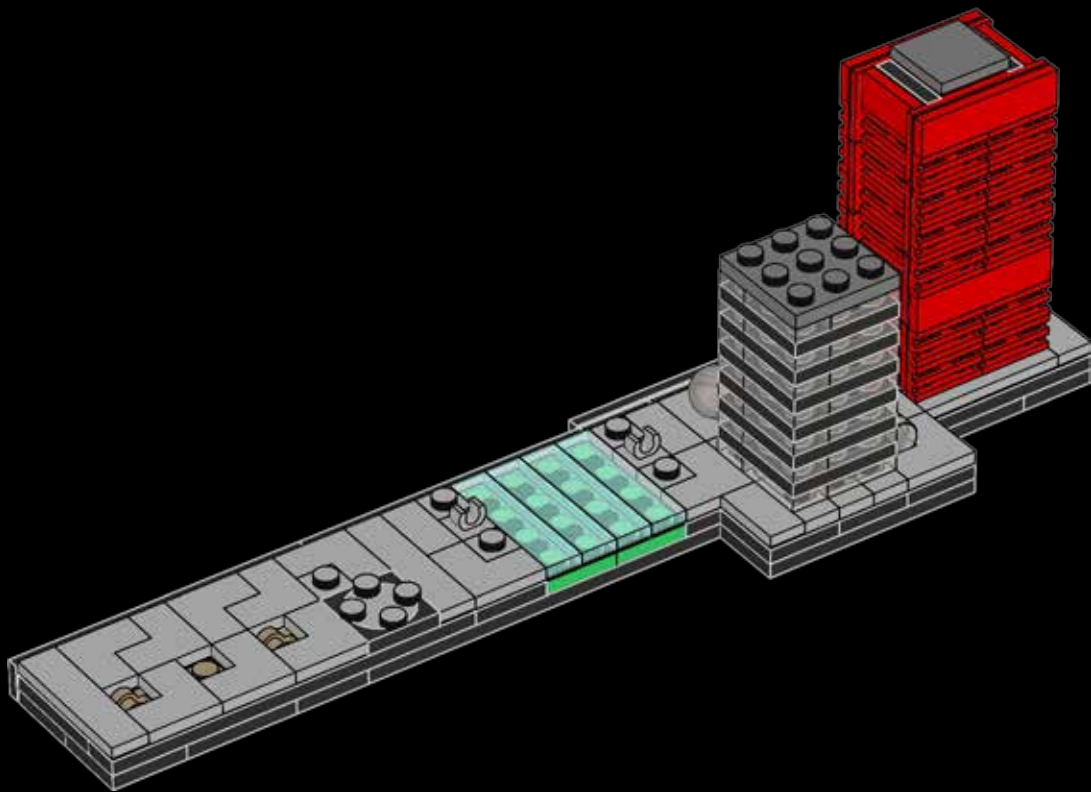

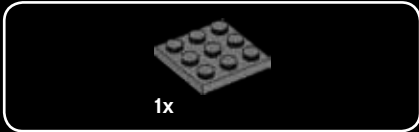

61



62

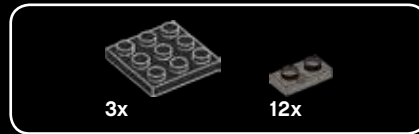
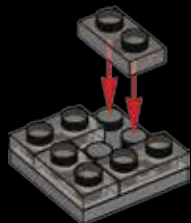

63

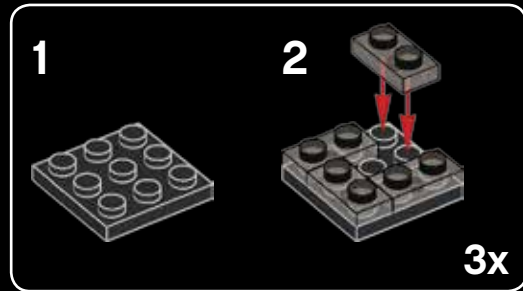



2x



2x



1x

64

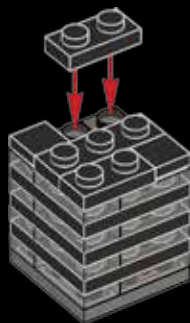

65

Within the tower, there are 25 miles (40.2 km) of plumbing, 1,500 miles (2,414 km) of electric wiring, 80 miles (129 km) of elevator cable, and 145,000 light fixtures.

La tour comprend 40,2 km de plomberie, 2 414 km de fils électriques, 129 km de câbles d'ascenseur et 145 000 appareils d'éclairage.

La torre contiene 40,2 km de tuberías, 2.414 km de cableado eléctrico, 129 km de cables de elevador y 145.000 puntos de luz.

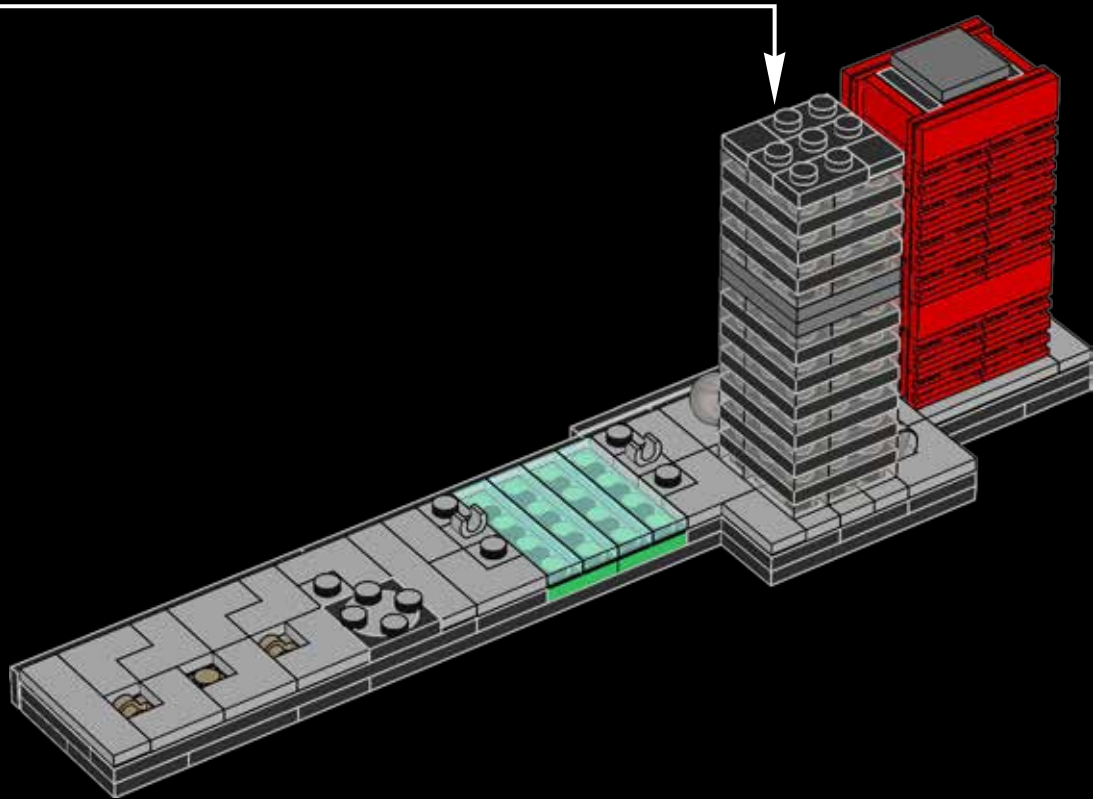



2x



2x

66

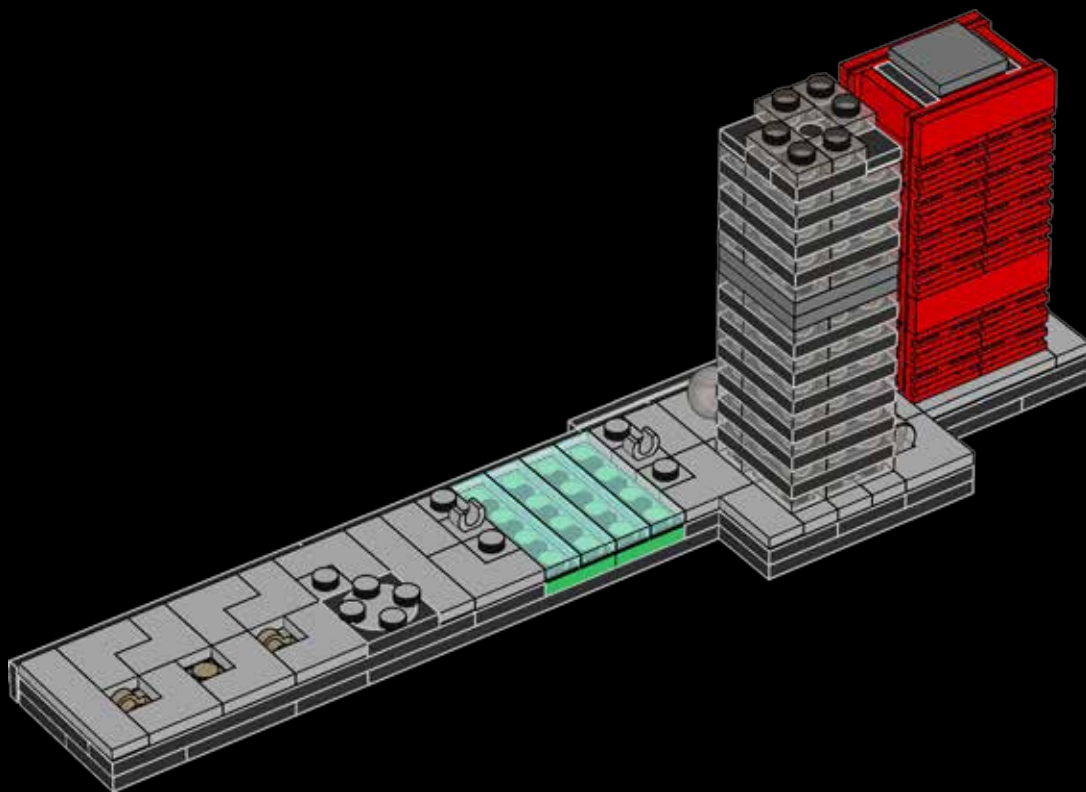



67

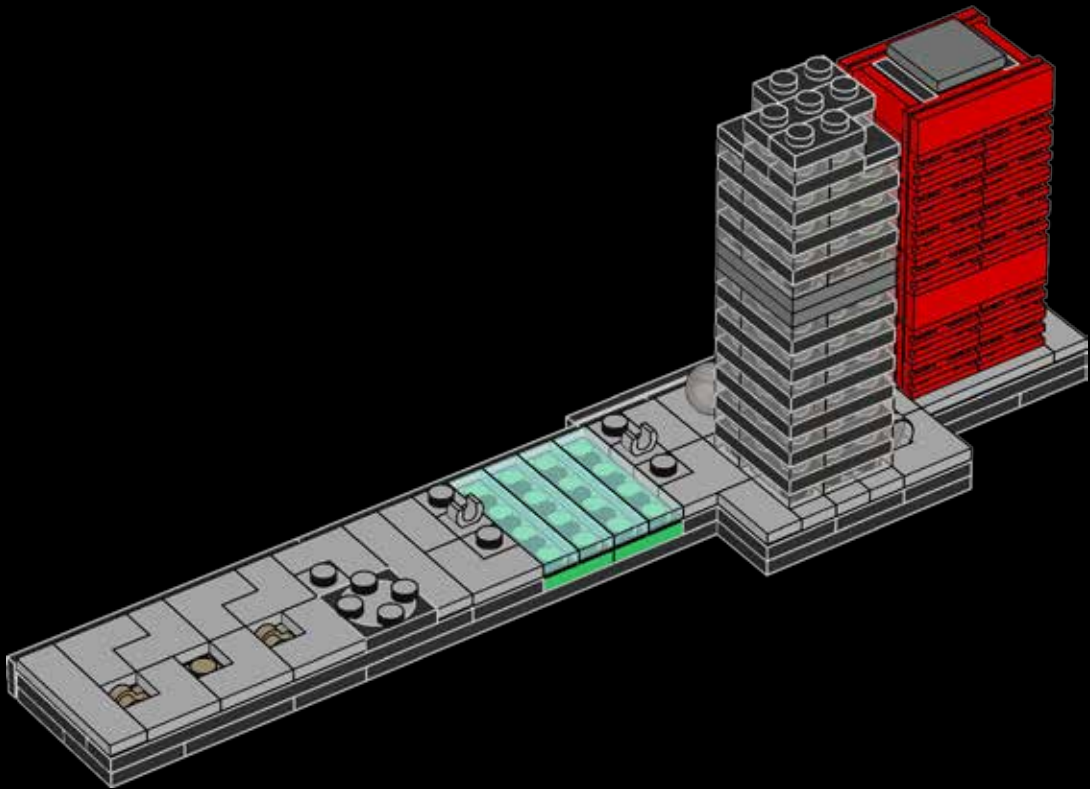



2x



2x

68

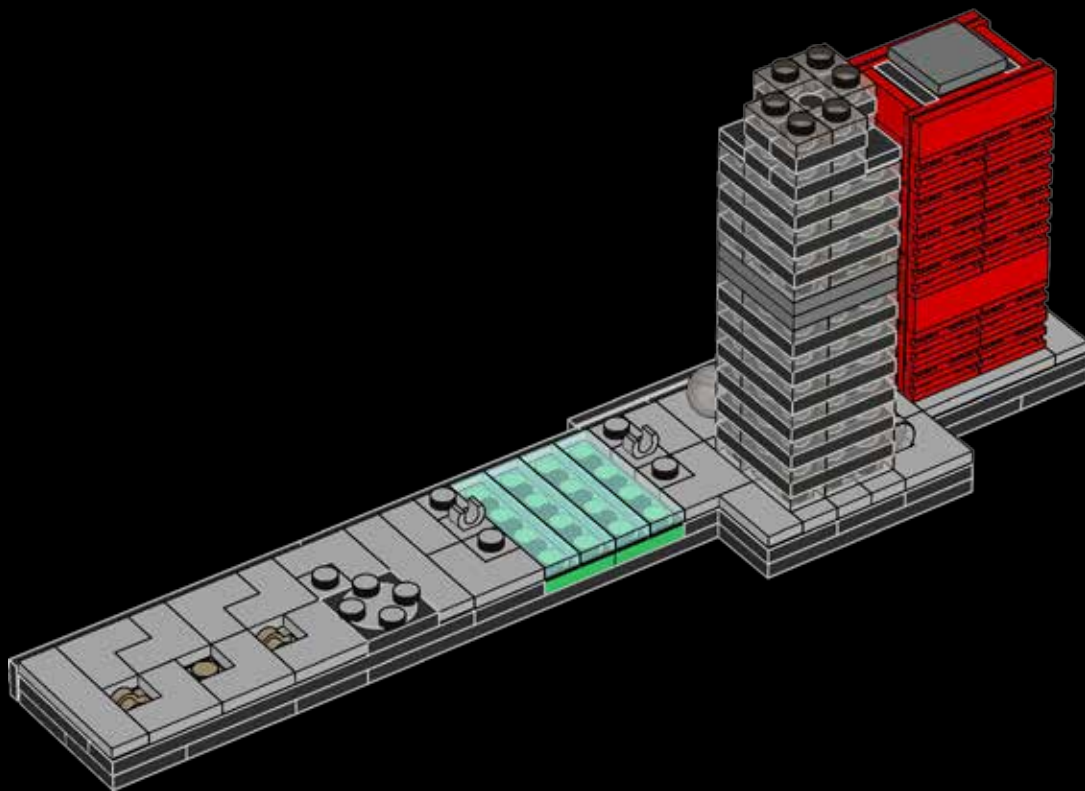



69

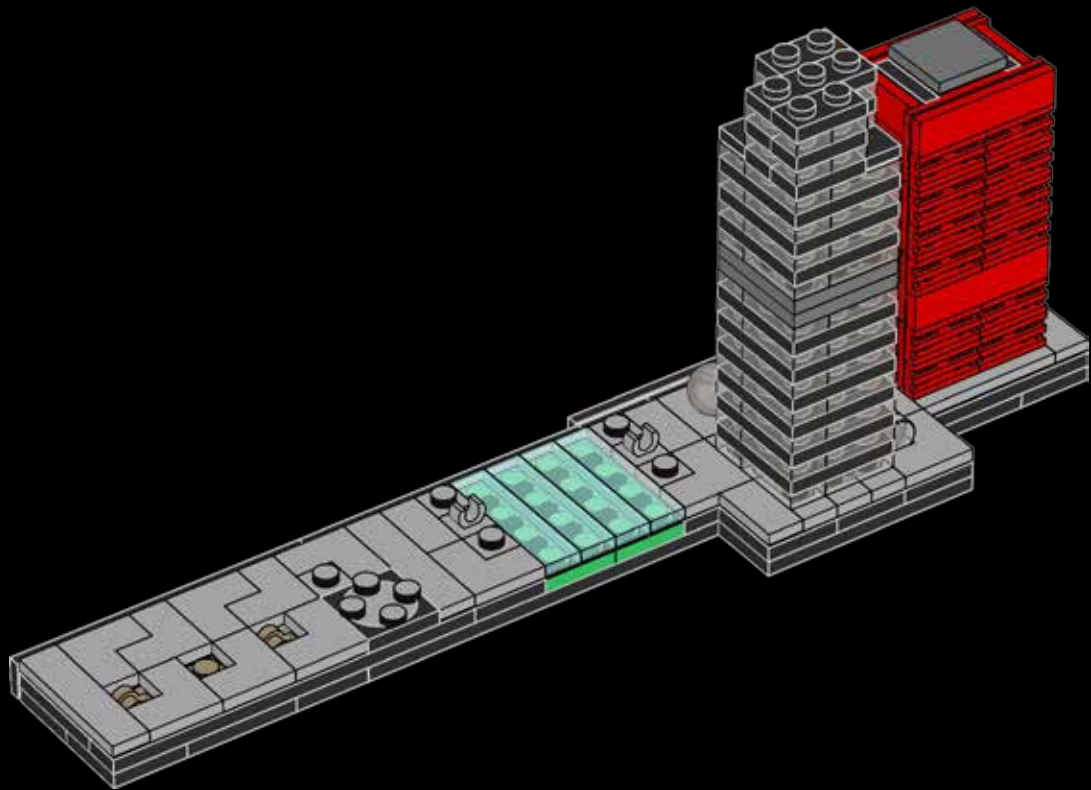



2x



2x

70

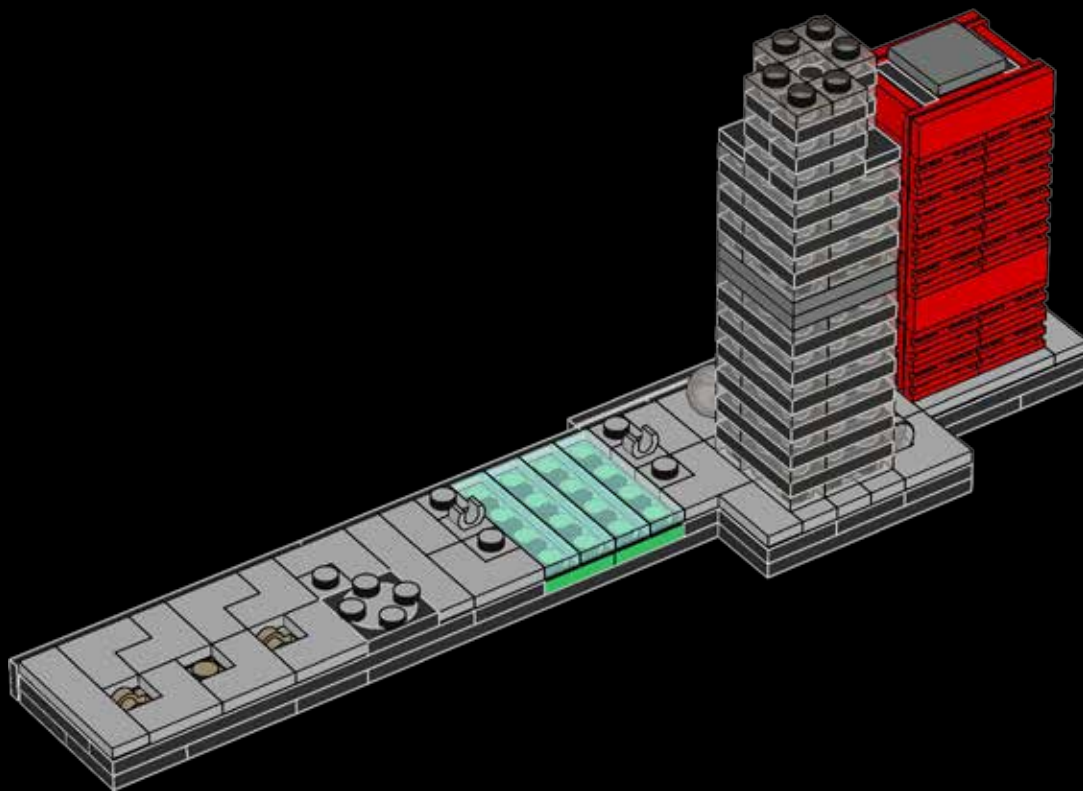



71

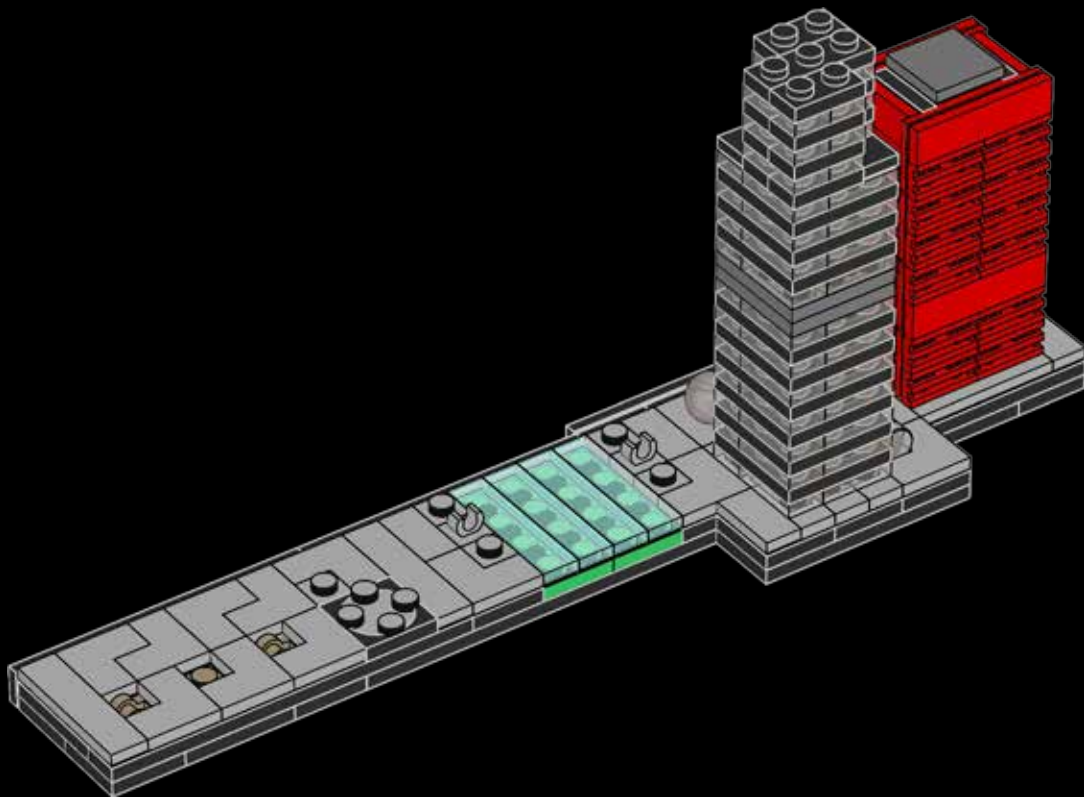



72

The tower weighs more than 222,500 tons (201,848,605 kg), took three years to complete and used enough concrete to make an eight-lane, five mile long (8 km) highway.

La tour pèse plus de 201 848 605 kg, sa construction a pris 3 ans et elle a nécessité autant de béton qu'une autoroute à huit voies de 8 km.

Pesa 201.848.605 kg, tardó tres años en completarse y en su construcción se usó concreto suficiente como para hacer una carretera de ocho carriles y 8 km de largo.

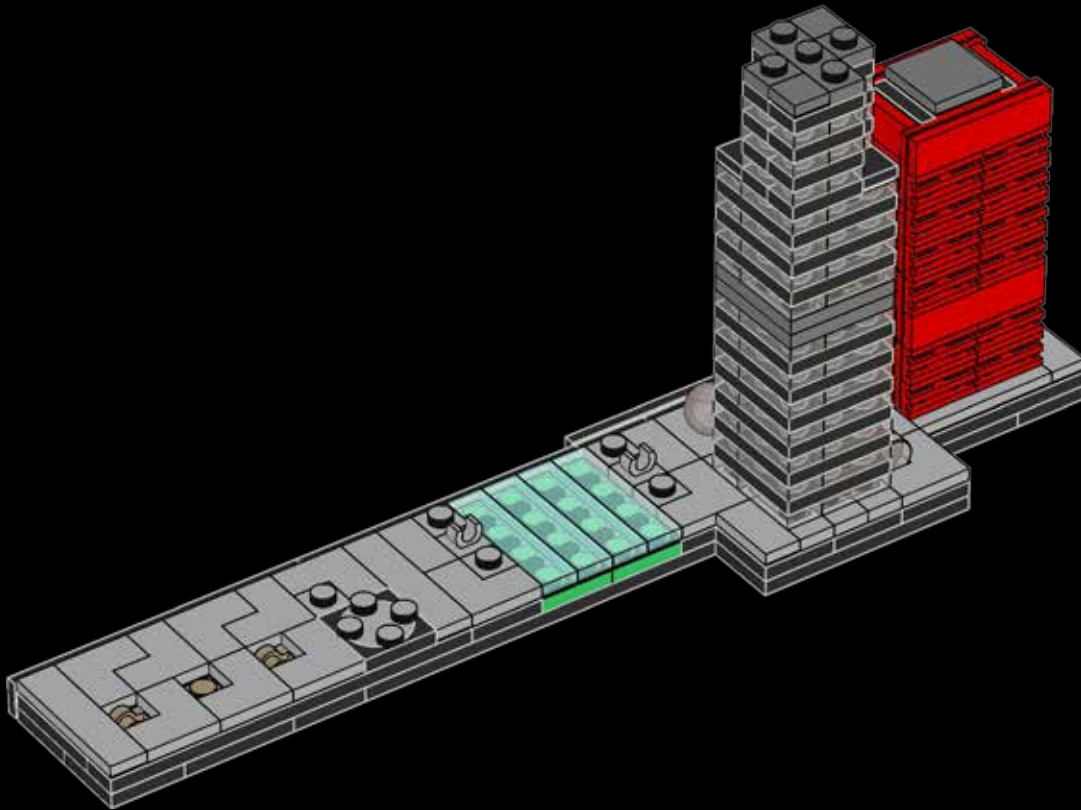



73

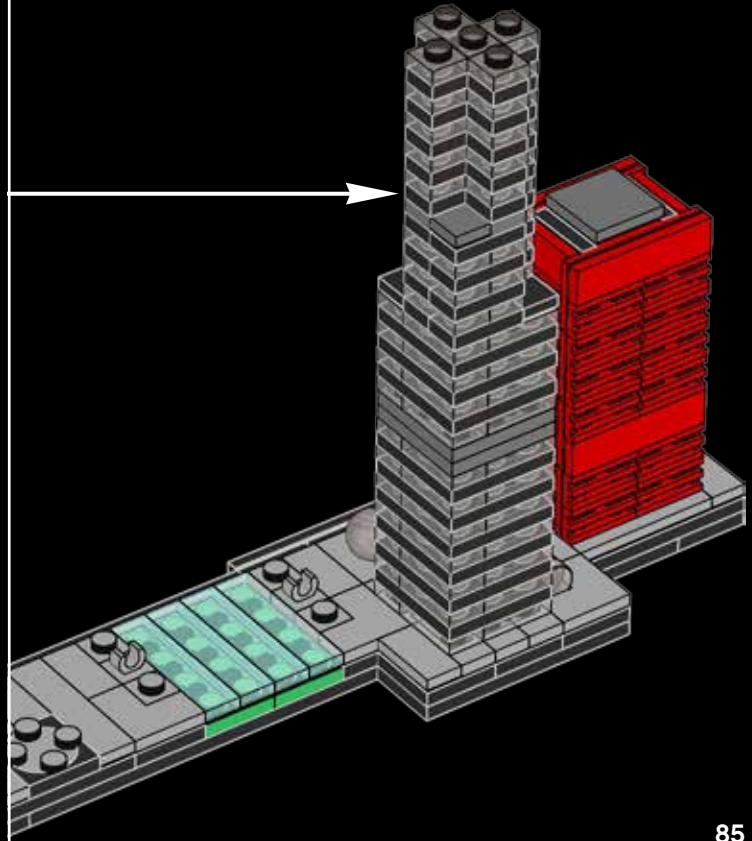
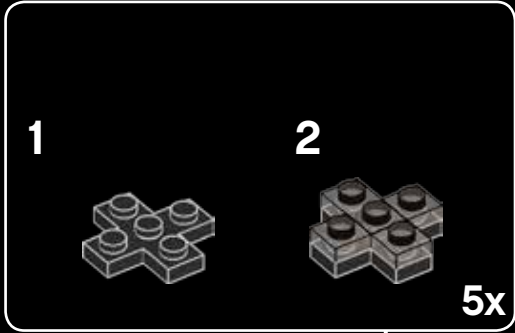



74

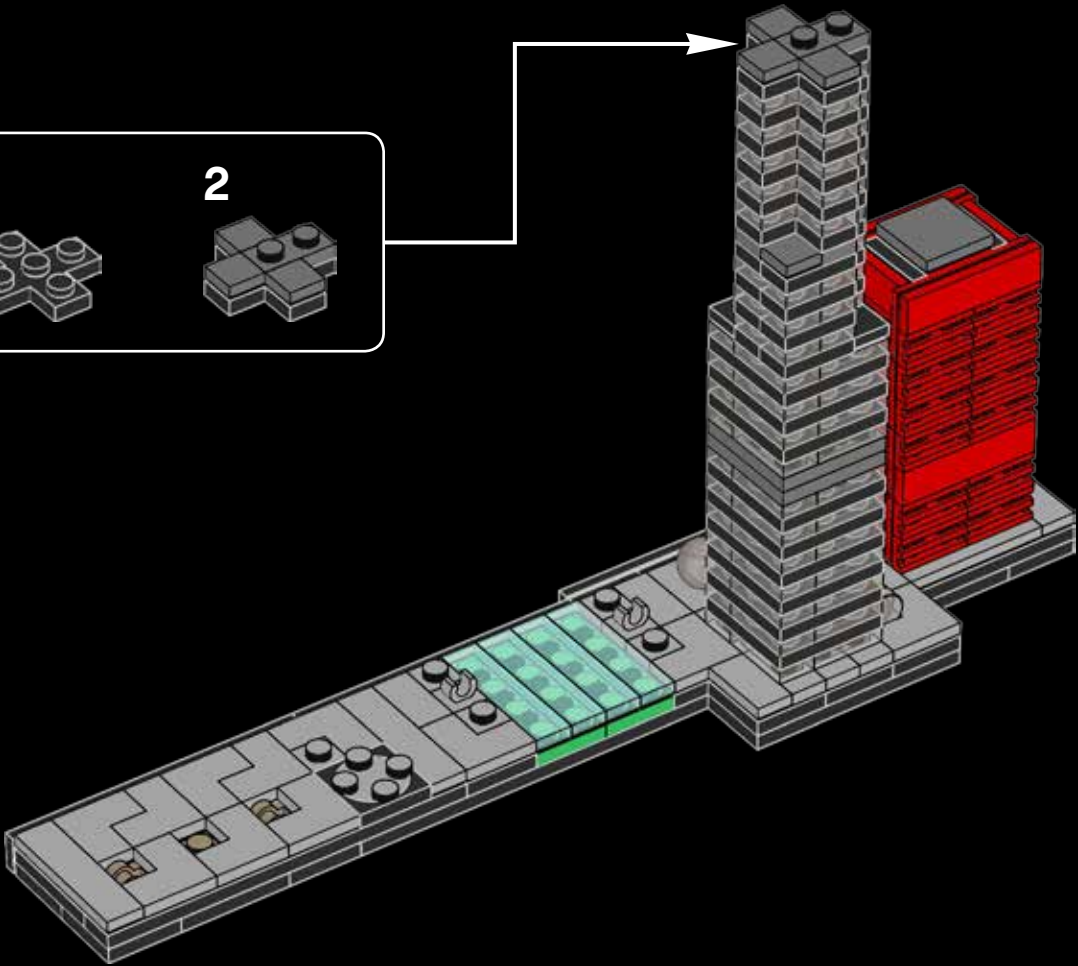
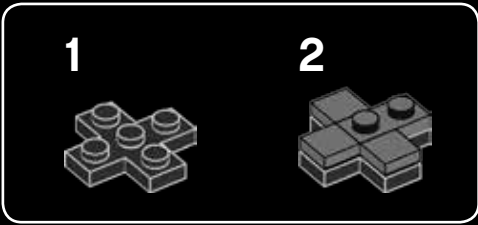



75

1



2

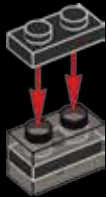

3

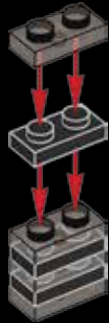

4

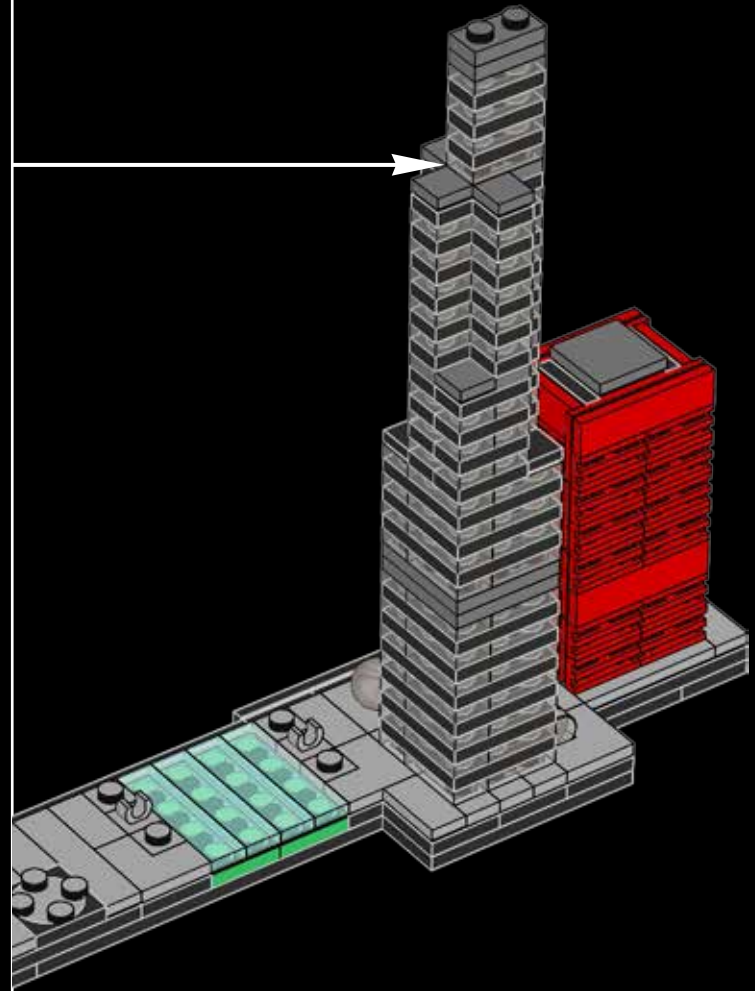



1x

76

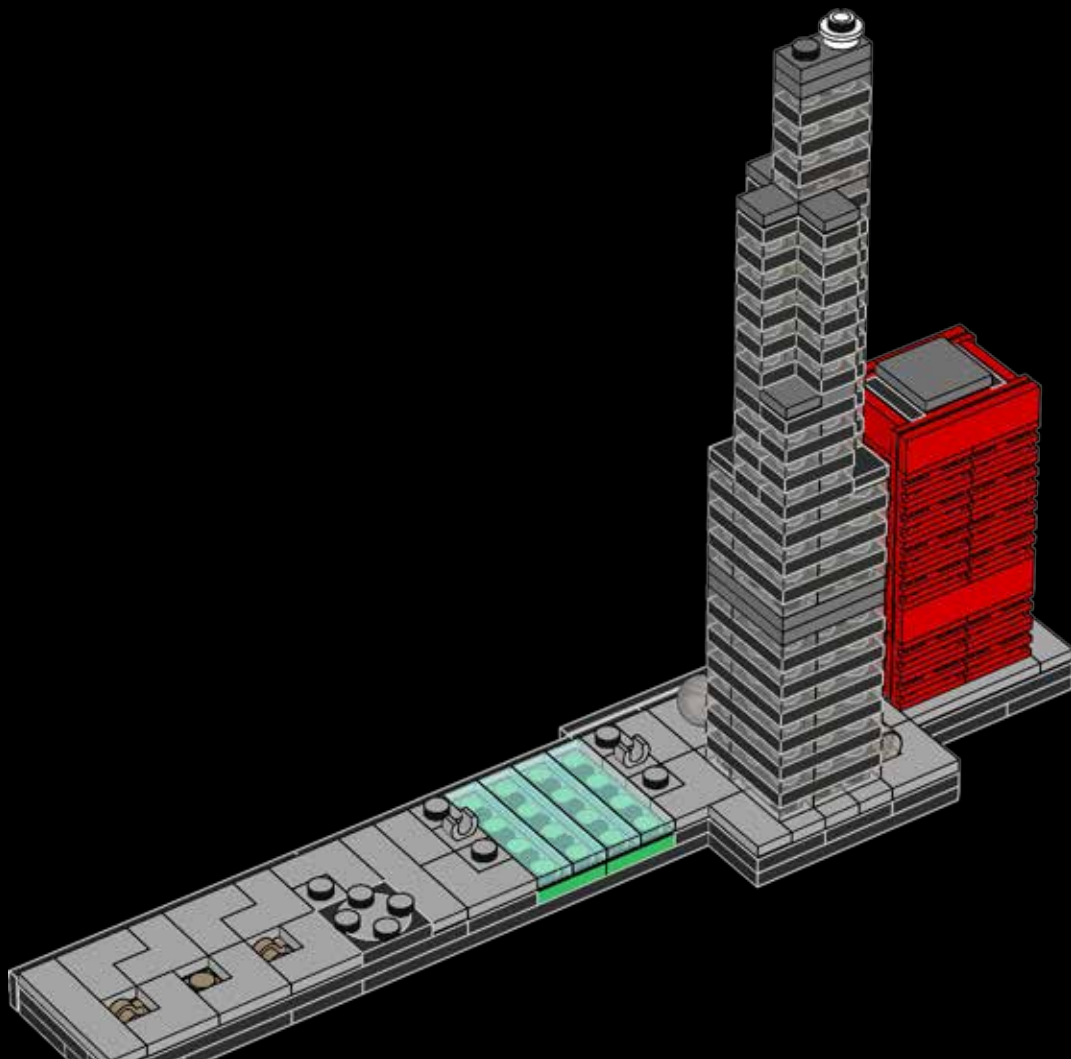

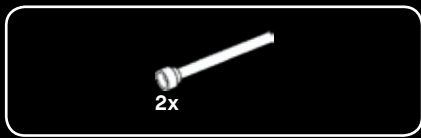

77

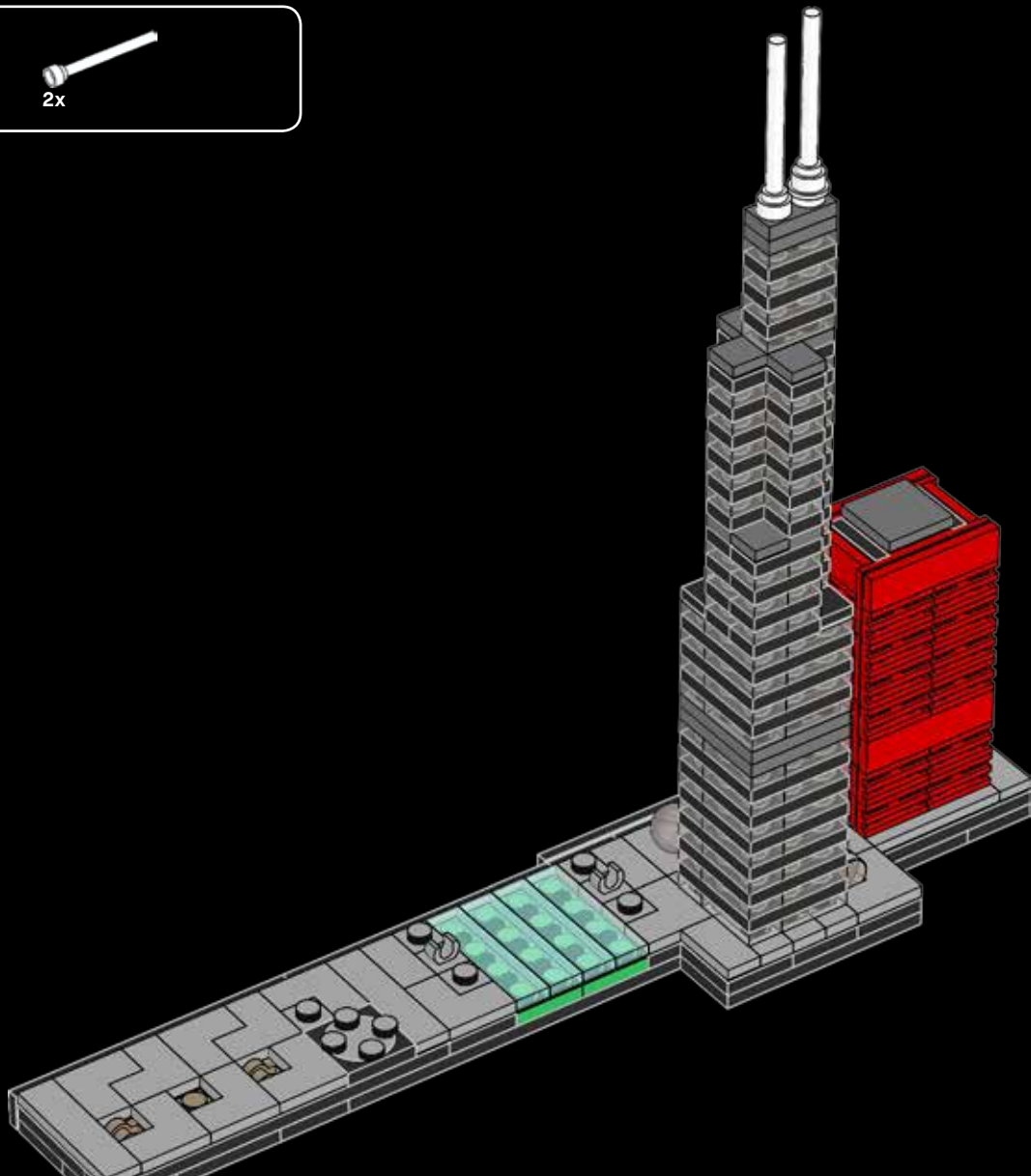



4x



4x



4x

78

1



2



4x

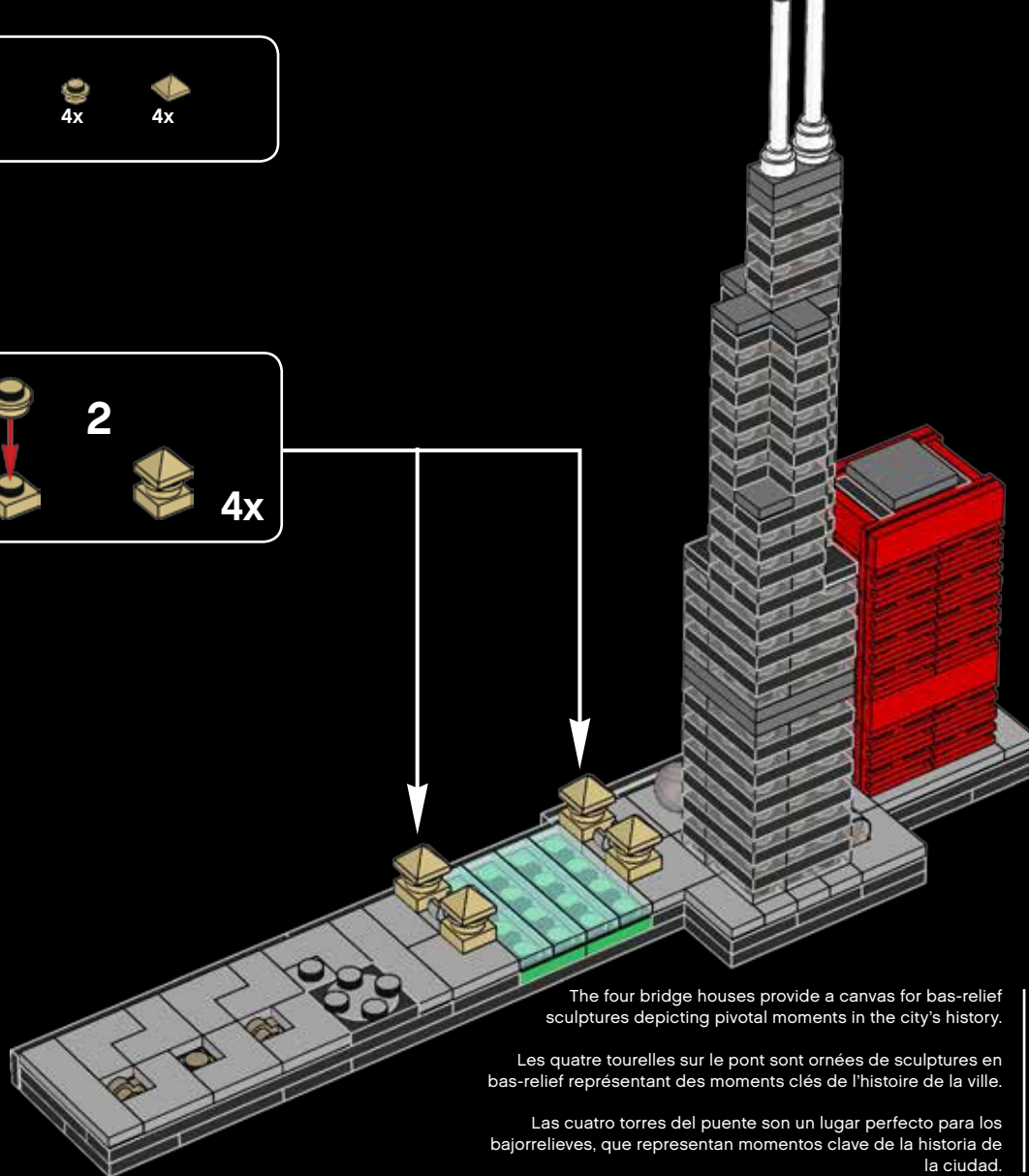

The four bridge houses provide a canvas for bas-relief sculptures depicting pivotal moments in the city's history.

Les quatre tourelles sur le pont sont ornées de sculptures en bas-relief représentant des moments clés de l'histoire de la ville.

Las cuatro torres del puente son un lugar perfecto para los bajorrelieves, que representan momentos clave de la historia de la ciudad.

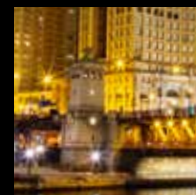



79

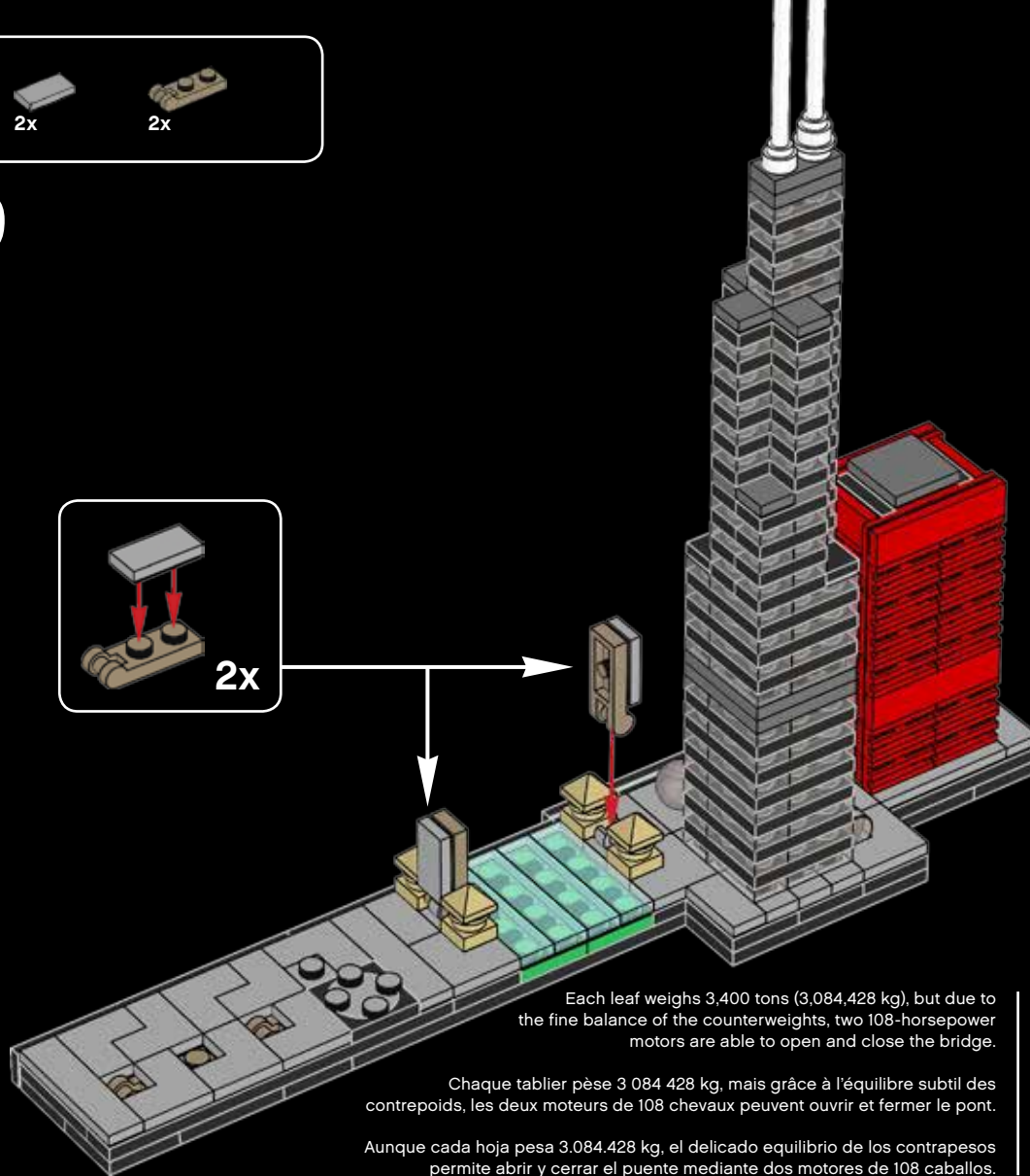
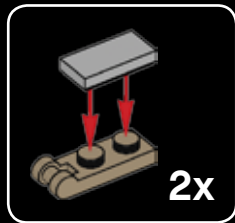

Each leaf weighs 3,400 tons (3,084,428 kg), but due to the fine balance of the counterweights, two 108-horsepower motors are able to open and close the bridge.

Chaque tablier pèse 3 084 428 kg, mais grâce à l'équilibre subtil des contrepoids, les deux moteurs de 108 chevaux peuvent ouvrir et fermer le pont.

Aunque cada hoja pesa 3.084.428 kg, el delicado equilibrio de los contrapesos permite abrir y cerrar el puente mediante dos motores de 108 caballos.





2x

80

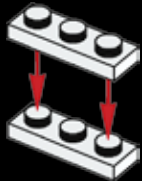

1x



1x

81

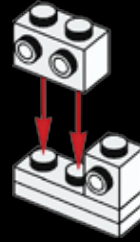

1x

82

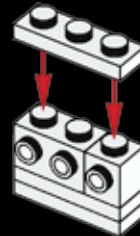

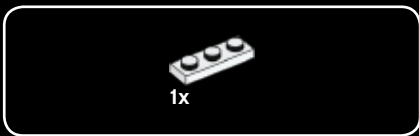

83

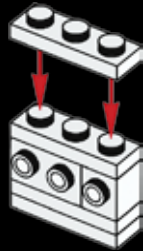

84

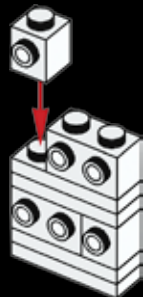

When The Wrigley Building opened, there was an observatory above the 26th floor in the Clock Tower. Admission was 5 cents and included a piece of Wrigley gum. The Clock Tower was inspired by La Giralda, which is now part of Spain's Seville Cathedral.



Lorsque le Wrigley Building a ouvert ses portes, il comprenait un observatoire au-dessus du 26^e étage de la tour de l'horloge. L'entrée coûtait 5 cents et incluait une gomme à mâcher Wrigley. La tour de l'horloge s'inspire de La Giralda, qui fait maintenant partie de la cathédrale de Séville, en Espagne.

Cuando el edificio Wrigley abrió sus puertas, la Torre del Reloj contaba con un mirador sobre la planta 26. La entrada costaba 5 centavos e incluía un chicle Wrigley. La Torre del Reloj se inspiró en la Giralda, parte de la catedral de Sevilla (España).



85

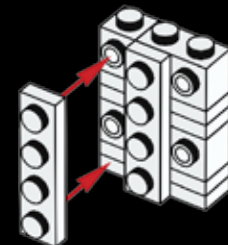



2x

86

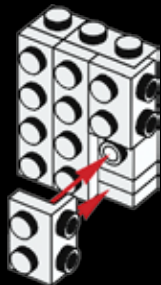

1x

87

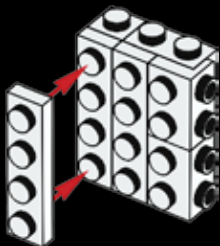

2x



4x

88

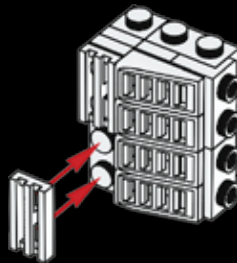

2x

89

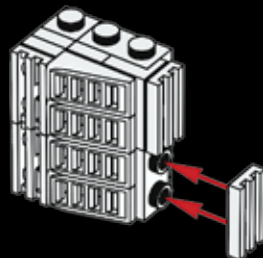



90

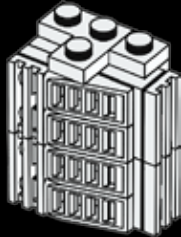

91

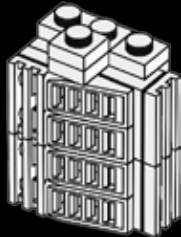

92

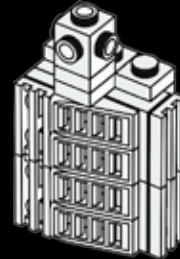

93





The Wrigley Building was the first to be air-conditioned in Chicago and the tallest at the time of its construction.

Au moment de sa construction, le Wrigley Building était le plus haut immeuble de la ville de Chicaco, ainsi que le premier à être équipé d'un système d'air climatisé.

El edificio Wrigley fue el primero de Chicago en tener aire acondicionado y el más alto en el momento de su construcción.

94

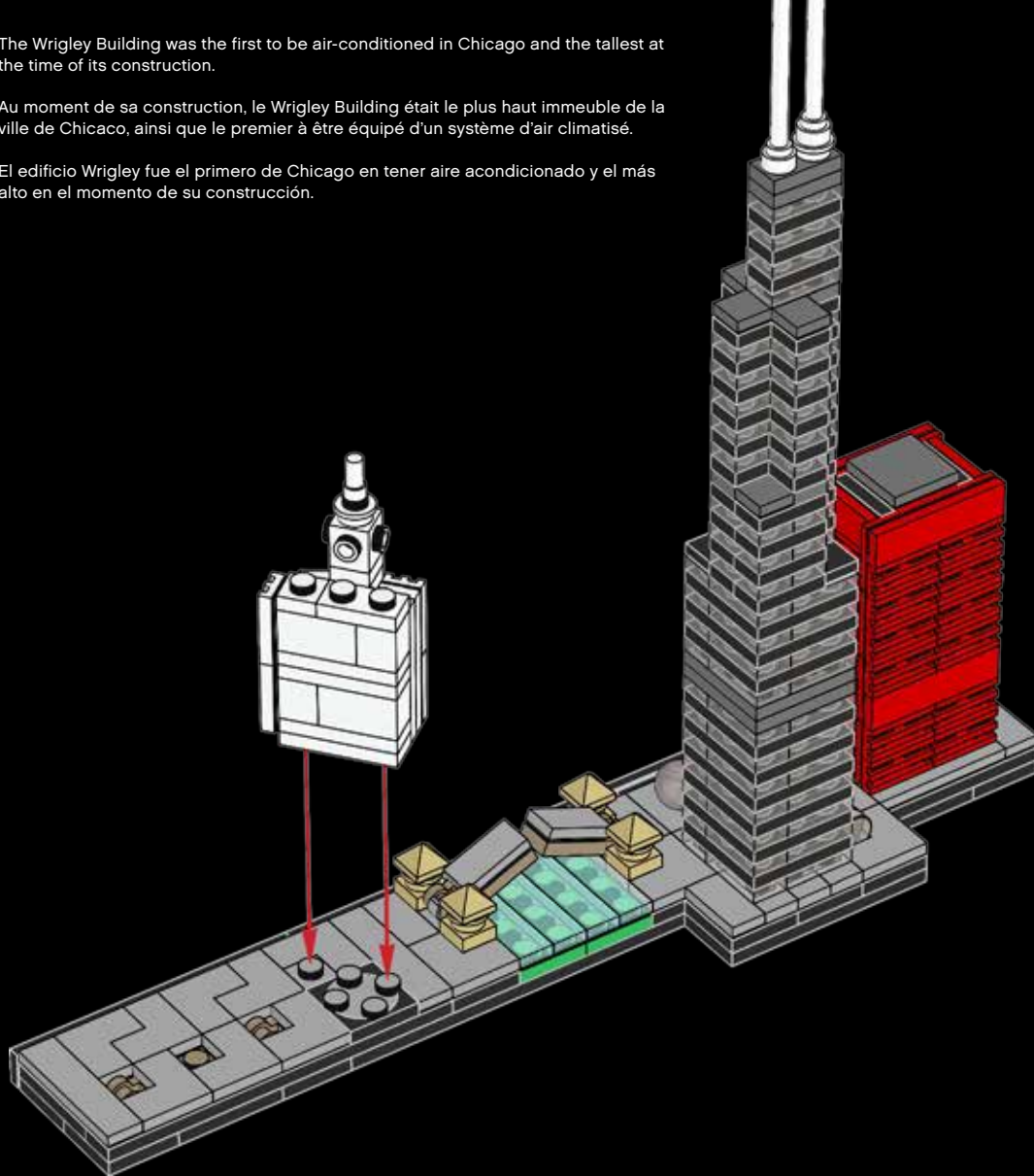



There are 1,632 steps from the main lobby to the observatory on level 94 of the tower.

Il y a 1 632 marches du hall principal à l'observatoire situé au 94^e étage de la tour.

1.632 peldaños separan el vestíbulo principal del mirador situado en la planta 94 de la torre.

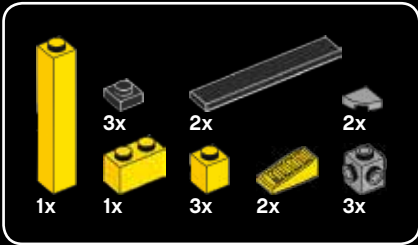

95

1



2



3



4

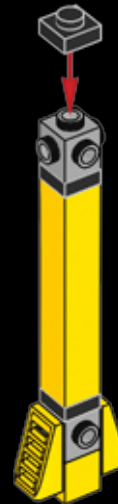

5



6

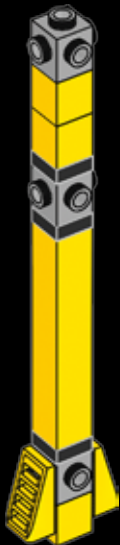

7



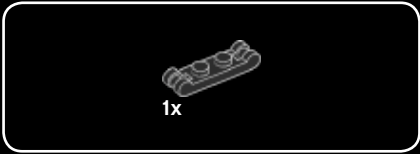
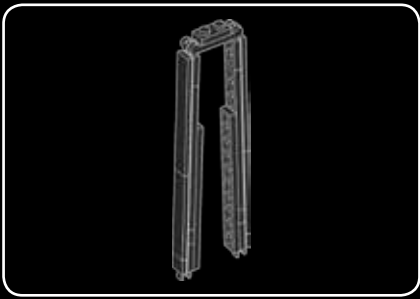

96

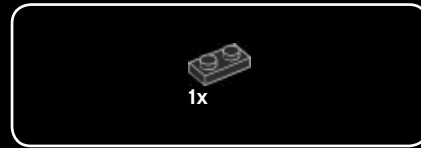

97

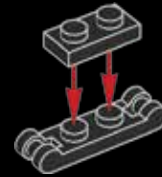

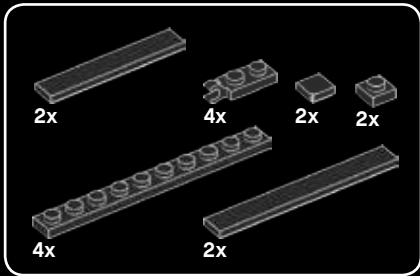
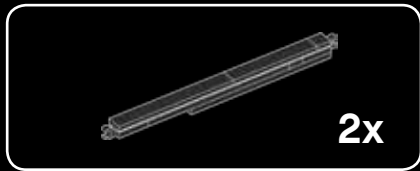

98

1

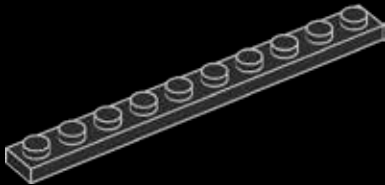

2

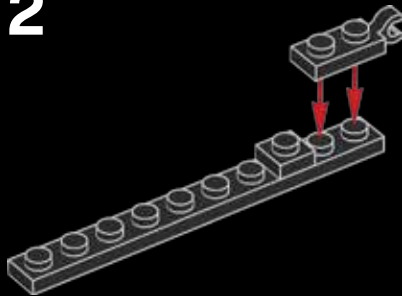

3

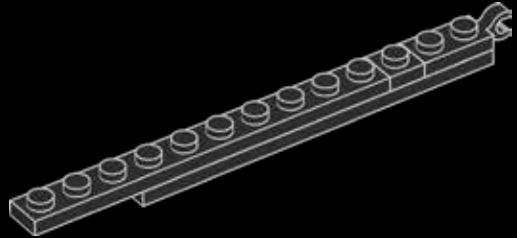

The tower's design was tested to withstand winds of 132 miles per hour (212.4 km per hour).

La conception de la tour a été testée pour résister à des vents de 212,4 km/h.

Las pruebas realizadas demostraron que la torre resiste vientos de hasta 212,4 km/h.

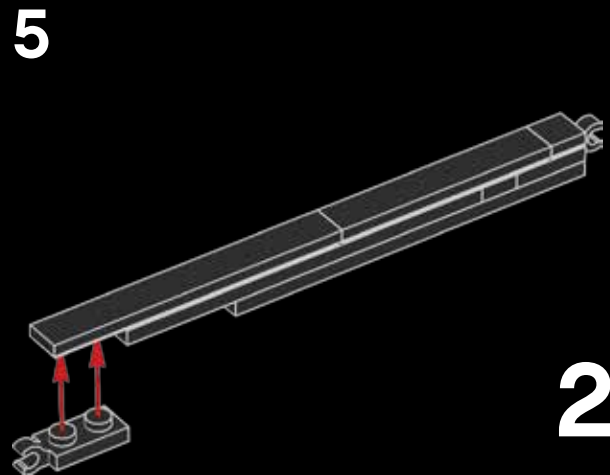
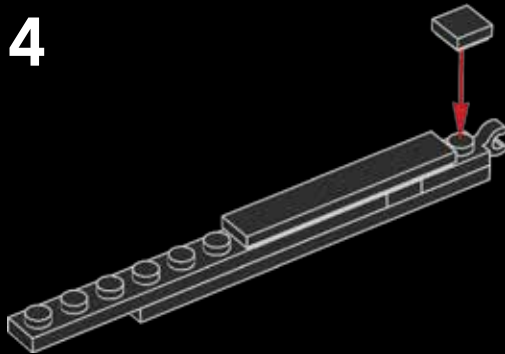

2x
101

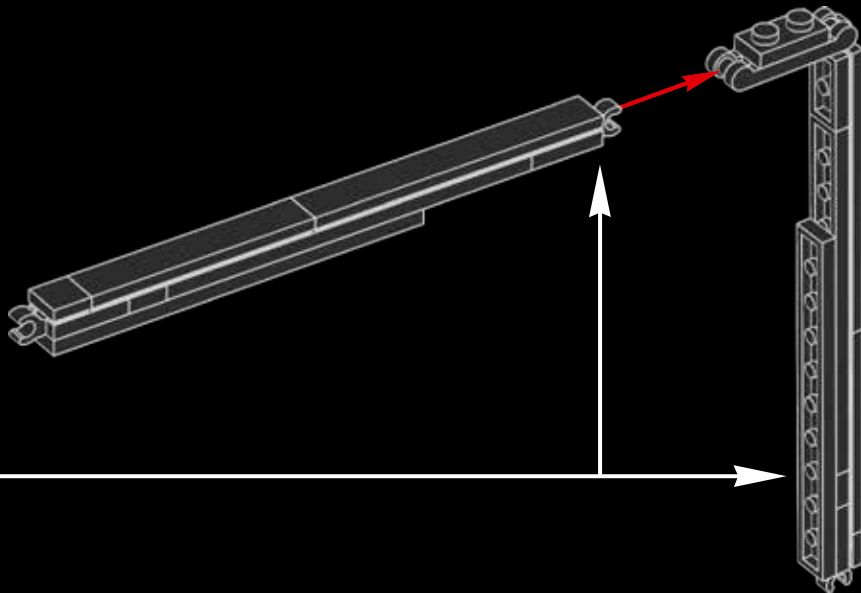

99

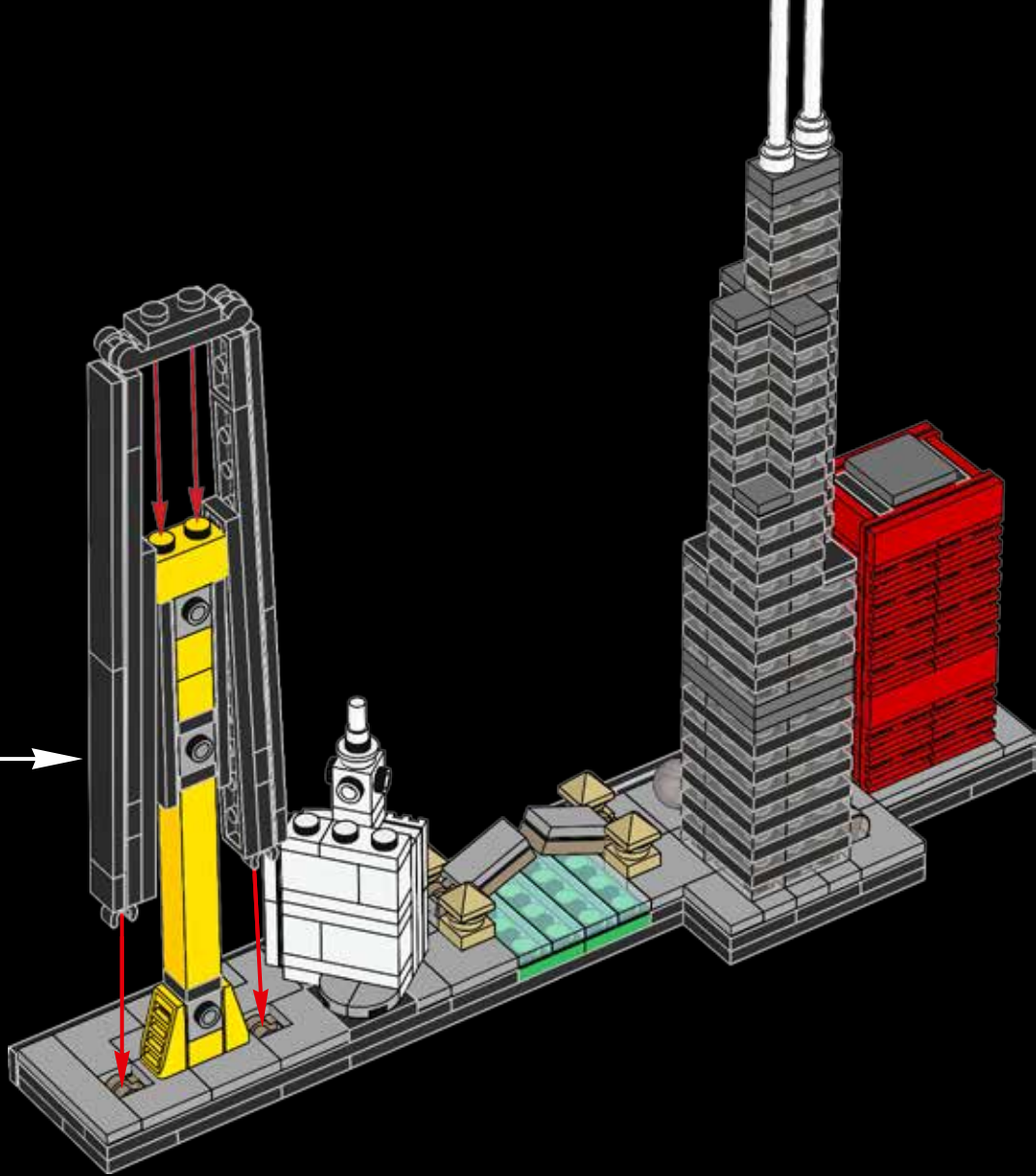

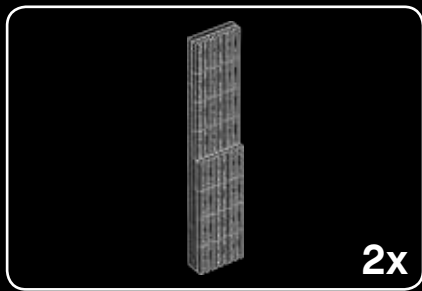

100

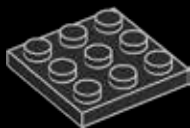

101

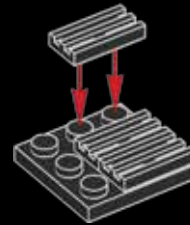

102

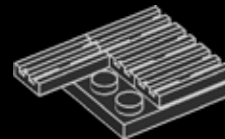

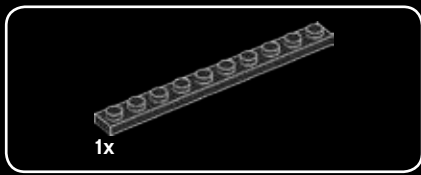

103

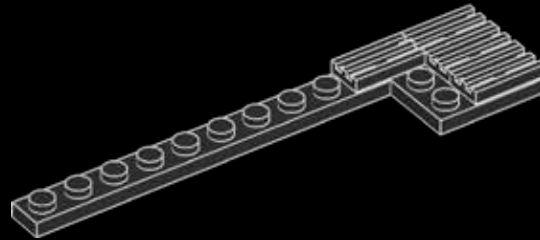

104

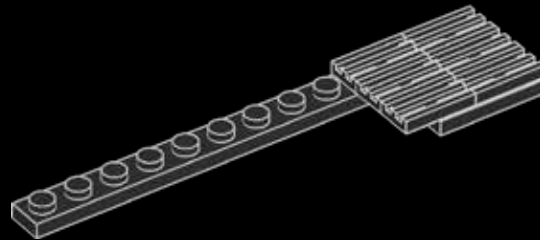

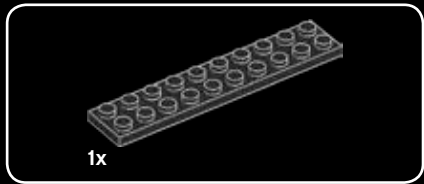

105

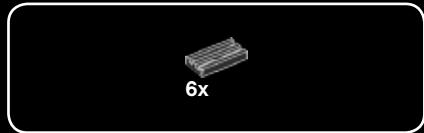
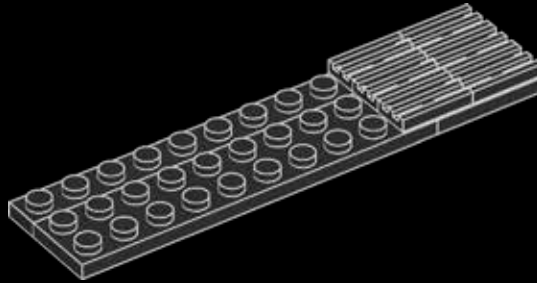

106

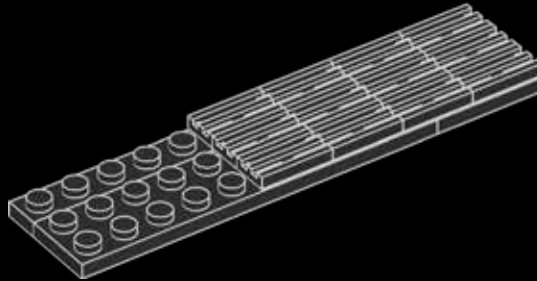

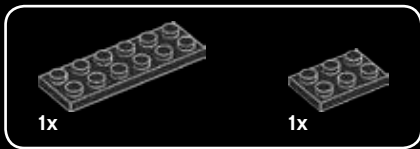

107

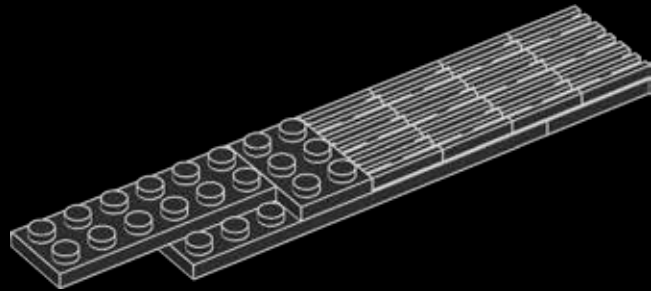

108

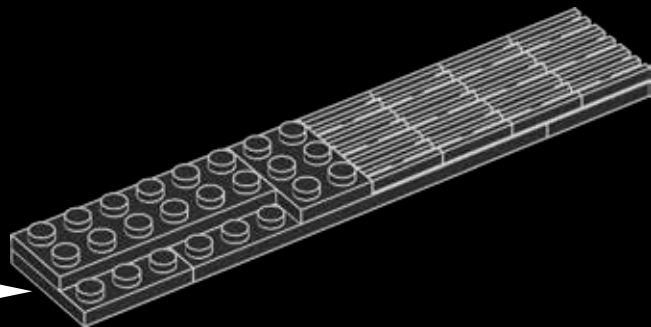
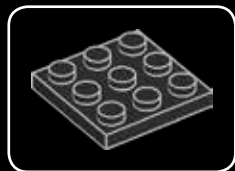

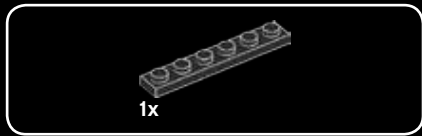

109

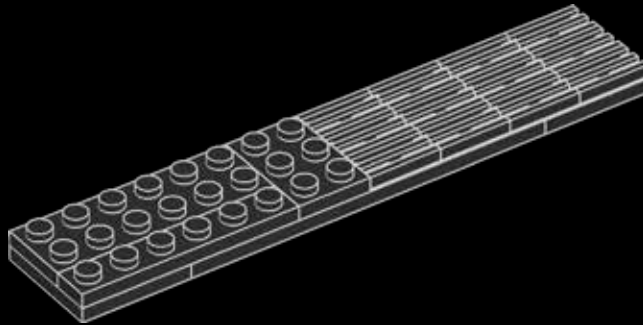

110

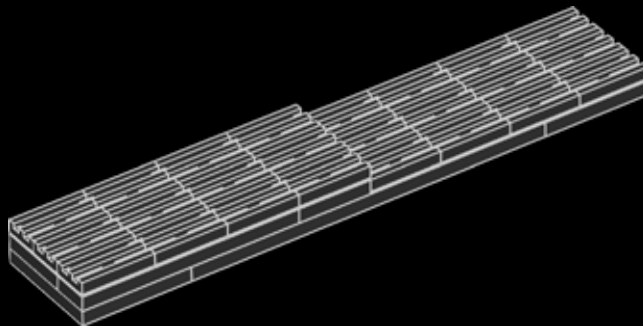

2x

111

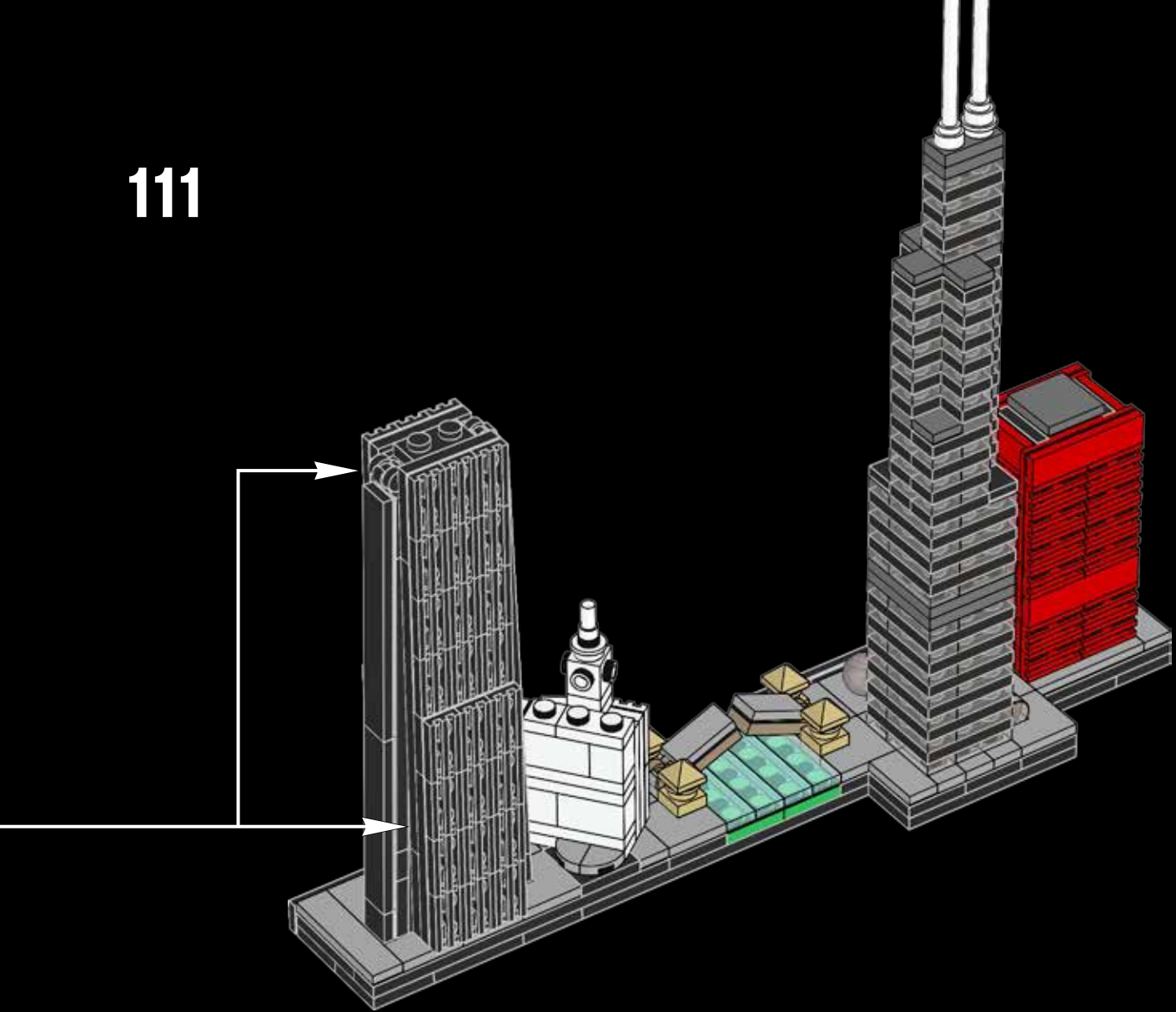

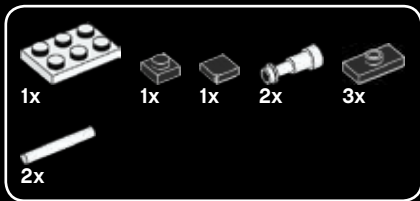

112

1



2

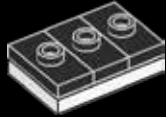

3

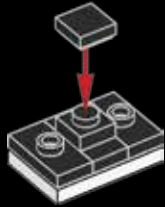

4



5

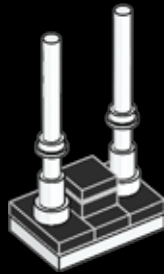

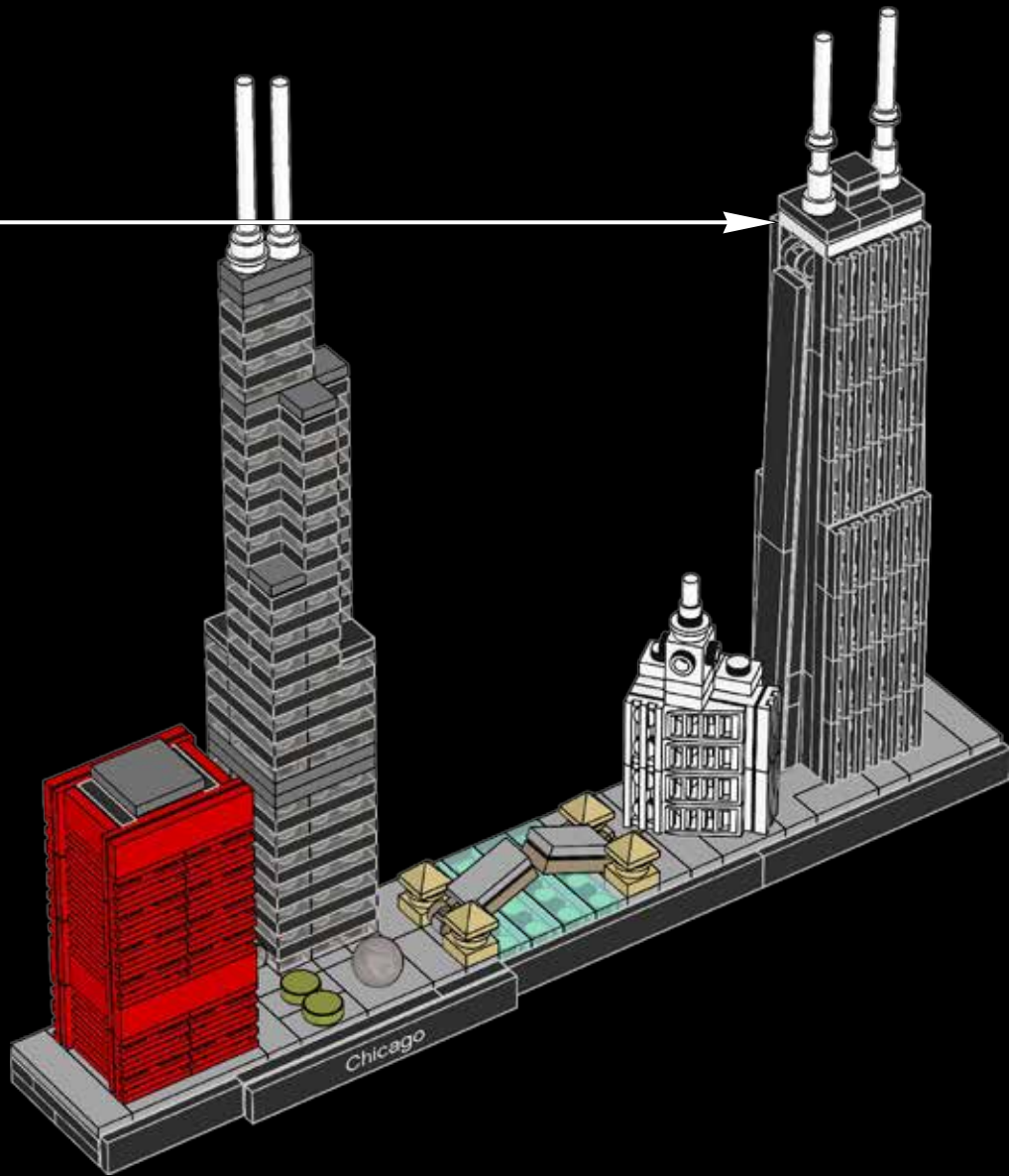
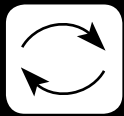



LEGO® Architecture – do you like it?

The LEGO Group would like your opinion on the new product you have just purchased. Your feedback will help shape the future development of this product series.

Please visit:

[LEGO.com/productsurvey](https://www.lego.com/productsurvey)

By completing our short feedback survey, you will be automatically entered into a drawing to win a LEGO® prize.

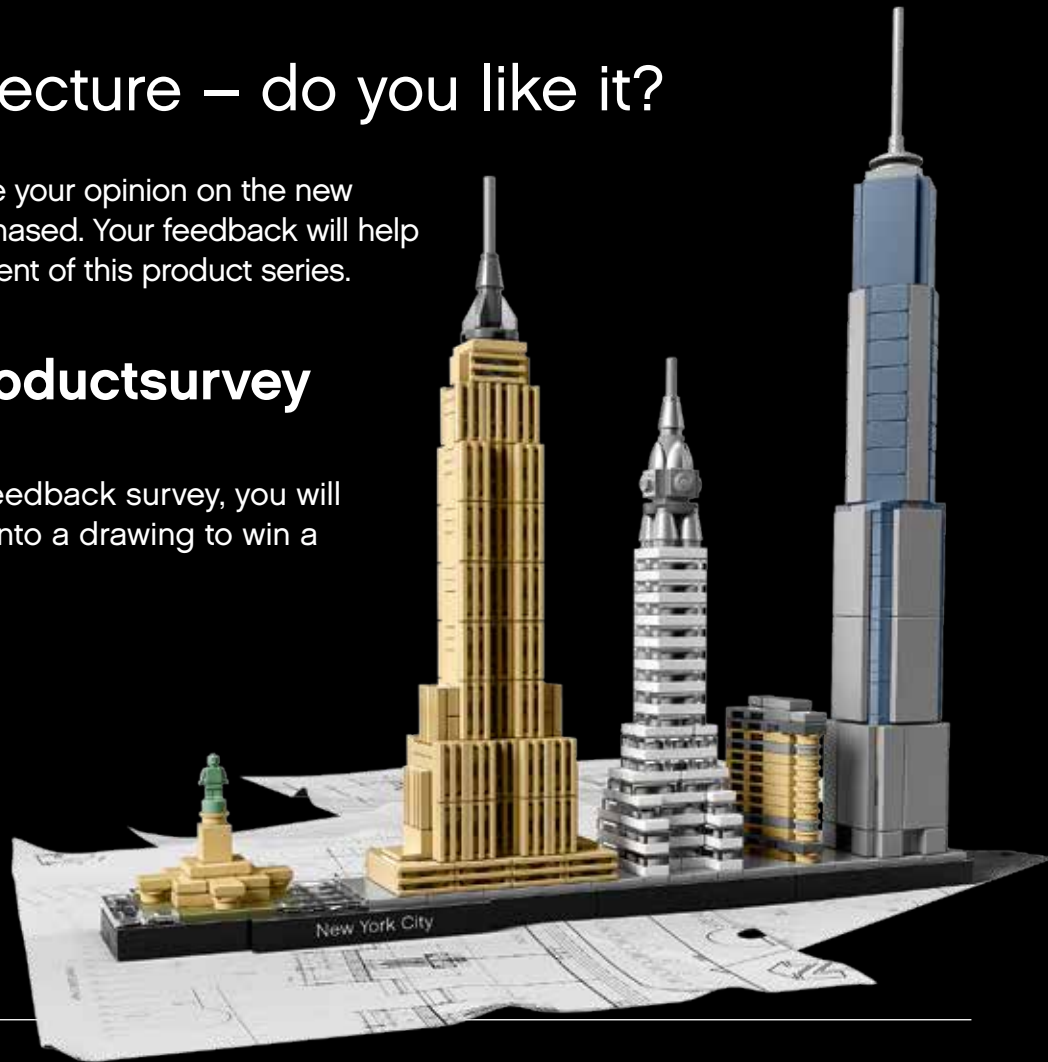

See website for official rules and details. Open to all countries where not prohibited.

LEGO and the LEGO logo are trademarks of the/son des marques de commerce du/son marcas registradas de LEGO Group.
©2017 The LEGO Group.

Aimez-vous LEGO® Architecture ?

Le Groupe LEGO aimerait connaître votre opinion sur le produit que vous venez d'acheter. Vos commentaires nous aideront à concevoir les futurs produits de cette gamme.

Rendez-vous sur :

[LEGO.com/productsurvey](https://www.lego.com/productsurvey)

En remplissant ce court sondage sur le produit, vous serez automatiquement inscrit à un tirage au sort pour gagner un prix LEGO®.



Consultez le site Web pour obtenir le règlement officiel et les détails. Ouvert à tous les résidents des pays autorisés.

LEGO and the LEGO logo are trademarks of the/son des marques de commerce du/son marcas registradas de LEGO Group.

©2017 The LEGO Group.

LEGO® Architecture: ¿te gusta?

The LEGO Group quiere conocer tu opinión acerca del nuevo producto que acabas de comprar. Tus comentarios nos ayudarán a dar forma a los futuros productos de esta serie. Visita:

[LEGO.com/productsurvey](https://www.lego.com/productsurvey)

Al rellenar esta breve encuesta de opinión, participarás automáticamente en el sorteo de un producto LEGO®.



Consulta las reglas oficiales y demás información en el sitio web. Válido en todos los países en los que esta actividad no esté prohibida.

LEGO and the LEGO logo are trademarks of the/son des marques de commerce du/son marcas registradas de LEGO Group.
©2017 The LEGO Group.

LEGO® Architecture—then and now

There has always been a natural connection between the LEGO® brick and the world of architecture. Fans who build with LEGO elements instinctively develop an interest in the form and function of the structures they create. At the same time, many architects have discovered that LEGO bricks are the perfect way of physically expressing their creative ideas.

This connection was confirmed in the early 1960s with the launch of the LEGO 'Scale Model' line. It matched the spirit of the age where modern architects were redefining how houses look and people were taking an active interest in the design of their new homes. These sets were designed to be different from the normal, brightly colored LEGO boxes; they also included a book on architecture as a source of inspiration.

Decades later, architect and LEGO fan Adam Reed Tucker, revived the idea of expressing architecture using LEGO bricks and in partnership with the LEGO Group, launched the LEGO Architecture line that we know today.

His first models, and the original sets in the current LEGO Architecture series, were interpretations of famous skyscrapers from his hometown of Chicago. Since then LEGO Architecture has developed and evolved, first with well-known buildings from other cities in the United States, and now with iconic structures from Europe, the Middle East and Asia.

The introduction of our LEGO Architecture Studio set echoes the ambitions of the earlier LEGO 'Scale Model' line and widens the potential of the LEGO Architecture series. Now you can enjoy building and learning about specific landmark buildings, or create exciting architectural models from your own fantasy. An inspiring 270-page book, featuring a number of renowned architects from around the world, guides you through the principles of architecture and encourages you in your own creative building.

LEGO® Architecture – Hier et aujourd'hui

Il y a toujours eu une connexion naturelle entre la brique LEGO® et le monde de l'architecture. Les fans qui construisent avec des éléments LEGO développent instinctivement un intérêt pour la forme et la fonction des structures qu'ils créent. De nombreux architectes ont quant à eux découvert que les briques LEGO sont la façon idéale de matérialiser leurs idées de création.

Cette connexion a été confirmée au début des années 1960 avec le lancement de la gamme « Maquettes à l'échelle » LEGO. Cette gamme correspondait à l'esprit de l'époque, alors que les architectes modernes redéfinissaient les maisons, et que les gens s'intéressaient activement à la conception de leur résidence. Ces ensembles originaux étaient conçus pour être différents des boîtes LEGO habituelles aux couleurs vives, et incluaient aussi « un livret d'architecture » comme source d'inspiration.

Quelques décennies plus tard, l'architecte et fan de LEGO Adam Reed Tucker a fait revivre l'idée d'exprimer l'architecture en utilisant des briques LEGO. En partenariat avec le Groupe LEGO, il lança la gamme LEGO Architecture que nous connaissons aujourd'hui.

Ses premiers modèles, et les ensembles originaux de la gamme LEGO Architecture actuelle, étaient des interprétations de célèbres gratte-ciel de sa ville natale de Chicago. La gamme LEGO Architecture a depuis évolué et s'est élargie, tout d'abord avec des bâtiments célèbres d'autres villes des États-Unis, puis avec de célèbres monuments d'Europe, du Moyen-Orient et d'Asie.

L'introduction de notre ensemble LEGO Architecture Studio fait écho aux ambitions de la précédente gamme « Maquettes à l'échelle » LEGO et accroît le potentiel de la gamme LEGO Architecture. Vous pouvez maintenant découvrir et construire des monuments célèbres ou créer de passionnants modèles architecturaux nés de votre imagination. Un livret d'inspiration de 270 pages, présentant plusieurs architectes célèbres du monde entier, vous guide parmi les principes de l'architecture et vous encourage dans votre propre construction créatrice.

LEGO® Architecture: entonces y ahora

Siempre ha existido una conexión natural entre el brick LEGO® y el mundo de la arquitectura. Los fans que construyen con elementos LEGO desarrollan instintivamente un interés por la forma y las funciones de las estructuras que crean. Al mismo tiempo, muchos arquitectos han descubierto que los bricks LEGO son una forma perfecta de expresar físicamente sus ideas creativas.

Esta relación se confirmó a principios de la década de 1960, con el lanzamiento de la línea «Scale Model» de LEGO. Encajaba bien con el espíritu de la época: un tiempo en el que los arquitectos modernos redefinían el aspecto de las casas y la gente se interesaba cada vez más por el diseño de su nuevo hogar. Los sets se diseñaron para que se diferenciaban de los normales, que se comercializaban en cajas de brillosos colores, e incluían un libro sobre la arquitectura que proporcionaba inspiración a sus usuarios.

Décadas más tarde, el arquitecto y fan de LEGO Adam Reed Tucker reavivó la idea de expresar la arquitectura usando bricks LEGO y, en colaboración

con The LEGO Group, lanzó la línea LEGO Architecture que hoy conocemos.

Sus primeros modelos, y los sets originales de la actual serie LEGO Architecture, eran interpretaciones de los rascacielos más famosos de su ciudad natal, Chicago. Desde entonces, LEGO Architecture se ha desarrollado y ha evolucionado, primero incorporando edificios célebres de otras ciudades de Estados Unidos y, ahora, estructuras emblemáticas de Europa, Oriente Próximo y Asia.

La introducción del set LEGO Architecture Studio recupera las ambiciones de la antigua línea «Scale Model» de LEGO y amplía el potencial de la serie LEGO Architecture. Hoy puedes disfrutar mientras construyes y aprendes sobre edificios célebres, o crear tus propios modelos arquitectónicos a partir de tu imaginación. Un instructivo libro de 270 páginas con materiales creados por arquitectos internacionales de gran reputación te guiará a través de los principios de la arquitectura y te animará a dar tus primeros pasos en el mundo de la construcción creativa.



21050
Studio

Celebrate the world of architecture and collect all the models
Célébrez le monde de l'architecture et collectionnez tous les modèles
Celebra el mundo de la arquitectura y colecciona todos los modelos



21024
Louvre



21030
United States Capitol Building
Le Capitole des États-Unis
Edificio del Capitolio de Estados Unidos

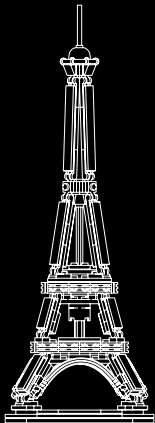

21019
The Eiffel Tower
La tour Eiffel
La torre Eiffel

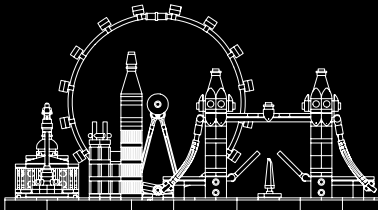

21034
London
Londres

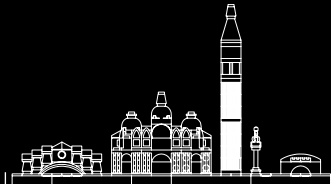

21026
Venice
Venise
Venecia

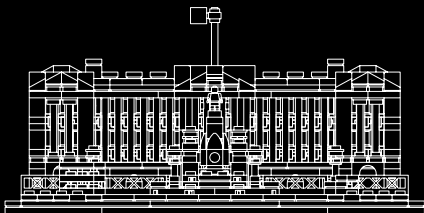

21029
Buckingham Palace
Le palais de Buckingham
Palacio de Buckingham

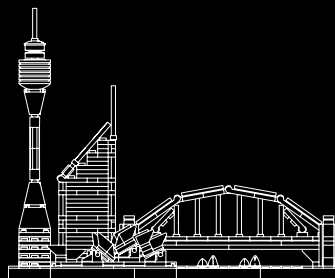

21032
Sydney
Sidney



21027
Berlin
Berlin
Berlin



21028
New York City
New York
Nueva York

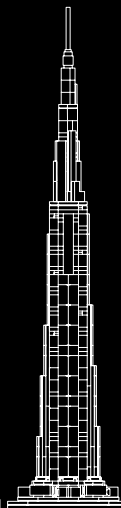

21031
Burj Khalifa

References:

Pictures -

© Shutterstock

© Offset

Text -

www.johnhancockcenterchicago.com

www.willistower.com

www.thewrigleybuilding.com

www.cityofchicago.org

www.architecture.org

Références :

Images -

© Shutterstock

© Offset

Texte -

www.johnhancockcenterchicago.com

www.willistower.com

www.thewrigleybuilding.com

www.cityofchicago.org

www.architecture.org

Referencias:

Fotografías -

© Shutterstock

© Offset

Texto -

www.johnhancockcenterchicago.com

www.willistower.com

www.thewrigleybuilding.com

www.cityofchicago.org

www.architecture.org

Customer Service
Kundenservice
Service Consommateurs
Servicio Al Consumidor
LEGO.com/service or dial

 00800 5346 5555 ;  1-800-422-5346 ; 

1x 6189137
 2x 4547649
 2x 4558952
 2x 302401
 2x 6058177
 4x 241201
 4x 6023804
 2x 6070327
 2x 6018774
 2x 6093526
 3x 242001
 4x 362301
 1x 302101
 3x 371001

2x 395701
 4x 4161734
 4x 4159553
 4x 6177165
 4x 306921
 36x 241221
 8x 6118830
 4x 243121
 3x 300524
 1x 6119192
 2x 4540384
 5x 300424

5x 307026
 6x 302426
 1x 4632571
 3x 6092585
 48x 241226
 14x 302326
 4x 4535739
 6x 302226
 1x 368026
 3x 242026
 6x 6097283
 7x 362326
 1x 6174624
 13x 6174917

1x 6099483
 4x 302126
 1x 243126
 4x 366626
 4x 663626
 4x 379526
 3x 4653049
 4x 416226
 1x 303226
 2x 303426

7x 447726
 3x 383226
 14x 302328
 1x 6000070
 1x 383228
 2x 3005740
 4x 4586557
 2x 6079000
 22x 6030982
 58x 6001197
 4x 6135607
 2x 6176433

2x 6071229
 5x 4211399
 3x 4211511
 1x 4540203
 8x 6066097
 8x 4211414
 1x 6126082
 12x 6065824
 4x 4654577
 5x 4211356
 2x 4210719
 5x 4210848
 3x 4211063
 1x 4211055

1x 4211133
 2x 6039176
 2x 6047015
 1x 6082975
 1x 4111971

