

LEGO

Architecture

21044

Paris

France

París

Francia



Paris, City of Lights

Paris, la Ville lumière

París, la Ciudad de la Luz

Without a doubt, Paris deserves its reputation as one of the most beautiful and romantic cities in the world. Historically, it was a magnet for artists, writers and political dissidents and it remains the avant-garde in terms of art, fashion, gastronomy and culture. With its glorious boulevards full of bistros and boutiques, and its stunning UNESCO heritage-protected skyline, it is one of Europe's largest and most memorable cities. This LEGO® Architecture Paris skyline distills some of the city's most iconic monuments into a LEGO microscale keepsake. We hope that it evokes good memories and associations of this global city.

Sans aucun doute, Paris mérite son titre de ville parmi les plus belles et les plus romantiques au monde. Elle est depuis toujours prisée des artistes, des écrivains et des dissidents politiques, et demeure à l'avant-garde dans le domaine des arts, de la mode, de la gastronomie et de la culture. Ses boulevards glorieux bordés de bistros et de boutiques ainsi que ses monuments classés au patrimoine de l'UNESCO en font l'une des villes les plus importantes et les plus mémorables de l'Europe. Cet ensemble LEGO® Architecture rassemble quelques-uns des monuments emblématiques de Paris en un souvenir miniature signé LEGO. Nous espérons que vous vous remémorerez de bons moments et créerez des liens avec cette ville internationale.

París se merece, no cabe duda, la reputación que posee como una de las ciudades más hermosas y románticas del mundo. Históricamente, ha atraído a artistas, escritores y disidentes políticos, y continúa a la vanguardia en los campos del arte, la moda, la gastronomía y la cultura. Con sus gloriosos bulevares repletos de bistrós y *boutiques*, y su impresionante horizonte, protegido como patrimonio de la humanidad por la Unesco, es una de las ciudades más grandes y memorables de Europa. Este horizonte LEGO® Architecture dedicado a París sintetiza algunos de los monumentos más representativos de la ciudad en un *souvenir* LEGO a microescala. Esperamos que te sirva para despertar bonitos recuerdos y asociaciones vinculados a esta ciudad internacional.

*"A walk about Paris
will provide lessons in
history, beauty, and in
the point of Life."*

Thomas Jefferson

*« Une promenade
autour de Paris fournira
des leçons d'histoire, de
beauté et de vie. »*

Thomas Jefferson

*"Un paseo por París
ofrece lecciones sobre
historia, belleza
y el sentido de la vida".*

Thomas Jefferson



Arc de Triomphe

L'Arc de Triomphe

Arco del Triunfo

Think of Paris and the Arc de Triomphe will spring to mind as one of its most significant commemorative monuments. The beautiful neoclassical arch was ordered in 1806 by Napoleon and designed by the architect Jean Chalgrin to honor those who fought and died for France in the French Revolution and Napoleonic Wars. Since then, it has been the rallying point of French troops parading after successful military campaigns and the site of the annual Bastille Day Parade.

Lorsque l'on pense à Paris, l'Arc de Triomphe est l'un des plus importants monuments commémoratifs qui nous viennent à l'esprit. La superbe arche néoclassique, commandée en 1806 par Napoléon et conçue par l'architecte Jean Chalgrin, commémore le souvenir des soldats morts au combat pour leur pays durant la Révolution française et les guerres napoléoniennes. Depuis, la structure a servi de point de ralliement à la parade des troupes françaises célébrant le succès des campagnes militaires et au défilé annuel de la fête nationale.

Es imposible pensar en París y no recordar el Arco del Triunfo: uno de sus monumentos conmemorativos más importantes. El precioso arco neoclásico fue encargado por Napoleón en 1806 y diseñado por el arquitecto Jean Chalgrin en honor a aquellos que lucharon y murieron por Francia durante la Revolución

francesa y las guerras napoleónicas. Desde entonces, se ha convertido en punto de paso imprescindible para las tropas francesas al desfilar luego de campañas militares exitosas, así como en el centro del desfile anual del Día de la Bastilla.



Champs-Élysées

Les Champs-Élysées

Campos Elíseos

One of the world's most beautiful and famous boulevards, the Champs-Élysées is synonymous with all that is glamorous and grand about Paris; luxury shops, cafes and theaters. Running almost 1.25 miles (2 kilometers) through the 8th arrondissement, it initially was an extension of the Tuilleries Gardens leading to the palace at Versailles, opened by Louis XIV in 1667, a date that many consider to be the birth of Paris as a grand city.

L'un des boulevards les plus beaux et les plus célèbres au monde, les Champs-Élysées sont synonymes de tout le prestige et le faste de Paris : boutiques de luxe, cafés et théâtres. Traversant le 8^e arrondissement sur près de deux kilomètres, l'avenue était à l'origine une extension du jardin des Tuileries menant au Palais de Versailles, ouvert en 1667 par Louis XIV. Beaucoup considèrent cette date comme le début de Paris à titre de grande ville.

Uno de los bulevares más hermosos y populares del mundo, el de los Campos Elíseos es sinónimo de todo lo que es glamoroso y grandioso en París: tiendas de lujo, cafeterías y teatros. Con una longitud de casi 2 km a través del VIII distrito, comenzó siendo una prolongación del jardín de las Tullerías que conducía al Palacio de Versailles y fue inaugurado por Luis XIV en 1667, año que muchos consideran el del nacimiento de París como gran ciudad.





Tour Montparnasse

La tour Montparnasse

Torre Montparnasse

This 688.9 ft. (210m) monolithic skyscraper is located in the Montparnasse area of Paris. Designed by the architects Eugène Beaudouin, Urbain Cassan, and Louis de Hoÿm de Marien, it was built by Campenon Bernard. It was the tallest tower until 2011 when the Tour First surpassed it. Loved and hated, it is often criticized for being out of place in the Paris skyline but offers unique panoramic views of the city's famous attractions.

Ce gratte-ciel monolithique de 210 mètres de hauteur s'élève dans le quartier du Montparnasse de Paris. Œuvre des architectes Eugène Beaudouin, Urbain Cassan et Louis de Hoÿm de Marien, la structure a été construite par Campenon Bernard. Il s'agissait de la plus haute tour jusqu'à ce que la tour First se hisse au premier rang en 2011. À la fois aimé et détesté, cet ouvrage est souvent sujet à critique pour être mal assorti à la silhouette de Paris, mais offre une vue panoramique sans pareille sur les attractions populaires de la ville.

Este monolítico rascacielos de 210 m se encuentra en el área de París conocida como Montparnasse. Diseñado por los arquitectos Eugène Beaudouin, Urbain Cassan y Louis de Hoÿm de Marien, la construcción es obra de Campenon Bernard. Fue la torre más alta hasta 2011, cuando la Torre First la superó. Amada por unos y odiada por otros, es criticada con frecuencia por parecer fuera de lugar en el horizonte de París, aunque ofrece unas extraordinarias vistas panorámicas de las atracciones más populares de la ciudad.



Grand Palais Le Grand Palais

The Grand Palais des Champs-Élysées was built in 1897 in preparation for the Universal Exposition of 1900 and is now a historical site, exhibition hall and museum complex. Its original purpose was to be the home of great artistic events in the city of Paris. Since its inauguration, this ornate building with its spectacular glass roof has seen a parade of art and cultural shows of all types.

Le Grand Palais des Champs-Élysées, bâti en 1897 en prévision de l'Exposition universelle de 1900, est maintenant un lieu historique, une salle d'exposition et un complexe muséal. Son objectif initial était d'être le berceau de grands événements artistiques dans la ville de Paris. Depuis son inauguration, ce bâtiment orné d'une verrière spectaculaire a été le théâtre d'expositions artistiques et culturelles en tout genre.

El Grand Palais des Champs-Élysées fue construido en 1897 con motivo de la Exposición Universal de 1900 y hoy comparte funciones como monumento histórico, sala de exposiciones y complejo museístico. Fue concebido como un espacio para organizar los grandes eventos artísticos de la ciudad de París. Desde su inauguración, este bellissimo edificio y su espectacular techo de vidrio han visto desfilar muestras de arte y cultura de todo tipo.

Eiffel Tower

La tour Eiffel

Torre Eiffel

Nothing represents Paris more than the iconic Tour Eiffel, or Eiffel Tower. Built between 1887-1889, it is named after the engineer Gustav Eiffel, who designed and built the wrought iron structure.

The actual design of the tower was by Maurice Koechlin and Émile Nouguier, who worked for Eiffel at the time, together with architect Stephen Sauvestre, and was inspired by the Latting Observatory in New York.

This much-loved global cultural icon of Paris was not, however, so popular on its inception; it was much maligned by leading artists and intellectuals of the time. Today, however, it is considered to be a magnificent example of structural art.

Il n'existe pas meilleur symbole parisien que l'emblématique tour Eiffel. La structure en fer forgé édiflée entre 1887 et 1889 doit son nom à l'ingénieur Gustave Eiffel, responsable de sa conception et de sa construction.

Inspirés par l'observatoire de Latting à New York, Maurice Koechlin et Émile Nouguier, qui travaillaient pour M. Eiffel à l'époque, ont dessiné la tour en collaboration avec l'architecte Stephen Sauvestre.

À l'époque de son inauguration, cette icône culturelle mondiale grandement prisée de Paris ne faisait pas tellement l'unanimité auprès des artistes et des intellectuels de renom, qui ne ménageaient pas leurs critiques. De nos jours, cependant, on la considère un magnifique exemple d'art structurel.



Ningún otro monumento representa el espíritu de París como la emblemática Torre Eiffel. Construida entre 1887 y 1889, su nombre rinde homenaje al ingeniero Gustave Eiffel, quien diseñó y construyó la estructura de hierro forjado.

El diseño visible de la torre, inspirado en el Observatorio Latting de Nueva York, fue obra de Maurice Koechlin y Émile Nouguier, que trabajaban para Eiffel en aquel entonces, en colaboración con el arquitecto Stephen Sauvestre.

Este icono cultural de París, hoy de fama internacional, no fue tan popular en sus principios, cuando debió enfrentar las muchas críticas de importantes artistas e intelectuales de la época. Hoy, sin embargo, es ampliamente considerado un majestuoso ejemplo de arte estructural.

The Louvre

Musée du Louvre

El Louvre

The Musée du Louvre opened in 1793, during the French Revolution, and from the very beginning was intended to provide inspiration for contemporary art. As a former royal residence, the Louvre is inextricably linked to eight centuries of French history. Over 35,000 artworks are displayed, including universally admired works such as the Mona Lisa by Leonardo da Vinci, the Winged Victory of Samothrace and the Venus de Milo.

Ouvert en 1793 pendant la Révolution française, le musée du Louvre a, dès ses débuts, eu pour ambition d'être une source d'inspiration pour les artistes contemporains. Ancienne résidence royale, le musée du Louvre est intimement lié à huit siècles d'histoire de France. Plus de 35 000 œuvres d'art y sont exposées, dont des chefs-d'œuvre universellement admirés comme la Joconde de Léonard de Vinci, la Victoire de Samothrace et la Vénus de Milo.

El Museo del Louvre fue inaugurado en 1793, durante la Revolución francesa, y ya en sus comienzos estaba entre sus objetivos servir como fuente de inspiración para el arte contemporáneo. Como la antigua residencia real que es, el Louvre está profundamente unido a ocho siglos de historia francesa. En sus salas se exhiben más de 35.000 obras de arte, algunas de ellas universalmente admiradas, como la Mona Lisa, de Leonardo da Vinci, la Victoria alada de Samotracia o la Venus de Milo.



1



2



3

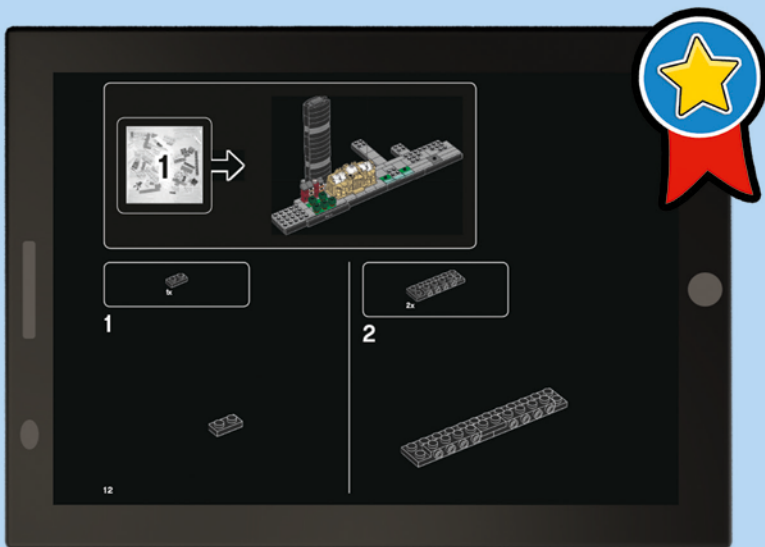

LEGO.com/apps

Check for compatibility
Vérifier la compatibilité
Comprueba tu compatibilidad

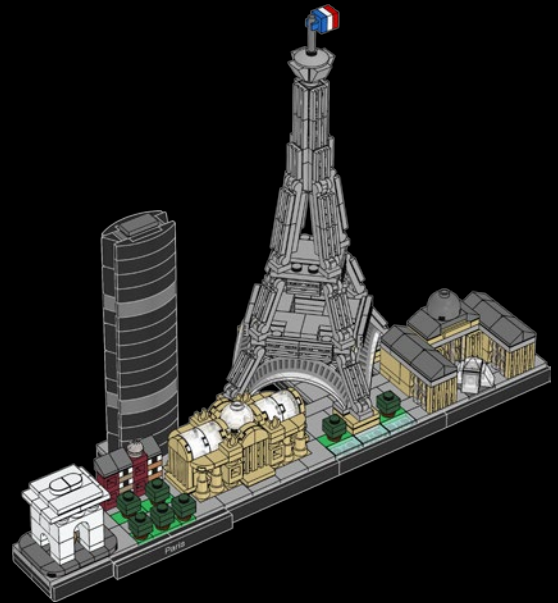
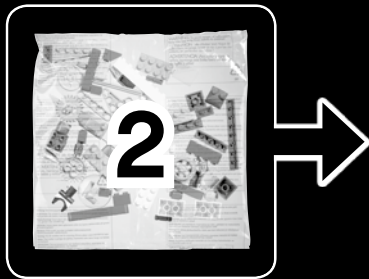
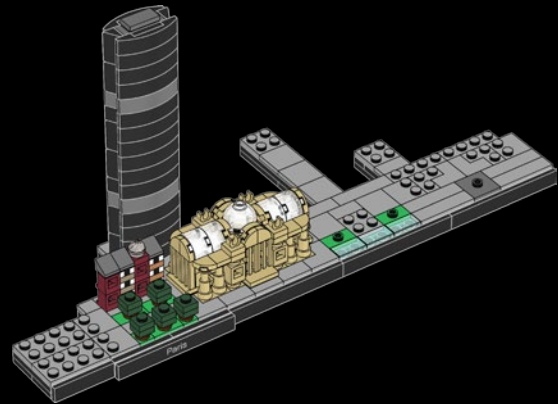
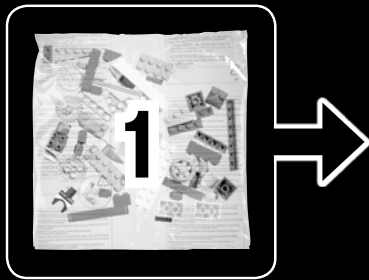

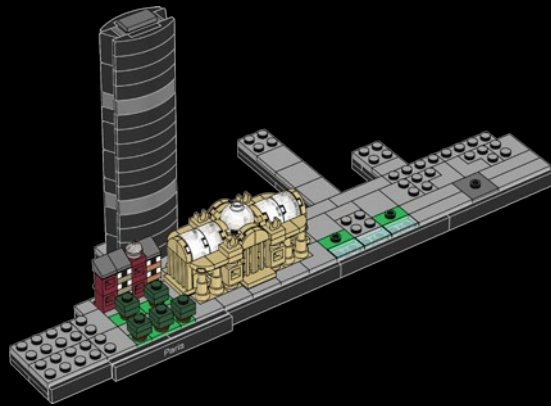

1x

1

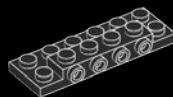
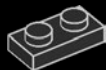

2x

2

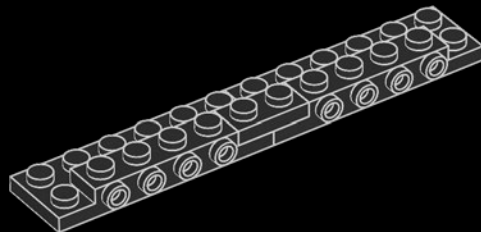



3

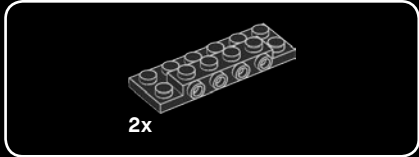
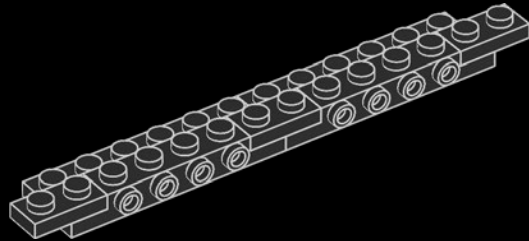

4

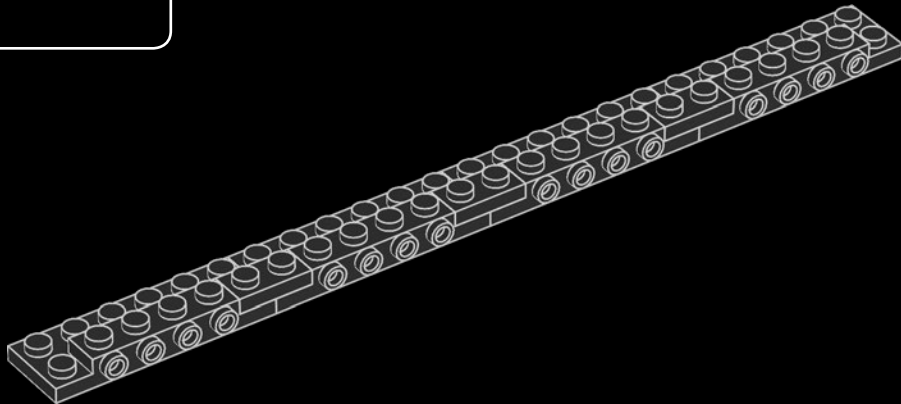



2x

5

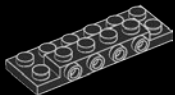
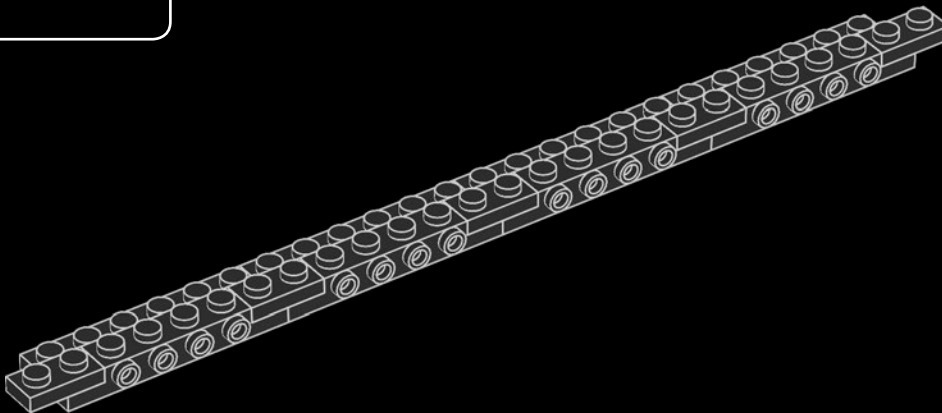

2x

6

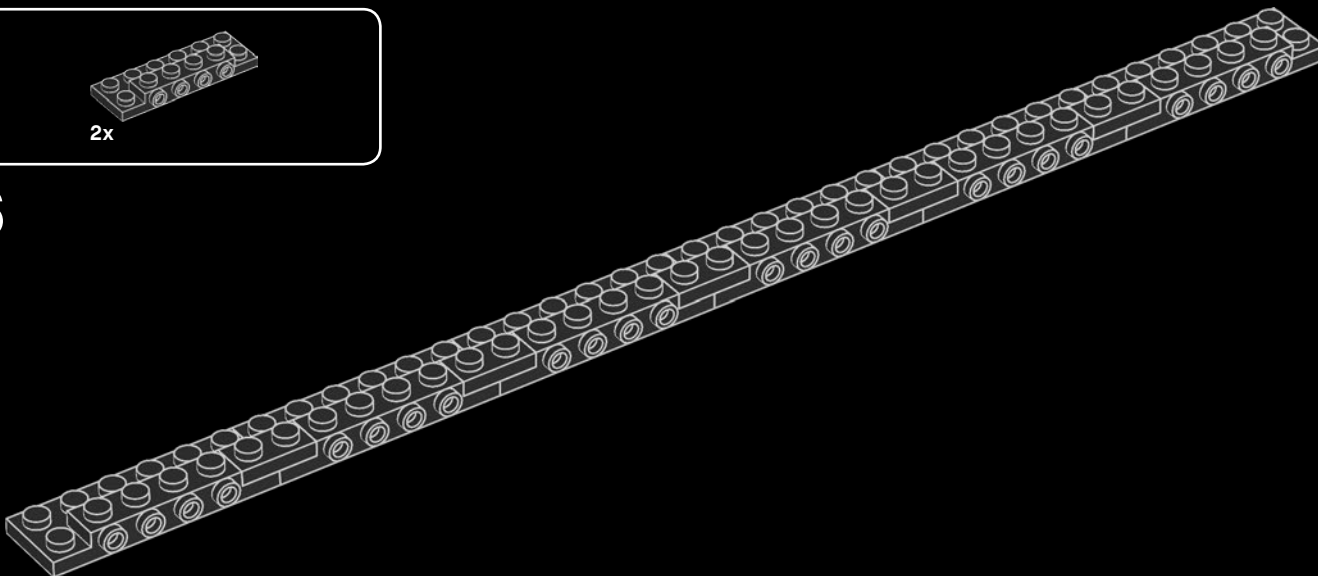

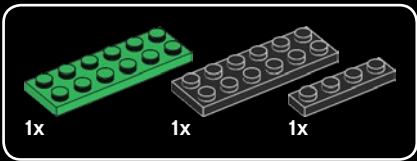

7

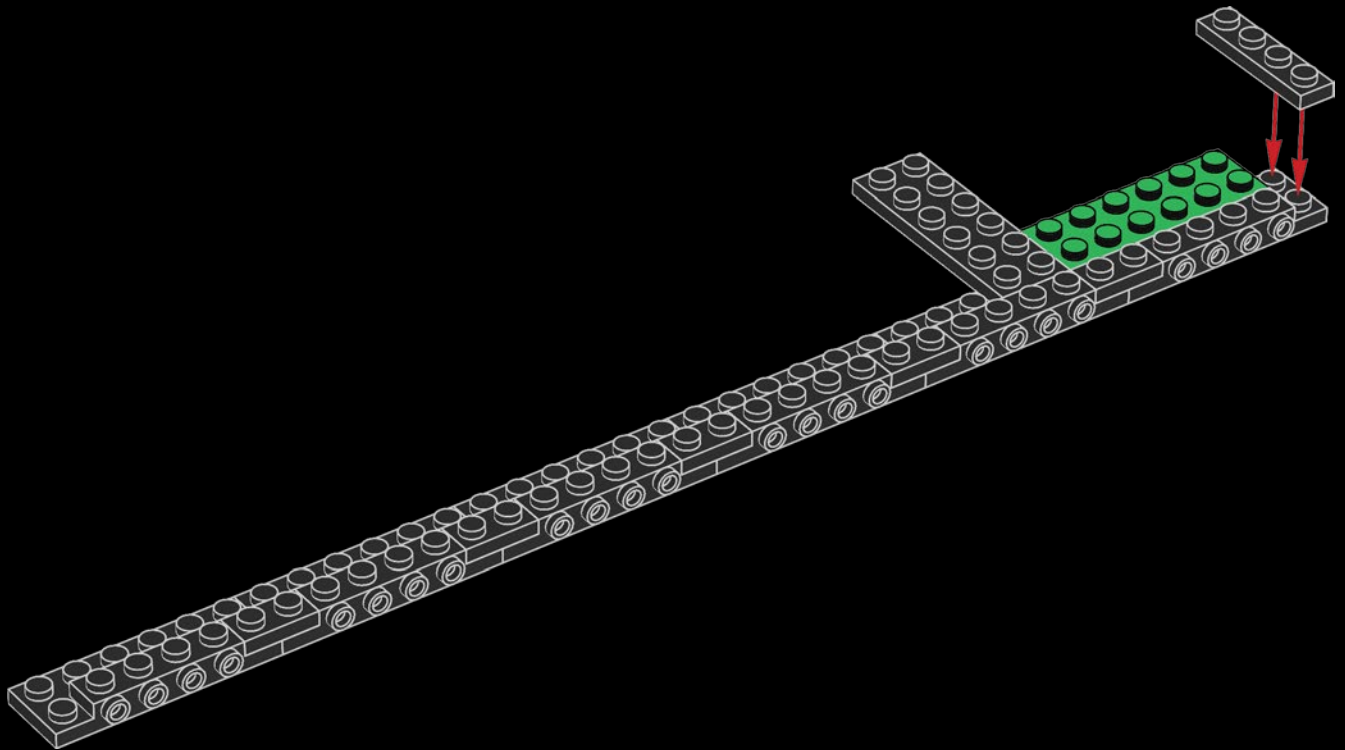

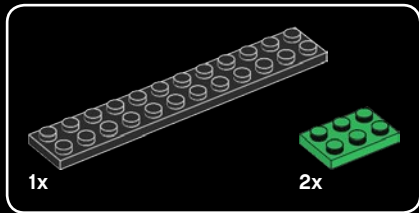

8

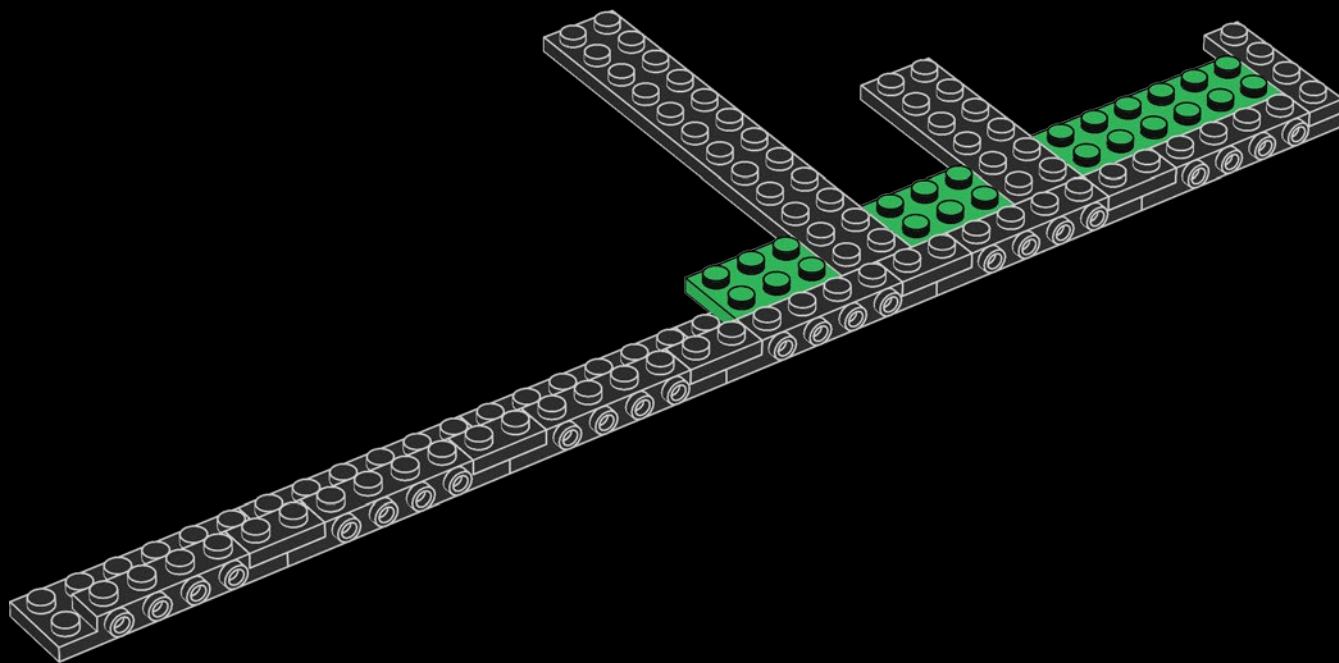

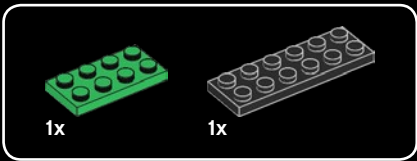

9

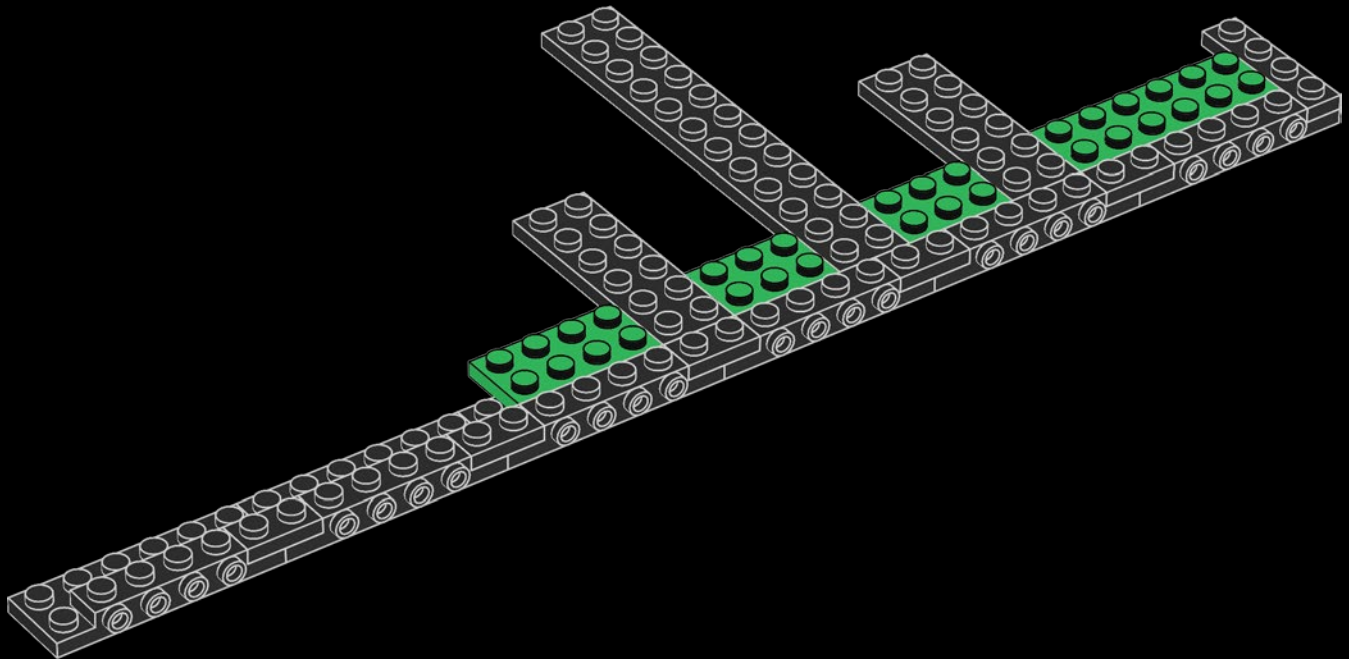

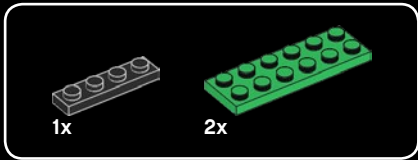

10

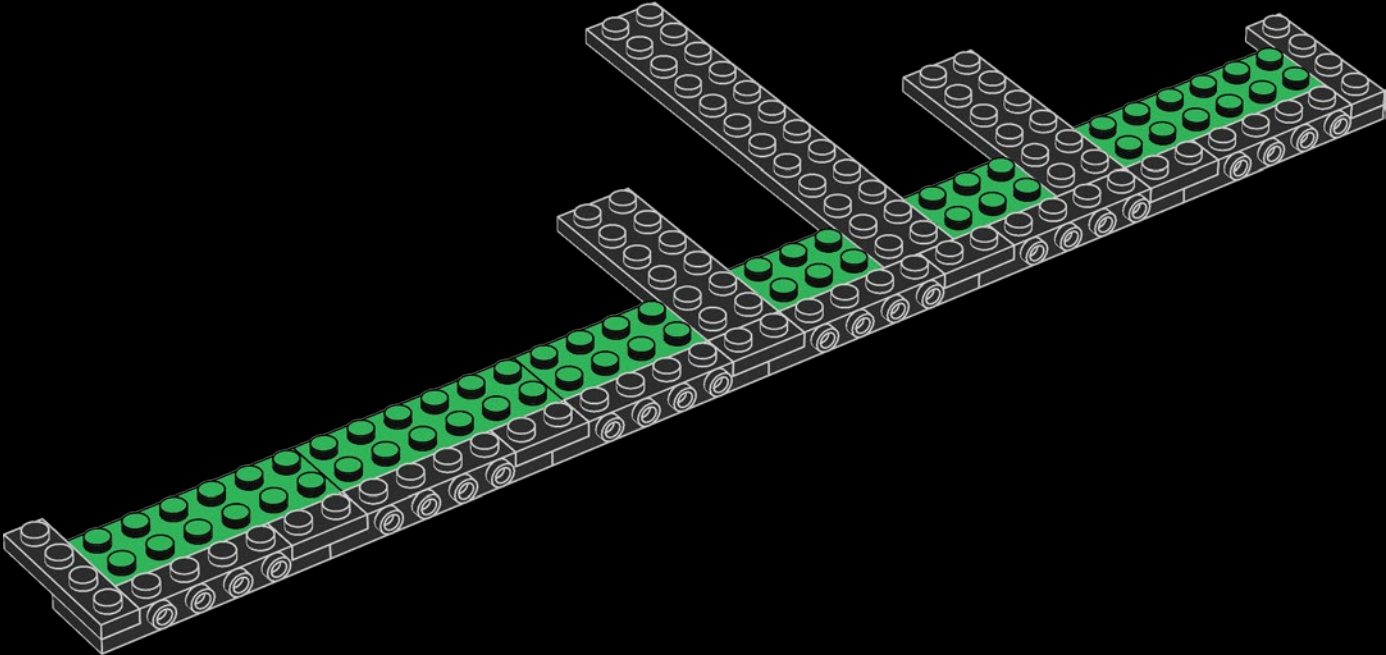

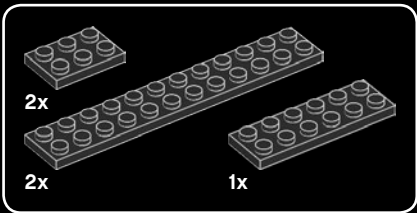

11

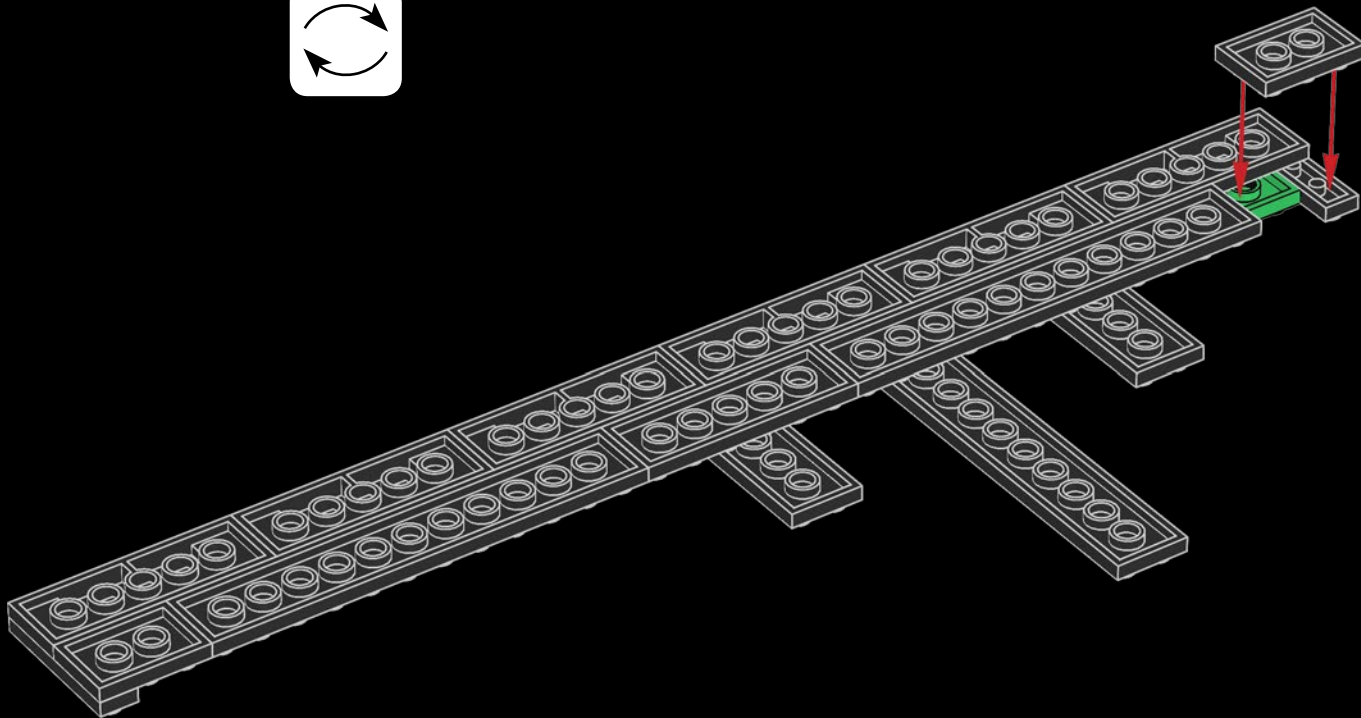

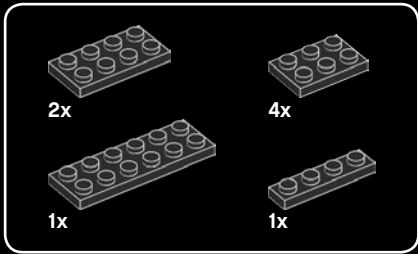

12

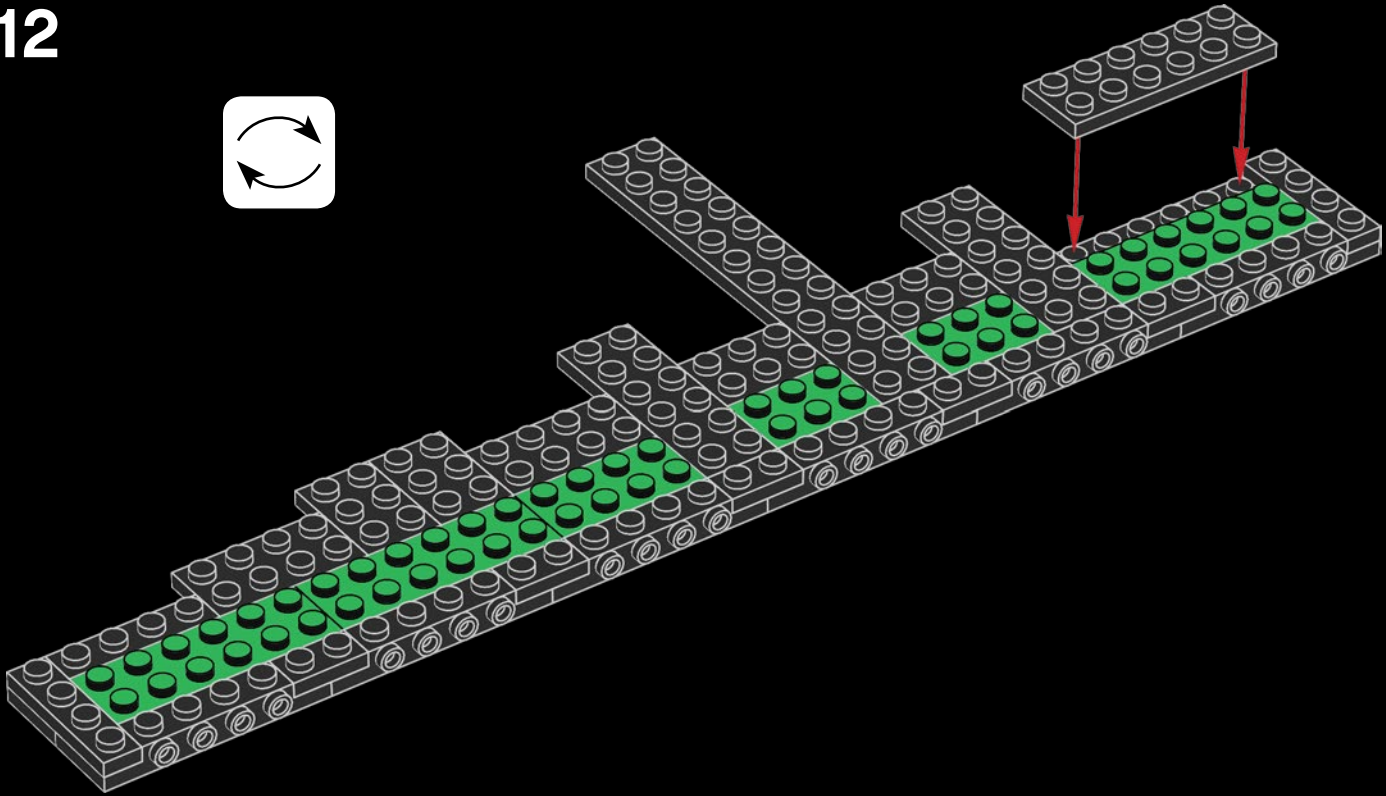

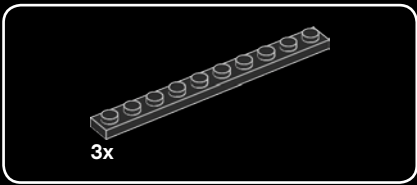

13

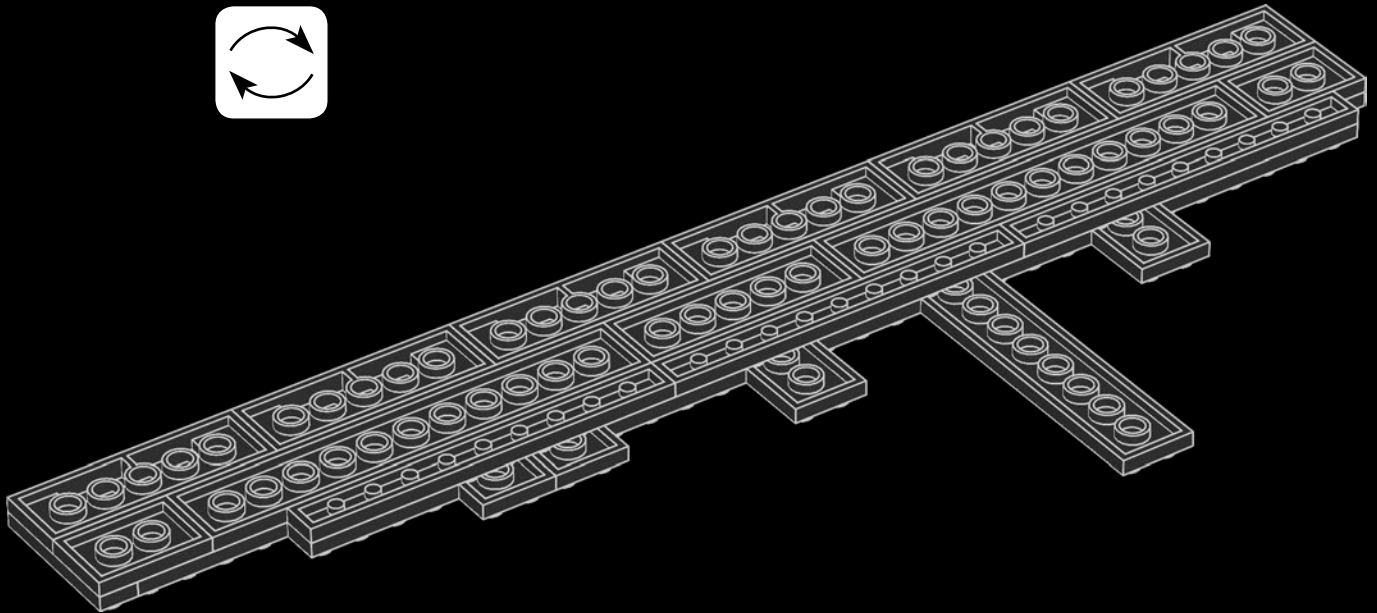

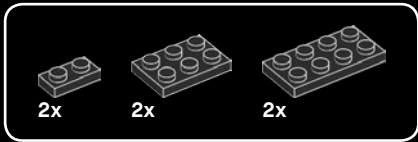

14

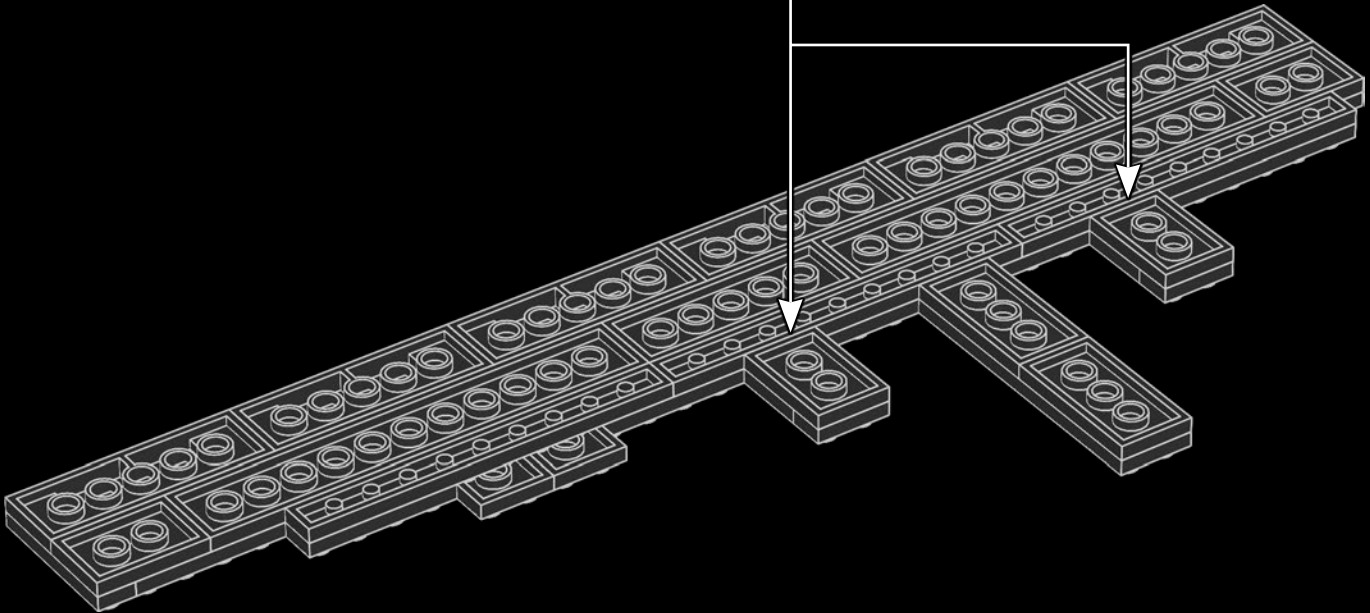
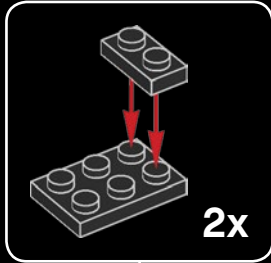

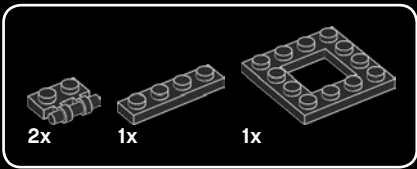

15

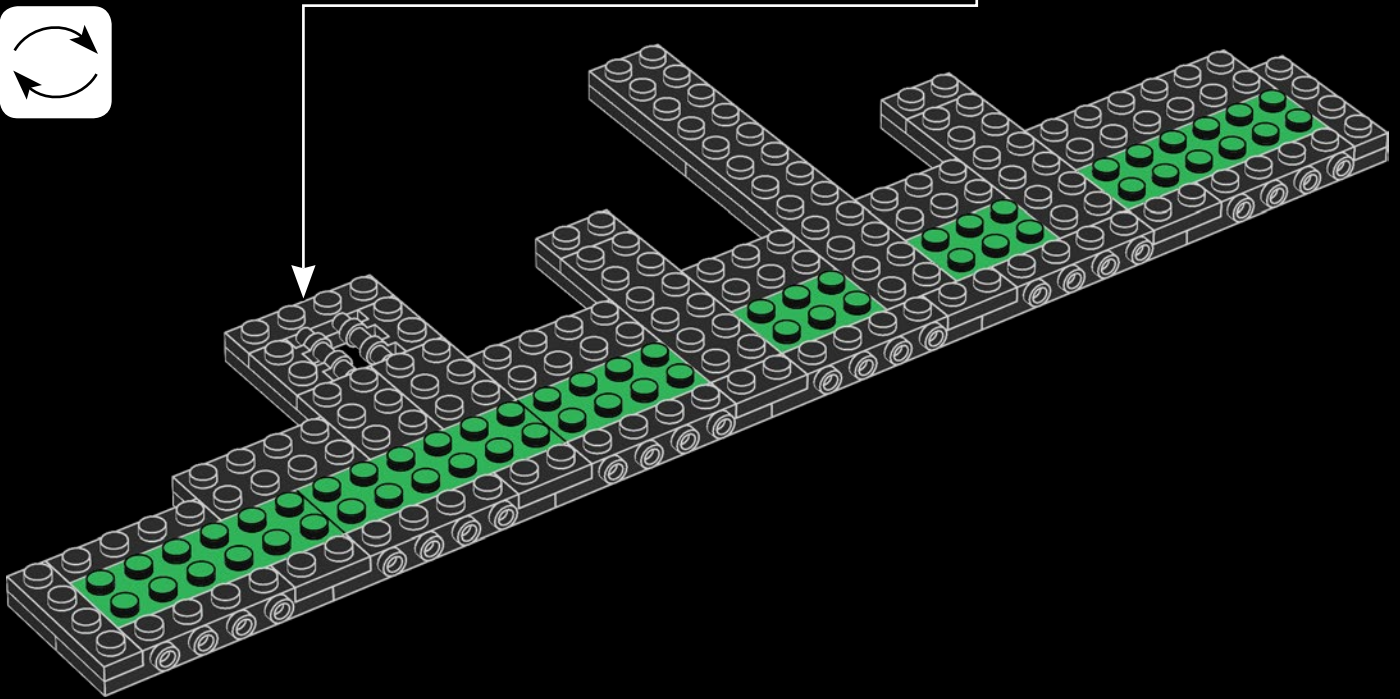
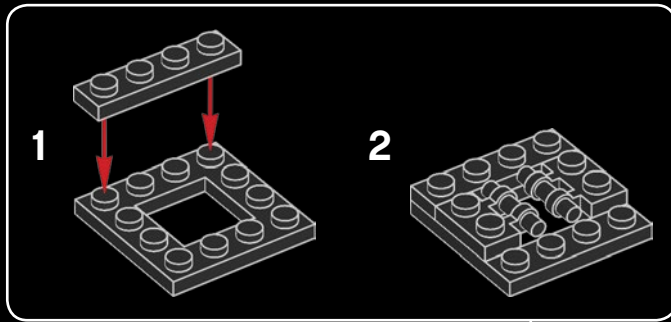

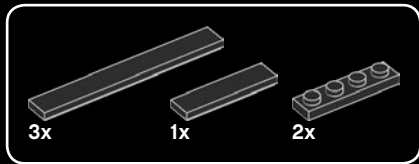

16

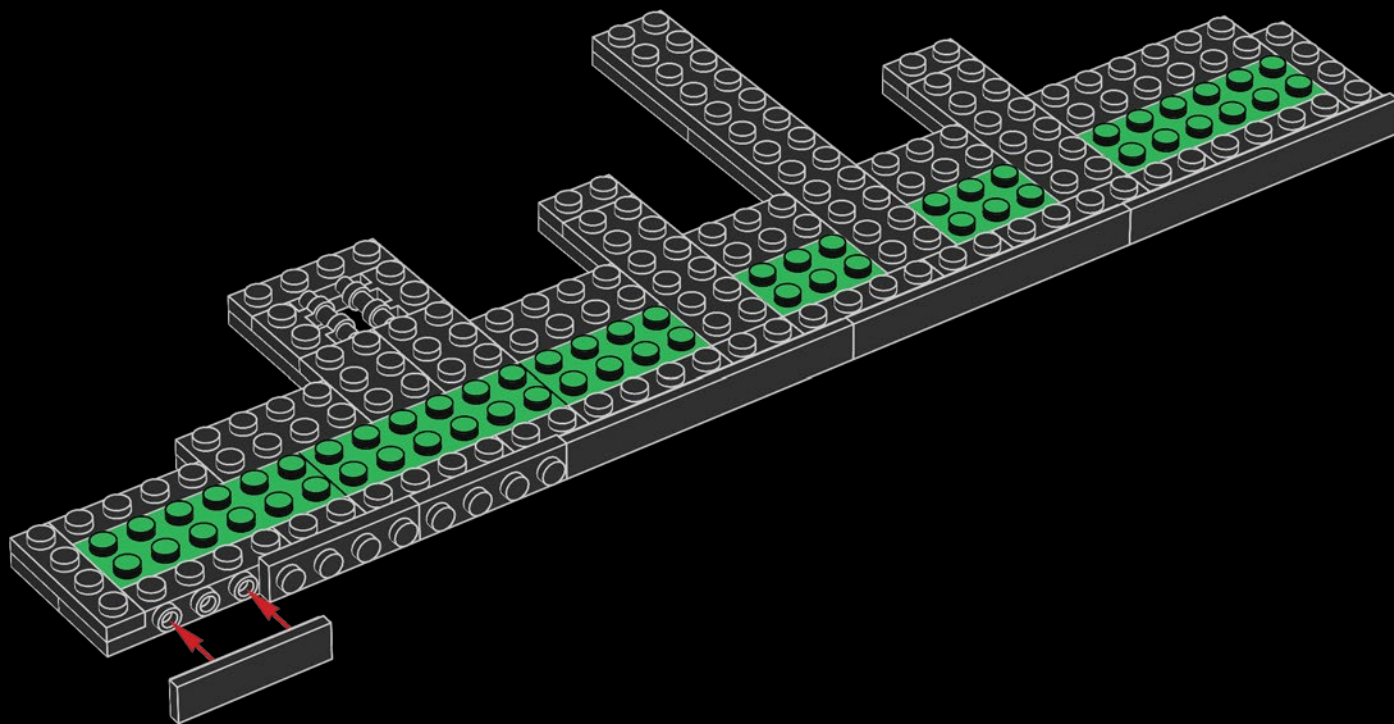

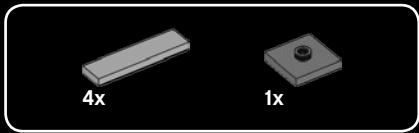

17

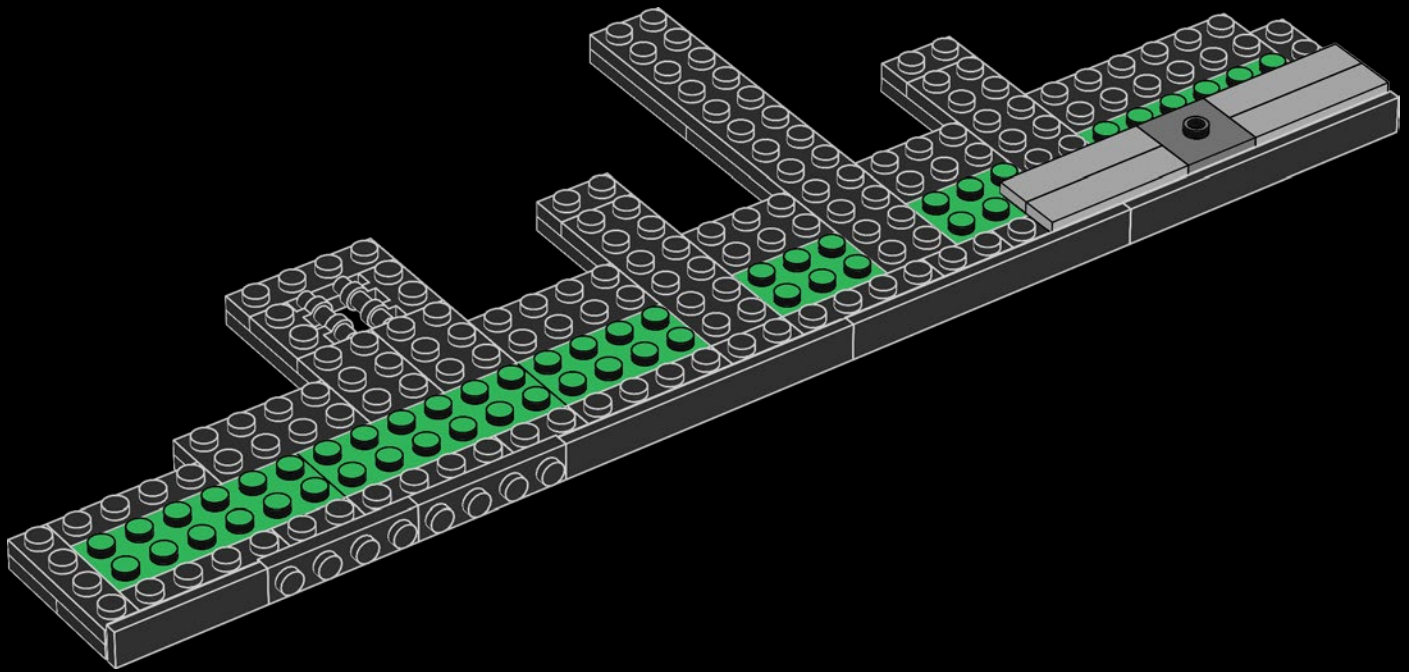

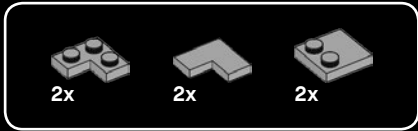

18

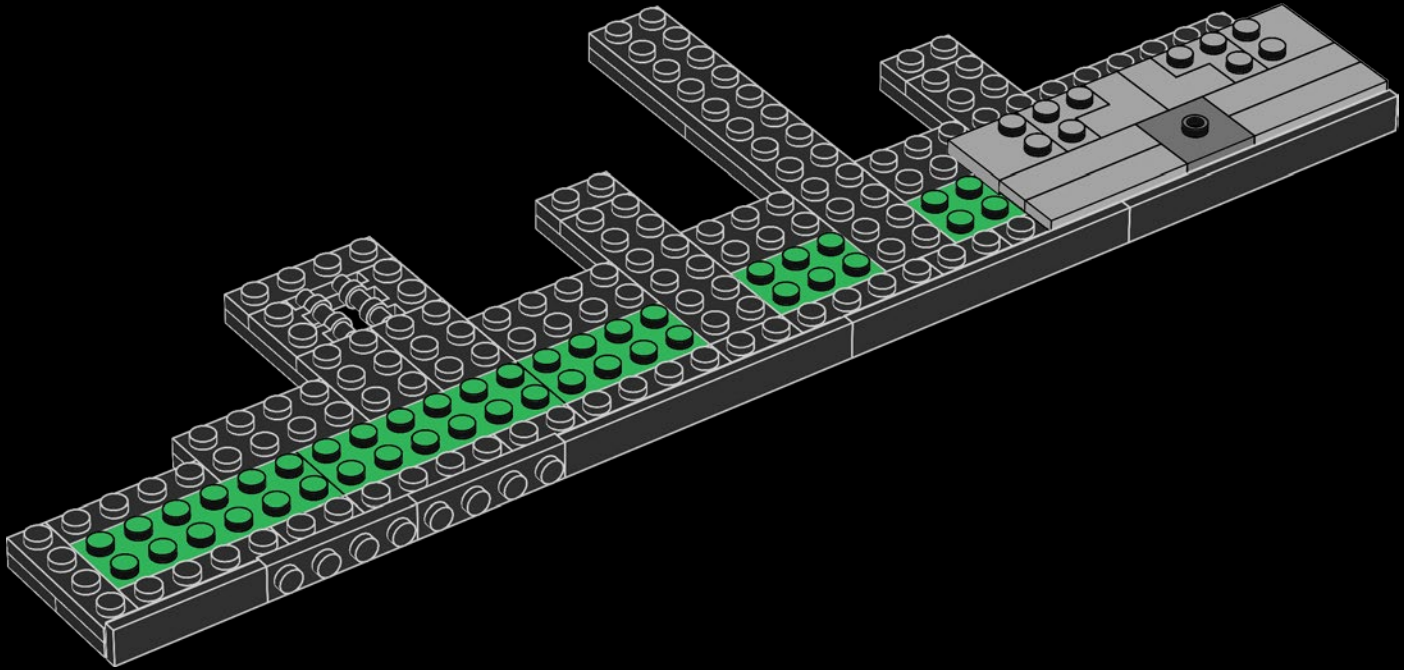

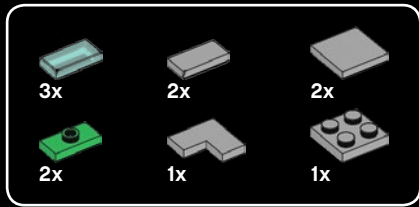

20

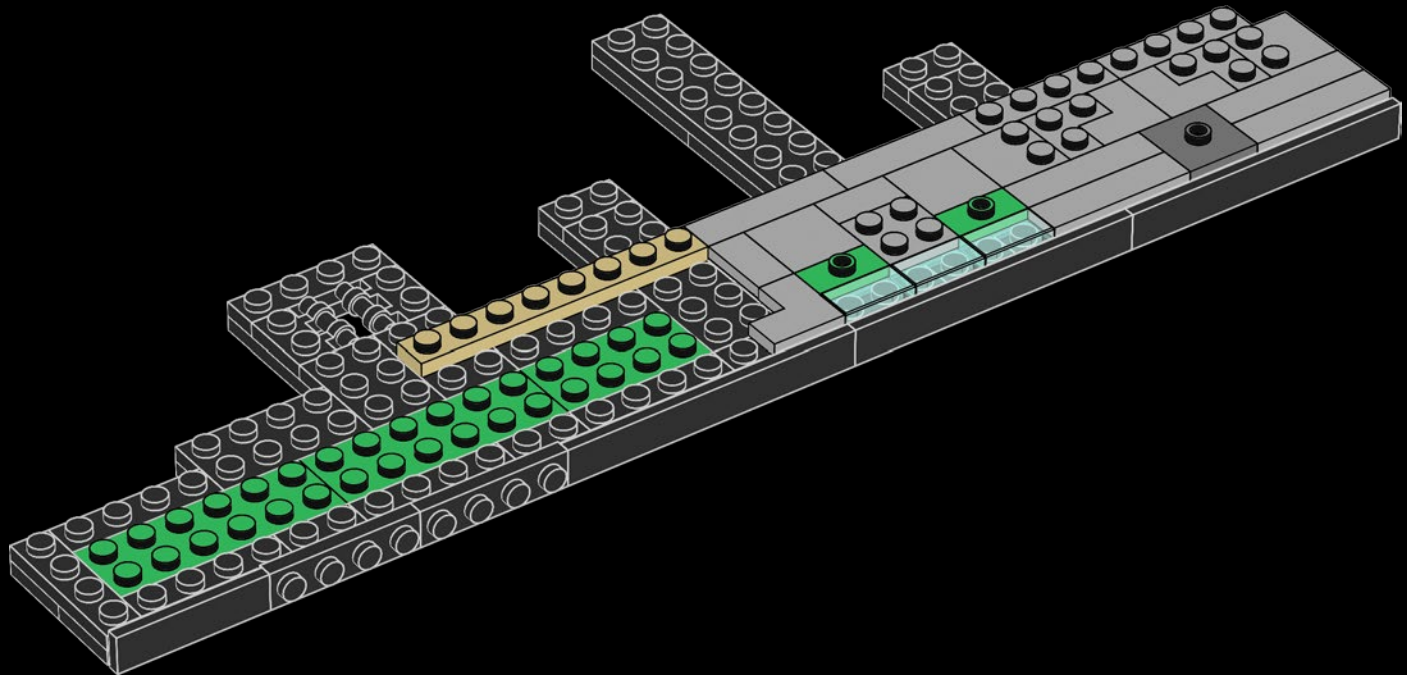



21

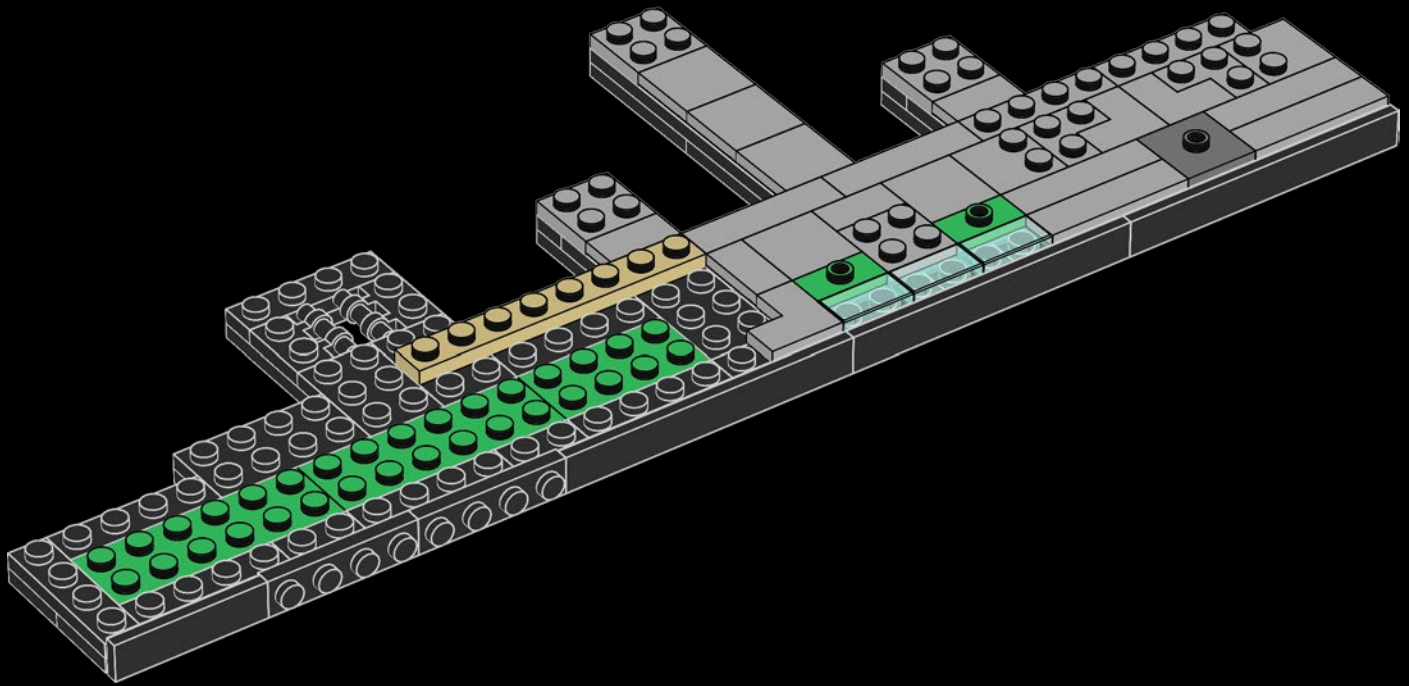

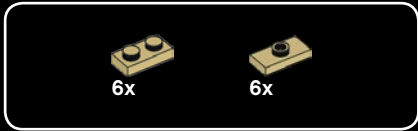

22

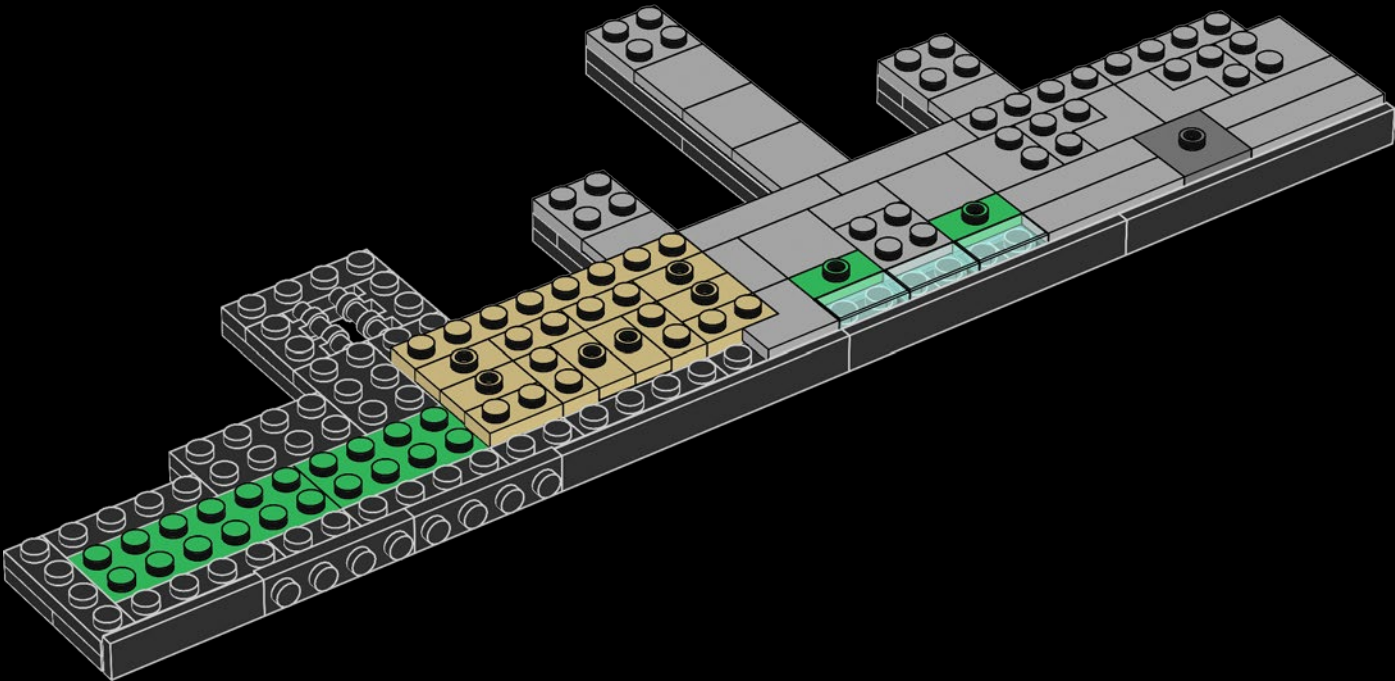

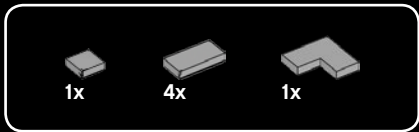

23

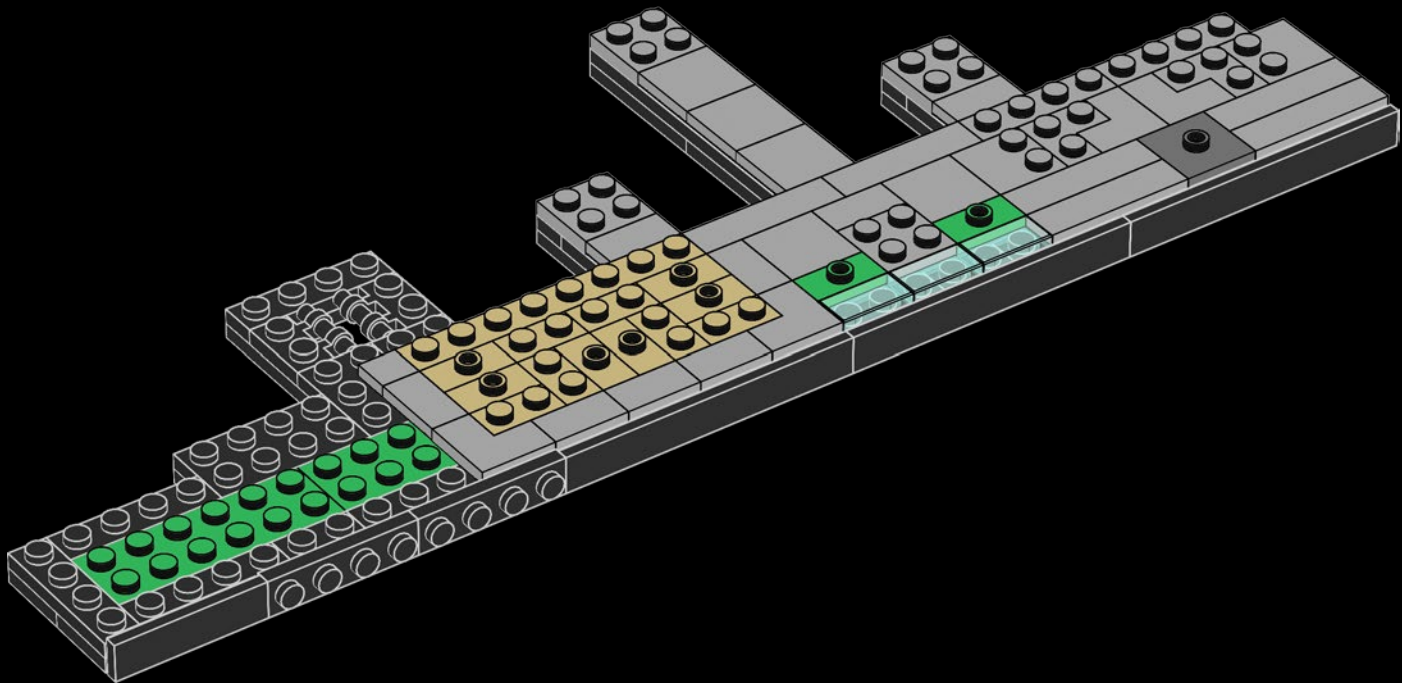



4x

24

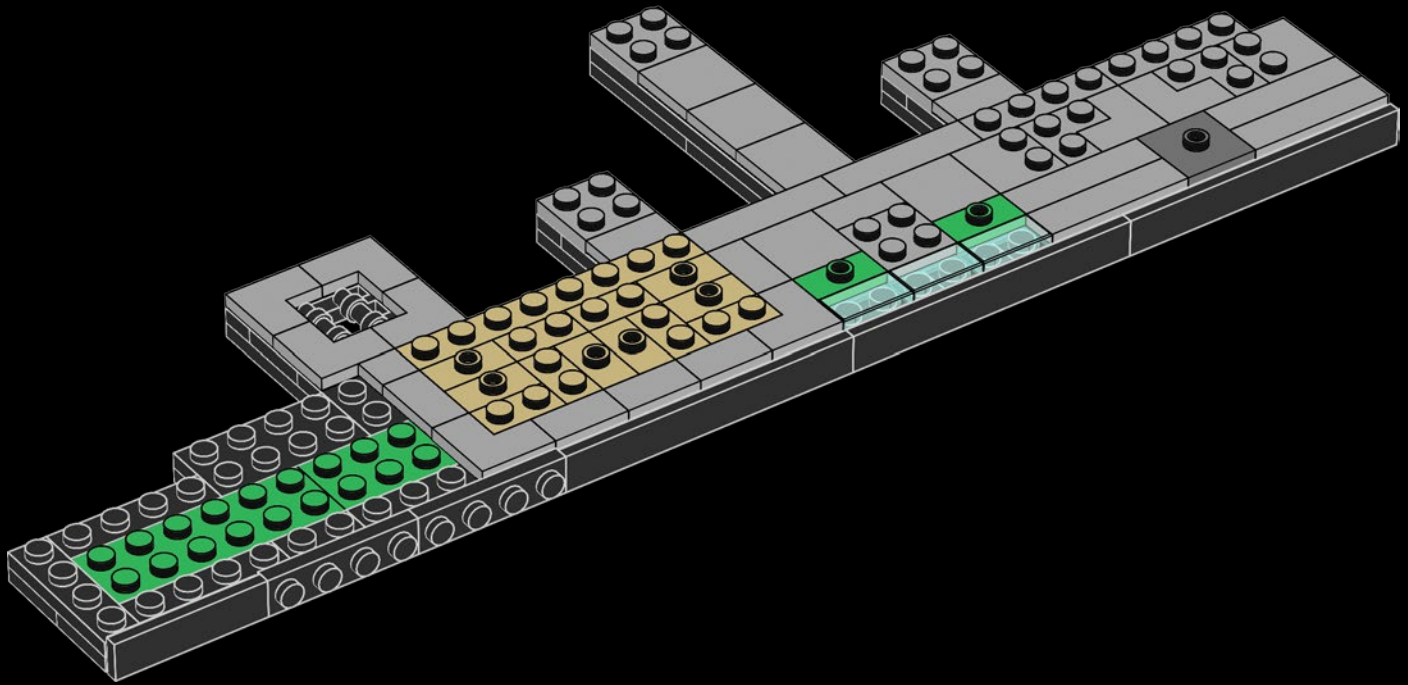

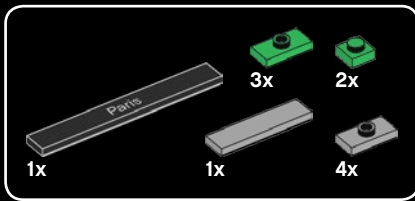

25

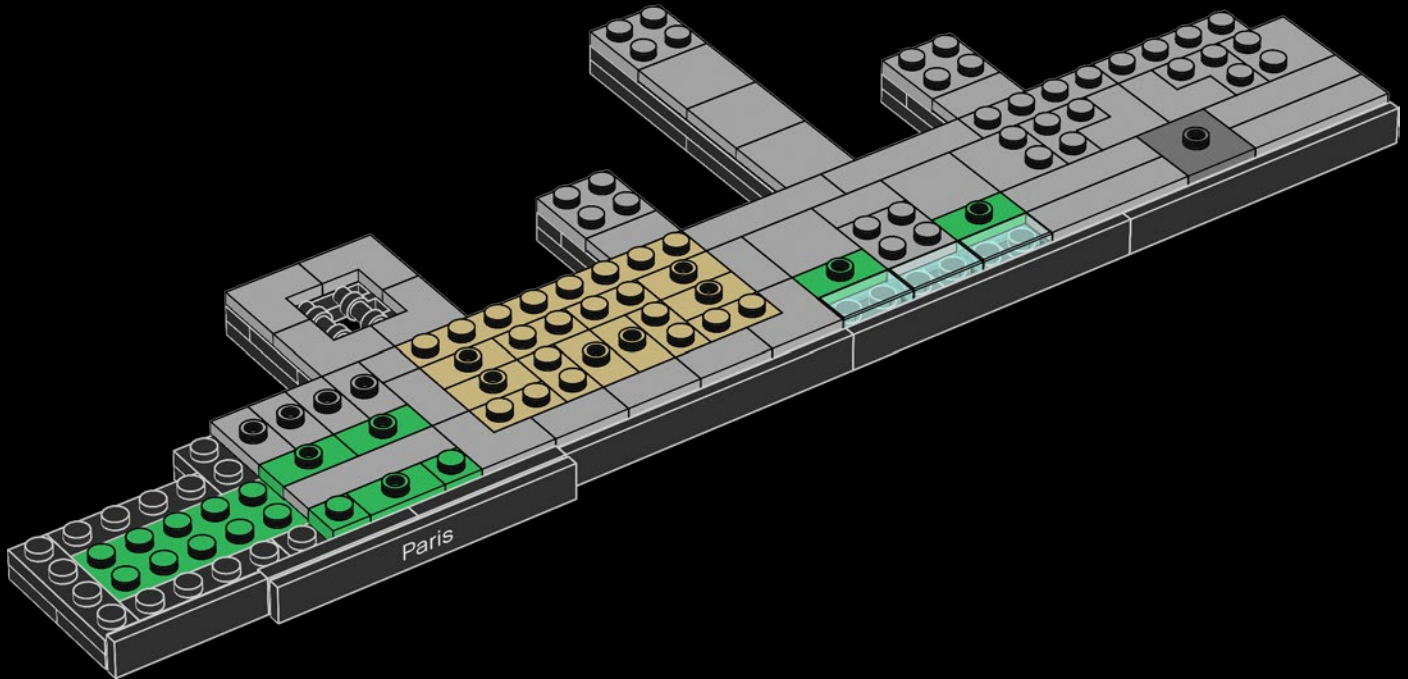

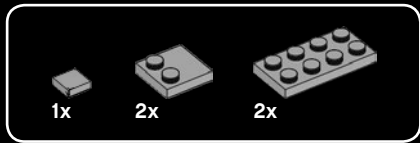

26

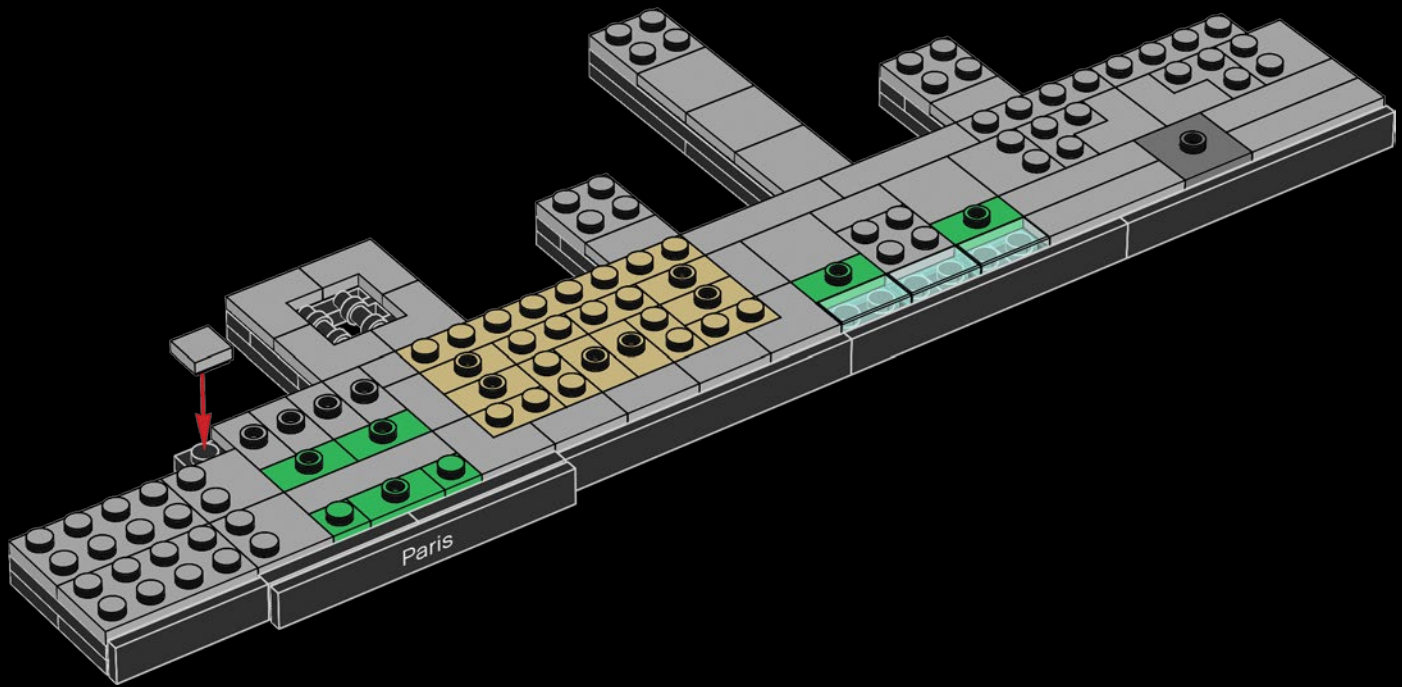



27

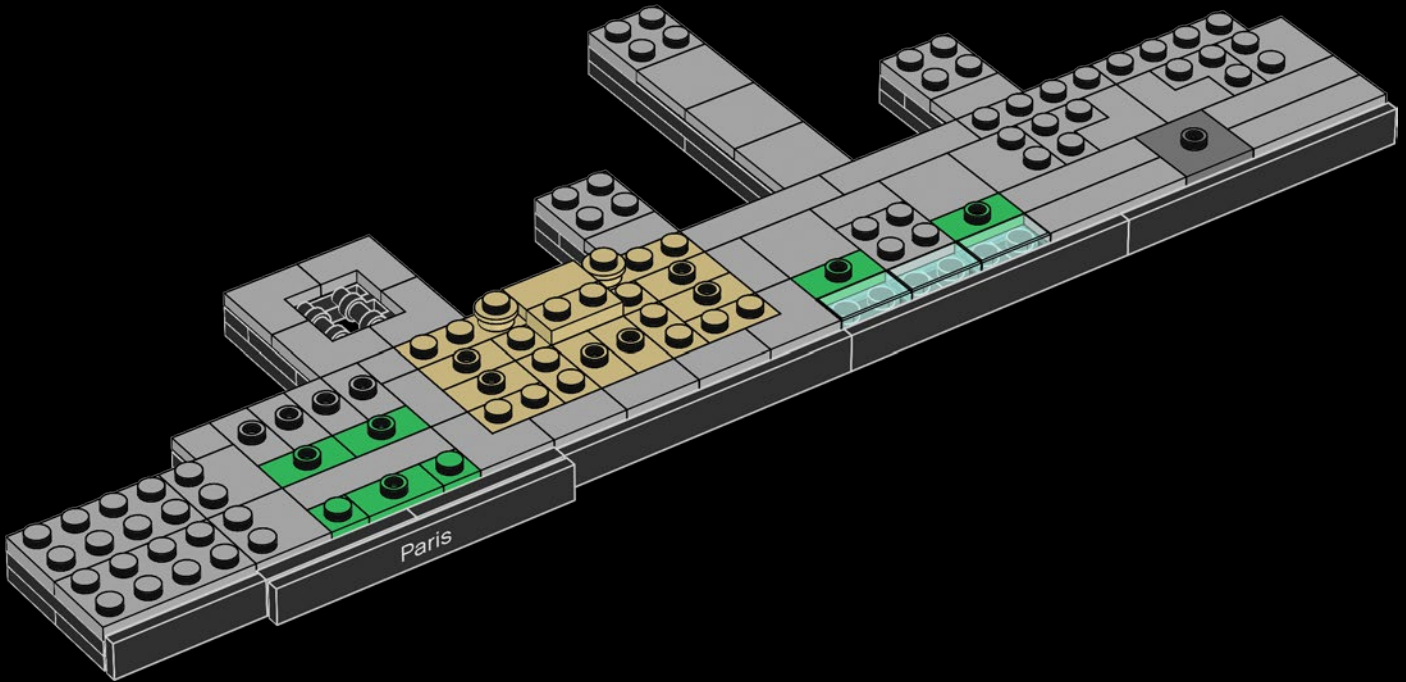



28

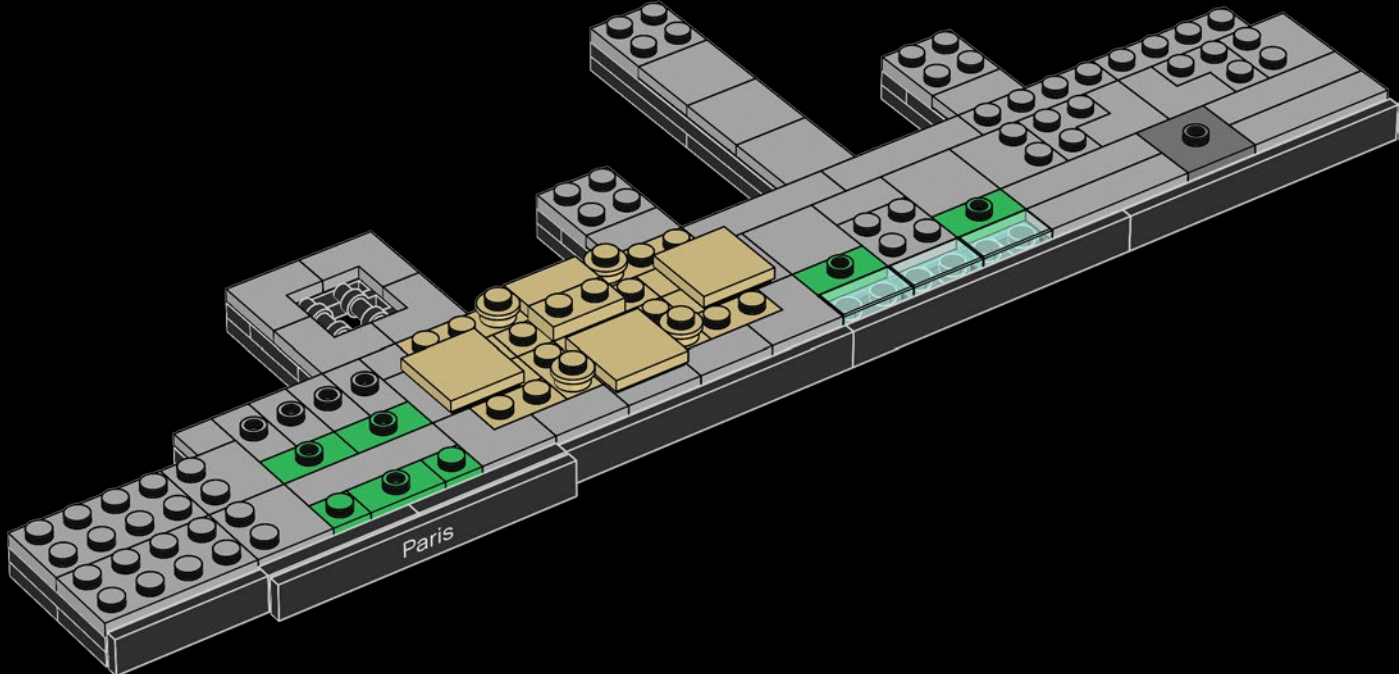

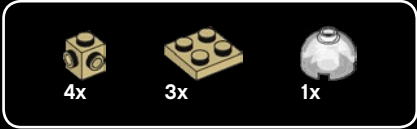

29

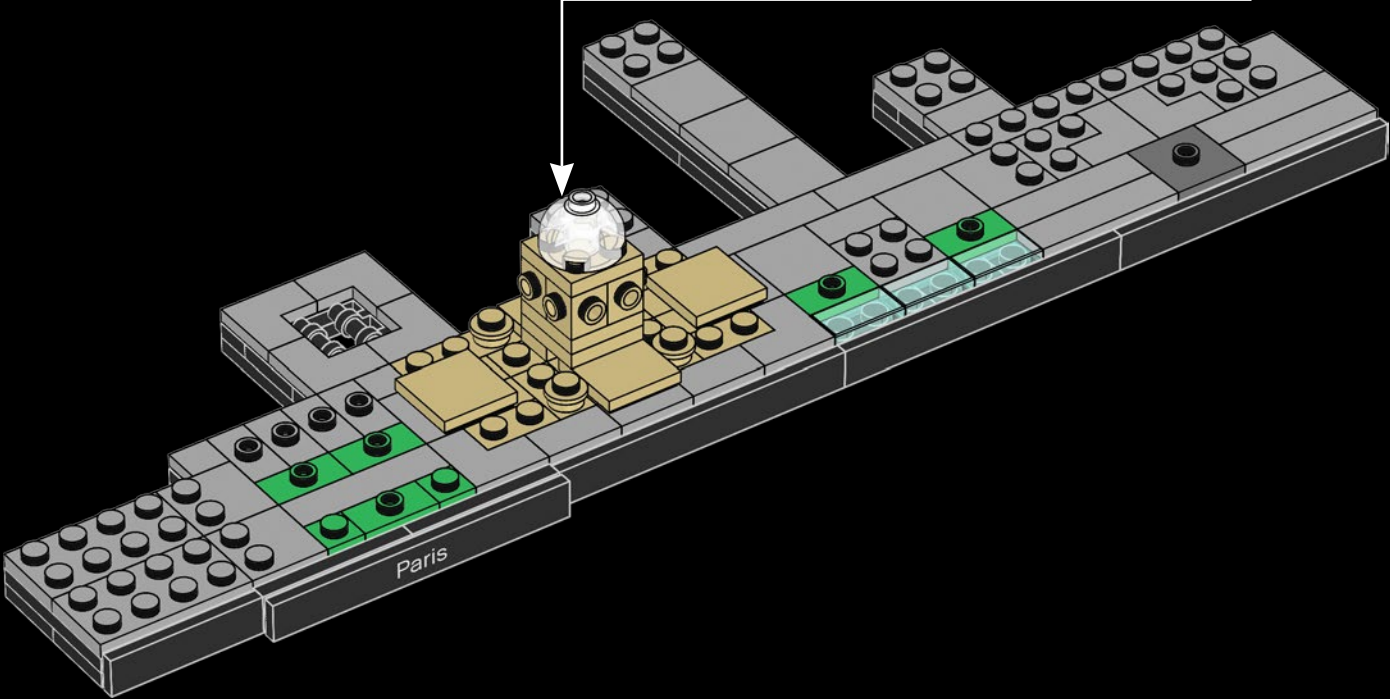
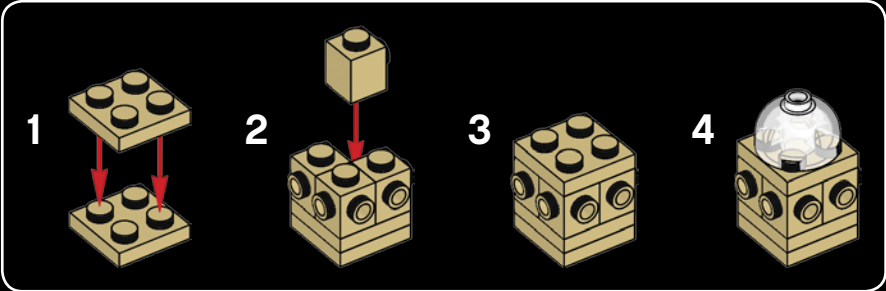



30

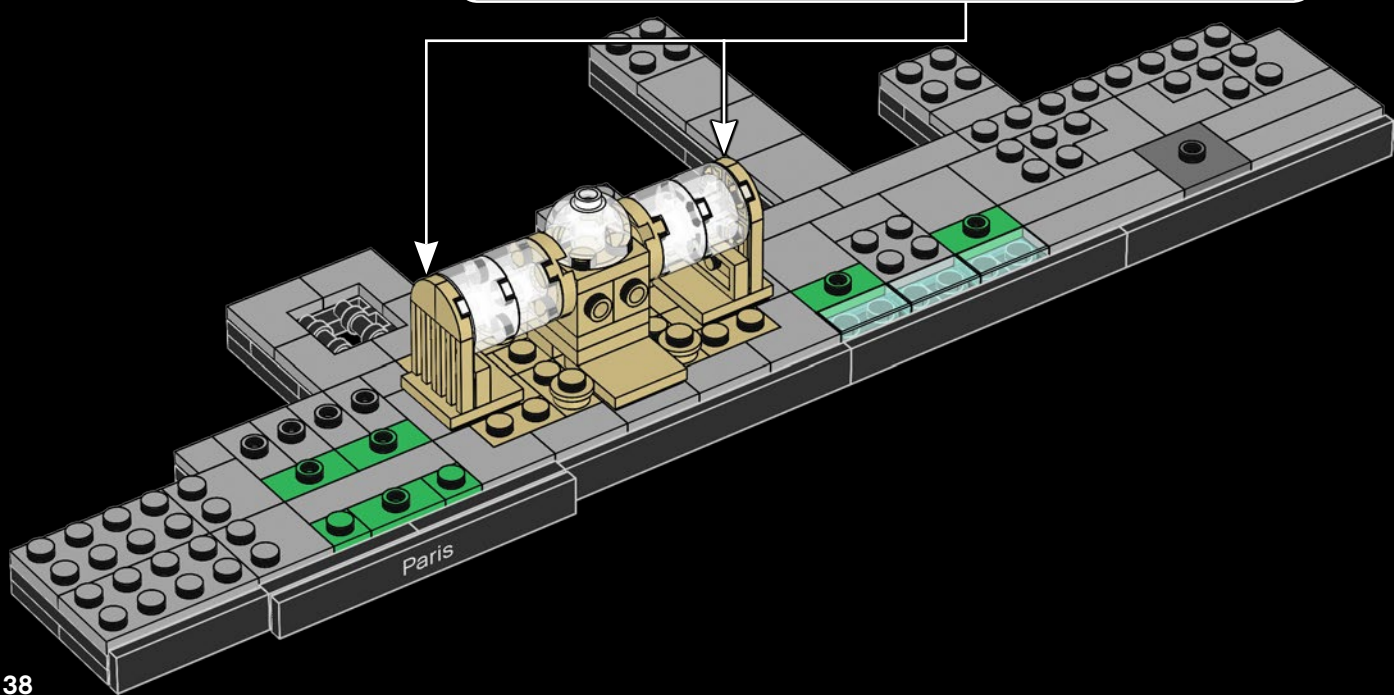
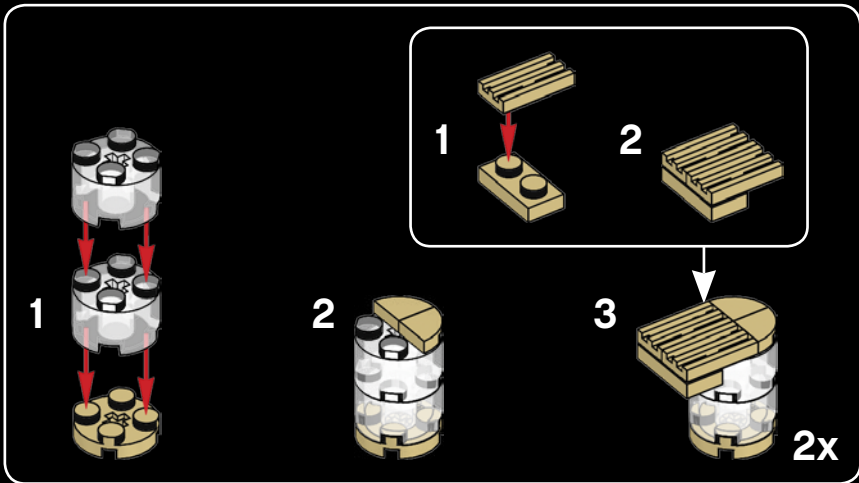



31

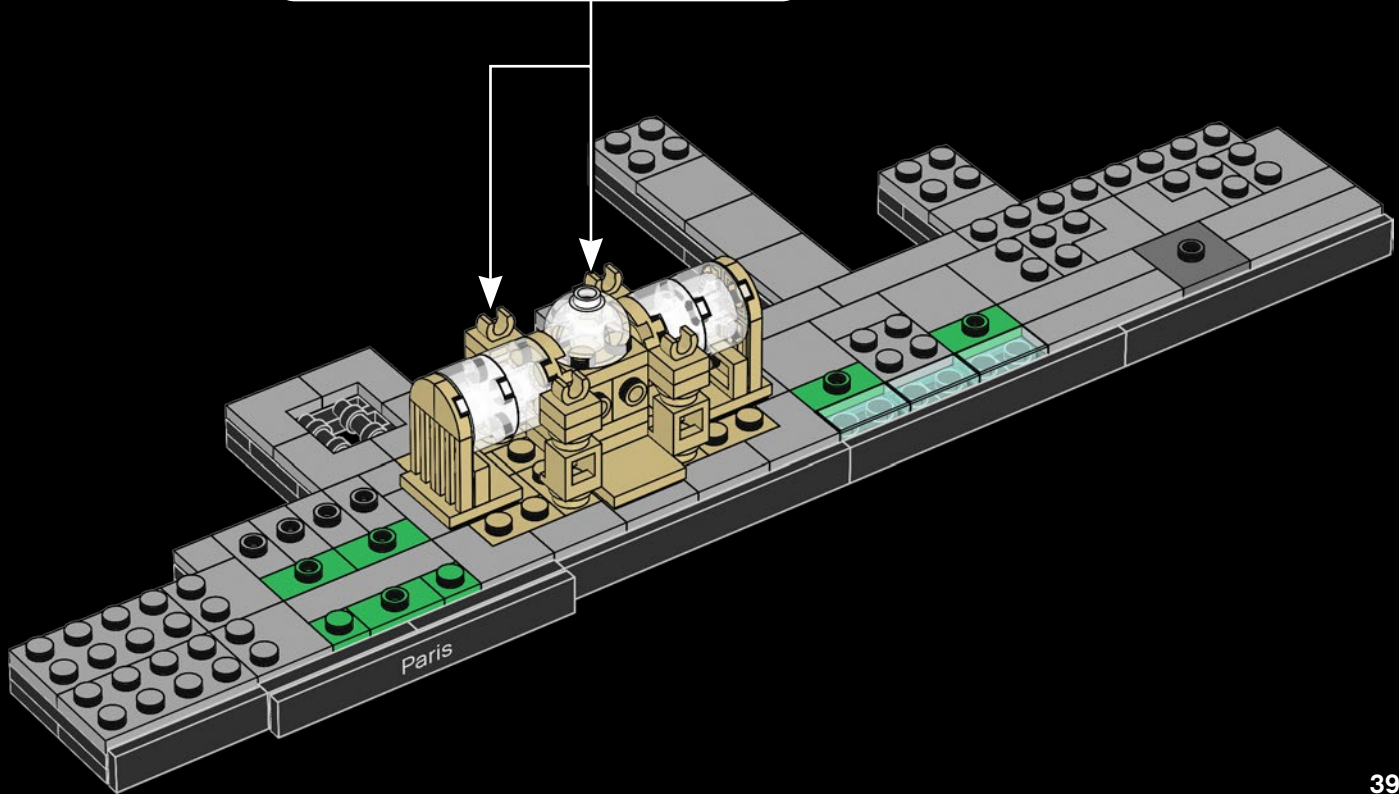
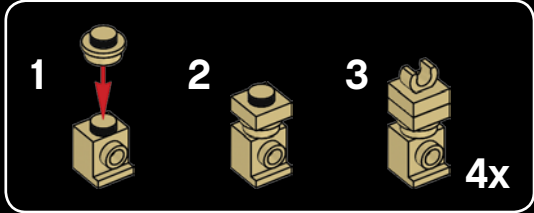



32

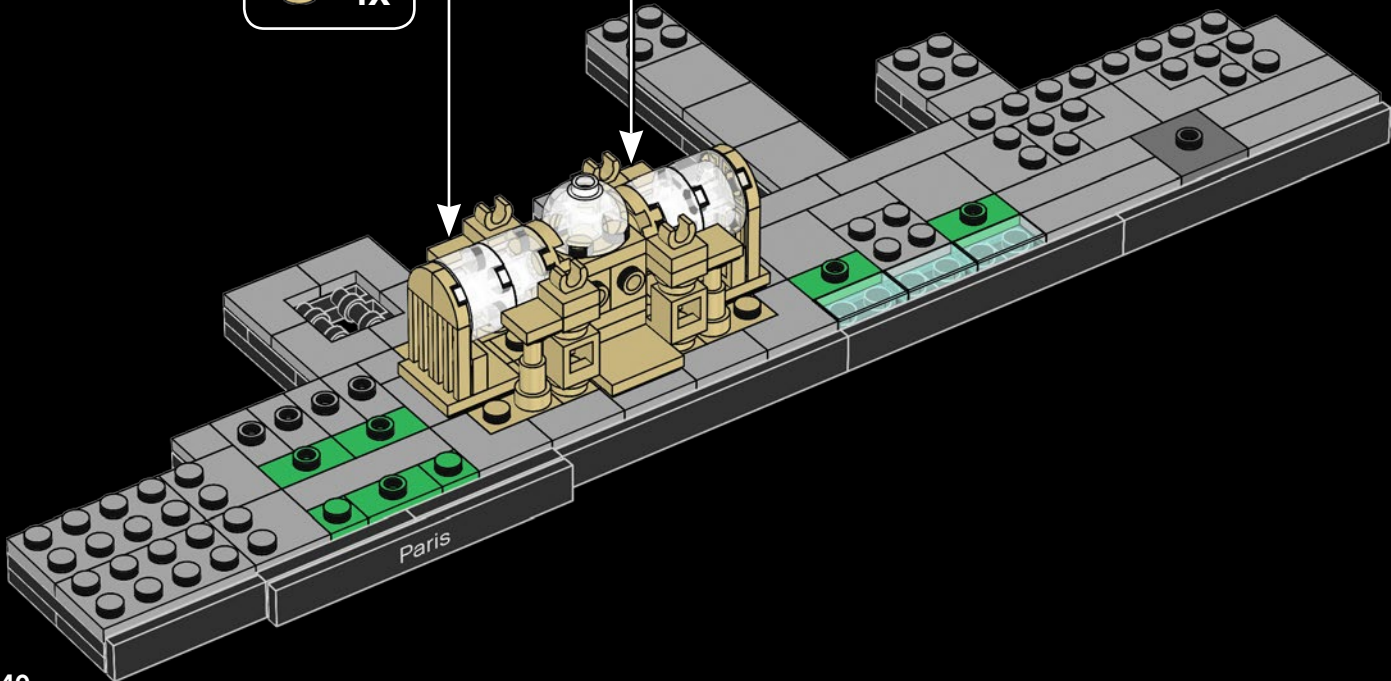
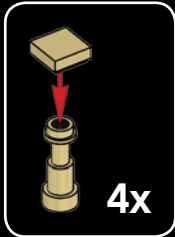



33

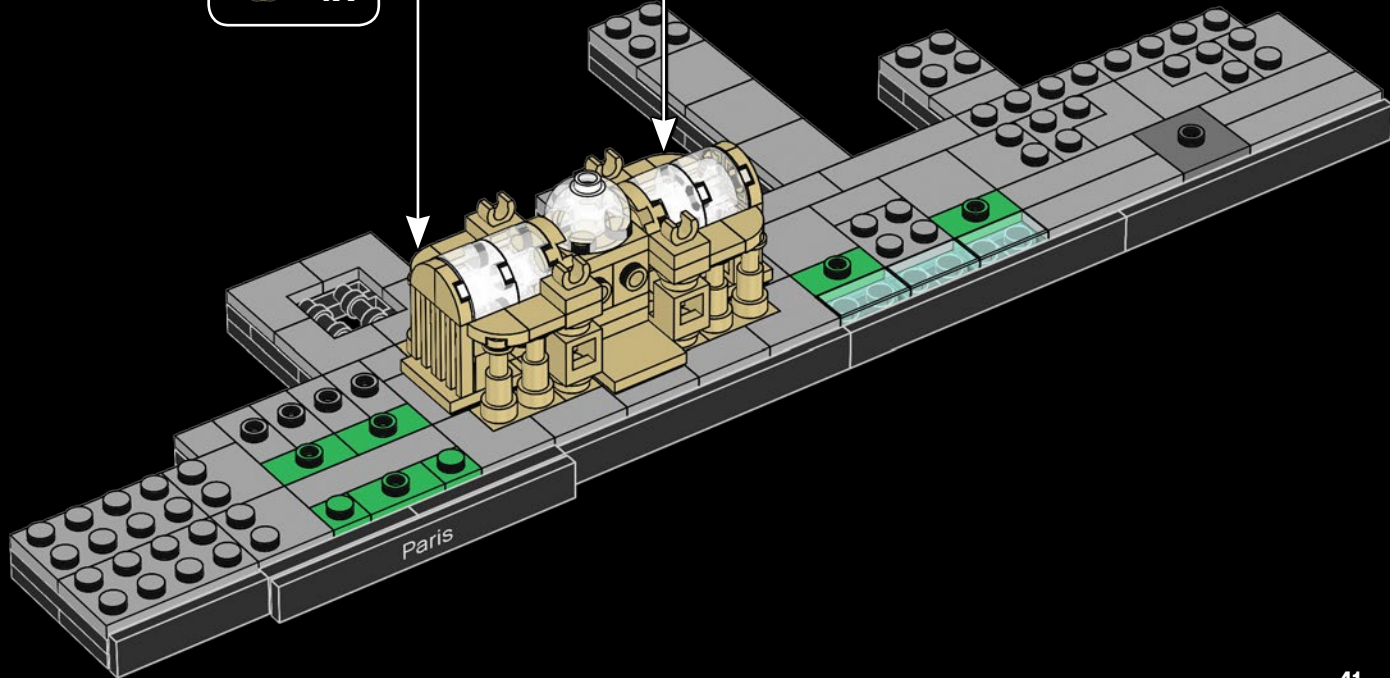
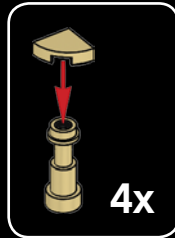

Delicate but strong
The Grand Palais is the largest existing ironwork and glass structure in the world.

Délicatesse rime avec robustesse
Le Grand Palais est la plus grande structure de ferronnerie en verre dans le monde.

Delicado pero robusto
El Grand Palais es la estructura de hierro y vidrio más grande que existe en el mundo.



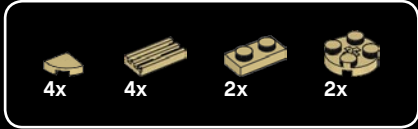

34

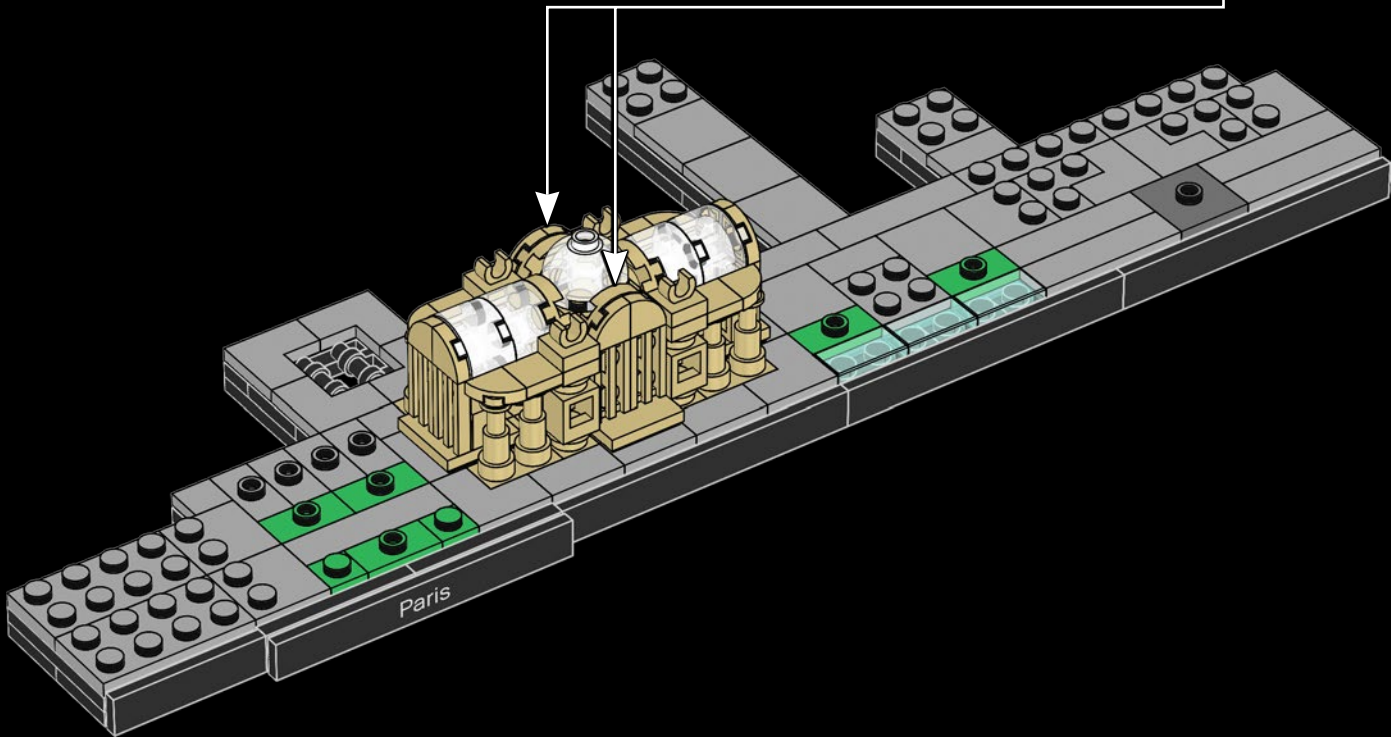
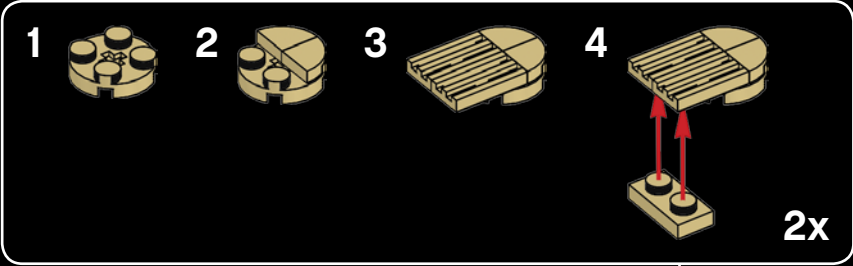

-  1x
-  1x
-  3x
-  3x
-  1x
-  2x

35

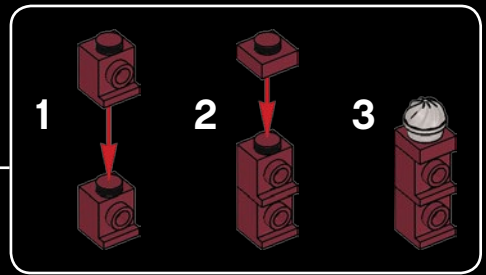
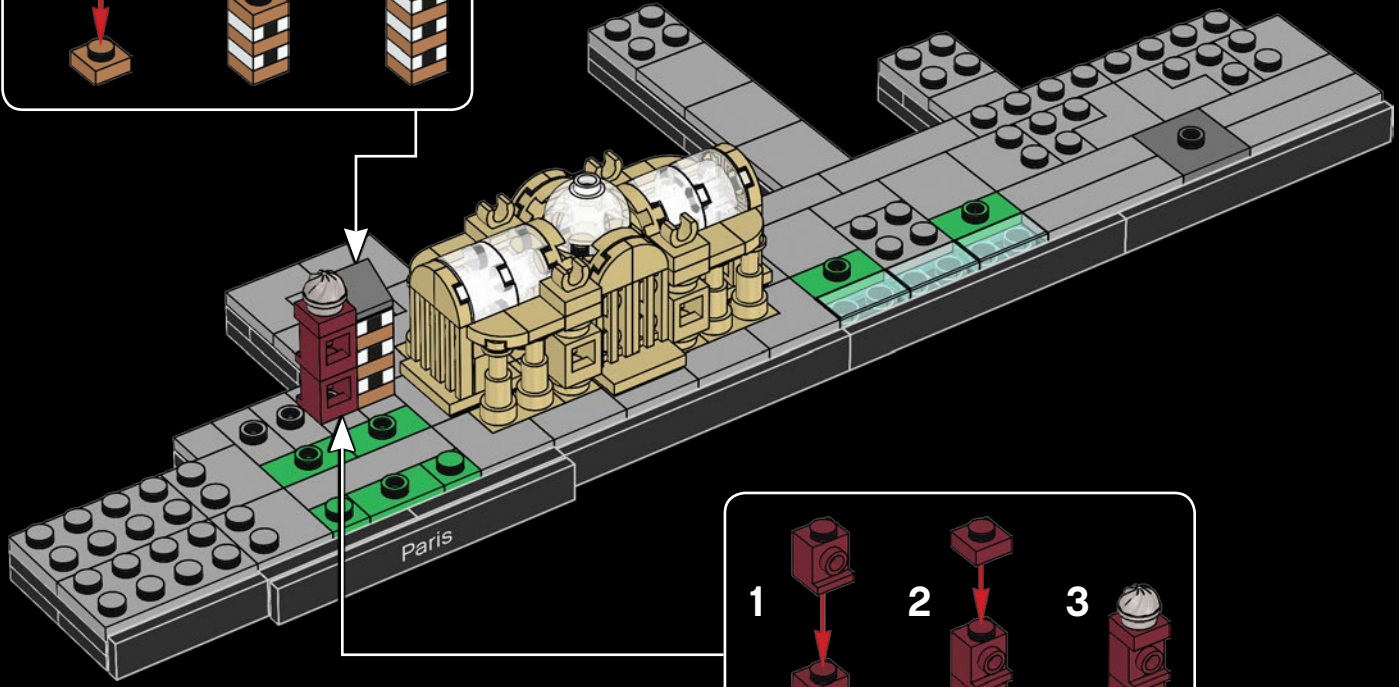
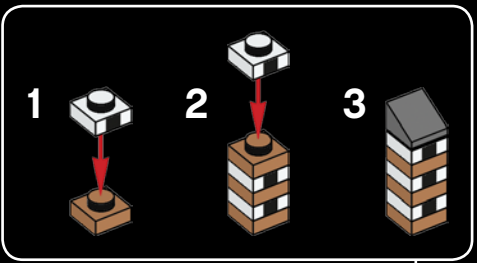



3x



3x



2x



2x

36

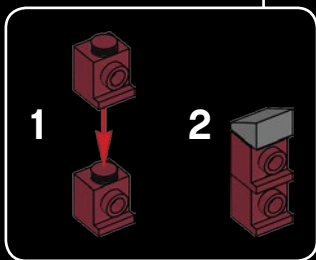
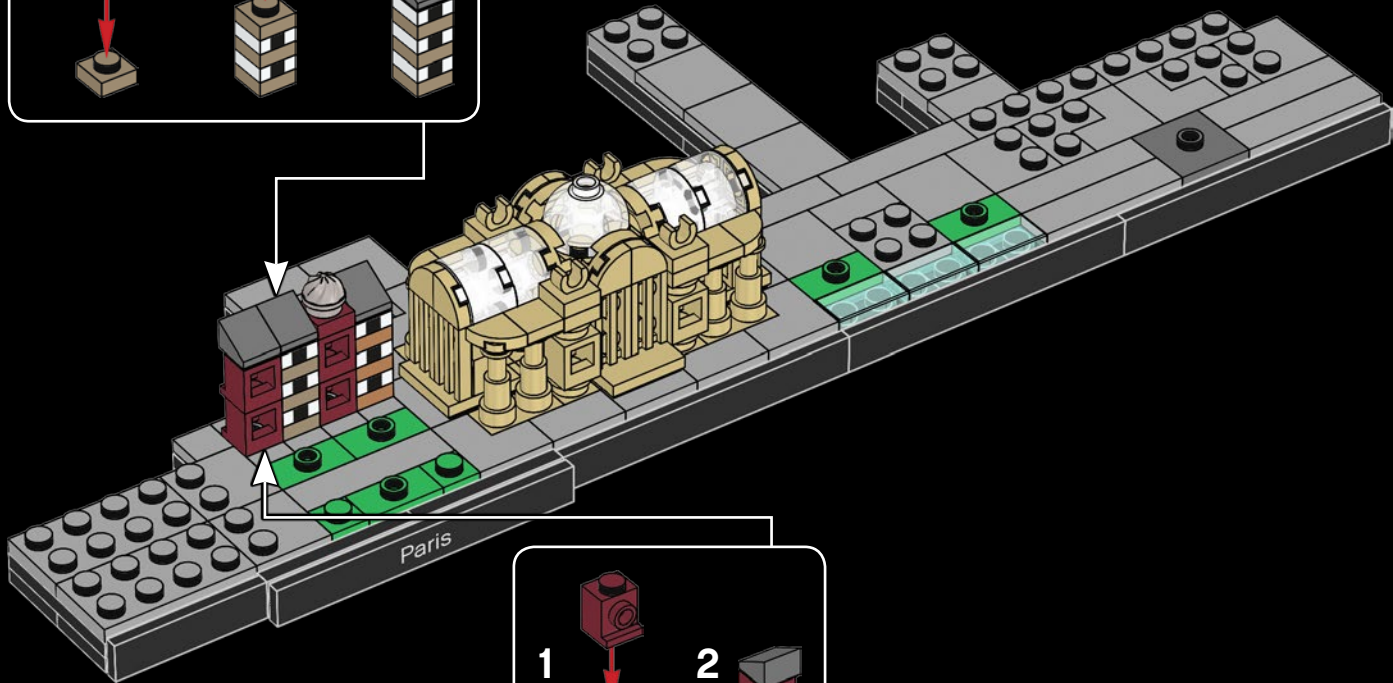
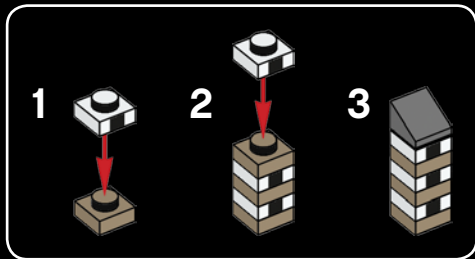



5x



10x

37

1



2



5x

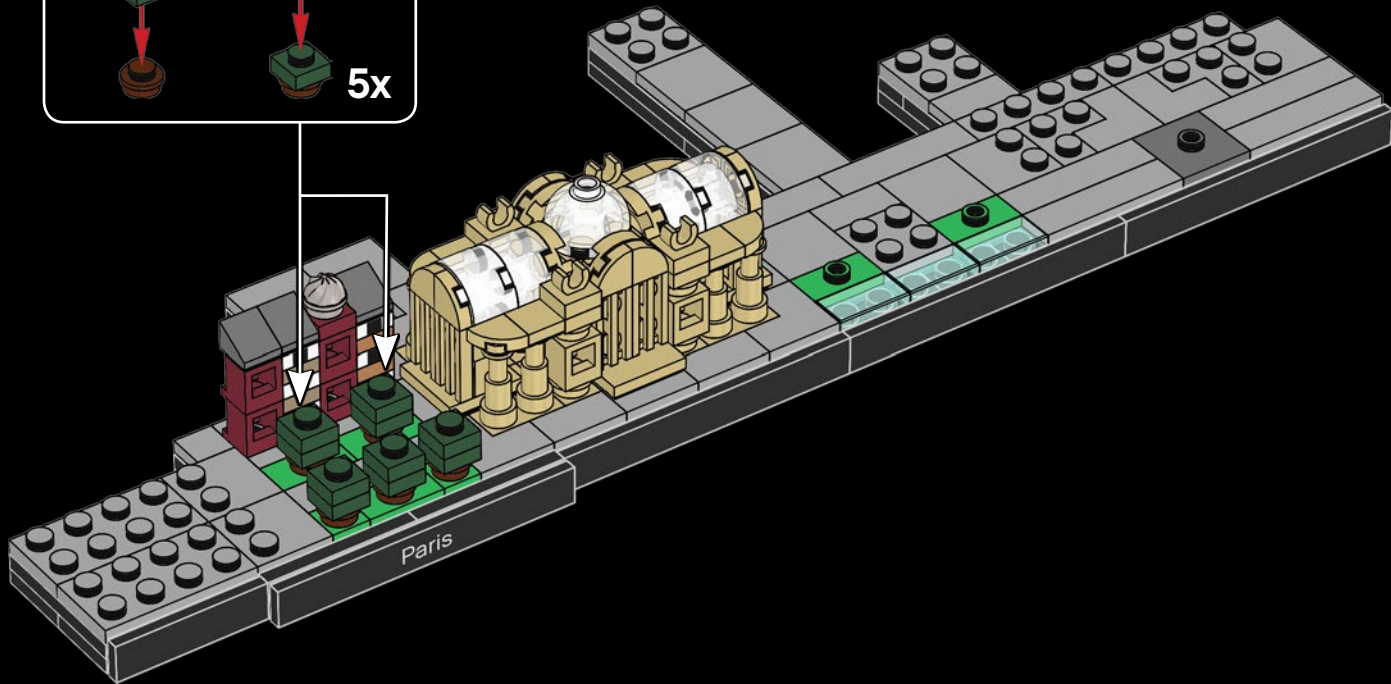

The Most Glamorous Cycle Path

This prestigious avenue has been the final destination of the Tour de France since 1975. The riders do a series of circuits back and forth along the Champs-Élysées as a finale before the awards ceremony.

La piste cyclable de classe à part

Cette prestigieuse avenue est la destination finale du Tour de France depuis 1975. Pour souligner la fin des courses, les cyclistes pédalent l'aller-retour sur une série de circuits longeant les Champs-Élysées avant la remise des prix.

El carril para bicicletas más glamoroso

Esta prestigiosa avenida ha sido el destino final del Tour de Francia desde 1975. Los ciclistas recorren una serie de circuitos hacia delante y hacia atrás a lo largo de los Campos Eliseos como gran final antes de la ceremonia de entrega de premios.

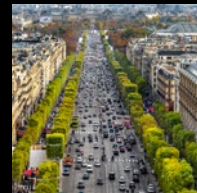

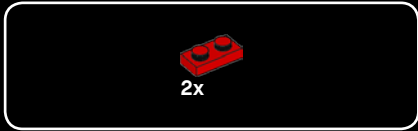
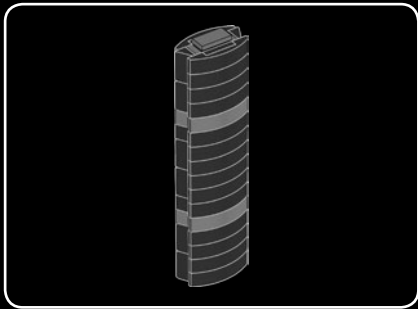

38

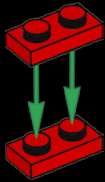

39

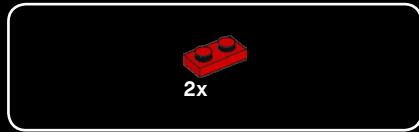

40

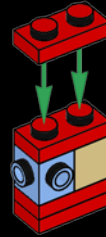

41



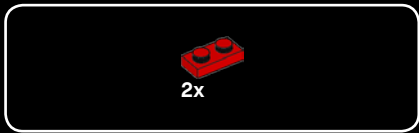

42



43

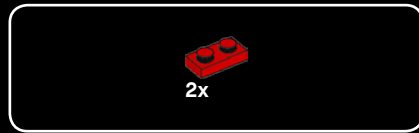

44



45





2x

46



1x



1x

47



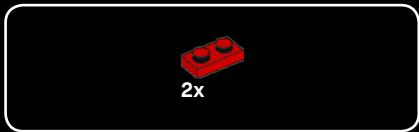

48



49





2x

50



1x



1x



1x

51



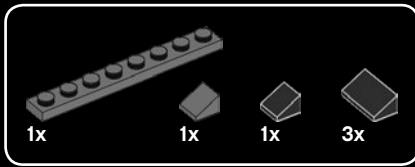

52

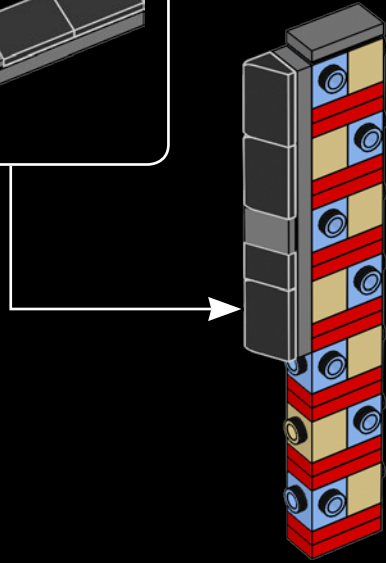
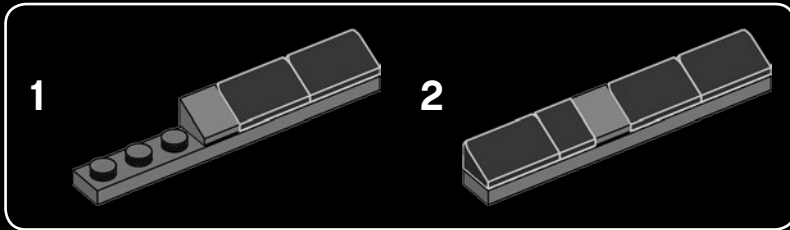

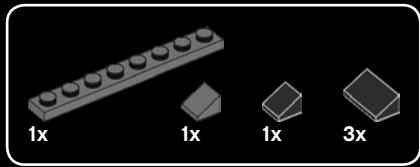

53

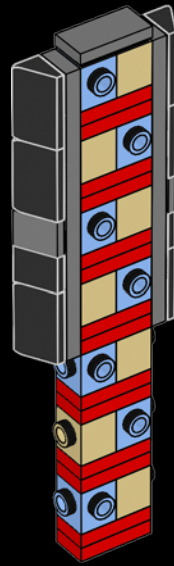
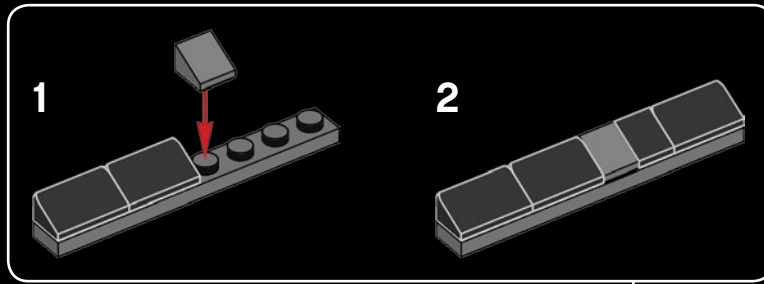

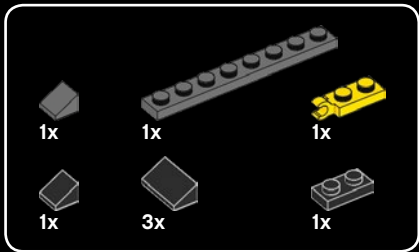

54

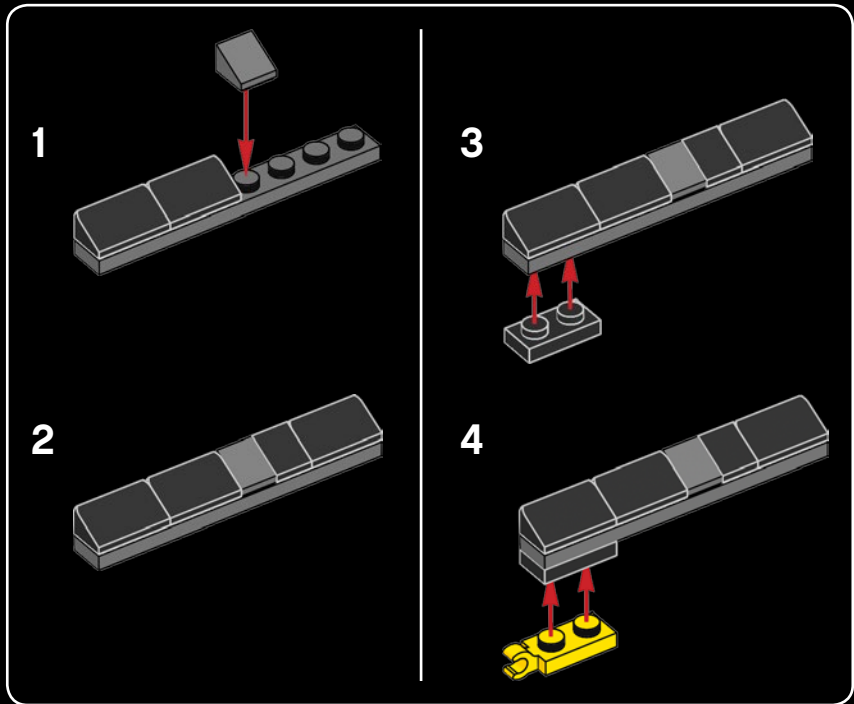
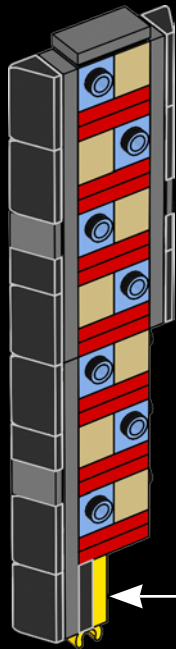

55

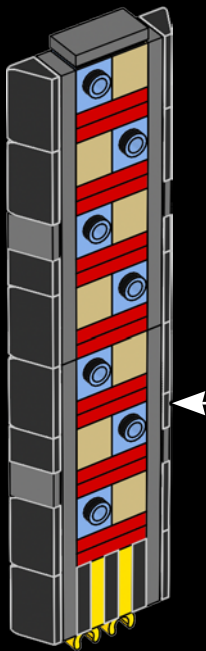
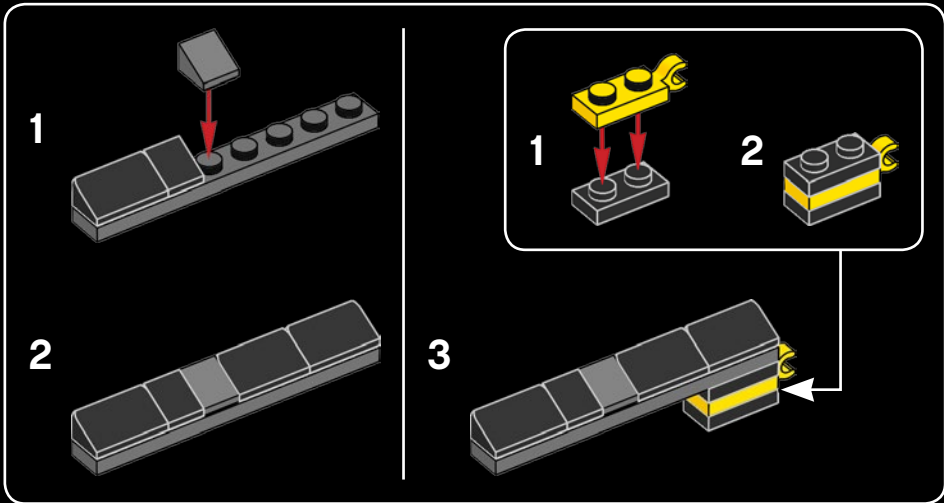
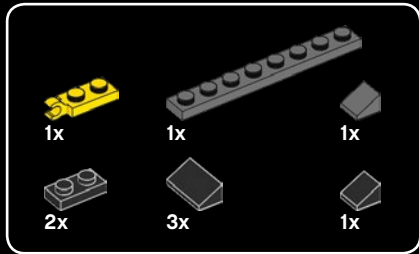

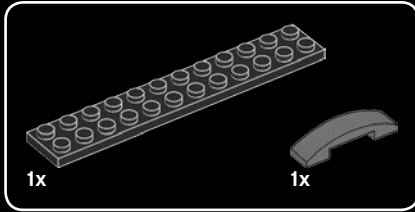
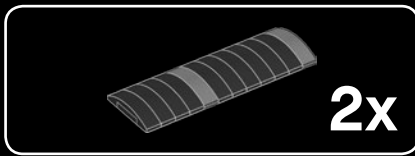

56

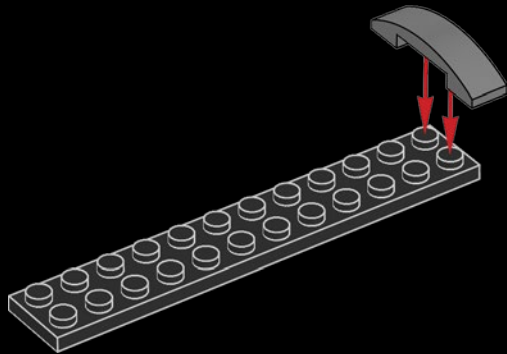

57

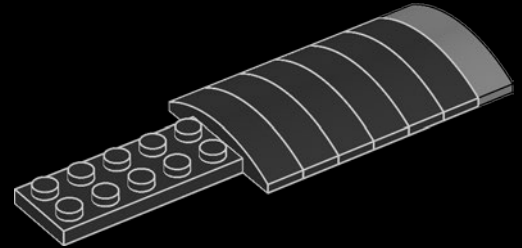

58

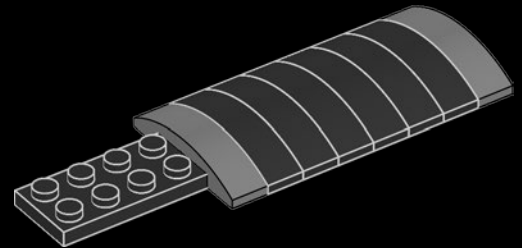



59

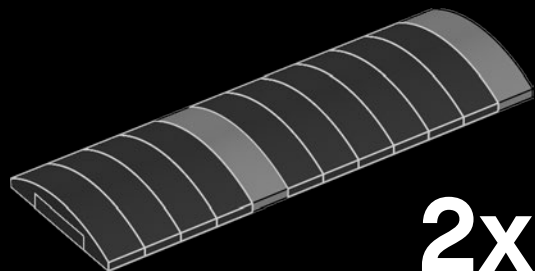

60

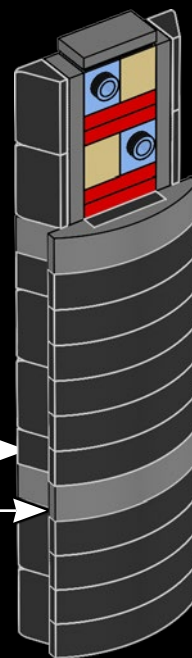

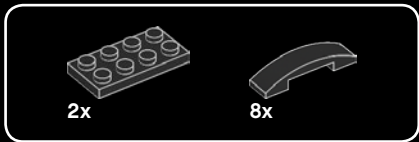

61

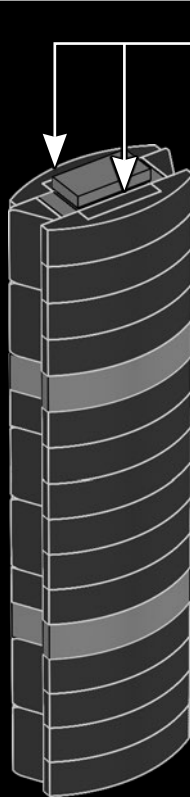
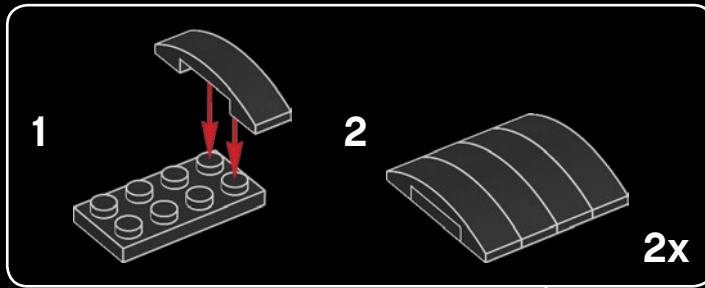

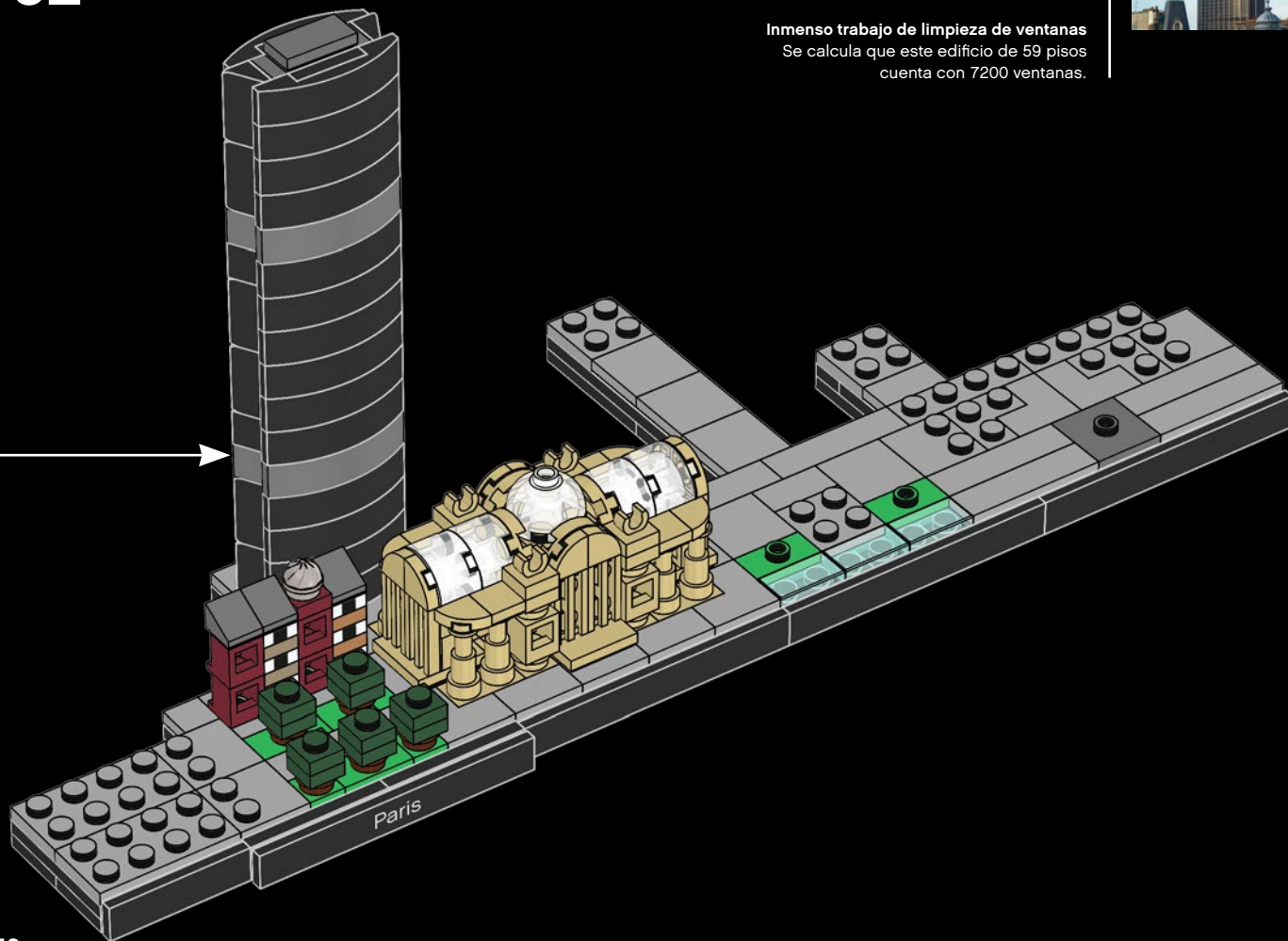

An Immense Window Cleaning Task
It is estimated that this 59-floor building has
7,200 windows.

Un nettoyage de vitre qui teste la patience
Ce bâtiment de 59 étages compterait
7200 fenêtres.

Inmenso trabajo de limpieza de ventanas
Se calcula que este edificio de 59 pisos
cuenta con 7200 ventanas.

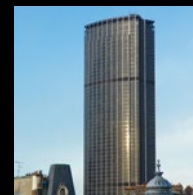

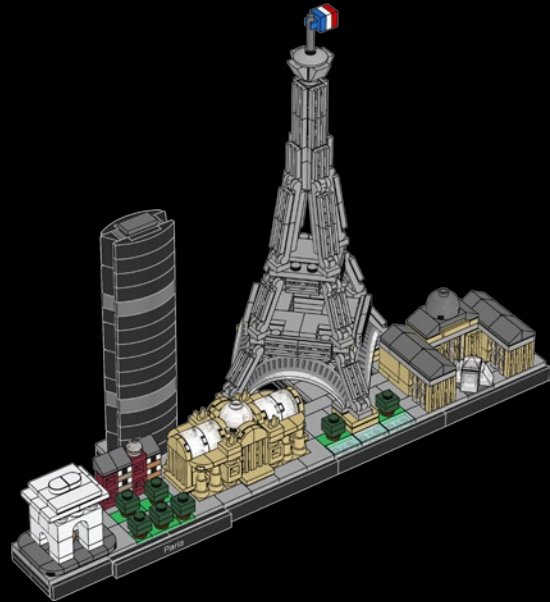

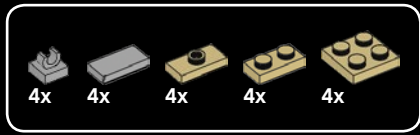

63

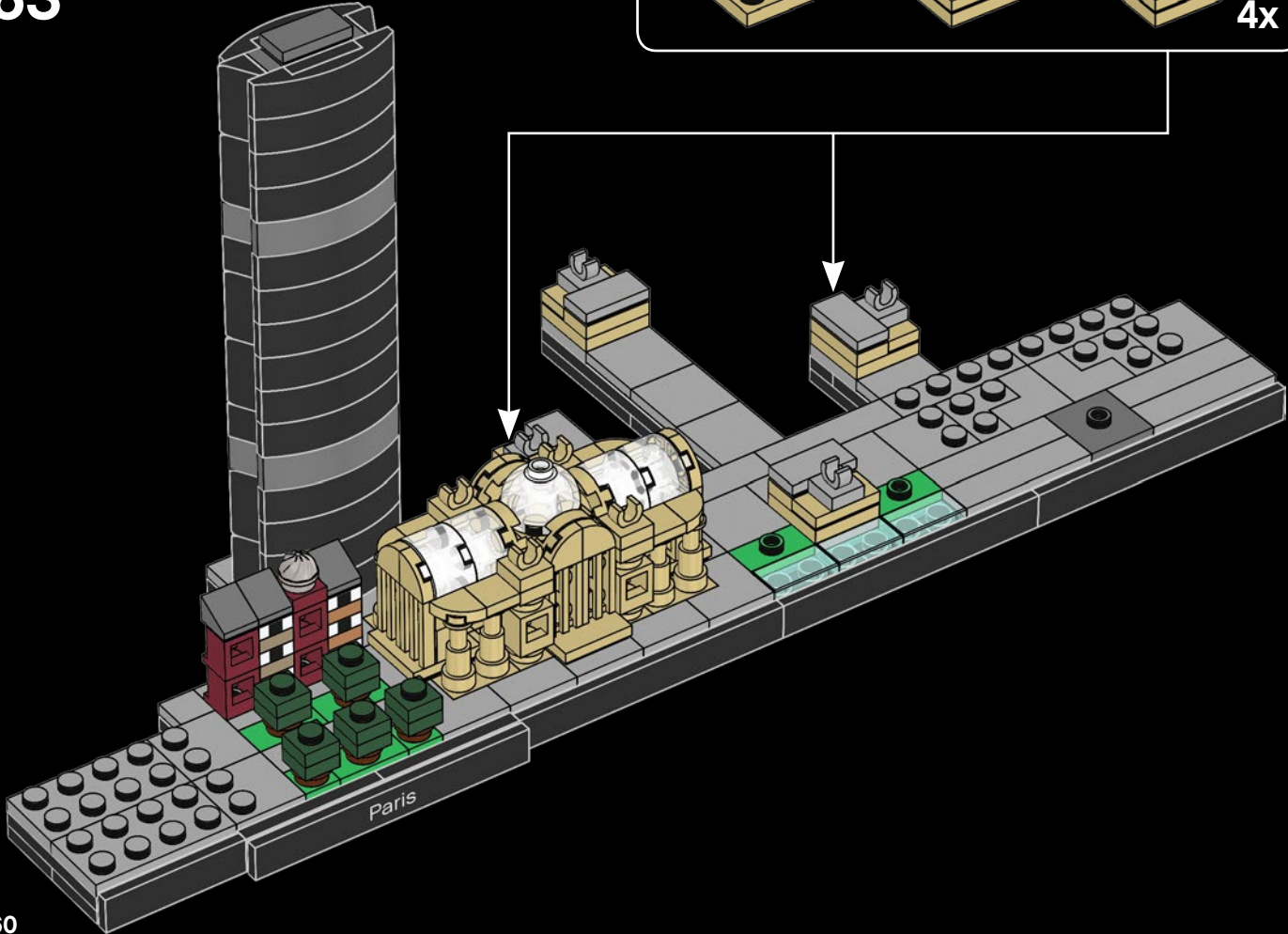
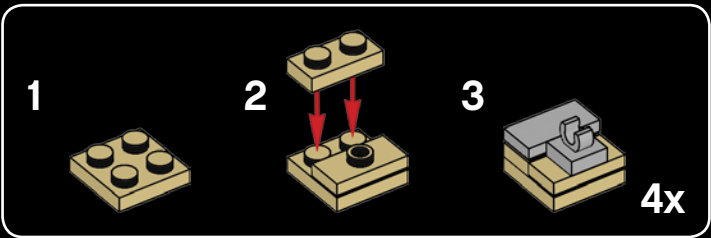

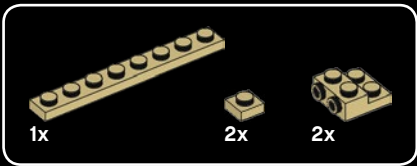

64

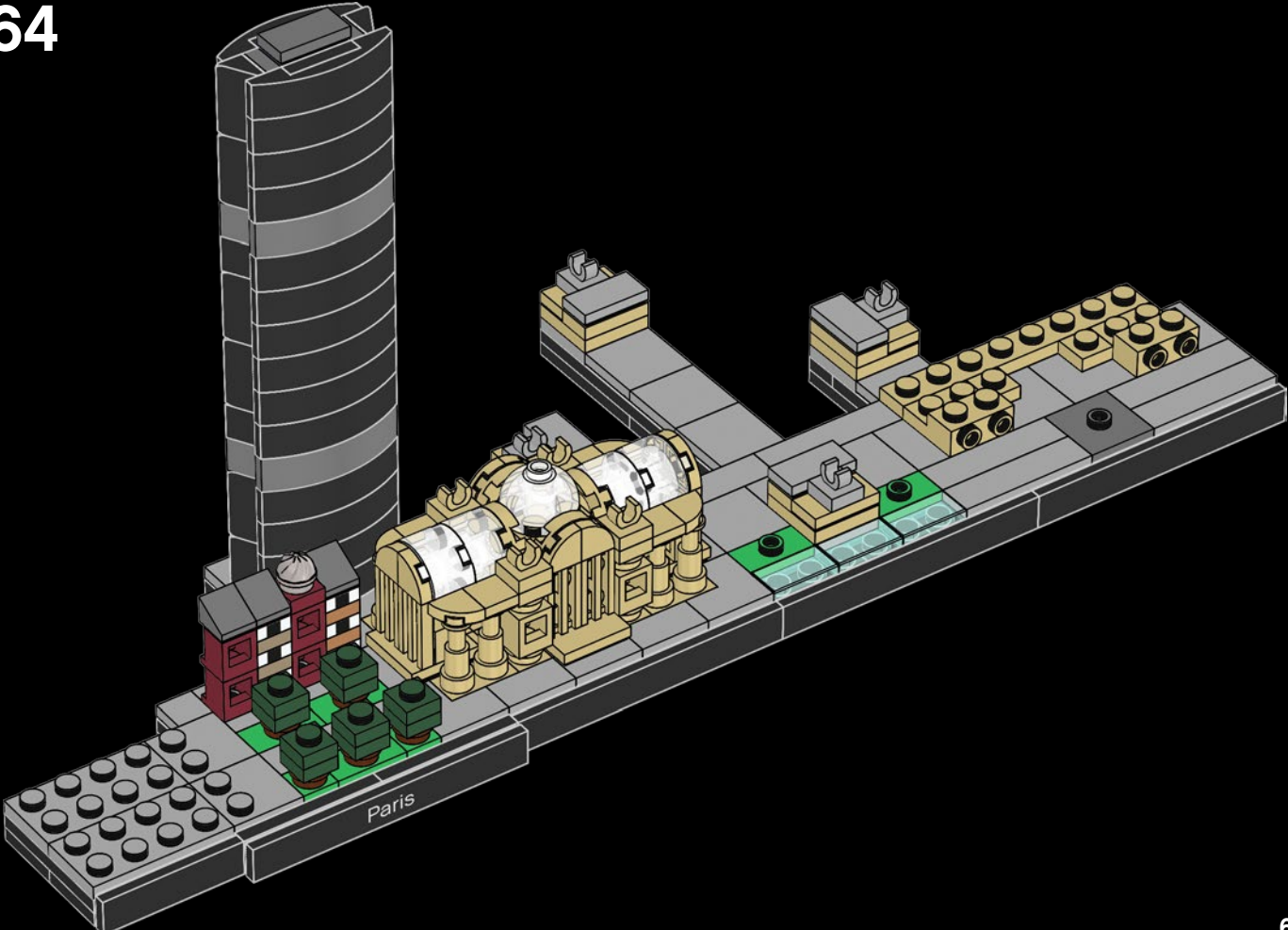



3x



2x

65

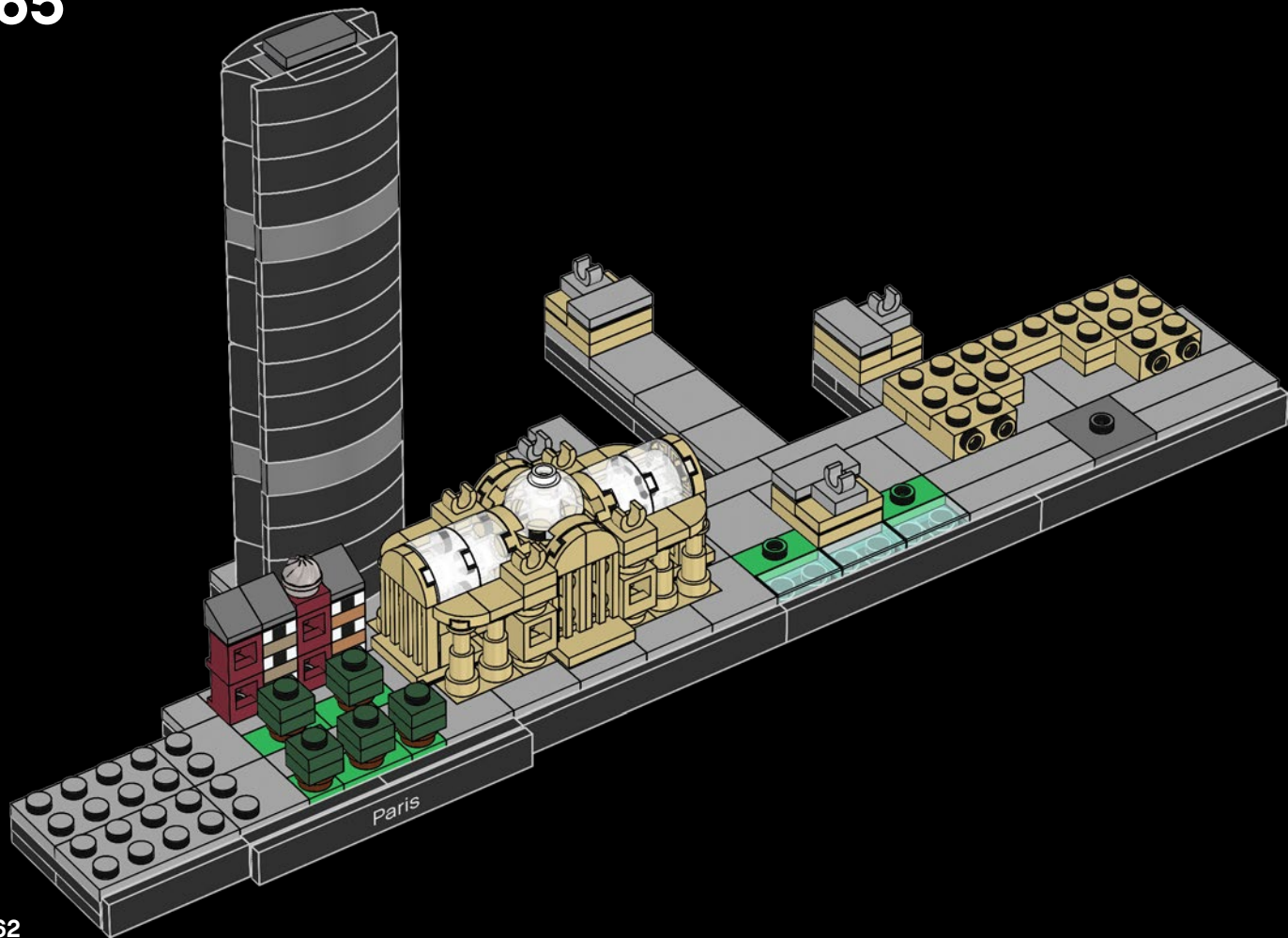

62

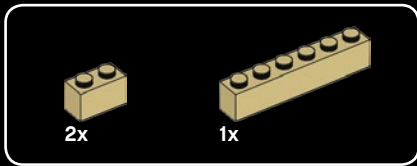



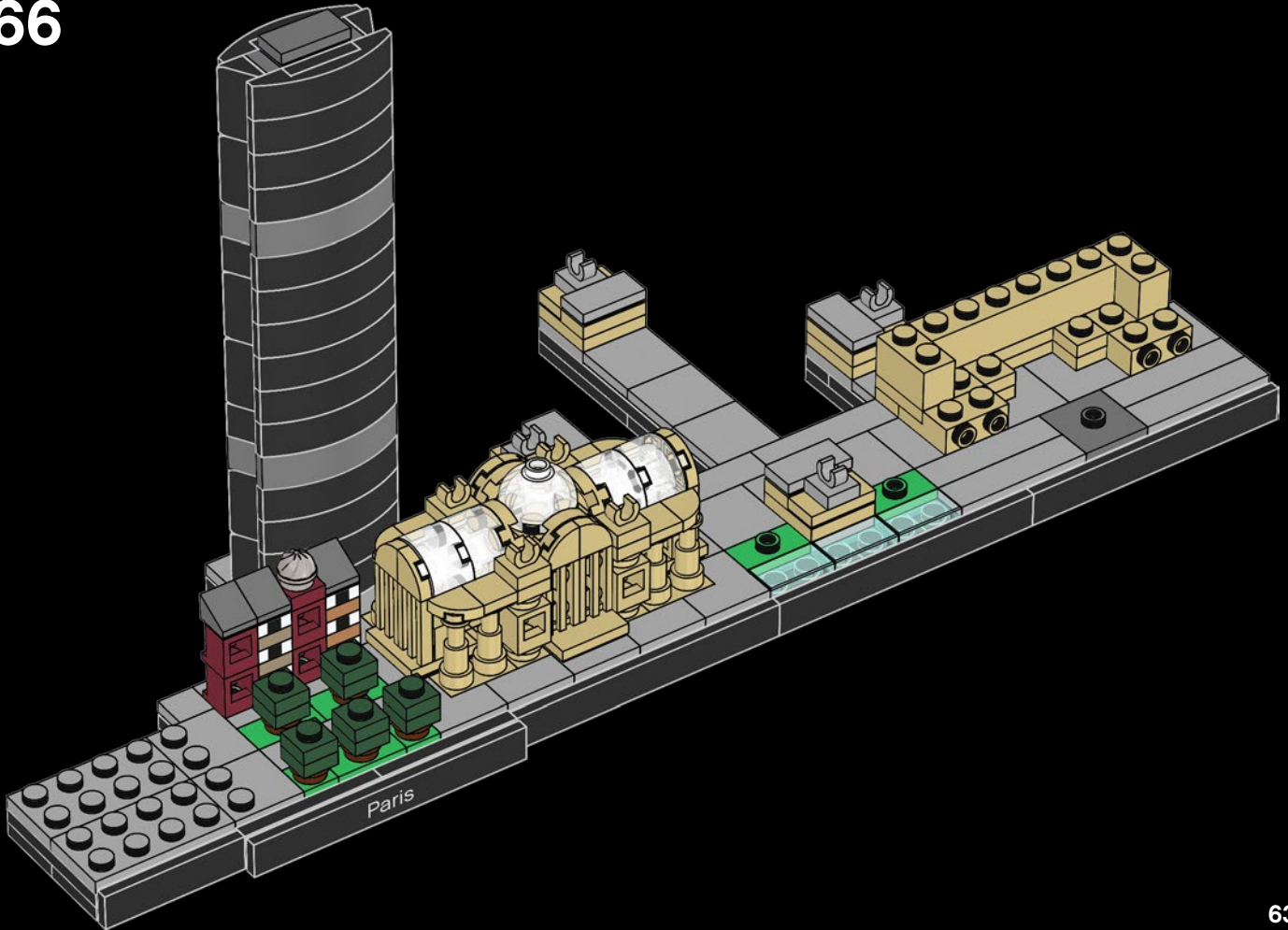



66



1x  4x  2x  1x 

67

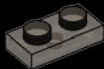
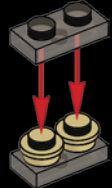
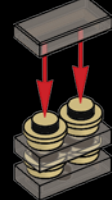
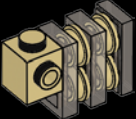
1  2  3  4  



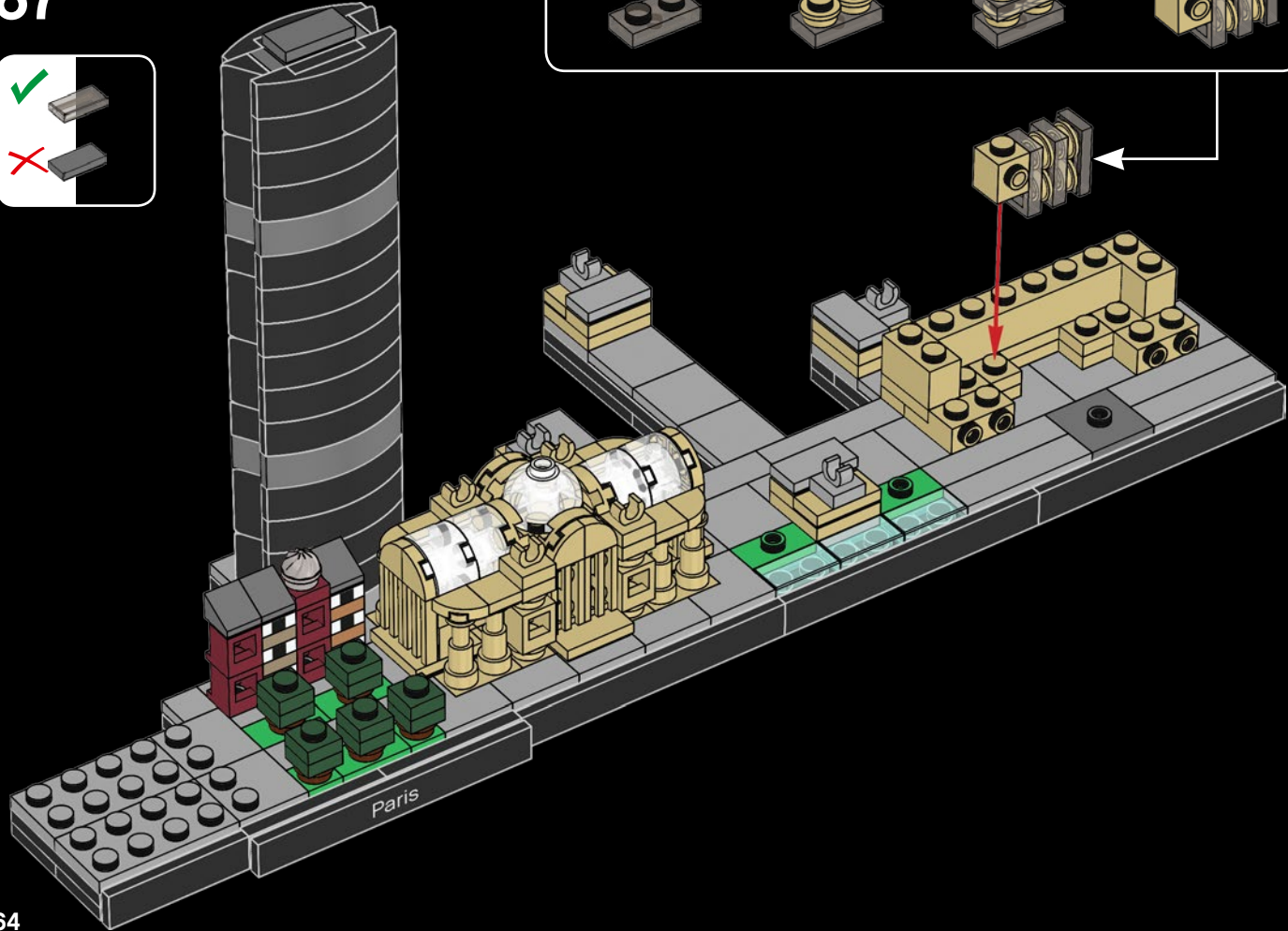

1x

68

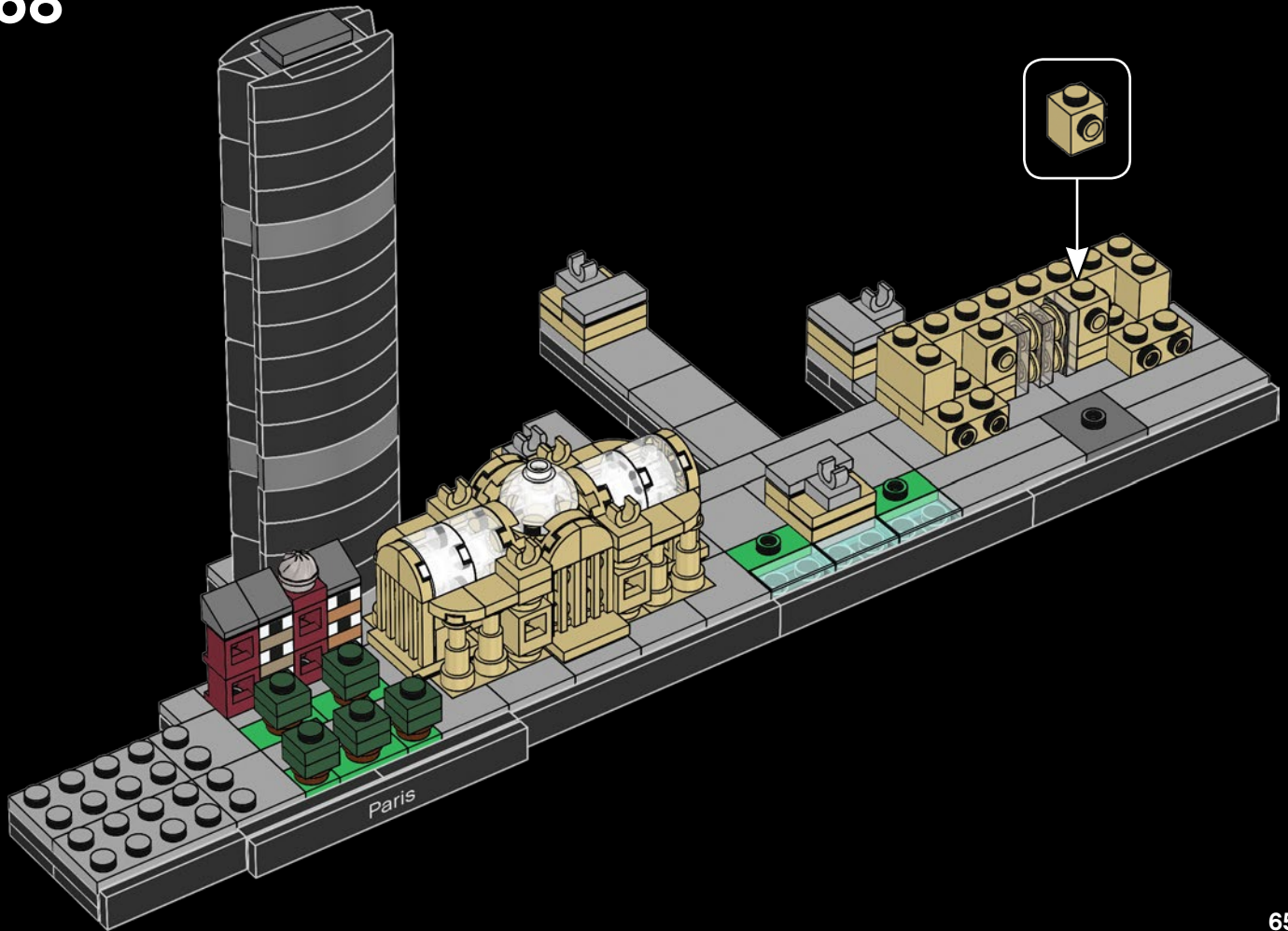

Paris



69

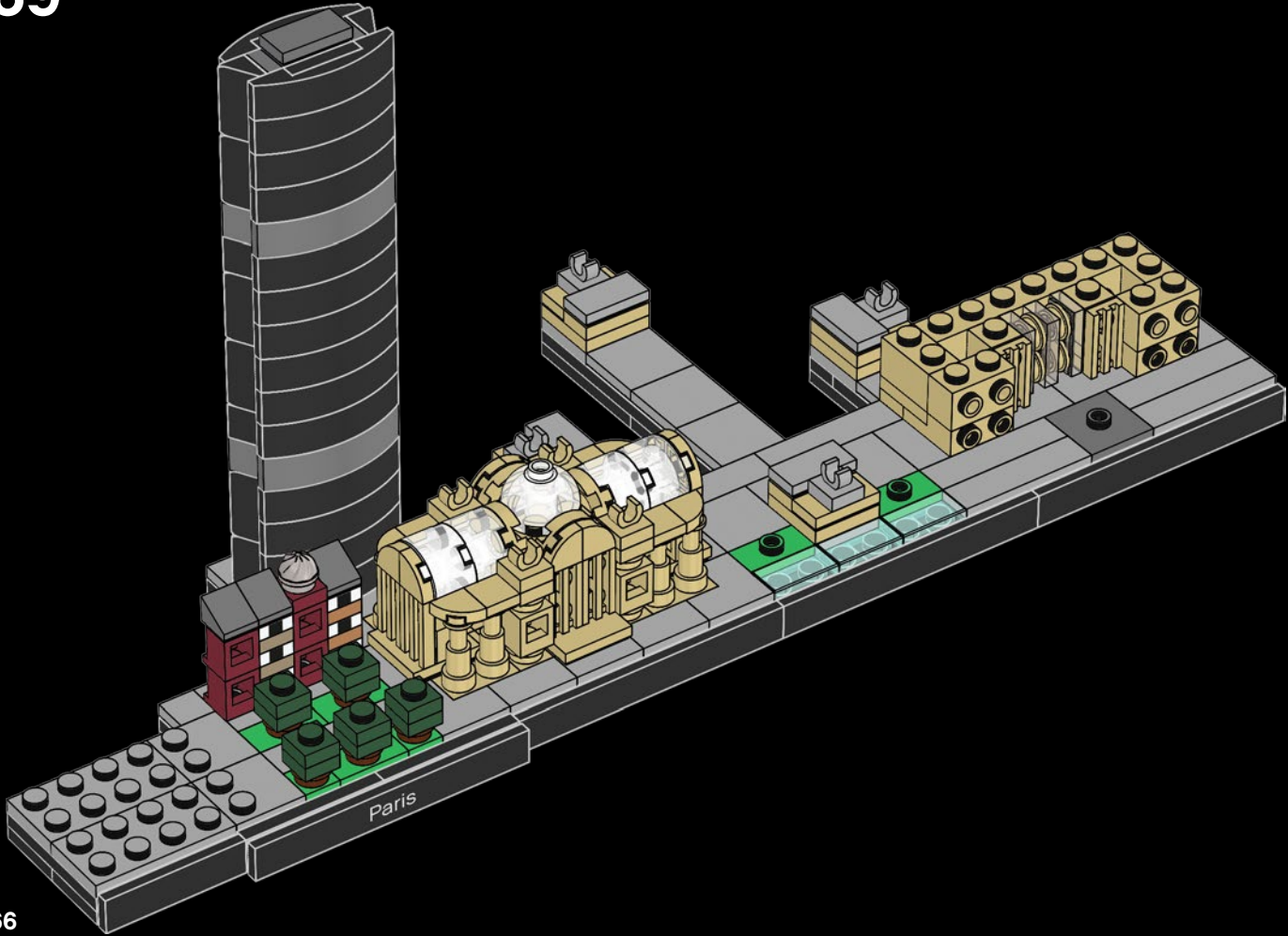

66



70

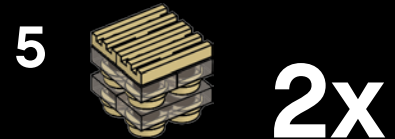
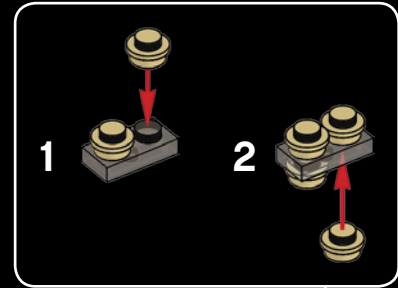
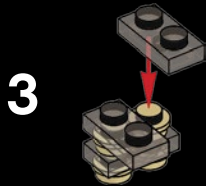
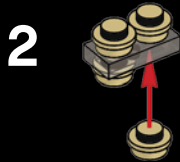
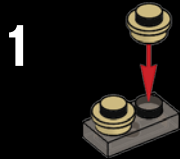

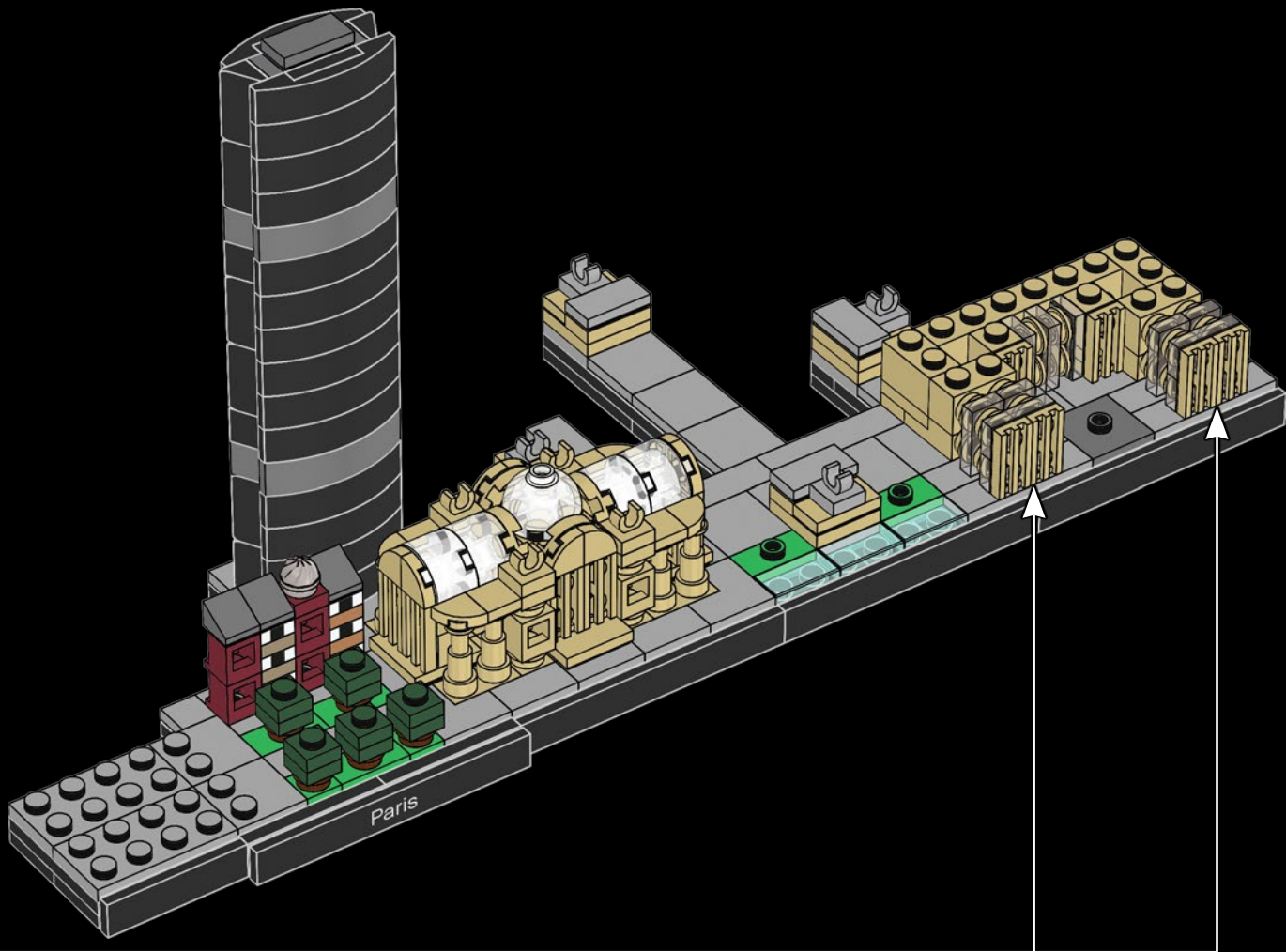

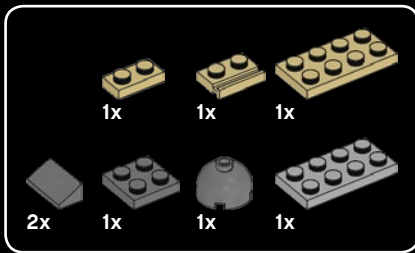

71

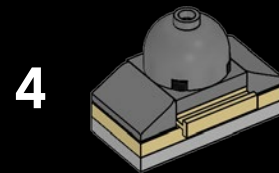
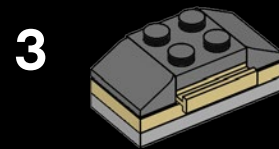
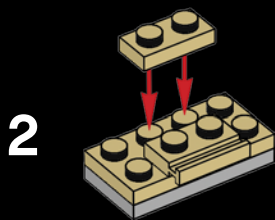
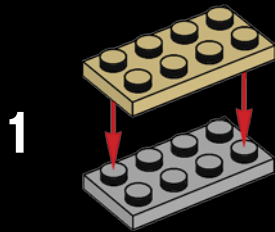

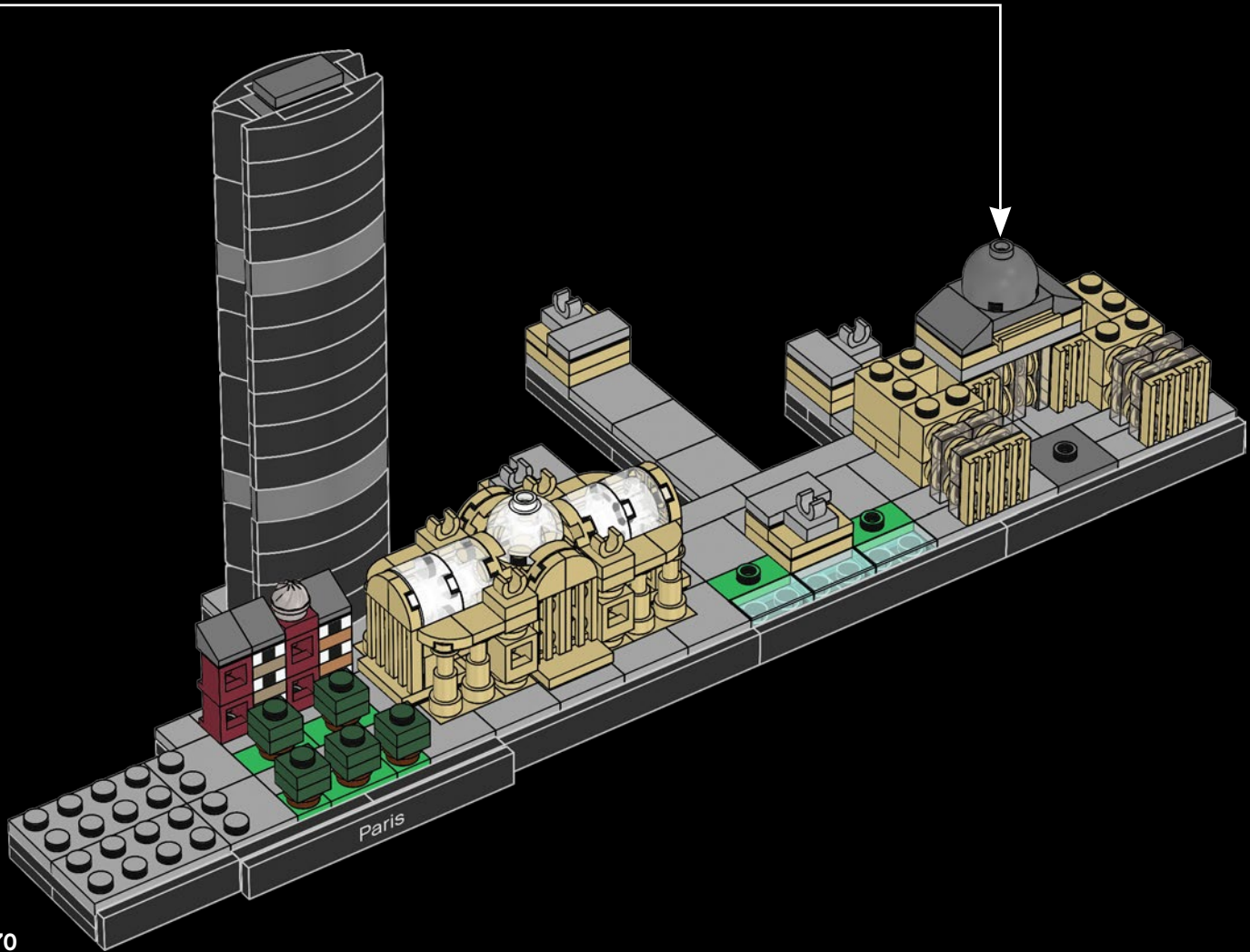

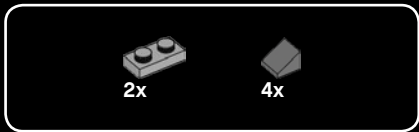

72

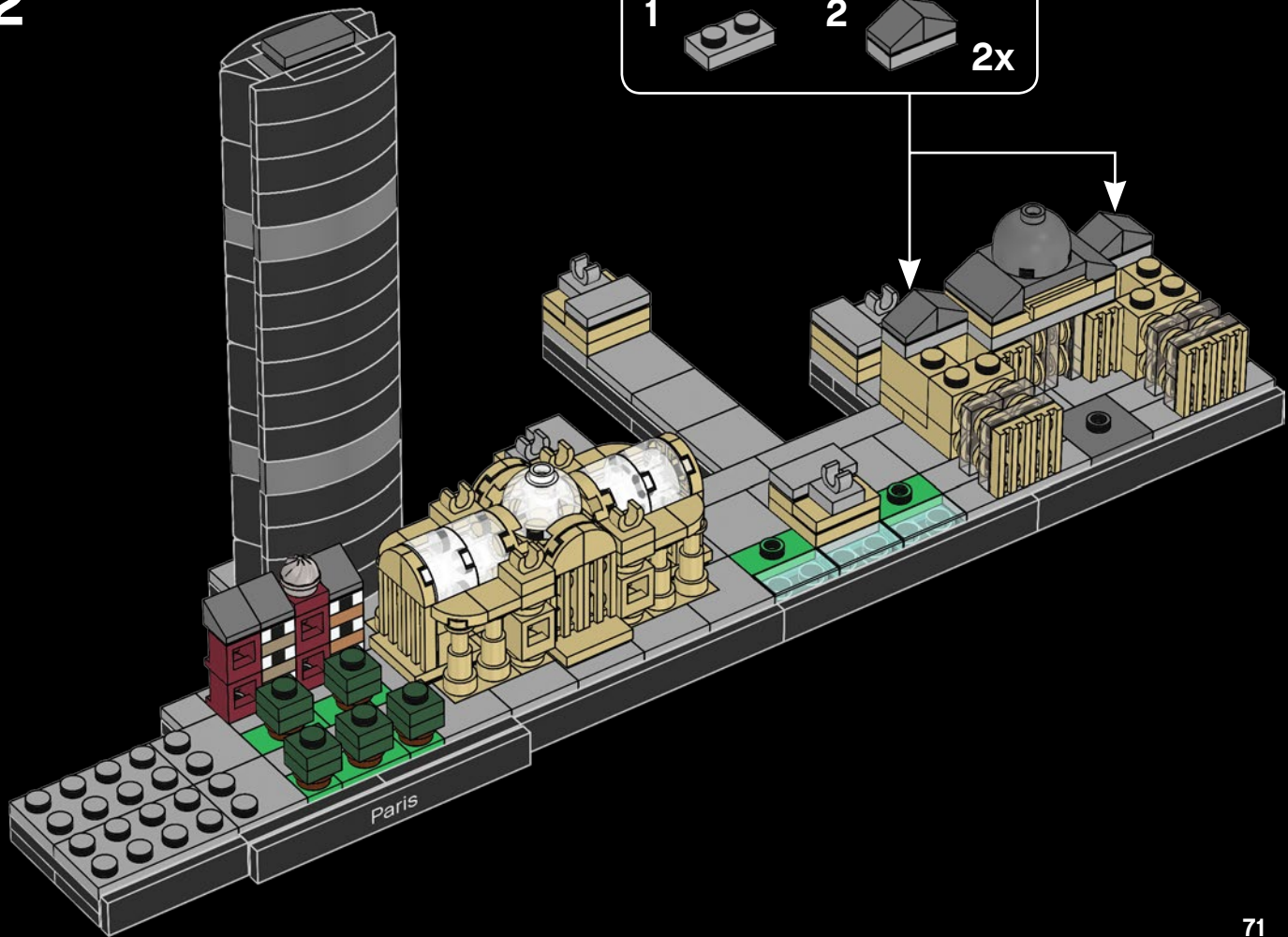
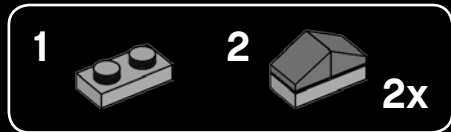

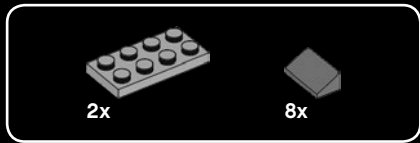

73

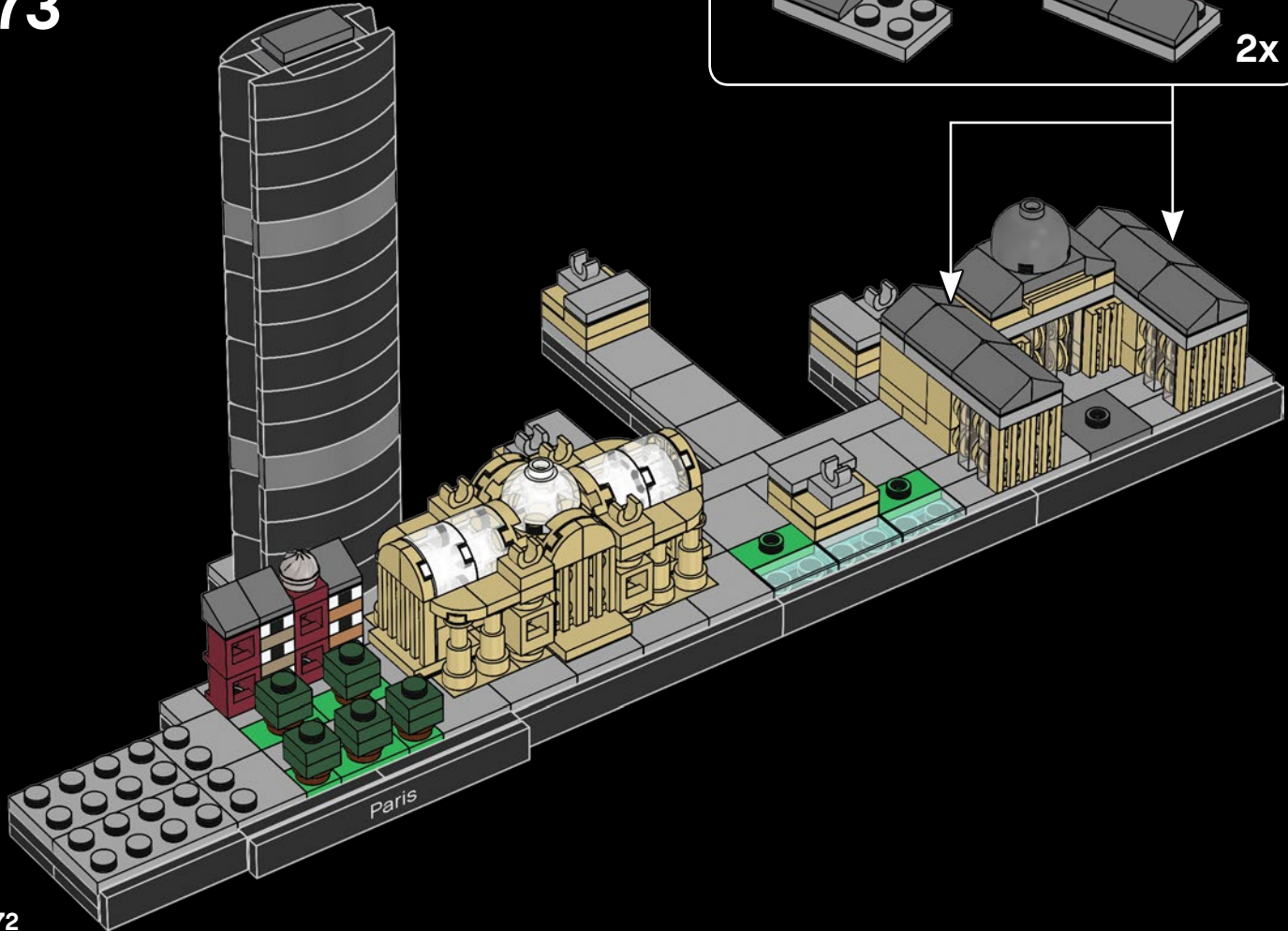
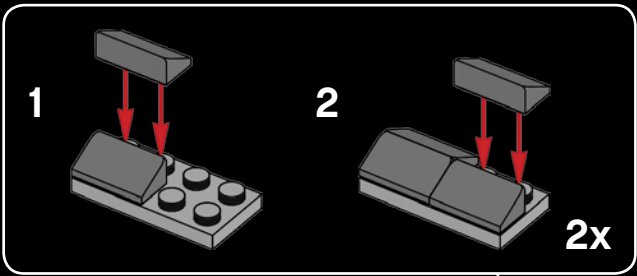

72



1x



4x



1x

74

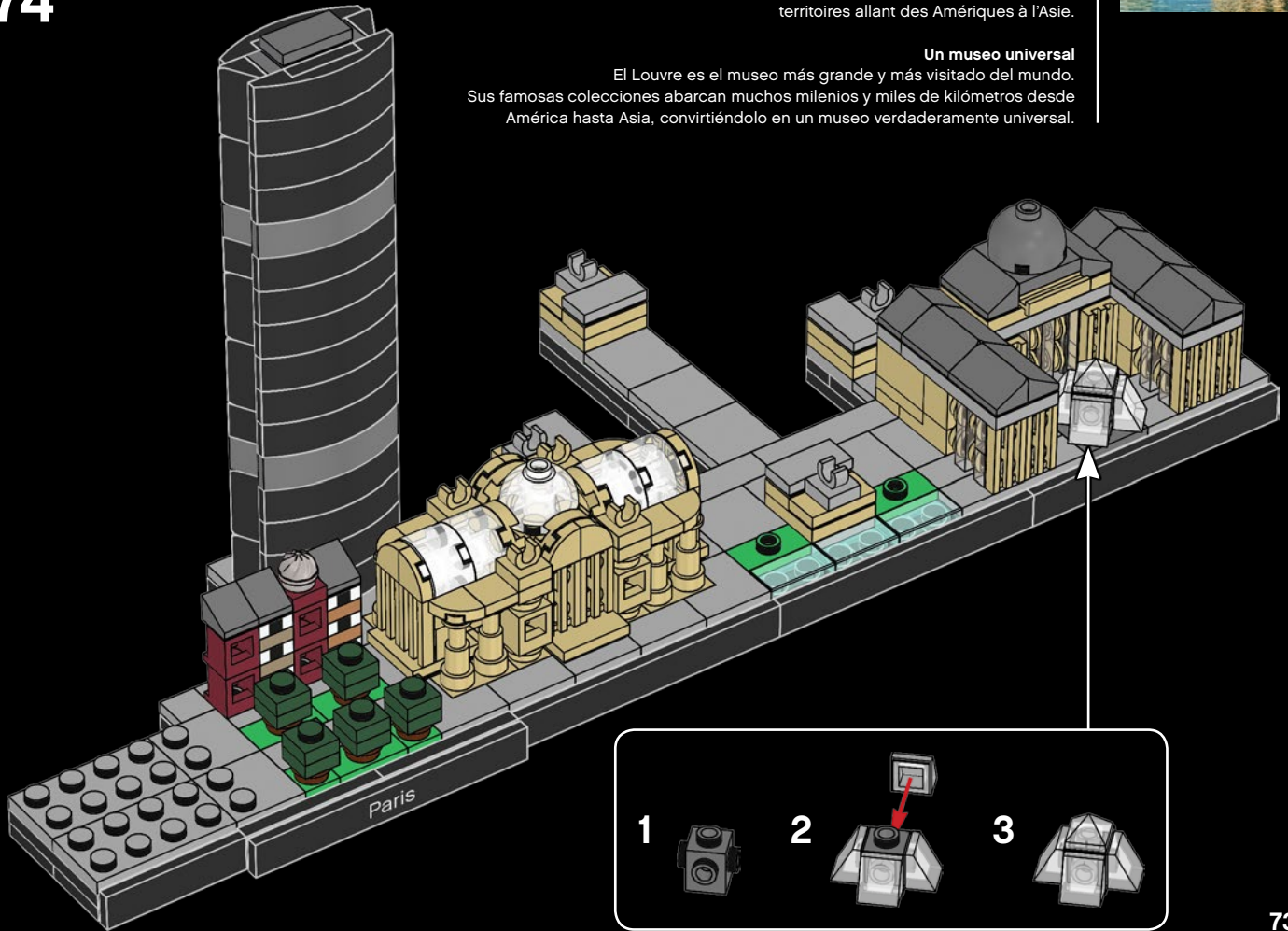

A universal museum

The Louvre is the largest and the most visited museum in the world. As a universal museum, its renowned collections span many millennia and miles, from the Americas to Asia.



Un musée universel

Le Louvre est le plus grand musée du monde et aussi le plus visité. Musée universel, il présente des collections couvrant plusieurs millénaires et des territoires allant des Amériques à l'Asie.

Un museo universal

El Louvre es el museo más grande y más visitado del mundo. Sus famosas colecciones abarcan muchos milenios y miles de kilómetros desde América hasta Asia, convirtiéndolo en un museo verdaderamente universal.

1



2

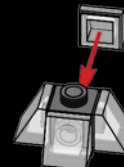

3





2x



4x

75

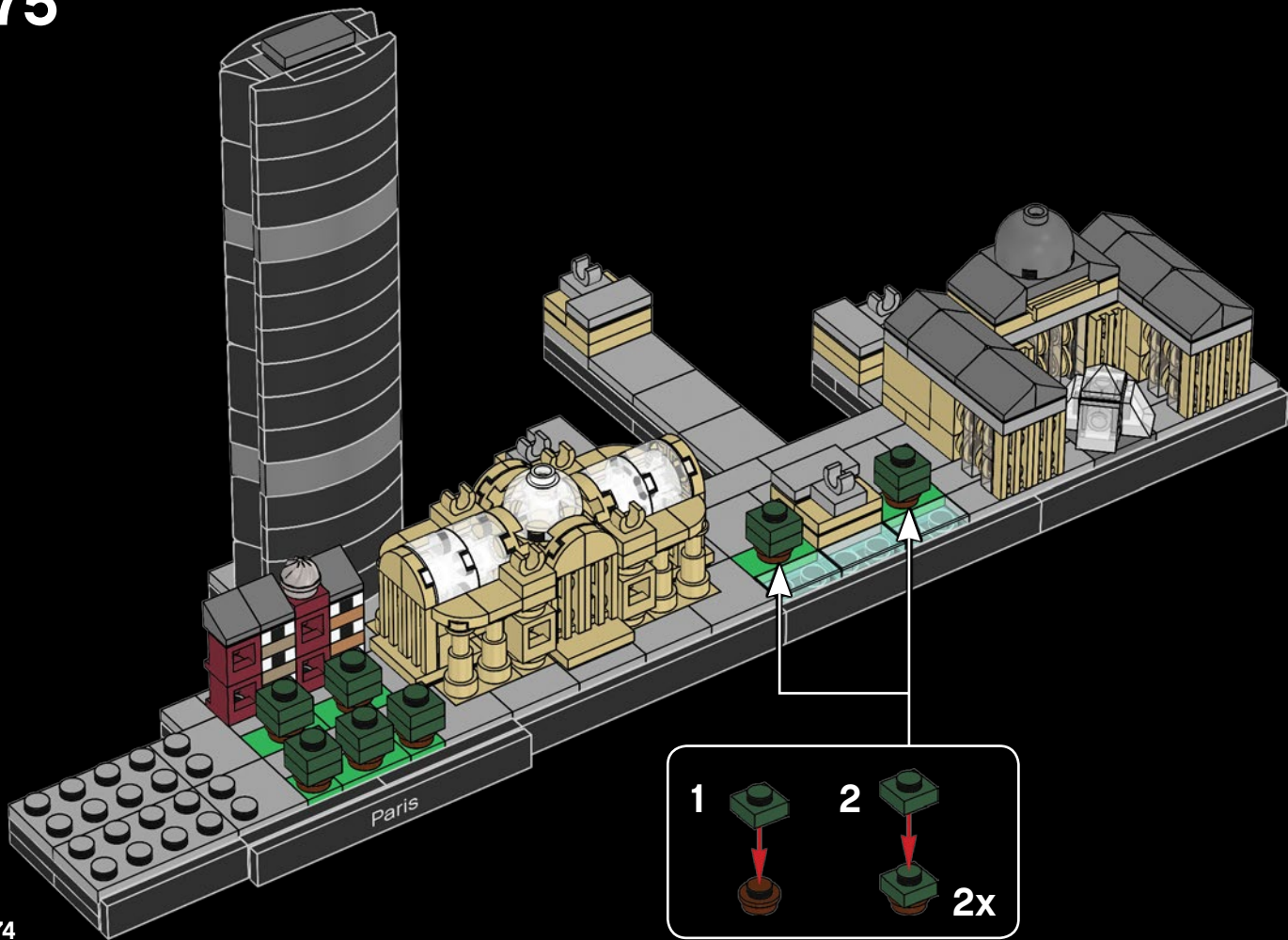

74

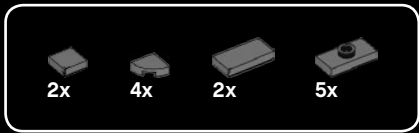

76

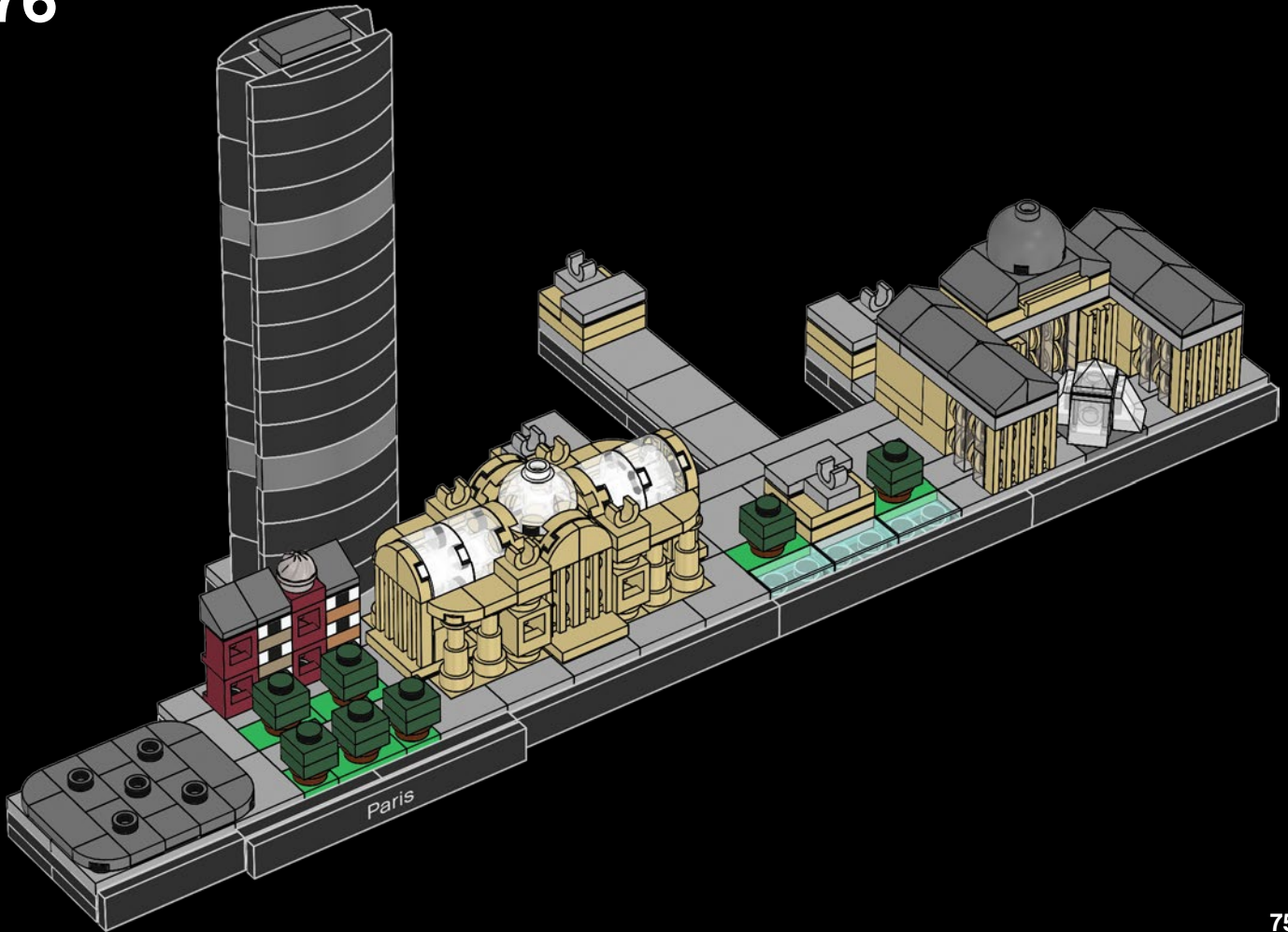



4x



1x

77

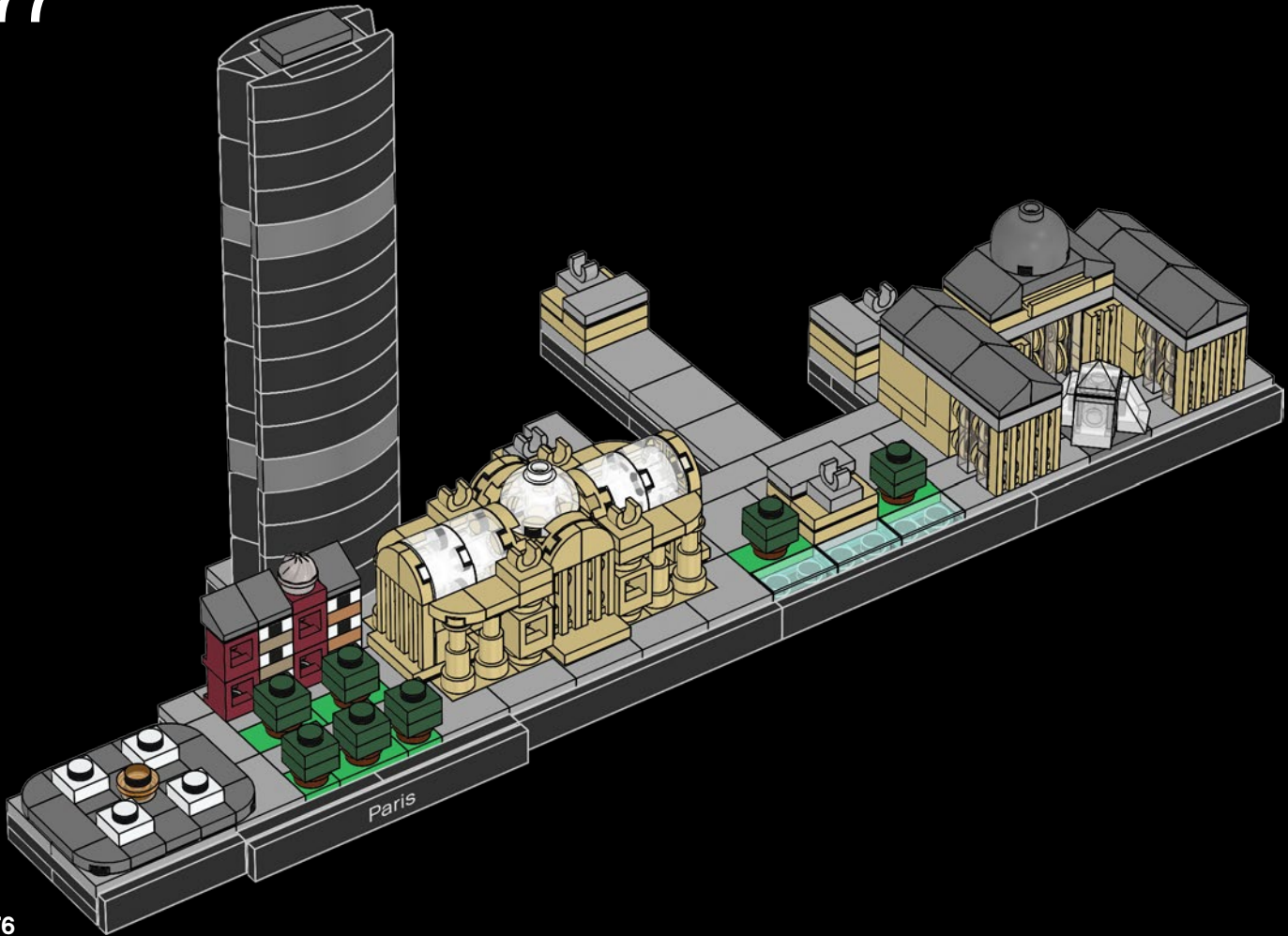

76

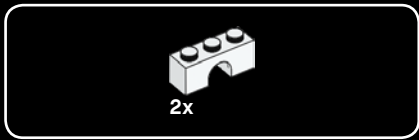

78

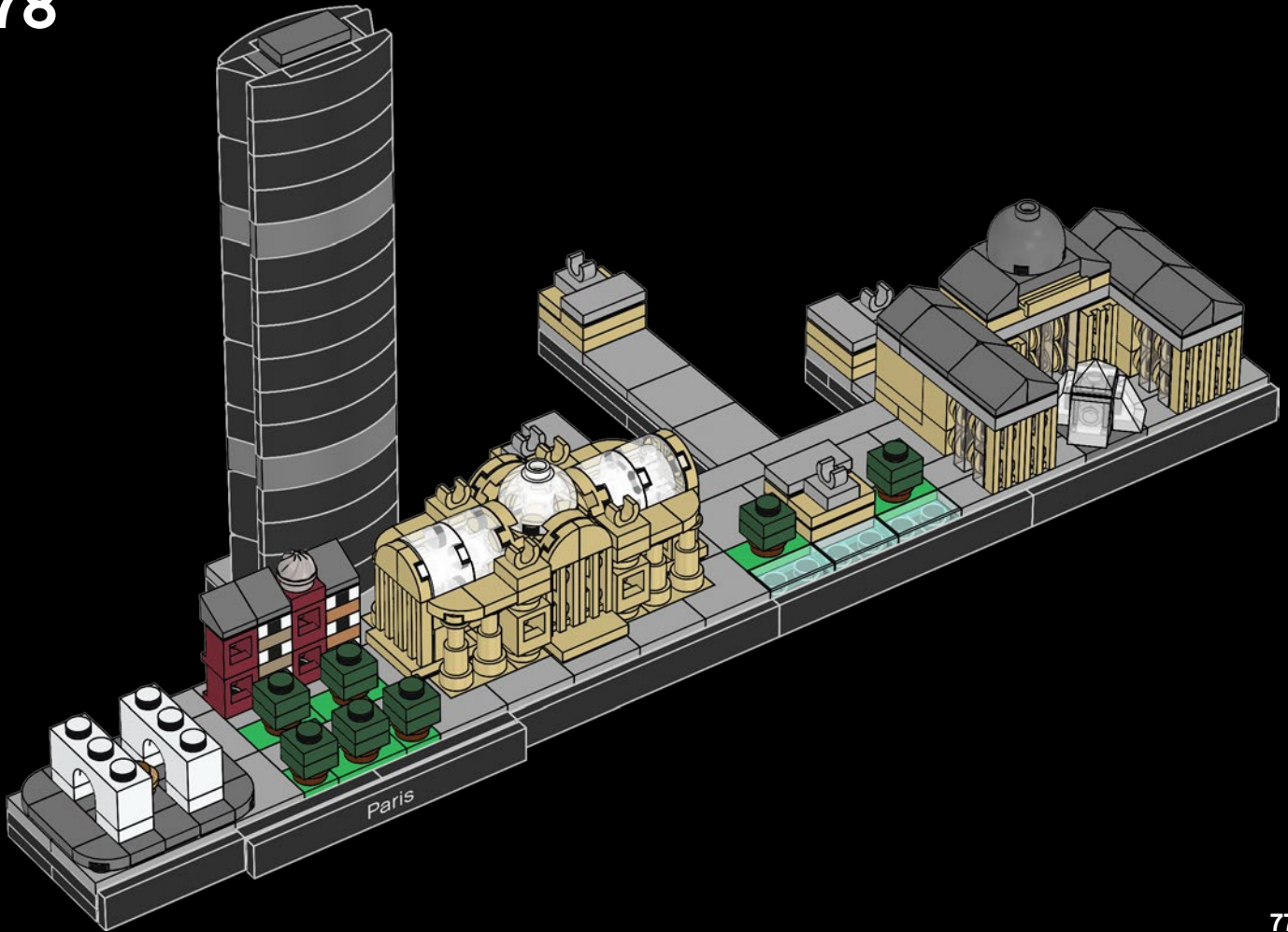



3x

79

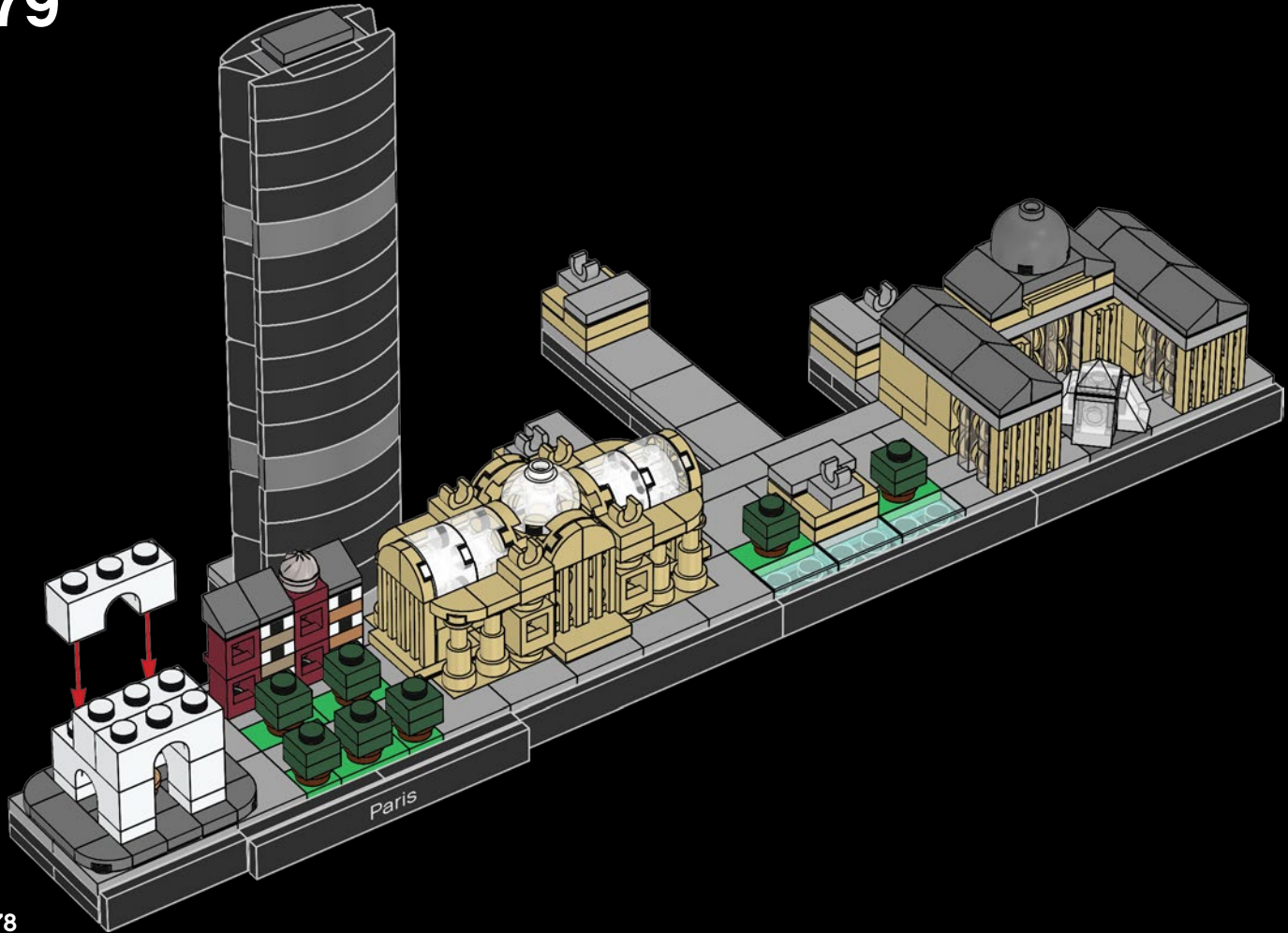

78



6x



2x

80

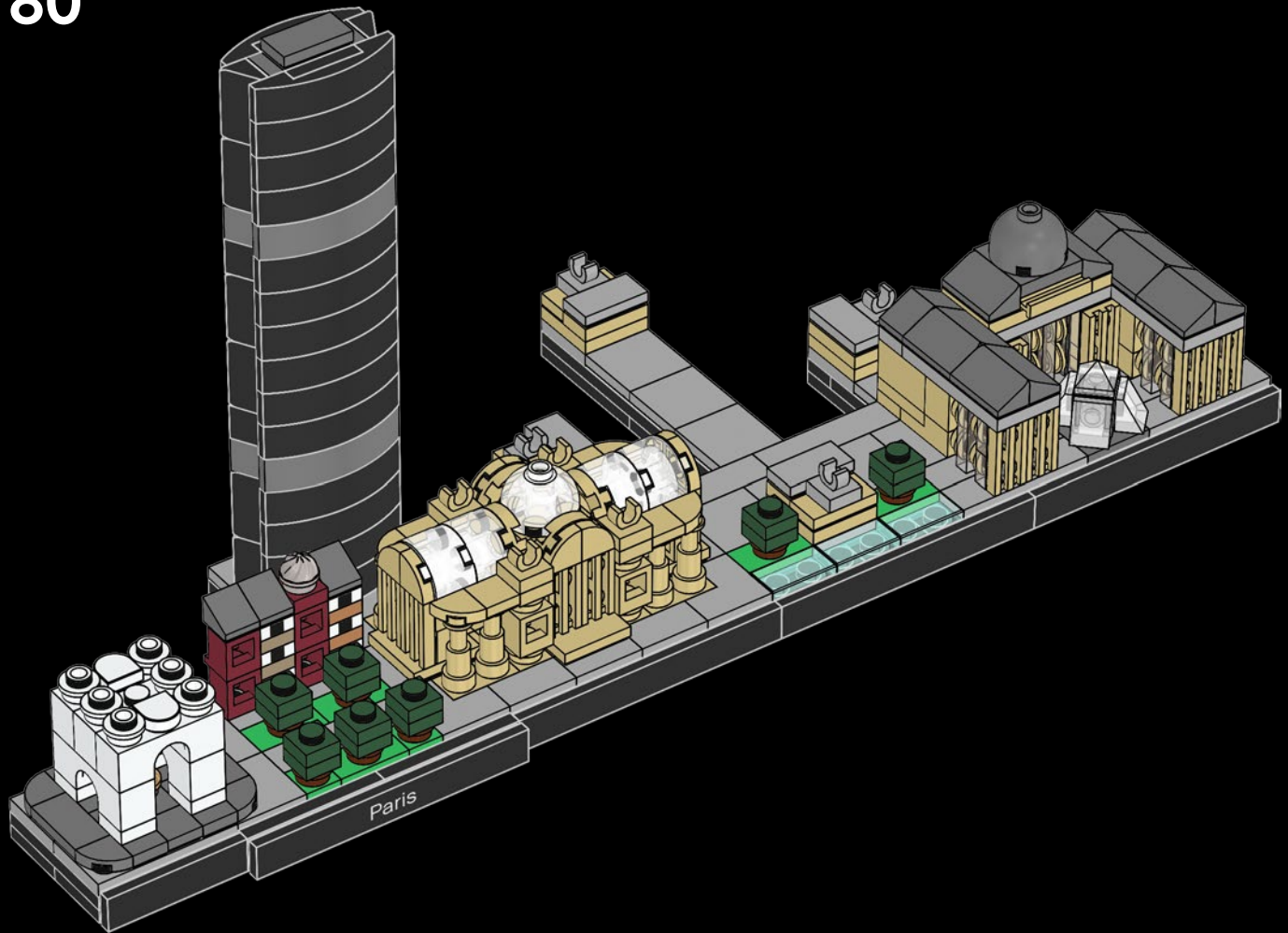



6x

81

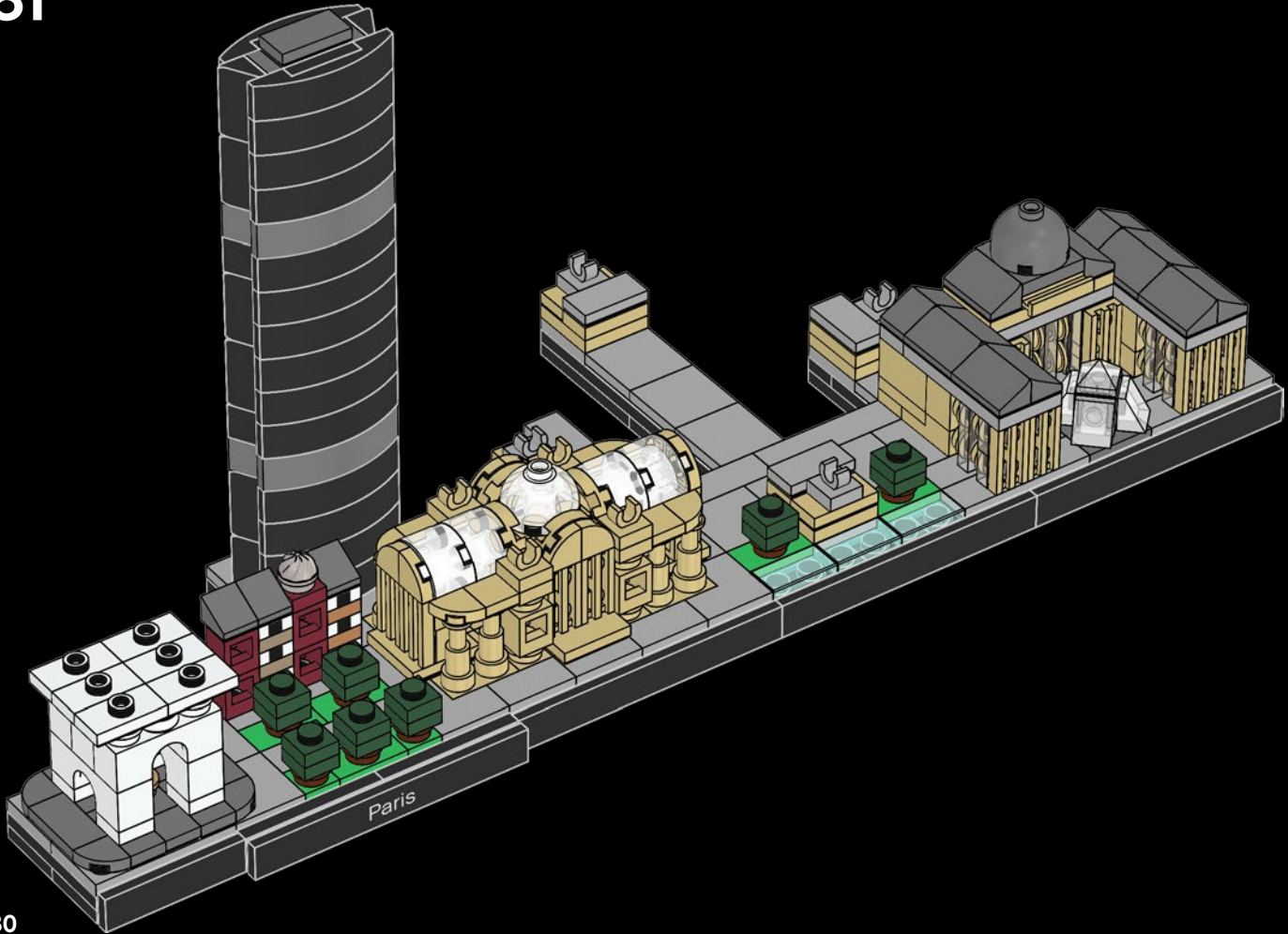

80

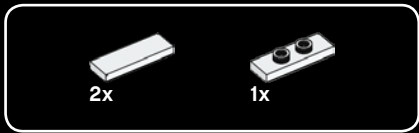

82

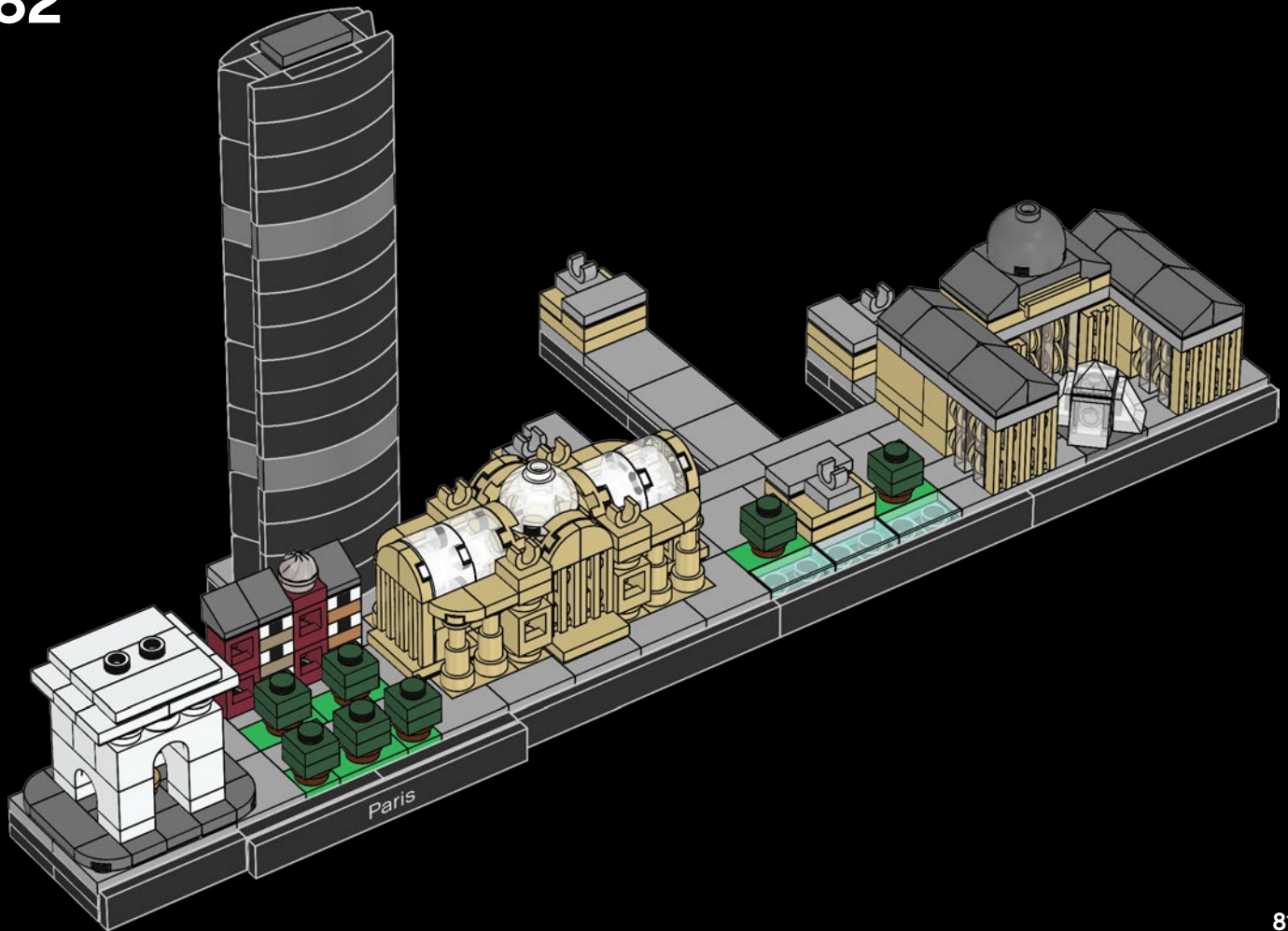

2x

83

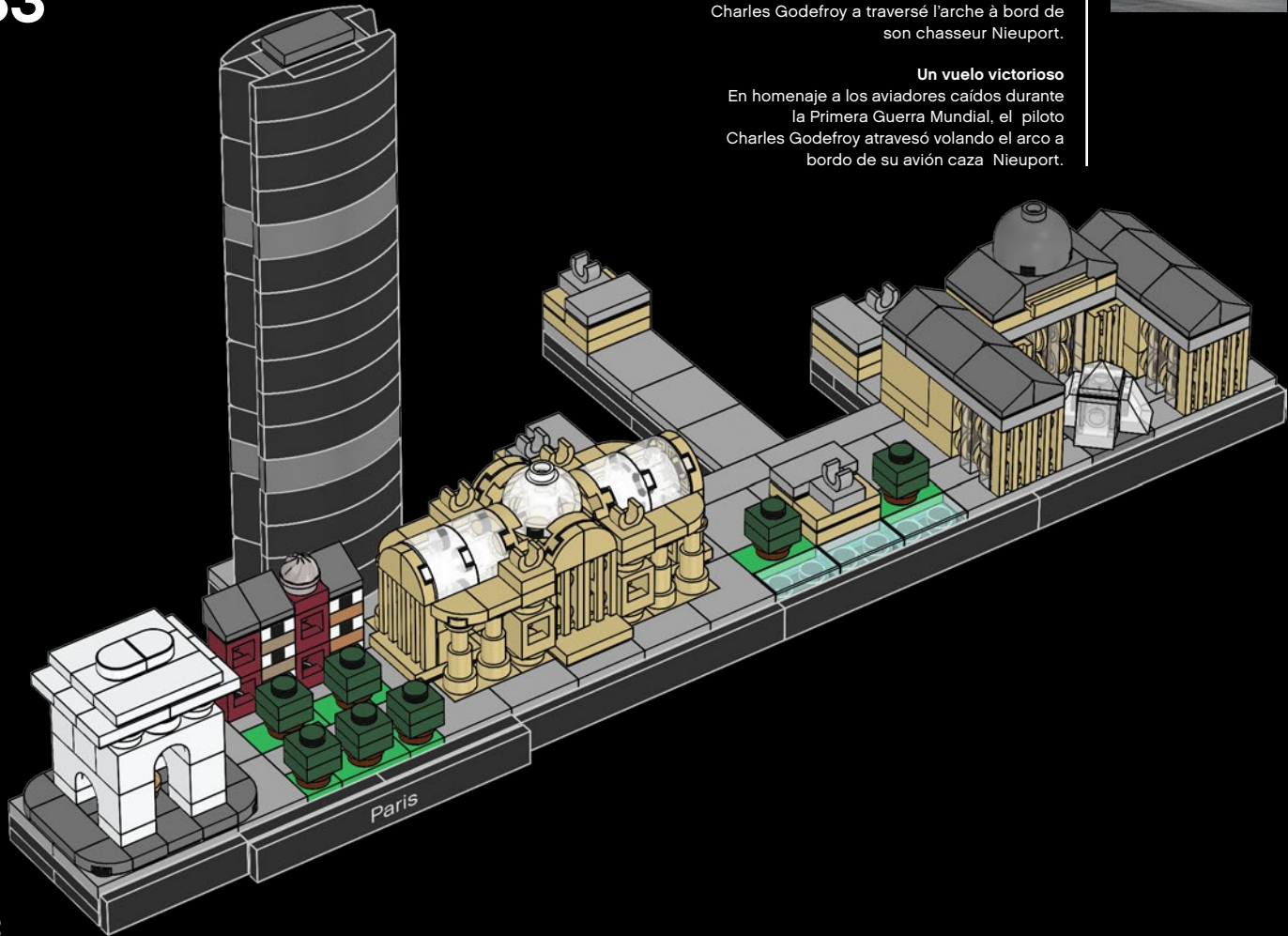

A Victorious Flight

As a salute to the airmen killed during WWI, pilot Charles Godefroy flew his Nieuport fighter plane through the Arch.

Un vol victorieux

En guise d'hommage aux aviateurs ayant péri durant la Première Guerre mondiale, le pilote Charles Godefroy a traversé l'arche à bord de son chasseur Nieuport.

Un vuelo victorioso

En homenaje a los aviadores caídos durante la Primera Guerra Mundial, el piloto Charles Godefroy atravesó volando el arco a bordo de su avión caza Nieuport.



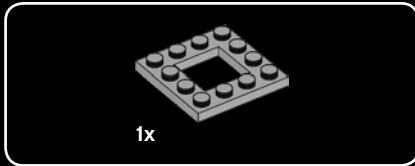
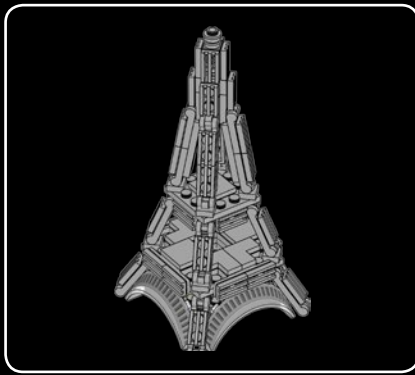

84

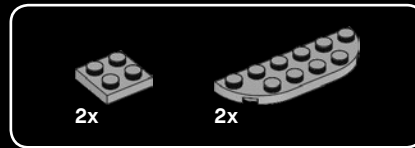
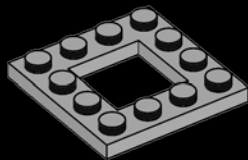

85

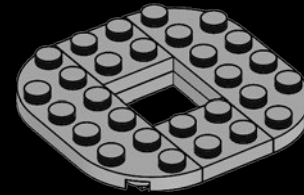

86

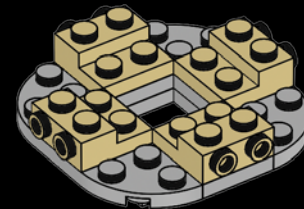



4x

87

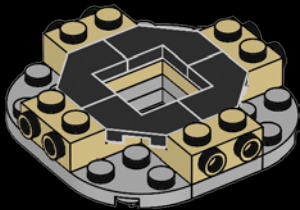

4x

88

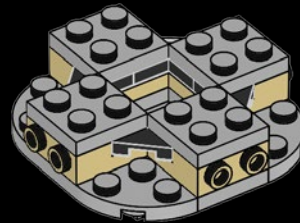



89

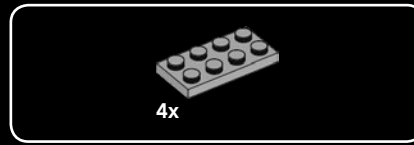
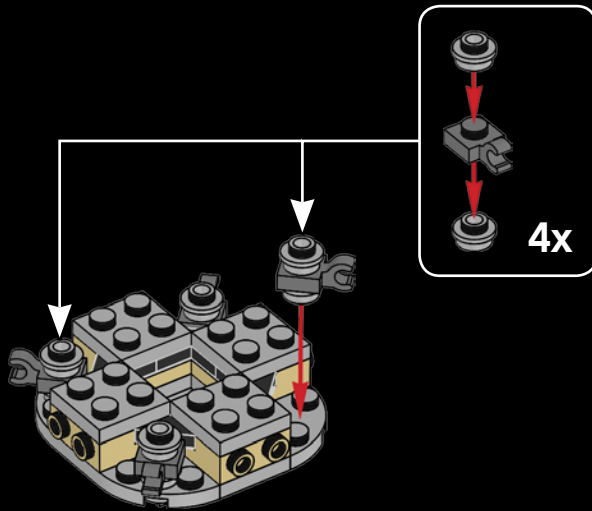

90

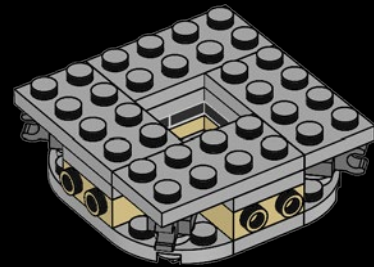

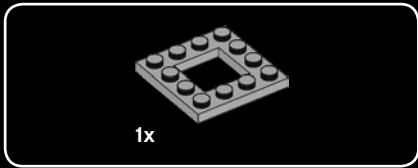

91

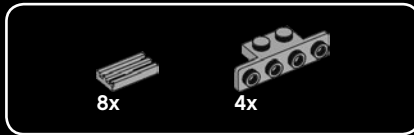
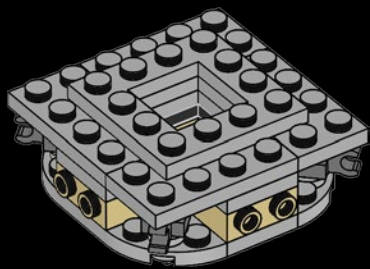

92

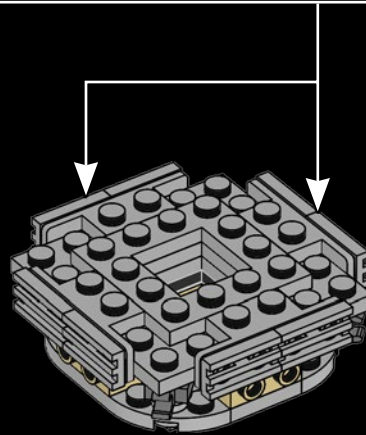
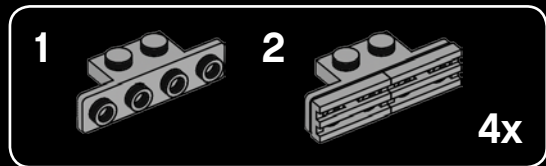

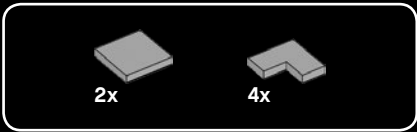

93

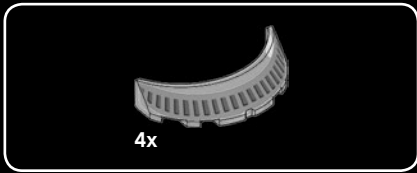
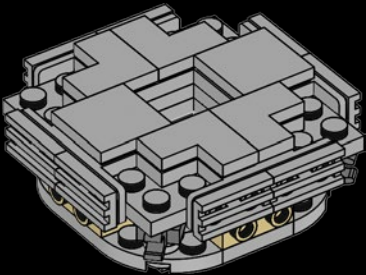

94

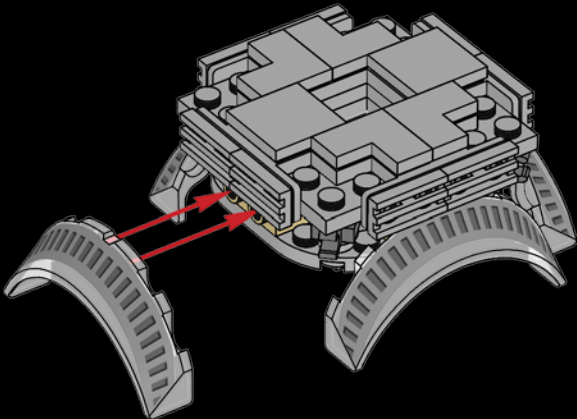

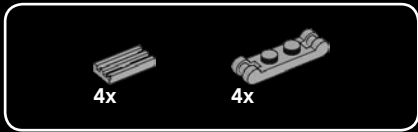

95

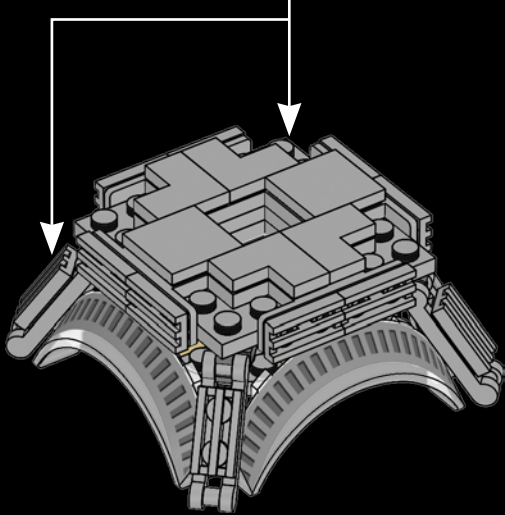
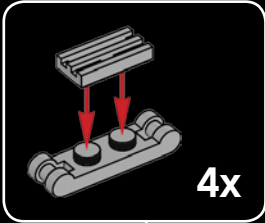

96

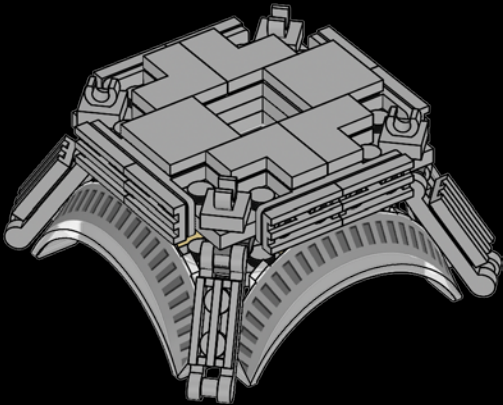

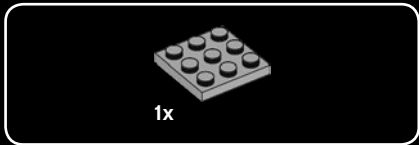
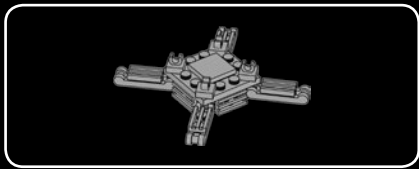

1x

97



2x

98

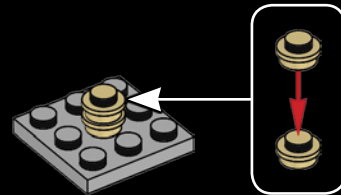

4x

4x

99

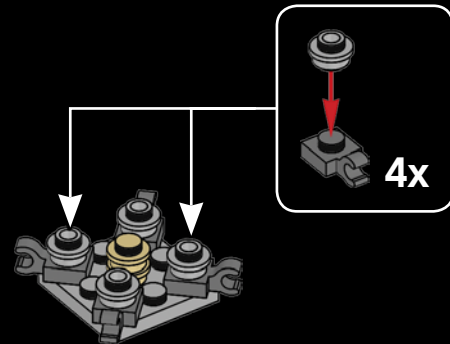

4x

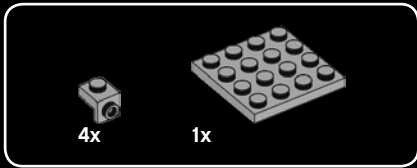

100

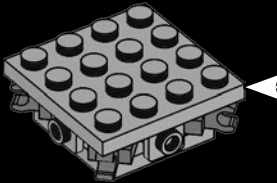
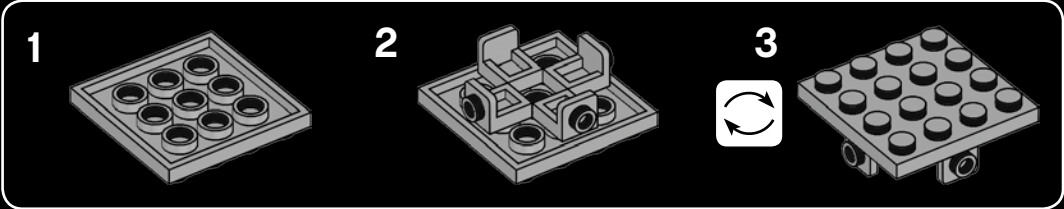

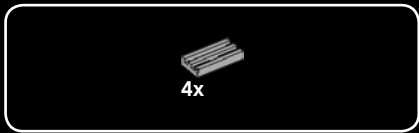

101

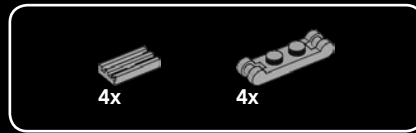
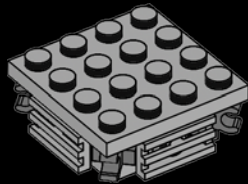

102

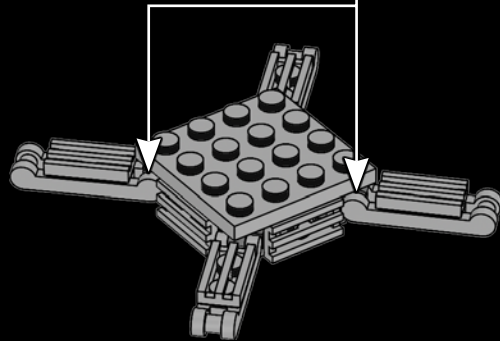
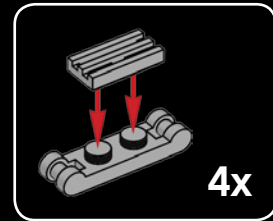

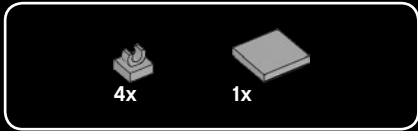

103

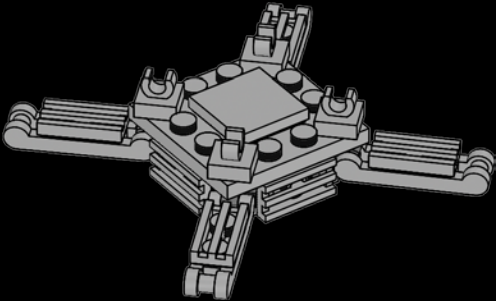

104

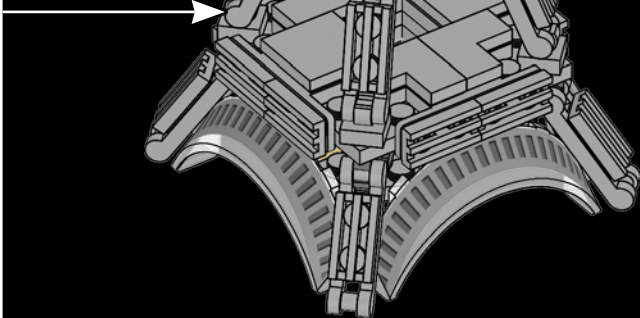

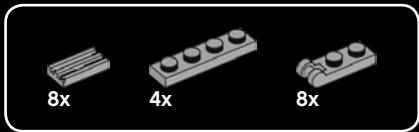

105

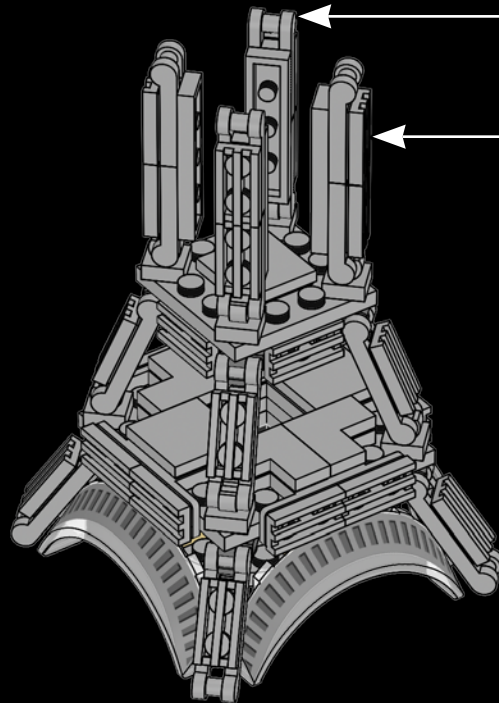
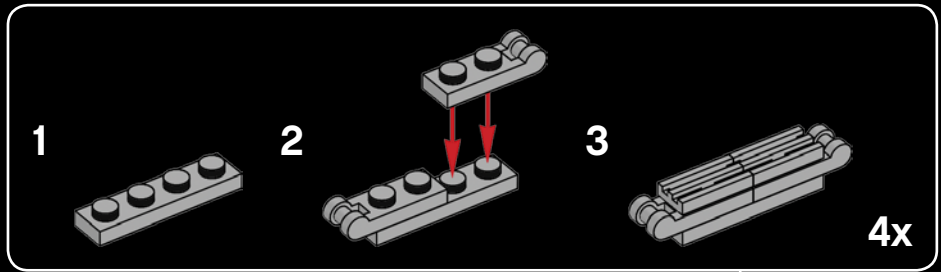



1x



1x

106

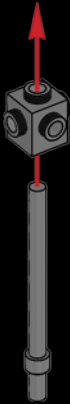

2x

107



1x

108



2x

109



1x

110



2x

111



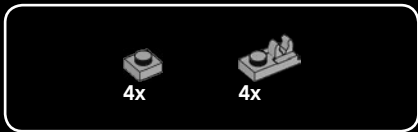

112

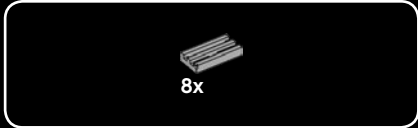
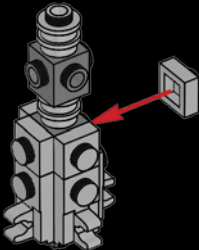

113

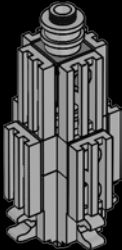

114

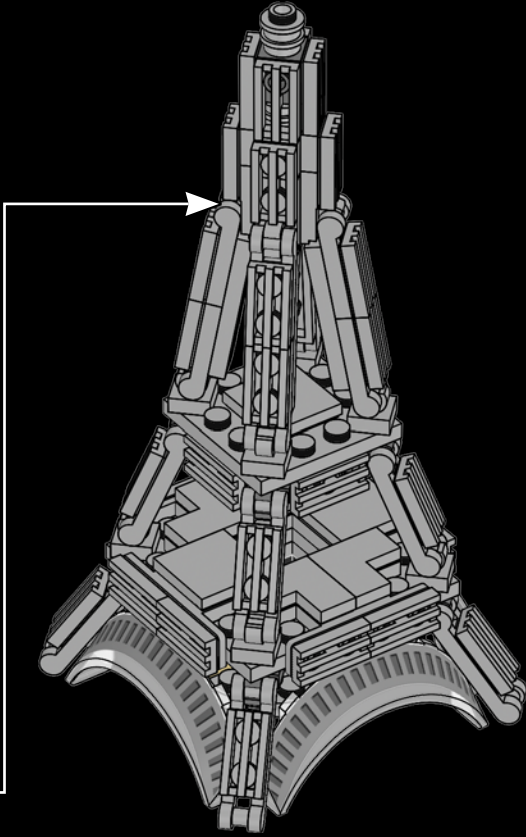

115

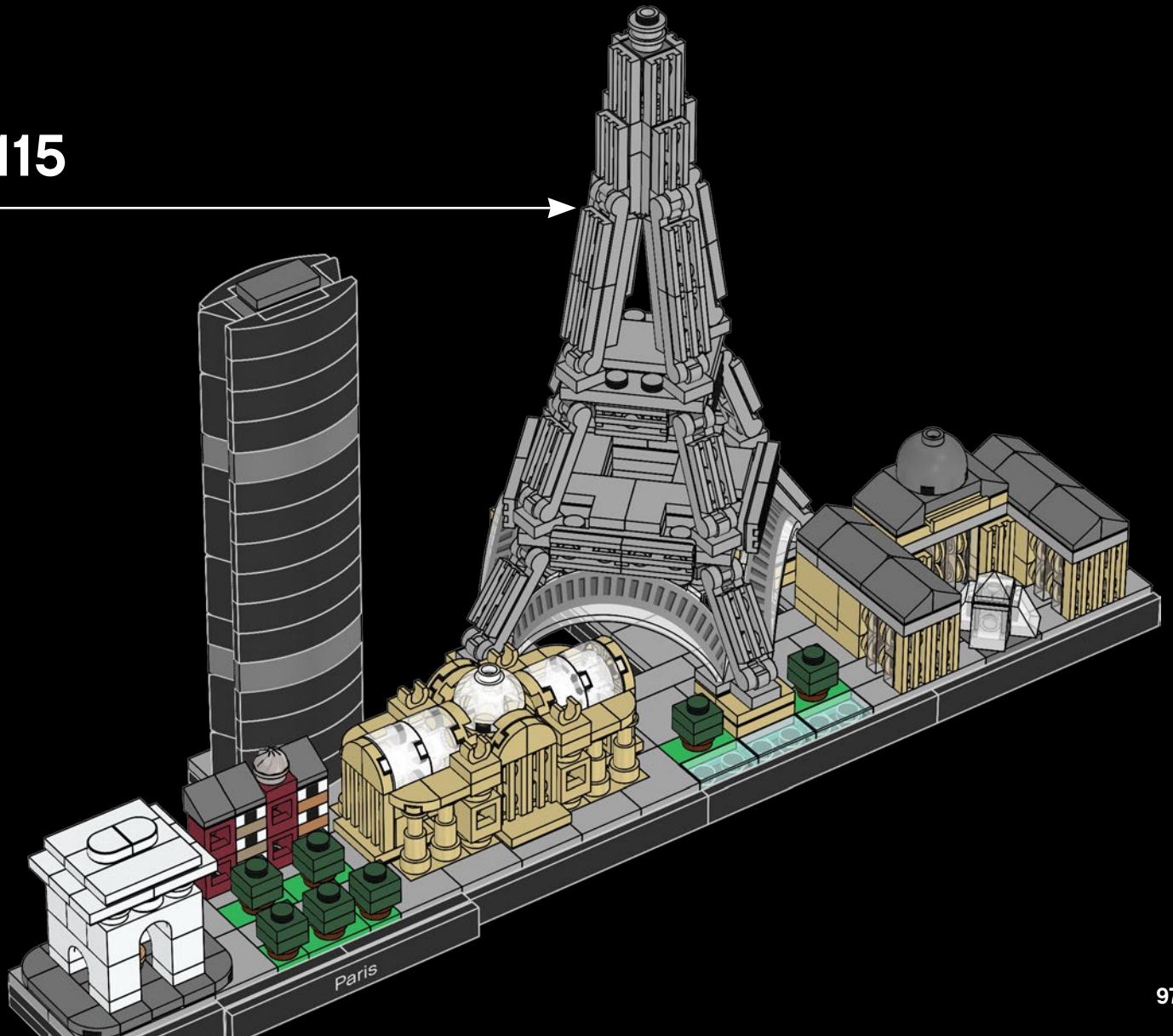

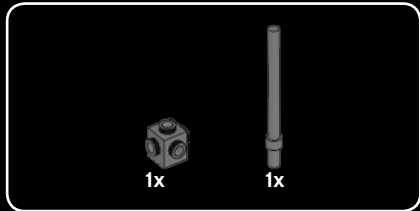
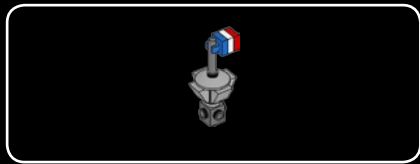

116

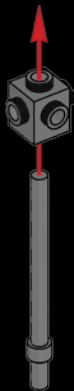

117

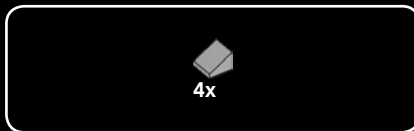

118





119

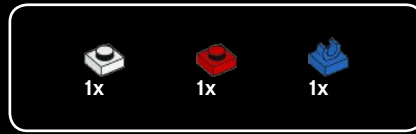

120

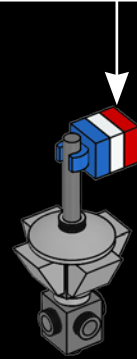
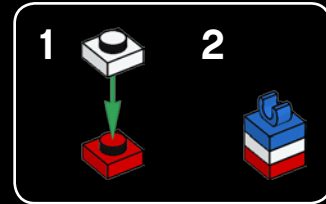

121

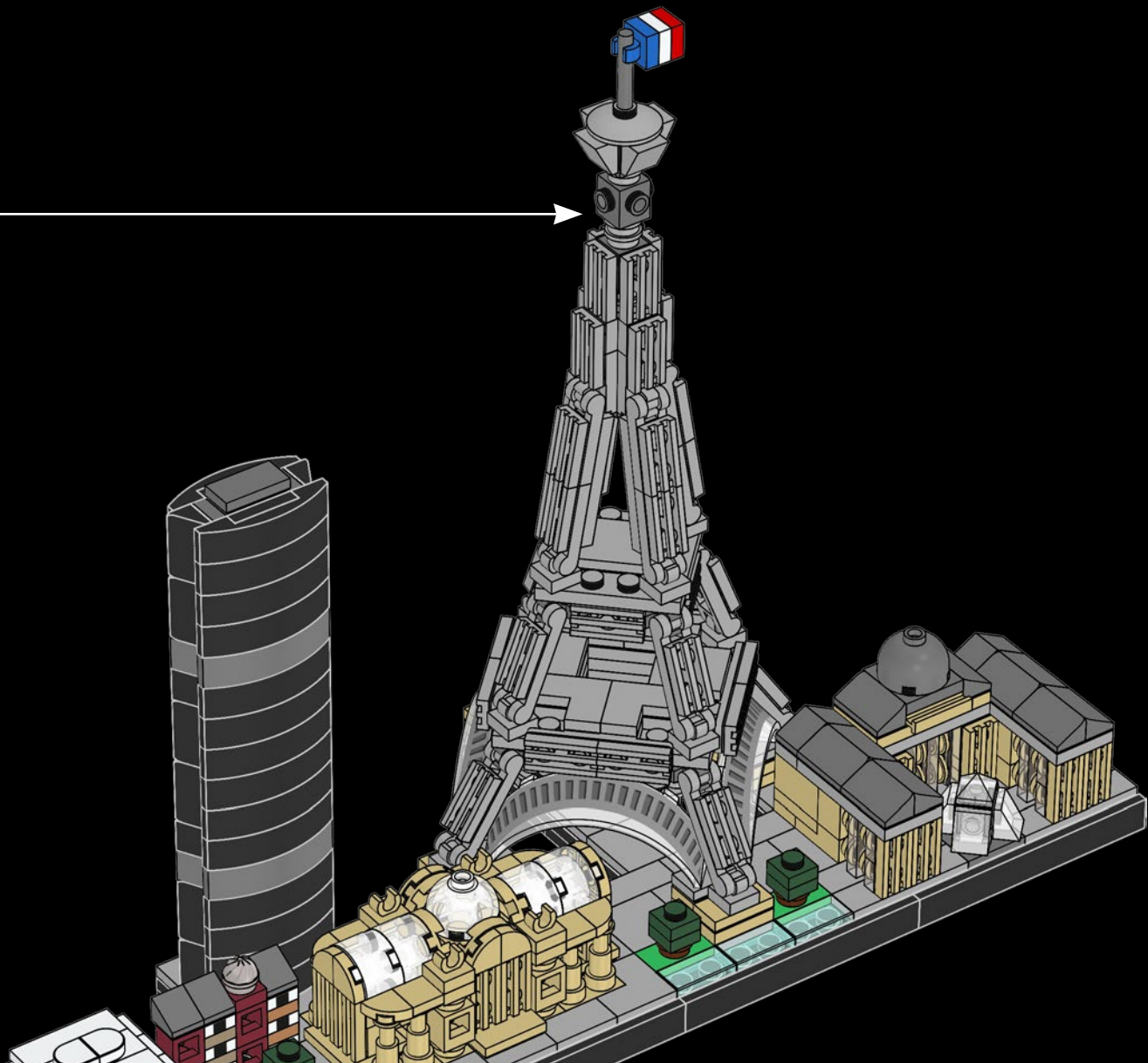

100



4x

122

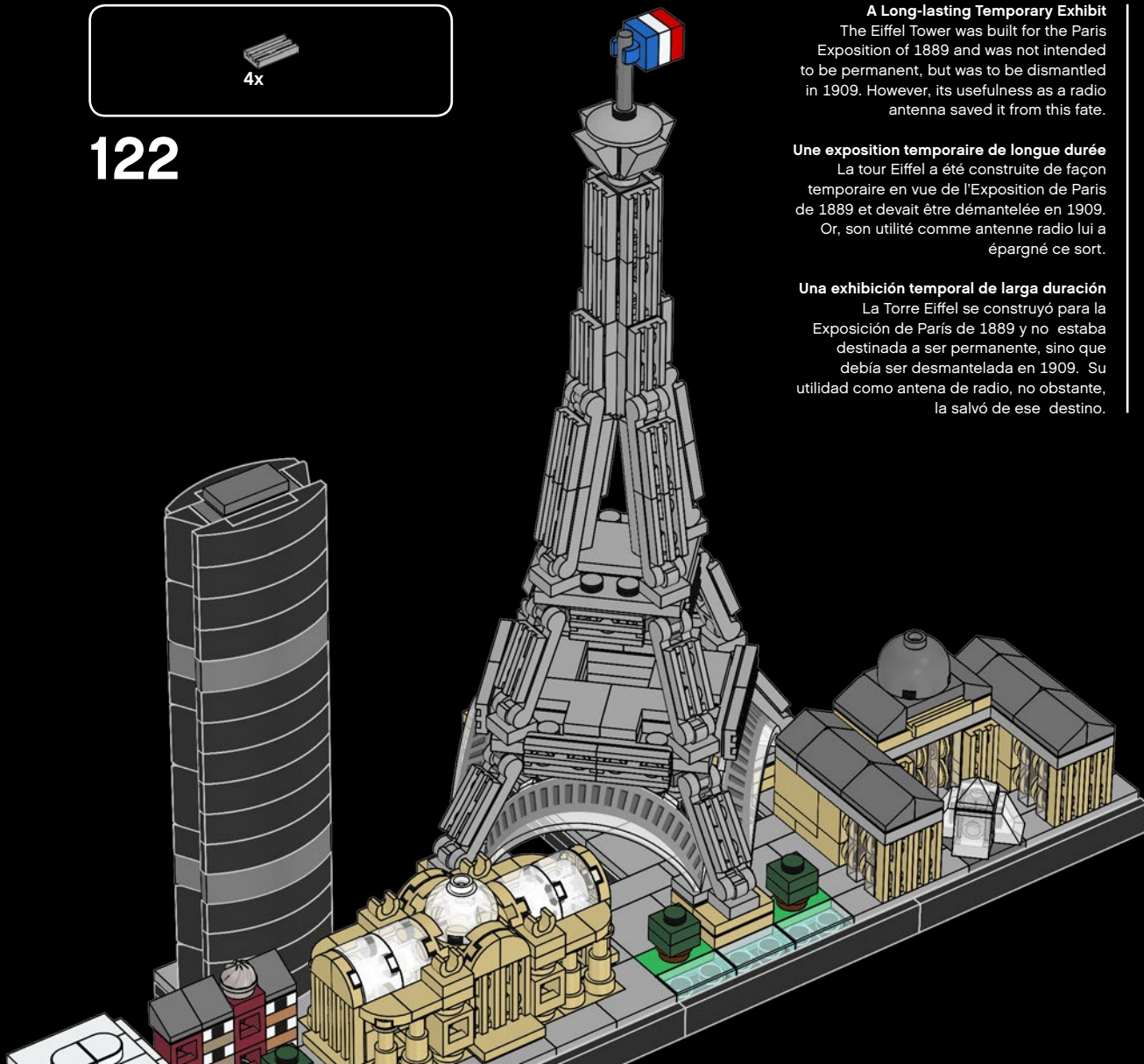

A Long-lasting Temporary Exhibit

The Eiffel Tower was built for the Paris Exposition of 1889 and was not intended to be permanent, but was to be dismantled in 1909. However, its usefulness as a radio antenna saved it from this fate.

Une exposition temporaire de longue durée

La tour Eiffel a été construite de façon temporaire en vue de l'Exposition de Paris de 1889 et devait être démantelée en 1909.

Or, son utilité comme antenne radio lui a épargné ce sort.

Una exhibición temporal de larga duración

La Torre Eiffel se construyó para la Exposición de París de 1889 y no estaba destinada a ser permanente, sino que debía ser desmantelada en 1909. Su utilidad como antena de radio, no obstante, la salvó de ese destino.





LEGO® Architecture – do you like it? Aimez-vous LEGO® Architecture ? LEGO® Architecture: ¿te gusta?

The LEGO Group would like your opinion on the new product you have just purchased. Your feedback will help shape the future development of this product series. Please visit:

Le Groupe LEGO aimerait connaître votre opinion sur le produit que vous venez d'acheter. Vos commentaires nous aideront à concevoir les futurs produits de cette gamme. Veuillez visiter :

The LEGO Group quiere conocer tu opinión acerca del nuevo producto que acabas de comprar. Tus comentarios nos ayudarán a dar forma a los futuros productos de esta serie. Visita:

[LEGO.com/productfeedback](https://www.lego.com/productfeedback)

By completing our short feedback survey, you will be automatically entered into a drawing to win a LEGO® prize.

En remplissant ce court sondage sur le produit, vous serez automatiquement inscrit à un tirage au sort pour gagner un prix LEGO®.

Al contestar este breve cuestionario de opinión, participarás automáticamente en el sorteo de un producto LEGO®.



Terms & Conditions apply. Des conditions générales s'appliquent. Sujeto a Términos y Condiciones.

LEGO® Architecture

The LEGO® Architecture series creatively captures the essence of many of the world's most iconic landmarks while giving you an enjoyable and engaging LEGO building experience.

Whether your interest is in travel, design, history or architecture, these sets are a physical memento of a great trip abroad, a famous building you know well, or a city you still dream of visiting.

Every LEGO Architecture set is designed to be displayed. Much more than just a photo, building and displaying your model on your desk, in the bookcase or on the shelf, lets you be transported every time you admire the view.

La série LEGO® Architecture capture l'essence de nombreux monuments parmi les plus célèbres du monde tout en vous offrant une expérience agréable et stimulante de construction LEGO.

Que votre intérêt porte sur les voyages, le design, l'histoire ou l'architecture, ces ensembles constituent un souvenir tangible d'un voyage mémorable, d'un célèbre bâtiment que vous connaissez bien ou d'une ville que vous rêvez de visiter.

Chaque ensemble LEGO Architecture est conçu pour être exposé. Construire votre modèle et l'exposer sur votre bureau, une bibliothèque ou une tablette vous fera voyager à chaque coup d'œil, bien plus qu'une simple photo ne pourrait le faire.

La línea LEGO® Architecture captura con creatividad la esencia de muchos de los monumentos más populares del mundo y pone a tu alcance una experiencia de construcción gratificante y cautivadora con el sello característico de LEGO.

Ya sea que sientas atracción por los viajes, el diseño, la historia o la arquitectura, estos sets expresan físicamente tus recuerdos de aquel fantástico viaje al extranjero, ese famoso edificio que conoces tan bien o la ciudad que sueñas con visitar algún día.

Todos los sets LEGO Architecture están diseñados para decorar. Mucho más que una simple fotografía, construir y exponer un modelo en tu escritorio, un librero o una repisa te traslada a otro lugar al admirar las vistas.

Follow us on

Suivez-nous sur

Síguenos en



Adam Reed Tucker is the co-developer of the LEGO Architecture product line.

Adam Reed Tucker est le codéveloppeur de la gamme de produits LEGO Architecture.

Adam Reed Tucker es el codesarrollador de la línea de productos LEGO Architecture.



Celebrate the world of architecture
and collect all the models

Célébrez le monde de l'architecture
et collectionnez tous les modèles

Celebra el mundo de la arquitectura
y colecciona todos los modelos



21041
Great Wall of China
La Grande Muraille de Chine
Gran Muralla China



21030
United States Capitol Building
Le Capitole des États-Unis
Edificio del capitolio de Estados Unidos



21042
Statue of Liberty
La statue de la Liberté
Estatua de la Libertad

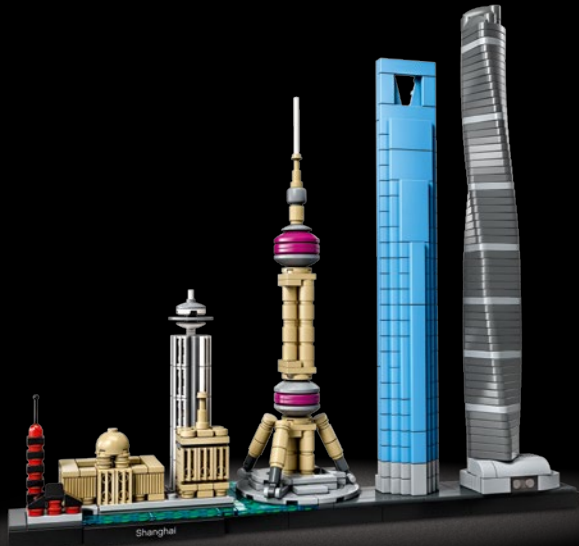

21039
Shanghai
Shanghái



21047
Las Vegas



21034
London
Londres



21028
New York City
New York
Nueva York

References

Références

Referencias

*Pictures -
Images -
Fotografías -*

© GettyImages

Customer Service
Kundenservice
Service Consommateurs
Servicio Al Consumidor
LEGO.com/service or dial

 00800 5346 5555 ;
 1-800-422-5346 ;



1



2



3

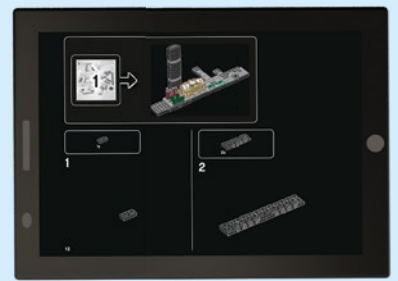



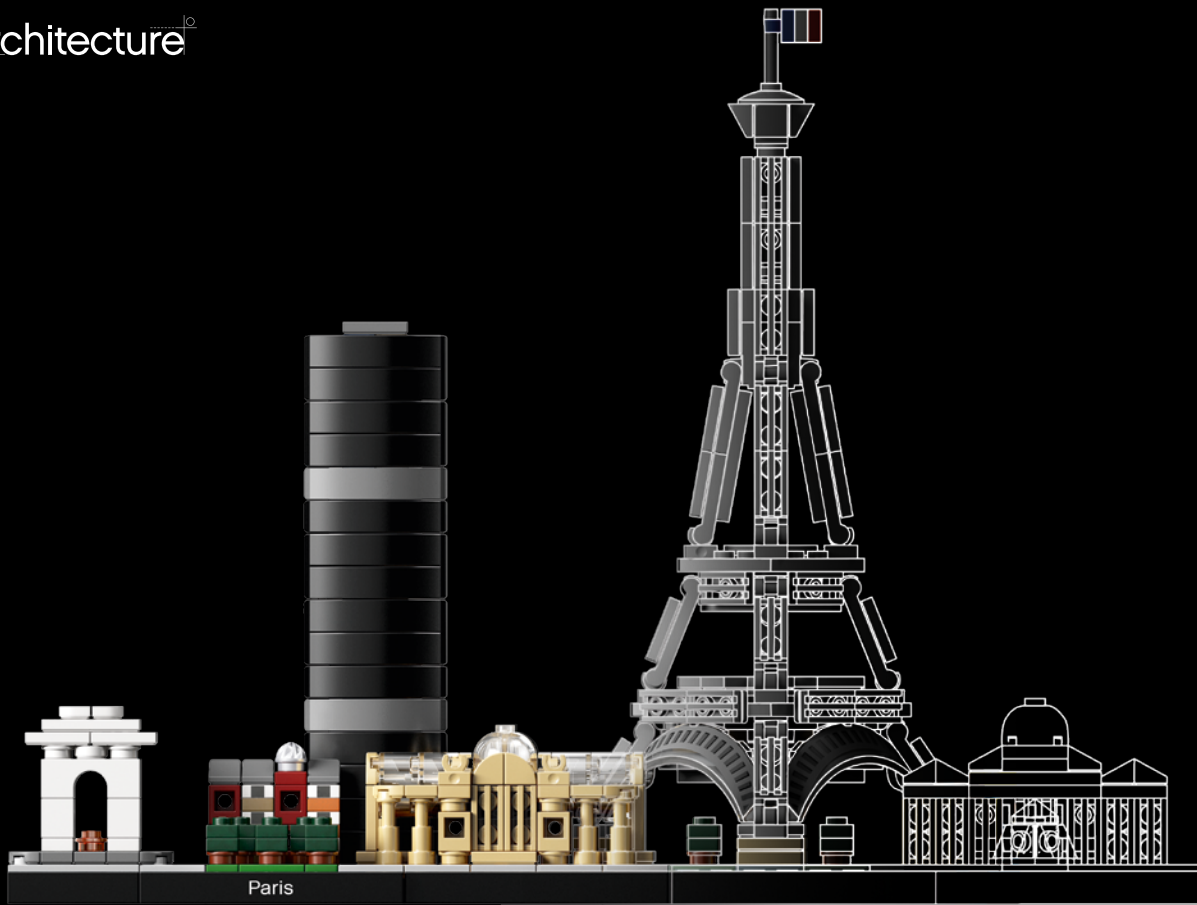

LEGO and the LEGO logo are trademarks of the/son des marques de commerce
du/son marcas registradas de LEGO Group. ©2019 The LEGO Group. 6281934

© Pyramide du Louvre, architecte I. M. Pei, musée du Louvre.

 [LEGO.com/architecture](https://www.lego.com/architecture)

Follow LEGO® Architecture on
Suivez LEGO® Architecture sur
Sigue a LEGO® Architecture en

