



- 🇬🇧 Booklet available in English on
- 🇩🇪 Heft in deutscher Sprache erhältlich auf
- 🇫🇷 Livret disponible en français sur
- 🇪🇸 Folleto disponible en español en
- 🇵🇹 Folheto disponível em português em
- 🇭🇺 A füzet magyarul ezen a honlapon olvasható:
- 🇮🇹 Libretto disponibile in Italiano su
- 🇨🇳 如需中文版手册，请访问：

[ideas.LEGO.com](http://ideas.LEGO.com)



# LEGO® BIRDS

There are over 10,000 known species of birds in the world today. They live and breed on all seven continents and thrive in diverse climates ranging from the tropics to Antarctica. They are such a natural part of our environment that we often take them for granted. That is why Thomas Poulsom's work is so fascinating. He encourages us to take a new look at something we know well, and while doing so proves—yet again—that almost anything can be built from LEGO® bricks.

“As a child I absolutely loved playing with LEGO bricks. I still remember the very first LEGO set my mum bought me when I was seven years old.”

“As often happens, my LEGO bricks were put aside when I became a teenager. It was only after seeing a friend's children playing with their LEGO sets that I decided to rescue my old LEGO bricks from the attic. That's when I became an adult LEGO builder!”

“I started off creating all sorts of cars and vehicles. Then one day, while I was in the garden, I started to think about what

else I could build with LEGO bricks. At that very moment a robin landed on the handle of my spade. It was a true eureka moment: I thought, ‘That's it! I'm going to build that in LEGO bricks.’”

“I've always had an interest in the natural world, especially birds. I think they are incredible creatures. I enjoy the challenge of building them in LEGO bricks, trying to give them real character and bring them to life in bricks.”

“I was amazed at the response when I posted them online; my birds started flying all around the world on the Internet! And now, thanks to LEGO Ideas, they are a real LEGO set. Incredible.”

“My goal is to continue building birds: a series from each continent of the world, then one dedicated to flightless birds and another to extinct birds. I hope to exhibit them all over the world to show kids and adults that there's more to this world than they think.”

Thomas Poulsom—Bristol, England



# COLIBRI THALASSINUS (GREEN VIOLETEAR)

Although among the tiniest birds in the world, hummingbirds are still some of the most spectacular. Incredibly fast in flight, they are the only bird able to fly forward as well as backward. Their habitat ranges from southern Mexico through Central America, and along mountain slopes of northwestern South America from northern Venezuela to central Bolivia.

## DESCRIPTION

The *Colibri thalassinus*, also known as the Green Violetear, is a medium-sized member of the hummingbird family. It averages around 3.8–4.7 in. (9.7–12 cm) in length, weighs from 0.17 to 0.20 oz. (4.8 to 5.6 g), and has a wingspan of between 2.3–2.7 in. (5.8–6.8 cm).

## BEHAVIOR

Like most hummingbirds, the Green Violetear is a solitary bird that prefers to forage alone. It feeds primarily on small insects and nectar, using its long bill and ability to hover to lap up

the nectar from flower heads. After mating, the male Green Violetear has nothing to do with nesting or the offspring. The female hummingbird incubates the eggs and cares for the young for 18–24 days until they are mature enough to leave the nest and begin foraging on their own.

## DID YOU KNOW?

Hummingbirds can hover in midair, fly sideways, and even fly upside down.

A hummingbird's wings beat about 70 times per second during normal flight. This increases to 200 times per second when diving.

Hummingbirds can hear better and see farther than humans can. Hummingbirds do not drink through their long beaks like a straw. They lap up nectar with their tongues.

Hummingbirds have very weak legs and feet, and can barely walk. They prefer to perch or fly.





# LES OISEAUX LEGO®

Il y a actuellement plus de 10 000 espèces d'oiseaux connues dans le monde. Ils vivent et se reproduisent sur les sept continents et évoluent dans des climats aussi divers que les tropiques ou l'Antarctique. Ils constituent une partie si naturelle de notre environnement que nous n'y faisons parfois plus attention. C'est pourquoi le travail de Thomas Poulson est si fascinant. Il nous encourage à jeter un regard nouveau sur quelque chose que nous connaissons bien tout en nous prouvant, une nouvelle fois, qu'il est possible de construire presque tout avec des briques LEGO®.

« Enfant, j'adorais jouer avec des briques LEGO. Je me souviens encore du tout premier ensemble LEGO que ma mère m'a acheté quand j'avais sept ans. »

« Comme il arrive souvent, mes briques LEGO furent délaissées quand je suis devenu adolescent. C'est seulement après avoir vu les enfants d'un ami jouer avec leurs ensembles LEGO que j'ai décidé de sortir mes vieilles briques LEGO du grenier. C'est alors que je suis devenu un constructeur LEGO adulte ! »

« J'ai commencé par créer toutes sortes de voitures et de véhicules. Et puis un jour, alors que j'étais dans le jardin, j'ai commencé à penser aux autres choses que je pouvais construire avec des briques LEGO. À ce moment précis, un rouge-gorge s'est posé sur la poignée de ma bêche. Ce fut une vraie révélation. J'ai pensé : C'est ça ! Voilà ce que je vais construire en briques LEGO. »

« J'ai toujours été intéressé par la nature, en particulier par les oiseaux. Je pense que ce sont des créatures incroyables. J'adore le défi de les construire en briques LEGO, en essayant de les doter d'une vraie personnalité et de leur donner vie avec des briques. »

« J'ai été stupéfait de la réponse lorsque je les ai mis en ligne : mes oiseaux ont commencé à s'envoler dans le monde entier sur Internet ! Et maintenant, grâce à LEGO Ideas, ils sont un vrai ensemble LEGO. Incroyable. »

« Mon but est de continuer à construire des oiseaux : une série de chaque continent du monde, puis une dédiée aux oiseaux qui ne volent pas et une autre aux oiseaux disparus. J'espère les exposer dans le monde entier pour montrer aux enfants et aux adultes que ce monde est plus riche qu'ils ne le pensent. »

Thomas Poulson - Bristol, Angleterre



# COLIBRI THALASSINUS (COLIBRI THALASSIN)

Les colibris figurent parmi les plus petits oiseaux du monde, mais ils sont aussi parmi les plus spectaculaires. Incroyablement rapides en vol, il s'agit du seul oiseau capable de voler vers l'avant et vers l'arrière. Leur habitat va du sud du Mexique jusqu'à l'Amérique centrale, et longe les pentes des montagnes du nord-ouest de l'Amérique du Sud, allant du nord du Venezuela jusqu'au centre de la Bolivie.

## DESCRIPTION

Le colibri thalassinus, ou colibri thalassin, est un oiseau de taille moyenne de la famille des colibris. Il mesure en moyenne de 9,7 à 12 cm de long, pèse de 4,8 à 5,6 g et a une envergure de 5,8 à 6,8 cm.

## COMPORTEMENT

Comme la plupart des colibris, le colibri thalassin est un oiseau solitaire qui préfère butiner seul. Il se nourrit principalement de petits insectes et de nectar, en utilisant son long bec et sa capacité à voler sur place pour aspirer le nectar des fleurs. Après l'accouplement, le colibri mâle ne s'occupe pas

du tout de la nidification ou des jeunes. La femelle colibri couve les œufs et s'occupe des jeunes pendant 18 à 24 jours jusqu'à ce qu'ils soient assez développés pour quitter le nid et commencer à butiner seuls.

## LE SAVAIS-TU ?

Les colibris peuvent voler sur place, de côté et même à l'envers.

Les ailes d'un colibri battent environ 70 fois par seconde pendant un vol normal. Ceci augmente à 200 fois par seconde quand ils plongent.

Les colibris entendent mieux et voient plus loin que les humains.

Les colibris ne boivent pas avec leur long bec comme avec une paille. Ils lapent le nectar avec leur langue.

Les colibris ont des pattes et des pieds très faibles et ils peuvent à peine marcher. Ils préfèrent se percher ou voler.





# AVES LEGO®

En la actualidad se conocen más de 10.000 especies de aves en el mundo. Viven y proliferan en los siete continentes, sobreviviendo en lugares con climas tan diferentes como los trópicos o la Antártida. Son una parte tan natural y cotidiana de nuestro entorno que a menudo damos por sentada su existencia. Es por eso que el trabajo de Thomas Poulsom es tan fascinante. Nos invita a contemplar desde un nuevo punto de vista algo que conocemos muy bien y, al hacerlo, demuestra de nuevo que casi todo se puede reproducir empleando bricks LEGO®.

«Cuando era niño, me encantaba jugar con mis bricks LEGO. Todavía recuerdo el primer set LEGO que mi mamá me compró cuando tenía siete años».

«Como suele suceder, dejé de jugar con bricks LEGO cuando llegué a la adolescencia. Más tarde vi al hijo de un amigo jugar con sus sets LEGO y decidí rescatar mis viejos bricks LEGO del desván. ¡Fue entonces cuando me convertí en un constructor LEGO adulto!»

«Comencé creando todo tipo de autos y vehículos. Un día, mientras estaba en el jardín, comencé a pensar en qué

más podría construir con bricks LEGO. En ese momento, un petirrojo se posó en mi pala. Fue una verdadera revelación. Pensé: "¡Eso es, voy a construirlo con bricks LEGO!"».

«Siempre me ha interesado la naturaleza y, en especial, las aves. Creo que son criaturas increíbles. Disfruto del desafío que supone construirlas con bricks LEGO, intentando transmitirles personalidad y hacer que cobren vida».

«Me asombró la respuesta que recibí cuando los publiqué en Internet; ¡mis pájaros habían comenzado a volar virtualmente por todo el mundo! Y ahora, gracias a LEGO Ideas, son un auténtico set LEGO. Es increíble».

«Mi objetivo es continuar construyendo aves: una serie por cada continente del mundo y, después, una dedicada a las aves que no vuelan y otra a las aves extintas. Espero poder exponerlas por todo el mundo para enseñar a niños y adultos que este mundo es mucho más grande de lo que creen».

Thomas Poulsom - Bristol (Inglaterra)



# COLIBRI THALASSINUS (COLIBRÍ OREJA VIOLETA)

Aunque se encuentra entre los pájaros más diminutos del mundo, el colibrí es también uno de los más espectaculares. Increíblemente rápido en vuelo, es la única especie capaz de volar hacia delante y hacia atrás. Su hábitat se extiende desde el sur de México hasta Centroamérica y, a lo largo de las pendientes montañosas del noroeste de Sudamérica, desde el norte de Venezuela hasta el área central de Bolivia.

## DESCRIPCIÓN

El Colibri thalassinus, conocido también como colibrí oreja violeta, es un miembro de mediano tamaño de la familia de los colibríes. Mide entre 9,7 y 12 cm de longitud, pesa entre 4,8 y 5,6 g, y posee una envergadura de entre 5,8 y 6,8 cm.

## COMPORTAMIENTO

Como la mayoría de los colibríes, el oreja violeta es un pájaro solitario que prefiere buscar su alimento sin compañía. Su dieta se basa principalmente en pequeños insectos y néctar, que lame de las flores usando su largo pico (aprovechando su habilidad para flotar en el aire). Tras emparejarse, el oreja

violeta macho pierde todo interés en anidar o criar a su descendencia. El colibrí hembra incuba los huevos y cuida de los polluelos durante un período de tiempo comprendido entre 18 y 24 días, hasta que son lo suficientemente maduros como para abandonar el nido y comenzar a alimentarse solos.

## ¿LO SABÍAS?

Los colibríes pueden flotar en el aire, volar hacia los lados, e incluso volar del revés.

El colibrí bate las alas unas 70 veces por segundo durante un vuelo normal; cuando bucea, llega a hacerlo hasta 200 veces por segundo.

Los colibríes escuchan mejor y ven más lejos que los seres humanos.

Los colibríes no beben a través de su largo pico como si se tratase de una paja; para alimentarse, lamen néctar con la lengua.

Las patas de los colibríes son muy débiles, por lo que apenas pueden caminar. Prefieren posarse o volar.





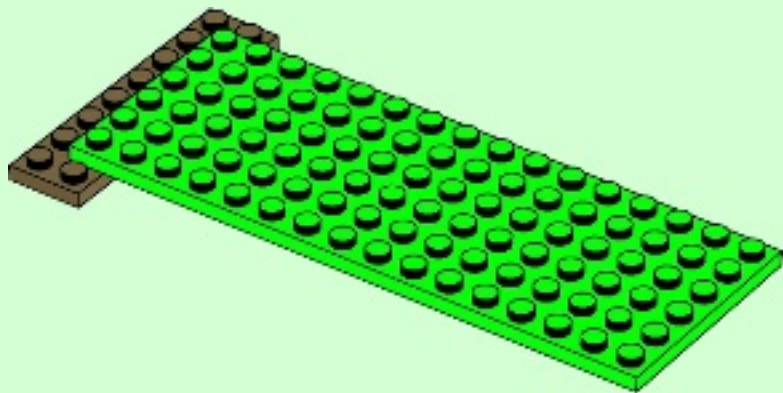
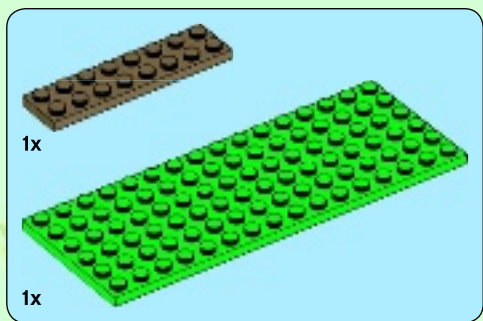
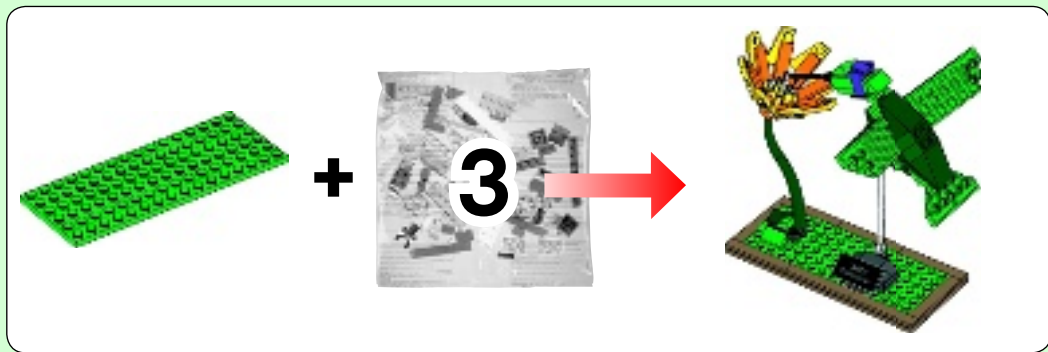

1

14

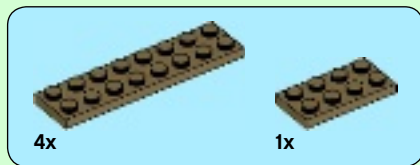

2

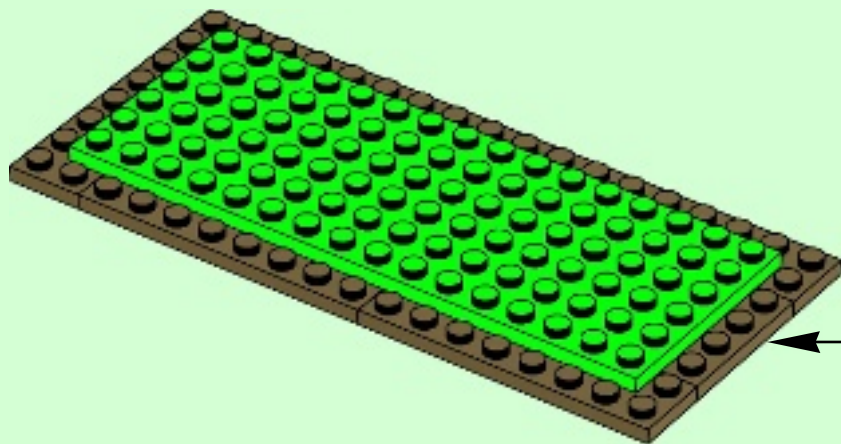

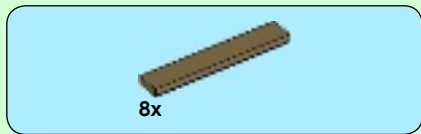

3

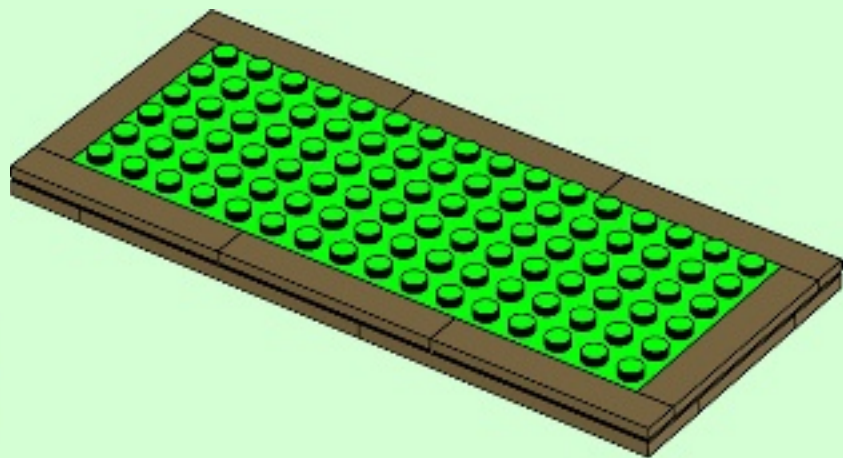





4

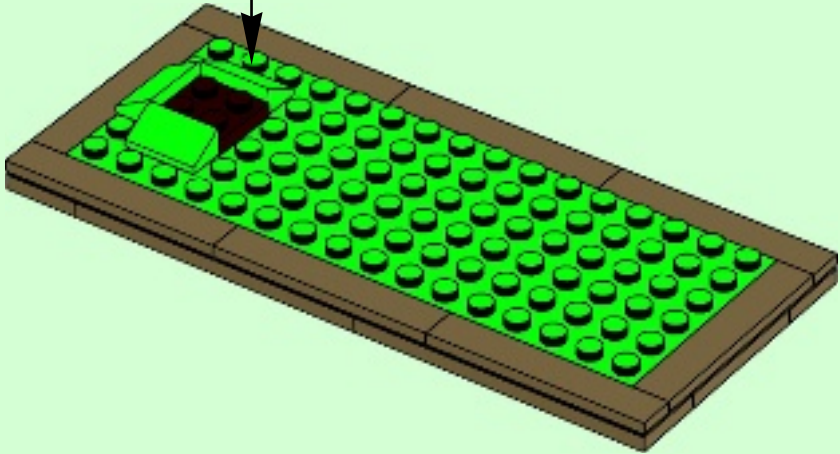
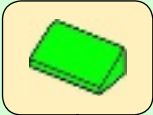



2x

5

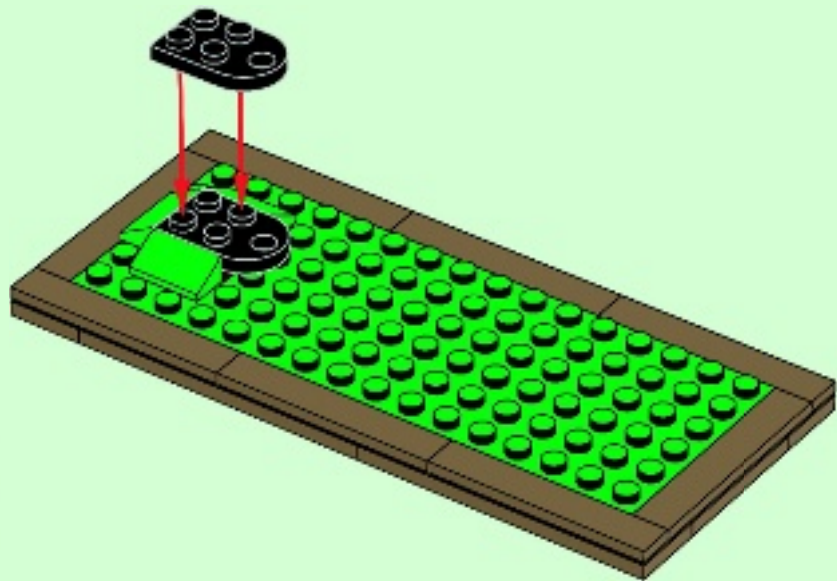



2x



2x

6

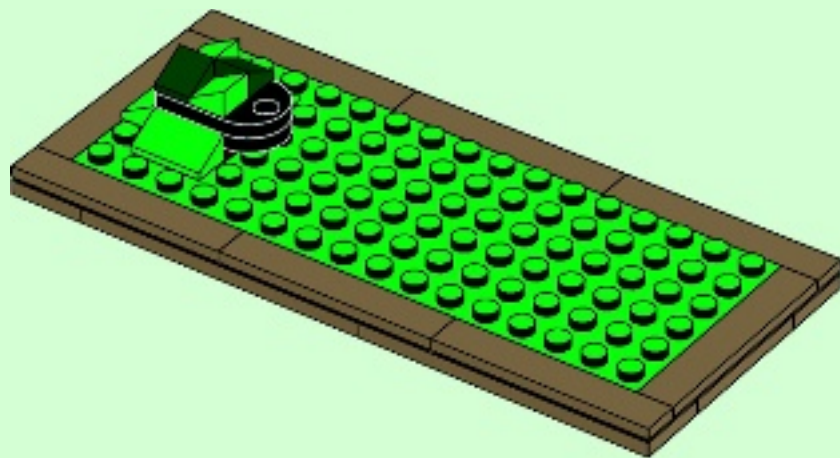

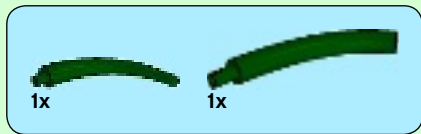

7

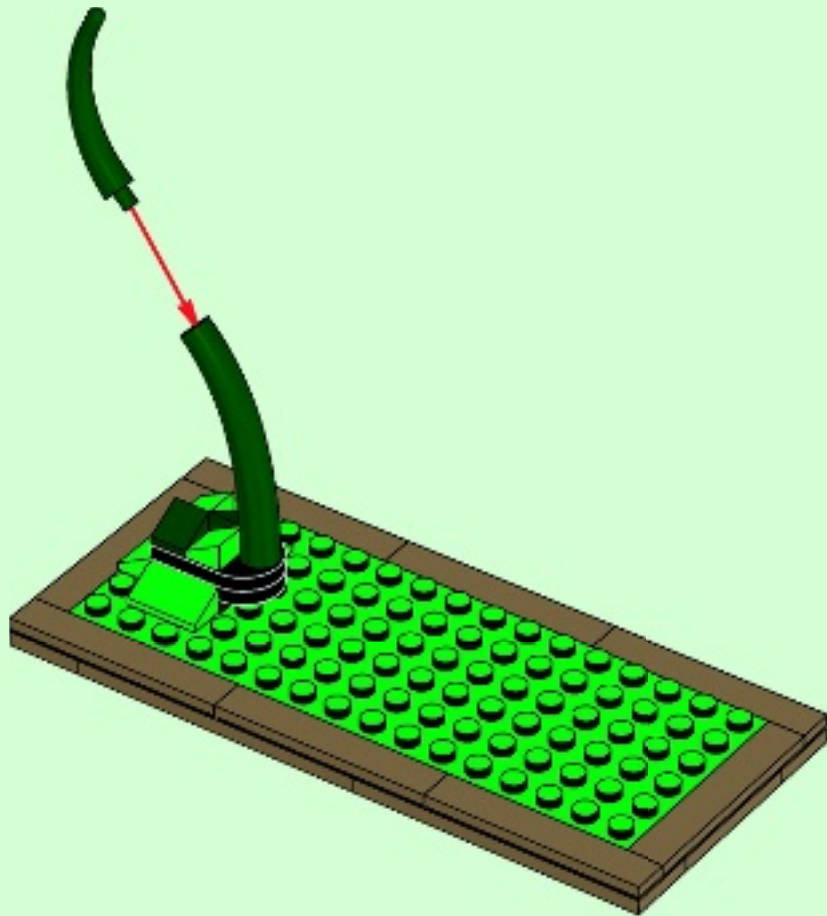



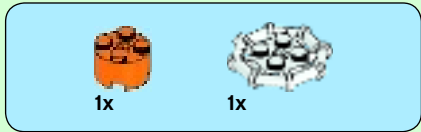

8

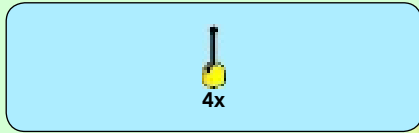

9





10

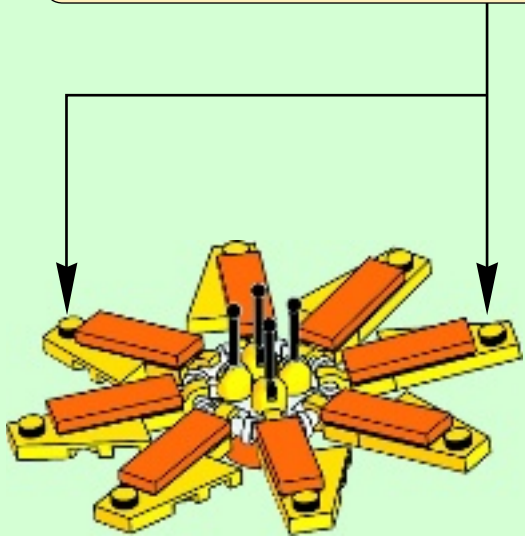
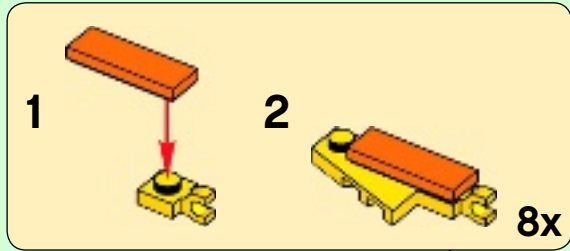

11

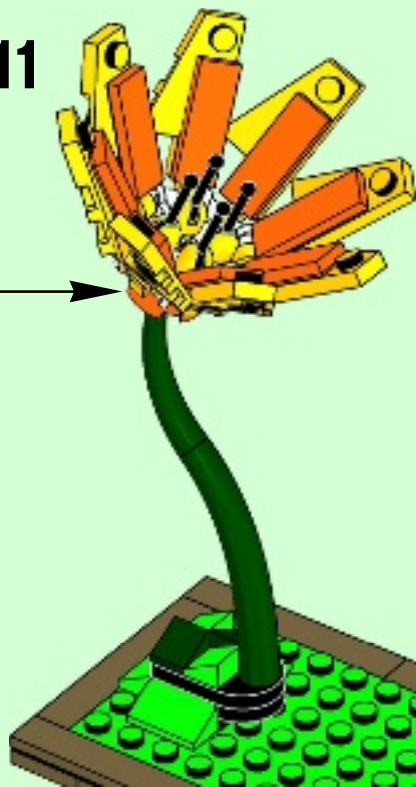



12





2x

13

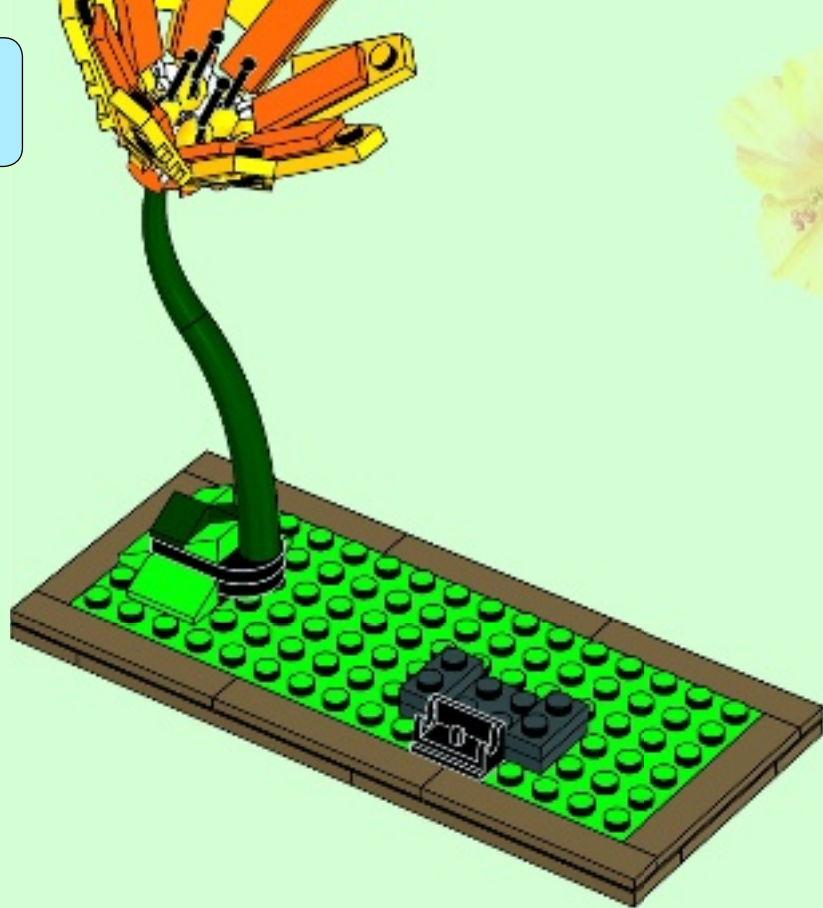





2x

14

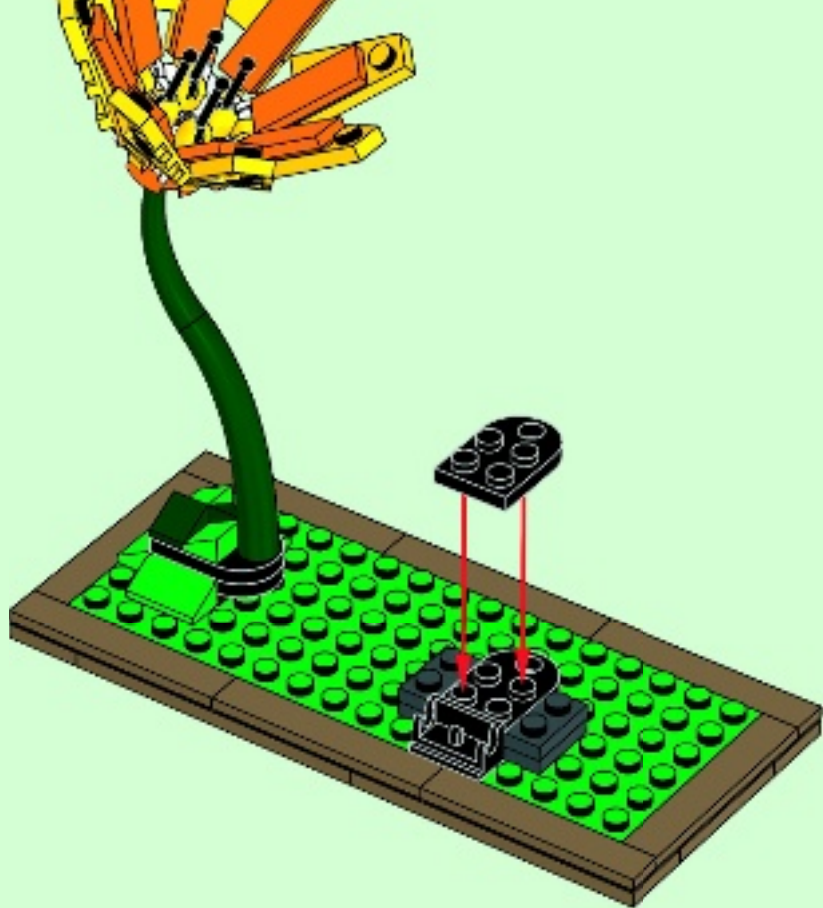



1x



4x

15





1x

16

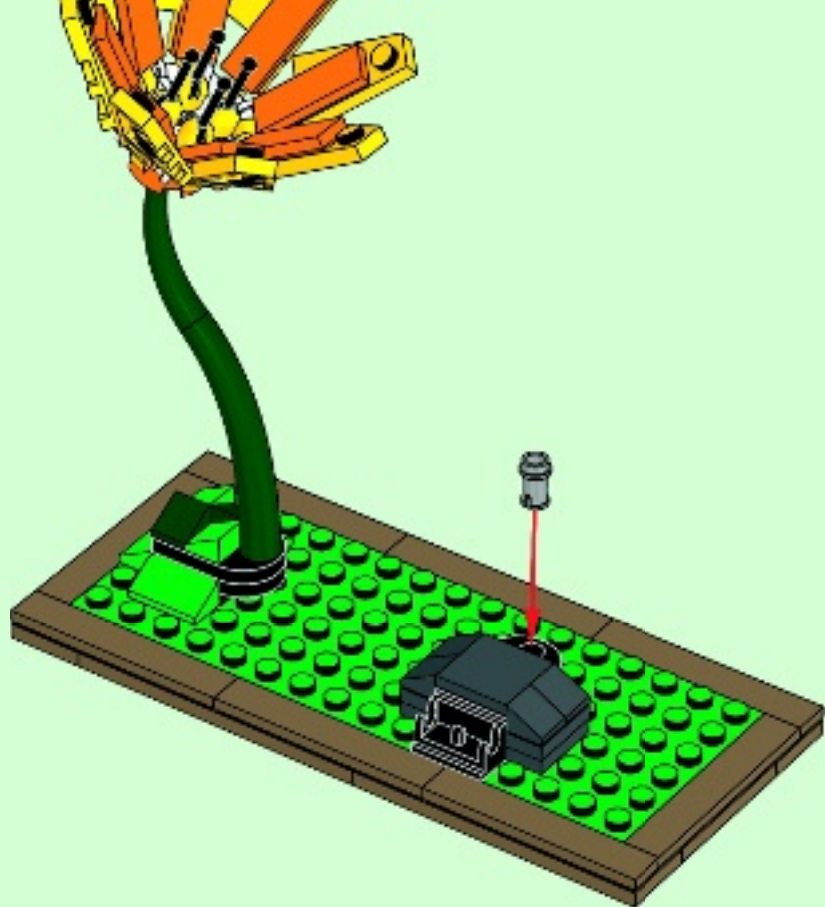



17



18

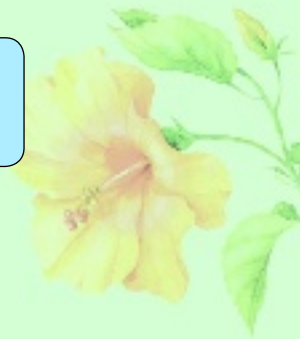



2x

19



30



1x



1x

20







21



22





2x



2x

# 23



1x



2x

# 24





25



26

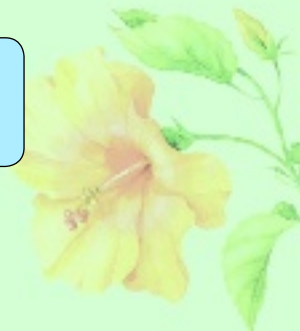



2x



2x



2x

# 27

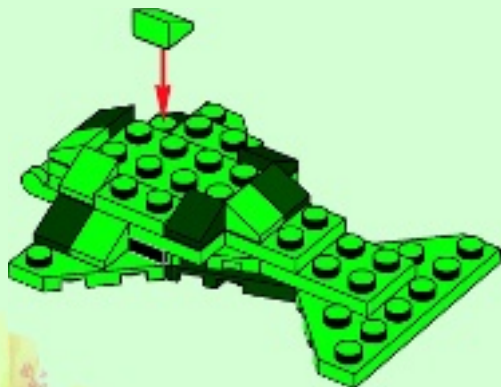

1x



1x



1x



1x

# 28

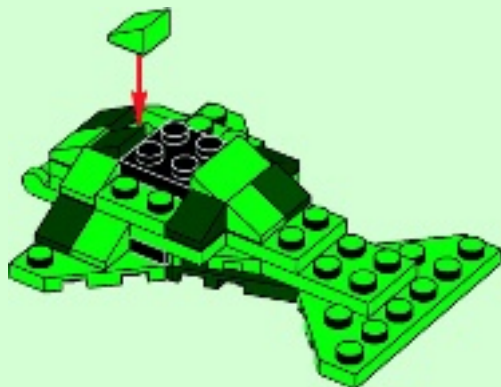



2x



2x

# 29



1x



1x

# 30

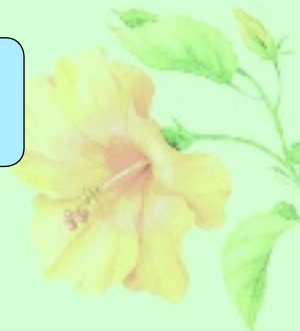





1x

31



36



32

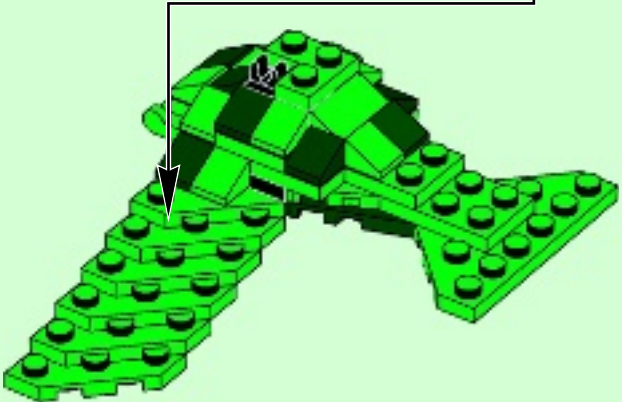
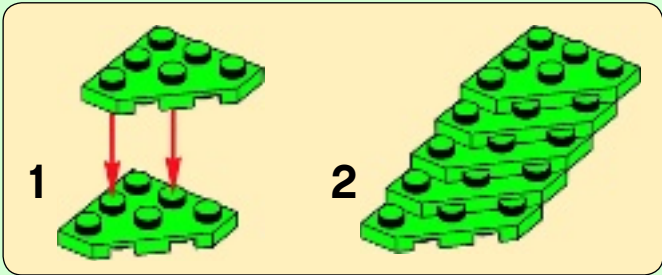



5x

33

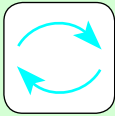

1

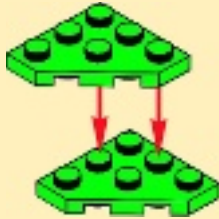

2

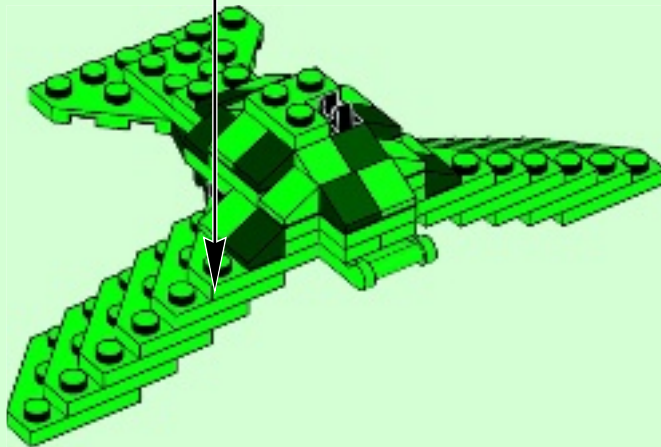
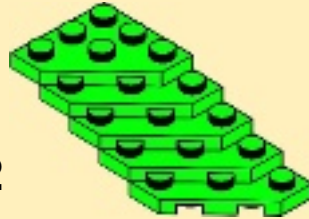



1x



1x

# 34

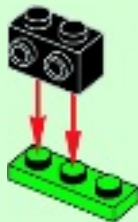

1x



1x

# 35

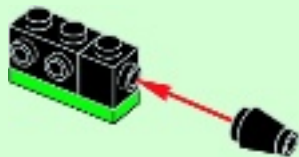



1x



1x

# 36

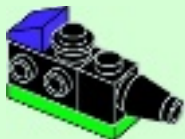

40



1x



1x

# 37

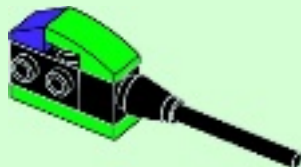



1x

38

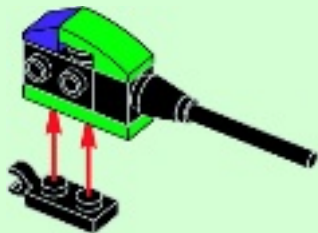

2x



2x

39

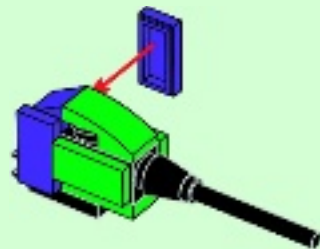



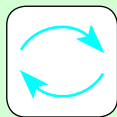

40

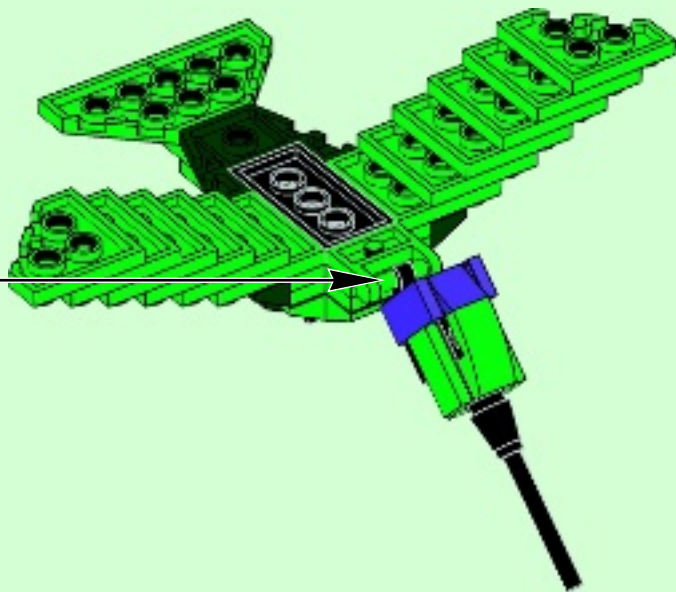



1x



1x

41

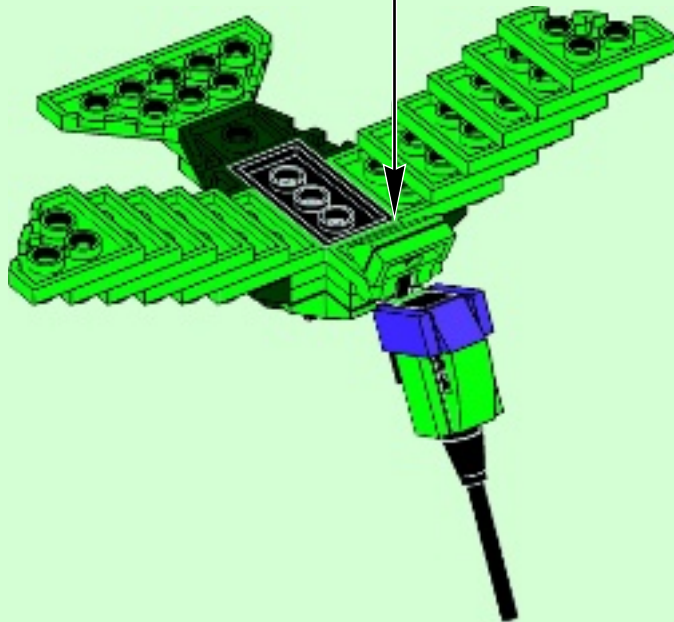
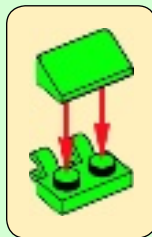



42



44



43





1x



1x

44



45

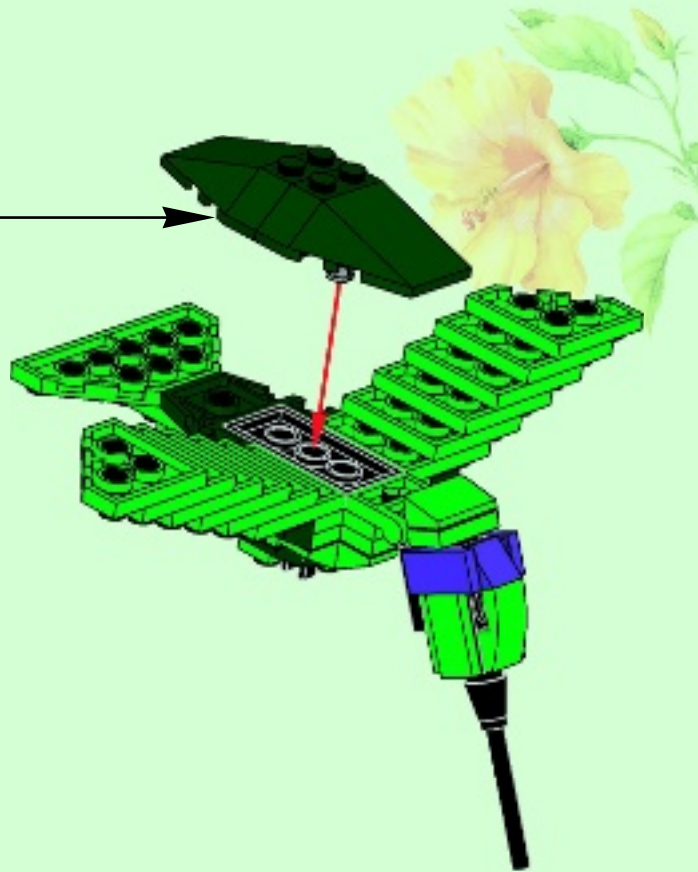

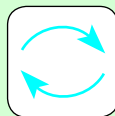
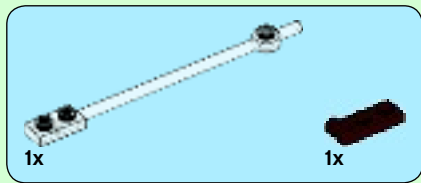

46

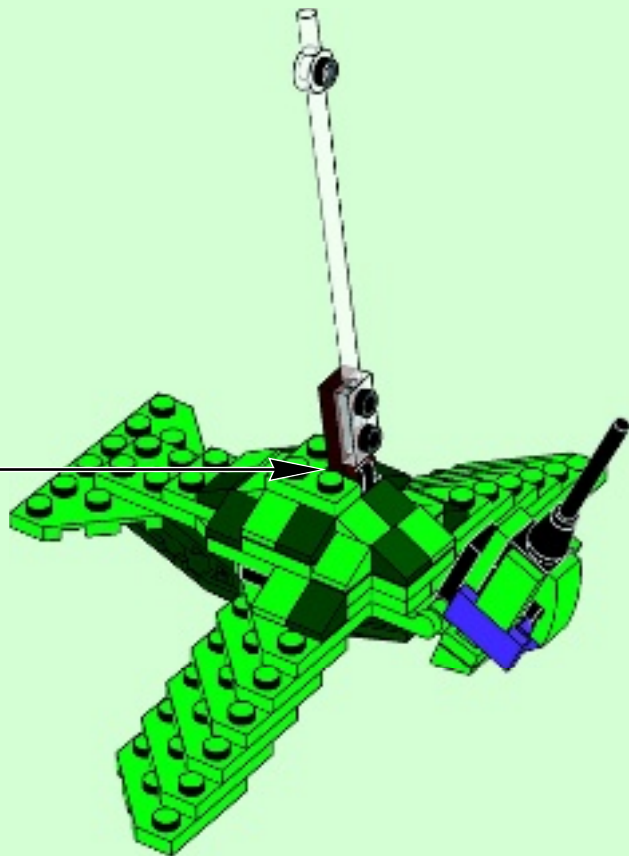
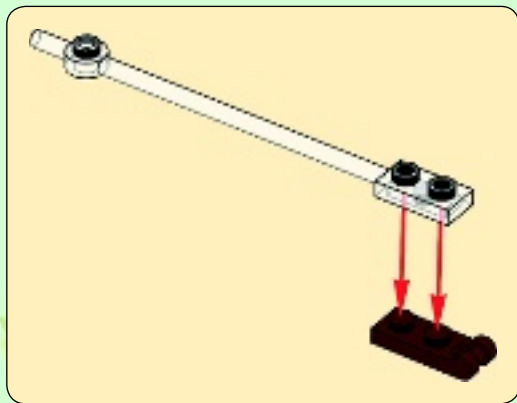

47

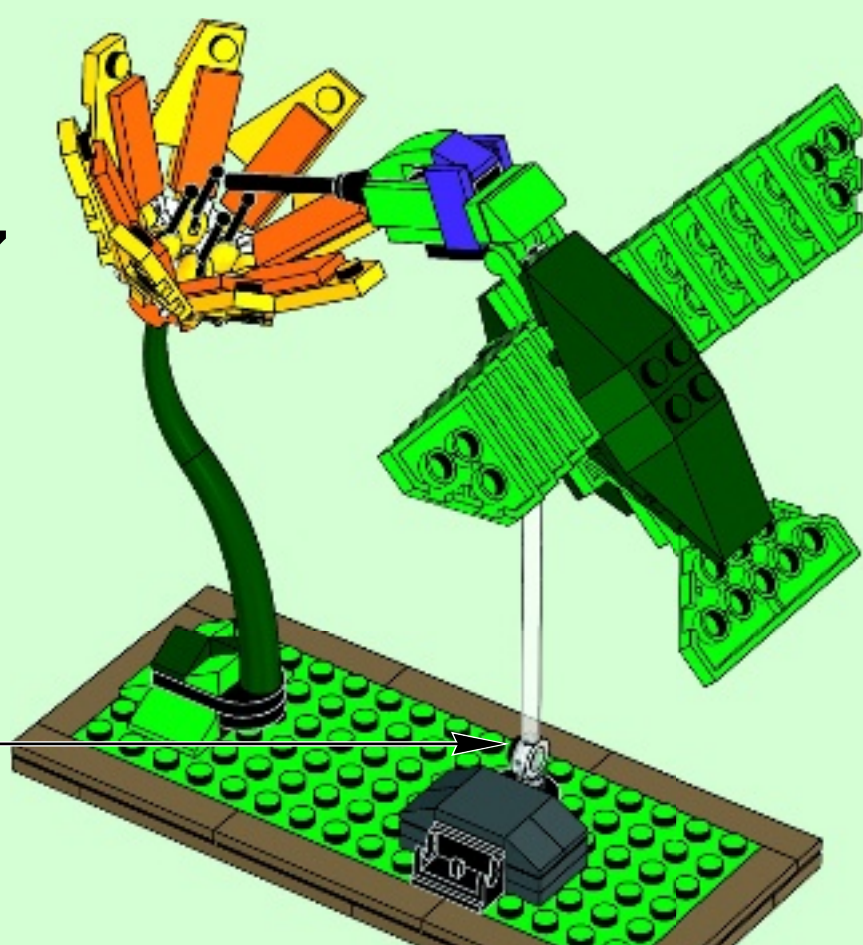

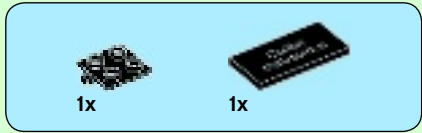

48

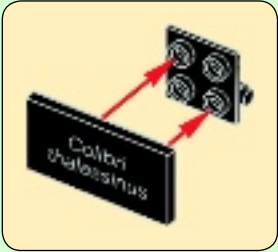
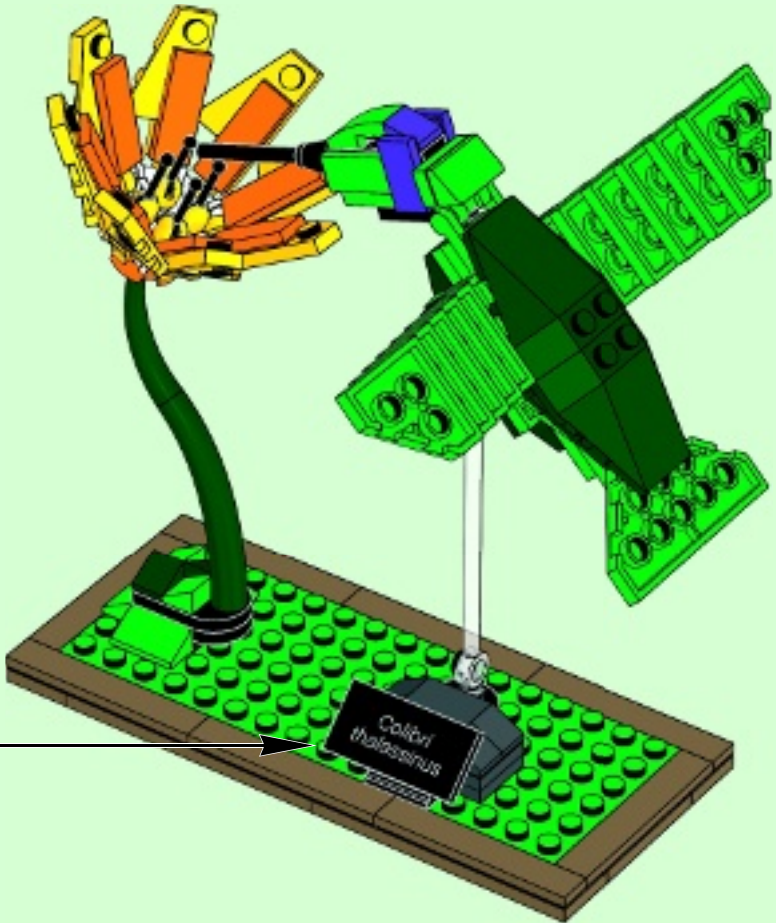





1x  
6009016



1x  
4140303



1x  
393726



1x  
4124096



1x  
4558954



1x  
4253815



1x  
4529236



3x  
302226



1x  
6115331



1x  
4598528



1x  
4535739



4x  
317626



2x  
370926



1x  
614126



1x  
4556159



1x  
4521931



1x  
6100220



11x  
4546705



5x  
6000071



1x  
6047426



2x  
306928



5x  
302328



5x  
4157120



2x  
302228



1x  
4107758



1x  
302128



1x  
302028



12x  
6114672



1x  
241928

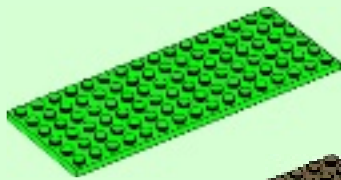

1x  
6032912



1x  
6010687



8x  
4540040



8x  
4179095



4x  
74156

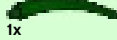

1x  
6114669



1x  
6114670



1x  
4267874



8x  
4507047



5x  
4246957



11x  
4504375



2x  
6101853



1x  
4649051



1x  
4141089



8x  
4620693



4x  
4504378



2x  
4211063



1x  
4211055



1x  
4211065



1x  
4216695



1x  
6102975



1x  
4237084



1x  
4211483



1x  
4567509



2x  
4613192

Customer Service

Kundenservice

Service Consommateurs

Servicio Al Consumidor

LEGO.com/service or dial



: 00800 5346 5555

: 1-800-422-5346



# IDEAS<sup>1</sup>

## A PLAYGROUND FOR INNOVATIVE LEGO<sup>®</sup> IDEAS

Do you have an exciting idea for a LEGO<sup>®</sup> model? Then why not make it into a LEGO Ideas project? You can share your product concept on [LEGO.com/ideas](https://www.lego.com/ideas) and see what other people think about it.

If your project gains 10,000 supporters, it will automatically qualify for the quarterly LEGO Review. This is where we take an in-depth look at the most popular projects and carefully evaluate them to discover the idea with the most potential. If your project makes it through the review, it will become an official LEGO product.

There are already over 250,000 active users and 15,000 projects on the LEGO Ideas website, and three LEGO Ideas products have already been launched. So take a look, sign up, and support your favorite ideas, or even better: upload your own project!

**[LEGO.com/ideas](https://www.lego.com/ideas)**





# IDEAS

## UN ESPACE POUR LES IDÉES LEGO® NOVATRICES

As-tu une idée de modèle LEGO® passionnante ? Alors pourquoi ne pas en faire un projet LEGO Ideas ? Tu peux partager ton concept de produit sur [LEGO.com/ideas](https://LEGO.com/ideas) et voir ce que les autres en pensent.

Si ton projet obtient l'appui de 10 000 personnes, il sera automatiquement qualifié pour l'examen LEGO trimestriel. Cet examen nous permet d'étudier en profondeur les projets les plus populaires et de les évaluer attentivement pour découvrir les idées ayant le plus grand potentiel. Si ton projet passe l'examen, il deviendra alors un produit LEGO officiel.

Il y a déjà 250 000 utilisateurs actifs et 15 000 projets sur le site Web LEGO Ideas et trois produits LEGO Ideas ont déjà été lancés. Alors va regarder, inscris-toi et soutiens tes idées préférées. Ou mieux encore : télécharge ton propre projet !

**[LEGO.com/ideas](https://LEGO.com/ideas)**





# IDEAS

## EL LUGAR EN EL QUE SE REÚNEN LAS IDEAS LEGO®

¿Tienes una buena idea para un modelo LEGO®? ¿Por qué no convertirla en un proyecto LEGO Ideas? Puedes compartirla en LEGO.com/ideas y ver lo que los demás piensan de ella.

Si tu proyecto consigue 10.000 votos, se clasificará automáticamente para la revisión trimestral de LEGO. Es entonces cuando daremos un vistazo a los proyectos más populares y los evaluaremos detenidamente para determinar qué idea tiene más potencial. Si tu proyecto supera la revisión, se convertirá en un producto LEGO oficial.

Ya hay más de 250.000 usuarios activos y 15.000 proyectos en el sitio web de LEGO Ideas. Además, tres proyectos LEGO Ideas se han convertido ya en productos reales y han salido a la venta. Ven a dar un vistazo, regístrate y apoya tus ideas favoritas. O aún mejor: ¡envía tu propio proyecto!

**[LEGO.com/ideas](https://www.lego.com/ideas)**





