

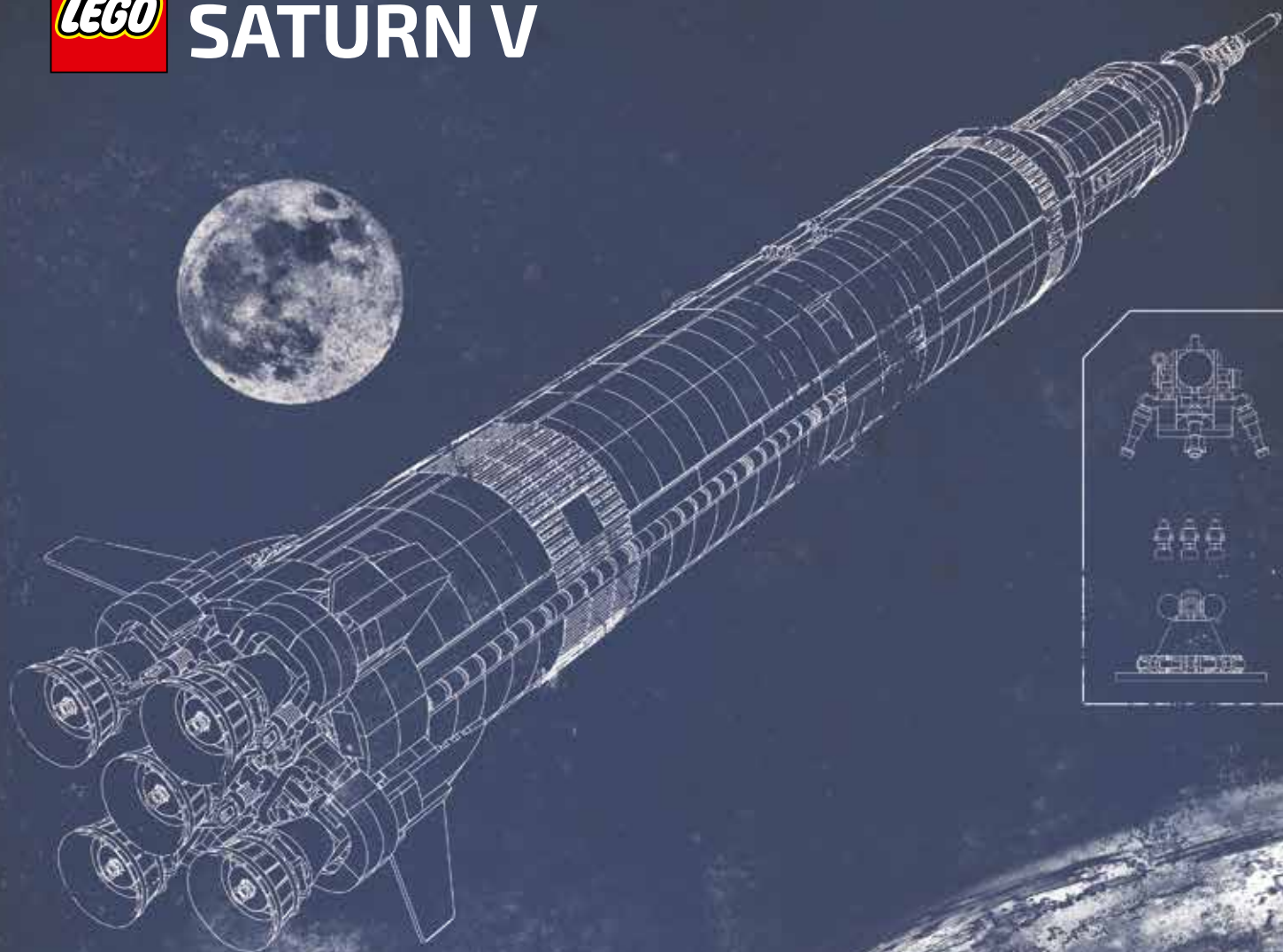

NASA APOLLO
SATURN V



SATURN V

BUILDING INSTRUCTIONS

INSTRUCCIONES DE MONTAGE

INSTRUCCIONES DE CONSTRUCCIÓN

- 21309 -



The Apollo Program

On May 25, 1961, President John F. Kennedy challenged his country to safely send and return an American to the Moon before the end of the decade. NASA met that challenge with the Apollo program. It would be the first time human beings left Earth orbit and visited another world. The Apollo program played a crucial role in space exploration and made it possible to explore more distant worlds further in the future.

The Apollo program consisted of 11 spaceflights. The first two missions, Apollo 7 and 9, were Earth-orbiting missions used to test the Command and Lunar Modules. The next two, Apollo 8 and 10, tested various components while orbiting the Moon, also taking photographs of the lunar surface. While Apollo 13 did not land on the moon due to a malfunction, a total of six other missions did and returned with a wealth of scientific data and almost 881.8 lbs (400 kilos) of lunar samples.

The first manned mission to the moon was Apollo 8. It circled around the moon on Christmas Eve in 1968. Just over six months later on July 20, 1969, the world witnessed one of the most astounding technological achievements of the 20th century when a NASA astronaut on Apollo 11 became the first human to set foot on the Moon.

The Apollo 11 mission lasted 195 hours, 18 minutes and 35 seconds - about 36 minutes longer than planned. After lunar orbit insertion, the Command Module (CM) and Lunar Module (LM) separated. While one crewmember remained in the CM, which orbited the Moon, the other two astronauts made the historic journey to the lunar surface in the LM. After exploring the surface and setting up experiments for 21 hours and 36 minutes, the astronauts returned safely to the CM and began the journey back to Earth.



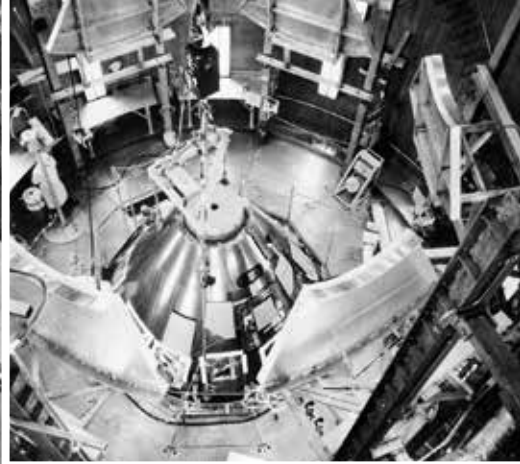

The Saturn V moves at one mile per hour down the crawlerway toward pad 39A

Workers prepare the S-IC first stage in the transfer aisle of the Vehicle Assembly Building

Photographers film the Apollo 11 rollout
Pre-flight training

Kennedy Space Center technicians inspect the LRV.



Saturn V

Saturn V was the most powerful rocket that had ever flown successfully and was used in the Apollo program in the 1960s and 1970s. The rocket was 363 ft. (111 m) tall and weighed 6.2 million lbs (2.8 million kilos) when fully fueled for liftoff. The Saturn V used for the later Apollo missions had three stages. Each stage would burn its engines until it was out of fuel and would then separate from the rocket. The engines on the next stage would fire, and the rocket would continue into space. The first stage had the most powerful engines, since it had the challenging task of lifting the fully fueled rocket off the ground. The first stage lifted the rocket to an altitude of about 42 miles (68 km). The second stage carried it from there almost into orbit. The third stage placed the Apollo spacecraft into Earth orbit and pushed it toward the moon.



The S-II second stage is moved into position for mating with the S-IC first stage

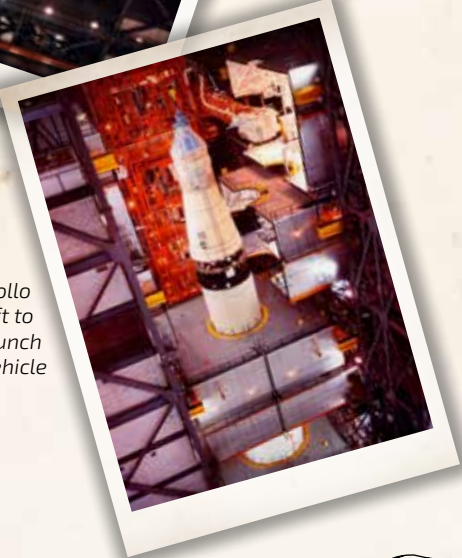

Mating of the Apollo 11 spacecraft to the Saturn V launch vehicle

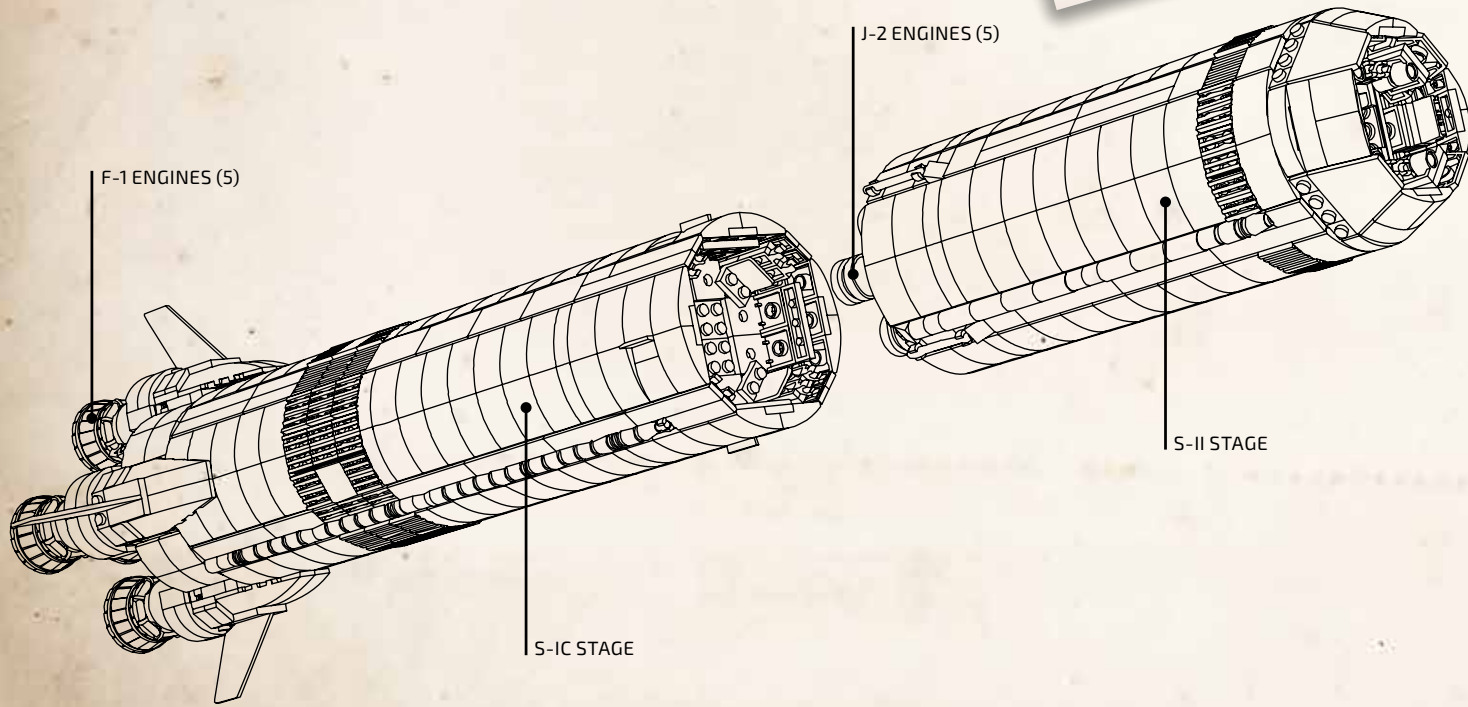

The Apollo 11 CSM being moved from work stand for mating



Lunar Module 5 ascent stage in Final Assembly area on overhead hoist

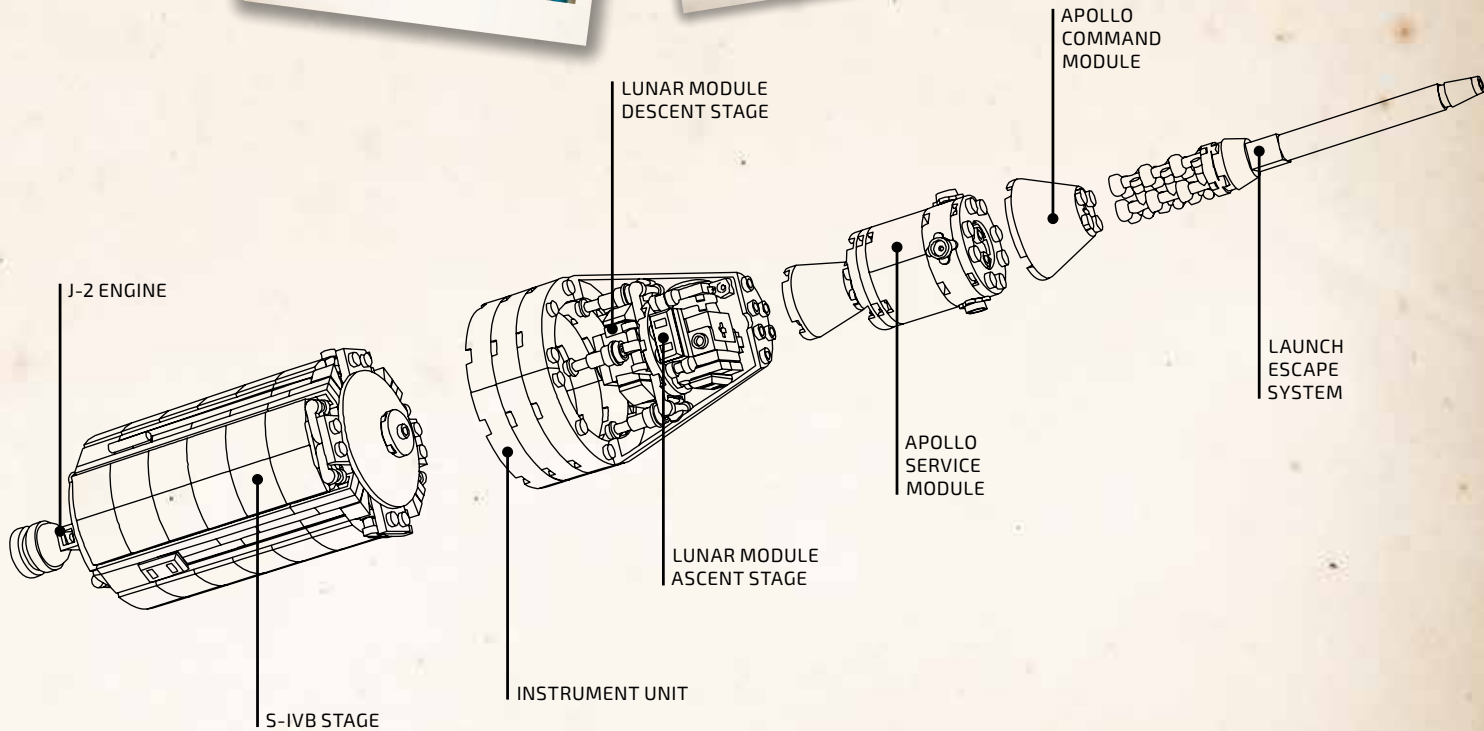
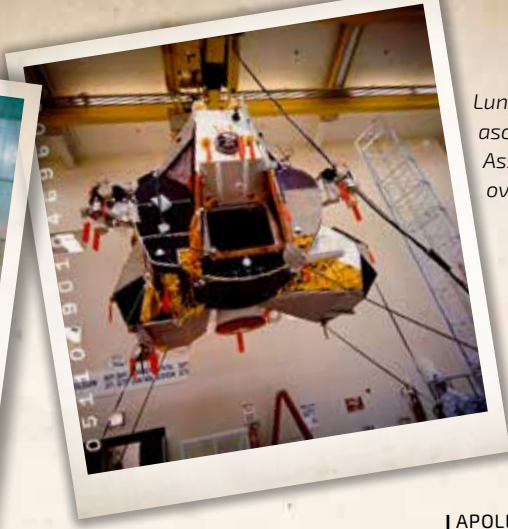

Transposition, docking, and extraction

Shortly after the trans-lunar injection maneuver that placed the Apollo spacecraft on its trajectory towards the Moon, the transposition and docking maneuver would be performed. This involved an astronaut separating the Apollo Command/Service Module (CSM) spacecraft from the adapter which fastened it to its launch vehicle upper stage, turning it around, and docking its nose to the Apollo Lunar Module (LM), then pulling the combined spacecraft away from the upper stage.



The Command/Service Module (CSM) separates from the adapter.



The CSM then turns around in preparation for docking with the Lunar Module (LM)



After docking, the CSM pulls the LM away from the launch vehicle's upper stage

Journey to the Moon

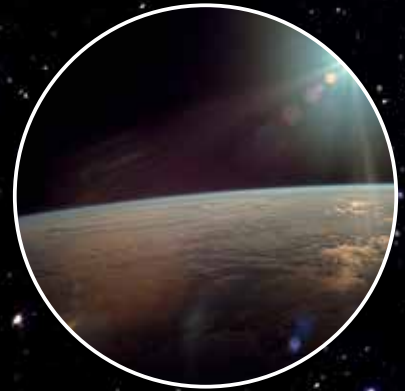

LIFTOFF

LAUNCH ESCAPE
TOWER JETTISON.

S-IVB 2ND ENGINE
IGNITION

CSM DOCKING WITH
LM/S-IVB.

S-IVB ENGINE CUTOFF.

CSM SEPARATION
FROM LM ADAPTER.

TRANSLUNAR
INJECTION "GO"
DECISION.

CSM 180°
TURNAROUND.

S-II/S-IVB
SEPARATION.
S-IV ENGINE IGNITION.

S-IVB ENGINE CUTOFF.

APOLLO SATURN V
ROLLS OUT OF THE
MASSIVE VEHICLE
ASSEMBLY BUILDING

THE FIRST STAGE
FALLS AWAY AS THE
S-II STAGE IGNITES



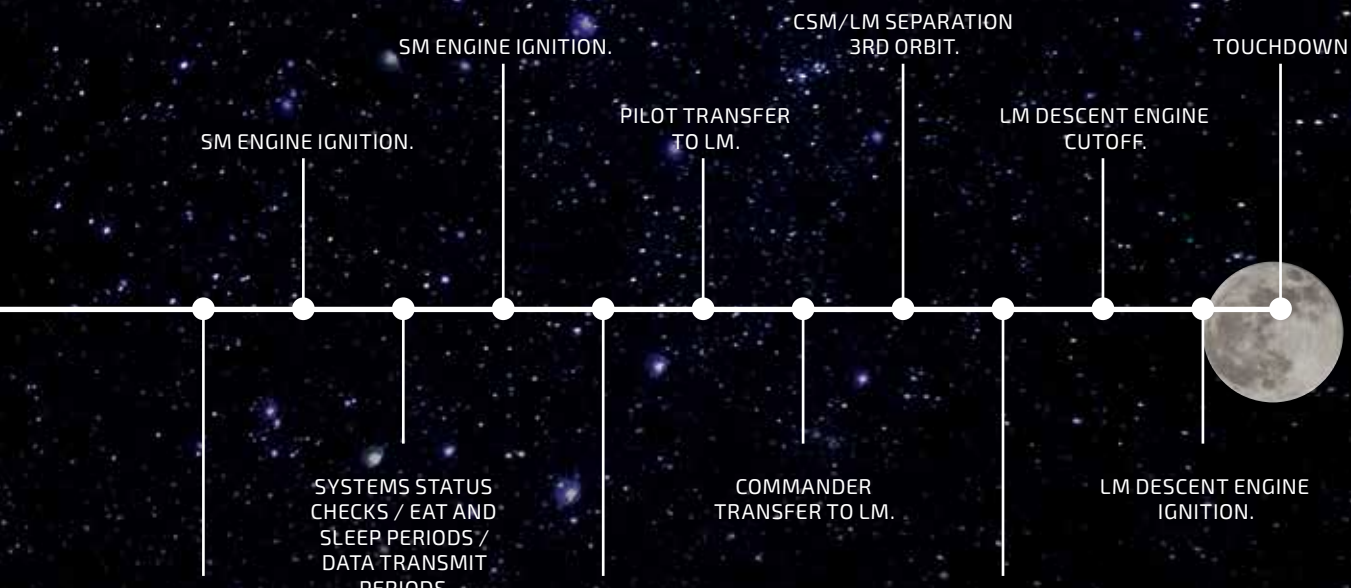

CSM SEPARATION FROM S-IVB.

BEGIN NAVIGATION SIGHTINGS.

LM DESCENT ENGINE IGNITION.

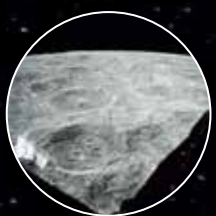

Fan designers

With a shared passion for both space exploration and LEGO® building, Valérie Roche (aka Whatsuptoday) and Felix Stiessen (aka Saabfan) worked closely together to create their impressive Apollo 11 Mission model for LEGO Ideas.

"The most challenging part was the Lunar Landing module. I (Felix) tried building it as small as possible (I wanted it to fit in the half-cone parts as seen in the model) while still looking good and accurate. After that, we began building the rocket around it. We also tried to make the rocket as sound as possible, so Valérie included pillars and beams inside for structural integrity."

"It actually took quite a long time to finish the whole model. There were often times when one

of us just abandoned the project for a few weeks and came back to it later; however, thanks to the fact that it is a collaborative project, it was always the case that one of us continued making progress on the project and re-motivated the other. All in all, we would say it took us about a year to complete."

"We were surprised (and happy, of course) when we learned our model would be the latest one in the LEGO Ideas series. What we like about the LEGO Ideas platform is the feedback and support you get from the community. It's great to reply to comments, read suggestions and improve your model in the updates. Of course, the chance of designing your own LEGO set is also really cool!"

Felix Stiessen



Valérie Roche





Carl Thomas Merriam (left)
Michael Psiaki (middle)
Austin William Carlson (right)

LEGO® designers

Michael Psiaki, Carl Thomas Merriam and Austin William Carlson are all full-time LEGO® designers and avid space enthusiasts, so this was a project they very much wanted to be a part of. As Michael explains:

"We were actually not asked. I was so excited when I heard that the project was potentially going to happen, and told Carl about it because I knew he was also a space fanatic. We decided it would be really cool to work together since it is such a big model, so we approached the Ideas team about helping to develop the product."

"We were amazed by how big the actual model was and how it was able to separate into all of the different stages and components. This was very difficult to implement in our final design, since we needed to make sure that the rocket was strong enough when connected together, but also easy to separate."





Le programme Apollo

Le 25 mai 1961, le président des États-Unis John F. Kennedy lança le défi suivant à son pays : parvenir, avant la fin de la décennie, à envoyer un Américain sur la Lune et à le faire revenir, en toute sécurité. Le programme Apollo permit à la NASA de relever ce défi. Pour la première fois, des êtres humains quittèrent l'orbite de la Terre pour partir explorer un autre monde. Le programme Apollo joua un rôle essentiel dans l'exploration spatiale et permit, par la suite, d'étudier des univers plus lointains.

Dans le cadre du programme Apollo, 11 voyages dans l'espace furent organisés. Les deux premières missions, Apollo 7 et 9, qui consistaient en des voyages en orbite autour de la Terre, avaient pour objectif de tester les modules lunaire et de commande. Les deux missions suivantes, Apollo 8 et 10, visaient à tester des composants en orbite autour de la Lune et à prendre des clichés de la surface lunaire. Même si une défaillance empêcha le vaisseau de la mission Apollo 13 d'atterrir sur la Lune, au total, six autres missions réussirent, et revinrent sur Terre avec une grande quantité de données scientifiques et près de 400 kg d'échantillons lunaires.

La première mission habitée vers la Lune fut Apollo 8. Au cours de cette mission menée en 1968, le vaisseau tourna autour de la Lune la veille de Noël. Un peu plus de six mois plus tard, le 20 juillet 1969, le monde entier assista à l'une des plus incroyables prouesses technologiques du XX^e siècle lorsque, dans le cadre de la mission Apollo 11, un astronaute de la NASA devint le premier homme à marcher sur la Lune.

La mission Apollo 11 dura 195 heures, 18 minutes et 35 secondes, c'est-à-dire environ 36 minutes de plus que prévu. Après leur mise sur orbite lunaire, les modules de commande et lunaire se séparèrent. Tandis que l'un des membres de l'équipage resta dans le module de commande, les deux autres astronautes accomplirent le voyage historique vers la surface de la Lune à bord du module lunaire. Après avoir exploré la surface et mis en place des expériences pendant 21 heures et 36 minutes, les astronautes rejoignirent le module de commande en toute sécurité avant de commencer le voyage de retour vers la Terre.



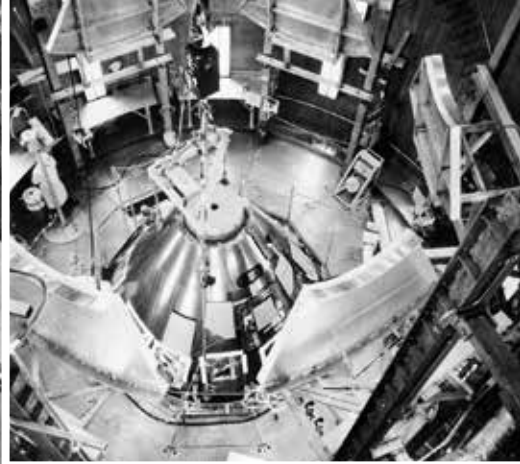

Le lanceur Saturne V se déplace à 1,6 kilomètre par heure le long de la route Crawlerway vers la rampe de lancement 39A

Les travailleurs préparent le premier étage S-IC dans l'aile de transition du bâtiment d'assemblage des véhicules

Les photographes filment le lancement d'Apollo 11

Formation de vol

Les techniciens du centre spatial Kennedy inspectent le Rover lunaire



Saturne V

La fusée Saturne V est la plus puissante à avoir jamais réussi à voler. Elle fut utilisée dans le cadre du programme Apollo dans les années 1960 et 1970. Elle mesurait 111 mètres de haut et pesait 2,8 millions de kilos lorsque ses réservoirs de carburant étaient pleins ; condition nécessaire à son décollage. La fusée Saturne V, utilisée pour les dernières missions Apollo, comptait trois étages. Les moteurs de chaque étage brûlaient la totalité du carburant qu'ils renfermaient avant de se détacher de la fusée. Les moteurs de l'étage suivant prenaient ensuite le relais, et la fusée poursuivait son voyage dans l'espace. Les moteurs du premier étage étaient les plus puissants, car c'était à eux qu'incombait la tâche difficile de faire s'élever la fusée alors que ses réservoirs de carburant étaient pleins. Le premier étage permettait de faire monter la fusée à environ 68 km d'altitude. Le deuxième prenait le relais à partir de là pour emmener la fusée presque jusqu'en orbite. Le troisième mettait le vaisseau Apollo en orbite autour de la Terre et le poussait vers la Lune.



Le deuxième étage S-II est placé en position pour l'accouplement avec le premier étage S-IC



Accouplement de la navette spatiale Apollo 11 au lanceur Saturne V

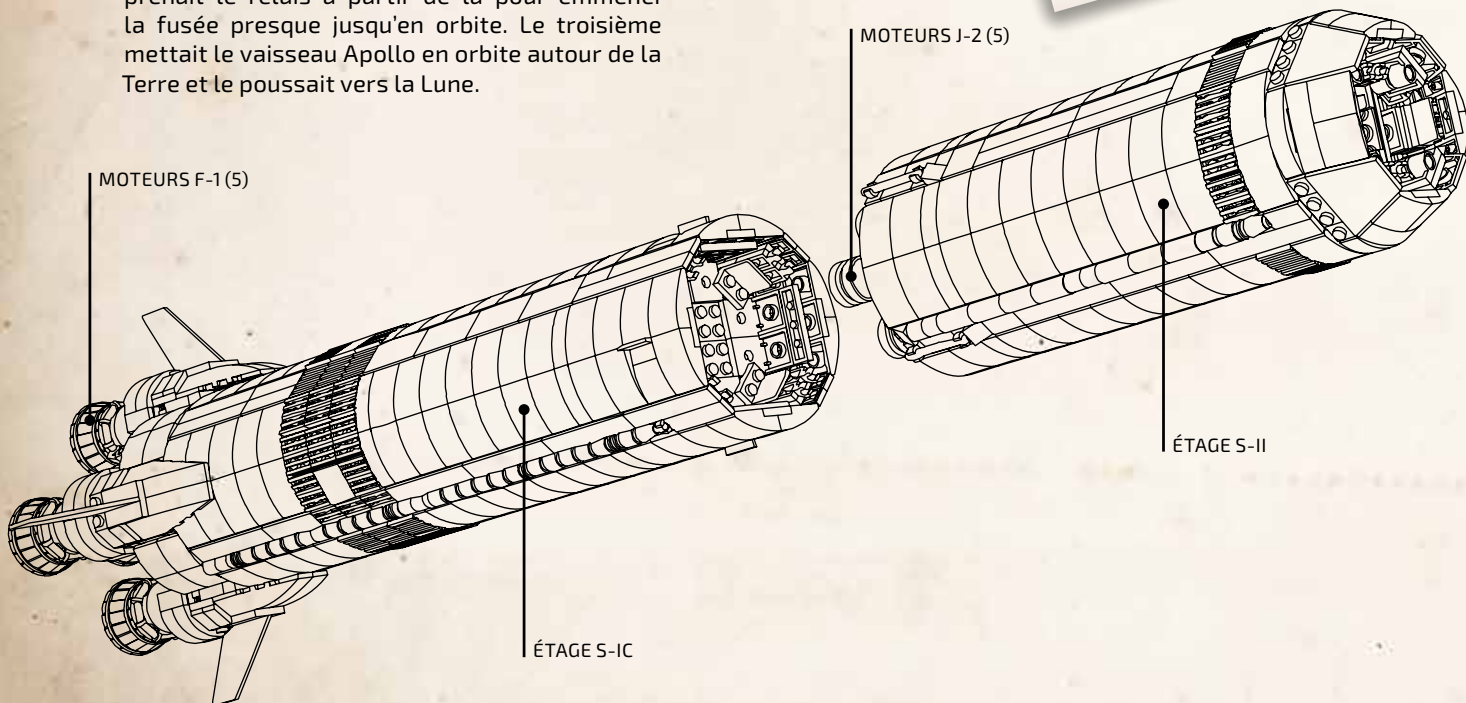

Le module de commande et de service d'Apollo 11 déplacé de l'échafaud de travail pour l'accouplement



L'étage de remontée du module lunaire 5 dans la zone d'assemblage final, soulevé par un palan

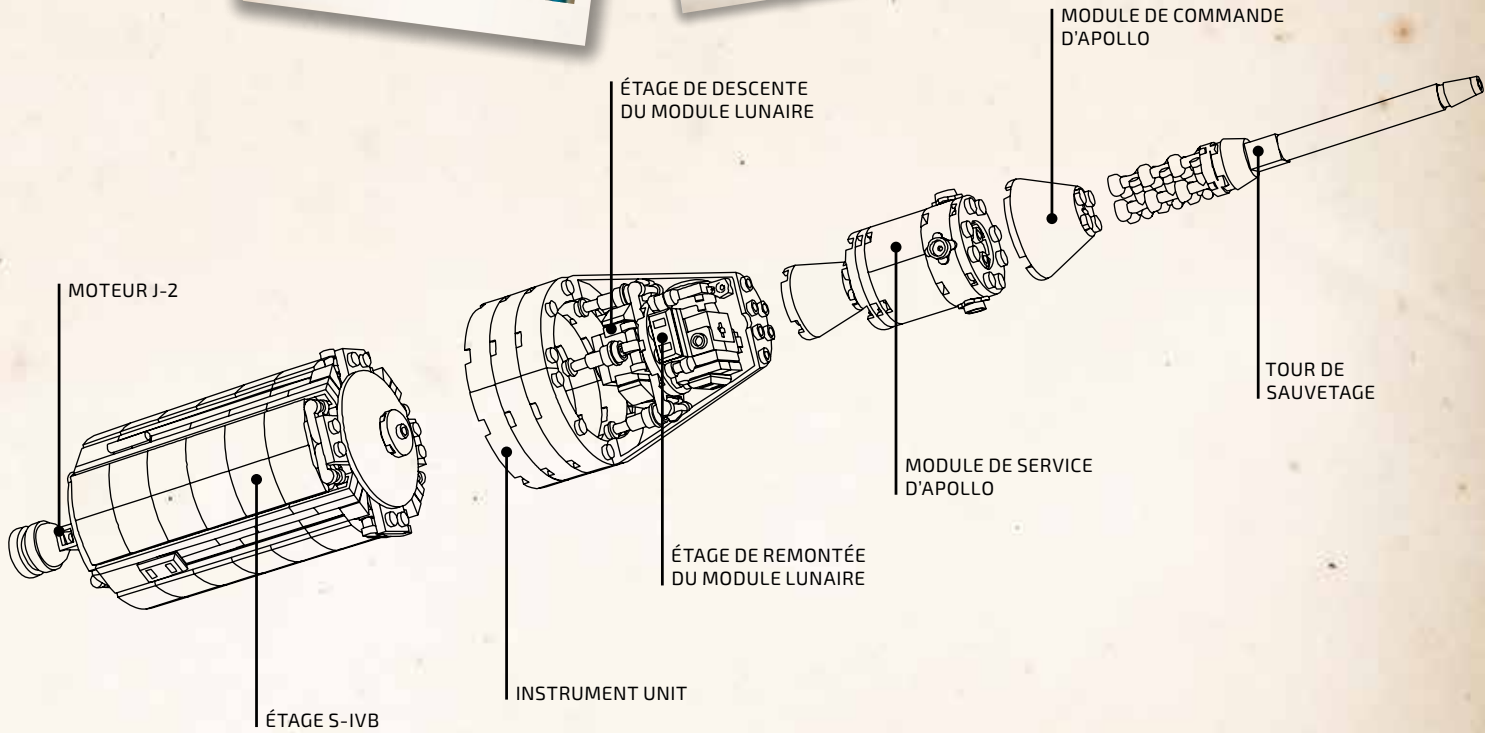

Transposition, amarrage et extraction

Peu de temps après la manœuvre d'injection translunaire, qui permettait de mettre le vaisseau spatial Apollo sur sa trajectoire vers la Lune, les manœuvres de transposition et d'amarrage étaient exécutées. Pour ce faire, l'un des astronautes devait détacher le module de commande et de service Apollo de l'adaptateur qui le reliait à l'étage supérieur, responsable du décollage. Afin d'y parvenir, l'astronaute devait faire tourner le module et en amarrer la tête au module lunaire Apollo, puis détacher le vaisseau ainsi combiné de l'étage supérieur.



Le module de commande et de service (CSM) se sépare de l'adaptateur



Le CSM se retourne ensuite et se prépare pour l'amarrage au module lunaire



Après l'amarrage, le CSM pousse le module lunaire pour l'éloigner de l'étage supérieur du lanceur

En route pour la Lune

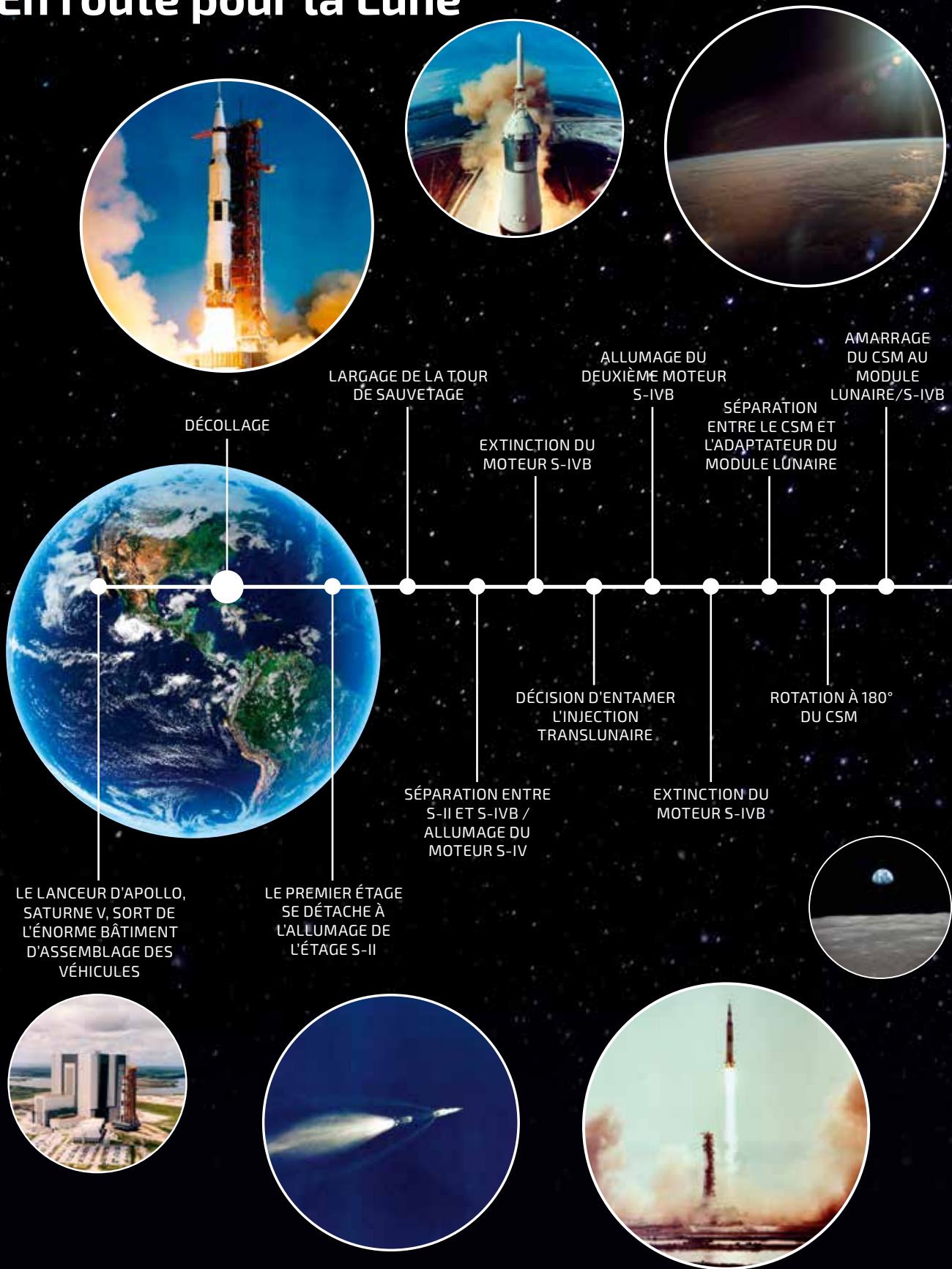



ALLUMAGE DU MOTEUR DU MODULE DE SERVICE

SÉPARATION ENTRE LE CSM ET LE MODULE LUNAIRE (3^e ORBITE)

ALUNISSAGE

ALLUMAGE DU MOTEUR DU MODULE DE SERVICE

TRANSFERT DU PILOTE AU MODULE LUNAIRE

EXTINCTION DU MOTEUR DE DESCENTE DU MODULE LUNAIRE

SÉPARATION ENTRE LE CSM ET LE S-IVB

VÉRIFICATIONS DE L'ÉTAT DES SYSTÈMES/ PÉRIODES DE RAVITAILLEMENT ET DE REPOS/ PÉRIODES DE TRANSMISSION DE DONNÉES

DÉBUT DES OBSERVATIONS DE NAVIGATION

TRANSFERT DU COMMANDANT AU MODULE LUNAIRE

ALLUMAGE DU MOTEUR DE DESCENTE DU MODULE LUNAIRE

ALLUMAGE DU MOTEUR DE DESCENTE DU MODULE LUNAIRE

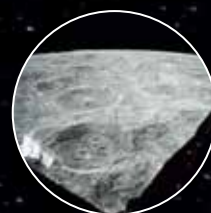

Fans designers

Partageant une passion pour l'exploration spatiale et les constructions LEGO®, Valérie Roche (aussi connue sous le nom de Whatsuptoday) et Felix Stiessen (aussi connu sous le nom de Saabfan) ont travaillé en étroite collaboration pour créer leur impressionnant modèle inspiré de la mission Apollo 11 pour LEGO Ideas.

Felix : « La partie la plus difficile à recréer était le module d'atterrissage lunaire. J'ai essayé de faire en sorte qu'il soit le plus petit possible (je voulais que l'on puisse l'insérer dans les pièces en forme de demi-cône, comme on peut le voir sur le modèle) tout en restant beau et fidèle au vaisseau d'origine. Après cela, nous avons commencé à construire la fusée en tenant compte des dimensions de ce module. Nous avons également tenté de rendre la fusée aussi solide que possible. C'est pourquoi Valérie a inclus des colonnes et des poutres à l'intérieur pour renforcer l'intégrité structurale. »

« La finalisation de la totalité du modèle nous a pris beaucoup de temps. Il est souvent arrivé que l'un d'entre nous abandonne tout simplement le projet pendant quelques semaines pour y revenir plus tard. Toutefois, étant donné qu'il s'agit d'une collaboration, il y avait toujours quelqu'un qui faisait avancer le projet, ce qui remotivait l'autre. Au total, il nous a fallu environ un an pour mener le projet à bien. »

« Nous avons été surpris (et heureux, bien sûr) lorsque nous avons appris que notre modèle intégrerait la gamme LEGO Ideas. En ce qui concerne la plateforme LEGO Ideas, nous aimons le fait de recevoir des commentaires et le soutien de la communauté. C'est super de pouvoir répondre aux commentaires, lire des suggestions et améliorer le modèle grâce à la section "Updates". Bien entendu, la possibilité de créer son propre ensemble LEGO est, elle aussi, vraiment géniale ! »

Felix Stiessen



Valérie Roche





Carl Thomas Merriam (à gauche)
Michael Psiaki (au milieu)
Austin William Carlson (à droite)

Designers LEGO®

Michael Psiaki, Carl Thomas Merriam et Austin William Carlson sont tous designers LEGO® à temps plein et des fans inconditionnels de l'espace. Il s'agissait donc d'un projet auquel ils avaient vraiment envie de participer. Michael explique d'ailleurs :

« En réalité, on ne nous a rien demandé. J'étais véritablement enthousiaste lorsque j'ai entendu dire que le projet allait peut-être se concrétiser et j'en ai parlé à Carl, car je savais qu'il était aussi fan de l'espace. Nous nous sommes dit qu'il serait vraiment sympa de travailler ensemble vu la taille imposante du modèle, c'est pourquoi nous avons contacté l'équipe chargée des projets Ideas afin de les aider à développer le produit. »

« Nous avons été impressionnés par la taille réelle du modèle, ainsi que par la façon dont il est possible d'en séparer les différents étages et composants. Il n'a vraiment pas été facile d'intégrer cette spécificité dans notre modèle final, car nous devions nous assurer que la fusée soit suffisamment solide une fois assemblée, mais également qu'elle soit facile à diviser. »





El programa Apolo

El 25 de mayo de 1961, el presidente John F. Kennedy desafió a su país a enviar a un americano a la Luna y traerlo de vuelta sano y salvo antes del final de esa década. La NASA aceptó el desafío con el programa Apolo. Sería la primera vez que un ser humano abandonase la órbita de la Tierra y visitase otro mundo. El programa Apolo interpretó un papel fundamental en la historia de la exploración espacial y abrió las puertas a la posibilidad de explorar mundos aún más lejanos.

El programa Apolo se componía de 11 vuelos espaciales. Las dos primeras misiones, denominadas Apolo 7 y Apolo 9, se desarrollaron en la órbita de la Tierra y sirvieron para probar el módulo de control y el módulo lunar. Las dos siguientes, denominadas Apolo 8 y Apolo 10, tenían por objetivo poner a prueba diferentes componentes en la órbita de la Luna y tomar fotografías de su superficie. Aunque la misión Apolo 13 no llegó a posarse en la Luna debido a problemas técnicos, sí que lo hicieron otras seis misiones que volvieron a la Tierra con gran cantidad de datos científicos y casi 400 kg de muestras lunares.

La primera misión tripulada a la Luna fue la Apolo 8, que describió una órbita completa alrededor del satélite en la Nochevieja de 1968. Tan sólo seis meses más tarde, el 20 de julio de 1969, el mundo fue testigo de uno de los logros tecnológicos más asombrosos del siglo XX cuando un astronauta de la NASA a bordo de la nave Apolo 11 se convirtió en el primer ser humano en pisar la superficie de la Luna.

La misión Apolo 11 duró 195 horas, 18 minutos y 35 segundos (unos 36 minutos más de lo planeado). Tras la entrada en la órbita lunar, el módulo de control (MC) y el módulo lunar (ML) se separaron. Mientras uno de los miembros de la tripulación permanecía en el MC, en órbita alrededor de la Luna, los otros dos astronautas emprendieron el histórico viaje a la superficie lunar en el ML. Después de explorar la superficie y realizar experimentos durante 21 horas y 36 minutos, los astronautas retornaron sanos y salvos al MC e iniciaron el viaje de vuelta a la Tierra.



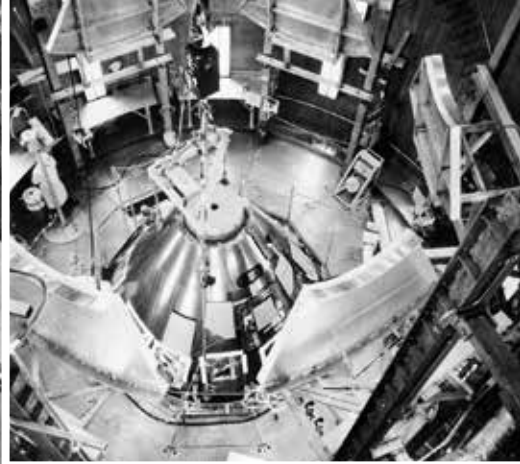

El Saturno V se desplaza a 1,6 km/h por la vía de transporte hasta la plataforma 39A

Los operarios preparan la primera fase (S-IC) en el corredor de transferencia del Edificio de Ensamblaje de Vehículos

Fotógrafos filman los preparativos de la misión Apolo 11

Entrenamiento previo al vuelo

Técnicos del Centro Espacial Kennedy inspeccionan el vehículo de exploración lunar (VEL)



Saturno V

El cohete Saturno V fue el más potente que jamás ha volado con éxito y formó parte del programa Apolo durante las décadas de 1960 y 1970. Medía 111 m de altura y, con el depósito lleno de combustible y preparado para el lanzamiento, pesaba 2,8 millones de kilogramos. El Saturno V que participó en las posteriores misiones Apolo se componía de tres fases. Cada fase debía alimentar sus motores hasta agotar el combustible para separarse entonces del cohete. A continuación, se ponían en marcha los motores de la siguiente fase, permitiendo al cohete continuar su viaje hacia el espacio. La primera fase contaba con los motores más potentes, pues su desafiante tarea era levantar el cohete del suelo con el depósito lleno de combustible. De este modo, era capaz de elevar el cohete a una altura de unos 68 km. A partir de entonces y hasta casi la entrada en órbita, la responsabilidad recaía sobre la segunda fase. La tercera fase era la encargada de poner en órbita la nave espacial Apolo e impulsarla hasta la Luna.



La segunda fase (S-II) se prepara para su acoplamiento a la primera fase (S-IC)



Acoplamiento de la nave espacial Apolo 11 al vehículo de lanzamiento Saturno V

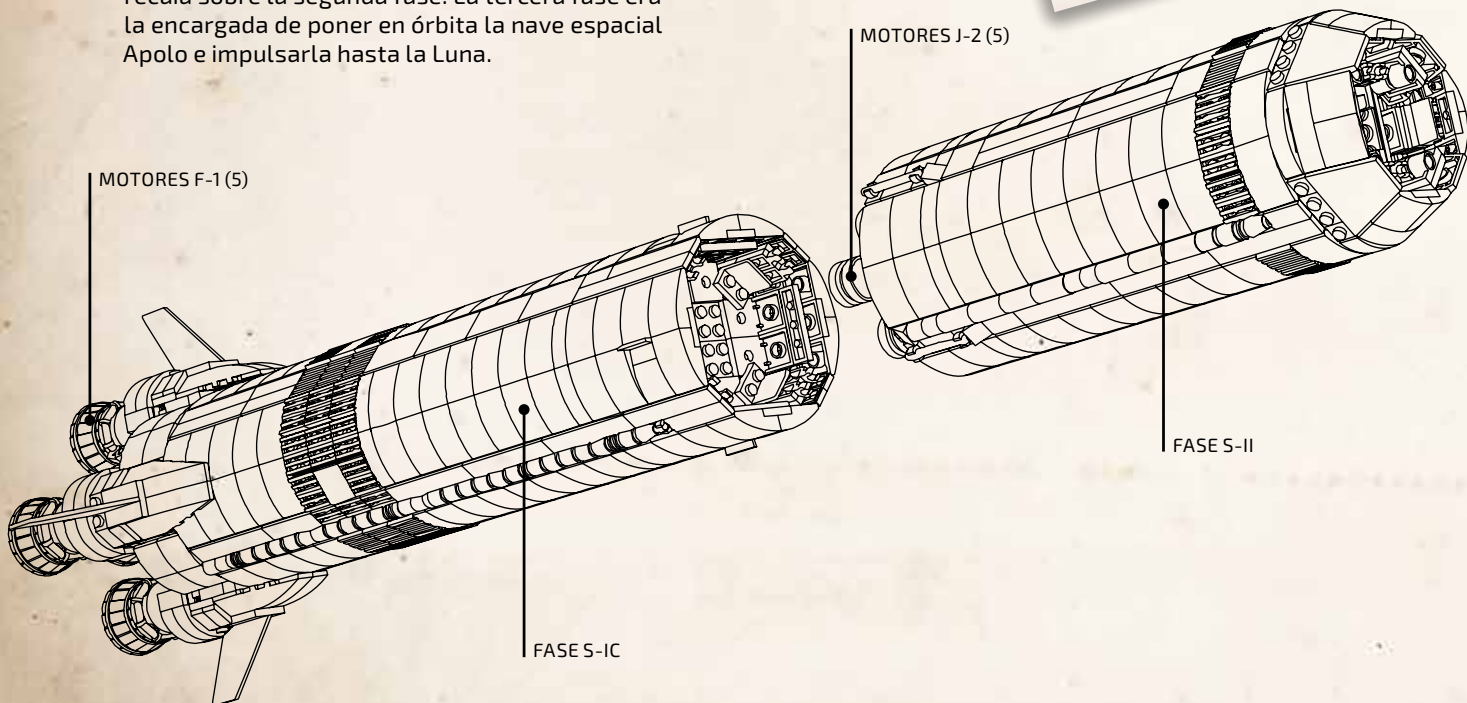

El MCA Apolo 11 se transporta desde el soporte de trabajo para su acoplamiento



Fase de ascenso (5) del módulo lunar en el área de ensamblaje final, sujeta a una grúa aérea

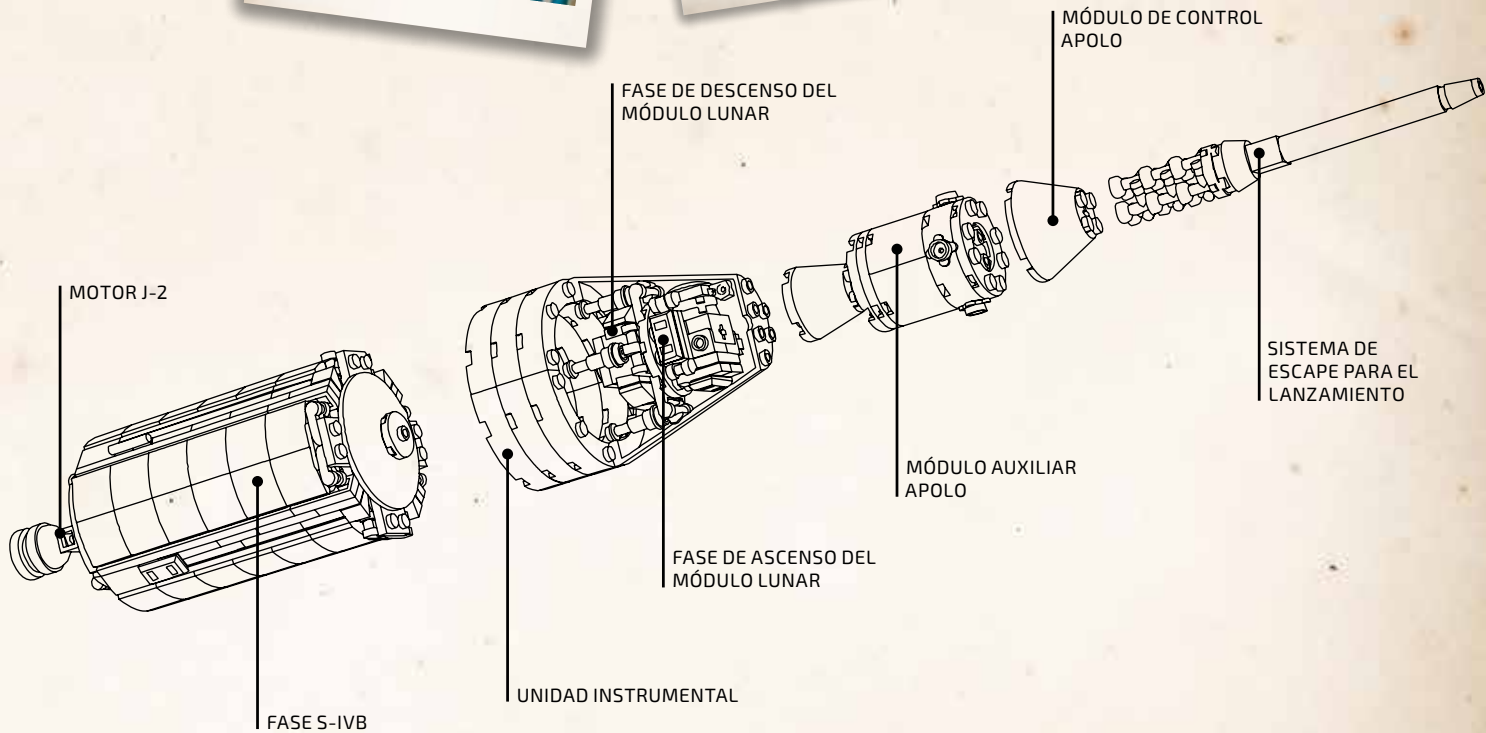

Transposición, acoplamiento y extracción

Poco después de la maniobra de inyección translunar que situó la nave espacial Apolo en su trayectoria hacia la Luna, tendrían lugar las maniobras de transposición y acoplamiento. Para llevarlas a cabo, un astronauta debía separar el módulo de control/auxiliar (MCA) del adaptador que lo mantenía sujeto a la fase superior de su vehículo de lanzamiento, darle la vuelta y acoplar el morro al módulo lunar (ML), separando entonces la nave espacial resultante de la fase superior.



El módulo de control/auxiliar (MCA) se separa del adaptador



El MCA se da la vuelta y se prepara para su acoplamiento al módulo lunar (ML)



Tras el acoplamiento, el MCA separa el ML de la fase superior del vehículo de lanzamiento

El viaje a la Luna

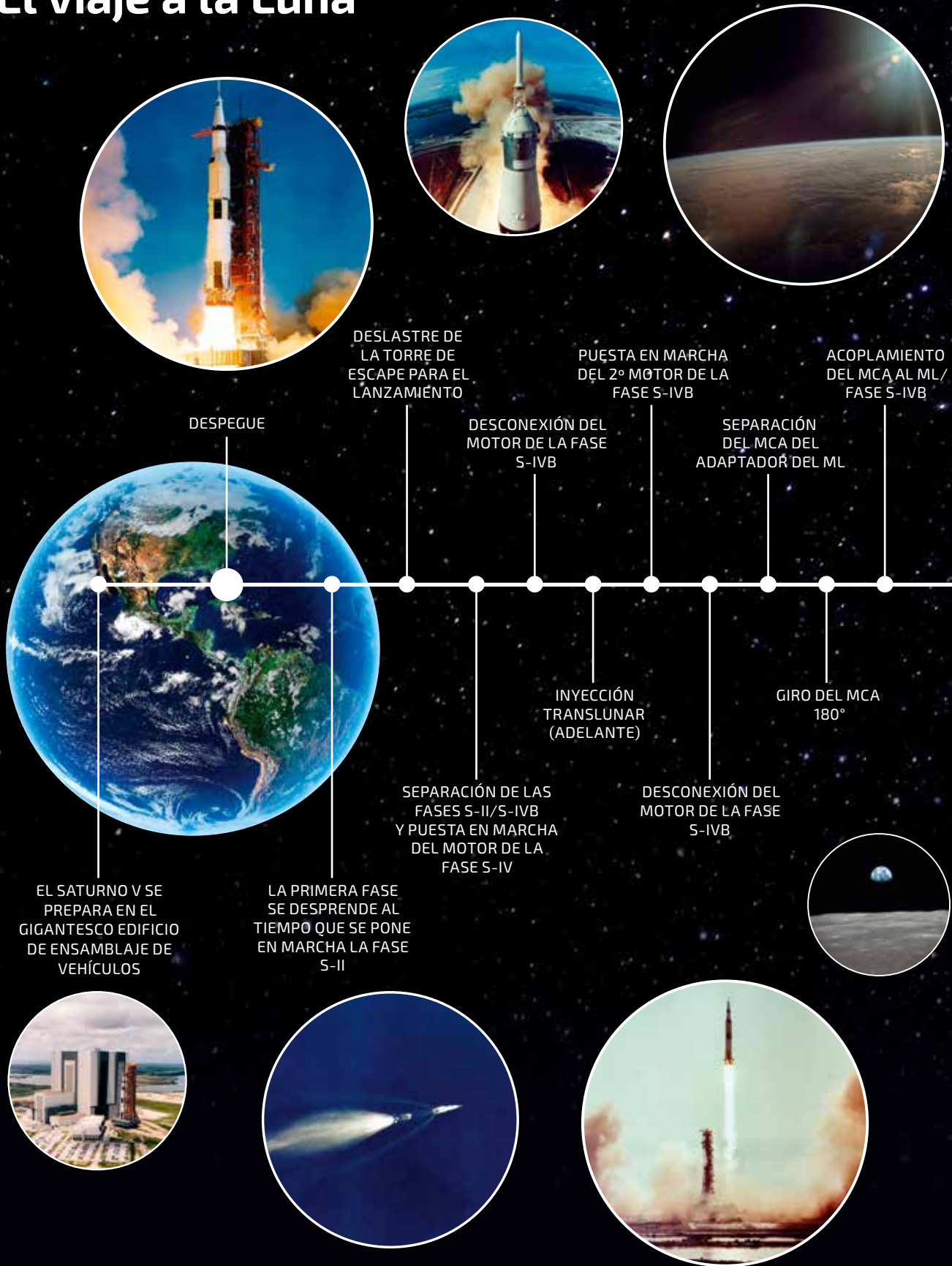



PUESTA EN MARCHA DEL MOTOR DEL MS

SEPARACIÓN DEL MCA/ML (3ª ÓRBITA)

ALUNIZAJE

PUESTA EN MARCHA DEL MOTOR DEL MS

TRANSFERENCIA DEL PILOTO AL ML

DESCONEXIÓN DEL MOTOR DE DESCENSO DEL ML

SEPARACIÓN DEL MCA DE LA FASE S-IVB

PRUEBAS DE ESTADO DE LOS SISTEMAS/ PERÍODOS DE ALIMENTACIÓN Y SUEÑO/ PERÍODOS DE TRANSMISIÓN DE DATOS

INICIO DE AVISTAMIENTOS PARA LA NAVEGACIÓN

TRANSFERENCIA DEL COMANDANTE AL ML

PUESTA EN MARCHA DEL MOTOR DE DESCENSO DEL ML

PUESTA EN MARCHA DEL MOTOR DE DESCENSO DEL ML

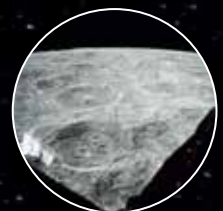

Los fans diseñadores

Con su pasión por la exploración espacial y la construcción con LEGO® como elemento común, Valérie Roche (alias Whatsuptoday) y Felix Stiessen (alias Saabfan) trabajaron estrechamente en la creación del impresionante modelo de la misión Apolo 11 para LEGO Ideas.

"La parte más complicada fue el módulo de alunizaje. Yo (Felix) intenté reducirlo a su mínima expresión (quería que cupiese entre las piezas de medio cono, como se aprecia en el modelo), sin perder los detalles estéticos. Fue entonces cuando comenzamos a construir el cohete a su alrededor. También queríamos que el cohete fuese lo más sólido posible, así que Valérie incluyó dentro columnas y vigas para aportar integridad estructural".

"En realidad, nos llevó bastante tiempo terminar el modelo completo. Sucedió con frecuencia que uno de

nosotros abandonaba el proyecto durante un par de semanas y lo recuperaba más tarde; no obstante, al ser un proyecto de equipo, siempre había alguien que seguía avanzando y motivaba al otro para continuar. En total, diríamos que nos llevó alrededor de un año terminarlo".

"Nos sorprendió (y también nos alegró, por supuesto) saber que nuestro modelo sería el próximo en incorporarse a la colección LEGO Ideas. Lo que nos gusta de la plataforma LEGO Ideas es la comunicación con la comunidad y el apoyo que recibimos. Es fantástico contestar los comentarios, leer las sugerencias y mejorar el modelo poco a poco. Aunque, claro está, ¡la oportunidad de diseñar tu propio set LEGO también es realmente increíble!".

Felix Stiessen



Valérie Roche





Carl Thomas Merriam (izquierda)
Michael Psiaki (centro)
Austin William Carlson (derecha)

Los diseñadores de LEGO®

Michael Psiaki, Carl Thomas Merriam y Austin William Carlson son diseñadores oficiales de LEGO® y grandes entusiastas de los temas espaciales, así que todos estaban muy interesados en formar parte de este proyecto. En palabras de Michael:

"En realidad, no nos lo pidieron. Me emocioné cuando escuché que el proyecto podía hacerse realidad y enseguida se lo dije a Carl, porque sabía que también es un fanático del espacio. Decidimos que sería fantástico trabajar juntos al ser un modelo tan grande, así que nos pusimos en contacto con el equipo de Ideas acerca de la posibilidad de contribuir al desarrollo del proyecto".

"Nos asombró lo grande que era el modelo real y cómo podía separarse en todas las fases y componentes. Este último aspecto fue muy difícil de integrar en nuestro diseño final, porque teníamos que asegurarnos de que el cohete fuese lo suficientemente sólido cuando todo estaba conectado, pero también fácil de separar".



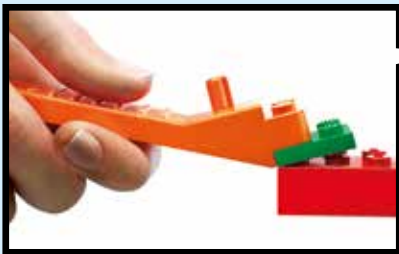

[LEGO.com/brickseparator](https://www.LEGO.com/brickseparator)

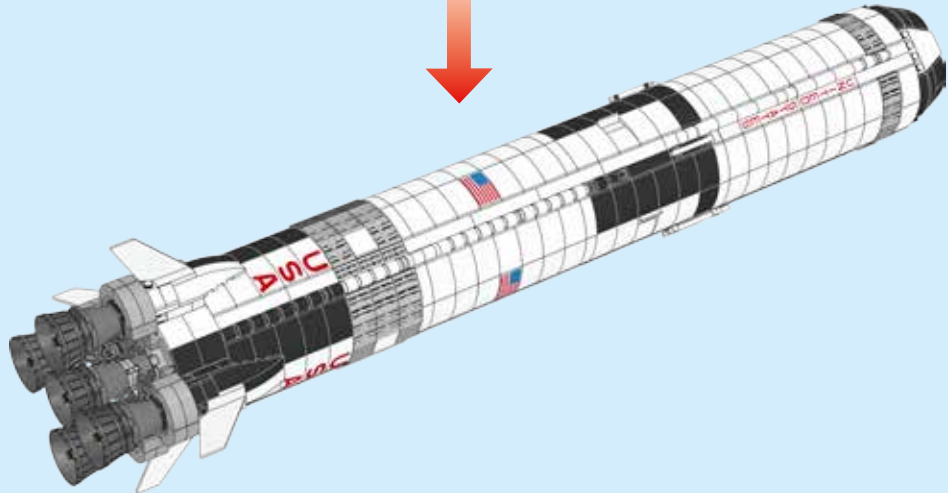
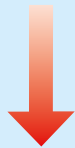
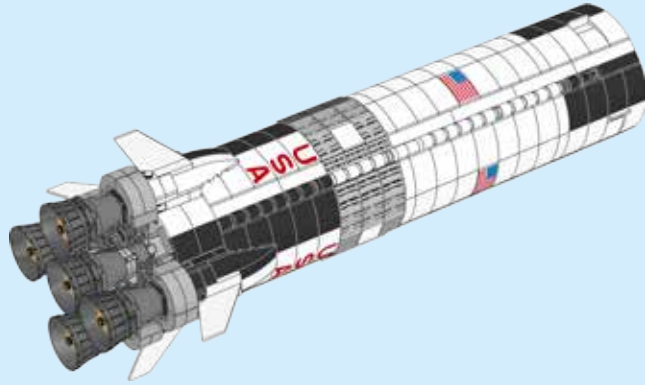
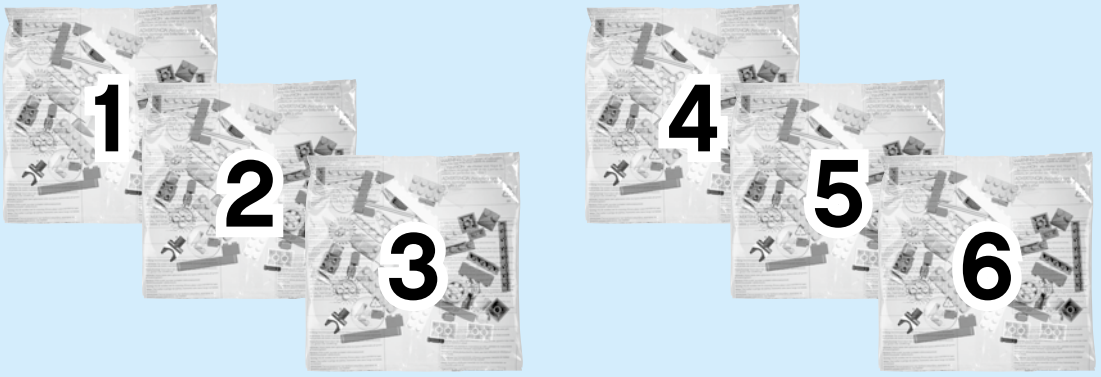

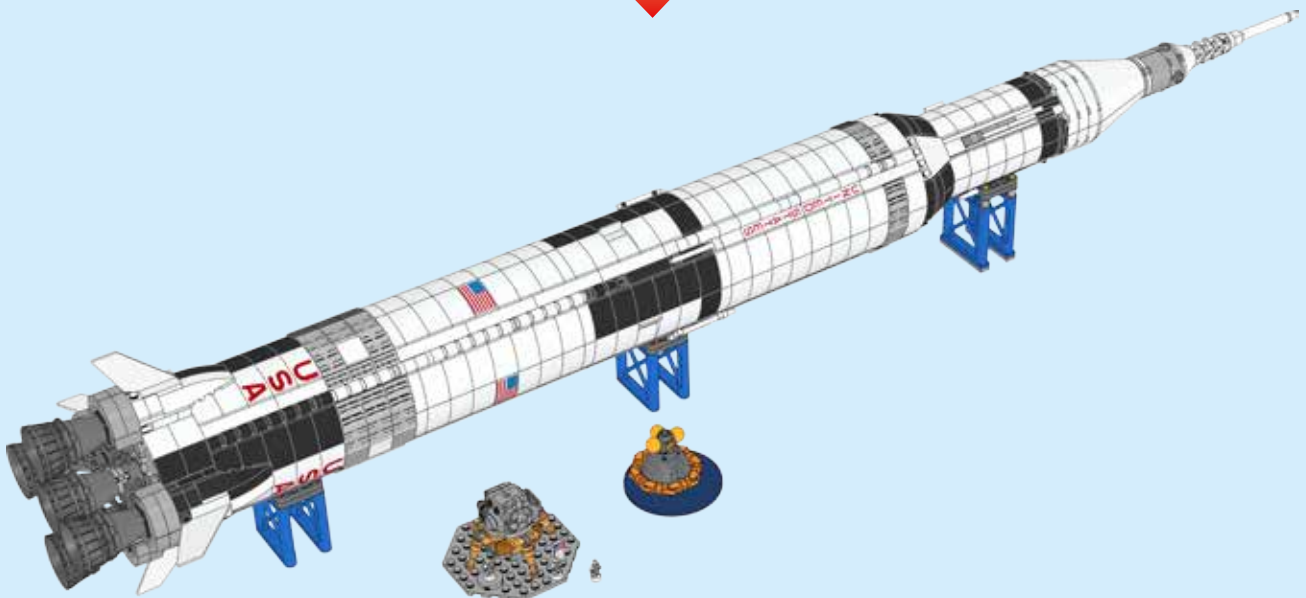
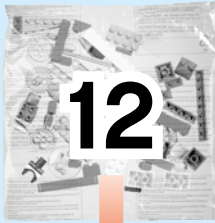
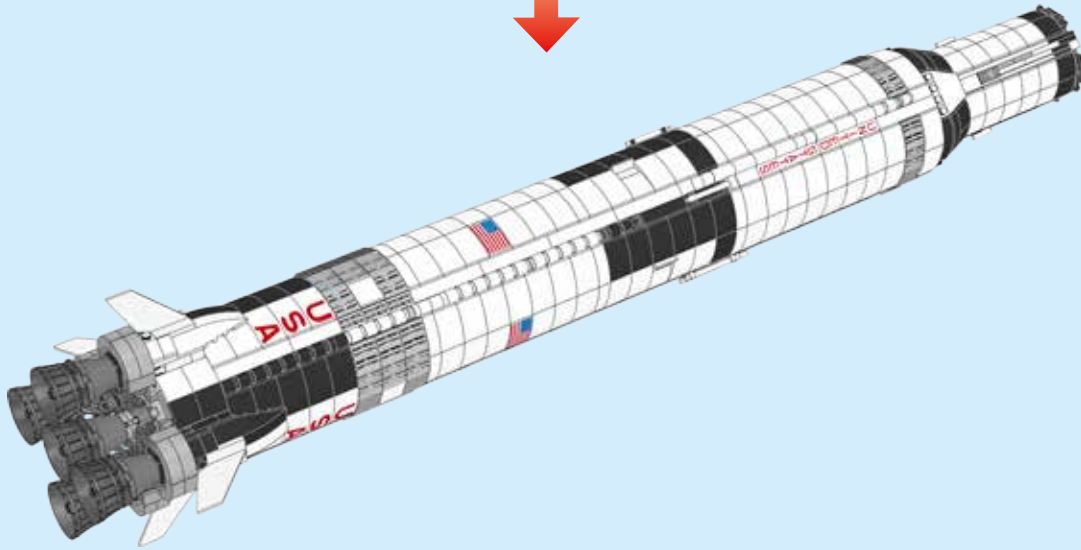
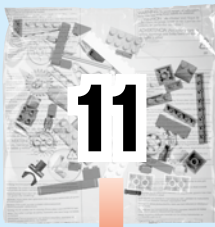

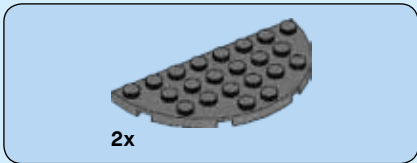
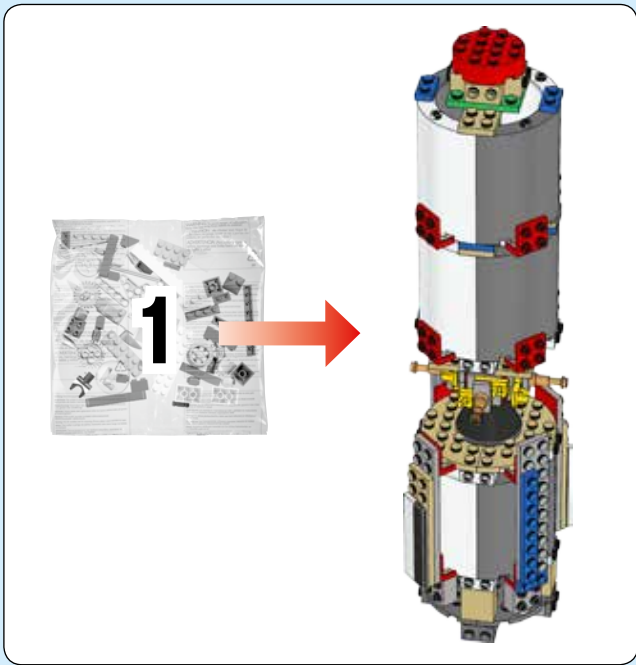

1

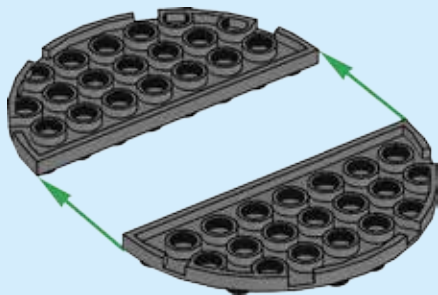

2

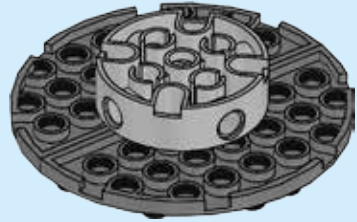

3

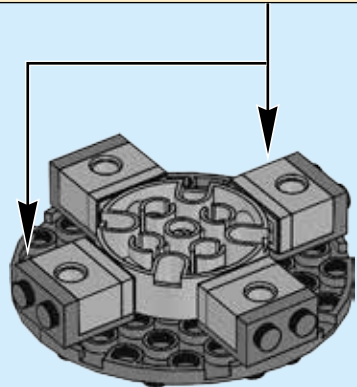
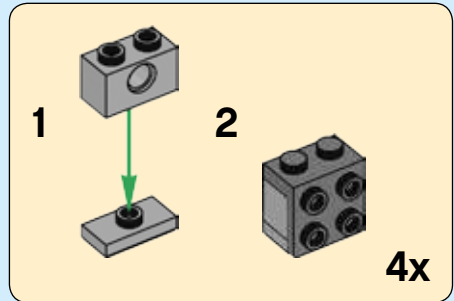

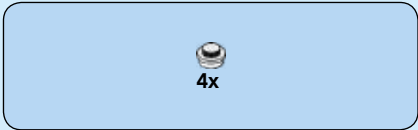

4

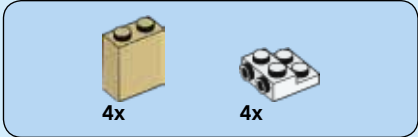
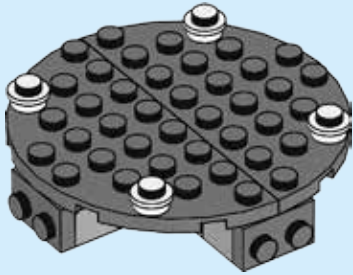
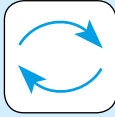

5

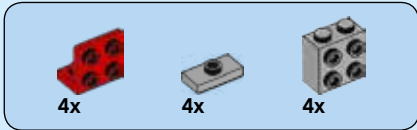
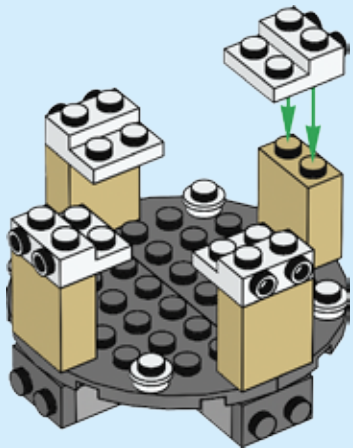

6

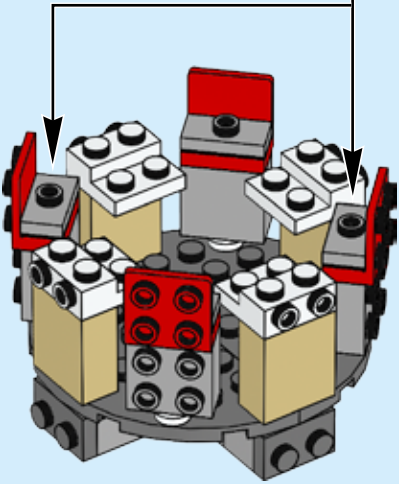
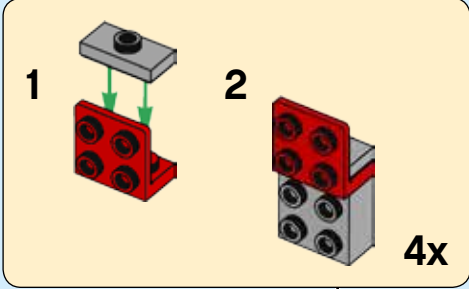

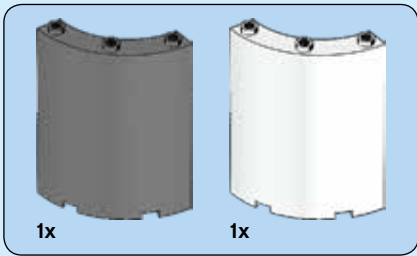

7

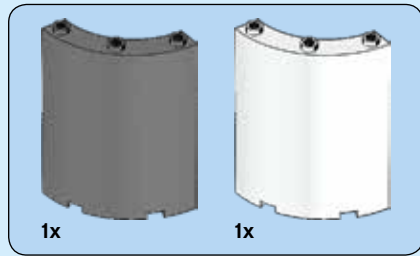
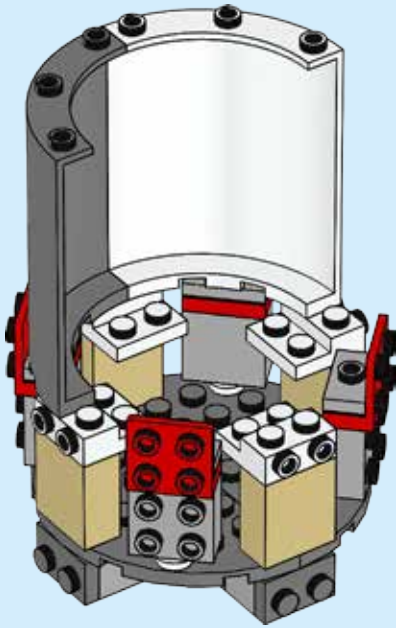

8

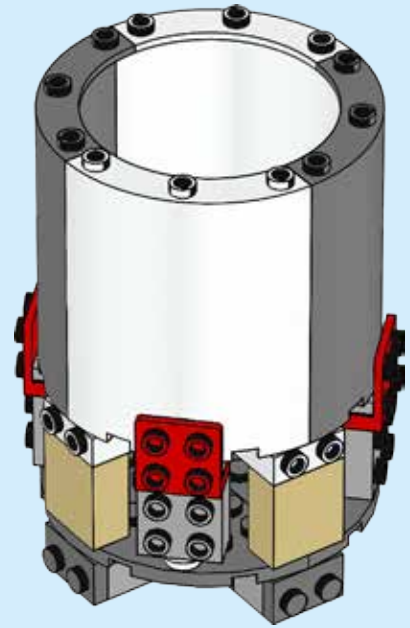

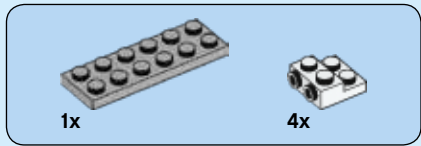

9

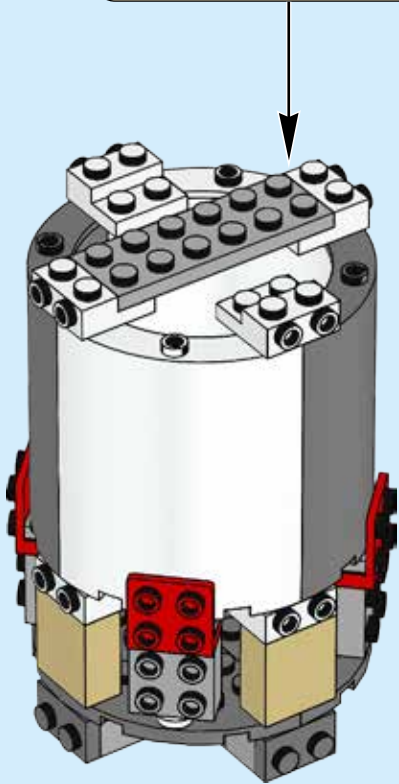
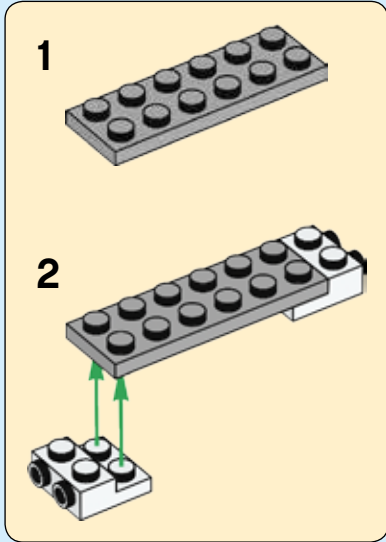

10

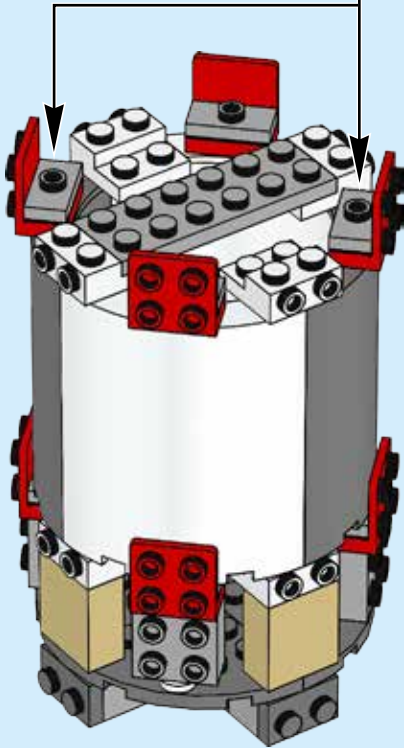
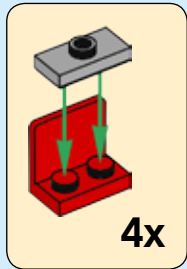

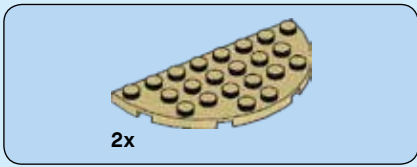

11

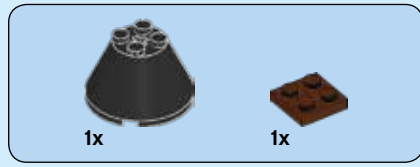
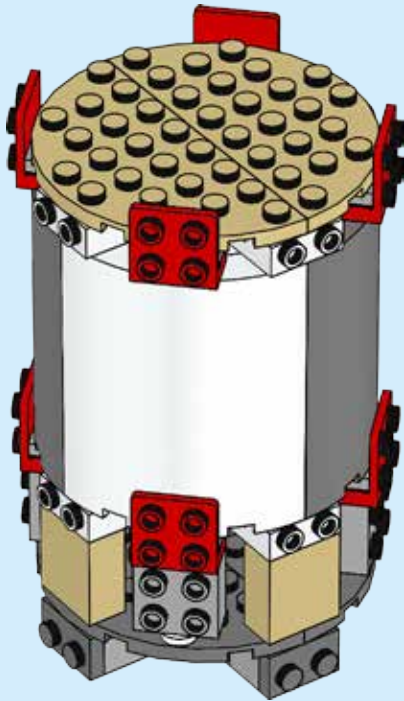

12

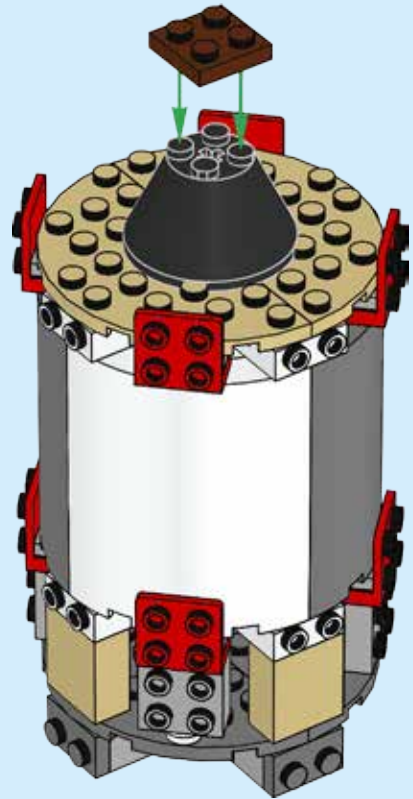



13

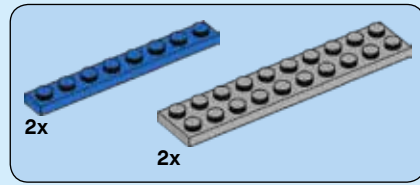
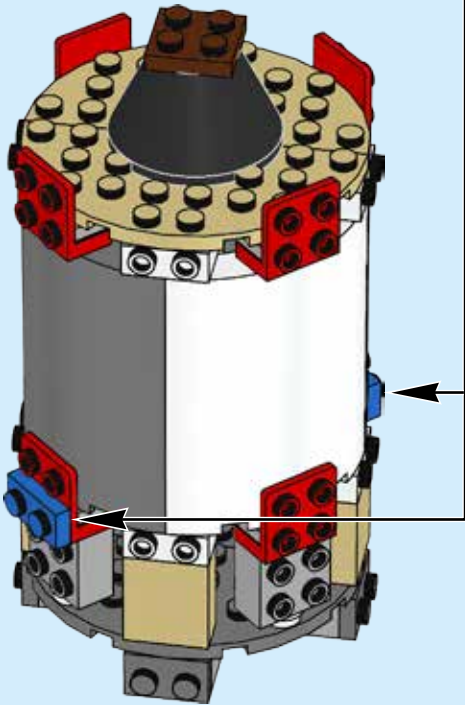
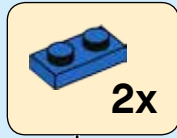
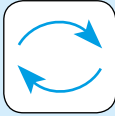

14

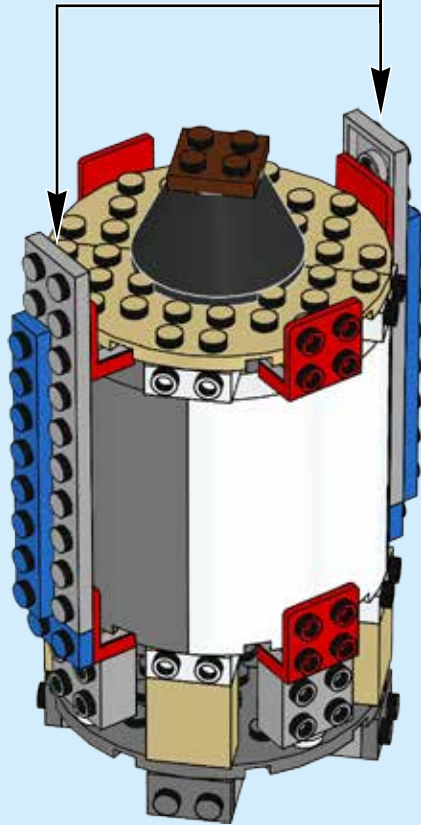
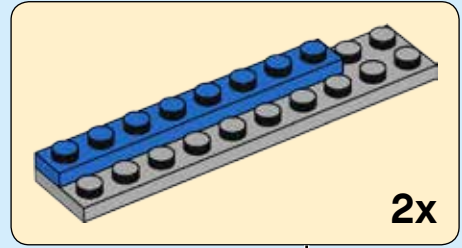

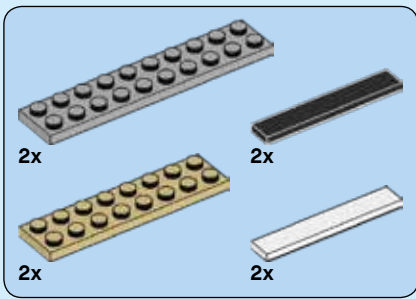

15

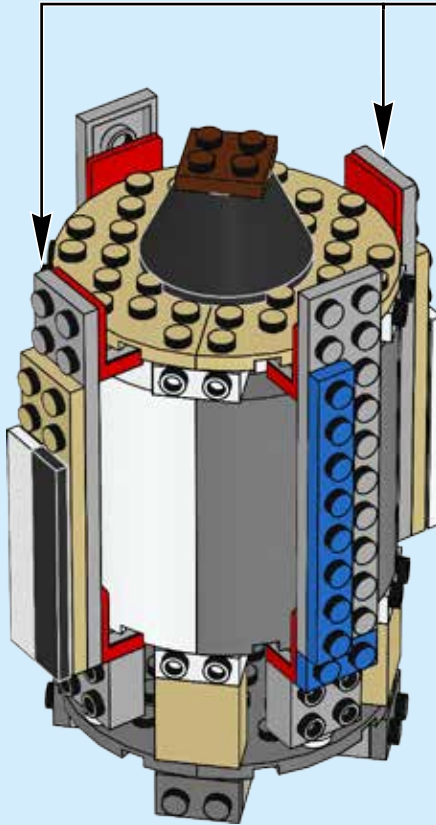
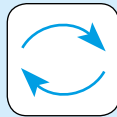
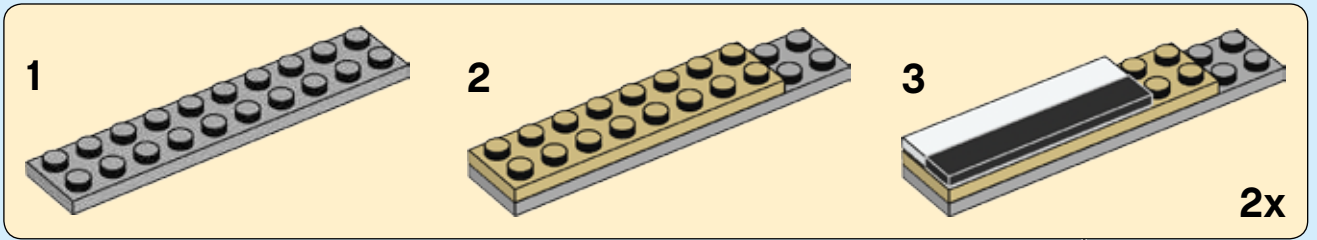



2x

16

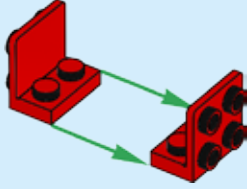

1x

17



2x

18

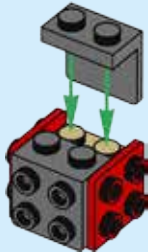

8x

19

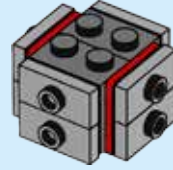

8x

20

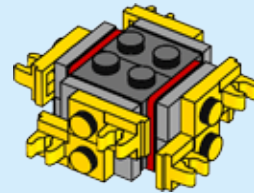

4x

21

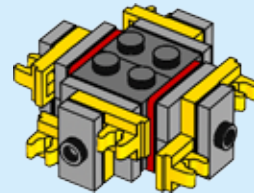

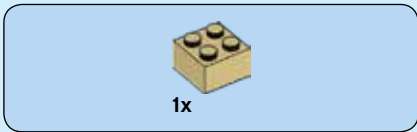

22

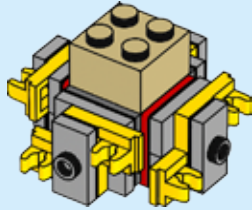

23

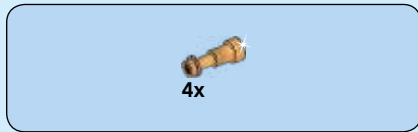
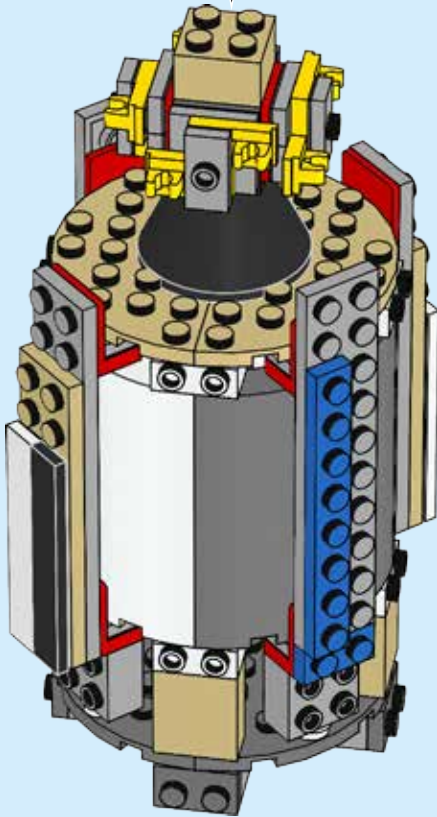

24

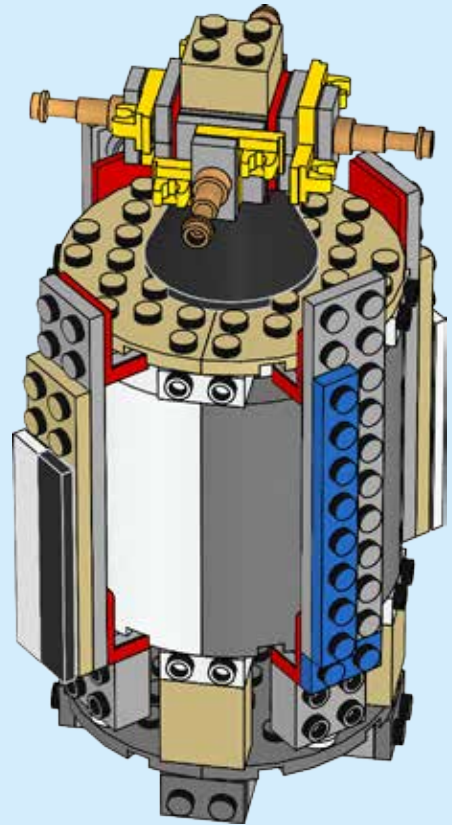

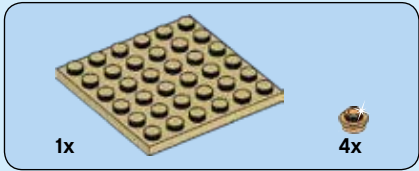
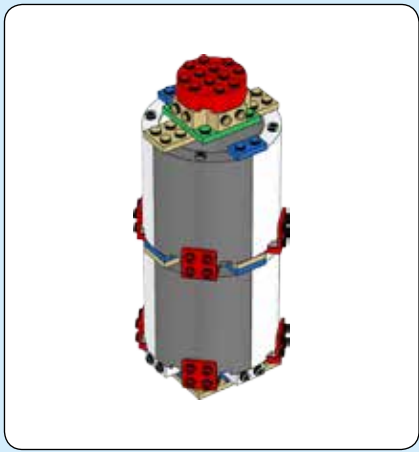

25

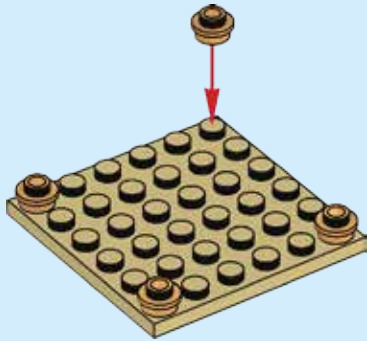

26

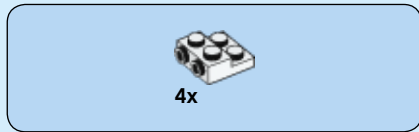
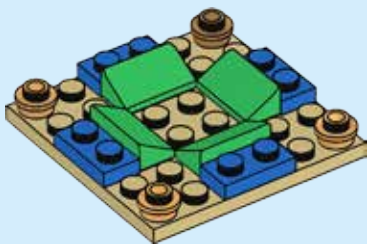

27

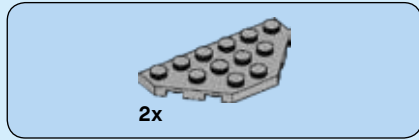
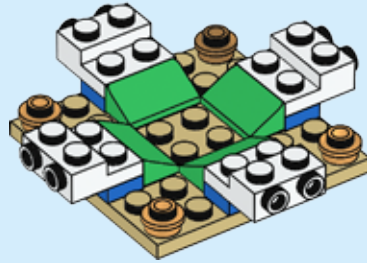

28

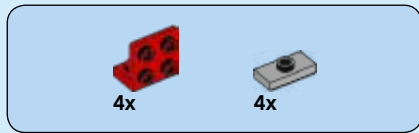
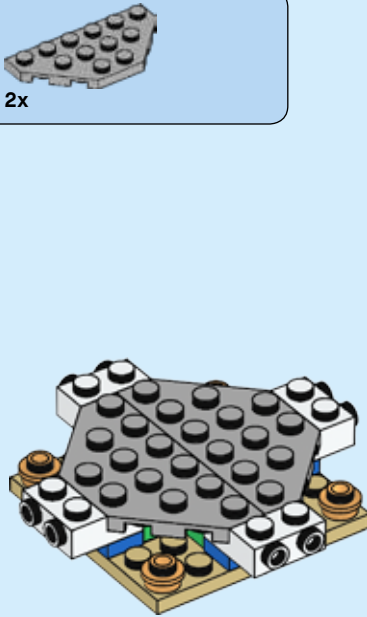

29

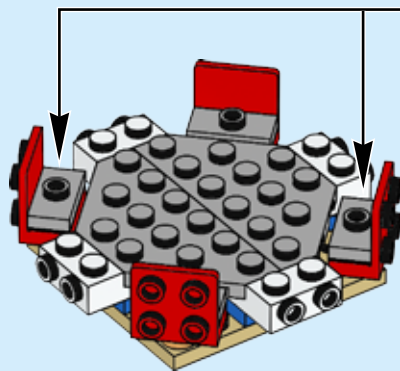
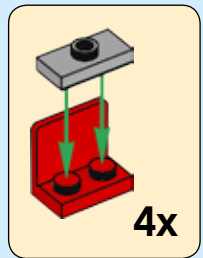

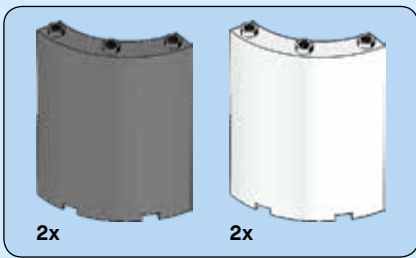

30

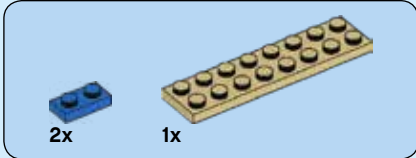
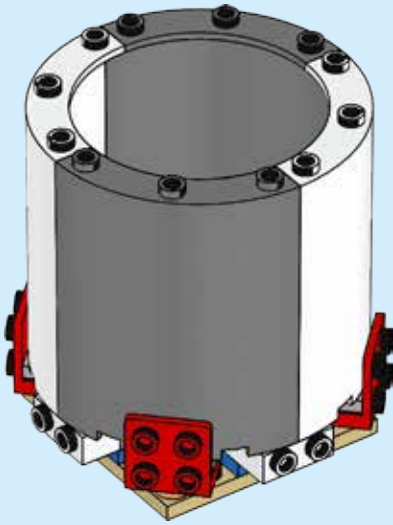

31

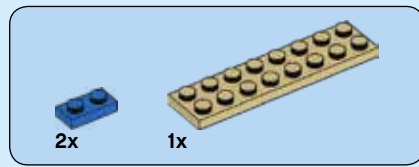
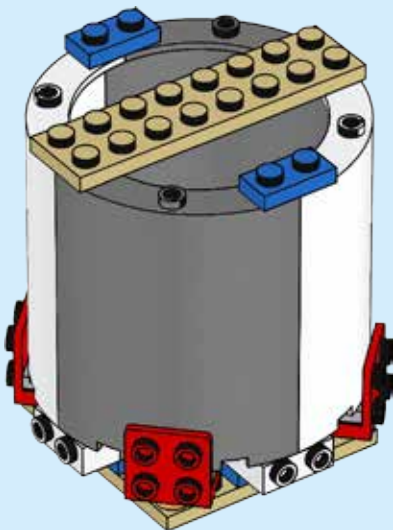

32

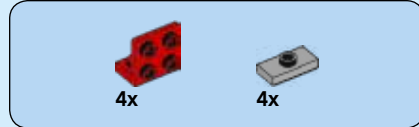
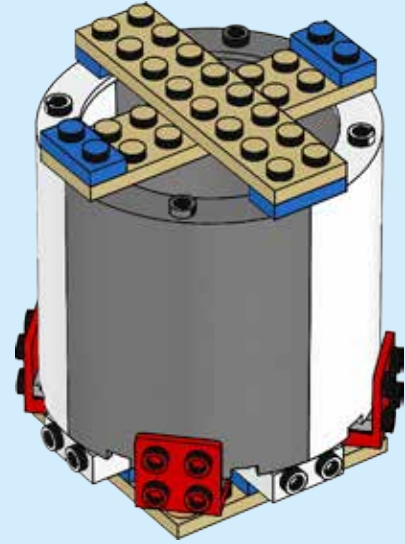

33

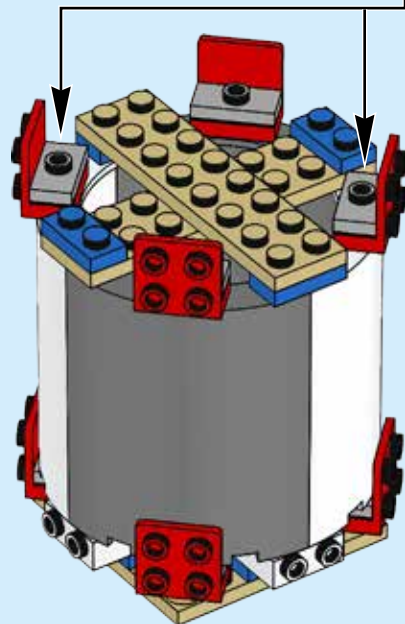
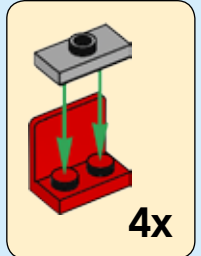

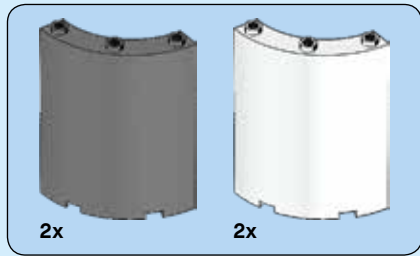

34

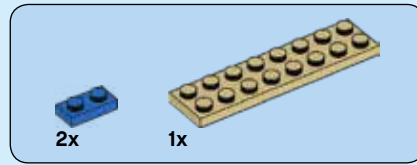
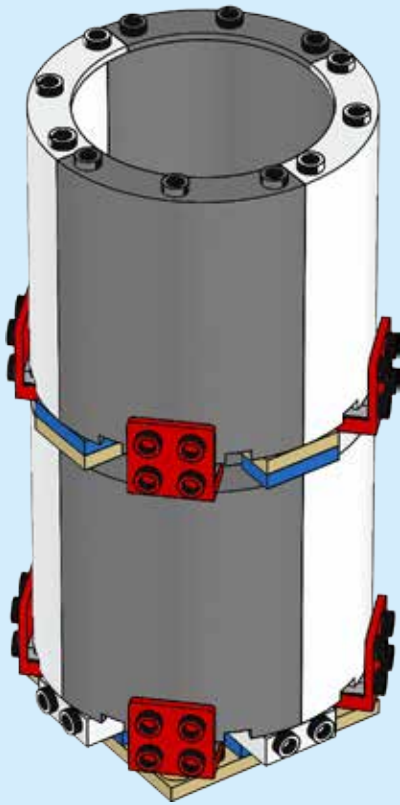

35

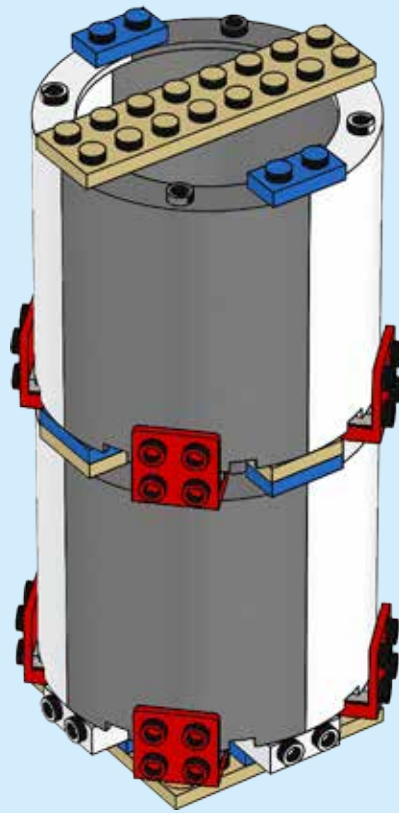

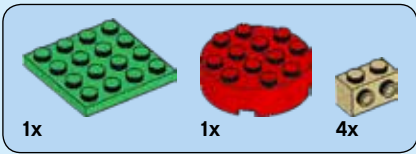

36

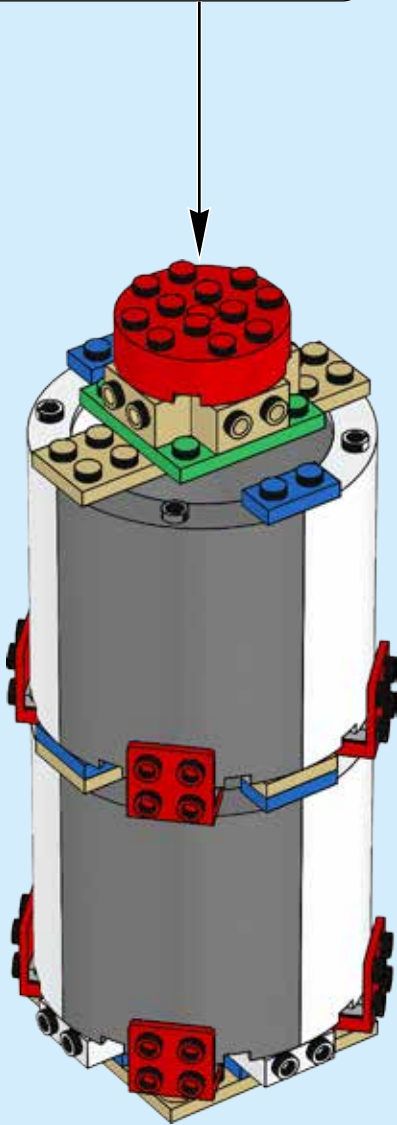
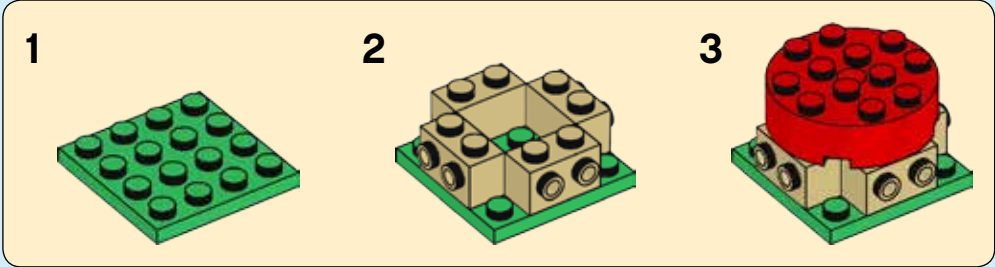

37

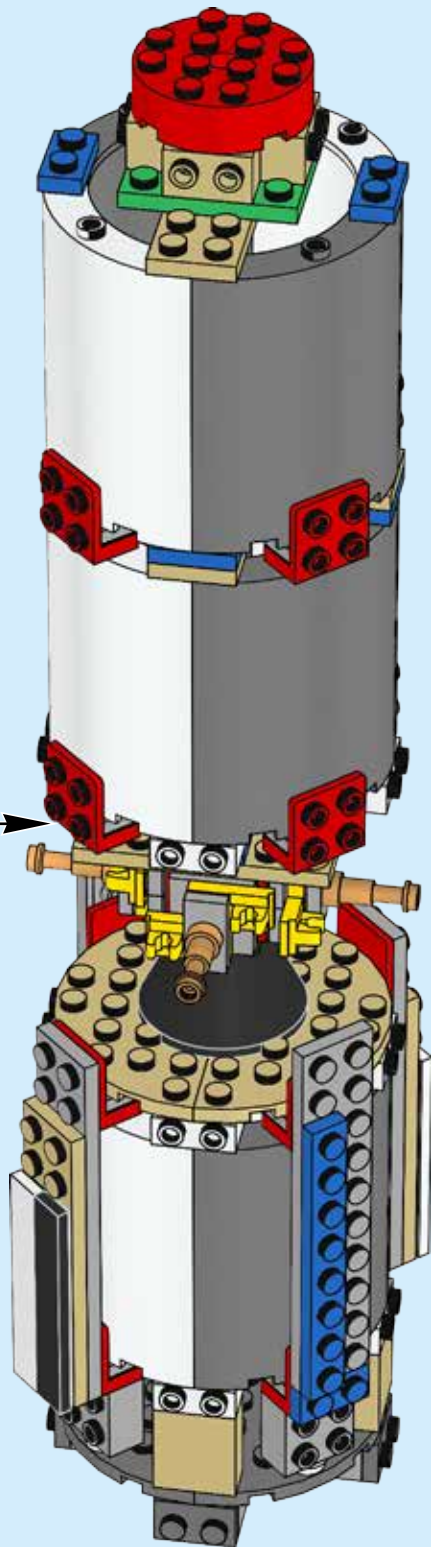

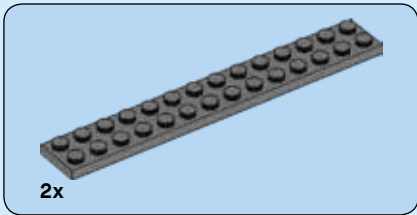
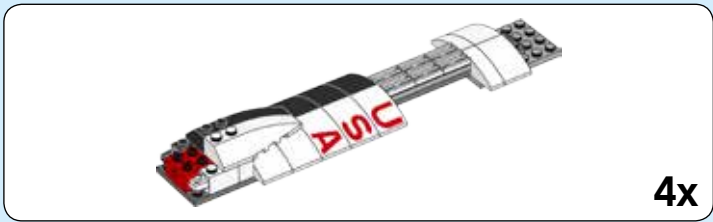
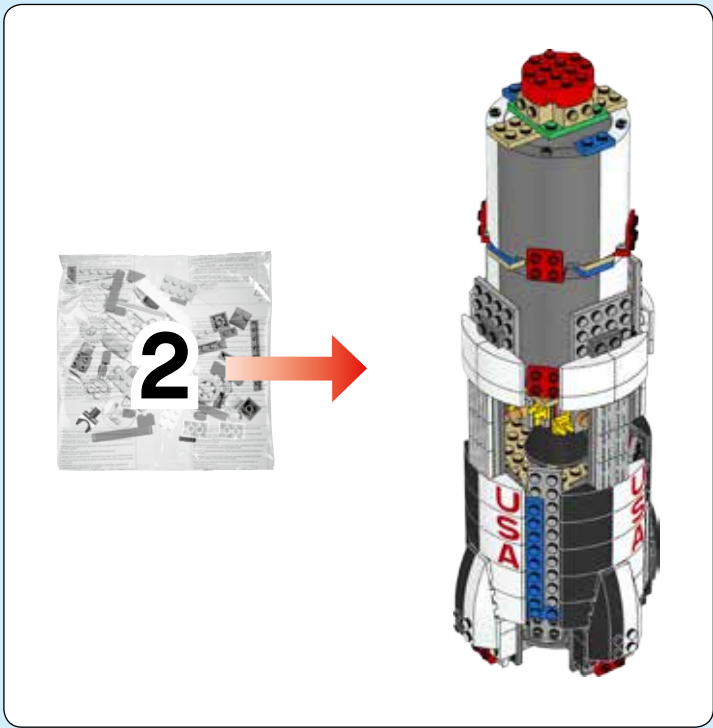

38

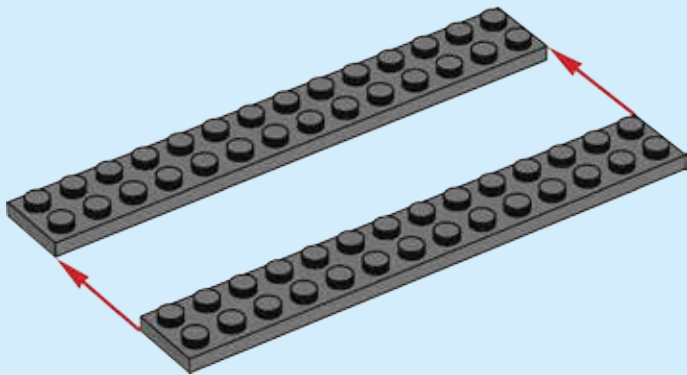

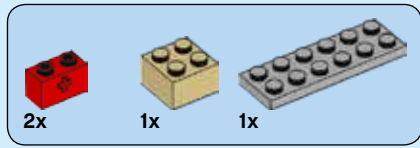

39

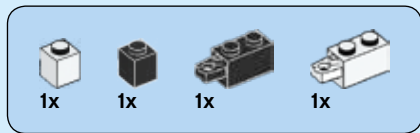
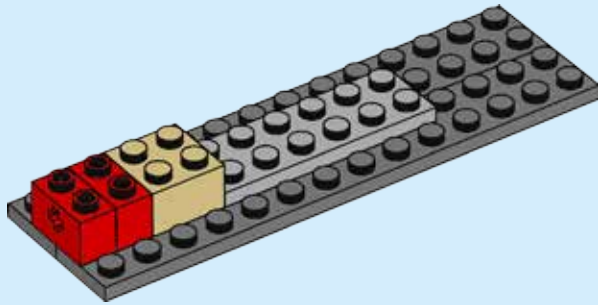

40

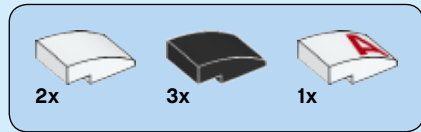
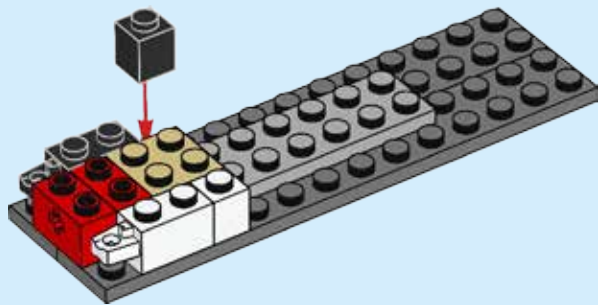

41

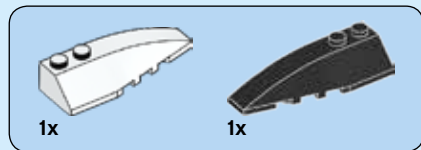
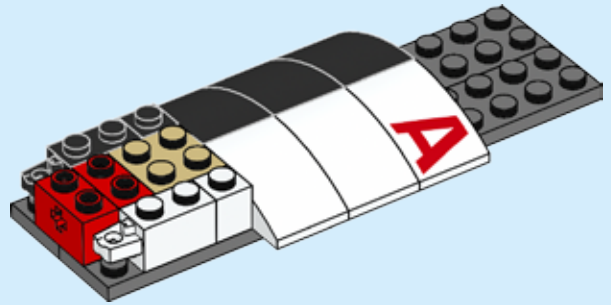

42

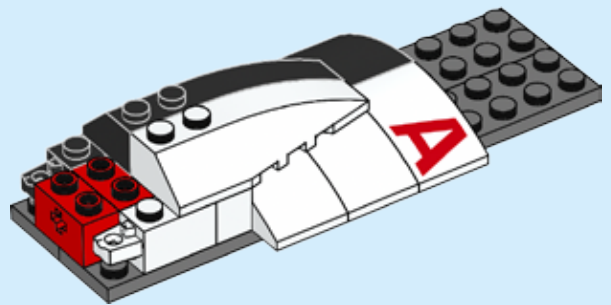

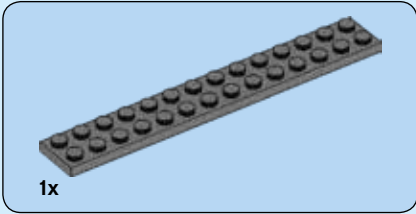
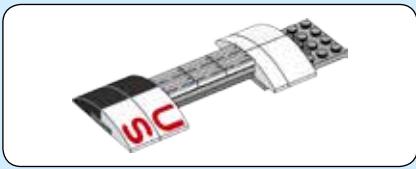

43

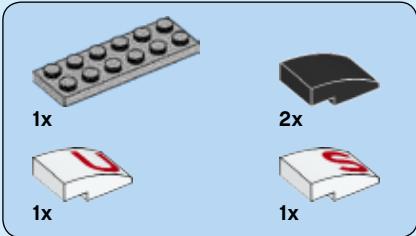
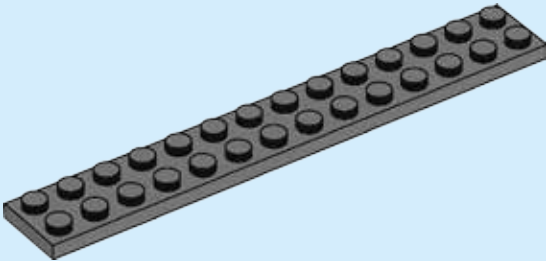

44

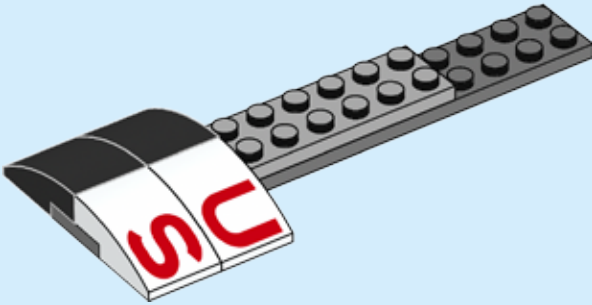



6x

45

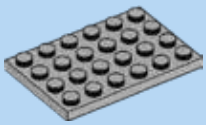
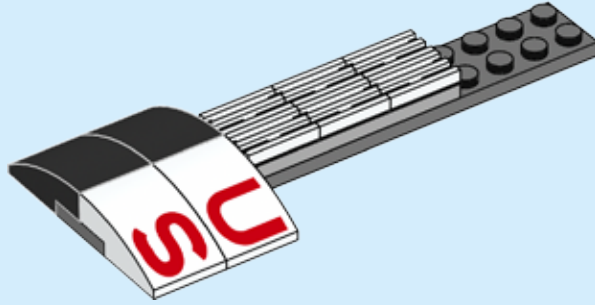

1x

46

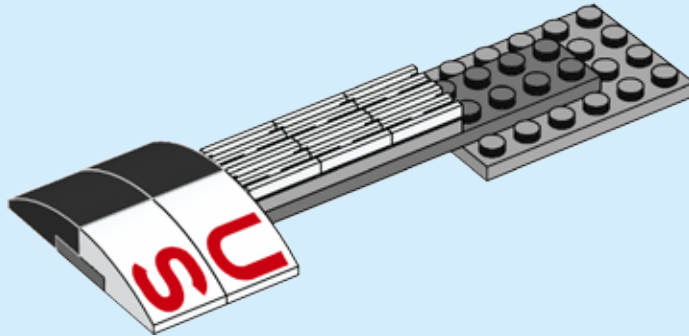

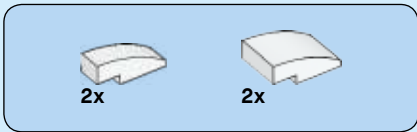

47

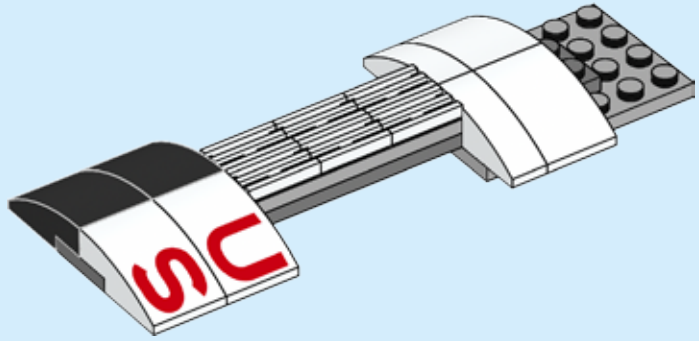

48

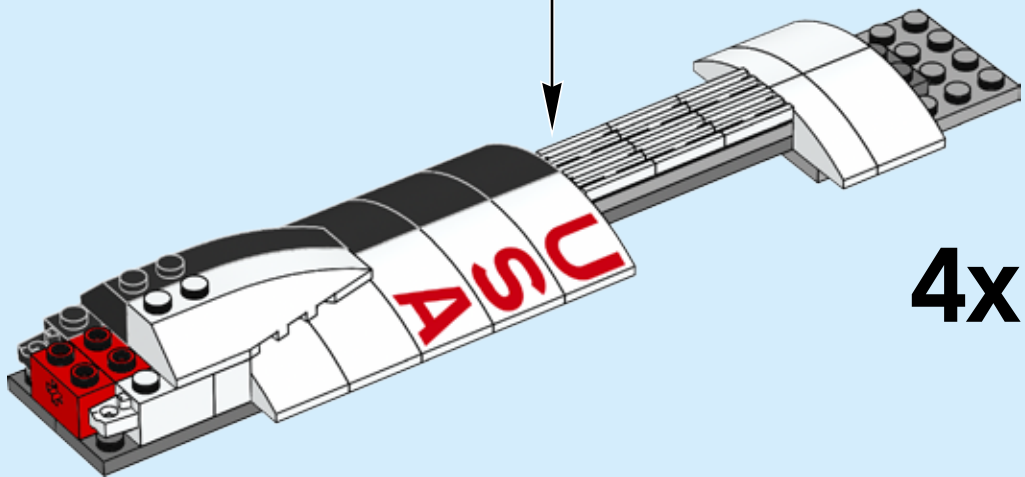

49

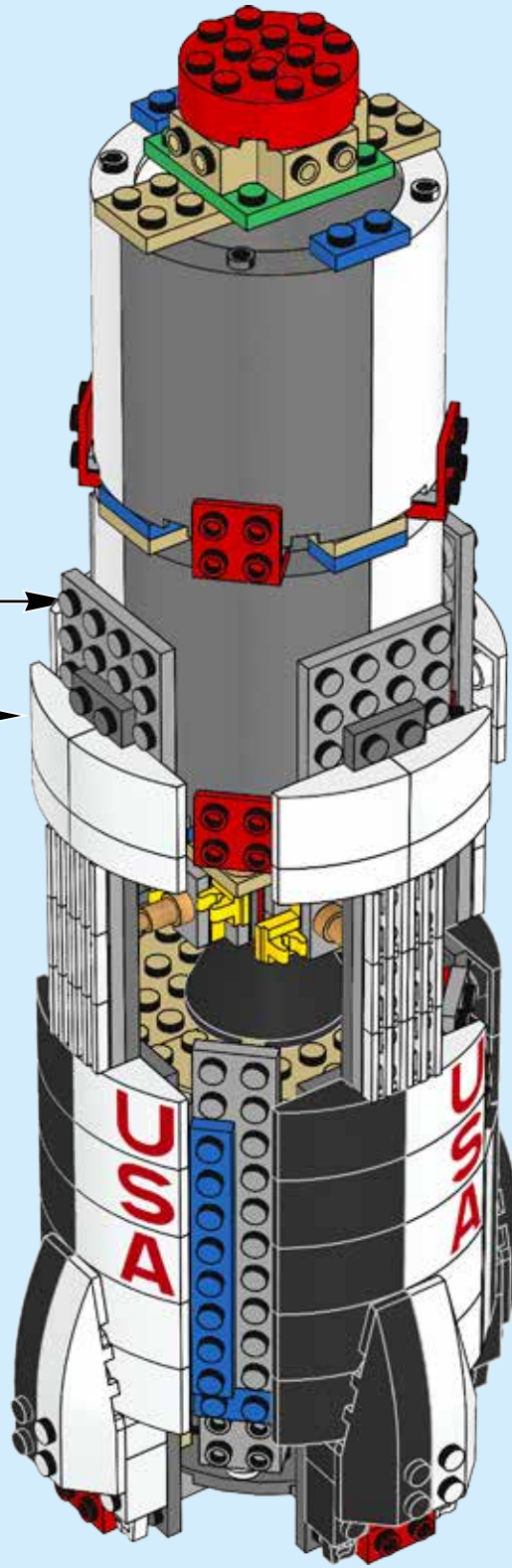

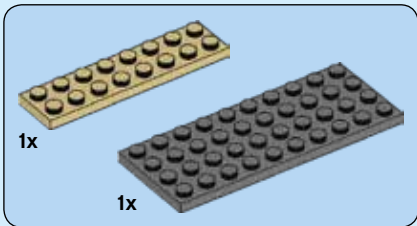
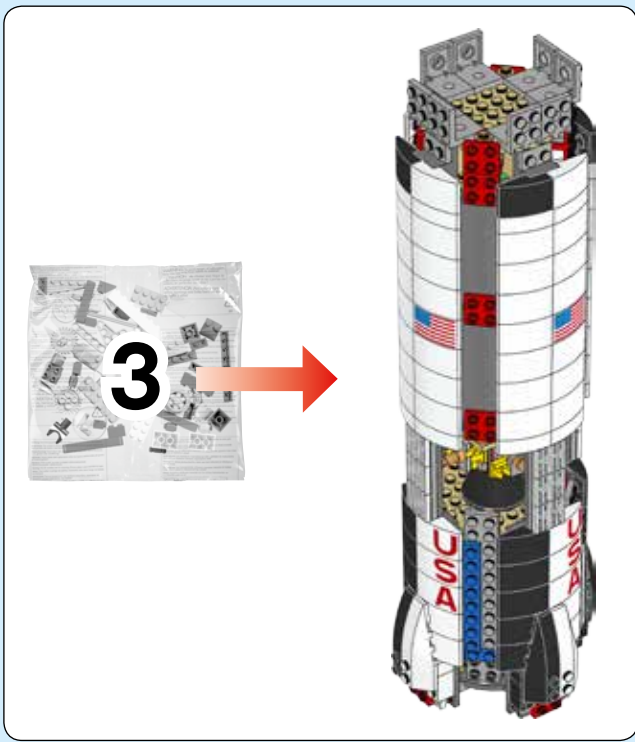

50

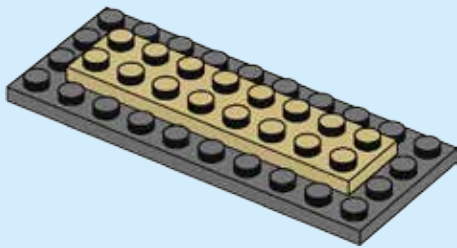

51

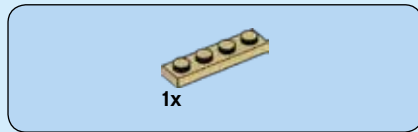
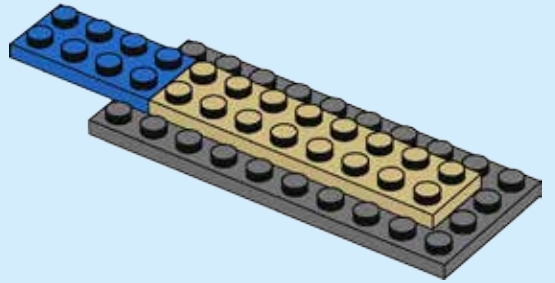

52

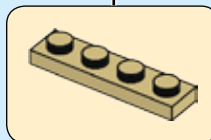
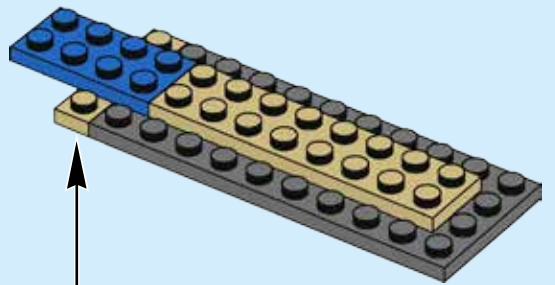



2x

53

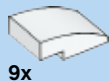
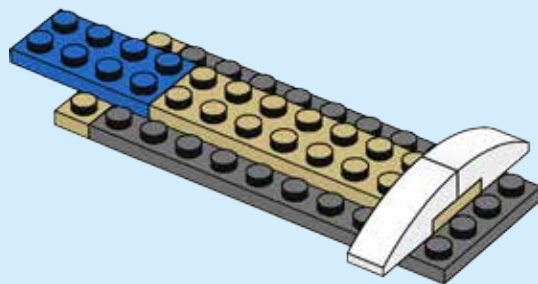

9x



1x

54

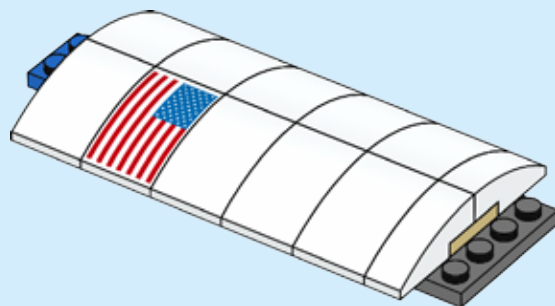

4x

55

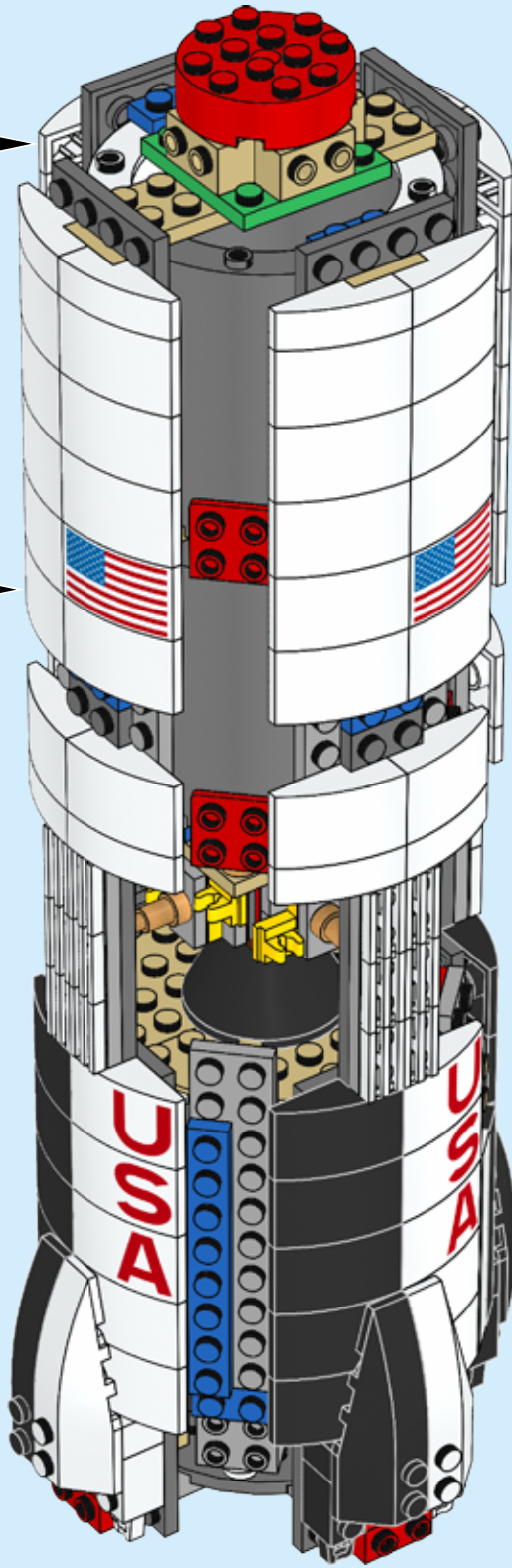

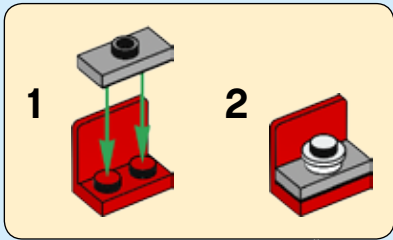
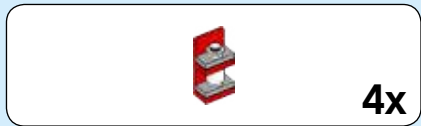

56

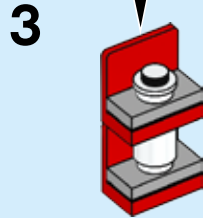
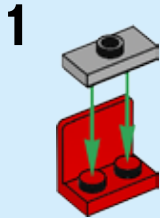

4x

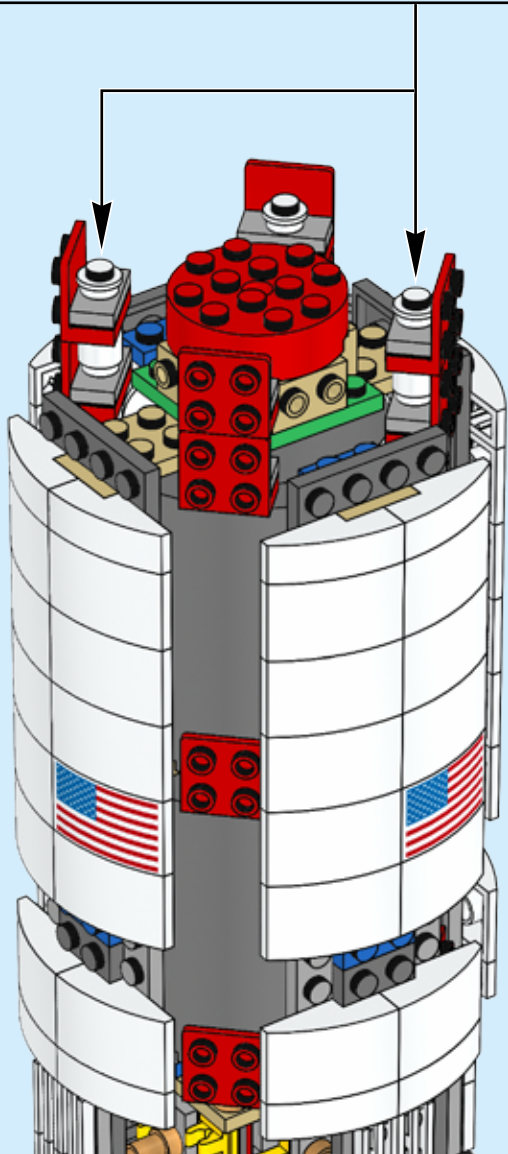

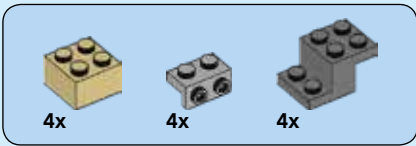

57

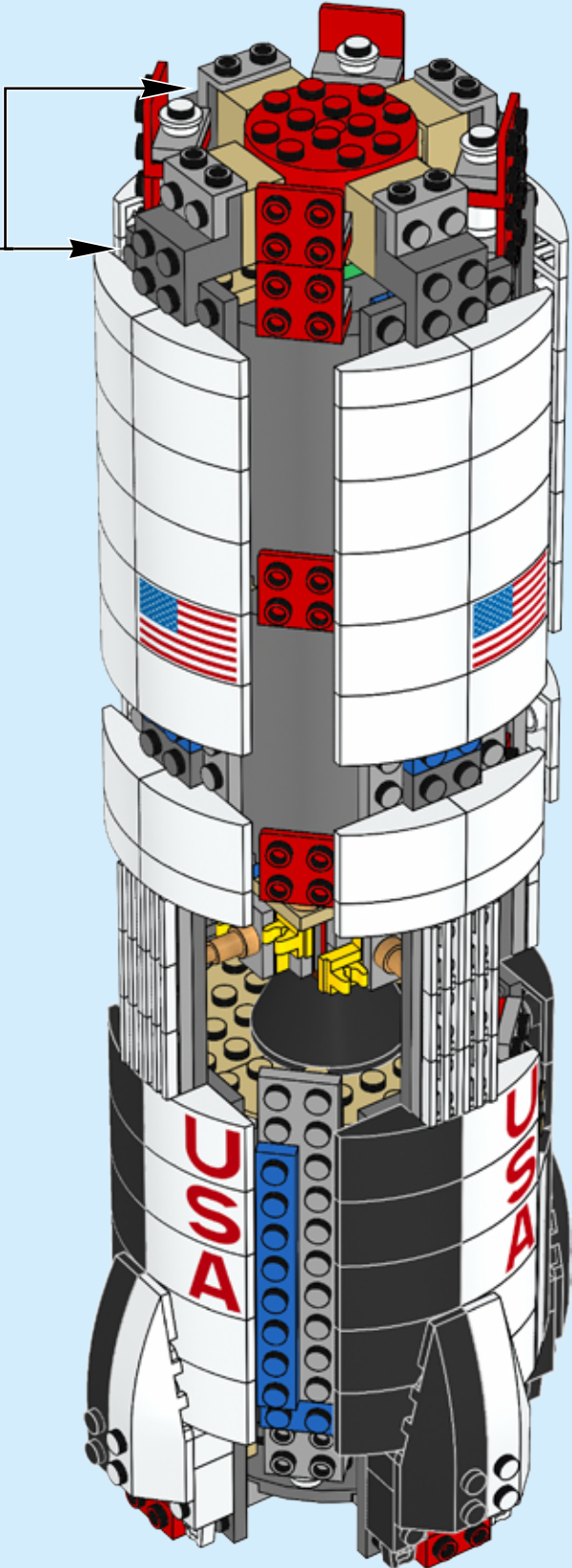
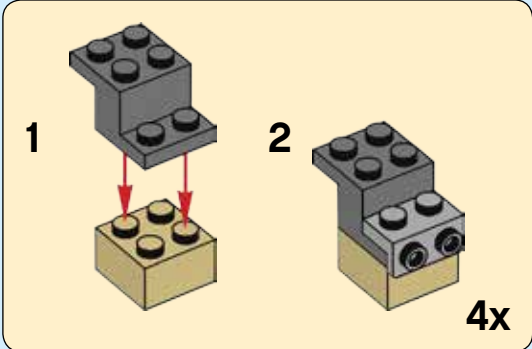

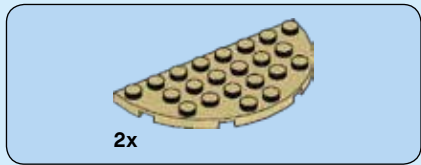

58

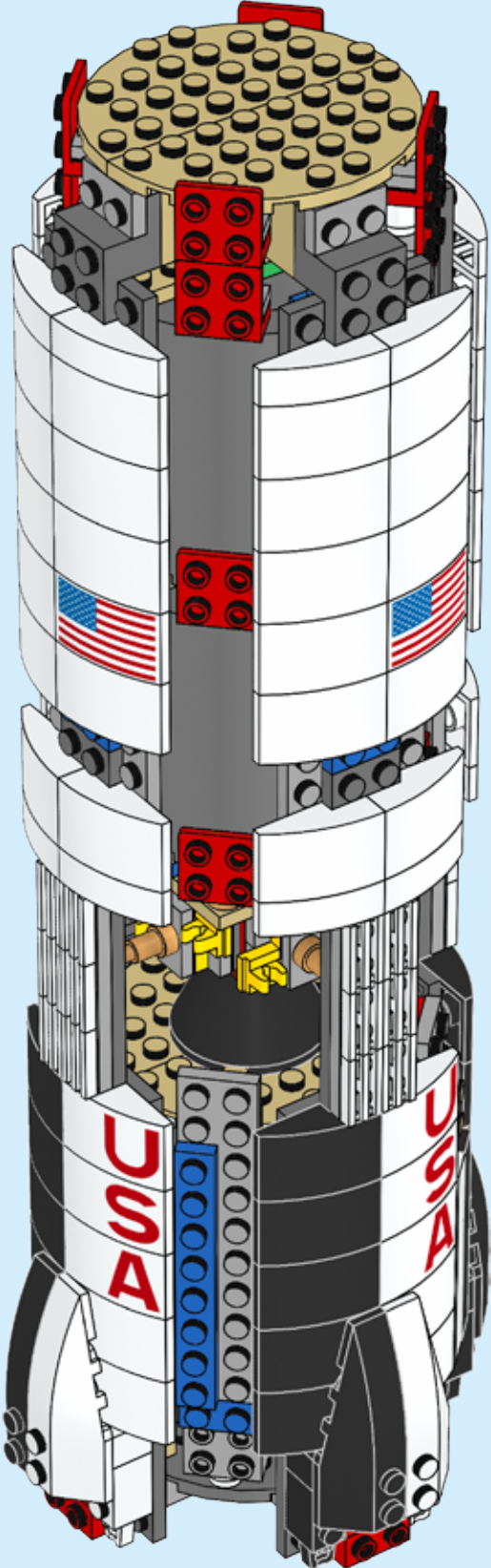

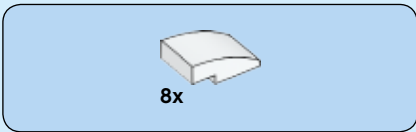

59

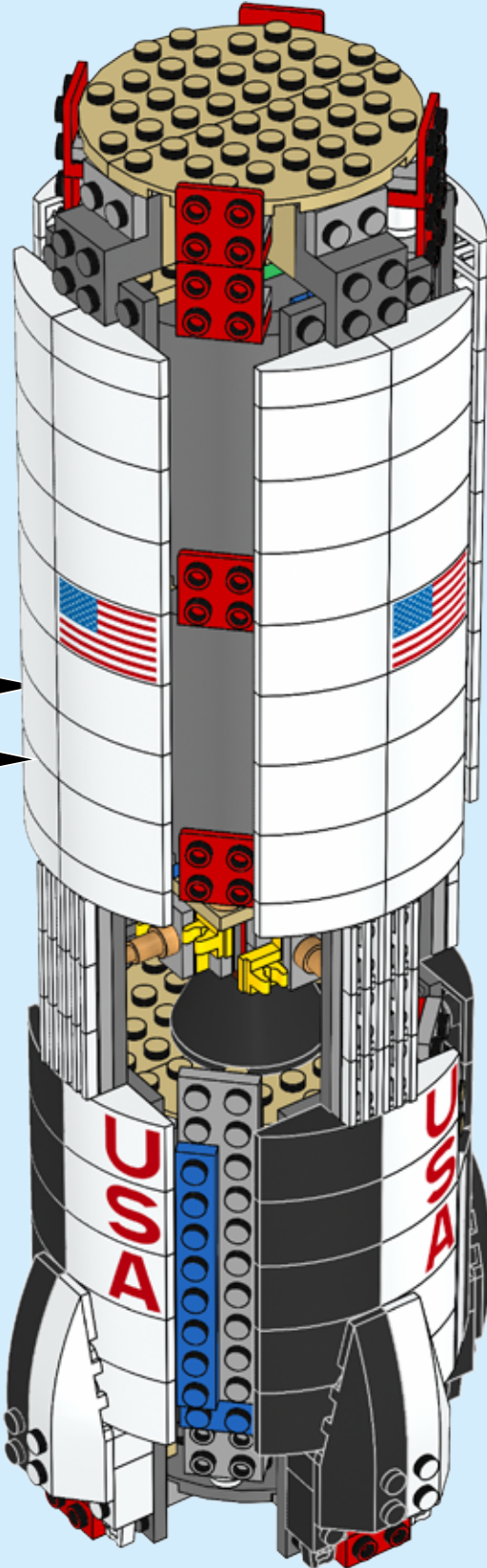
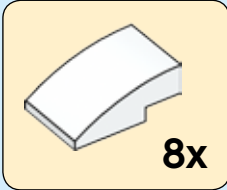

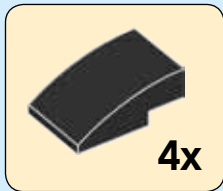
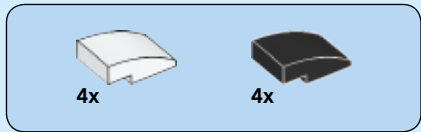

60

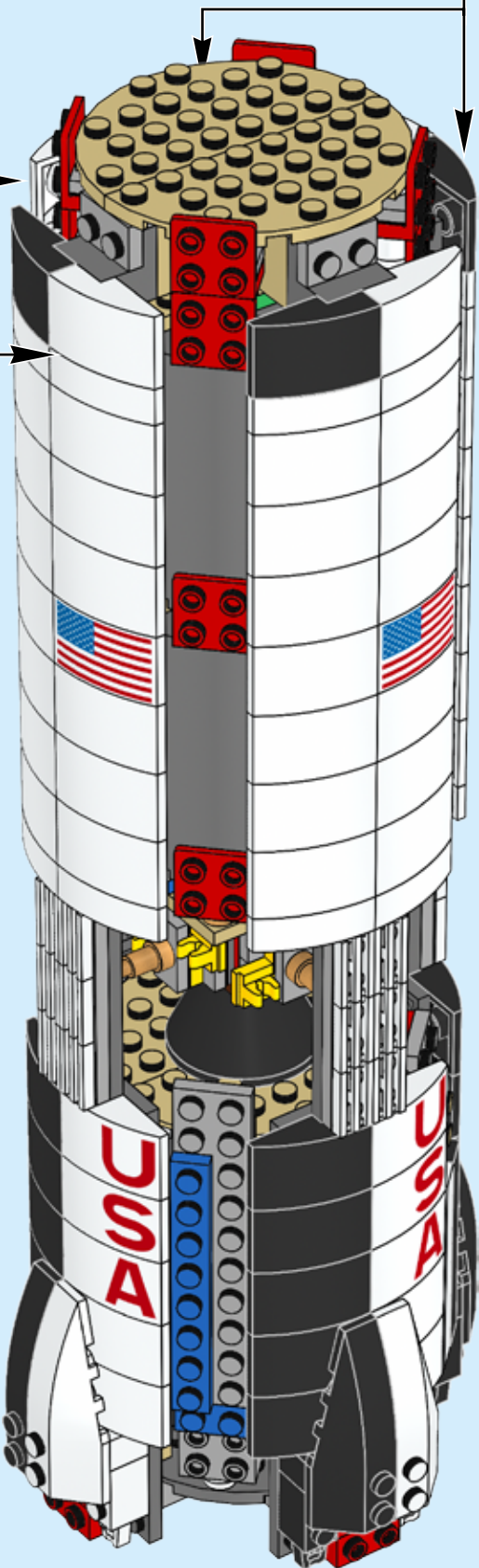
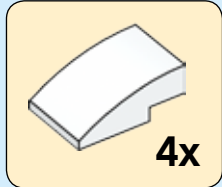



4x

61

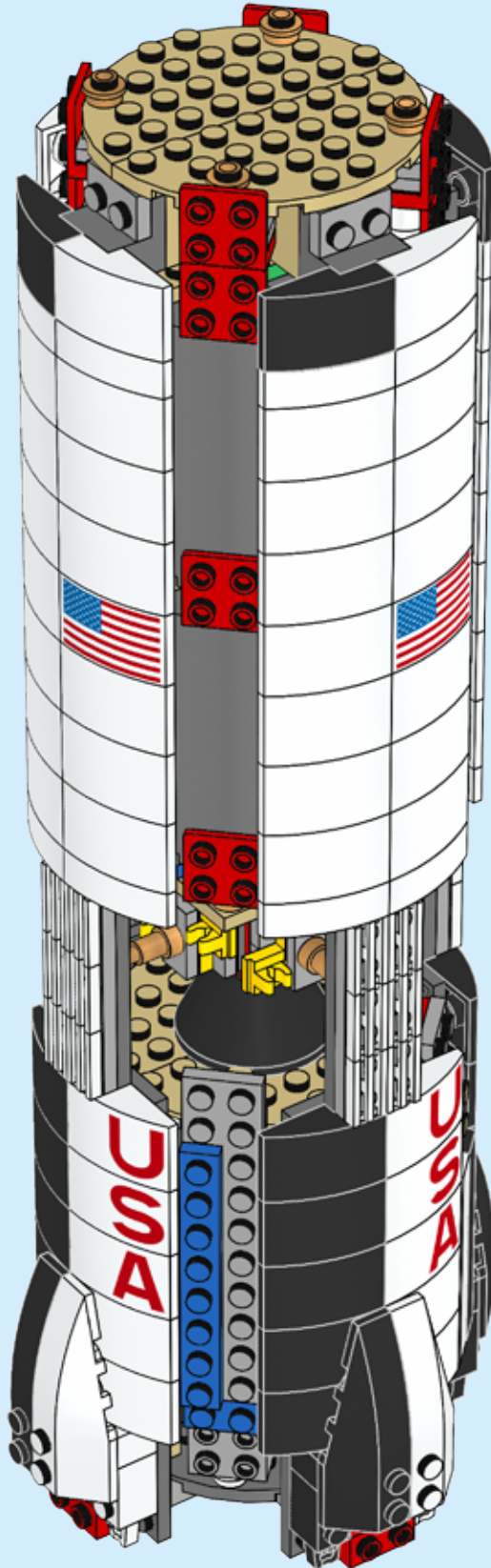



8x

62

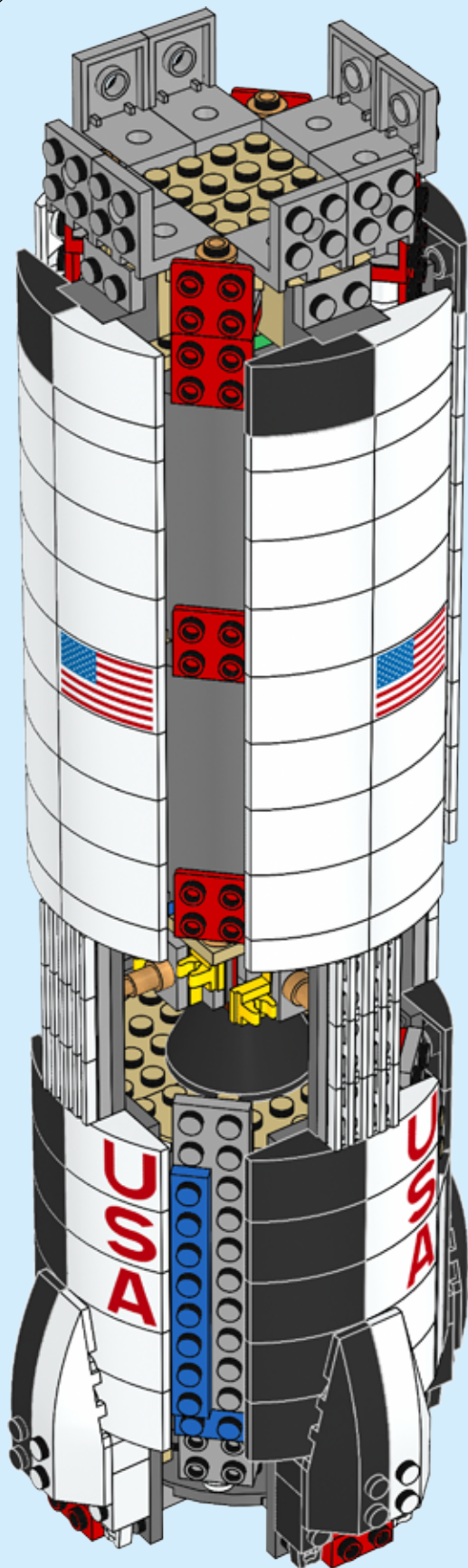

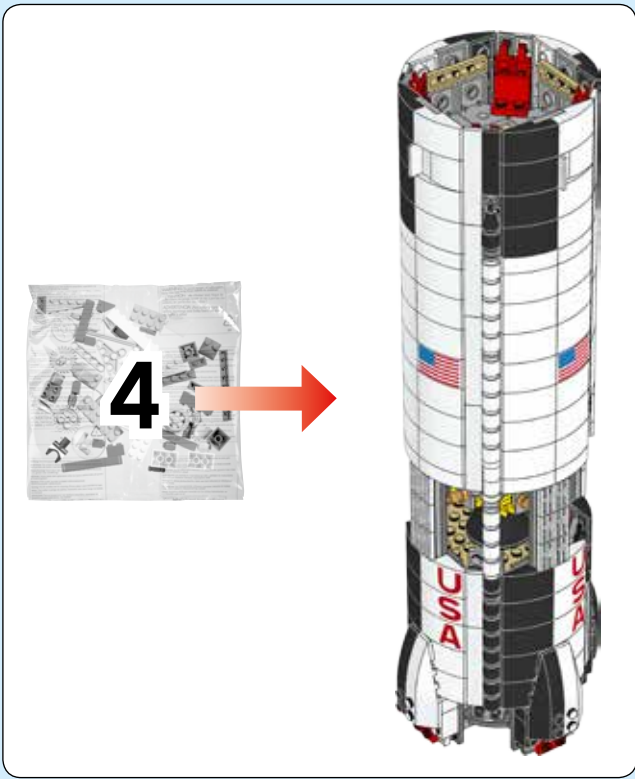

63

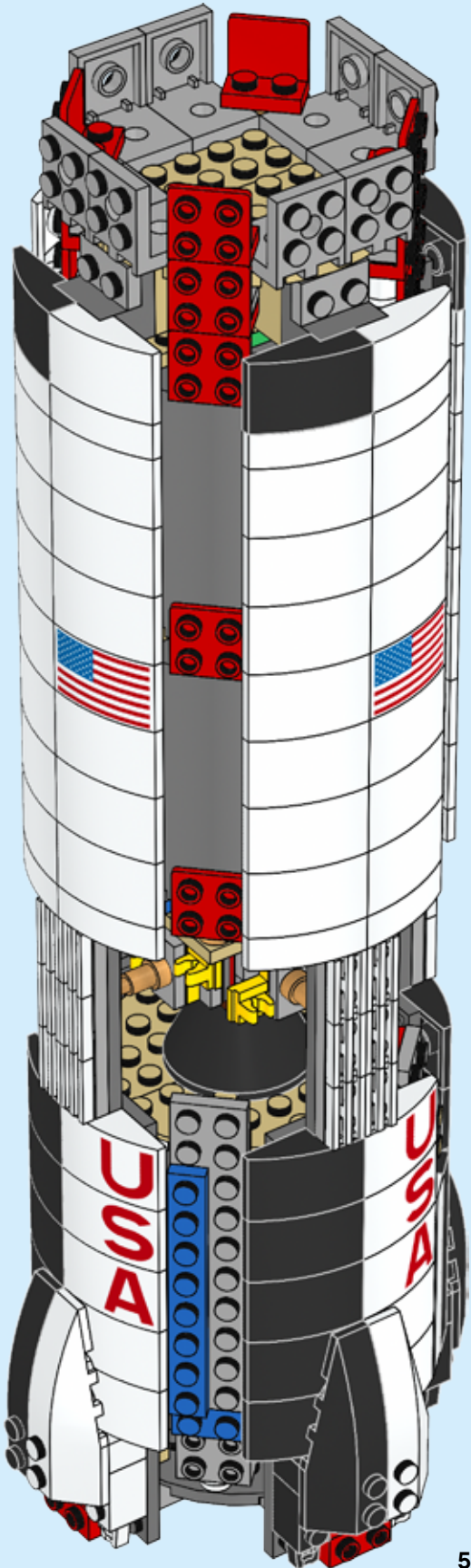

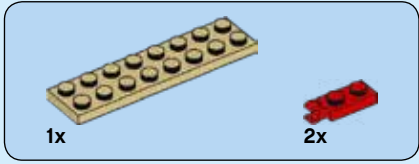
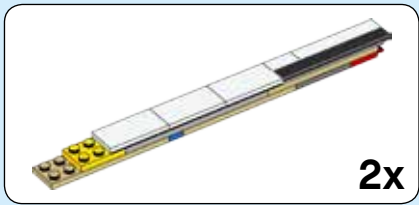

64

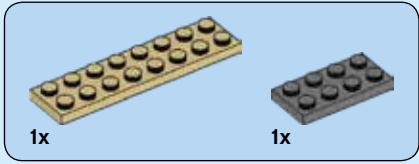
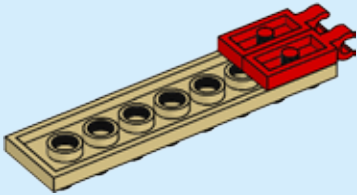

65

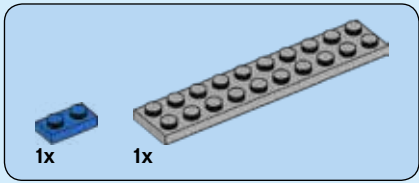
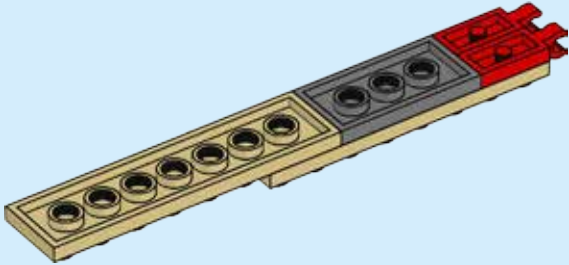

66

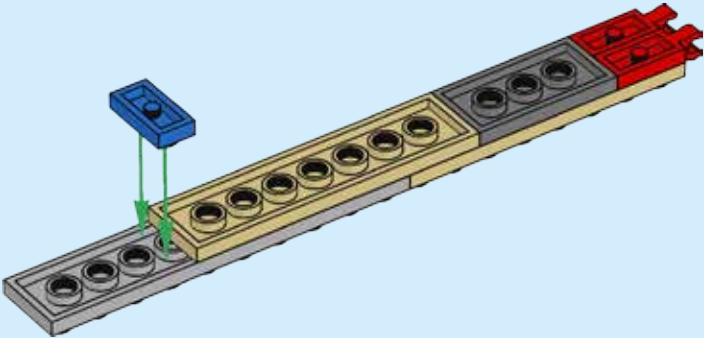

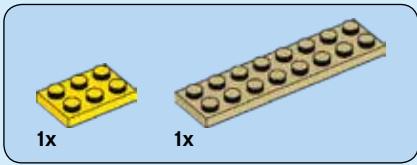

67

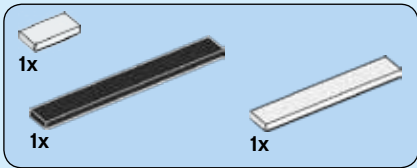
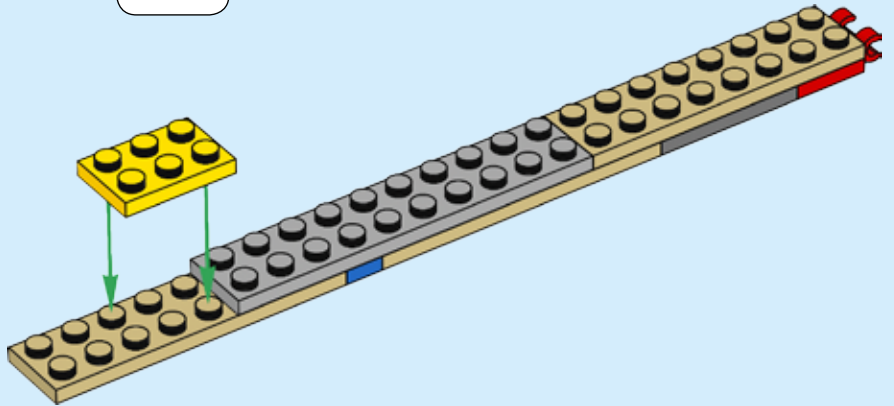

68

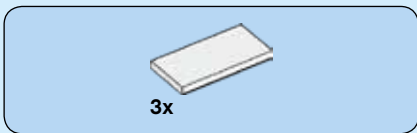
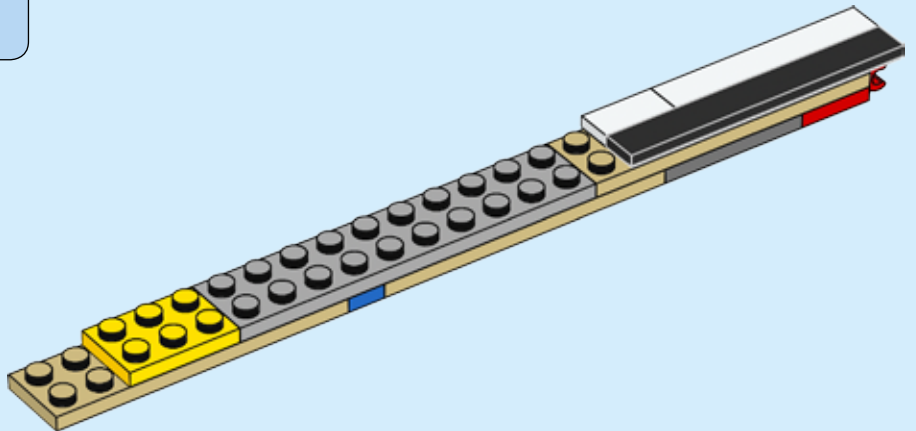

69

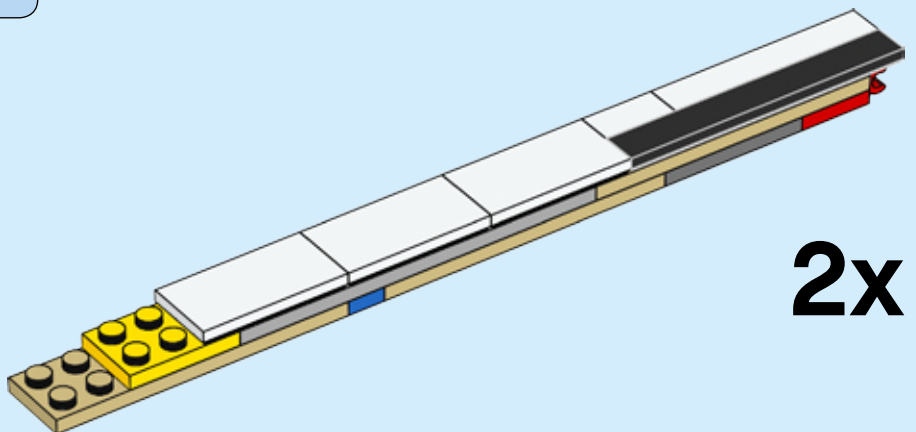

70

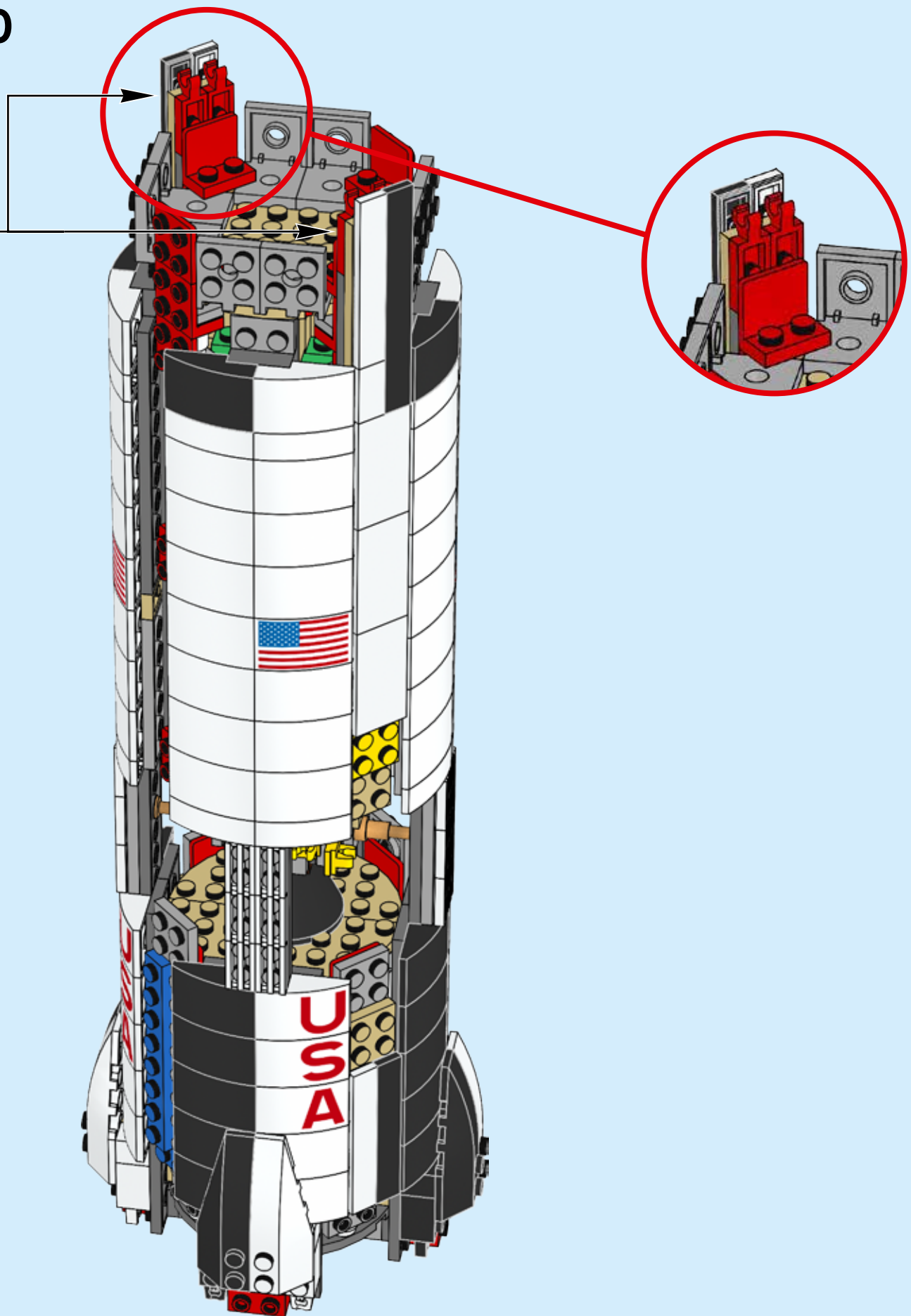

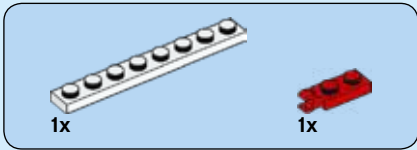
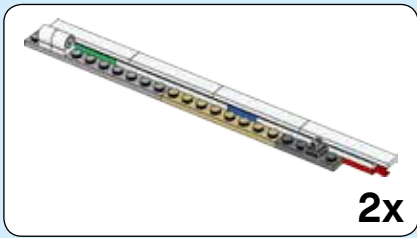

71

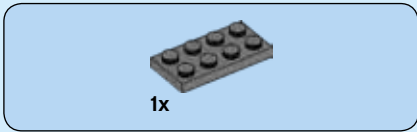
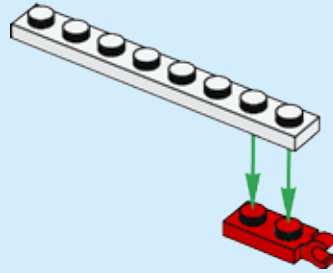

72

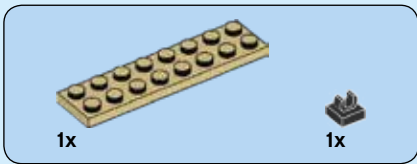
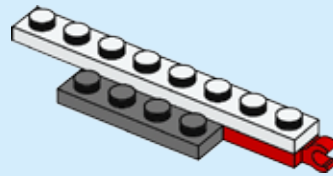

73

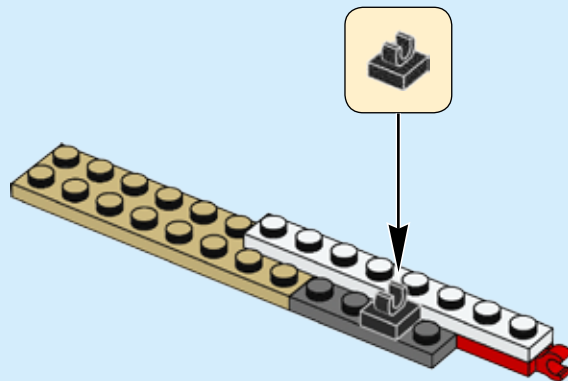

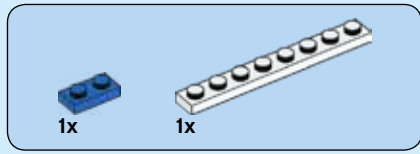

74

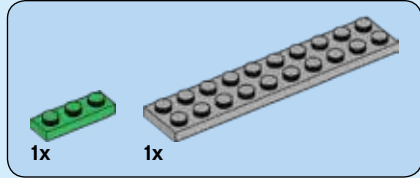
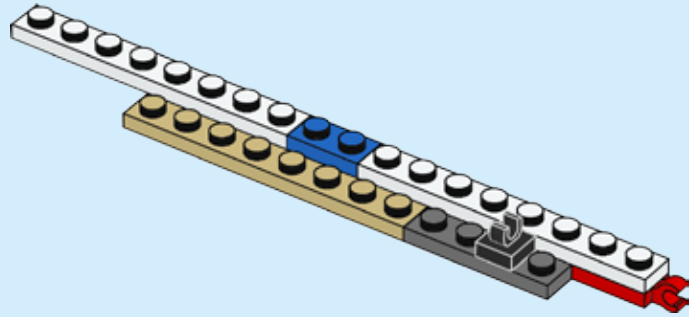

75

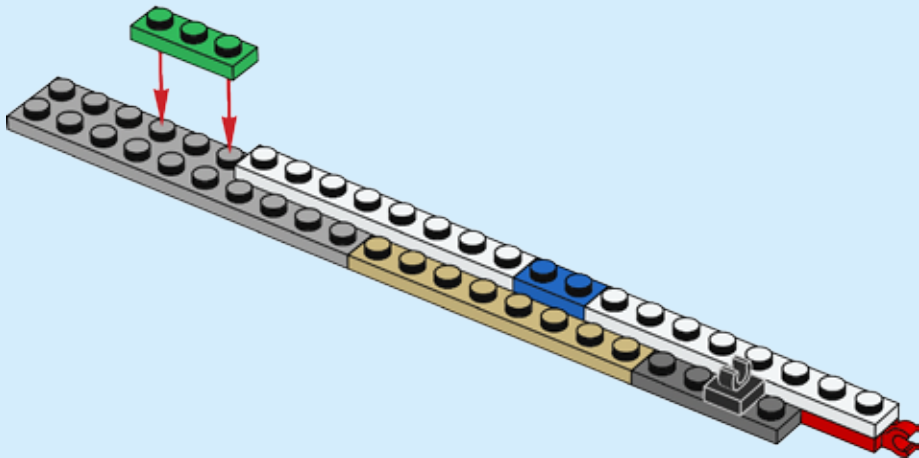

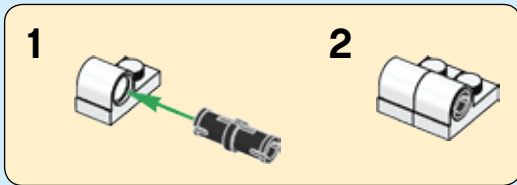
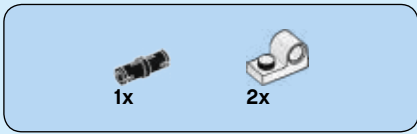

76

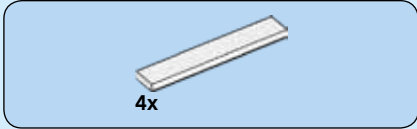
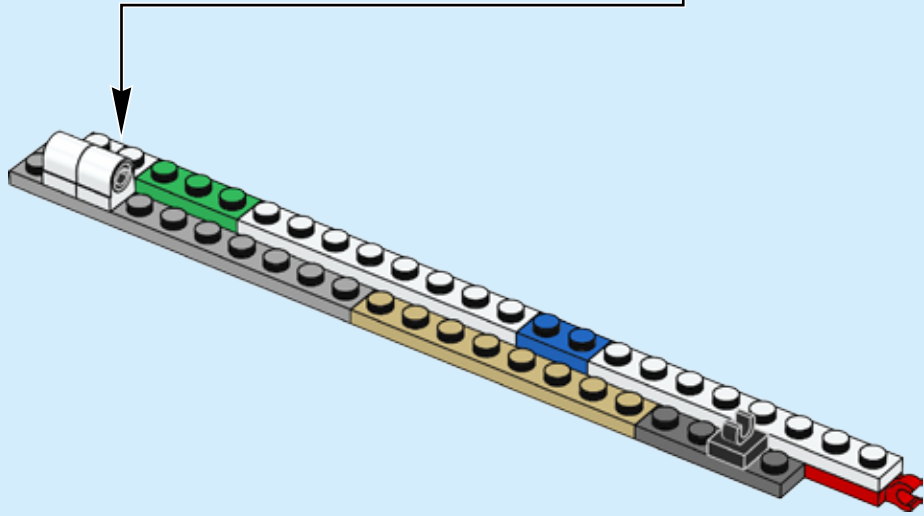

77

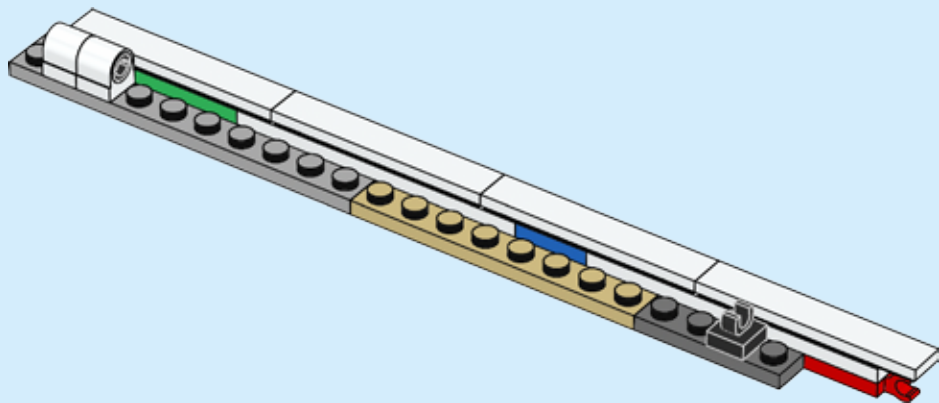

2x

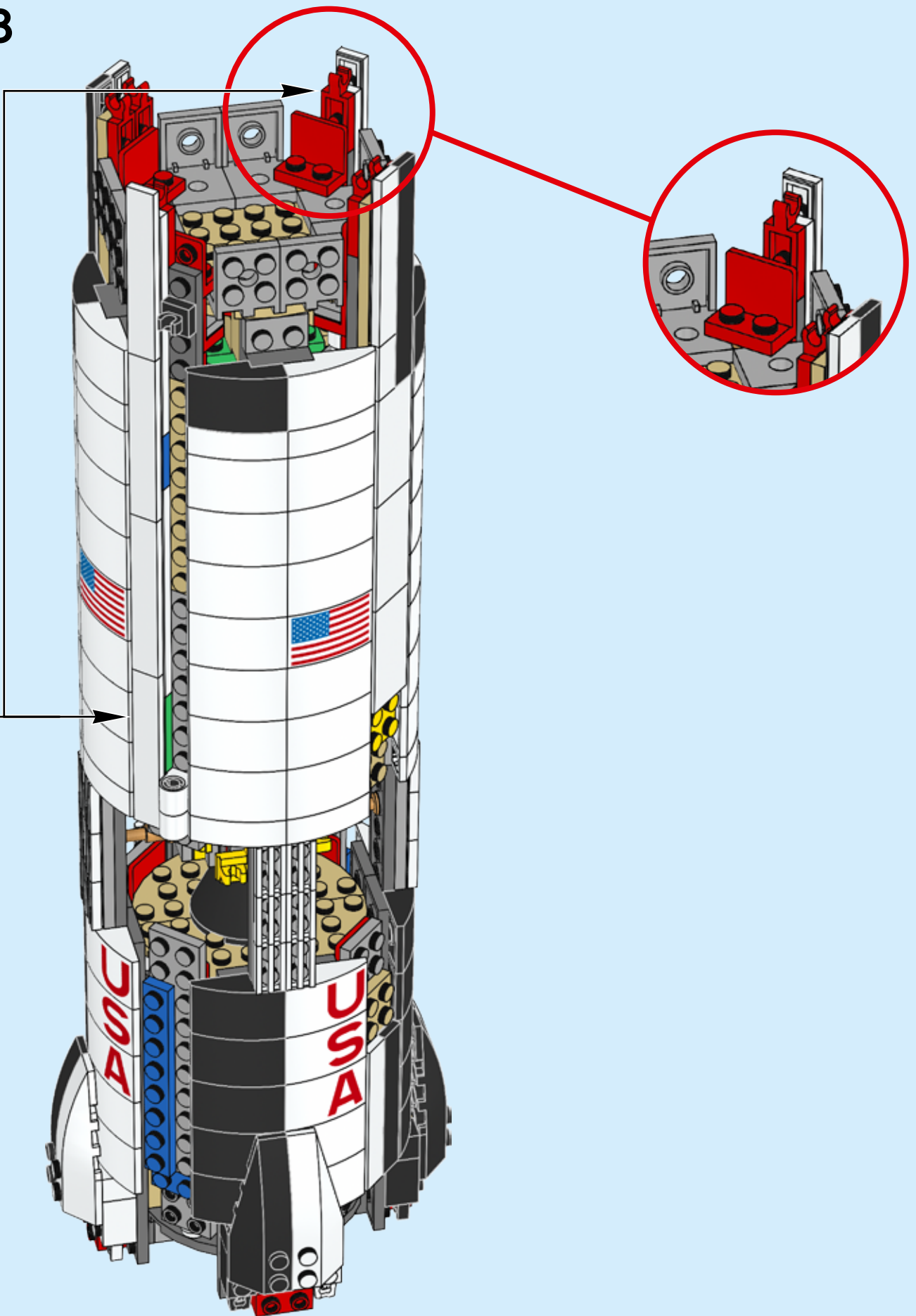

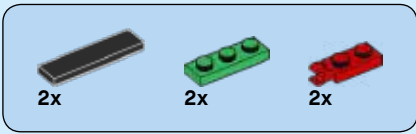

79

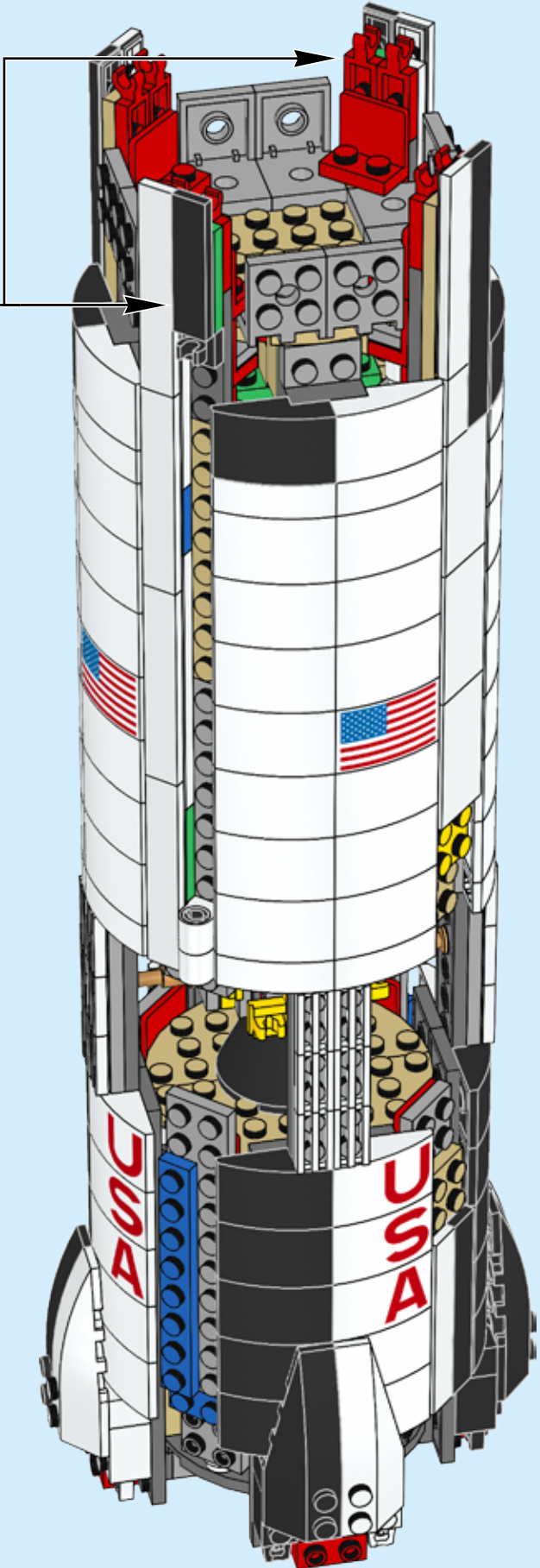
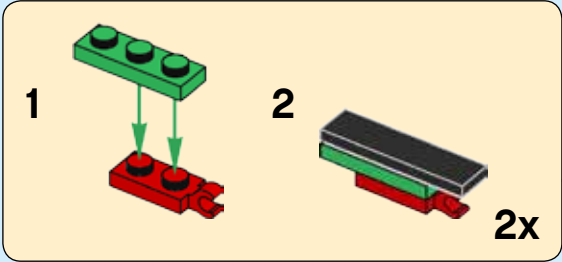

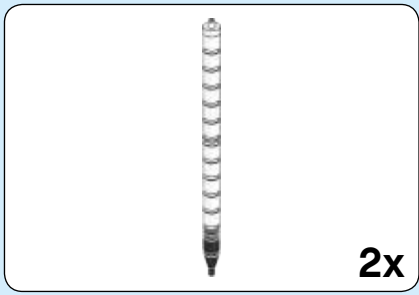

80

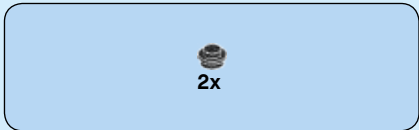

81

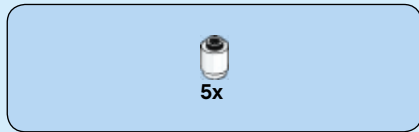

82

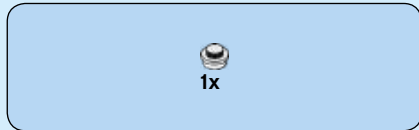

83



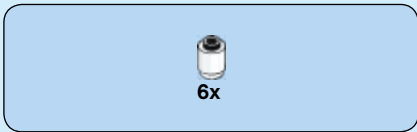

84

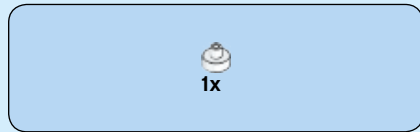

85



2x

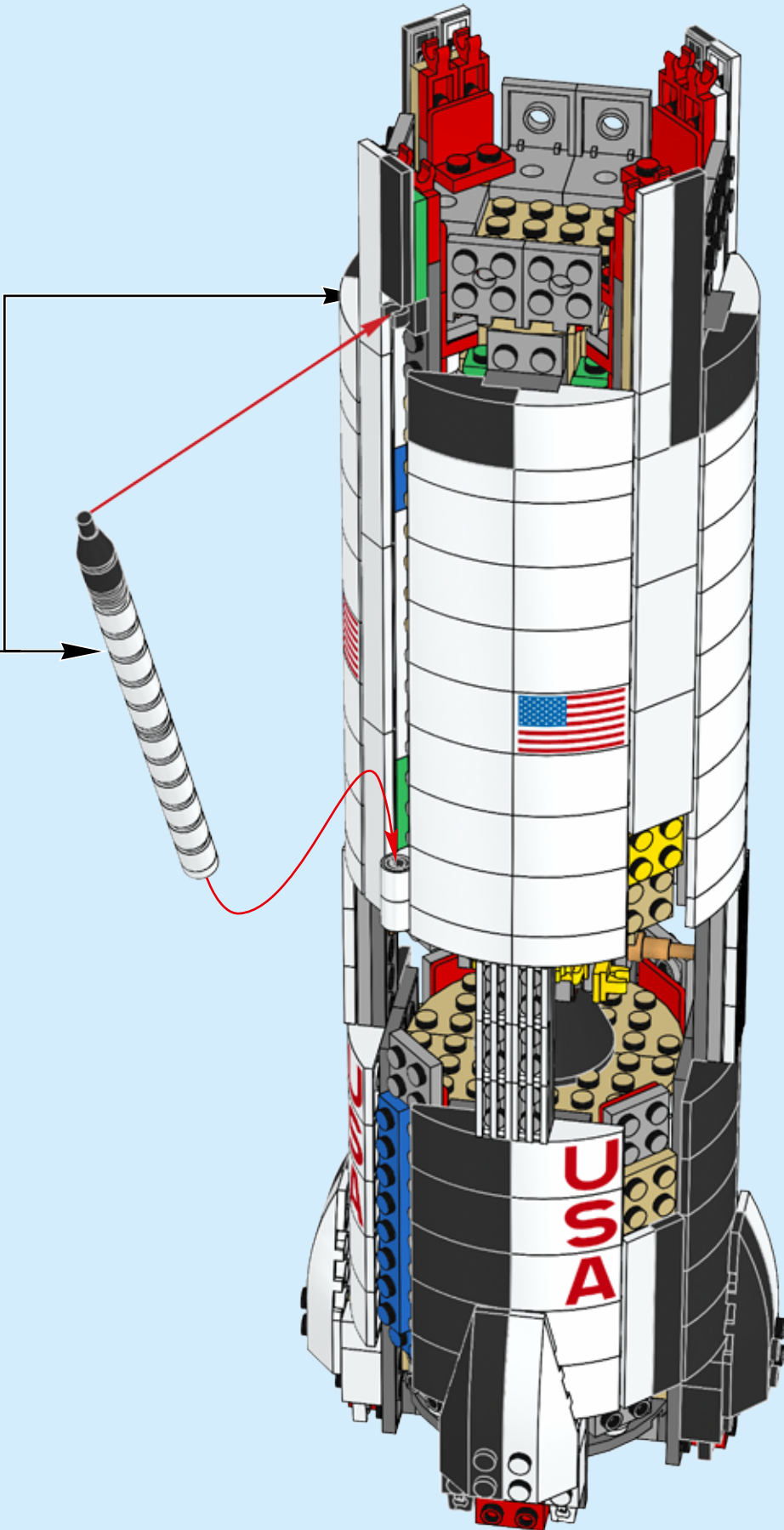

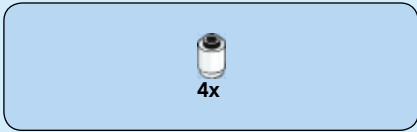

87

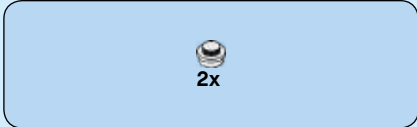

88

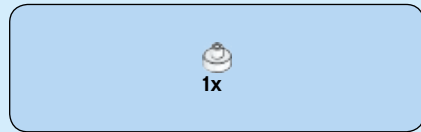

89

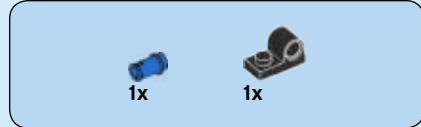

90

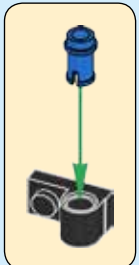

2x

91

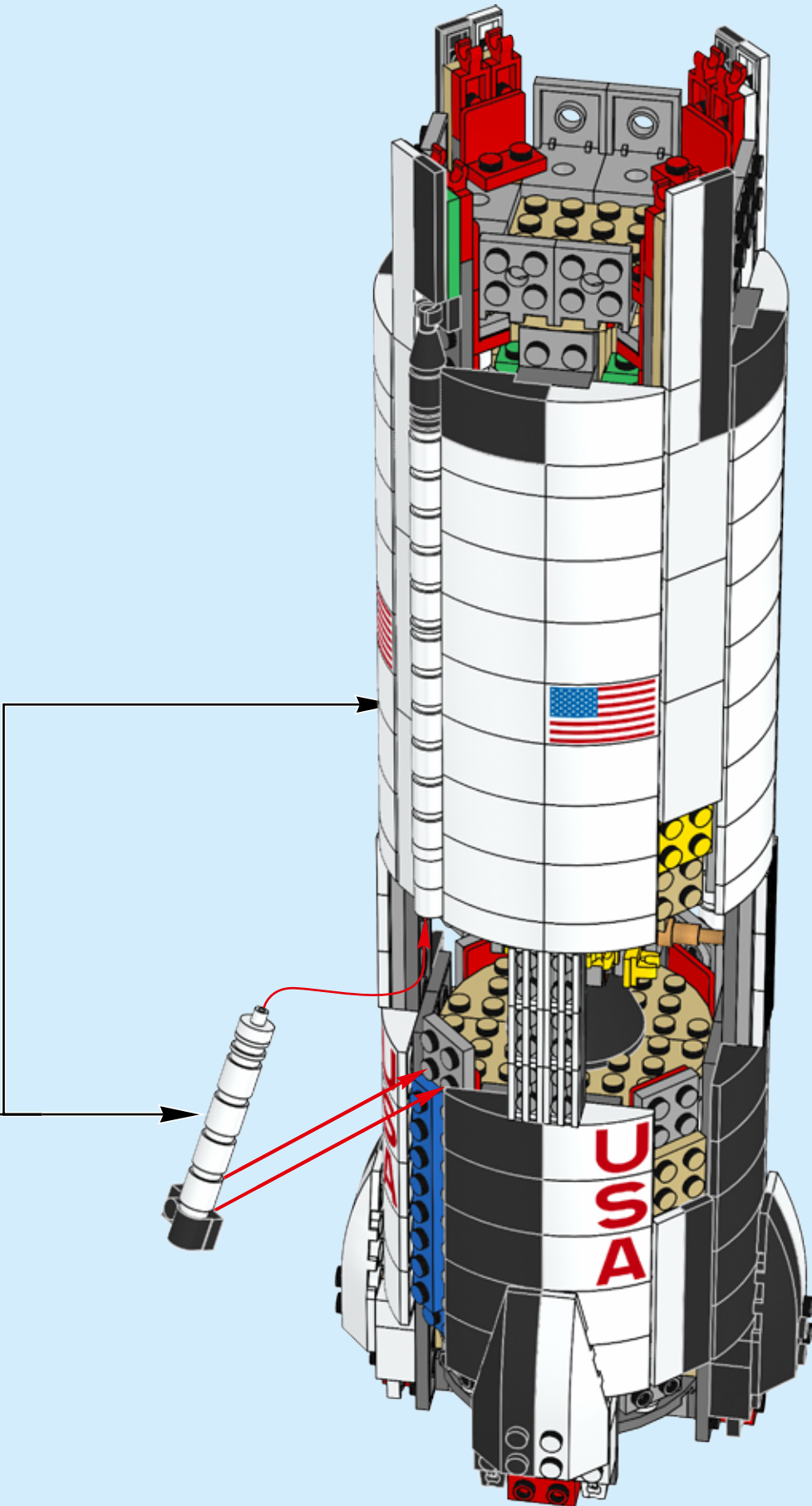



92

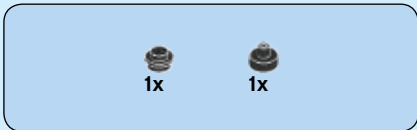

93

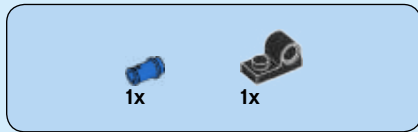

94

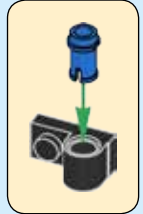

2x

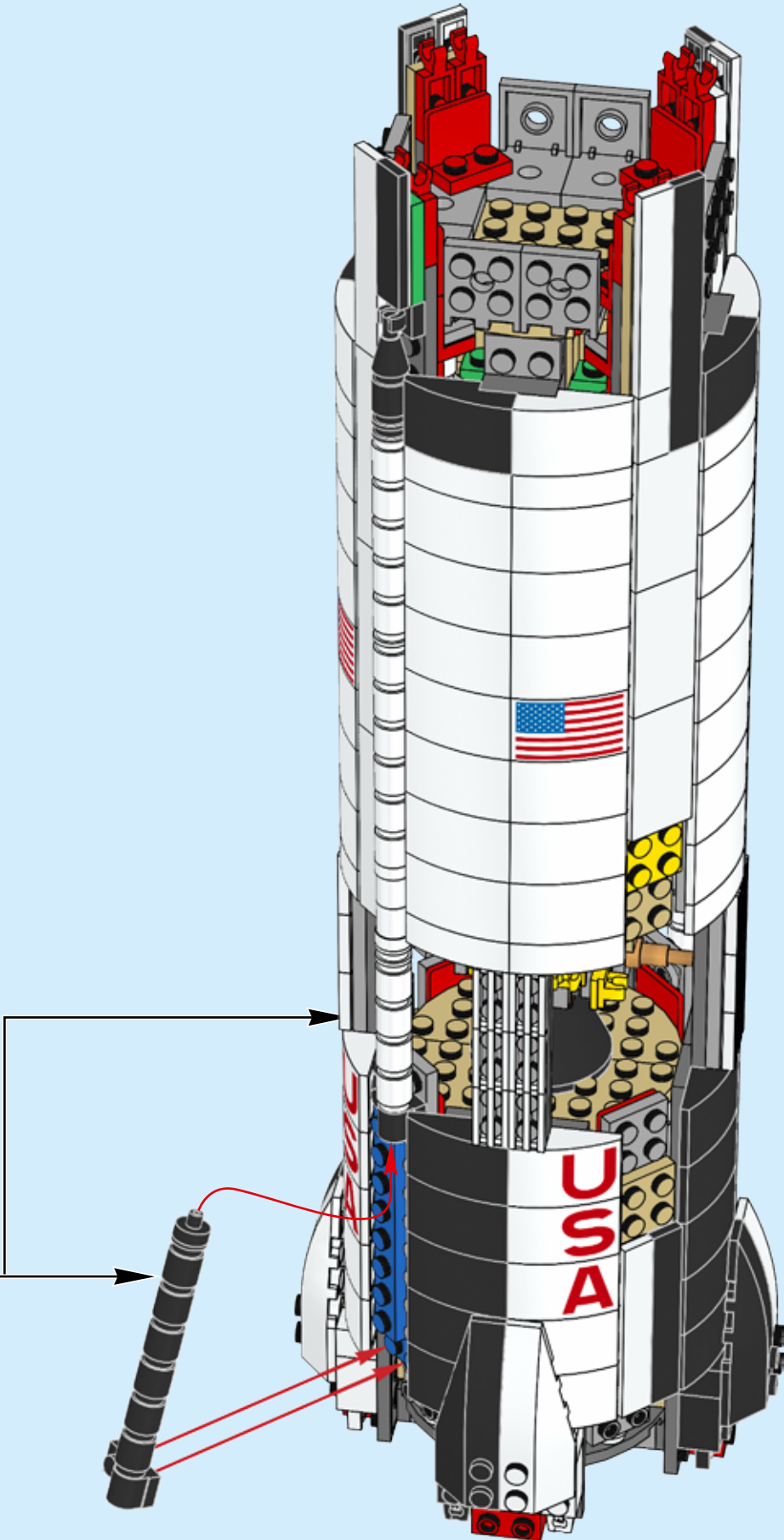

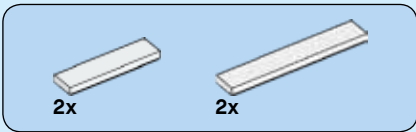

96

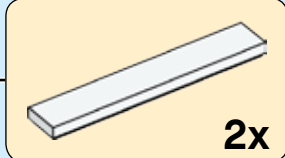
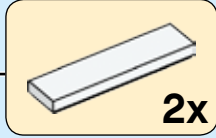
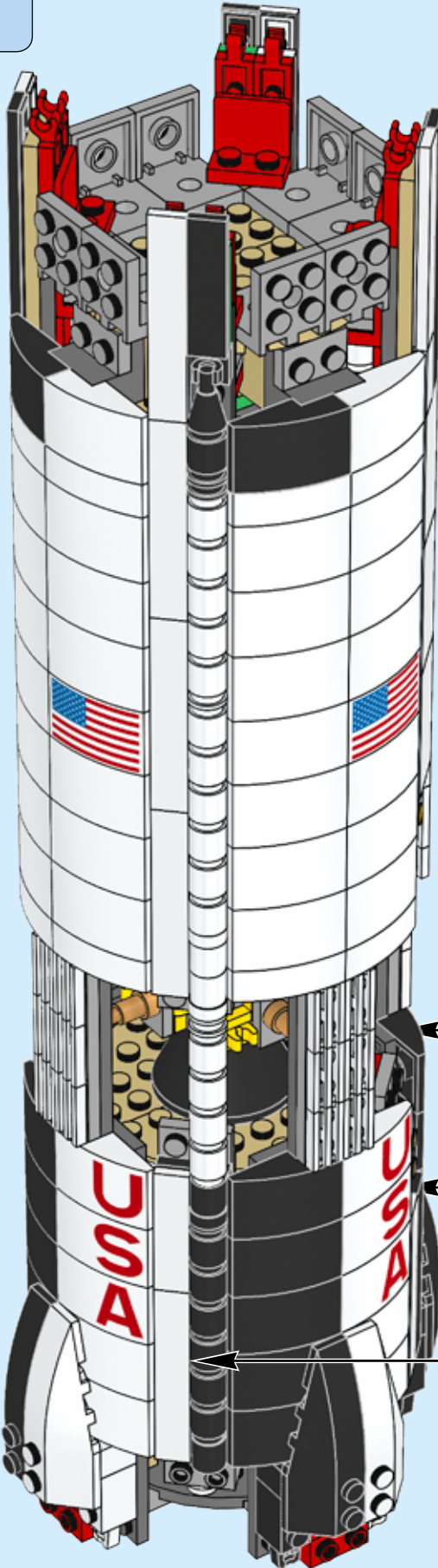

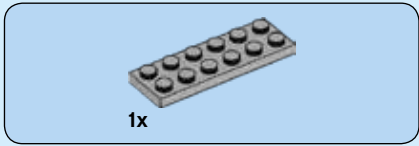

97

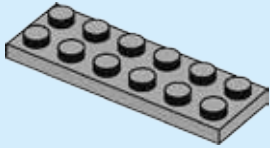

98

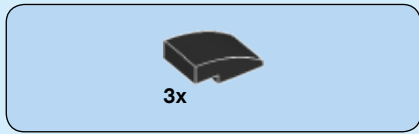
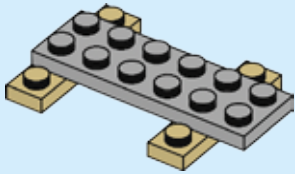

99

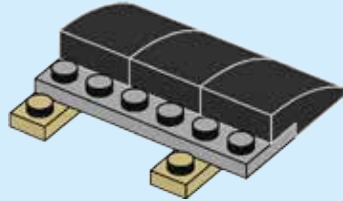

100

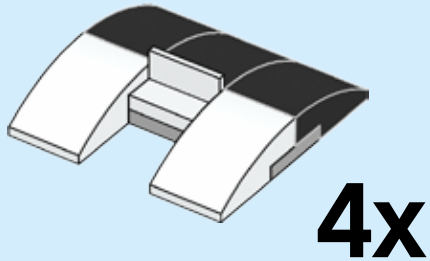

101

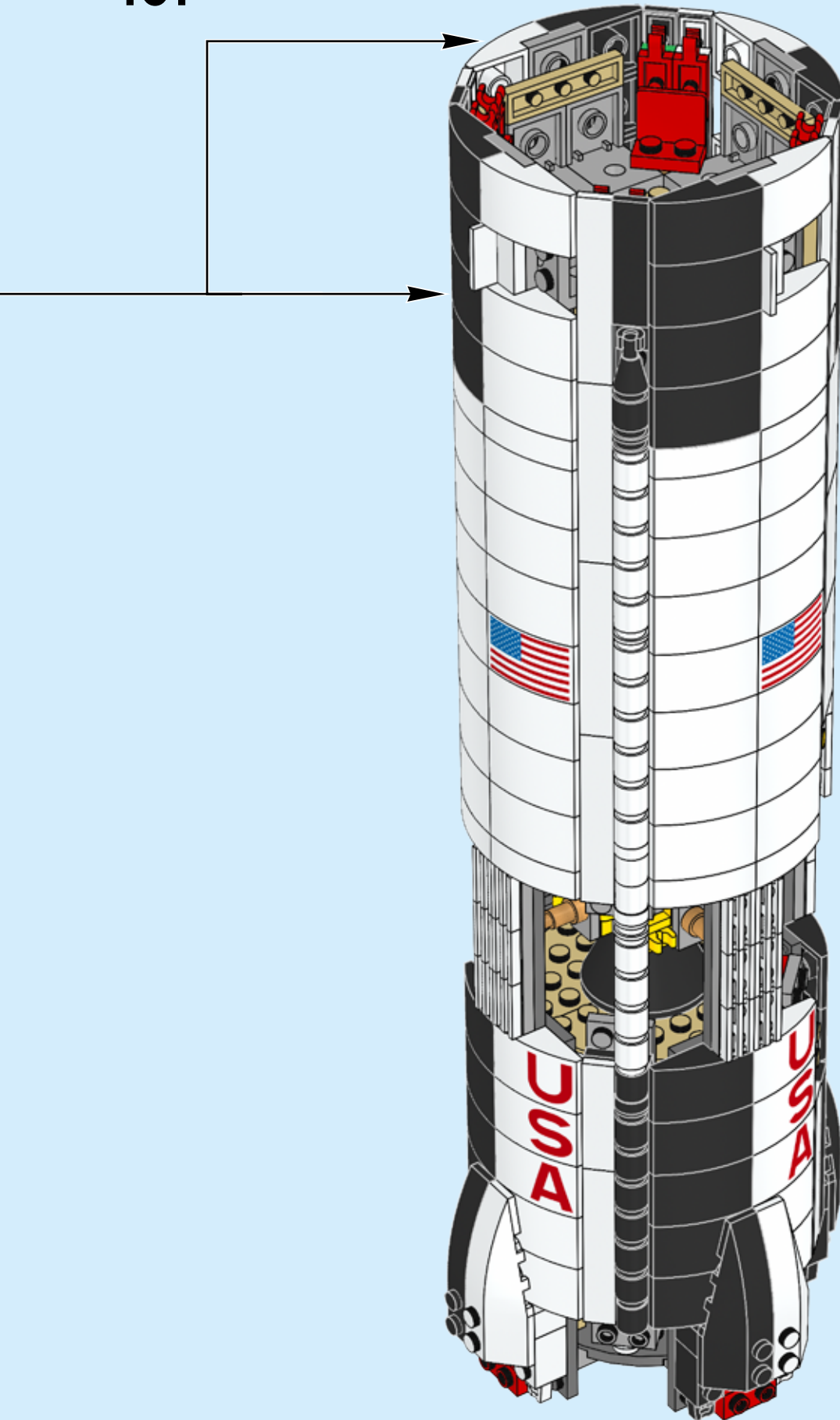

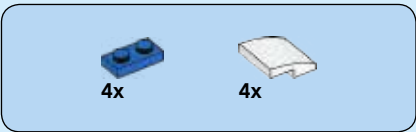

102

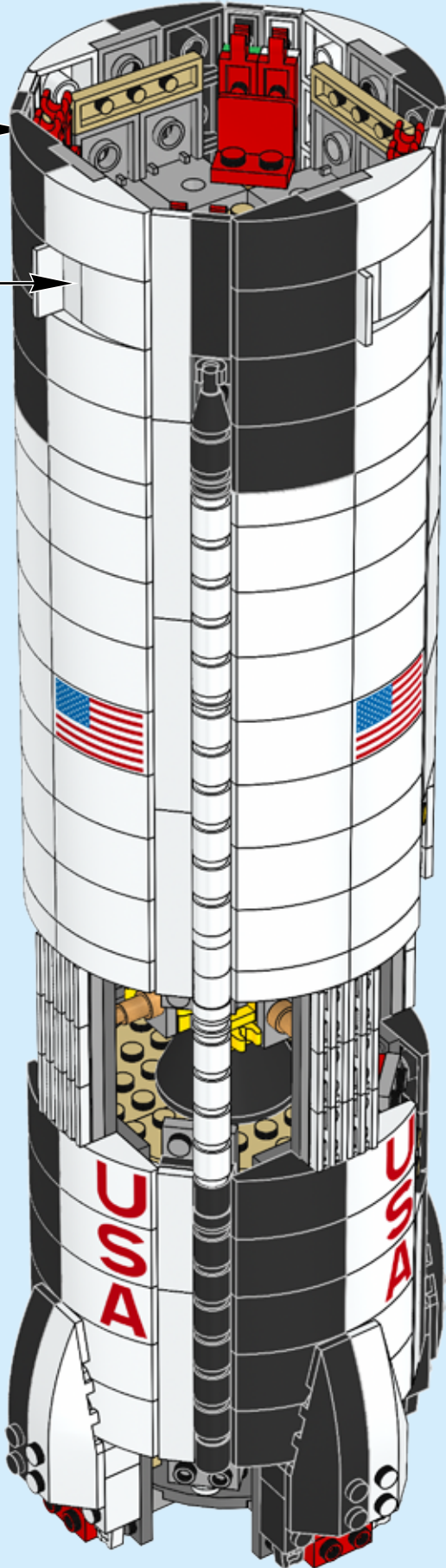
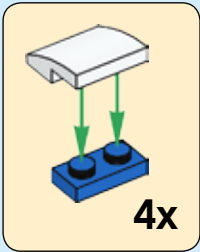

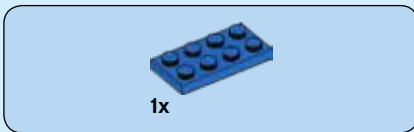
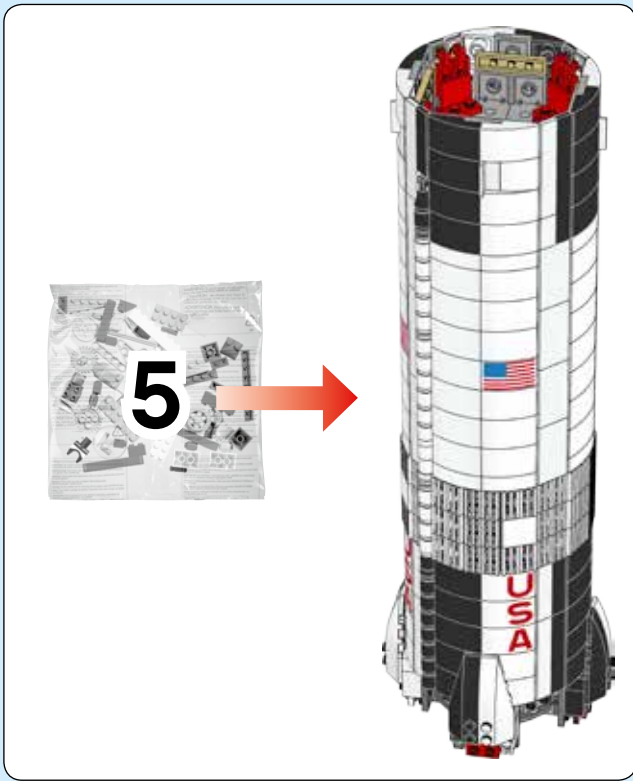

103

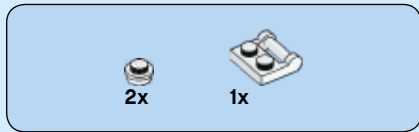

104

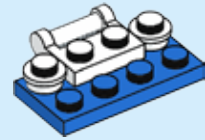

105

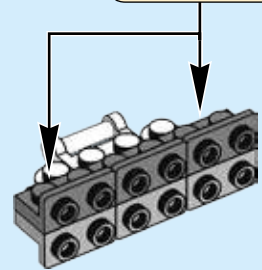
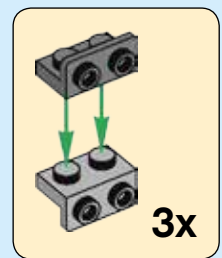



2x

106

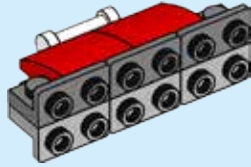

4x



1x

107

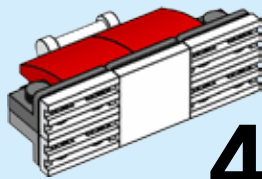

4x

108

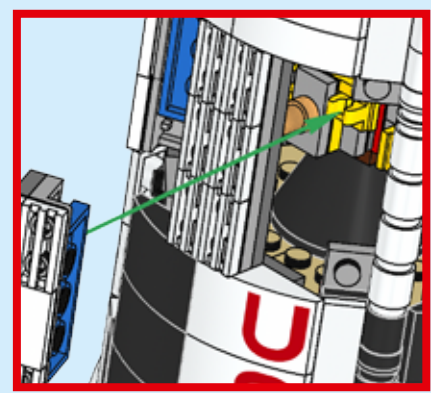
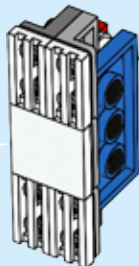
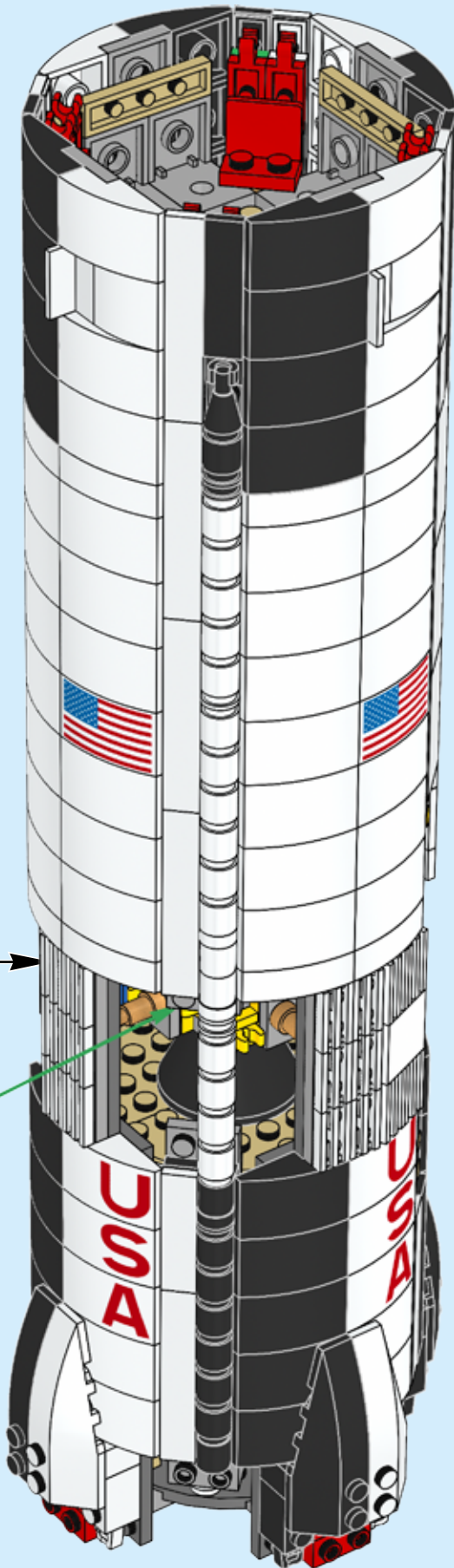

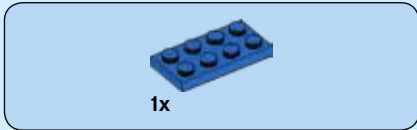

109

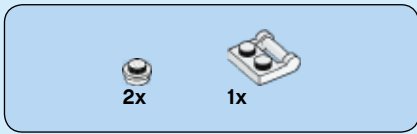

110

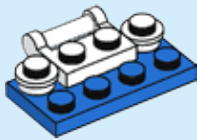

111

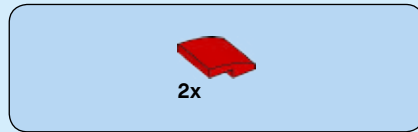
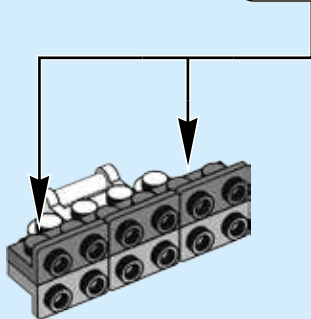
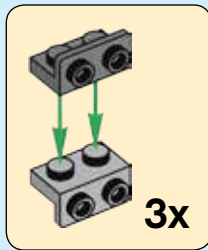

112

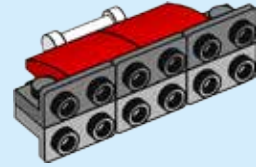

113

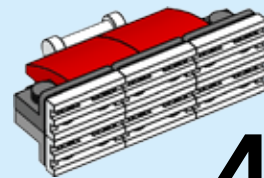

4x

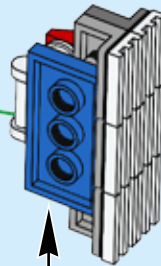
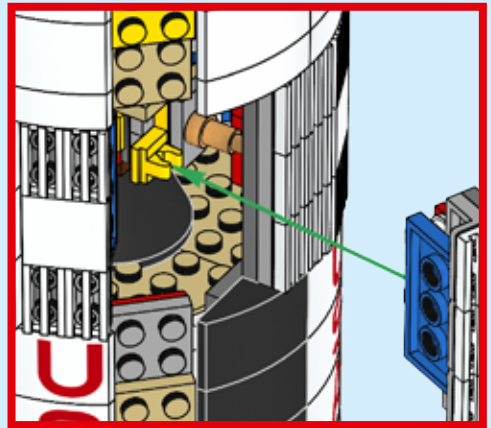
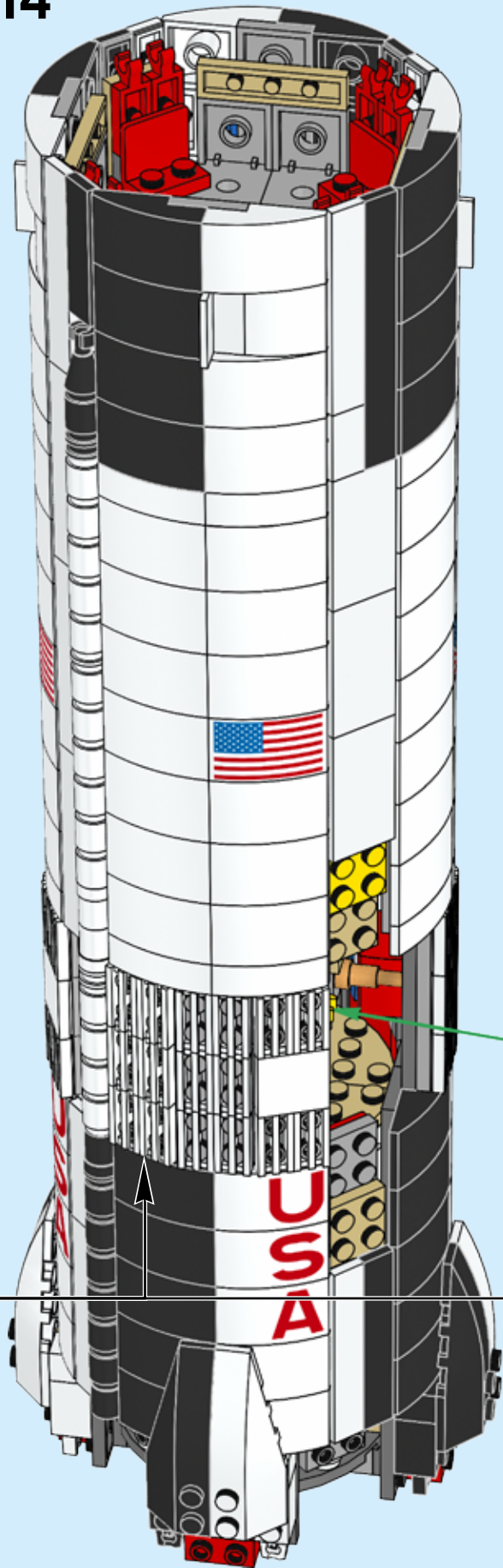

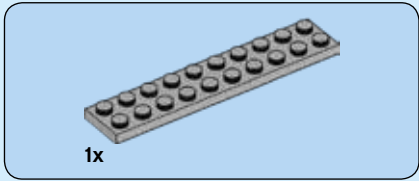
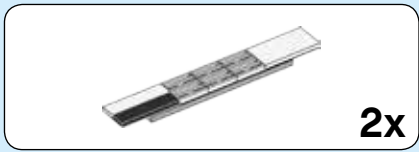

115

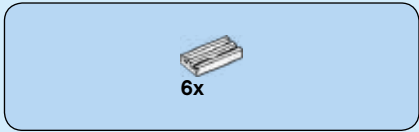
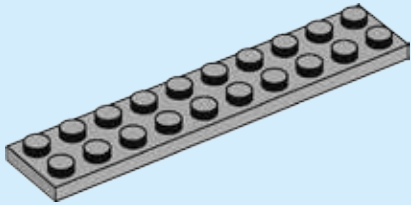

116

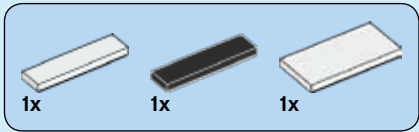
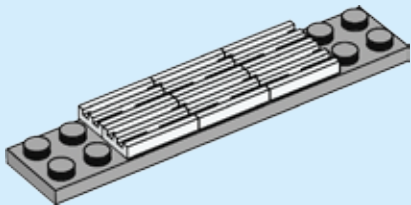

117

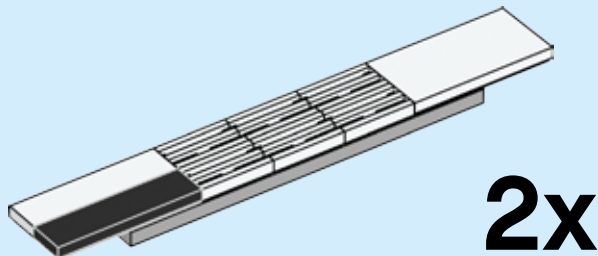

118

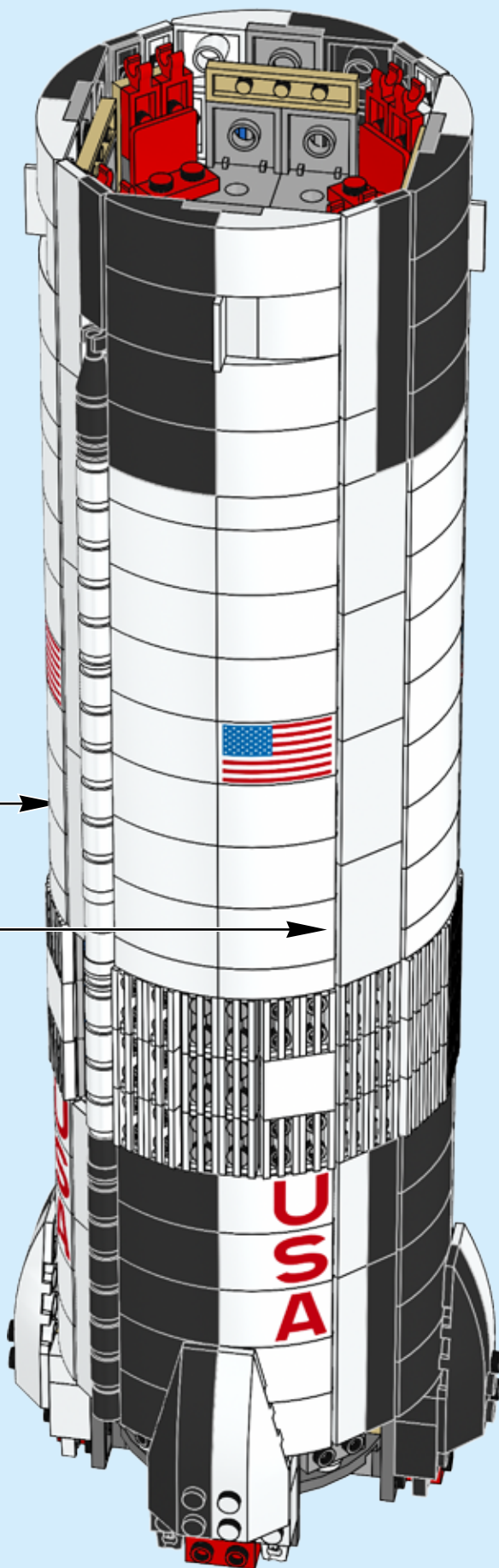

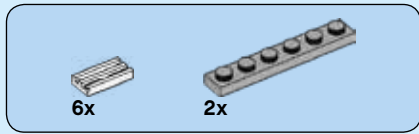

119

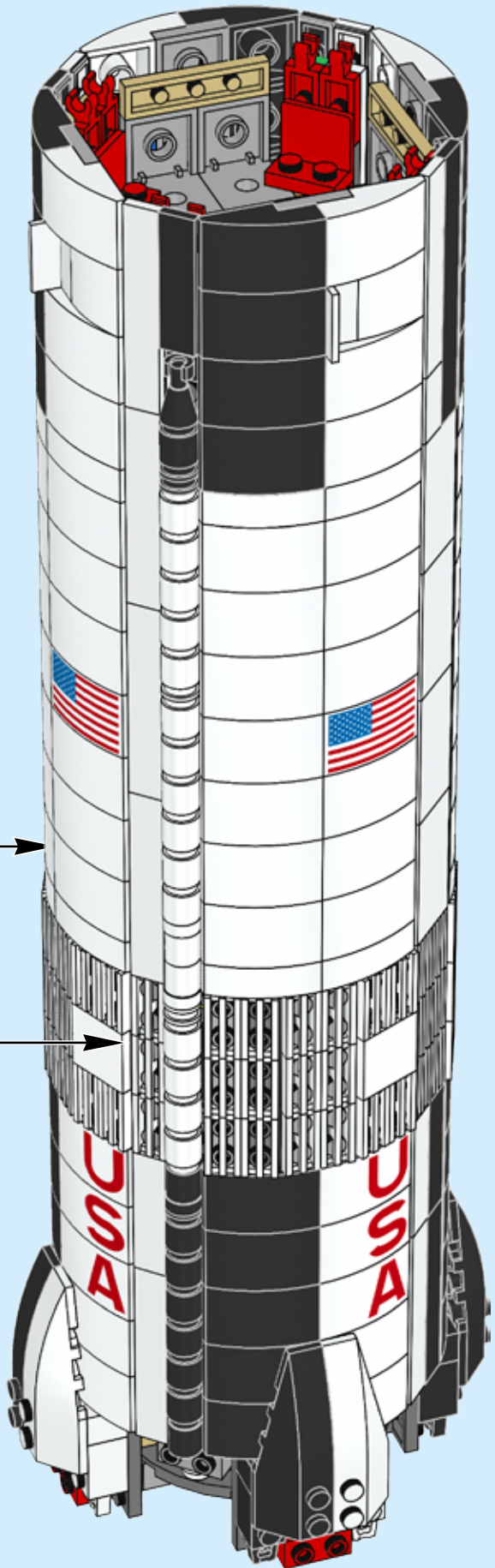
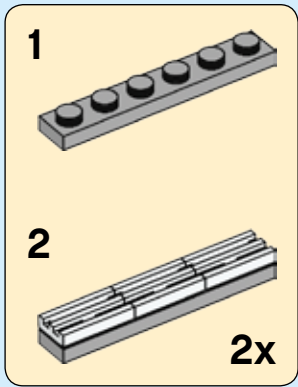

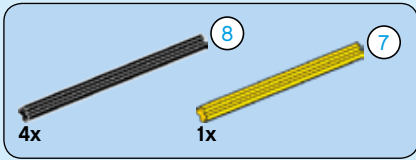
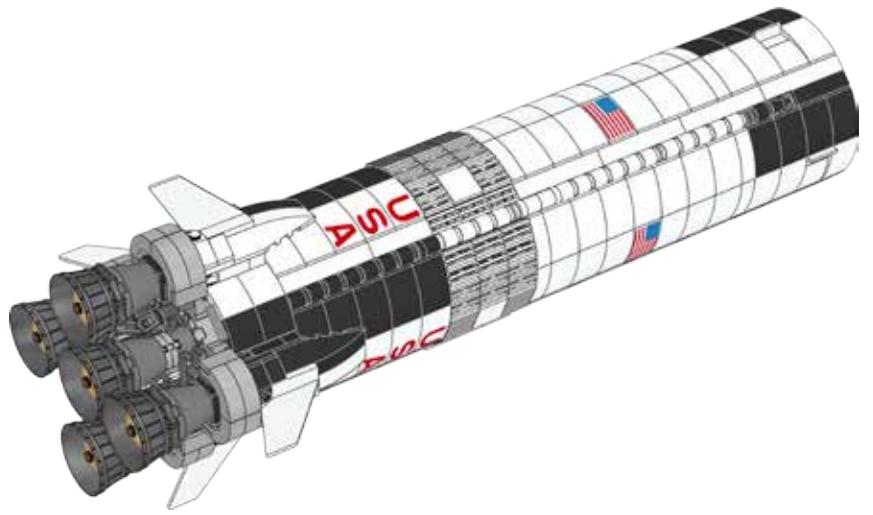

120

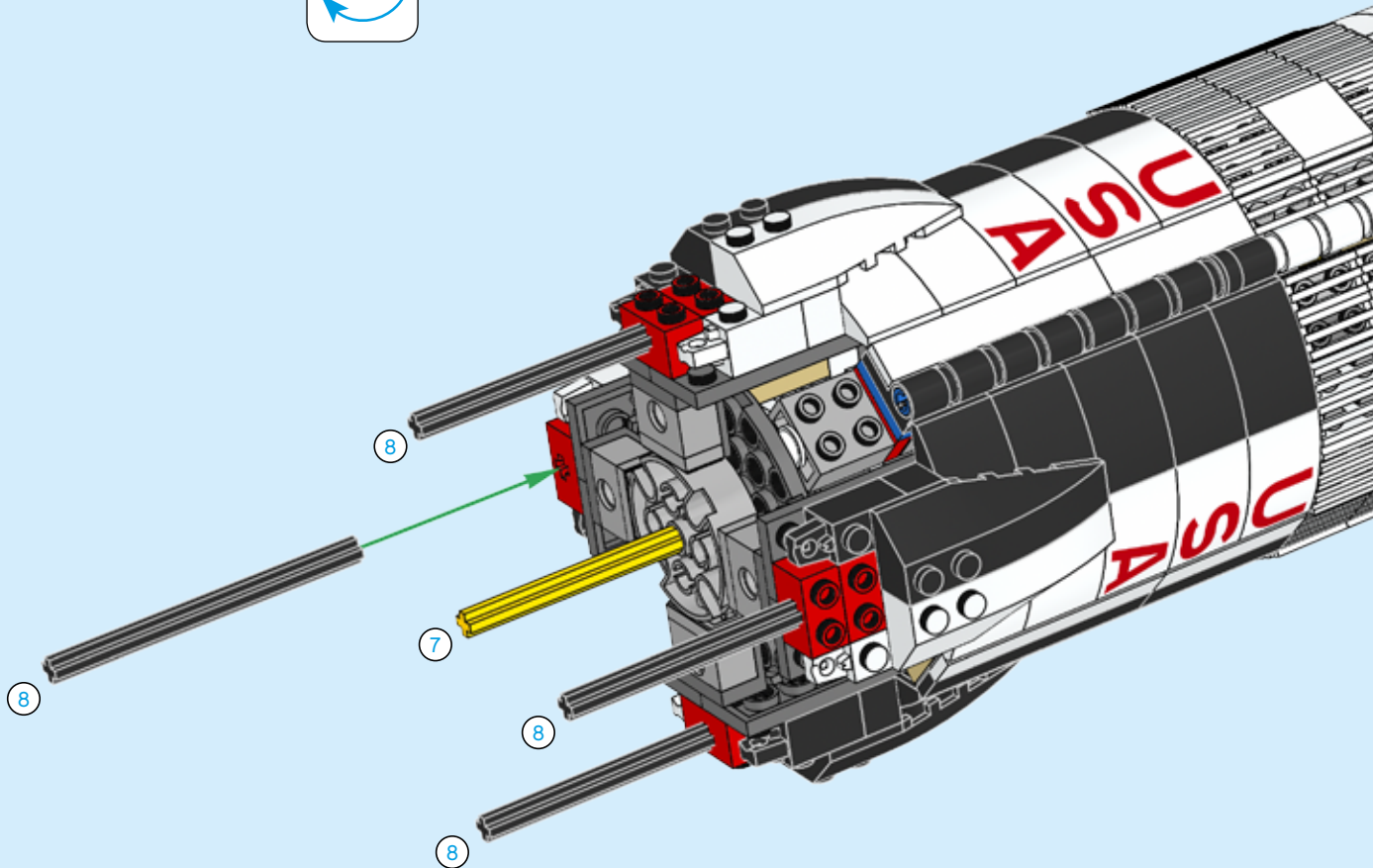
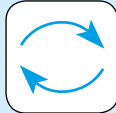

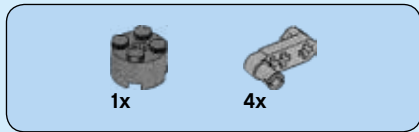

121

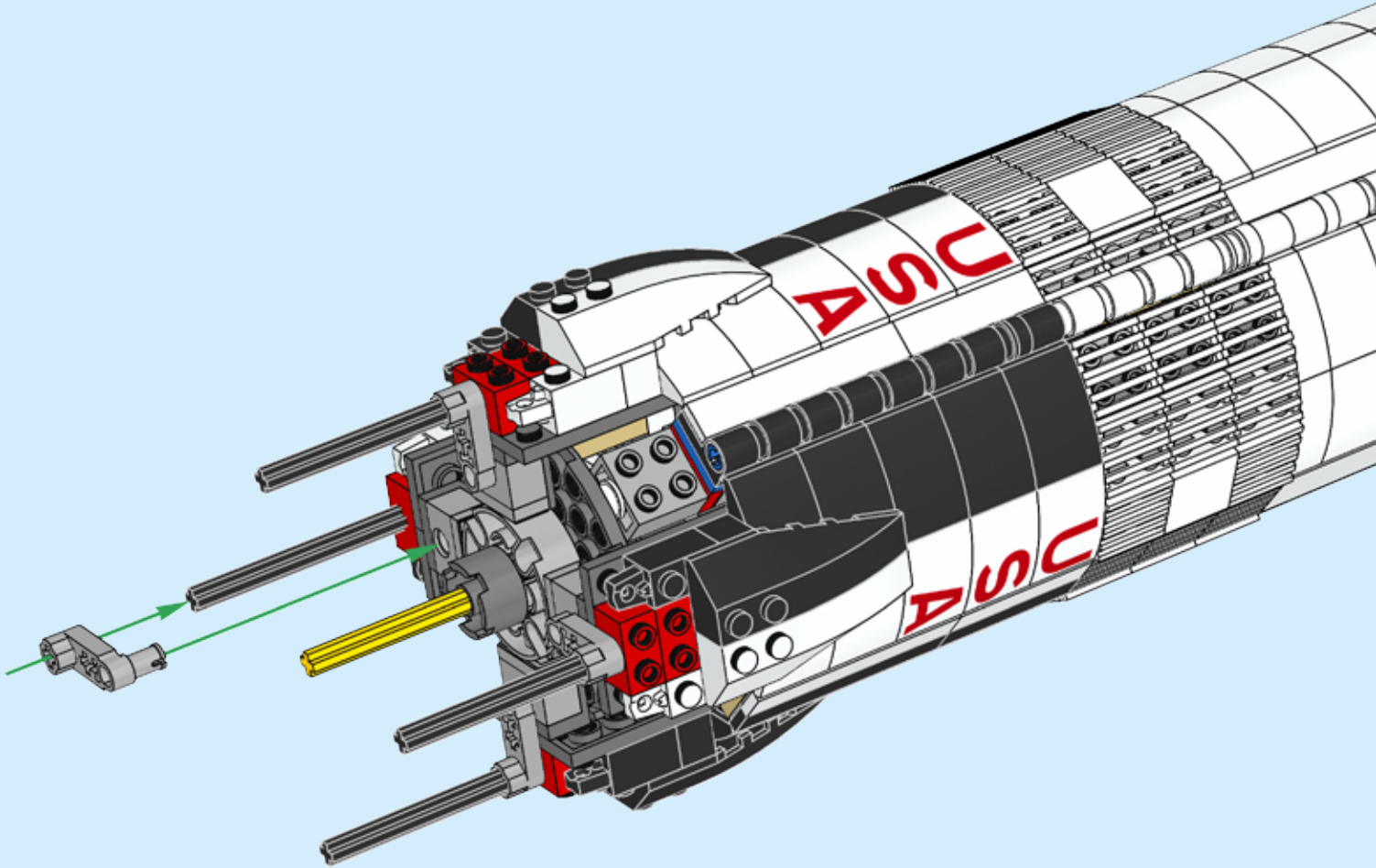

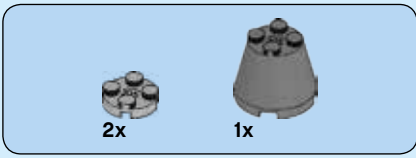

122

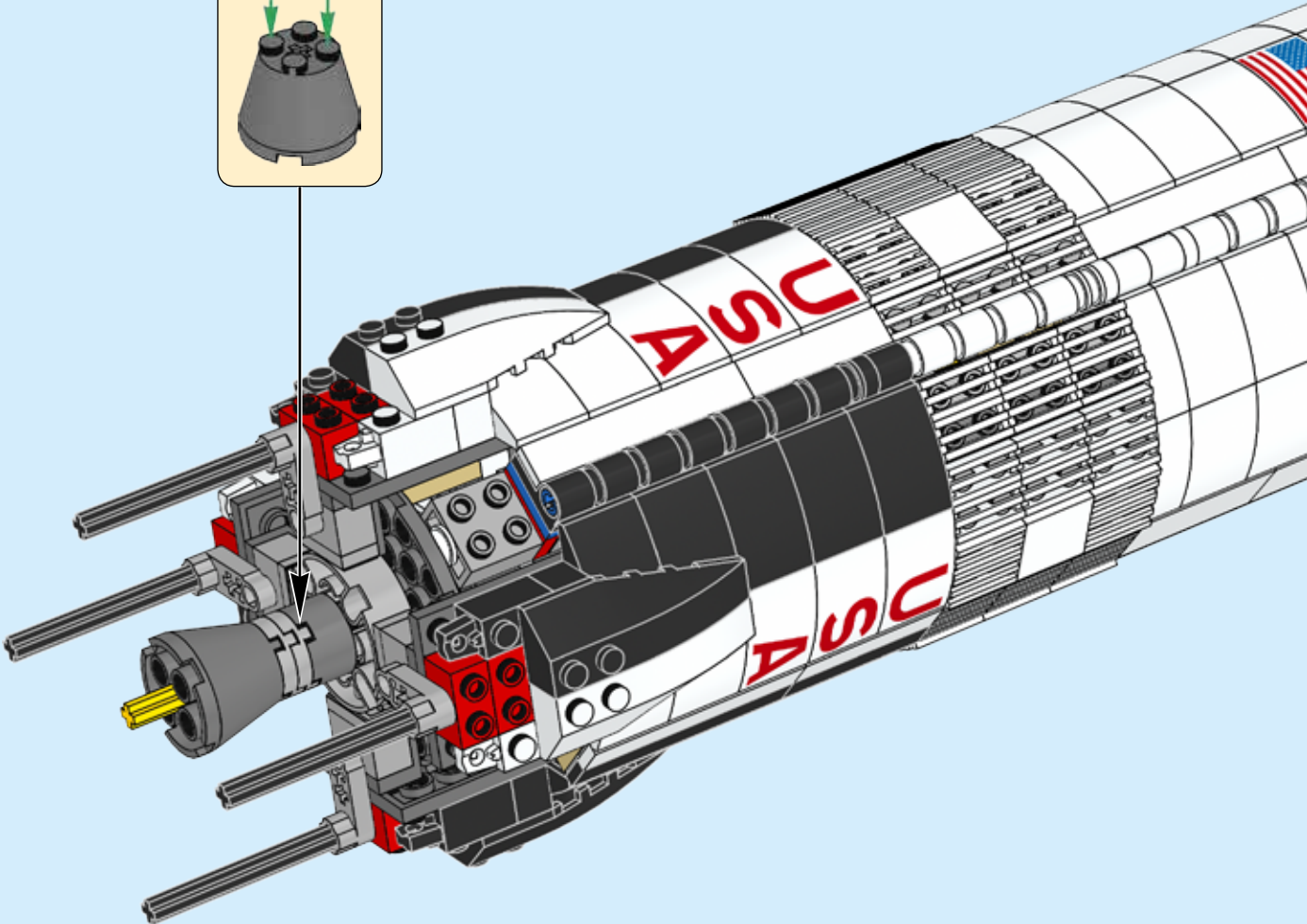
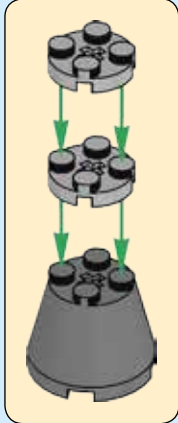

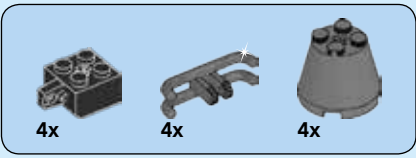

123

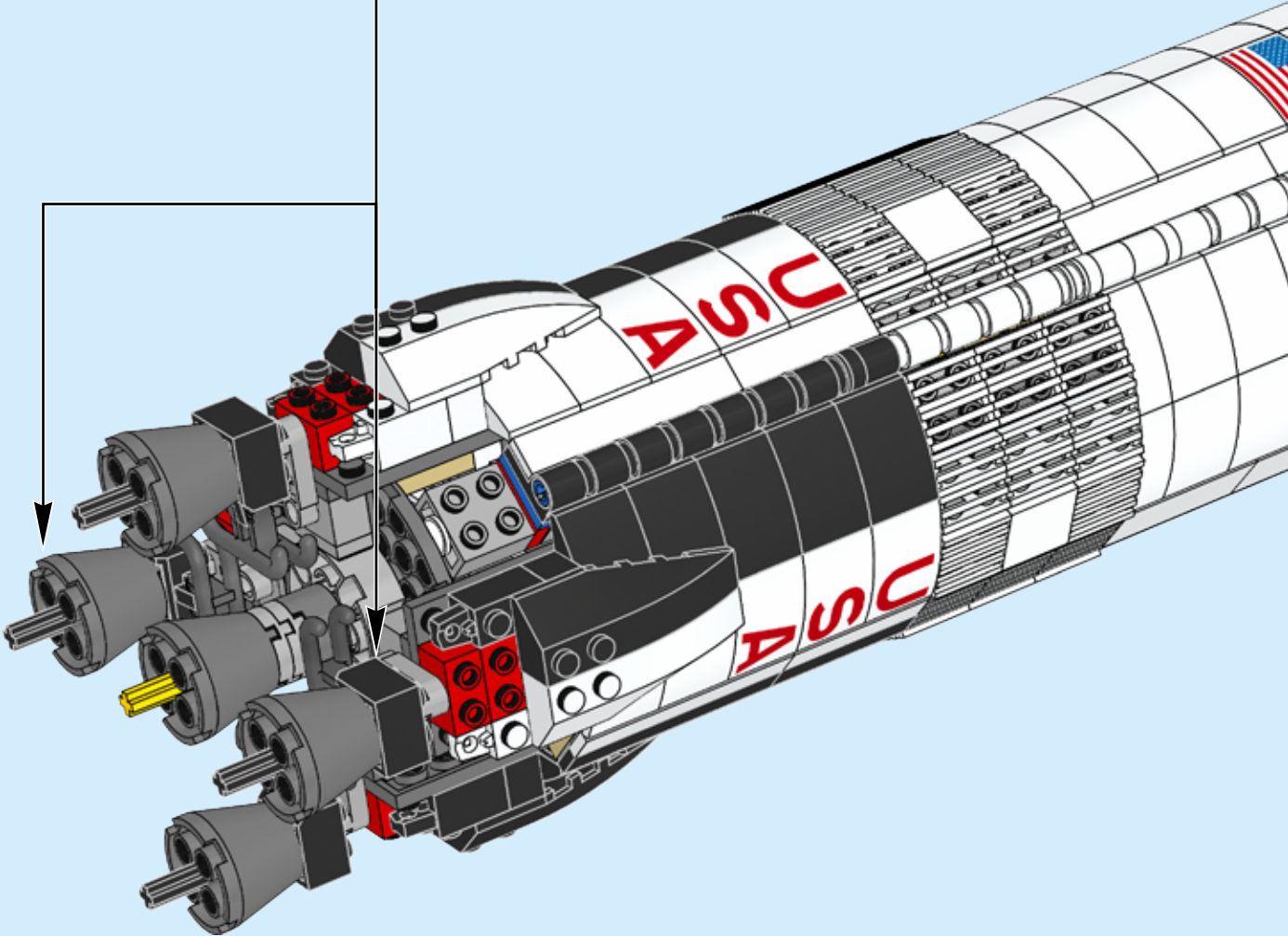
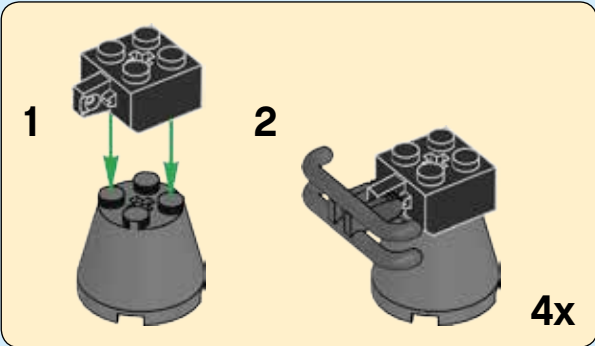



124

1

2

3

4
5x

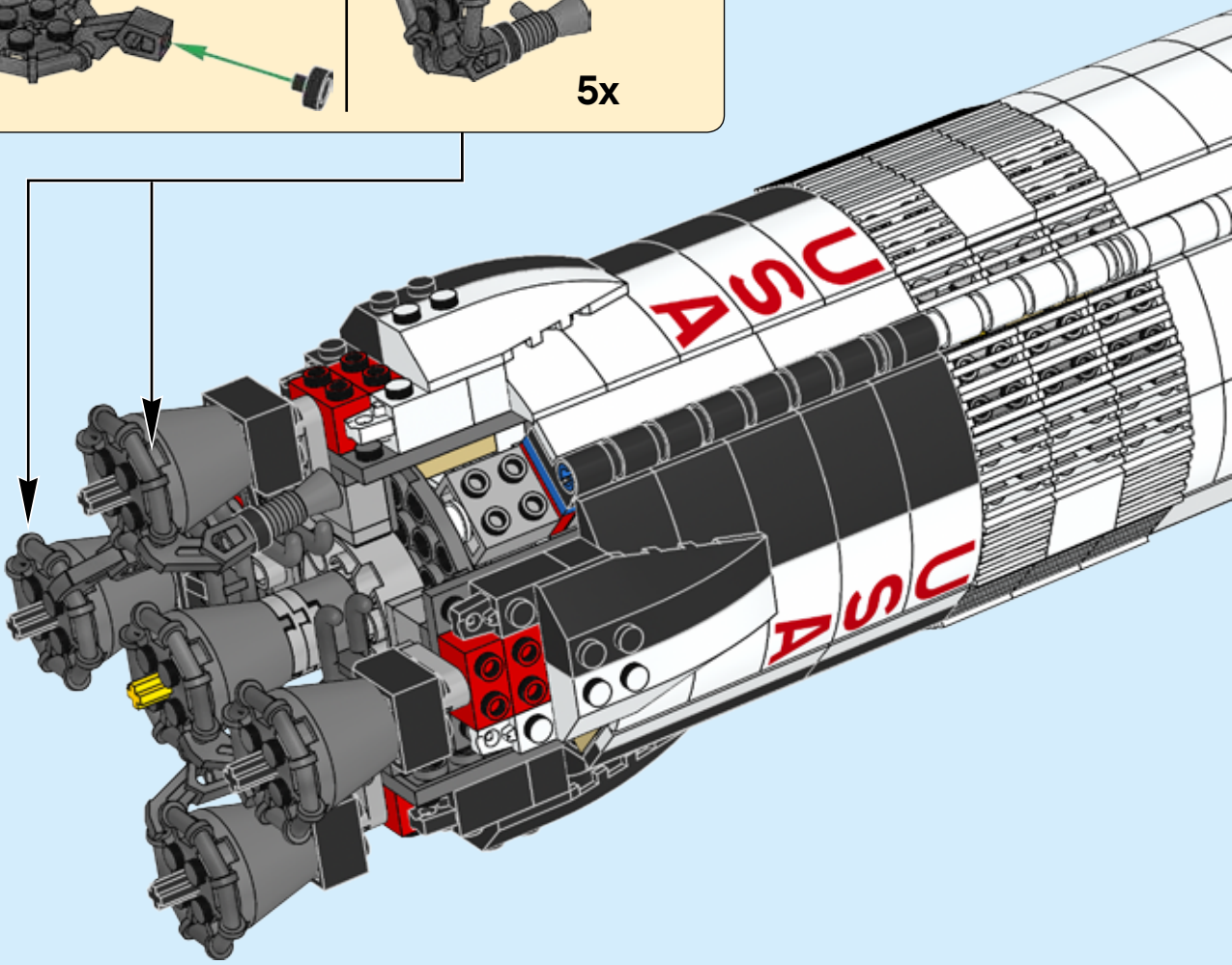

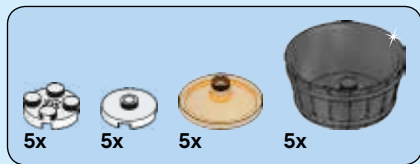

125

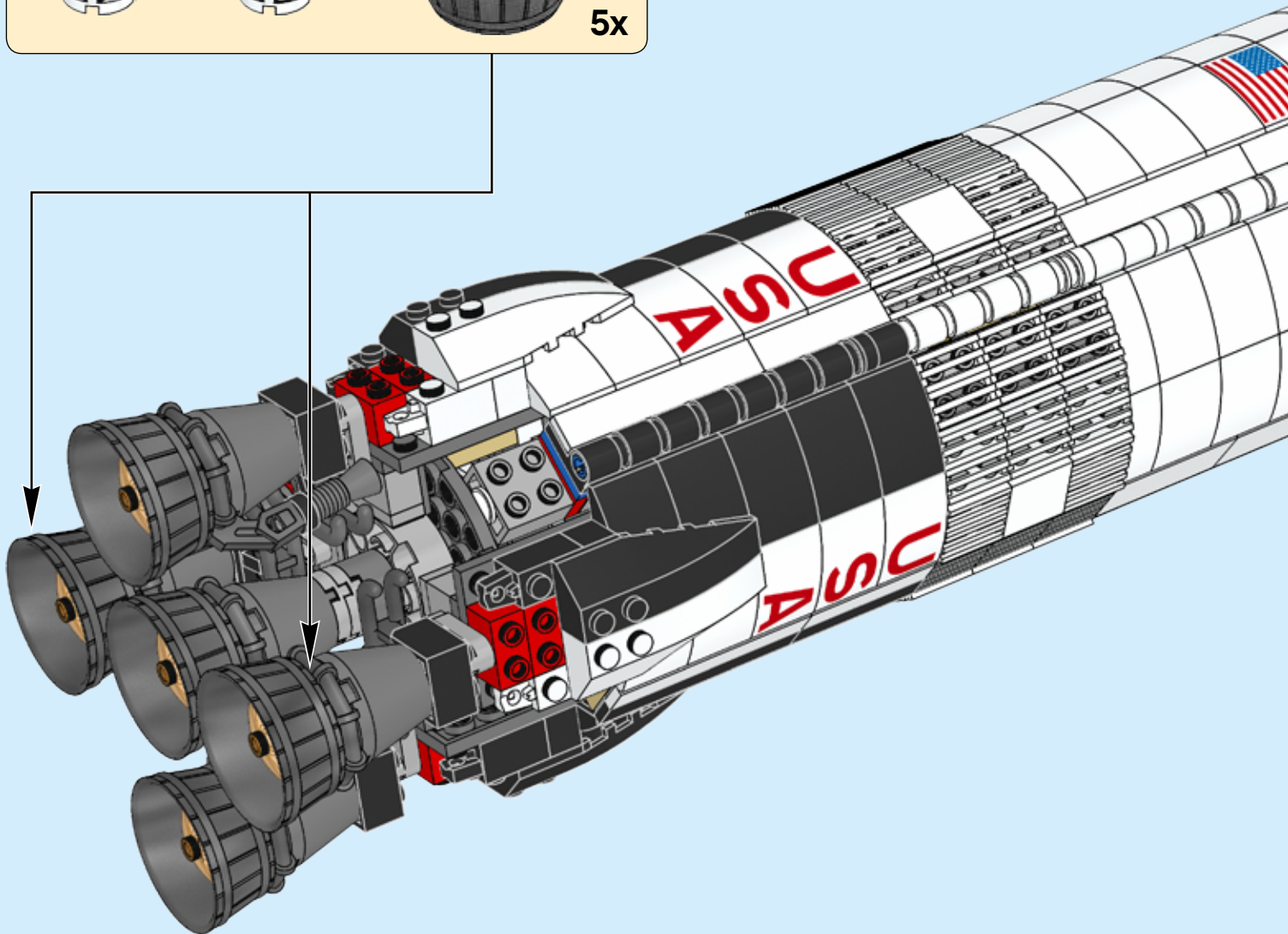
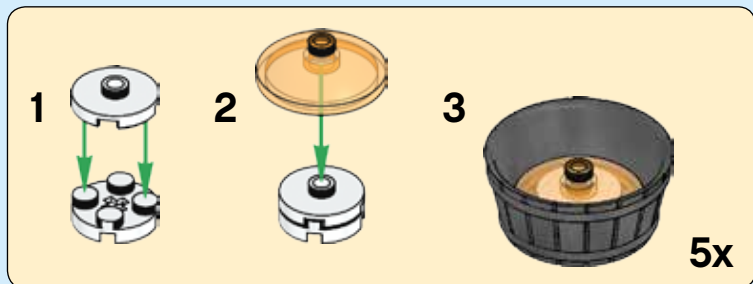

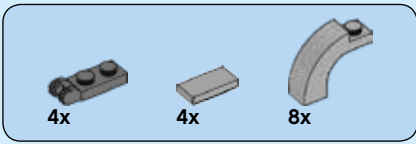

126

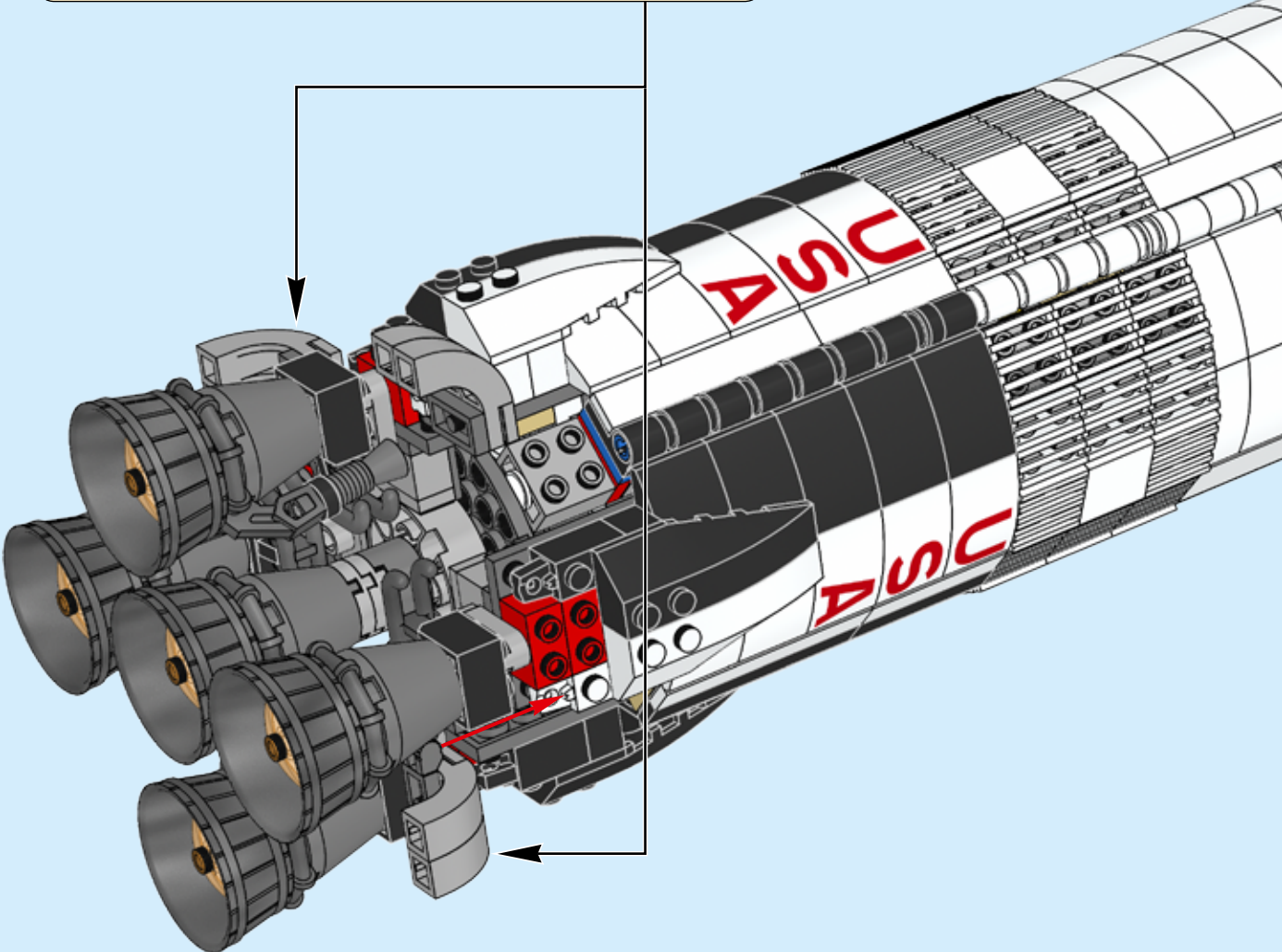
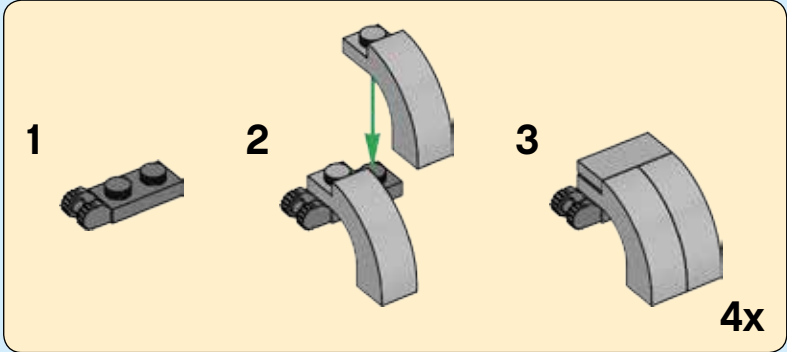

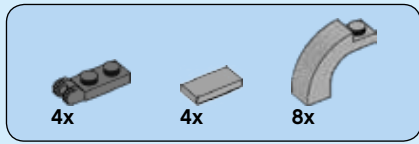

127

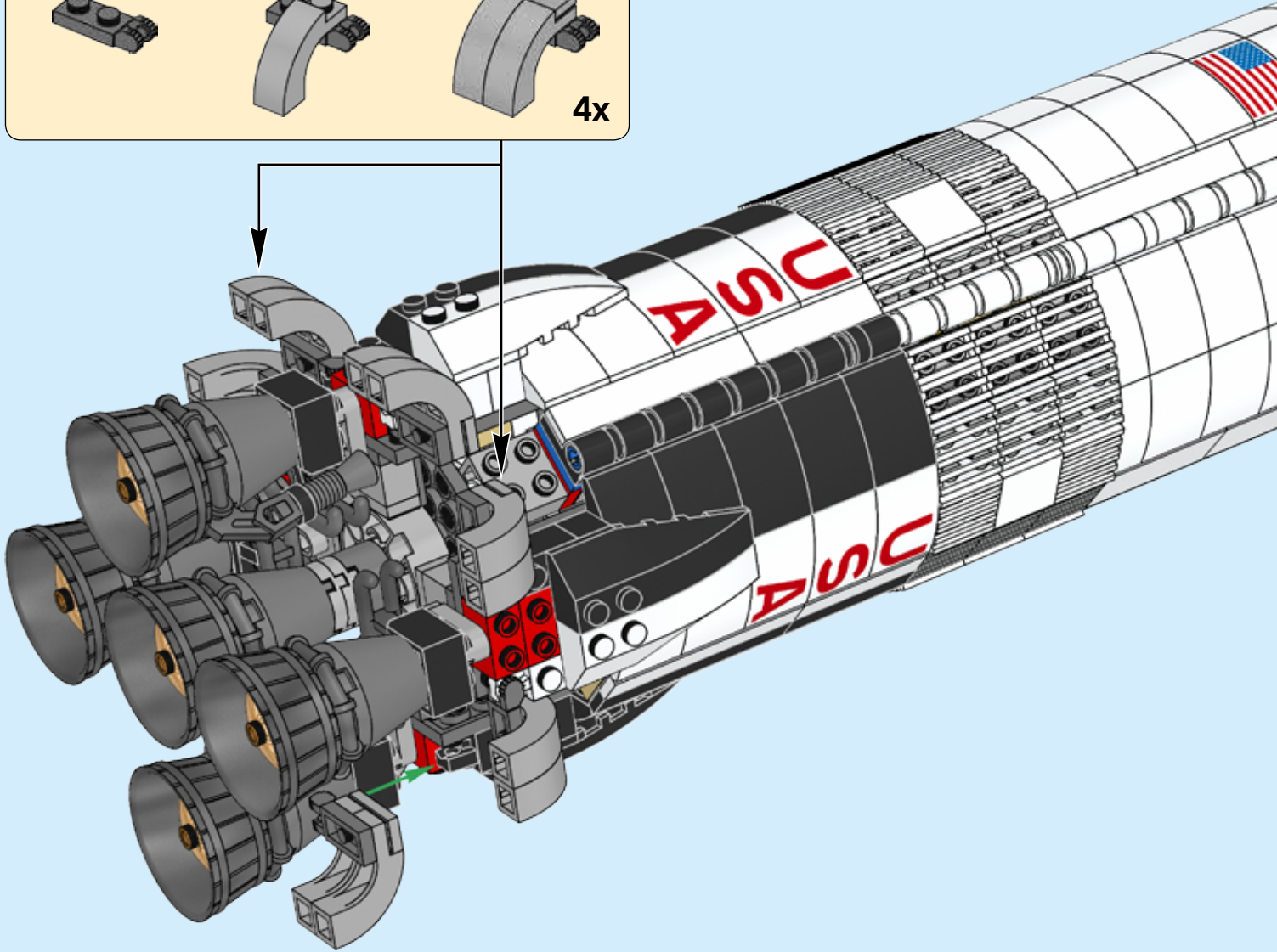
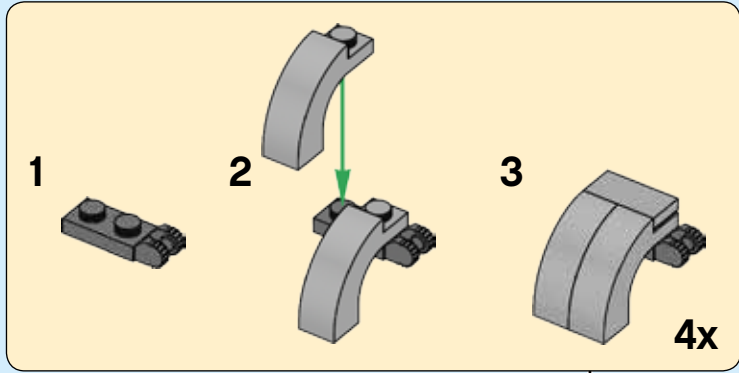

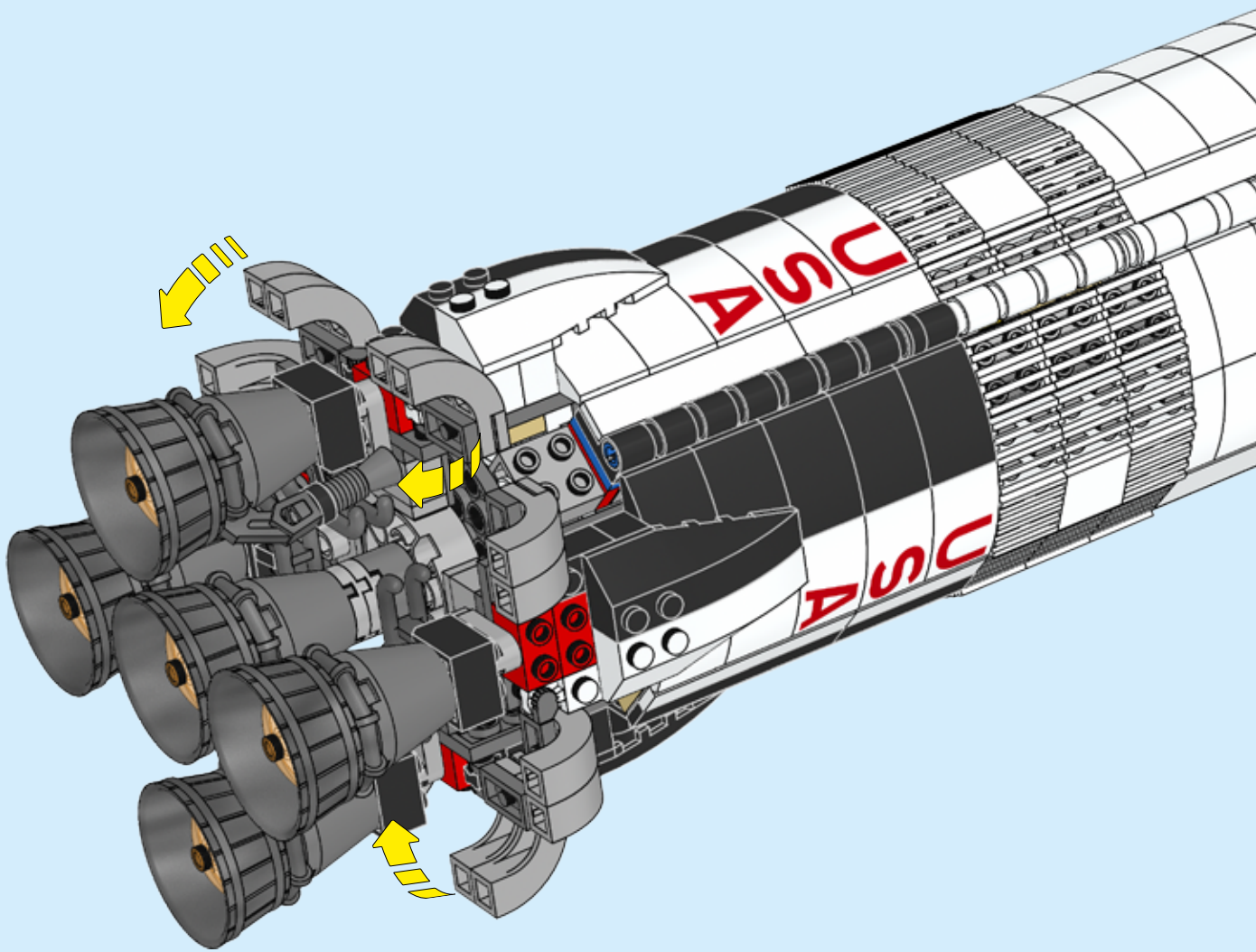



129

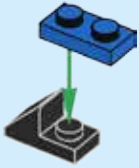

130

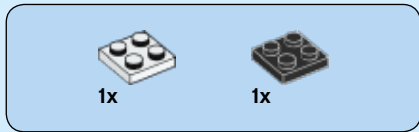

131

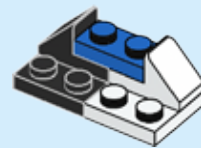

132

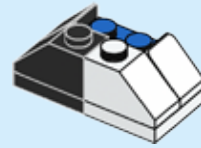

4x

133

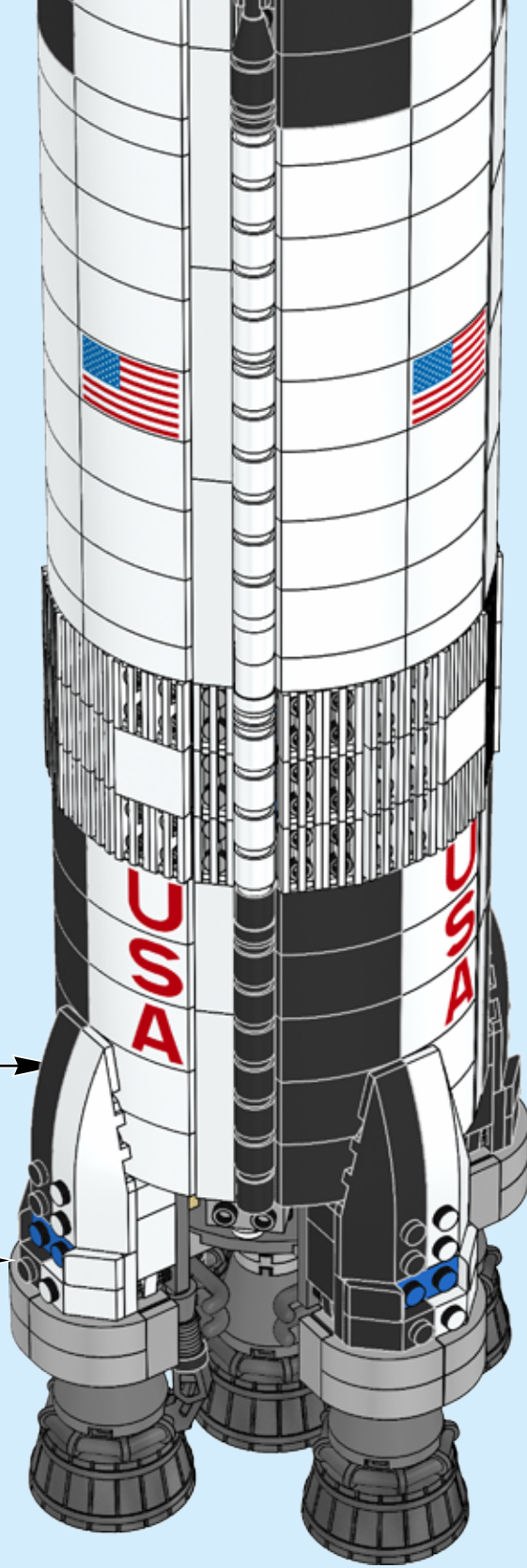

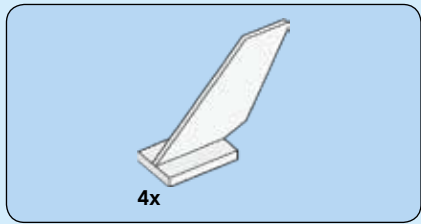

134

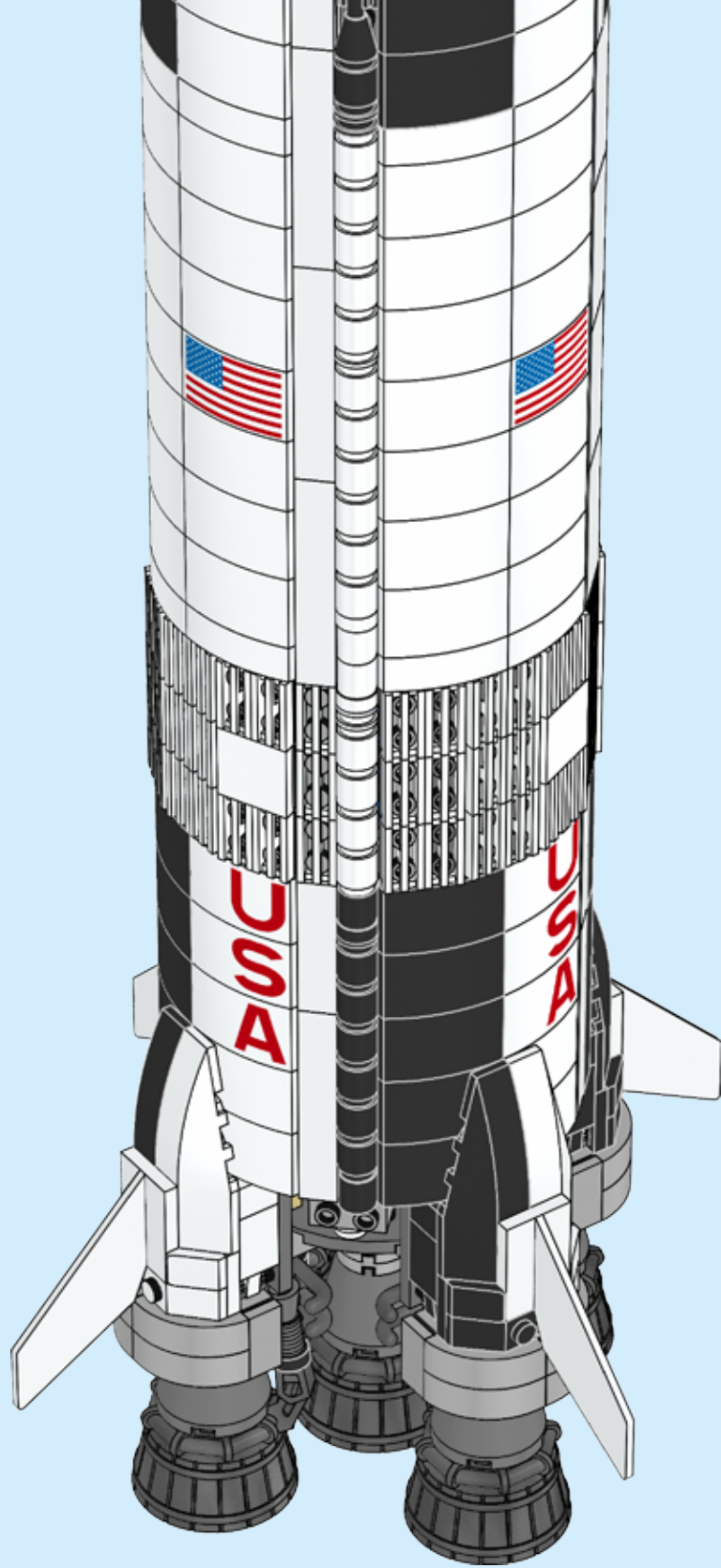

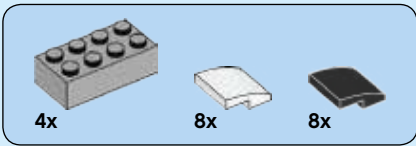

135

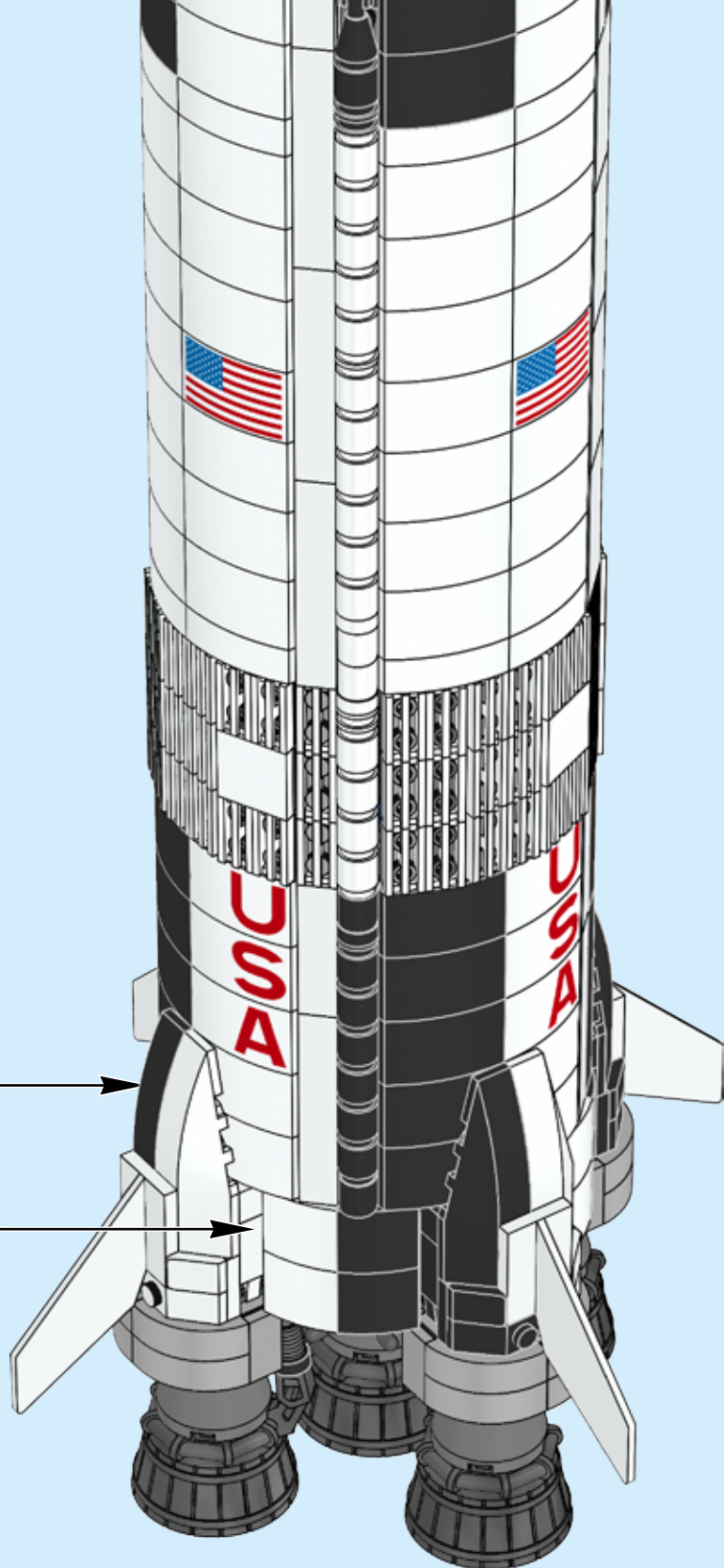
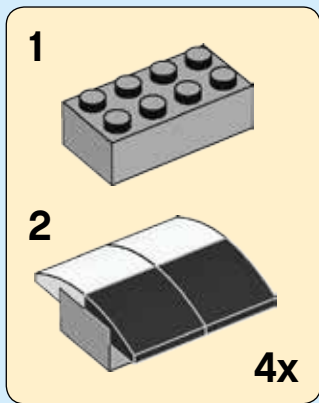

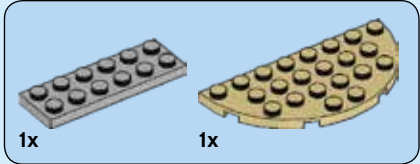
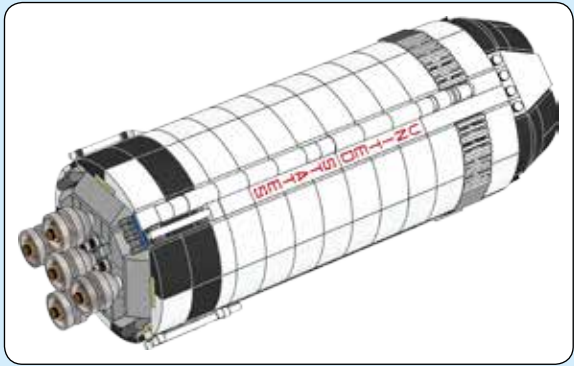
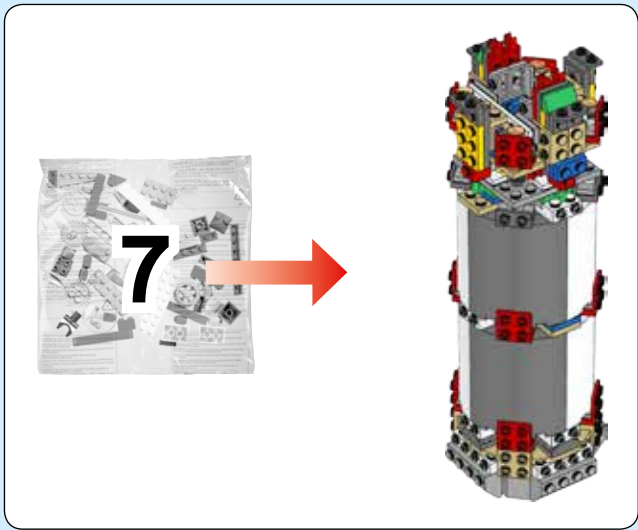

136

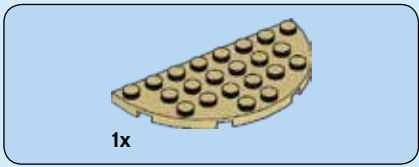
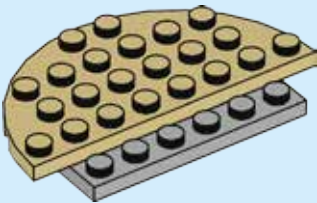

137

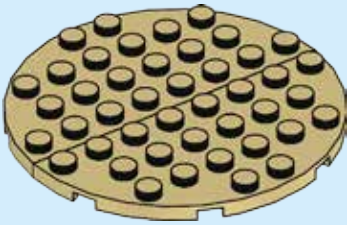

138

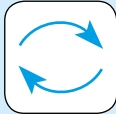

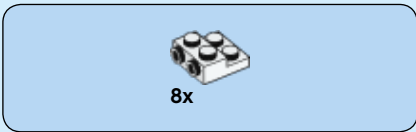

139

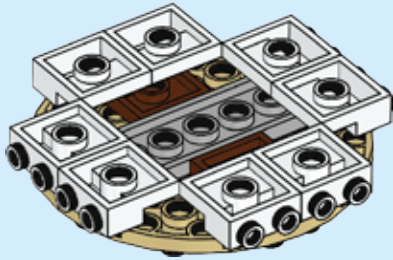

140

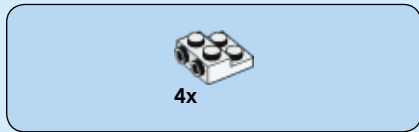
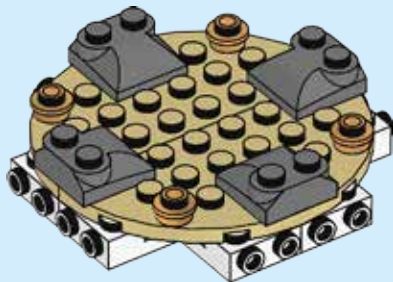
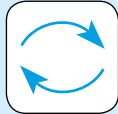

141

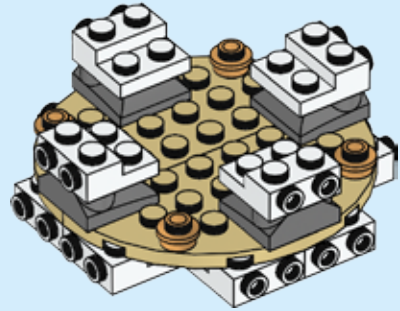

142

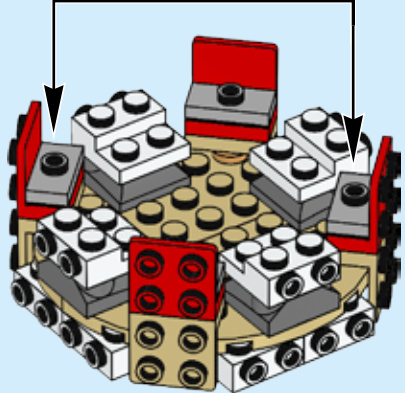
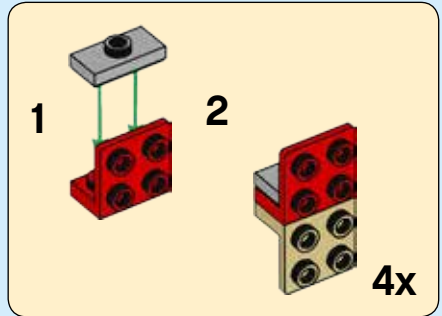

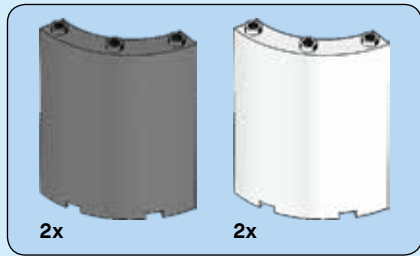

143

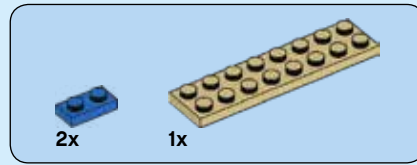
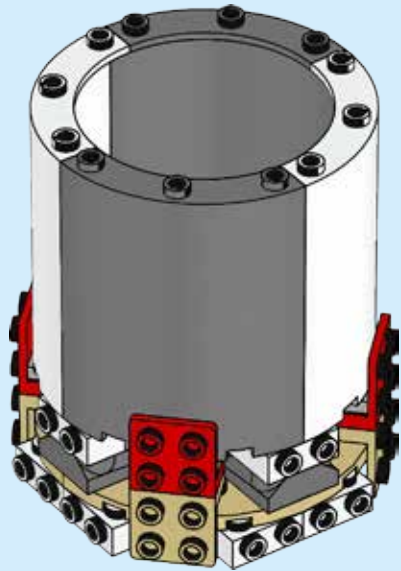

144

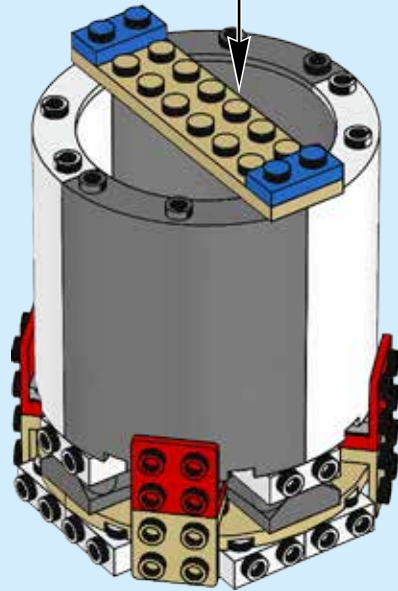
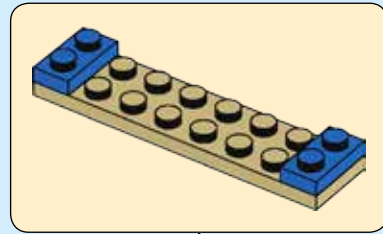

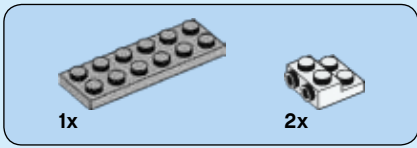

145

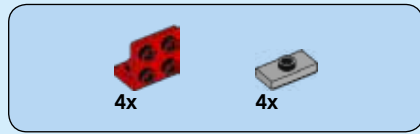
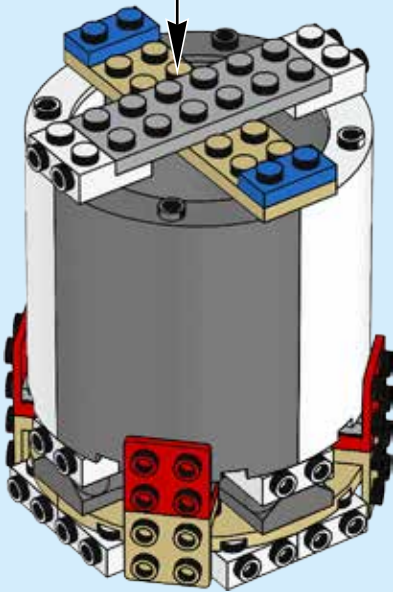
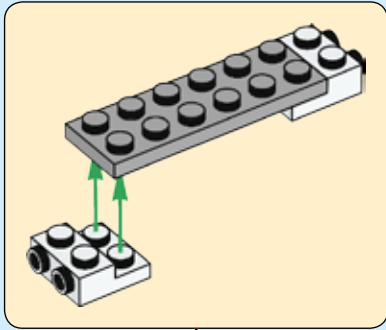

146

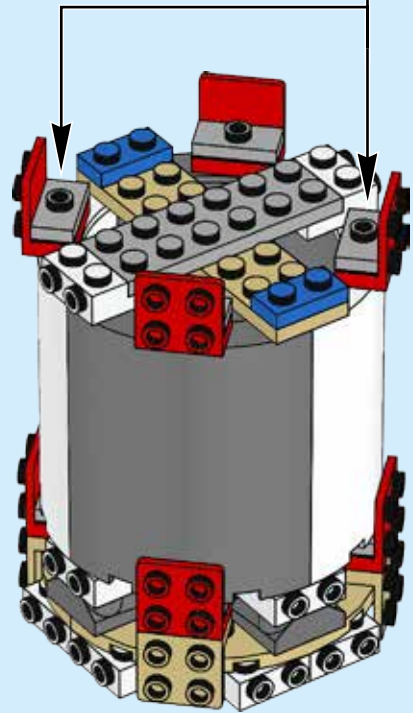
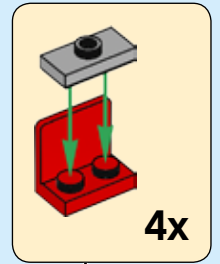

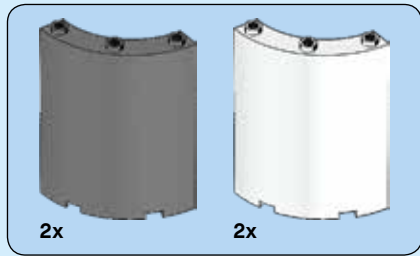

147

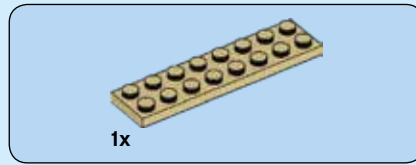
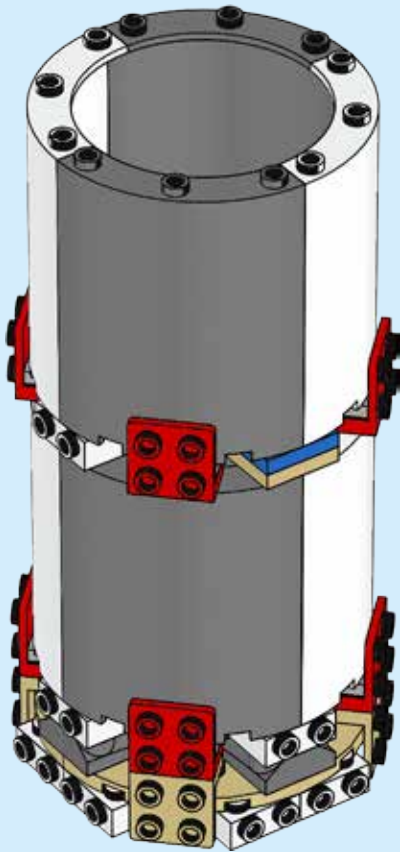

148

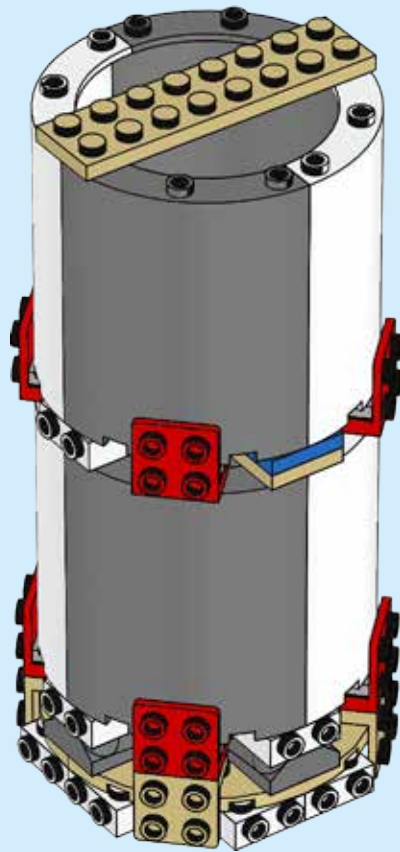

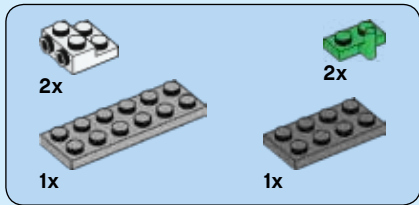

149

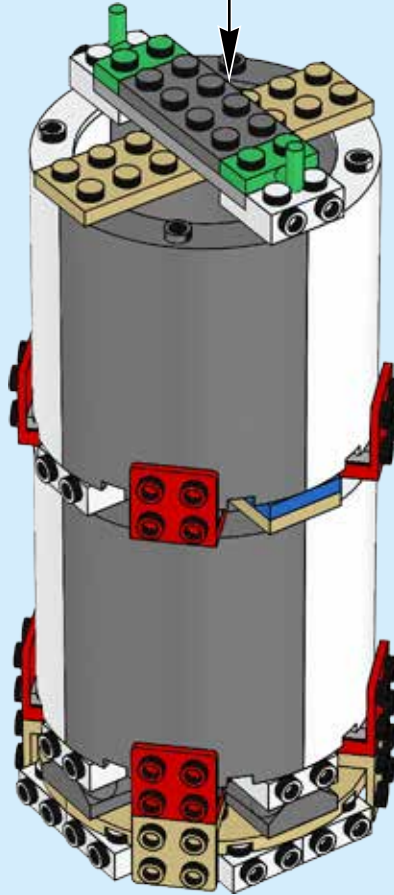
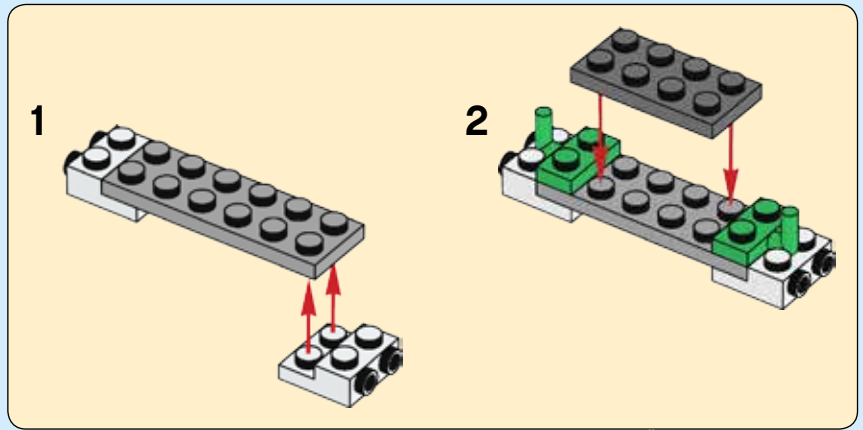



150

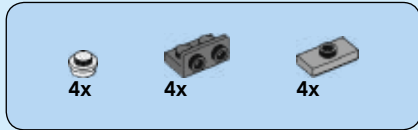
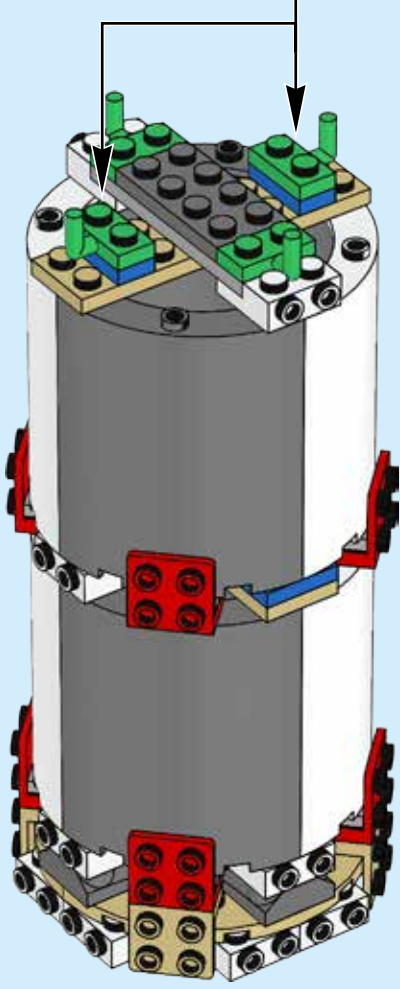
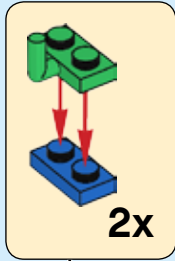

151

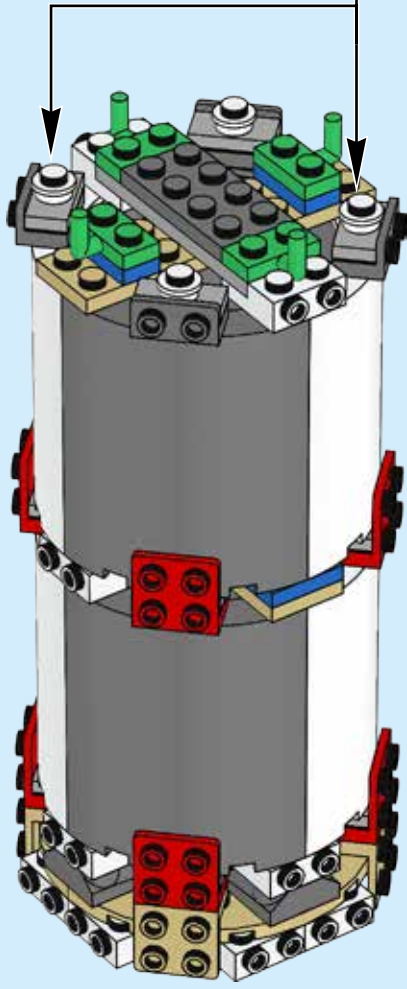
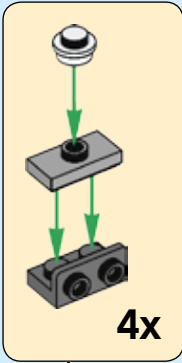

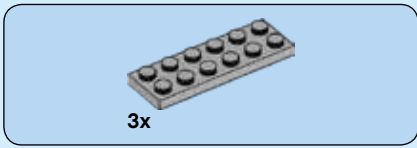

152

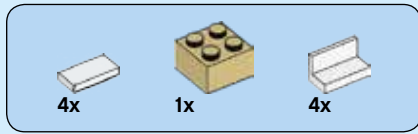
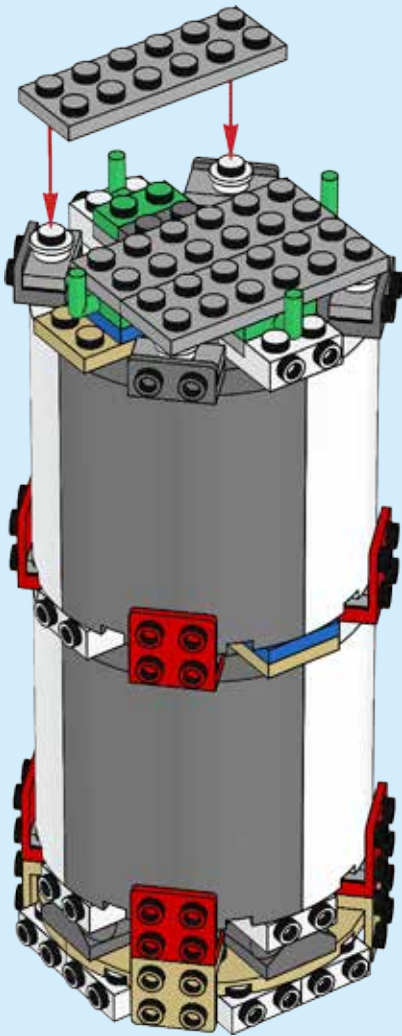

153

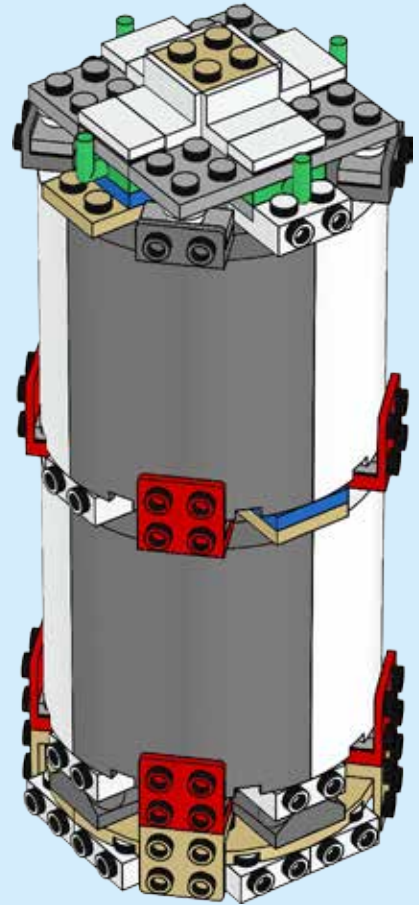



1x

154

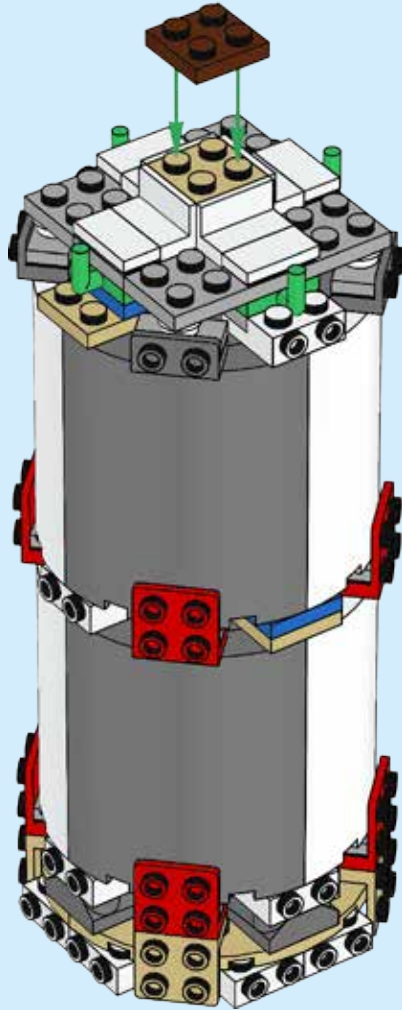



155

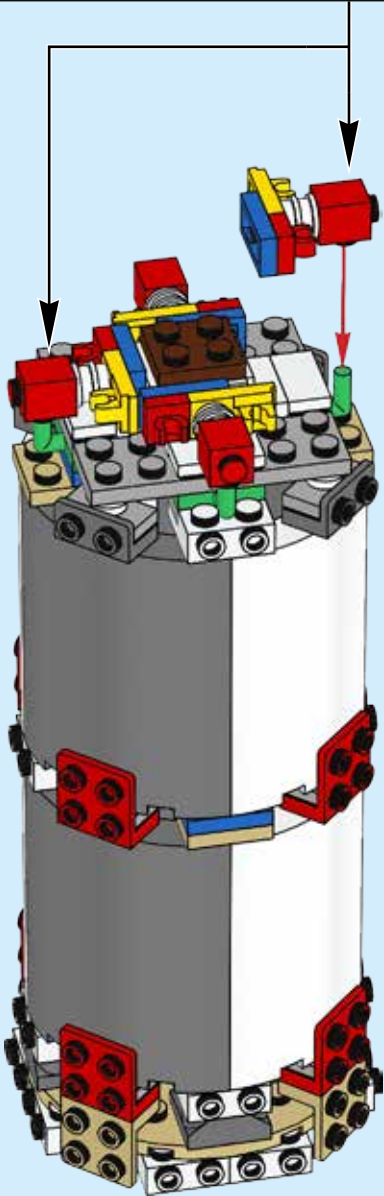
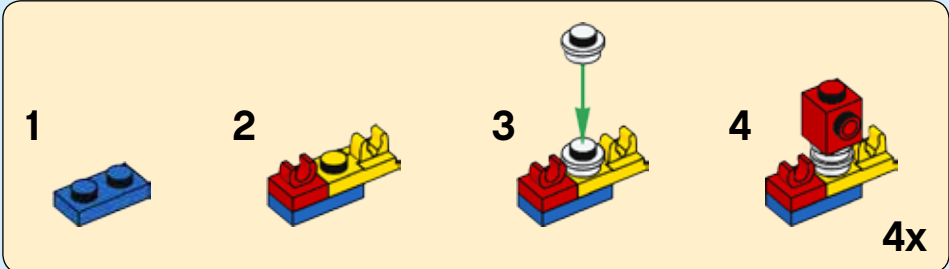



4x



4x

156

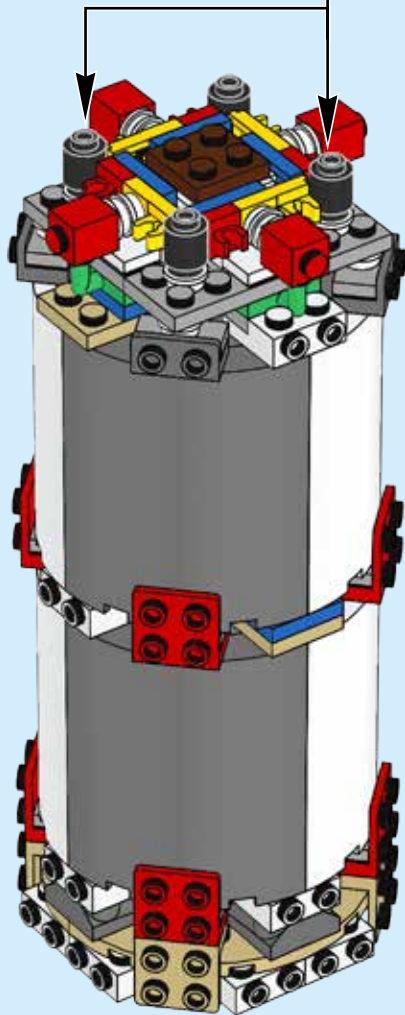
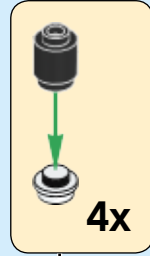

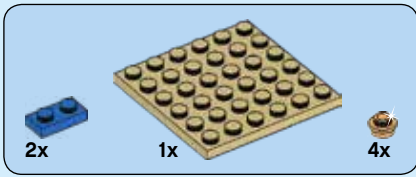

157

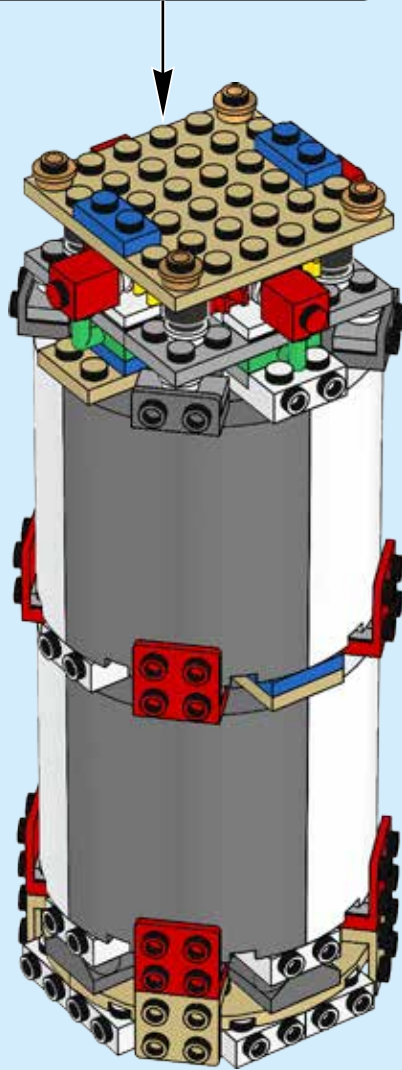
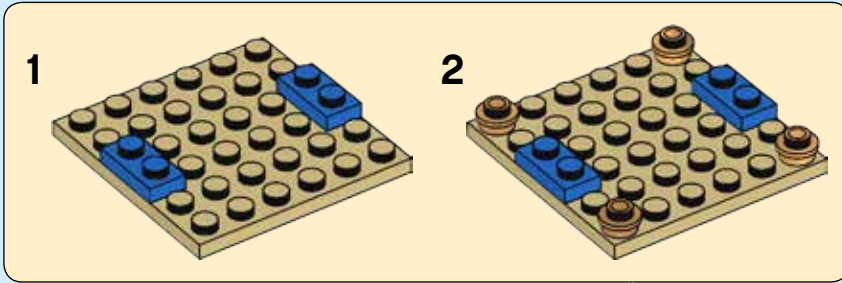

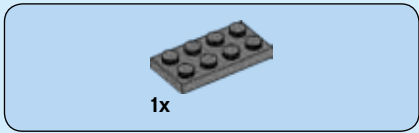
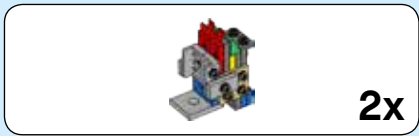

158

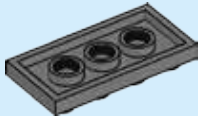

159

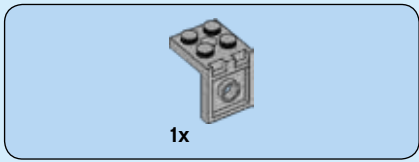
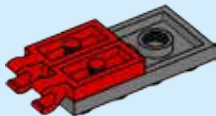

160

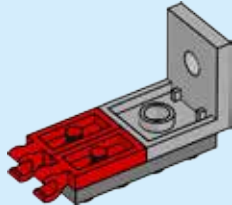

161

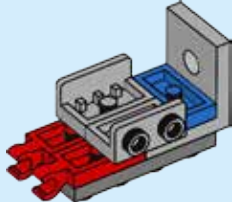

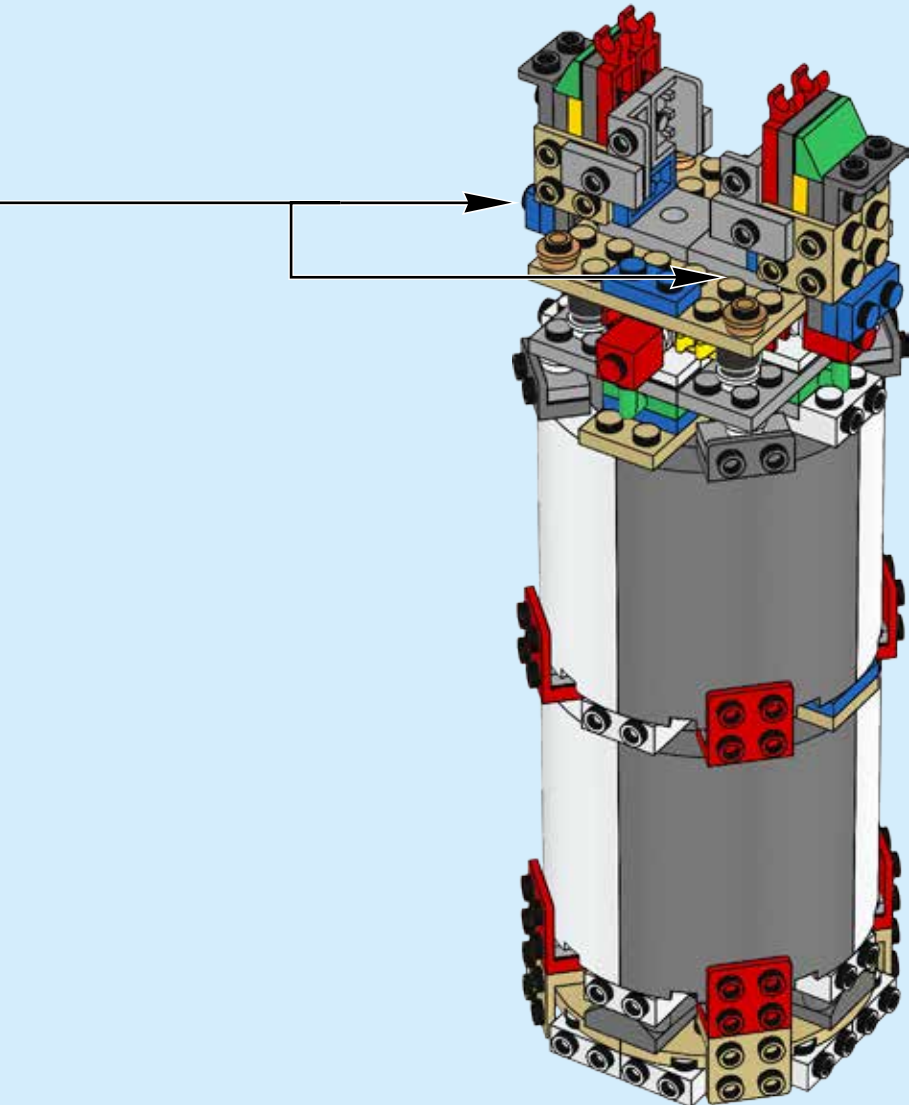

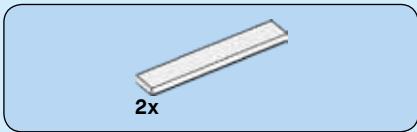

167

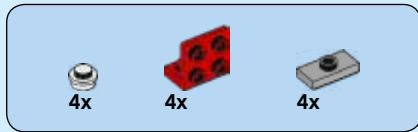
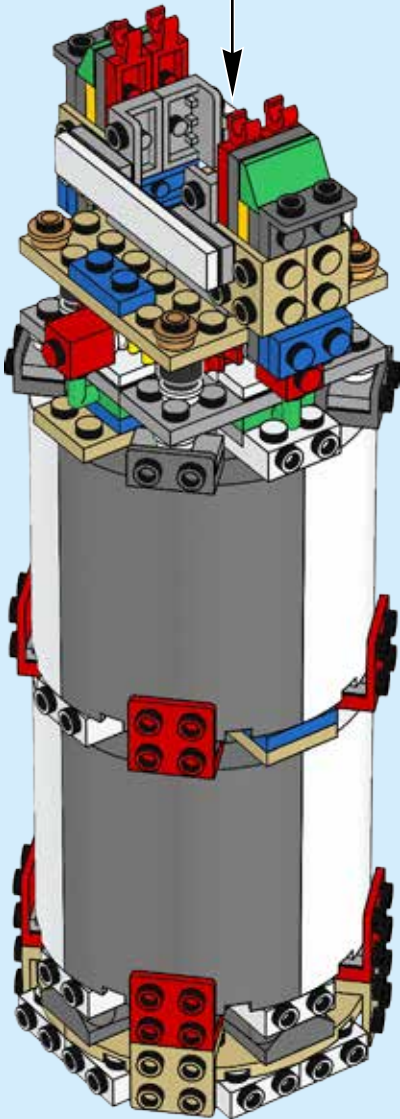
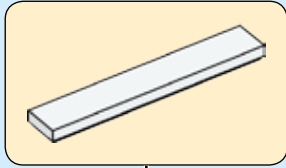

168

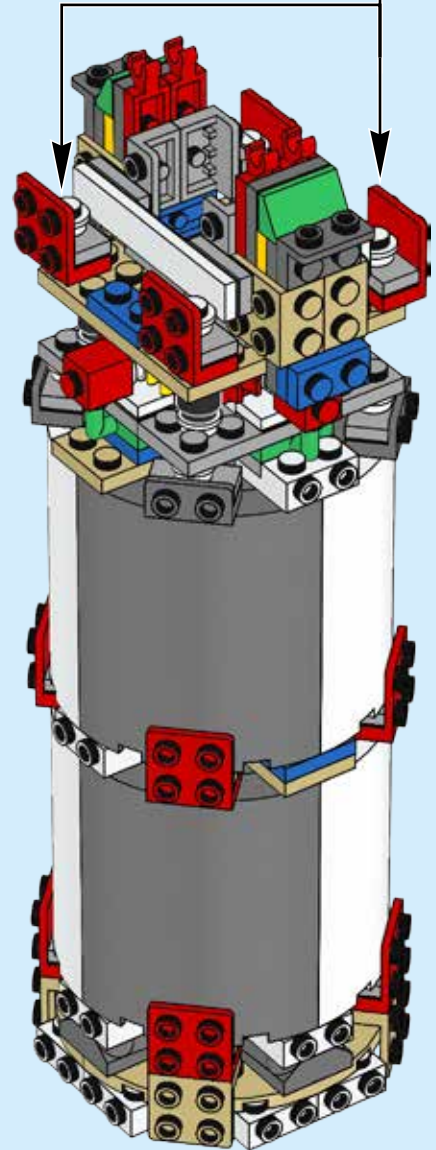
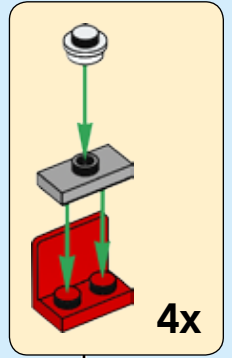



169

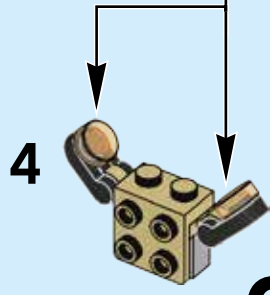
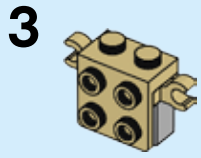
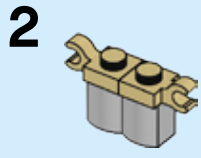

2x

170

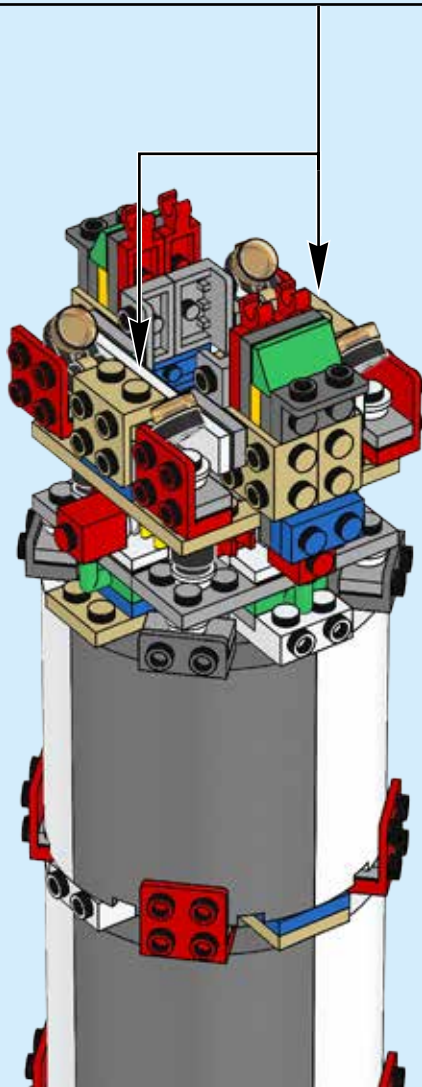

171

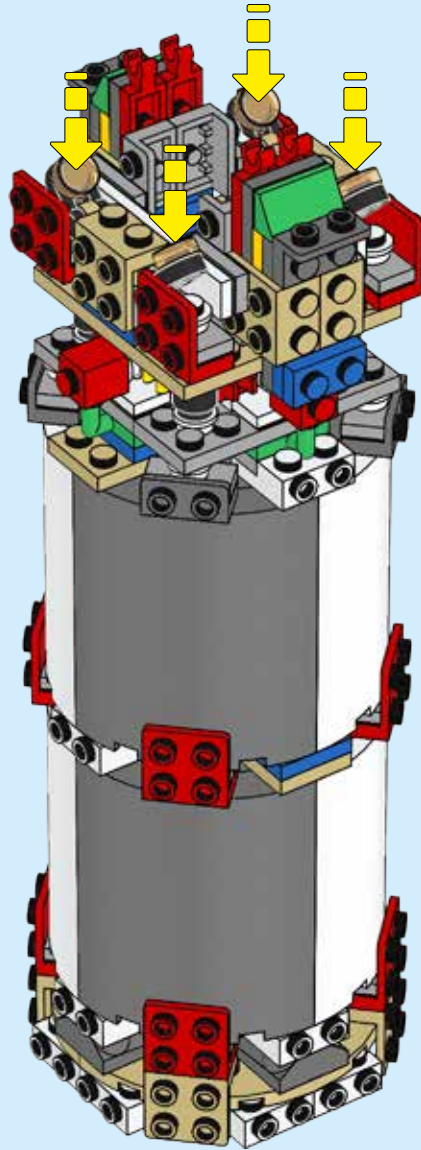

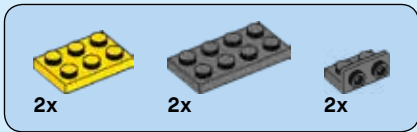

172

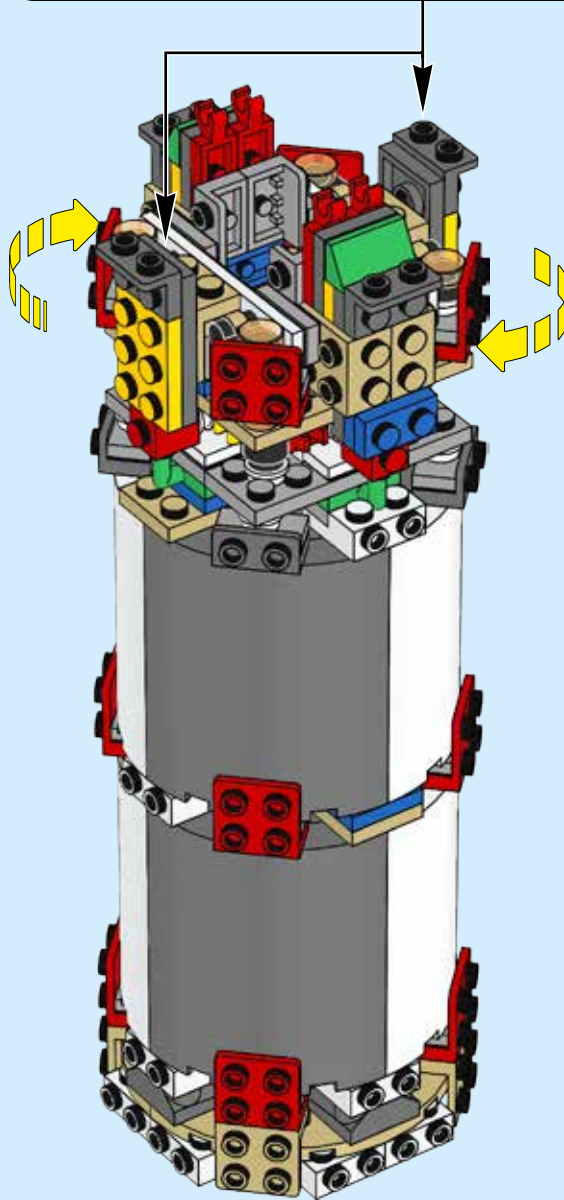
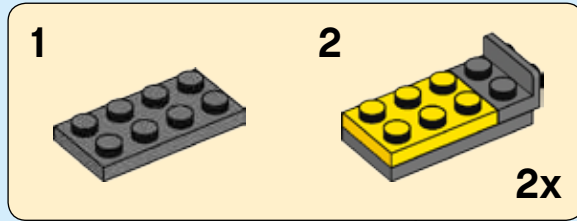

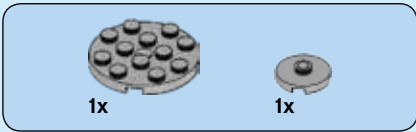
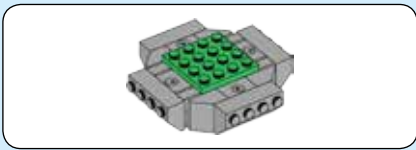

173

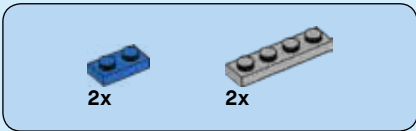
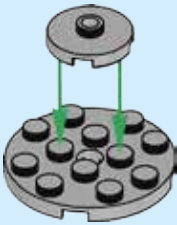

174

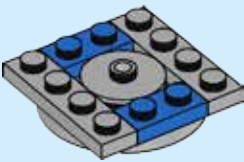

175

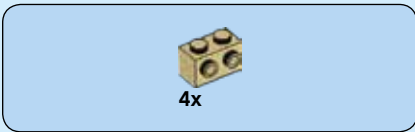

176

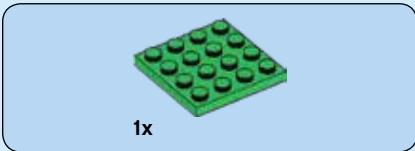
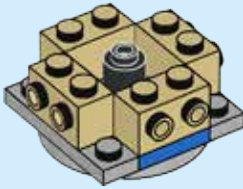

177

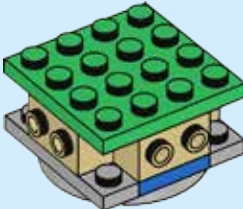

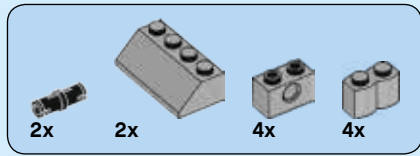

178

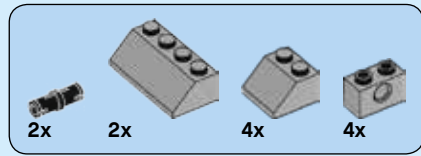
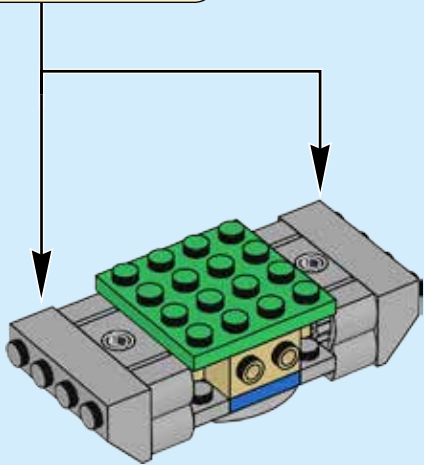
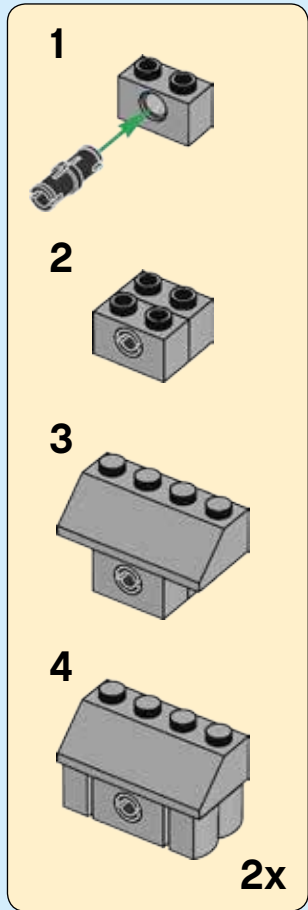

179

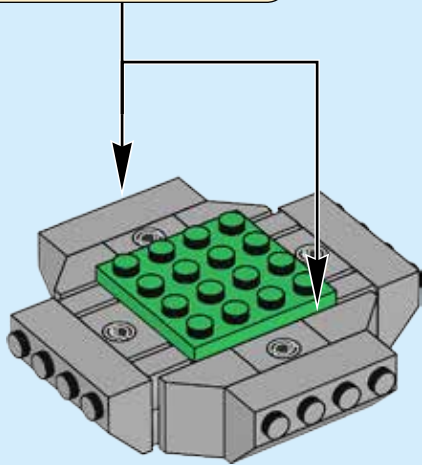
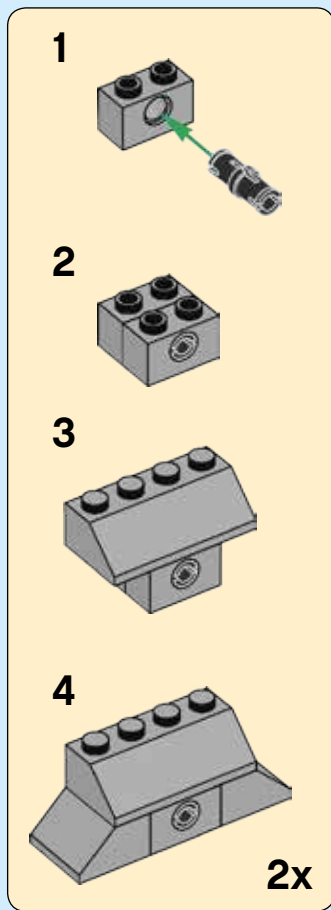

180

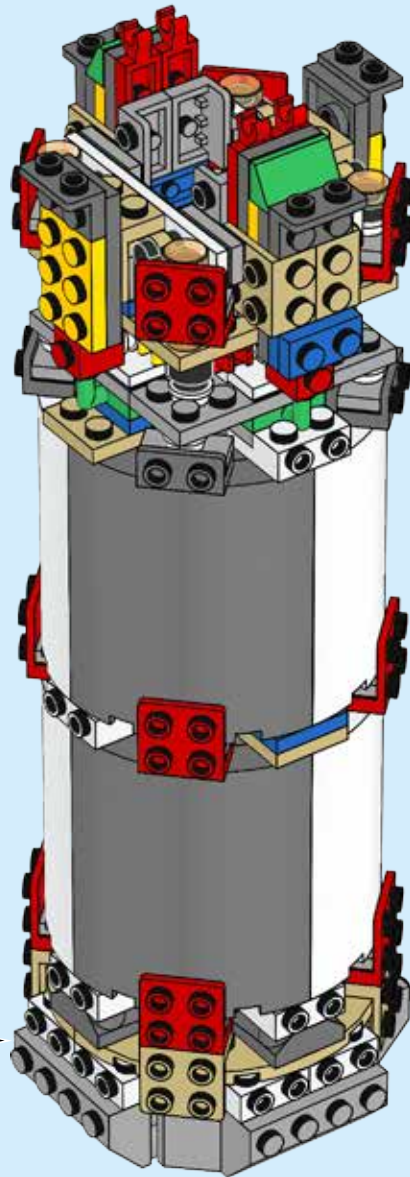

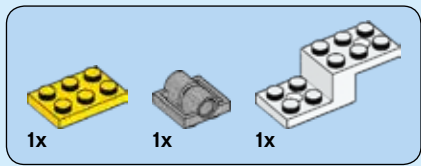
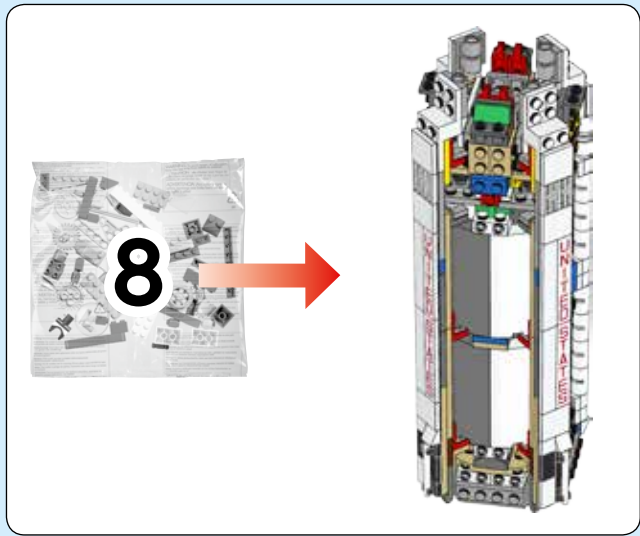

181

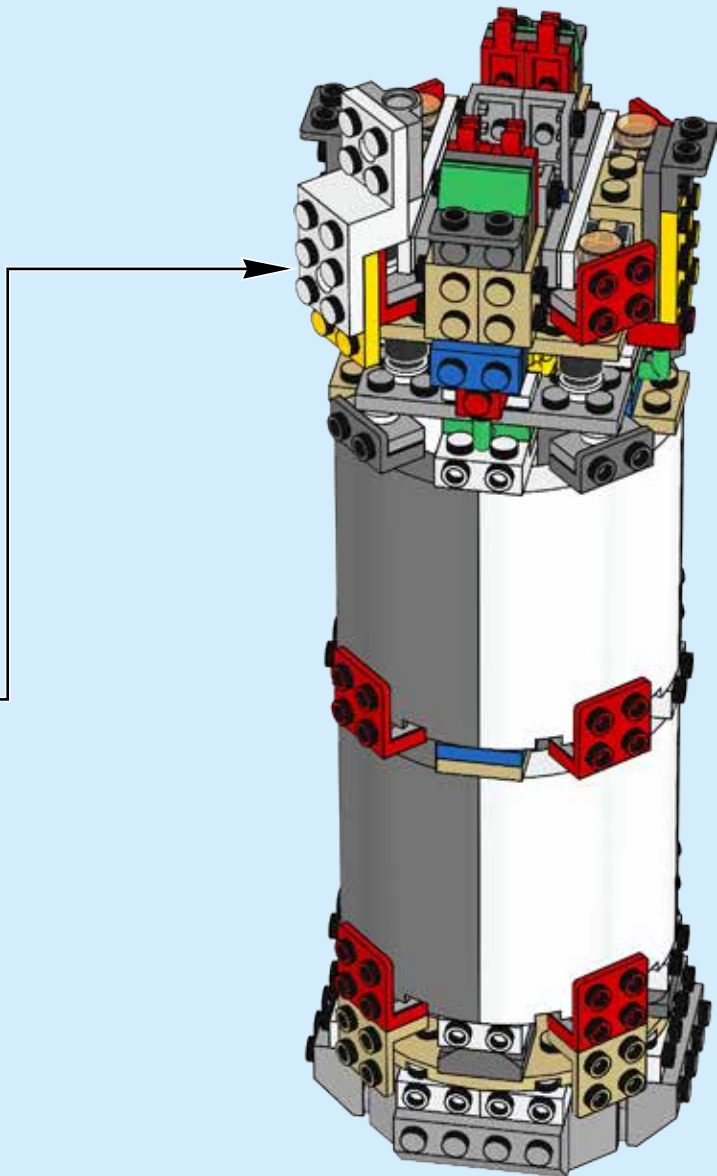
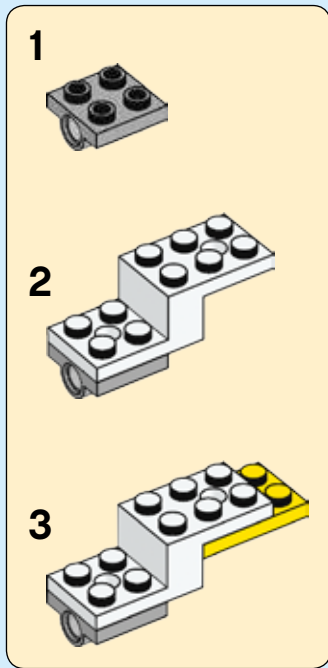

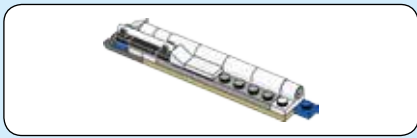

182

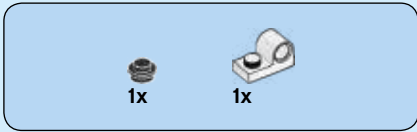
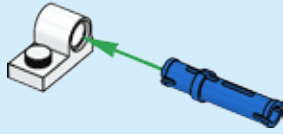

183

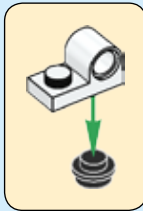

184

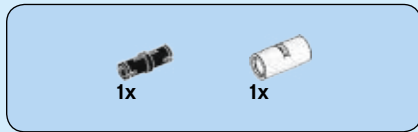
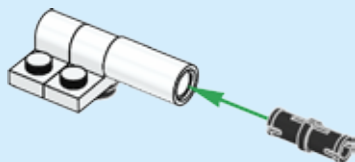

185

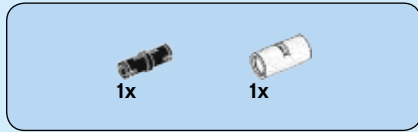
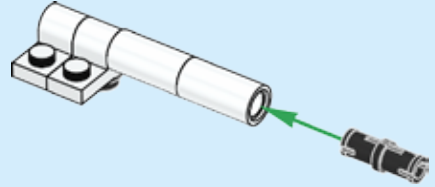

186

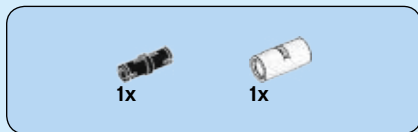
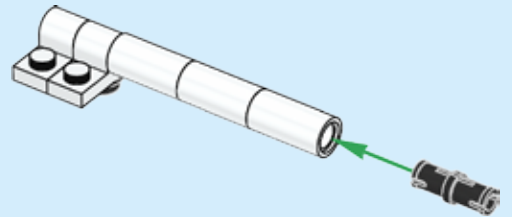

187

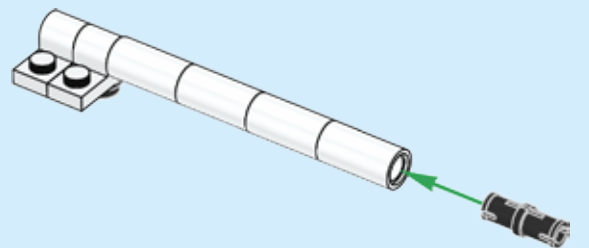

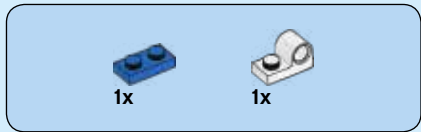

188

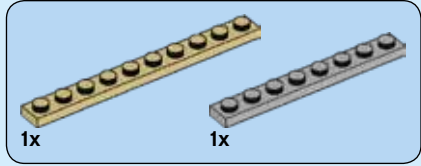
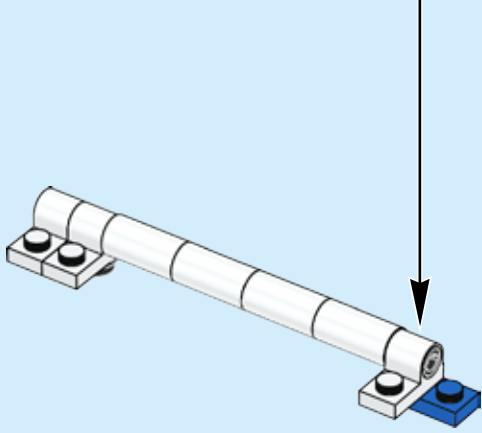
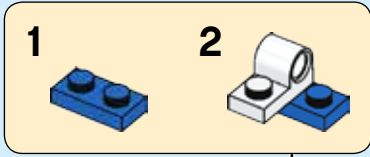

189

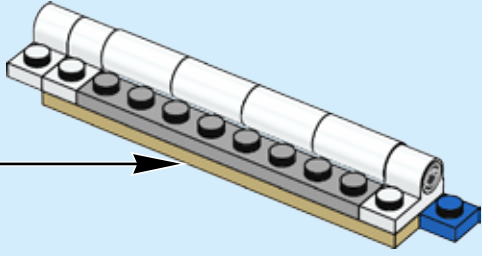
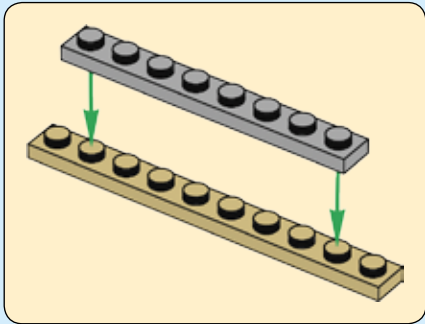

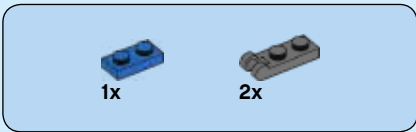

190

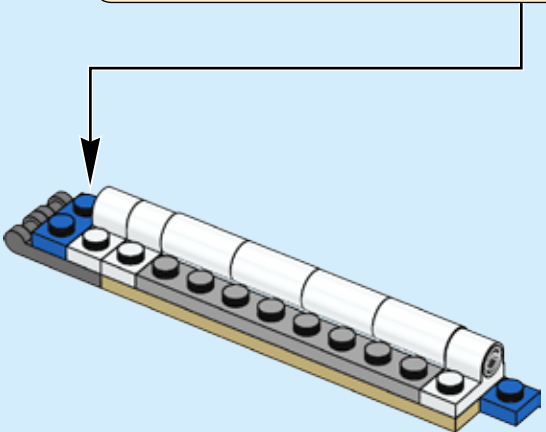
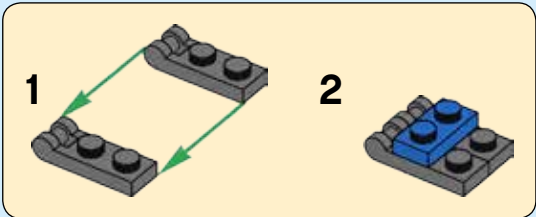

191

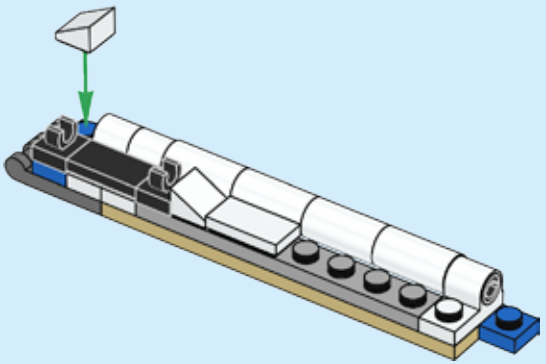



192

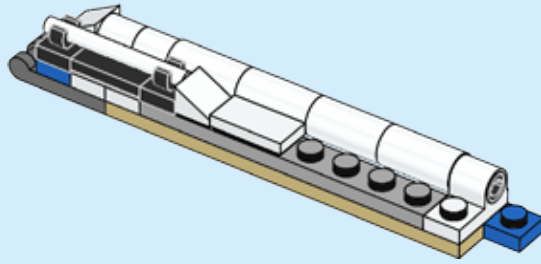

193

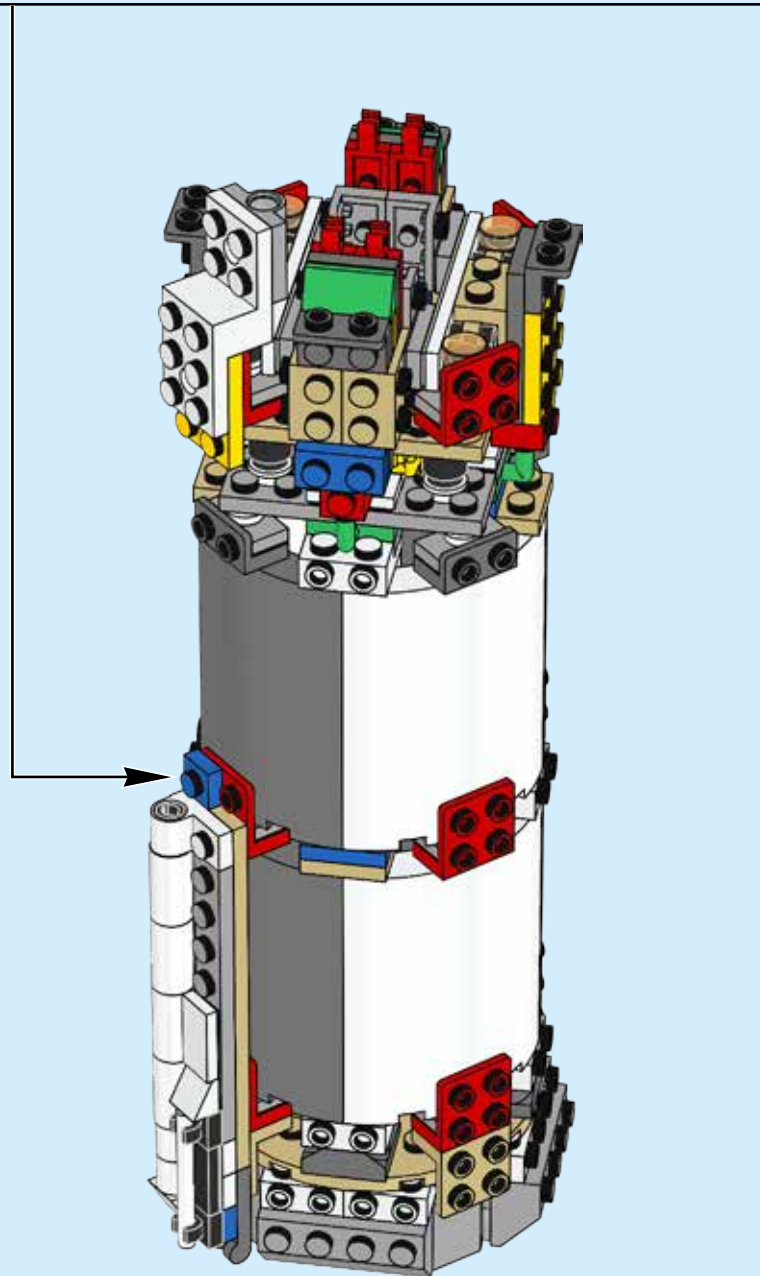



194

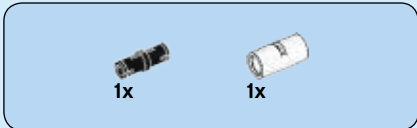

195

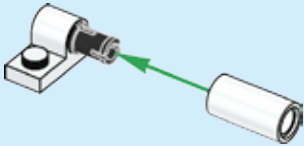

196

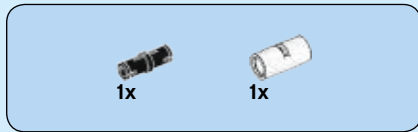
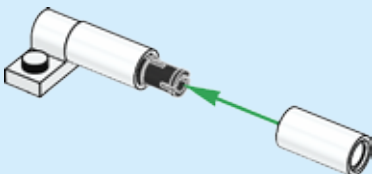

197

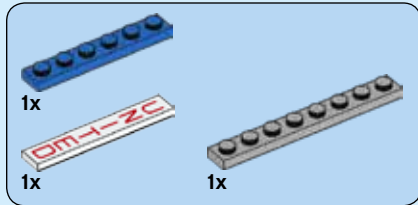
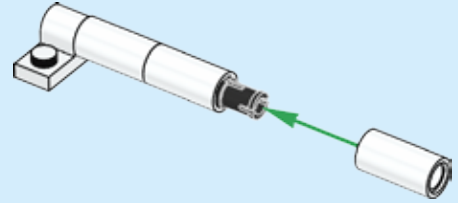

198

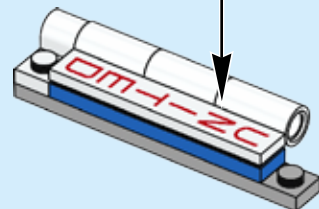
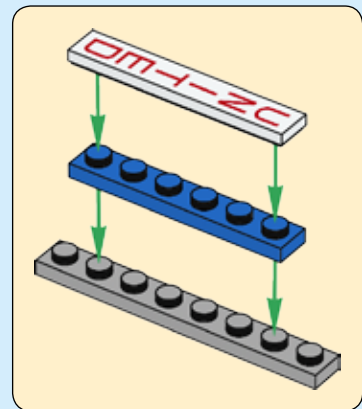

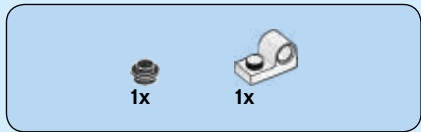

199

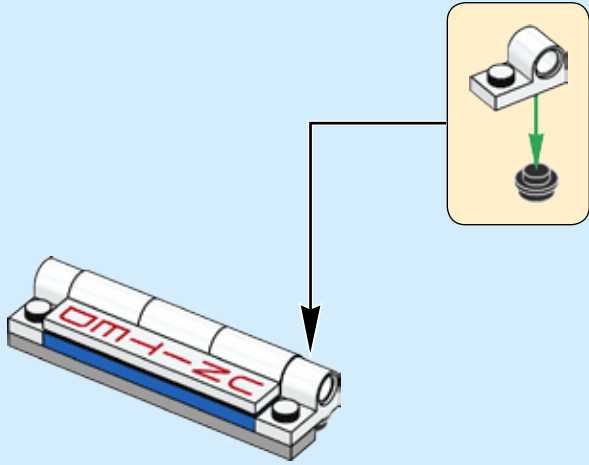

200

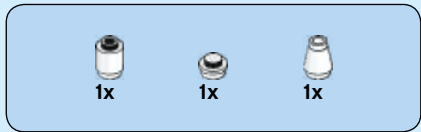
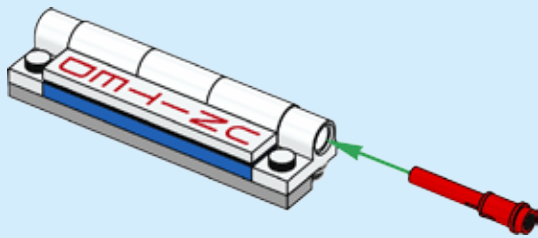

201

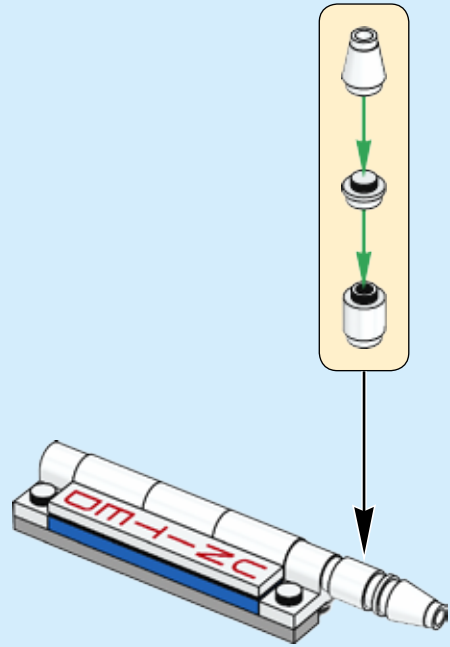

202

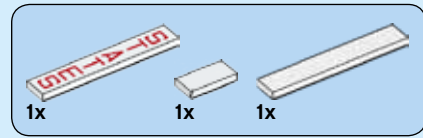
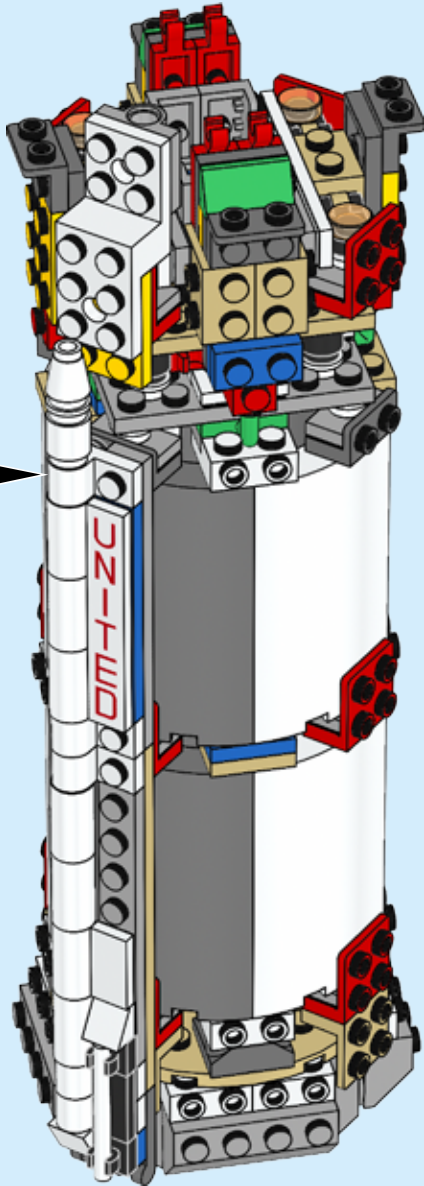

203

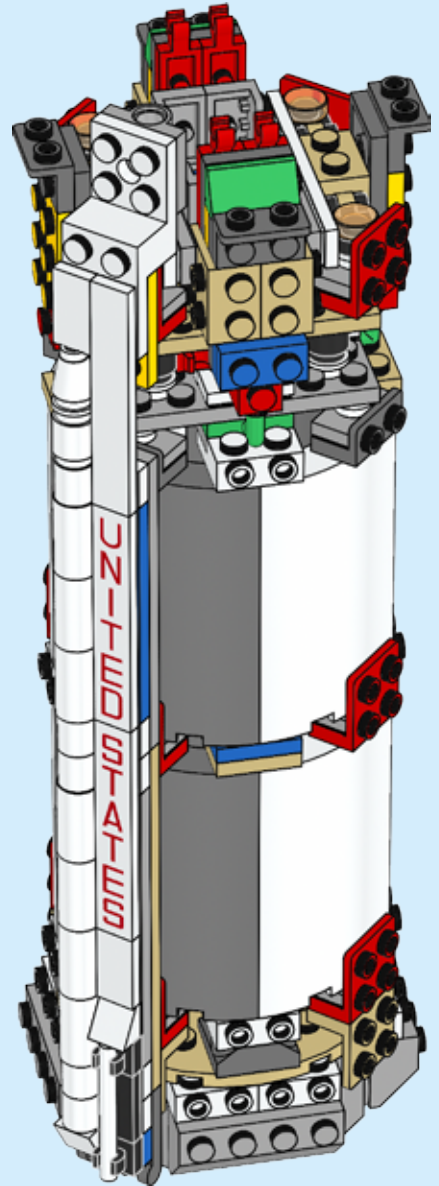

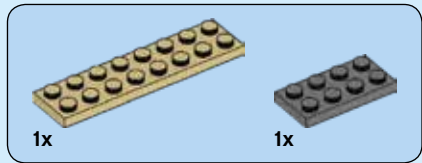

204

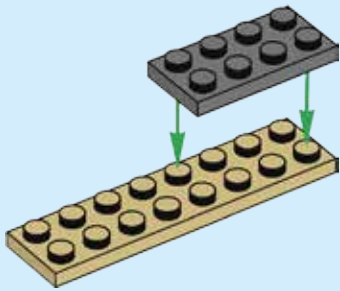

205

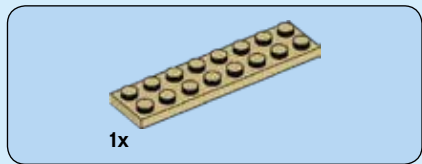
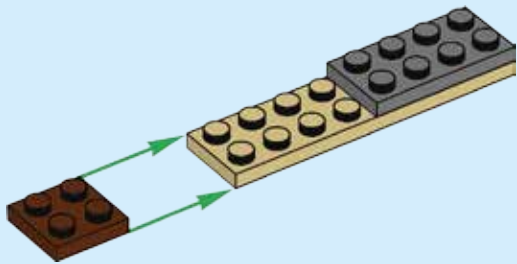

206

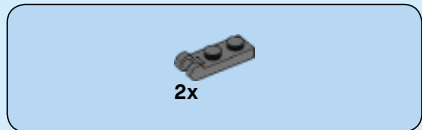
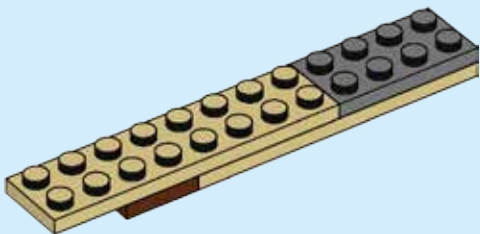

207

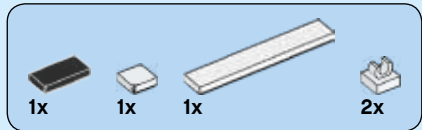
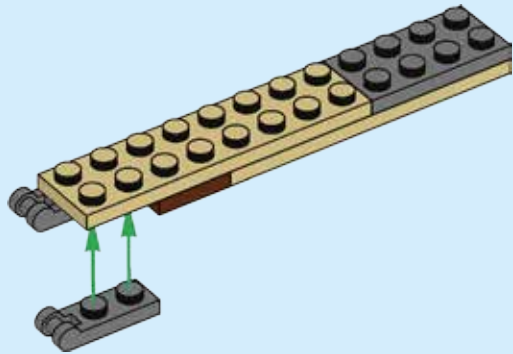

208

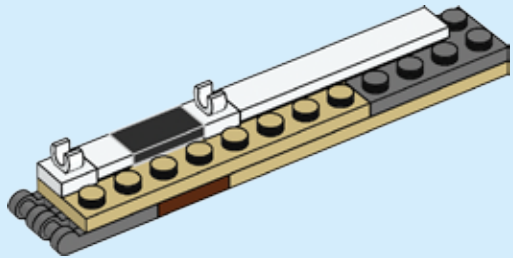

209

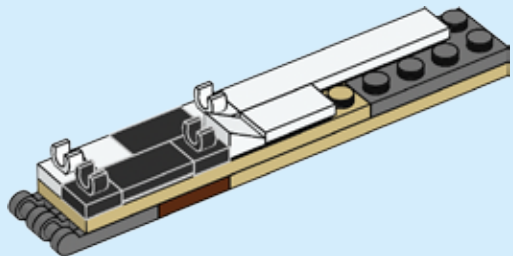

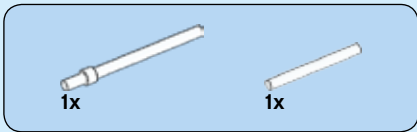

210

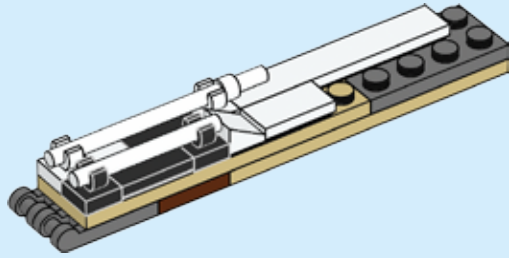

211

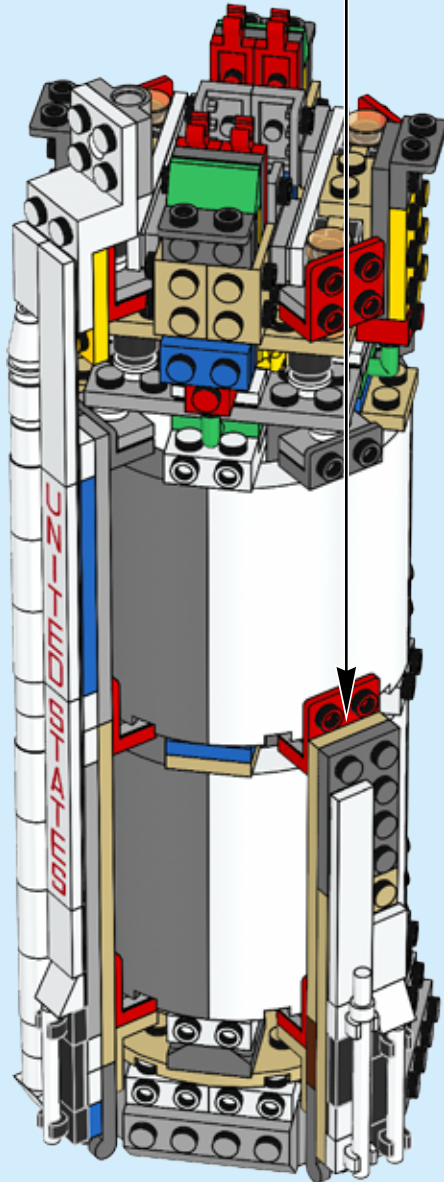

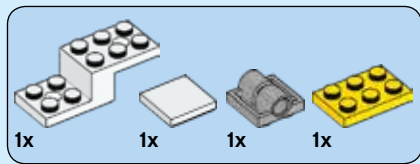

212

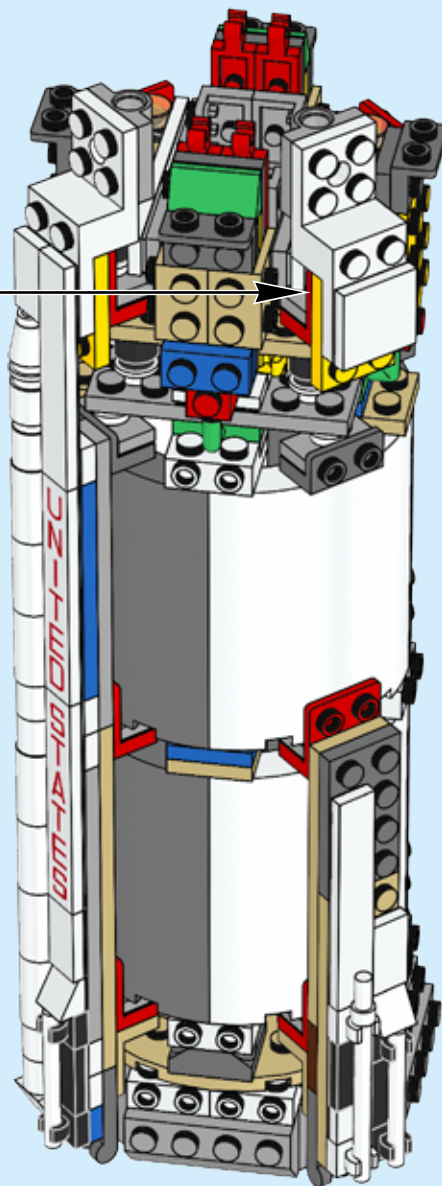
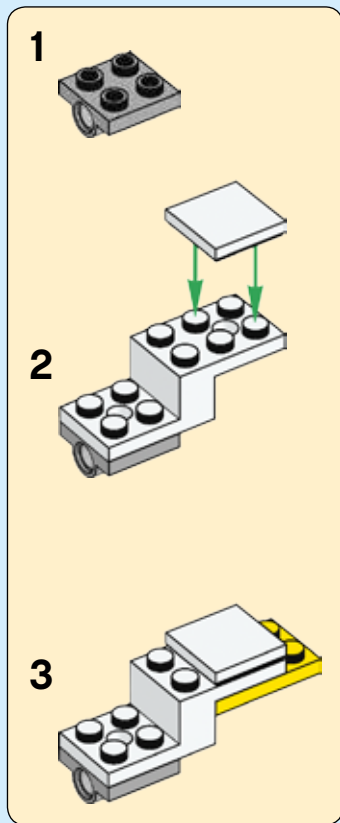

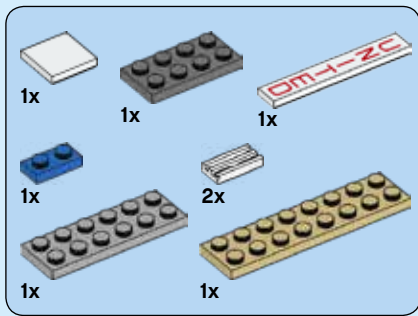

213

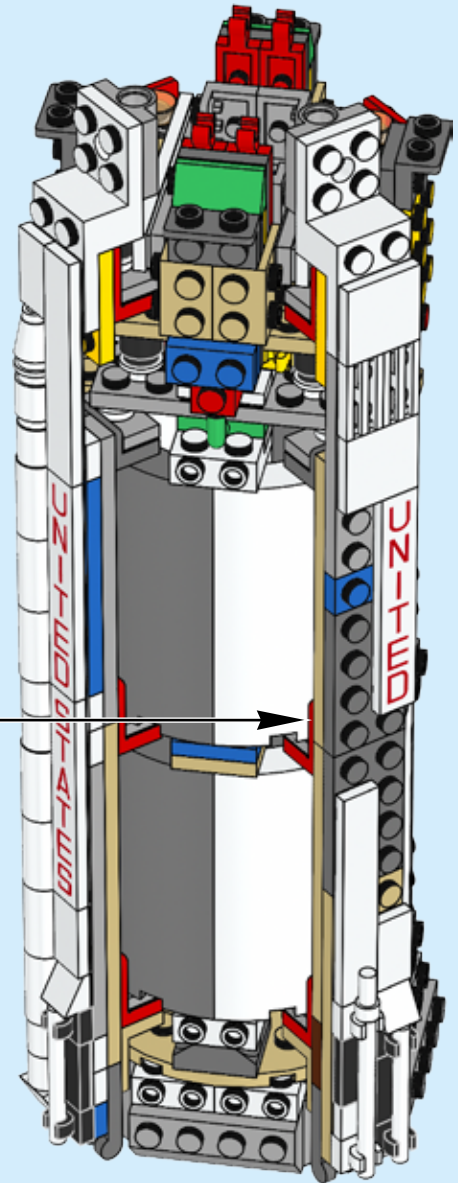
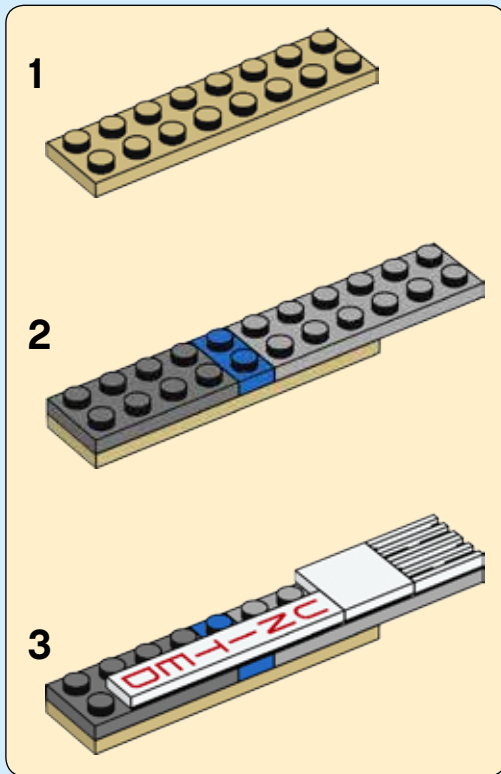

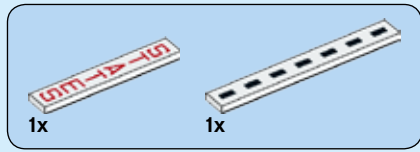

214

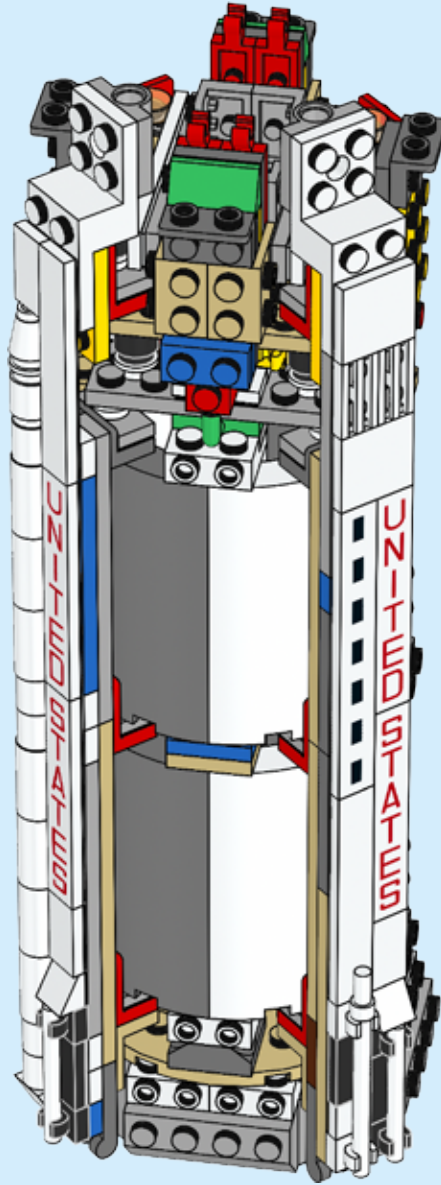

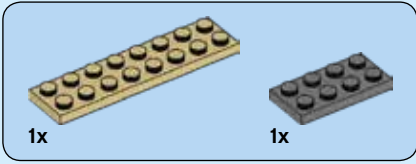
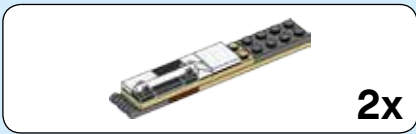

215

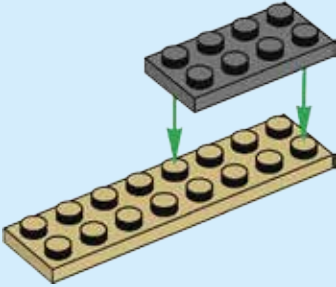

216

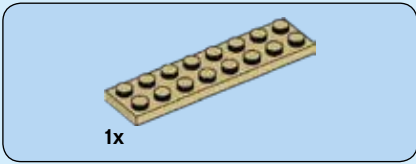
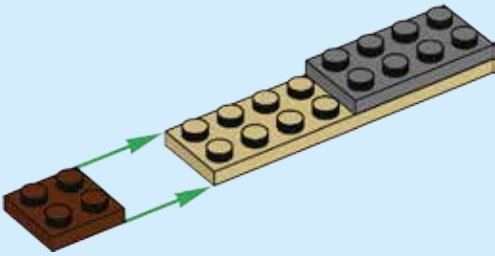

217

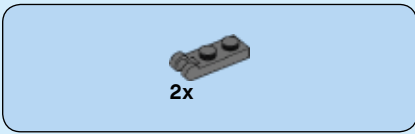
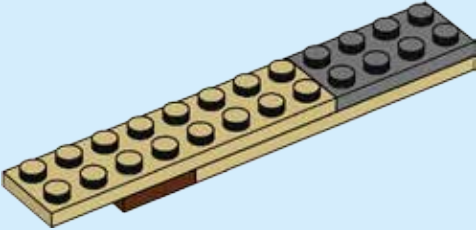

218

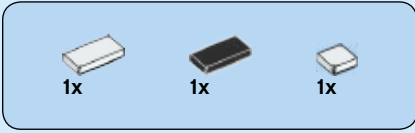
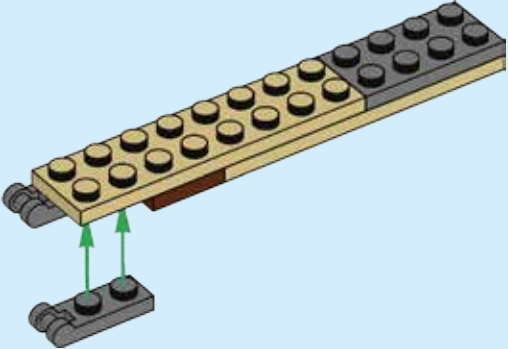

219

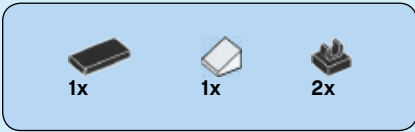
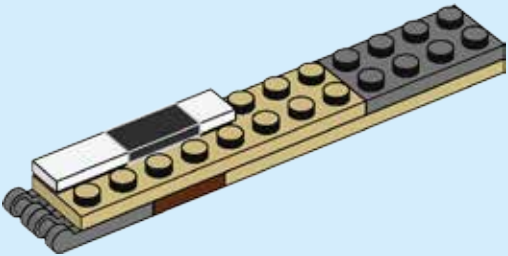

220

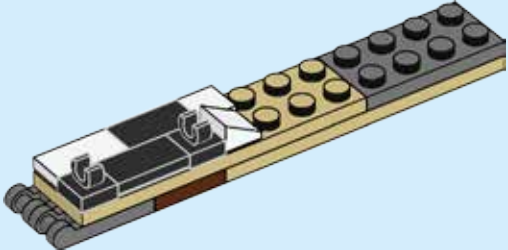

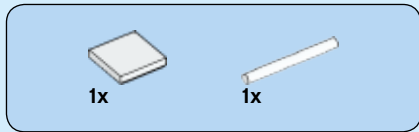

221

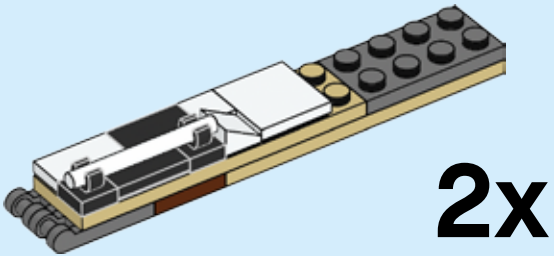

222

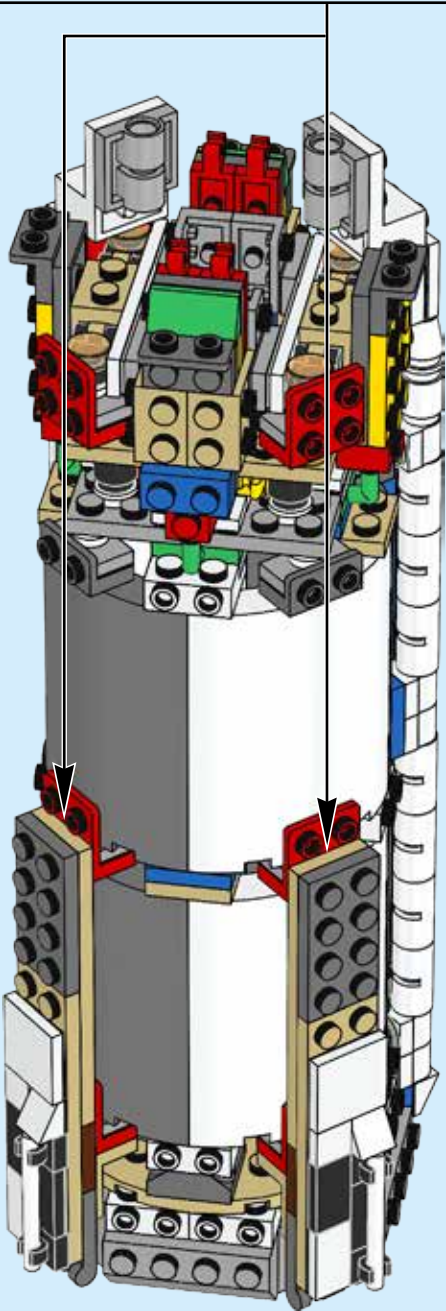
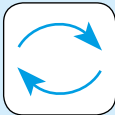

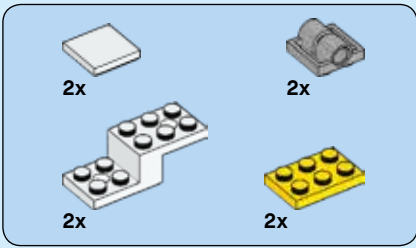

223

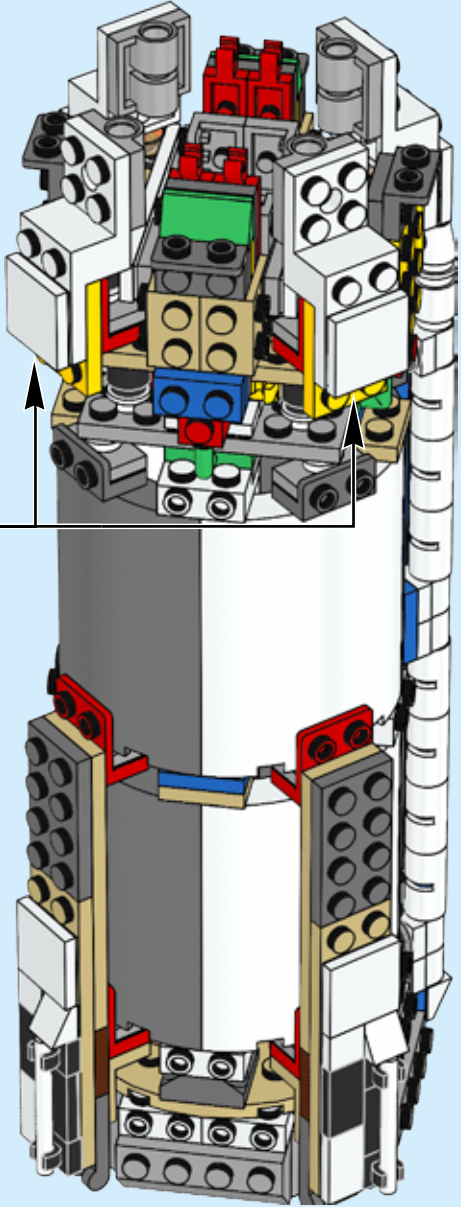
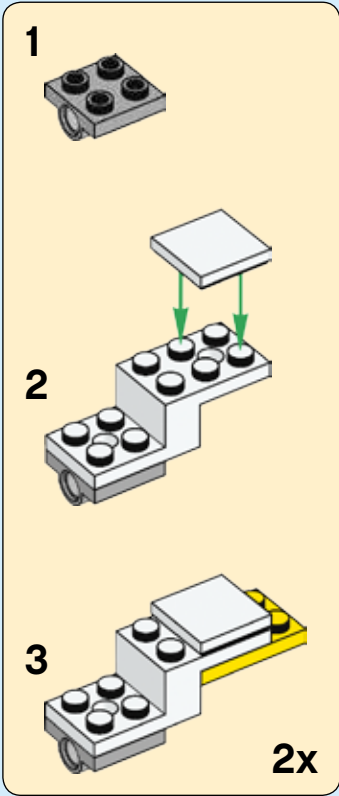

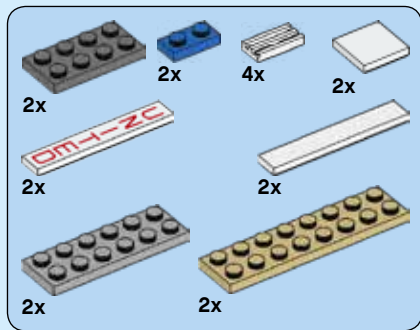

224

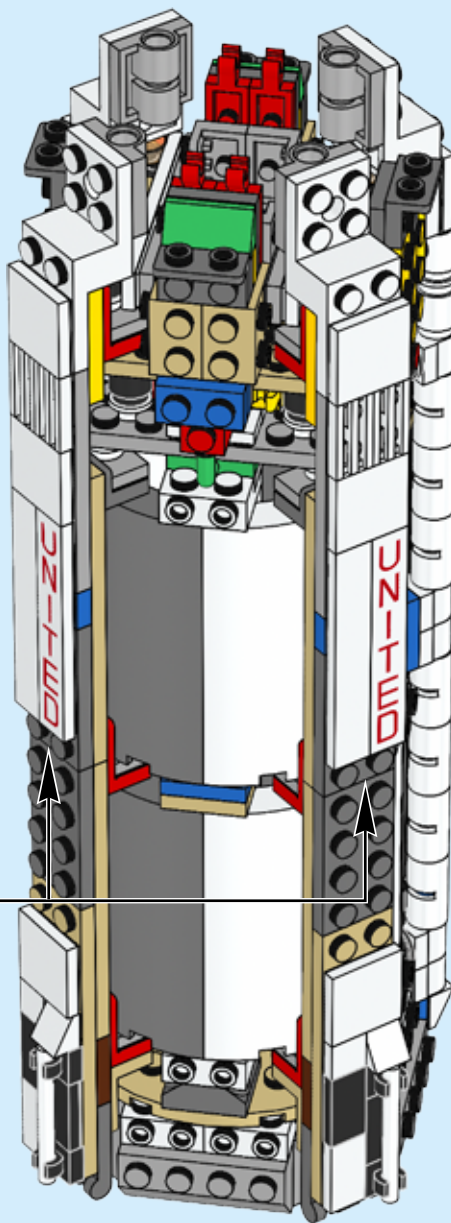
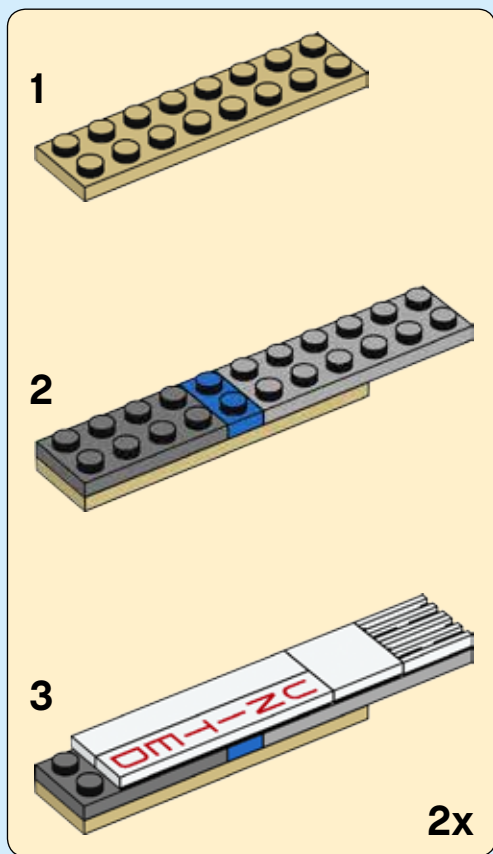

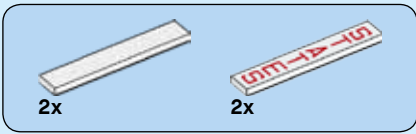

225

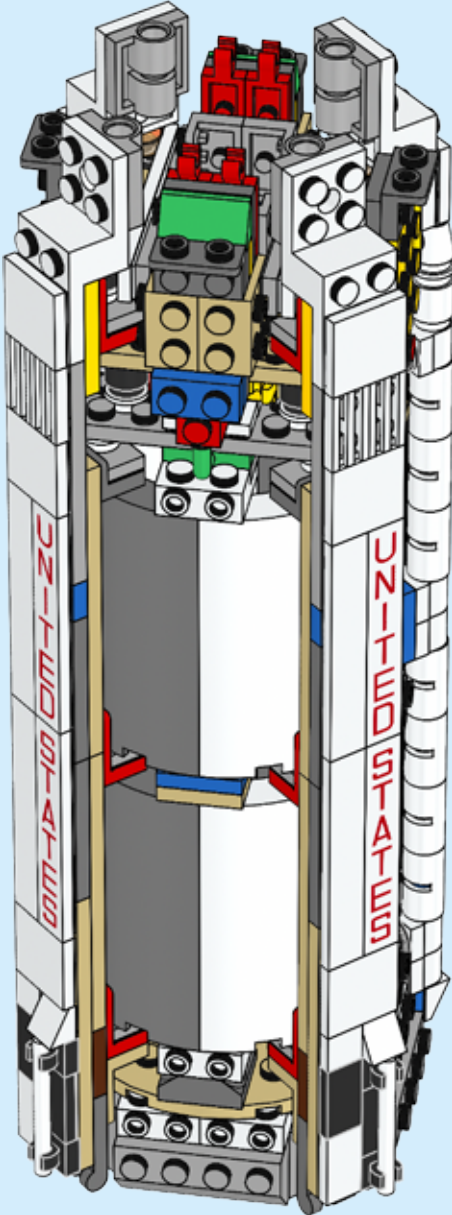

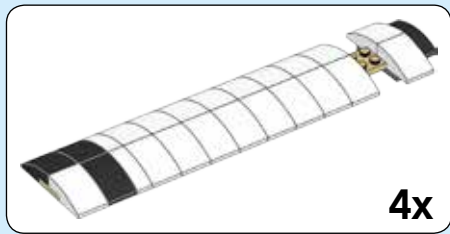
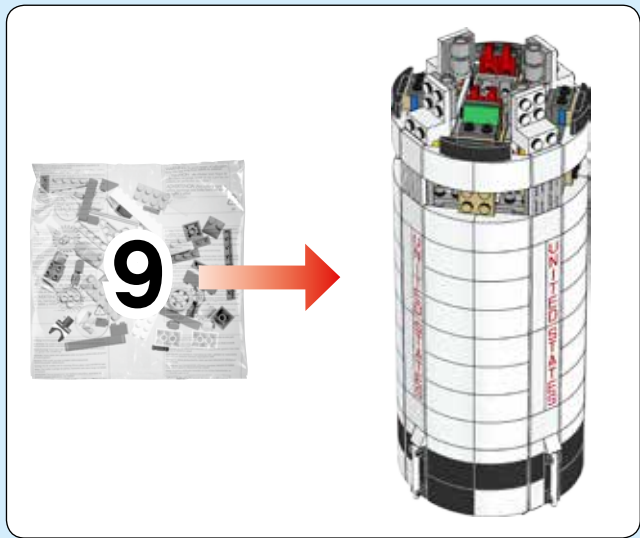

226

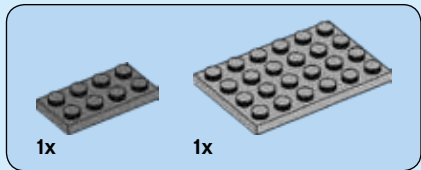
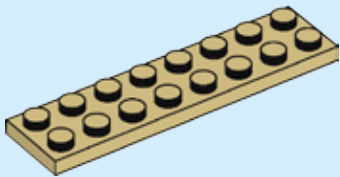

227

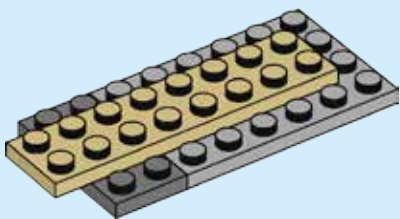

228

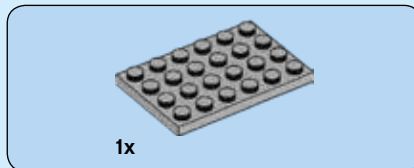
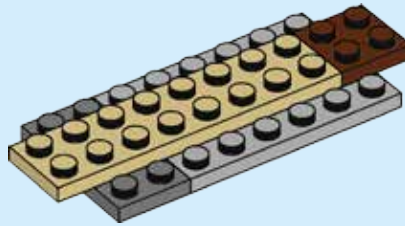

229

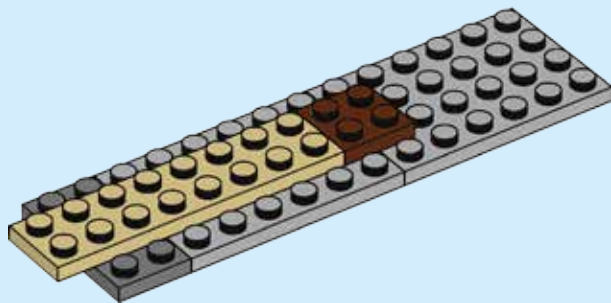

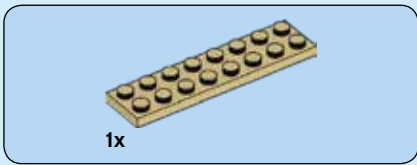

230

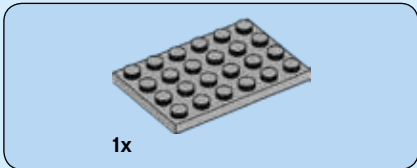
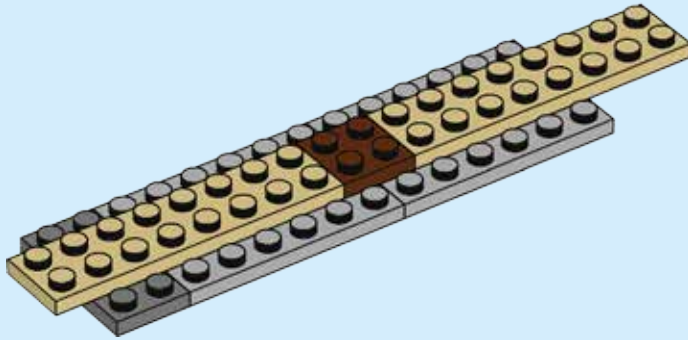

231

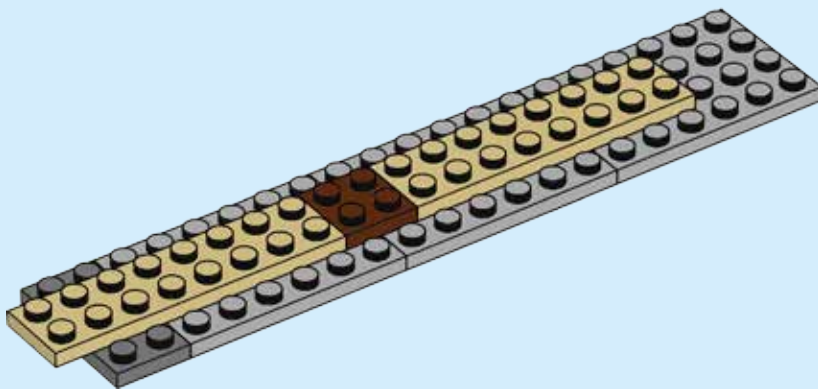

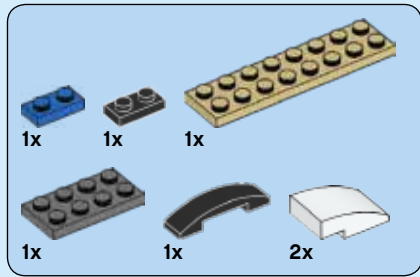

232

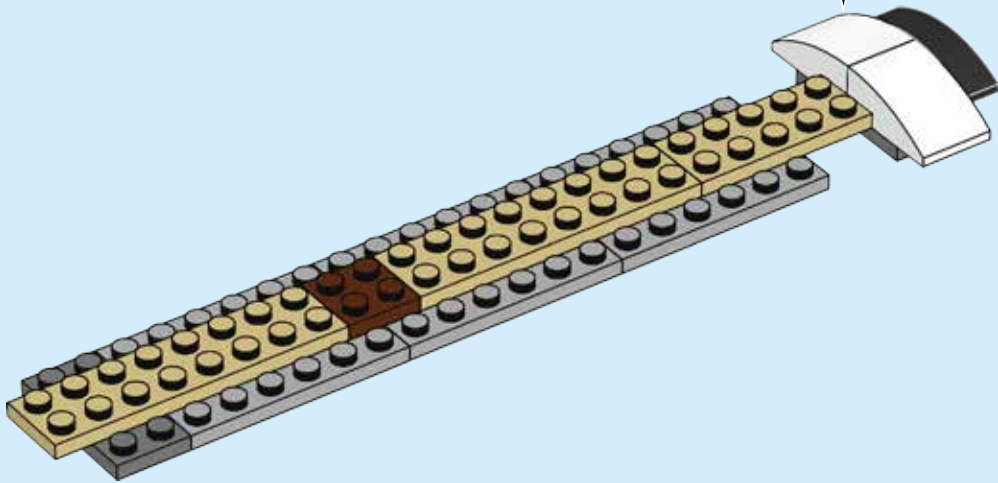
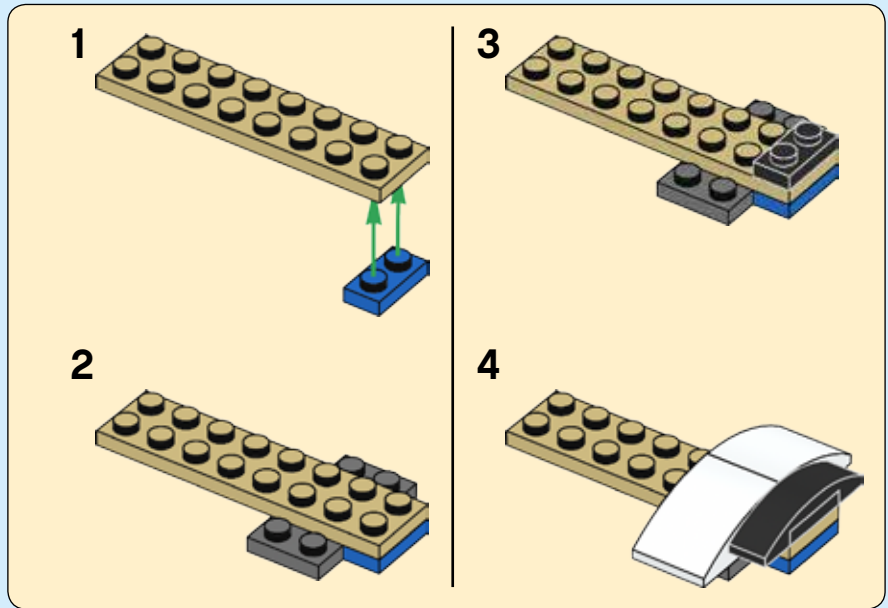

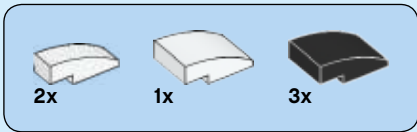

233

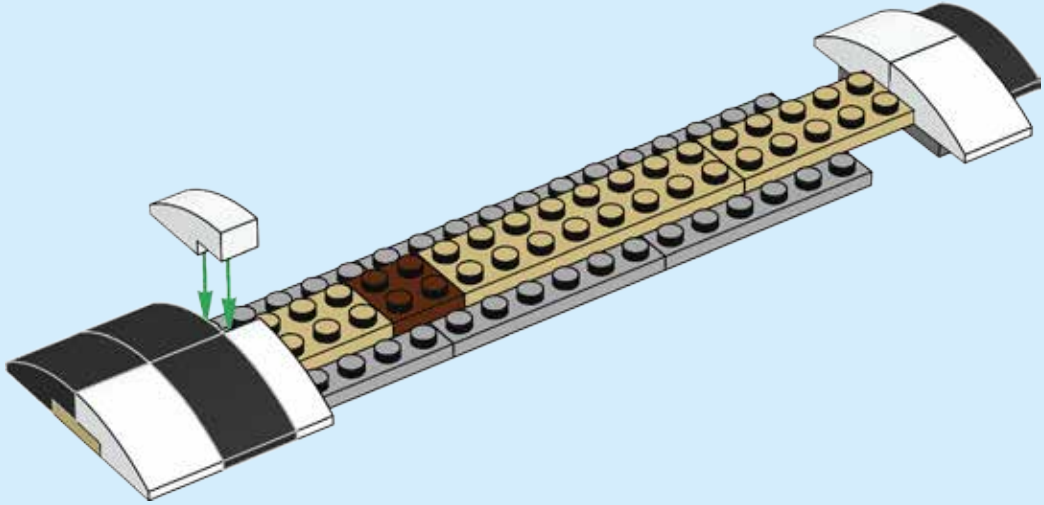

234

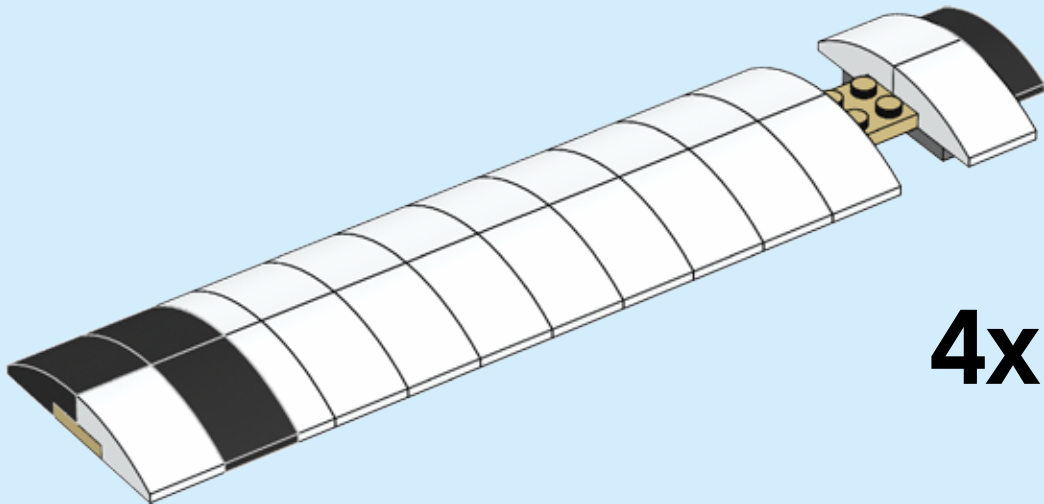

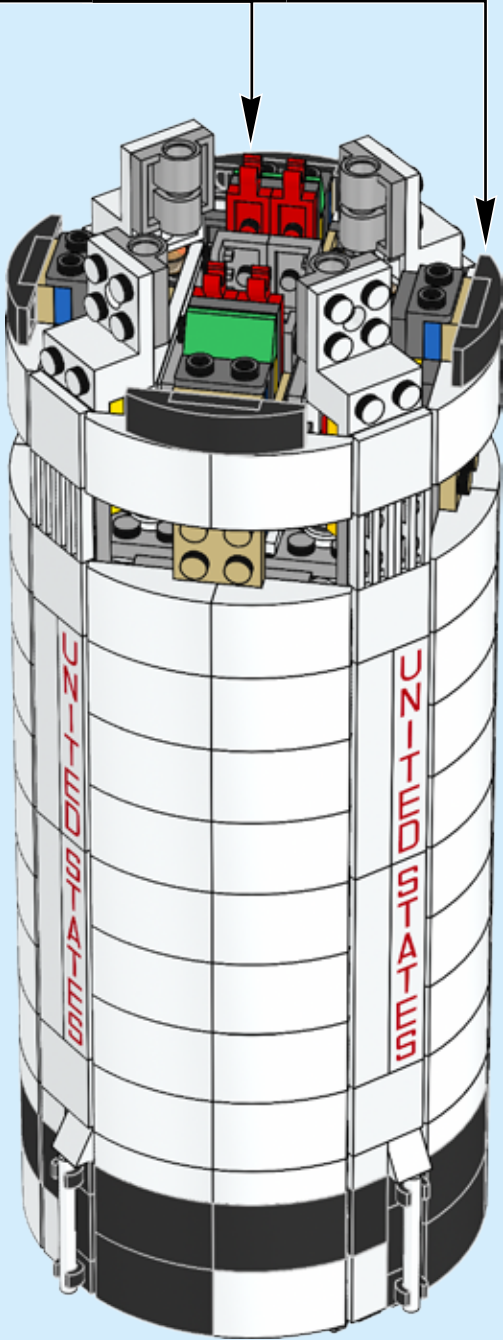

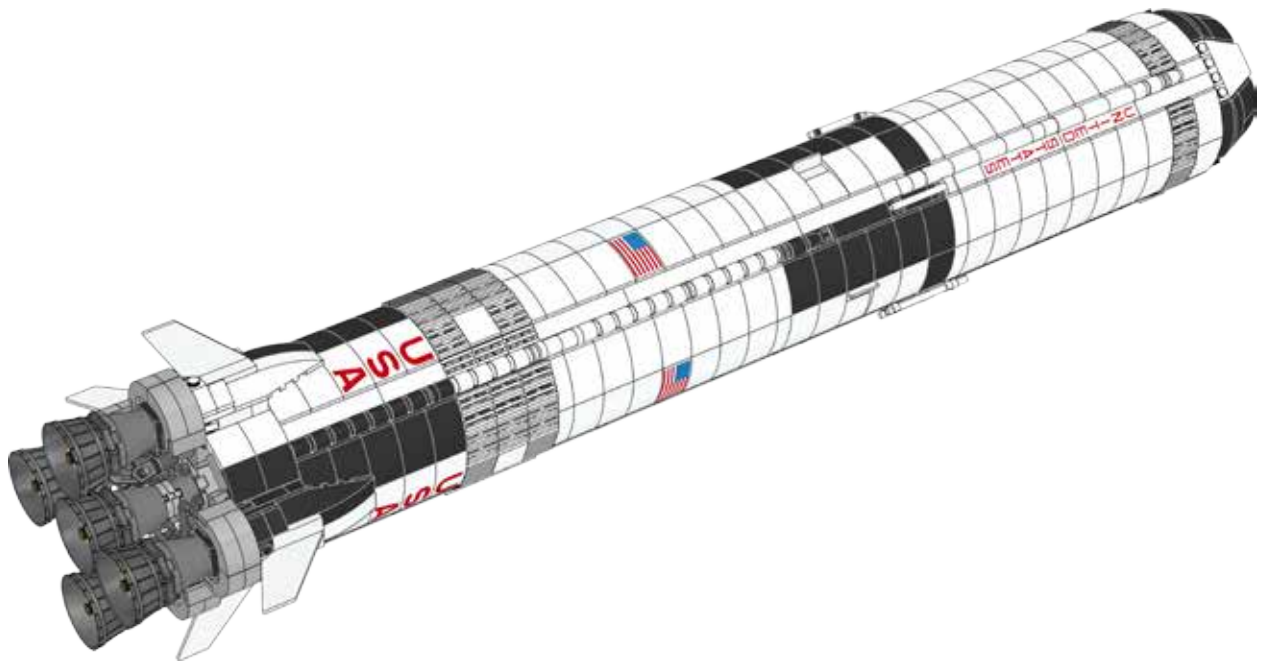



236

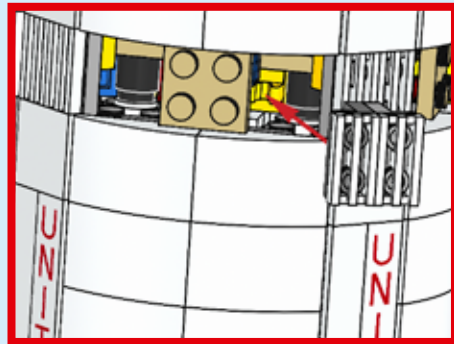
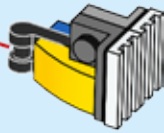
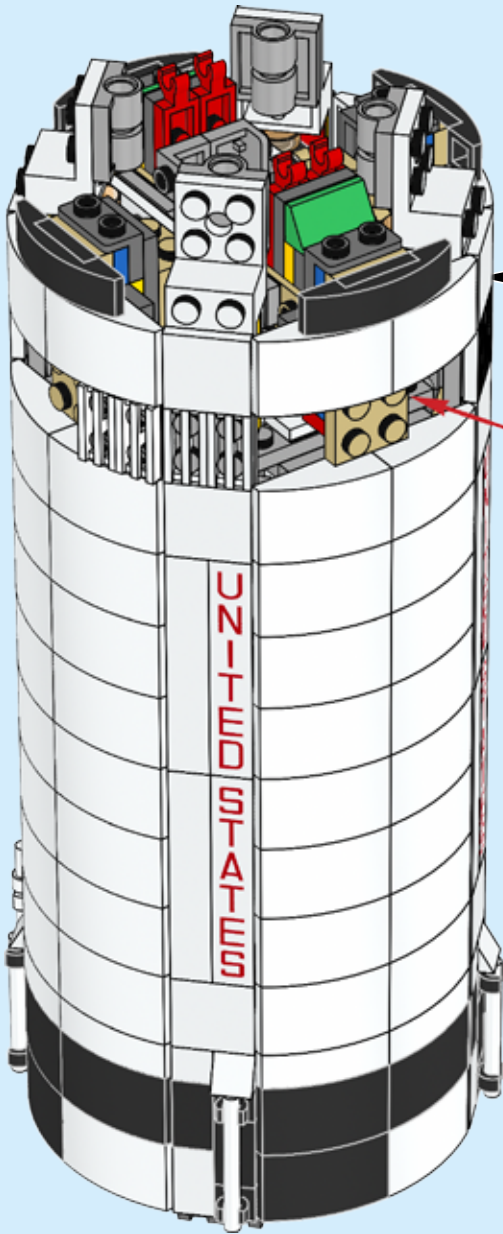
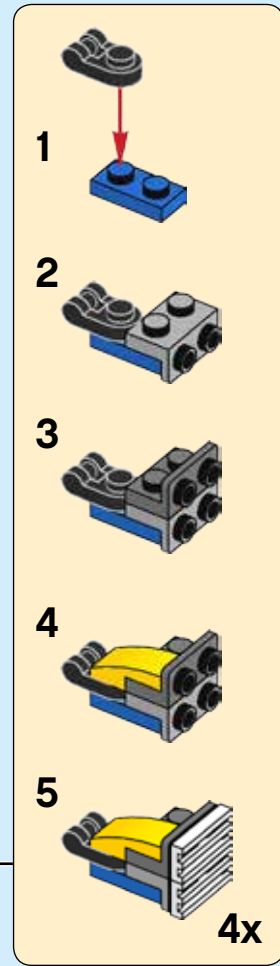



237

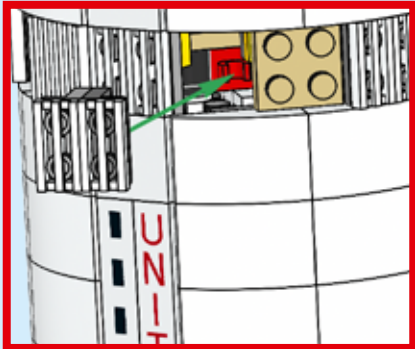
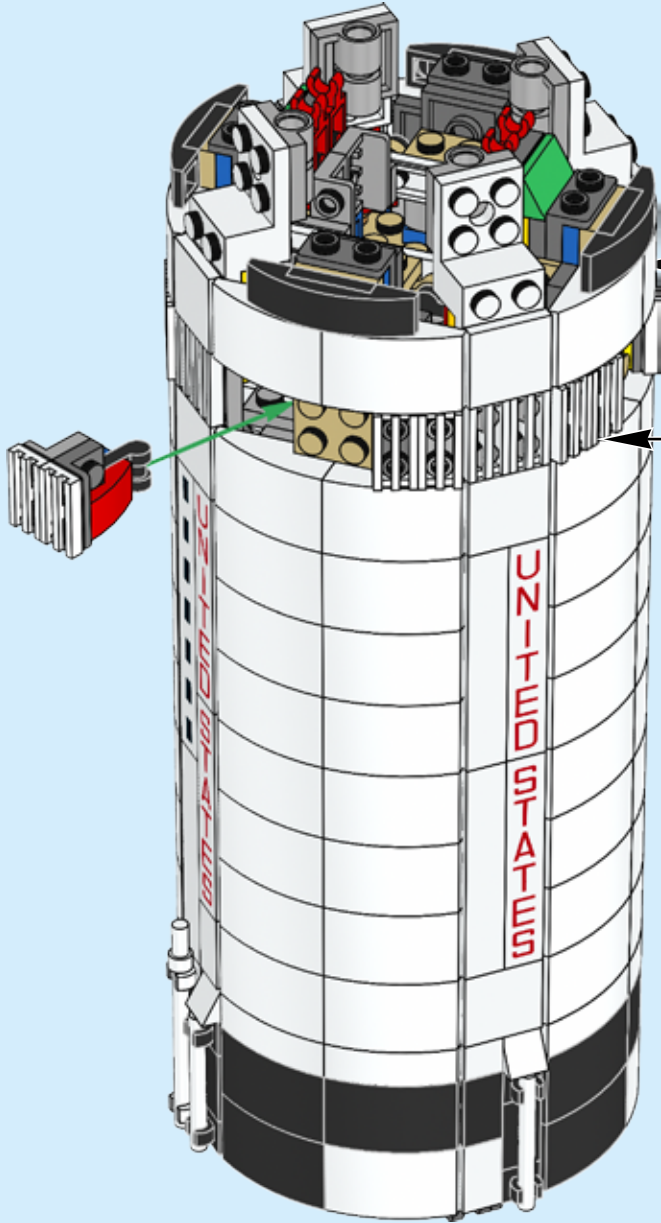
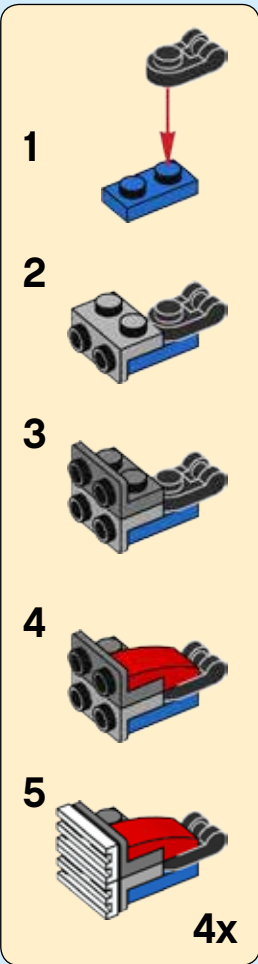

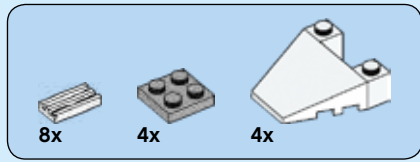

238

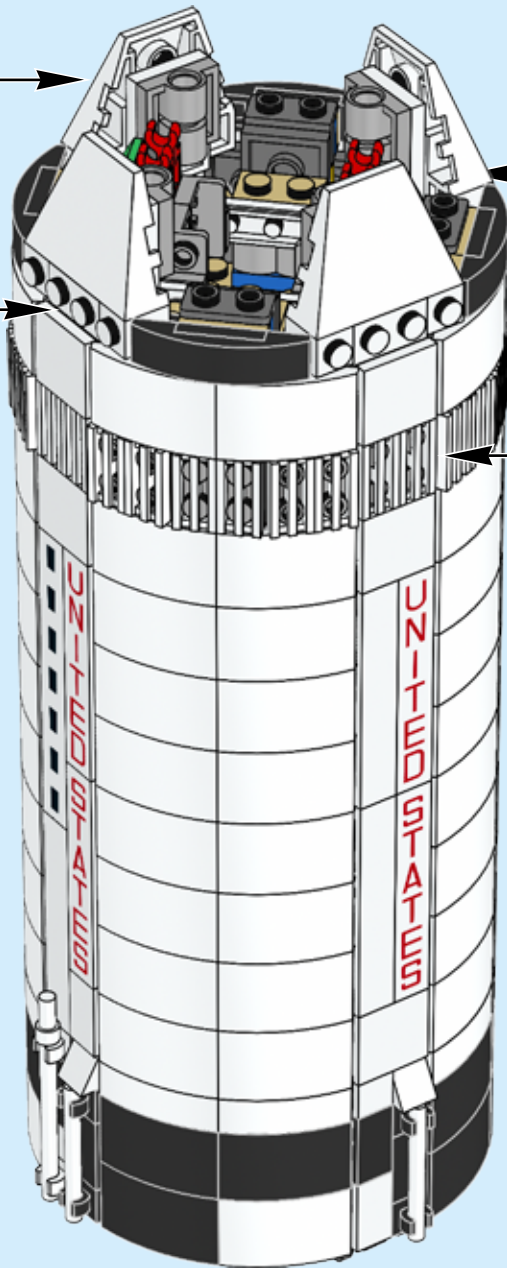
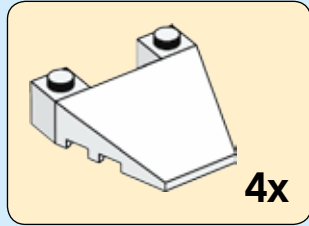
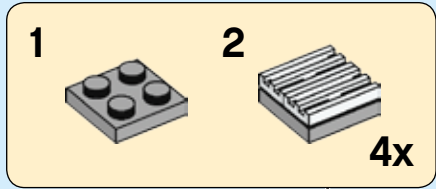



239

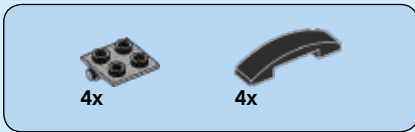
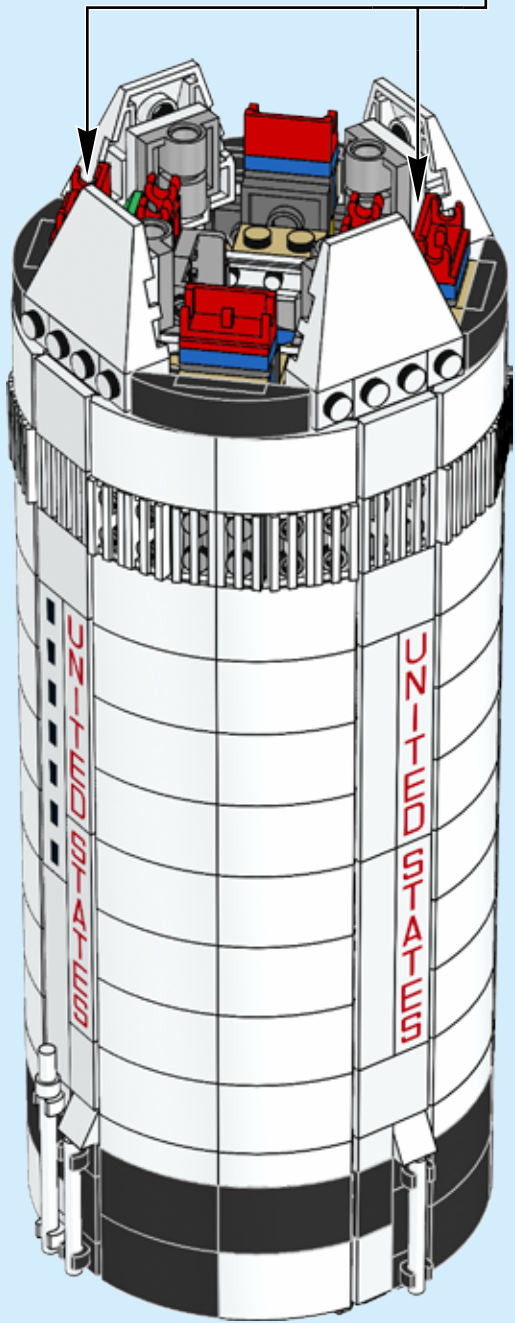
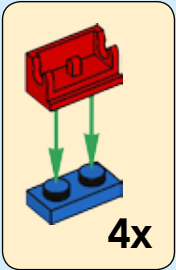

240

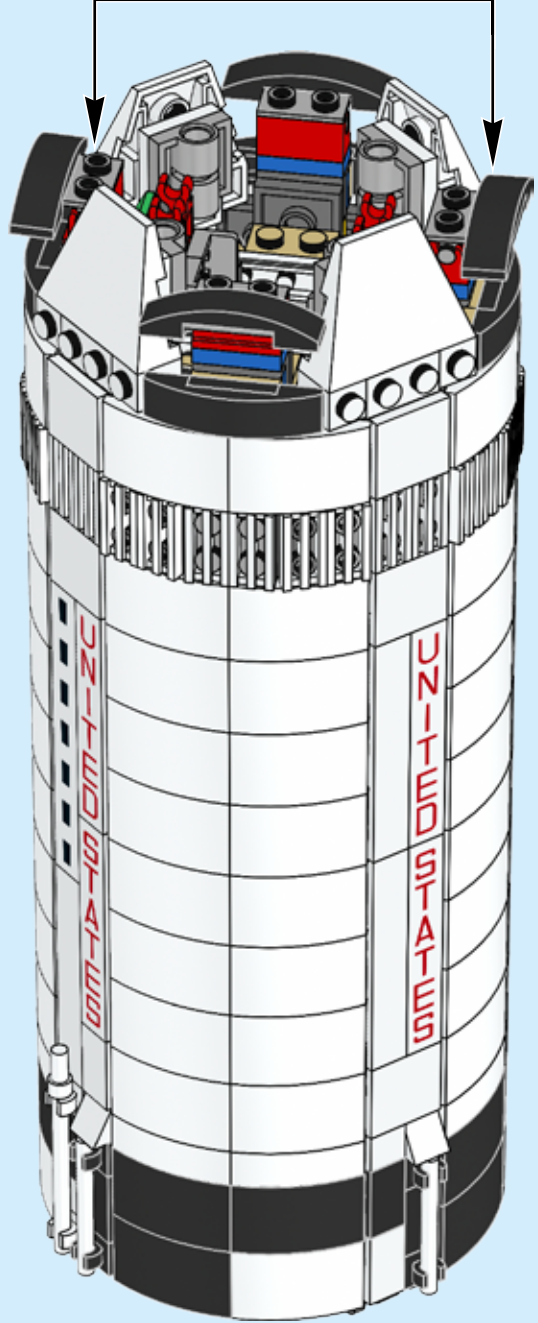
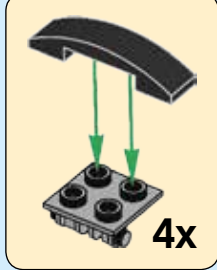

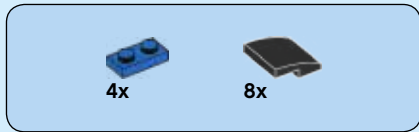

241

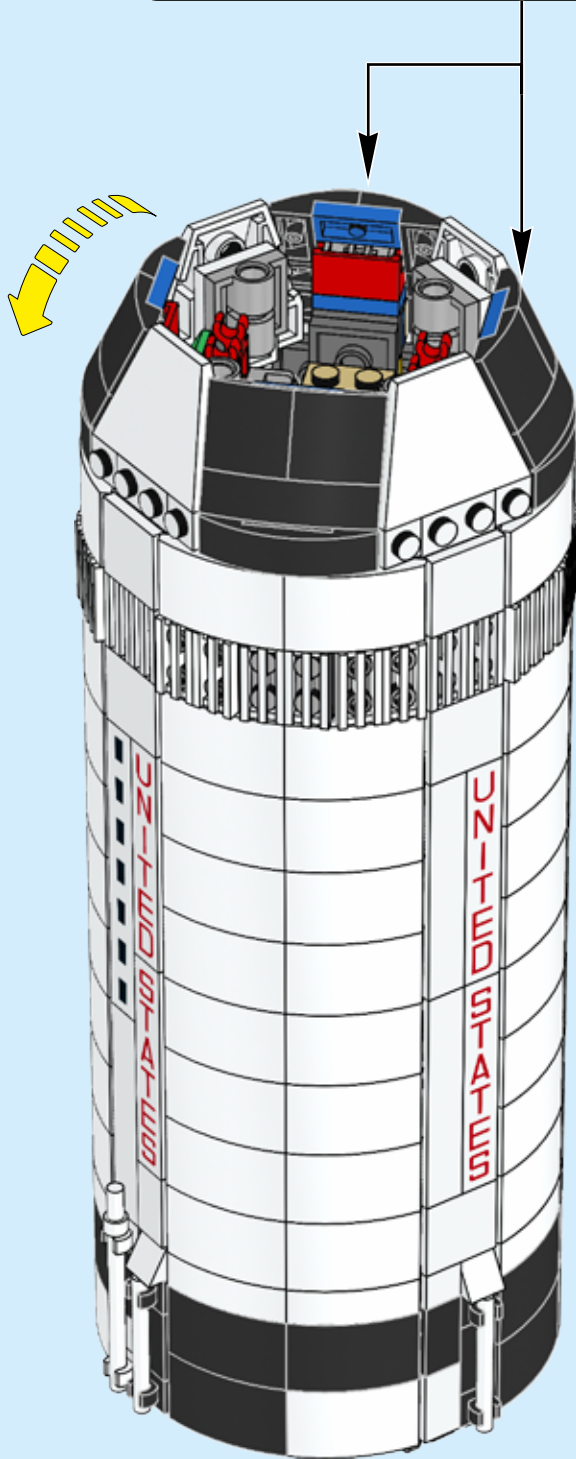
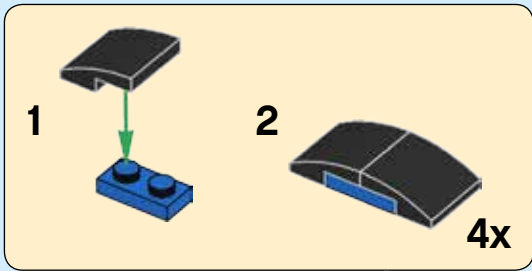



242

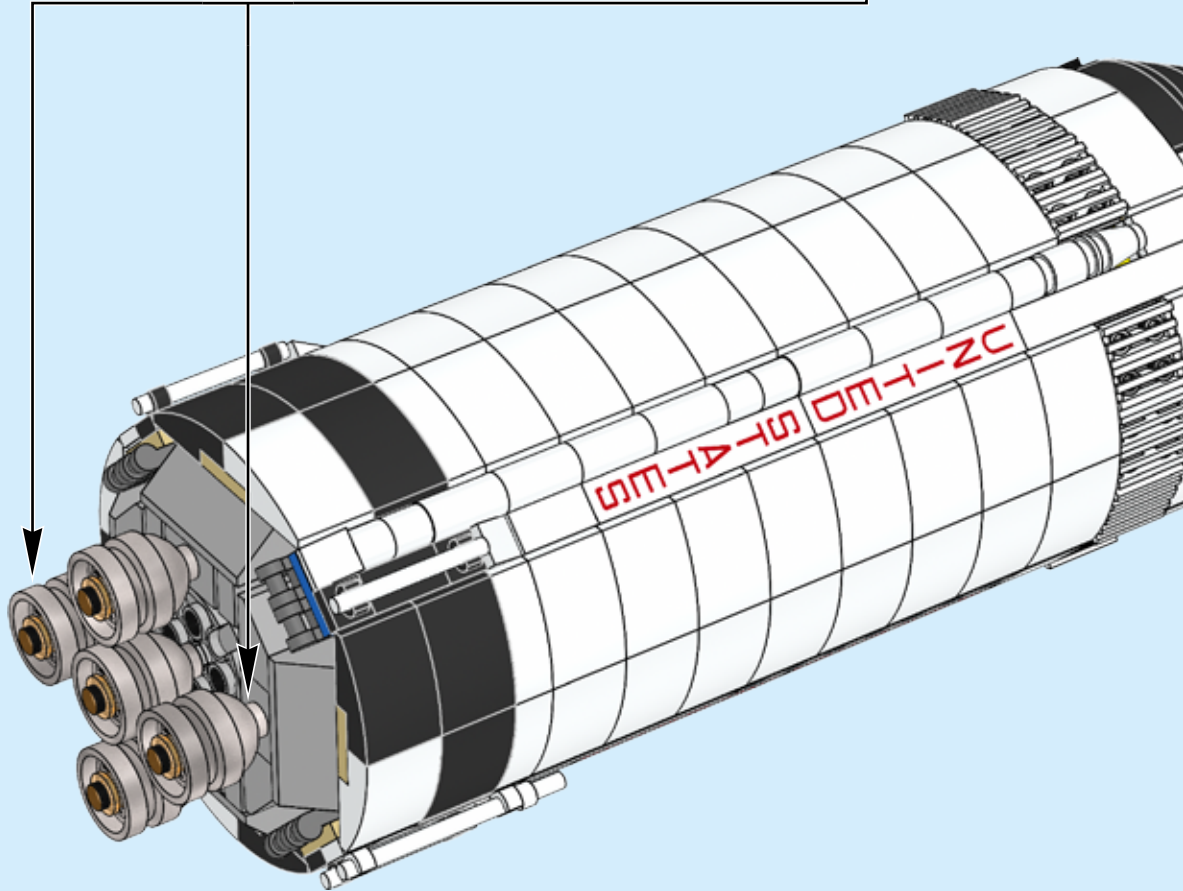
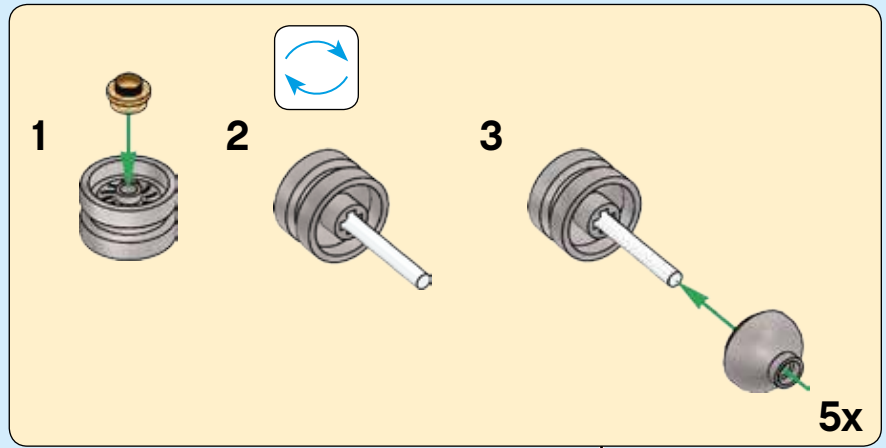
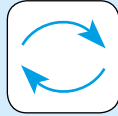

243

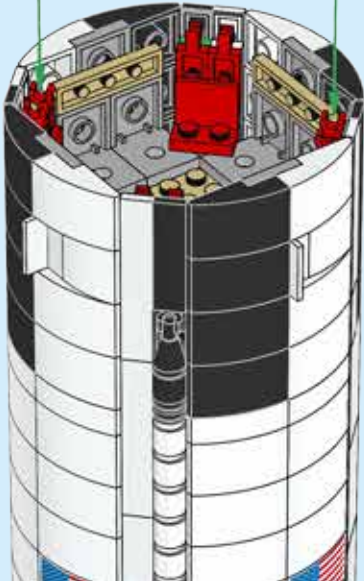
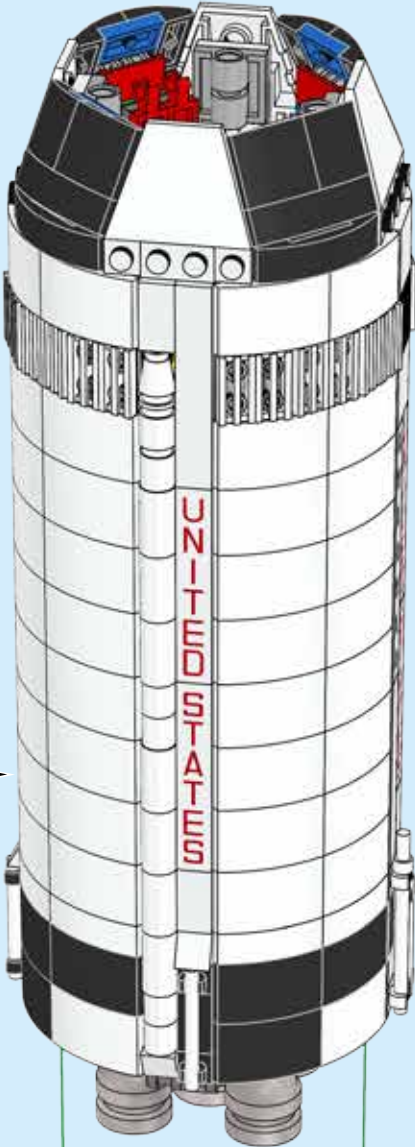

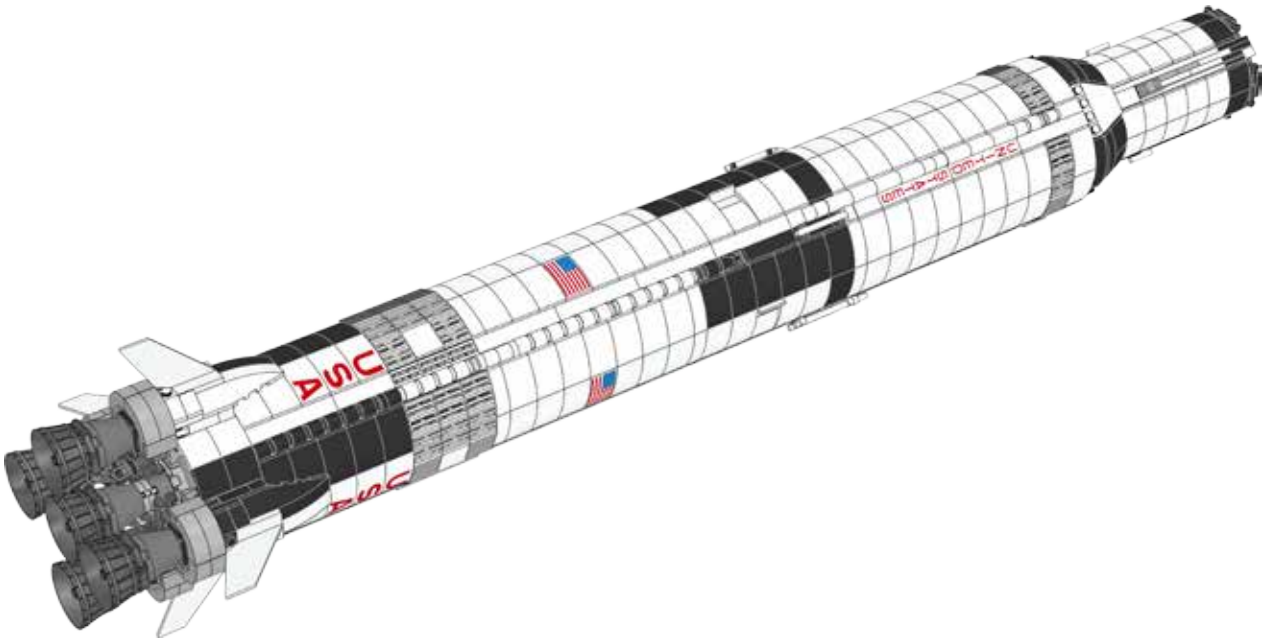

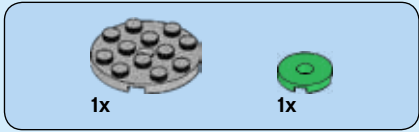
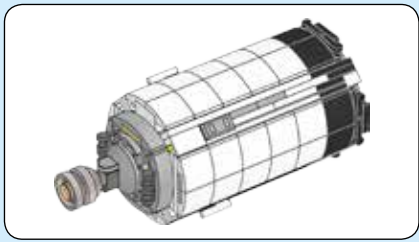

244

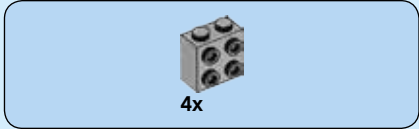
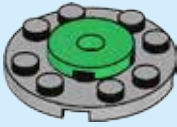

245

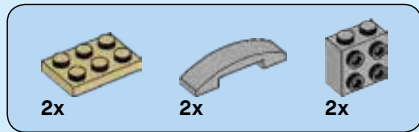
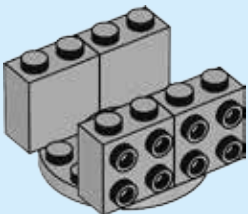

246

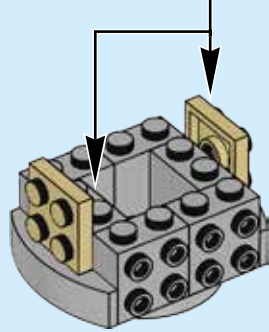
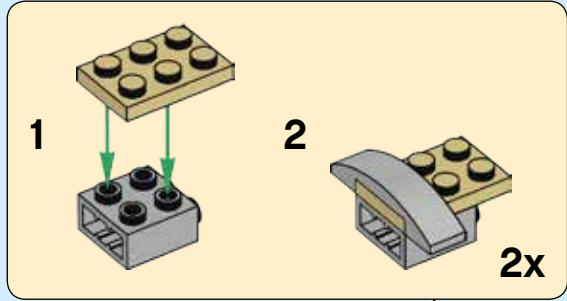

247

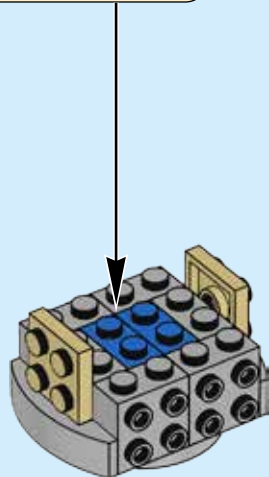
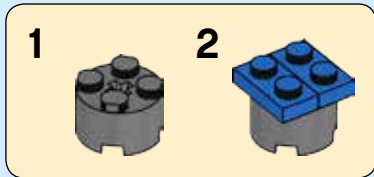

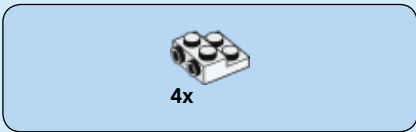

248

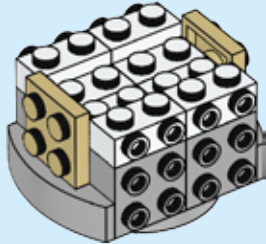

249

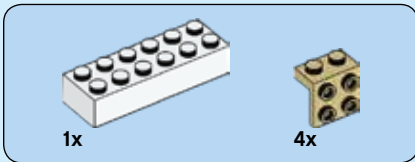
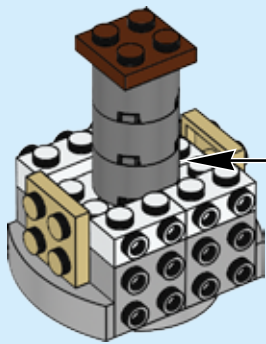
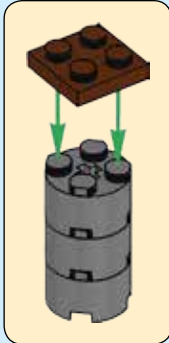

250

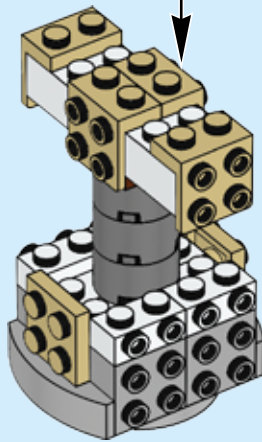
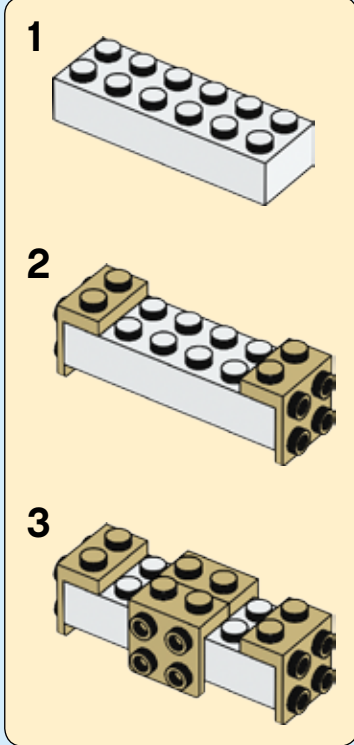

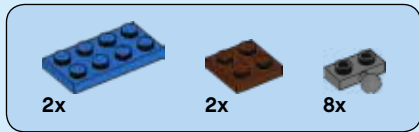

251

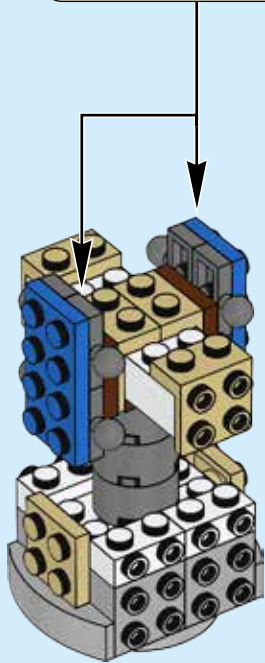
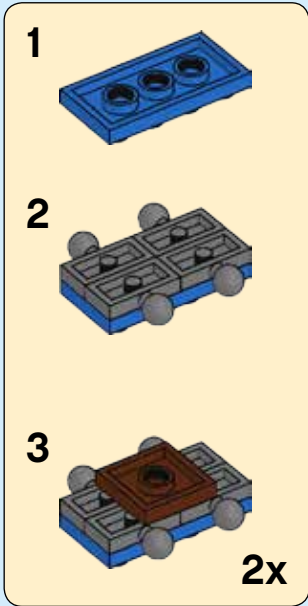

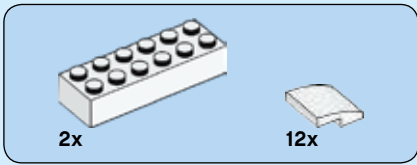

252

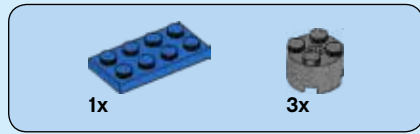
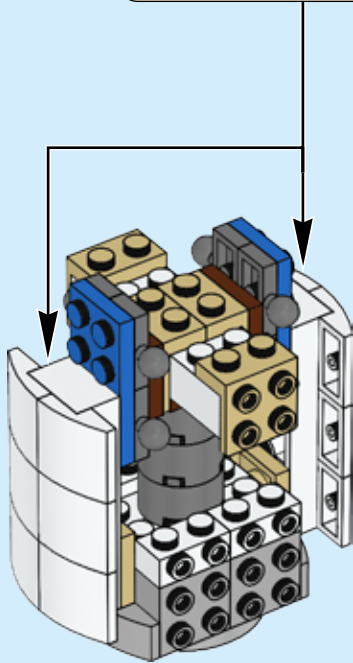
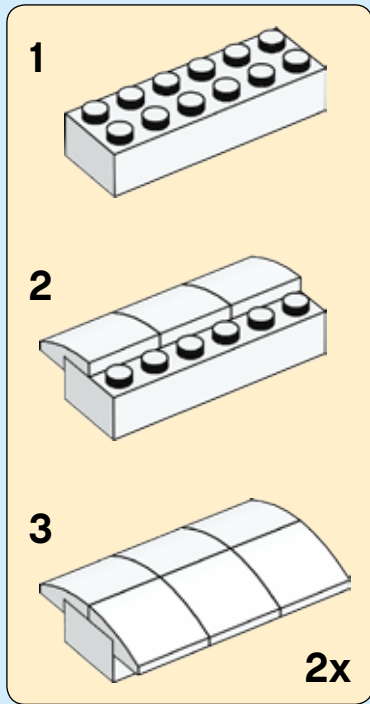

253

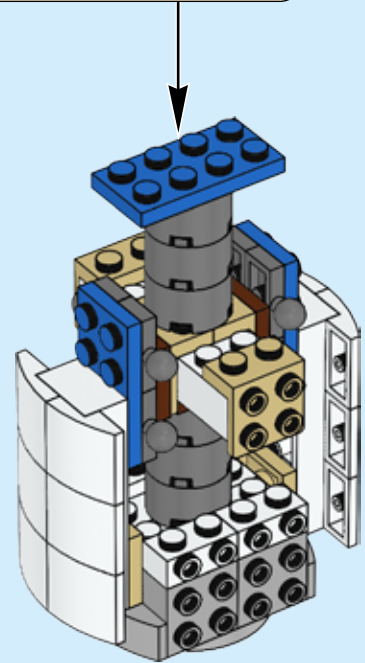
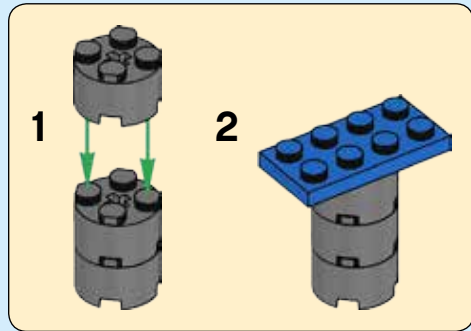



254

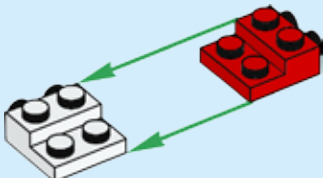

255



256

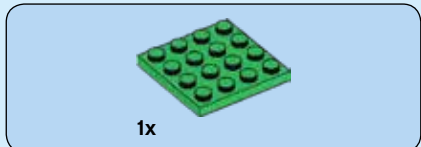

257

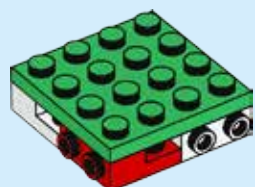



258

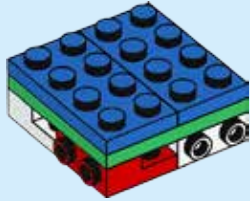

259

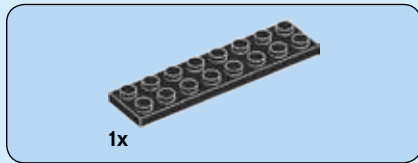
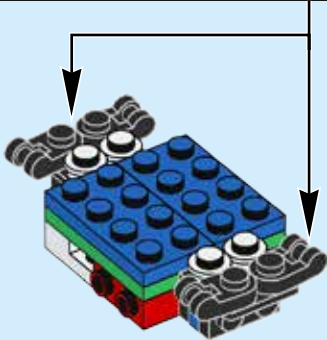
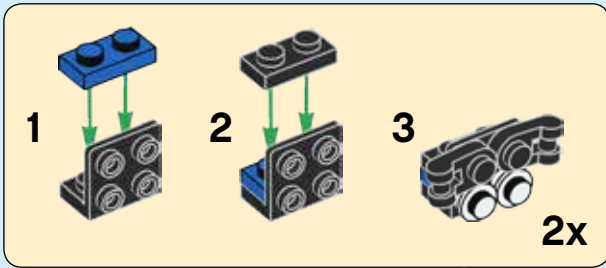

260

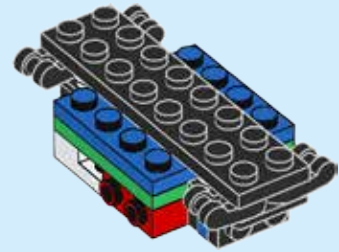

261

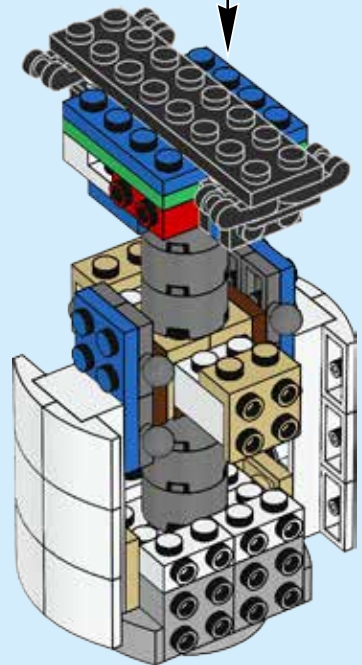

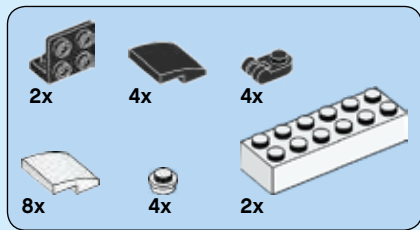

262

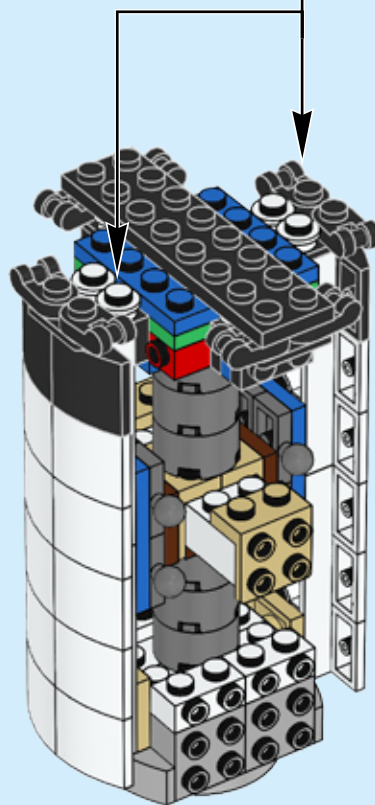
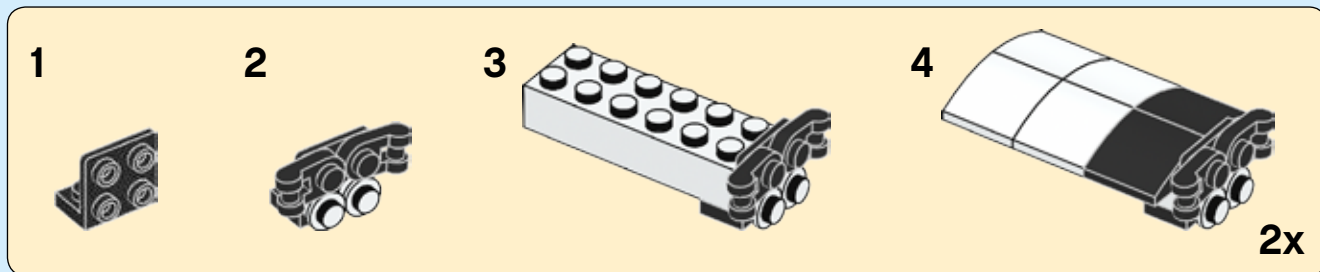



263

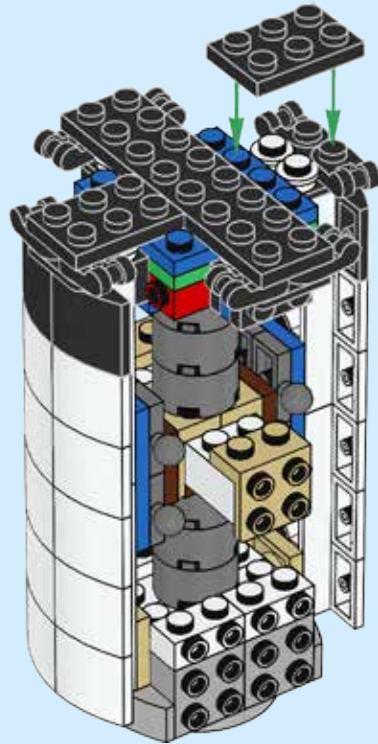

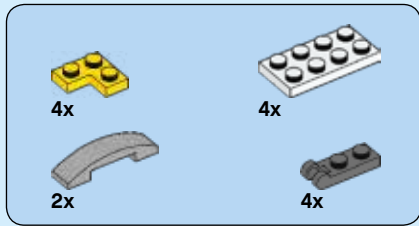

264

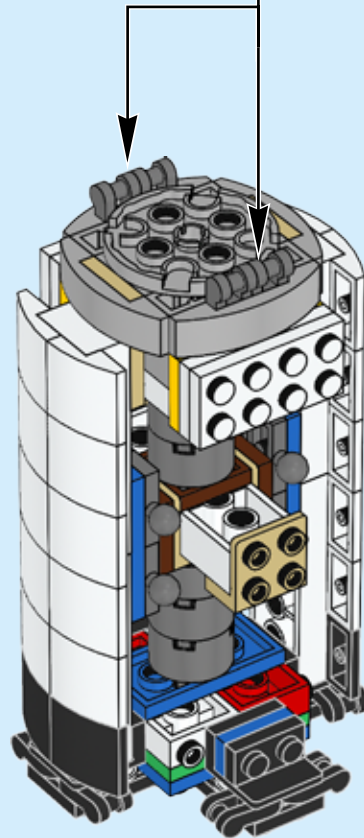
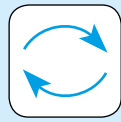
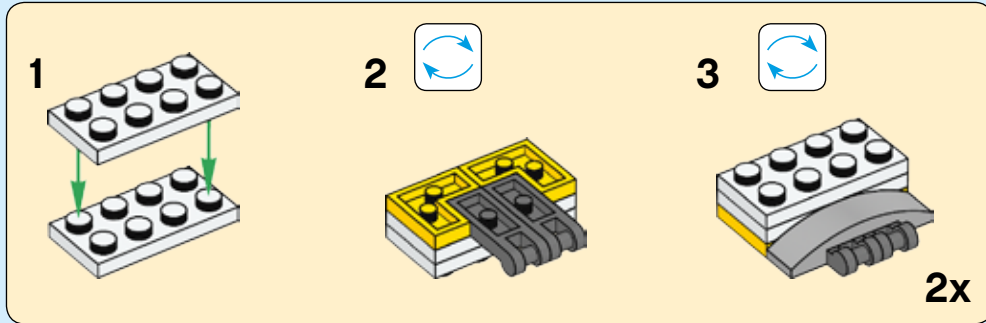

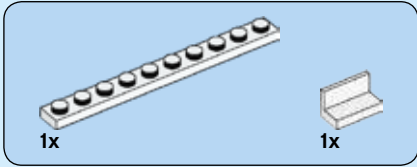
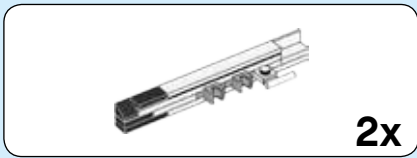

265

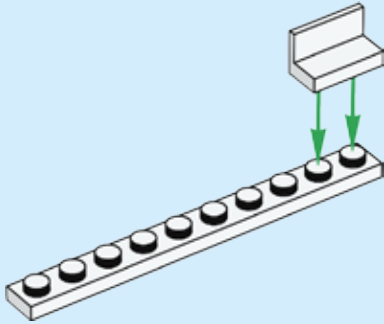

266

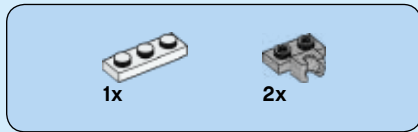
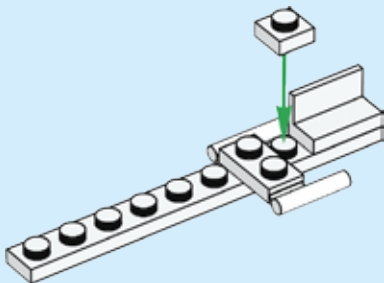

267

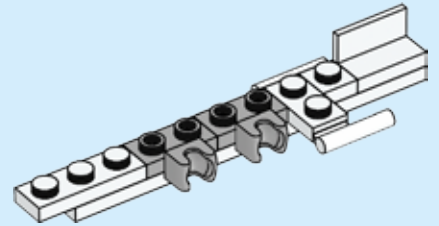

268

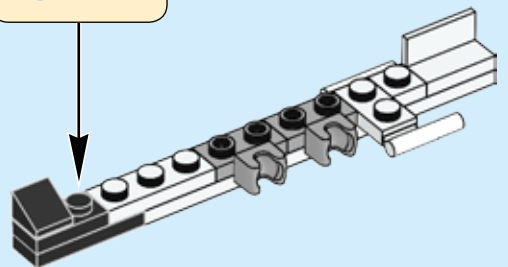
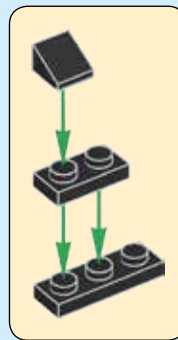

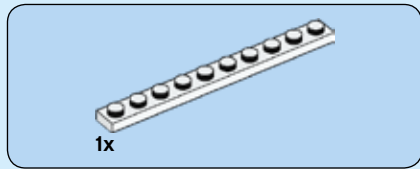

269

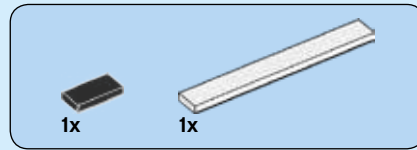

270

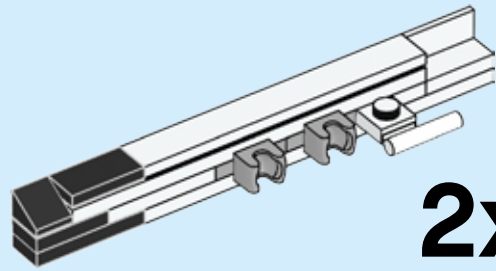
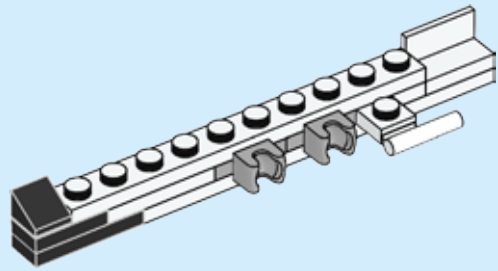

2x

271

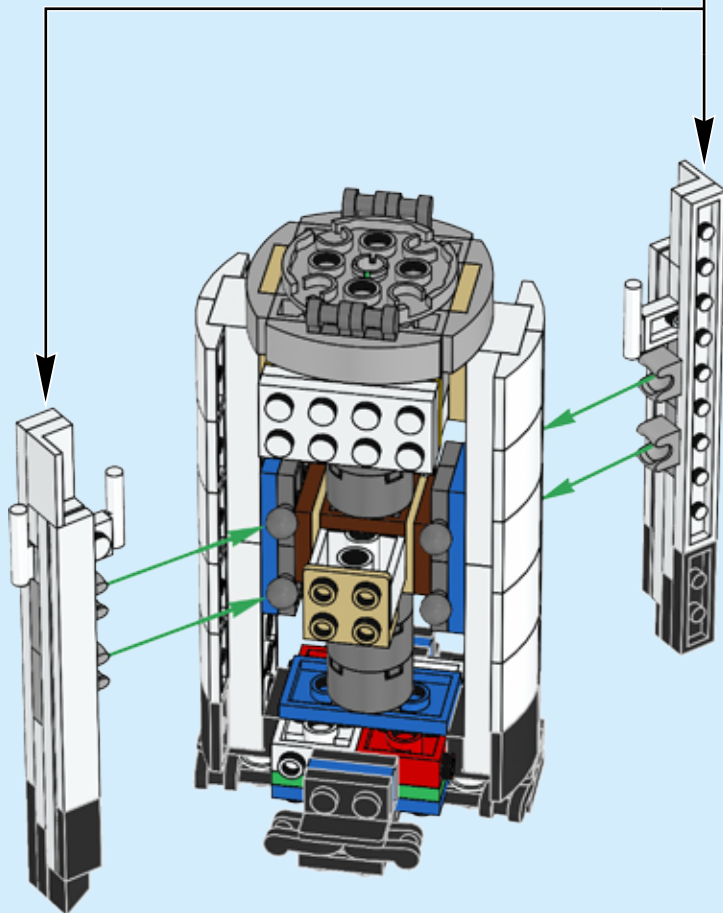

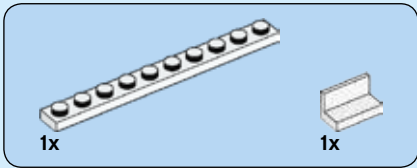
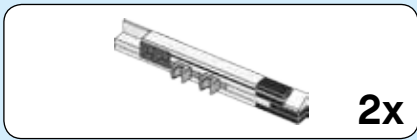

272

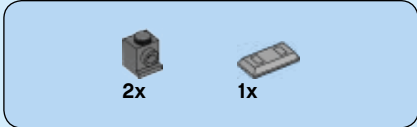
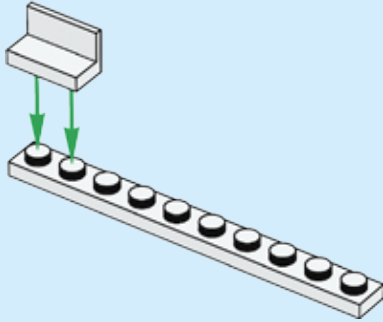

273

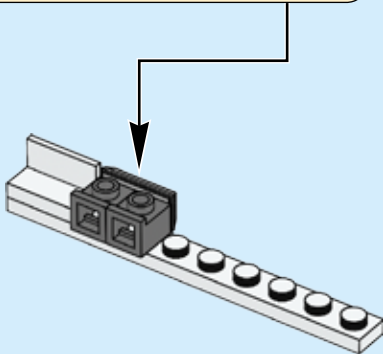
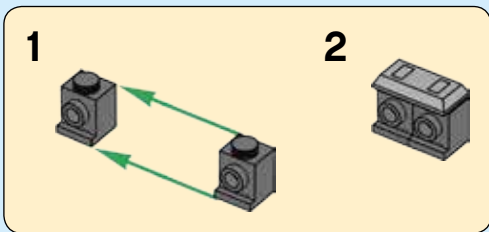

274

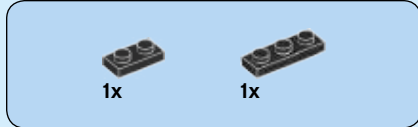
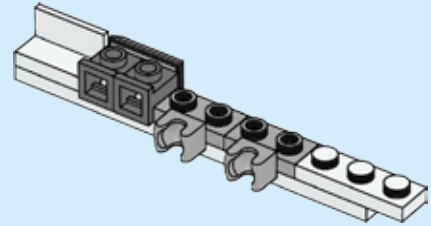

275

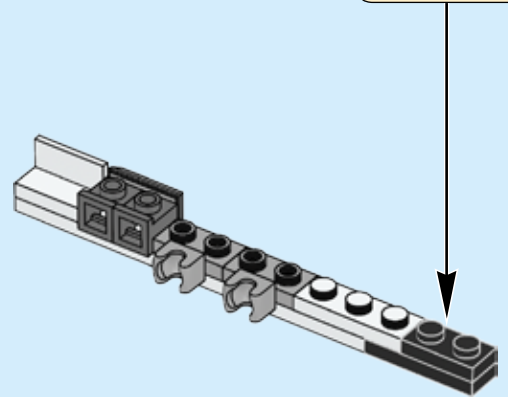
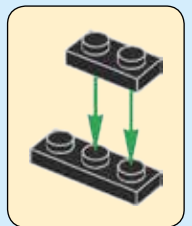

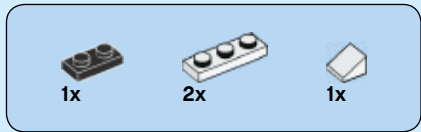

276

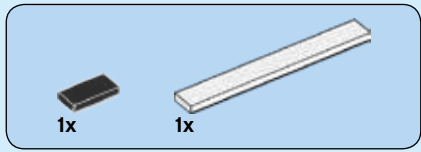
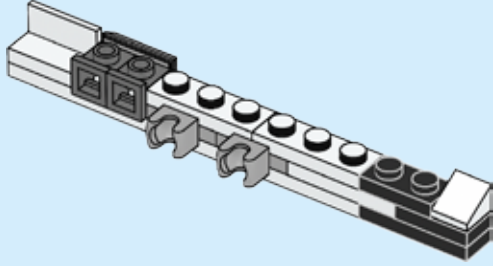

277

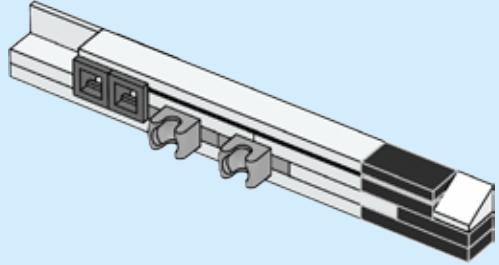

2x

278

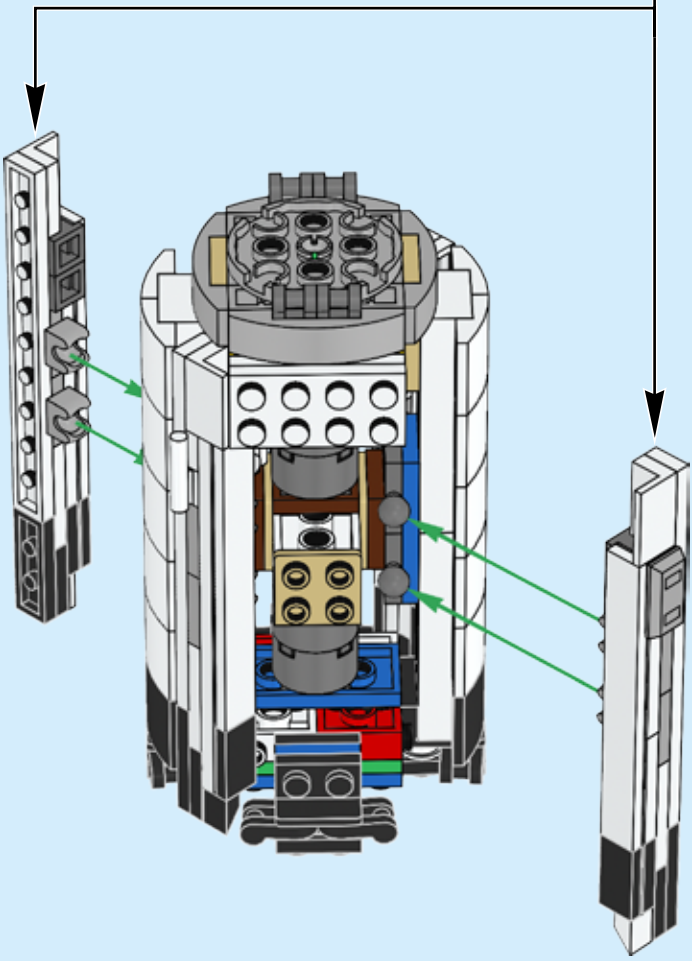

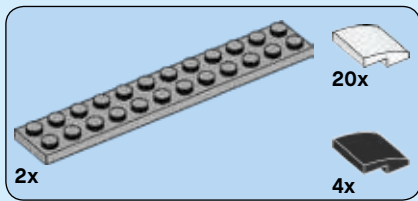

279

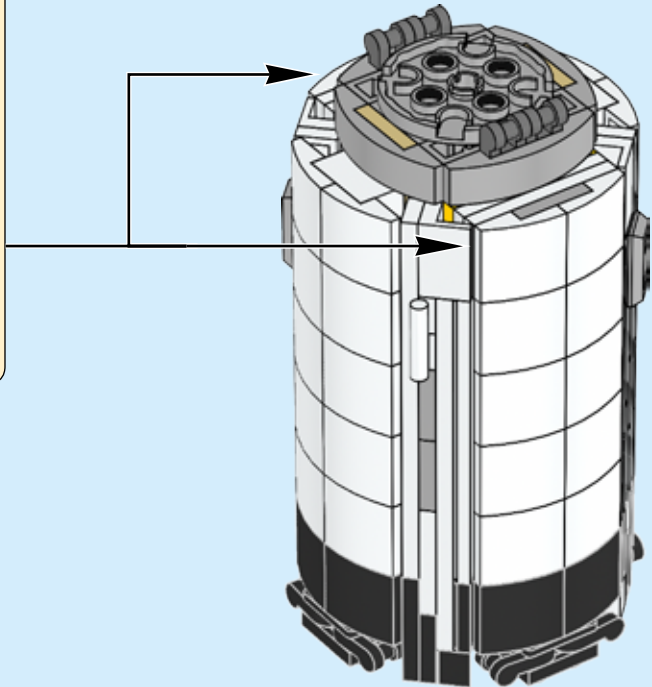
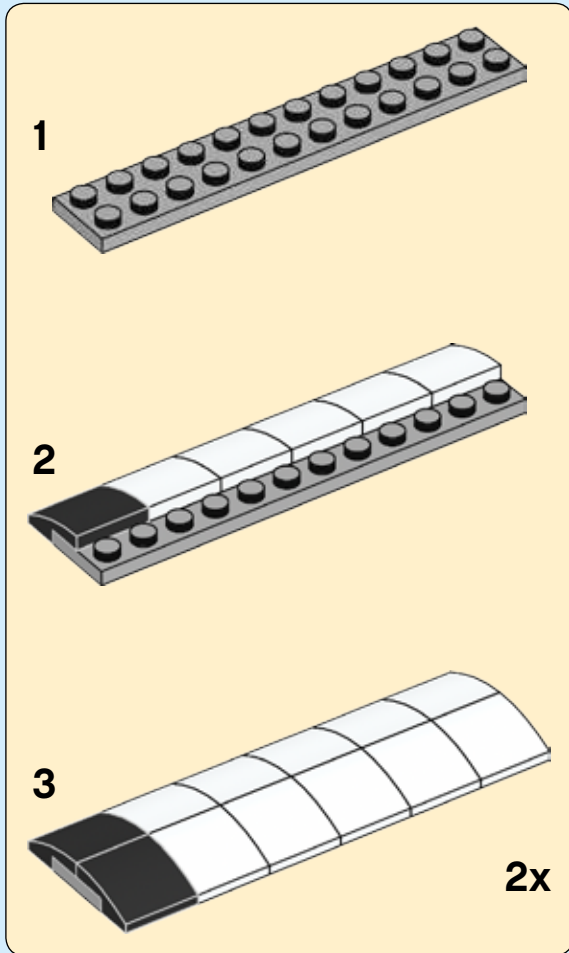



280

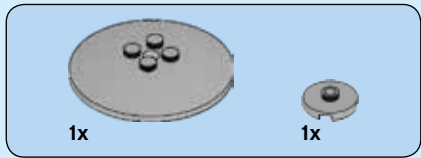
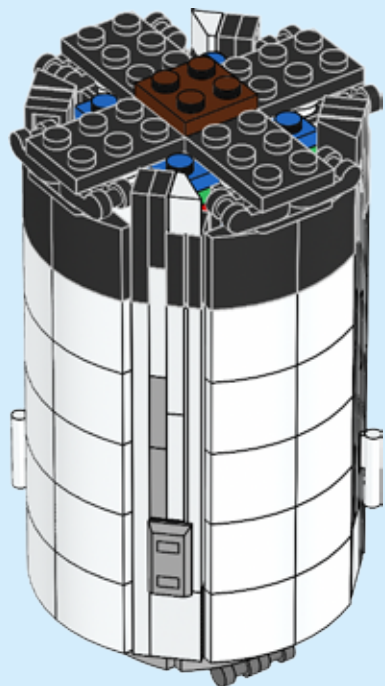
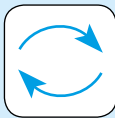

281

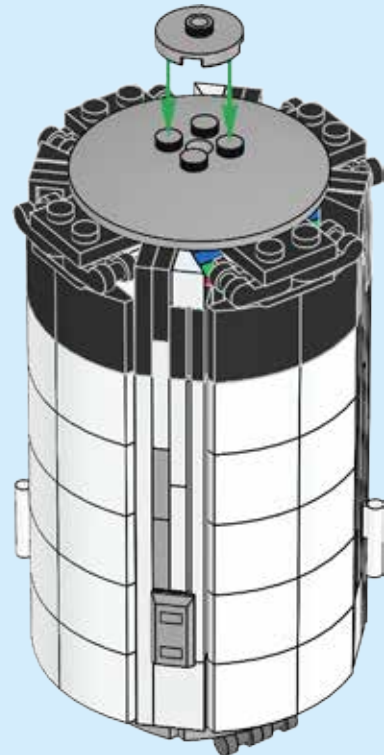

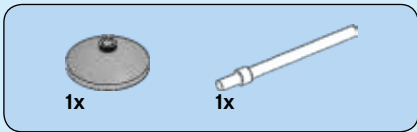

282

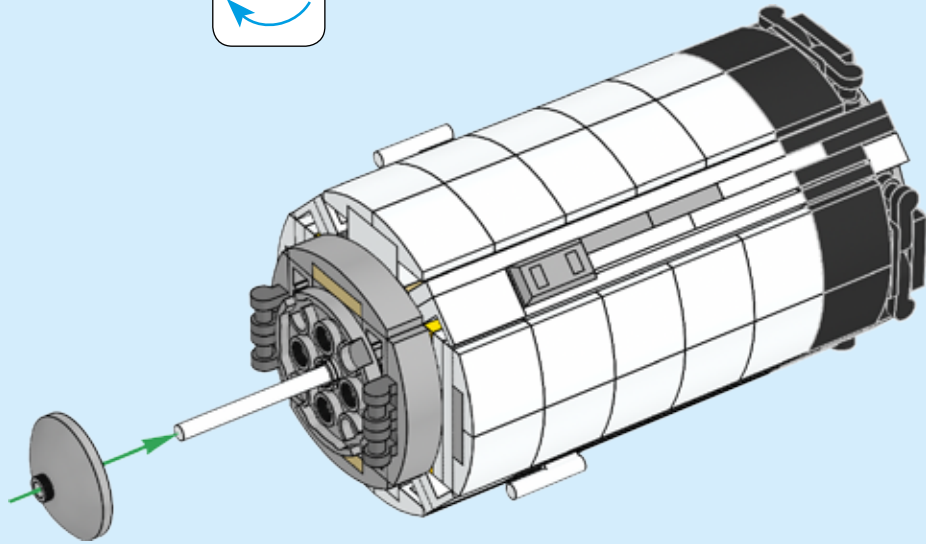
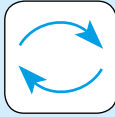

283

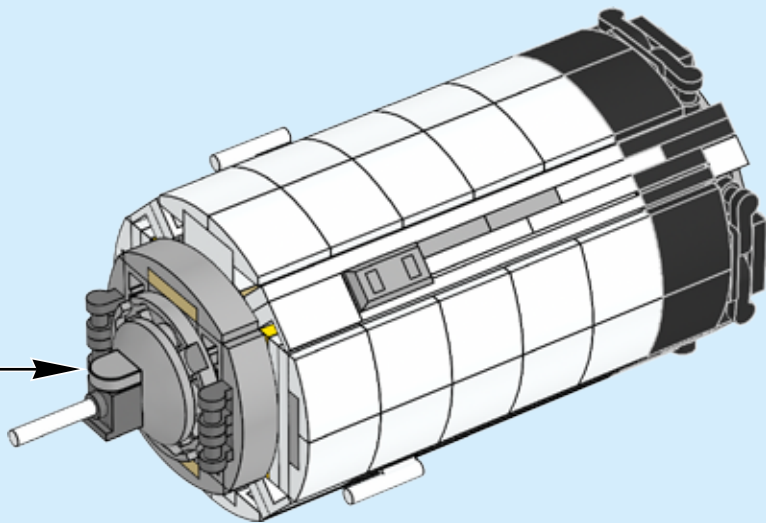
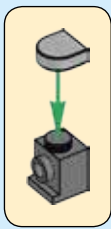



1x

284

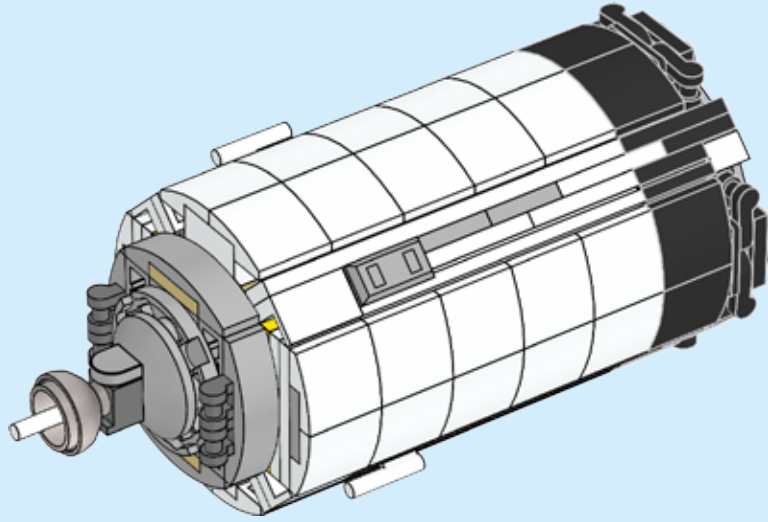

1x



1x

285

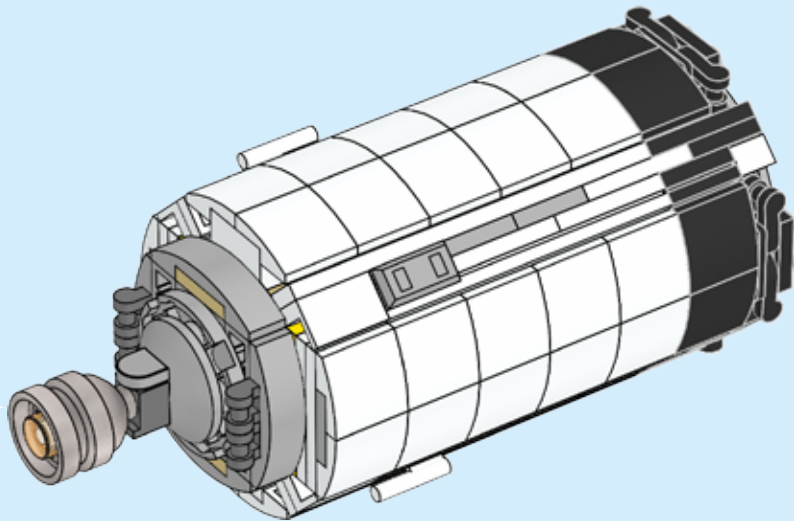

286

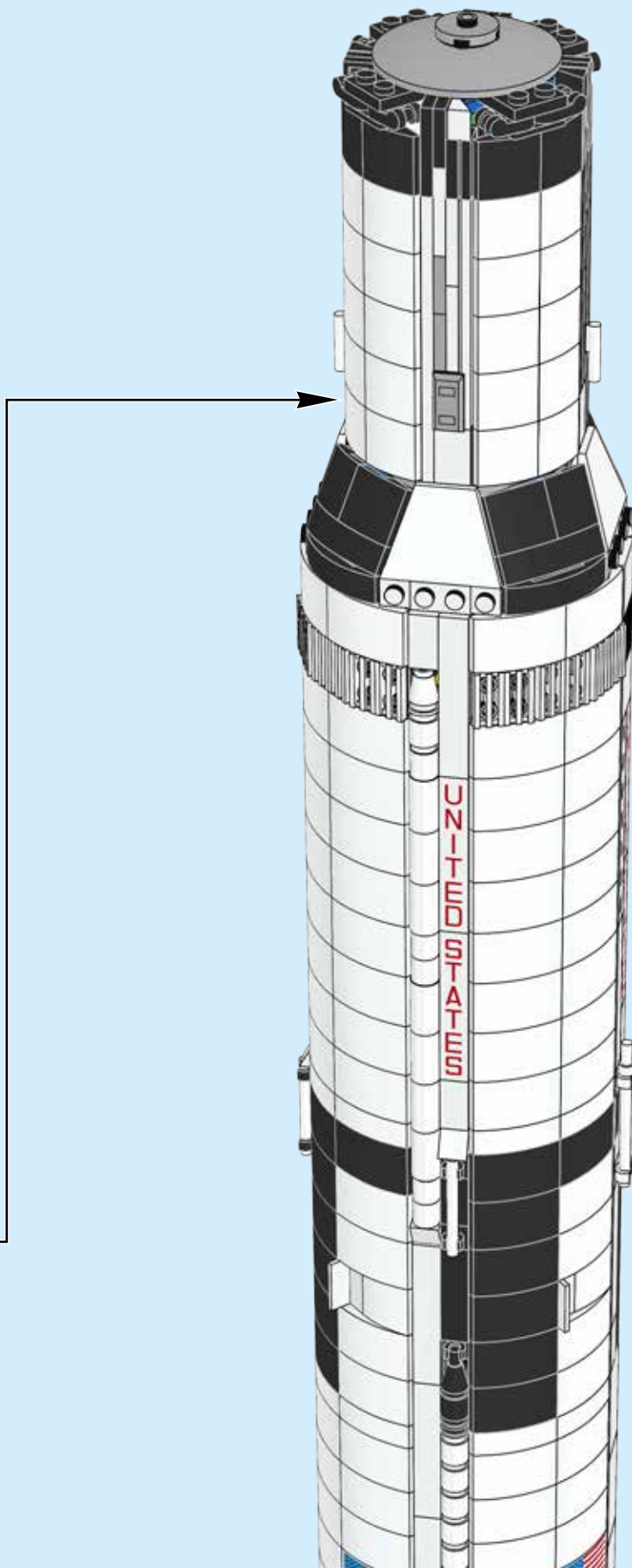

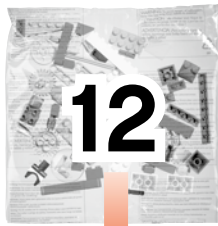

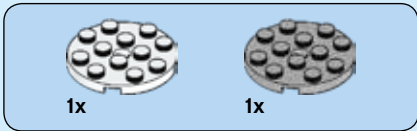
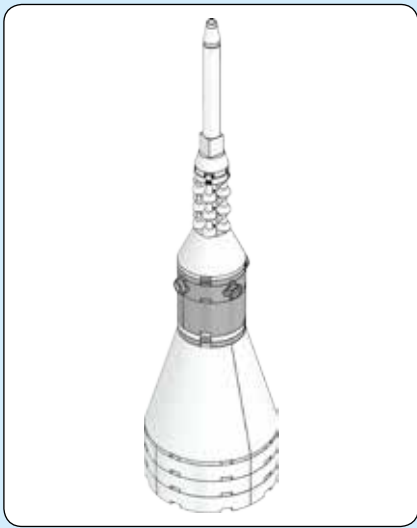

287

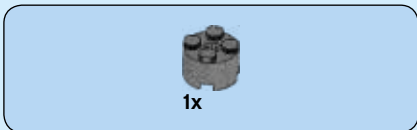
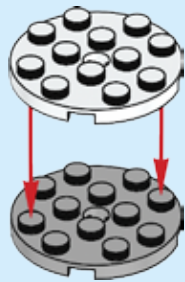

288

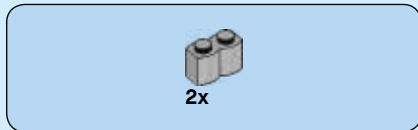
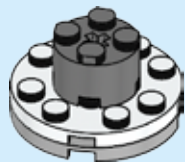

289

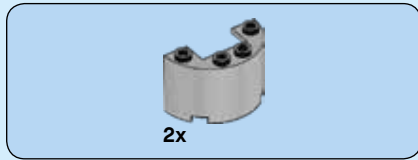
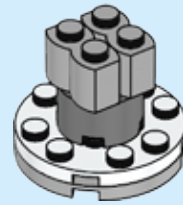

290

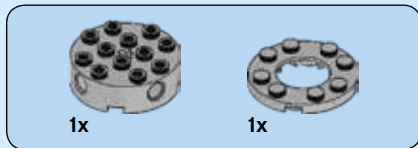

291



4x

292

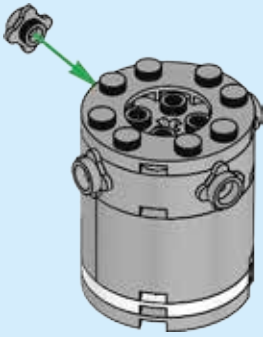

1x

293

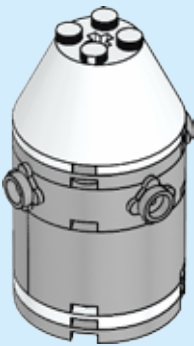

12x

294

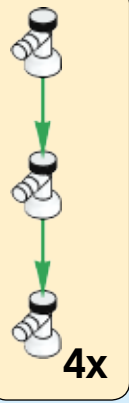

4x



1x

295

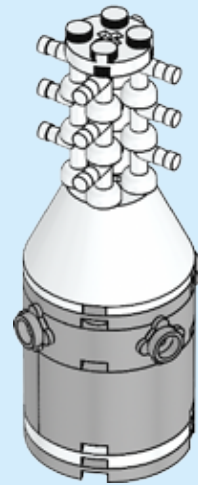

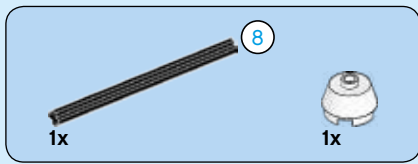

296

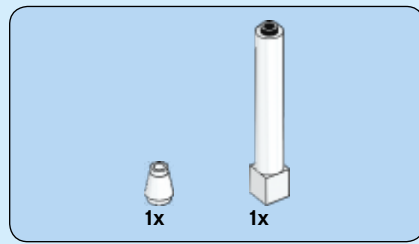
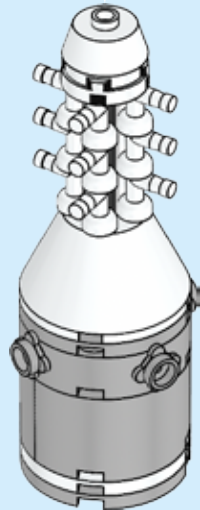
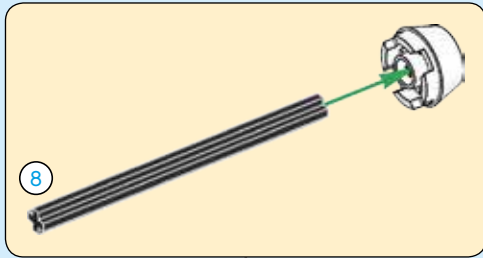

297

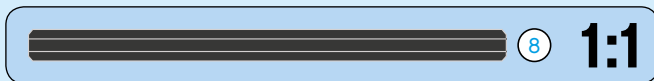
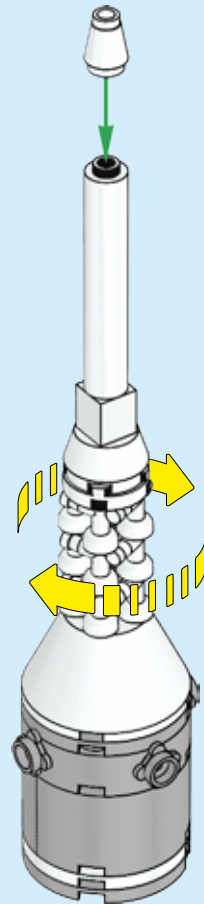

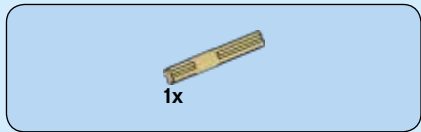

298

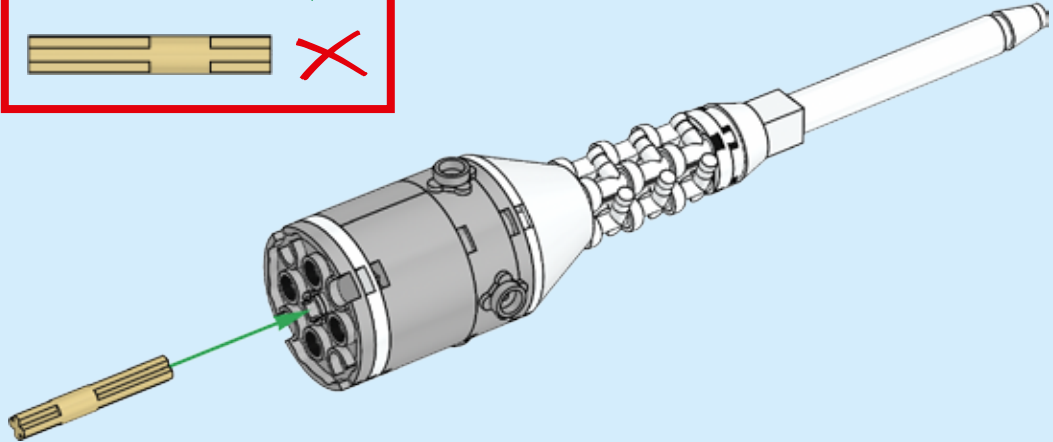
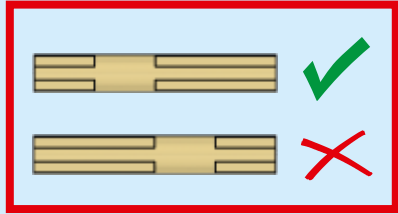
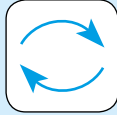

299

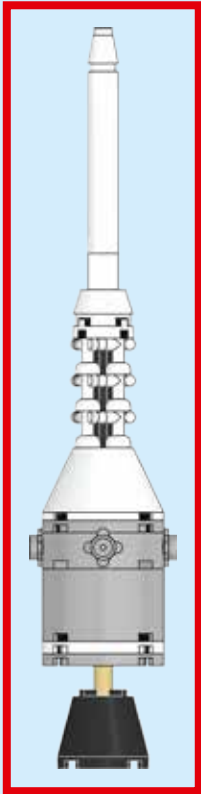
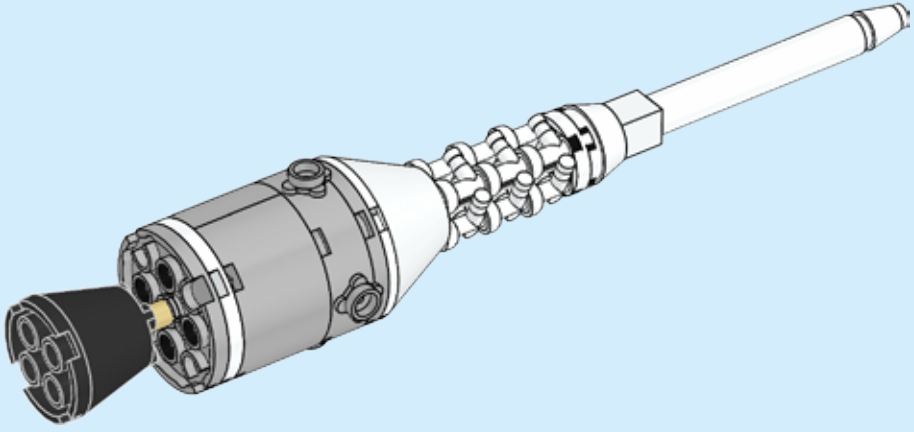

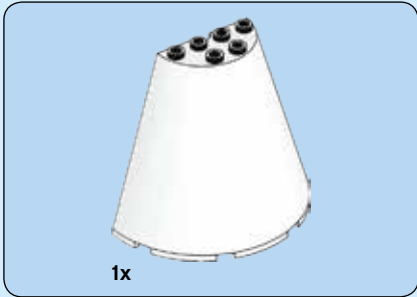

300

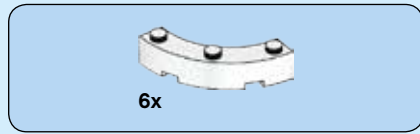
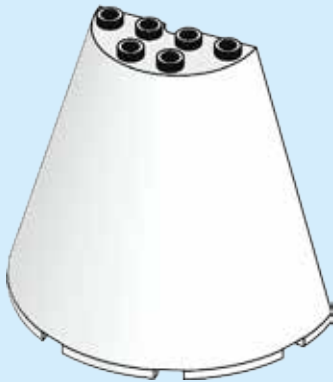

301

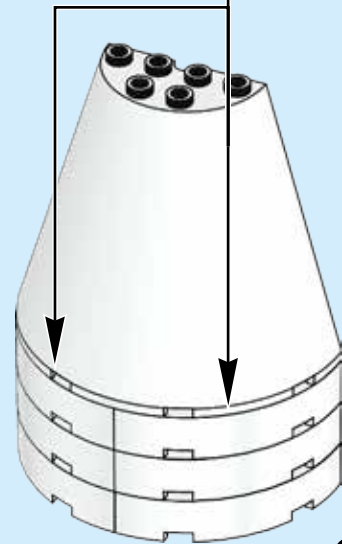
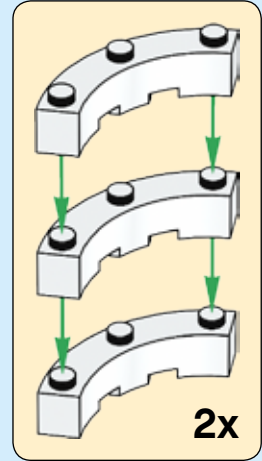

2x

302

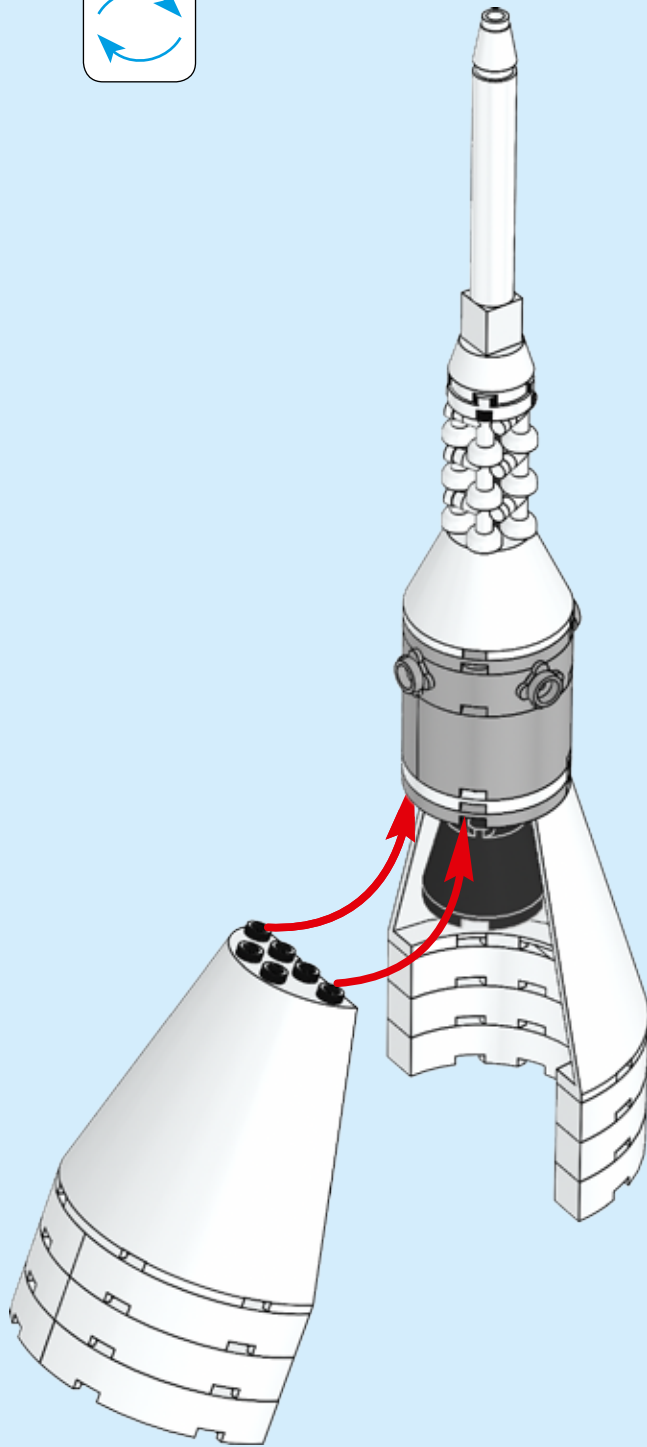
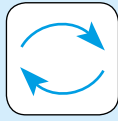

303

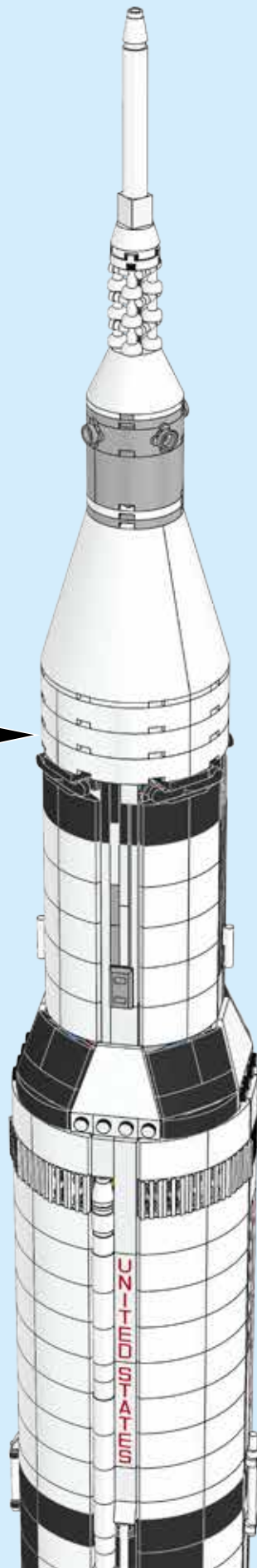

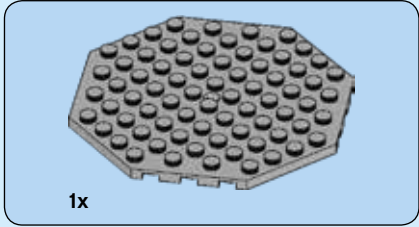
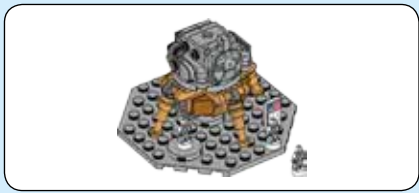

304

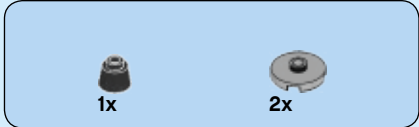
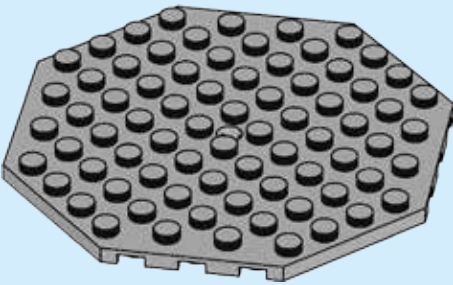

305

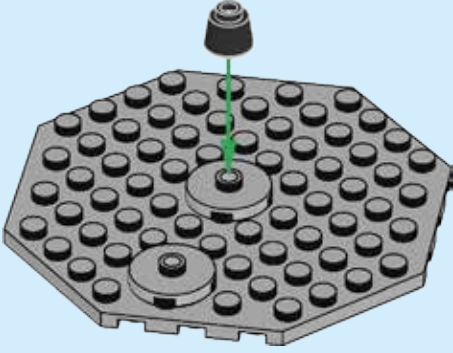

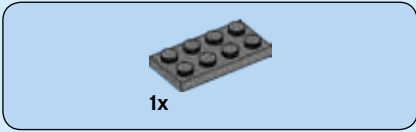

306

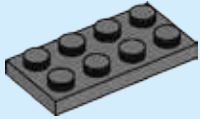

307

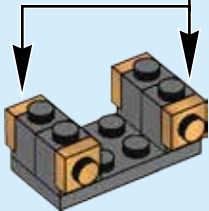
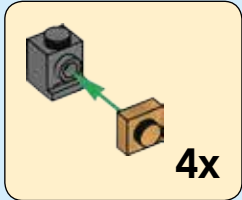

308

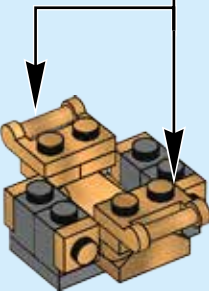
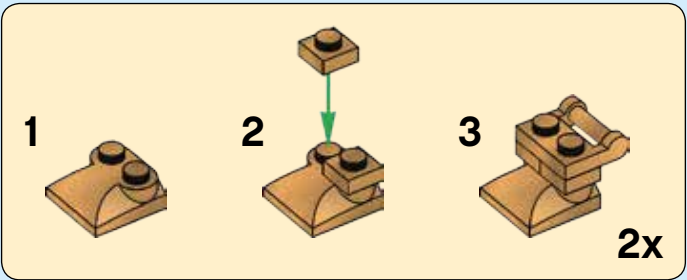



309

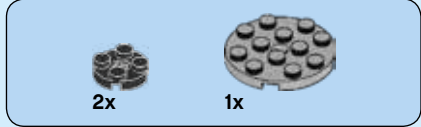
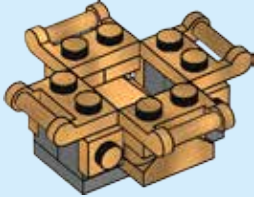

310

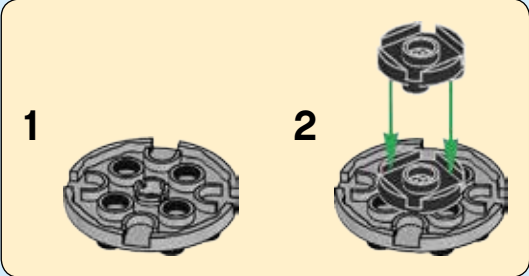

311

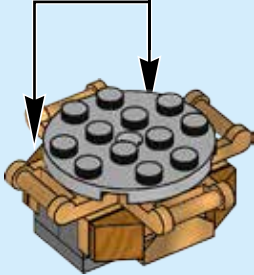

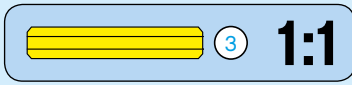
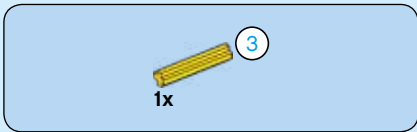

312

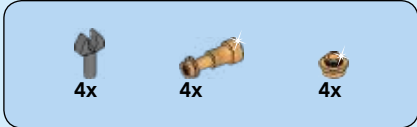

313

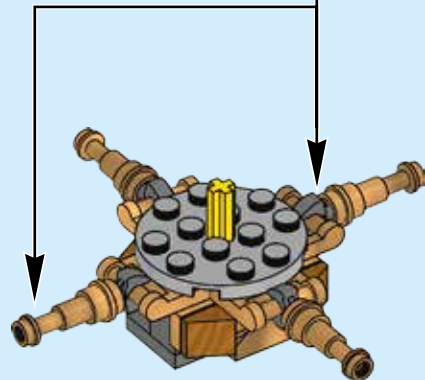
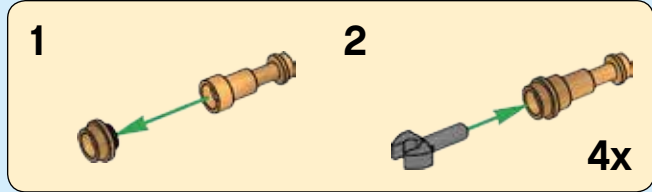

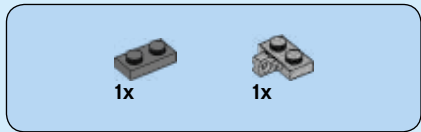

314

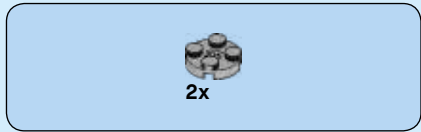
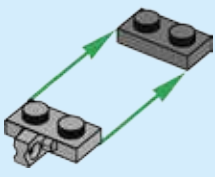

315

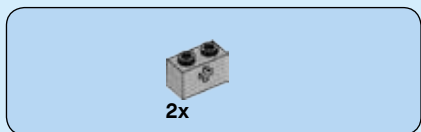
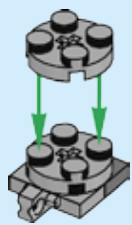

316

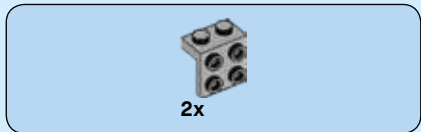
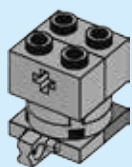

317

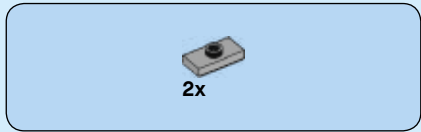
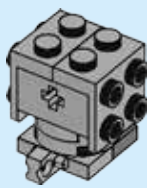

318

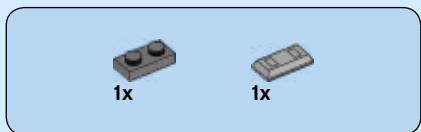
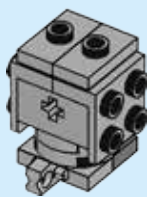

319

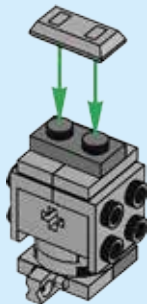

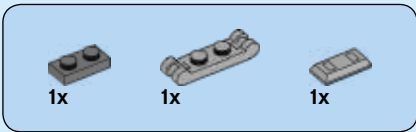

320

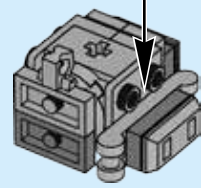
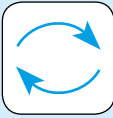
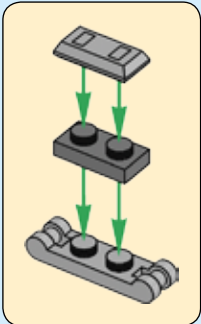

321

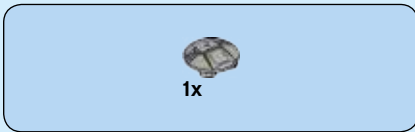
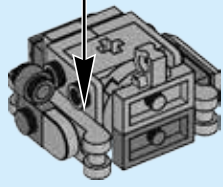
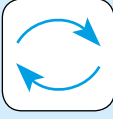
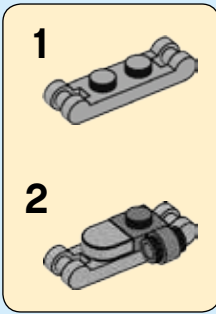

322

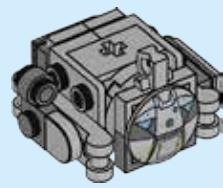

323

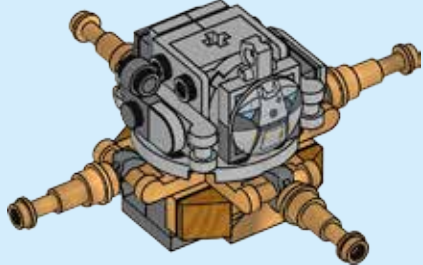

324

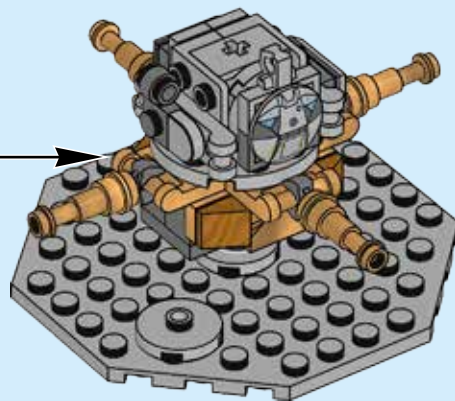

325

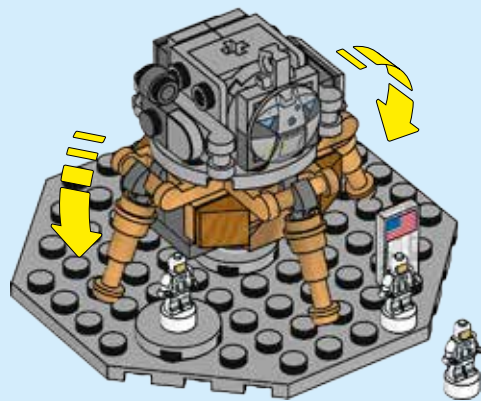

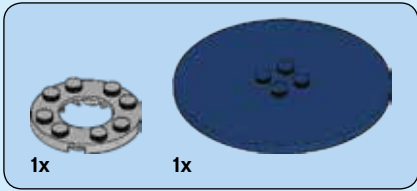
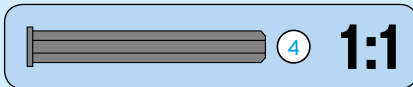

326

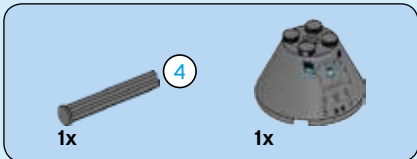
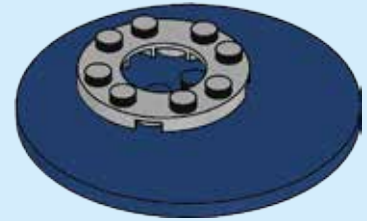

327

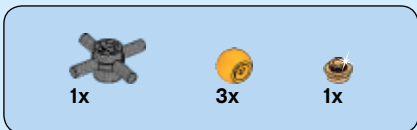
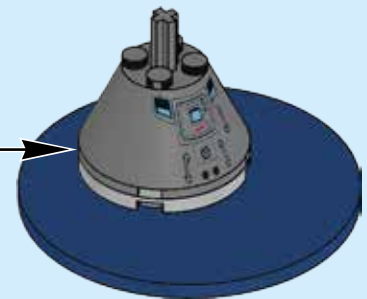
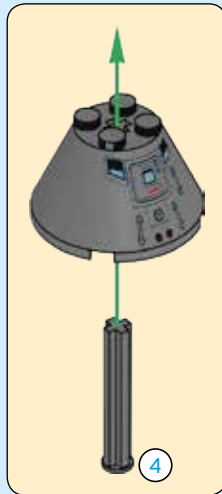

328

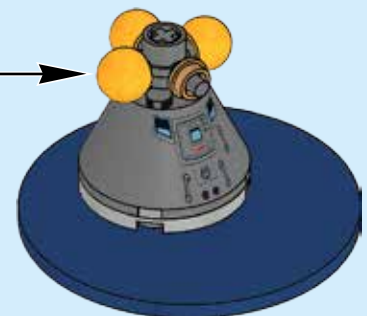
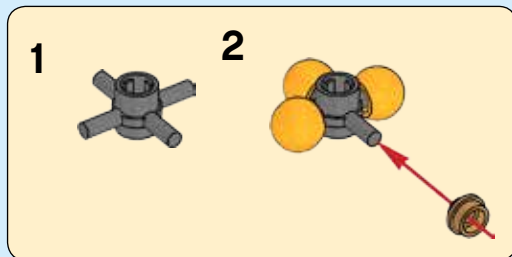



8x

329

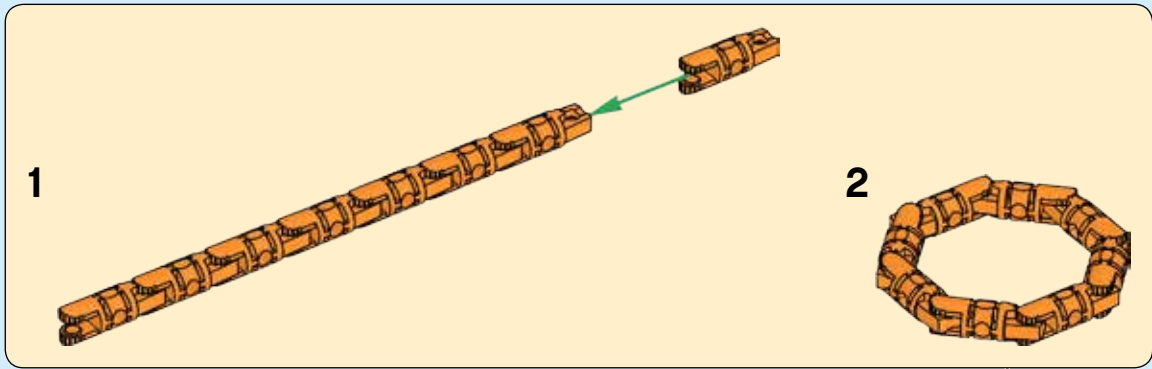

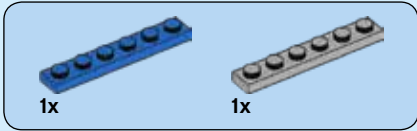
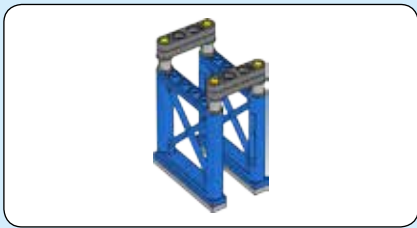

330

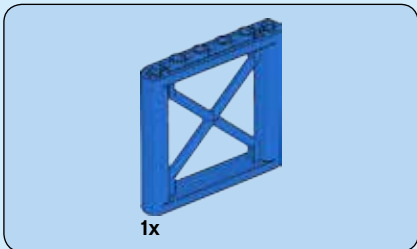
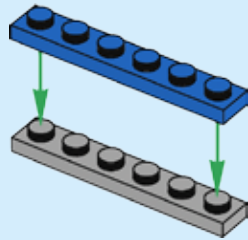

331

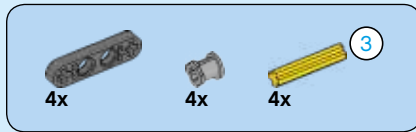
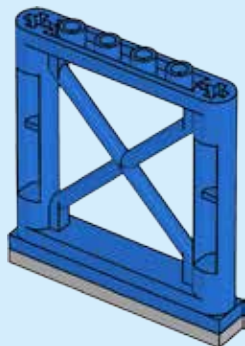

332

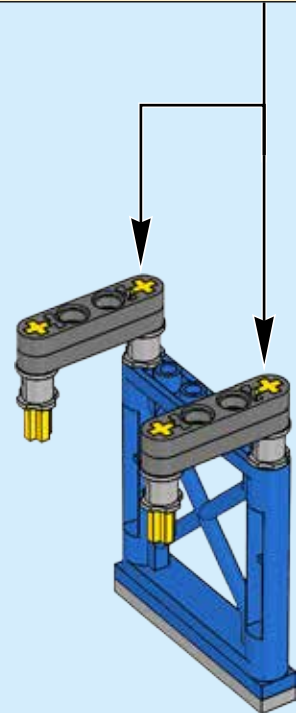
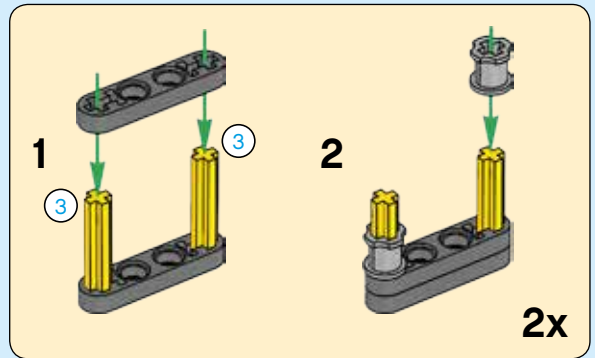
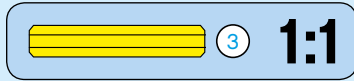

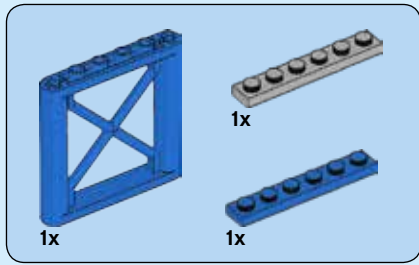

333

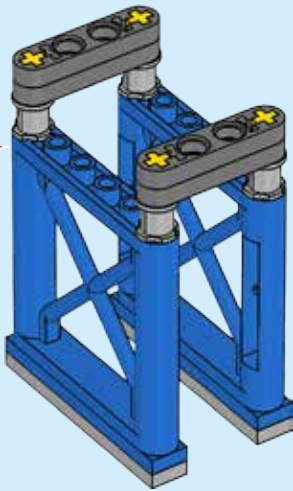
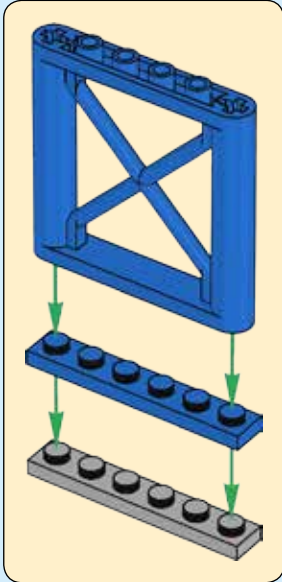

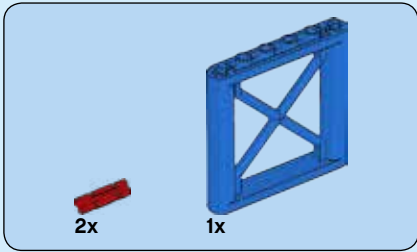
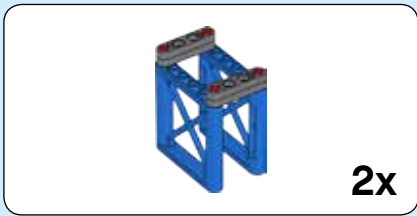

334

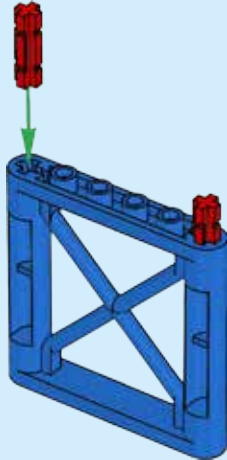

335

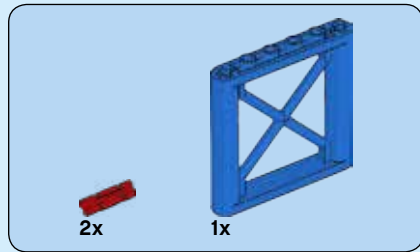
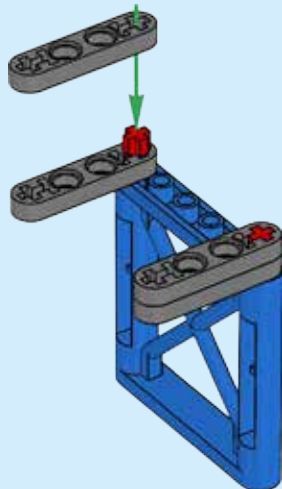

336

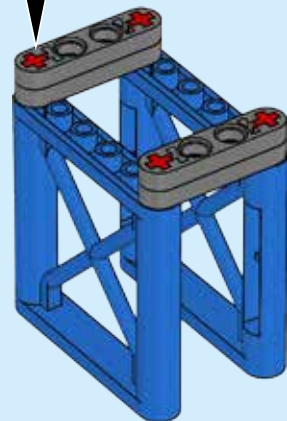
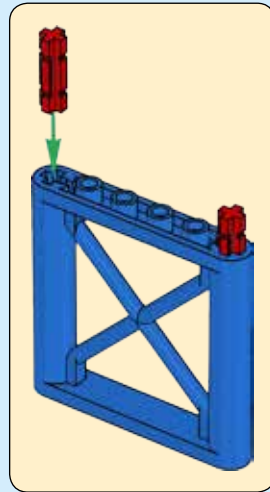

2x
191

337

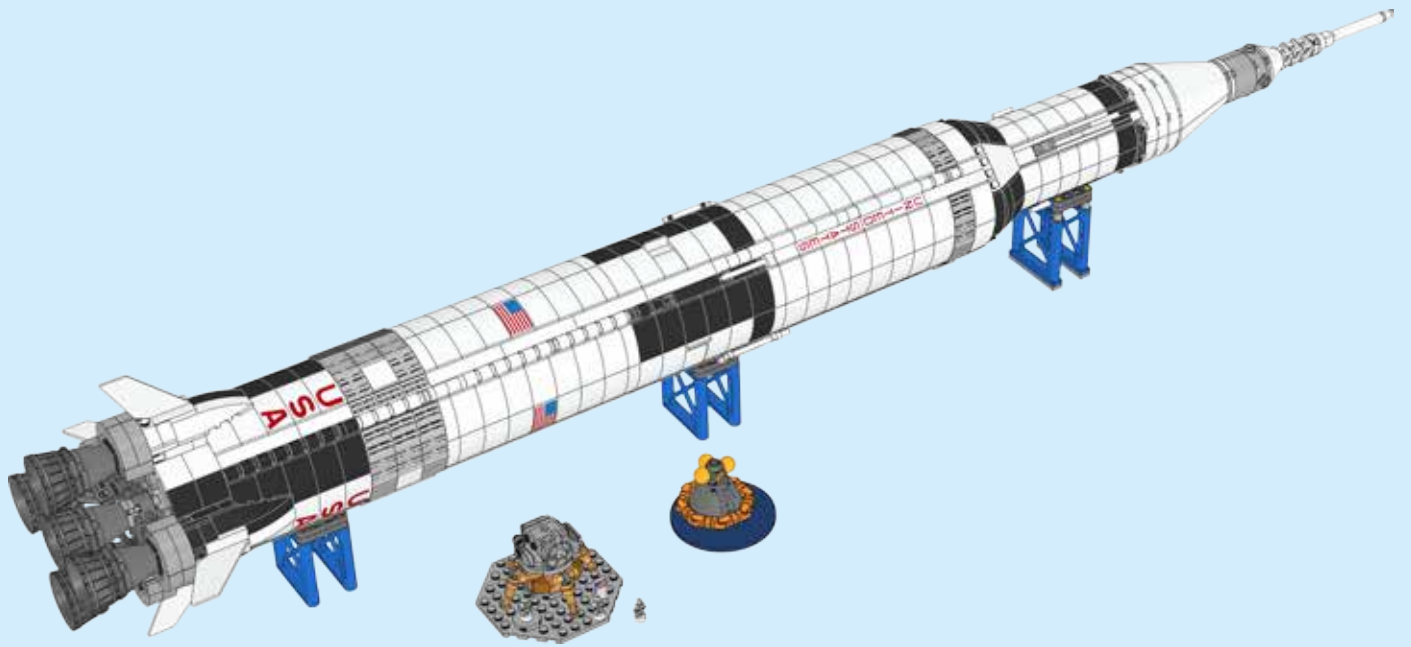

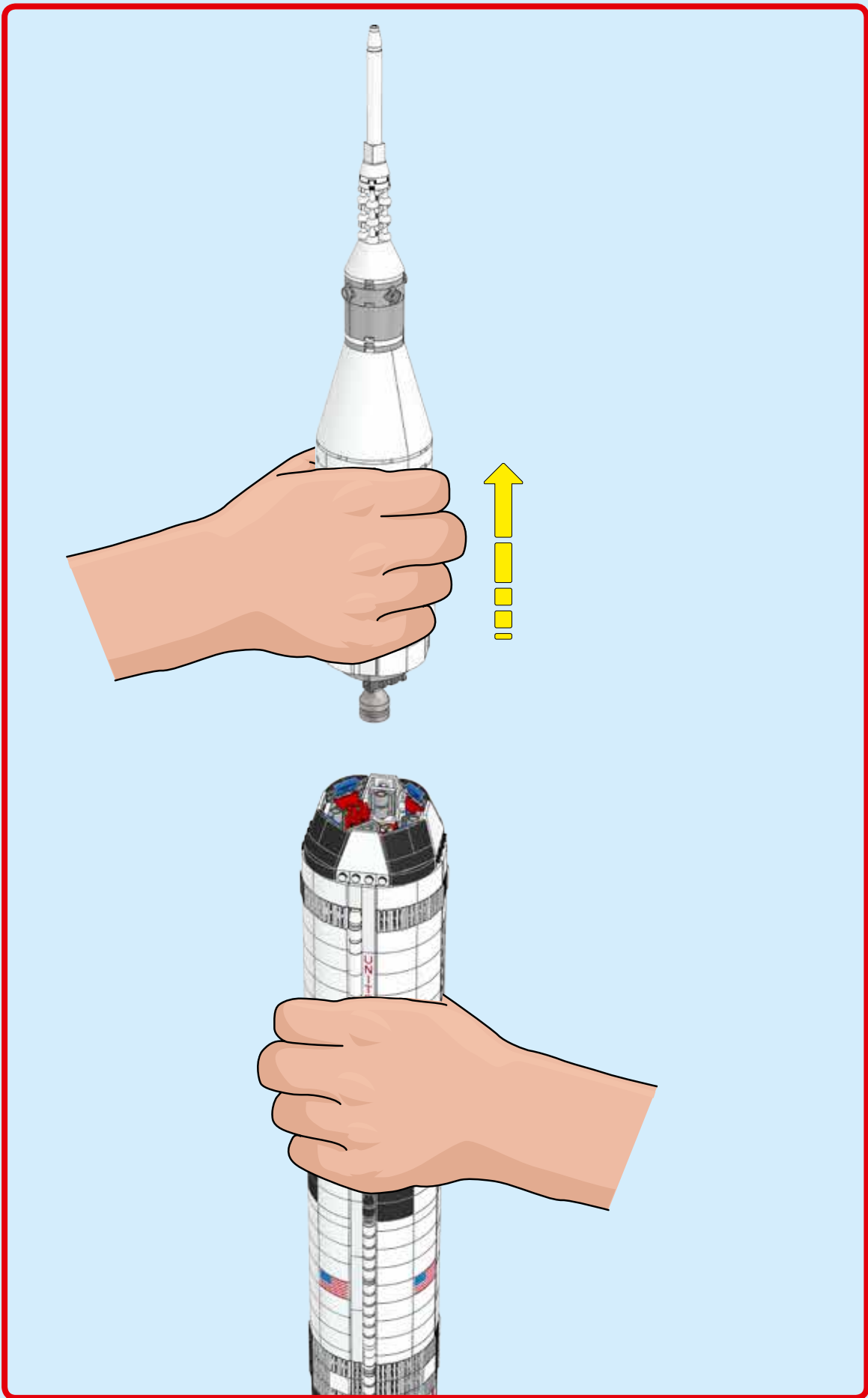

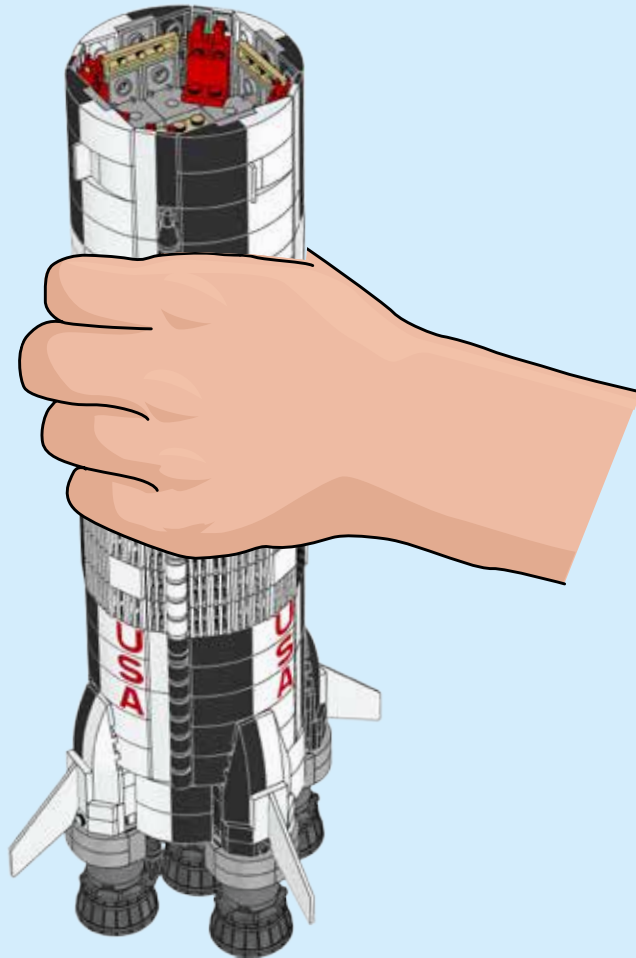
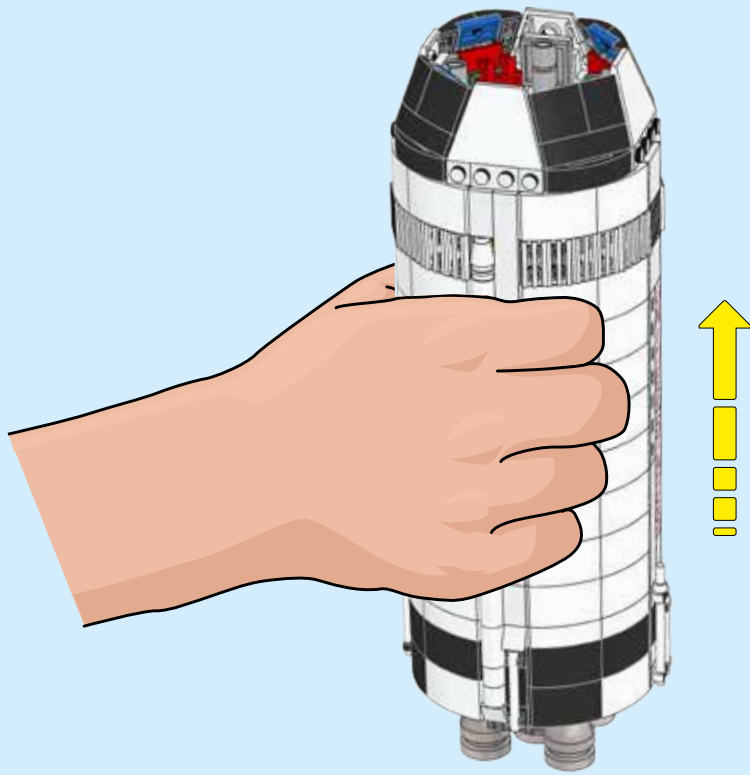

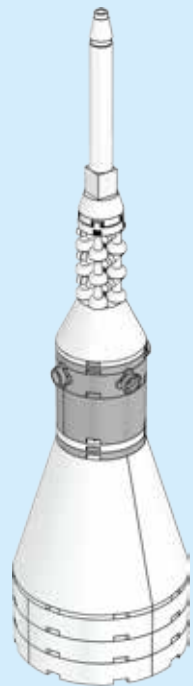
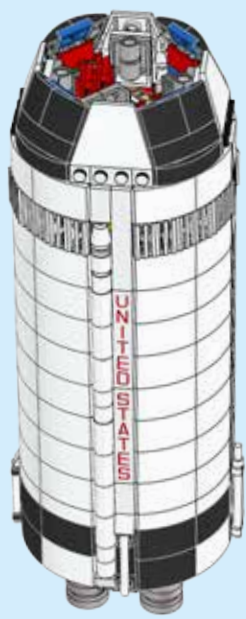
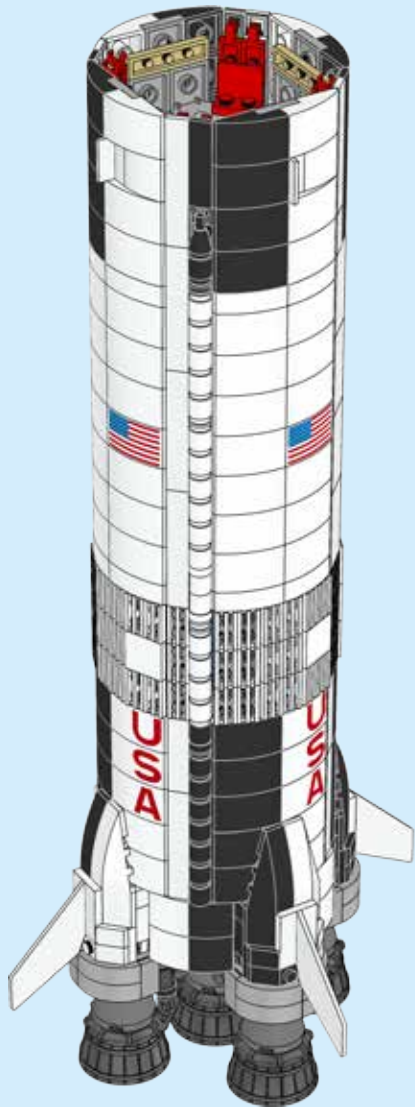

- 3x 6199668
- 35x 306201
- 2x 4518400
- 59x 614101
- 4x 6178492
- 12x 459901
- 1x 6073345
- 2x 302401
- 2x 6054551
- 7x 4504369
- 4x 300501
- 3x 307001
- 6x 403201
- 1x 4649167
- 5x 6093053
- 4x 6069002
- 9x 6057414
- 12x 6146215
- 112x 241201
- 7x 6173116
- 11x 306901
- 4x 4121932
- 8x 4222017
- 4x 302201
- 52x 6047220
- 12x 306801
- 4x 6055883
- 34x 6046979
- 8x 362301
- 24x 4249112
- 9x 6116602
- 148x 6132212
- 4x 6199669
- 4x 6199671
- 4x 6199672
- 4x 6199673
- 2x 383901
- 4x 243101
- 1x 4515347
- 1x 6108662
- 4x 302001
- 8x 4560178
- 4x 4629916
- 2x 6081986
- 4x 6053026
- 22x 663601
- 4x 623901
- 4x 6199652
- 4x 6199662
- 4x 4160101
- 12x 4215470
- 10x 4513990
- 5x 4181142
- 4x 346001
- 4x 416201
- 1x 6201676
- 2x 6096681
- 6x 447701
- 4x 4520947
- 8x 6024495
- 4x 4159279
- 14x 6117975
- 11x 4114306
- 2x 4118790
- 1x 4666999
- 12x 4113233
- 6x 6123812
- 40x 4113988
- 2x 4125217
- 1x 4143409
- 4x 6072998
- 4x 4558886
- 8x 4142865
- 4x 393721
- 4x 6029946
- 42x 6001806
- 12x 4534648
- 16x 6105976
- 2x 6061711
- 1x 4526119
- 8x 6196217
- 1x 4610843
- 4x 4143005
- 71x 302323
- 1x 4514553
- 17x 302023
- 6x 6186296
- 3x 366623
- 2x 346023
- 12x 6171814
- 4x 6029947
- 4x 242024
- 5x 6130007
- 10x 302124
- 1x 6130009
- 2x 6056234
- 19x 306226
- 8x 614126
- 7x 6167933
- 10x 6066102
- 2x 4504382
- 4x 300526
- 20x 6157554
- 2x 403226
- 13x 4121715
- 4x 6069000
- 11x 306926
- 4x 4121966
- 4x 6114987
- 12x 302326
- 4x 6000650
- 4x 302226
- 24x 6053077
- 4x 4143751
- 1x 4500978
- 4x 4163904
- 4x 362326
- 1x 6203937
- 48x 6147790
- 2x 302126
- 8x 4613153
- 4x 243126
- 1x 4143243
- 2x 663626
- 4x 4160130
- 5x 370726
- 2x 416226
- 1x 303426
- 1x 6074954
- 6x 6000071
- 4x 6073022
- 4x 4107758



3x
4243821



1x
6199664



8x
6200047



1x
4654448



1x
6200046



5x
4222960



5x
4646865



5x
6185735



3x
6071608



16x
4216695



2x
6151688



4x
6182167



4x
4211622



4x
4211475



1x
6199828



8x
4550325



4x
6183782



1x
4211814



62x
6066097



8x
6043656



8x
4211414



4x
6134378



12x
4211440



10x
6123809



2x
6117967



40x
4654582



4x
4563045



4x
4211376



4x
4211397



4x
4211410



4x
4211881



10x
6019212



1x
6070564



16x
4625619



2x
6206249



2x
6093058



2x
6134782



2x
6134782



4x
4622803



2x
4211445



4x
4211409



4x
4515351



2x
6028015



2x
4211527



4x
4211385



2x
4211352



4x
4211438



1x
4211796



22x
4211452



2x
4211425



16x
4211404



10x
4211462



1x
6034493



2x
4211360



4x
4289542



9x
4211044



9x
4249139



1x
4632574



8x
6039479



3x
4211063



5x
4210698



6x
6117972



40x
6000606



1x
4222192



4x
4218696



8x
4210884



12x
4521187



5x
6201630



12x
4210749



4x
6099909



1x
6083620



1x
6199823



26x
4211065



10x
4221749

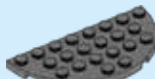

2x
6141856

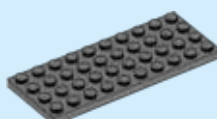

4x
4211122



12x
6000970



21x
6141499



8x
6069887



8x
4538126



4x
4585493



2x
4286597



6x
6102756



6x
6102594



5x
6008484



4x
6200049



5x
6197967



5x
6197966



4x
6191668

4



Customer Service

Kundenservice

Service Consommateurs

Servicio Al Consumidor

LEGO.com/service or dial



: 00800 5346 5555

: 1-800-422-5346



IDEAS

LEGO® REVIEW
EXAMEN LEGO®
REVISIÓN DE LEGO®

SHARE YOUR IDEA
PARTAGE TON IDÉE
COMPARTE TU IDEA

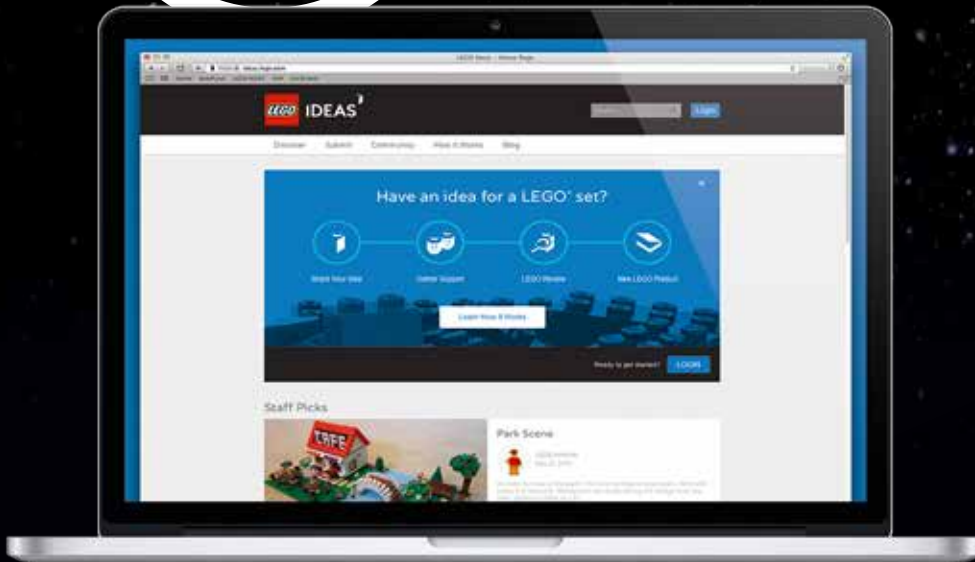
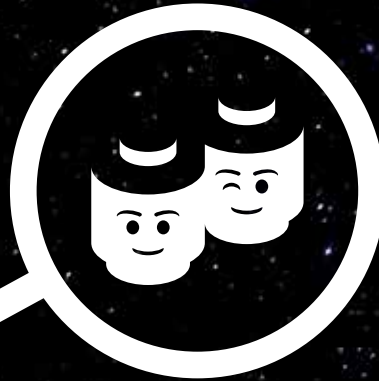

GATHER SUPPORT
OBTIENS DE L'APPUI
OBTÉN APOYOS

NEW LEGO® PRODUCT
NOUVEAU PRODUIT LEGO®
NUEVO PRODUCTO LEGO®



[LEGO.COM/IDEAS](https://www.lego.com/ideas)



IDEAS

Do you like this LEGO® Ideas set?

The LEGO® Group would like your opinion on the new product you have just purchased. Your feedback will help shape the future development of this product series. Please visit:

[LEGO.com/productsurvey](https://www.lego.com/productsurvey)

By completing our short feedback survey, you will be automatically entered into a drawing to win a LEGO® prize.

See website for official rules and details. Open to all countries where not prohibited.



Aimez-vous cet ensemble LEGO® Ideas ?

Le Groupe LEGO® aimerait connaître votre opinion sur le produit que vous venez d'acheter. Vos commentaires nous aideront à concevoir les futurs produits de cette gamme. Veuillez visiter :

[LEGO.fr/productsurvey](https://www.lego.fr/productsurvey)

En remplissant ce court sondage sur le produit, vous serez automatiquement inscrit à un tirage au sort pour gagner un prix LEGO®. Consultez le site Web pour obtenir le règlement officiel et les détails. Ouvert à tous les résidents des pays autorisés.

¿Te gusta este set LEGO® Ideas?

The LEGO® Group quiere conocer tu opinión acerca del nuevo producto que acabas de comprar. Tus comentarios nos ayudarán a dar forma a los futuros productos de esta serie. Visita:

[LEGO.com/productsurvey](https://www.lego.com/productsurvey)

Al contestar este breve cuestionario de opinión, participarás automáticamente en el sorteo de un producto LEGO®. Consulta las reglas oficiales y demás información en el sitio web. Válido en todos los países en los que esta actividad no esté prohibida.