

# Seinfeld™



Booklet available in English on  
Livret disponible en français sur  
Folleto disponible en español en



# Seinfeld™



## ▶ The Show About Nothing

An Emmy and Golden Globe winner for Best Comedy Series, *Seinfeld* is one of the most popular, most award-winning and longest-running comedy series of all time. Jerry Seinfeld stars as a stand-up comedian whose life in New York City is made even more chaotic by his quirky group of friends who join him in wrestling with life's most perplexing, yet often trivial questions. Often described as "a show about nothing," *Seinfeld* mines the humor in life's mundane situations like waiting in line, searching for a lost item, or the trials and tribulations of dating.

## ▶ La série à propos de rien

Lauréate d'un Emmy et d'un Golden Globe pour la meilleure série comique, *Seinfeld* est l'une des séries comiques les plus populaires et les plus primées de tous les temps, et ayant duré le plus longtemps. Jerry Seinfeld joue le rôle d'un humoriste dont la vie à New York devient des plus chaotiques alors que ses amis excentriques se joignent à lui pour jongler avec les questions les plus déconcertantes, mais souvent anodines de la vie. Souvent décrite comme « une série à propos de rien », *Seinfeld* exploite le côté comique des situations banales de la vie comme faire la queue, trouver un objet perdu, ou chercher l'âme sœur.

## ▶ El programa sobre nada

Ganadora de un Emmy y un Globo de Oro a la mejor serie de comedia, *Seinfeld* es una de las comedias televisivas más populares, premiadas y de mayor permanencia al aire de todos los tiempos. Jerry Seinfeld interpreta a un comediante cuya vida en la ciudad de Nueva York no podría ser más caótica, en buena parte por su extravagante grupo de amigos, con quienes lucha contra las preguntas más desconcertantes y, con frecuencia, banales de la vida. Con frecuencia descrita como *un programa sobre nada*, la serie *Seinfeld* explota el humor que encierran las situaciones más cotidianas, como hacer cola, la búsqueda de un objeto perdido o las complicaciones y tribulaciones de las citas.

« Je vais jouer moi-même le rôle d'un comique qui vit à New York, et j'aurai un ami, et un voisin, et une ex-petite amie, ce qui est vrai. »

*(Le Show - S04E03)*



"I would play myself, as a comedian living in New York, and I have a friend, and a neighbor and an ex-girlfriend, which is all true."

*(The Pitch - S04E03)*

"Actuaría de mí mismo y, como comediante viviendo en Nueva York, yo tengo un amigo y un vecino, una exnovia... Todo eso es cierto".

*(El programa, S04E03)*

## Jerry Seinfeld

Jerry Seinfeld, an exaggerated, fictionalized version of his real-life namesake, is the calm center around which his ensemble of quirky, impulsive, delightfully dramatic friends revolves. Ever the curious observer in his own and others' lives, interactions and relationships, he ponders everything and nothing with his perceptive wit, dry humor and friendly sarcasm. He is the undisputed champion of poking at the little idiosyncrasies we recognize in the TV series' characters and ourselves – a talent he gladly shares with his friends and stand-up comedy show audiences.

Jerry Seinfeld, une version exagérée et romancée de son homonyme de la vie réelle, est le noyau serein autour duquel gravite son groupe d'amis excentriques, impulsifs et merveilleusement dramatiques. Fin observateur en ce qui concerne la vie, les interactions et les relations interpersonnelles, il réfléchit à tout et à rien avec son esprit perspicace, son humour pince-sans-rire et son sarcasme amical. Il est le champion incontesté pour mettre au jour les petites manies que nous reconnaissons tant chez les personnages de la série télévisée qu'en nous-mêmes – un talent qu'il partage volontiers avec ses amis et le public de ses spectacles d'humour.

Jerry Seinfeld, una versión exagerada y ficticia de su homónimo en la vida real, es el centro sereno en torno al cual gira el grupo de amigos más peculiar, impulsivo y deliciosamente dramático que pudiera existir. Como curioso observador de su propia vida y la de los demás, de sus interacciones y sus relaciones, reflexiona sobre todo y sobre nada con su ingenio perspicaz, su humor ácido y su simpático sarcasmo. Es el campeón indiscutible de escudriñar en las pequeñas idiosincrasias que reconocemos en los personajes de la serie para televisión y en nosotros mismos, un talento que comparte gustosamente con sus amigos y el público de sus monólogos de humor.

## Cosmo Kramer

- ▶ Jerry's lanky, eternally optimistic friend and neighbor who always seems to have a new money-making idea up his sleeve. Loved by his friends and fans alike for his unique vintage style and crazy hair, his signature cigars and sidesplitting statements, inventions and, not least, scene-stealing entrances into Jerry's apartment.
- ▶ Ami et voisin dégingandé et éternellement optimiste de Jerry, il semble toujours avoir une nouvelle idée derrière la tête pour faire de l'argent. Il est apprécié tant par ses amis que par les amateurs de la série pour son style rétro unique, sa chevelure ébouriffée, ses cigares, ses déclarations hilarantes, ses inventions et, bien sûr, ses entrées remarquées dans l'appartement de Jerry.
- ▶ Amigo y vecino de Jerry, larguirucho y eternamente optimista, Cosmo siempre parece tener una nueva idea para hacer dinero. Sus amigos y admiradores lo aprecian por su original estilo retro y su loco peinado, sus característicos puros y sus graciosísimas afirmaciones, sus inventos y, no menos importante, sus estruendosas irrupciones en el departamento de Jerry.



## Newman

- ▶ The mailman from down the hall is often Kramer's eager partner in several dubious plots and money-making schemes. He is also prone to self-indulging drama and, most importantly, Seinfeld's sworn archnemesis.
- ▶ Le facteur qui habite à l'autre bout du couloir s'engage souvent avec Kramer dans des combines douteuses et des plans pour faire de l'argent. Il est également enclin à s'apitoyer sur son sort et surtout, il est l'ennemi juré de Seinfeld.
- ▶ El cartero del final del pasillo suele ser el impaciente socio de Kramer en sus dudosas confabulaciones y planes para ganar dinero. También es propenso al dramatismo egocéntrico y, sobre todo, archienemigo declarado de Seinfeld.



## Elaine Marie Benes

- ▼ Jerry's ex-girlfriend-turned-best-friend... What's The Deal? She's an editor and writer, a remarkable dancer, and always bracingly unapologetic about expressing her strong opinions and emotions in no uncertain terms, including telling people to shut up or get out.
- ▼ L'ex-petite amie devenue meilleure amie de Jerry... Que dites-vous de ça ? Éditrice, rédactrice et remarquable danseuse, elle ne mâche jamais ses mots quand il est question d'exprimer ses opinions tranchées et ses émotions, ni de dire à quelqu'un de se taire ou de sortir.
- ▼ La exnovia de Jerry es también su mejor amiga... ¿Qué problema hay? Editora, escritora y una extraordinaria bailarina, siempre expresa sin reparos sus rotundas opiniones e intensas emociones en términos inequívocos, llegando incluso a hacer callar a la gente o irse del lugar.



## George Louis Costanza

- ▼ George is Jerry's best friend since school, and his polar opposite. Self-deprecating but not without his moments of (sometimes unwarranted) self-confidence. He has very little patience and often acts before he thinks, which never fails to land him in all kinds of self-inflicted trouble and embarrassment.
- ▼ George est le meilleur ami de Jerry depuis l'école, et son parfait contraire. Il nage généralement dans l'autodérision, mais il lui arrive d'avoir de l'assurance (parfois injustifiée). Il est peu patient et agit souvent sans réfléchir, ce qui ne manque jamais de lui occasionner des tonnes de problèmes et de le mettre dans l'embarras.
- ▼ George es el mejor amigo de Jerry desde la escuela, y también su polo opuesto. Se desprecia a sí mismo, pero no carece de momentos de gran autoestima (normalmente, injustificados). Tiene muy poca paciencia y acostumbra actuar antes de pensar, lo que no deja de causarle todo tipo de problemas autoinfligidos y situaciones vergonzosas.





## Meet Brent Waller

LEGO® Ideas fan designer Brent Waller is a 3D Environment Artist and co-founder of a video game company in Brisbane, Australia, and an active participant in the LEGO Ideas community.

"LEGO sets were my favorite toys as a kid and now, as an adult, it's still a creative outlet I love."

### The inspiration

Brent loved watching *Seinfeld* as a young adult in the mid- to late 90s. He started re-watching the show again recently and made it his mission to make the best possible rendition of Jerry's apartment and his gang of friends.

"I spent a fair bit of time on research and trying to figure out exactly what color the walls were painted. They sometimes seemed to change with each episode! I had the show on in the background the entire time and ended up using a scale model for reference. The biggest challenges were all the kitchen details – cupboards, items and decorations – and then designing the angled walls and built-in furniture. I hope you'll enjoy the result. Thanks for your support!"



## Rencontre avec Brent Waller

Concepteur amateur et membre actif de la communauté LEGO® Ideas, Brent Waller est un artiste d'environnement 3D et le cofondateur d'une société de jeux vidéo à Brisbane, en Australie.

« Les ensembles LEGO étaient mes jouets préférés quand j'étais petit, et c'est un exutoire créatif que j'adore encore aujourd'hui. »

### L'inspiration

Jeune adulte du milieu à la fin des années 90, Brent adorait regarder *Seinfeld*. Il a récemment recommencé à regarder la série et s'est donné la mission de reproduire le plus fidèlement possible l'appartement et le groupe d'amis de Jerry.

« J'ai passé pas mal de temps à chercher et à essayer de déterminer de quelle couleur les murs étaient peints. Ils semblaient parfois changer de couleur à chaque épisode ! J'ai fait jouer la série en arrière-plan tout au long du processus et j'ai fini par utiliser un modèle réduit comme référence. Les plus grands défis étaient de reproduire les détails de la cuisine – les armoires, les objets et les décorations – puis de concevoir les murs en angle et les meubles encastrés. J'espère que vous apprécierez le résultat. Merci de votre soutien ! »

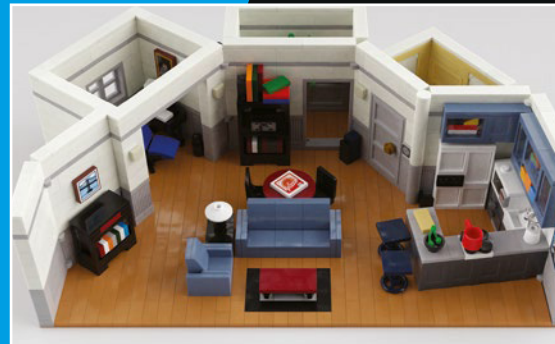

## Te presentamos a Brent Waller

Fan diseñador y activo miembro de la comunidad de LEGO® Ideas, Brent Waller es diseñador de entornos 3D y cofundador de una empresa de videojuegos en Brisbane (Australia).

"Jugar con sets LEGO era uno de mis pasatiempos favoritos cuando era niño. Hoy, como adulto, sigue siendo una actividad creativa que encuentro fascinante".

### La inspiración

A Brent le encantaba ver *Seinfeld* cuando era joven, a mediados y finales de los 90. Hace poco volvió a ver la serie y se propuso crear la mejor interpretación posible del departamento de Jerry y su pandilla de amigos.

"Pasé mucho tiempo investigando y tratando de averiguar de qué color estaban pintadas las paredes exactamente. ¡A veces parecían cambiar según el episodio! Tuve el programa reproduciéndose todo el tiempo en segundo plano y acabé usando un modelo a escala como referencia. Lo más complicado fue reproducir todos los detalles de la cocina (los gabinetes, objetos y adornos), así como diseñar las paredes en ángulo y los muebles empotrados. Espero que les guste el resultado. ¡Gracias por su apoyo!".



## César

"I was so impressed with Brent's model of Jerry's apartment. The kitchen accessories, the paintings on the wall, the green bicycle – I think fans will love all the accurate details and references to iconic scenes and episodes."

--César Carvalhosa Soares,  
LEGO® Model Designer

## Crystal

"I LOVE the show and all the classic shenanigans they get into, so our greatest challenge by far was limiting all the details we wanted to add. My favorite things we put in are the Uncle Leo portrait, the *Prognosis Negative* DVD, and Jerry's signature 90's hairdo wig."

--Crystal Marie Fontan,  
LEGO Senior Graphic Designer

## Madison

"Everyone in this design team is a true *Seinfeld* fan and I hope that translates into the model. I loved recreating Newman (my favorite character), recreating 'The Kramer' and cramming the front of the fridge with details."

--Madison O'Neil,  
LEGO Senior Graphic Designer



## César

« J'ai été très impressionné par le modèle de l'appartement de Jerry créé par Brent. Les accessoires de cuisine, les toiles sur le mur, le vélo vert – je crois que les amateurs vont adorer les petits détails ainsi que les références à des scènes et à des épisodes emblématiques. »

--César Carvalhosa Soares,  
concepteur de modèles LEGO®

## Crystal

« J'ADORE la série et toutes ses situations farfelues inoubliables, et restreindre la quantité de détails à inclure représentait un défi de taille. Mes éléments favoris sont le portrait de l'oncle Leo, le DVD de *Diagnostic négatif* et la perruque de la coiffure classique des années 90 de Jerry. »

--Crystal Marie Fontan,  
graphiste principale LEGO

## Madison

« Tout le monde dans l'équipe de conception adore *Seinfeld*, et j'espère que le modèle en fait montre. J'ai adoré recréer Newman (mon personnage préféré) et Kramer et remplir l'avant du frigo de détails. »

--Madison O'Neil,  
graphiste principal LEGO



## César

"Me impresionó mucho el modelo de Brent del departamento de Jerry. Los accesorios de la cocina, los cuadros en las paredes, la bicicleta verde... Creo que a los fans les encantarán todos esos detalles tan precisos, por no hablar de las referencias a las escenas y episodios que todos recuerdan".

--César Carvalhosa Soares,  
diseñador de modelos LEGO®

## Crystal

"ME ENCANTAN la serie y los clásicos líos en los que se meten, así que nuestro mayor desafío, con diferencia, fue limitar todos los detalles que queríamos incluir. De las cosas que añadimos, mis favoritas son el retrato del tío Leo, el DVD de *Pronóstico Negativo* y la peluca de Jerry, con el peinado típico de los 90".

--Crystal Marie Fontan,  
diseñadora gráfica sénior de LEGO

## Madison

"Todos los que formamos parte de este equipo de diseño somos verdaderos fans de *Seinfeld* y espero que eso se haya transmitido al modelo. Me encantó recrear a Newman (mi personaje favorito) y a Kramer, así como abarrotar de detalles la puerta del refrigerador".

--Madison O'Neil,  
diseñador gráfico sénior de LEGO





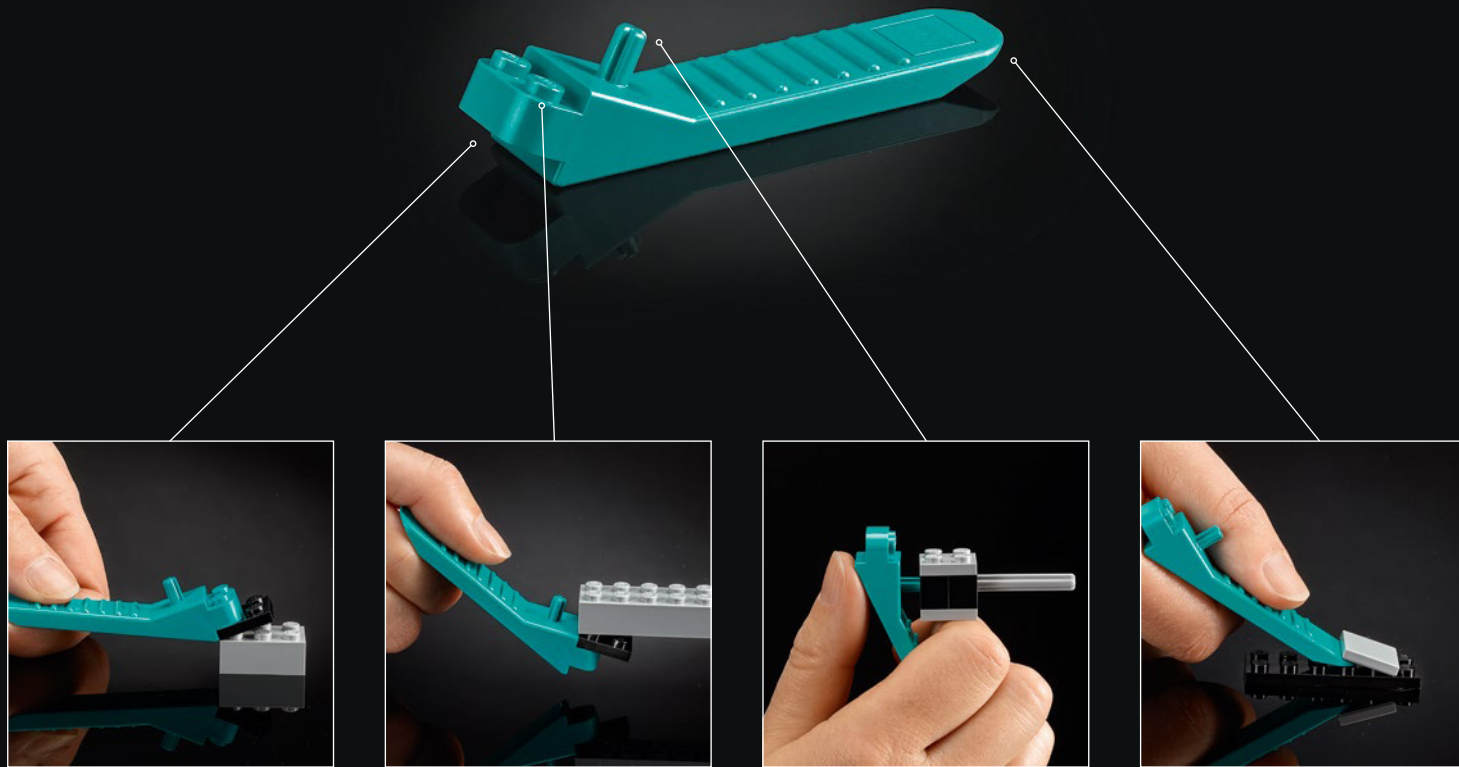

[LEGO.com/brickseparator](https://www.lego.com/brickseparator)

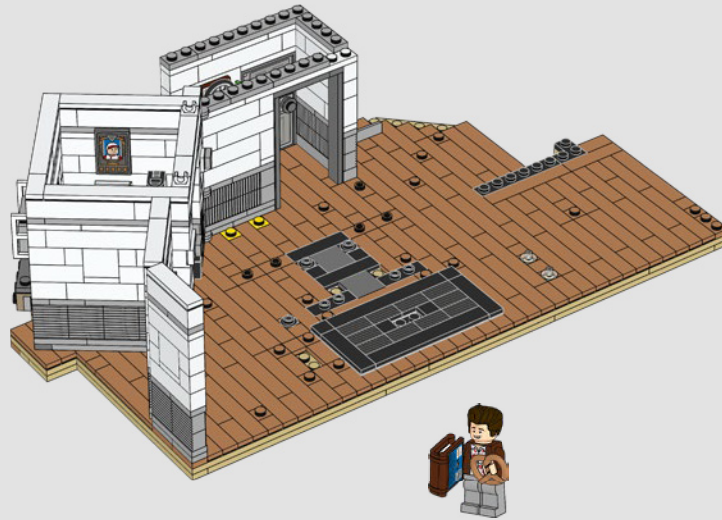
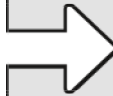
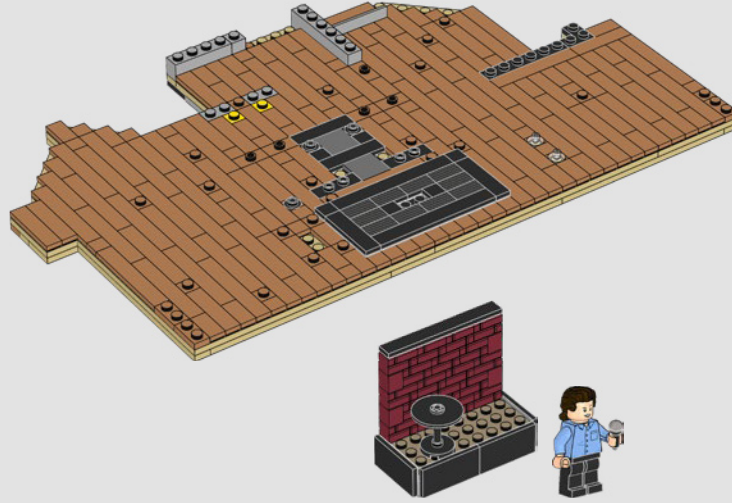
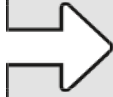

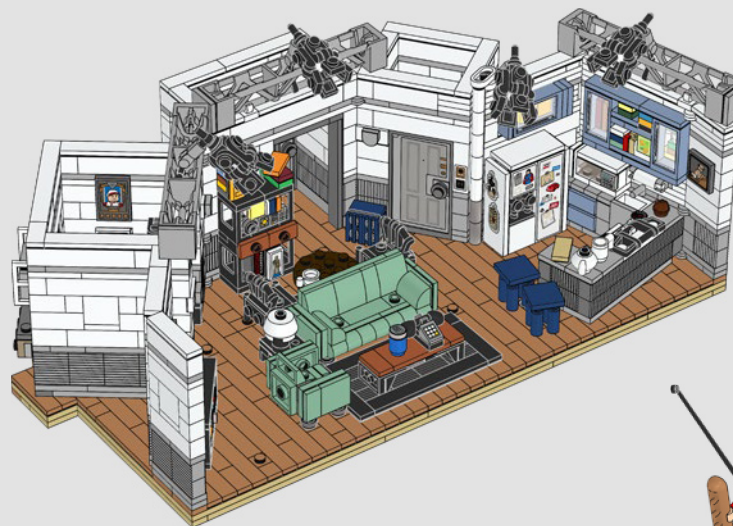
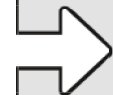
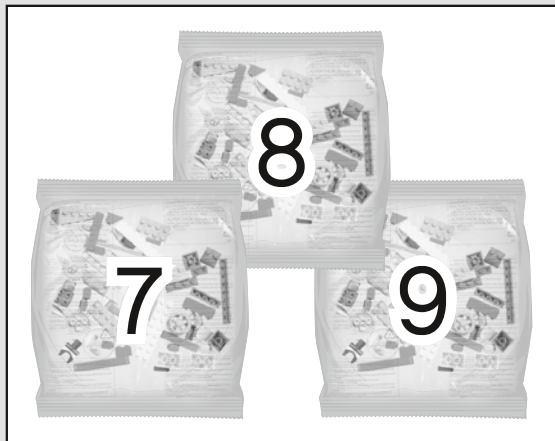
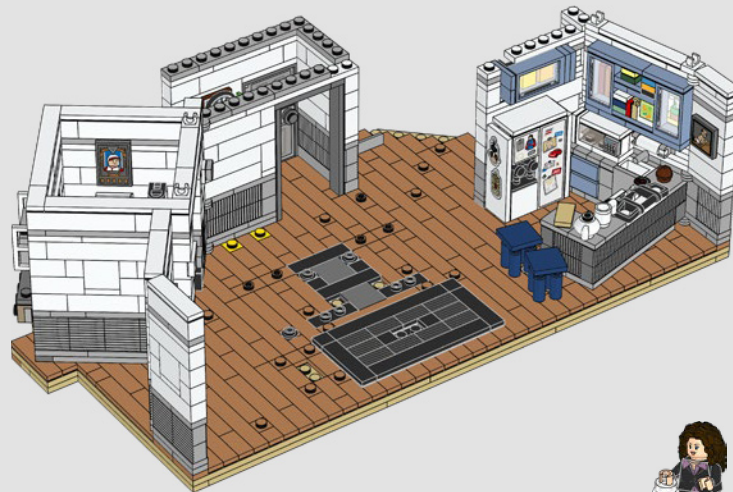

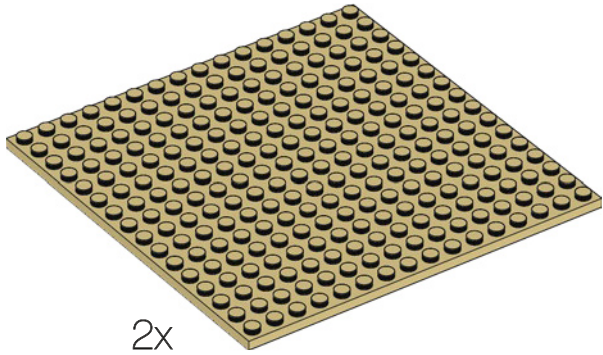

2x

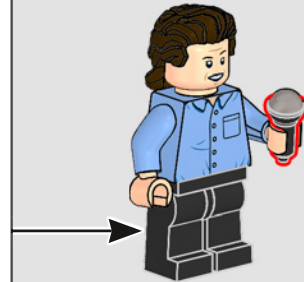
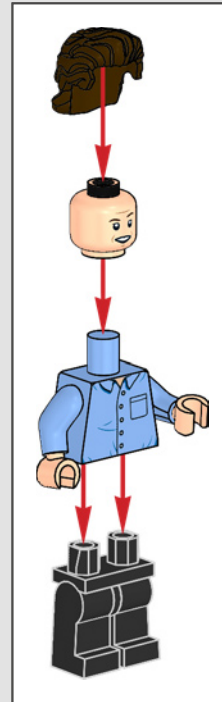
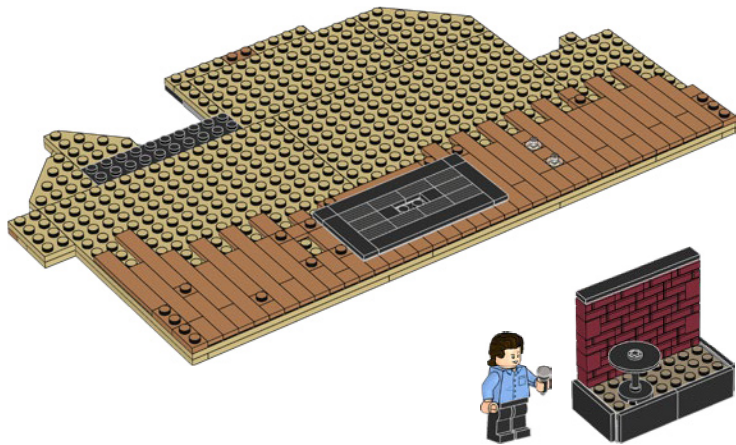
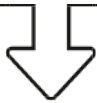

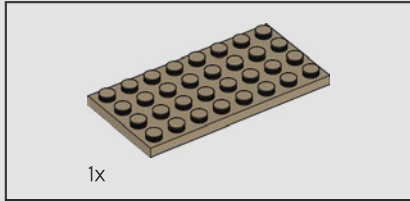

1

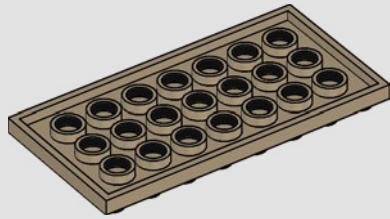

2

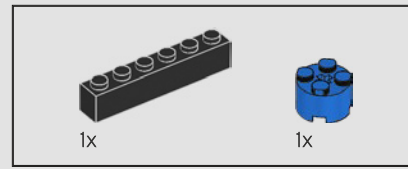
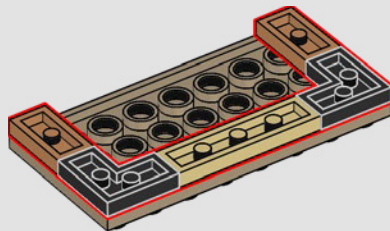

3

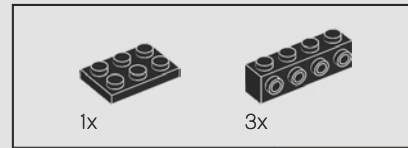
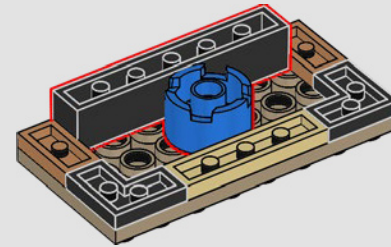

4

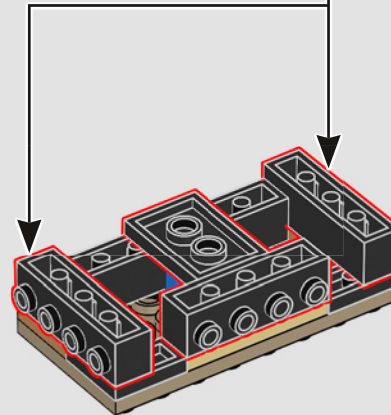
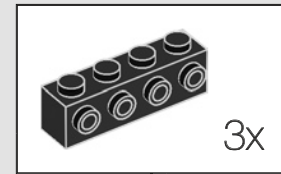



5

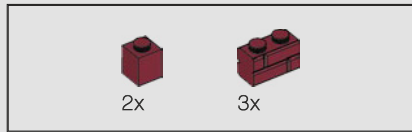
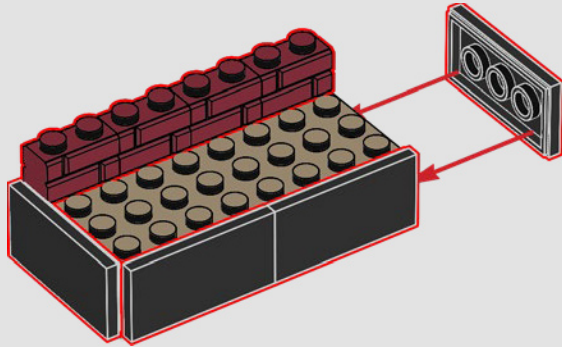

6

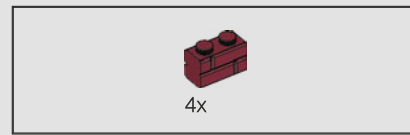
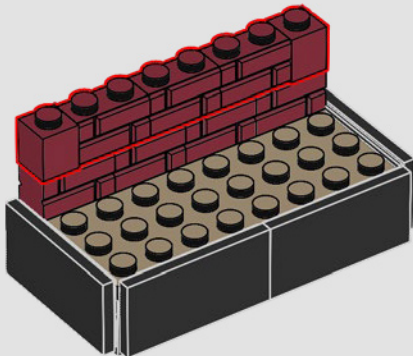

7

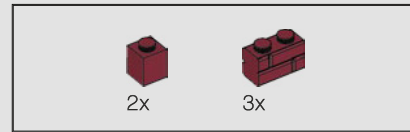
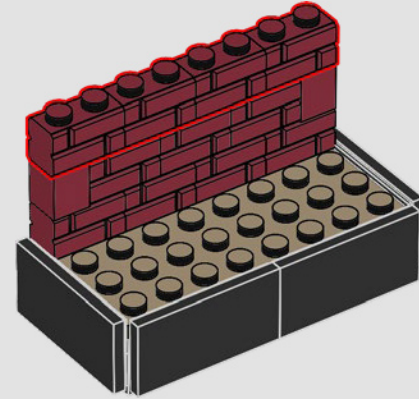

8

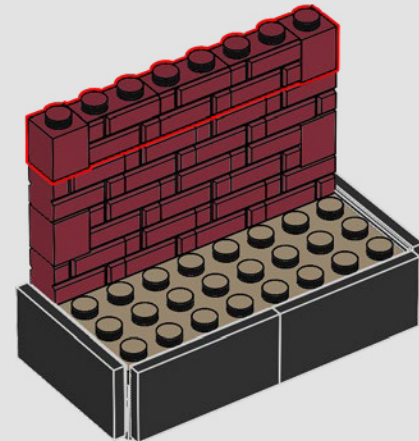

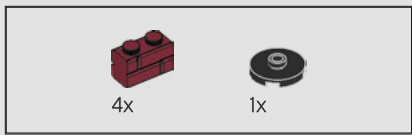

9

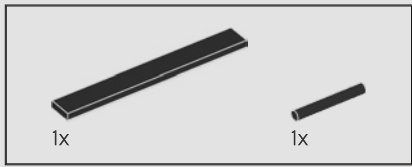
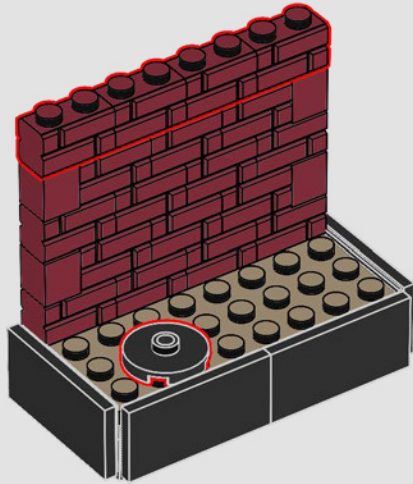

10

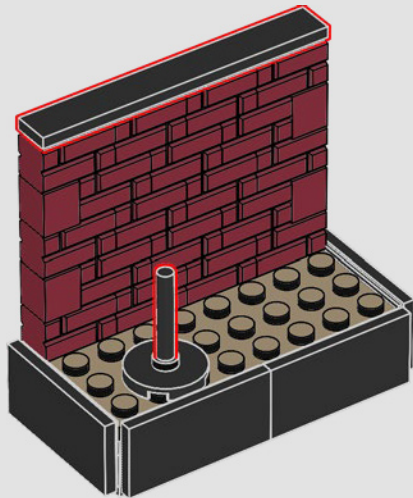

11

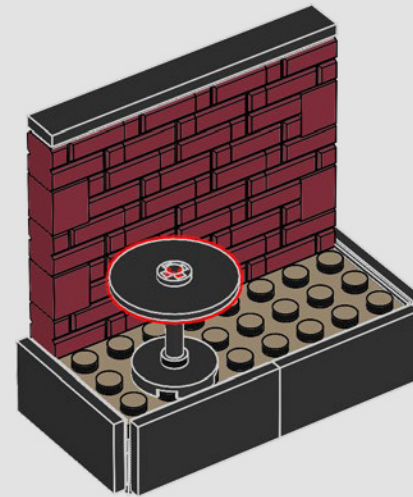



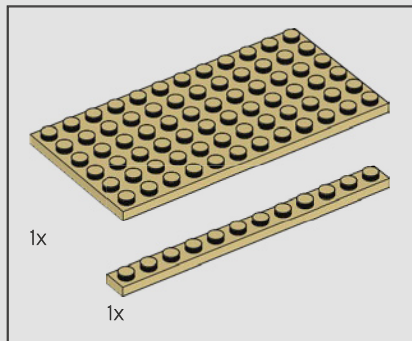
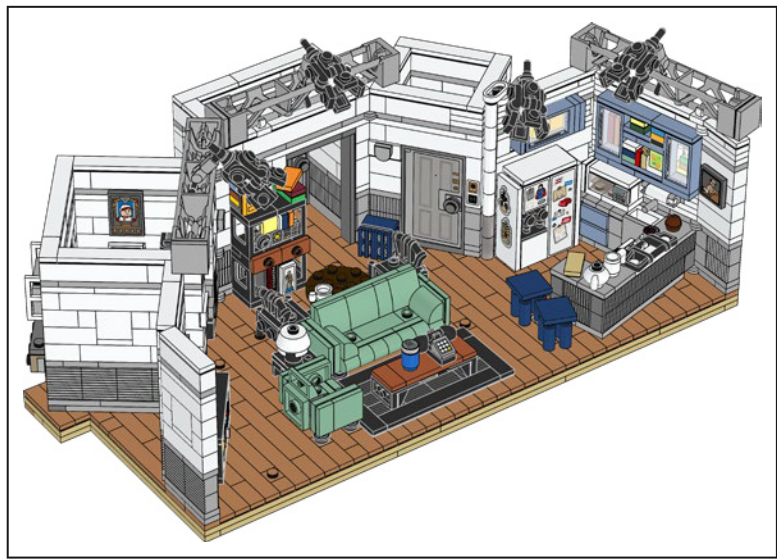

1

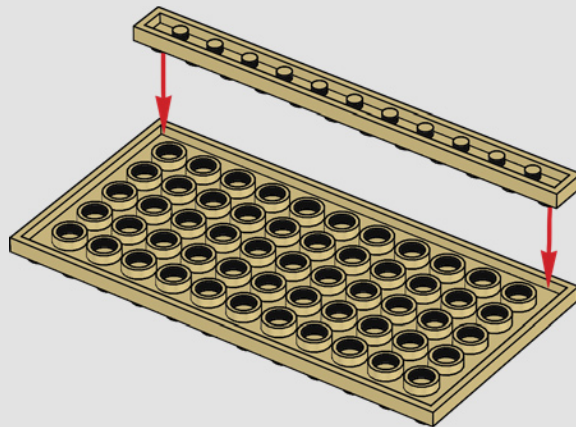

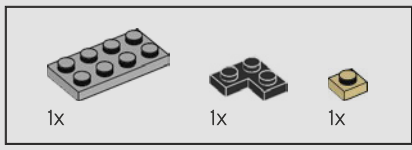

2

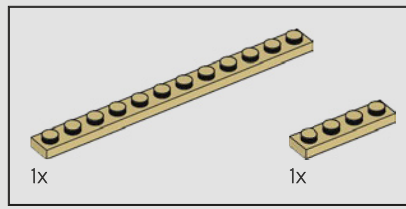
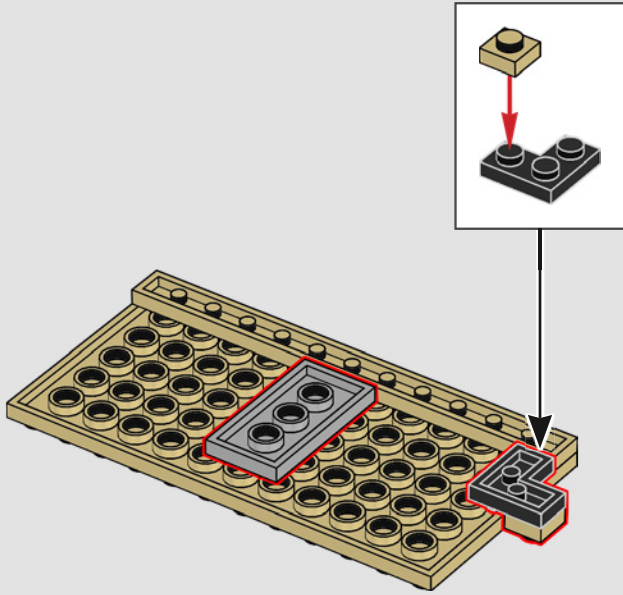

3

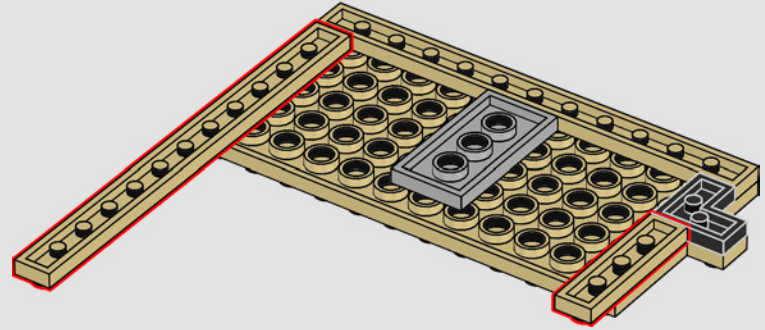



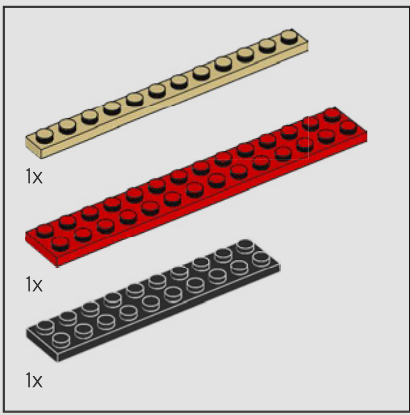

5

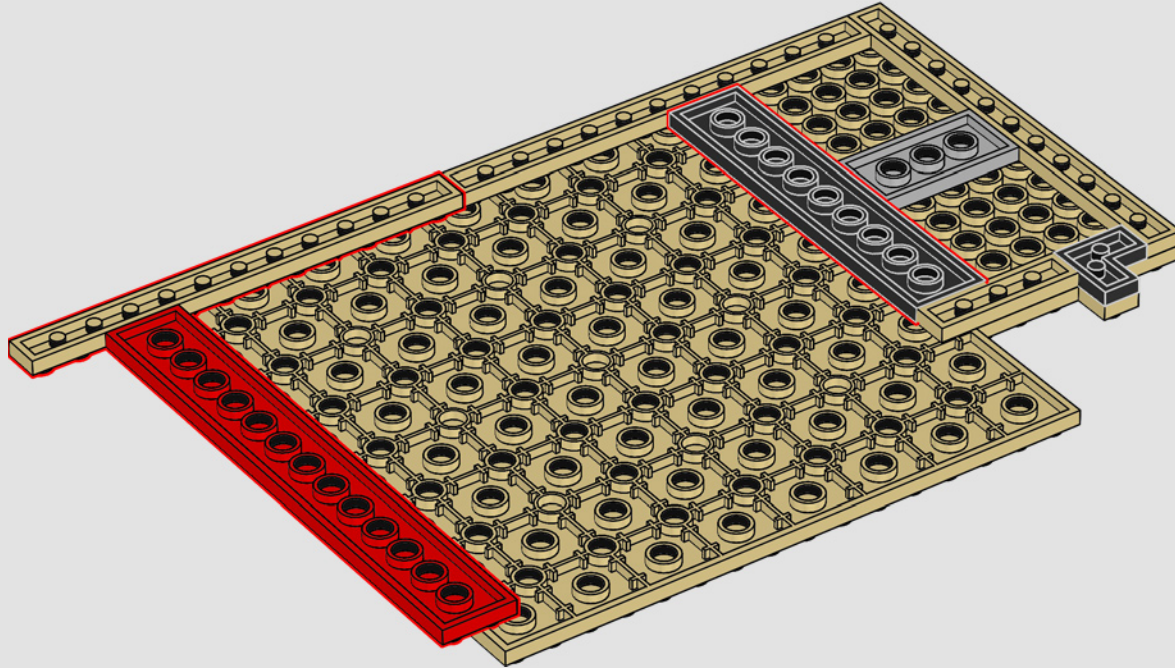

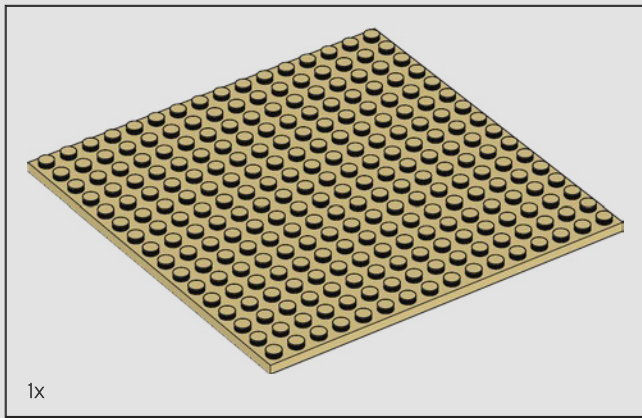

6

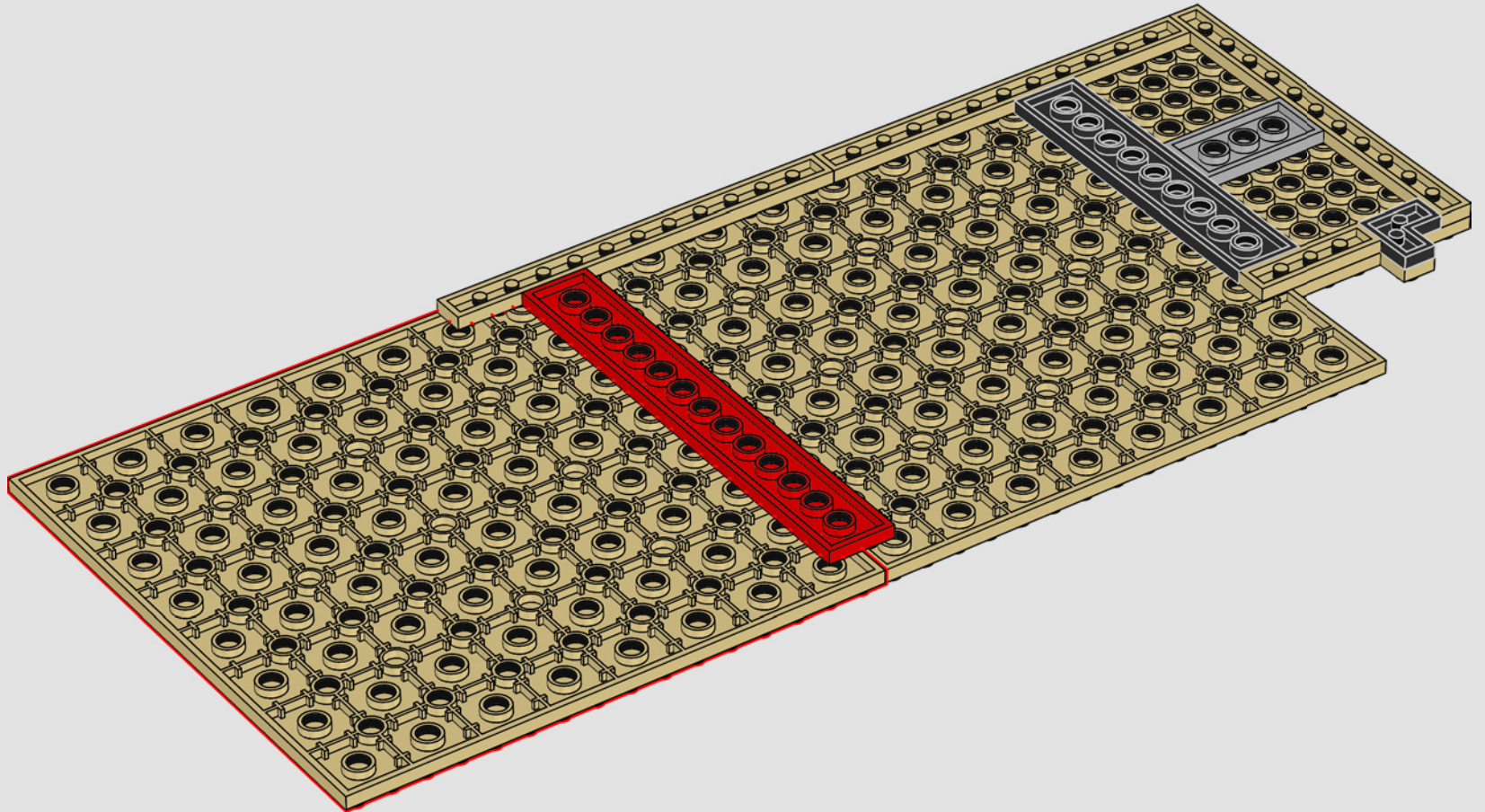

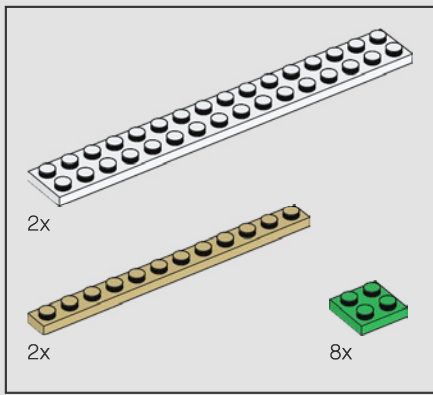

7

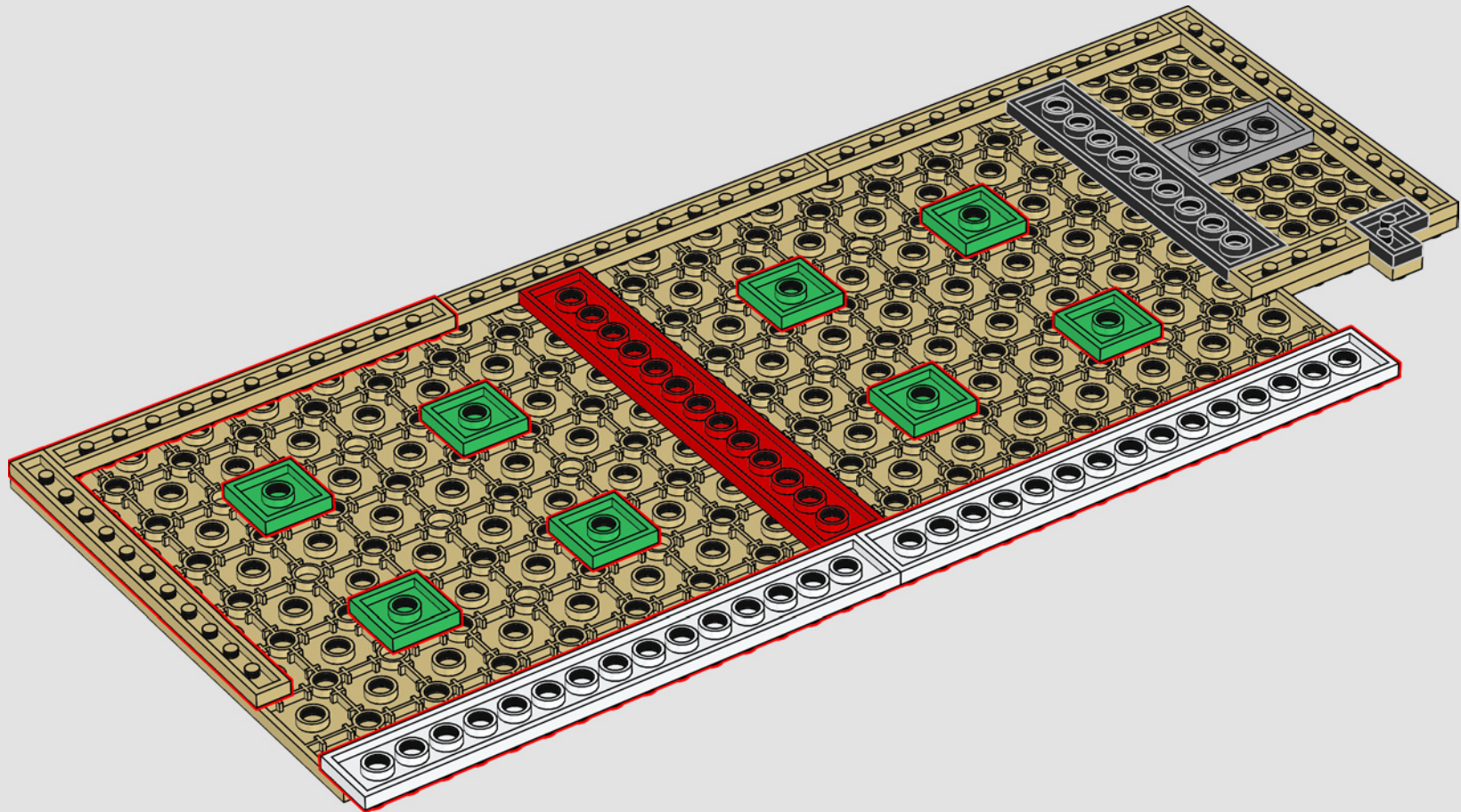

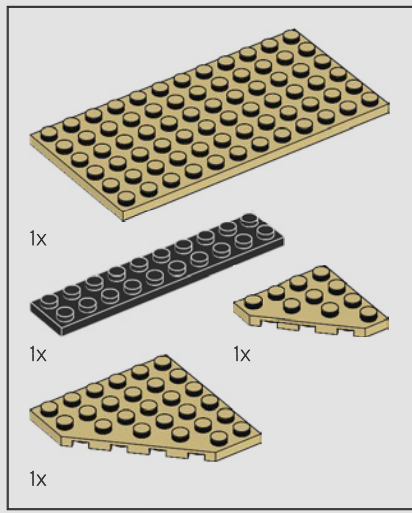

8

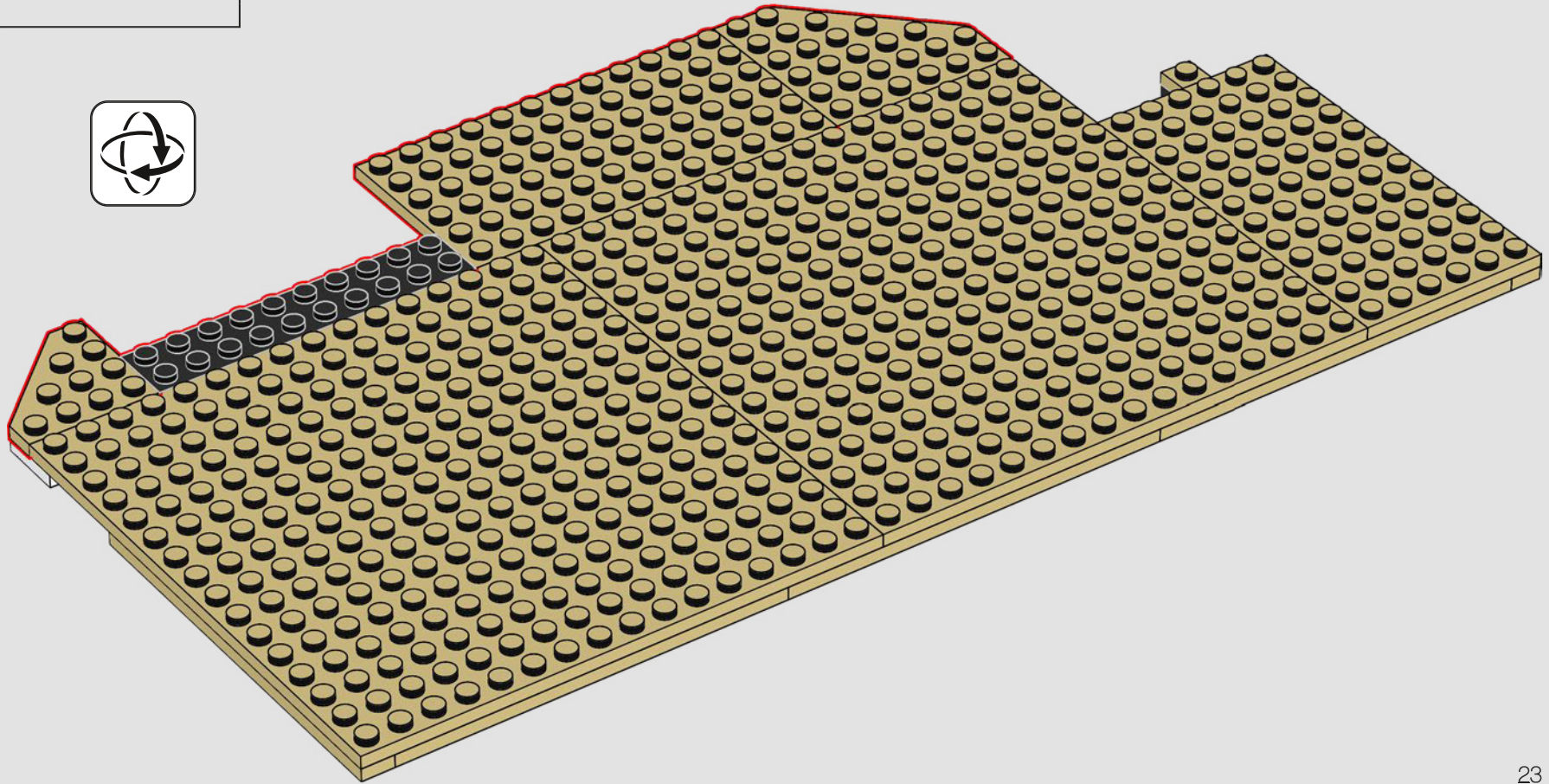

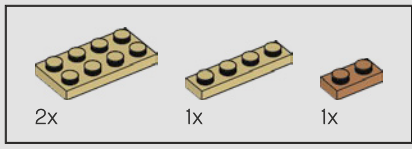

9

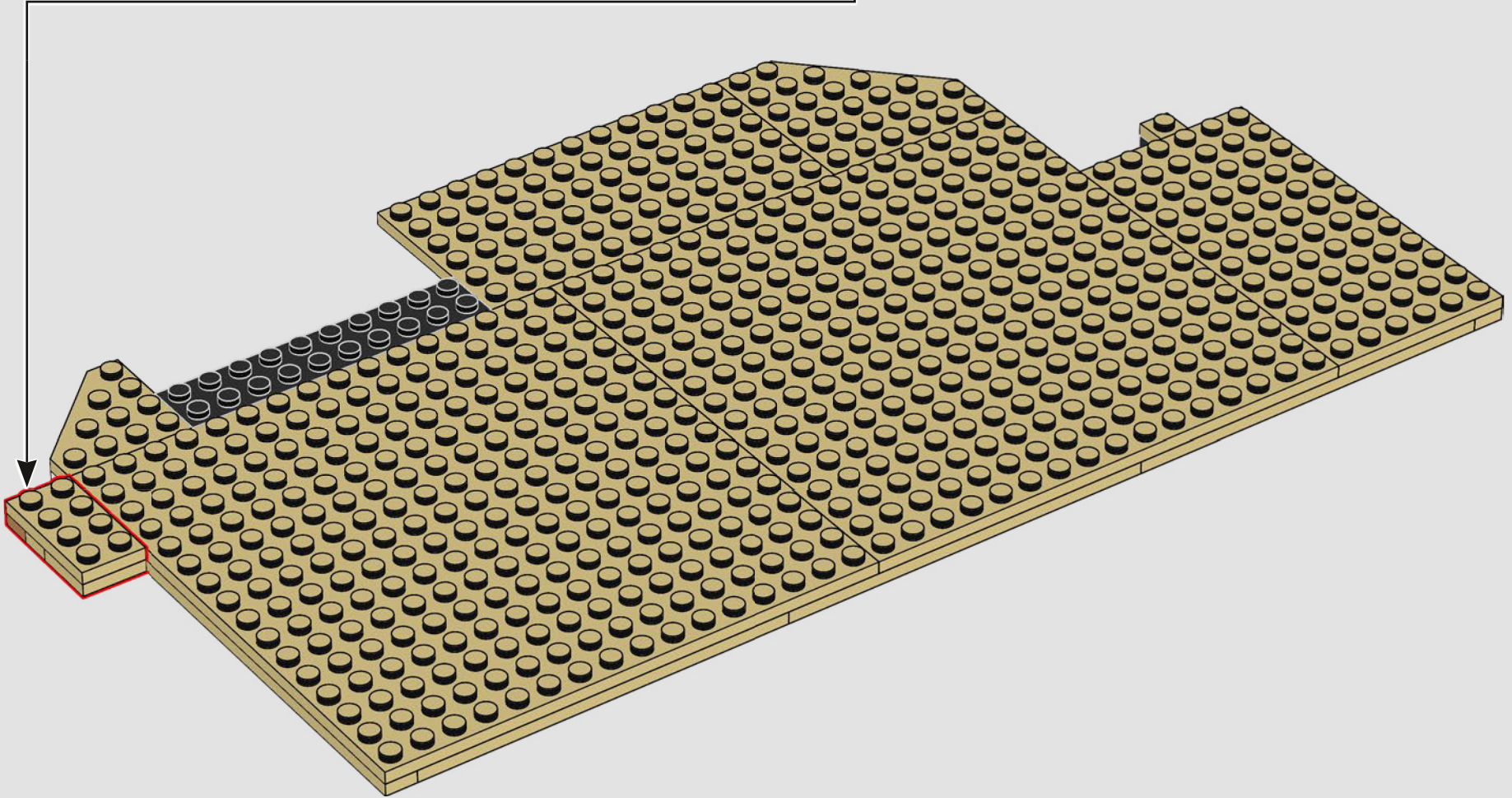
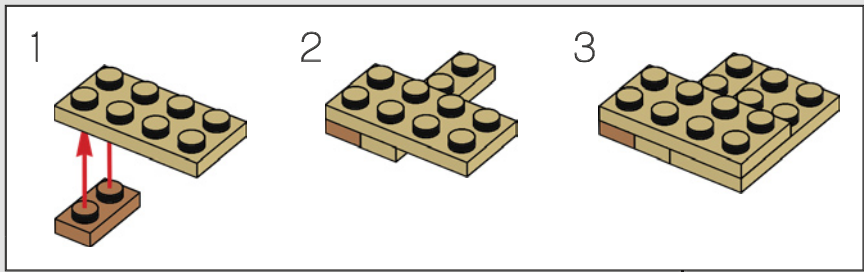



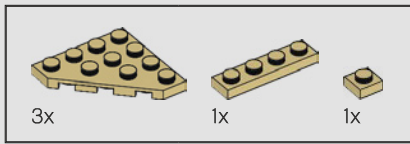

10

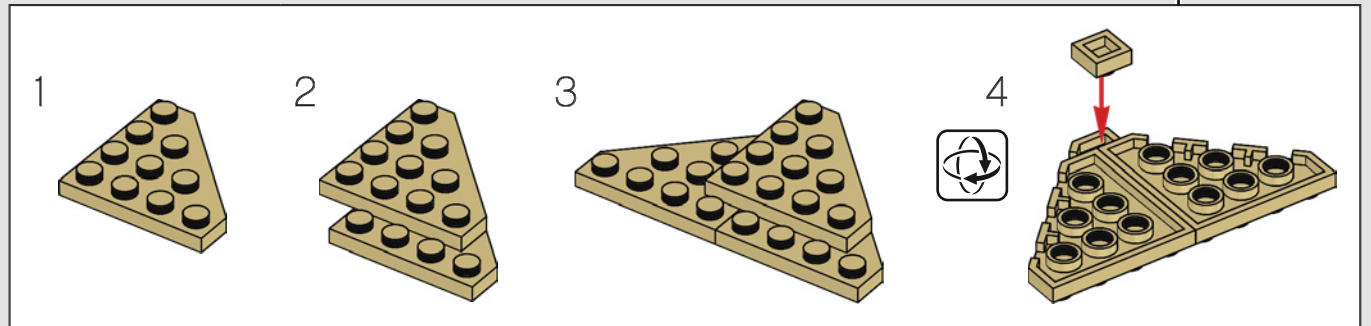
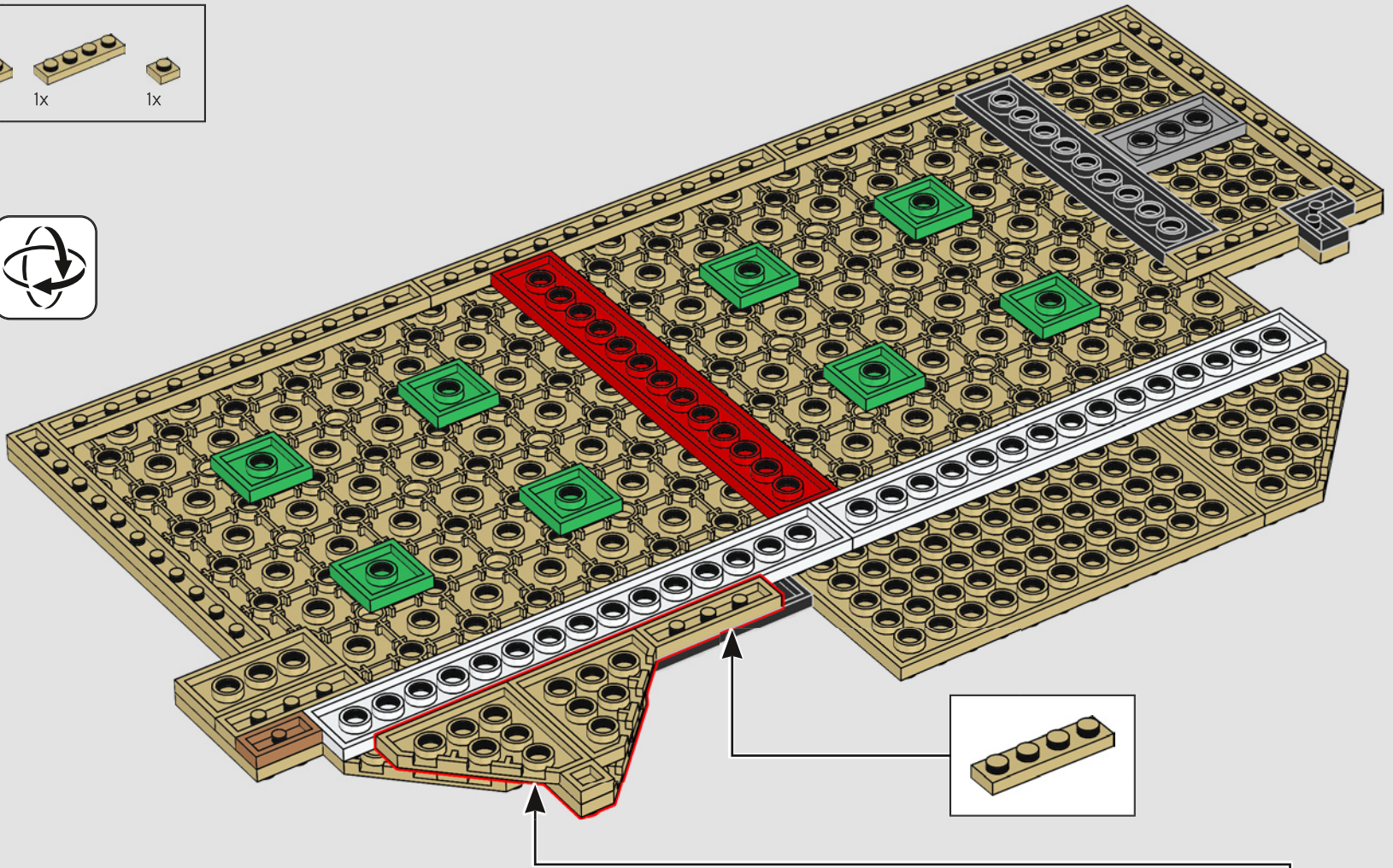

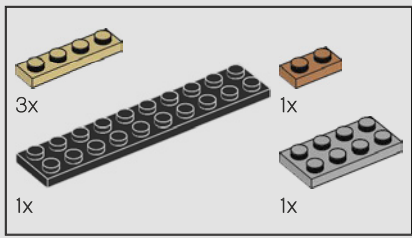

11

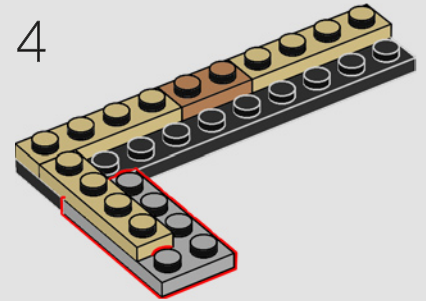
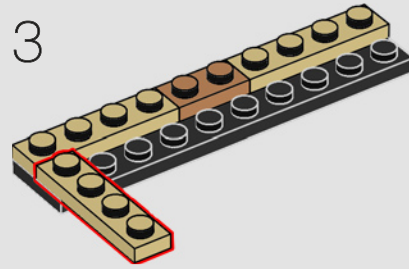
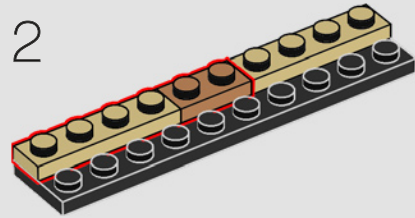
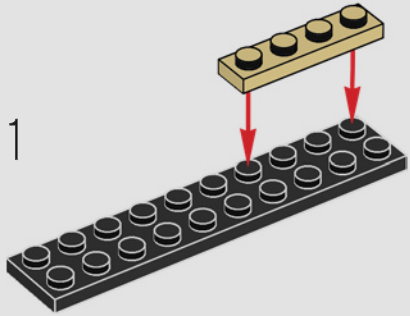

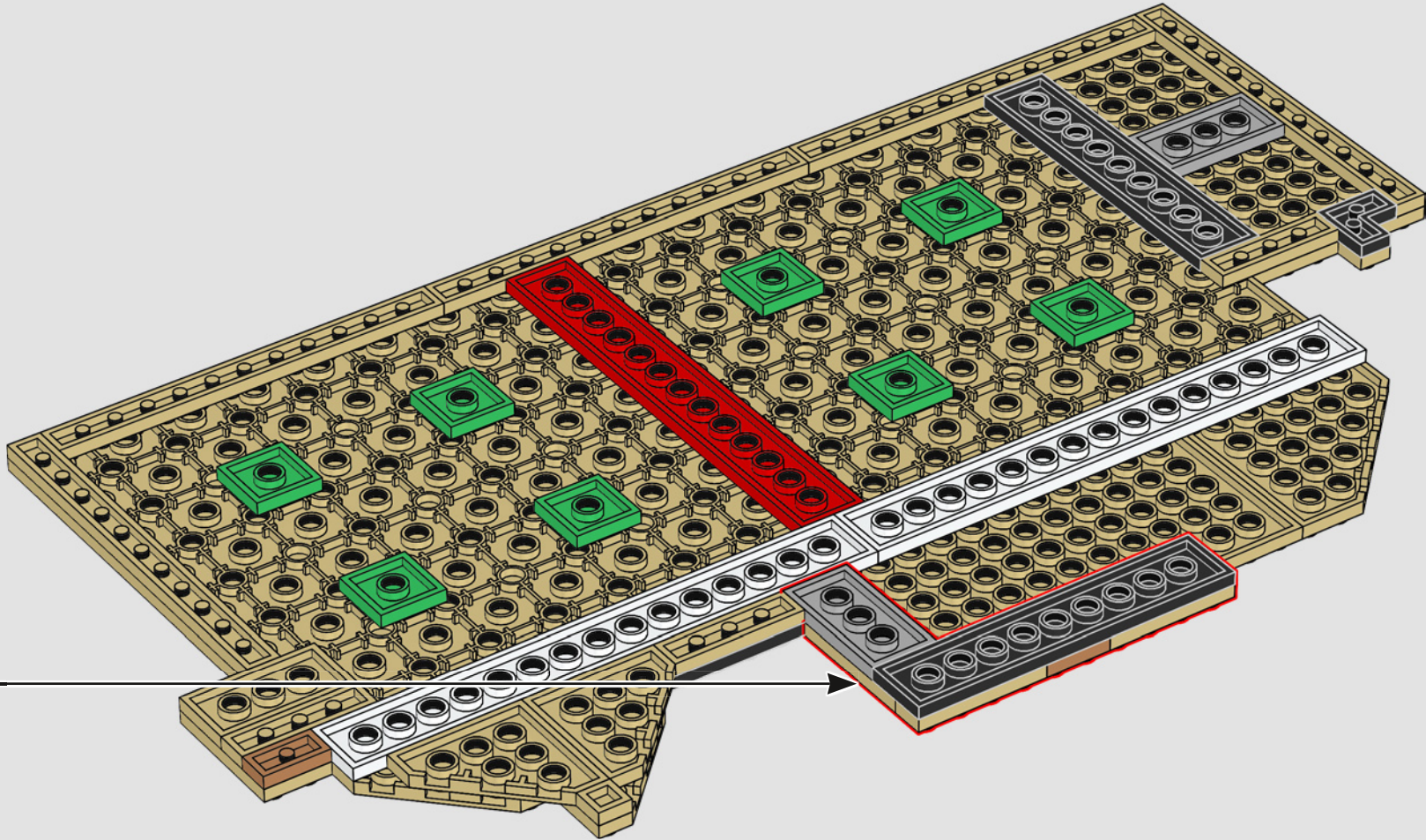



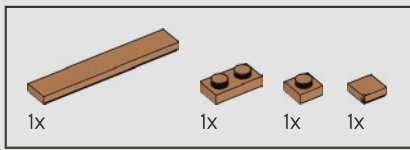

13

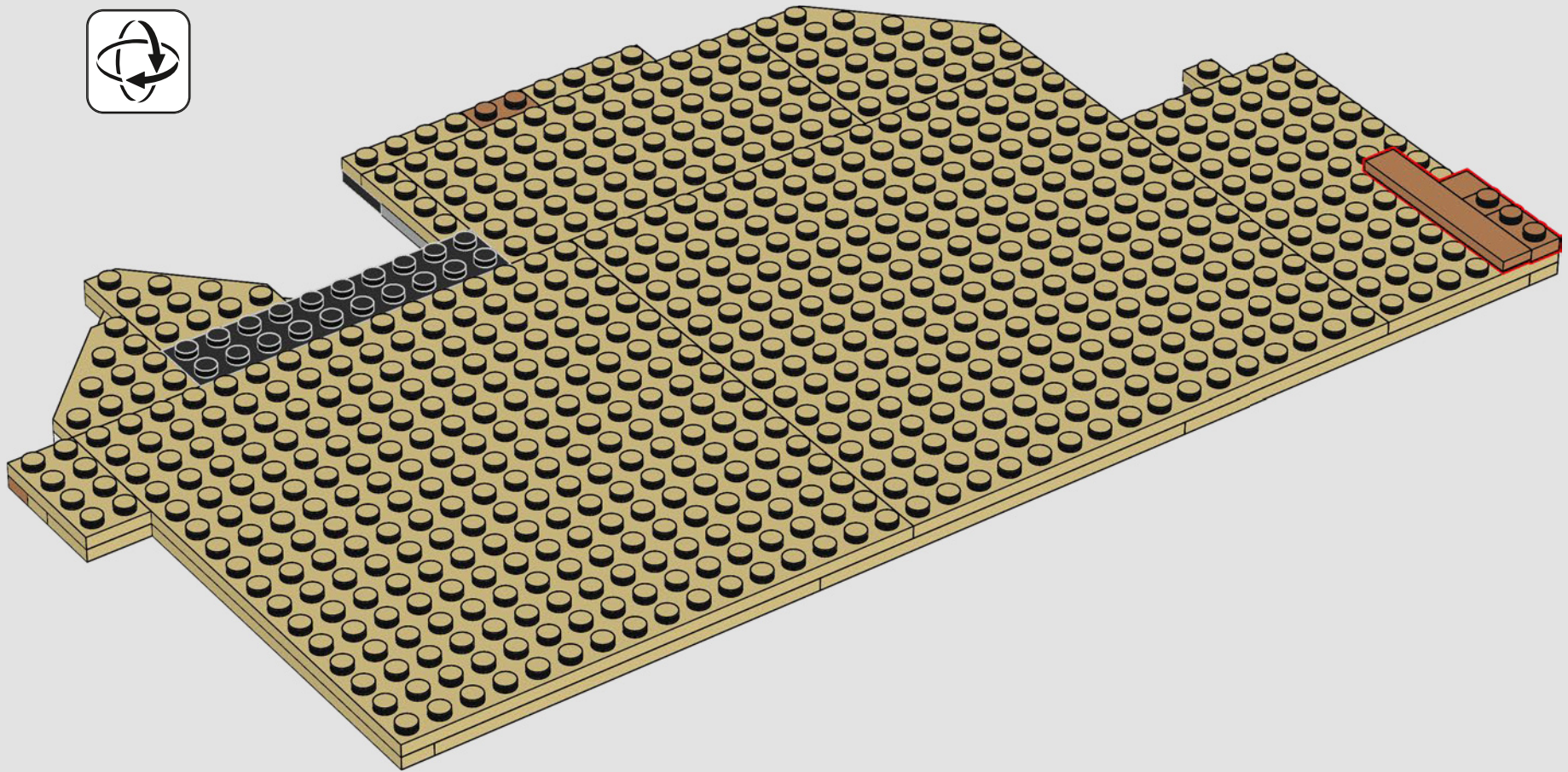

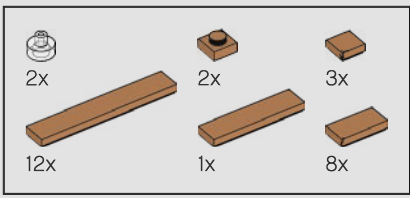

14

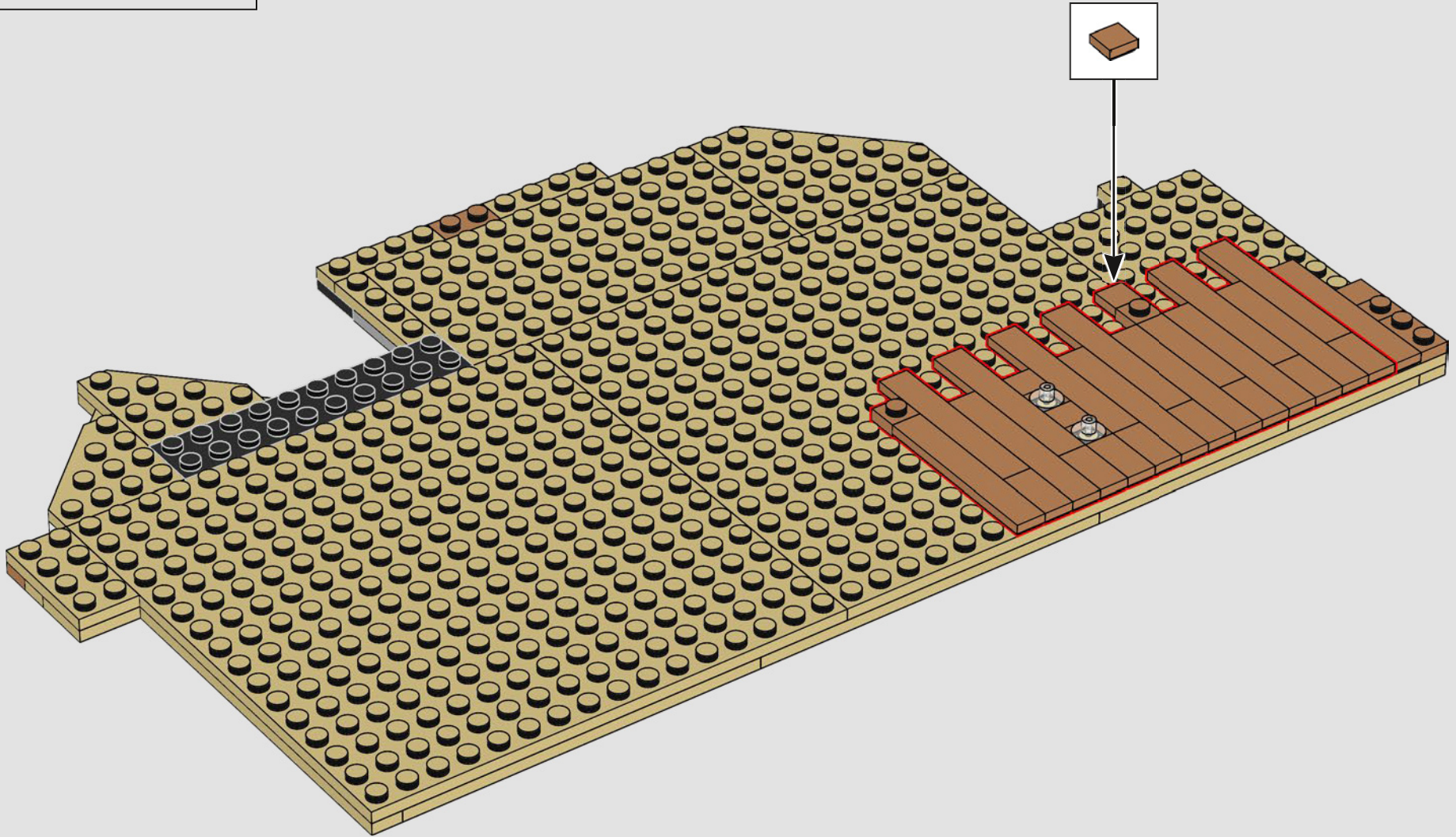

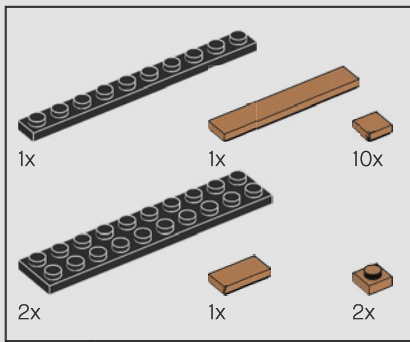

15

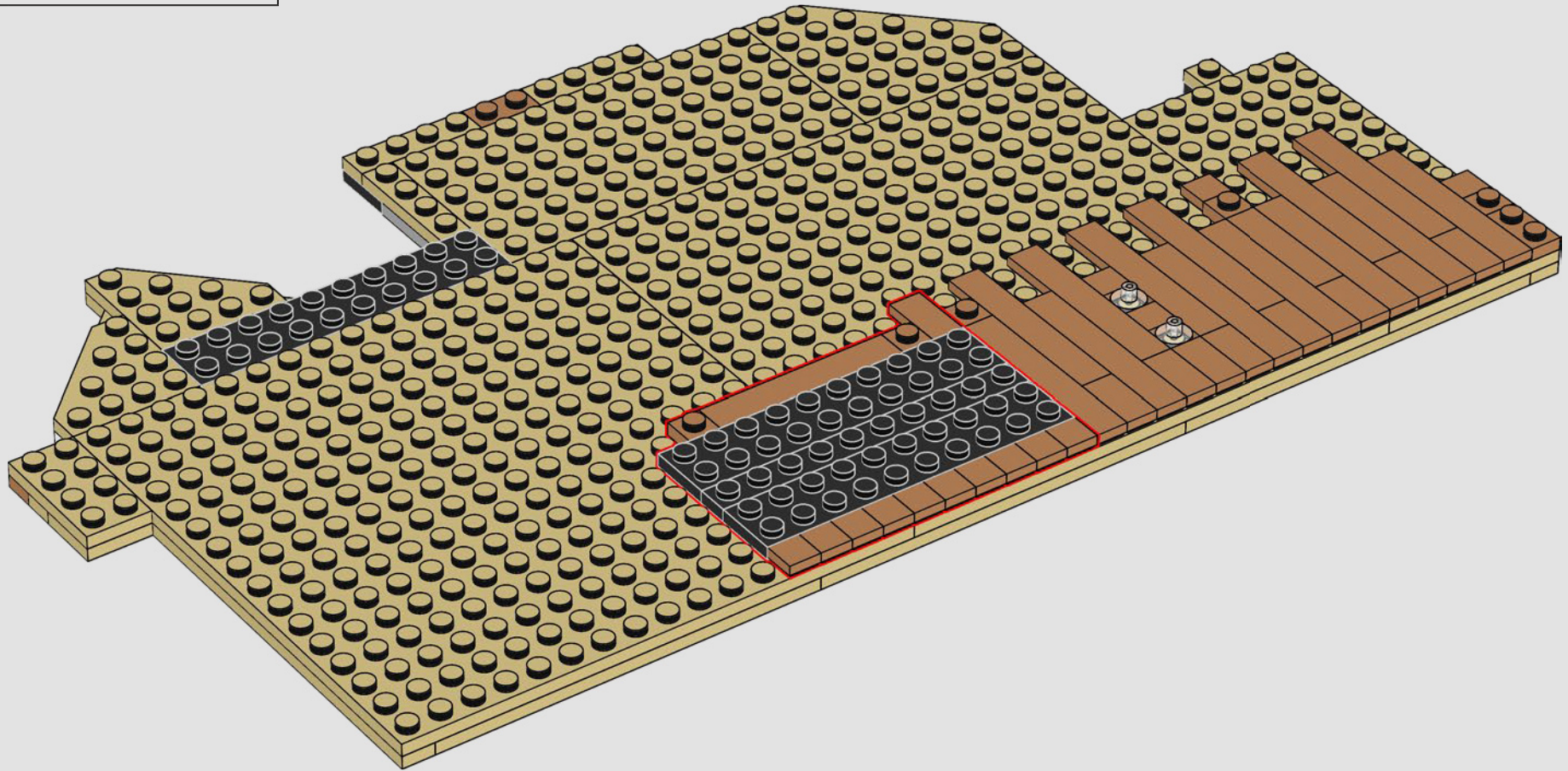

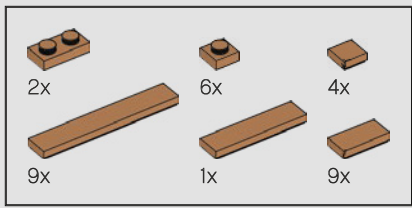

16

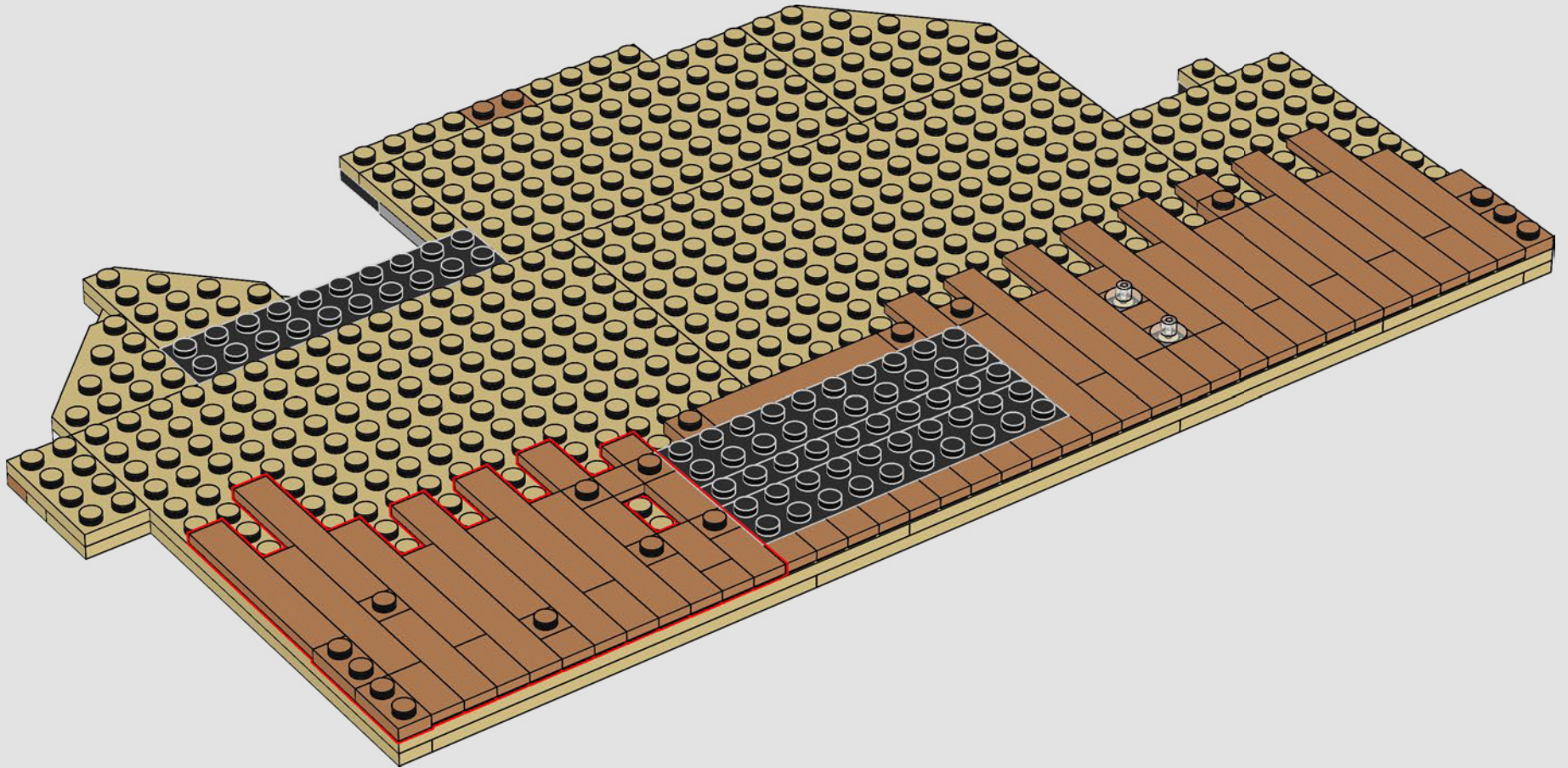



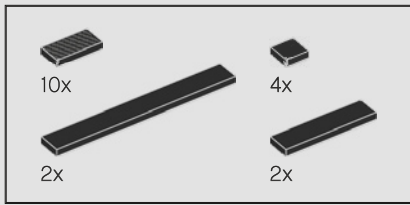

17

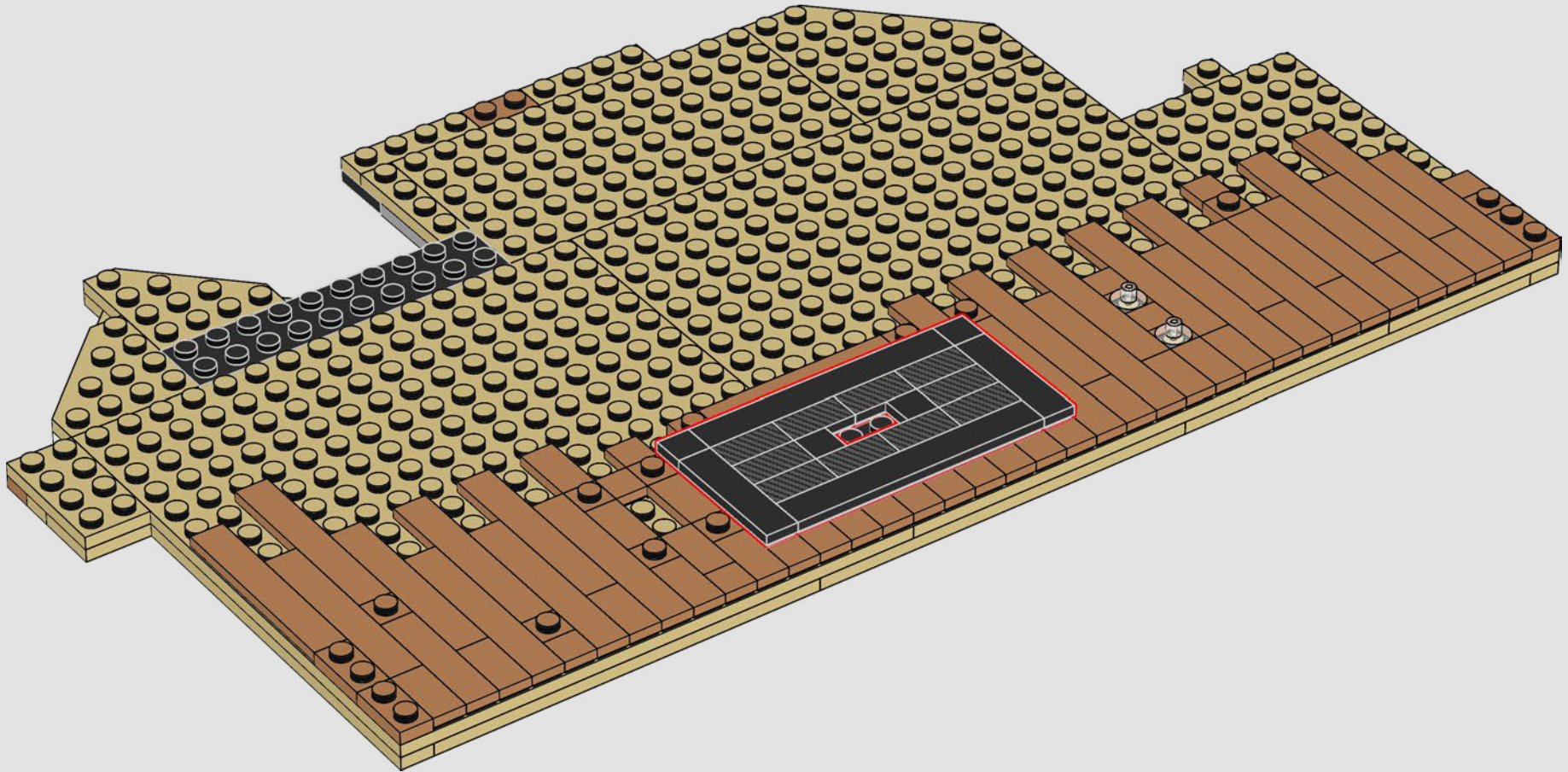

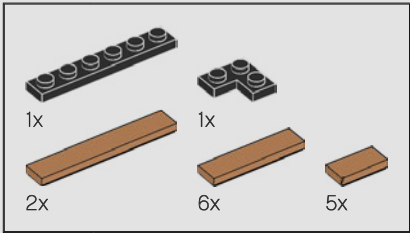
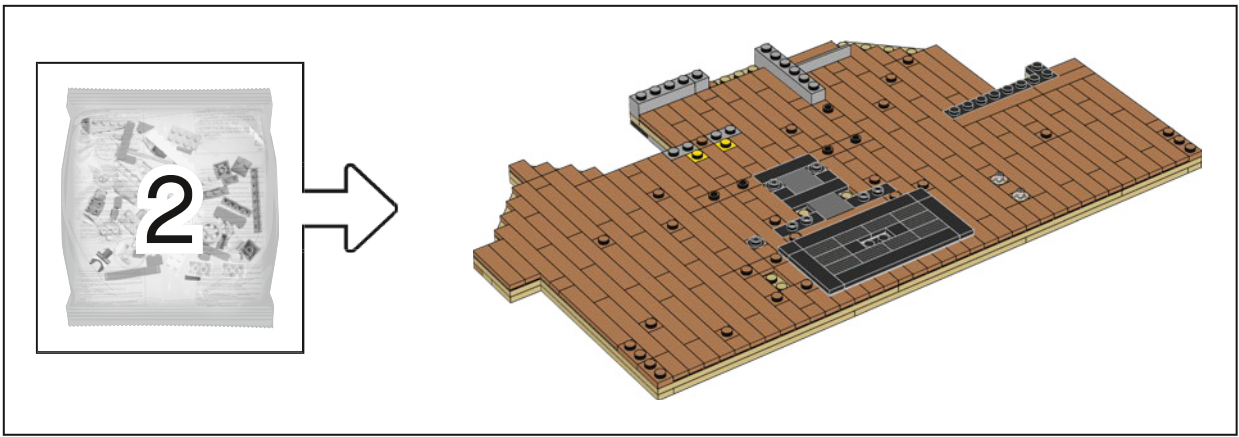

18

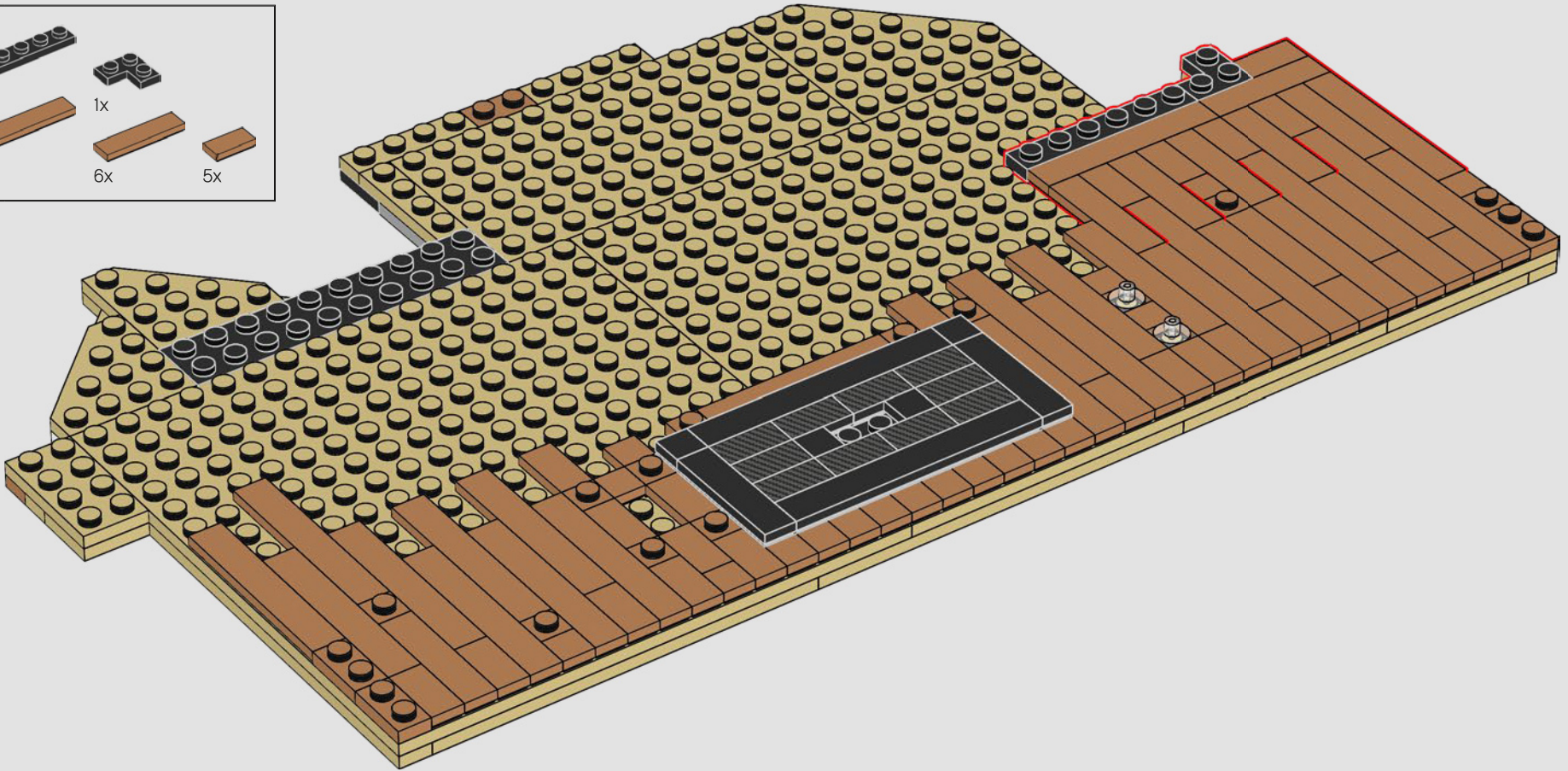

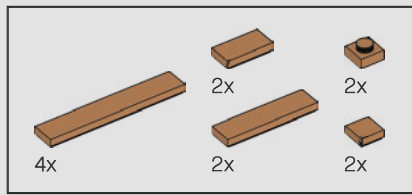

19

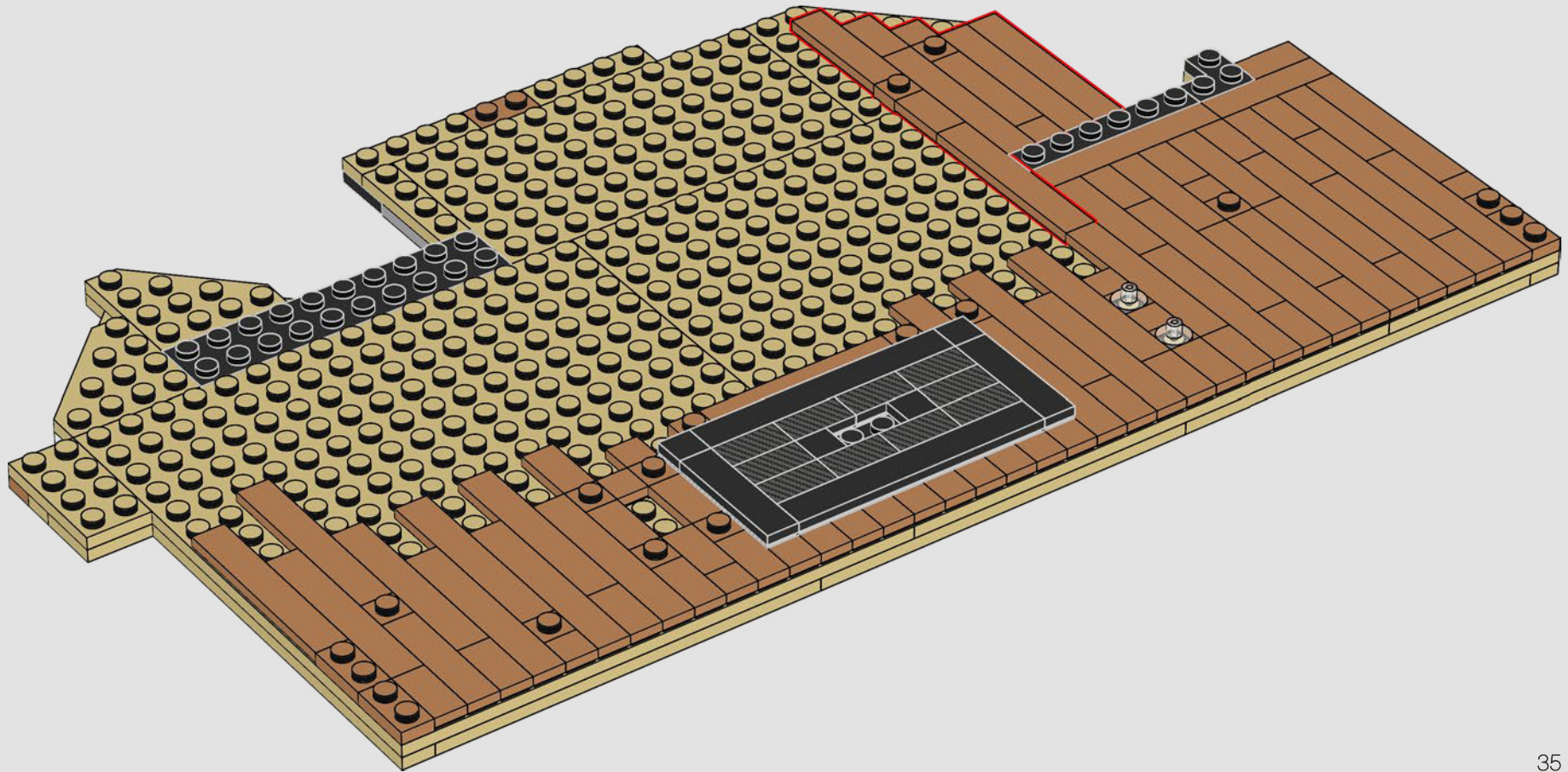

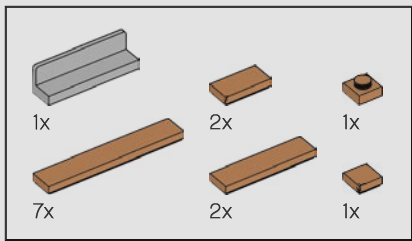

20

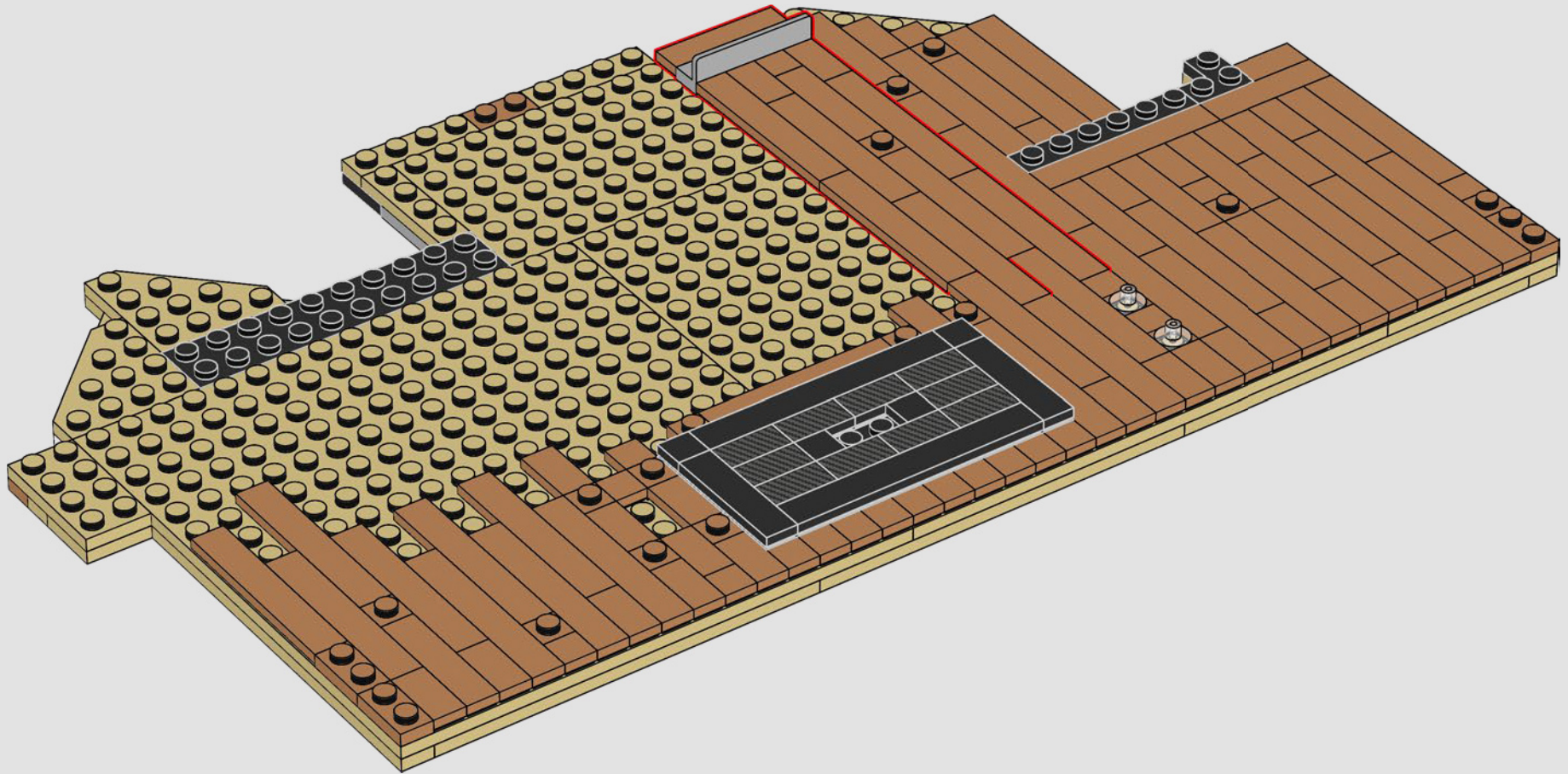

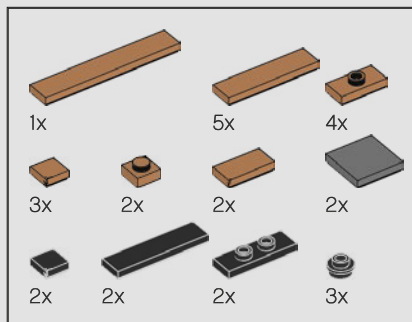

21

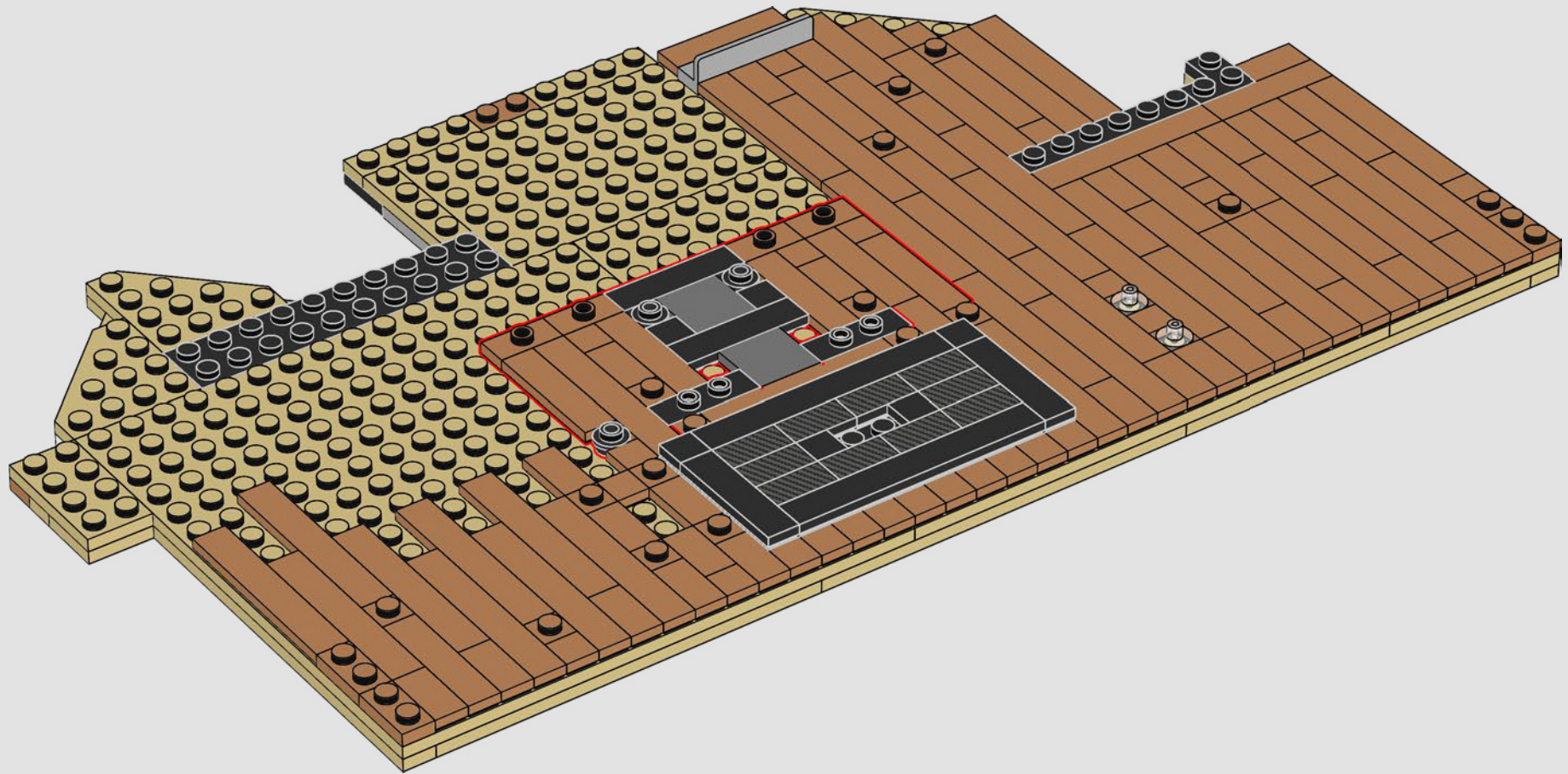





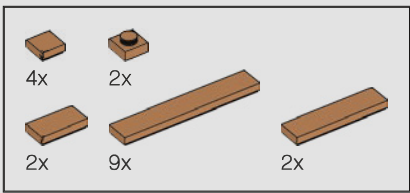

24

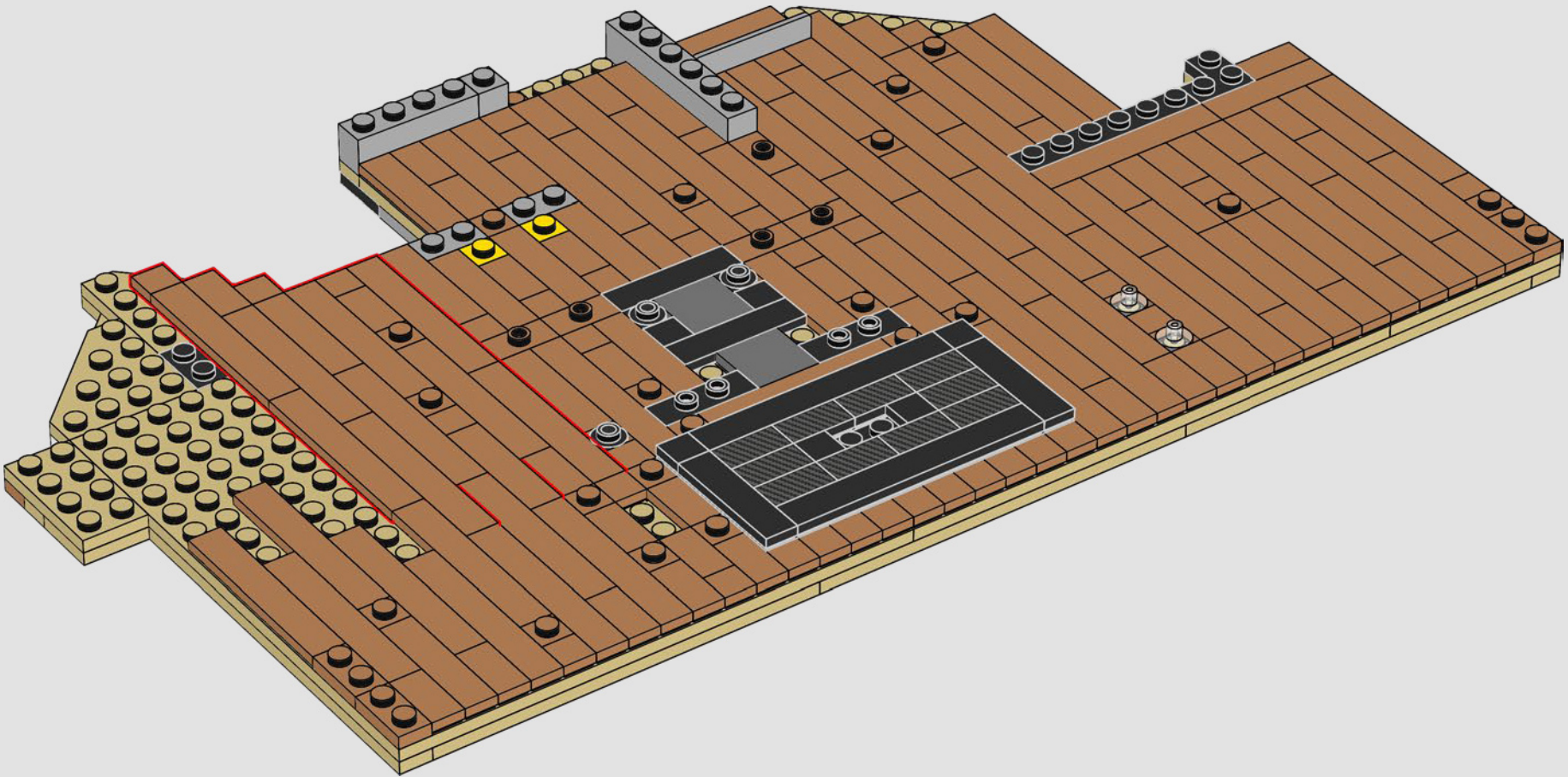



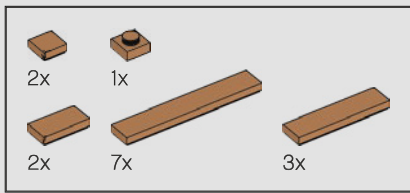

25

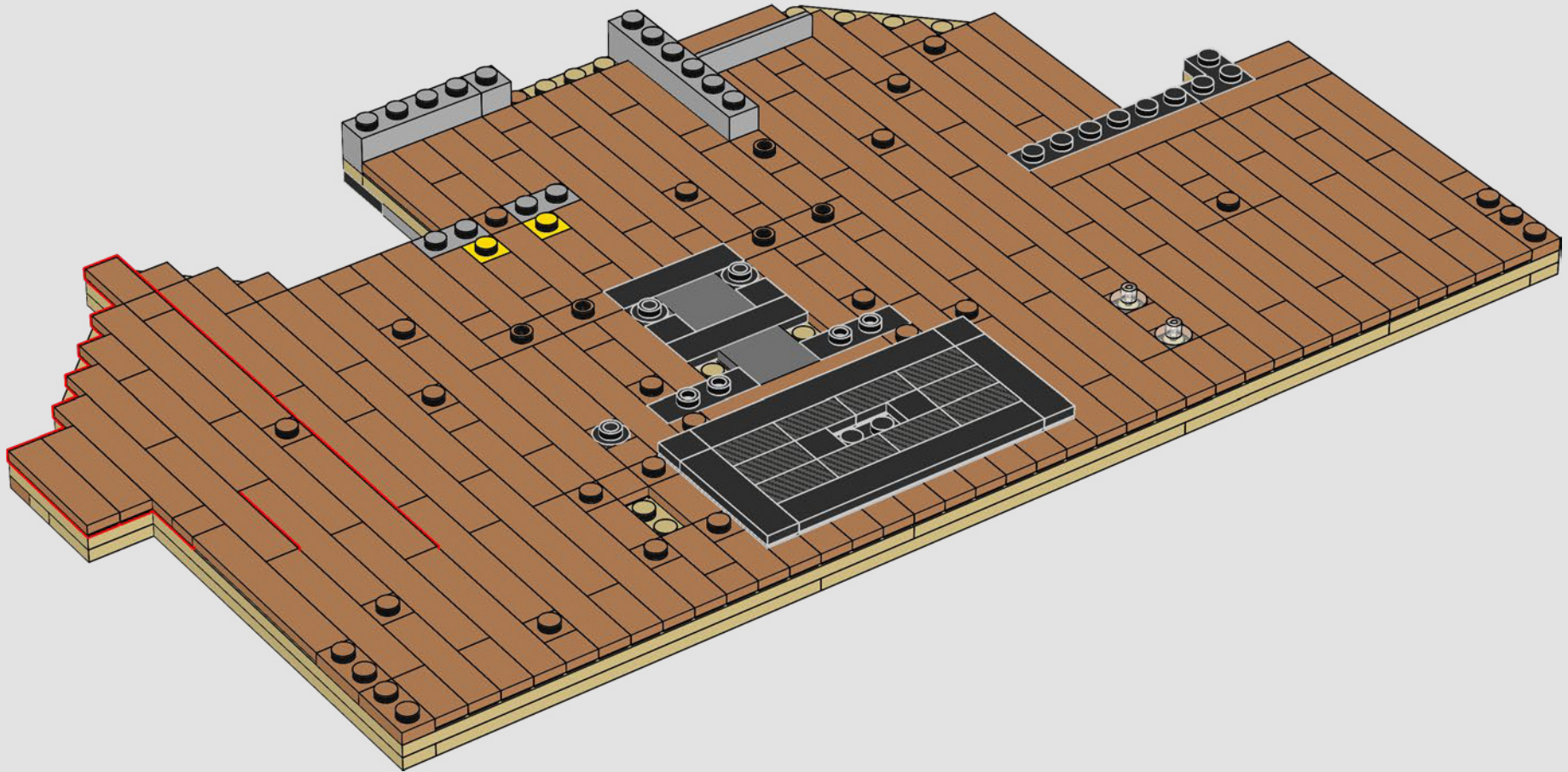

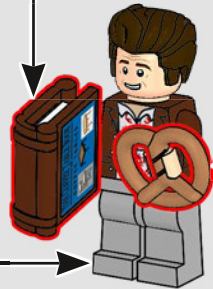
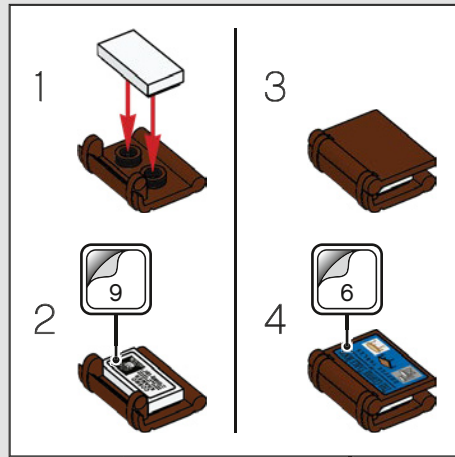
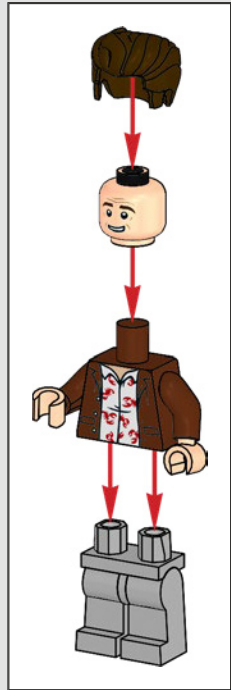
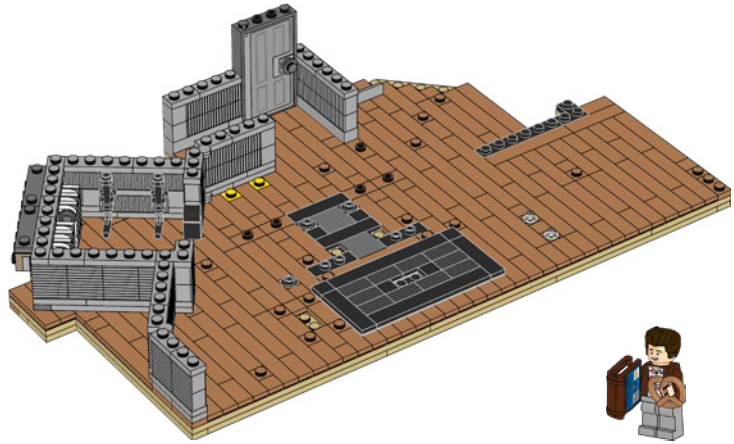
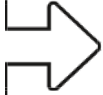

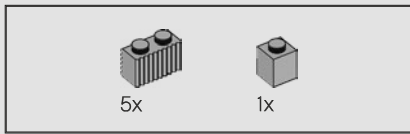

26

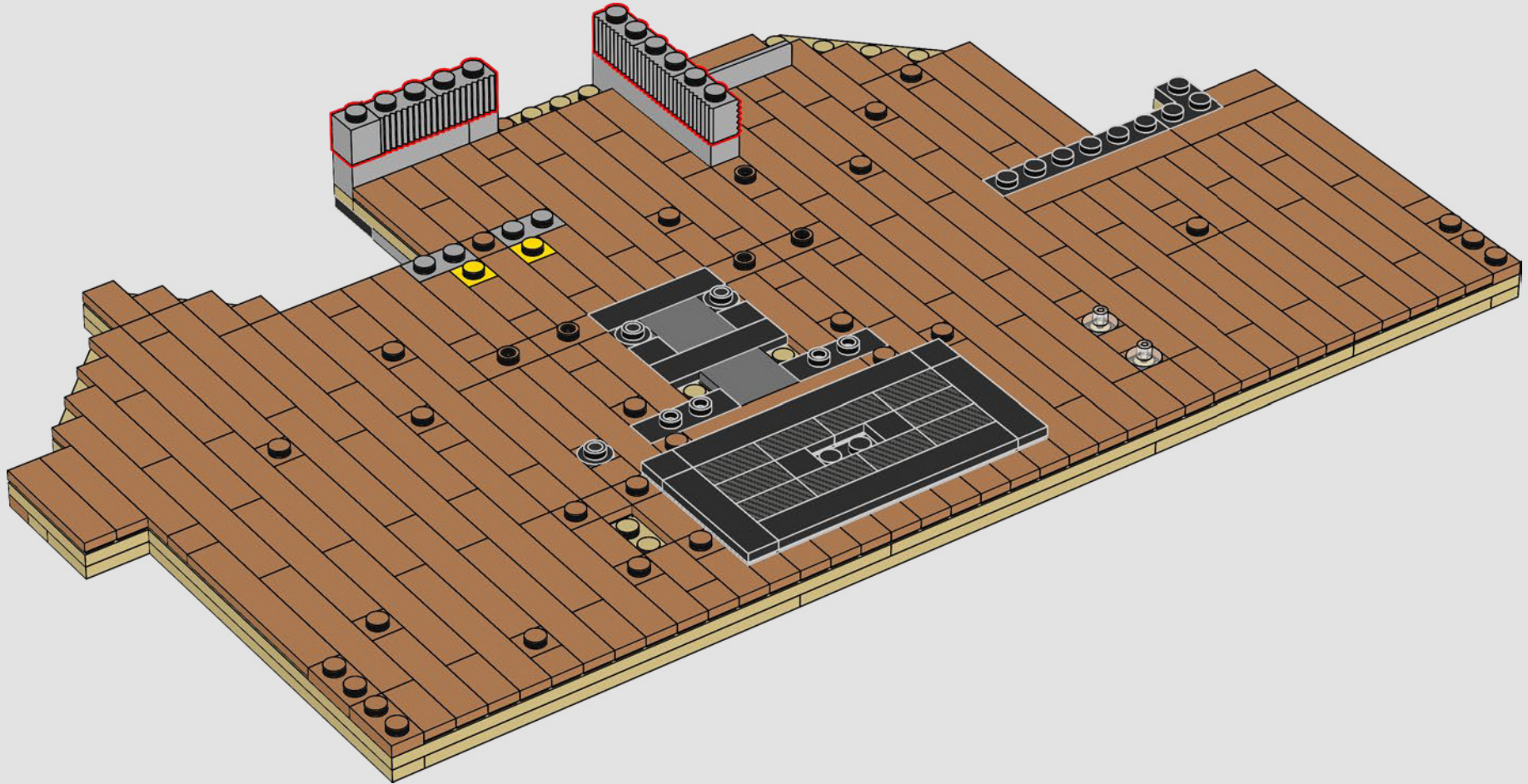

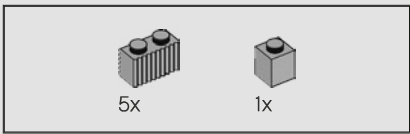

27

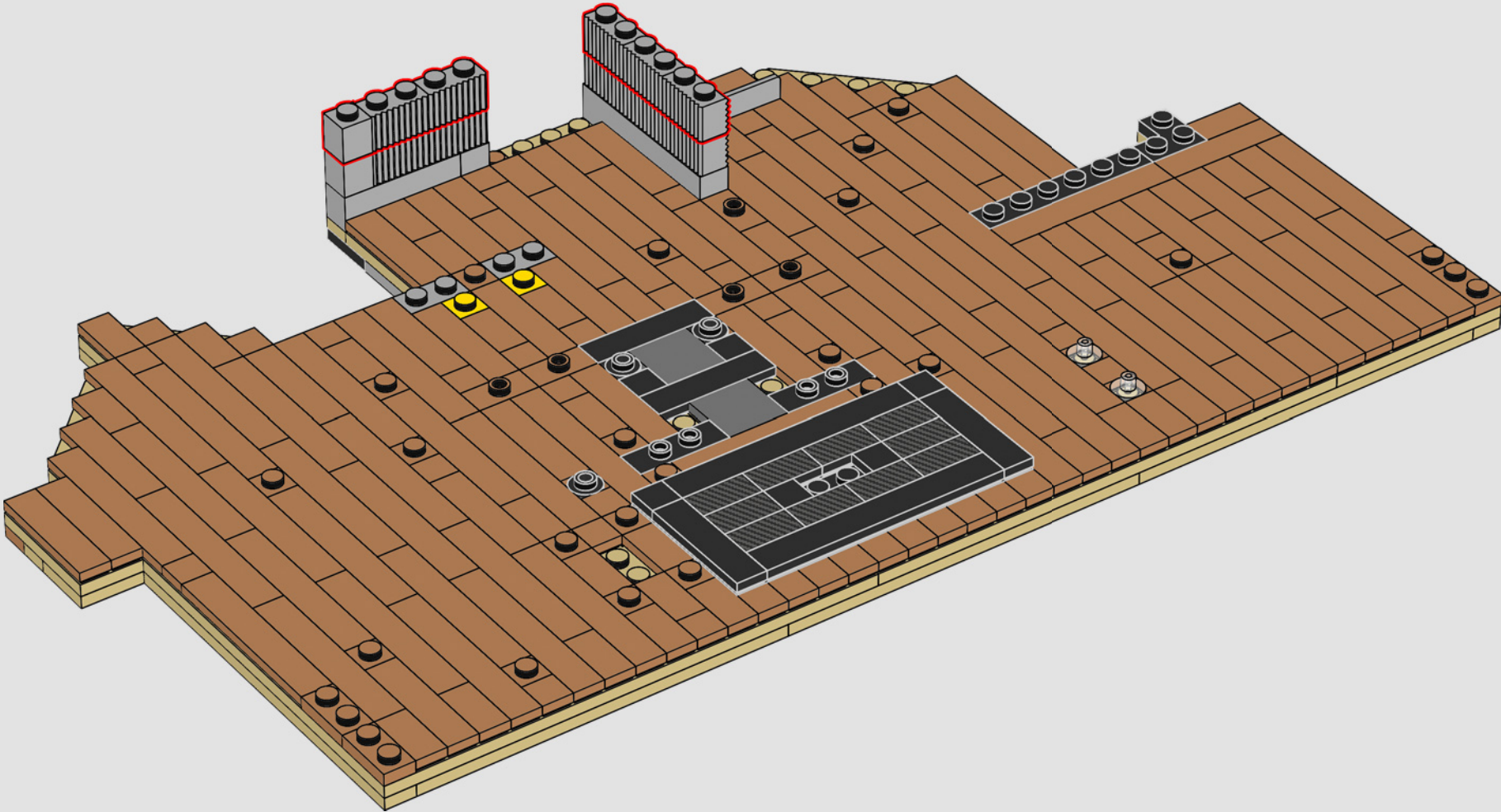



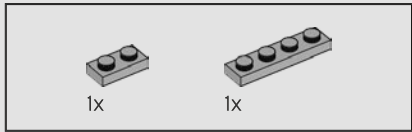
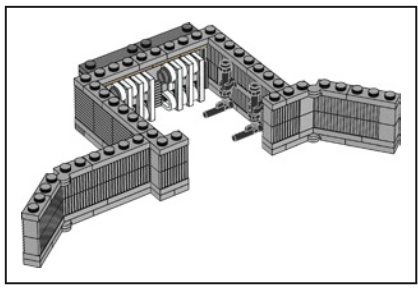

29

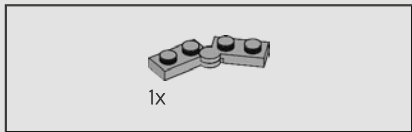
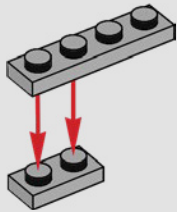

30

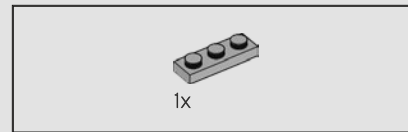
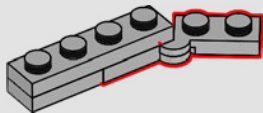

31

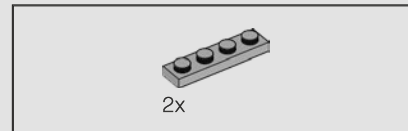
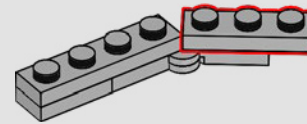

32

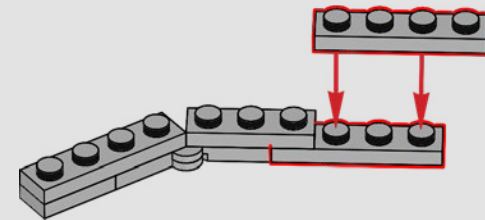

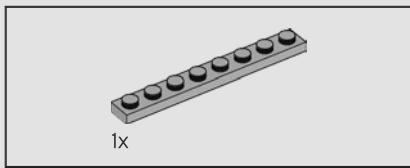

33

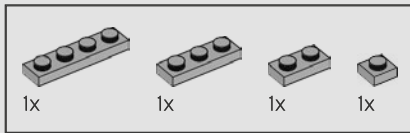
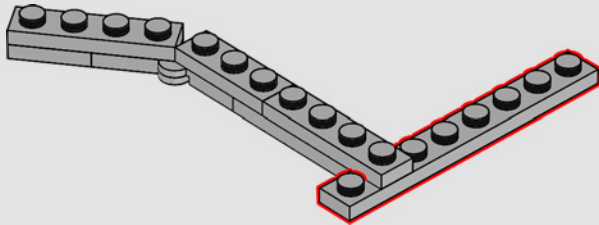

34

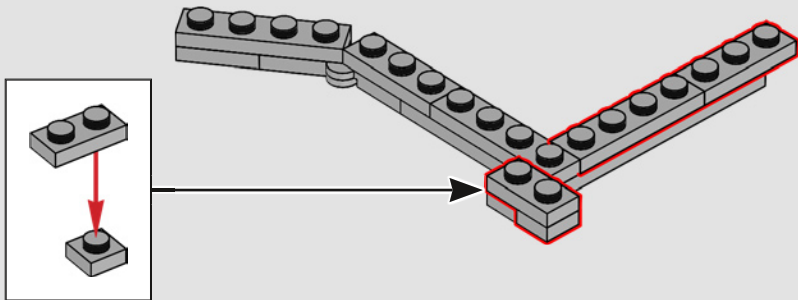

35

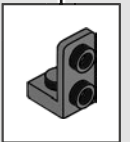
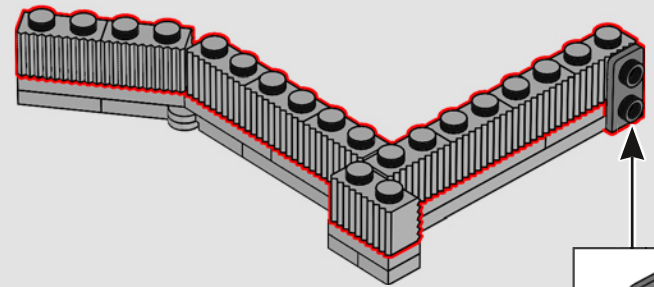



10x

36

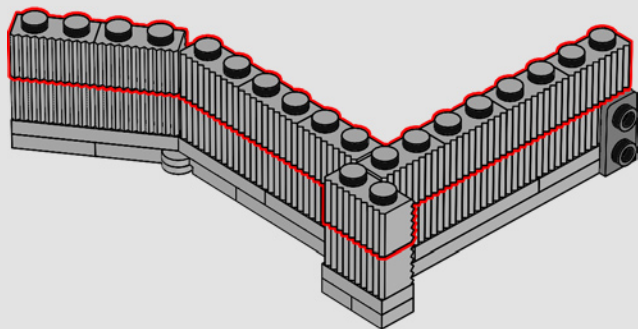

1x

2x

2x

1x

37

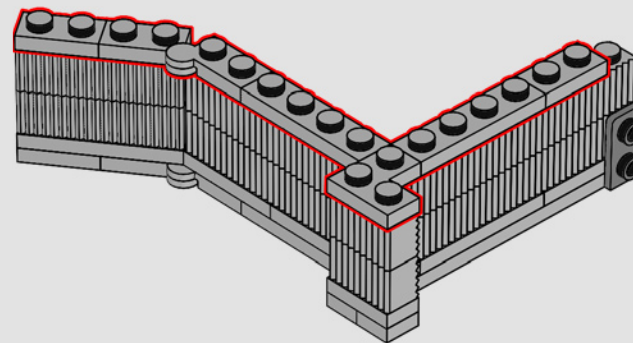



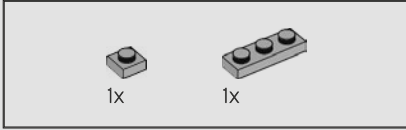
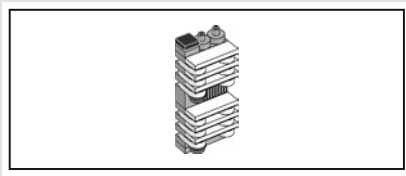

38

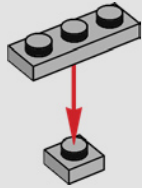

39

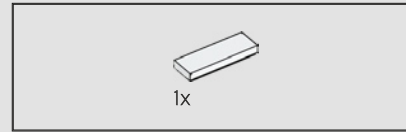
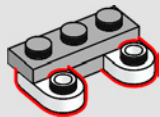

40



41



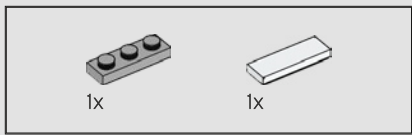

42

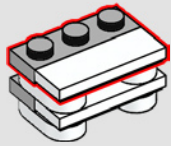

43

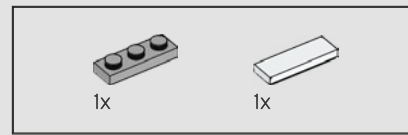
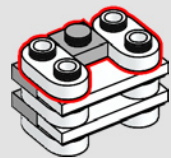

44

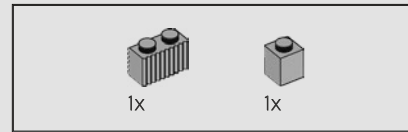
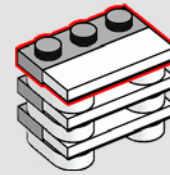

45

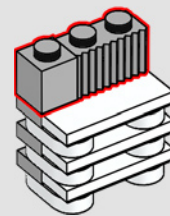

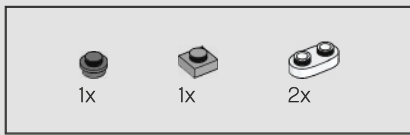

46

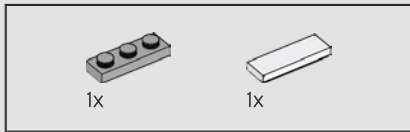
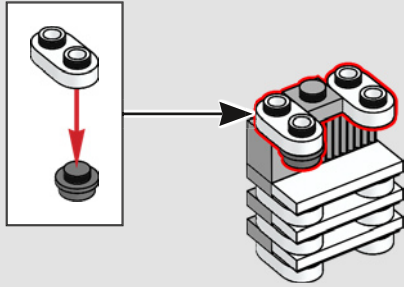

47

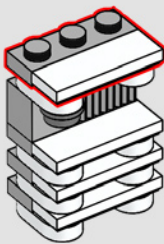

48

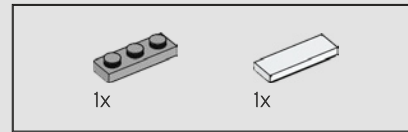
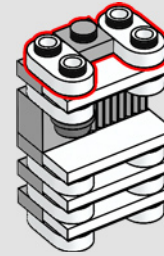

49

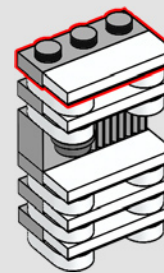

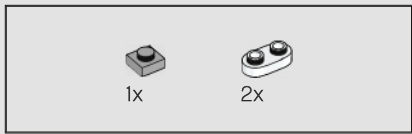

50

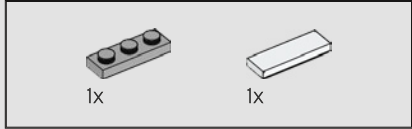
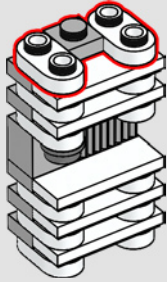

51

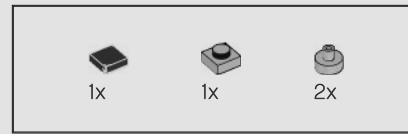
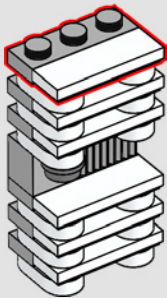

52

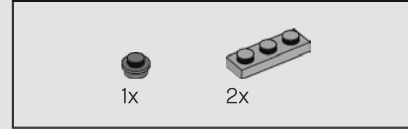
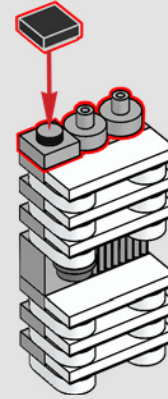

53

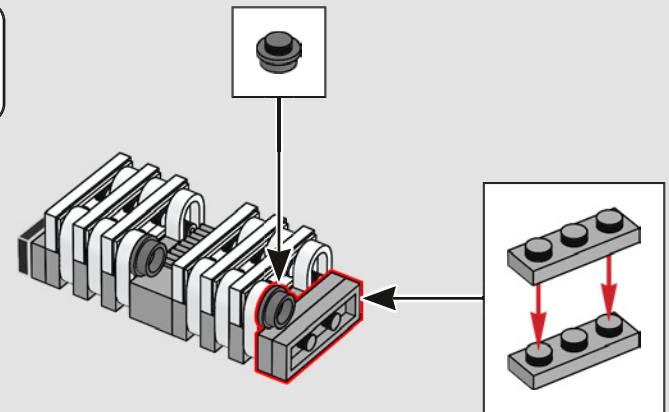

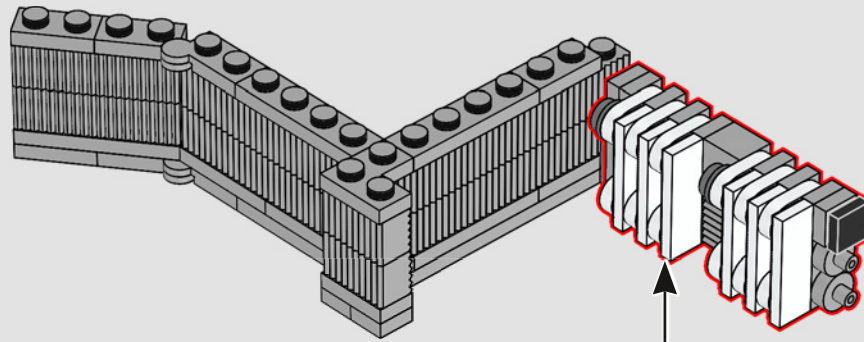

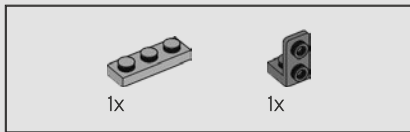
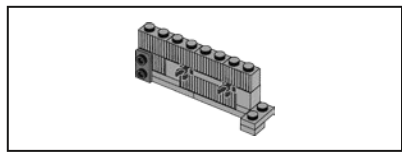

55

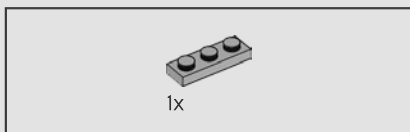
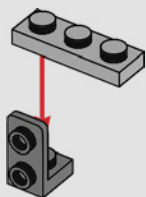

56

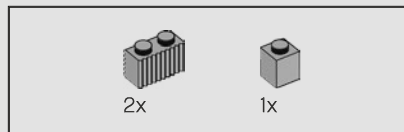
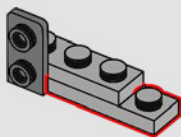

57

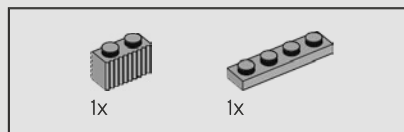
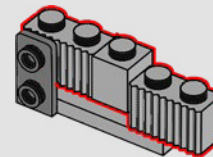

58

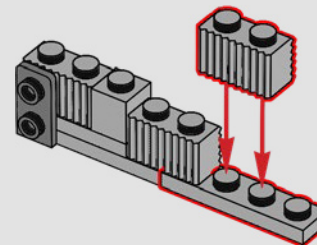

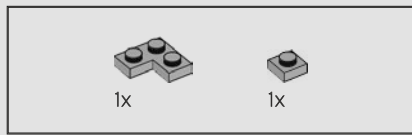

59

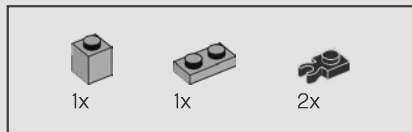
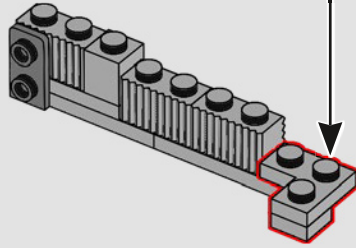
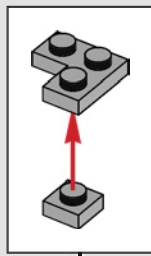

60

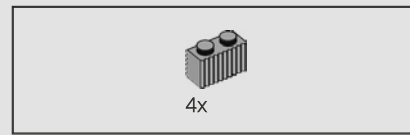
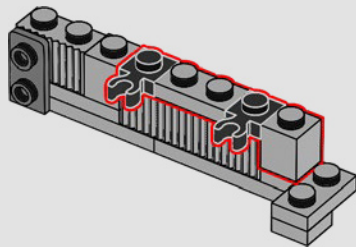

61

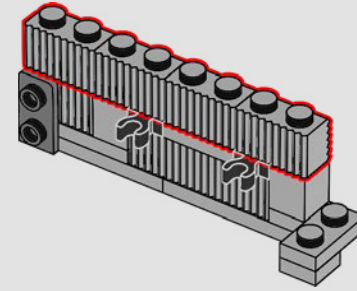

62

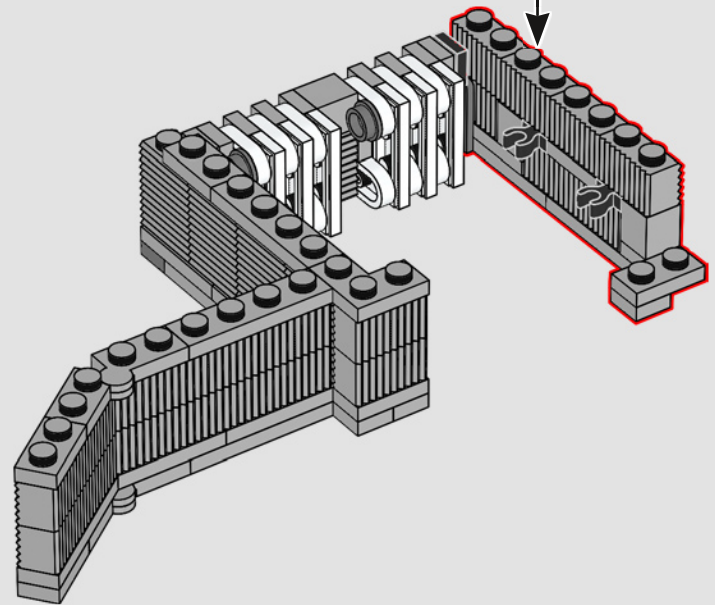

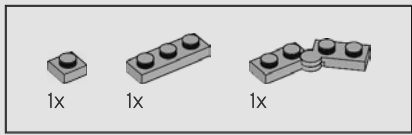

63

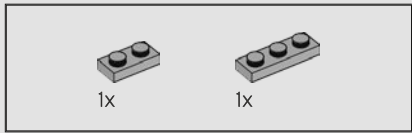
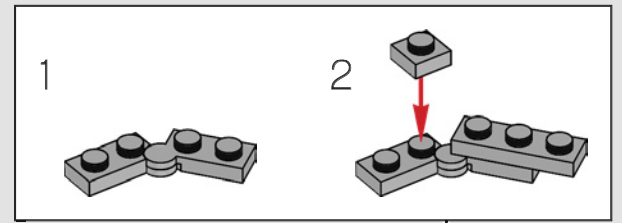
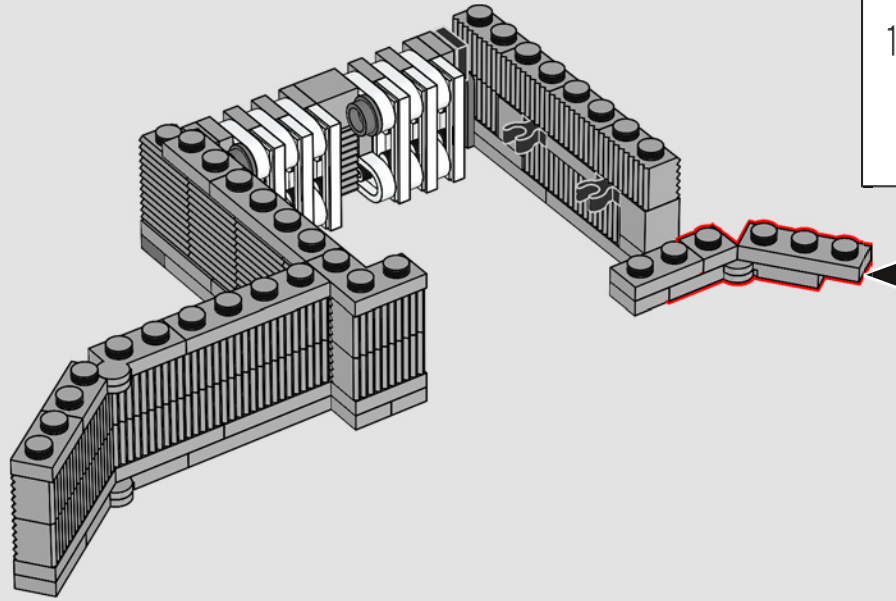

64

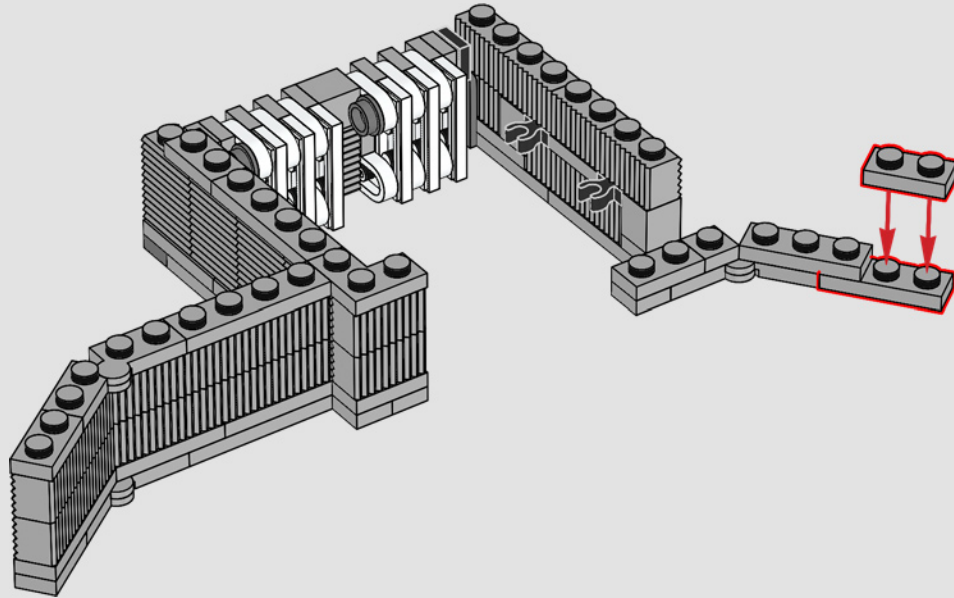



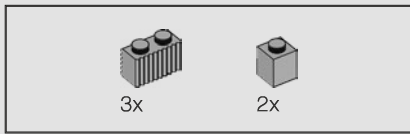

65

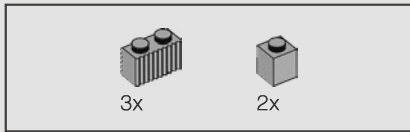
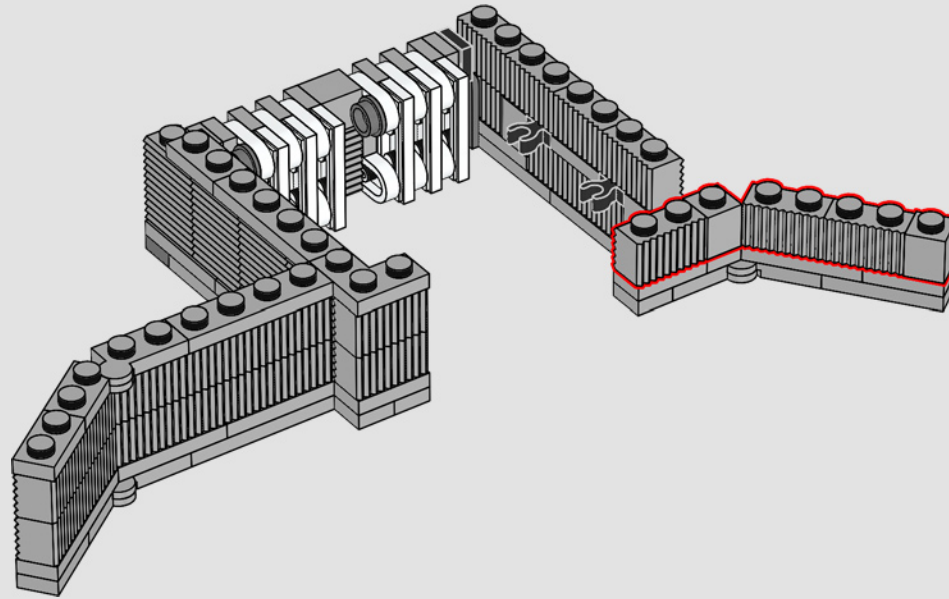

66

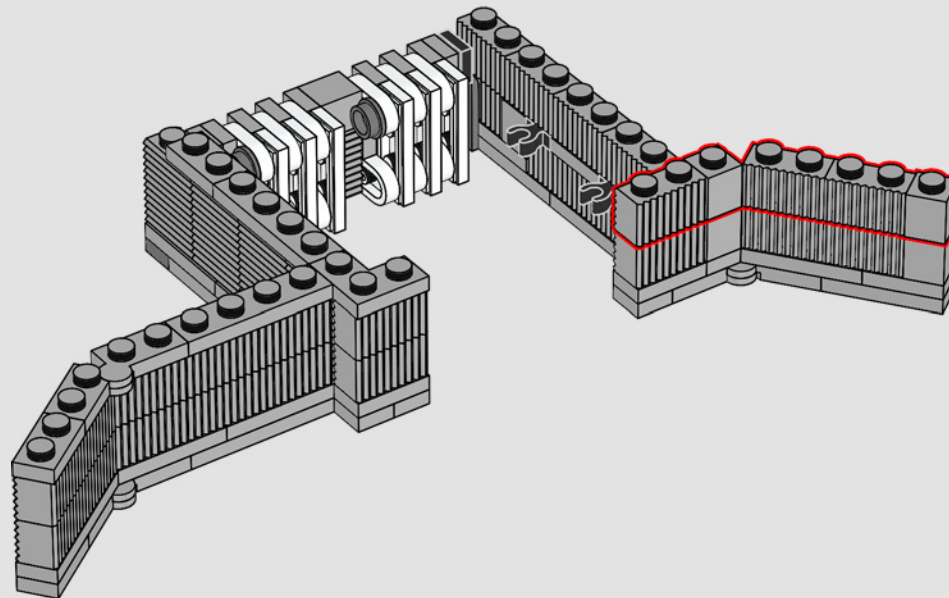

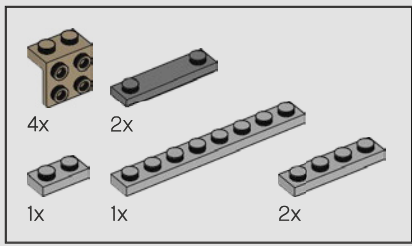

67

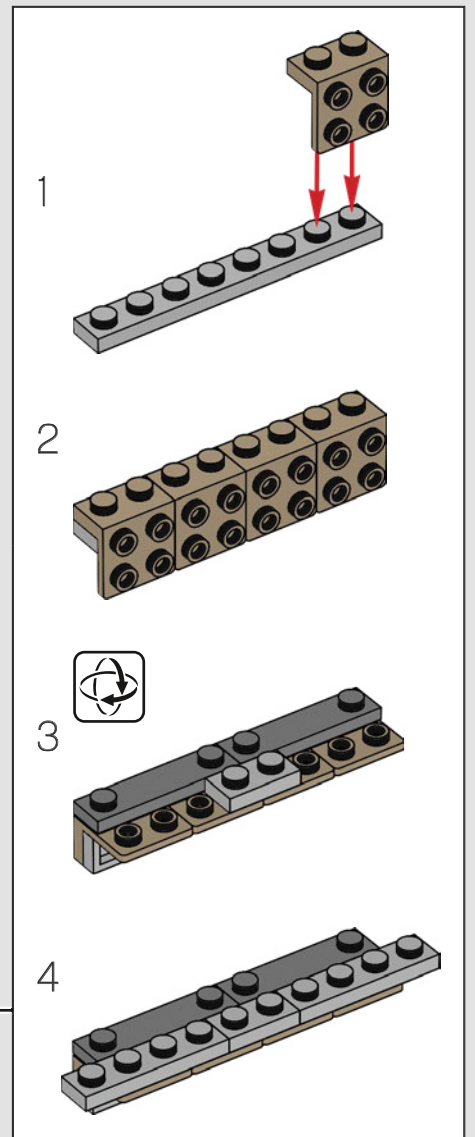
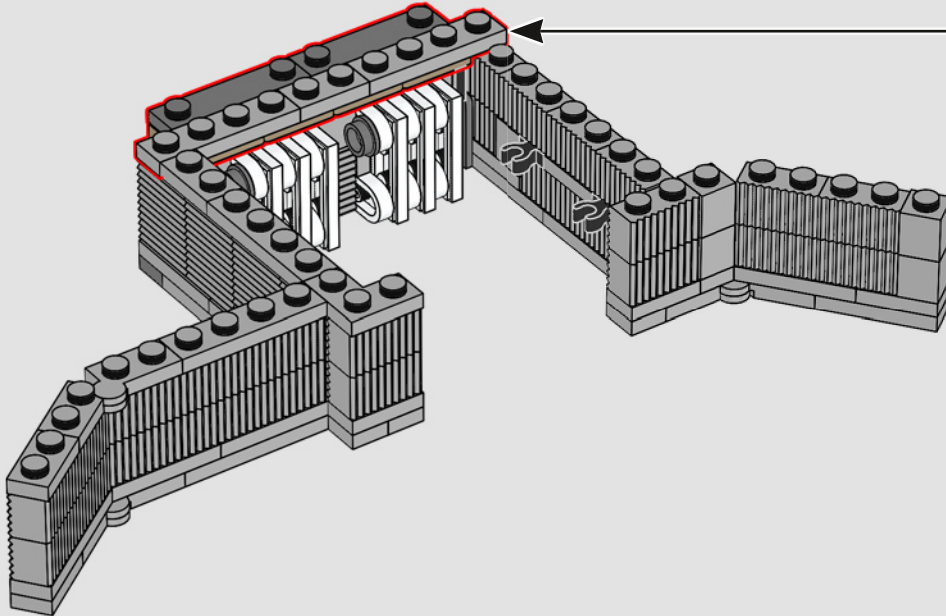

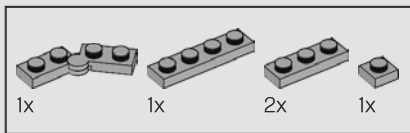

68

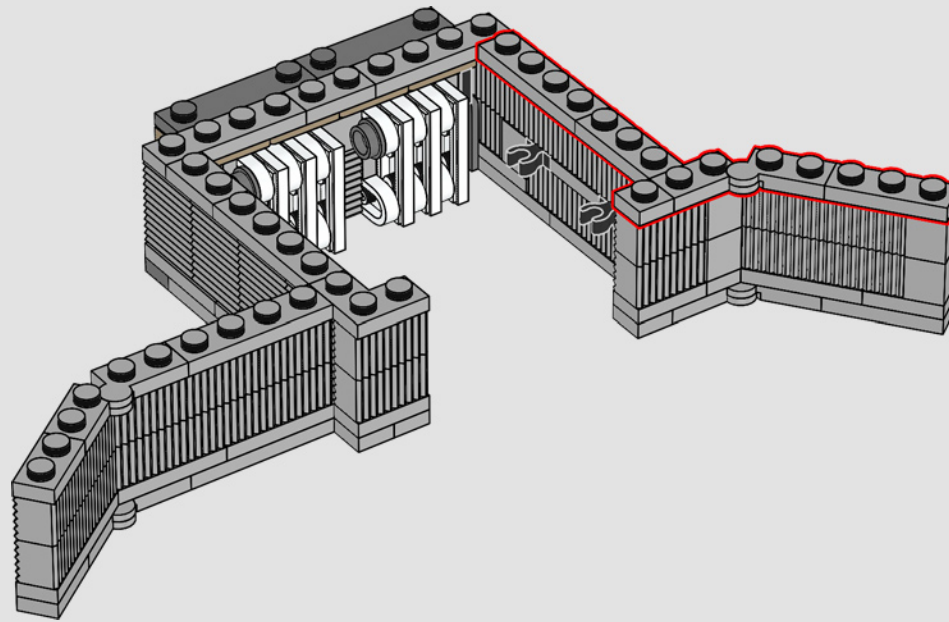

69

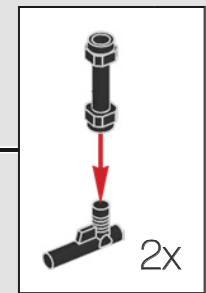
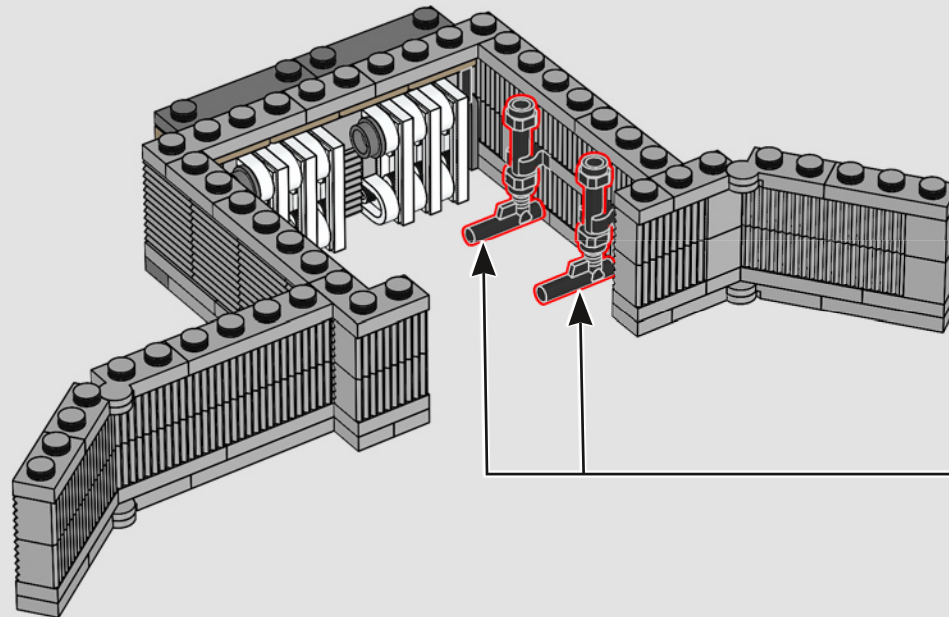

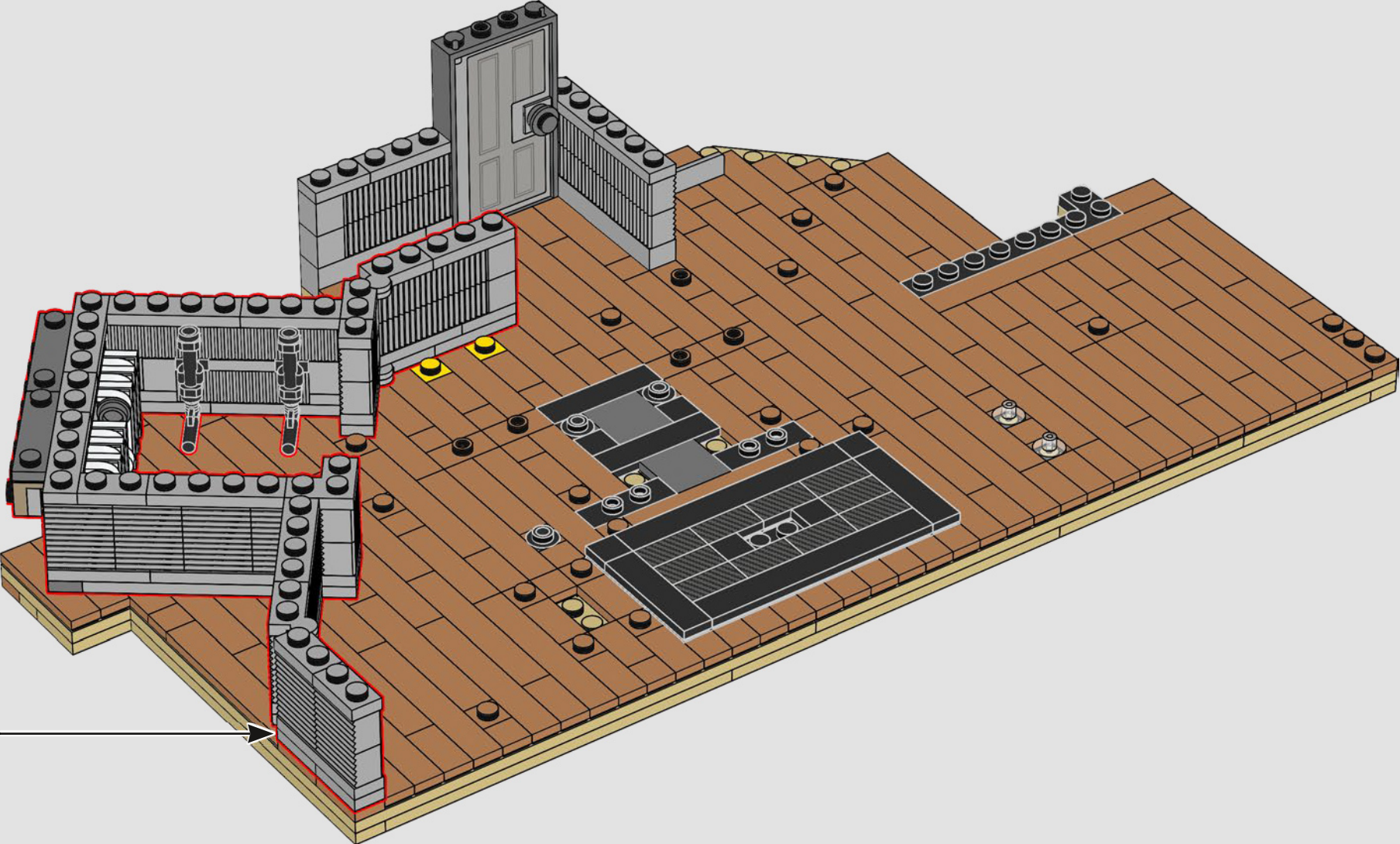



71

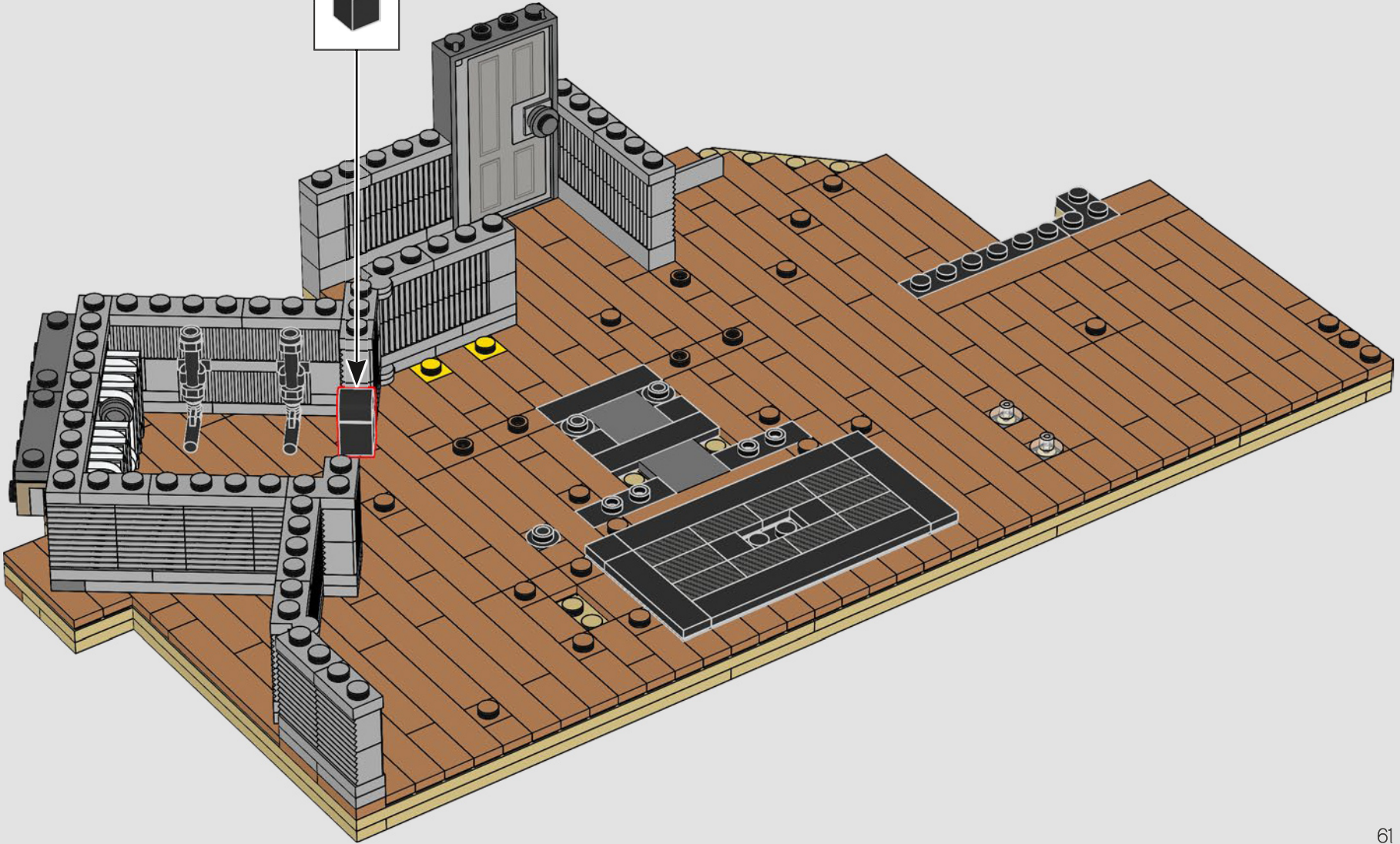
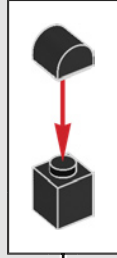

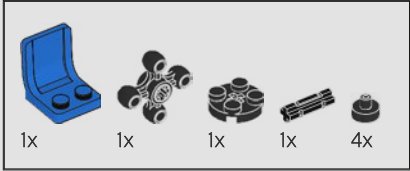
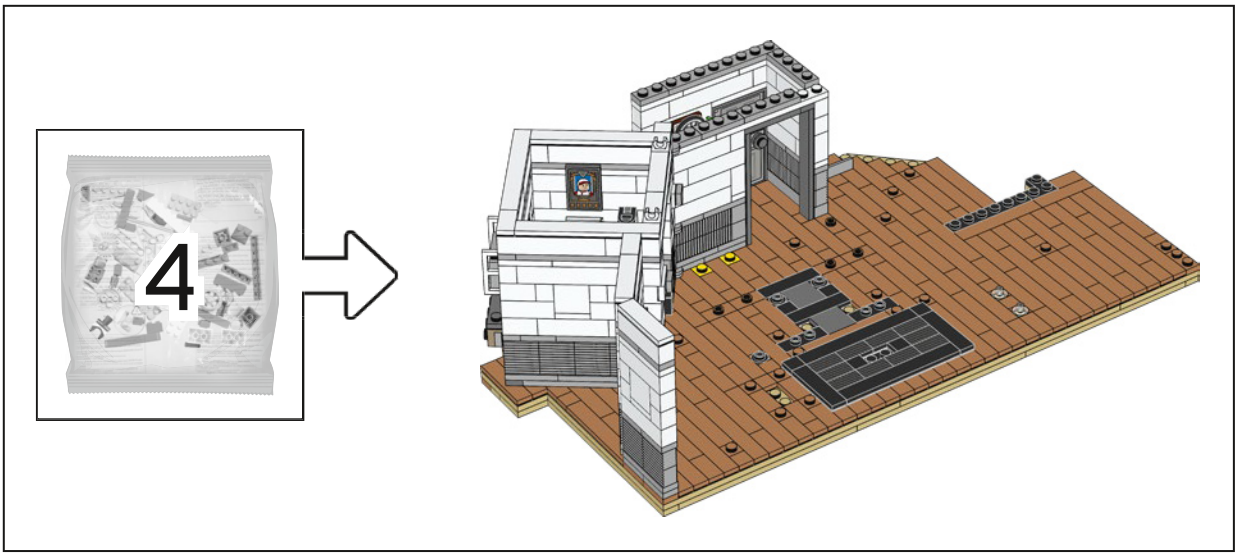

72

1

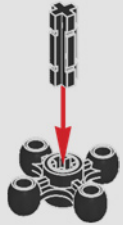

2

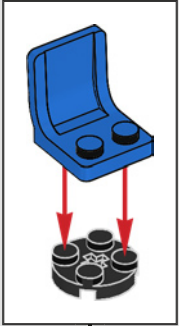

3

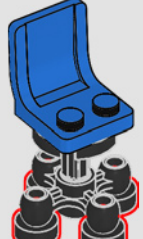

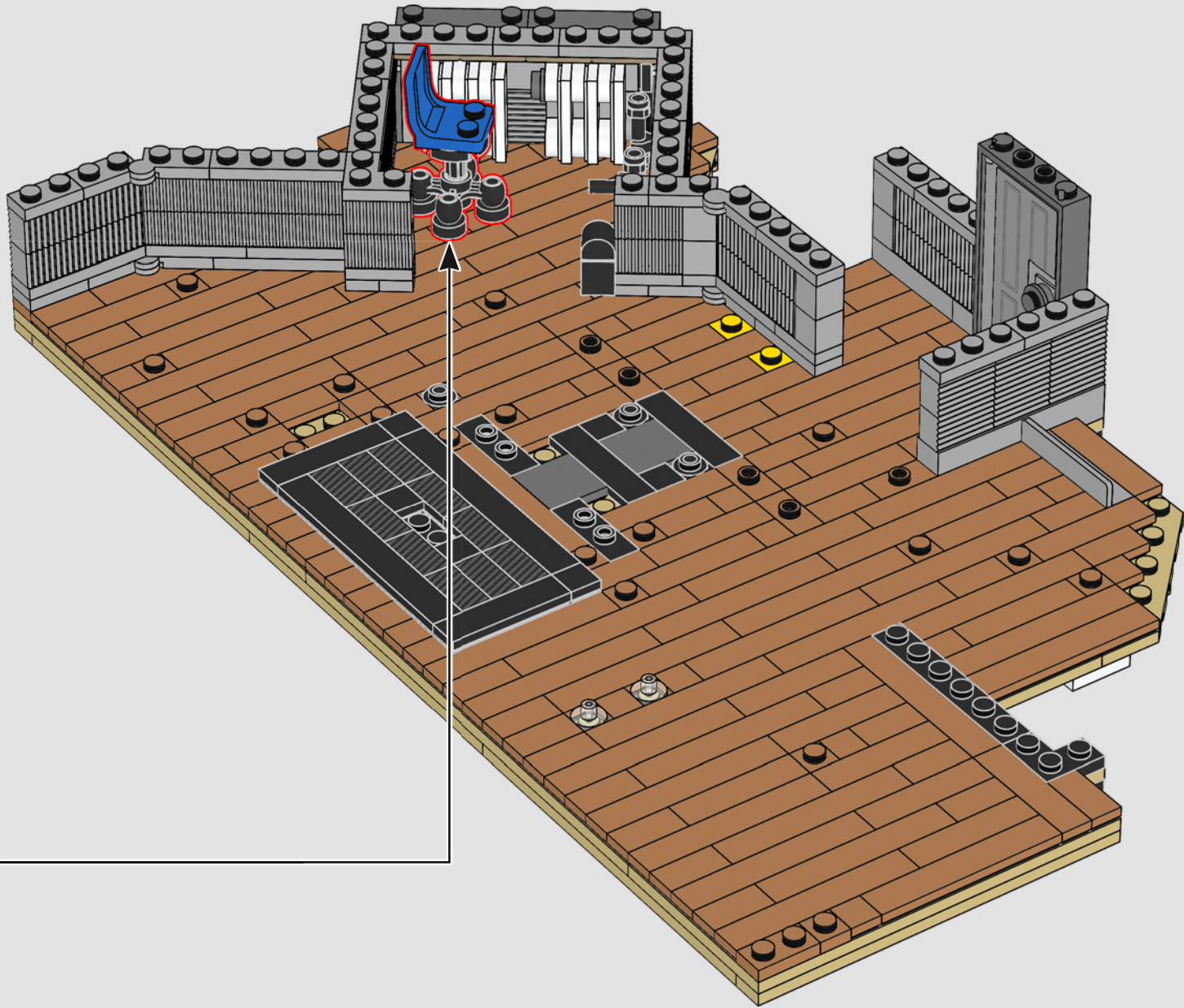

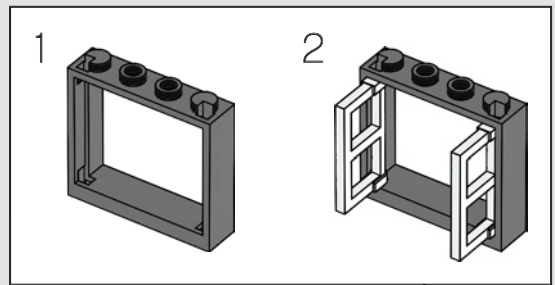
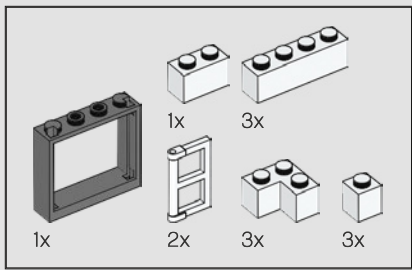

73

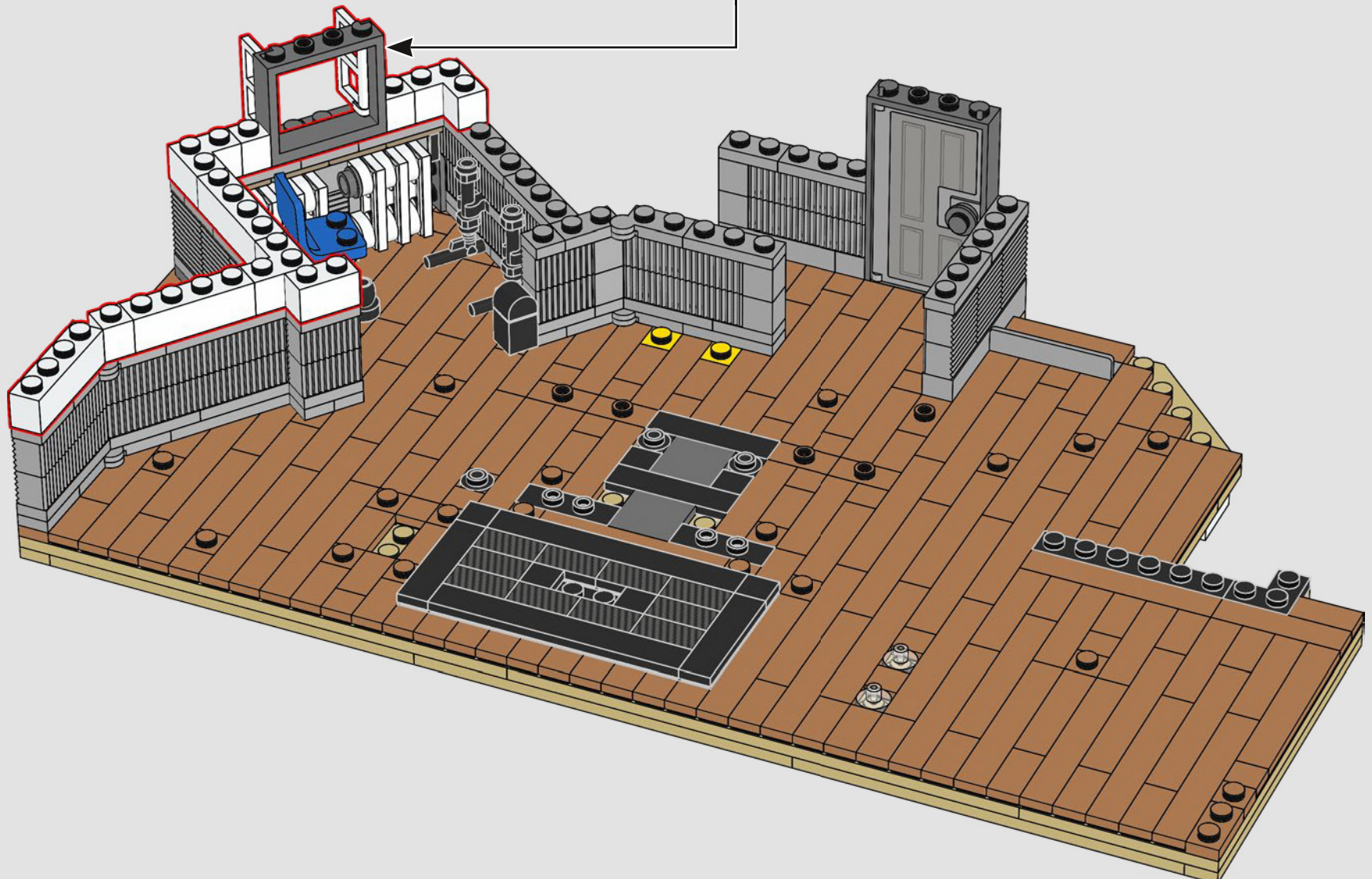



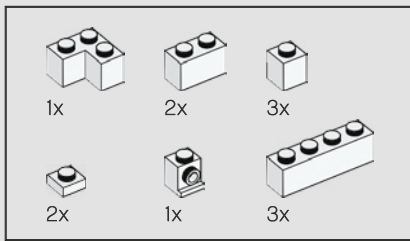

74

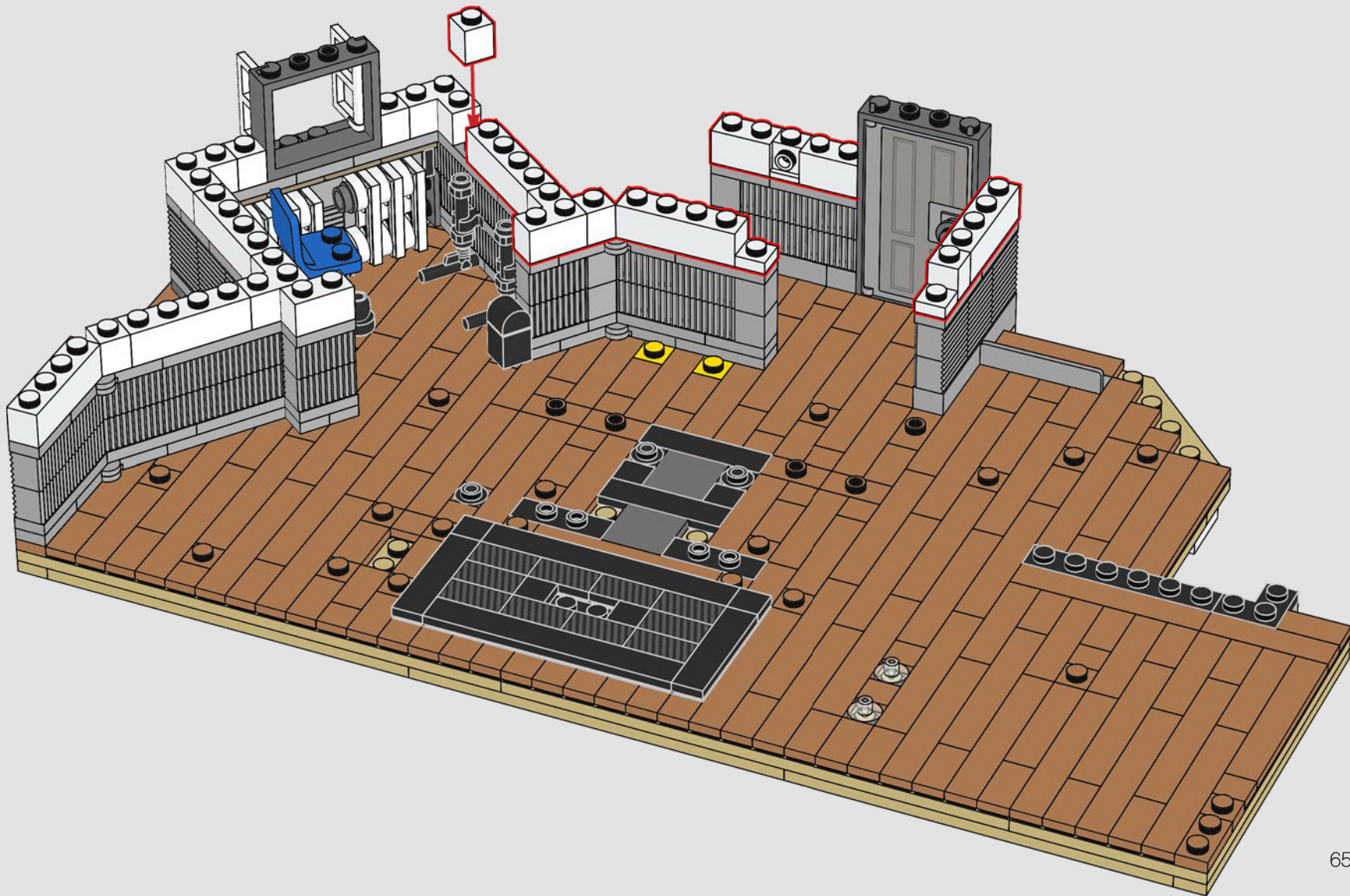

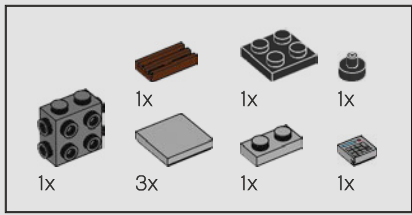

75

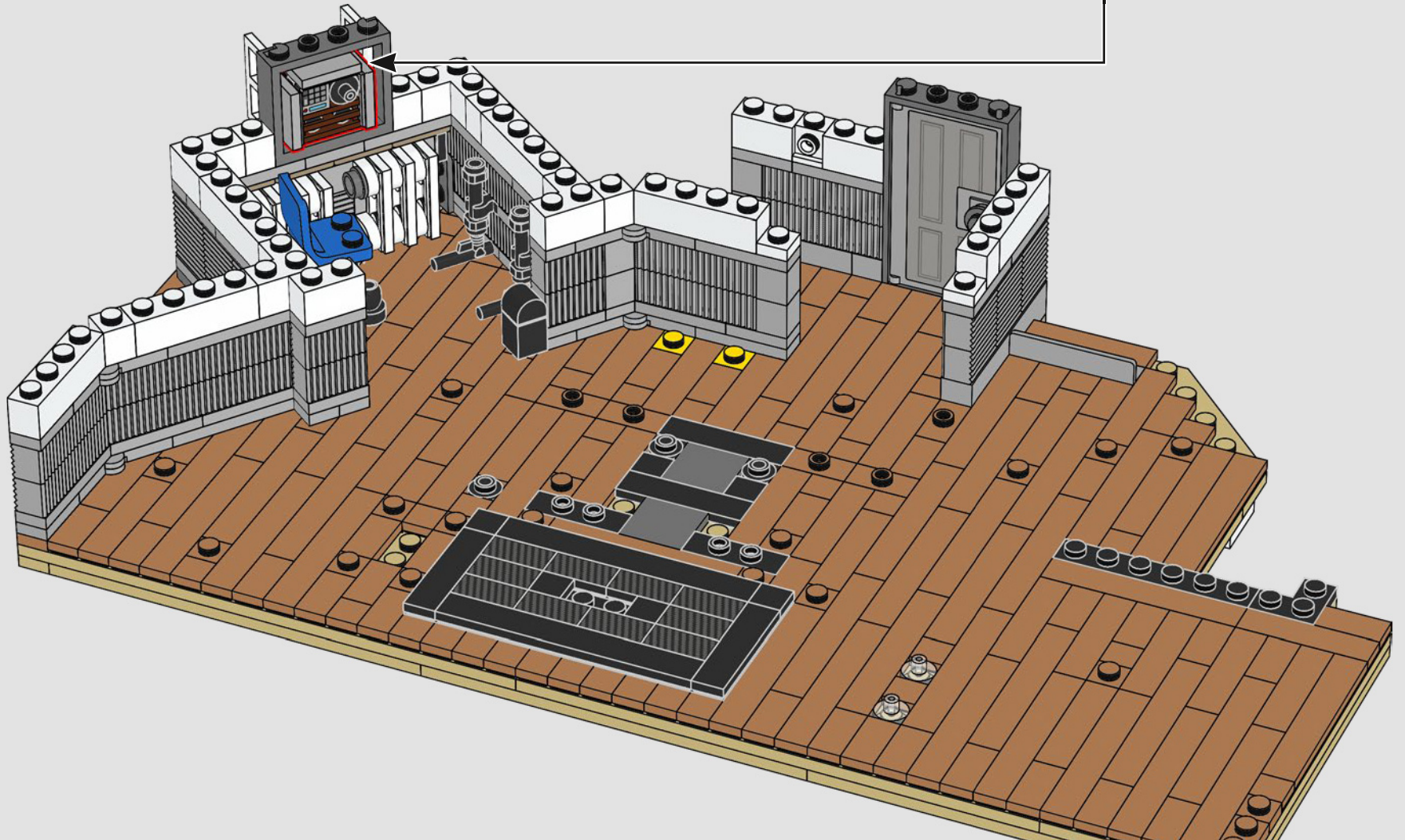
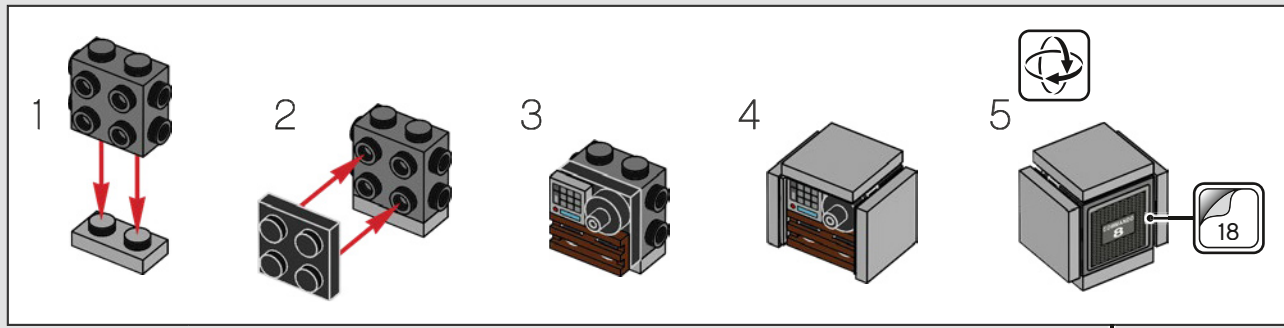

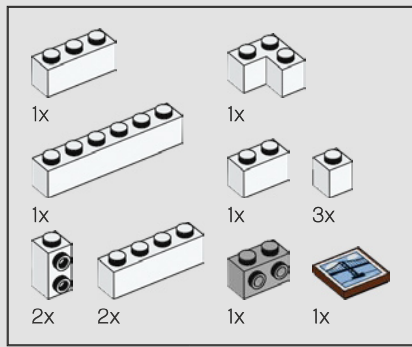

76

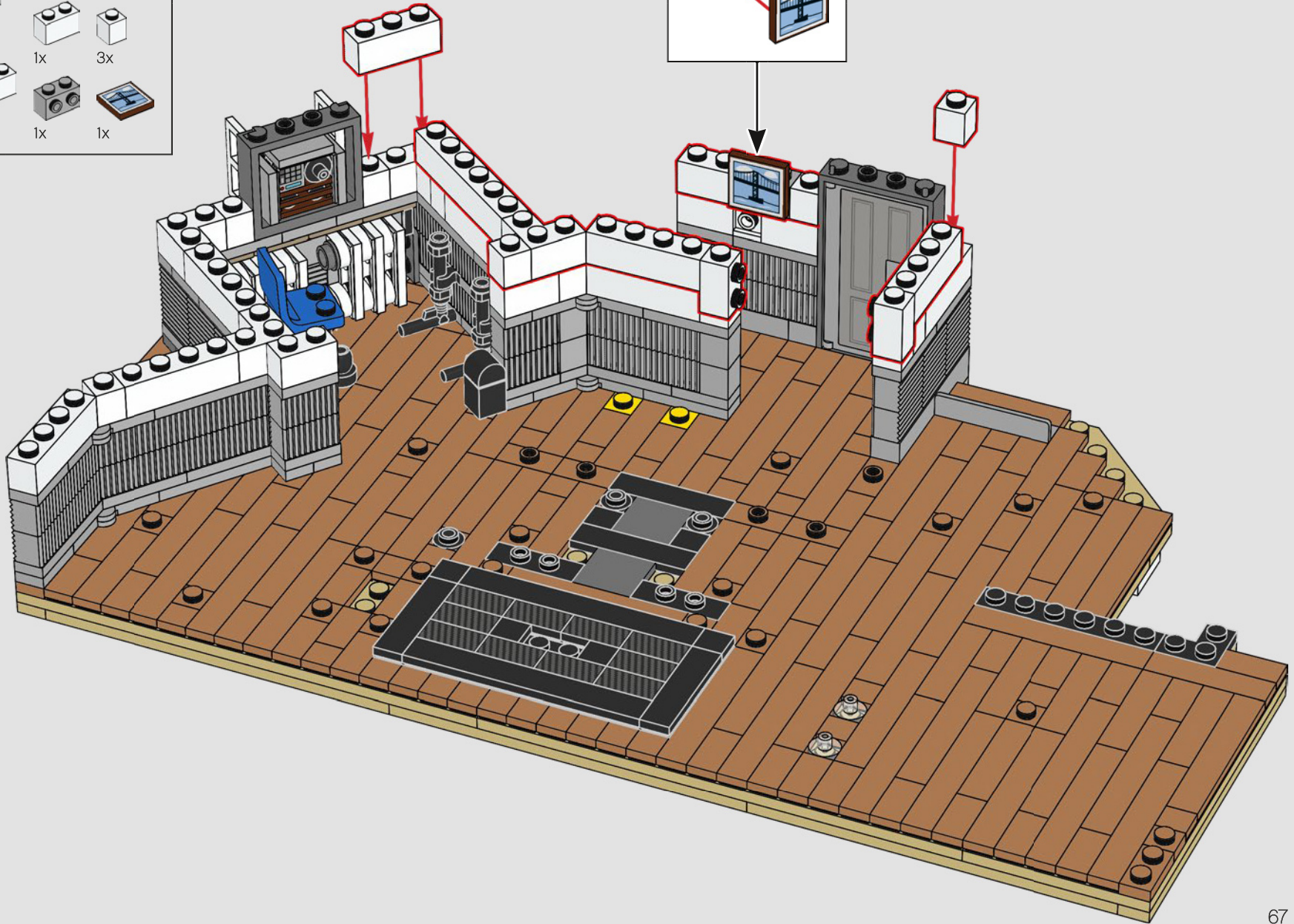
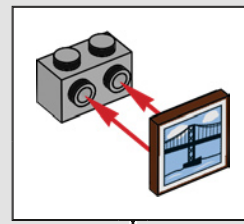

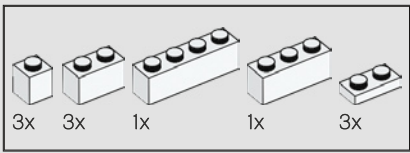

77

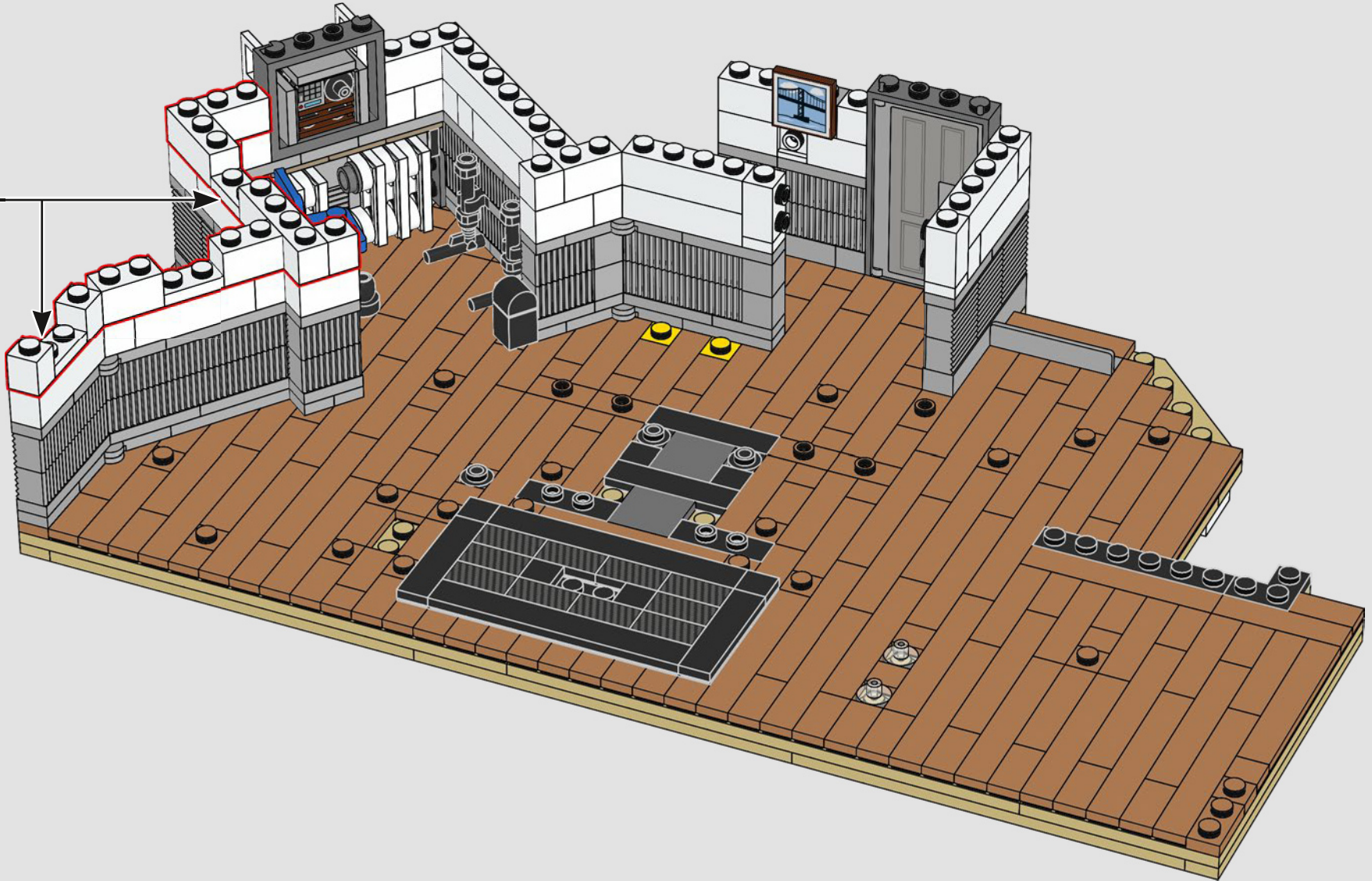
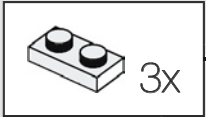

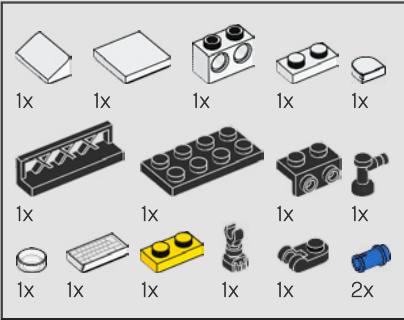

78

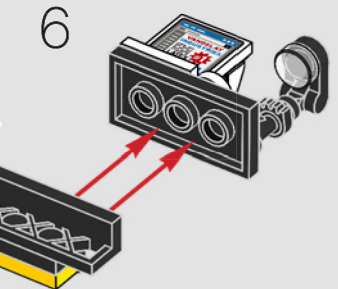
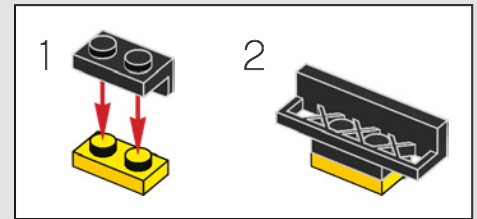
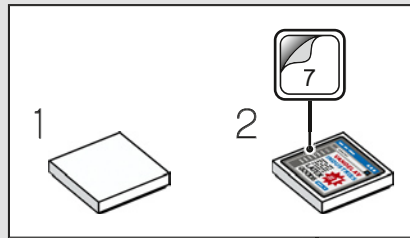
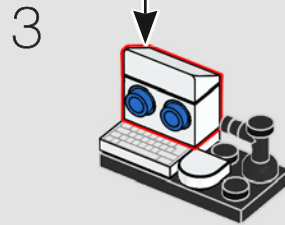
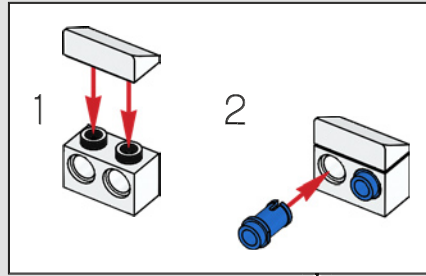
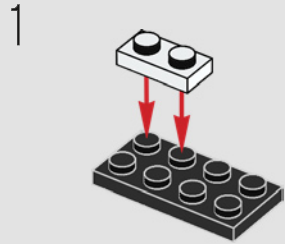

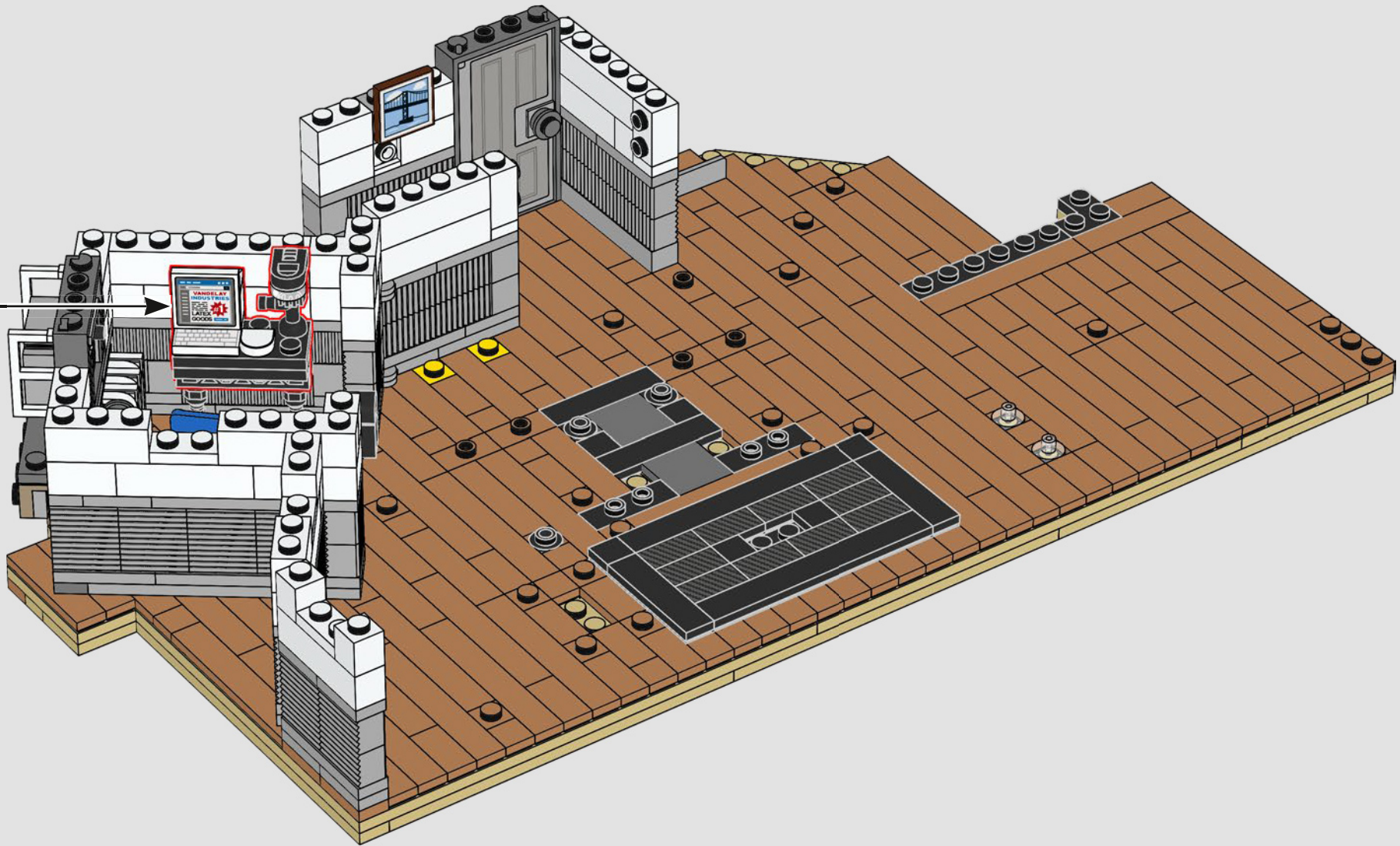

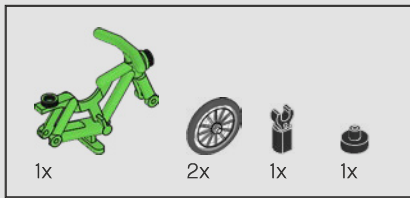

79

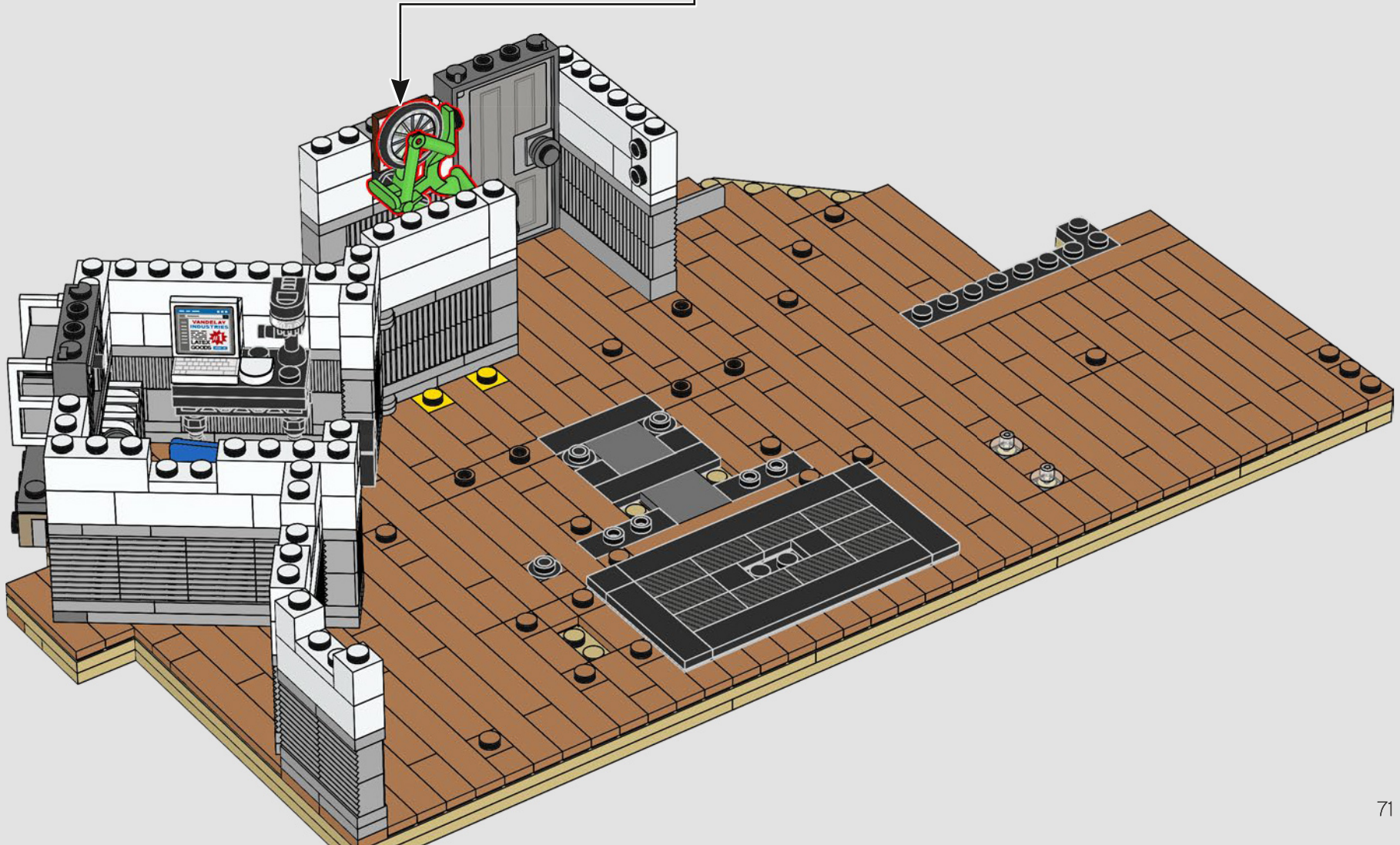
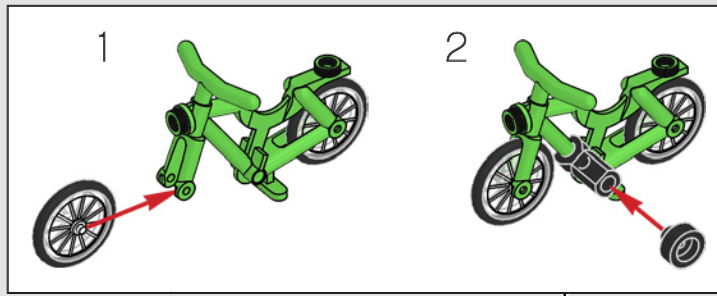

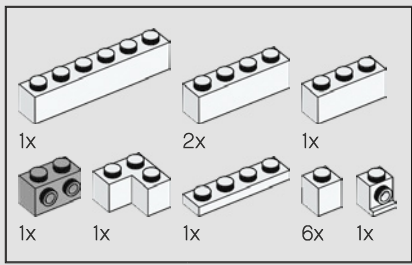

80

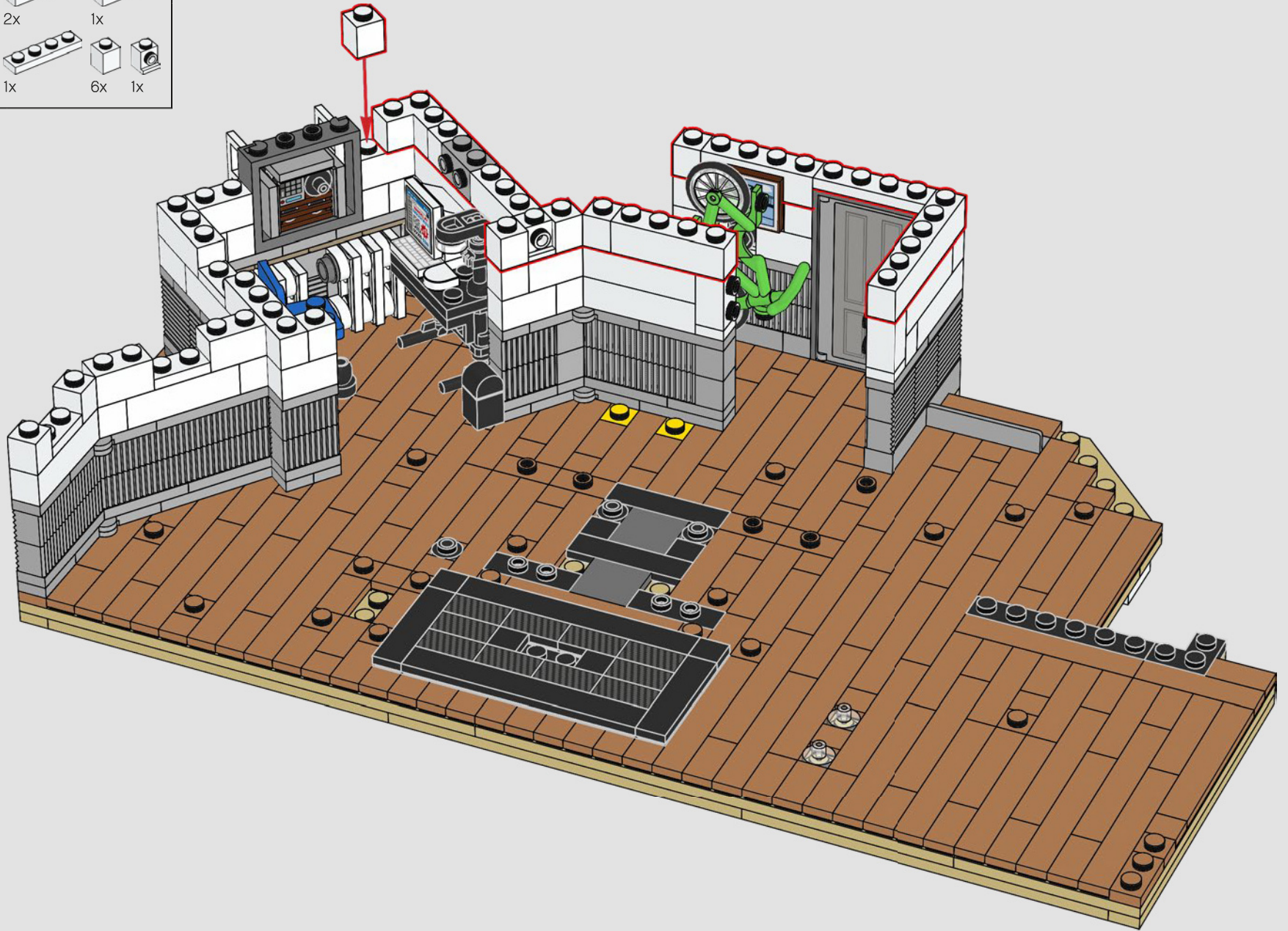



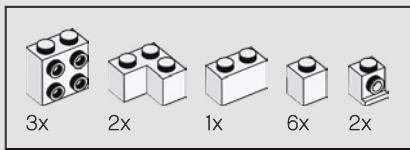

81

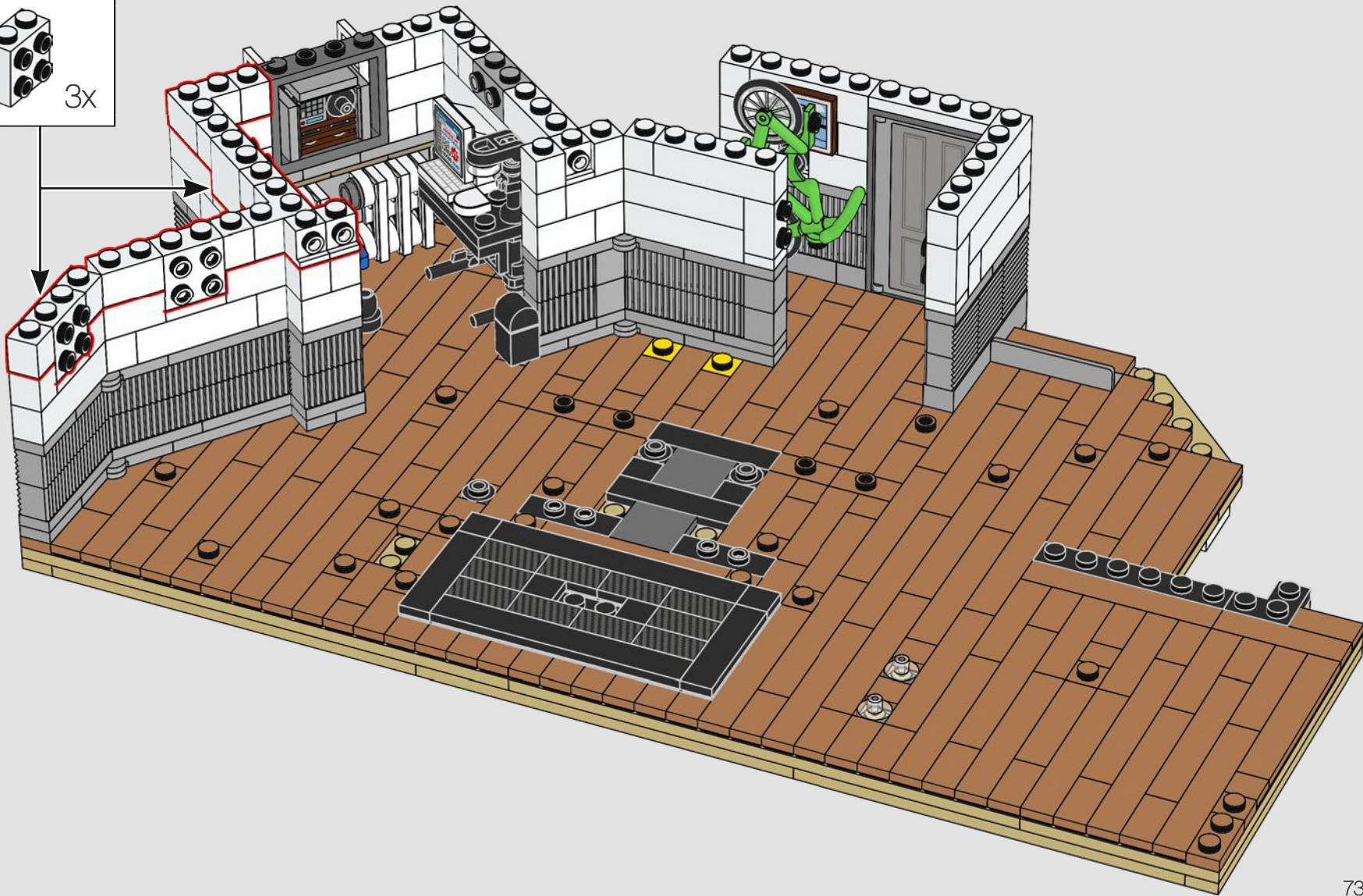
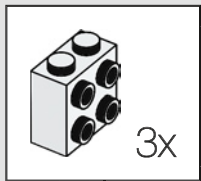

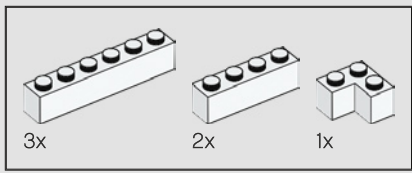

82

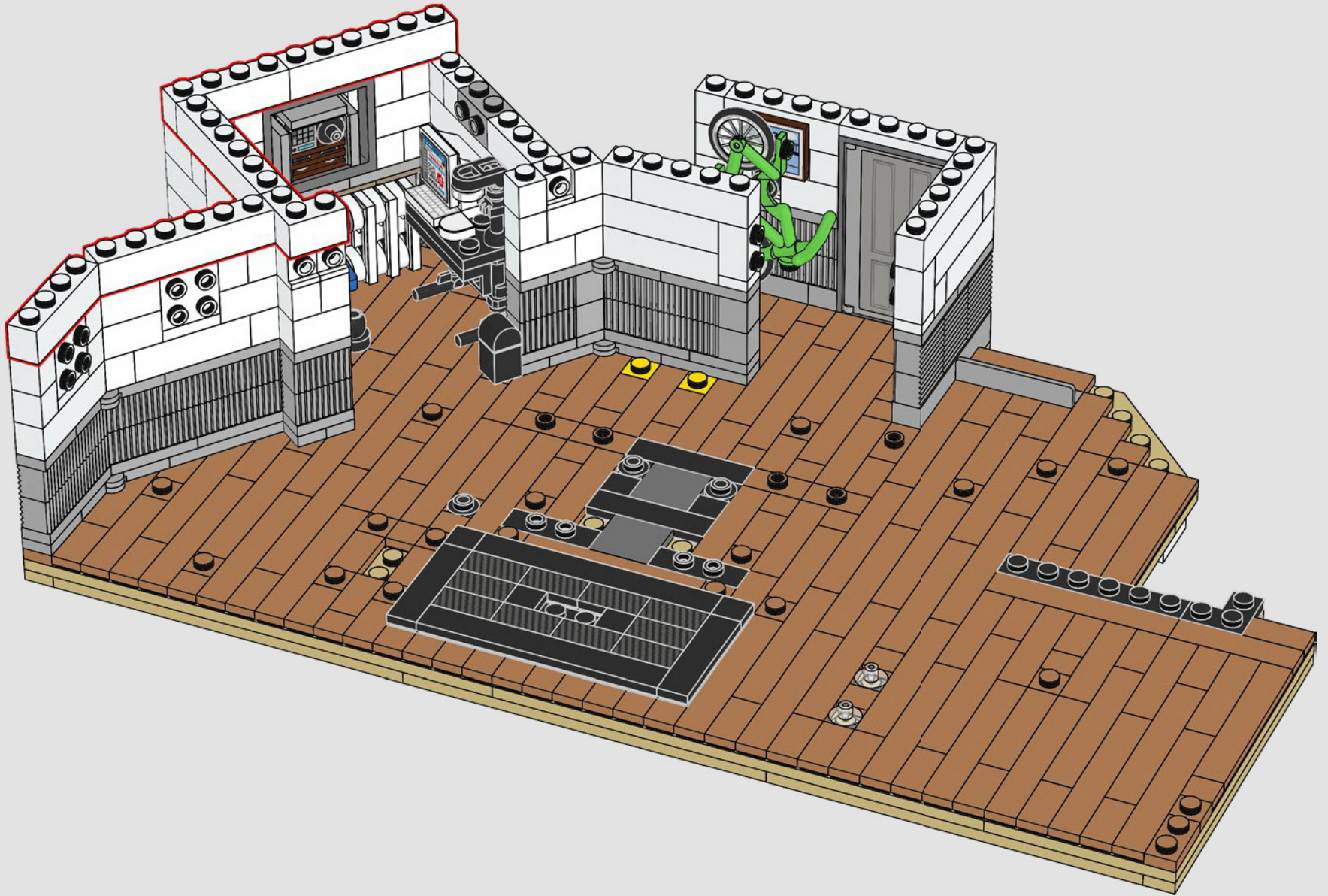

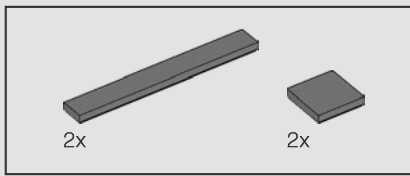

83

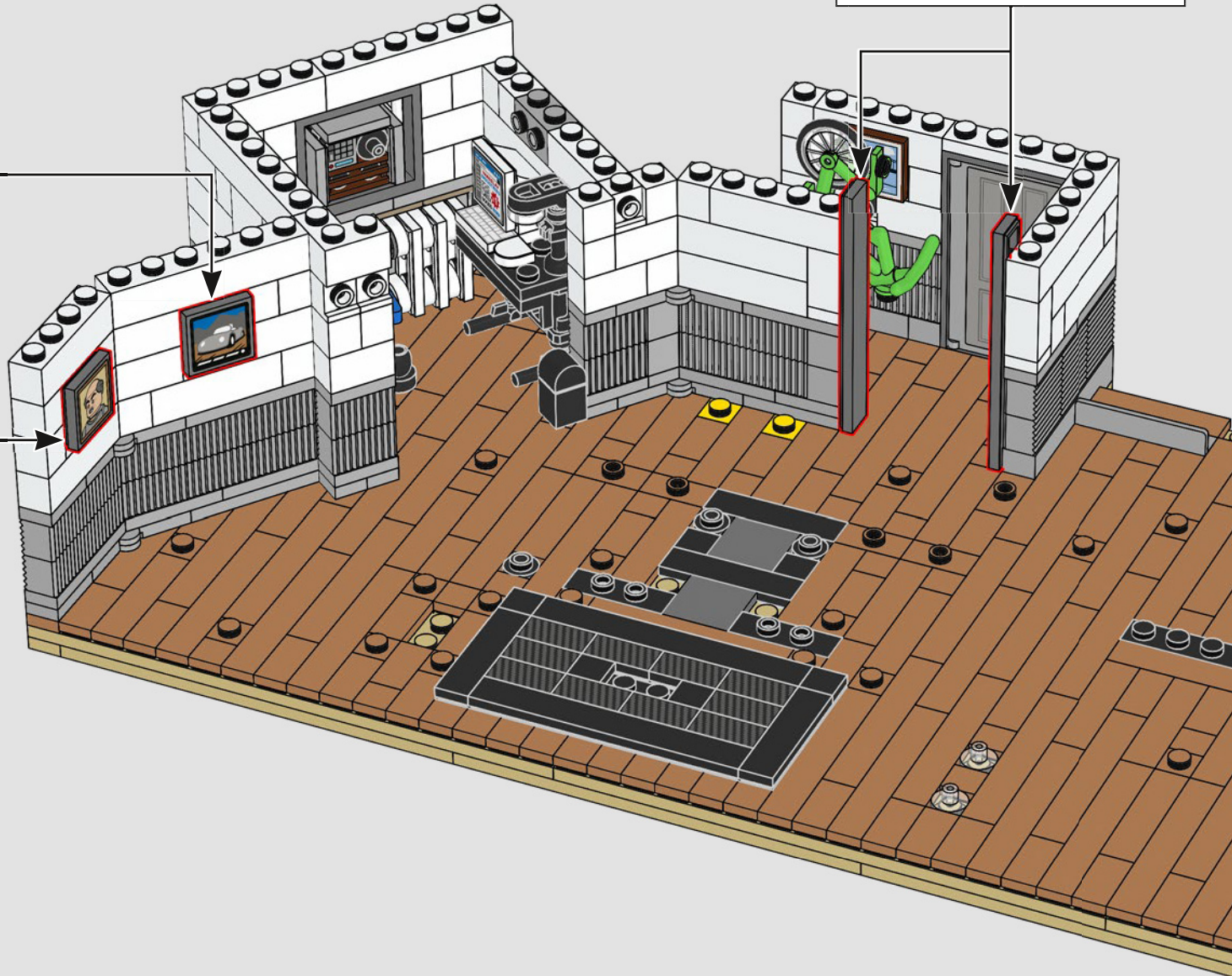
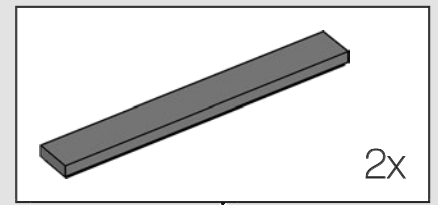
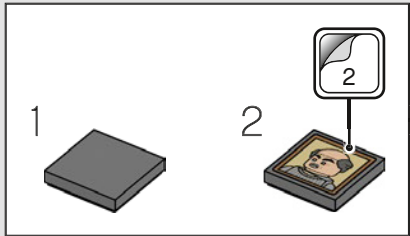
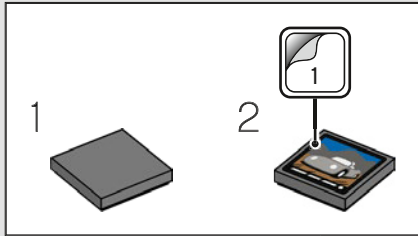

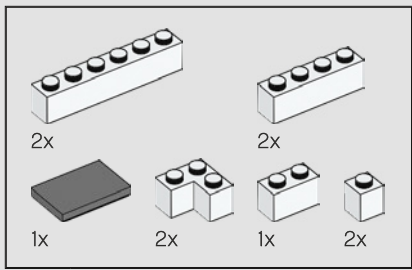

84

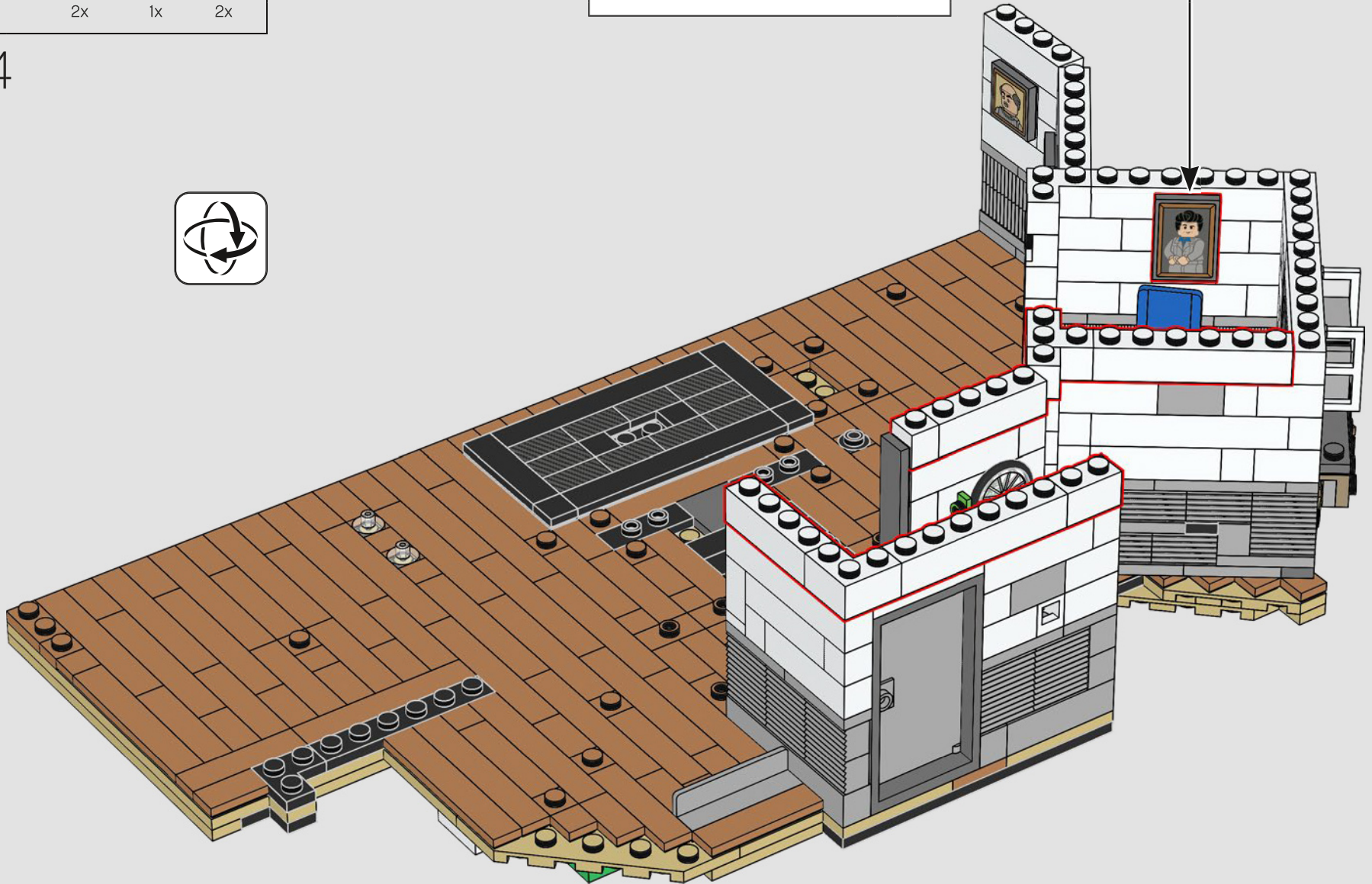
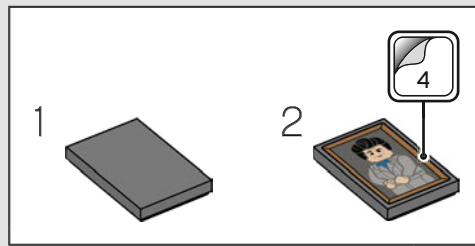

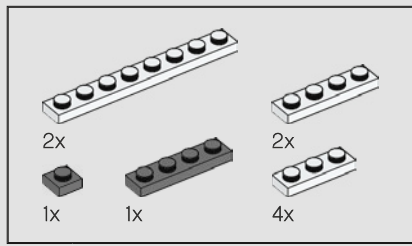

85

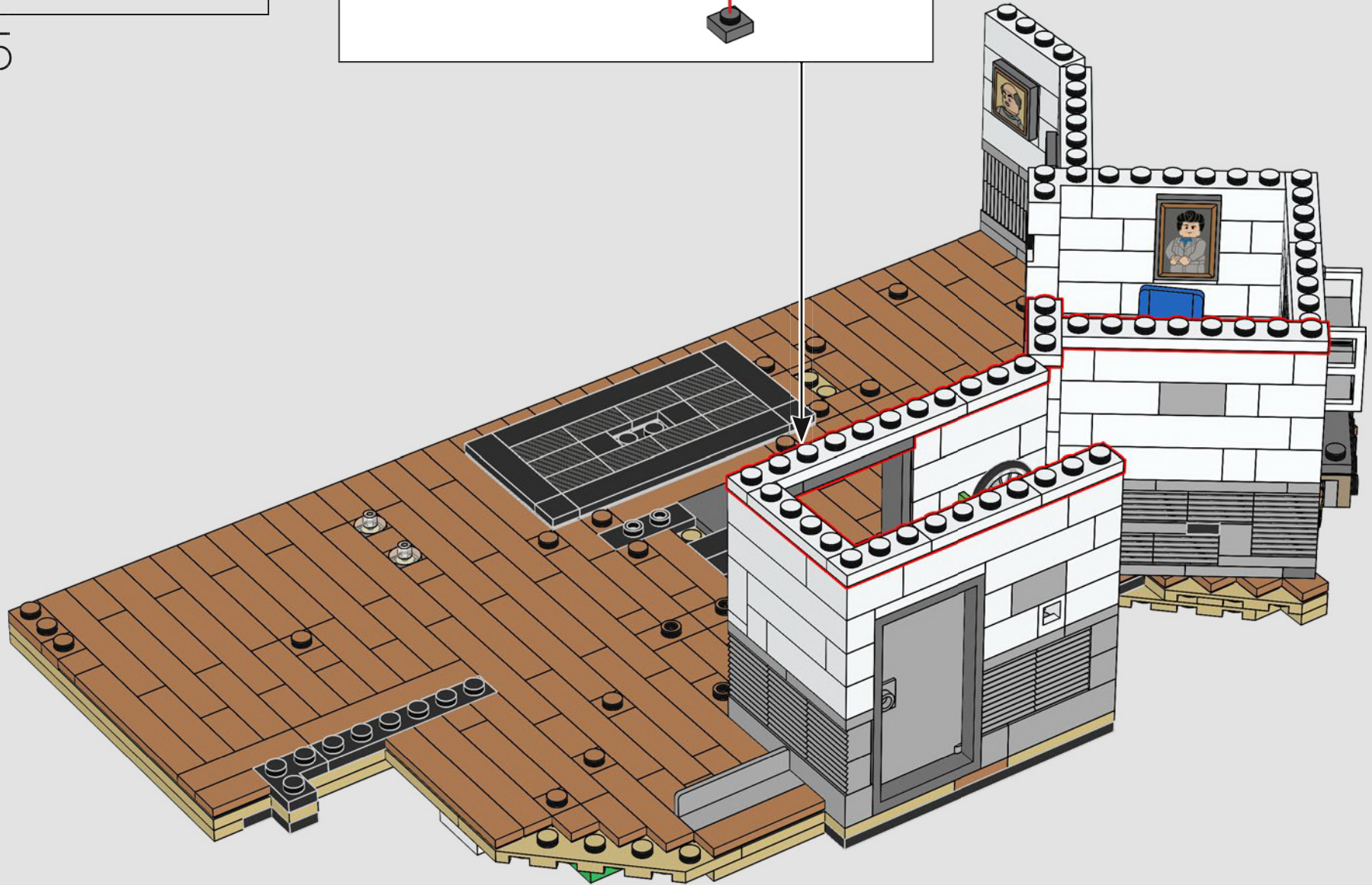
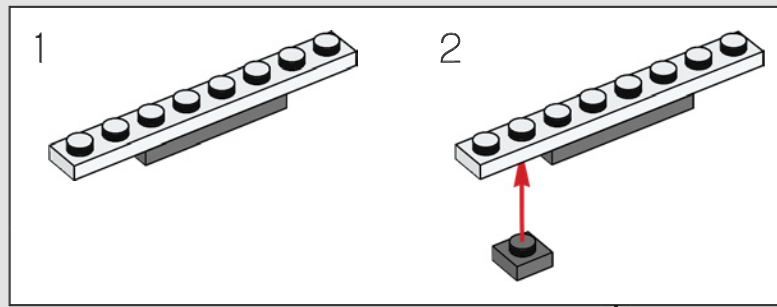

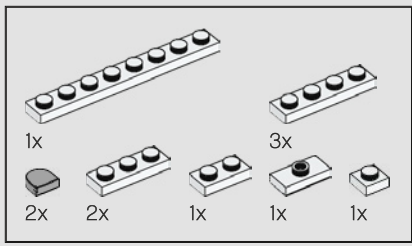

86

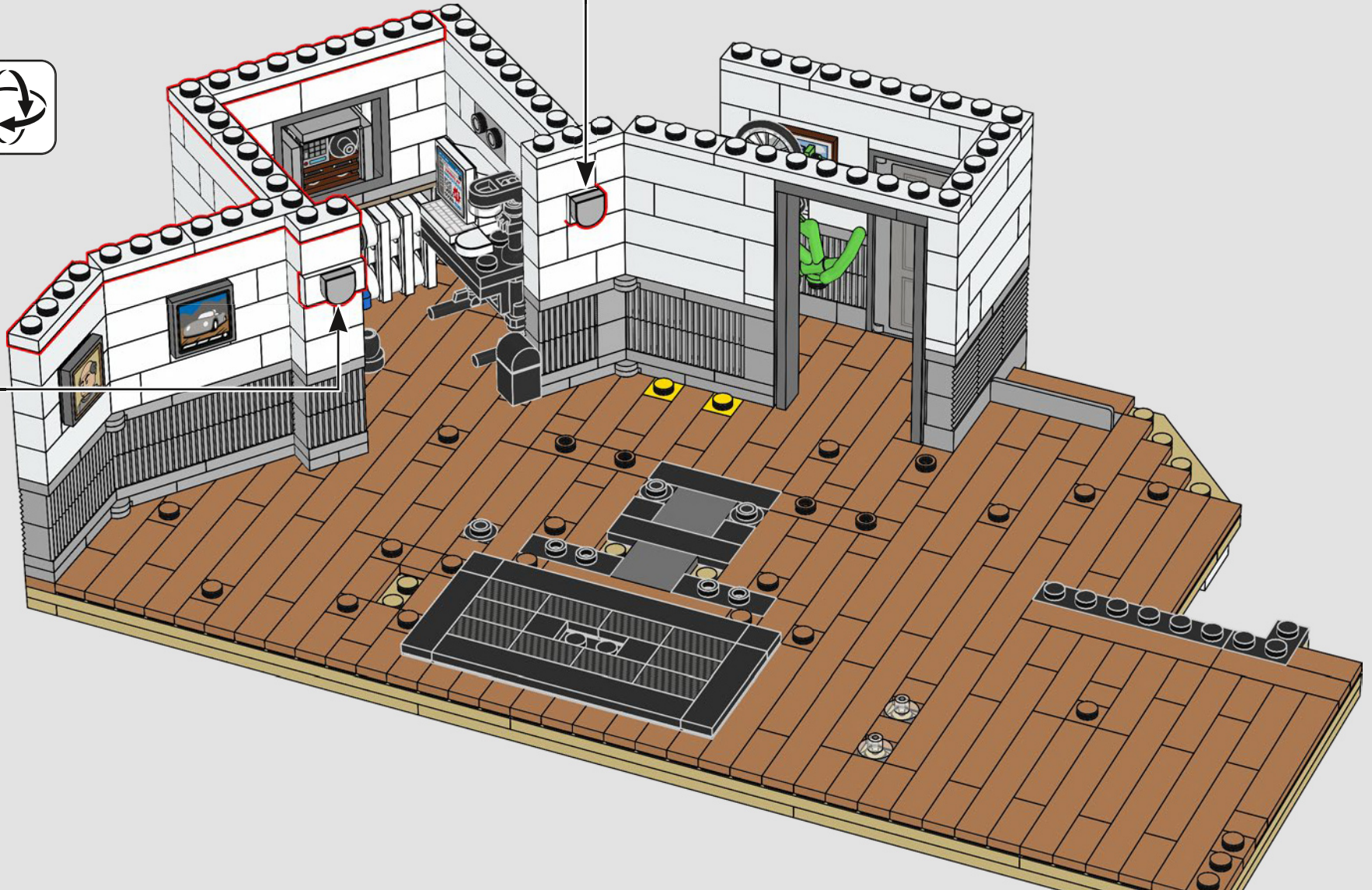
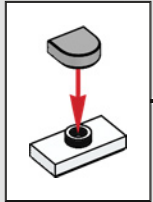
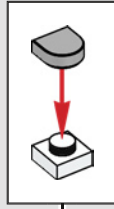

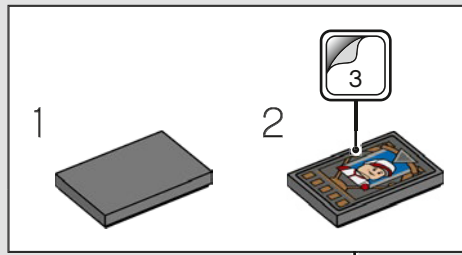
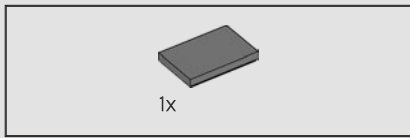

87

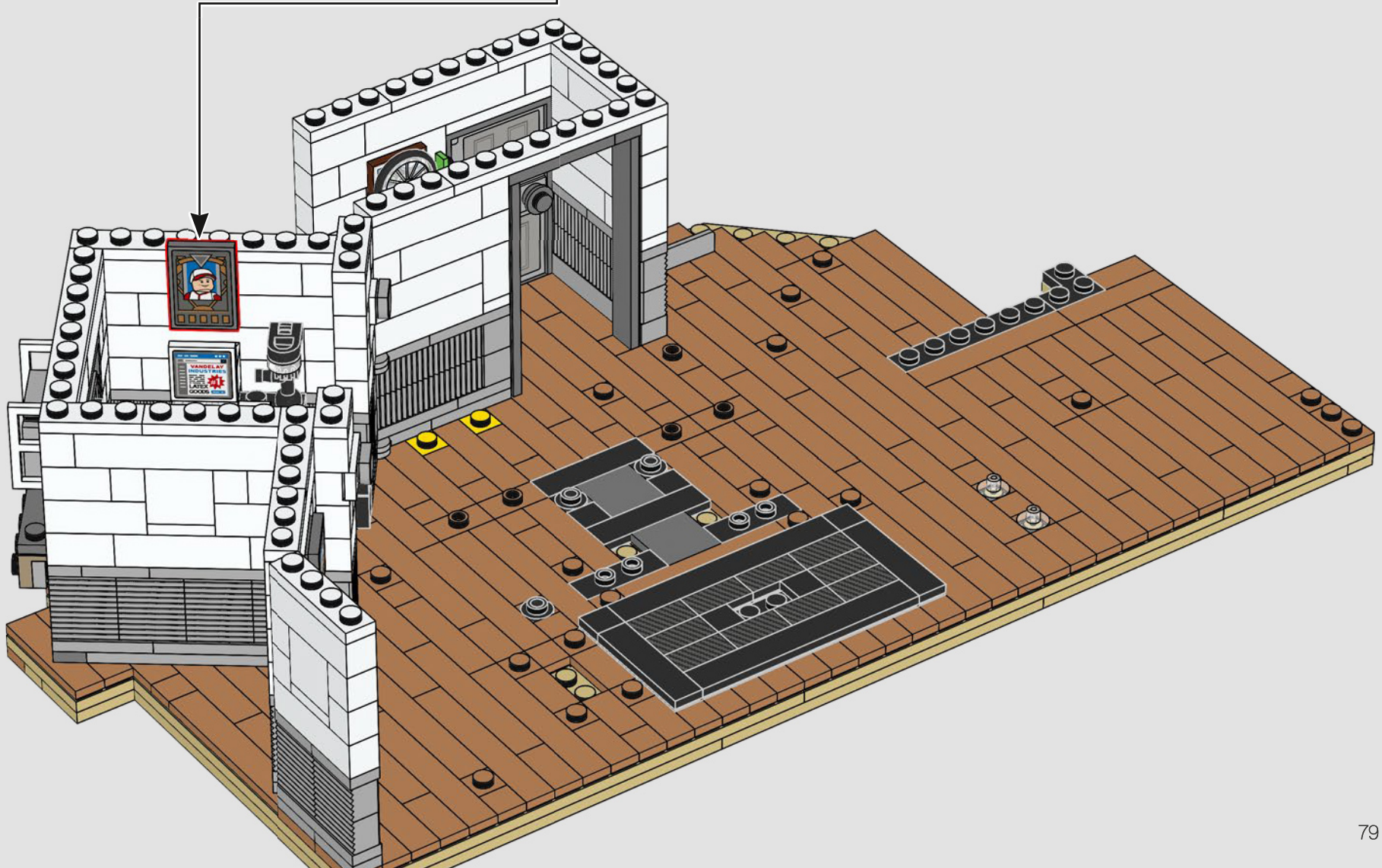

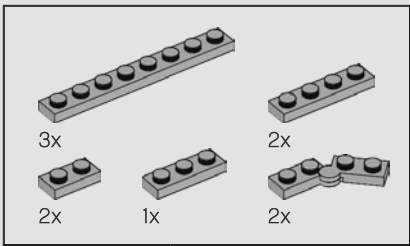

88

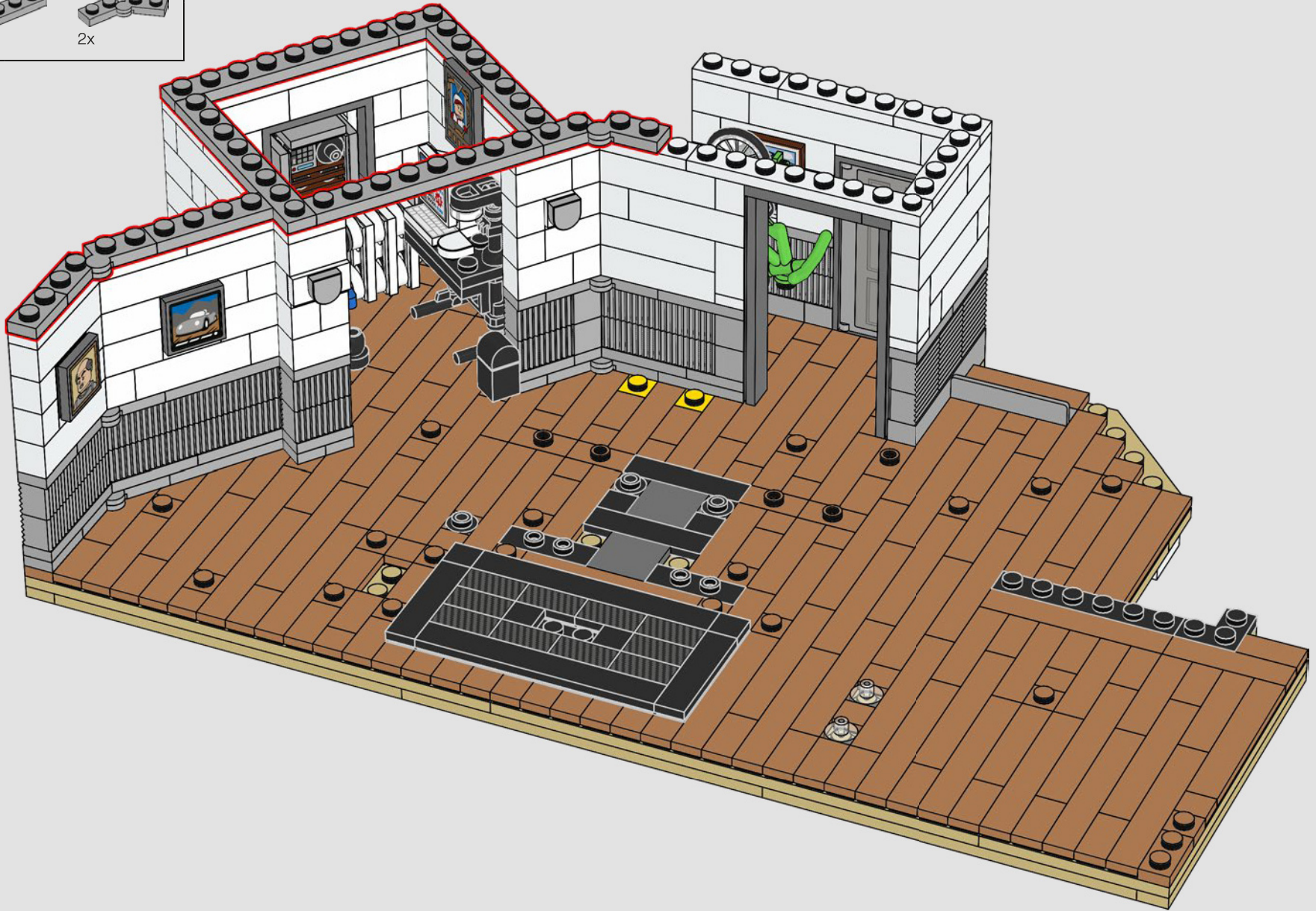



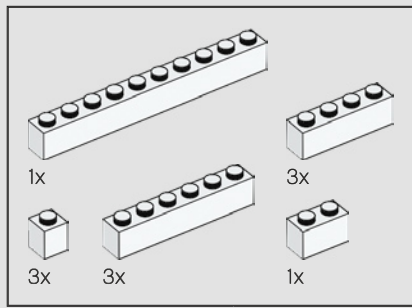

89

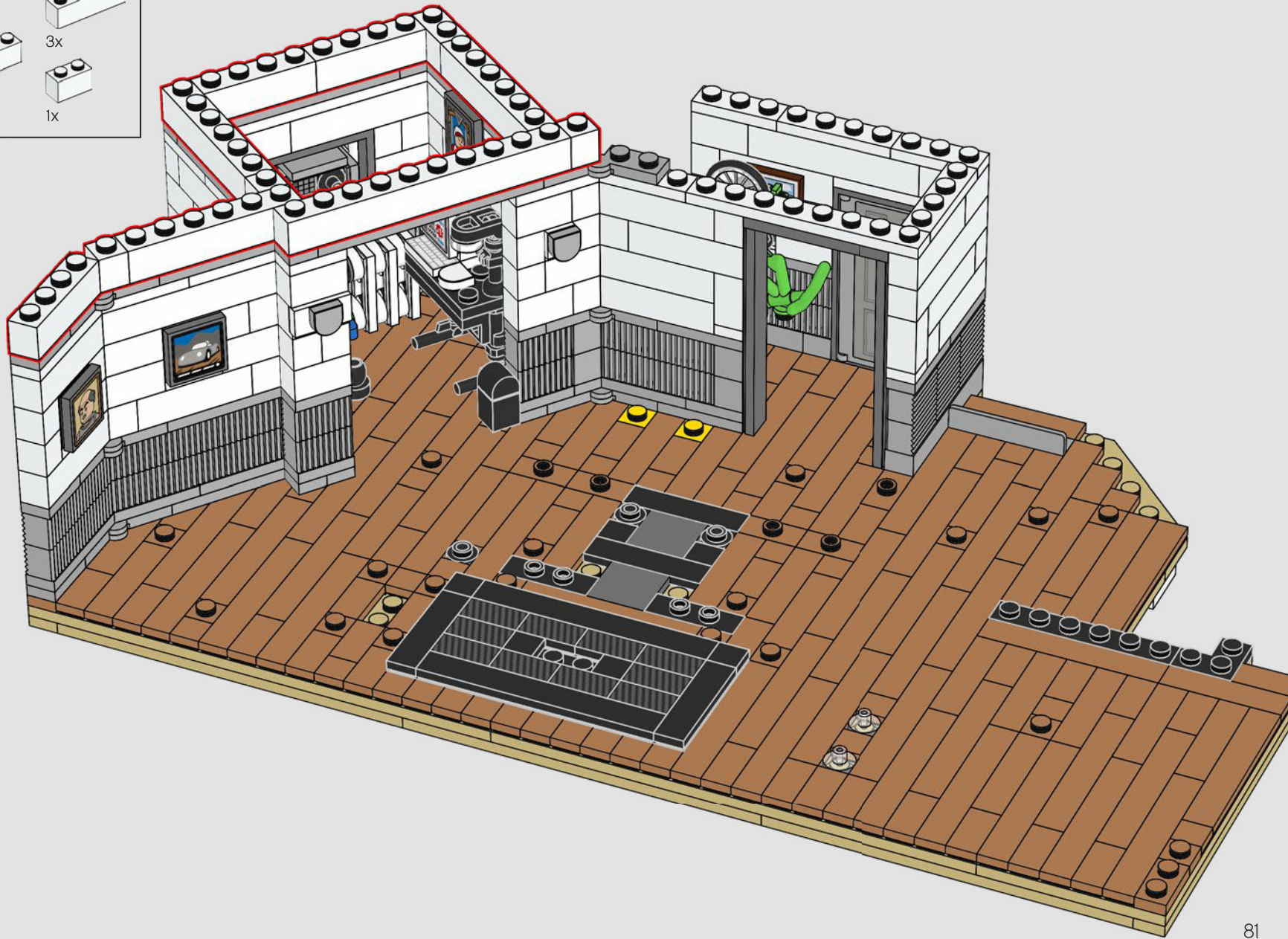

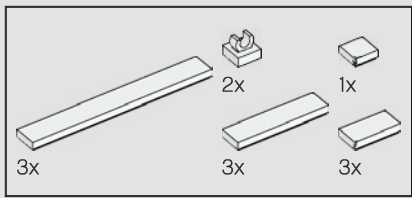

90

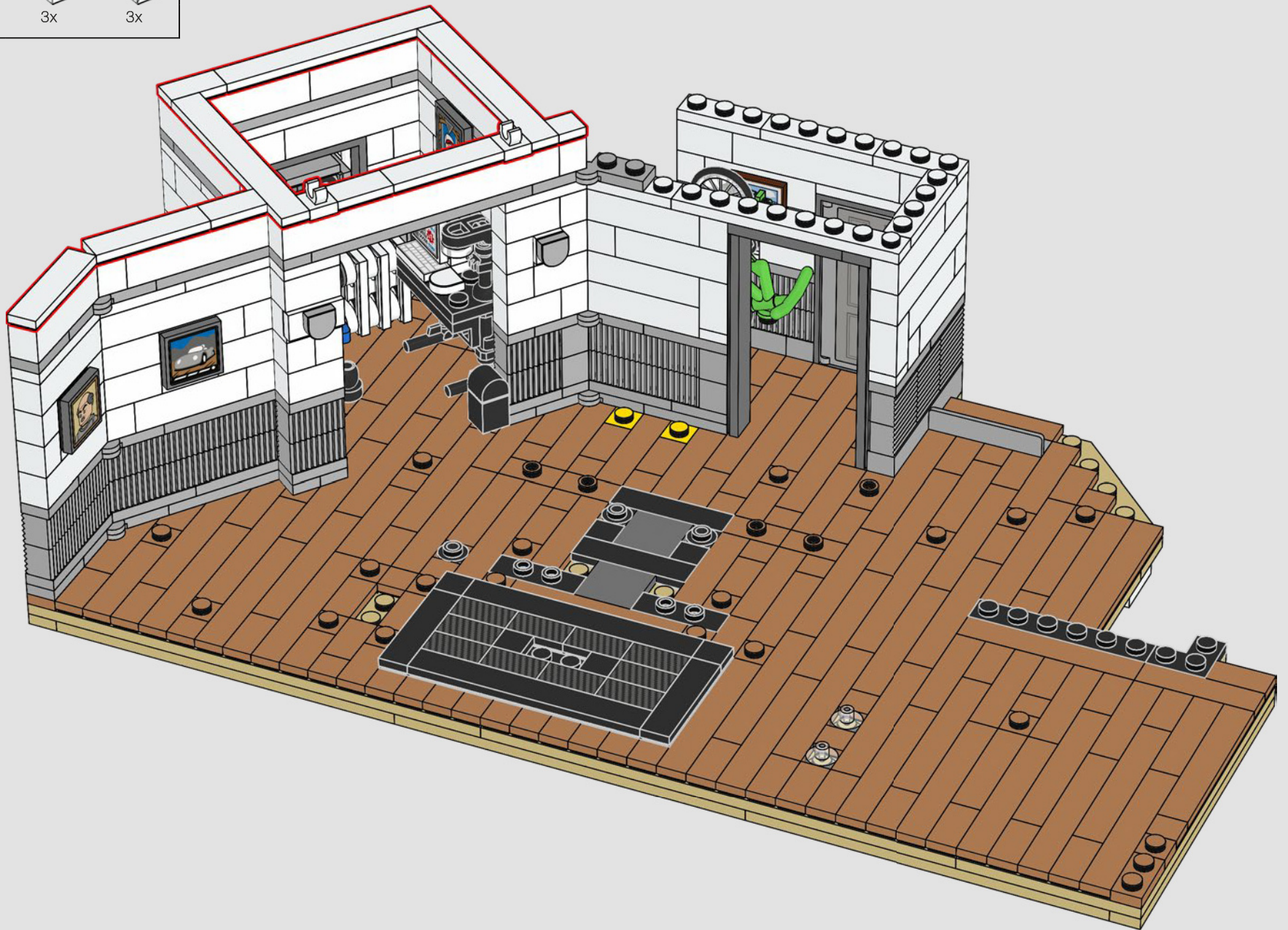

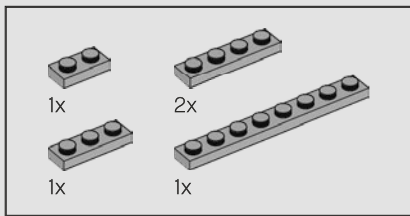

91

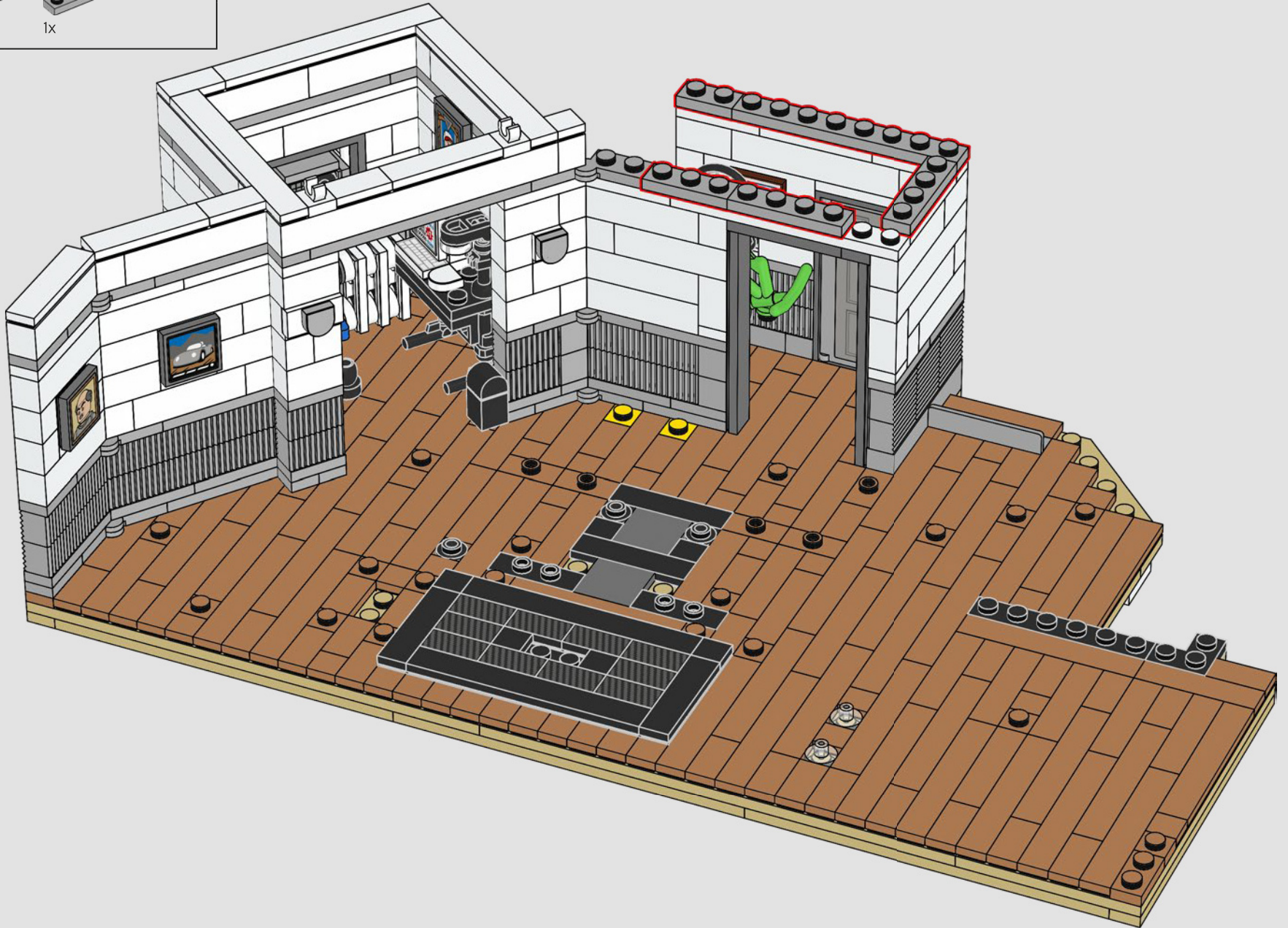

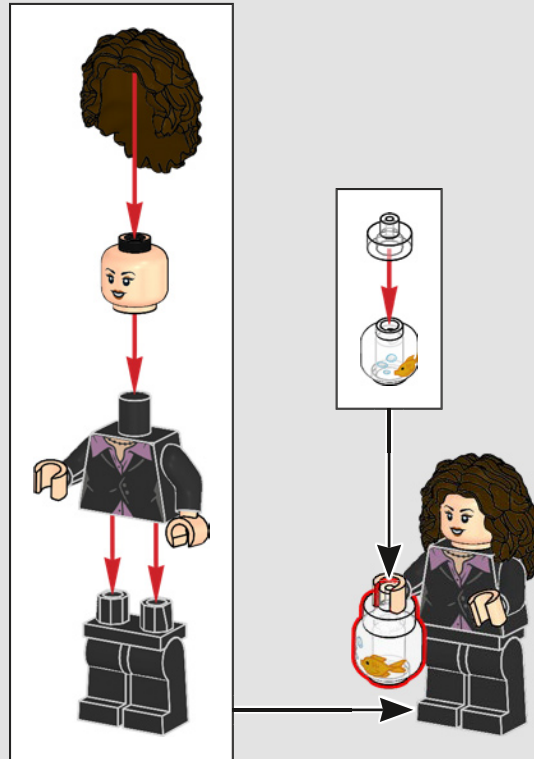
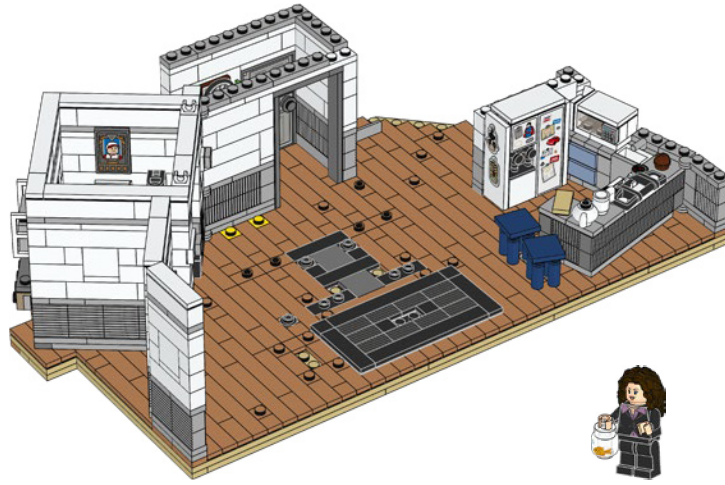

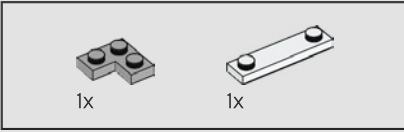
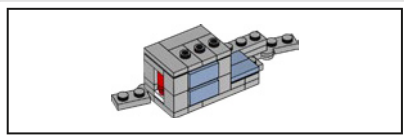

92

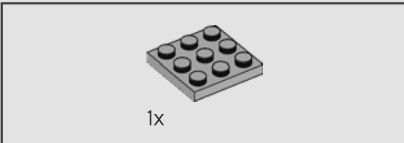
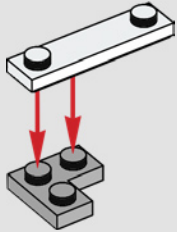

93

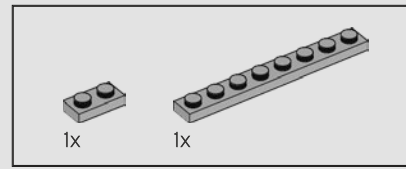
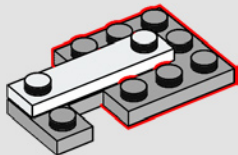

94

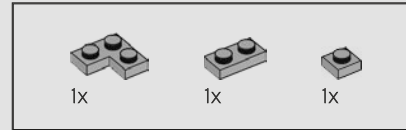
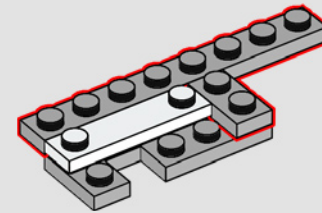

95

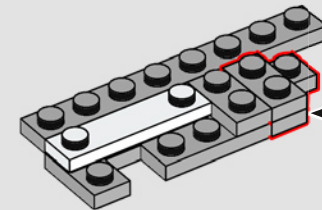
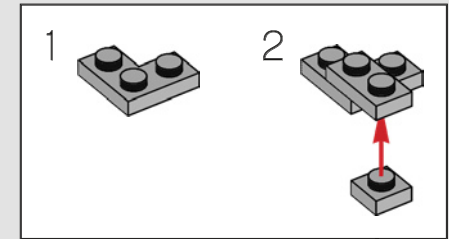

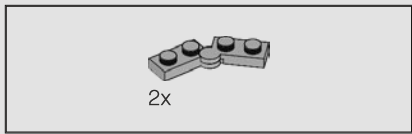

96

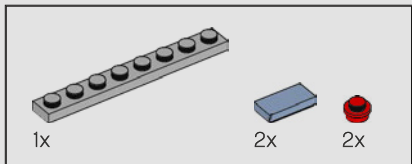
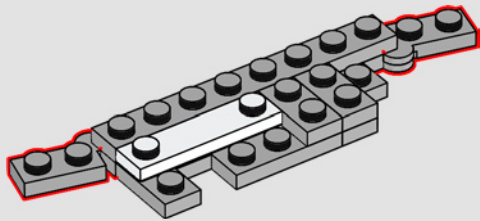

97

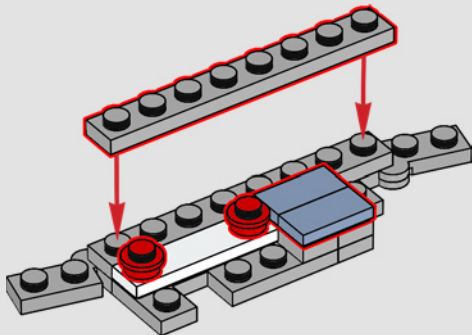

98

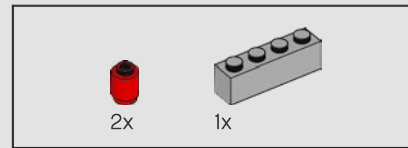
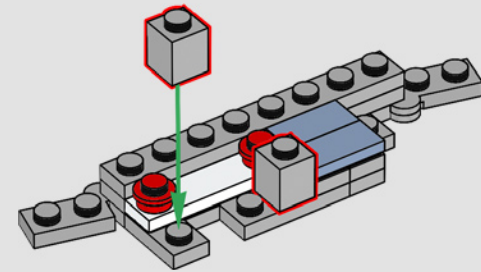

99

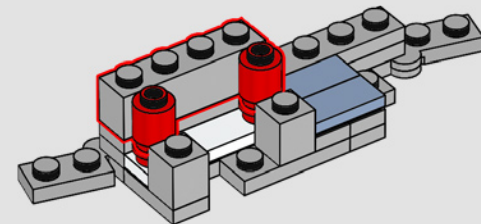



100

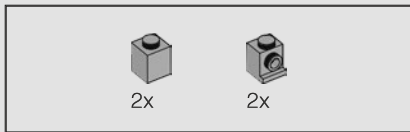
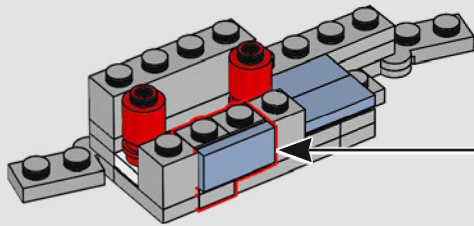
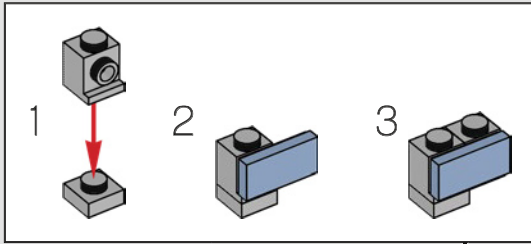

101

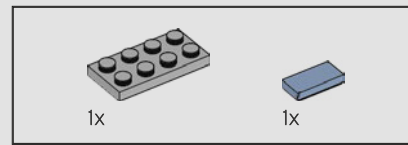
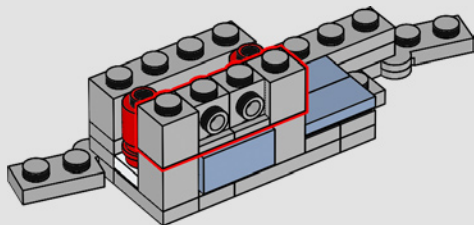

102

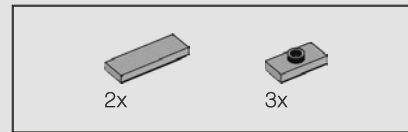
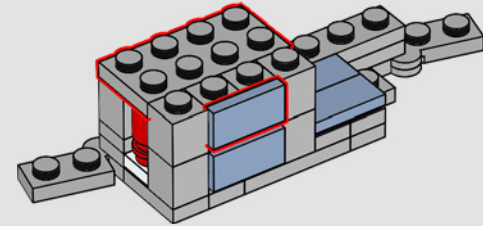

103

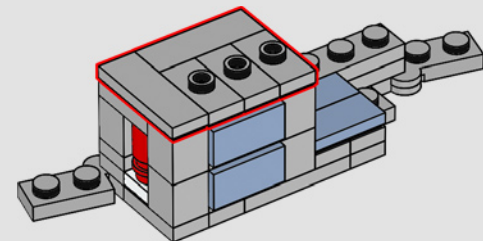

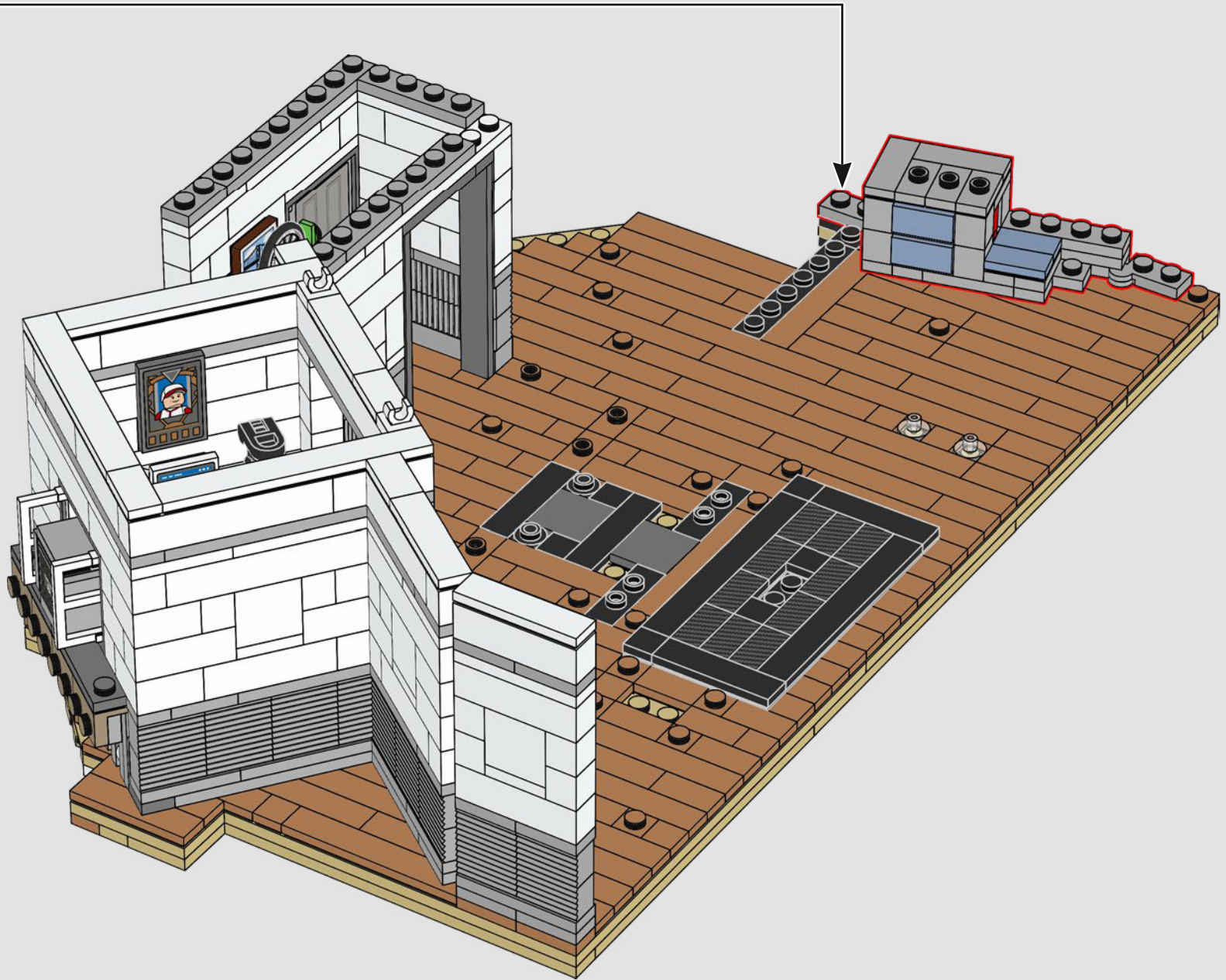



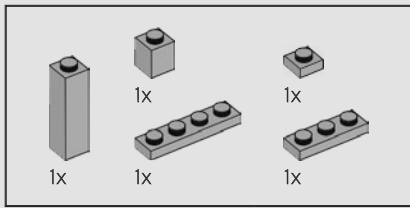

105

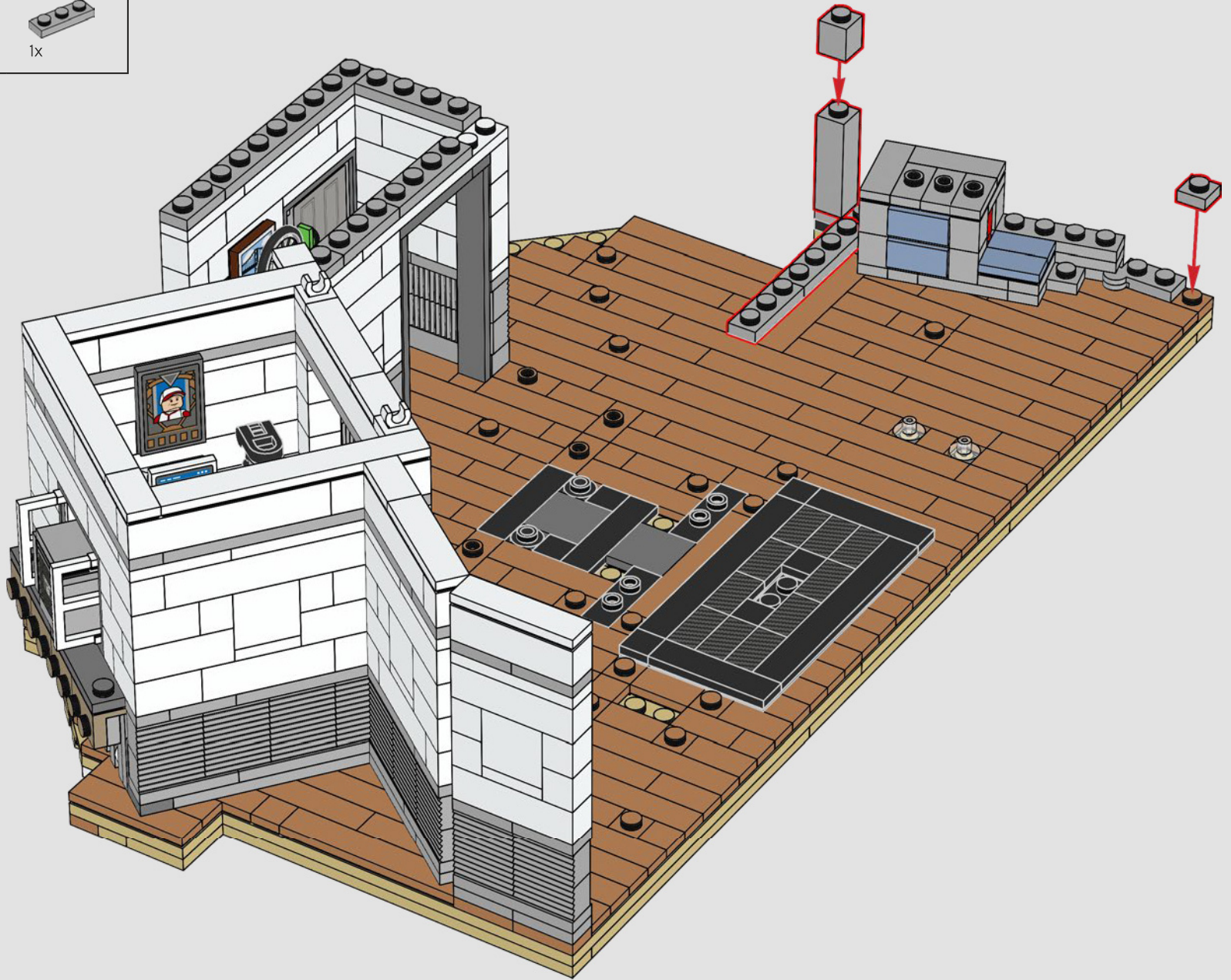

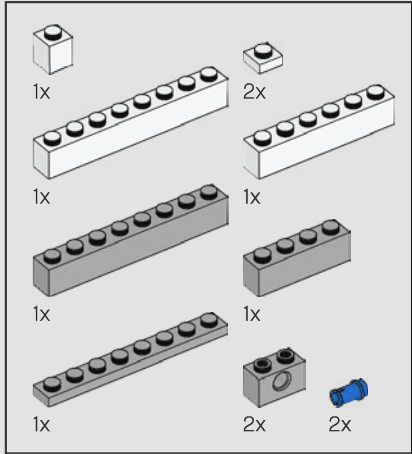
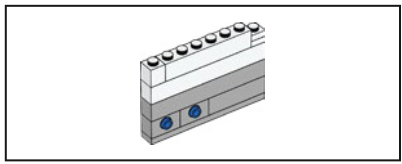

106

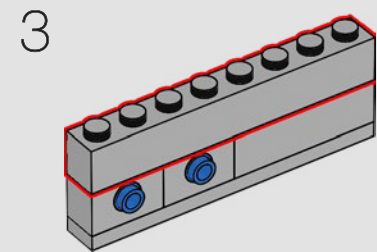
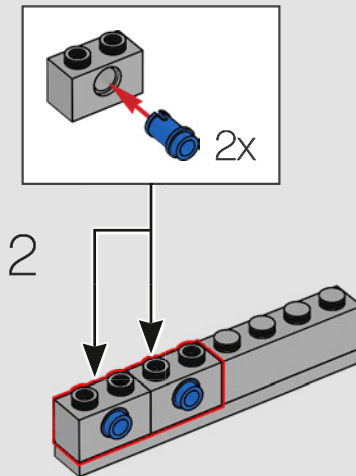
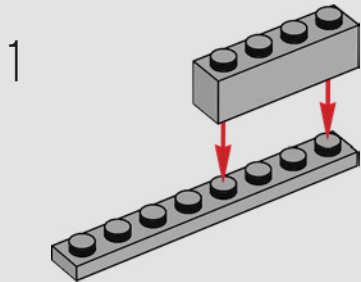

4

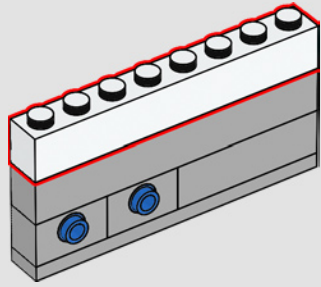

5

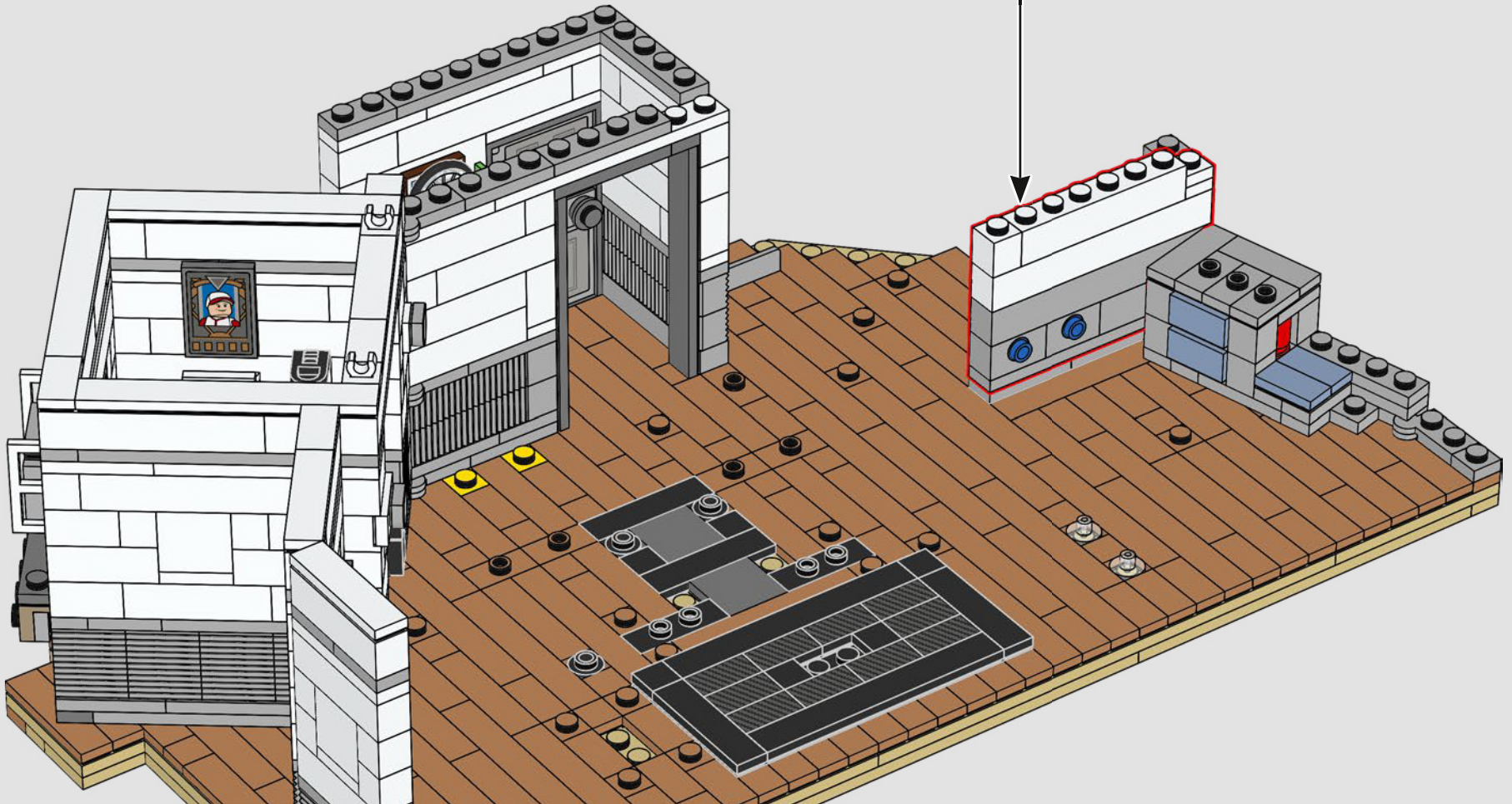
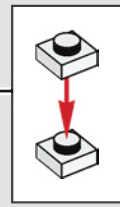
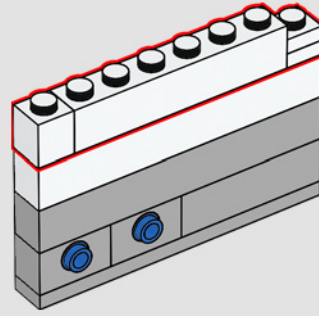

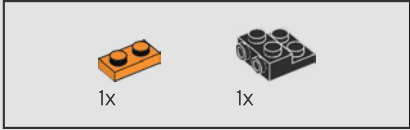

107

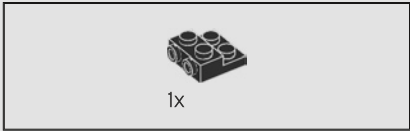

108

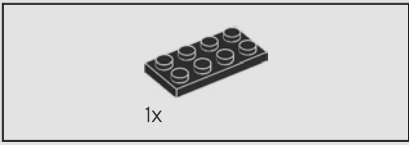
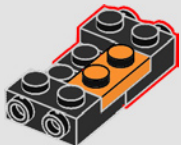

109

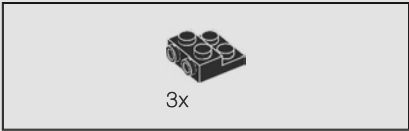
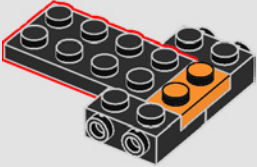

110

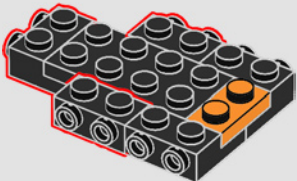

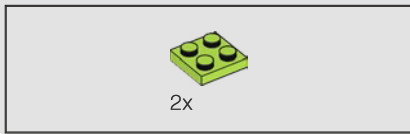

111

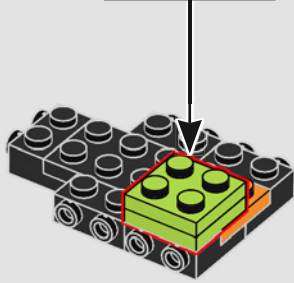
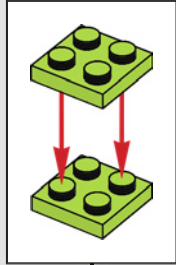

112

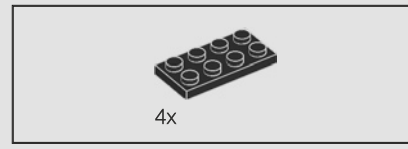
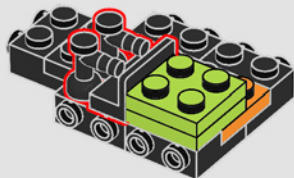

113

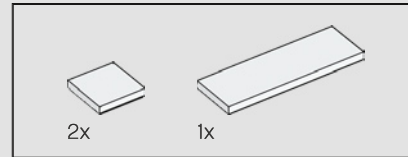
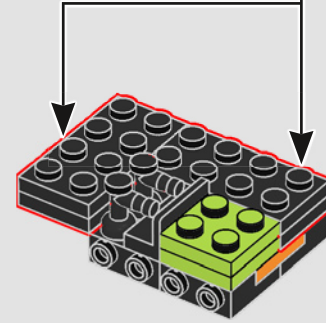
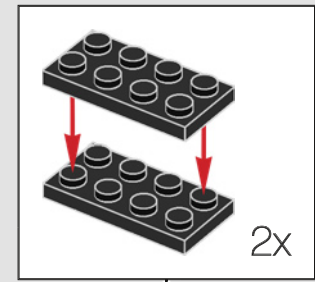

114

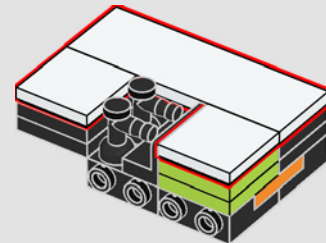

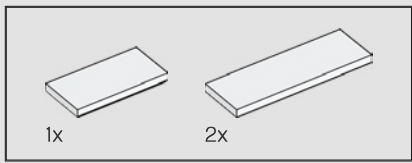

115

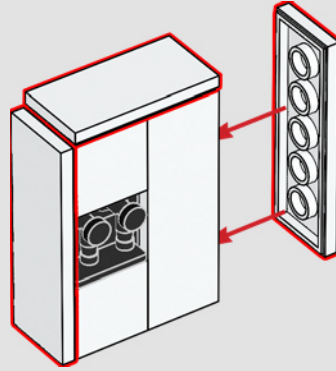

116

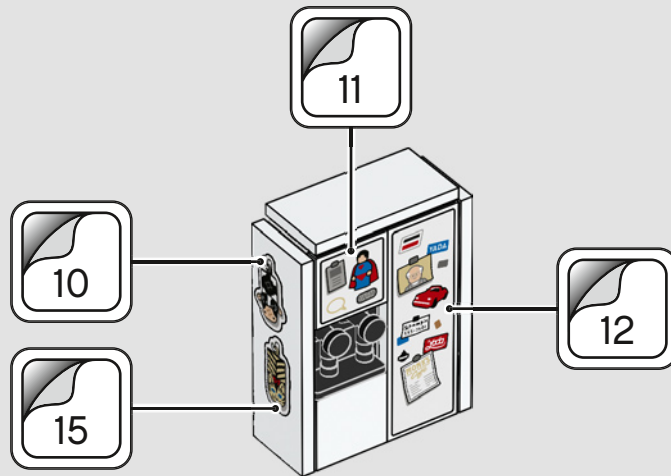

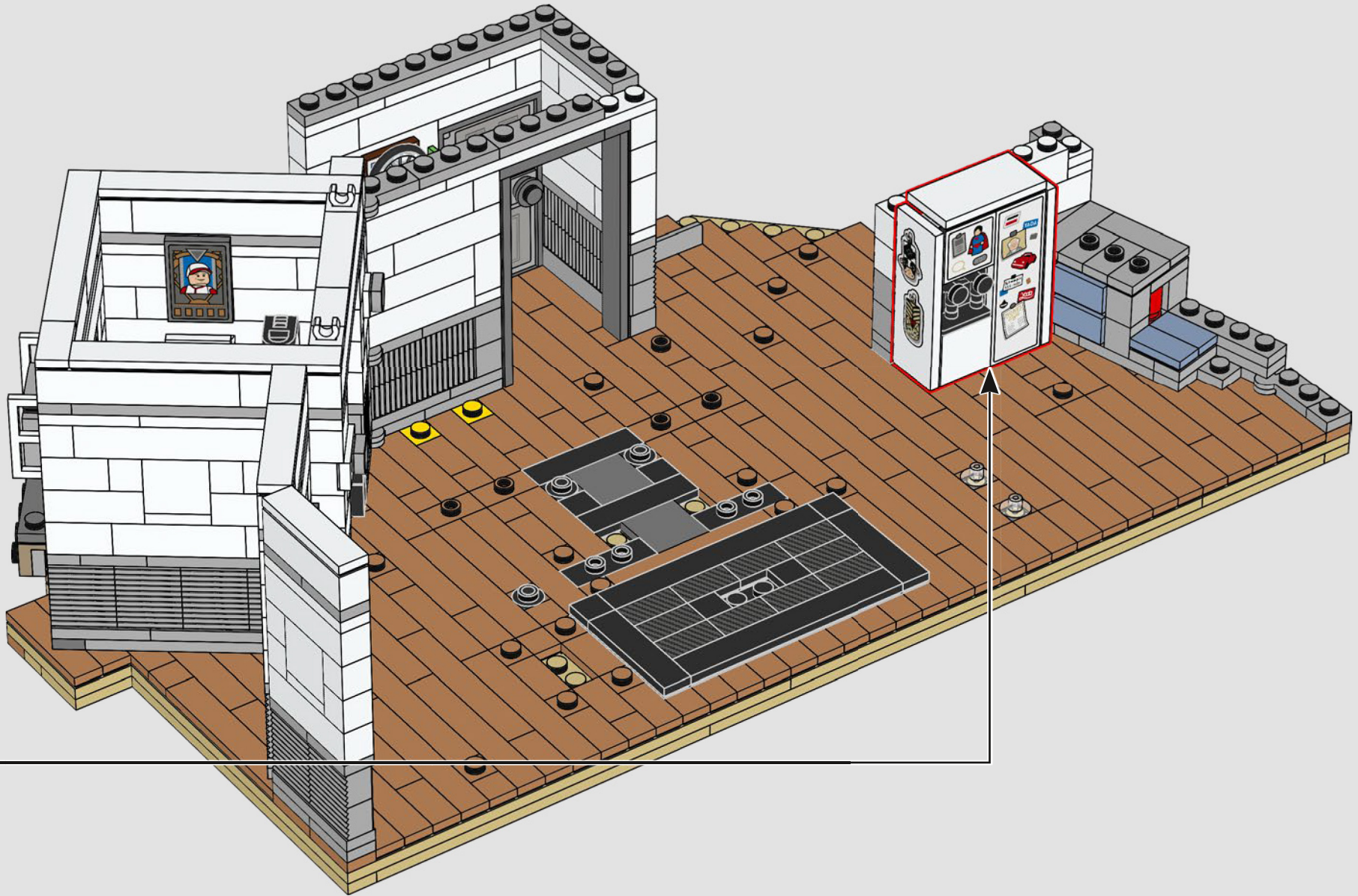

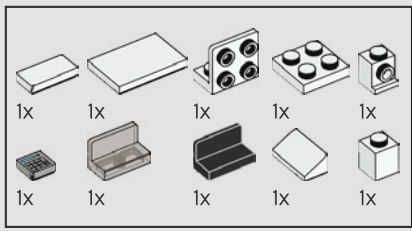

118

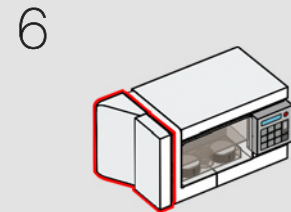
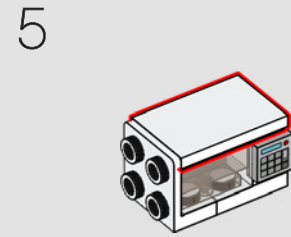
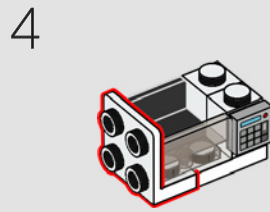
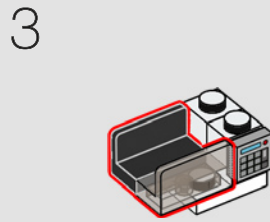
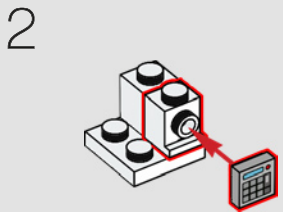
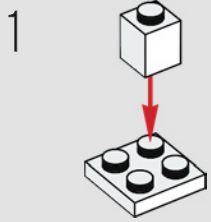



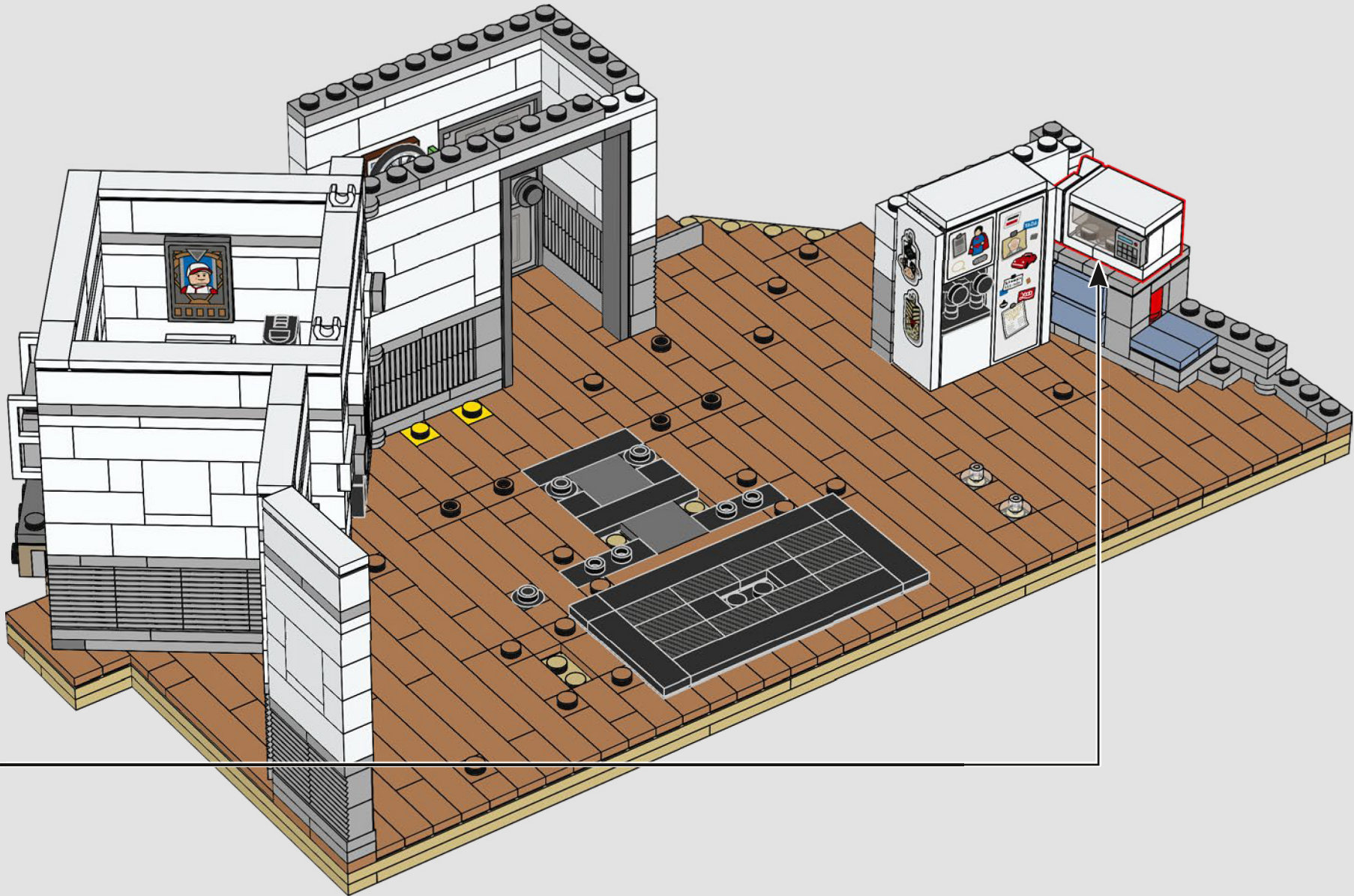

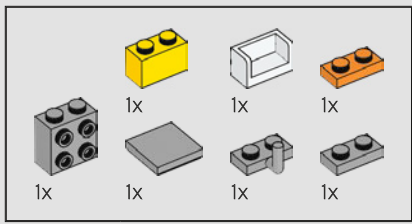

119

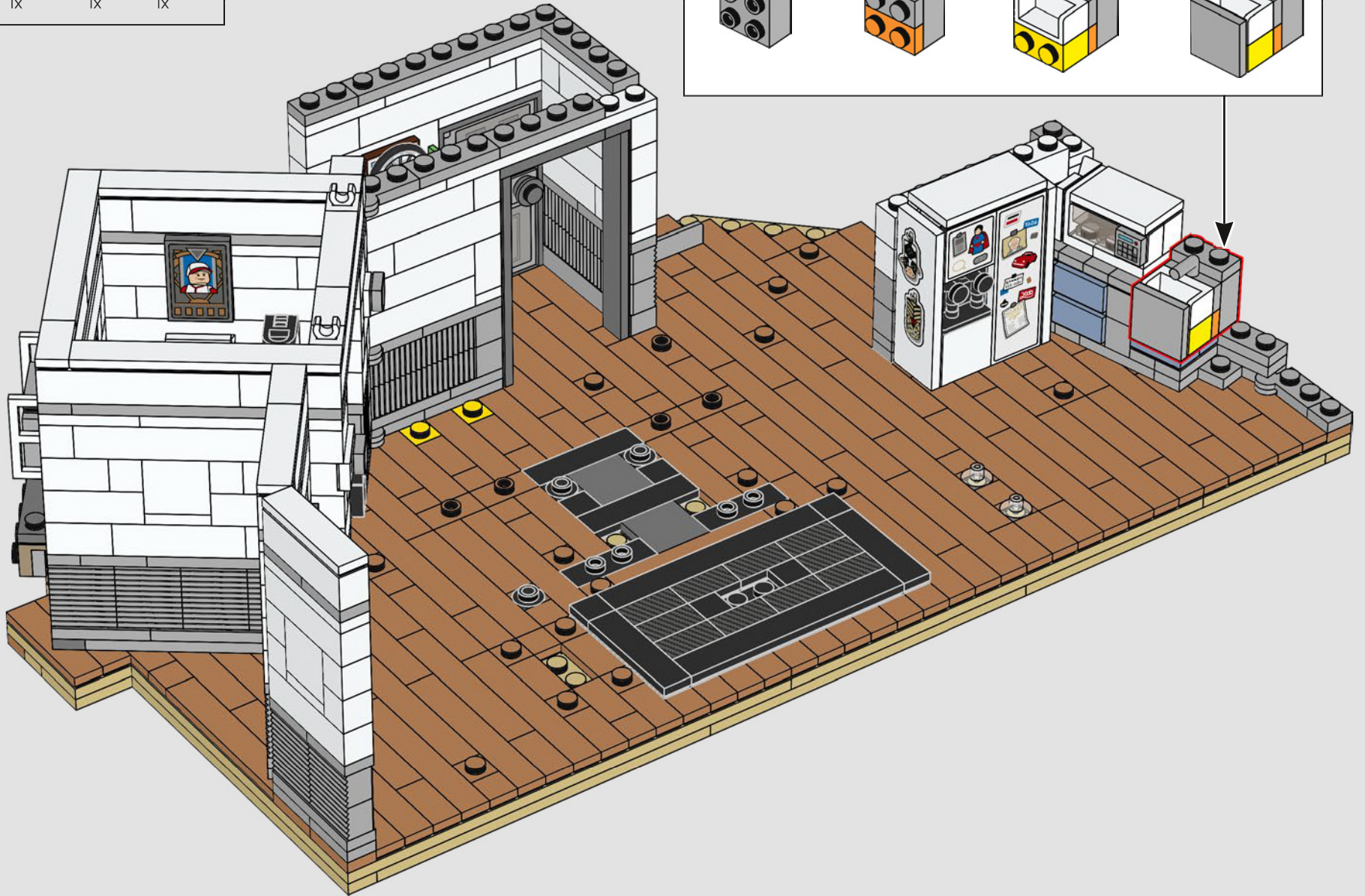
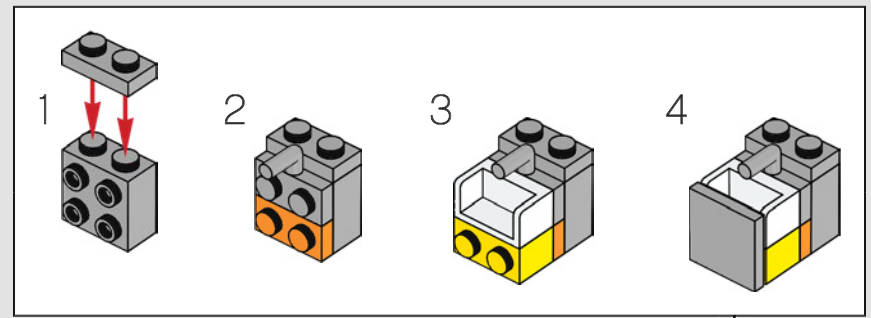

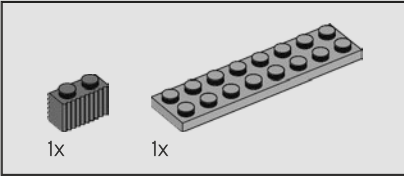
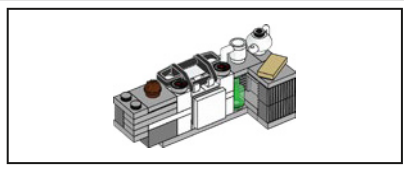

120

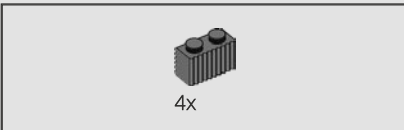
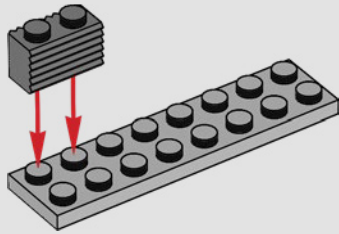

121

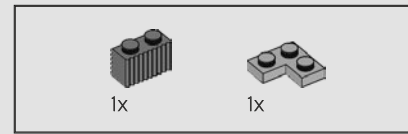
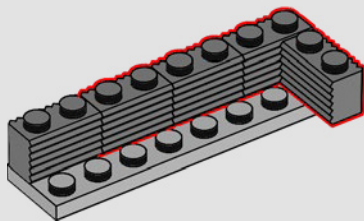

122

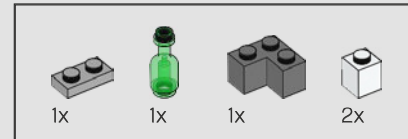
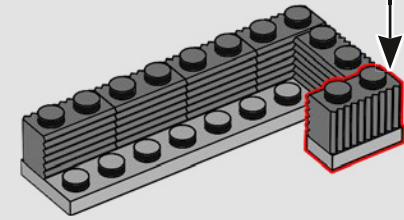
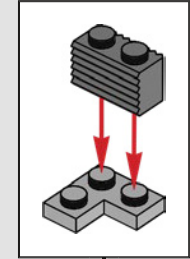

123

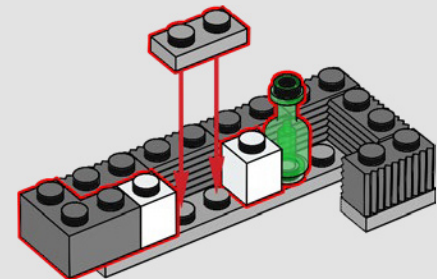

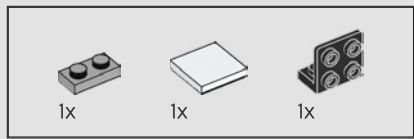

124

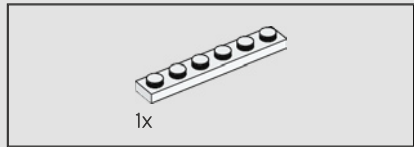
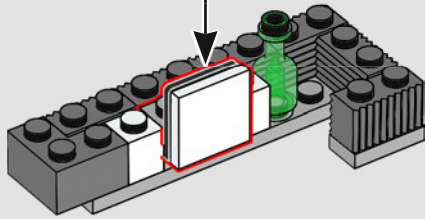
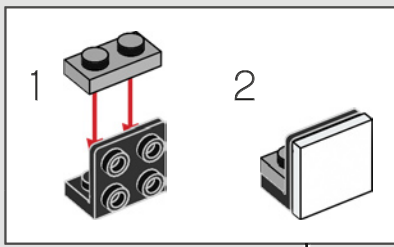

125

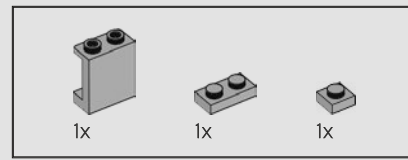
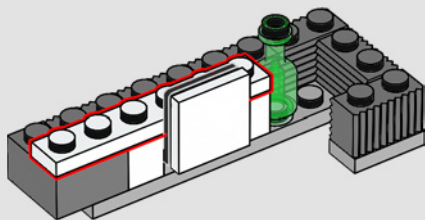

126

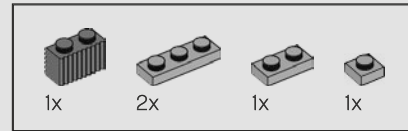
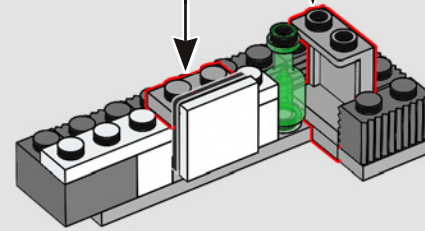
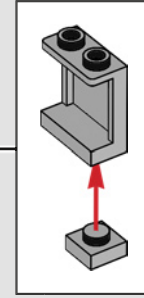
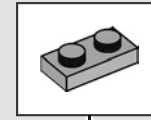

127

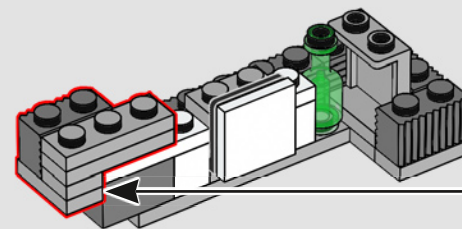
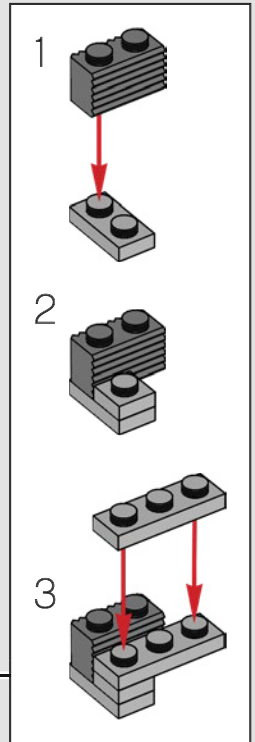

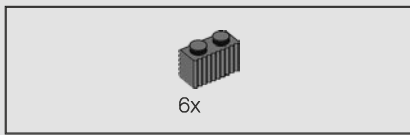

128

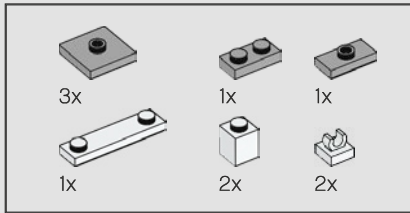
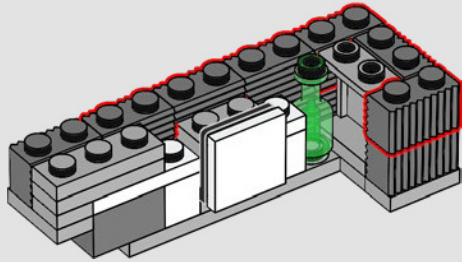

129

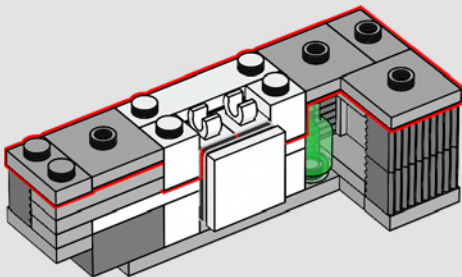

130

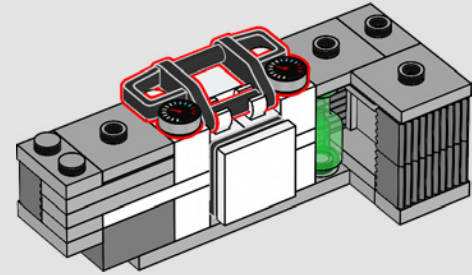

131

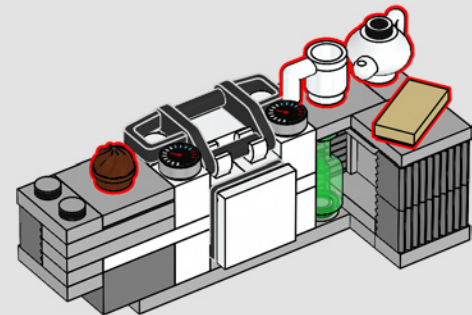

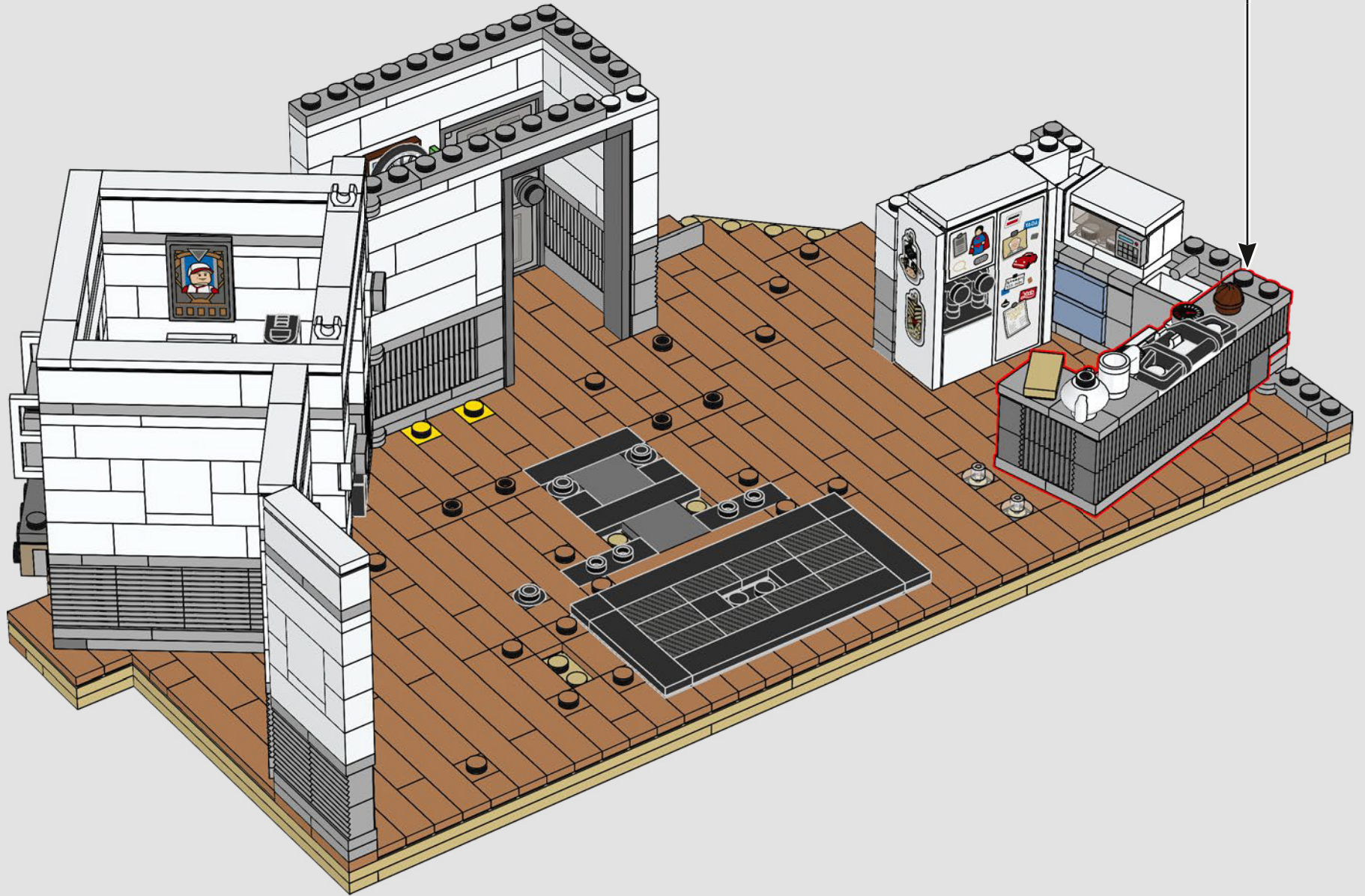

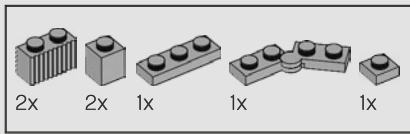

133

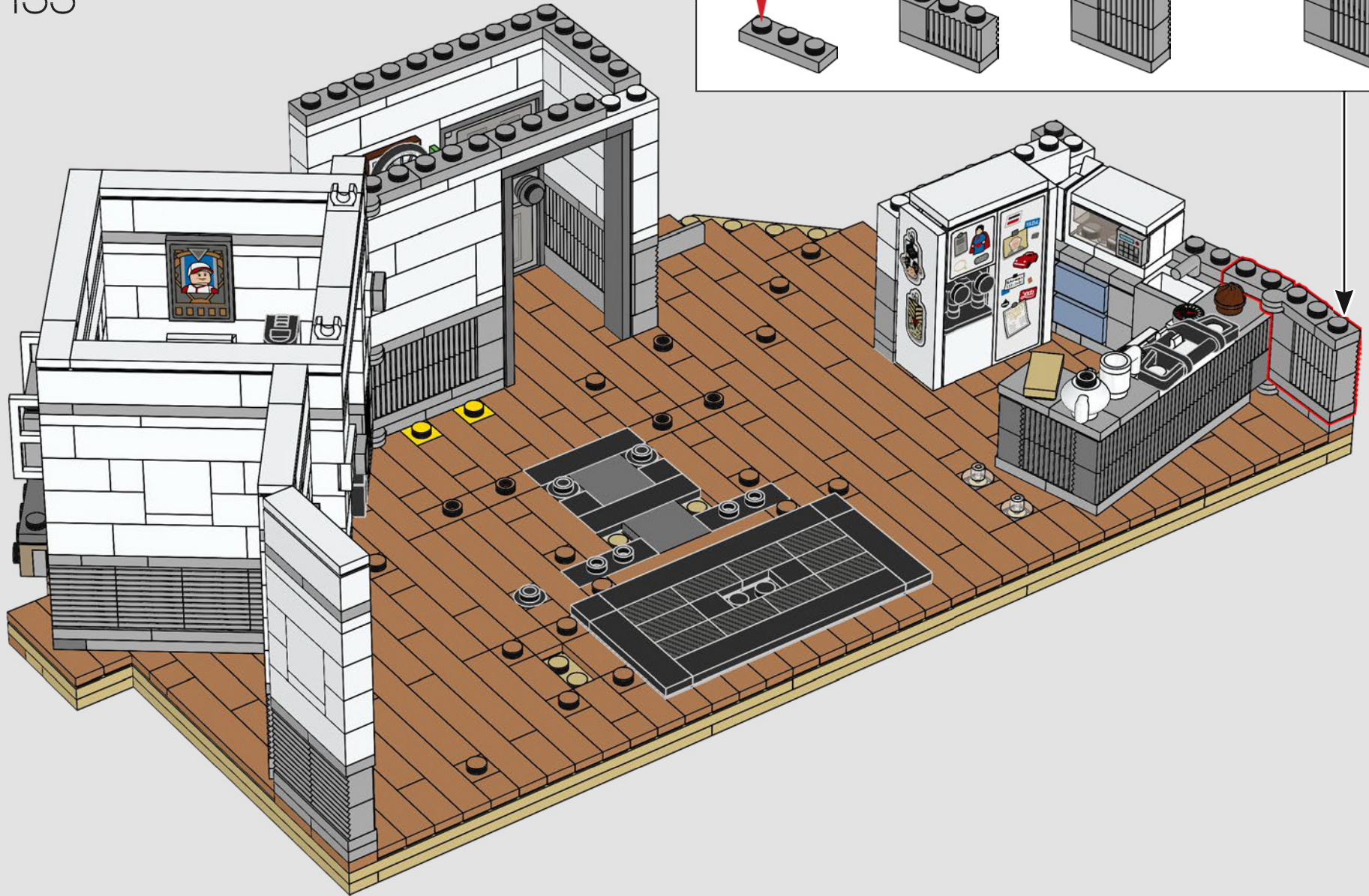
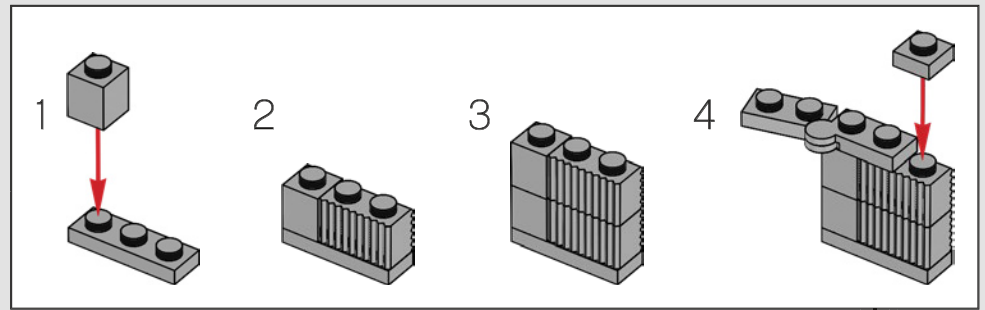



134

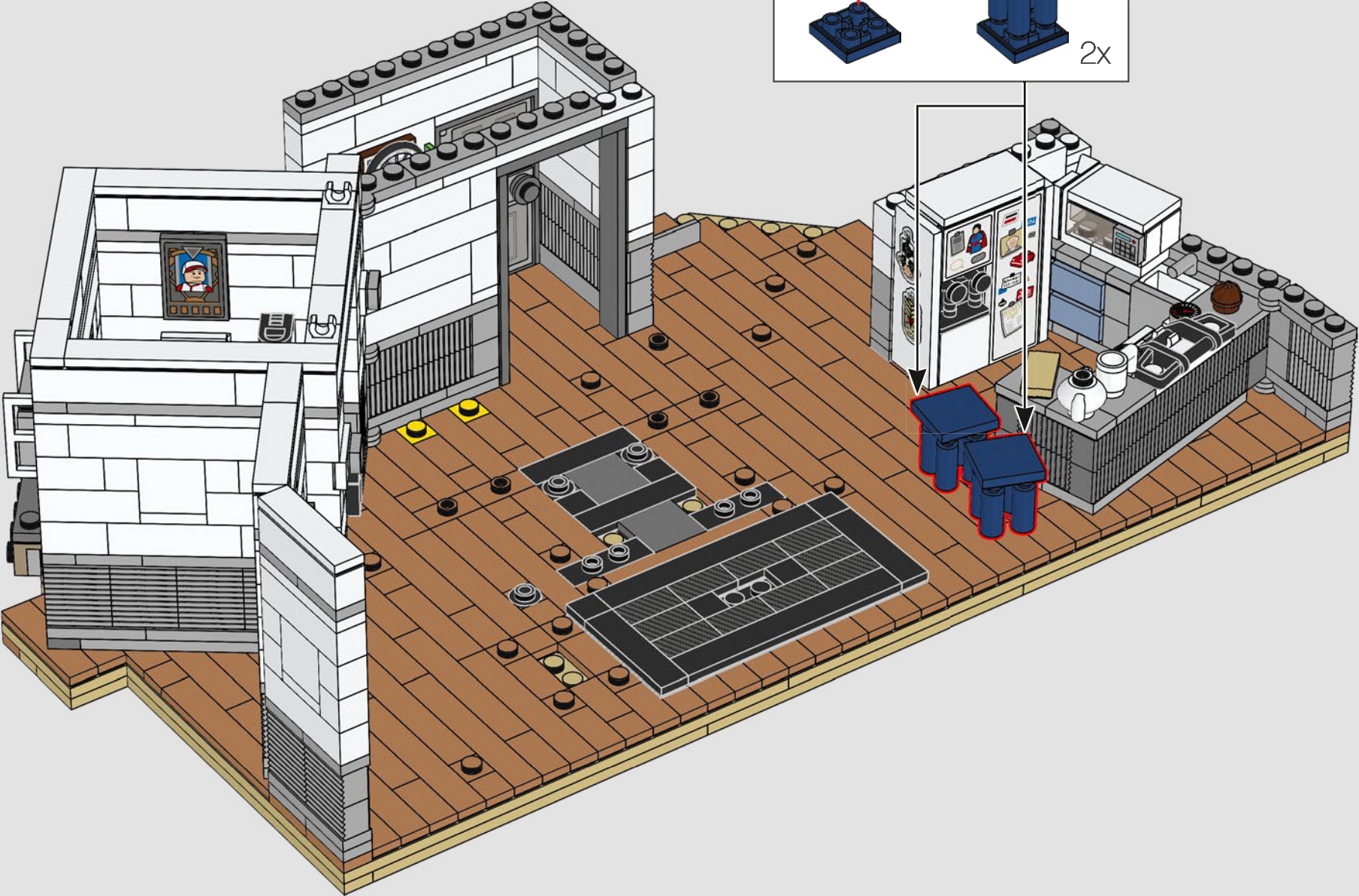
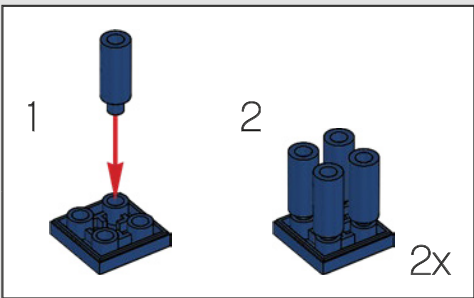



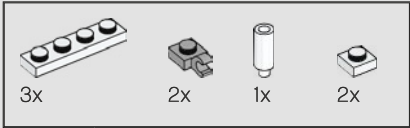
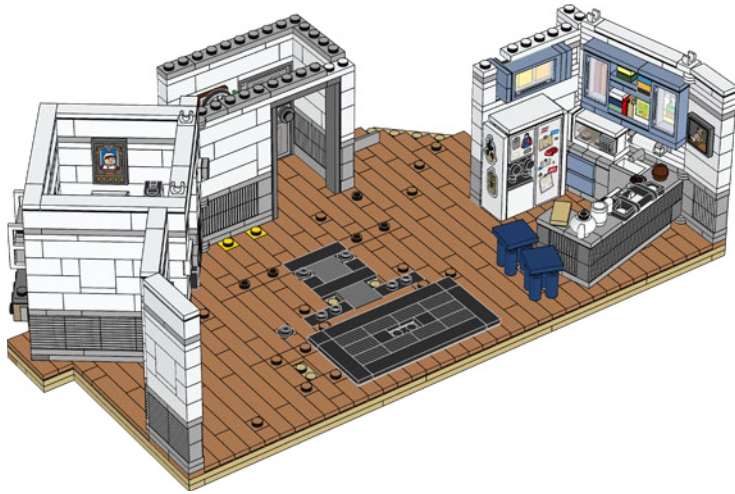

135

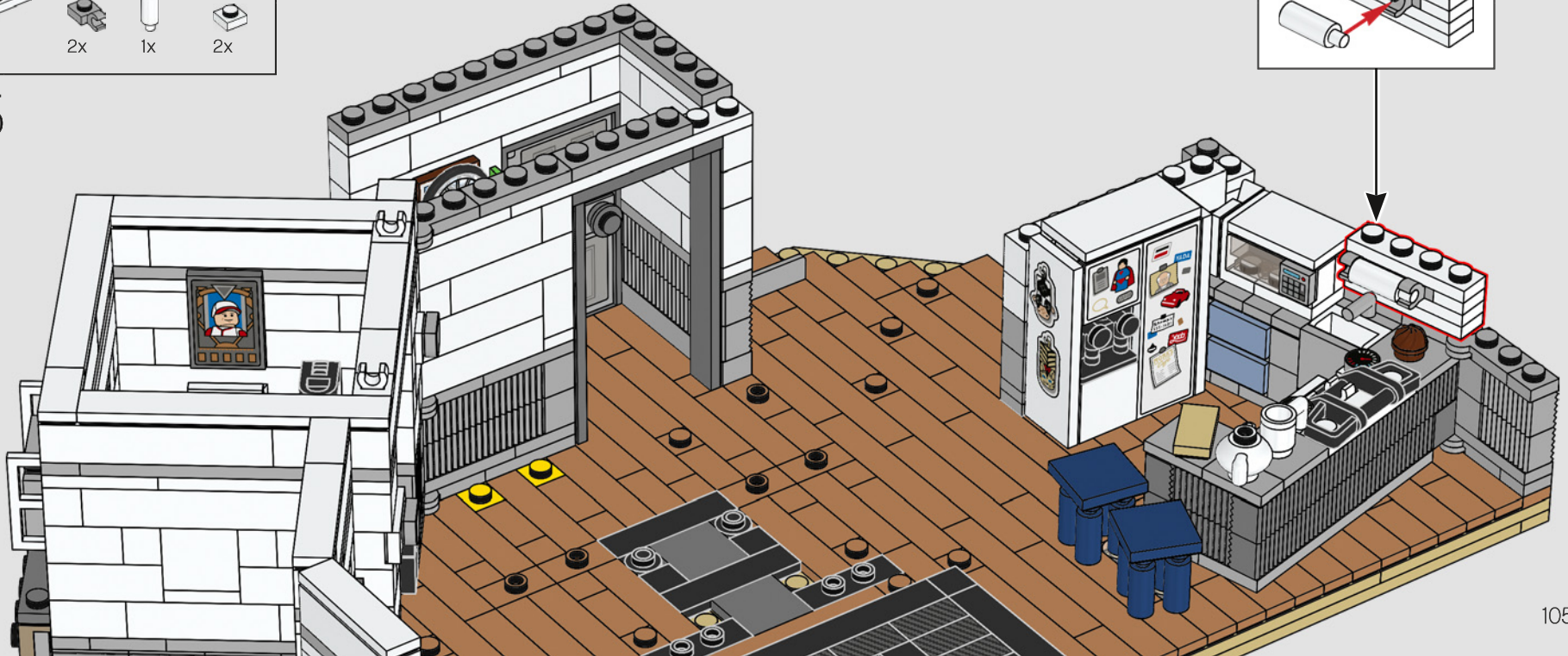
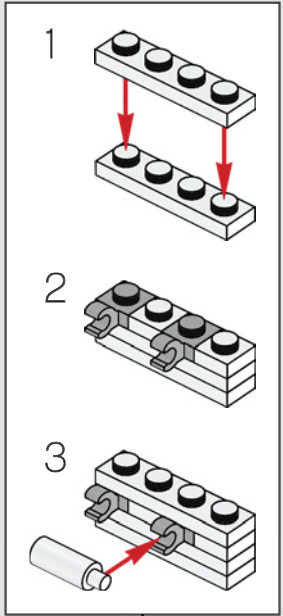

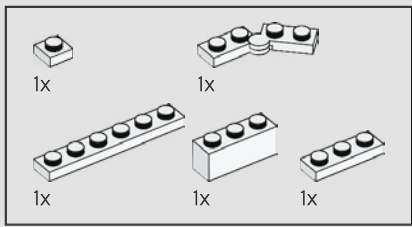

136

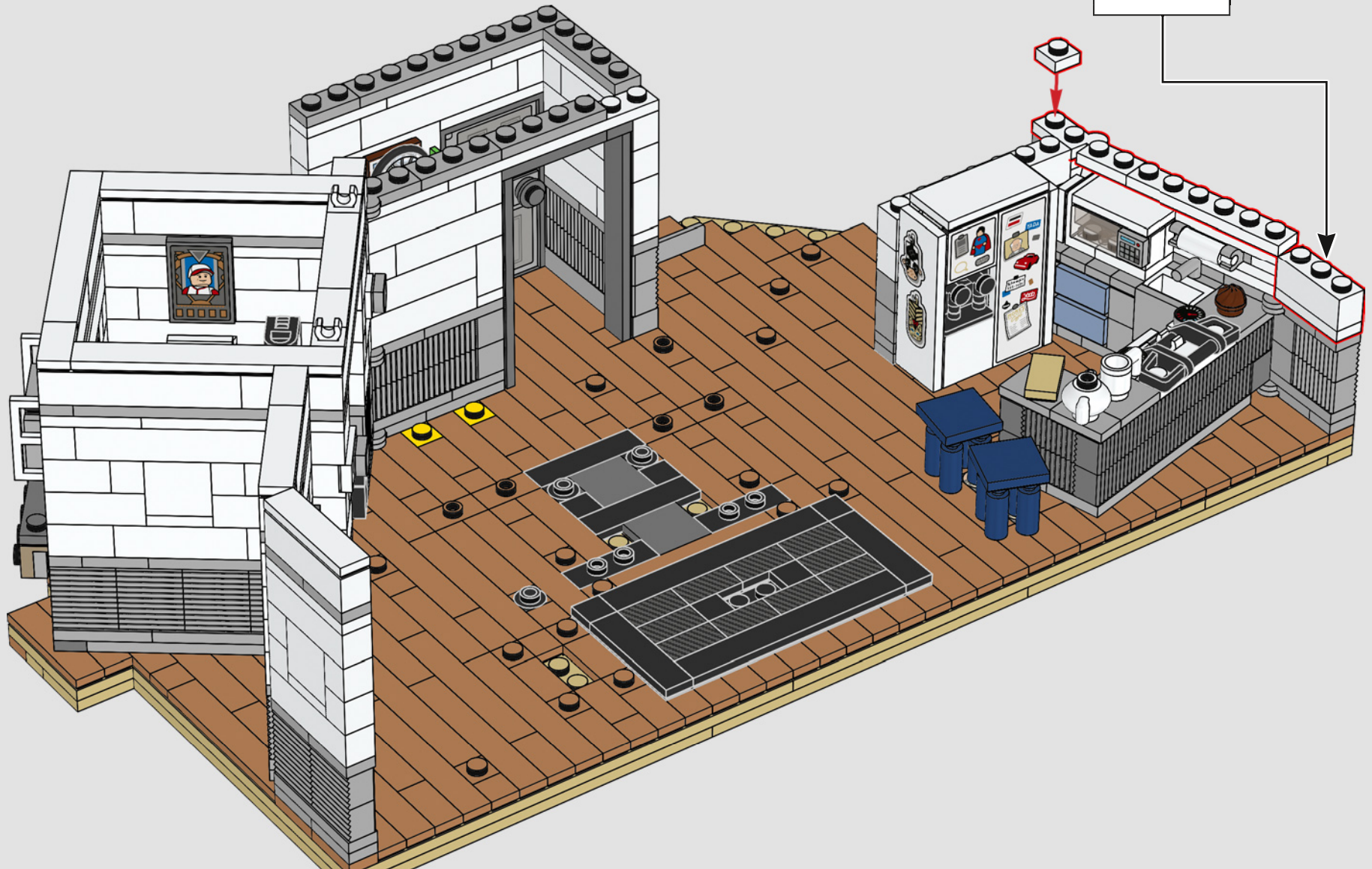

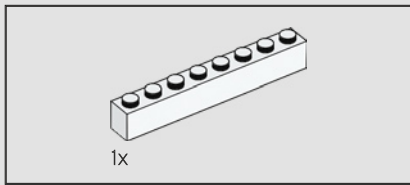

137

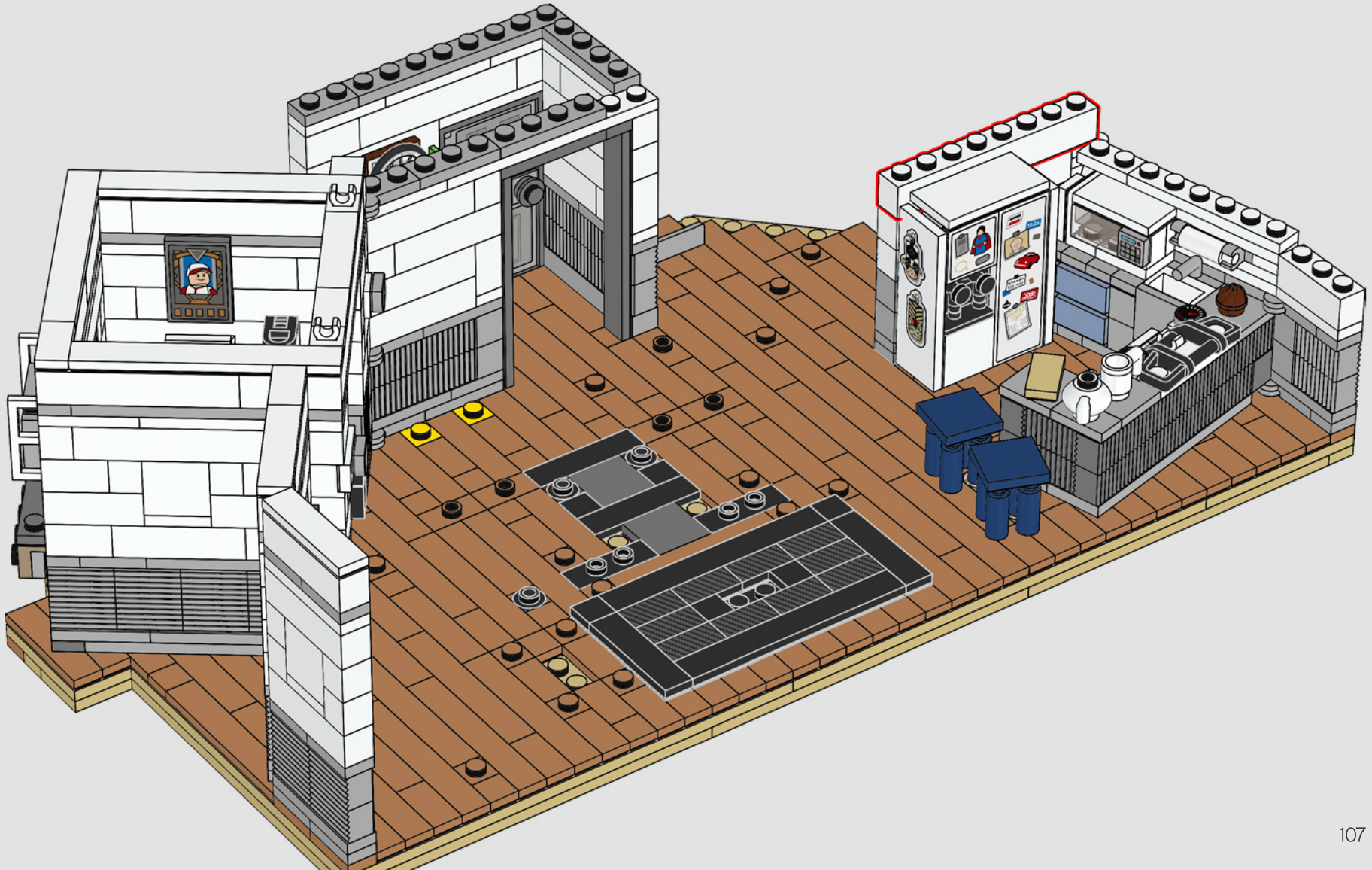

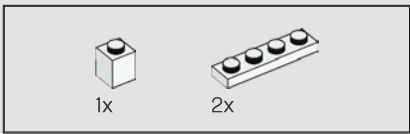

138

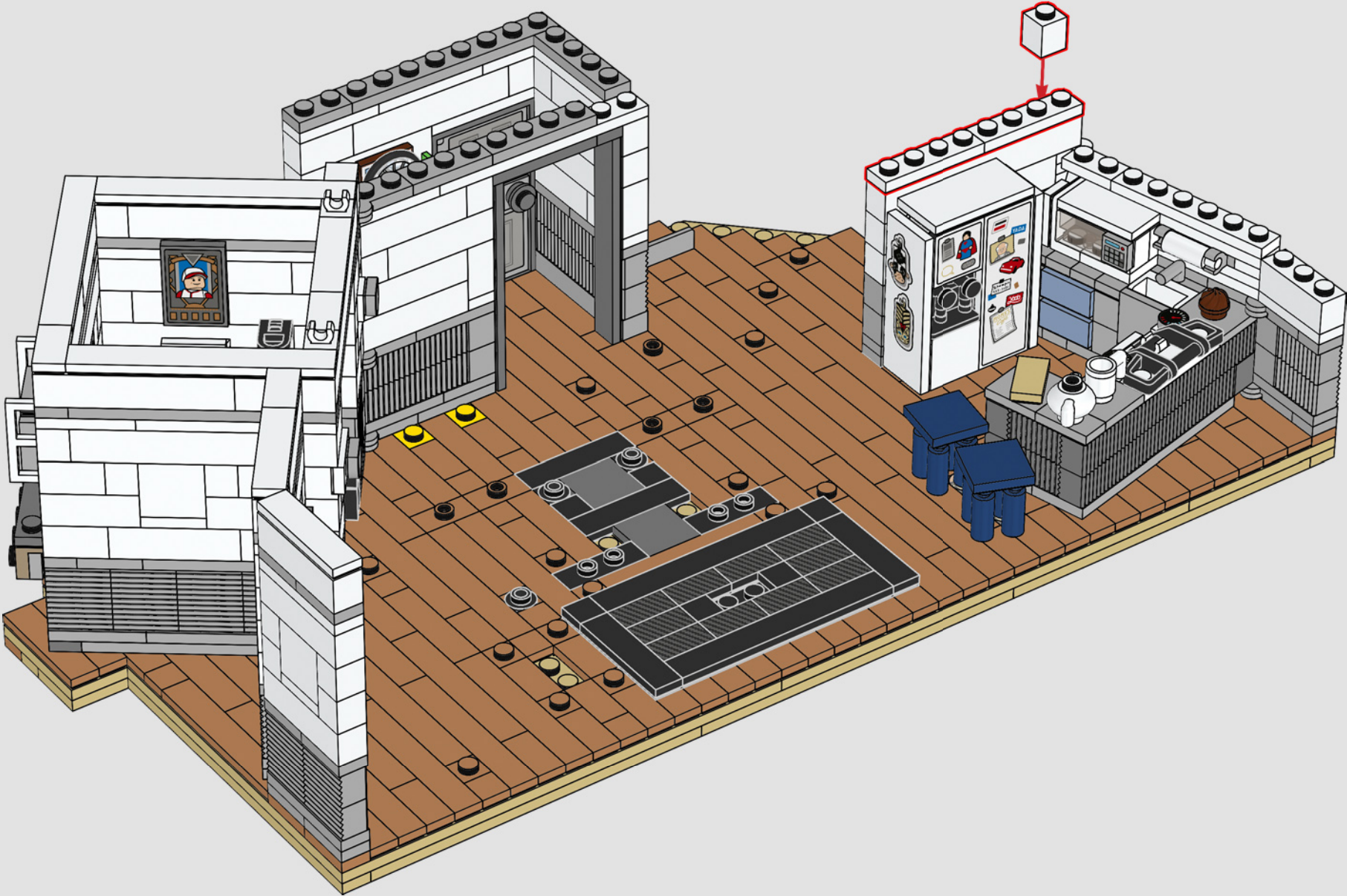

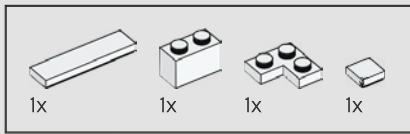

139

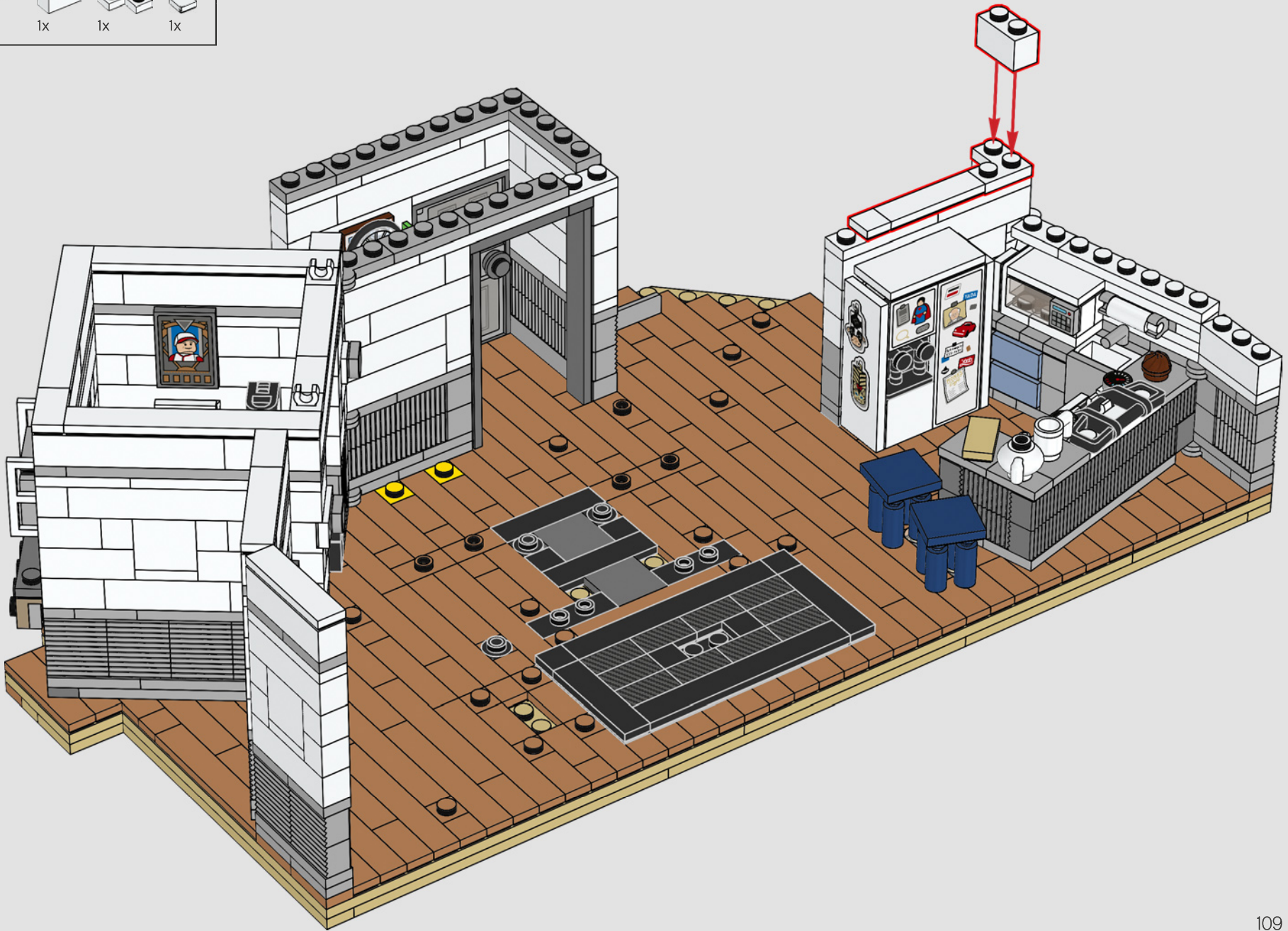

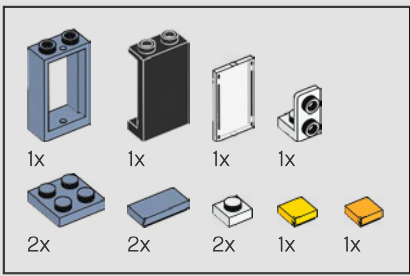

140

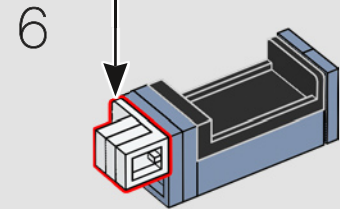
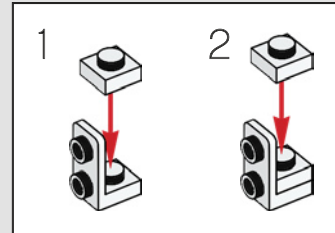
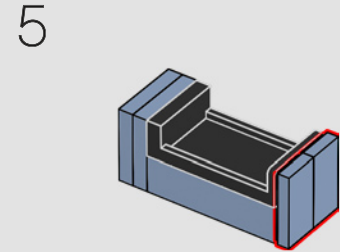
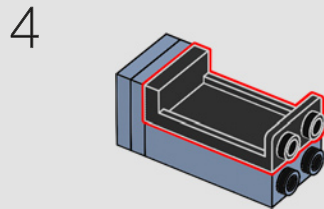
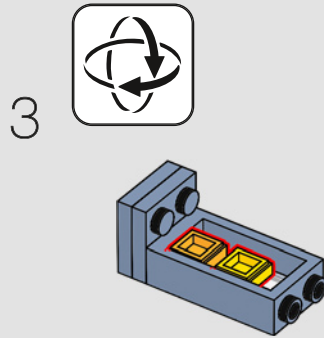
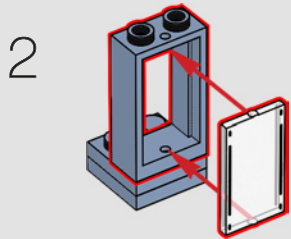
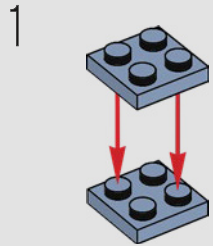

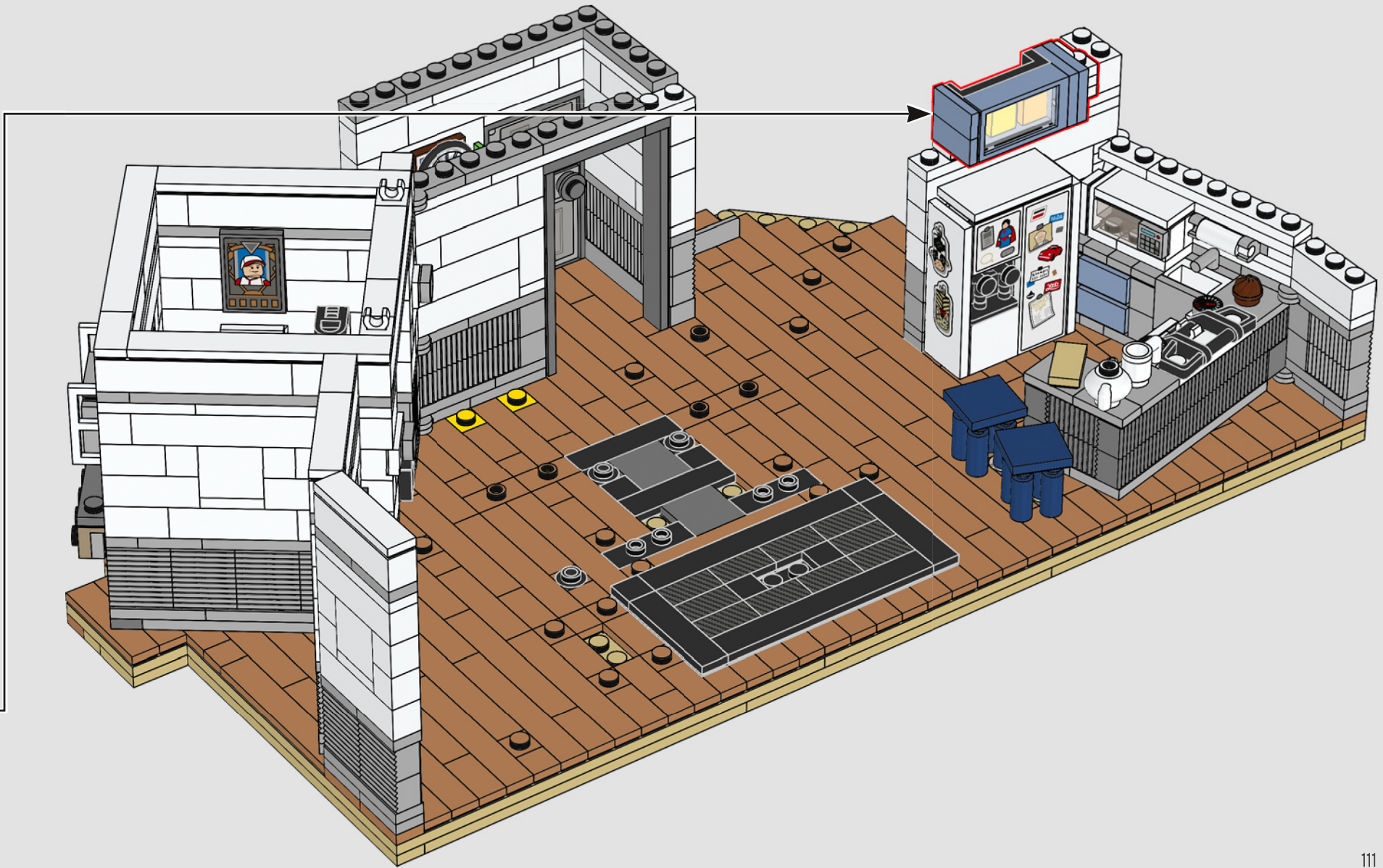

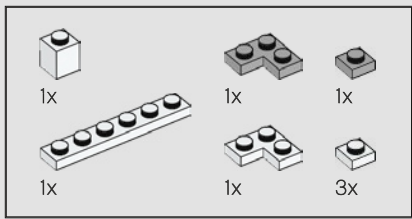

141

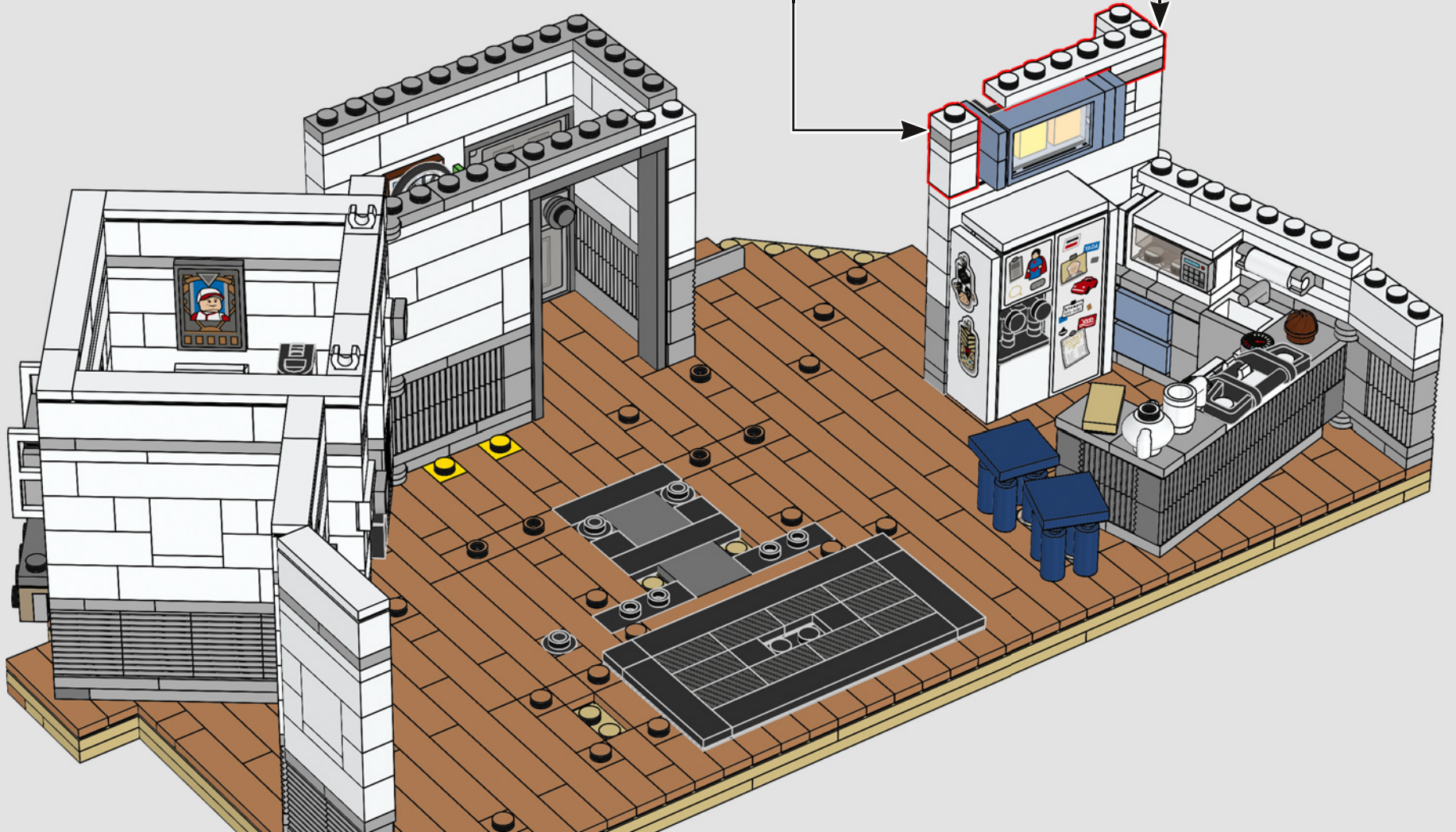
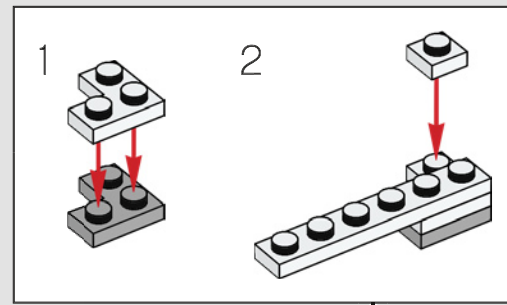
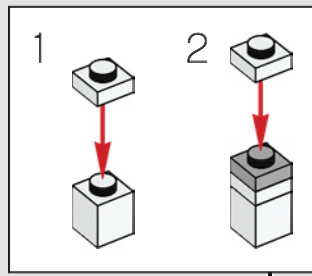



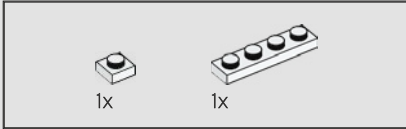
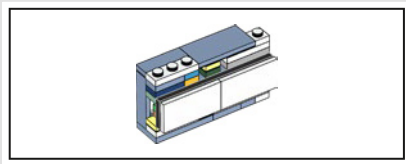

142

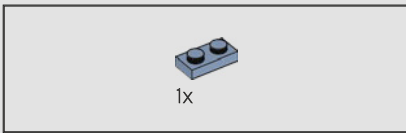
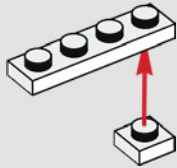

143

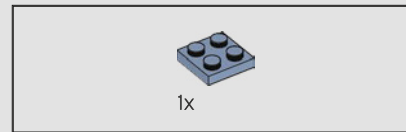
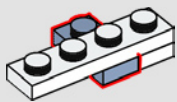

144

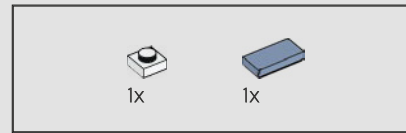
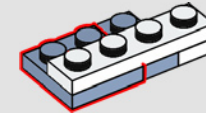

145

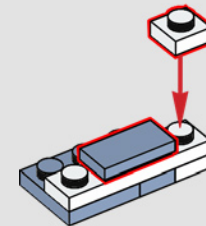



1x

146

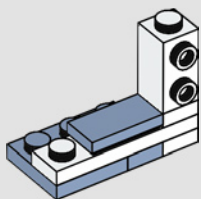

1x

1x

1x

147

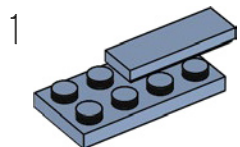

2

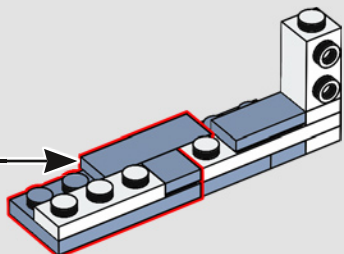
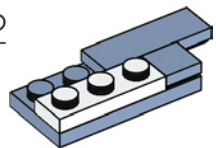

2x

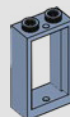

2x

148

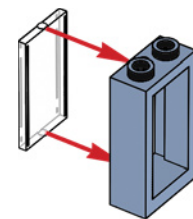
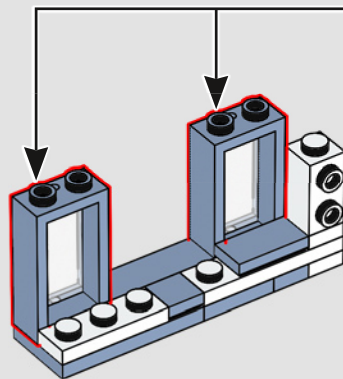

2x



1x



1x



1x



1x

149

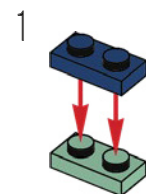

1

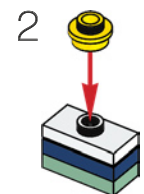

2

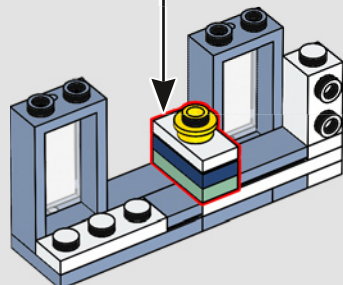

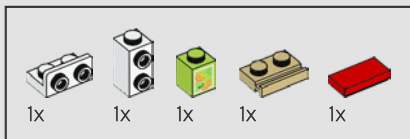

150

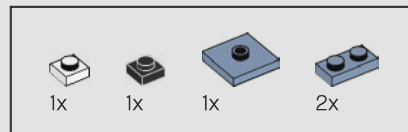
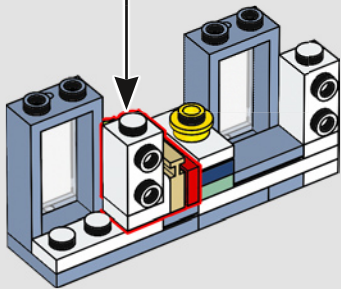
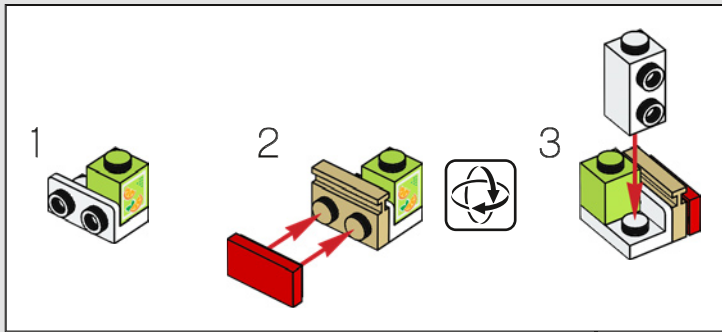

151

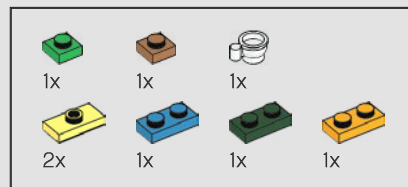
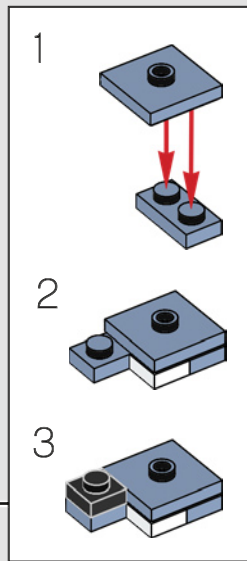
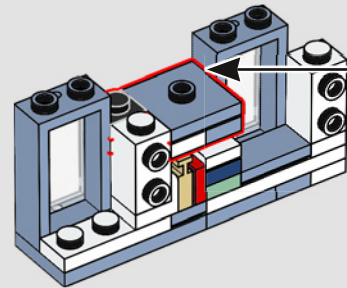

152

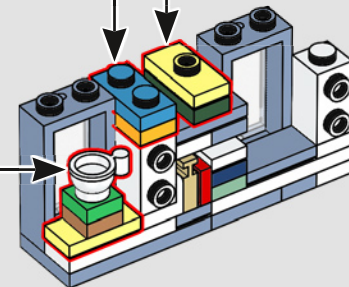
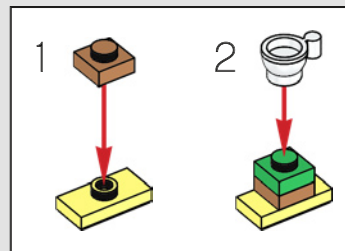
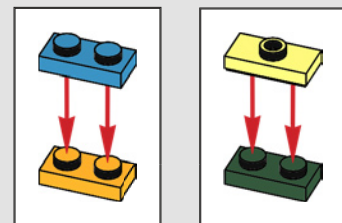

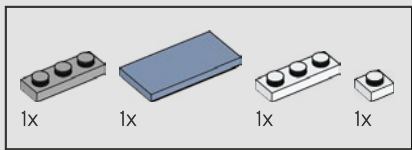

153

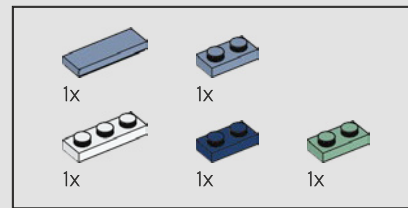
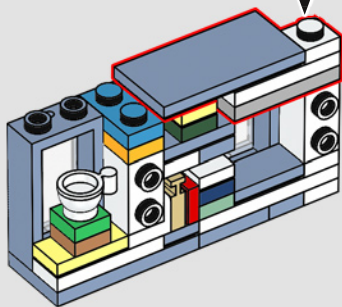
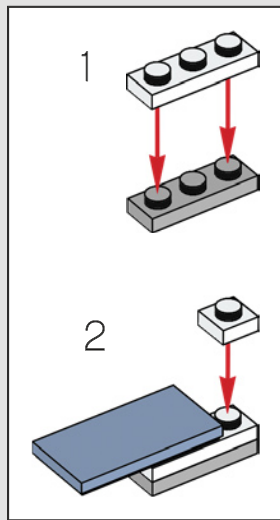

154

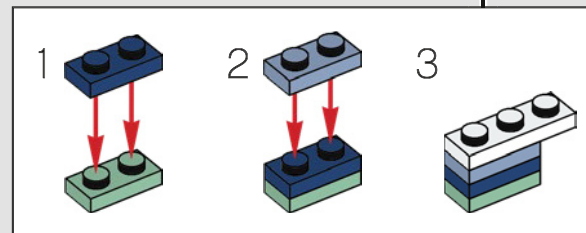
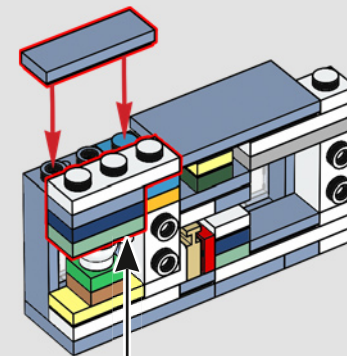

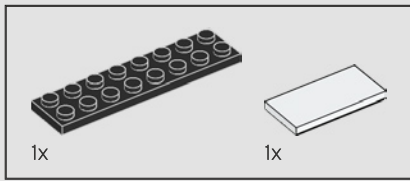

155

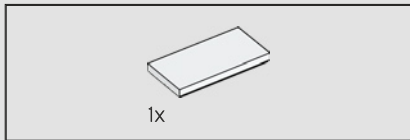
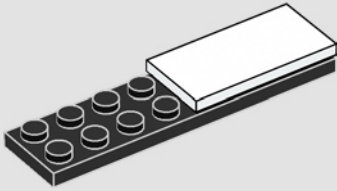

156

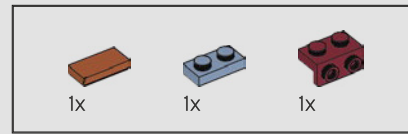
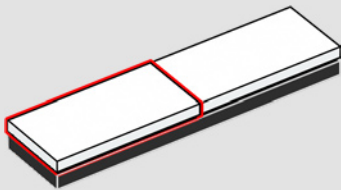

157

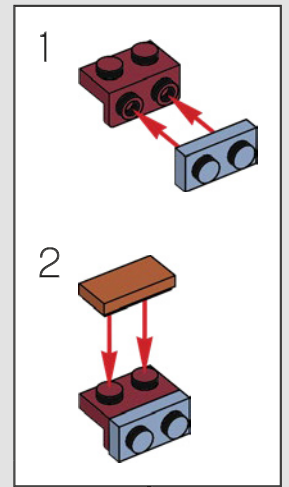
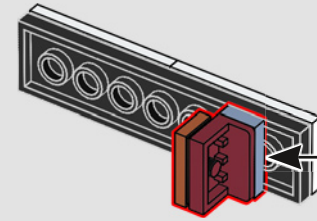

158

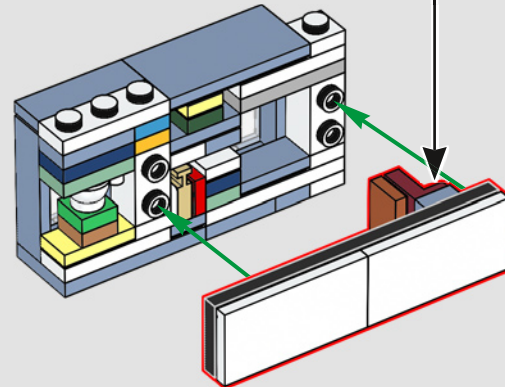

159

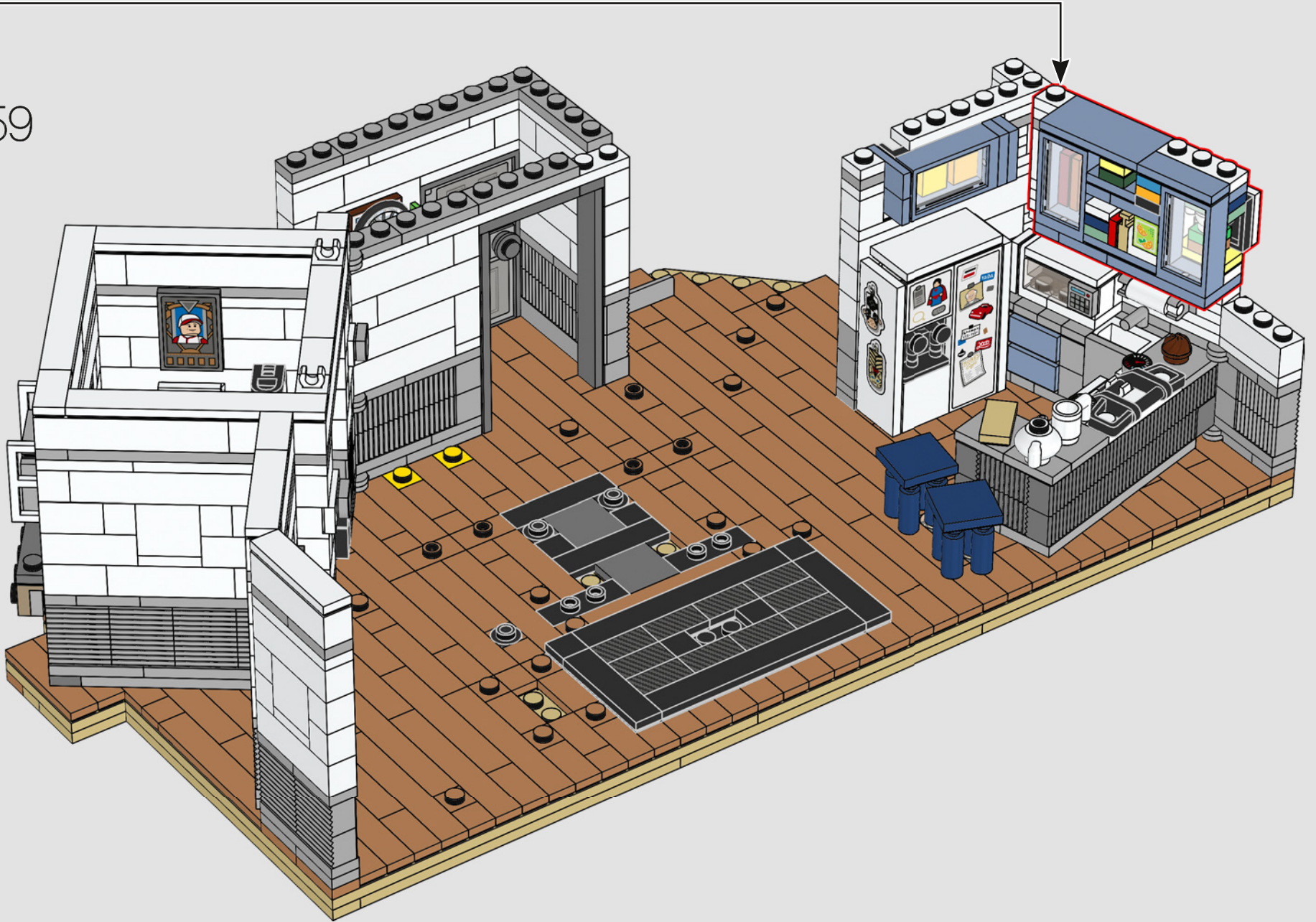

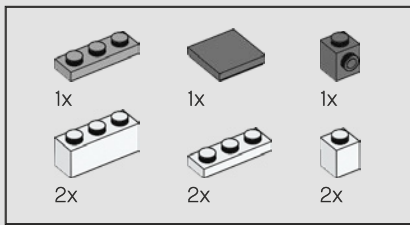

160

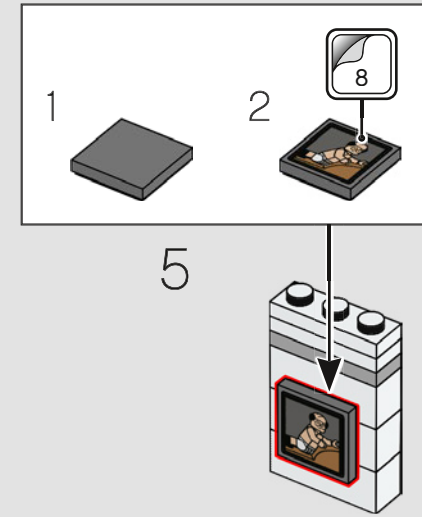
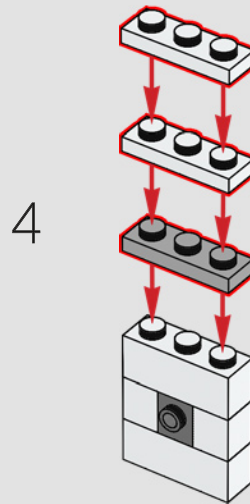
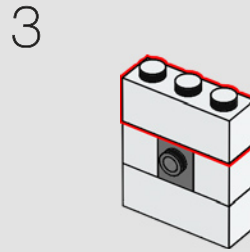
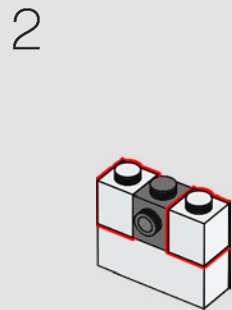
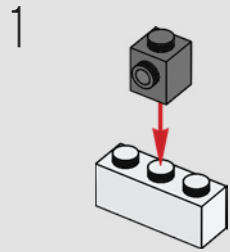

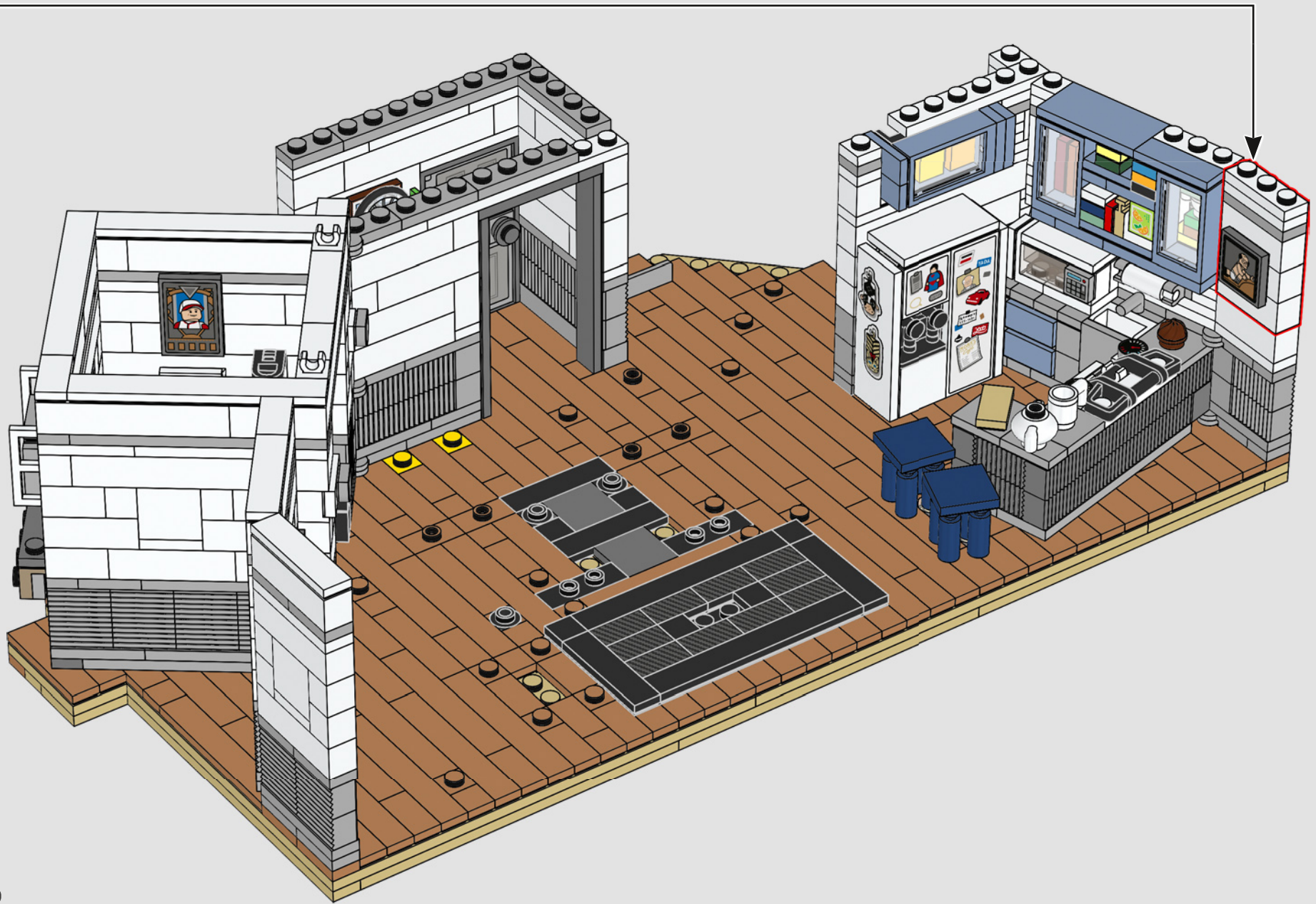



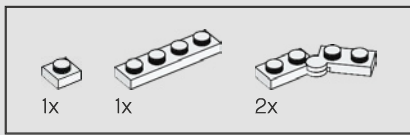

161

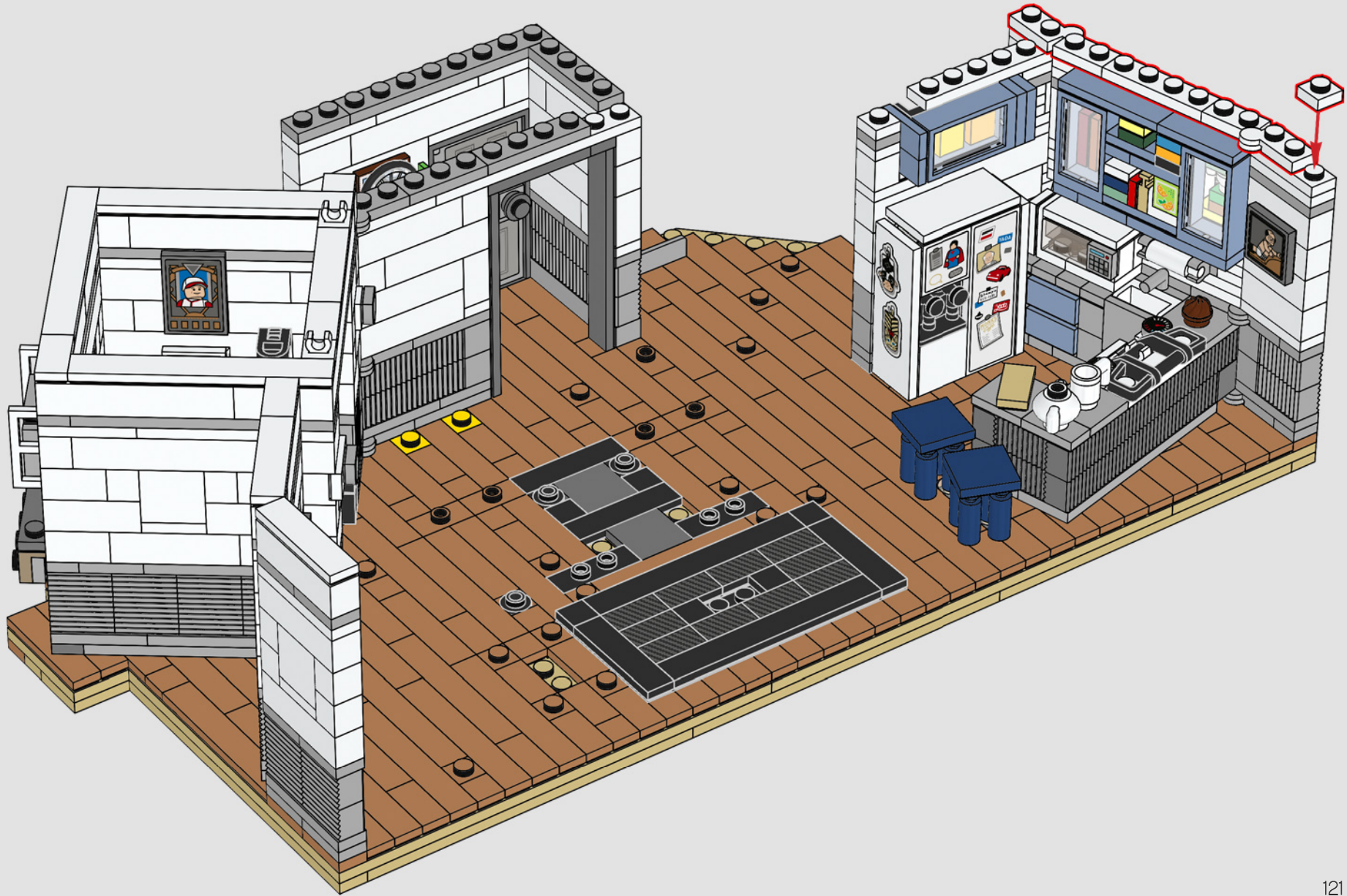

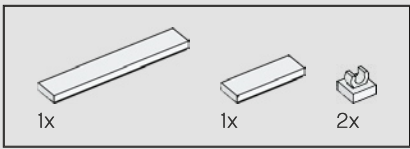

162

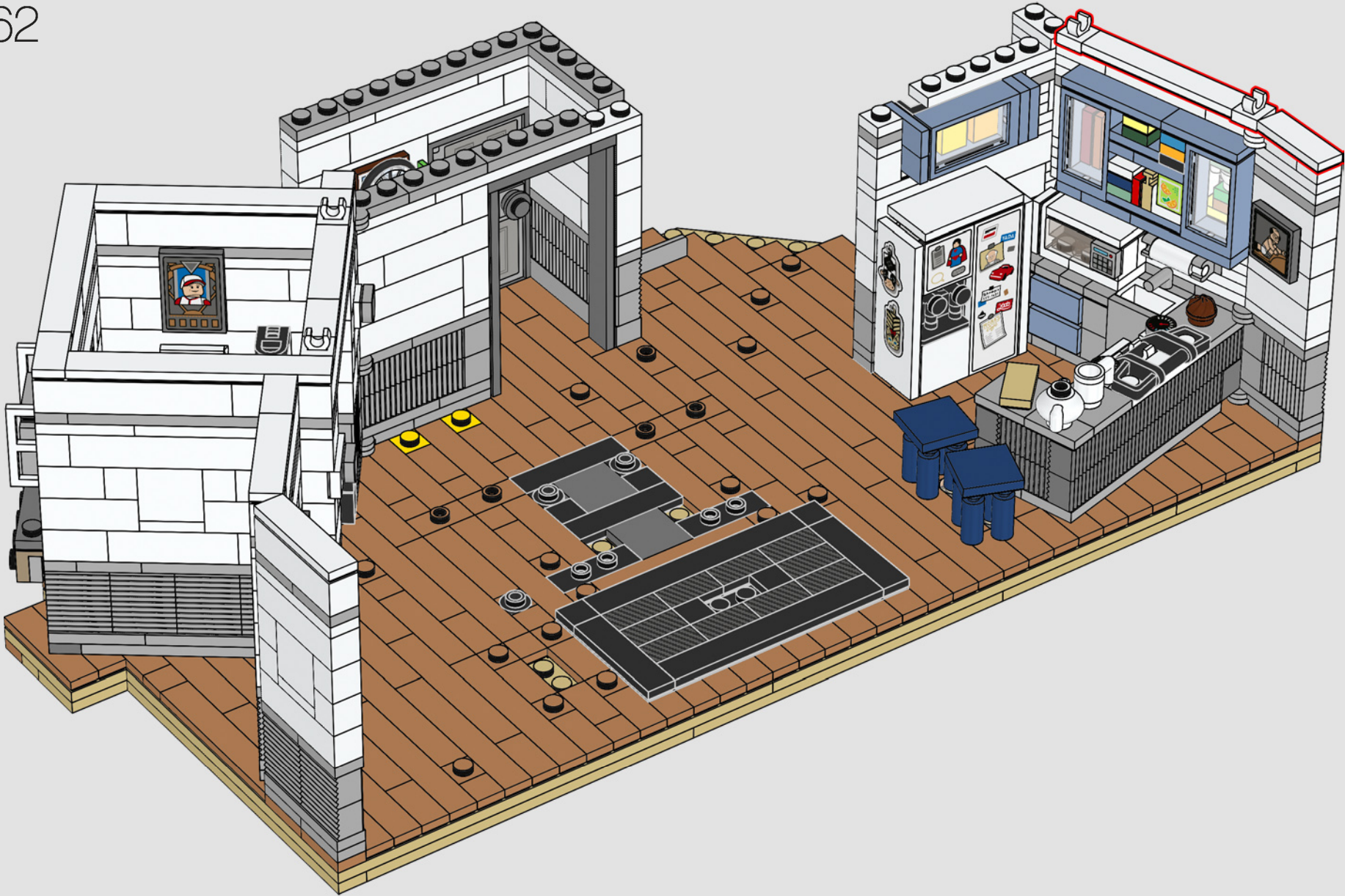

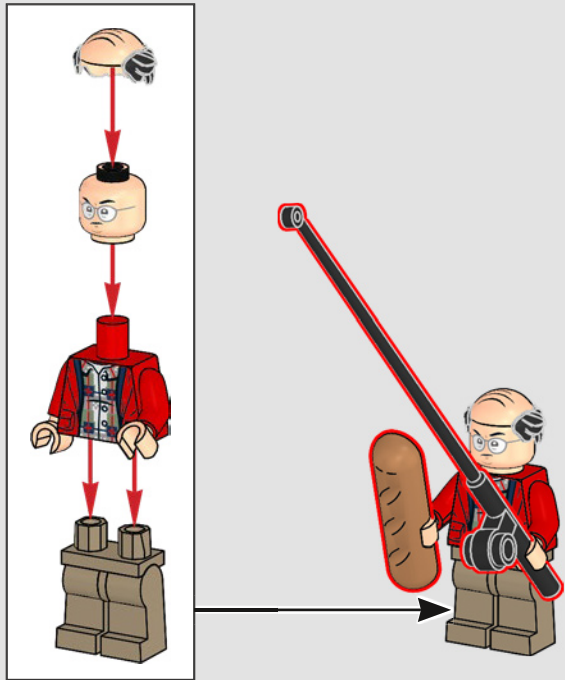
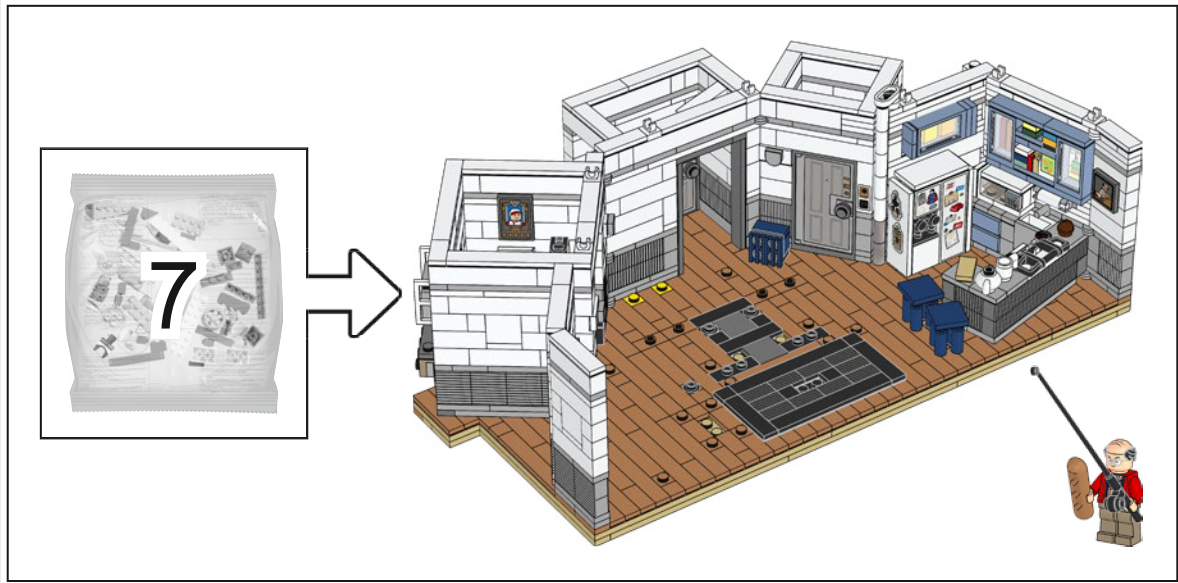

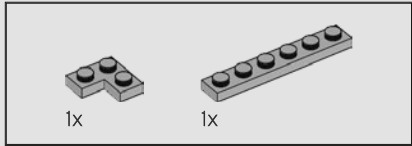
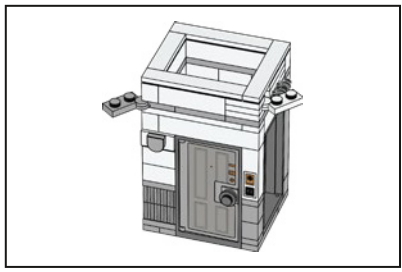

163

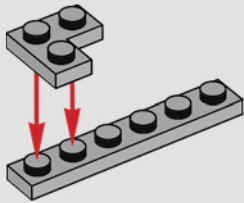

164

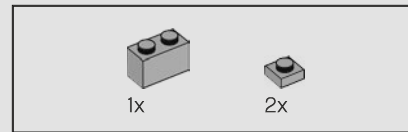
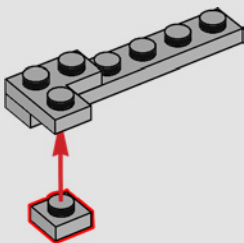

165

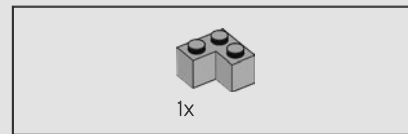
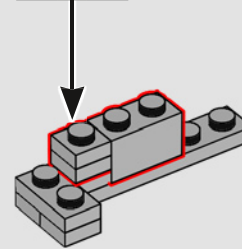
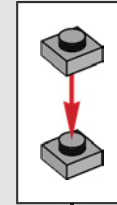

166

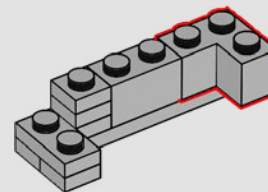

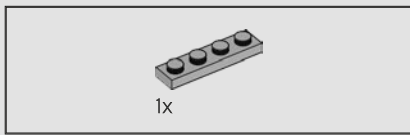

167

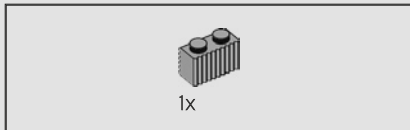
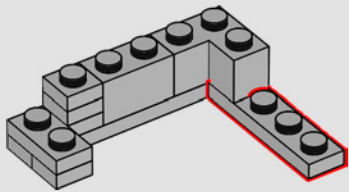

168

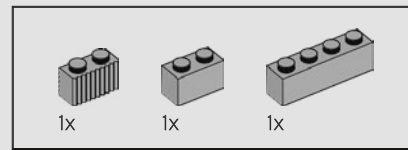
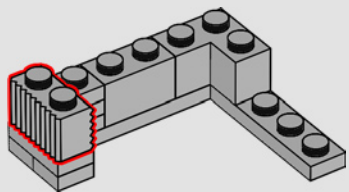

169

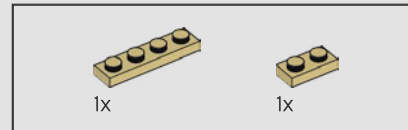
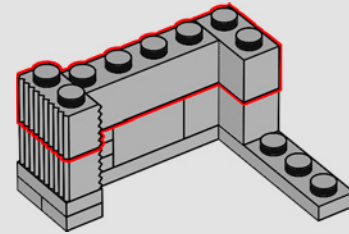

170

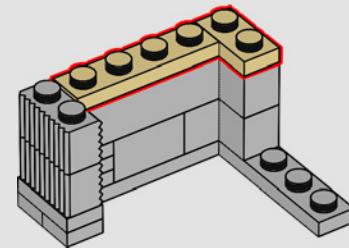

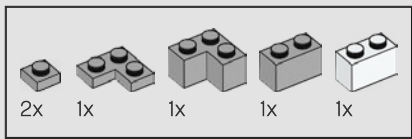

171

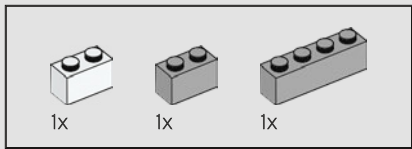
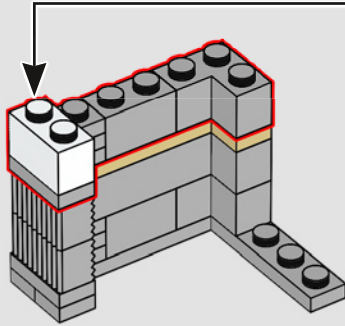
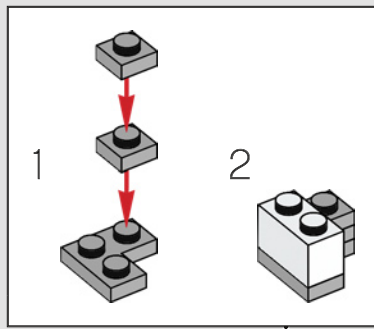

172

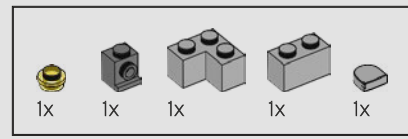
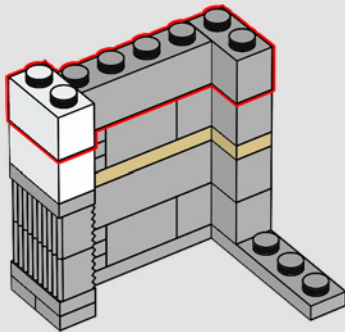

173

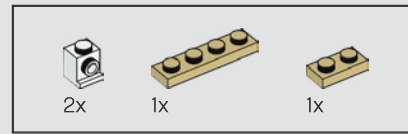
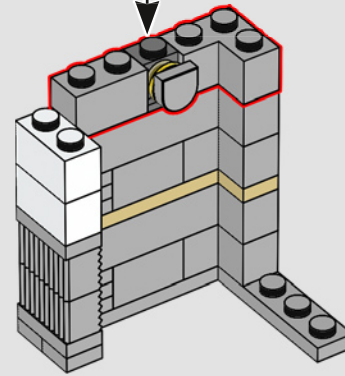
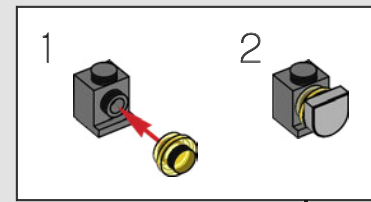

174

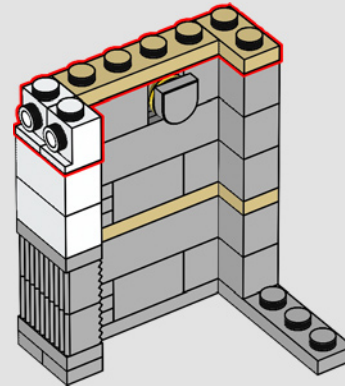

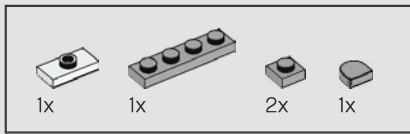

175

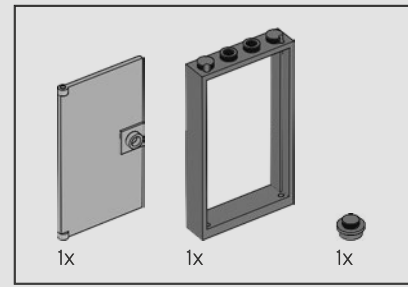
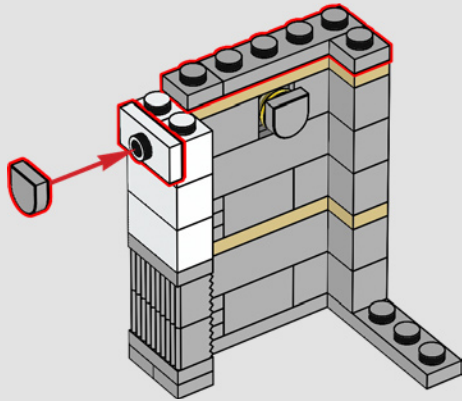

176

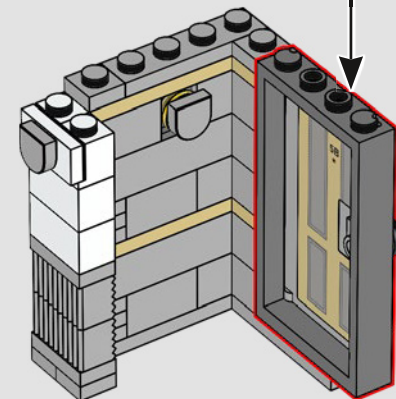
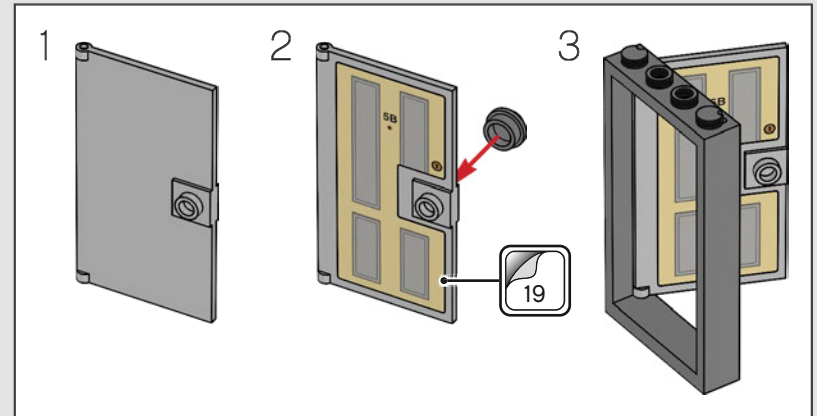

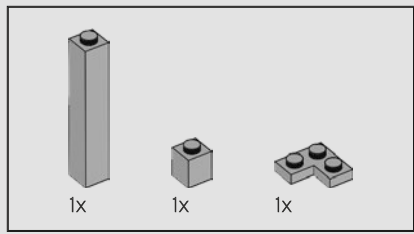

177

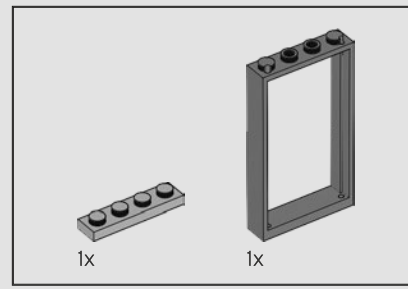
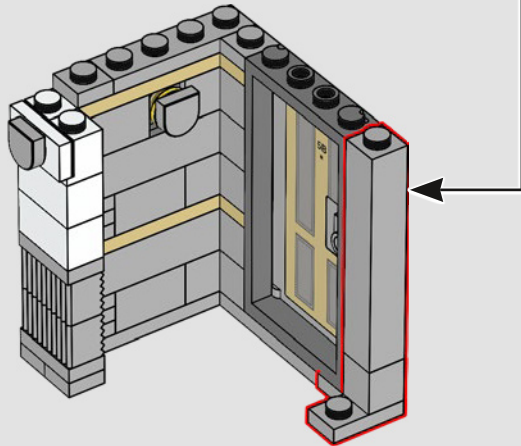
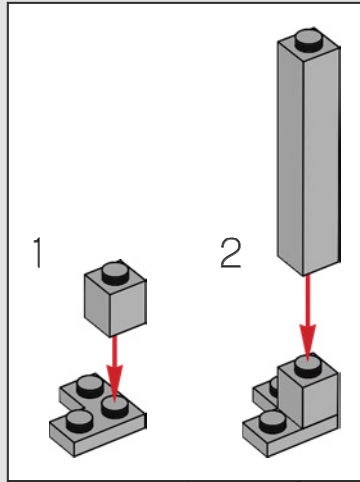

178

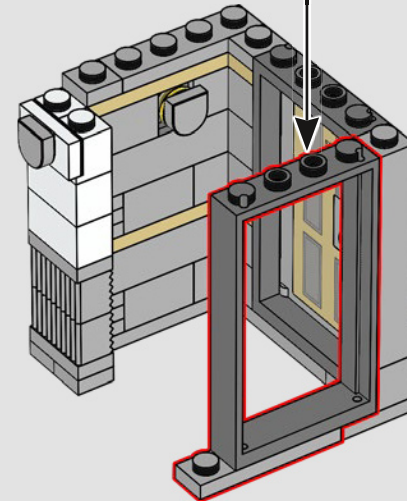
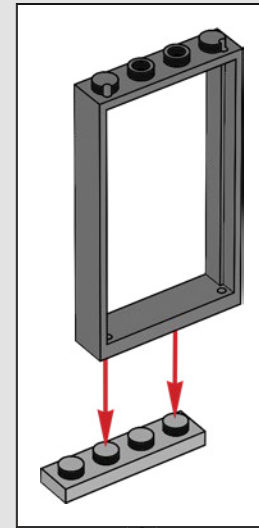



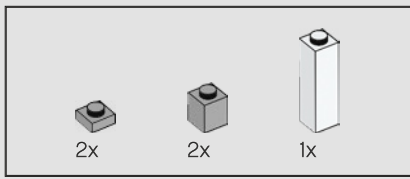

179

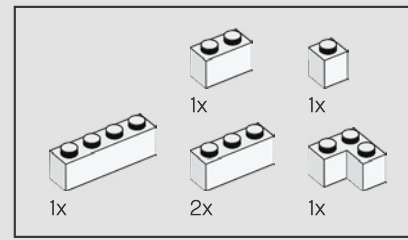
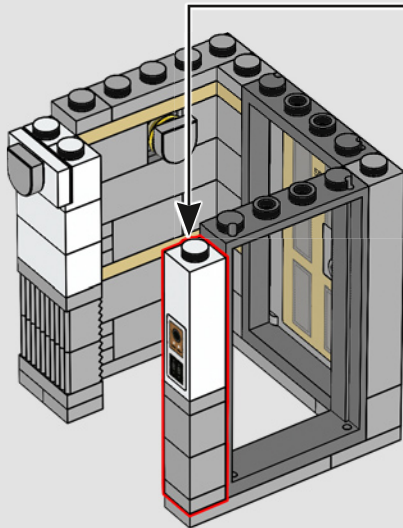
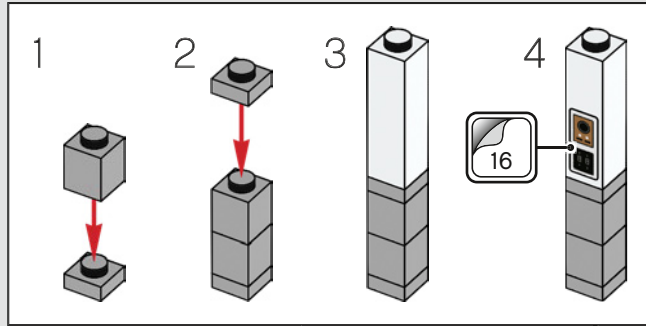

180

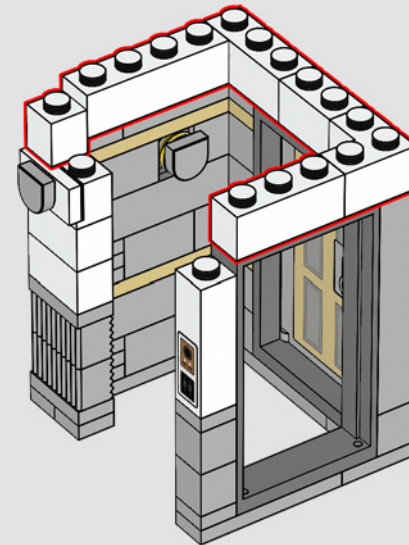

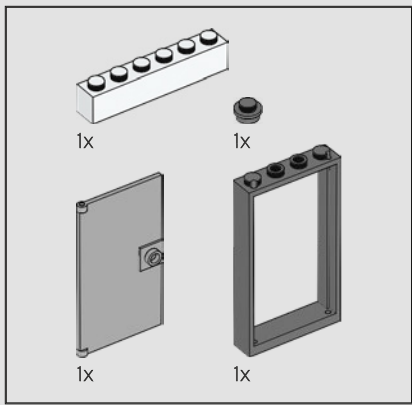

181

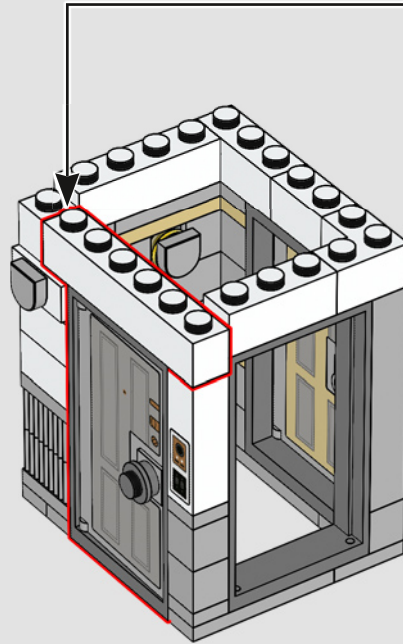
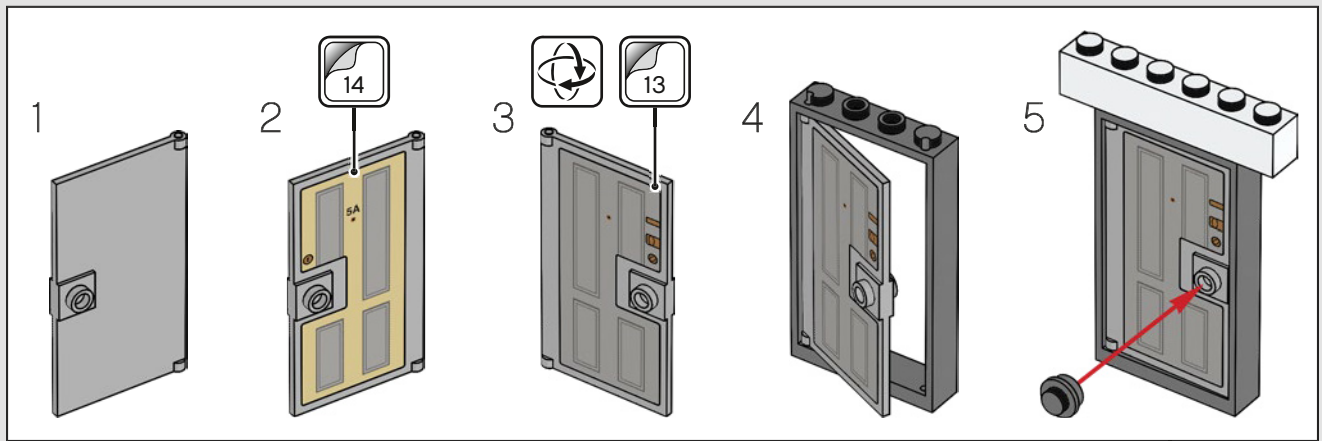

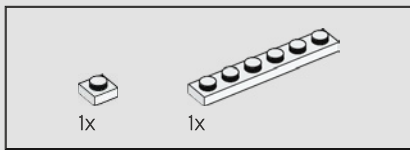

182

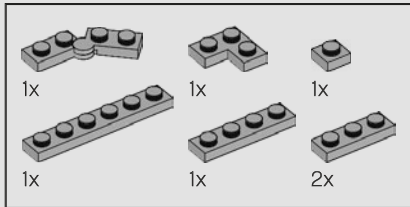
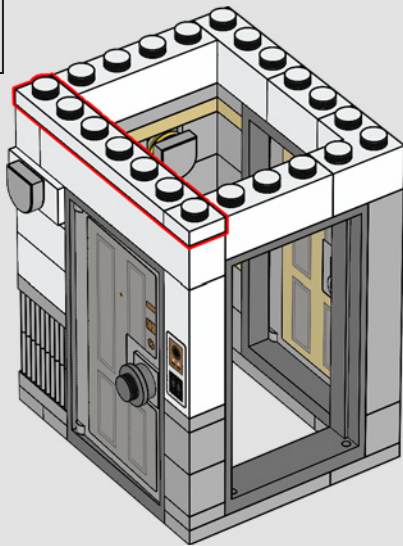

183

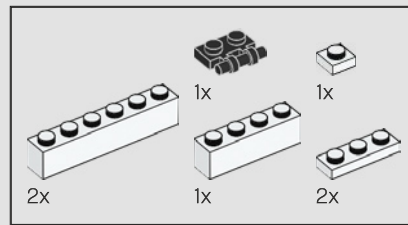
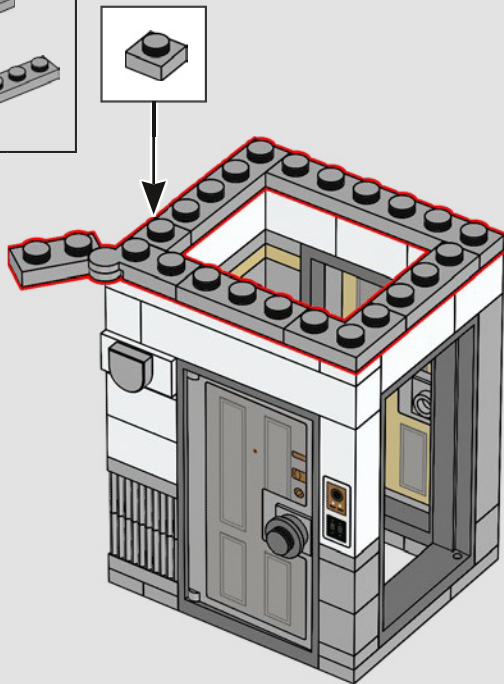

184

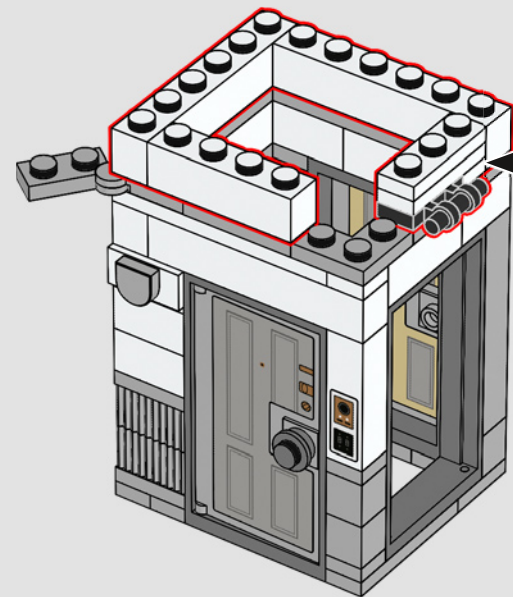
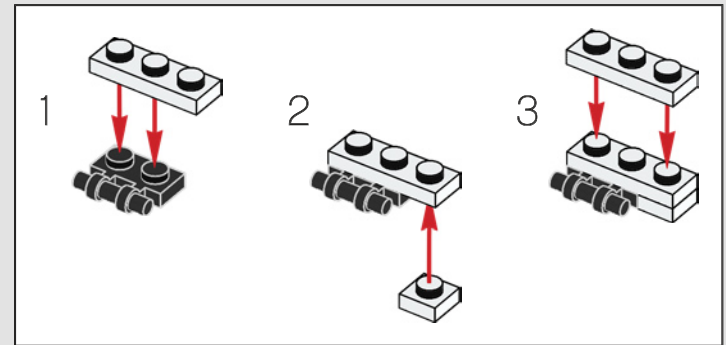

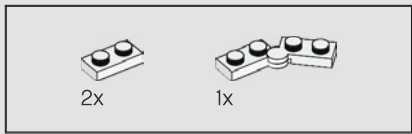

185

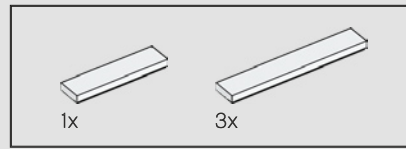
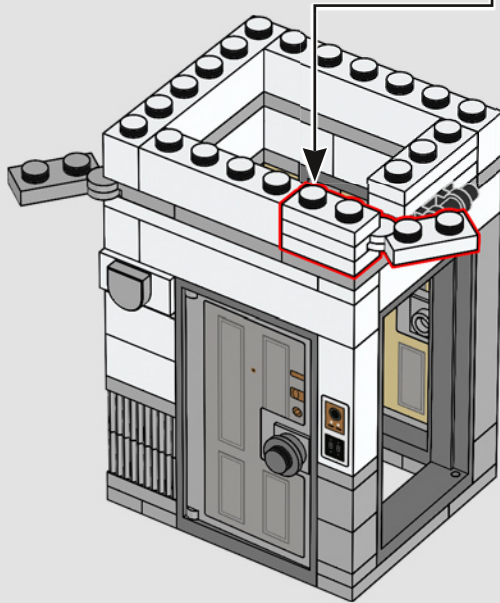
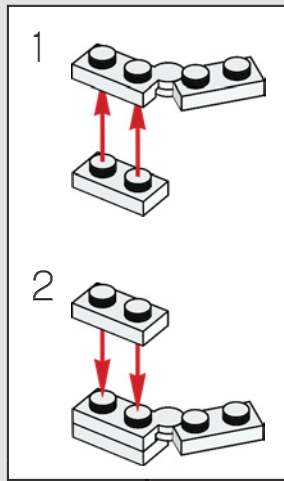

186

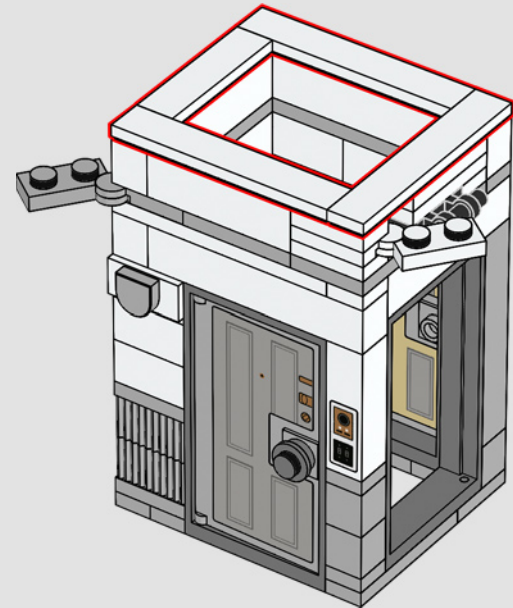

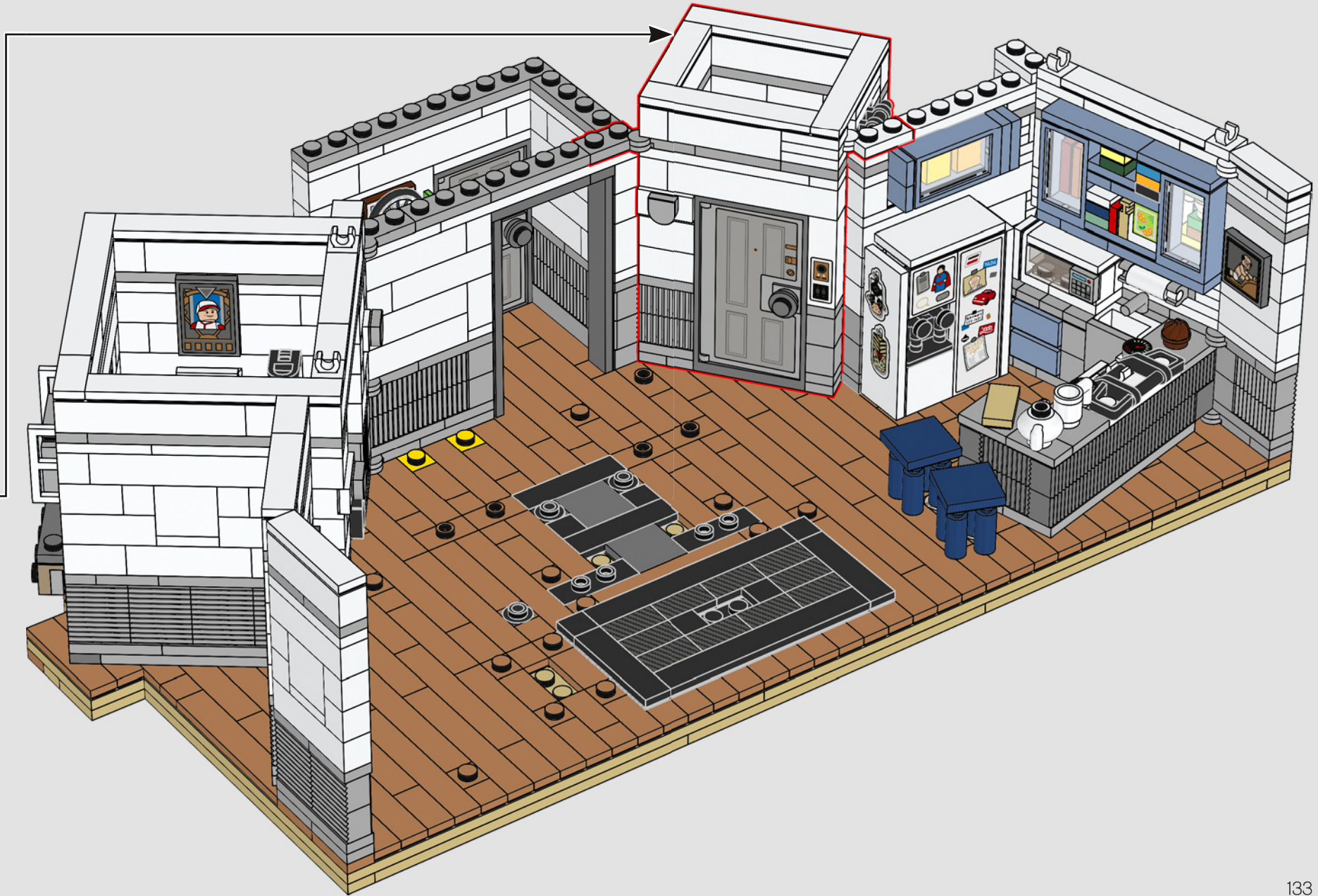

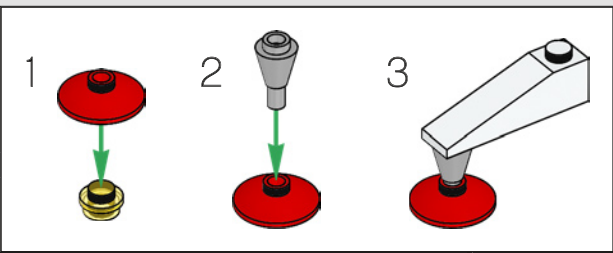
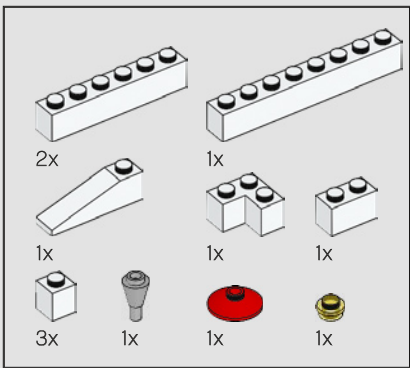

188

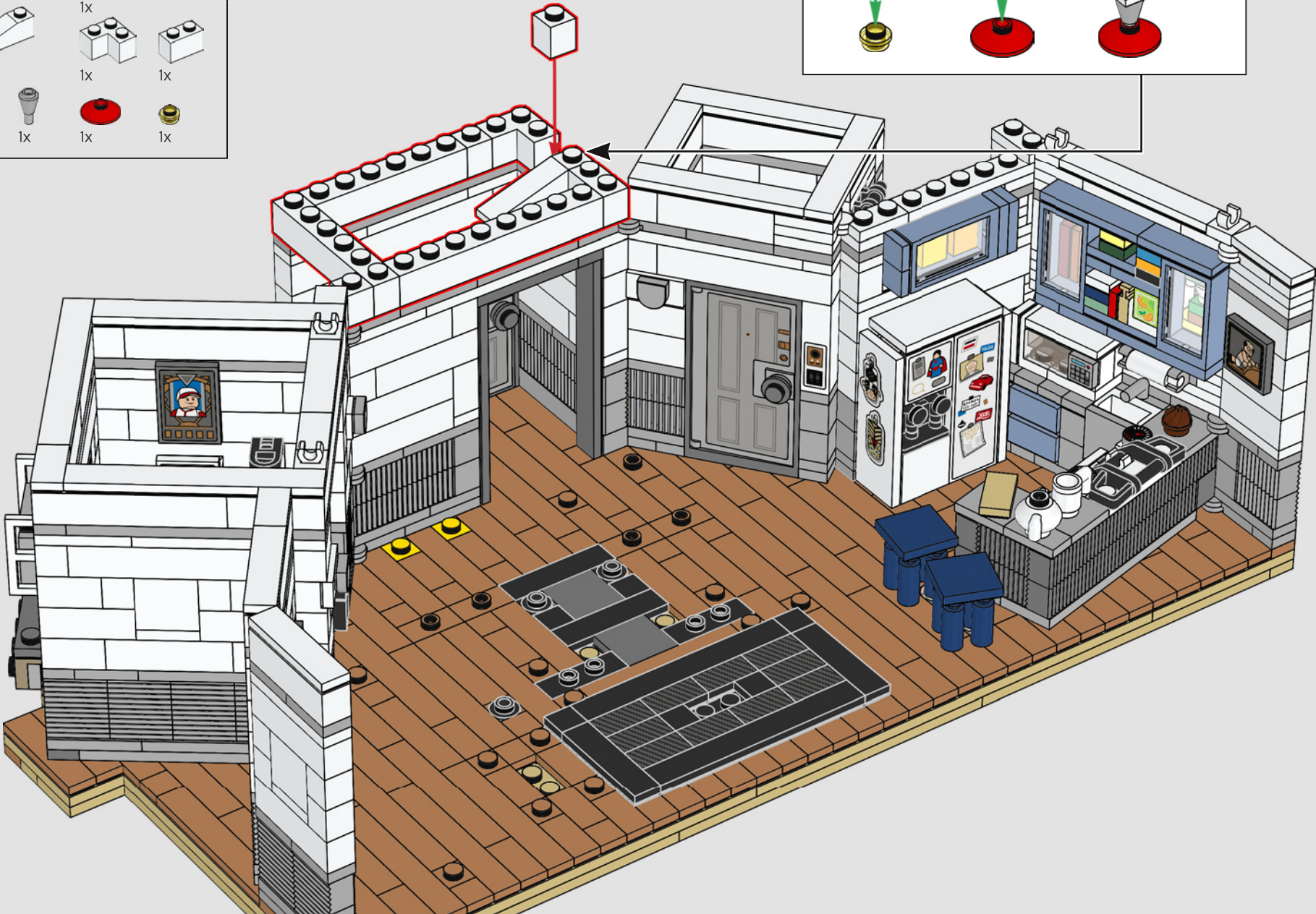

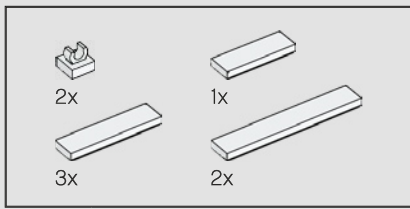

189

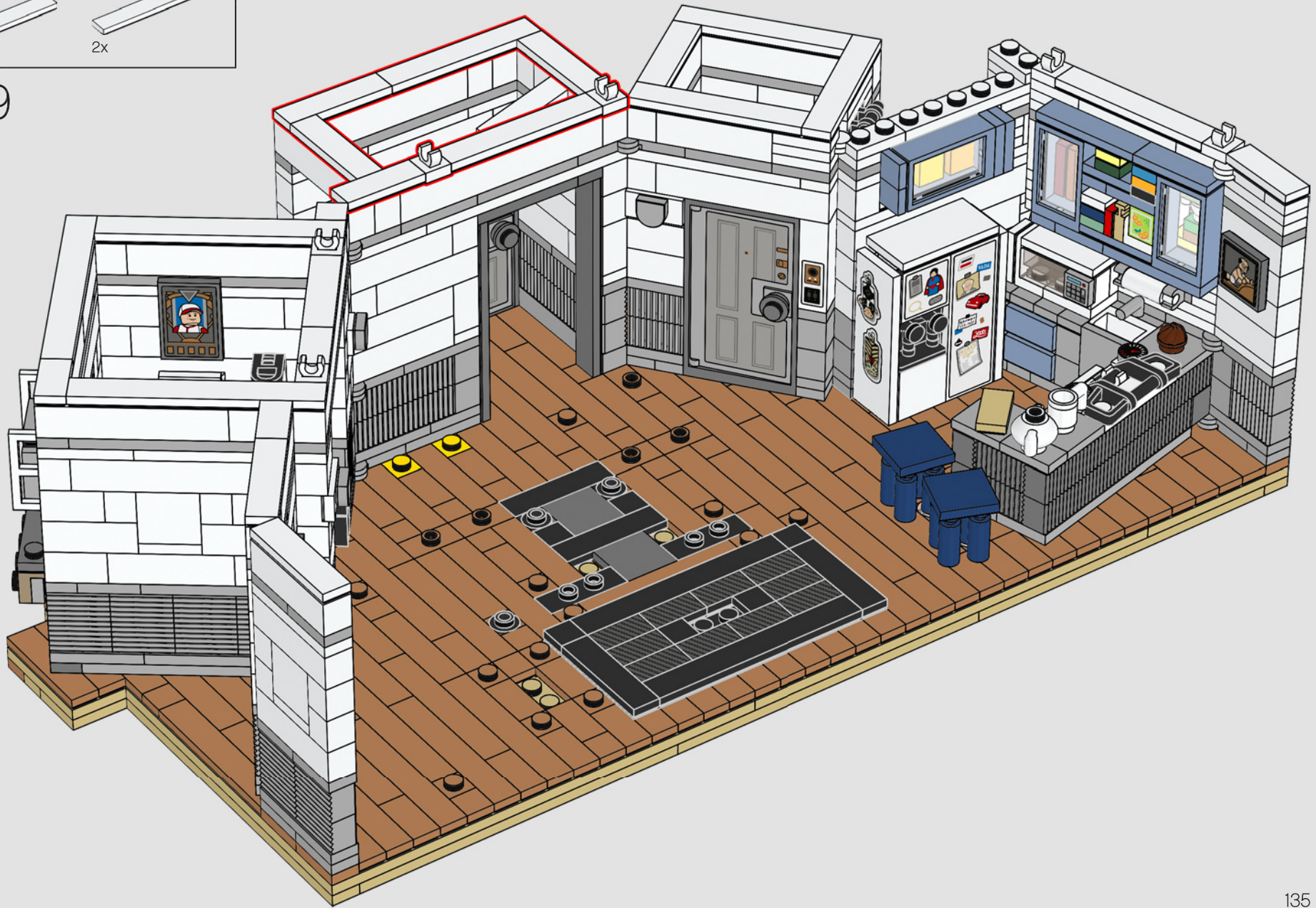

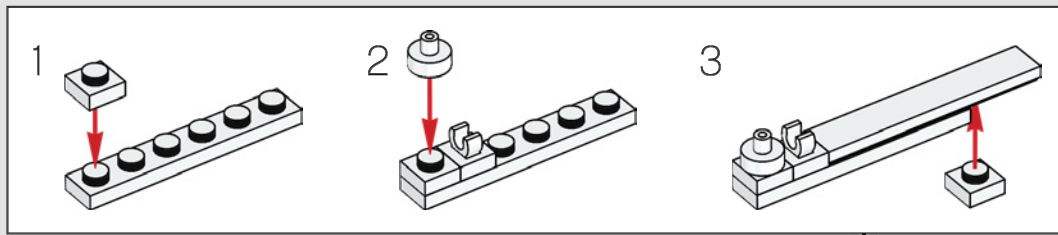
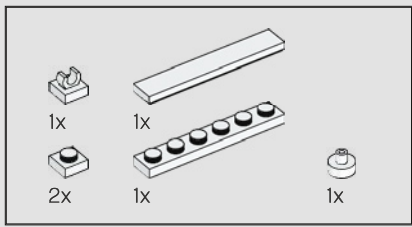

190

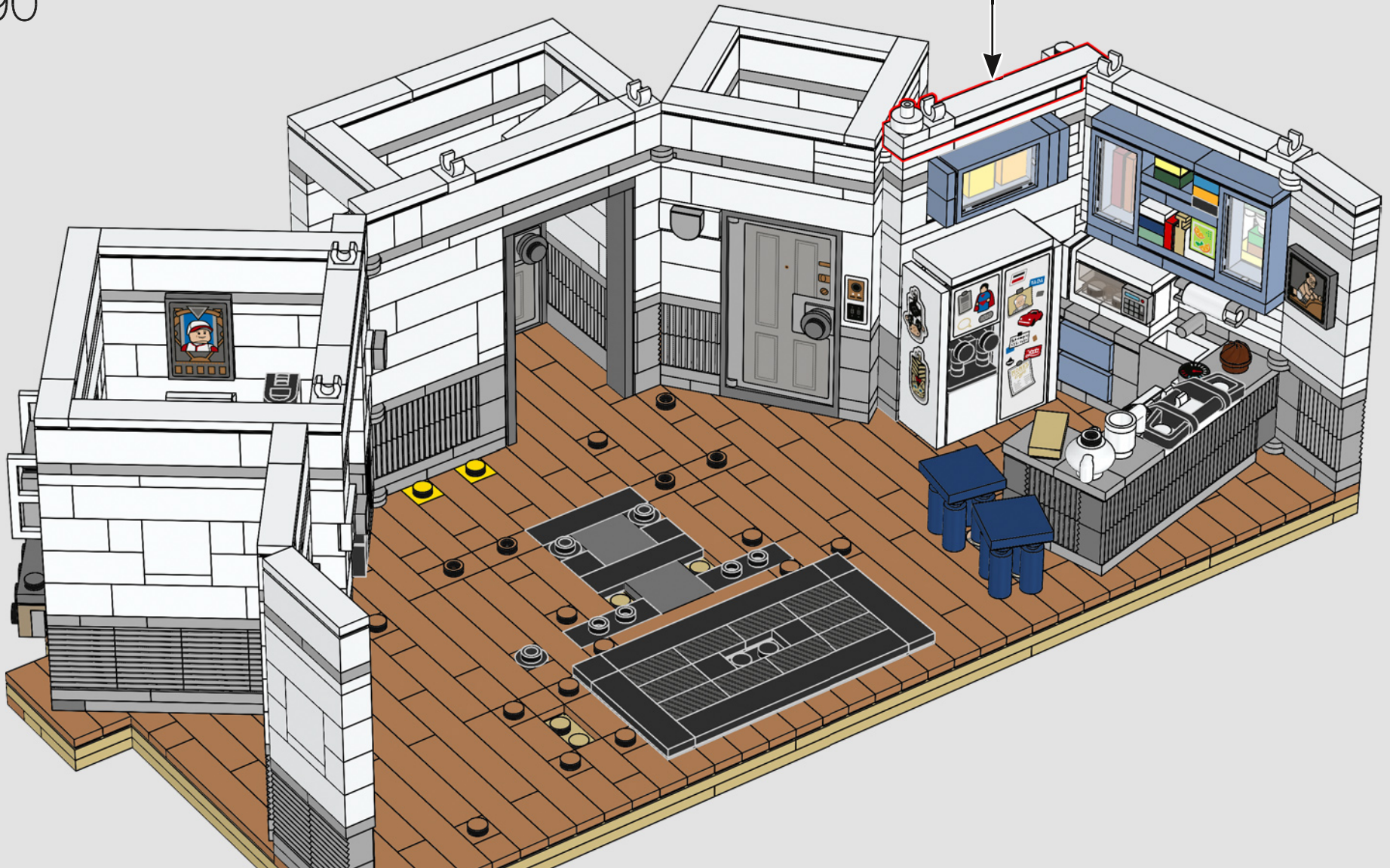



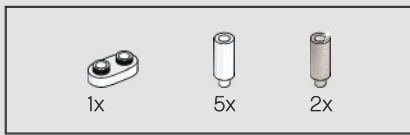

191

1



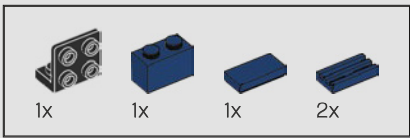

192

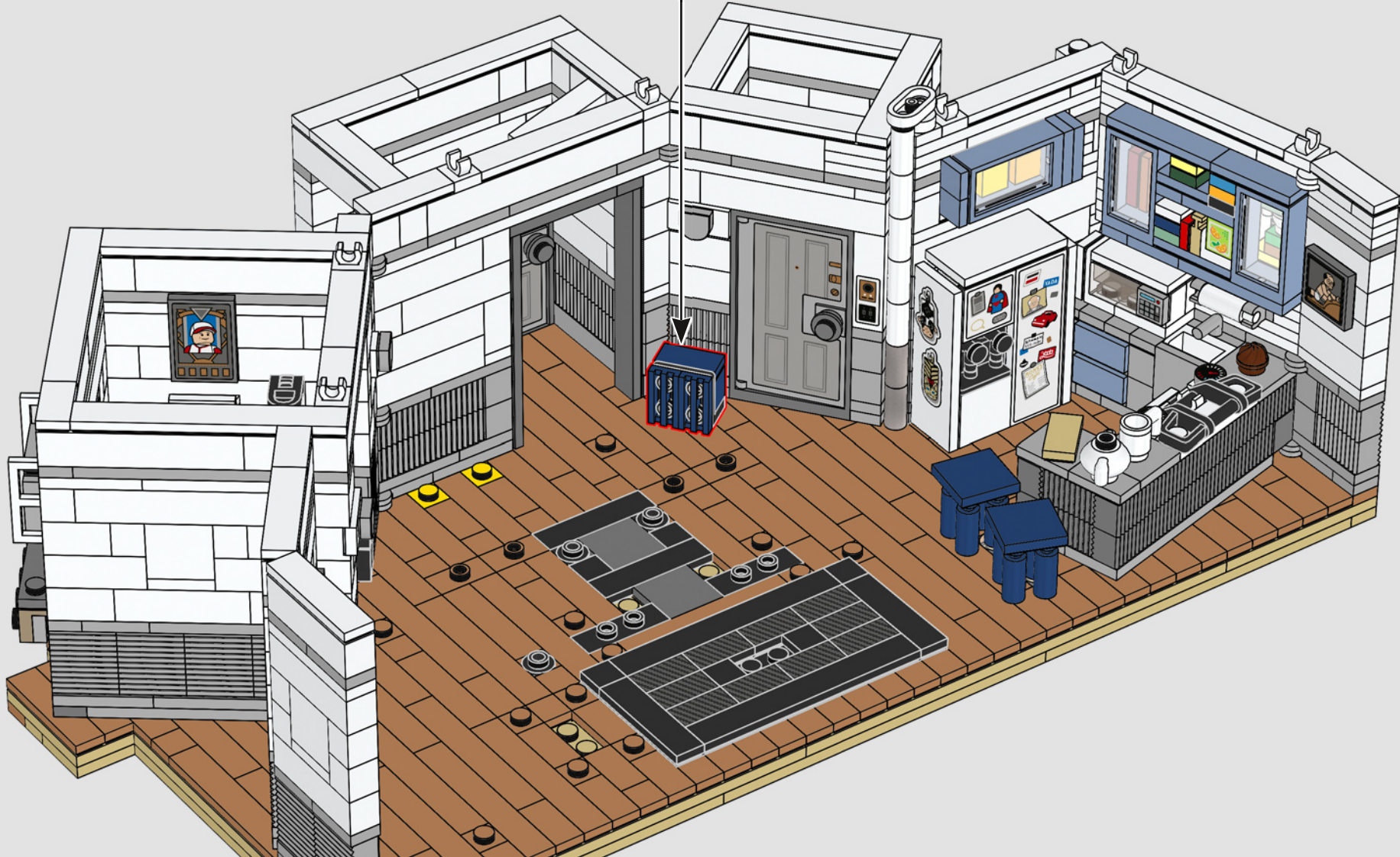
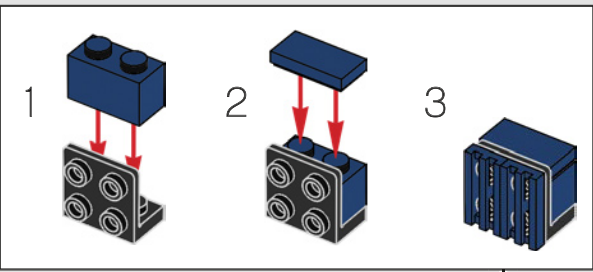

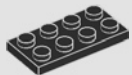
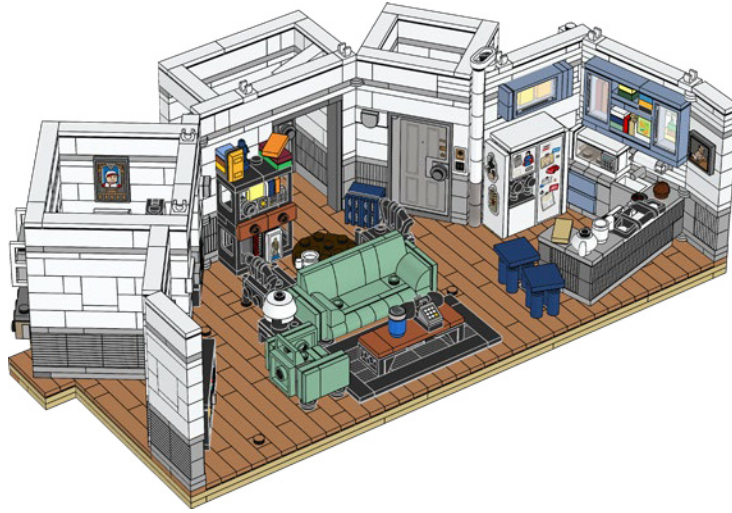
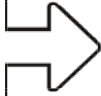

1x



1x

193

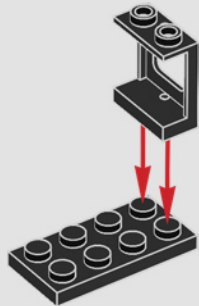

1x



1x

194

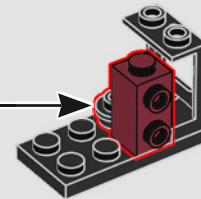

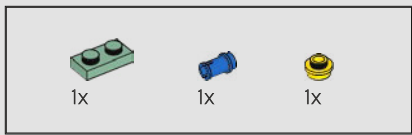

195

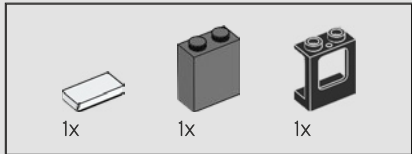
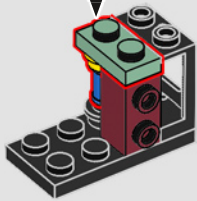
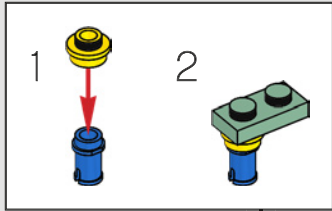

196

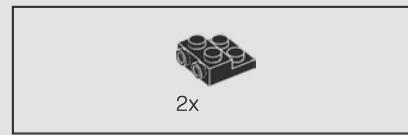
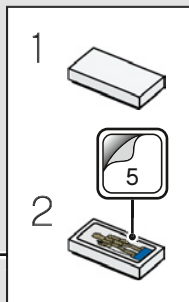
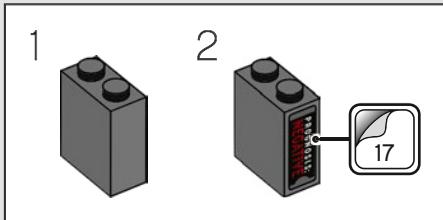

197

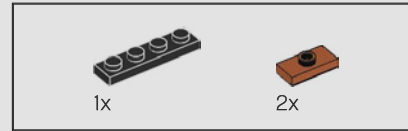
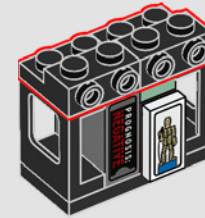

198

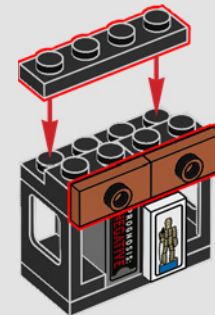

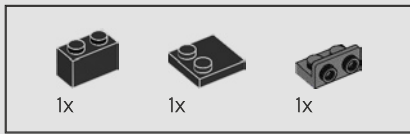

199

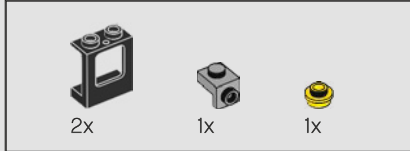
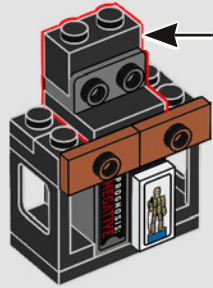
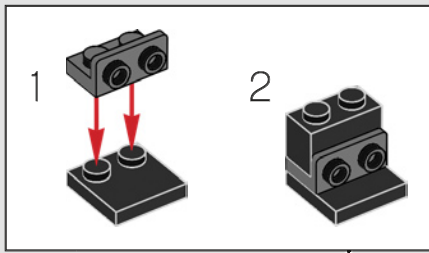

200

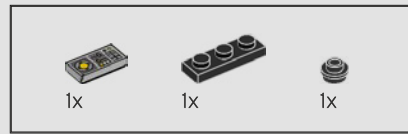
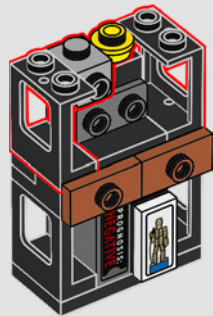

201

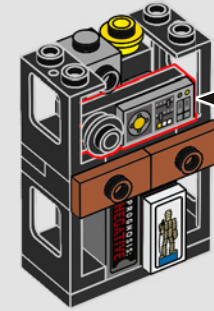
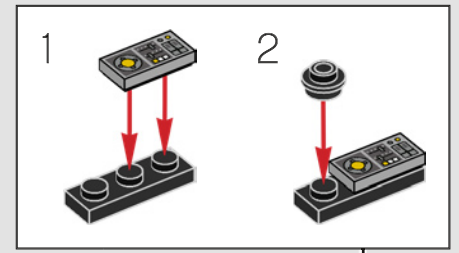

202

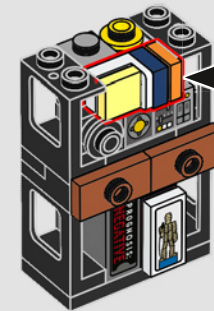
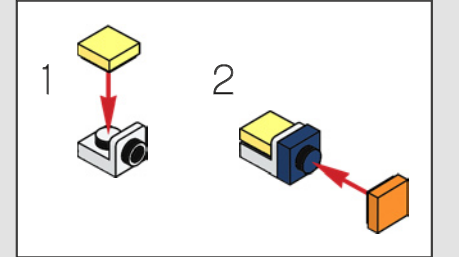



203

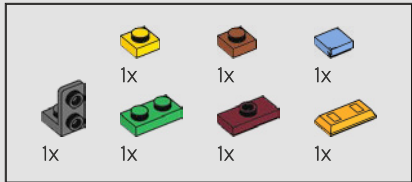
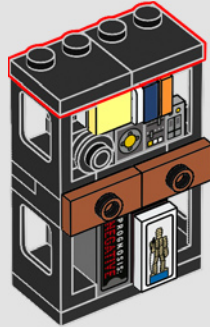

204

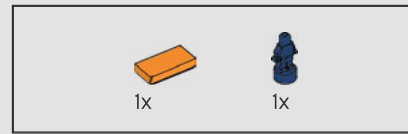
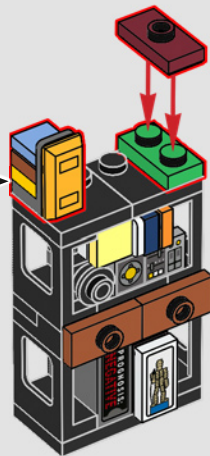
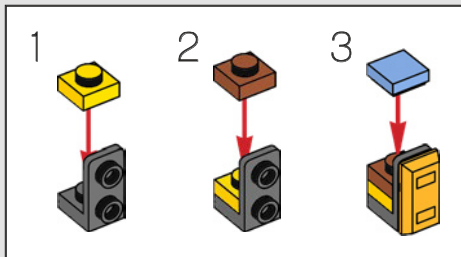

205

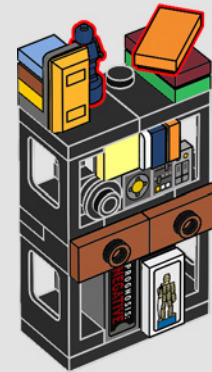

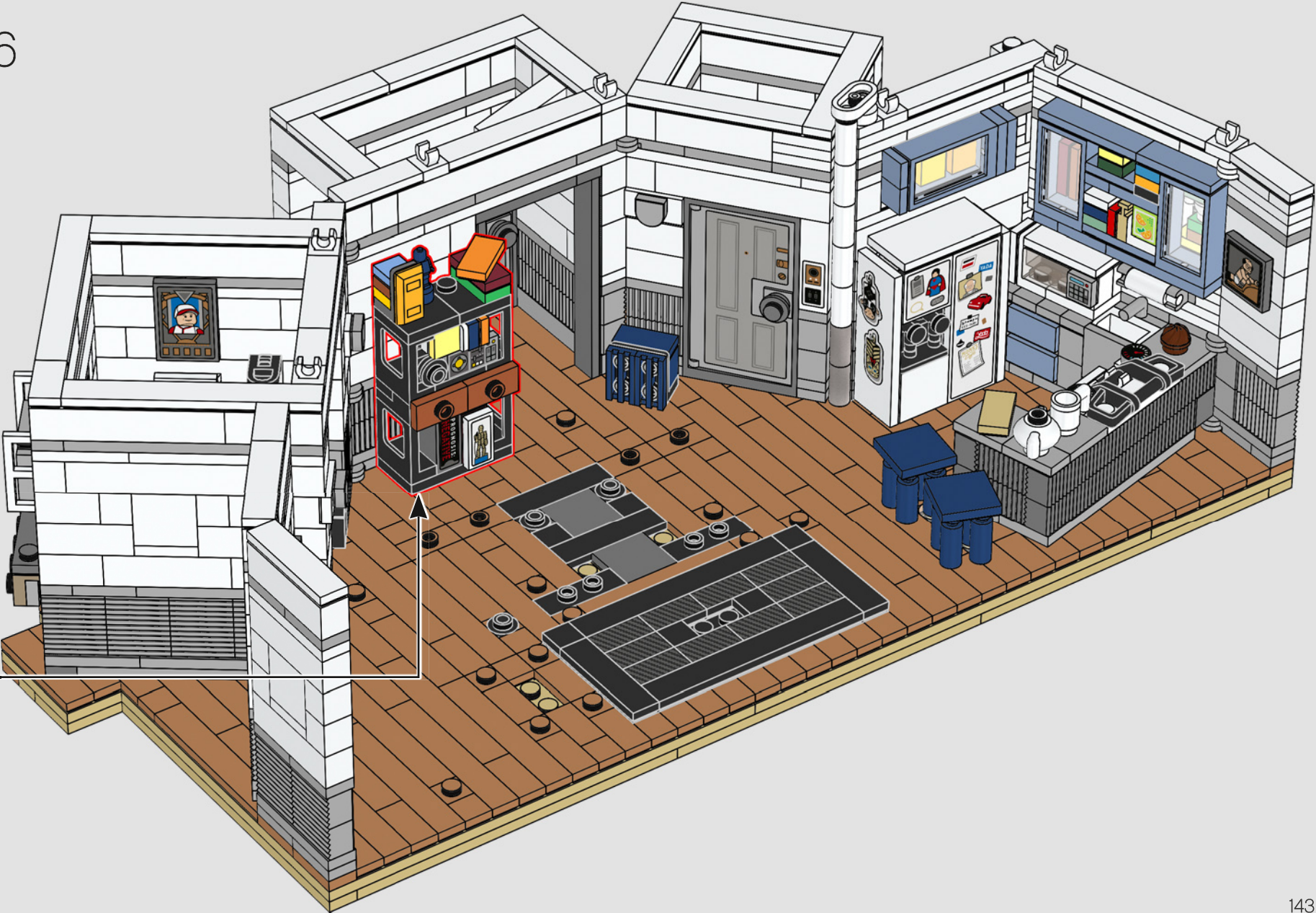

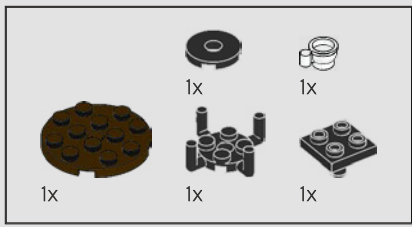

207

1

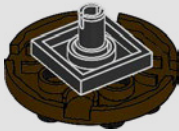

2

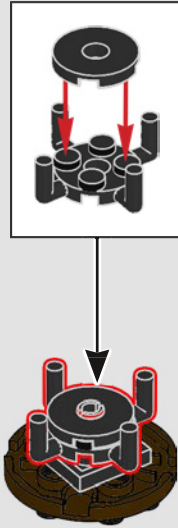

3

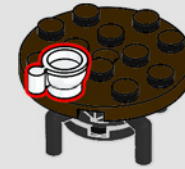
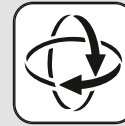







208

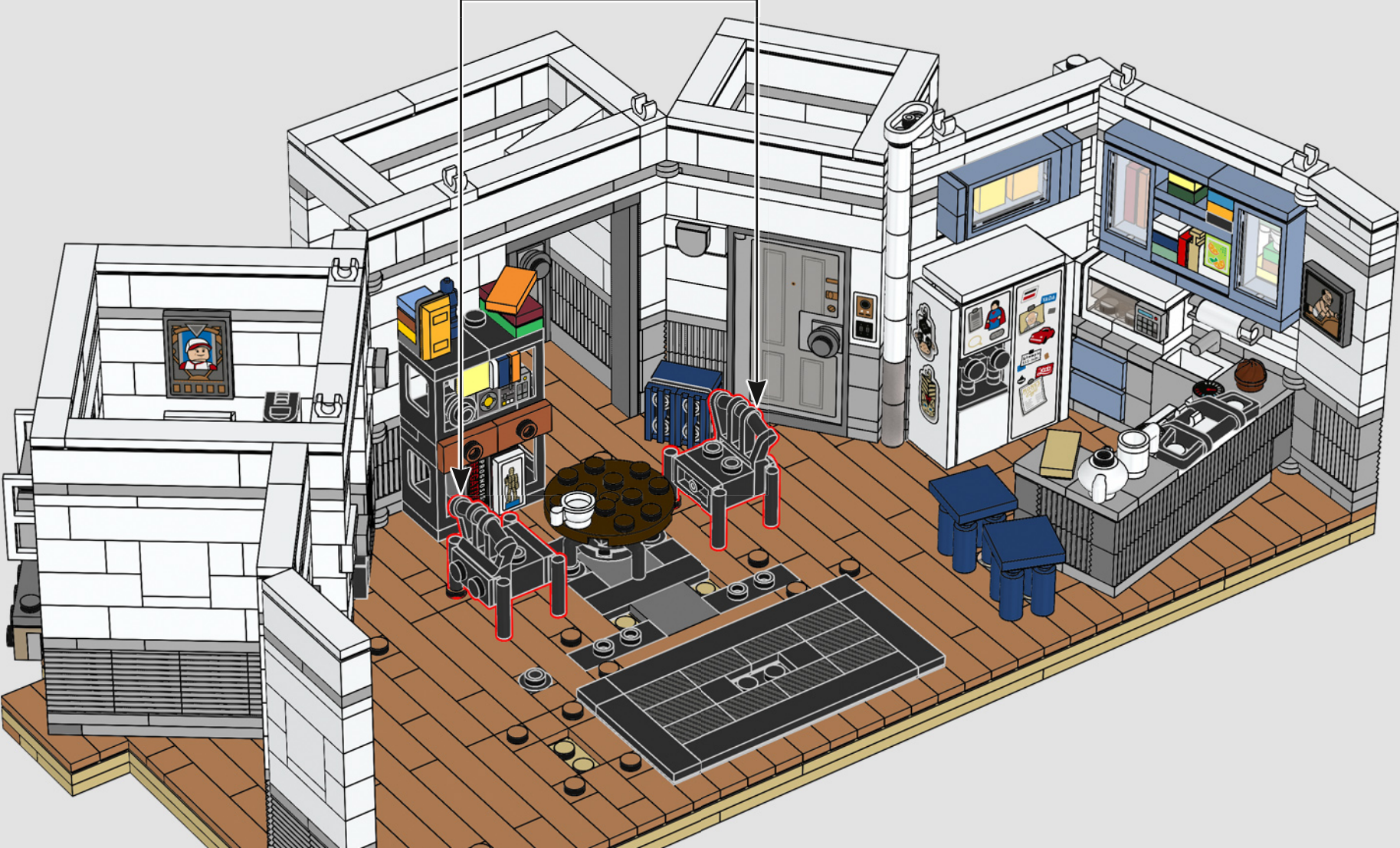
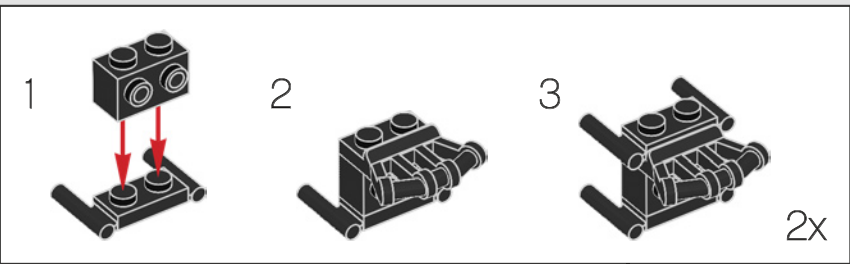

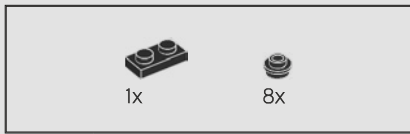

209



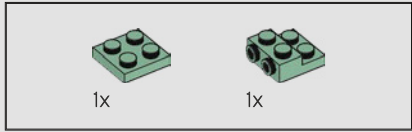
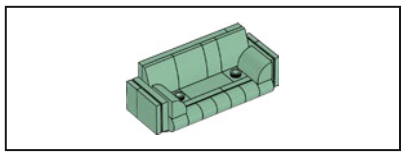

210

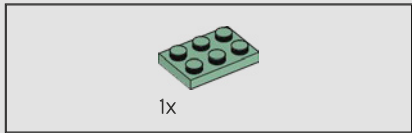
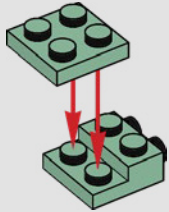

211

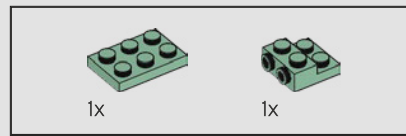
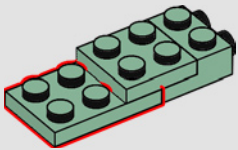

212

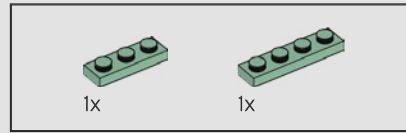
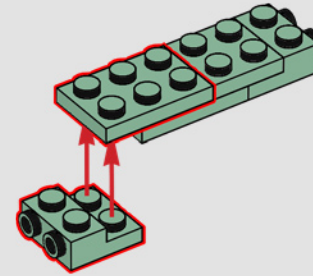

213

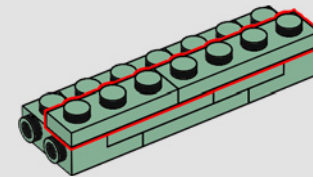

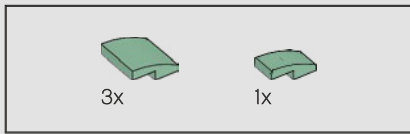

214

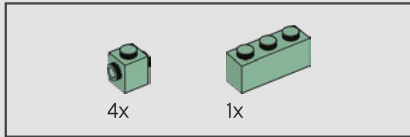
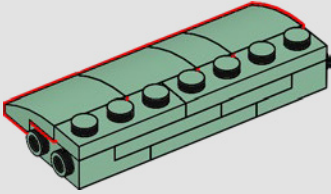

215

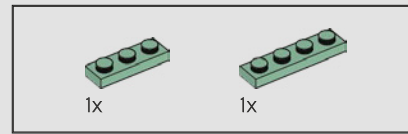
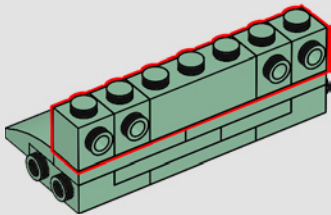

216

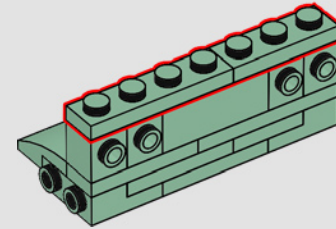

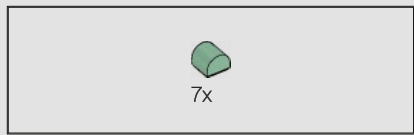

217

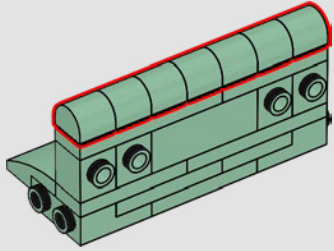

218

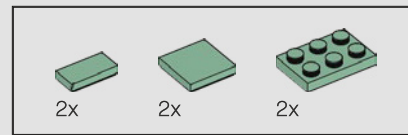
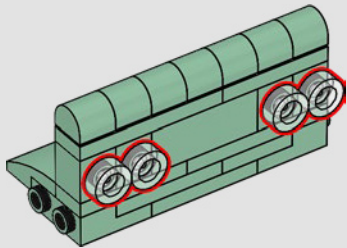

219

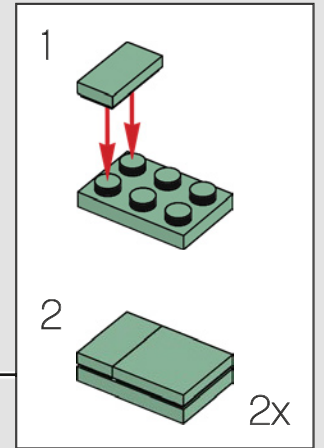
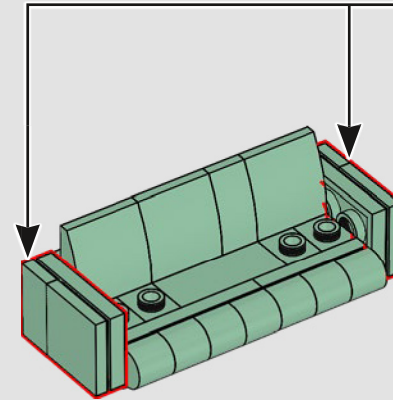
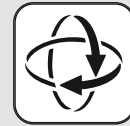

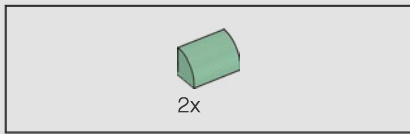

220

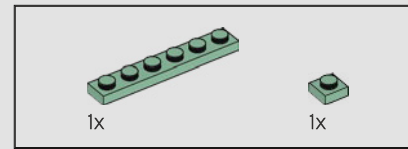
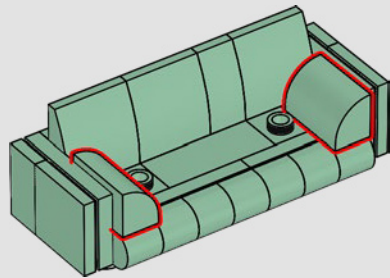

221

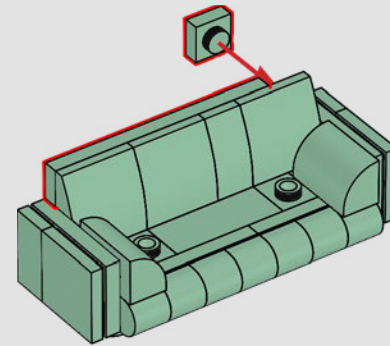

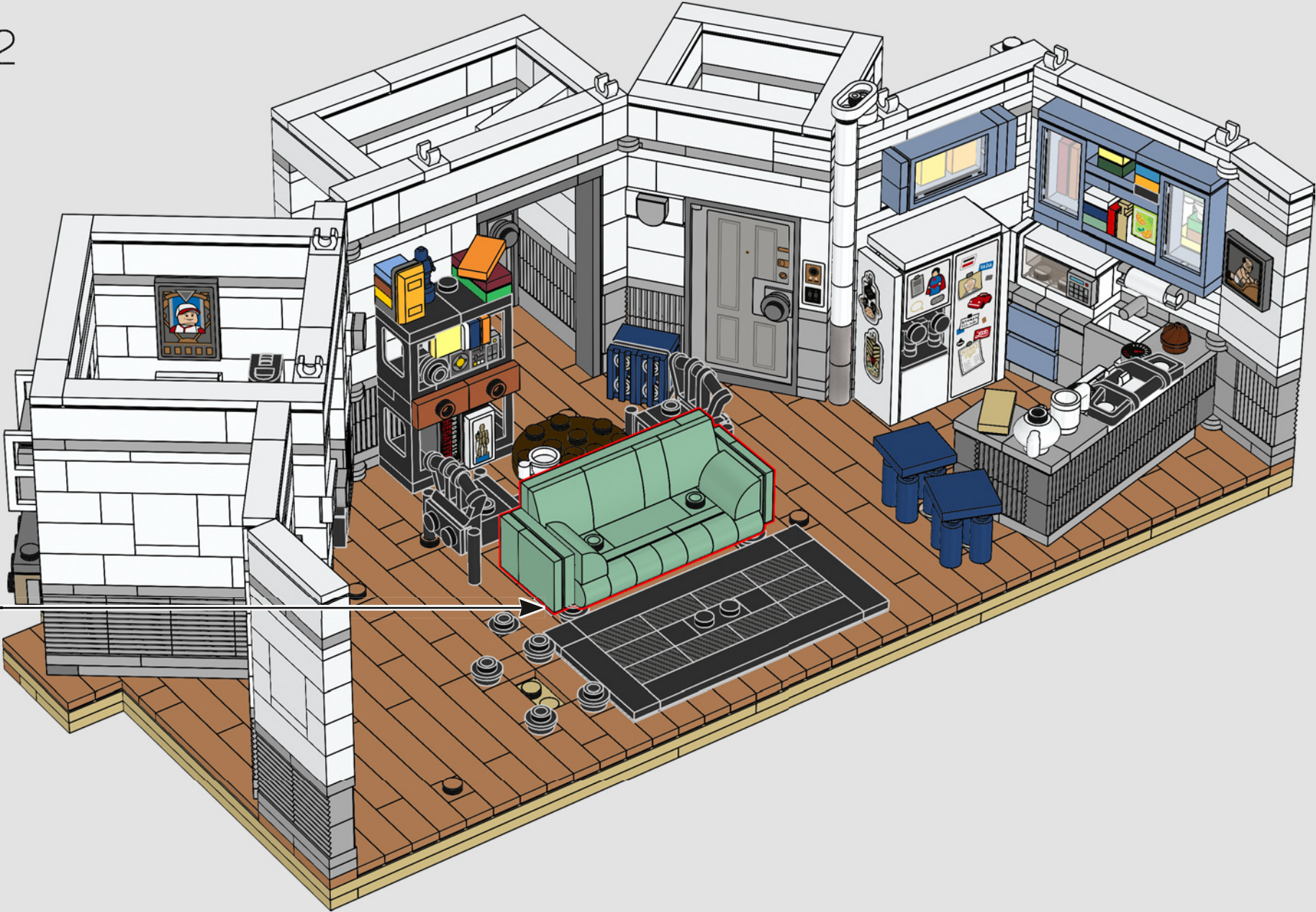



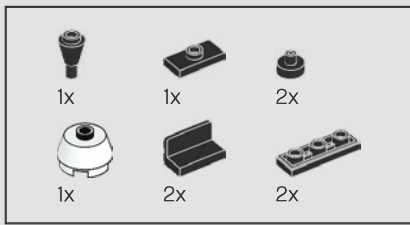

223

1

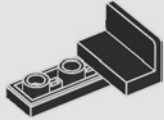

2

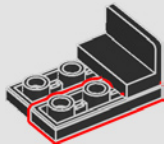

3

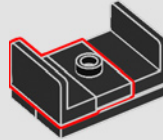

4

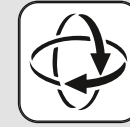
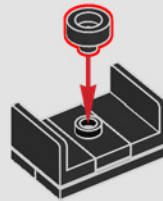

5

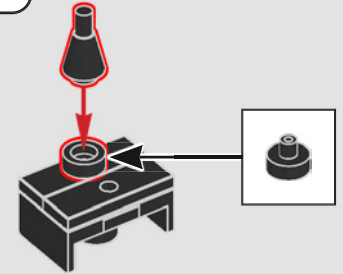

6

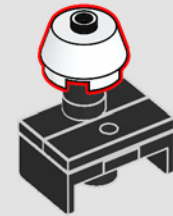

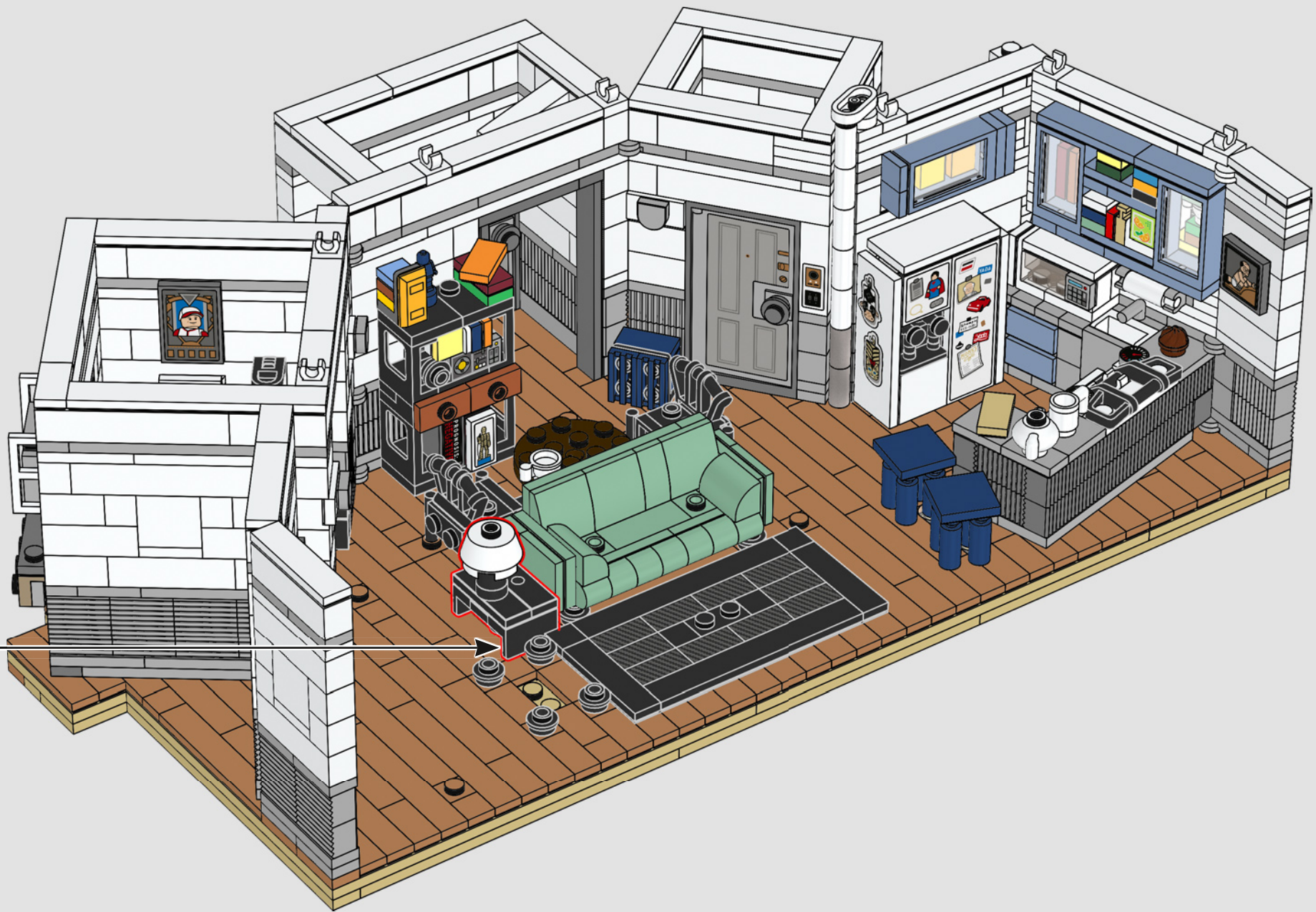

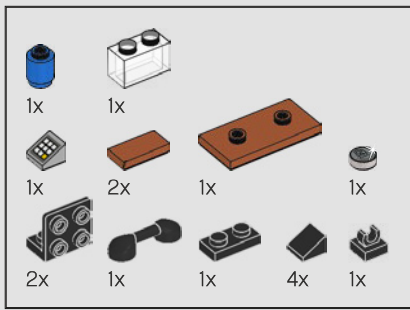

224

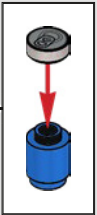
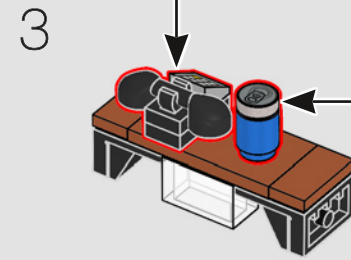
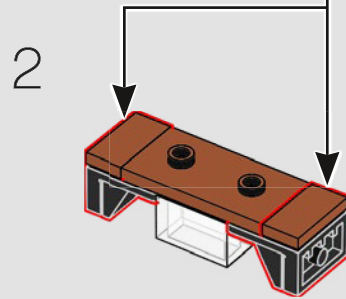
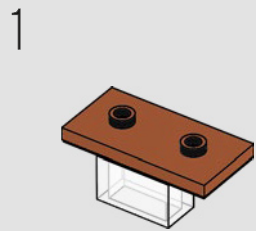
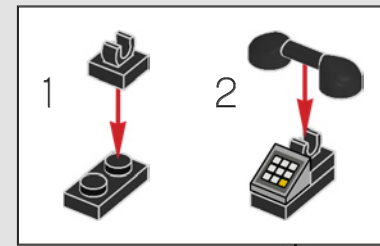
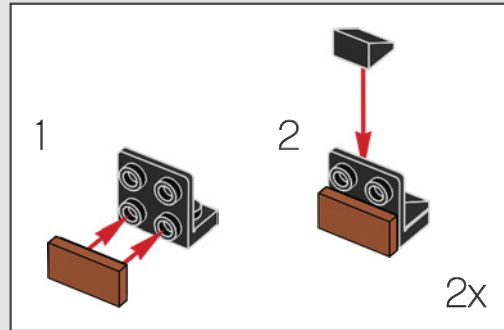



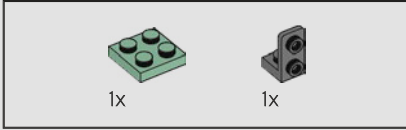
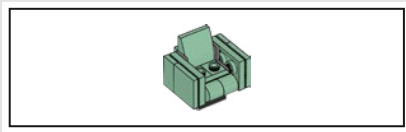

225

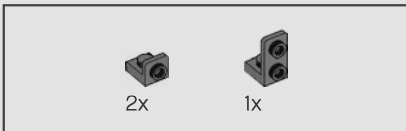

226

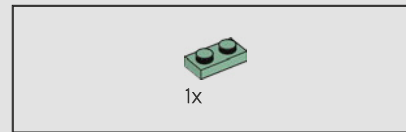
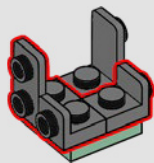

227

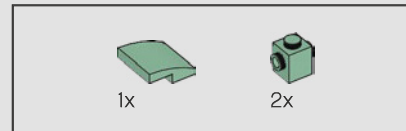
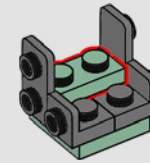

228

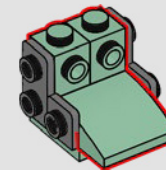

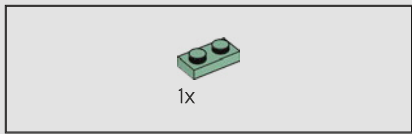

229

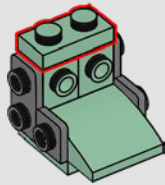

230

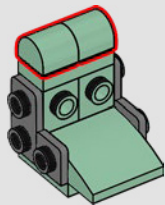

231

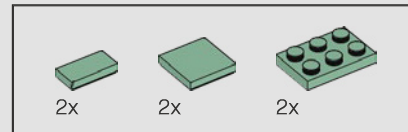
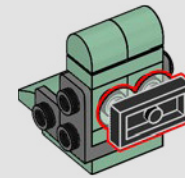
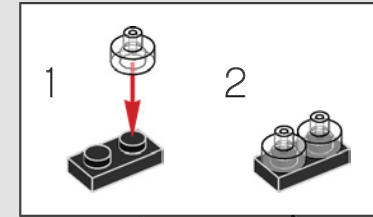

232

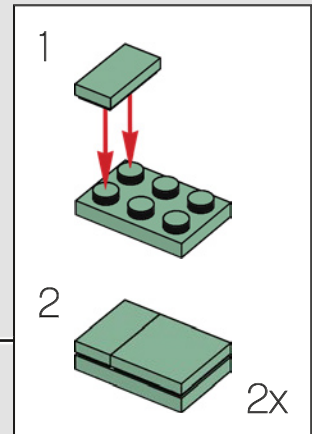
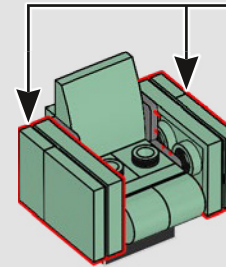

233

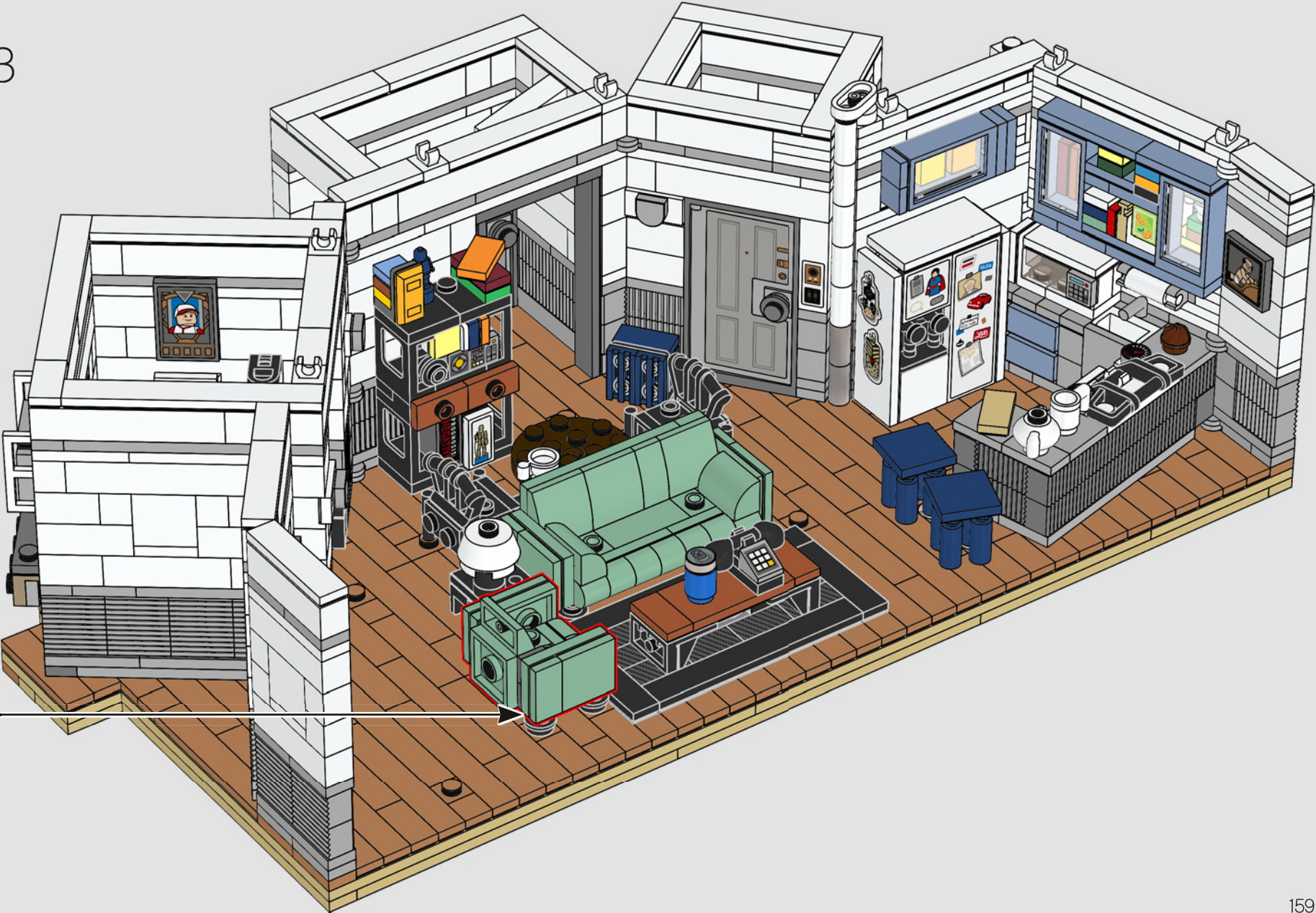

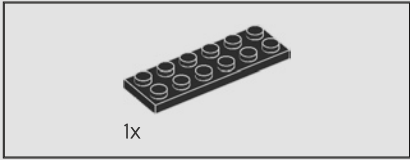
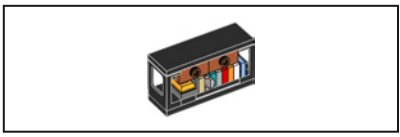

234

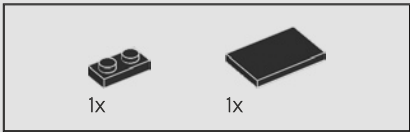
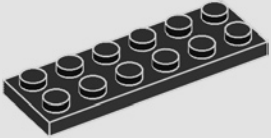

235

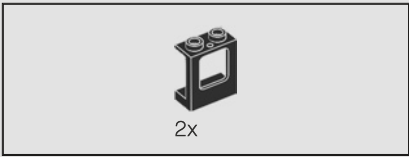
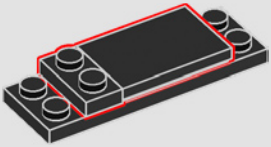

236

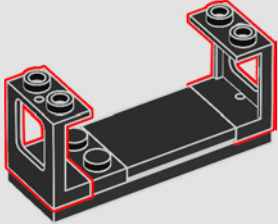



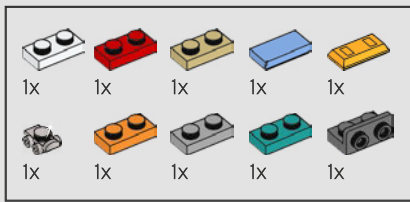

237

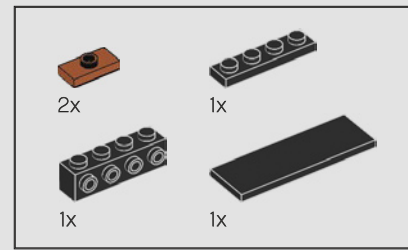
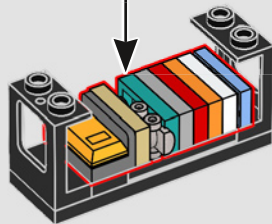
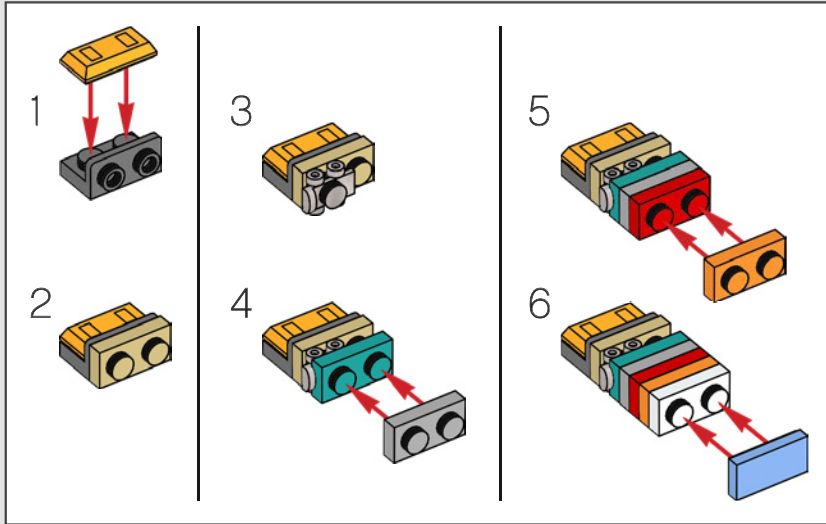

238

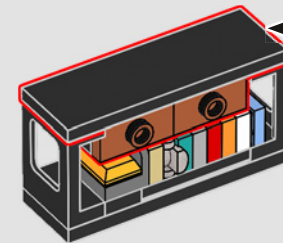
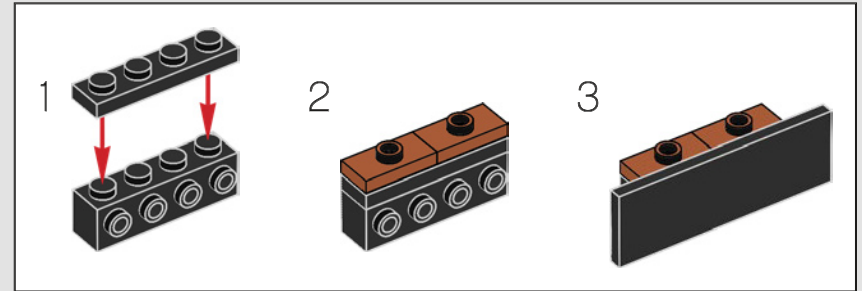

239

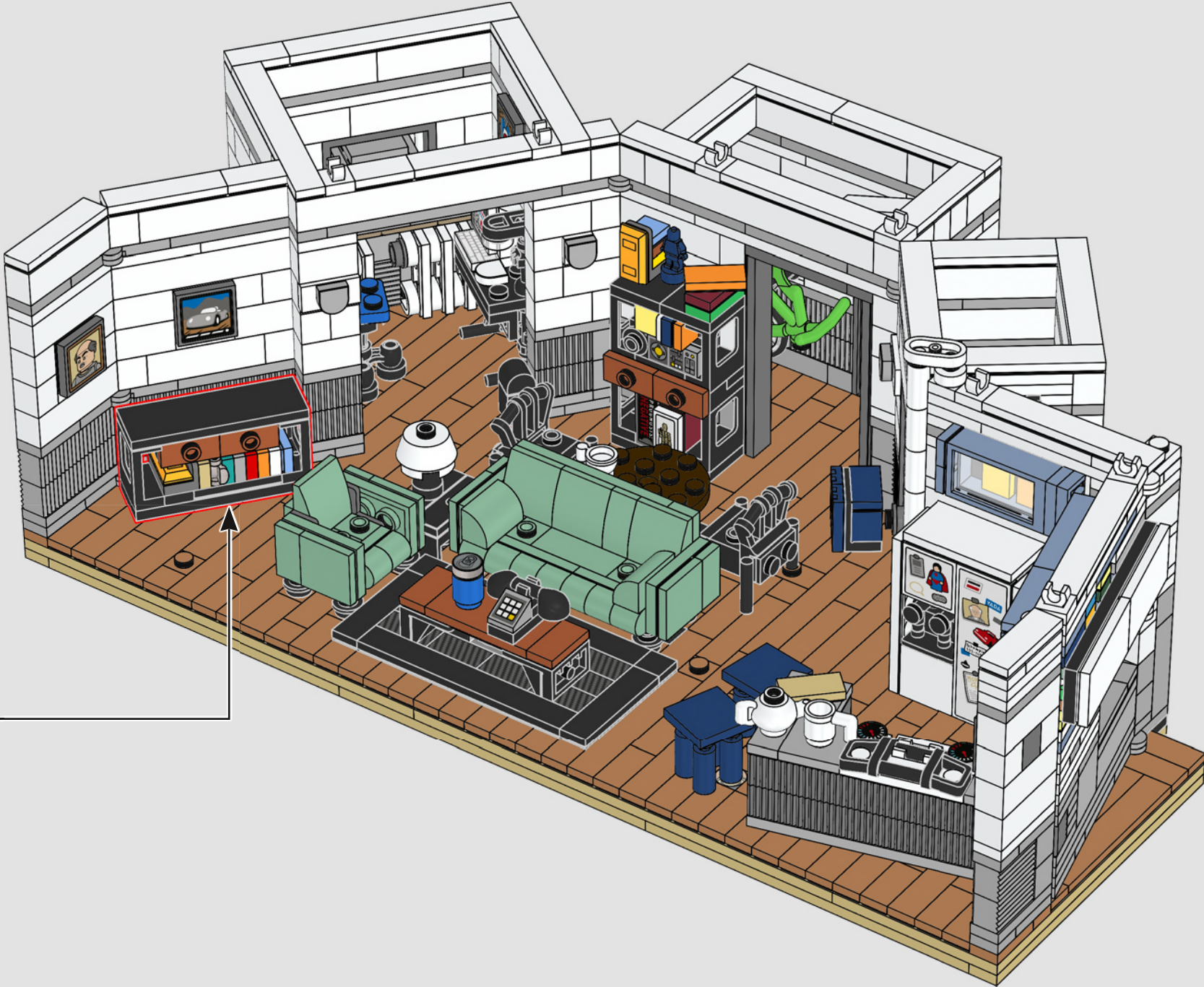

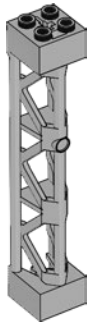

3x

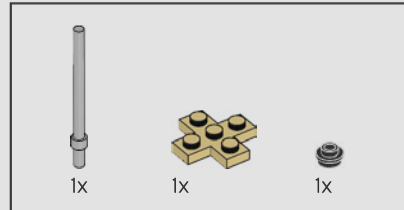
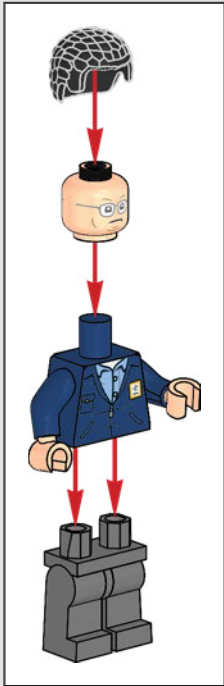
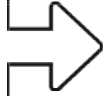

1

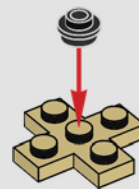

2

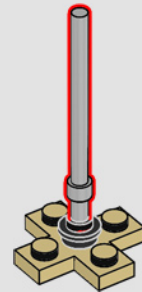

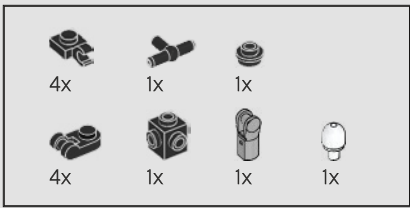

240

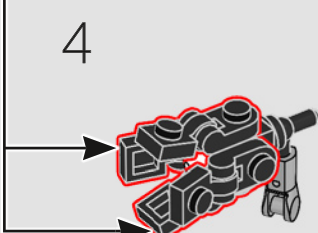
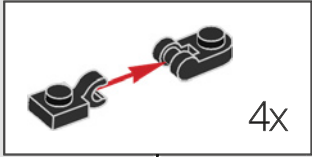
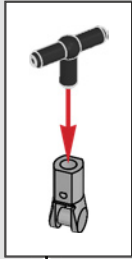
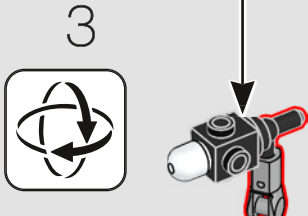
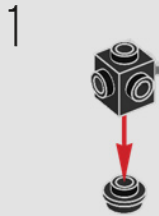

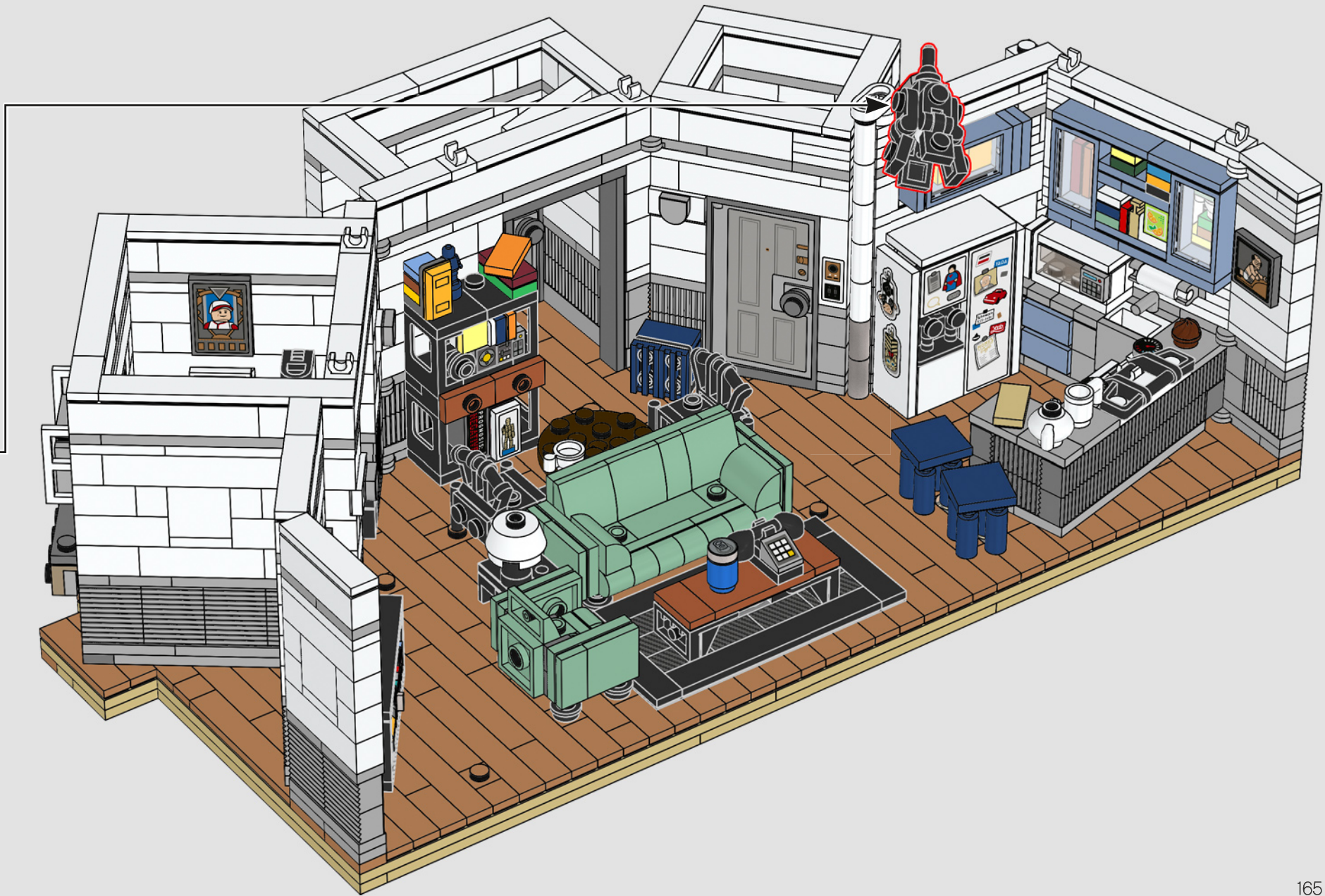

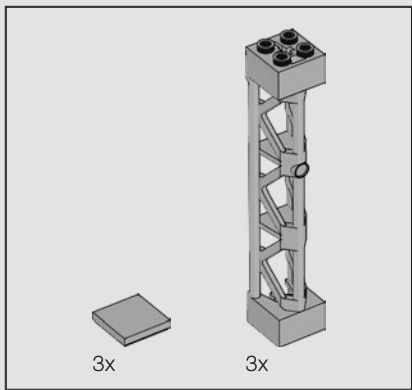

241

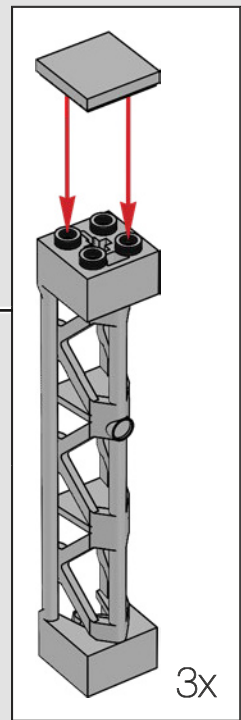
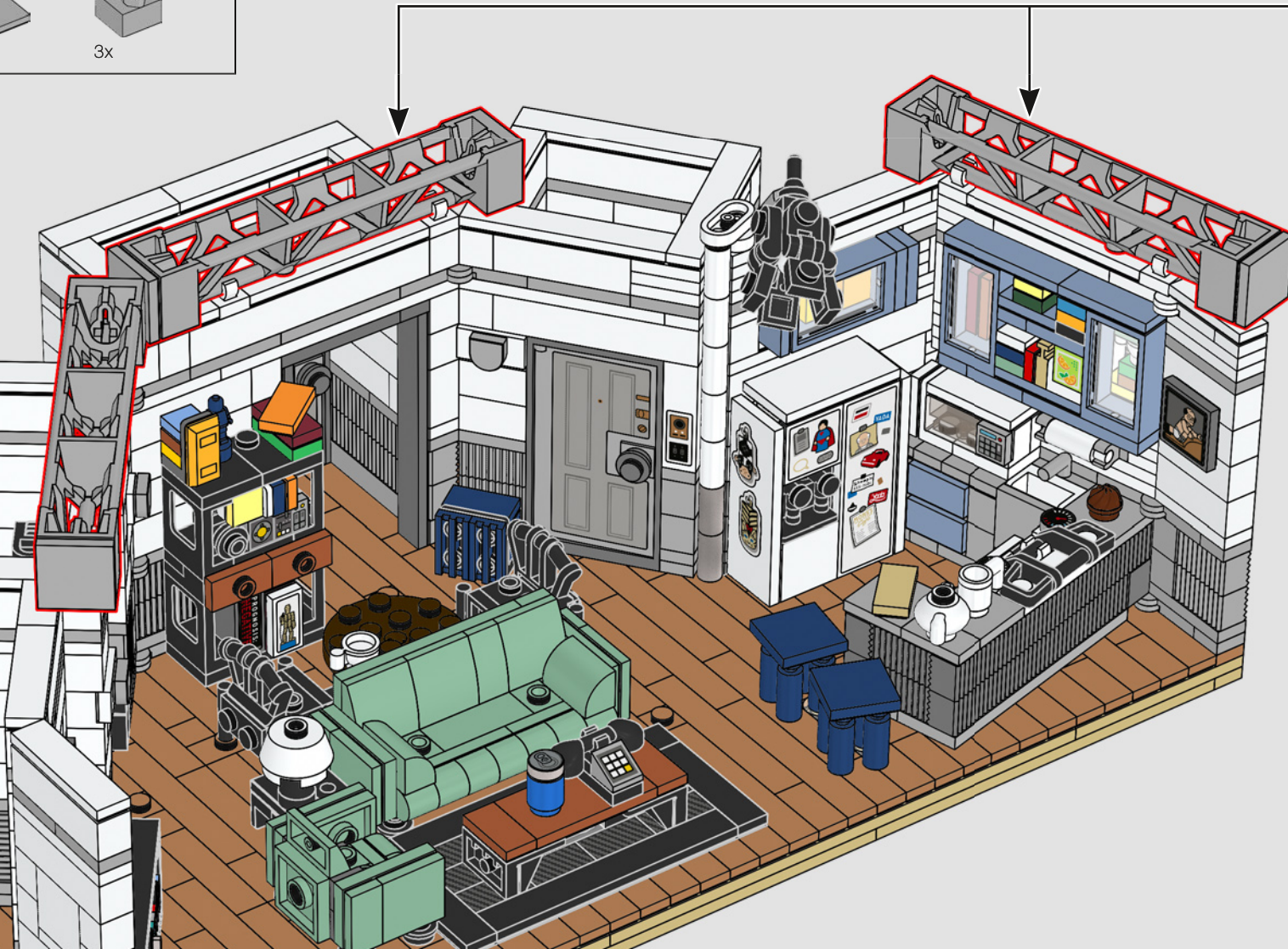

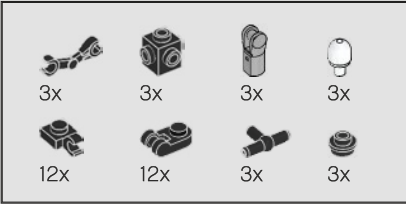

242

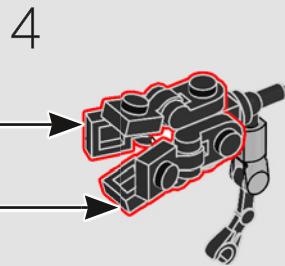
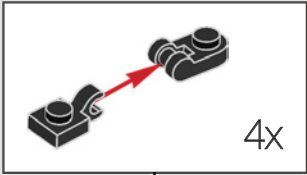
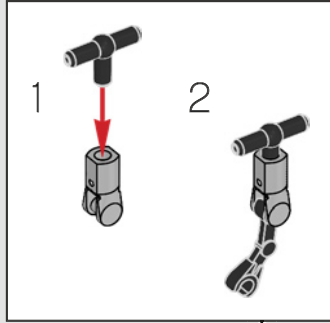
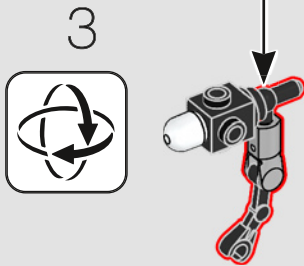
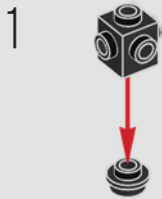

3x

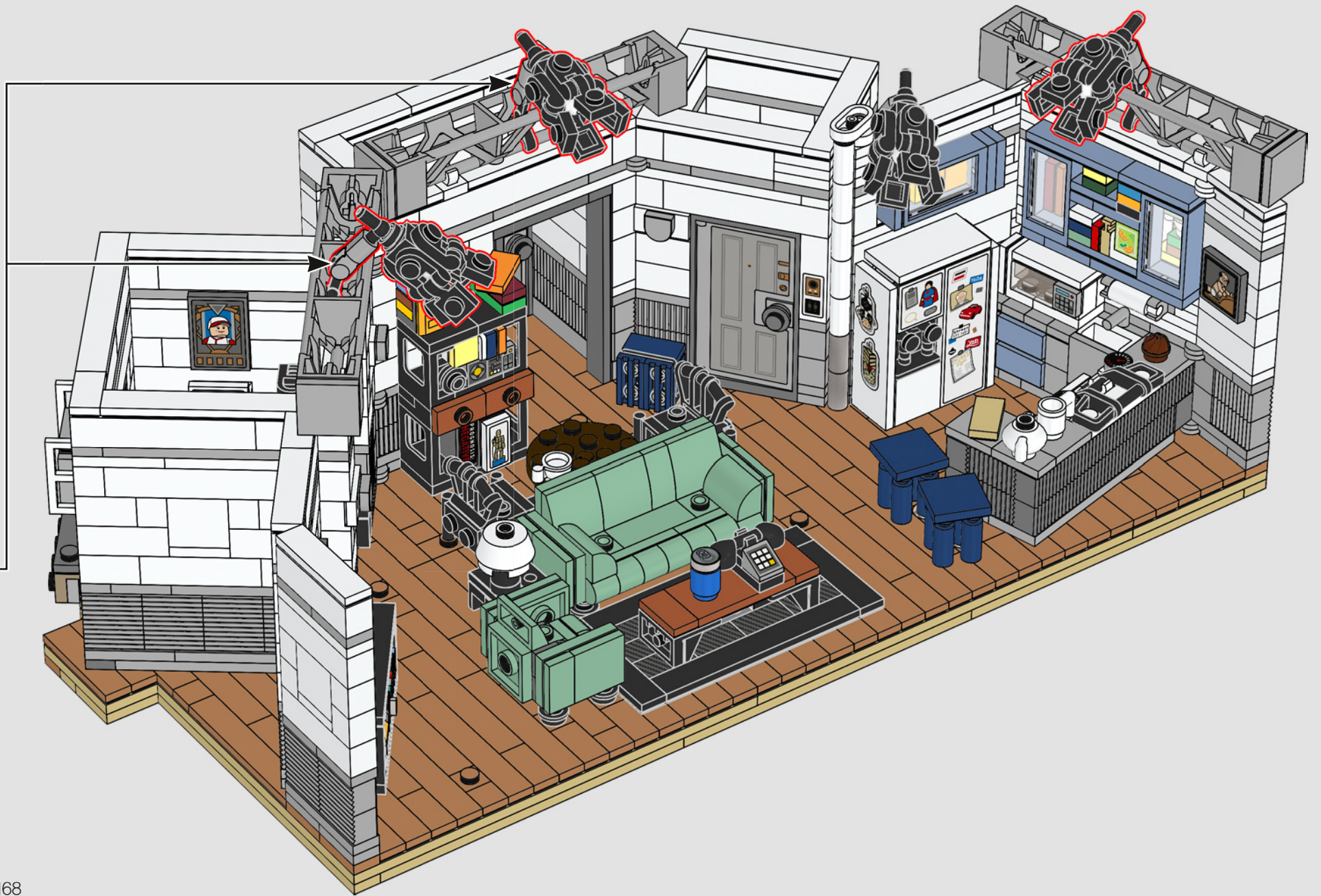







# IDEAS

GATHER SUPPORT  
OBTIENS DE L'APPUI  
OBTÉN APOYOS

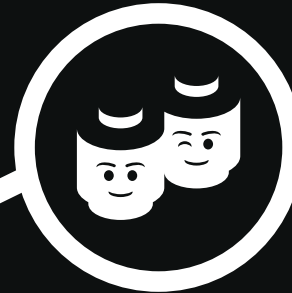

SHARE YOUR IDEA  
PARTAGE TON IDÉE  
COMPARTE TU IDEA

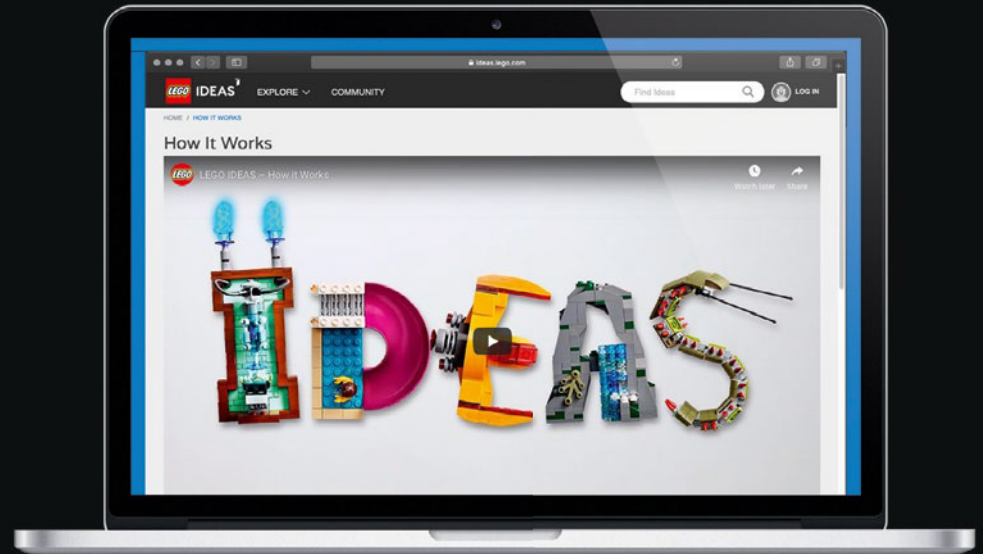

NEW LEGO® PRODUCT  
NOUVEAU PRODUIT LEGO®  
NUEVO PRODUCTO LEGO®



LEGO® REVIEW  
EXAMEN LEGO®  
REVISIÓN DE LEGO®



©Disney. Based on the "Winnie the Pooh" works by A.A. Milne and E.H. Shepard.



# FEEDBACK AND WIN



## FEEDBACK AND WIN

Your feedback will help shape the future development of this product series.

Please visit:

## FEEDBACK UND GEWINNEN

Dein Feedback trägt zur Weiterentwicklung dieser Produktreihe bei.

Geh auf:

## COMMENTEZ ET GAGNEZ

Vos commentaires nous aideront à concevoir les futurs produits de cette gamme.

Rendez-vous sur :

## COMENTA Y GANA

Tu opinión nos ayudará a dar forma al desarrollo de esta serie de productos en el futuro.

Visita:

## 反馈有奖

您的反馈将有助于我们在今后改进本系列产品。

请访问：

[LEGO.com/productfeedback](https://www.lego.com/productfeedback)

By completing, you will automatically enter a drawing to win a LEGO® set.

Terms & Conditions apply.

Durch Ausfüllen nimmst du automatisch an der Verlosung eines LEGO® Preises teil.

Es gelten die Teilnahmebedingungen.

En envoyant vos commentaires, vous serez automatiquement inscrit(e) à un tirage au sort qui vous permettra de remporter un prix LEGO®.

Offre soumise à conditions.

Al contestar, participarás automáticamente en el sorteo y podrás ganar un set LEGO®.

Sujeto a Términos y Condiciones.

完成我们的反馈调查，即可自动进入抽奖环节，赢取乐高®套装。

适用《条款和条件》。

LEGO and the LEGO logo are trademarks of the/son des marques de commerce du/son marcas registradas de LEGO Group. ©2021 The LEGO Group.



SEINFELD and all related characters and elements © & ™ Castle Rock Entertainment.  
WB SHIELD: TM & © WBEL. (s21)

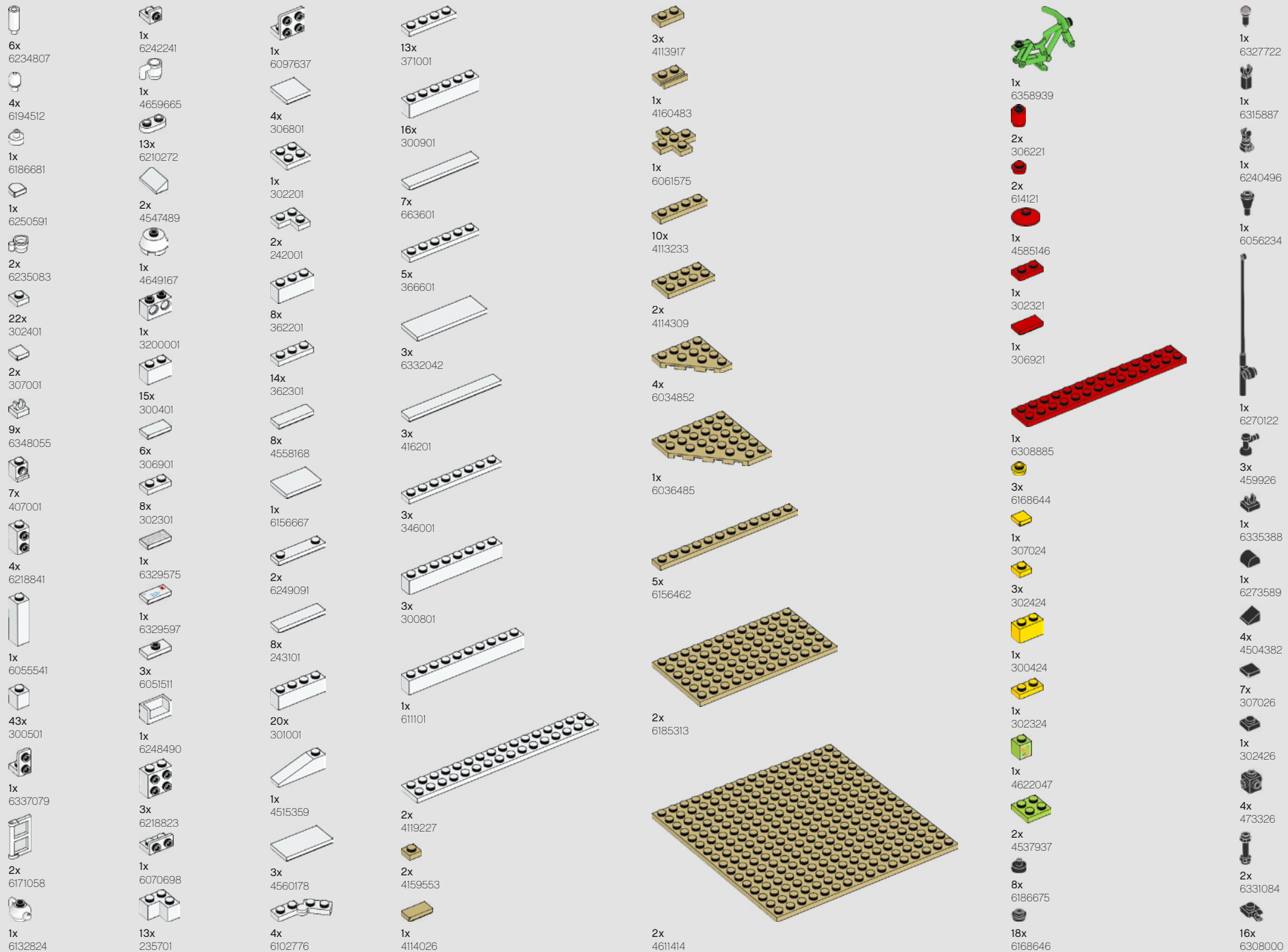

1x 6122096  
4x 6104209  
17x 6157554  
2x 6330189  
2x 4537551  
1x 6143850  
1x 4109810  
1x 403226  
1x 6195325  
2x 9339  
1x 4614788  
4x 6146220  
2x 6138173  
1x 300426  
1x 300526

4x 302326  
10x 6302572  
1x 6092585  
6x 4539128  
3x 6330086  
1x 6016172  
4x 6000650  
1x 4140588  
1x 6151289  
1x 6093525  
1x 6284188  
1x 302226  
1x 6328479  
3x 6192346  
4x 242026  
7x 6052126

1x 4218868  
1x 6313508  
1x 362326  
2x 6199908  
2x 4604304  
1x 6207258  
1x 6162892  
1x 302126  
4x 383926  
4x 243126  
4x 4162443  
2x 371026  
1x 4187209  
4x 4560182

2x 6272184  
7x 302026  
1x 366626  
1x 300926  
1x 379526  
1x 6318582  
3x 416226  
1x 303426  
1x 447726  
5x 383226  
1x 302428  
1x 302328  
9x 302228

1x 306223  
5x 4143005  
1x 614323  
1x 407923  
1x 6186012  
4x 6092602  
3x 4614158  
1x 6288614  
1x 6247364  
1x 6274738  
9x 6186867  
1x 6323497  
3x 6252258  
2x 6163986  
1x 6244904  
1x 4653988

1x 6248957  
1x 6124349  
1x 6138232  
7x 6142505  
5x 6198156  
3x 6253441  
3x 6062089  
1x 6057880  
2x 6262031  
1x 6122977  
1x 6170418  
4x 6343976  
29x 4211429  
2x 4558169

2x 6329581  
1x 6167667  
2x 6258831  
4x 4211476  
28x 4211399  
1x 6343004  
2x 6329583  
1x 6061702  
1x 4211362  
20x 4211389  
1x 6248078  
2x 6335378  
48x 4211383  
1x 4227657  
1x 4593679

4x 6250597  
4x 6066097  
5x 4211388  
2x 4211440  
1x 6329662  
23x 4211398  
1x 6261353  
2x 6015344  
1x 6123809  
3x 6126082  
7x 4211413  
3x 4211349  
10x 4211353  
3x 6186292

3x  
6248917

1x  
6071299

5x  
4211394

19x  
4211445

1x  
6015347

10x  
6102769

4x  
4211395

1x  
4211393

2x  
4211438

9x  
4211425

1x  
4211392

1x  
4211406

9x  
6335233

1x  
4558595

1x  
4188771

3x  
4177932

1x  
6013102

1x  
6275877

2x  
6195266

1x  
4524098

4x  
6275485

1x  
6006524

1x  
6213777

1x  
6254100

1x  
4527526

1x  
4168345

2x  
6240216

4x  
4541376

1x  
6311108

18x  
6093908

1x  
6092597

1x  
6264026

1x  
6065504

1x  
6028736

2x  
6236454

8x  
6337523

1x  
6301330

1x  
4184108

1x  
4249891

1x  
4528488

2x  
6022579

2x  
4528981

2x  
6285466

1x  
6246893

1x  
6099189

6x  
6125672

4x  
4616578

5x  
4655080

2x  
6278541

1x  
6196591

2x  
6186823

4x  
6133896

4x  
6080431

2x  
6223171

2x  
6069257

1x  
6330616

6x  
6184348

2x  
6100234

1x  
6099187

1x  
6060731

1x  
6174229

1x  
6167879

1x  
4224243

1x  
6348008

1x  
6348011

1x  
6348017

1x  
6348022

5x  
4210633

1x  
4558955

1x  
4211044

1x  
4210719

2x  
6225494

5x  
6336390

13x  
4210636

1x  
4222693

1x  
4210978

2x  
6000606

1x  
6314192

5x  
4211055

1x  
4211109

2x  
6187008

1x  
4211001

2x  
6257592

1x  
4551044

4x  
6262942

2x  
4211008

1x  
6348025

1x  
6362687

1x  
6362763

1x  
6021997

1x  
6362756

1x  
6362772

1x  
6362777

1x  
6362776

1x  
6086672

1x  
6362773

1x  
6238774

1x  
6005030

22x  
6215606

37x  
6177146

1x  
6192835

44x  
6021997

7x  
6218360

5x  
6292154

1x  
4622738

30x  
6102998

57x  
6102995

2x  
6336564

1x  
6322904

1x  
6215447

Customer Service  
Kundenservice  
Service Consommateurs  
Servicio Al Consumidor  
LEGO.com/service or dial

: 00800 5346 5555  
: 1-800-422-5346



