

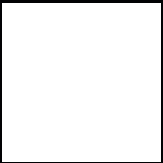

1



Booklet available in English on
Livret disponible en français sur
Folleto disponible en español en





We're making our packaging more sustainable

We're transitioning from single-use plastic to paper-based packaging. As we progress, you may find a mix of paper and plastic in our boxes.

Nous rendons nos emballages plus durables

Nous passons des emballages en plastique à usage unique aux emballages à base de papier. Durant la transition, vous pourriez trouver un mélange de papier et de plastique dans nos boîtes.

Queremos hacer más sustentables nuestros materiales de embalaje

Estamos cambiando las bolsas de plástico desechables por bolsas con base de papel. Conforme avanzamos en este propósito, puedes encontrar una mezcla de papel y de plástico en nuestras cajas.

[LEGO.com/sustainable-packaging](https://www.lego.com/sustainable-packaging)

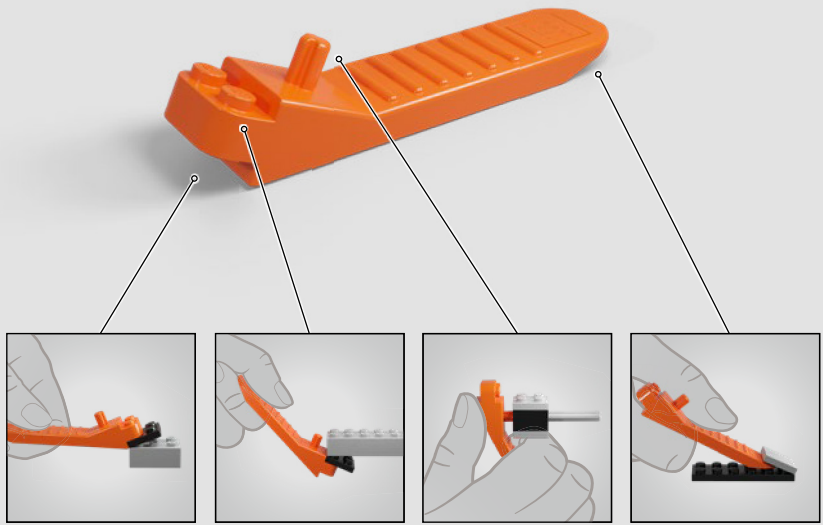

A beacon of safety

For as long as humans have traveled the seven seas, safe navigation has been vital to explorers and travelers, fishermen and merchants, navies and blue-water sailors. Stone arrangements, bonfires, cressets or braziers were used as coastal landmarks to help seafarers steer clear of perils, day and night.

The earliest known stone lighthouse that resembled the structures we know today, the Lighthouse of Alexandria, was built in Egypt over 2,000 years ago. Until the early 1900s, lighthouse keepers would live in accommodations on the property and be available around the clock to keep candles, coal, sperm whale oil, kerosene, paraffin, or gas flames burning.

Each lighthouse is unique, with signature colors or features to make them easily recognizable in daylight, too. As landmarks in the geographical sense, and in technological advances, these beacons continue to keep sailors safe. Additional safety equipment like foghorns and the electronic Automatic Identification System (AIS) are now standard in most lighthouses, and most are fully automated and maintained by official agencies.

With more than 23,500 lighthouses covering 372,000 miles (598,675.5 kilometers) of coastline around the world, they represent part of our collective history, adventure and the promise of safe havens in a stormy sea.



Pigeon Point Lighthouse, 1872, one of the tallest lighthouses in America

Mis en service en 1872, le phare de Pigeon Point est l'un des plus hauts phares d'Amérique

Faro Pigeon Point (Estados Unidos, 1872): uno de los faros más altos de los Estados Unidos



Souter Lighthouse, 1871, world's first lighthouse built to use electricity

Construit en 1871, le phare de Souter est le premier phare au monde conçu pour être alimenté à l'électricité

Faro Souter (Inglaterra, 1871): el primer faro del mundo construido que usaba electricidad

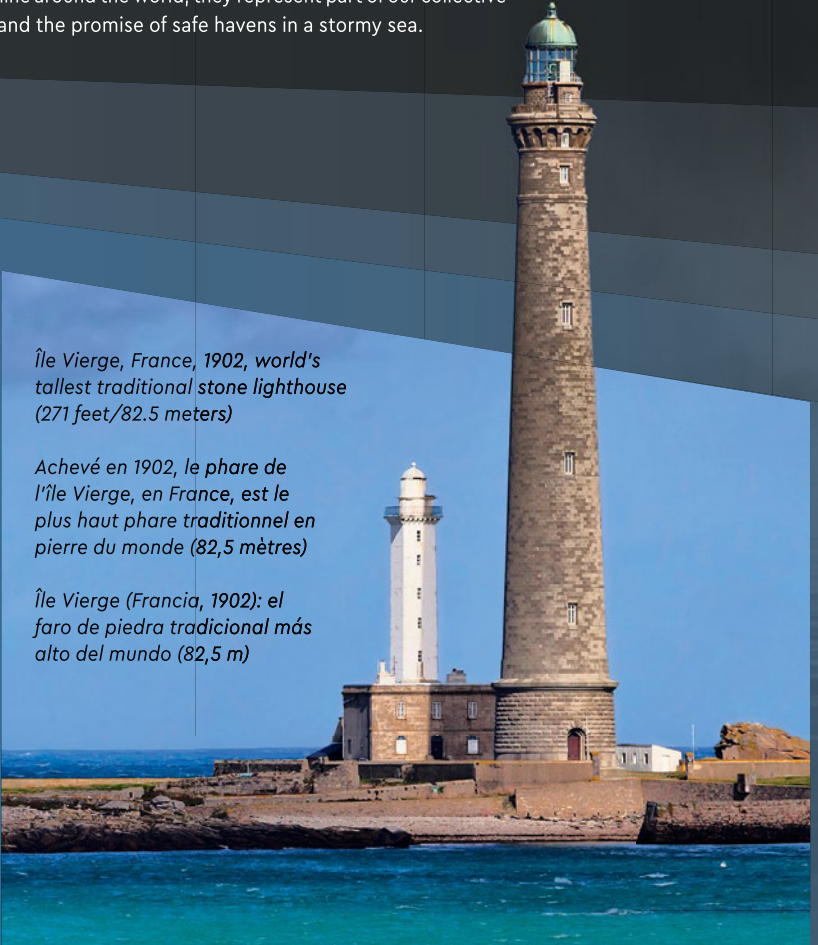

Île Vierge, France, 1902, world's tallest traditional stone lighthouse (271 feet/82.5 meters)

Achévé en 1902, le phare de l'île Vierge, en France, est le plus haut phare traditionnel en pierre du monde (82,5 mètres)

Île Vierge (France, 1902): el faro de piedra tradicional más alto del mundo (82,5 m)

Un signal essentiel

Depuis que l'homme sillonne les sept mers, il est vital pour les explorateurs et les voyageurs, les pêcheurs et les marchands, les forces navales et les marins de haute mer de naviguer en toute sécurité. Des agencements de pierres, des feux, des flambeaux ou des braseros étaient utilisés comme points de repère côtiers pour aider les navigateurs à contourner les obstacles, de jour comme de nuit.

Le plus ancien phare en pierre comparable aux structures que nous connaissons aujourd'hui, le phare d'Alexandrie, a été construit en Égypte il y a plus de 2 000 ans. Jusqu'au début des années 1900, les gardiens de phare vivaient dans des logements sur la propriété et travaillaient jour et nuit pour maintenir allumées les flammes de bougies, de charbon, d'huile de cachalot, de kérosène, de paraffine ou de gaz.

Chaque phare est unique et présente des couleurs ou des caractéristiques qui le rendent facilement reconnaissable en plein jour. Monuments géographiques et témoins des avancées technologiques, les phares continuent d'assurer la sécurité des marins. Des équipements de sécurité supplémentaires, tels que les cornes de brume et le système d'identification automatique (SIA), sont désormais la norme dans la plupart des phares, et la majorité d'entre eux sont entièrement automatisés et entretenus par des organismes officiels.

Avec plus de 23 500 phares couvrant 598 675,5 kilomètres de côtes à travers le monde, ils représentent une page de notre histoire collective, l'aventure et la promesse d'un sanctuaire dans une mer déchaînée.

Un símbolo de seguridad

Desde que el ser humano navega por los océanos, la seguridad en el mar ha sido fundamental para exploradores y viajeros, pescadores y comerciantes, armadas y marineros de alta mar. Instalaciones de piedra, fogatas, pebeteros y candiles han servido a lo largo de la historia como puntos de referencia en la costa para ayudar a los navegantes a evitar el peligro, tanto de día como de noche.

El primer faro de piedra del que hay registro y que se asemeja a las estructuras que conocemos hoy, el Faro de Alejandría, se construyó en Egipto hace más de 2000 años. Hasta principios del siglo XX, los fareros vivían en los alojamientos del edificio y debían estar disponibles a todas horas para mantener prendidas las velas, el carbón, el aceite de ballena, el queroseno, la parafina o el gas, y evitar que las llamas se apagaran.

No hay dos faros iguales y todos ellos cuentan con colores o rasgos característicos que los hacen fácilmente reconocibles también a plena luz del día. Como puntos de referencia en un sentido geográfico, y gracias a los avances tecnológicos, estas señales luminosas siguen velando por la seguridad de los marinos. En la actualidad, la mayoría de los faros cuentan con equipos de seguridad complementarios, como sirenas de niebla y sistemas electrónicos AIS (Automatic Identification System), están totalmente automatizados y son mantenidos por organismos oficiales.

Los más de 23.500 faros que vigilan 598.675,5 km de costa en todo el mundo forman parte indisoluble de nuestra historia colectiva, del espíritu de aventura y de la promesa de un refugio seguro en aguas tempestuosas.

Tower of Hercules, Spain, late 1st century A.D., oldest known extant lighthouse

Construite en Espagne à la fin du 1^{er} siècle après J.-C., la tour d'Hercule est le plus ancien phare encore actif

Torre de Hércules (España, finales del siglo 1 d. C.): el faro más antiguo conocido que se mantiene en pie en la actualidad



Eddystone Lighthouse, England, 1698-1881, world's first open-ocean lighthouse

Construit entre 1698 et 1881, le phare d'Eddystone, en Angleterre, est le premier phare de haute mer au monde

Faro de Eddystone (Inglaterra, 1698-1881): el primer faro del mundo en mar abierto



The Lighthouse of Alexandria, Egypt, 280-247 BC, is the oldest known lighthouse

Construit entre 280 et 247 avant J.-C., le phare d'Alexandrie, en Égypte, est le plus ancien phare connu

Faro de Alejandría (Egipto, 280-247 a. C.): el faro más antiguo conocido

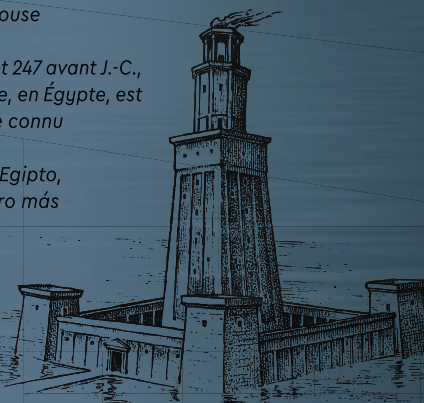

The Fresnel lens

Obviously, the further a lighthouse beacon can reach in the worst weather conditions, the better. During the 1600–1700s, mirrors, parabolic reflectors and Argand lamps created increasingly brighter beams. The Fresnel lens, invented in 1821, revolutionized the construction of lighthouses. Through layers of ring-shaped glass lenses, a light source could now be concentrated into a narrow beam, dramatically enhancing both the intensity and nominal range of light. This was likely the most significant development in lighthouse design until the introduction of electrical lights, and it is still in use today.

Fresnel lenses used in lighthouses are now often made of plastic, making them both lighter in use and cheaper to manufacture. With modern, automated rotation functions and electrical light sources, they can create powerful range and enhance visibility. Fresnel lenses are also used in floodlights, ship lanterns and even in cameras.

To recreate the characteristic rotating light function, the LEGO® Ideas design team developed a LEGO version of the Fresnel lens. A lot of research went into replicating the original engineering of the lens, followed by performance tests to achieve a smooth and authentic experience.

La lentille de Fresnel

Bien entendu, plus la portée du signal d'un phare est importante même dans les pires conditions météorologiques, mieux c'est. Au cours des années 1600 et 1700, les miroirs, les réflecteurs paraboliques et les lampes Argand ont permis de créer des faisceaux de plus en plus brillants. La lentille de Fresnel, inventée en 1821, a révolutionné la construction des phares. Grâce à cette lentille divisée en sections annulaires, une source de lumière peut désormais être concentrée en un faisceau étroit, ce qui améliore considérablement l'intensité et la portée nominale de la lumière. Jusqu'à l'introduction des lampes électriques, il s'agissait probablement de la plus importante innovation apportée aux phares, et elle est toujours utilisée aujourd'hui.

De nos jours, les lentilles de Fresnel utilisées dans les phares sont souvent en plastique, ce qui les rend à la fois plus légères et moins chères à fabriquer. Grâce à des fonctions de rotation modernes et automatisées et à des sources lumineuses électriques, elles peuvent atteindre une portée considérable et améliorer la visibilité. Les lentilles de Fresnel sont également utilisées dans les projecteurs, les lanternes de bateaux et même dans les appareils photo.

Pour recréer la lumière rotative caractéristique, l'équipe de conception de LEGO® Ideas a développé une version LEGO de la lentille de Fresnel. De nombreuses recherches ont été menées pour reproduire l'ingénierie originale de la lentille, puis des tests de performance ont été effectués pour garantir une expérience fluide et authentique.



*Prototypes of the LEGO®
Fresnel lens element*

*Prototypes de l'élément de
lentille de Fresnel LEGO®*

*Prototipos del elemento
LEGO® que representa
el lente de Fresnel*



El lente de Fresnel

Obviamente, cuanto más lejos pueda llegar la luz de un faro en las peores condiciones climáticas, mejor. En los siglos XVII y XVIII se crearon espejos, reflectores parabólicos y quinqués para incrementar la intensidad del haz de luz. El lente de Fresnel, inventado en 1821, revolucionó la construcción de los faros. Mediante lentes de vidrio anulares organizados en capas, ahora era posible concentrar una fuente de luz en un haz estrecho que mejoraba tanto la intensidad como el alcance nominal de la luz. Probablemente, este fue el avance más importante del diseño de los faros hasta la introducción de la luz eléctrica, y todavía hoy se utiliza.

Los lentes de Fresnel que usan los faros en la actualidad suelen ser de plástico, lo que los hace más ligeros y baratas de fabricar. Junto con modernas funciones de rotación automatizada y fuentes de luz eléctricas, permiten obtener un gran alcance y, al mismo tiempo, mejoran la visibilidad. Los lentes de Fresnel también se emplean en focos, señales náuticas e incluso cámaras fotográficas.

Para recrear la característica función de rotación de la luz, el equipo de diseño de LEGO® Ideas desarrolló una versión LEGO del lente de Fresnel. Se investigó mucho para replicar la ingeniería original del lente y se llevaron a cabo pruebas de desempeño para lograr una experiencia sencilla y auténtica.



*Front: Sandro's brother;
Middle: Sandro;
Back: Sandro's father.
Private photo from family
trip to Gaspésie.*

*Avant : le frère de Sandro;
Centre : Sandro;
Arrière : le père de Sandro.
Photo privée d'un voyage
familial en Gaspésie.*

*Delante: el hermano de Sandro;
en el centro: Sandro;
atrás: el papá de Sandro
(fotografía privada de un
viaje familiar a la Gaspesía)*



Meet the Fan Designer

Sandro Quattrini (LEGO® Ideas name: Roses Must Build) is a 20-year-old film animation student from Canada. When not busy at university, he spends time with friends, or rearranges his LEGO collection, very often into new builds.

"I've been building LEGO sets since I was five years old. It's a way to unplug and relax. I love building tall structures. My mother loves lighthouses and has been telling me to build one ever since we took a trip around the Gaspésie Peninsula (Quebec) years ago. We visited enormous stone lighthouses on rocky beaches and small, abandoned wooden ones. From titanic structures that tower over their towns to cozy little

houses that sit calmly far away from civilization, where all you hear is the sound of waves crashing against rocks. That's the essence I wanted to capture, and their solitary nature.

I built the lantern room first, then two sides of the tower and only then did I think of adding the turning-light mechanism! Everything took time and trial-and-error, and my limited selection of bricks forced me to be creative with shapes and techniques. It's a challenging and rewarding experience. It was a huge surprise when it reached 10,000 supporters. I didn't realize it had been featured on LEGO fan websites and blogs. I am so thankful for everyone's support. Enjoy building!"



Sandro with his original model

Sandro avec son modèle original

Sandro con su modelo original



Rencontre avec le concepteur amateur

Sandro Quattrini (pseudonyme LEGO® Ideas : Roses Must Build) est un étudiant canadien en animation cinématographique de 20 ans. En dehors de ses études universitaires, il passe du temps avec ses amis ou remanie sa collection LEGO, très souvent pour créer de nouvelles constructions.

« Je construis des ensembles LEGO depuis que j'ai cinq ans. C'est un bon moyen de se déconnecter et de se détendre. J'adore construire de grandes structures. Ma mère adore les phares et me demande d'en construire un depuis que nous avons visité la péninsule gaspésienne (au Québec) il y a quelques années. Nous avons visité d'énormes phares en pierre sur des plages rocheuses et de petits phares en bois abandonnés. Des structures titanesques qui surplombent leurs villes aux petites maisons douillettes isolées de la civilisation, où l'on n'entend que le bruit des vagues qui se fracassent contre les rochers. Je voulais saisir cette âme, et leur nature solitaire.

J'ai d'abord construit la salle de la lanterne, puis les deux côtés de la tour, et ce n'est qu'ensuite que j'ai pensé à ajouter le mécanisme de la lumière tournante ! Tout a nécessité beaucoup de temps et d'essais et erreurs, et mon choix limité de briques m'a obligé à faire preuve de créativité pour les formes et les techniques. C'est une expérience stimulante et enrichissante. J'ai été très surpris de voir que le modèle avait rassemblé 10 000 soutiens. Je n'avais pas réalisé qu'il avait été présenté sur des sites et des blogs d'amateurs de LEGO. Je vous remercie infiniment pour votre soutien. Bonne construction ! »

Conoce al fan diseñador

Sandro Quattrini (conocido en LEGO® Ideas como Roses Must Build) tiene 20 años y estudia animación cinematográfica en Canadá. Cuando no está ocupado en la universidad, le gusta pasar tiempo con sus amigos y reestructurando su colección LEGO, lo que, muy frecuentemente, da lugar a nuevos modelos.

"Construyo con LEGO desde que tenía cinco años. Es mi forma de desconectarme y relajarme. Me encanta construir estructuras de gran altura. Mi mamá siente pasión por los faros y llevaba años pidiéndome que creara uno a raíz de un viaje que hicimos por la península de la Gaspesia (Quebec). Visitamos enormes faros de piedra en playas rocosas y también pequeños faros de madera abandonados. Desde titánicas estructuras que se alzan orgullosas sobre sus ciudades hasta acogedoras casitas asentadas serenamente lejos de la civilización, donde lo único que se oye es el sonido de las olas rompiendo contra las rocas. Esa era la esencia que quería capturar, además de su naturaleza solitaria.

Acabé primero la sala de la linterna y luego dos lados de la torre. ¡No fue hasta entonces que se me ocurrió incorporar un mecanismo que hiciera girar la luz! Los pasos tomaron tiempo y procesos de prueba y error, y mi limitada selección de bricks me obligó a ser creativo en cuanto a las formas y técnicas. Fue una experiencia desafiante y gratificante. Me sorprendió muchísimo llegar a los 10.000 votos. No sabía que había salido en sitios web y blogs de fans de LEGO. Estoy muy agradecido por el apoyo que recibí de todo el mundo. ¡Disfruten construyendo!"

Private photos from
family trip to Gaspésie

Photo privée d'un voyage
familial en Gaspésie

Fotografías privadas de un
viaje familiar a la Gaspesia



Meet the LEGO® Lighthouse Keepers

"I am a huge fan of maritime history and lighthouses. They were mechanical and civil engineering marvels of the 19th century, with the sole, noble purpose of protecting mariners. Sandro's design was amazing, and I wanted the model to stay true to his original design. The challenge was to make the electronic components fit into the model without compromising the building process, looks or playability. I have enjoyed designing this model immensely, especially the lantern room, and I hope that people will enjoy building the model and discovering all the details we have incorporated into it."

—Luka Kapeter, LEGO® Senior Model Designer

"We incorporated lots of graphic design details and references to Sandro and his passion. My favorites are the map of the Gaspésie Peninsula on the desk, the sepia photo of Sandro and his family and a 19th century 'portrait' as a nod to the era of the invention of the Fresnel lens. All the details really set the mood for the model."

—Claus Tannebæk Madsen, LEGO® Senior Graphic Designer

"The lens design is dependent on several variable dimensions. The LEGO® System sets some of those dimensions in stone (like position of the light source compared to the lens itself), and that makes some parts of the design process easier and others more of a challenge. In the end I think we struck a nice balance, with a good light beam and the iconic look of a real lighthouse lens."

—Peter de Fine Licht, LEGO® Senior Play Designer, Elements



Rencontre avec les gardiens de phare LEGO®

« Je suis un grand amateur d'histoire maritime et de phares. Ce sont des merveilles d'ingénierie mécanique et civile du 19^e siècle, dont l'unique et noble objectif était de protéger les marins. Le concept de Sandro était incroyable, et je voulais que le modèle reste fidèle au concept original. Le défi consistait à intégrer les composants électroniques dans le modèle sans compromettre le processus de construction, l'apparence ou la jouabilité. J'ai adoré concevoir ce modèle, en particulier la salle de la lanterne, et j'espère que les gens prendront plaisir à construire le modèle et à découvrir tous les détails que nous y avons incorporés. »

–Luka Kapeter, concepteur principal de modèles LEGO®

« Nous avons inclus de nombreux détails graphiques et références à Sandro et à sa passion. Mes préférés sont la carte de la péninsule gaspésienne sur le bureau, la photo sépia de Sandro et de sa famille et le "portrait" du 19^e siècle, clin d'œil à l'époque de l'invention de la lentille de Fresnel. Tous les détails donnent un caractère particulier au modèle. »

–Claus Tannebæk Madsen, graphiste principal LEGO®

« La conception de la lentille dépend de plusieurs dimensions variables. Le système LEGO® grave dans le marbre certaines de ces dimensions (comme la position de la source lumineuse par rapport à la lentille elle-même), ce qui facilite certaines parties du processus de conception et en rend d'autres plus difficiles. Au final, je crois que nous avons trouvé un bon équilibre, avec un faisceau lumineux performant et l'aspect emblématique d'une vraie lentille de phare. »

–Peter de Fine Licht, concepteur principal de jeu LEGO®, éléments

Conoce a los guardianes del faro LEGO®

“Soy un fan incondicional de la historia marítima y los faros. Eran maravillas de la mecánica y la ingeniería civil en el siglo XIX, con el único y noble propósito de proteger a los marineros. El diseño de Sandro era impresionante y quería que el modelo fuera fiel a su propuesta original. El desafío era lograr que los componentes electrónicos cupieran en el modelo sin comprometer el proceso de construcción, el aspecto o la jugabilidad. Disfruté inmensamente diseñando este modelo (especialmente, la sala de la linterna). Espero que la gente se divierta construyendo el set y descubriendo todos los detalles que incorporamos”.

–Luka Kapeter, modelista sénior de LEGO®

“Introdujimos un montón de detalles de diseño gráfico y referencias a Sandro y su pasión. Mis favoritos son el mapa de la península de la Gaspesia en el escritorio, la foto sepia de Sandro y su familia, y un 'retrato' del siglo XIX a modo de guiño a la época en la que se inventó el lente de Fresnel. Todos esos detalles crean la atmósfera del modelo”.

–Claus Tannebæk Madsen, diseñador gráfico sénior de LEGO®

“El diseño del lente depende de varias dimensiones variables. El sistema LEGO® System impone sin margen algunas de esas dimensiones (como la posición de la fuente de luz en comparación con el lente mismo), pero eso facilita ciertas partes del proceso de diseño y dificulta otras. Al final, creo que encontramos un equilibrio adecuado, con un buen haz de luz y el inconfundible aspecto de un auténtico lente de faro”.

–Peter de Fine Licht, diseñador de juego sénior de LEGO® (elementos)

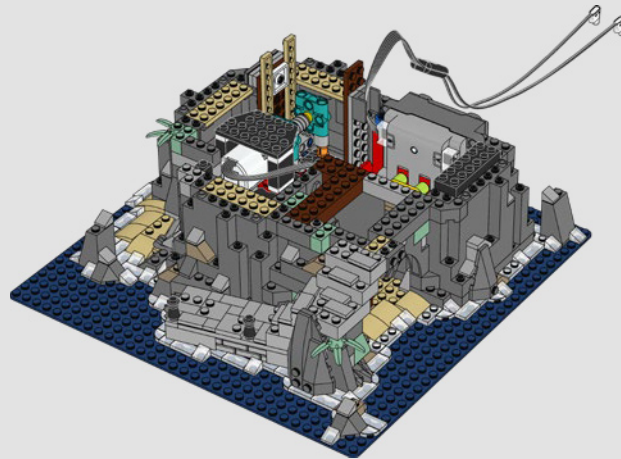
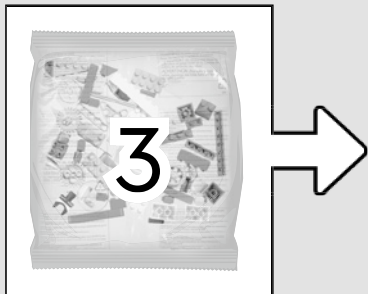
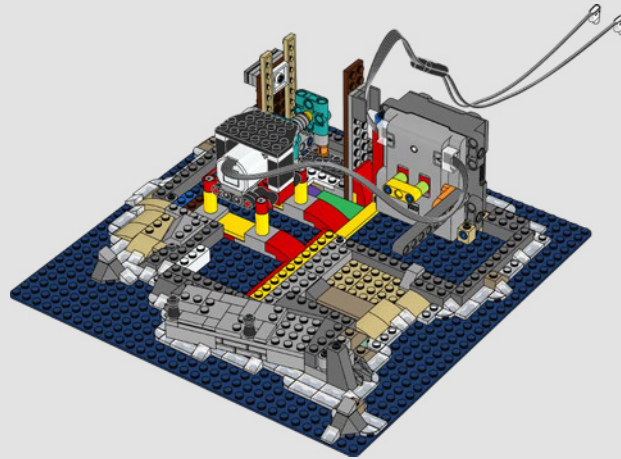
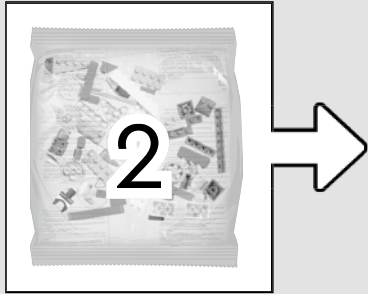
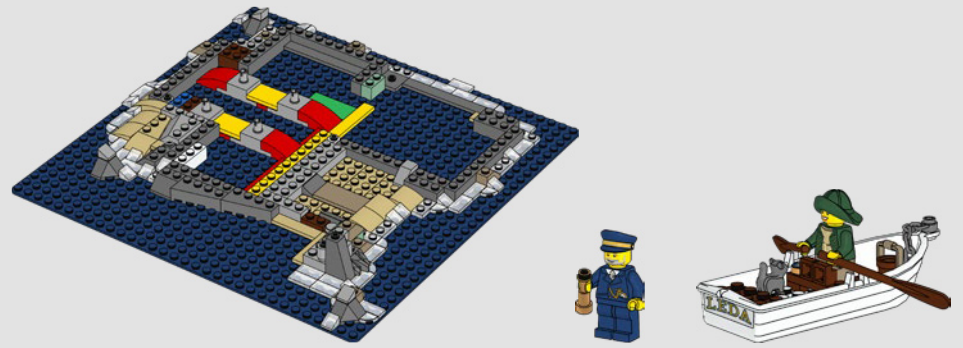
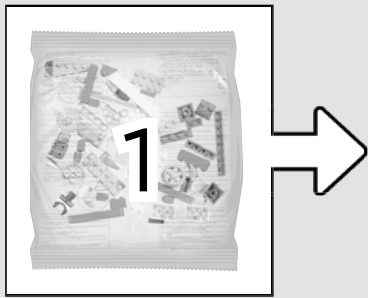

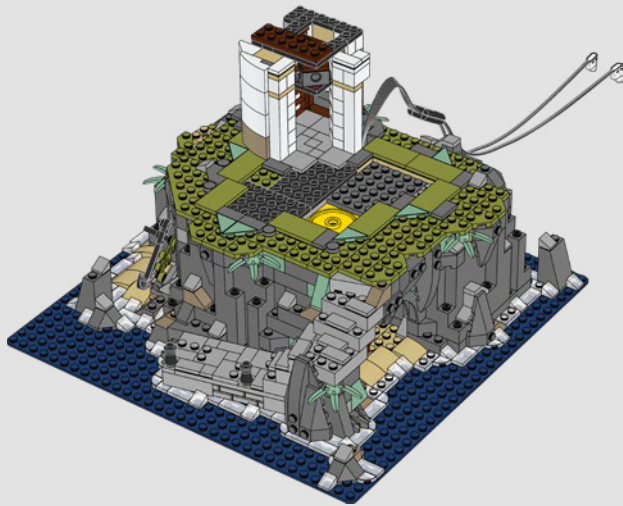
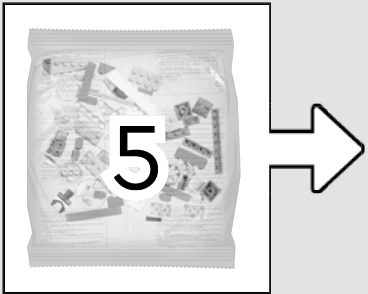
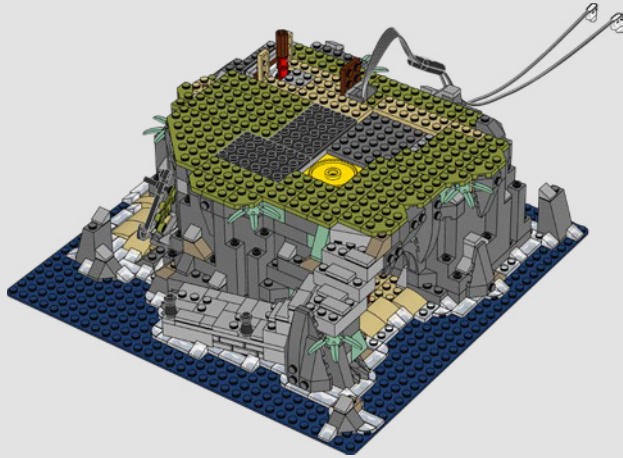
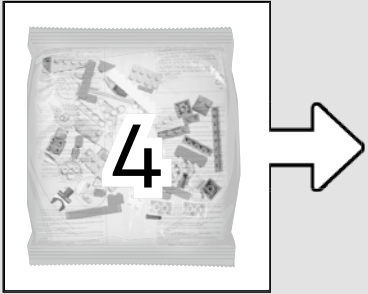

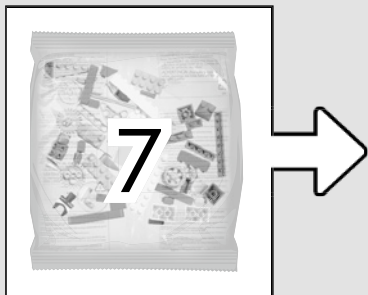
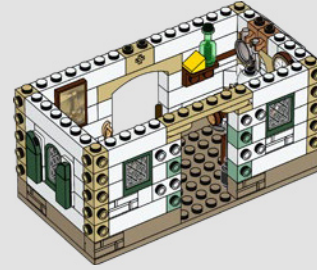
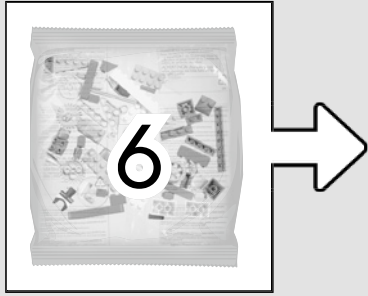

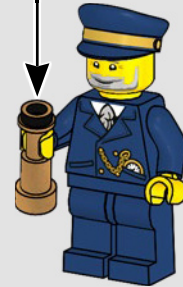
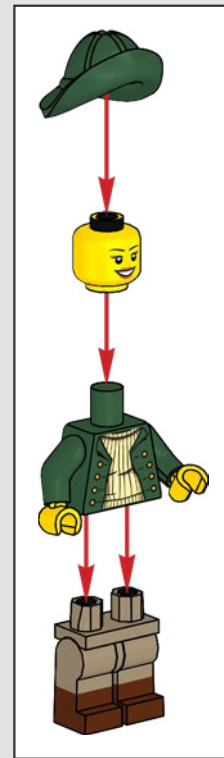
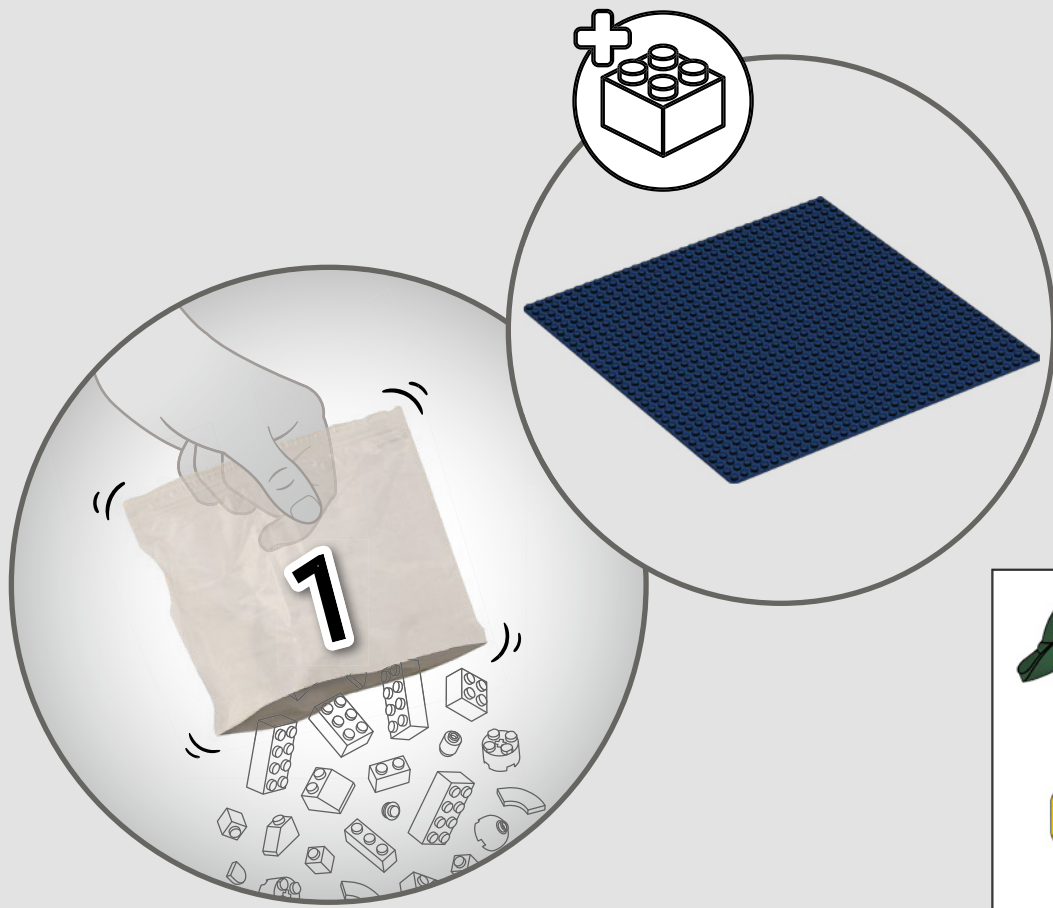

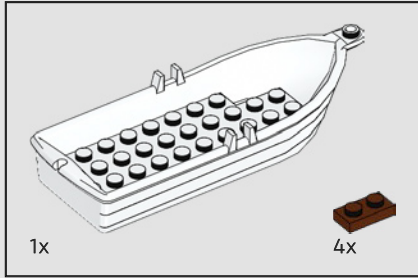
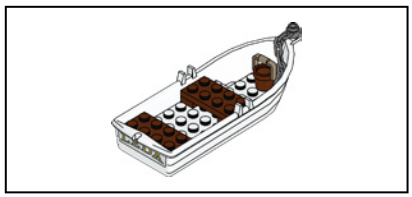

1

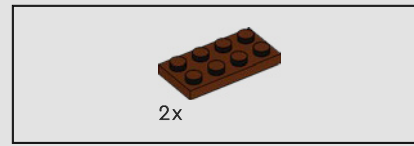
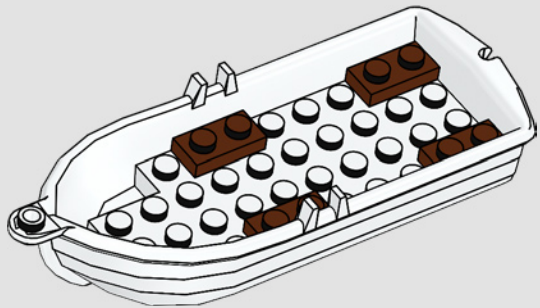

2

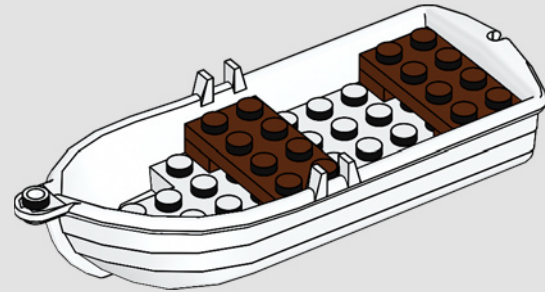

3

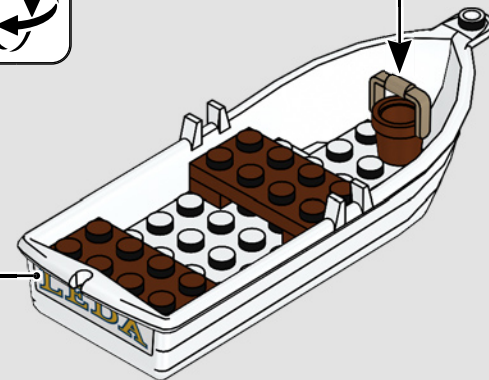
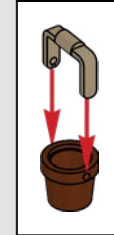
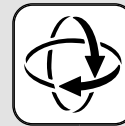

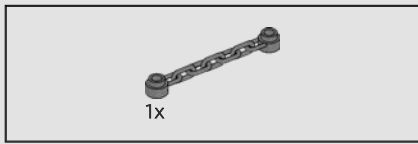

4

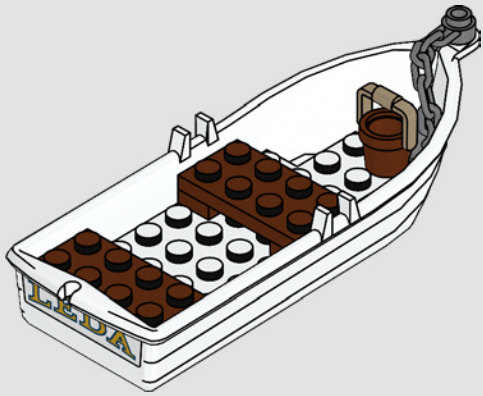

5

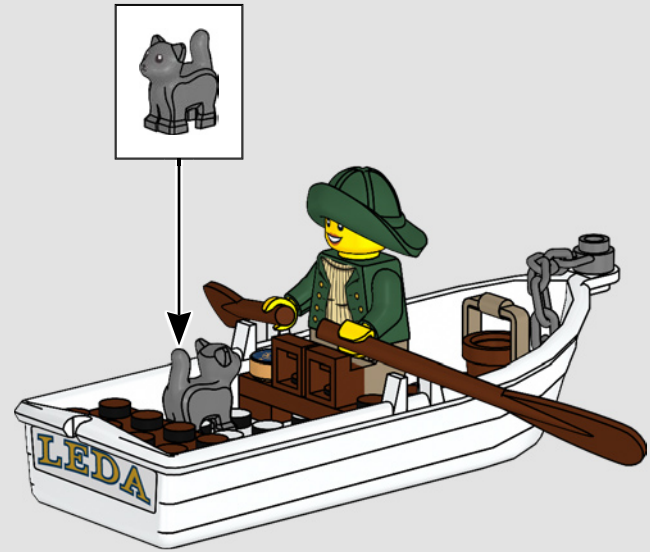



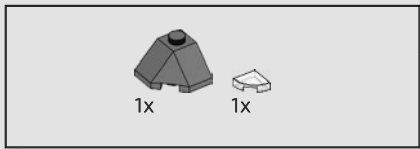

1

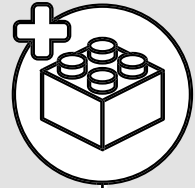

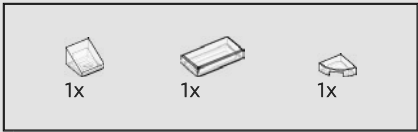

2

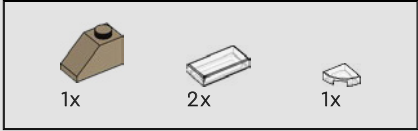
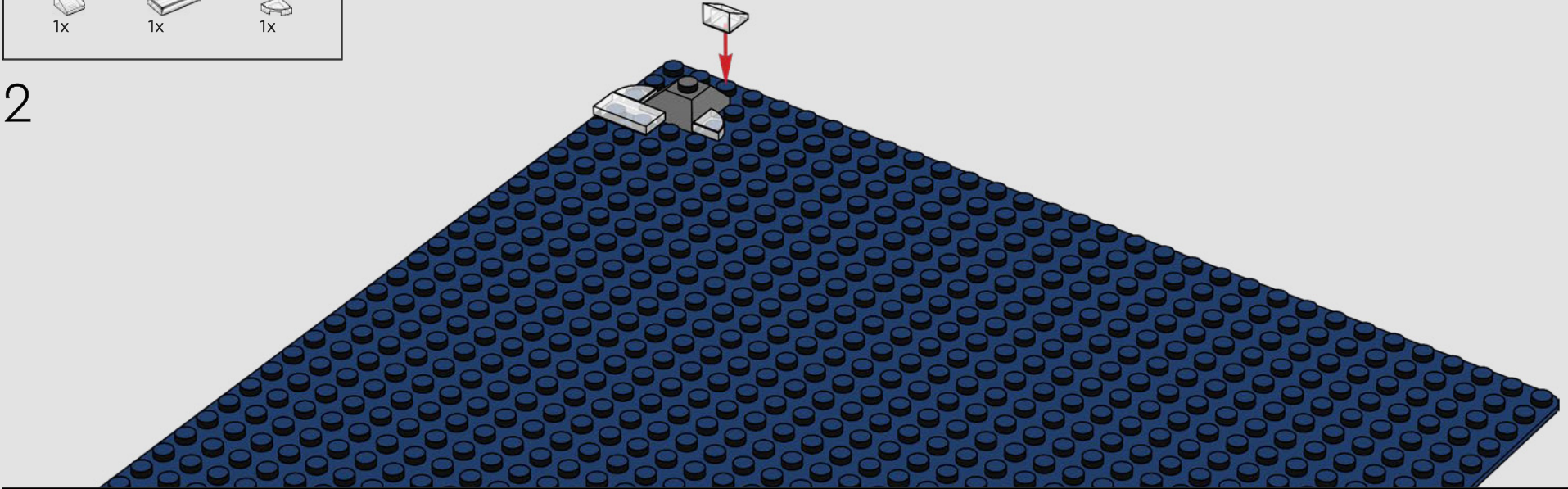

3

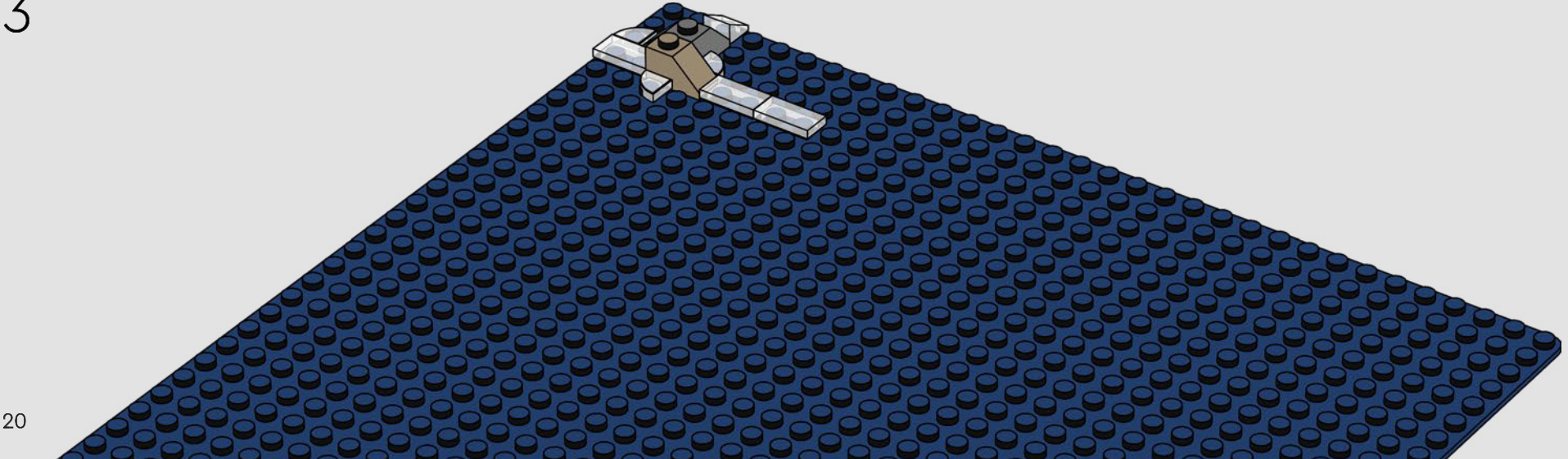

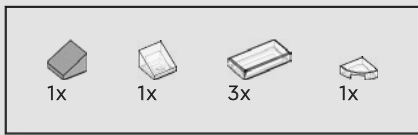

4

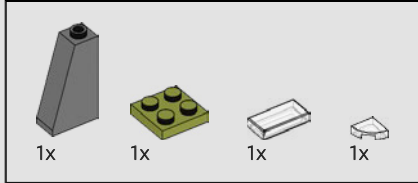
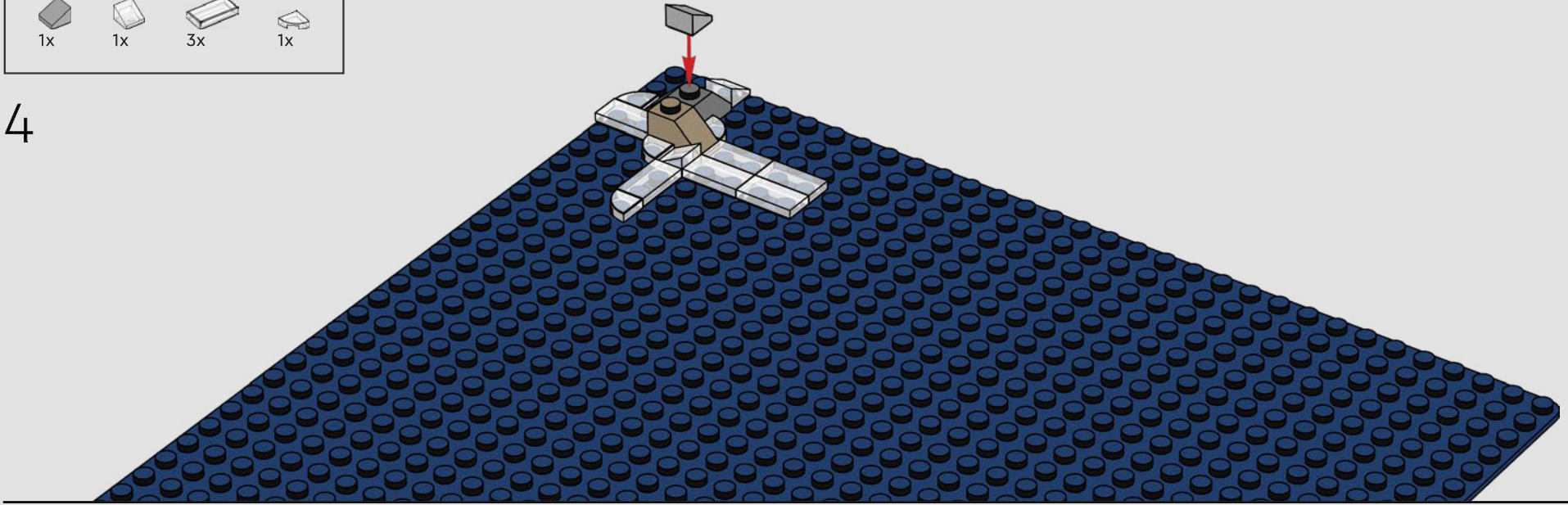

5

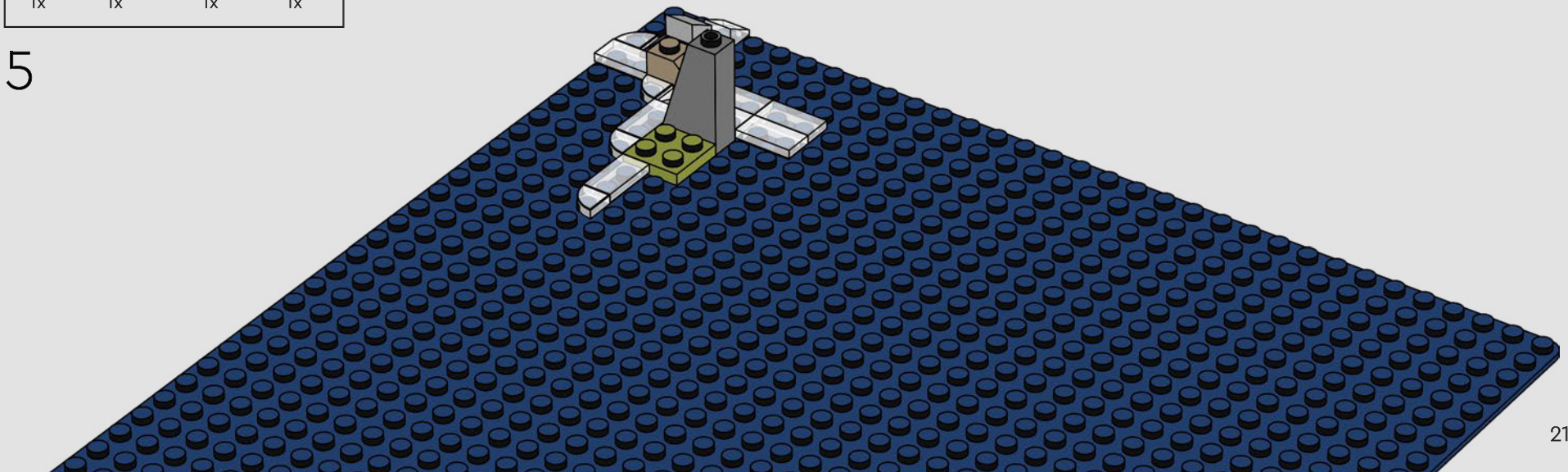

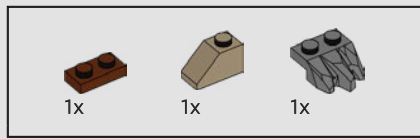

6

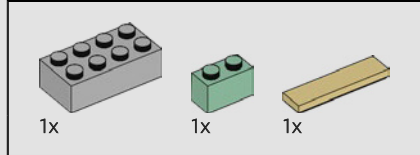
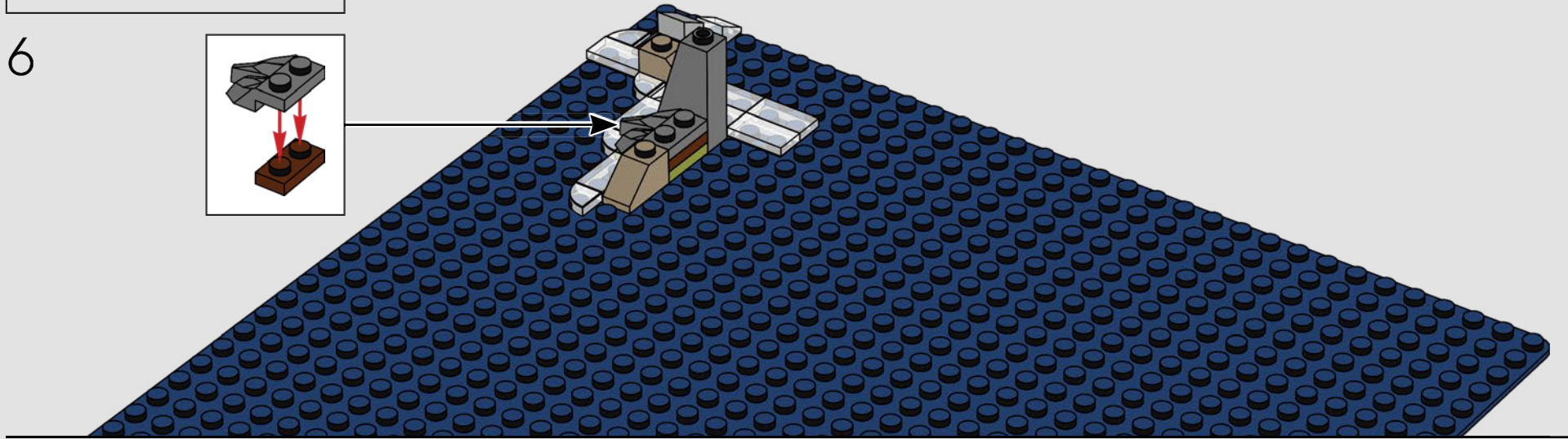
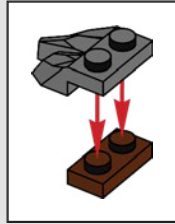

7

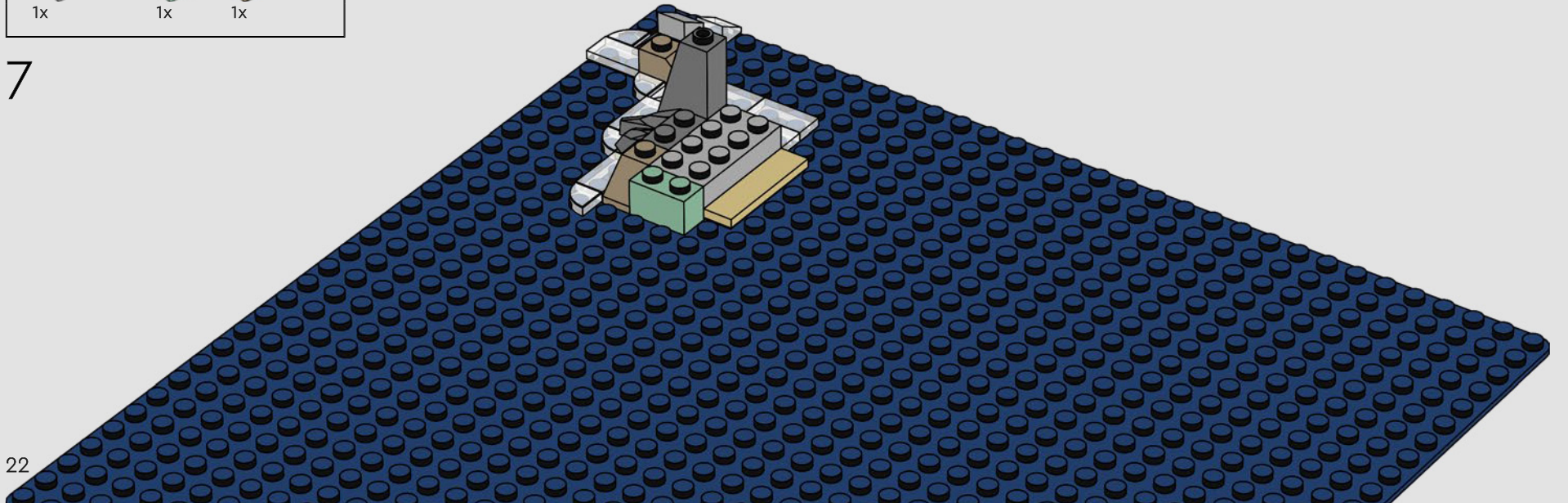

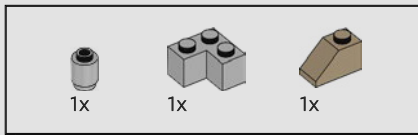

8

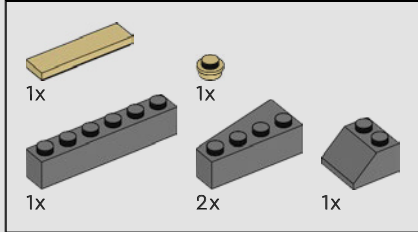
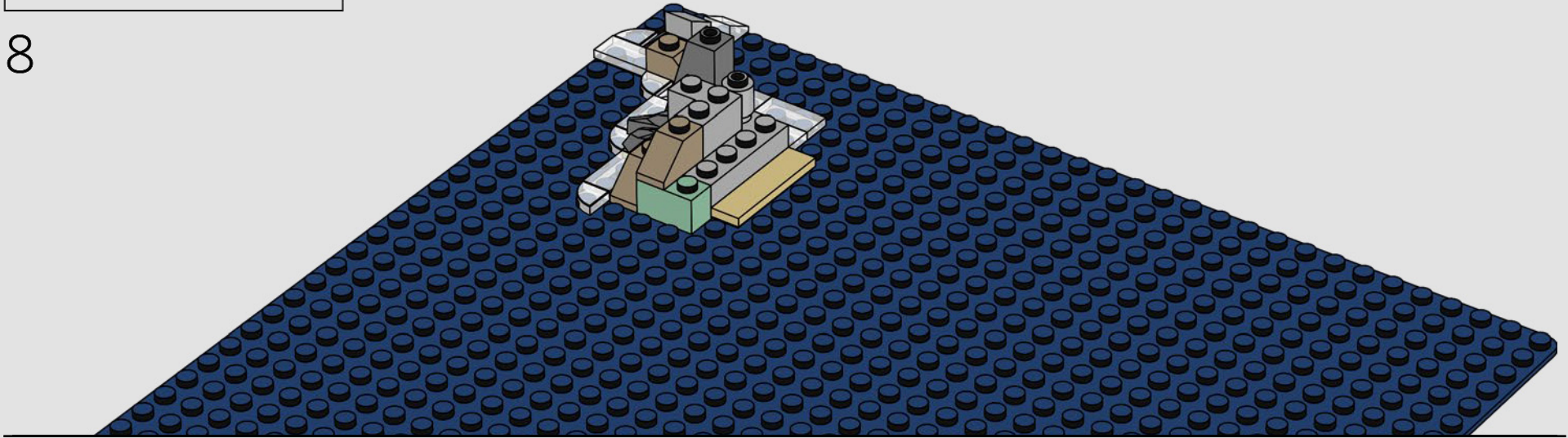

9

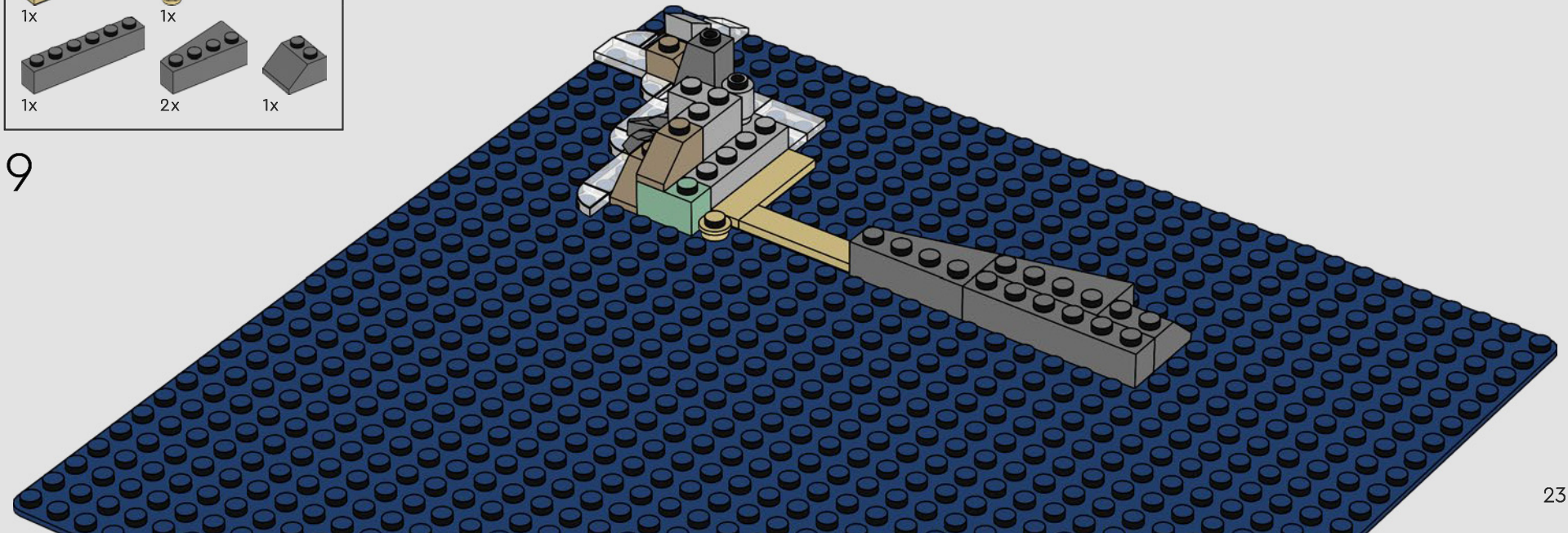

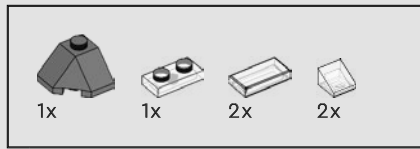

10

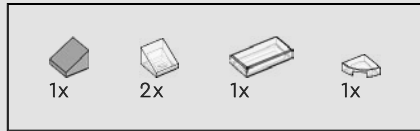
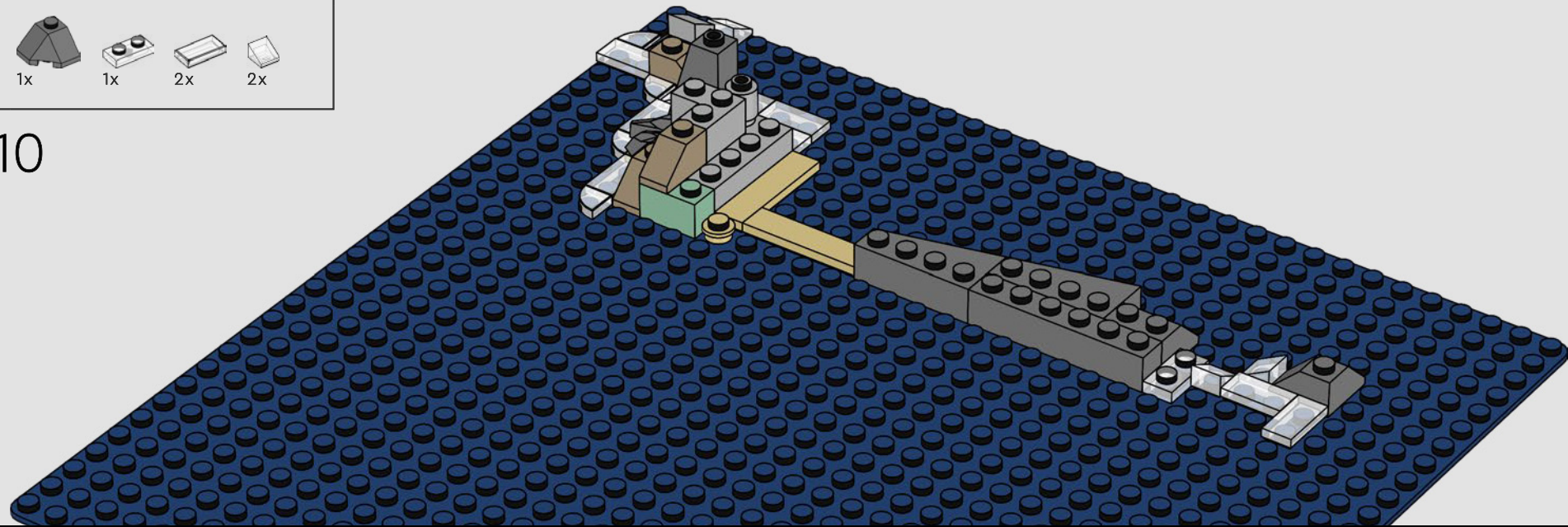

11

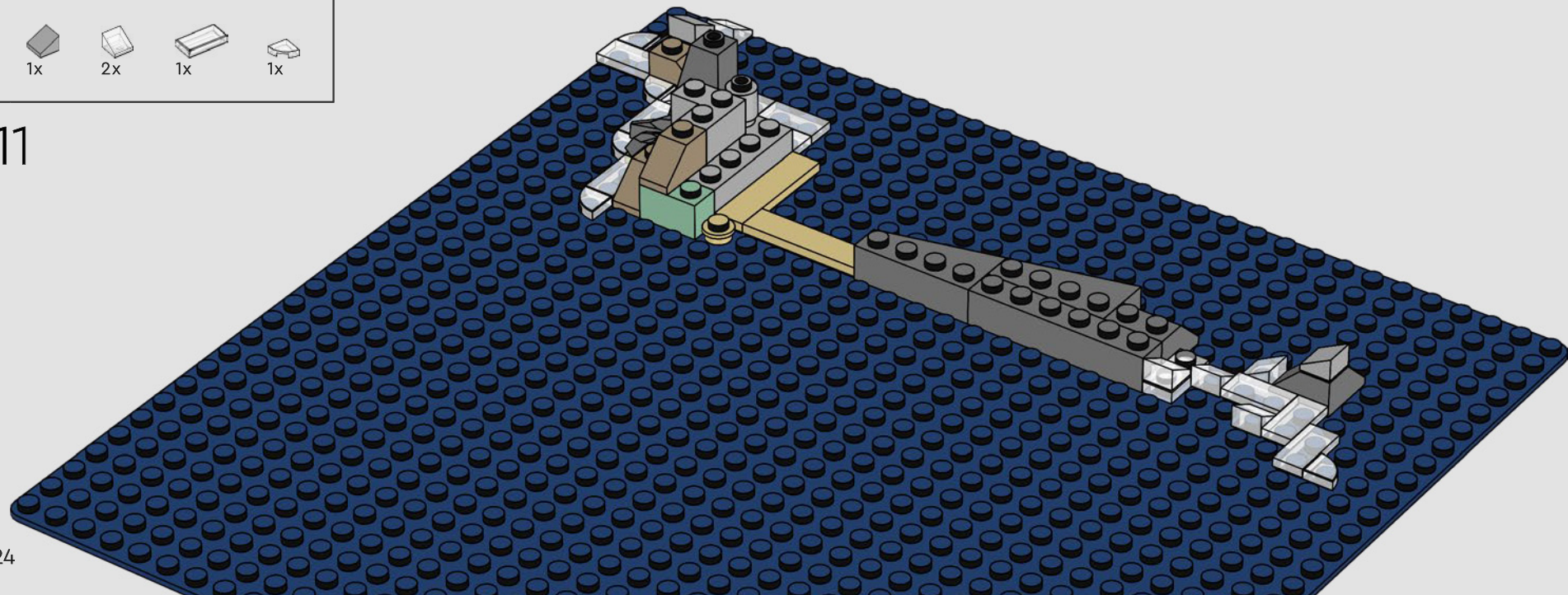

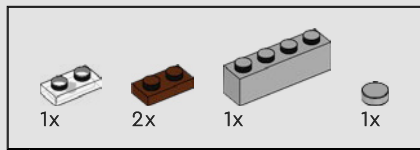

12

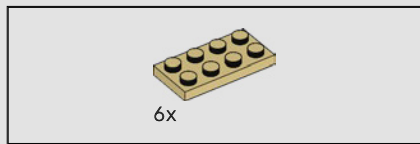
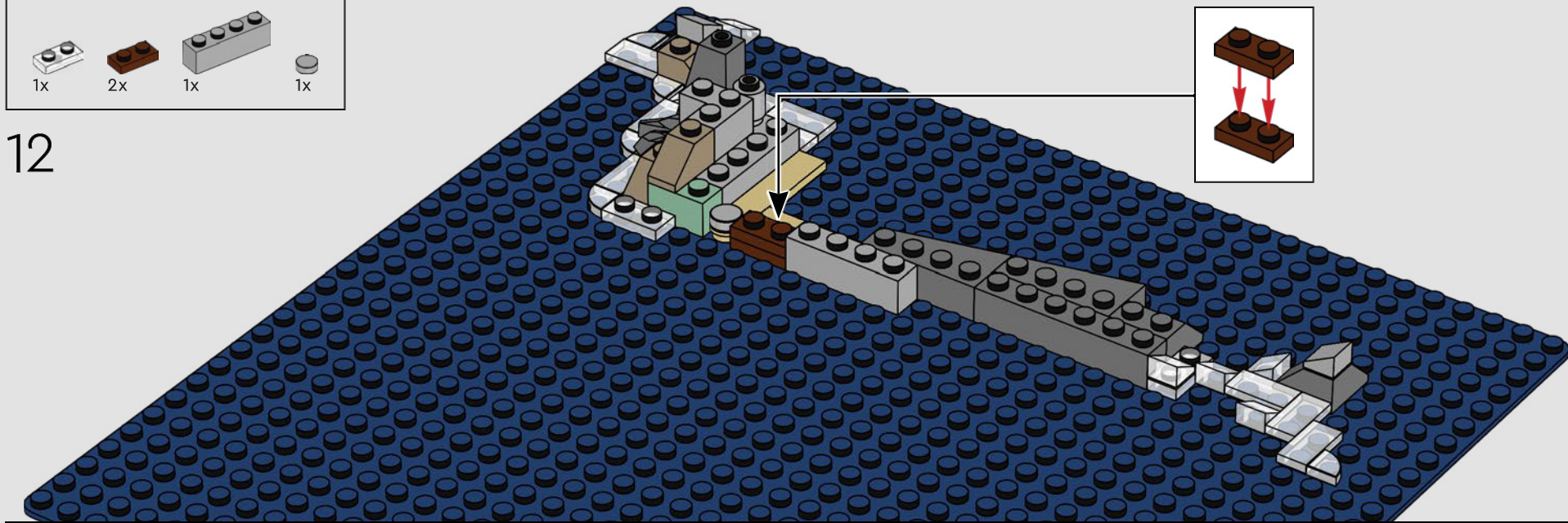

13

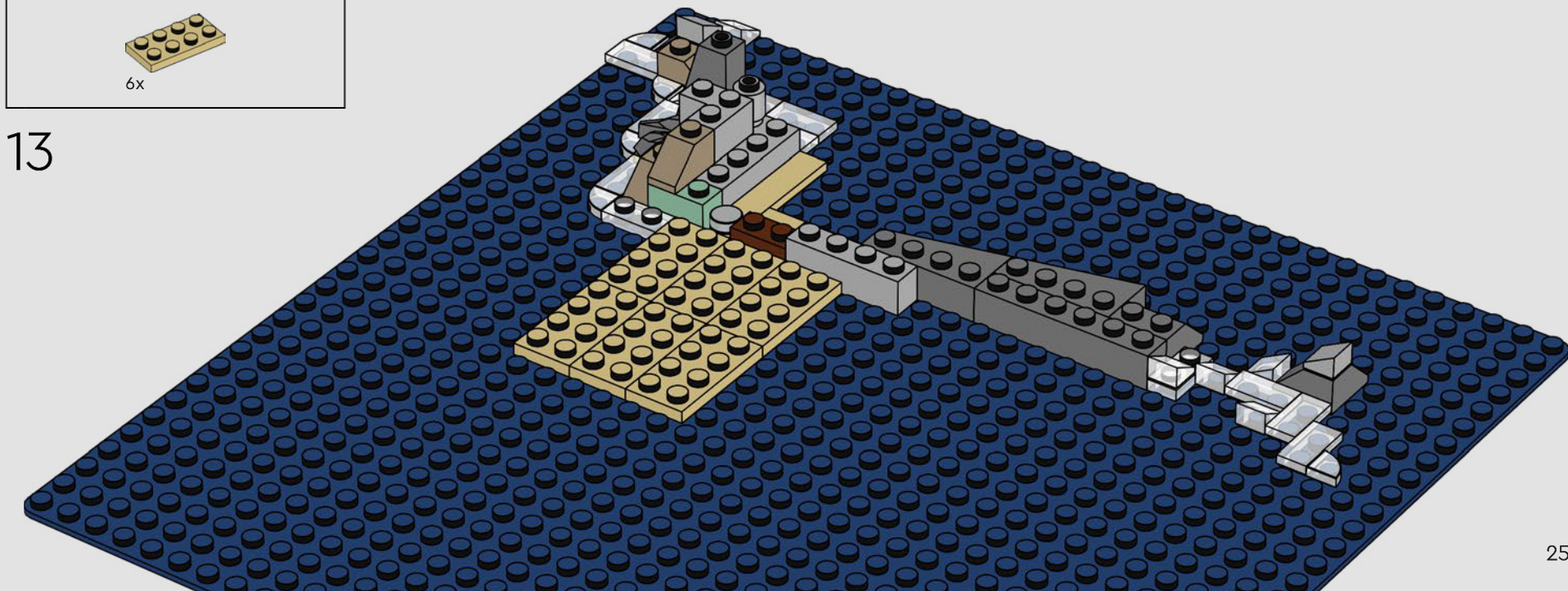

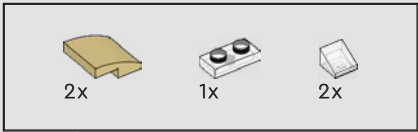

14

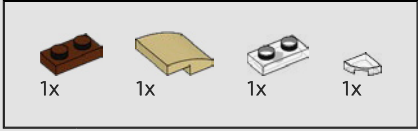
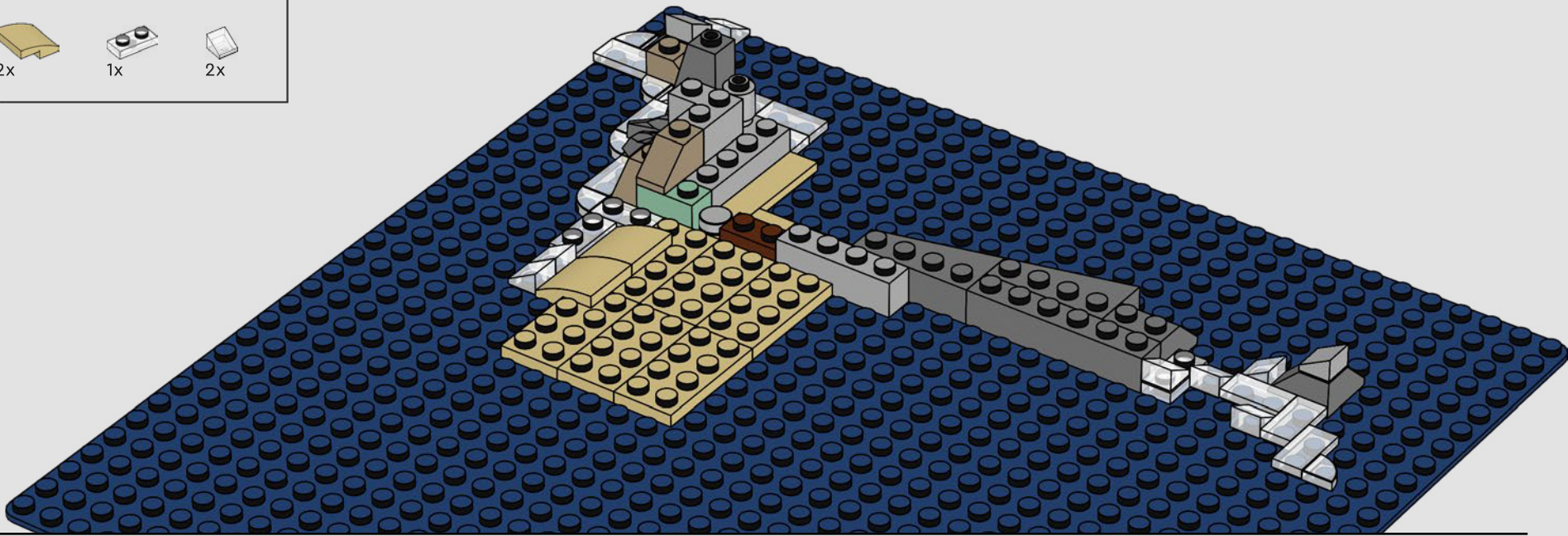

15

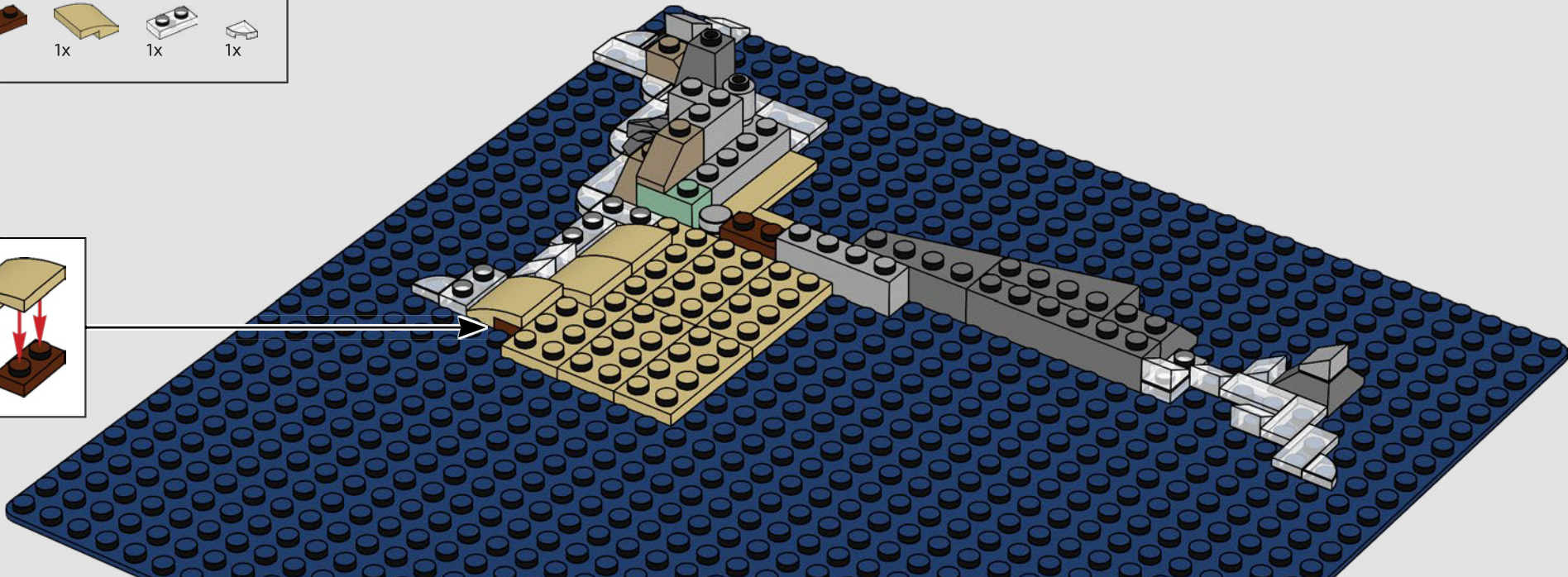
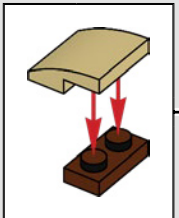

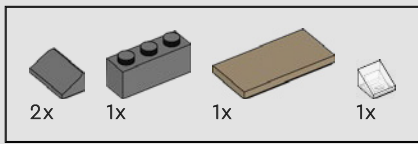

16

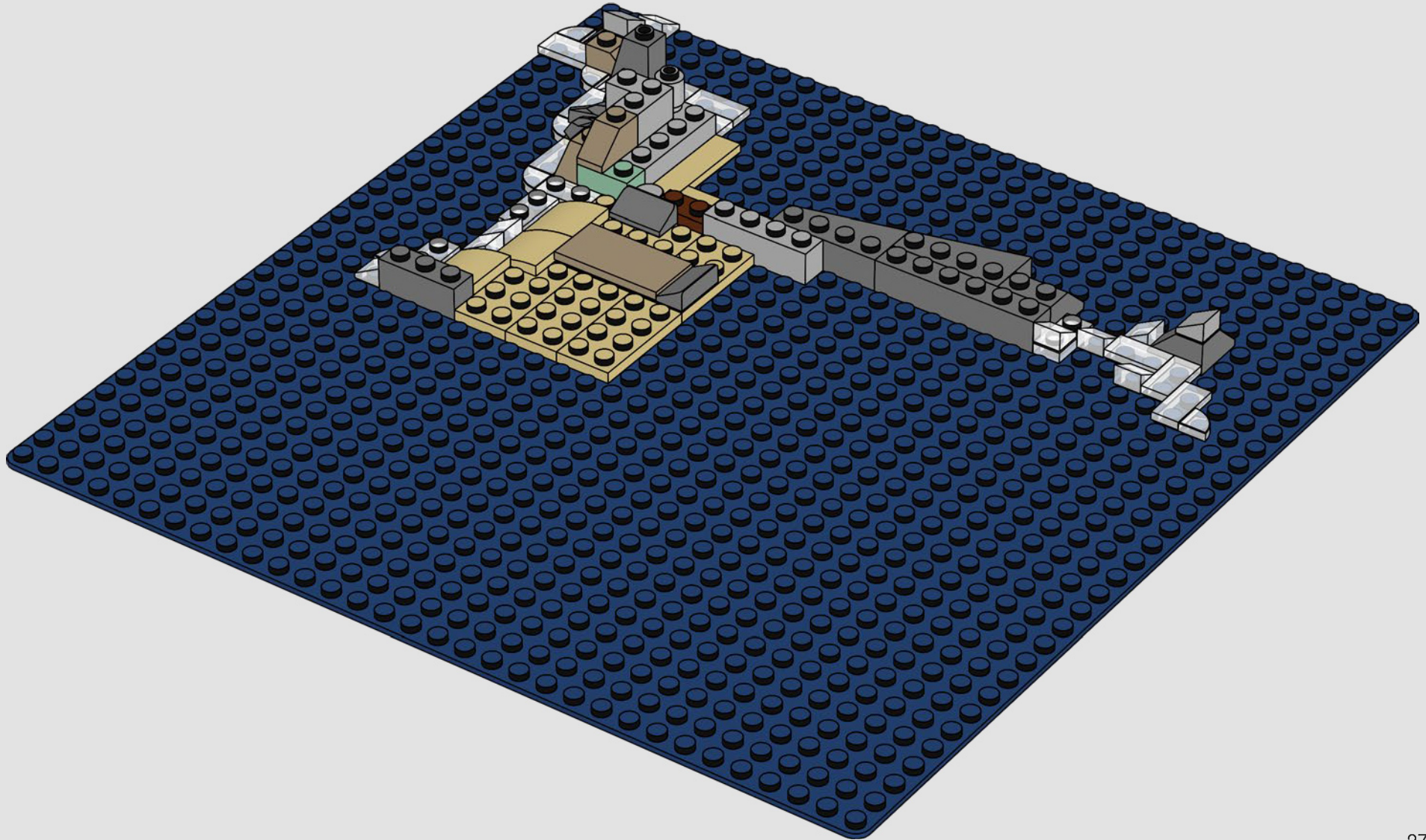

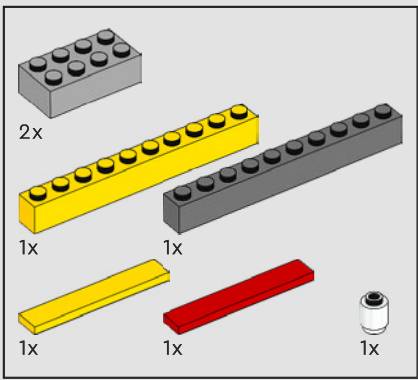

17

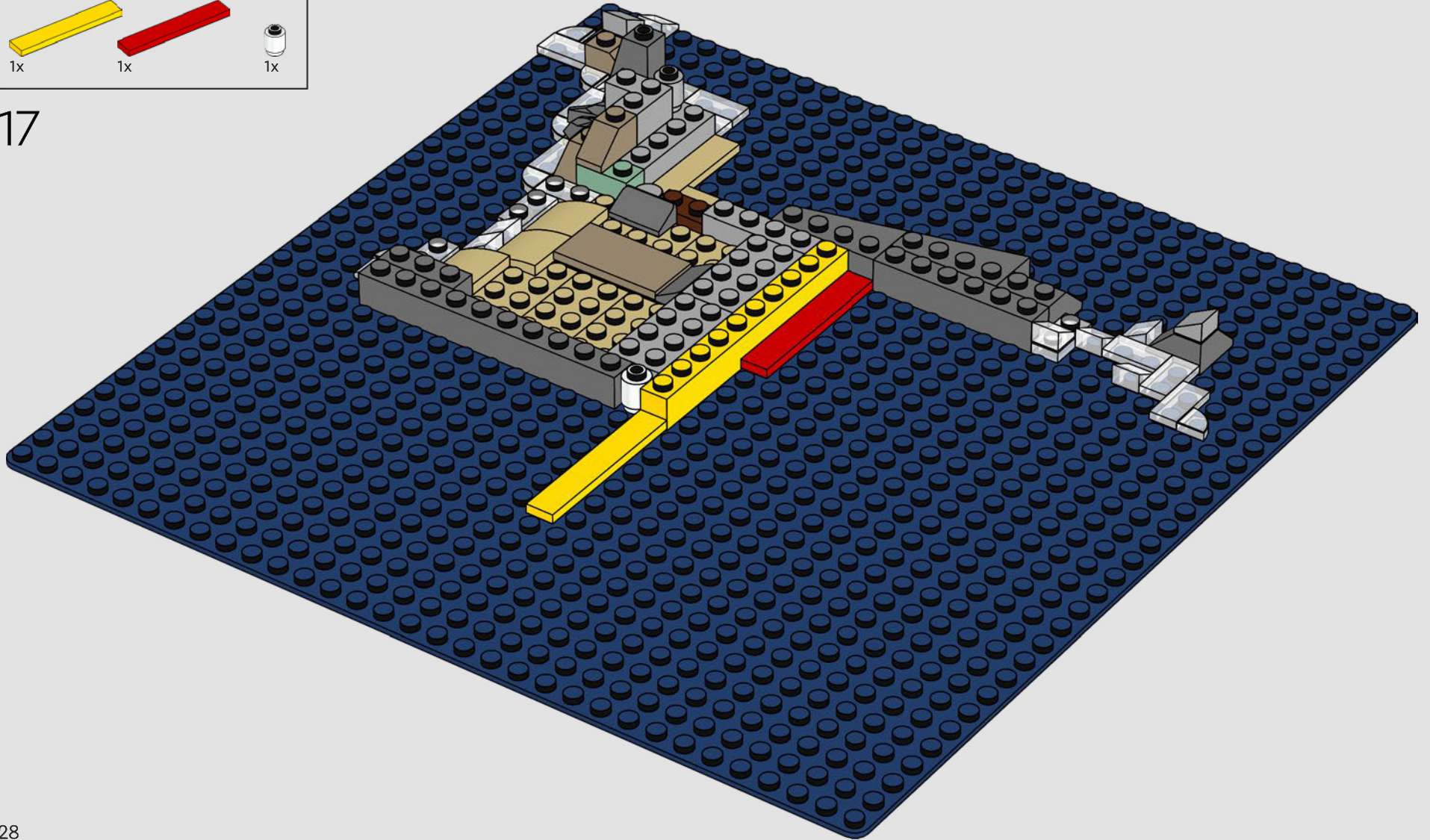

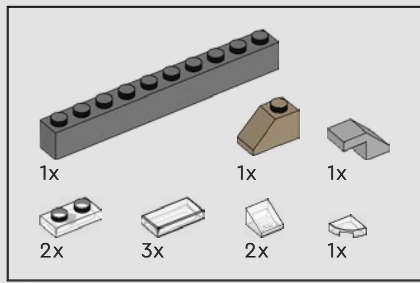

18

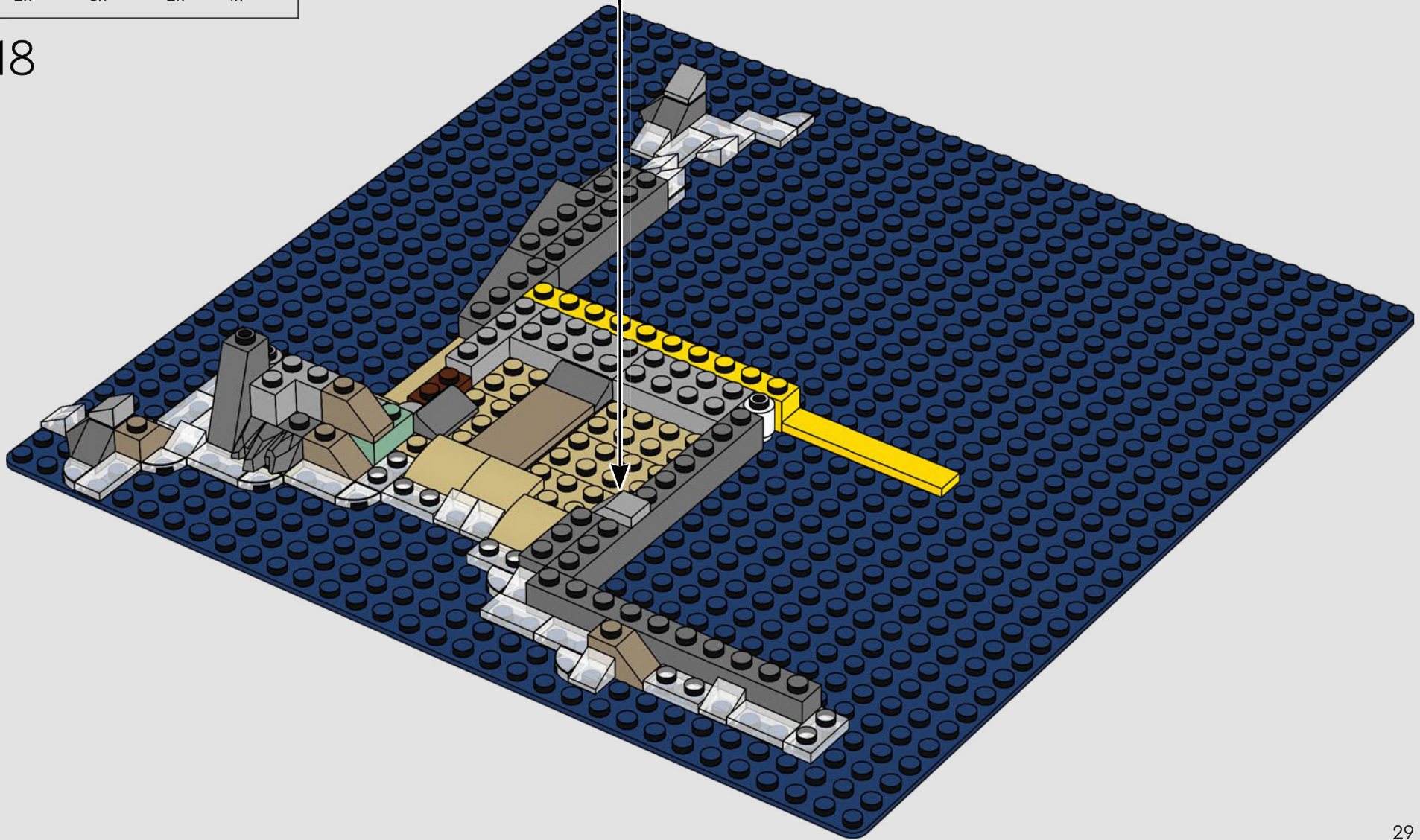
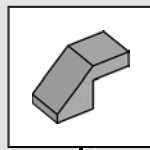

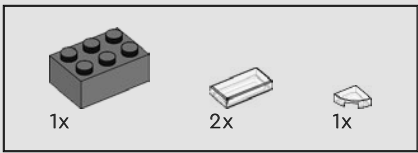

19

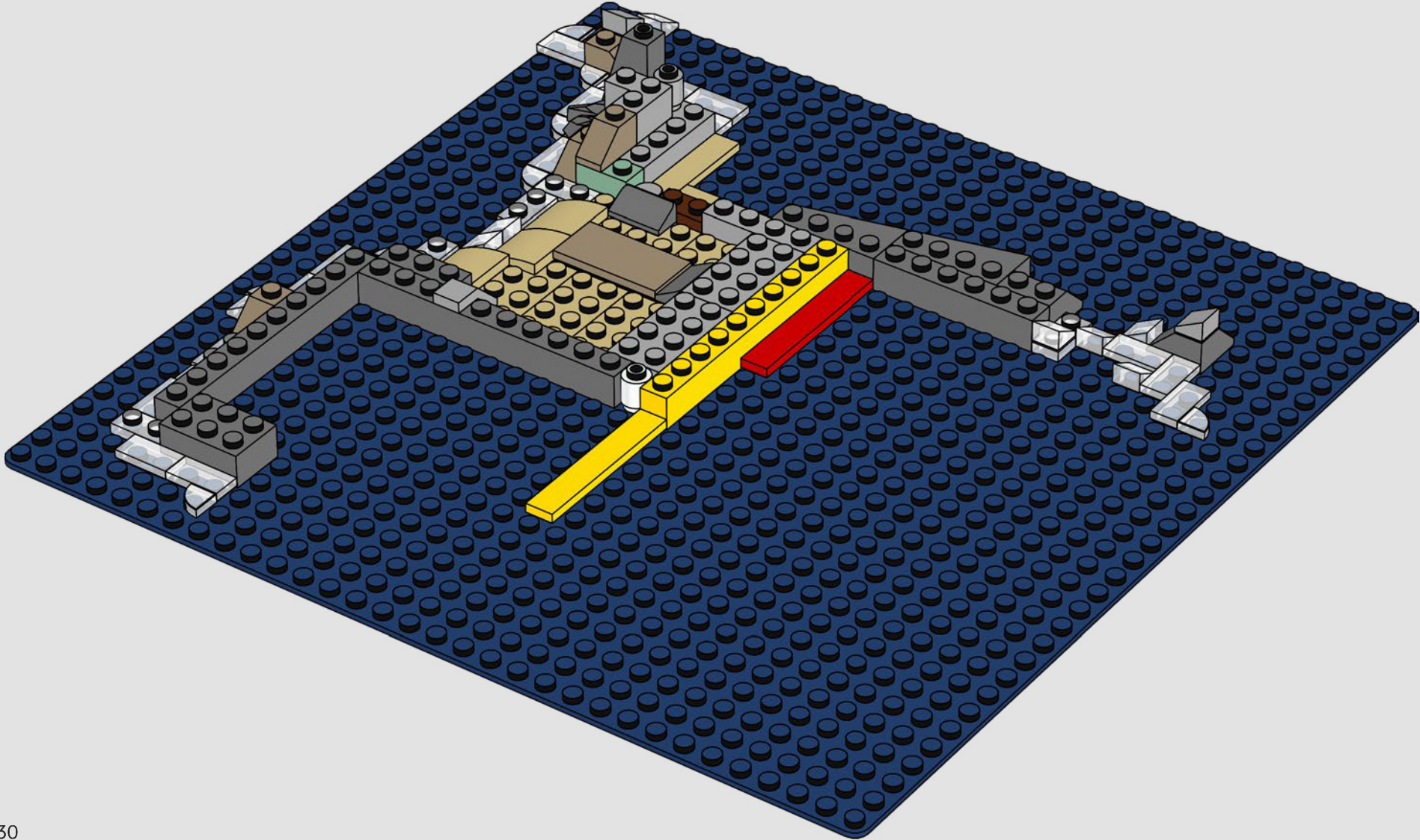

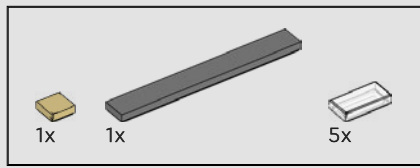

20

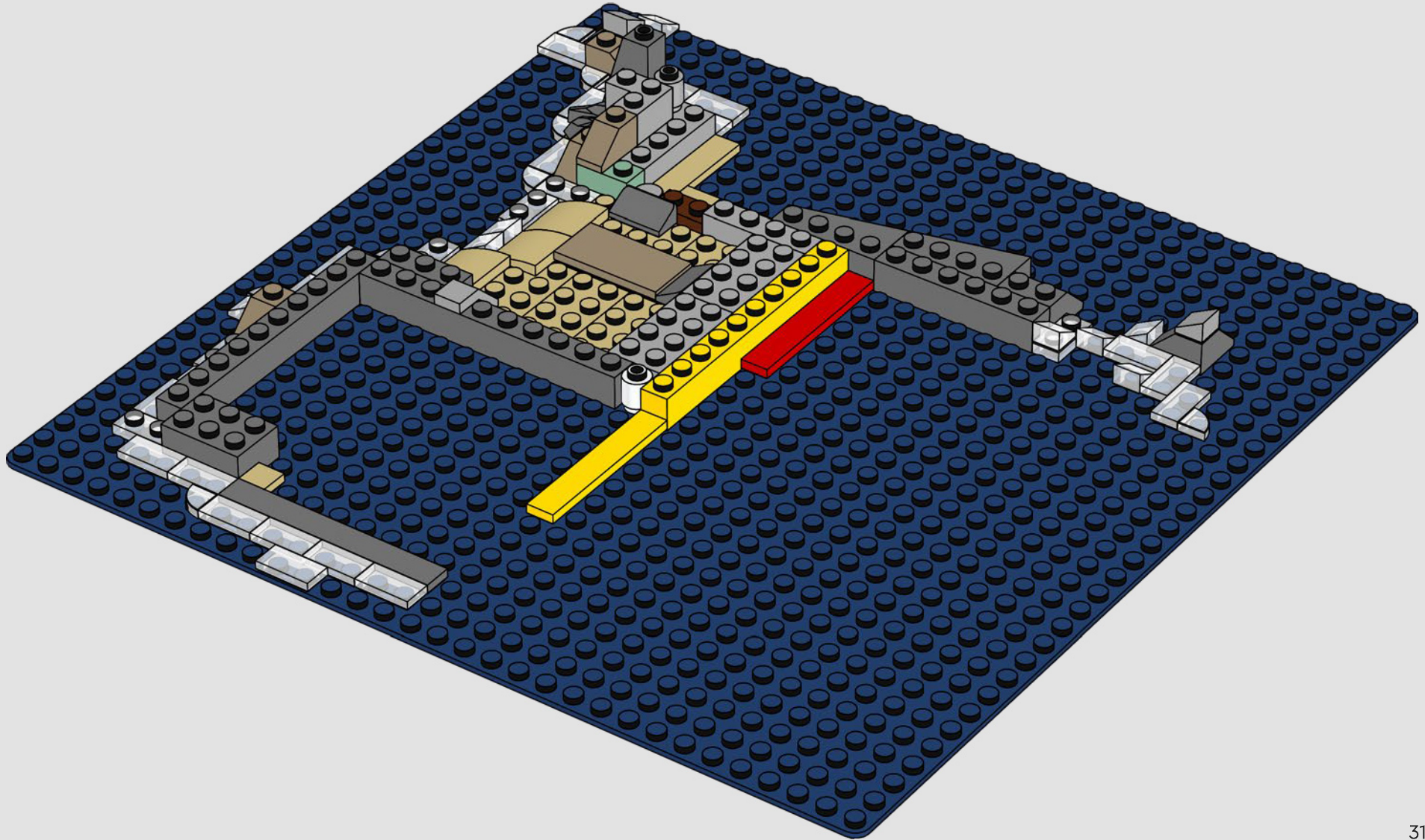

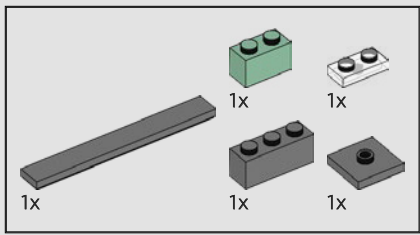

21

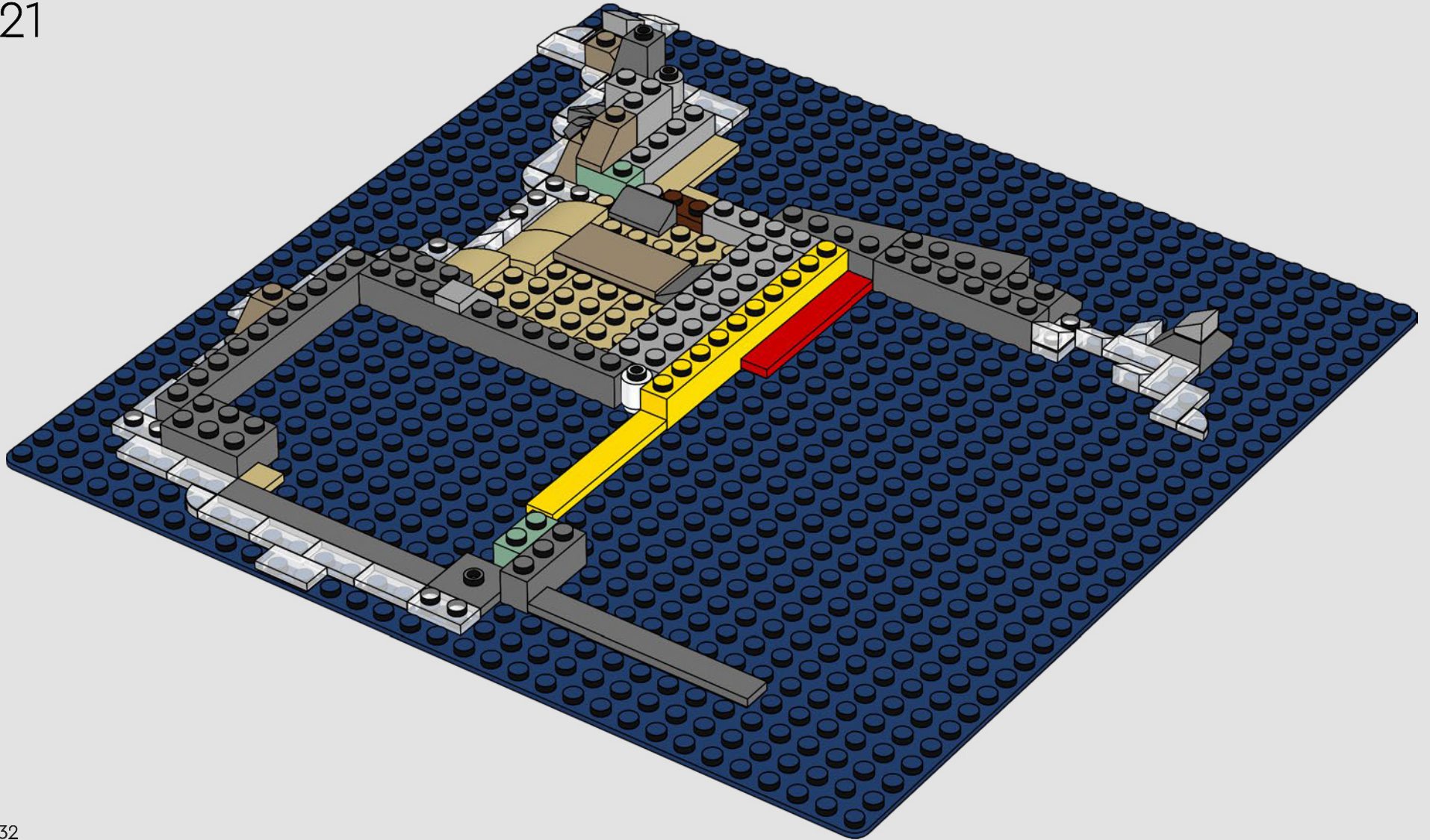

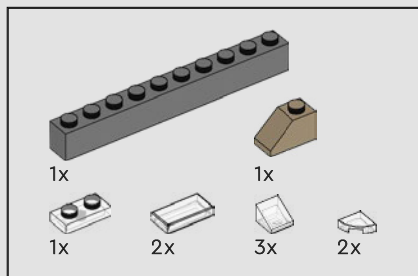

22

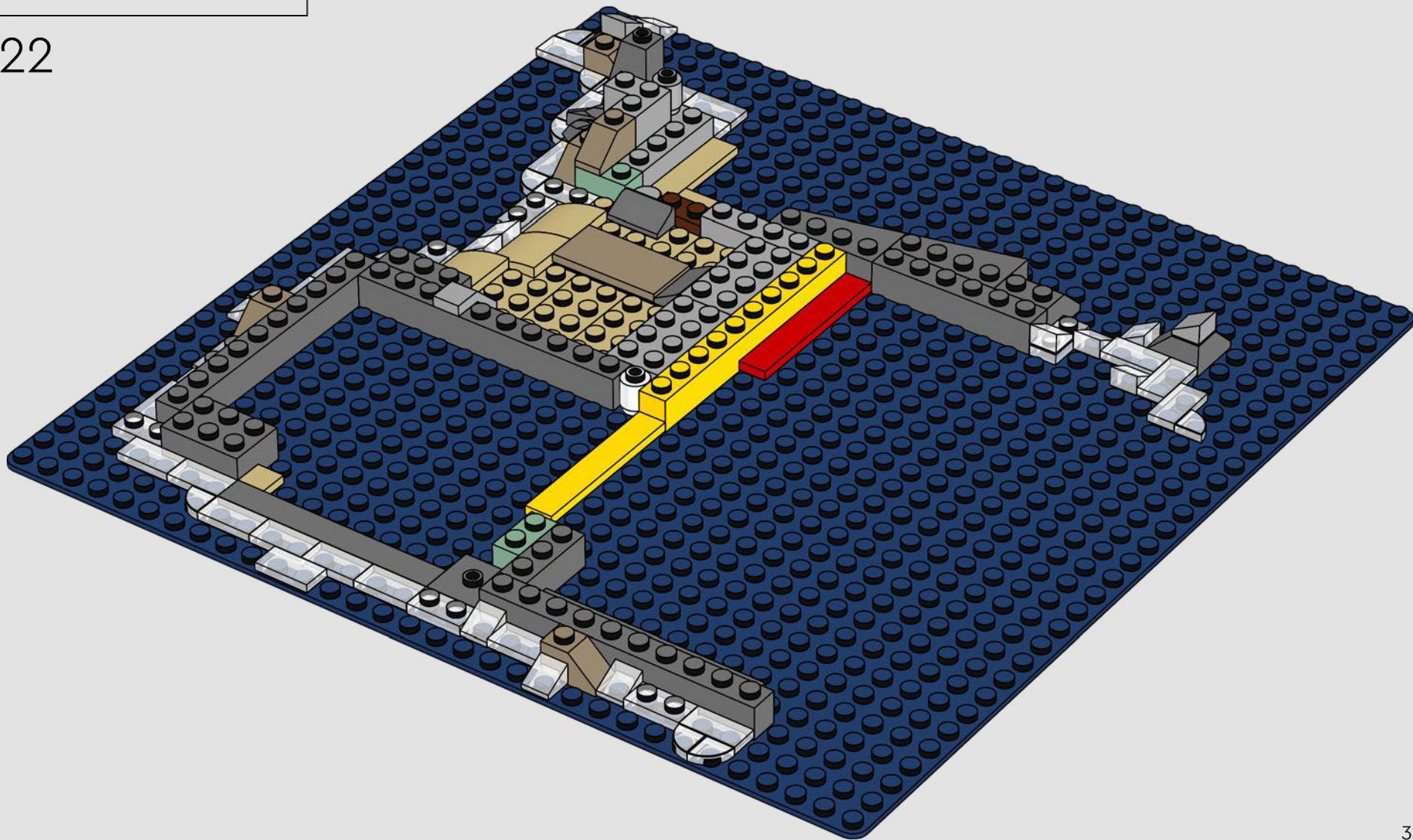

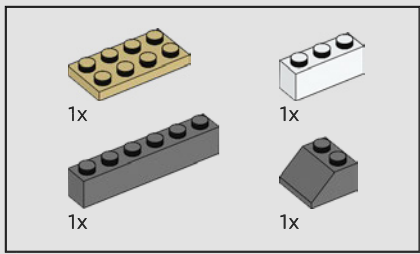

23

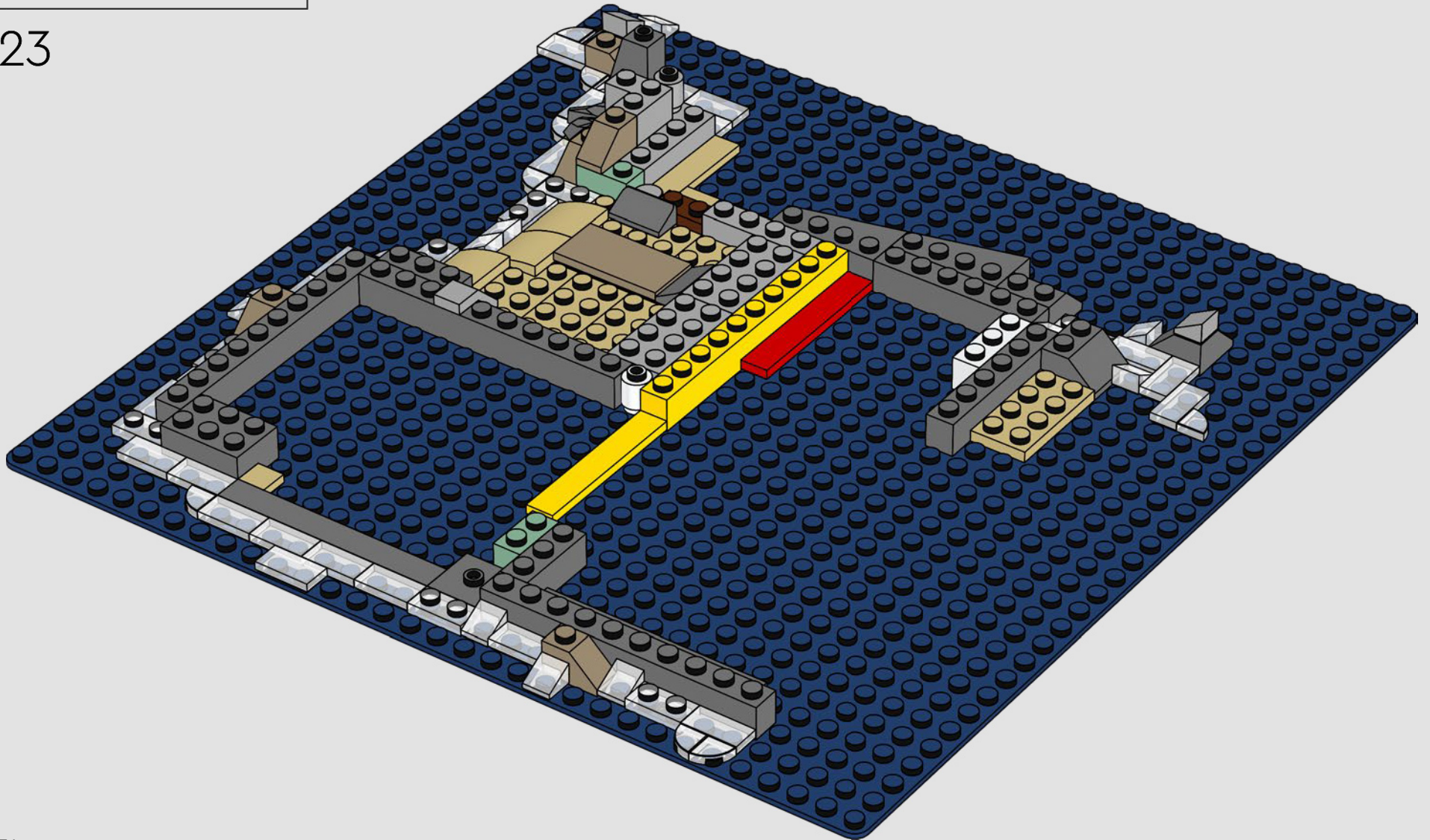

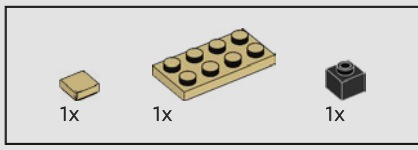

24

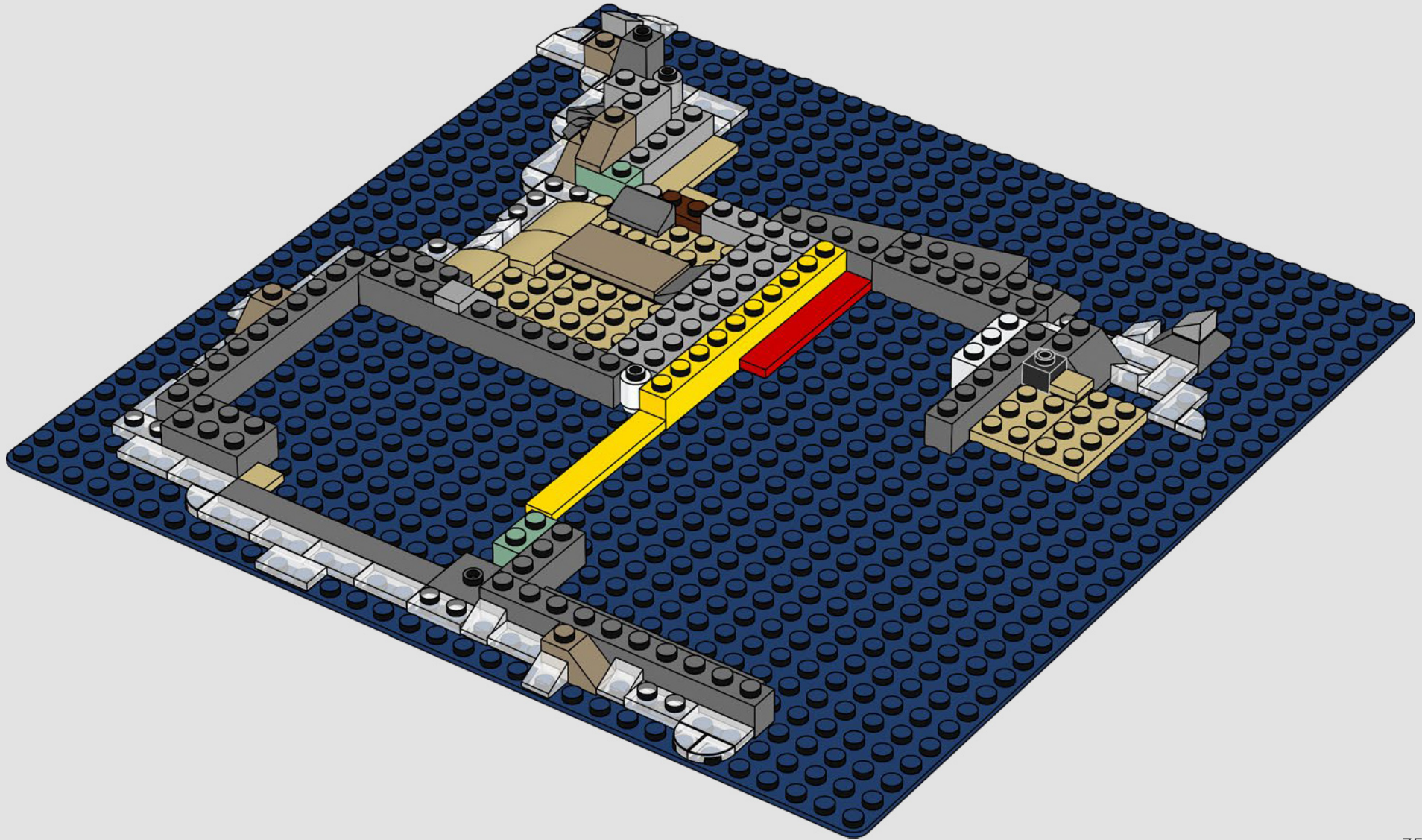

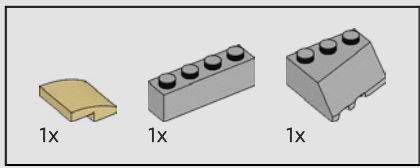

25

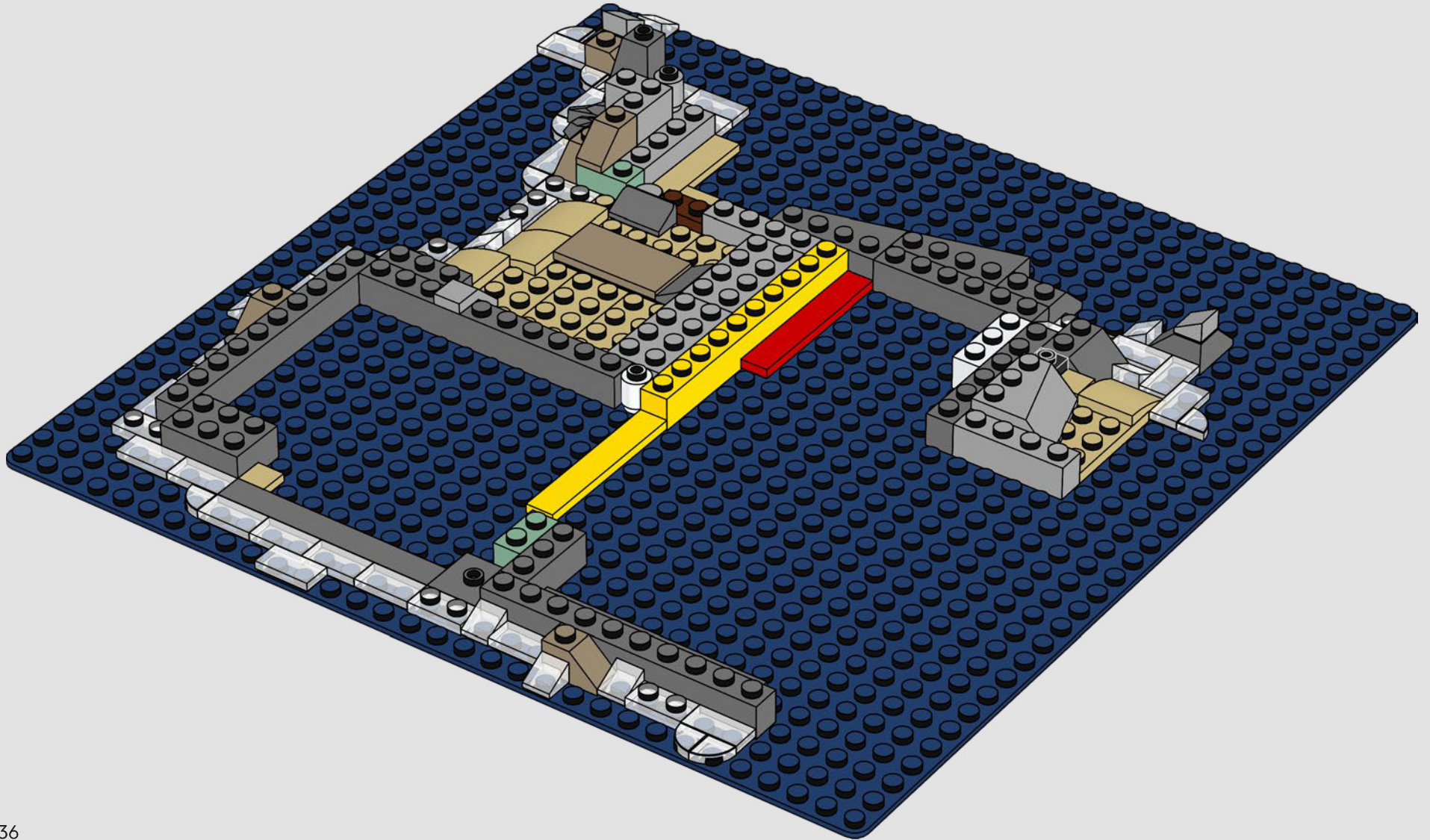

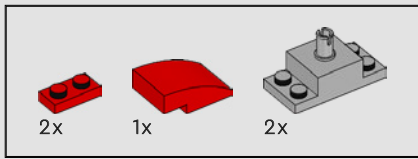

26

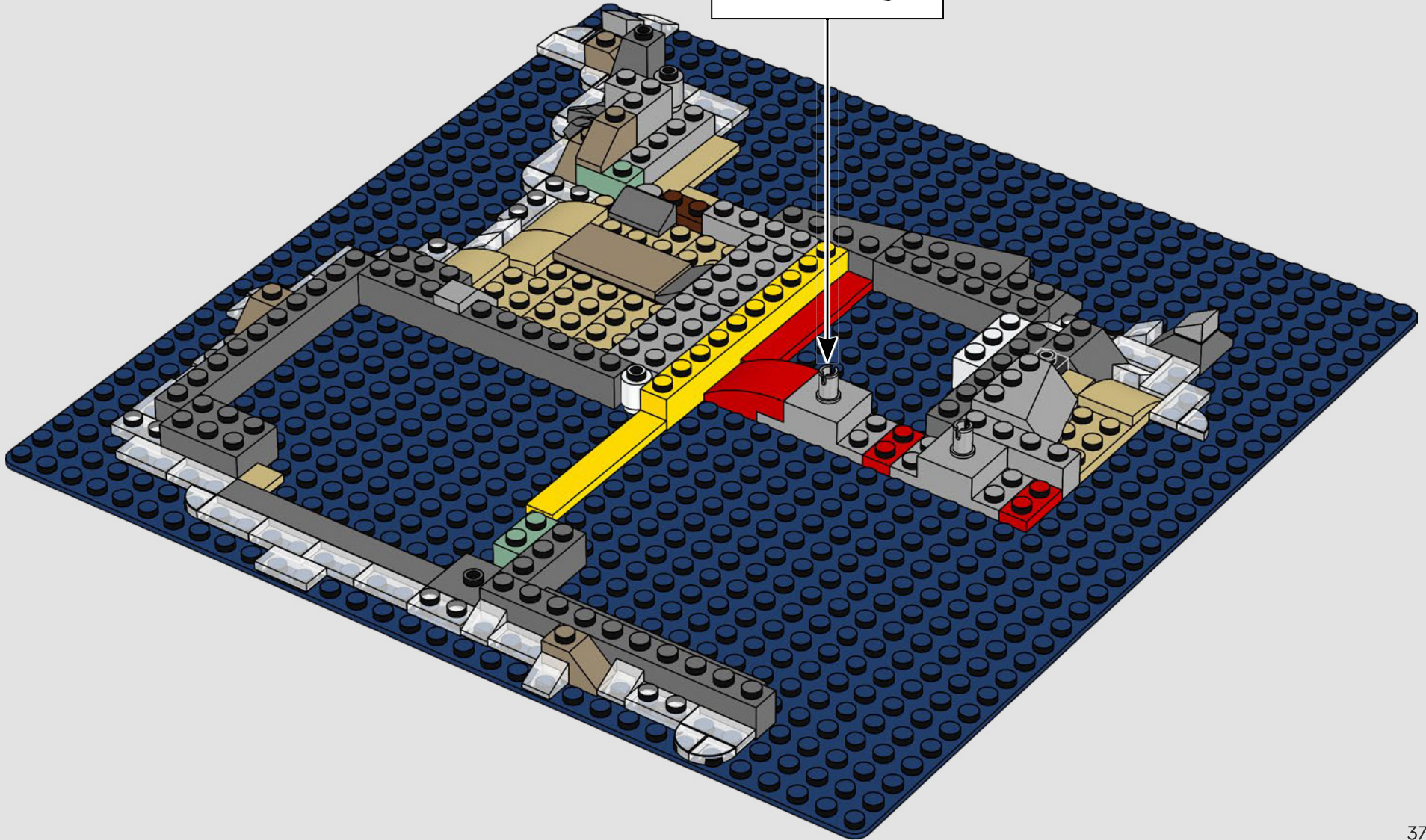
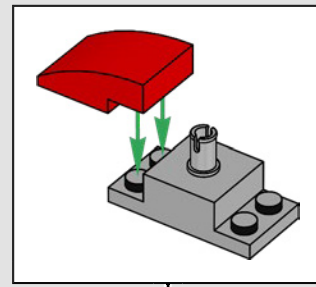

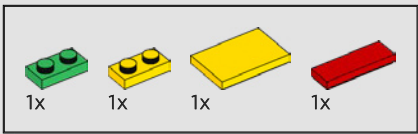

27

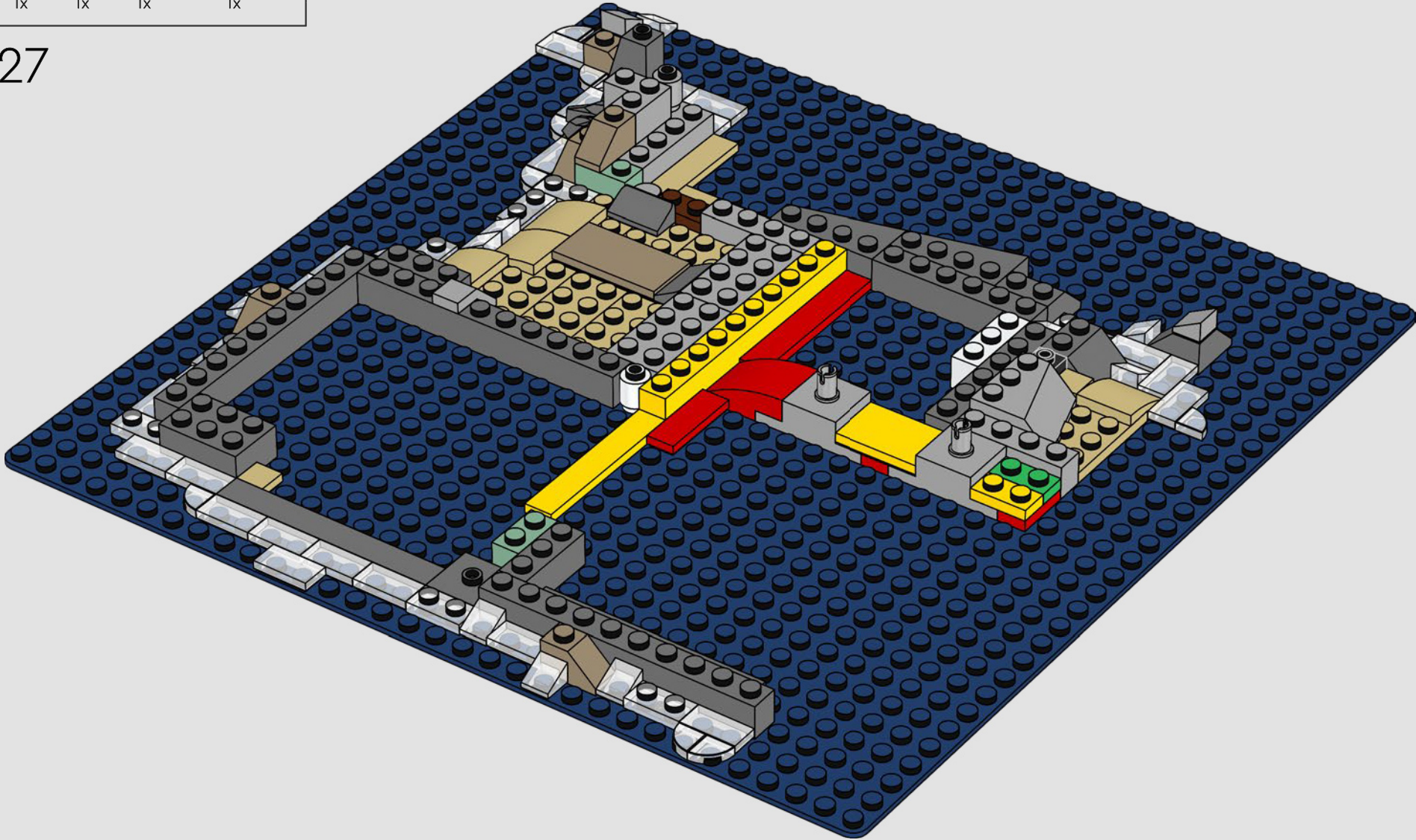

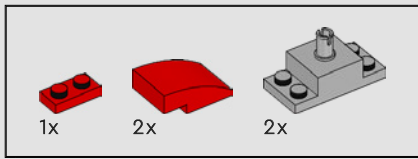

28

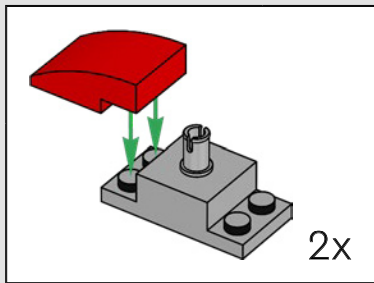
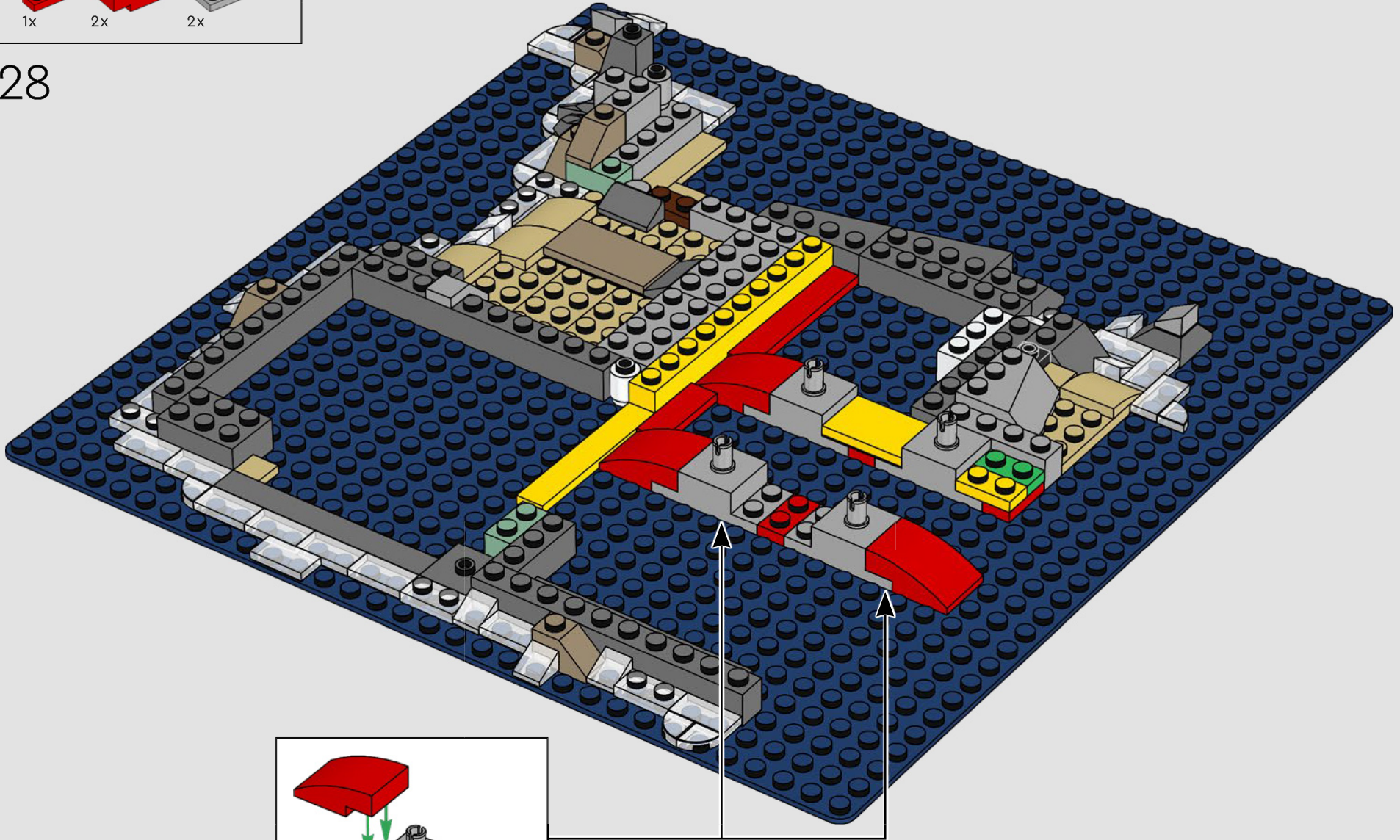

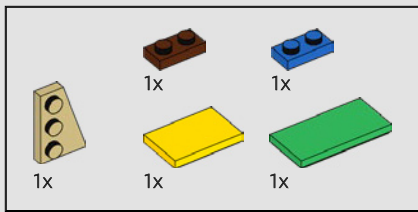

"This small assembly of mismatched plates pays tribute to all the LEGO® fan builders who have had to work with a limited selection of pieces and who have needed to use whatever parts they could find to substitute the elements they were missing."

- LEGO® Ideas Fan Designer Sandro Quattrini

« Ce petit assemblage de plaques dépareillées rend hommage à tous les constructeurs amateurs de LEGO® qui ont dû travailler avec une sélection limitée de pièces et qui ont dû utiliser toutes les pièces qu'ils pouvaient trouver pour remplacer les éléments qui leur manquaient. »

- Sandro Quattrini, concepteur amateur LEGO® Ideas

"Este pequeño conjunto de placas desiguales es un homenaje a todos los fans y constructores LEGO® que han tenido que trabajar alguna vez con una gama limitada de piezas y se vieron obligados a usar las que pudieron encontrar para reemplazar los elementos que les faltaban".

- Sandro Quattrini, fan diseñador de LEGO® Ideas

29

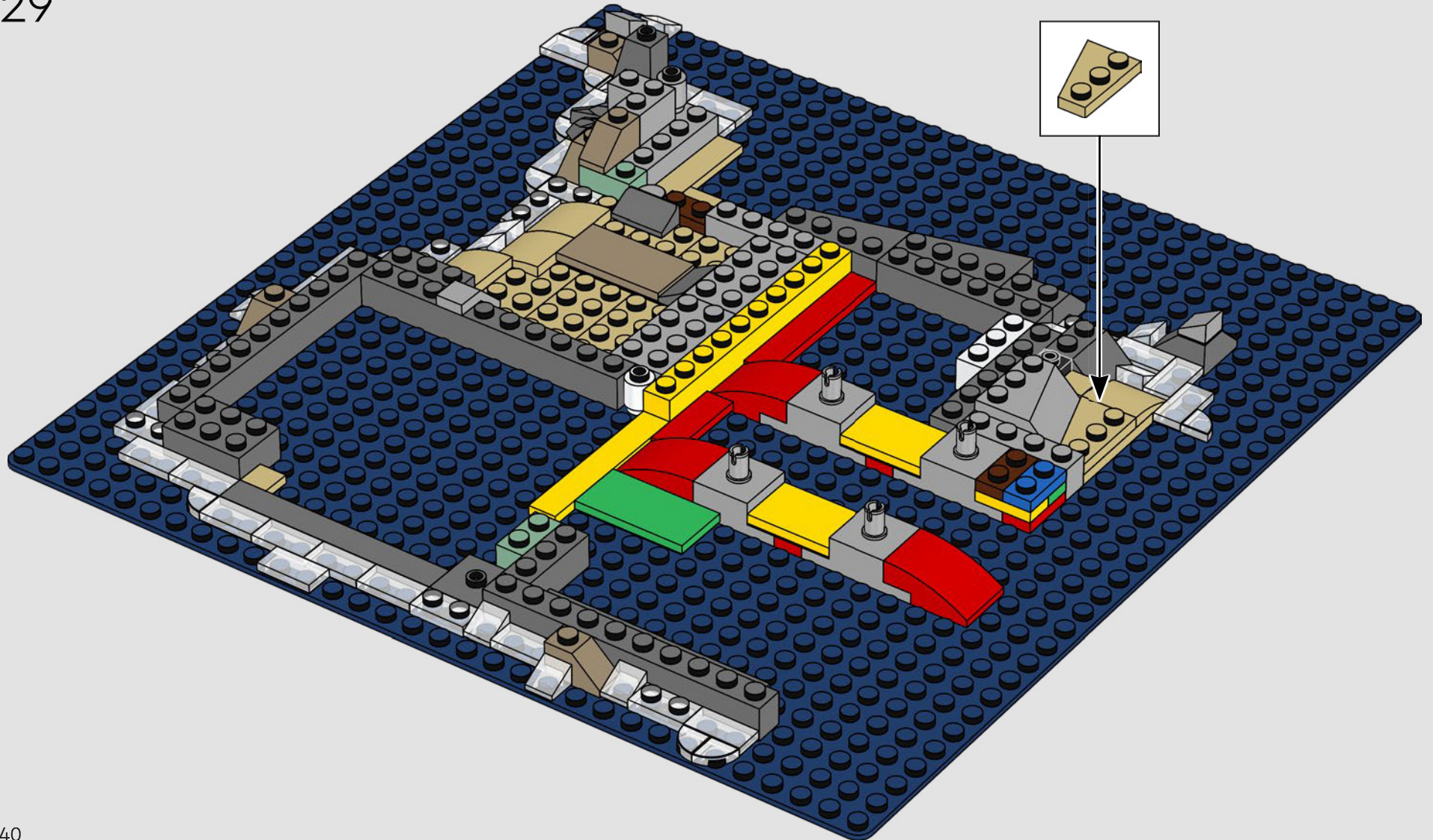

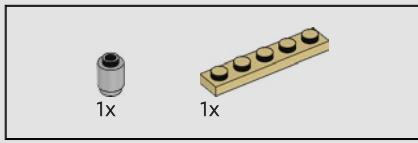

30

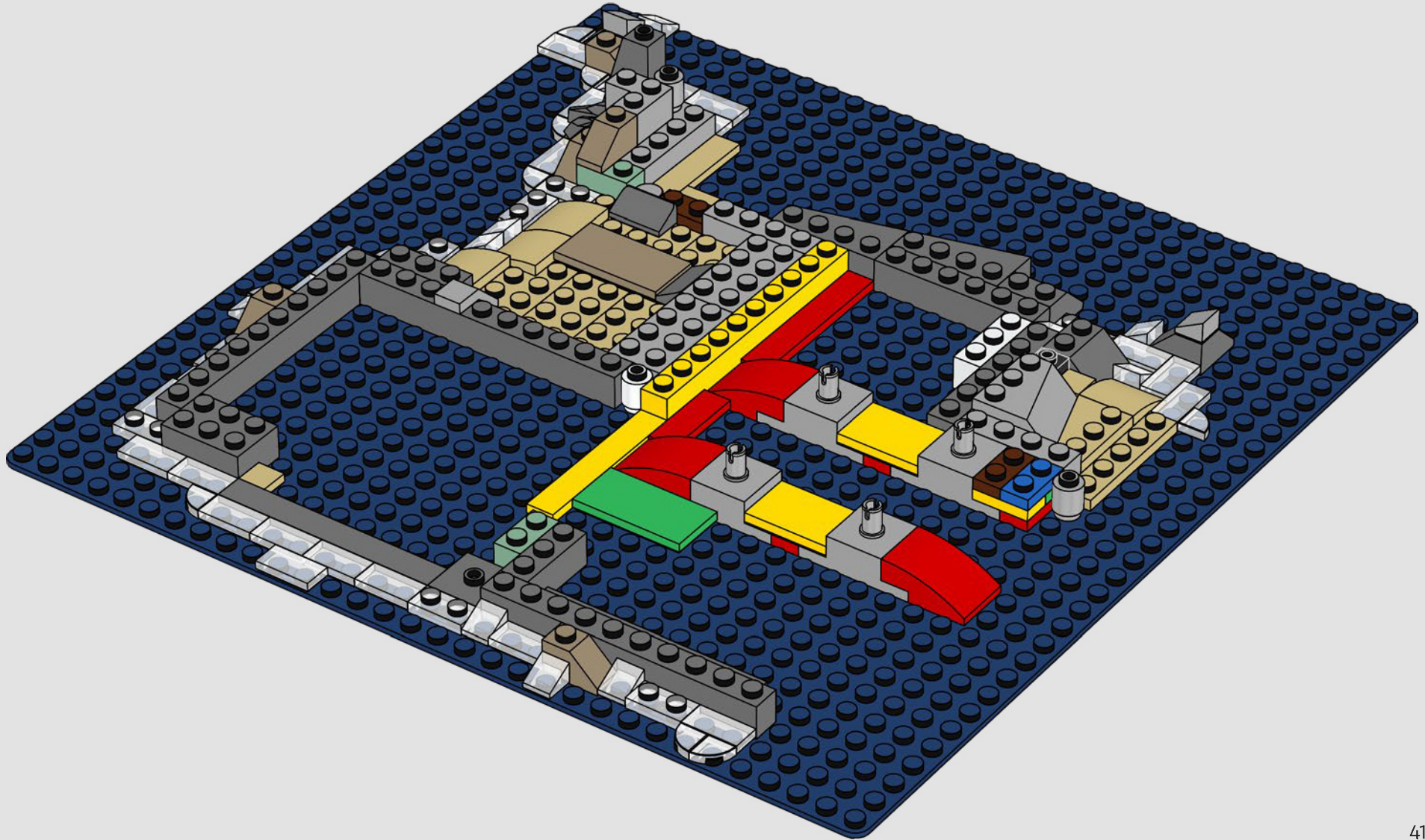

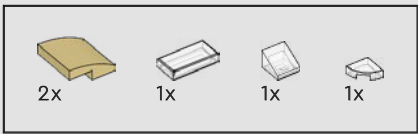

31

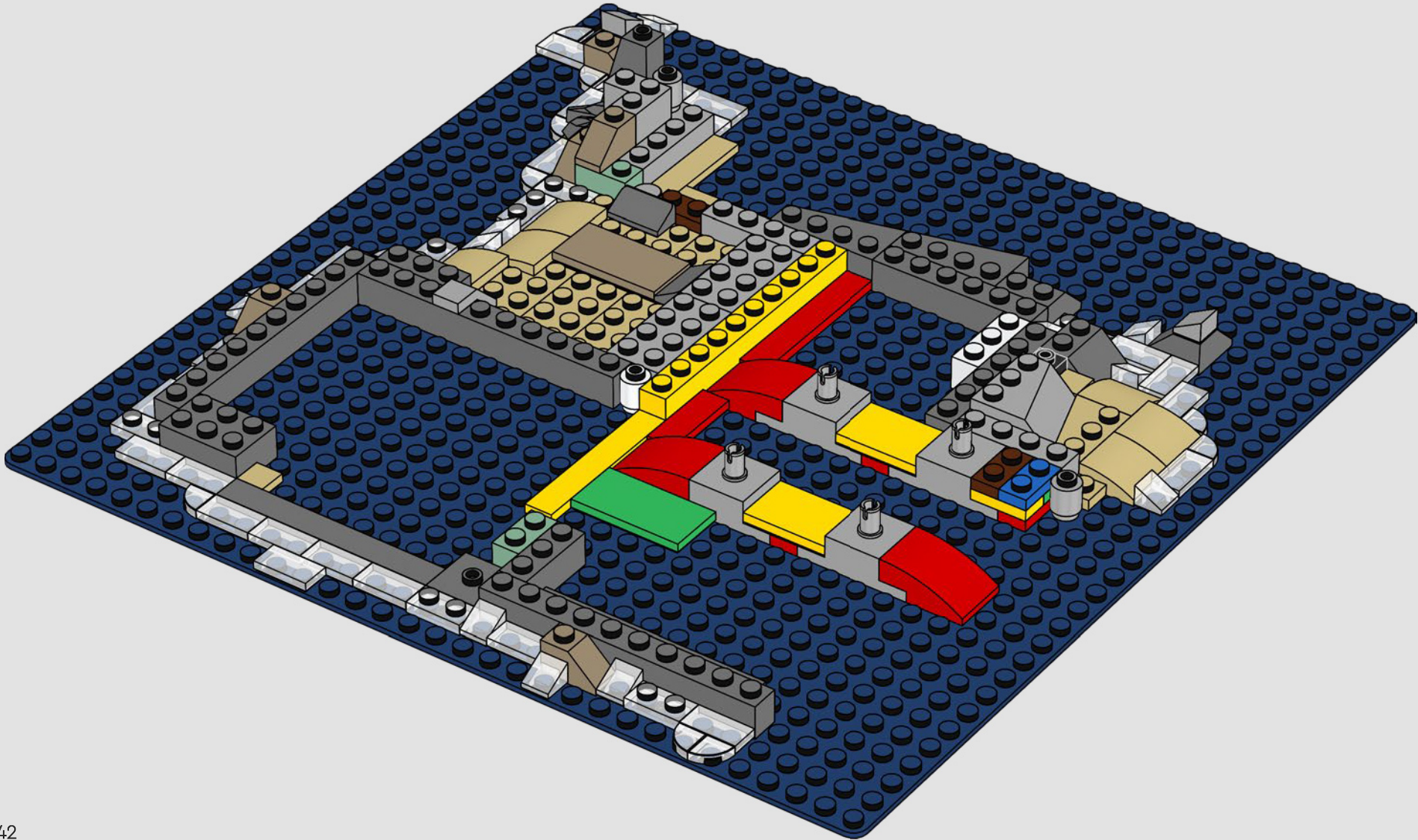

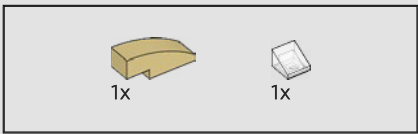

32

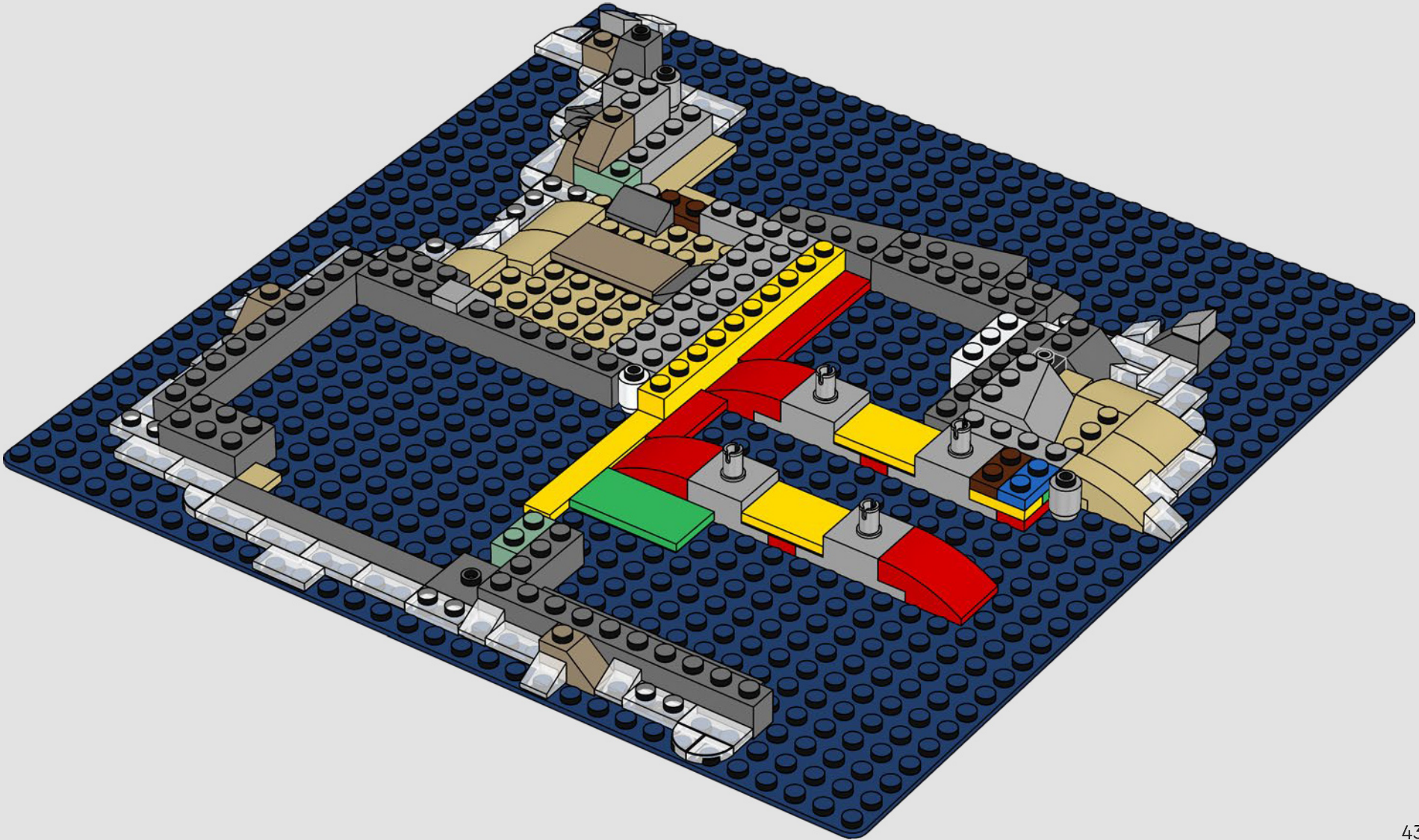

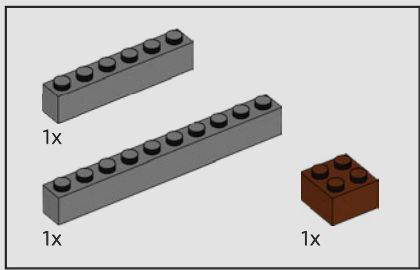

33

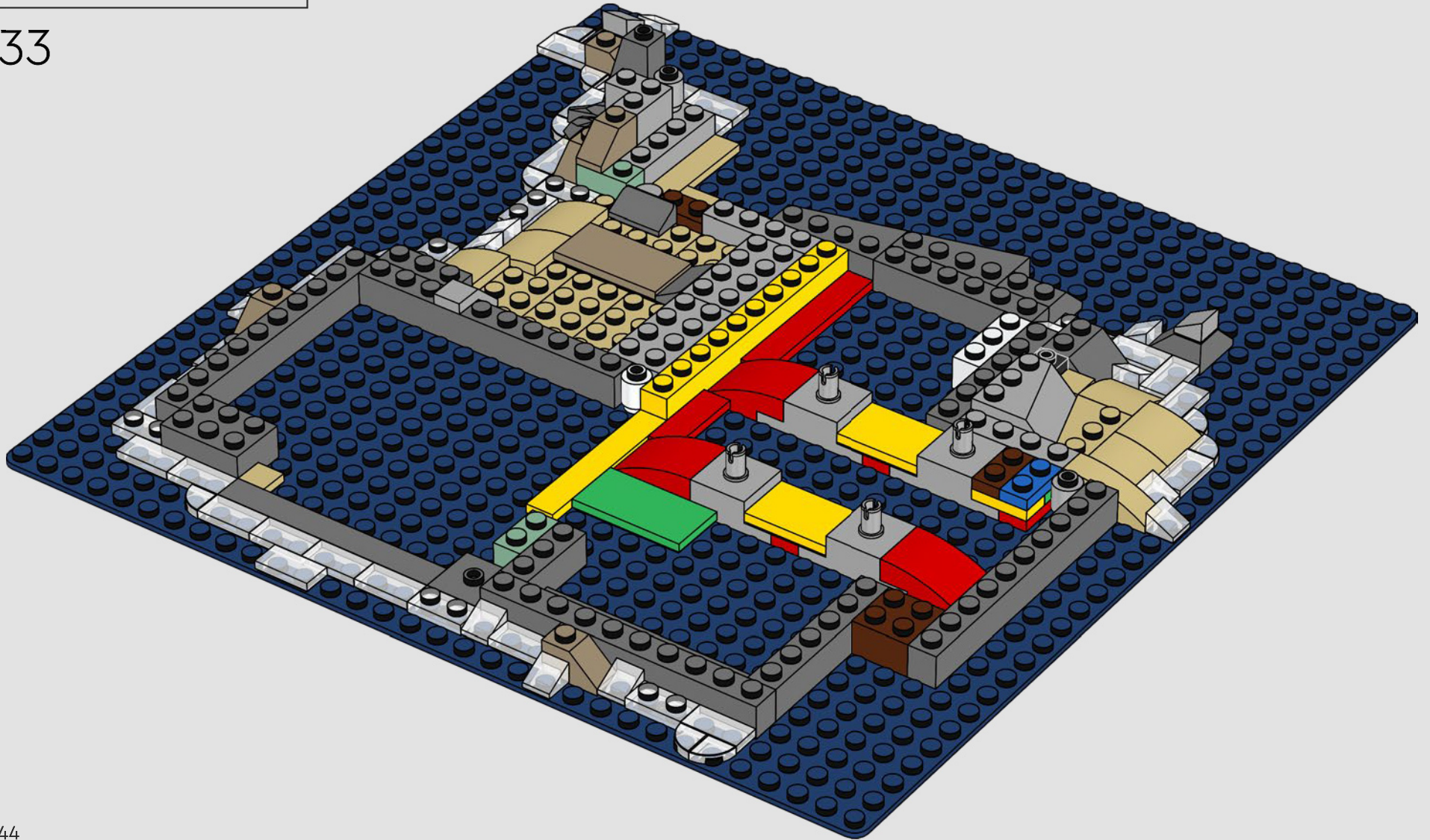

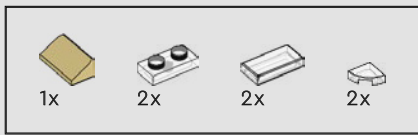

34

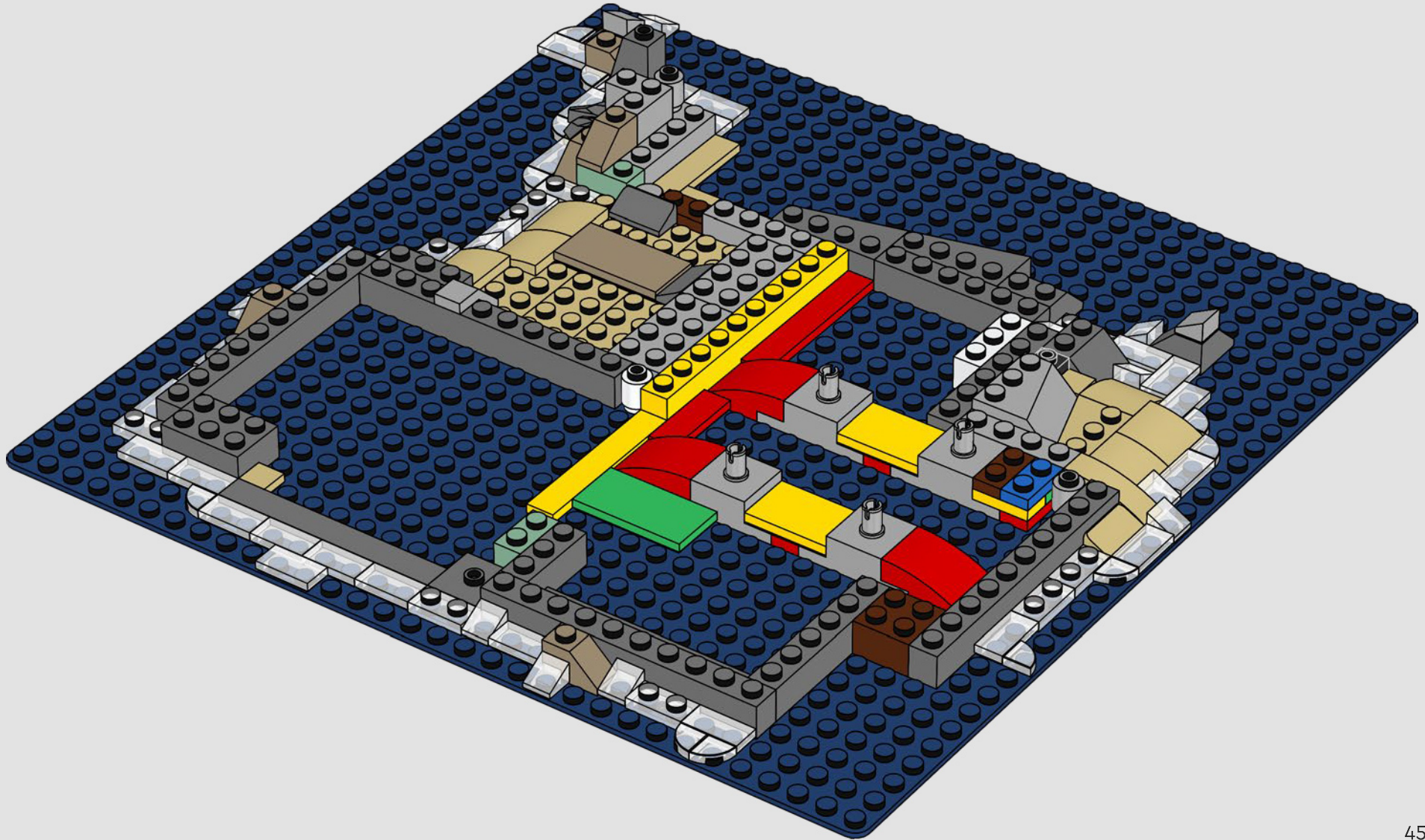

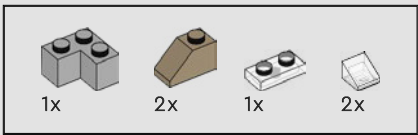

35

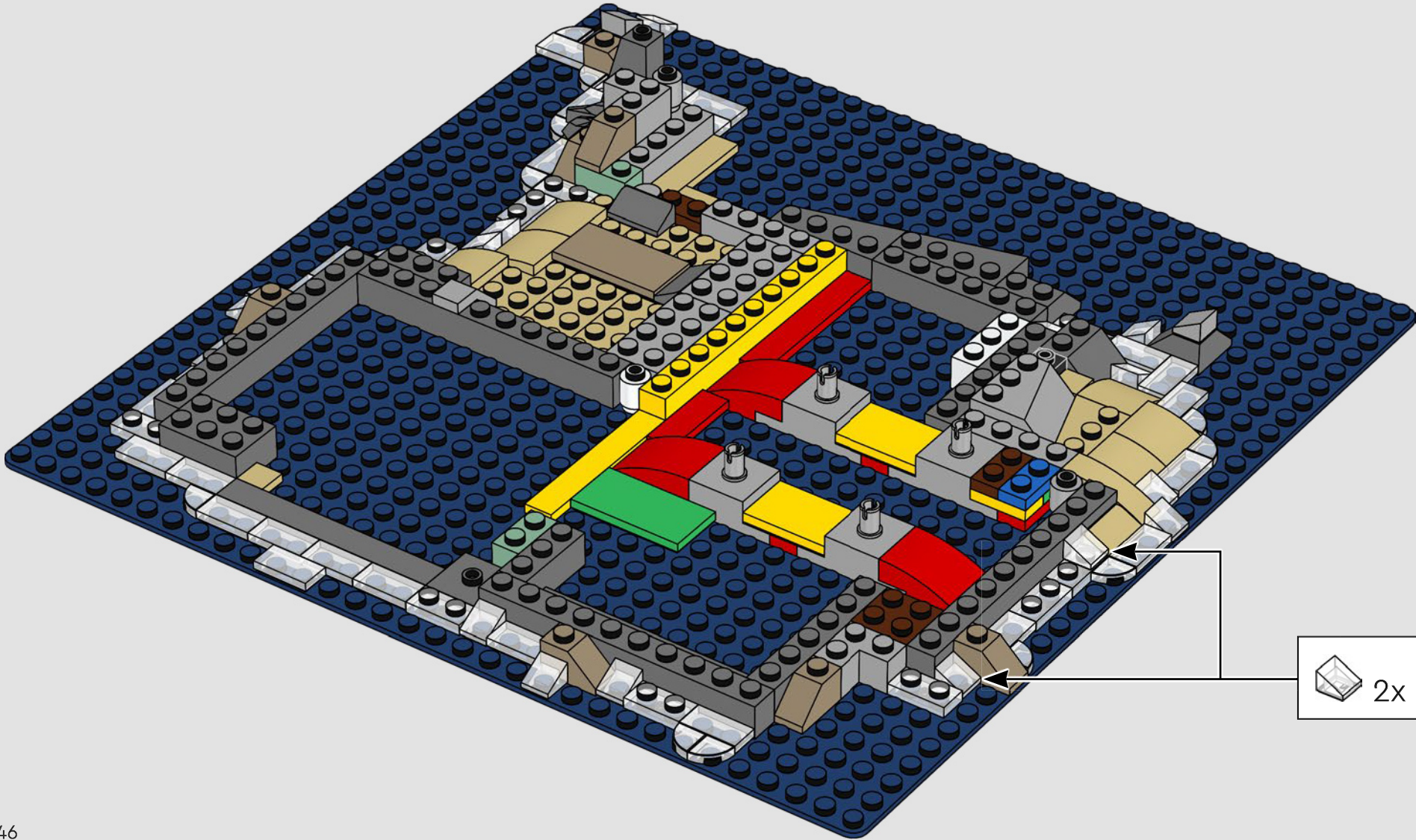

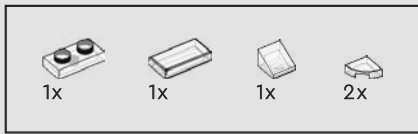

36

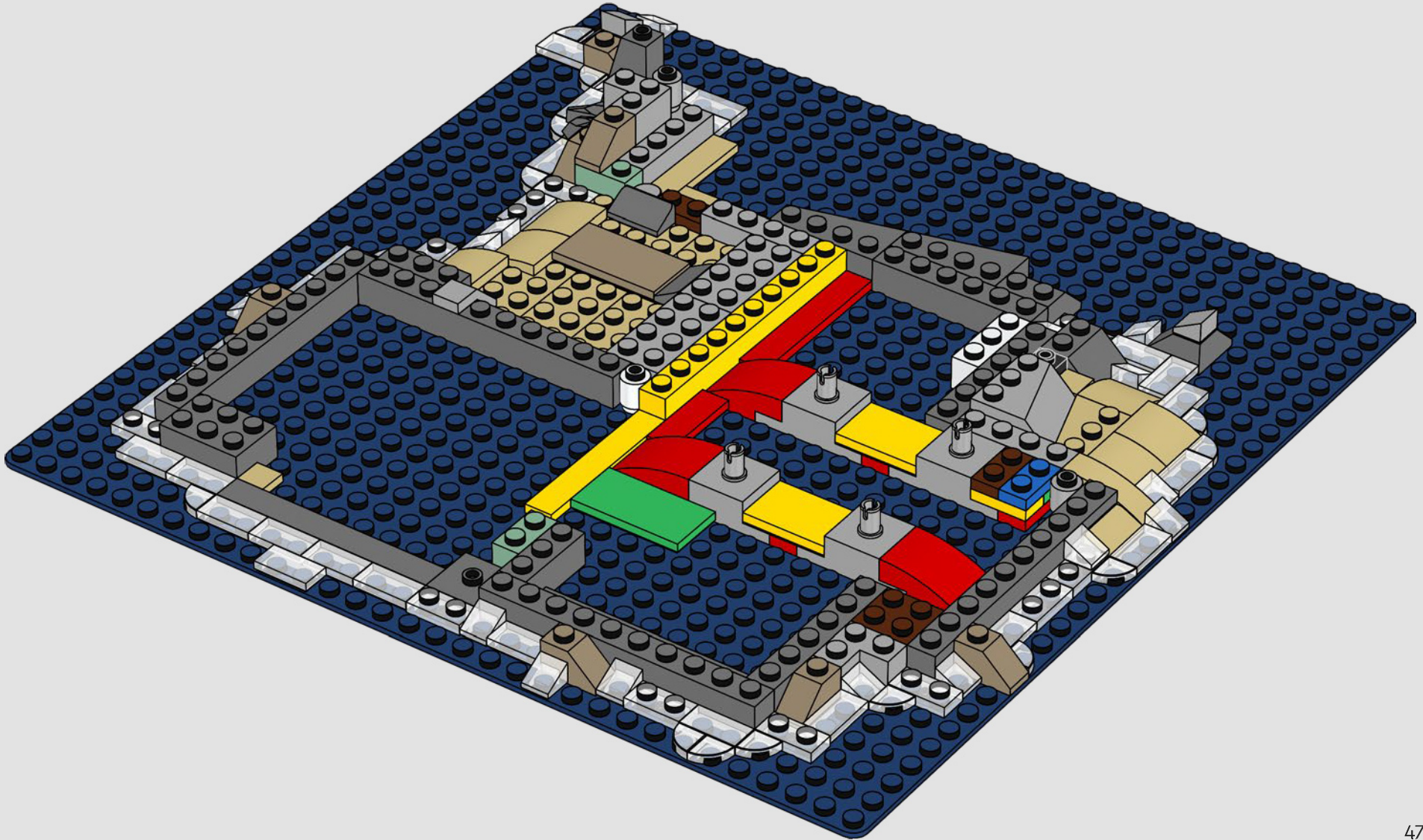



37

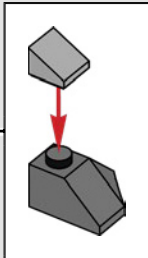
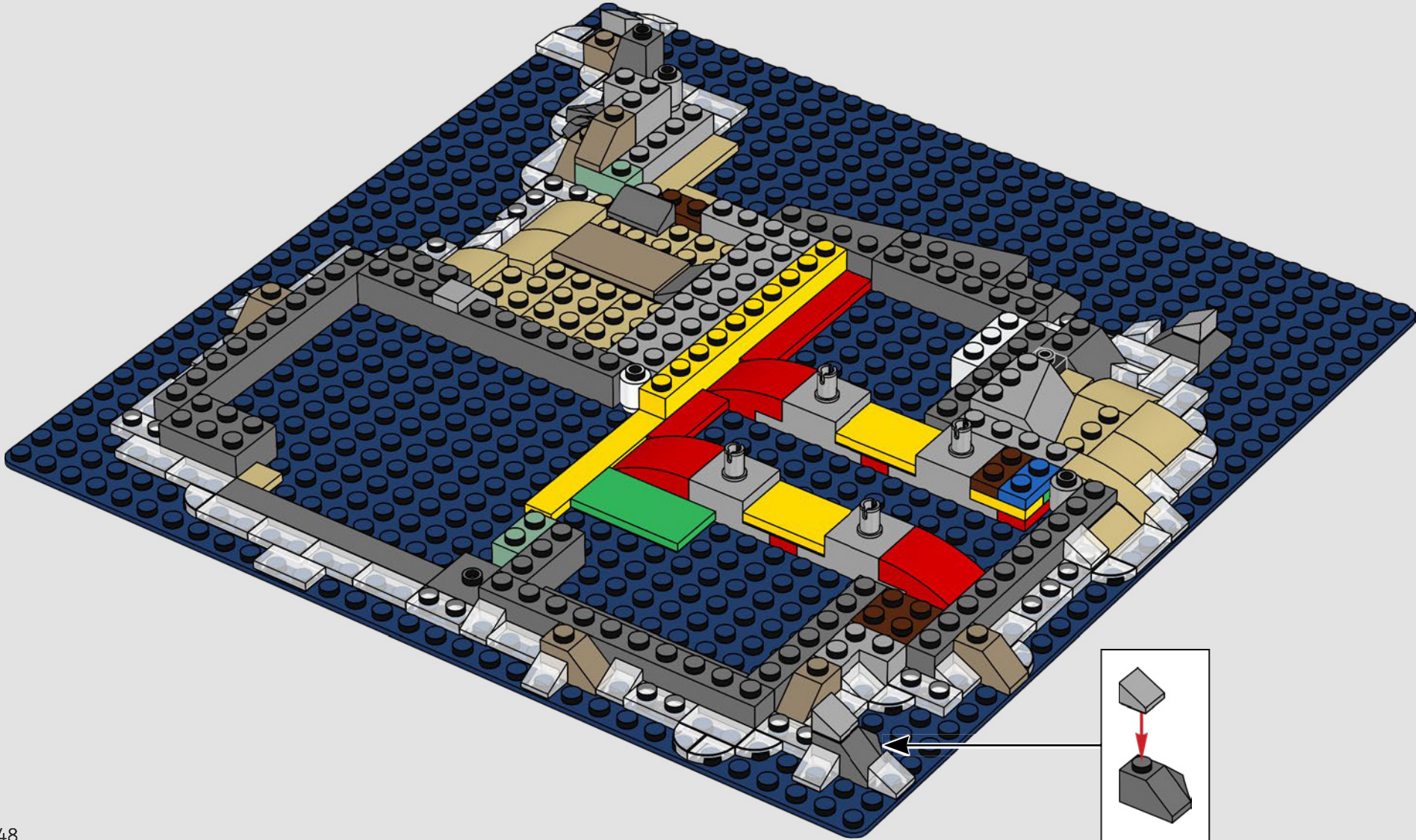

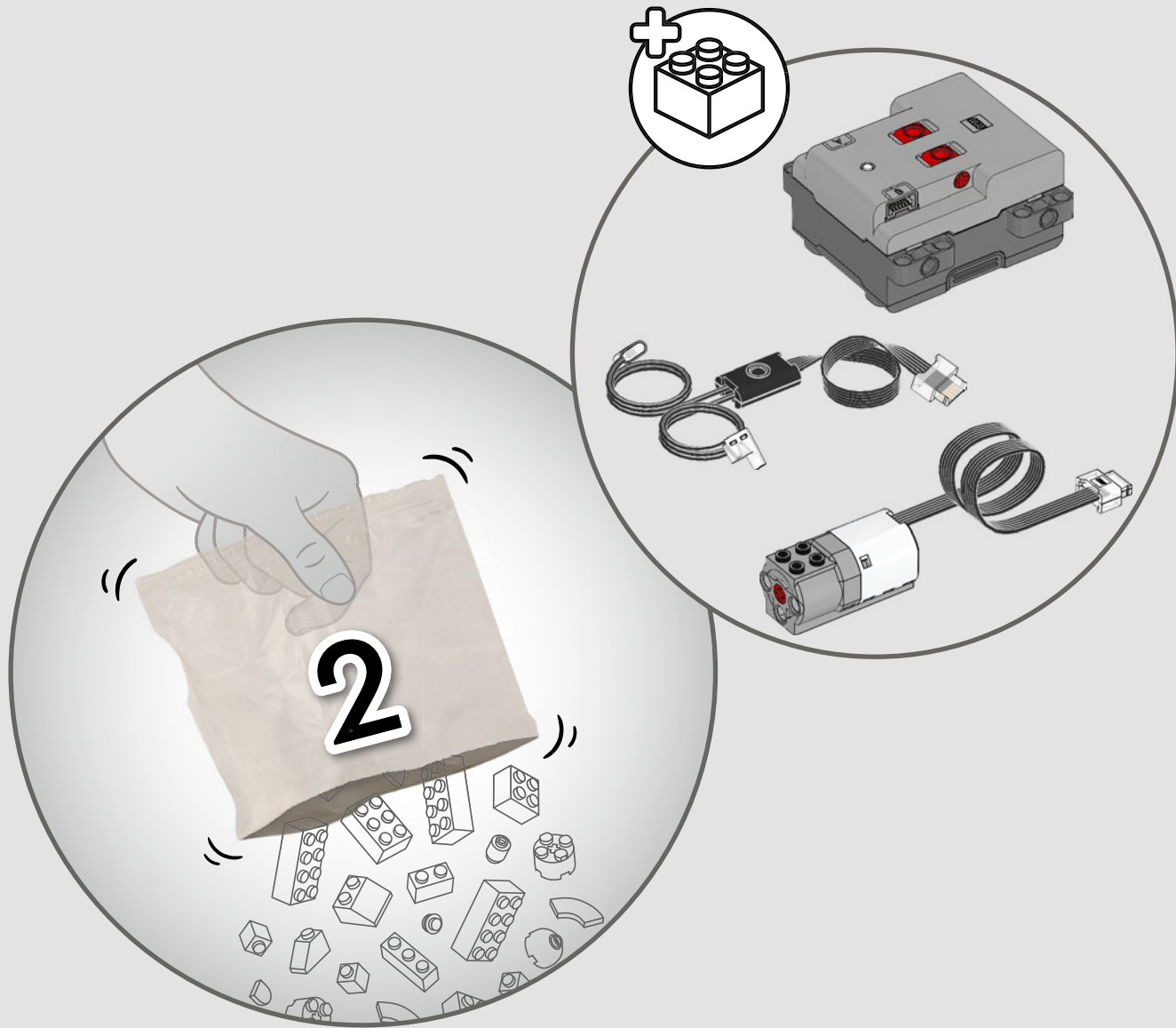

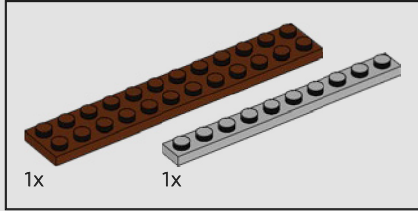
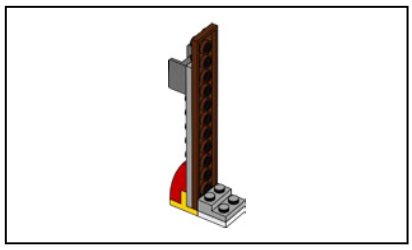

38

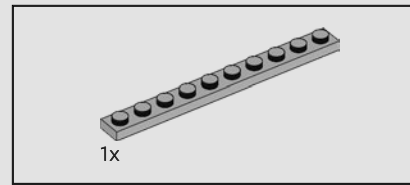
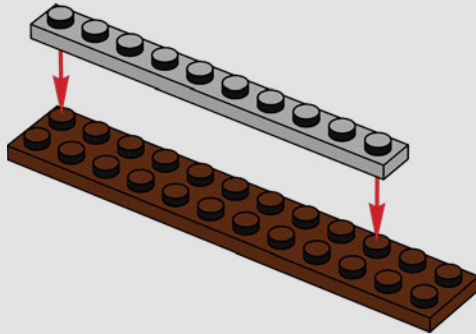

39

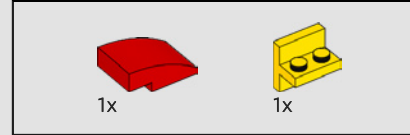
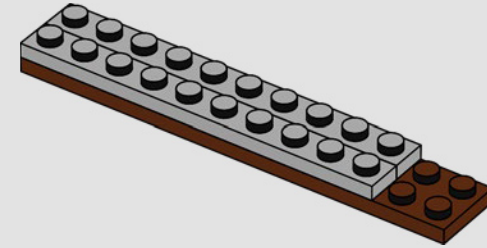

40

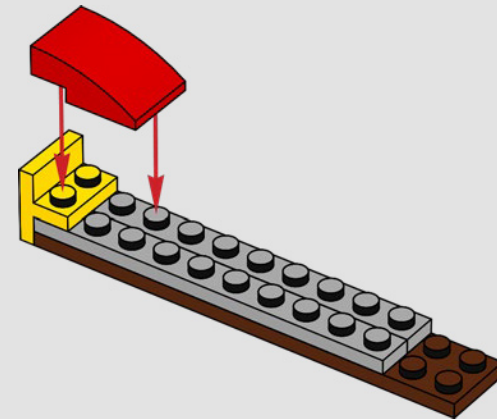

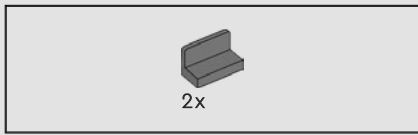

41

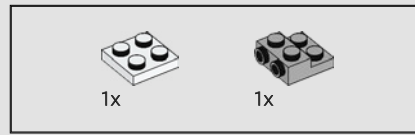
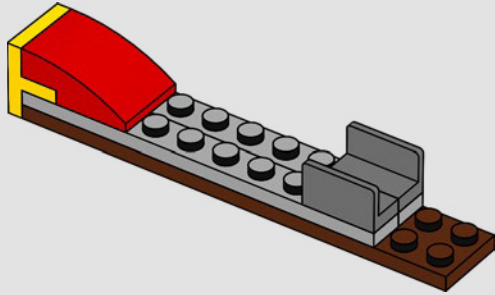

42

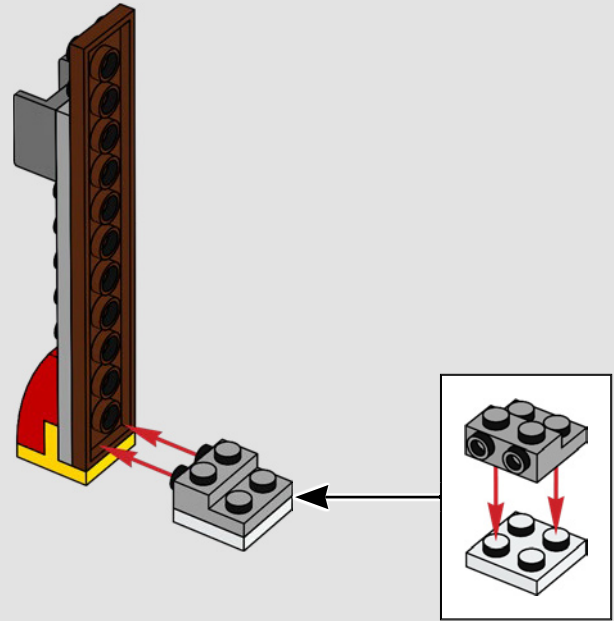
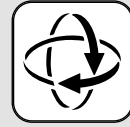

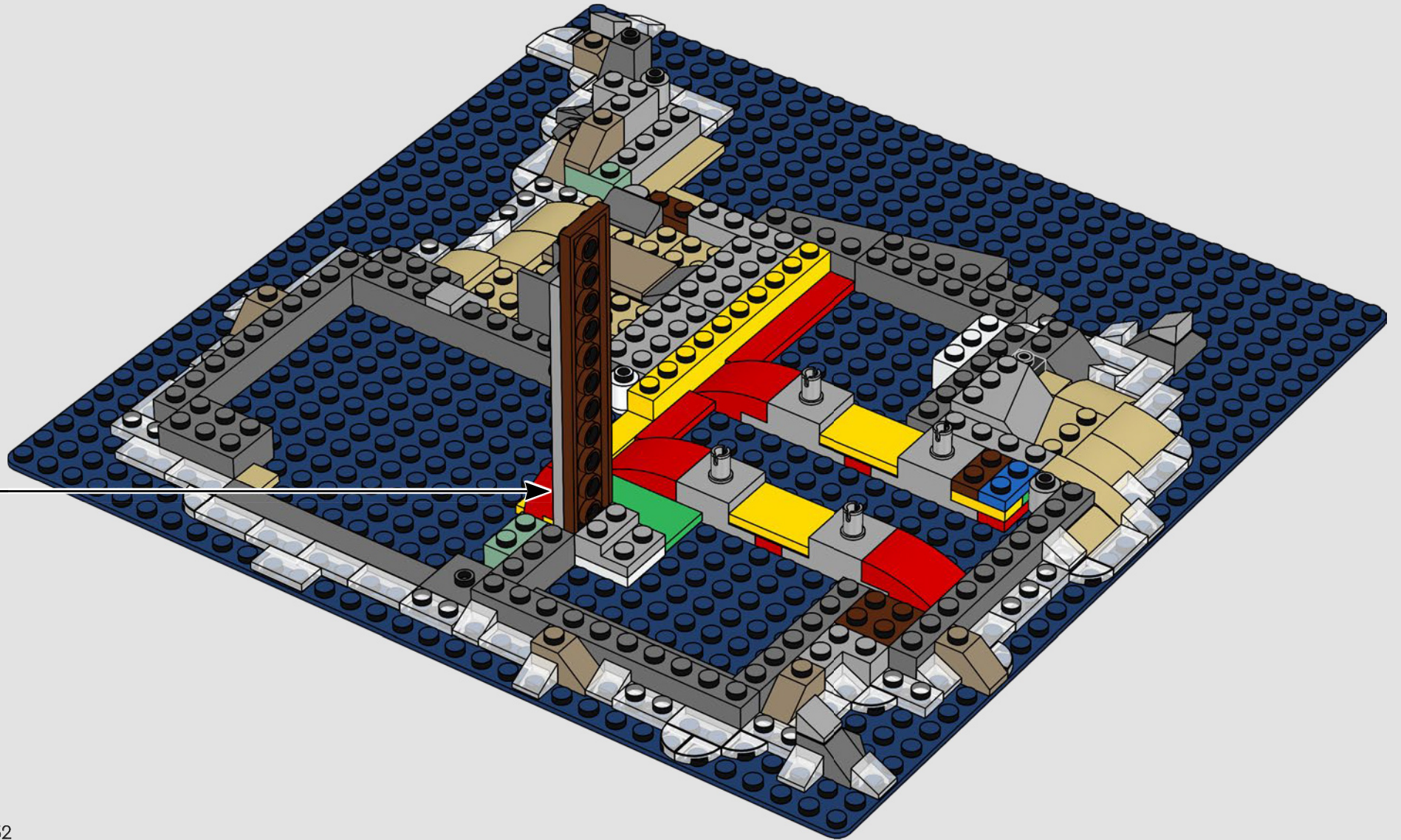

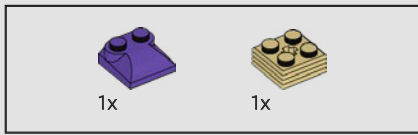

44

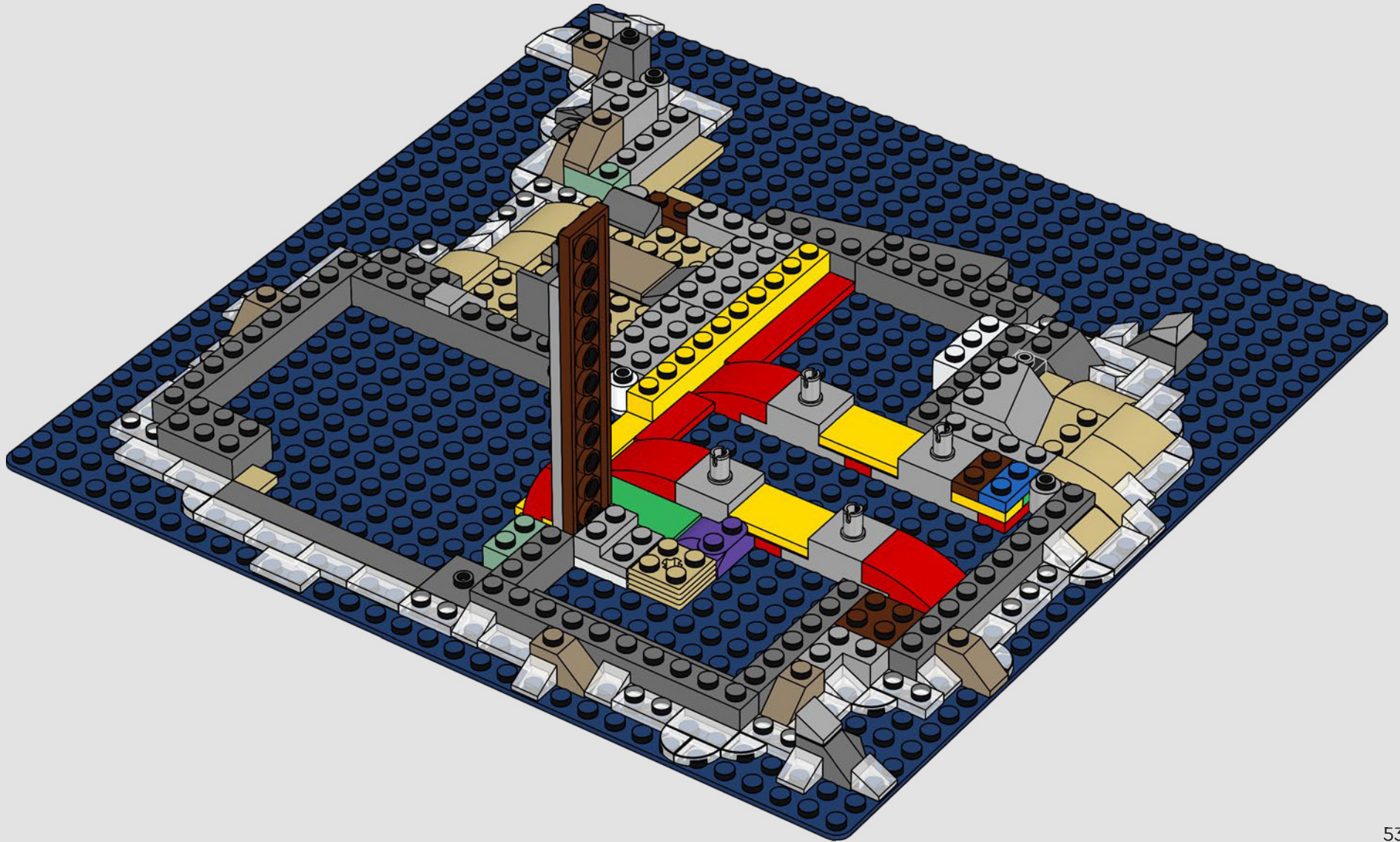

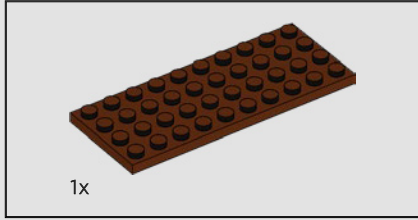
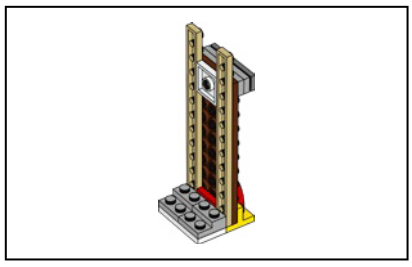

45

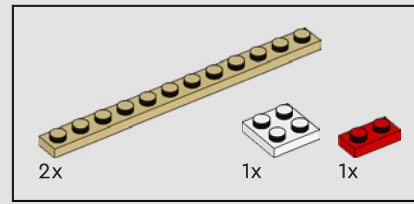
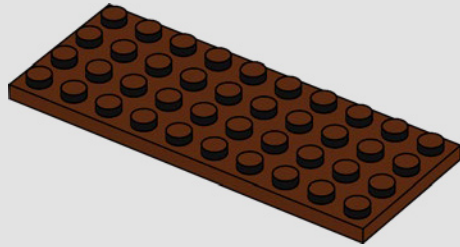

46

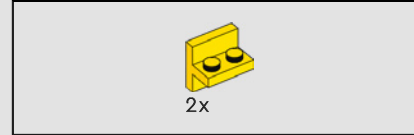
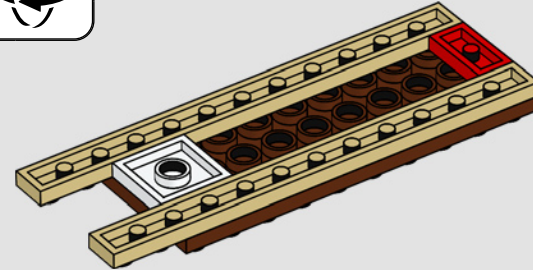
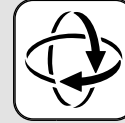

47

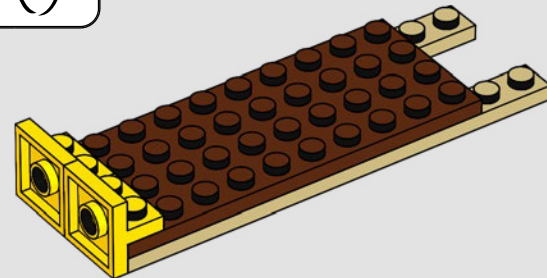
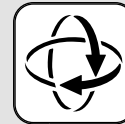

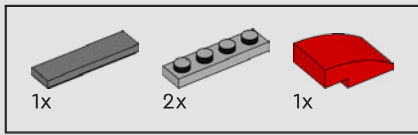

48

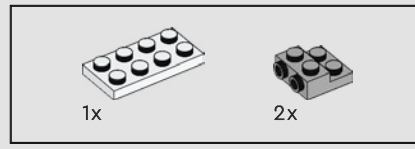
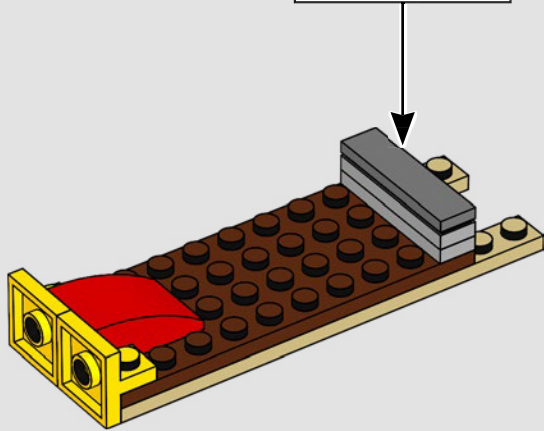
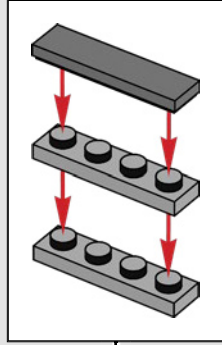

49

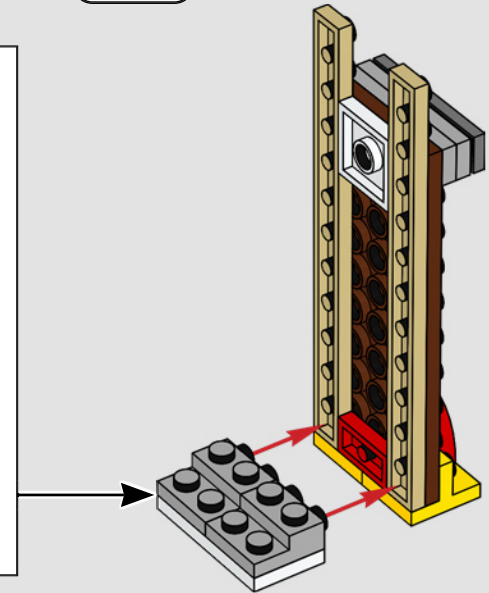
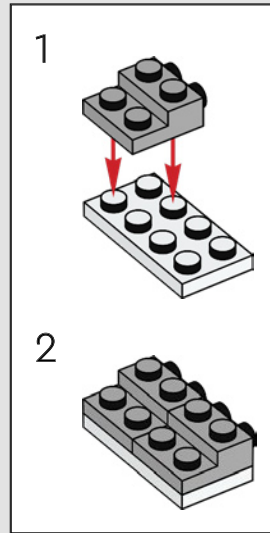
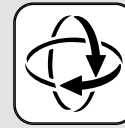

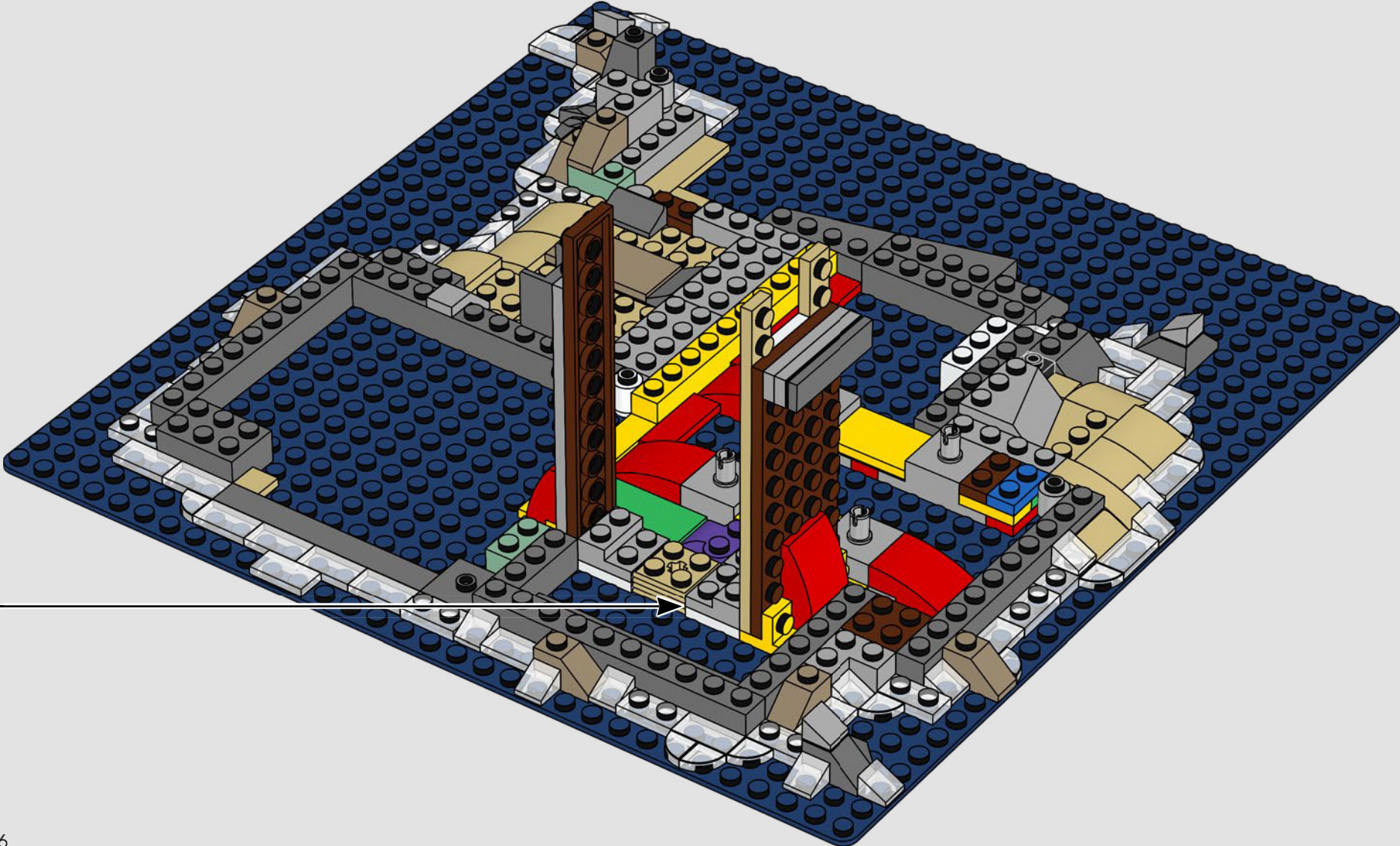

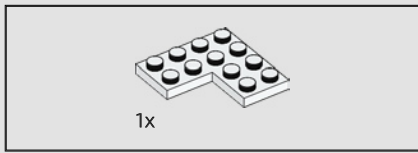

51

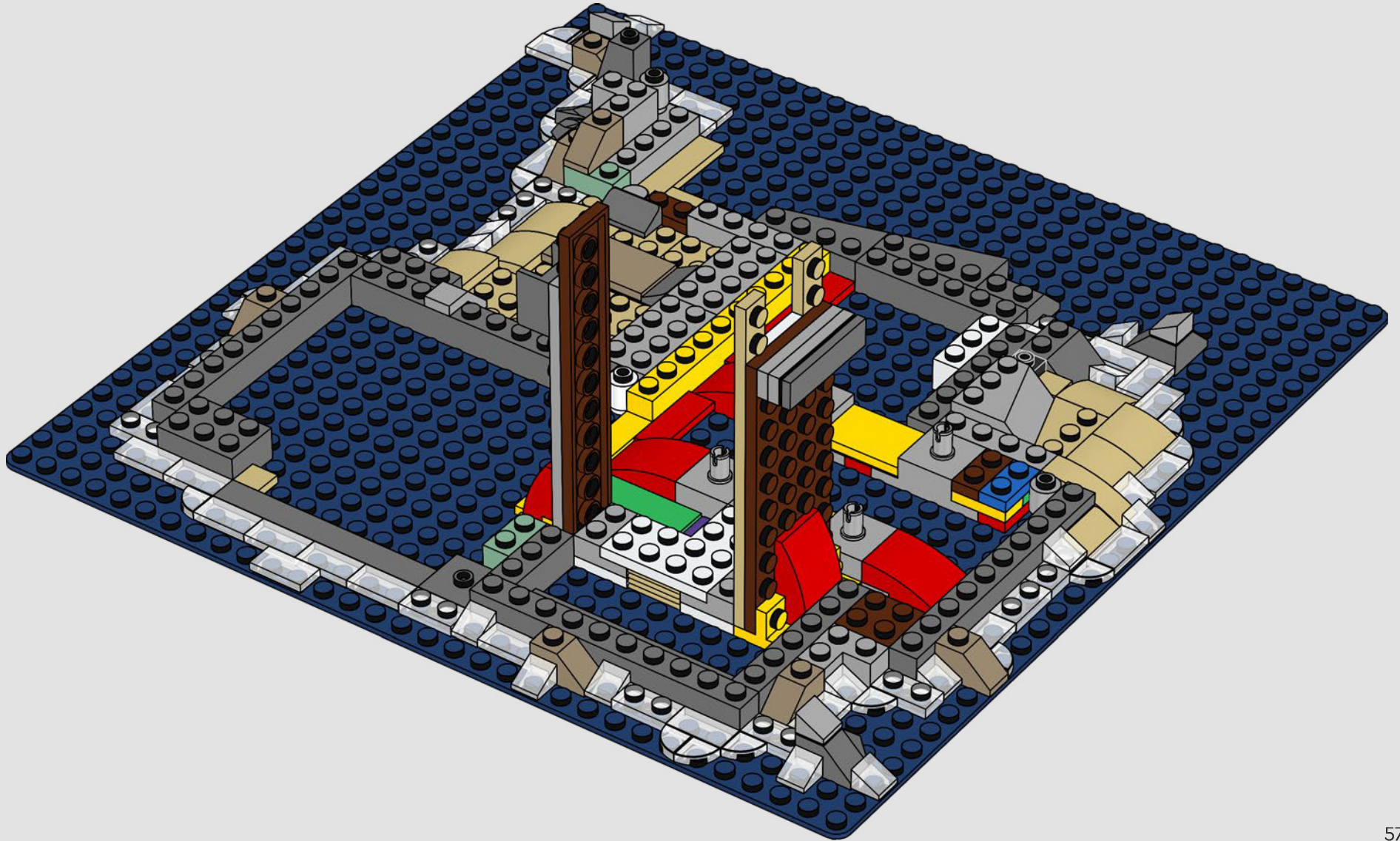

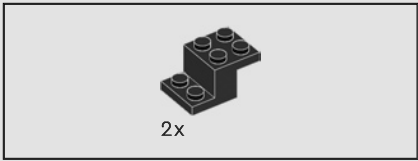

52

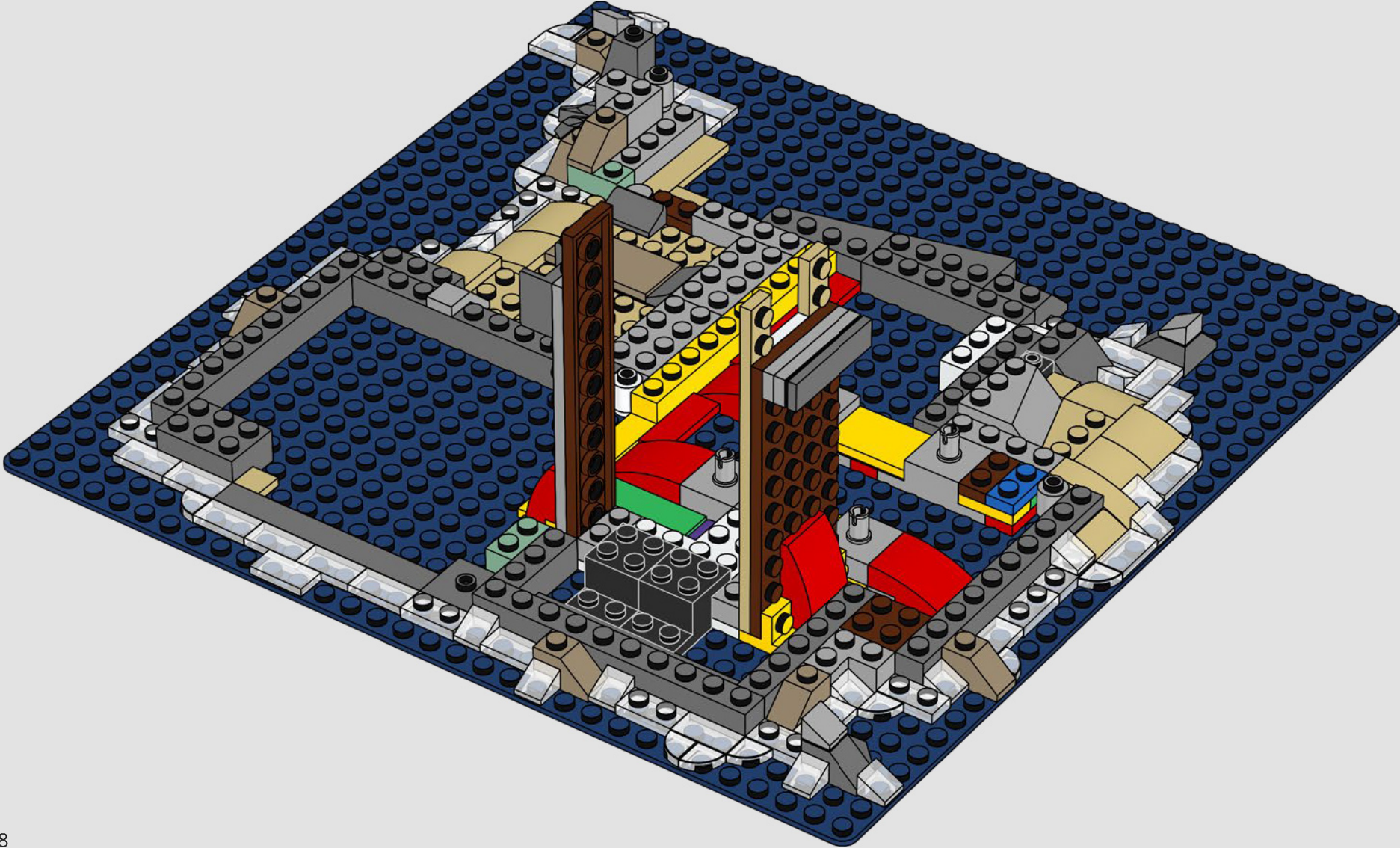

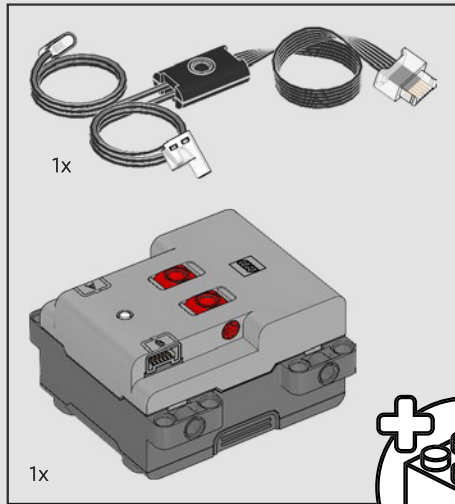
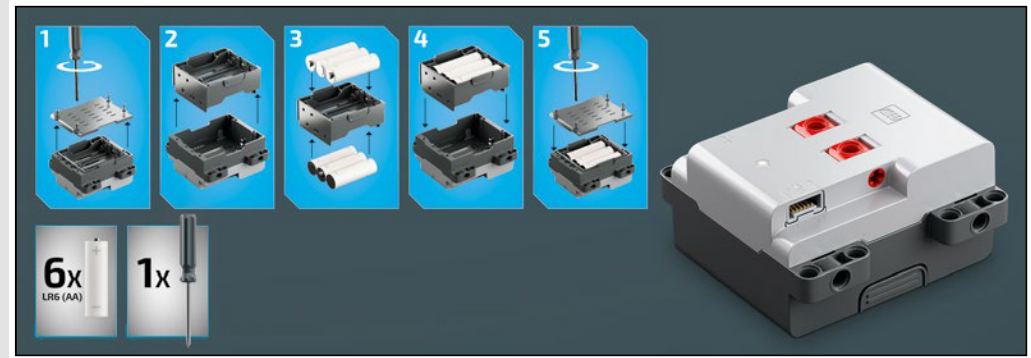
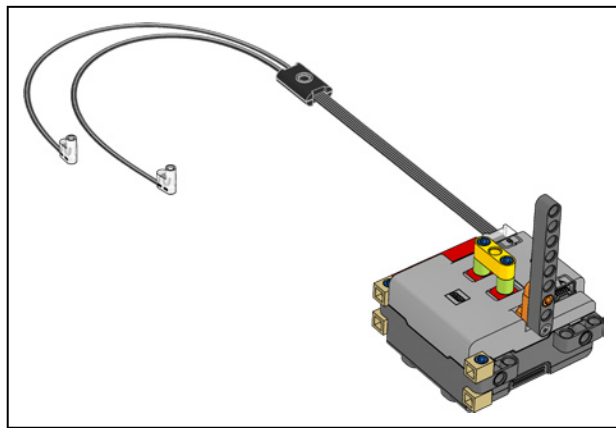

53

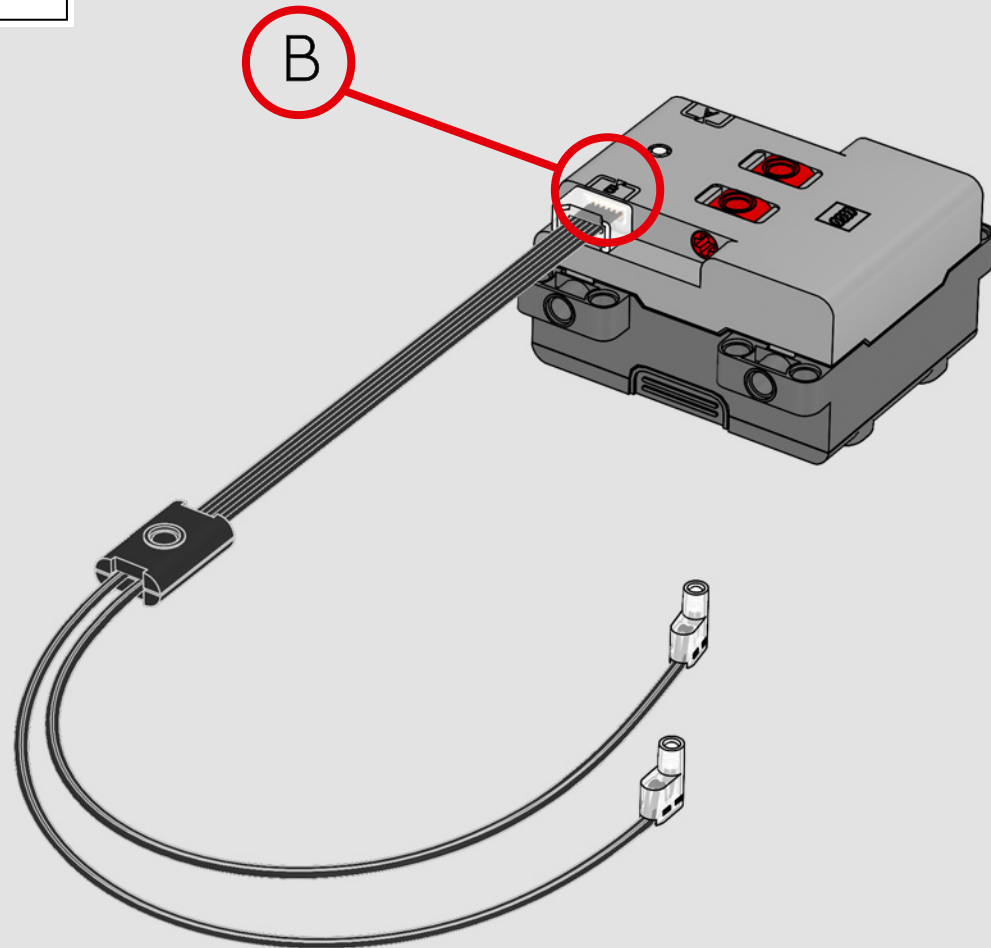



54

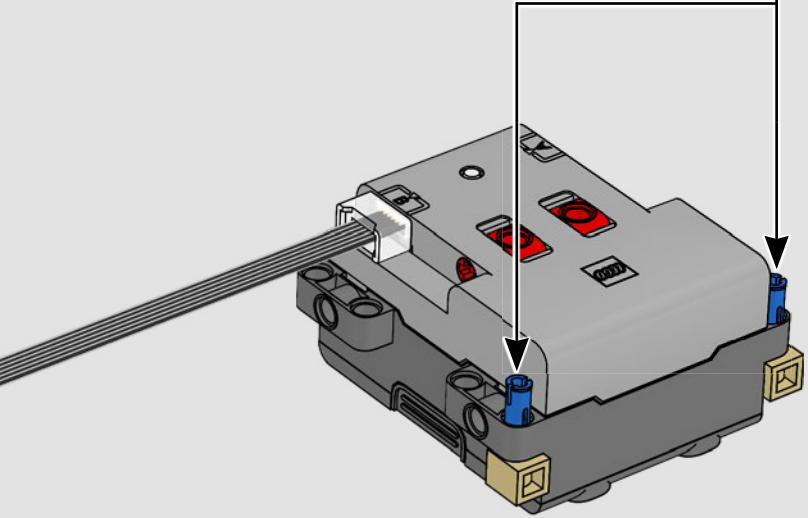
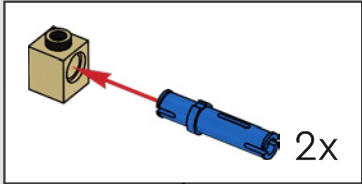

55

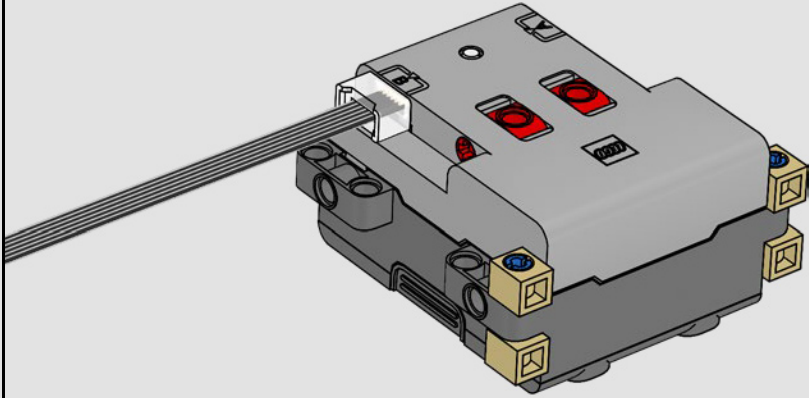

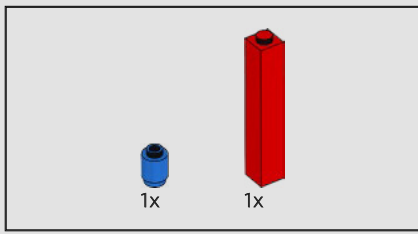

56

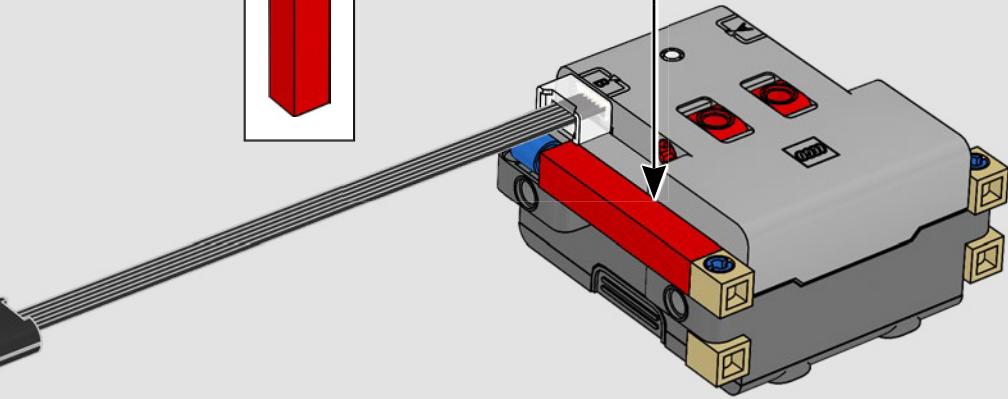
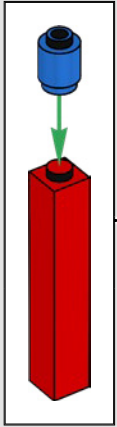

57

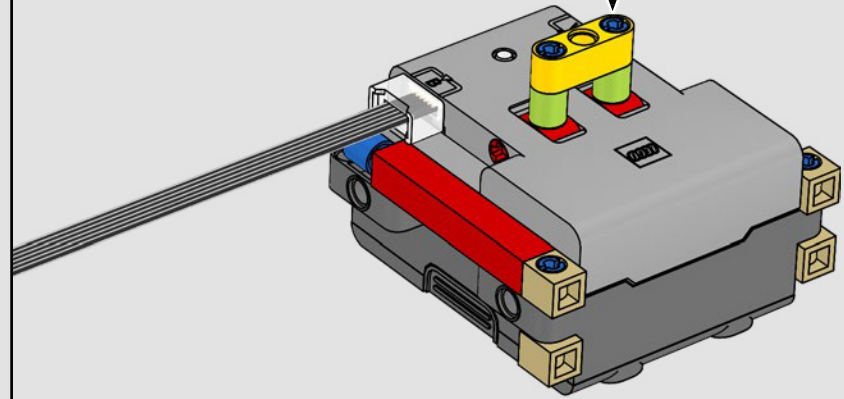
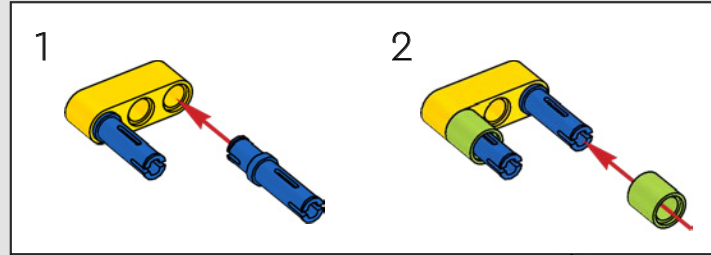

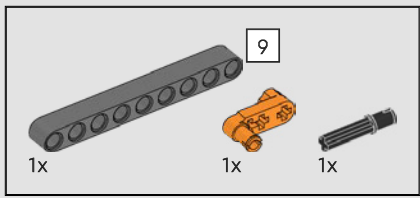

58

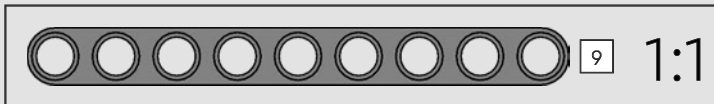
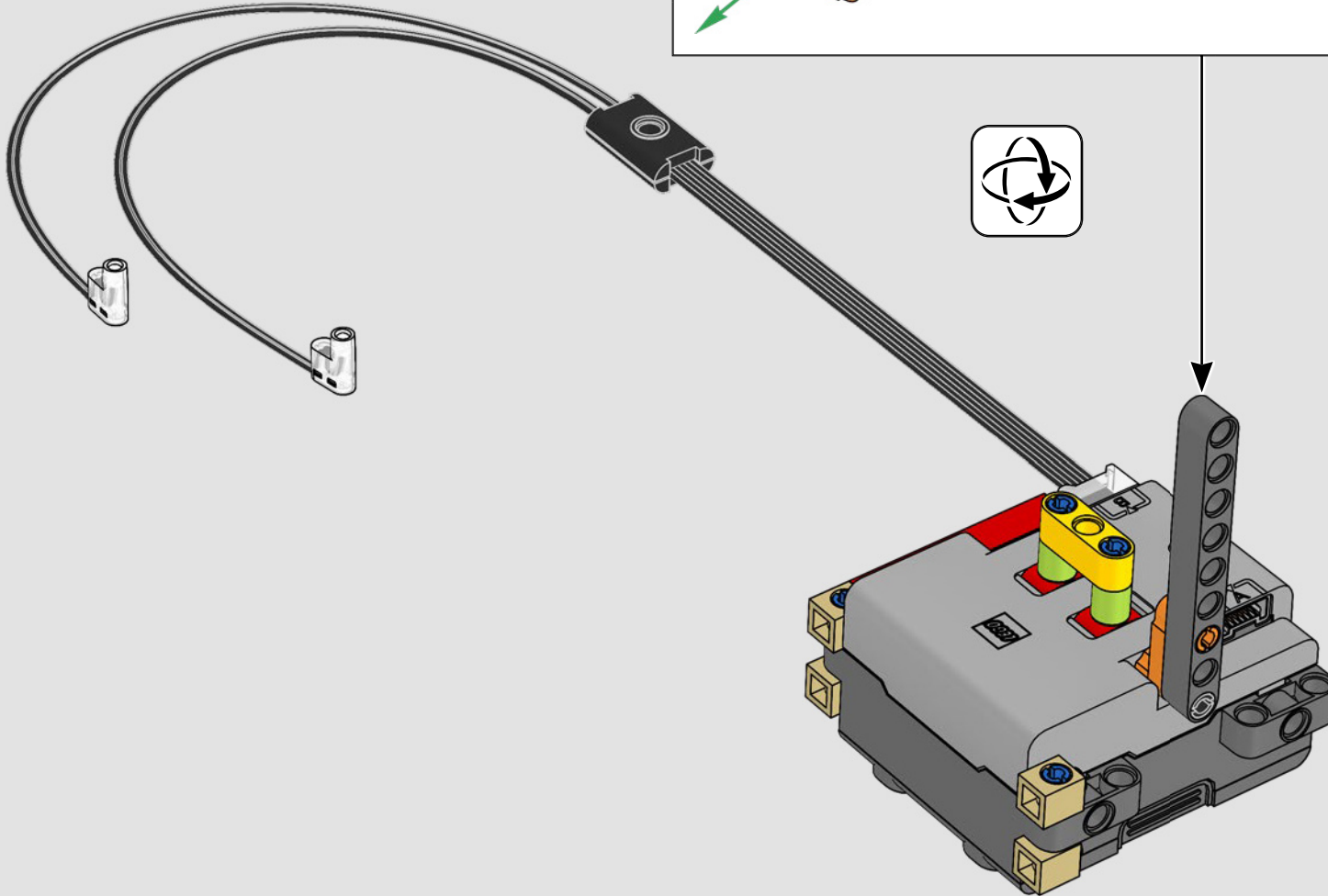
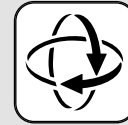
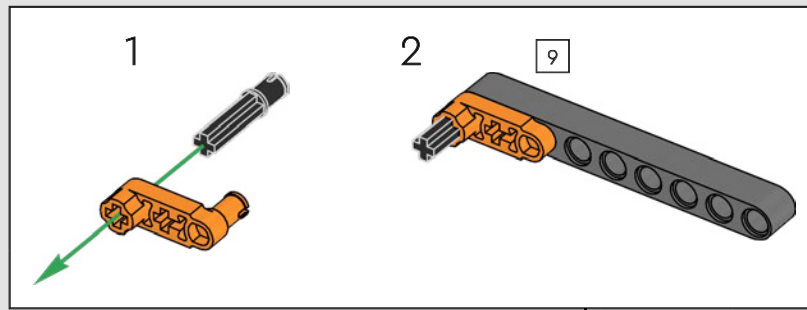

59

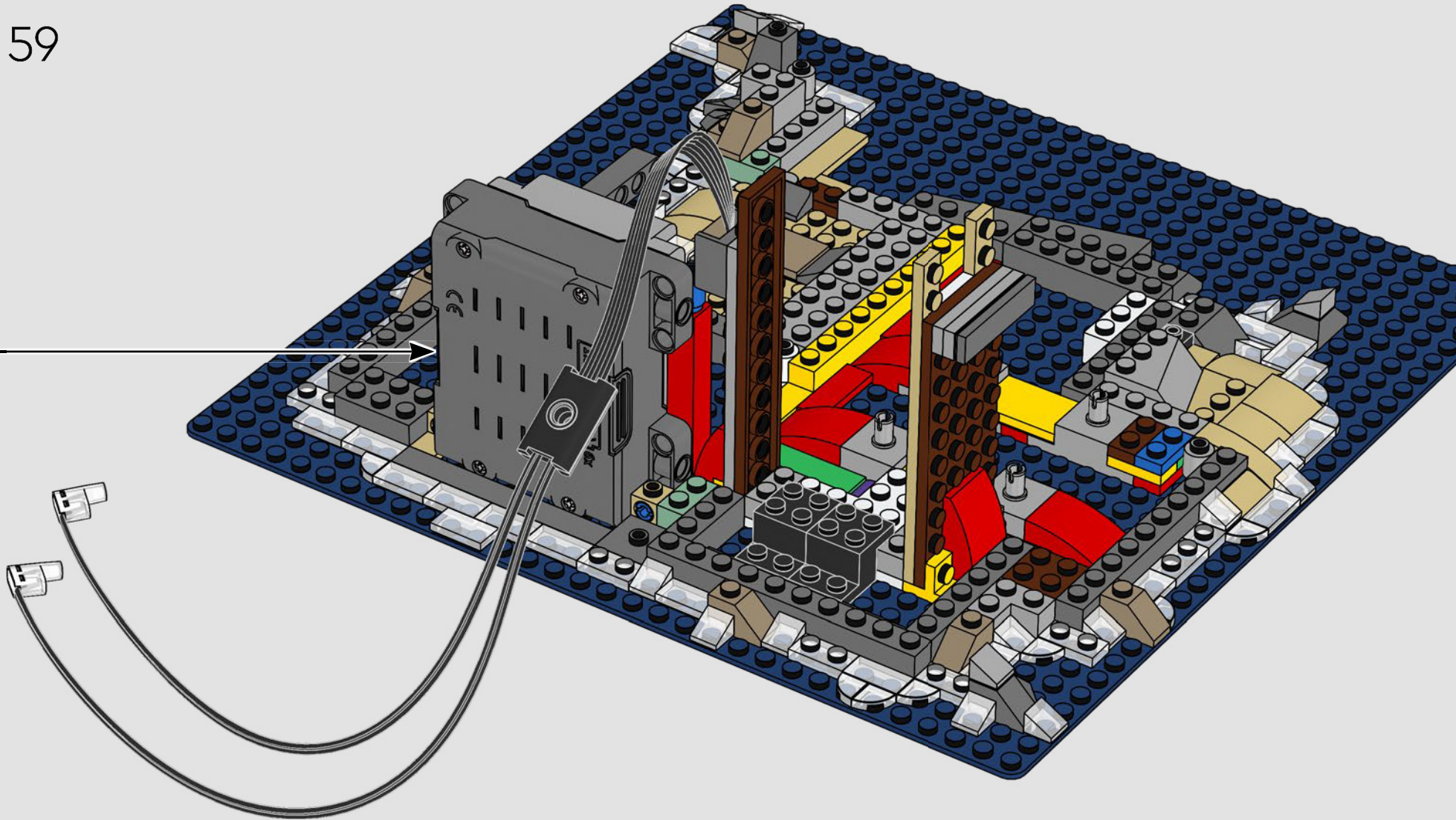

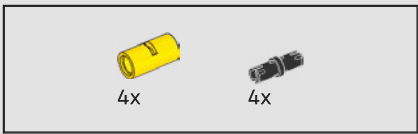

60

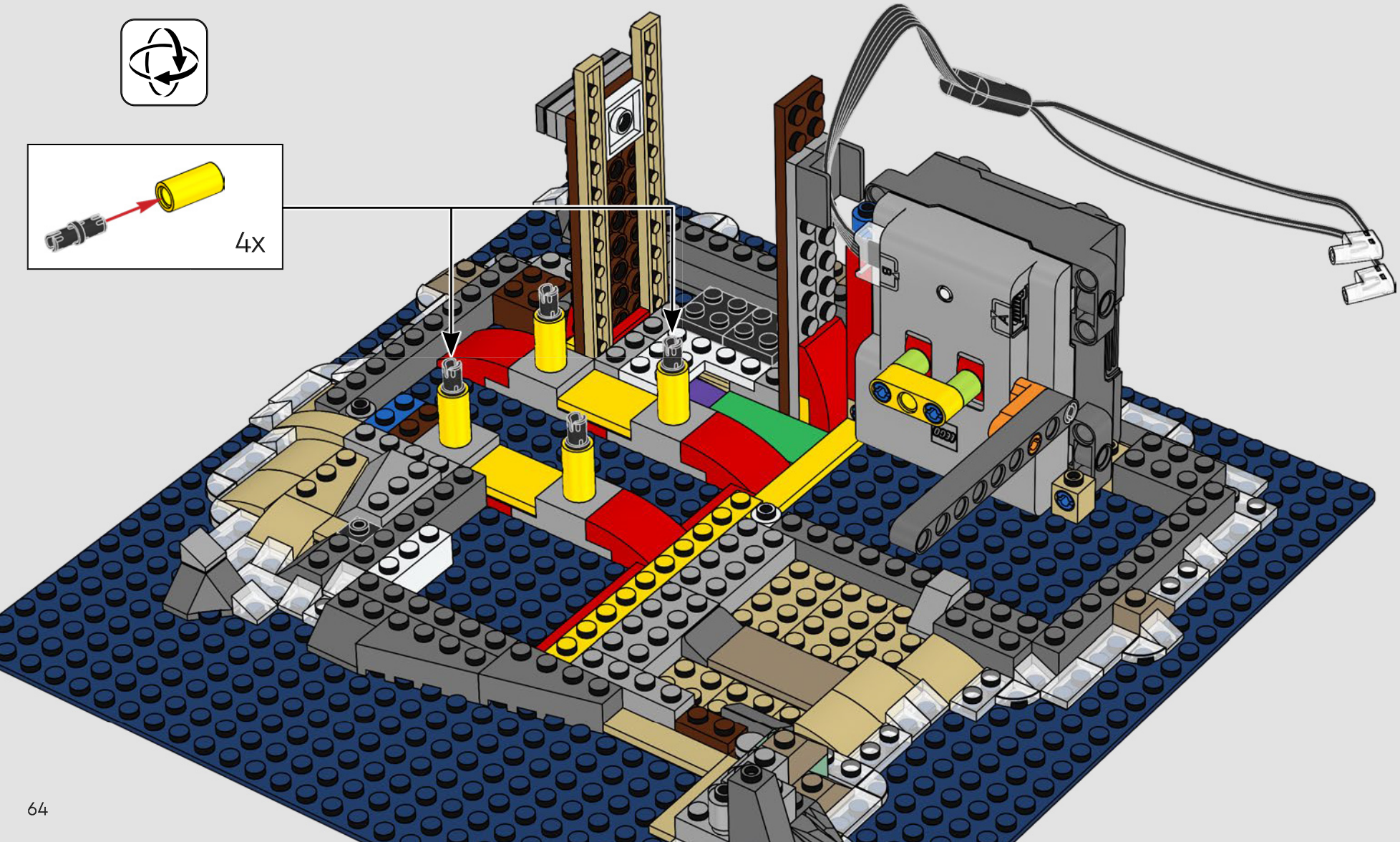
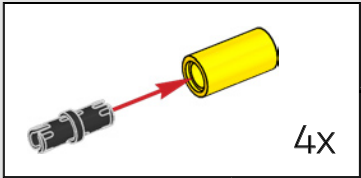

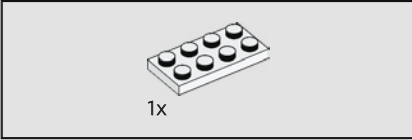
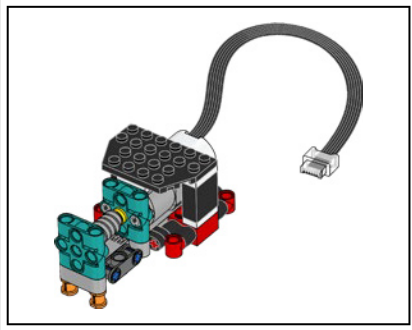

61

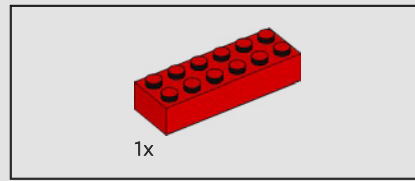

62

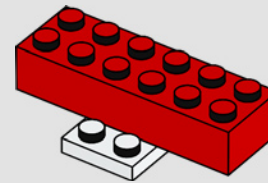

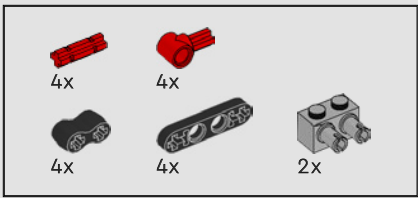

63

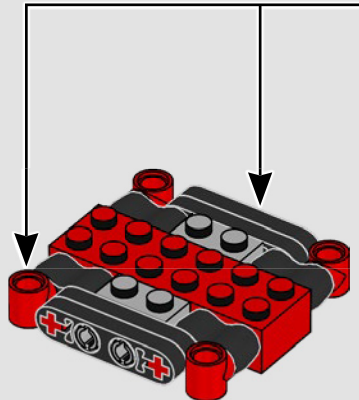
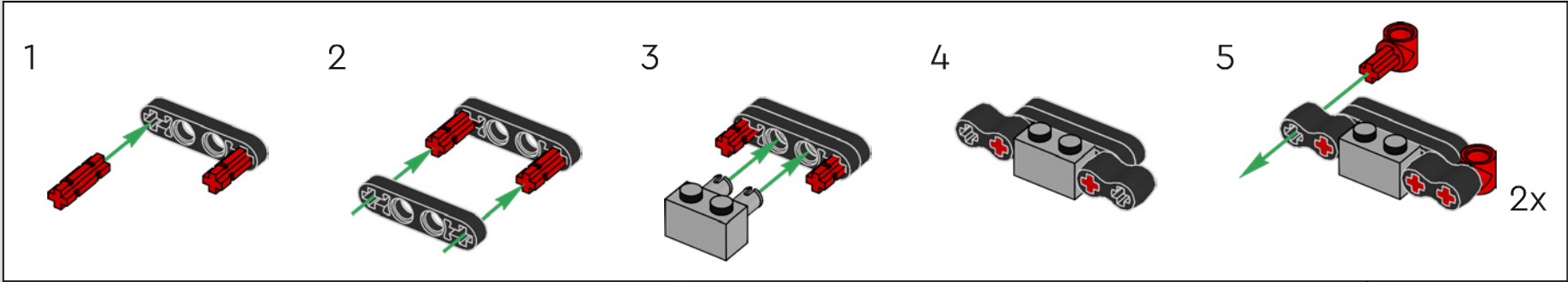

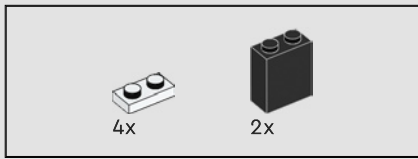

64

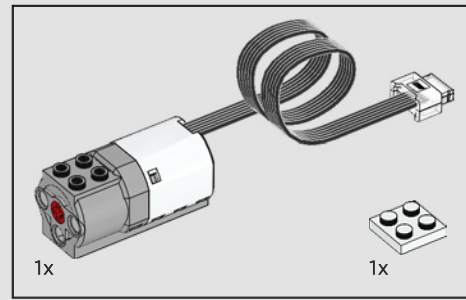
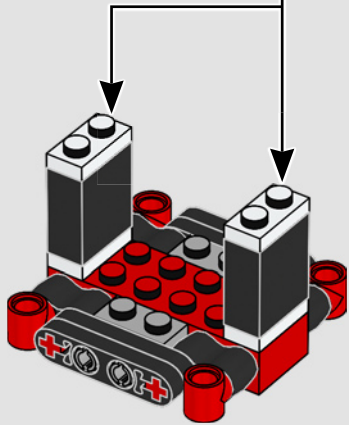
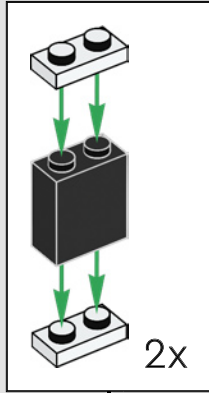

65

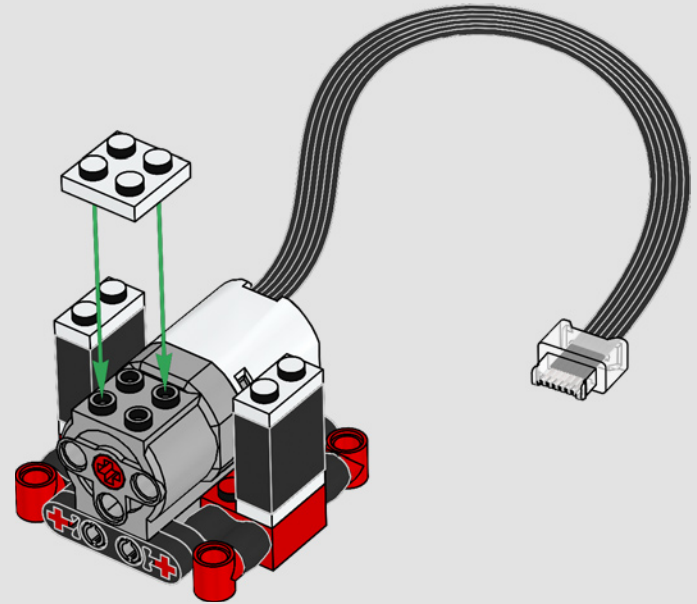

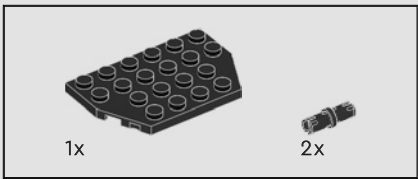

66

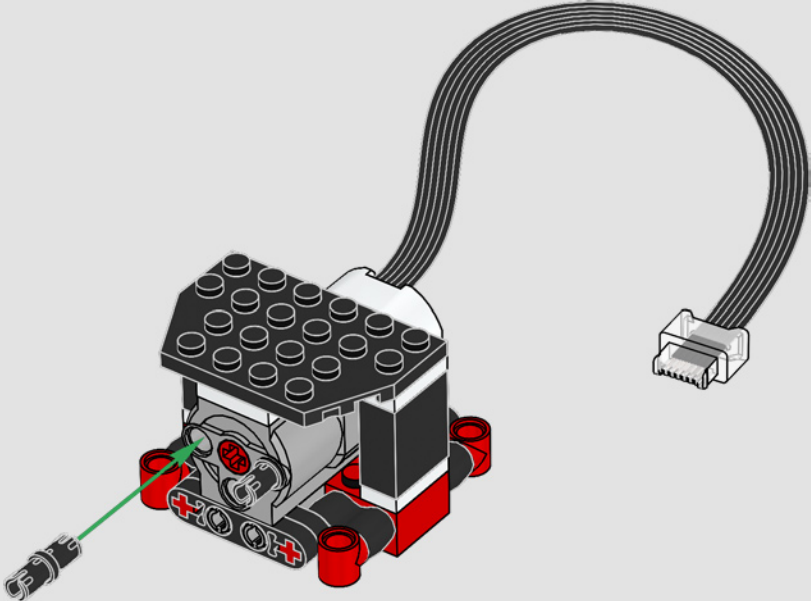

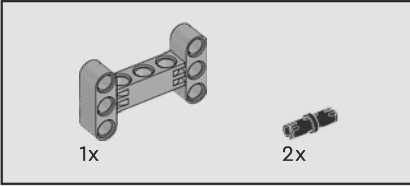
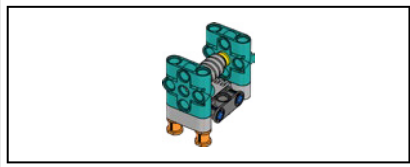

67

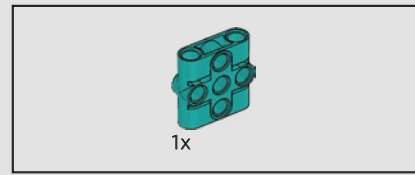
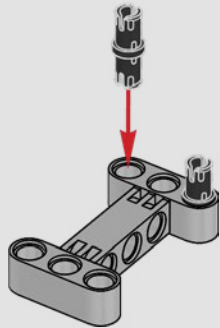

68

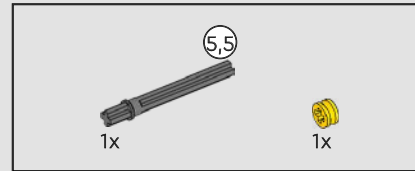
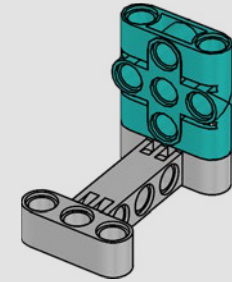

69

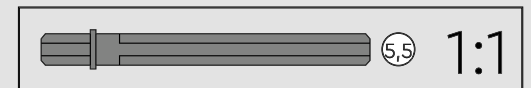
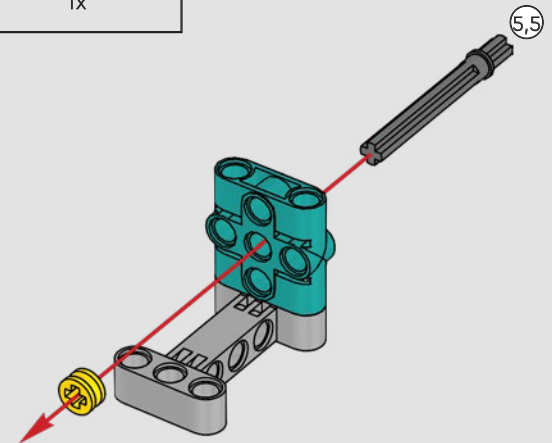



70

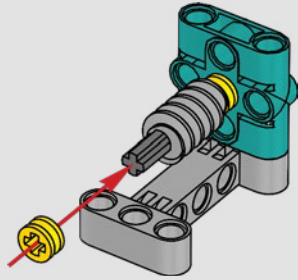

71

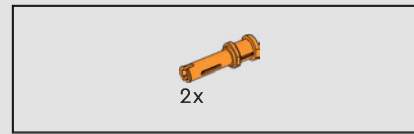
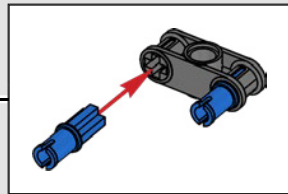
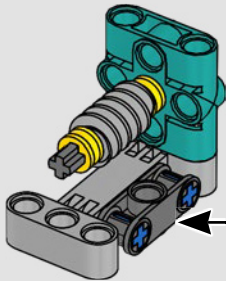

72

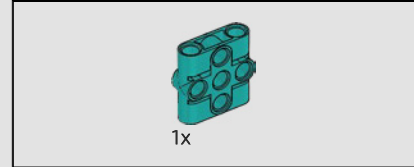
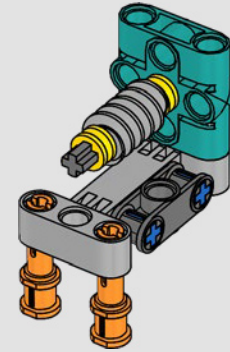

73

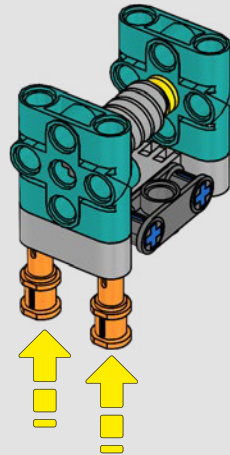

74

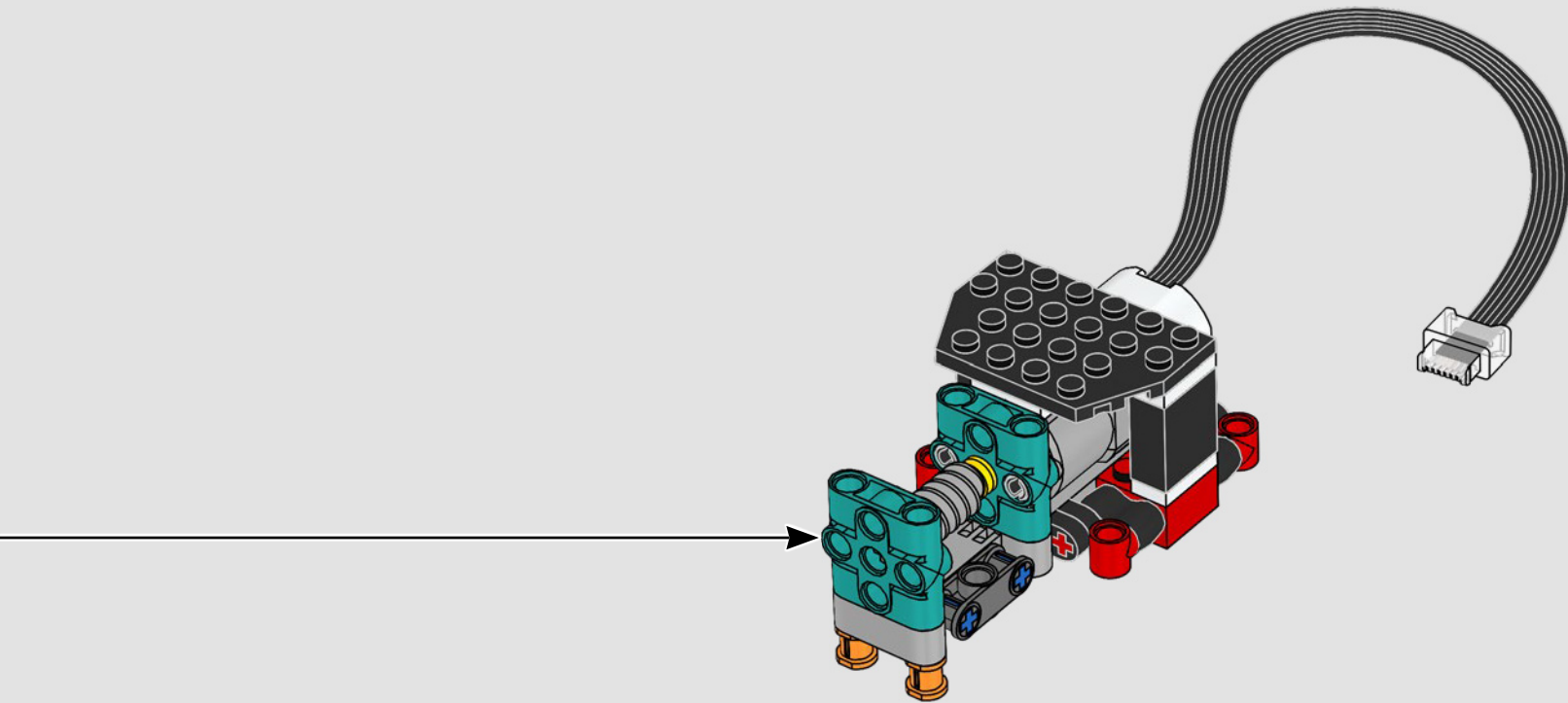

75

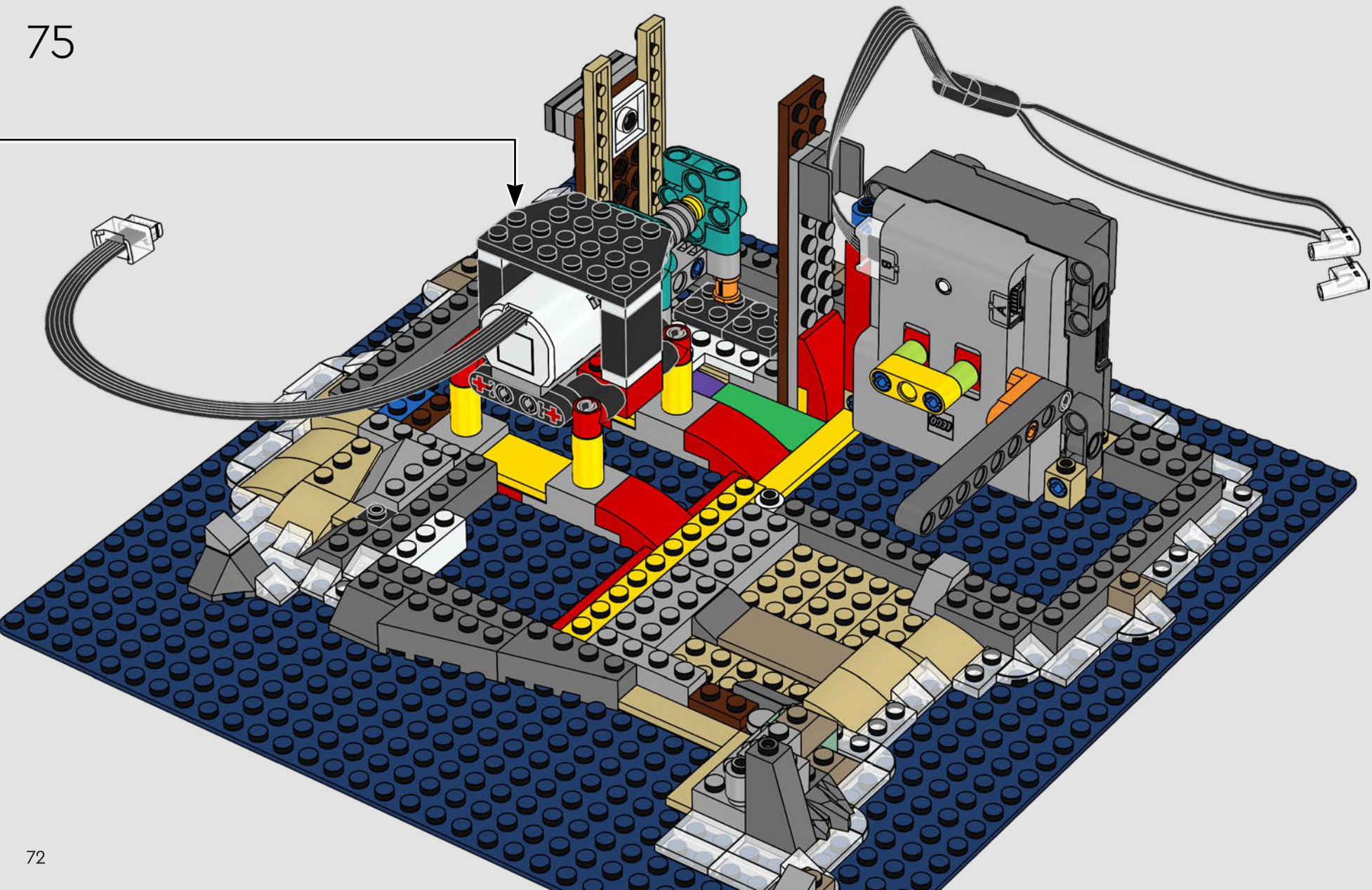

76

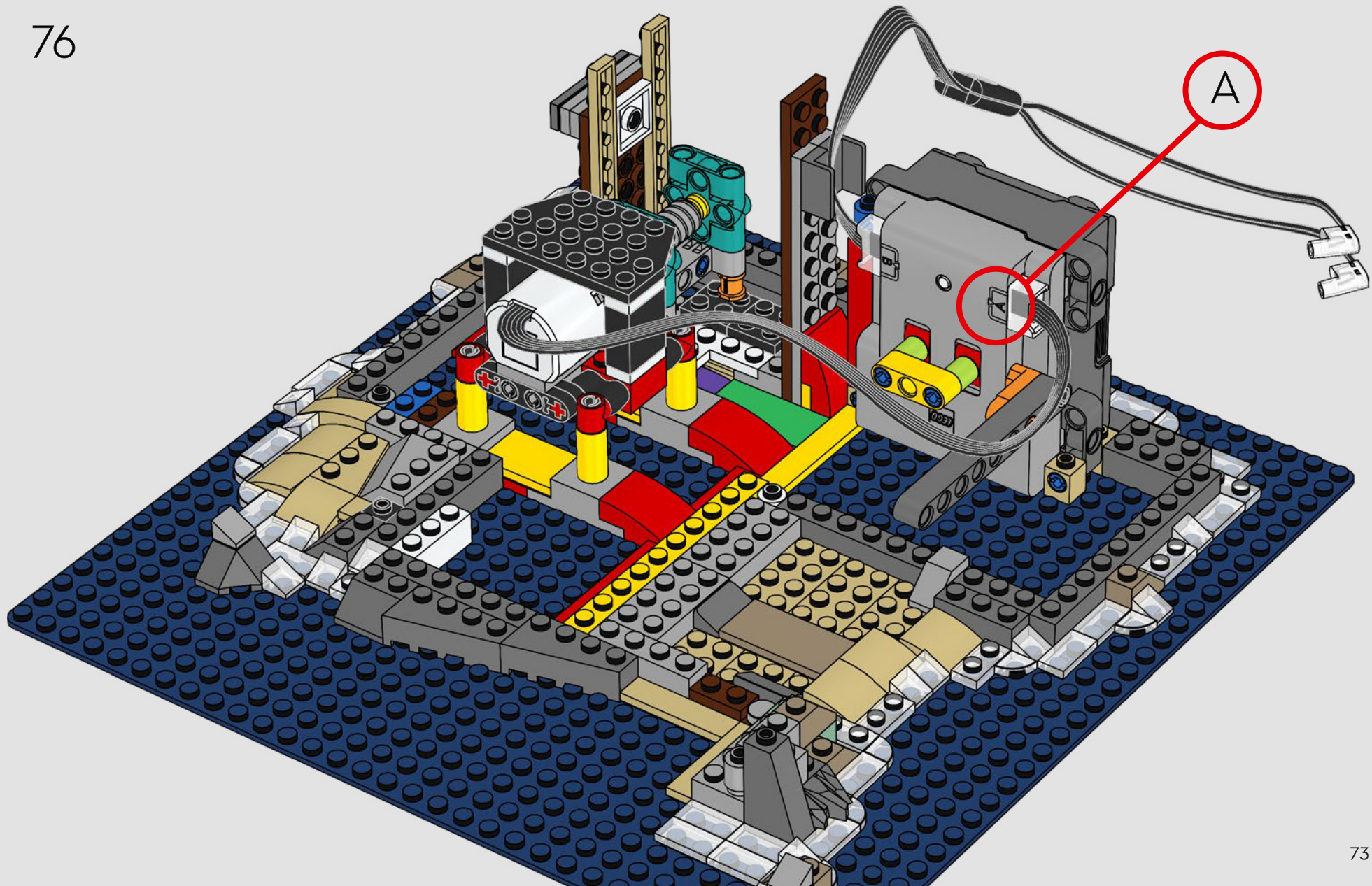

2x 4x 1x

77

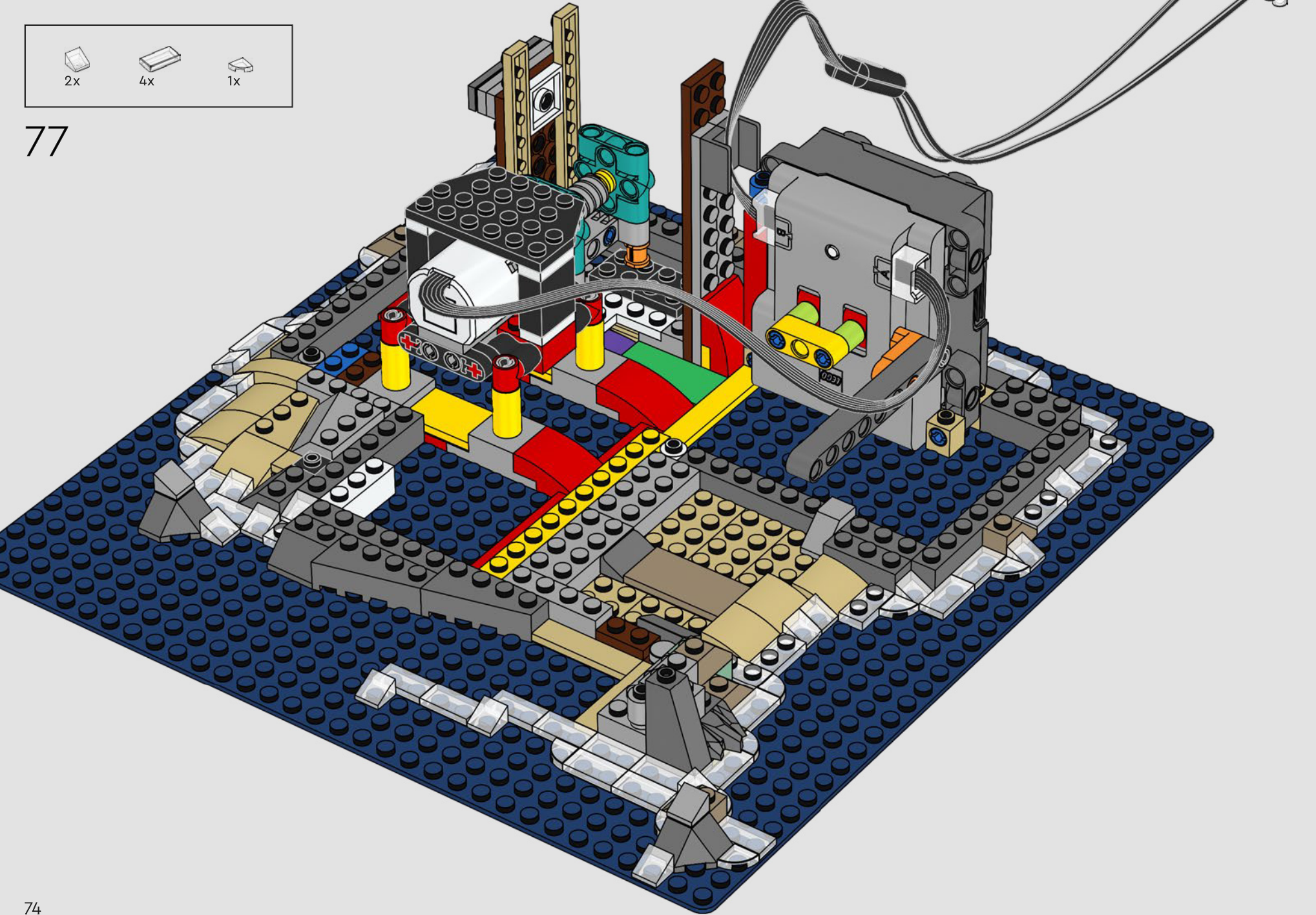

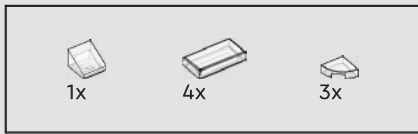

78

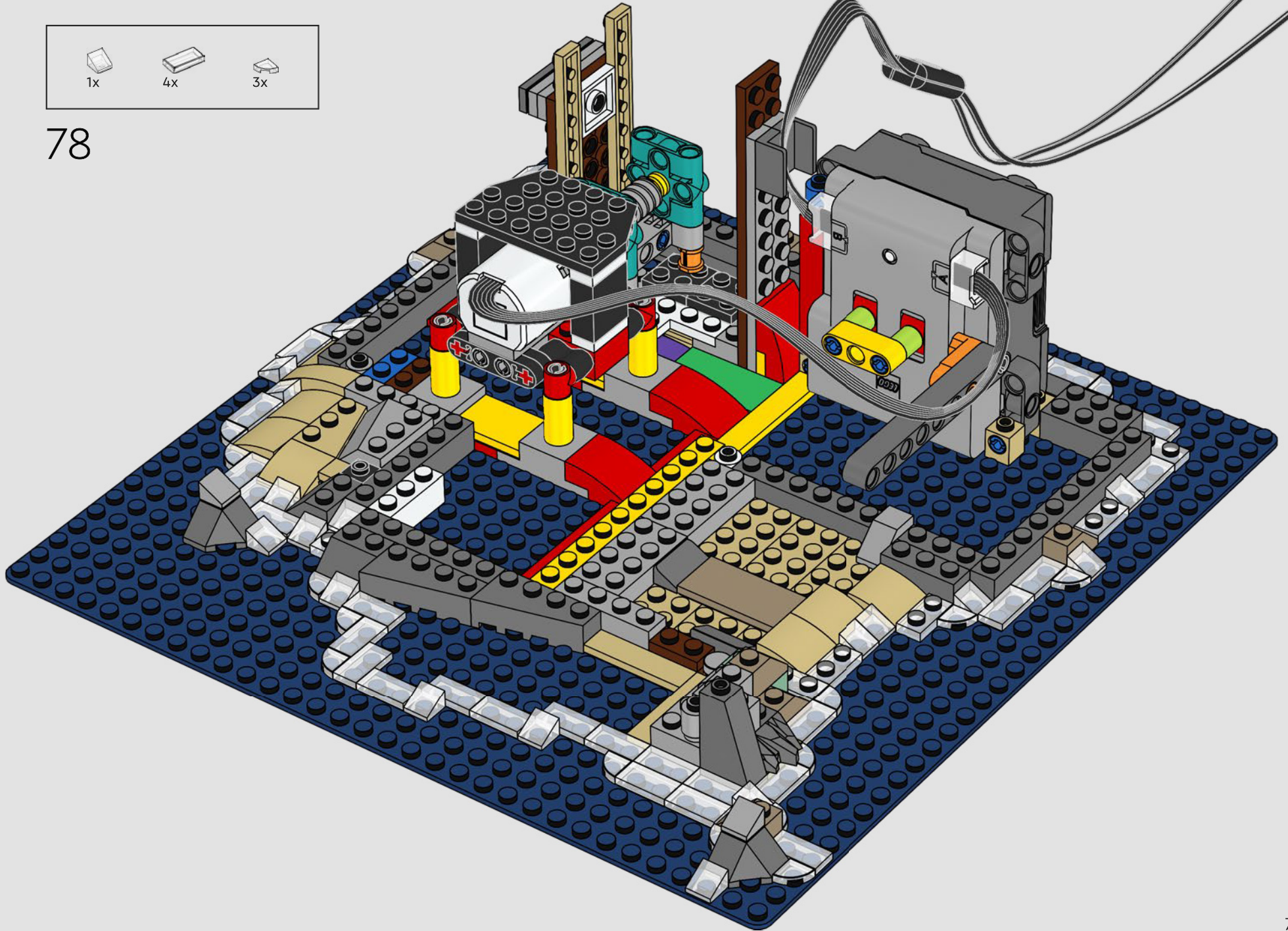

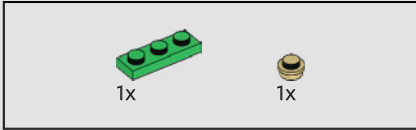
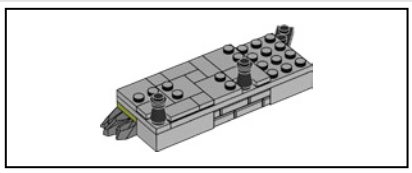

79

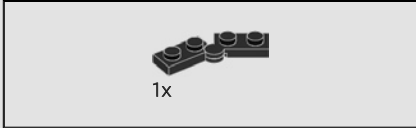
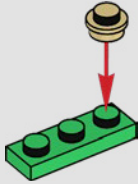

80

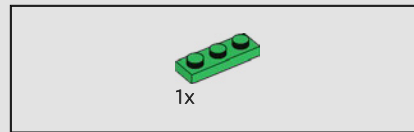
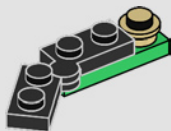

81

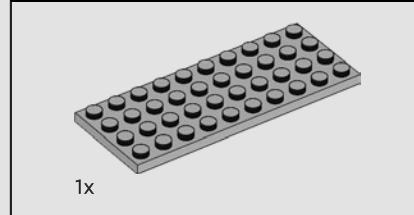
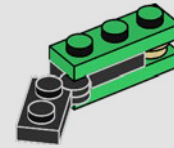

82

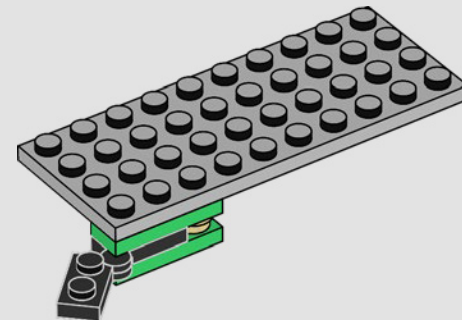

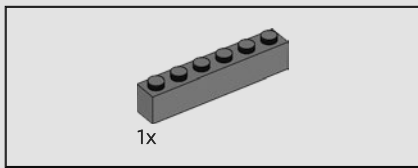

83

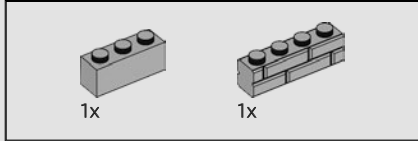
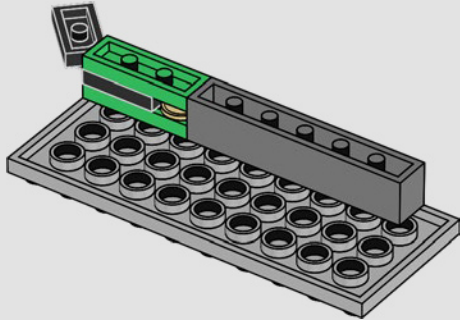

84

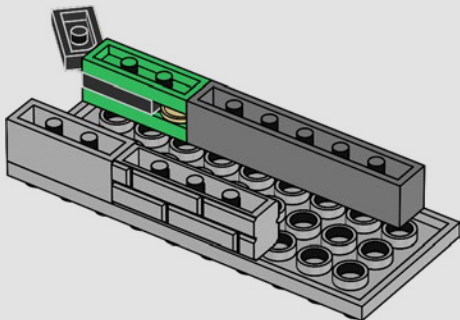

85

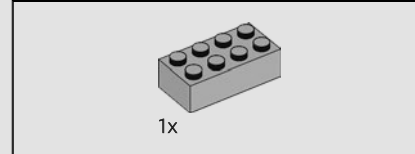
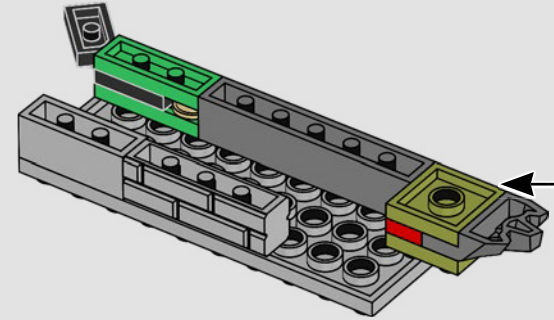
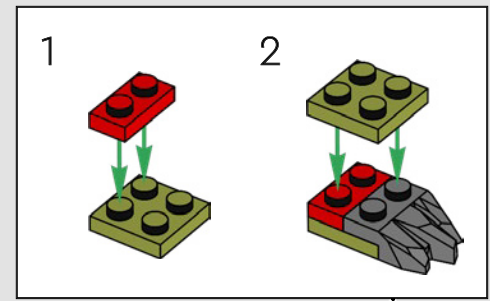

86

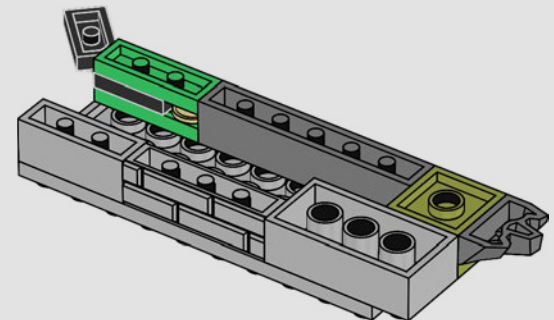

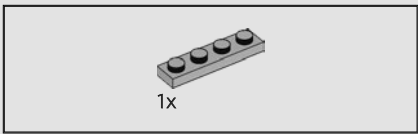

87

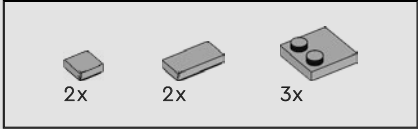
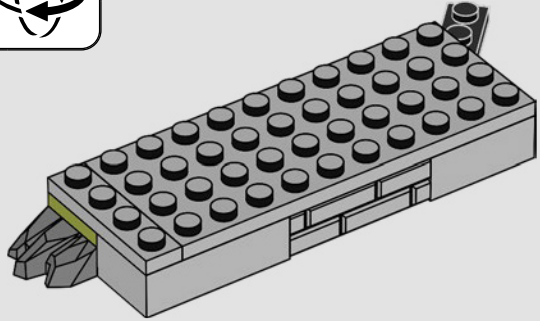

88

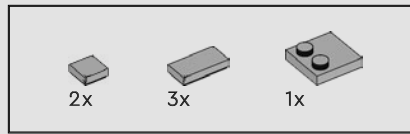
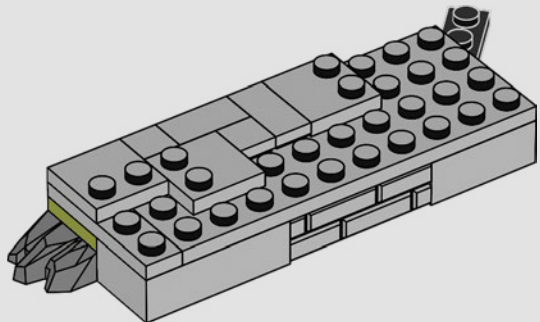

89

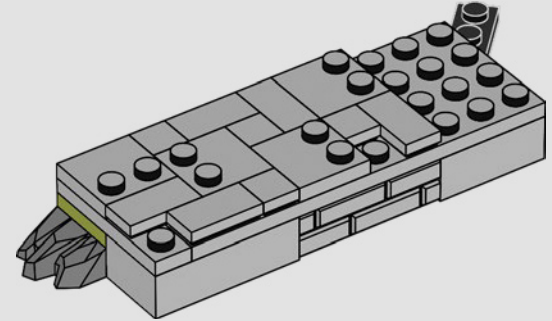

90

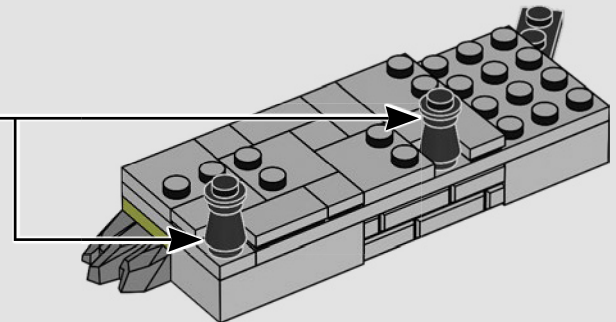
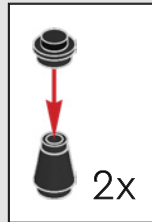



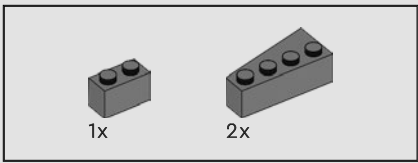

92

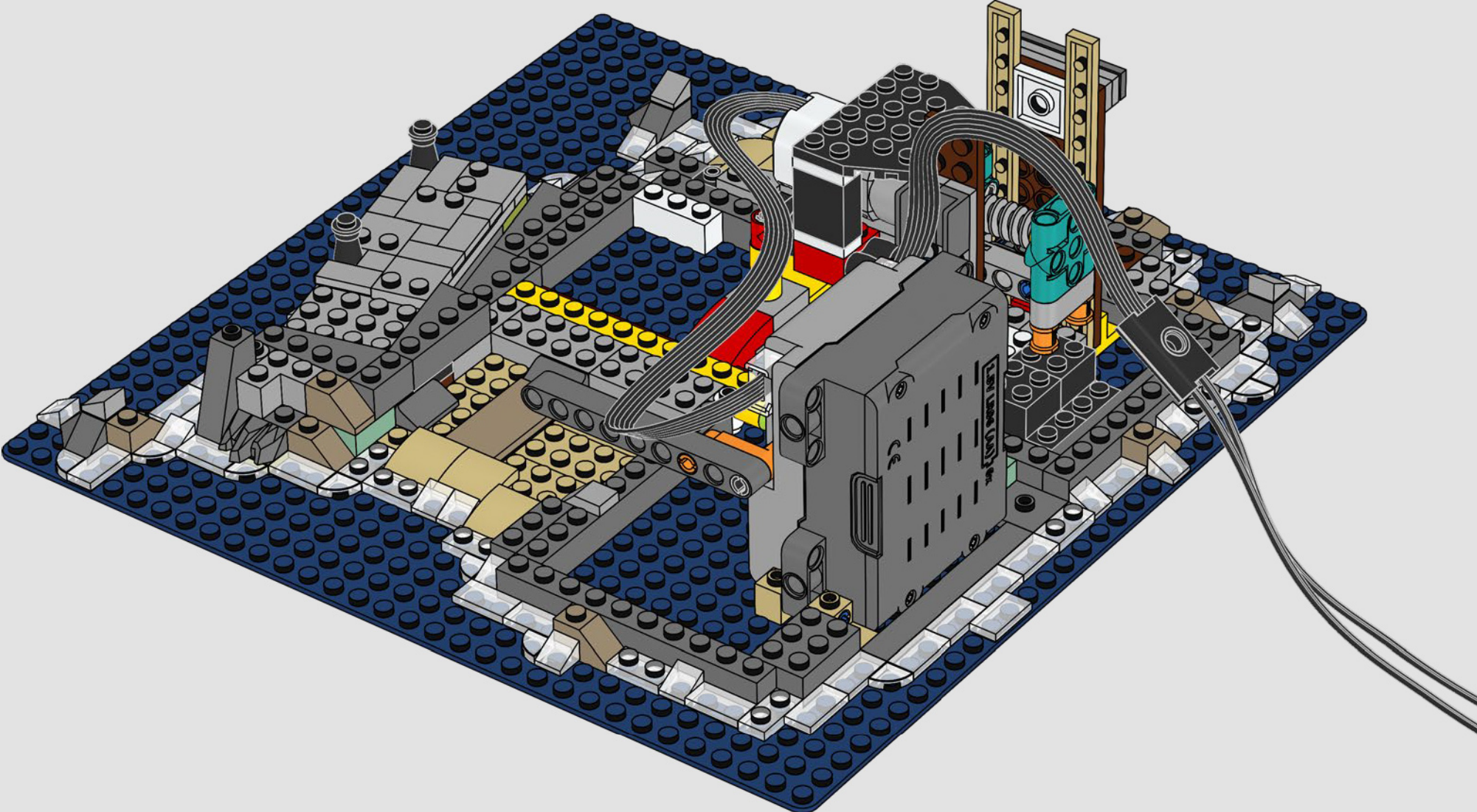

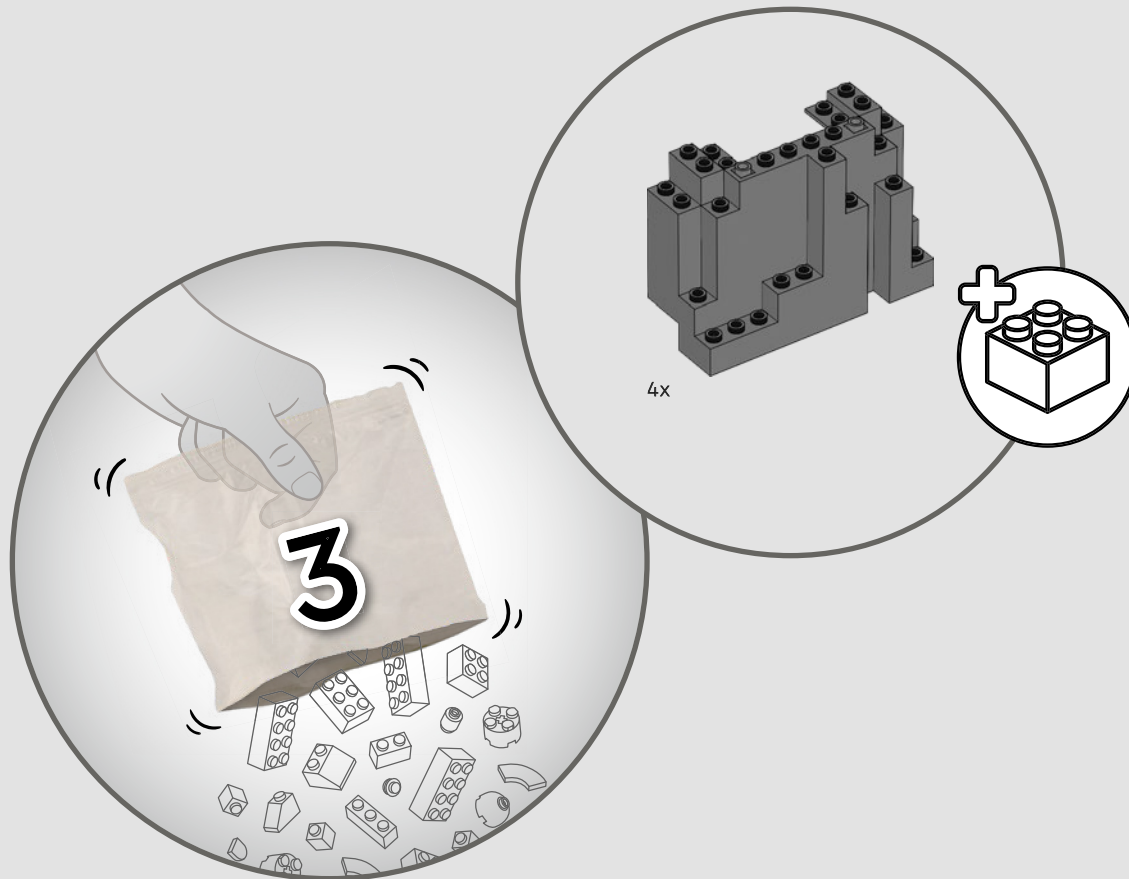

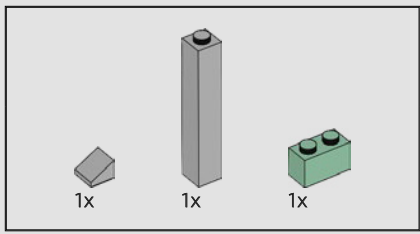

93



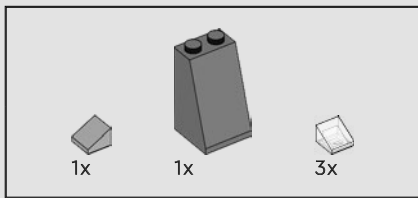

94

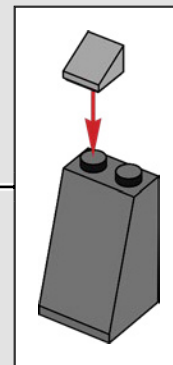
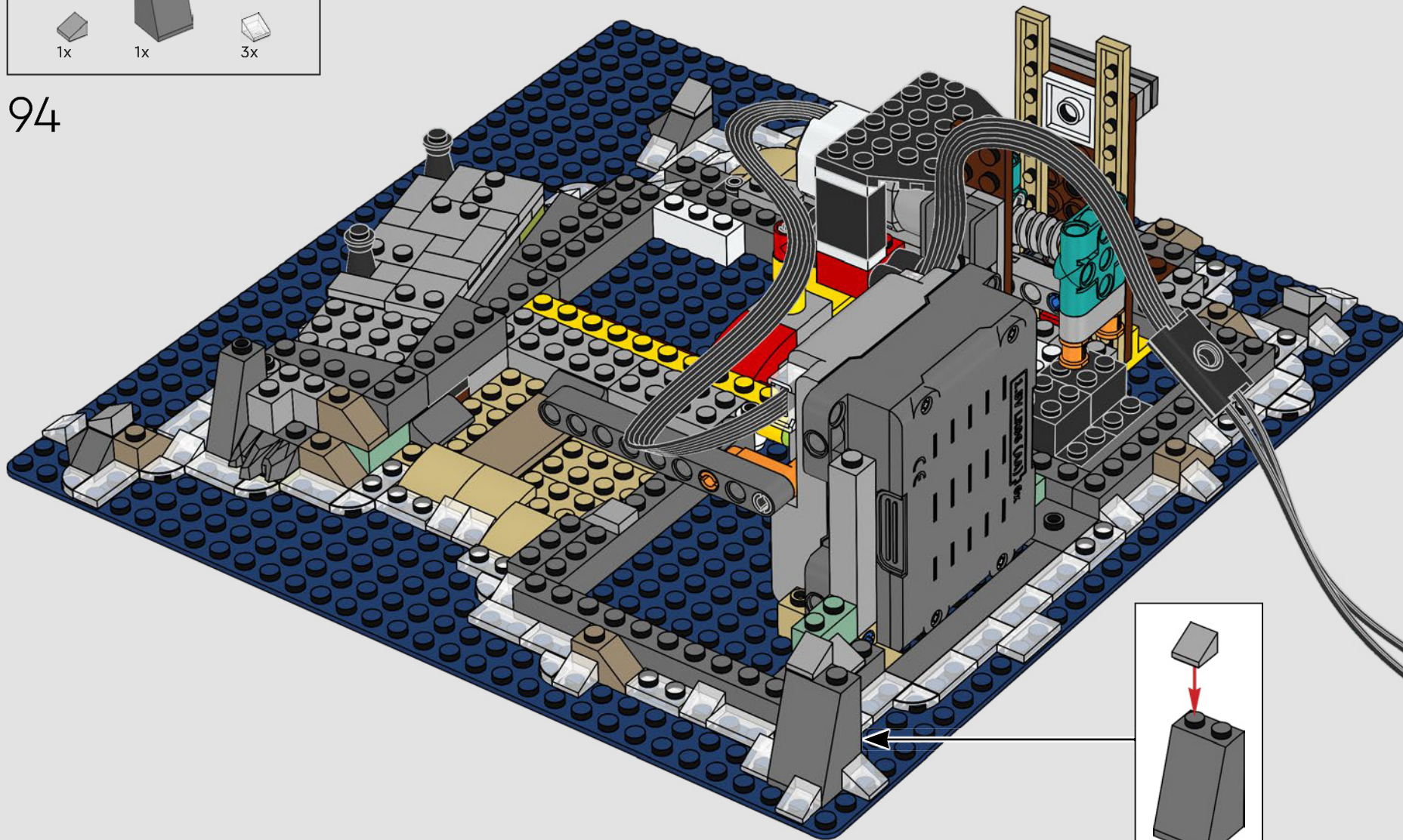

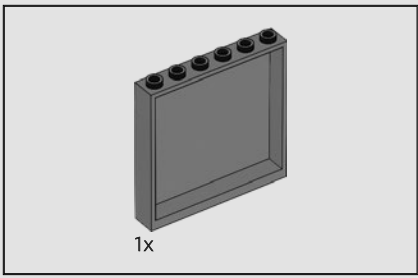

95

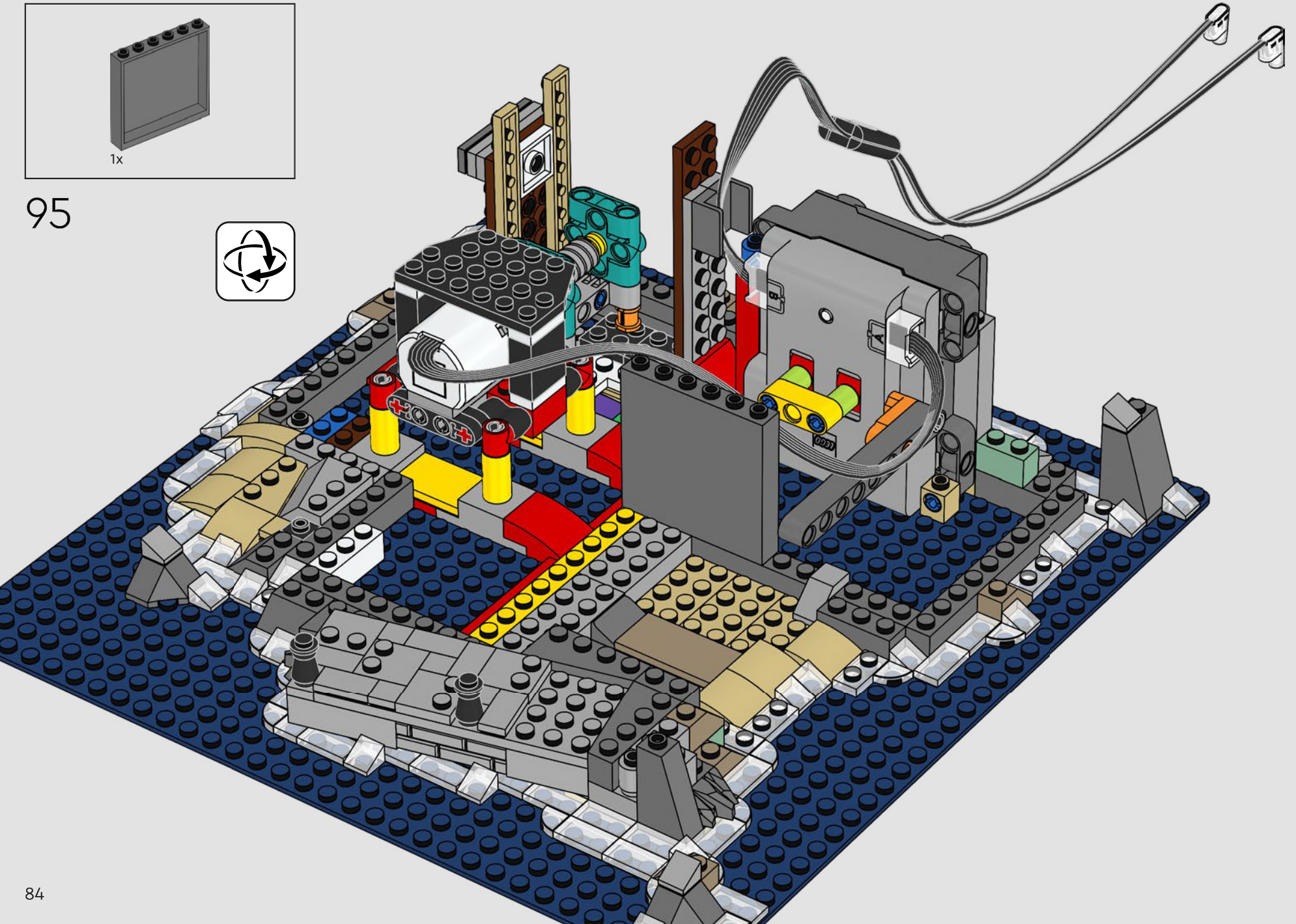

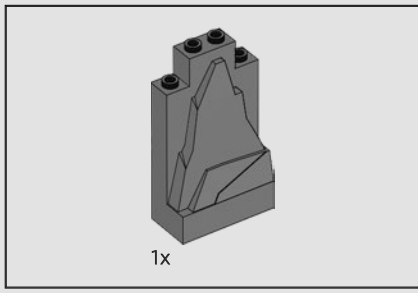

96

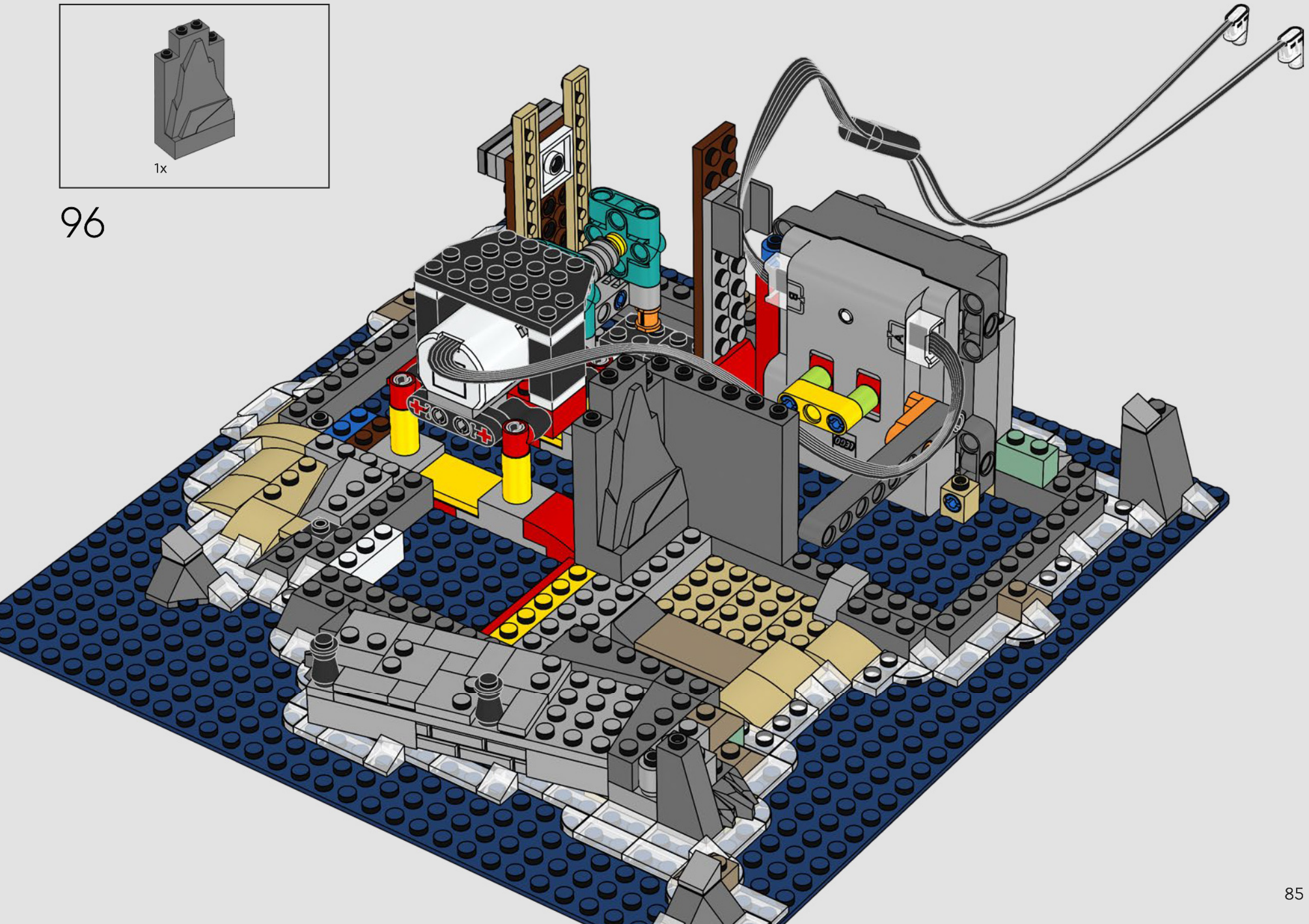

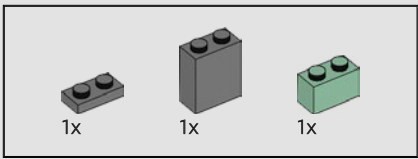

97

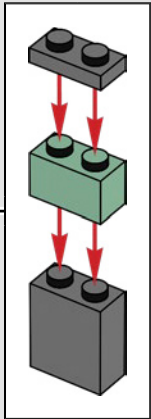
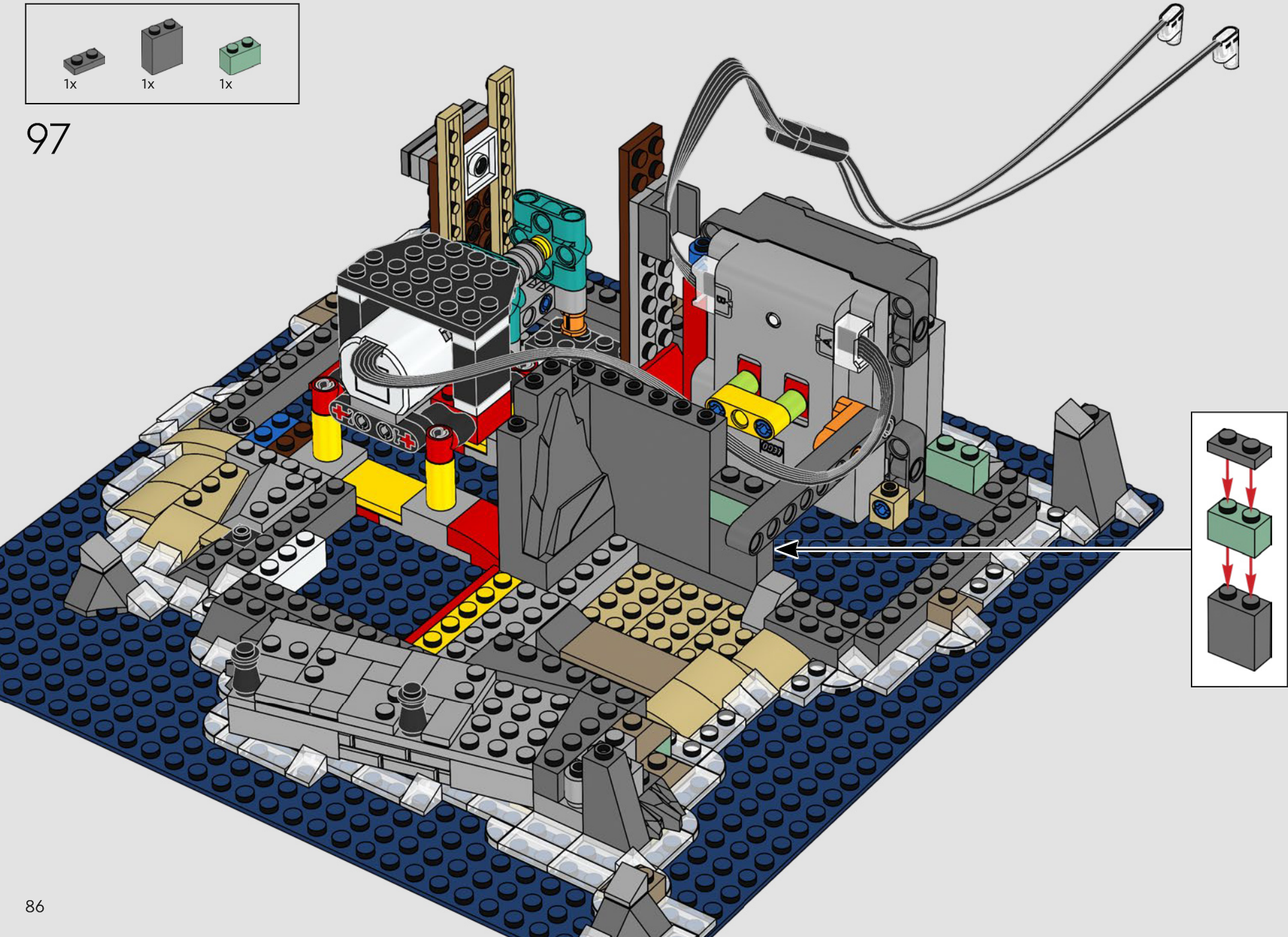

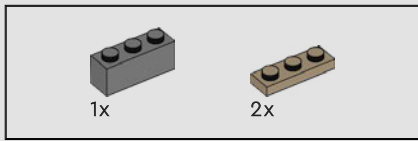

98

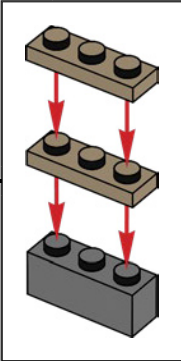
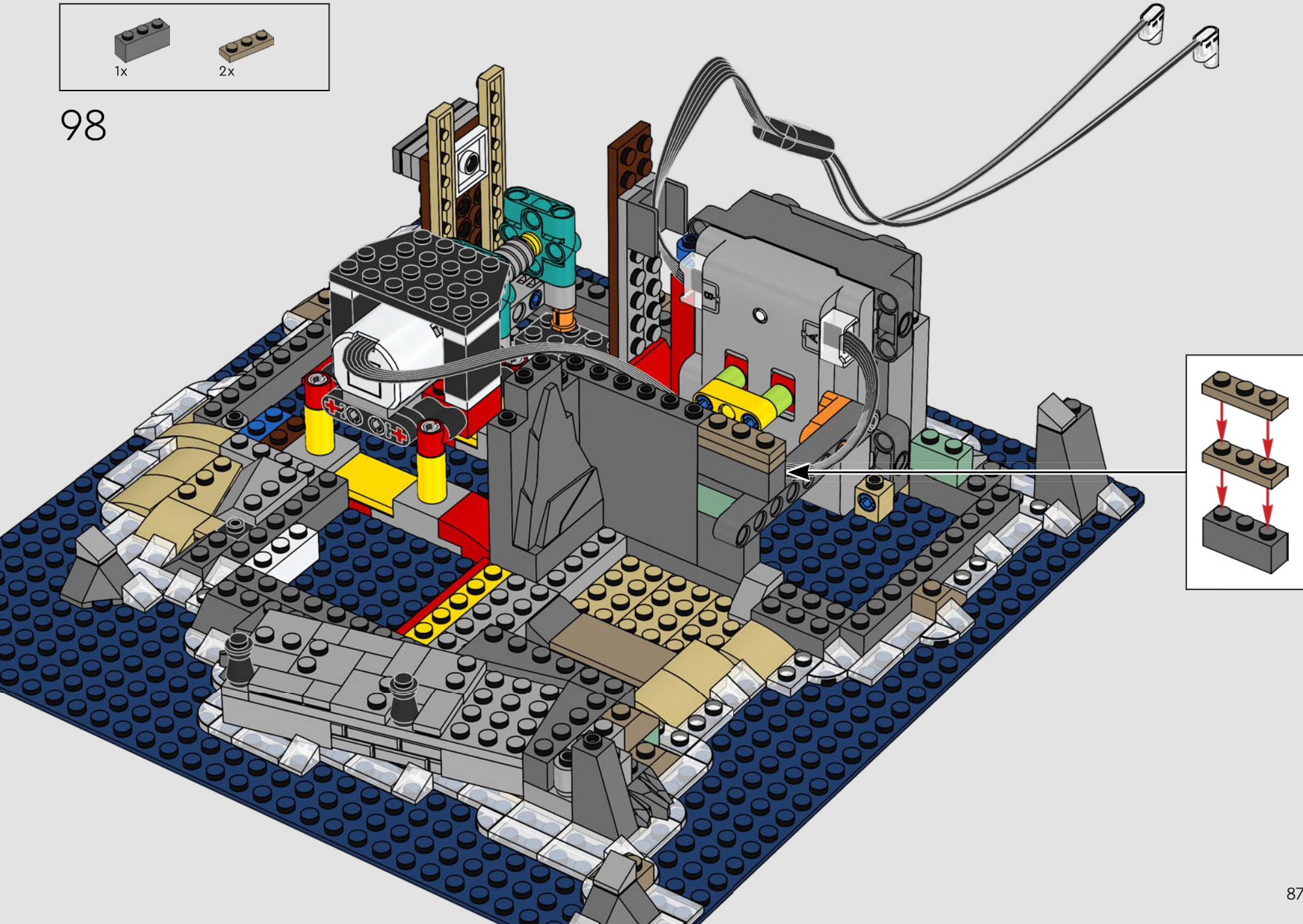

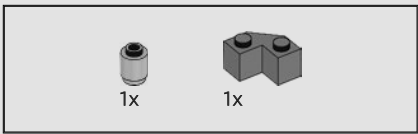

99

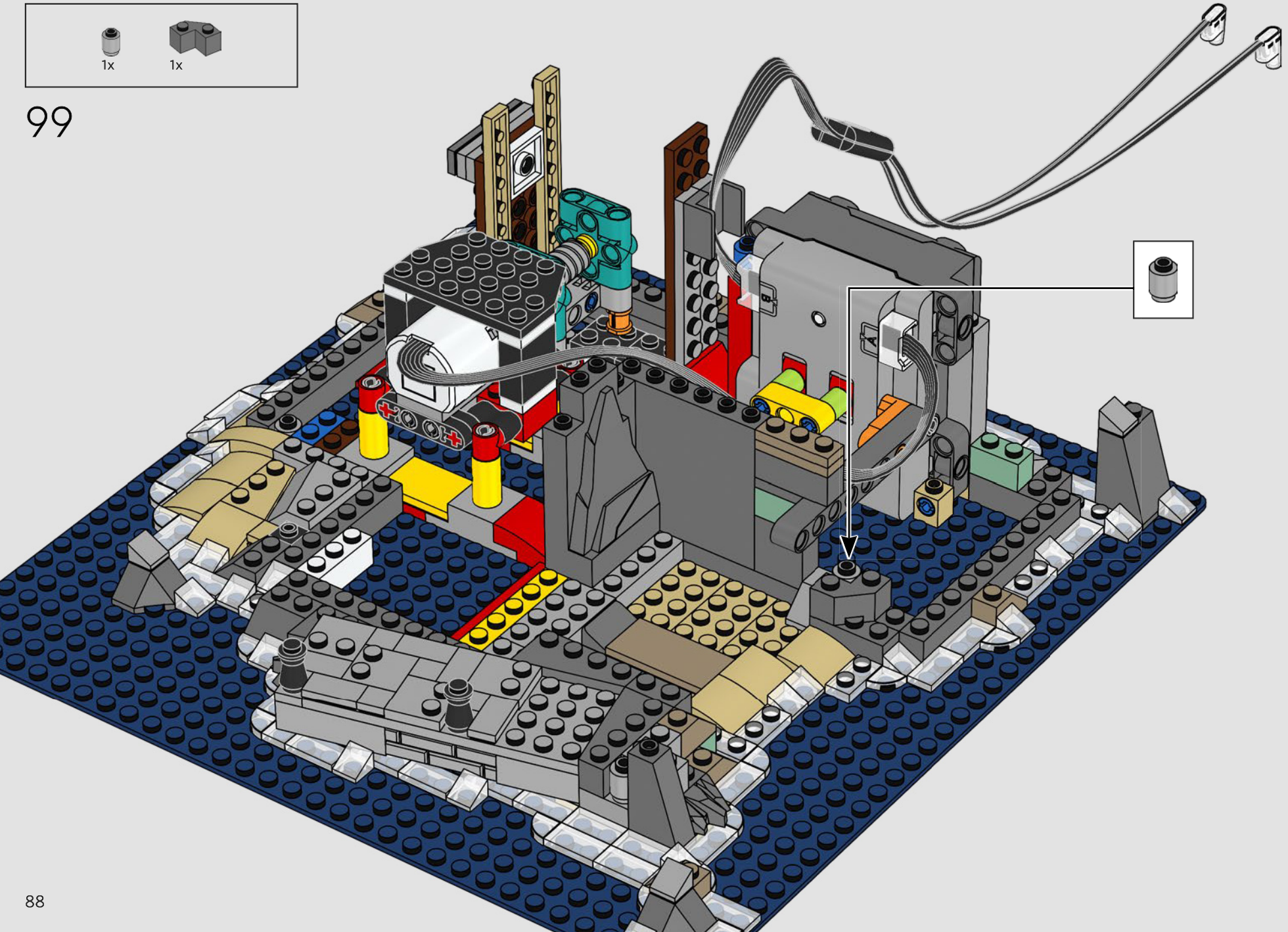

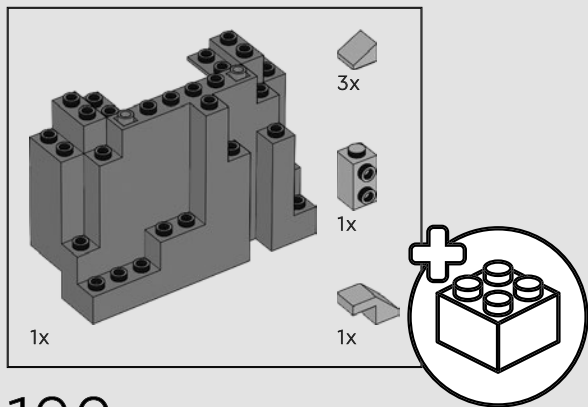

100

1

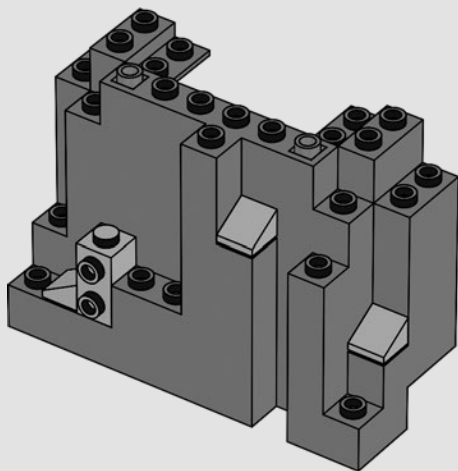

2

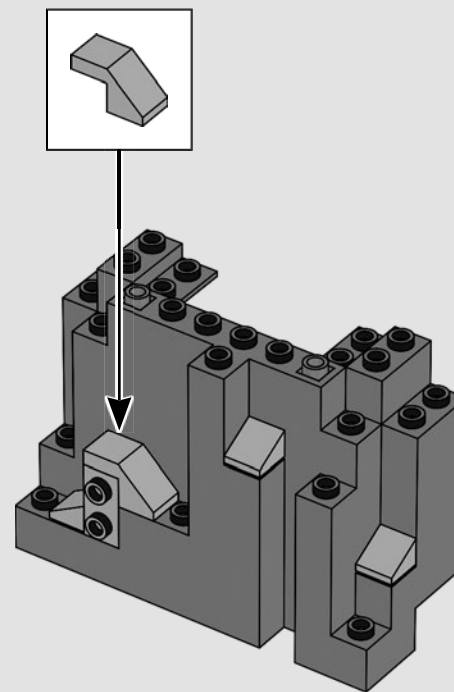

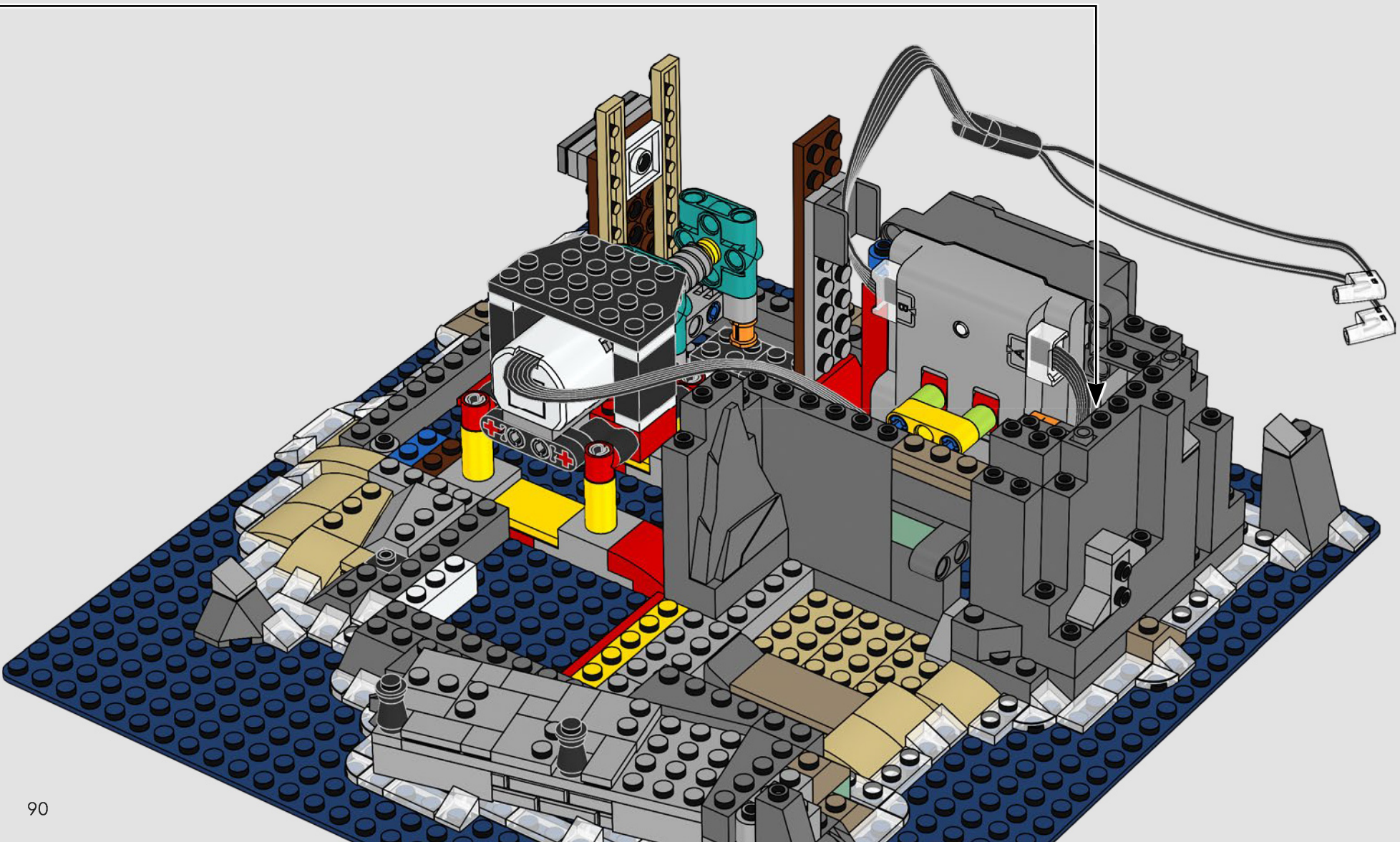

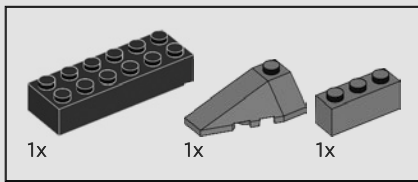

101

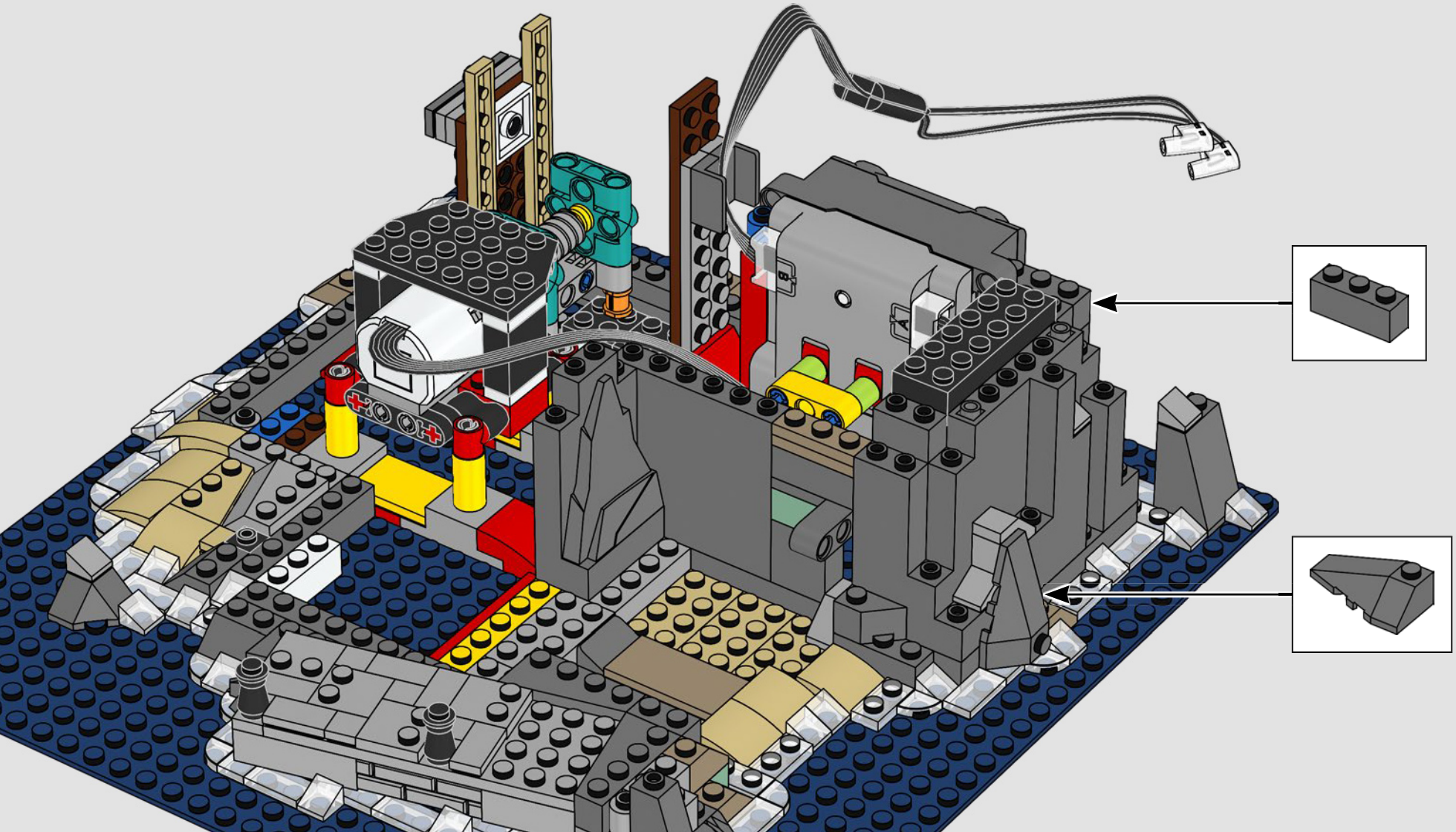

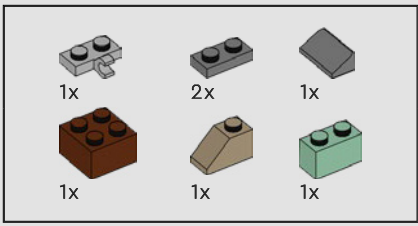

102

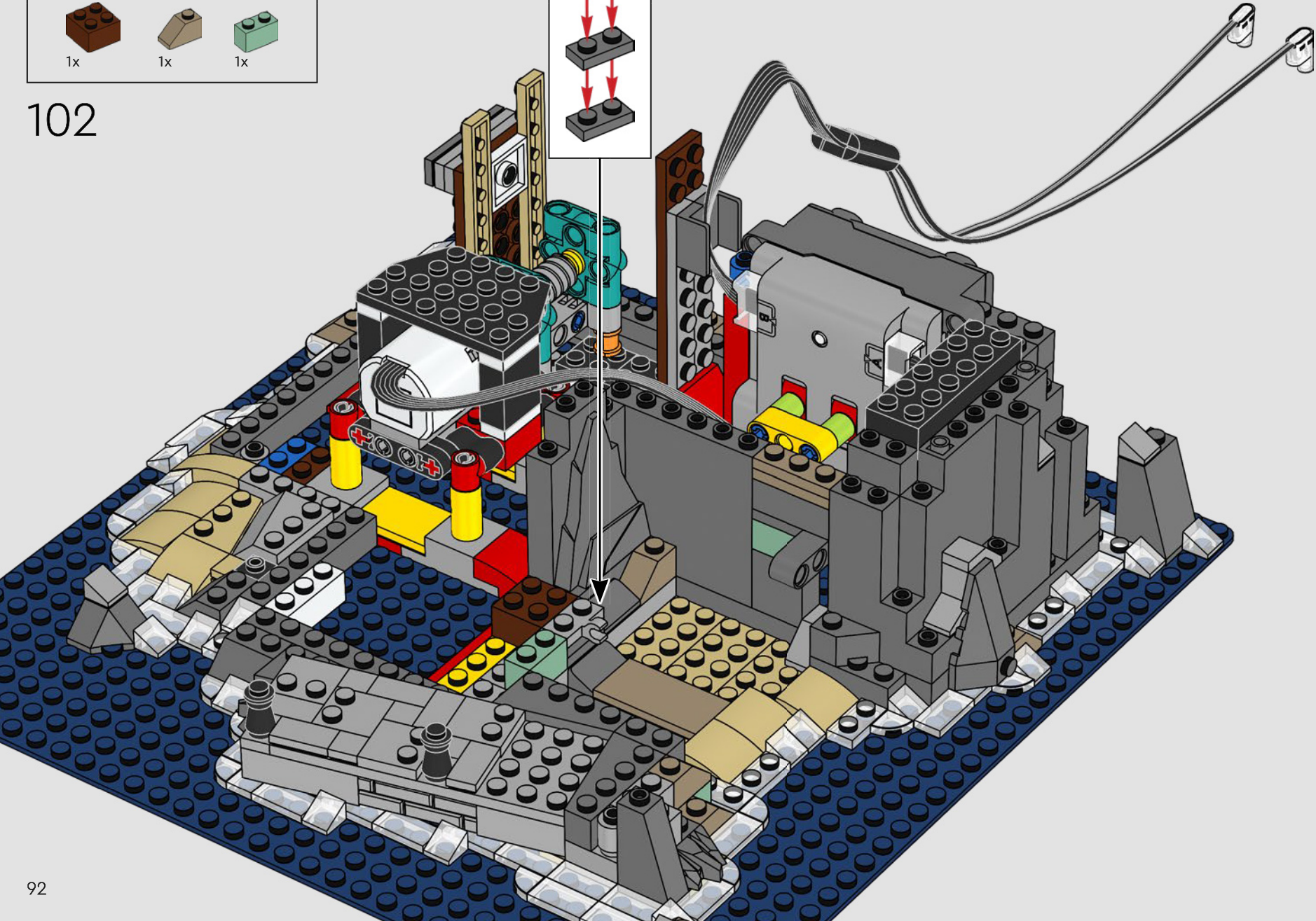
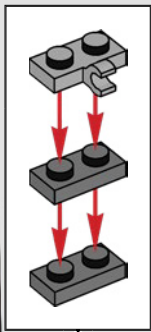

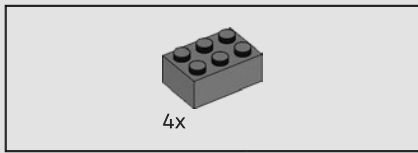

103

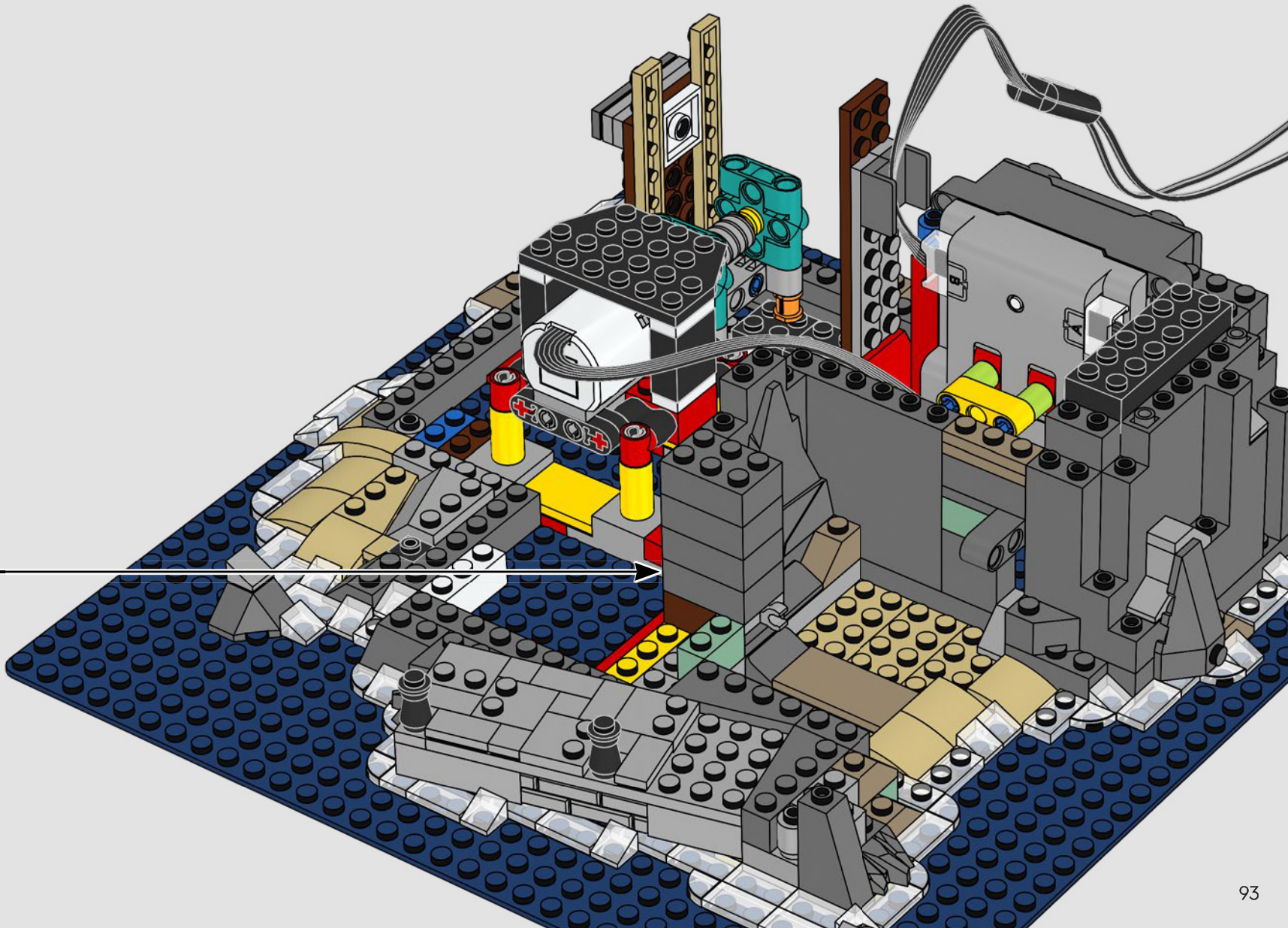
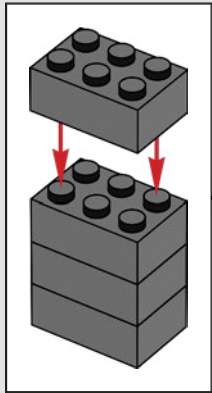

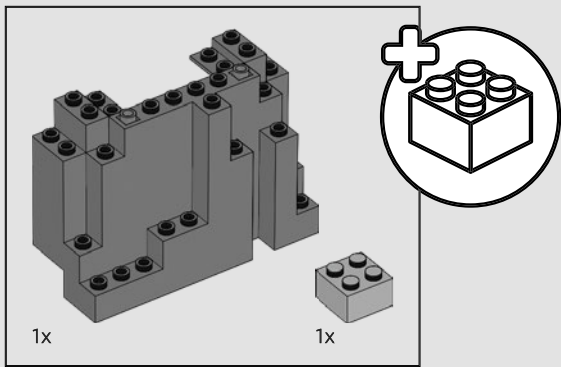

104

1

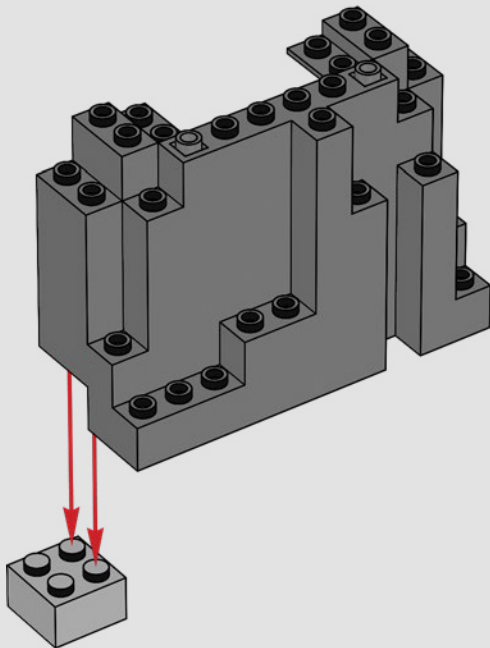

2

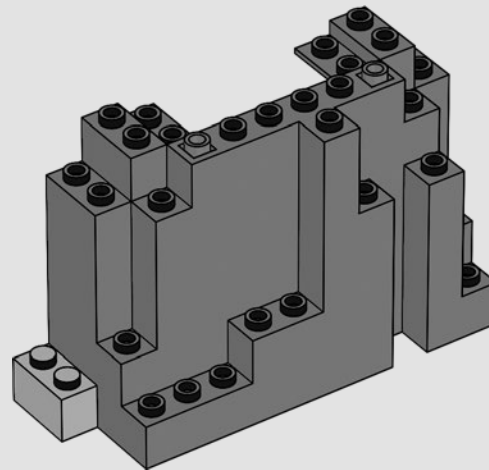

105

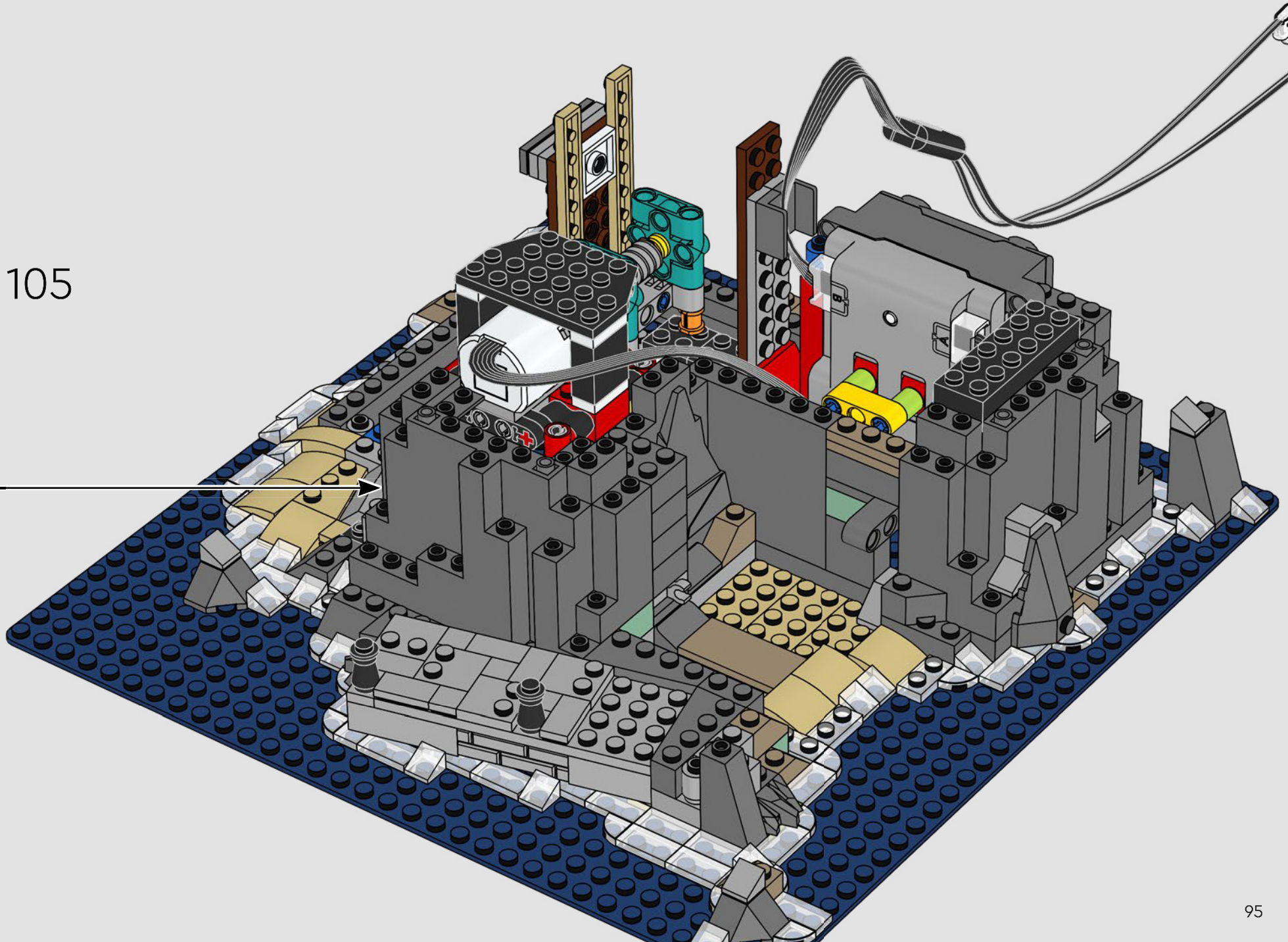

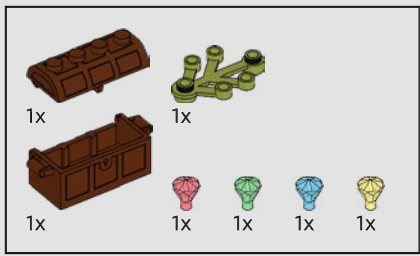

106

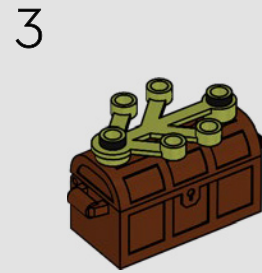
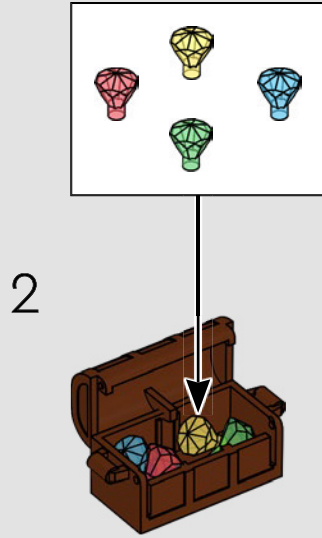
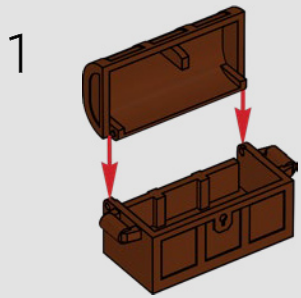

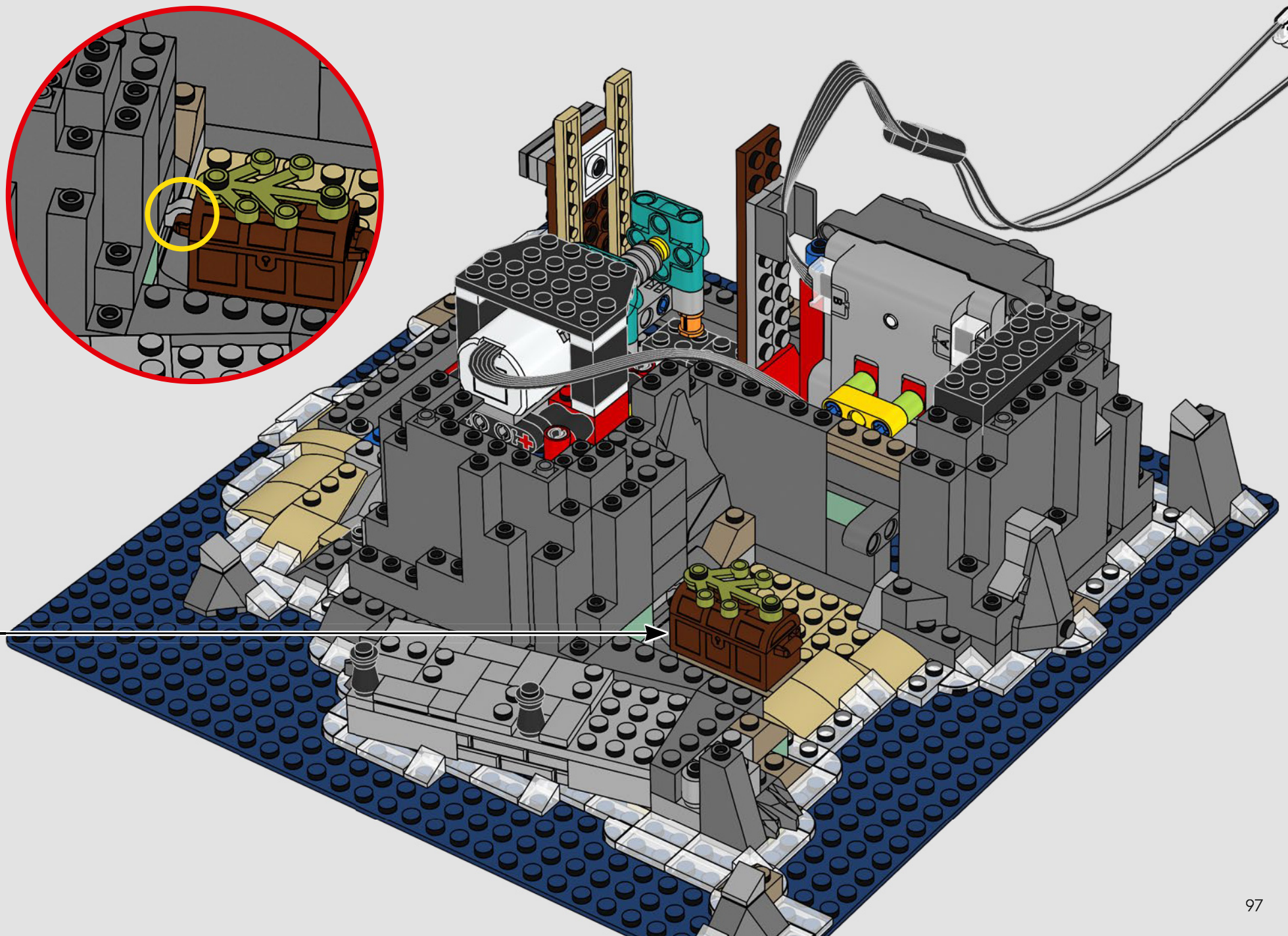
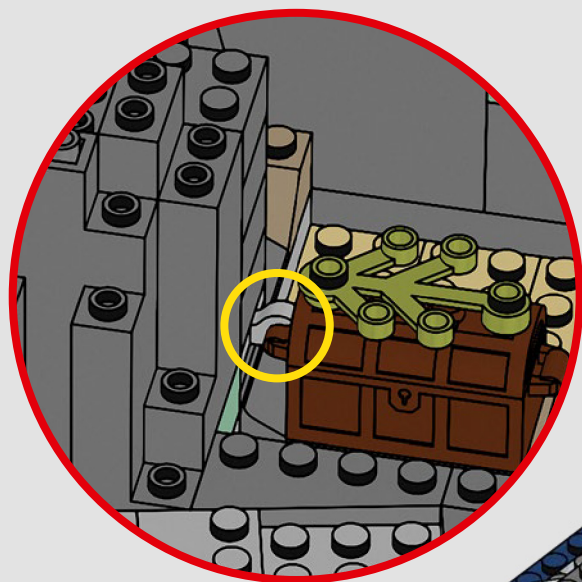

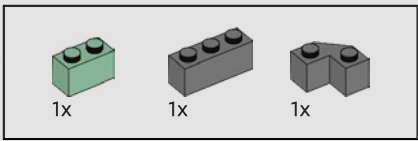

107

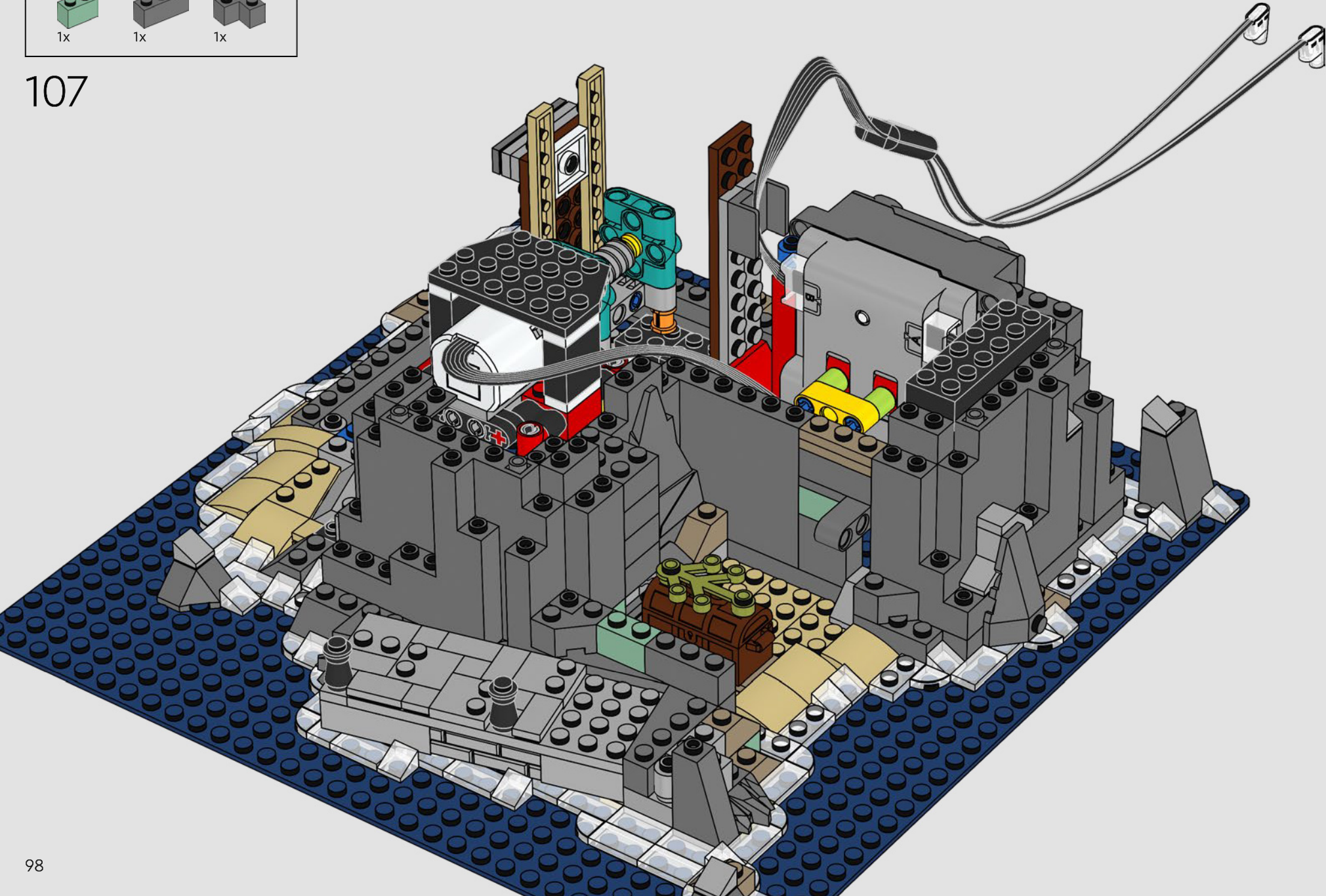

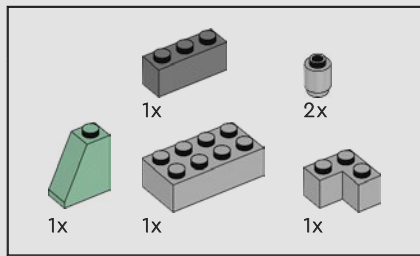

108

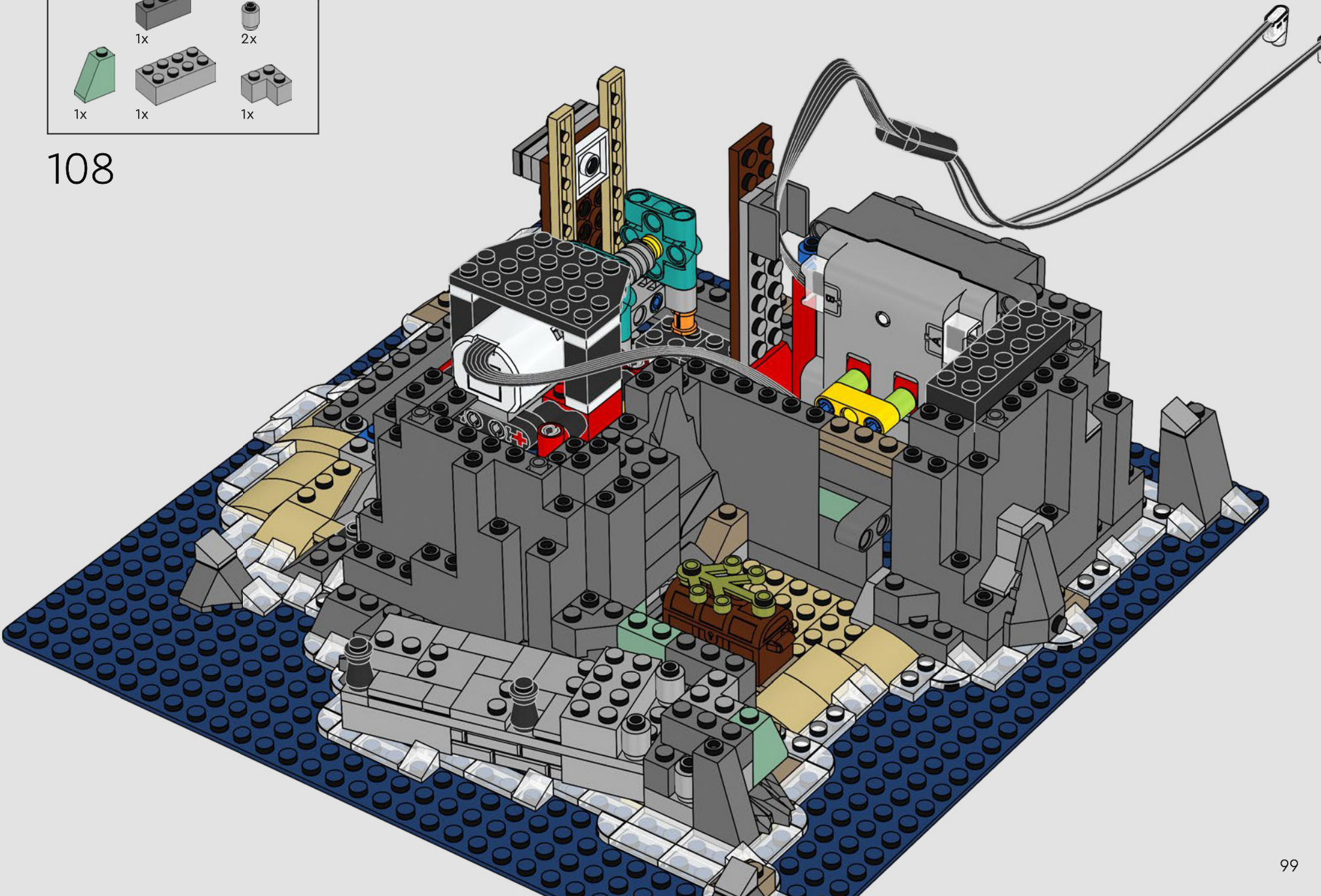

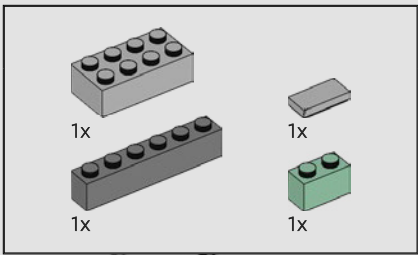

109

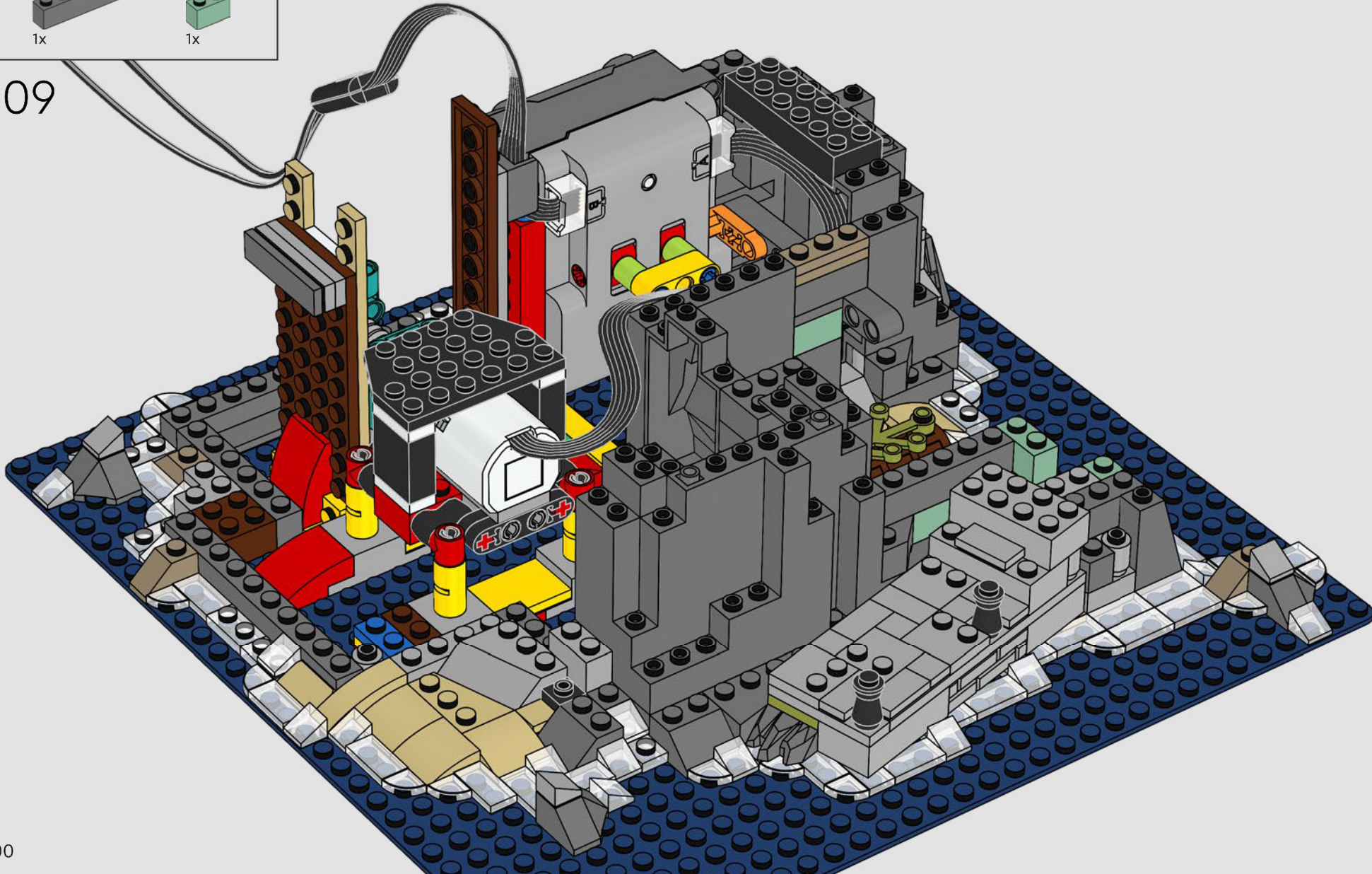

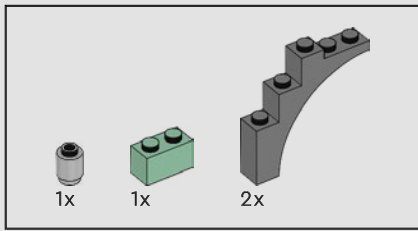

110

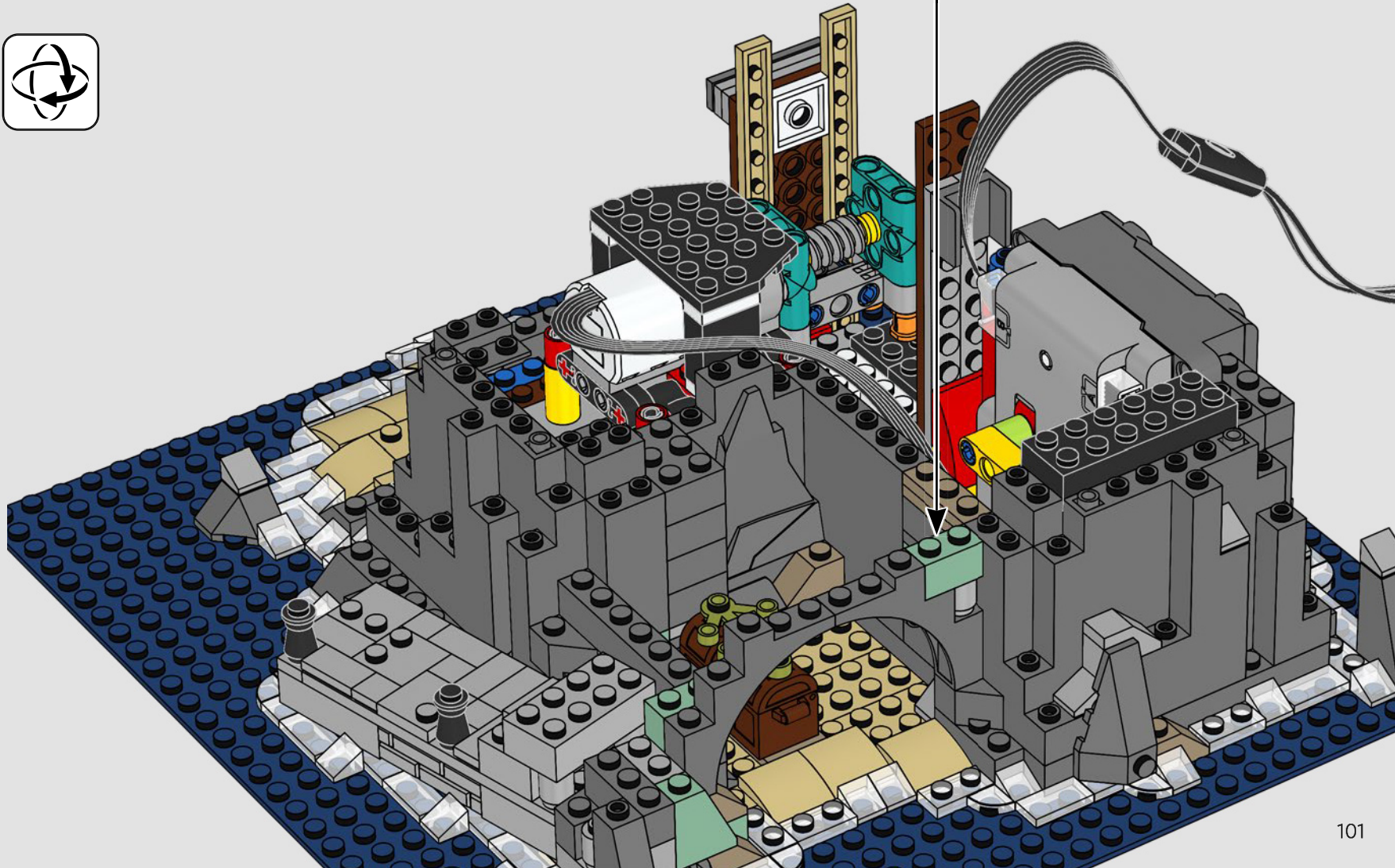
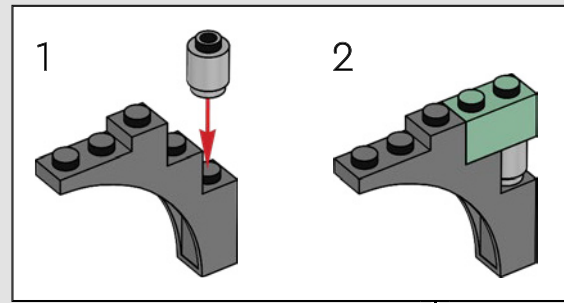

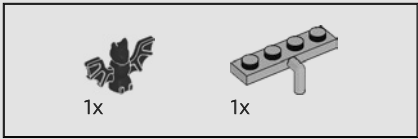

111

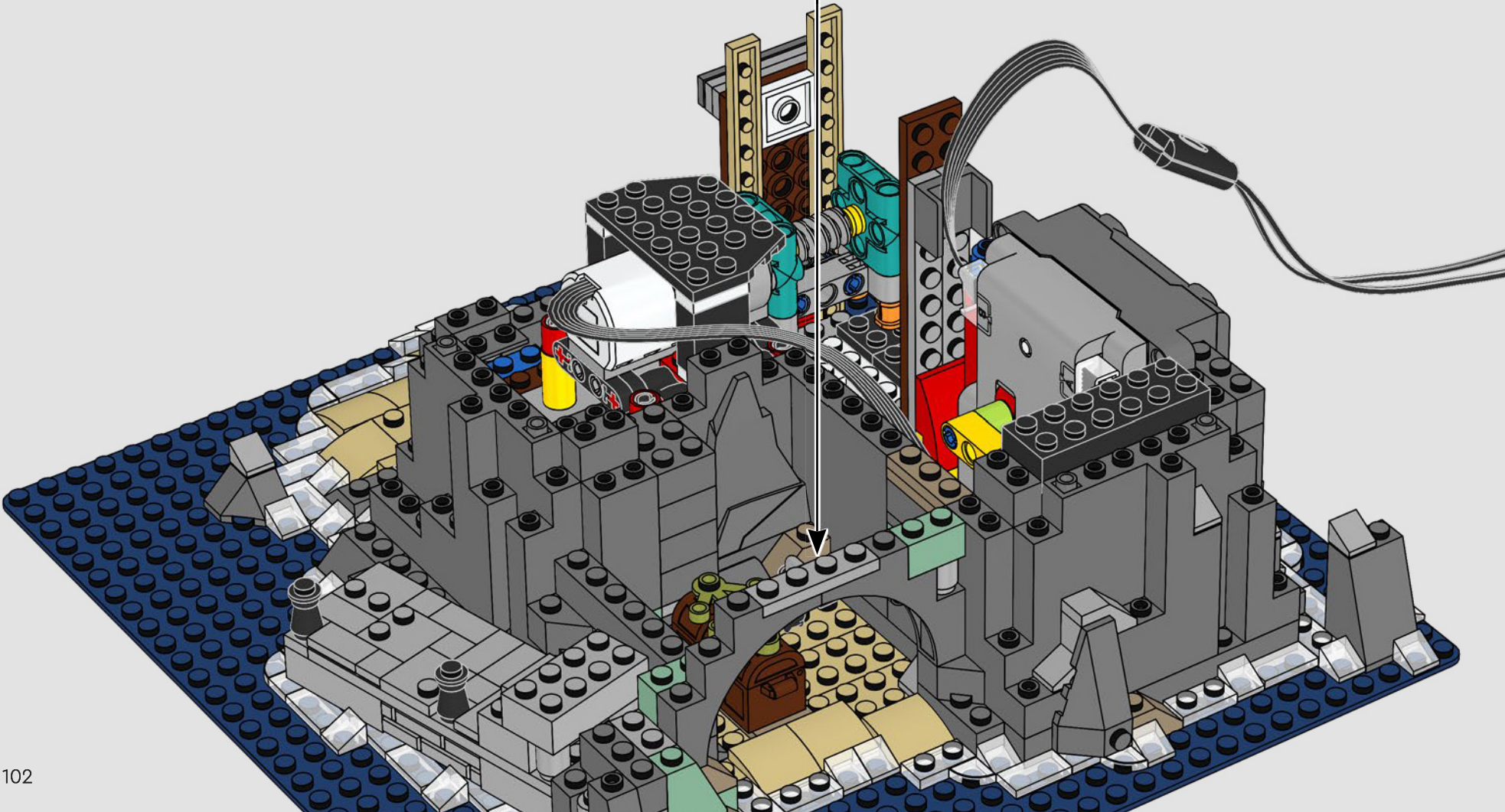
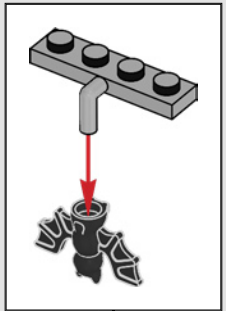

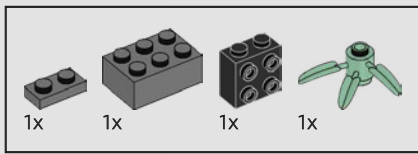

112

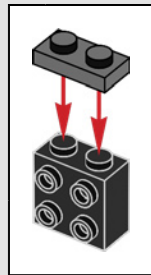
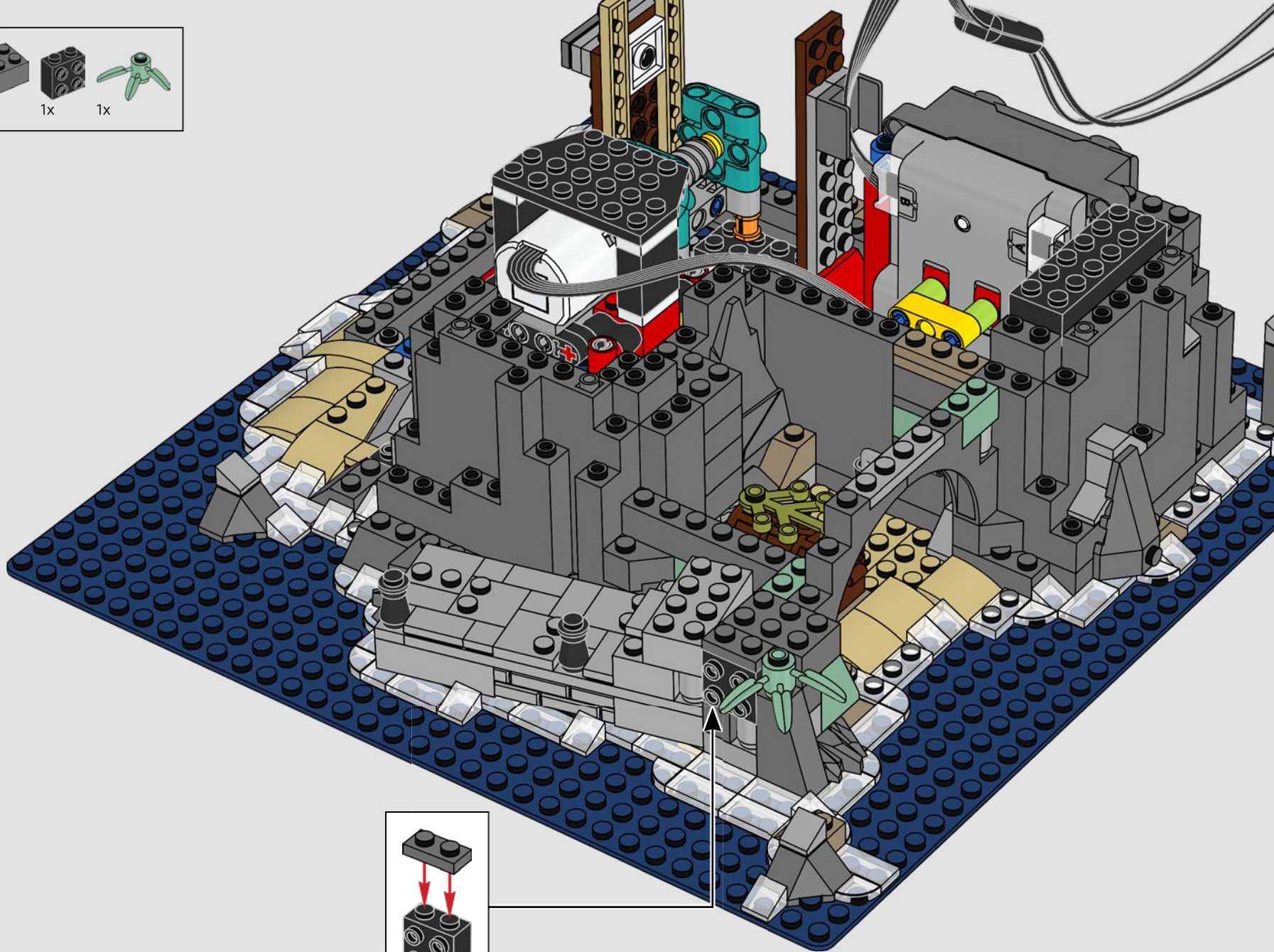

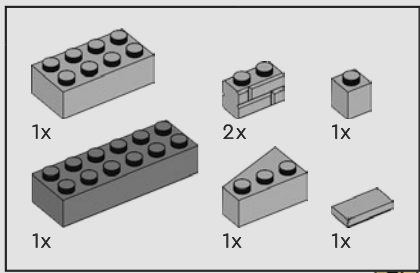

113

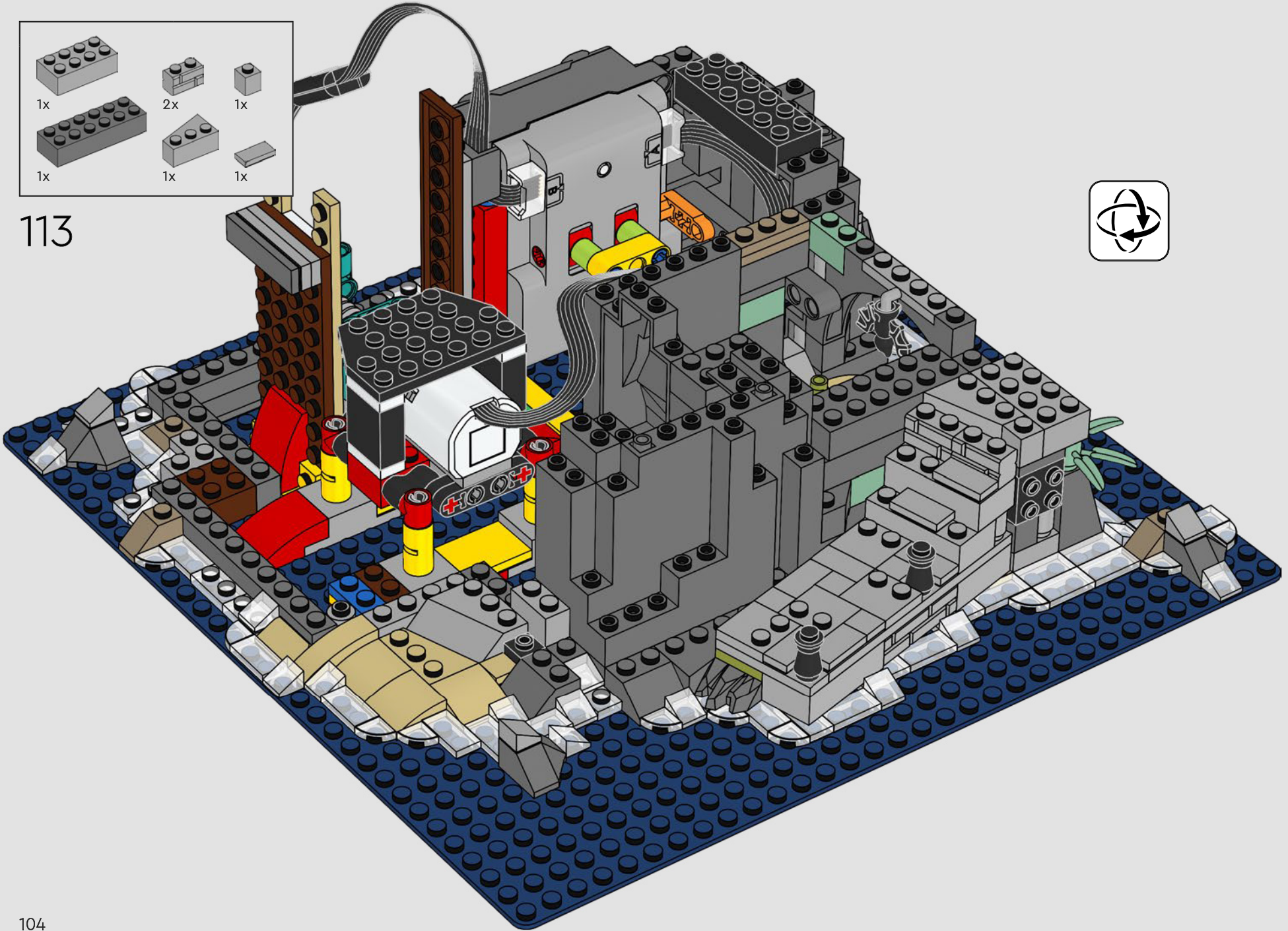

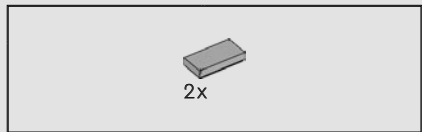

114

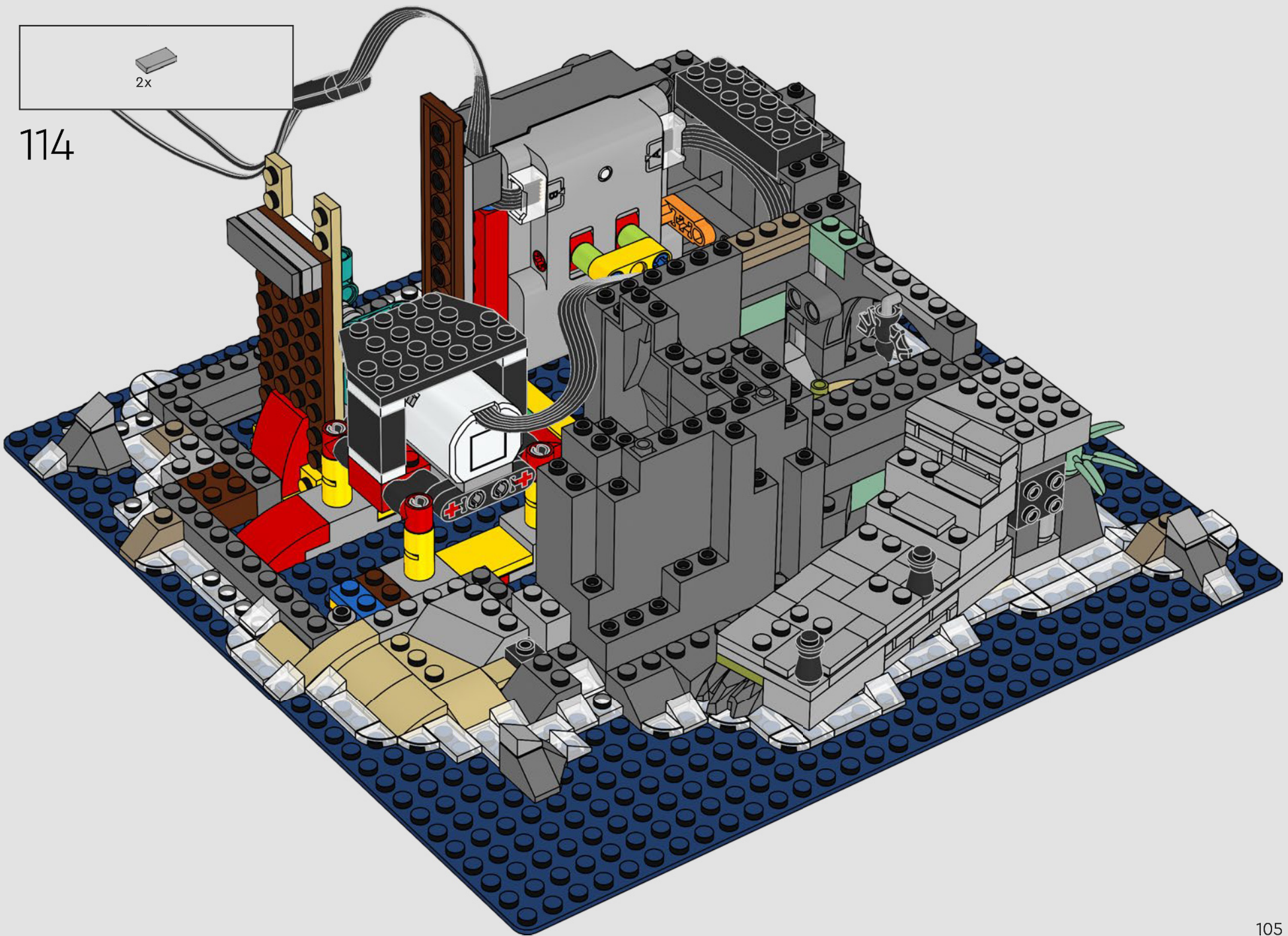

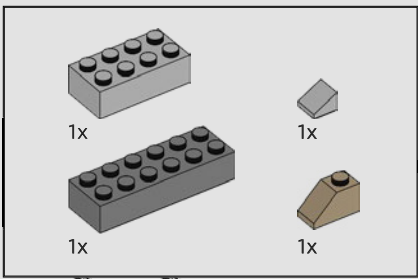

115

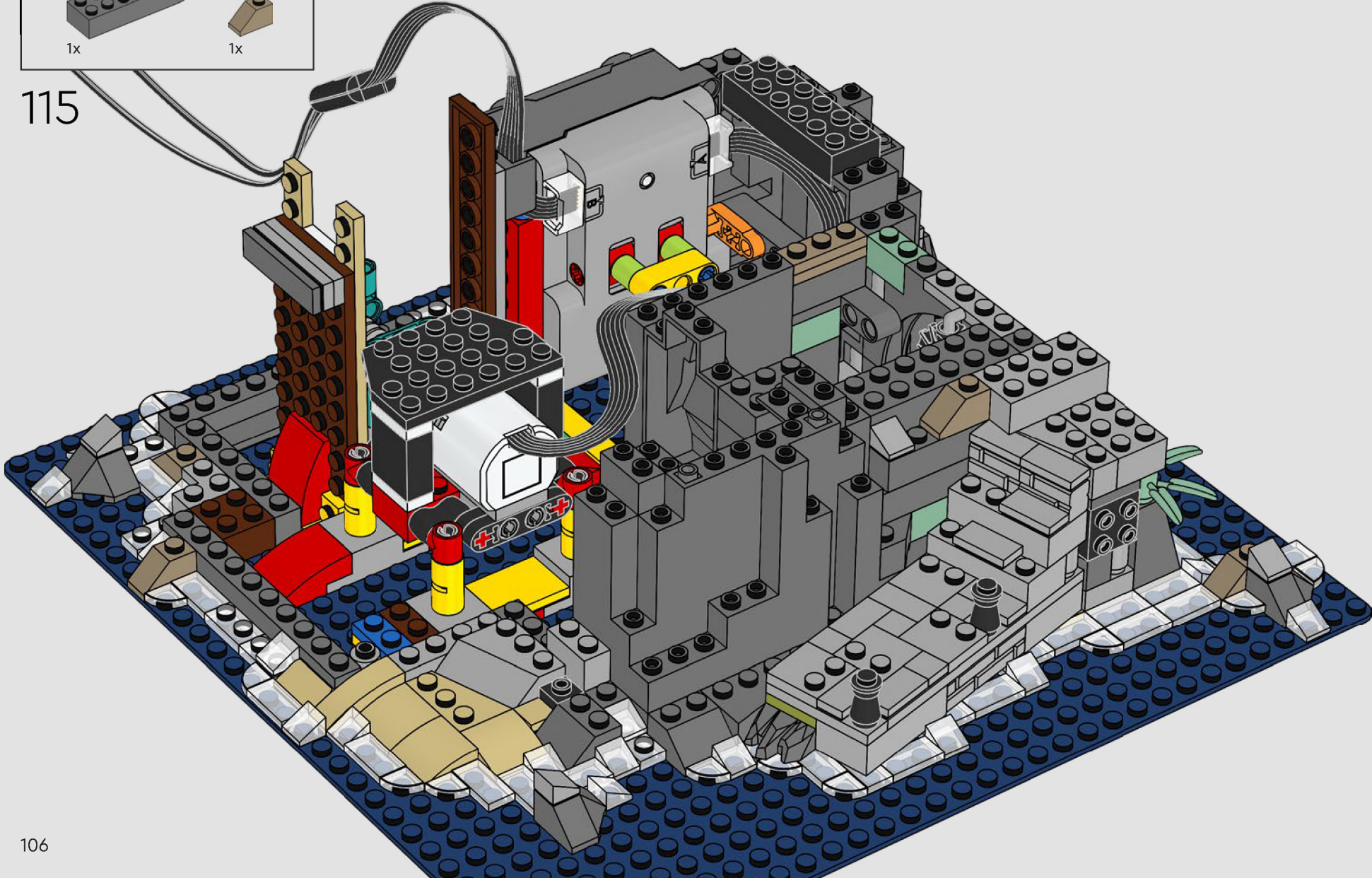

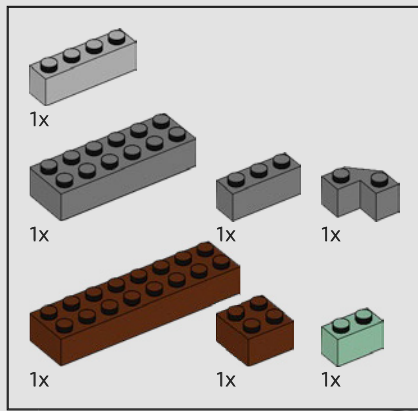

116

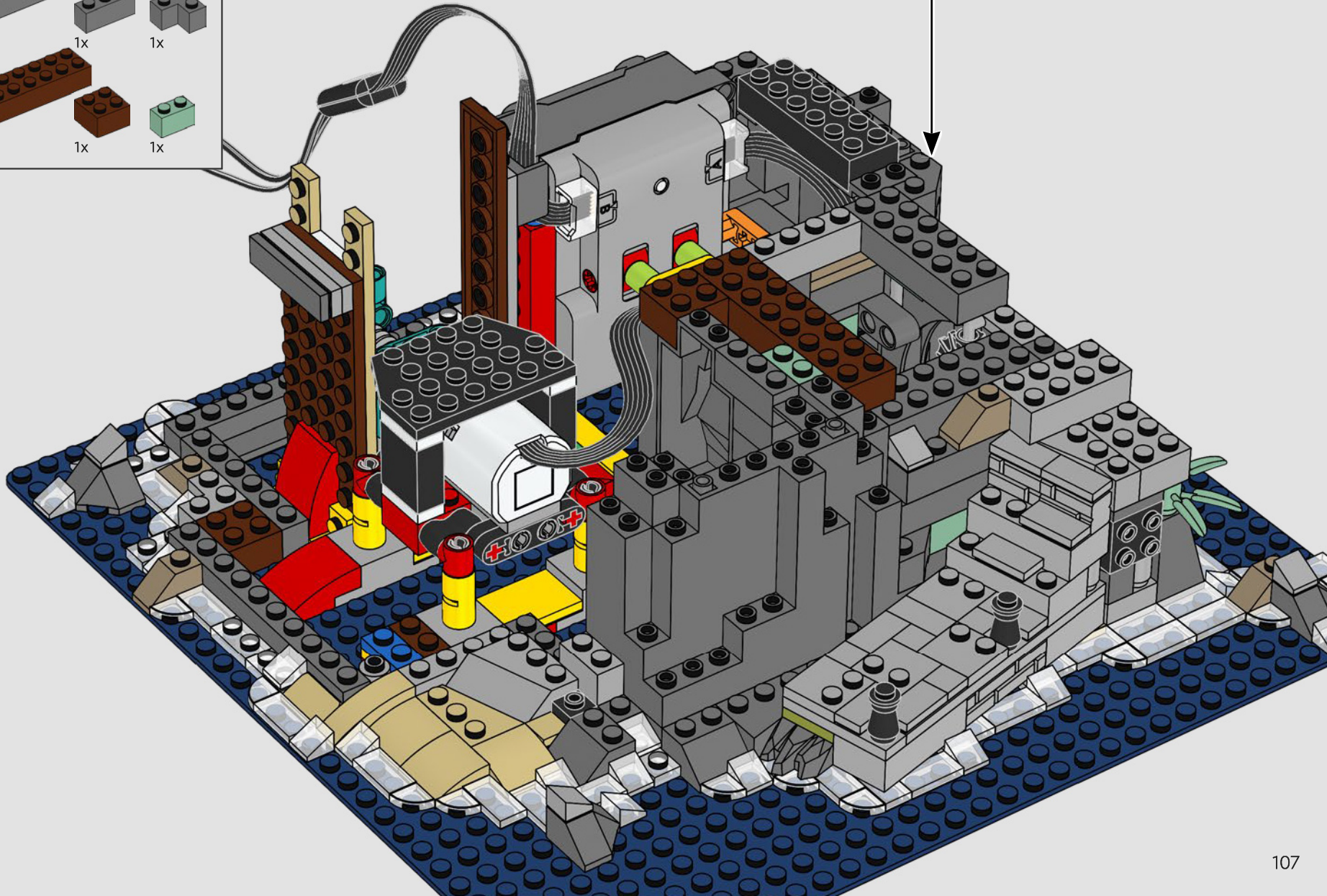
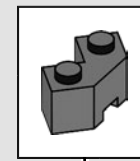

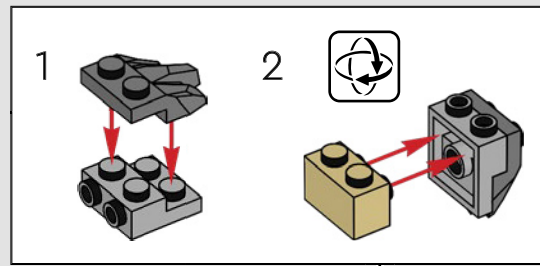
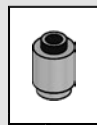
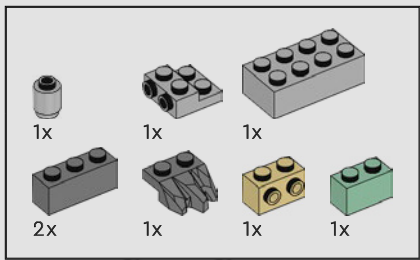

117

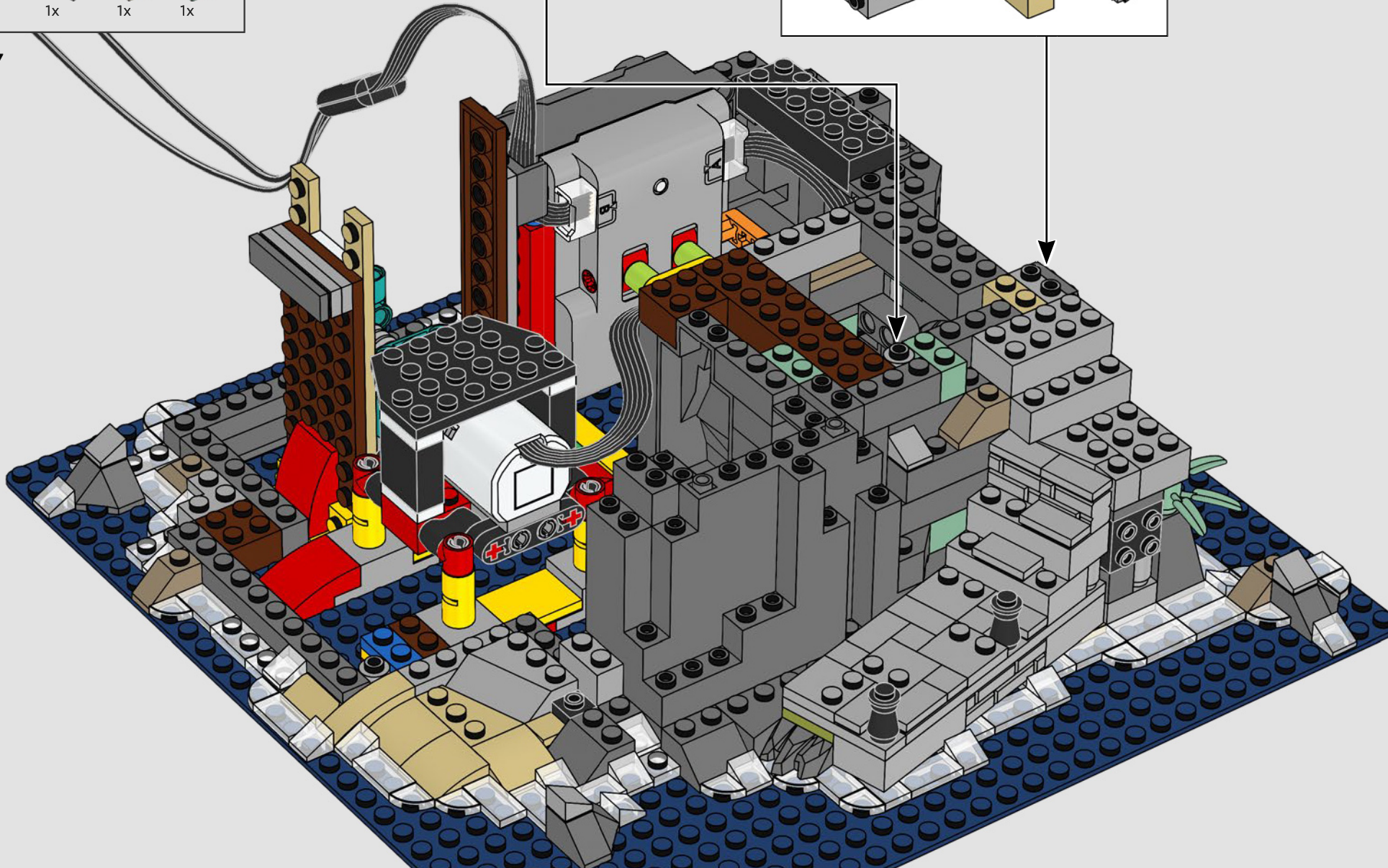

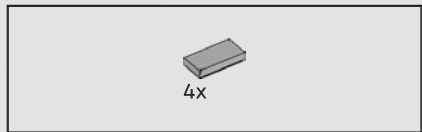

118

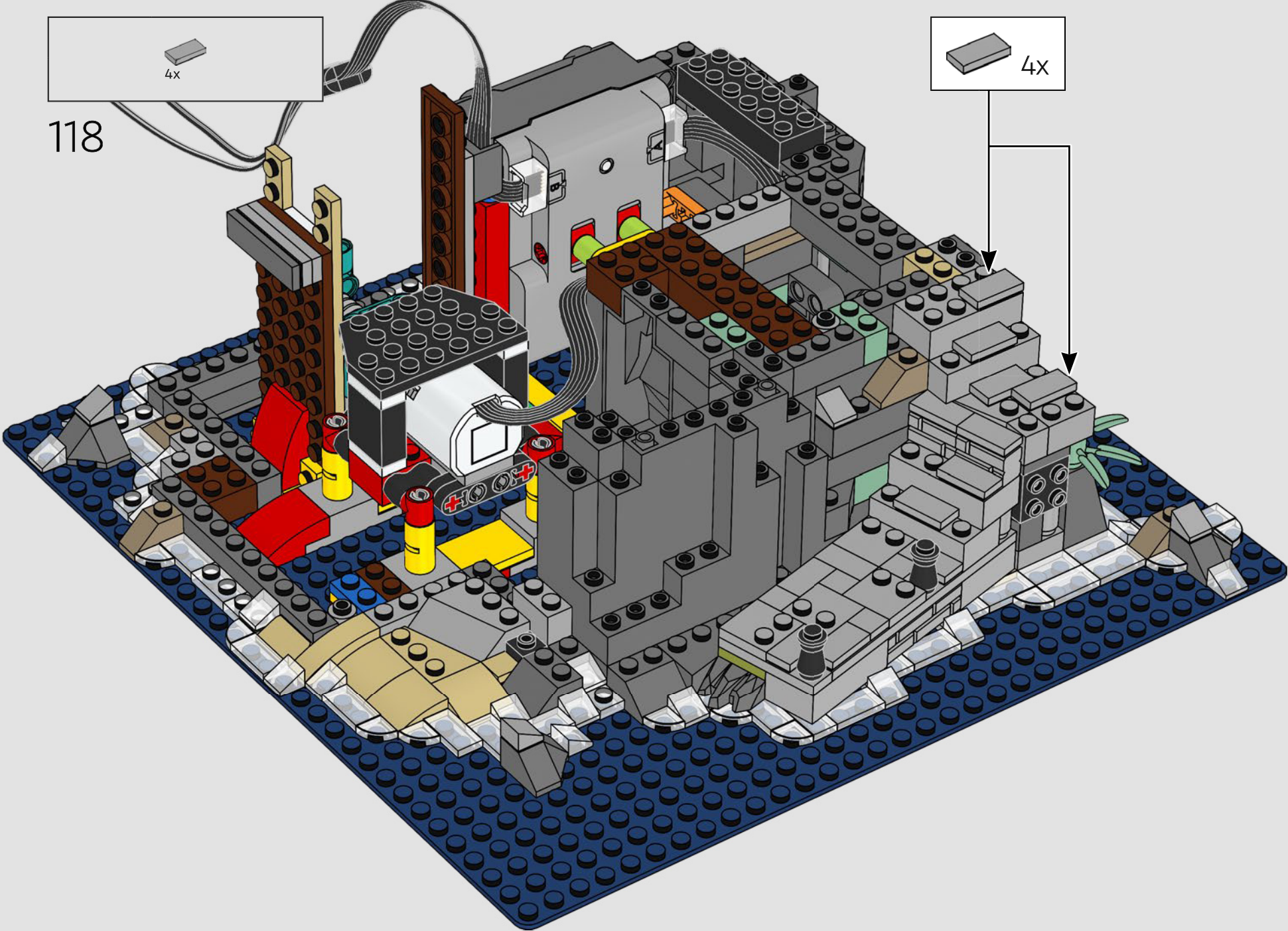
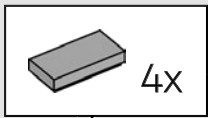

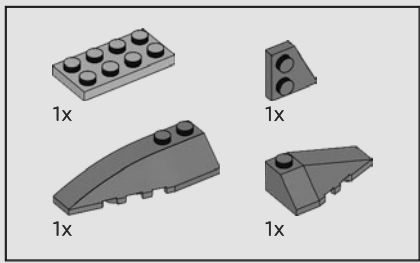

119

1

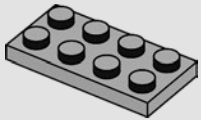

2

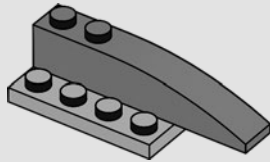

3

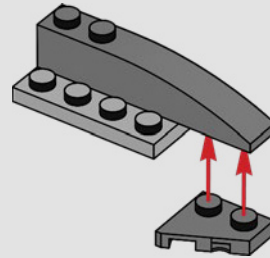

4

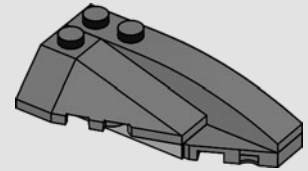

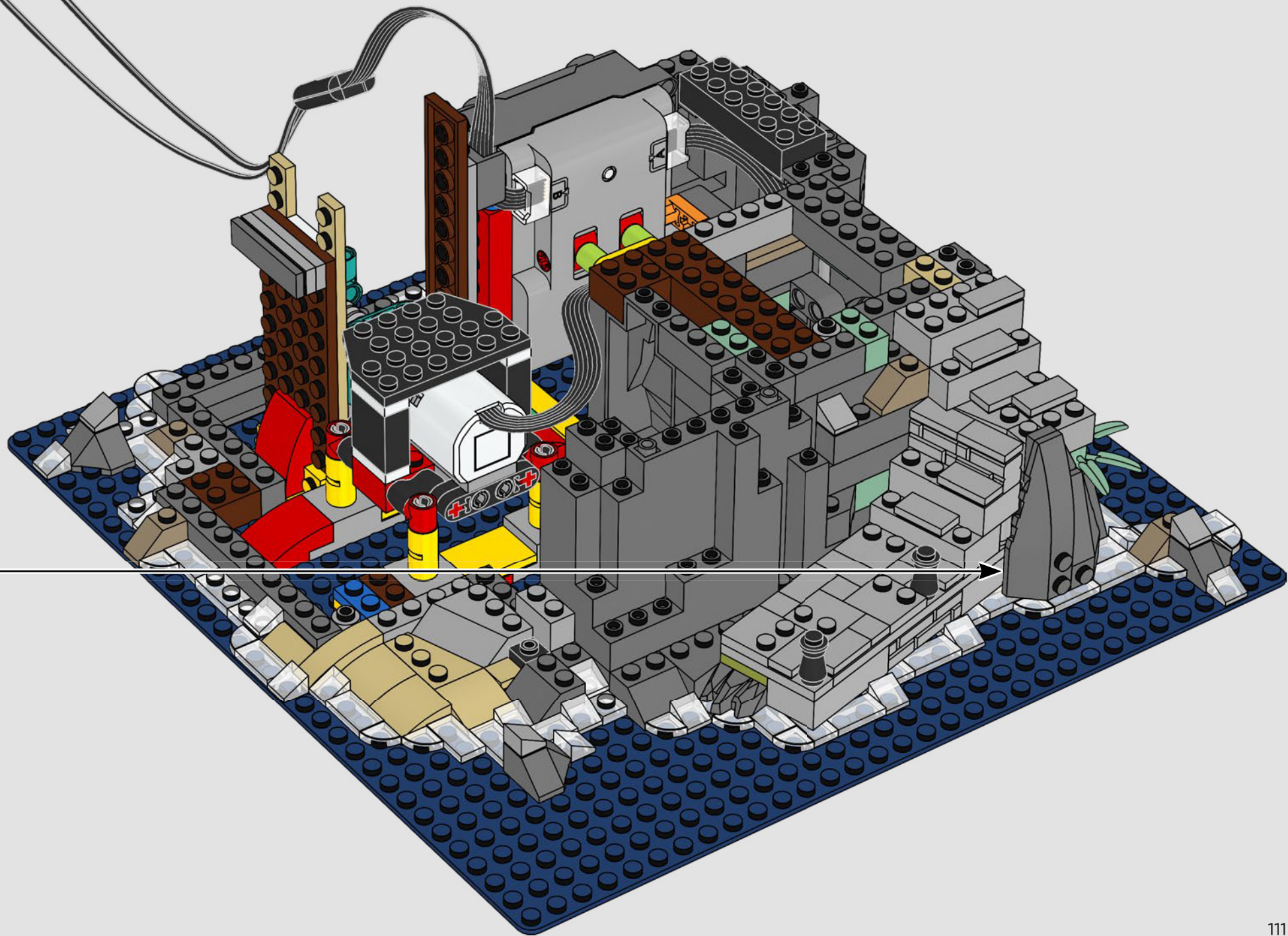

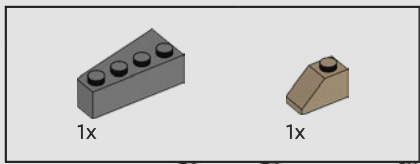

120

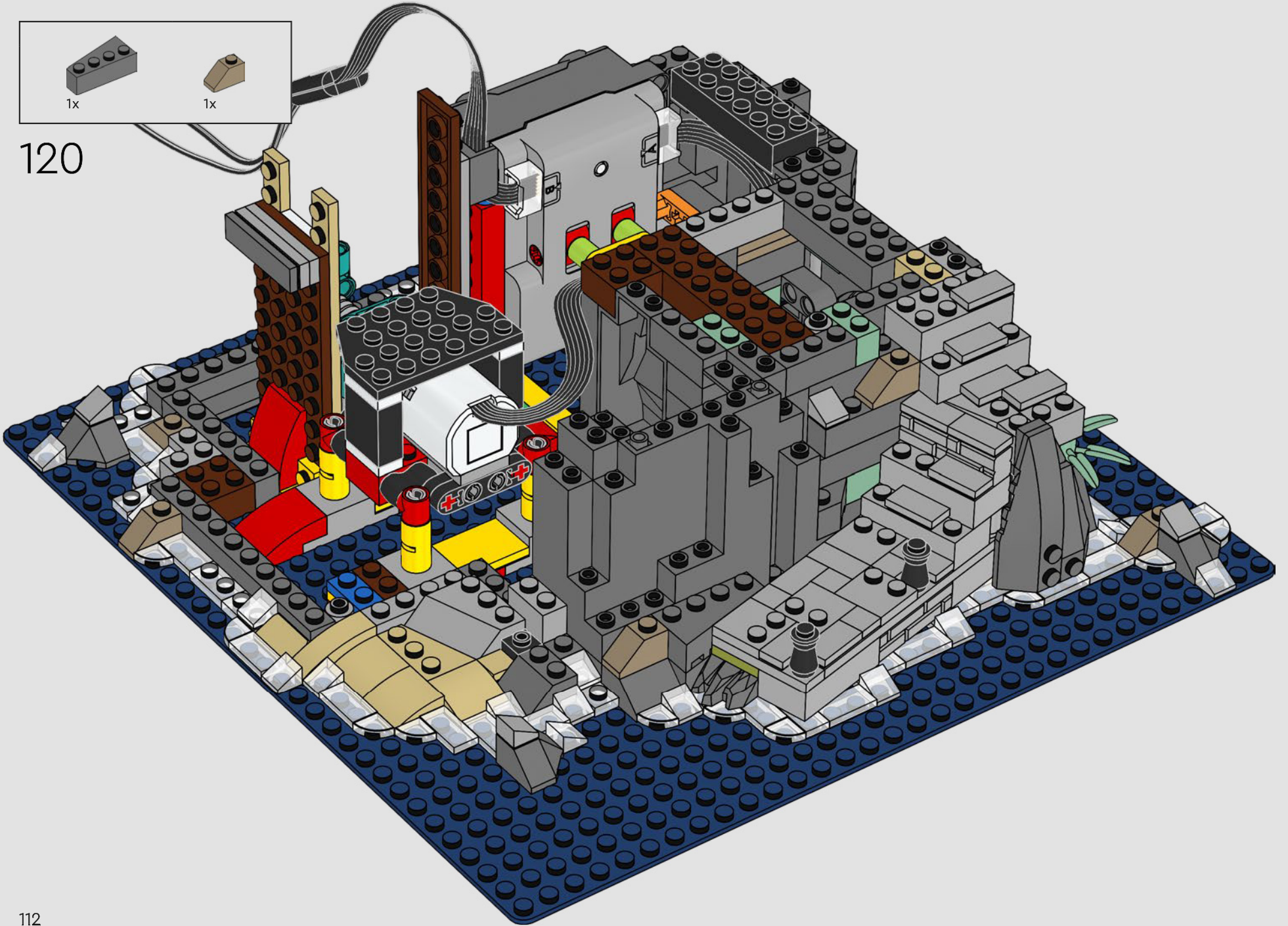

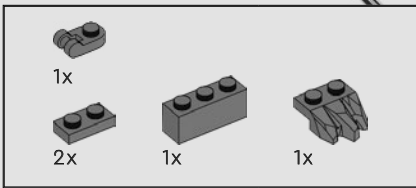

121

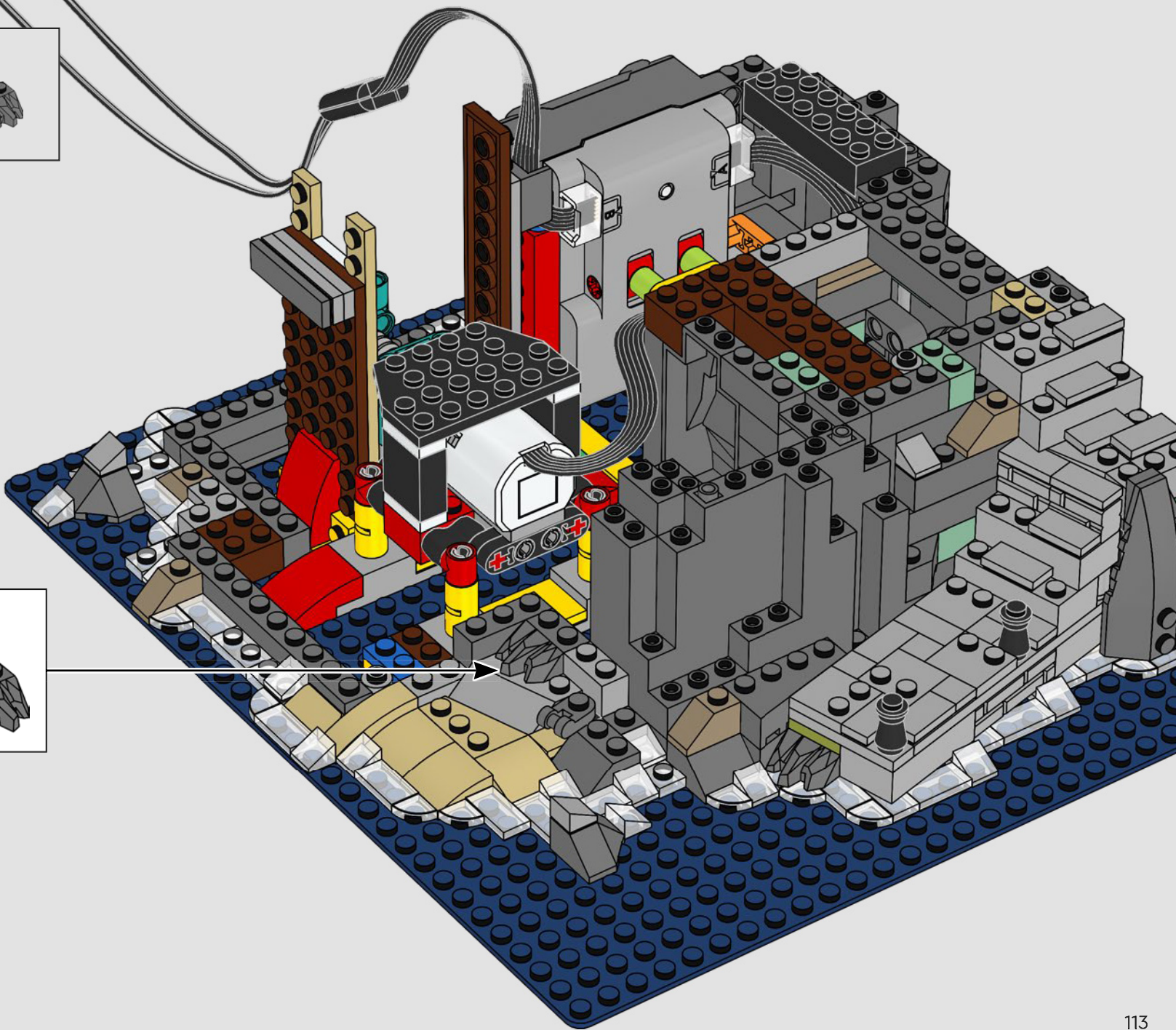
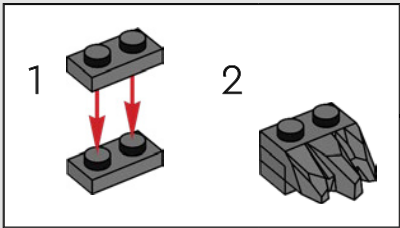



3x

122

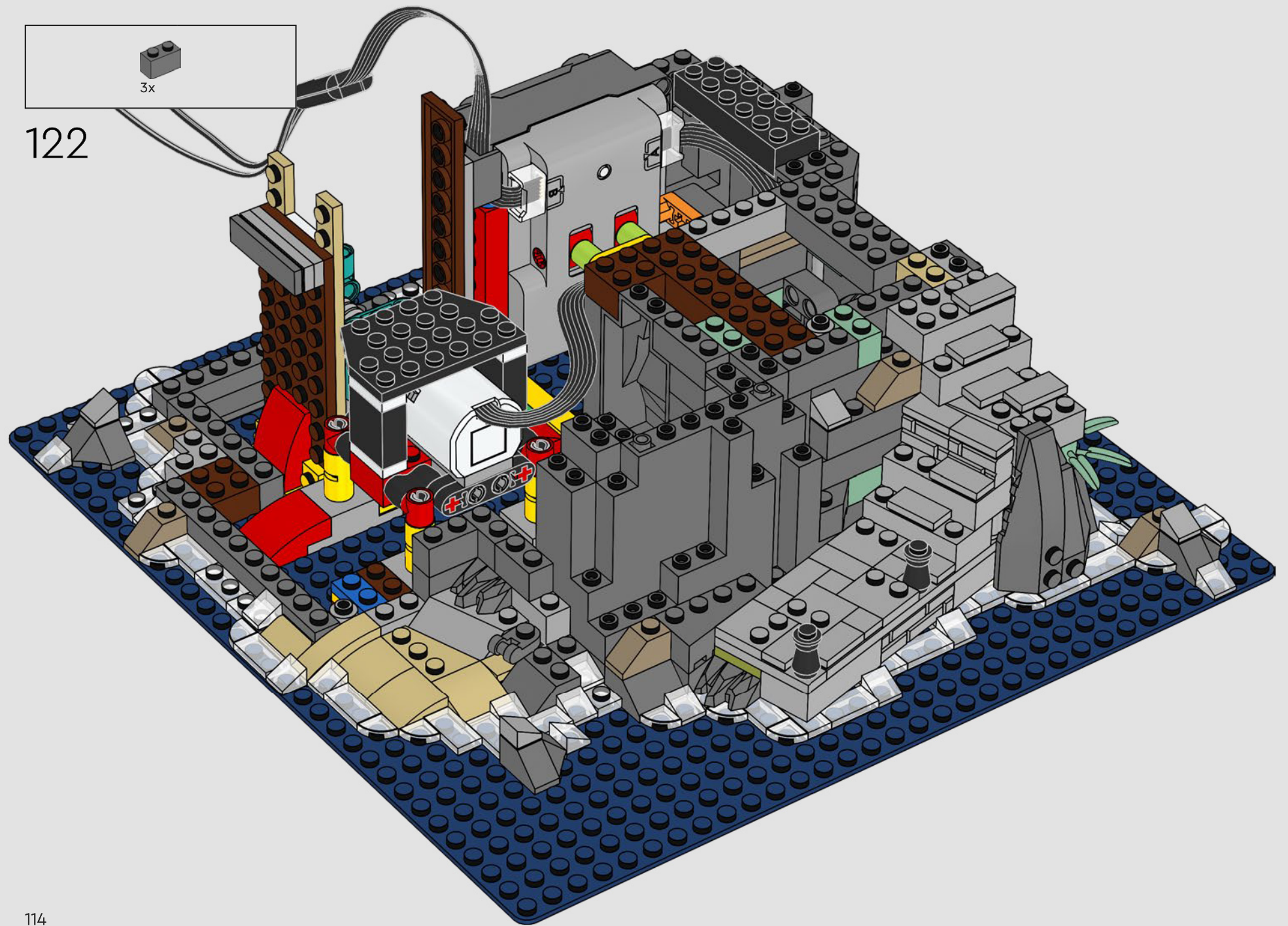

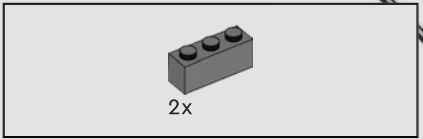

123

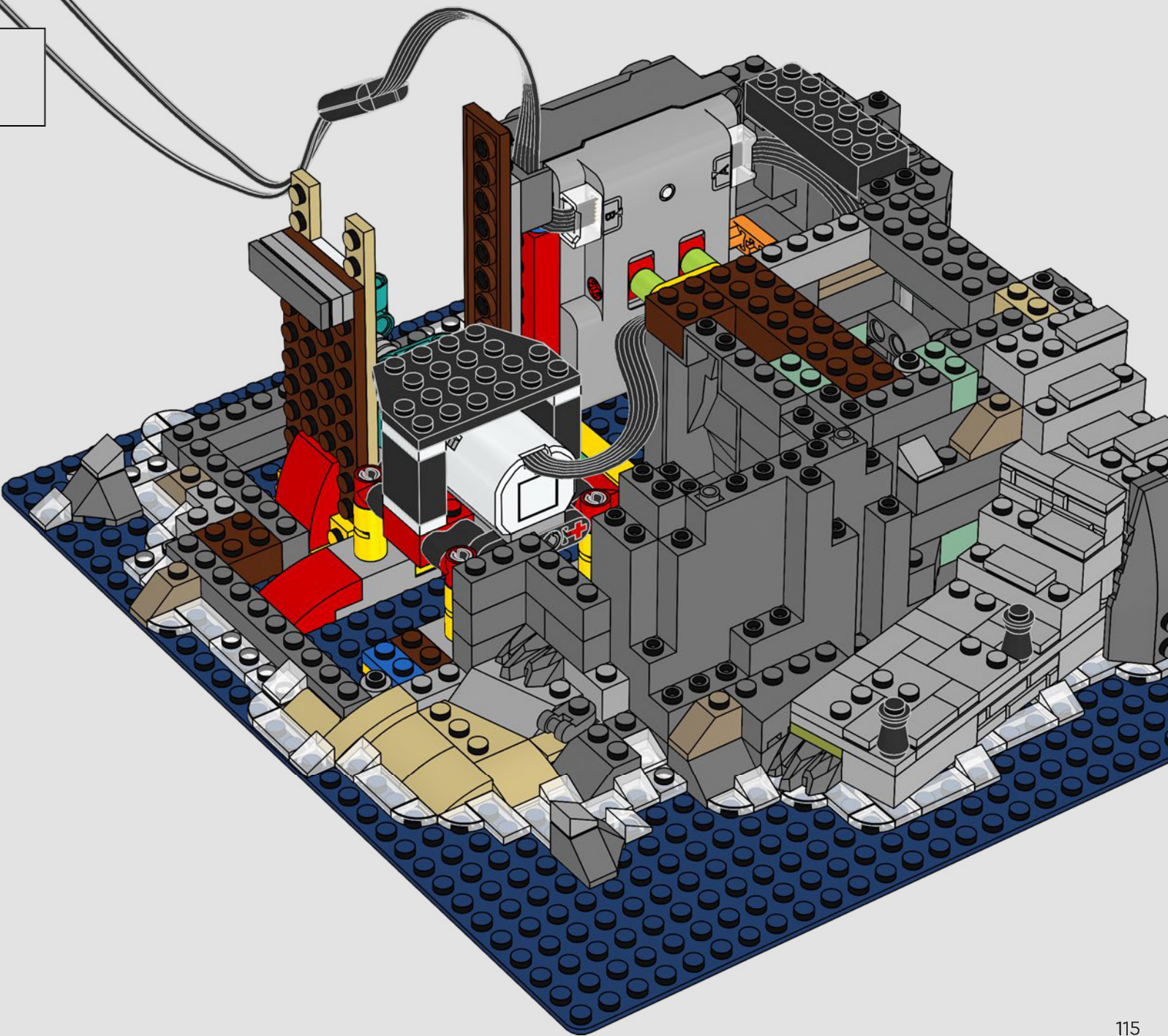

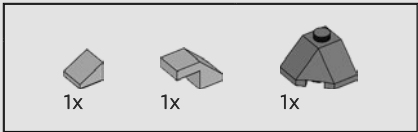

124

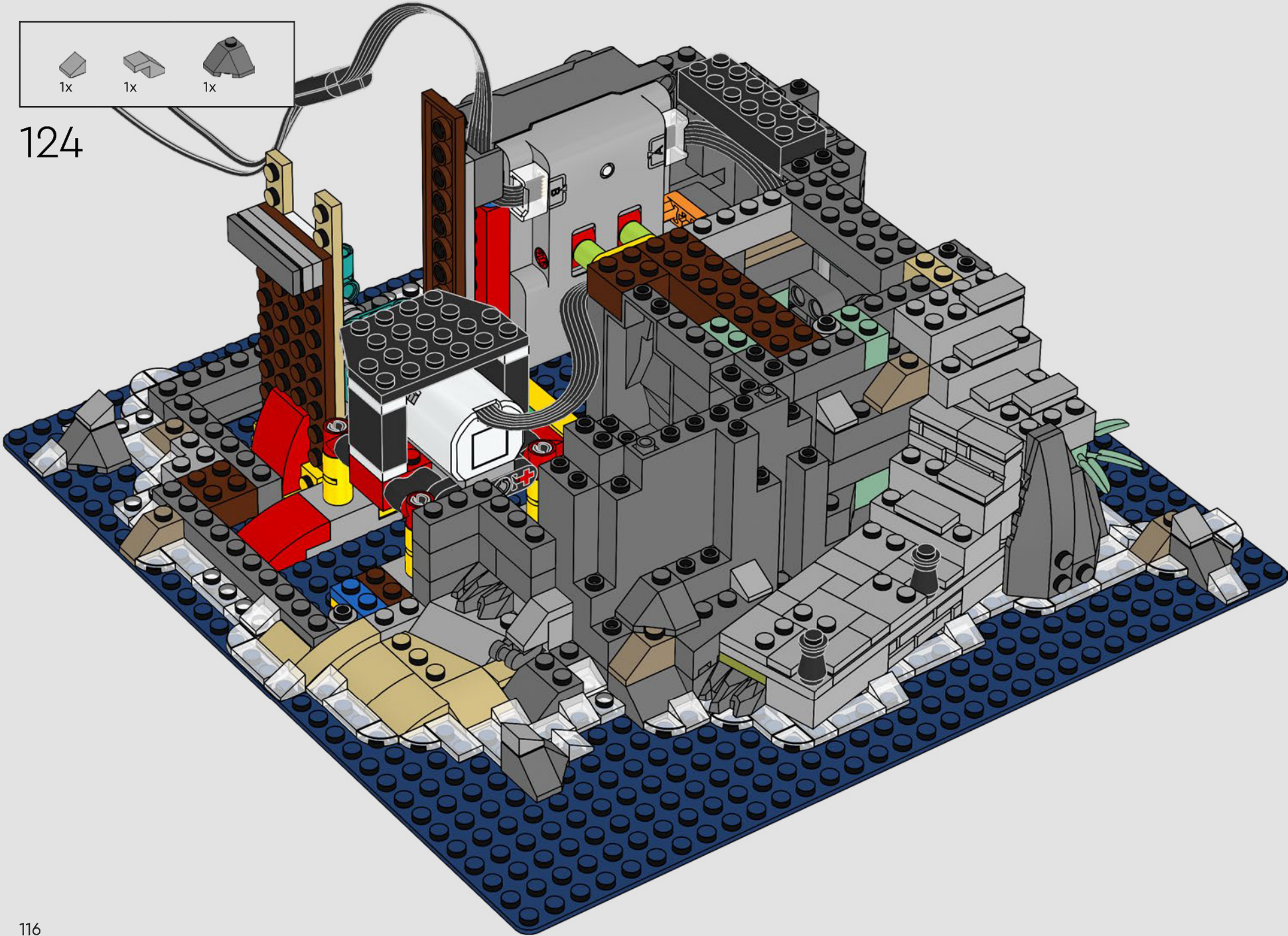

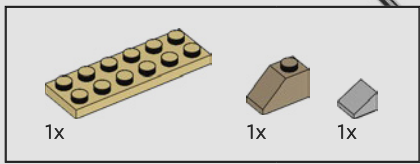

125

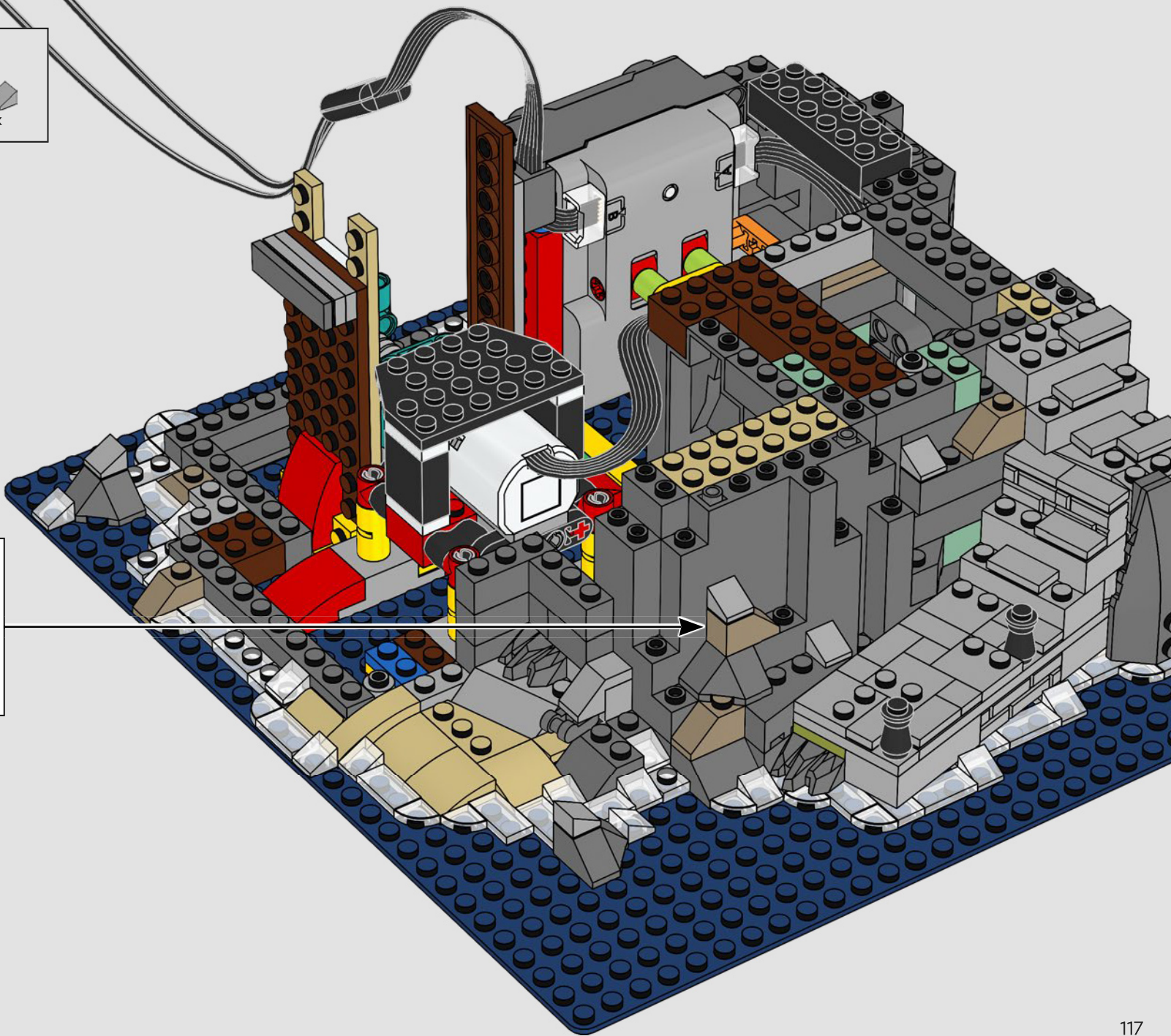
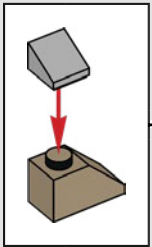

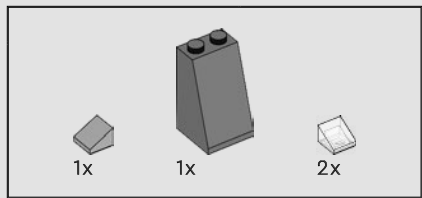

126

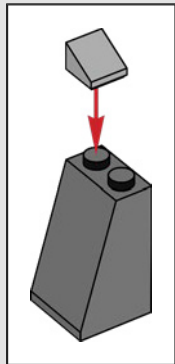
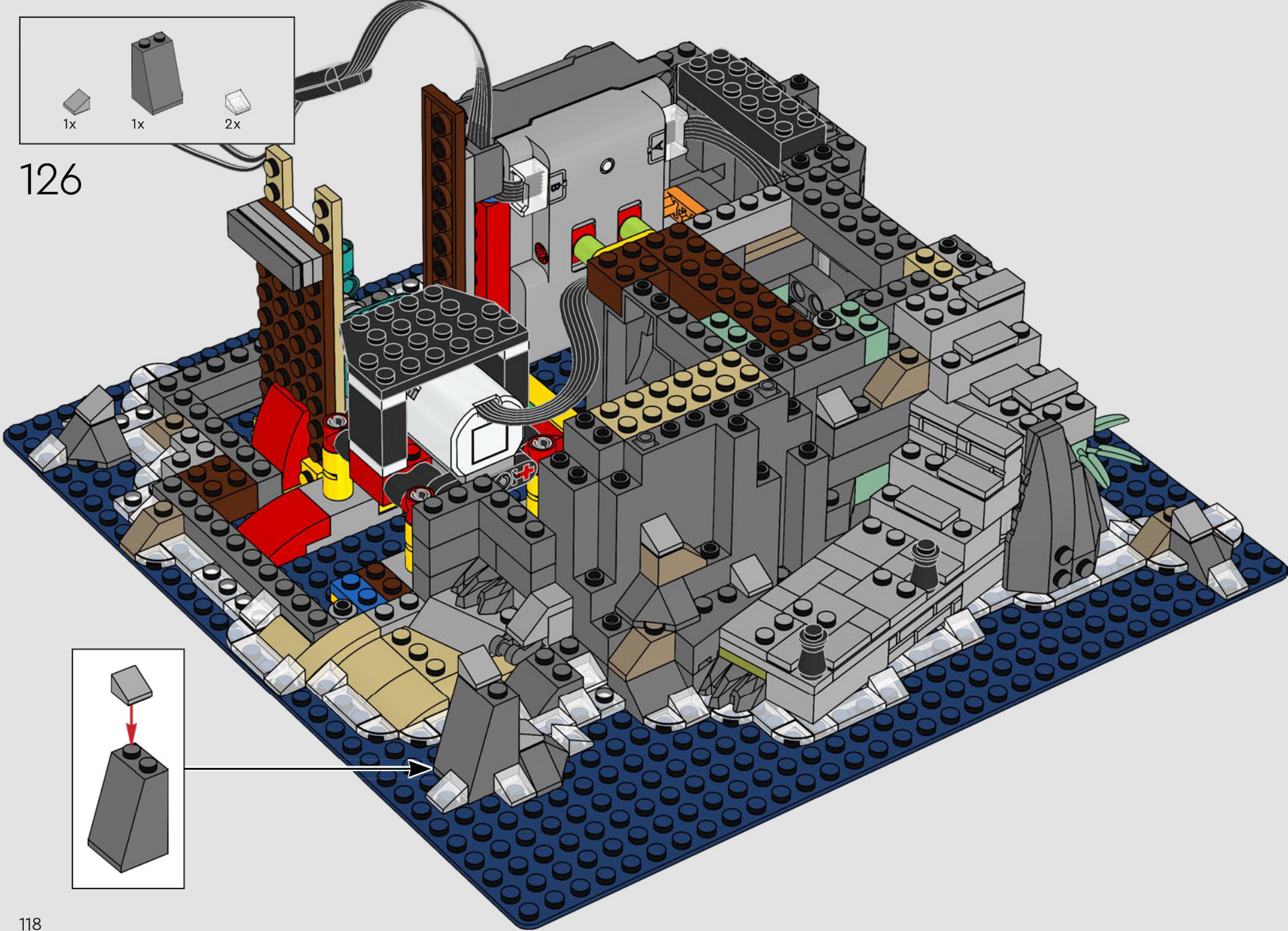

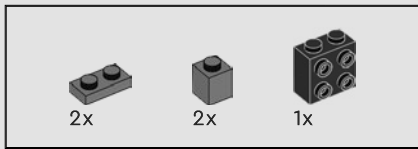

127

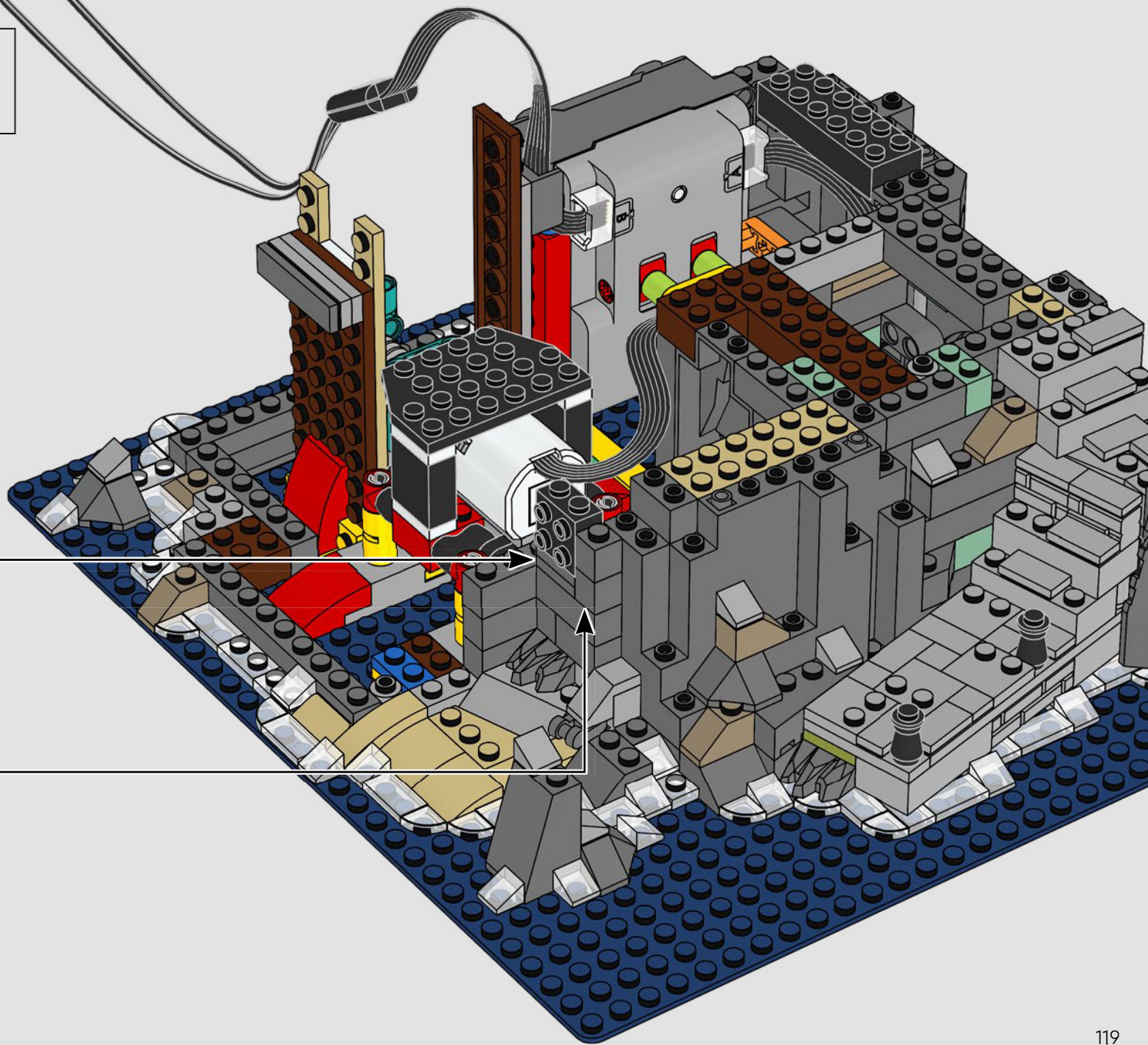
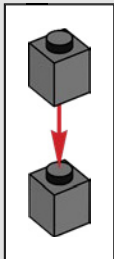
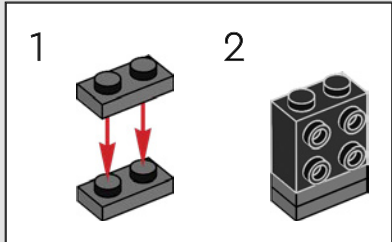

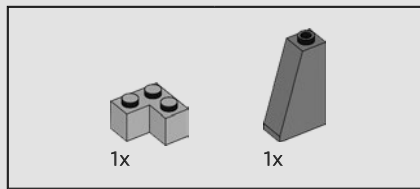

128

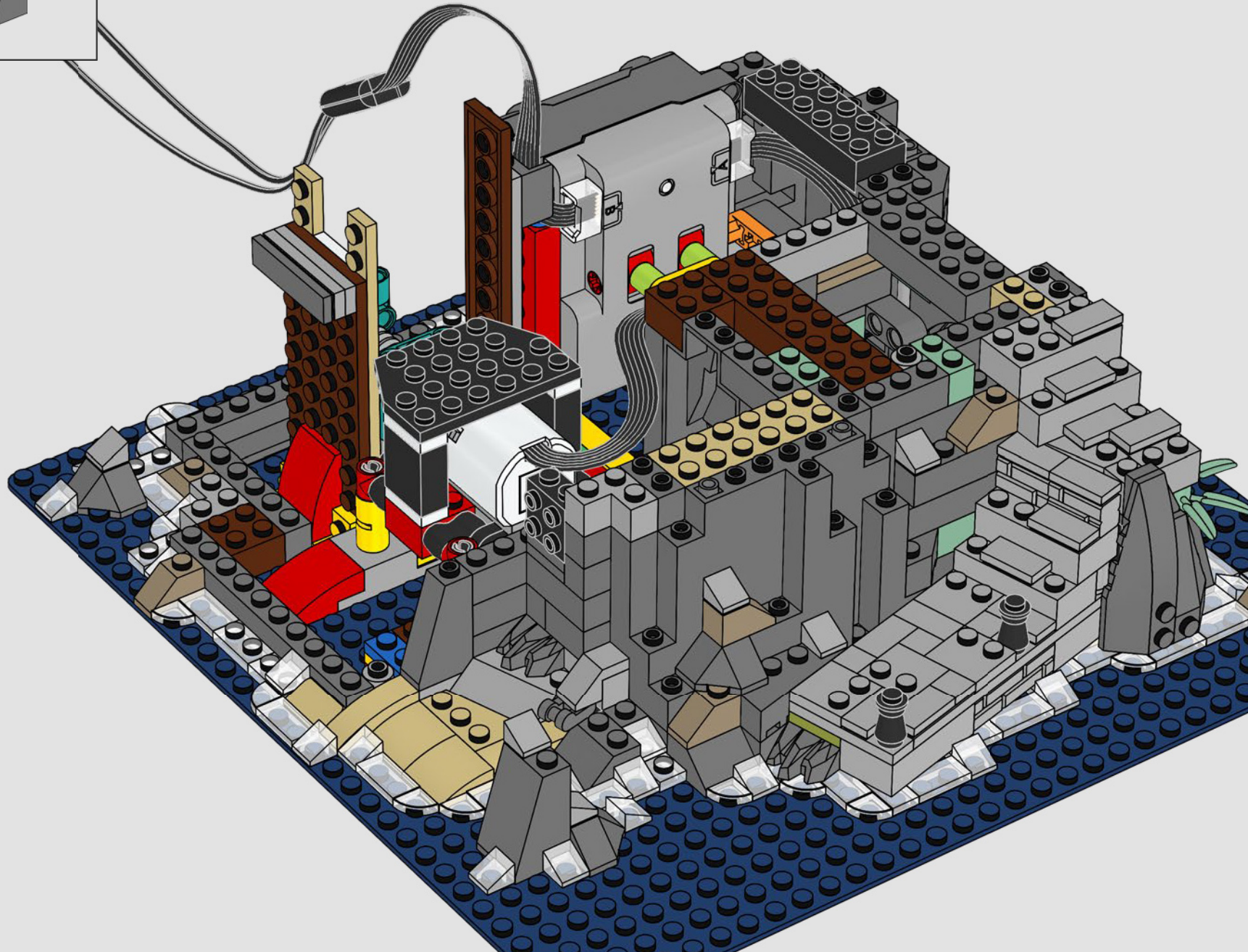

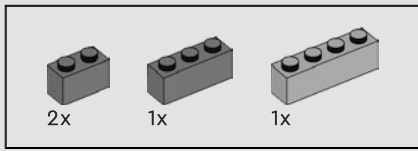

129

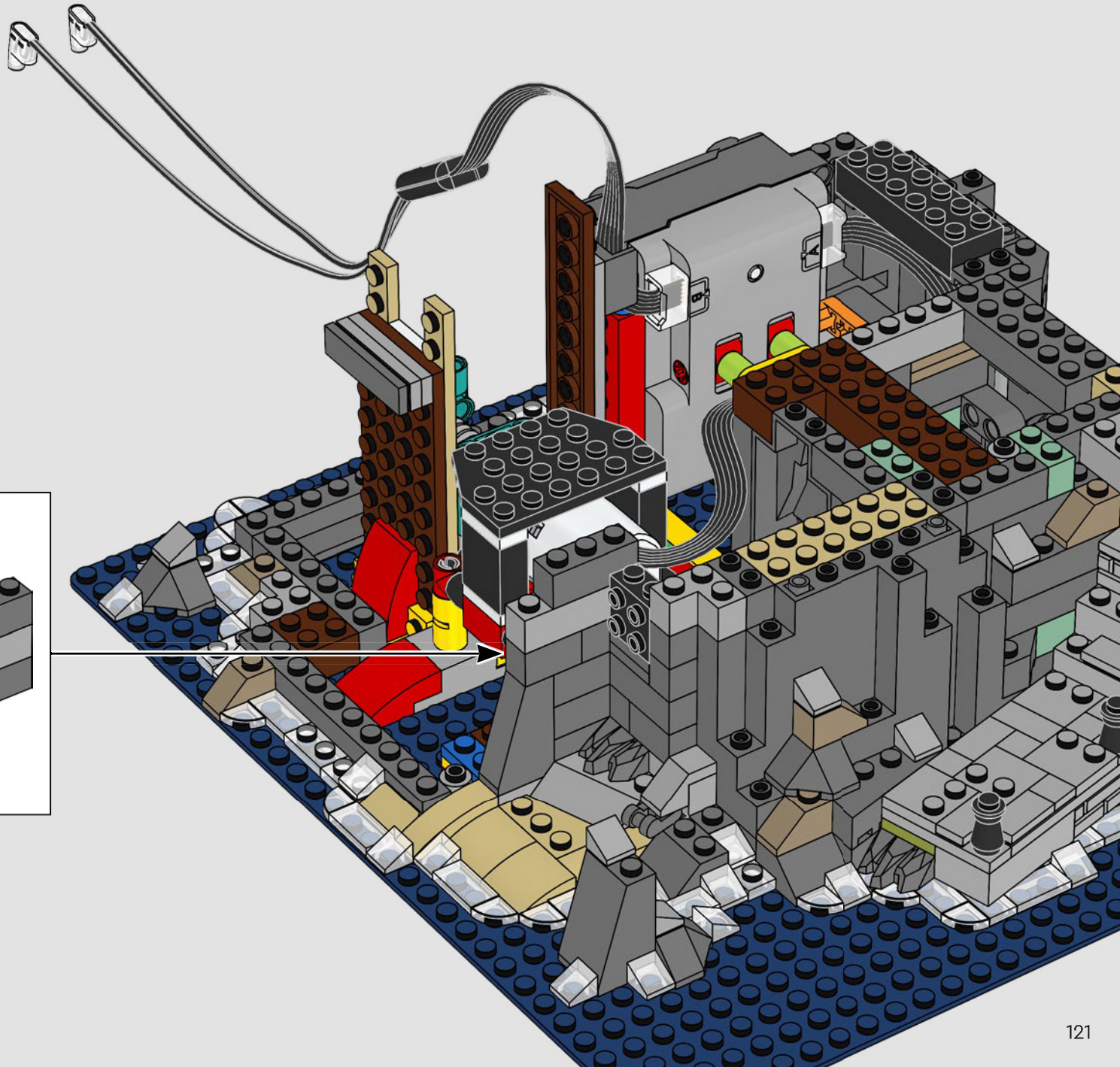
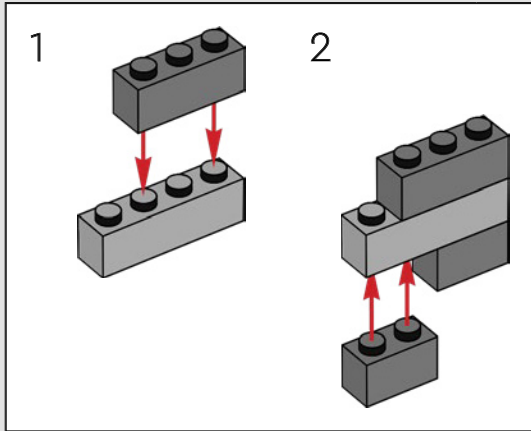

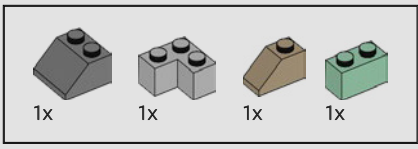

130

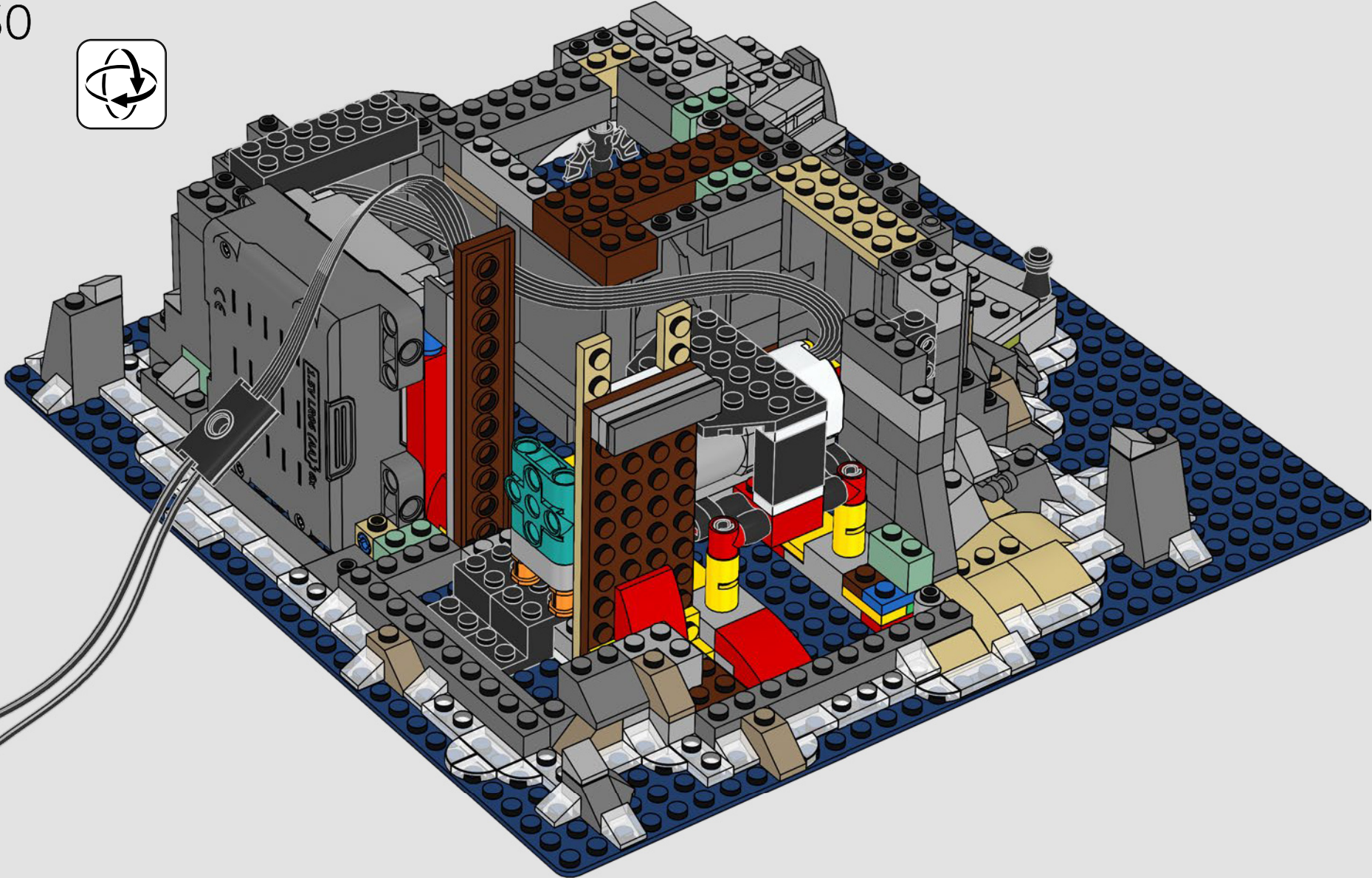

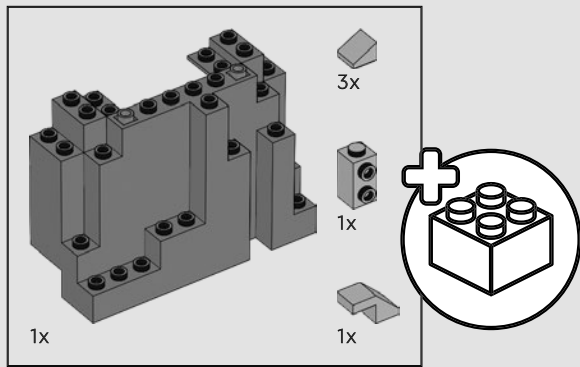

131

1

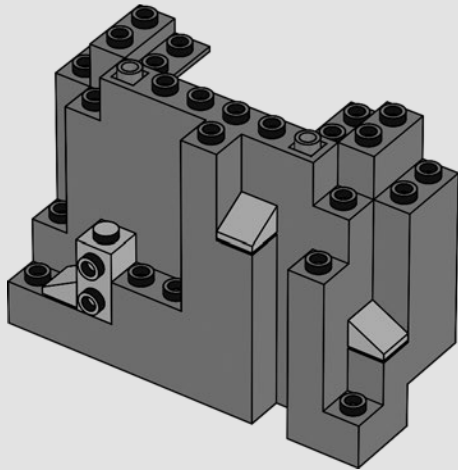

2

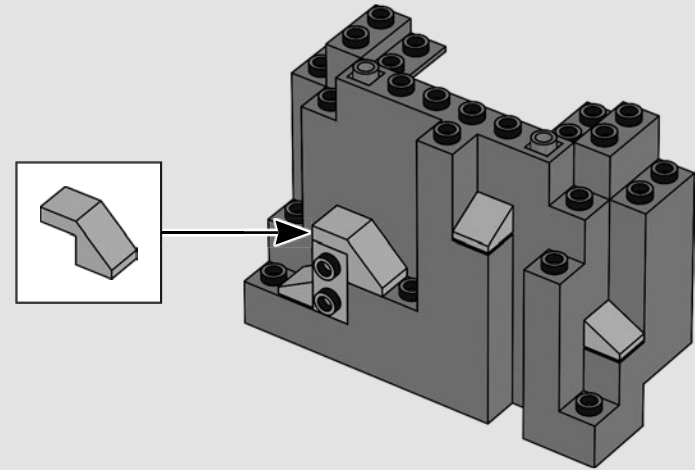

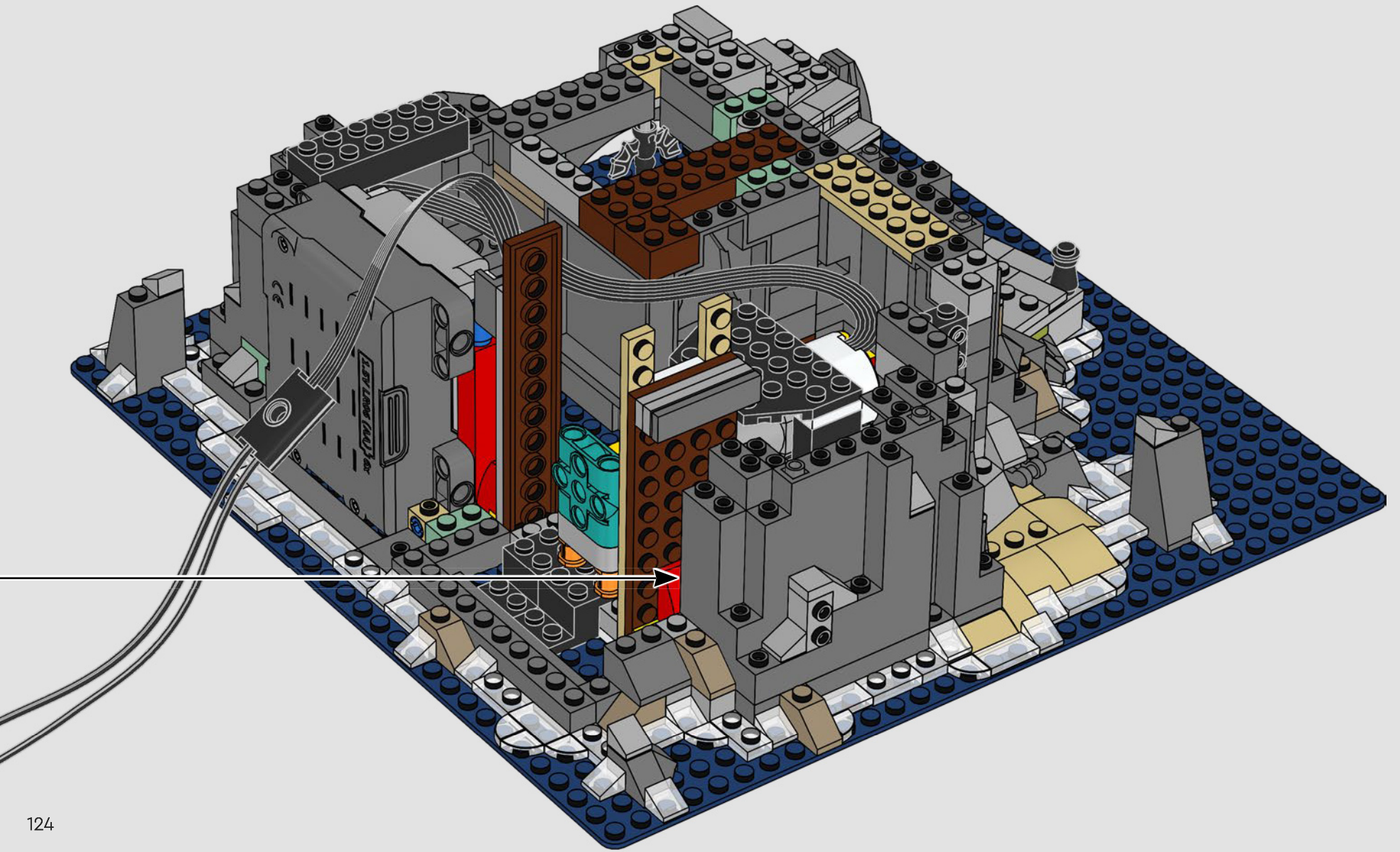

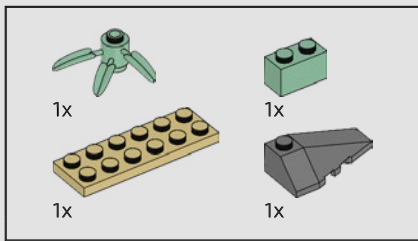

132

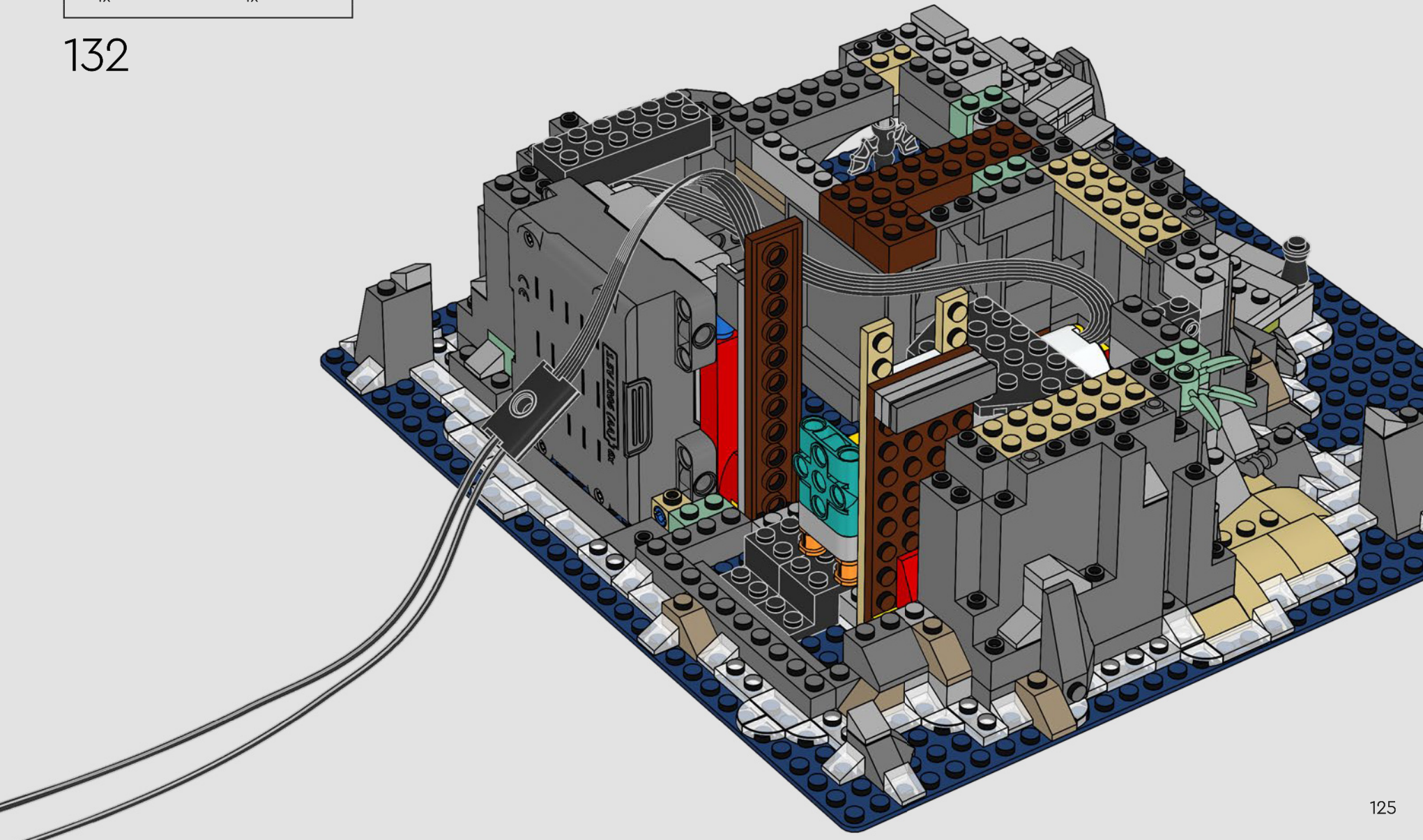

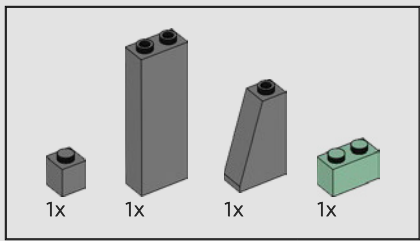

133

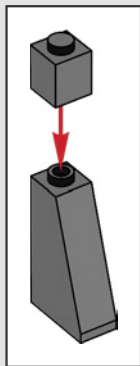
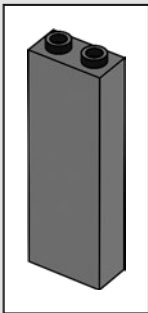
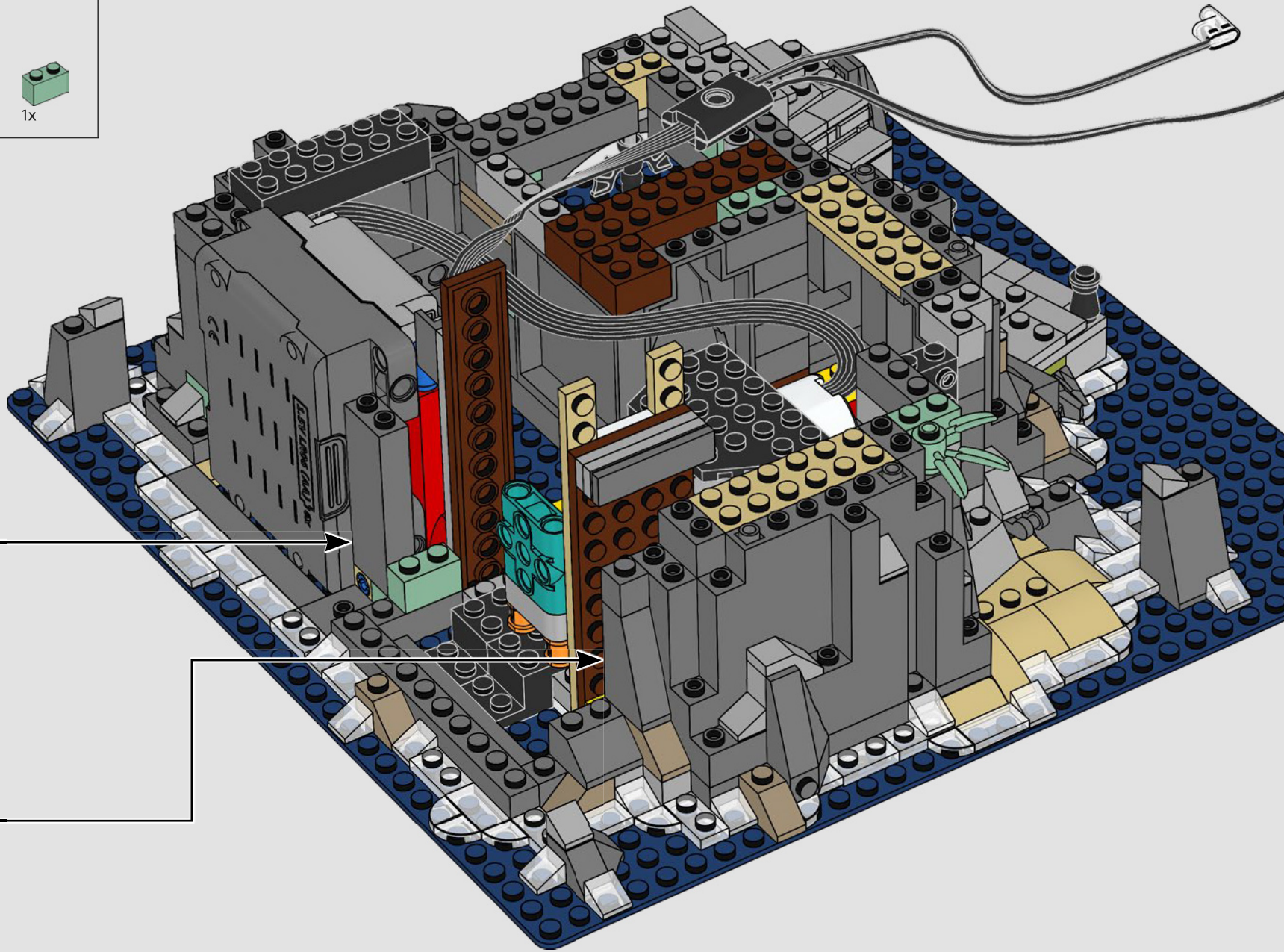

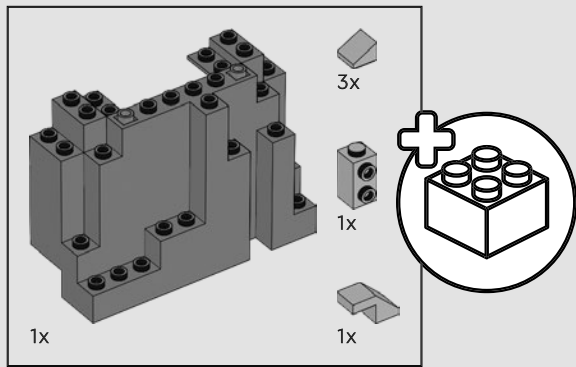

134

1

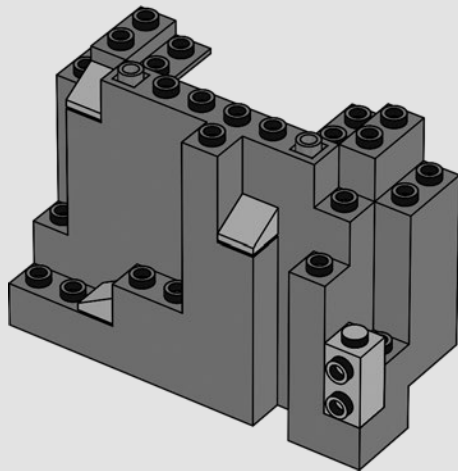

2

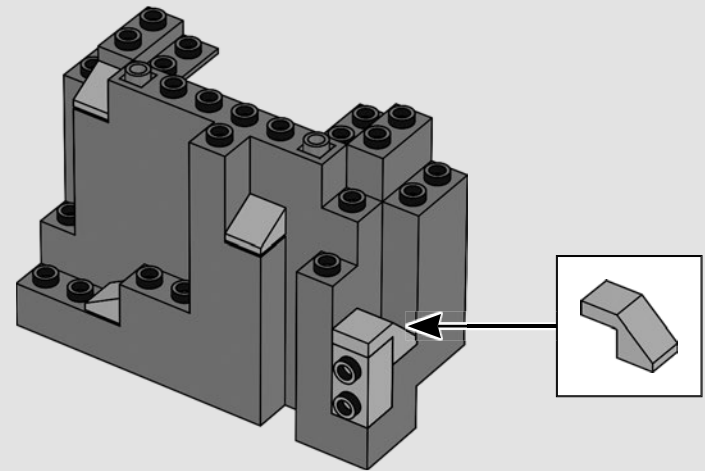

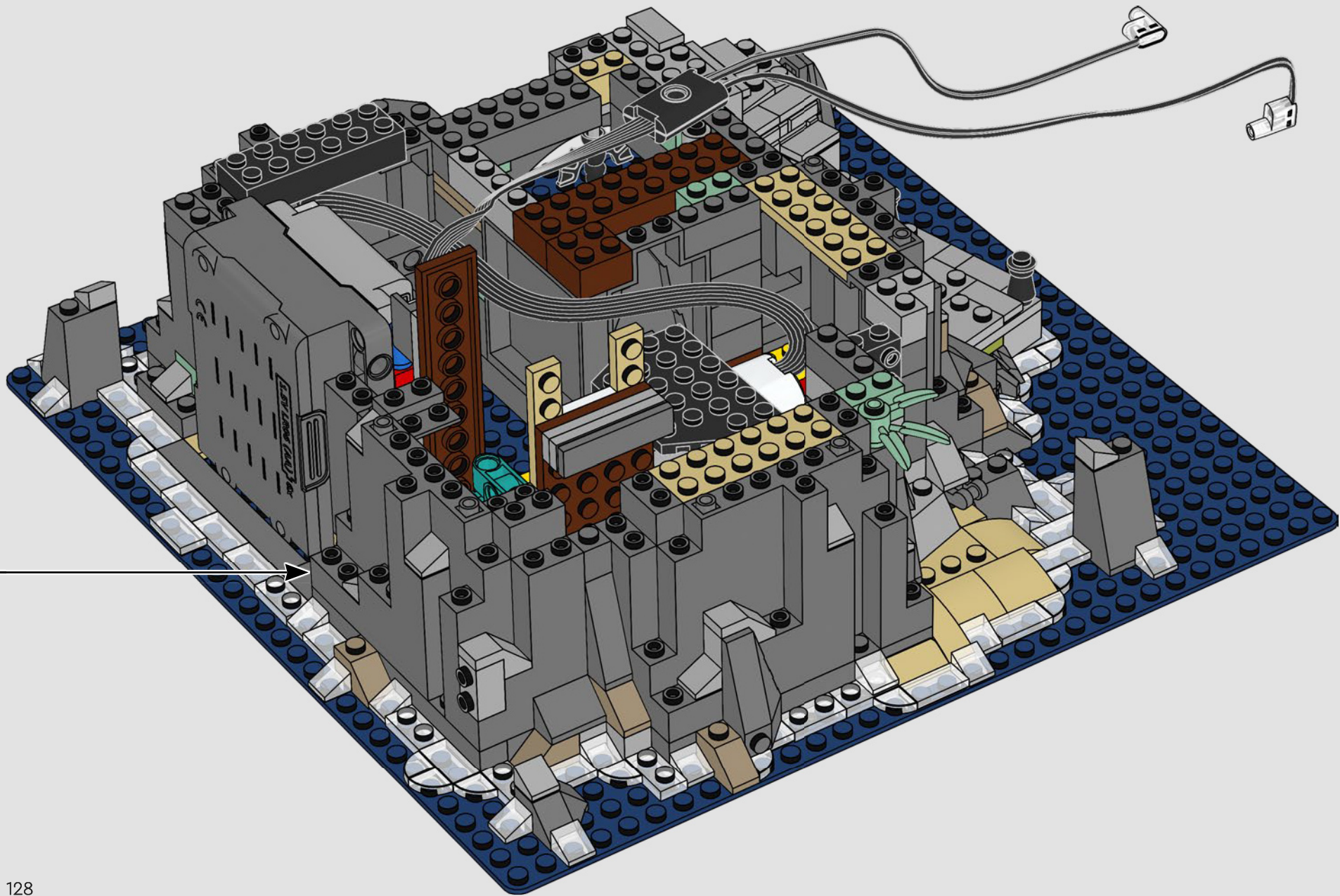

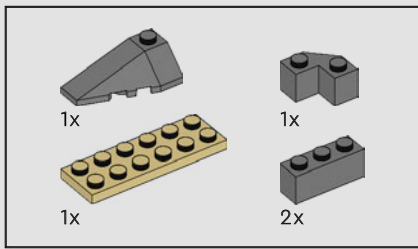

135

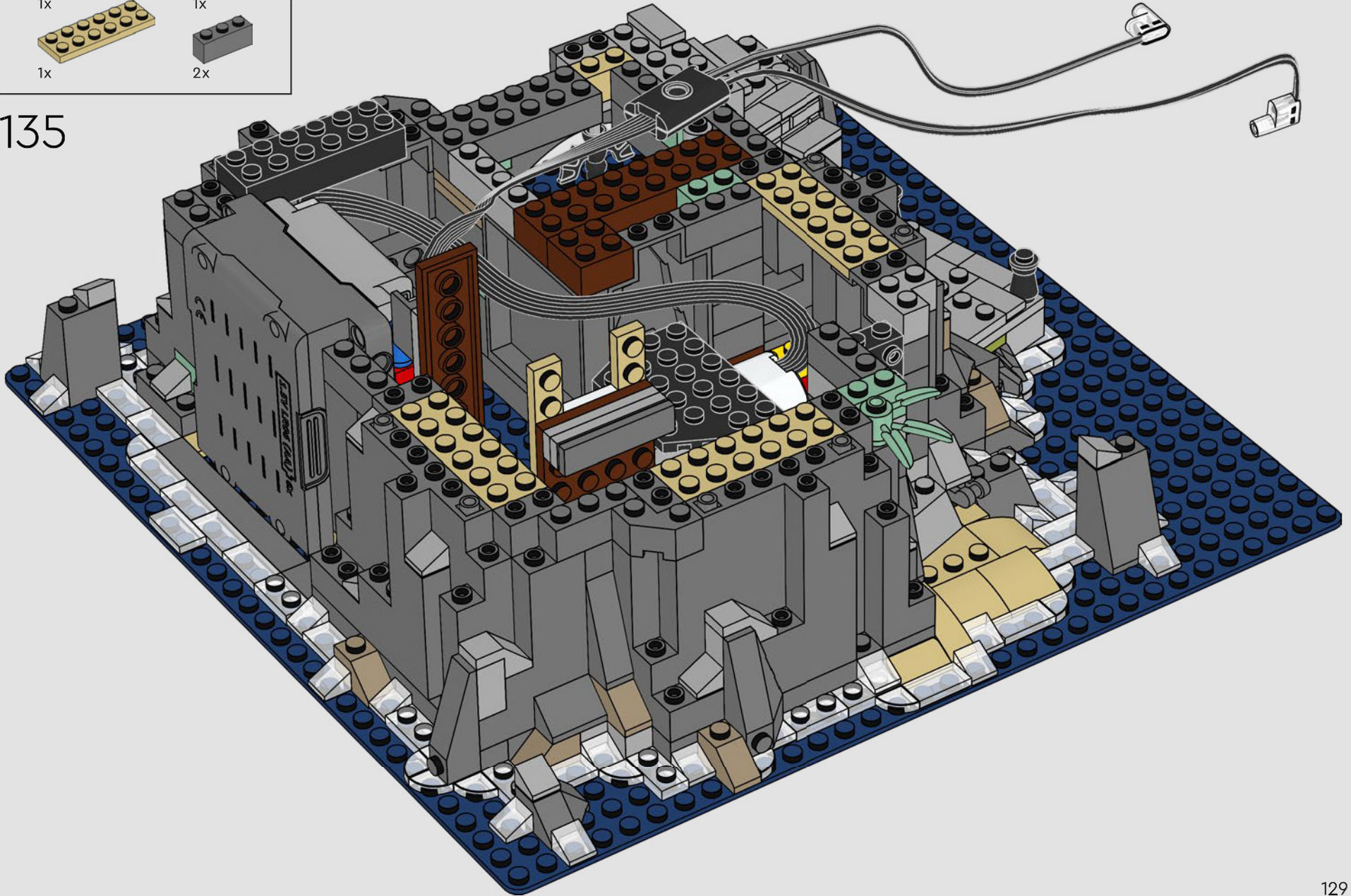



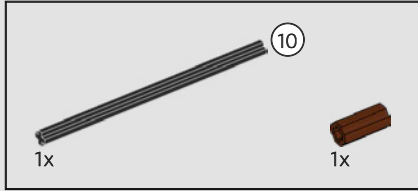
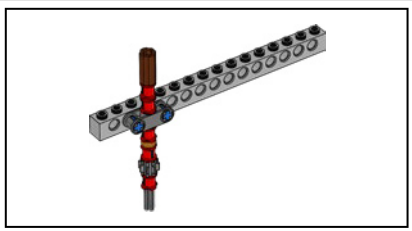

137

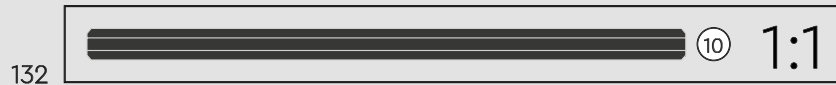
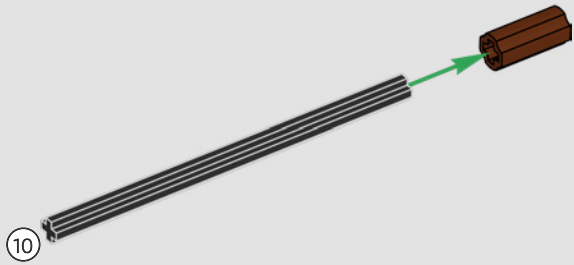

132



138

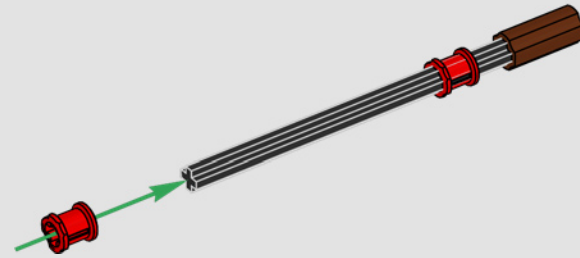

139

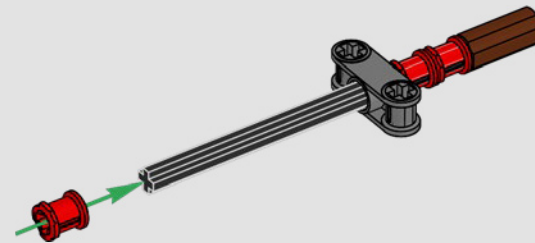



140

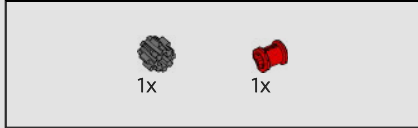
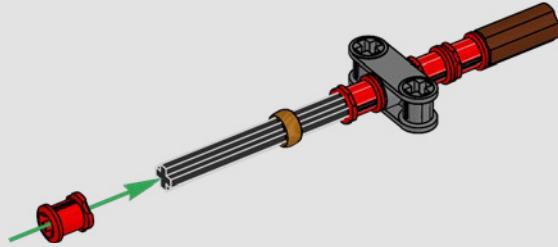

141

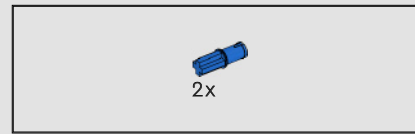
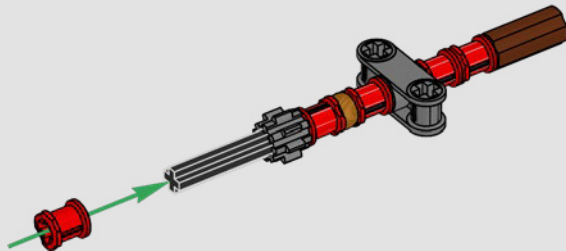

142

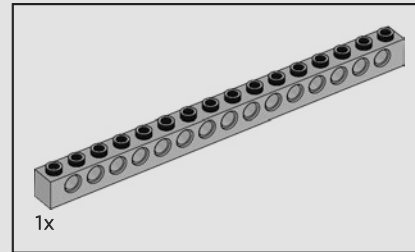
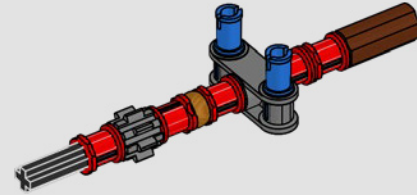

143

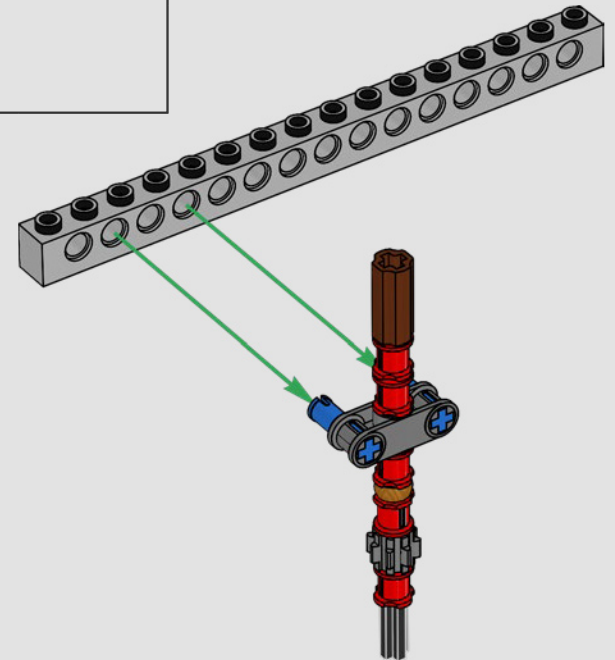

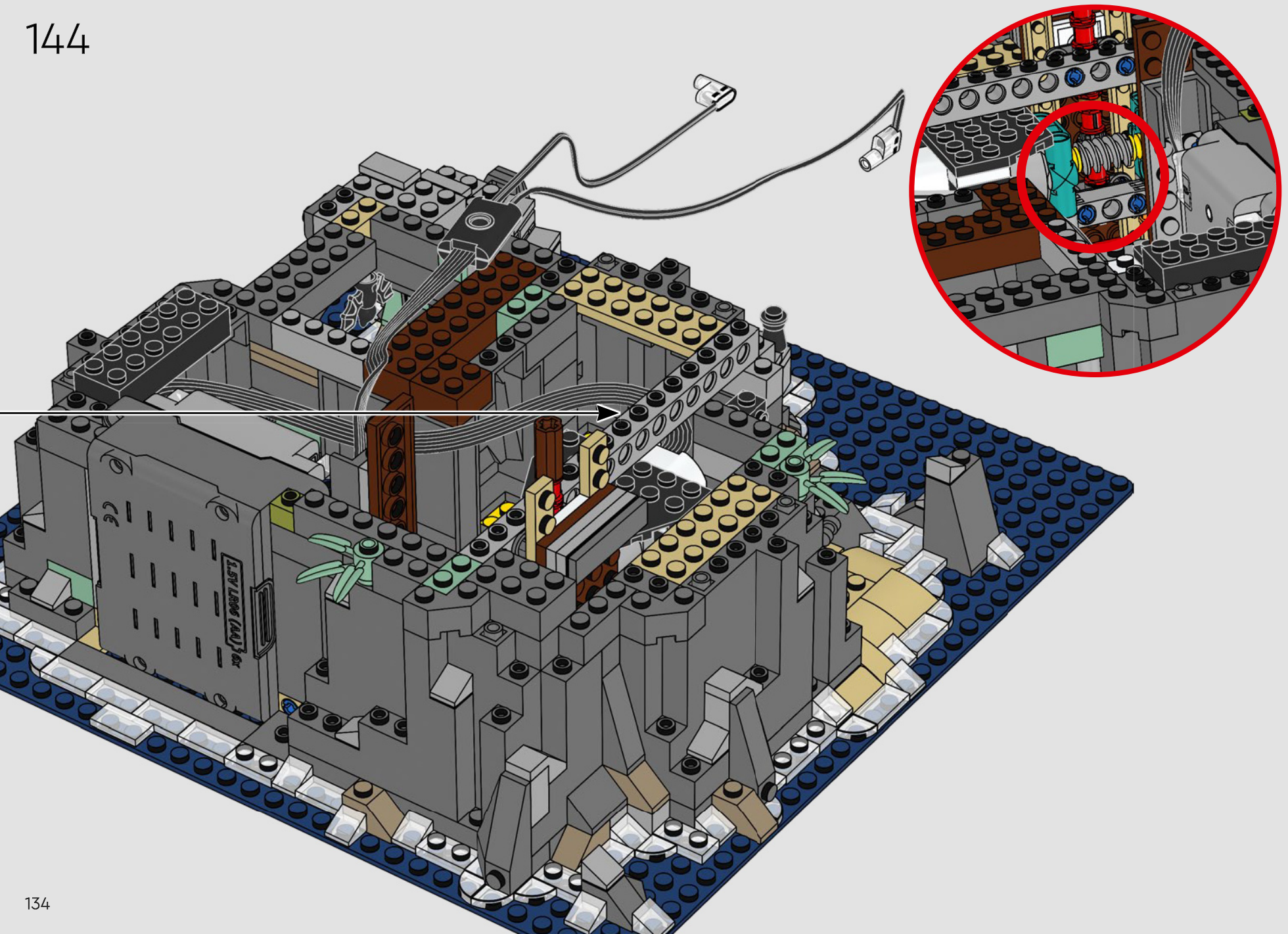

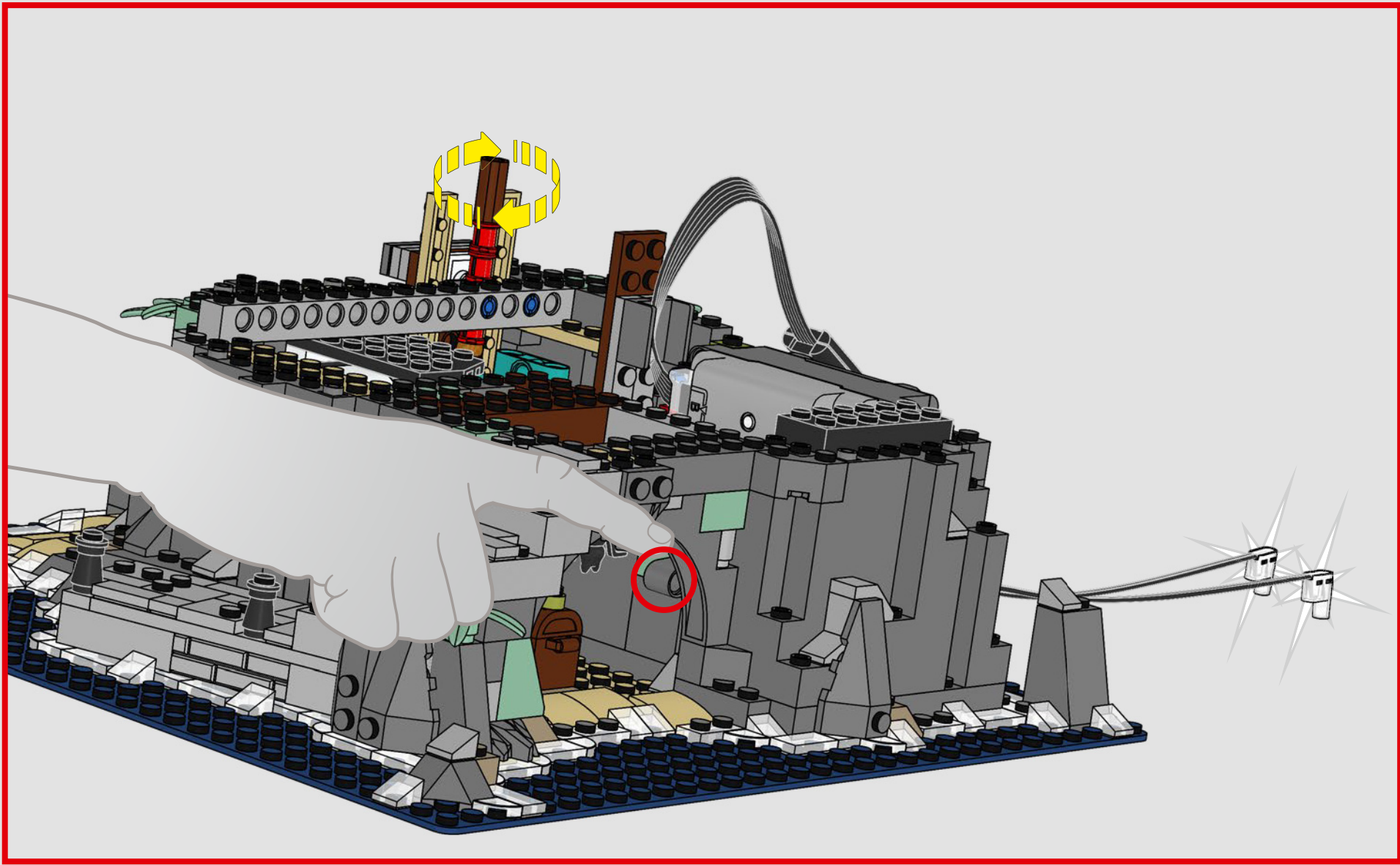

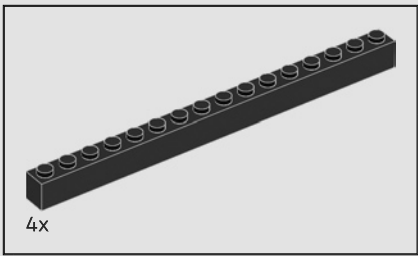

145

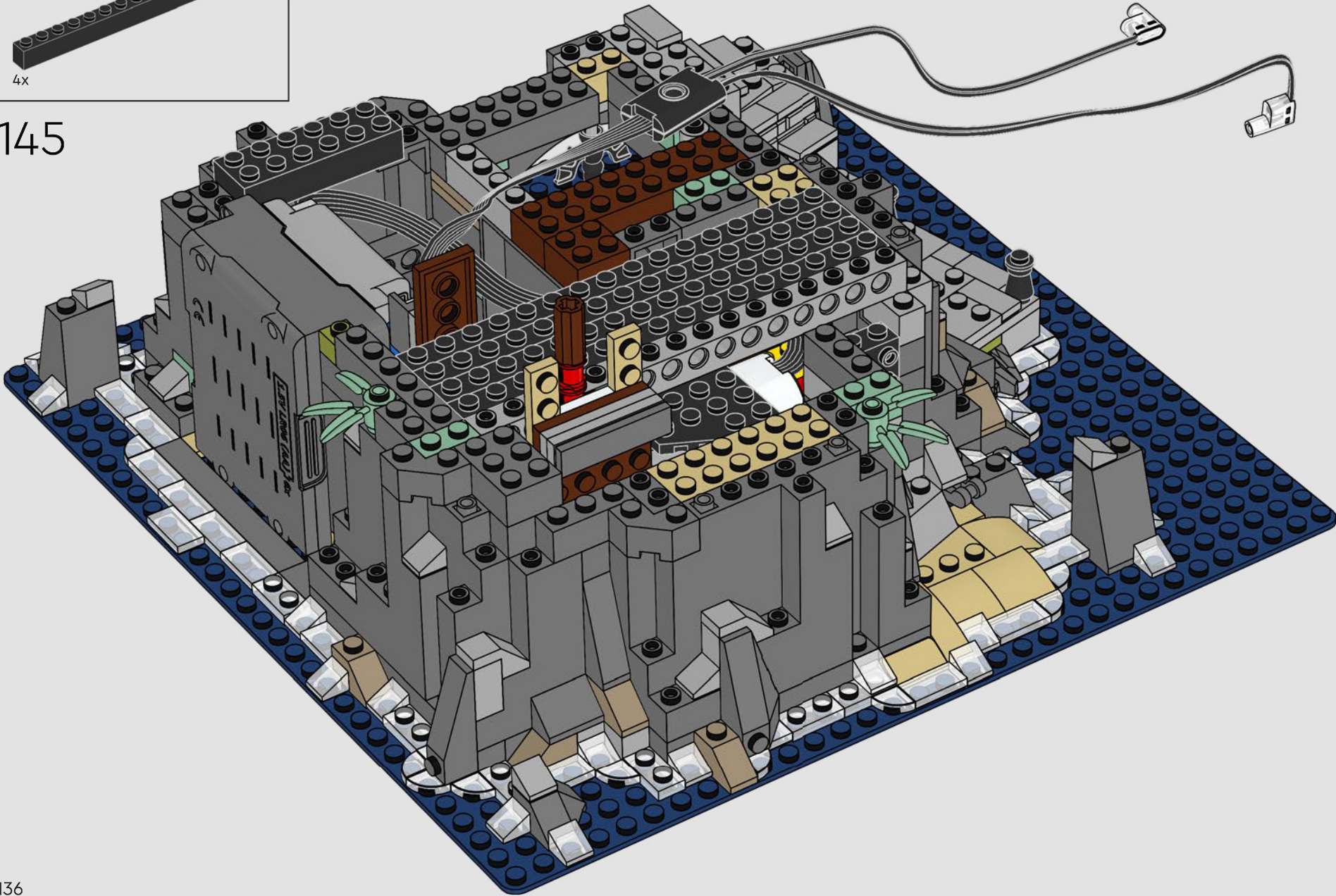

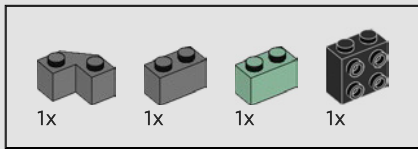

146

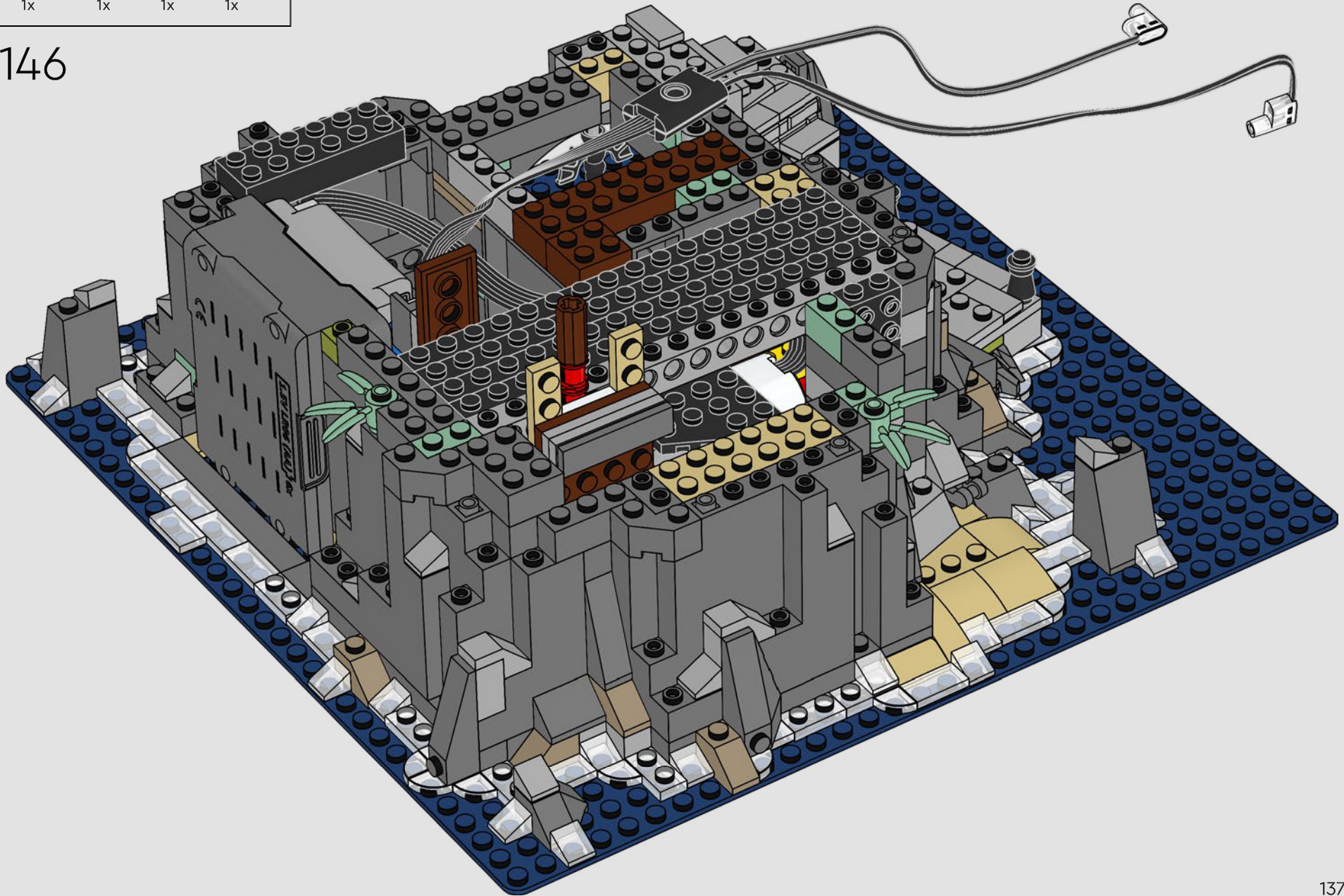

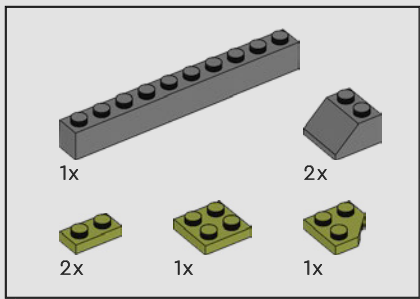

147

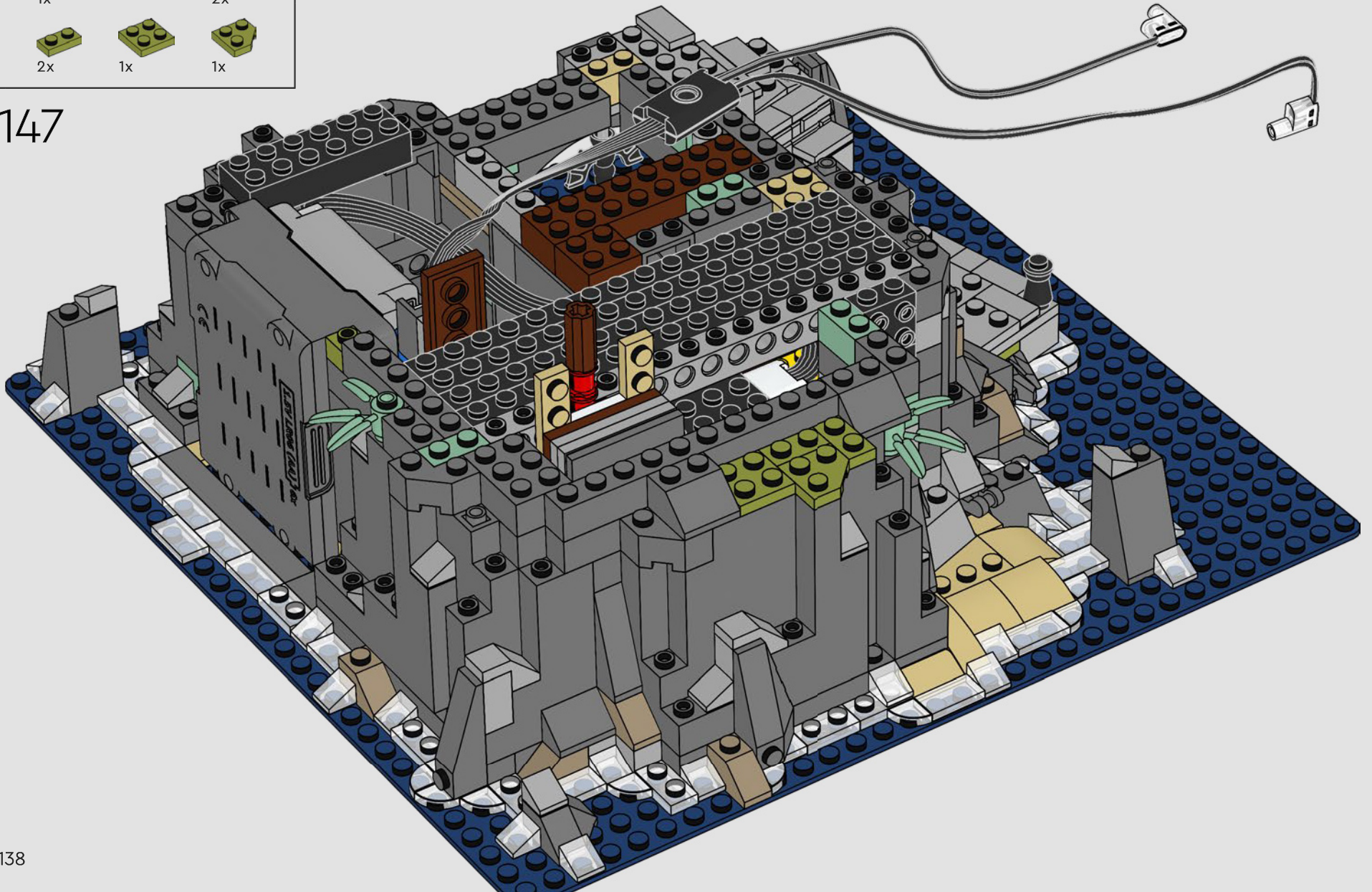

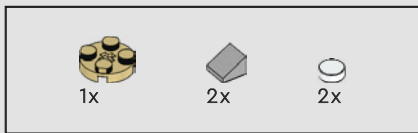

148

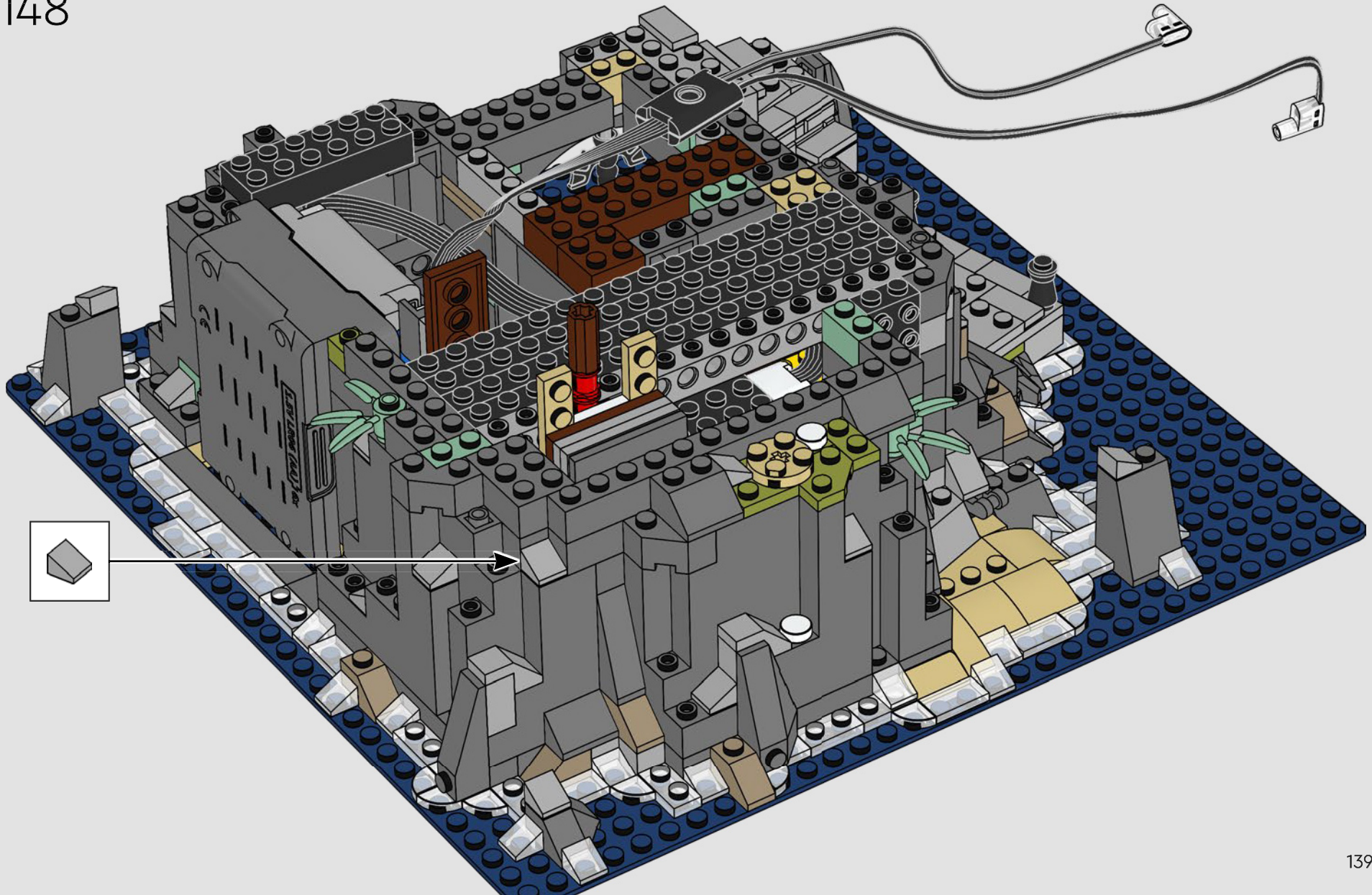

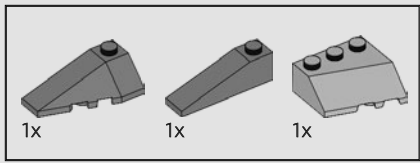

149

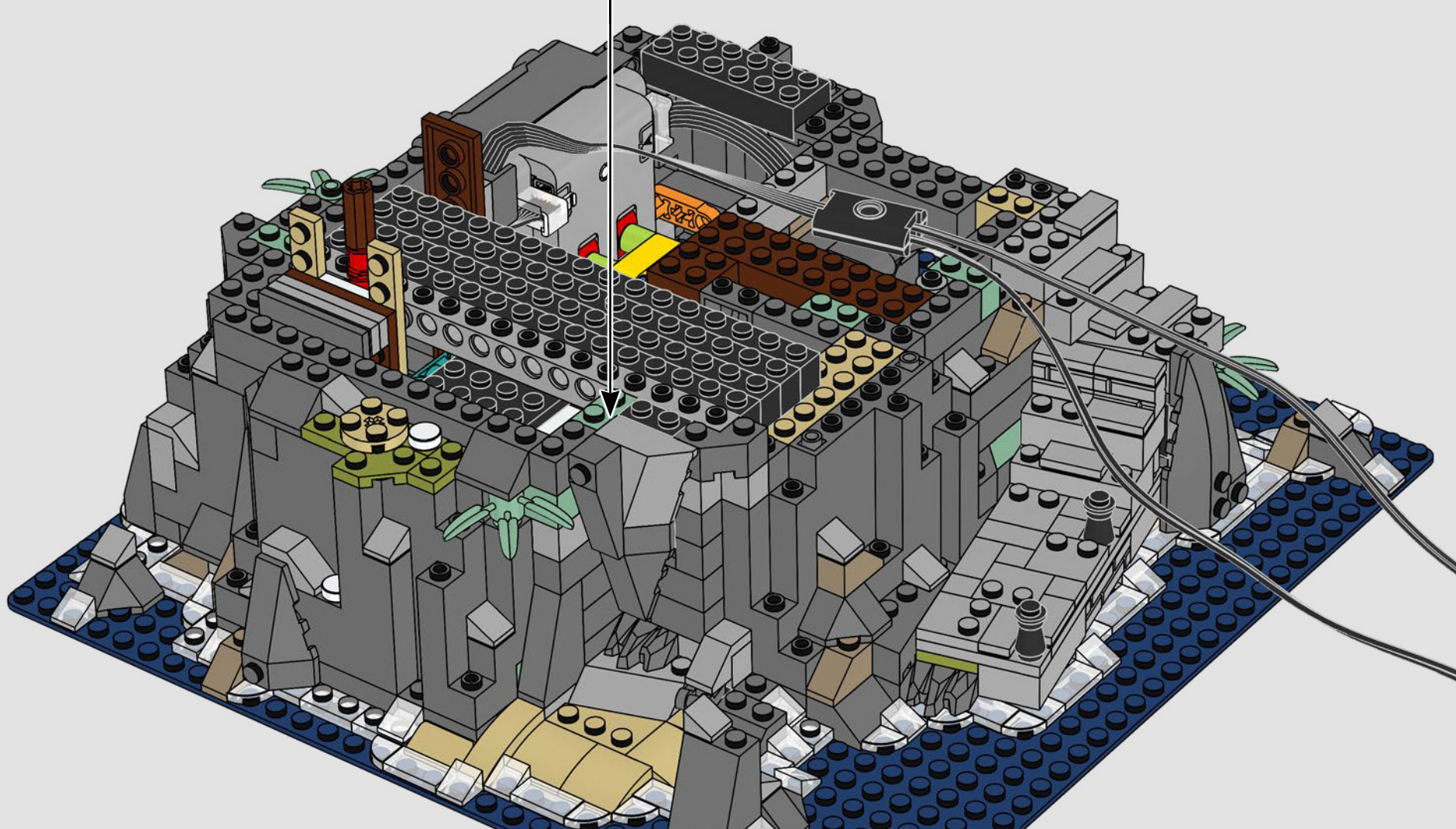
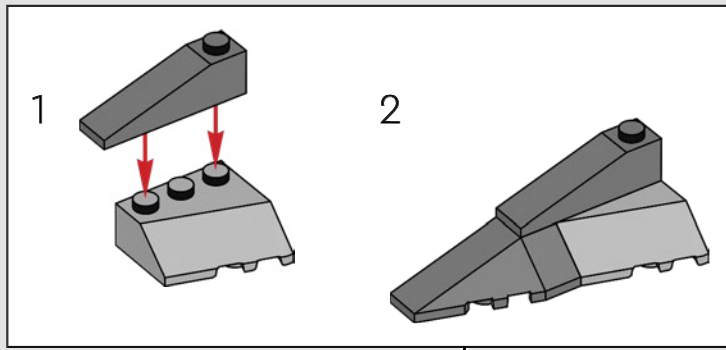



150

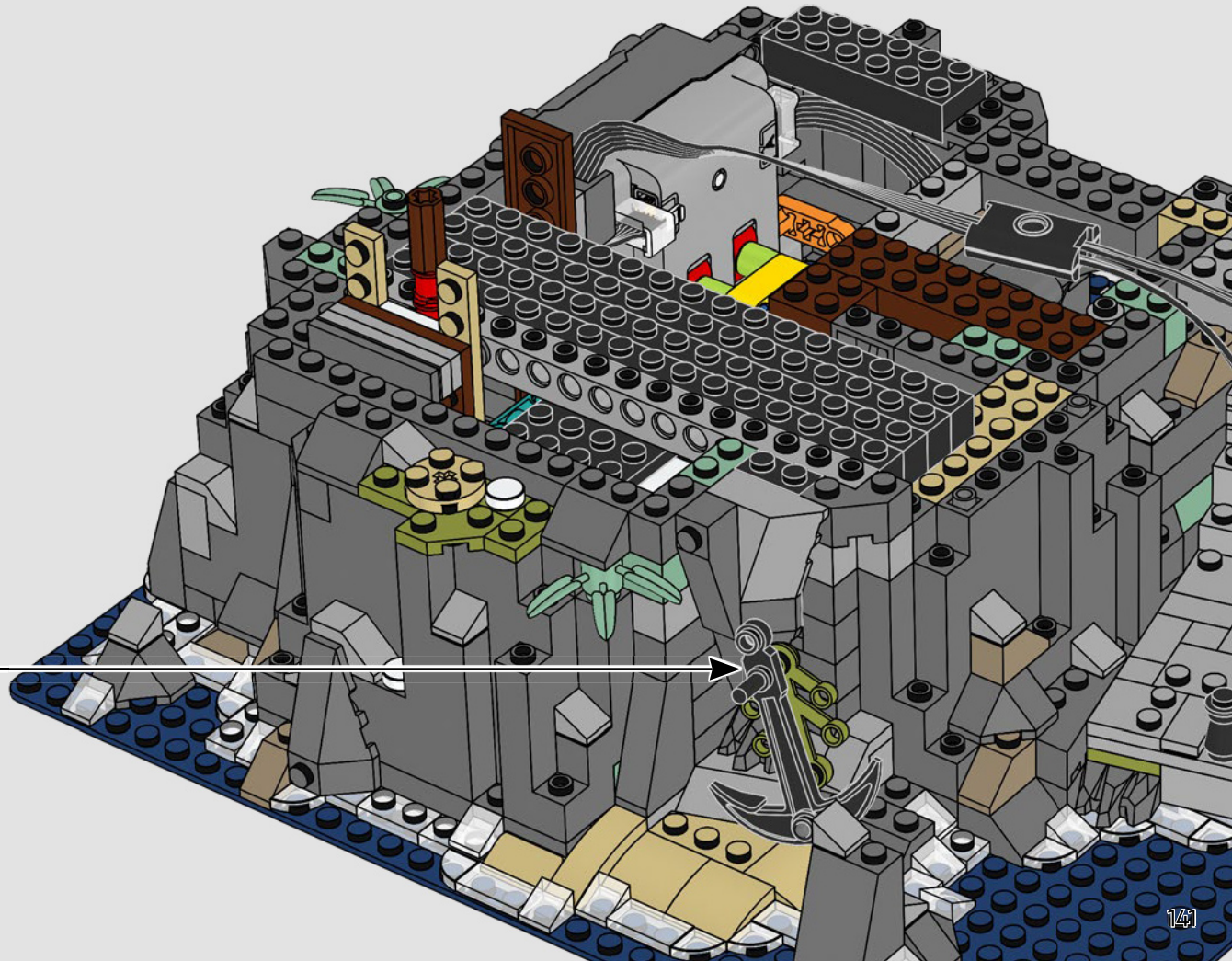
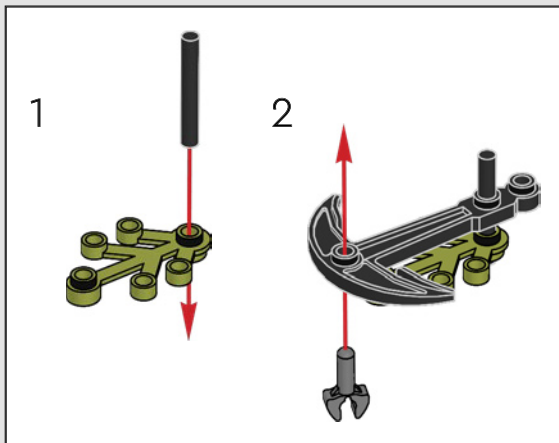

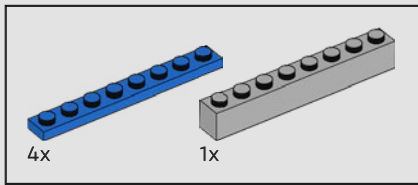

152

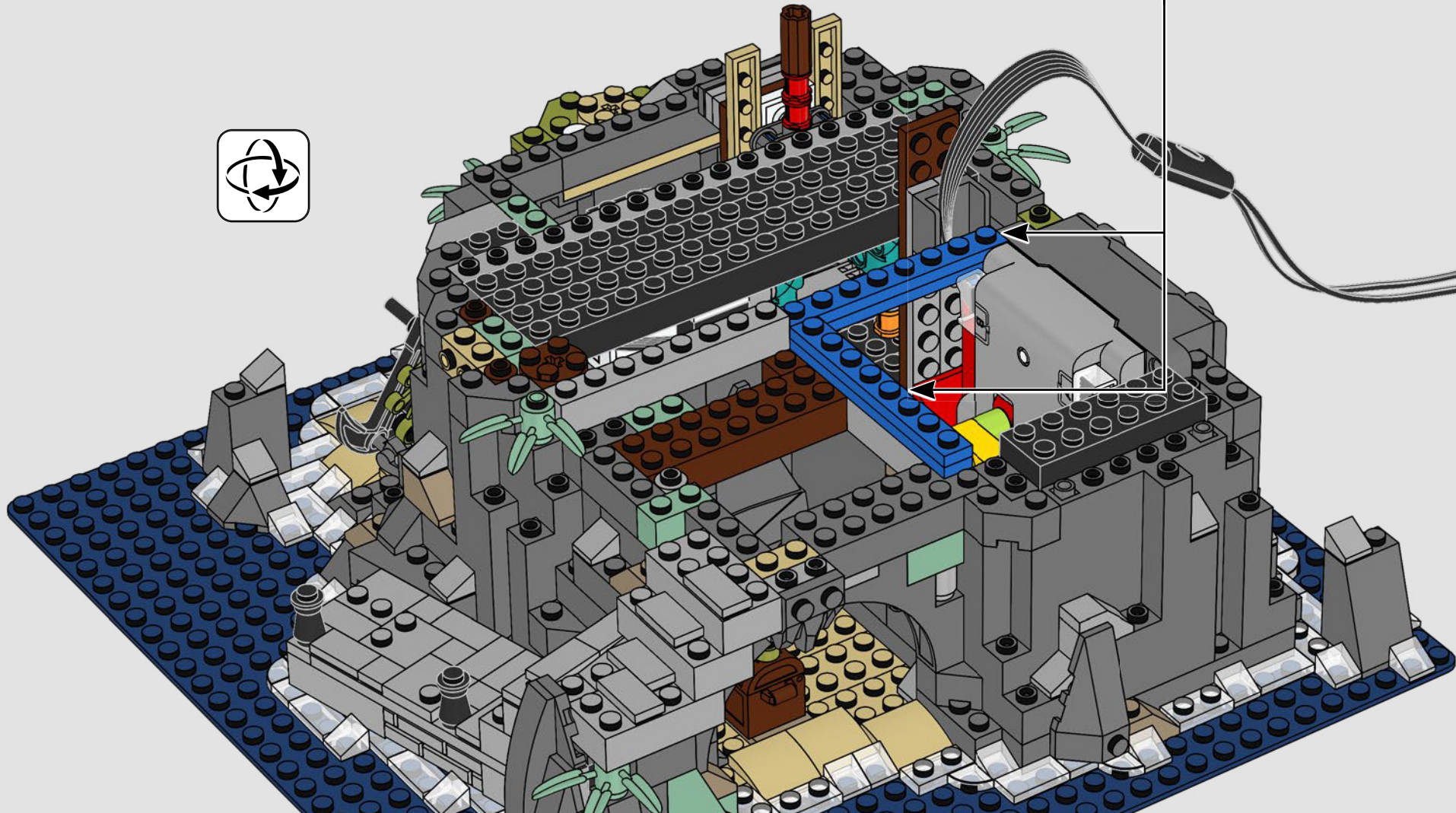
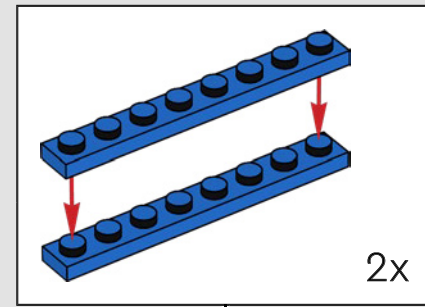

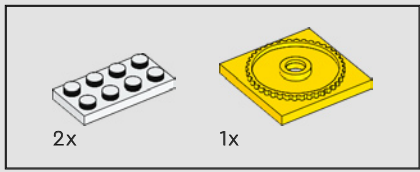

153

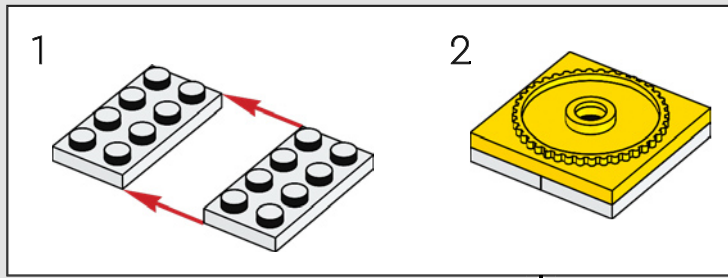

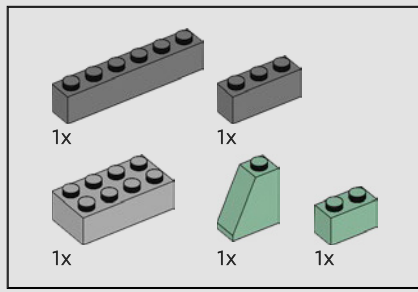

154

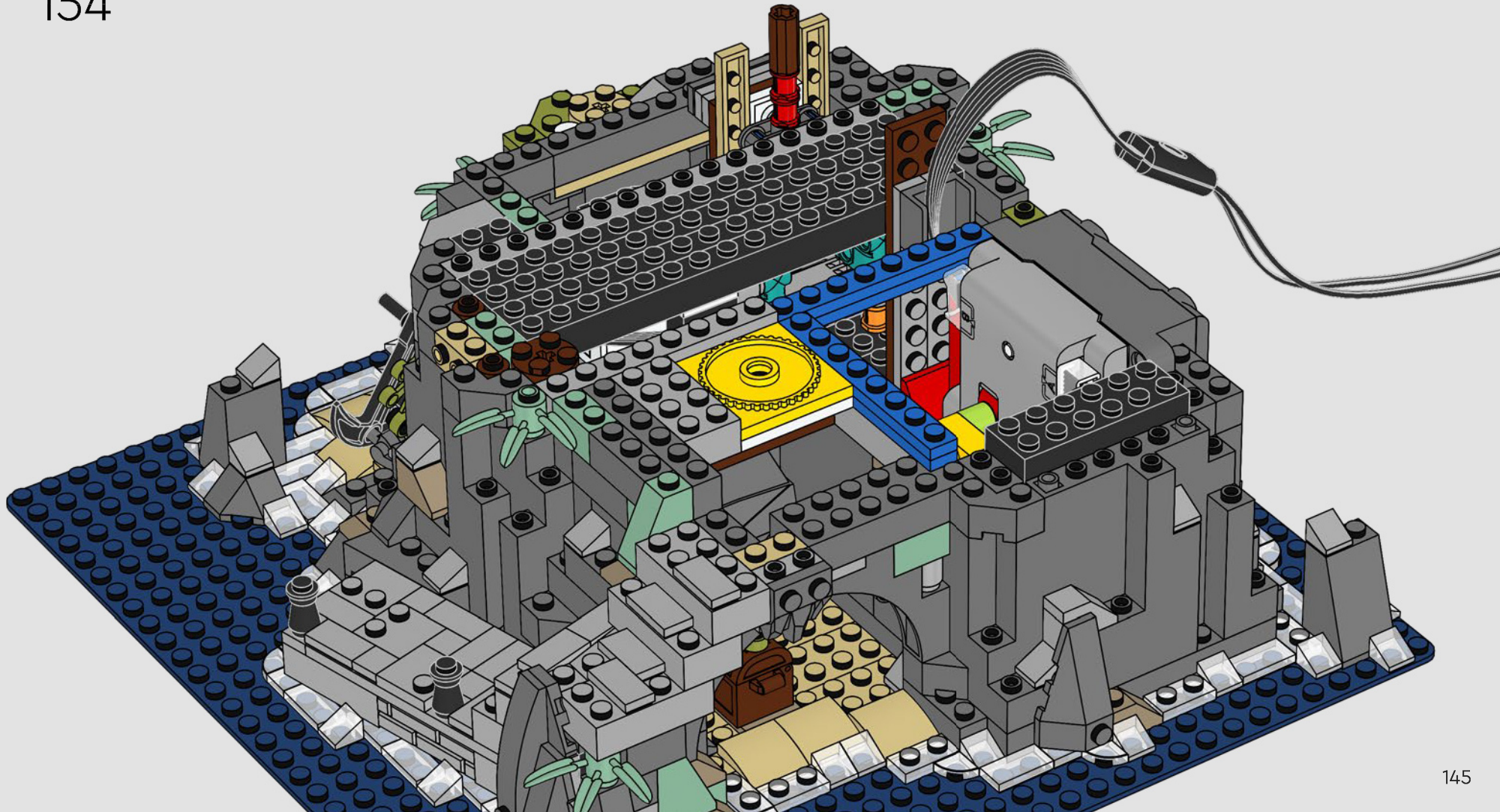

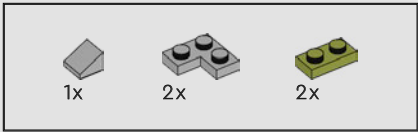

155

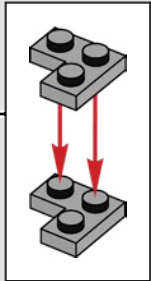
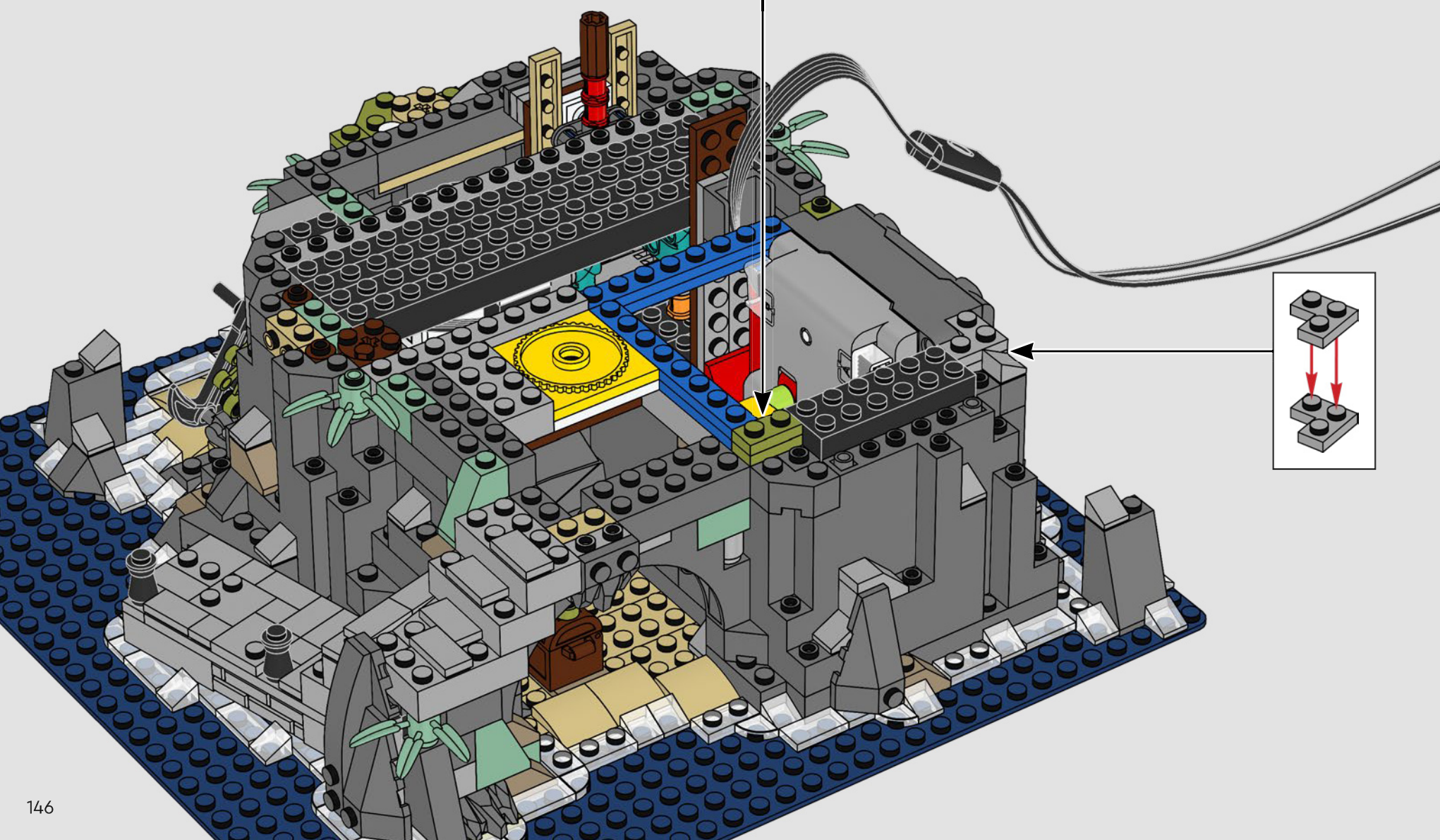
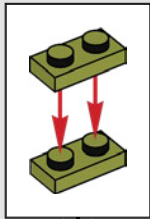

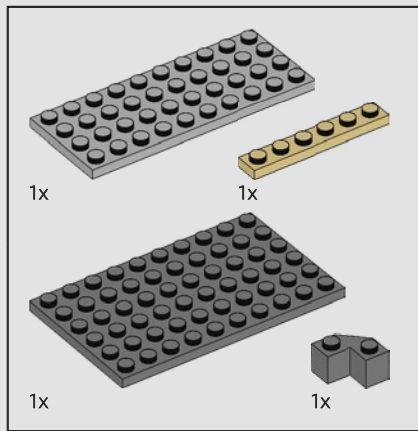

156

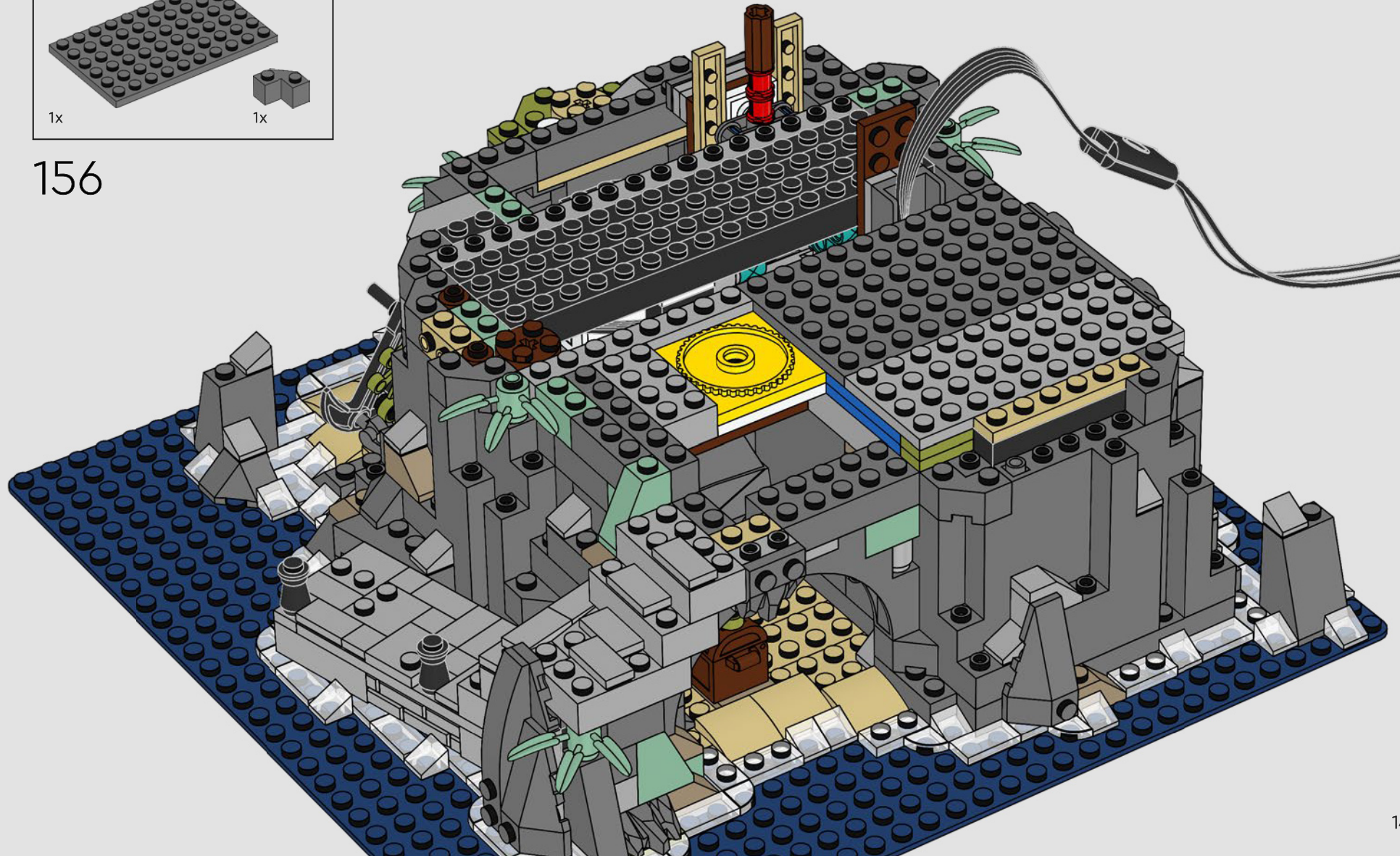

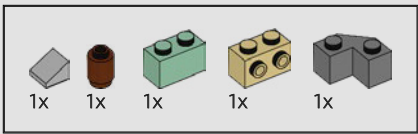

157

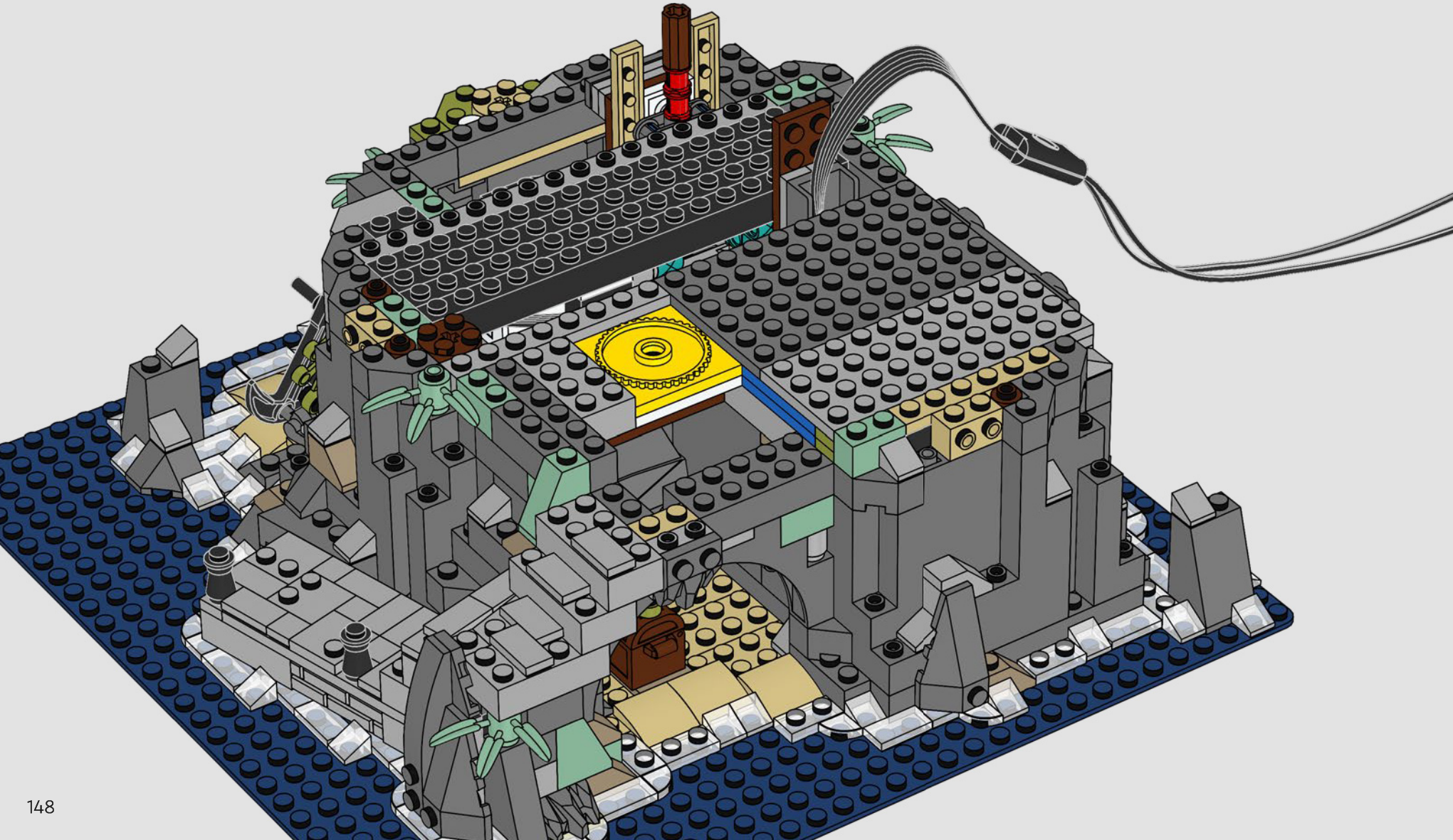

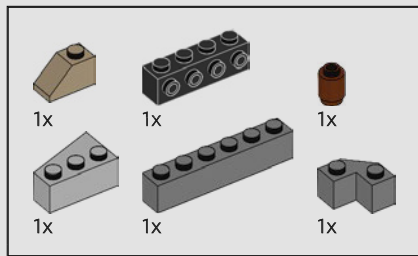

158

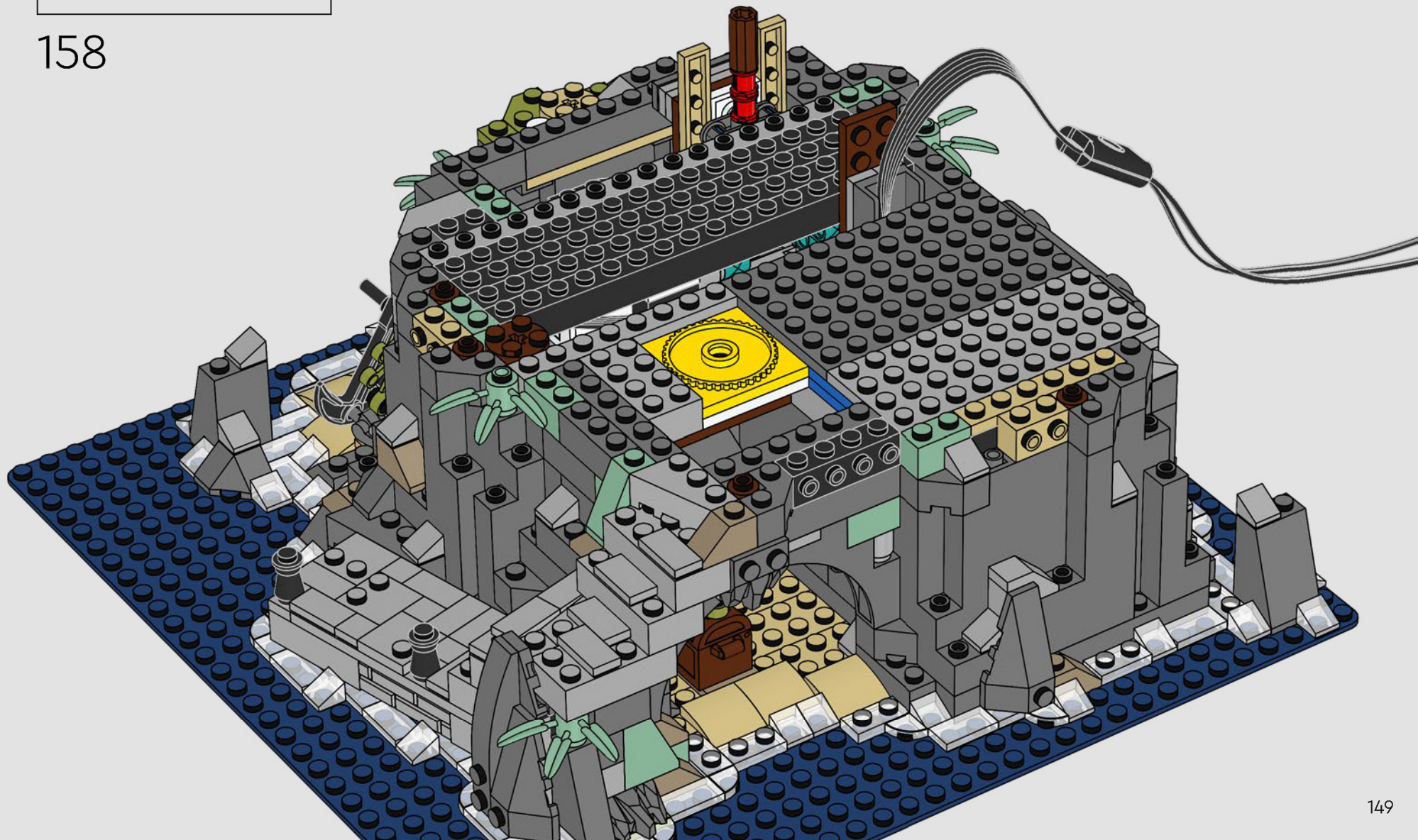

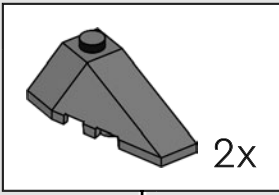
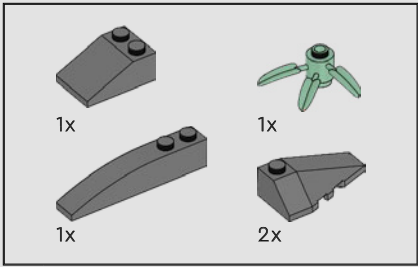

159

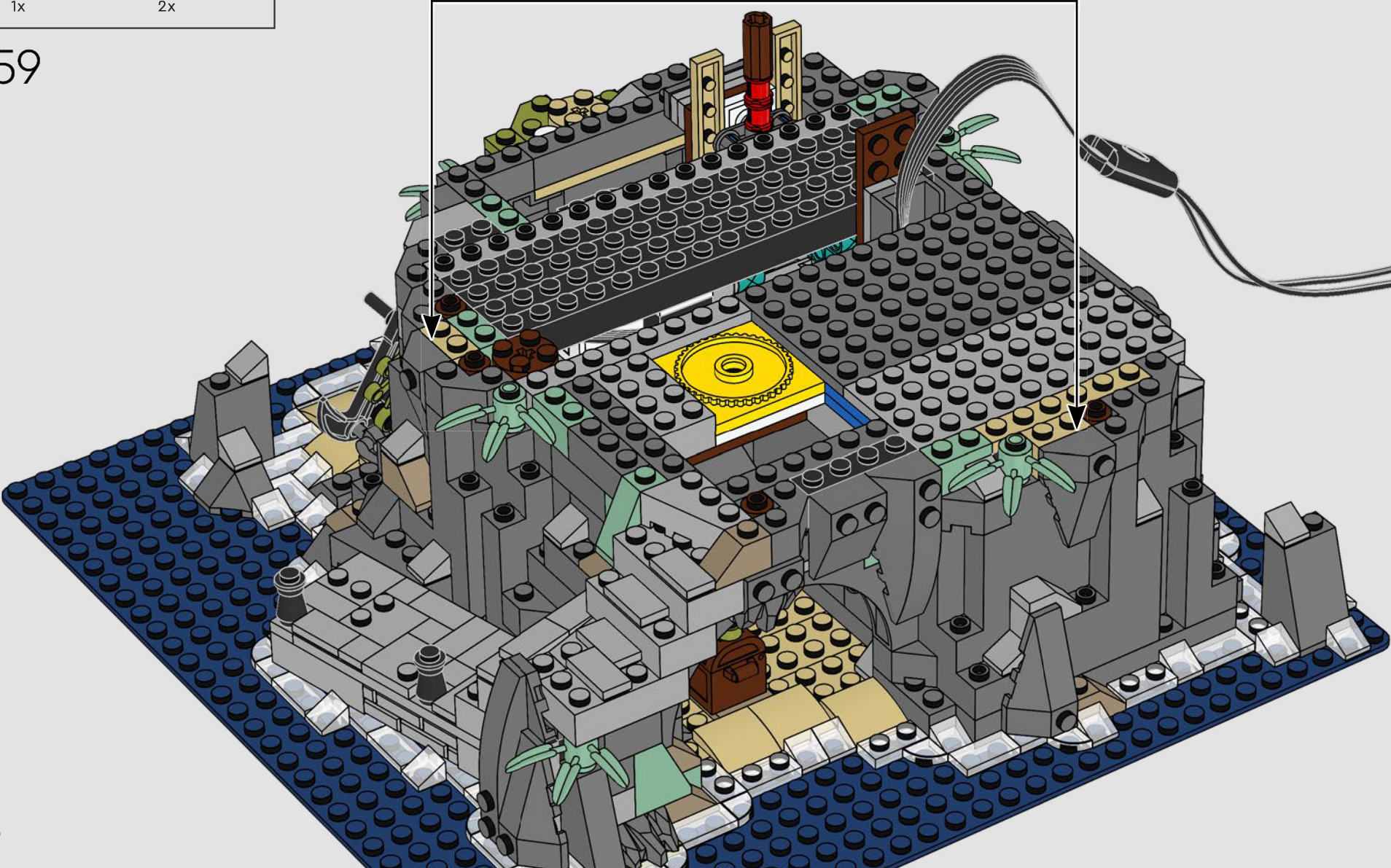

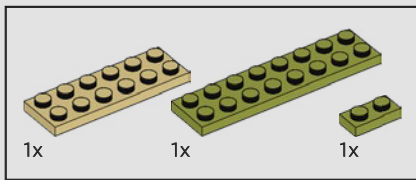

160

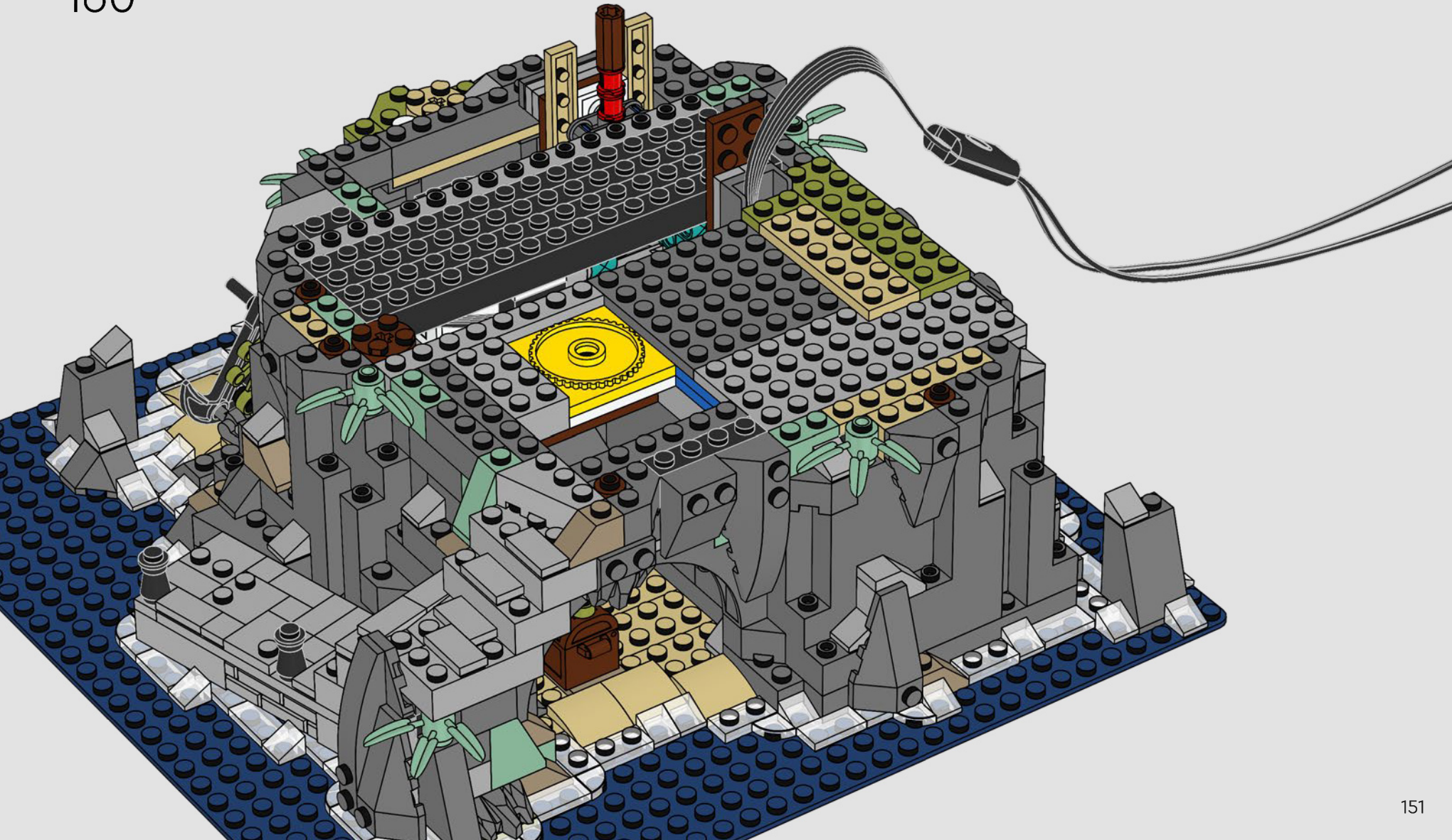

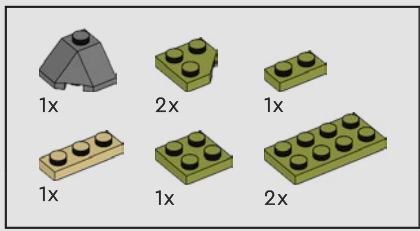

161



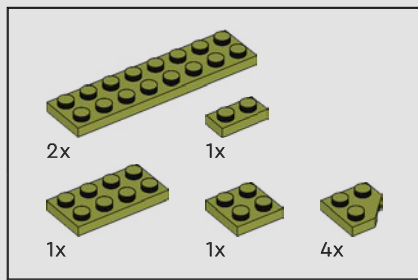

162



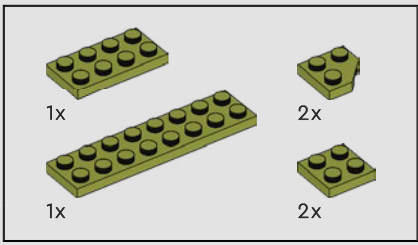

163

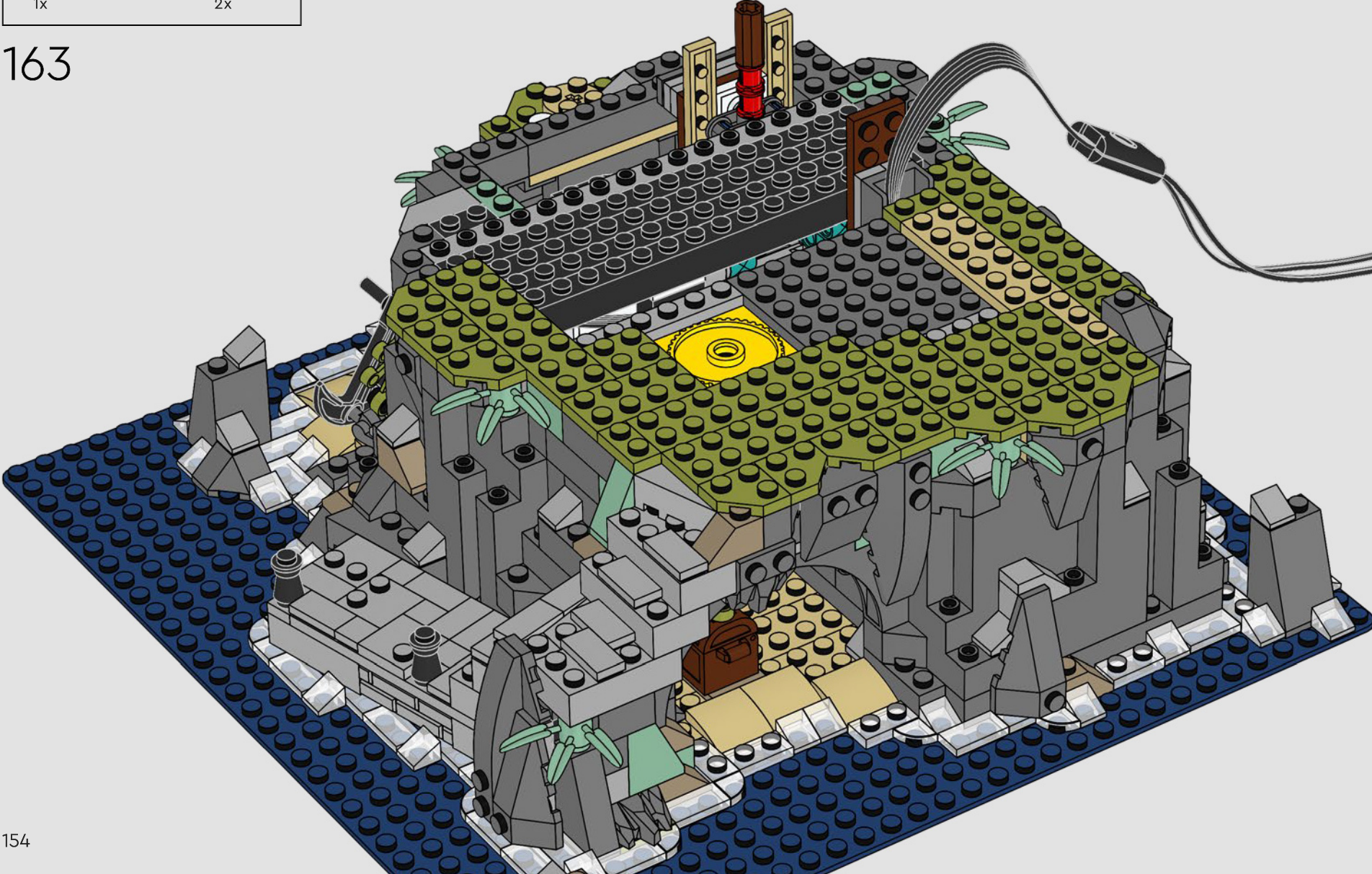

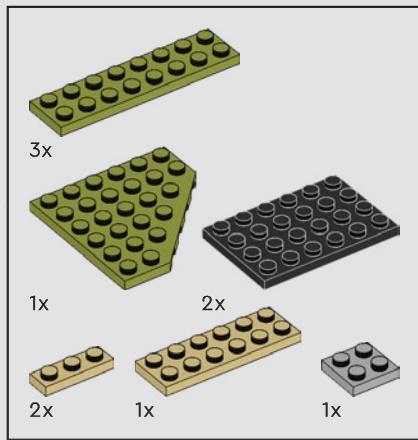

164

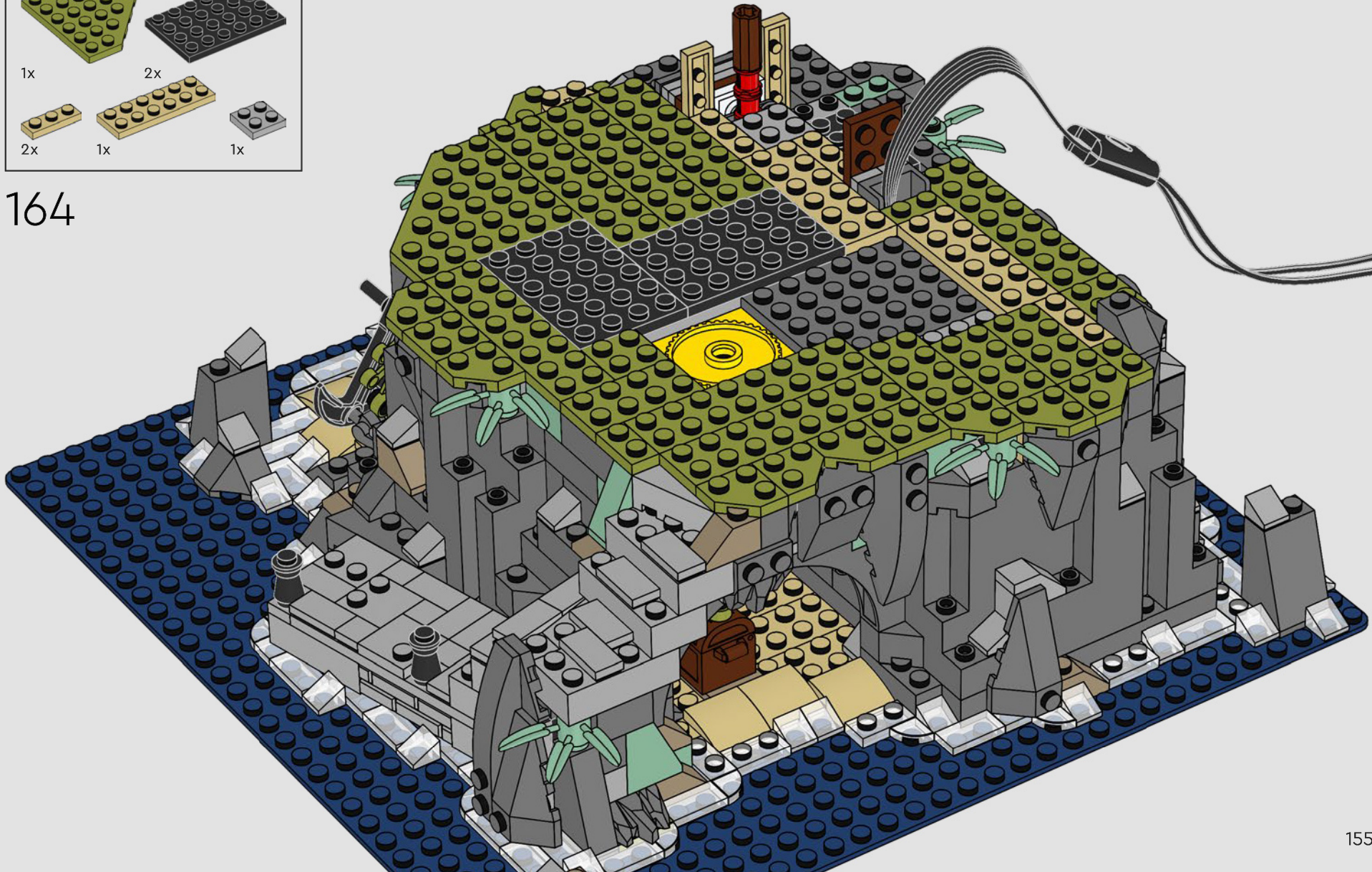

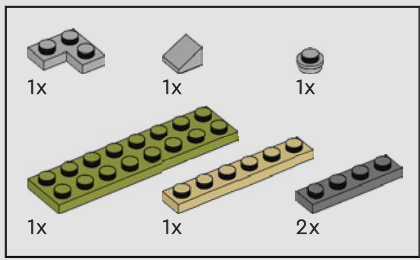

165

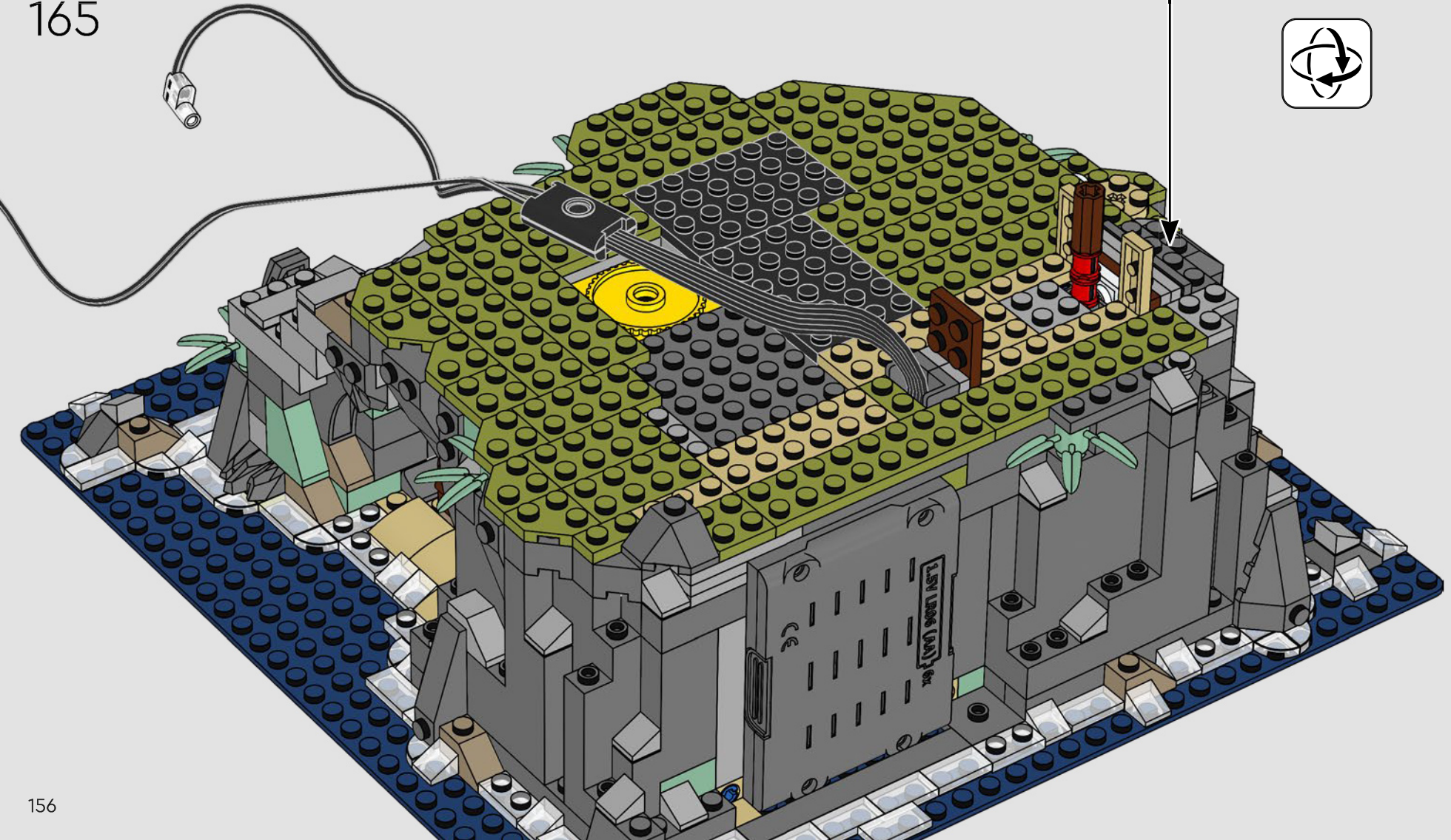
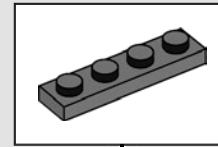

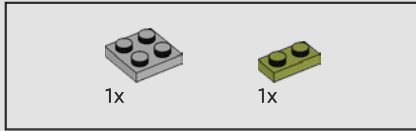
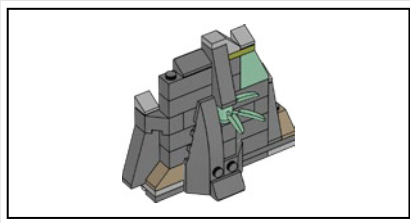

166

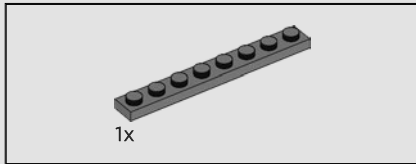
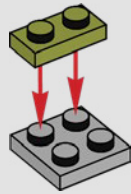

167

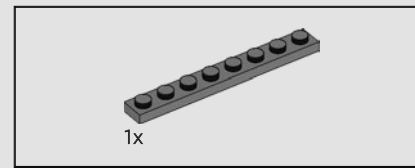
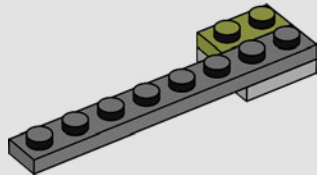

168

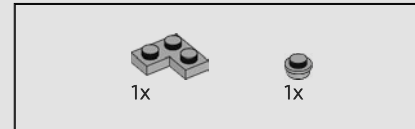
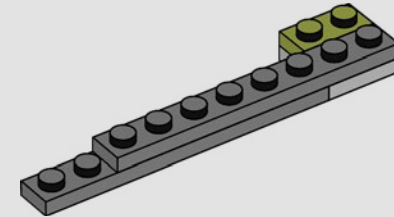

169

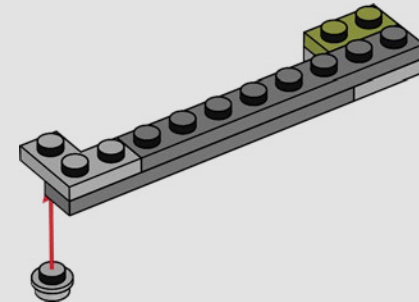

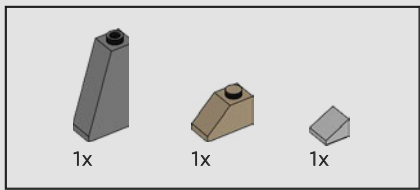

170

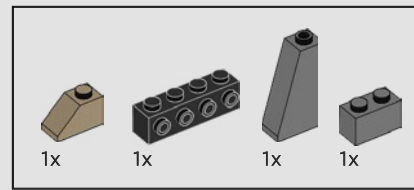
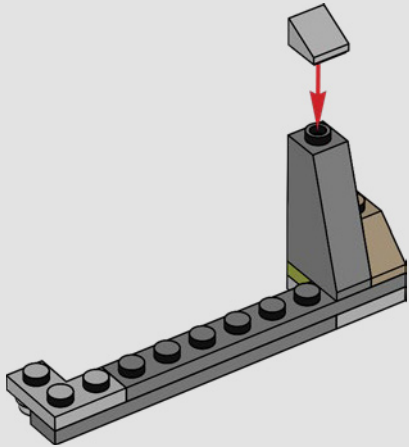

171

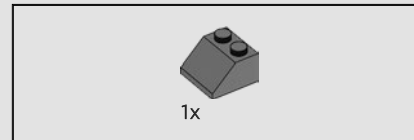
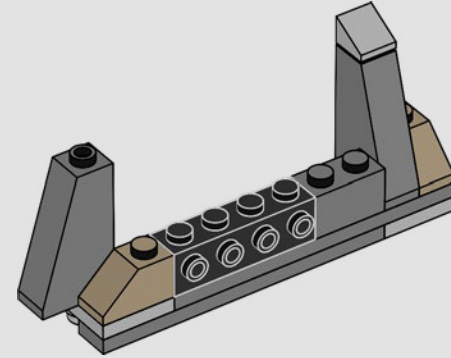

172

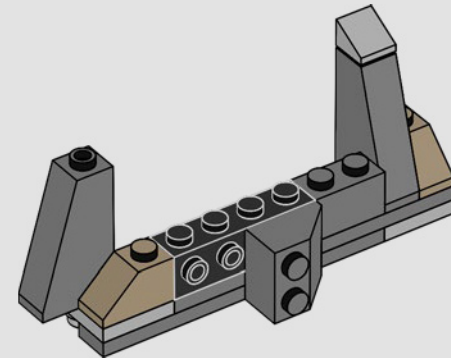

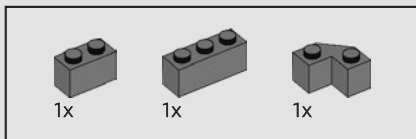

173

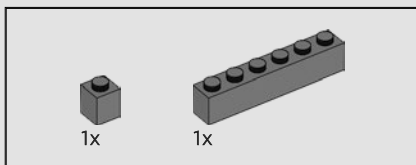
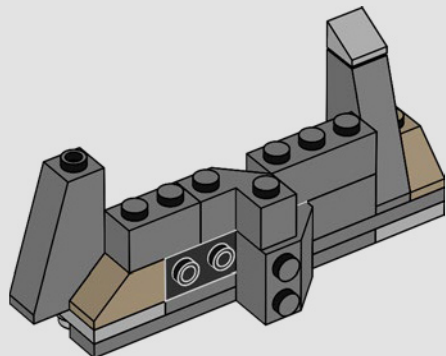

174

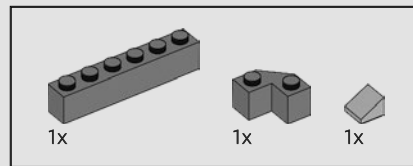
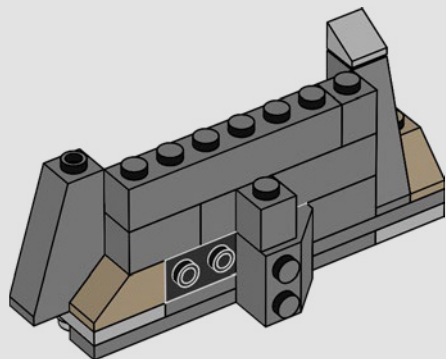

175

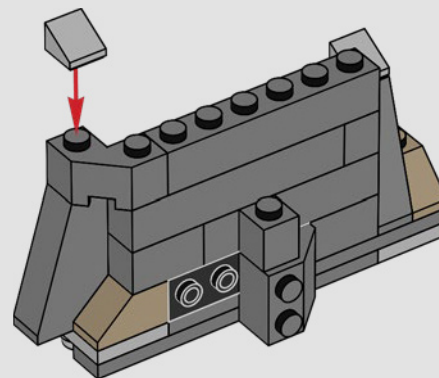

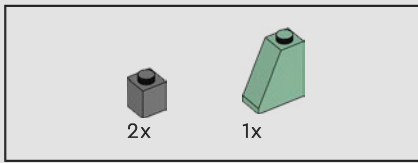

176

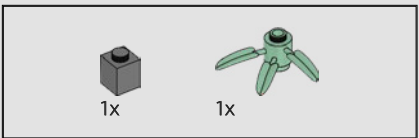
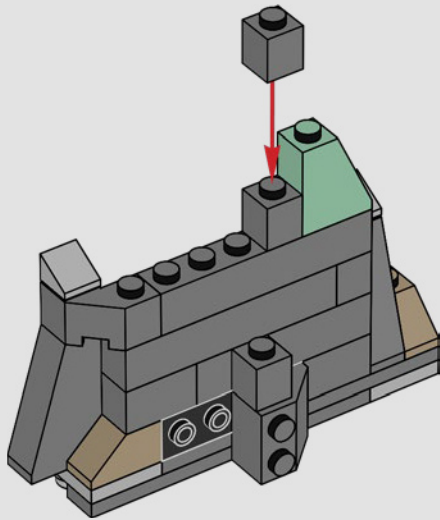

177

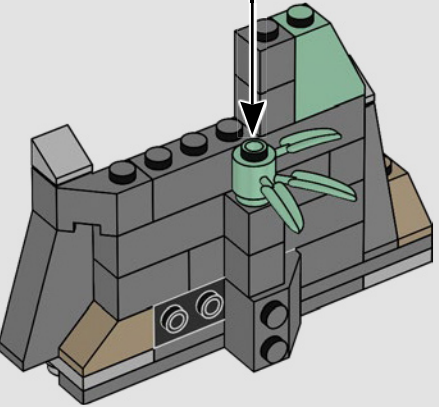
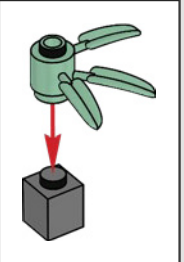

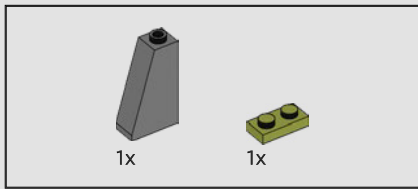

178

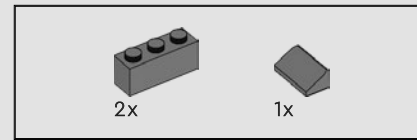
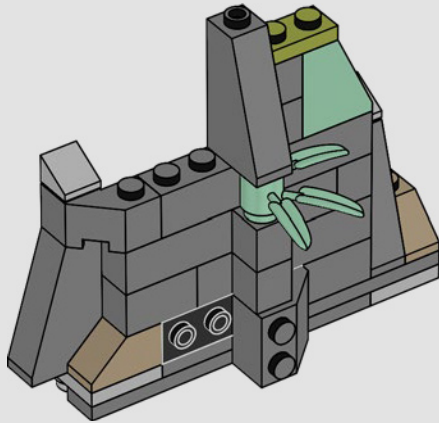

179

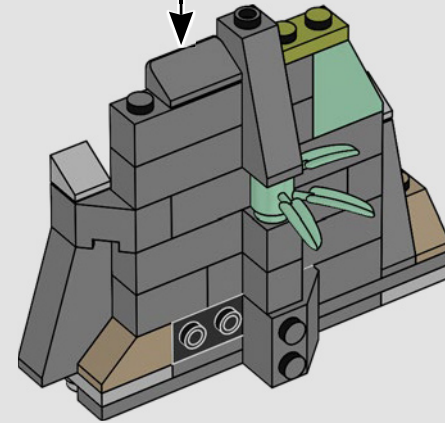
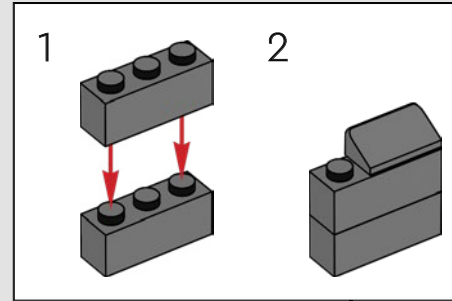

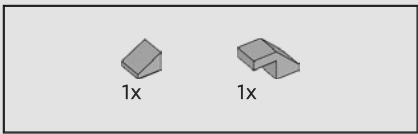

180

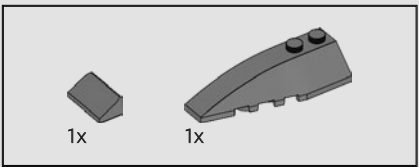
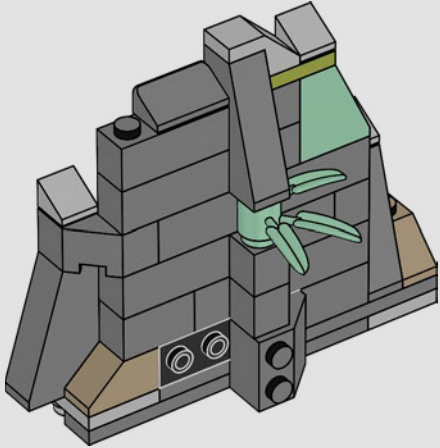

181

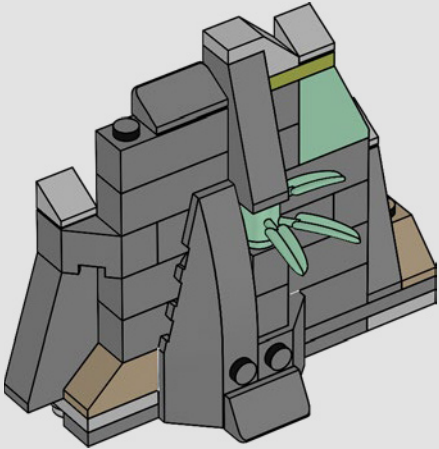
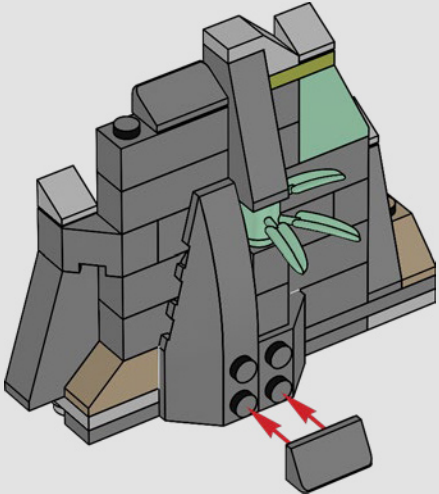

182

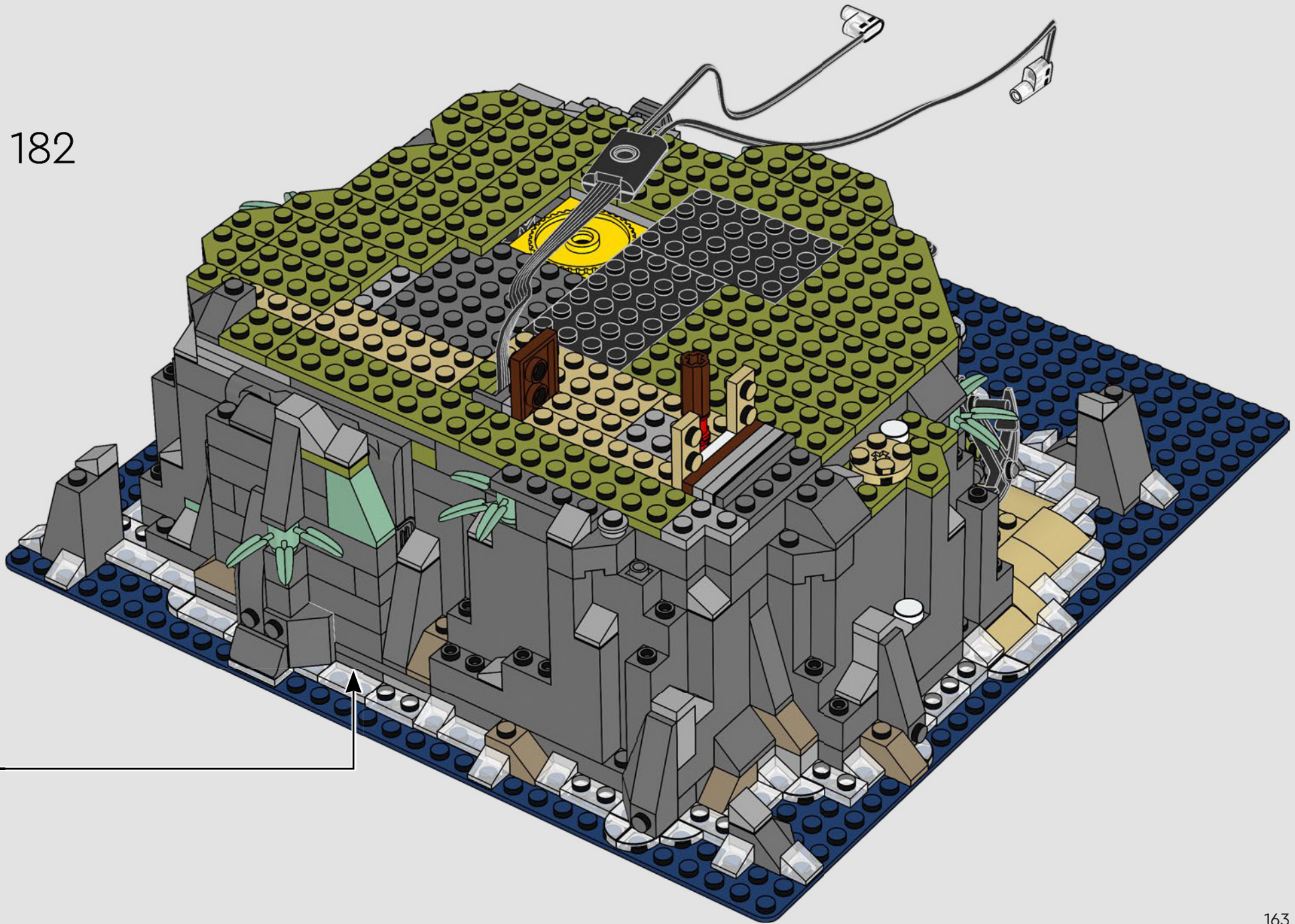





183

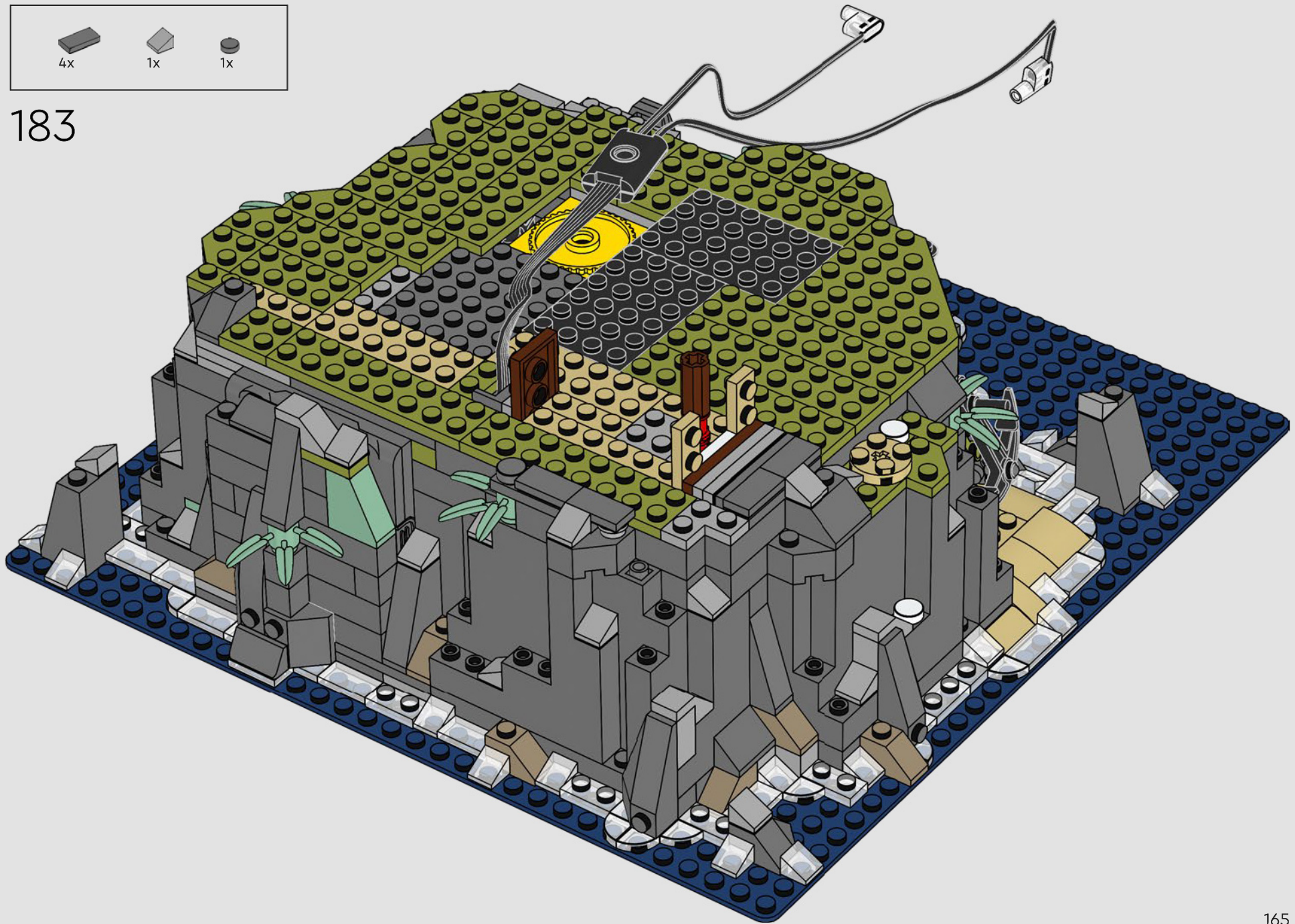

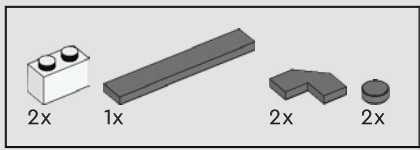

184

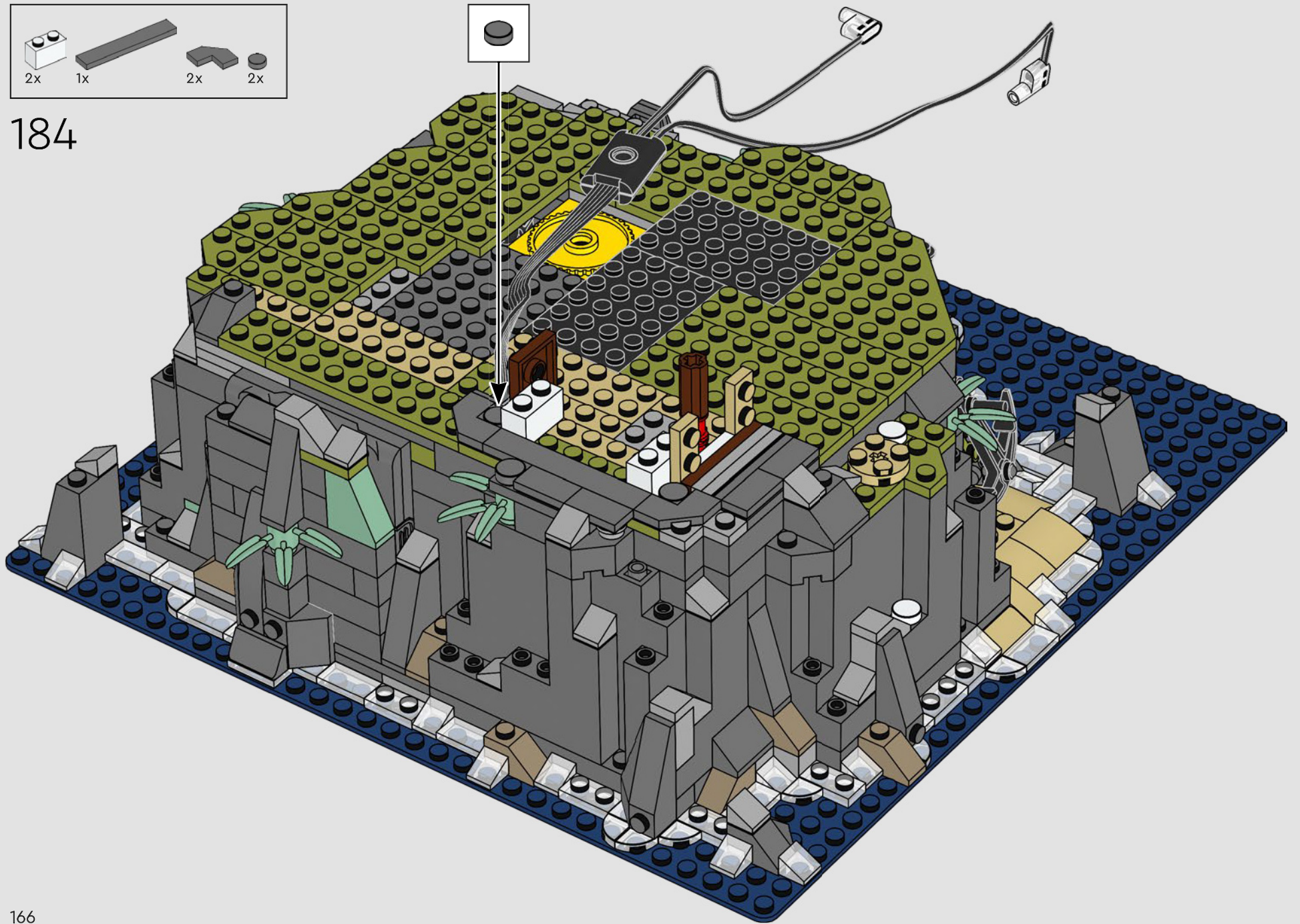

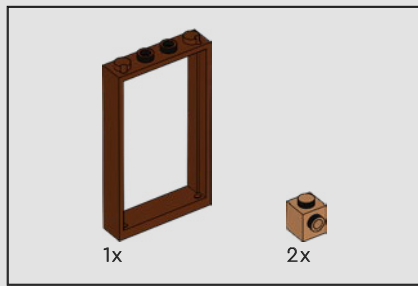

185

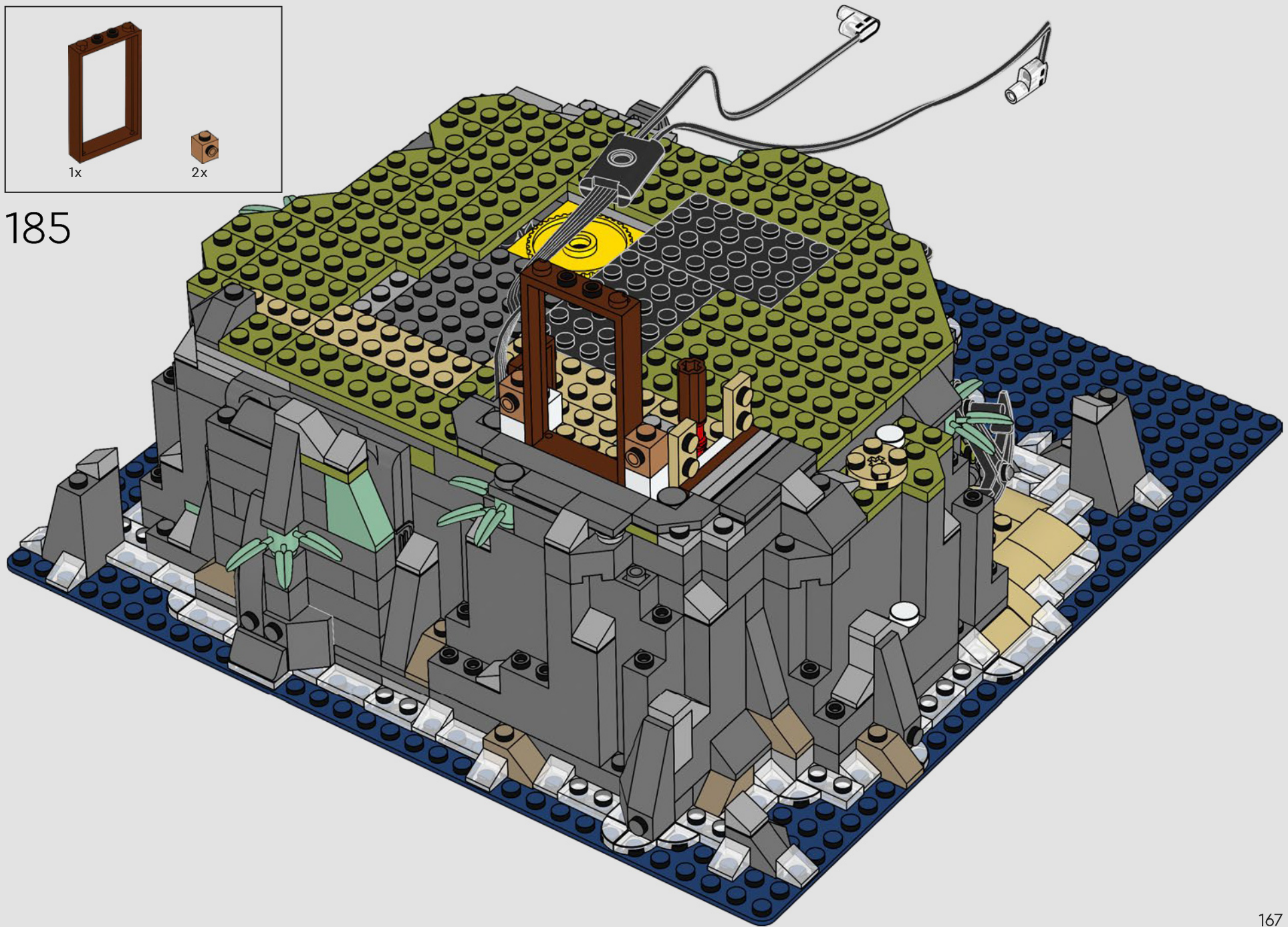

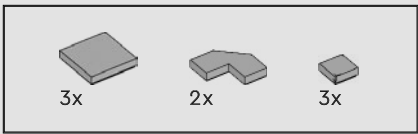

186

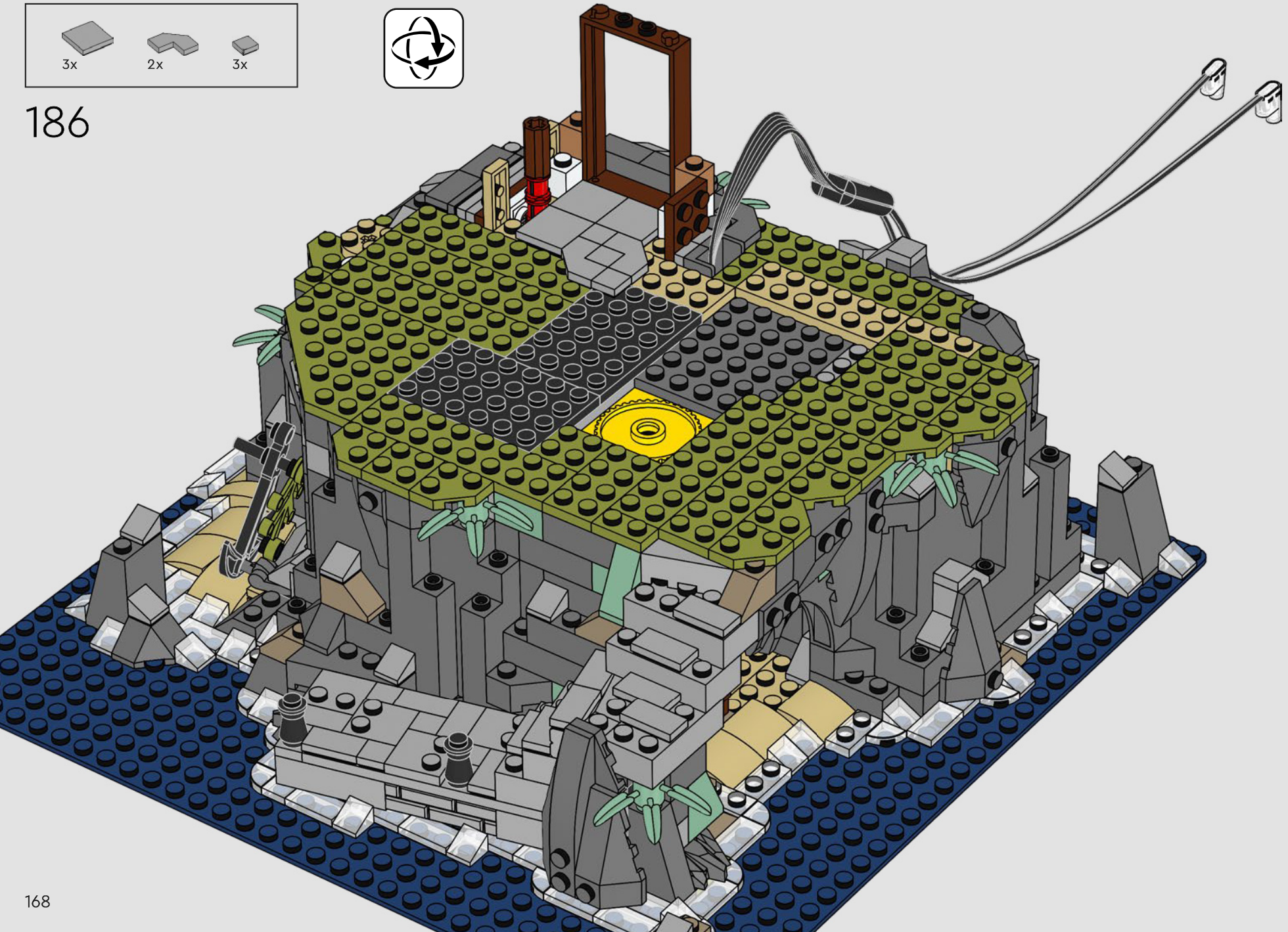

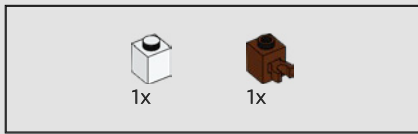

187

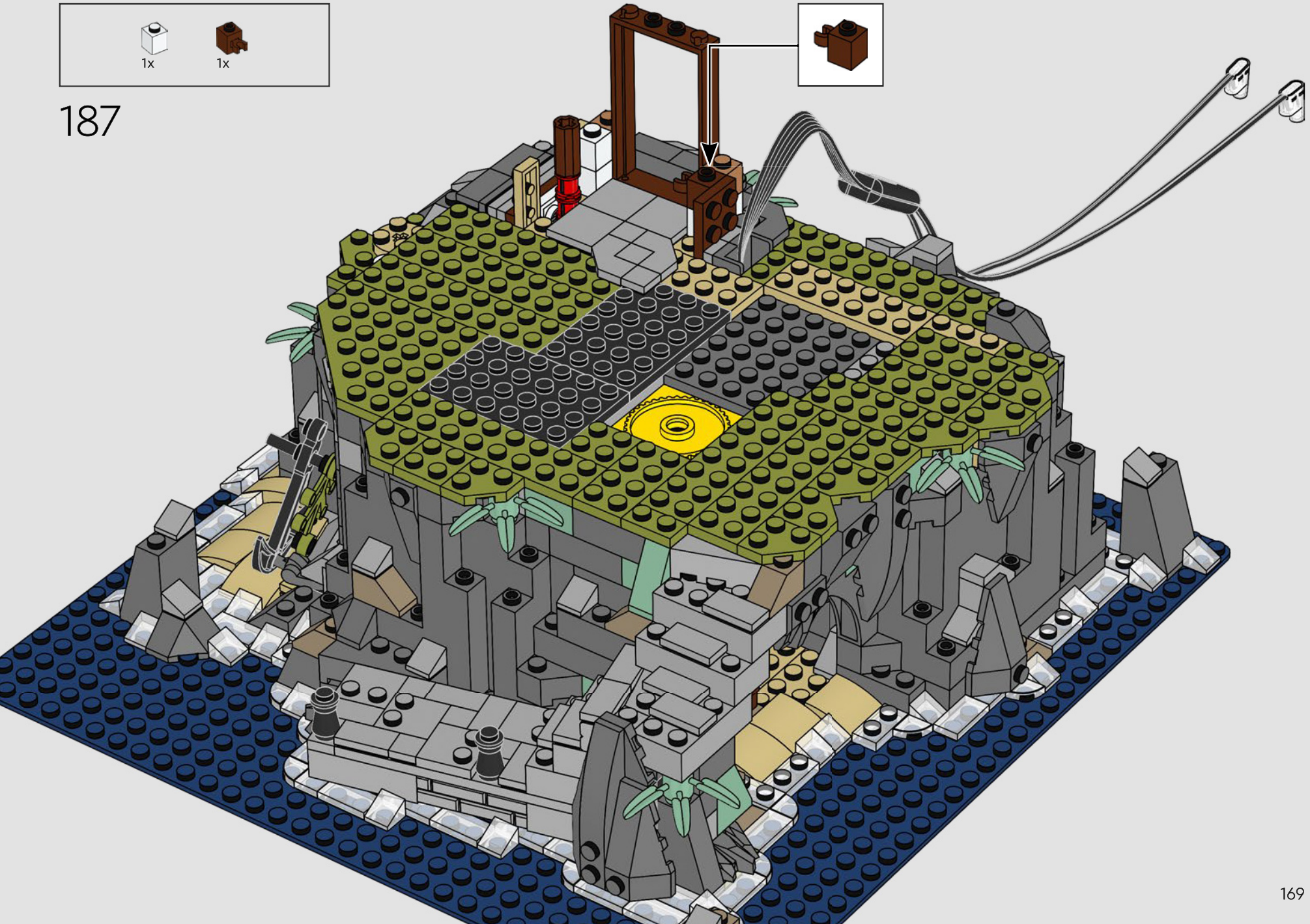
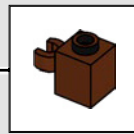

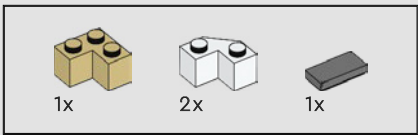

188

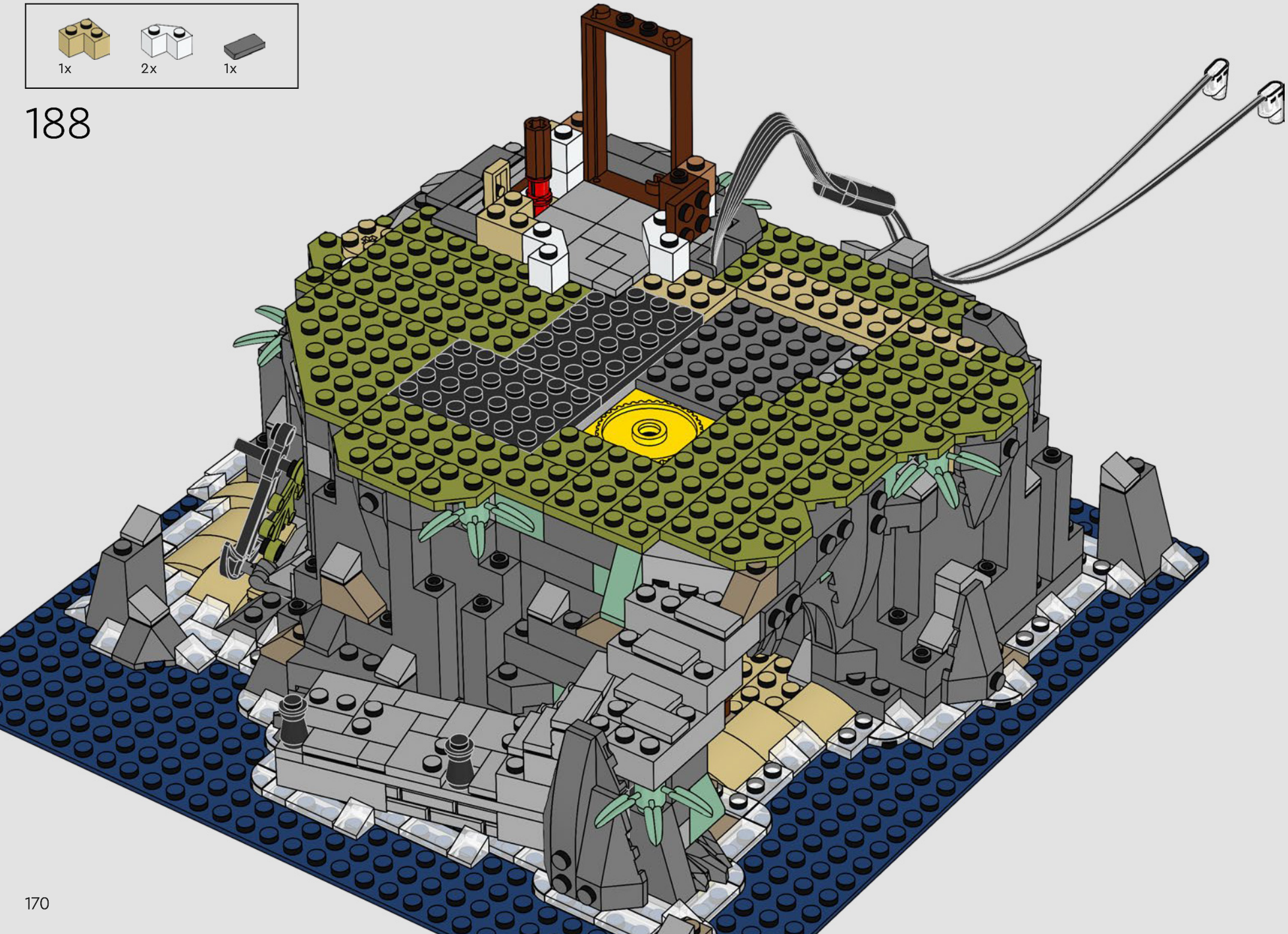

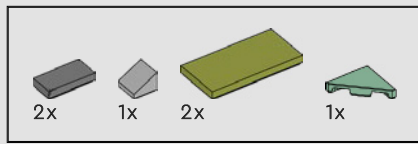

189

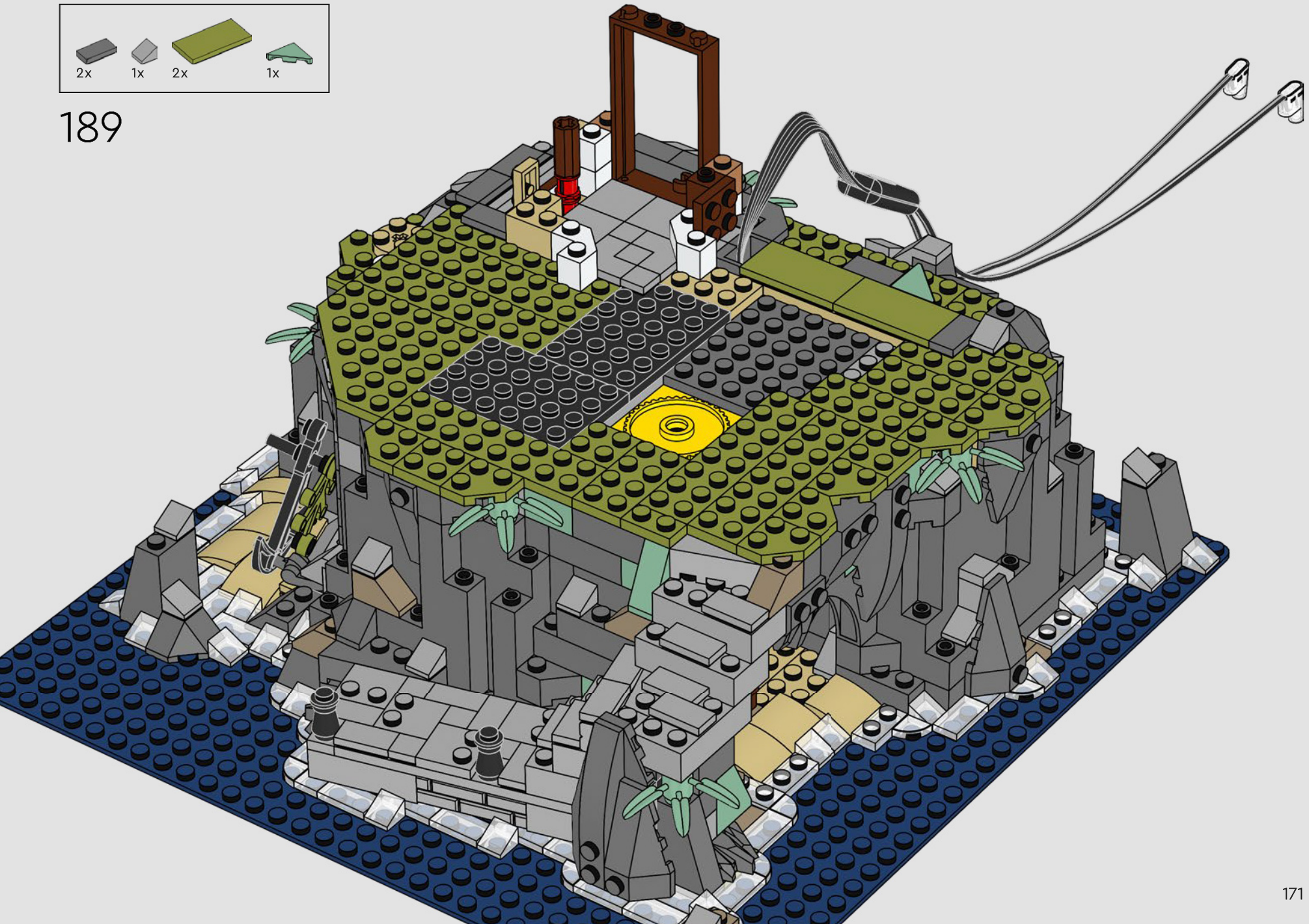

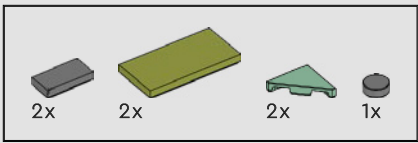

190

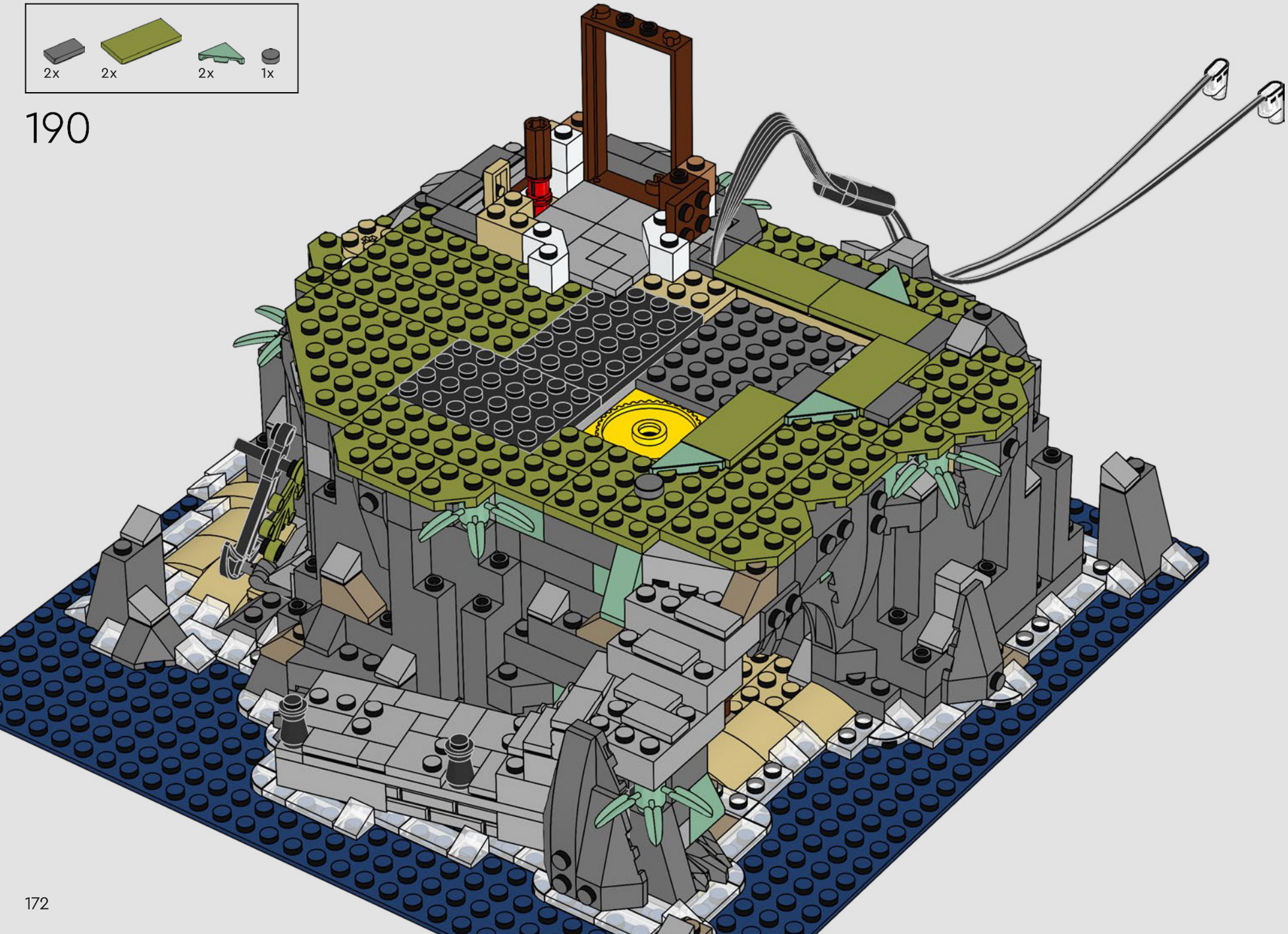

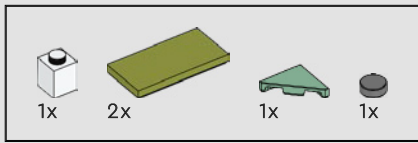

191

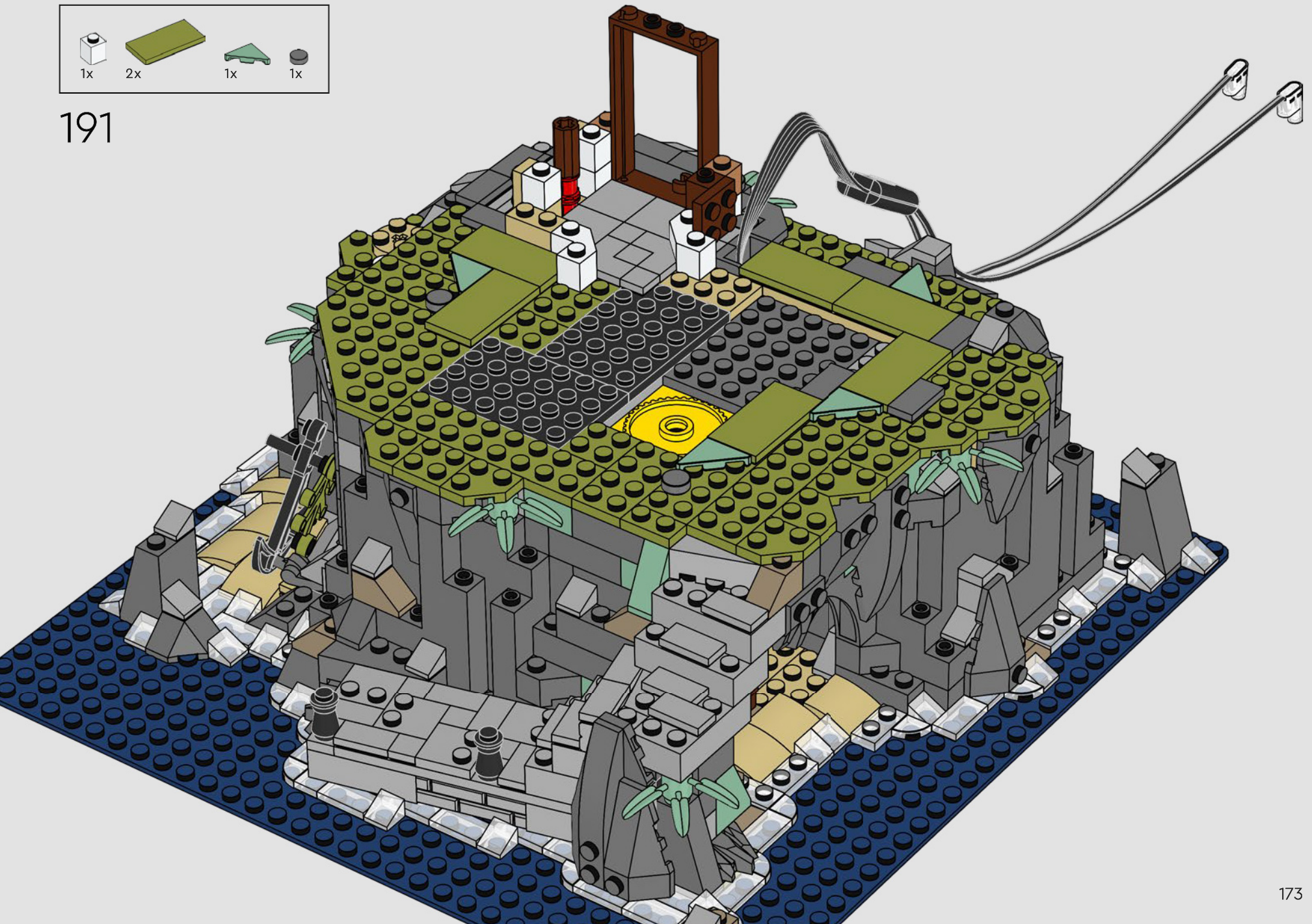

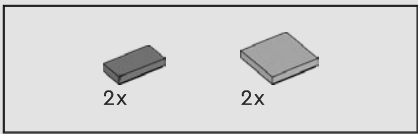

192



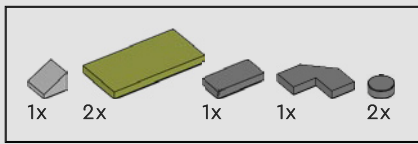

193

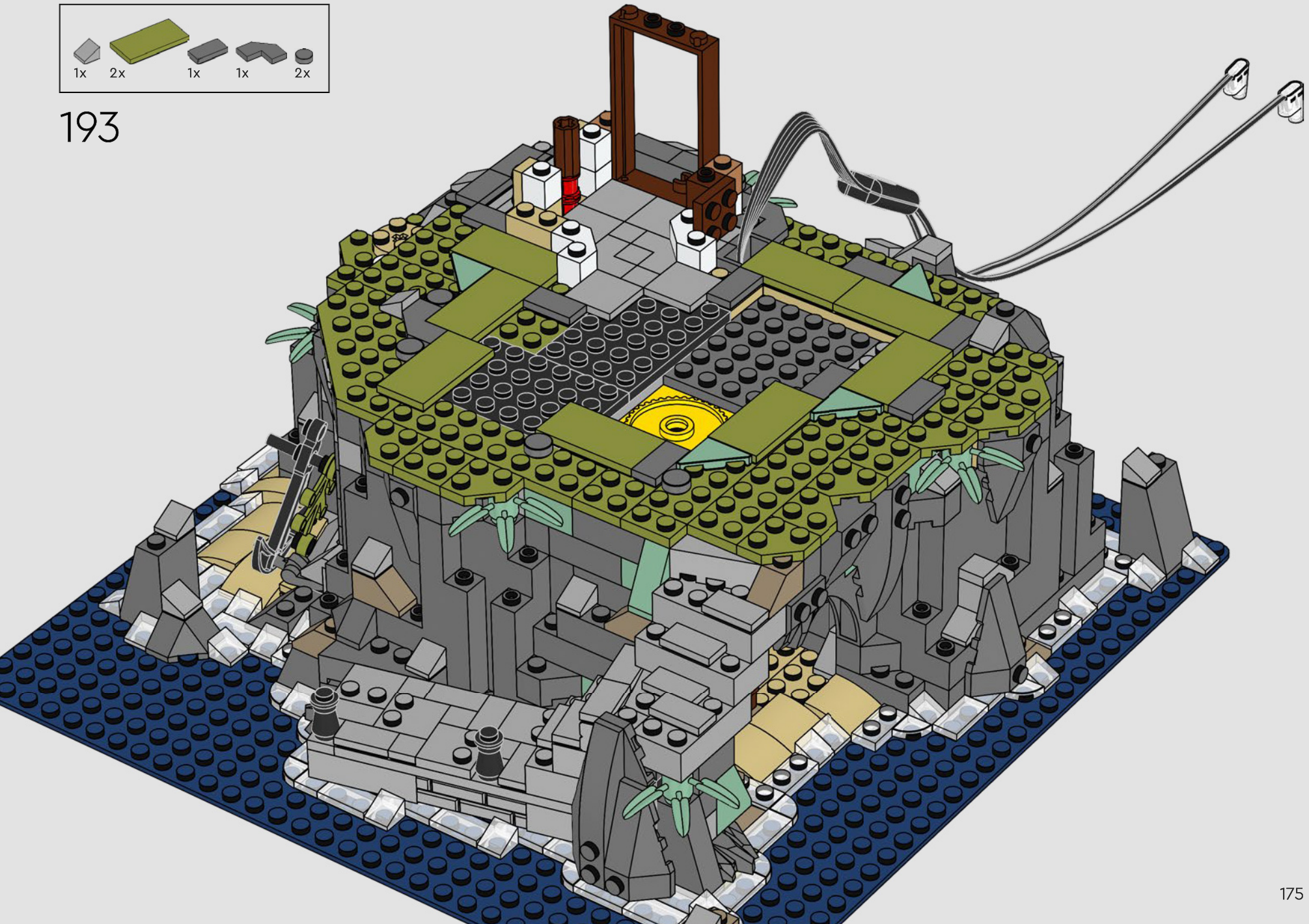

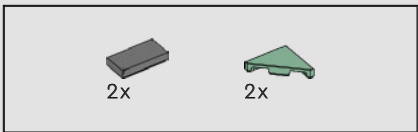

194

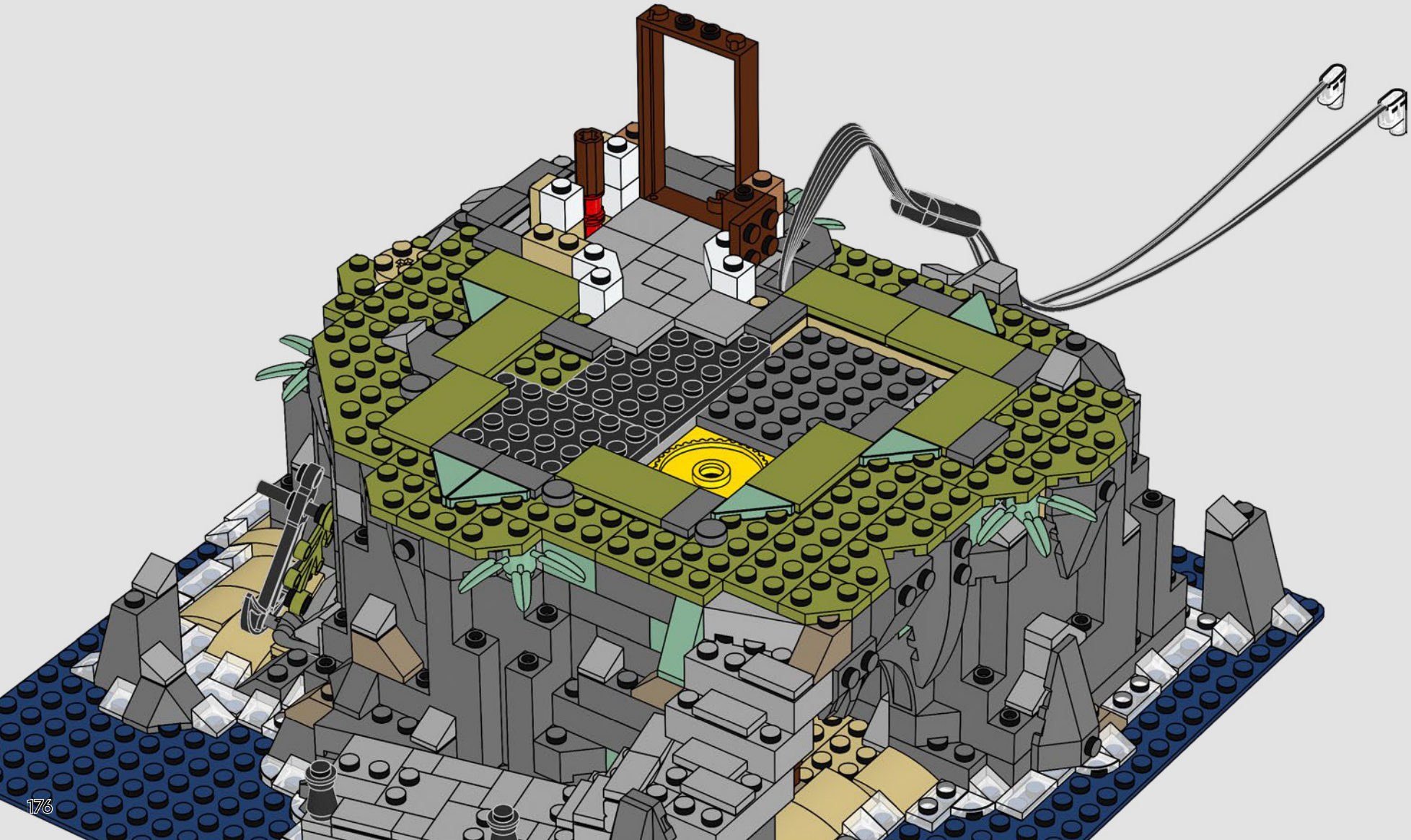

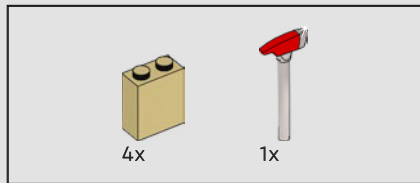

195

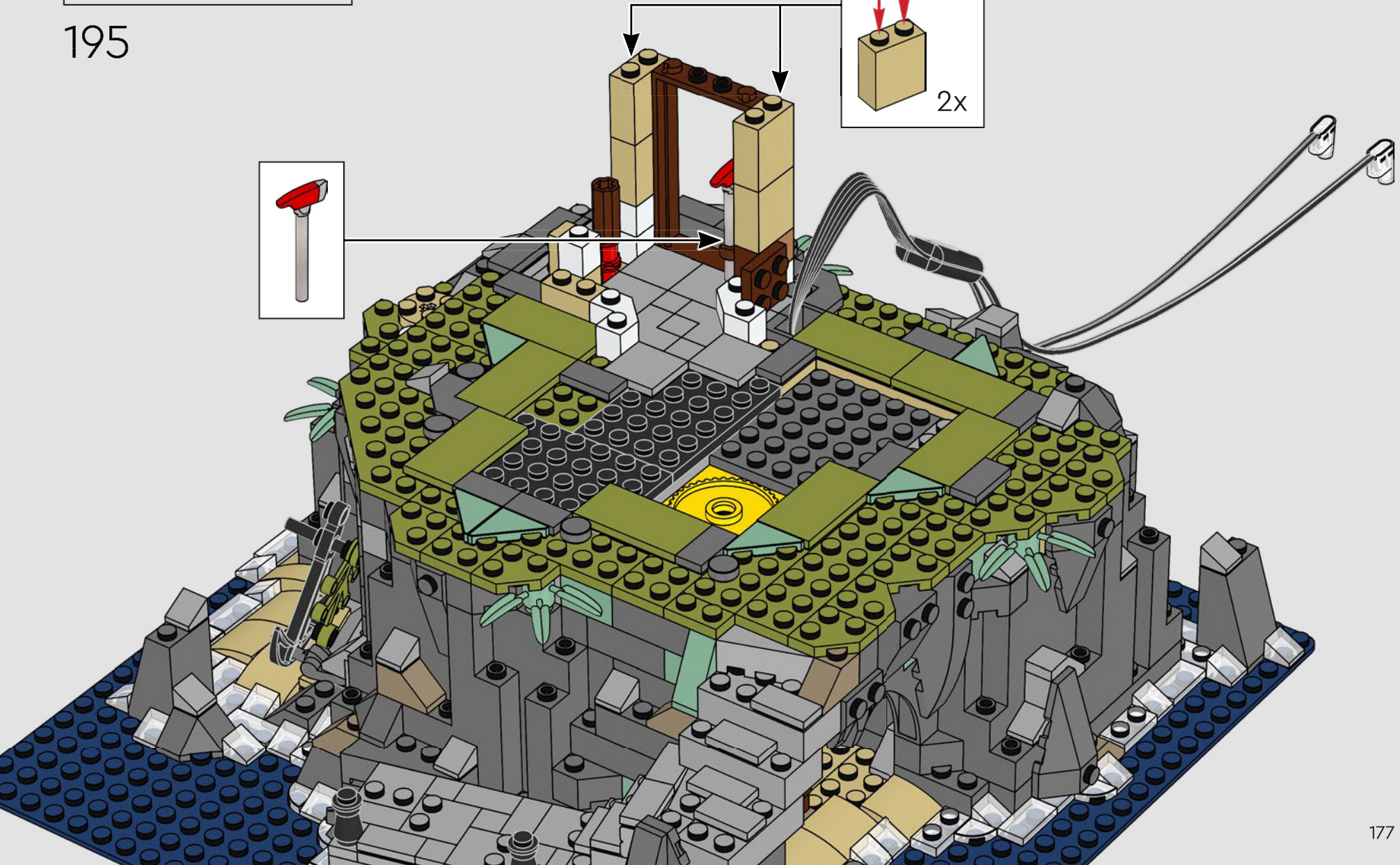
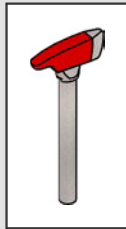
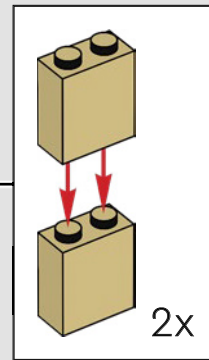



1x

196

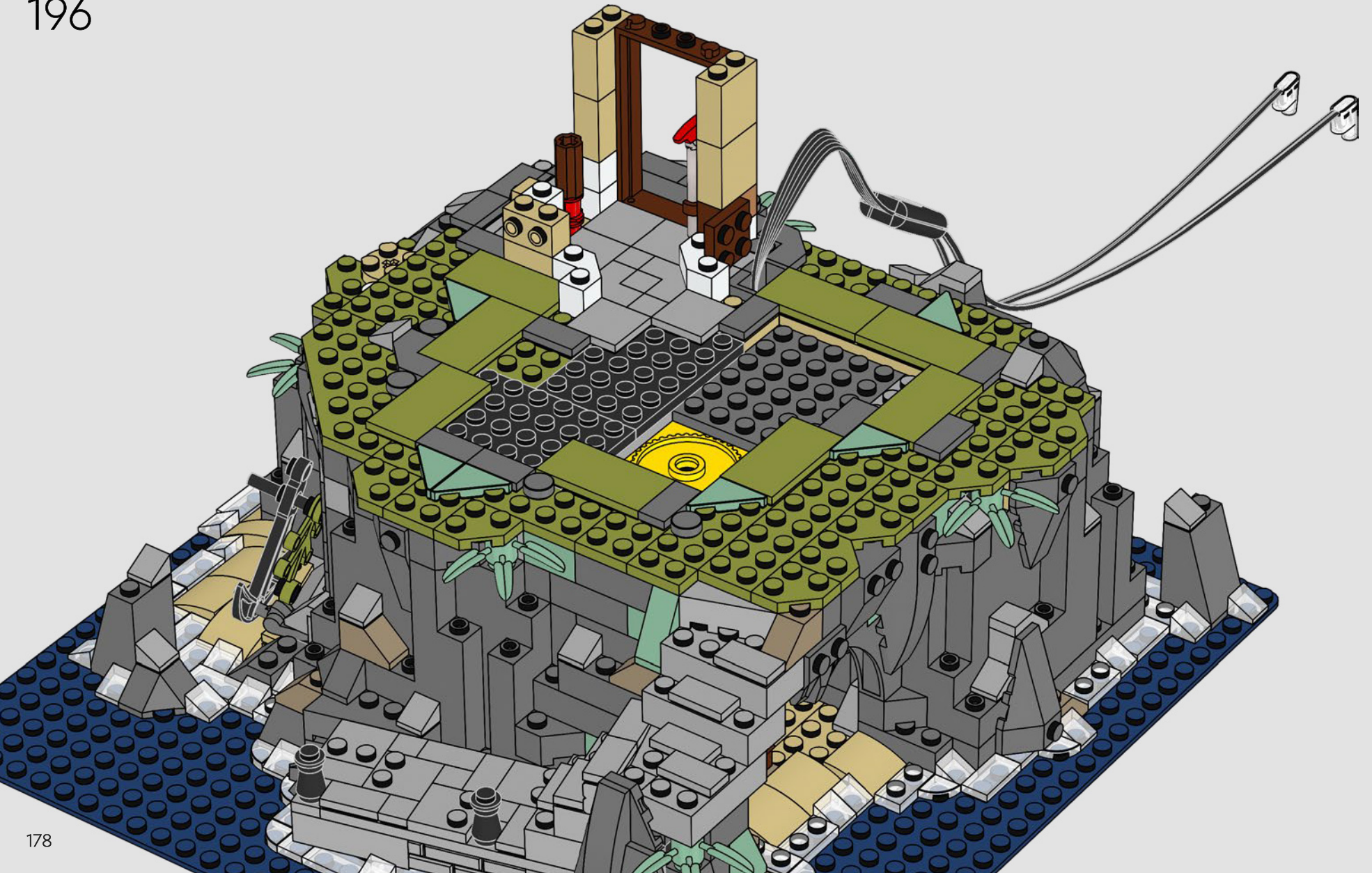

178

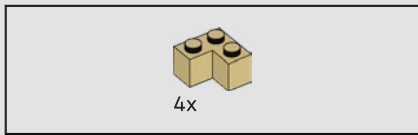

197

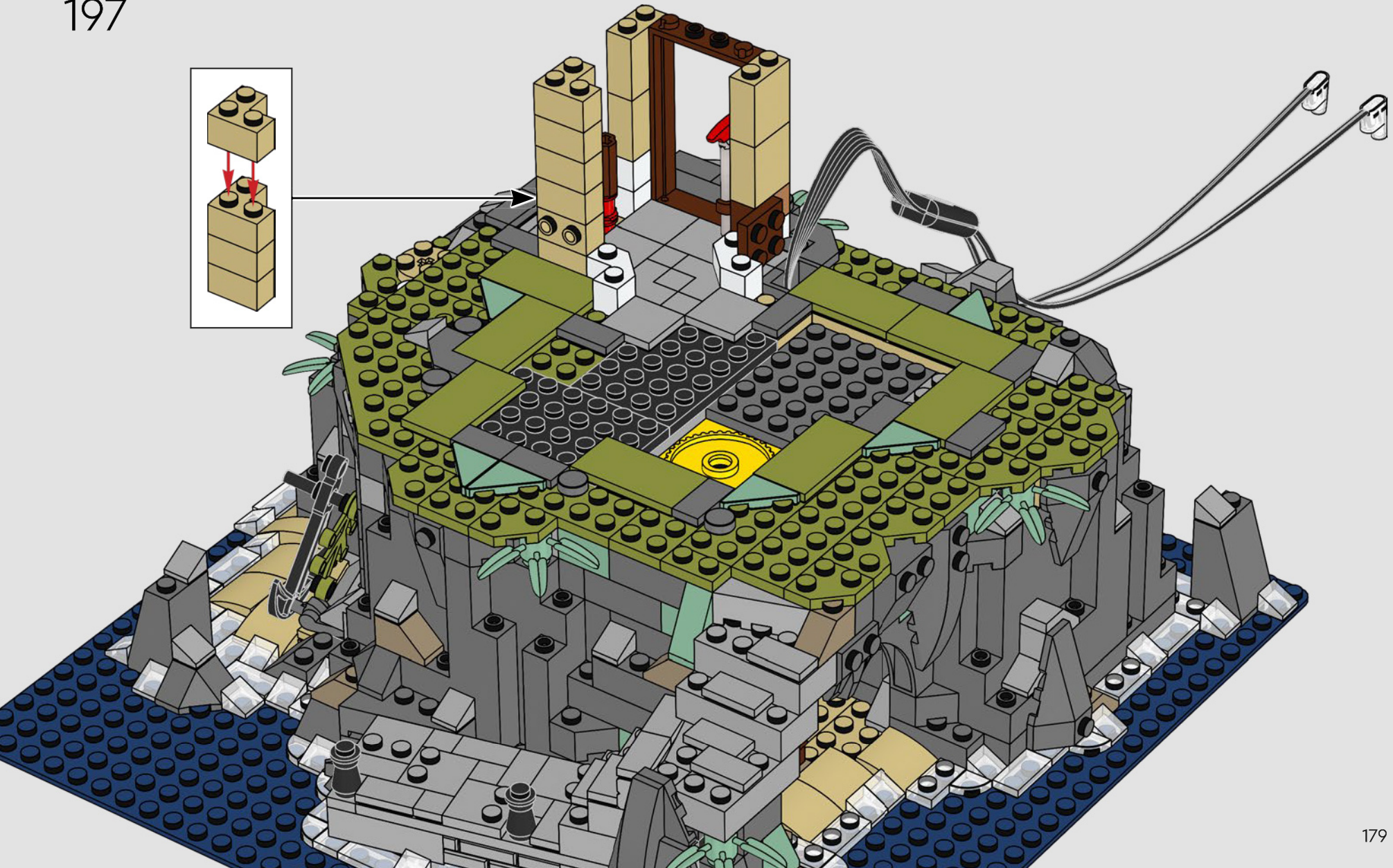
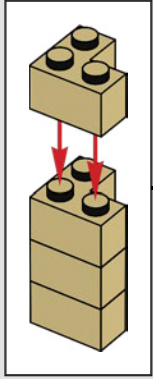

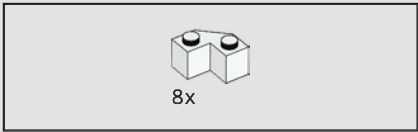



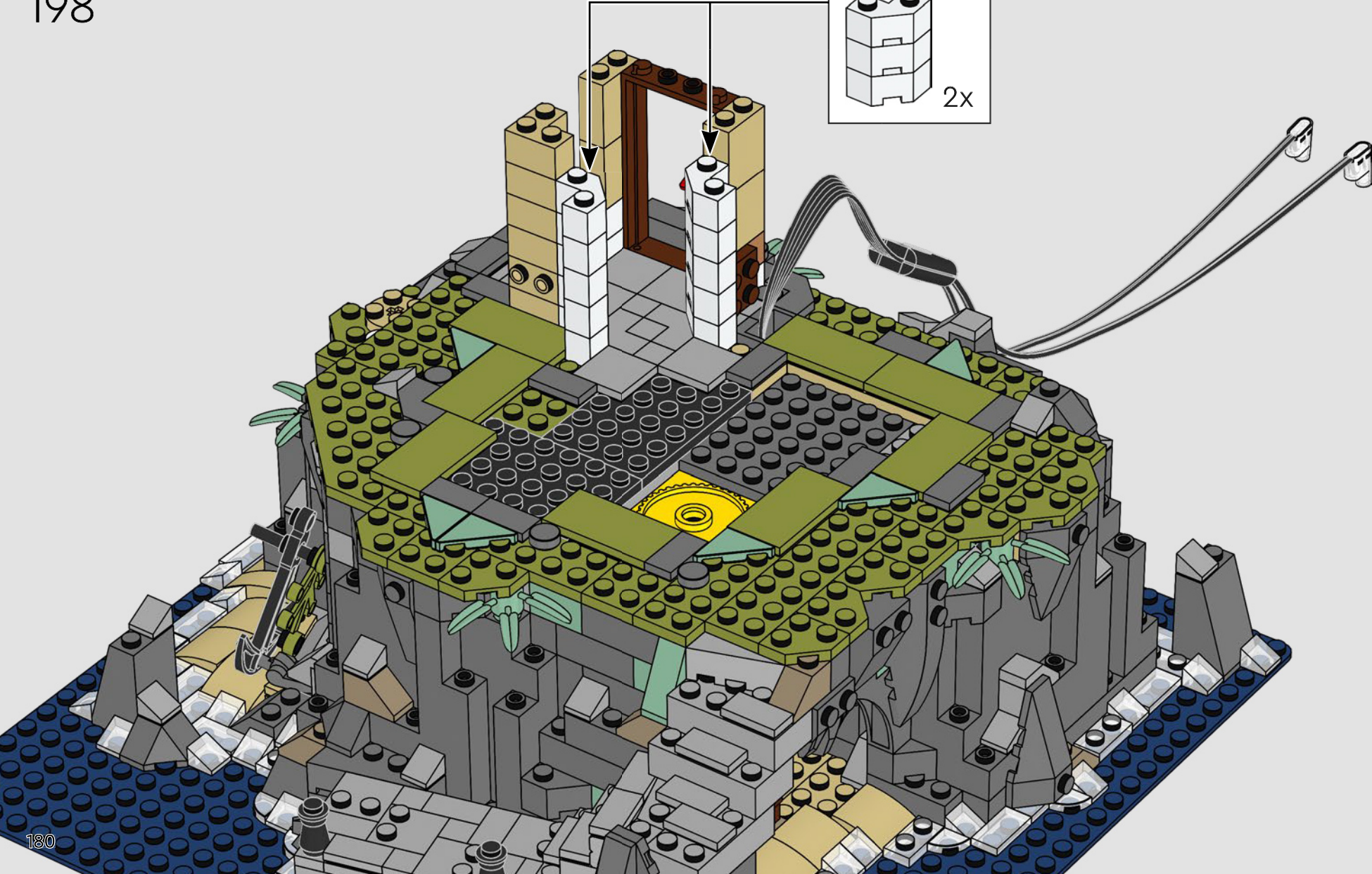
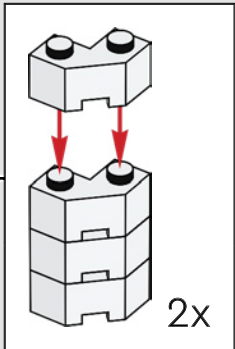

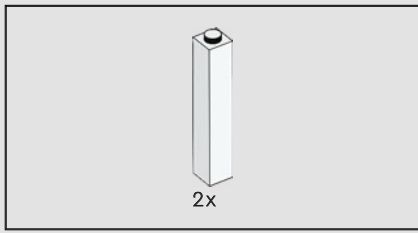
198



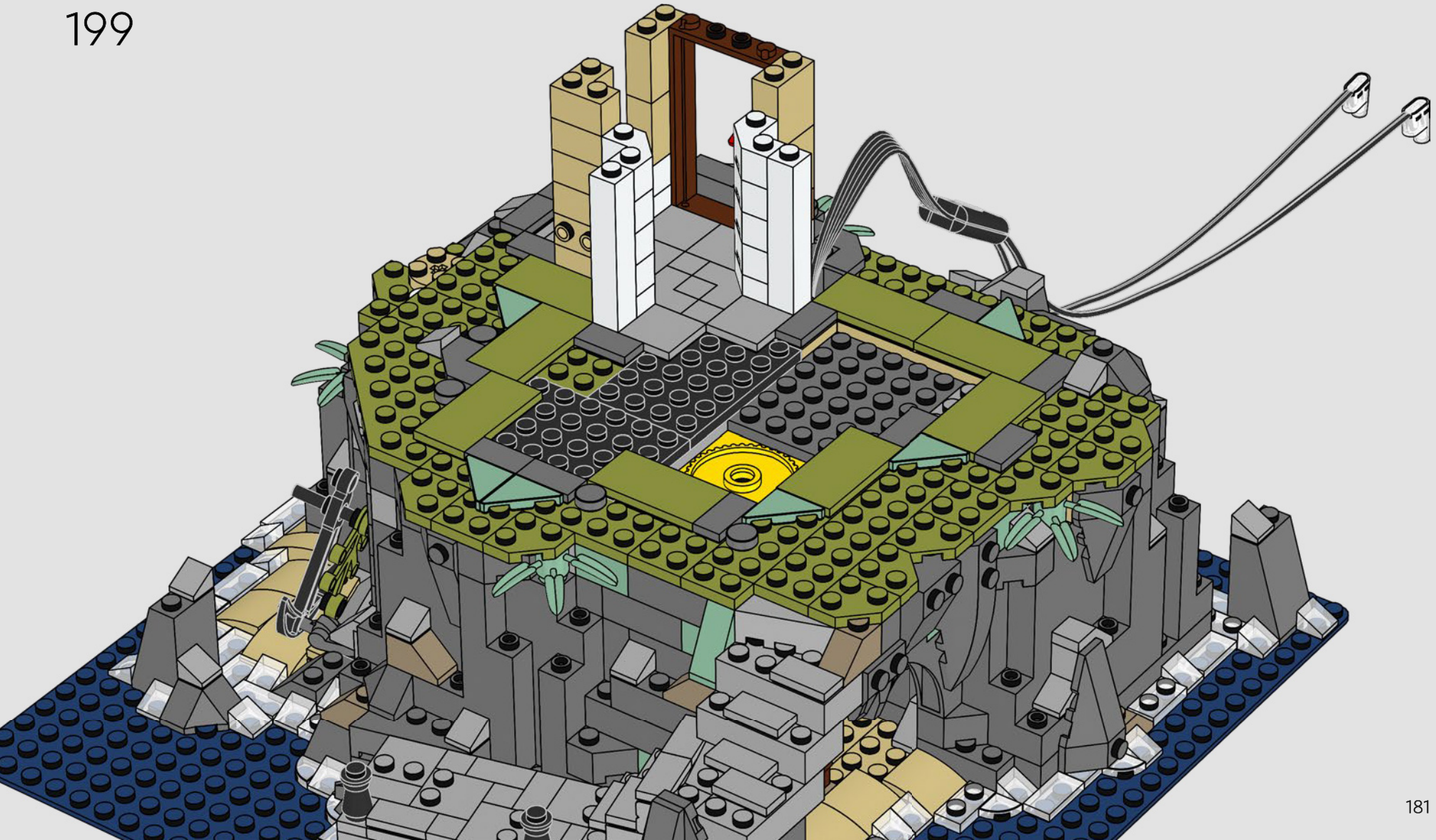

199



		
1x	2x	1x

200

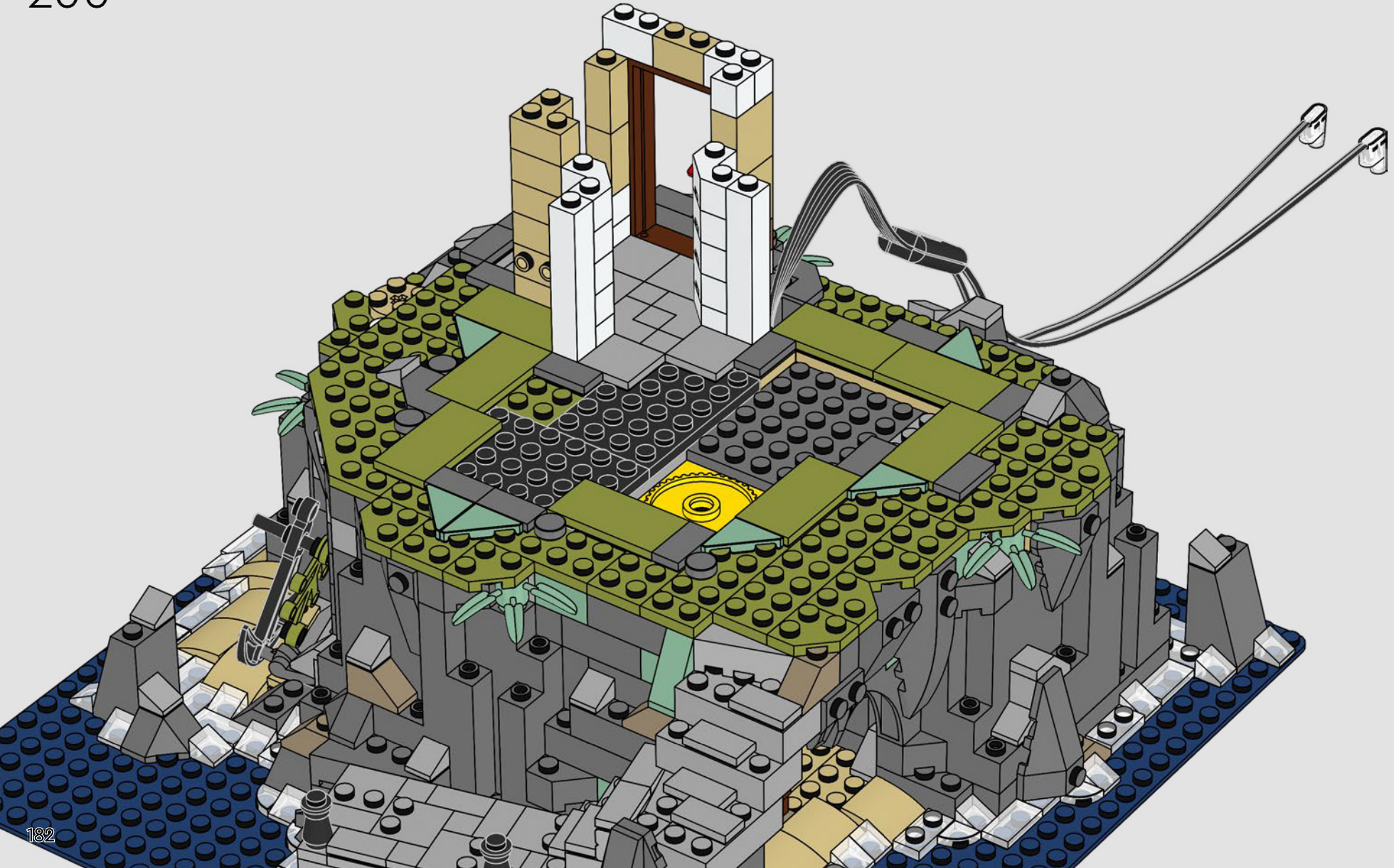

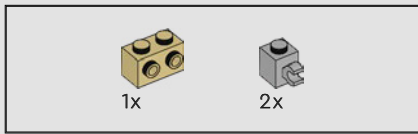

201

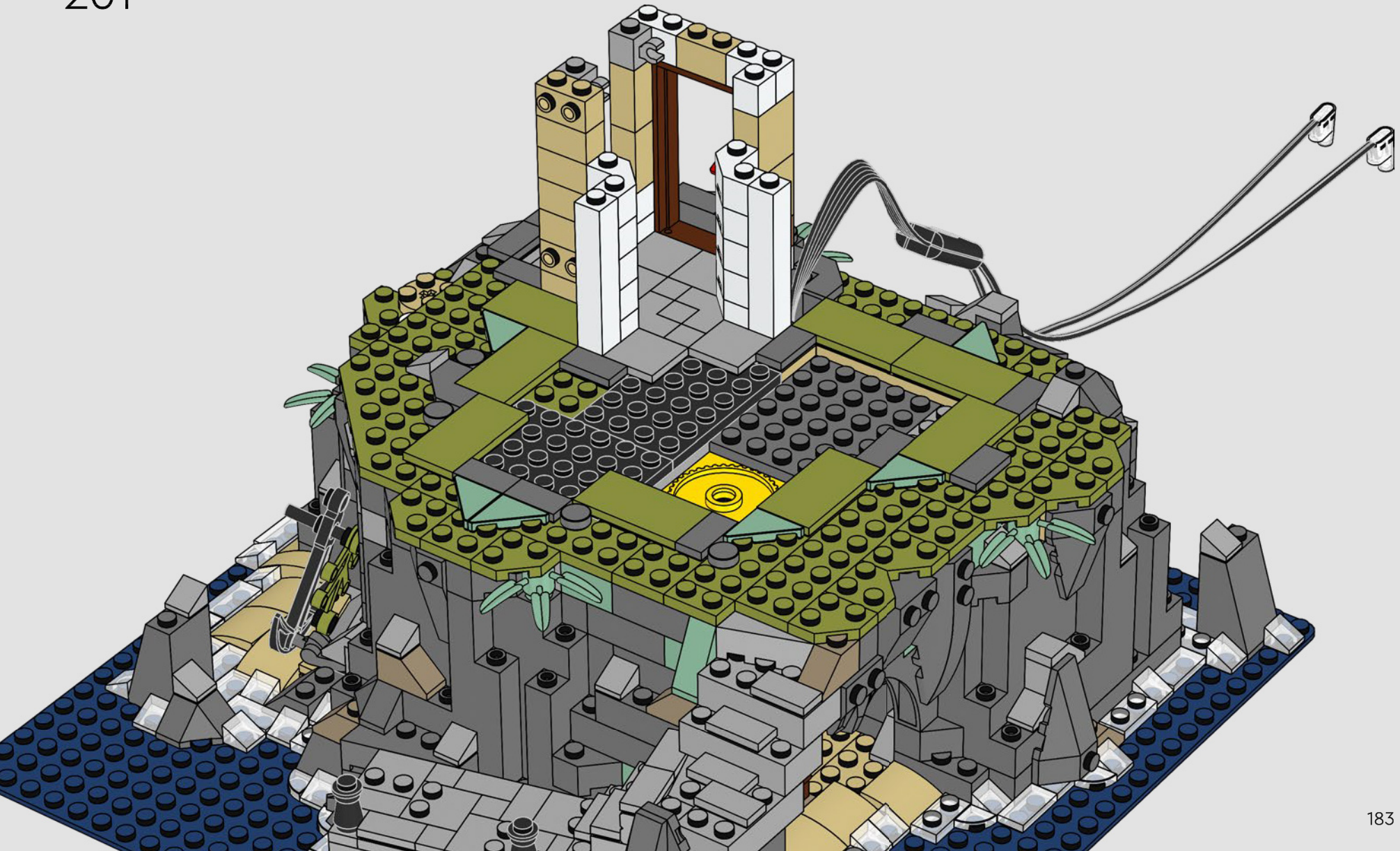



2x

202

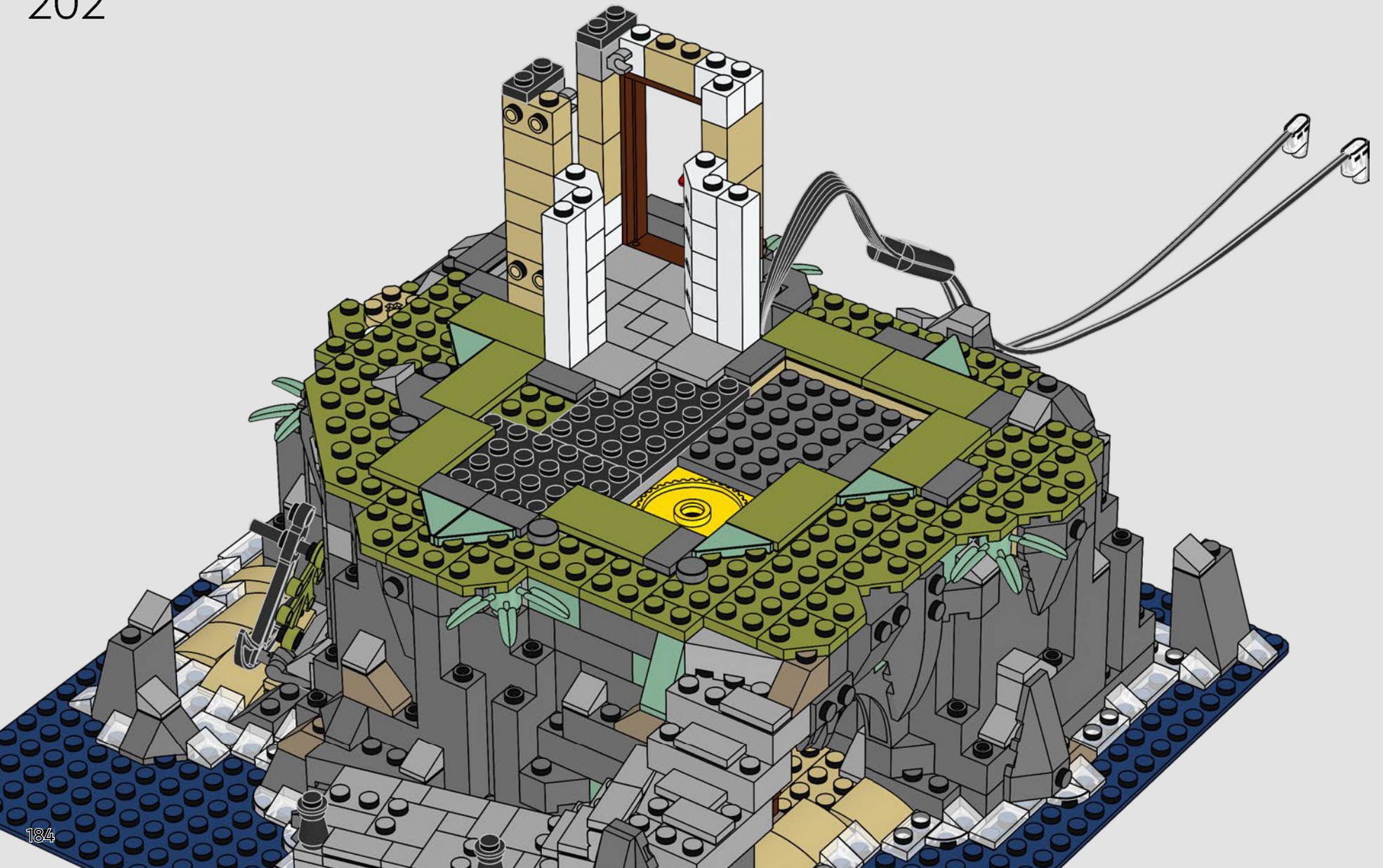

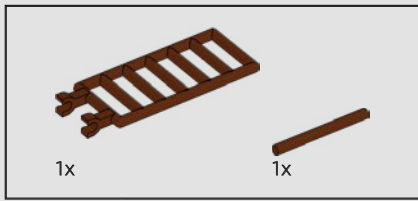

203

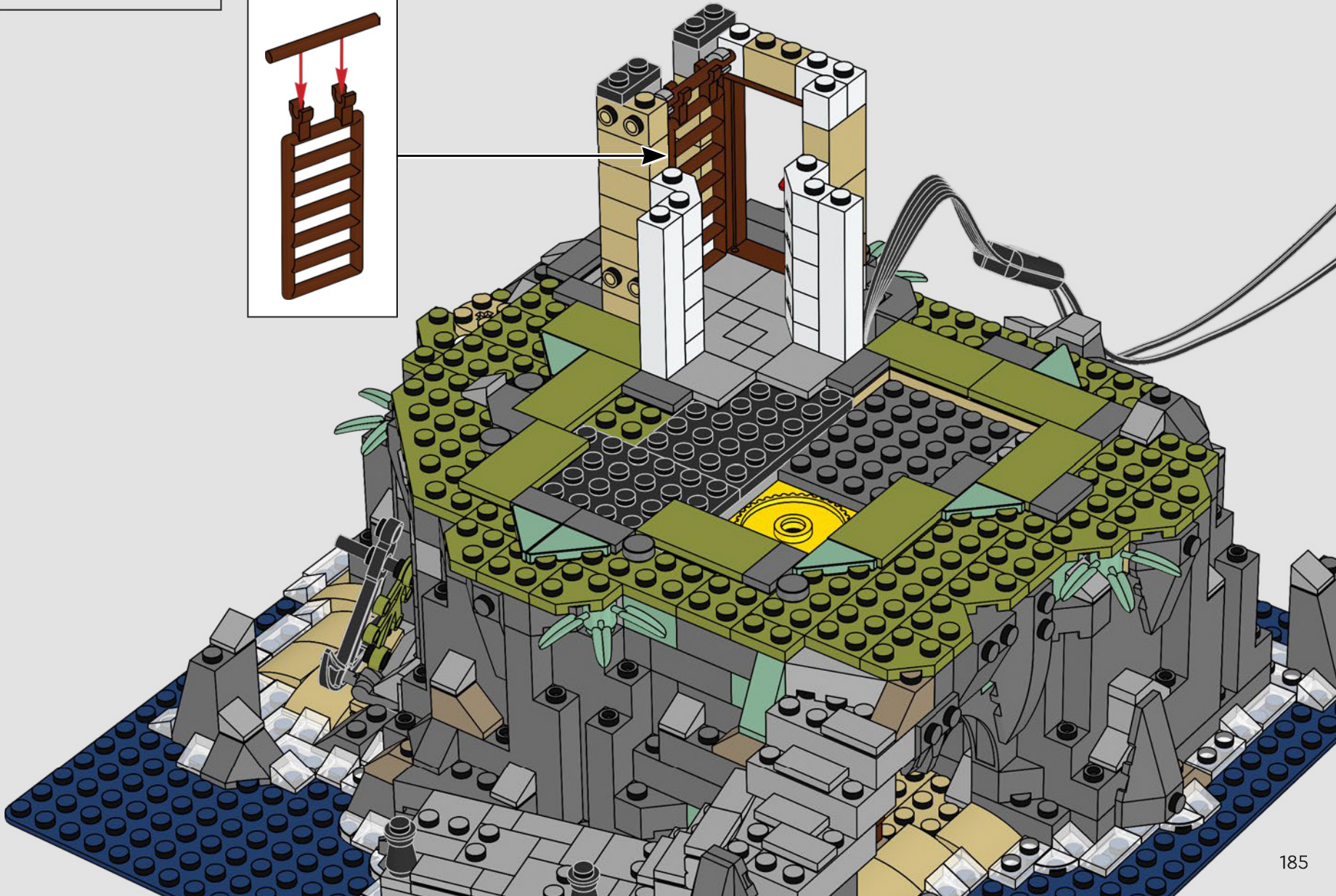
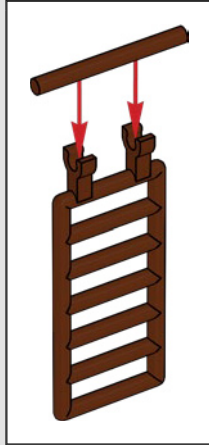

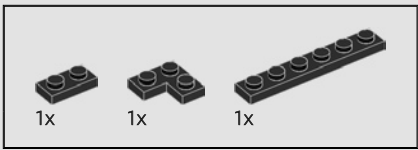

204

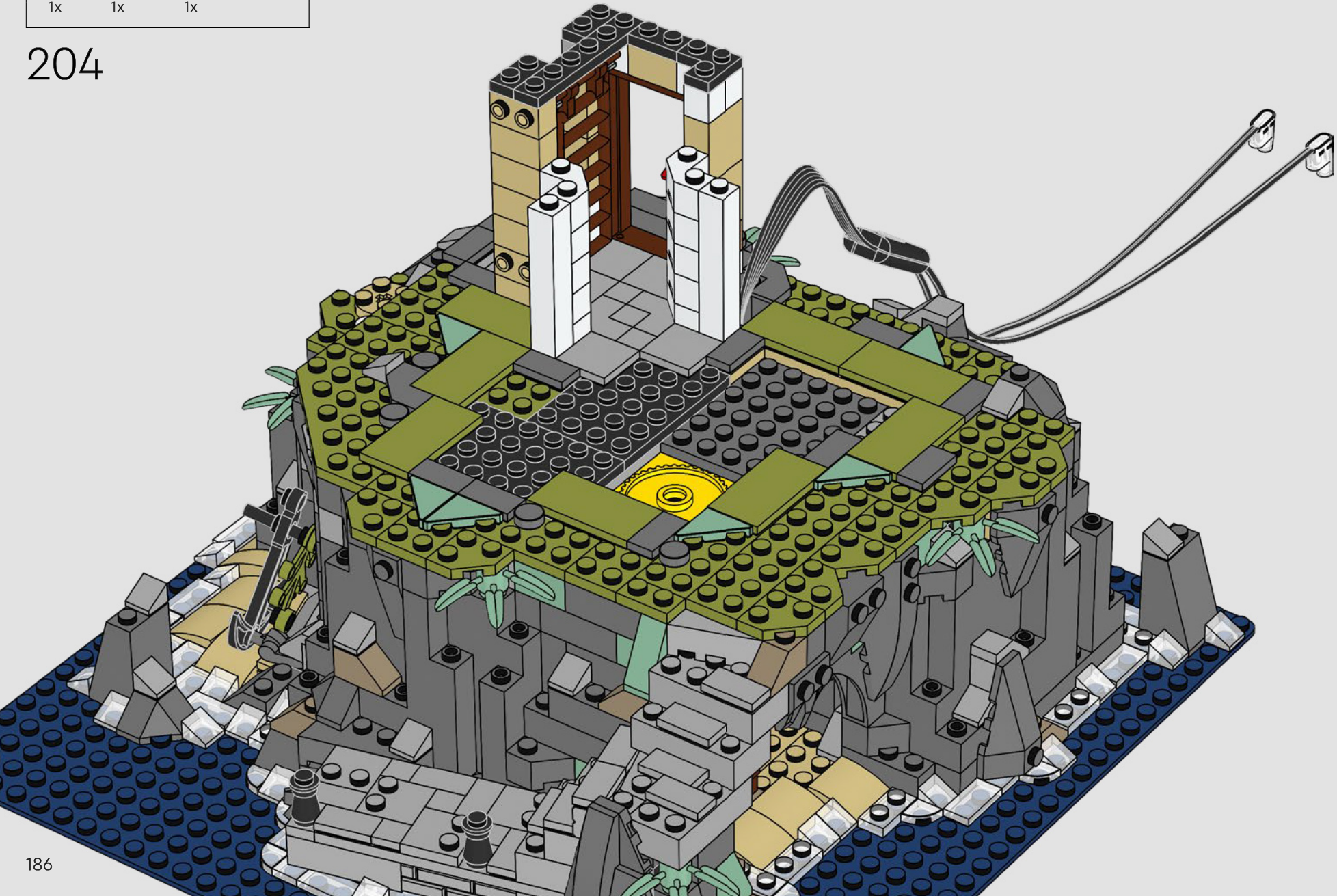

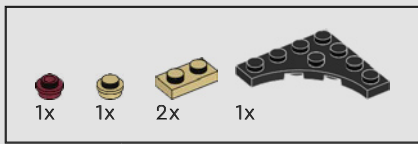

205

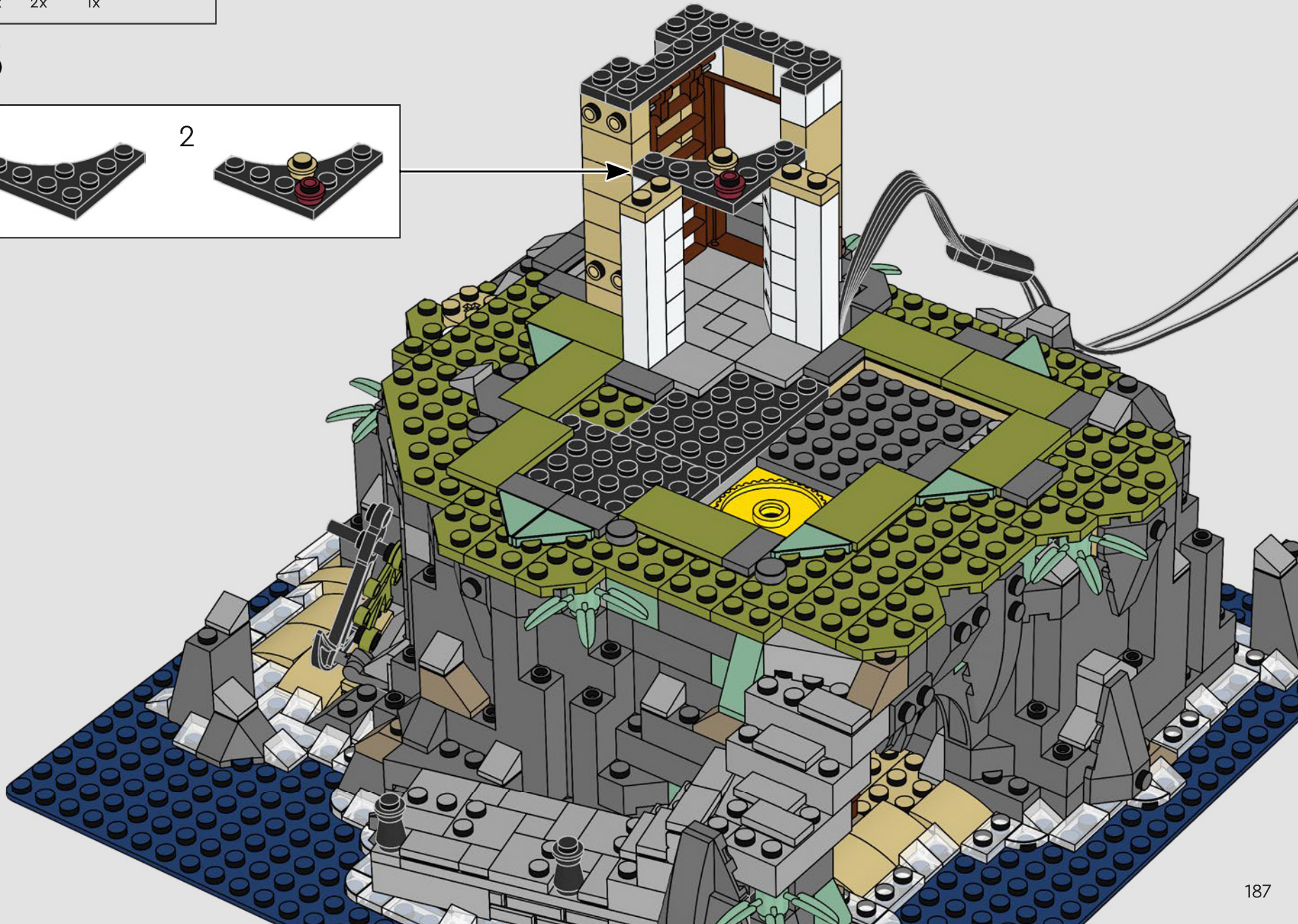
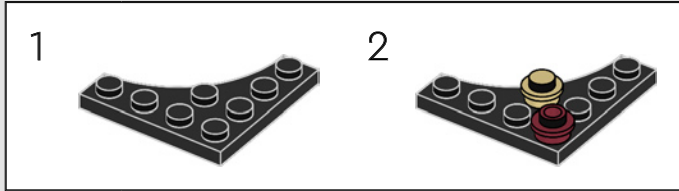

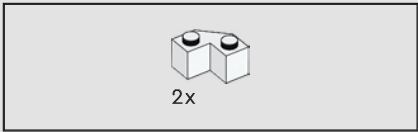

206

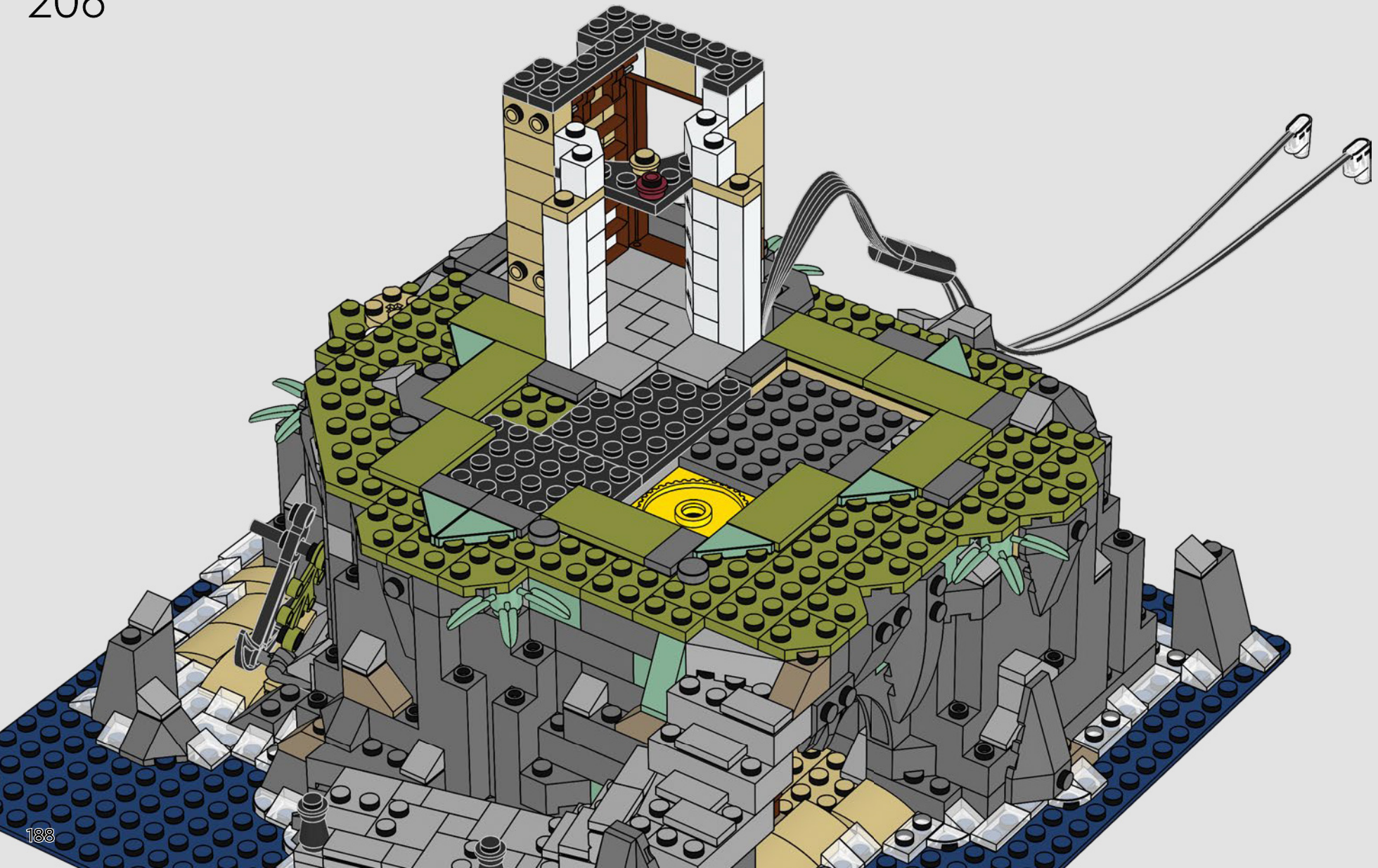



207

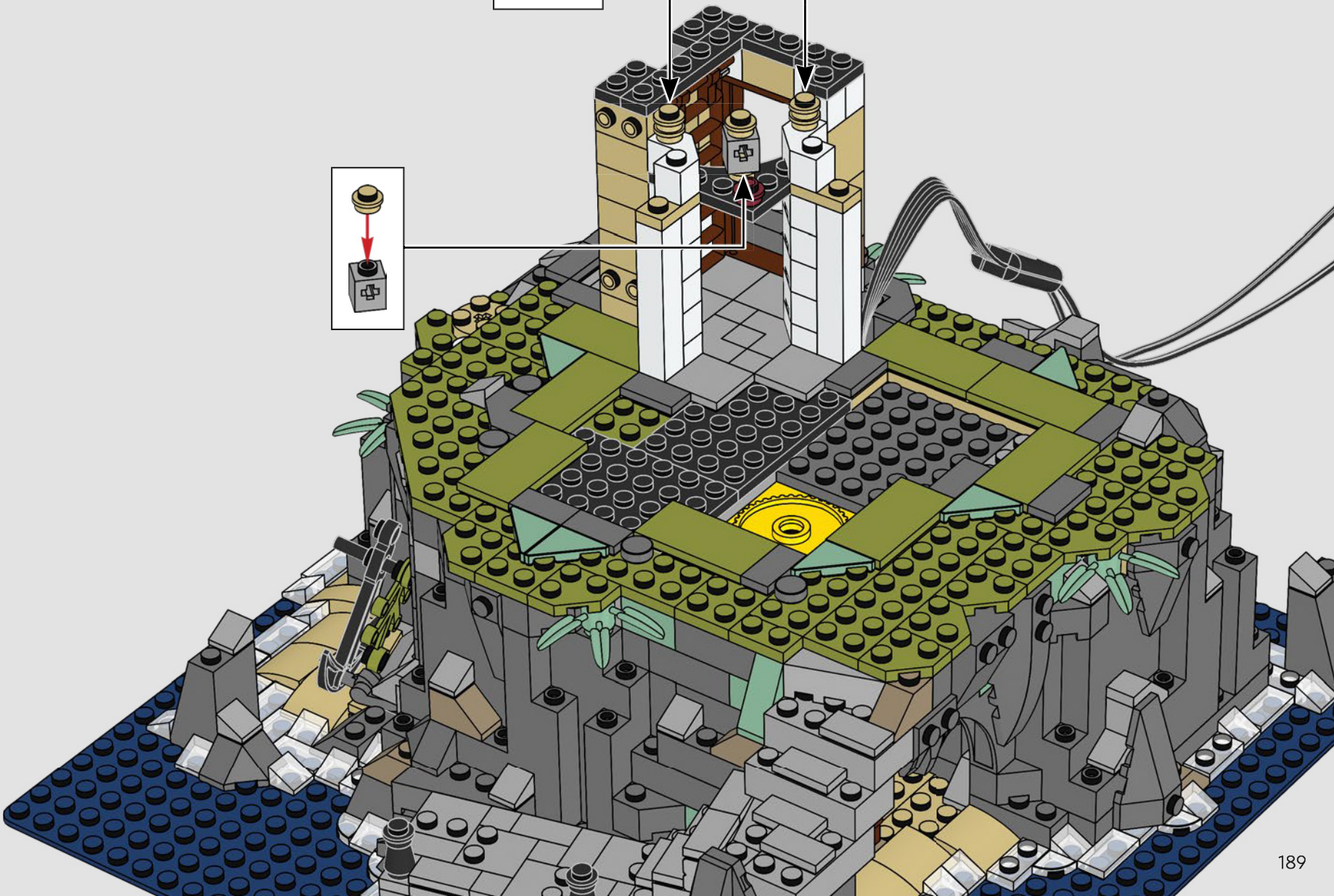
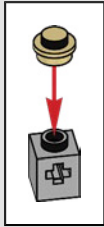
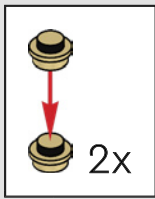

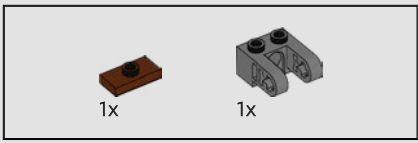

208

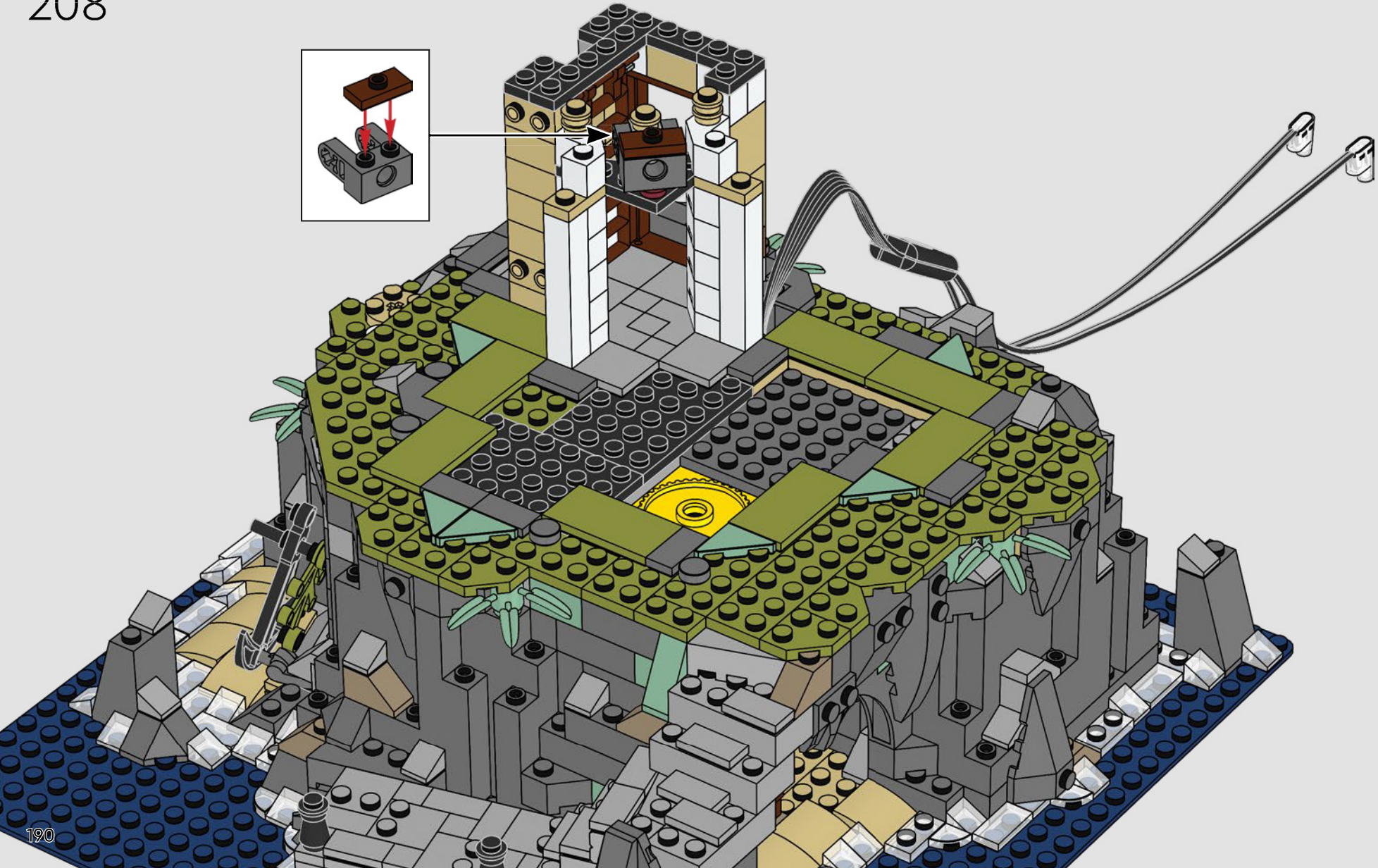
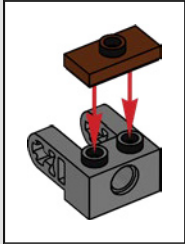

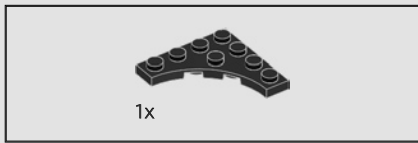

209

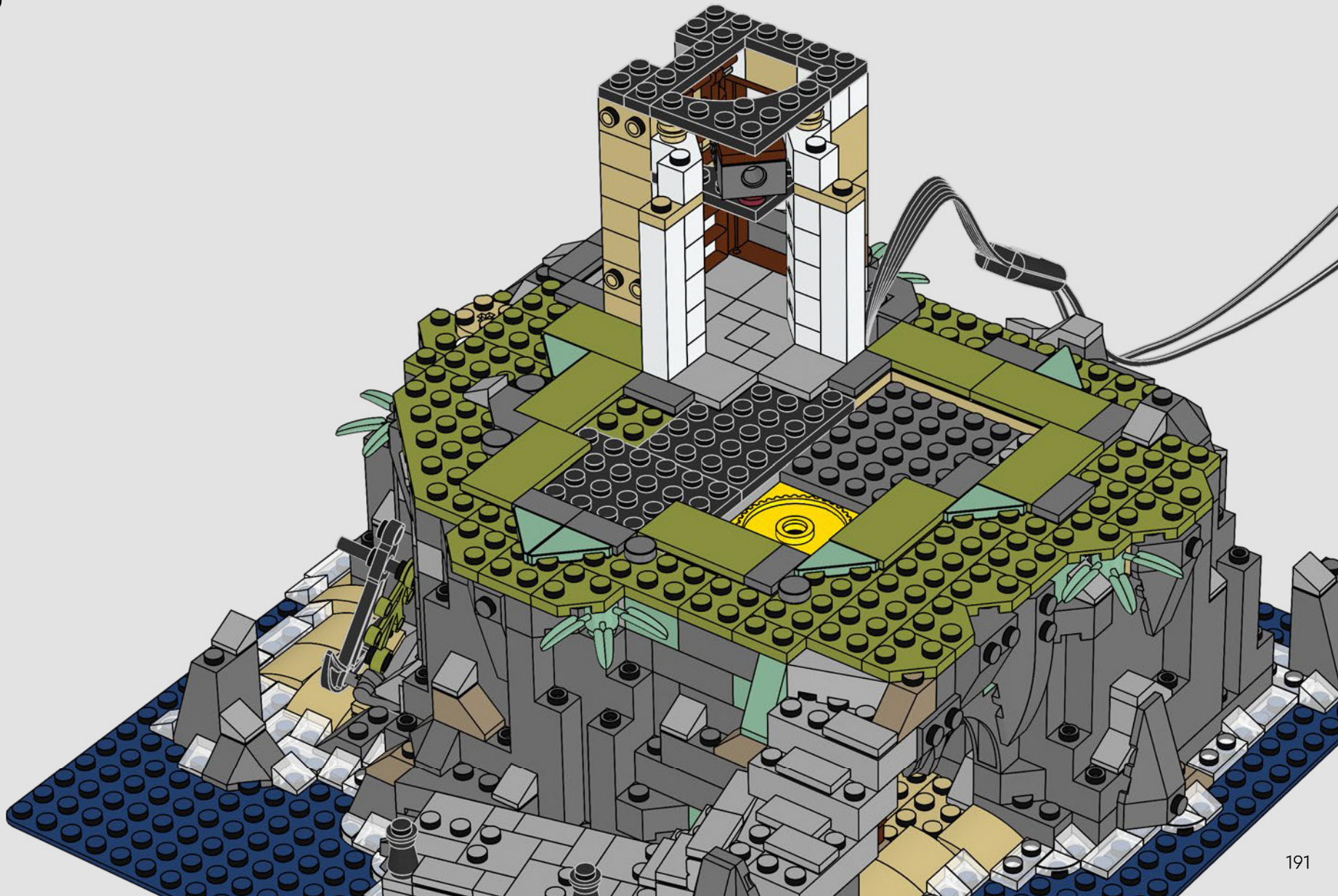

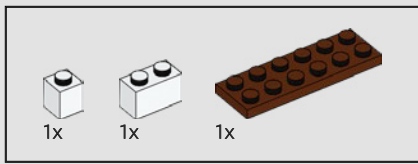

210

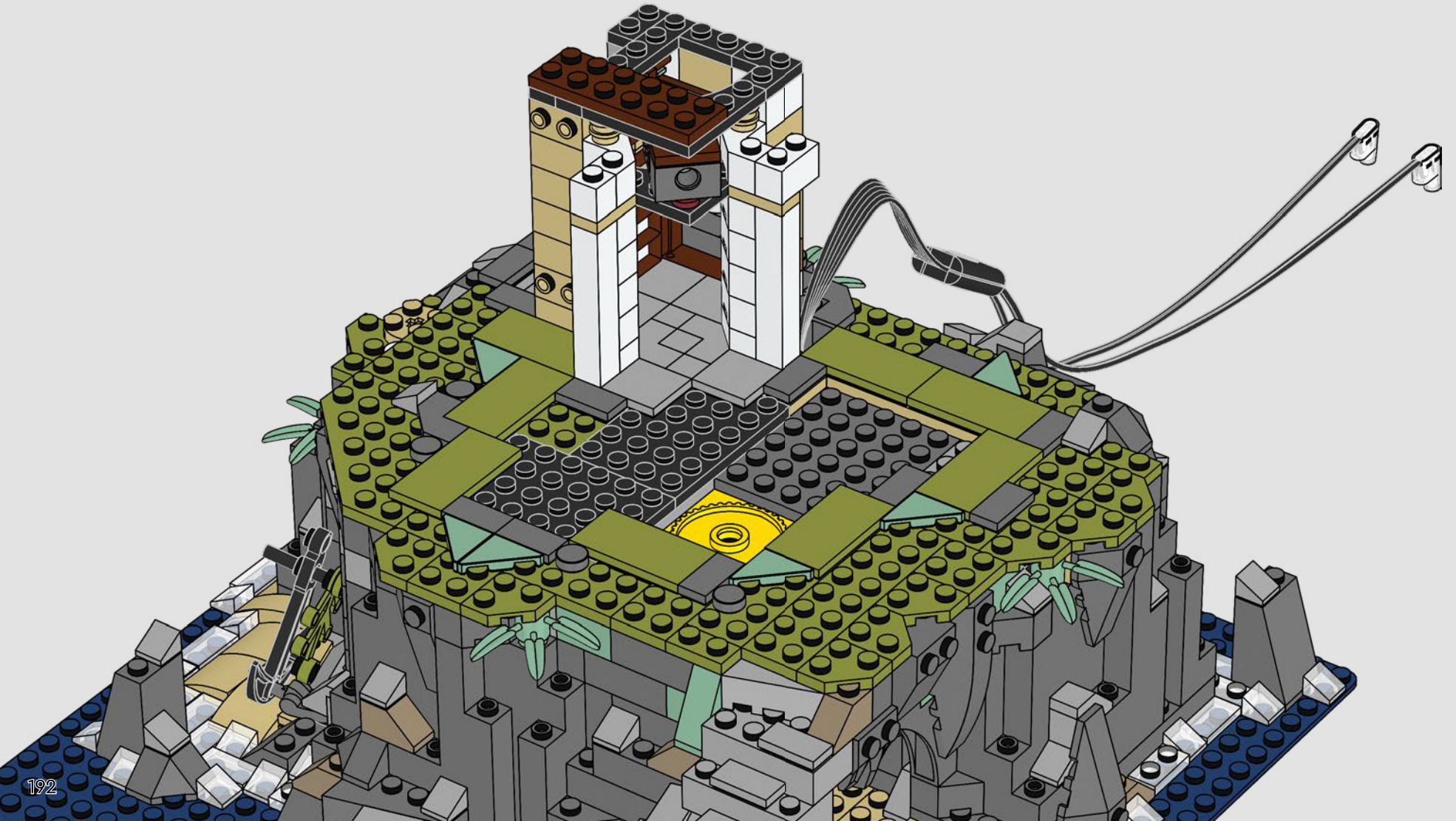

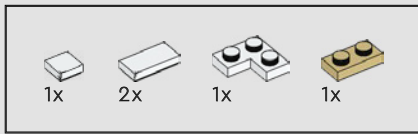

211

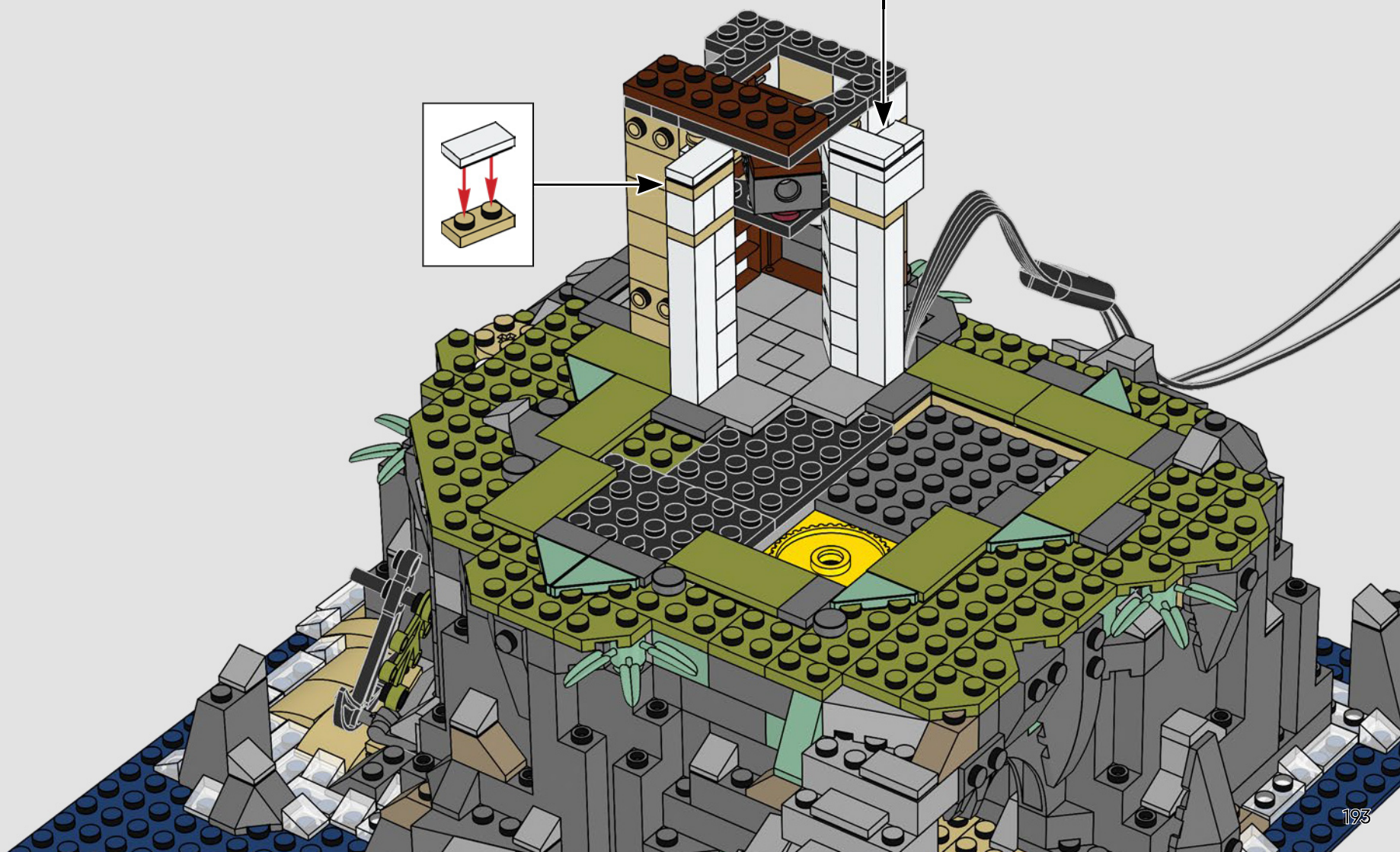
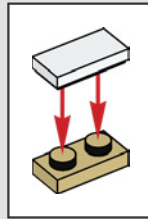
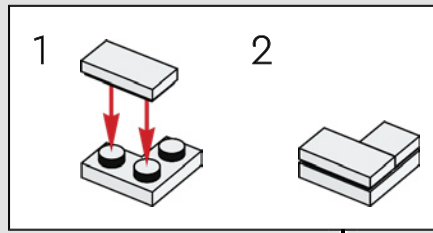

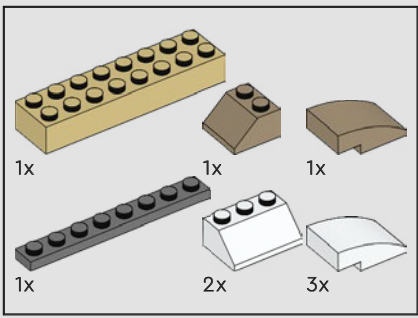

212

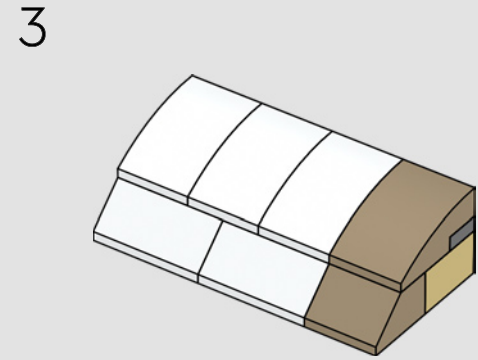
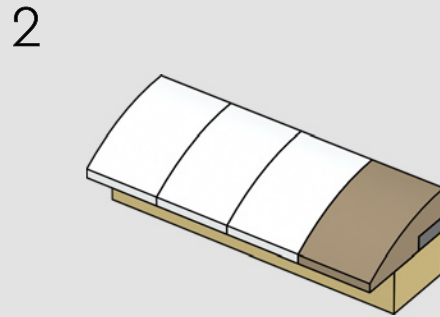
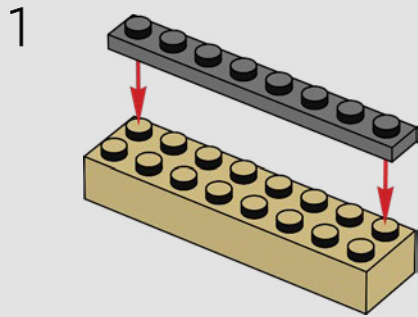



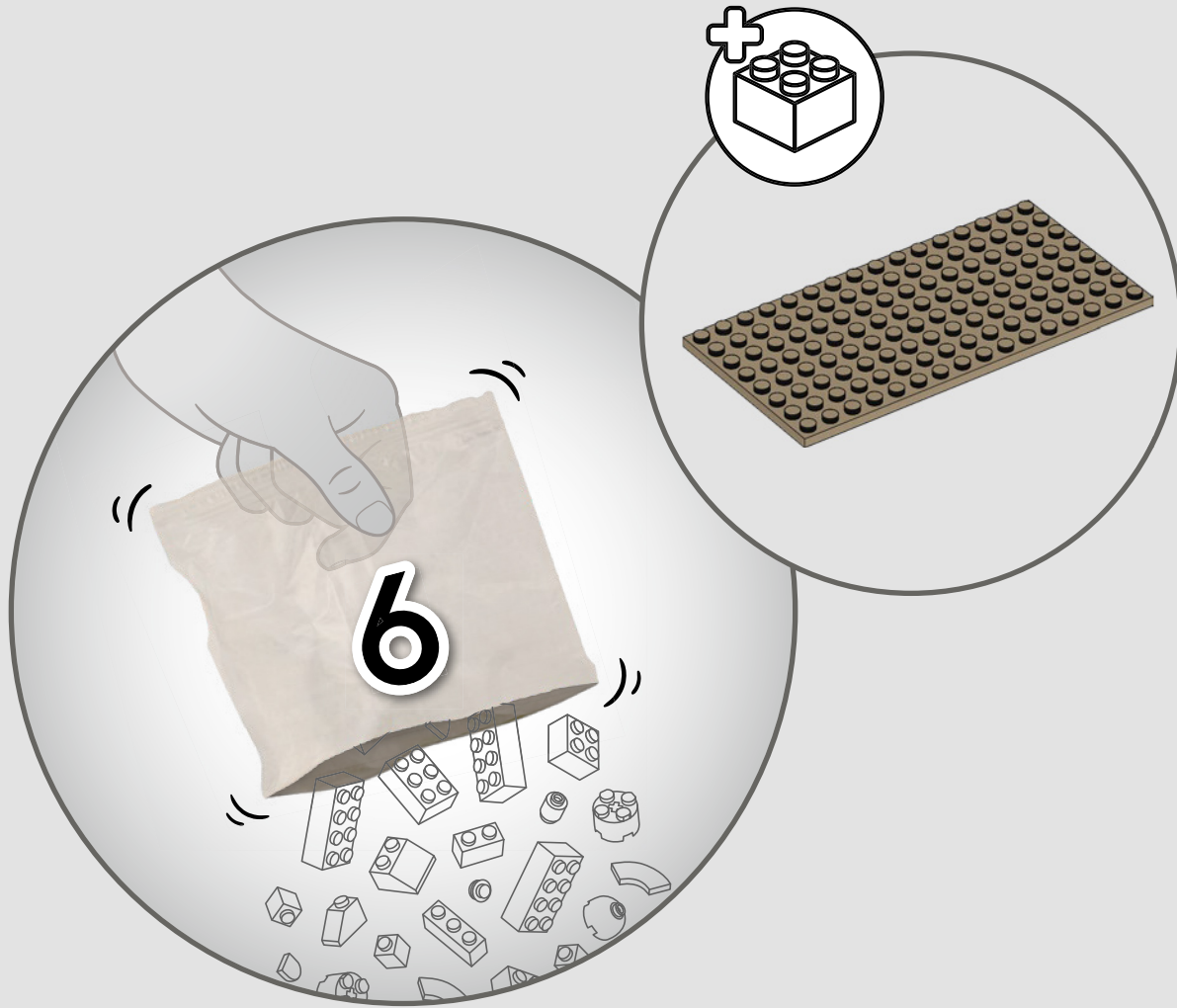

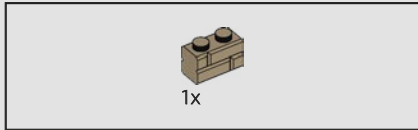
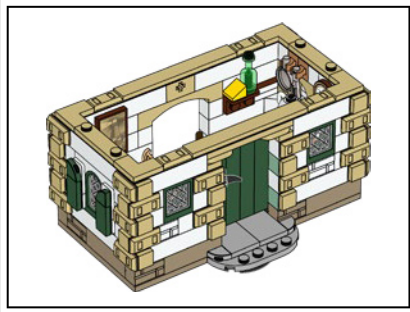

213

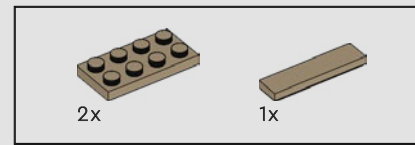
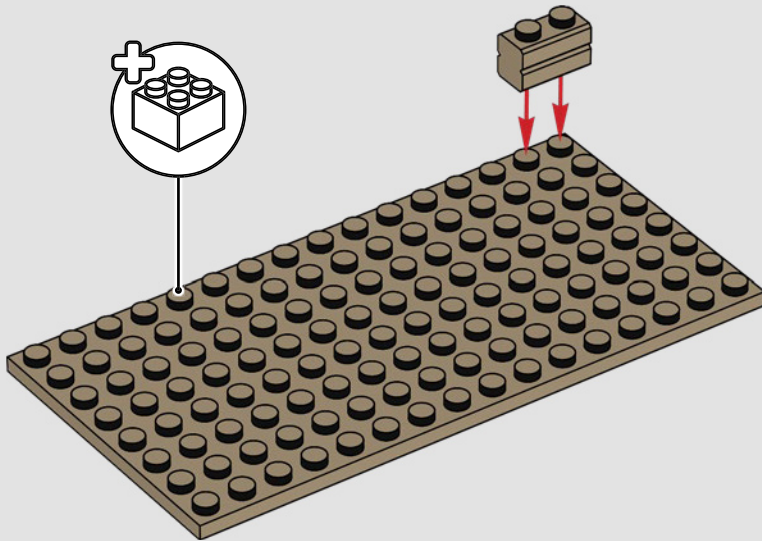

214

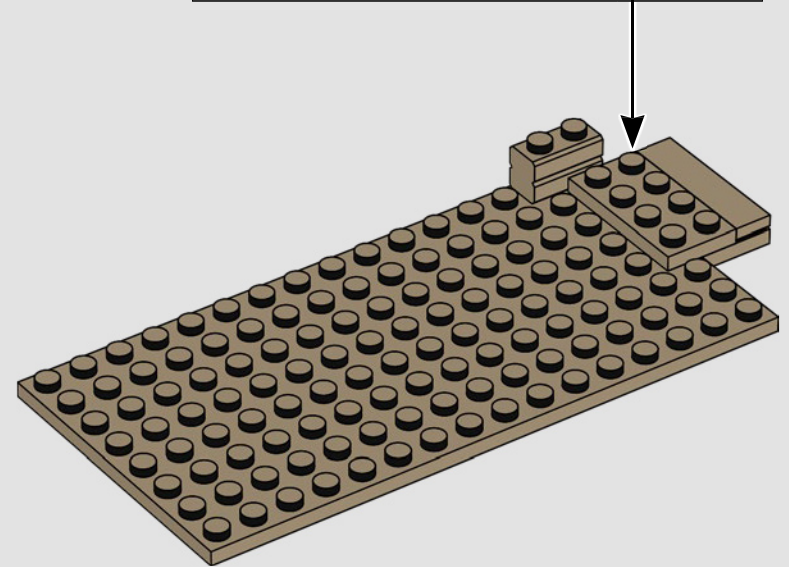
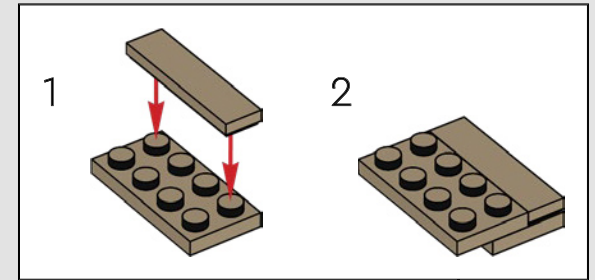

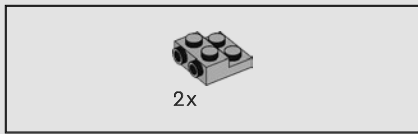

215

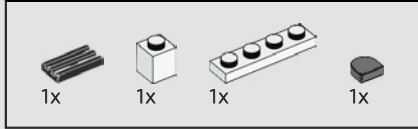
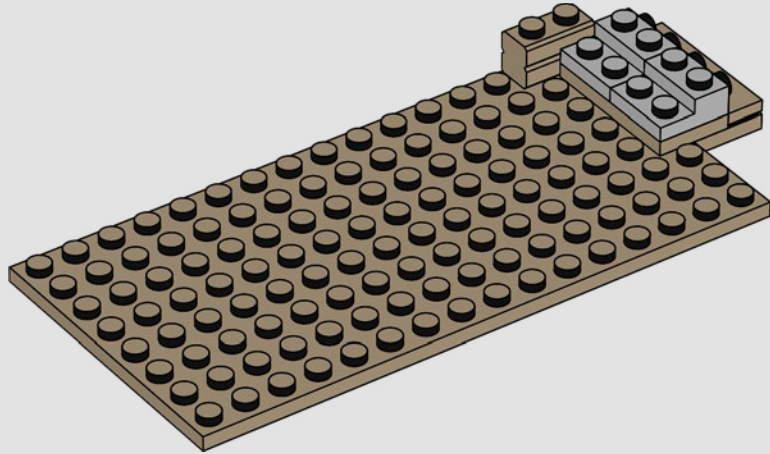

216

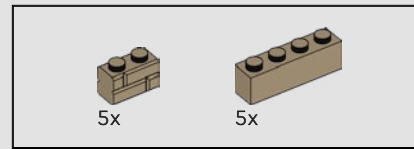
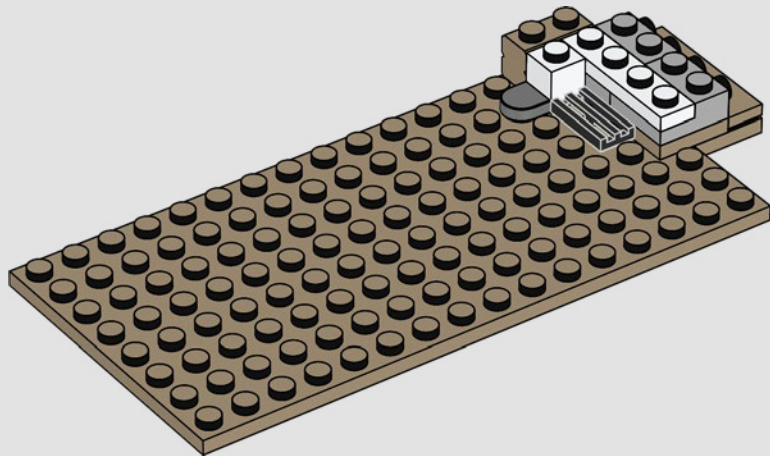

217

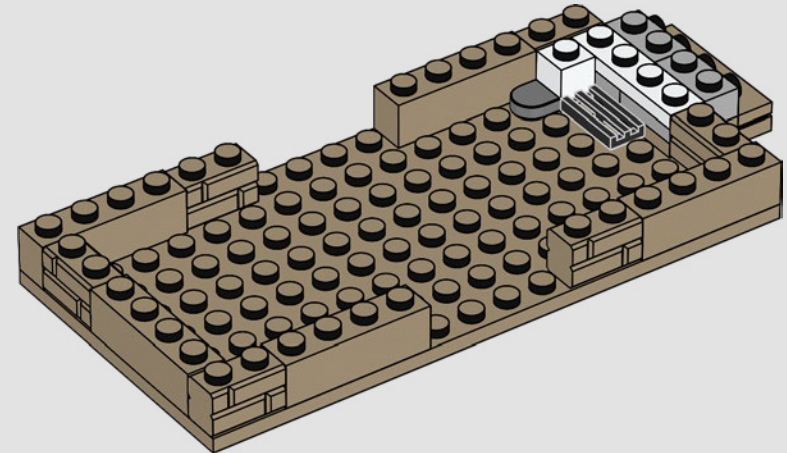

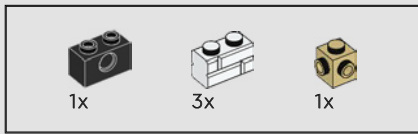

218

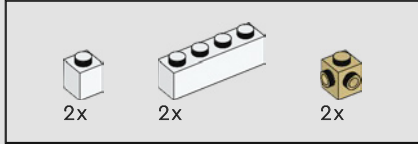
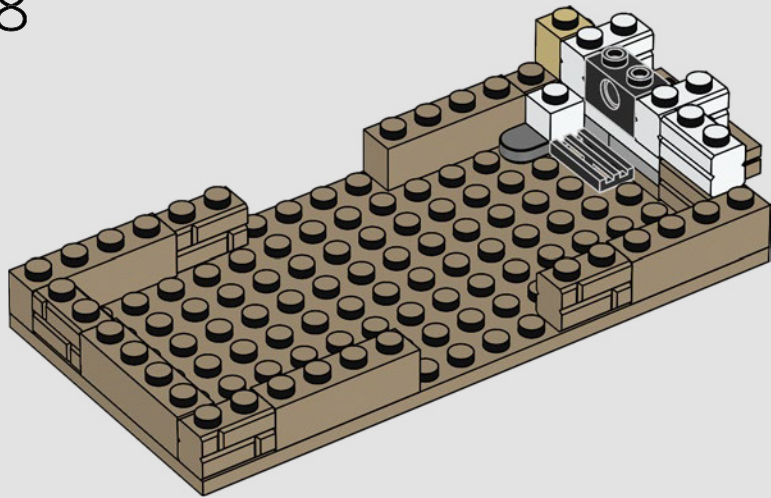

219

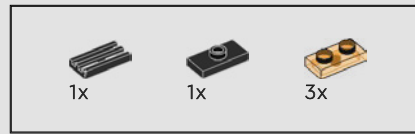
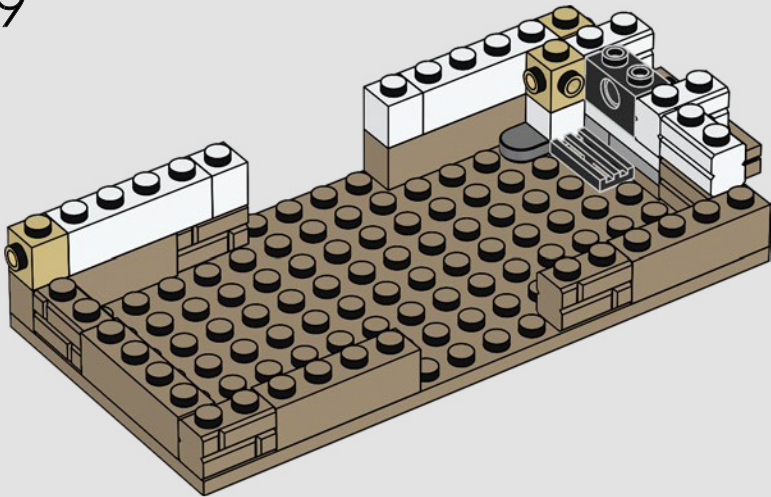

220

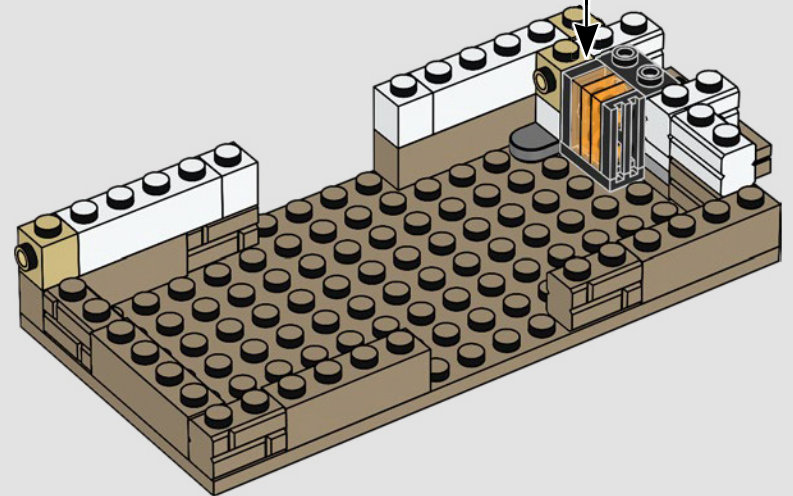
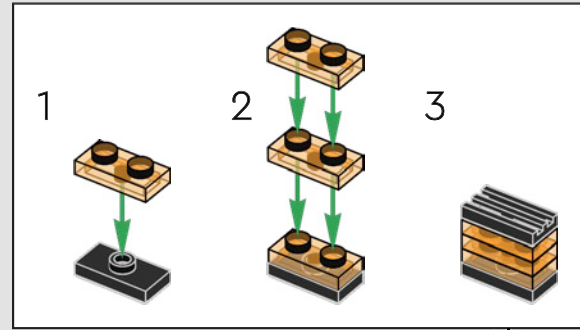



221

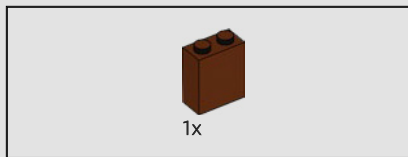
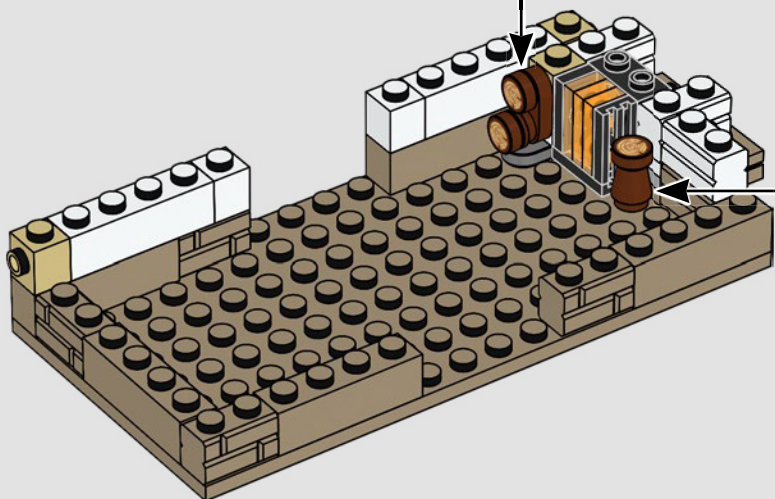
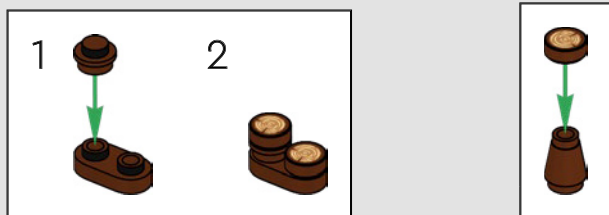

222

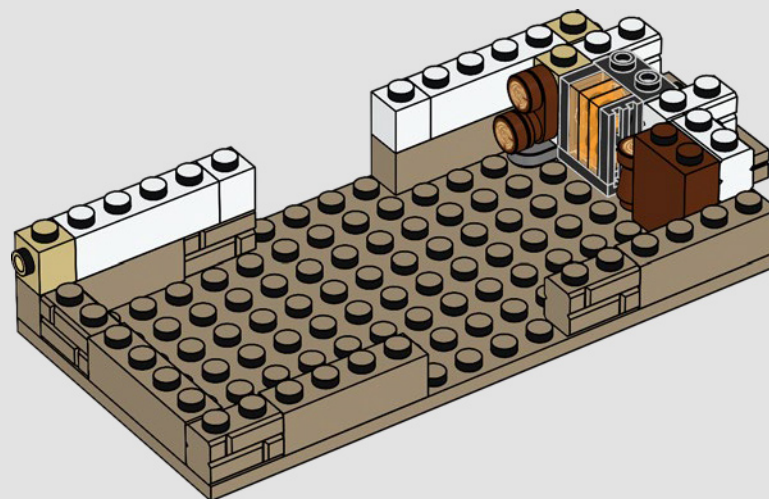

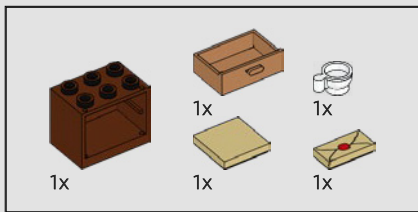

223

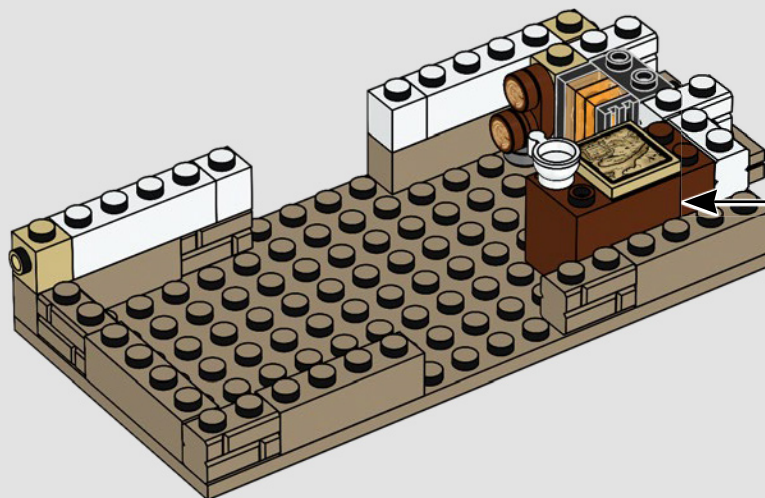
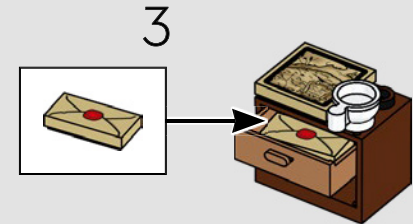
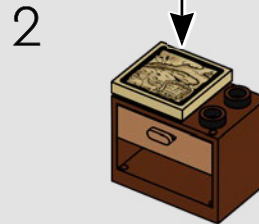
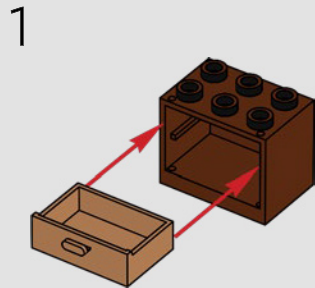
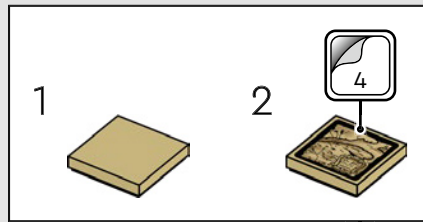

8x

224

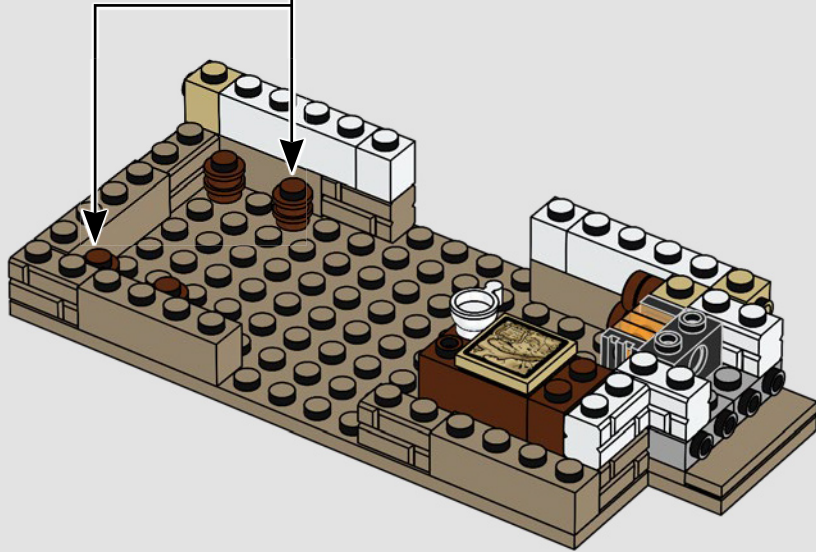
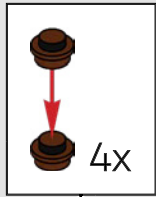

4x

225

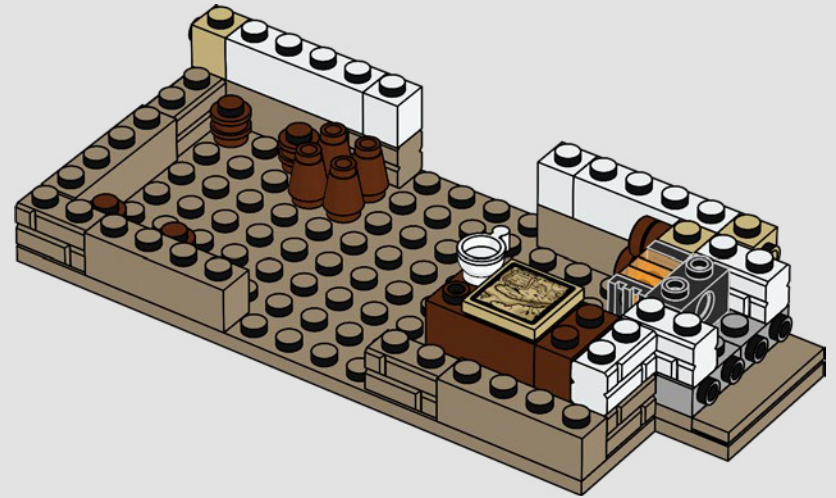

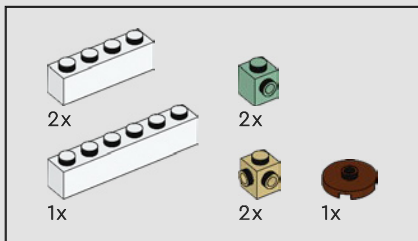

226

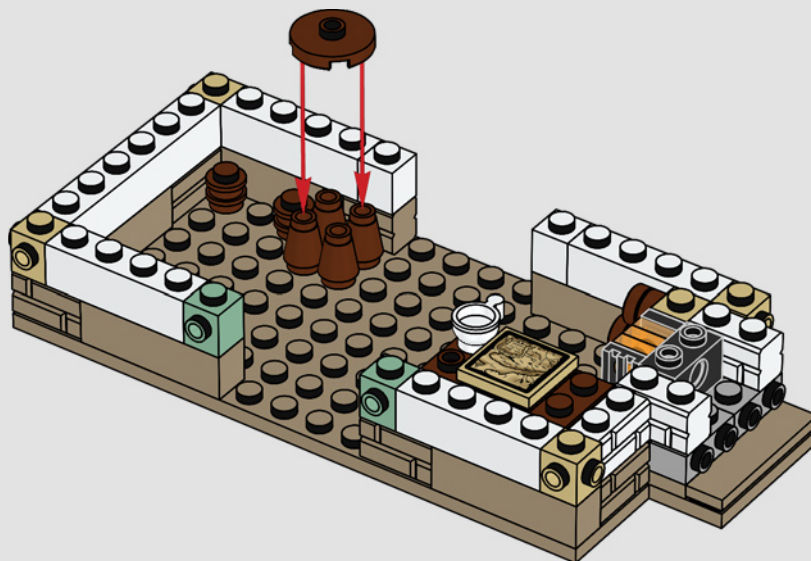

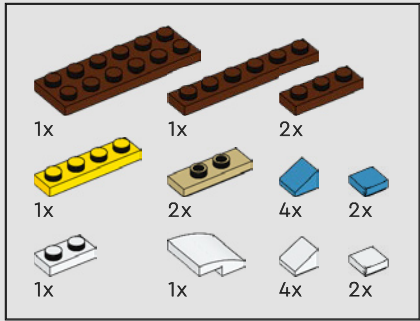

227

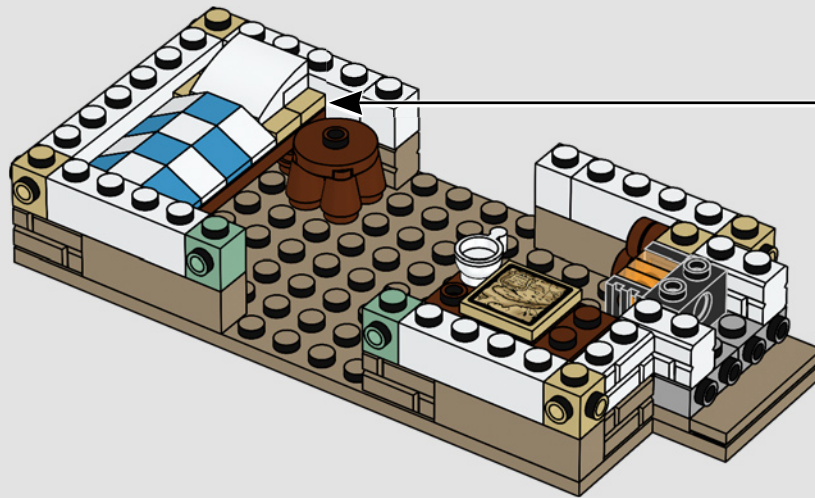
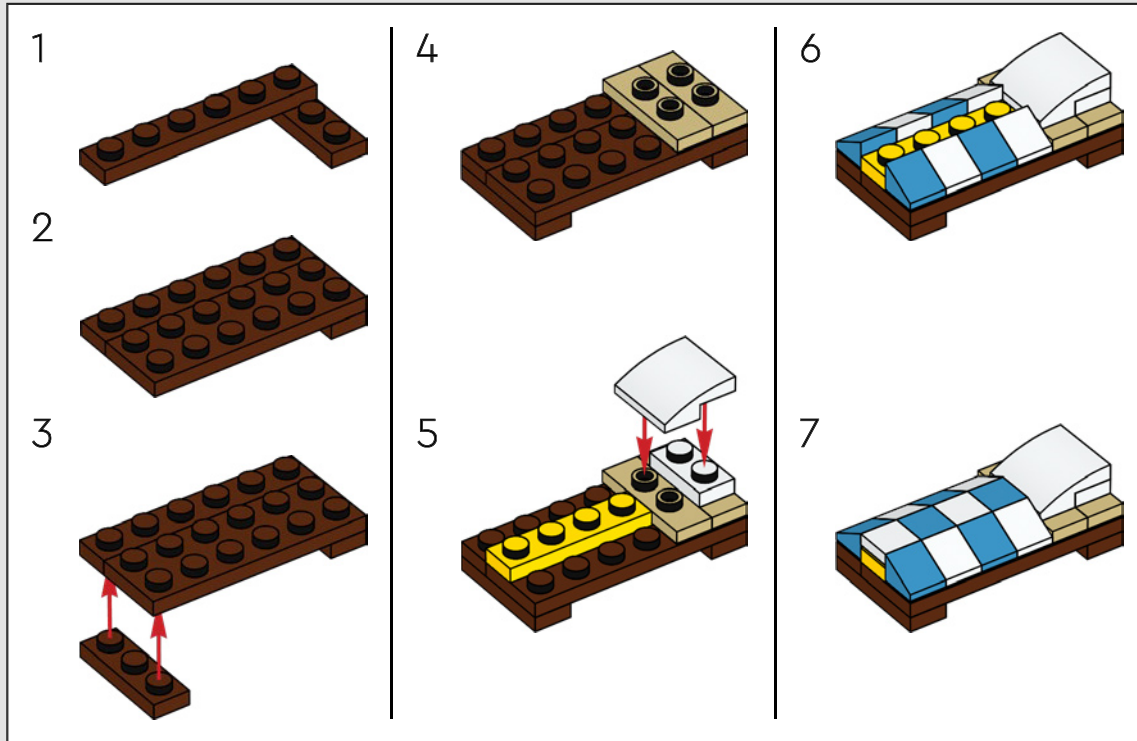



228

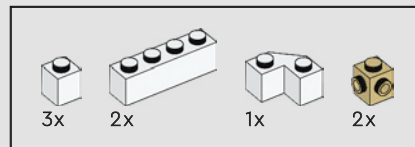
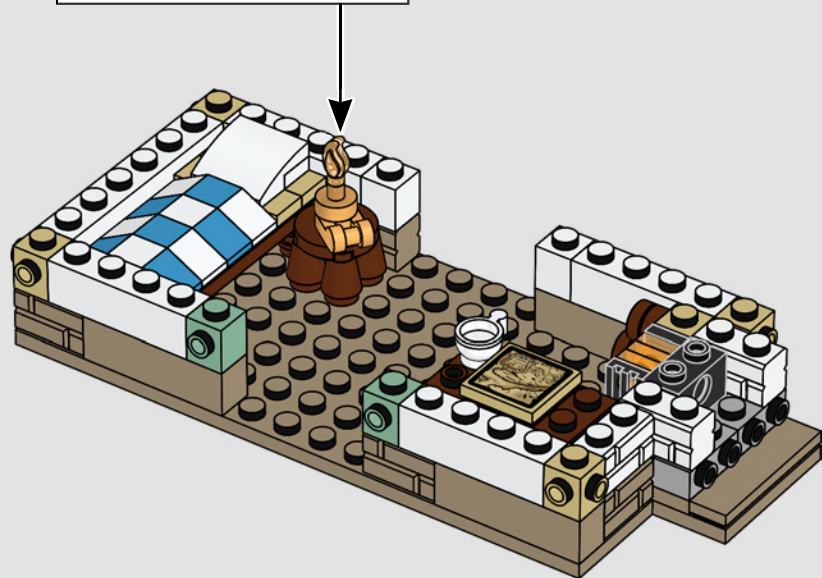
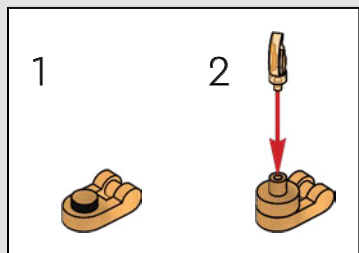

229



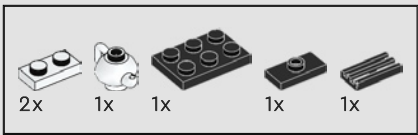

230

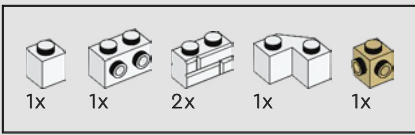
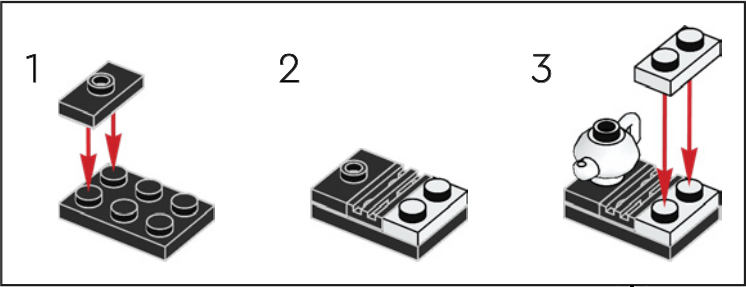

231

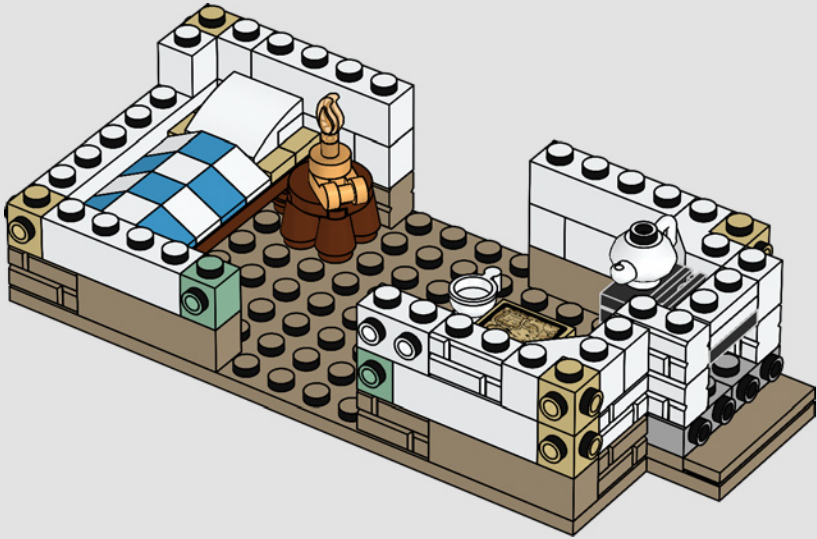

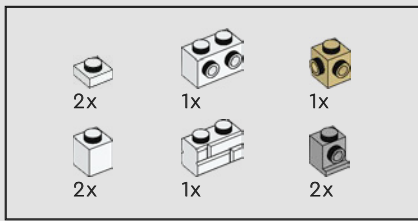

232

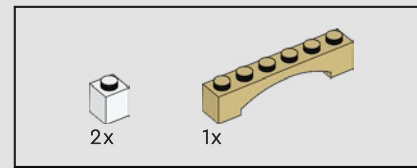
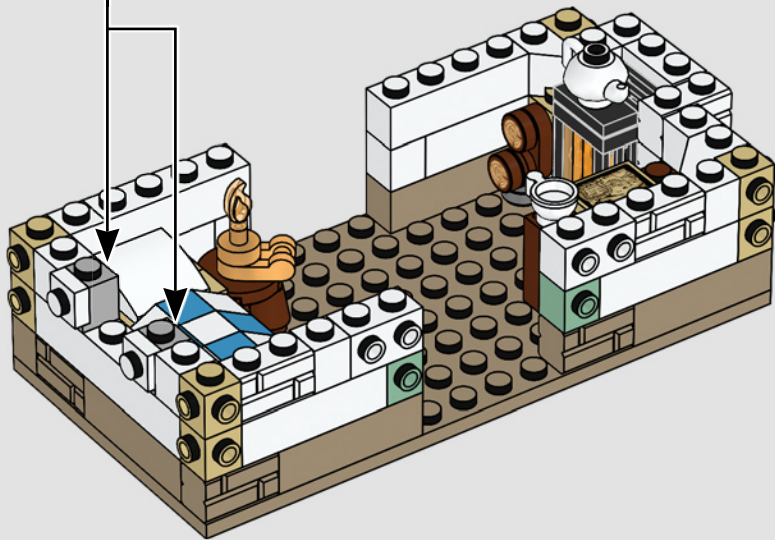
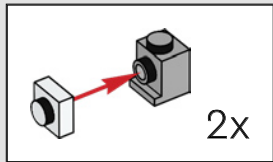

233

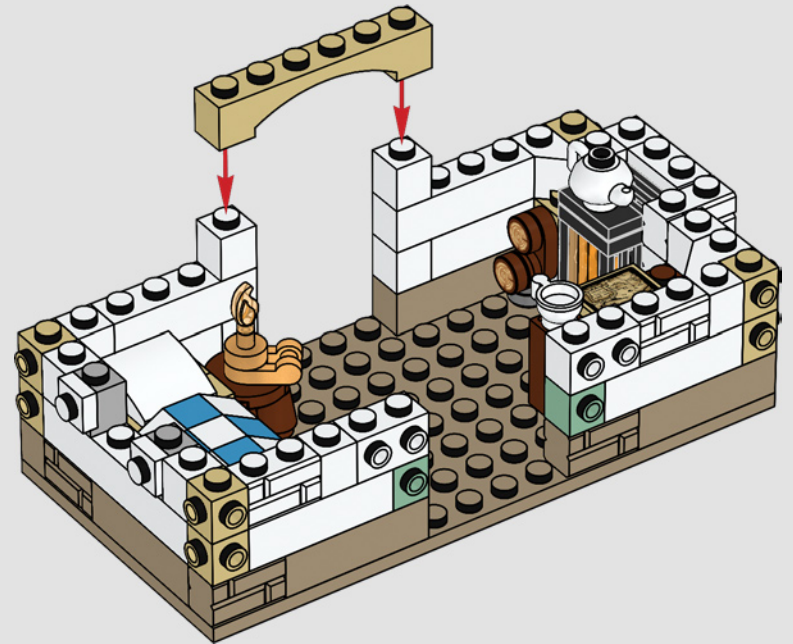

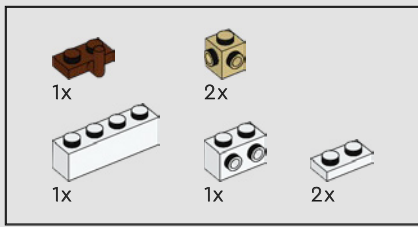

234

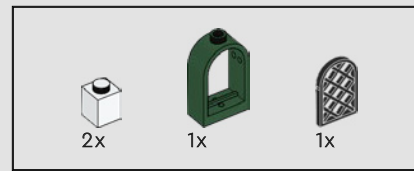
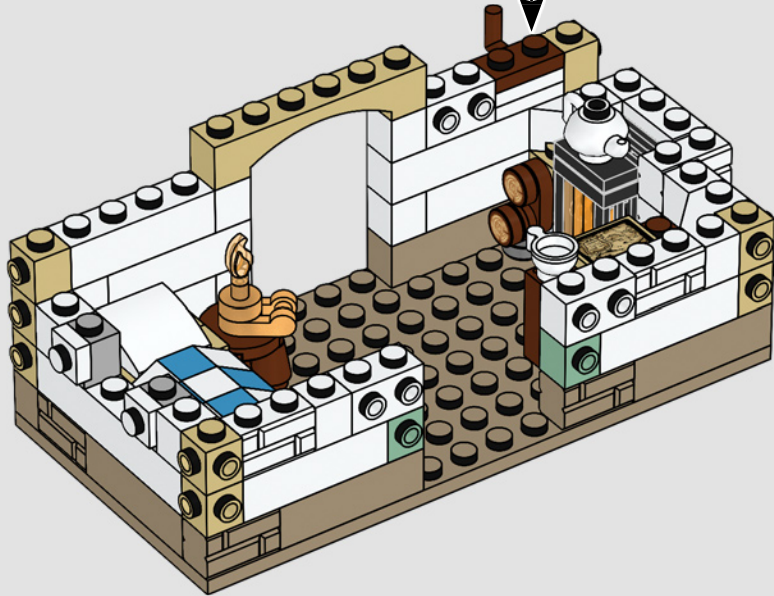
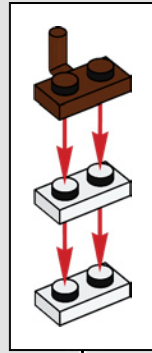

235

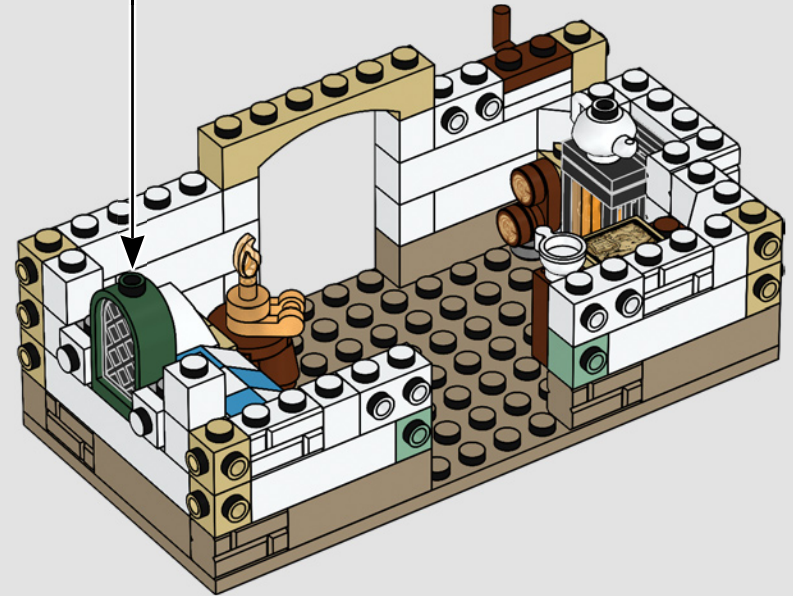
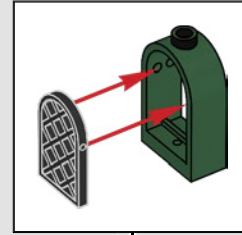

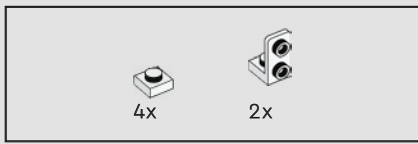

236

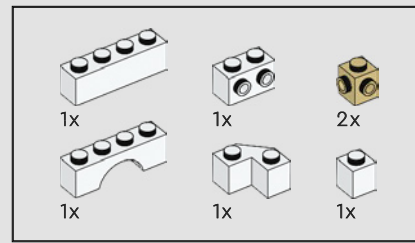
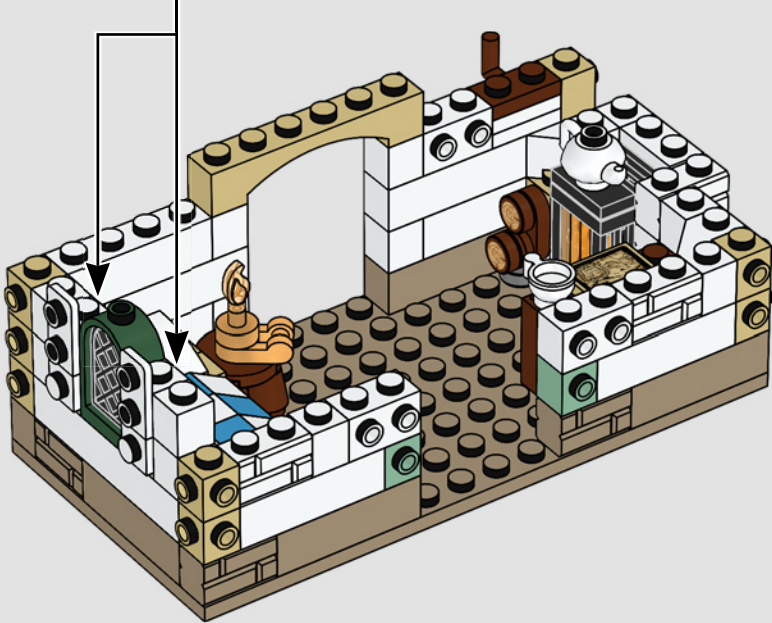
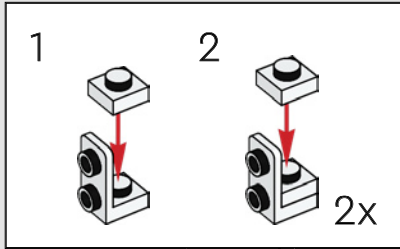

237

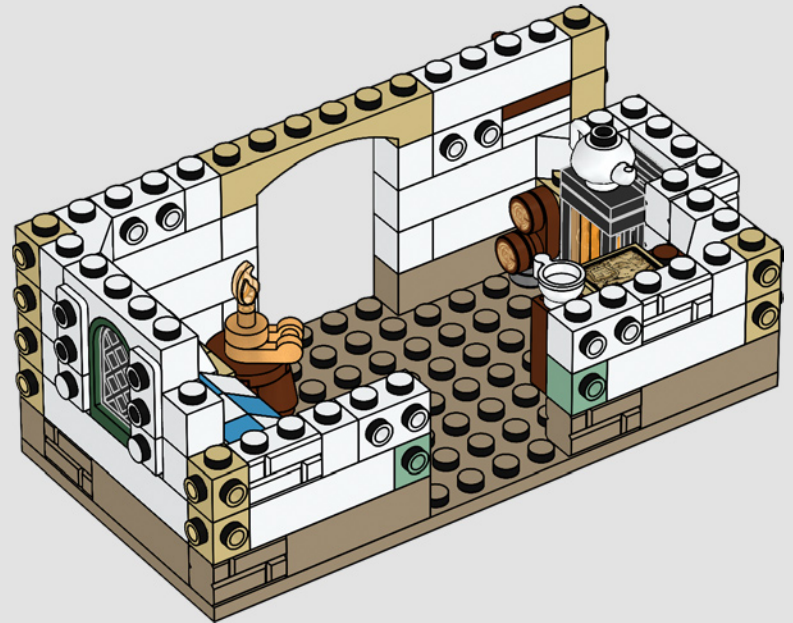

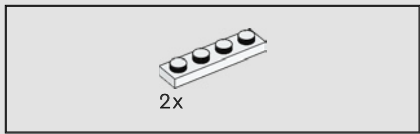

238

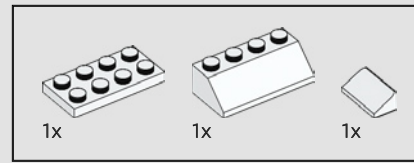
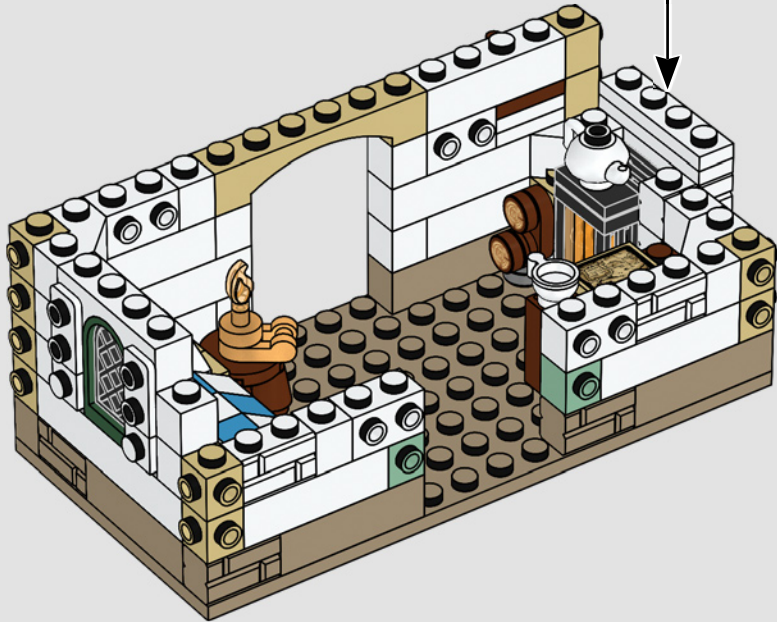
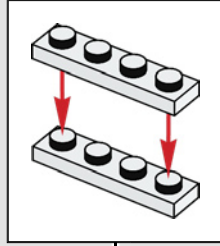

239

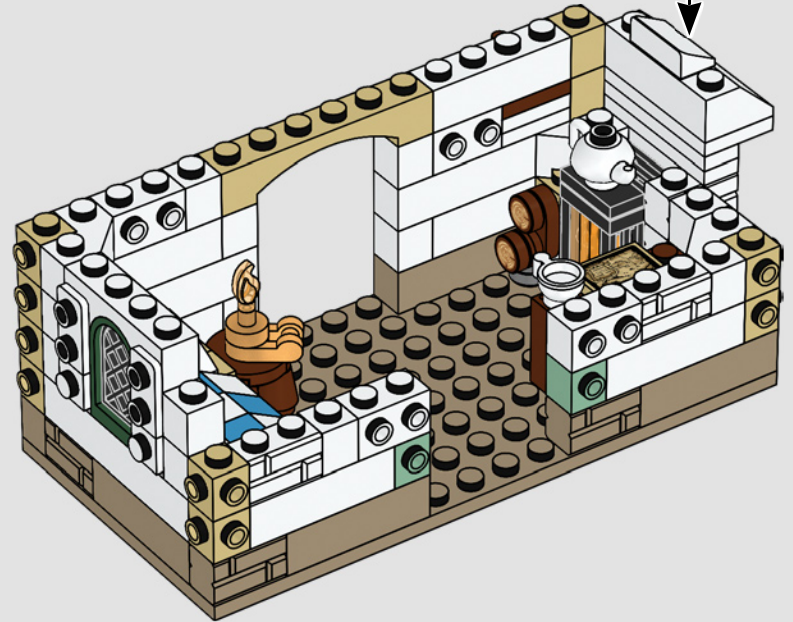
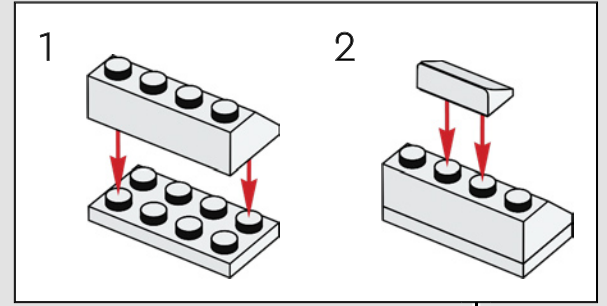

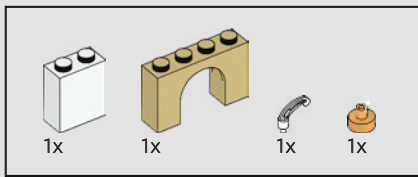

240

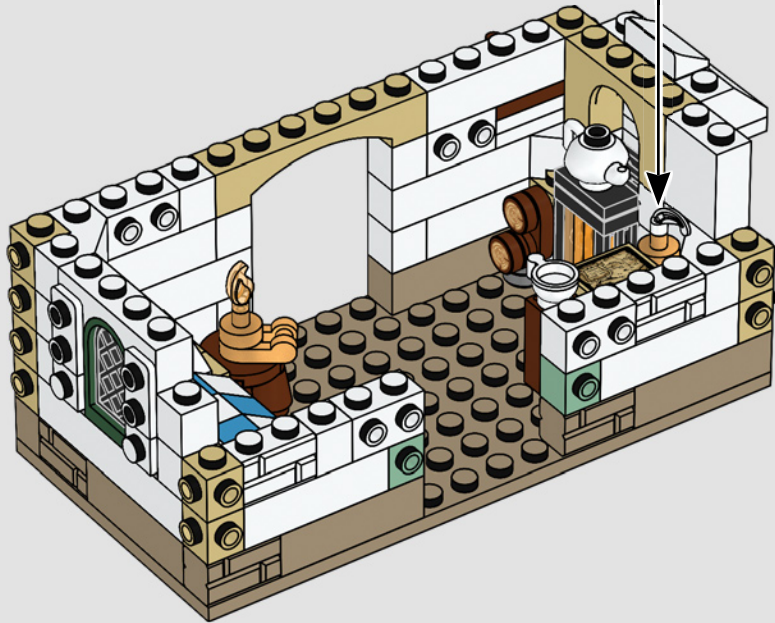
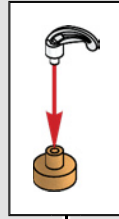

241

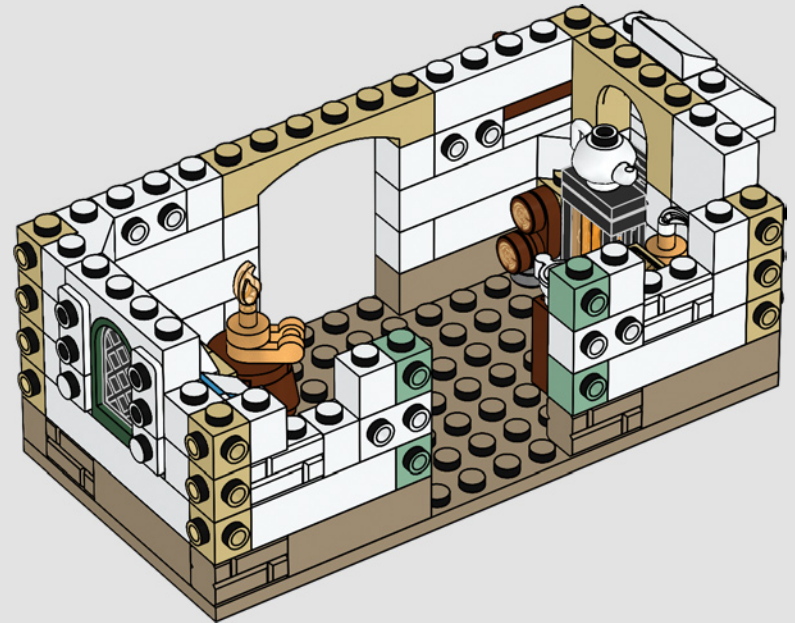

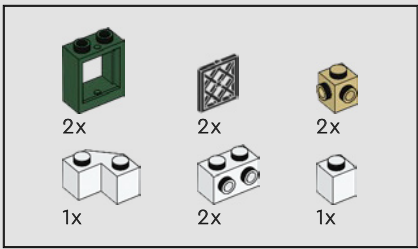

242

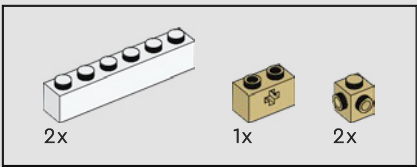
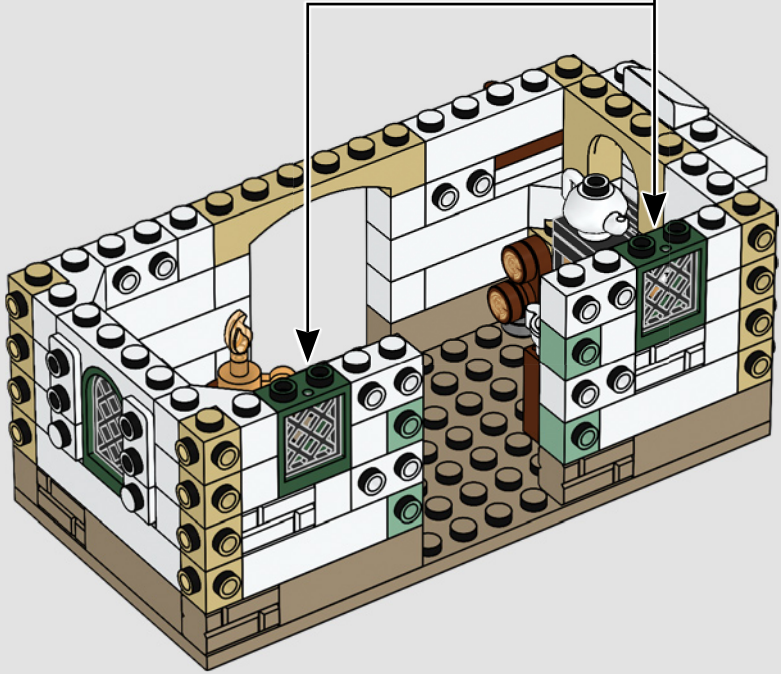
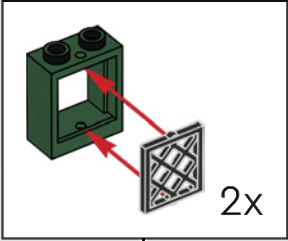

243

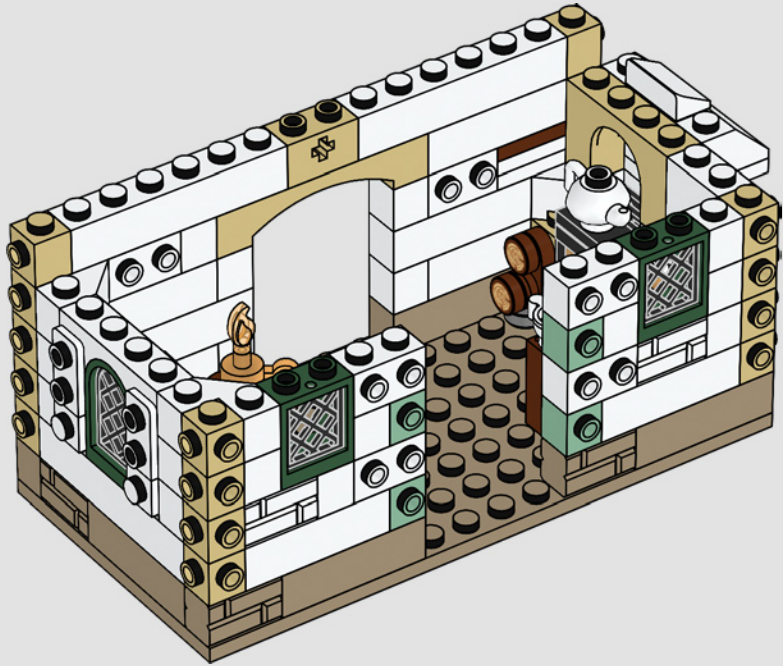

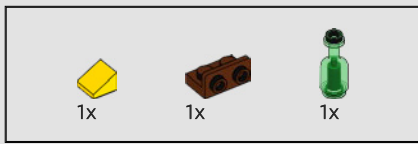

244

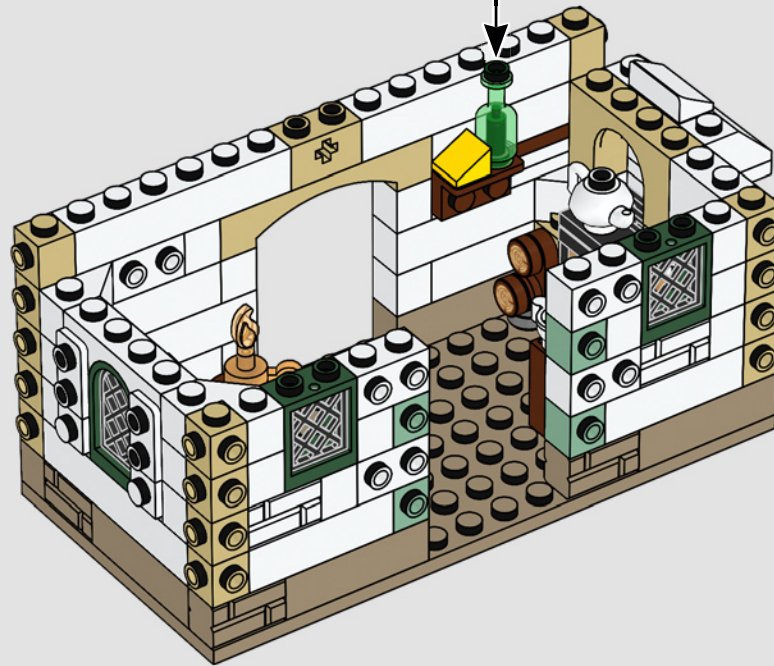
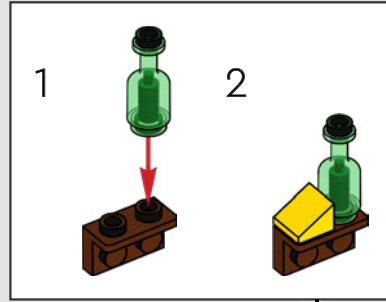

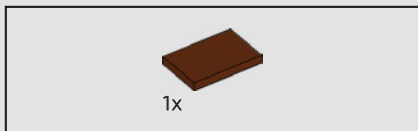

245

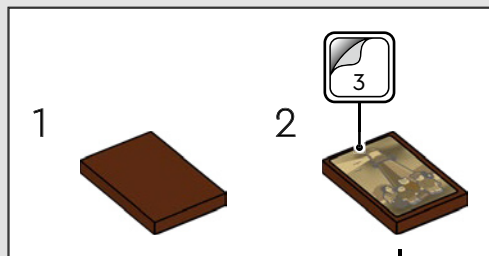

This sticker was inspired by a private photo from Sandro from a family trip to Gaspésie. In the LEGO® version we added Sandro's mother to complete the photo. Original photo. From left to right: Sandro, Sandro's father and Sandro's brother. Private photo from family trip to Gaspésie.

Cet autocollant a été inspiré par une photo privée de Sandro, prise lors d'un voyage familial en Gaspésie. Dans la version LEGO®, nous avons ajouté la mère de Sandro pour compléter la photo.

Photo originale. De gauche à droite : Sandro, le père de Sandro et le frère de Sandro. Photo privée d'un voyage familial en Gaspésie.

Esta calcomanía está inspirada en una fotografía privada de Sandro durante un viaje familiar a la Gaspesia. En la versión LEGO® incluimos a la mamá de Sandro para que la fotografía estuviera completa.

Fotografía original. De izquierda a derecha: Sandro, el papá de Sandro y el hermano de Sandro (fotografía privada de un viaje familiar a la Gaspesia).

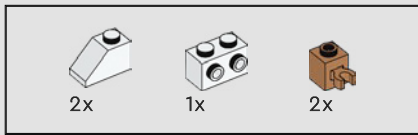

246

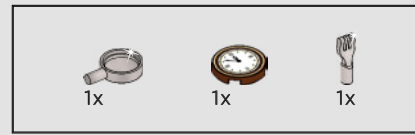
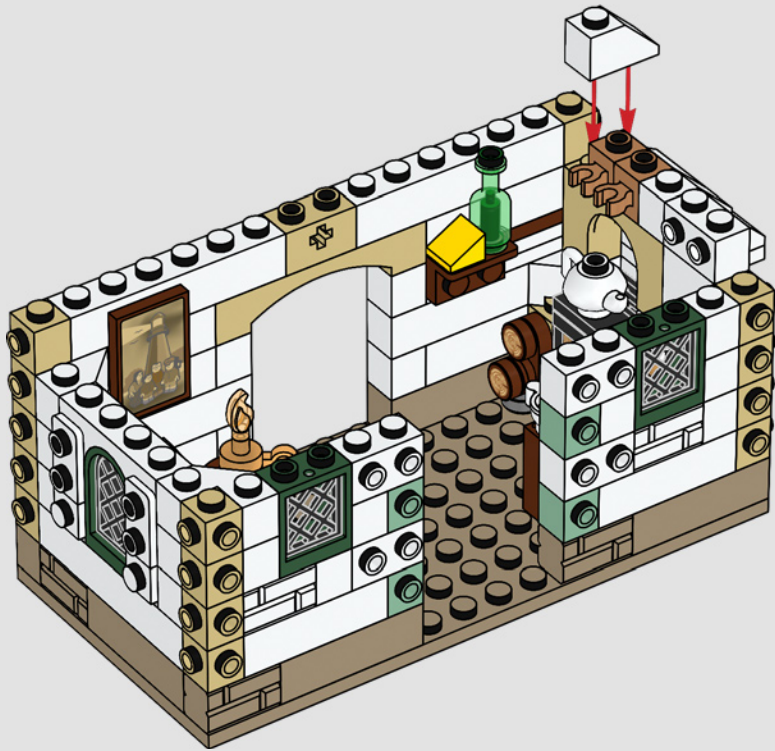

247

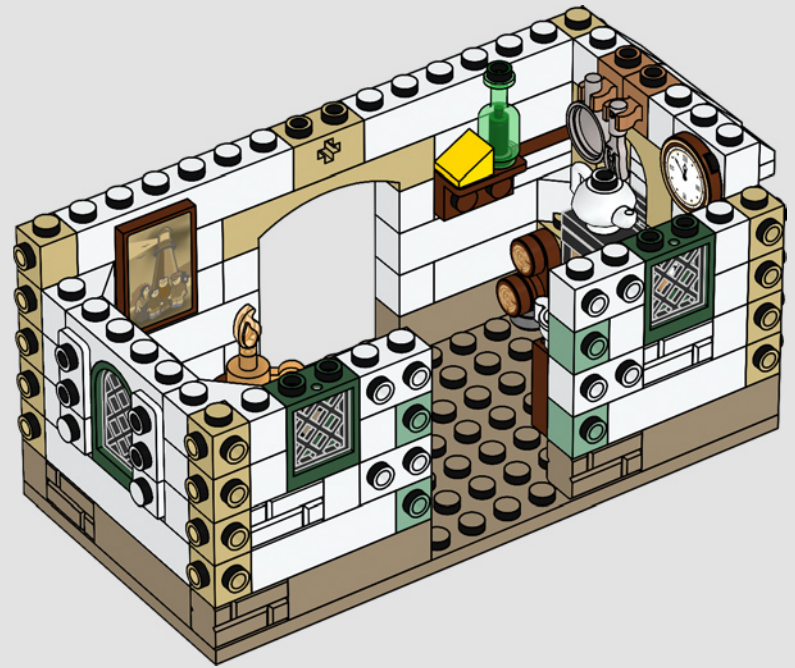

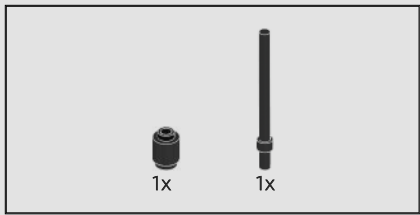

248

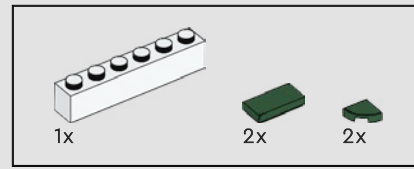
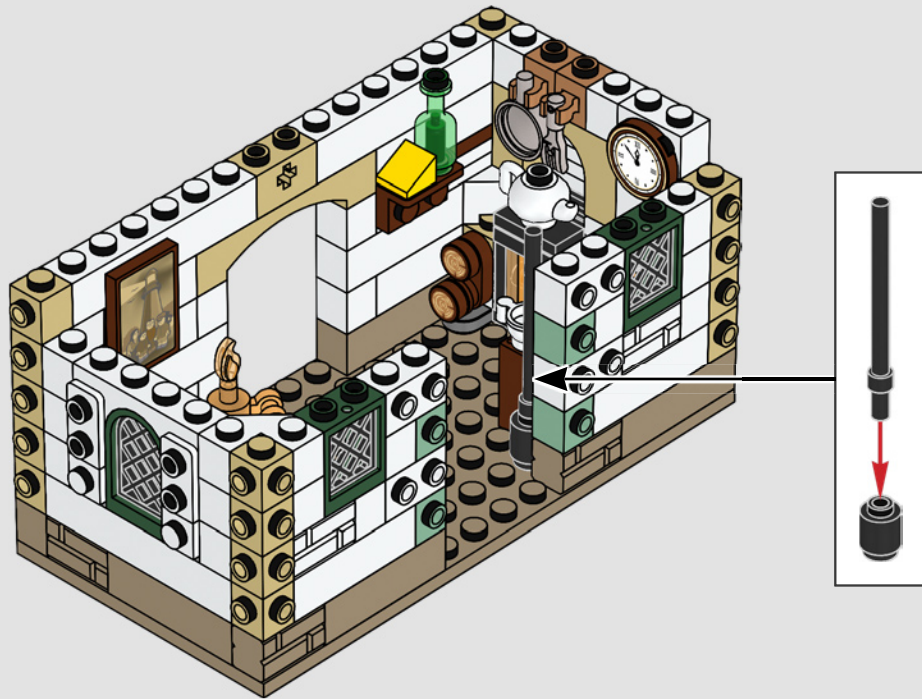

249





250

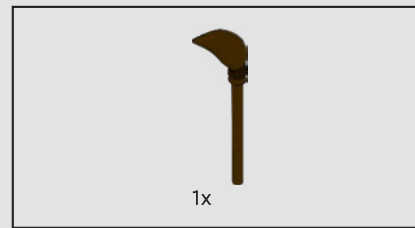

251

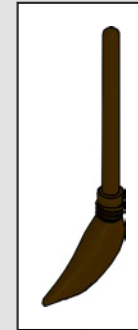

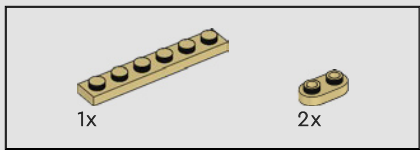

252

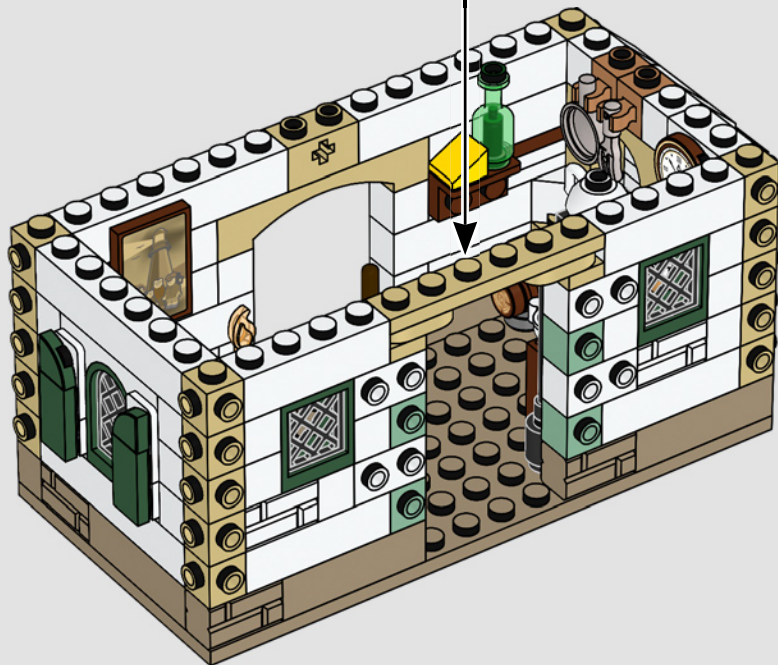
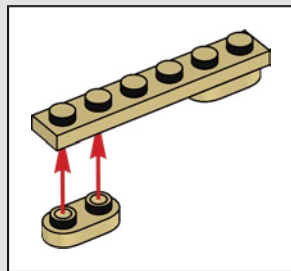



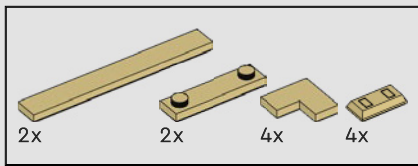

253

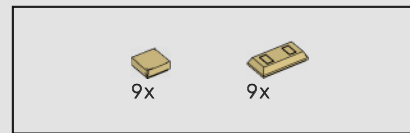
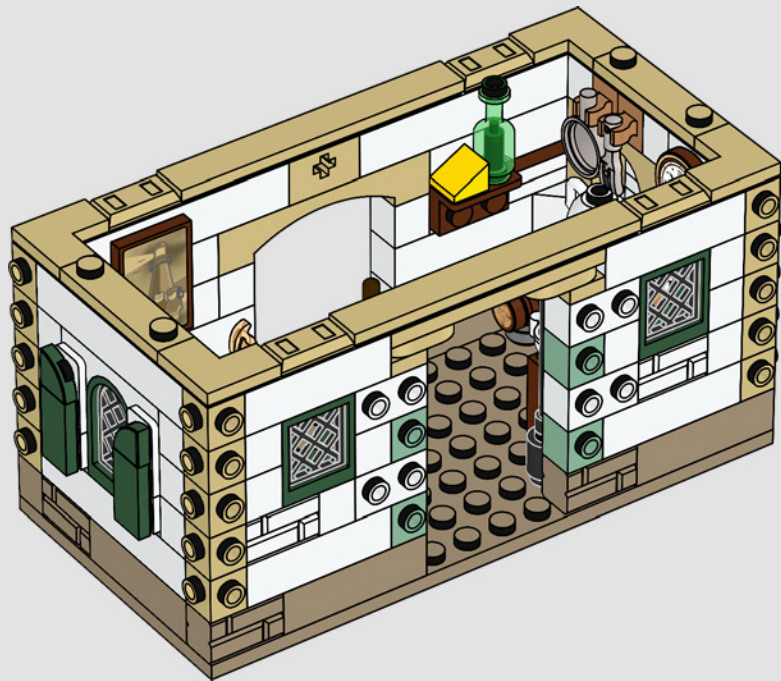

254

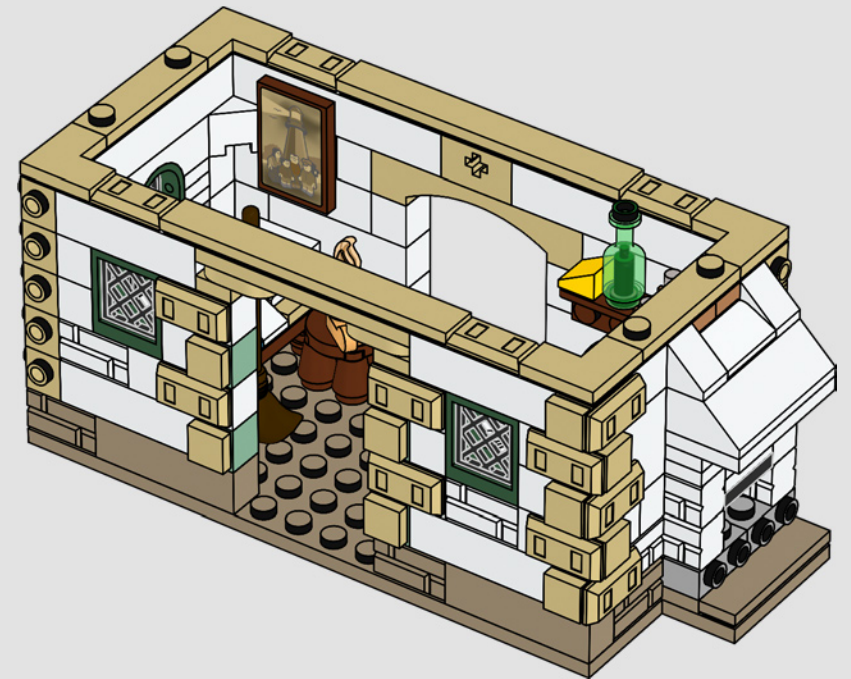

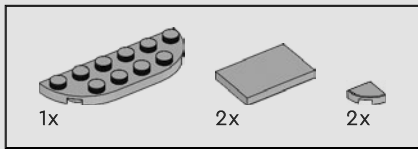

255

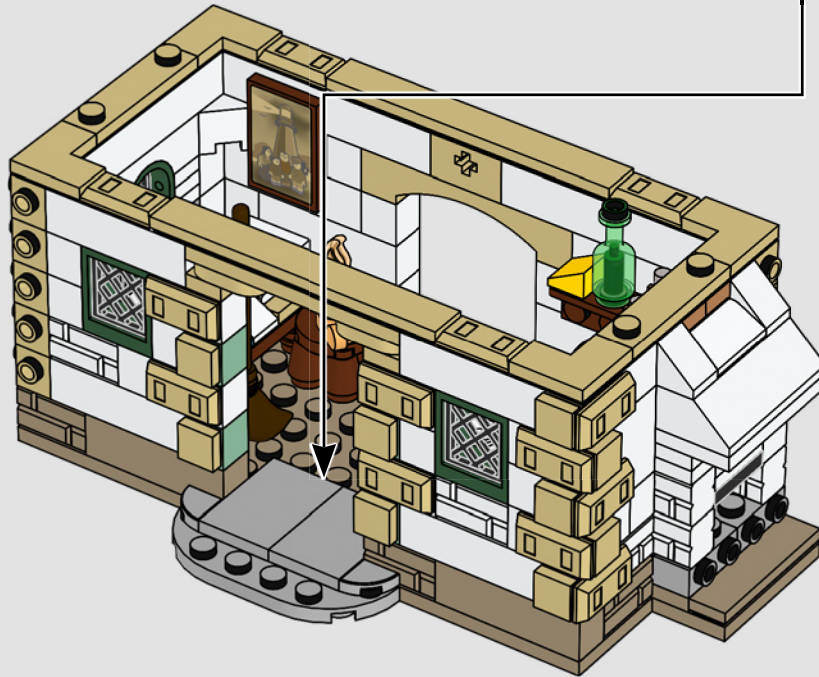
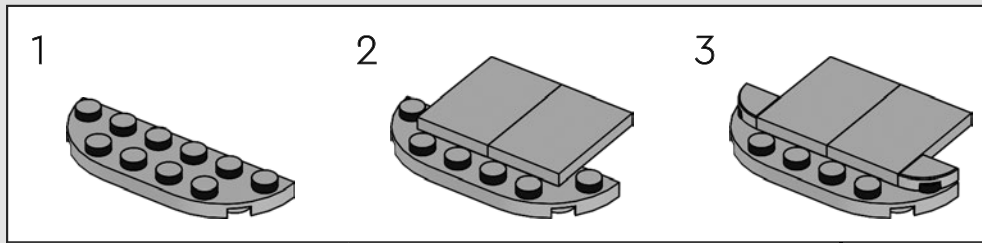

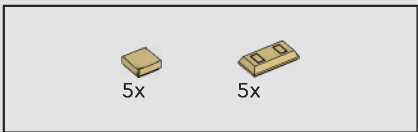

256

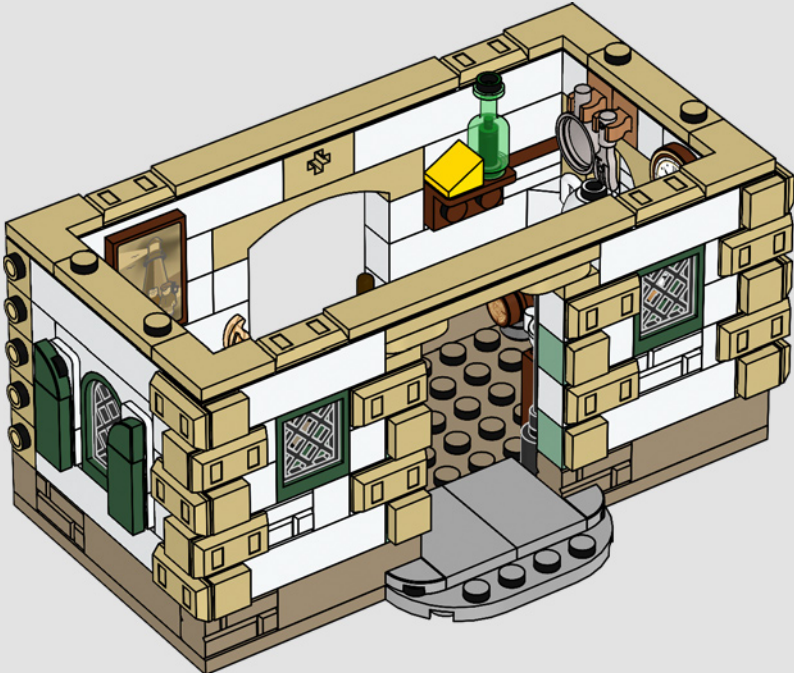

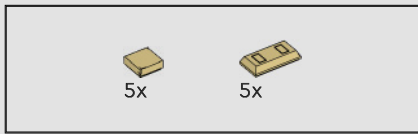

257

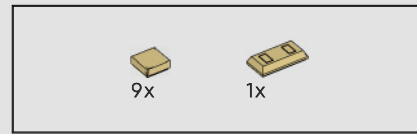
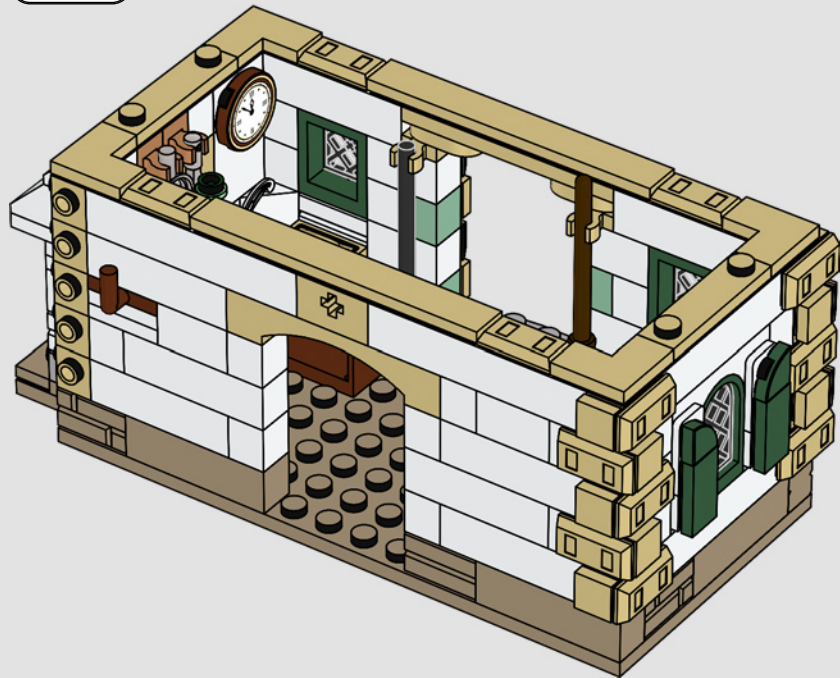

258

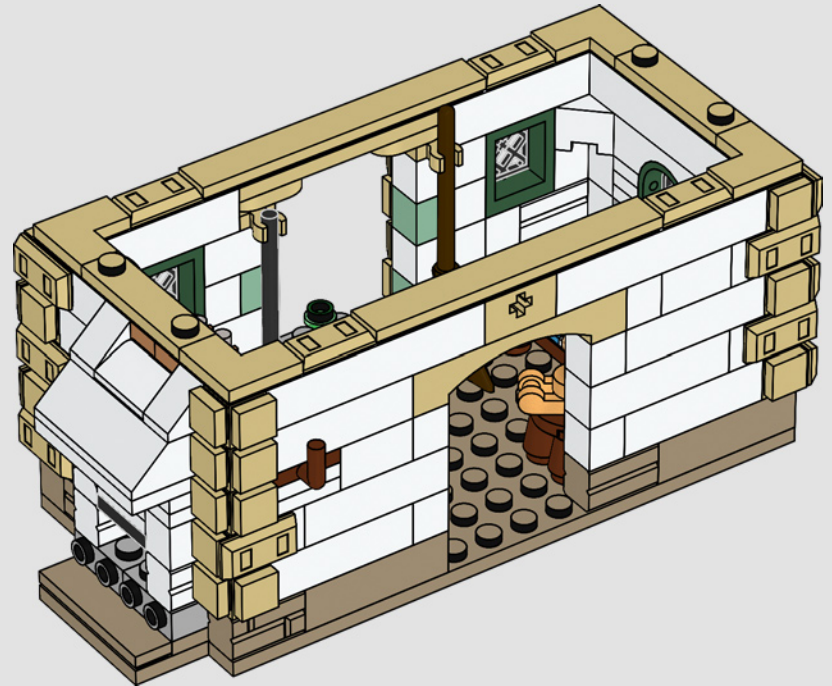

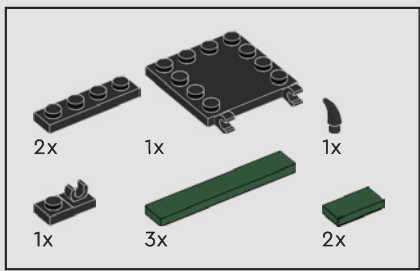

259

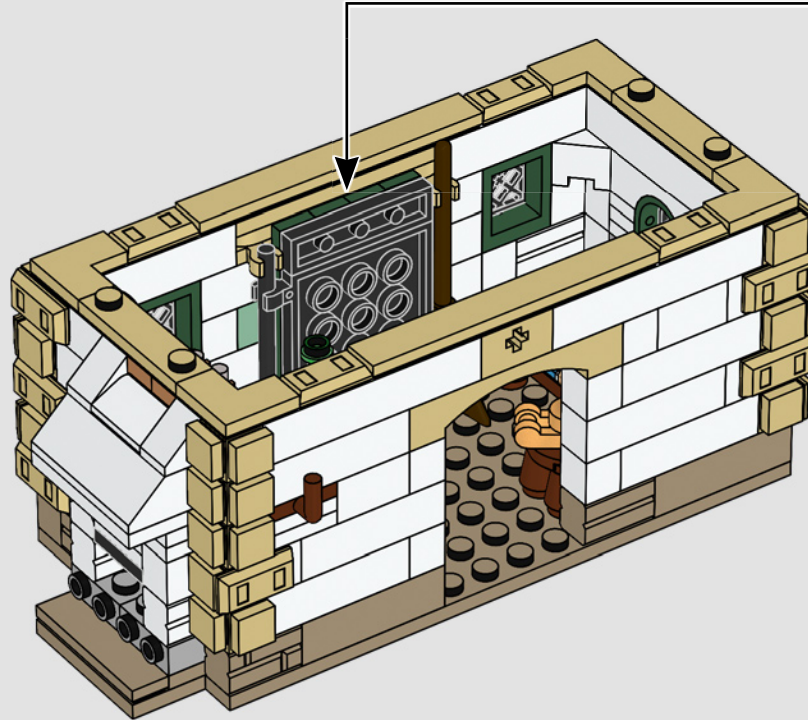
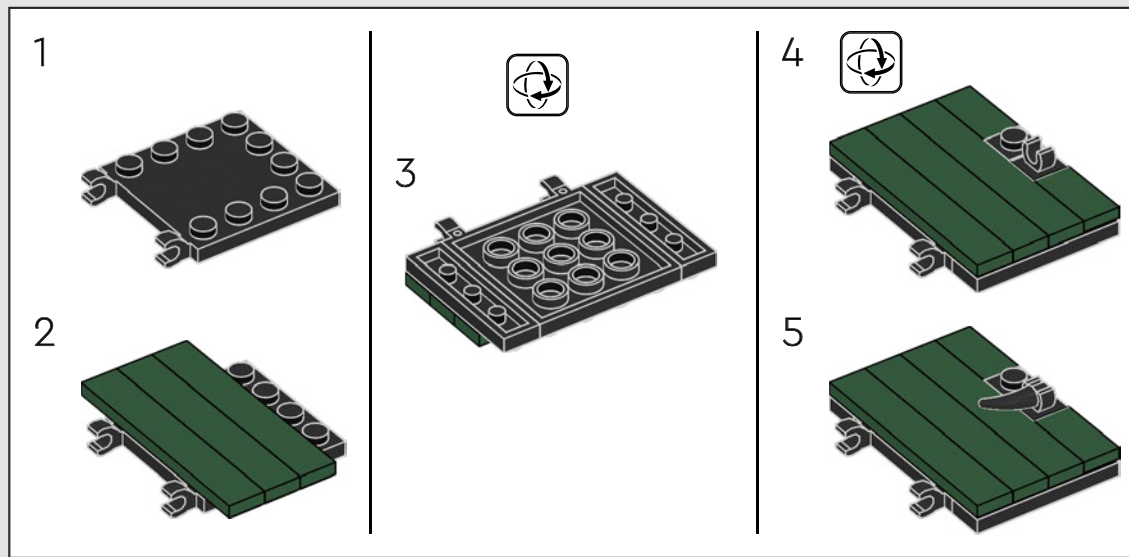

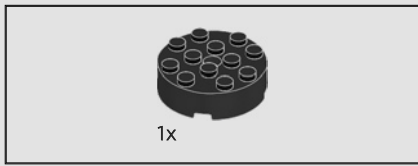

260

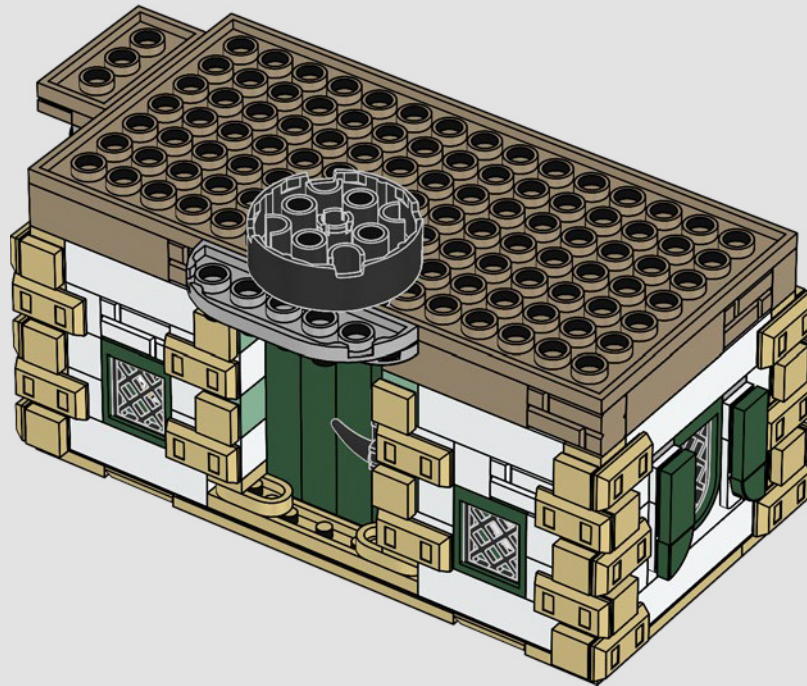



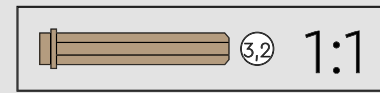
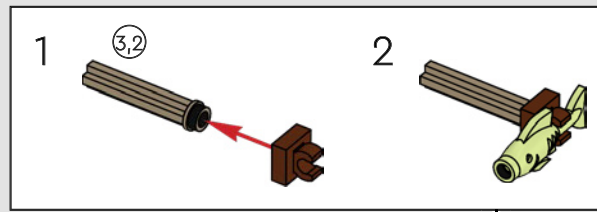
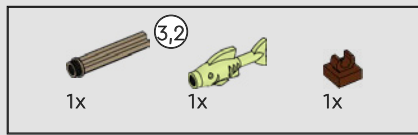

262



2x  1x 

263

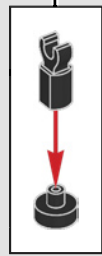
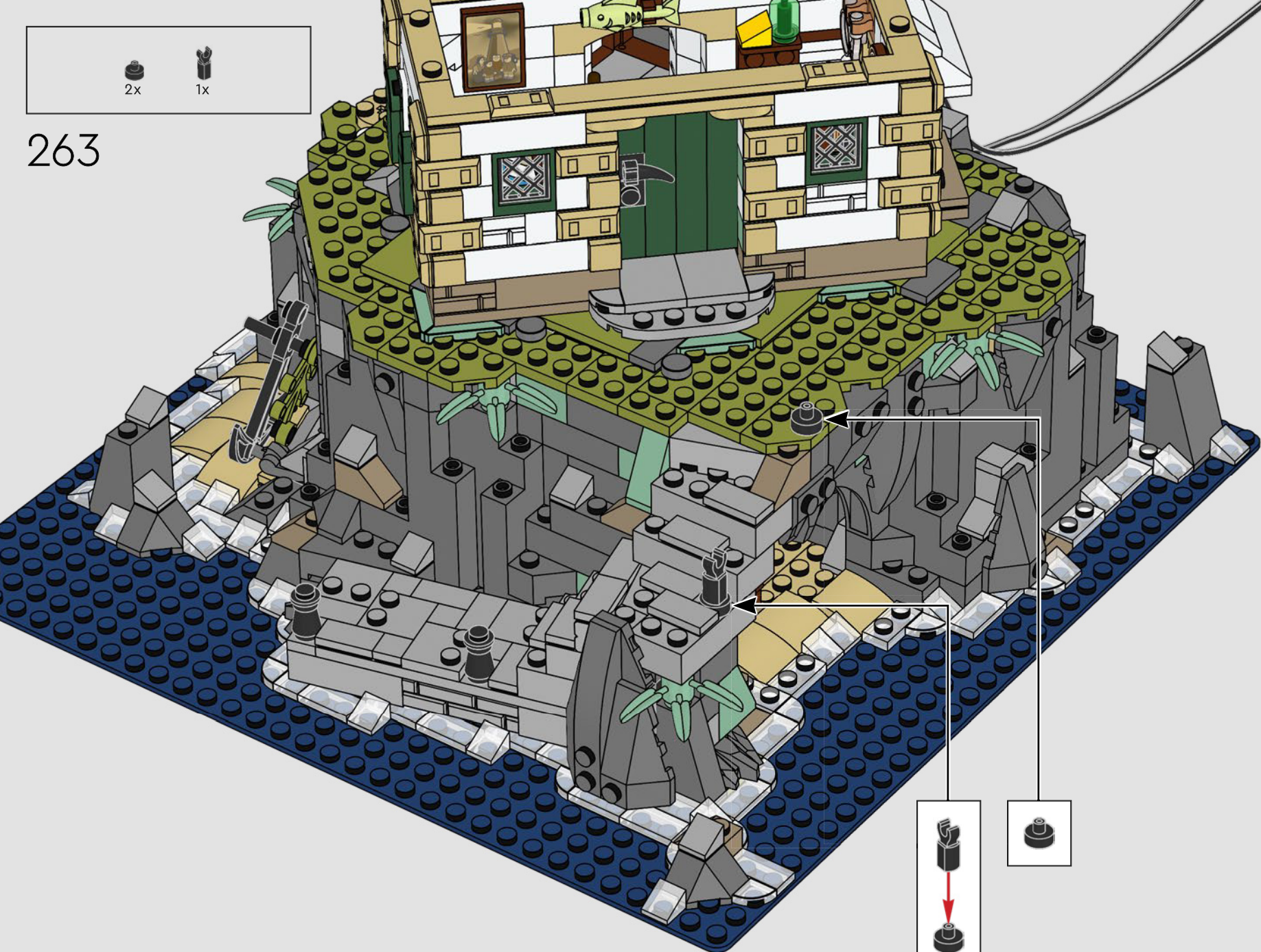



264

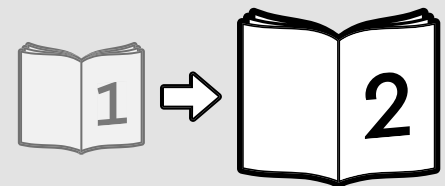
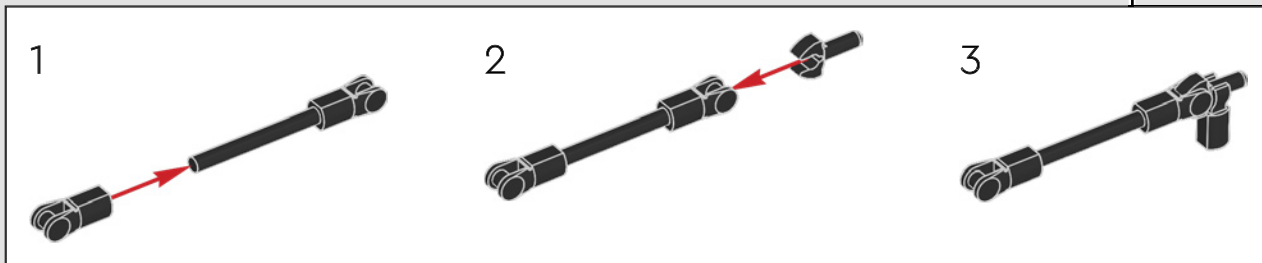
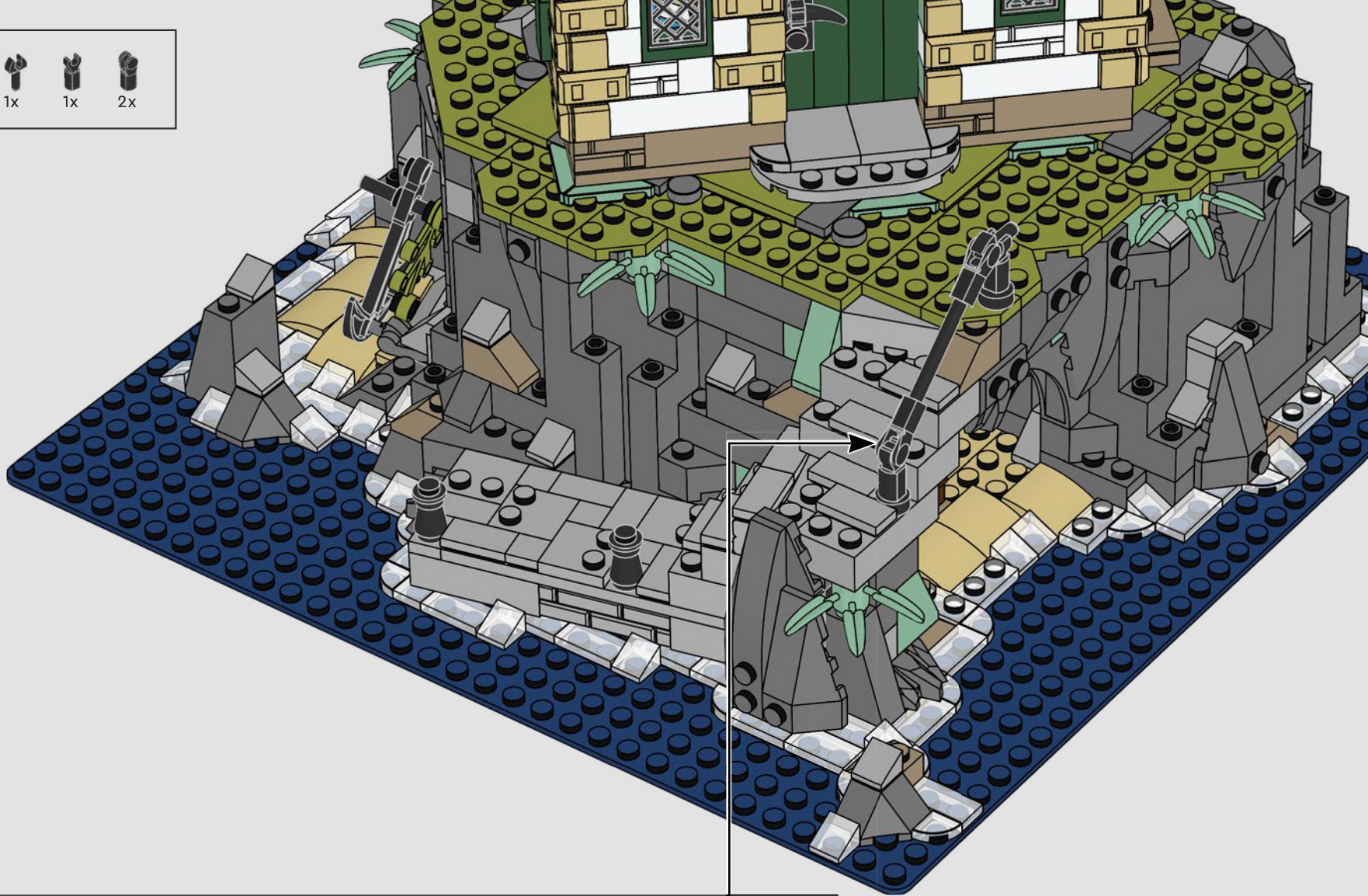

EN

Important information about batteries

Never use different types of batteries together, or a combination of old and new batteries. Always remove the batteries if the product is not to be used for a long time or if the batteries have run down. Never use damaged batteries. Only use alkaline type batteries. Insert the batteries so that the poles are correctly positioned. Never attempt to recharge non-rechargeable batteries. Never short-circuit the battery holder.

DE

Wichtige Informationen zu Batterien

Benutzen Sie niemals unterschiedliche Arten von Batterien oder alte und neue gleichzeitig. Nehmen Sie stets die Batterien heraus, wenn mit dem Modell längere Zeit nicht gespielt wird oder wenn die Batterien leer sind. Verwenden Sie niemals beschädigte Batterien. Verwenden Sie ausschließlich Alkali-Batterien. Achten Sie beim Einsetzen der Batterien auf die richtige Polung. Versuchen Sie unter keinen Umständen, „normale“ Batterien wieder aufzuladen. Schließen Sie das Batteriefach niemals kurz.

FR

Informations importantes concernant les piles

Ne jamais utiliser un mélange de différents types de piles, ou de piles neuves et de piles anciennes ou déjà utilisées. Toujours retirer les piles si le produit n'est pas utilisé durant une période prolongée ou si les piles sont vides. Ne jamais utiliser de piles endommagées. N'utiliser que des piles alcalines. En insérant les piles, respecter scrupuleusement le sens d'orientation des pôles (+/-). Ne jamais essayer de recharger des piles non rechargeables. Ne jamais court-circuiter le compartiment des piles.

IT

Importanti informazioni sulle batterie

Non usare mai contemporaneamente batterie di tipo diverso o batterie nuove e usate insieme. Rimuovere sempre le batterie qualora il prodotto non venga utilizzato per periodi prolungati, oppure se le batterie sono esauste. Non utilizzare mai batterie danneggiate. Utilizzare solo batterie di tipo alcalino. Inserire le batterie avendo cura che la loro polarità sia corretta. Non tentare mai di ricaricare batterie non ricaricabili. Non cortocircuitare mai il portabatterie.

NL

Belangrijke informatie over batterijen

Gebruik nooit verschillende soorten of een combinatie van oude en nieuwe batterijen tegelijkertijd. Verwijder de batterijen altijd als je het product lange tijd niet wilt gebruiken of als batterijen leeg zijn. Gebruik nooit beschadigde batterijen. Gebruik alleen alkalinebatterijen. Plaats de batterijen met de polen in de juiste richting. Probeer nooit niet-oplaadbare batterijen opnieuw op te laden. Laat de batterijhouder nooit kortsluiten.

ES

Información importante acerca de las pilas

No use pilas de diferentes tipos ni pilas nuevas y antiguas para alimentar el producto. Extraiga las pilas del producto si este va a permanecer sin uso durante un período prolongado de tiempo o aquellas se han agotado. No use pilas dañadas. Use solo pilas alcalinas. Inserte las pilas de modo que los polos queden situados en las posiciones correctas. No trate de cargar pilas no recargables. No cortocircuite el compartimento de las pilas.

DA

Vigtige oplysninger om batterier

Brug aldrig forskellige batterityper sammen eller en kombination af gamle og nye batterier. Fjern altid batterierne, hvis produktet ikke skal bruges i lang tid, eller hvis batterierne er flade. Brug aldrig beskadigede batterier. Brug kun alkaliske batterier. Sæt batterierne i, så polerne vender den rigtige vej. Forsøg aldrig at oplade ikke-genopladelige batterier. Kortslut aldrig batteriholderen.

IS

Mikilvægar upplýsingar um rafhlöður

Aldrei skal nota mismunandi gerðir rafhlaðna samtímis, né nýjar og eldri rafhlöður samtímis. Ef ekki á að nota tækið í lengri tíma eða ef rafhlöðurnar eru orðnar tómar skal fjarlægja rafhlöðurnar. Aldrei skal nota rafhlöður sem hafa skemmt. Eingöngu má nota alkaline-rafhlöður. Setja skal rafhlöðurnar í þannig að plús- og mínusskaut þeirra snúi rétt. Aldrei skal reyna að endurhlaða rafhlöður sem ekki eru endurhlaðanlegar. Aldrei ætti að valda skammhlaupi í rafhlöðuhólfinu.

FI

Tärkeää tietoa paristoista

Älä koskaan käytä erityyppisiä paristoja yhdessä. Älä myöskään käytä samassa laitteessa sekä vanhoja että uusia paristoja. Poista paristot tuotteesta aina, kun se on pitemmän aikaa käyttämättä, tai kun paristot ovat tyhjentyneet. Älä koskaan käytä viallisia paristoja. Käytä vain alkaliparistoja. Aseta paristot siten, että navat osoittavat oikeaan suuntaan. Älä koskaan aiheuta oikosulkua pariston kosketintien välillä.

SV

Viktig information om batterier

Använd aldrig olika sorters batterier samtidigt, och inte heller en kombination av gamla och nya batterier. Ta alltid ur batterierna om produkten inte ska användas under en längre tid eller om batterierna är slut. Använd aldrig skadade batterier. Använd endast alkaliska batterier. Sätt i batterierna så att polerna hamnar i rätt läge. Försök aldrig ladda icke-laddningsbara batterier. Kortslut aldrig batteriutrymmets kontaktytor.

NO

Viktig informasjon om batterier

Bruk aldri ulike typer batterier sammen og heller aldri gamle og nye batterier sammen. Ta alltid ut batteriene hvis produktet ikke skal brukes på lang tid, eller hvis batteriene er brukt opp. Bruk aldri skadde batterier. Bruk bare alkaliske batterier. Sett inn batteriene med polene vendt riktig vei. Forsøk aldri å lade opp ikke-oppladbare batterier. Kortslett aldri batteriholderen.

PT

Informação importante sobre as pilhas

Nunca use diferentes tipos de pilhas em simultâneo, ou uma combinação de pilhas usadas e novas. Retire sempre as pilhas se o produto não for usado durante muito tempo ou se as pilhas já não tiverem carga. Nunca use pilhas danificadas. Use apenas pilhas alcalinas. Insira as pilhas de forma a que os polos fiquem corretamente posicionados. Nunca tente recarregar pilhas não recarregáveis. Nunca deixe o compartimento das pilhas entrar em curto-circuito.

EL

Σημαντικές πληροφορίες για τις μπαταρίες

Μην χρησιμοποιείτε ποτέ διαφορετικούς τύπους μπαταριών μαζί και μην συνδυάζετε παλιές και καινούργιες μπαταρίες. Αφαιρείτε πάντα τις μπαταρίες αν δεν σκοπεύετε να χρησιμοποιήσετε το προϊόν για αρκετό καιρό ή αν οι μπαταρίες έχουν αδειάσει. Ποτέ μην χρησιμοποιείτε μπαταρίες που έχουν φθορές. Χρησιμοποιείτε μόνο αλκαλικές μπαταρίες. Τοποθετήστε τις μπαταρίες με τους πόλους στη σωστή θέση. Μην επιχειρήσετε ποτέ να επαναφορτίσετε μη επαναφορτιζόμενες μπαταρίες. Ποτέ μην βραχυκυκλώνετε τη θήκη των μπαταριών.

JA

電池取扱に関する重要事項

異なるタイプの電池や古い電池を混ぜて使用しないでください。商品を長時間使用しないときや電池が切れたときは、電池を必ず取り外してください。不具合のある電池は絶対に使用しないでください。アルカリタイプの電池のみを使用してください。電極を確認して電池を正しい向きに入れてください。充電式ではない電池は絶対に充電しないでください。電池ホルダをショートさせないでください。

ZH

電池使用注意事項

请勿同时使用不同类型的电池，或把新旧程度不同的电池混合使用。如果产品将有长时间不会使用，或者电池已经没电，请注意取出电池。切勿使用已破损的电池。仅可使用碱性电池。装入电池时请注意正负极。请勿尝试给非充电电池充电。切勿对电池仓进行短路连接。

KO

배터리 사용 시 주의사항

다른 종류의 배터리를 함께 사용하거나, 새 전지와 오래된 전지를 혼용하지 마세요. 배터리가 방전되었거나 장기간 제품을 작동하지 않을 때에는 반드시 배터리를 분리하세요. 파손된 배터리는 사용하지 마세요. 알칼라인 타입의 배터리만을 사용하세요. 양극과 음극의 위치를 잘 맞춰서 넣으세요. 일반 배터리는 충전해서 사용할 수 없습니다. 배터리 홀더의 접촉부에 배터리를 정확히 끼워서 사용하세요.

RU

Необходимая информация об элементах питания

Ни в коем случае не используйте одновременно элементы питания различных типов, а также элементы питания с разным сроком годности. В обязательном порядке вынимайте элементы питания из терминалов в случае, если вы не пользуетесь прибором в течение долгого времени, либо в случае, если в элементах питания закончился заряд. Ни в коем случае не используйте поврежденные элементы питания. Используйте только элементы питания щелочного типа. Установите элементы питания, соблюдая указанную полярность. Ни в коем случае не пытайтесь подзарядить непerezаряжаемые элементы питания. Ни в коем случае не пытайтесь замкнуть полюса в устройстве для элементов питания.

PL

Ważne informacje dotyczące baterii

Nigdy nie należy stosować razem różnych rodzajów baterii ani stosować równocześnie starych i nowych baterii. Jeżeli produkt nie jest używany przez dłuższy czas lub jeżeli baterie się wyczerpały, należy wyjąć baterie. Nigdy nie należy stosować uszkodzonych baterii. Należy używać wyłącznie baterii alkalicznych. Przy wkładaniu baterii należy zwrócić uwagę na właściwe położenie biegunów. Nigdy nie należy próbować ładowania baterii jednorazowych. Nigdy nie należy doprowadzać do zwarcia w gnieździe baterii.

CZ

Důležitá informace o bateriích

Nikdy nepoužívejte najednou různé typy baterií nebo kombinaci starých a nových baterií. Nebude-li se výrobek delší dobu používat nebo jsou-li baterie vybité, vždy je vyjměte z výrobku. Nikdy nepoužívejte poškozené baterie. Používejte pouze alkalické baterie. Baterie instalujte se správnou orientací pólů. Nikdy se nesnažte nabíjet baterie, které nejsou nabíjitelné. Nikdy nezkratujte kontakty v prostoru pro baterie.

SK

Dôležitá informácia o batériách

Nikdy nepoužívajte naraz odlišné typy batérií ani nekombinujte staré batérie s novými. Batérie vždy vyberte, ak sa výrobok nebude dlhšie používať, alebo ak sa batérie vybili. Nikdy nepoužívajte poškodené batérie. Používajte iba alkalické batérie. Batérie vkladajte so správnou orientáciou pólou. Nikdy sa nesnažte nabíjať batérie, ktoré nie sú nabíjateľné. Nikdy neskratujte kontakty v priestore pre batérie.

HU

Fontos tudnivalók az elemekről

Soha ne használjon különböző típusú elemeket, illetve ne használjon vegyesen új és használt elemeket. Mindig távolítsa el az elemeket, ha a készüléket előre láthatóan hosszabb ideig nem fogják használni, vagy ha az elemek lemerültek. Soha ne használjon megrongálódott elemeket. Csak alkáli elemeket használjon! Az elemeket helyesen helyezze be, a polaritásuknak megfelelően. Soha ne próbálja meg feltölteni a nem tölthető elemeket. Soha ne hozzon létre rövidzárlatot az elemtartó kivezetésén.

UA

Необхідна інформація про батареї

Ніколи не використовуйте одночасно батареї різних типів або батареї з різним терміном придатності. Обов'язково вилучайте батареї з приладу, якщо довго не користуєтесь ним, або якщо в батареї вже скінчився заряд. Ніколи не використовуйте пошкоджені батареї. Використовуйте лише лужні батареї. Вставляйте батареї, враховуючи задану полярність. У будь-якому випадку не намагайтеся підзарядити батареї, що не підлягають підзарядці. У будь-якому випадку не намагайтеся зробити коротке замикання в приладі для батареї.

HR

Važne obavijesti o bateriji

Nikada nemoj koristiti različite vrste baterija zajedno, isto tako ni kombinaciju starih i novih baterija. Uvijek izvadi baterije ako dugo nečeš koristiti proizvod ili ako su one potrošene. Nikada nemoj koristiti oštećene baterije. Upotrebljavajte samo alkalne baterije. Umetni baterije pazeći da dobro okreneš polove. Nikada ne pokušavaj puniti baterije koje nisu predviđene za punjenje. Nikada ne izazivaj kratki spoj u držaču baterija.

SR

Vажне информације о батеријама

Никада не користите различите типове батерија заједно нити комбинацију старих и нових батерија. Увек извадите батерије уколико производ нећете дуже време користити или уколико су батерије празне. Никада не користите оштећене батерије. Користите само алкалне батерије. Ставите батерије тако да су полови правилно позиционирани. Никада не покушавајте да пуните батерије које не могу да се пуне. Никада не изазивајте кратак спој у кућишту за батерије.

MK

Vажни информации за батериите

Никога не користете различити типови батерије заједно или комбинација од стари и нови батерије. Секогаш отстранувајте ги батериите доколку не го користите производот подолго време или доколку се потрошиле. Никога не користете оштетени батерије. Користете само алкални батерије. Вметнете ги батериите така што точно ќе ги наместите половите. Никога не обидувајте се да ги полните батериите за еднократна употреба. Никога не предизвикувајте краток спој на држачот за батерије.

SL

Pomembne informacije o baterijah

Nikoli ne uporabljajte skupaj različnih baterij ali kombinacije starih in novih baterij. Vedno odstranite baterije, če izdelka dlje časa ne boste uporabljali ali če so iztrošene. Nikoli ne uporabljajte poškodovanih baterij. Uporabljajte le alkalne baterije. Baterije vstavite tako, da so njihovi poli pravilno obrnjeni. Nikoli ne poskušajte polniti baterij, ki niso akumulatorske. Pazite, da ležišč za baterije ne boste spravili v kratek stik.

RO

Informații importante despre baterii

Nu folosiți niciodată împreună tipuri diferite de baterii, sau o combinație de baterii vechi și noi. Îndepărtați întotdeauna bateriile dacă produsul nu este folosit timp îndelungat sau dacă bateriile s-au epuizat. Nu folosiți niciodată baterii deteriorate. Utilizați numai baterii de tip alcalin. Introduceți bateriile astfel ca polii să fie poziționați corect. Nu încercați niciodată să reîncărcați baterii nereîncărcabile. Nu scurtcircuitați niciodată suportul bateriei.

BG

Важна информация за батериите

Никога не използвайте едновременно различни типове батерии или комбинация от стари и нови батерии. Винаги изваждайте батериите, ако izdeliето няма да се използва продължително време или ако батериите са се изтозили. Никога не използвайте повредени батерии. Използвайте само алкални батерии. Поставете батериите така, че полюсите да са разположени правилно. Никога не опитвайте да зареждате батерии, които не са акумулаторни. Никога не свързвайте на късо контактите на отделението за батериите.

LV

Svarīga informācija par baterijām

Nekad vienlaikus nelietojiet dažādu tipu, kā arī vecas un jaunas baterijas. Vienmēr izņemiet baterijas, ja tās ir izlādējušas vai ja produkts ilgāku laiku netiek lietots. Nekad nelietojiet bojātas baterijas. Izmantojiet tikai sārna tipa baterijas. Ievietojot baterijas, ievērojiet pareizu polaritāti. Nekad nemēģiniet uzlādēt baterijas, kas nav uzlādējamās. Nepieļaujiet savienojumu bateriju nodalījumā.

ET

Oluline teave patareide kohta

Ära kunagi kasuta koos erinevat tüüpi patareisid, samuti vanu ja uusi patareisid. Kui mänguasja ei kasutata pika aja jooksul, võta patarei sellest välja. Ära kunagi kasuta kahjustatud patareisid. Kasuta ainult leelispatareisid. Pane patareid mänguasja sisse nii, et pluss- ja miinusklemmi asend oleks õige. Ära kunagi proovi akulaadijaga laadida tavalisi patareisid. Patareipesa klemmide vahel ei tohi tekkida lühist.

LT

Svarbi informacija apie elementus

Vienu metu nenaudokite skirtingų elementų, taip pat su naujais elementais nenaudokite senų. Jei nenaudosite gaminio ilgesnį laiką arba jei elementai išseko, visuomet išimkite juos iš gaminio. Niekada nenaudokite pažeistų elementų. Naudokite tik šarminius elementus. Elementus dėkite atsižvelgdami į jų poliškumą. Niekada nebandykite įkrauti vienkartinį elementų. Saugokitės, kad elementų įdėkle nesukeltumėte trumpojo jungimo.

TR

Piller hakkında önemli bilgiler

Hiçbir zaman farklı tipte pilleri ya da eski pillerle yeni pilleri bir arada kullanmayın. Ürün uzun süre kullanılmayacaksa ya da piller bitmişse, pilleri ürünün içinden çıkarın. Hiçbir zaman zedelenmiş piller kullanmayın. Sadece alkalin piller kullanın. Pilleri kutupları doğru konumda olacak şekilde yerleştirin. Hiçbir zaman, şarj edilebilir olmayan pilleri şarj etmeye çalışmayın. Hiçbir zaman pil kutusuna kısa devre yaptırmayın.

AR

معلومات مهمة عن البطاريات

يحظر استخدام أنواع مختلفة من البطاريات معا أو مزيج من البطاريات القديمة و الجديدة. أحرص دائما على نزع البطاريات في حال عدم استخدام المنتج لفترة طويلة أو إذا نفذت طاقة البطاريات. تجنب استخدام البطاريات التالفة. لا تستخدم إلا البطاريات القلوية فقط. قم بتفكيك البطاريات بحيث تكون الأقطاب في موضعها الصحيح. يحظر إعادة شحن البطاريات غير القابلة لإعادة الشحن. تجنب إحداث دائرة قصر في حامل البطارية.

ID

Informasi penting tentang baterai

Jangan gunakan baterai yang jenisnya berlainan, atau mencampur baterai lama dan baterai baru. Lepas baterai jika produk tidak akan digunakan untuk waktu lama atau jika baterai sudah lemah. Jangan gunakan baterai yang rusak. Gunakan hanya baterai alkali. Masukkan baterai dengan posisi kutub yang tepat. Jangan pernah coba mengisi ulang baterai biasa. Jangan pernah membuat arus pendek pada dudukan baterai.

MS

Maklumat penting tentang bateri

Jangan guna jenis bateri yang berbeza bersama-sama, atau gabungan bateri baharu dan lama. Tanggalkan bateri jika produk tidak akan digunakan untuk tempoh masa yang lama atau jika bateri telah kehabisan kuasa. Jangan guna bateri yang rosak. Guna bateri jenis alkali sahaja. Selitkan bateri supaya paksi berada pada kedudukan yang betul. Jangan cuba untuk mengecas semula bateri yang tidak boleh dicaskan semula. Jangan pintas litar pemegang bateri.



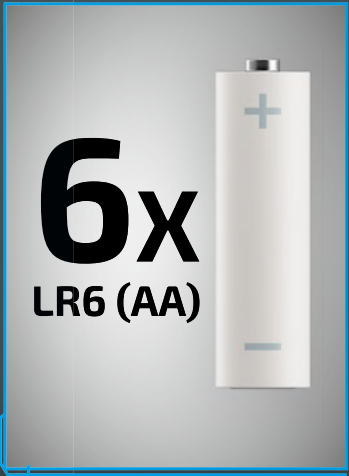
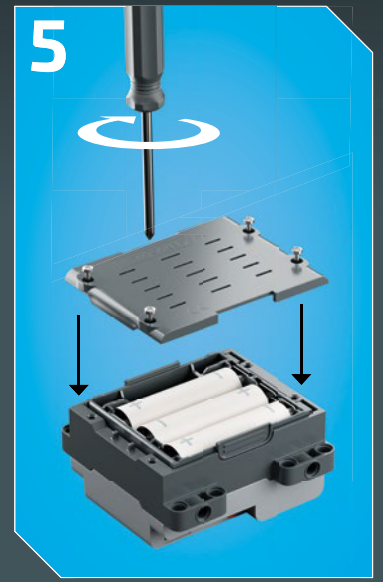
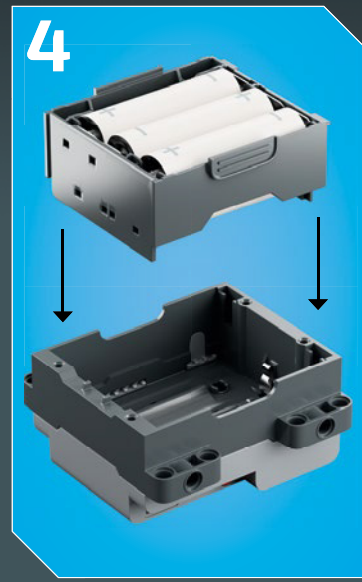
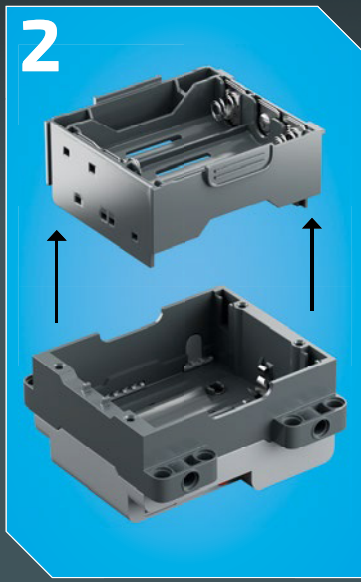
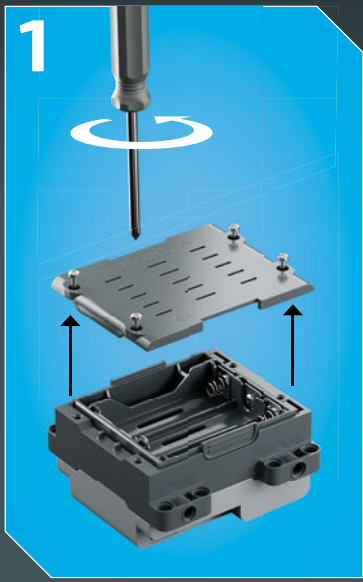

- EN Please retain the leaflet and packaging as they contain important information
- DE Broschüre und Verpackung bitte aufbewahren, sie enthalten wichtige Informationen
- FR Veuillez conserver le dépliant et l'emballage, car ils contiennent des informations importantes
- IT Conserva l'opuscolo e la confezione in quanto contengono informazioni importanti
- NL Bewaar a.u.b. de folder en verpakking: die bevatten belangrijke informatie
- ES Conserve el folleto y el embalaje; contienen información importante
- DA Gem hæftet og emballagen, da de indeholder vigtige oplysninger
- IS Geymið bæklinginn og umbúðirnar þar sem þau innihalda mikilvægar upplýsingar
- FI Säilytä esite ja pakkaus, koska ne sisältävät tärkeää tietoa
- SV Spara broschyren och förpackningen eftersom de innehåller viktig information
- NO Hæftet og emballasjen inneholder viktig informasjon og skal beholdes
- PT Por favor guarde o folheto e a embalagem, pois contém informação importante
- EL Κρατήστε το φυλλάδιο και τη συσκευασία γιατί περιέχουν σημαντικές πληροφορίες
- JA 説明書とパッケージには重要な情報が含まれていますので保管しておいてください
- ZH 说明书和包装均包含重要信息, 请妥善保存
- KO 중요한 정보가 담겨 있으므로 리플릿과 포장을 보관해주세요
- RU Пожалуйста, сохраните эту брошюру и упаковку, поскольку они содержат важную информацию
- PL Prosimy zachować ulotkę i opakowanie, ponieważ zawierają one ważne informacje
- CZ Ponechte si prosím leták i obal, neboť obsahují důležité informace
- SK Ponechajte si prosím leták aj obal, pretože obsahujú dôležité informácie
- HU Kérjük, őrizze meg a szórólapot és a csomagolást, mert fontos tudnivalókat tartalmaznak
- UA Будь ласка, зберігайте вкладиш та упаковку, оскільки вони містять важливу інформацію
- HR Spremite letak i ambalažu jer sadrže važne obavijesti
- SR Молимо да сачувате упутство и паковање јер се на њима налазе важне информације
- MK Чувајте ги брошурата и амбалажата бидејќи содржат важна информација
- SL Prosimo, da brošurico in embalažo shranite, saj vključujeta pomembne informacije
- RO Vă rugăm să păstrați prospectul și ambalajul întrucât conțin informații importante
- BG Запазете листовката и опаковката, тъй като съдържат важна информация
- LV Lūdzu, saglabājiet bukletu un iepakojumu, jo uz tā ir norādīta svarīga informācija
- ET Hoidke infoleht ja pakend alles, sest nendele on märgitud oluline teave
- LT Išsaugokite informacinį lapelį ir pakuotę, nes ant jų pateikiama svarbi informacija
- TR Önemli bilgiler içerdiği için broşürü ve ambalajı saklayın
- AR الرجاء الاحتفاظ بالنشرة والغلاف لاحتوائهما على معلومات هامة
- ID Harap simpan brosur dan kemasan ini karena berisi informasi penting
- MS Sila simpan risalah dan pembungkusan kerana ia mengandungi maklumat penting

LEGO System A/S
Aastvej 1
DK-7190 Billund

有毒有害物质/元素的名称及含量表						
根据中国<电子信息产品污染控制管理办法>						
有毒有害物质/元素						
部件名称	铅 (Pb)	汞 (Hg)	镉 (Cd)	六价铬 (Cr(VI))	多溴联苯 (PBB)	多溴二联苯 (PBDE)
印刷电路板组件	X	O	O	O	O	O

本表格依据 SJ/T 11364 的规定编制。
 O:表示该有害物质在该部件所有均质材料中的含量均在GB/T 26572 规定的限量要求以下。
 X:表示该有害物质至少在该部件的某一均质材料中的含量超出GB/T 26572 规定的限量要求。
 (由于技术原因目前尚未能替代化,除非破坏产品,否则消费者接触不到相关组件。)



EN
Protect the environment by not disposing of this product with your household waste.
Check with your local authority for recycling advice and facilities. Penalties may apply for improper disposal.

DE
Schützen Sie die Umwelt und entsorgen Sie dieses Produkt nicht mit Ihrem Hausmüll.
Informationen zu Recycling-Möglichkeiten erhalten Sie bei den örtlichen Behörden. Bei unsachgemäßer Entsorgung können Strafen verhängt werden.

FR
Protégez l'environnement : ne jetez pas ce produit avec vos autres déchets ménagers.
Contactez les autorités locales pour obtenir des informations sur le recyclage et connaître les points de collecte. Des sanctions peuvent être appliquées en cas d'élimination inappropriée.

IT
Proteggi l'ambiente! Non smaltire questo prodotto con i rifiuti domestici.
Per consulenza sul riciclaggio dei rifiuti e le strutture di riciclaggio, rivolgersi alle proprie autorità locali. Uno smaltimento improprio può comportare sanzioni.

NL
Bescherm het milieu: gooi dit product niet samen met het andere huisvuil weg.
Raadpleeg de plaatselijke instanties voor locaties van milieustations en advies over hergebruik. In geval van onjuiste verwijdering kunnen boetes worden opgelegd.

ES
Proteja el medio ambiente no deshaciéndose de este producto junto con sus residuos domésticos.
Solicite asesoramiento e información sobre instalaciones de reciclaje a las autoridades locales. La eliminación inadecuada puede ser objeto de sanciones.

DA
Beskyt miljøet! Smid ikke dette produkt ud sammen med husholdningsaffaldet.
Få vejledning om genbrug og genbrugsstationer hos din kommune.
Ukorrekt bortskaffelse kan medføre bøde eller straf.

IS
Stuðlið að umhverfisvernd með því að farga þessari vöru ekki með heimilissorpi.
Leitið upplýsinga um endurvinnslu- og förgunarstaði hjá yfirvöldum á hverjum stað. Viðurlögum kann að vera beitt ef förgun er ekki með réttum hætti.

FI
Tämä tuote on hävitettävä ympäristöstävällisesti ja erillään muusta talousjätteestä.
Tietoja kierrätyksestä ja keräyspisteiden sijainnista saat paikkakuntasi teknisestä virastosta. Epäasianmukaisesta hävittämisestä saattaa aiheutua seuraamuksia.

SV
Skydda miljön genom att inte kasta denna produkt bland ditt hushållsavfall.
Kontakta din kommun för frågor om återvinning och miljöstationer. Påföljder kan tillkomma för felaktig avyttring.

NO
Beskytt miljøet. Ikke kast dette produktet i husholdningsavfallet.
Kontakt kommunen for veiledning om gjenbruk og miljøsasjoner. Feil avfallshåndtering kan være straffbart.

PT
Proteja o ambiente não eliminando este produto com o seu lixo doméstico.
Consulte as autoridades locais para informação sobre reciclagem e sistemas de recolha. Podem ser aplicadas coimas por eliminação inadequada.

EL
Προστατέψτε το περιβάλλον. Μην πετάτε αυτό το προϊόν μαζί με τα συνηθισμένα οικιακά απορρίμματα.
Επικοινωνήστε με τις τοπικές αρχές σχετικά με συμβουλές και εγκαταστάσεις ανακύκλωσης. Ενδέχεται να επιβάλλονται κυρώσεις για ακατάλληλη διάθεση απορριμμάτων.

JA
環境保護のため、本製品は家庭ごみとは別に処分してください。
リサイクルに関する指示や施設については、お住まいの地方自治体にお問い合わせください。不適切な廃棄を行った場合、罰則が適用されることがあります。

ZH
注意保护环境，请勿将本产品与生活垃圾一起丢弃处理。
请咨询当地相关部门，了解与回收相关的设施与建议。
处理不当可能会导致处罚。

KO
환경 보호를 위해 이 제품을 생활폐기물과 함께 버리지 마십시오.
재활용 방법 및 시설에 관한 사항은 현지 관계 당국에 문의하십시오. 부적절하게 폐기할 경우 벌칙이 부과될 수 있습니다.

RU
Позаботьтесь об окружающей среде: не утилизируйте этот продукт вместе с бытовым мусором.
Узнайте в органах местного самоуправления правила вторичной переработки и утилизации таких отходов.
В случае ненадлежащей утилизации могут быть наложены штрафы.

PL
Aby chronić środowisko naturalne, nie należy wyrzucać tego produktu wraz z odpadkami z gospodarstwa domowego.
W celu uzyskania wskazówek dotyczących recyklingu oraz adresów zakładów należy skontaktować się z lokalnym urzędem.
Za nieprzestrzeganie zasad związanych z utylizacją odpadów grożą kary.

CZ
Nevyhazujte tento produkt do domácího odpadu, chraňte životní prostředí.
Zjistěte si prosím u místních úřadů možnosti recyklace a dostupná zařízení.
Nesprávná likvidace může být pokutována.

SK
Nevyhadzujte tento produkt do domáceho odpadu, chráňte životné prostredie.
Zistite si na miestnych úradoch možnosti recyklácie a dostupné zariadenia.
Za nesprávnu likvidáciu môžu byť uložené sankcie.

HU
Környezetét óvja, ha ettől a terméktől nem a háztartási hulladékkal együtt válik meg.
Érdeklődjék a lakóhelyéhez közel eső hatóságnál az újrahasznosítás módjáról és lehetőségeiről. A nem megfelelő hulladékelhelyezésért büntetés járhat.



UA
Допоможіть захистити довкілля: не утилізуйте цей виріб разом із побутовим сміттям.
Вказівки з утилізації та відомості про пункти прийому з'ясуйте в місцевих компетентних органів. У разі неналежної утилізації можуть застосовуватися штрафи.

HR
Zaštitite okoliš tako da ovaj proizvod ne odložite u otpad zajedno s kućanskim otpadom.
Od lokalnih vlasti zatražite savjet ili informacije o pogonima za recikliranje. Moguća je kazna za nepropisno zbrinjavanje.

SR
Zaštitite životnu sredinu tako što nećete da odlažete ovaj proizvod sa kućnim otpadom.
Распитайте се код локалног надлежног органа о начину рециклаже и о сабирном центру. У случају неправилног одлагања у отпад, могу бити изречене казне.

MK
Zaštitete ja okolinata tako što nema da se oslobodite od proizvodot so domashniot otpad.
Консултирајте се со локалните власти за да дознаете за советите и објектите за рециклирање. Возможно е да бидат применети казни за неправилно исфрлање.

SL
Zaščitite okolje! Okolje varujte tako, da tega izdelka ne zavržete skupaj z gospodinjiskimi odpadki.
Pri krajevni upravi preverite, kakšne možnosti in kateri obrati za recikliranje obstajajo v vaši okolici. Za nepravilno odlaganje odpadkov vas lahko doleti kazen.

RO
Protejați mediul înconjurător și nu vă debarașați de acest produs împreună cu deșeurile menajere
Consultați autoritățile locale pentru îndrumări și facilități de reciclare.
Dezafectarea necorespunzătoare poate atrage sancțiuni.

BG
Защитете околната среда и не изхвърляйте този продукт заедно с битовите си отпадъци.
Свържете се с местните власти относно съвети и съоръжения за рециклиране. Възможно е да има глоби за неправилно изхвърляне.

LV
Lai saudzētu vidi, neizmetiet šo izstrādājumu kopā ar sadzīves atkritumiem.
Vērsieties vietējās varas iestādēs, lai noskaidrotu, kur un kā tas nododams pārstrādei. Par neatbilstošu likvidēšanu var tikt piemērots sods.

ET
Keskkonda saate kaitsta nii, et ei kõrvalda seda toodet koos olmejäätmetega.
Nüuandeid toote taaskasutusse võtmise ja ümbertöötlemispunktide kohta saate asjaomaselt kohalikult asutuselt.
Nüuetele mittevastav kasutuselt kõrvaldamine võib kaasa tuua trahvid.

LT
Saugokite aplinką: nemeskite šio produkto kartu su buitinėmis atliekomis.
Atsižvelkite į savo vietos valdžios rekomendacijas dėl pakartotinio panaudojimo ir sąlygas. Už netinkamą šalinimą gali būti taikomos baudos.

TR
Bu ürünü, evsel atıklarla birlikte atmayarak çevreyi koruyun.
Geri dönüşüm tavsiyeleri ve tesisler hakkında bilgi için yerel yönetimle iletişim kurun. Uygunsuз atılması durumunda cezalar uygulanabilir.

AR
احم البيئة بعدم التخلص من هذا المنتج مع المخلفات المنزلية.
استشر السلطة المحلية لديك للحصول على نصح بخصوص إعادة تدوير المخلفات ومرافقه.
قد يتم تطبيق عقوبات على التخلص غير السليم.

ID
Jagalah lingkungan dengan tidak membuang produk ini bersama sampah rumah tangga Anda.
Periksa peraturan pemerintah setempat tentang saran dan fasilitas daur ulang. Pembuangan yang tidak sesuai ketentuan dapat dikenakan denda.

MS
Lindungi alam sekitar dengan tidak melupuskan produk ini bersama sisa isi rumah anda.
Rujuk pihak berkuasa tempatan anda tentang nasihat dan kemudahan kitar semula. Penalti boleh dikenakan untuk pelupusan yang tidak wajar.

This device complies with part 15 of the FCC Rules. Operation is subject to the following two conditions:
(1) This device may not cause harmful interference, and (2) this device must accept any interference received, including interference that may cause undesired operation.

NOTE: This equipment has been tested and found to comply with the limits for a Class B digital device, pursuant to part 15 of the FCC Rules. These limits are designed to provide reasonable protection against harmful interference in a residential installation. This equipment generates, uses and can radiate radio frequency energy and, if not installed and used in accordance with the instructions, may cause harmful interference to radio communications. However, there is no guarantee that interference will not occur in a particular installation. If this equipment does cause harmful interference to radio or television reception, which can be determined by turning the equipment off and on, the user is encouraged to try to correct the interference by one or more of the following measures:

- Reorient or relocate the receiving antenna.
- Increase the separation between the equipment and receiver.
- Connect the equipment into an outlet on a circuit different from that to which the receiver is connected.
- Consult the dealer or an experienced radio/TV technician for help.

Caution: changes or modifications not expressly approved by the party responsible for compliance could void the user's authority to operate the equipment.

This Class B digital apparatus complies with Canadian ICES-003.
Cet appareil numérique de la classe B est conforme à la norme
NMB-003 du Canada.



FEEDBACK AND WIN



FEEDBACK AND WIN

Your feedback will help shape the future development of this product series.

Please visit:

FEEDBACK UND GEWINNEN

Dein Feedback trägt zur Weiterentwicklung dieser Produktreihe bei.

Geh auf:

COMMENTEZ ET GAGNEZ

Vos commentaires nous aideront à concevoir les futurs produits de cette gamme.

Rendez-vous sur :

COMENTA Y GANA

Tu opinión nos ayudará a dar forma al desarrollo de esta serie de productos en el futuro.

Visita:

反馈有奖

您的反馈将有助于我们在今后改进本系列产品。

请访问：

[LEGO.com/productfeedback](https://www.lego.com/productfeedback)

By completing, you will automatically enter a drawing to win a LEGO® set.

Terms & Conditions apply.

Durch Ausfüllen nimmst du automatisch an der Verlosung eines LEGO® Preises teil.

Es gelten die Teilnahmebedingungen.

En envoyant vos commentaires, vous serez automatiquement inscrit(e) à un tirage au sort qui vous permettra de remporter un prix LEGO®.

Offre soumise à conditions.

Al contestar, participarás automáticamente en el sorteo y podrás ganar un set LEGO®.

Sujeto a Términos y Condiciones.

完成我们的反馈调查，即可自动进入抽奖环节，赢取乐高®套装。

适用《条款和条件》。

