

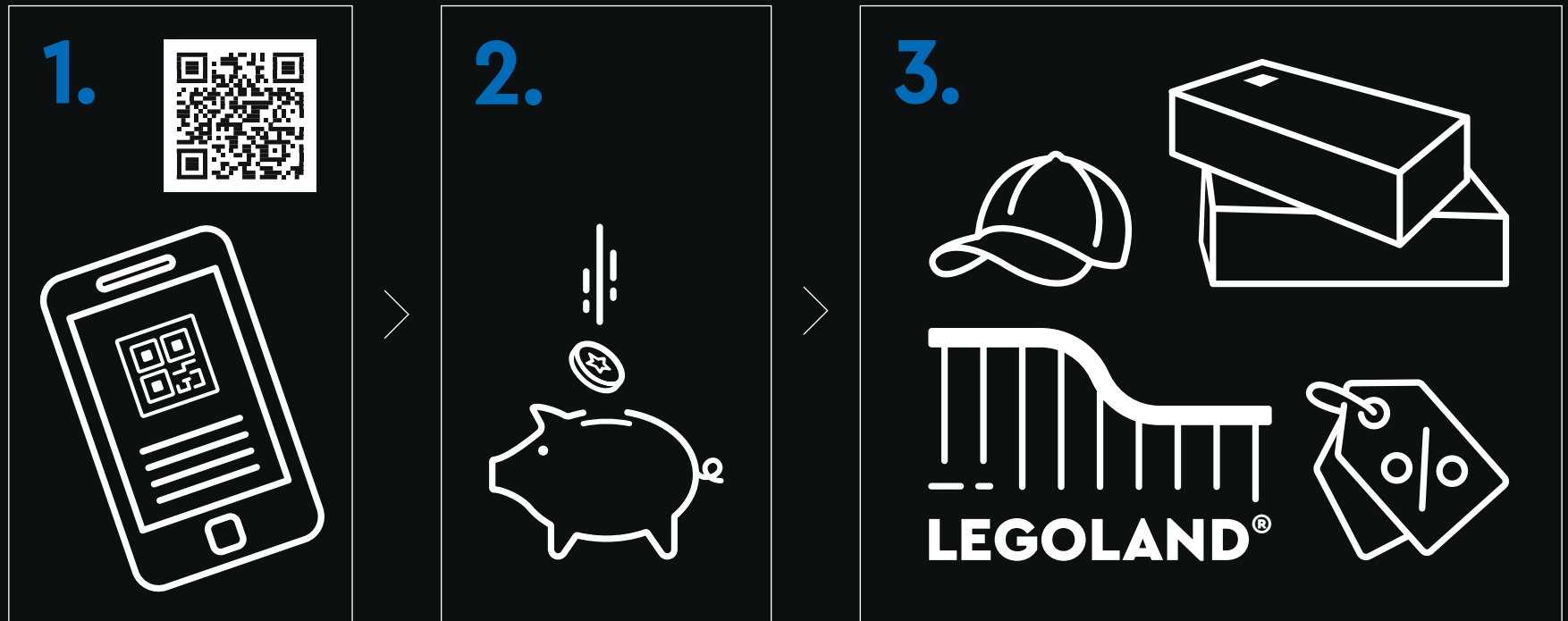



LEGO.com/sustainable-packaging

LEGO® VIP



1. Sign up **2.** Earn points for purchases **3.** Redeem points for rewards, experiences, discounts & more | **1.** Melde dich an **2.** Sammle Punkte bei jedem Kauf **3.** Löse die Punkte für Belohnungen, Erlebnisse, Rabatte und Ähnliches ein | **1.** Inscrivez-vous **2.** Gagnez des points lors de vos achats **3.** Échangez vos points contre des récompenses, des expériences, des remises et bien plus encore | **1.** Iscriviti **2.** Guadagna punti con i tuoi acquisti **3.** Riscatta punti per premi, esperienze, sconti e altro ancora | **1.** Regístrate **2.** Gana puntos por tus compras **3.** Canjea puntos por recompensas, experiencias, descuentos y mucho más | **1.** Registe-se **2.** Ganhe pontos em compras **3.** Troque os pontos para prémios, experiências, descontos e muito mais | **1.** 注册 **2.** 购物赚积分 **3.** 用积分兑换奖励、体验、折扣等 | **1.** Zarejestruj się **2.** Zdobywaj punkty za zakupy **3.** Wymieniaj punkty na rabaty, przygody i inne nagrody | **1.** Zaregistrujte se **2.** Sbírejte body za nákupy **3.** Vyměňujte body za odměny, zážitky, slevy a spoustu dalšího | **1.** Zaregistrujte se **2.** Získavajte body za nákupy **3.** Uplatnite si body a získajte odmeny, rôzne zážitky, zľavy a ešte viac | **1.** Regisztrálj **2.** Szerezz pontokat minden vásárlással **3.** Váltsd be pontjaidat jutalmakra, élményekre, kedvezményekre és egyebekre | **1.** Înscric-te **2.** Câștigă puncte pentru achiziții **3.** Valorifică puncte pentru recompense, experiențe, reduceri și multe altele | **1.** Регистрируйте се **2.** Получайте точки за покупки **3.** Используйте точки за награды, услуги, отстъпки и т.н. | **1.** Reģistrējies **2.** Pelni punktus par pirkumiem **3.** Izmanto punktus, lai saņemtu balvas, izklaides iespējas, atlaides un daudz ko citu | **1.** Registreeru **2.** Teeni ostude eest punkte **3.** Lunasta punktide eest preemiad, elamused, allahindlused ja muu | **1.** Užsiregistruokite **2.** Pelnykite taškus už pirkinius **3.** Panaudokite taškus atlygiui, funkcijoms, nuolaidoms ir ne tik





**RENCONTRE
AVEC LE FAN
CONCEPTEUR**

E

Le réalisateur et scénariste français Thomas Lajon (pseudonyme L.E.t.s.G.O® sur LEGO® Ideas) a eu son premier set LEGO à l'âge de quatre ans. Il aime toujours autant construire. Aujourd'hui, il partage sa passion LEGO (et ses briques) avec les personnes qu'il aime le plus.

« J'ai toujours été un grand fan de locomotives, et si je pouvais voyager dans le temps (et avoir les moyens de payer un billet), je prendrais l'*Orient-Express* ! Il semble tout droit sorti d'un autre monde, c'est ce que j'aime concernant ce train. Ce train somptueux a emmené des passagers à travers l'Europe dans des wagons de luxe pendant près d'un siècle. Il reste au cœur de nombreuses histoires et mythes. Et pour moi, qui travaille dans le domaine de l'écriture de scénario et du cinéma, l'*Orient-Express* inspire des récits d'aventure et m'invite au voyage. L'*Orient-Express* est un train de rêve avec ses

magnifiques wagons créés par de grands artisans et designers. Il est inaccessible et stimule notre imagination. Il est présent dans des histoires fabuleuses, dans la littérature, des chansons et des films. »

« Ce modèle est mon tout premier projet LEGO Ideas. Il a fallu des heures, des jours et des nuits de préparation, de conception et de patience ! J'ai construit mon modèle en regardant des centaines de photos de l'extérieur et de l'intérieur des wagons de la locomotive Pacific 231 K 8. Le set final est magnifique, et l'équipe de concepteurs LEGO a fait un travail fantastique pour donner vie à ce rêve. Mon détail préféré est le miroir convexe qui reflète l'intérieur du wagon-lit. Pour moi, c'est la cerise sur le gâteau. Et je tiens à envoyer mes pensées et mes remerciements à chacun des 10 000 supporters LEGO Ideas qui ont fait de ce moment de bonheur une réalité ! »



Contribution originale de Thomas

OUVRIR LA VOIE À UN NOUVEAU MONDE



Pendant la révolution industrielle, les trains et les chemins de fer sont devenus des symboles du progrès technologique et du pouvoir politique. Des milliers de kilomètres de nouveaux rails et itinéraires ont été créés entre les régions, transcendant les frontières et apportant une nouvelle vie avec eux. Ils ont favorisé le transport des marchandises, la création de nouveaux emplois, la croissance économique et ouvert la voie à de nouvelles possibilités de voyages exotiques pour des millions de personnes dans le monde

entier. Le transport international de passagers en était encore à ses balbutiements, avec une coordination ou une efficacité transfrontalière limitée. Avec la tension politique qui s'étend à travers l'Europe, le statut neutre de la Belgique jouera un rôle important dans la mise en place des voies du progrès mondial alors que la nation établit des liaisons ferroviaires stratégiquement importantes vers et à travers de grandes parties du continent et des colonies.

UNE PERCÉE DIPLOMATIQUE

- En 1876, l'ingénieur et entrepreneur belge visionnaire Georges Nagelmackers fonde la Compagnie Internationale des Wagons-Lits (CIWL). Il pressent l'énorme potentiel des voyages de luxe s'adressant à la catégorie aisée. En pionnier, il crée la première chaîne de trains de luxe, inspirés par les wagons-restaurants et les wagons-lits qui gagnent en popularité aux États-Unis. Ses trains se répandront par la suite dans le monde entier. Grâce à de longues négociations diplomatiques et, sans aucun doute, à une persévérance et à un optimisme sans précédent, Nagelmackers obtient les permis et contrats nécessaires auprès des États voisins pour permettre à ses trains de traverser l'Europe sans entrave, de Paris à Constantinople. Supervisées par des hommes et des femmes talentueux du monde entier, la conception, la construction et la maintenance sont un modèle de qualité, de perfection et d'innovation. Les nouveaux trains sont une porte ouverte vers de nouveaux horizons intrigants et romantiques, de nouveaux rêves et de nouveaux mondes.



E

UN PORTAIL VERS L'AVENTURE

S

- La capitale de l'Empire ottoman, devenue une nouvelle destination populaire, est une source d'inspiration pour les artistes et les écrivains européens. On la considère alors comme une porte d'entrée vers le mystère et l'attrait de l'Extrême-Orient. Premier train transcontinental européen, l'*Orient-Express* devient le symbole du voyage et de l'aventure. Le train permet à Nagelmackers de promouvoir sa nouvelle société à travers de vastes campagnes publicitaires composées d'affiches colorées, de cartes postales et de souvenirs à collectionner. Ces campagnes mettent en avant des images de monuments et symboles ottomans, des couleurs et compositions dans des teintes ocre ou des modèles portant des vêtements d'inspiration égyptienne ou arabe. Le magazine officiel Wagons-Lits promeut les services, itinéraires et articles de divertissement proposés par la société, et présente des photographies de célébrités profitant du luxe à bord, des wagons-restaurants aux wagons-lits exquis en passant par les bagagistes et conducteurs impeccablement vêtus, perpétuant le glamour, le mythe et l'exclusivité de l'*Orient-Express*.



SI CES WAGONS POUVAIENT PARLER...



Suite au voyage inaugural réussi de l'*Orient-Express* en octobre 1883, la CIWL ne cesse d'ajouter de nouveaux itinéraires au cours des décennies suivantes et ce, jusqu'au XX^e siècle. Comme Nagelmackers l'avait pressenti, les gens sont attirés par la qualité, le luxe et la promesse d'aventure. L'*Orient-Express* connaît un tournant décisif en 1934. La sortie du roman à succès d'Agatha Christie, *Le crime de l'Orient-Express*, met le

train sous le feu des projecteurs, lui conférant une aura de glamour, de passion et de mystère et le propulsant sur la scène mondiale en tant que phénomène culturel du XX^e siècle. Une légende moderne est née. Quatre décennies plus tard, la première adaptation cinématographique continue de captiver l'imagination d'un nouveau public.

N

L'ORIENT-EXPRESS EN PÉRIODE DE CHANGEMENT



1867

Lors d'un voyage aux États-Unis, Georges Nagelmackers découvre les wagons-restaurants et les wagons-lits modernes. Il entrevoit leur potentiel de redéfinition du voyage.

1883

Le 4 octobre, l'*Orient-Express* entreprend son voyage inaugural : un aller-retour de Paris à Constantinople, avec un retour le 16 octobre. Deux douzaines de passagers sont invités à ce « voyage médiatique » sur les rives de la mer Noire, où la dernière partie du voyage se fait en bateau à vapeur.

1889

L'*Orient-Express* relie désormais Paris à Constantinople via Budapest, Belgrade et Sofia en 67 heures et 46 minutes.

1918

La légende raconte que l'armistice de 1918 a été signé à bord de l'*Orient-Express*. En réalité, il a été signé dans un wagon appartenant à un autre des trains de la compagnie : le wagon-restaurant n° 2419, dans la clairière de Rethondes, dans la forêt de Compiègne.

1919

Inauguration du train *Simplon-Orient-Express* de Londres et Paris à Constantinople via l'Italie. Initiative de collaboration entre alliés, l'itinéraire reflète la nouvelle situation géopolitique en Europe après la Première Guerre mondiale.



Voyagez dans le temps et revivez les moments emblématiques de l'histoire de l'*Orient-Express*.

1922

Un grand nombre de wagons détruits ou confisqués pendant la Première Guerre mondiale ont besoin d'être réparés ou remplacés. Le teck remplace l'acier le cas échéant, et les wagons sont modernisés avec la teinte bleu nuit emblématique de la maison.

1929

Pendant des jours, une tempête de neige piège l'*Orient-Express* dans la ville turque de Çerkezköy. L'événement inspire le classique d'Agatha Christie, *Le Crime de l'Orient-Express* (publié en 1934).

1934

La sortie du roman à succès d'Agatha Christie, *Le Crime de l'Orient-Express*, mettant en vedette le détective belge fictif Hercule Poirot, propulse le train vers de nouveaux sommets de gloire en tant qu'icône culturelle.

1946

Après une interruption dans toute l'Europe pendant la Seconde Guerre mondiale, le train menant à Istanbul reprend du service.

1974

Le premier film basé sur le roman d'Agatha Christie *Le Crime de l'Orient-Express* est présenté en première mondiale et devient un classique de l'époque moderne.

1977

Confronté à la concurrence féroce du transport aérien de luxe moderne, l'*Orient-Express* effectue son dernier voyage à Istanbul le 20 mai.



RENCONTRE AVEC LES DESIGNERS LEGO®

- « Le set original de Thomas était extrêmement précis et détaillé. Sa passion pour l'ère de la vapeur était évidente. Nous avons fait tout notre possible pour reproduire de façon très réaliste l'expérience du voyage de luxe dans le modèle LEGO® final. Il y a le wagon-restaurant ainsi qu'un wagon-lit, et après des recherches approfondies et des consultations avec des experts, nous avons pu recréer certains détails en version LEGO, comme les panneaux en marqueterie et les miroirs en cristal taillé présents dans le modèle d'origine. J'espère que nos fans de trains LEGO aimeront les nombreuses pièces réalisées pour ce set. Un tout nouvel élément de poutre conçu pour les tiges d'accouplement de la locomotive, des stylos utilisés pour les sifflets et un seau utilisé pour la cheminée ne sont que quelques-uns de mes préférés. Le modèle est également plus grand que les trains LEGO traditionnels. Il y a donc plus de place à l'intérieur pour exposer les détails et, bien sûr, jouer !

–Ollie Gregory,
LEGO® Ideas Senior Model Designer

W

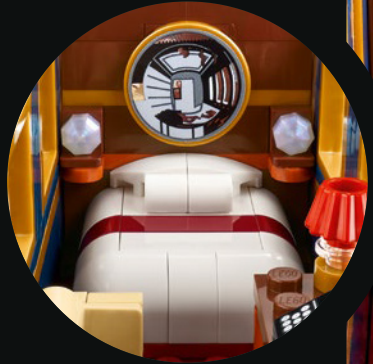

« Le modèle de Thomas était un véritable saut dans le passé. J'ai adoré travailler dessus ! J'ai beaucoup aimé les panneaux en marqueterie, le verre, le miroir convexe, le miroir avec les oiseaux et tous les détails inspirés du train original. Nous voulions que les décorations donnent vraiment vie à l'intérieur et ajoutent un peu de l'ADN LEGO®. Tous les oiseaux, les fleurs et les feuilles sont des éléments LEGO, mais cela a été un vrai casse-tête de trouver la combinaison parfaite de couleurs et de détails. Nous avons testé beaucoup de designs et d'impressions, de logos et de polices pour

arriver au résultat souhaité. Un autre aspect amusant mais complexe a été la conception de minifigurines. L'*Orient-Express* est un train mythique de la culture populaire. Le casting de personnages intrigants est un reflet de cela. Vous trouverez notamment un nouveau serveur et une journaliste, un chef de train, un pompier, un concierge, un porteur de bagages, une duchesse distinguée, un scientifique et plus encore. J'espère que le set stimulera votre imagination ! »

Kjeld Walther Sørensen,
LEGO® Ideas Graphic Designer

S

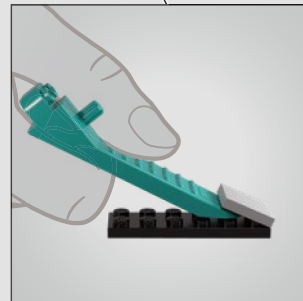
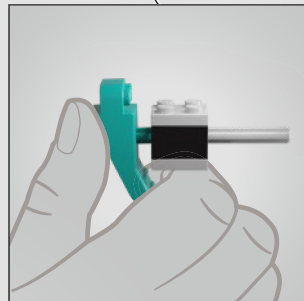
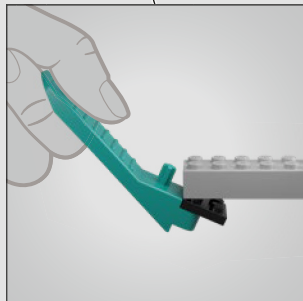
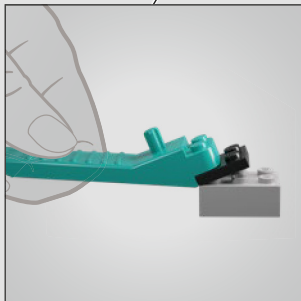
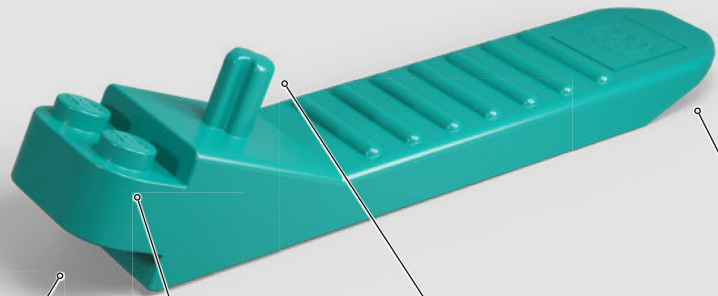

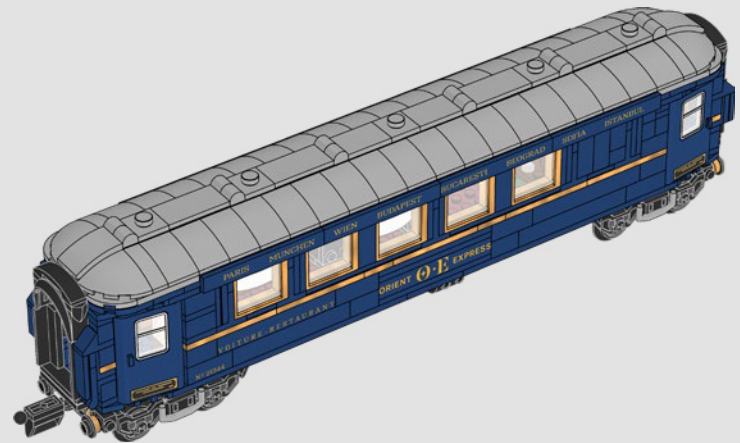
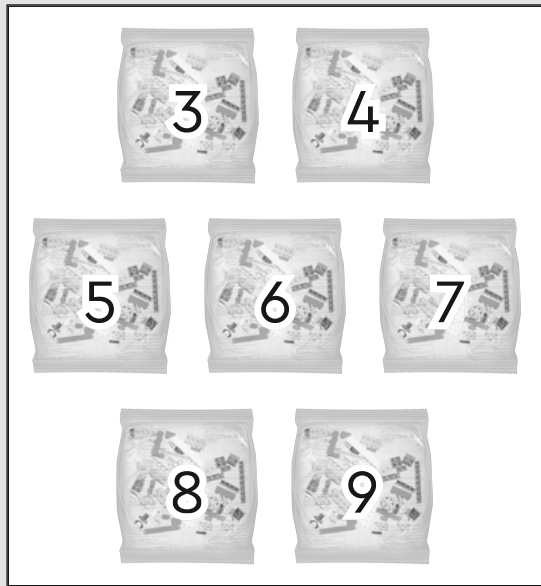
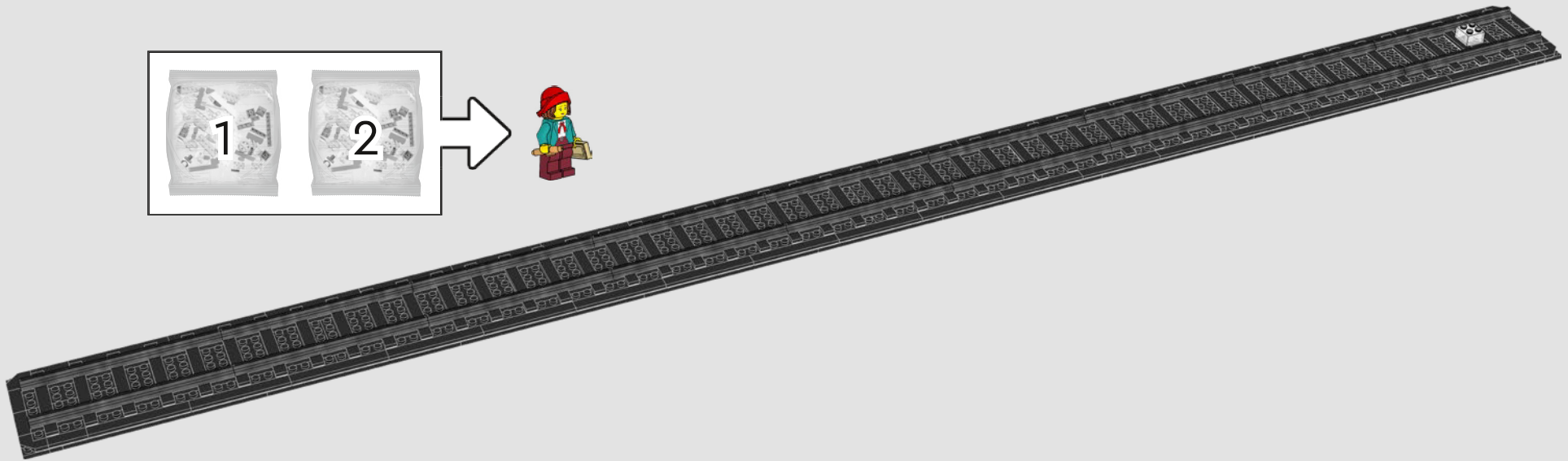

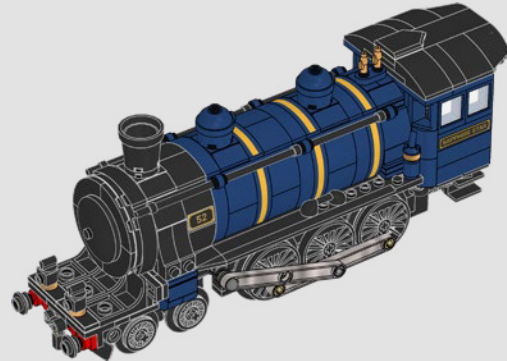
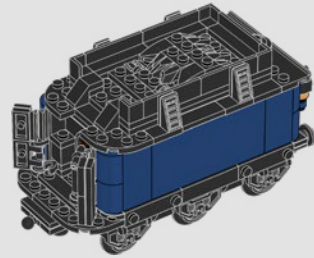
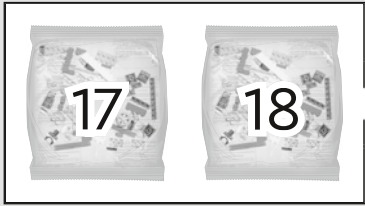
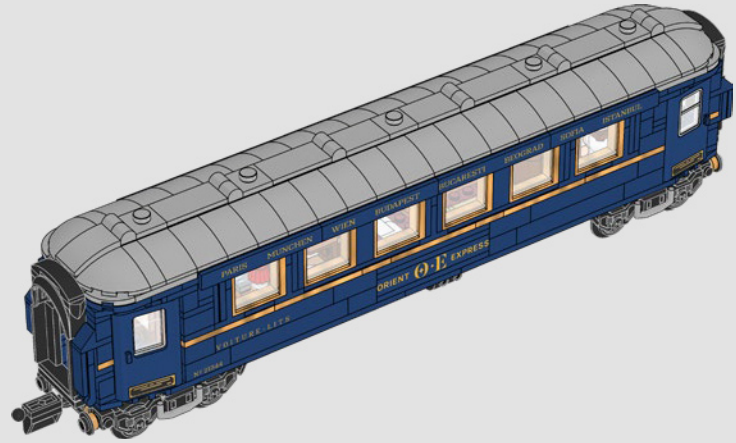
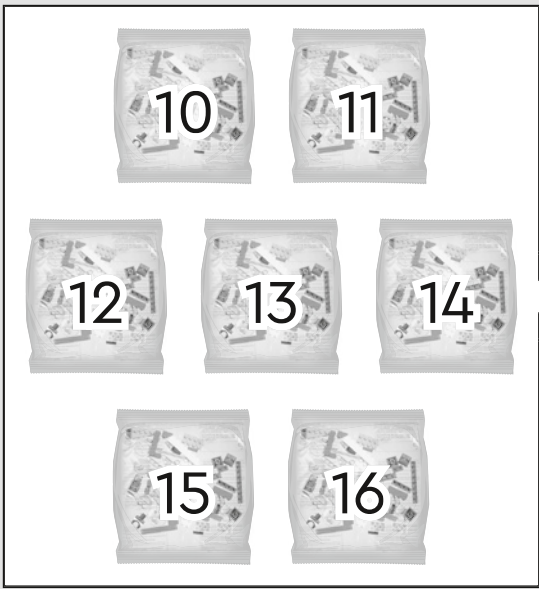

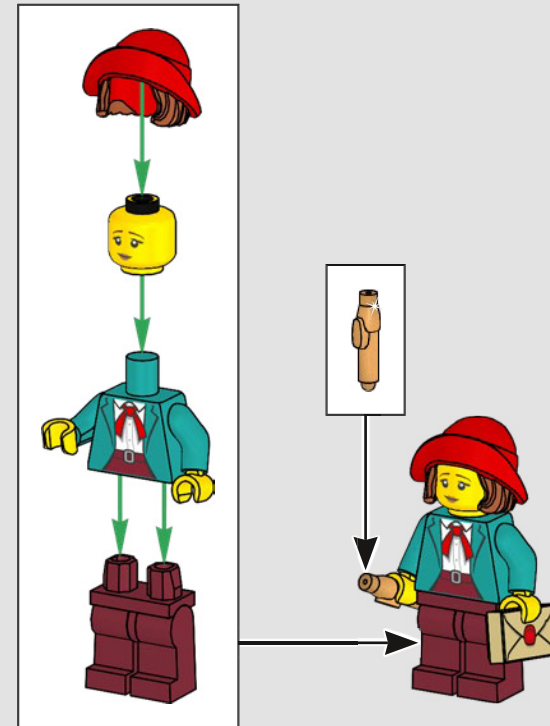
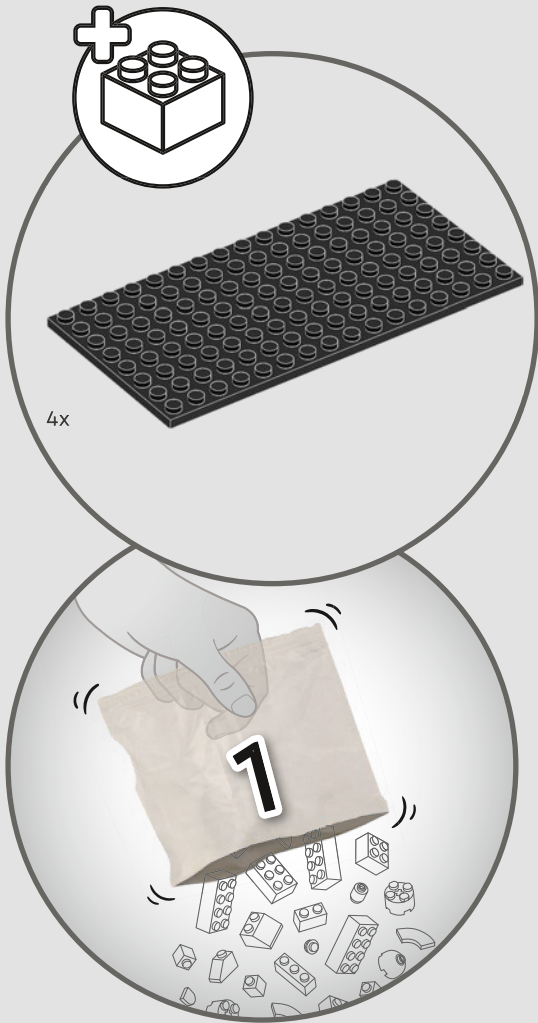

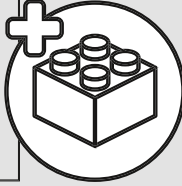
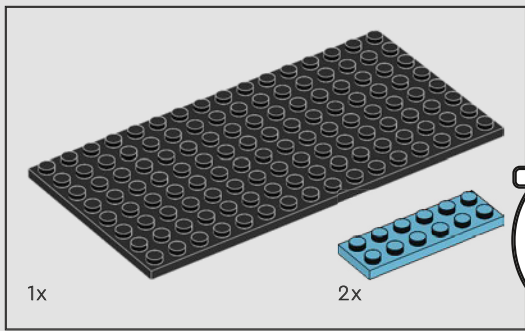

1

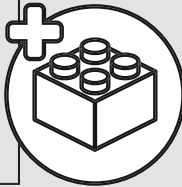
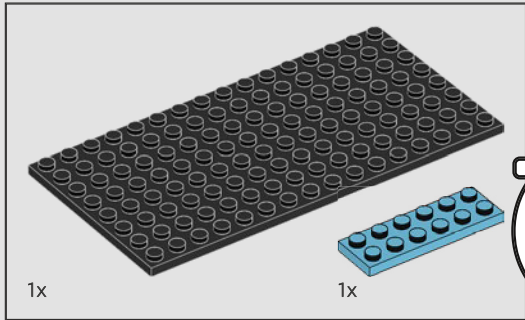
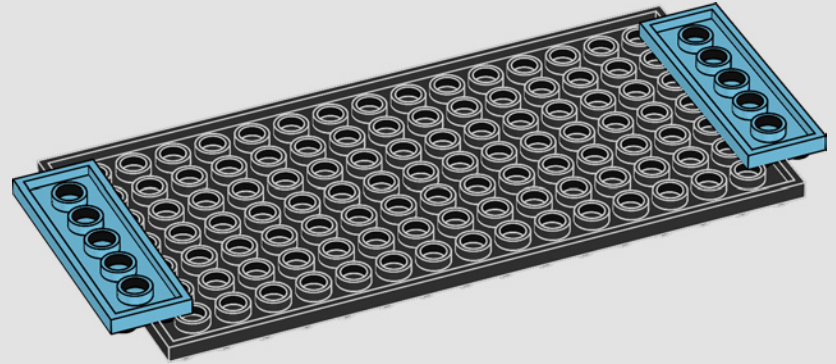

2

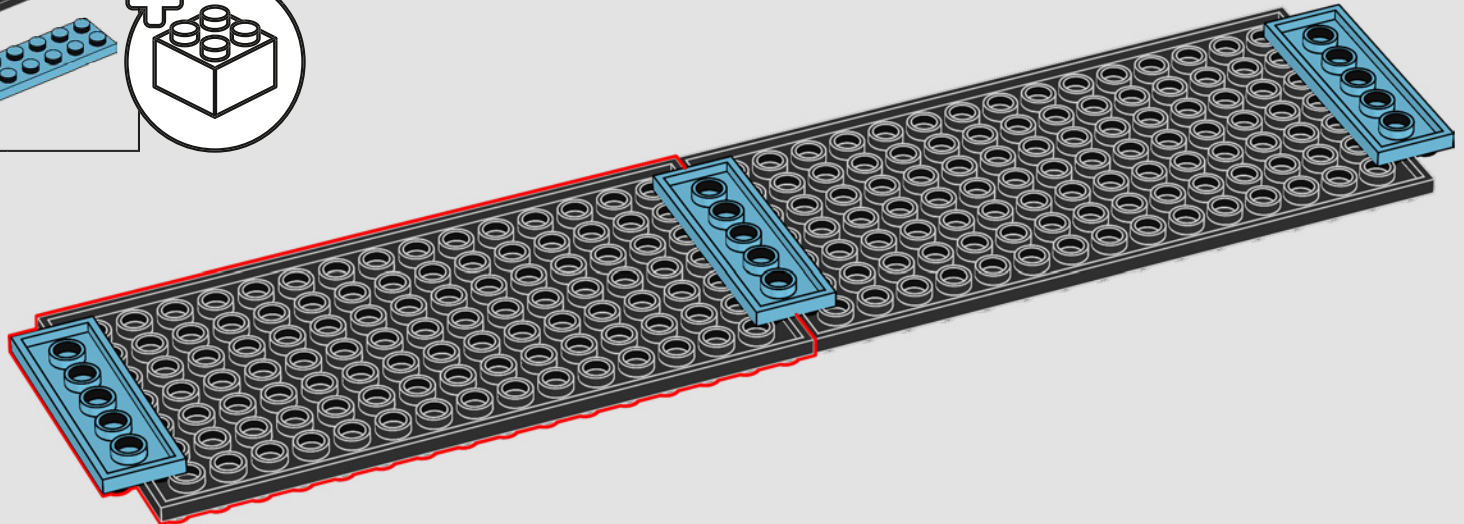

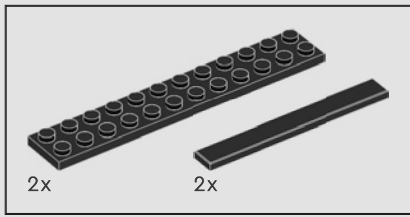

3

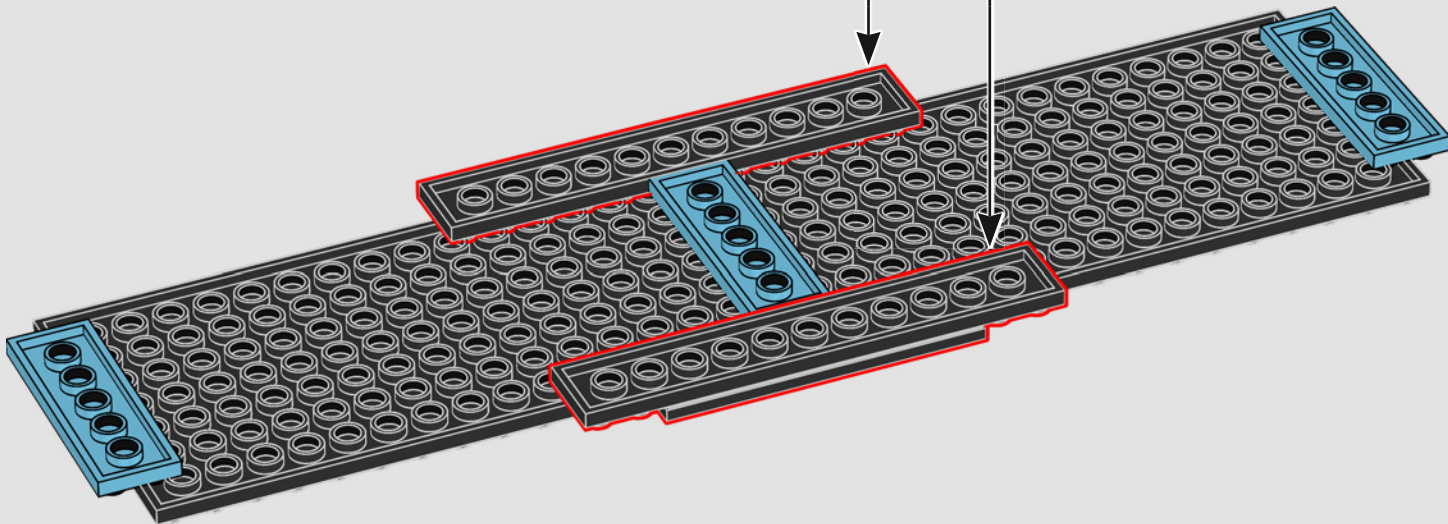
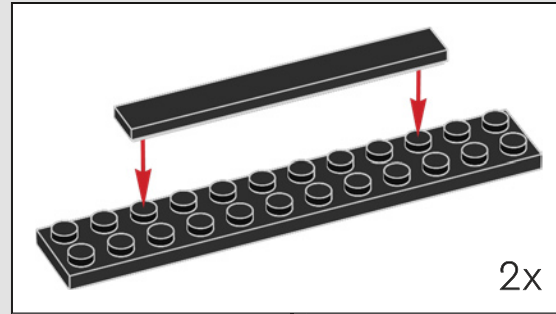

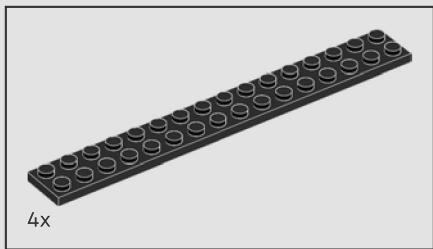

4

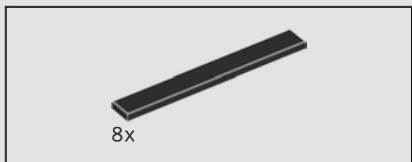
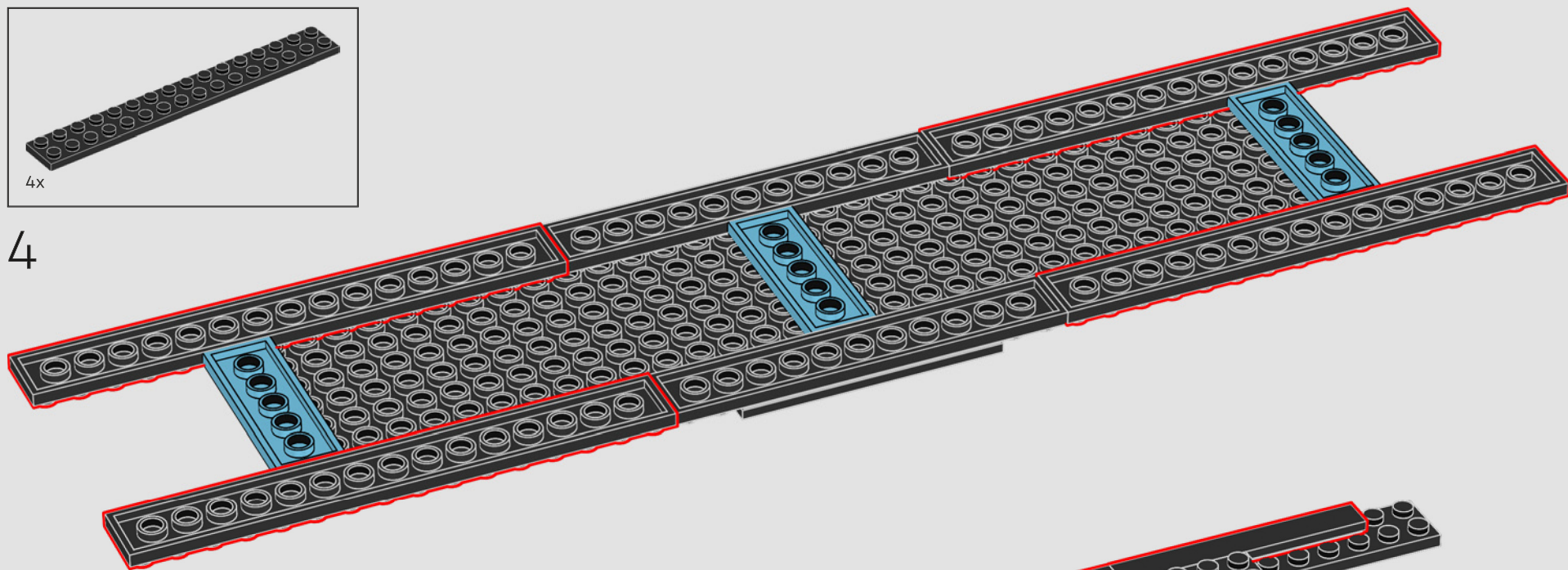

5

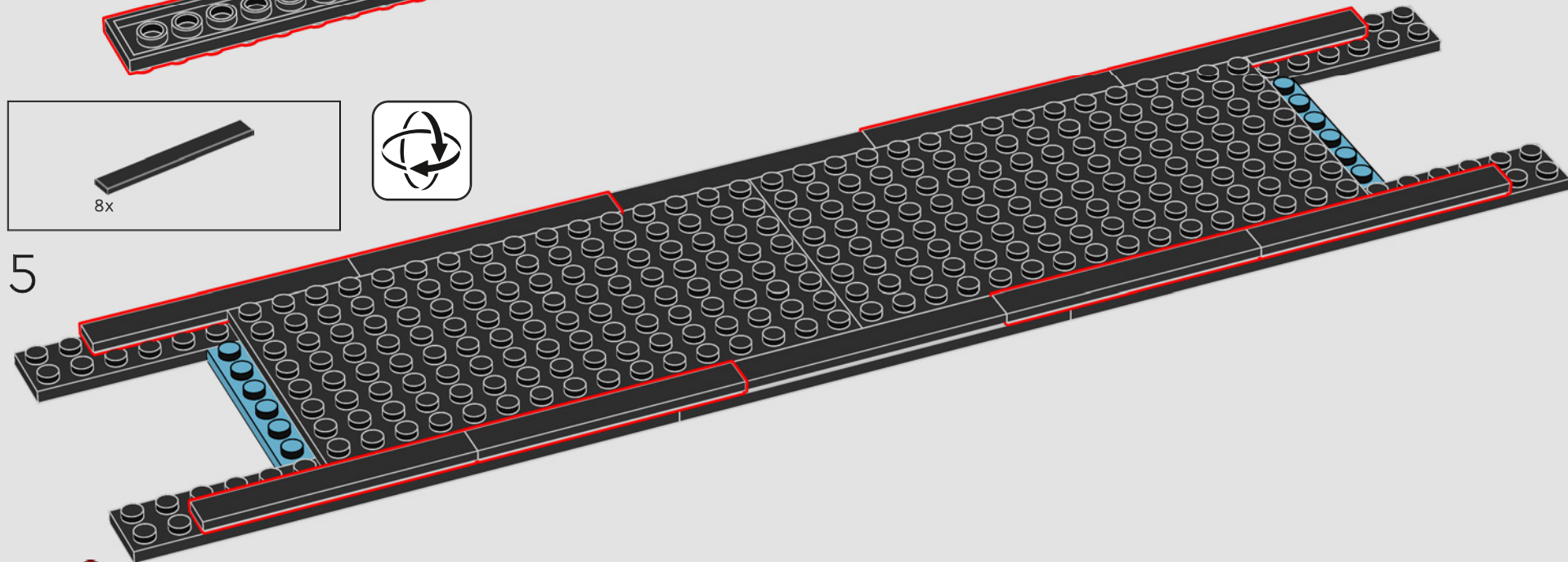

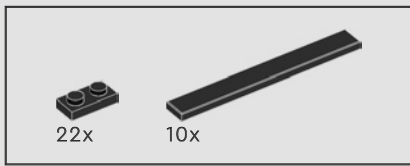

6

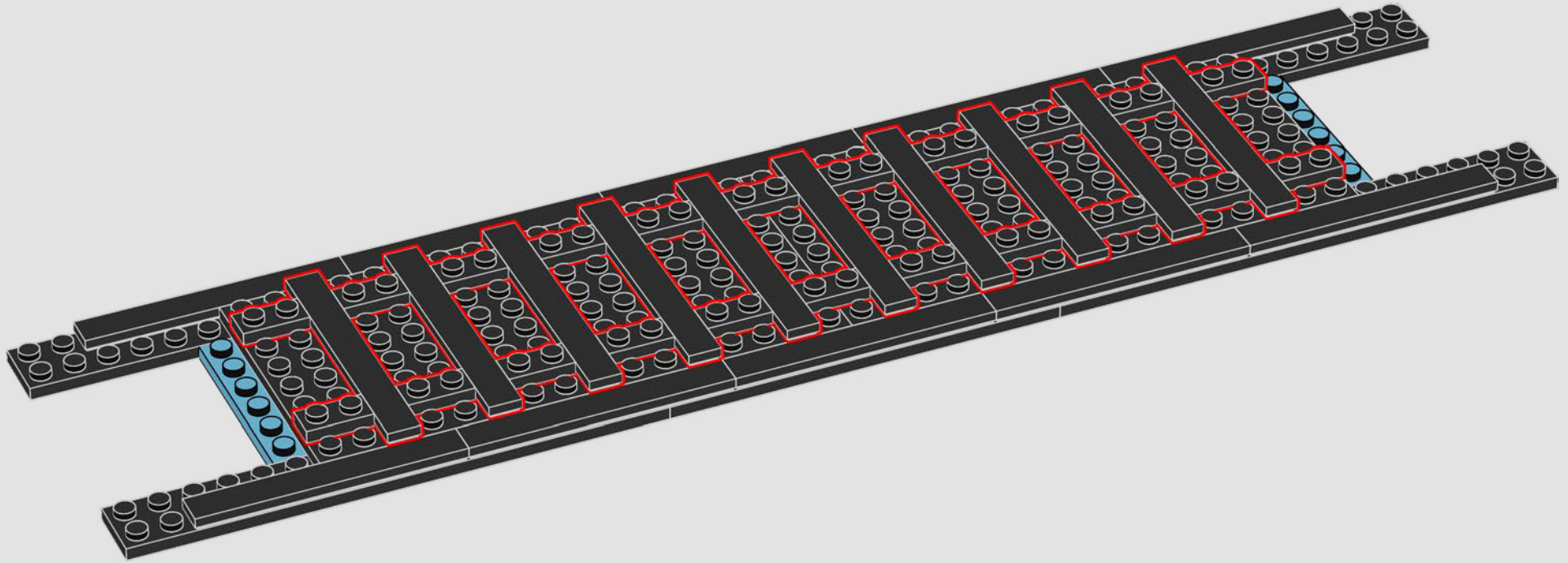

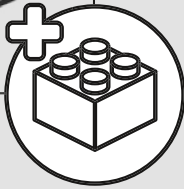
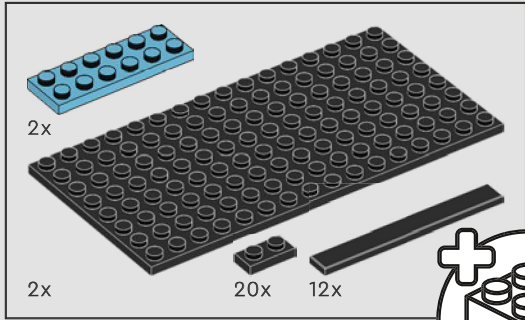
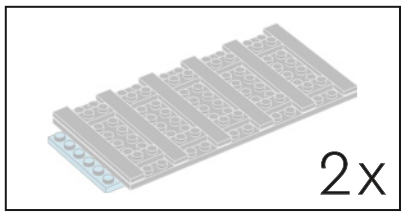

7

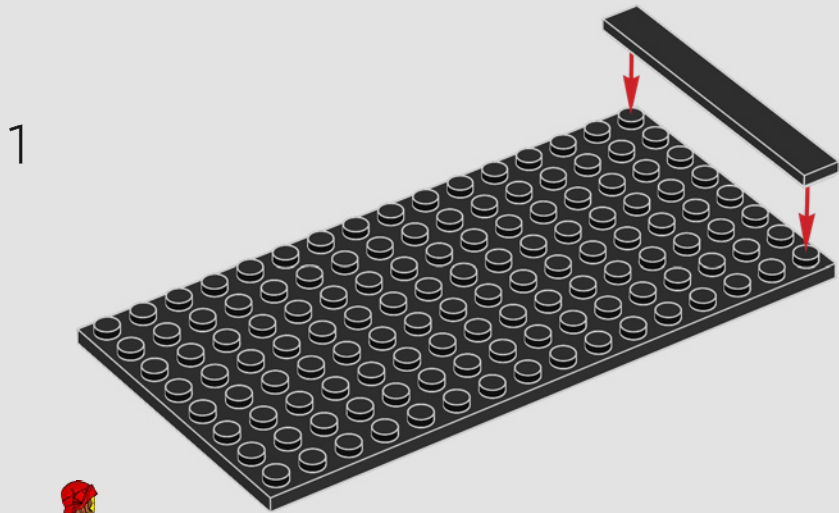

2

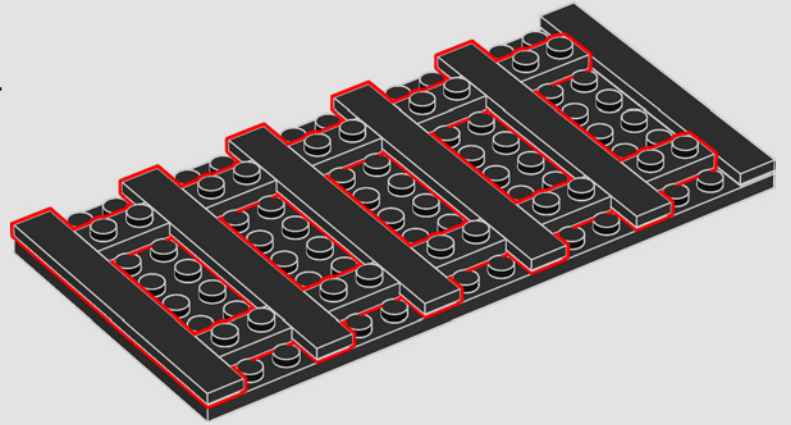

3

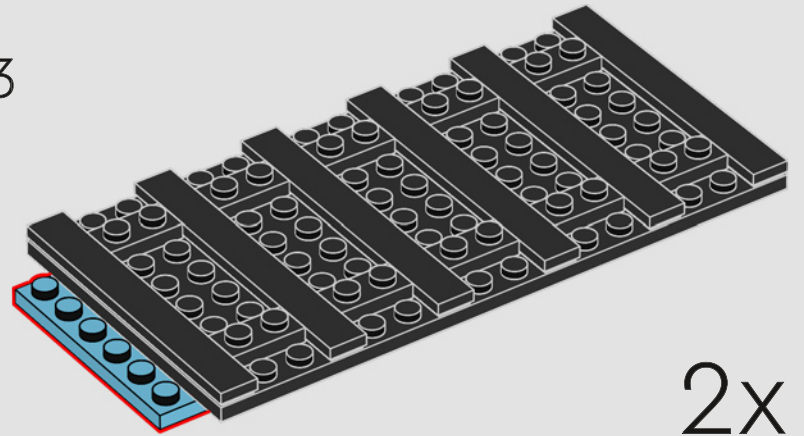

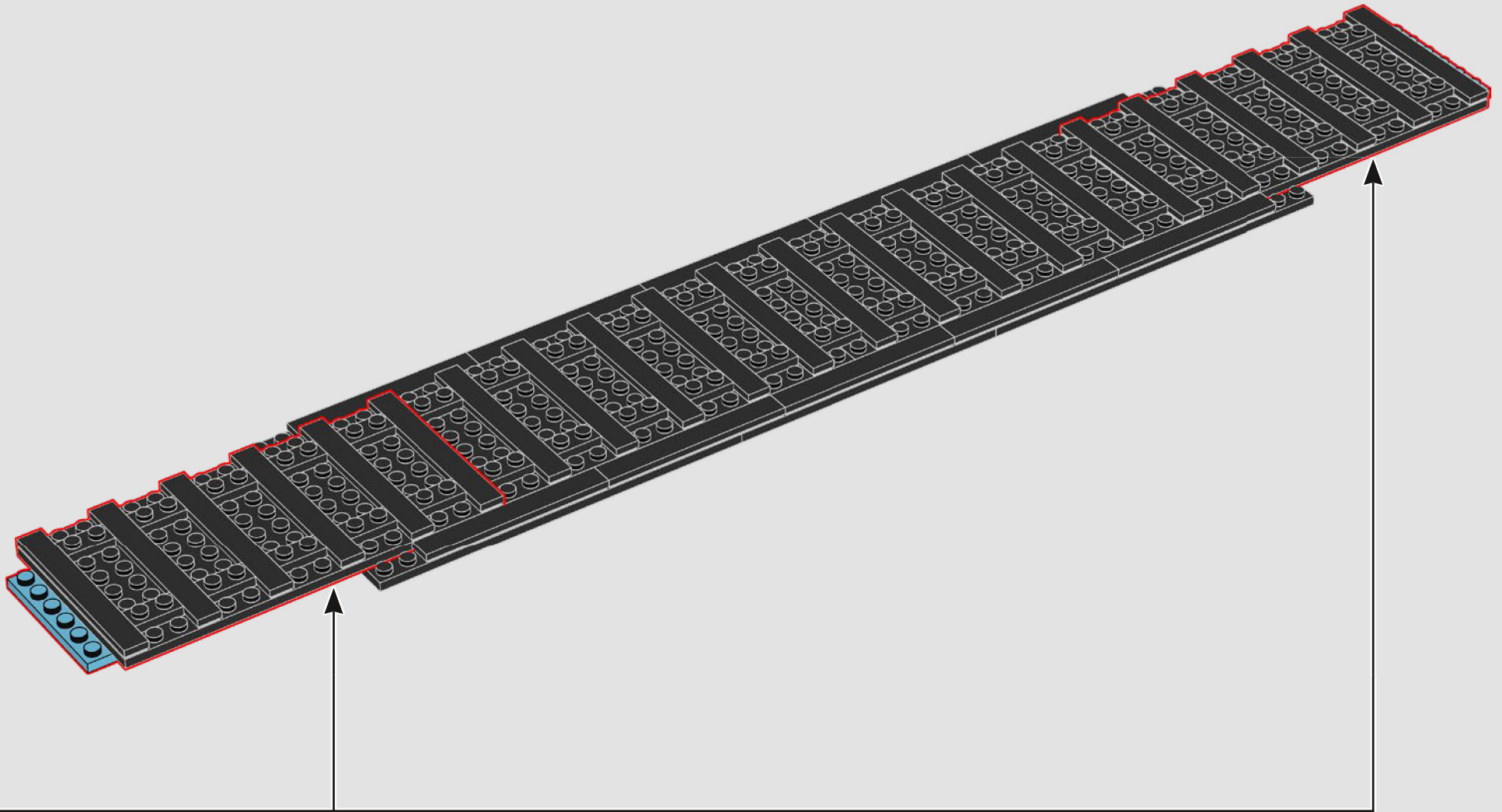

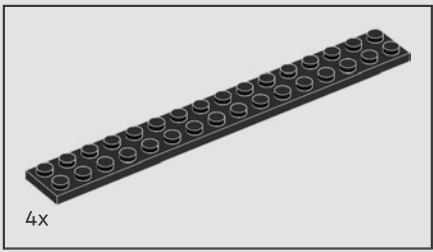

8

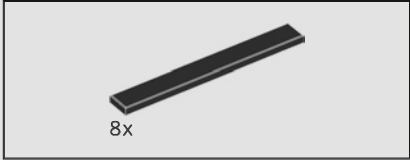
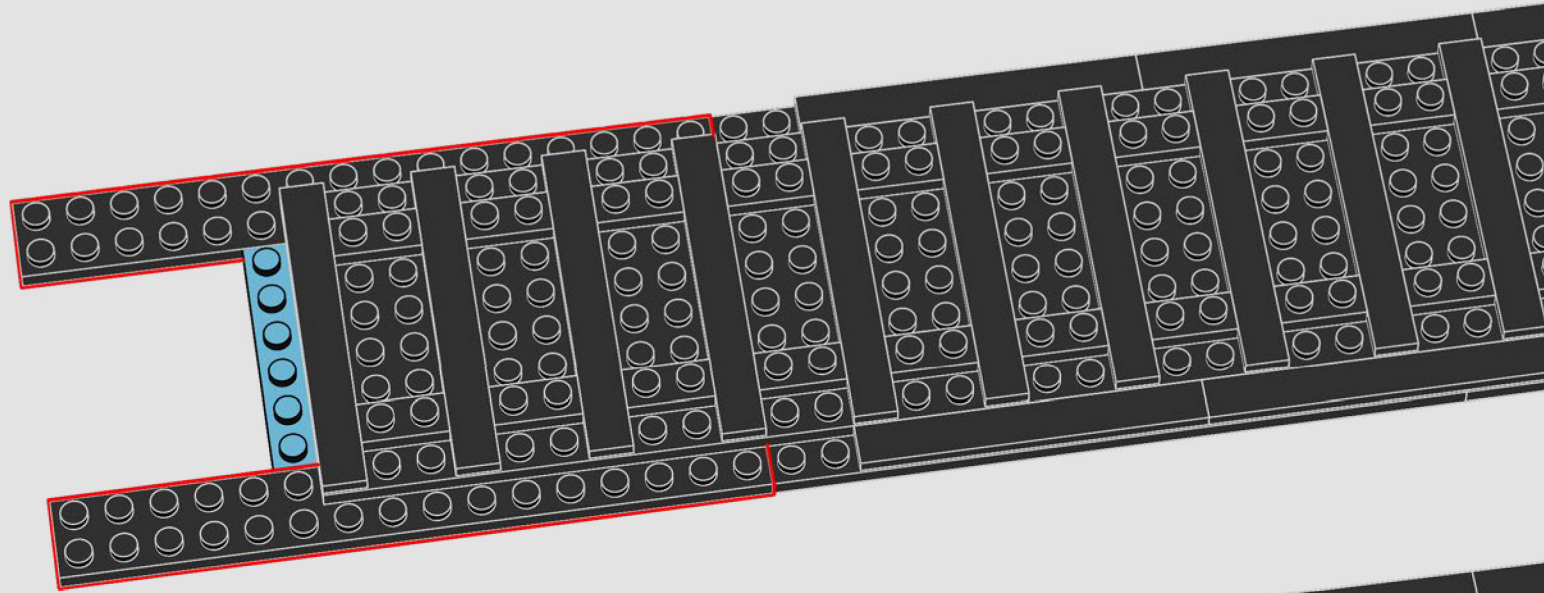

9

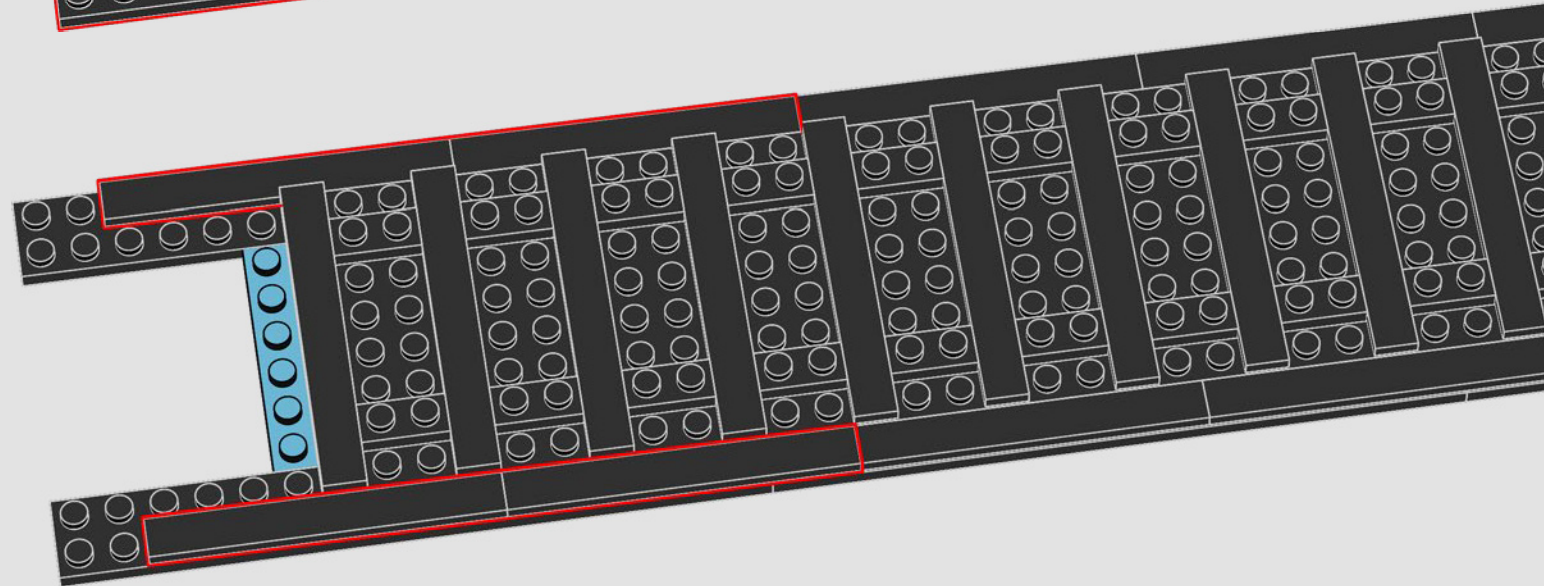

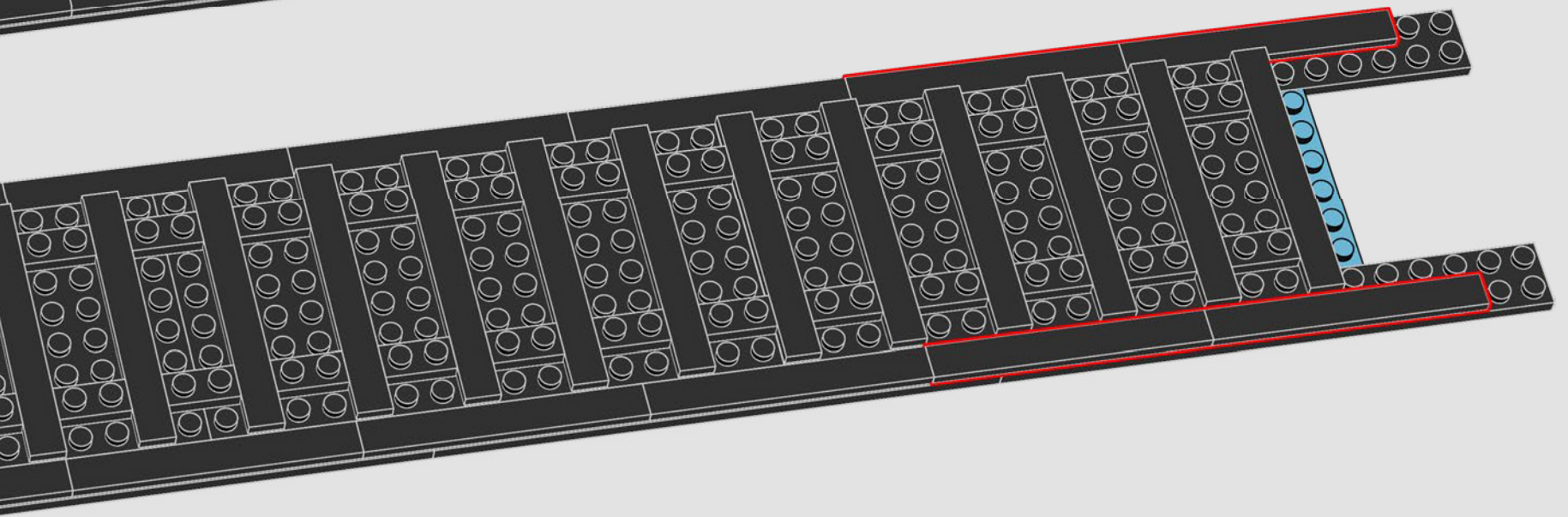
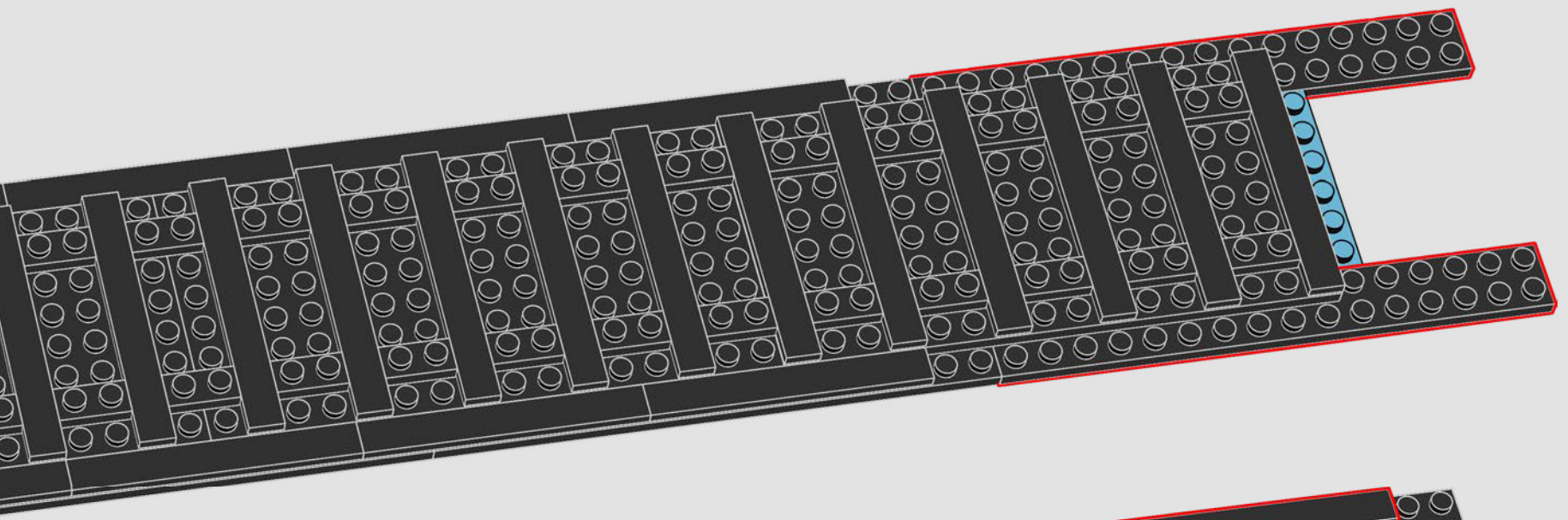

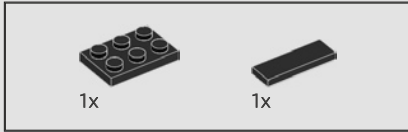
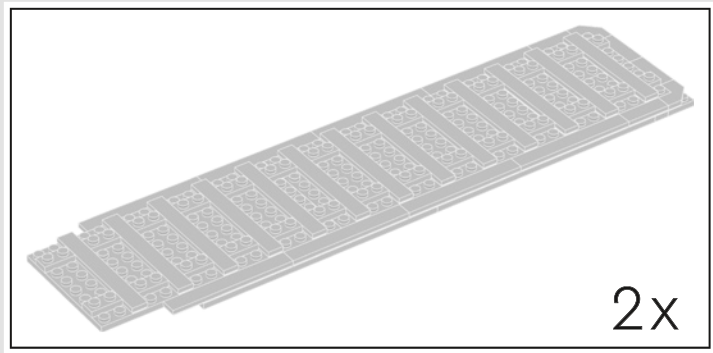
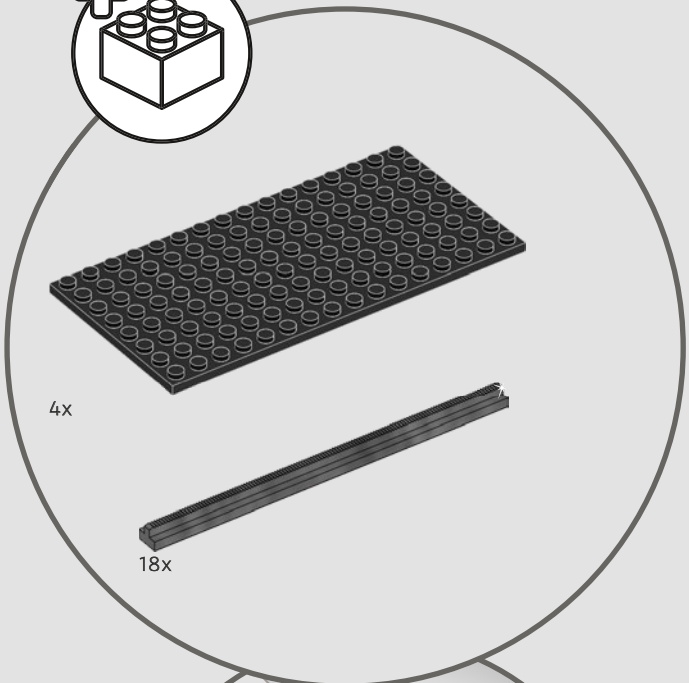
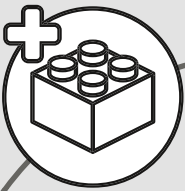

10

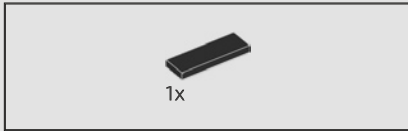
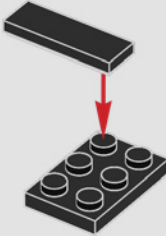

11

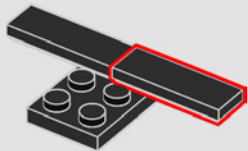

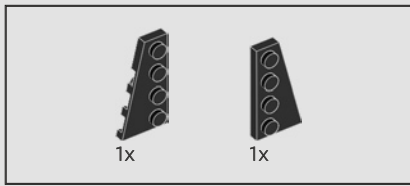

12

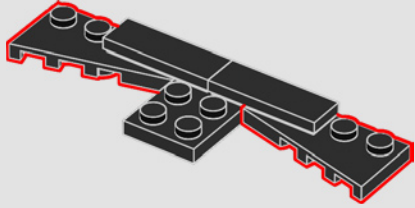

13

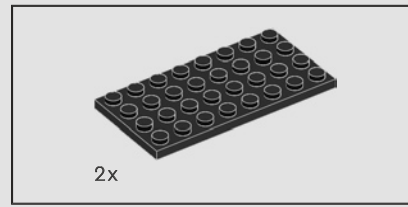
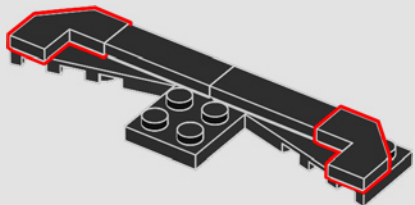

14

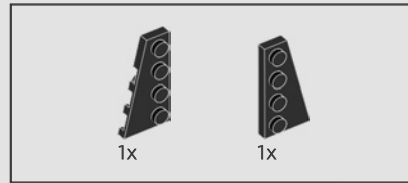
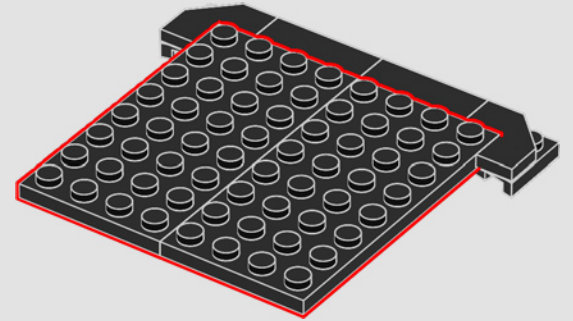

15

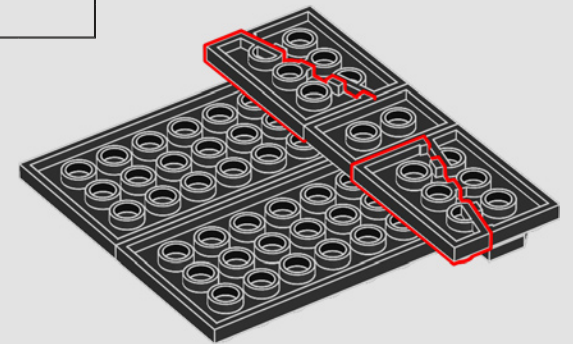

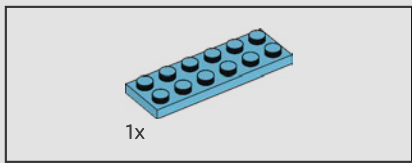

16

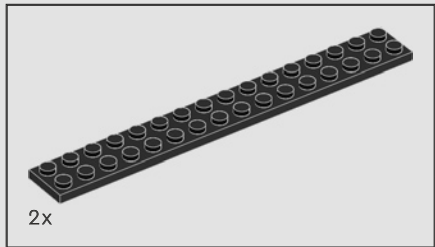
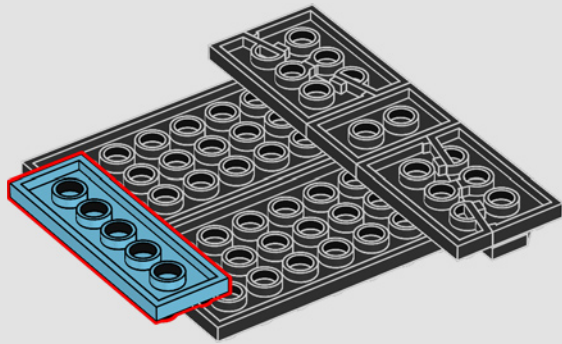

17

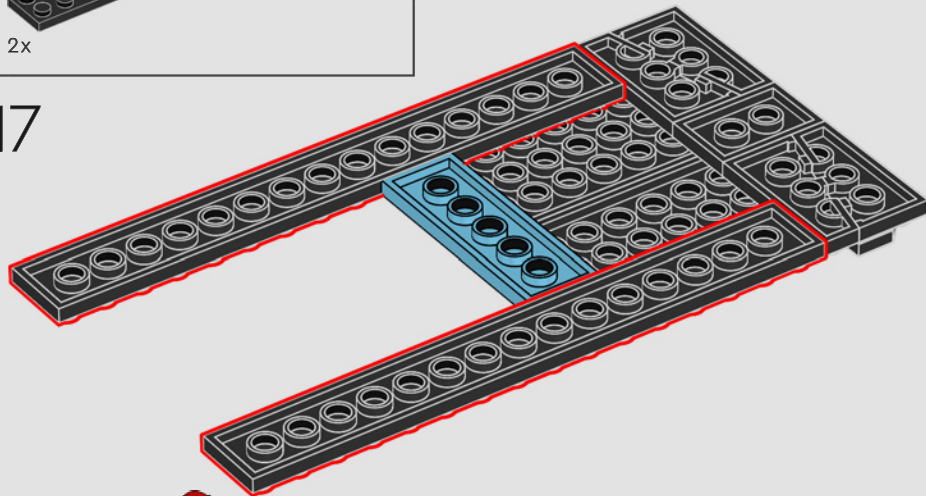

18

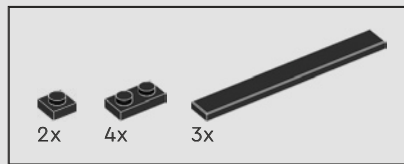
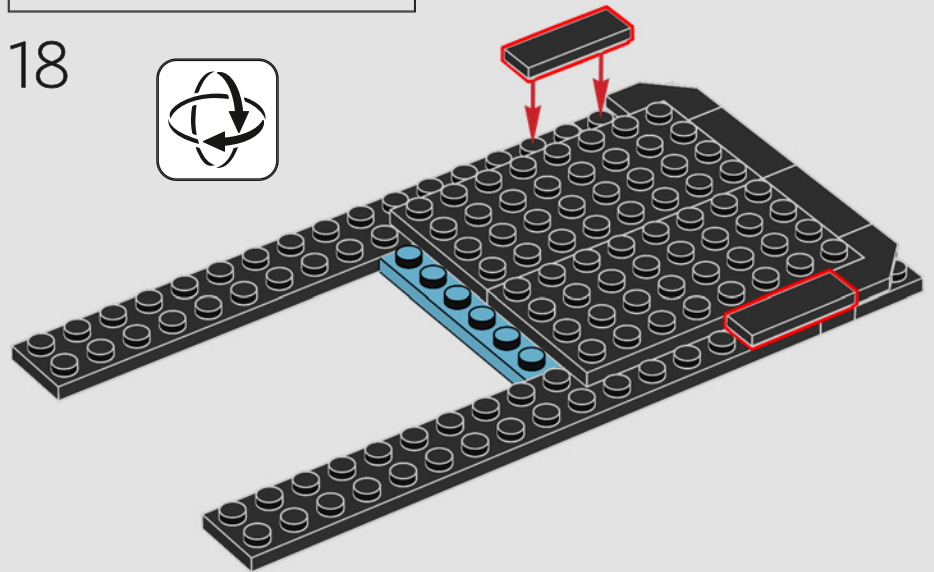

19

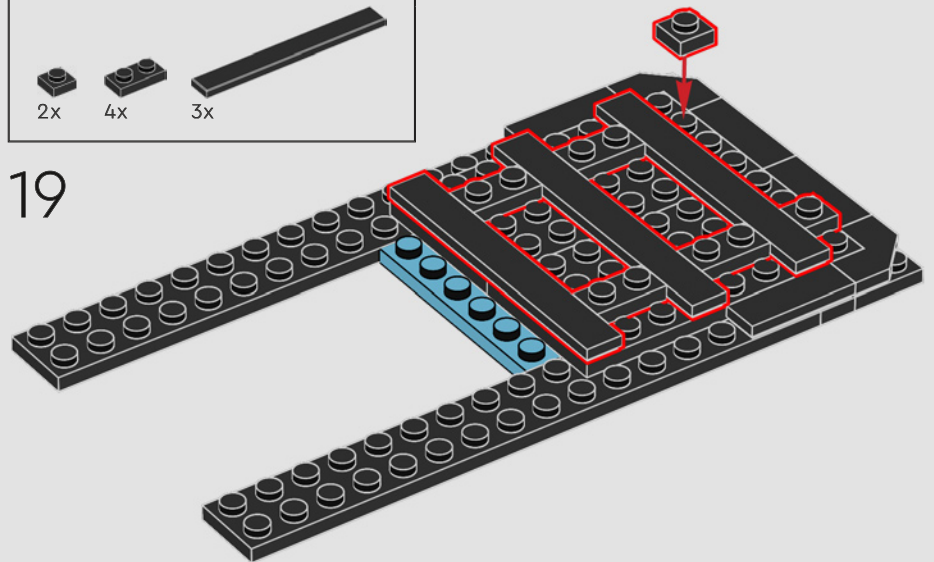

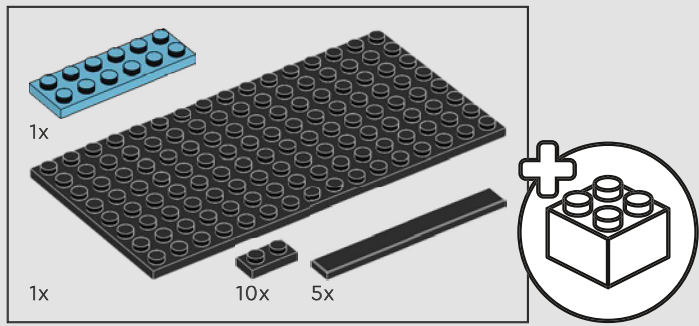

20

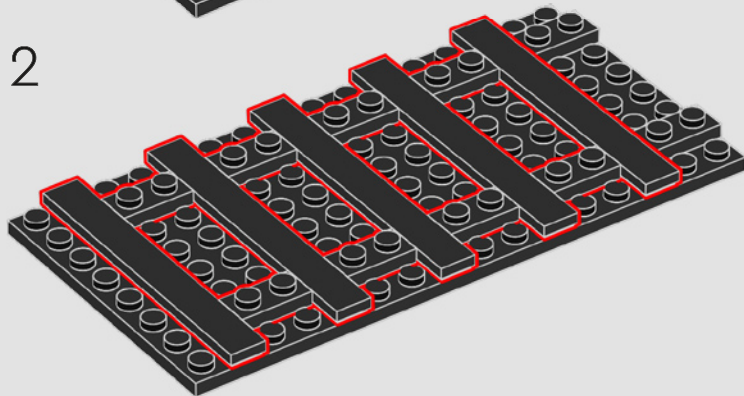
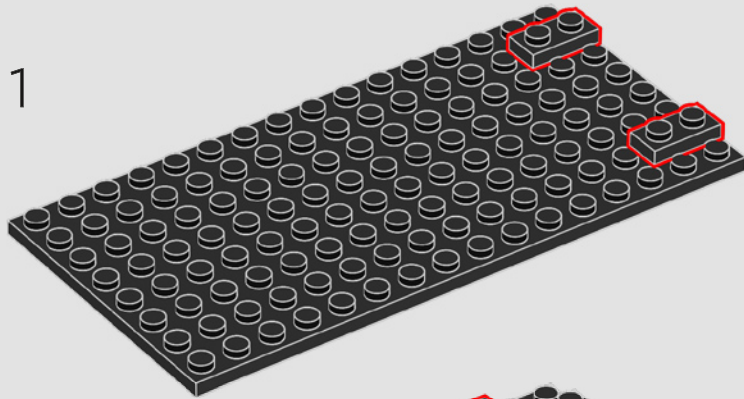

3

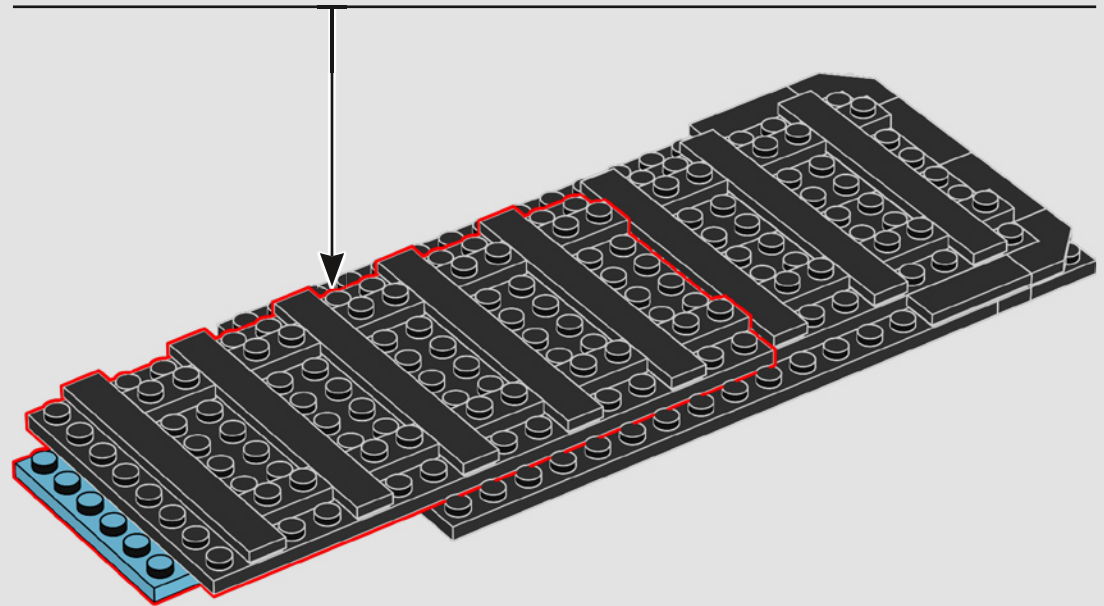
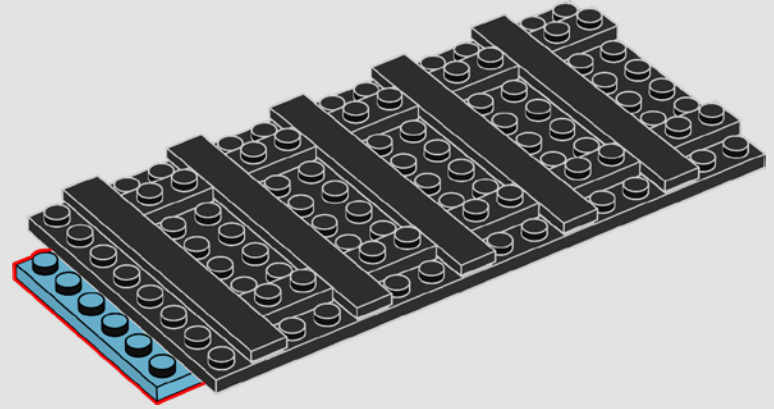

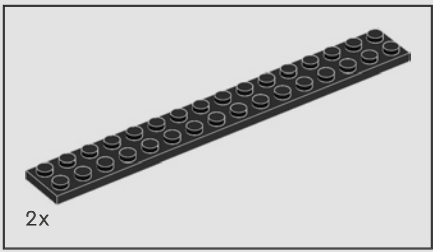

21

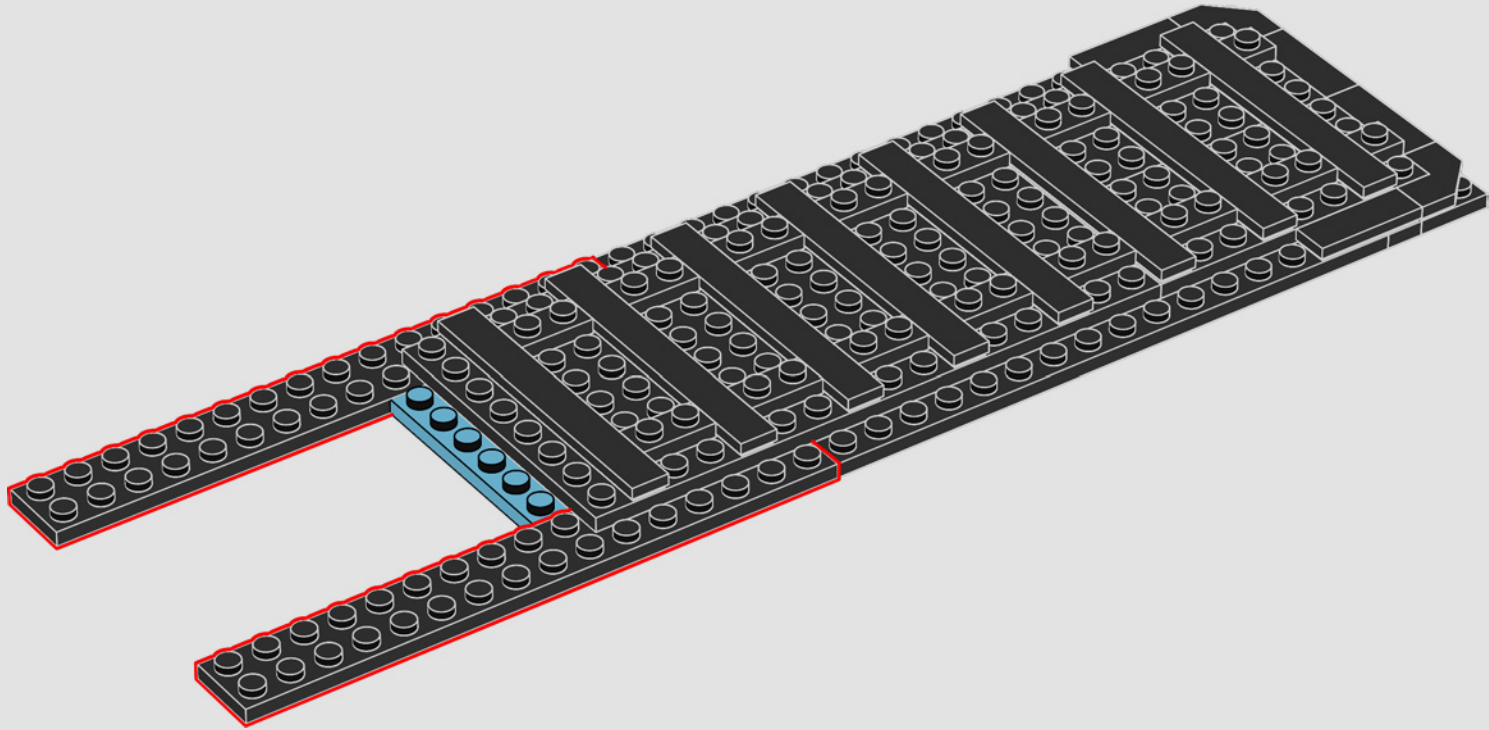

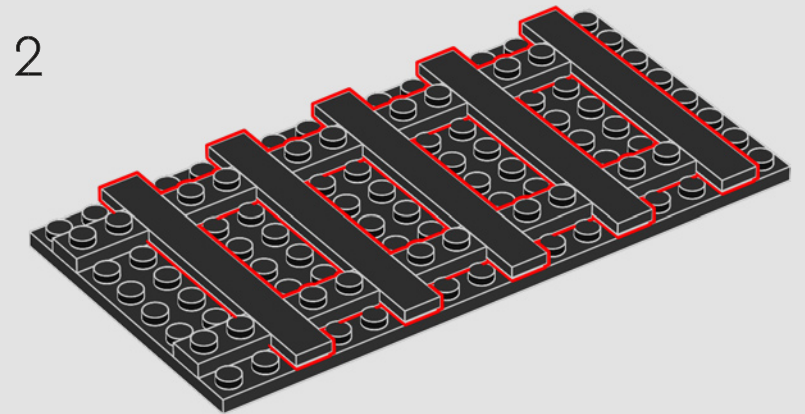
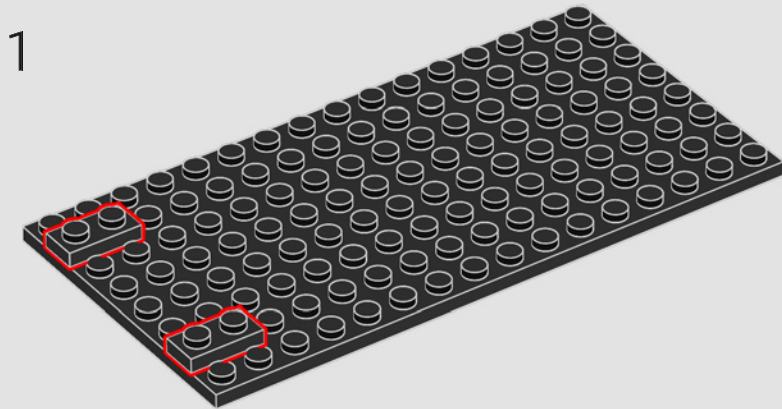
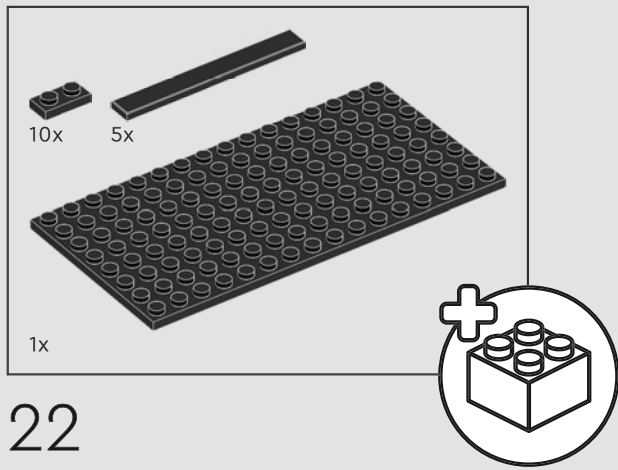

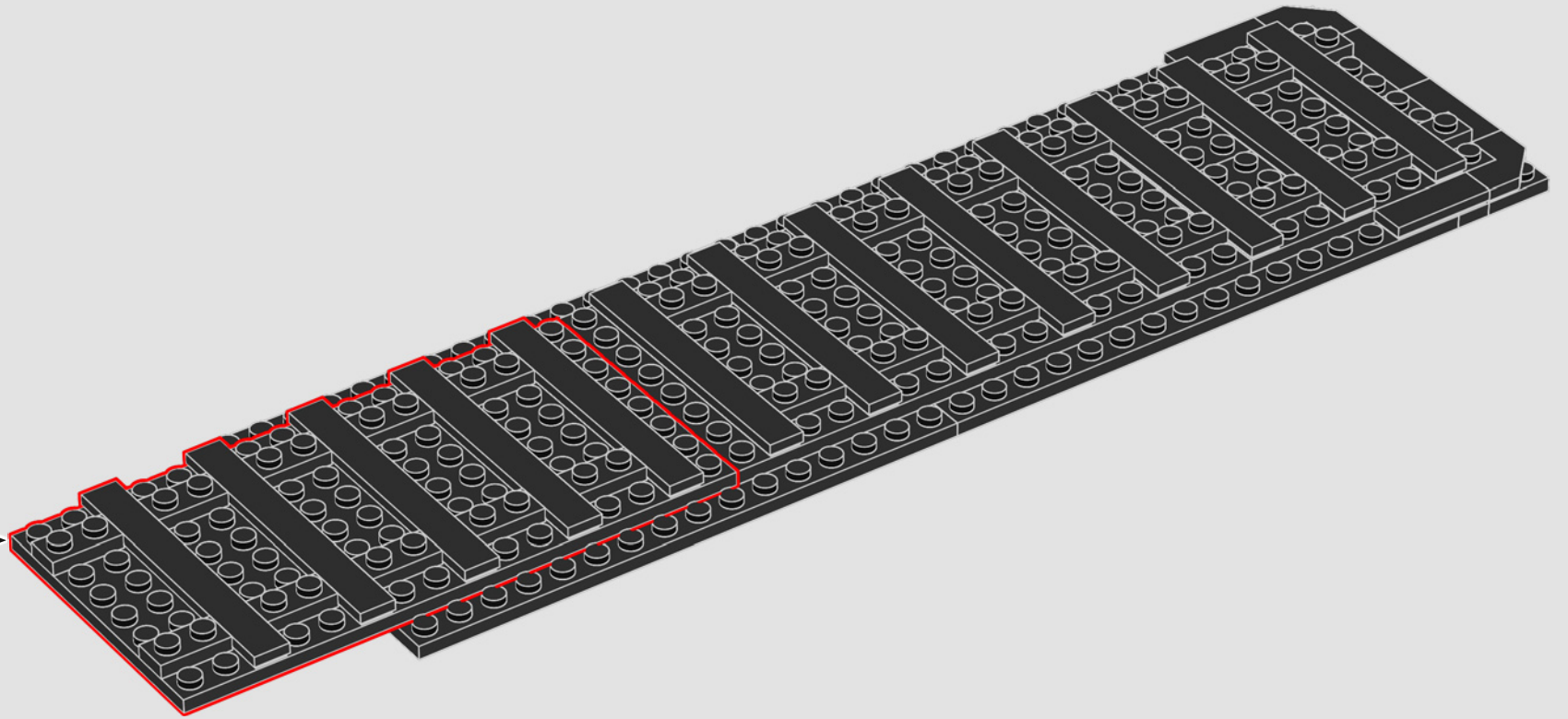

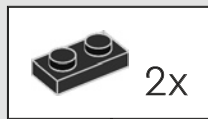

23

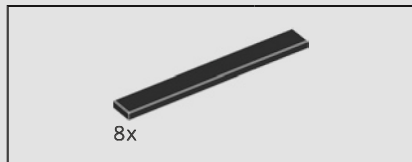
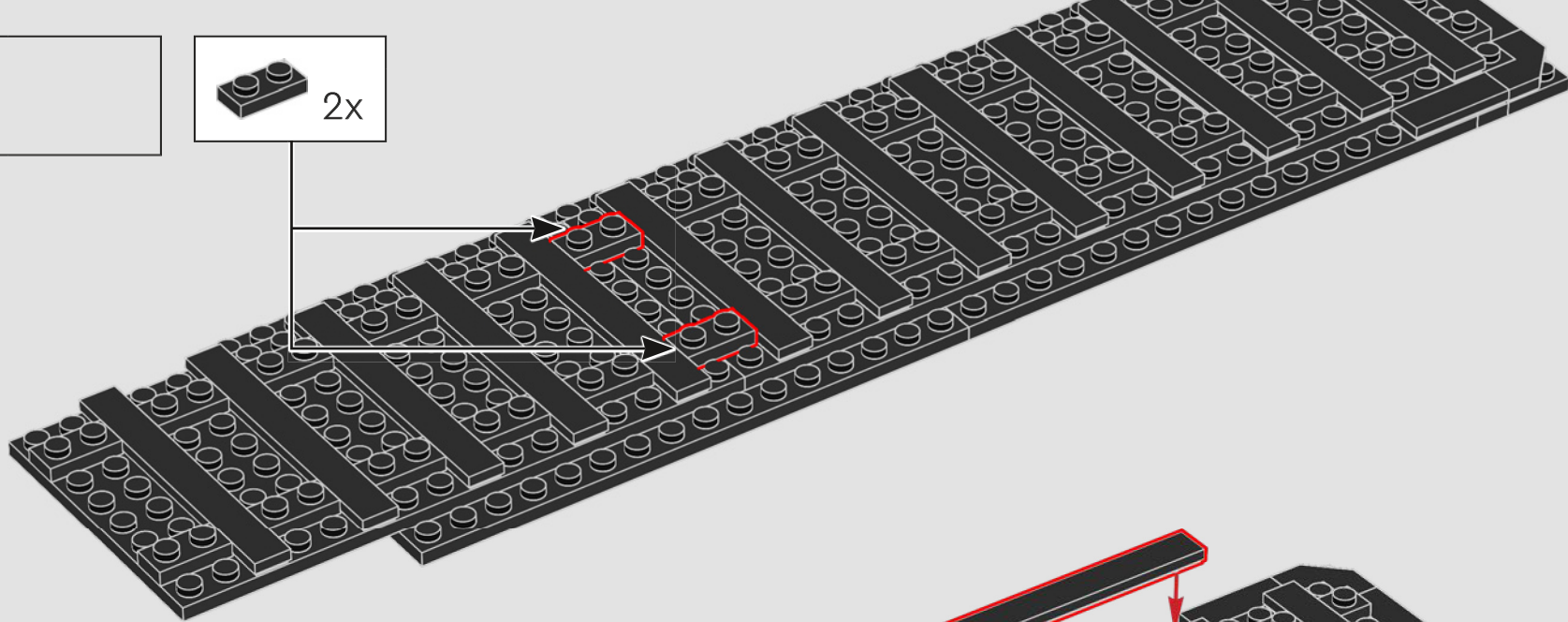

24

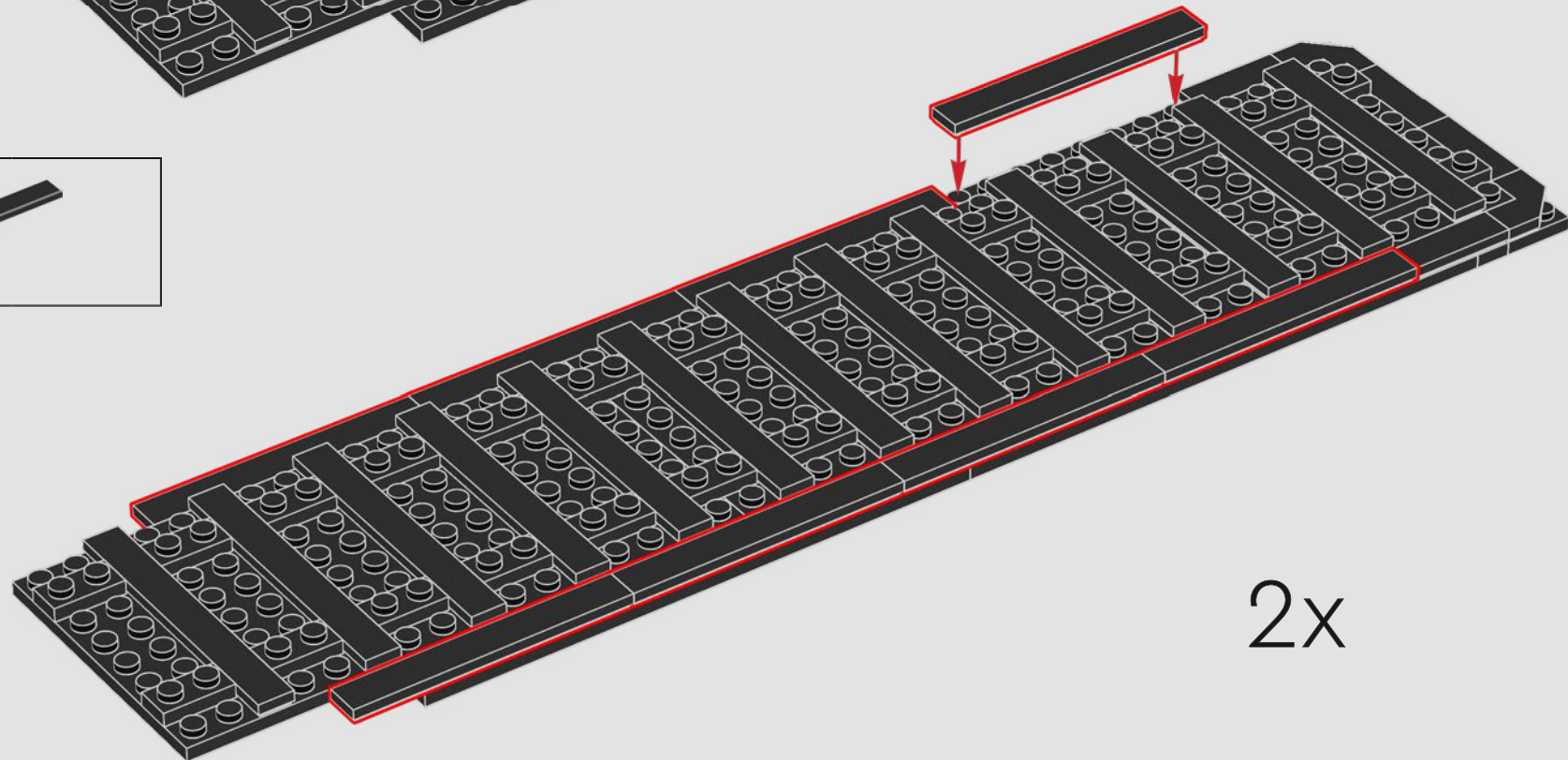

2x



2x

25

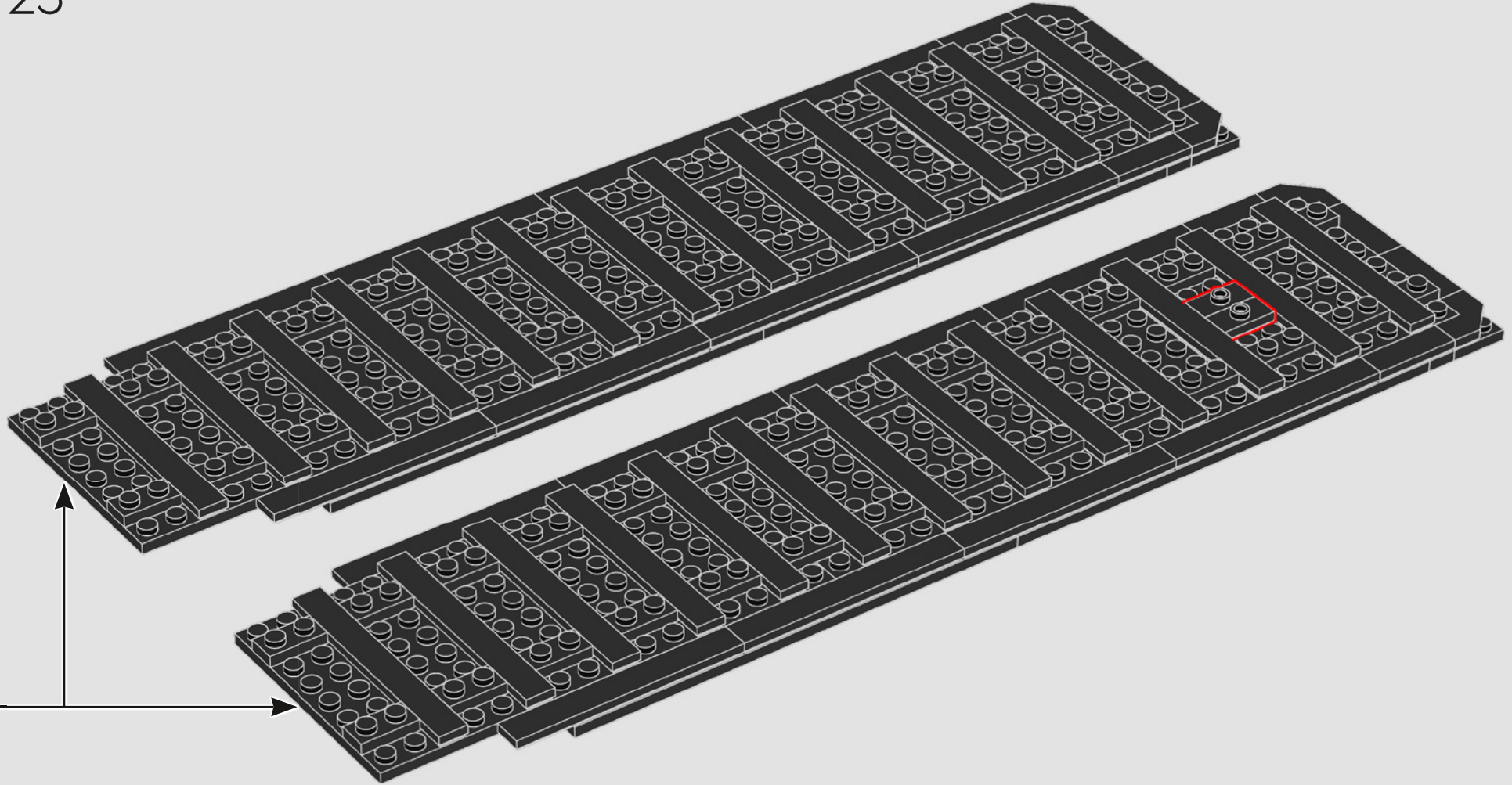

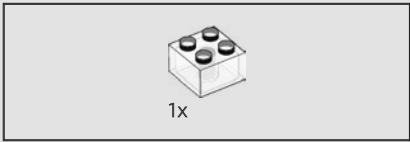

26

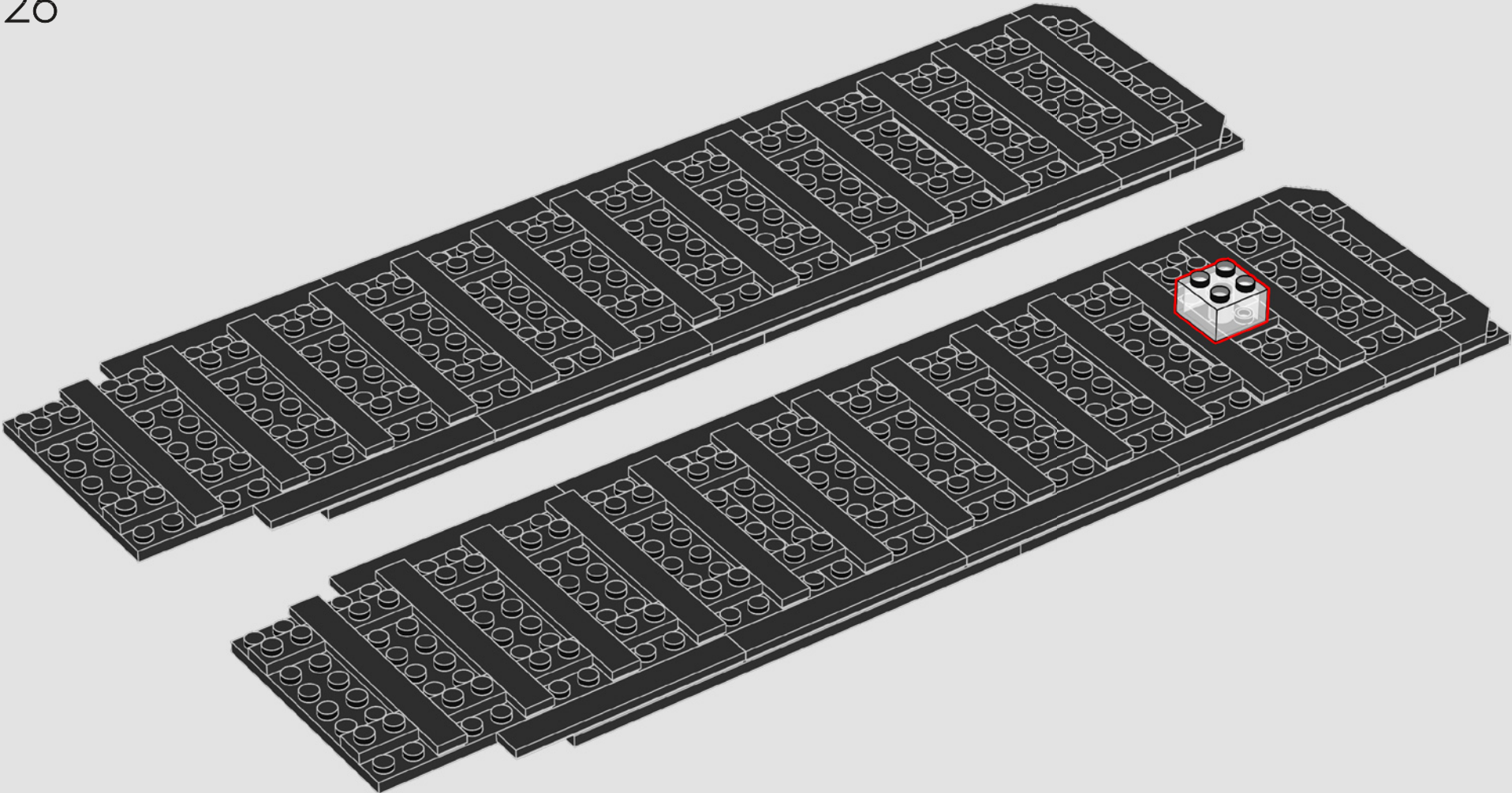

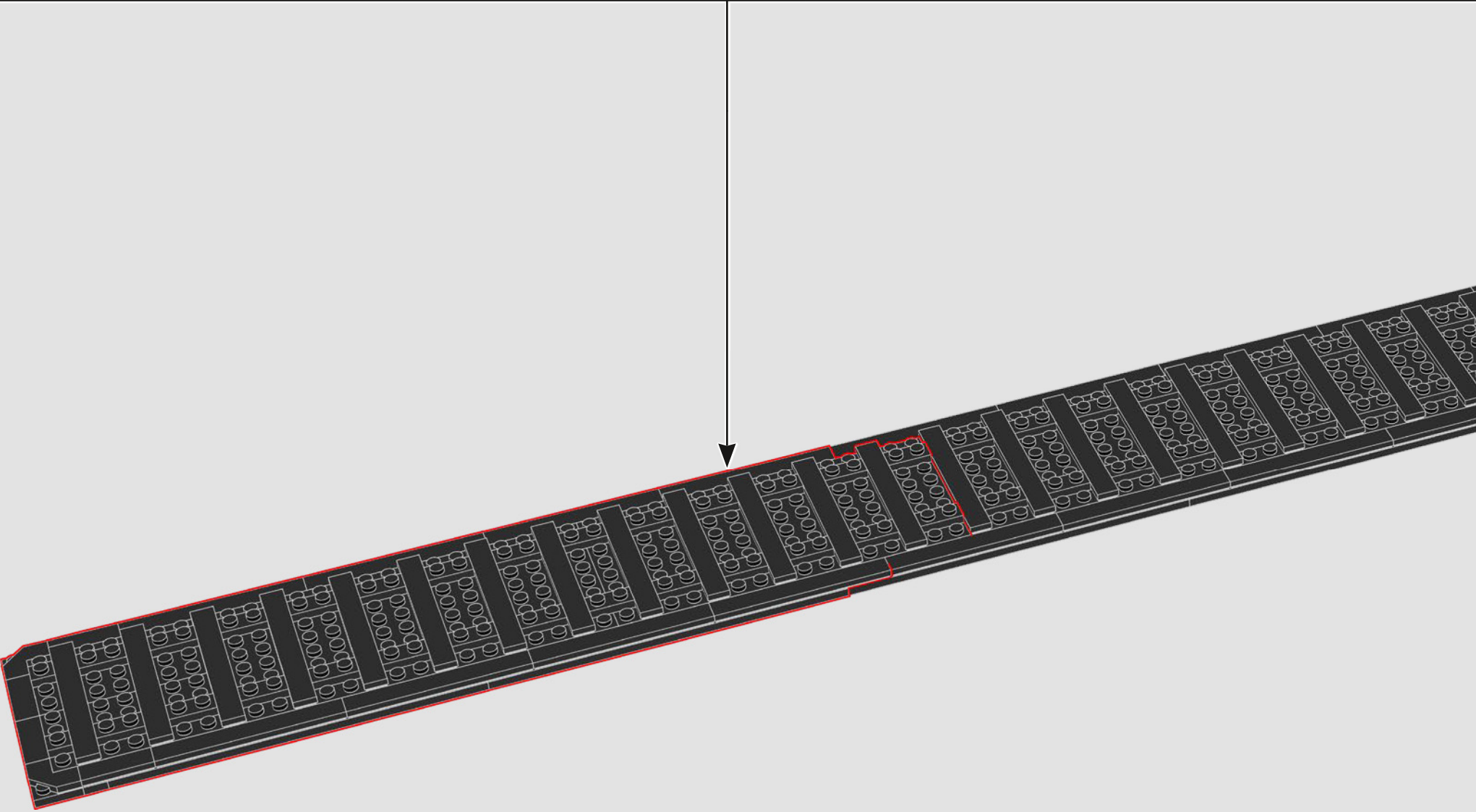

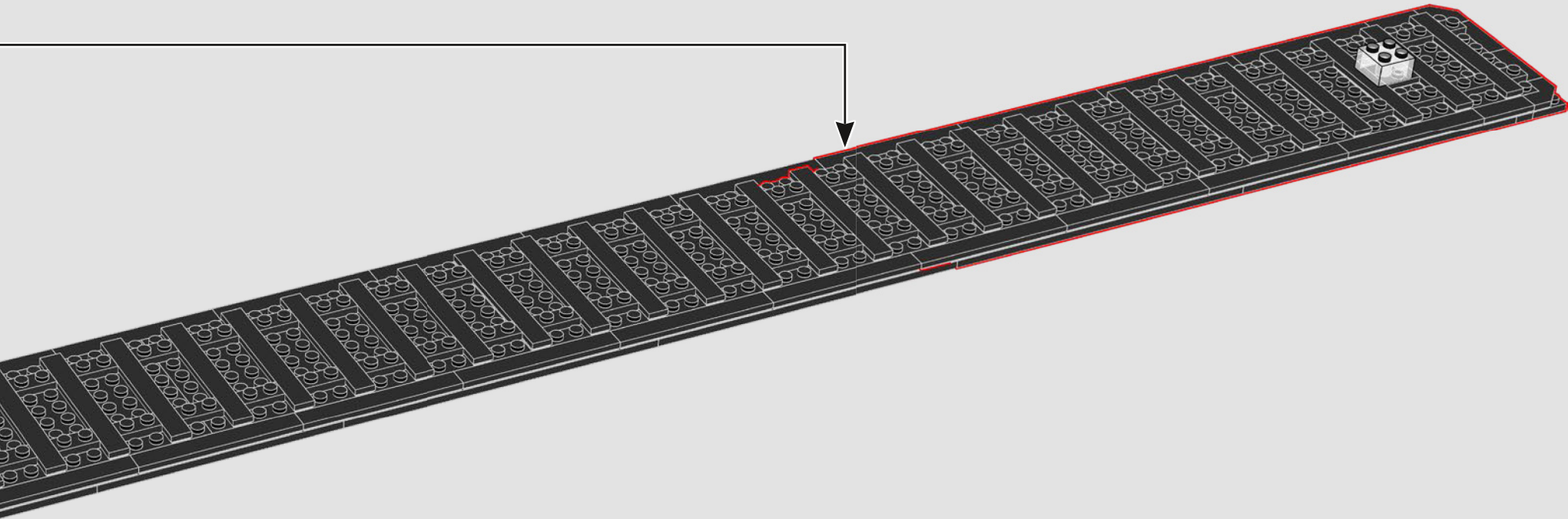

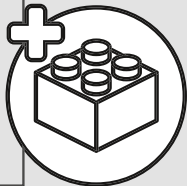
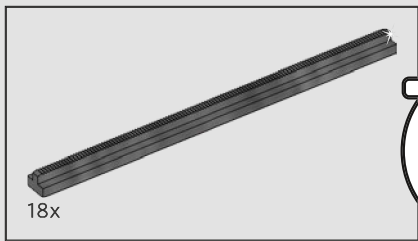

28

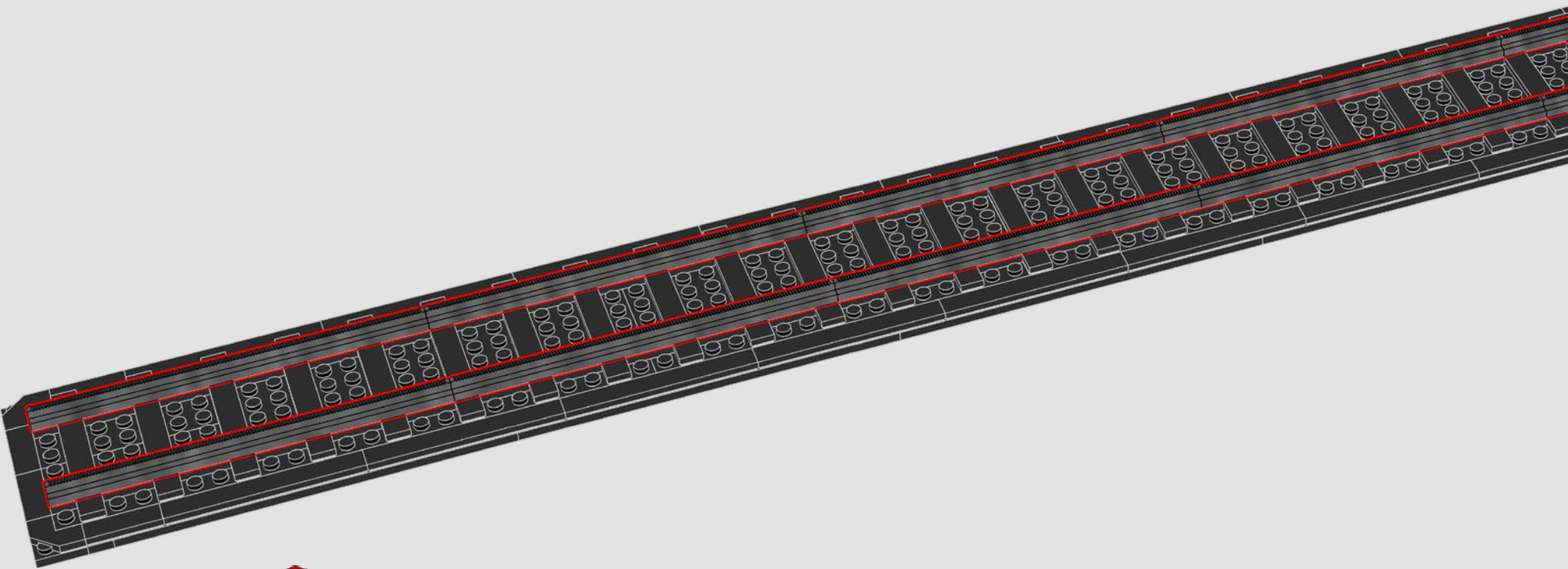

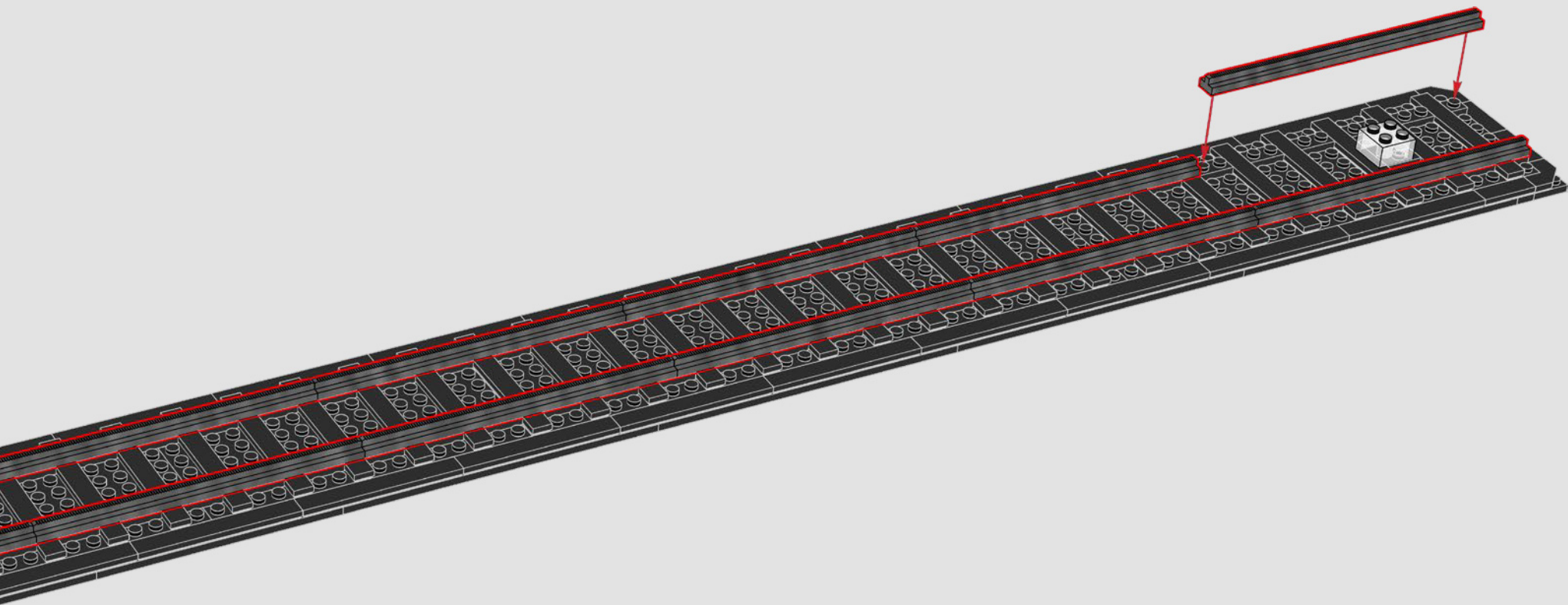

..... ●

Départ : PARIS

« Le voyage a commencé à la Gare de l'Est, les passagers attendaient avec impatience l'arrivée du train. »

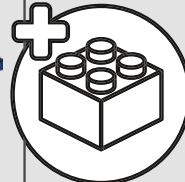
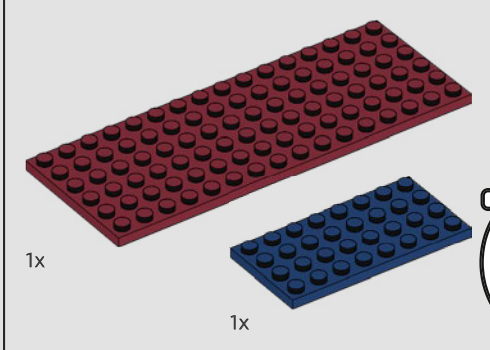
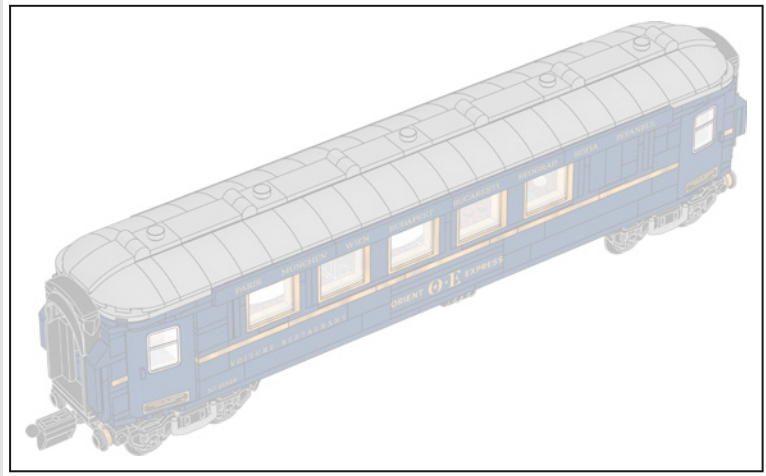

29

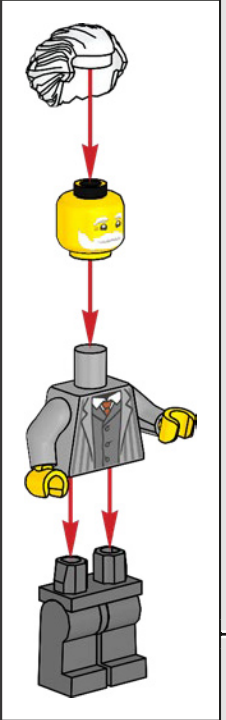
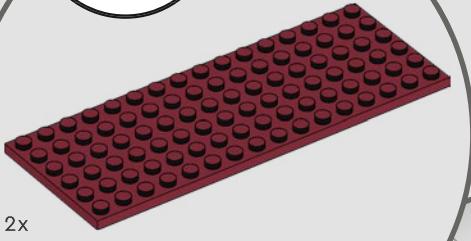
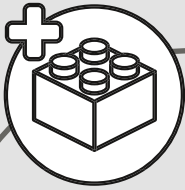
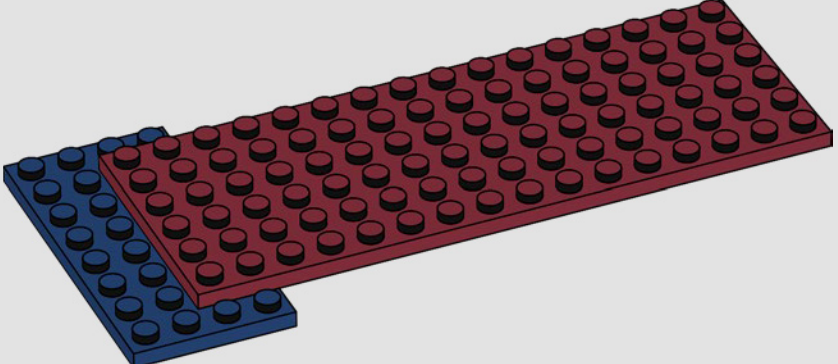

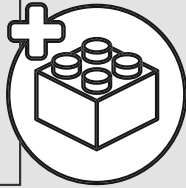
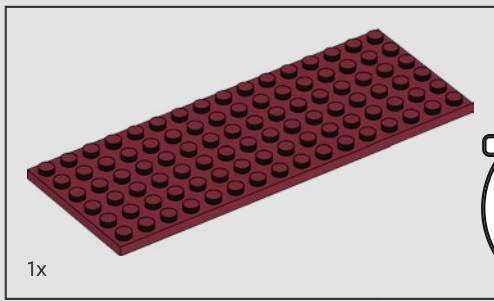

30

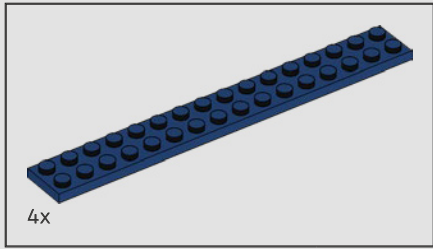
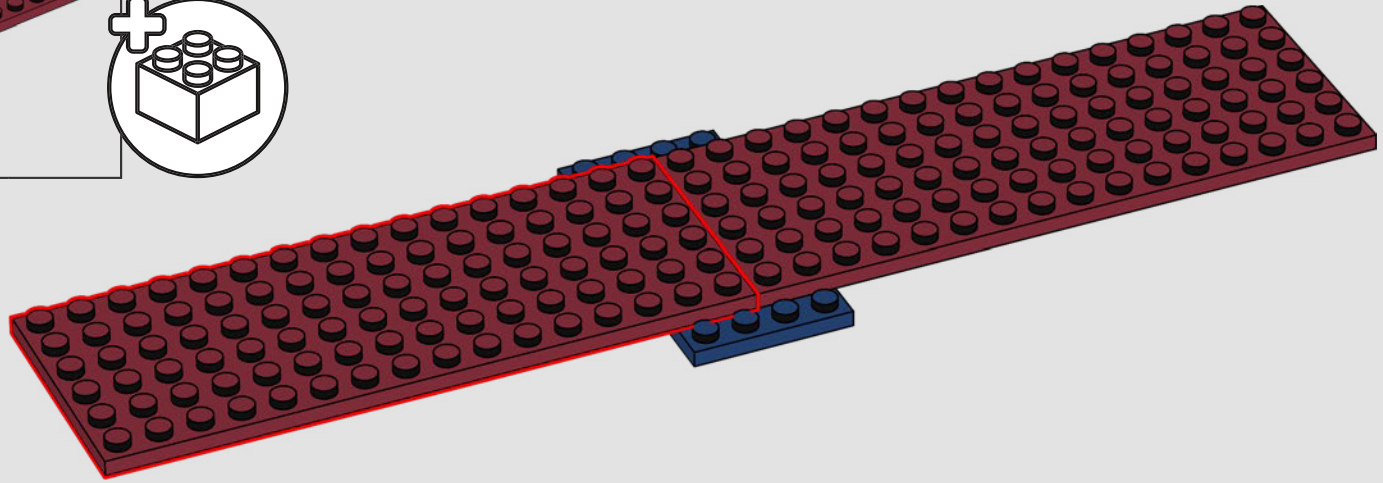

31

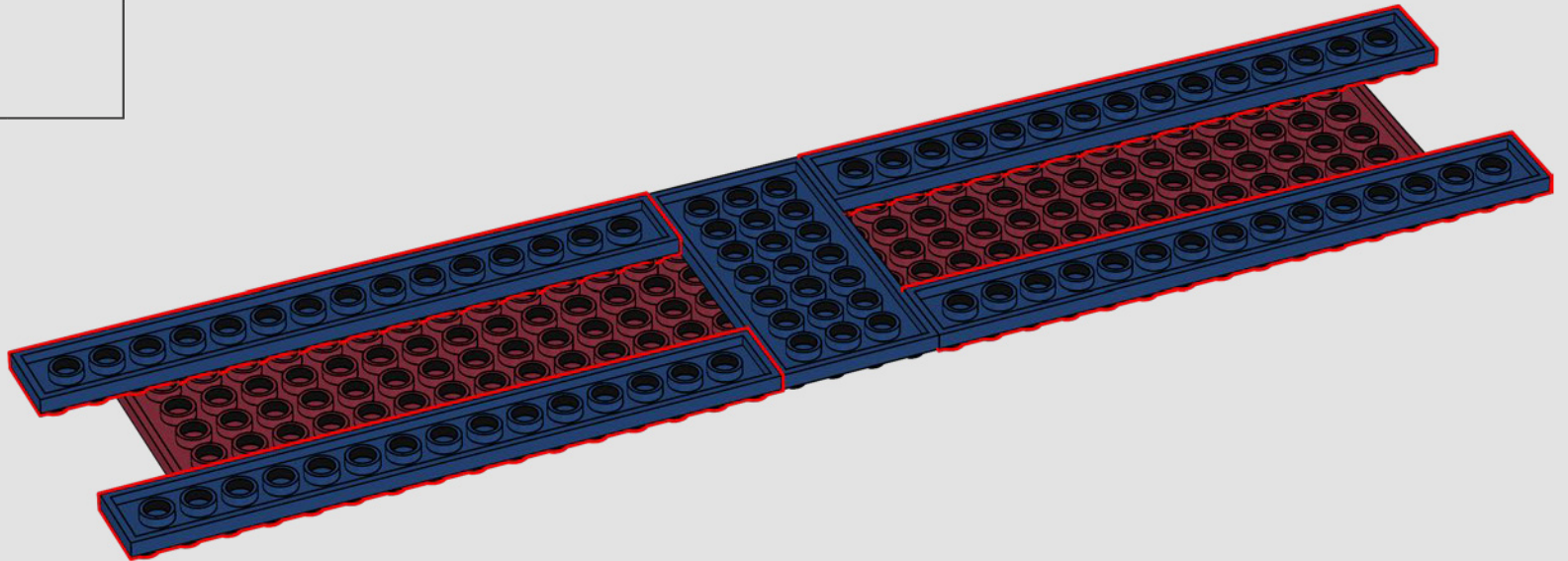

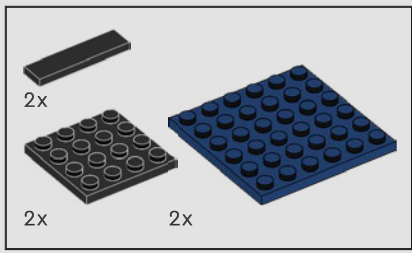

32

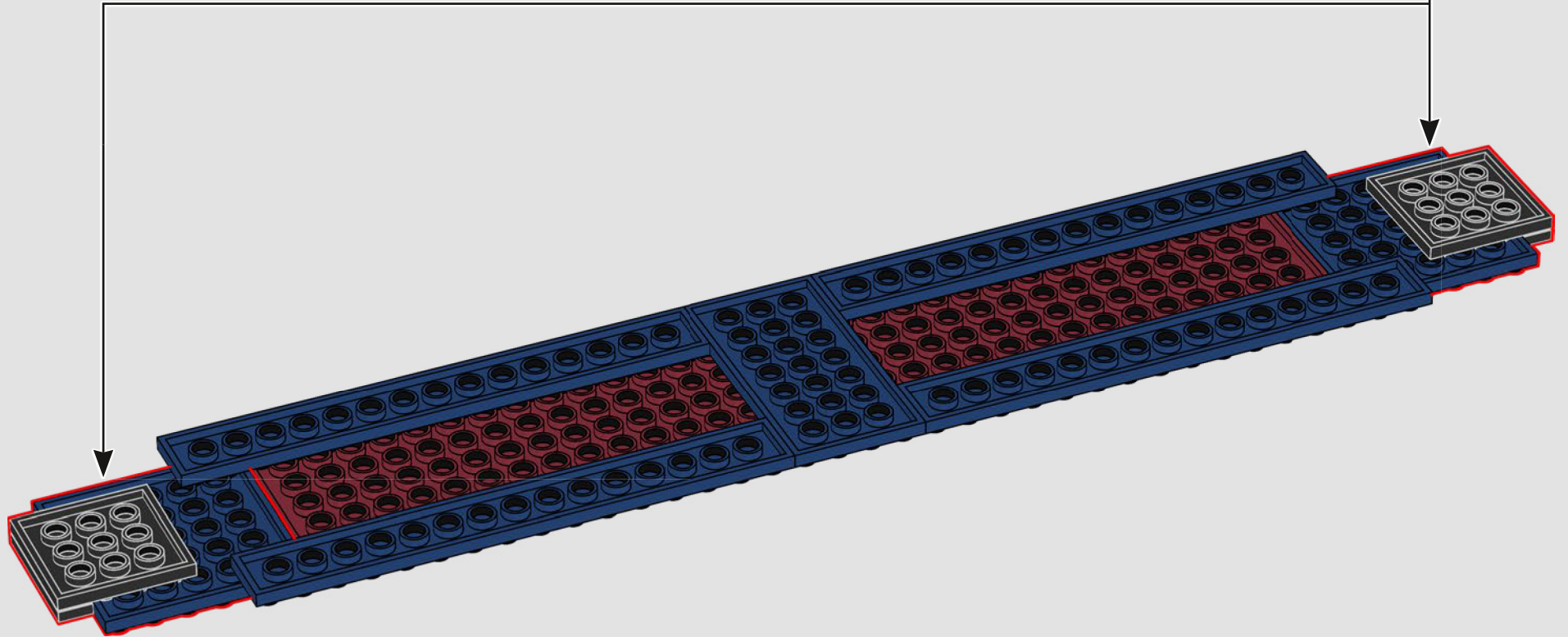
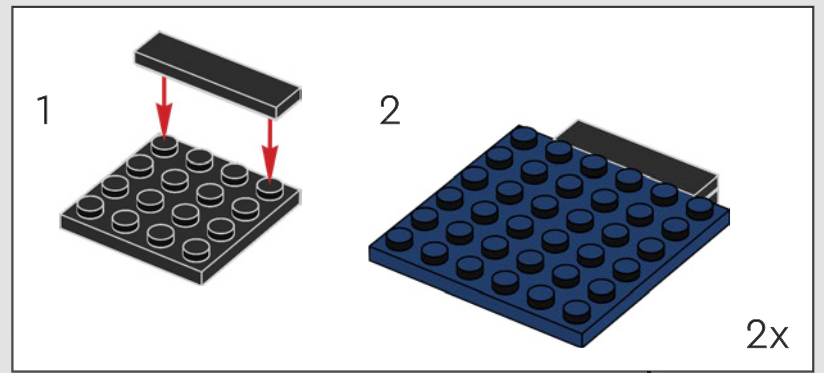

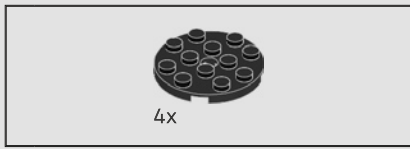

33

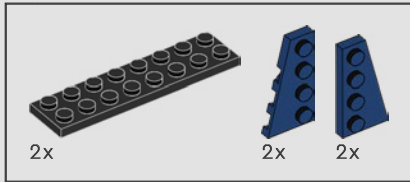
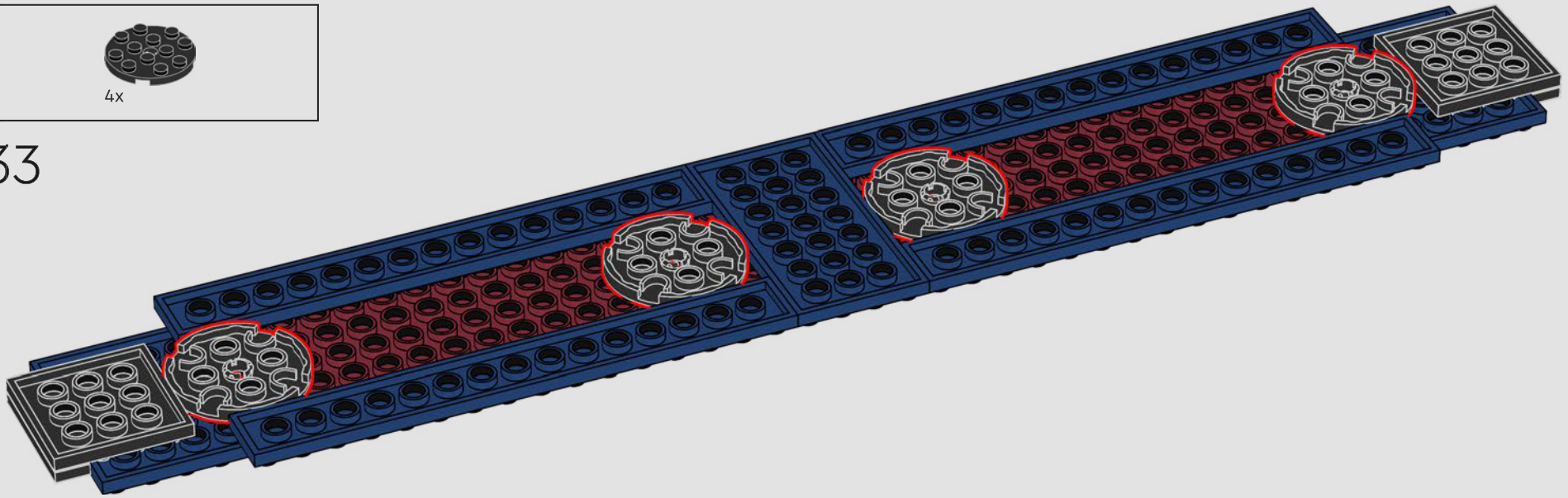

34

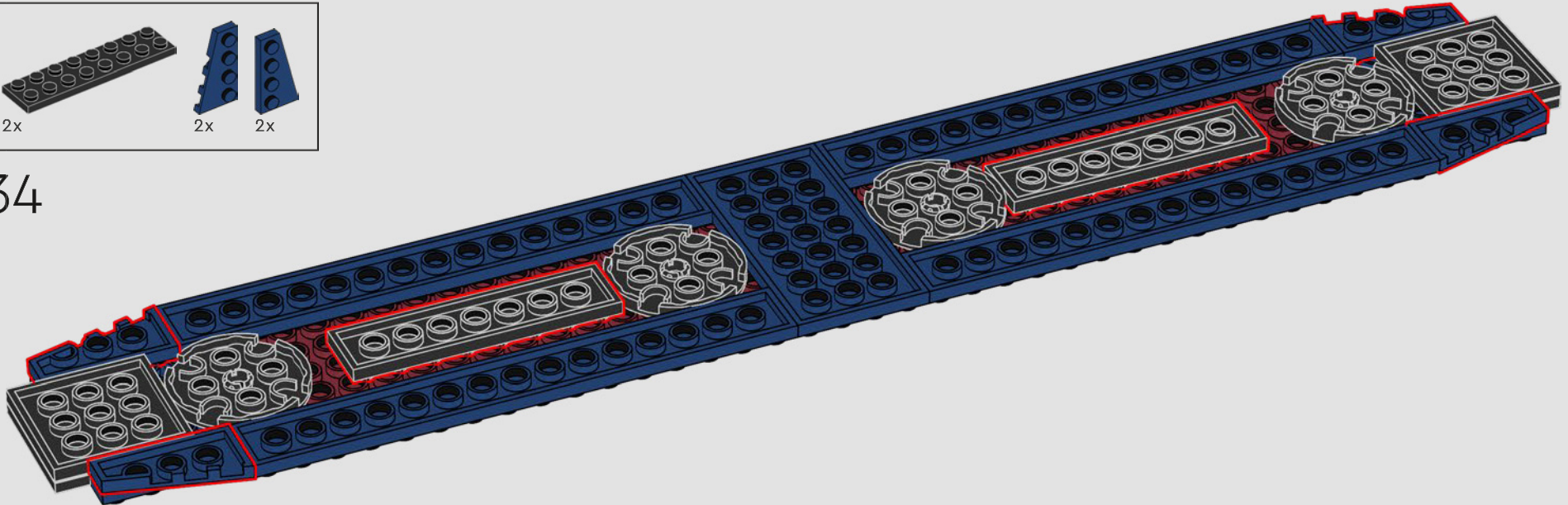



35

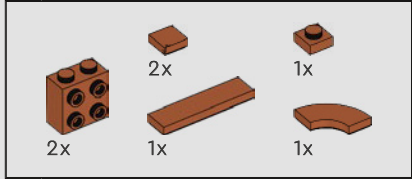
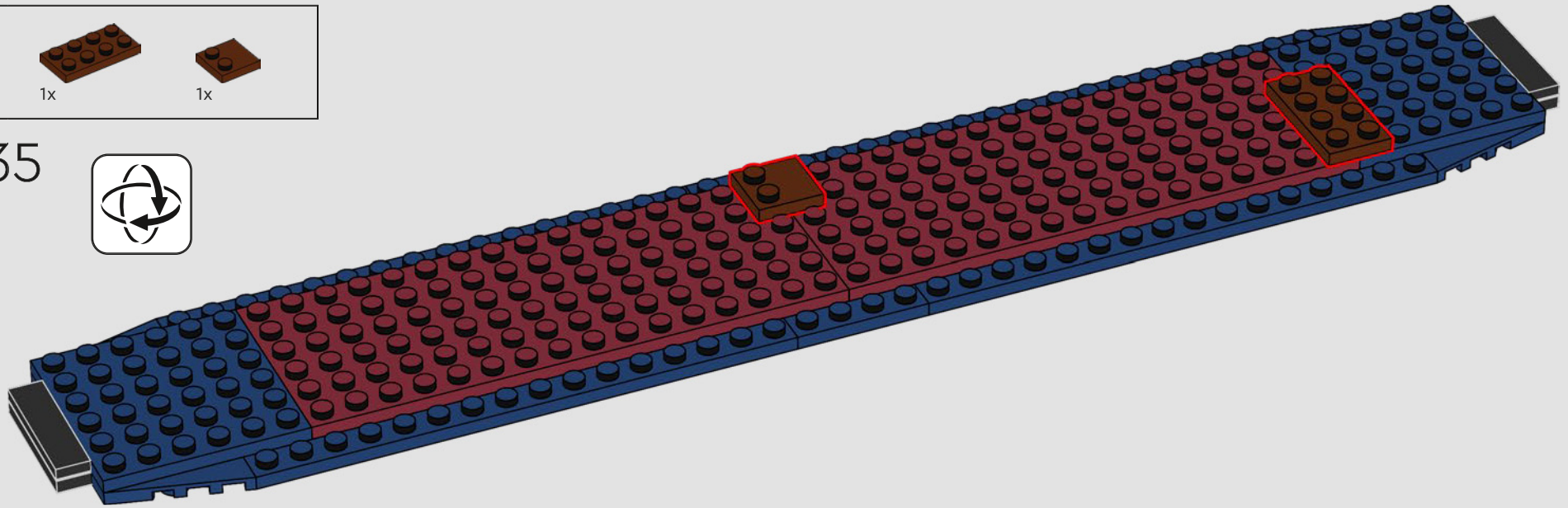

36

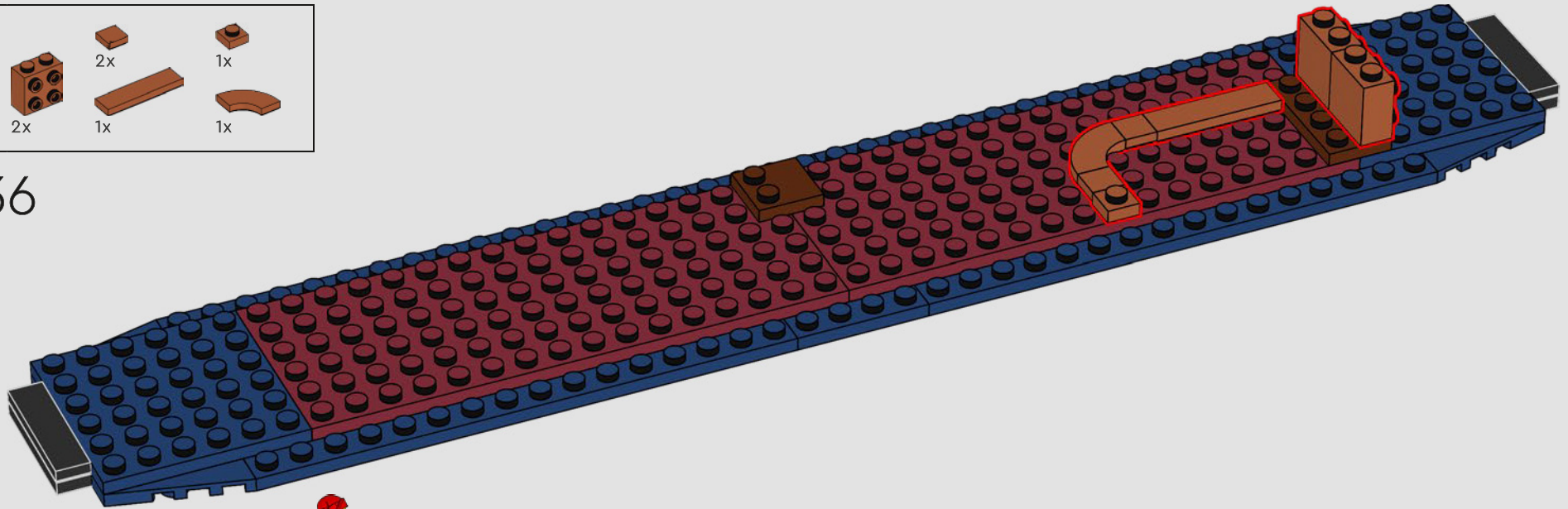

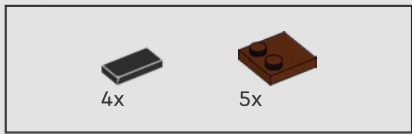

37

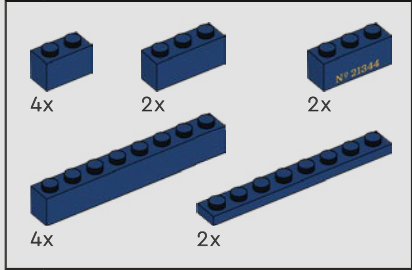
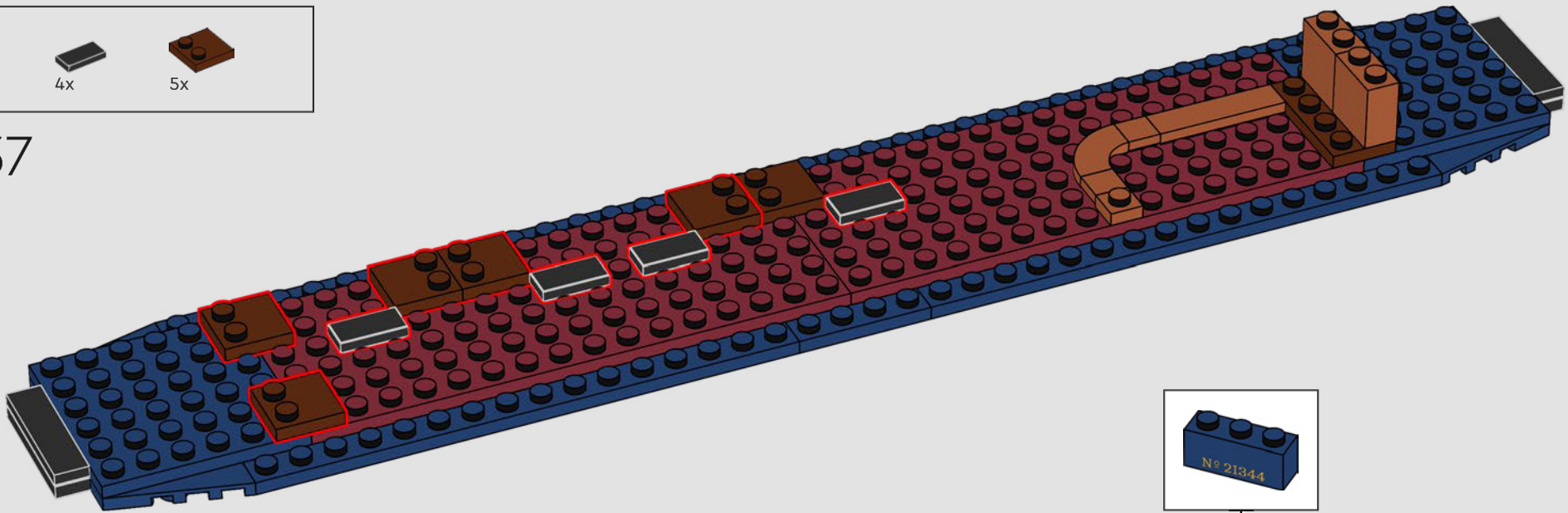

38

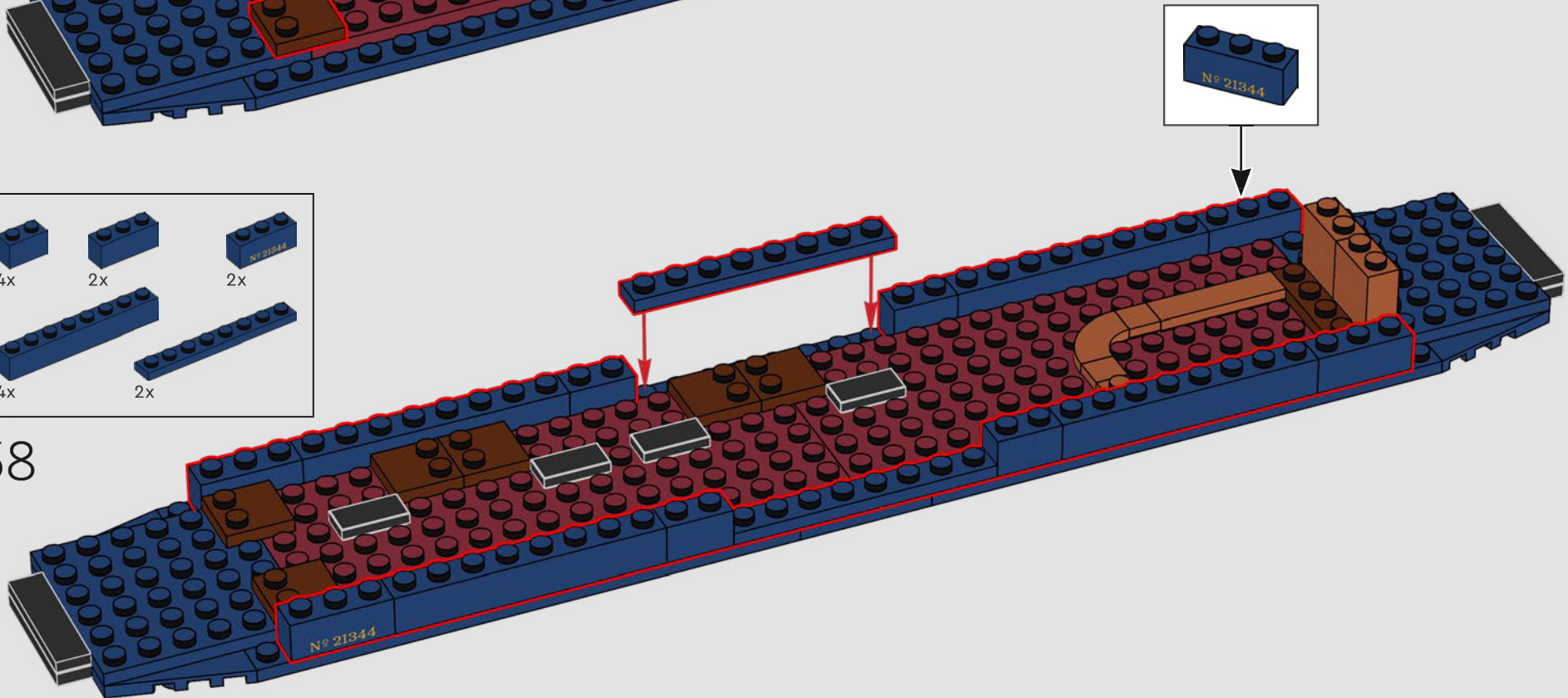

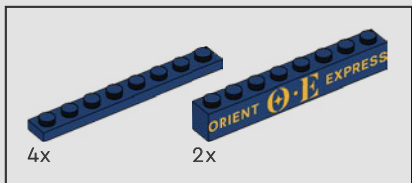

39

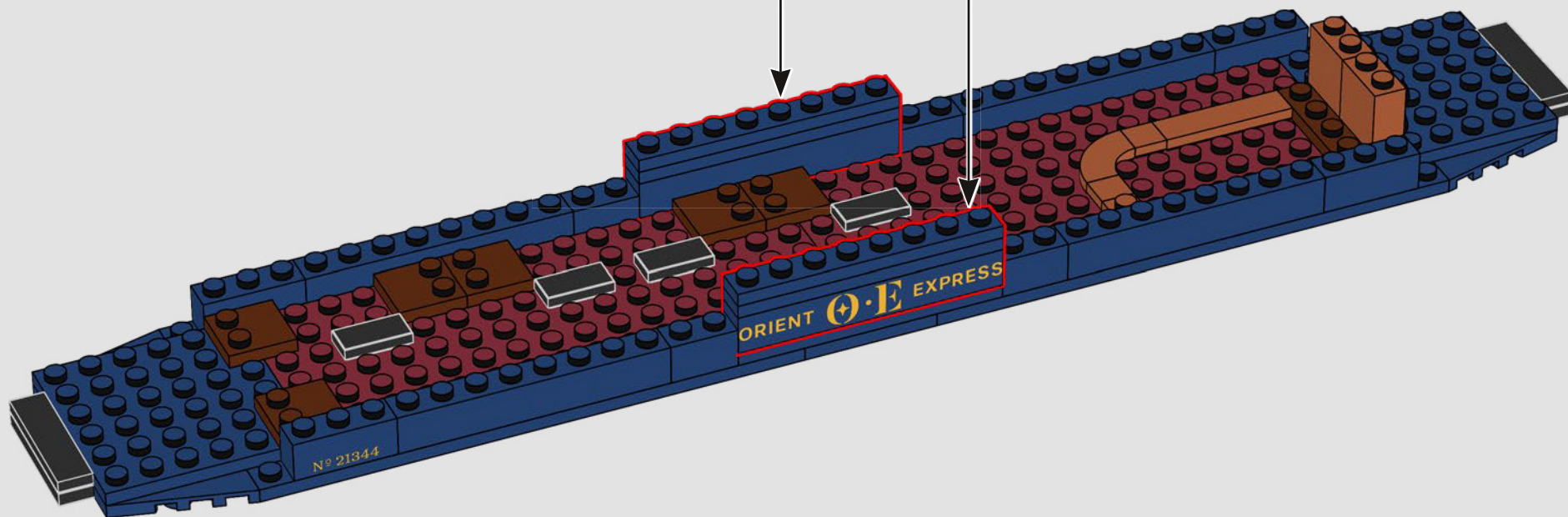
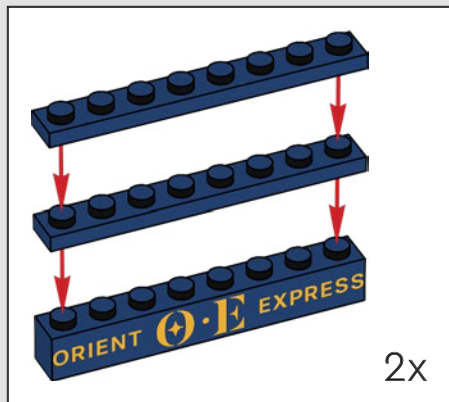

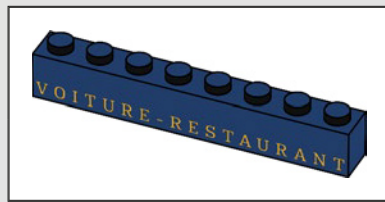
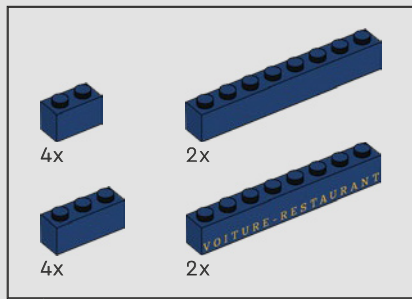

40

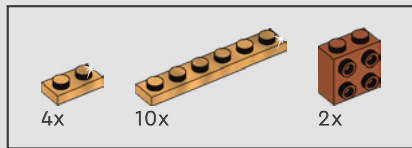
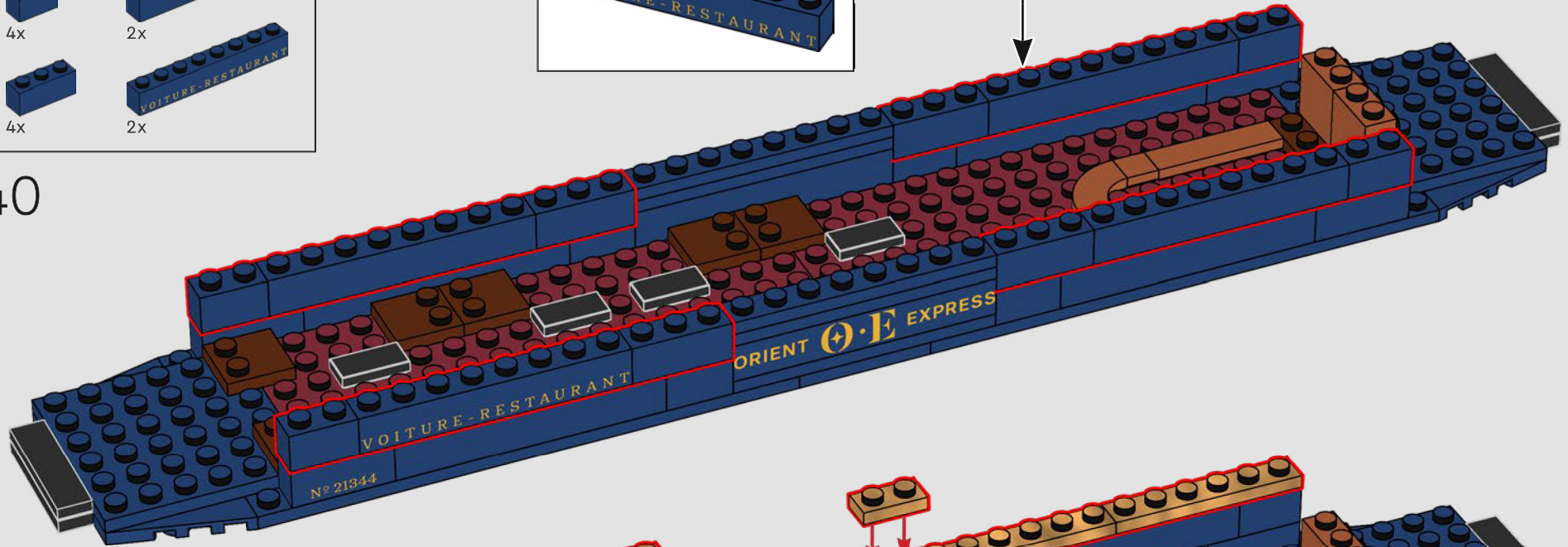

41

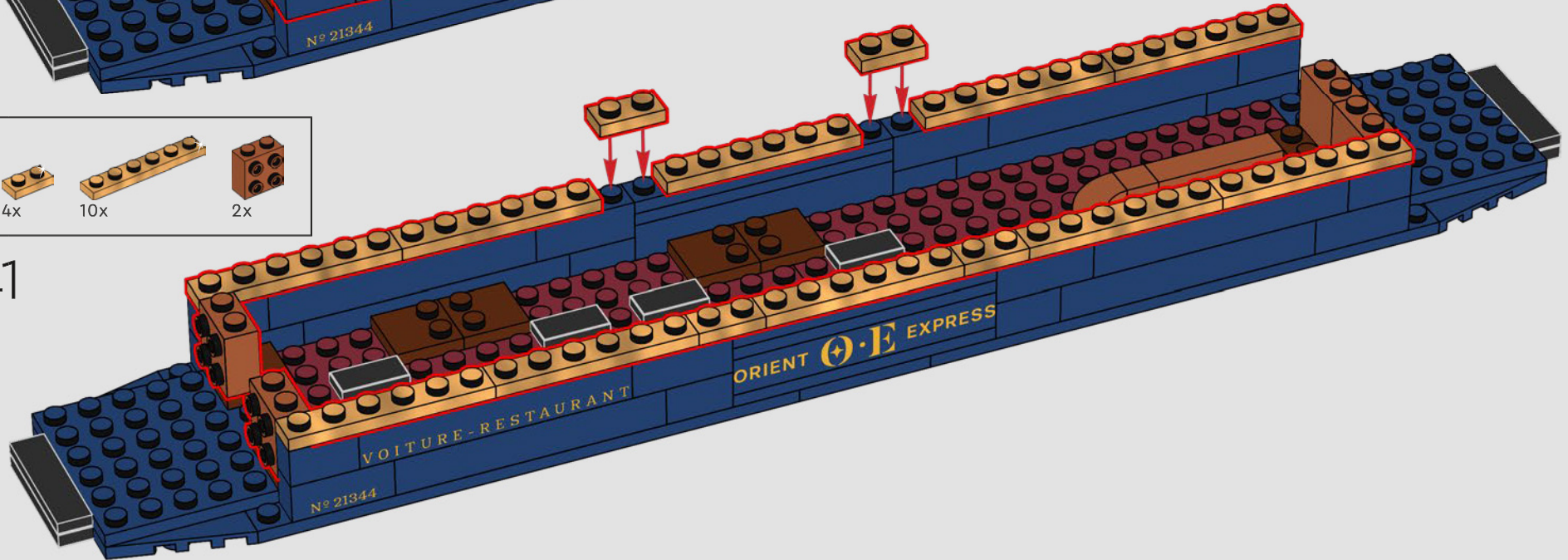

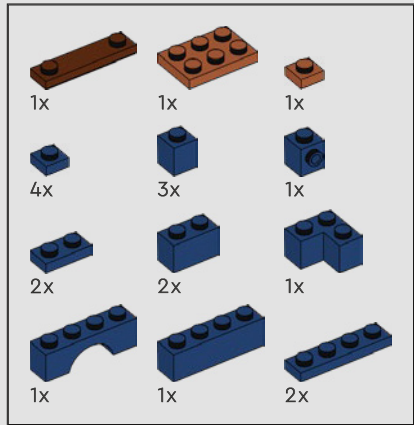

42

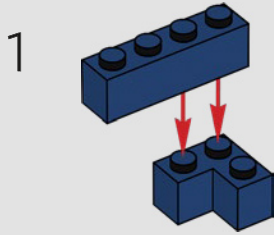

2

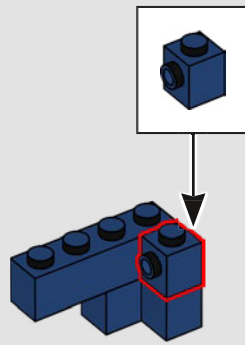

3

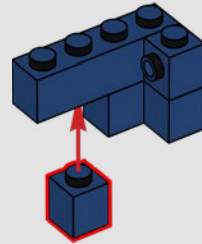

4

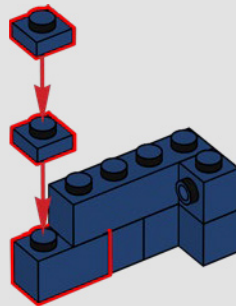

5

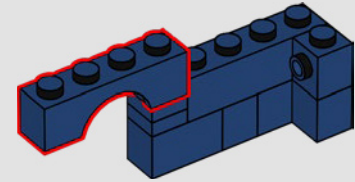

6

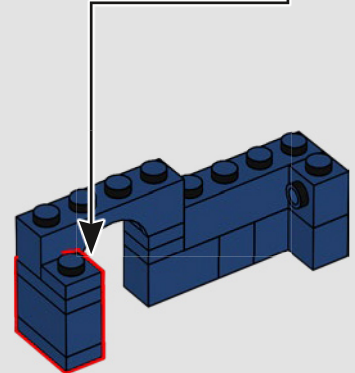
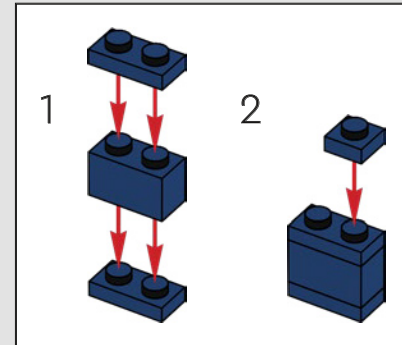

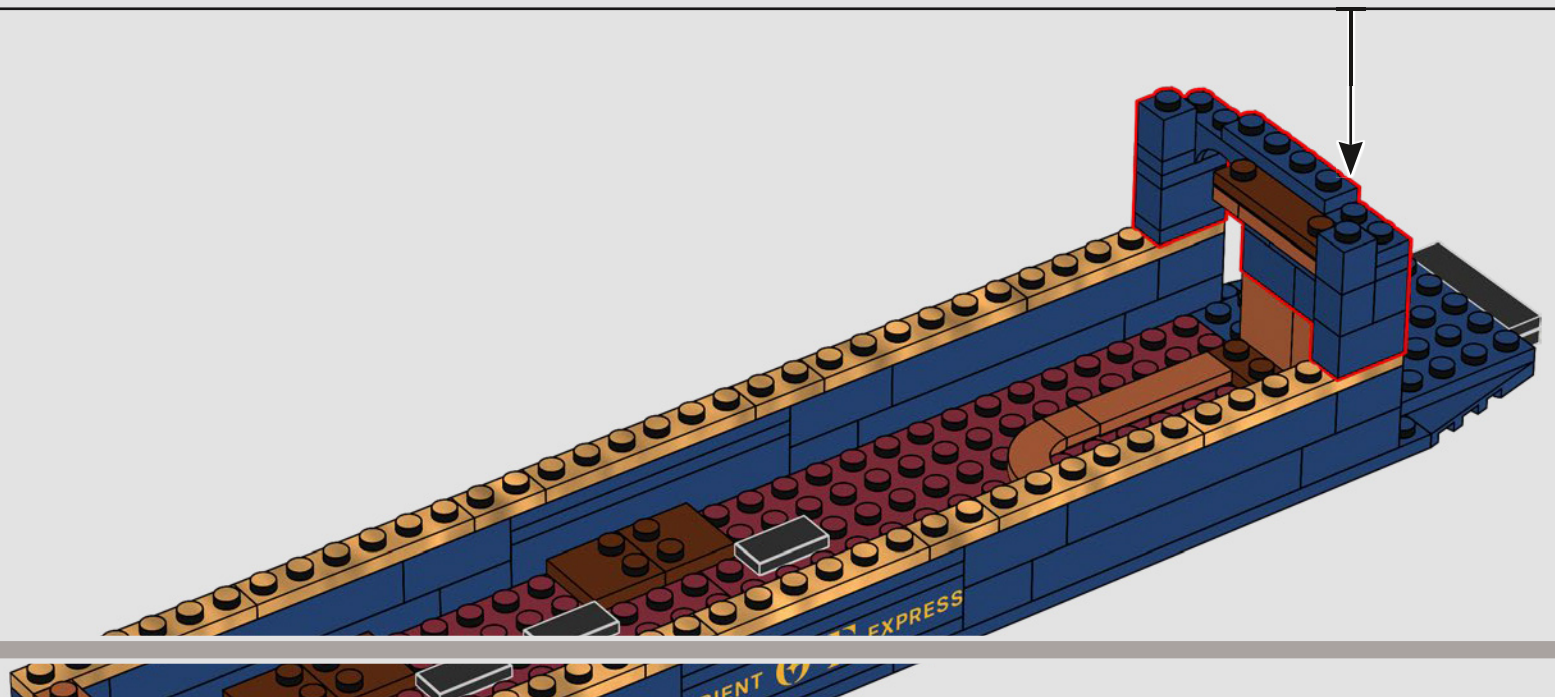
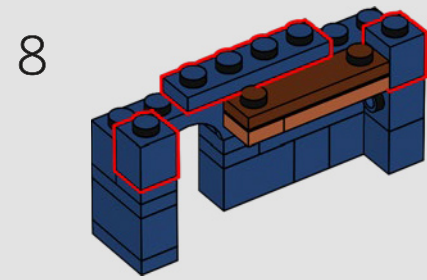
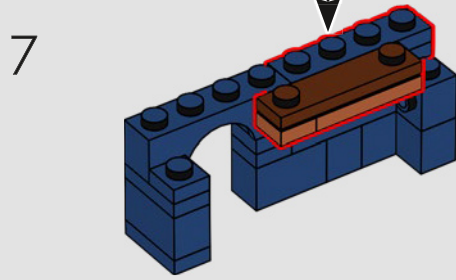
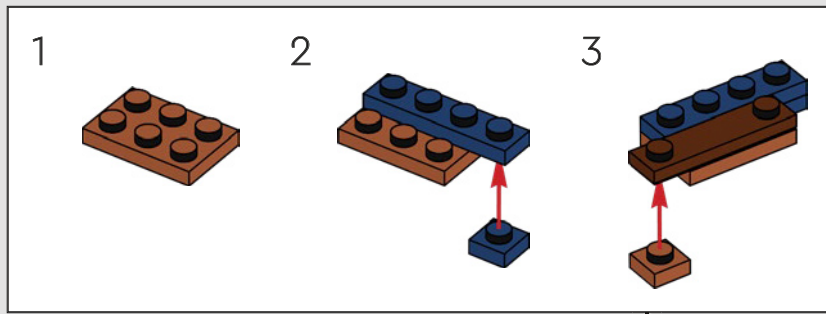

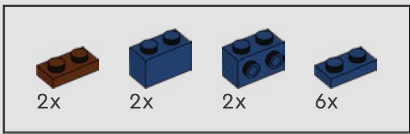

43

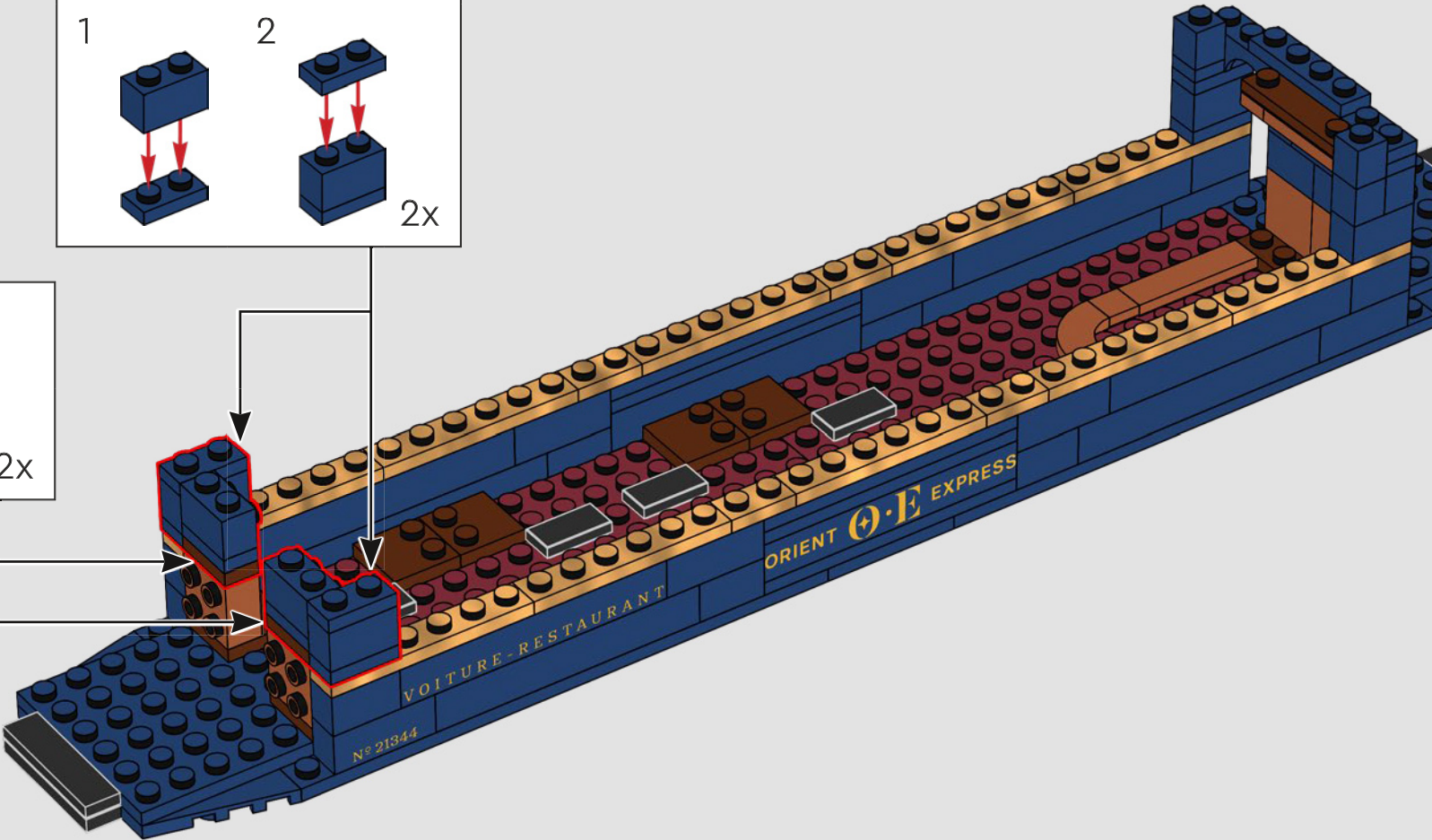
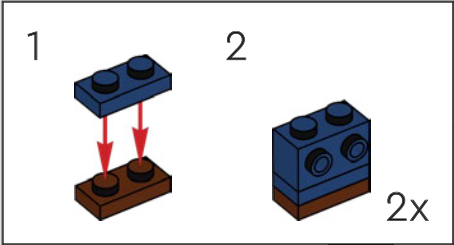
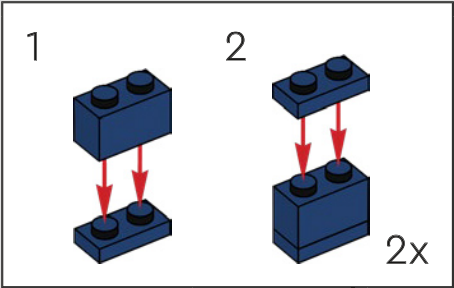

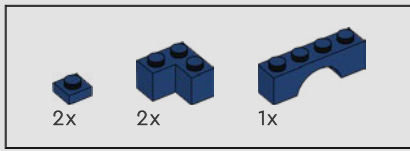

44

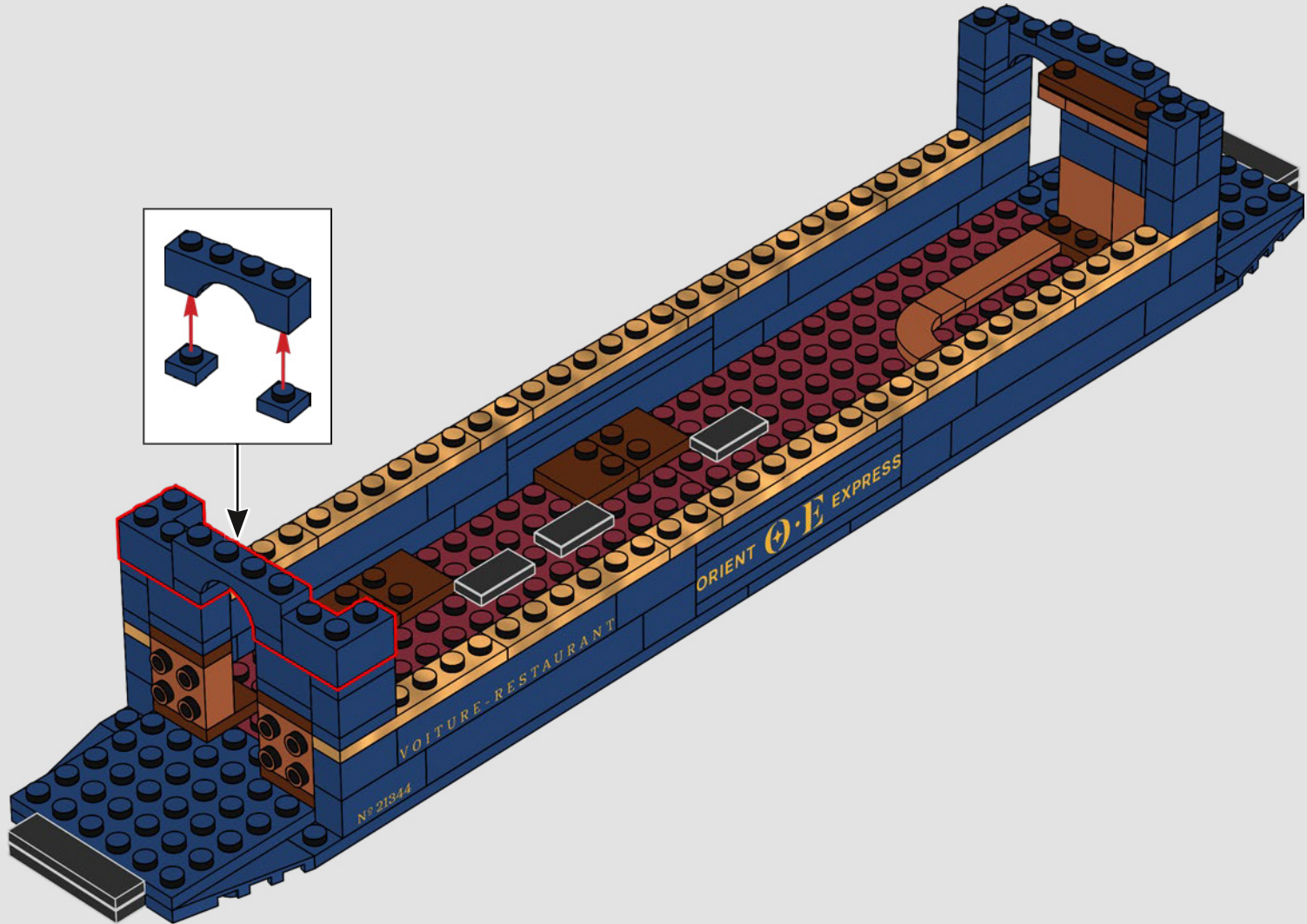

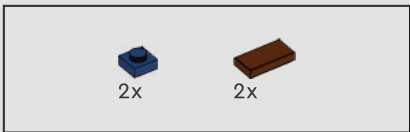

45

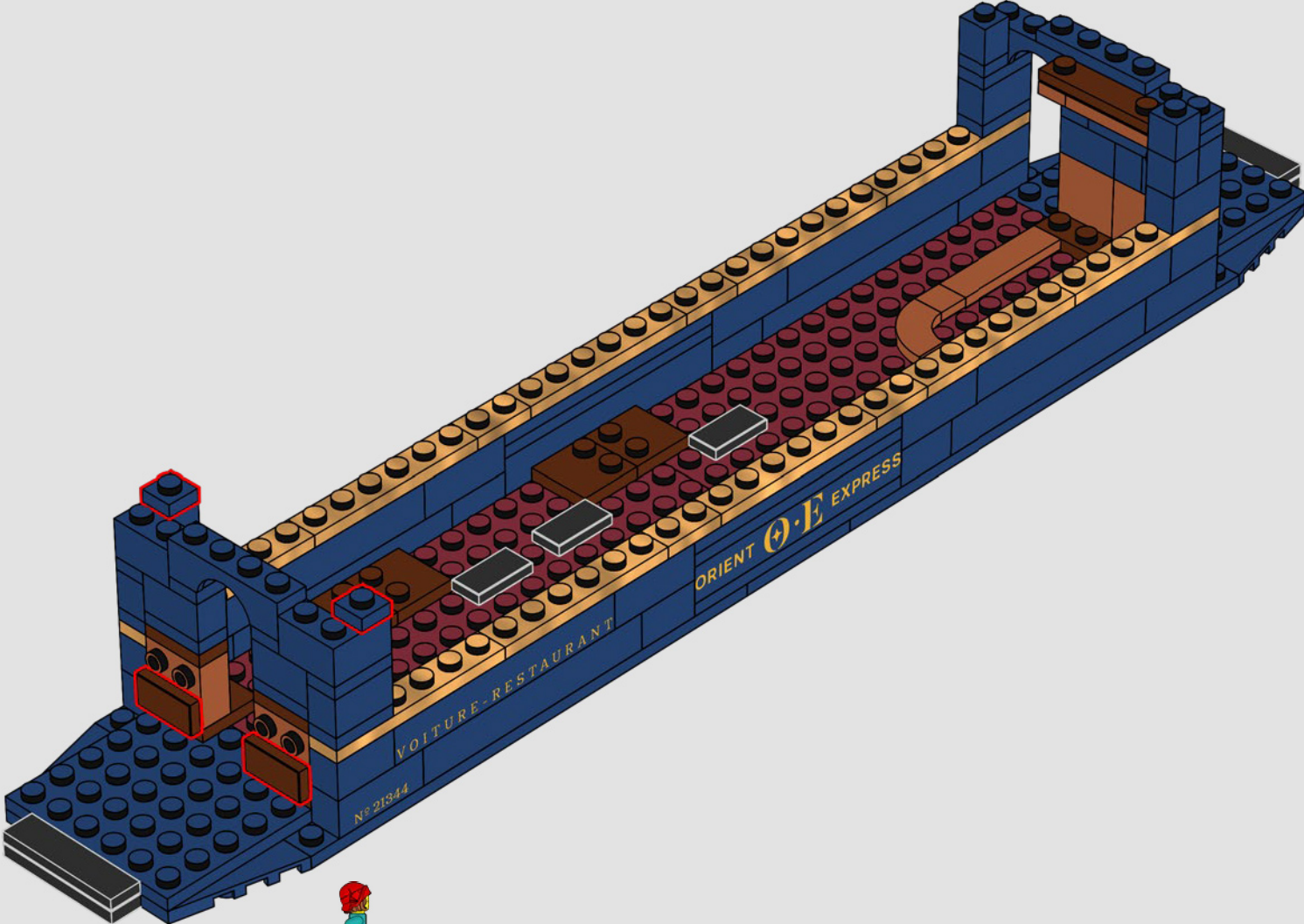

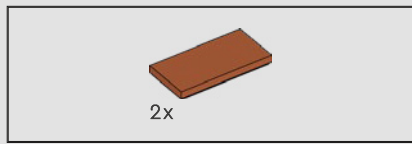

46

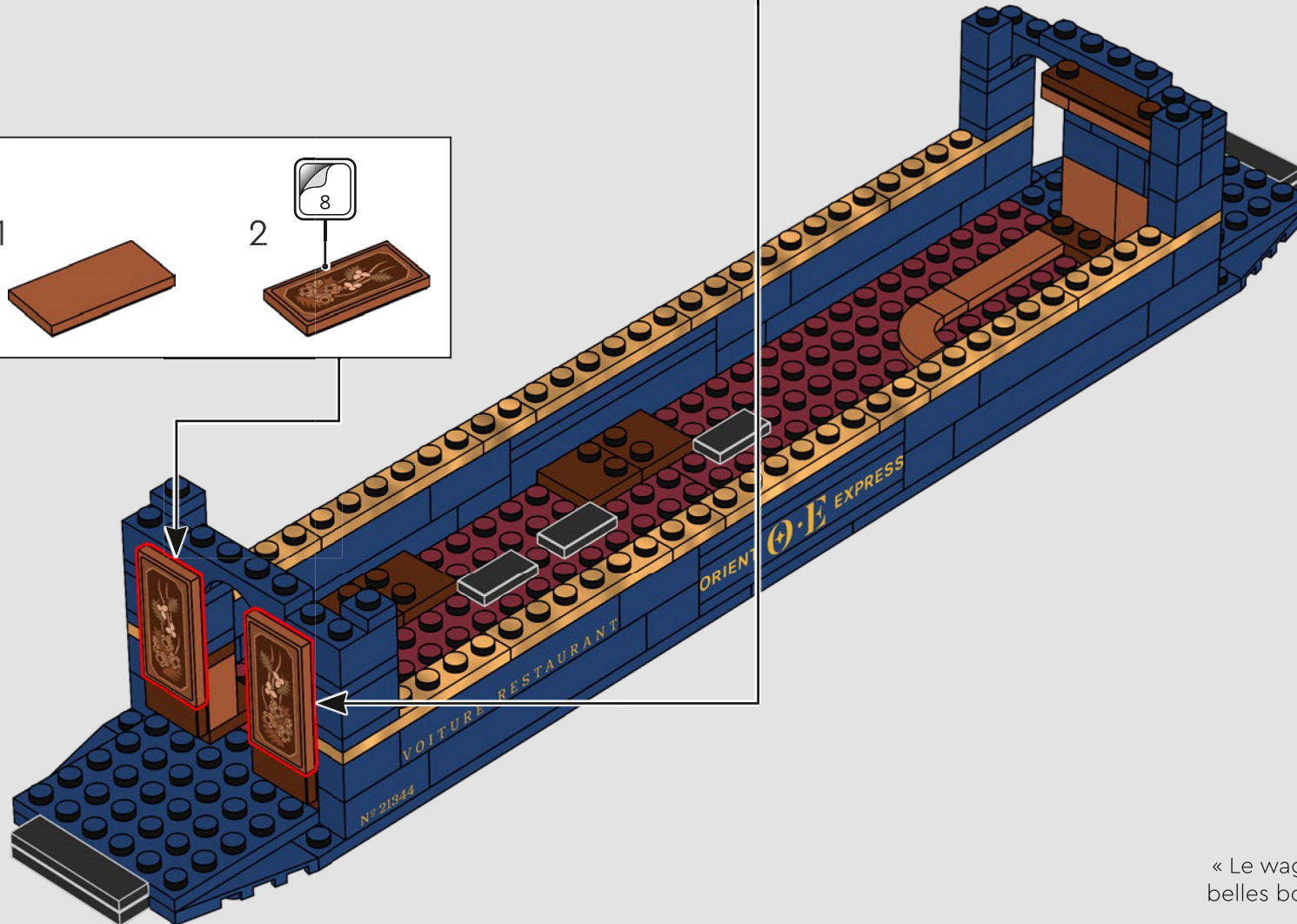
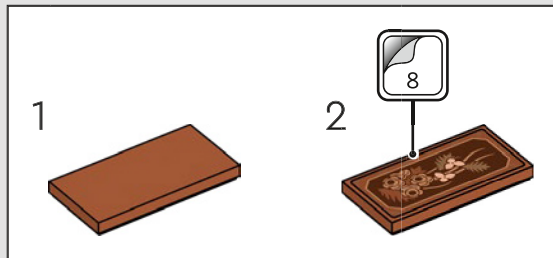
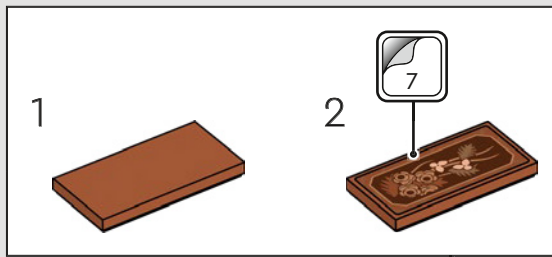

..... ●
« Le wagon-restaurant est décoré de belles boiseries de fleurs exotiques. »

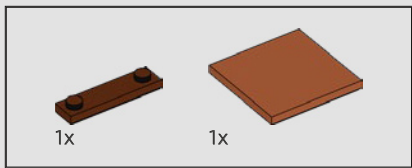

47

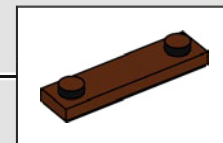
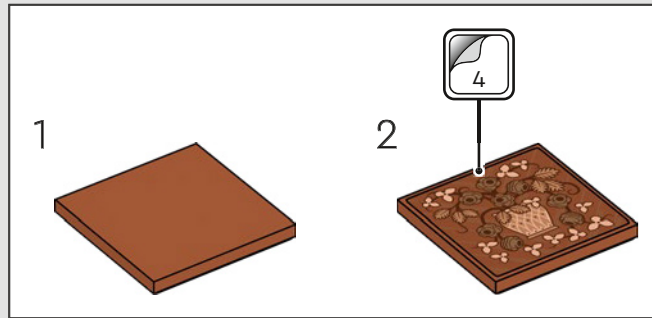
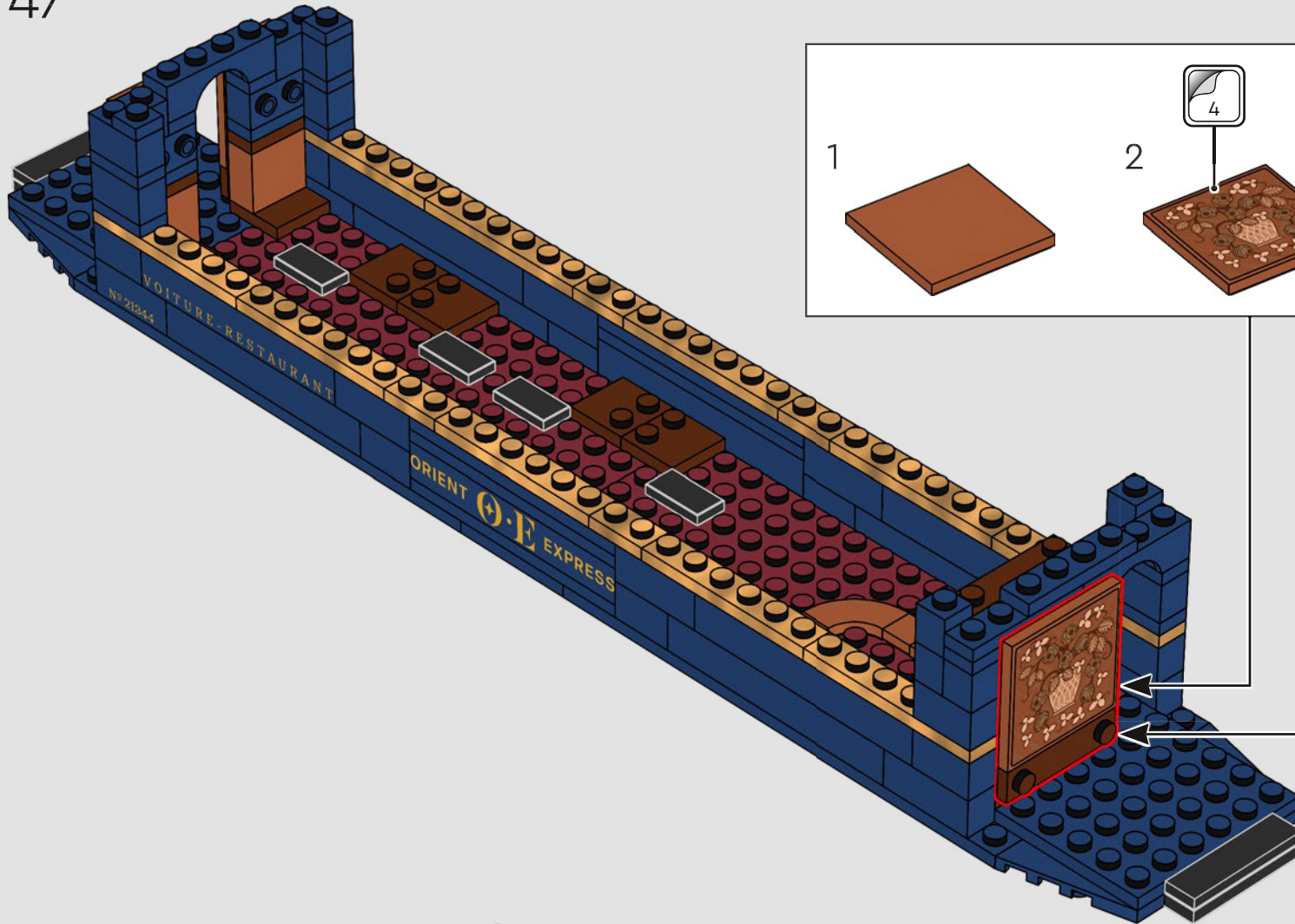

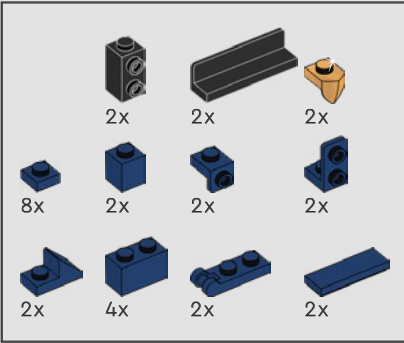
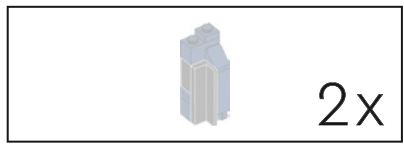

48

1

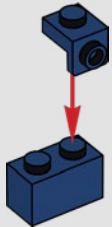

2

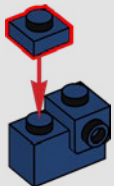

3

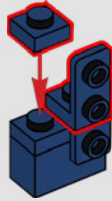

4

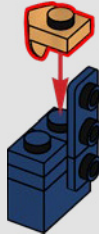

5

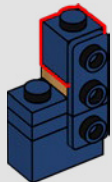

6

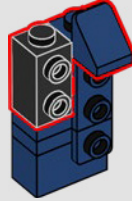

7

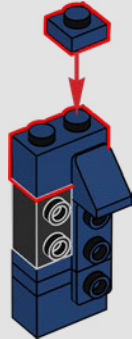

8

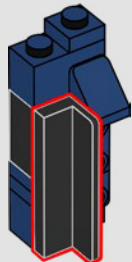

9

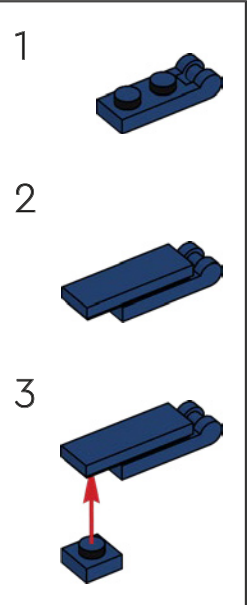
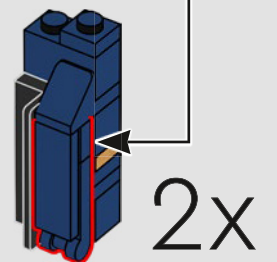

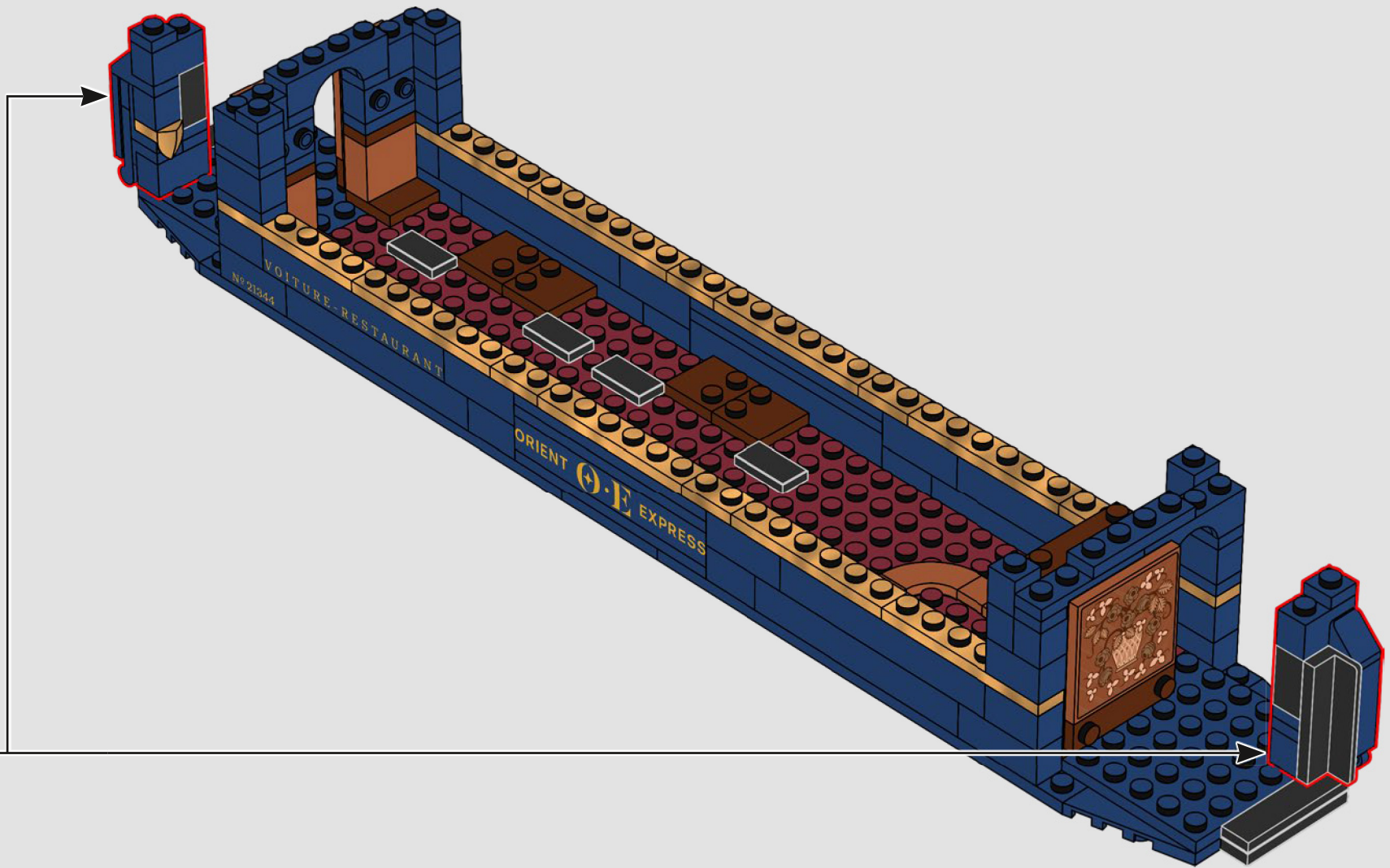

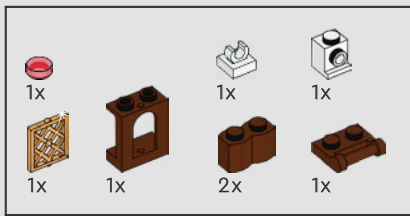

49

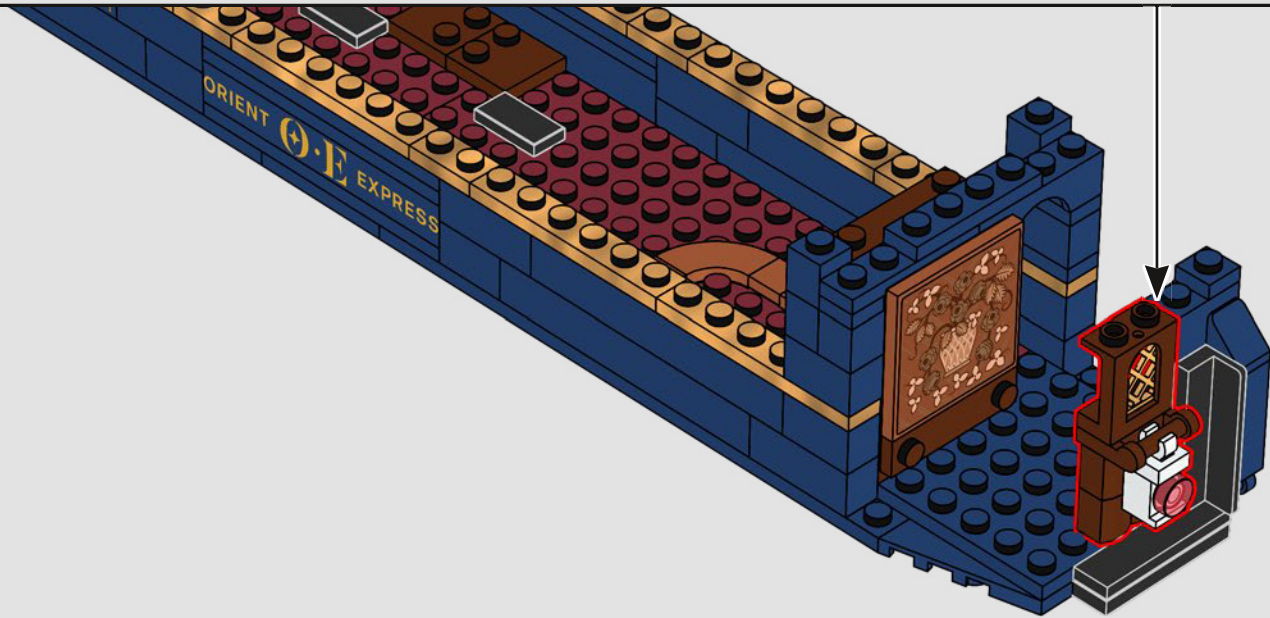
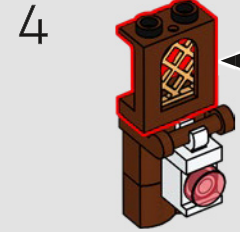
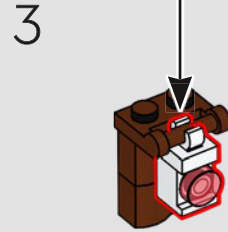
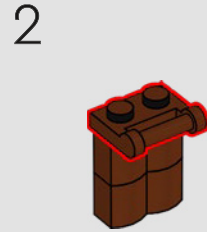
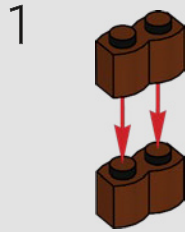
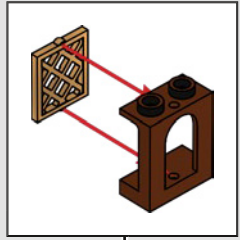
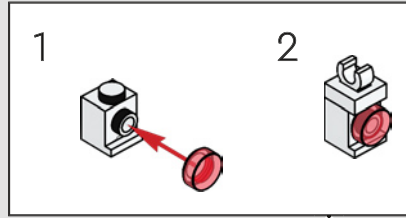



2x



2x



4x



2x



4x



2x



4x



2x



2x



2x



2x

50

1

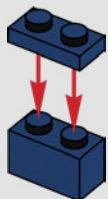

2

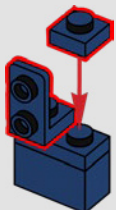

3



4

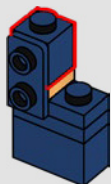

5

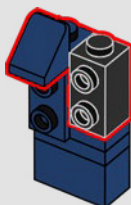

6

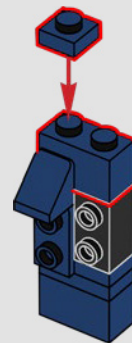

7

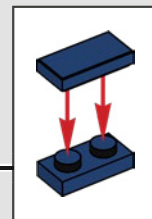
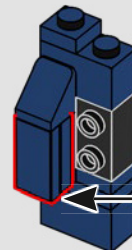

8

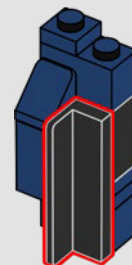

2x



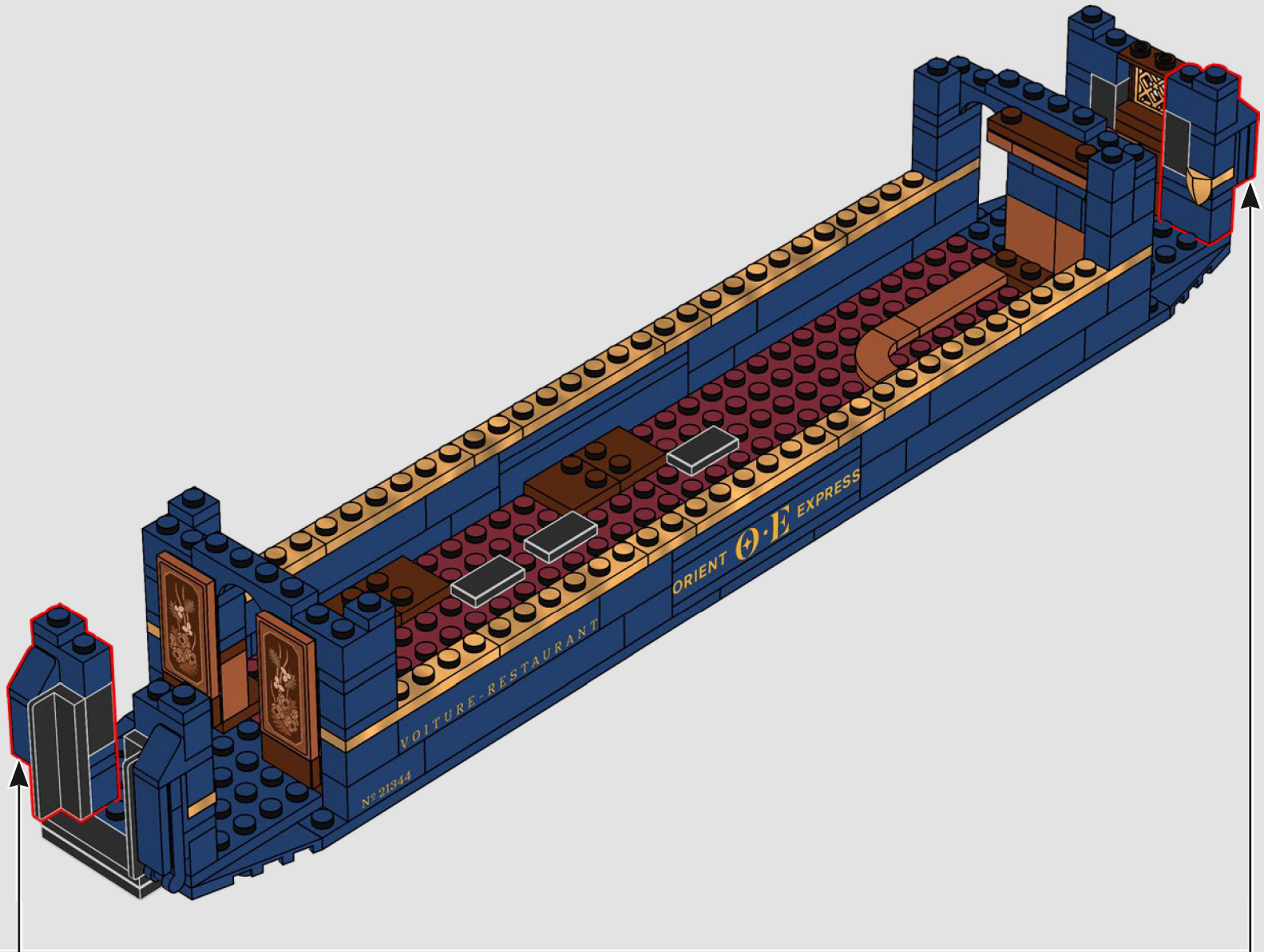

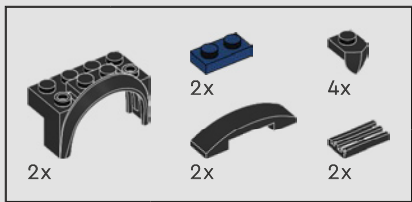

51

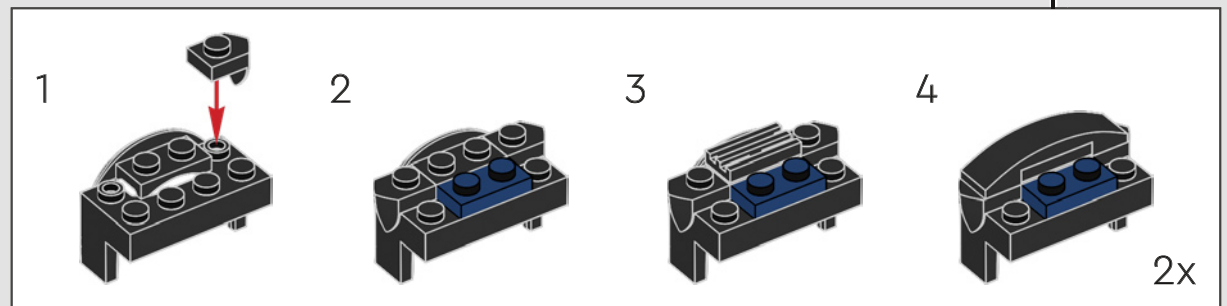
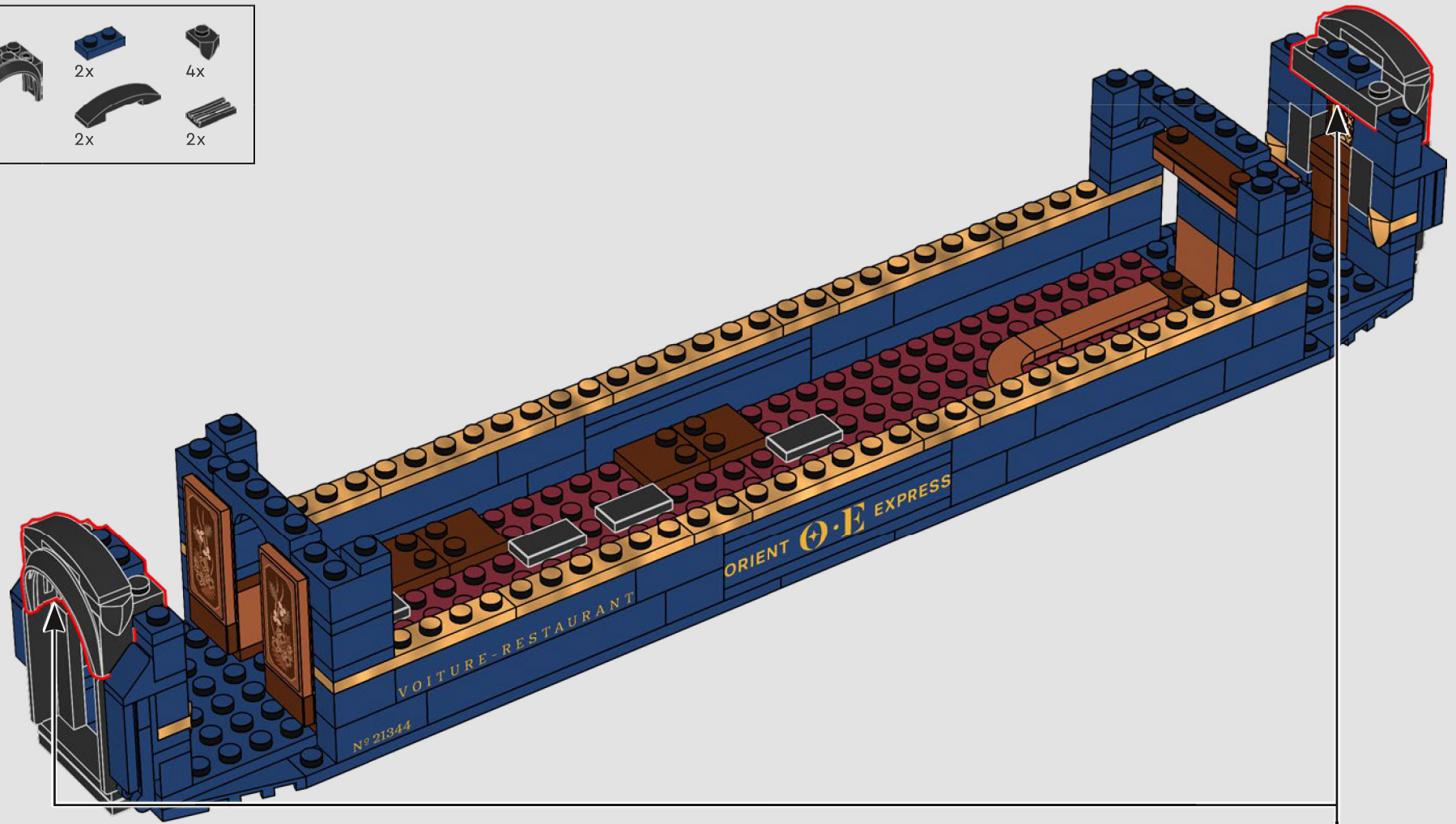

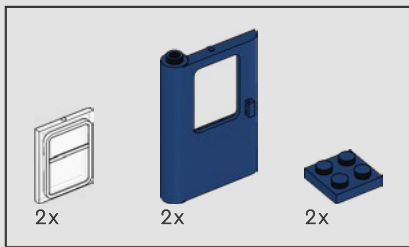

52

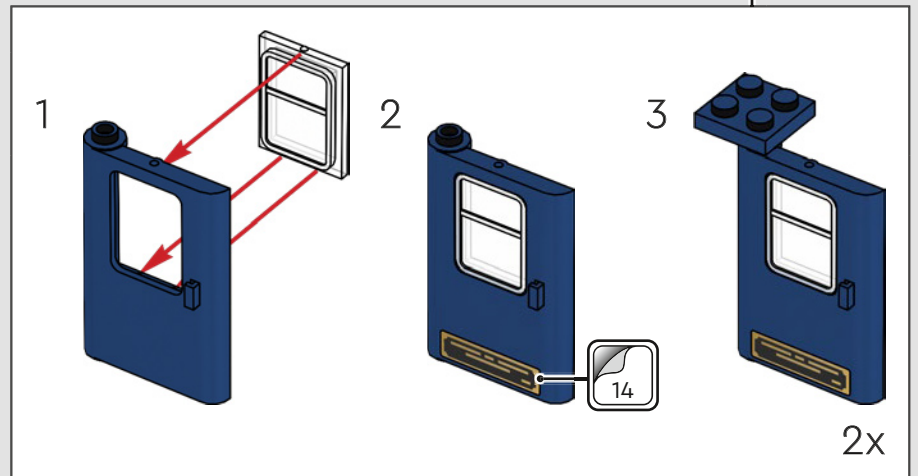
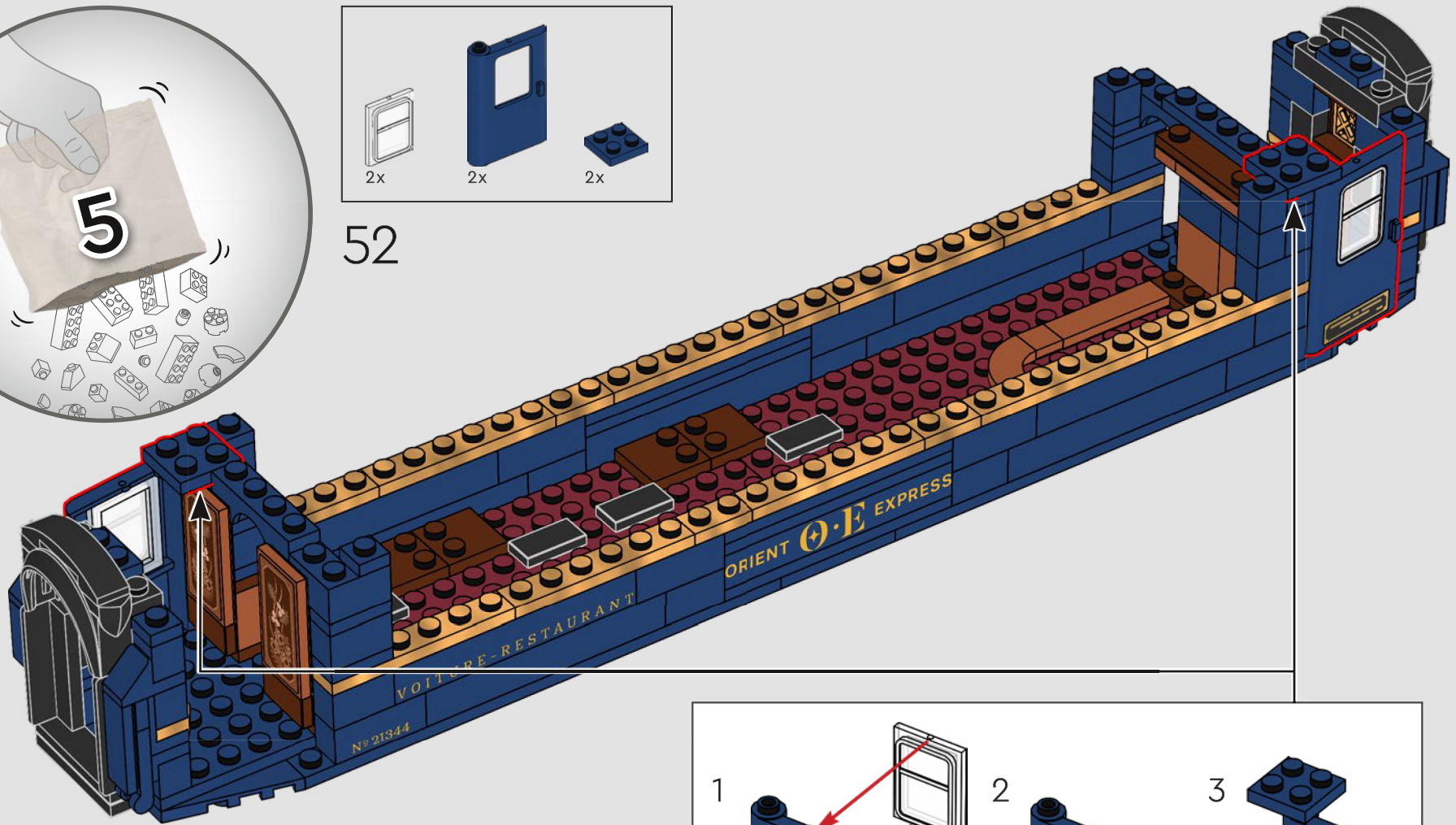

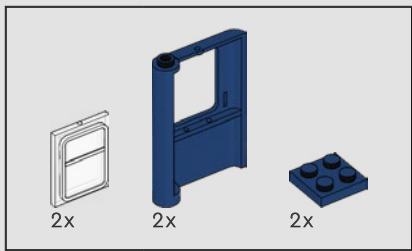

53

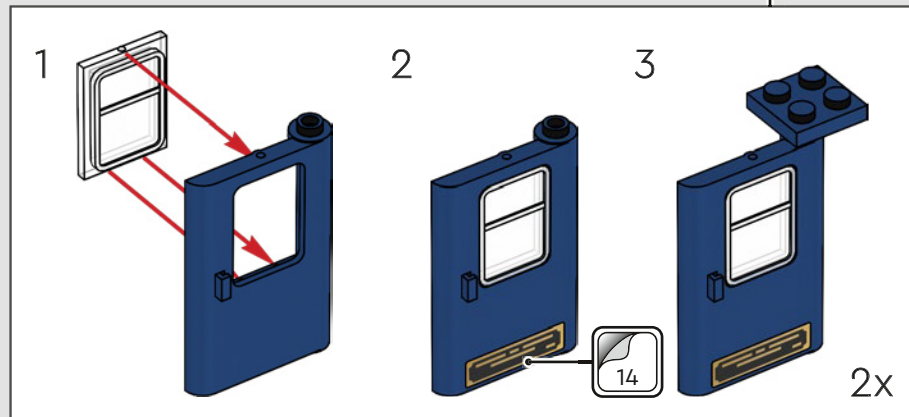
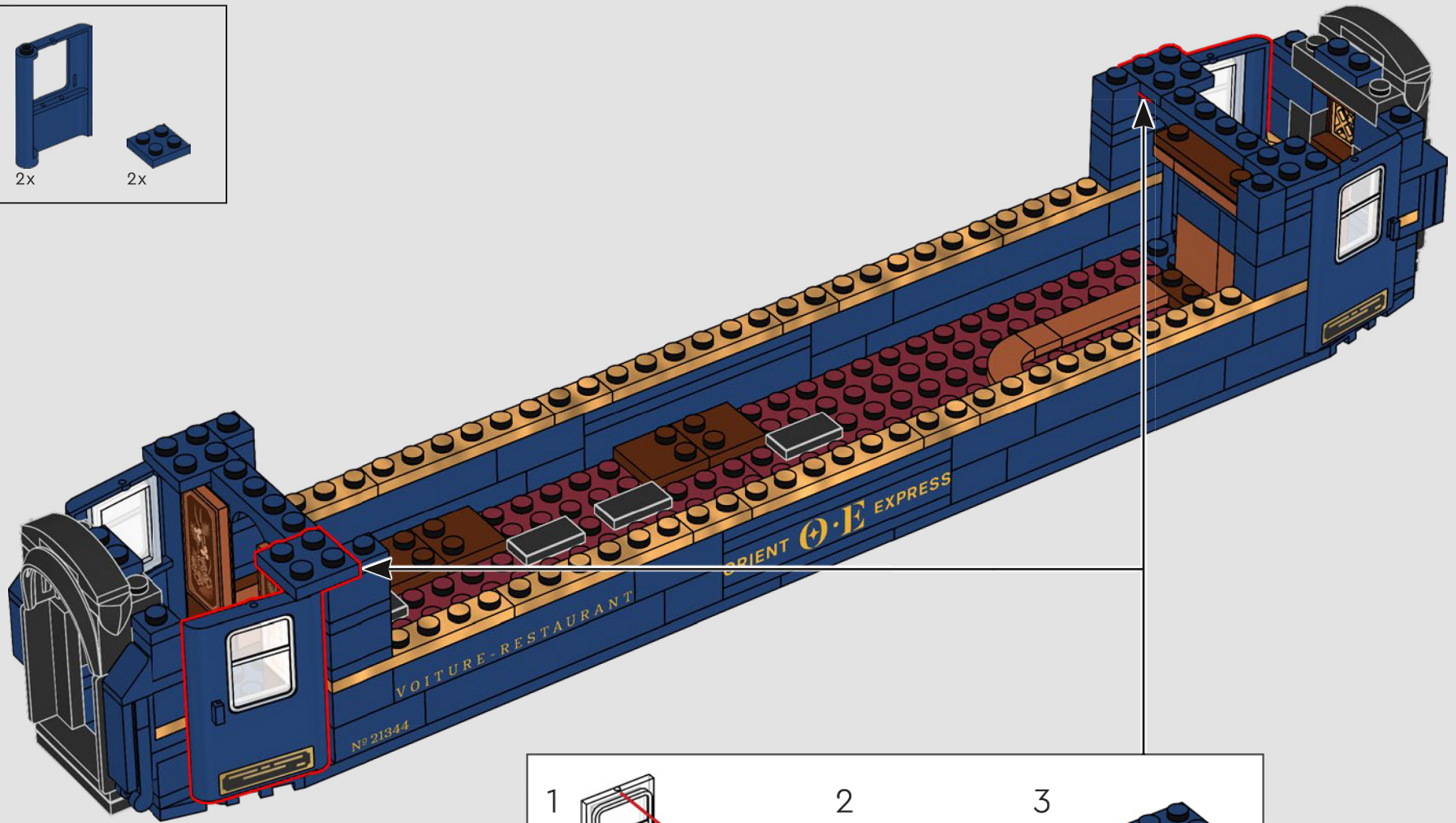

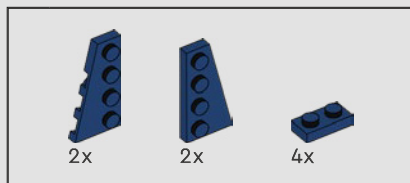

54

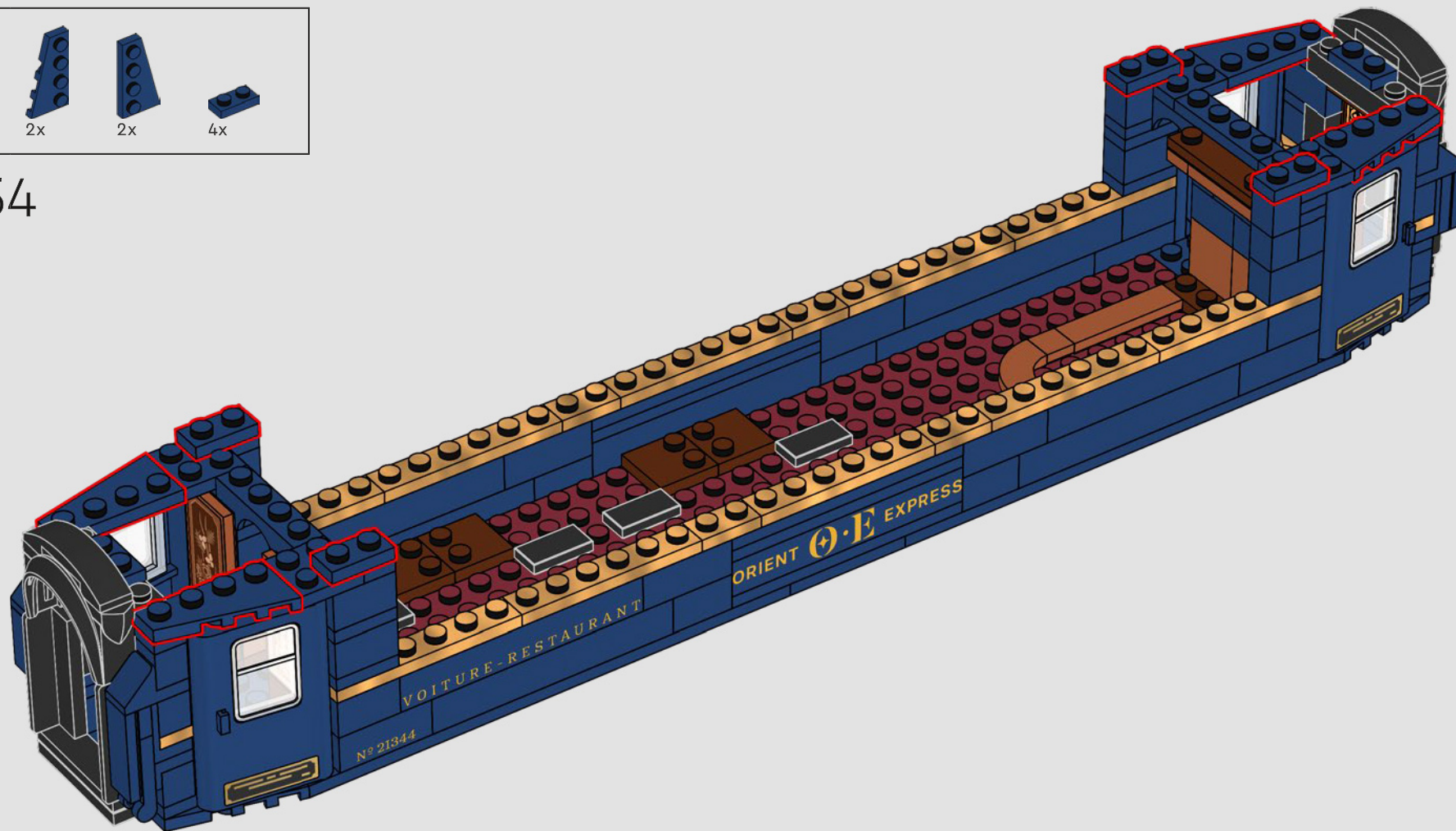

..... ●
« Chaque porte comprend une plaque en laiton
avec le nom du fabricant, un gage de qualité. »

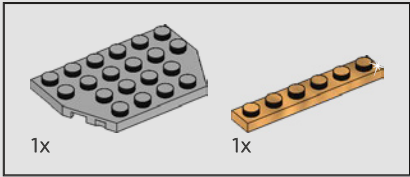
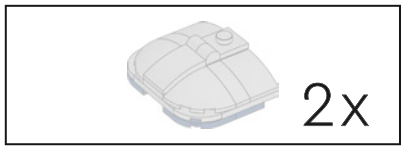

55

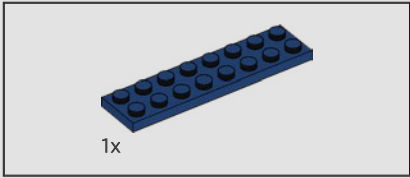
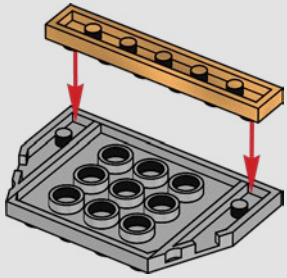

56

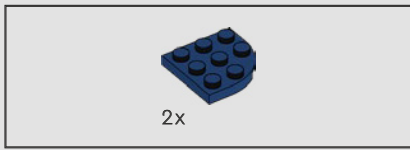
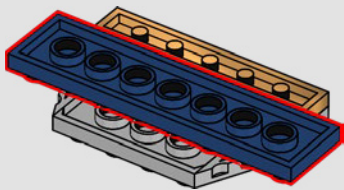

57

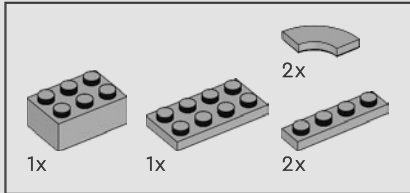
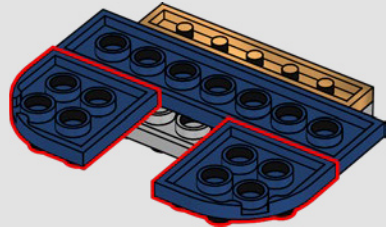

58

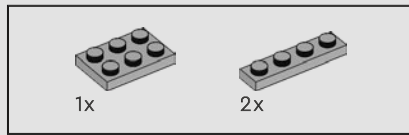
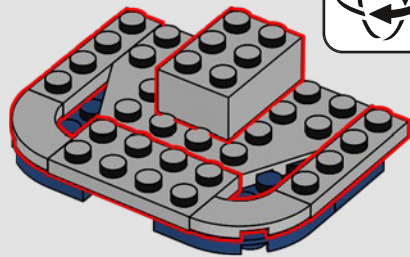

59

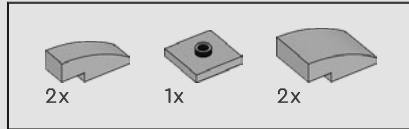
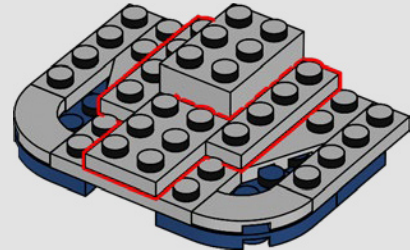

60

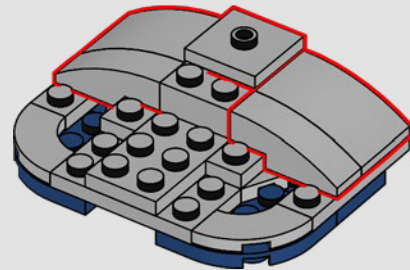

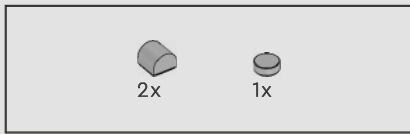

61

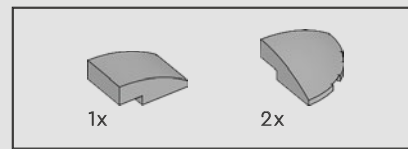
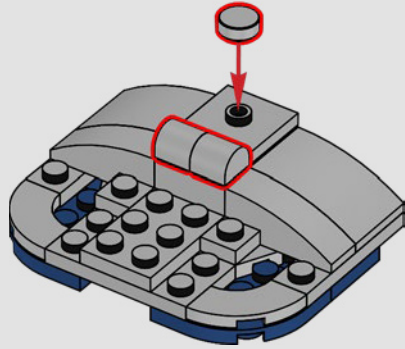

62

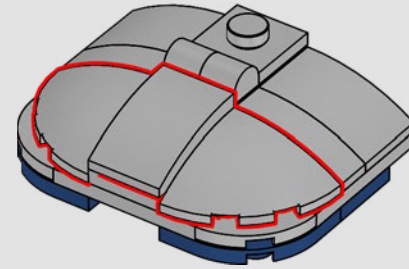

2x

63

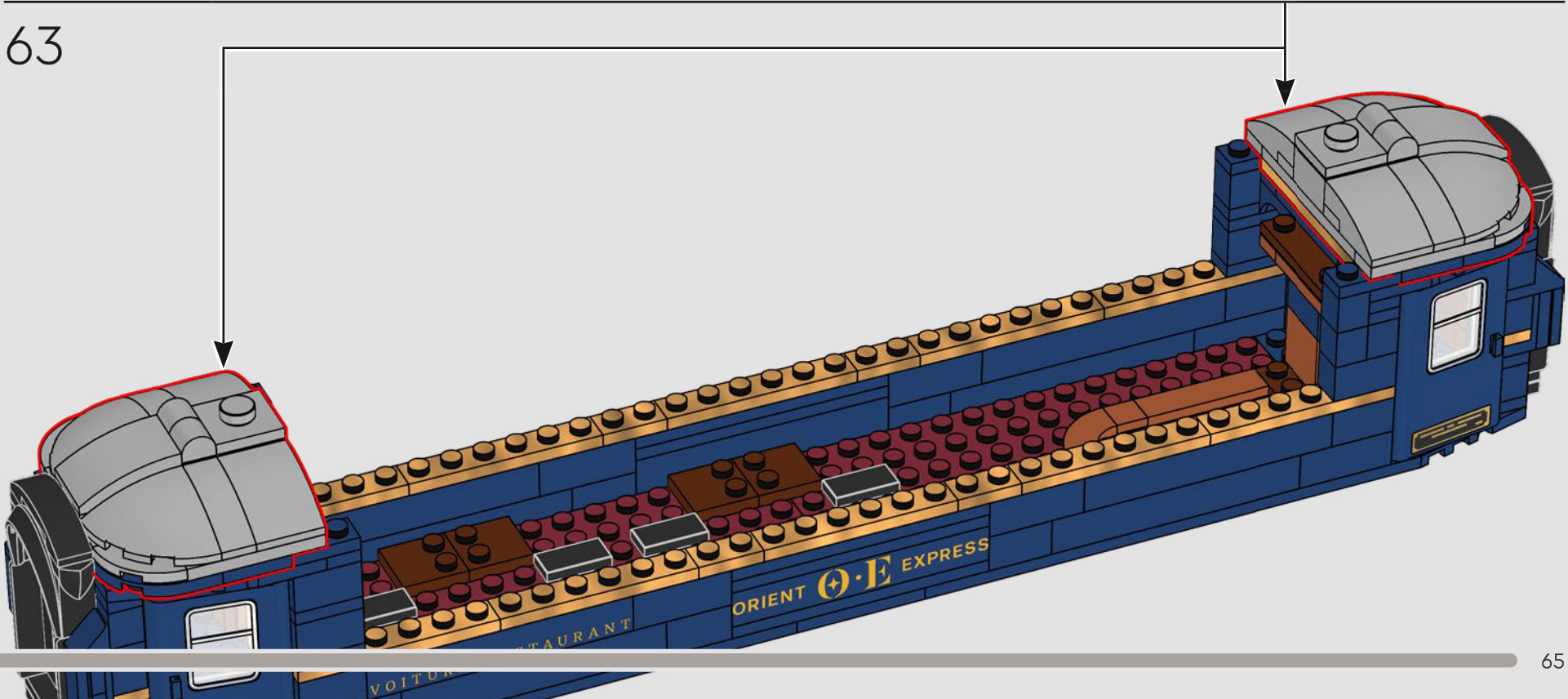

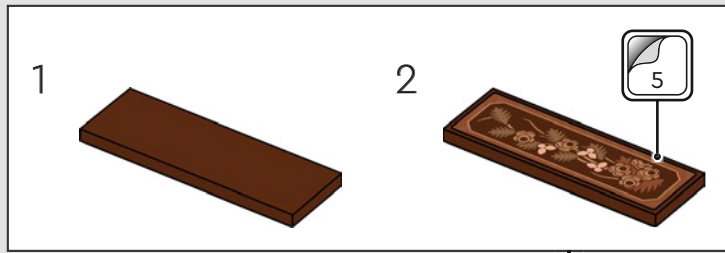
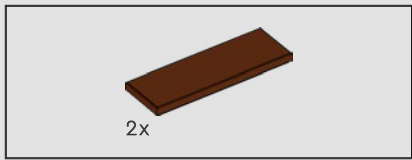

64

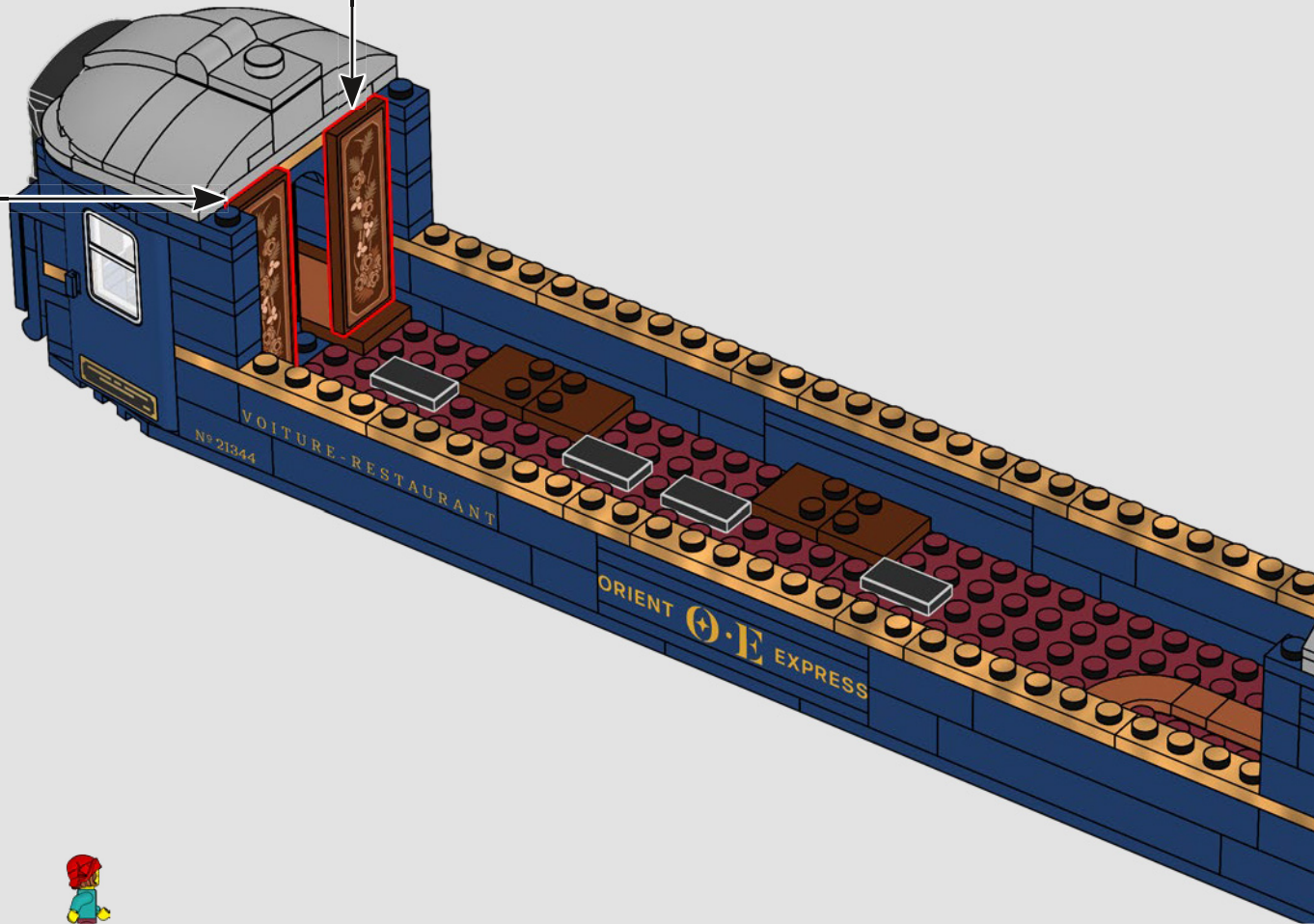
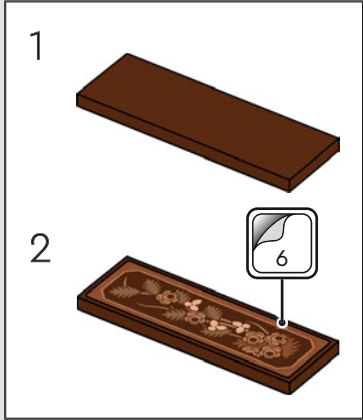

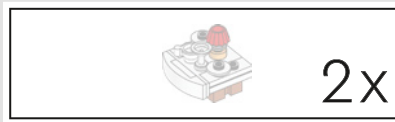
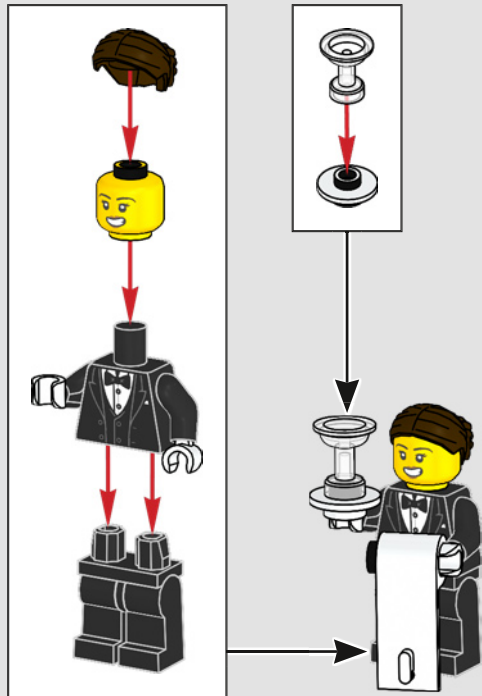

65

1

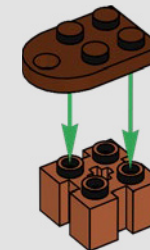

Prochain arrêt : MUNICH
« À bord, il y a un serveur
et un wagon-restaurant. »

2



3

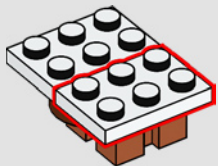

4

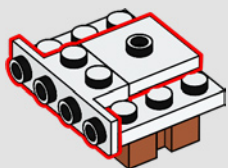

5

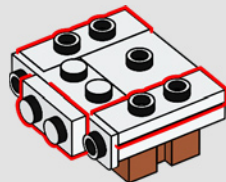

6

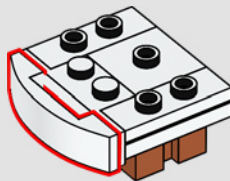

7

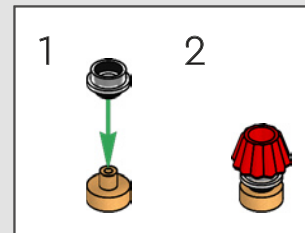
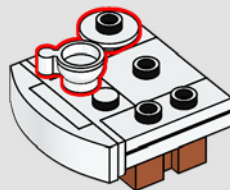

8



9

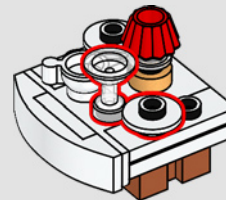

2x



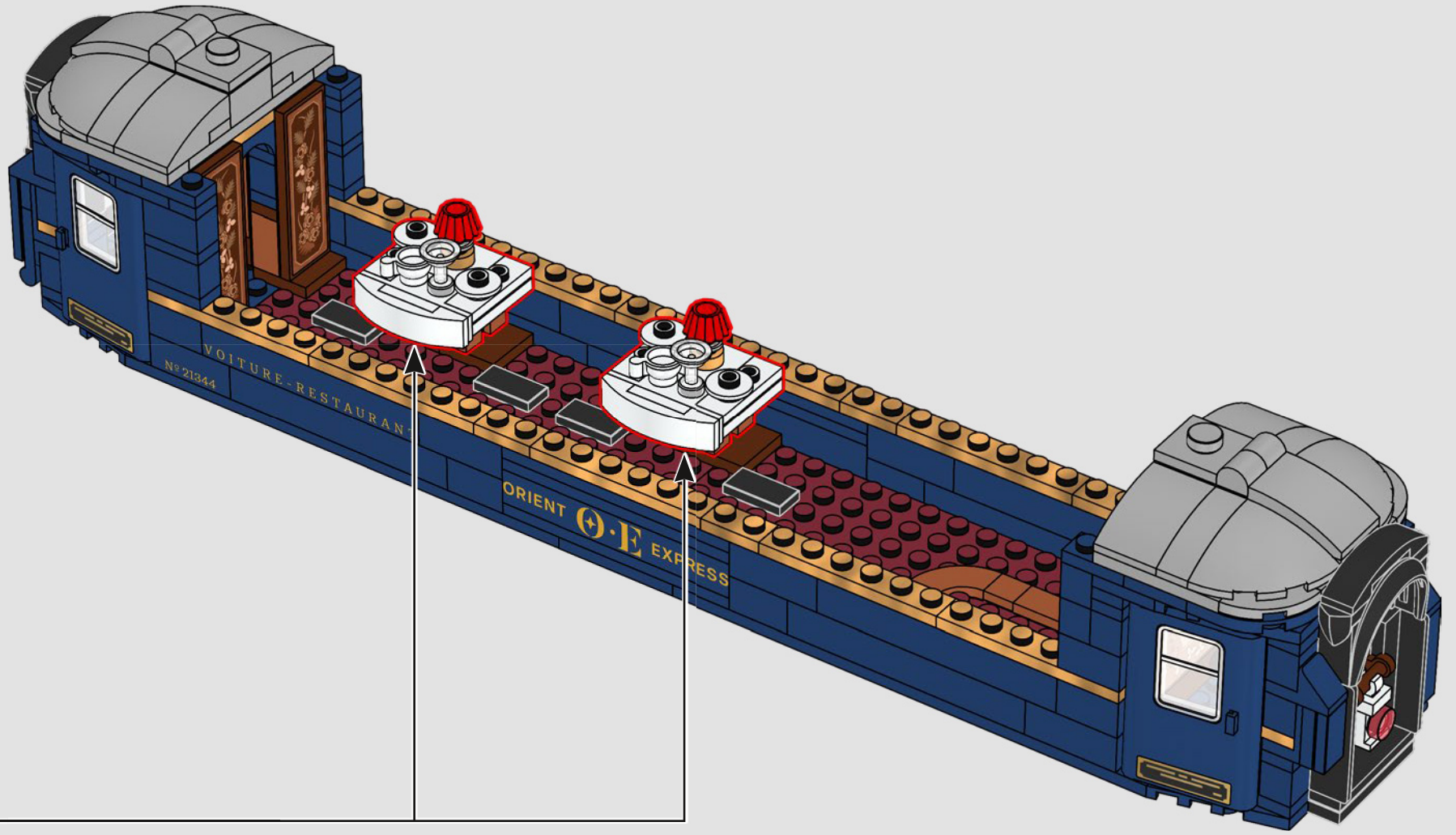

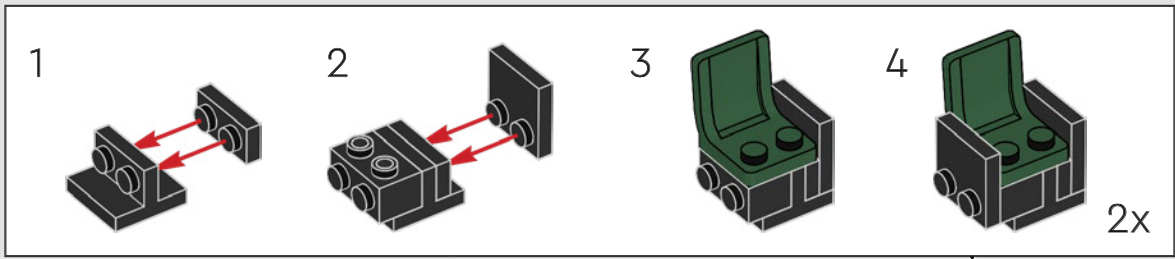
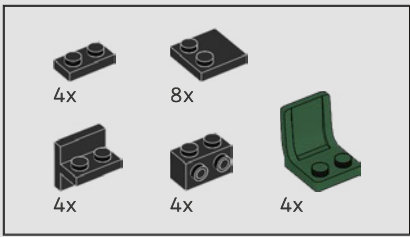

66

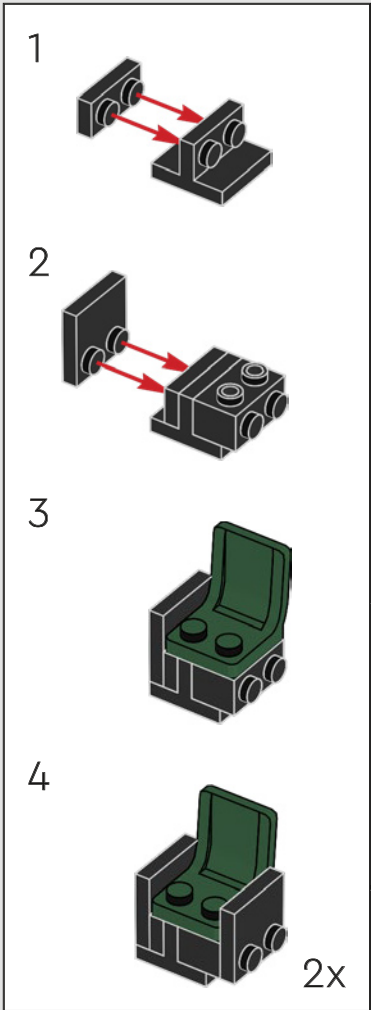

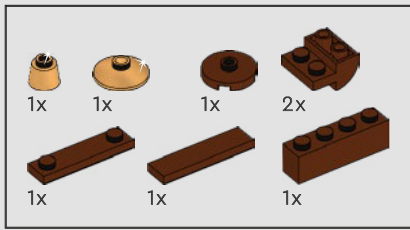

67

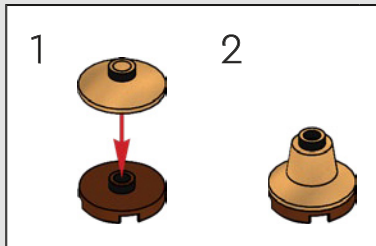
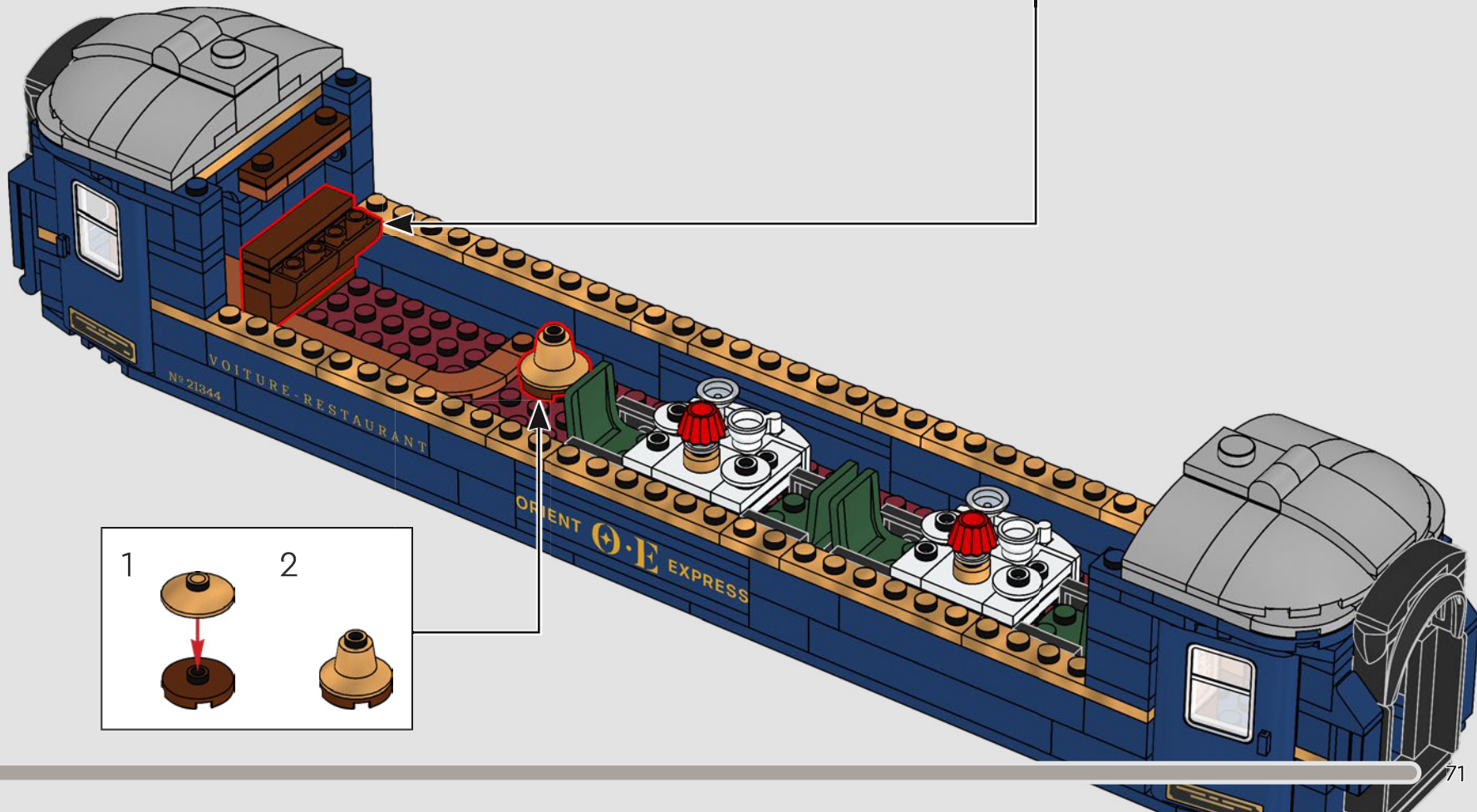
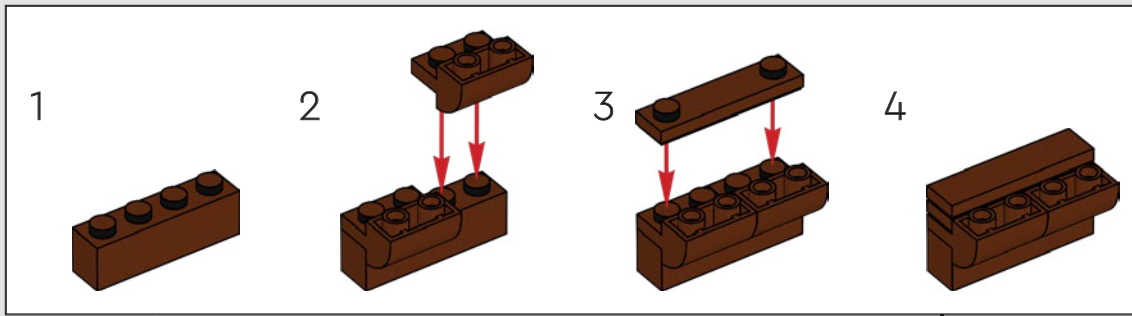

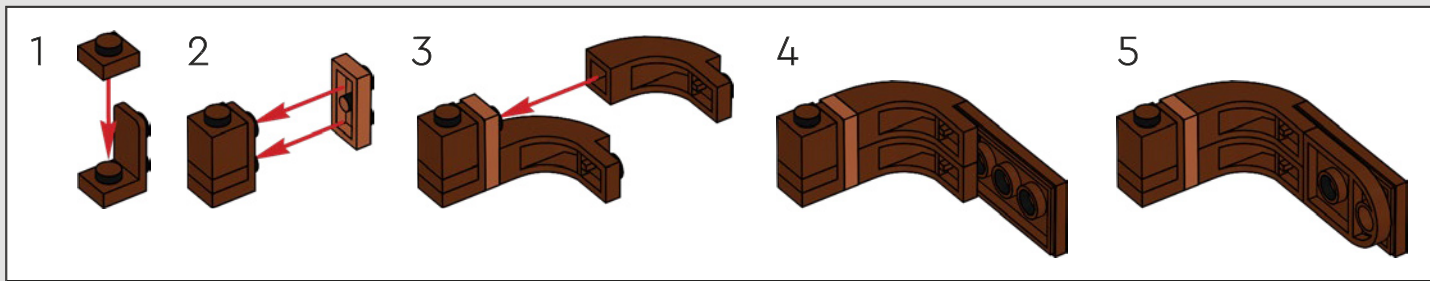
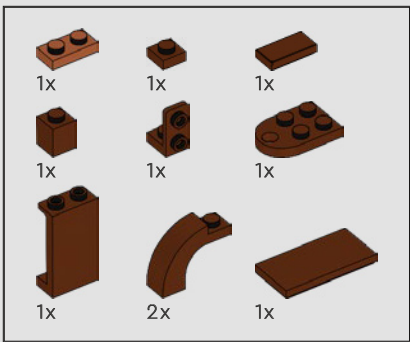

68

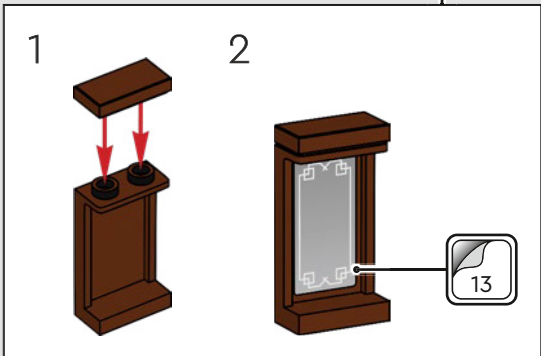
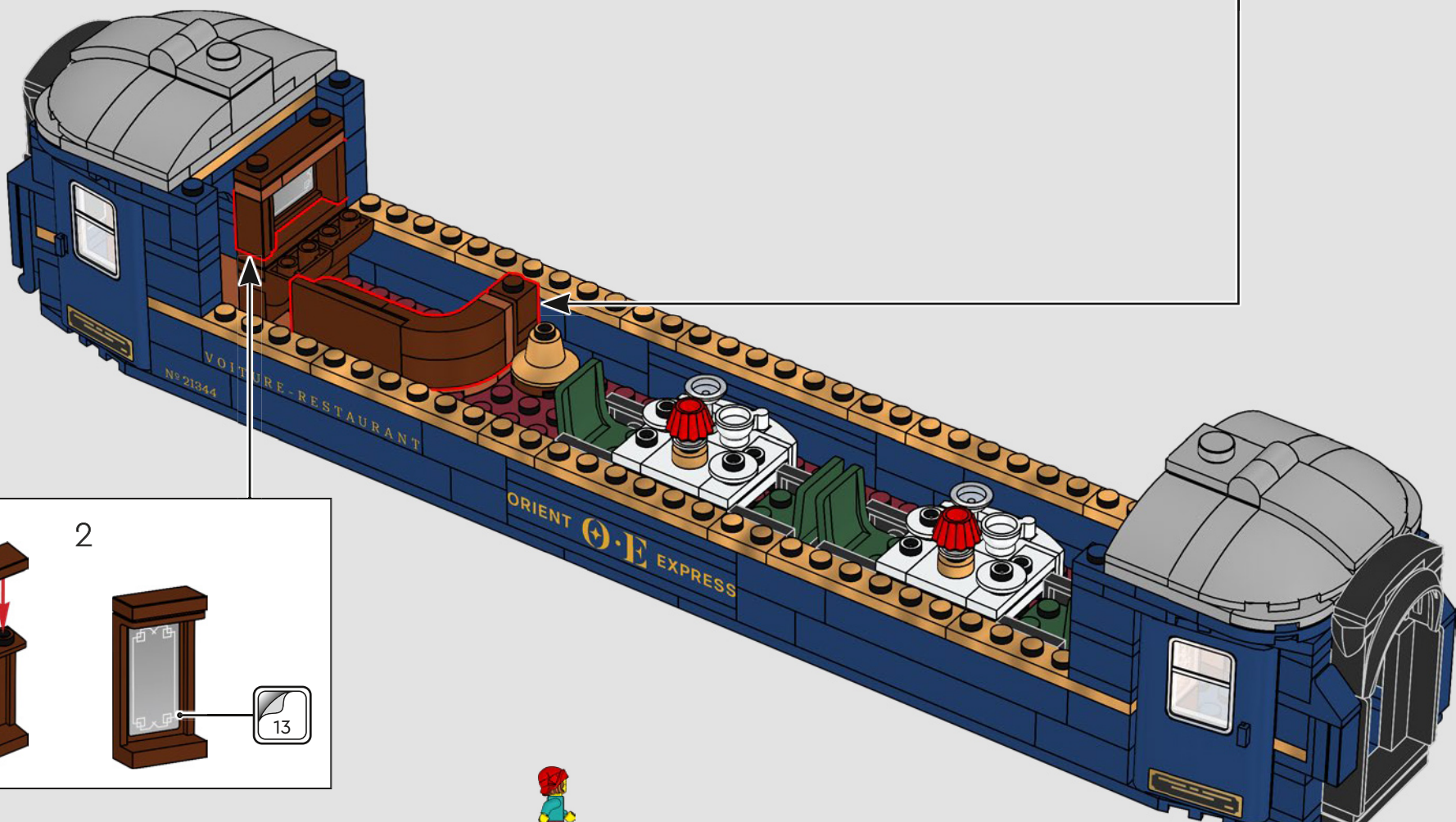



69

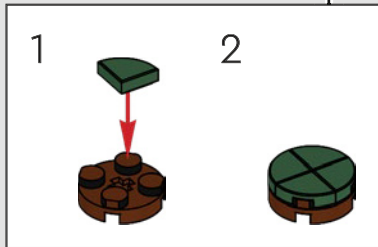
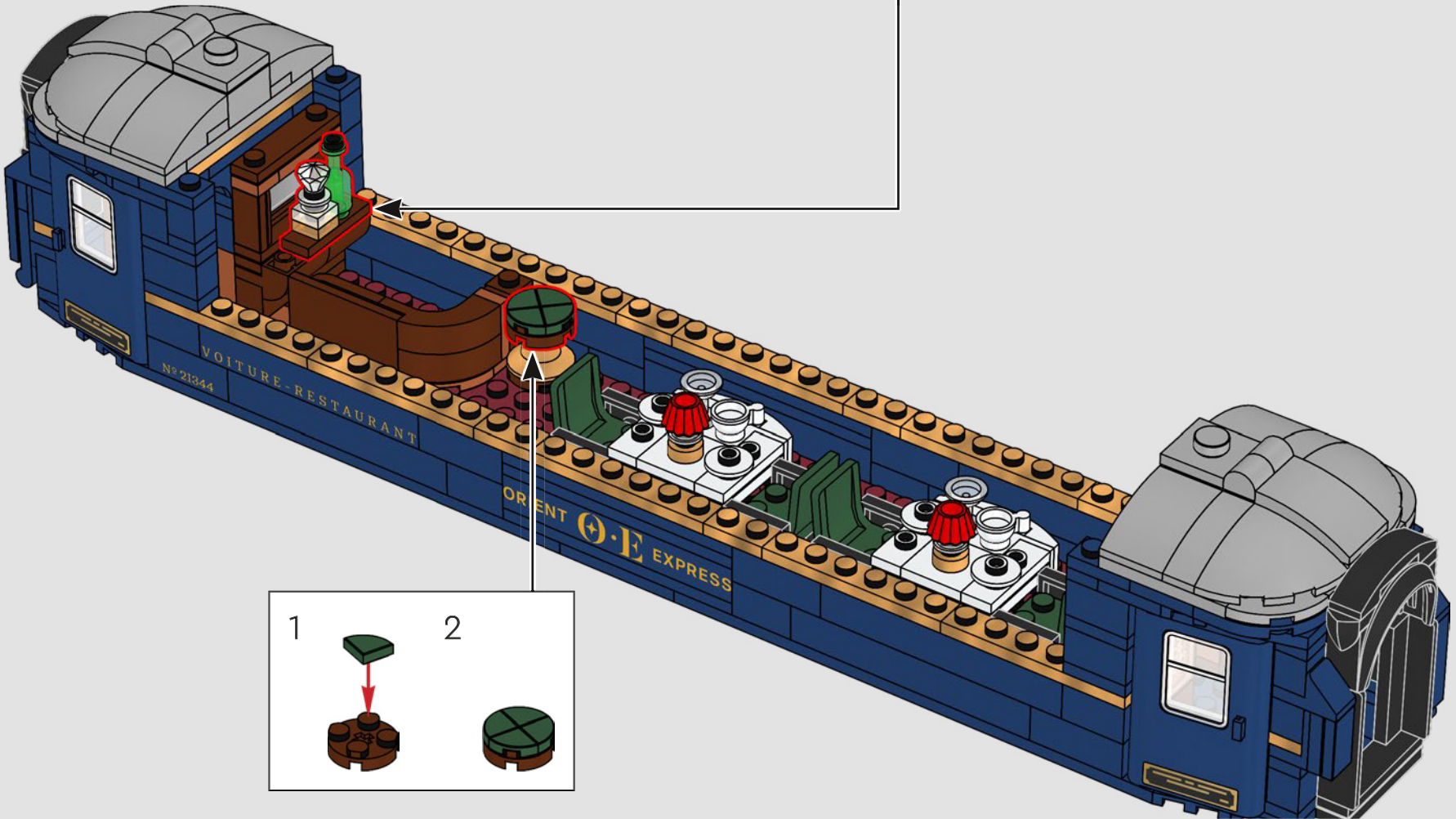
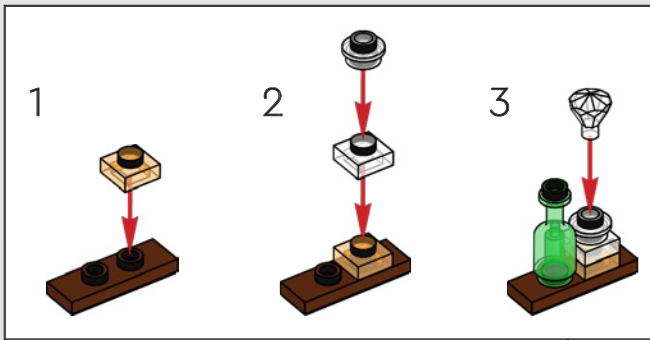

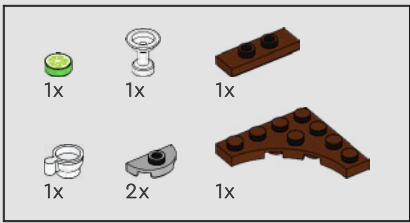

70

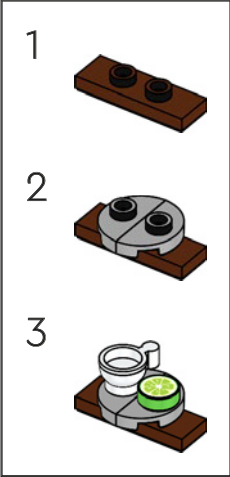
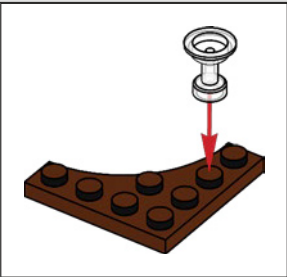

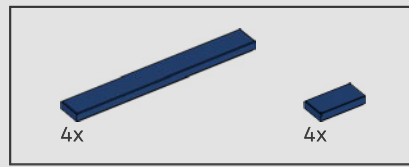

71



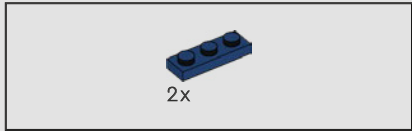
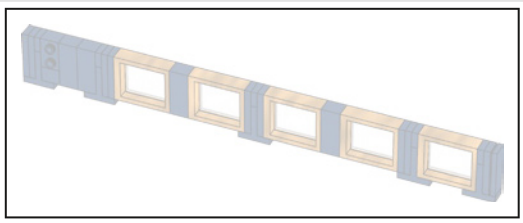

72

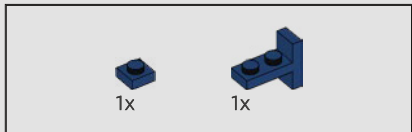
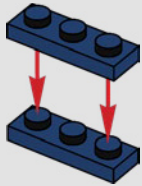

73

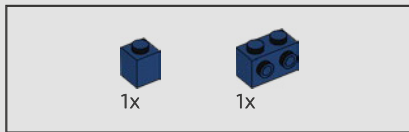
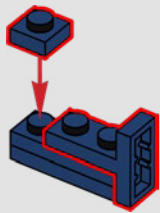

74

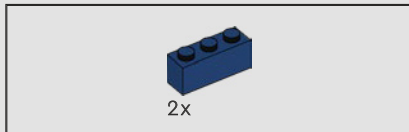
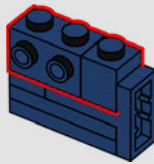

75

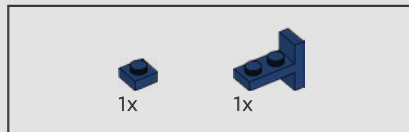
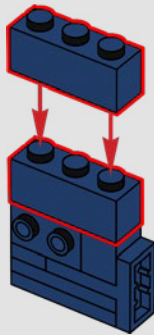

76

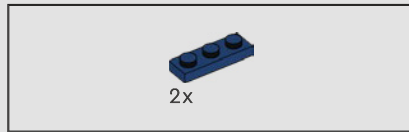
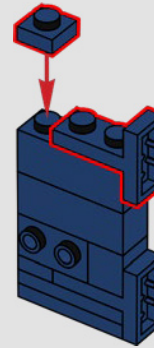

77

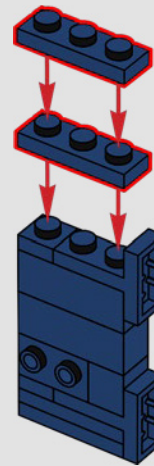

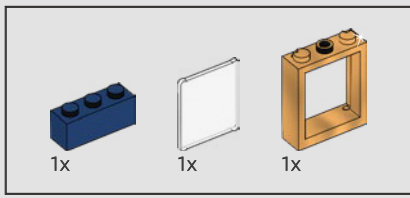

78

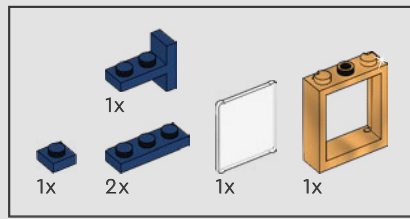
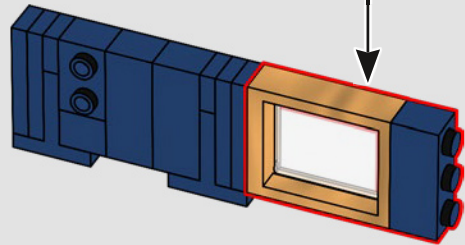
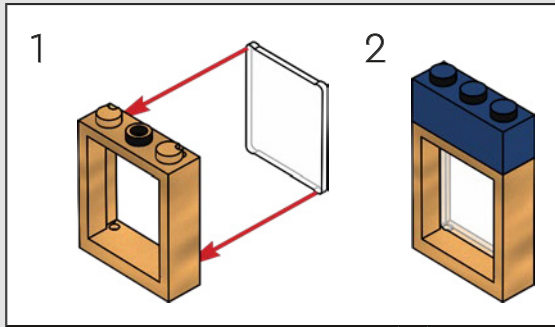

79

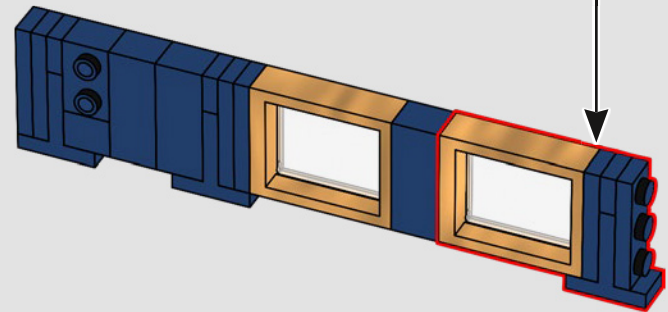
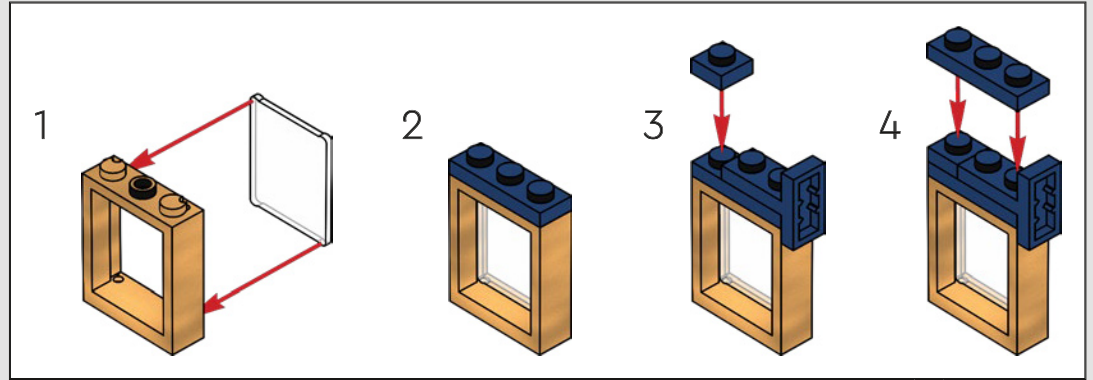

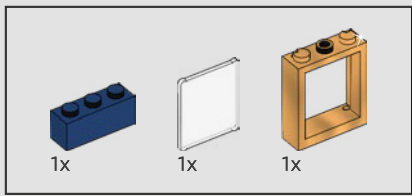

80

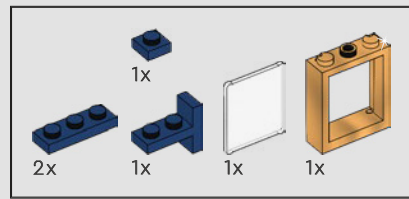
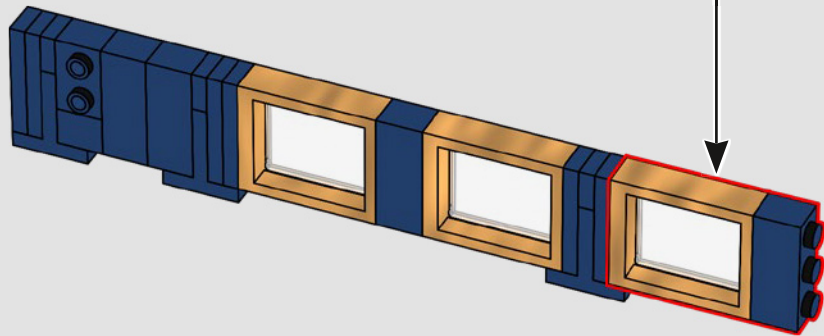
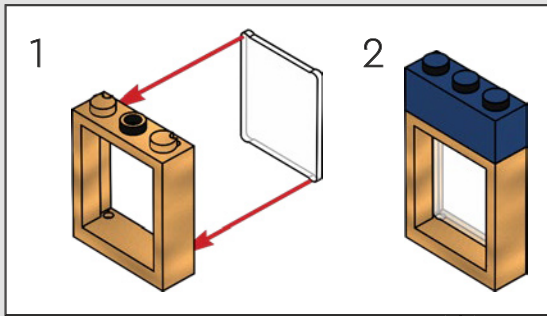

81

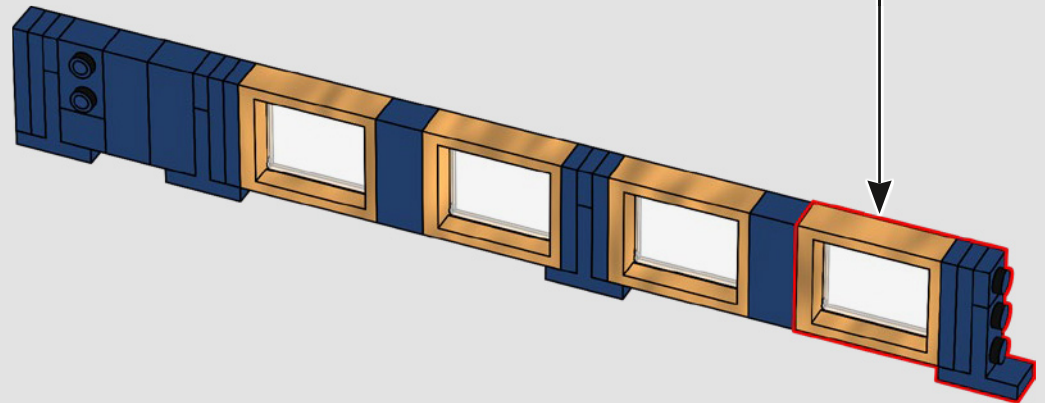
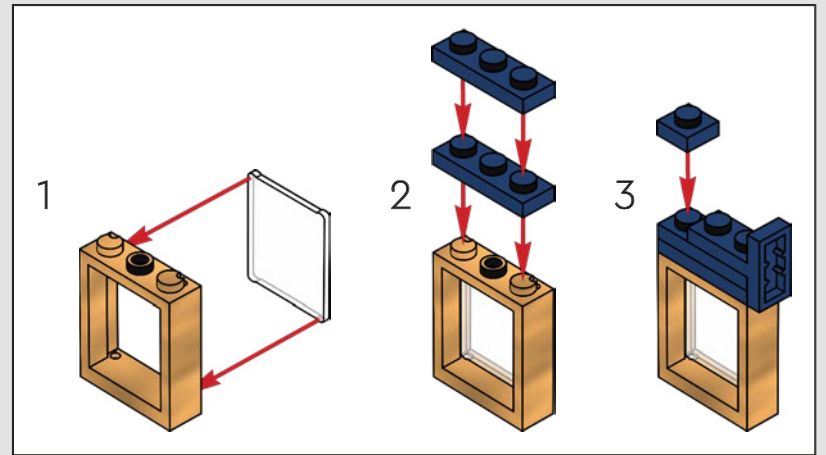

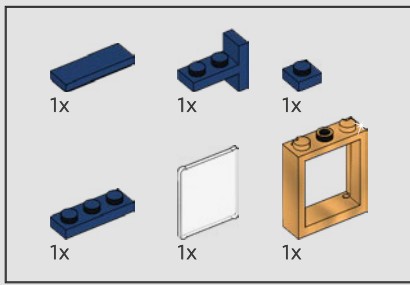

82

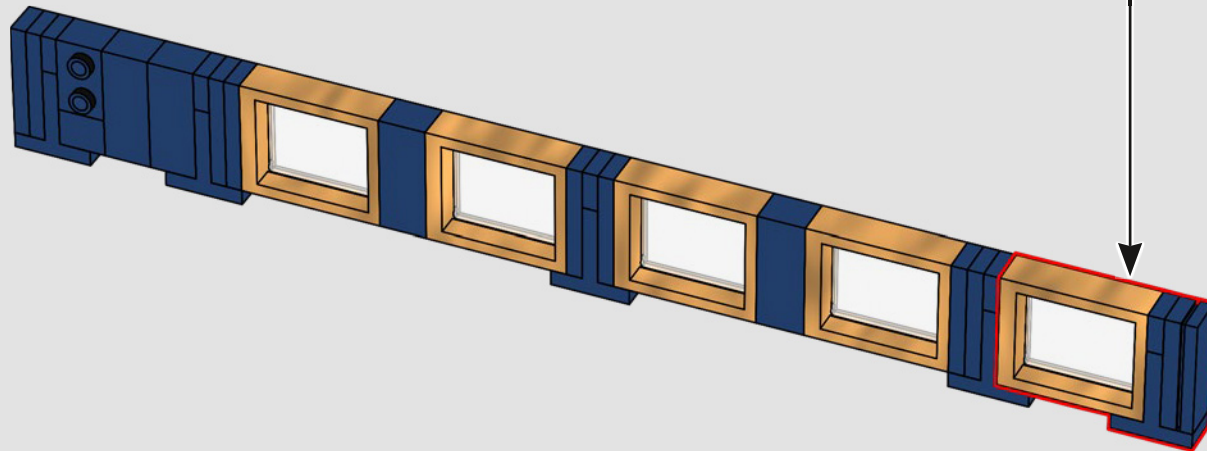
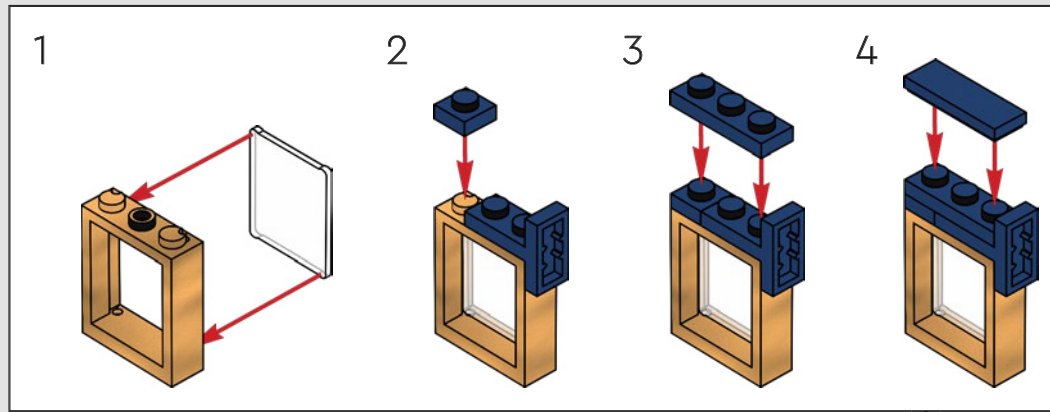

83

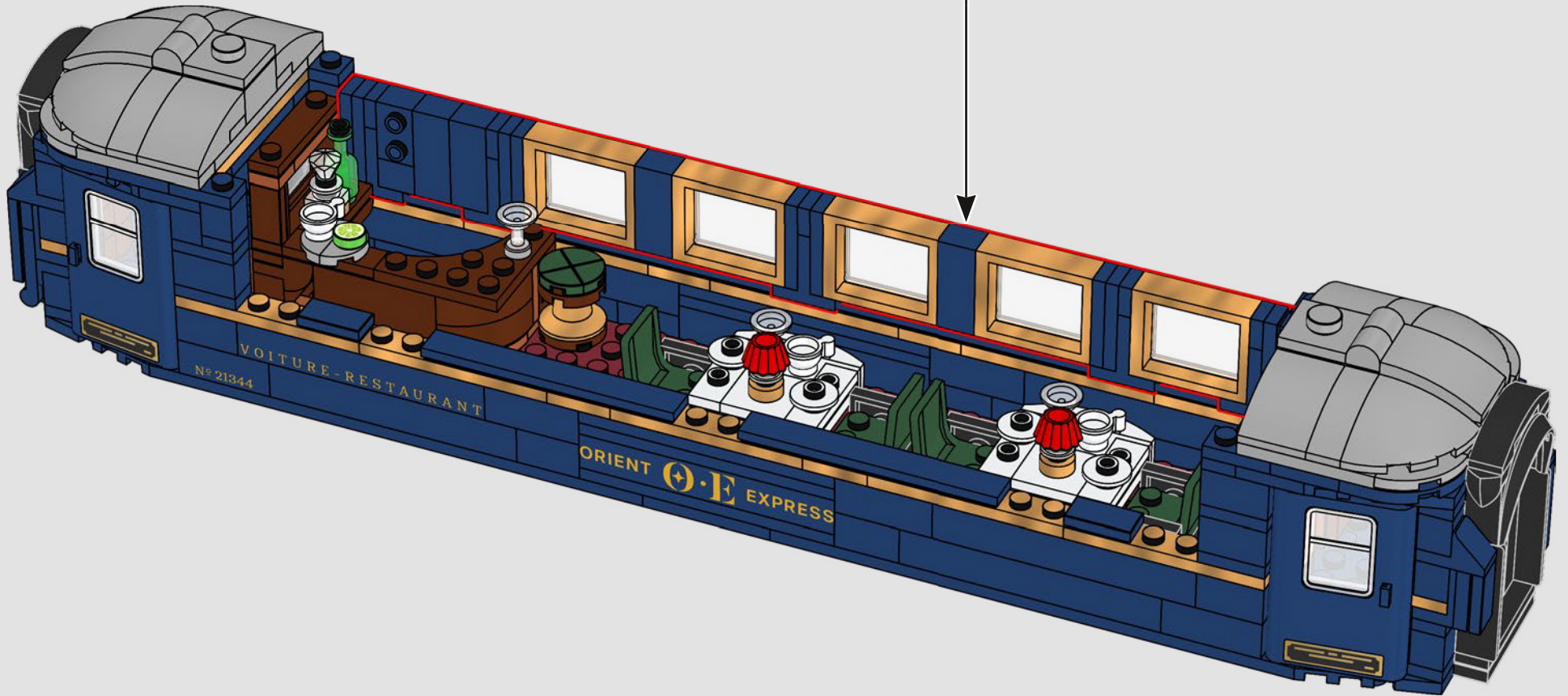

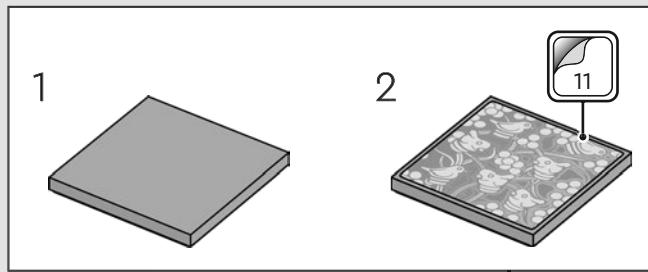
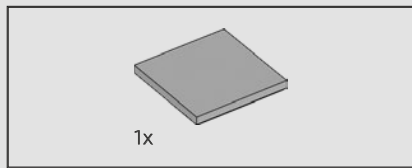

« Des miroirs en cristal taillé exquis ornent l'intérieur de ce wagon. »

84

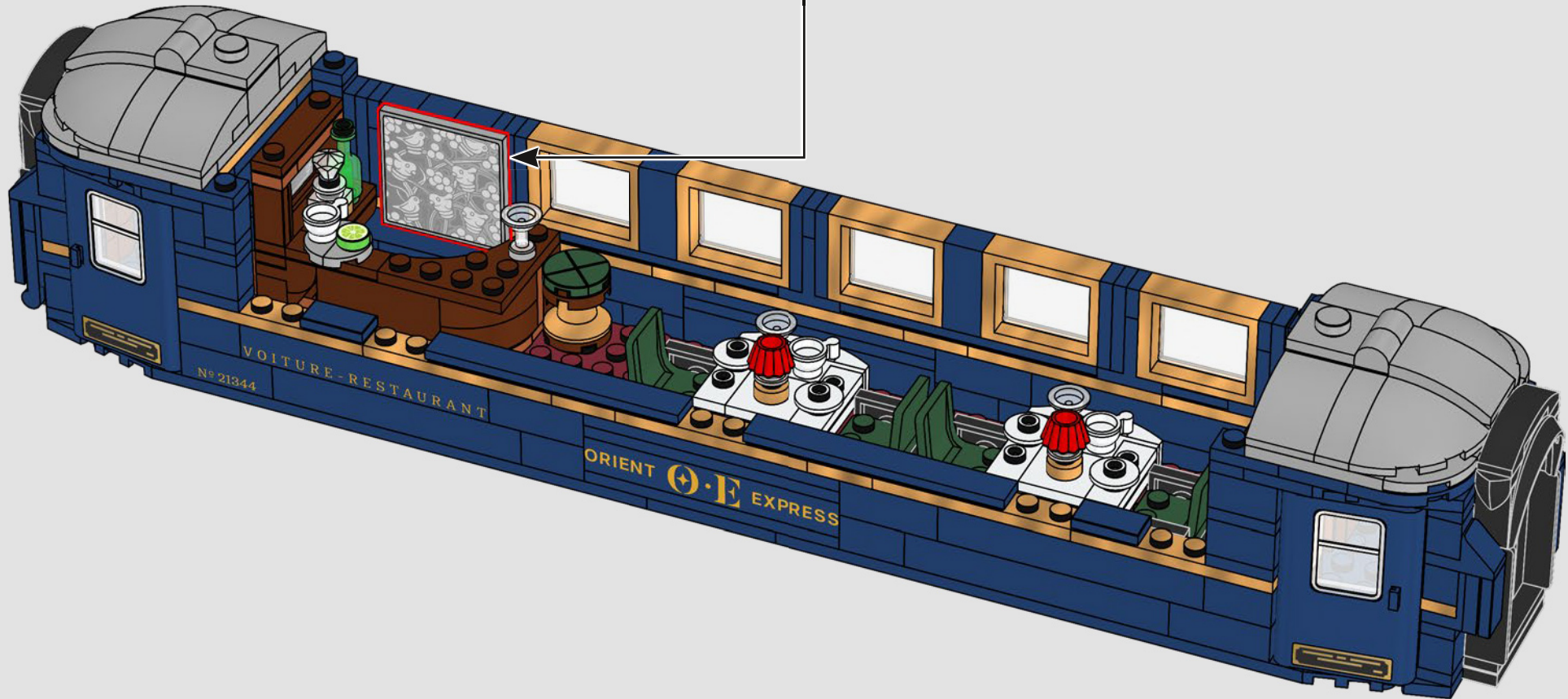

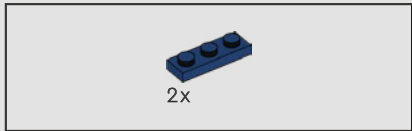
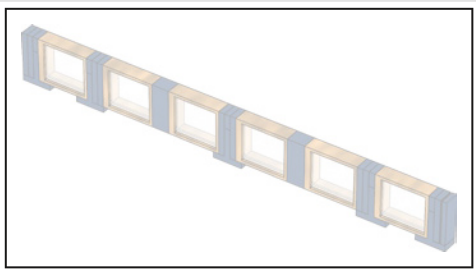

85

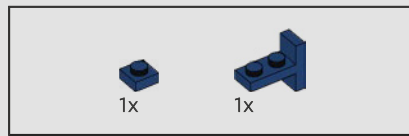
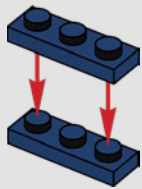

86

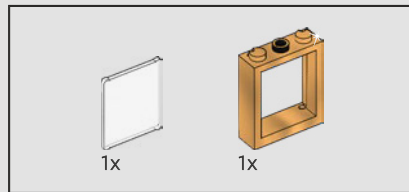
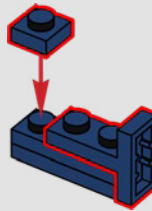

87

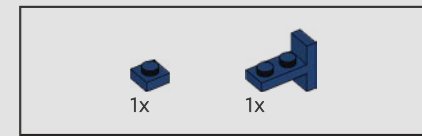
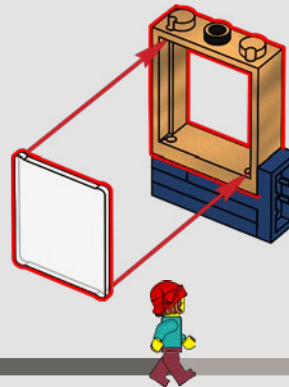

88

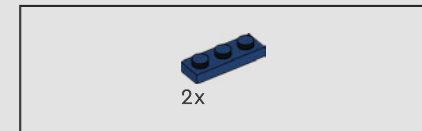
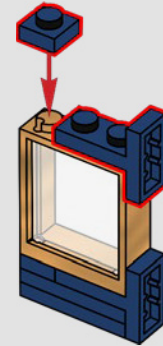

89

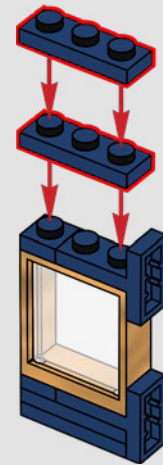

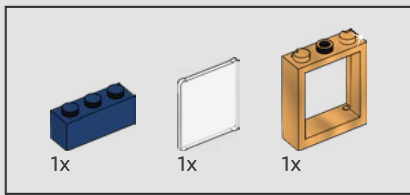

90

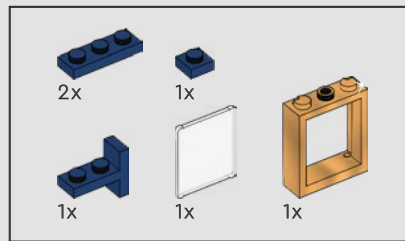
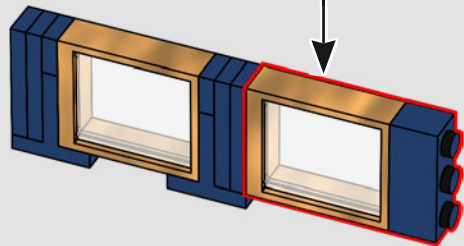
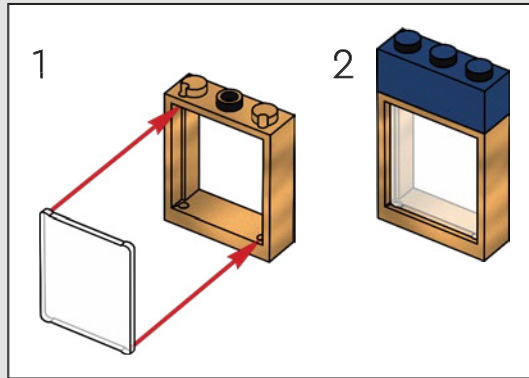

91

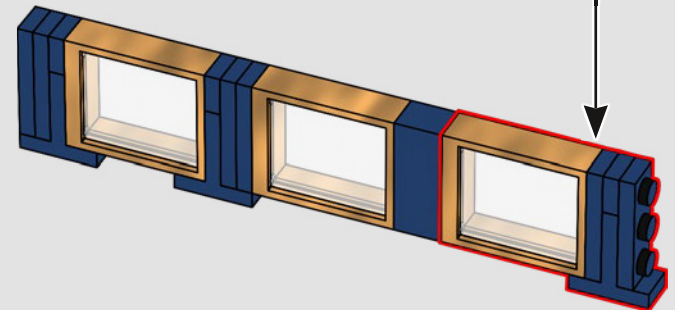
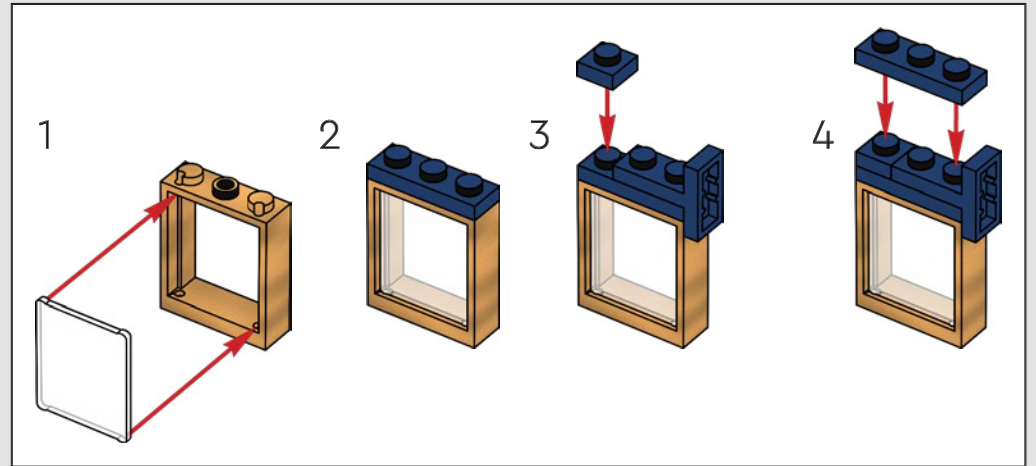

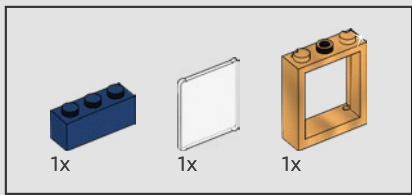

92

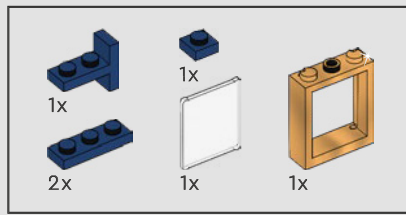
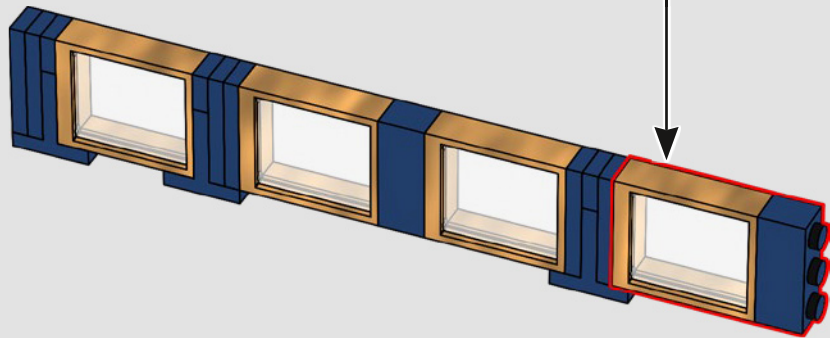
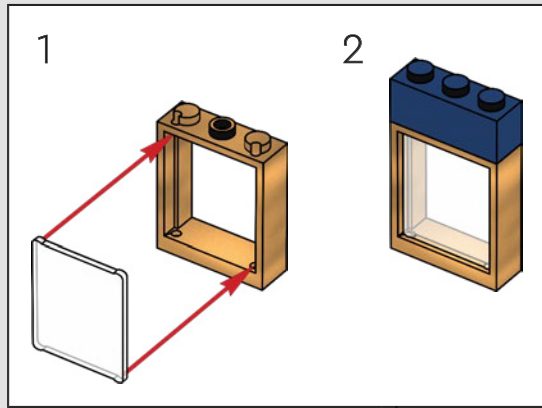

93

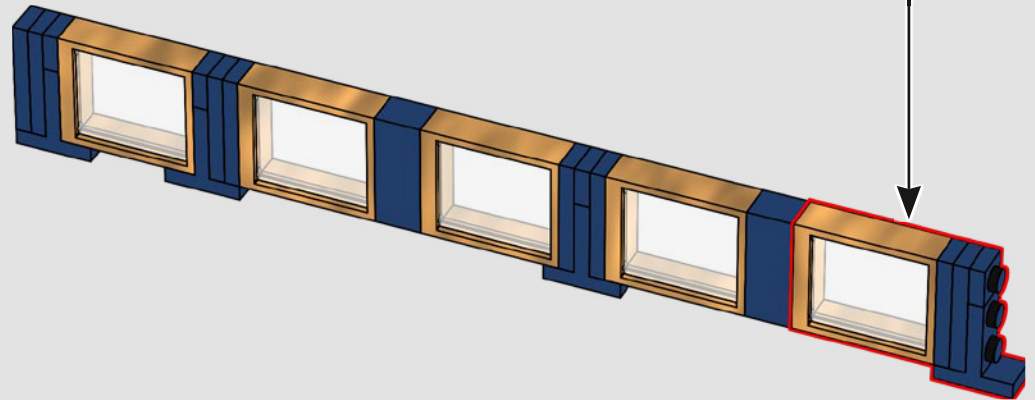
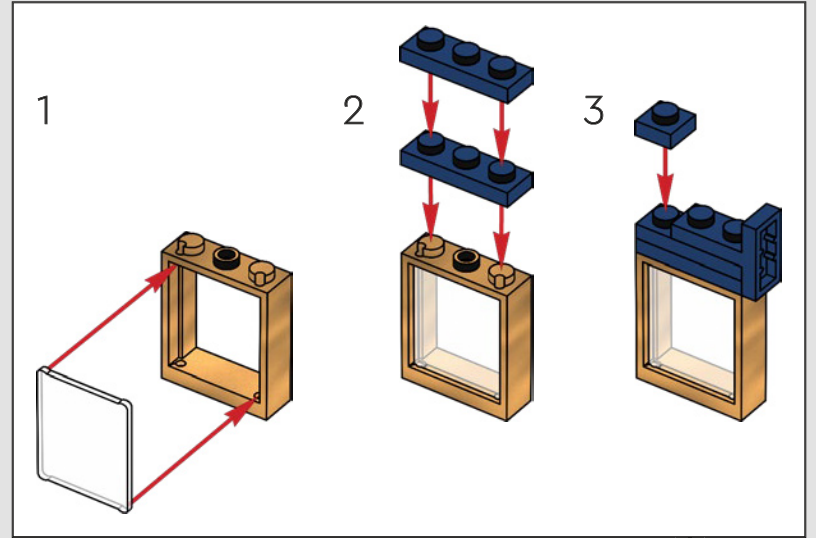

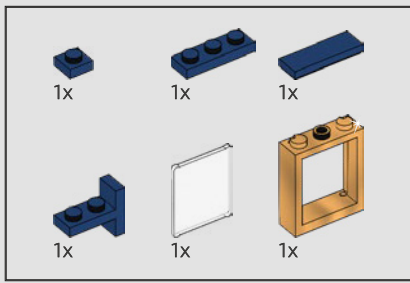

94

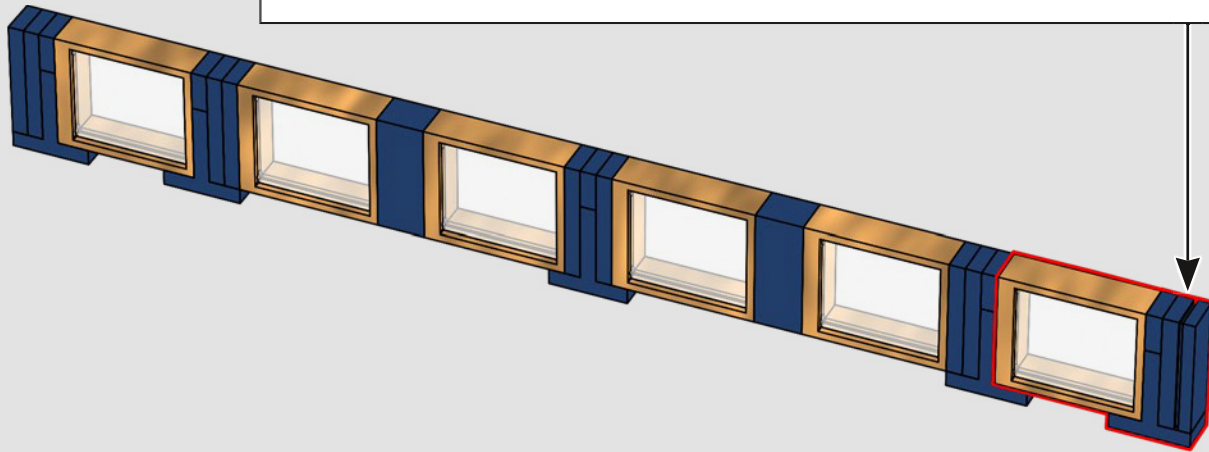
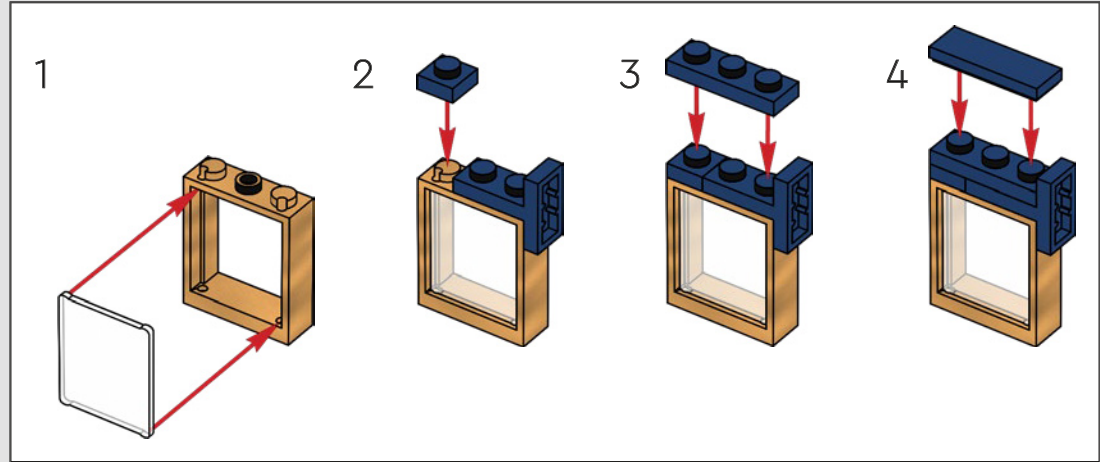



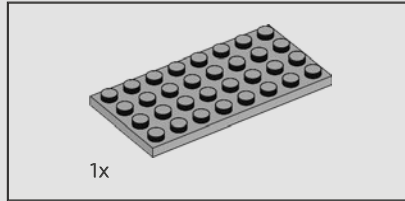
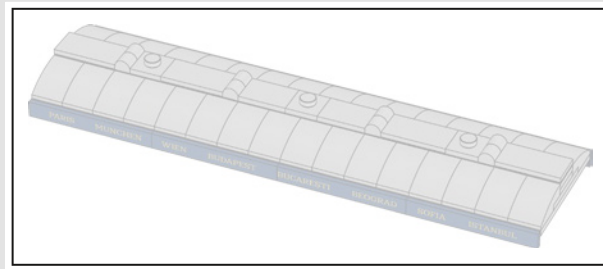

96

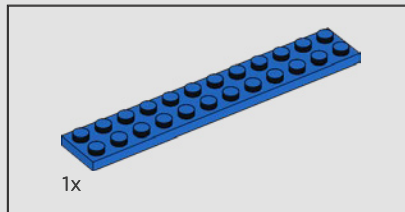
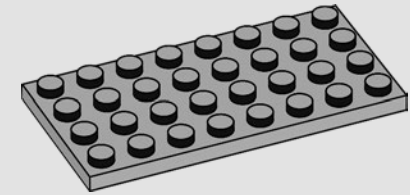

97

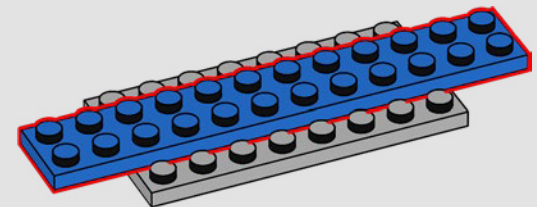

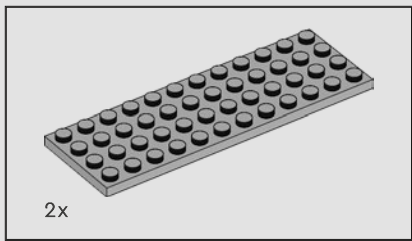

98

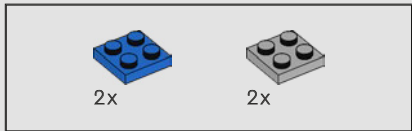
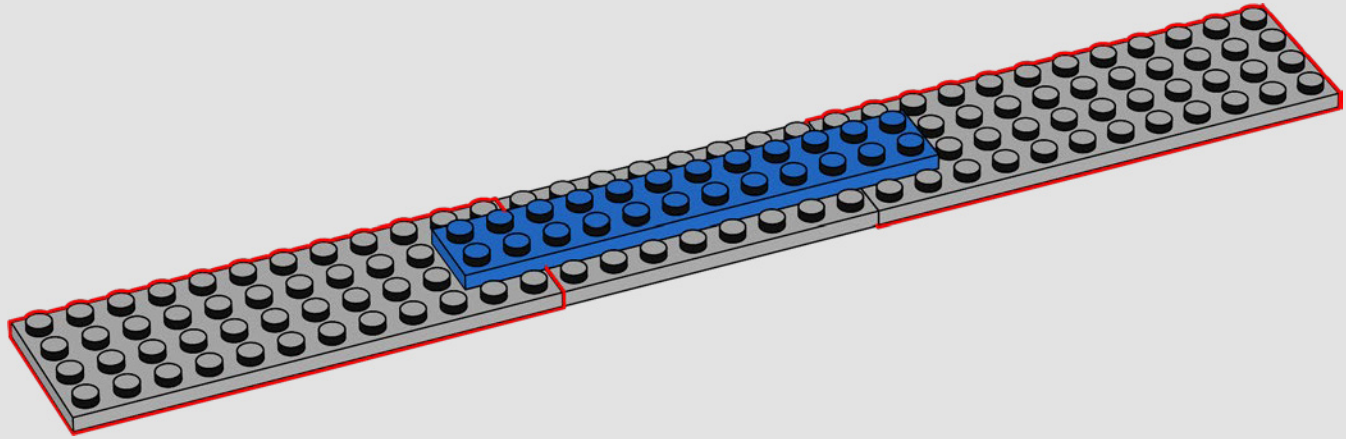

99

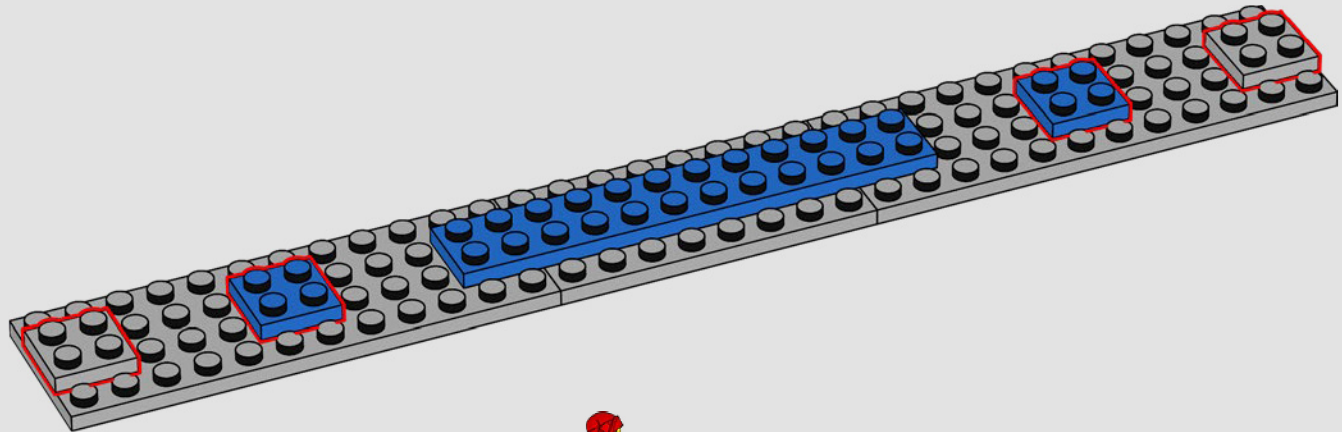

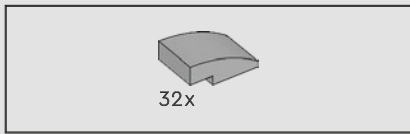

100

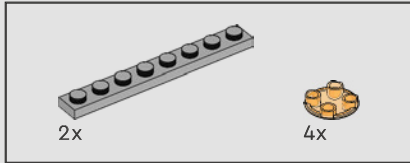
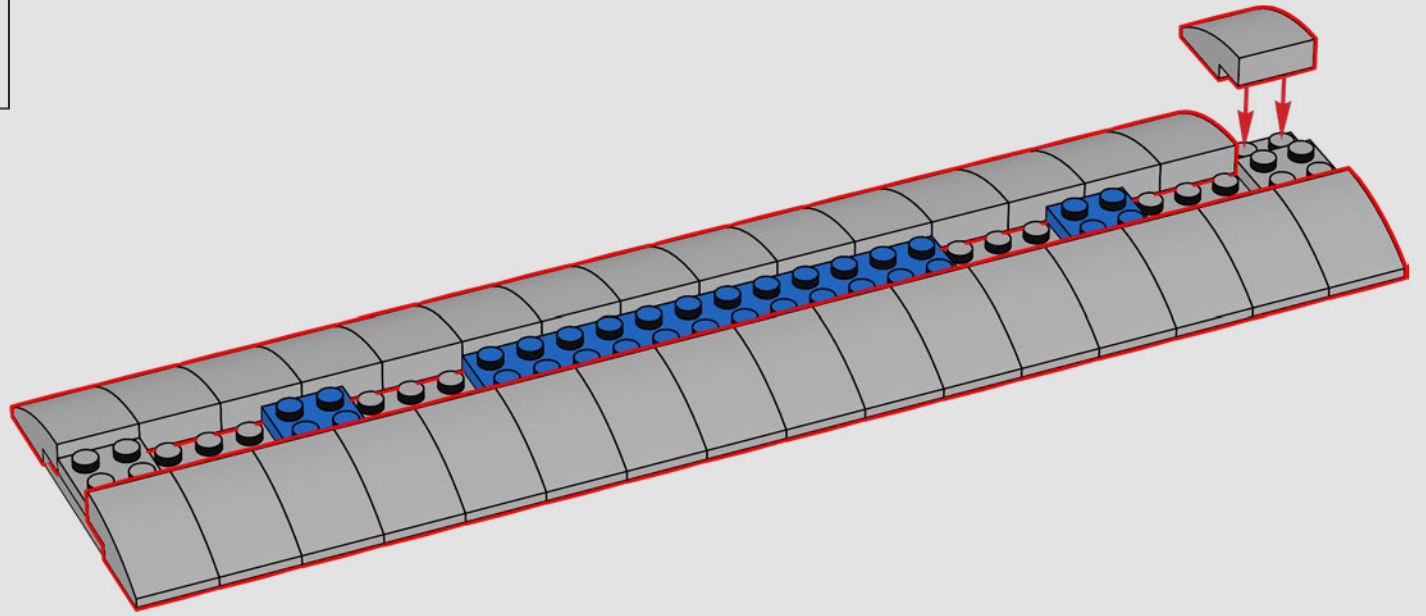

101

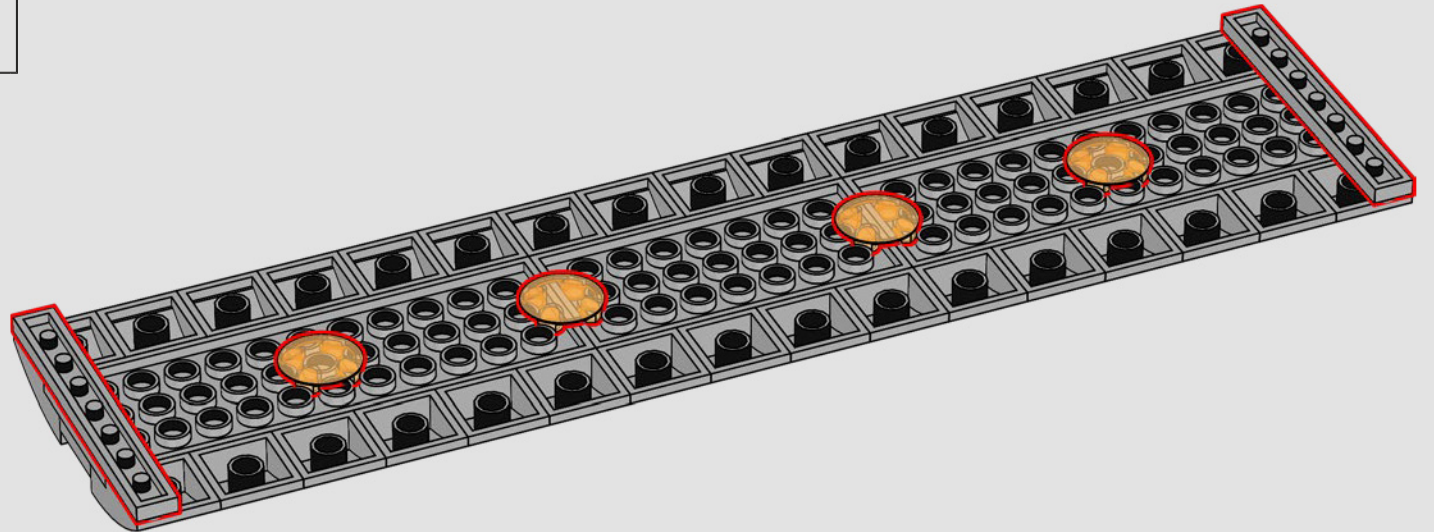

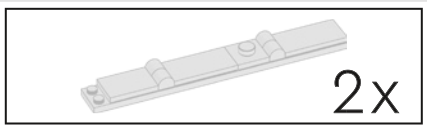

2x

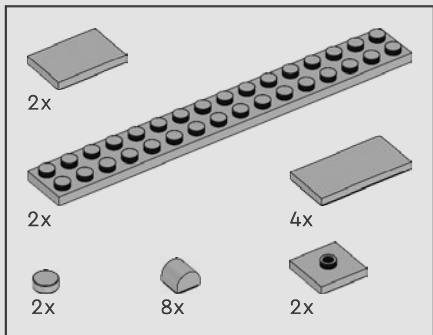

102

1

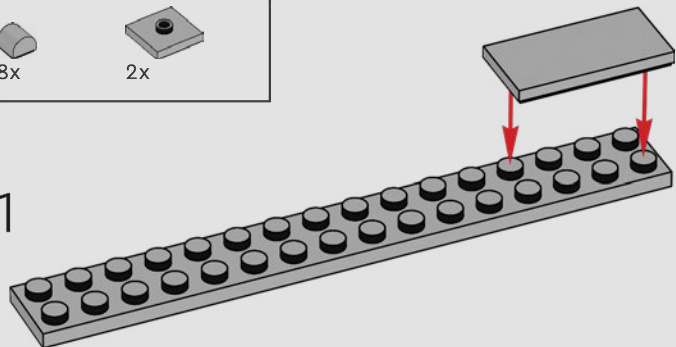

2

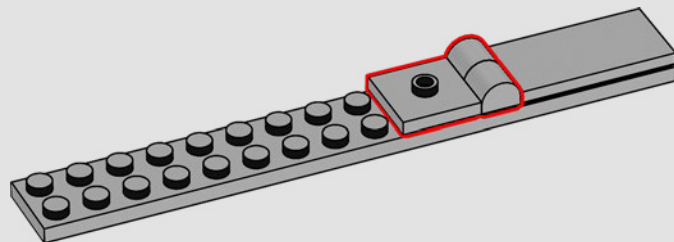

3

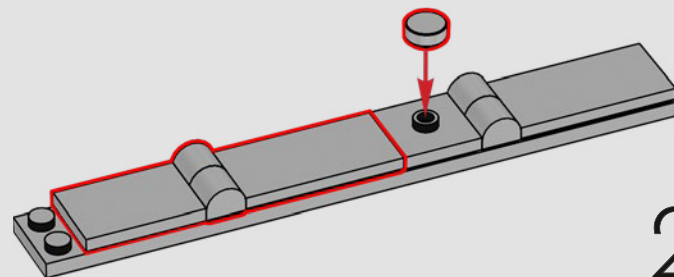

2x

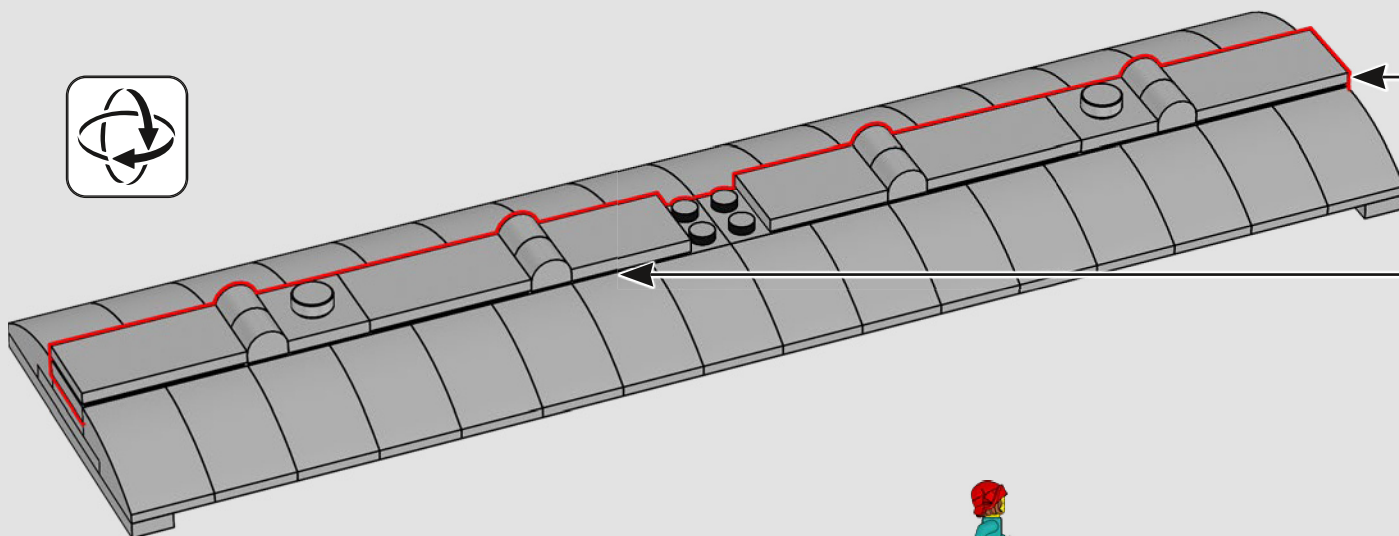

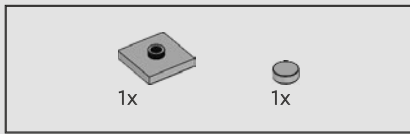

103

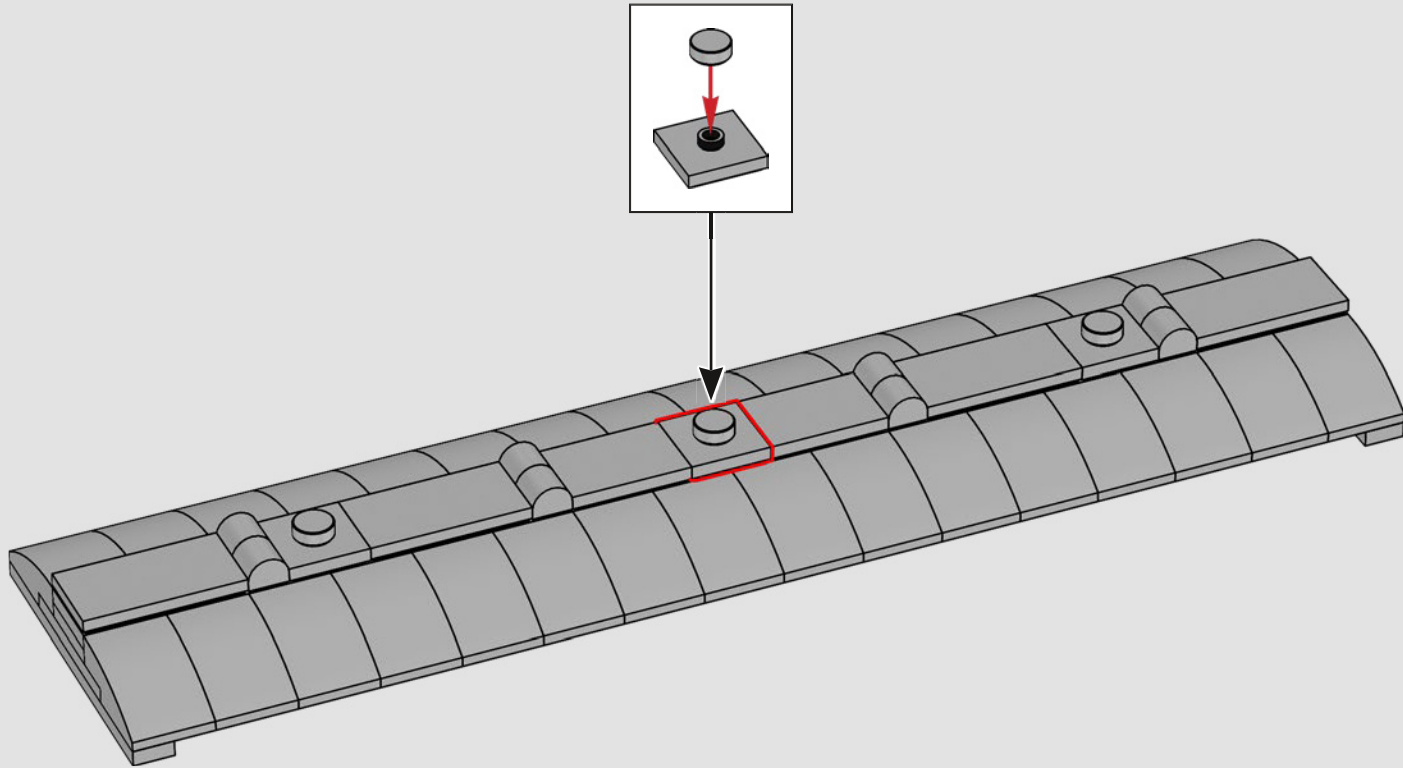

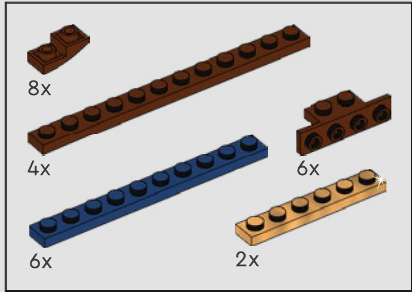
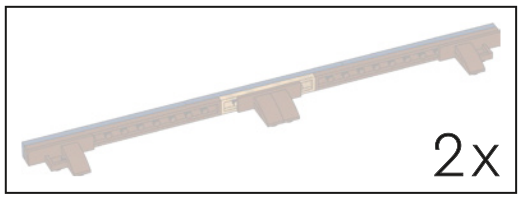

104

1

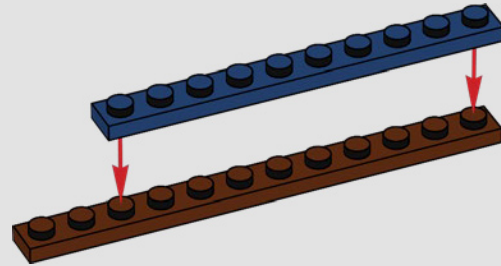

2

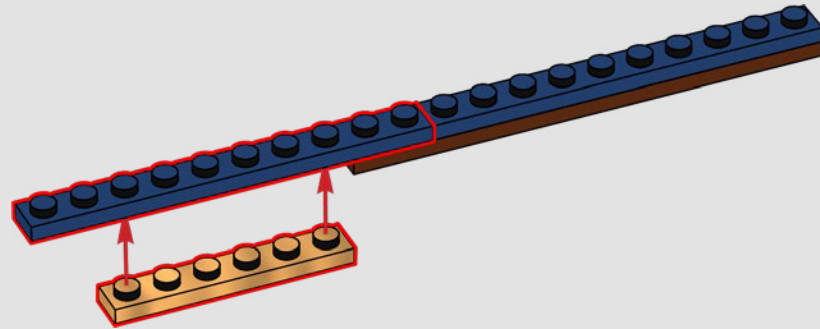

3

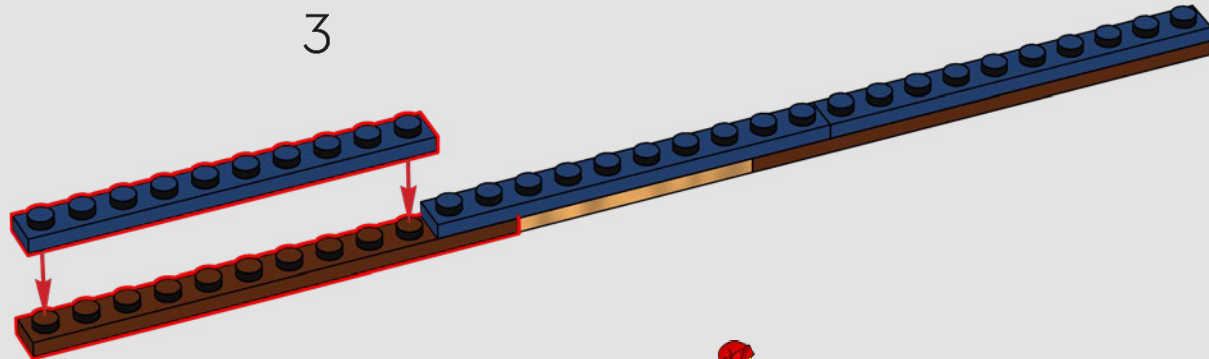

4

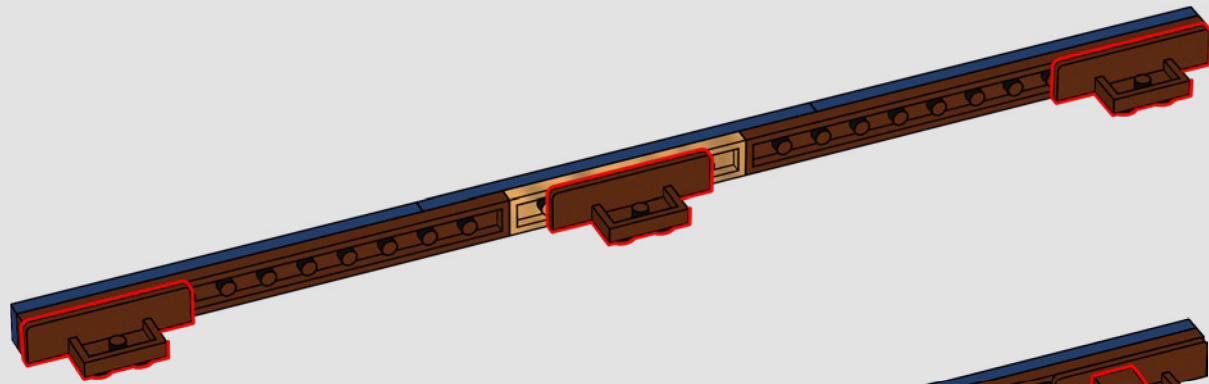

5

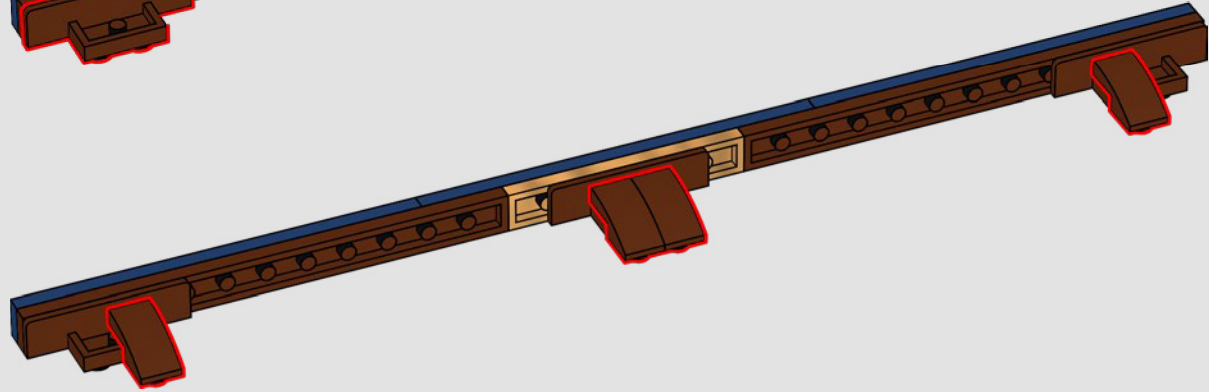

2x

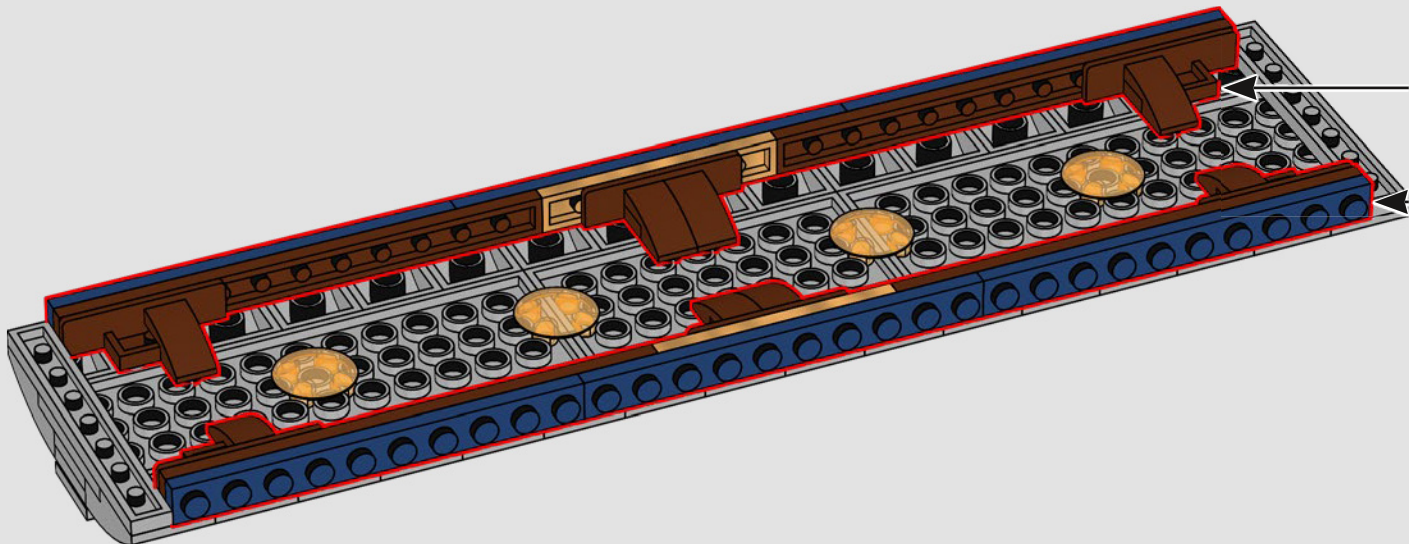

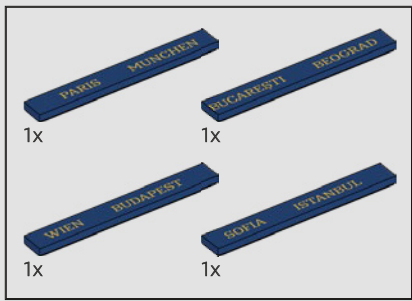

105

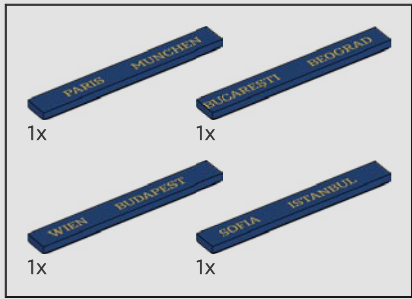
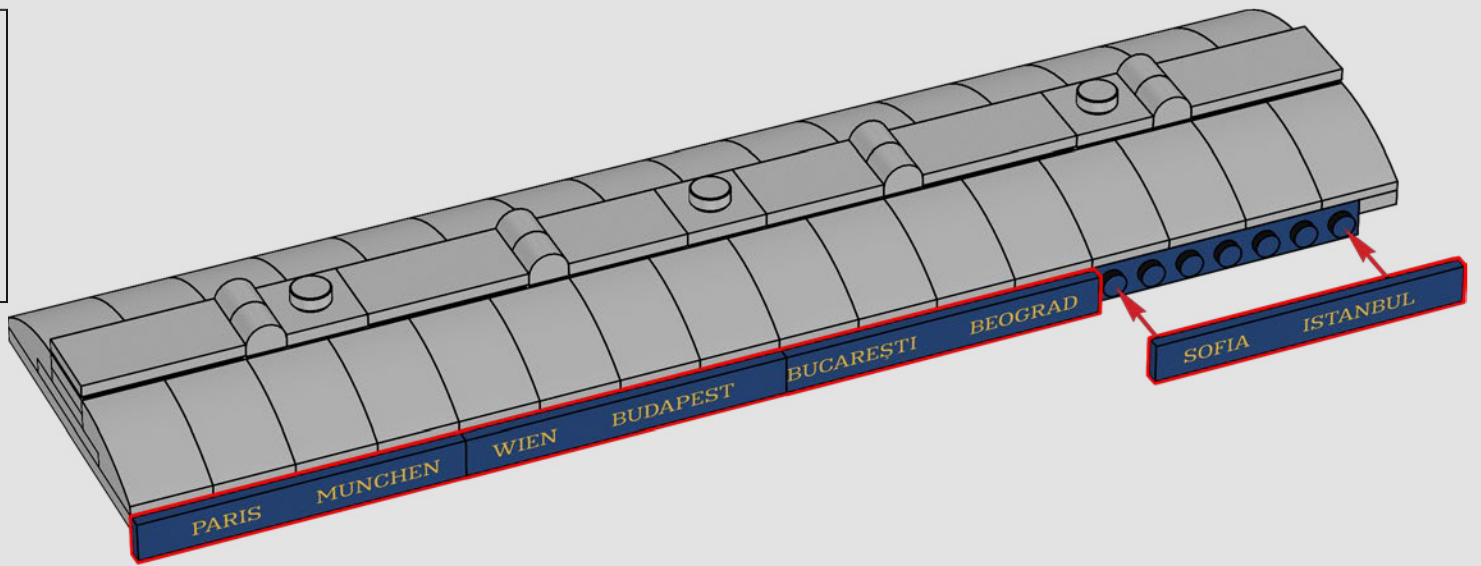

106

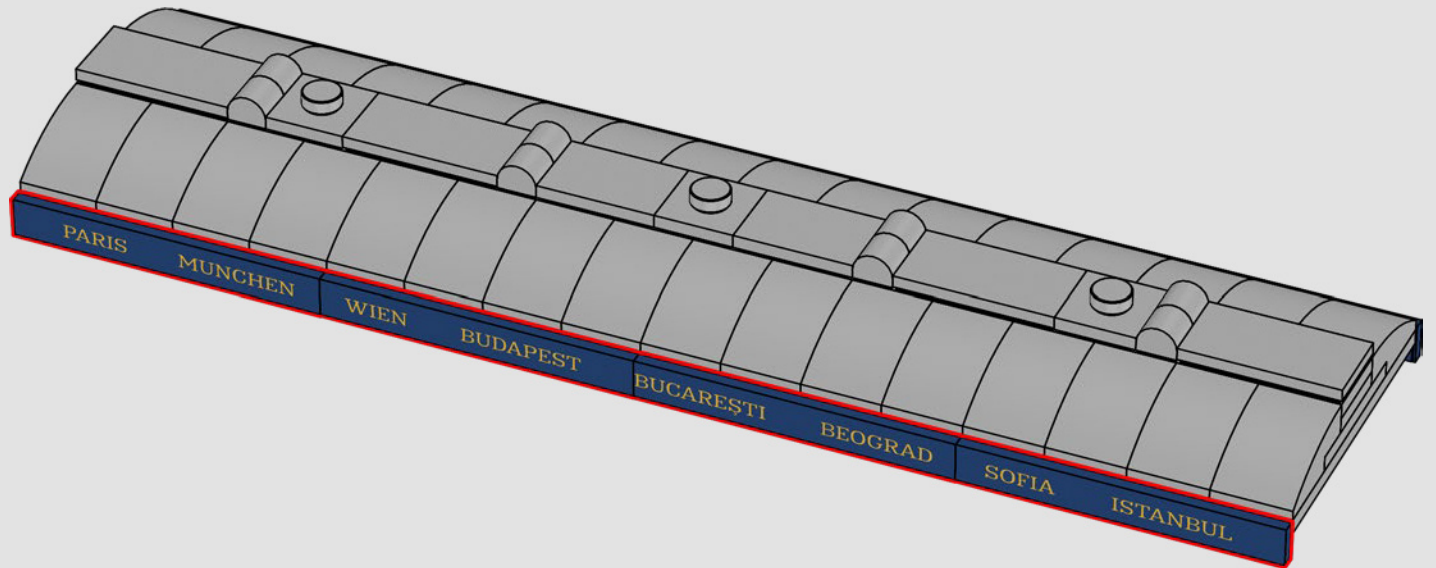

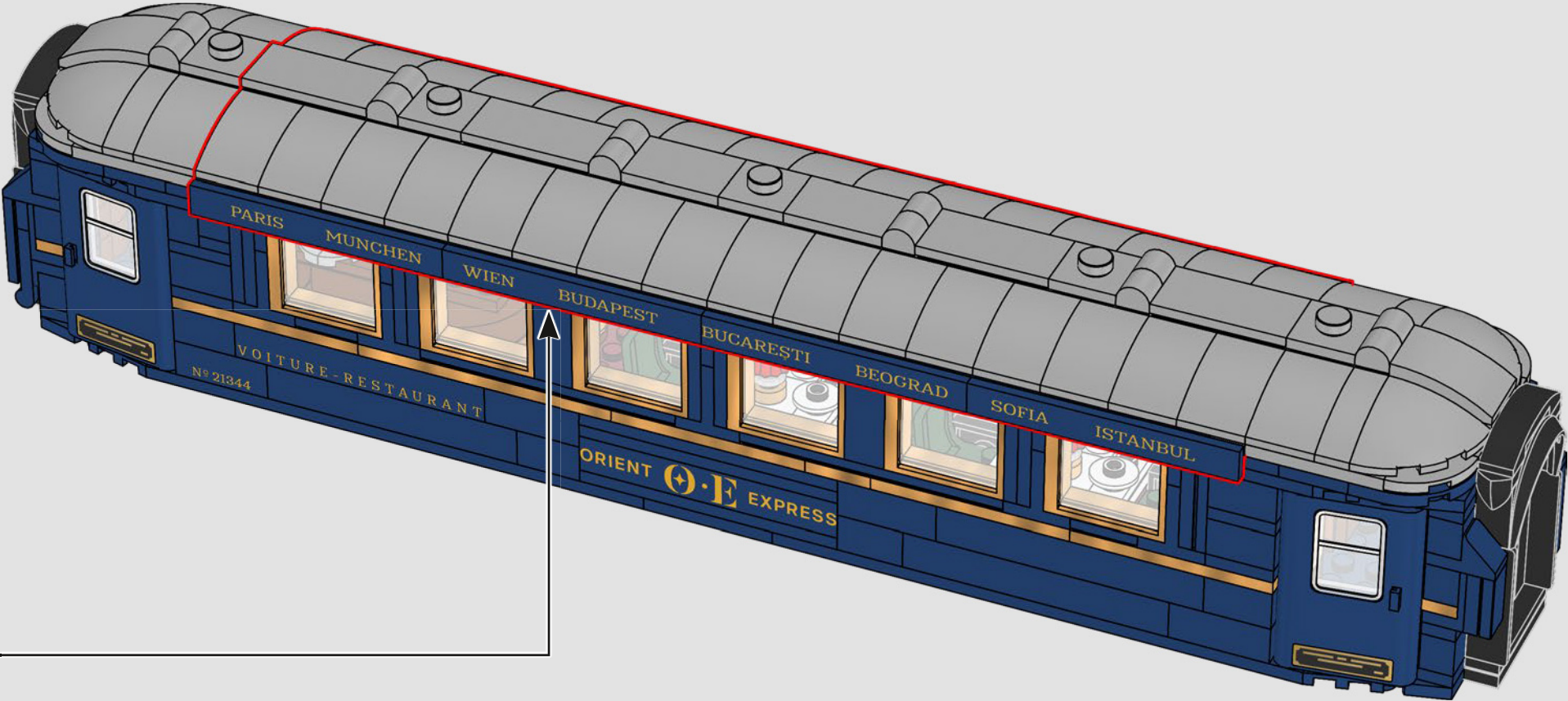

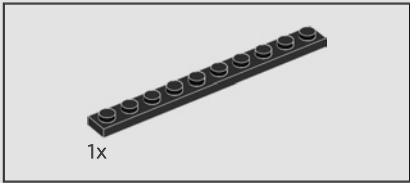
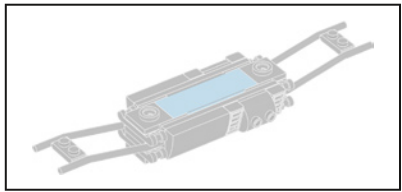

108

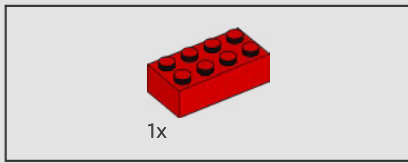
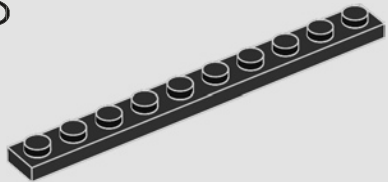

109

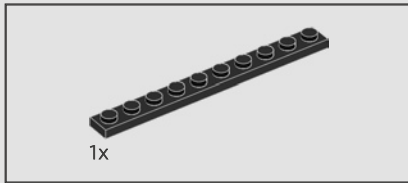
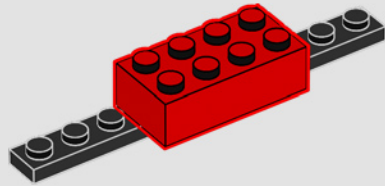

110

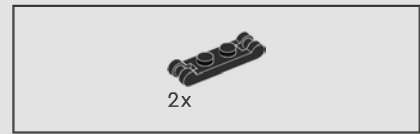
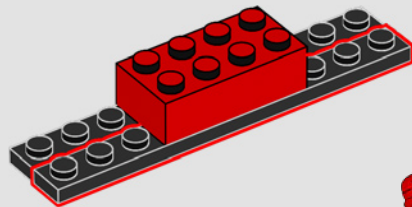

111

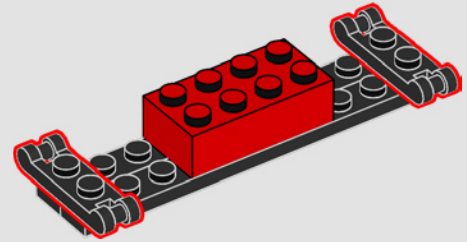

112

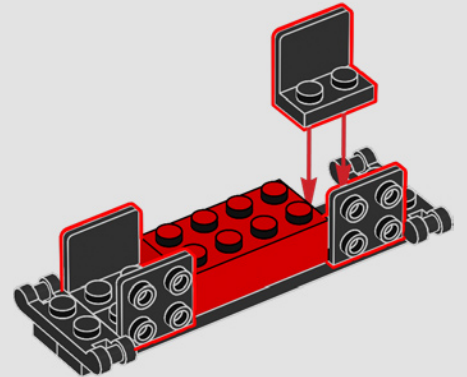

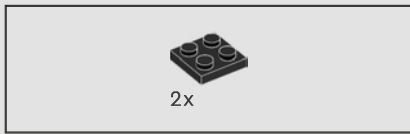

113

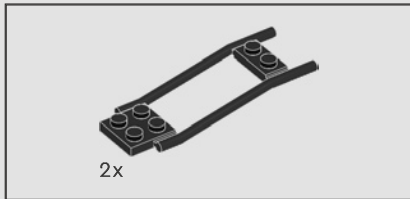
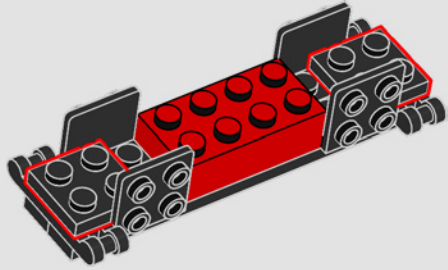

114

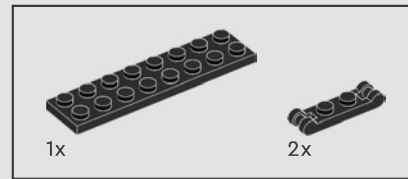
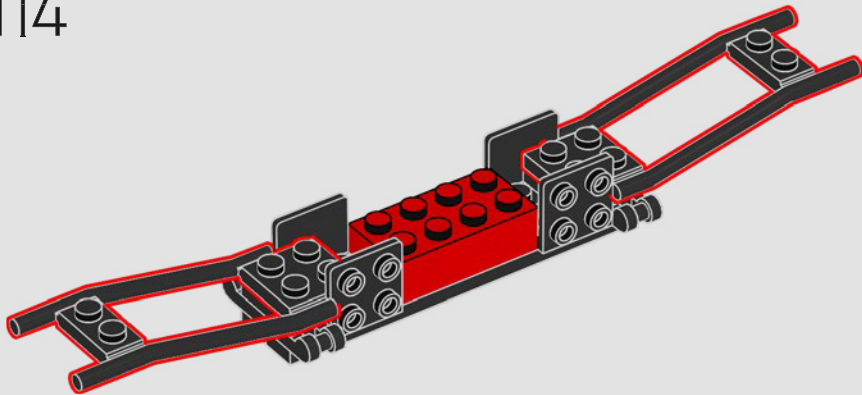

115

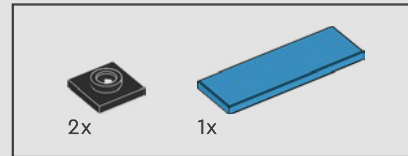
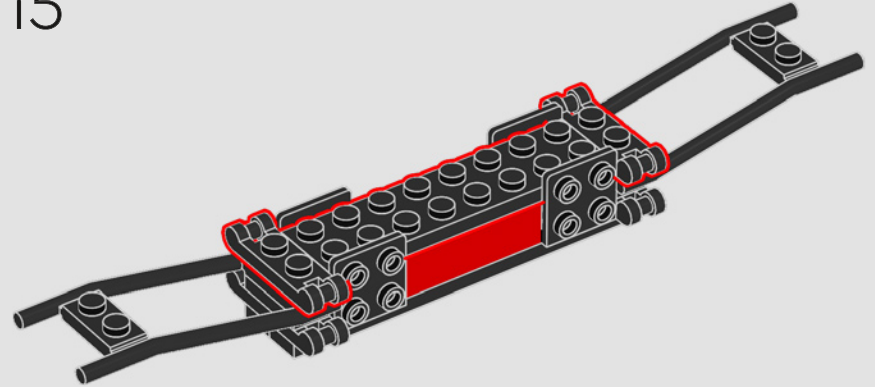

116

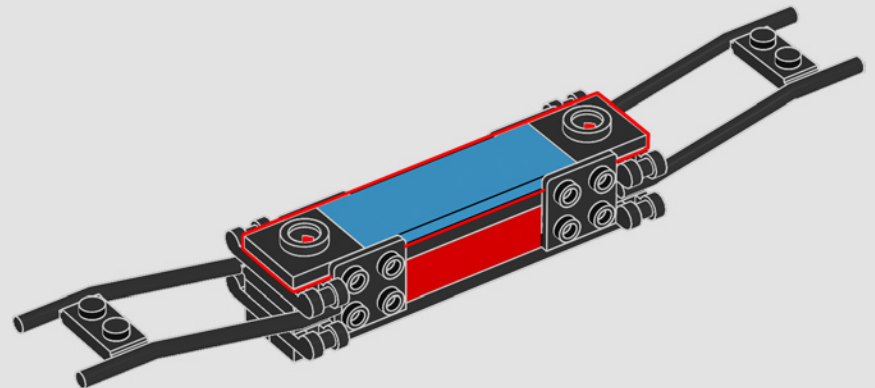

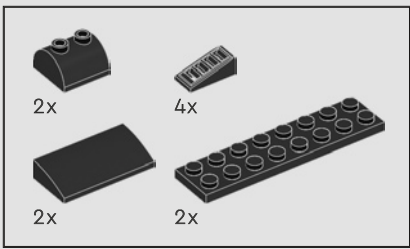

117

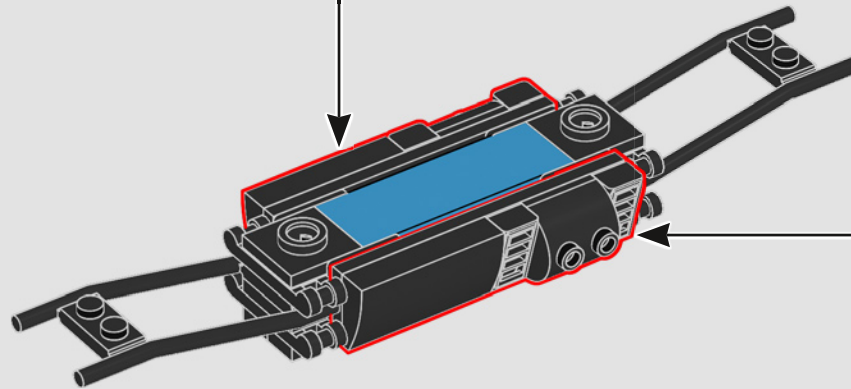
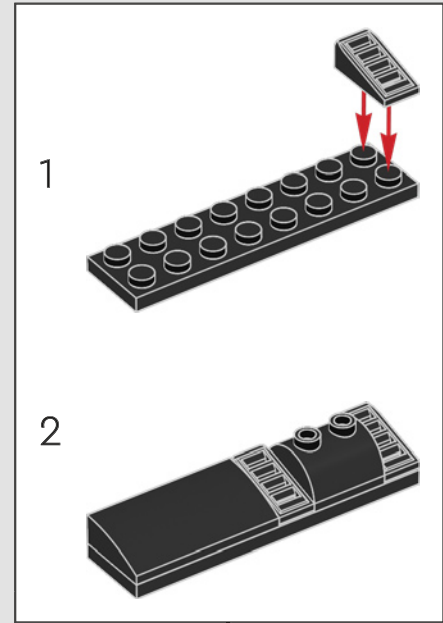
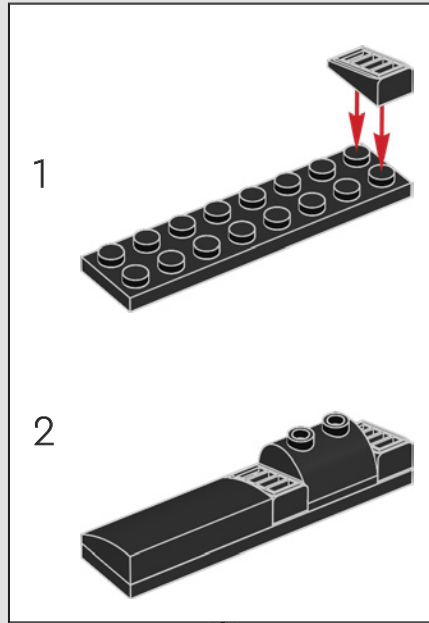

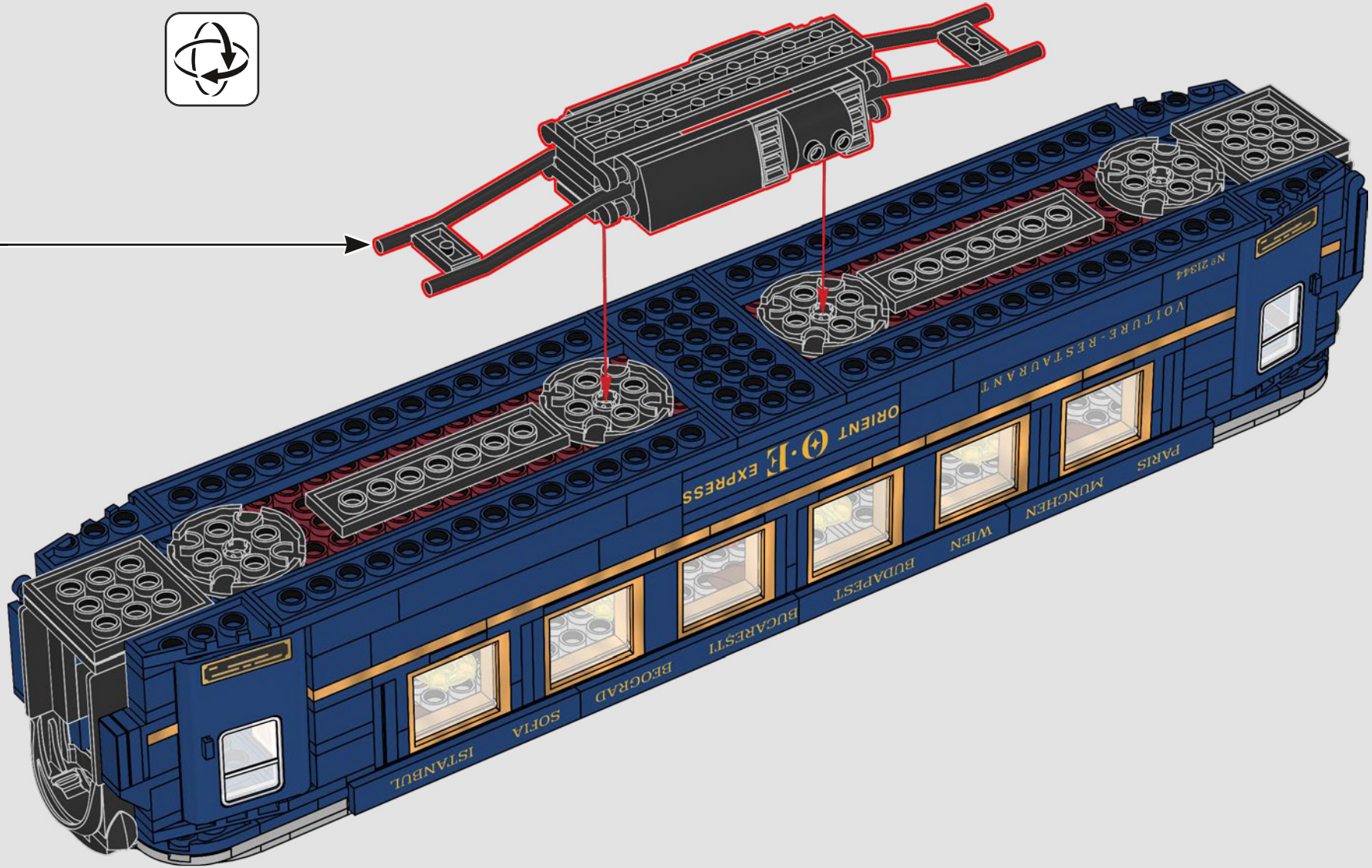

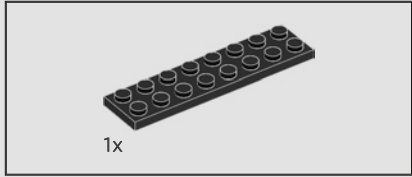
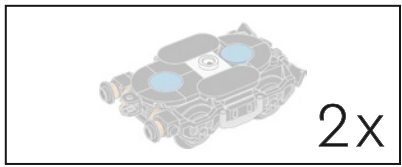

119

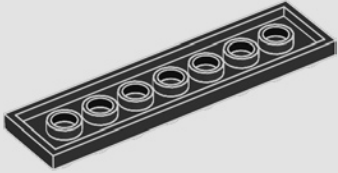

120

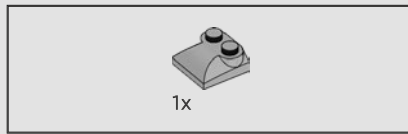
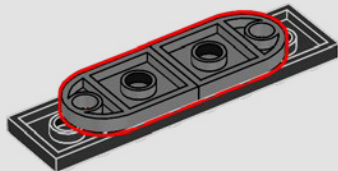

121

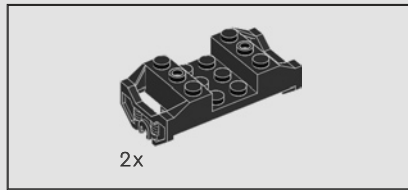
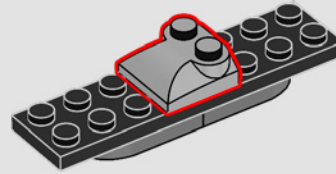

122

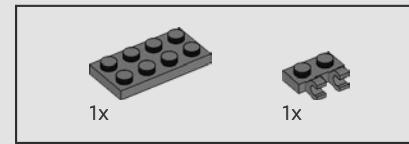
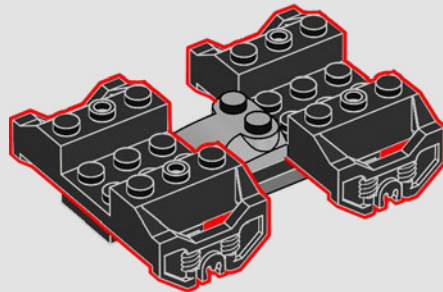

123

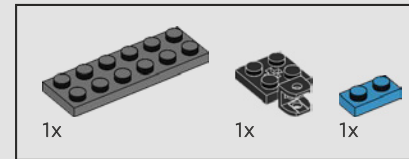
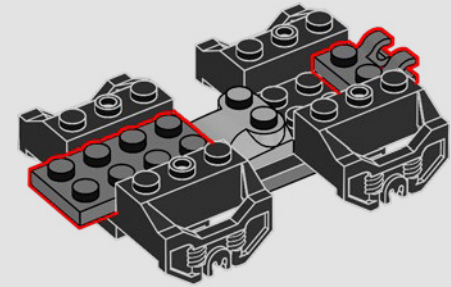

124

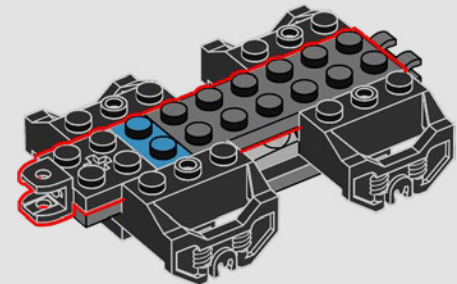

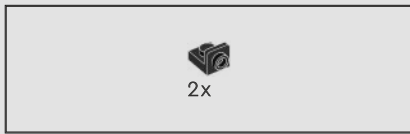

125

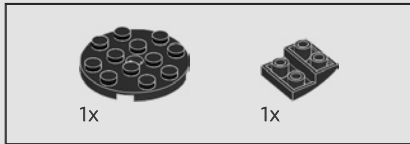
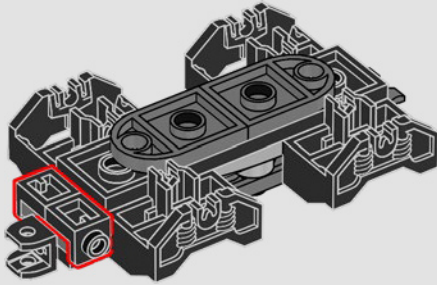

126

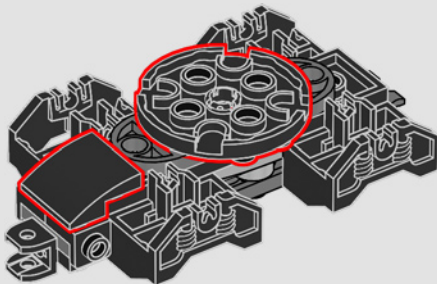

127

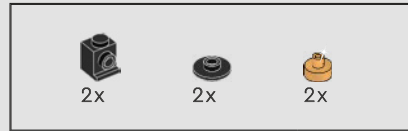
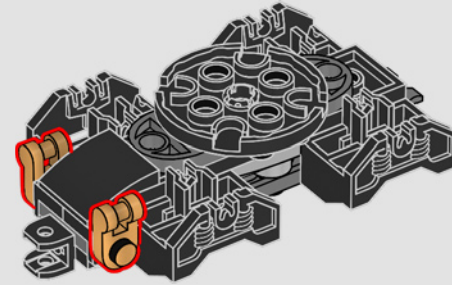

128

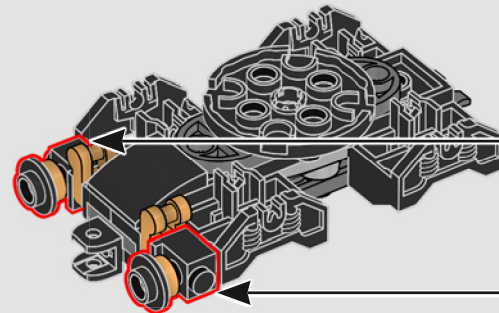
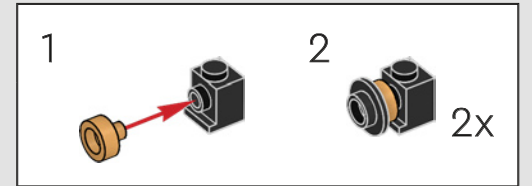

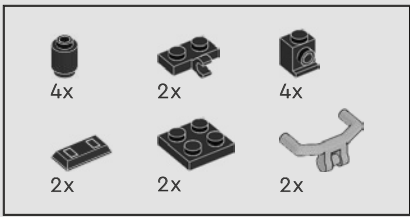

129

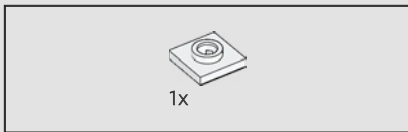
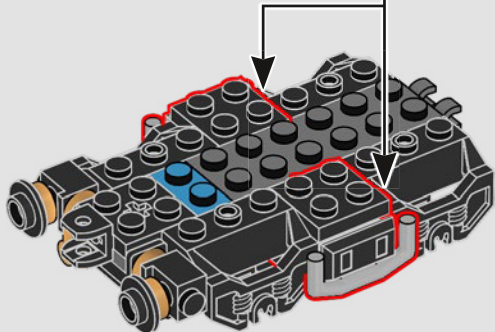
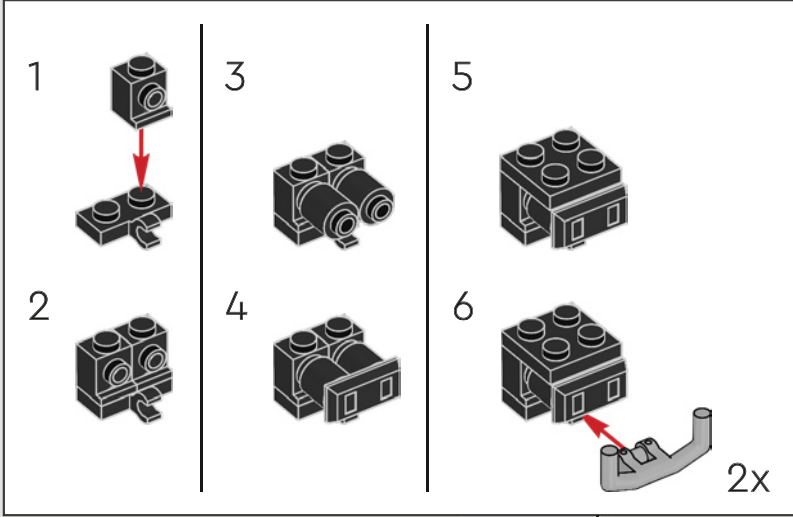

130

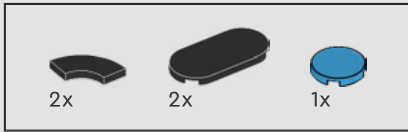
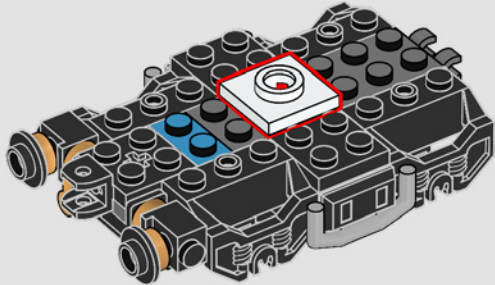

131

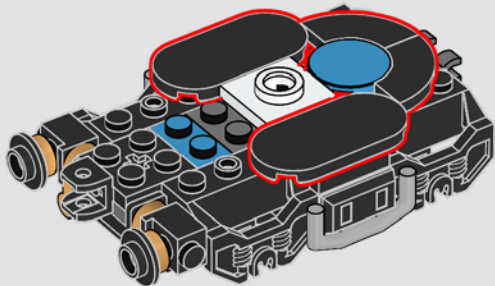



132

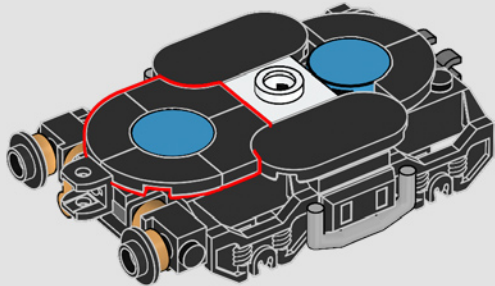

133

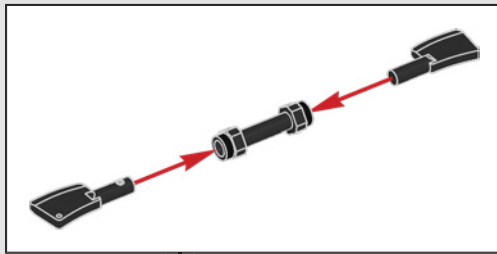
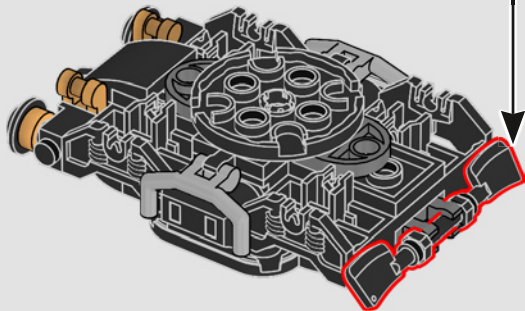

134

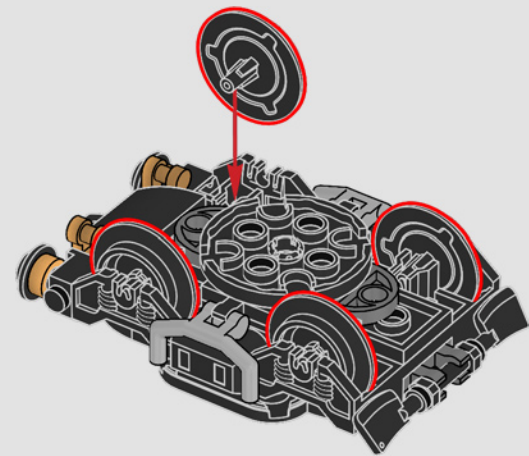

2x

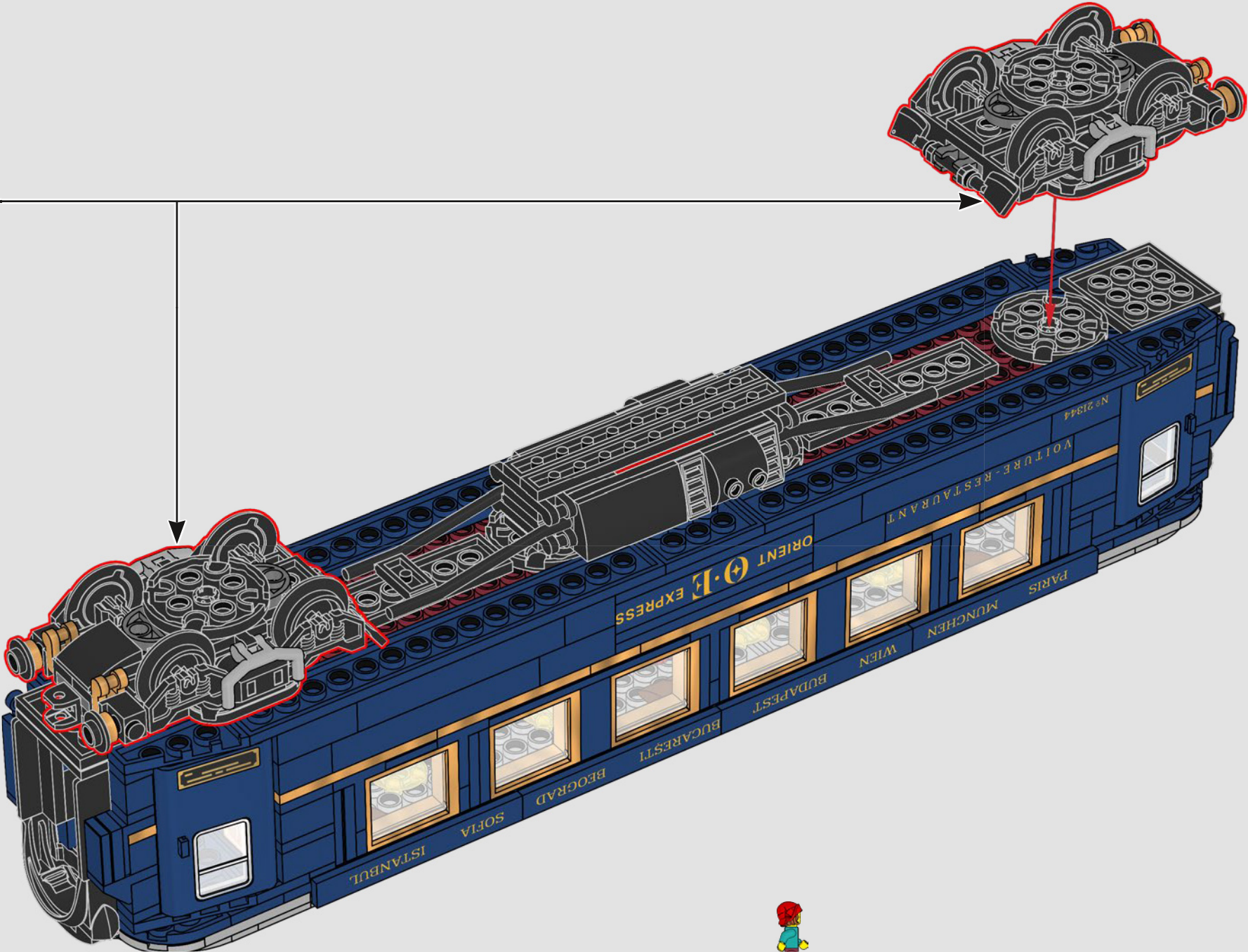

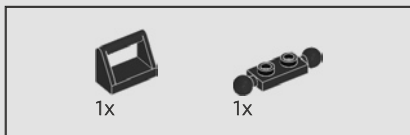

●
Prochain arrêt : VIENNE
« Après une merveilleuse soirée gastronomique,
il était temps de se rendre au wagon-lit. »

136

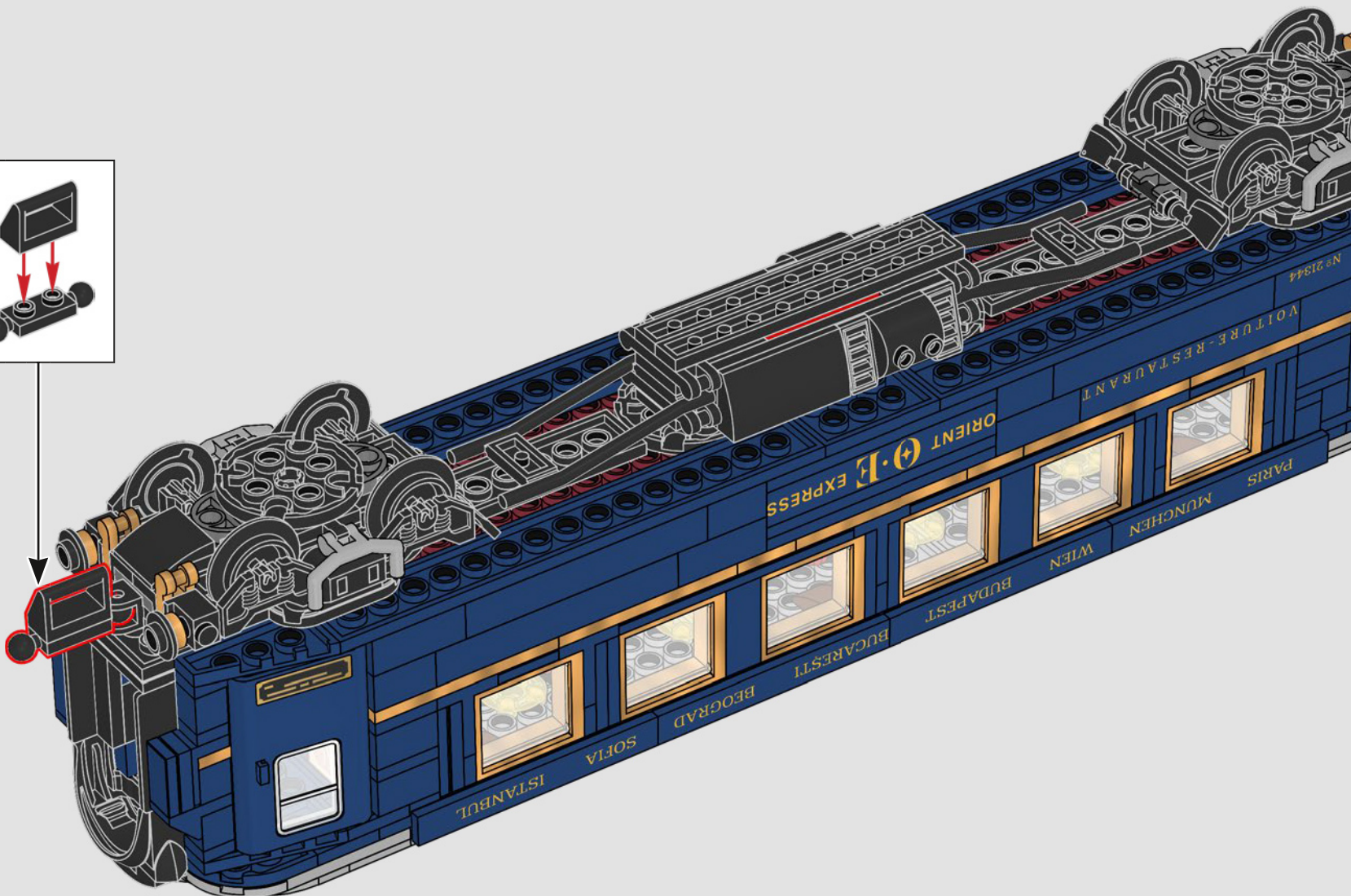
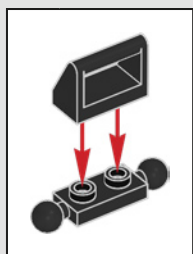

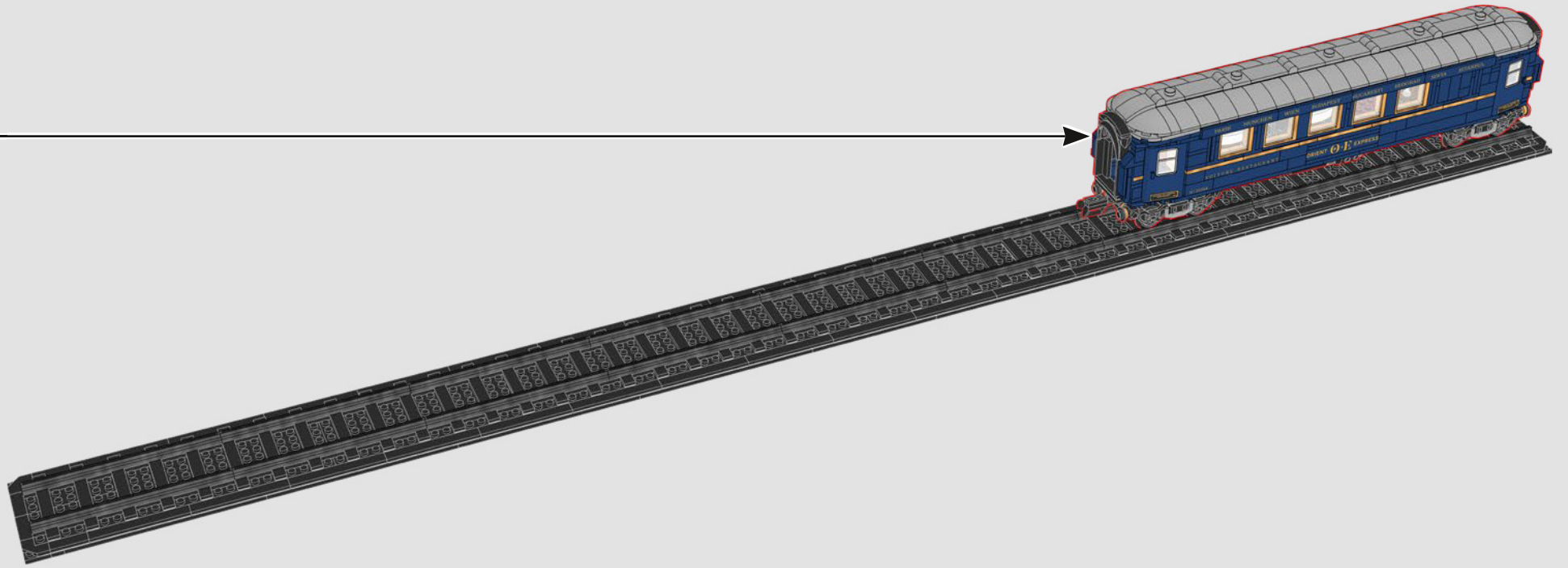

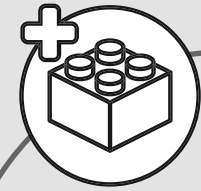
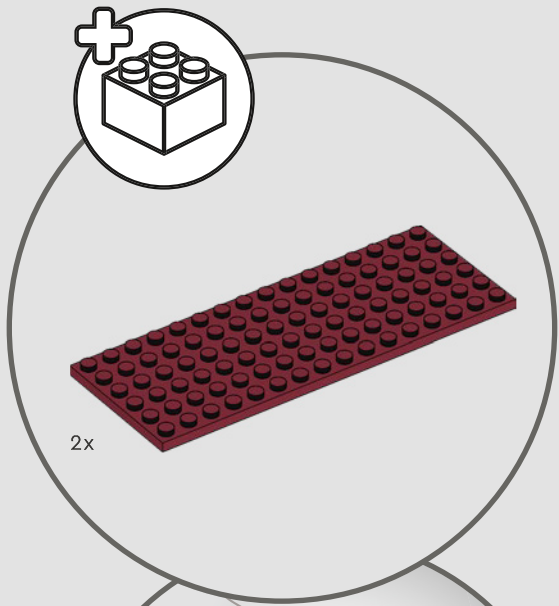

2x



10

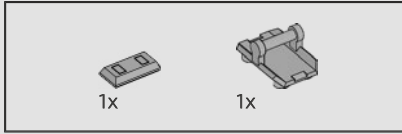

1x

1x

1

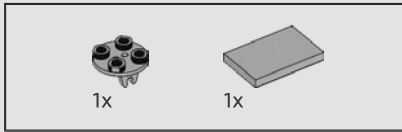
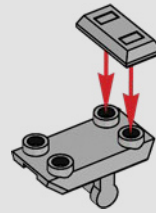

1x

1x

2

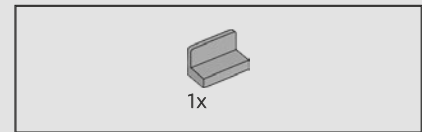

1x

3

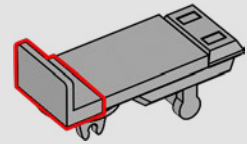

1x

4

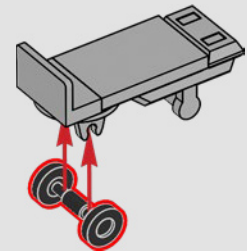

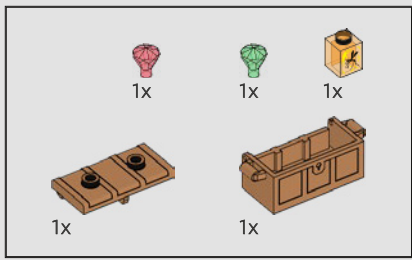

5

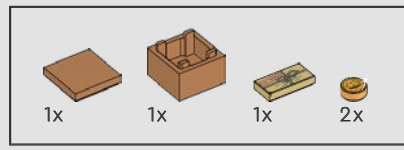
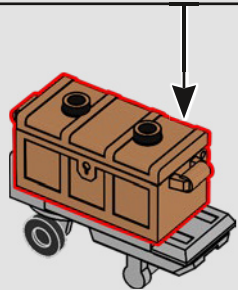
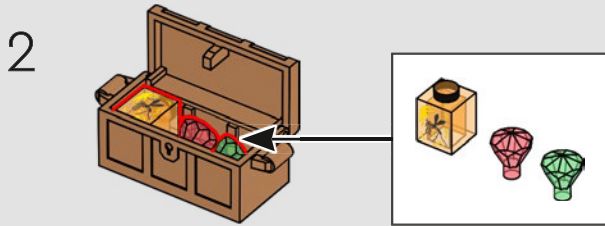
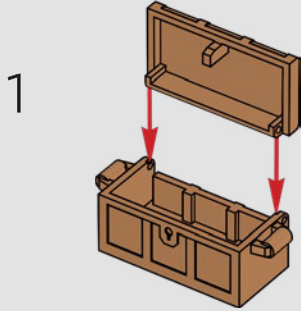

6

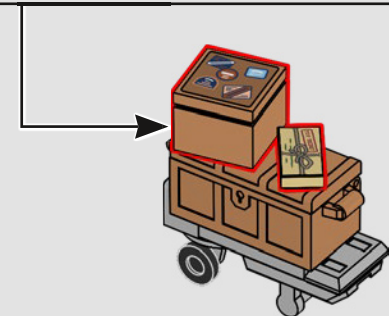
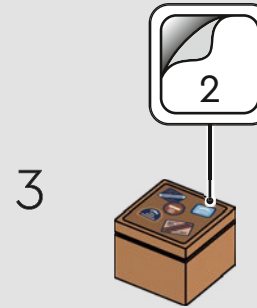
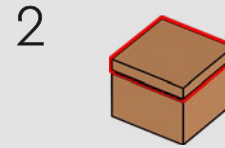
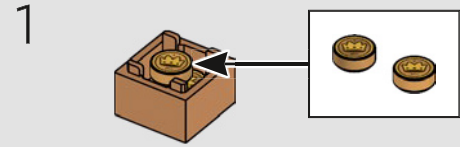

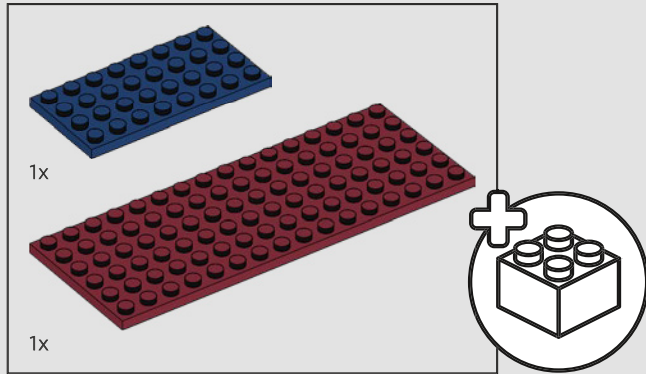
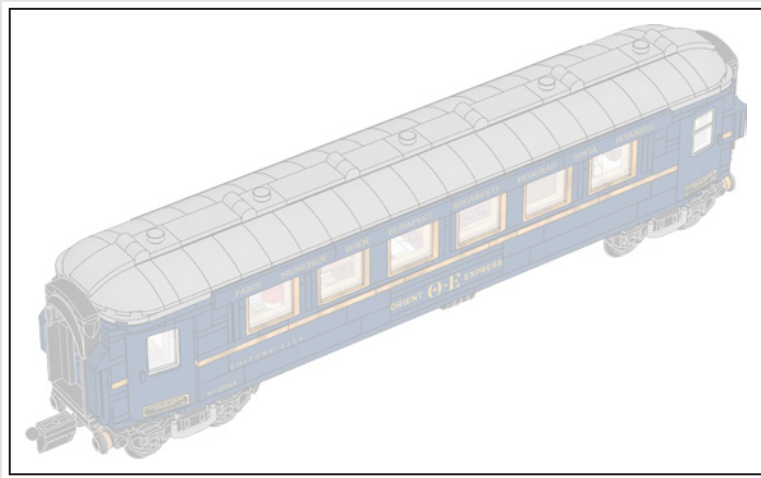

138

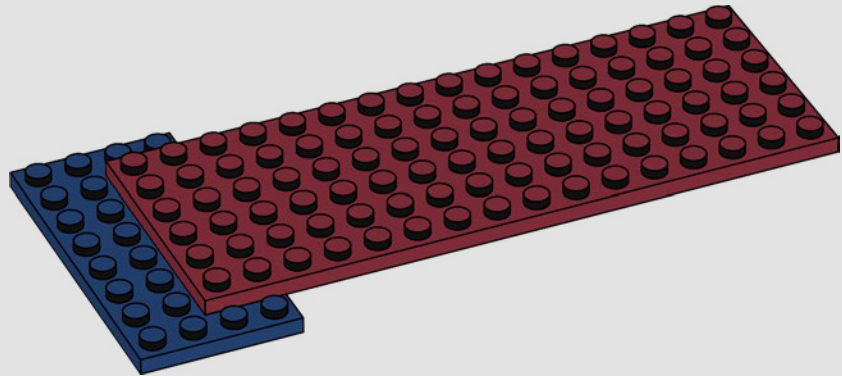

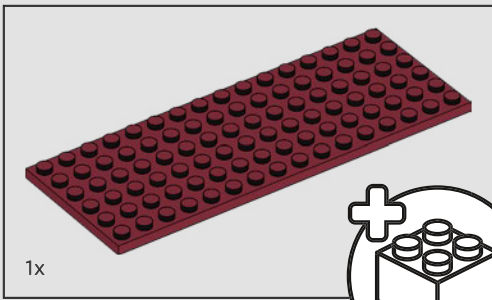

1x

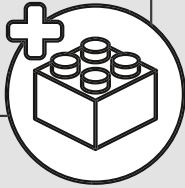

139

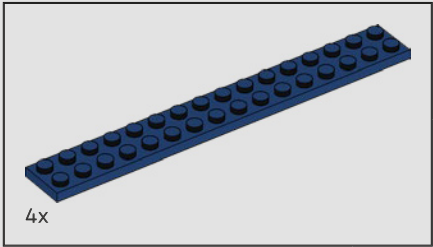
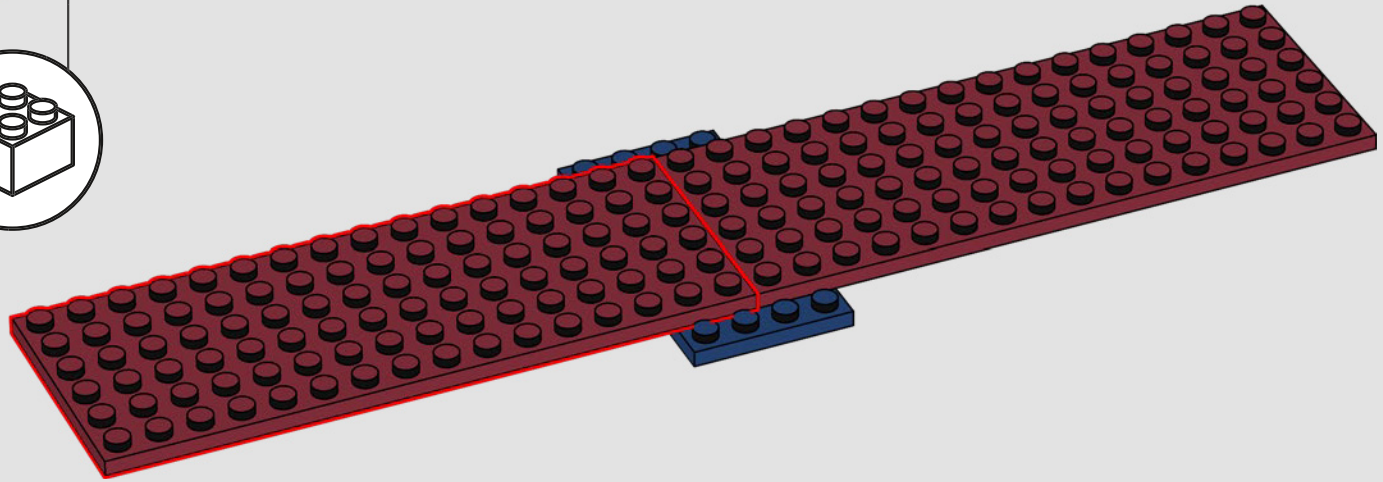

4x

140

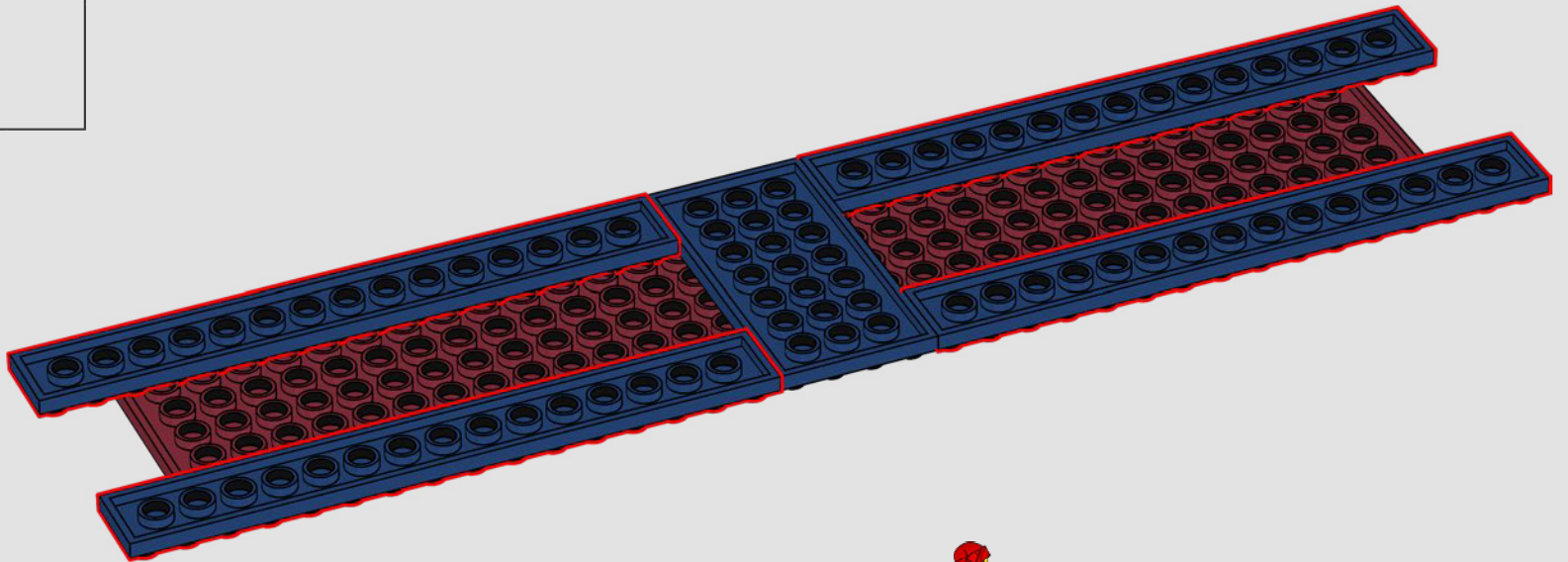

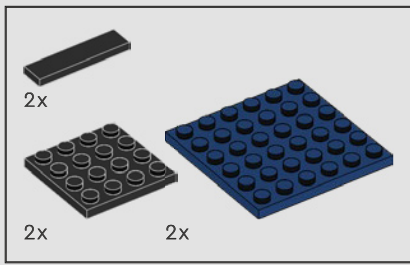

141

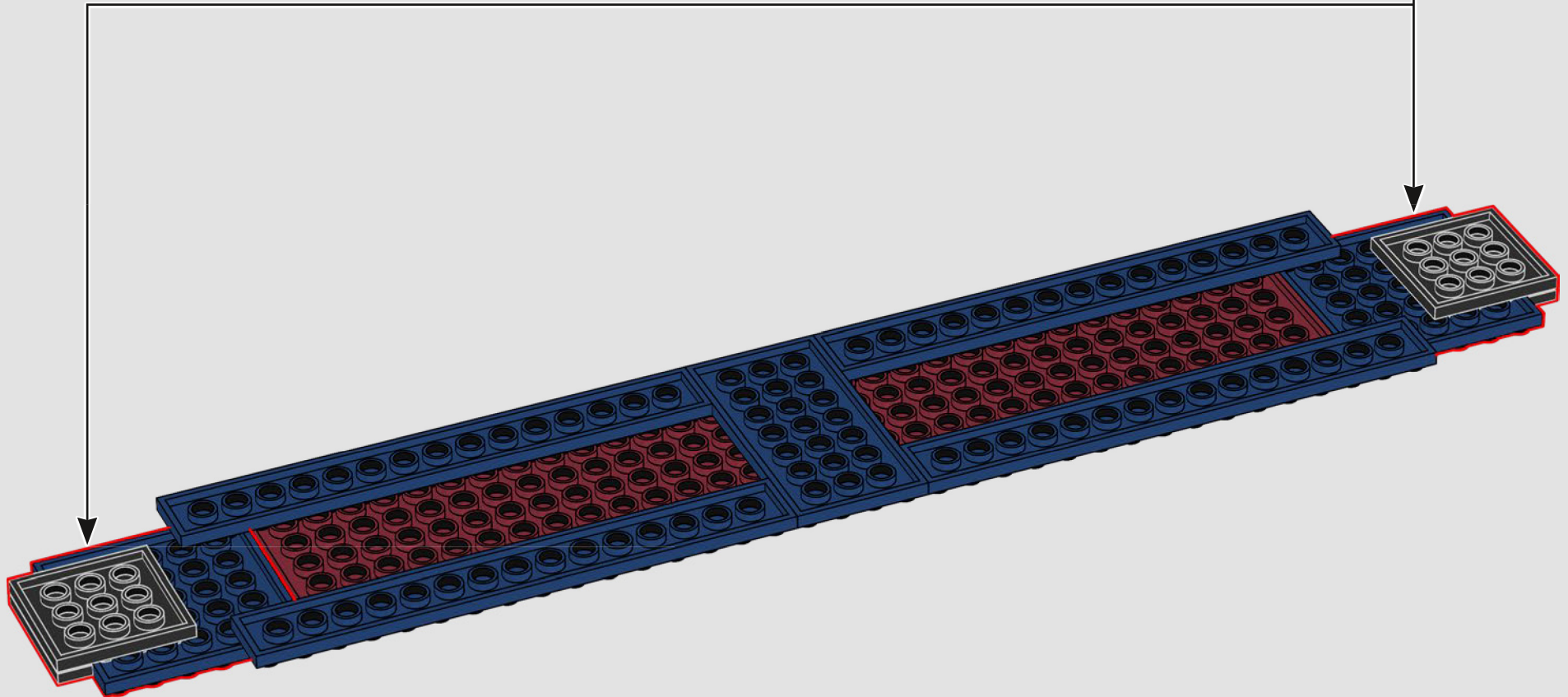
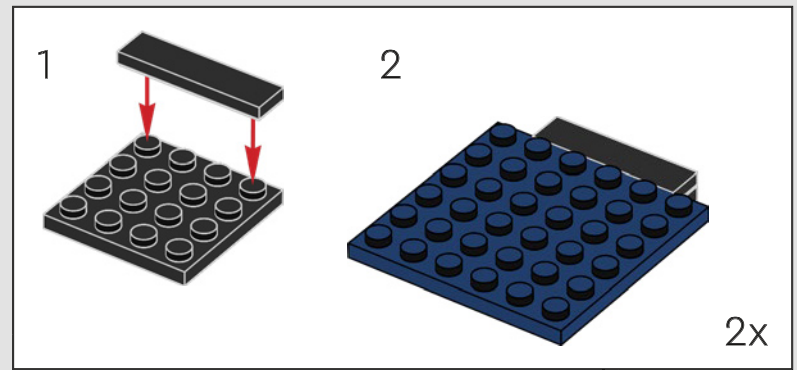

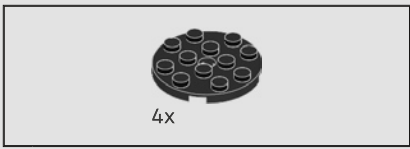

142

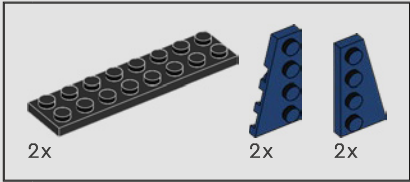
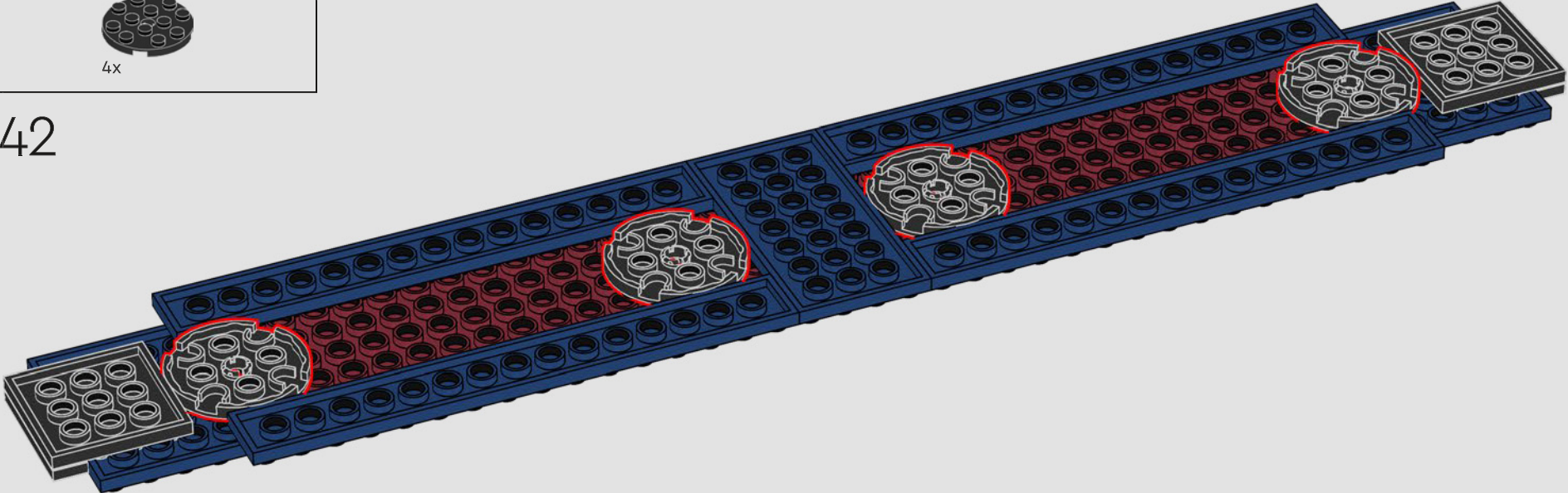

143

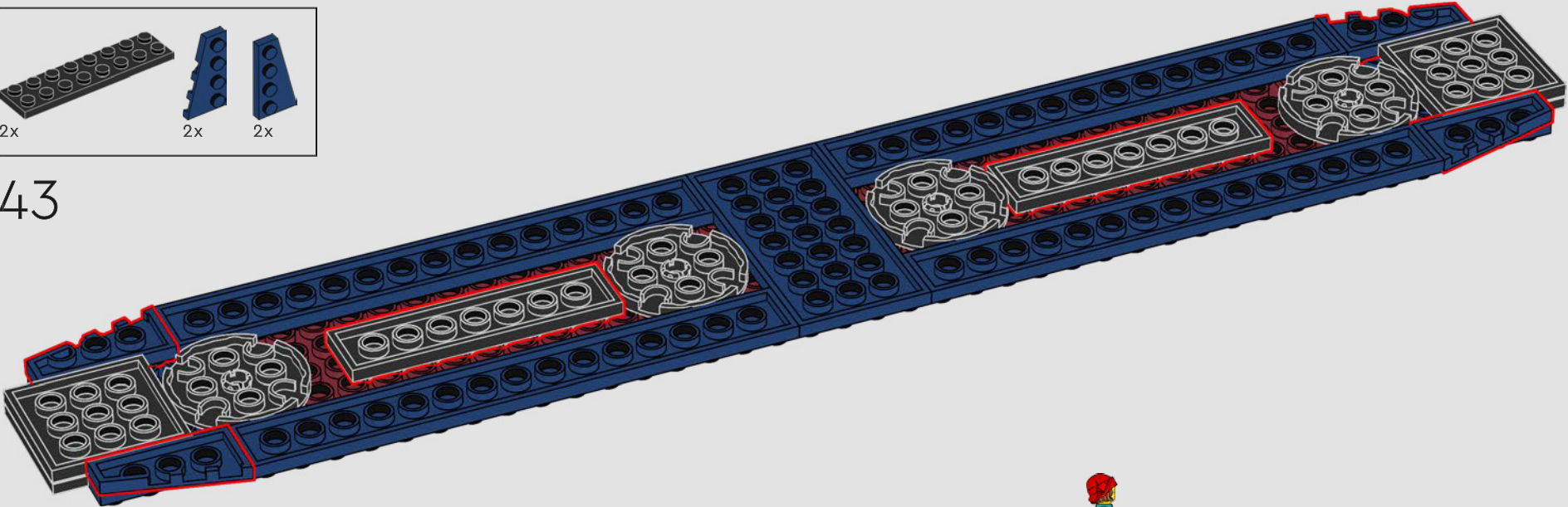

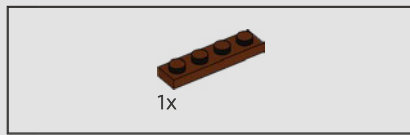

144

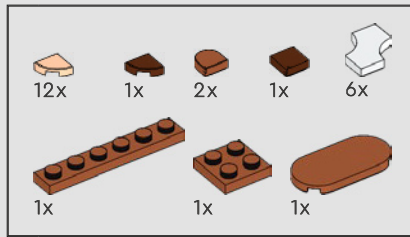
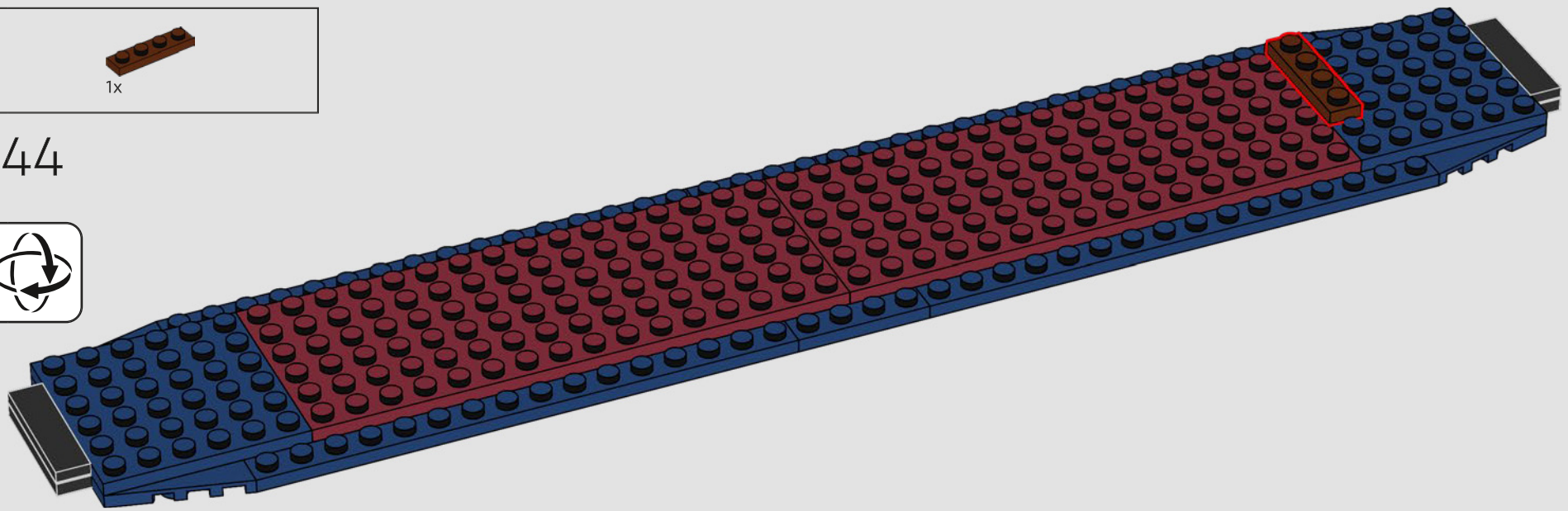

145

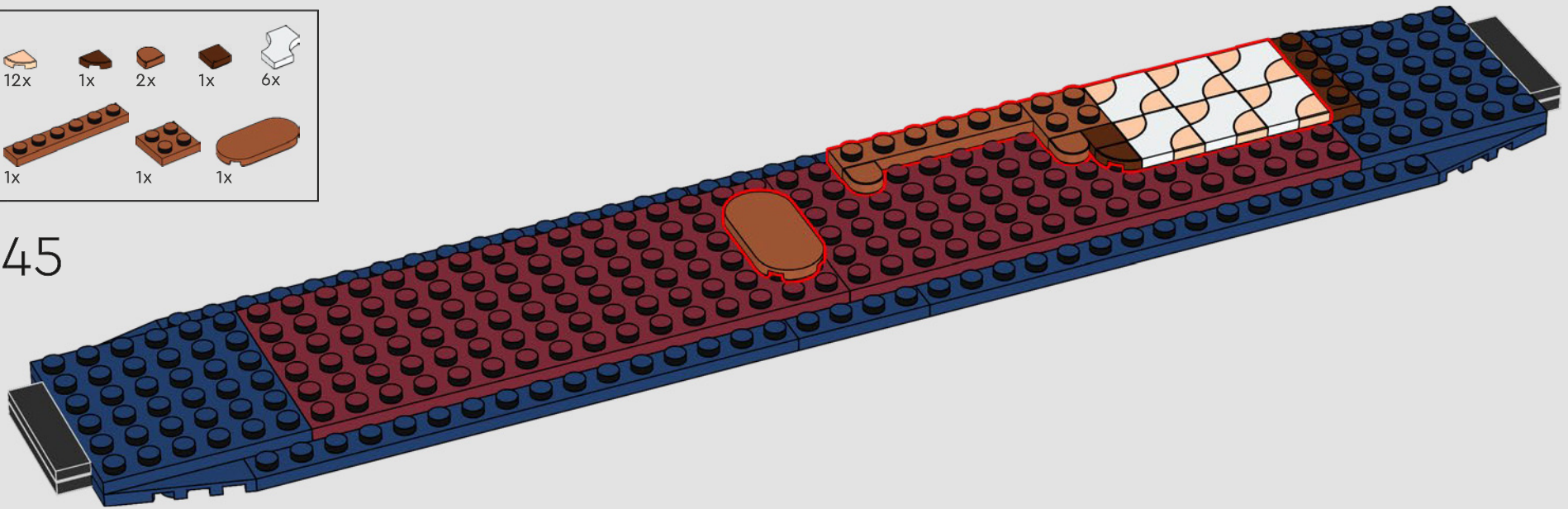

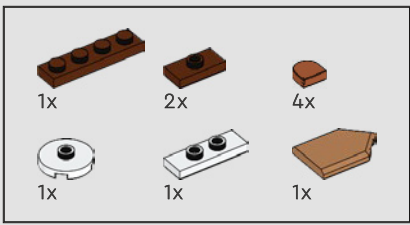

146

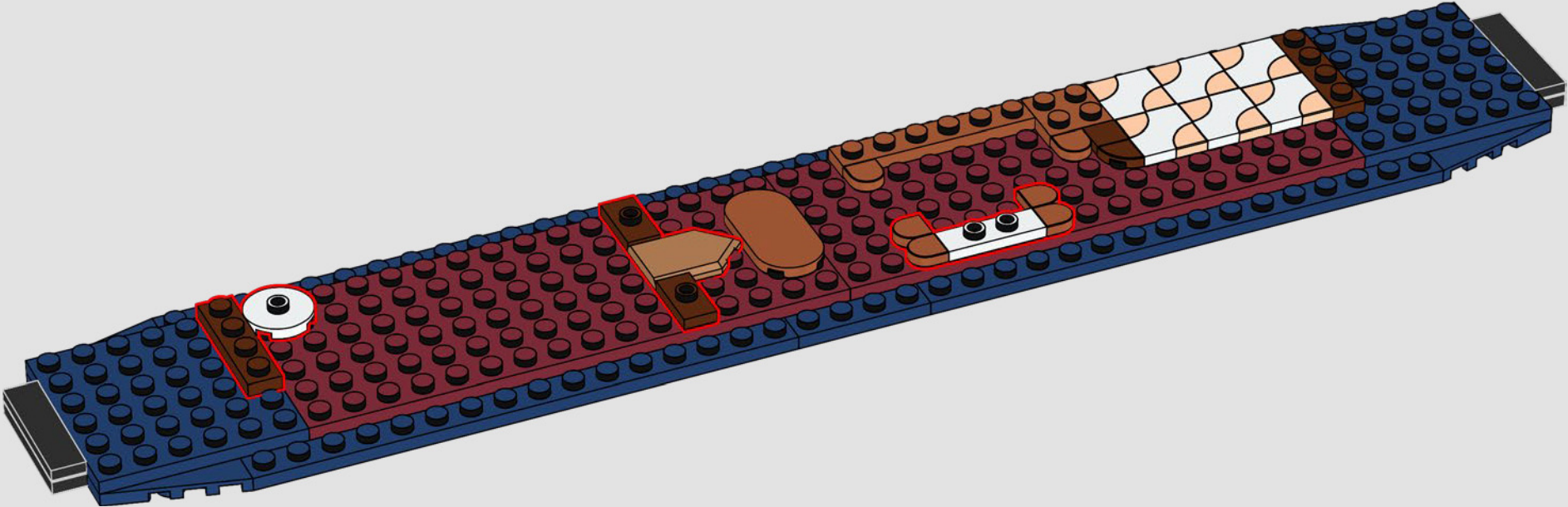

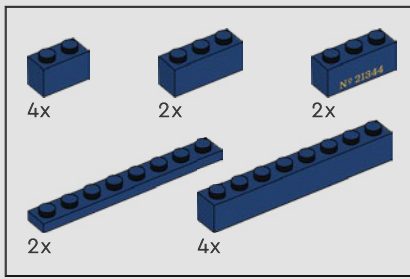

147

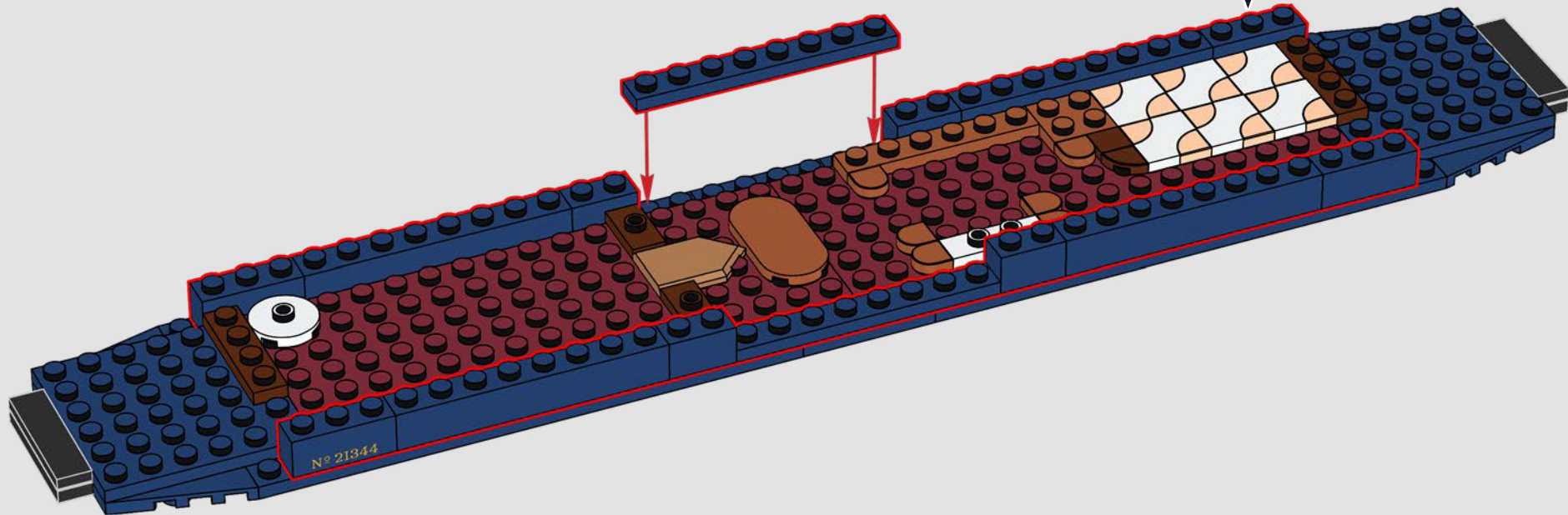
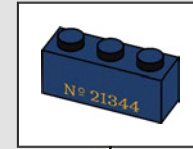

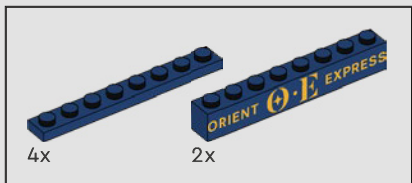

148

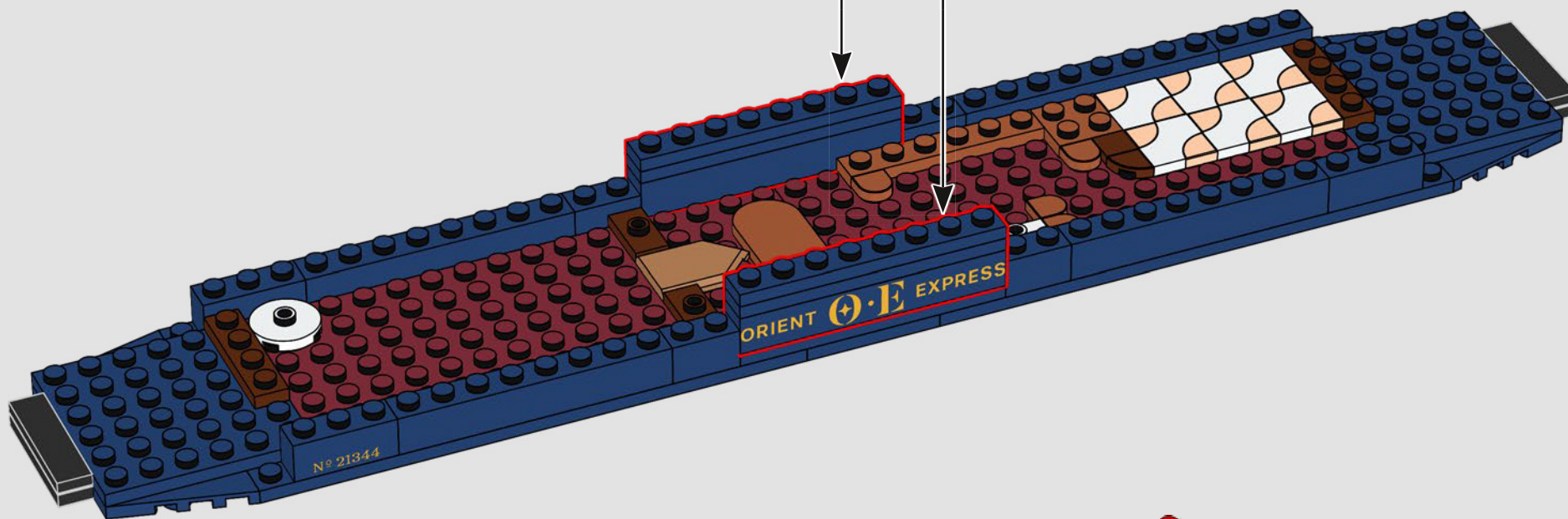
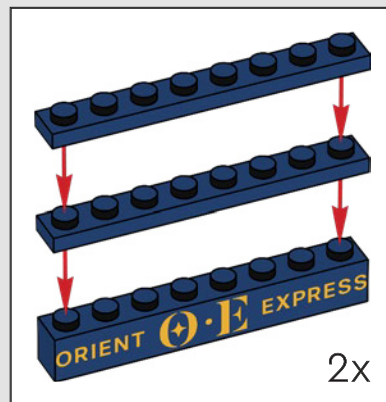

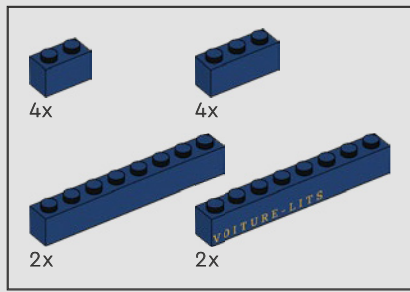

149

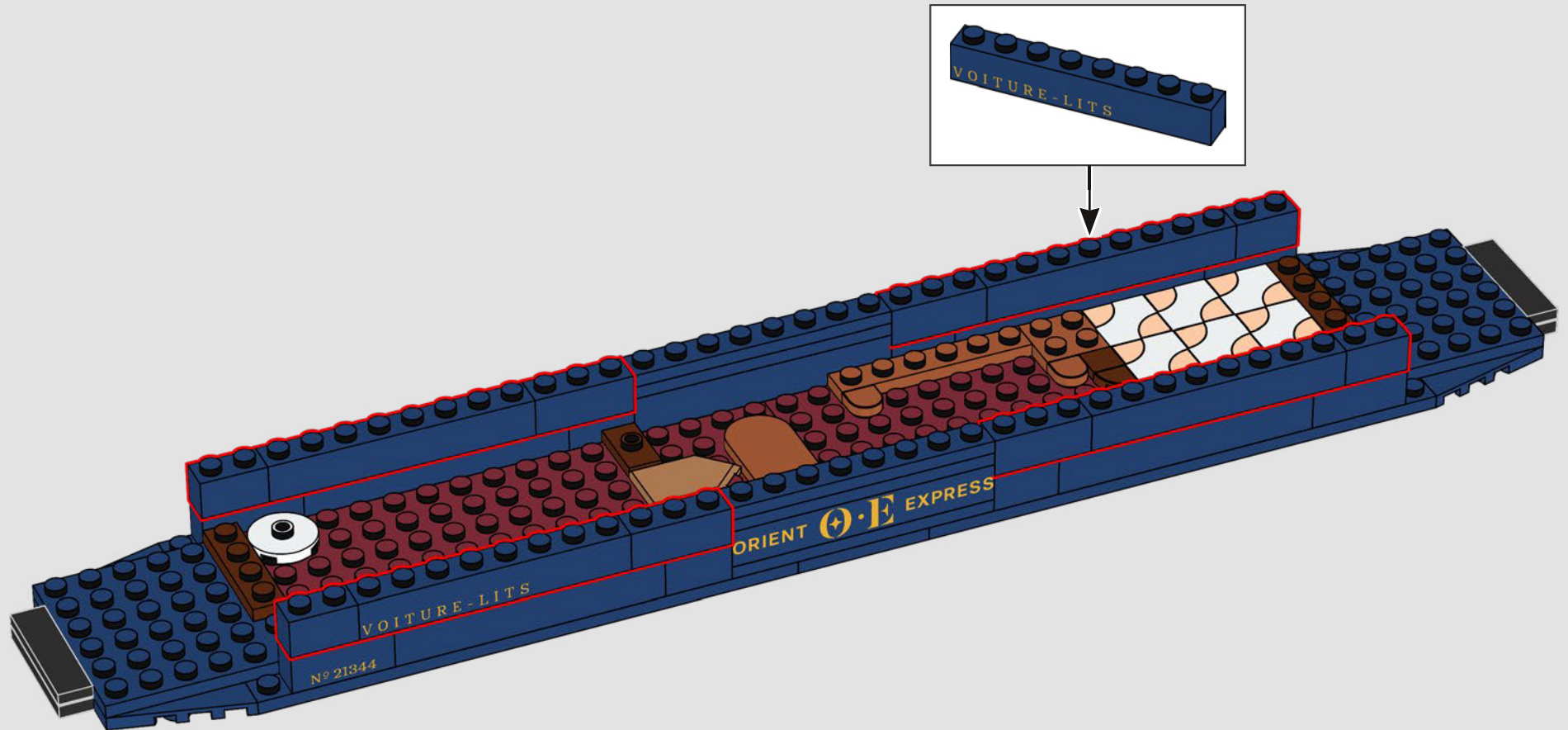

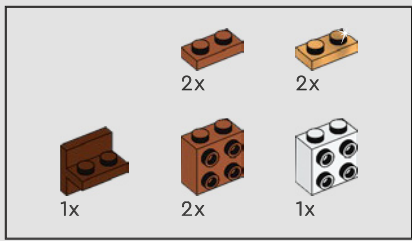

150

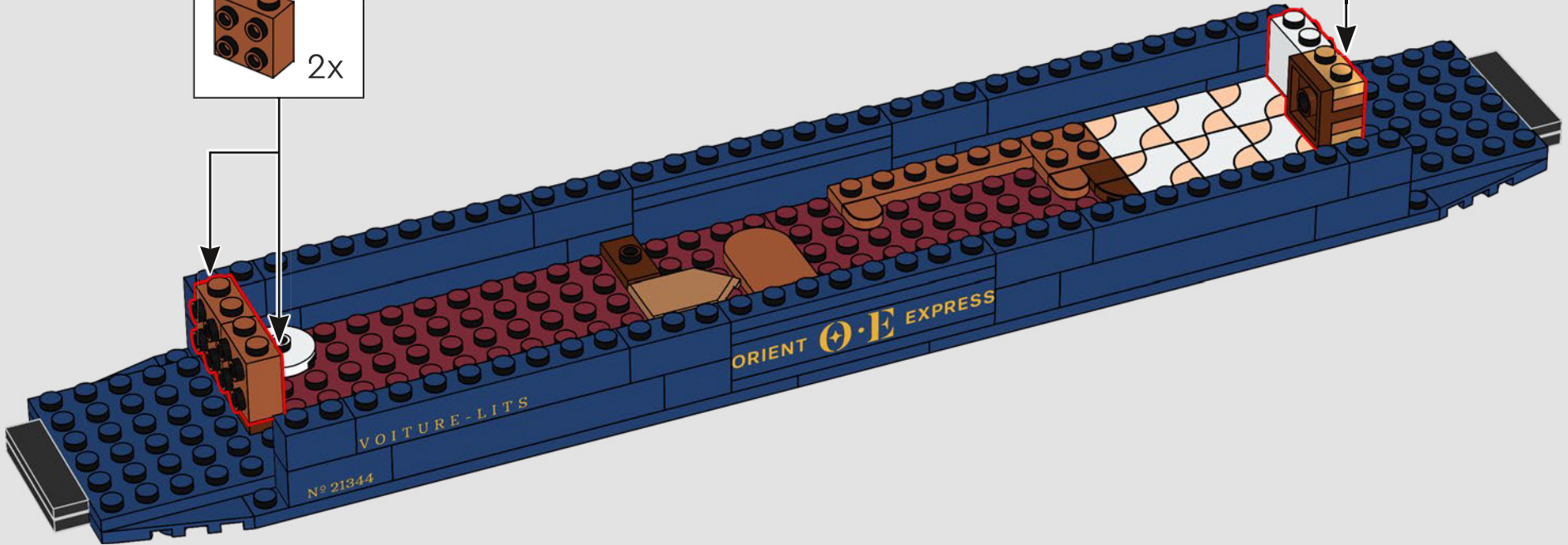
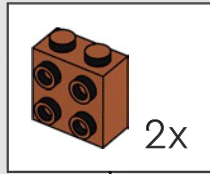
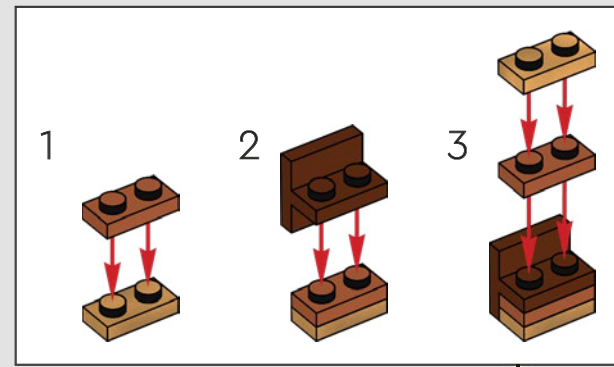

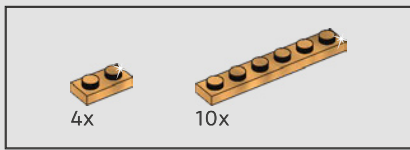

151

Prochain arrêt : BUDAPEST
« En naviguant le long du Danube vers Budapest,
l'eau brillait comme de l'or. »

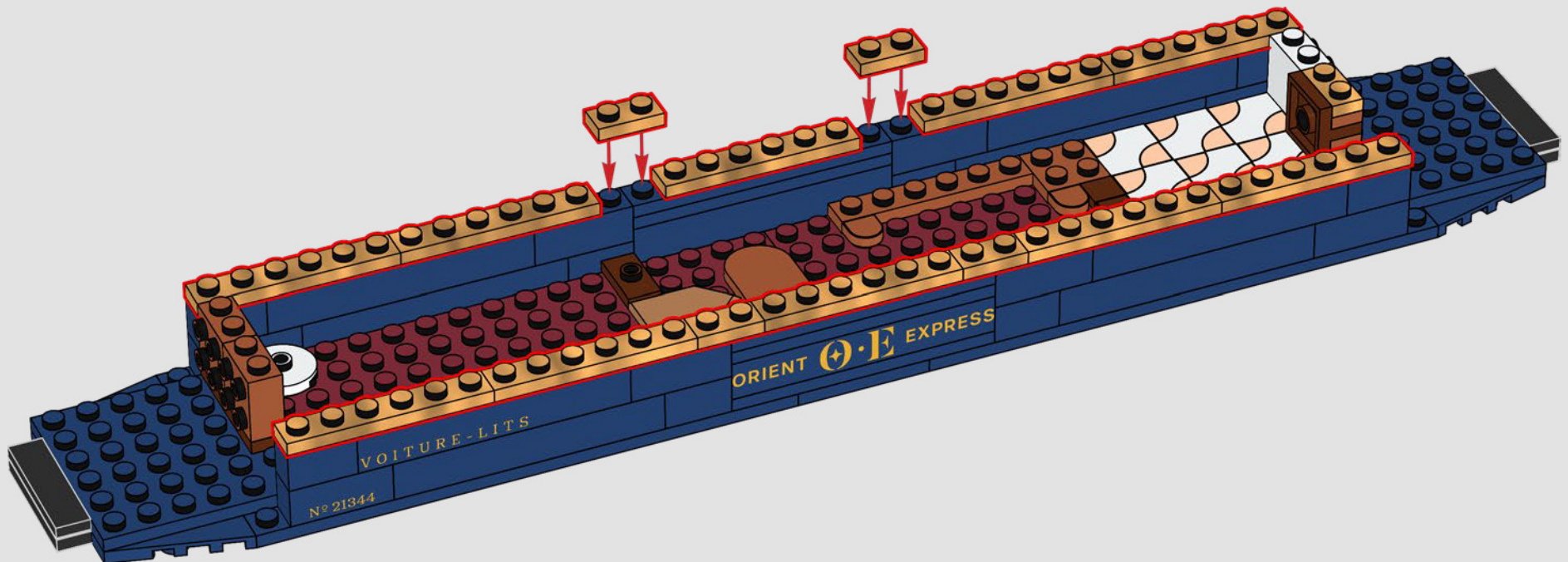

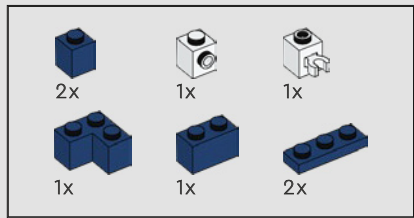

152

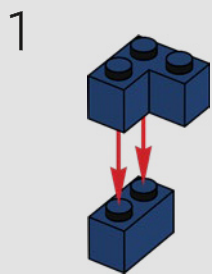

2

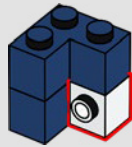

3

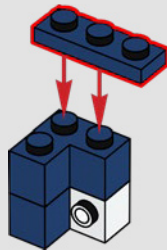

4

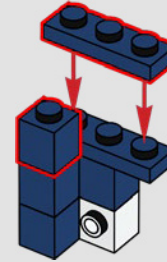

5

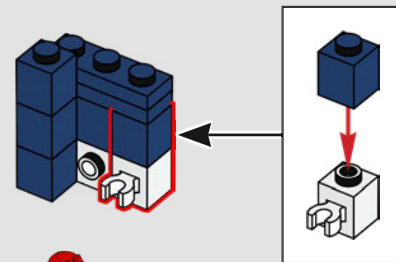

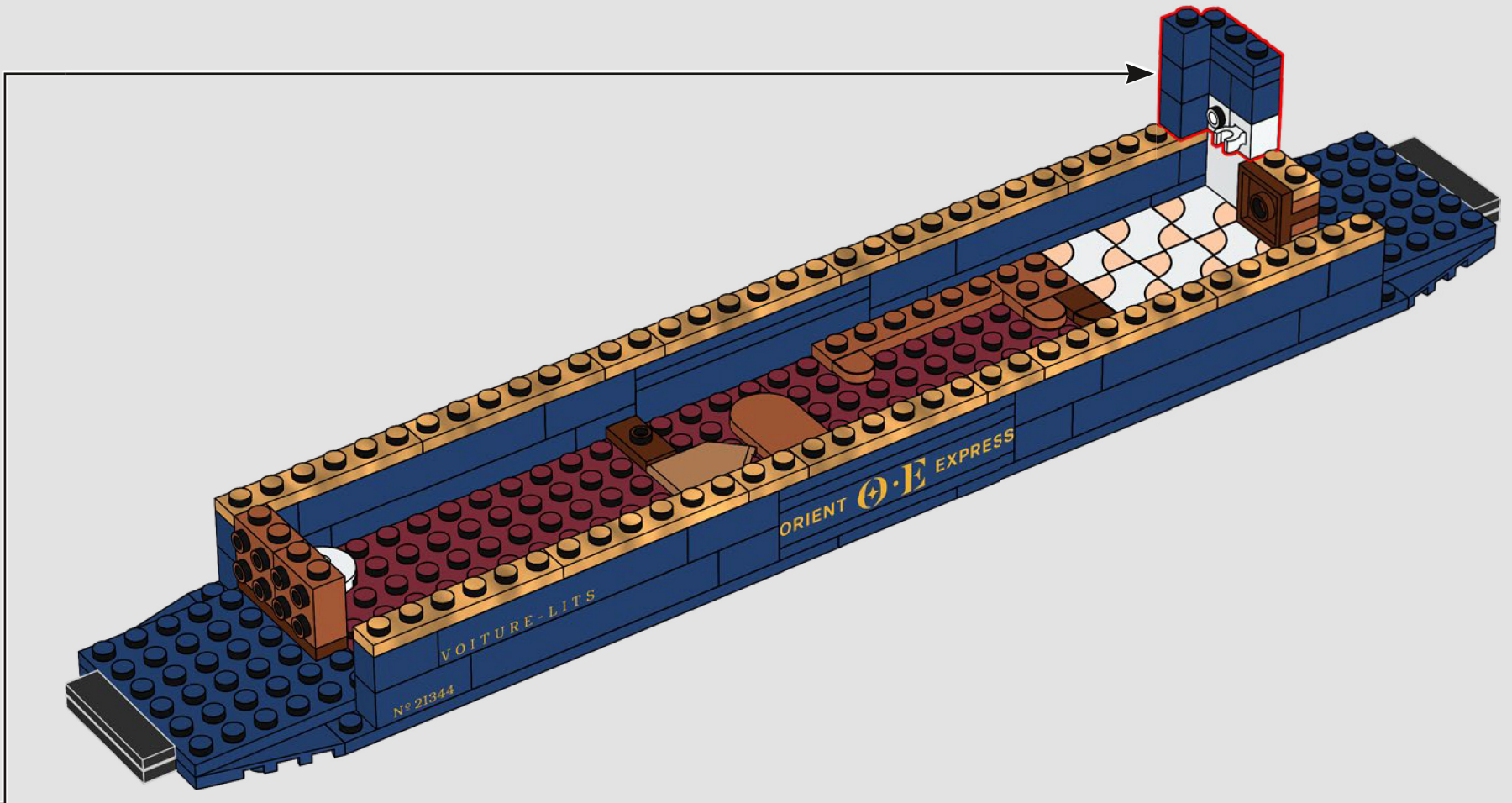

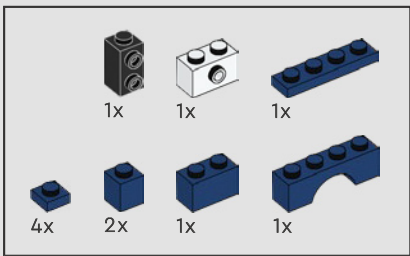

153

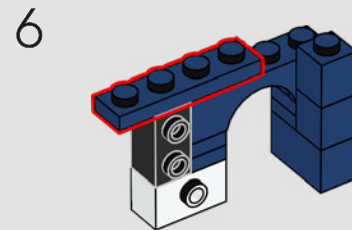
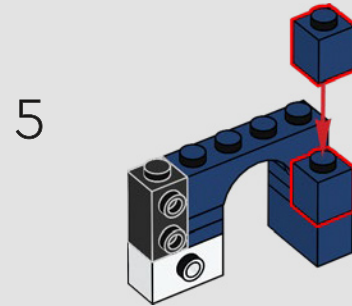
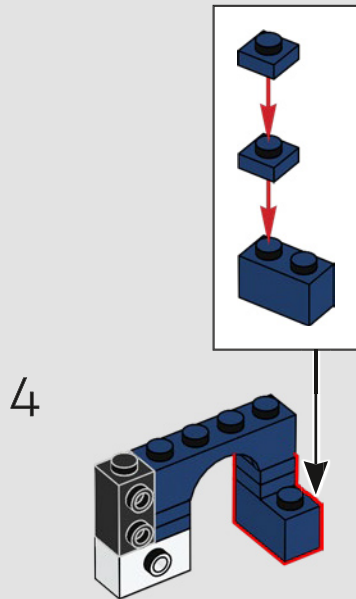
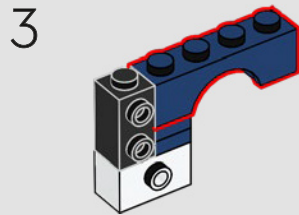
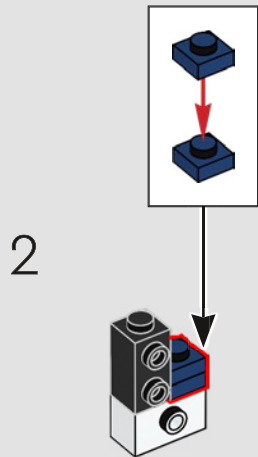
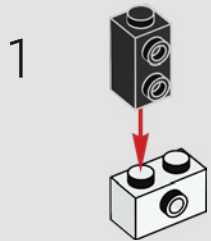

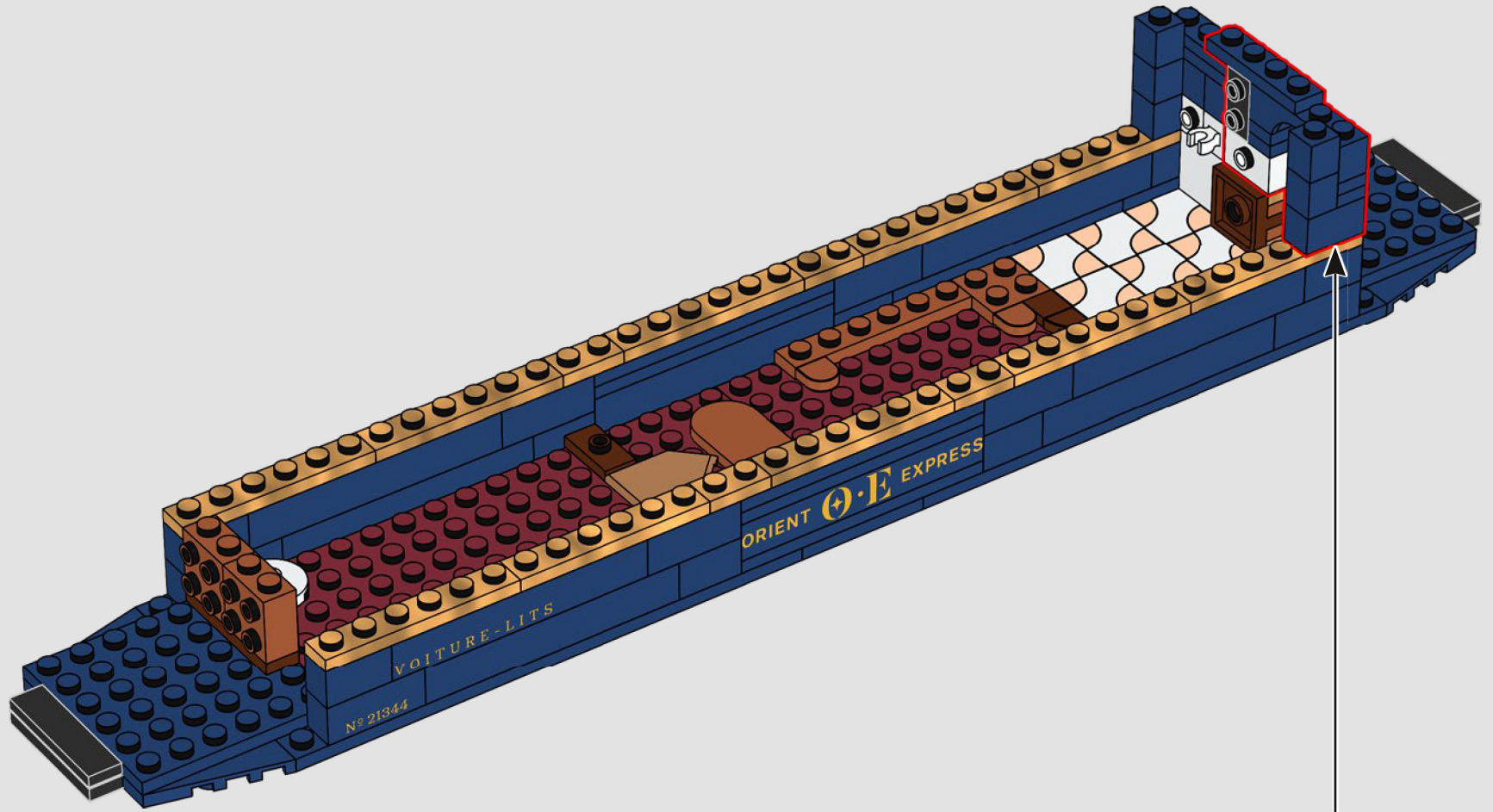

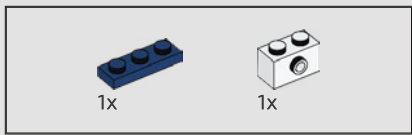

154

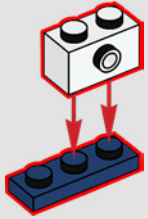

155

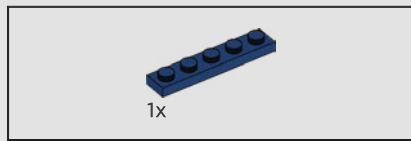
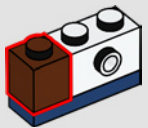

156

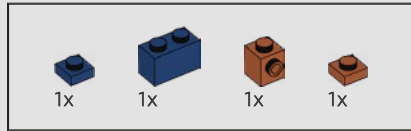
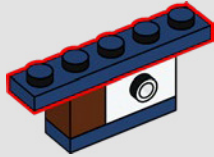

157

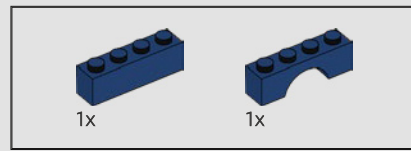
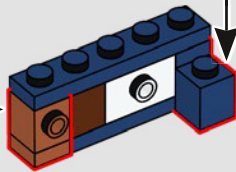
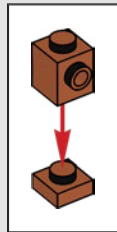
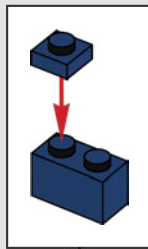

158

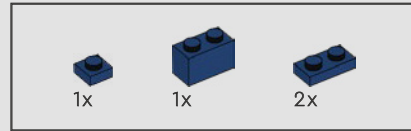
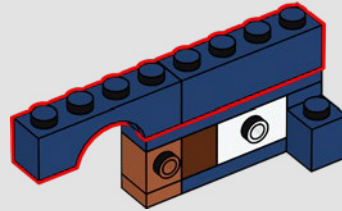

159

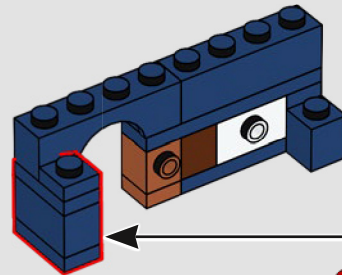
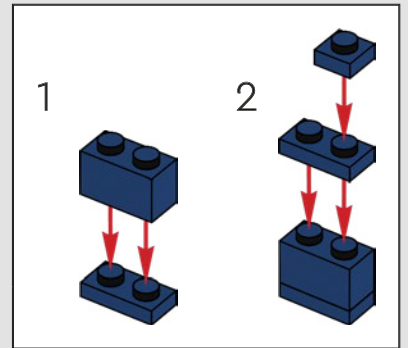

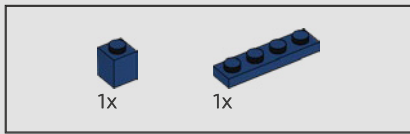

160

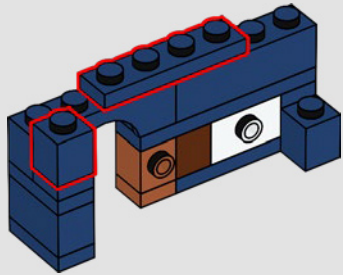

161

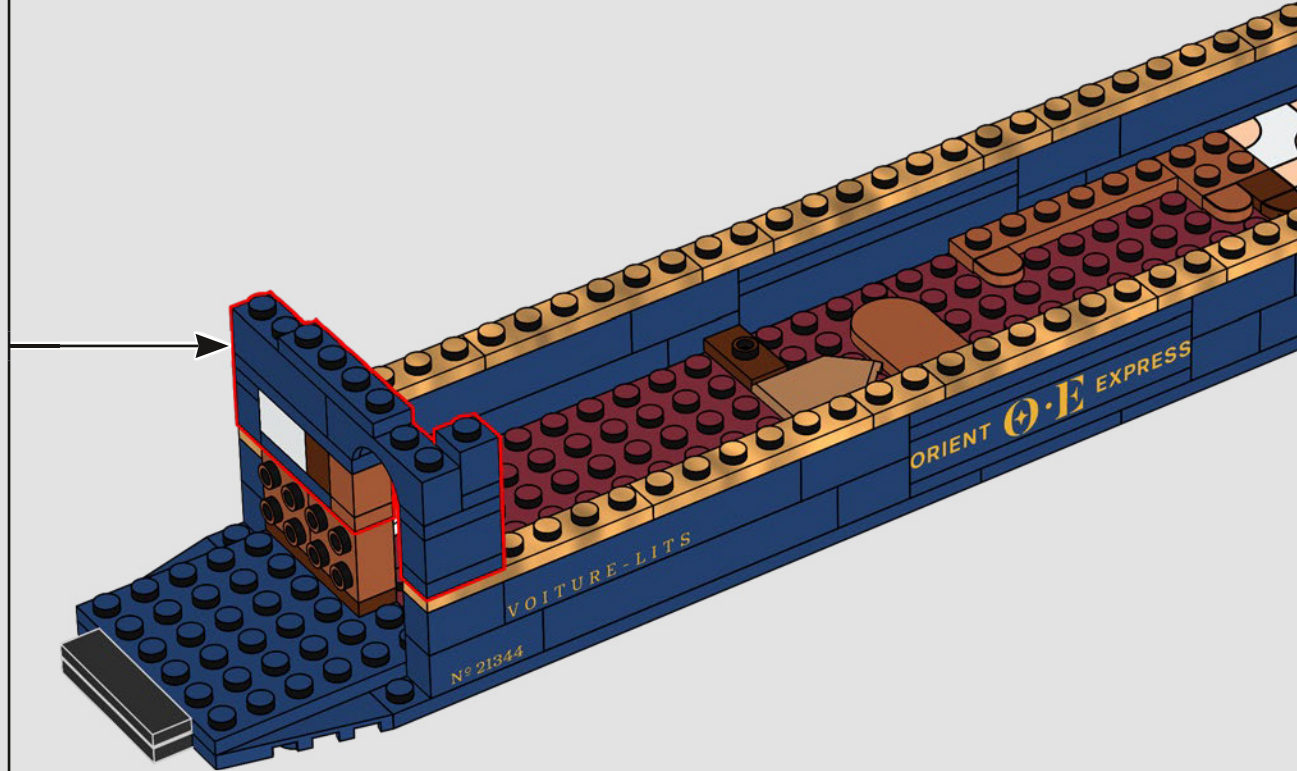

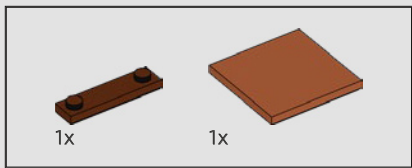

162

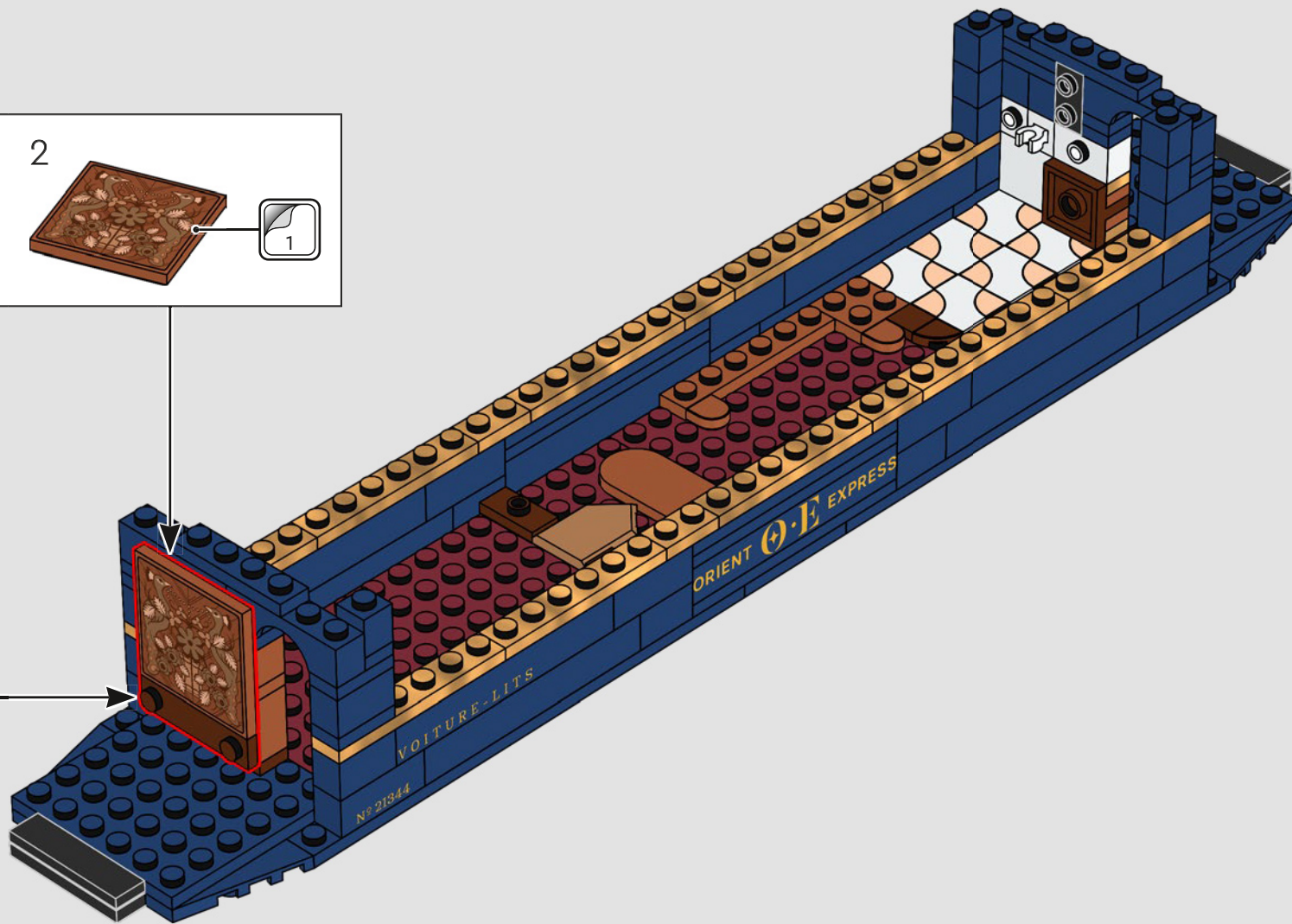
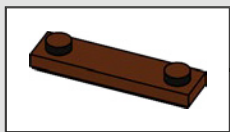

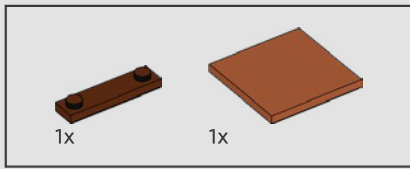

163

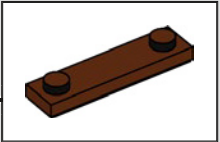
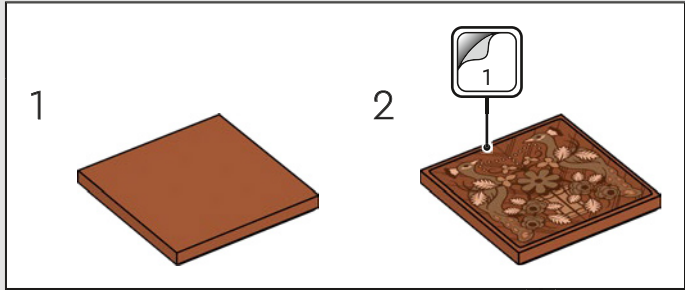
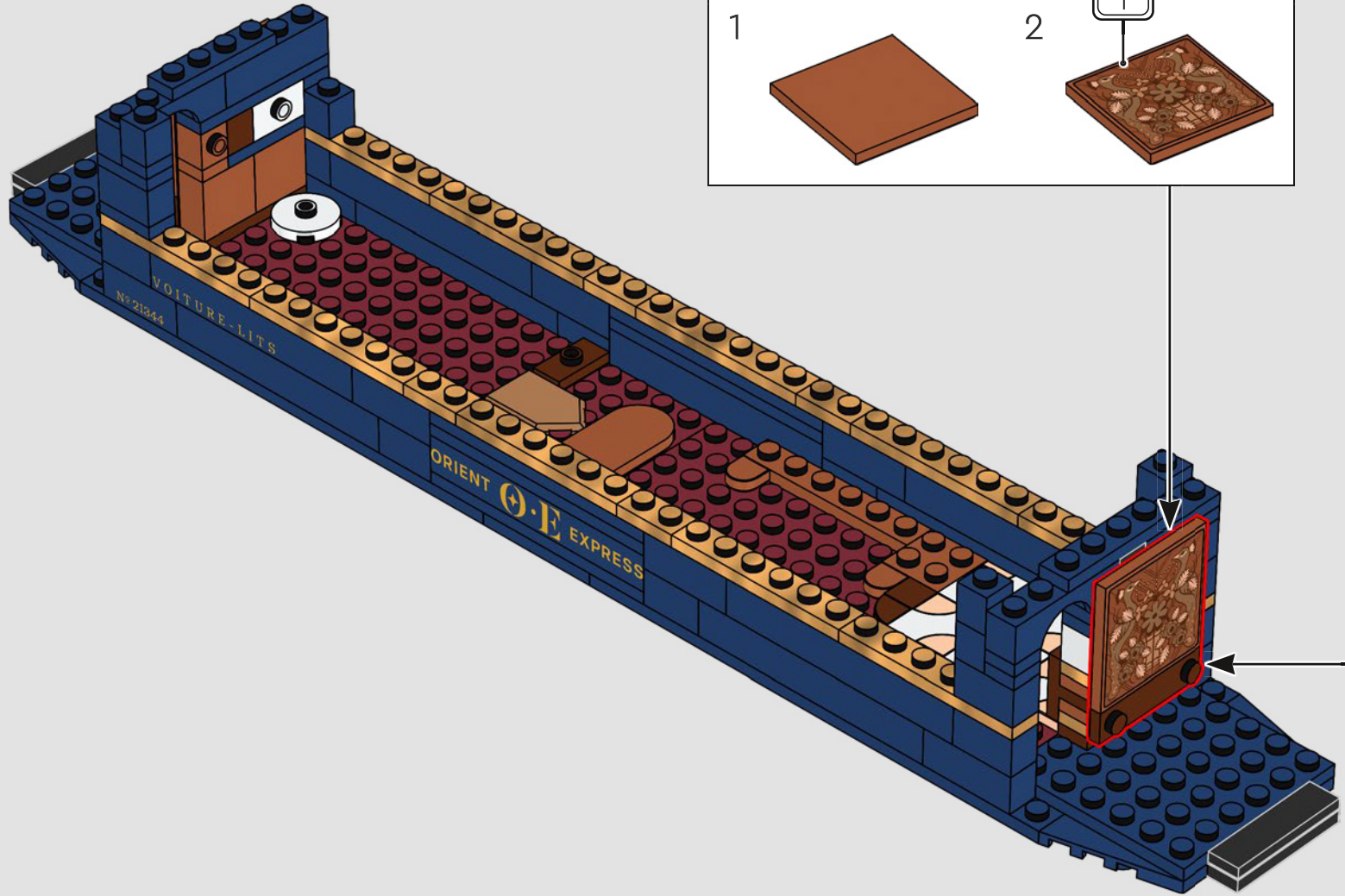

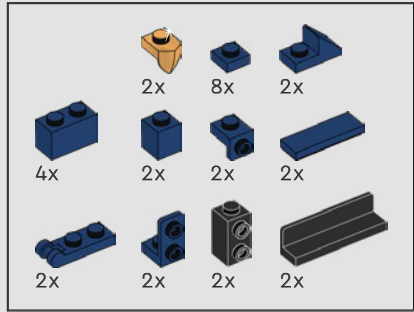
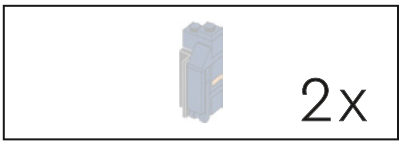

164

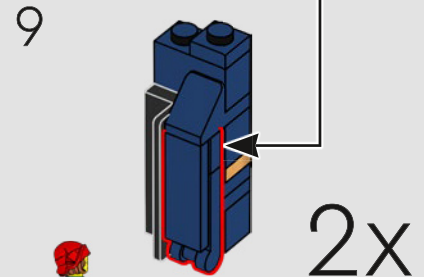
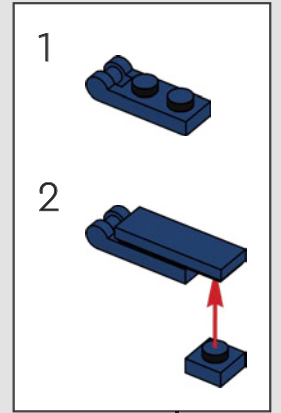
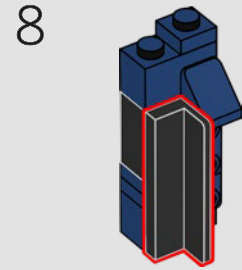
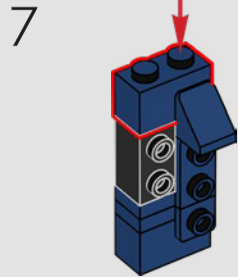
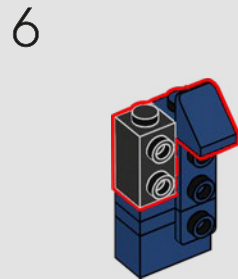
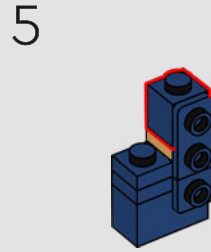
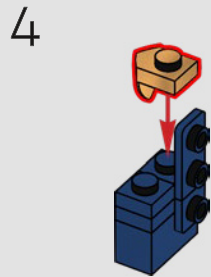
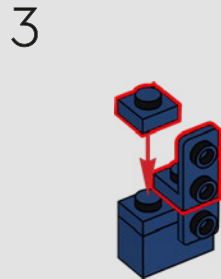
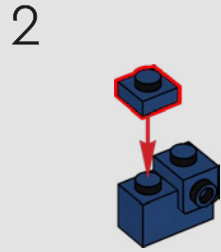
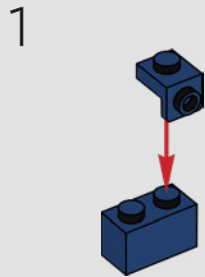

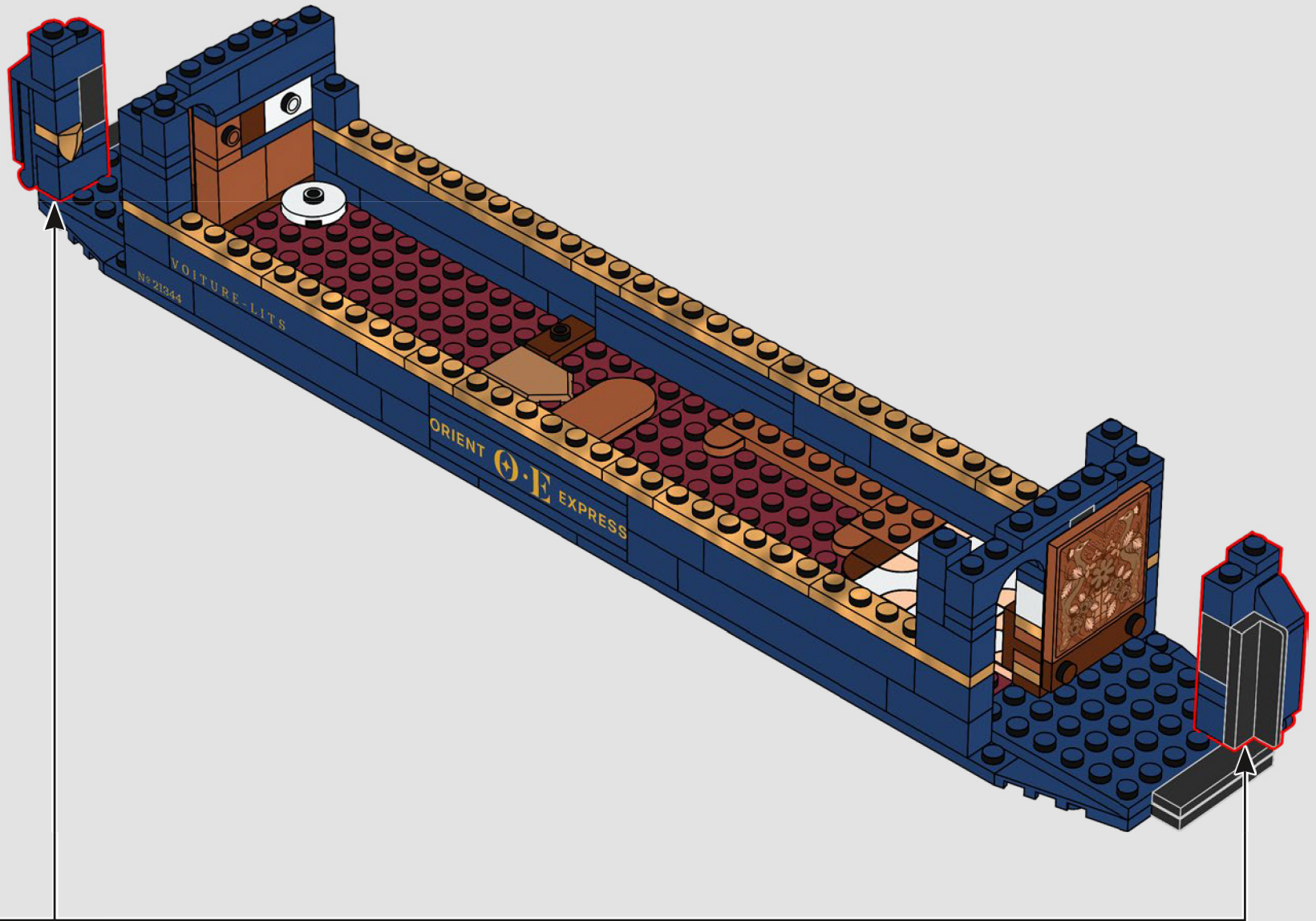



2x

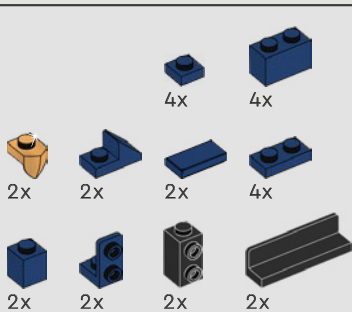

165

1

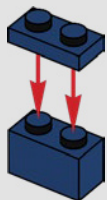

2

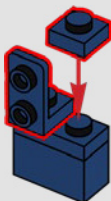

3

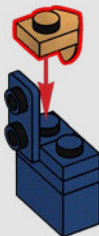

4

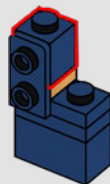

5

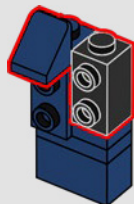

6

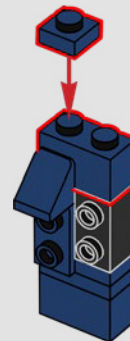

7

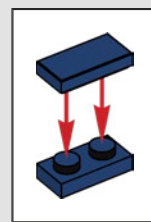

8

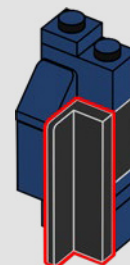

2x



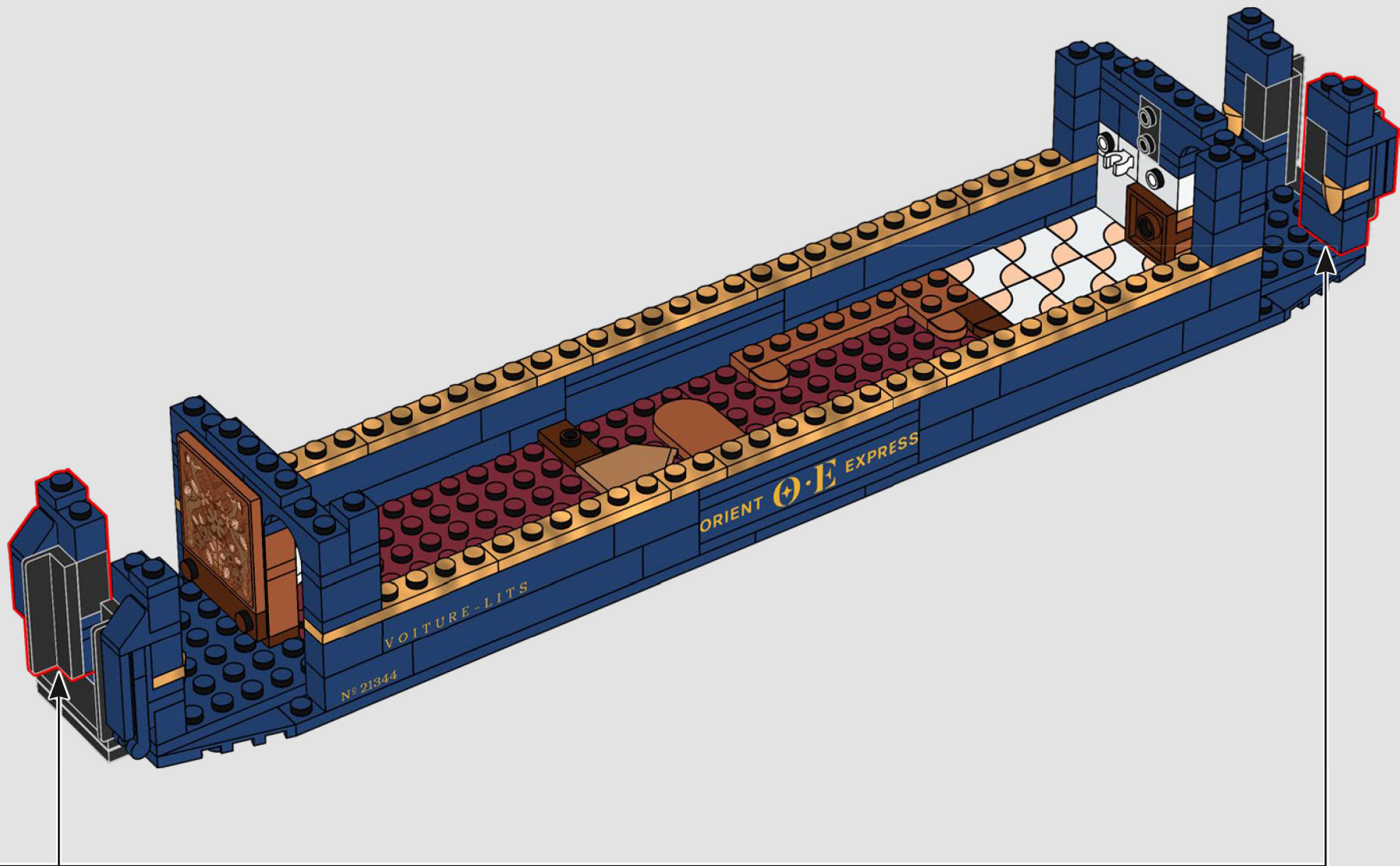

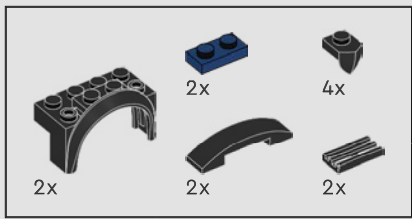

166

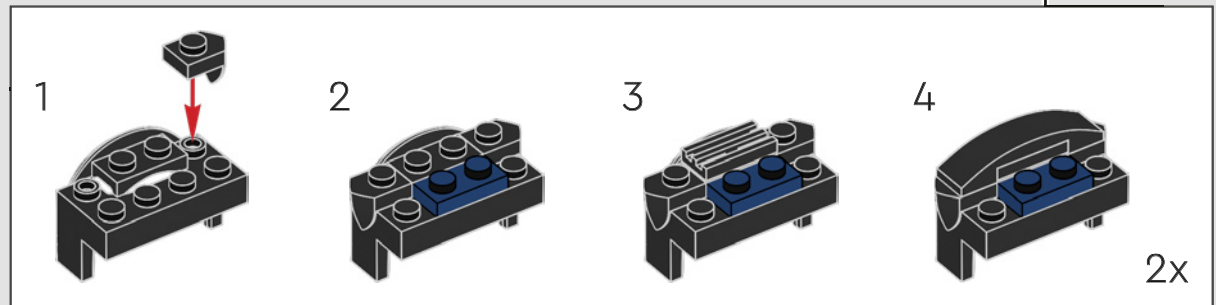
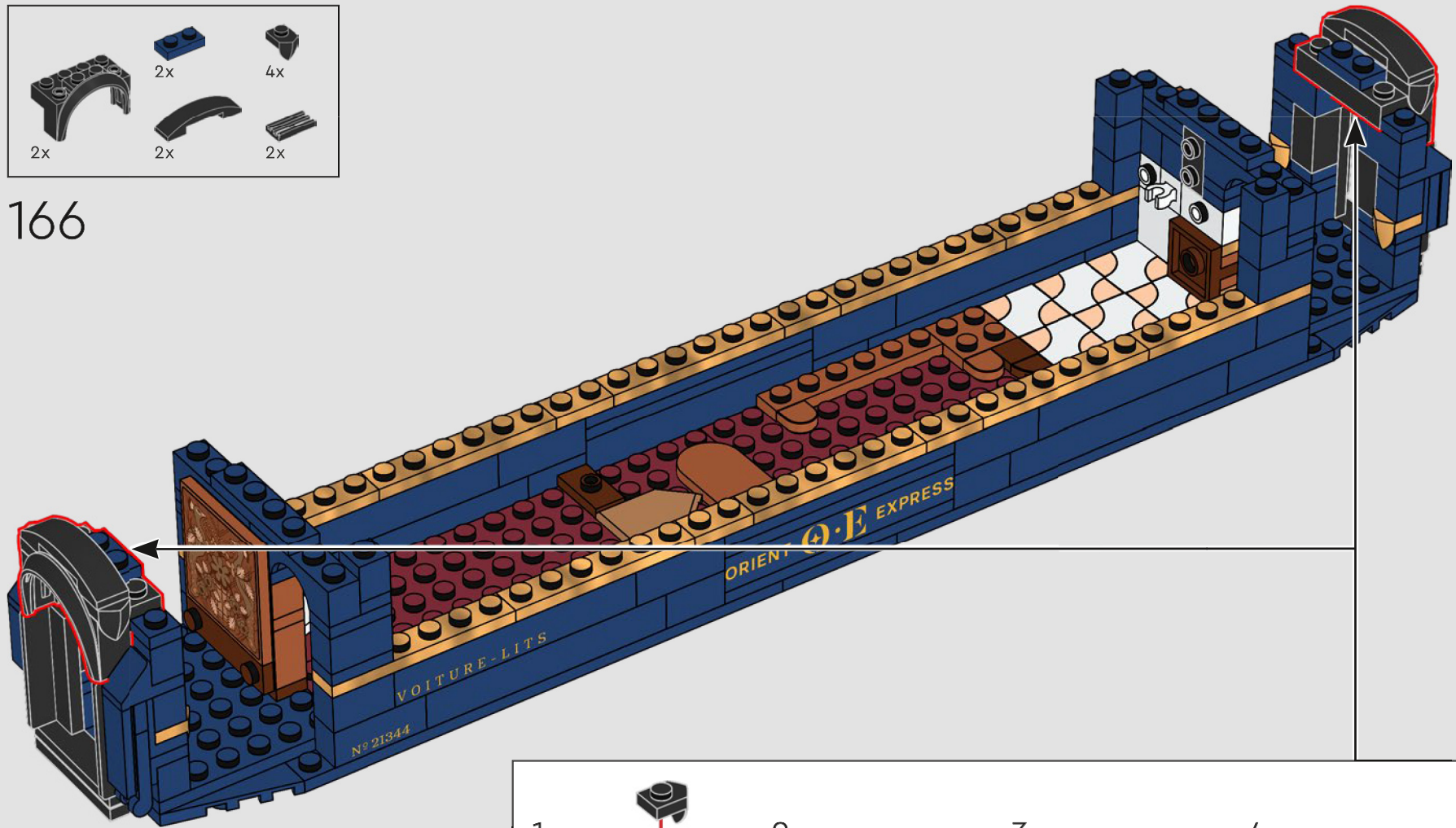

..... ●
« Chaque wagon-lit dispose de son propre chef
de train pour répondre à tous nos besoins. »

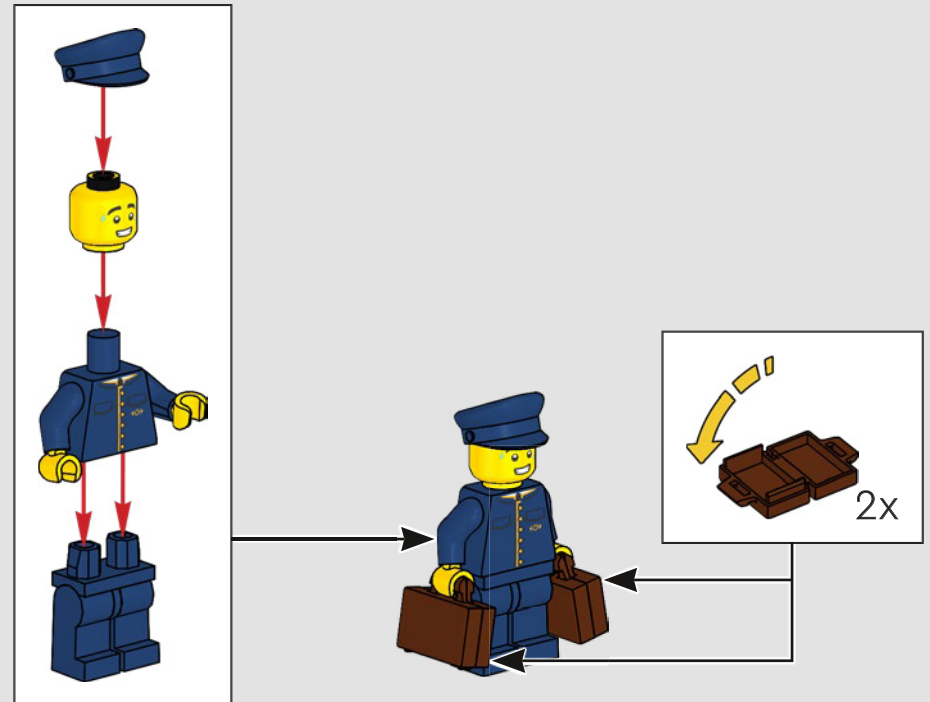

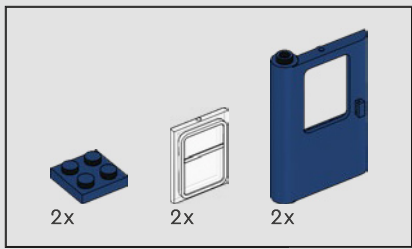

167

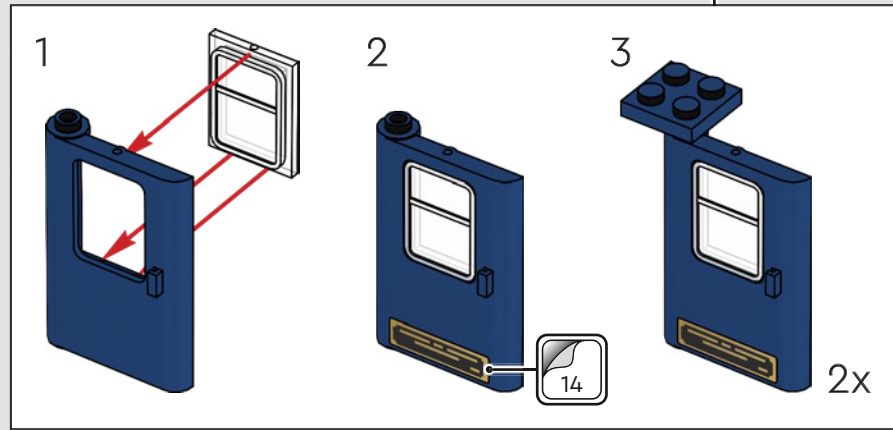
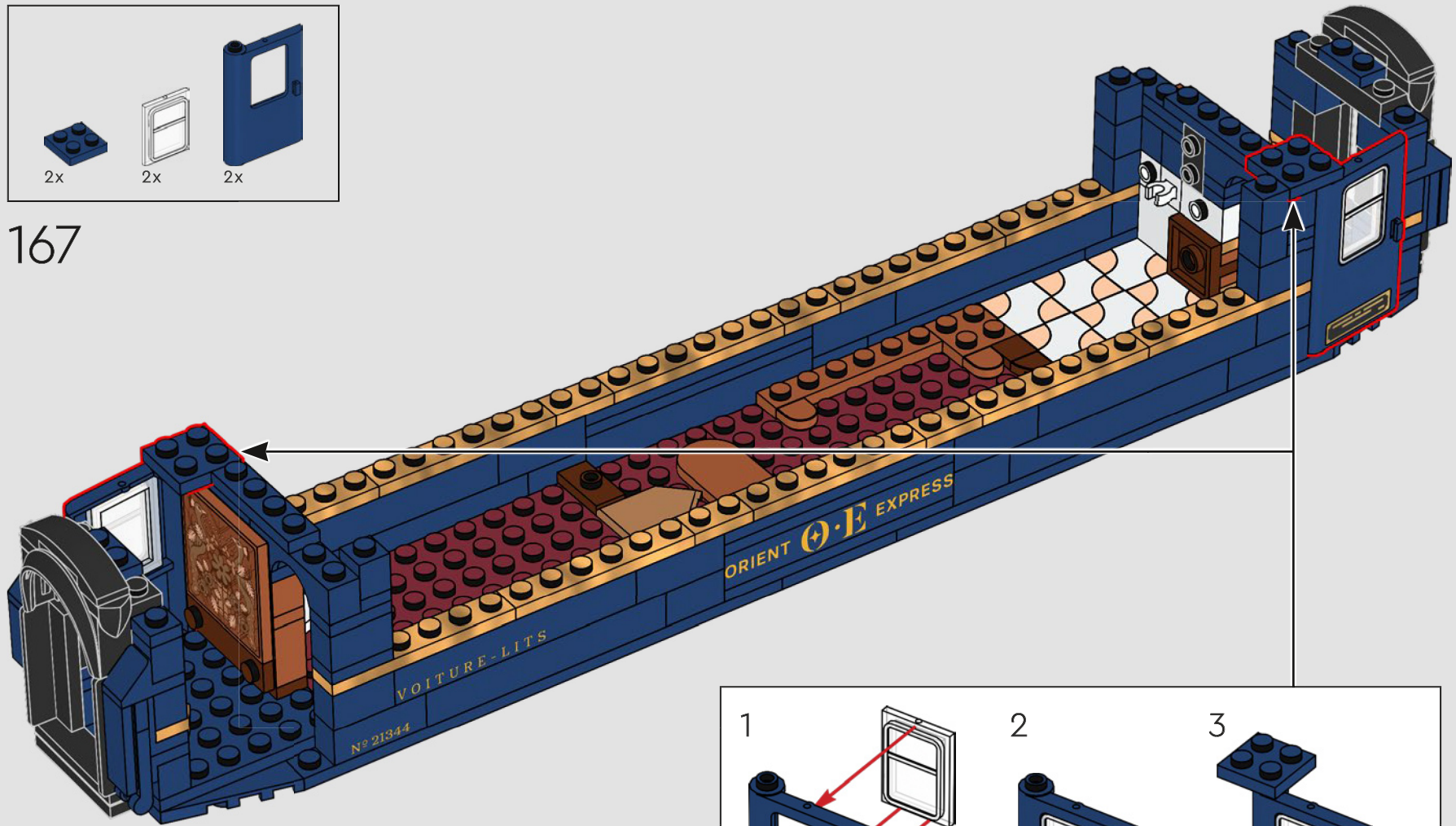

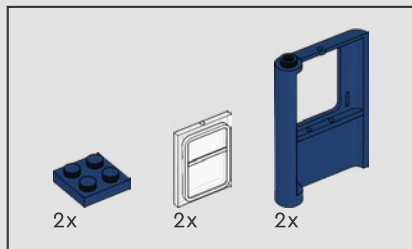

168

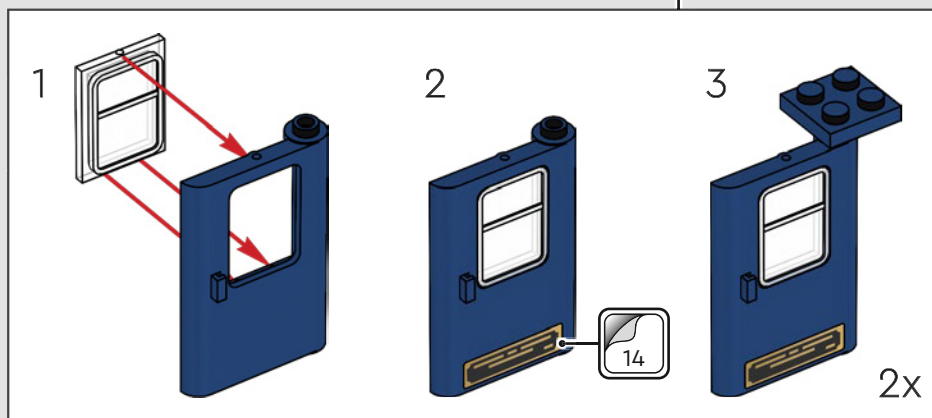
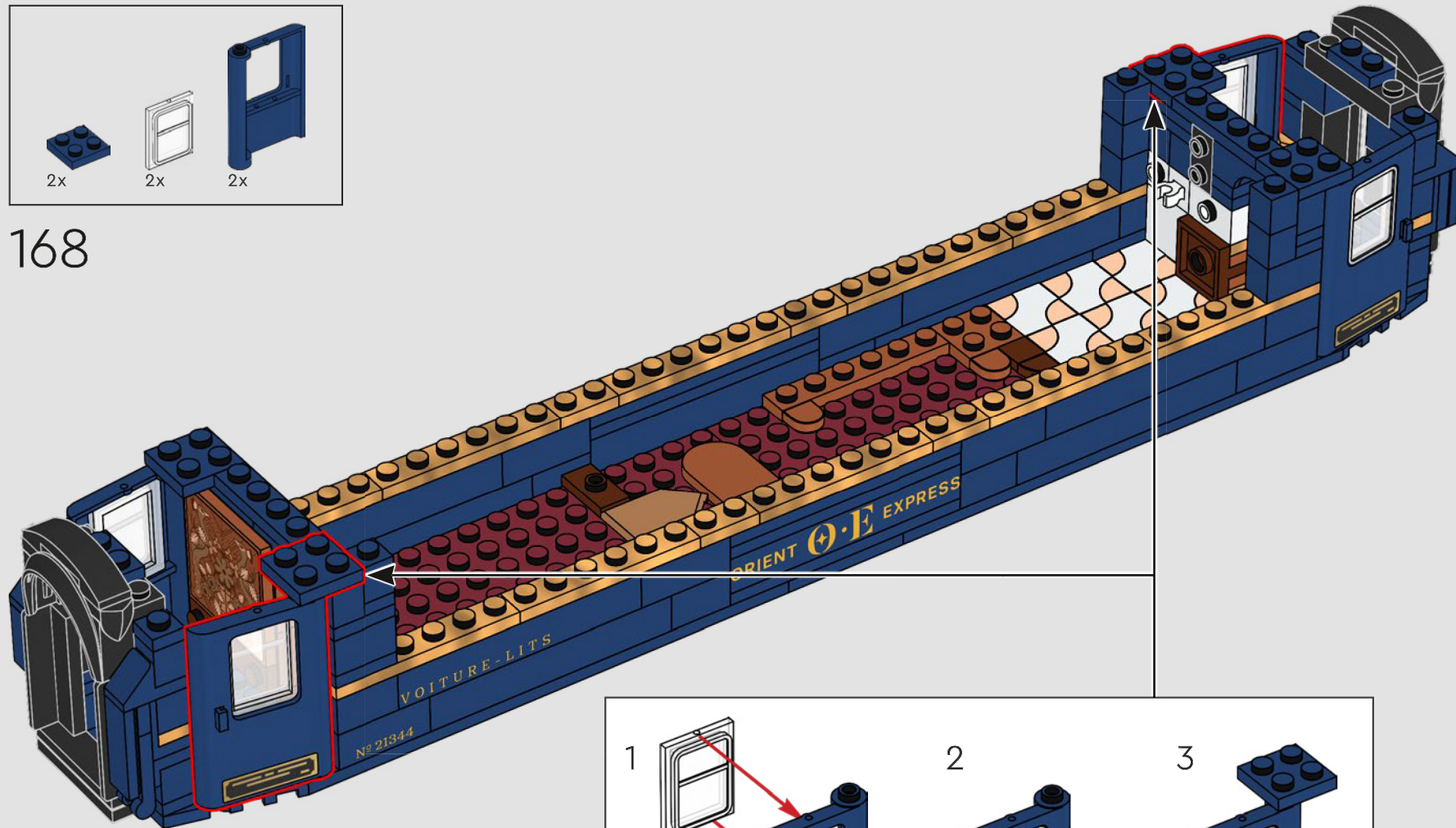

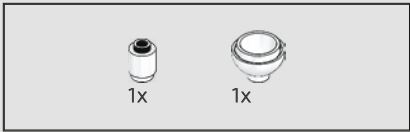

169

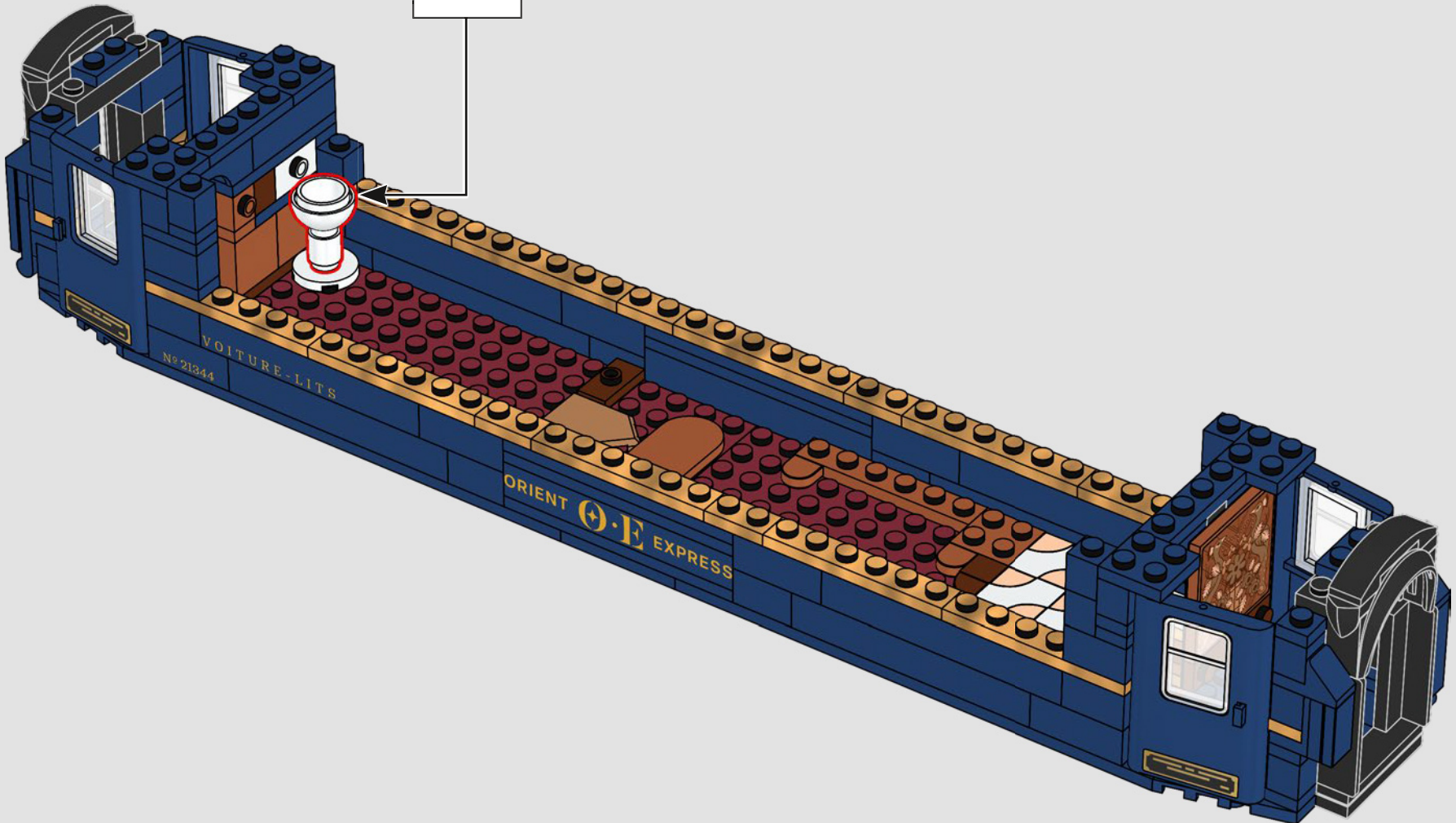



170

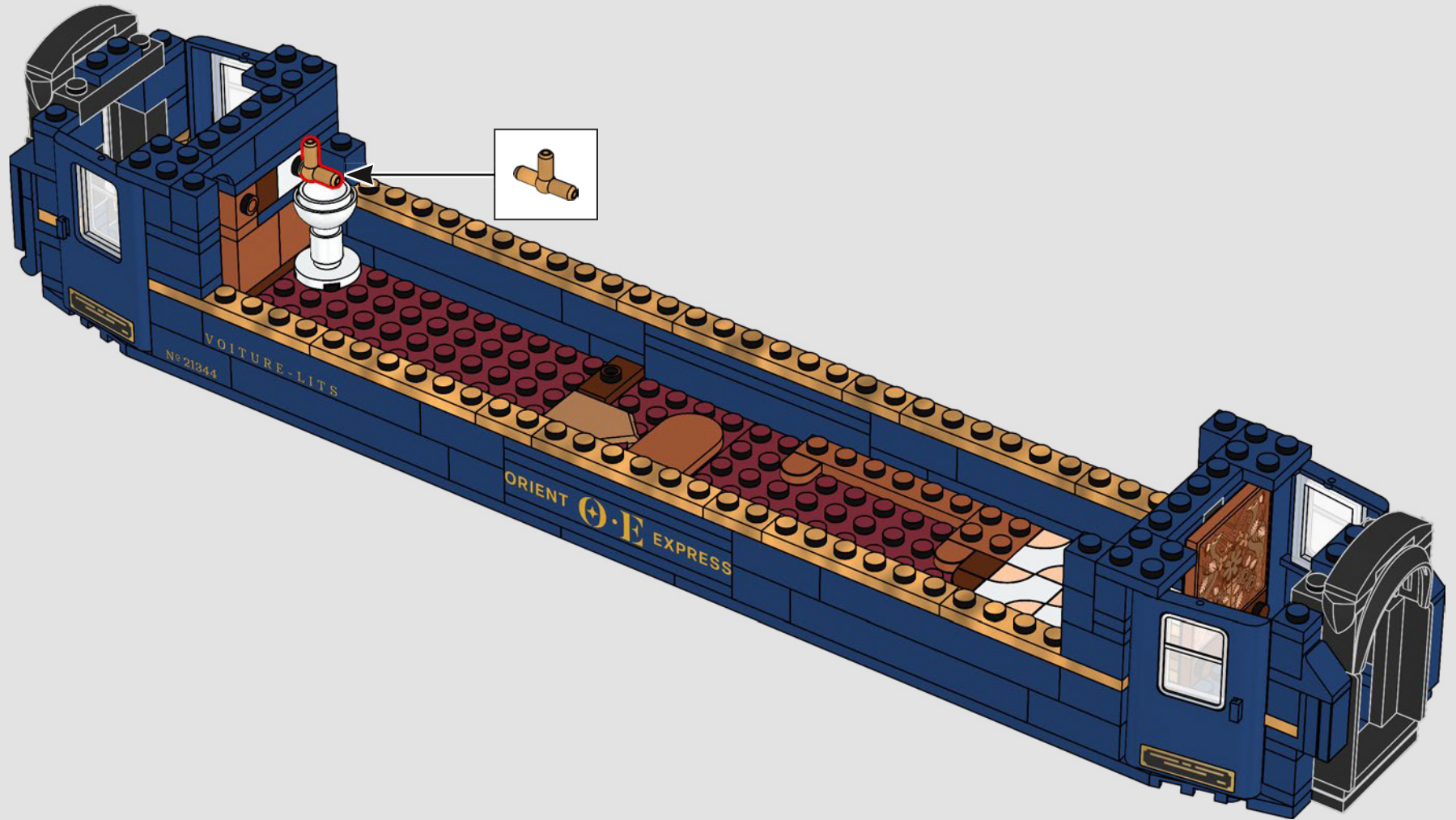

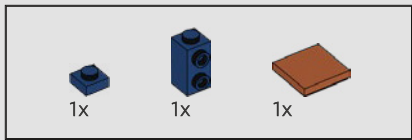

171

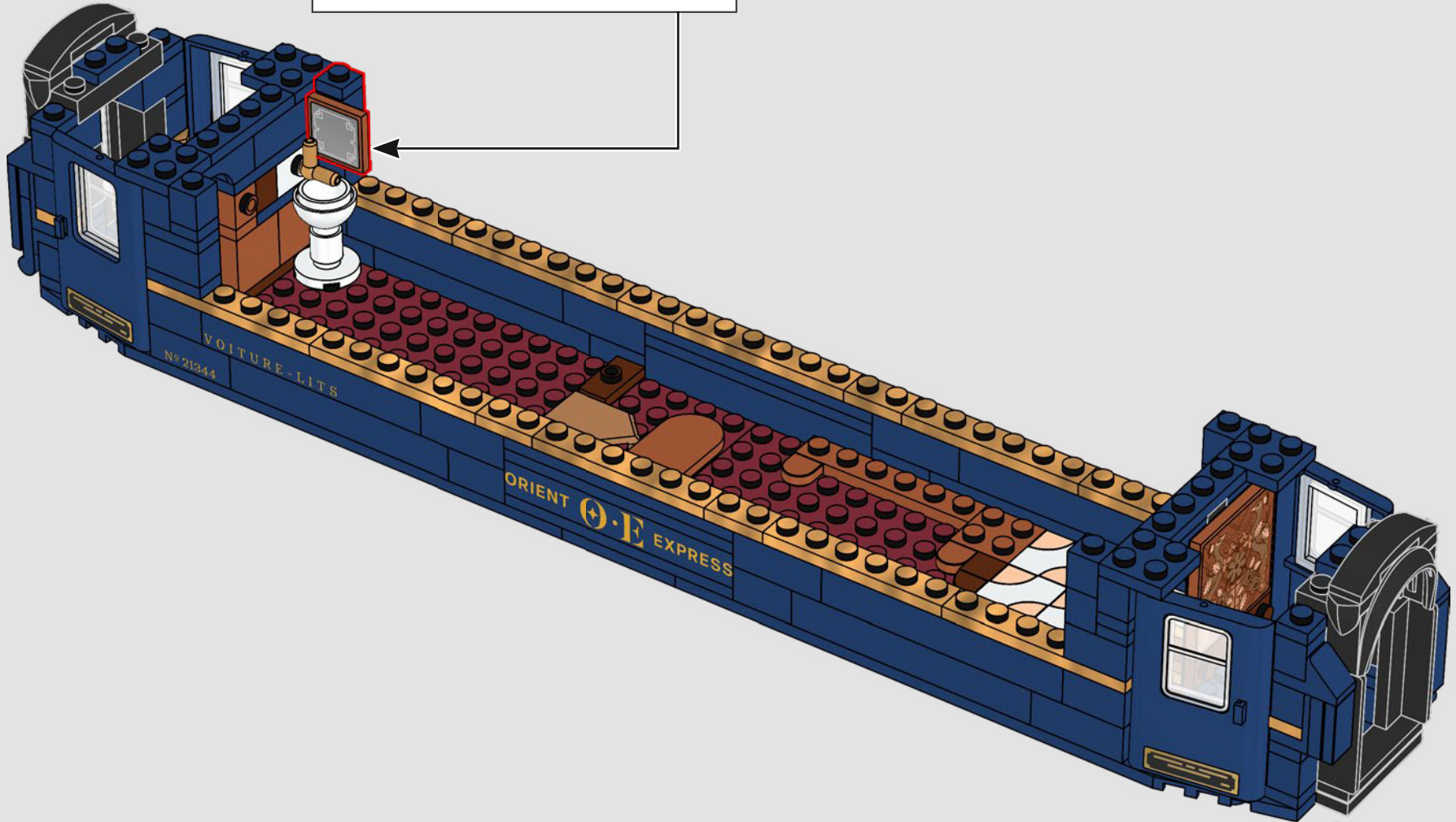
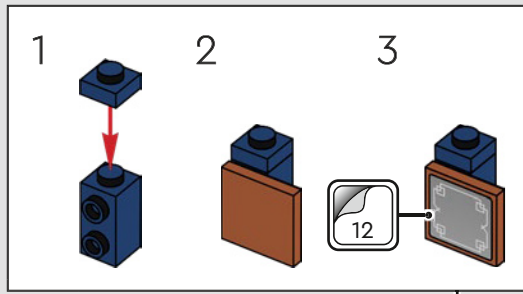

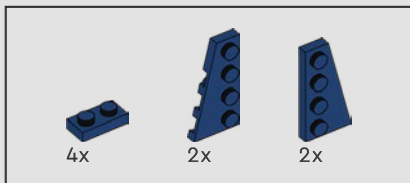

172

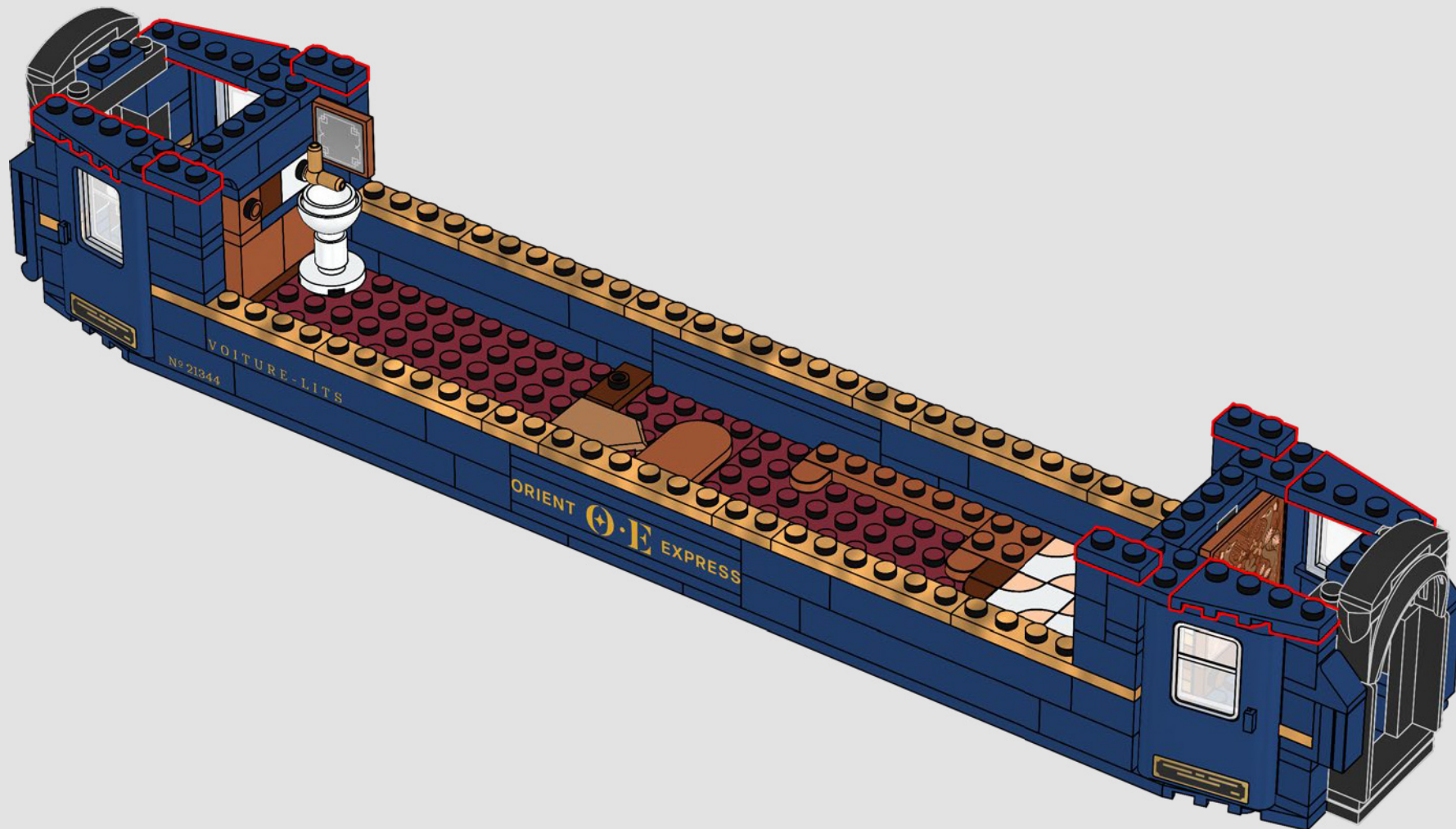

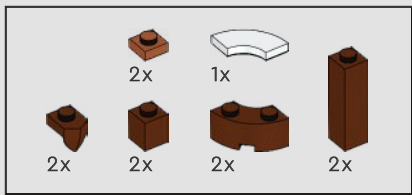

173

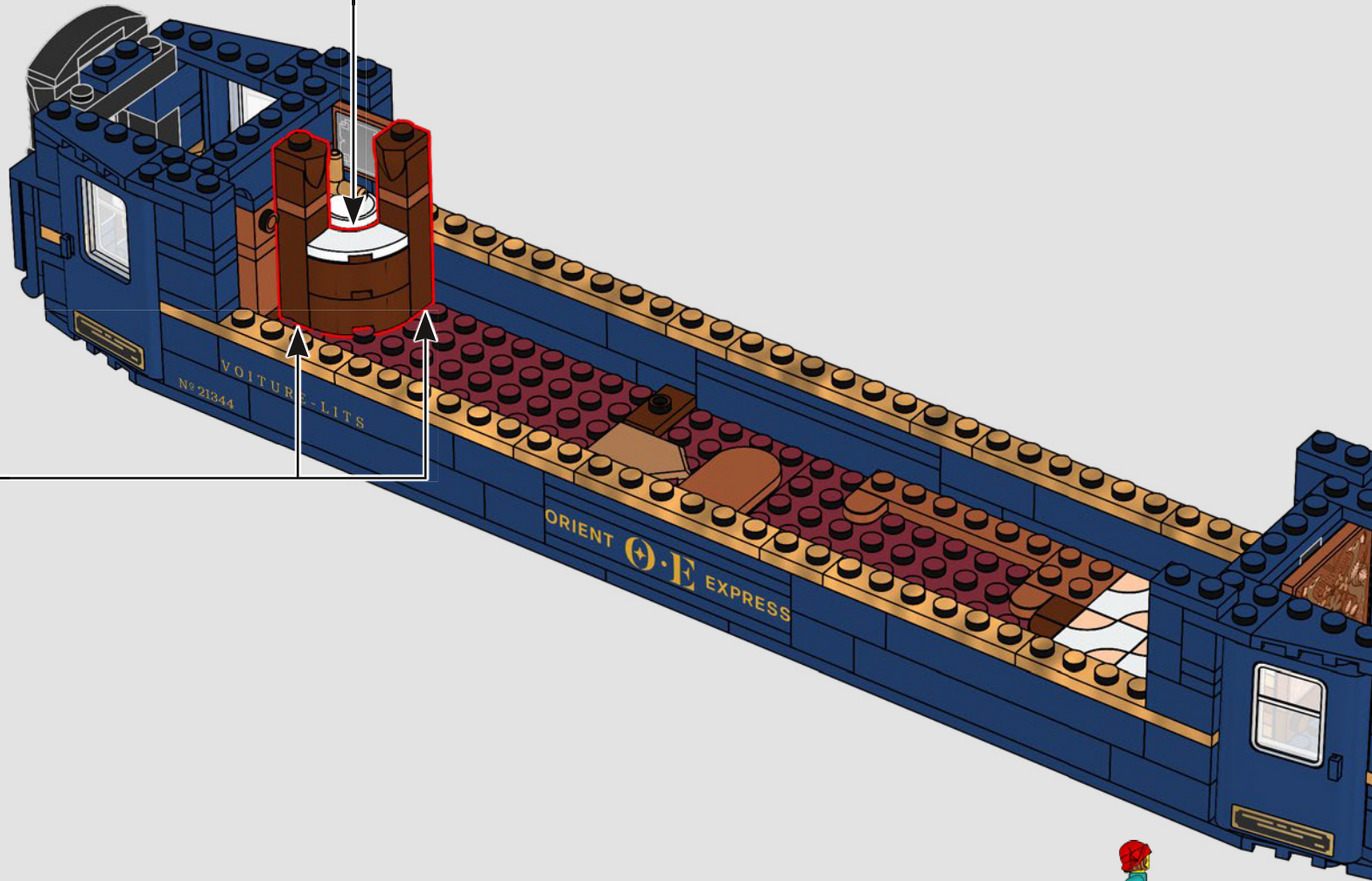
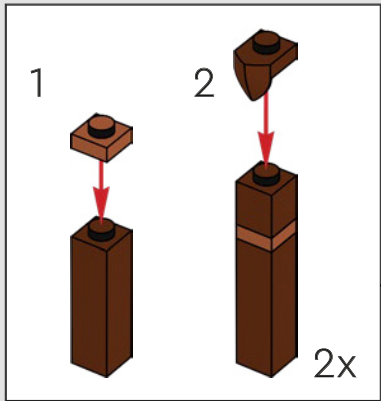
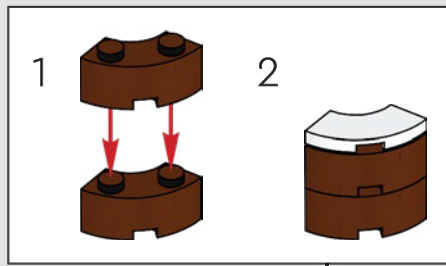

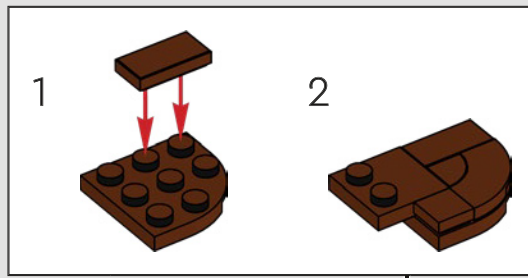
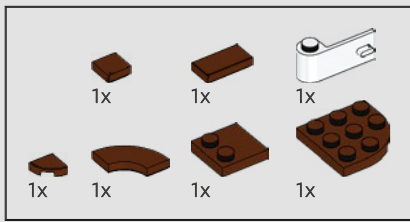

174

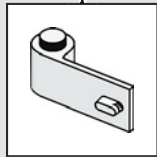
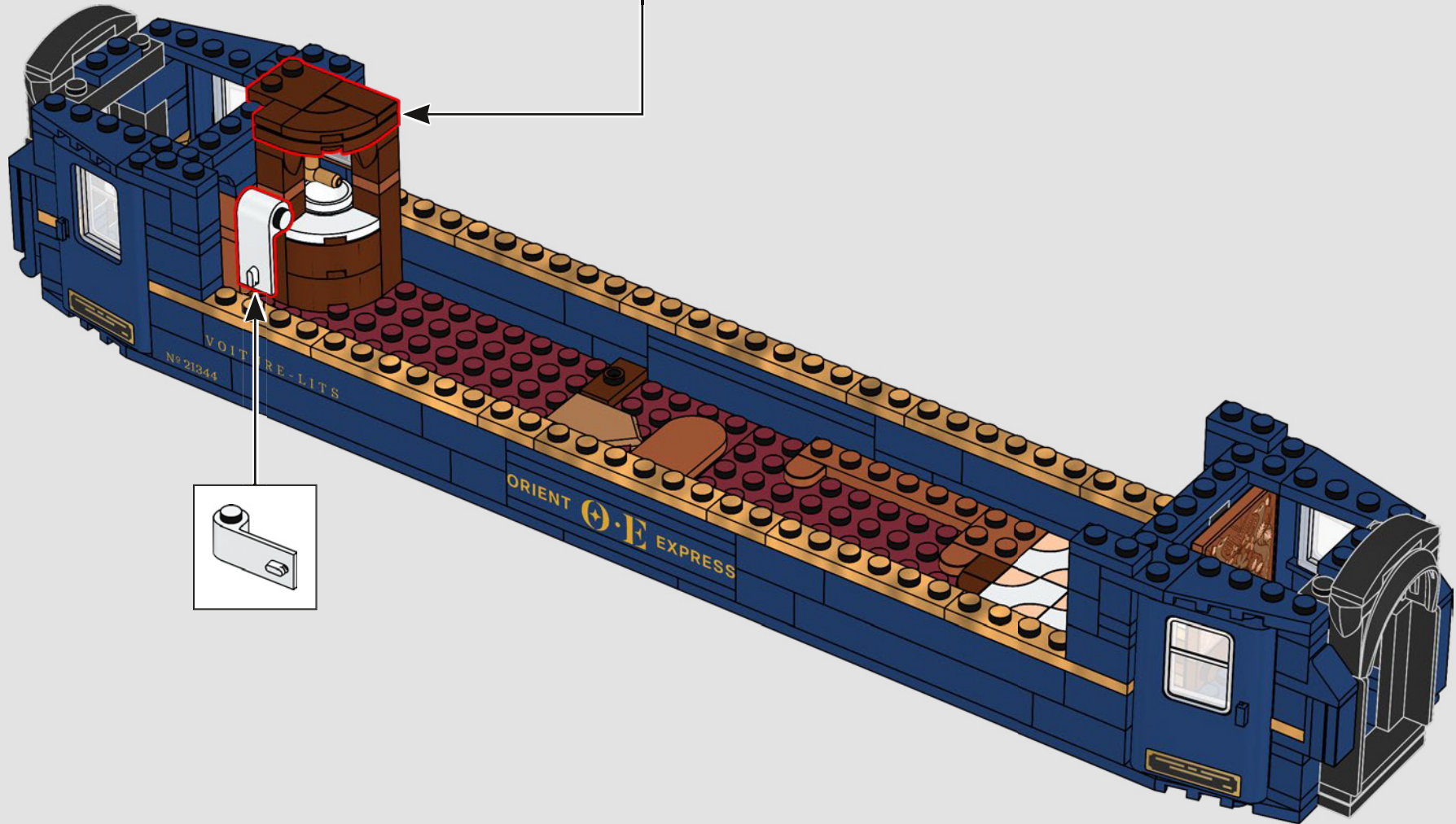



175

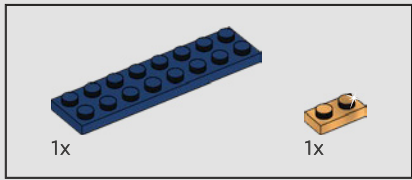
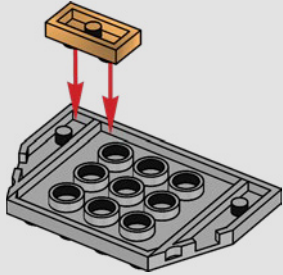

176

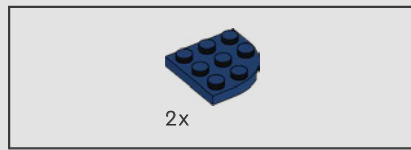
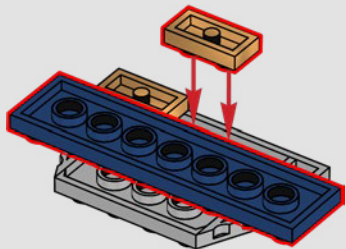

177

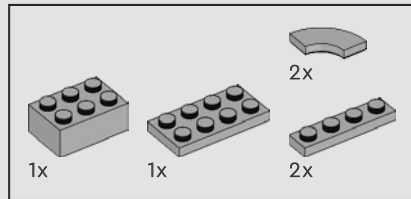
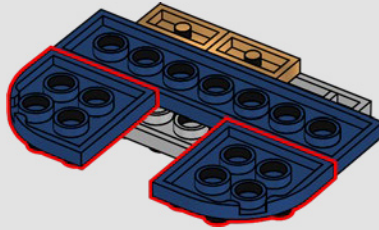

178

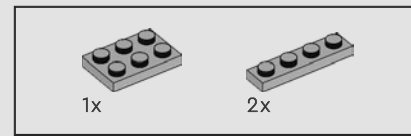
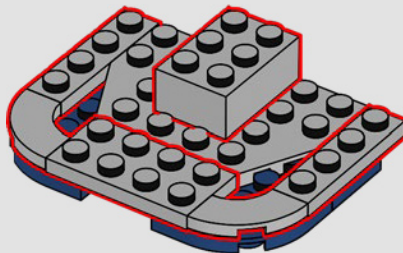

179

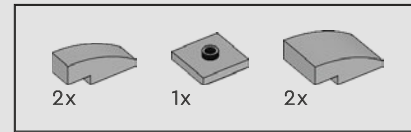
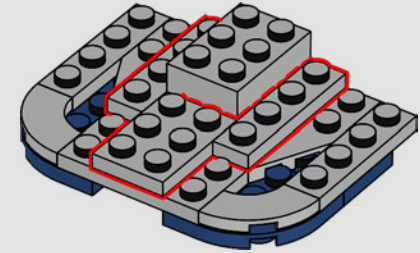

180

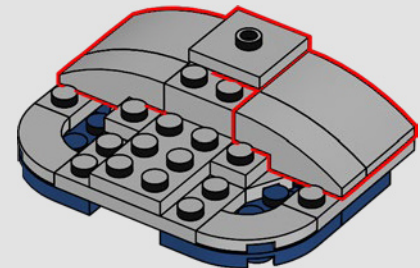



181

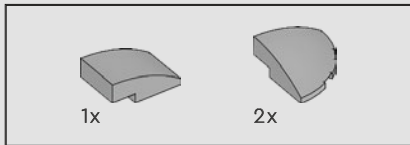
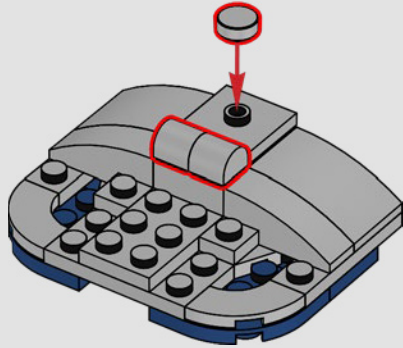

182

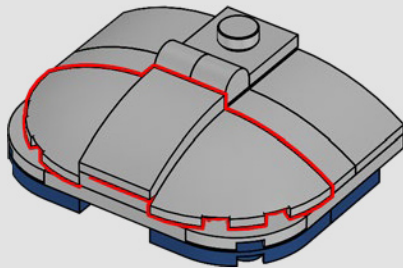

183

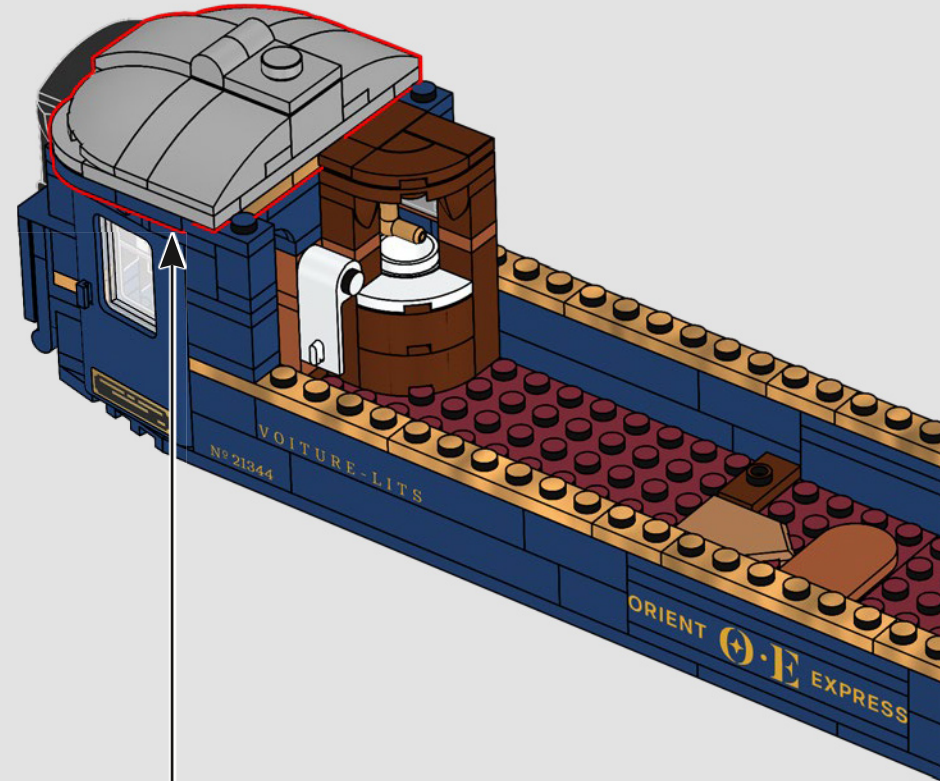

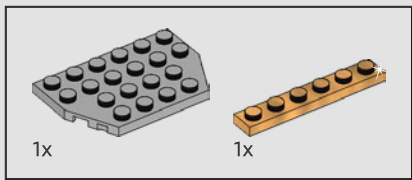

184

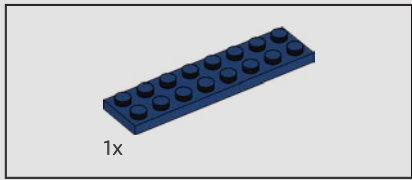
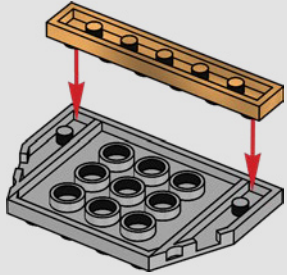

185

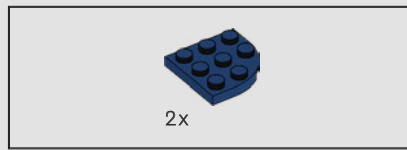
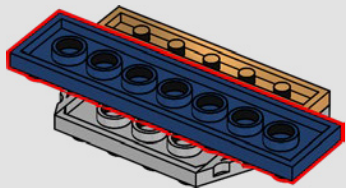

186

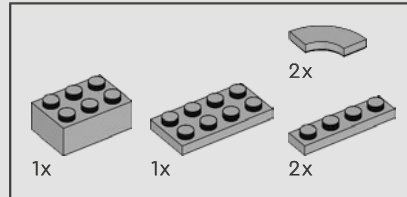
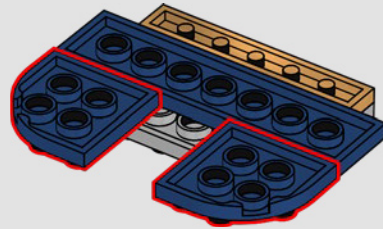

187

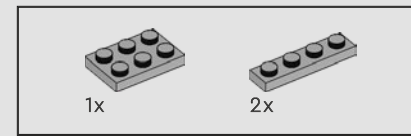
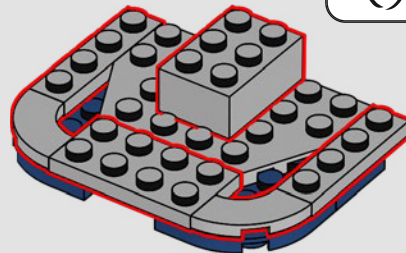

188

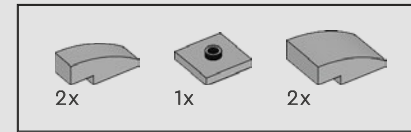
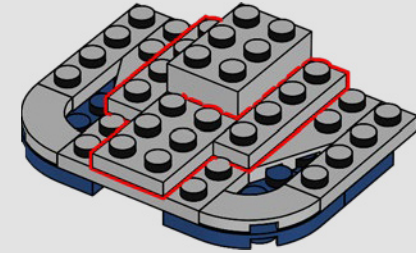

189

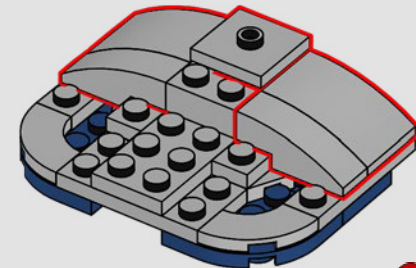

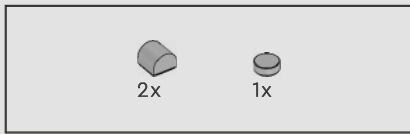

190

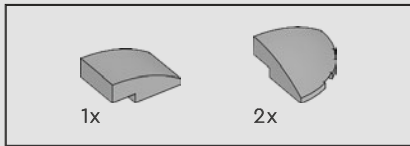
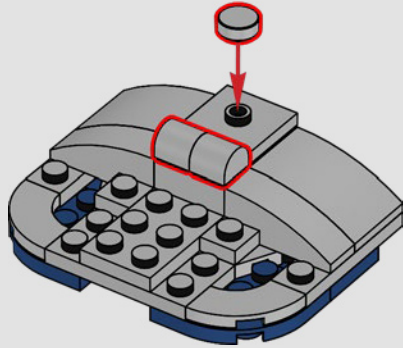

191

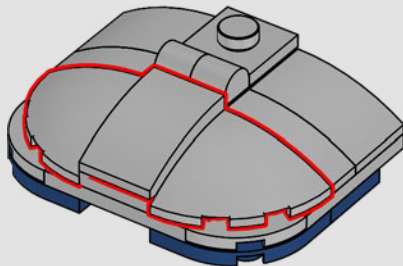

192

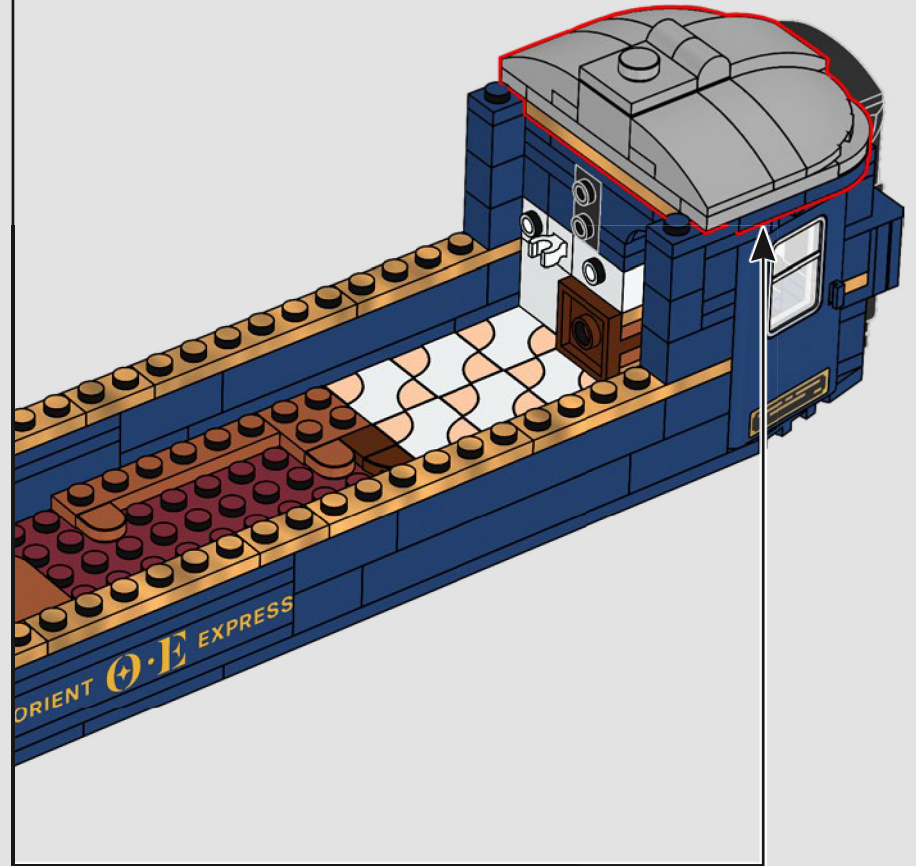

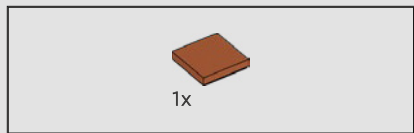

193

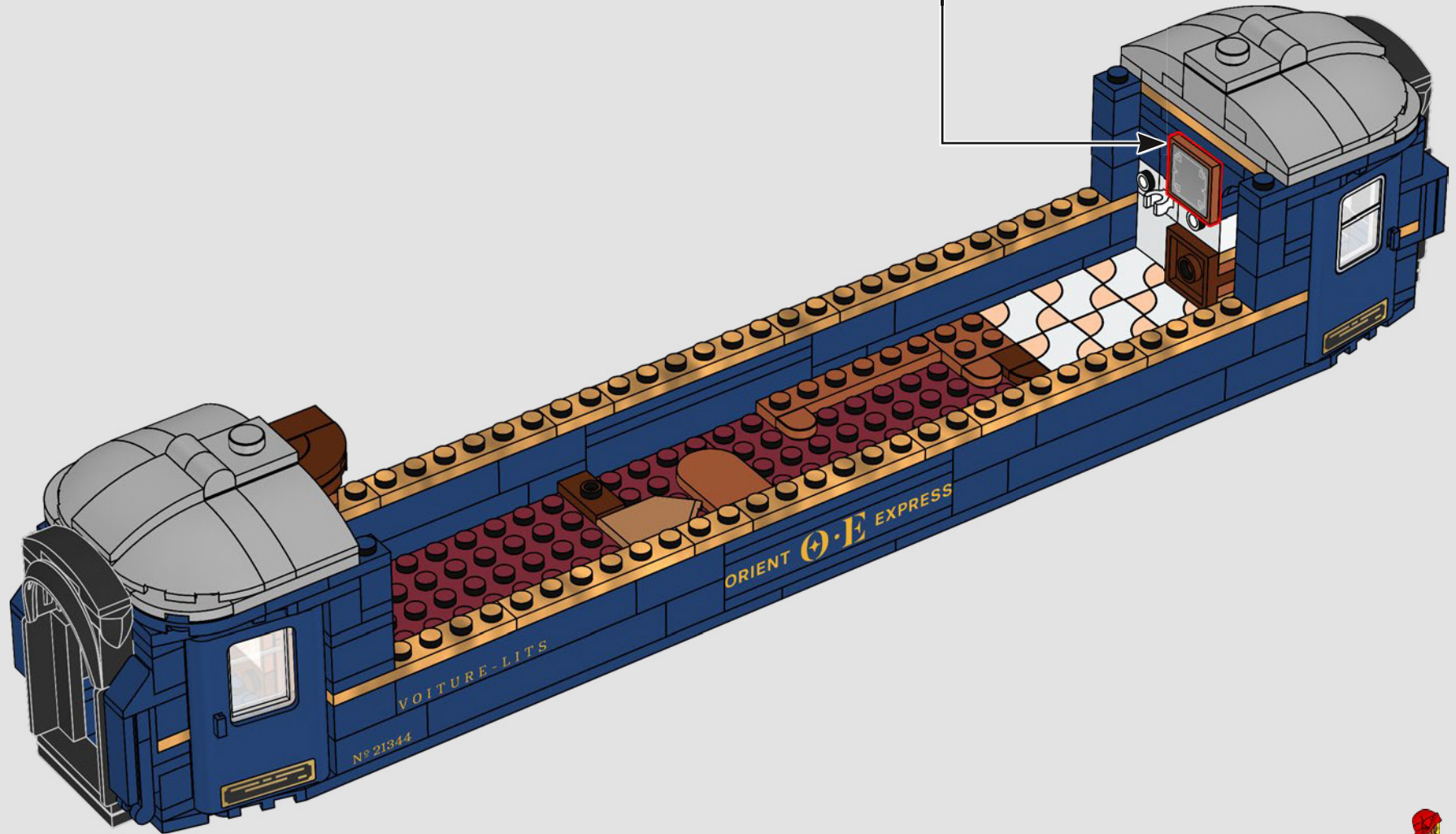
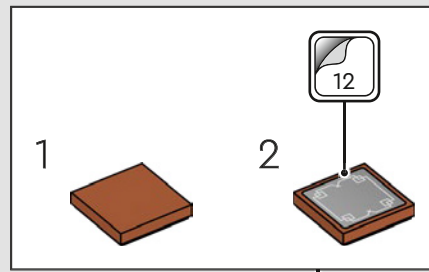

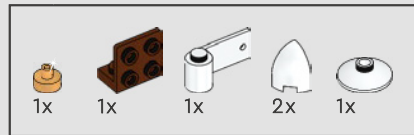

194

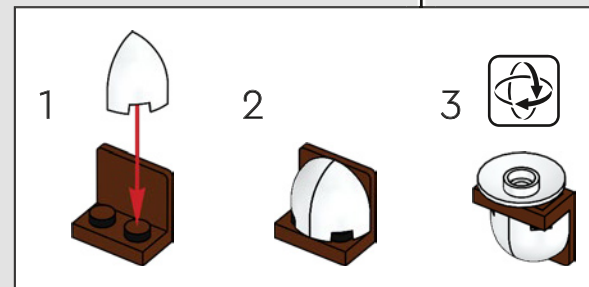
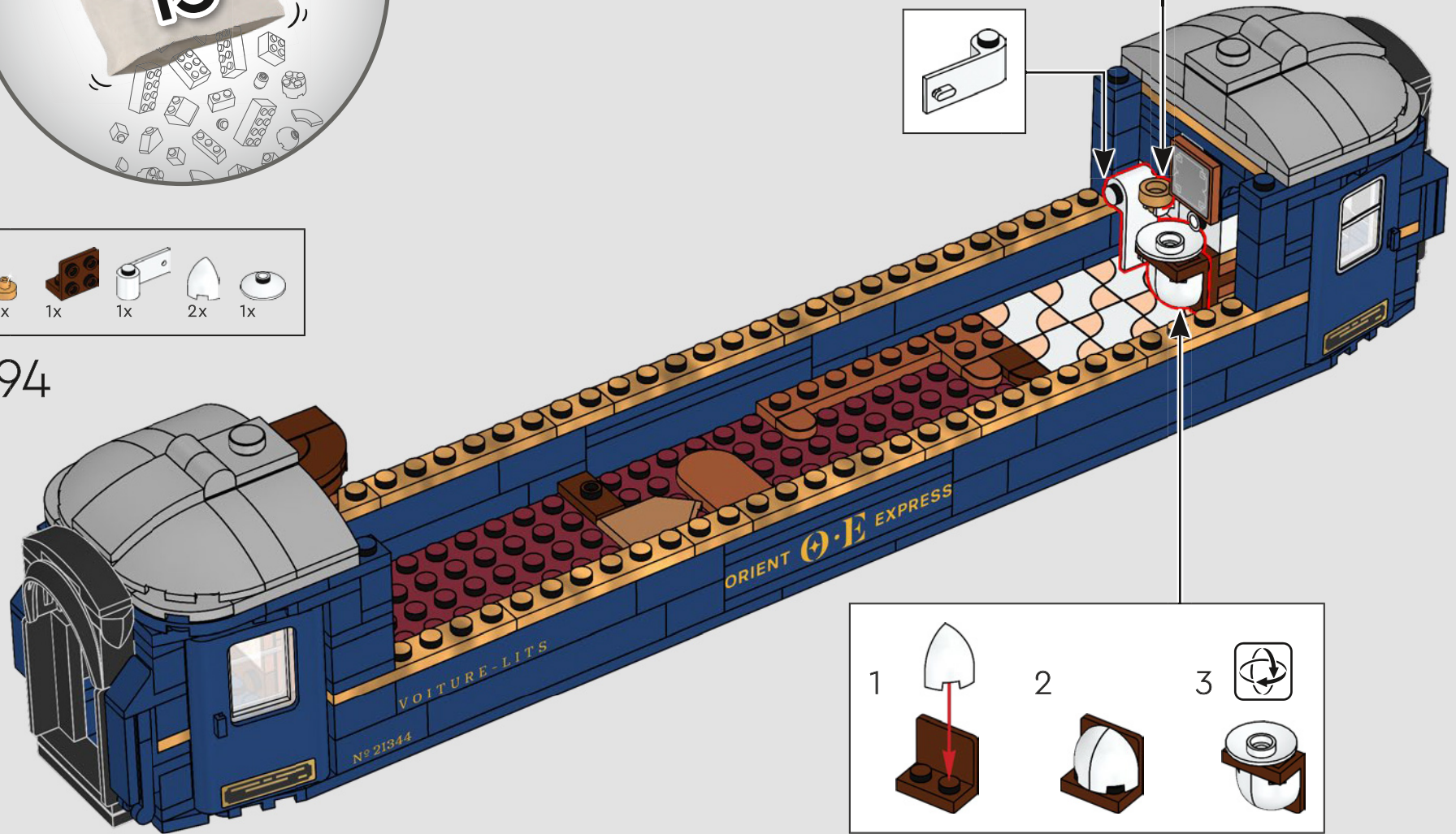

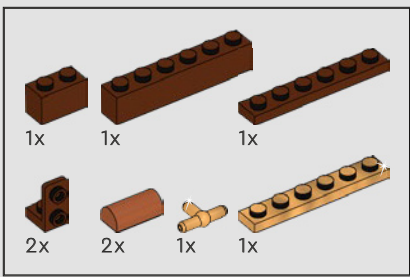

195

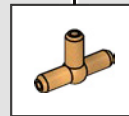
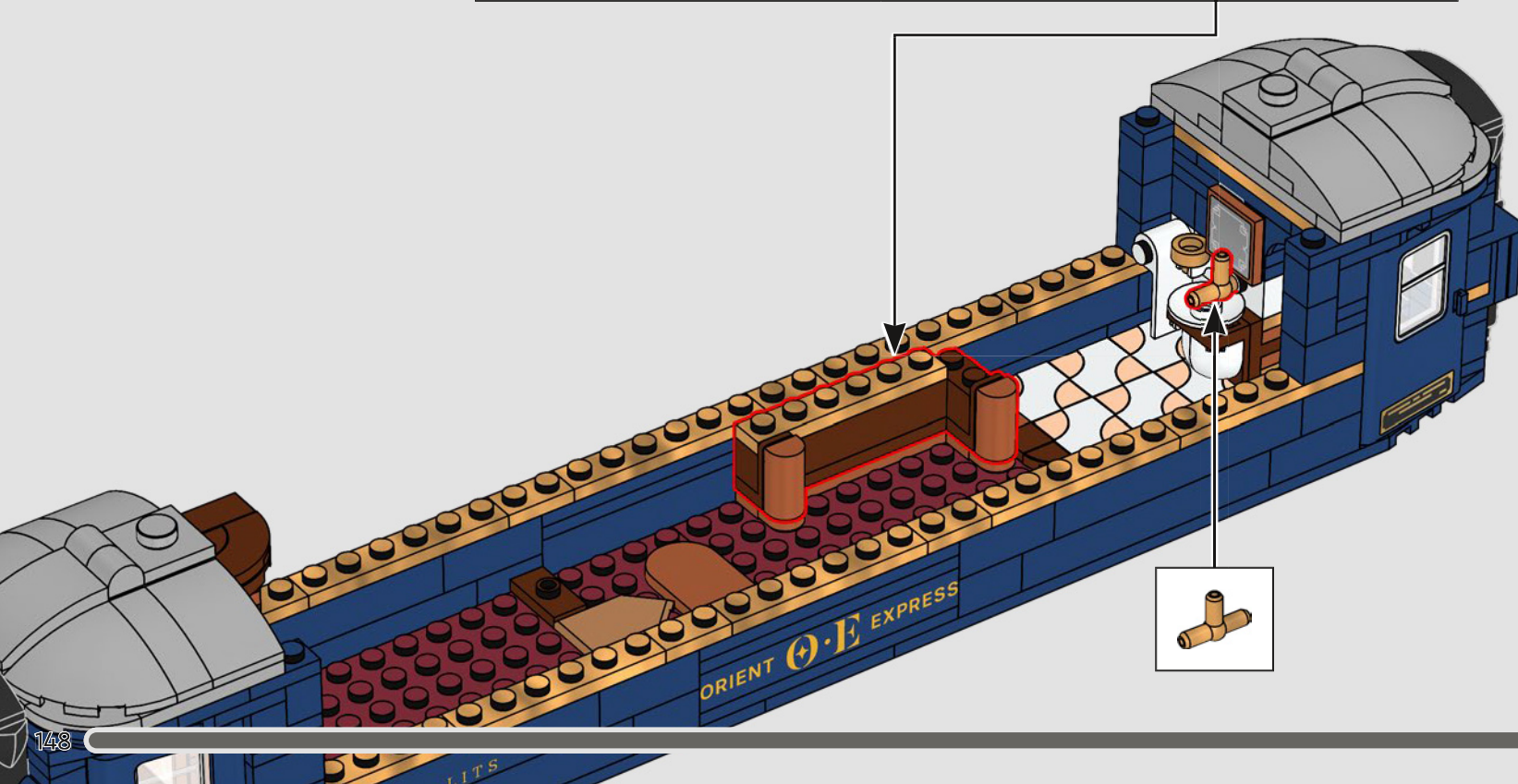
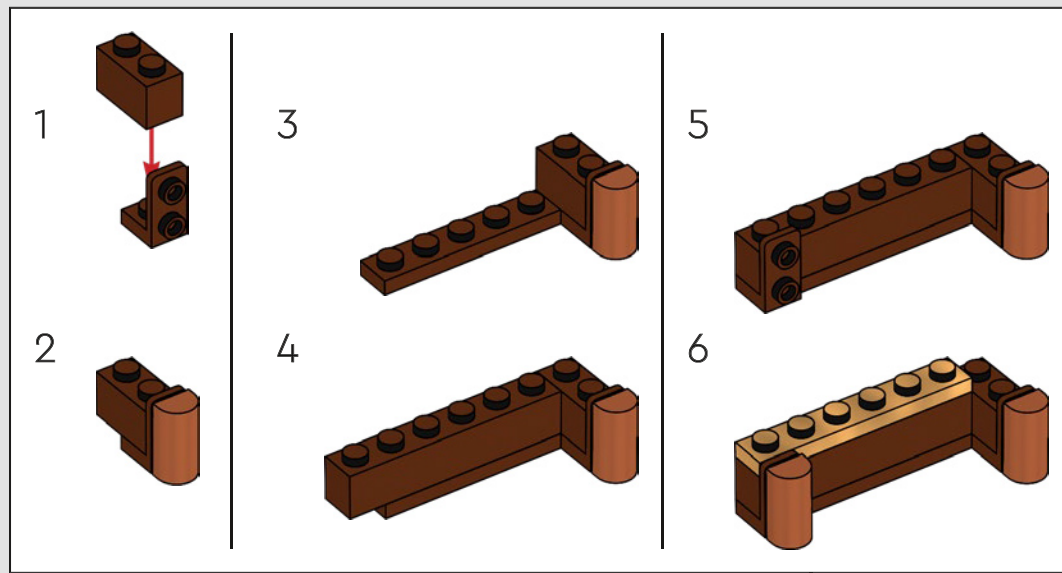

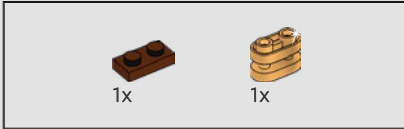
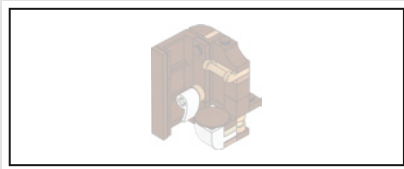

196

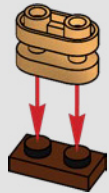

197



198

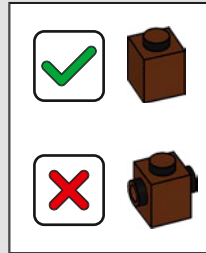

199

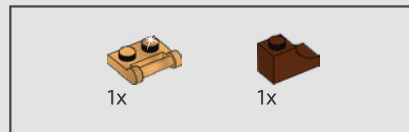

200

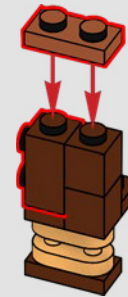
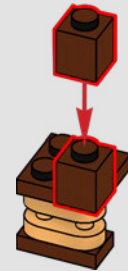

201

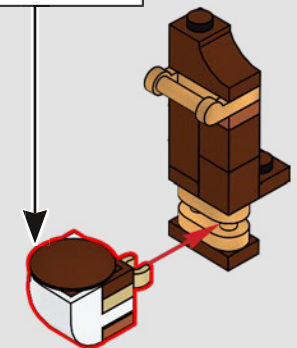
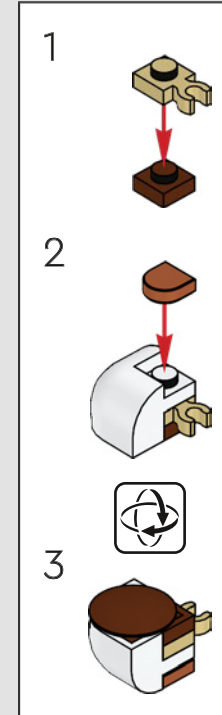

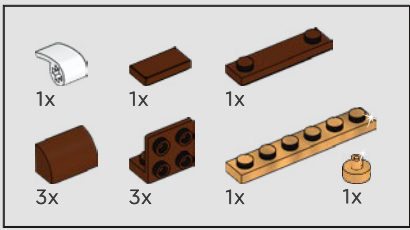

202

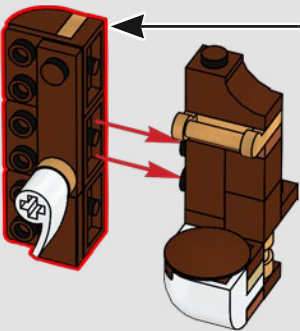
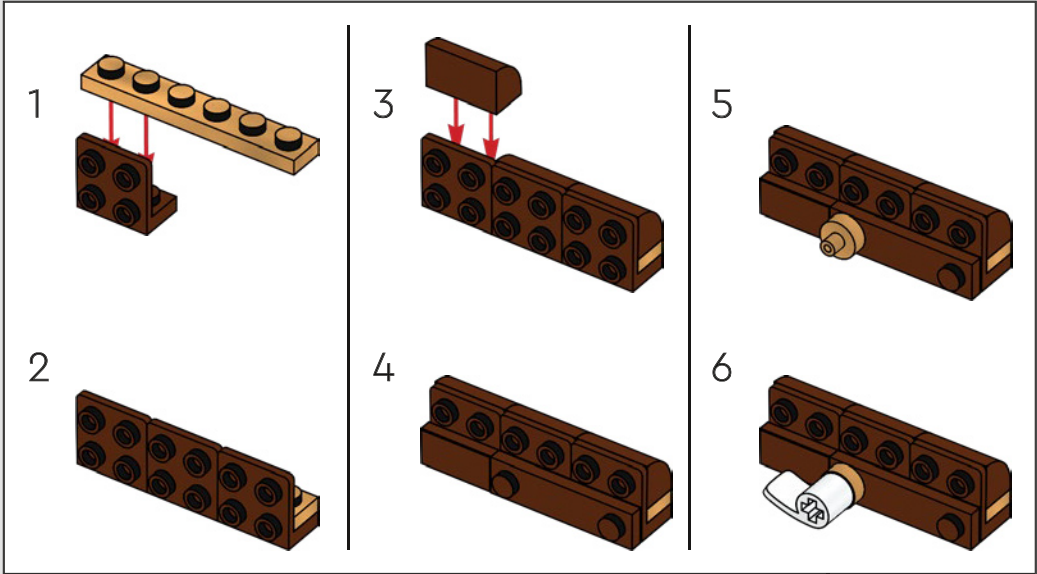

203

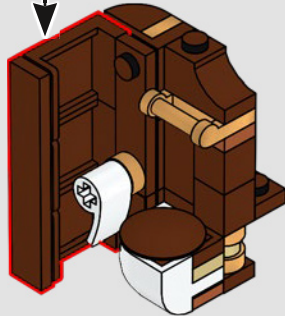
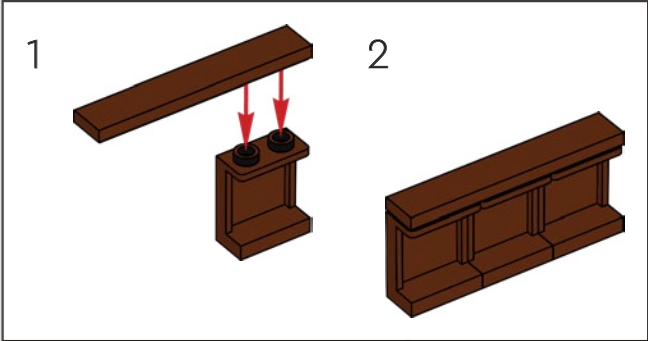

204

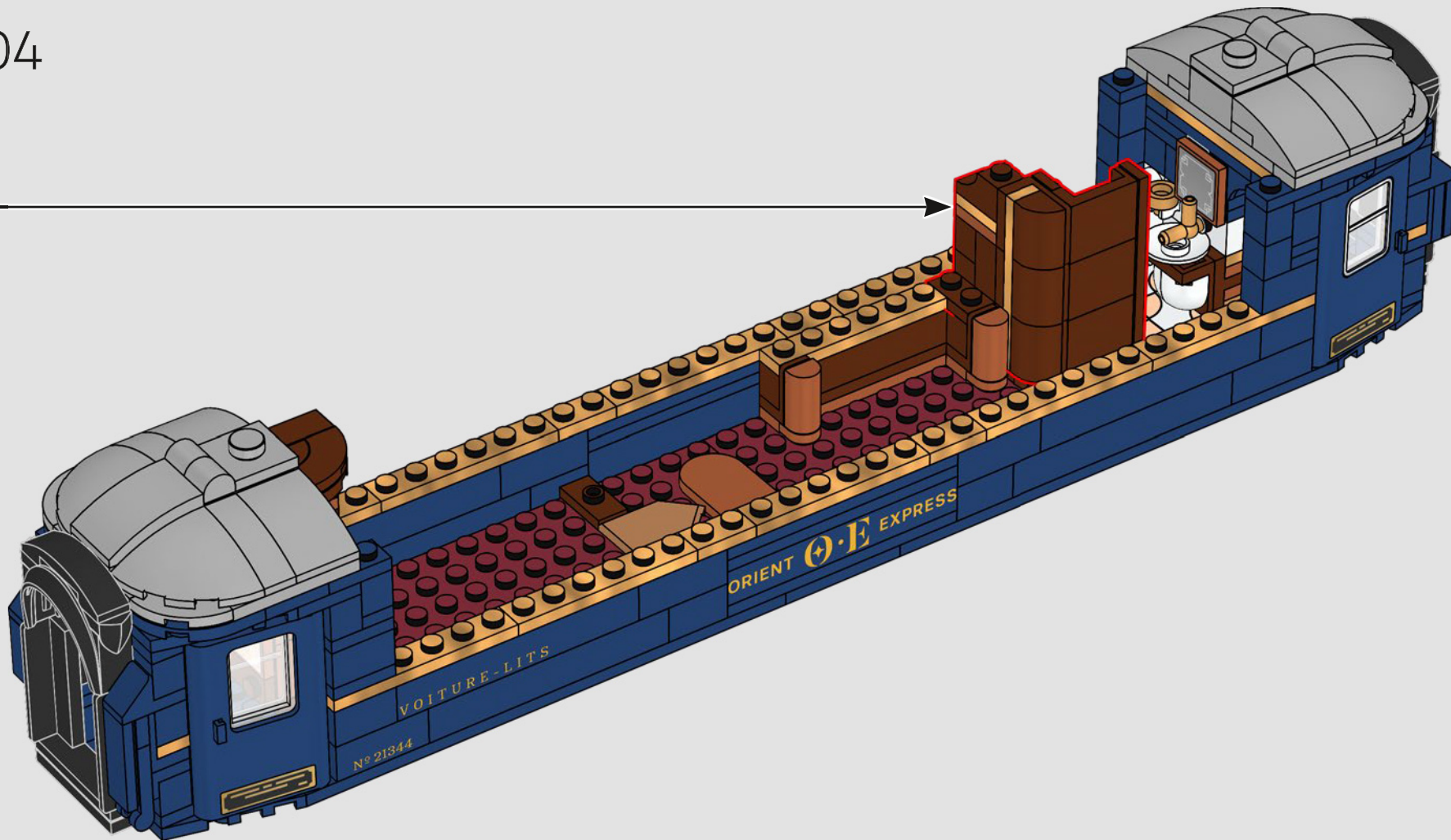

« Les wagons de première classe disposent d'une salle de bain privée avec de sublimes carreaux. »

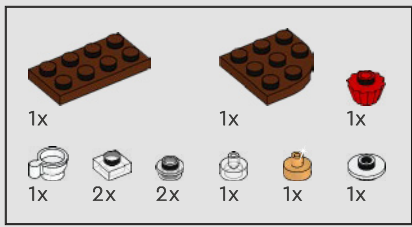

205

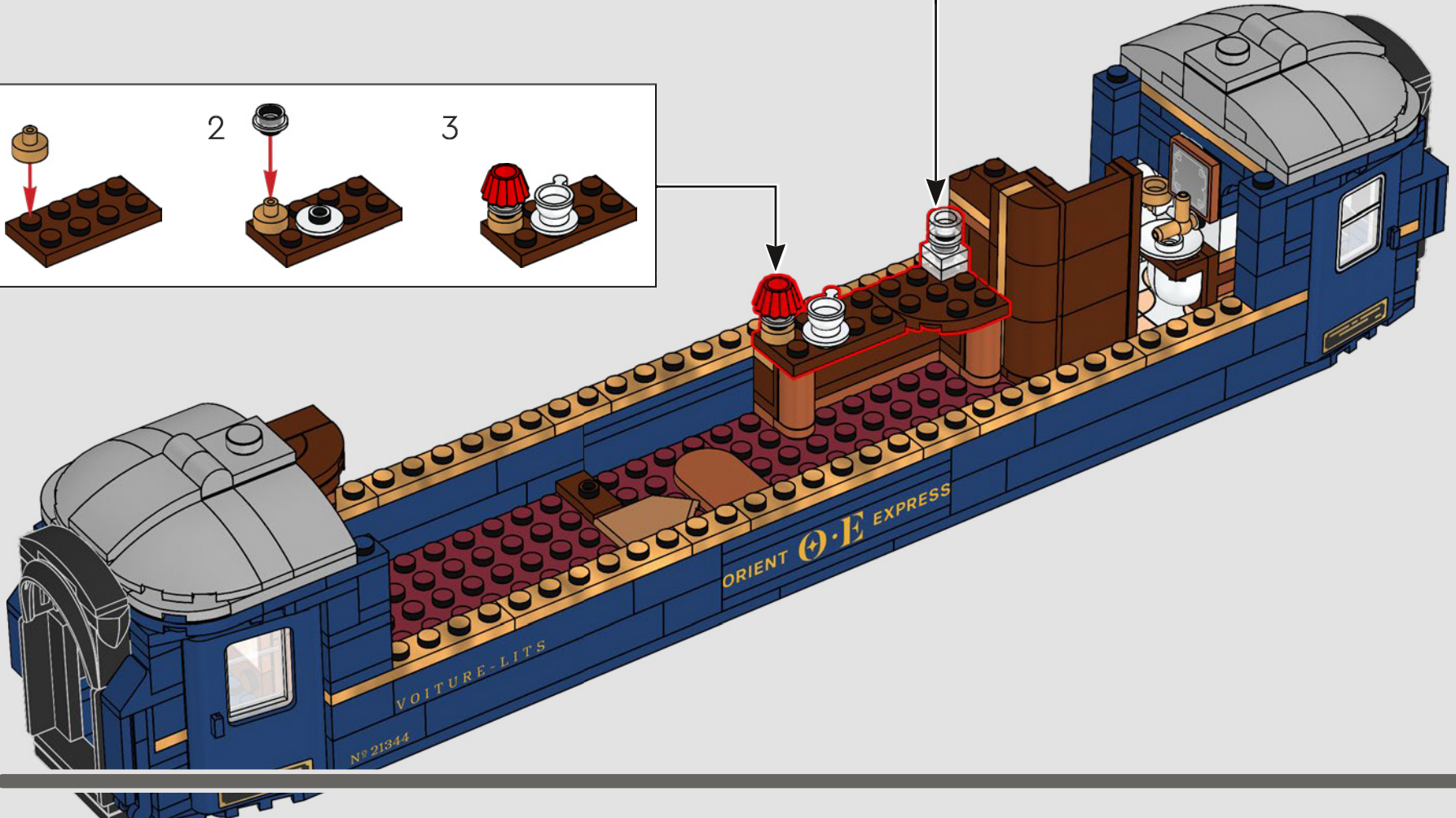
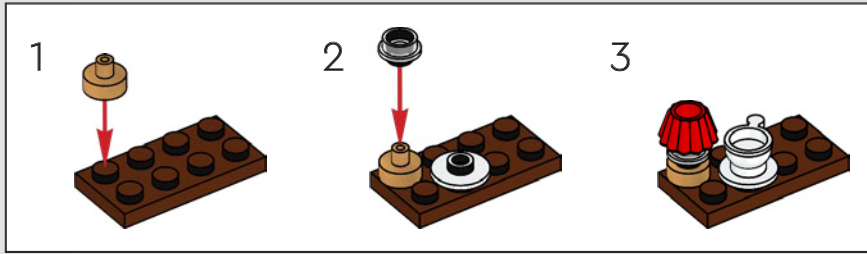
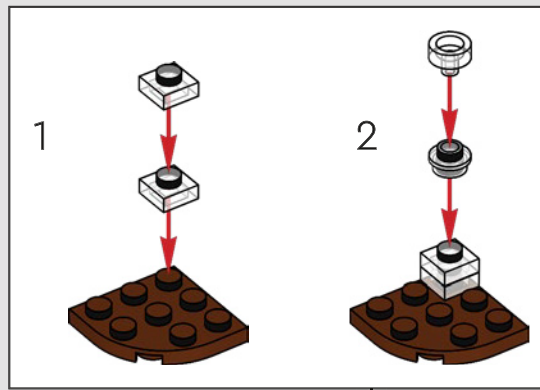

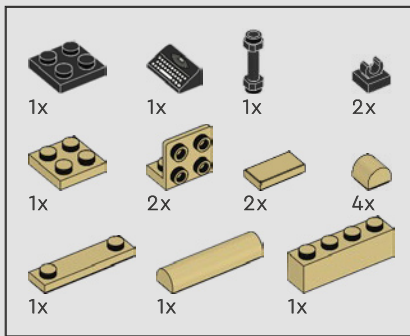

206

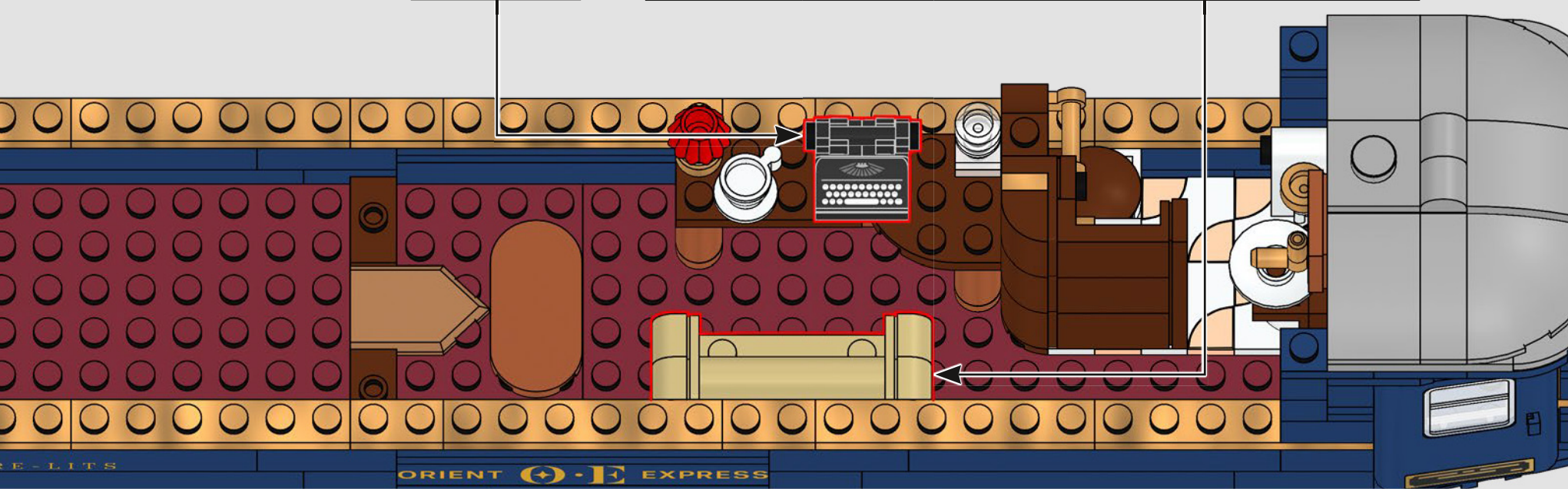
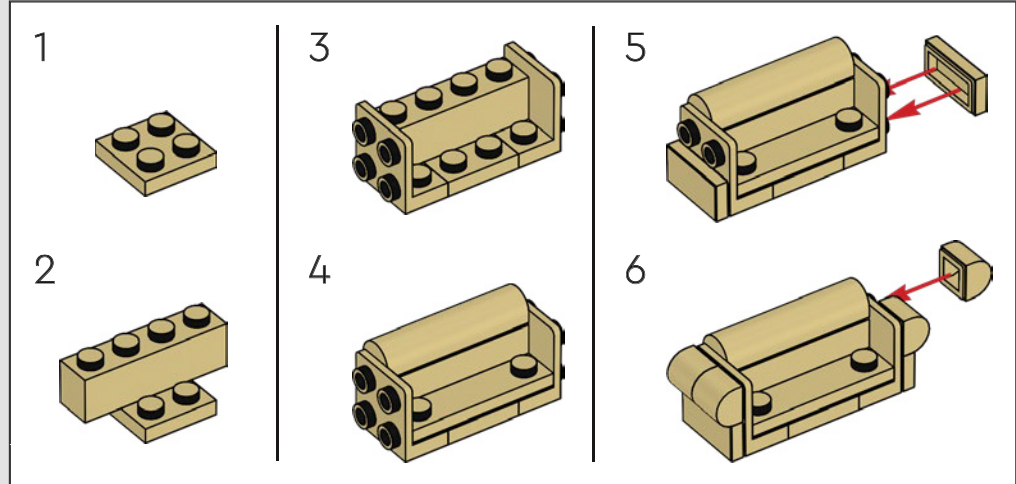
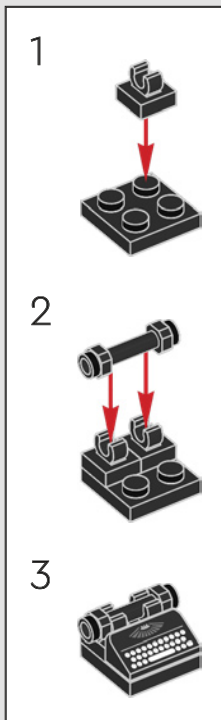

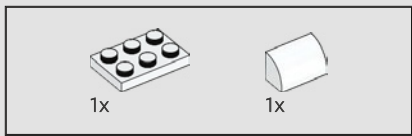

207

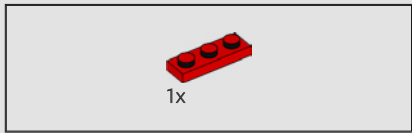
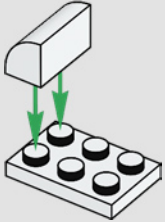

208

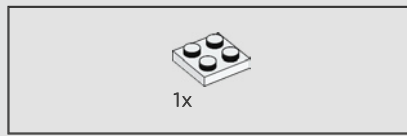
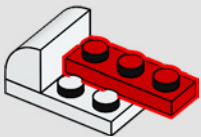

209

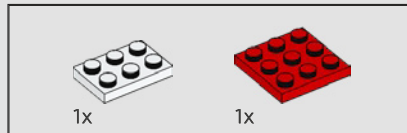
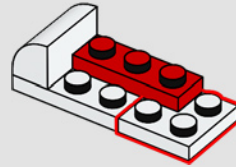

210

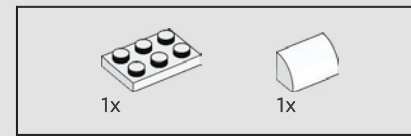
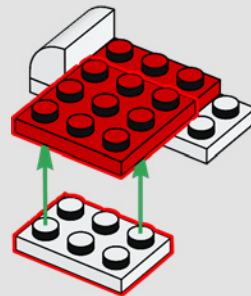

211

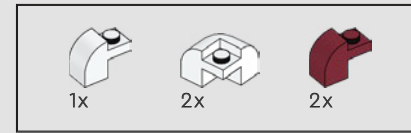
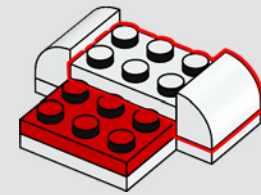

212

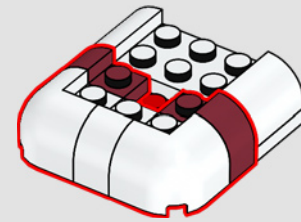

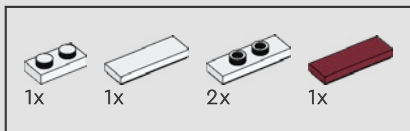

213

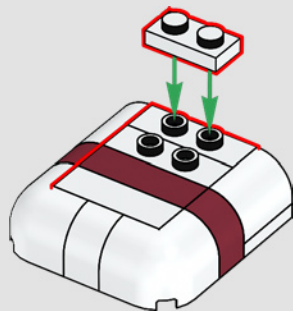

214

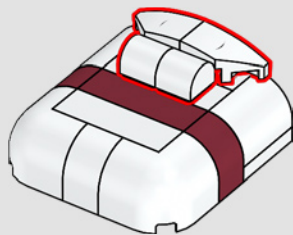

215

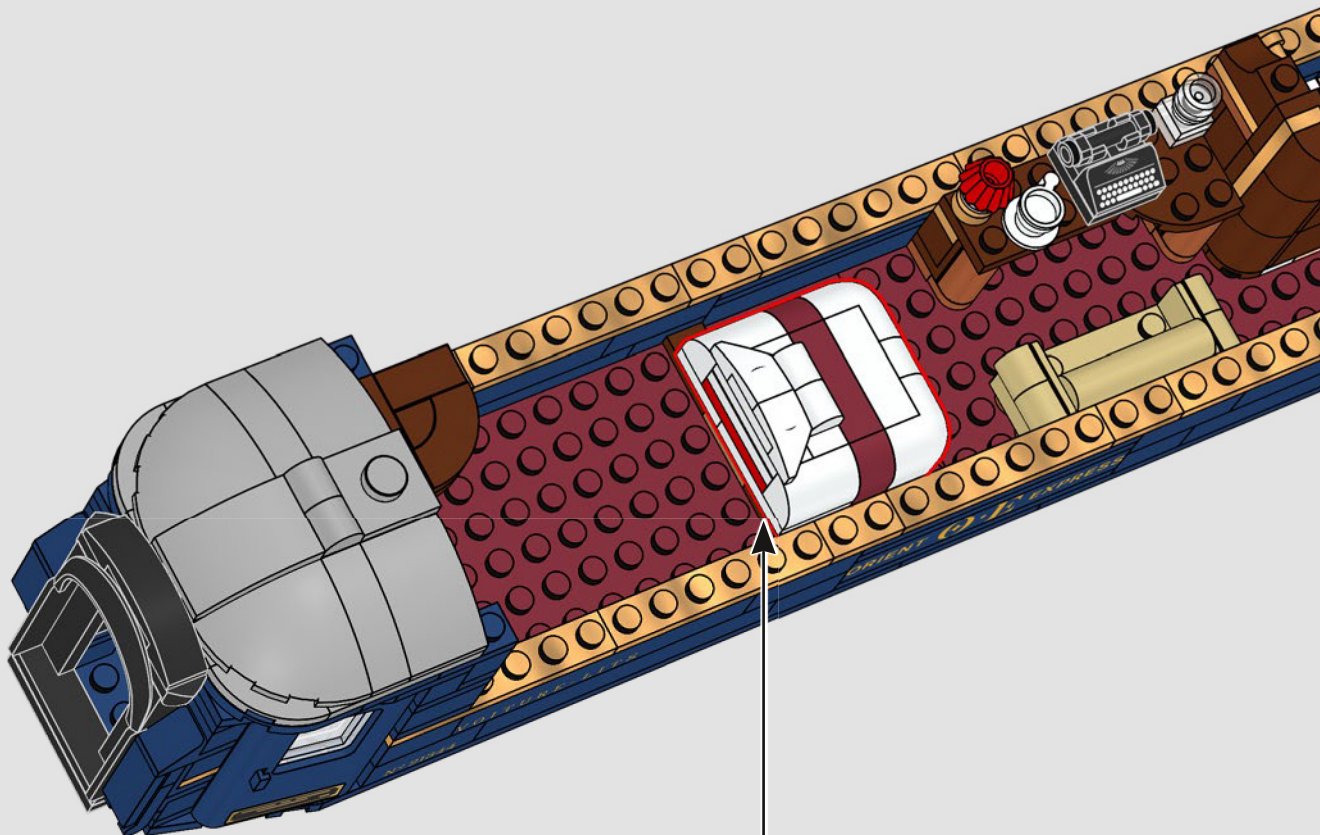

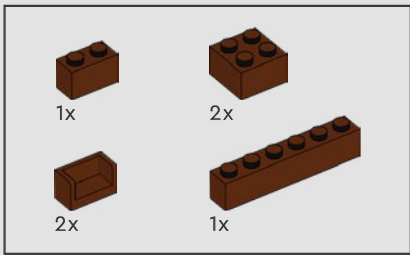

216

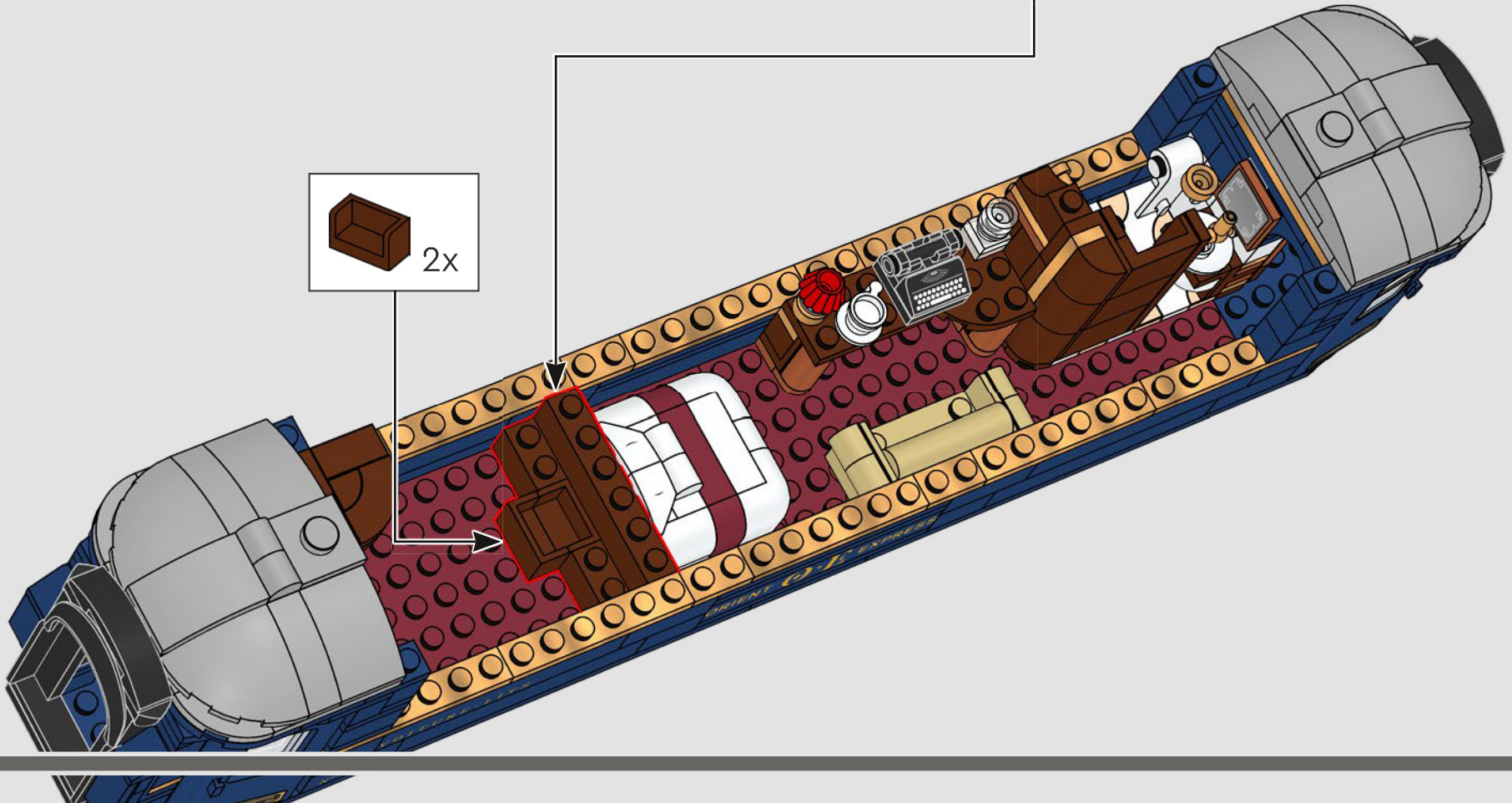
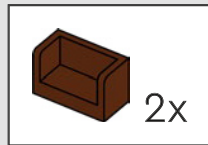
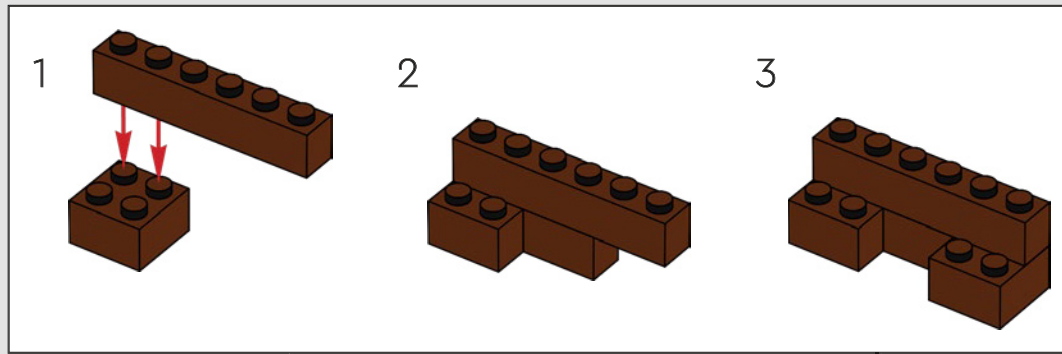



217

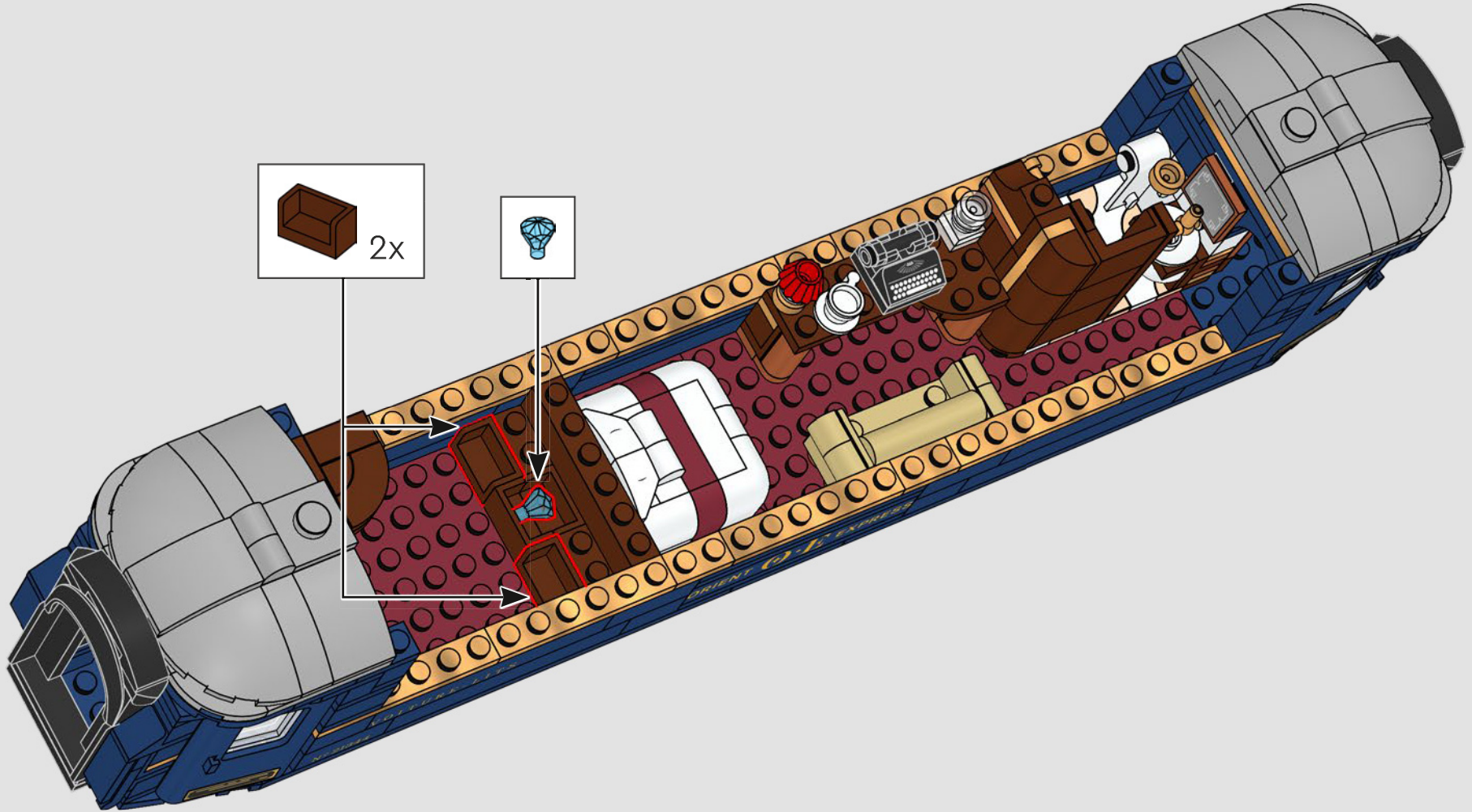

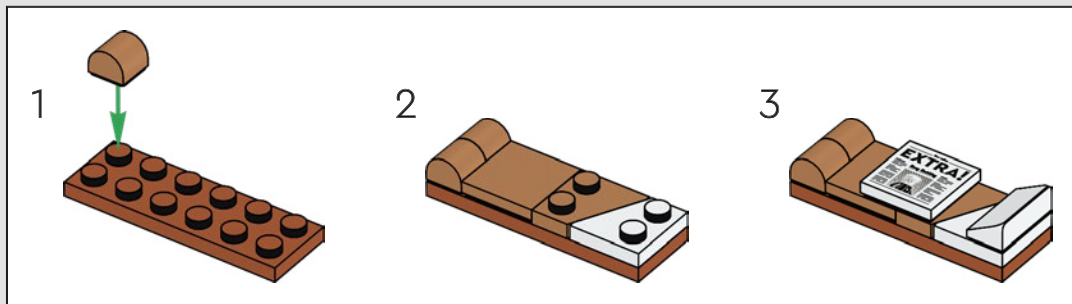
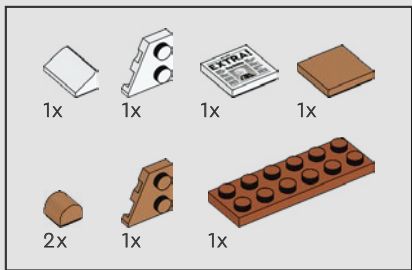

218

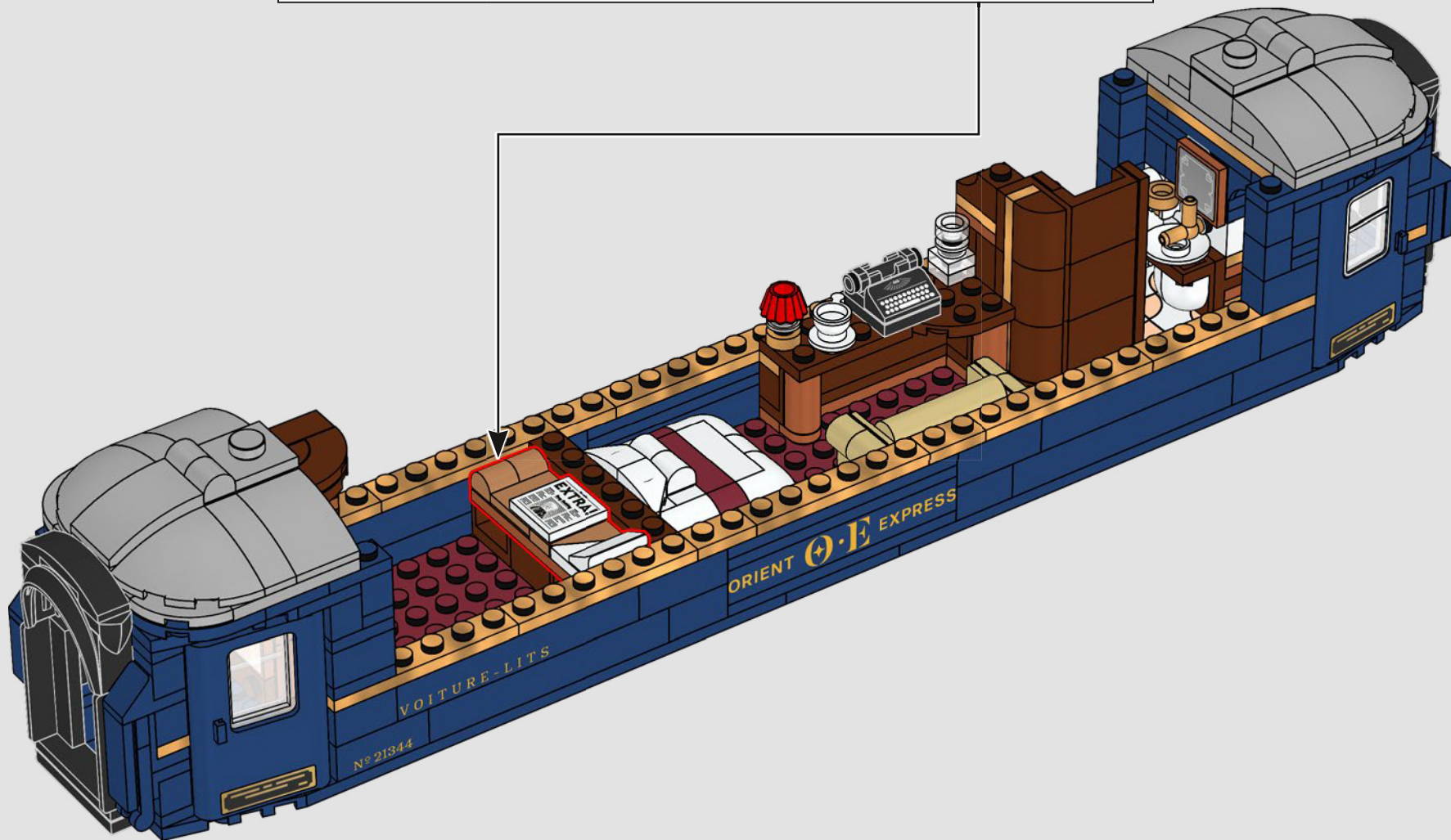



219

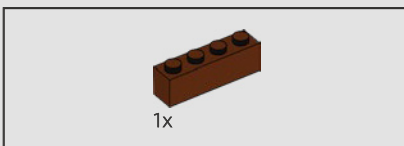
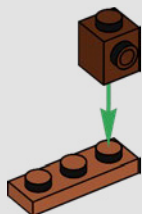

220

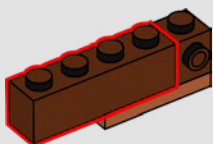

221

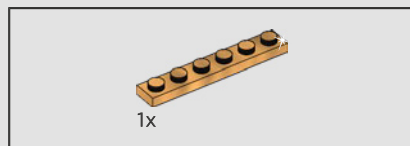
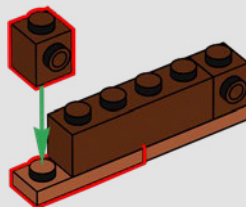

222

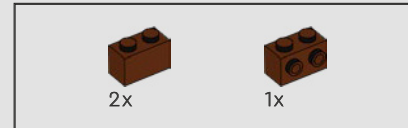
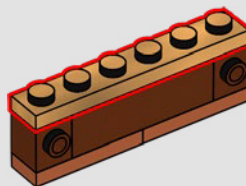

223

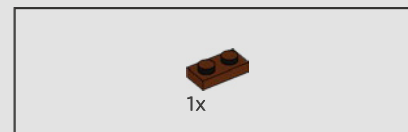
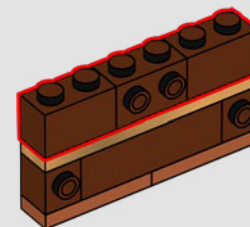

224

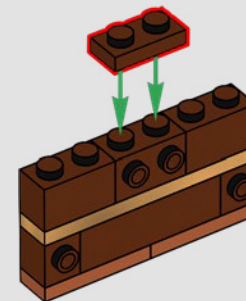



225

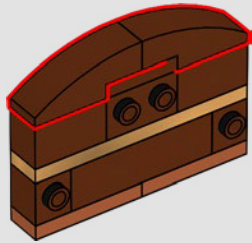

226

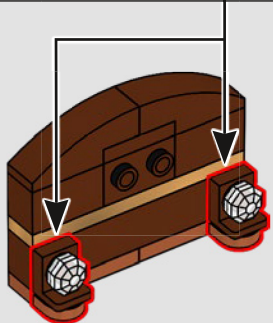
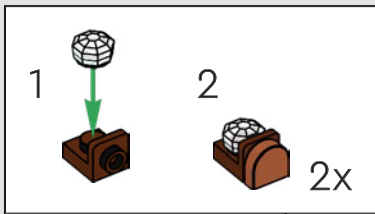

227

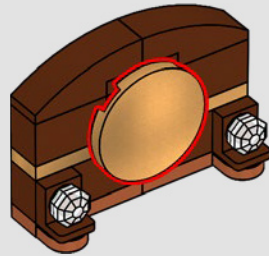

228

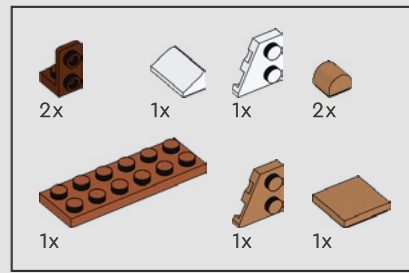
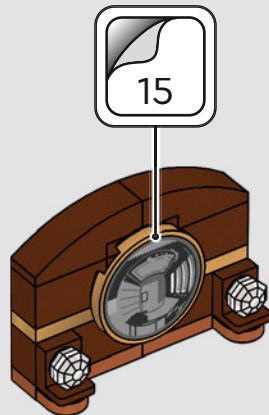

229

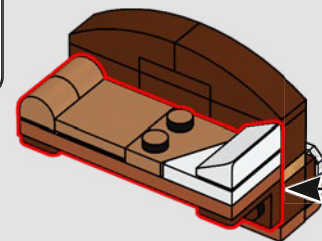
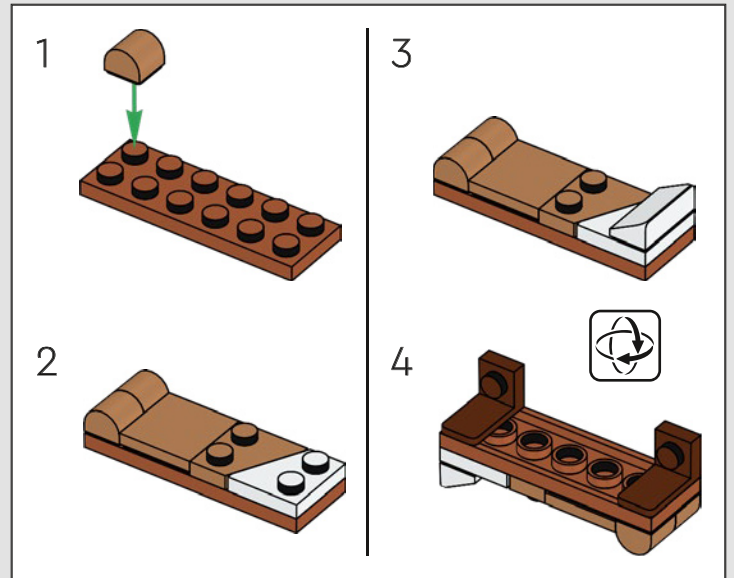

230

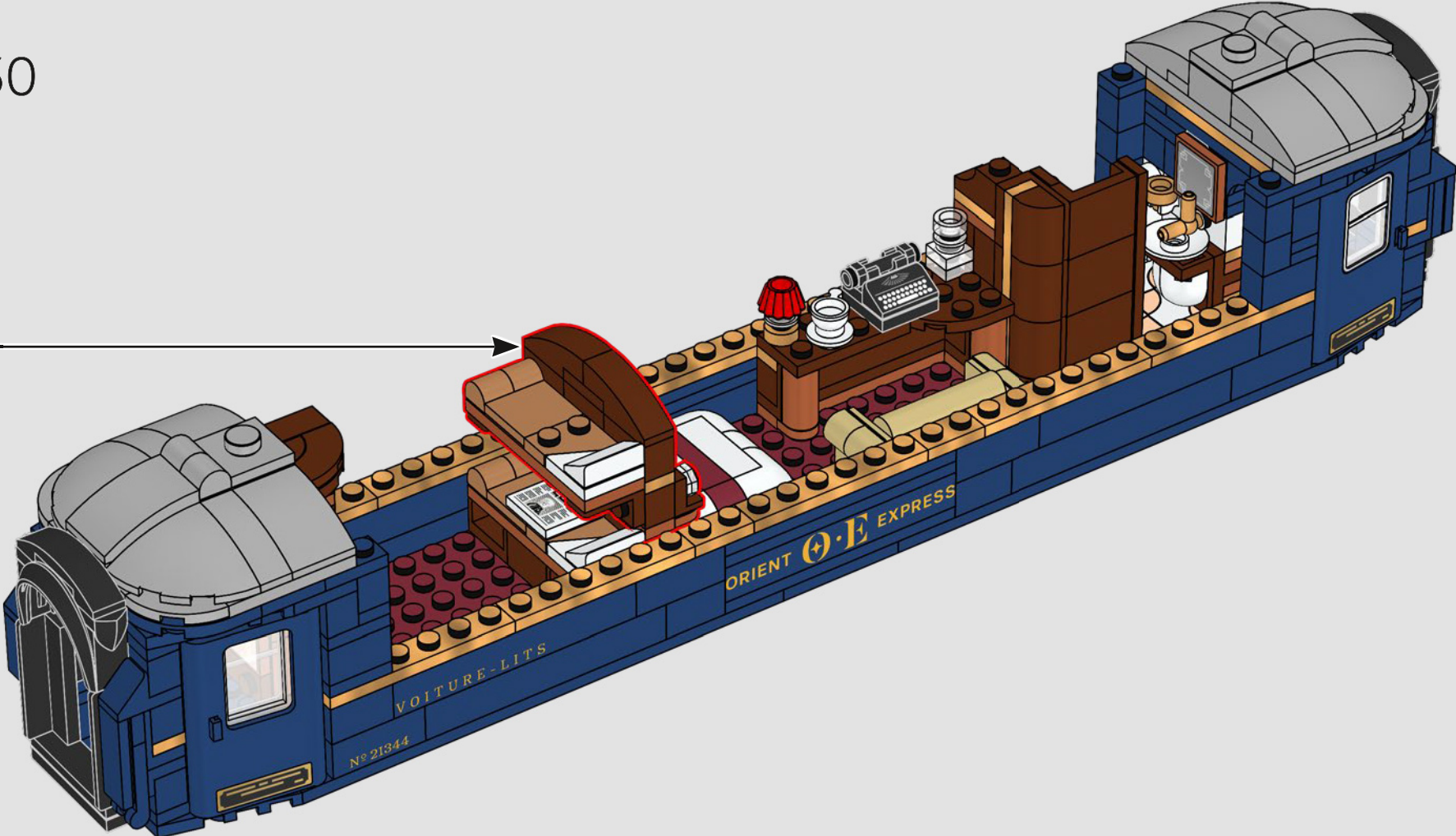

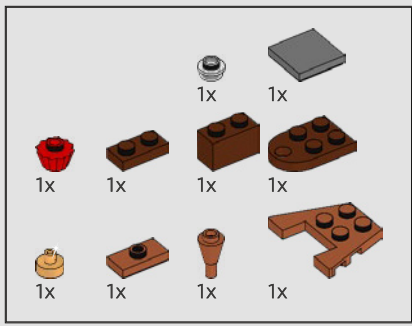

231

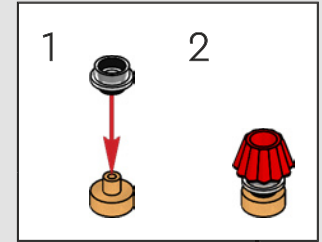
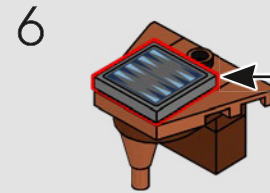
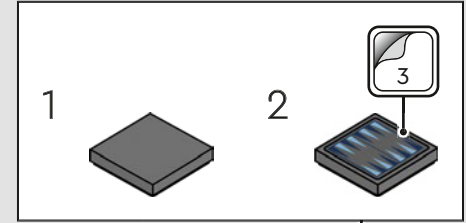
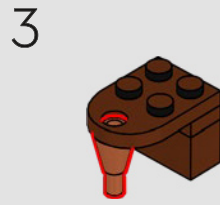
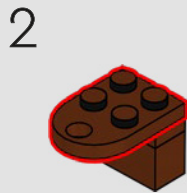
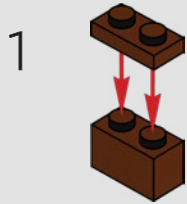

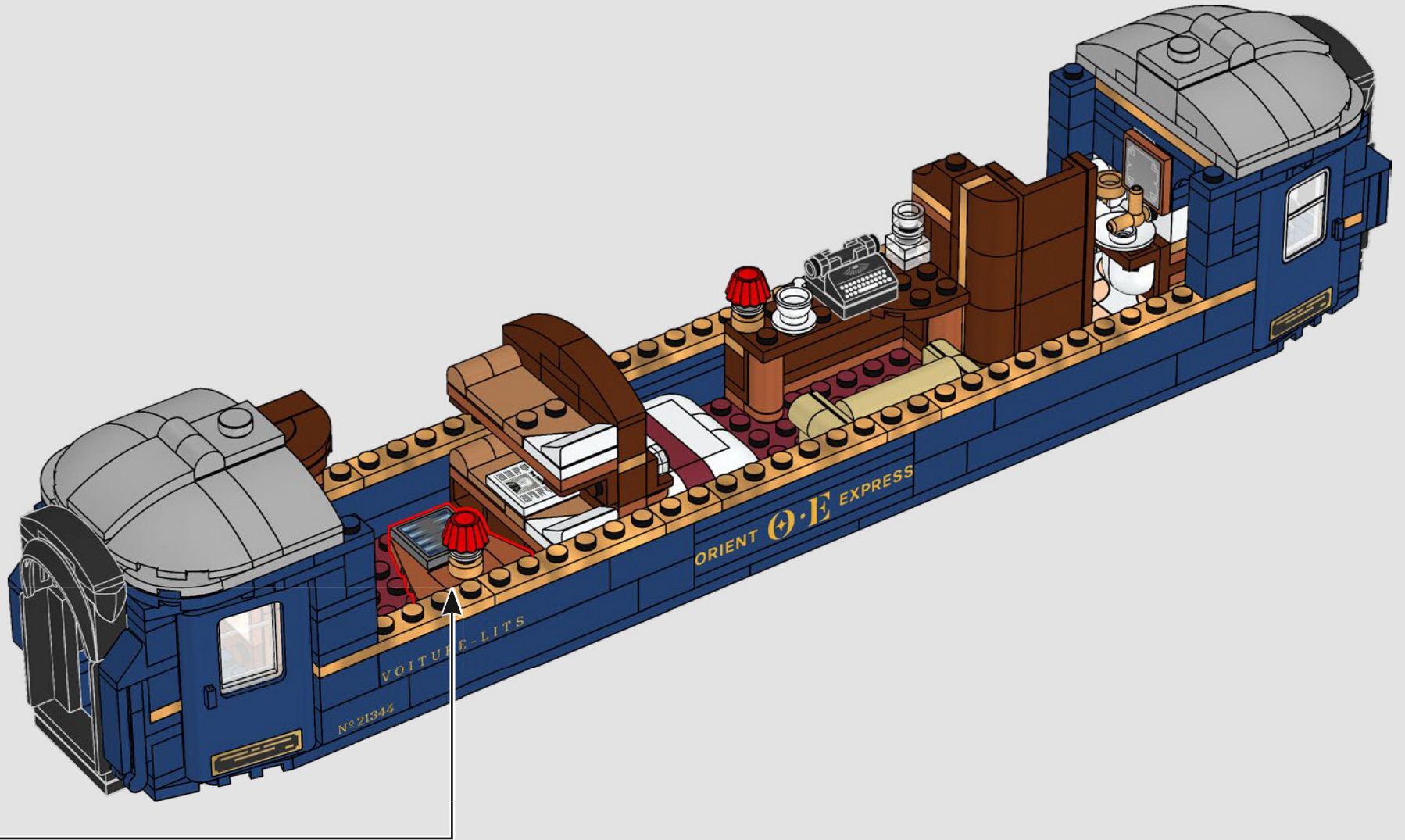



●
Prochain arrêt : BUCAREST

« Cette ville dynamique est notre prochain arrêt.
Les grands boulevards grouillent de monde. »

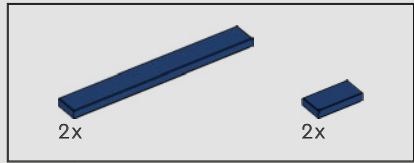

232

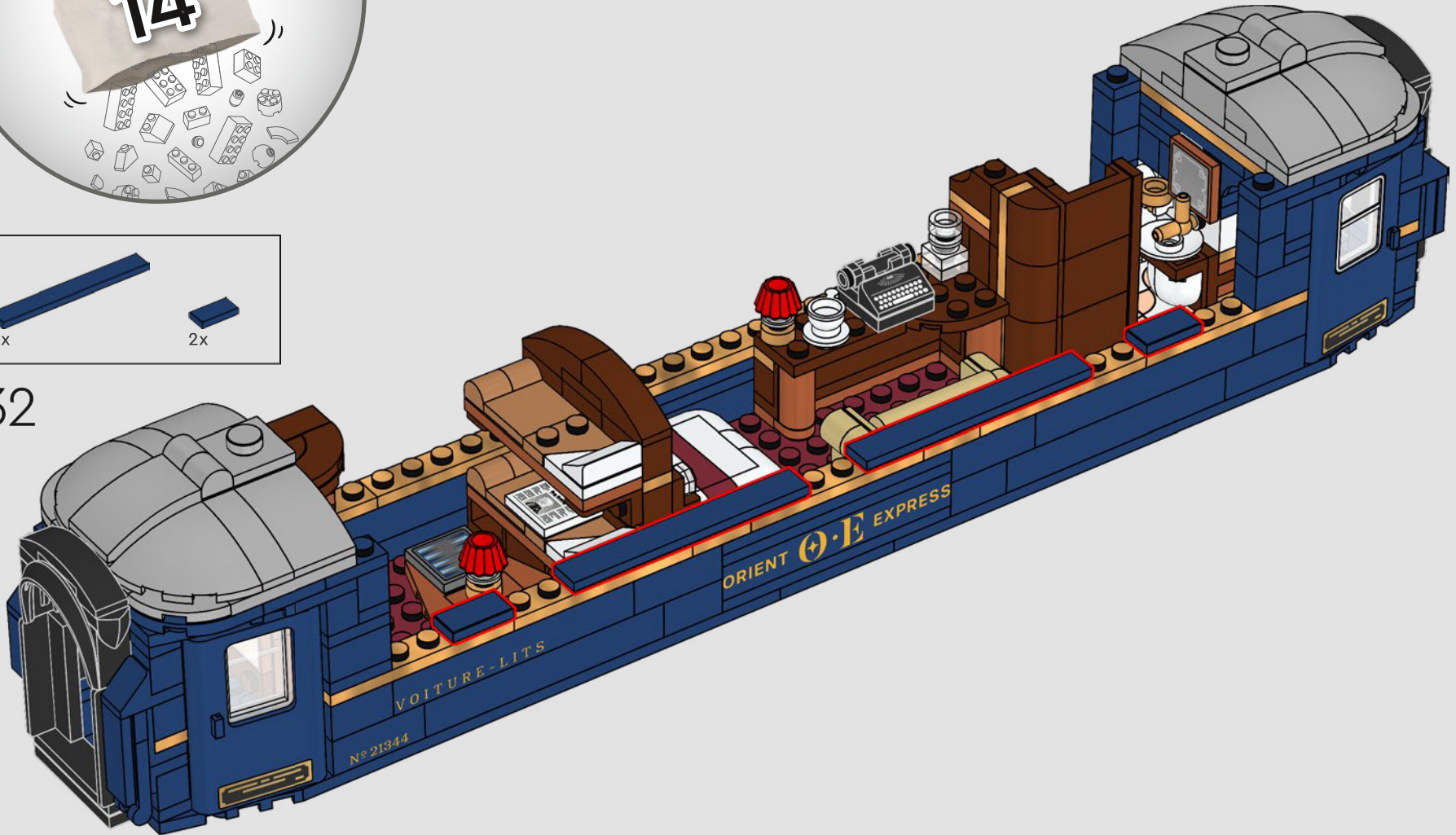

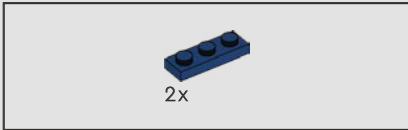
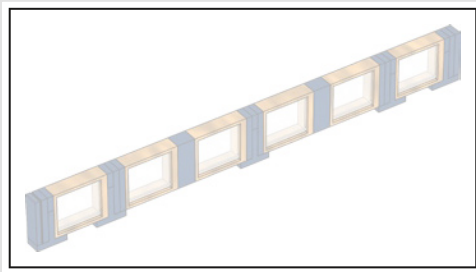

2x

233

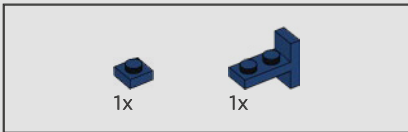
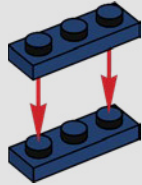

1x

1x

234

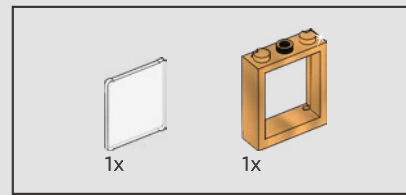
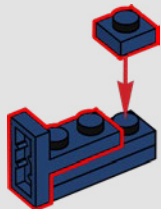

1x

1x

235

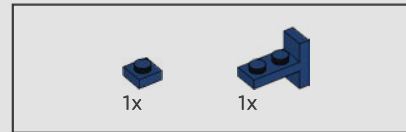
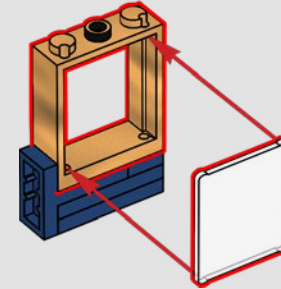

1x

1x

236

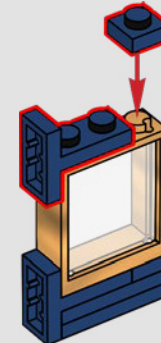

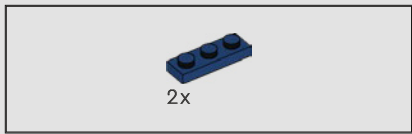

237

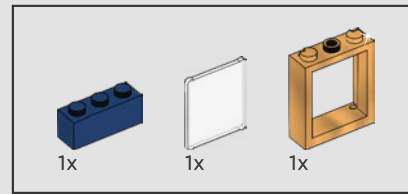
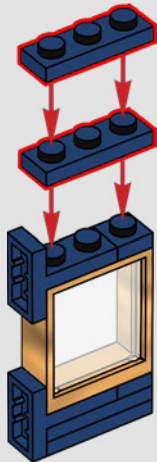

238

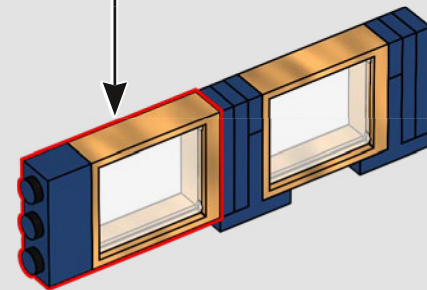
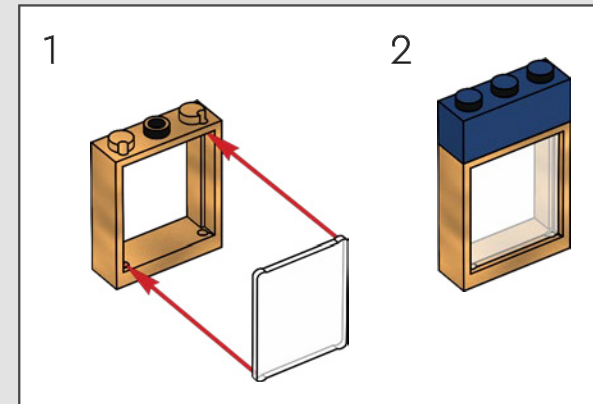

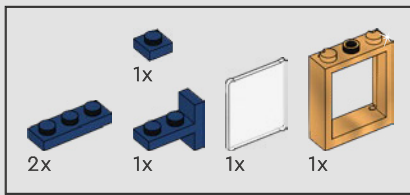

239

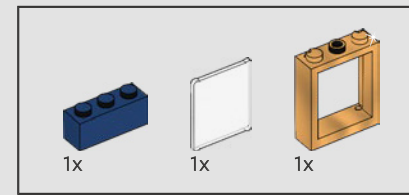
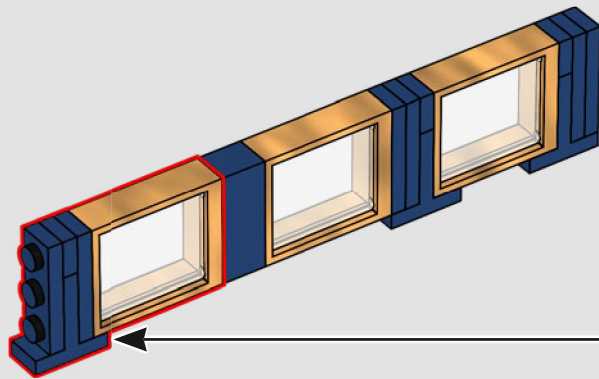
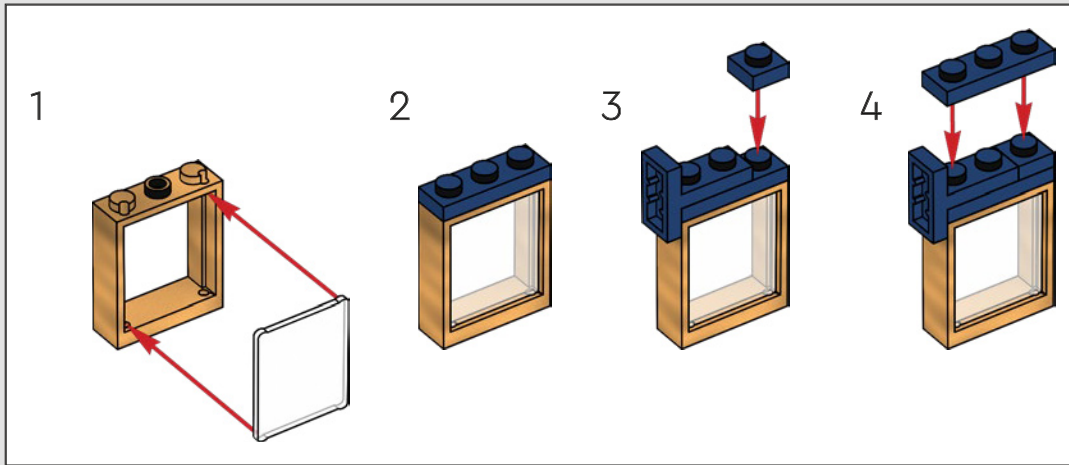

240

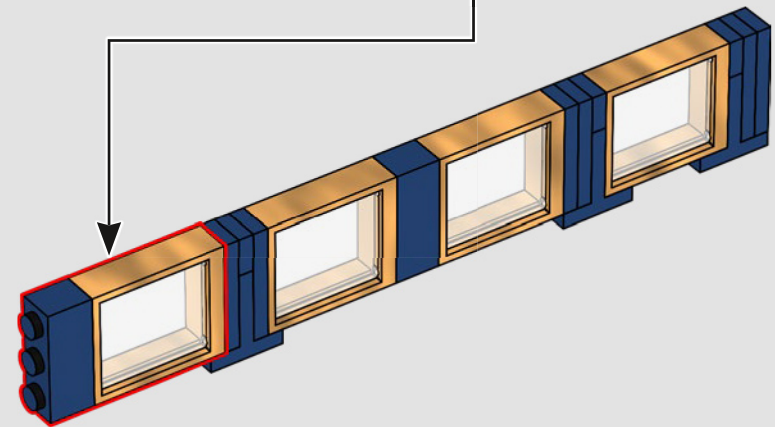
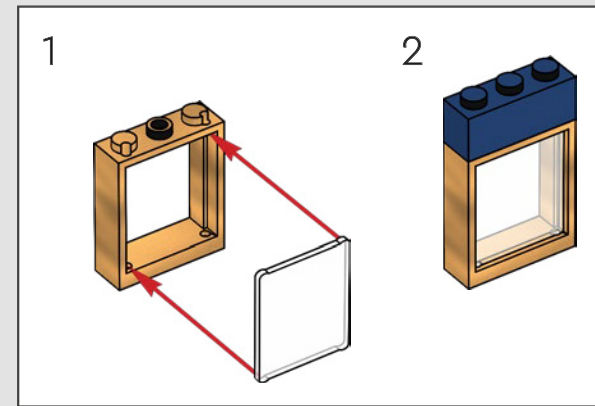

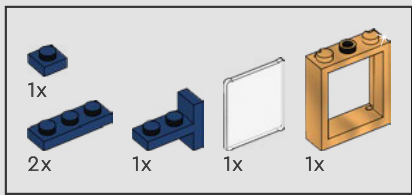

241

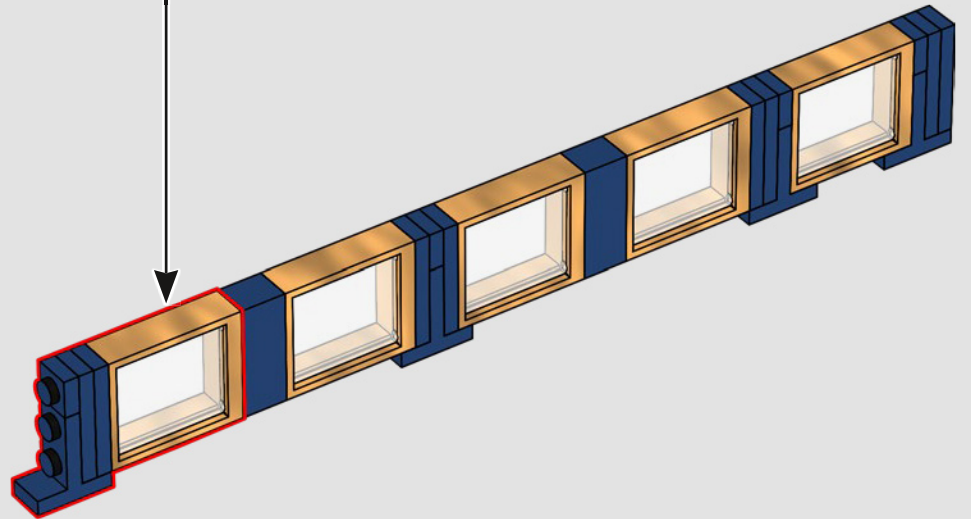
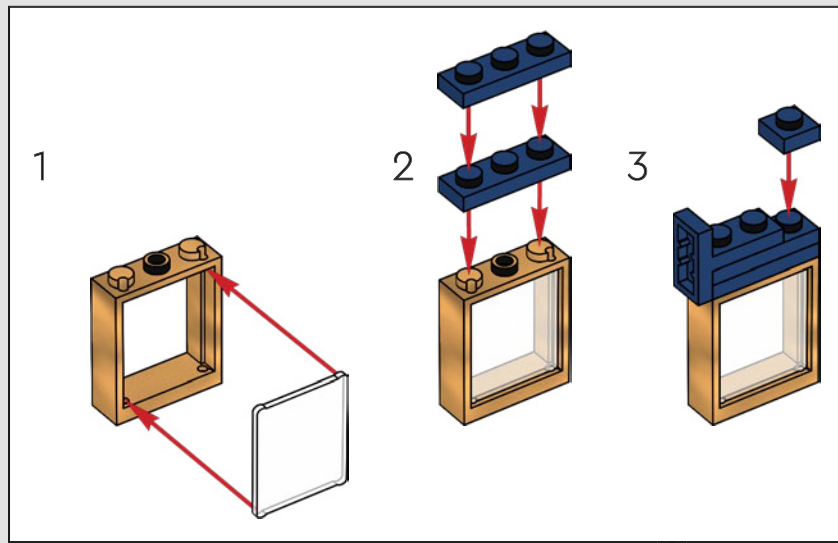

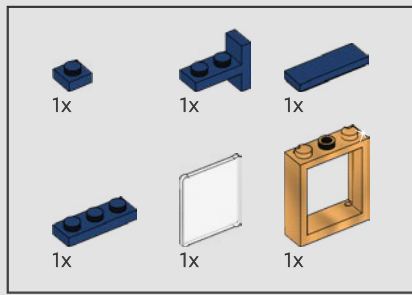

242

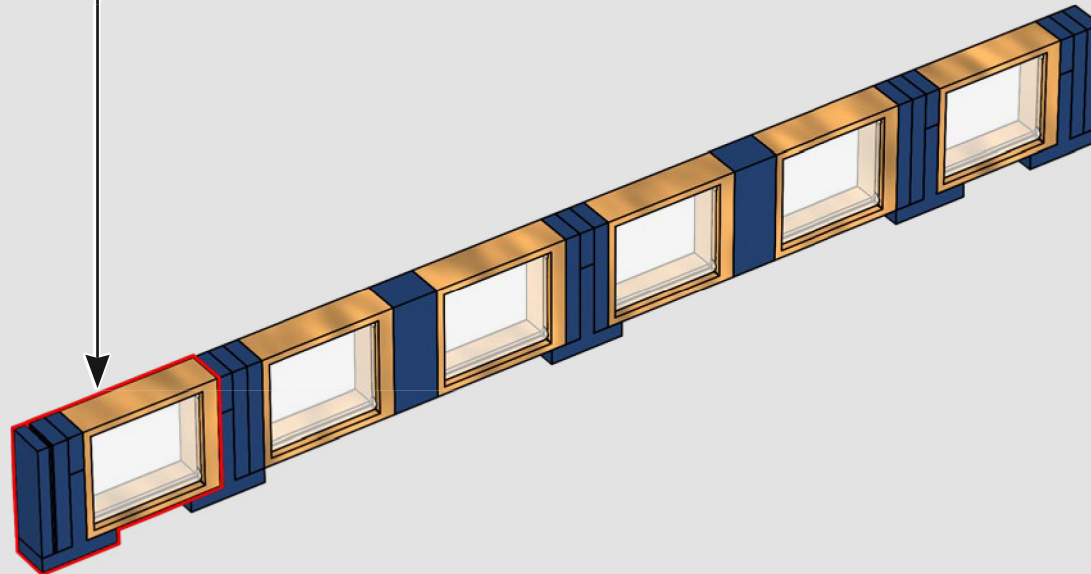
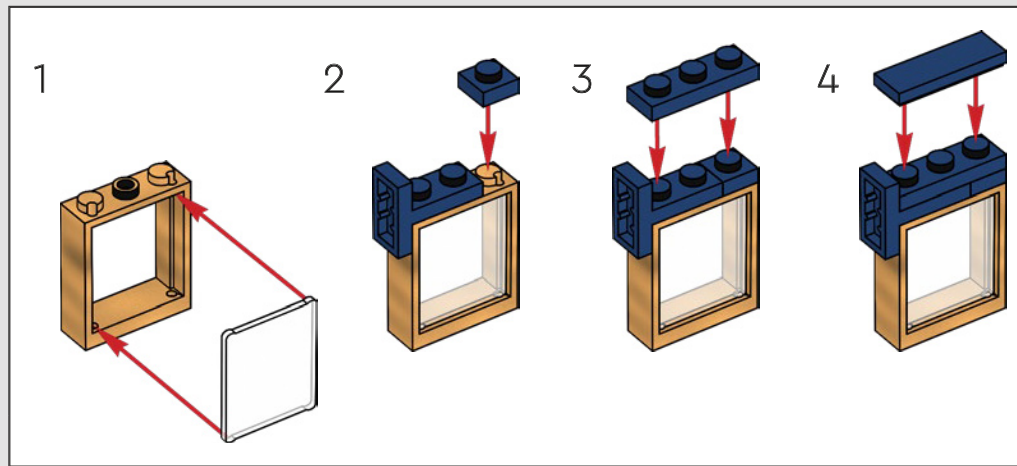

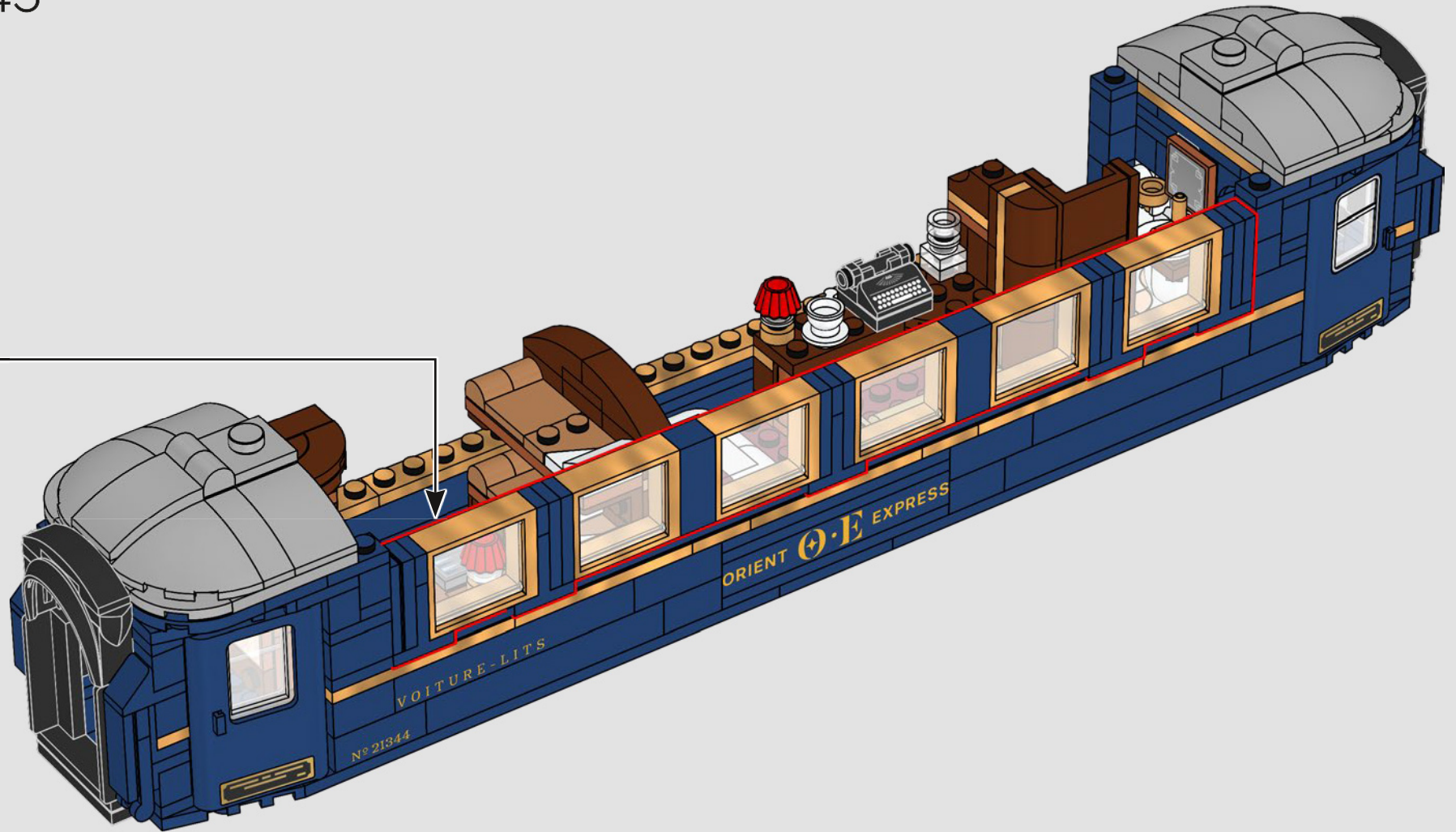

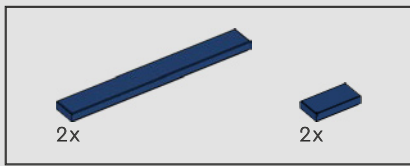

244

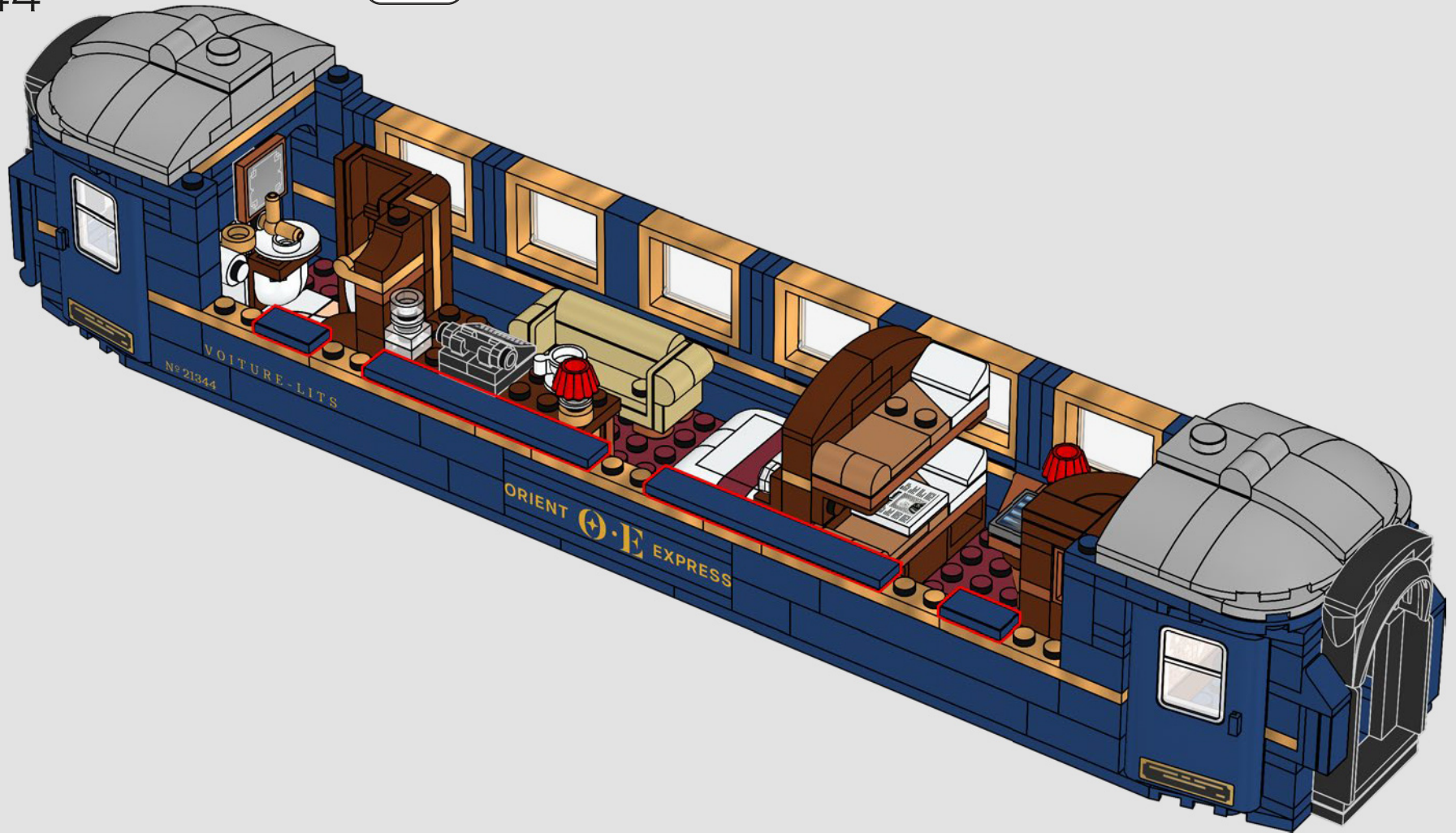

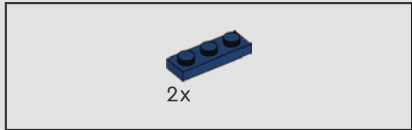
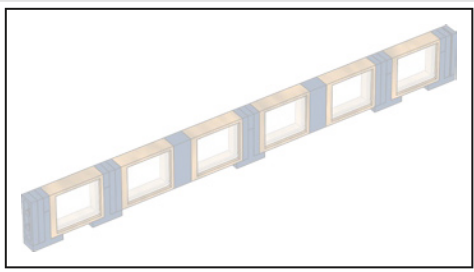

2x

245

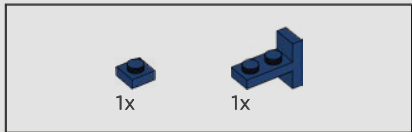
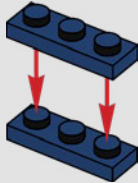

1x

1x

246

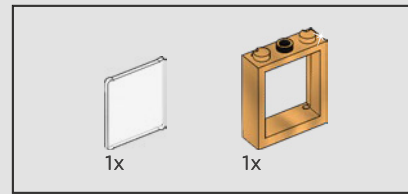
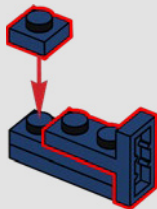

1x

1x

247

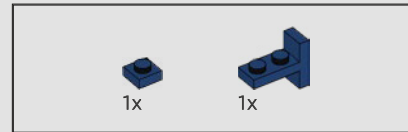
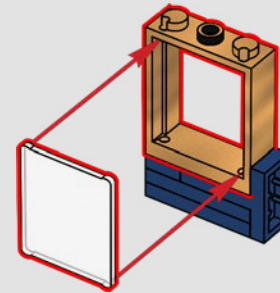

1x

1x

248

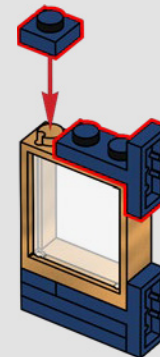

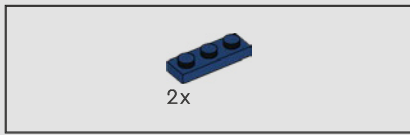

249

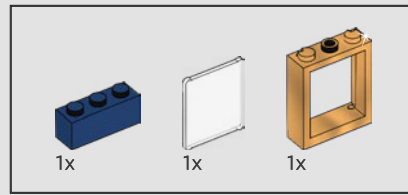
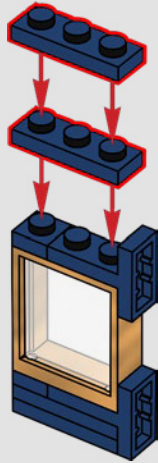

250

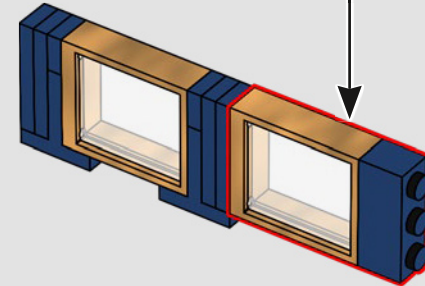
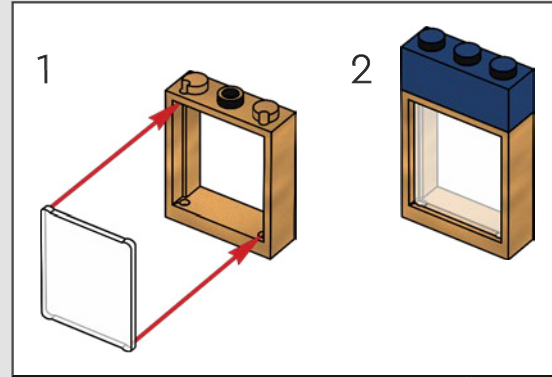

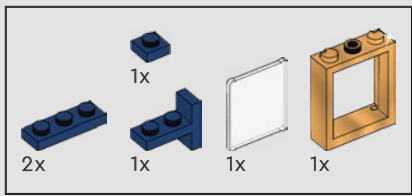

251

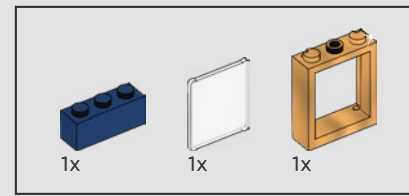
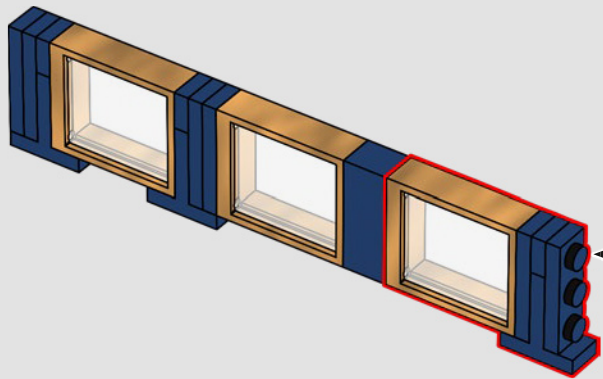
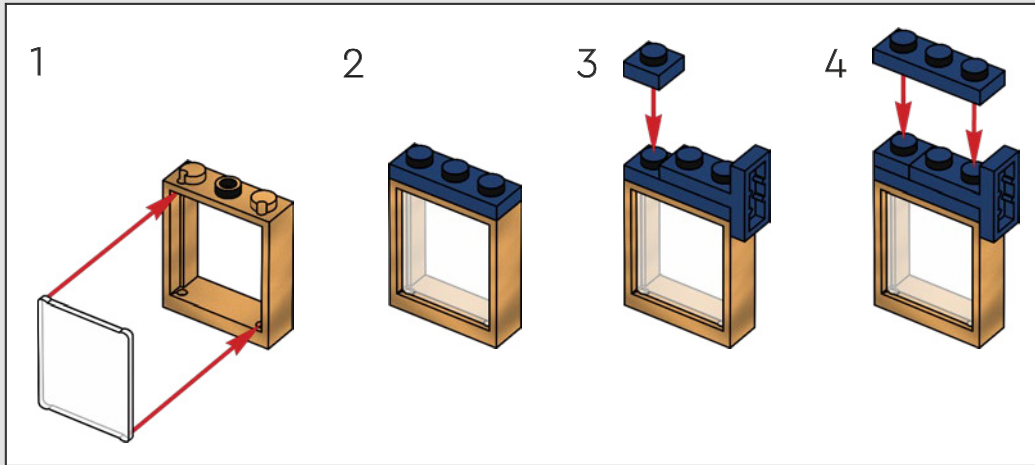

252

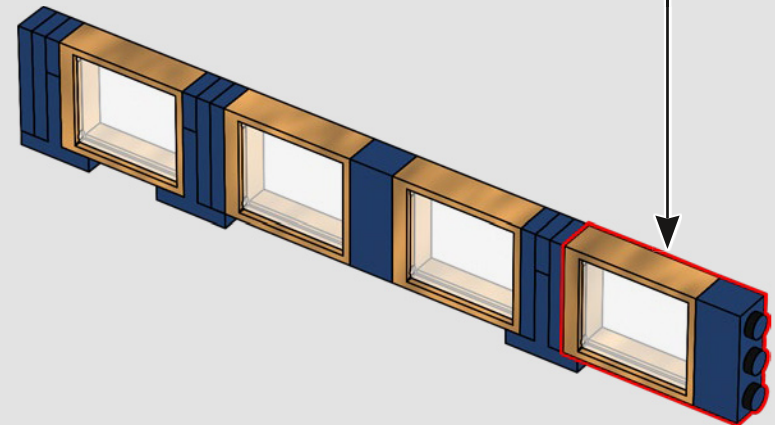
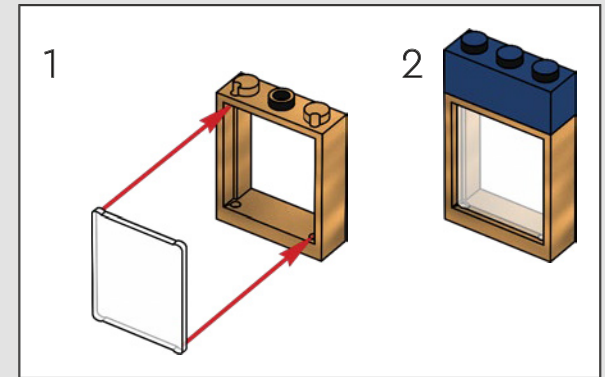

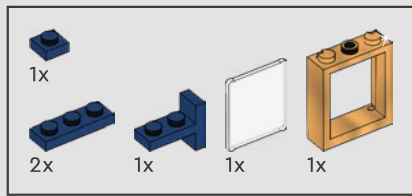

253

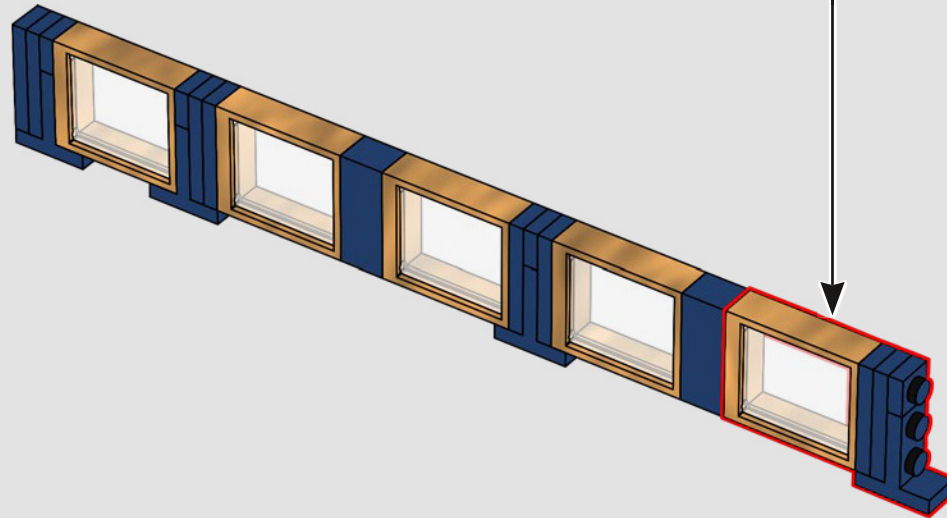
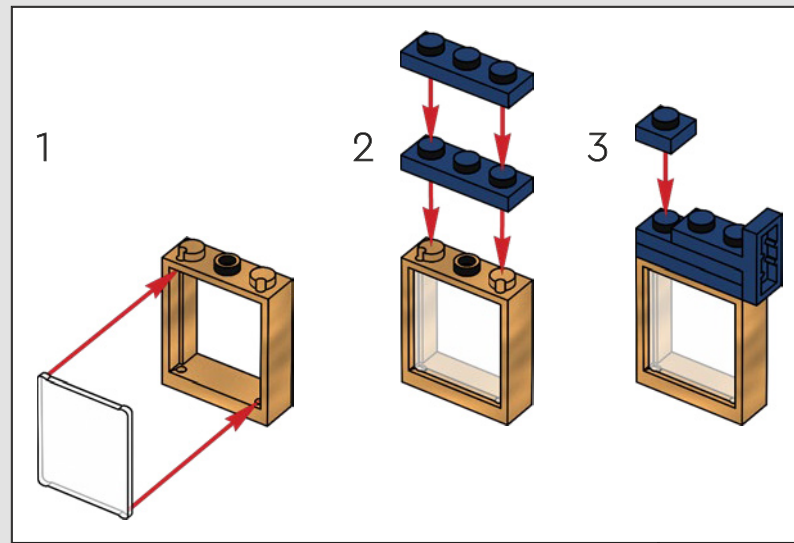

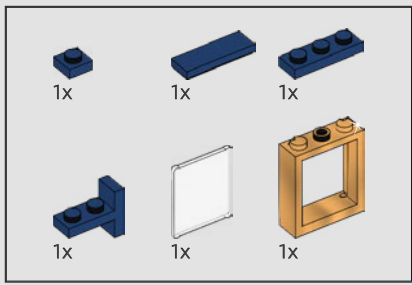

254

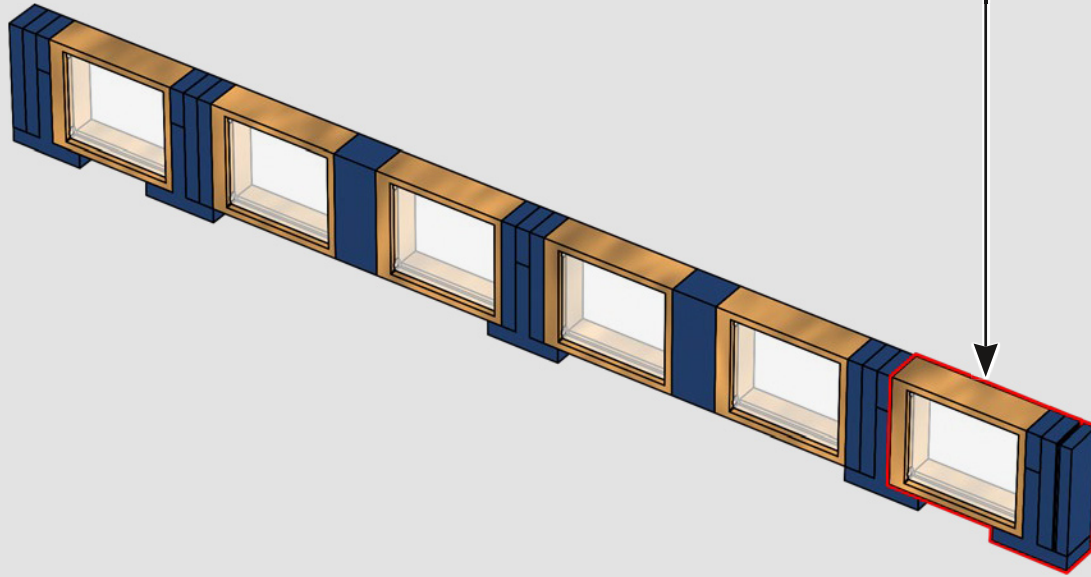
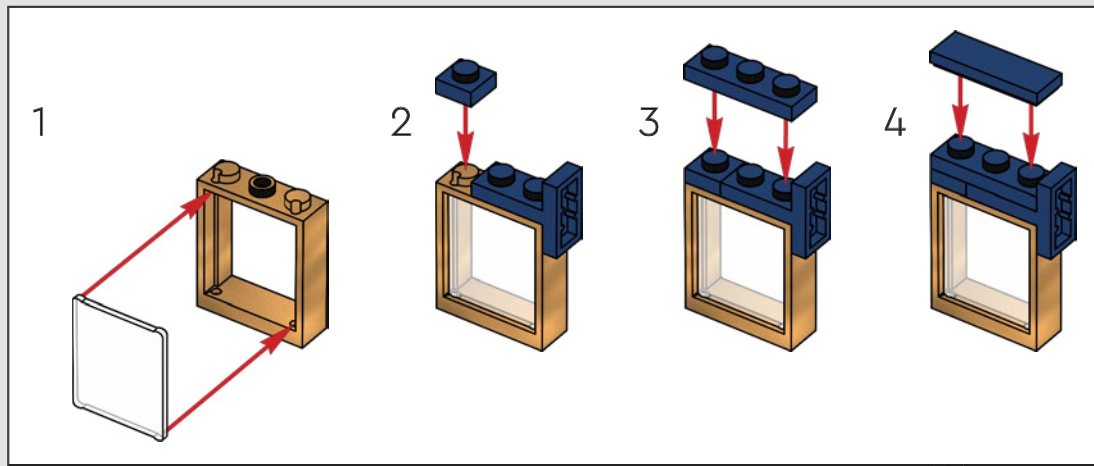

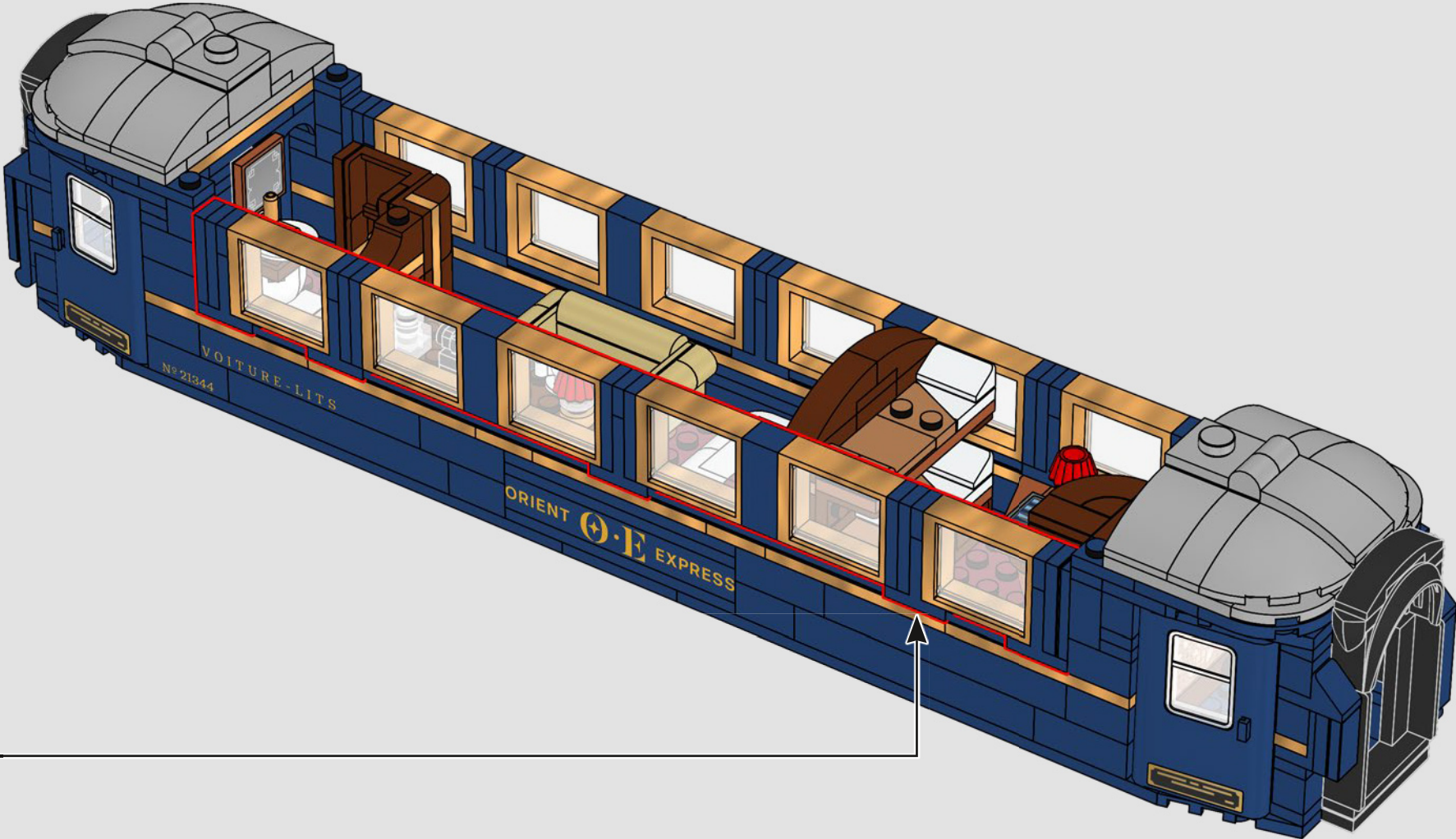



●
« Les passagers transportent toutes sortes de bagages, des objets d'art aux objets personnels... certains ont BEAUCOUP de bagages ! »

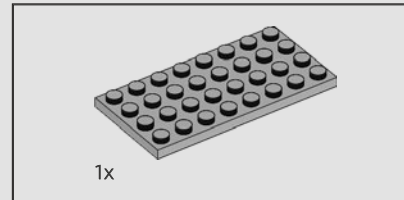
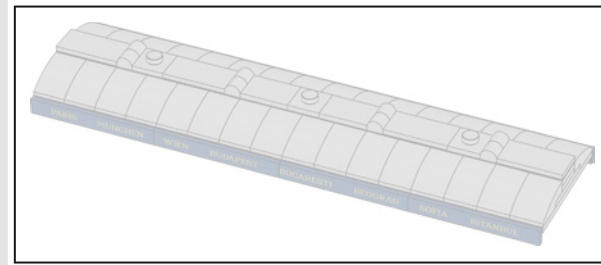
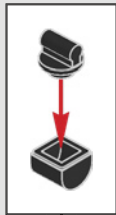
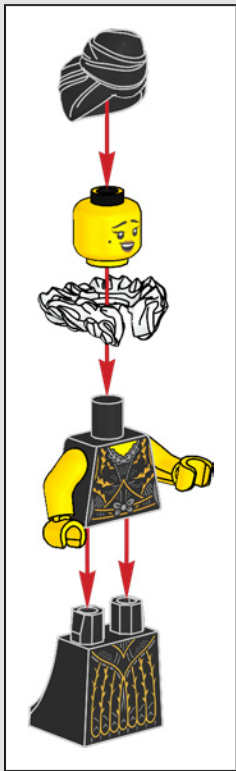

256

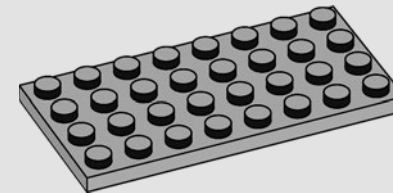

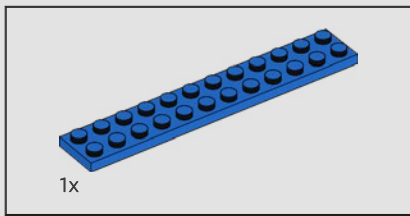

257

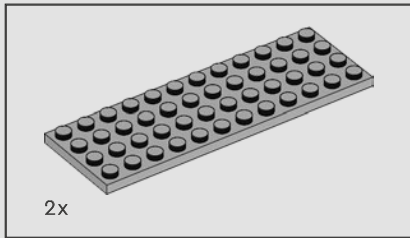
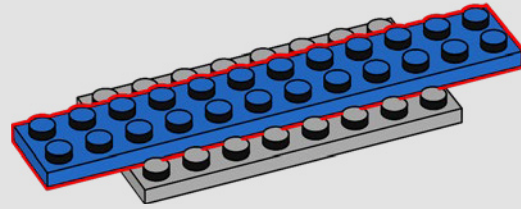

258

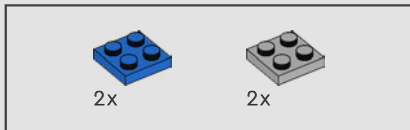
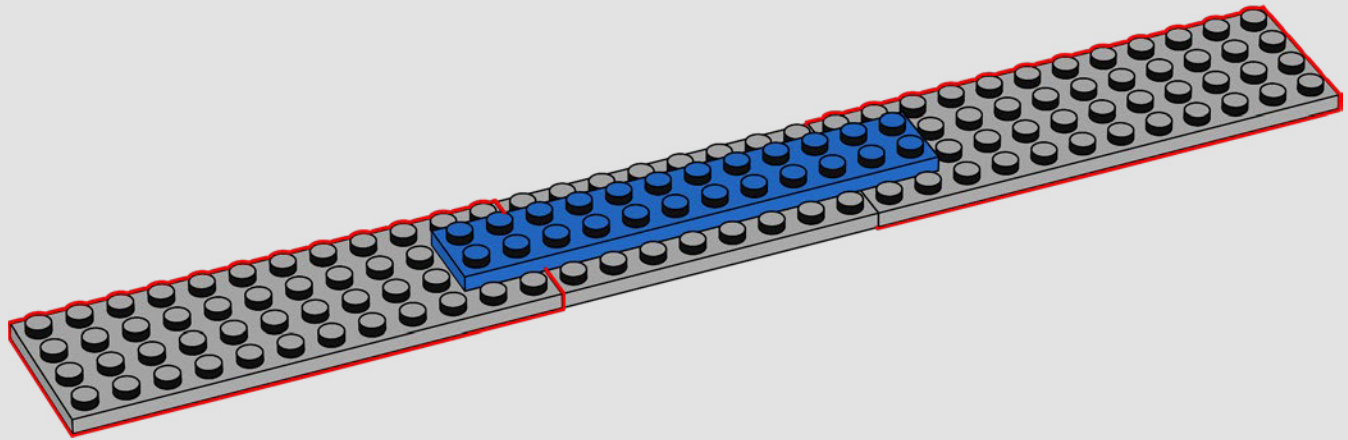

259

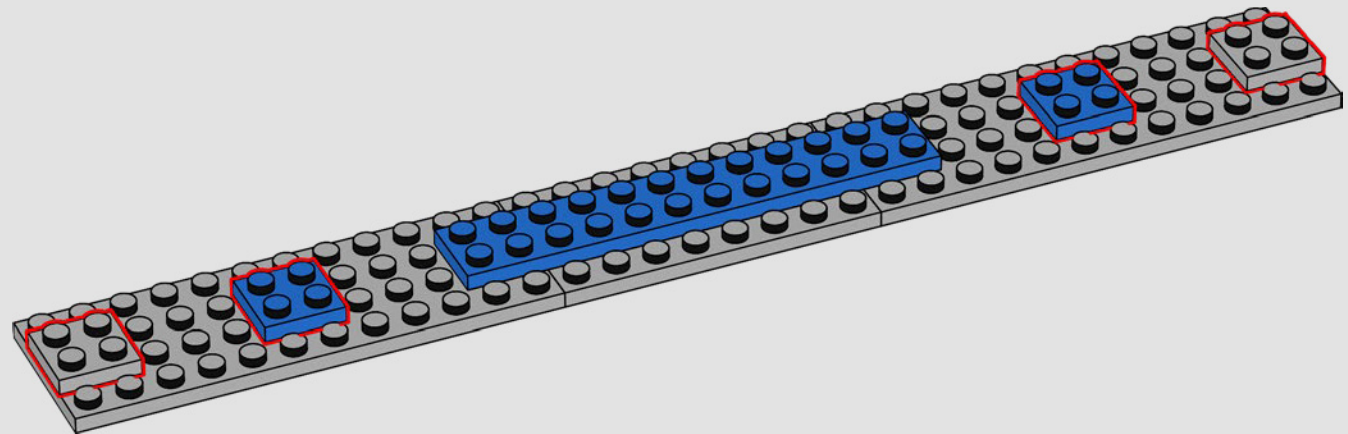



260

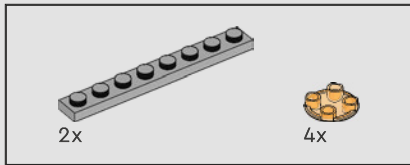
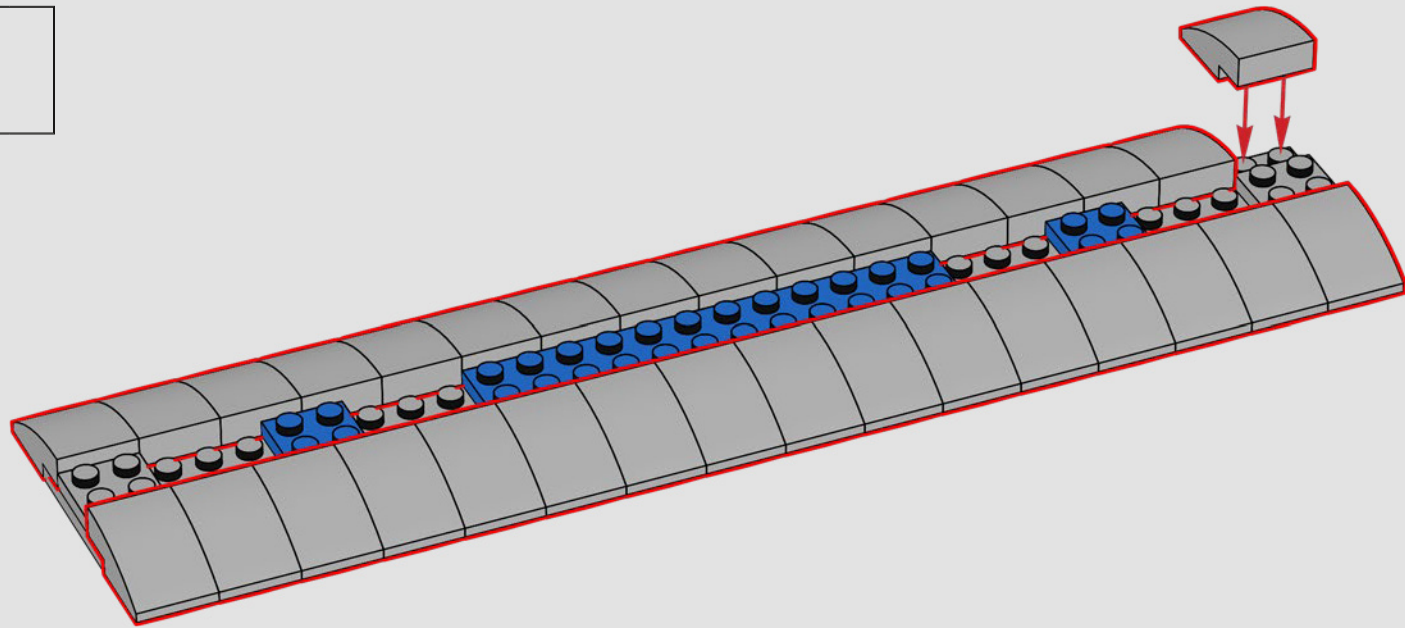

261

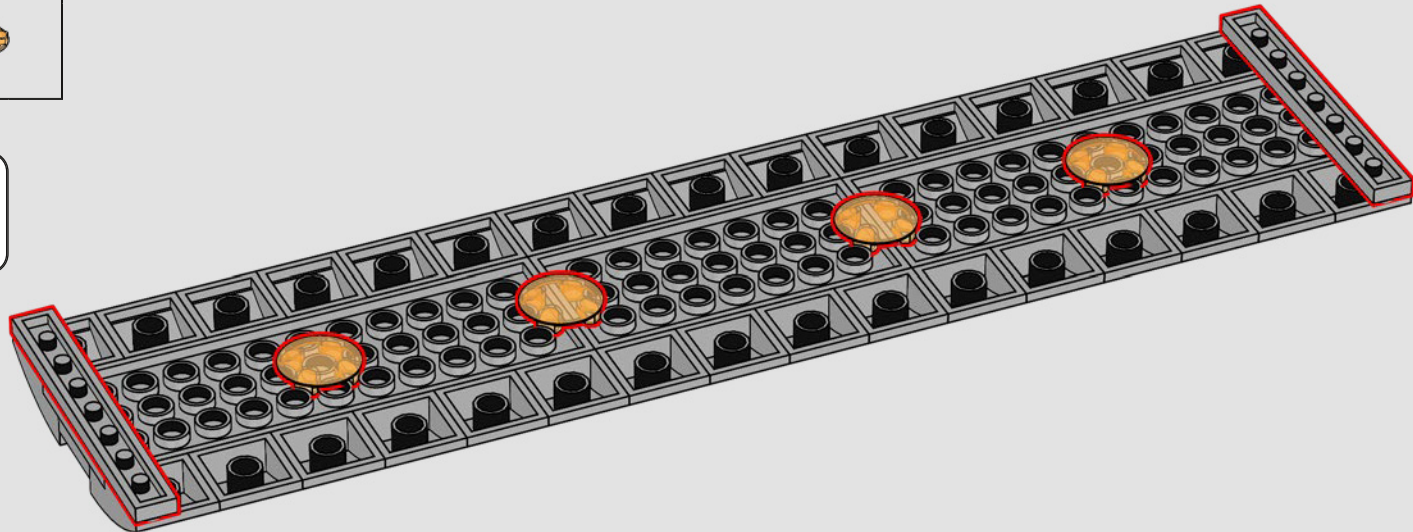

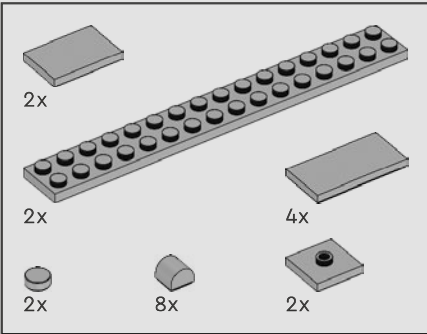
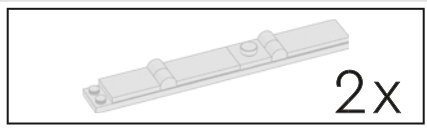

262

1

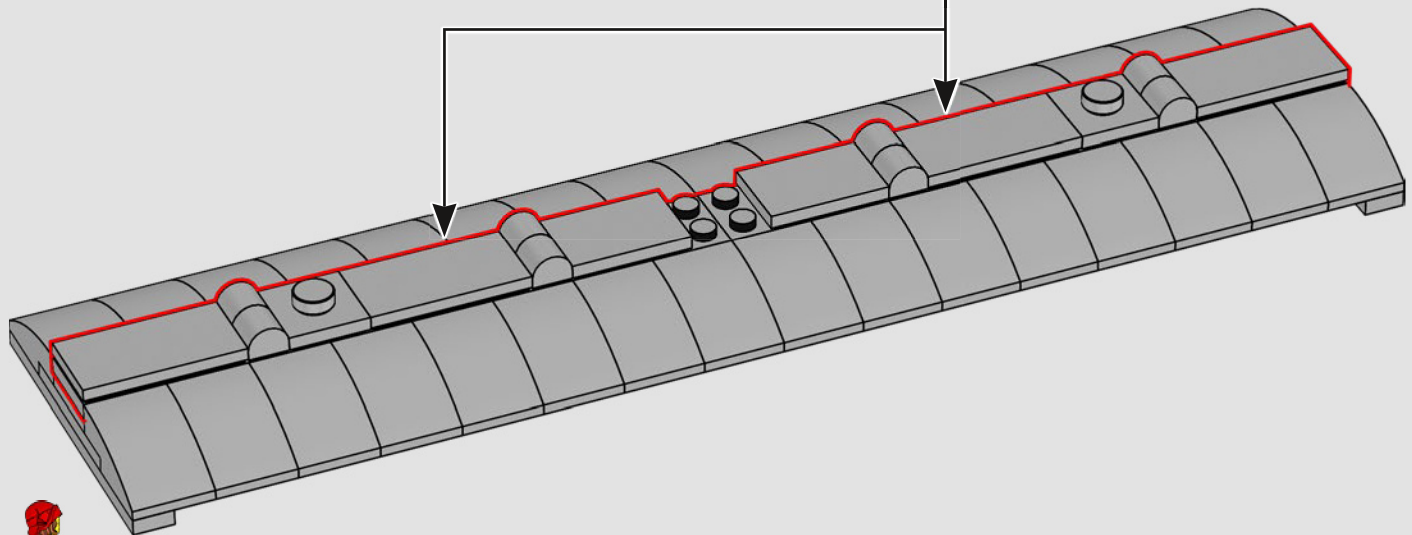
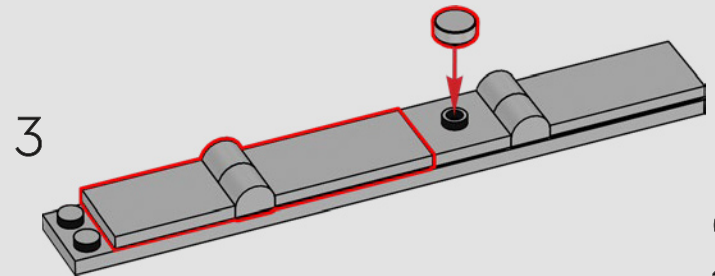
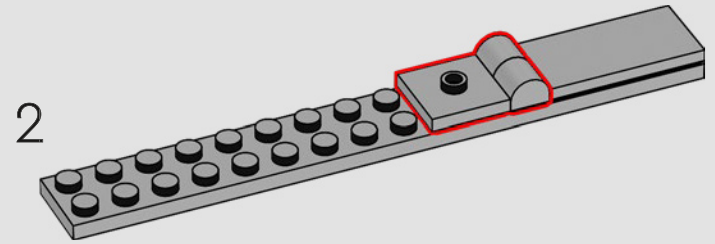
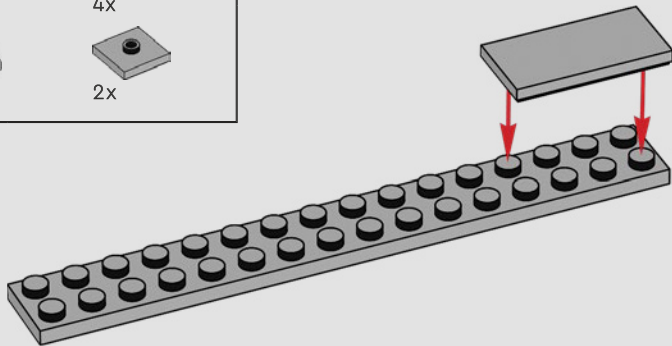

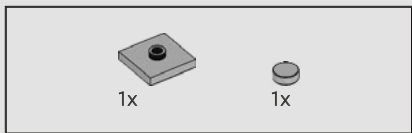

263

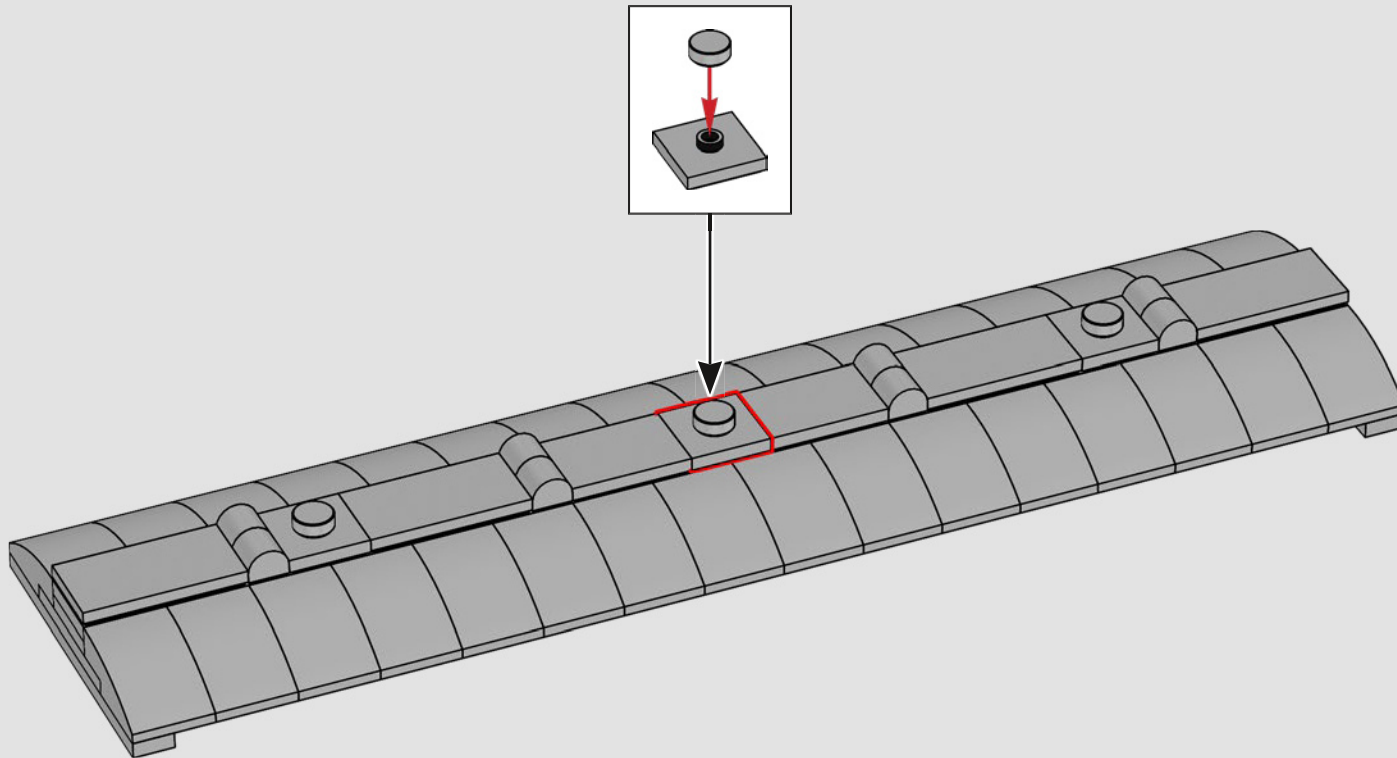

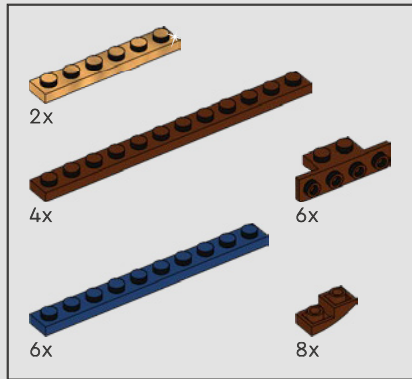
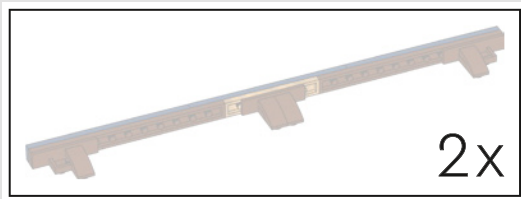

264

1

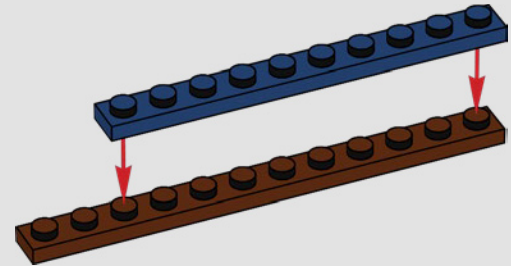

2

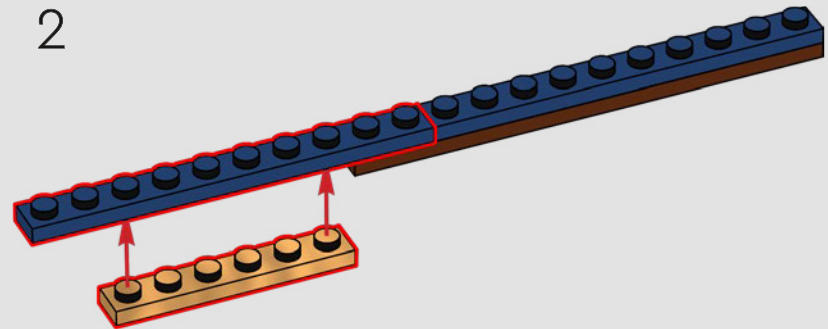

3

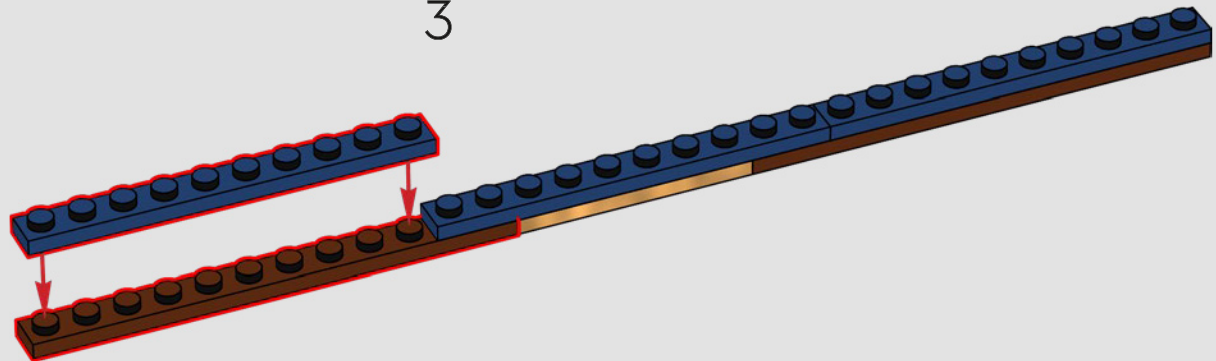

4

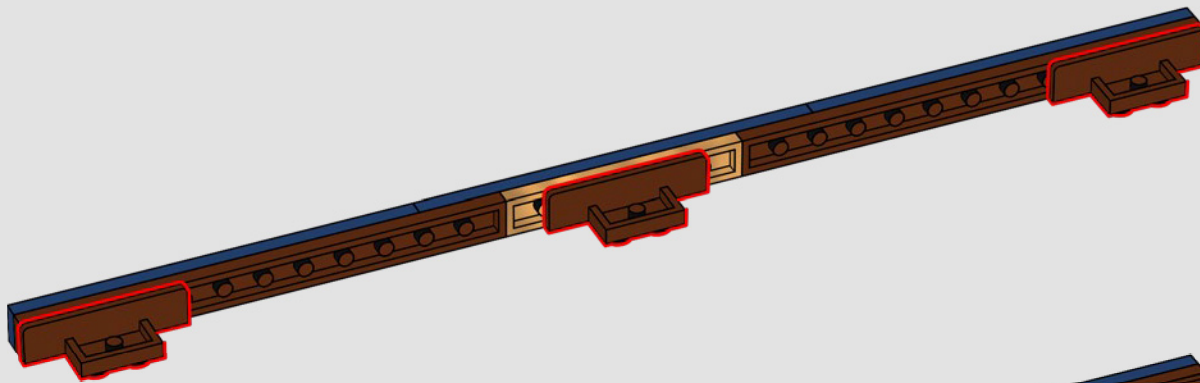

5

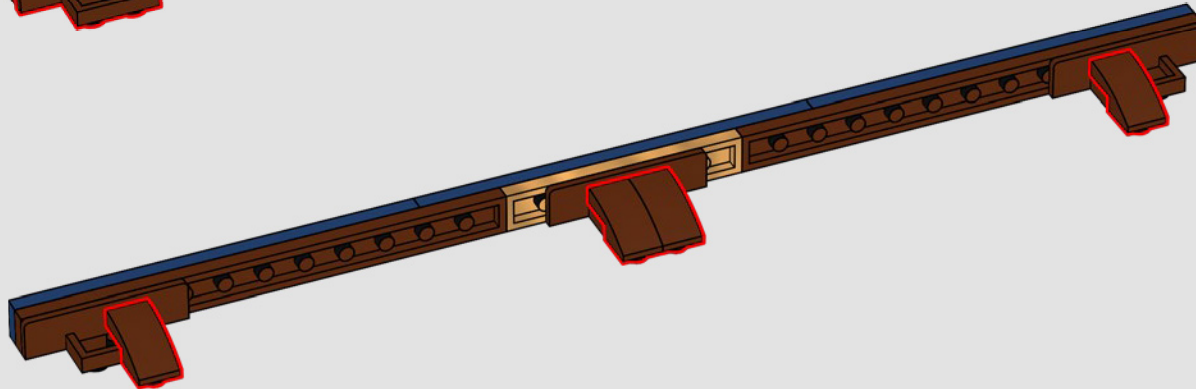

2x

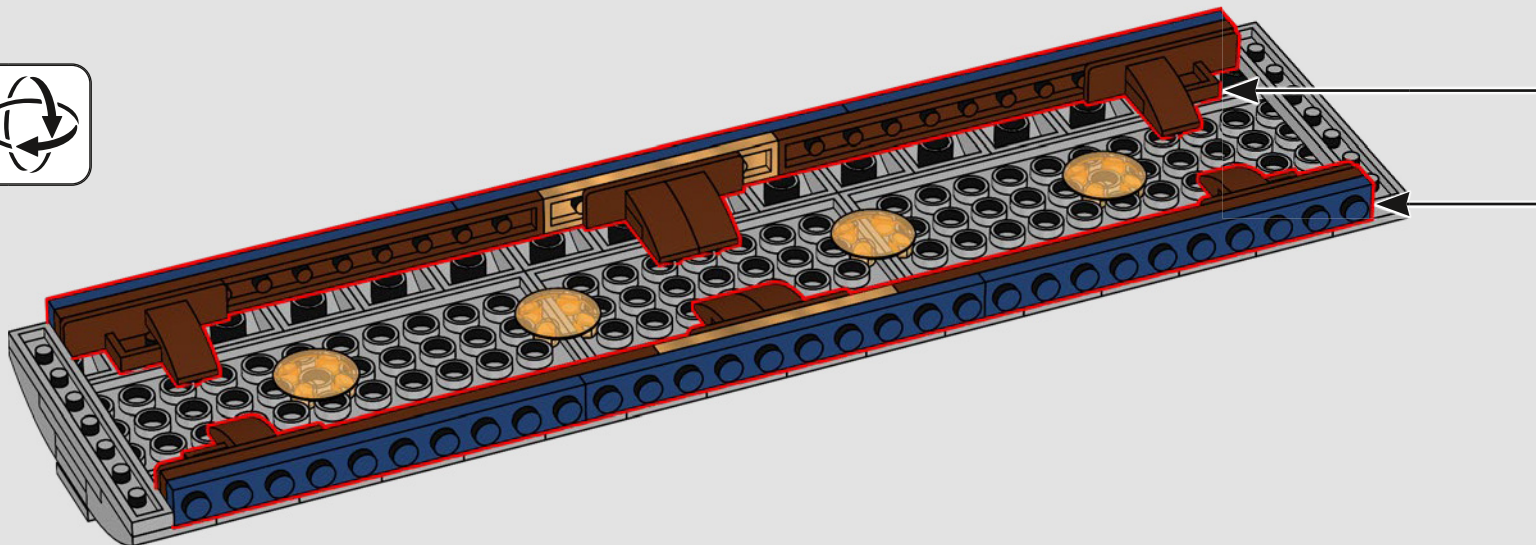

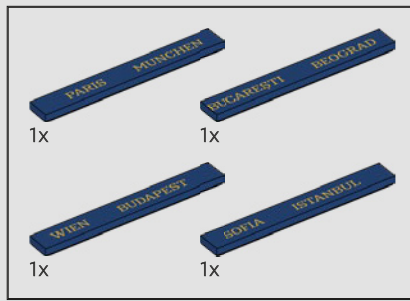

265

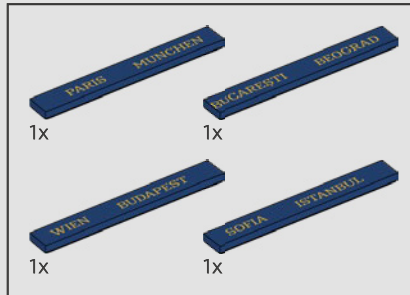
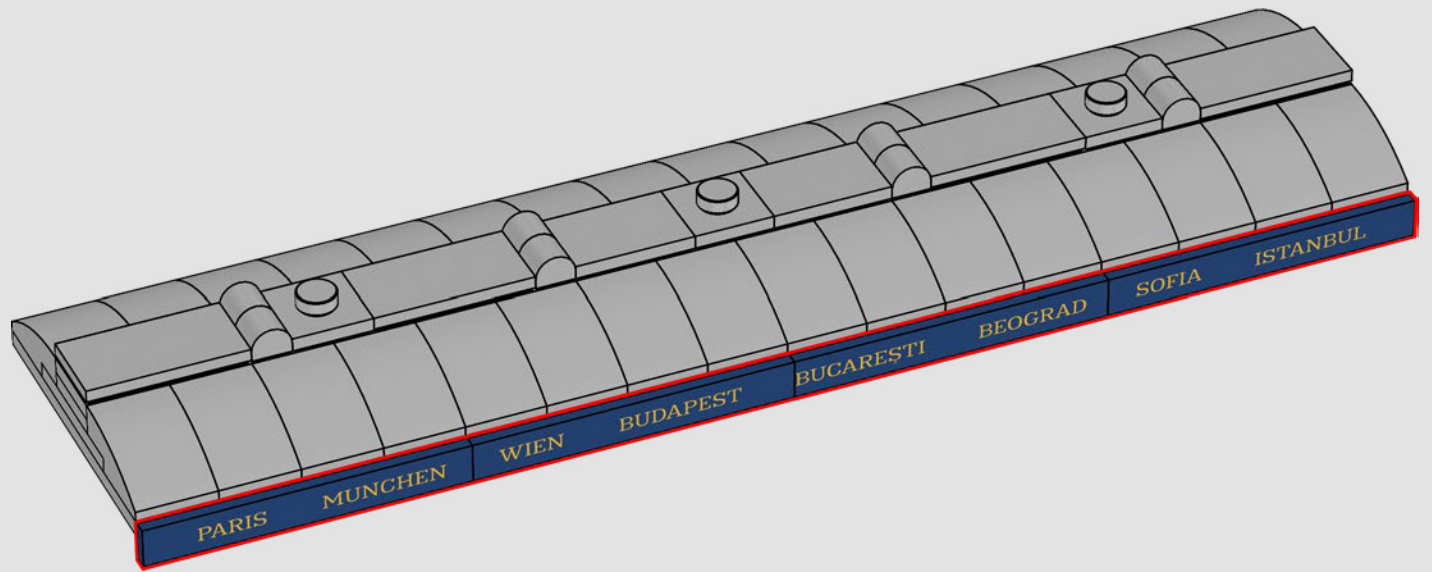

266

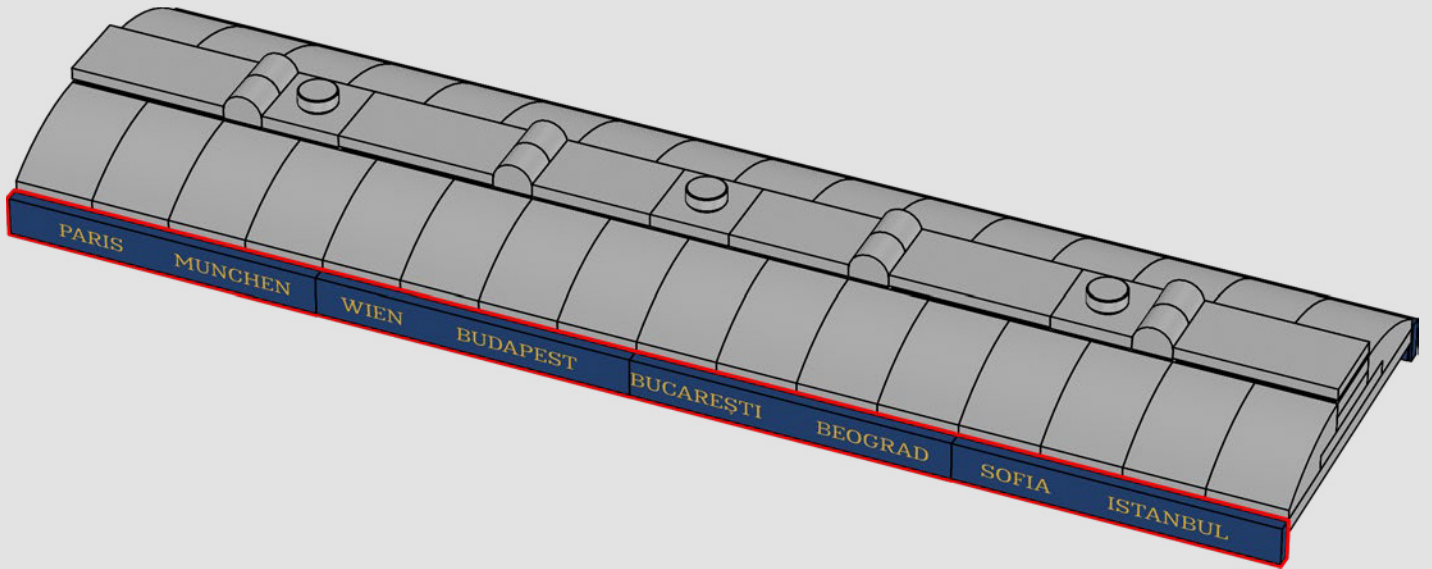

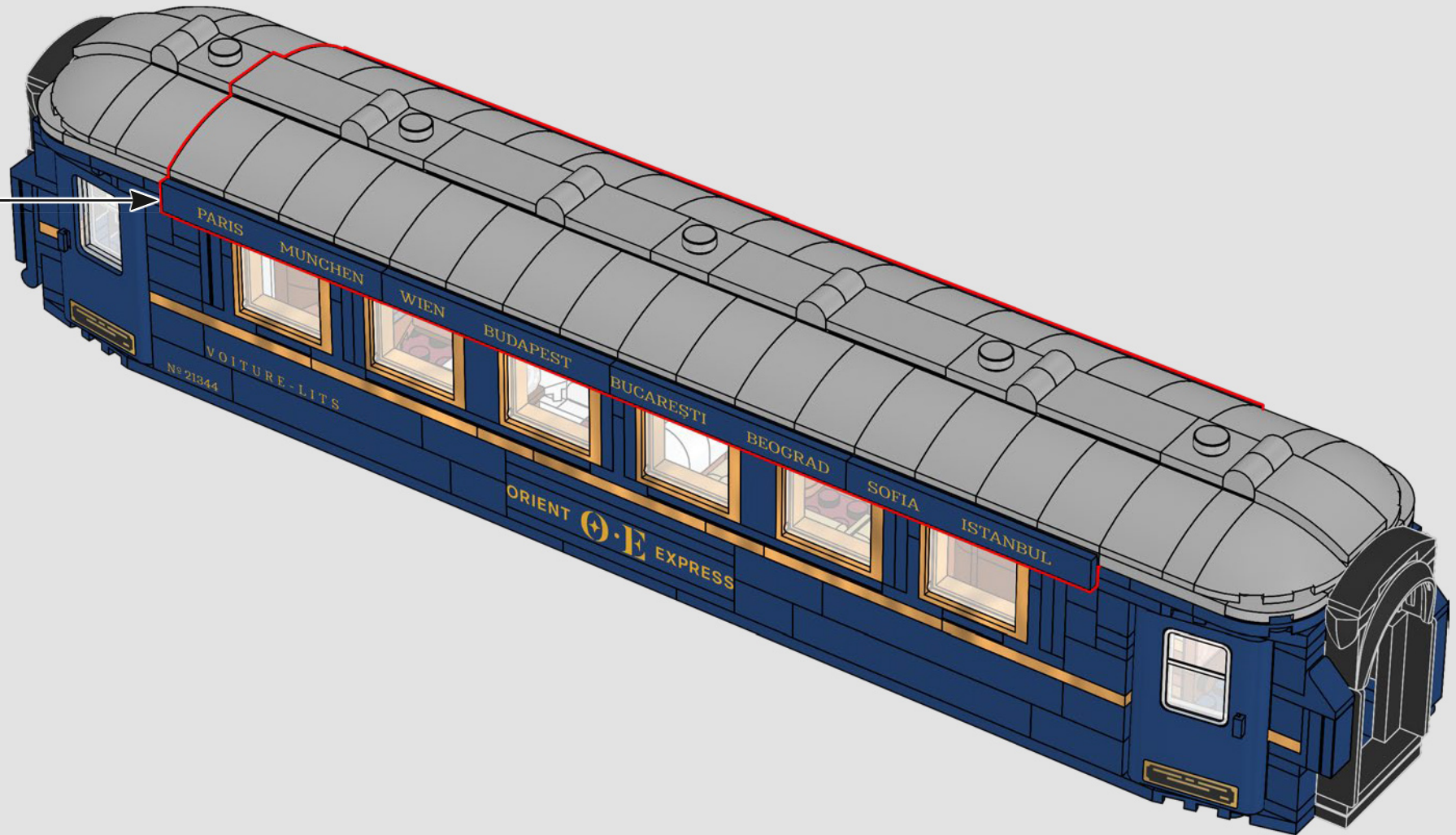

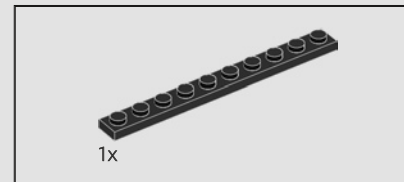
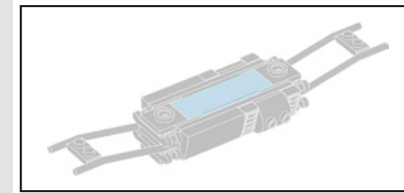
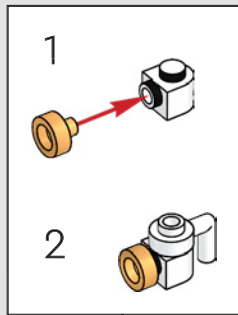
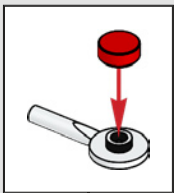
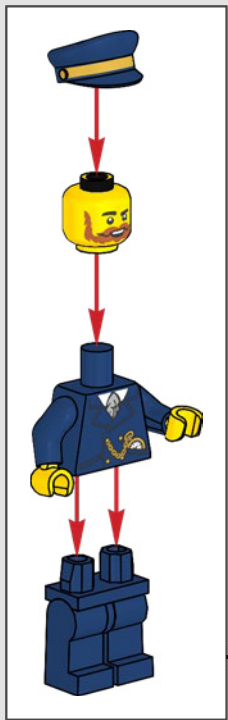

268

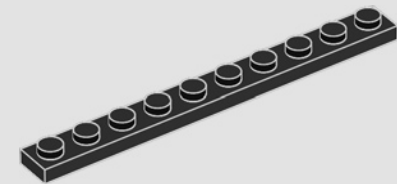

●
Prochain arrêt : BELGRADE
« Le chef de gare supervise l'attelage
de chaque wagon au train. »



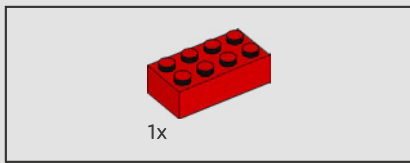

269

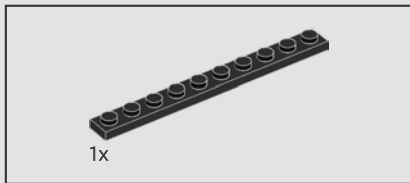
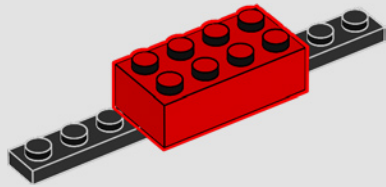

270

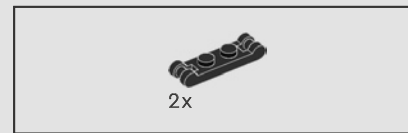
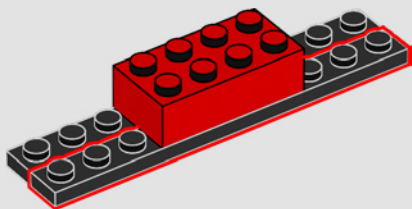

271

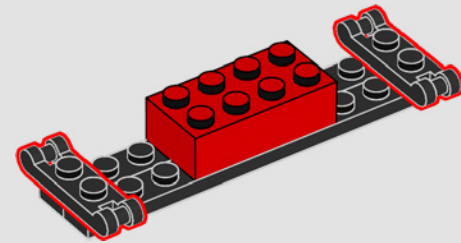

272

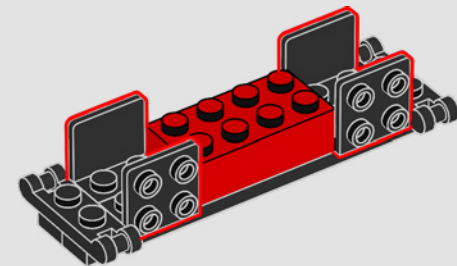

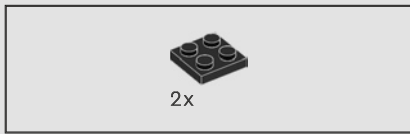

273

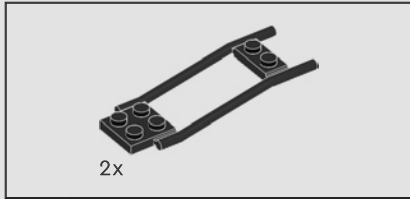
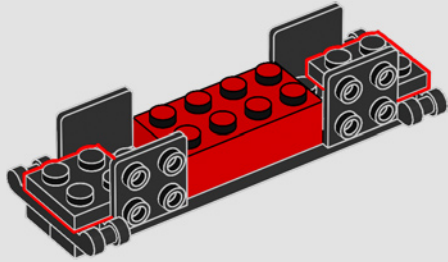

274

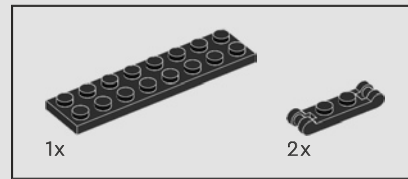
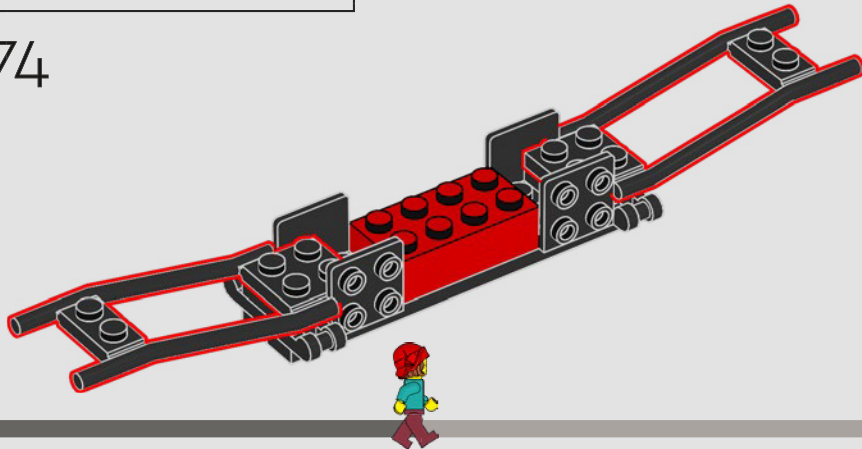

275

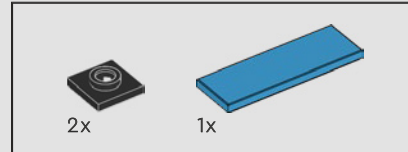
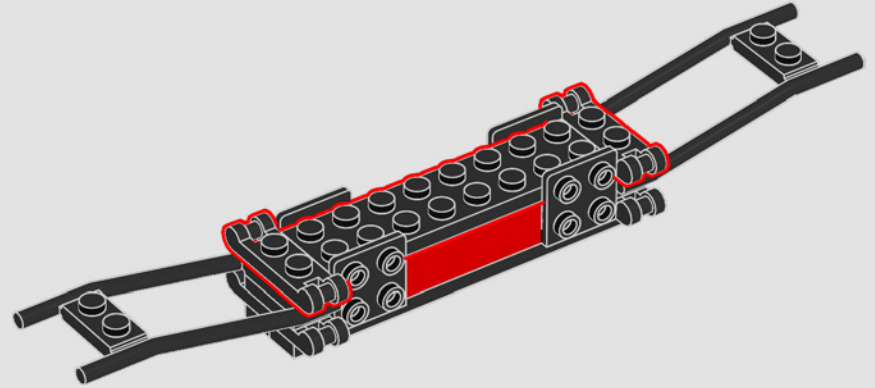

276

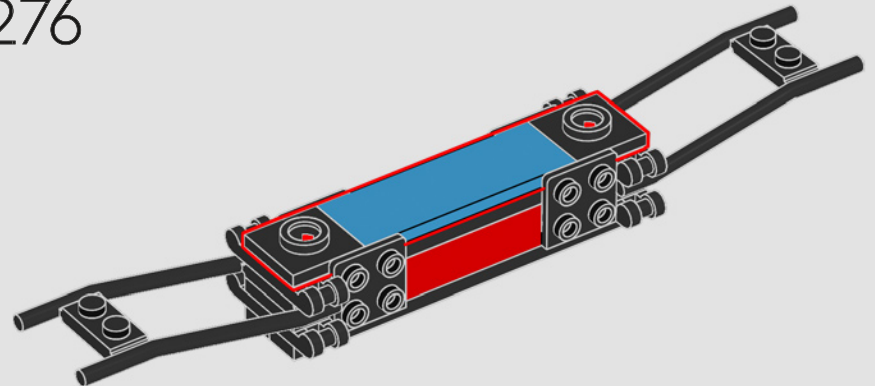

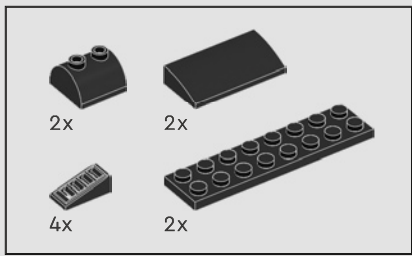

277

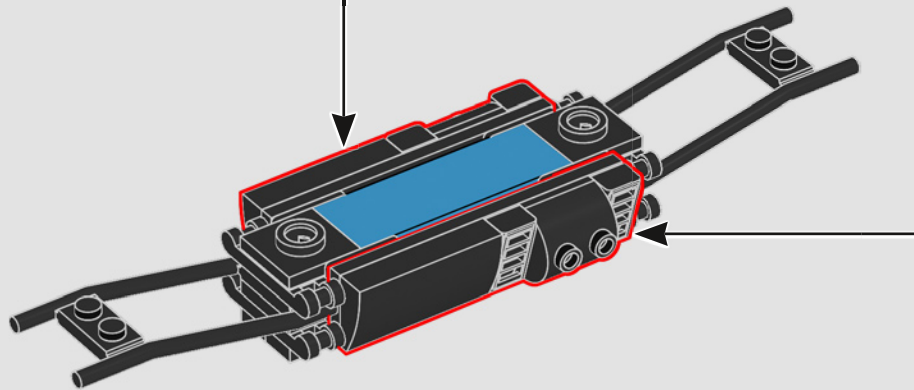
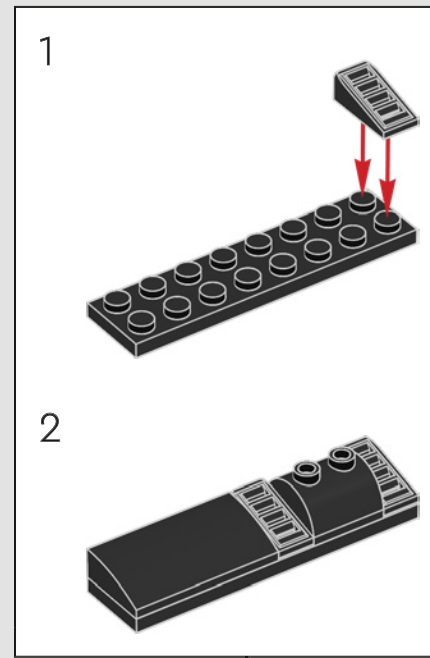
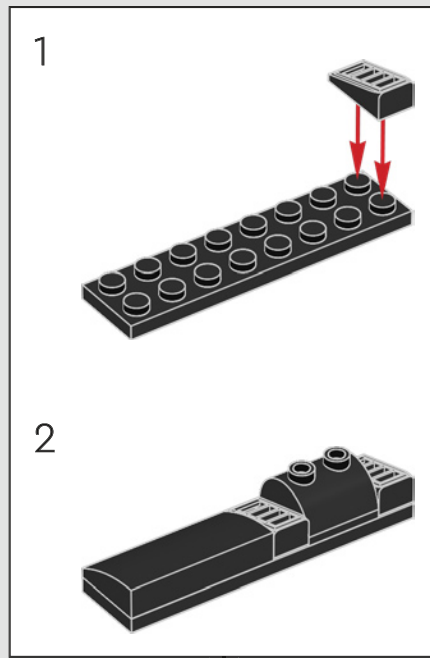

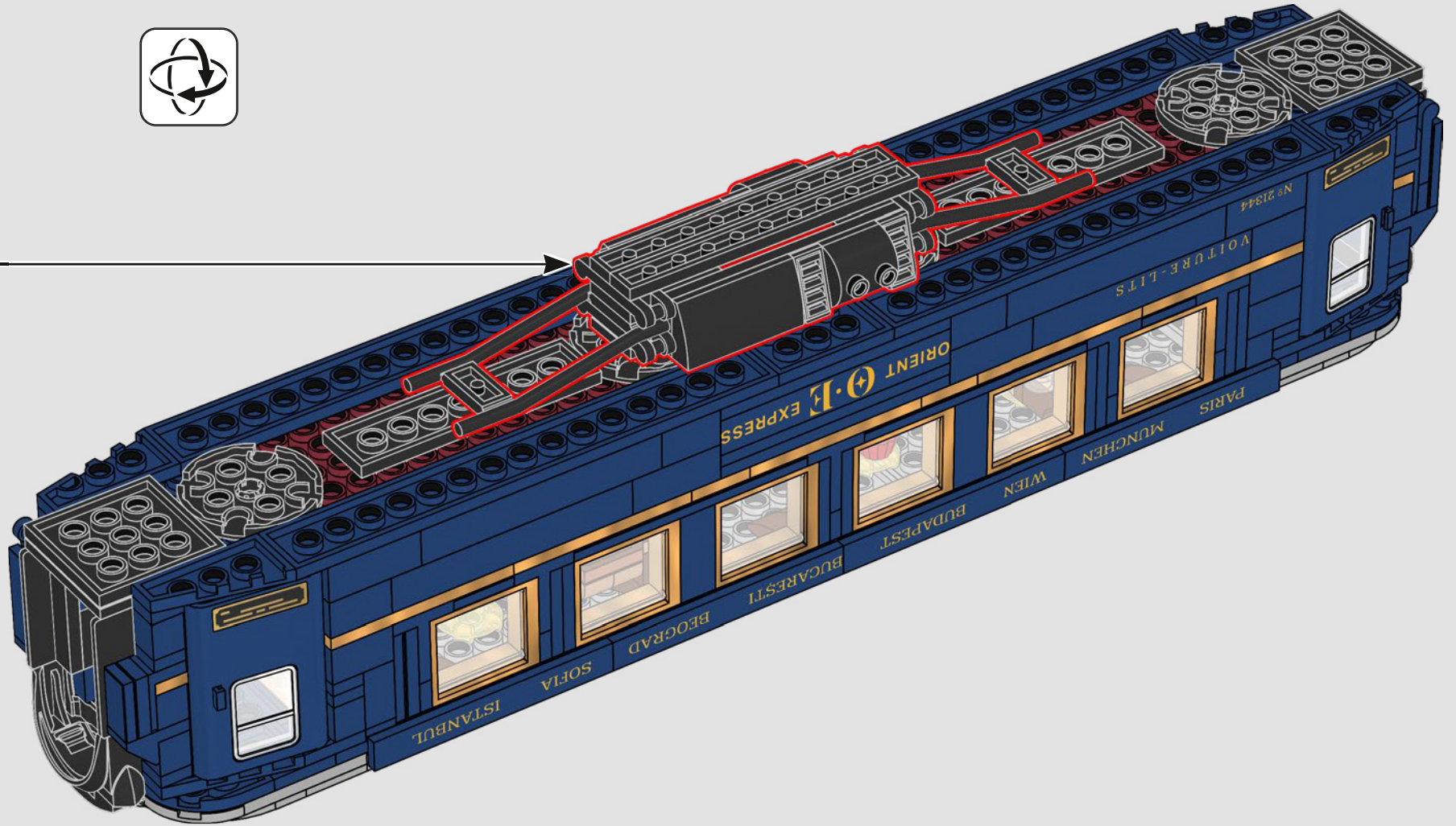

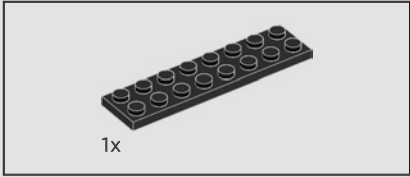
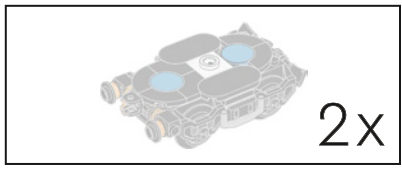

279

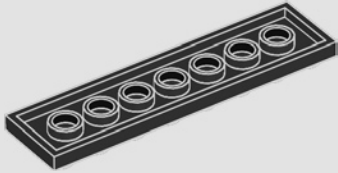

280

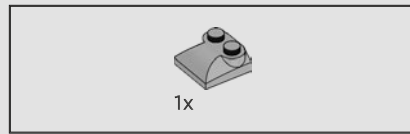
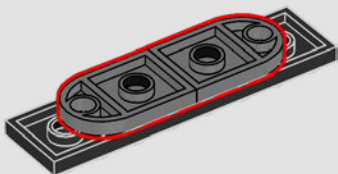

281

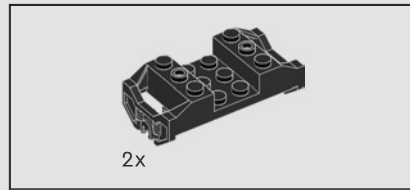
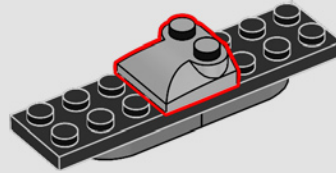

282

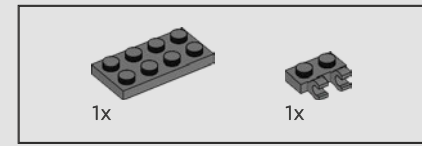
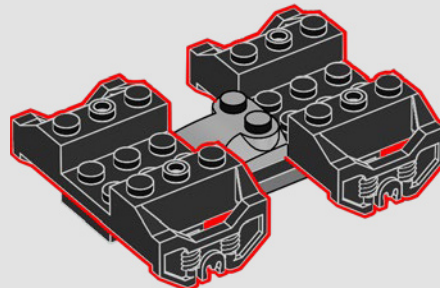

283

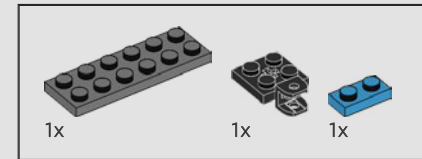
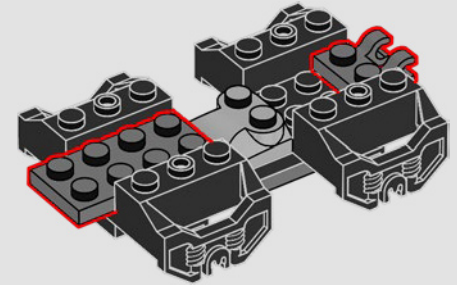

284

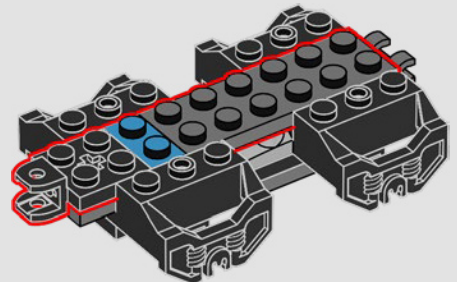



285

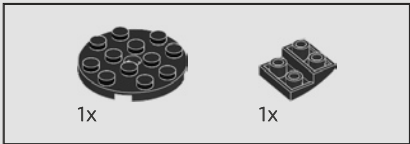
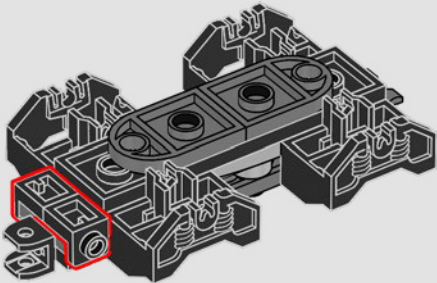

286

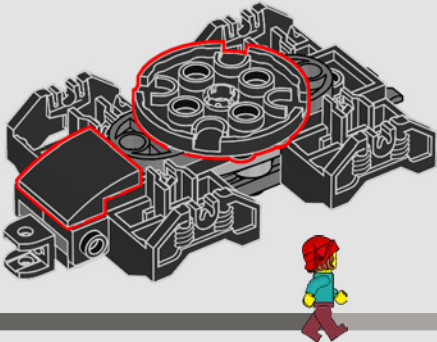

287

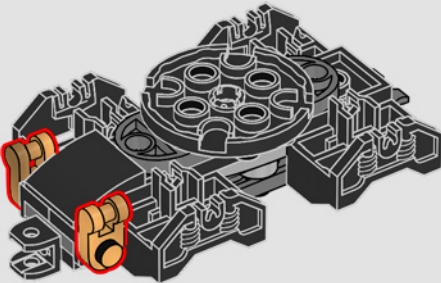

288

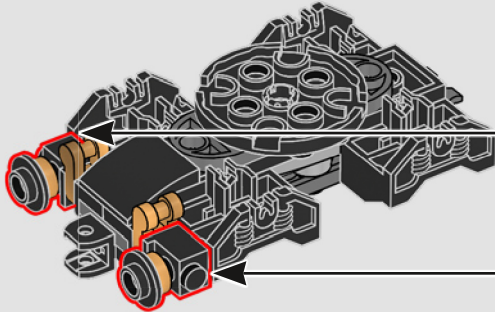
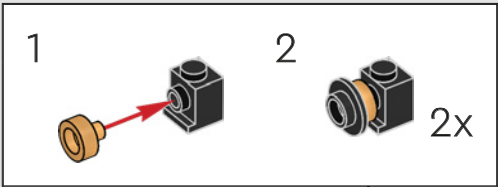

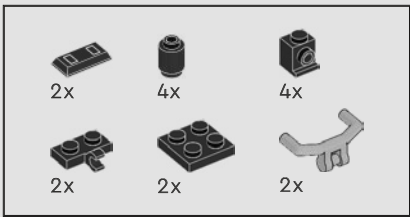

289

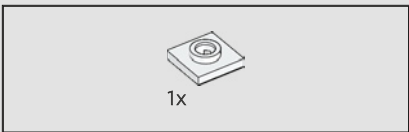
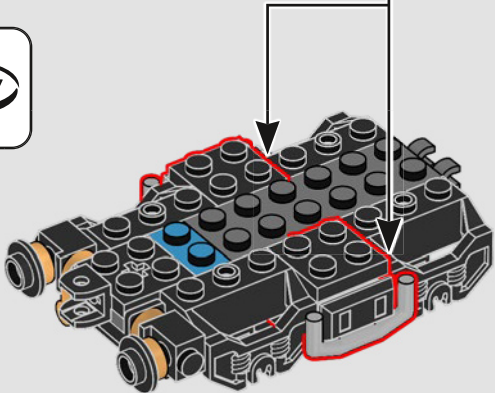
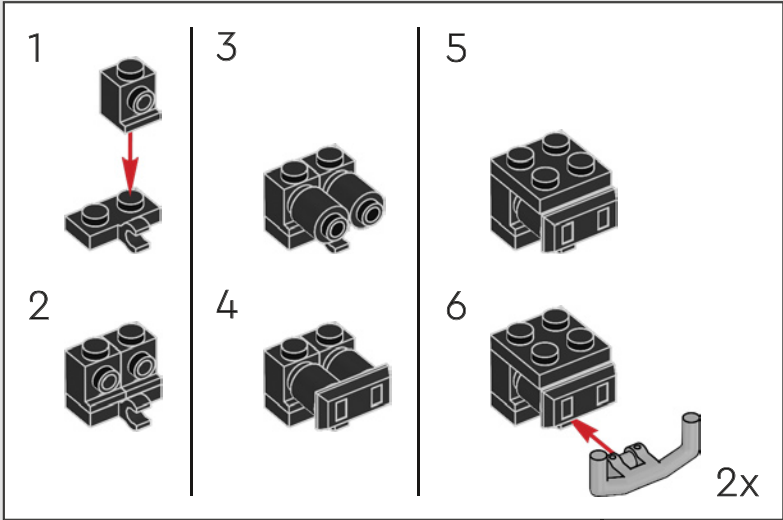

290

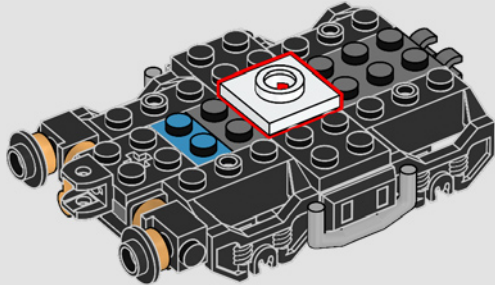

291

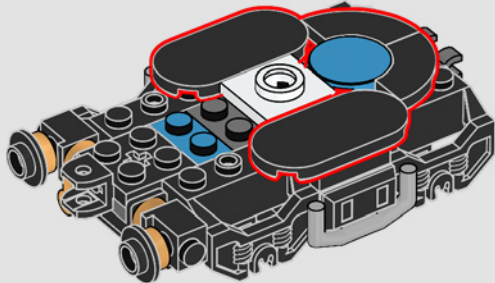

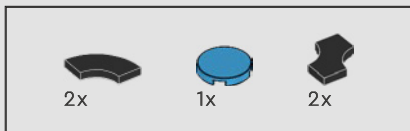

292

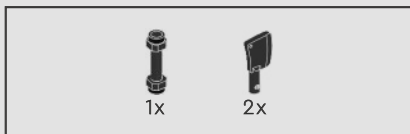
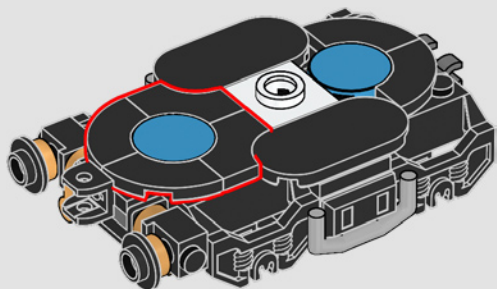

293

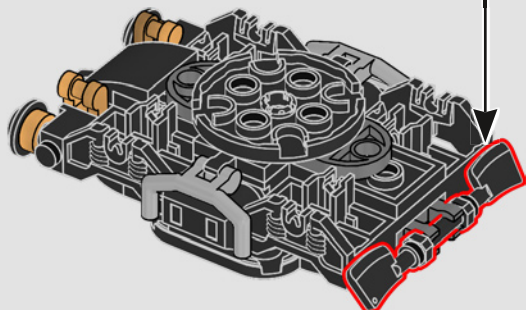
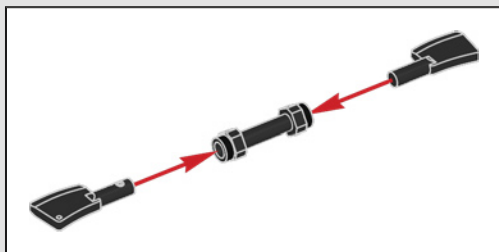

294

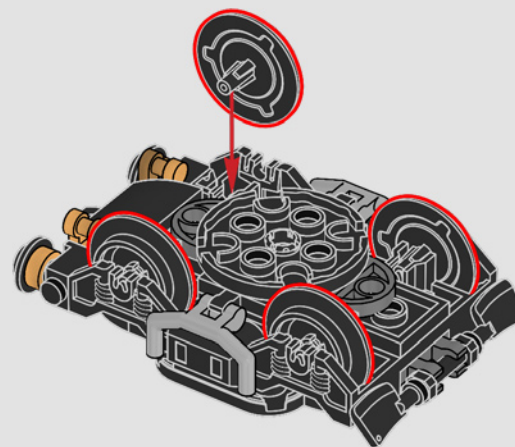

2x

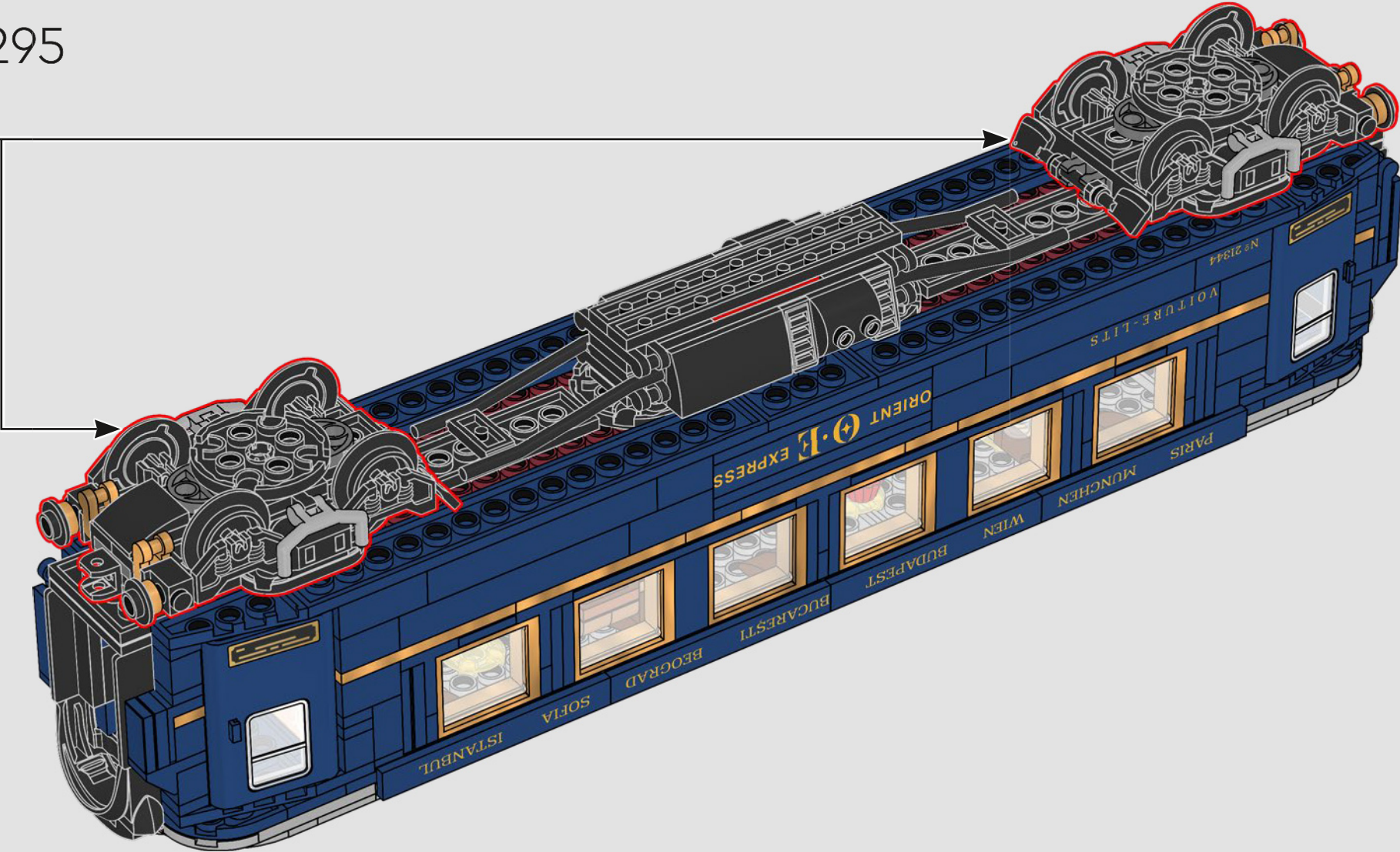

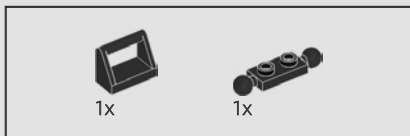

296

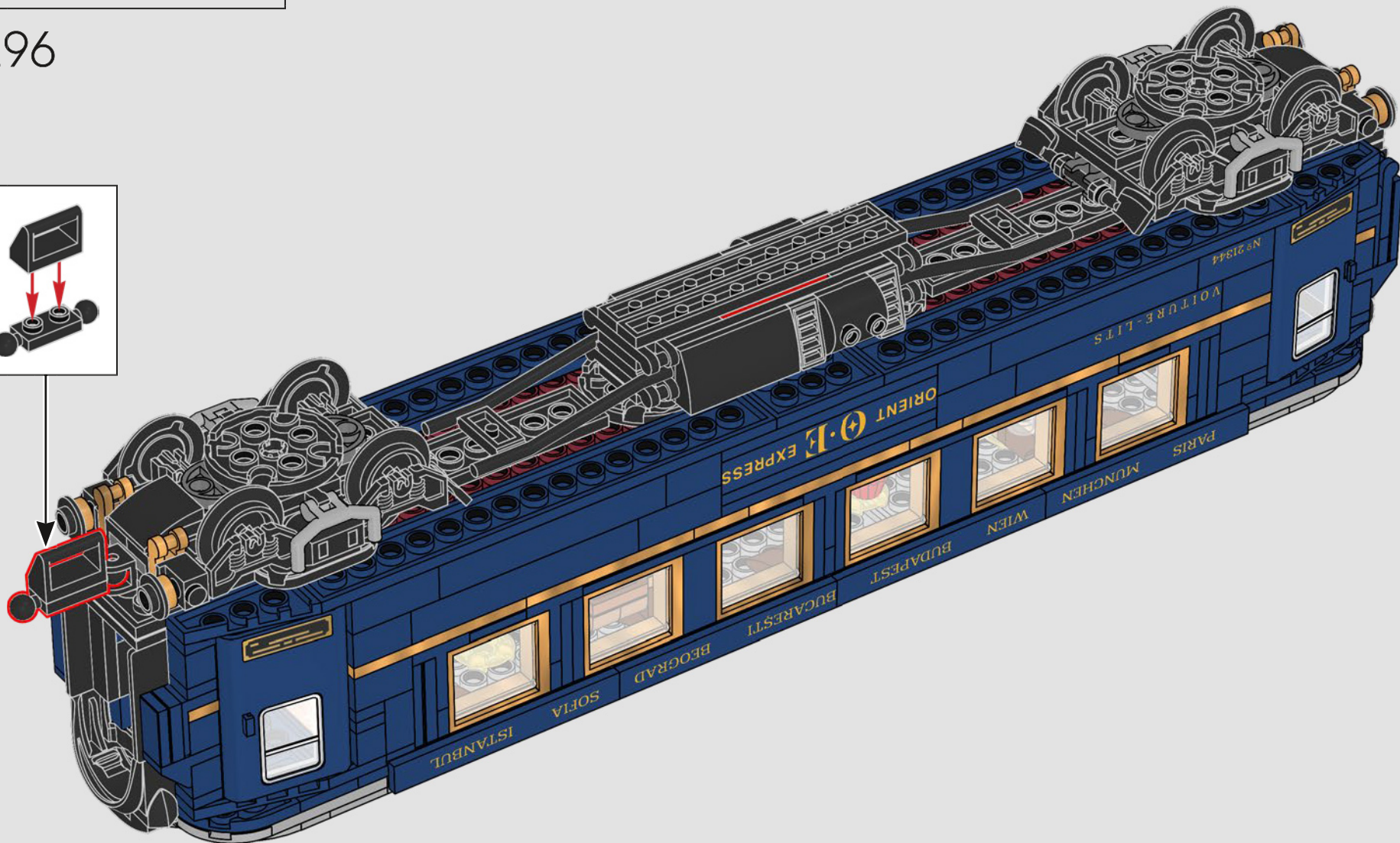
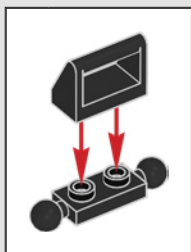

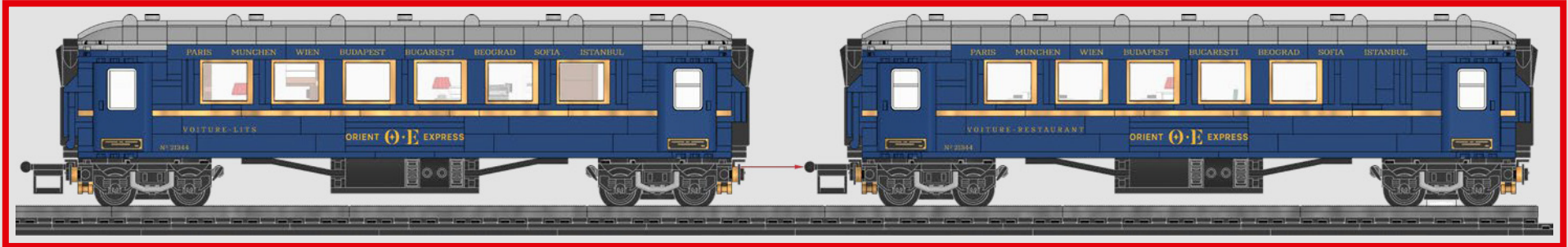
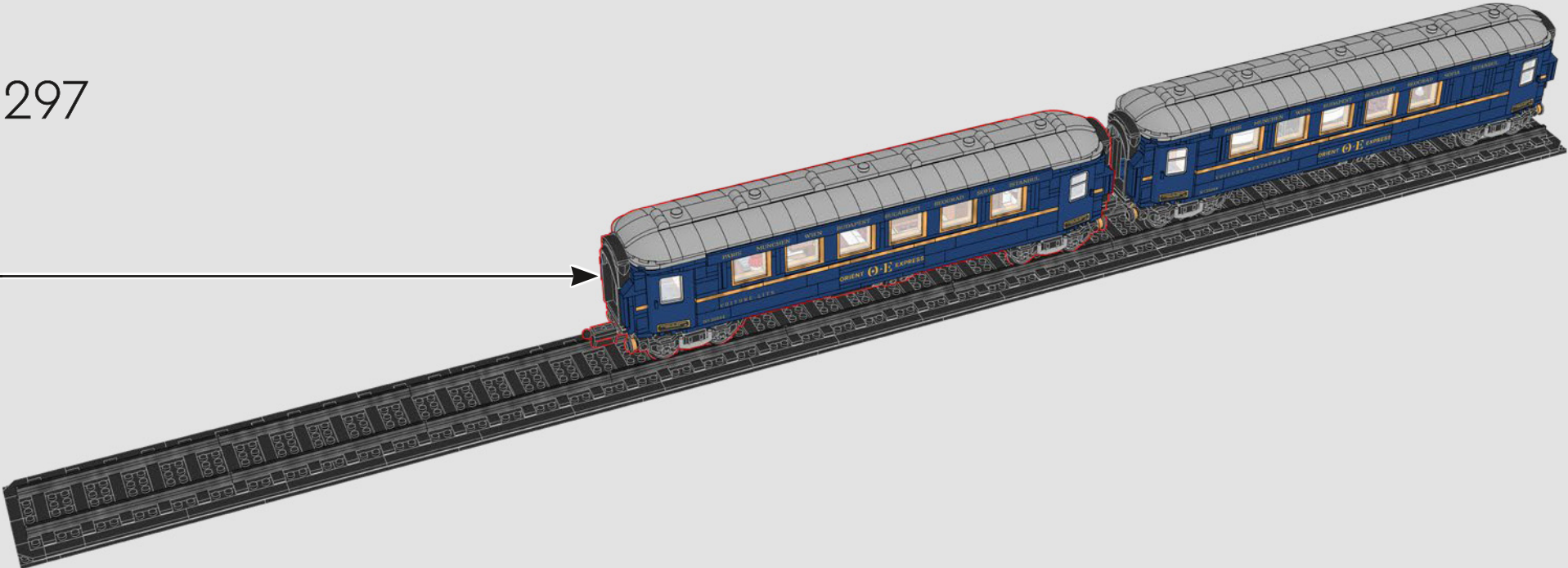

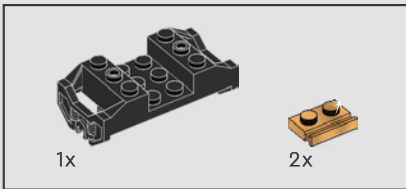
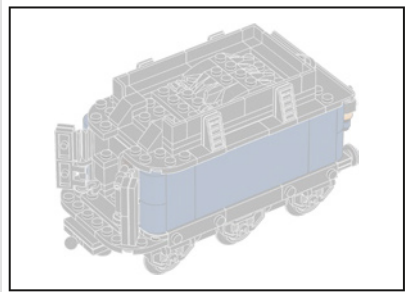

298

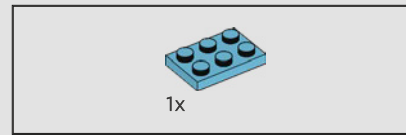
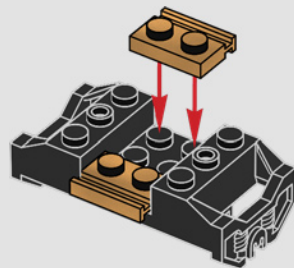

299

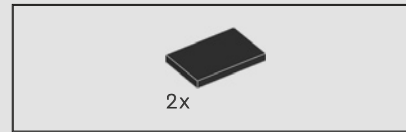
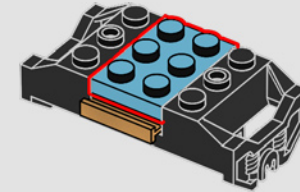

300

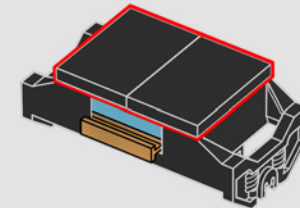

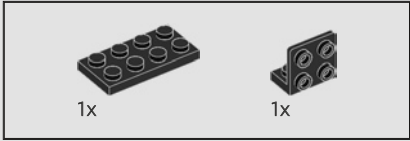
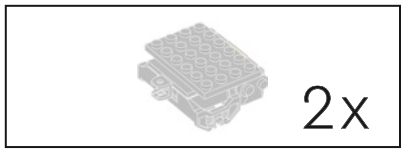

301

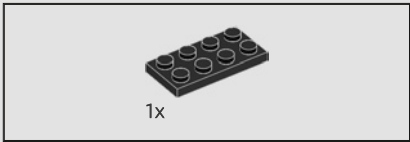
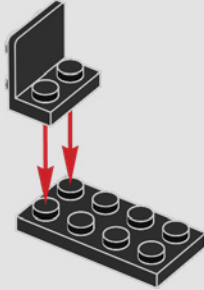

302

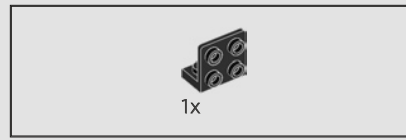
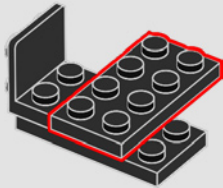

303

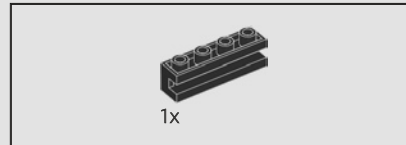
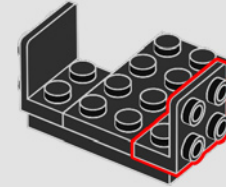

304

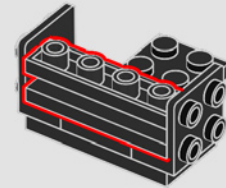



305

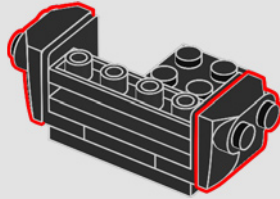

306

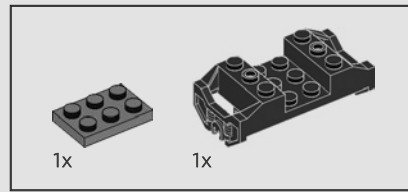
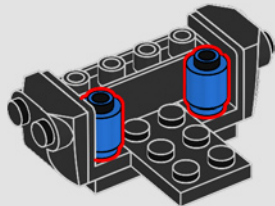

307

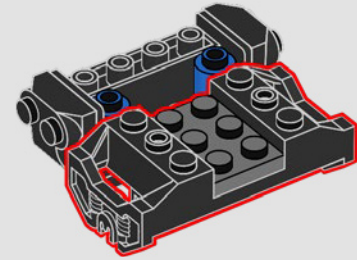
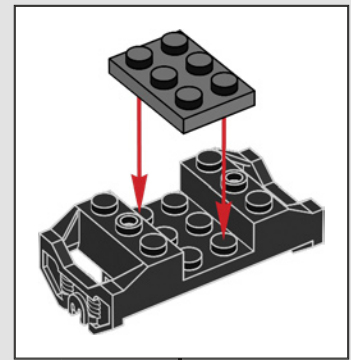

308

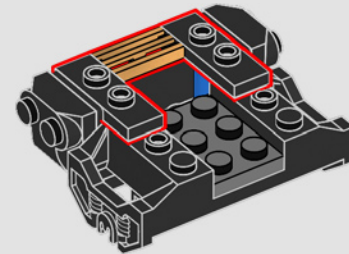

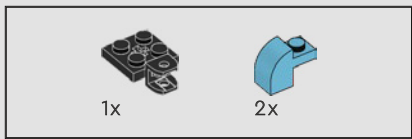

309

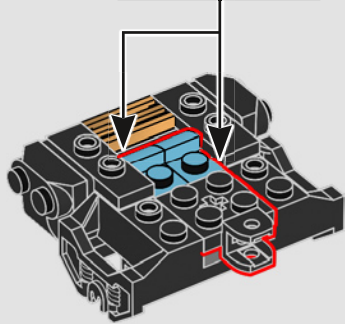
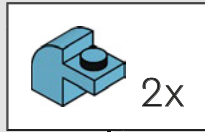

310

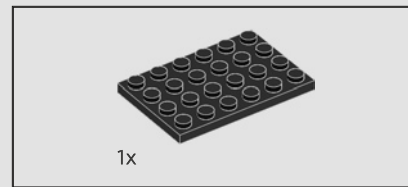
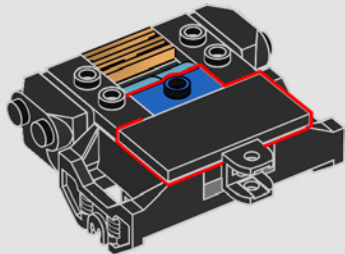

311

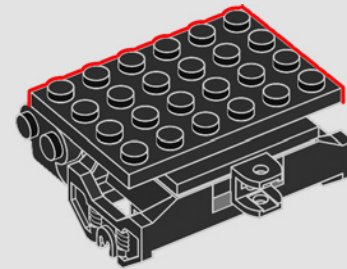

2x

312

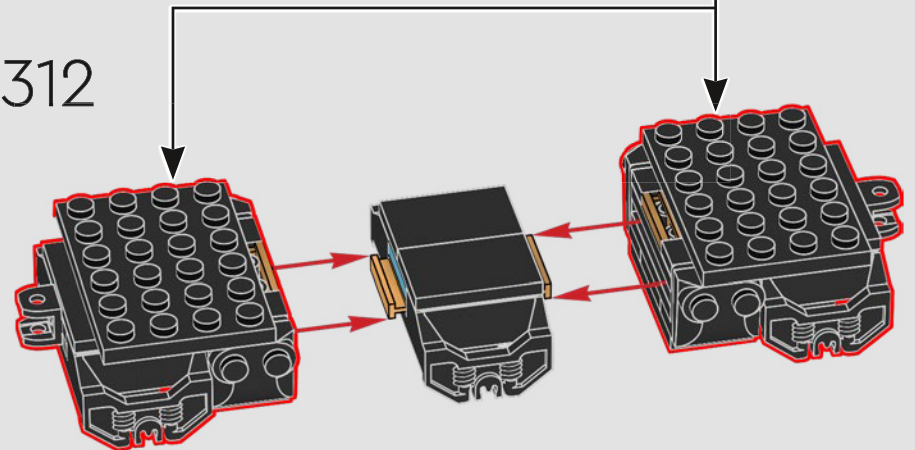

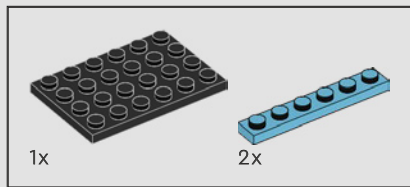

313

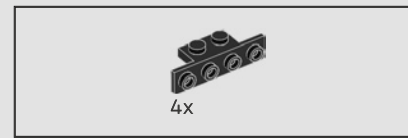
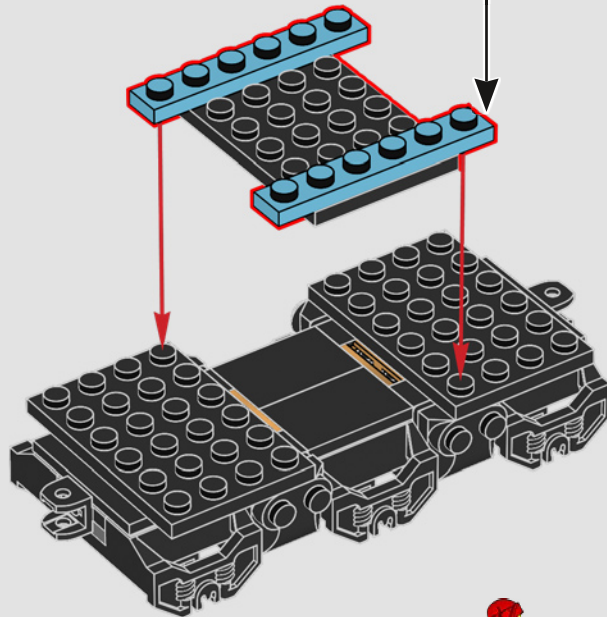
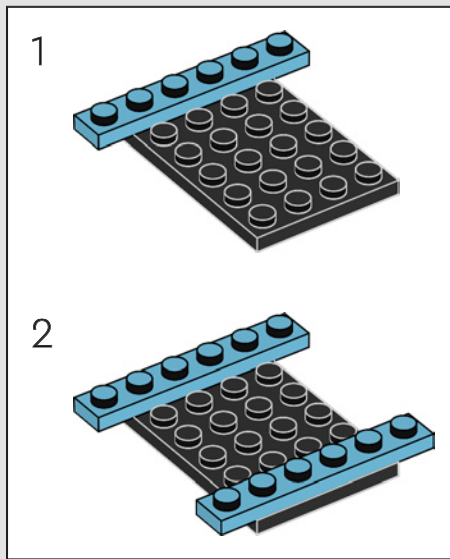

314

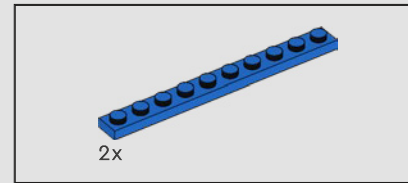
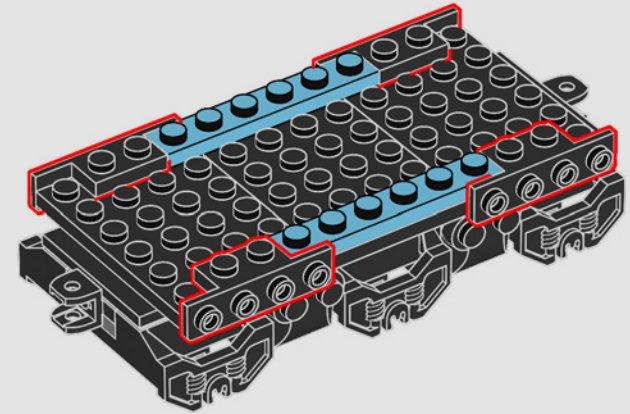

315

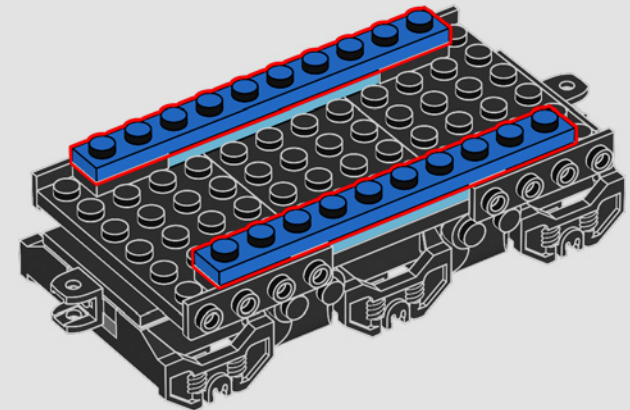

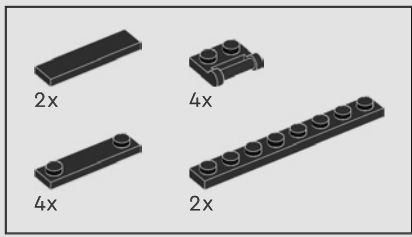

316

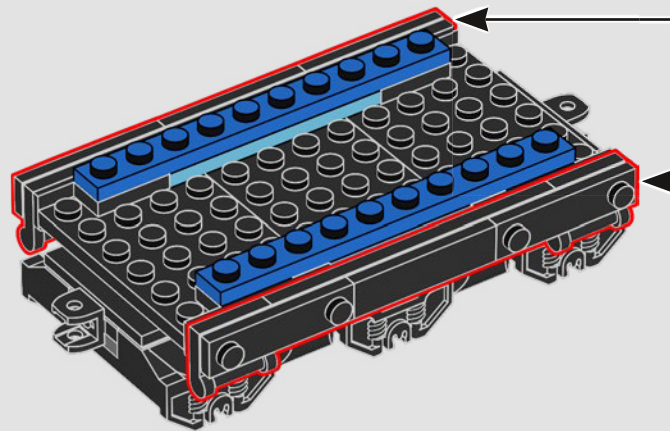
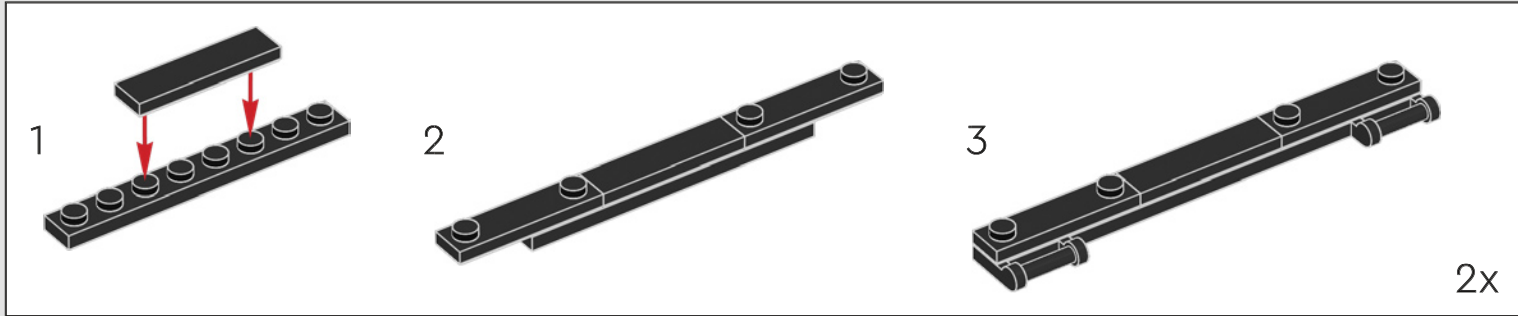

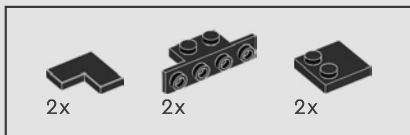

317

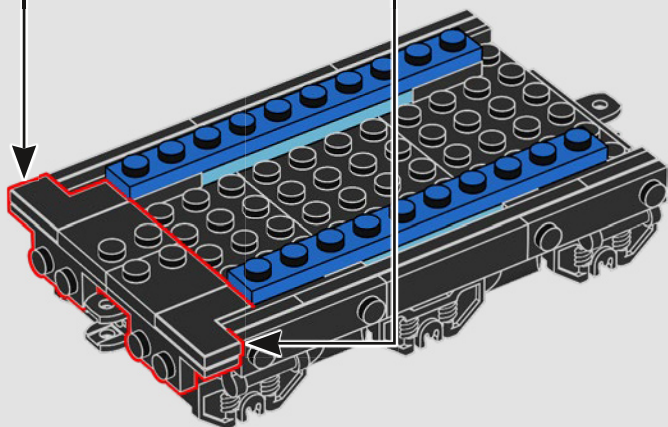
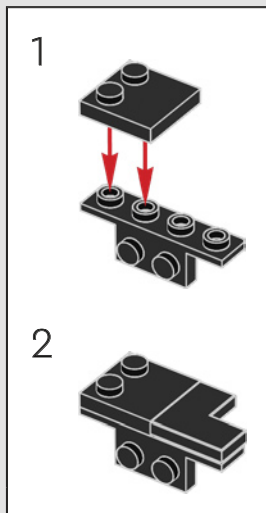
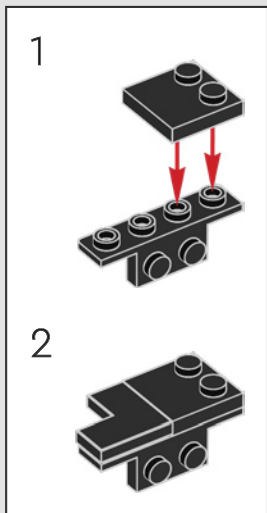

318

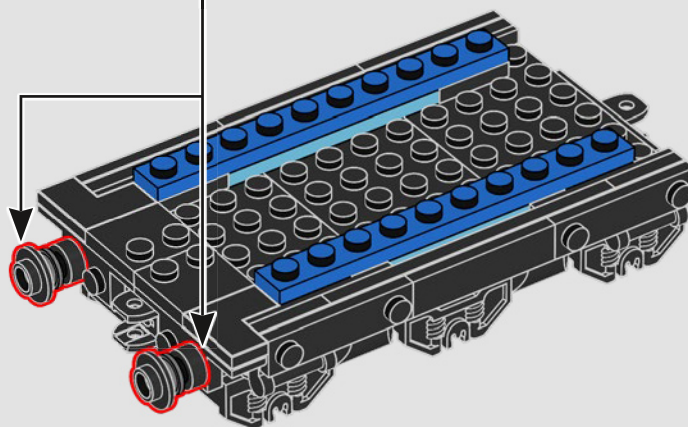
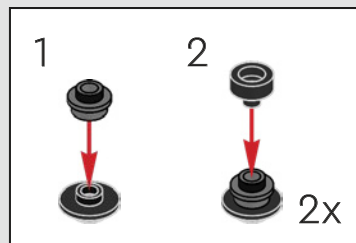

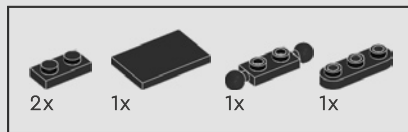

319

« La vapeur continue de s'échapper du moteur.
Le ravitailleur à charbon doit être grand pour
alimenter une telle locomotive. »

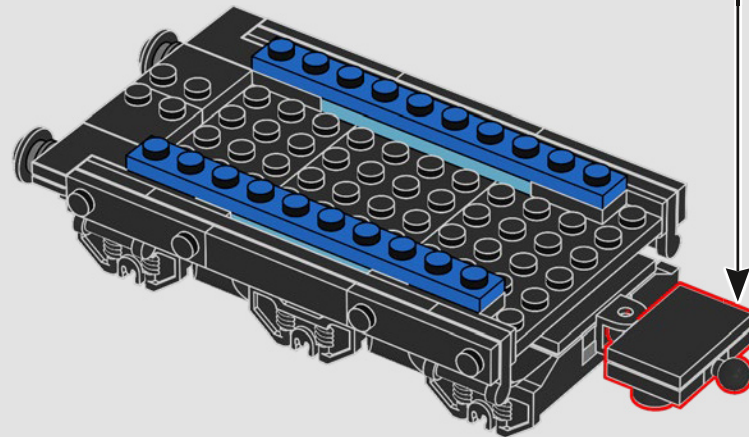
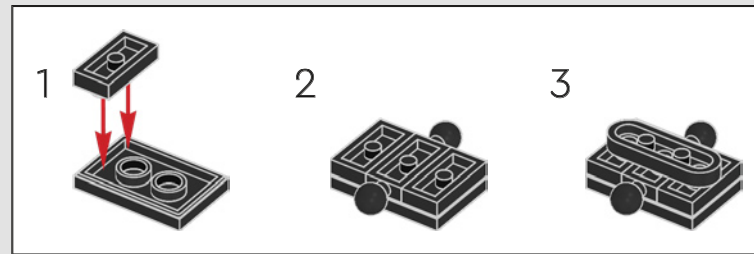

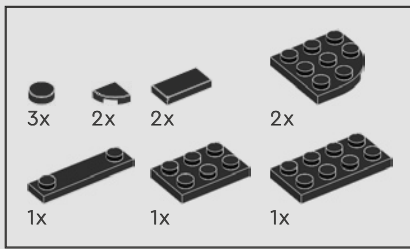

320

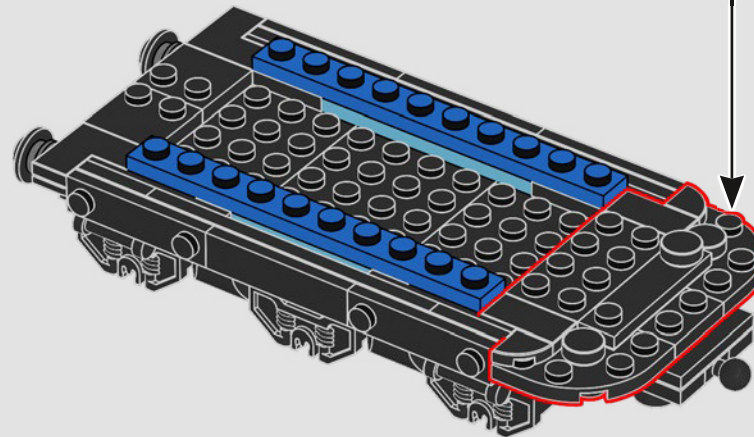
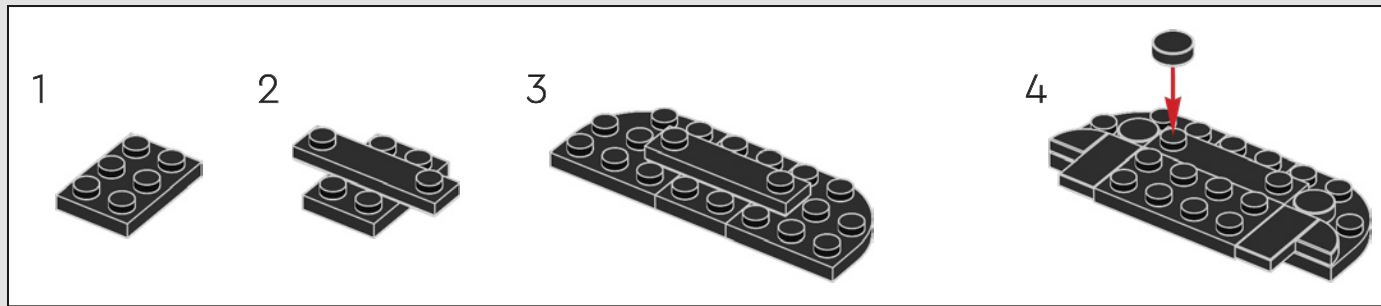

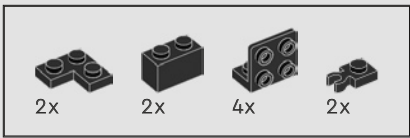

321

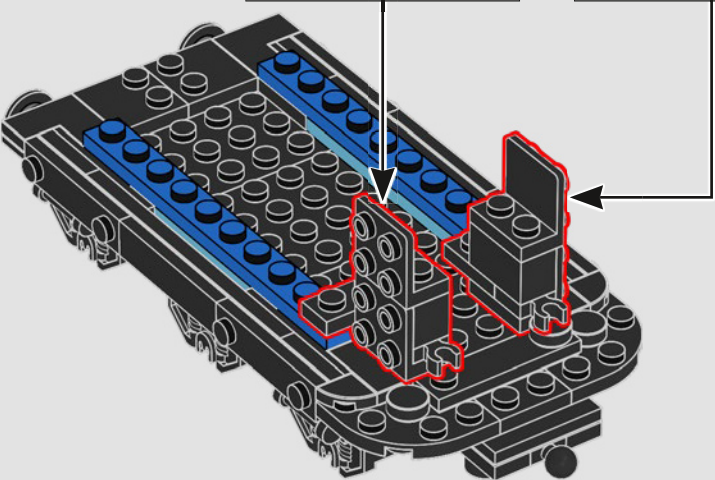
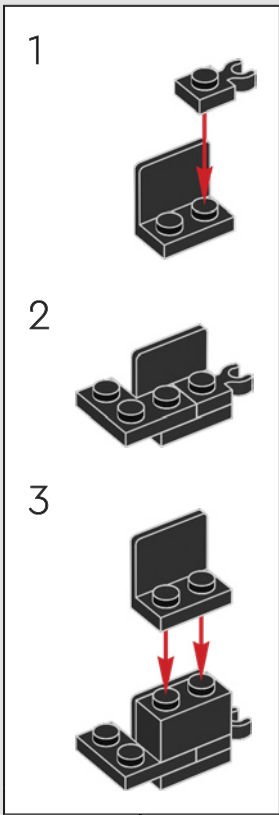
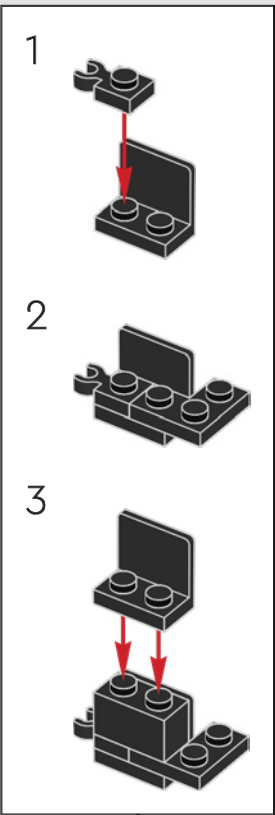



322

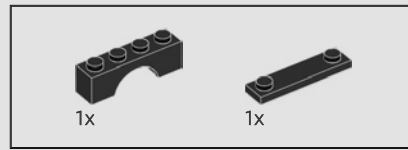
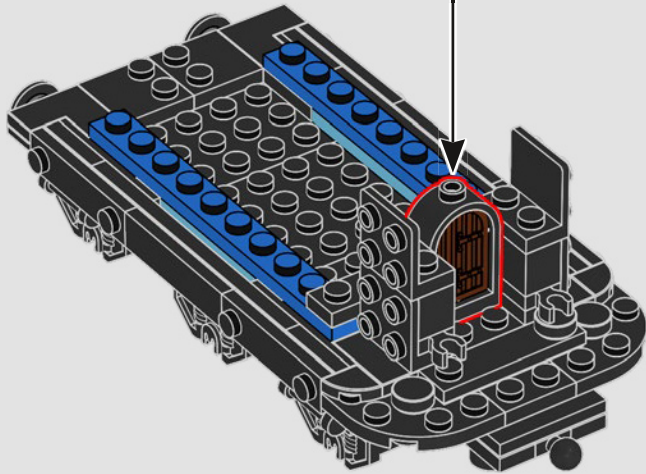
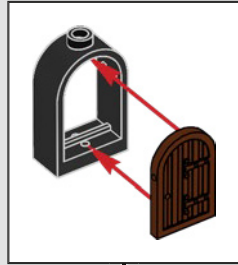

323

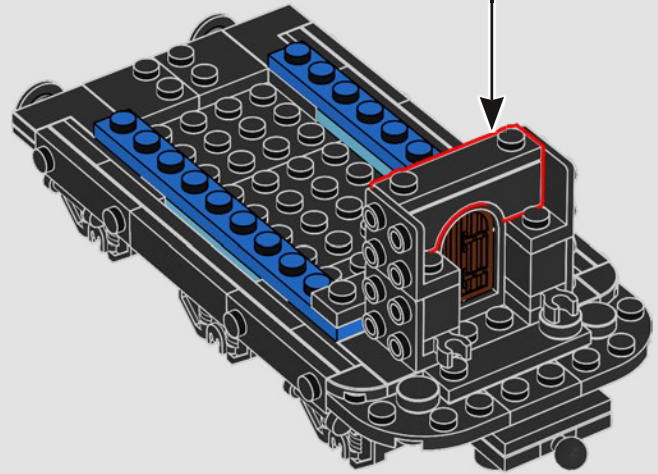
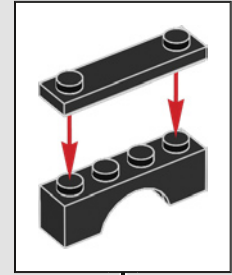



326

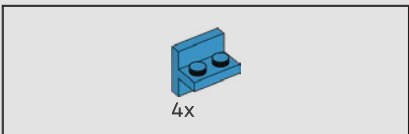
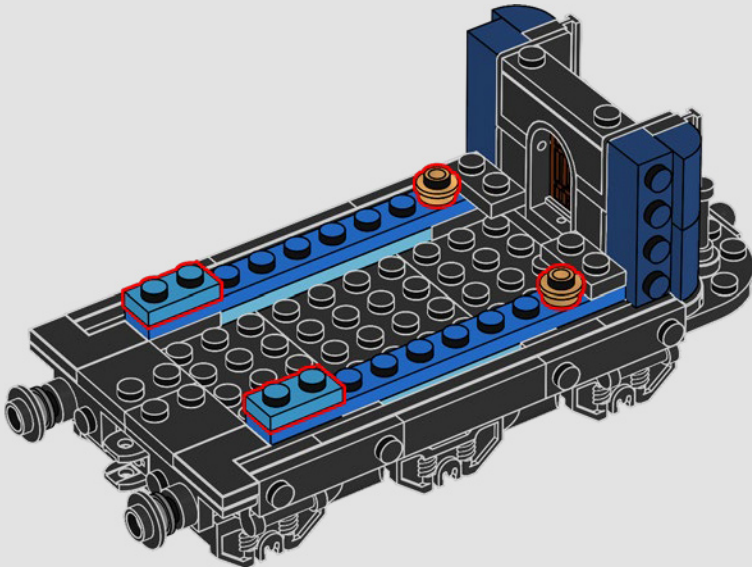

327

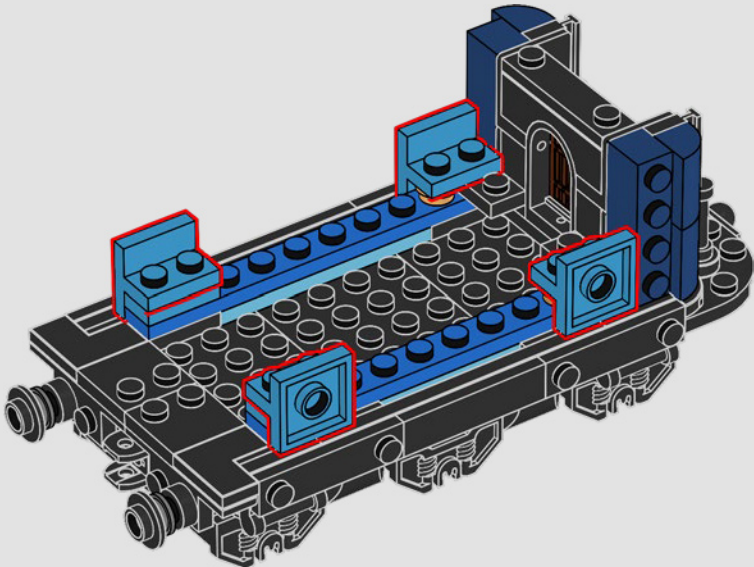

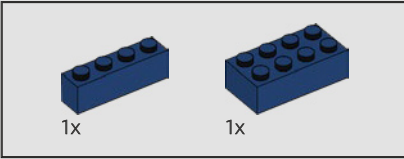
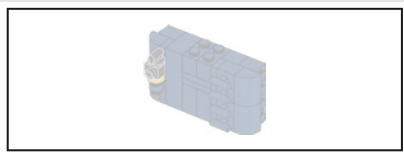

330

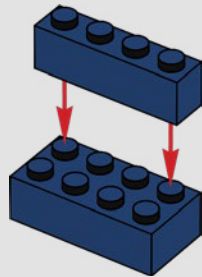

331

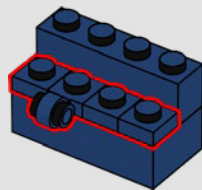

2x

332

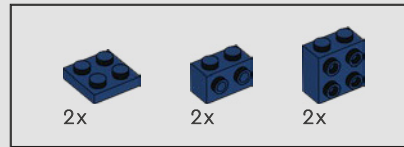
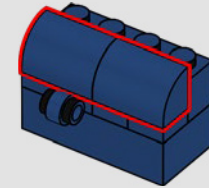

2x

2x

2x

333

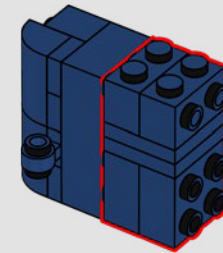
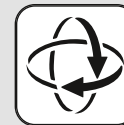
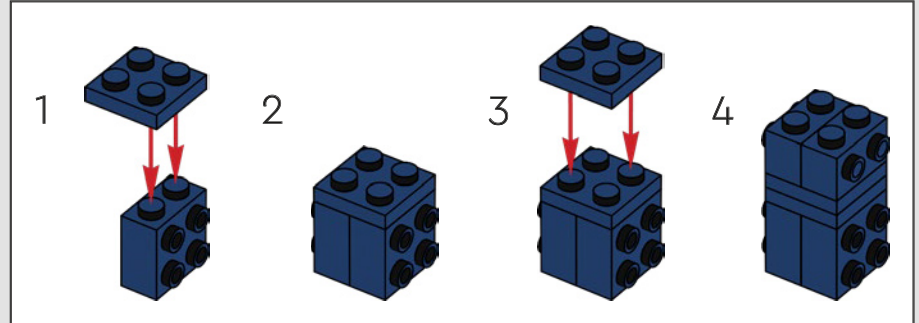

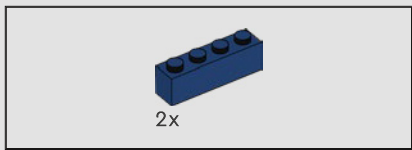

334

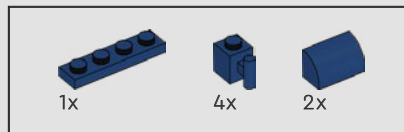
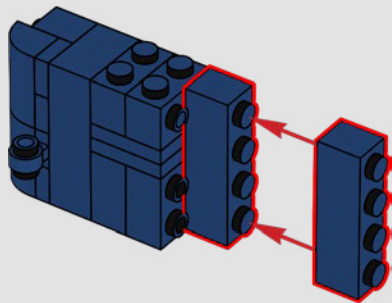

335

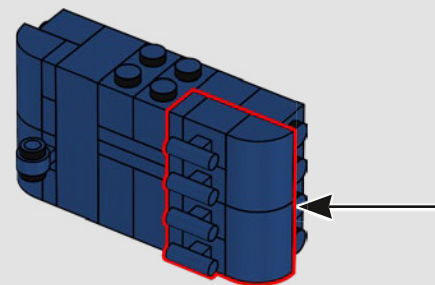
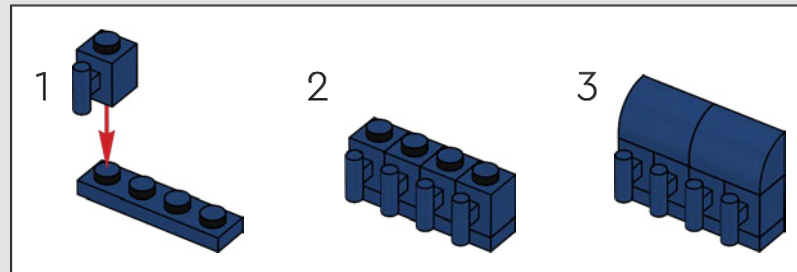



336

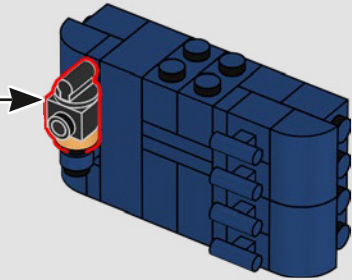
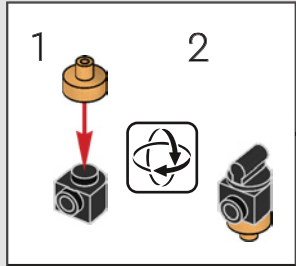

337

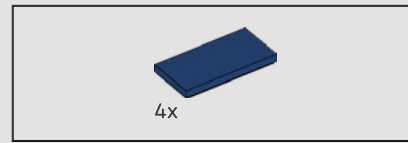
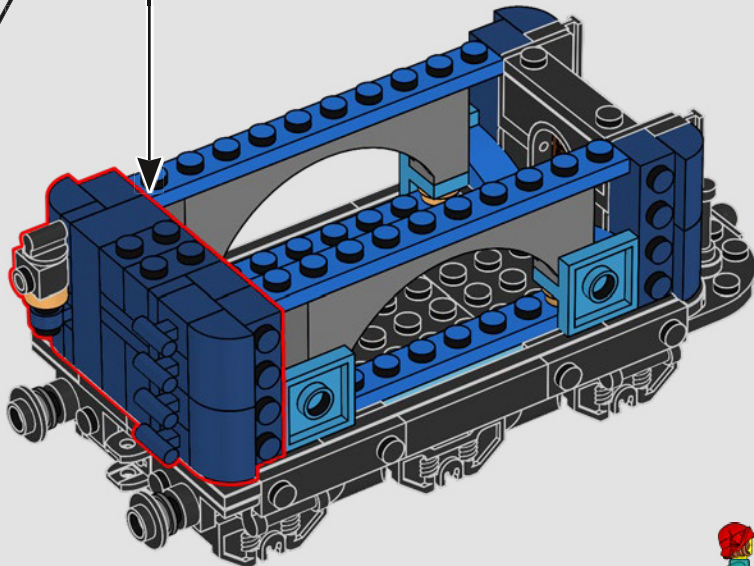

338

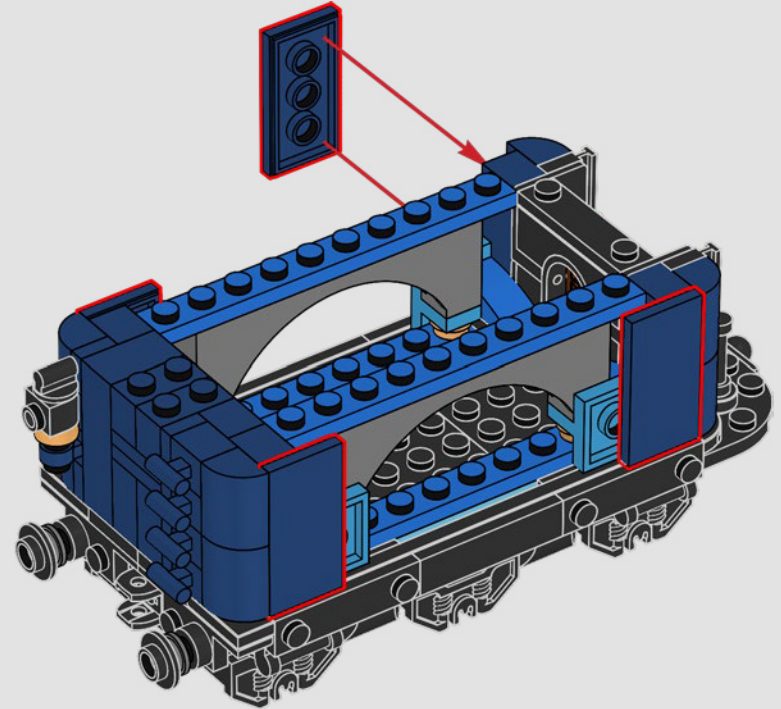

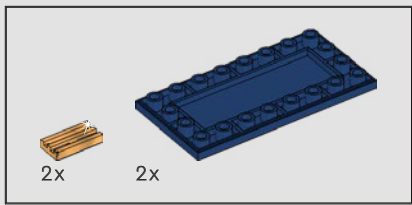

339

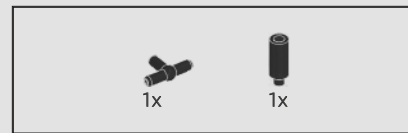
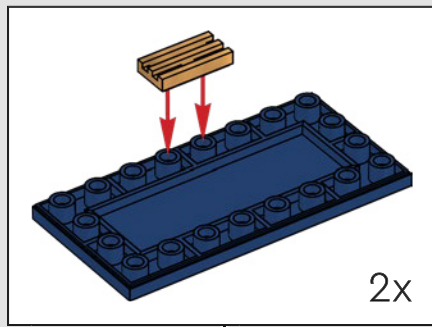

340

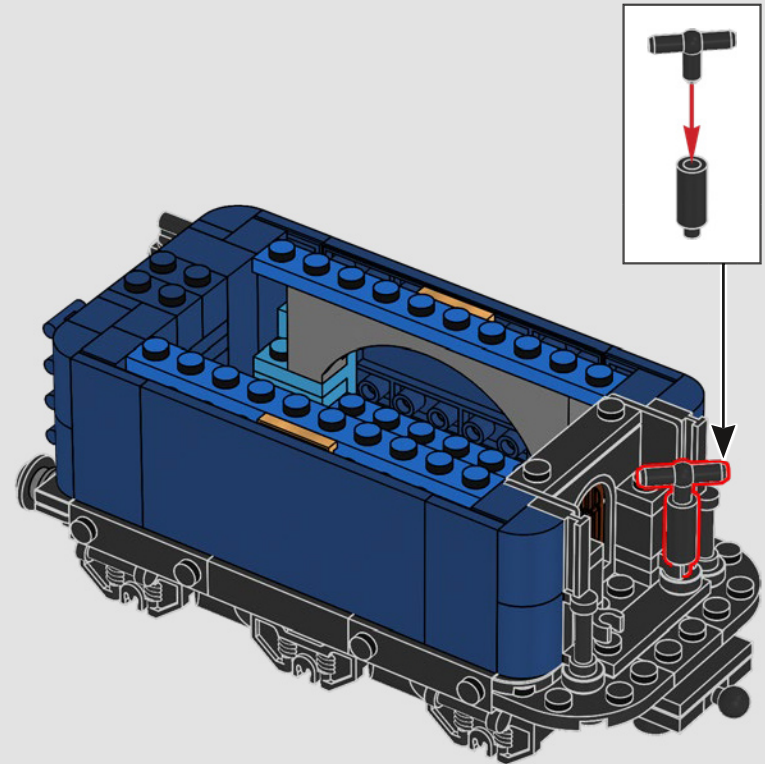
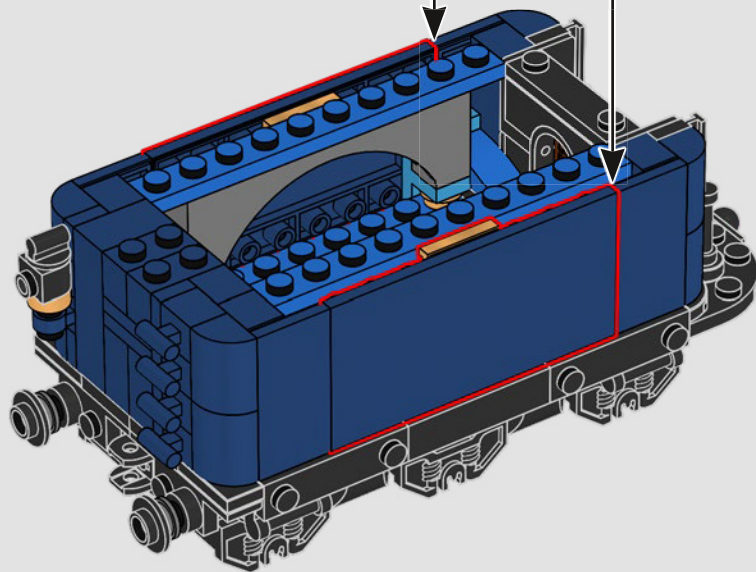

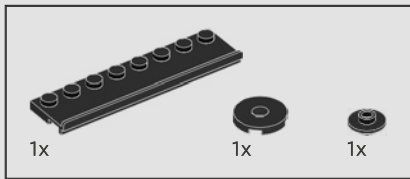

341

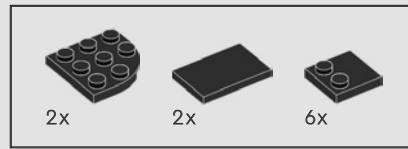
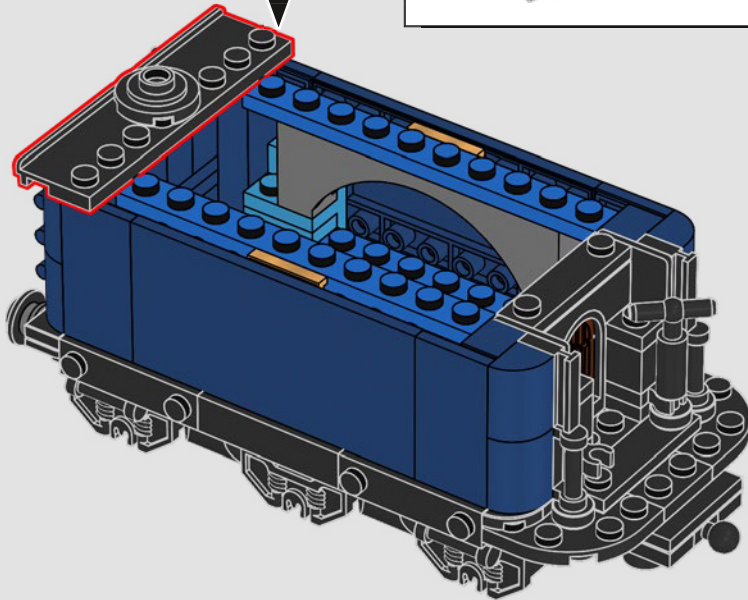
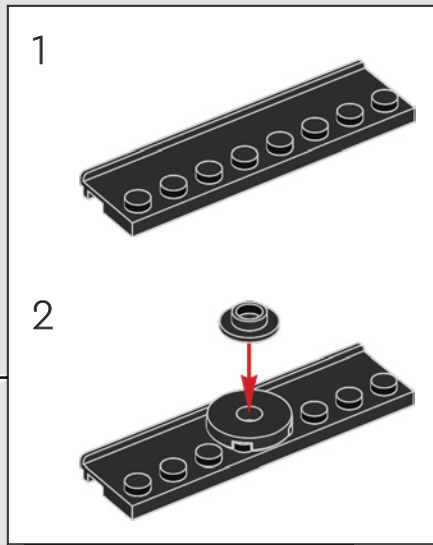

342

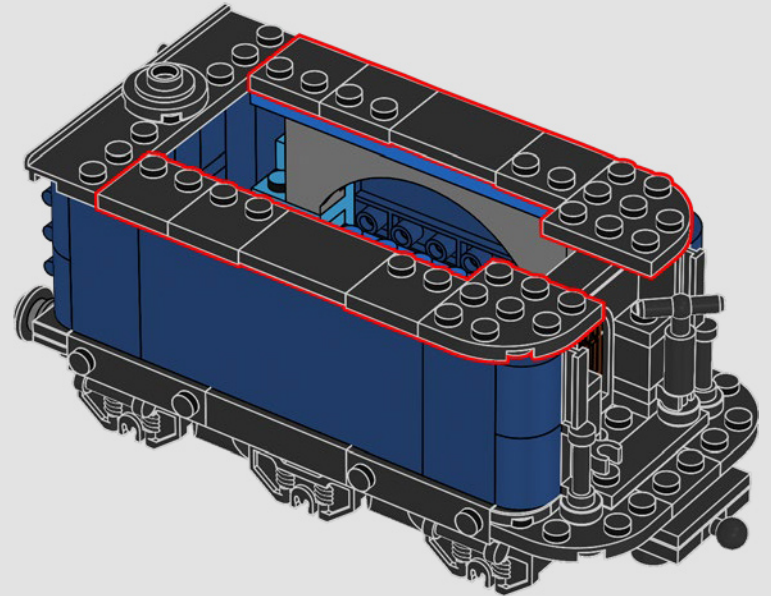

5

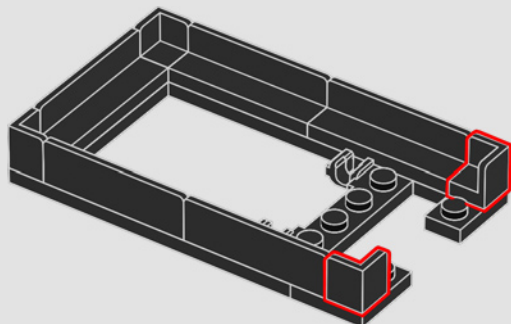

6

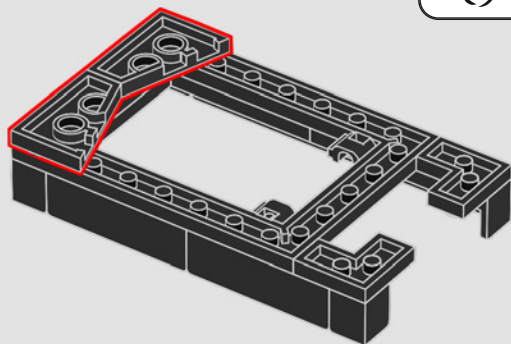

7

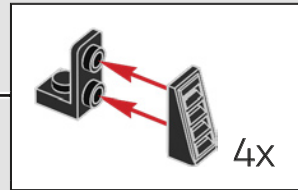
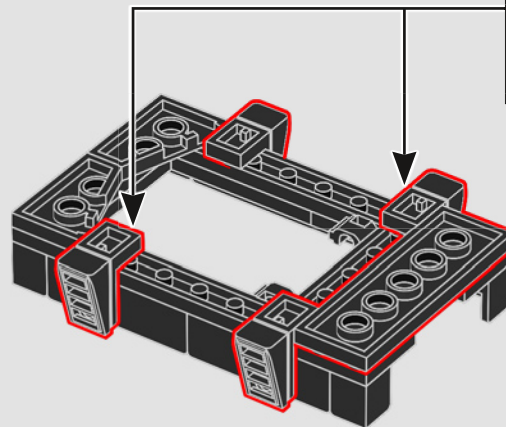

8

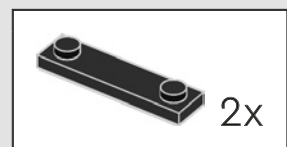
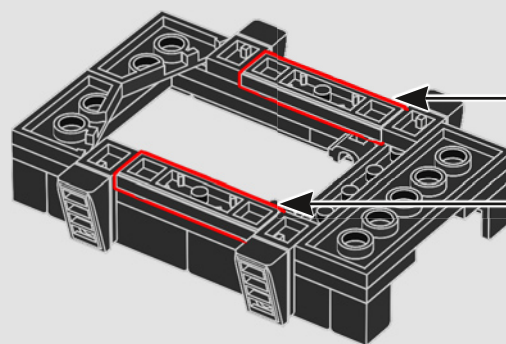



9

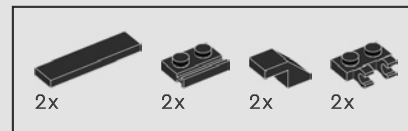
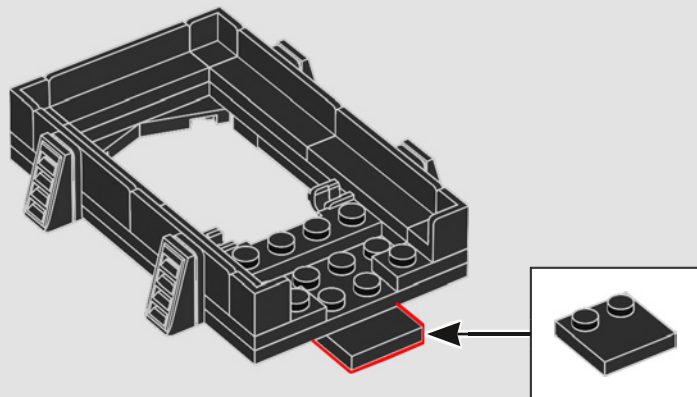

344

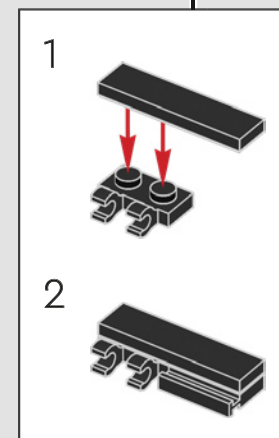
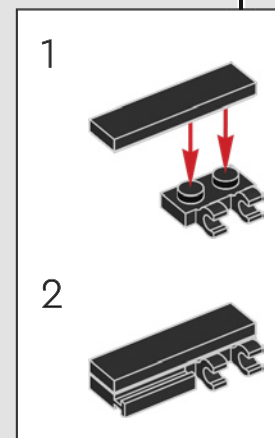
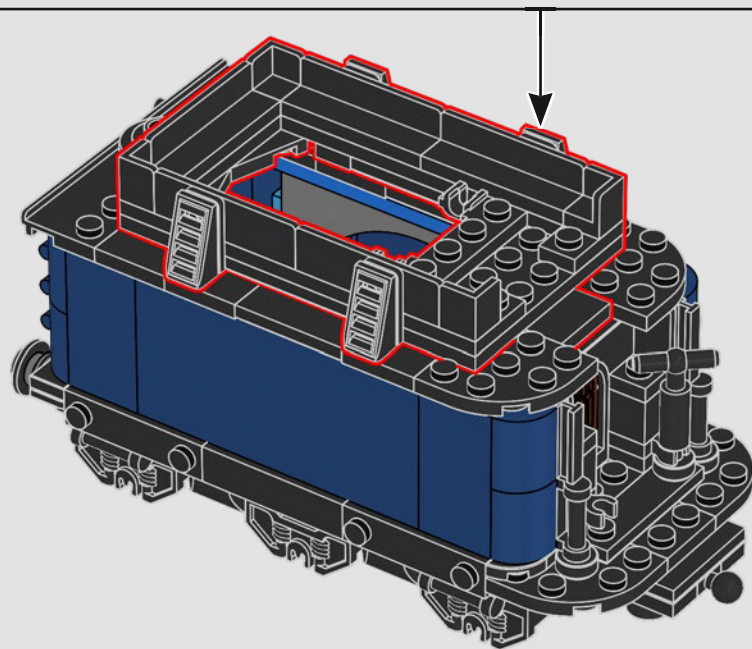
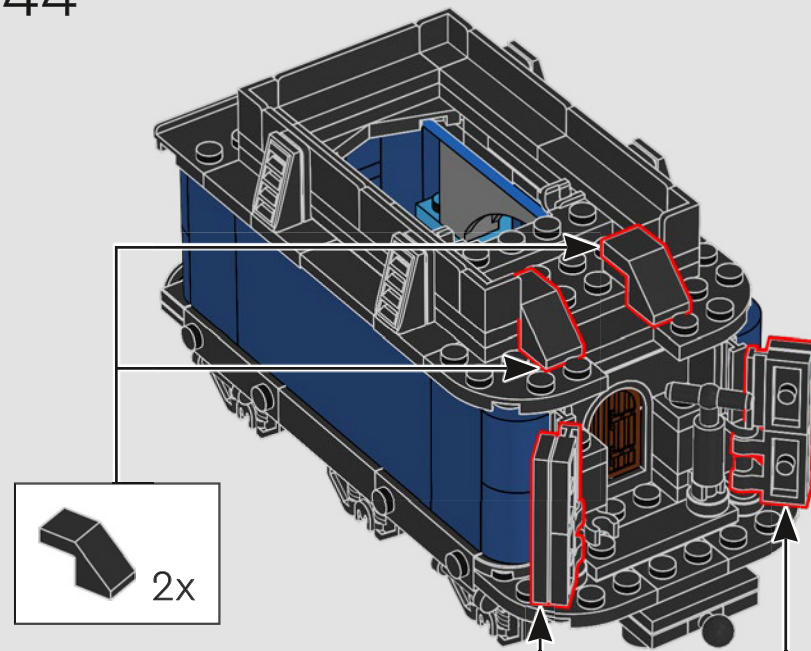



345

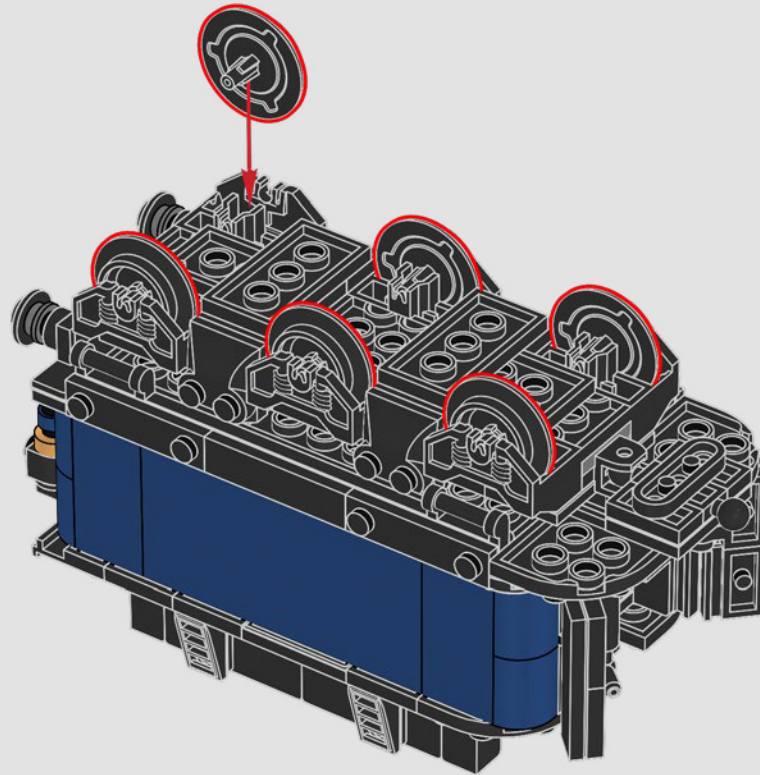

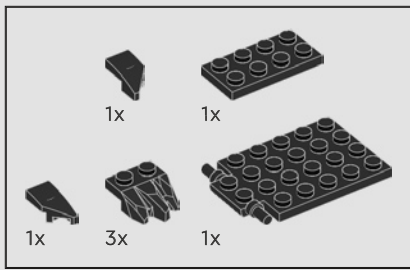

346

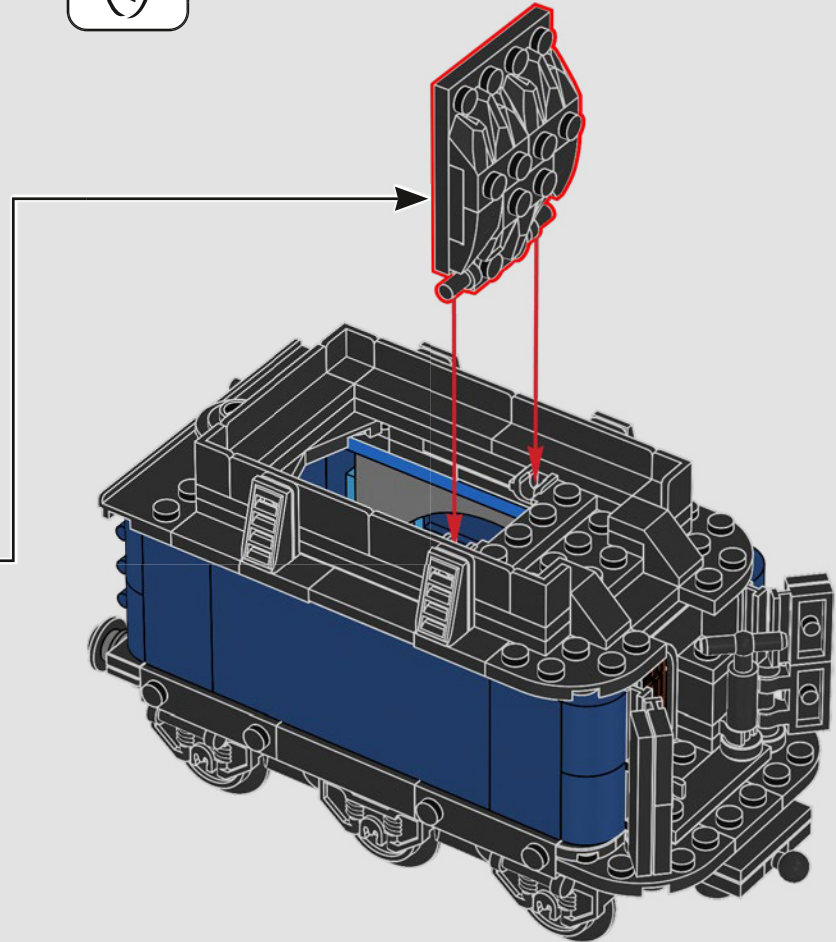
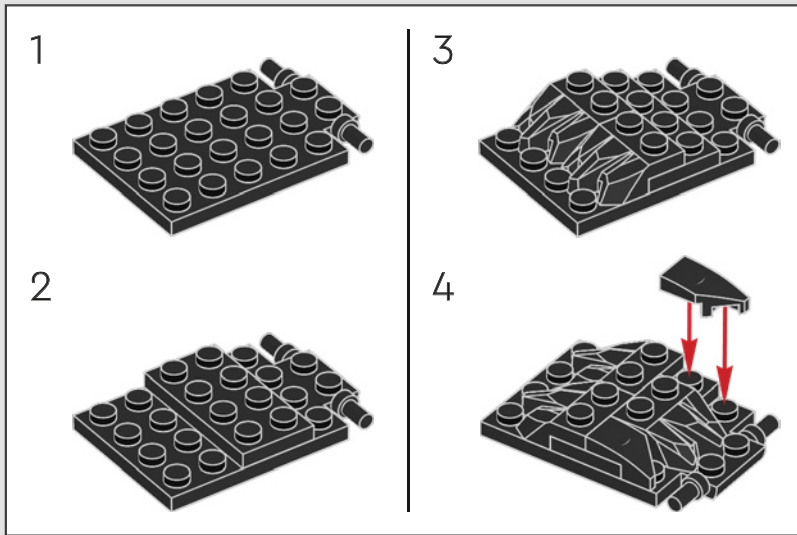

347



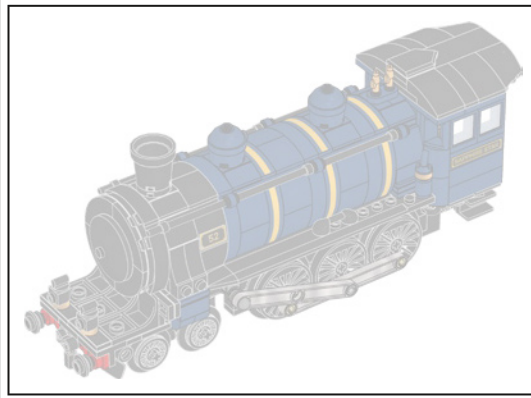
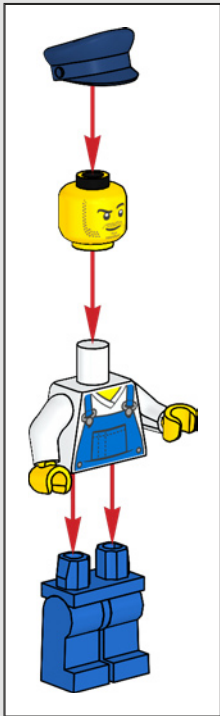

348

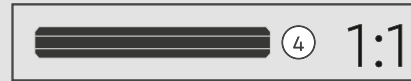
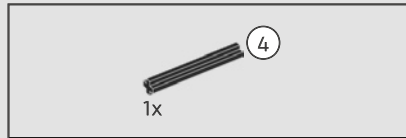

349

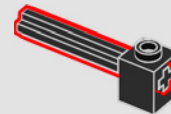

« Le conducteur de train attise le feu et maintient le moteur en bon état tout au long de notre voyage. »



350

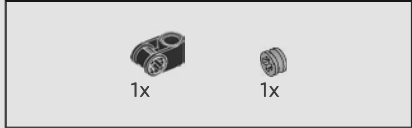
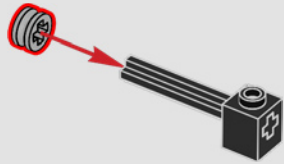

351

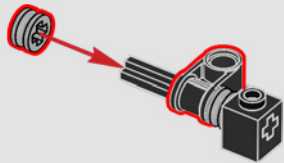

352

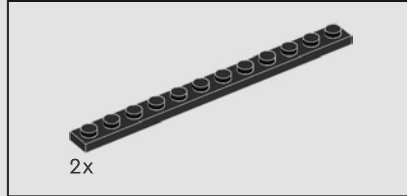
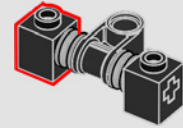

353

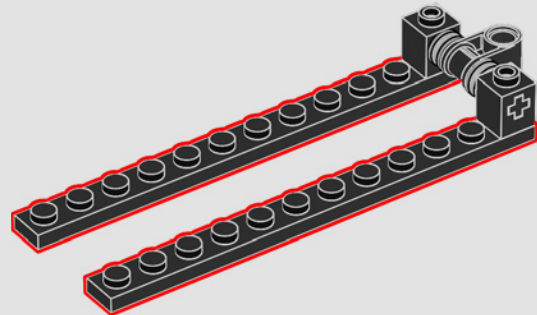

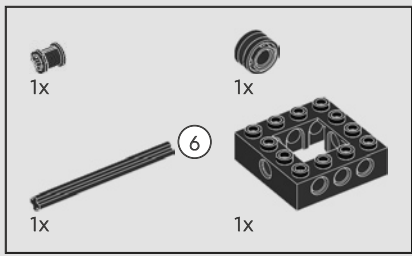

354

1

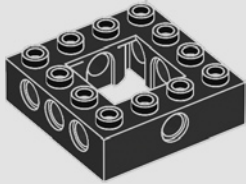

2

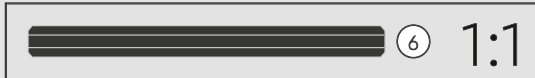
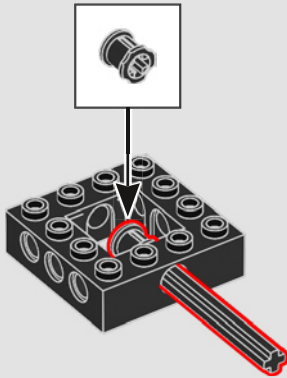

3

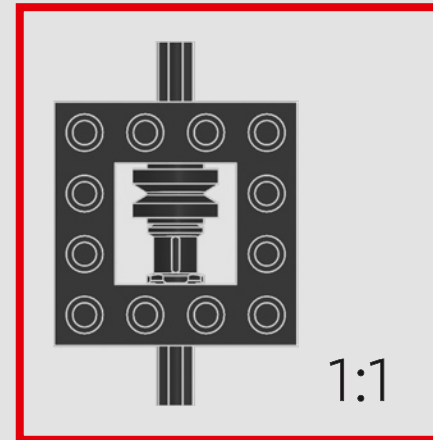
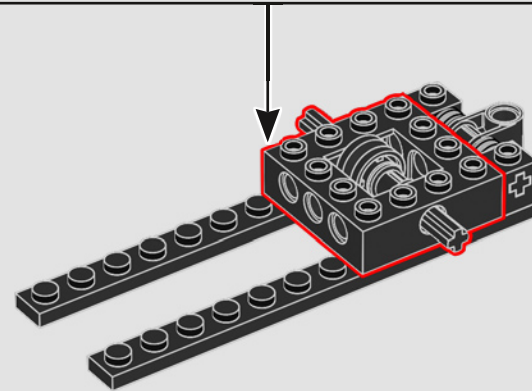
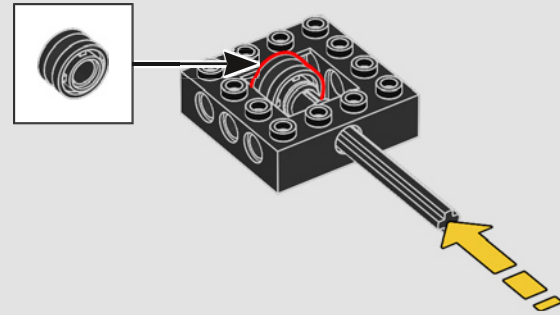

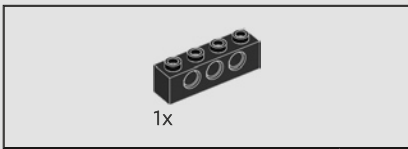

355

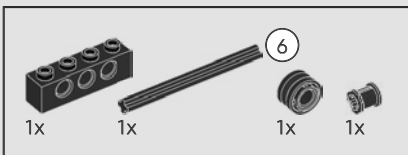
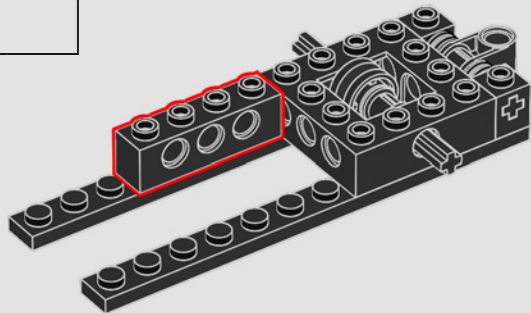

356

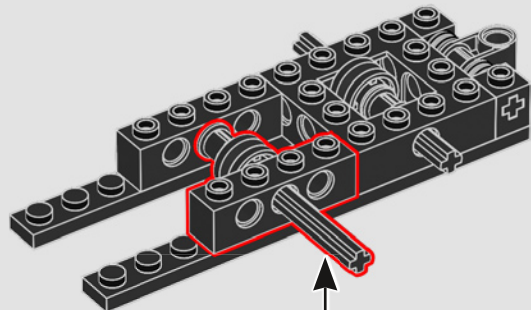
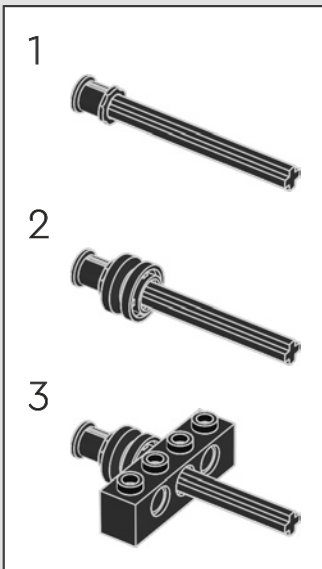

357

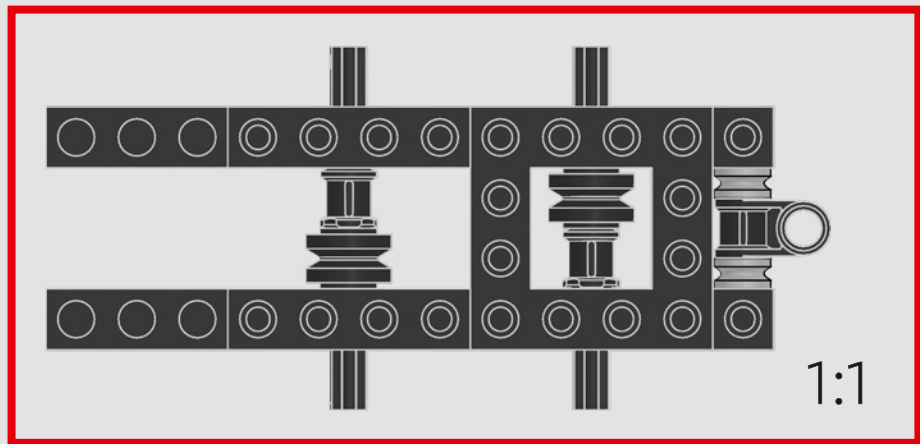
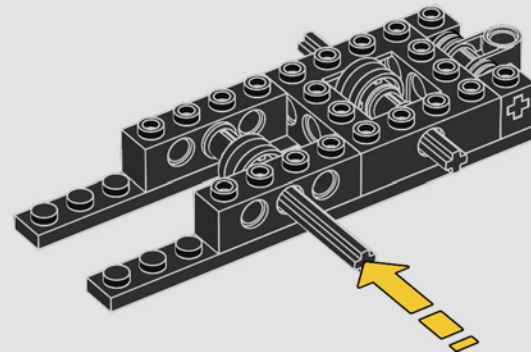

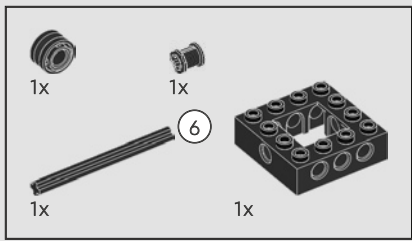

358

1

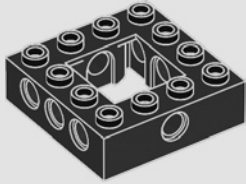

2

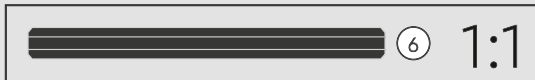
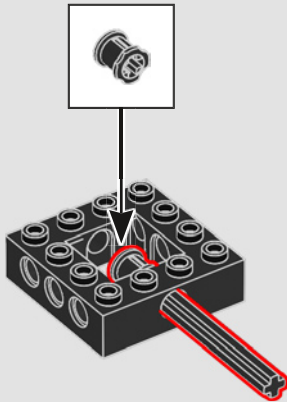

3

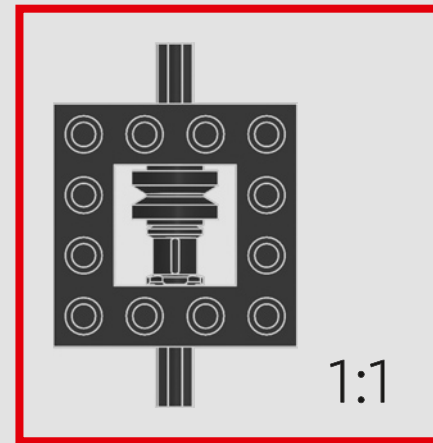
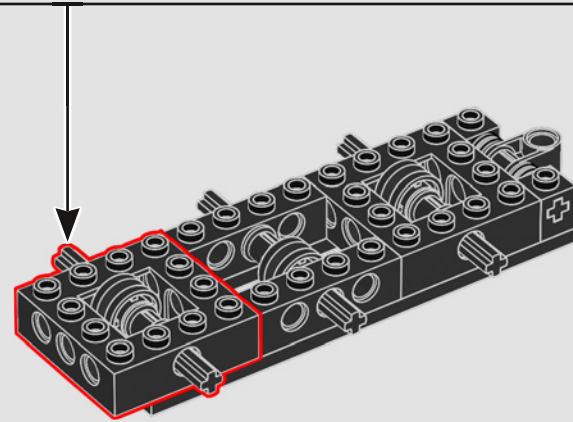
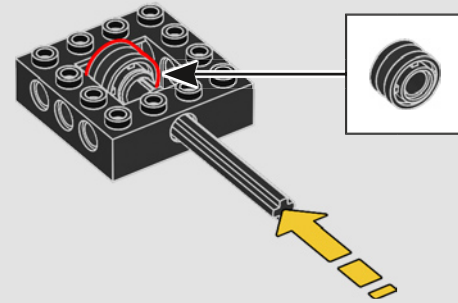

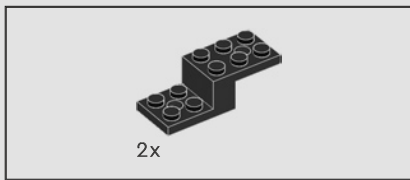

359

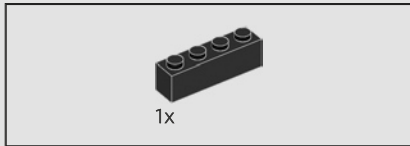
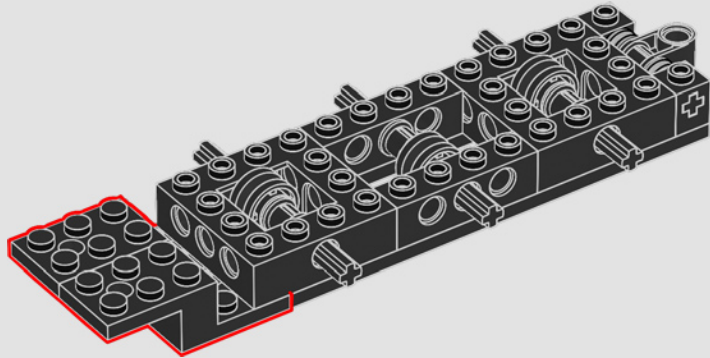

360

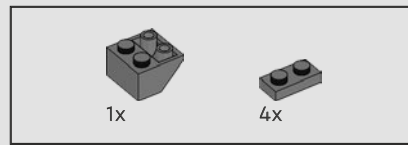
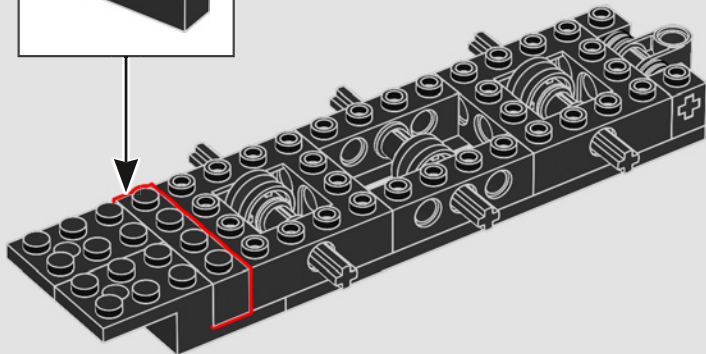
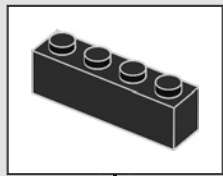

361

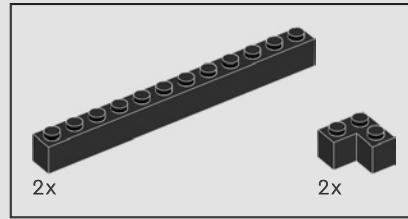
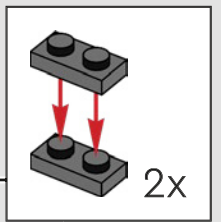
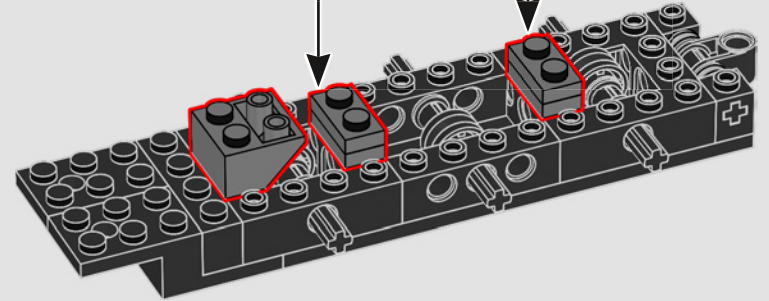

362

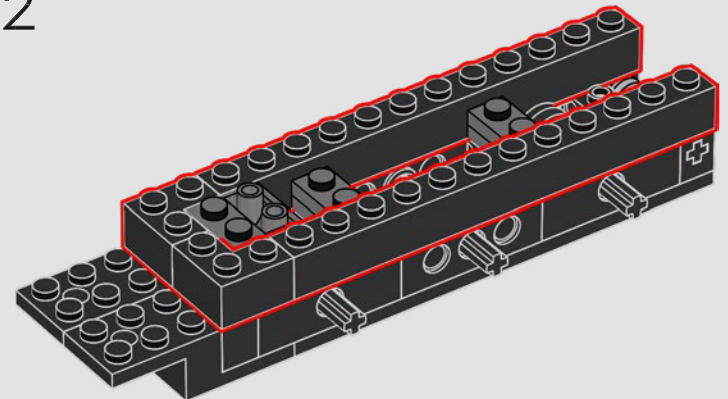



363

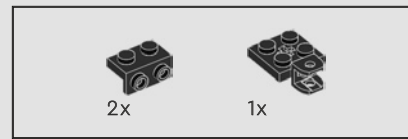
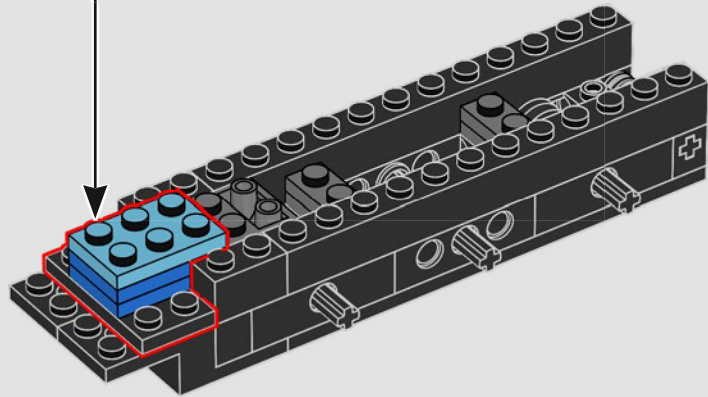
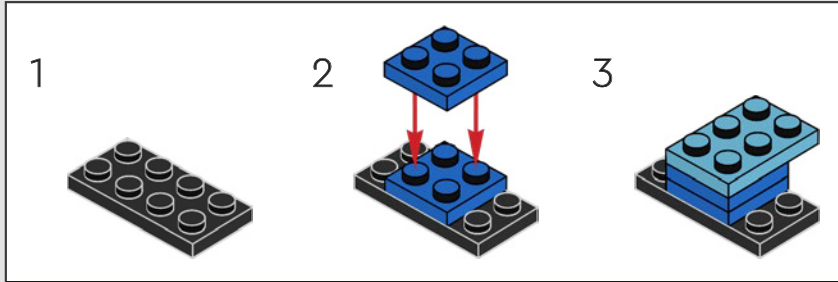

364

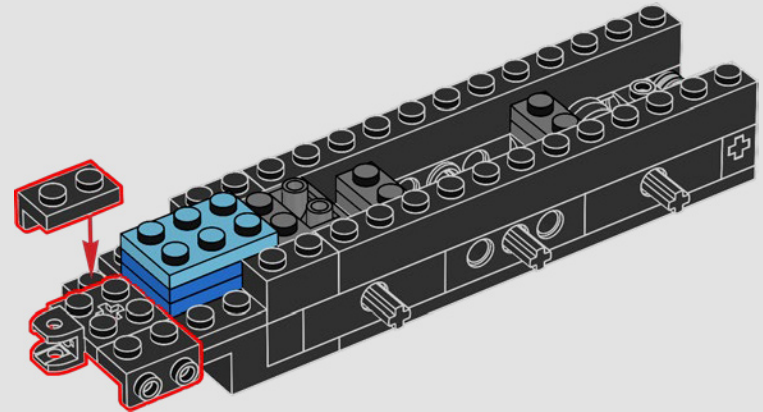

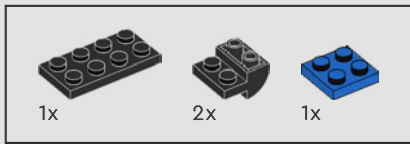

365

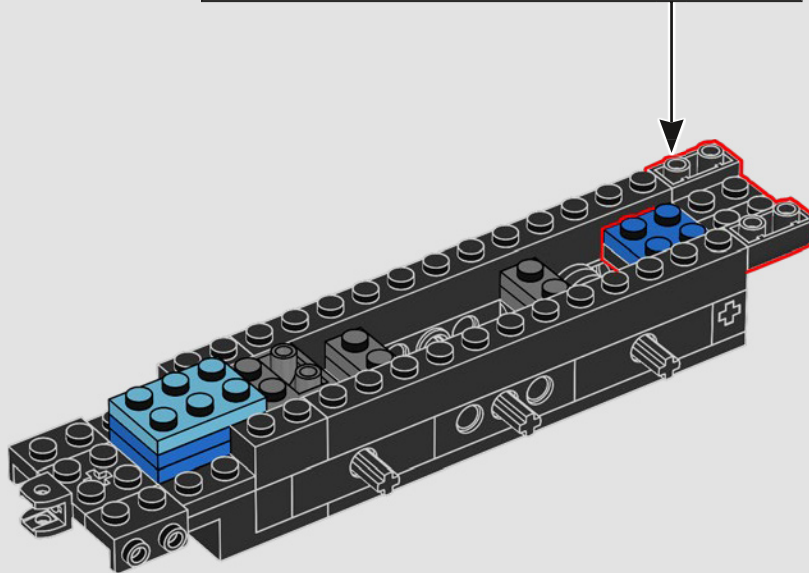
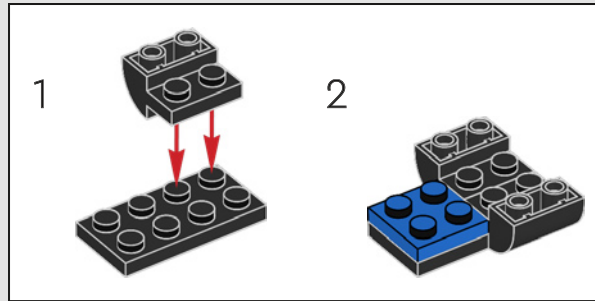

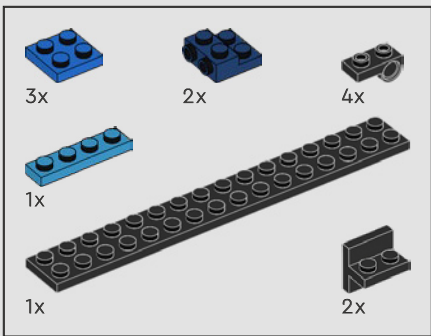

366

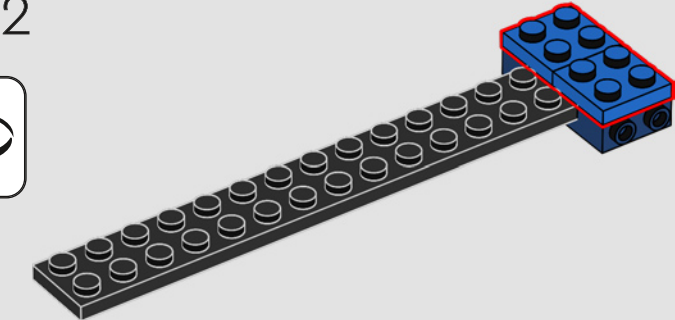
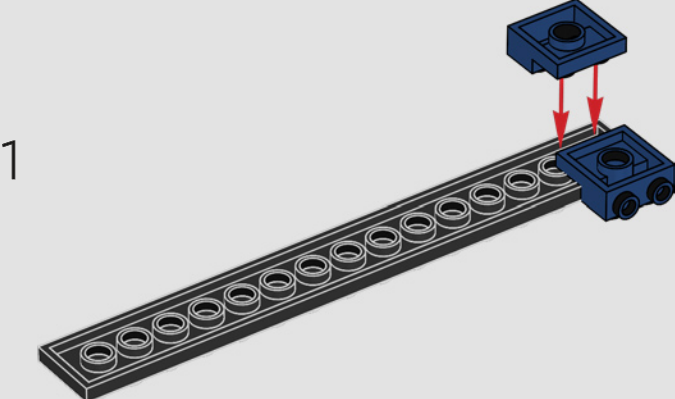

3

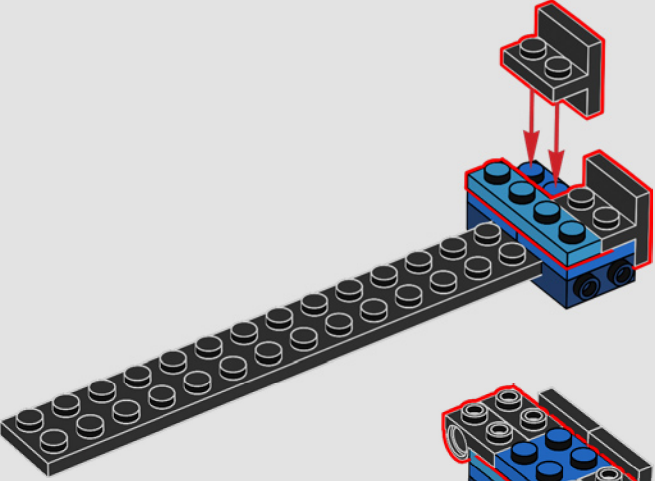

4

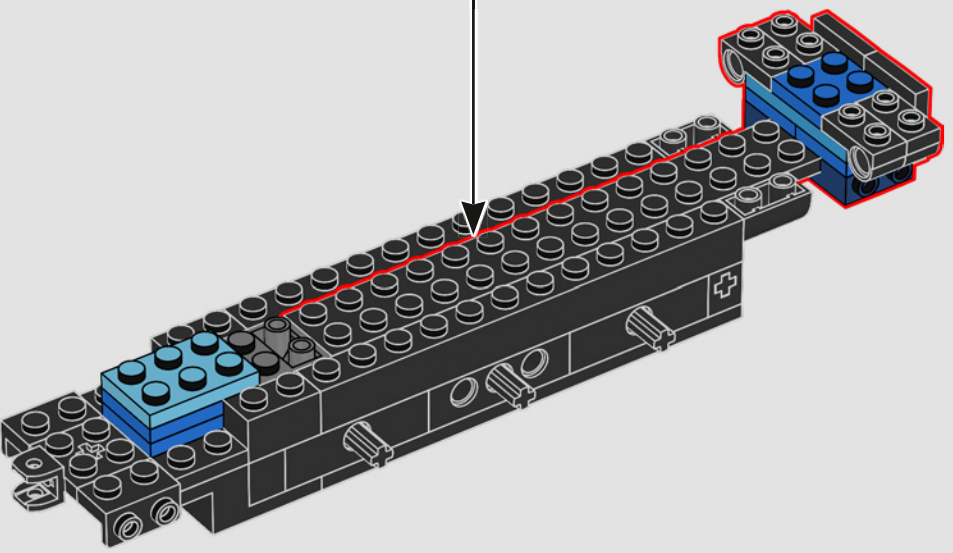
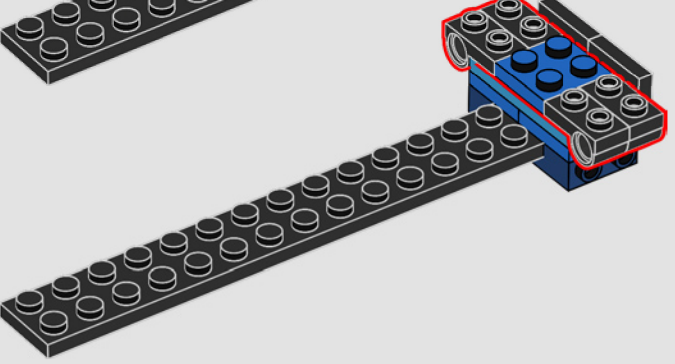

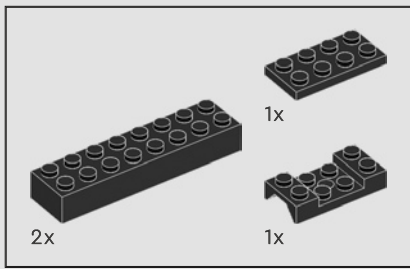

367

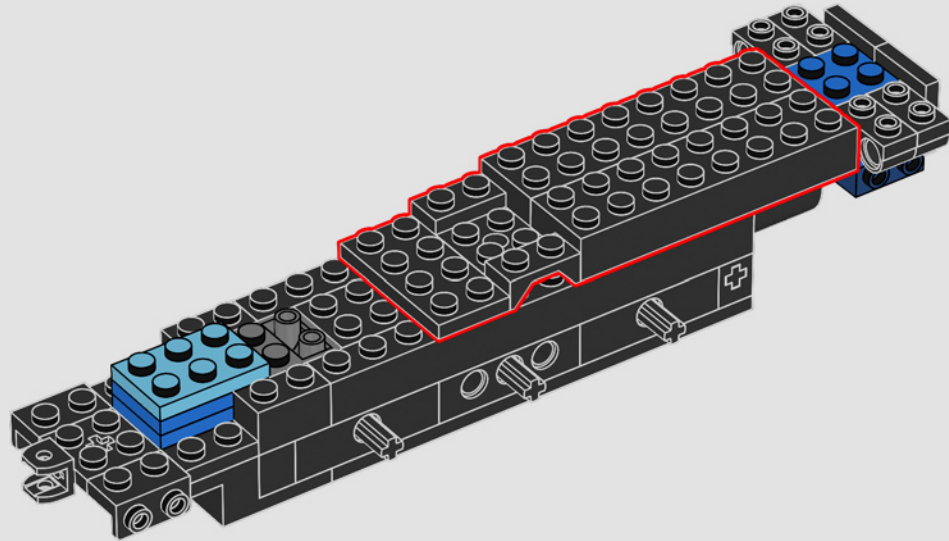

368

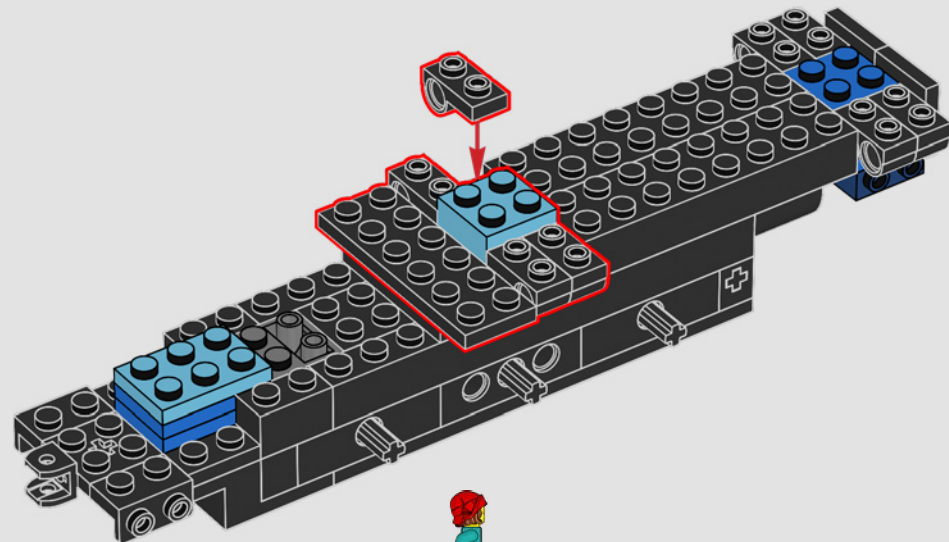

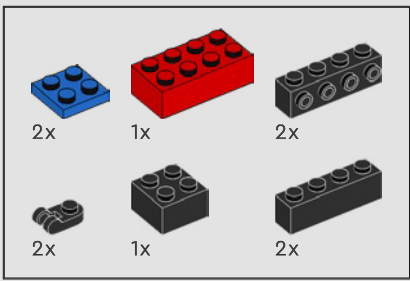

369

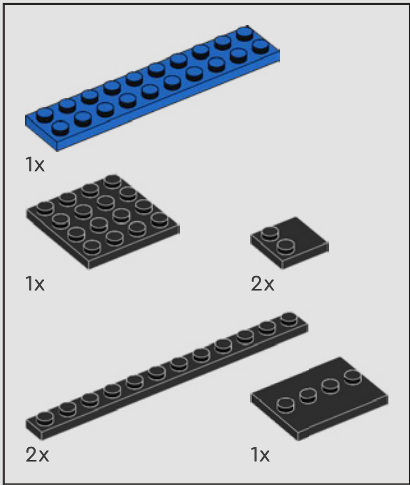
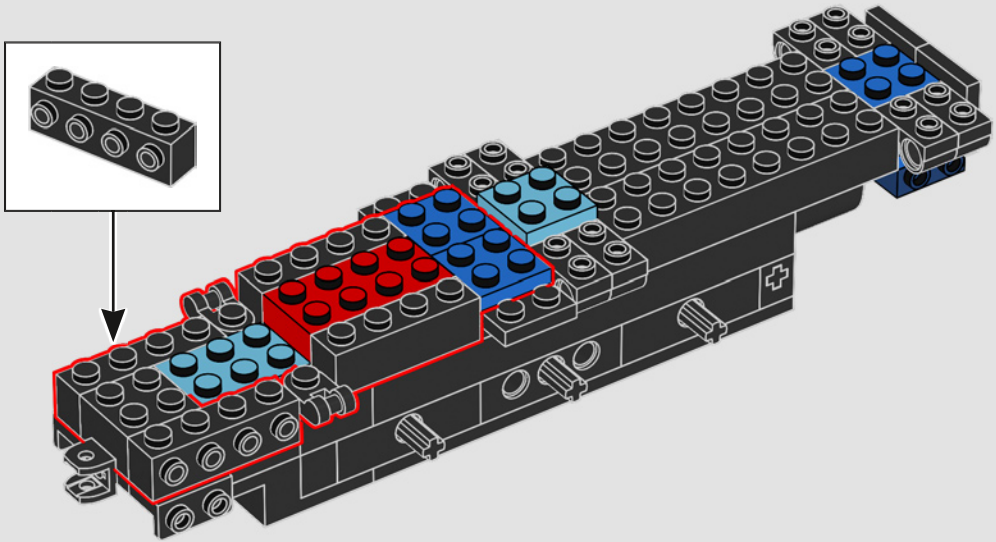

370

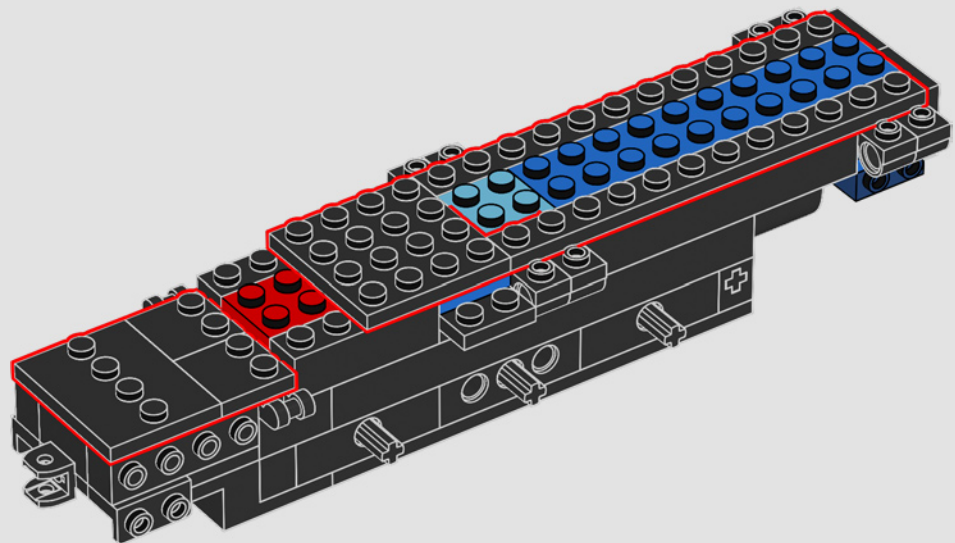



371

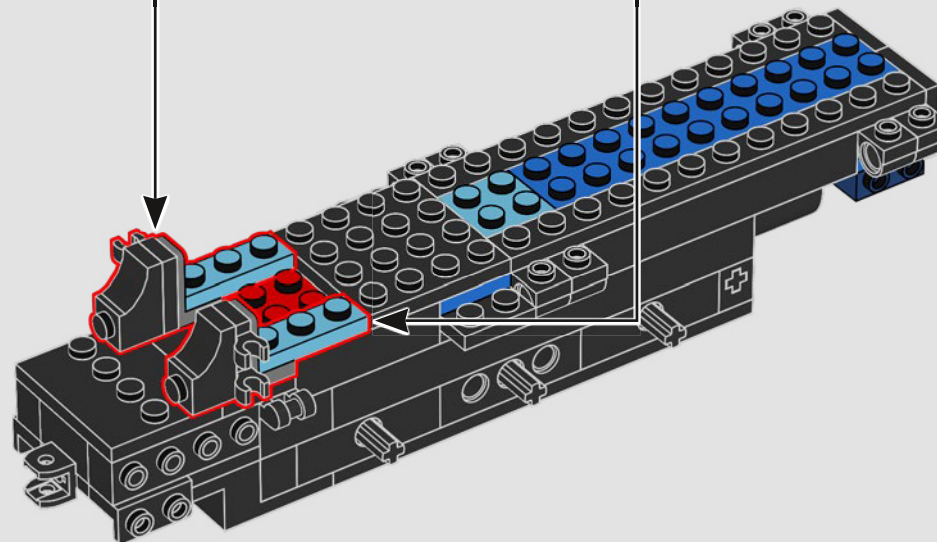
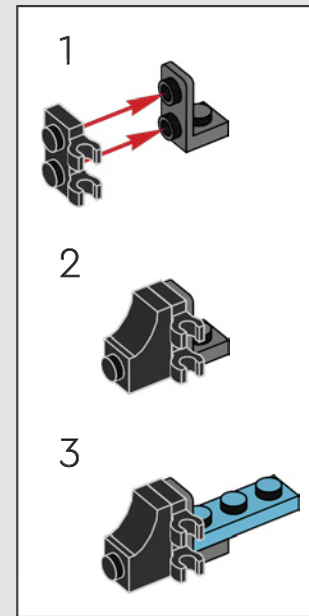
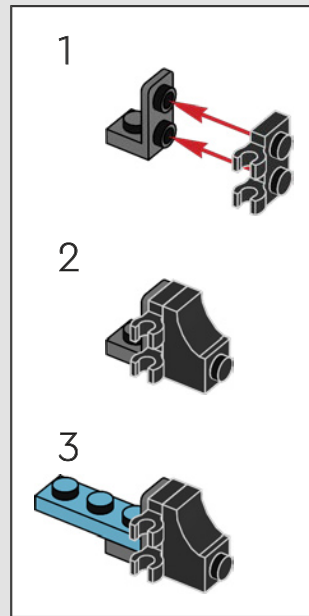

Prochain arrêt : SOFIA
« À toute vapeur à travers
les montagnes des Balkans.
Direction notre prochaine
destination urbaine. »

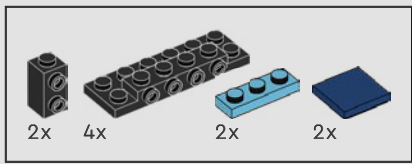

372

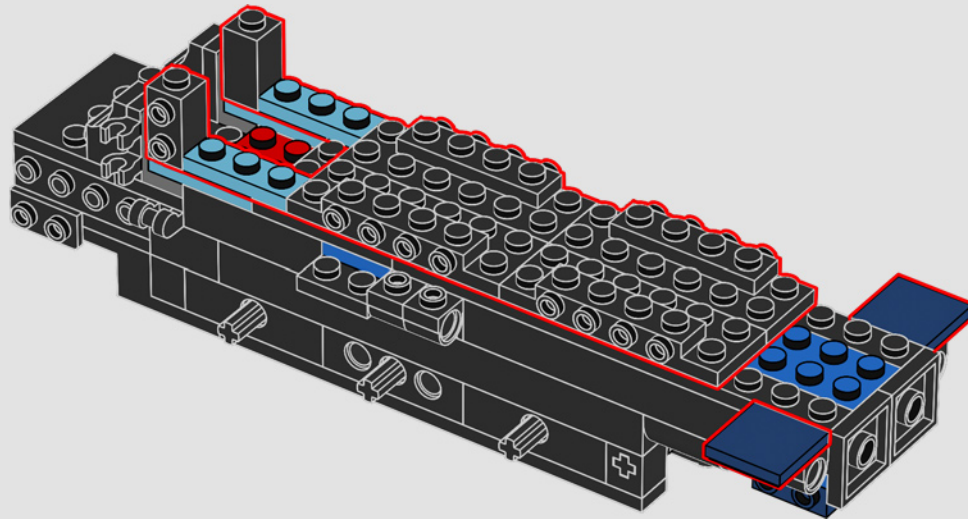

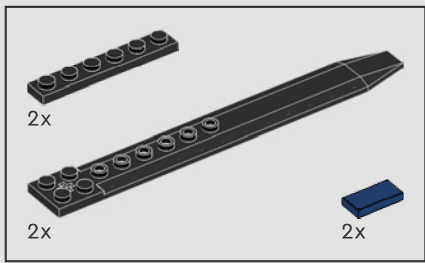

373

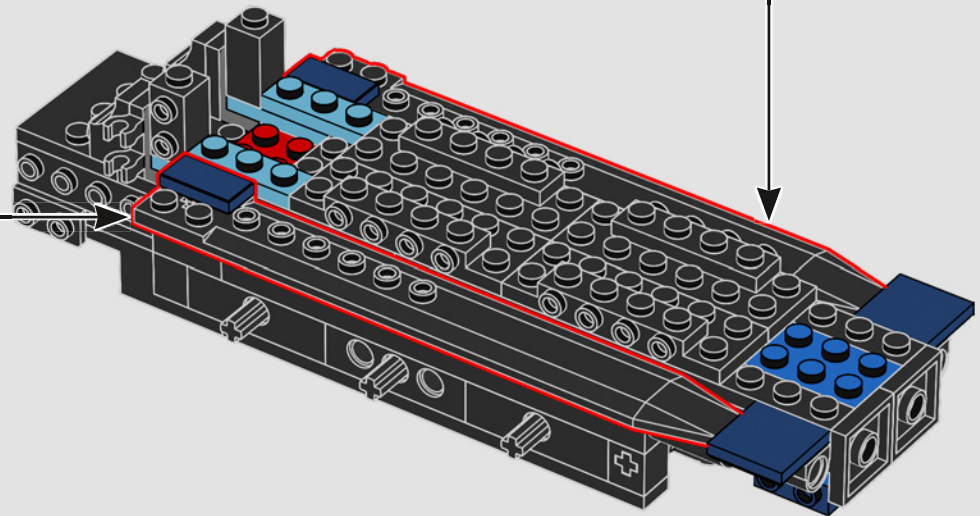
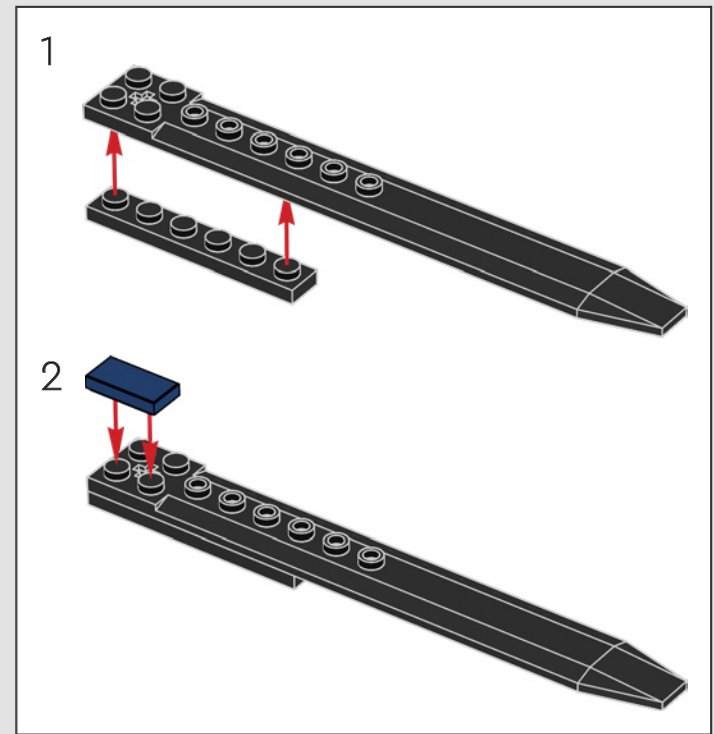
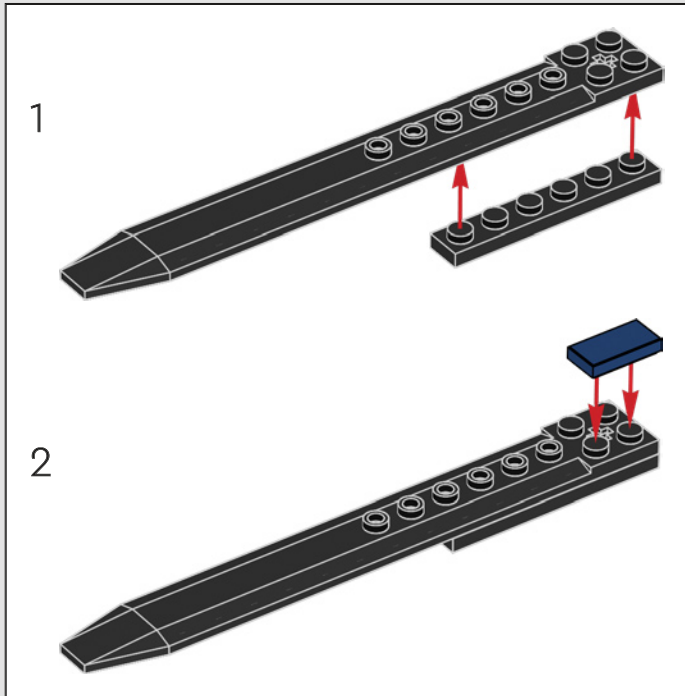

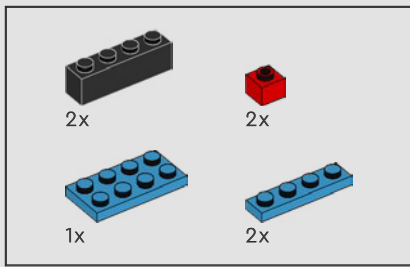

374

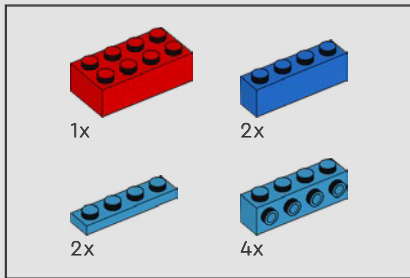
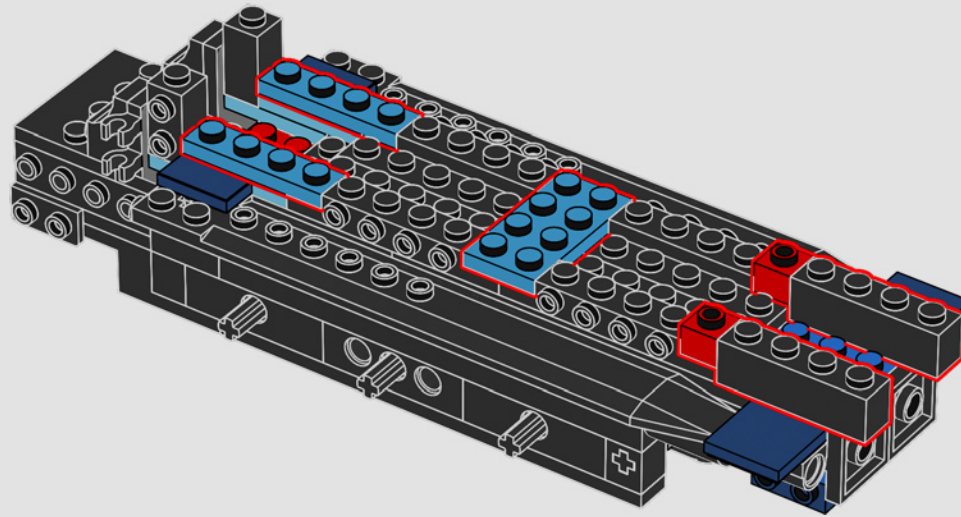

375

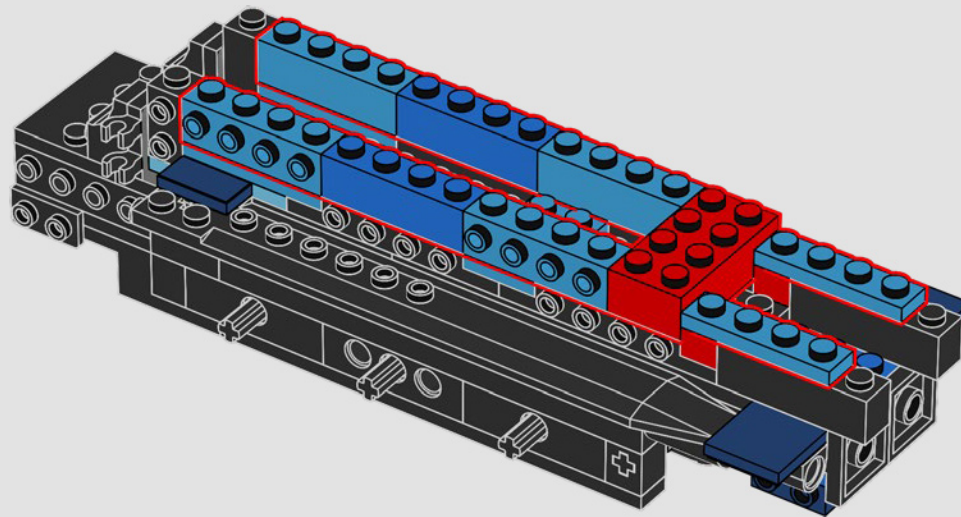

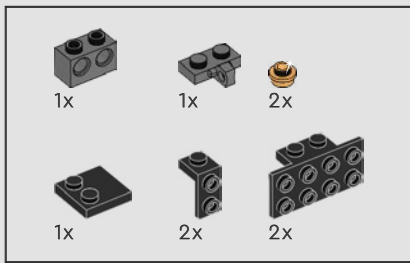

376

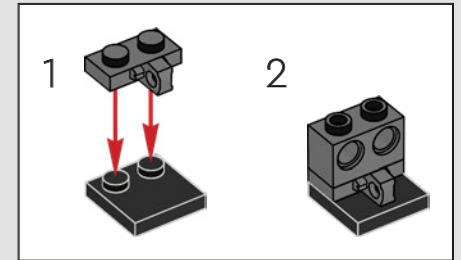
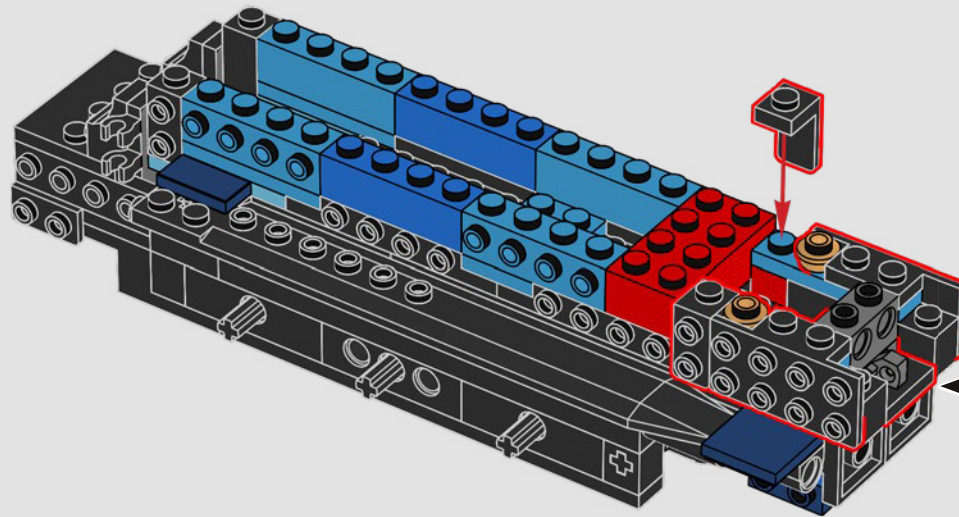

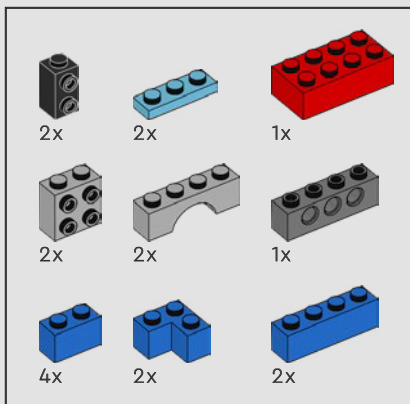

377

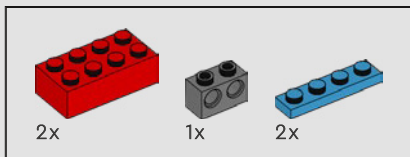
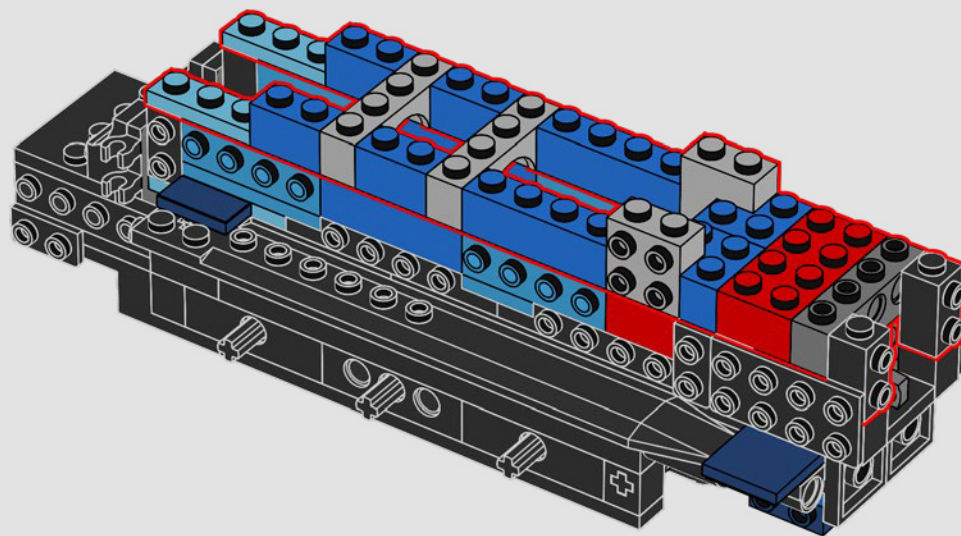

378

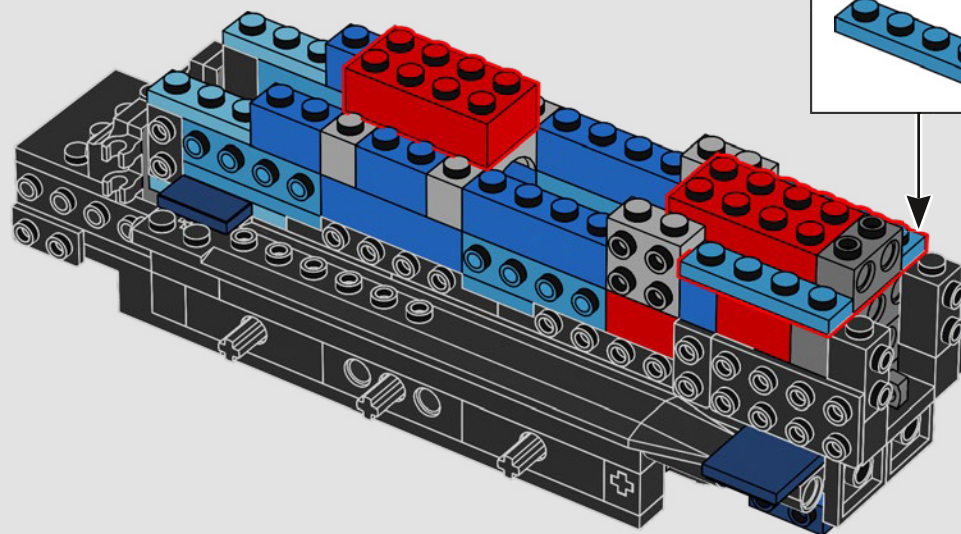

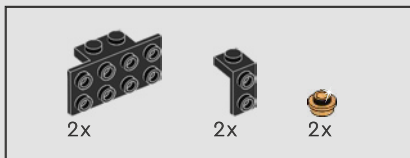

379

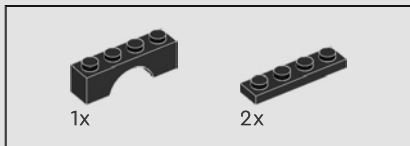
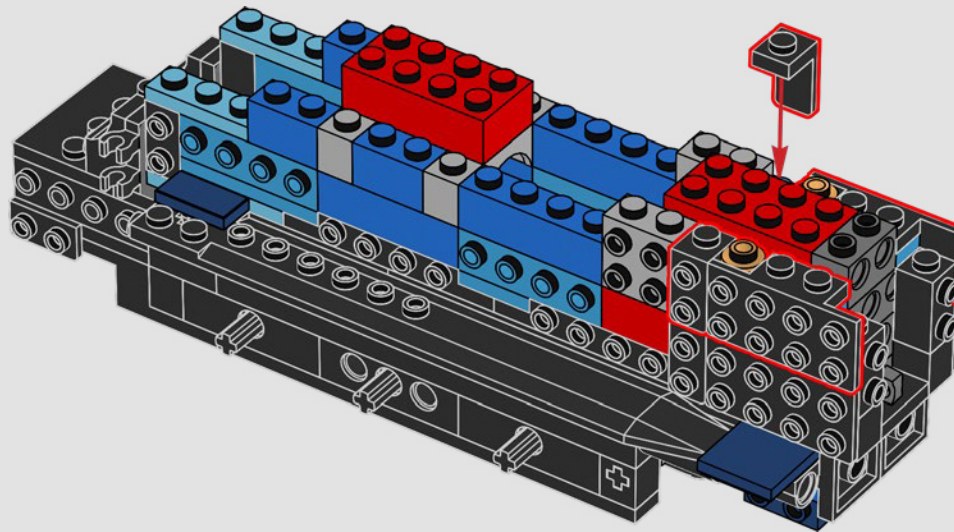

380

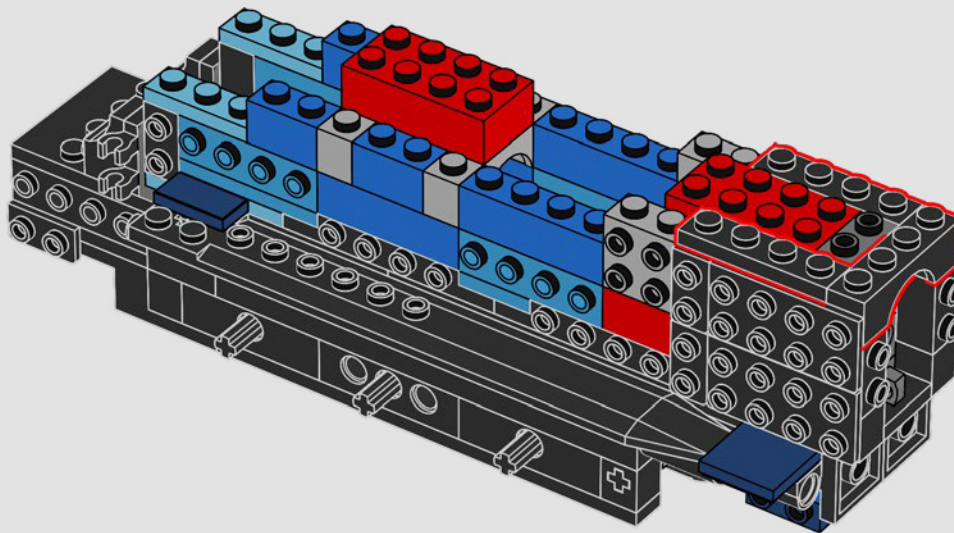

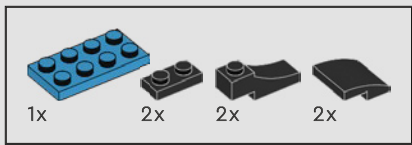

381

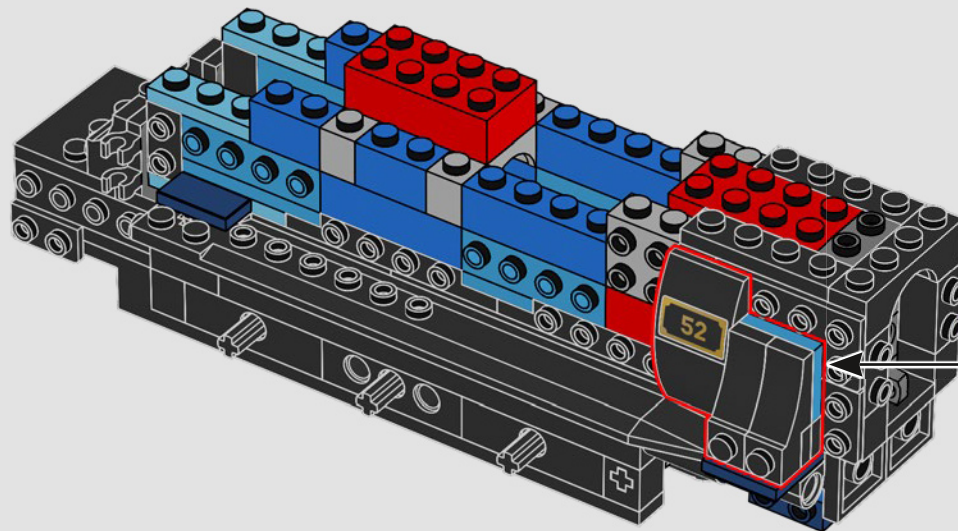
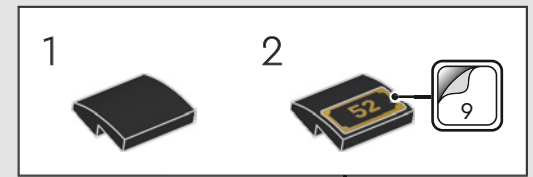
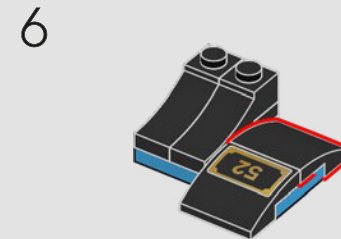
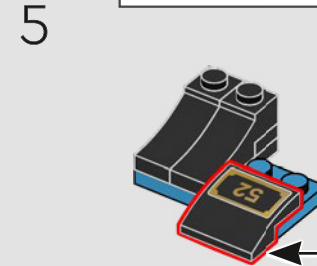
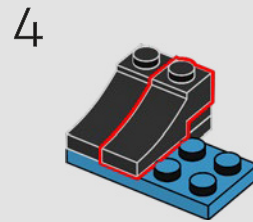
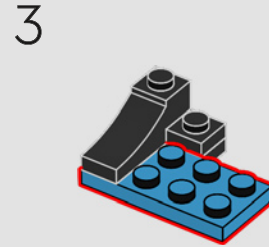
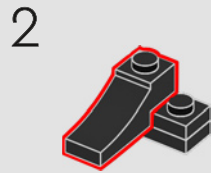
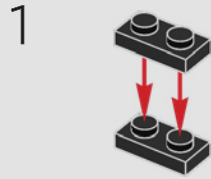

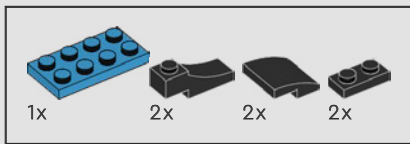

382

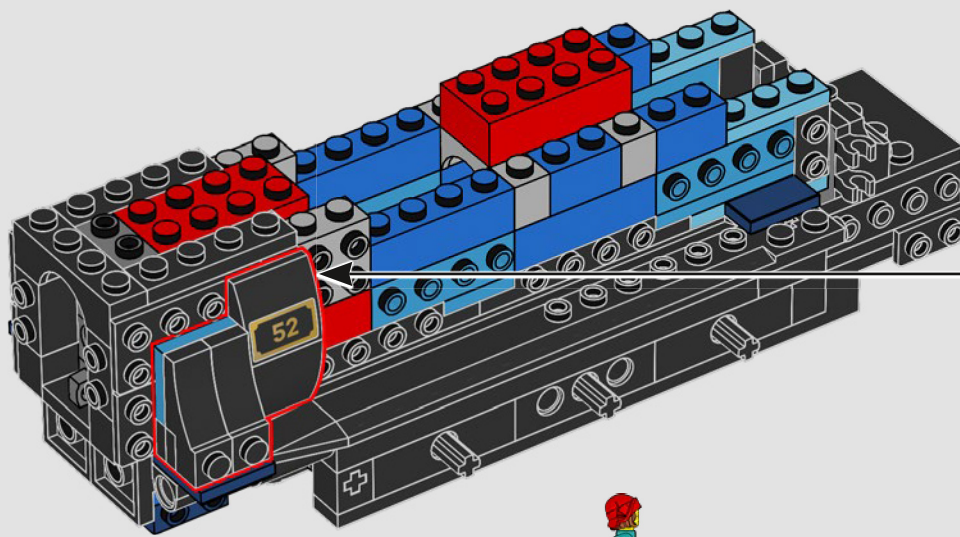
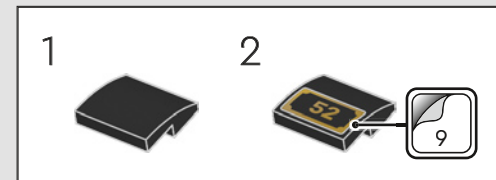
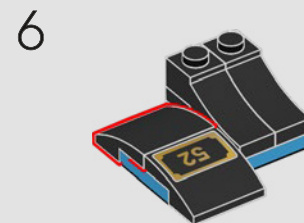
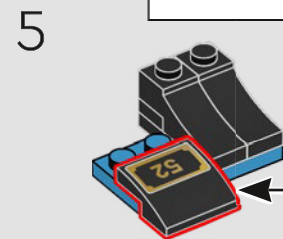
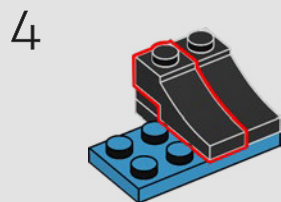
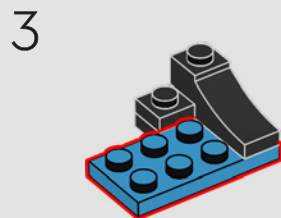
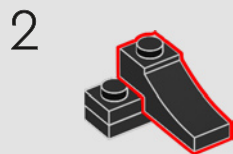
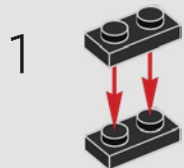

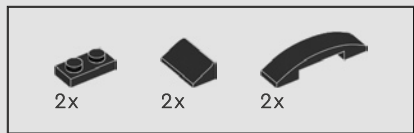

383

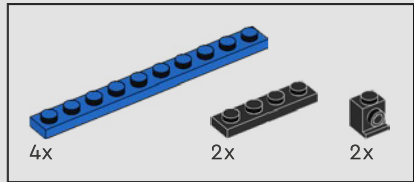
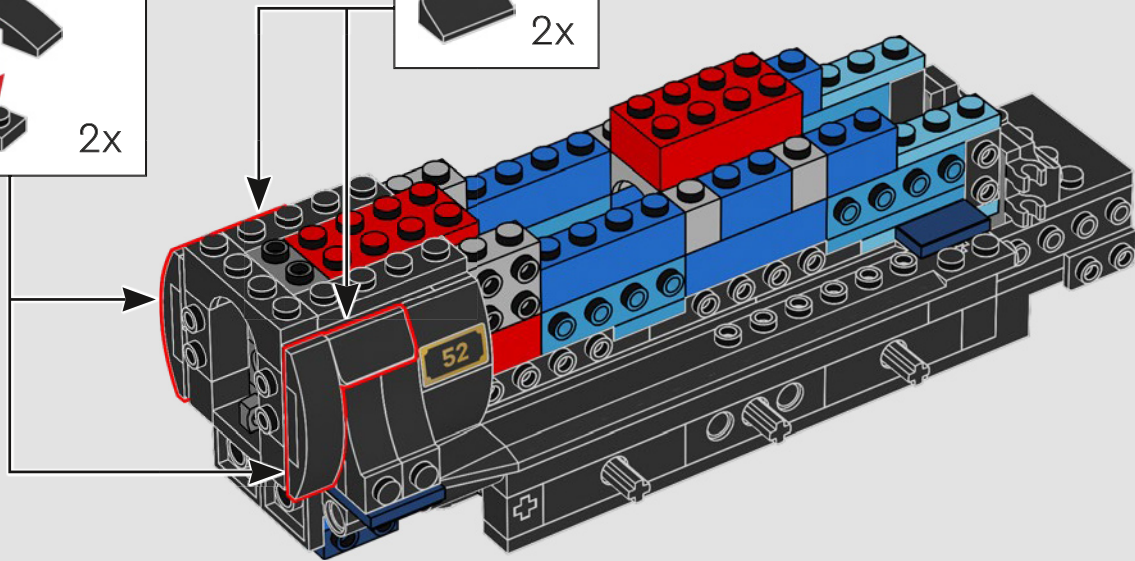
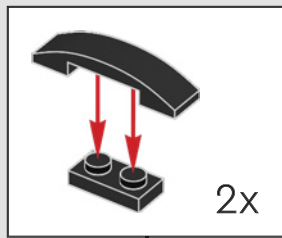

384

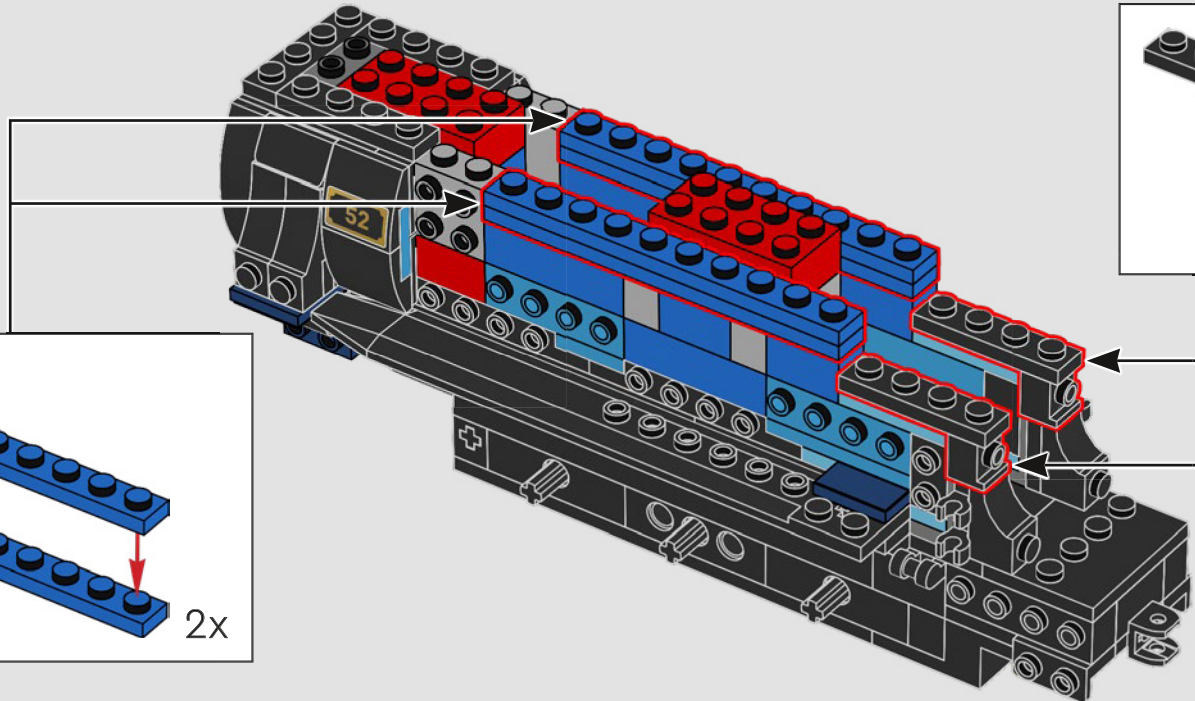
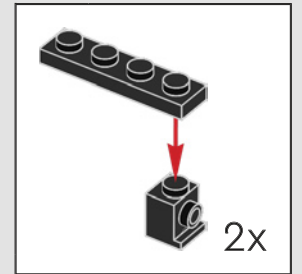
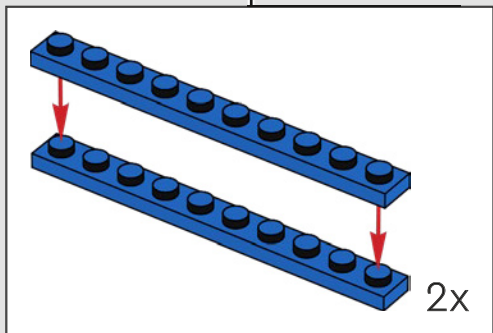

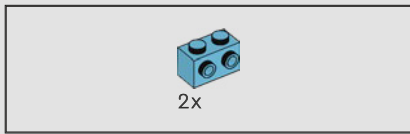

385

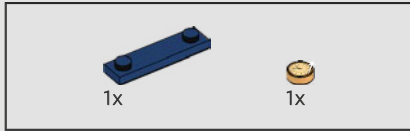
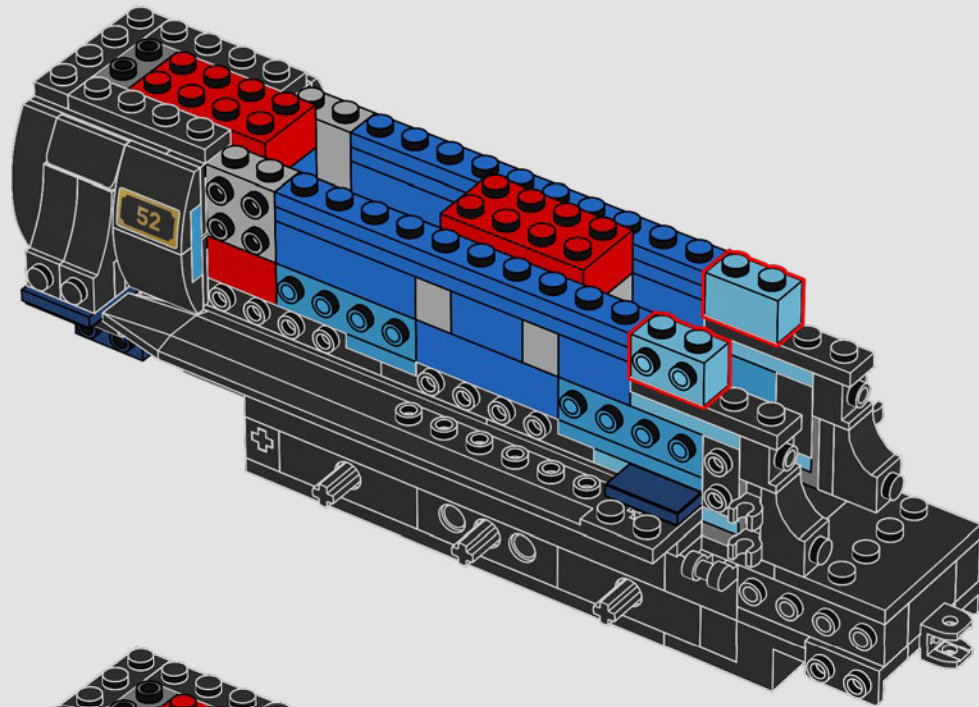

386

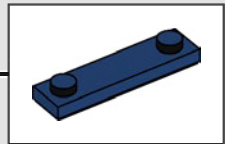
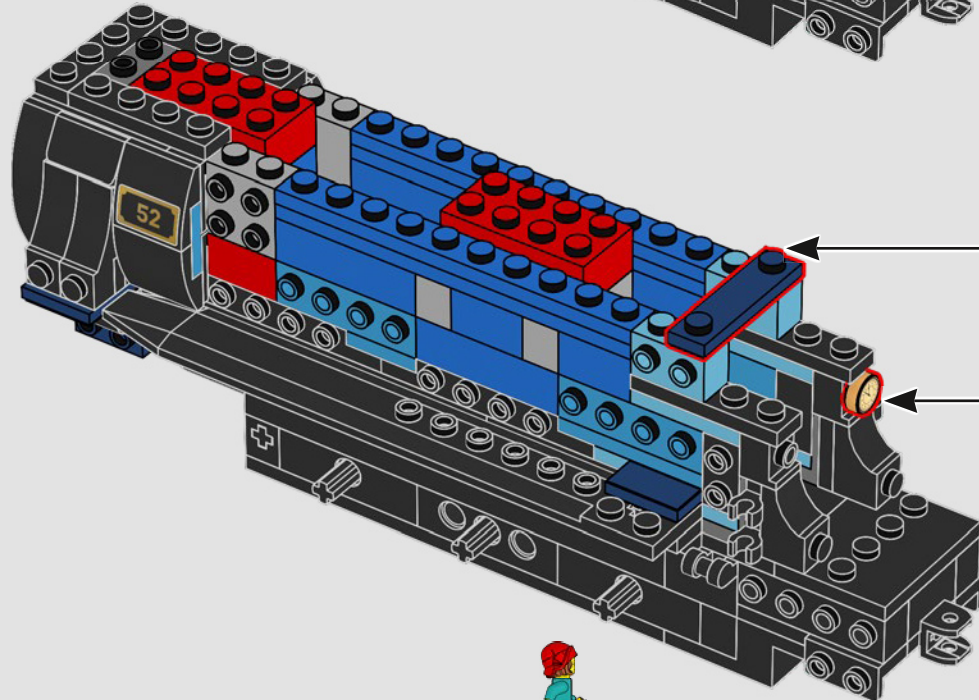

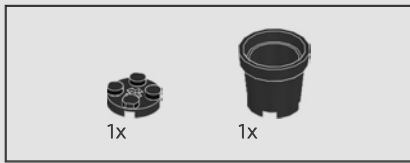

388

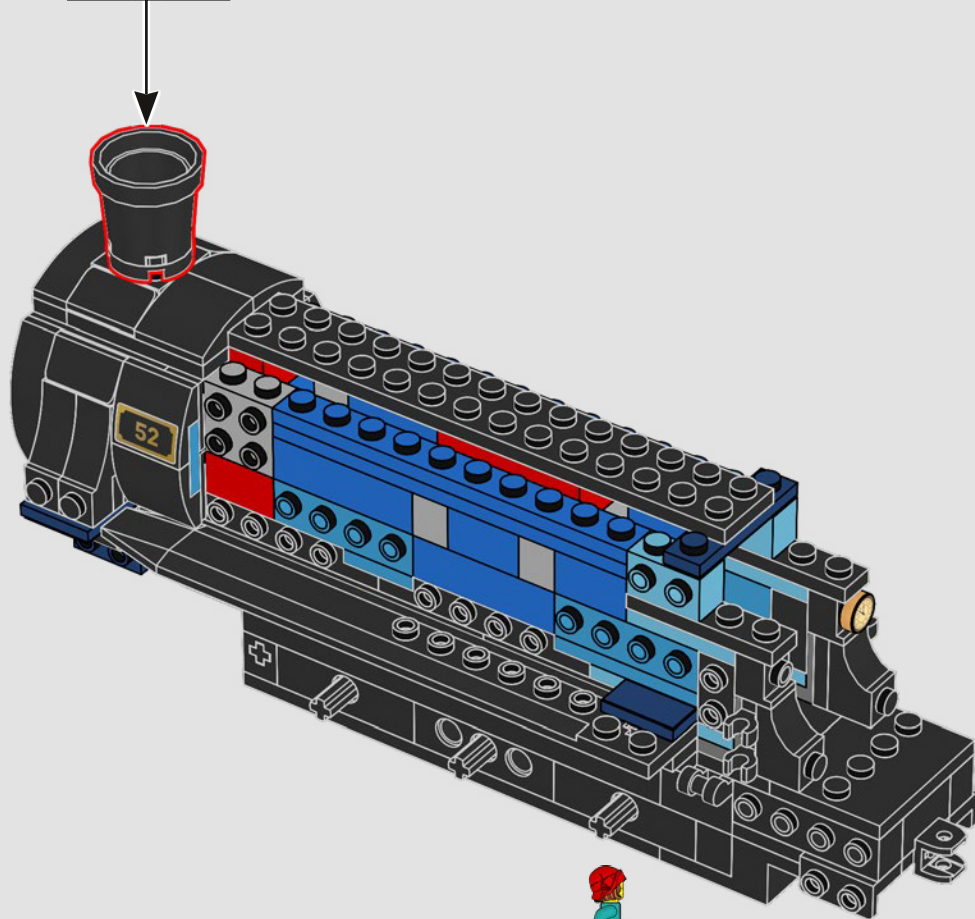
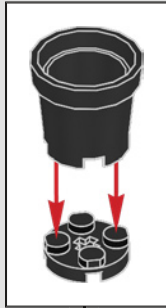

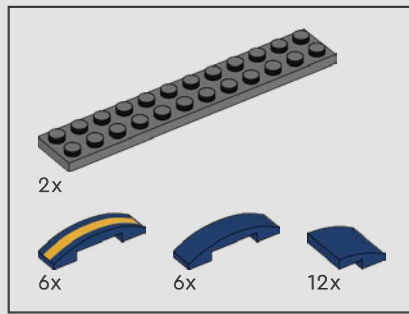

389

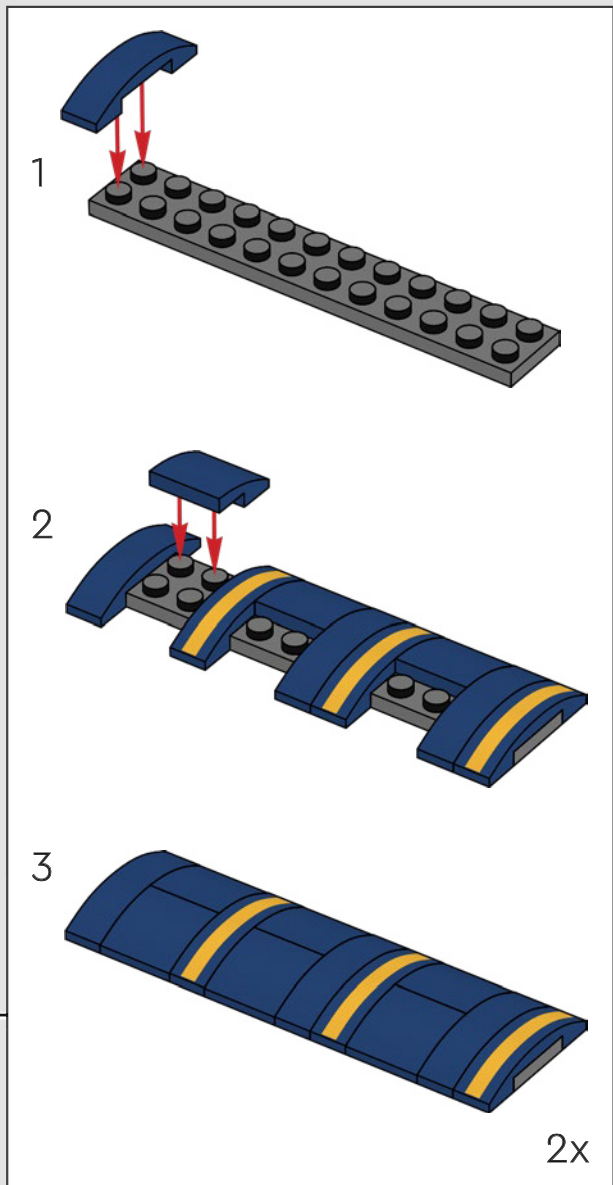
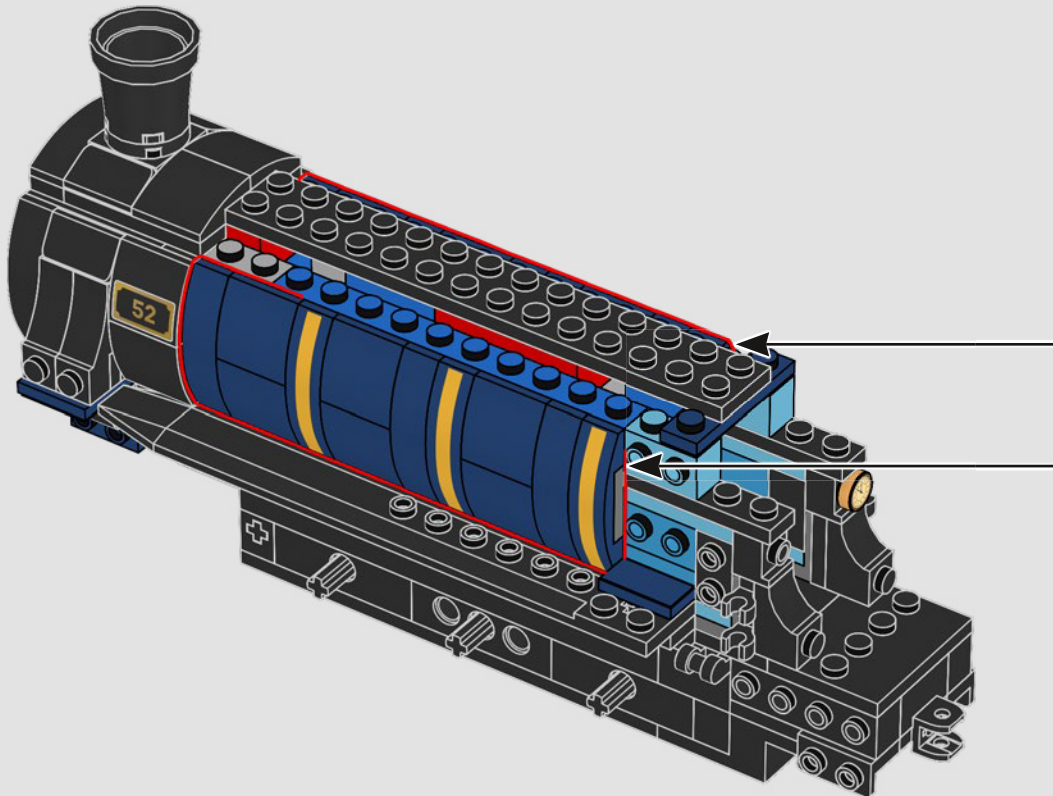

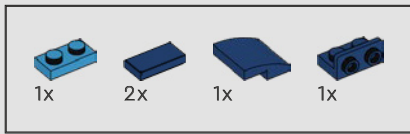

390

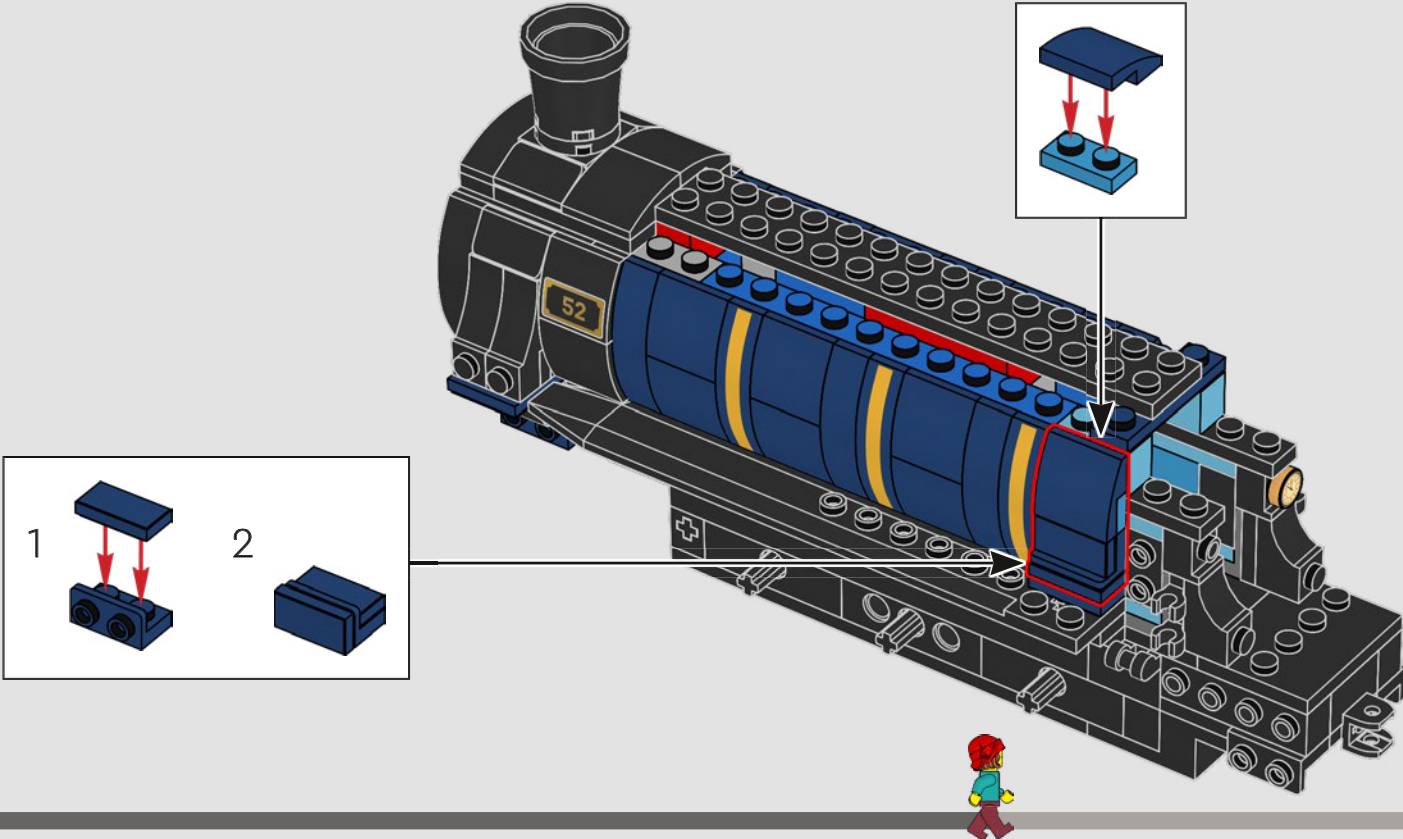

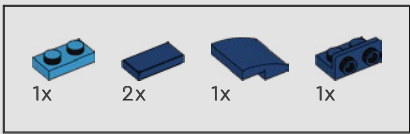

391

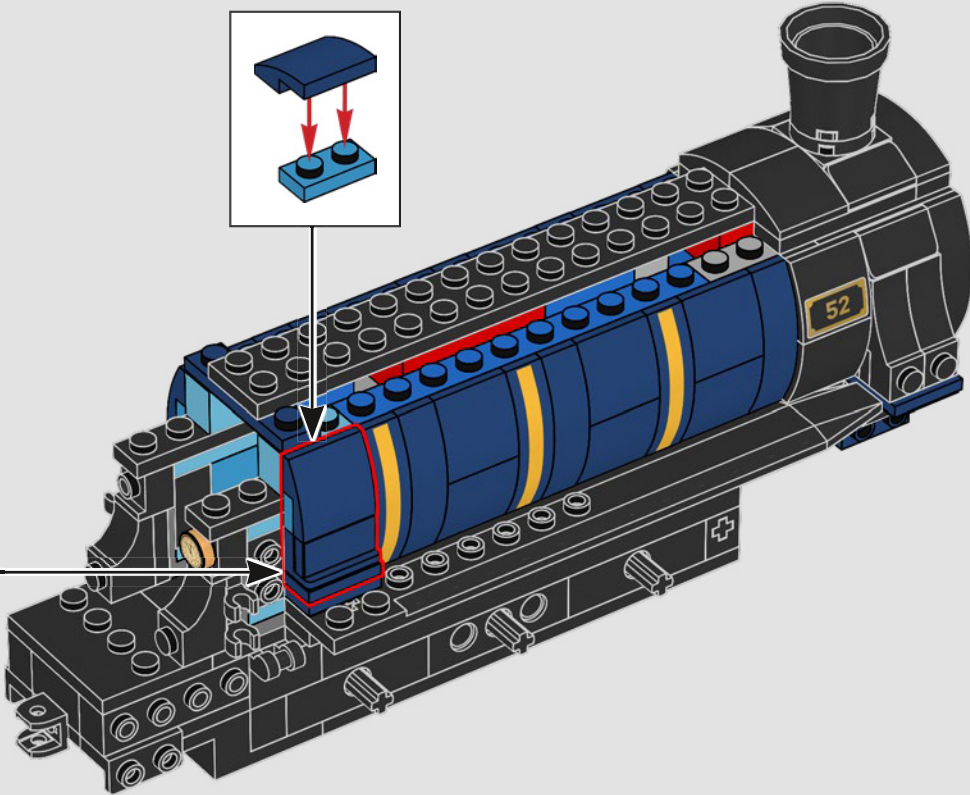
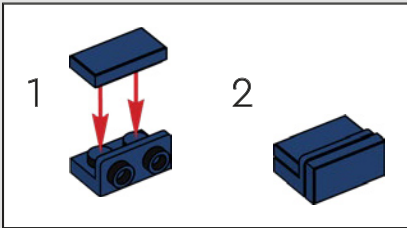
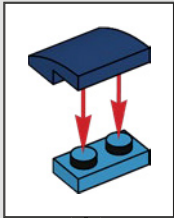

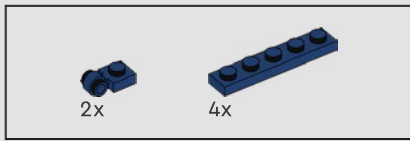

392

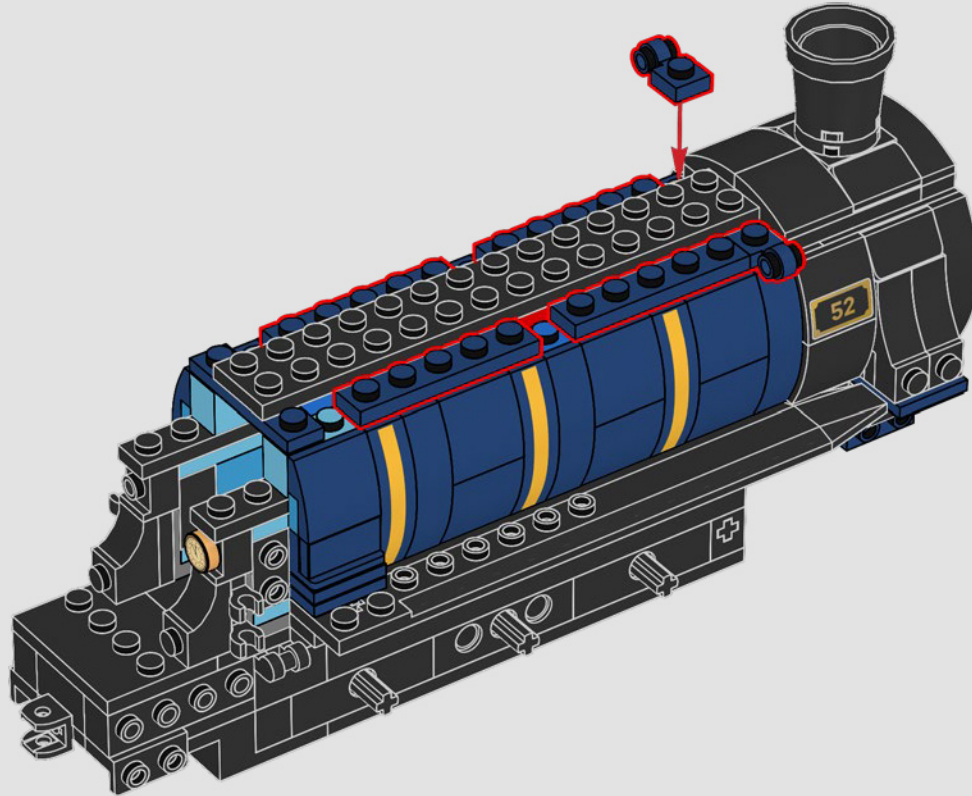

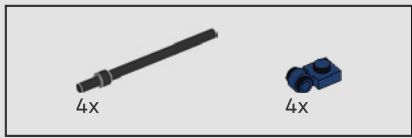

393

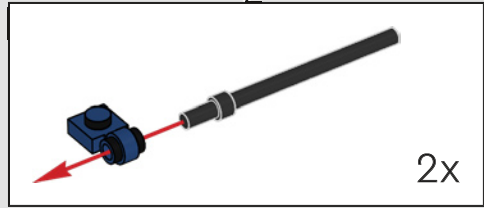
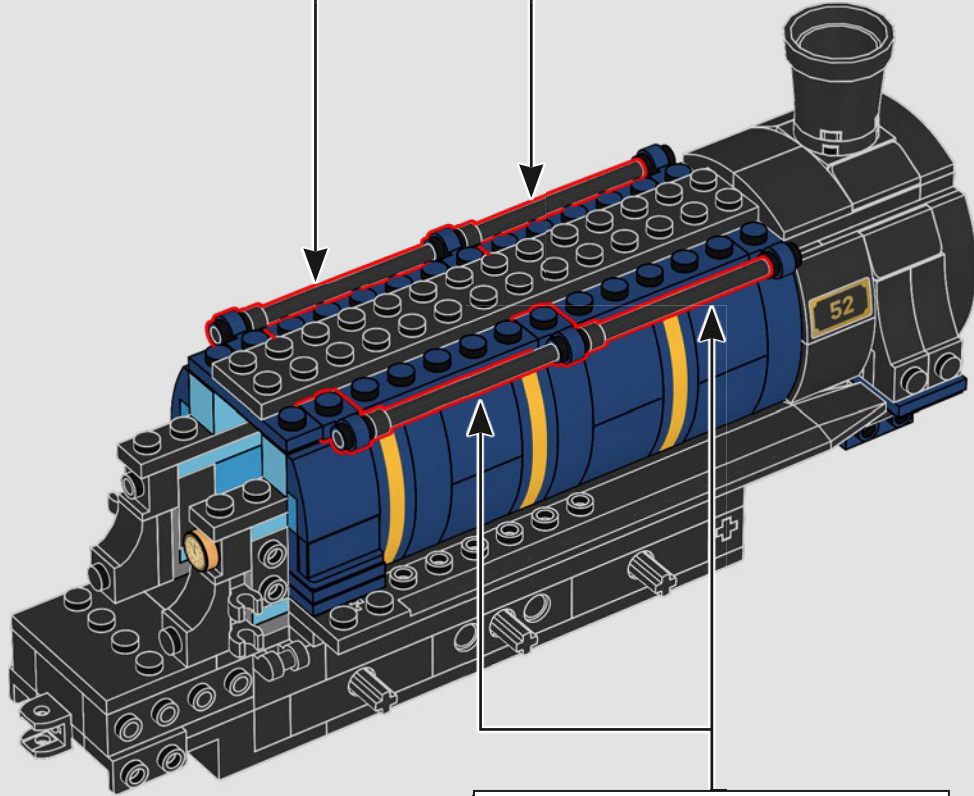
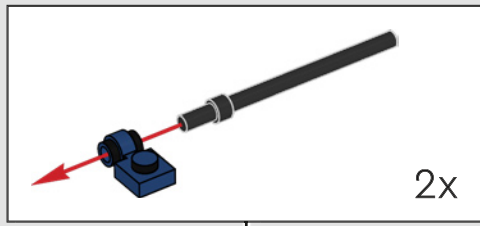

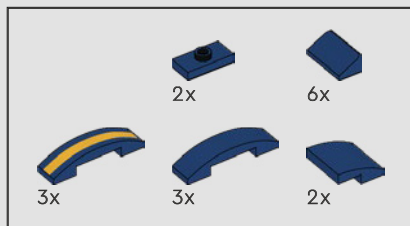

394

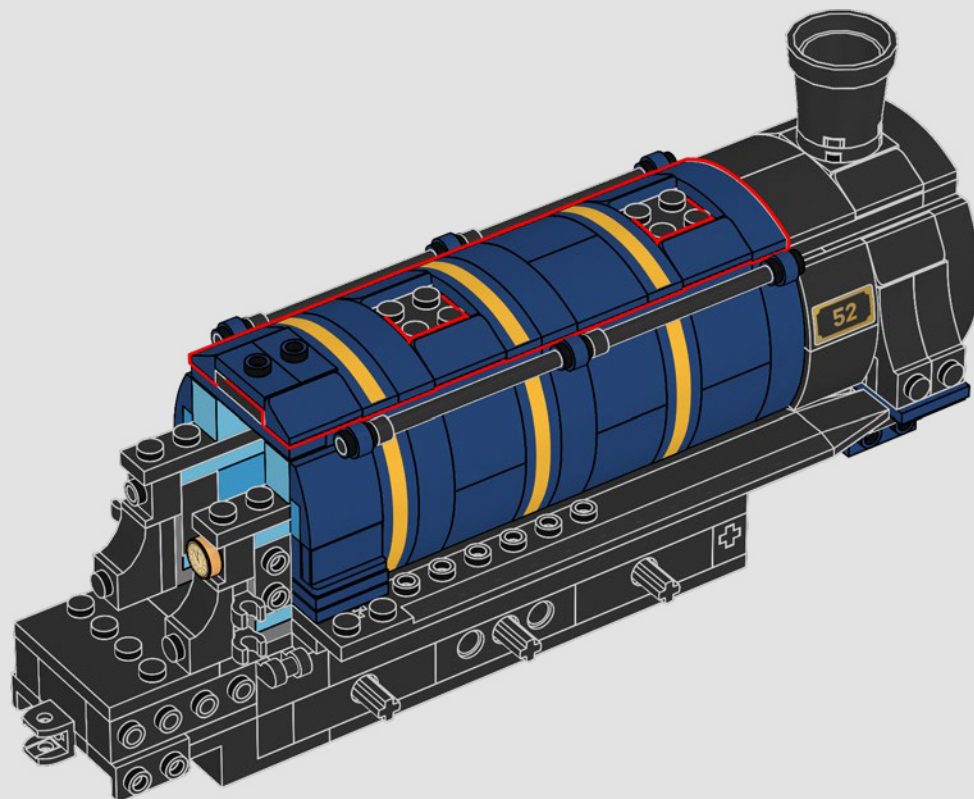



395

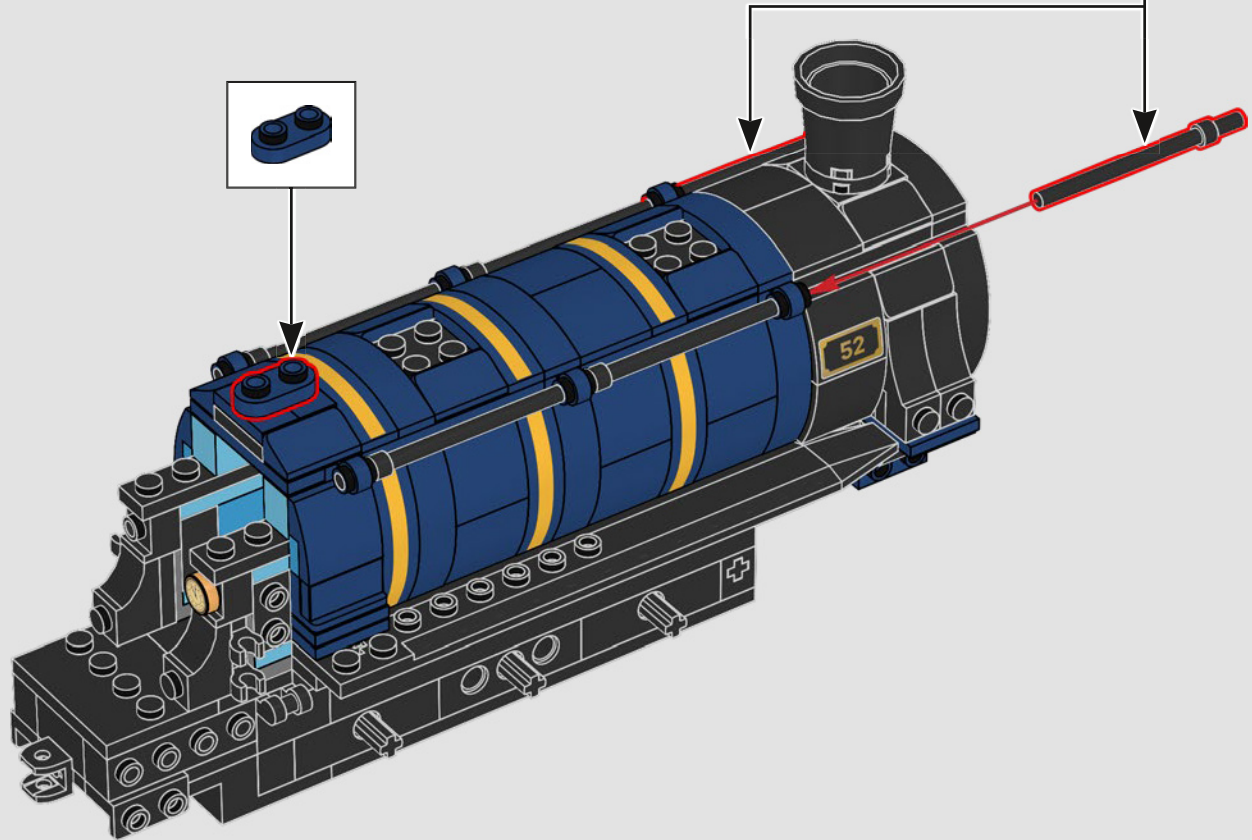

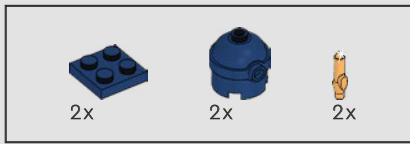

396

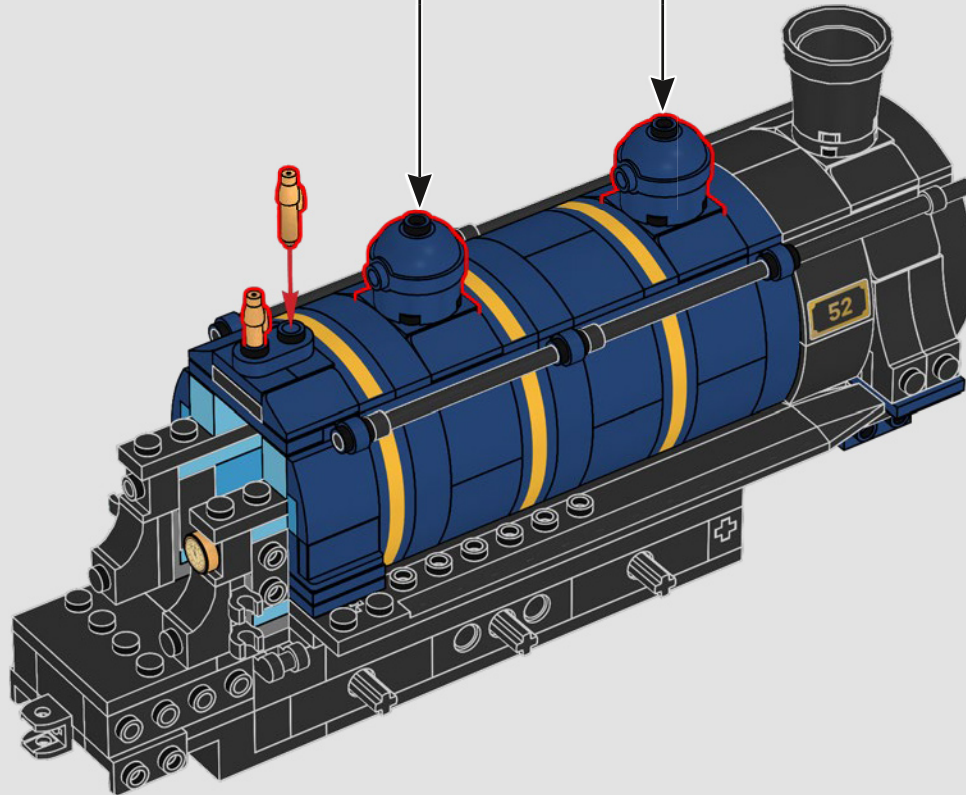
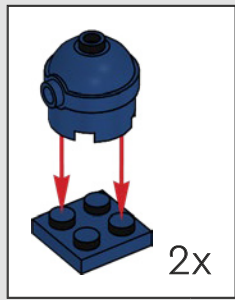

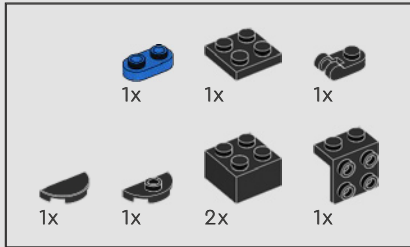
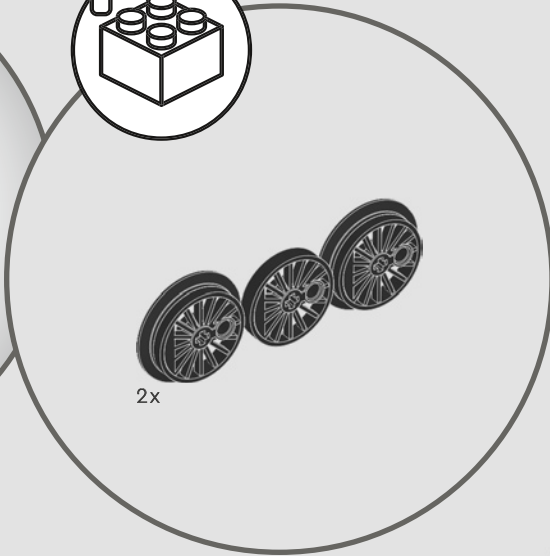
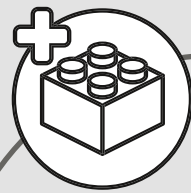

397

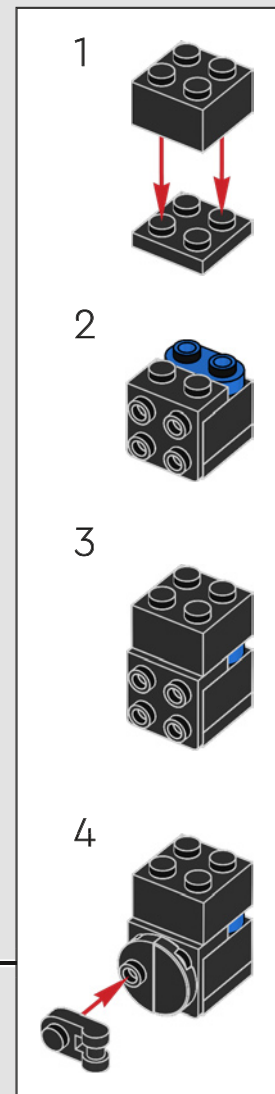
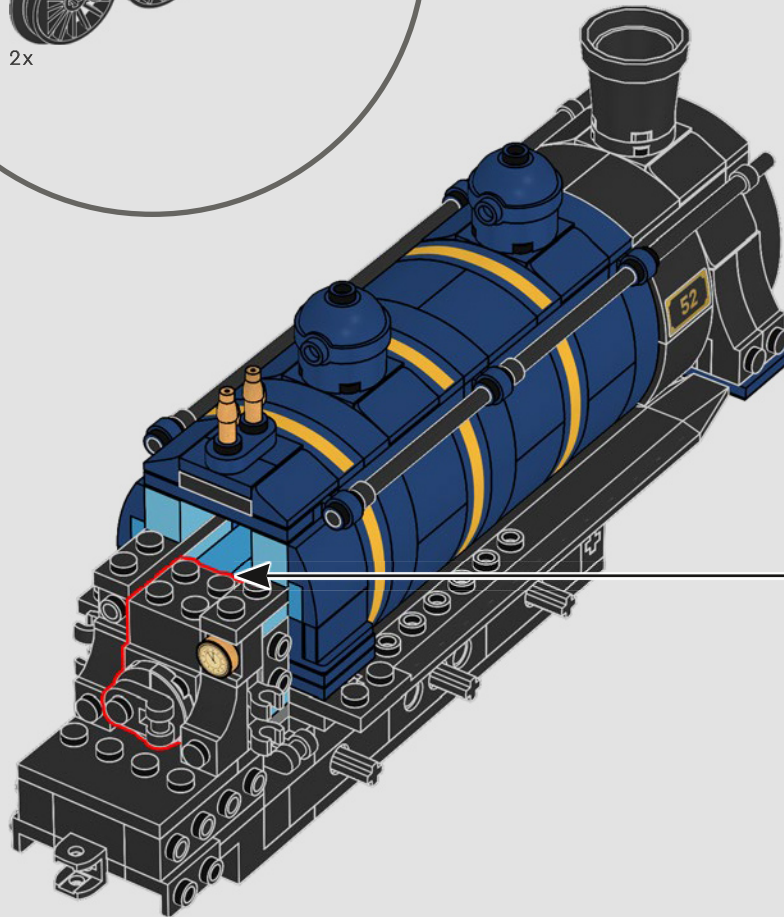



398

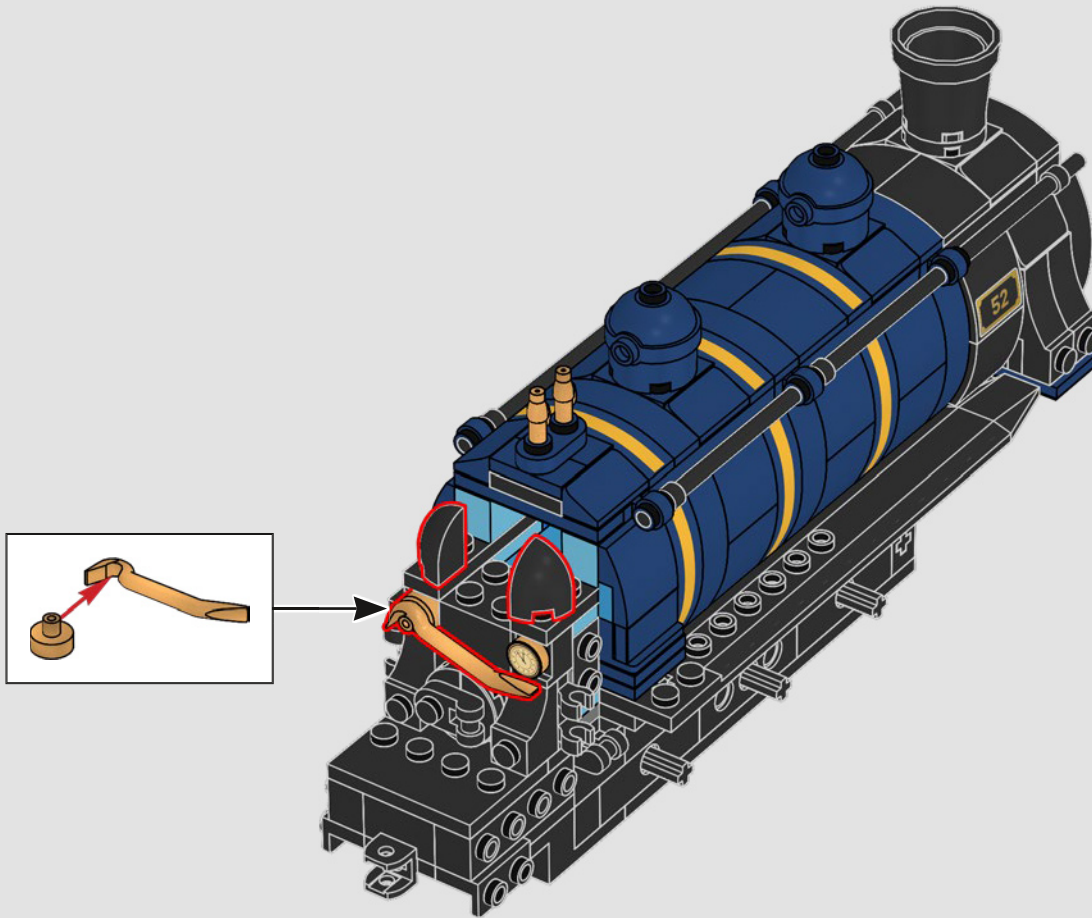

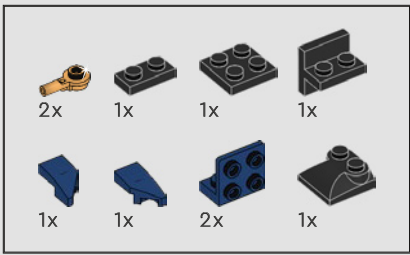

399

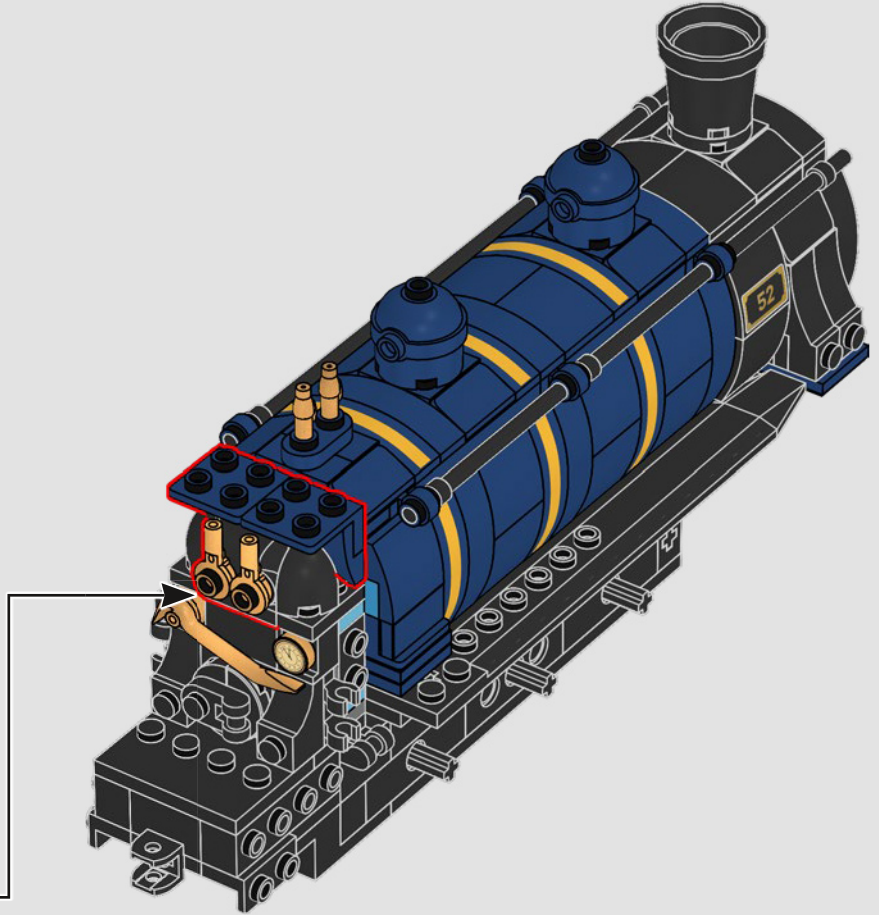
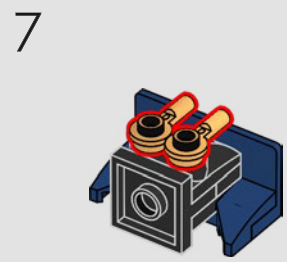
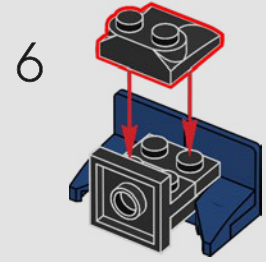
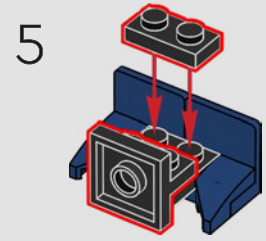
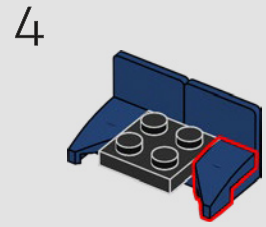
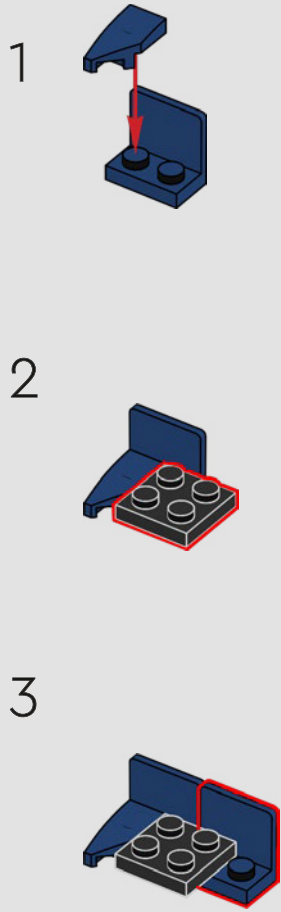

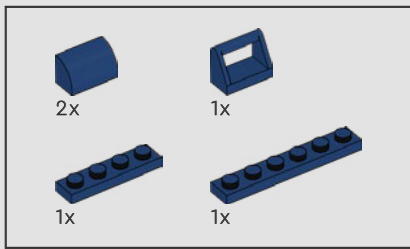

400

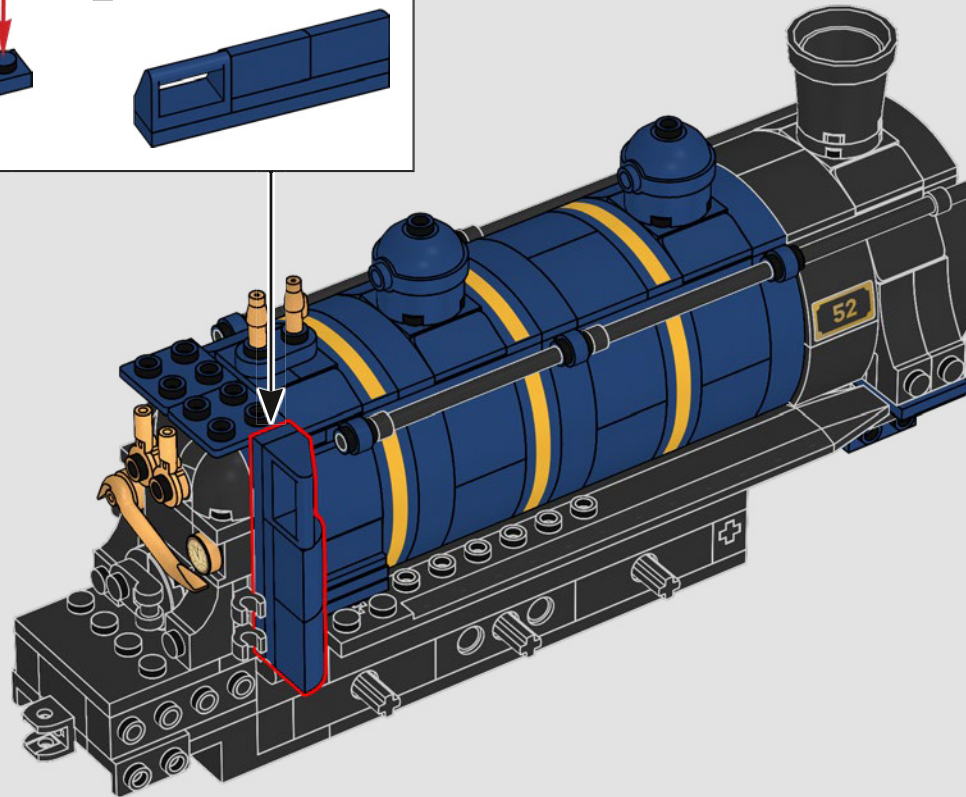
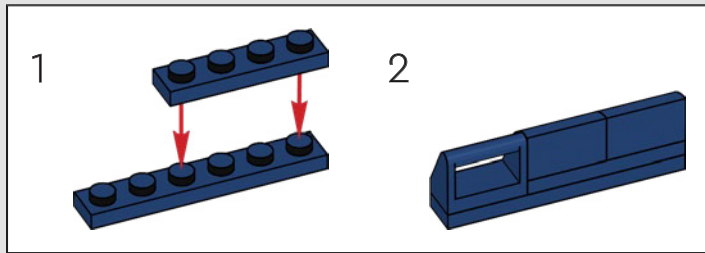

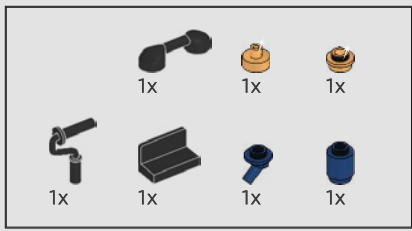

401

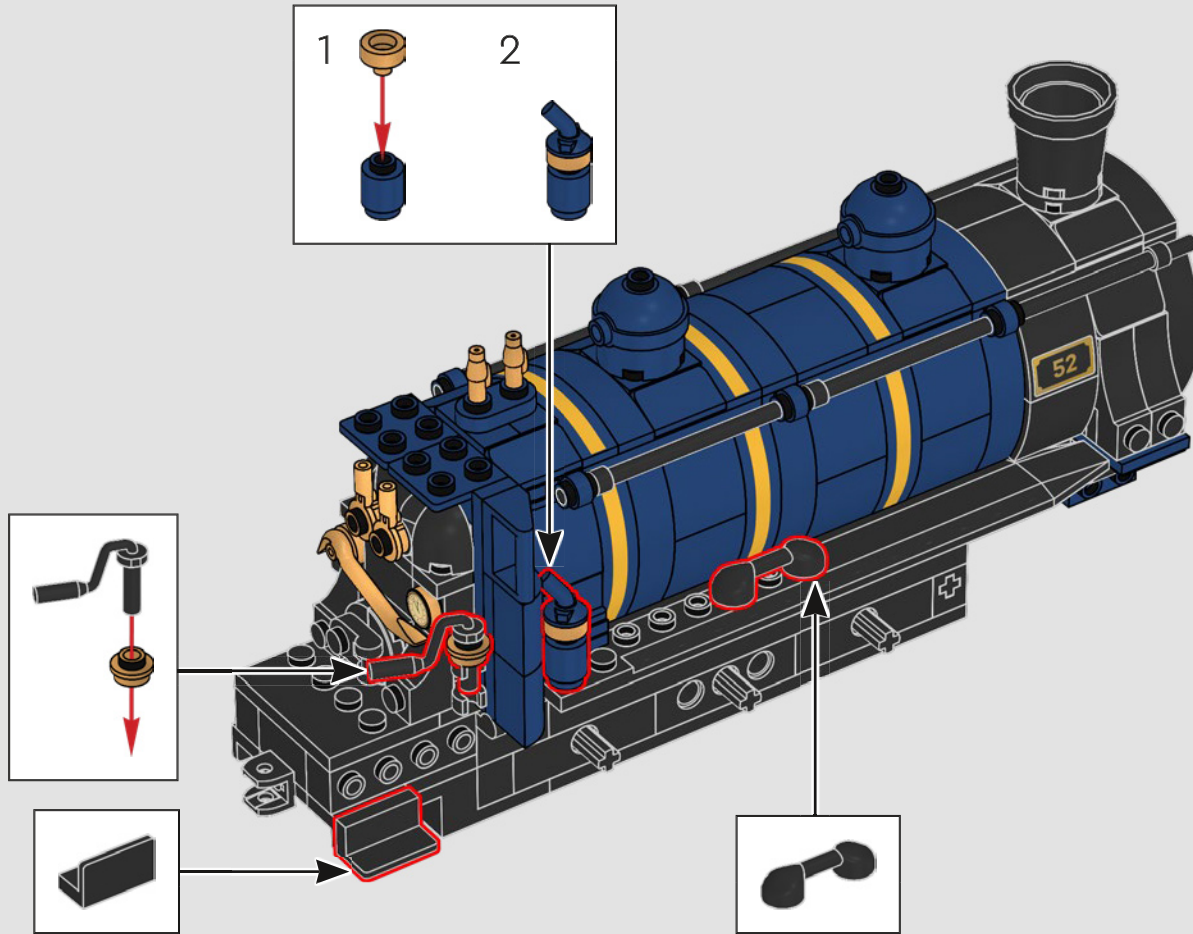

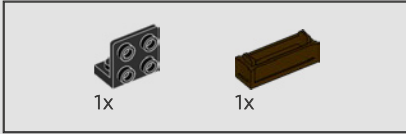
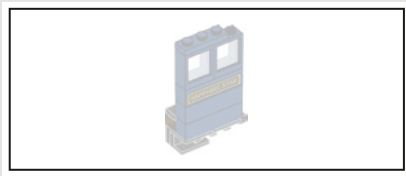

402

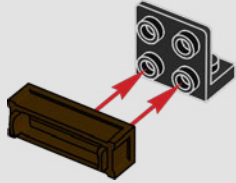

403

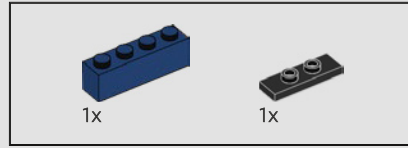
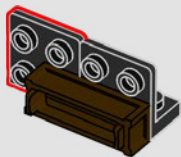

404

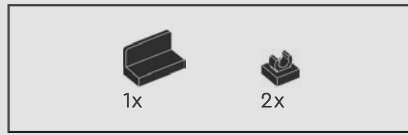
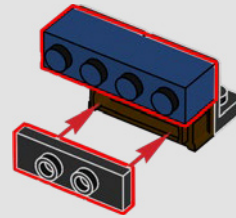

405

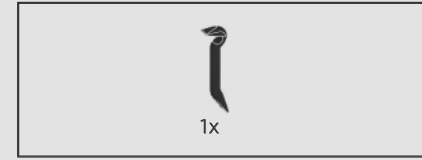
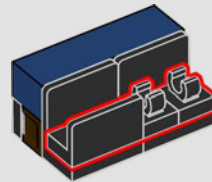

406

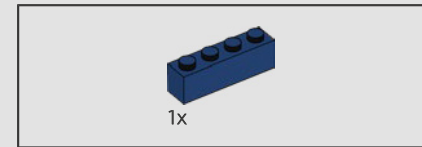
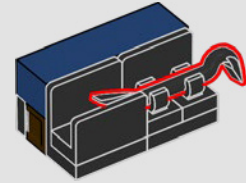

407

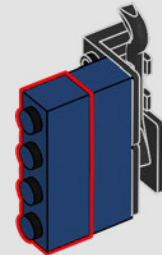
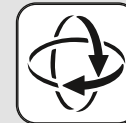

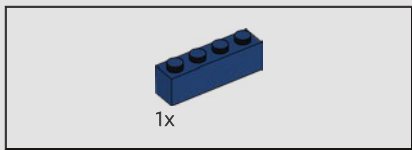

408

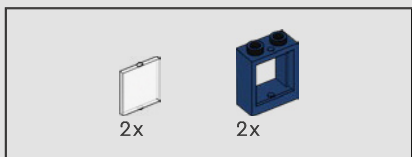
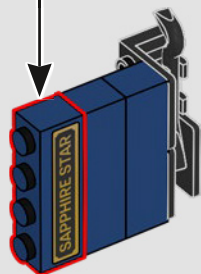
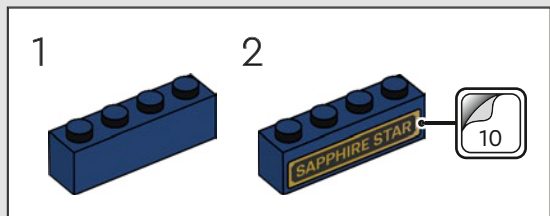

409

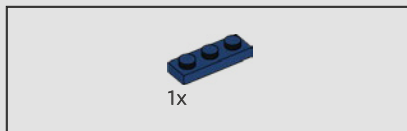
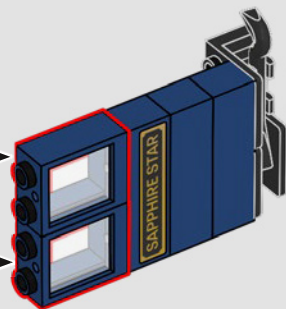
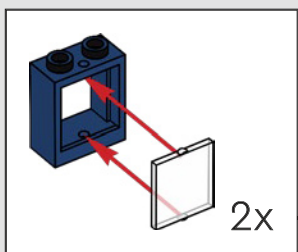

410

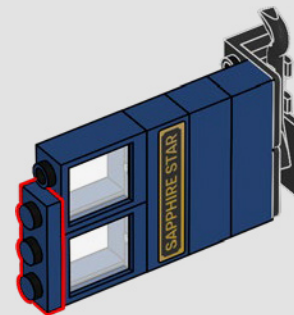

411

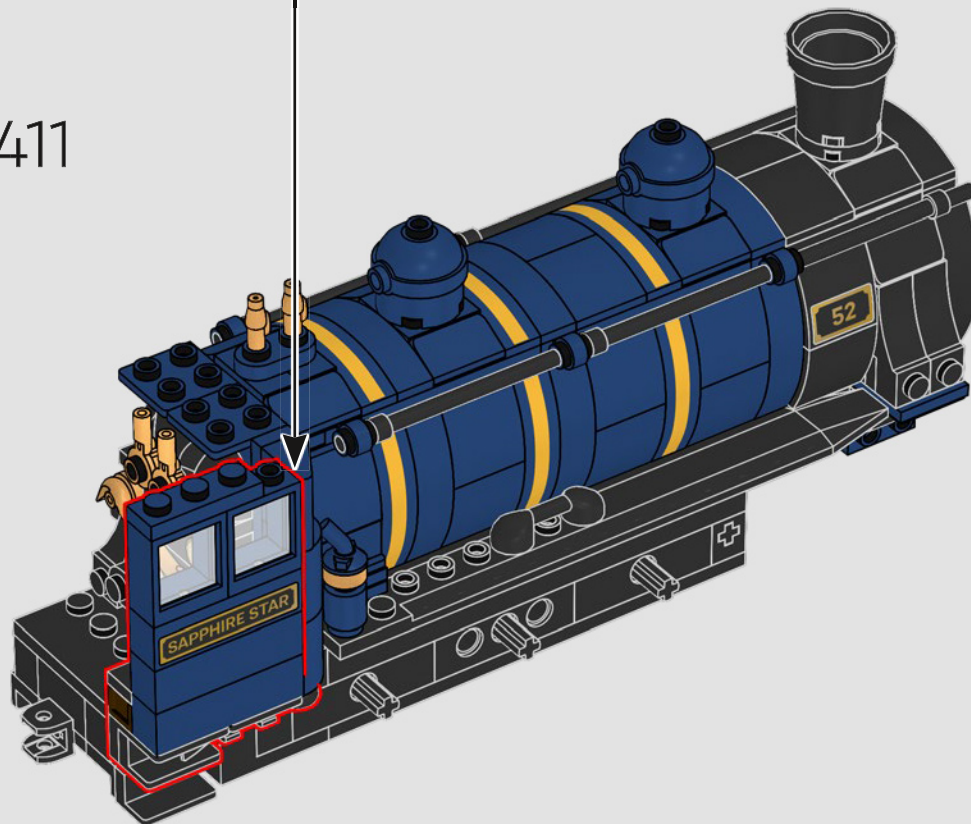

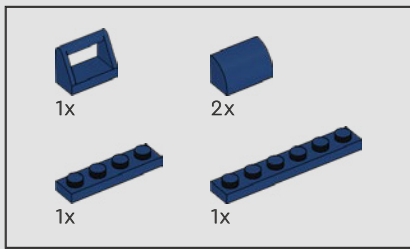

412

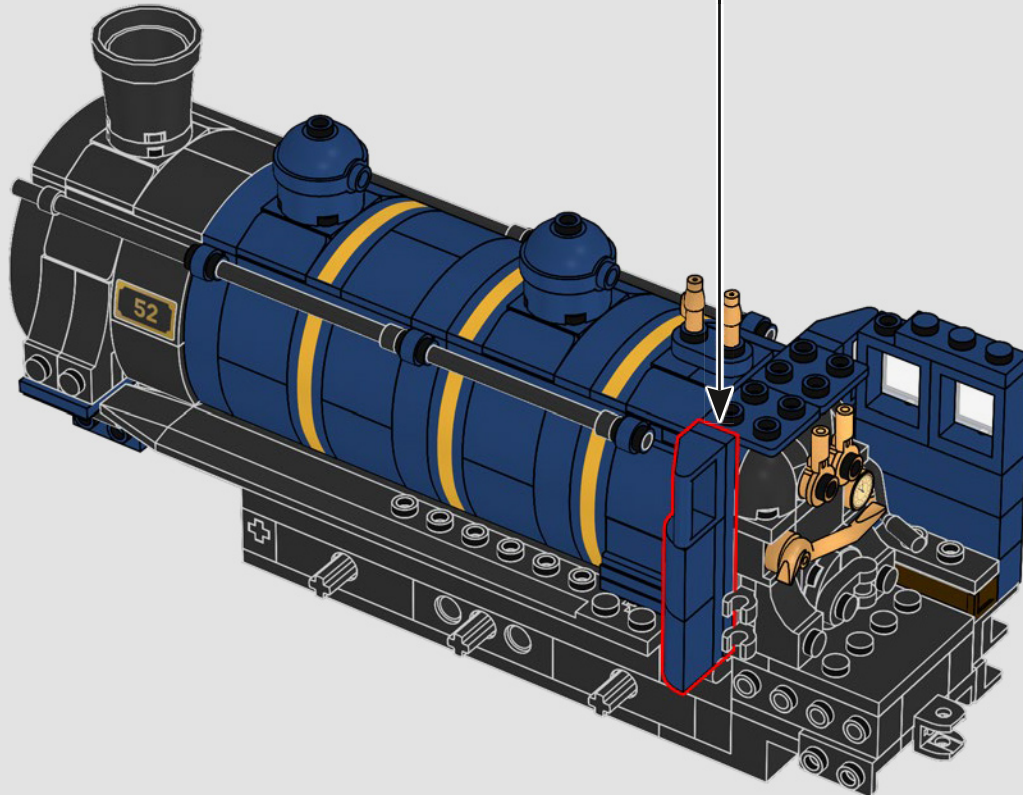
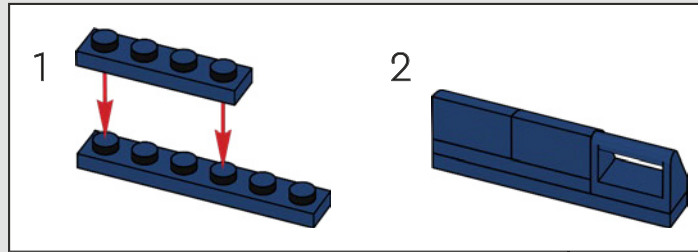

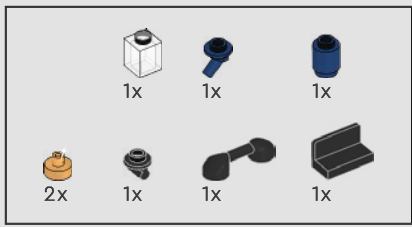

413

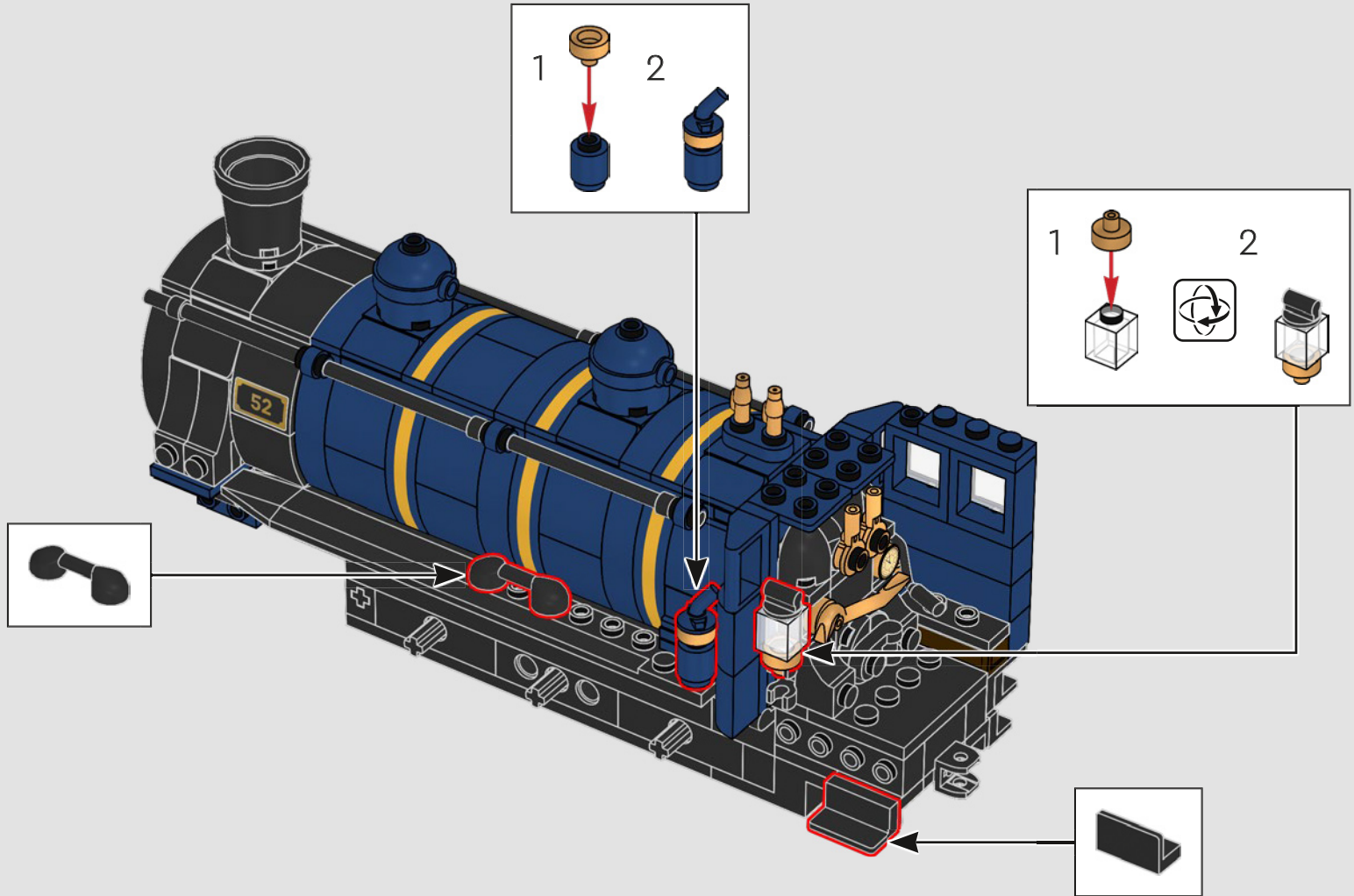

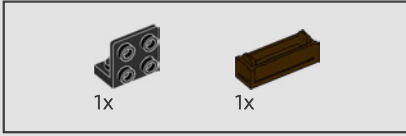
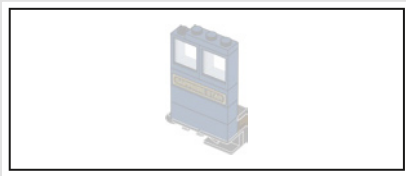

414

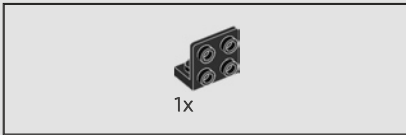
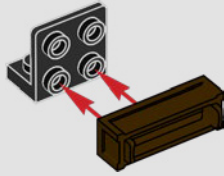

415

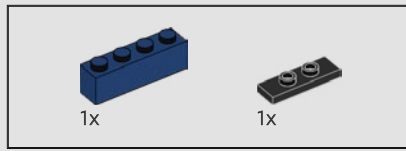
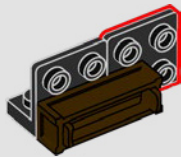

416

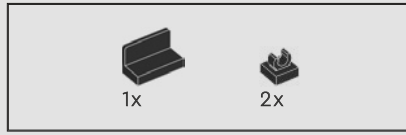
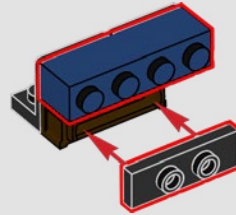

417

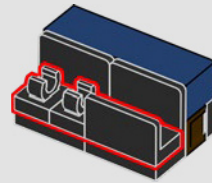

418

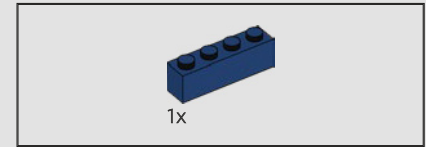
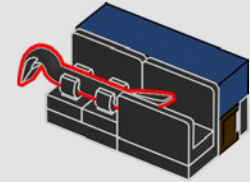

419

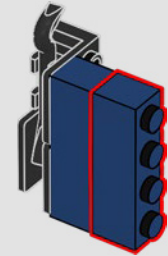

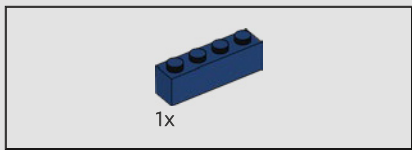

420

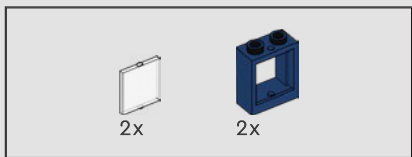
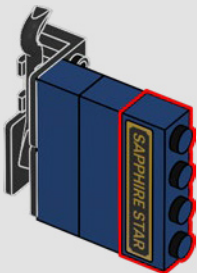
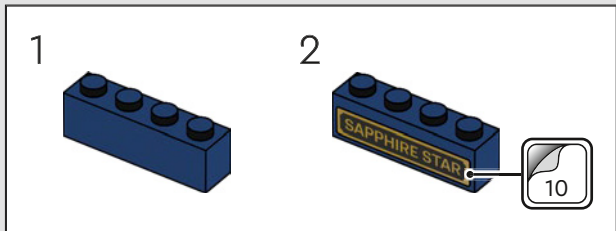

421

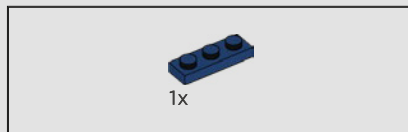
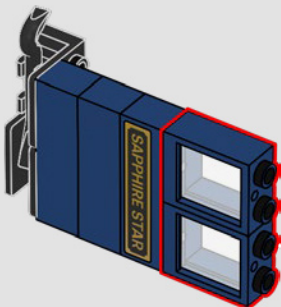
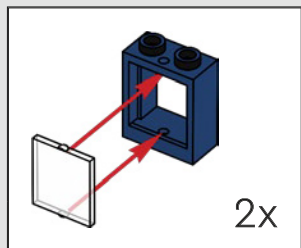

422

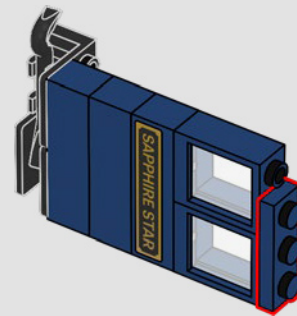

423

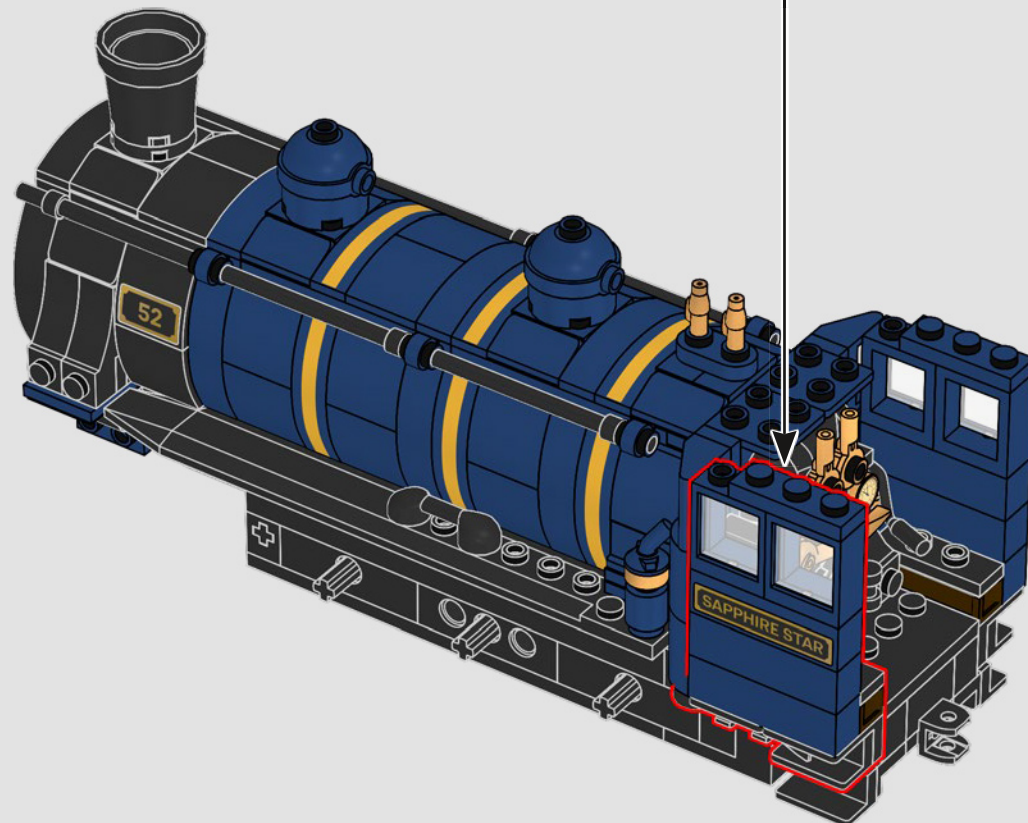

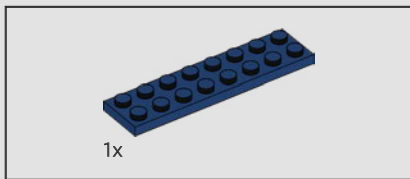

424

..... ●
« Le Sapphire Star... un véritable joyau !
Il me rappelle un train de nuit que j'ai pris
sur l'île d'Émeraude il y a des années. »

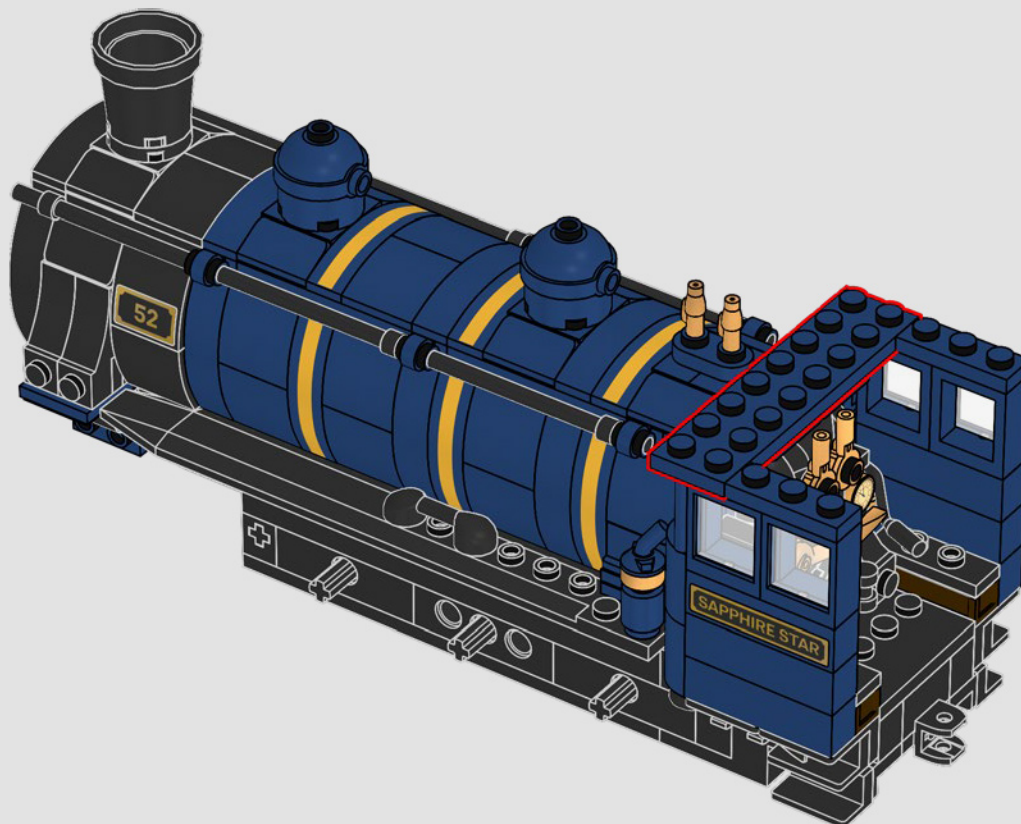

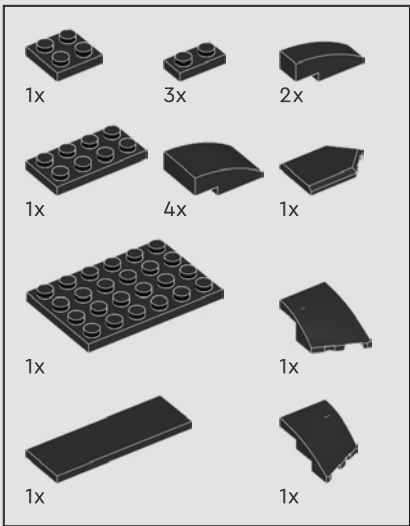

425

1

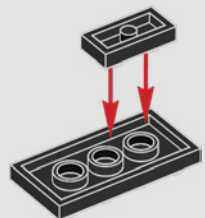

2

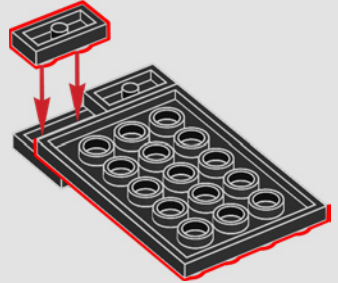

3

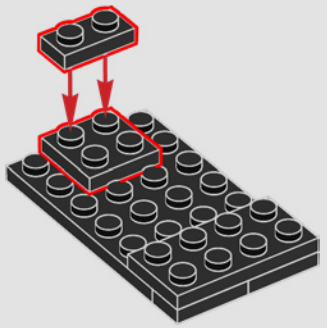

4

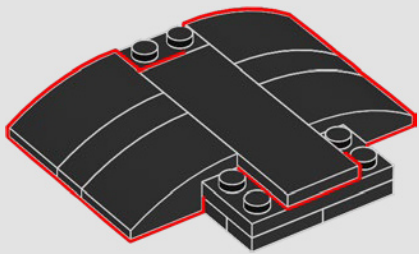

5

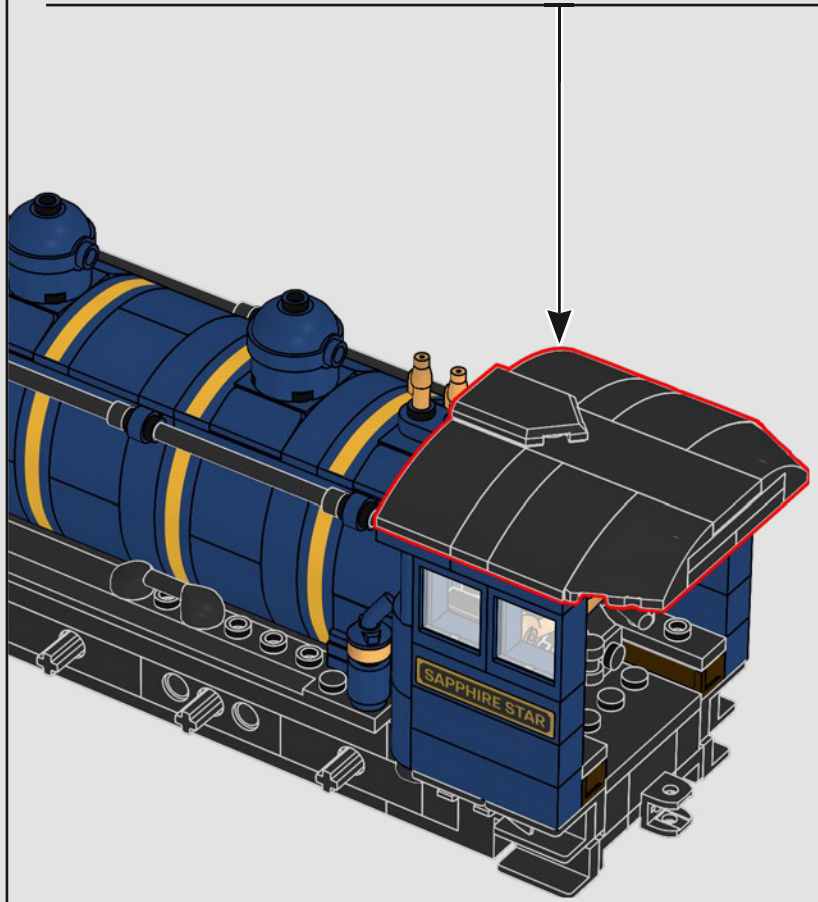
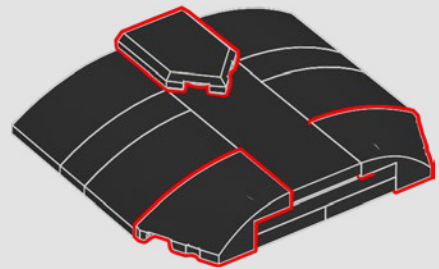

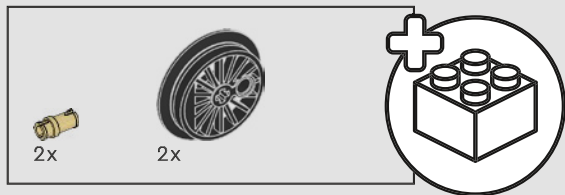

426

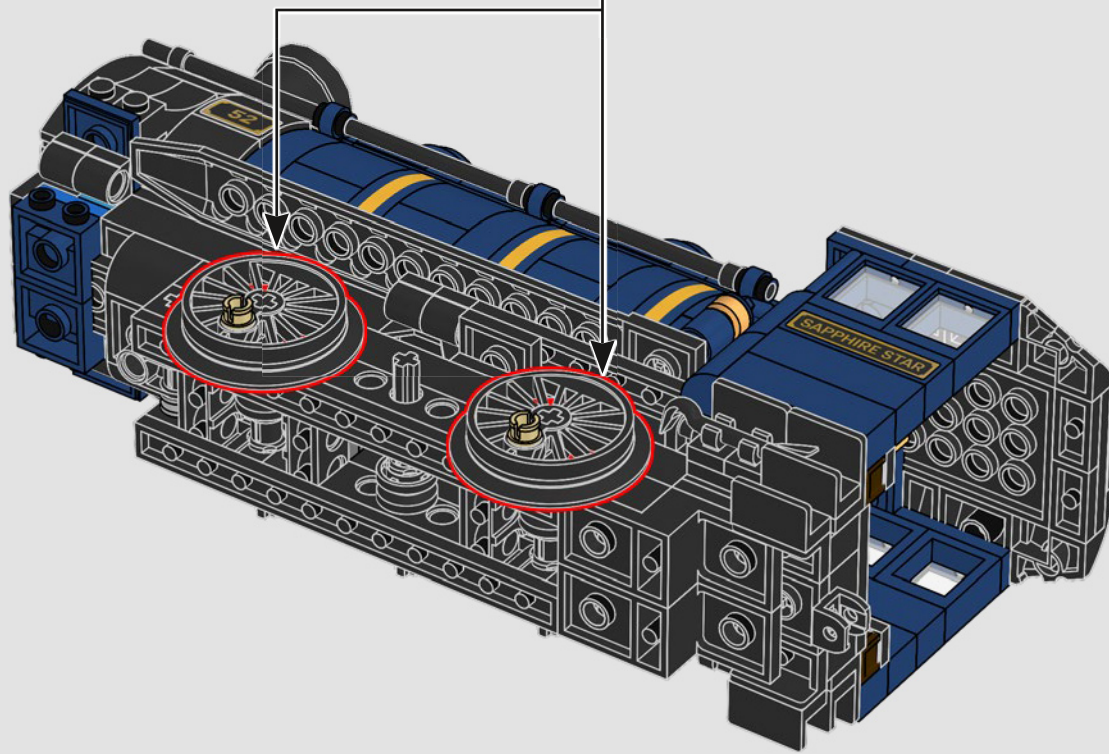
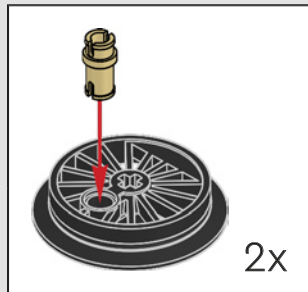

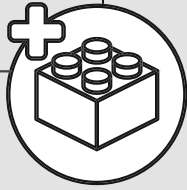
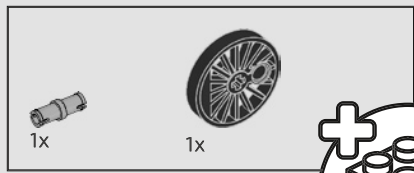

427

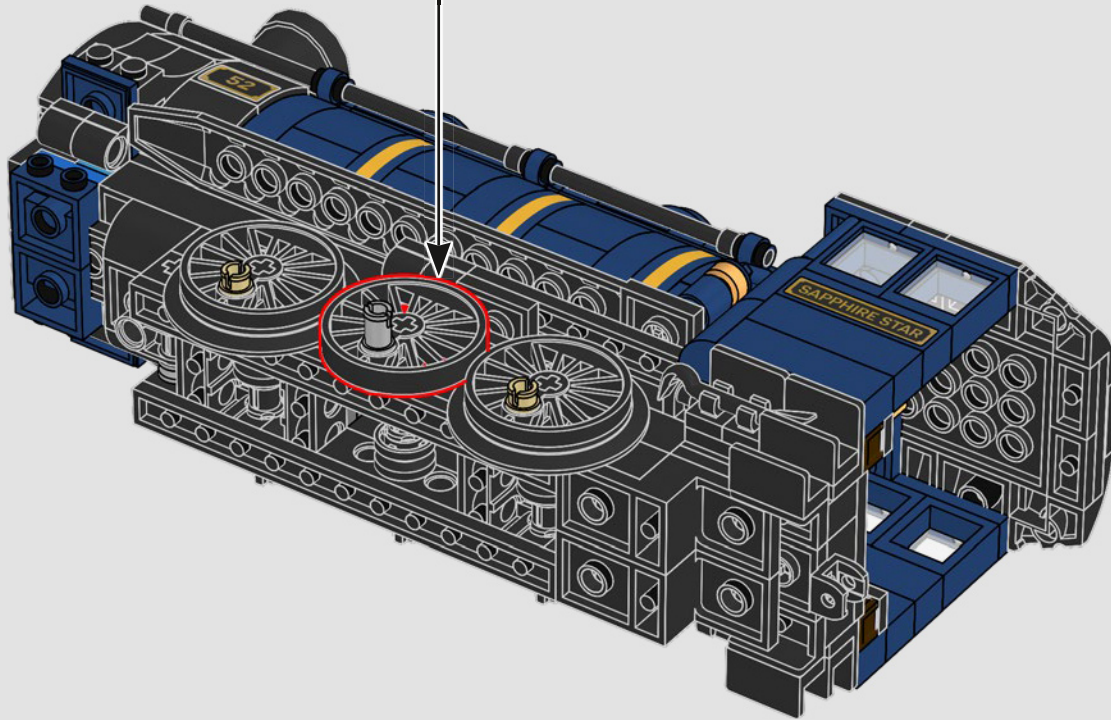
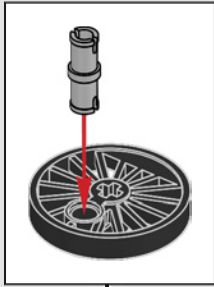

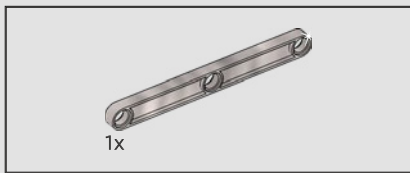

..... ●
« Ces tiges d'accouplement argentées sont de nouvelles pièces créées spécialement pour cette locomotive. »

428

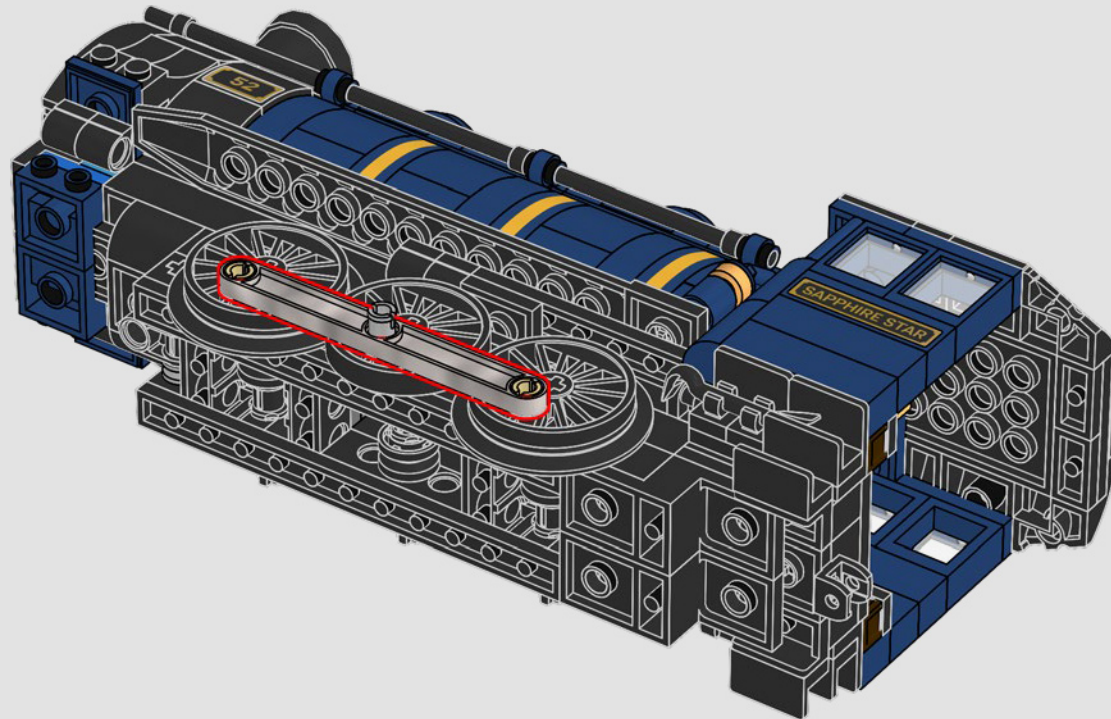



429

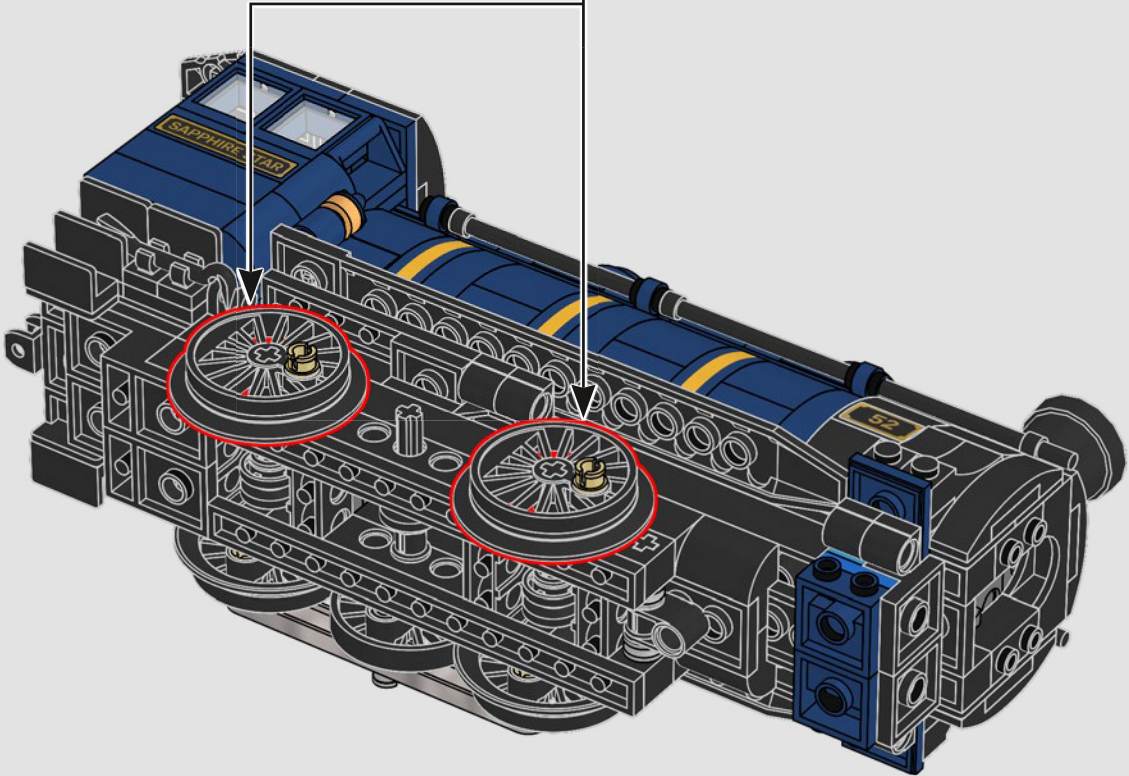
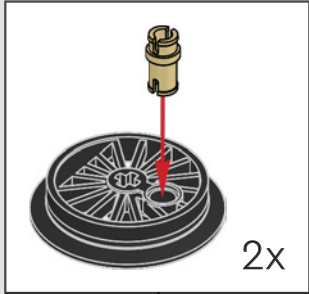
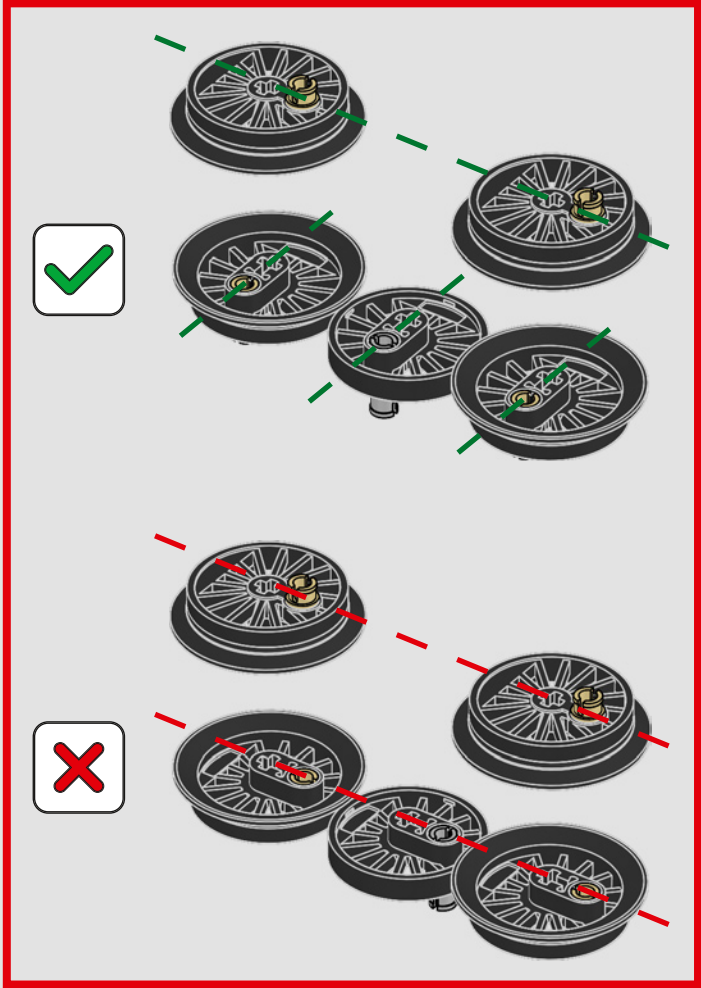



430

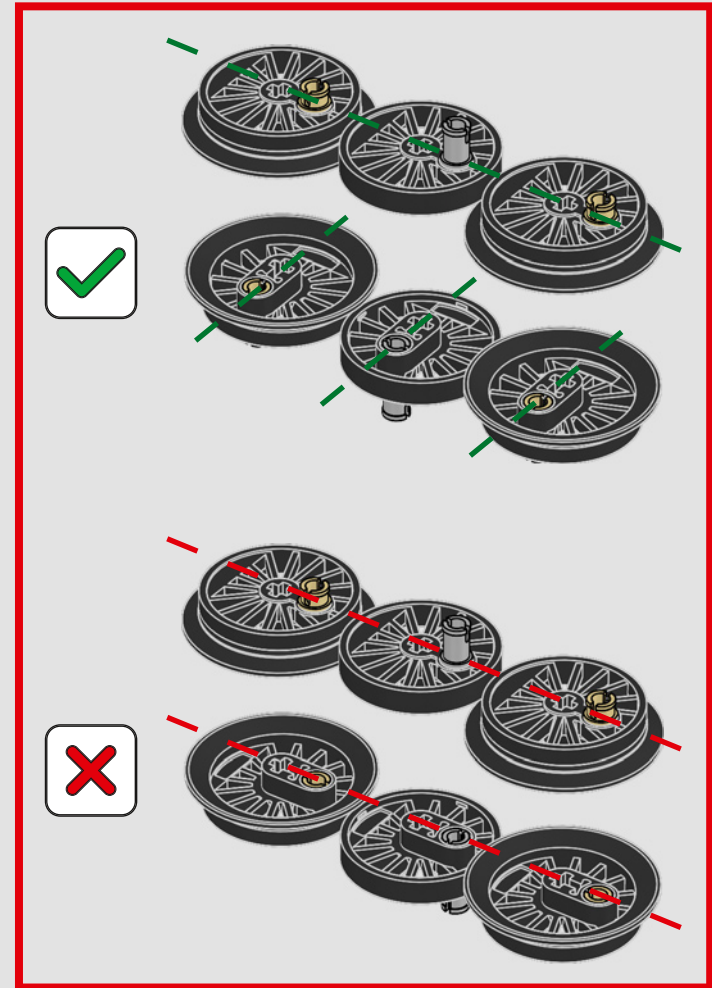
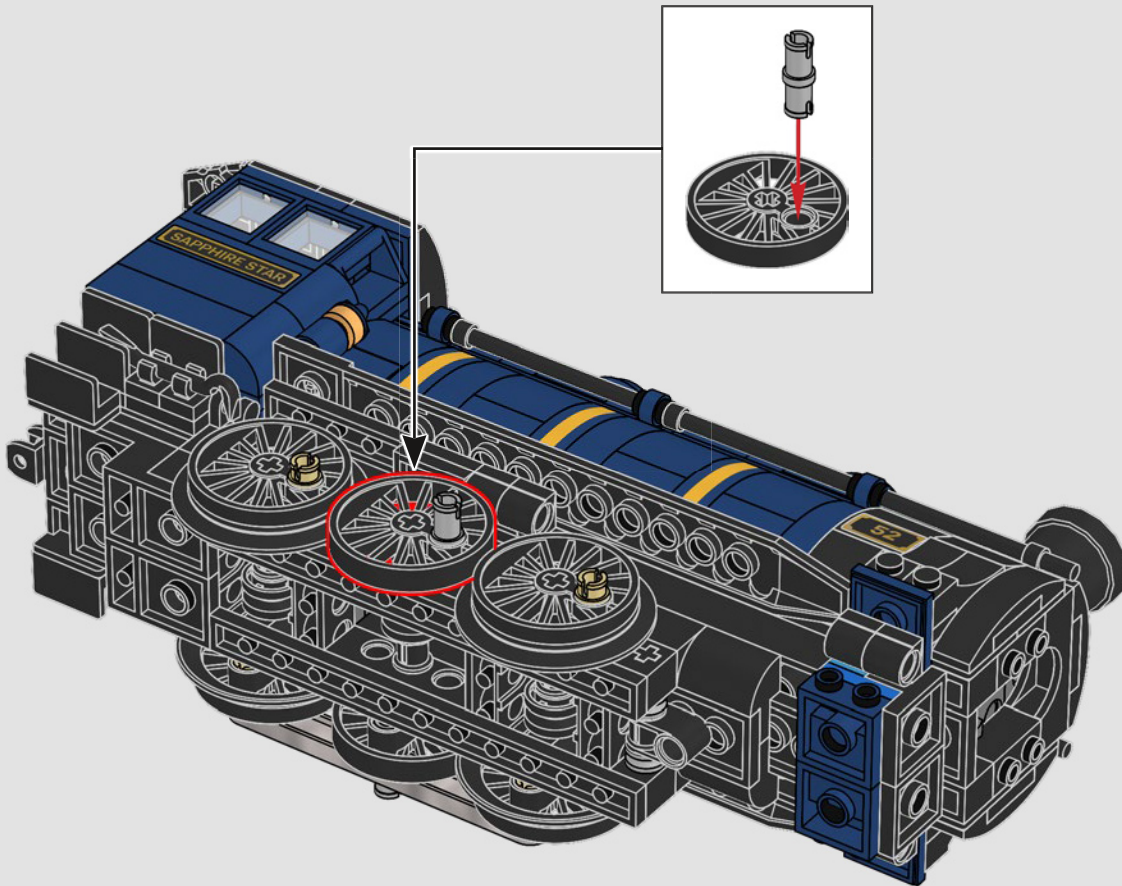

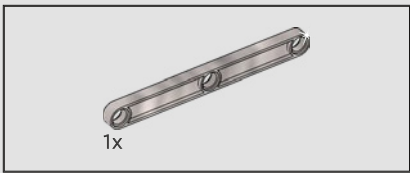

431

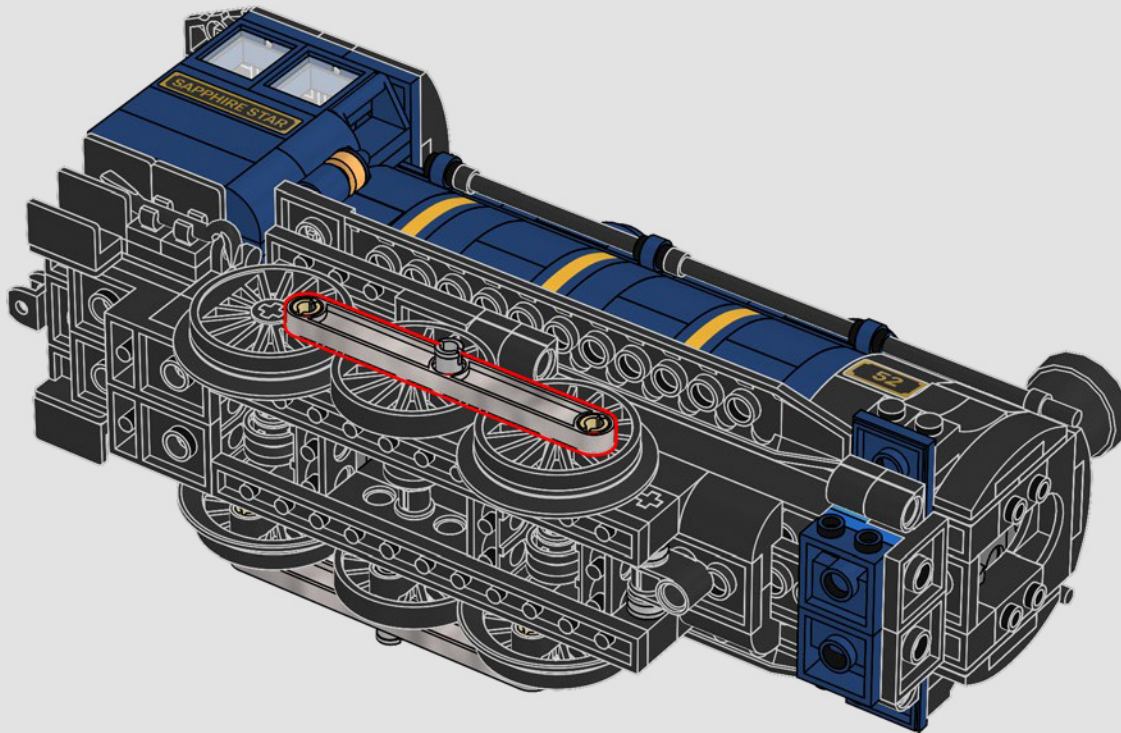

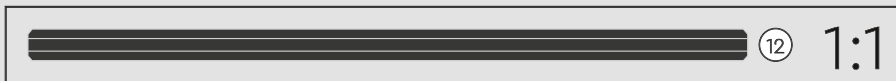
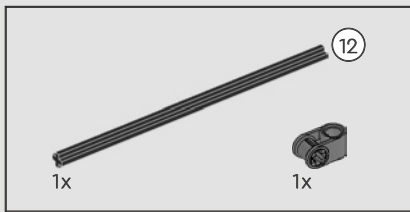

432

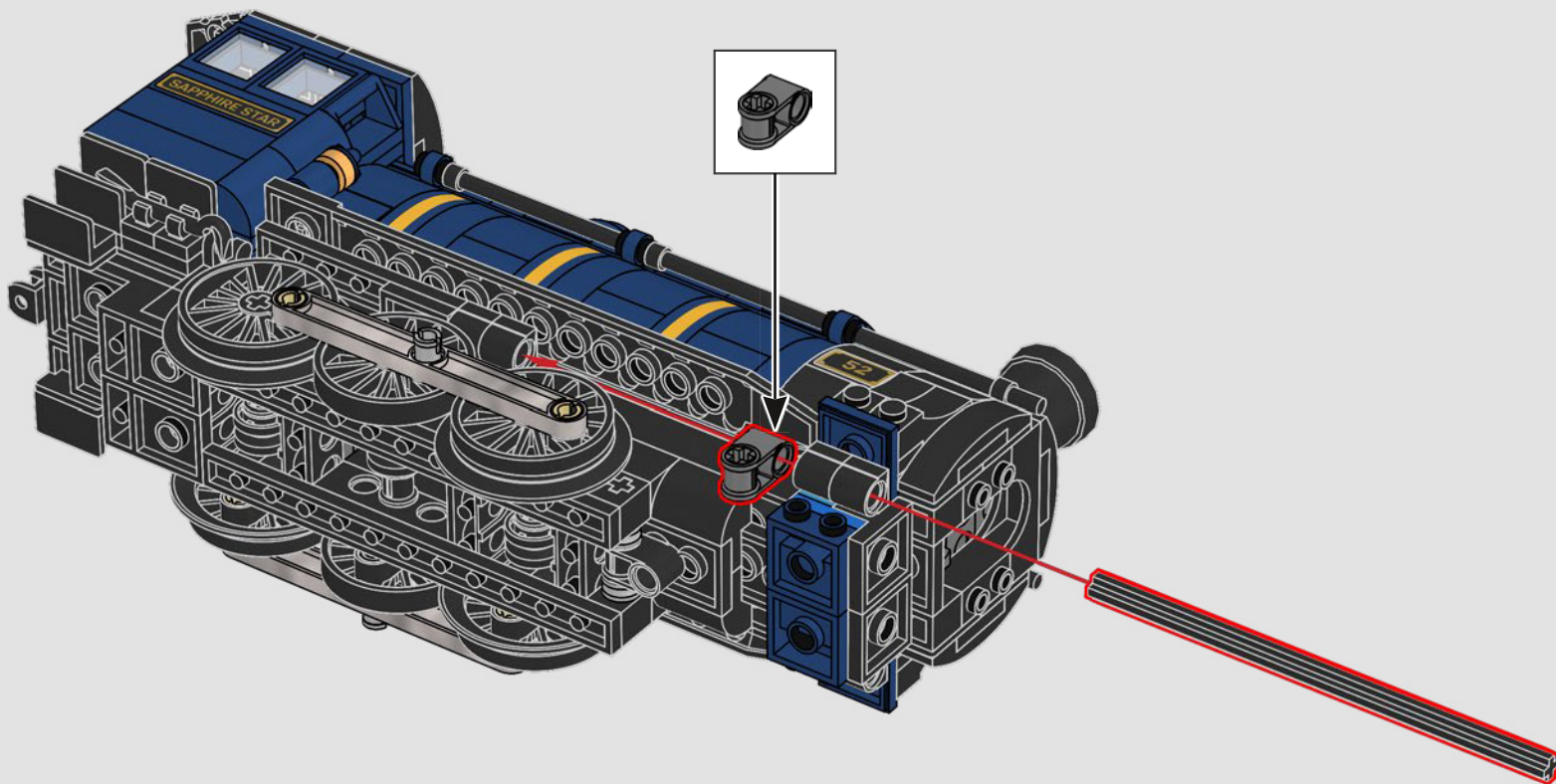

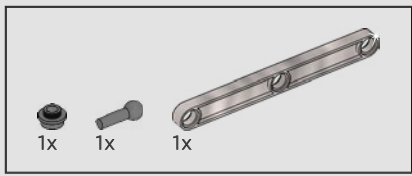

433

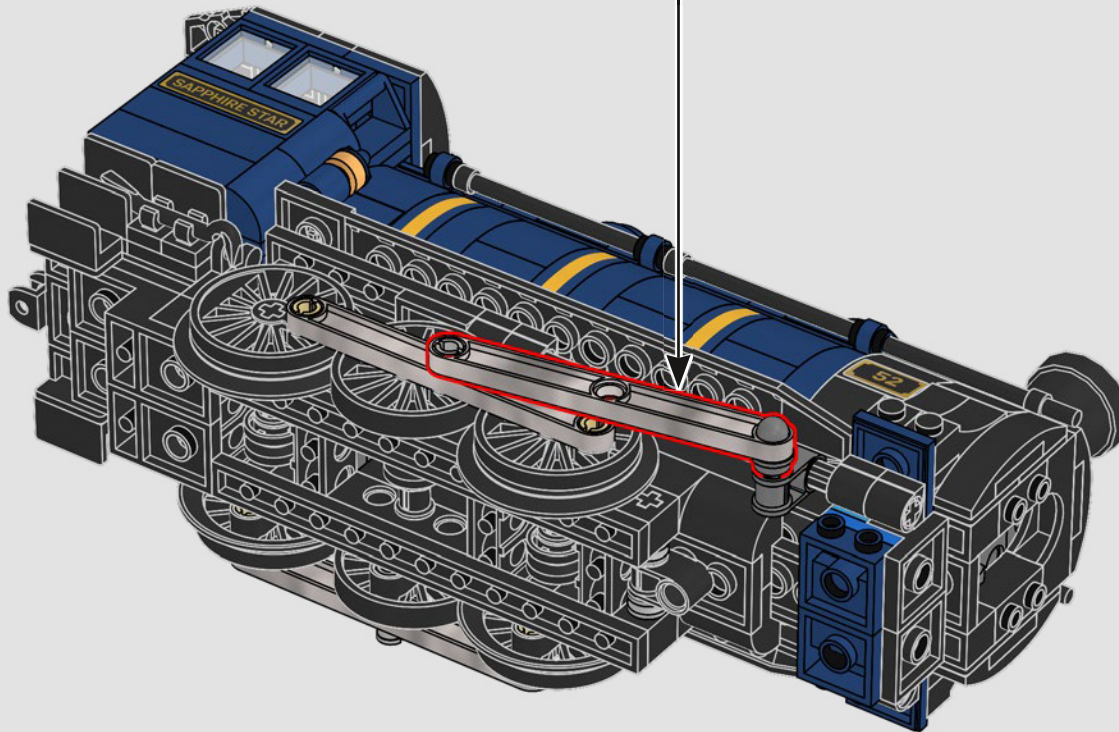
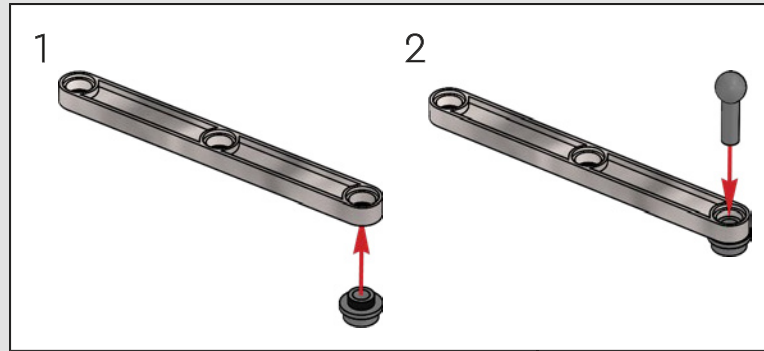

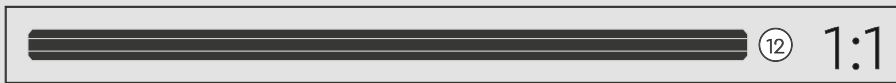
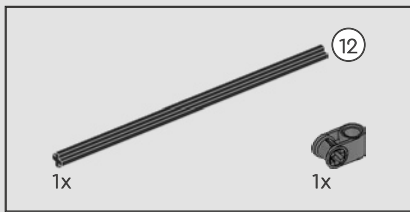

434

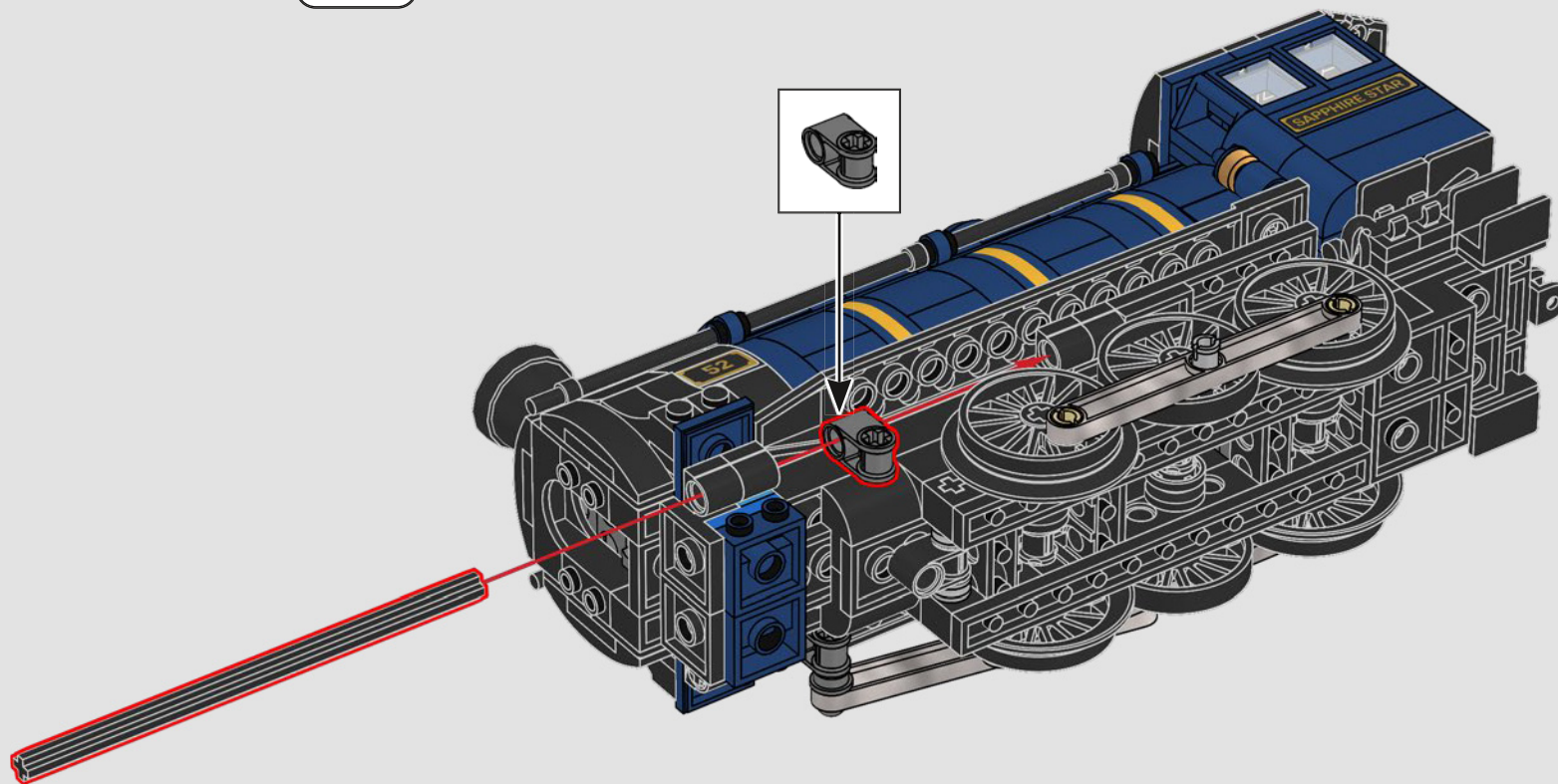

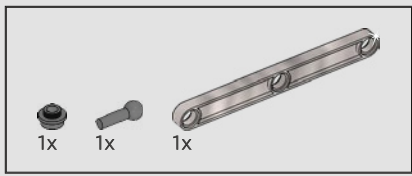

435

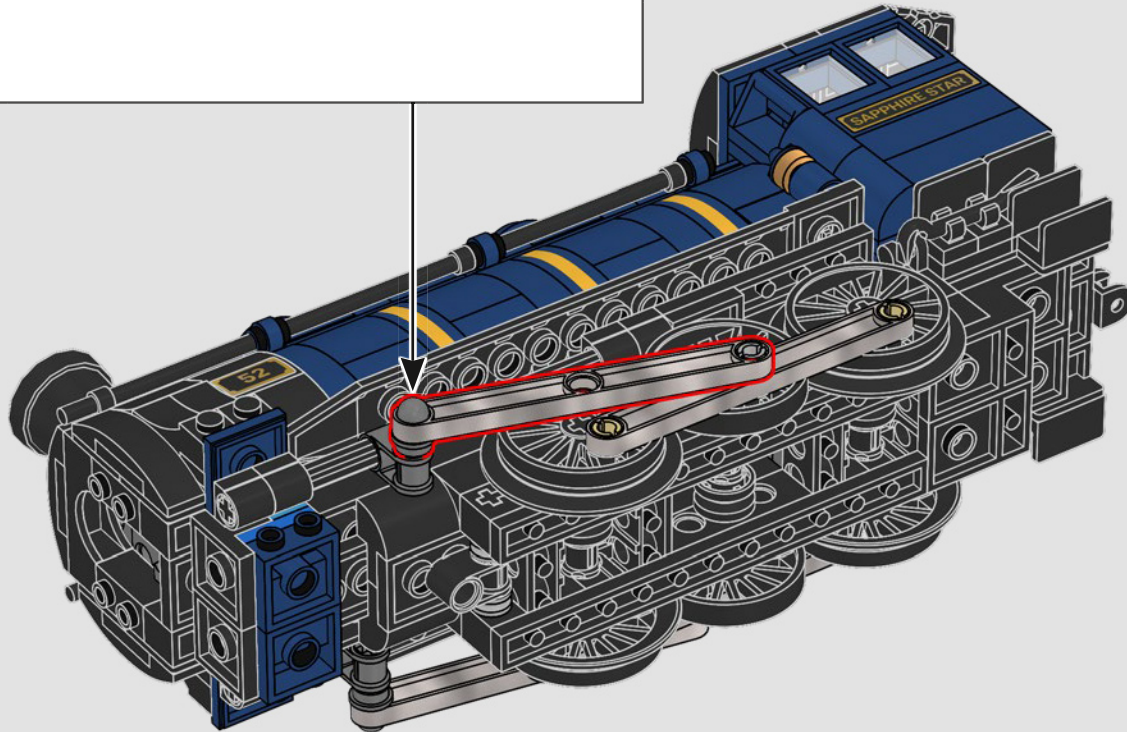
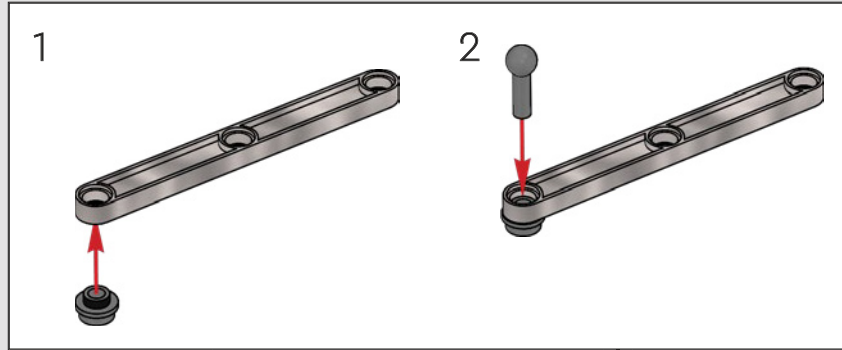

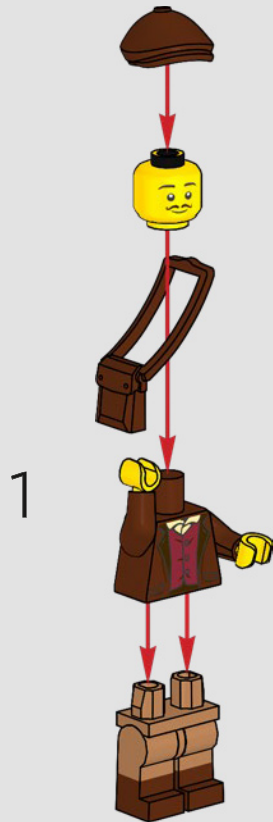
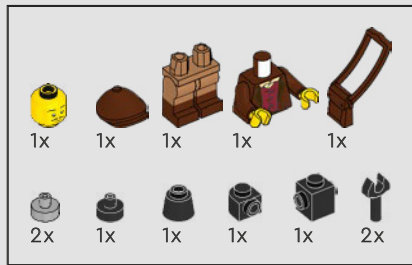

1

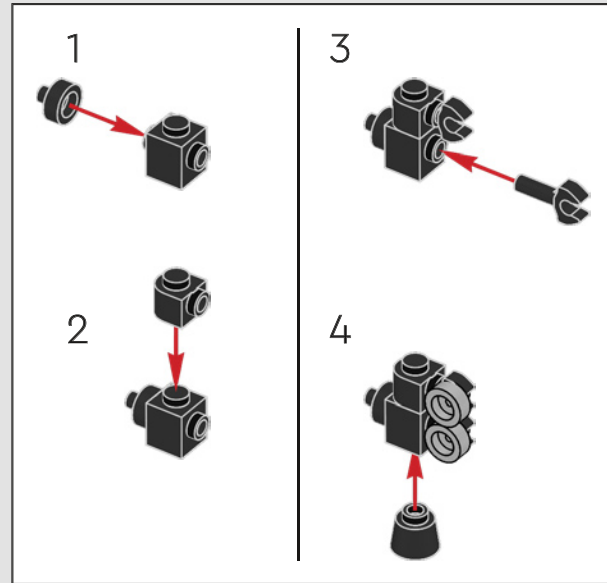

2



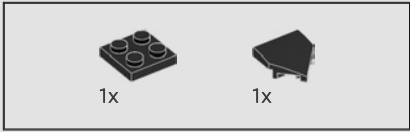
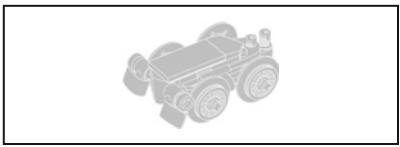

436

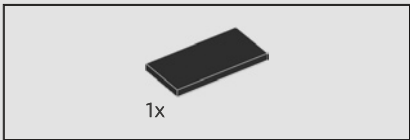
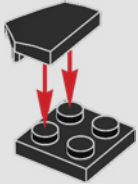

437

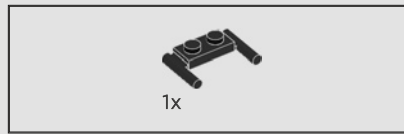
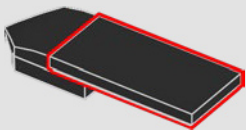

438

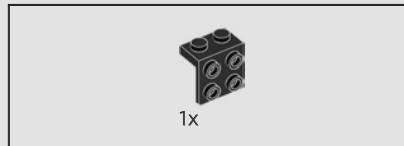
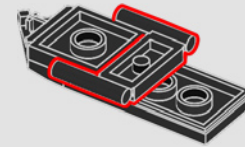

439

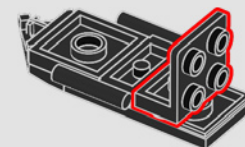

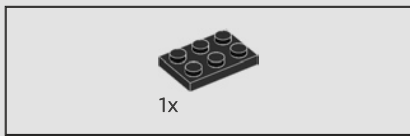

440

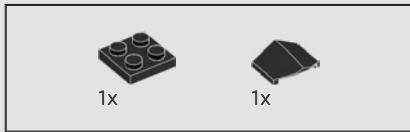
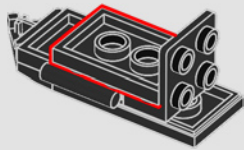

441

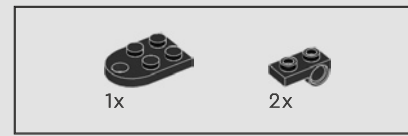
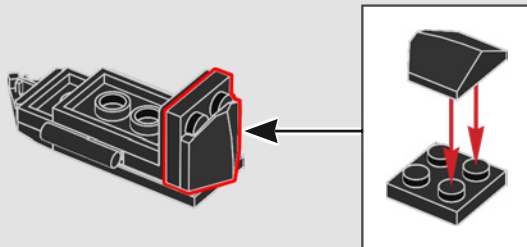

442

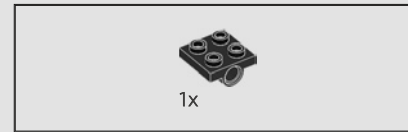
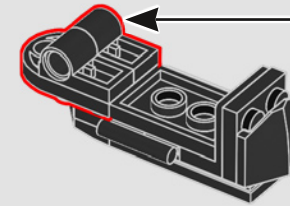
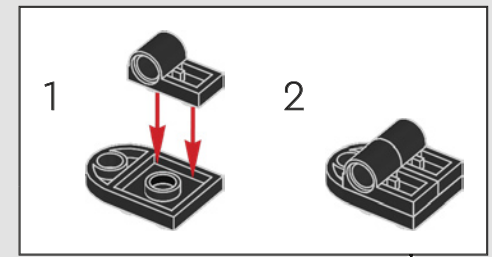

443

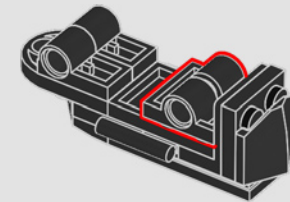

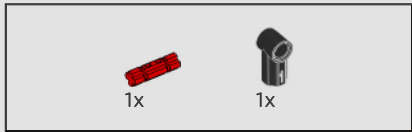
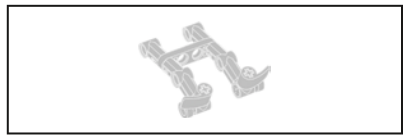

444

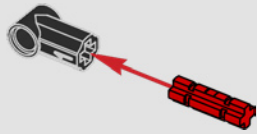

445

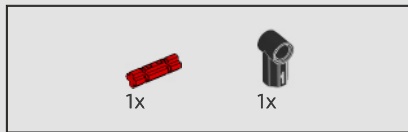

446

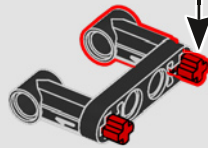
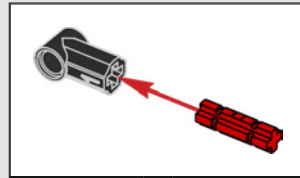

447

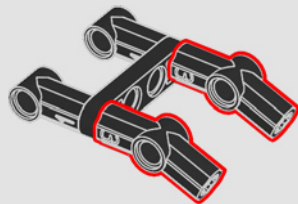

448

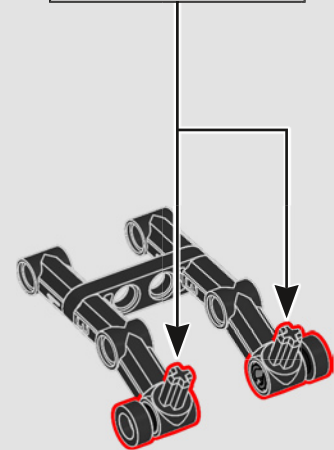
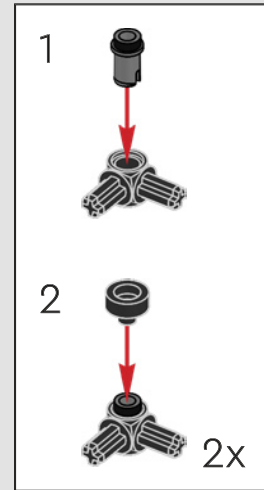



449

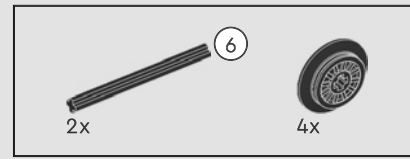
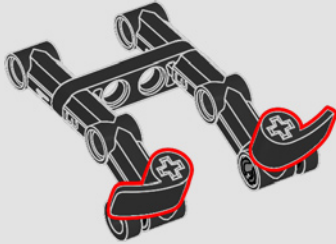

451

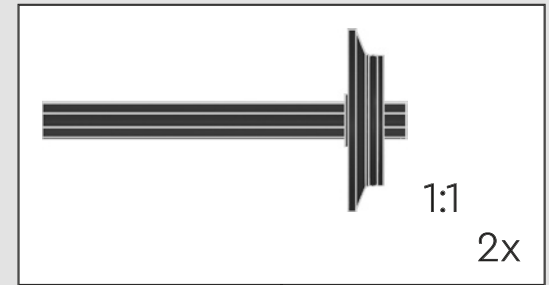
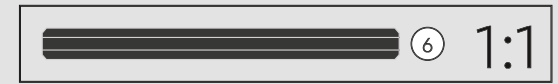

450

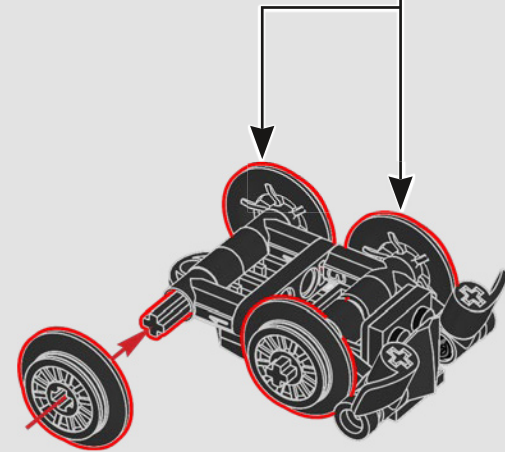
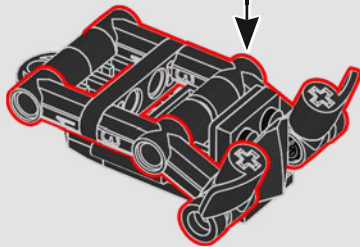

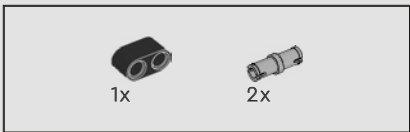

452

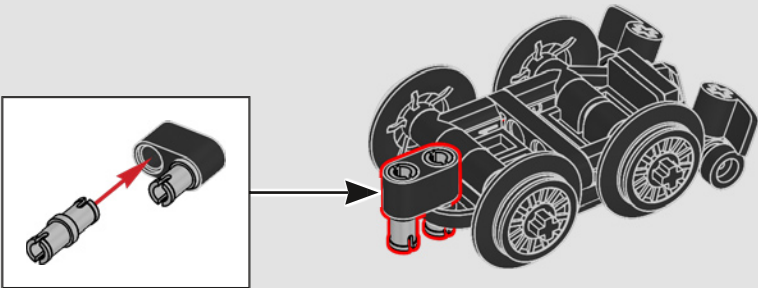

453

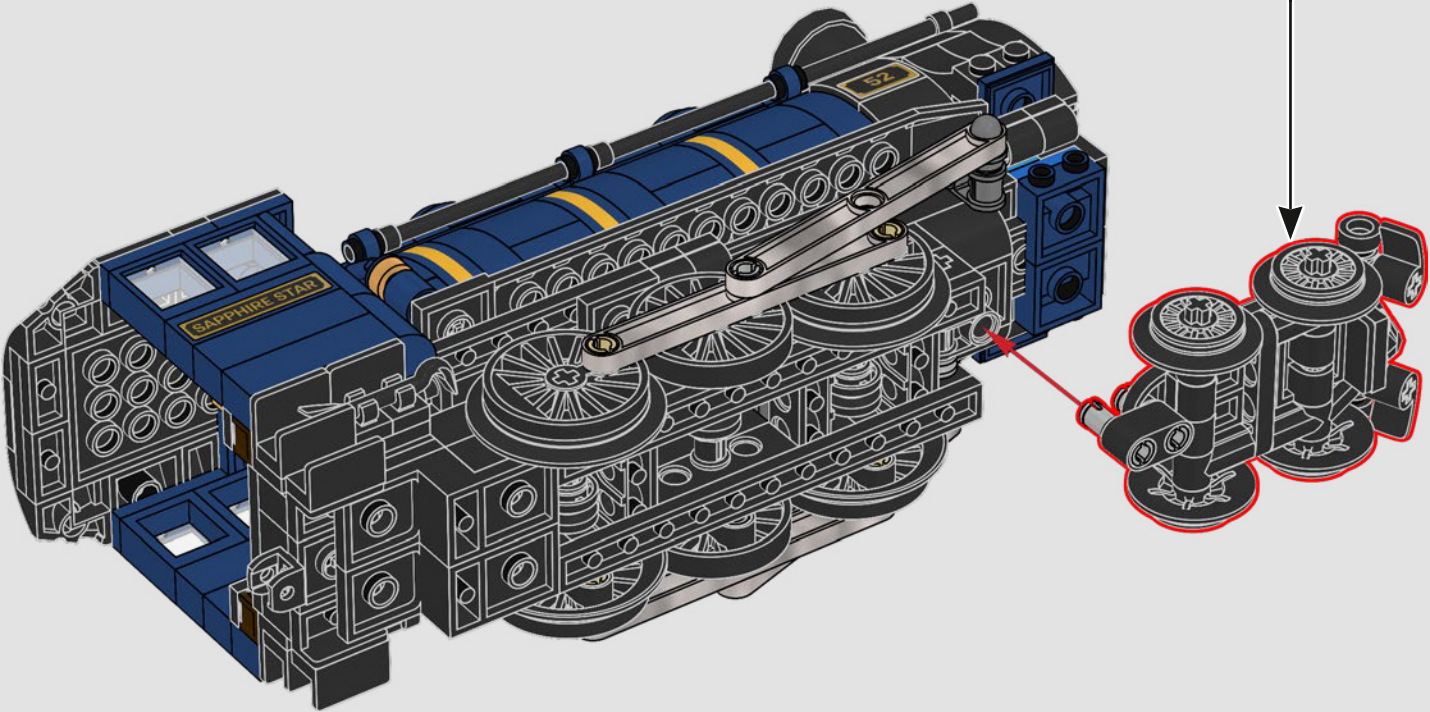

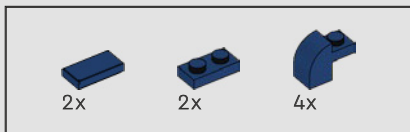

454

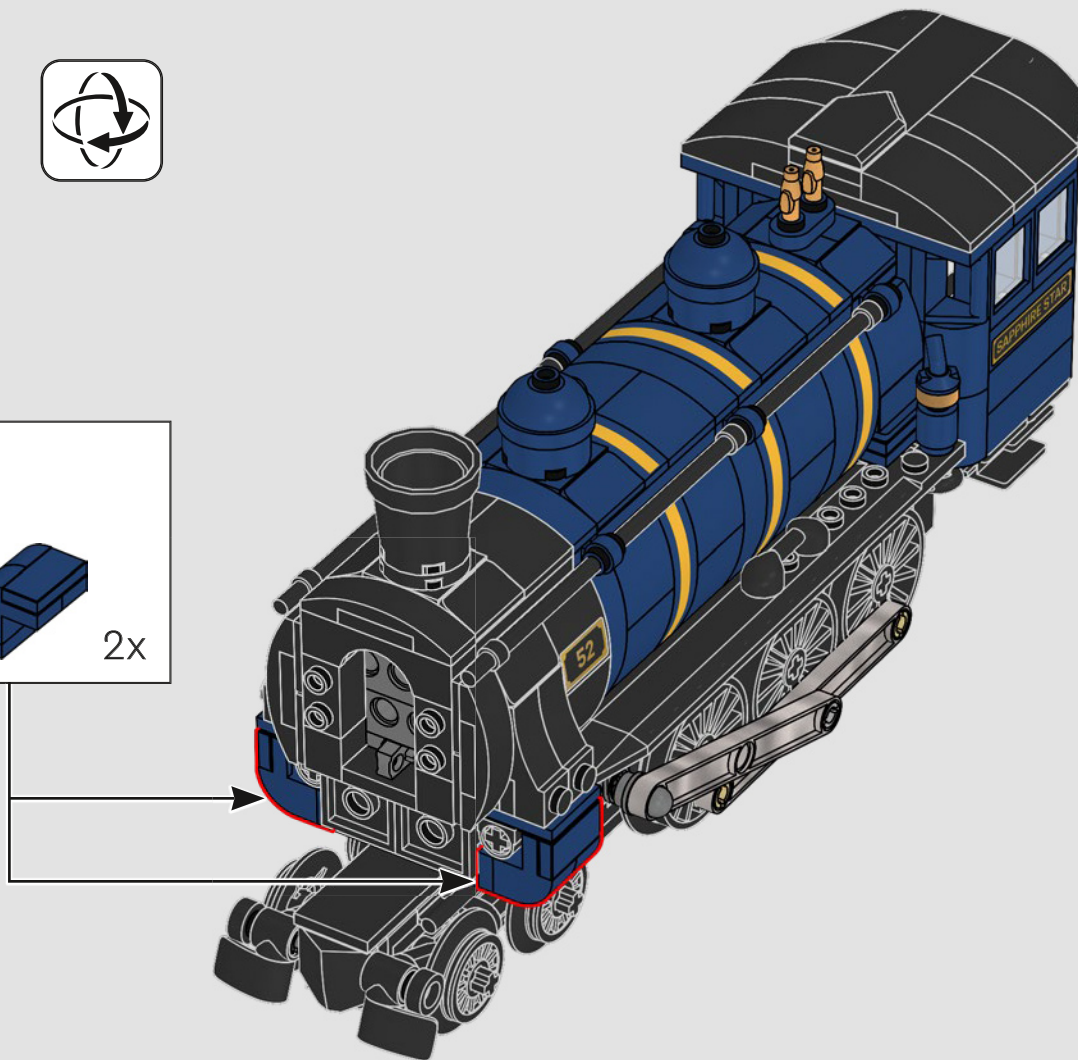
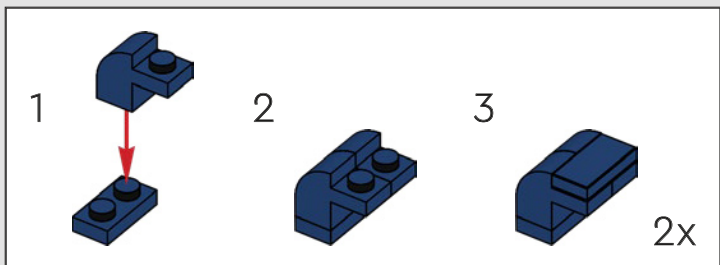

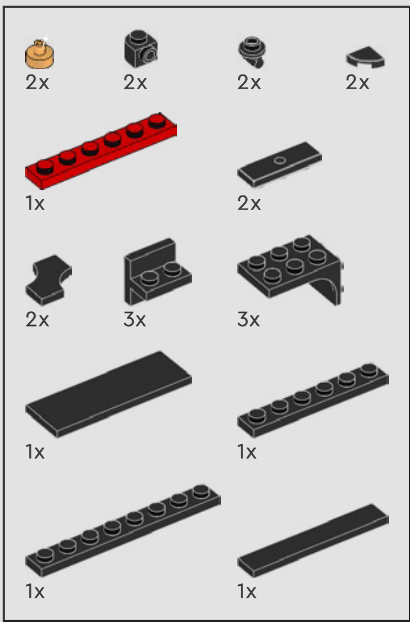

455

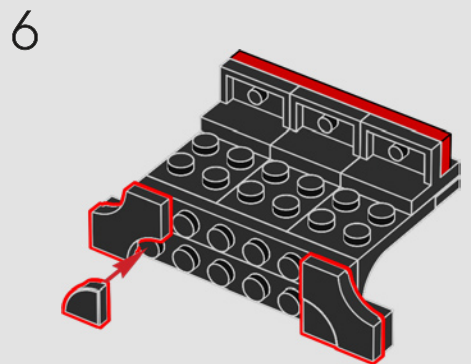
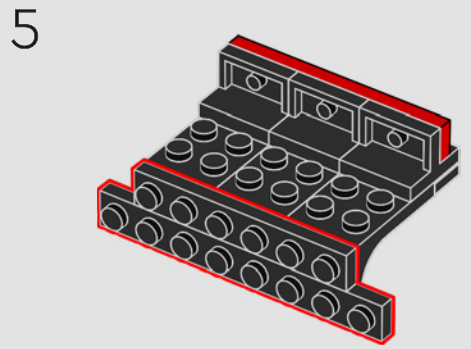
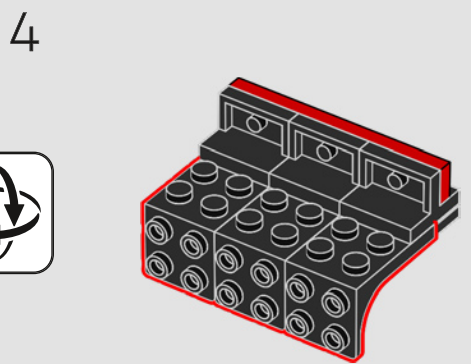
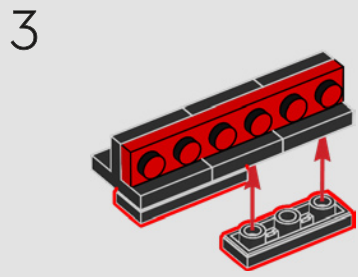
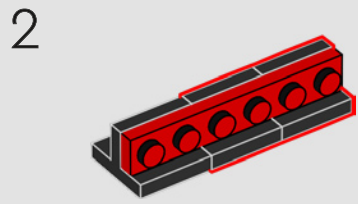
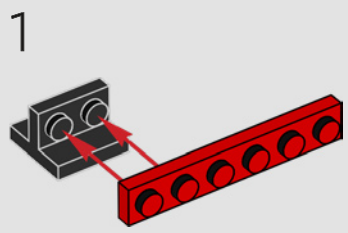

7

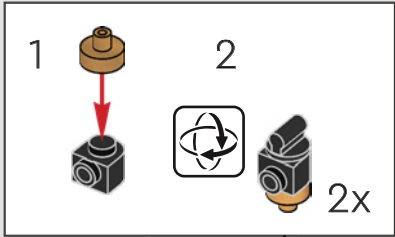
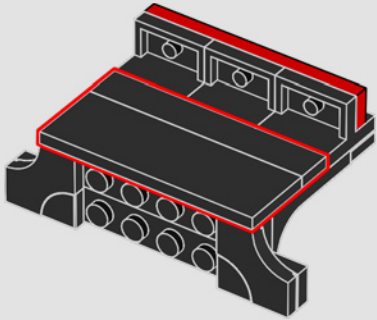

8

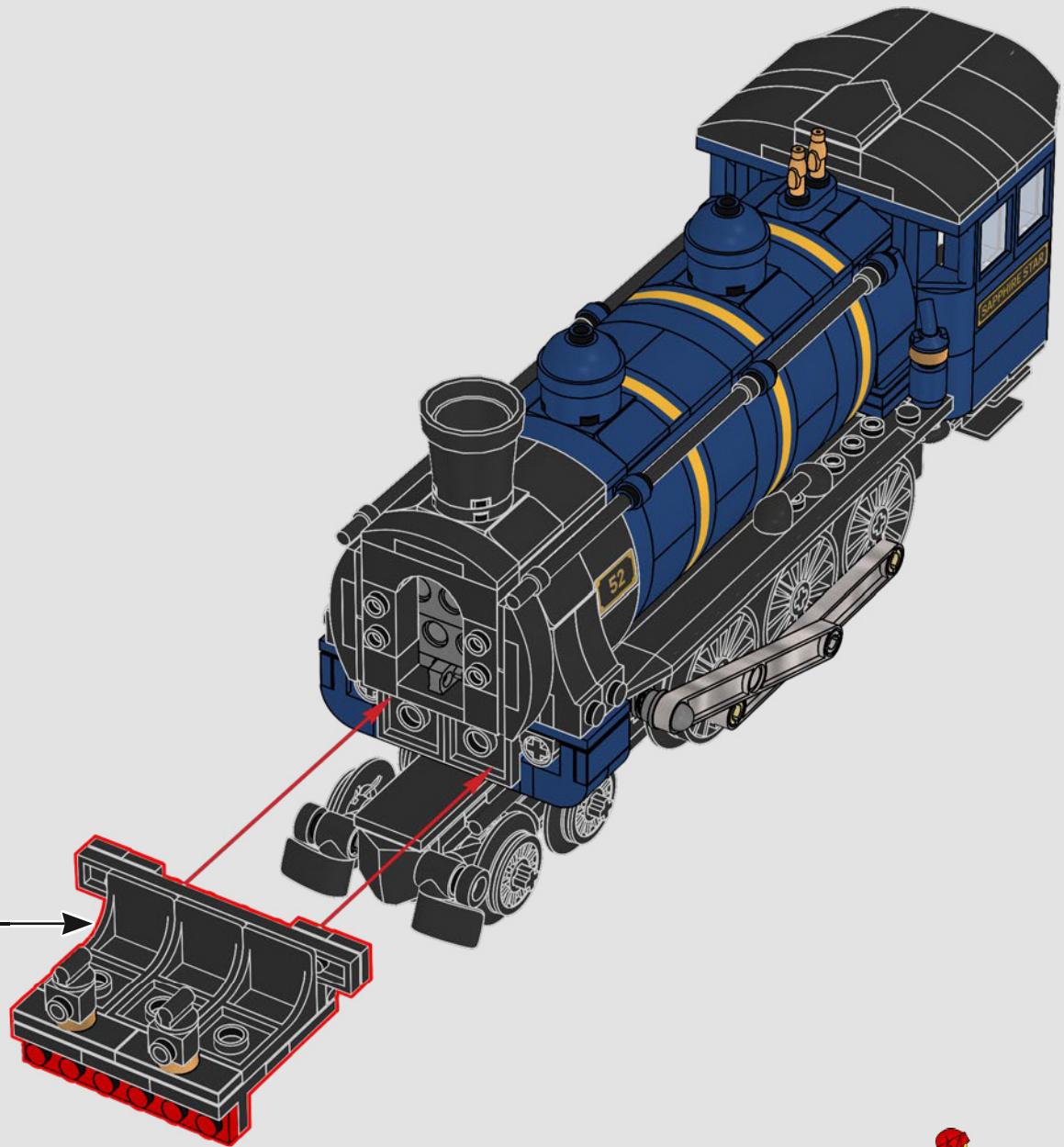
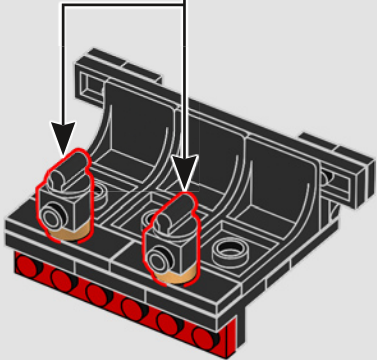

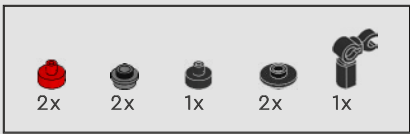

456

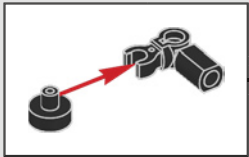
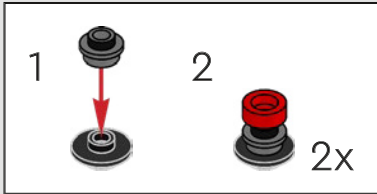
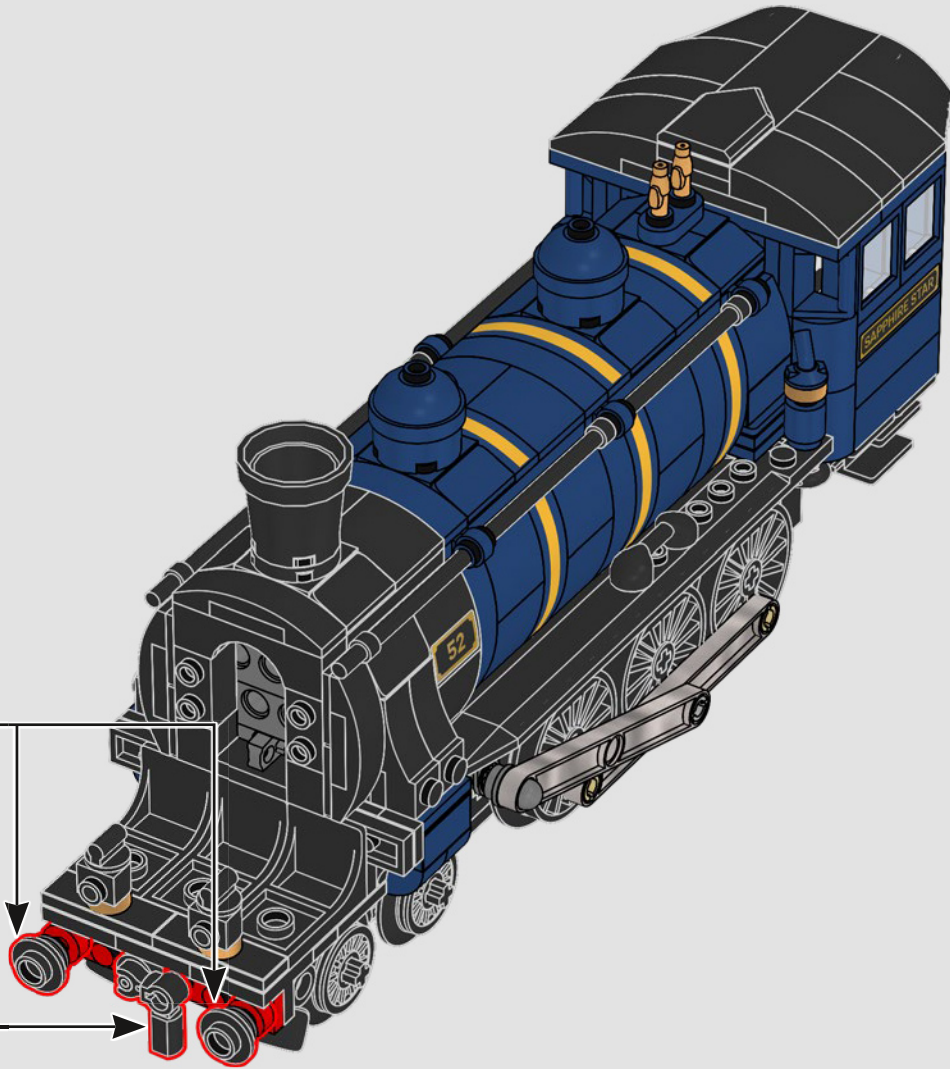

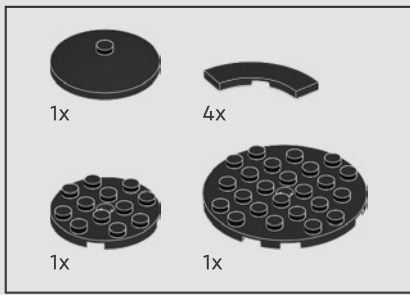

457

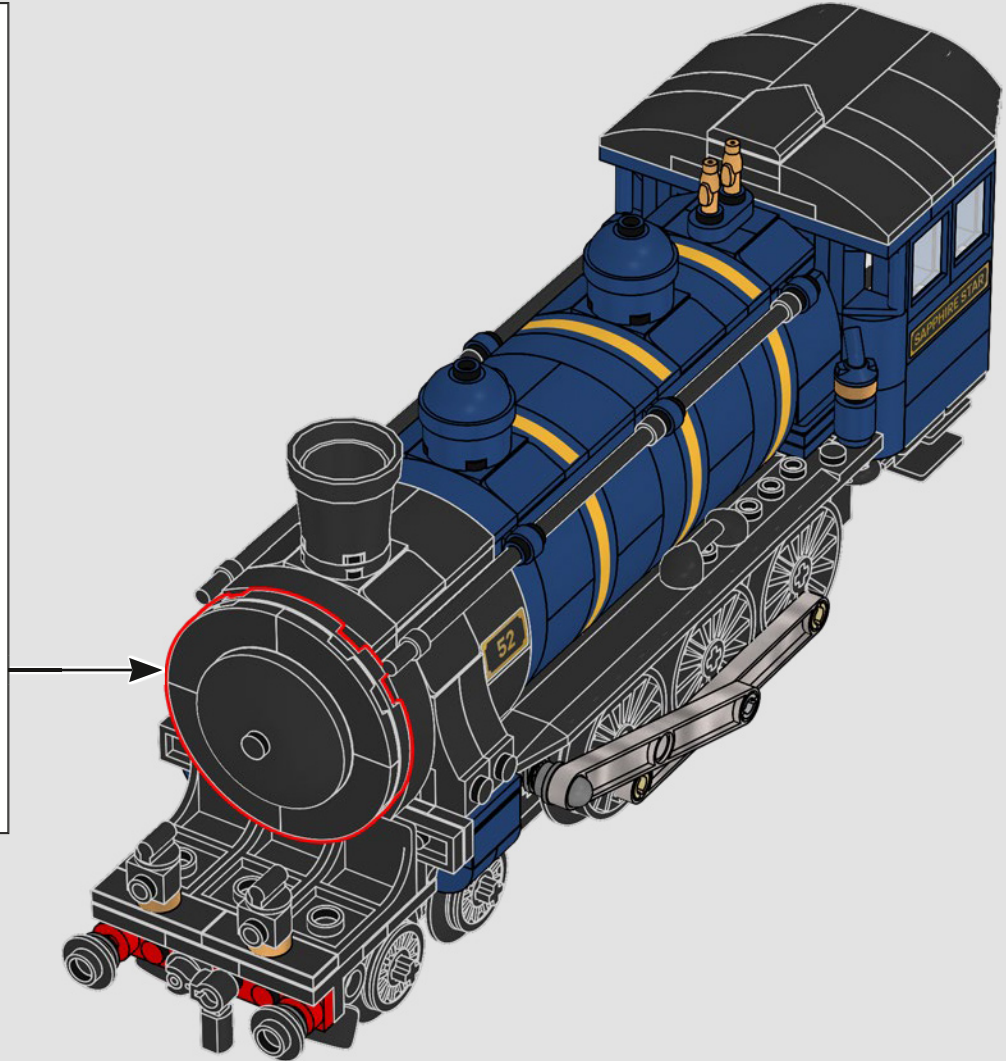
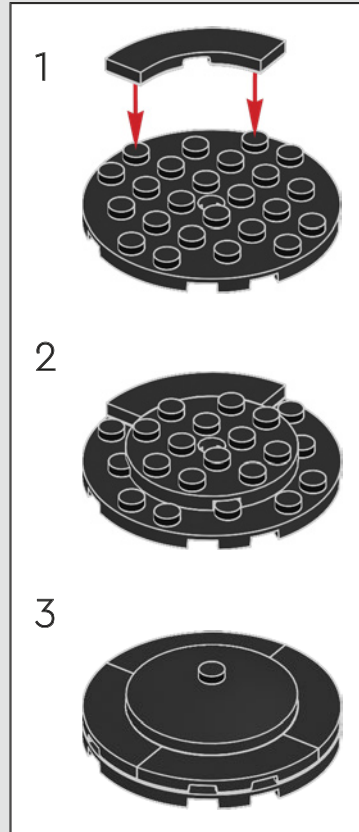

●
Destination : ISTANBUL

« La destination finale. De là, il est possible de continuer vers des endroits exotiques comme Bagdad, Le Caire, Téhéran, Jérusalem ou Bombay ! »

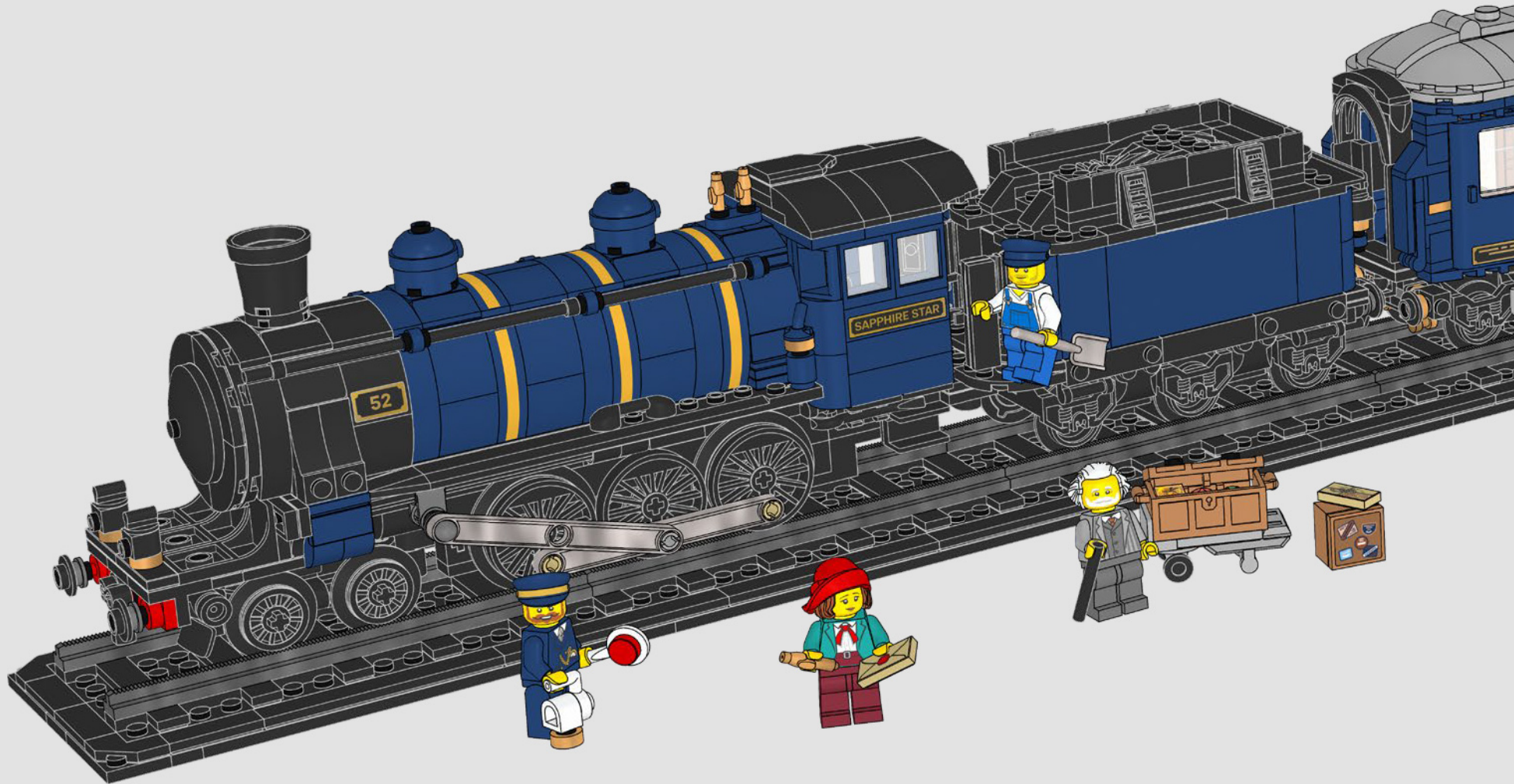

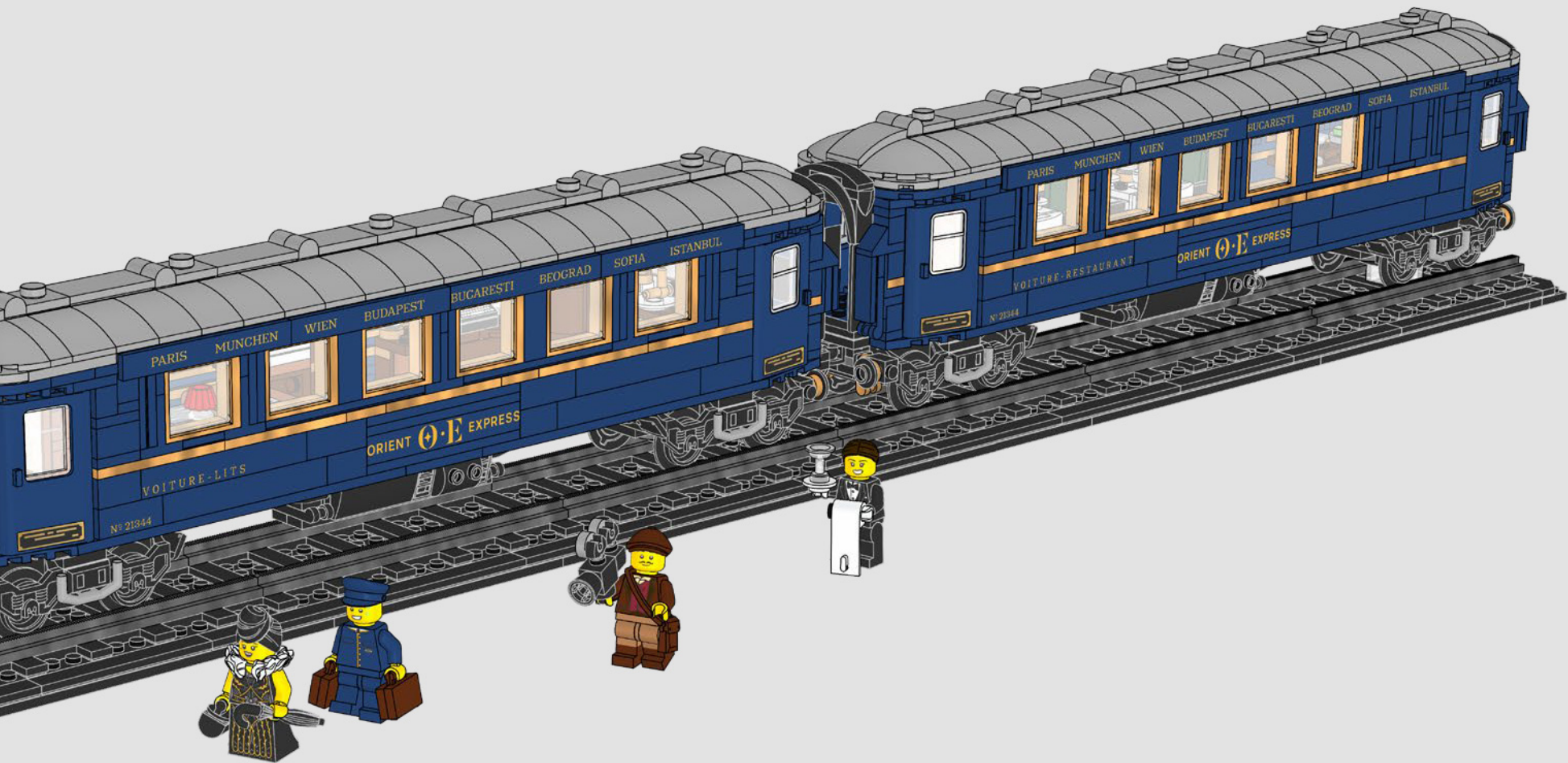



IDEAS

GATHER SUPPORT
HOL DIR UNTERSTÜTZUNG
RECUEILLEZ DES VOTES
CHIEDI DI ESSERE SUPPORTATO
CONSIGUE APOYOS
OBTÉM APOIO
争取支持
ZDOBĄDŹ GŁOSY

ZÍSKEJTE PODPORU
ZÍSKAJTE PODPORU
SZEREZZ TÁMOGATÁST!
CERE SPRIJIN
ПОЛУЧЕТЕ ПОДКРЕПА
IEGŪSTI ATBALSTU
KOGU TOĒTUST
RINK PALAIKYMĄ

SHARE YOUR IDEA
TEILE DEINE IDEE
PARTAGEZ VOTRE IDÉE
CONDIVIDI LA TUA IDEA
COMPORTE TU IDEA
PARTILHA A TUA IDEIA
分享创意
PODZIEL SIĘ POMYSŁEM

SDÍLEJTE SVÉ NÁPADY
ZDIEĽAJTE SVOJE NÁPADY
OSZD MEG AZ ÖTLETED!
İMPĀRTĀŠEŠTE IDEEA TA
СПОДЕЛЕТЕ ИДЕИТЕ СИ
PARĀDI SAVU IDEJU
JAGA OMA IDEED
PASIDALINK SAVO IDĒJA

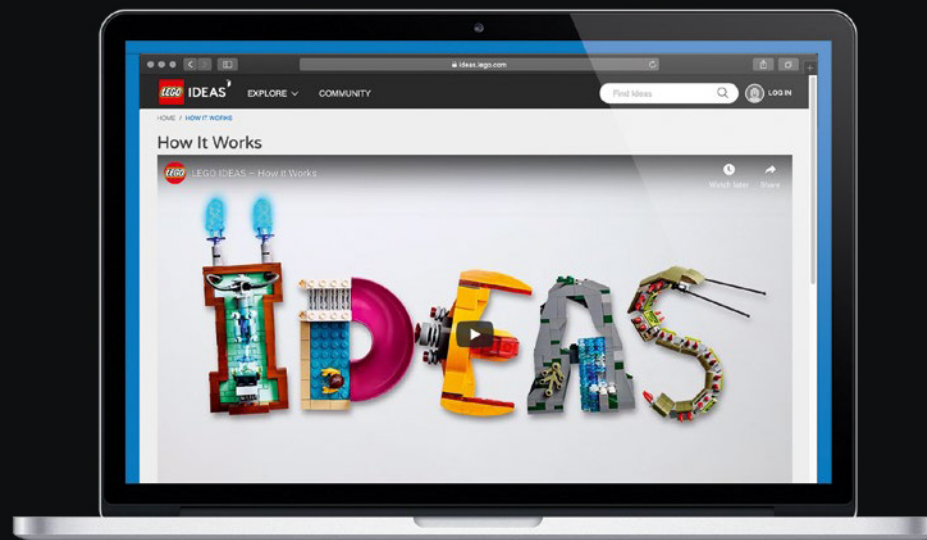
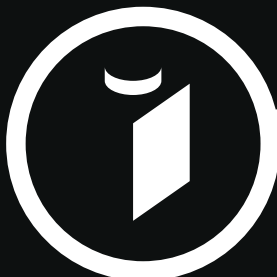
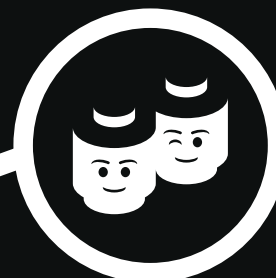

LEGO® REVIEW
LEGO® PRÜFUNG
EXAMEN PAR LEGO®
REVIEW LEGO®
REVISIÓN DE LEGO®
AVALIAÇÃO LEGO®
乐高®审核
OCENA LEGO®

OUZENÍ DESIGNÉRY LEGO®
POSÚDENÉ DIZAJNÉRMÍ LEGO®
LEGO® VÉLEMÉNYEZÉS
VERIFICARE LEGO®
ПРЕГЛЕД НА LEGO®
LEGO® RECENZIIA
LEGO® ARVUSTUS
LEGO® APŽVALGA

NEW LEGO® PRODUCT
NEUES LEGO® PRODUKT
NOUVEAU PRODUIT LEGO®
NUOVO PRODOTTO LEGO®
NUEVO PRODUCTO LEGO®
NOVO PRODUTO LEGO®
全新乐高®产品
NOWY PRODUKT LEGO®



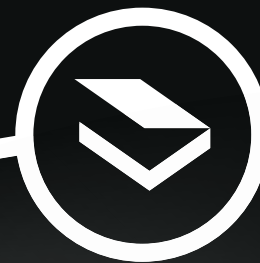





















































































NOVÁ STAVEBNICE LEGO®
NOVÁ STAVEBNICA LEGO®
ÚJ LEGO® TERMÉK
PRODUS LEGO® NOU
НОВ ПРОДУКТ LEGO®
JAUNS LEGO® PRODUKTS
UUS LEGO® TOODE
NAUJAS LEGO® PRODUKTAS



ideas.LEGO.com

1x 407001	1x 6434569	1x 474001	1x 4114084	4x 306223	1x 6123730	16x 306226	1x 6181713	1x 4177444	5x 301026	4x 303226
1x 4558952	3x 302301	1x 6172674	1x 6257600	2x 6055065	1x 6218310	2x 6436425	2x 6369578	1x 6261371	4x 371026	14x 303426
1x 6321349	1x 302201	2x 4537987	1x 6352222	2x 6092582	1x 6384058	2x 6344819	1x 6308912	2x 6396456	8x 6254045	3x 346026
1x 6218823	2x 6126046	1x 4527637	2x 6174925	12x 302223	1x 6384051	4x 4548180	4x 6211476	4x 302426	8x 243126	3x 346026
1x 6218823	1x 6415097	1x 6219621	4x 6013938	1x 6315482	1x 6434805	1x 6323421	2x 6458098	110x 302326	8x 243126	3x 346026
2x 6383982	1x 4558168	1x 6334236	2x 6215539	4x 6315482	1x 6288000	2x 6267487	4x 4200023	6x 306926	10x 302026	4x 447726
1x 306201	7x 6195371	1x 390001	1x 6284574	1x 9341	1x 6372016	1x 6273589	6x 6053077	4x 241226	3x 4560182	4x 303526
2x 6442360	7x 302101	6x 6475151	1x 6465499	4x 300423	1x 6352820	1x 6181720	1x 6390748	4x 6092585	1x 6076678	2x 6037390
1x 6050914	1x 6446788	4x 6235083	4x 6454454	2x 4558606	6x 6186675	4x 6138173	4x 6328095	4x 242026	1x 663626	4x 4514845
2x 4547489	1x 6348055	1x 6396958	2x 4142865	4x 301023	26x 407026	2x 265326	2x 4251161	19x 302226	3x 366626	2x 611226
1x 6213880	1x 6437184	4x 6238334	2x 6397571	8x 447723	13x 6228987	2x 4162443	1x 6390749	20x 6192346	5x 4243819	2x 244526
2x 6258135	2x 6168618	2x 4114026	1x 6284163	1x 362321	1x 4214559	2x 370126	4x 6147790	2x 6133722	2x 6318582	18x 428226
1x 6213881	6x 6449595	1x 6284163	1x 6455324	1x 6217123	2x 300426	2x 6039194	7x 4613153	8x 4558170	2x 379526	8x 6094066
2x 6248827	2x 6132203	4x 6286329	1x 6286329	1x 383223	2x 235726	2x 365926	2x 365926	6x 6199908	2x 379526	
1x 6285777	1x 6093053	1x 6375672	1x 6455324	7x 300121	2x 235726	2x 365926	2x 365926	5x 302126	2x 379526	
3x 6299937	2x 6023806	1x 4113916	1x 4113916	1x 366621	3x 300326	2x 6222427	4x 4587844	5x 6162892	82x 416226	

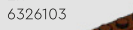
- 17x 4255413
- 40x 4249891
- 2x 6454453
- 4x 6228123
- 4x 6453215
- 22x 6233955
- 13x 4264569
- 1x 6275133
- 2x 6463543
- 4x 6465404
- 2x 6463544
- 12x 6277303
- 17x 4255413
- 1x 6224377
- 4x 6256616
- 2x 6429965
- 5x 6135606
- 2x 4177741
- 6x 6216905
- 8x 6186683
- 1x 6214811
- 1x 6214812
- 12x 6384915
- 4x 6411363
- 16x 6061569
- 9x 6037886
- 9x 6453216
- 4x 6464198
- 62x 4184108
- 2x 6092588
- 32x 4528981
- 20x 4528488
- 12x 6037890
- 2x 4205004
- 8x 6132566
- 41x 4177735
- 7x 4502089
- 1x 6256610
- 4x 4569836
- 5x 6384913
- 2x 4508313
- 4x 6453208
- 12x 6250216
- 4x 6453207
- 8x 4507080
- 4x 6453209
- 4x 6453210
- 5x 6027627
- 4x 6106692
- 12x 6200663
- 2x 6429734
- 2x 6454464
- 8x 6120642
- 7x 6328107
- 2x 6097457
- 2x 6224472
- 2x 6371455
- 20x 6464203
- 2x 6470186
- 4x 6407191
- 1x 6236571
- 8x 4502091
- 8x 4529954
- 8x 6251836
- 4x 6382723
- 1x 6253883
- 8x 6450823
- 4x 6254479
- 2x 6409752
- 1x 6410902
- 2x 6391515
- 2x 4162916
- 1x 6463580
- 1x 6409766
- 4x 6454450
- 4x 6454451
- 4x 6315608
- 1x 6435099
- 1x 6308322
- 1x 6252040
- 8x 6171727
- 4x 4538760
- 2x 4210762
- 1x 4213607
- 1x 4211000
- 2x 6336390
- 1x 6266248
- 4x 6350292
- 8x 4225733
- 6x 6231765
- 1x 4222693
- 2x 6261374
- 4x 4211063
- 1x 4211055
- 2x 4211043
- 4x 4211065
- 4x 4211002
- 2x 6313652
- 2x 4211067

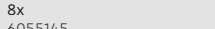
 2x 6258831	 5x 6171894	 1x 6146223	 1x 6201911	 2x 6253167	 2x 6149677	 1x 6236915
 10x 6284071	 4x 4211396	 1x 6468371	 1x 6468374	 1x 6397820	 5x 6341553	 4x 6172636
 4x 4211386	 16x 4211445	 1x 6195471	 1x 6408343	 2x 6322211	 2x 6238874	 12x 6168623
 2x 6123809	 4x 4211395	 1x 6152344	 2x 6268857	 3x 6311210	 4x 6226436	 1x 4211159
 8x 6407412	 8x 4560183	 1x 6195471	 1x 6270078	 16x 6172922	 1x 6290983	 1x 6037289
 24x 6262085	 1x 6402193	 8x 4644102	 2x 6329114	 1x 6365885	 2x 6251470	 1x 6102360
 8x 4251163	 4x 4211425	 4x 4494475	 6x 4211242	 2x 6409552	 1x 4211190	 1x 6342958
 76x 6132207	 4x 4211425	 2x 6271165	 2x 6177699	 2x 6299939	 6x 6257604	 2x 4283660
 2x 4211435	 2x 4211407	 4x 4211807	 2x 4211180	 2x 6325975	 2x 4211186	 1x 6228841
 4x 4211397	 4x 4211401	 1x 6134378	 5x 4211149	 2x 4211288	 1x 4579690	 1x 6424037
 10x 6126082	 4x 4211486	 2x 6420741	 2x 4211210	 2x 4221744	 1x 4211204	 1x 6398342
		 8x 6163990	 2x 4211225	 5x 4211151	 1x 4221590	 1x 6063447
		 4x 4211725	 2x 4211193	 1x 4211257	 2x 6326103	 4x 6291040
				 7x 6196221	 8x 6055145	 3x 6064188

2x
6395635

2x
6364352

3x
6464199

12x
6218047

4x
4490599

22x
6186672

2x
6335111

8x
6212377

2x
6338242

30x
6449109



 [LEGO.com/service](https://www.LEGO.com/service)

2x
6375358

1x
6372427

7x
6190252

1x
6400656

1x
6327553

1x
6477142

1x
6173139

1x
6056774

8x
6083975

1x
6370621

2x
6452472

1x
4585493

23x
6459521

1x
6451126

2x
6310366

4x
6296061

3x
6102990

2x
6433733

1x
6435640

1x
6467618

1x
6435310

1x
6394960

1x
6102984

2x
6287309

12x
6275872

8x
4653988

4x
6424641

8x
6346764

7x
6133728

4x
6250001

3x
6210675

2x
6337197

4x
6453350

1x
6210601

18x
6454456

1x
4653970

2x
6348142

4x
6335566

6x
6119107

2x
4619513

2x
4625036

9x
6146926

2x
6411330

1x
4583299

1x
4541496

4x
6411595



YOU COULD WIN



YOU COULD WIN

Your feedback will help shape the future development of this product series.

Visit:

DU KÖNNTEST GEWINNEN

Dein Feedback trägt zur Weiterentwicklung dieser Produktreihe bei.

Geh auf:

VOUS POURRIEZ GAGNER

Vos commentaires nous aideront à concevoir les futurs produits de cette gamme.

Visitez :

POTRESTI VINCERE TU

La tua opinione ci aiuterà a migliorare la creazione futura di questa linea di prodotti.

Visita:

PUEDES GANAR

Tu opinión contribuirá al futuro de esta serie de productos.

Visita:

轻松获奖

您的反馈将有助于我们在今后改进本产品系列。

请访问:

[LEGO.com/productfeedback](https://www.lego.com/productfeedback)

You also have the chance to win a LEGO® set.

Terms and conditions apply.*

Außerdem hast du die Chance, ein LEGO® Set zu gewinnen.

Es gelten die Teilnahmebedingungen.*

Vous pourriez également gagner un ensemble LEGO®.

Des conditions s'appliquent.*

Hai anche la possibilità di vincere un set LEGO®.

Termini e condizioni sono applicabili.*

También tienes la oportunidad de ganar un set LEGO®.

Aplican términos y condiciones.*

您还有机会赢取乐高®套装。

条款和条件适用。*

*[LEGO.com/productfeedback-terms](https://www.lego.com/productfeedback-terms)

ORIENT EXPRESS



LEGO and the LEGO logo are trademarks of the LEGO Group. ©2023 The LEGO Group.
ORIENT EXPRESS™ is a registered trade mark of Orient Express. All rights reserved.