



NINJAGO

Masters of Spinjitzu

2506



1

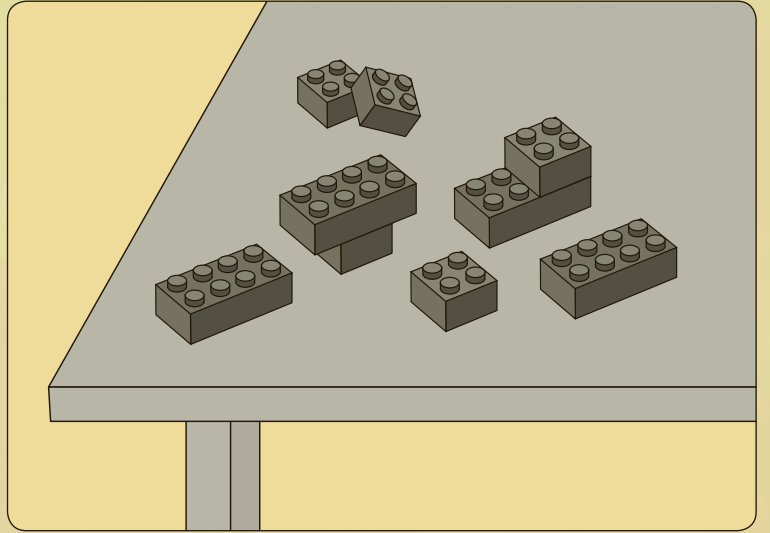
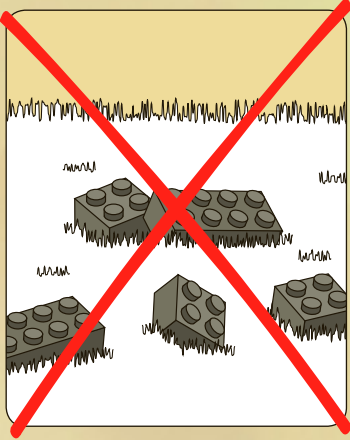

2



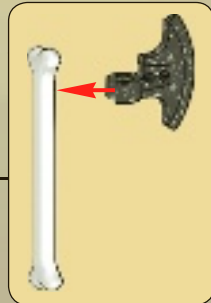
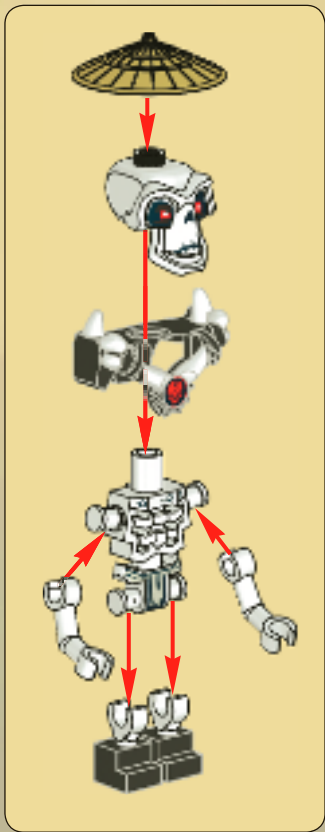
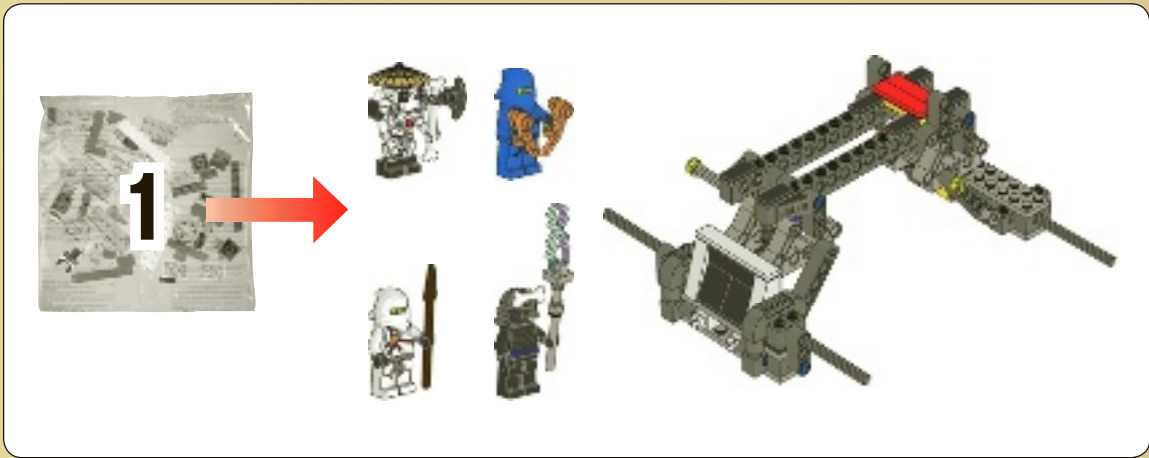

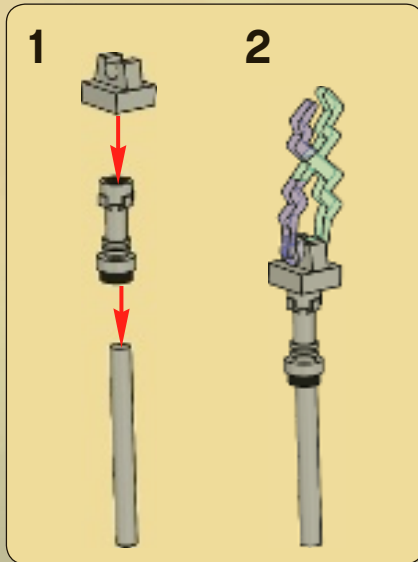
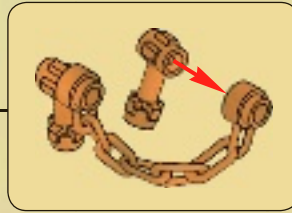

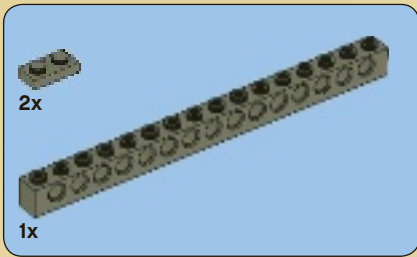
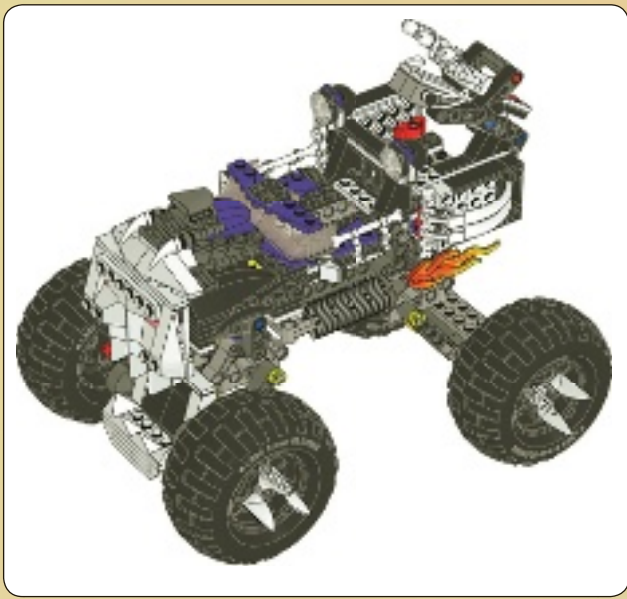

1

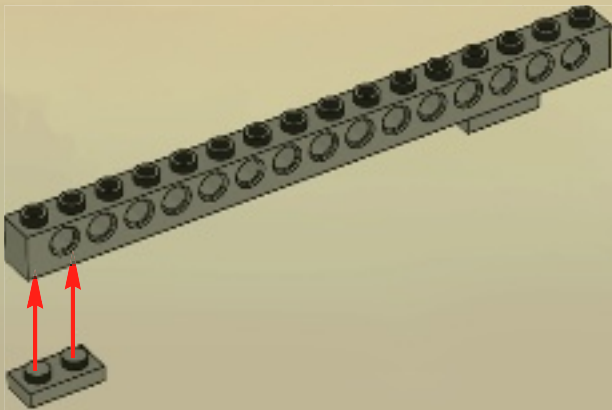

2

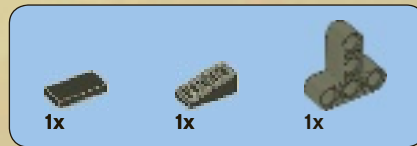
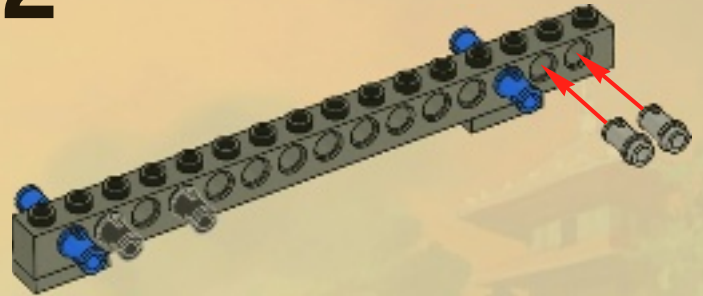

3

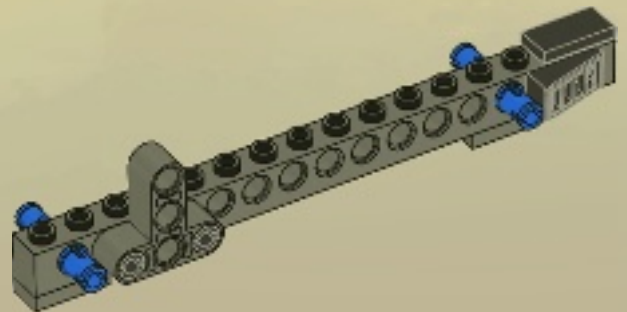



4

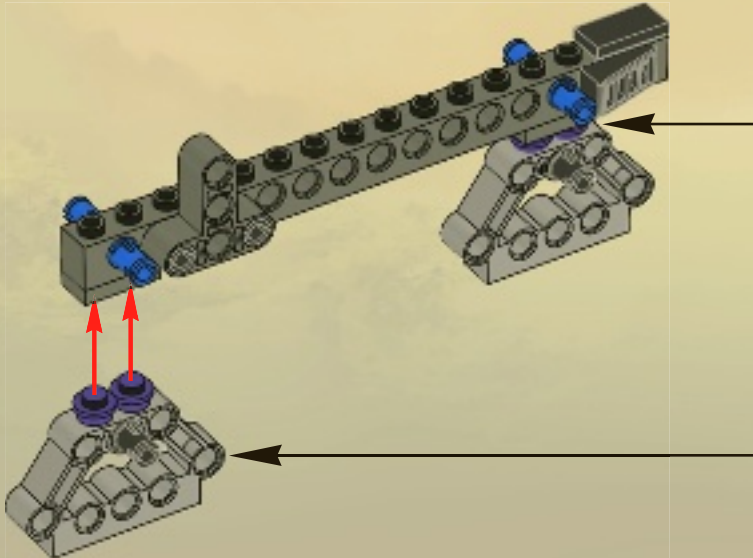
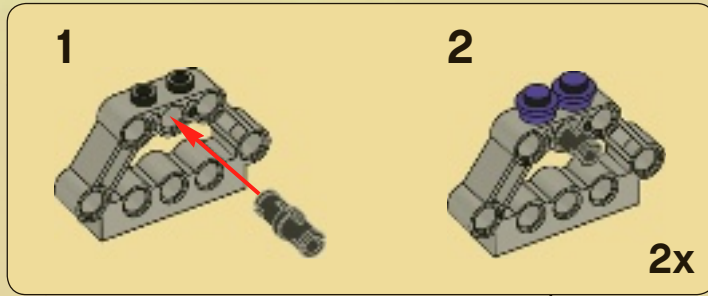

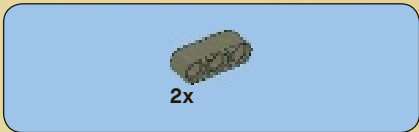

5

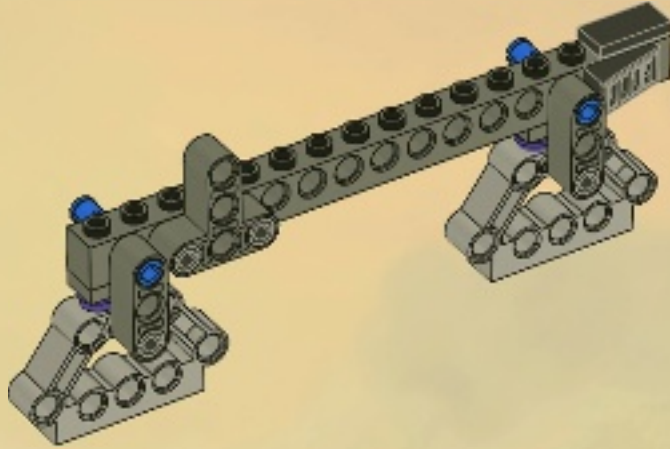

6

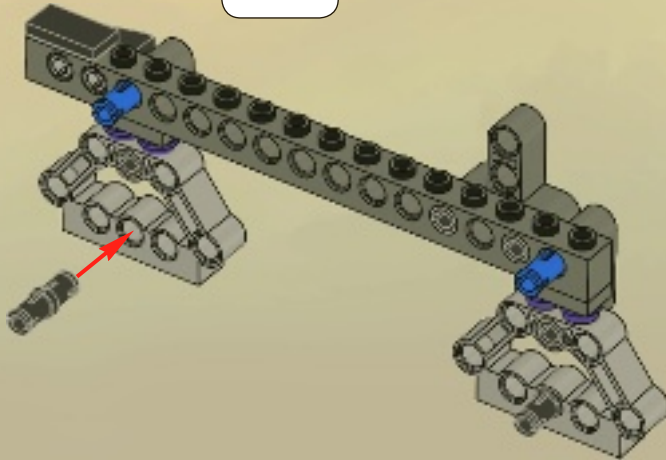



2x

7

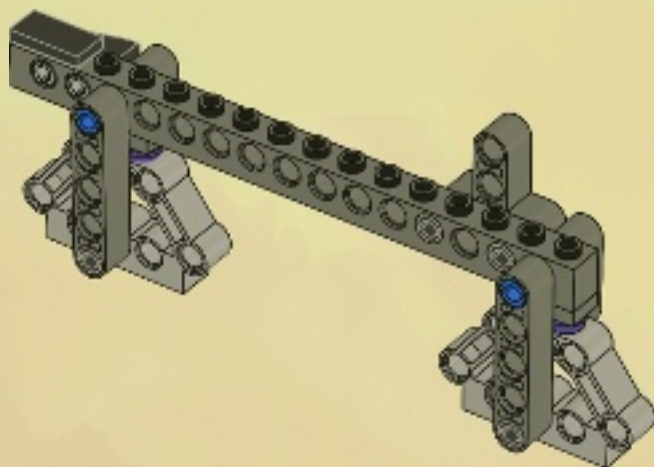

2x

8

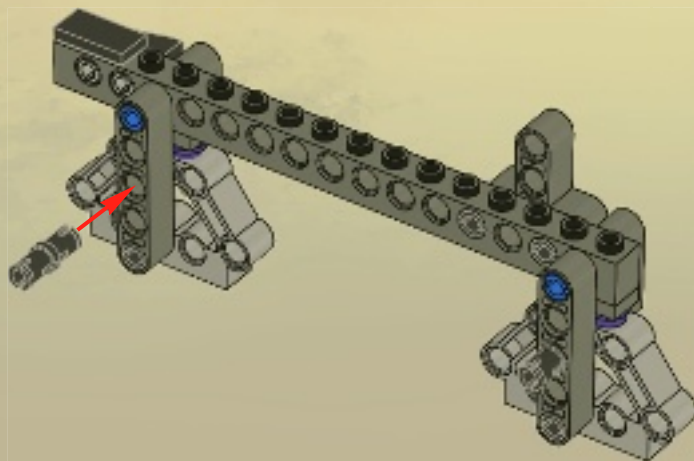



9

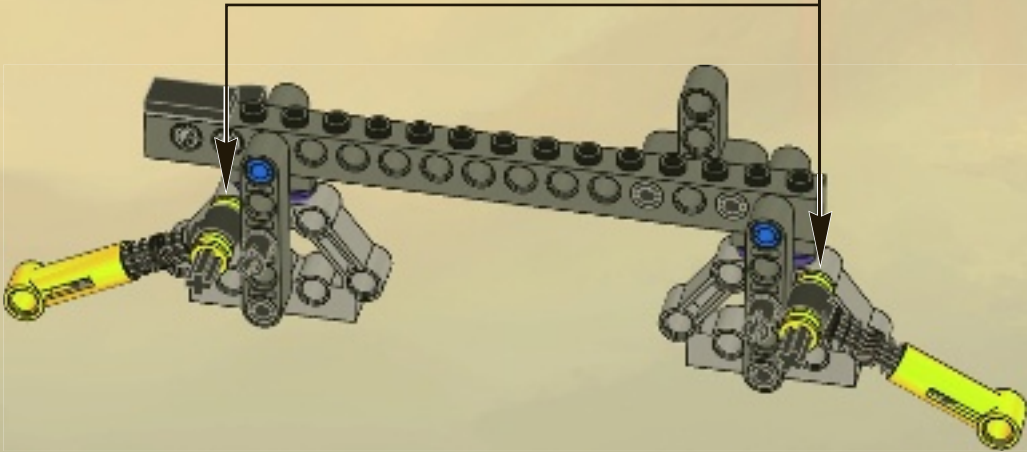

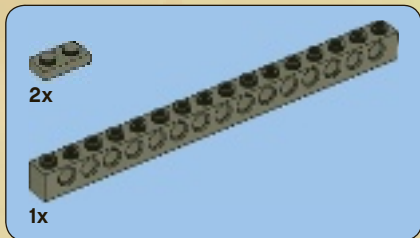
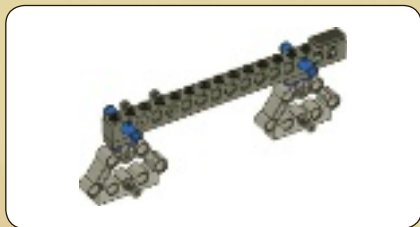

1

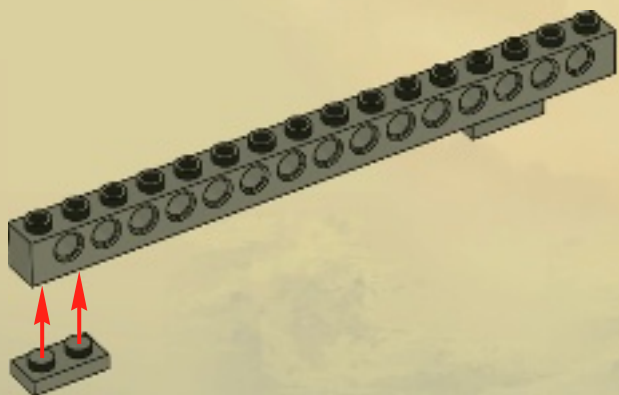

2

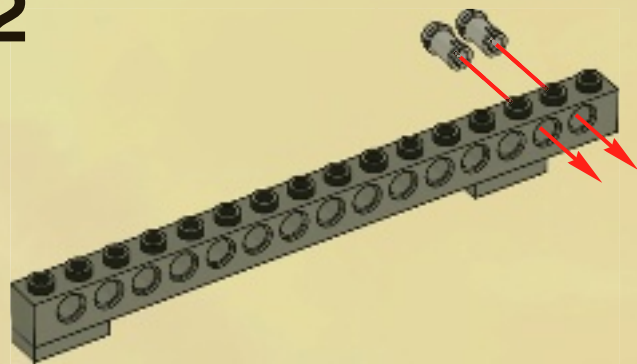

3

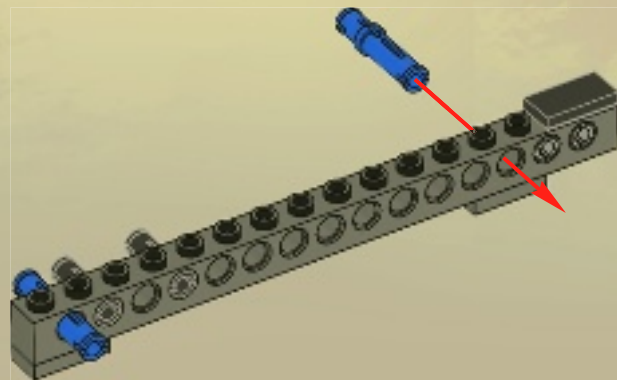



4

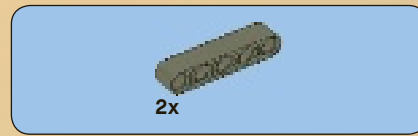
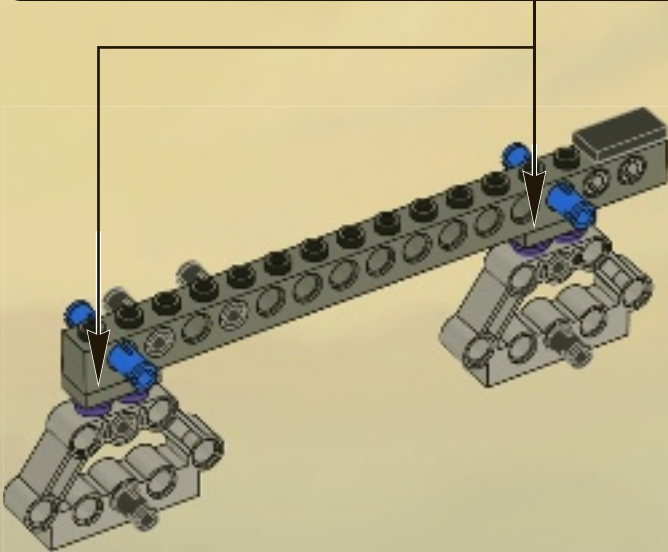
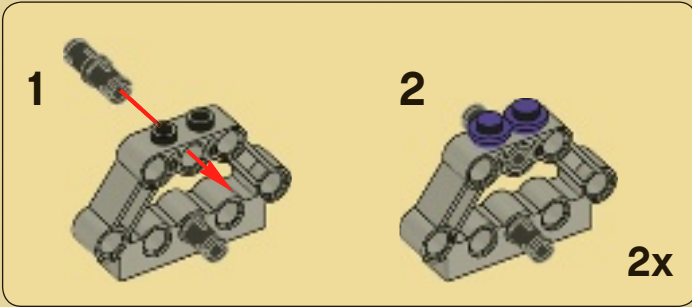

5

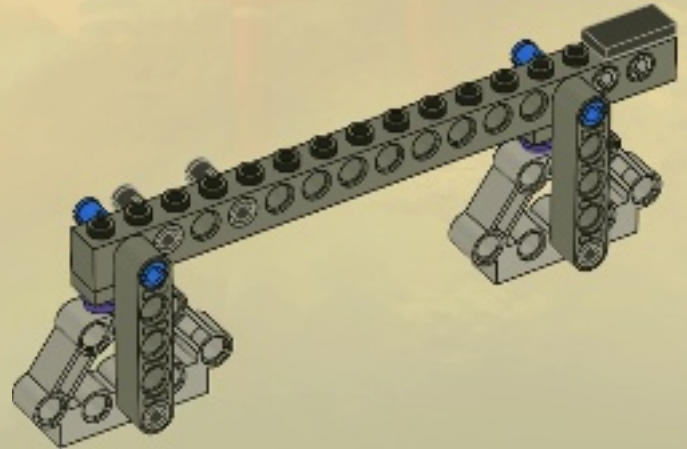

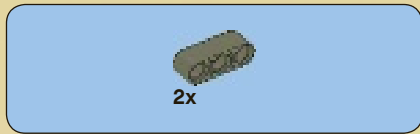

6

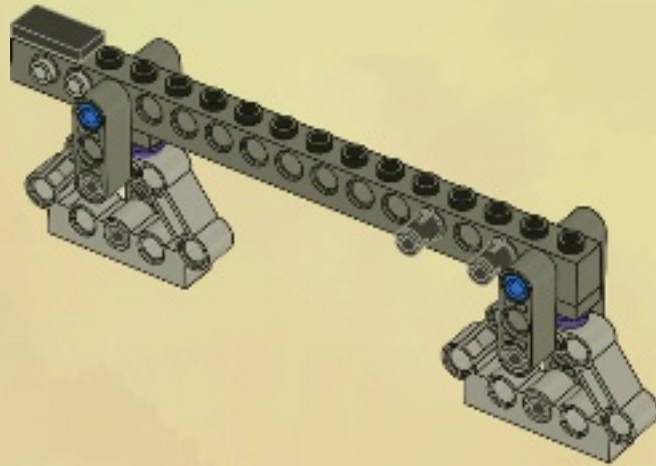

10

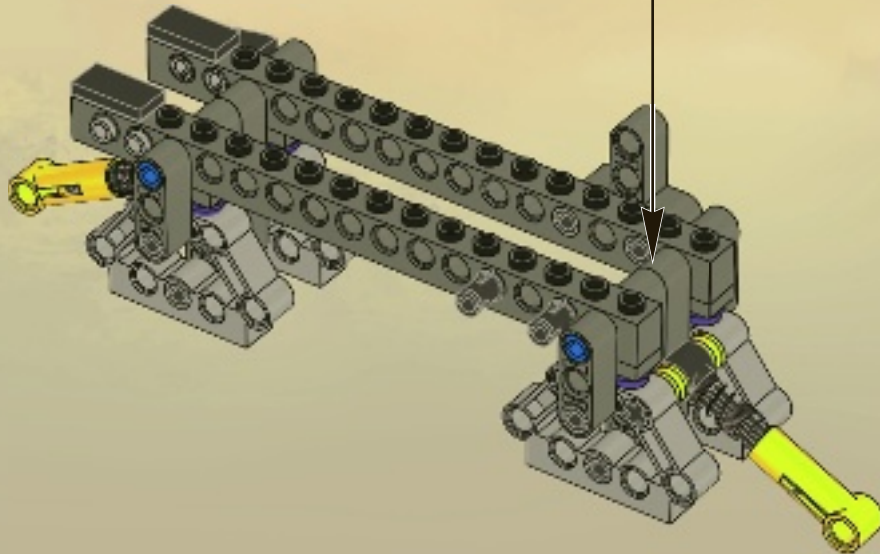



11

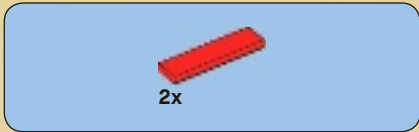
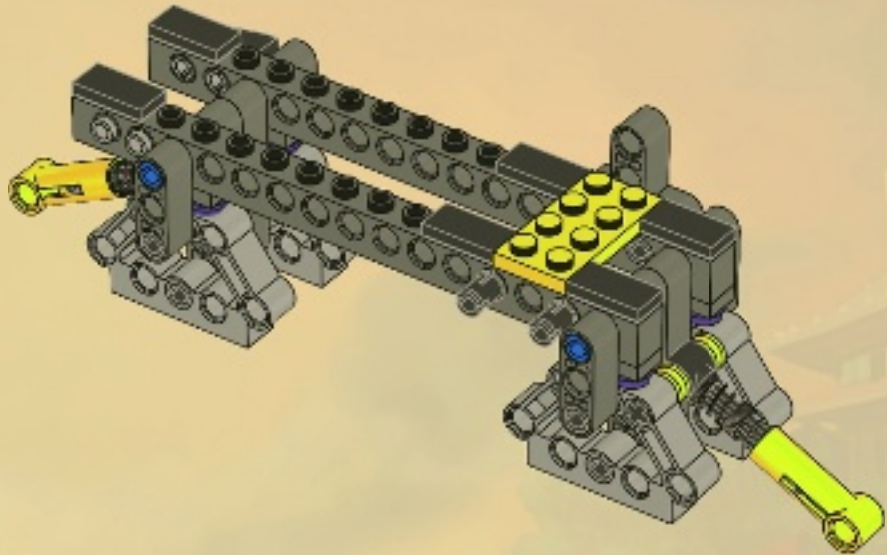

12

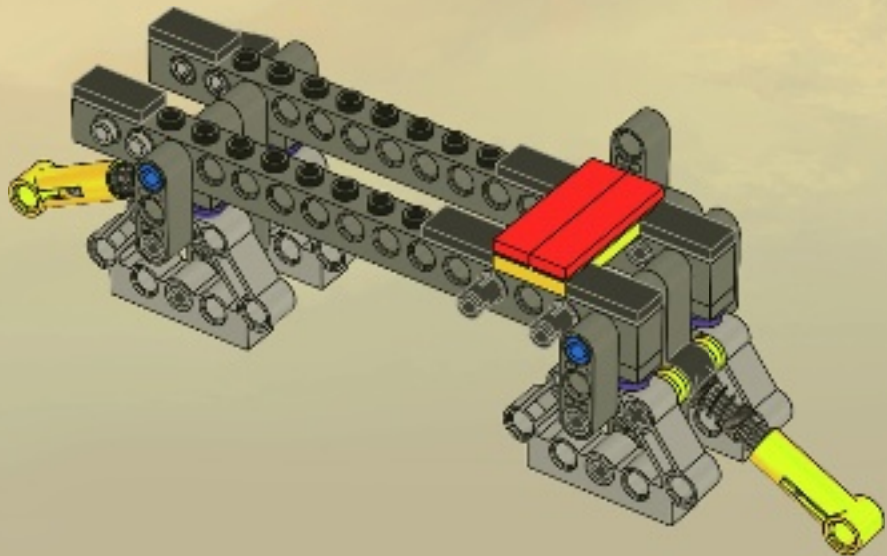

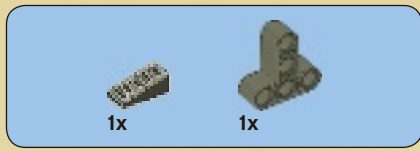

13

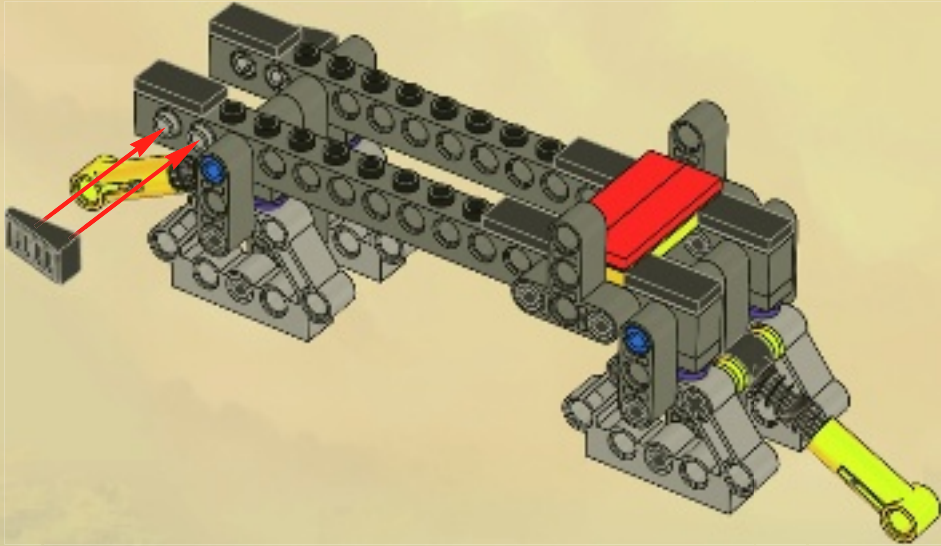

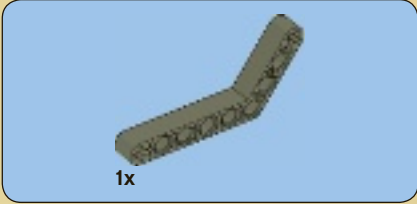
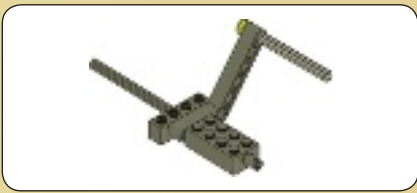

1

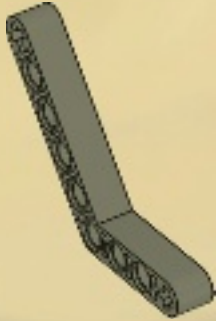

2

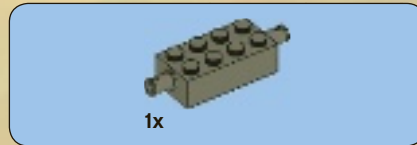
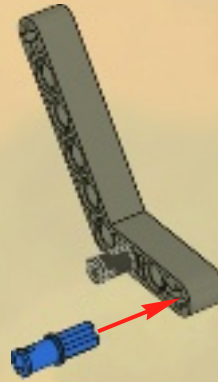

3

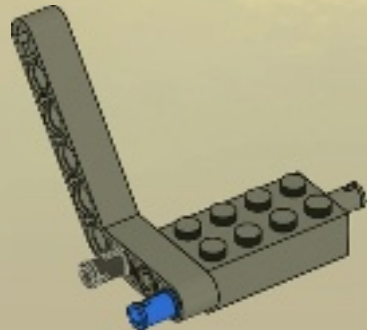

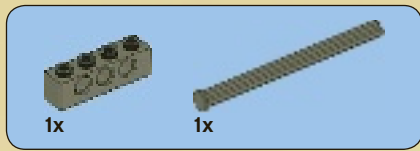

4

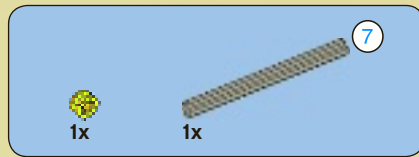
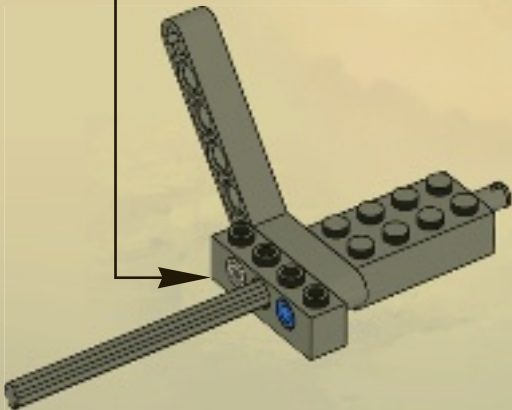
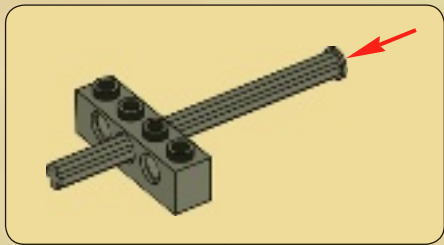

5

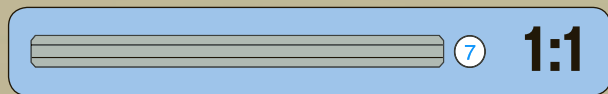
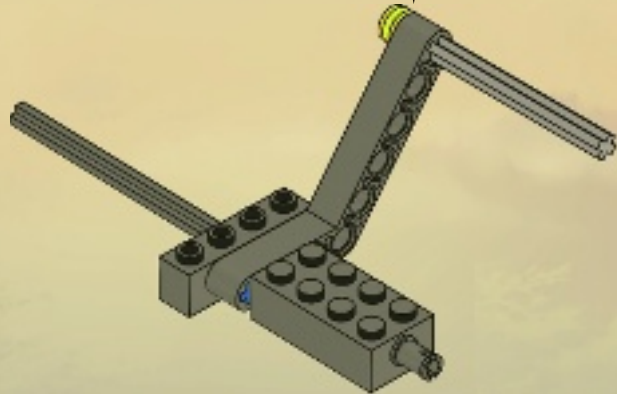
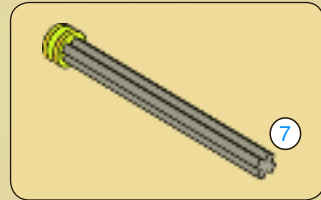

14

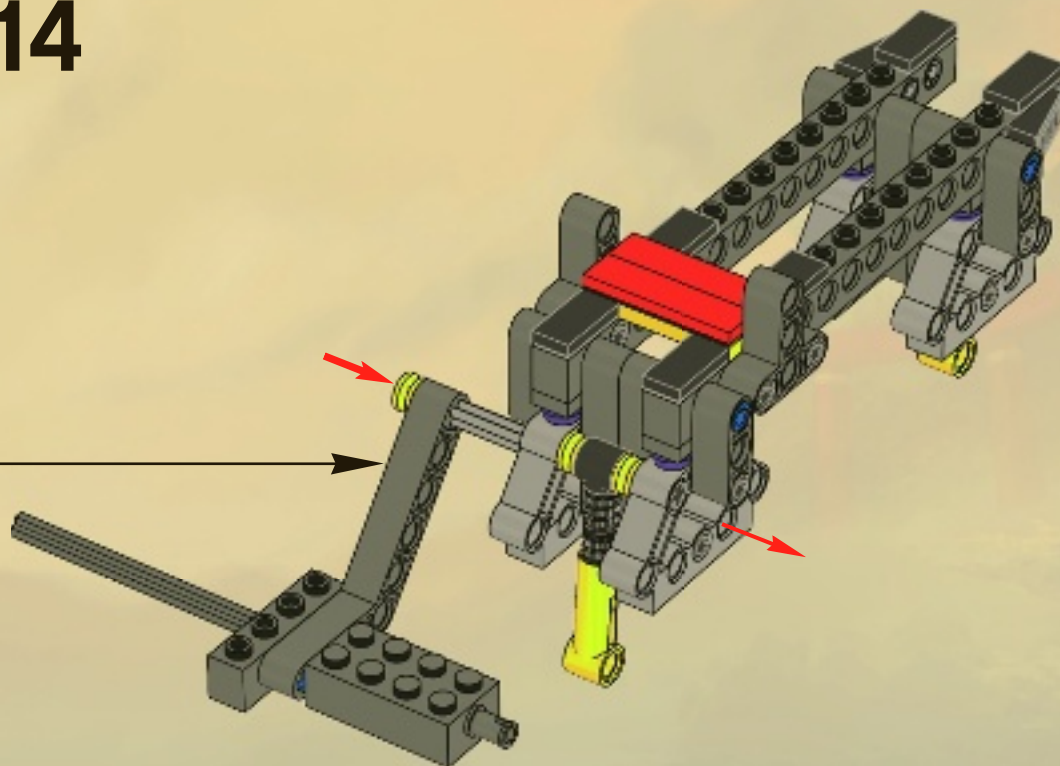

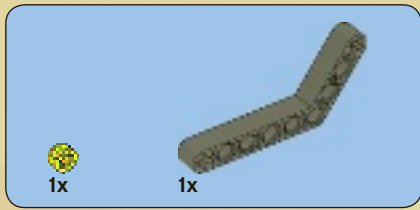

15

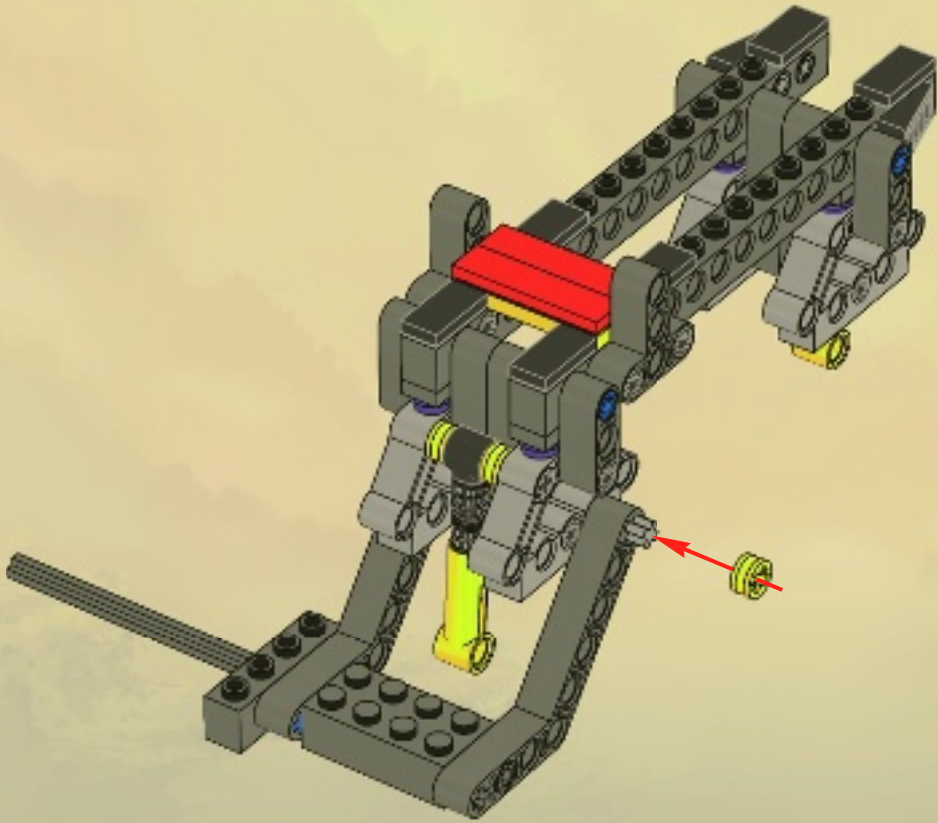



1x



1x

16

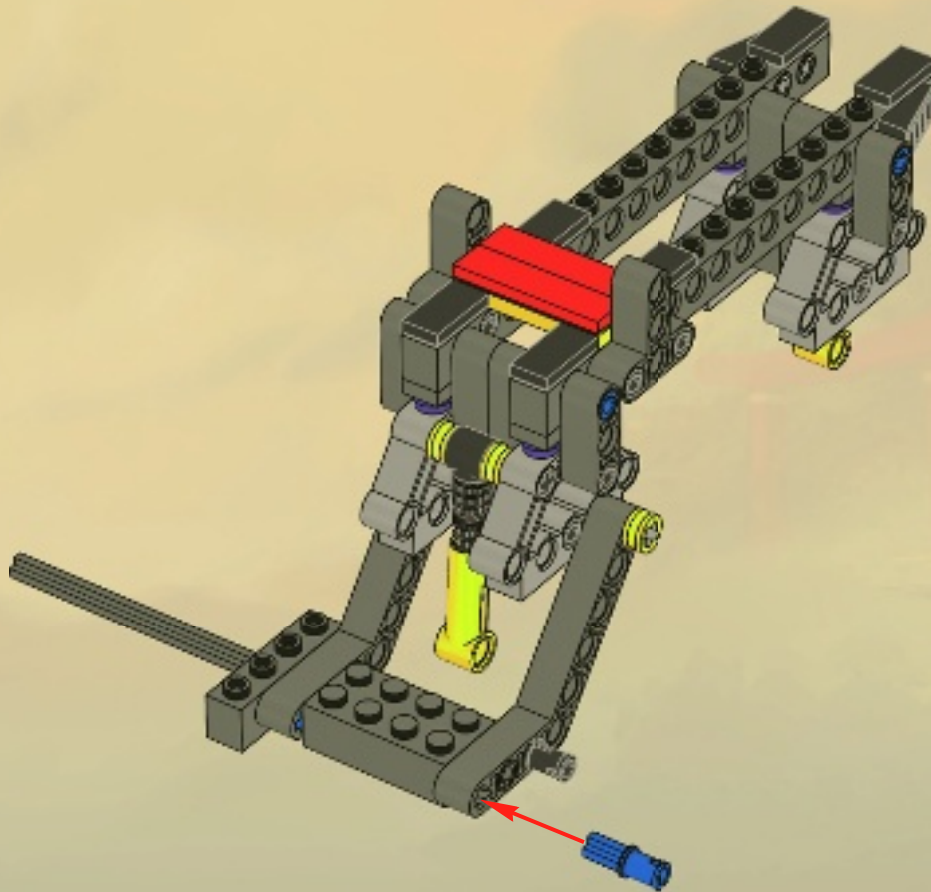

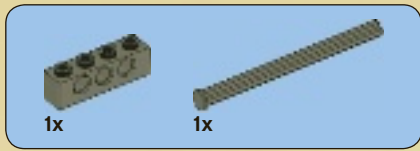

17

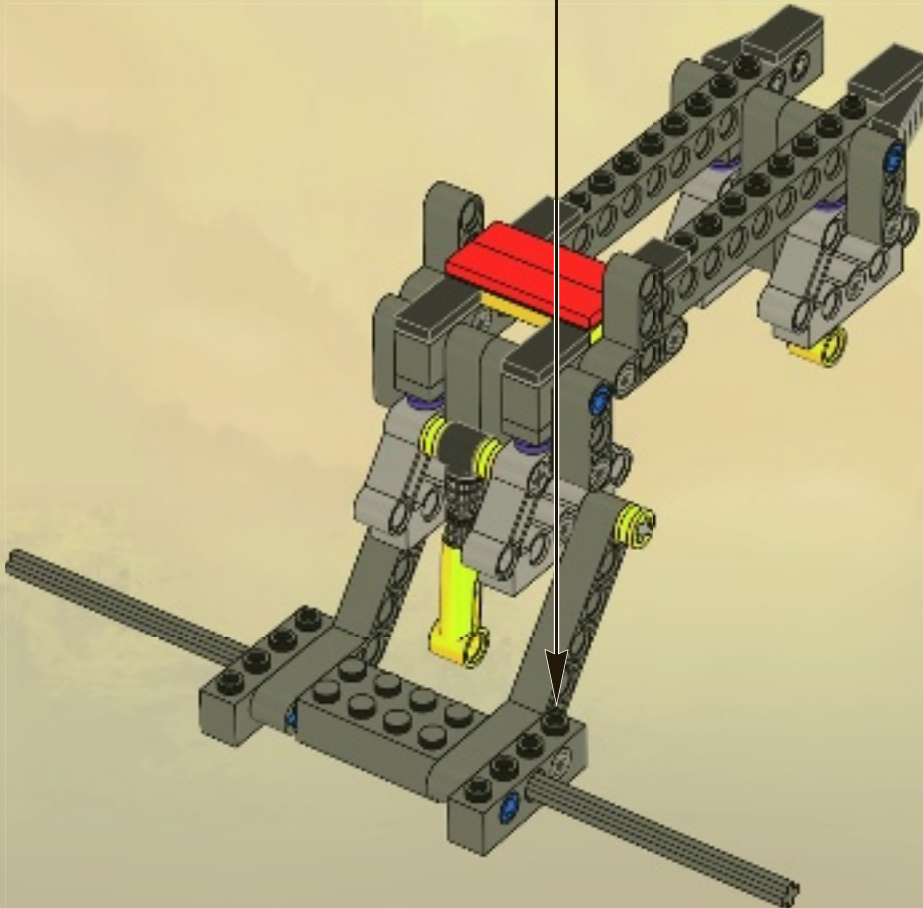
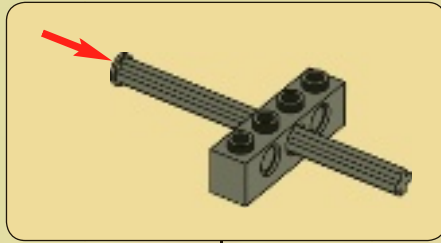



2x

18

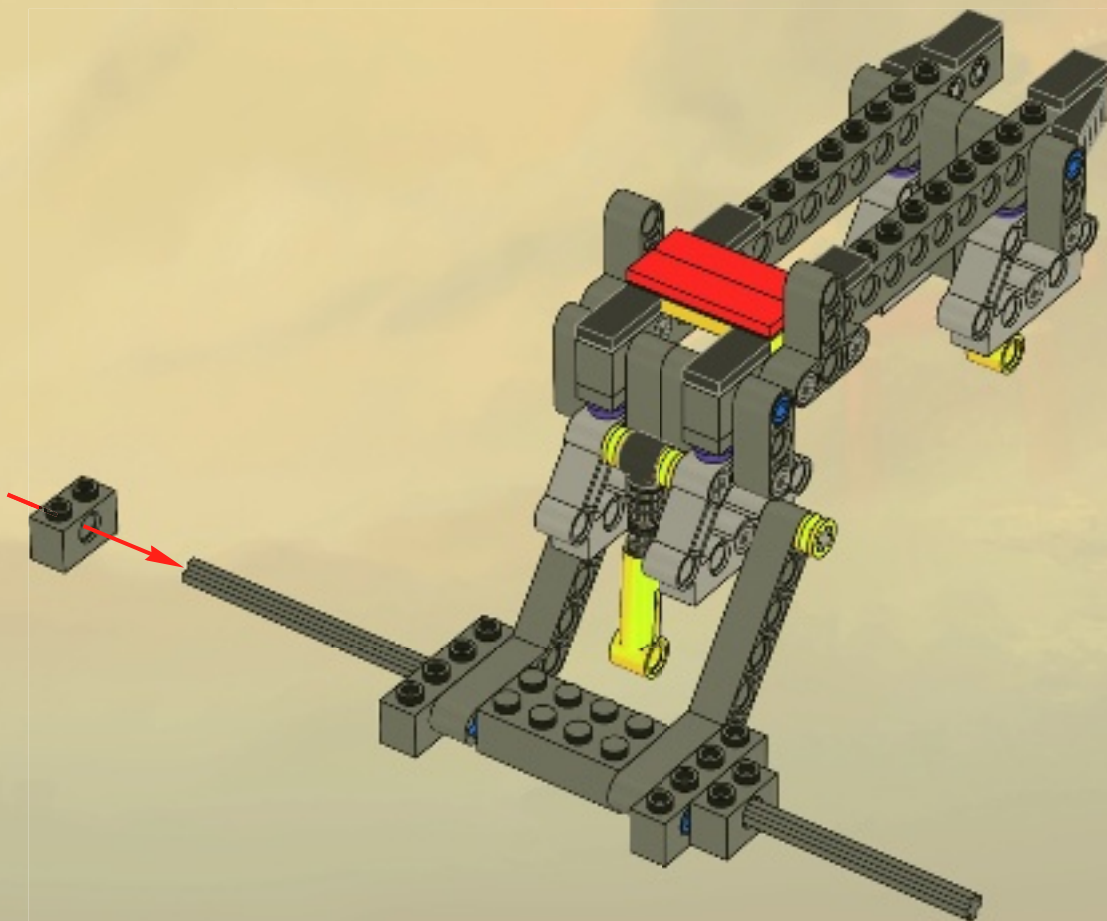

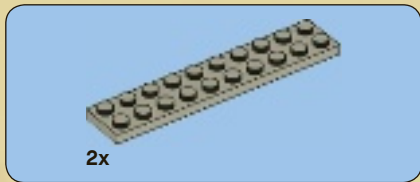

19

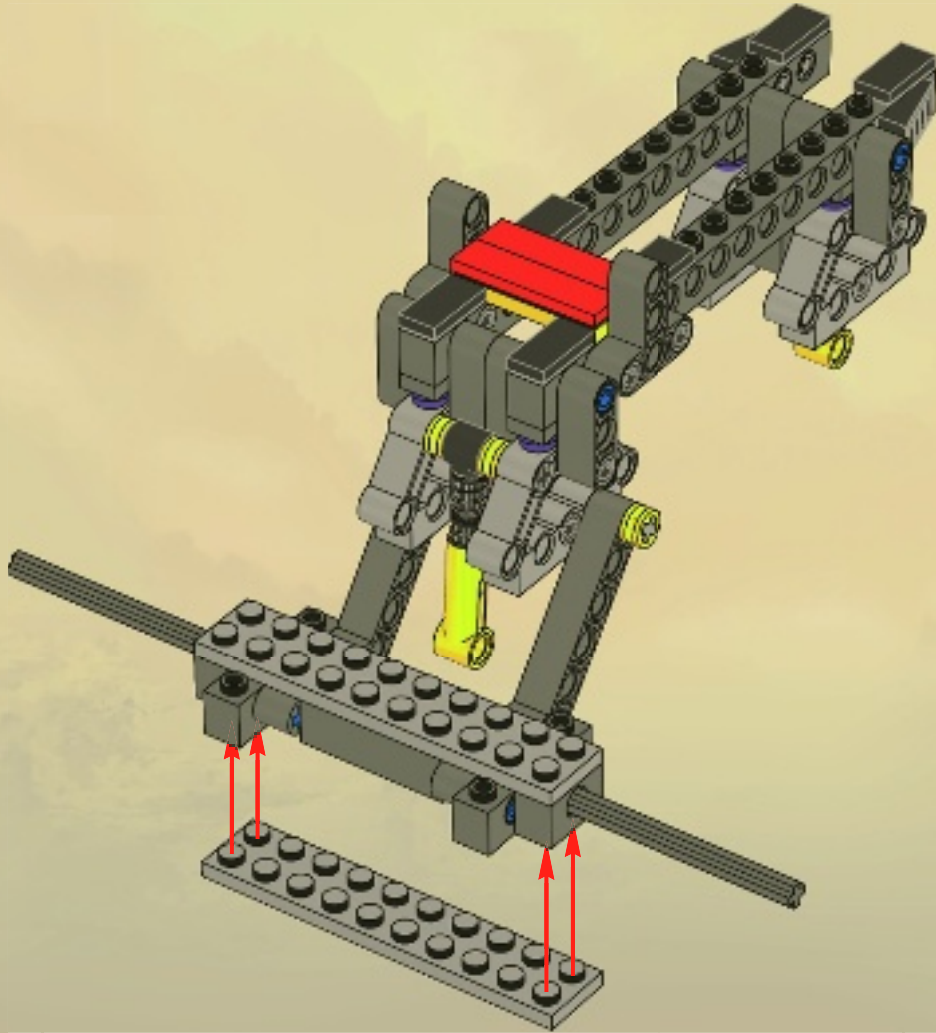

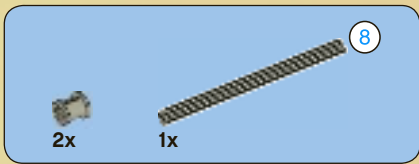

20

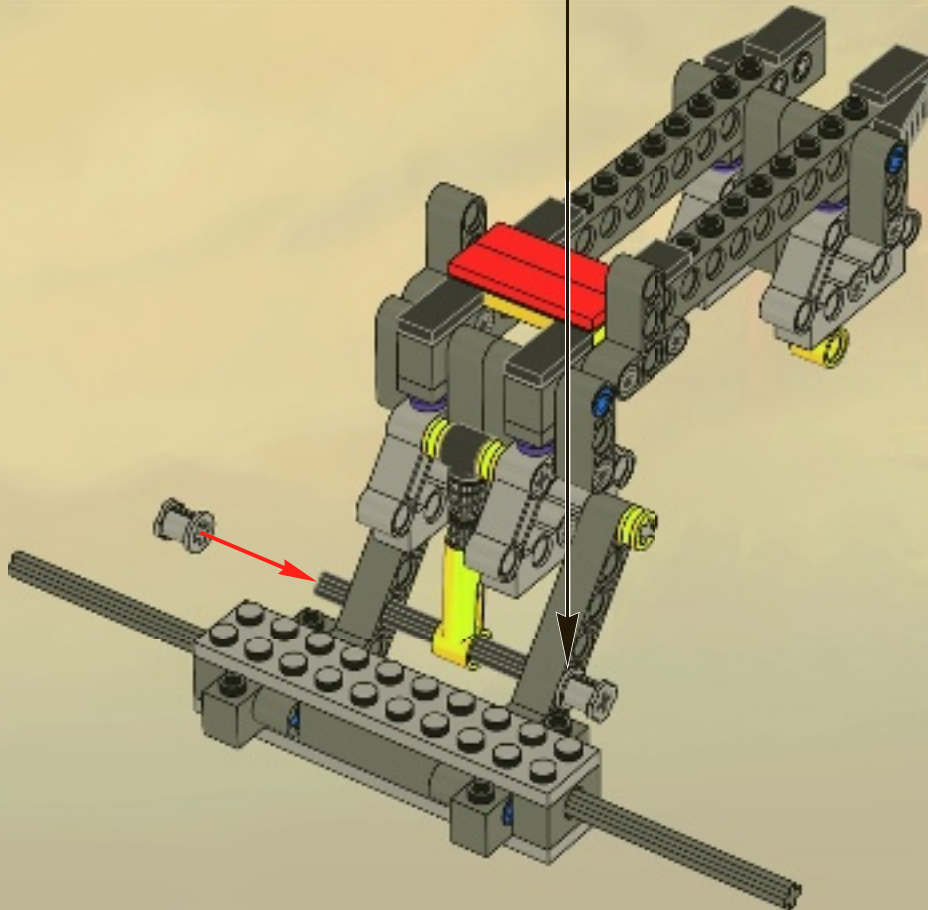
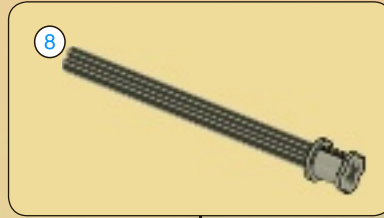

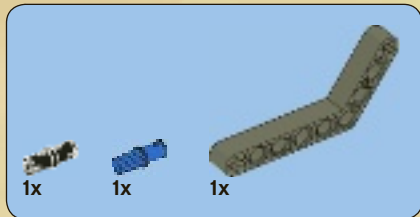
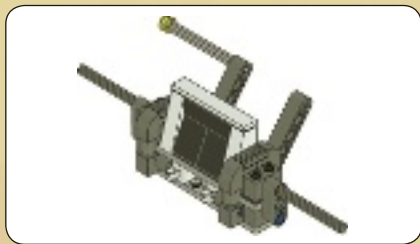

1

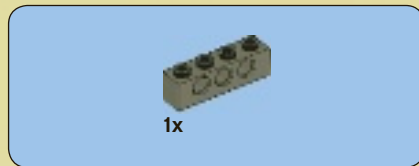
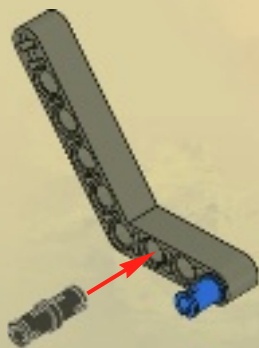

2

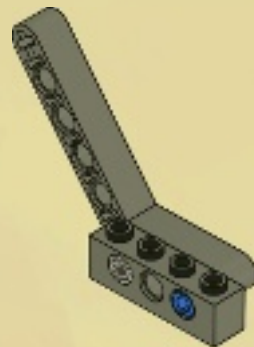

3

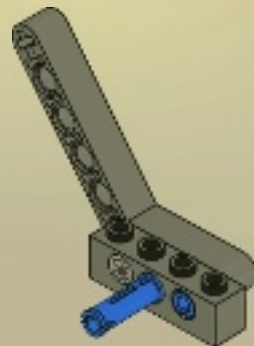

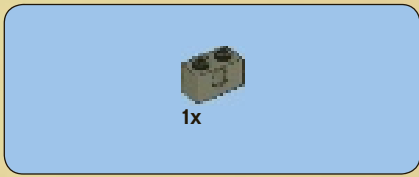

4

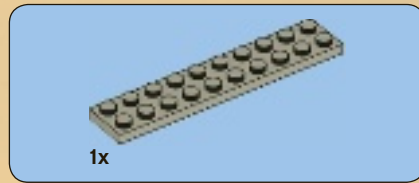
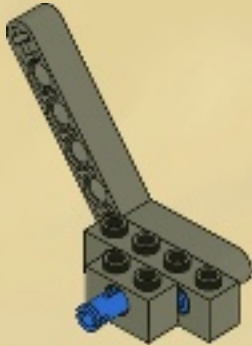

5

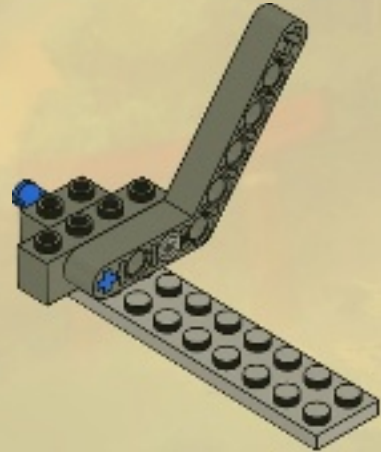

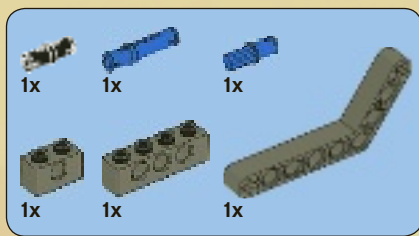

6

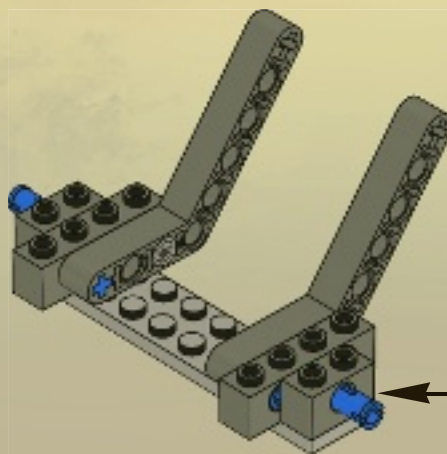
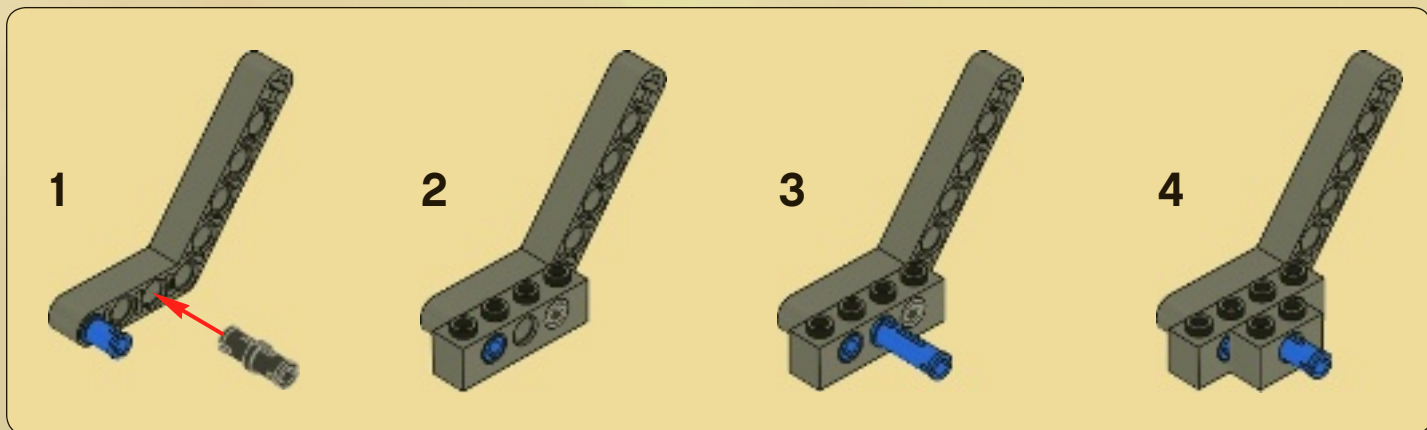



2x

7

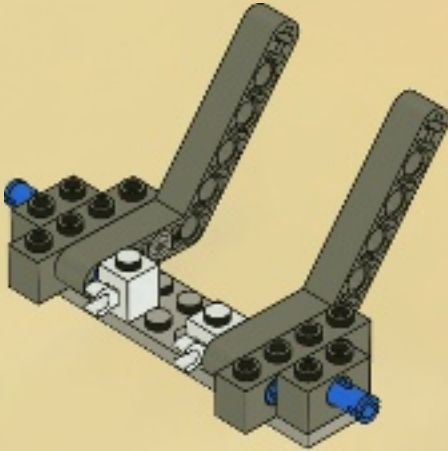

1x

8

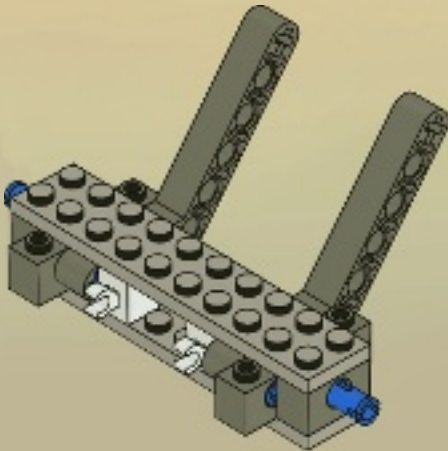

4x

9

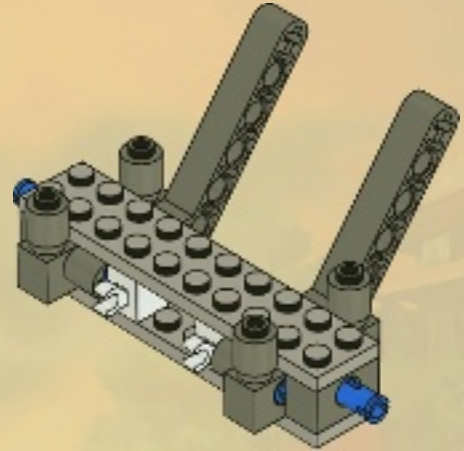

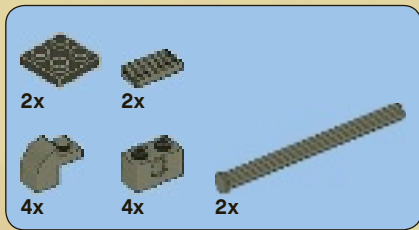

10

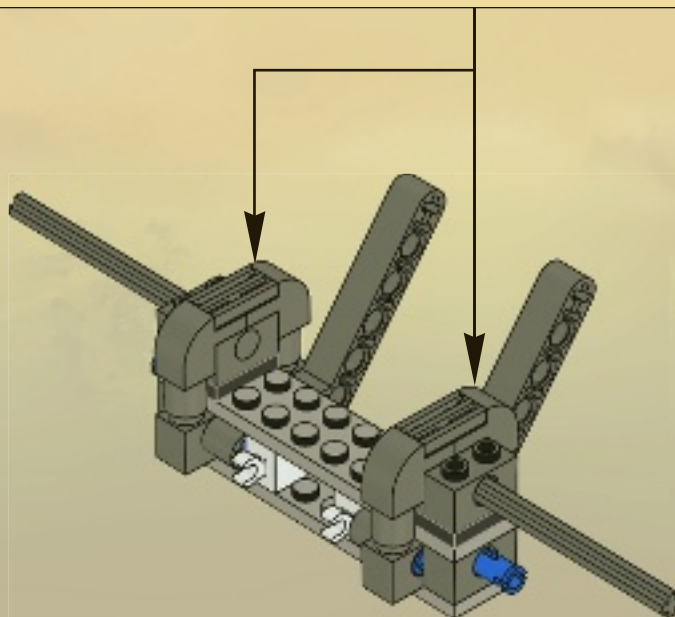

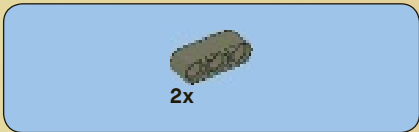

11

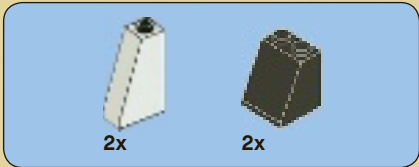
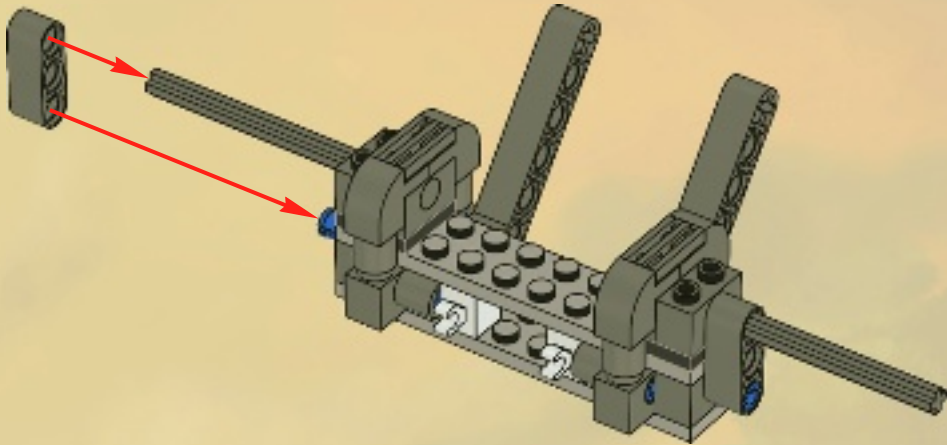

12

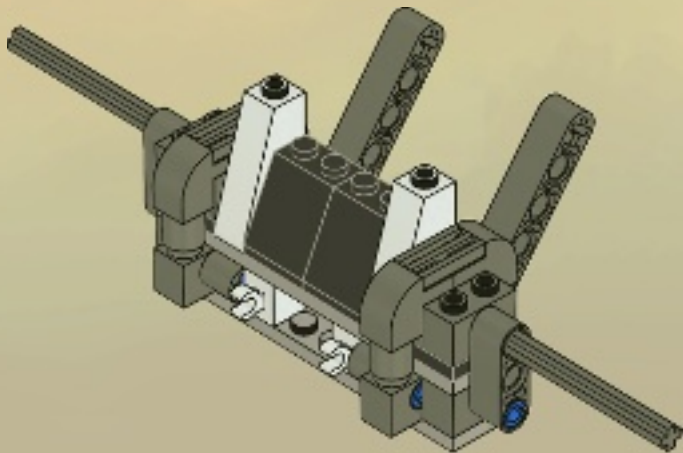

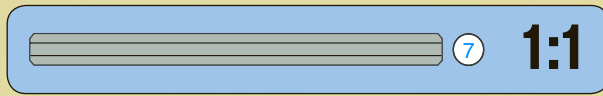
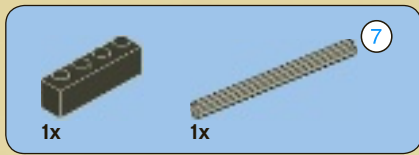

13

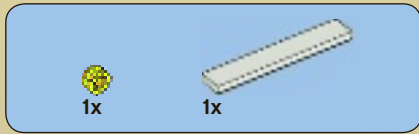
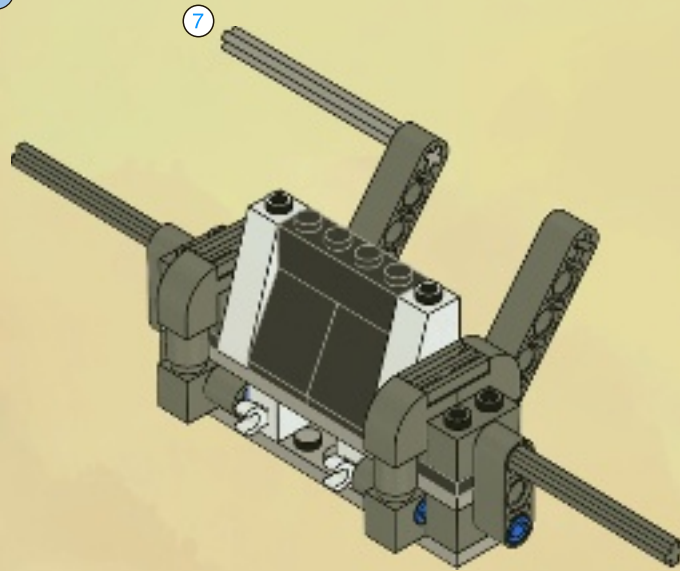

14

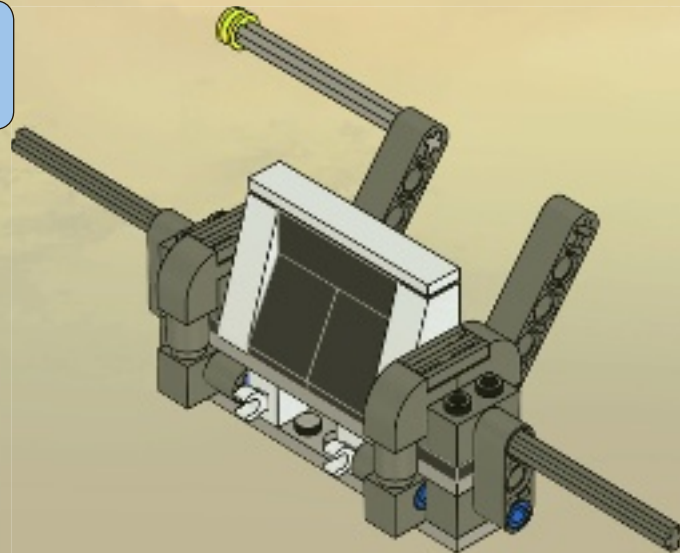



1x

21

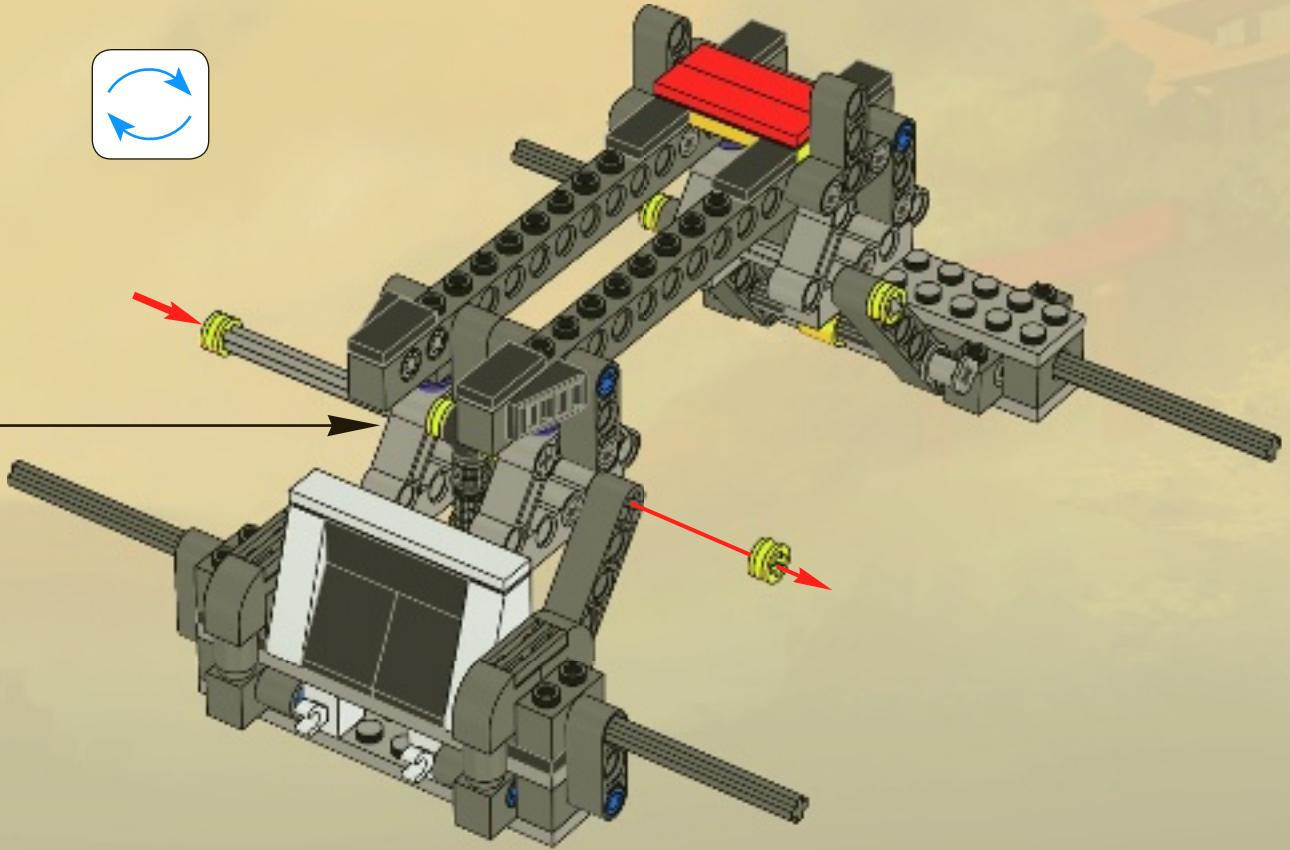

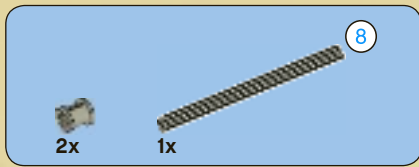

22

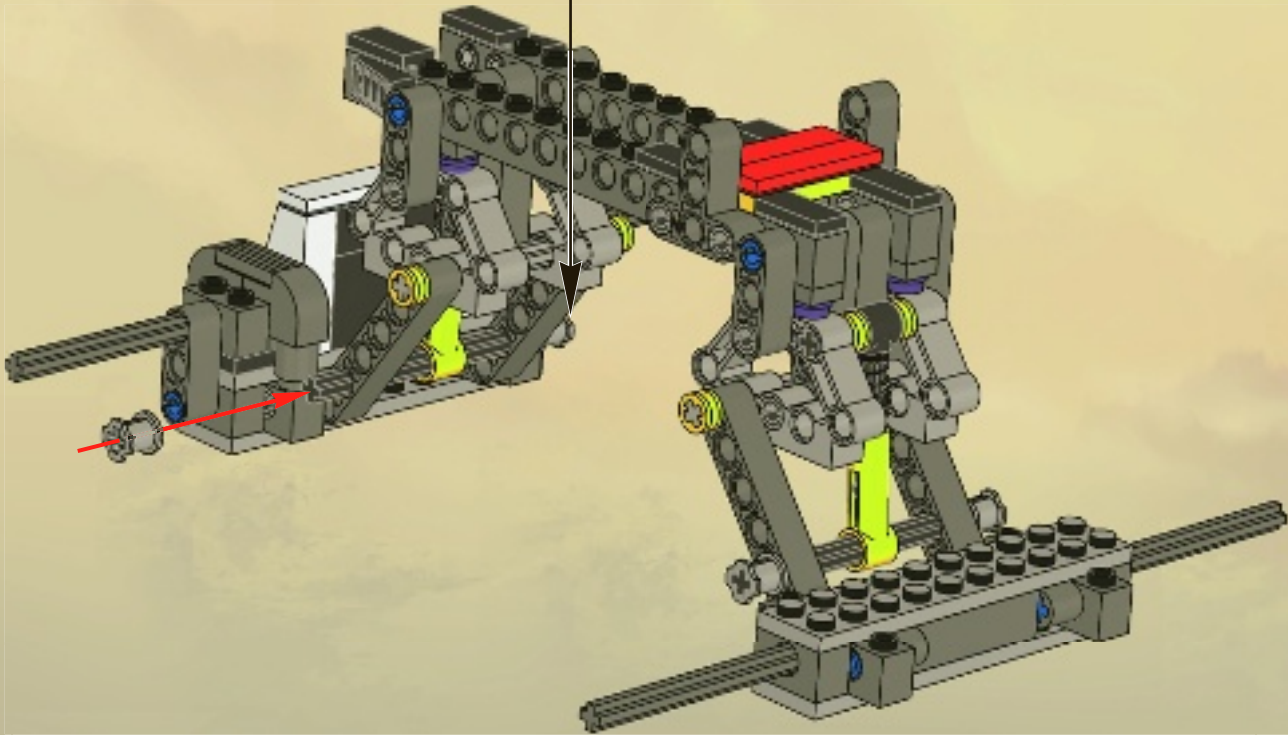
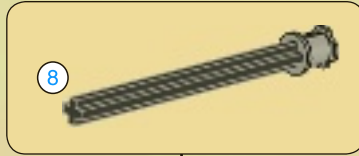

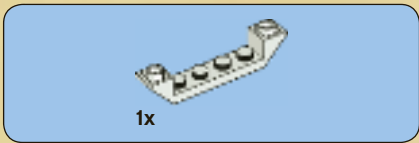
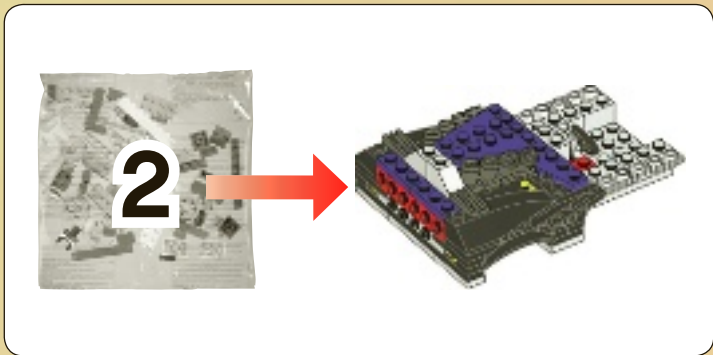

1

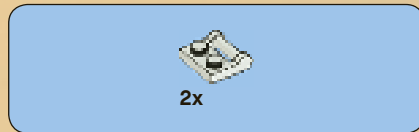
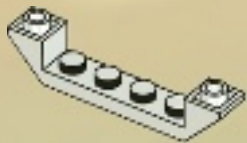

2

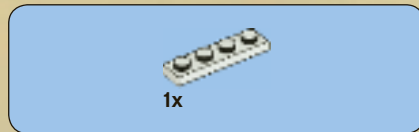
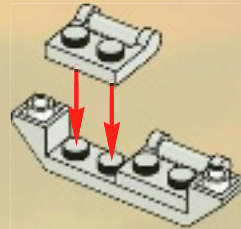

3

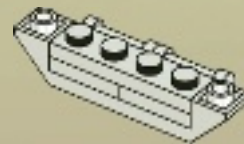

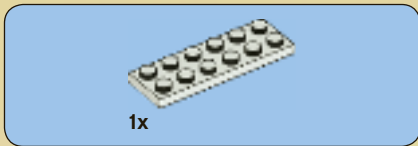

4

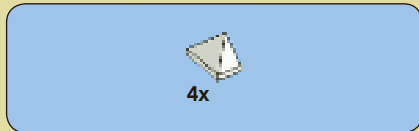
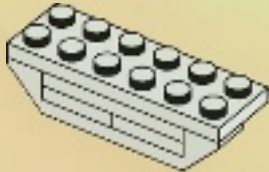

5

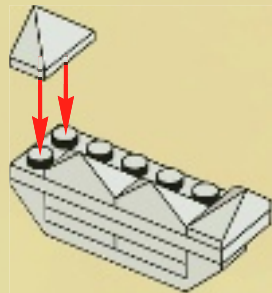

23

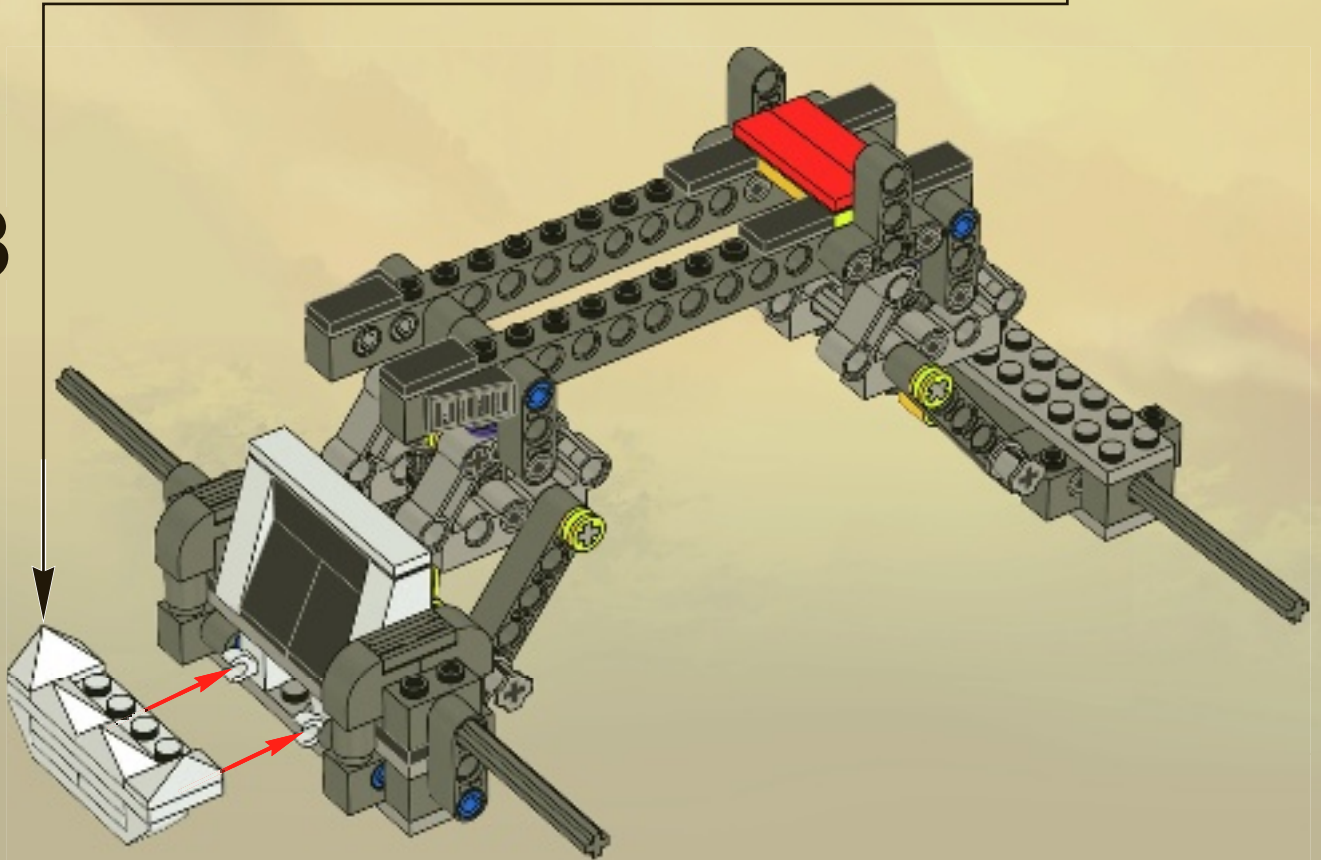

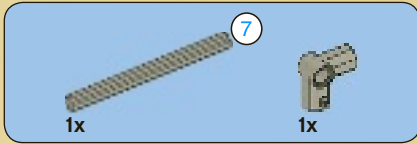

1

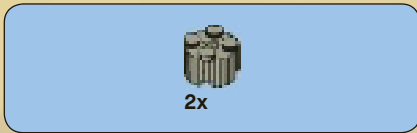
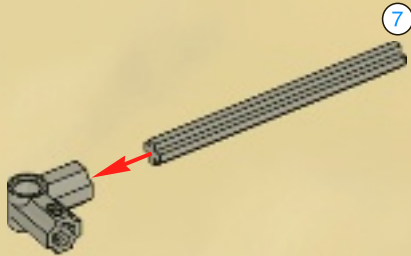

2

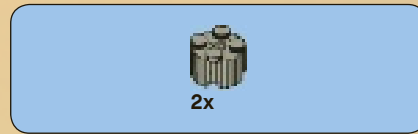
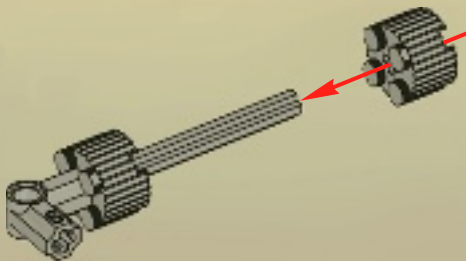

3

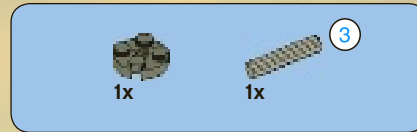
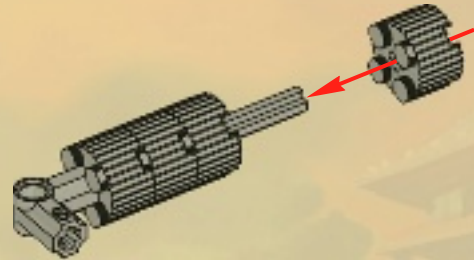

4

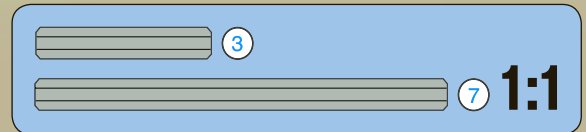
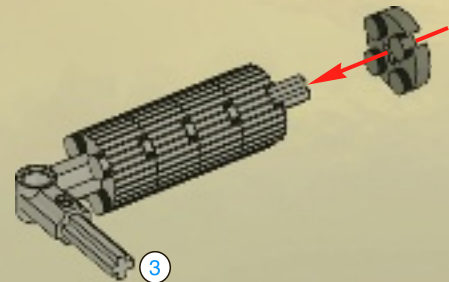



5

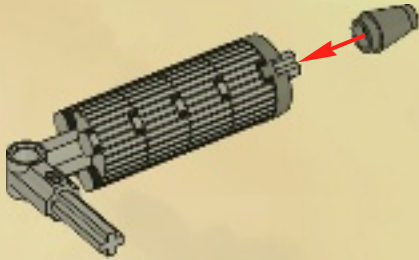

6

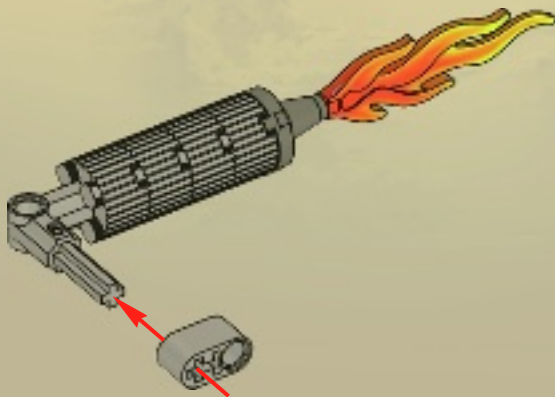

7

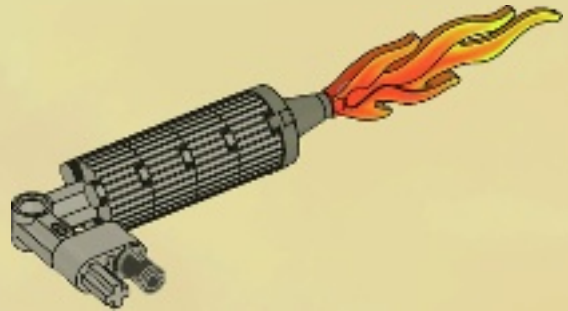

2x

24

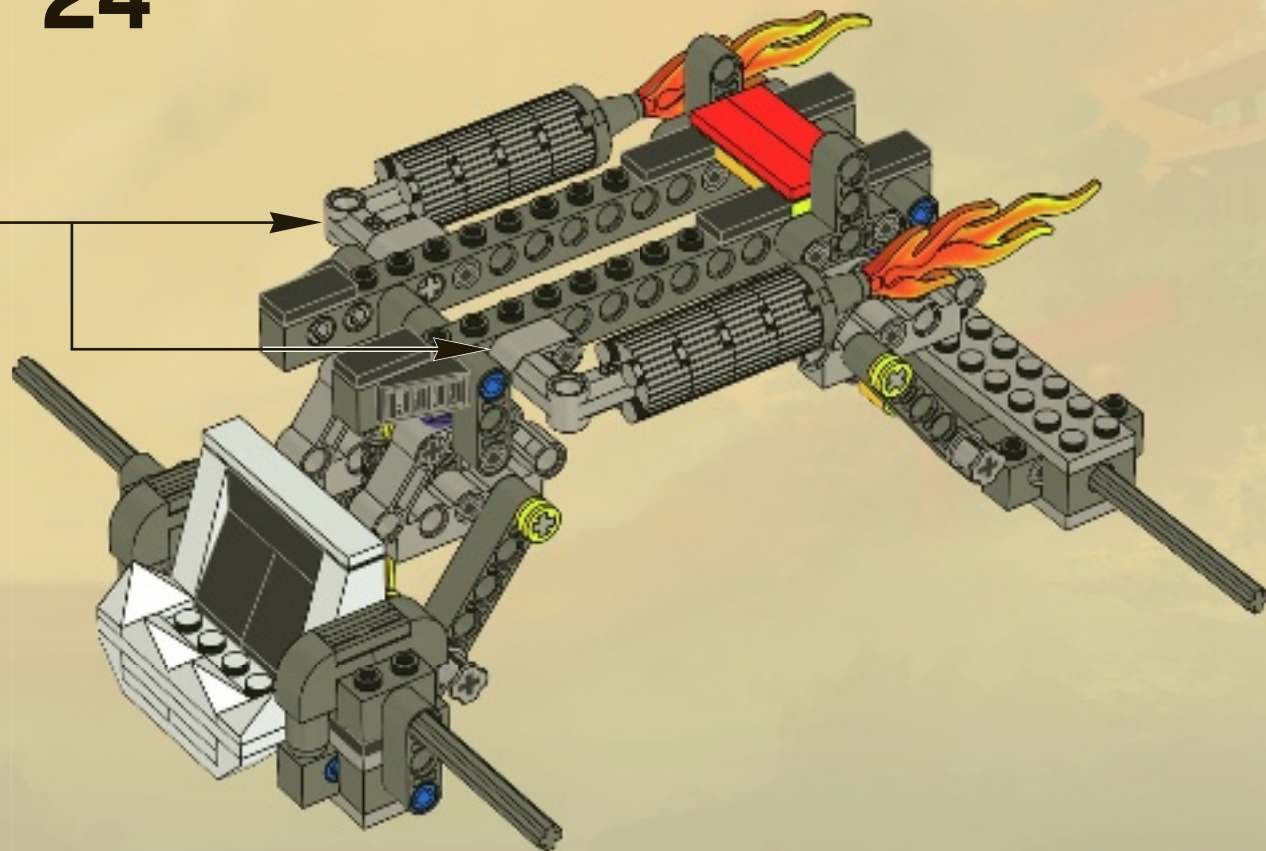

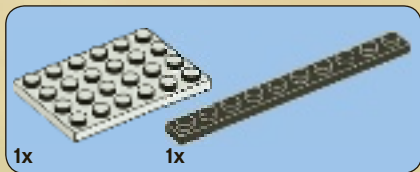
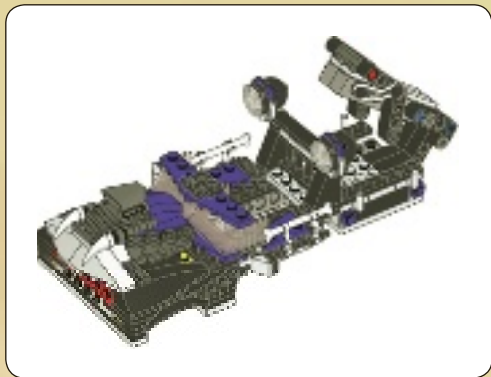

1

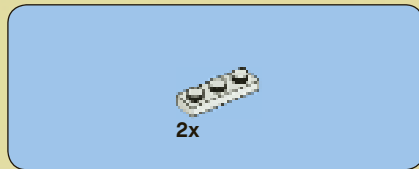
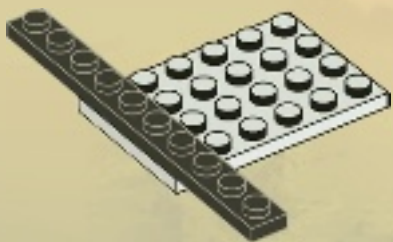

2

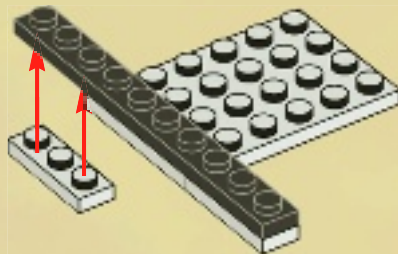

3

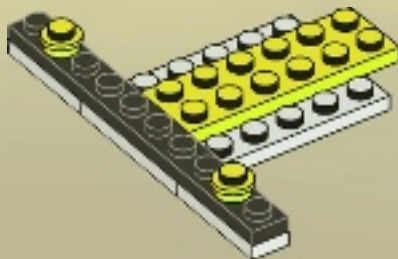

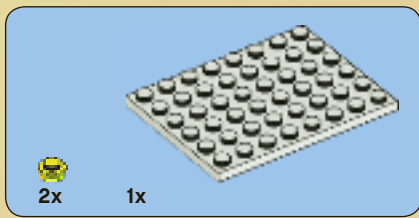

4

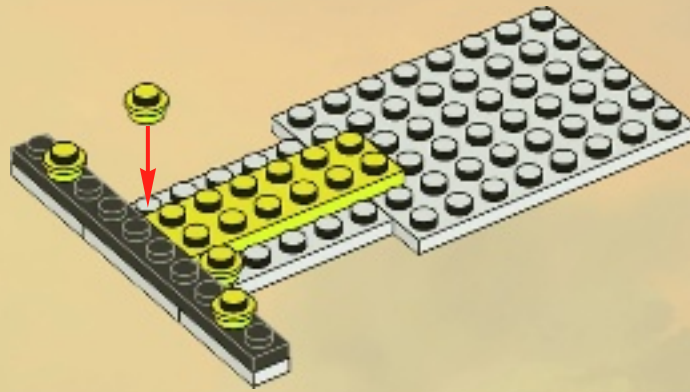

5

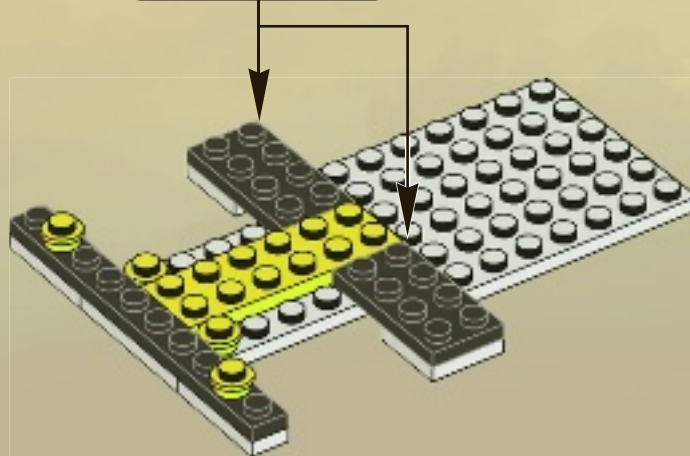
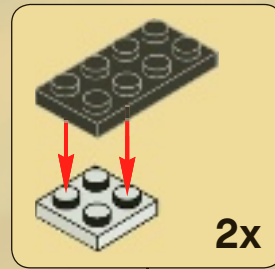



6

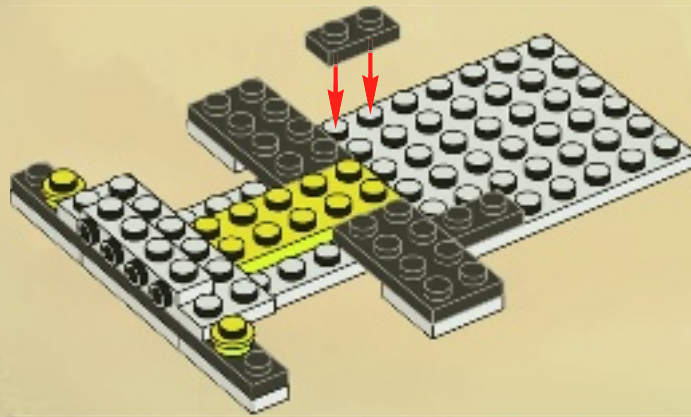



2x

7

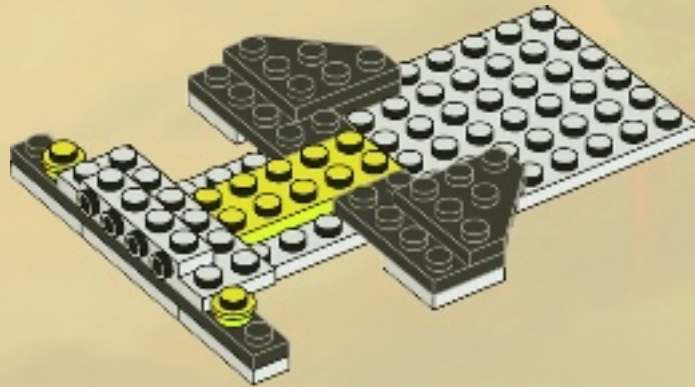

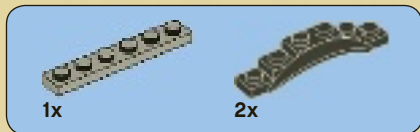

8

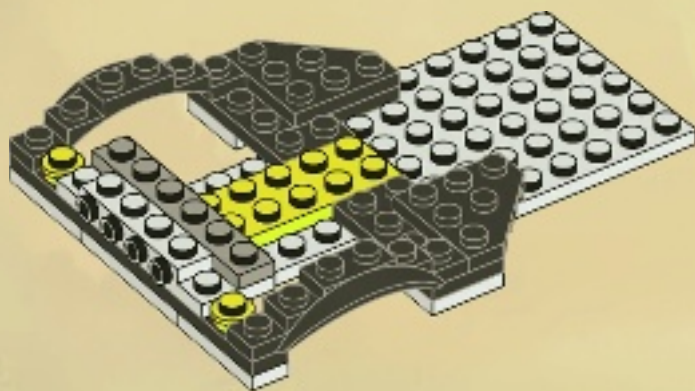



2x

9

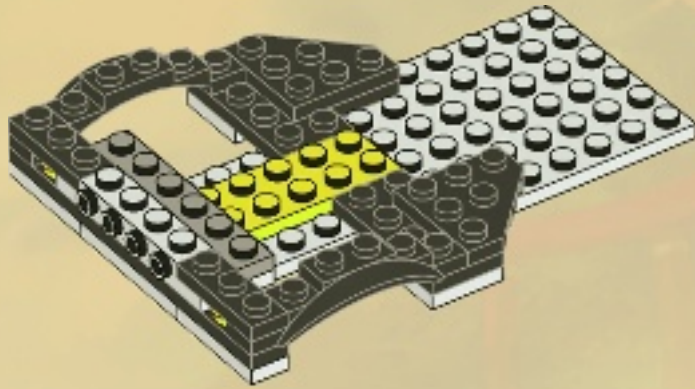



10

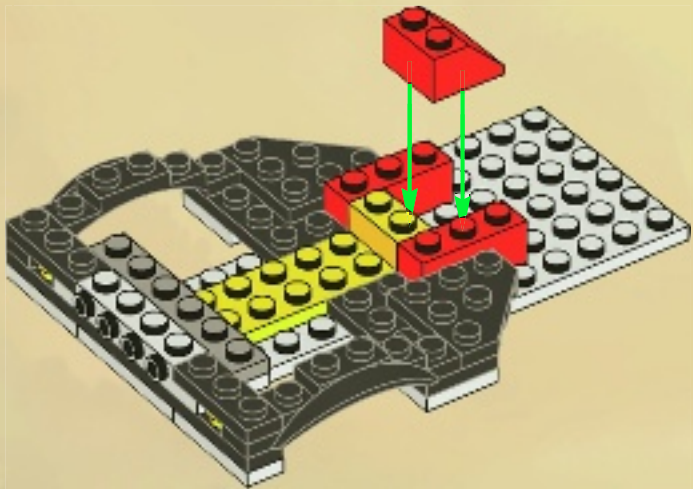



4x



2x

11

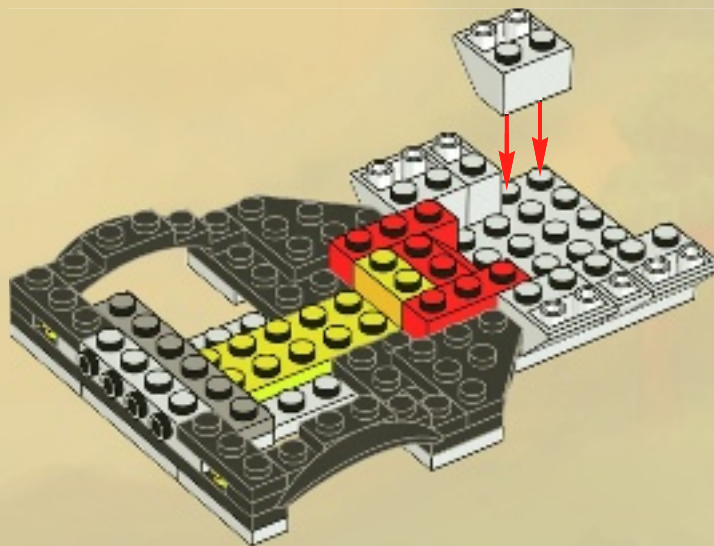

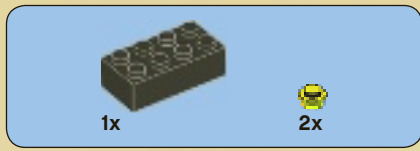

12

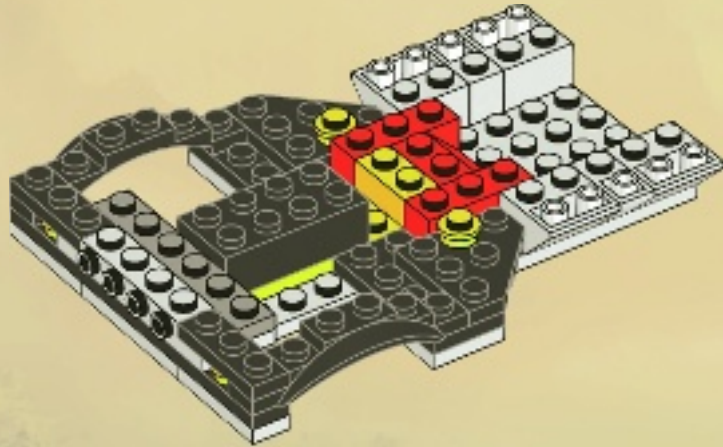

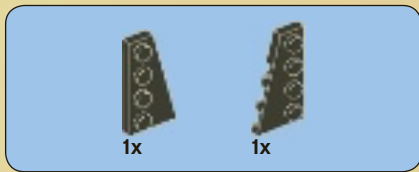

13

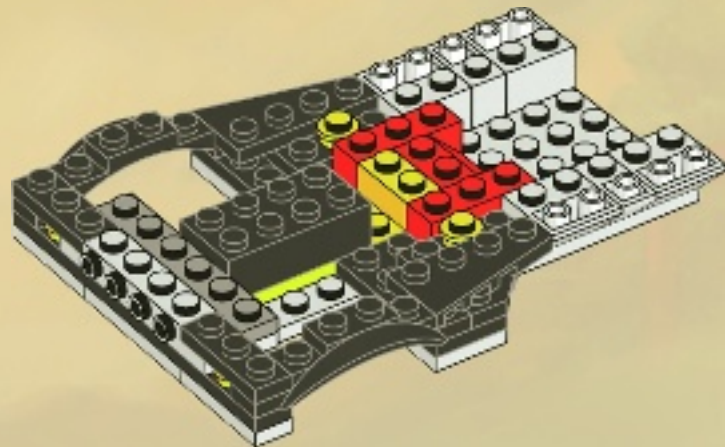

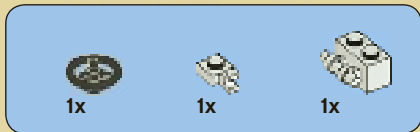

14

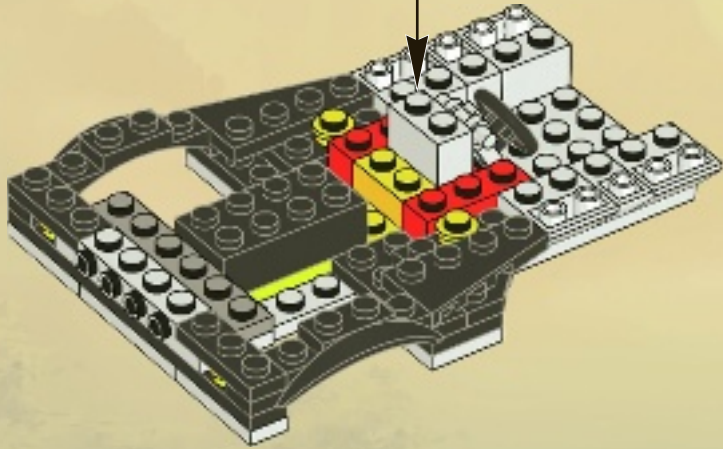
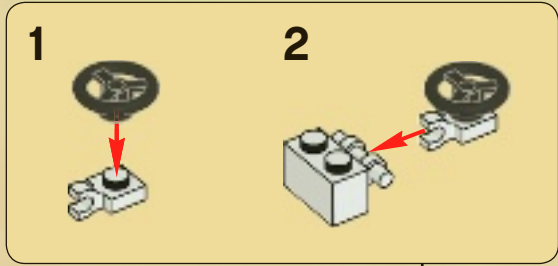



15

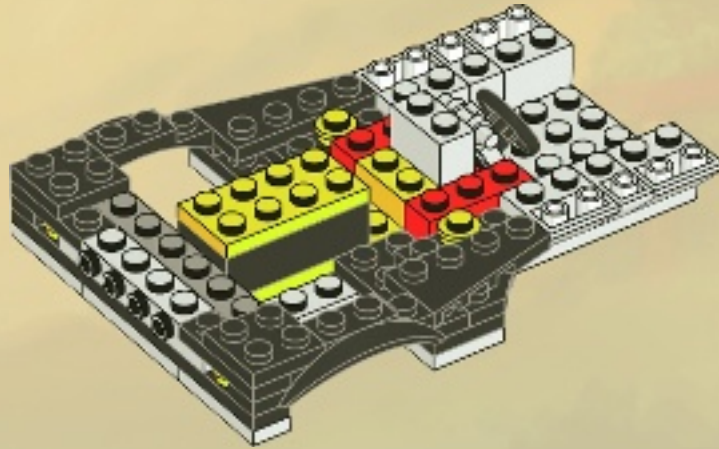



16

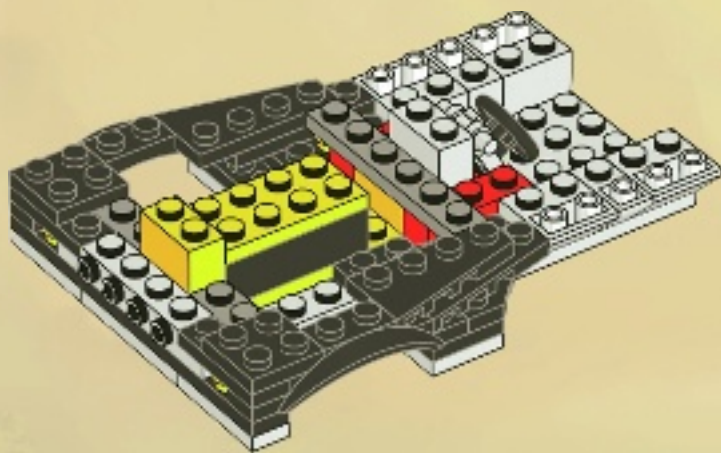

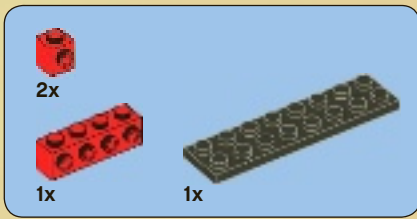

17

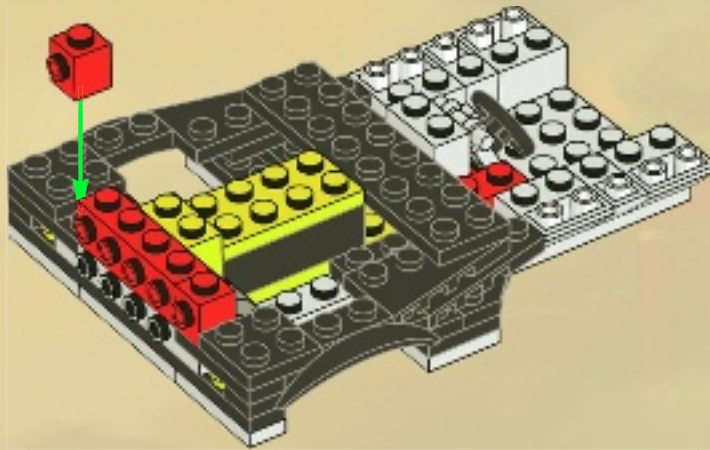

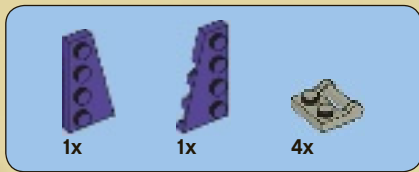

18

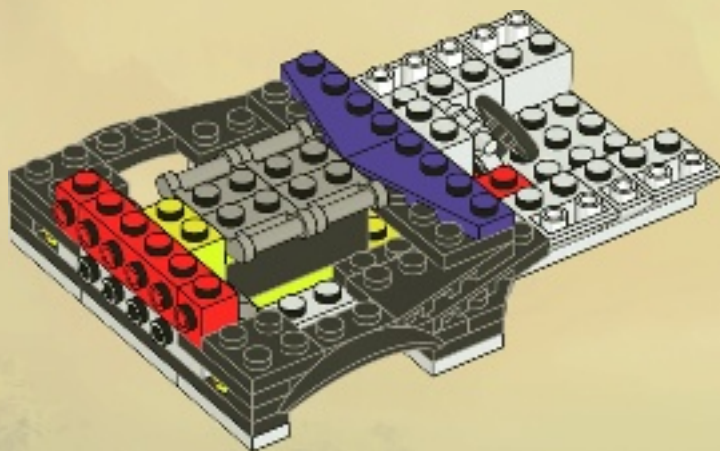



8x



8x

19

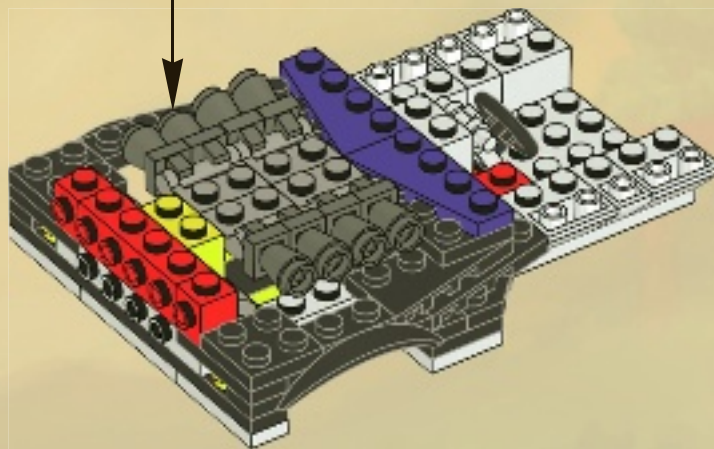
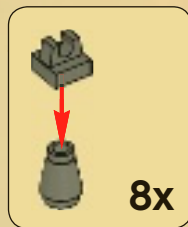

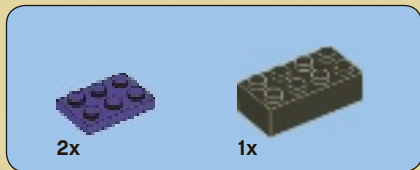

20

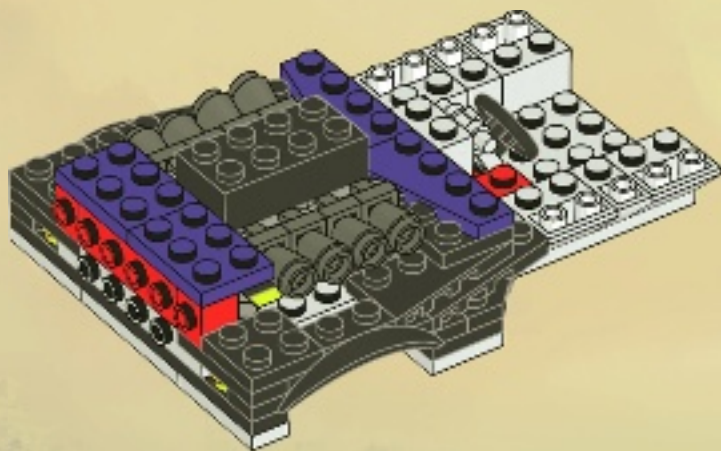

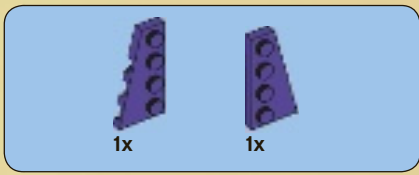

21

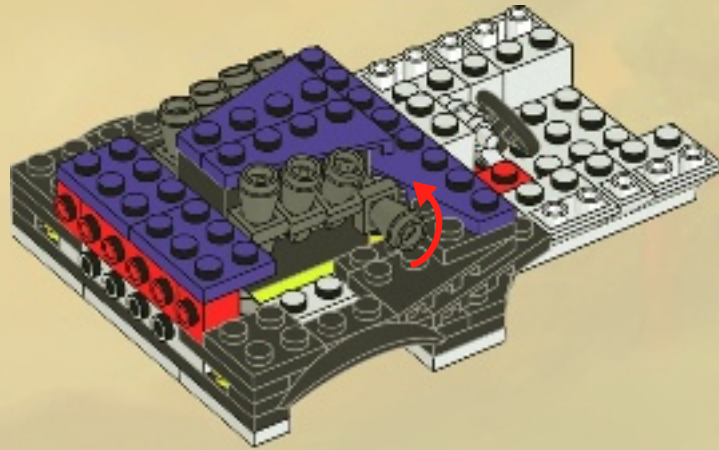

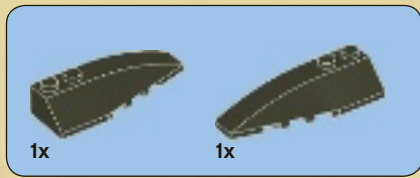

22





2x



2x

23

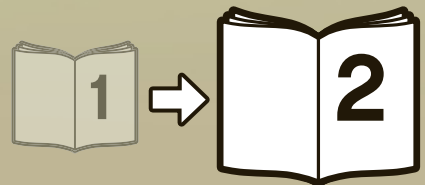



NINJAGO

Masters of Spinjitzu



2254



2257



2174



2175



2255



2256



NINJAGO

Masters of Spinjitzu



NINJAGO.COM



WIN!

Go to www.LEGOsurvey.com/product to fill out a survey for a chance to win a cool LEGO® Product.

No purchase necessary.

Open to all residents where not prohibited.



www.LEGO.com



www.LEGOsurvey.com/product

GEWINNE! WIN!

Nimm an der Umfrage auf www.LEGOsurvey.com/product teil und hab die Chance ein cooles LEGO® Produkt zu gewinnen!

Die Teilnahme am Gewinnspiel führt zu keinerlei Kaufverpflichtungen. Teilnahme in allen nicht ausgeschlossenen Ländern möglich.

Ga naar www.LEGOsurvey.com/product, vul een enquêteformulier in en maak kans op een cool LEGO® product.

Geen aankoopverplichting. Iedereen mag deelnemen, uitgezonderd ingezetenden van landen waar een enquêteverbod geldt.

GAGNE! 当てよう!

Visite www.LEGOsurvey.com/product pour répondre à un questionnaire et avoir une chance de gagner un produit LEGO® très cool!

Aucune obligation d'achat. Ouvert à tous les résidents des pays autorisés.

www.LEGOsurvey.com/product にアクセスして、アンケートにご記入ください。当選者にはレゴ®製品を差し上げます。

お買い上げの必要はありません。

禁止されていない限り、すべての皆様にご利用いただけます。