



# Friends



30401



6188455

LEGO.com/friends

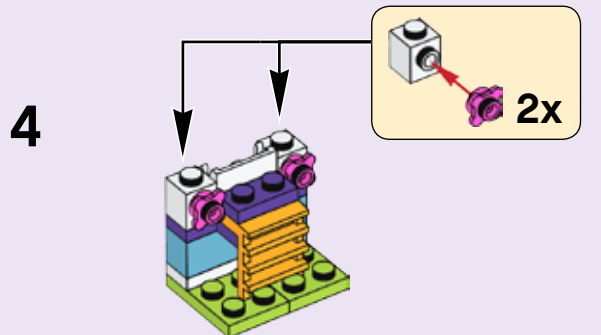
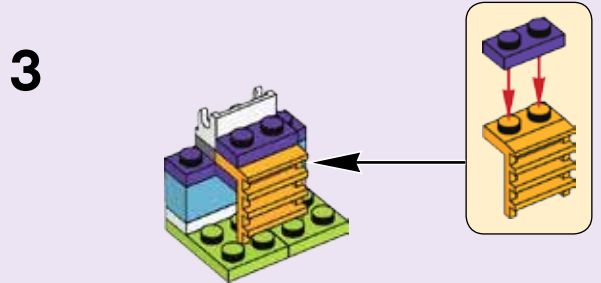
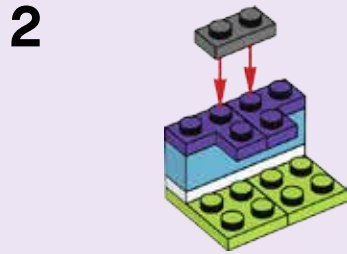
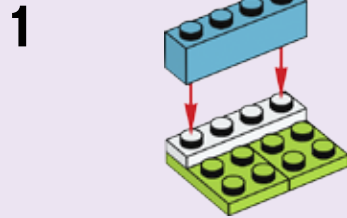
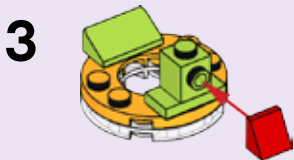
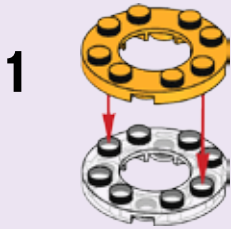
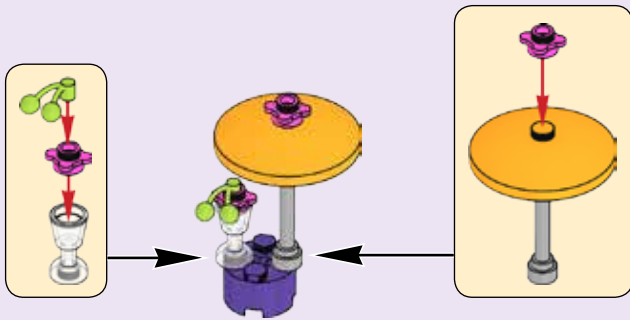

5

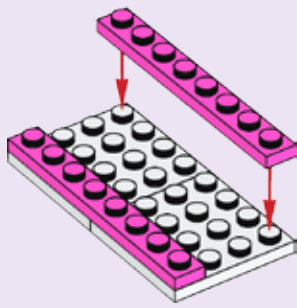

6

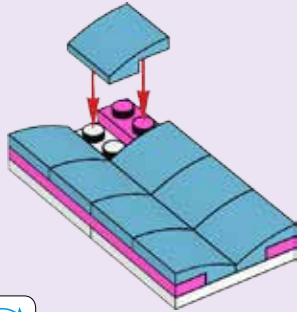

7

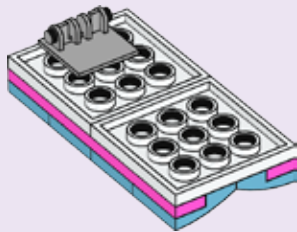

8

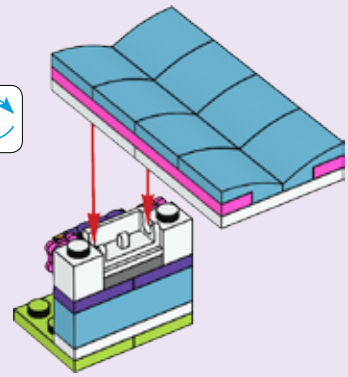

9

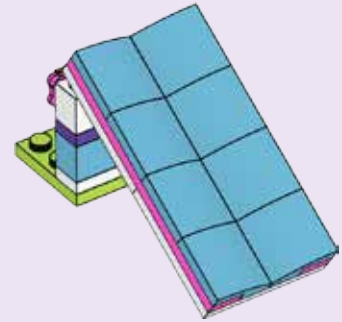

LEGO.com/service

LEGO, the LEGO logo and the FRIENDS logo are trademarks of the LEGO Group. ©2017 The LEGO Group. 6188455



41305



41307



41314



41311



41309



41308



41306

LEGO Friends

