



CREATOR™

3 IN 1

31098



3 in 1
3 en 1
3 em 1
3 az 1-ben
Trīs vienā
3 合 1

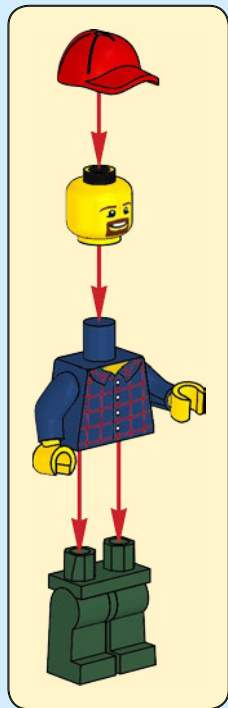
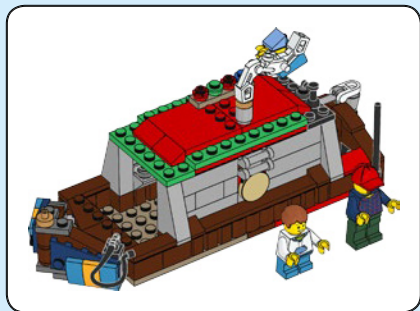

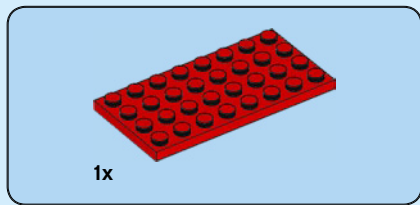

1

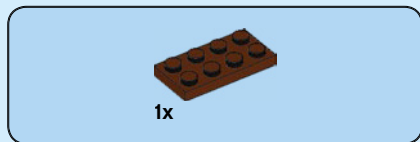
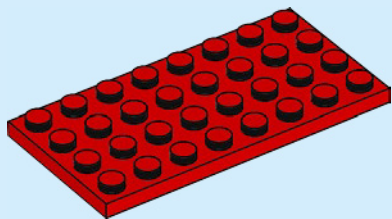

2

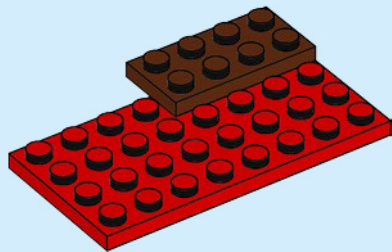

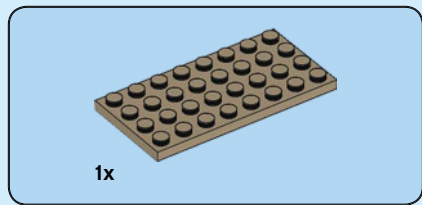

3

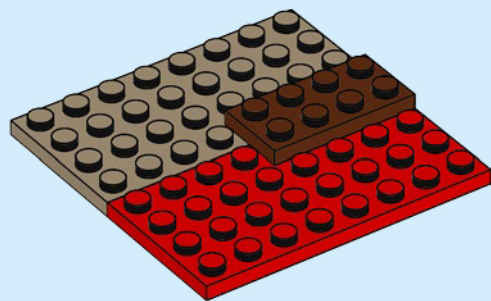

4



4

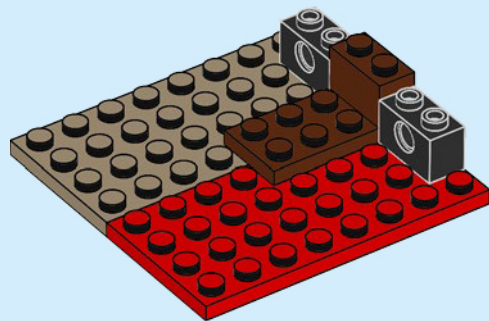



2x

5

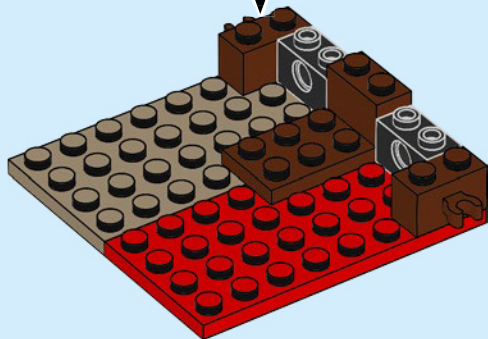

2x



1x

6

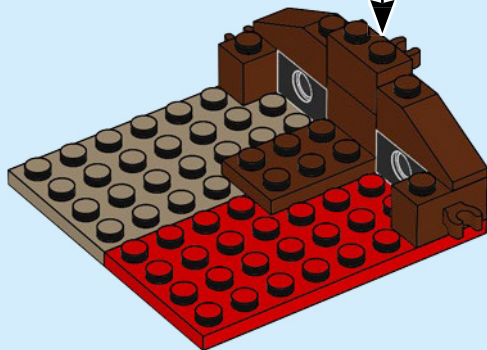
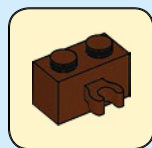



2x

7

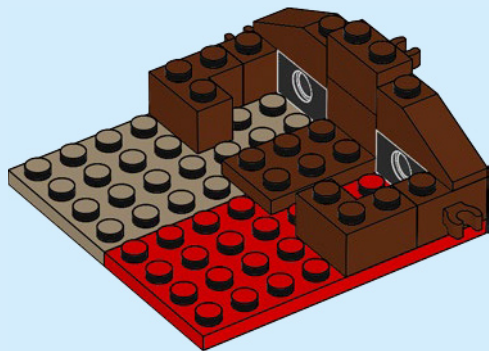

6



2x



2x

8

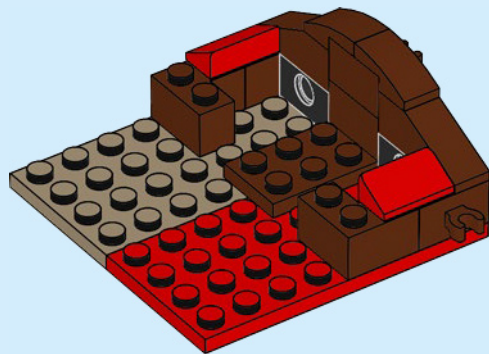

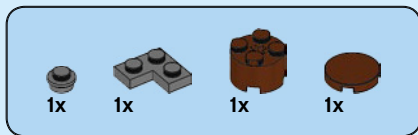

9

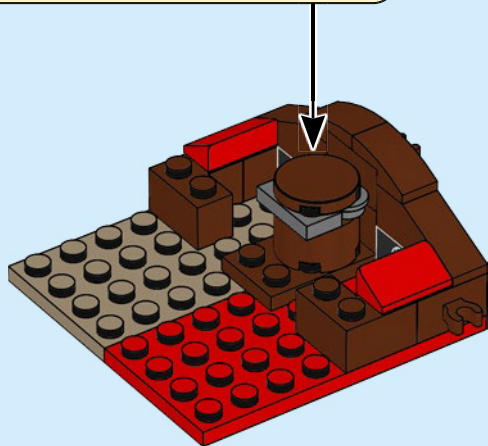

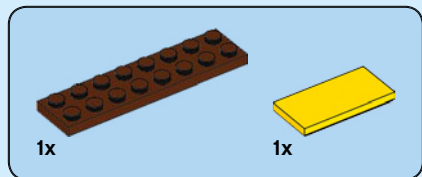

10

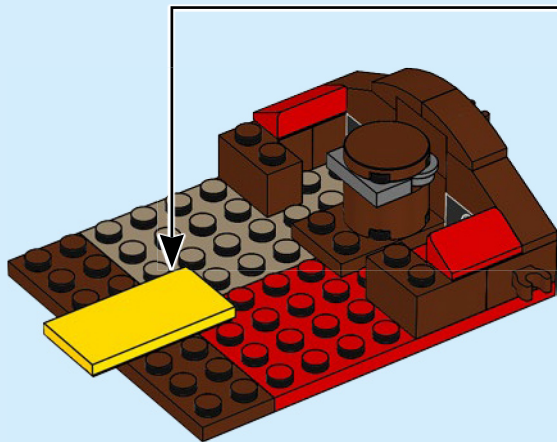
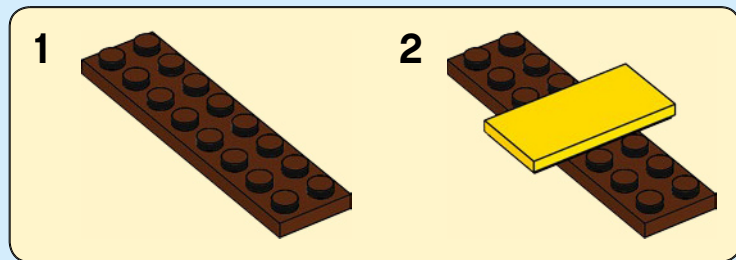

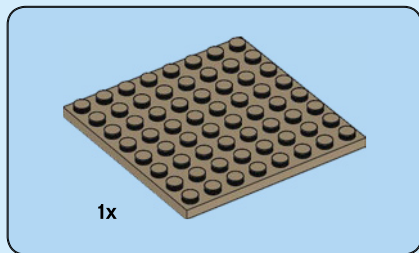

11

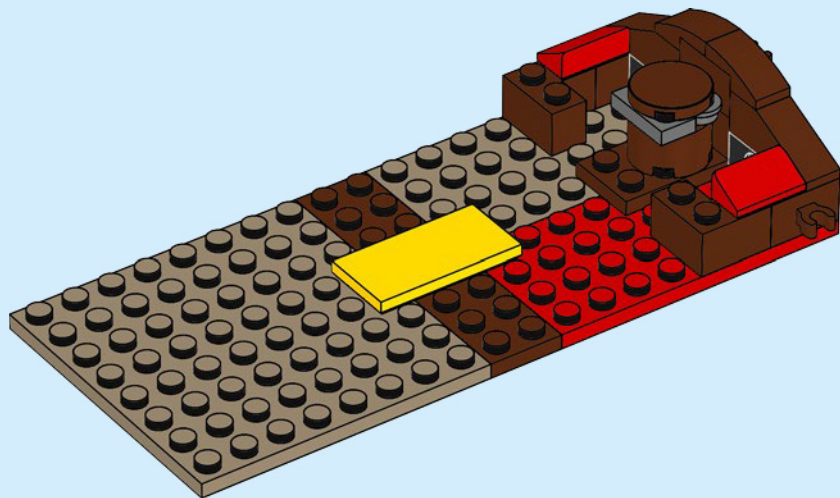



2x

12

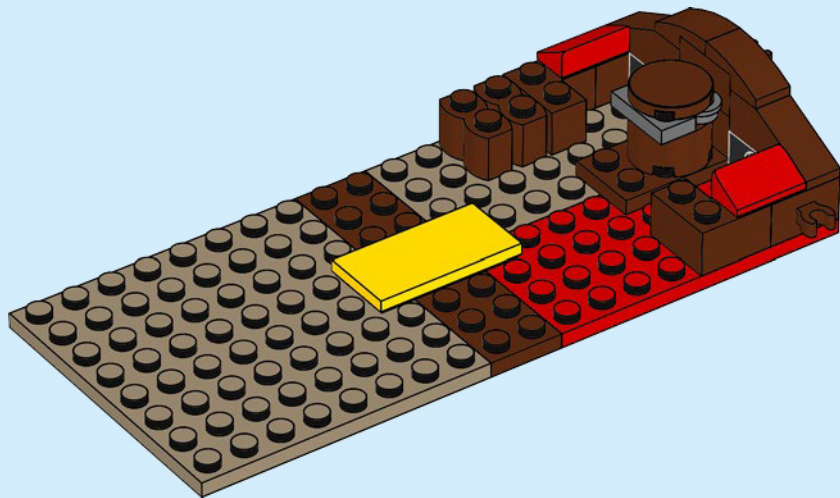



1x



1x

13

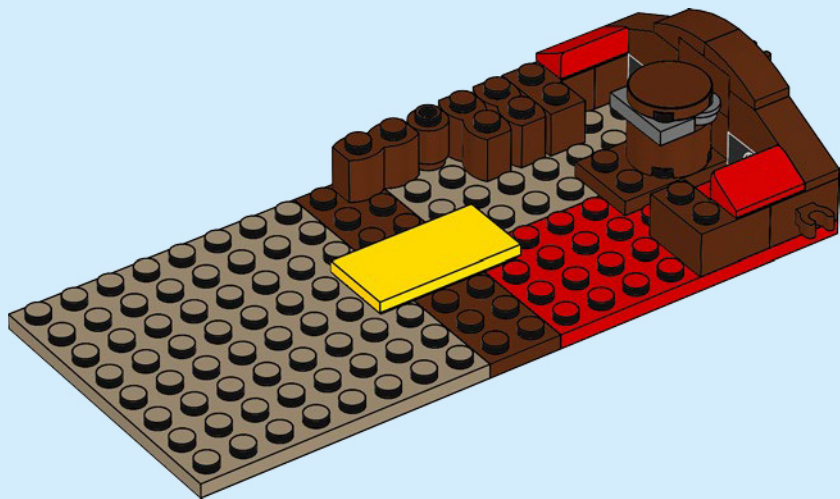



1x

14

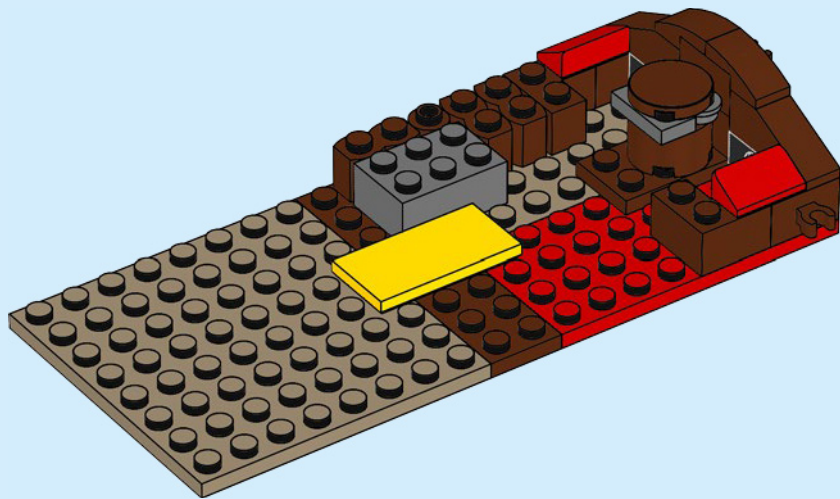



2x



1x

15

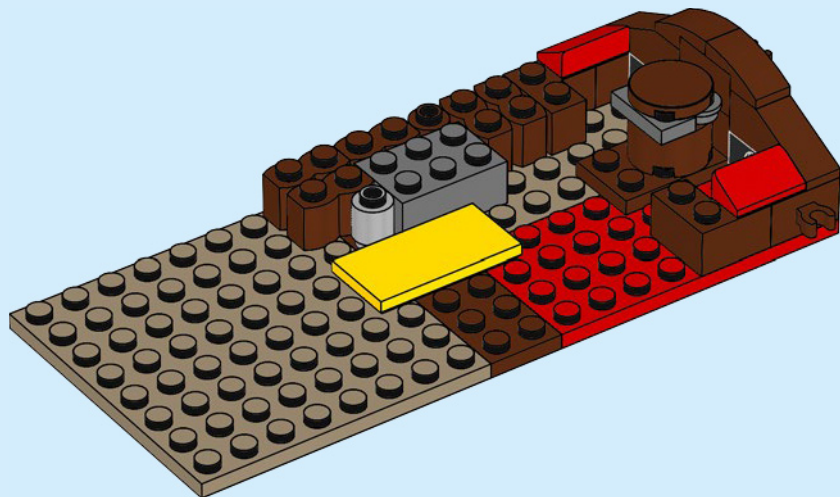



1x

16

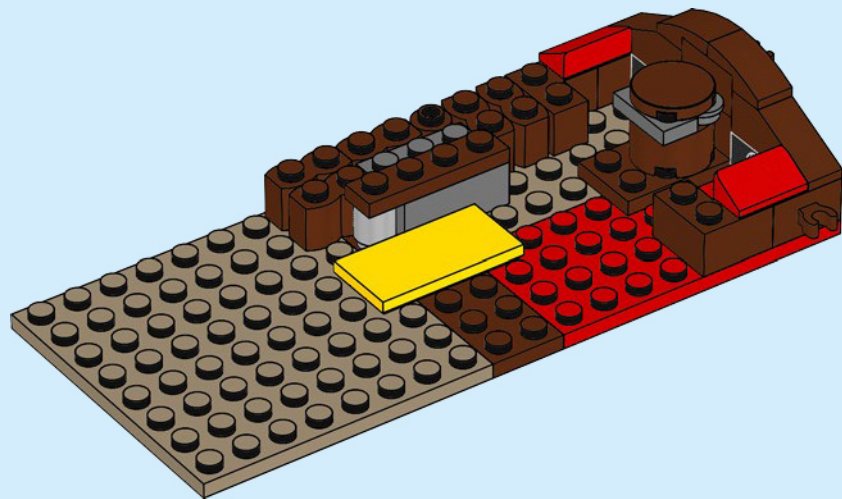



3x

17

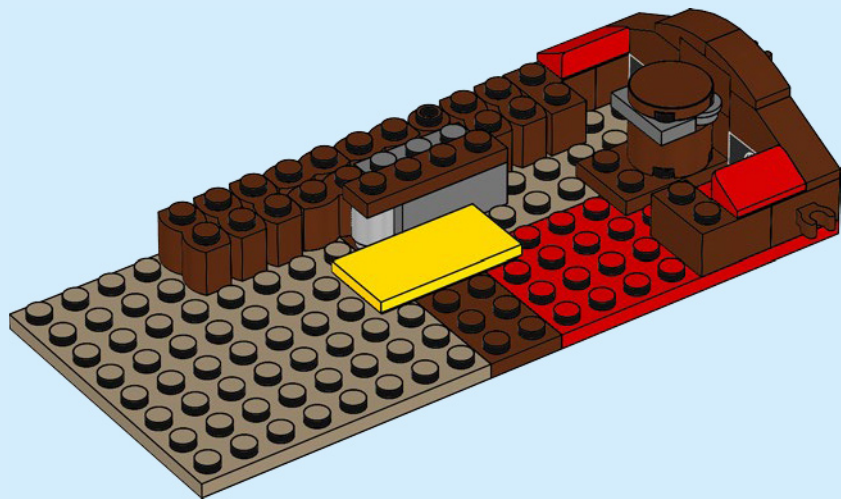



1x



1x

18

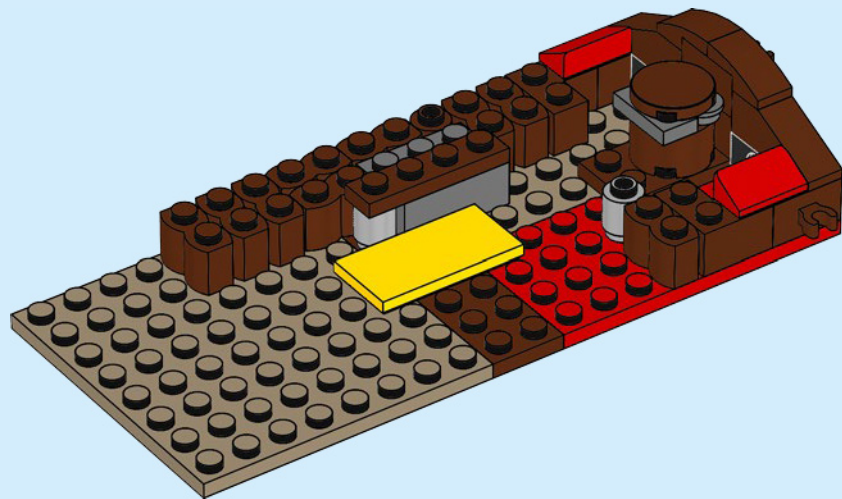



2x



1x

20

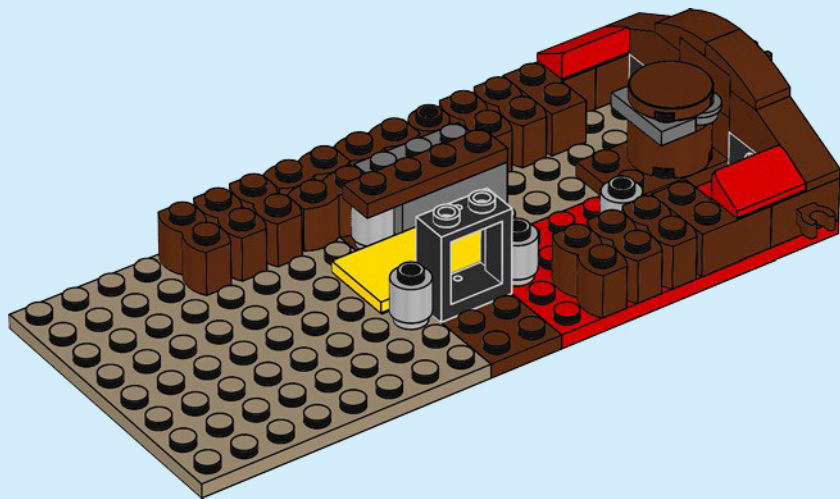

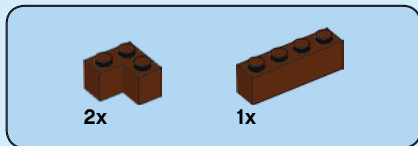

23

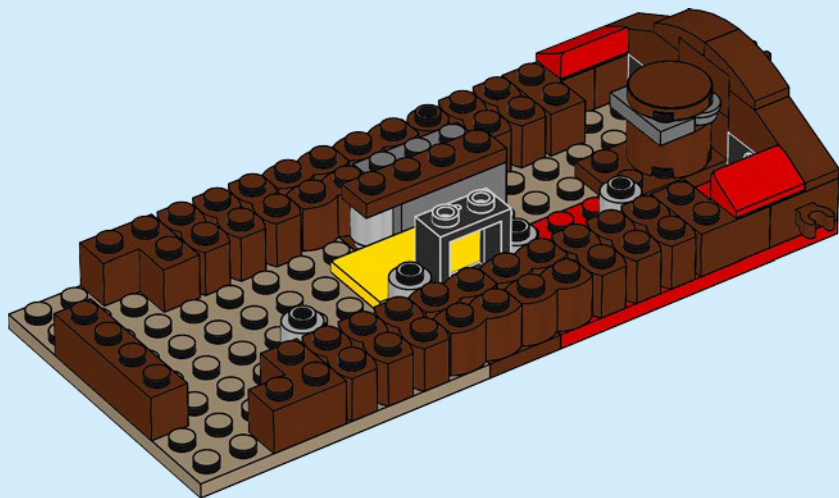

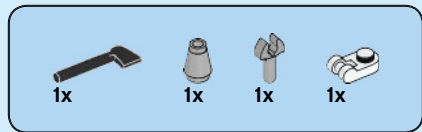

24

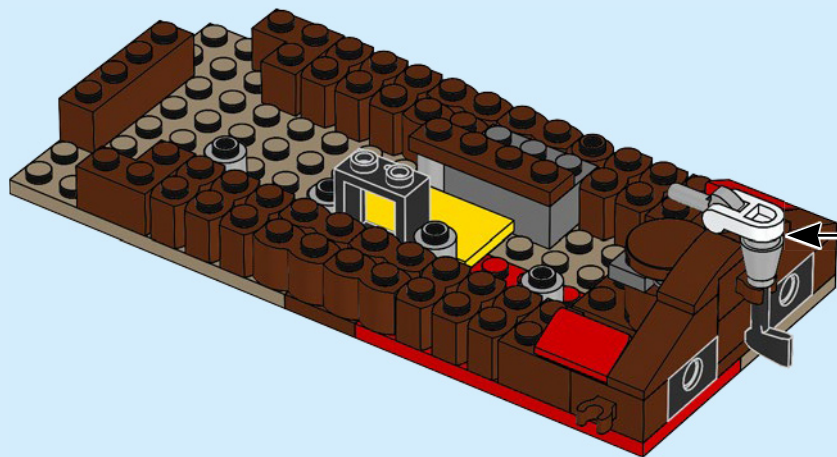
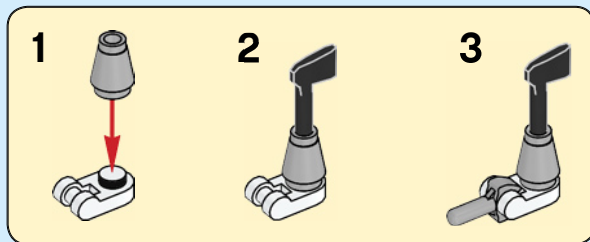

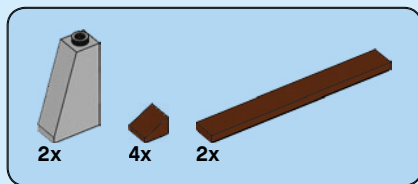

25

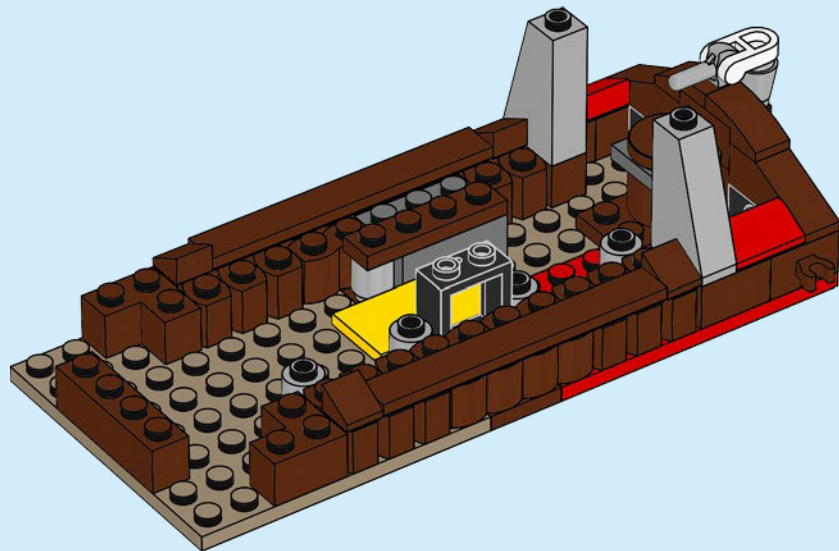

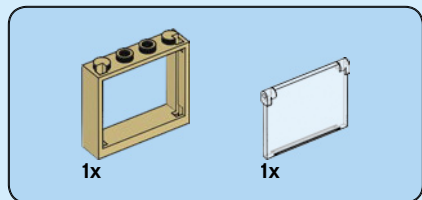

26

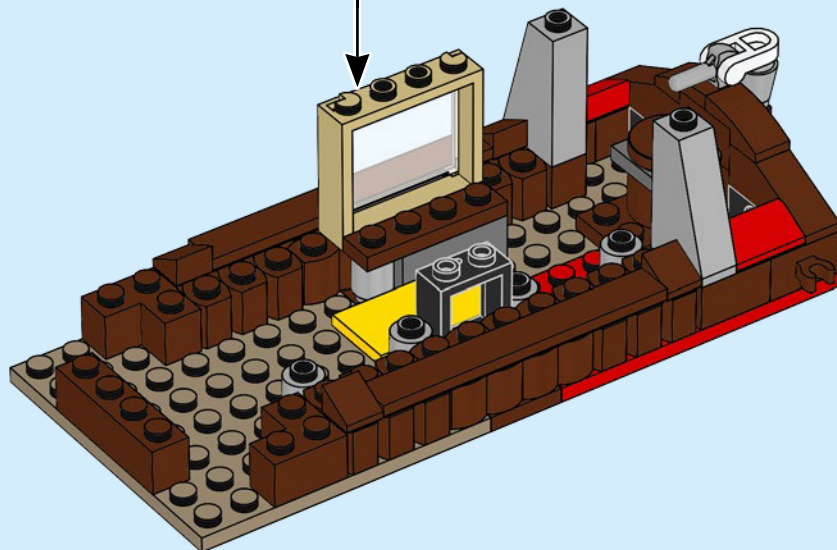
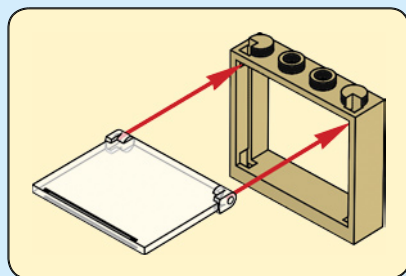

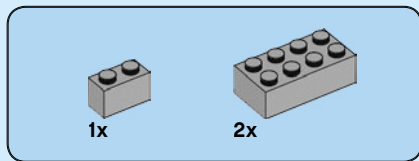

27

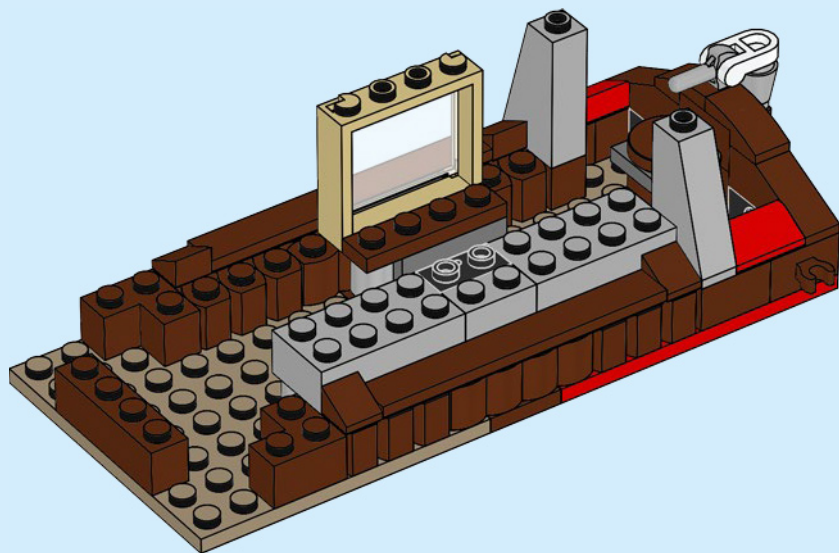

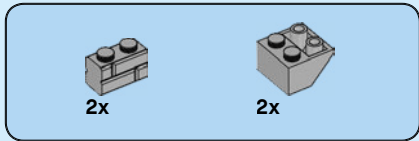

28

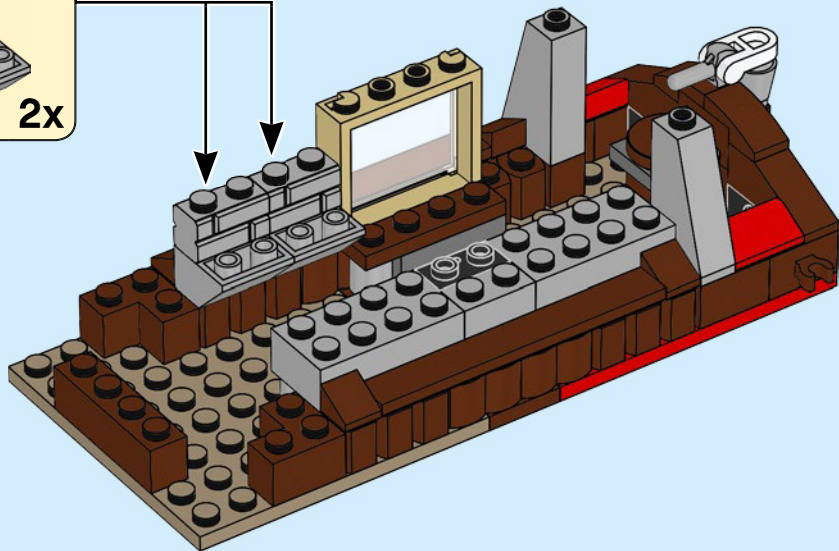
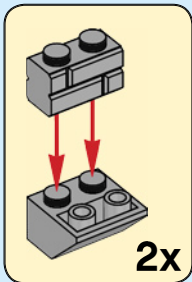

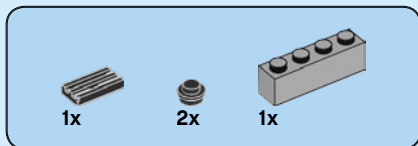

29

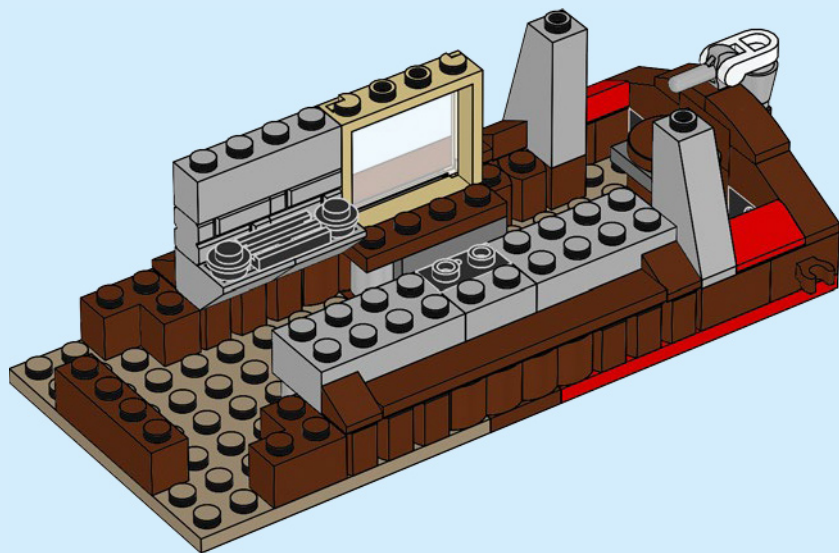



2x



1x

30

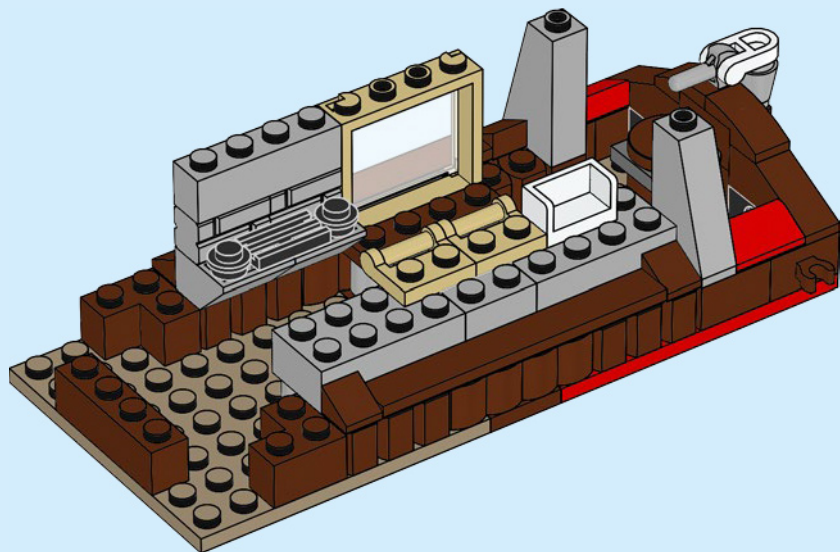

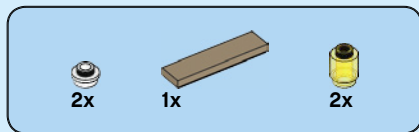

31

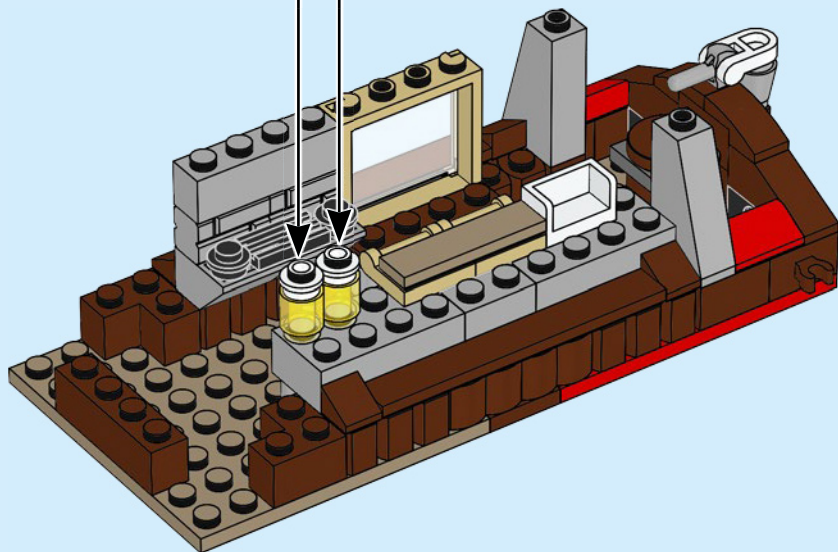
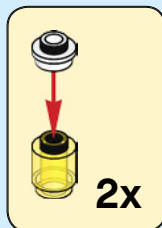

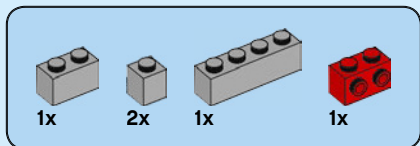

32

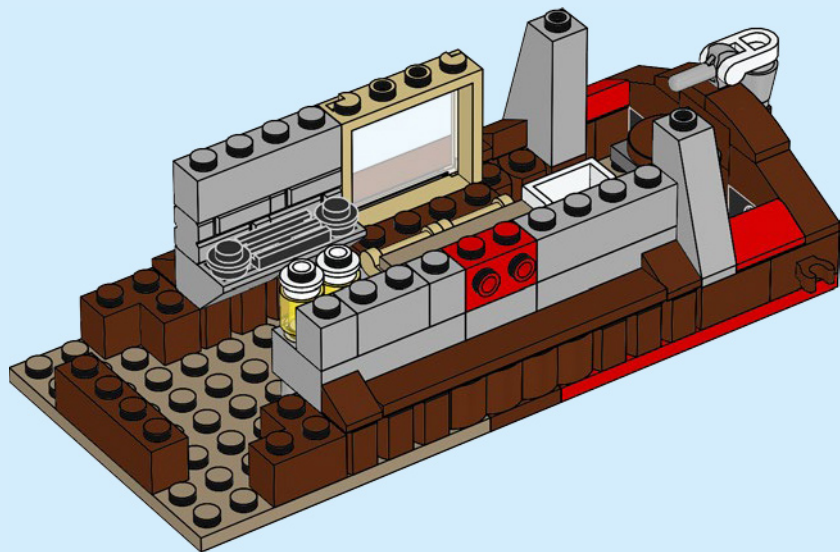

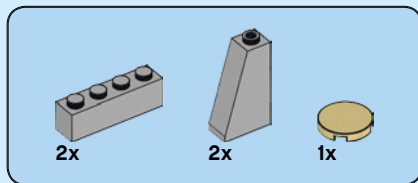

33

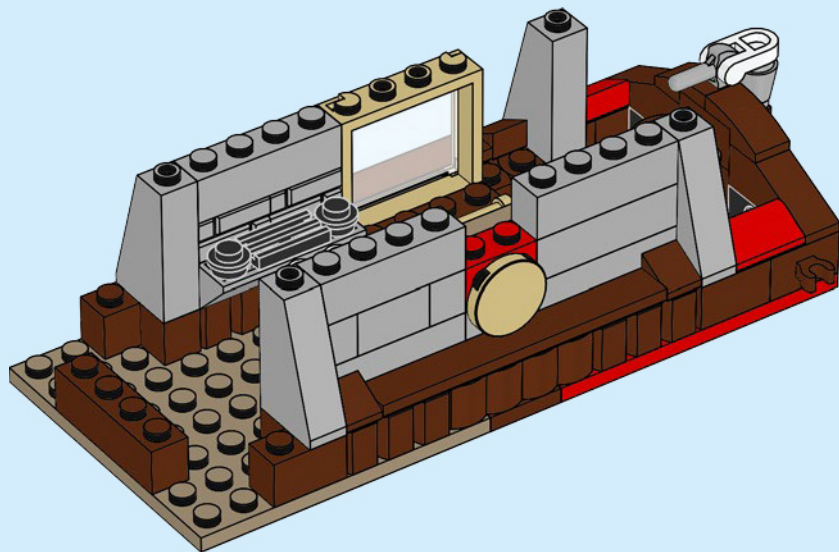

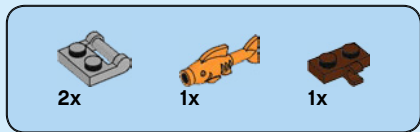

34

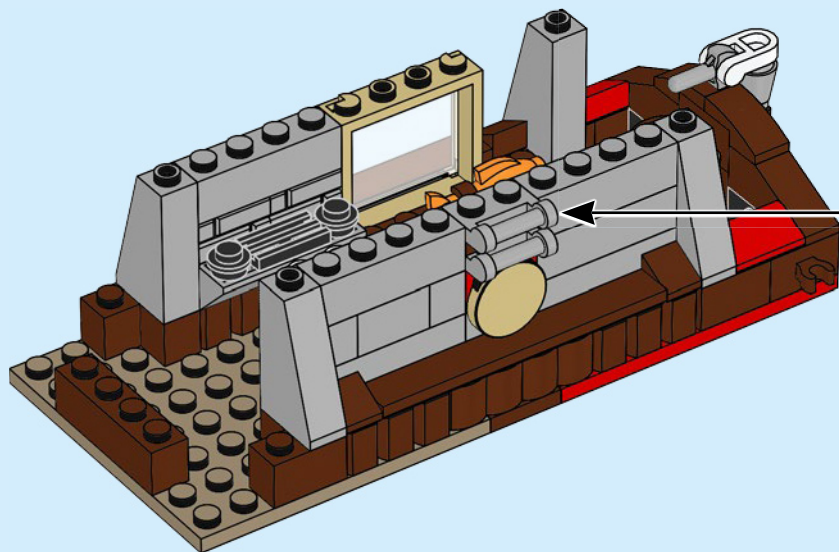
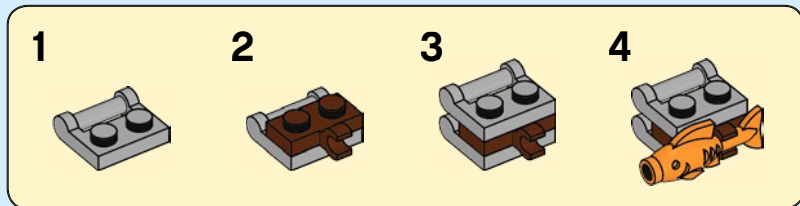

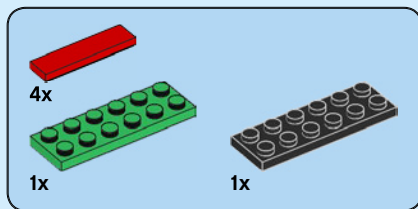

35

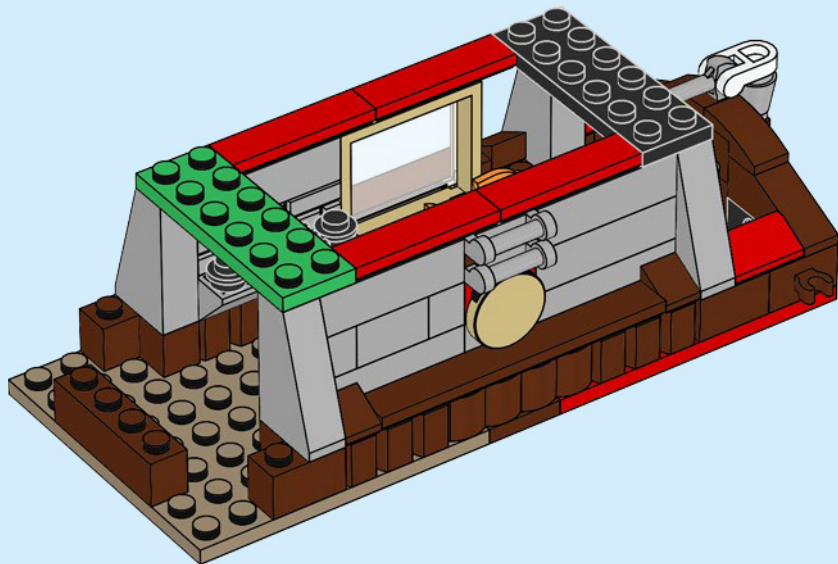



36

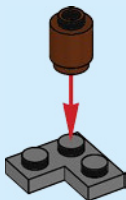

34

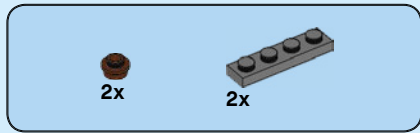

37

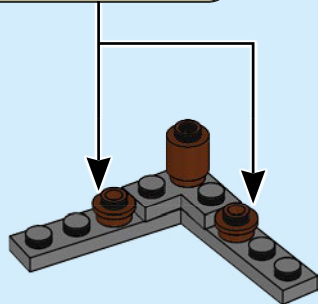
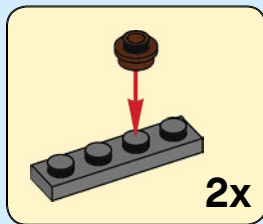



2x

38

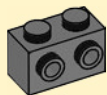

2x

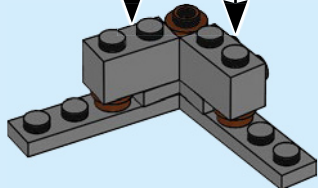

1x



1x

39

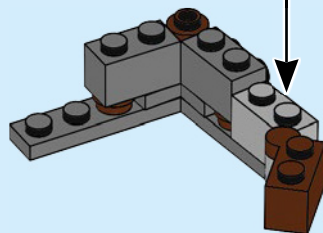
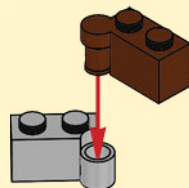



1x



1x

40

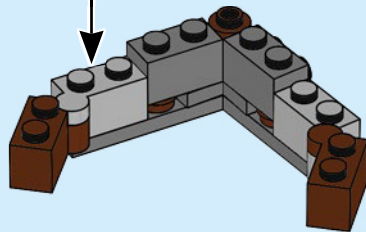
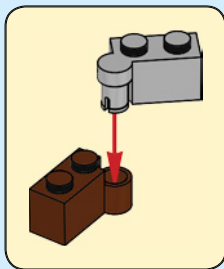



1x



1x



1x

41

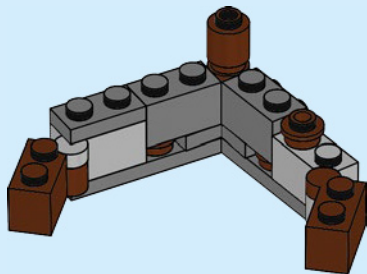

2x



1x



1x

42

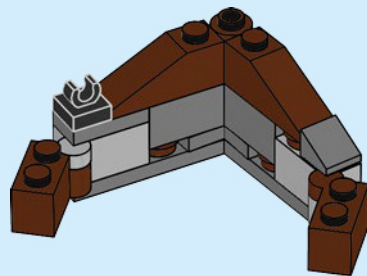



1x



1x

43

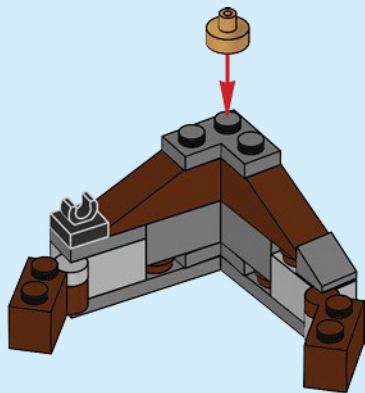

1x

44

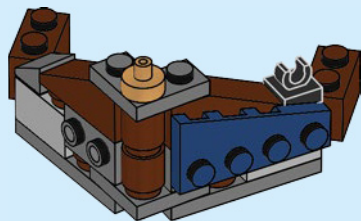
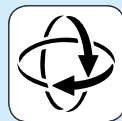



1x



2x

45

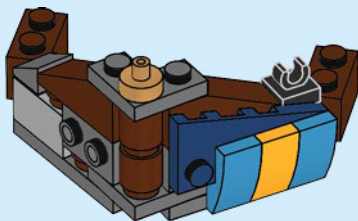

1x

46

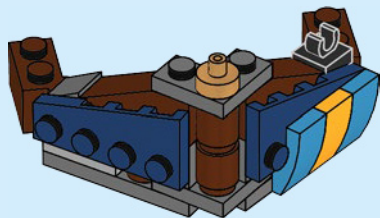



1x



2x

47

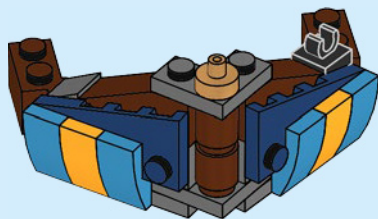

48



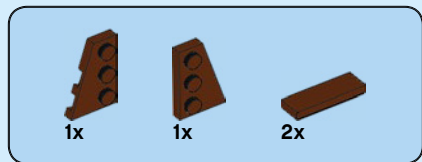

49

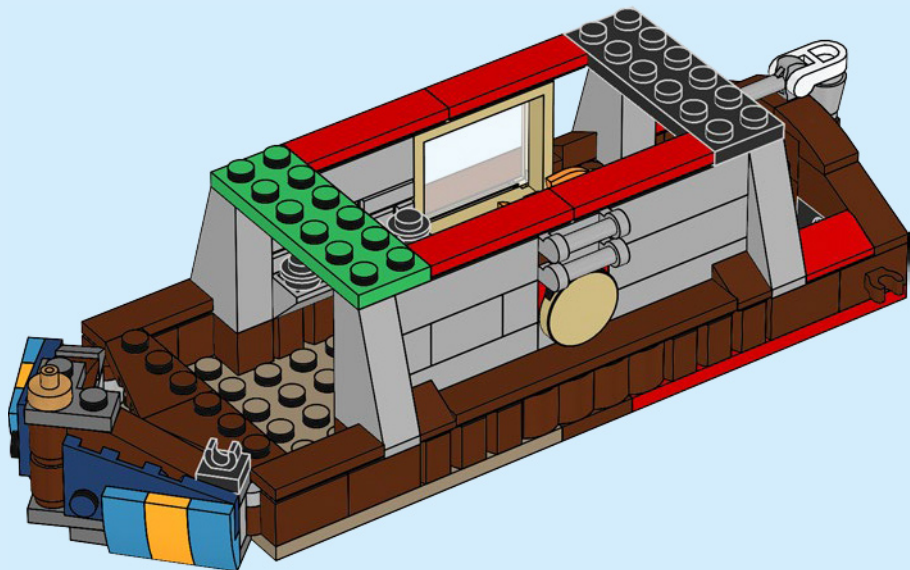

42

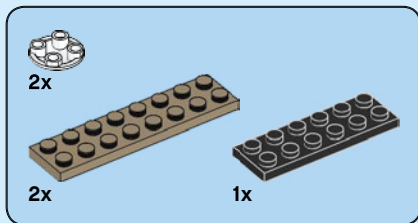

50

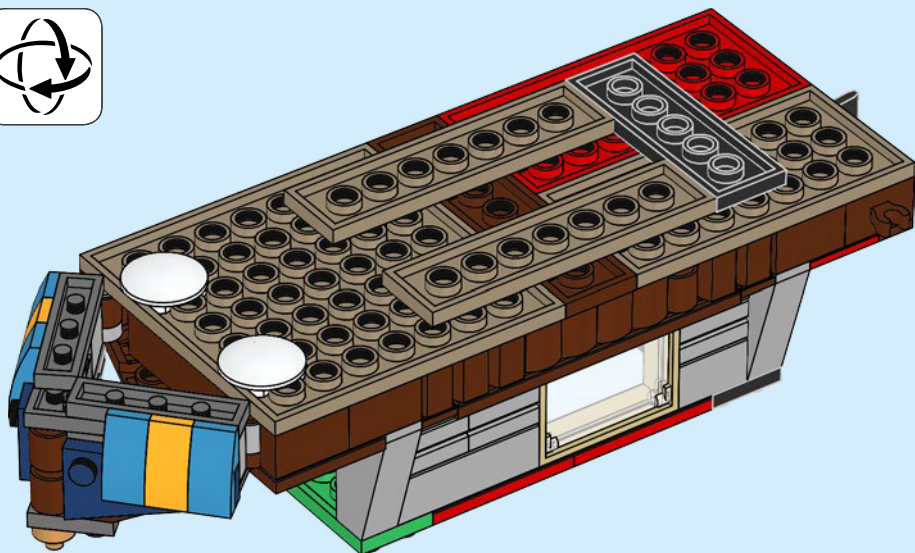



1x



4x

51



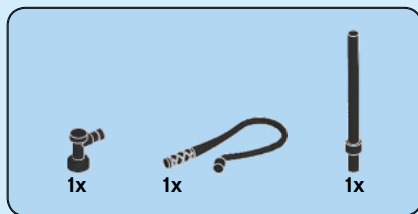

52

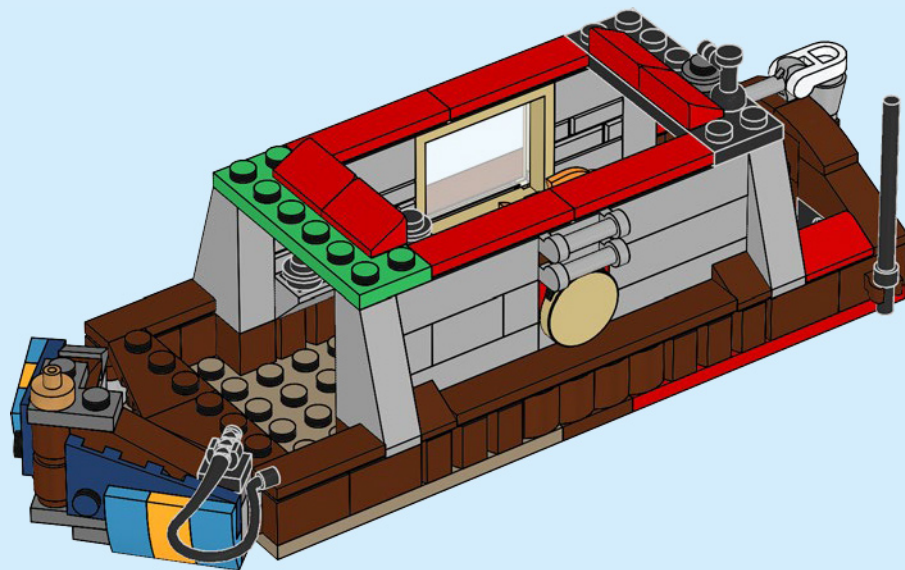

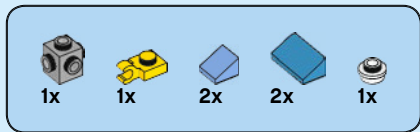

53

1

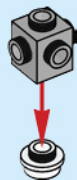

2



3



4



5



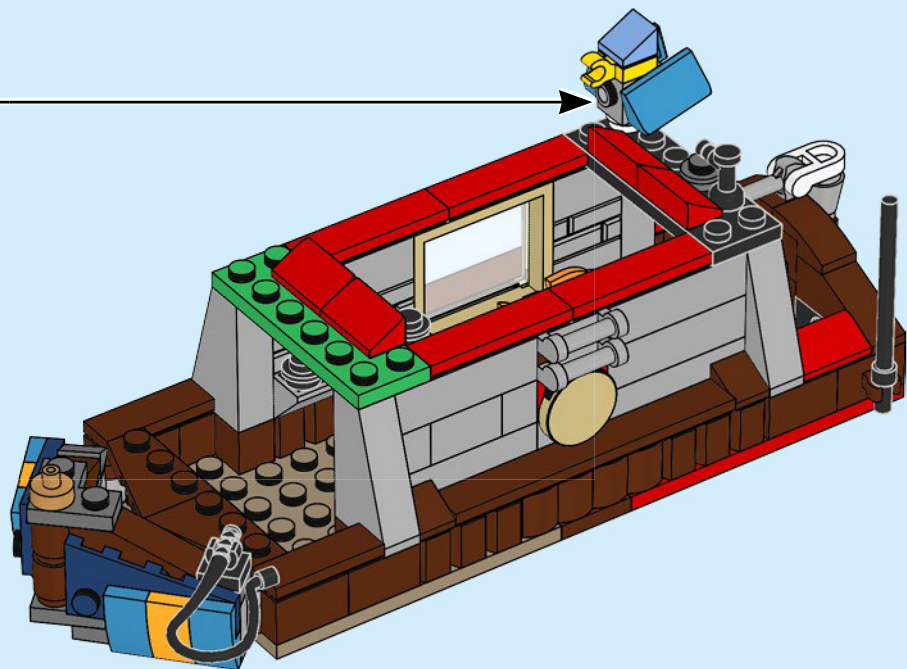

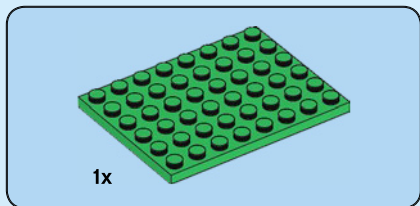
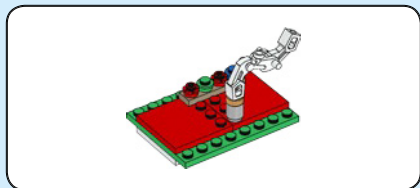

54

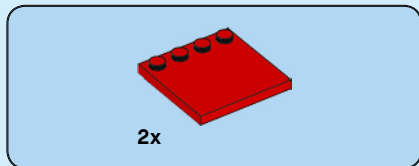
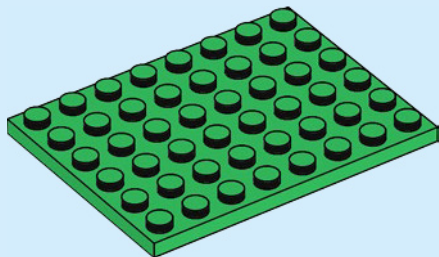

55

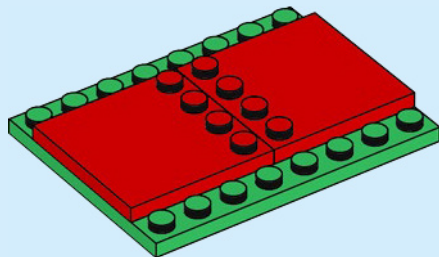



2x

56

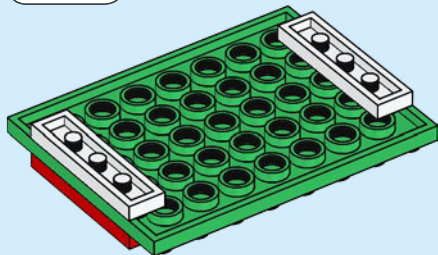

1x

57

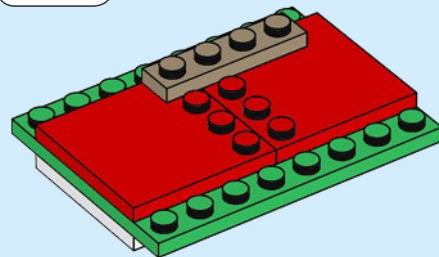



1x



1x



2x

58

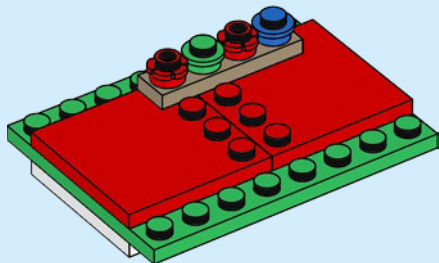

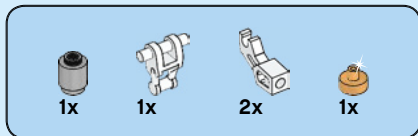

59

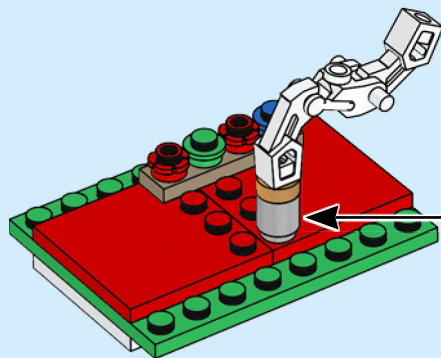
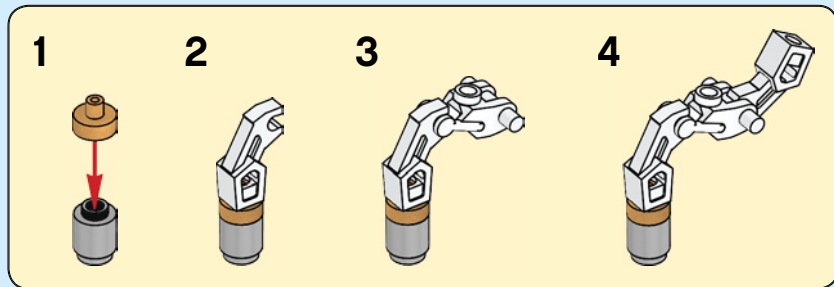

60

