



CREATOR™



31136



3 in 1
3 en 1
3 em 1
3合1

3 w 1
3 v 1
3 az 1-ben
3 in 1

„3 в 1“
Kolm ühes
3 viename



 **FR**
DONNEZ
OU
RECYCLEZ

 OU  OU 

ASSOCIATION MAGASIN DÉCHÈTERIE

Adresses sur quefairedemesdechets.fr



LEGO.com/sustainable-packaging



BUILDER



Apple and the Apple logo are trademarks of Apple Inc., registered in the U.S. and other countries and regions. App Store is a service mark of Apple Inc. Google Play and the Google Play logo are trademarks of Google LLC. Tencent and the Tencent logo are trademarks of Tencent Inc.

EN Ask parents' permission before going online | **DE** Eltern um Erlaubnis bitten, bevor du online gehst | **FR** Demande l'autorisation d'un parent avant d'aller en ligne | **IT** Chiedi il permesso ai tuoi genitori prima di andare online | **ES** Pídeles permiso a tus papás antes de conectarte a Internet | **PT** Pede autorização aos pais antes de acederes online | **JA** オンラインになる前に ほか者の方のきよかをもらおう | **ZH** 上网前应先征得父母的同意 | **KO** 온라인 접속 전에 보호자 동의가 필요합니다 | **RU** Спроси разрешения у родителей, прежде чем заходить в интернет | **PL** Poproś rodziców o zgodę, zanim wejdiesz do Internetu | **CS** Než půjdeš na internet, požádej rodiče o svolení | **SK** Skôr než pôjdeš na internet, vypýtaj si povolenie od rodičov | **HU** Kérj szülői engedélyt, mielőtt online csatlakoznál! | **RO** Cere permisiunea părinților înainte de a te conecta online | **BG** Поискайте разрешение от родител, преди да влезете онлайн | **LV** Pirms došanās tiešsaistē palūdz atļauju vecākiem | **ET** Enne Interneti kasutamist küsi vanematelt luba | **LT** Prieš prisijungdami prie interneto, atsklauskite tėvų

[LEGO.com/devicecheck](https://www.lego.com/devicecheck)

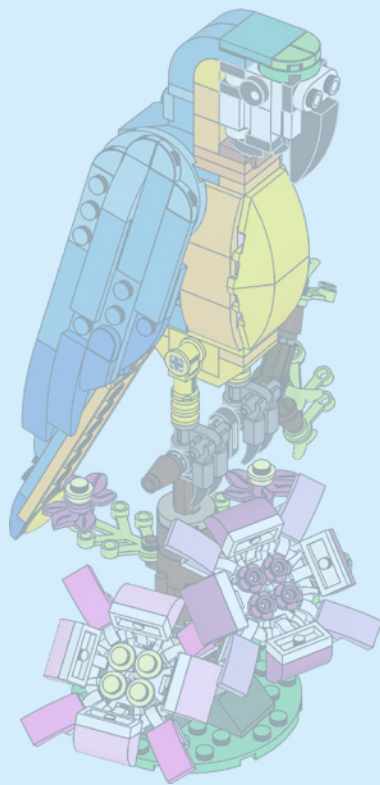

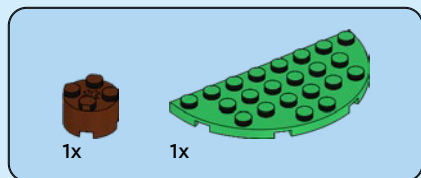

1

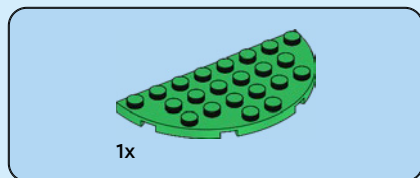
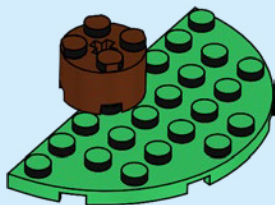

2

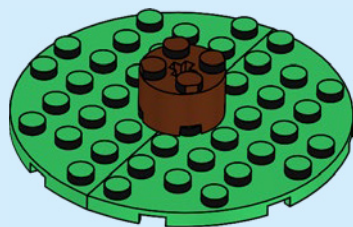



4x

3

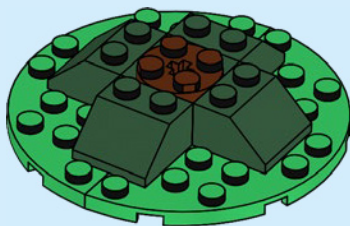

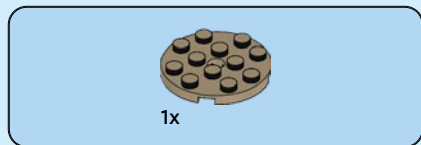

4

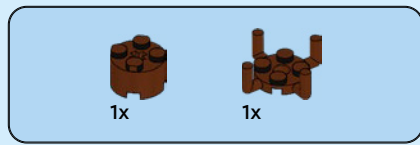
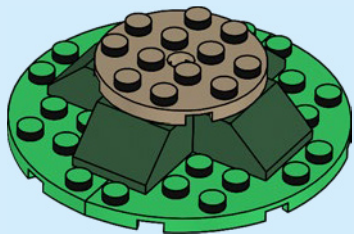

5

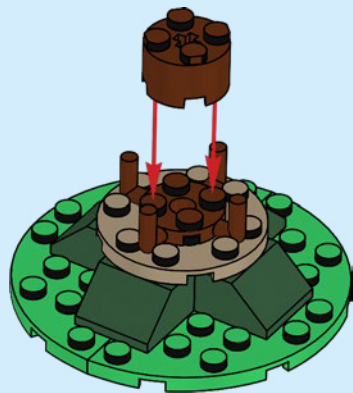

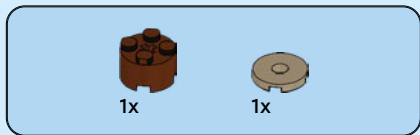
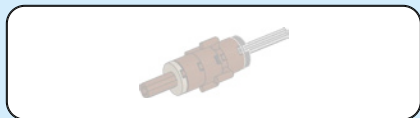

6

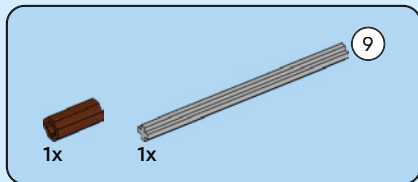
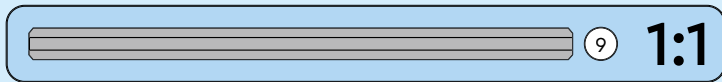
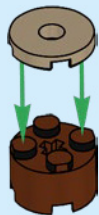

7

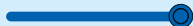
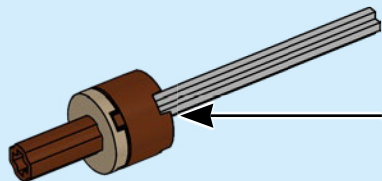
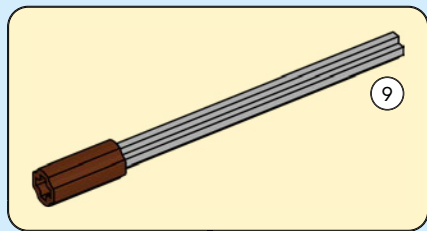



1x



1x

8

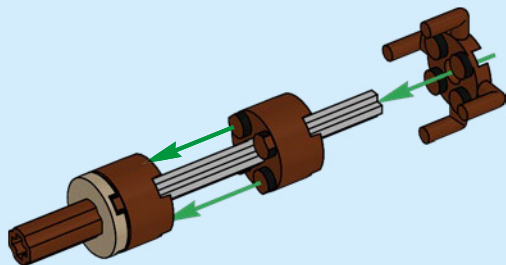

1x



1x

9

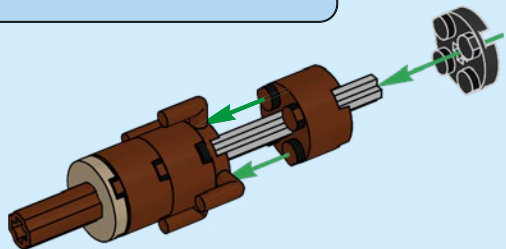

10

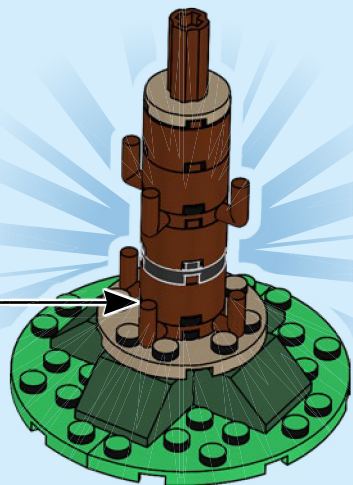

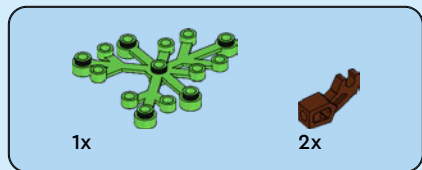

11

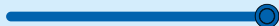
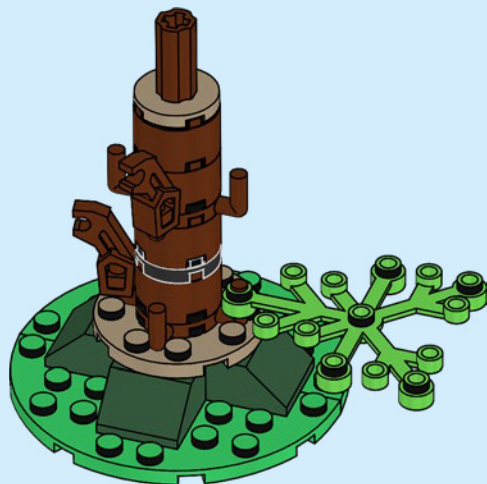



1x

12

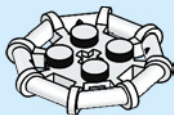

4x

13





14

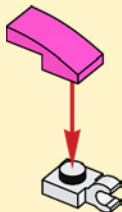

4x

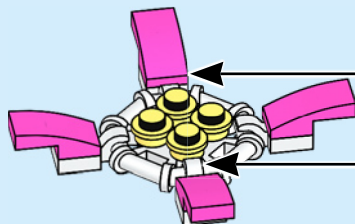

15

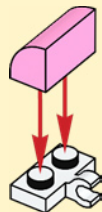

4x

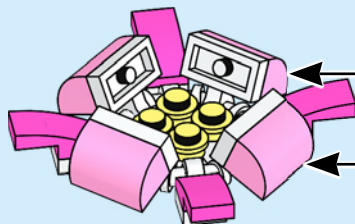

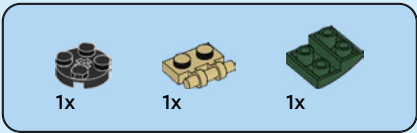

16

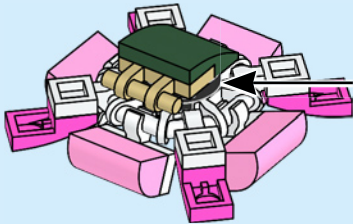

17

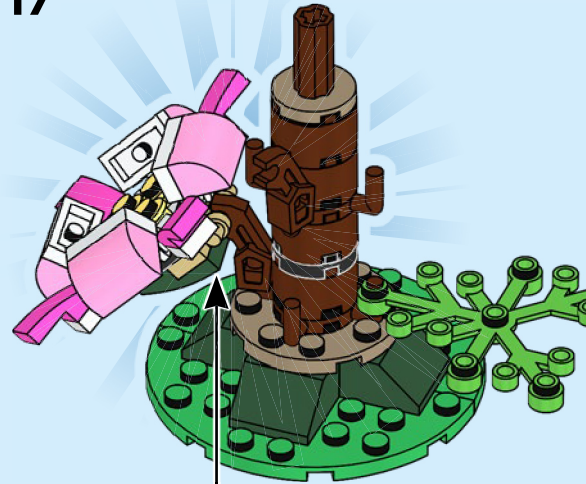



1x



18



4x

19





4x



4x

20

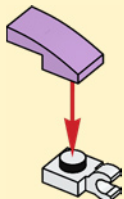

4x

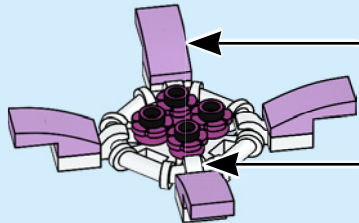

4x



4x

21

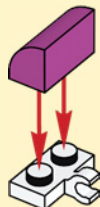

4x



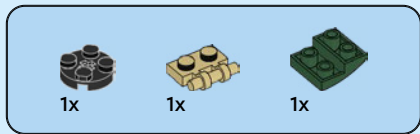

22

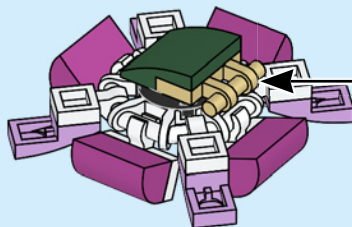
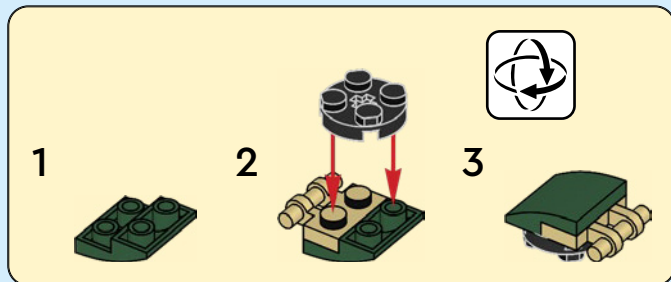

23

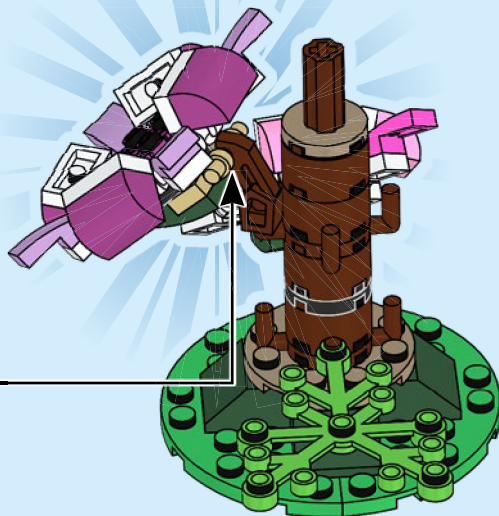



24

1



2

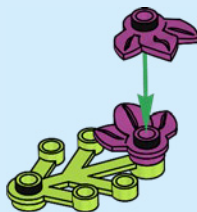

3



2x



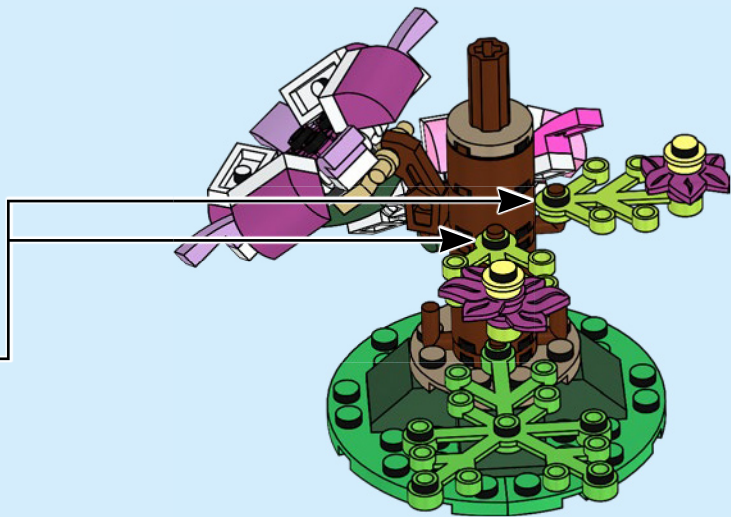



1x



1x

25

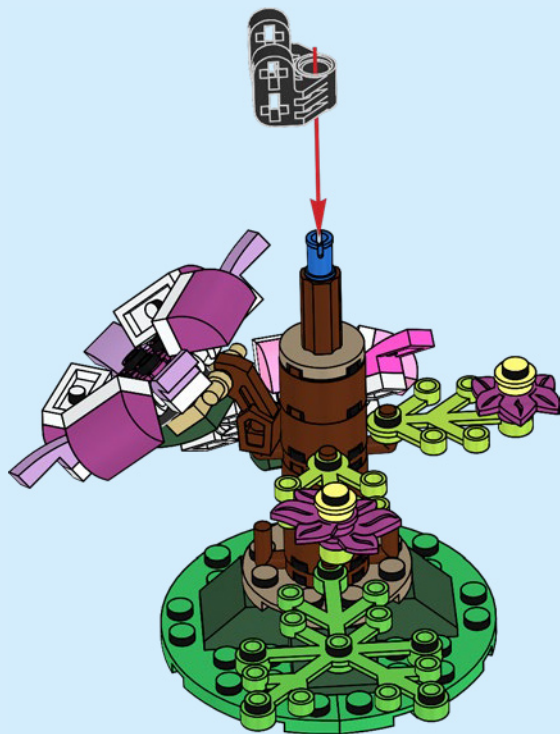



2x



1x



1x

26



4



4

1:1



1x

27

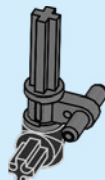



2x

28



2x

29

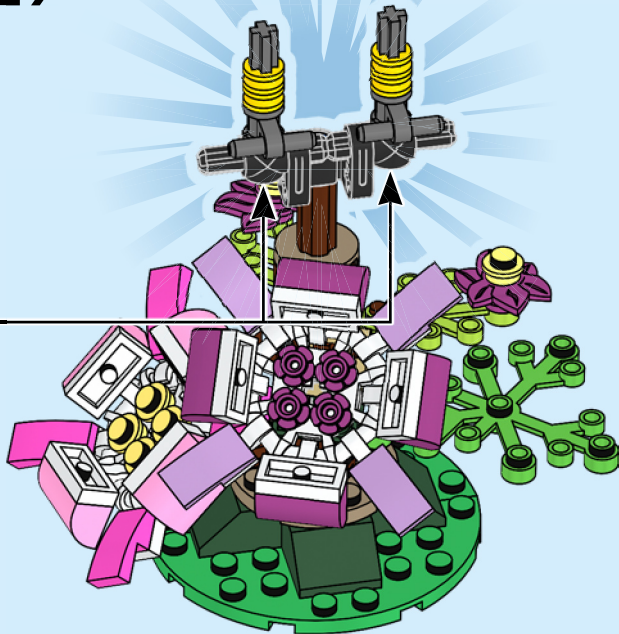



30

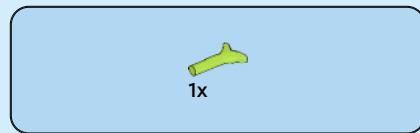
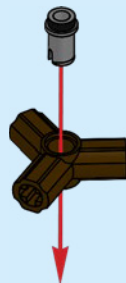

31

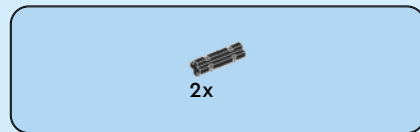

32





2x

33



2x

34

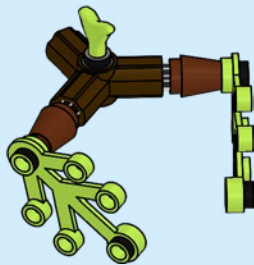



2x

35

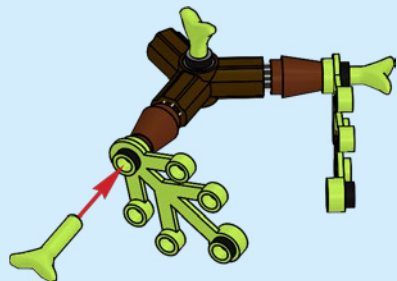

36

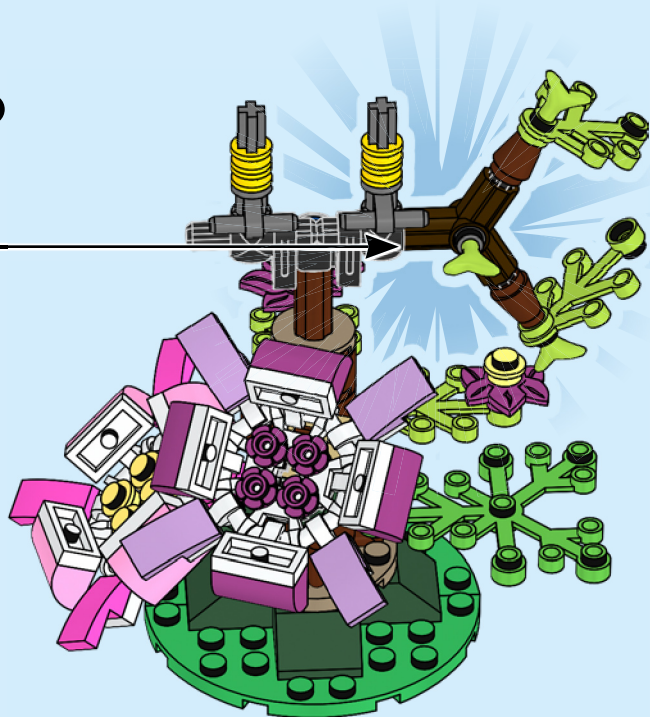



4x



4x

37



4x

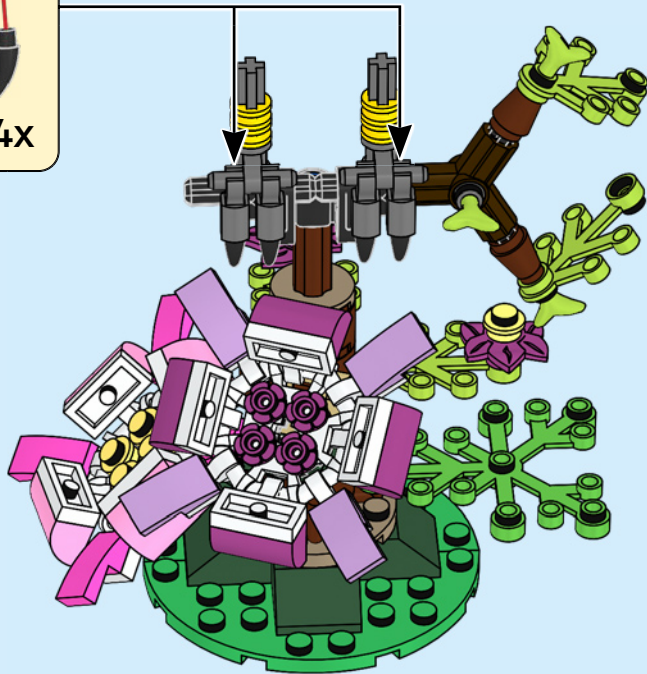



1x

38

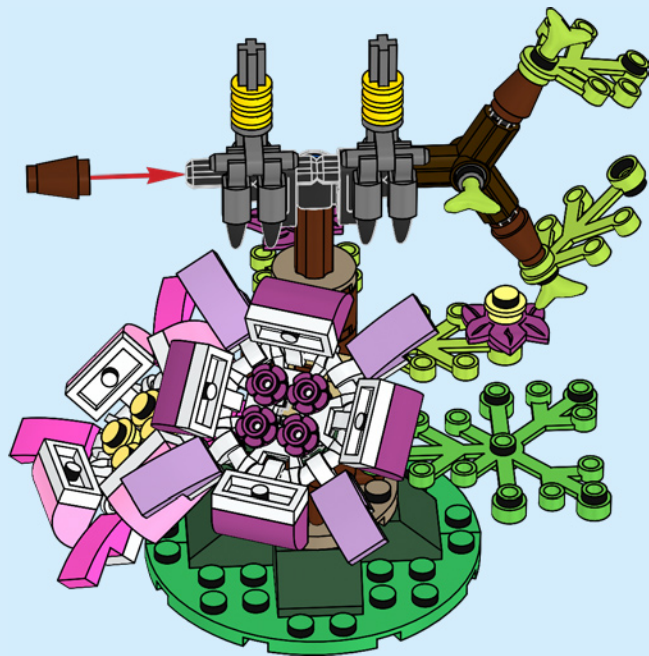

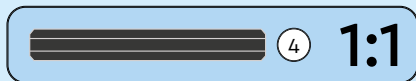
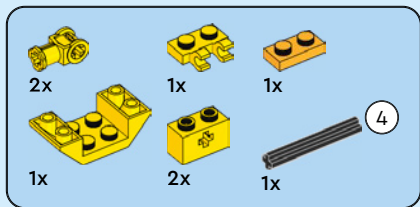

39

1

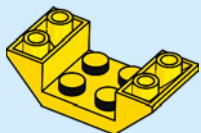

2



3

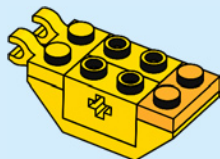

4

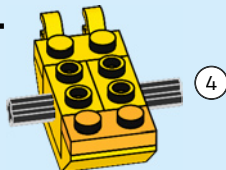

5

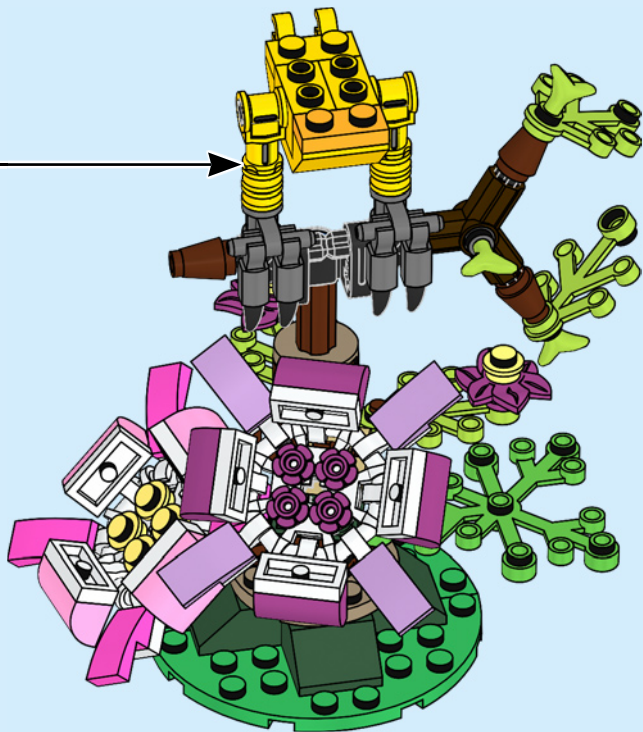
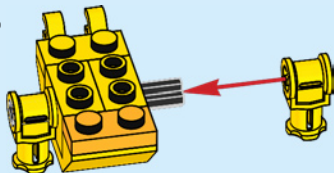

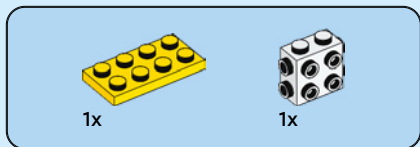
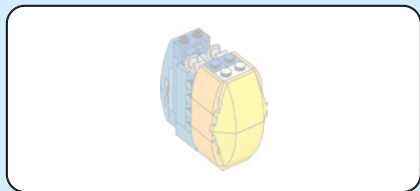

40

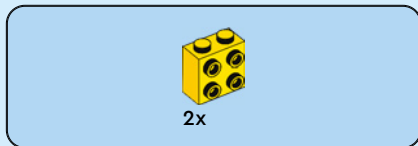
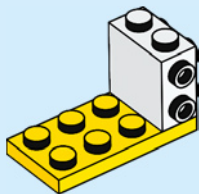

41

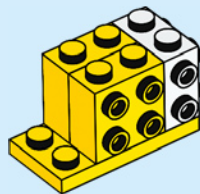



1x

42

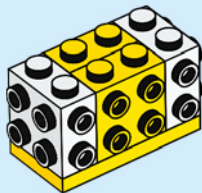

1x



1x

43

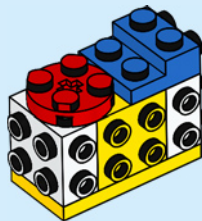



1x



1x

44

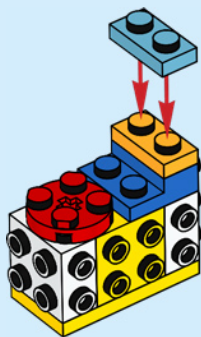

1x

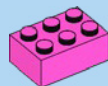

1x

45

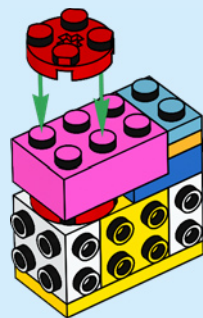

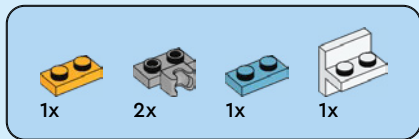

46

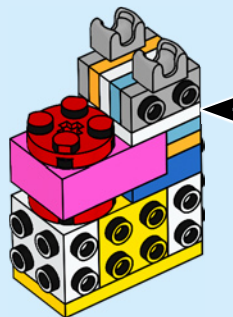
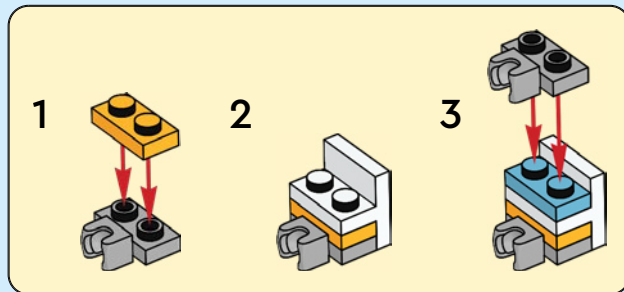

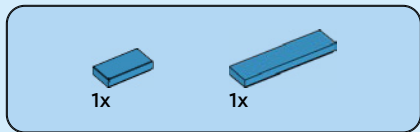

47

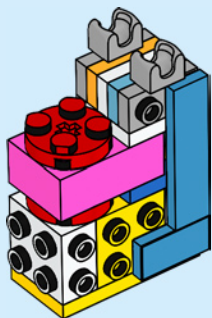

48

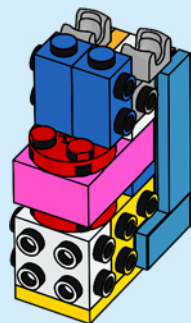



1x

49

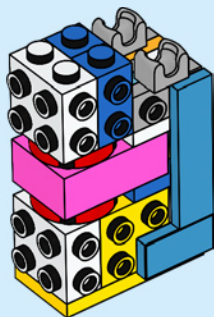

1x



1x

50

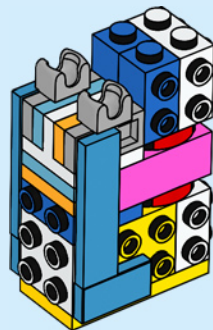

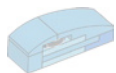

1x

51

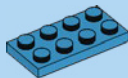
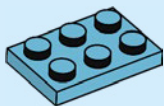

1x

52

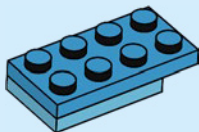

1x

53

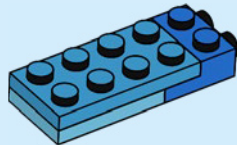



1x

54

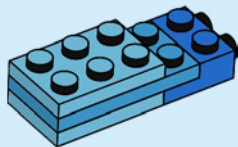

1x



1x

55

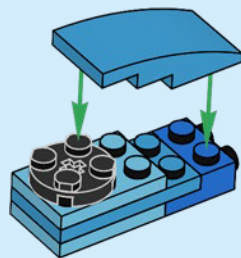

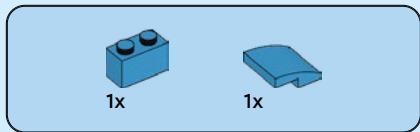

56

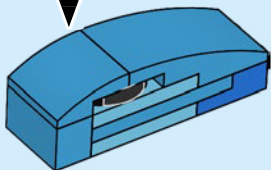
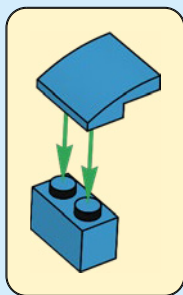

57

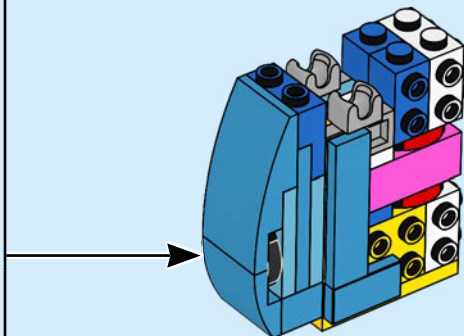

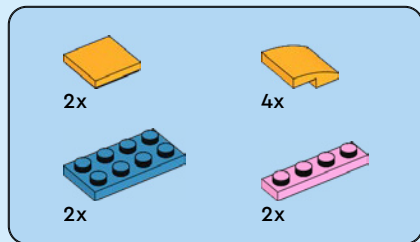

58

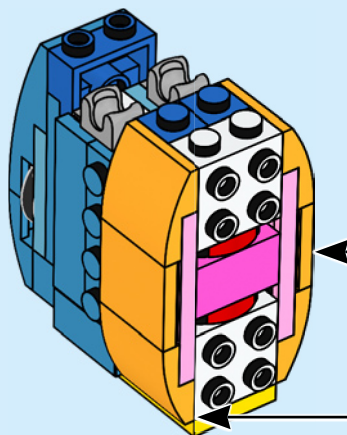
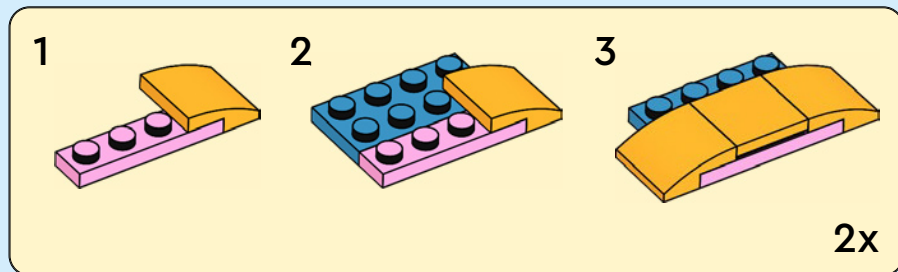

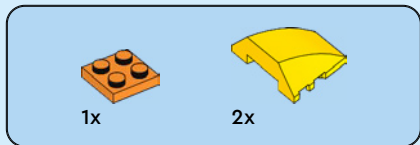

59

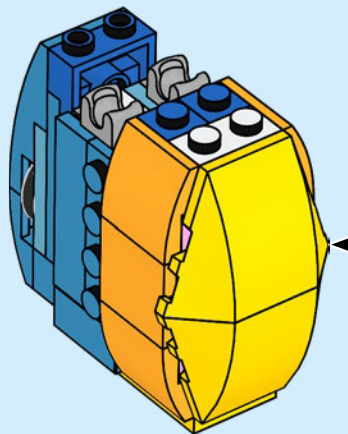
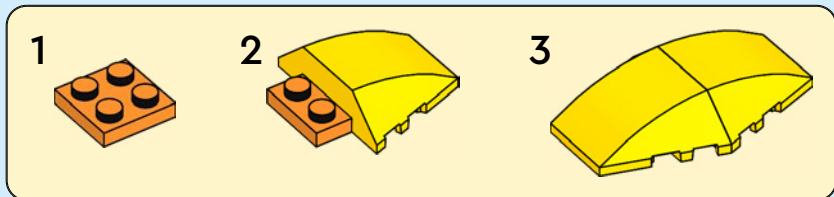

60

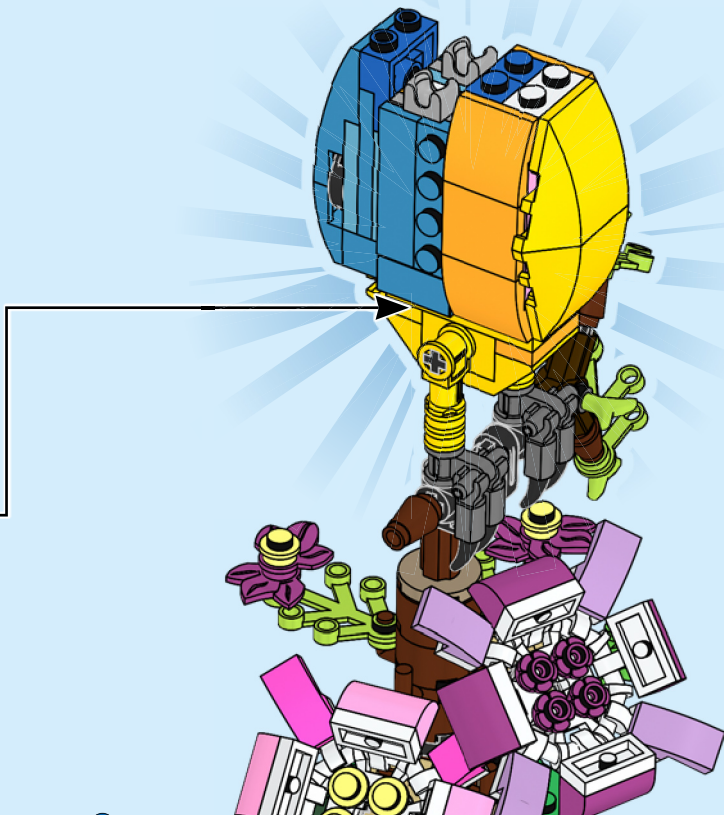

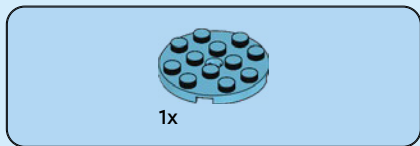
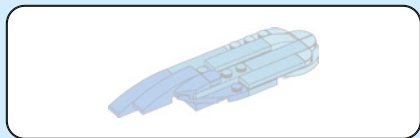

61

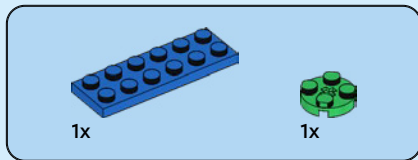

62

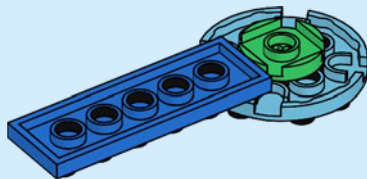

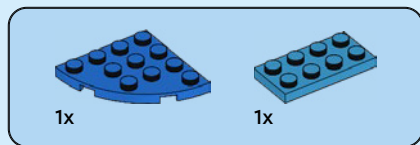

63

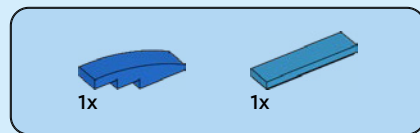
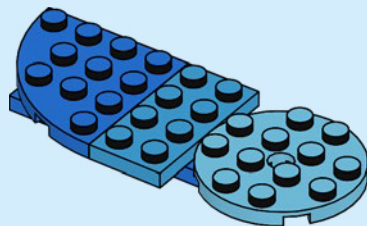

64

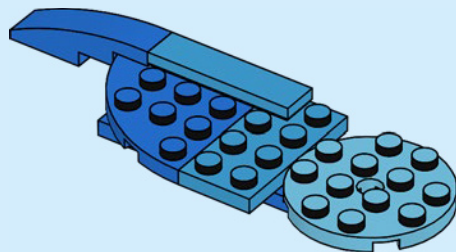

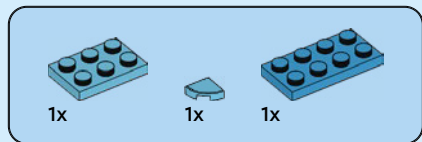

65

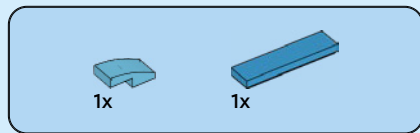
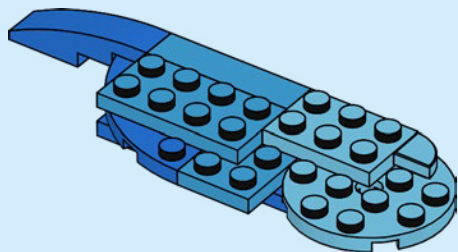

66

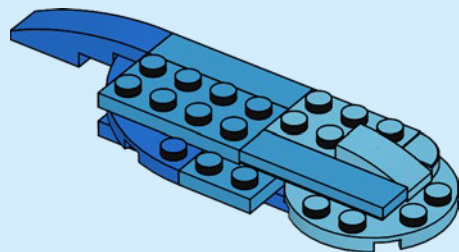



3x

67

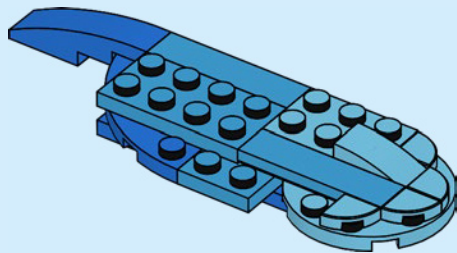

2x

68

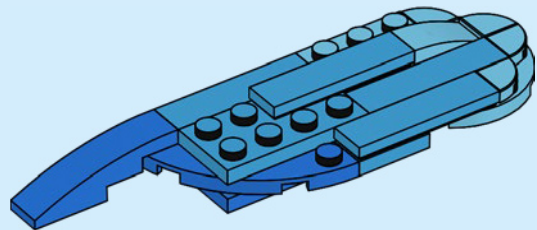



1x

69

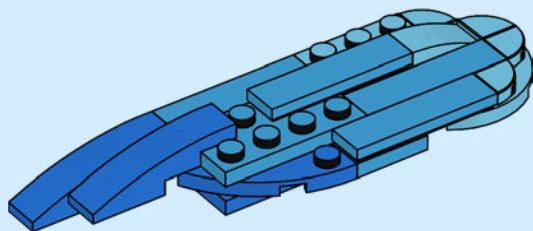

1x



1x

70

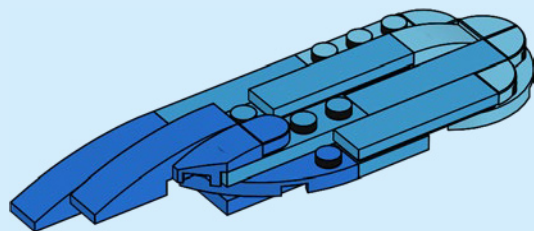



1x

71

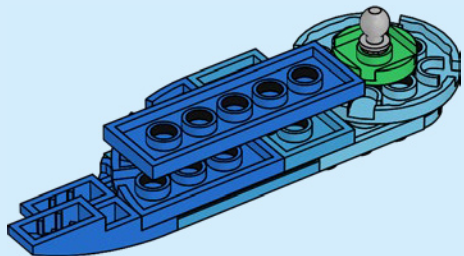

72

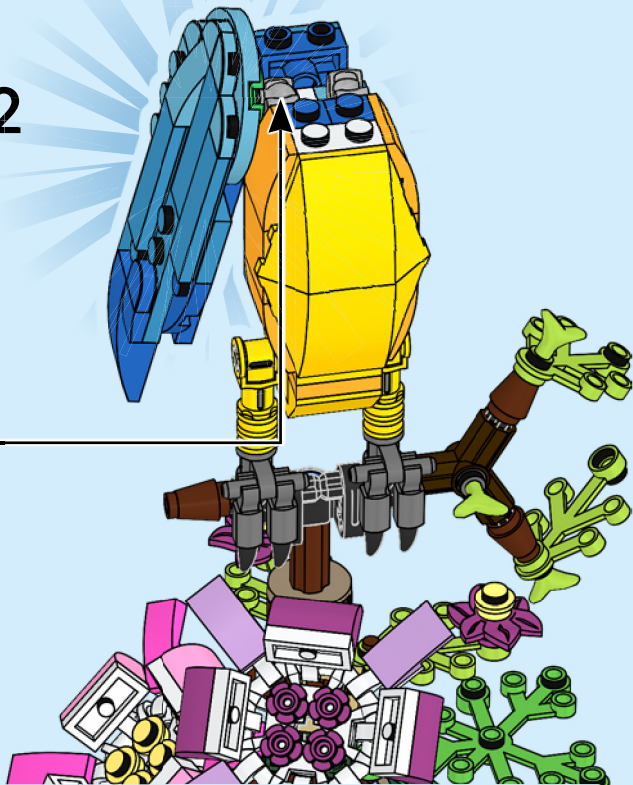

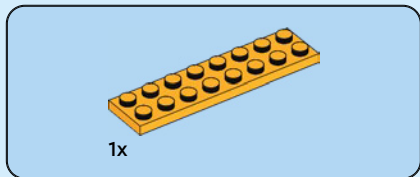
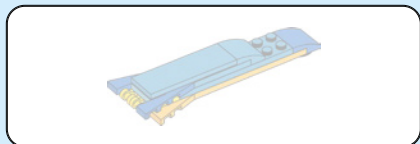

73

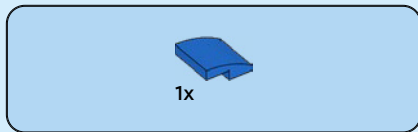
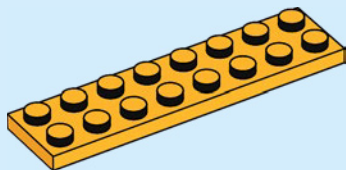

74

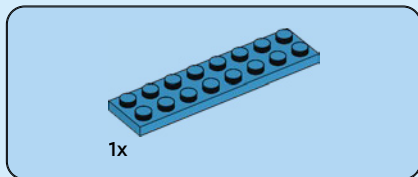
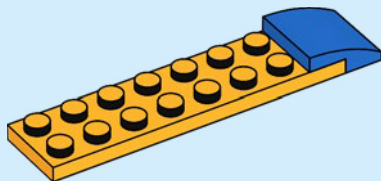

75

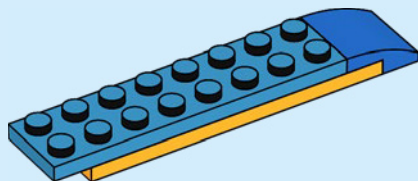



1x



1x

76

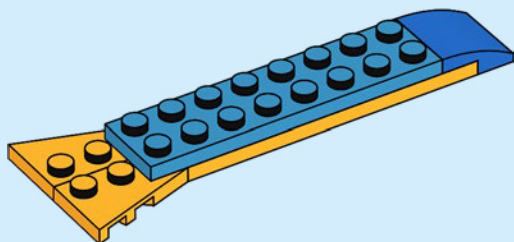

2x

77

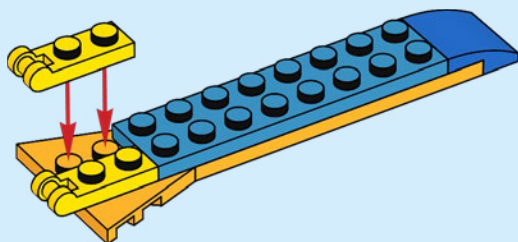

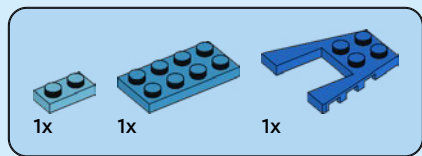

78

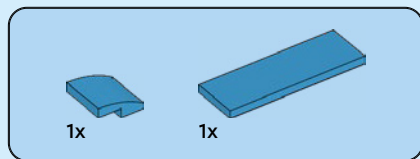
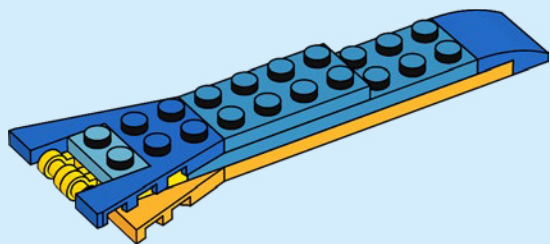

79

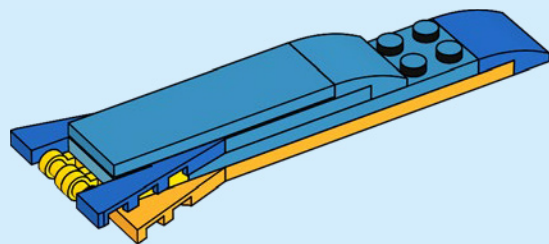



1x

80

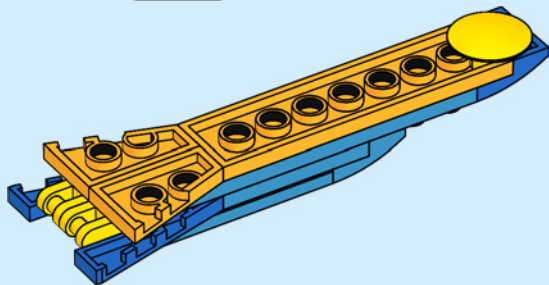

81

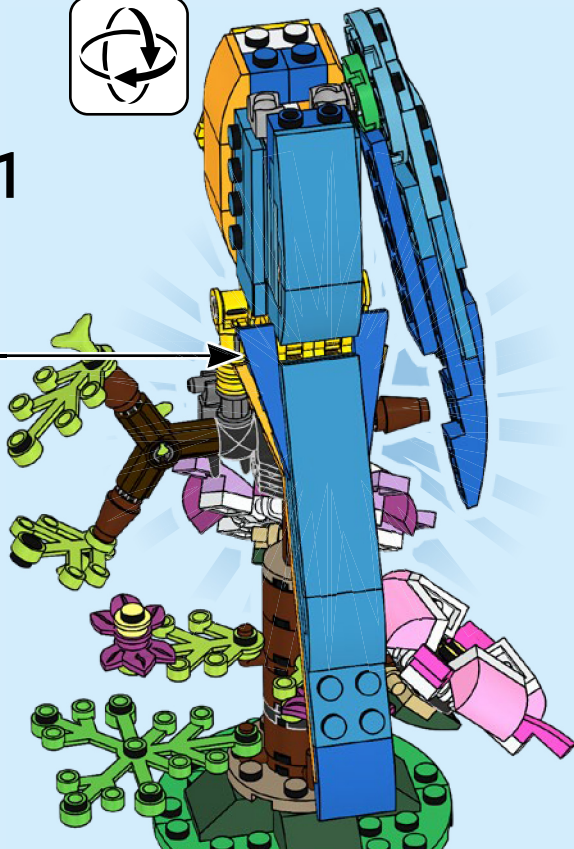

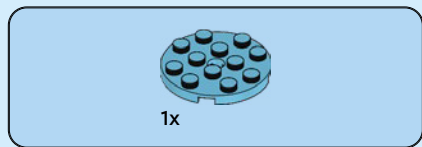
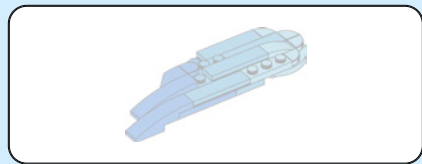

82

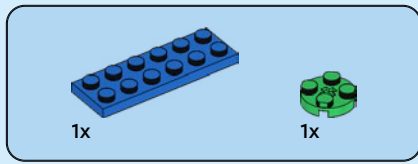
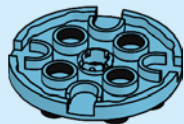

83

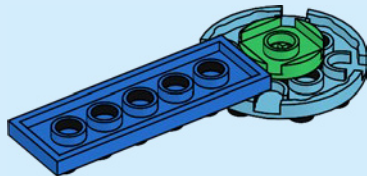

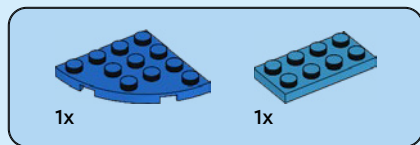

84

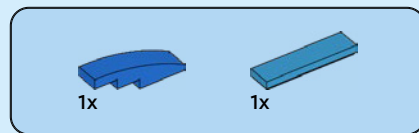
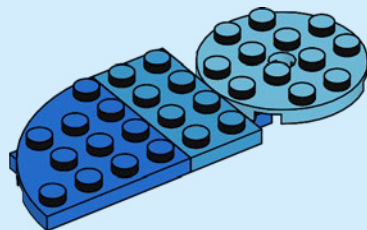

85

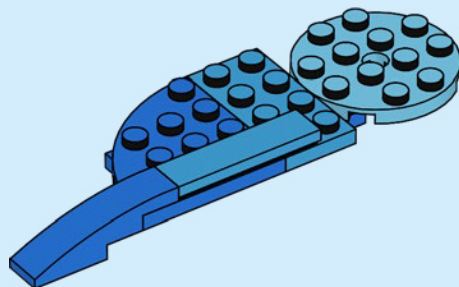

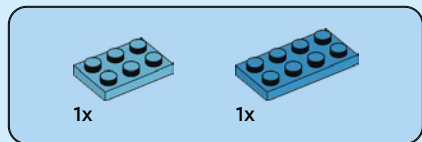

86

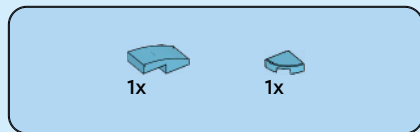
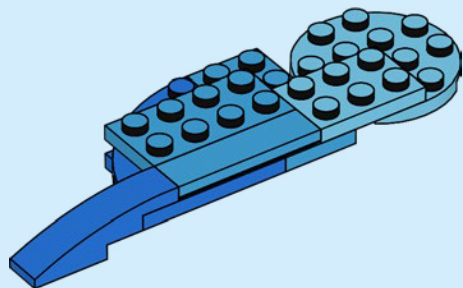

87

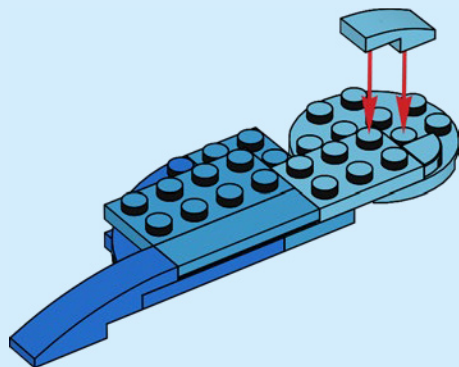



2x

88

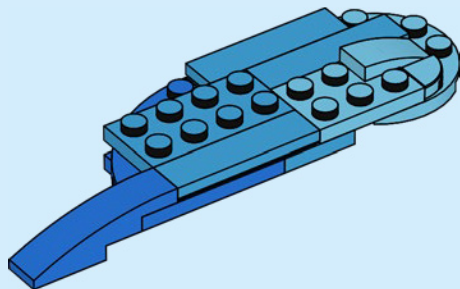

3x

89

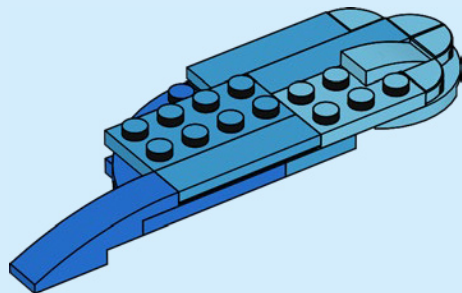



1x



1x

90

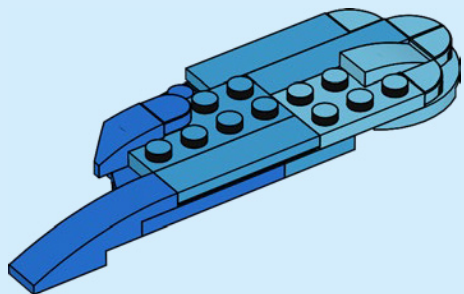

1x



1x

91

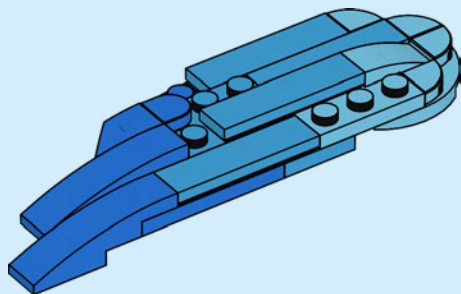



1x

92

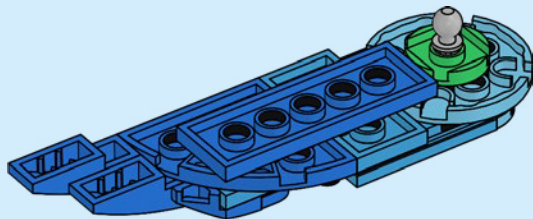

93

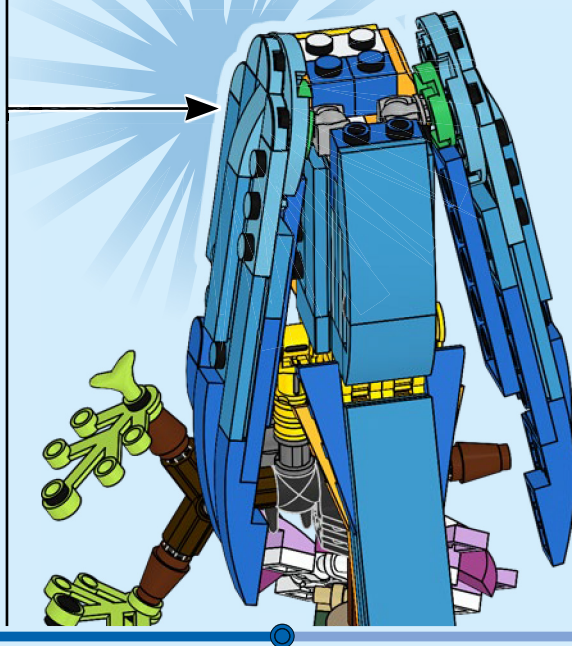

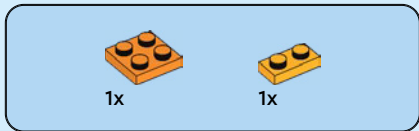
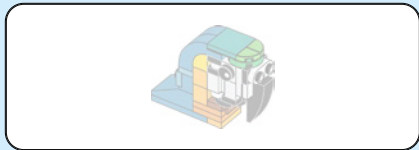

94

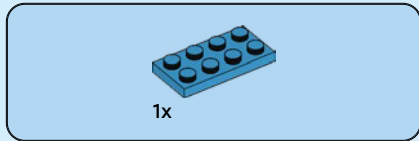
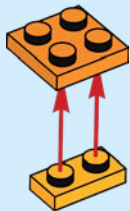

95

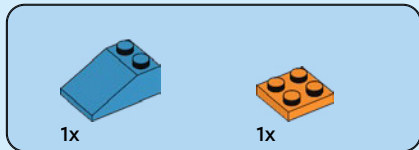
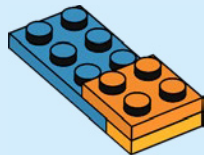

96

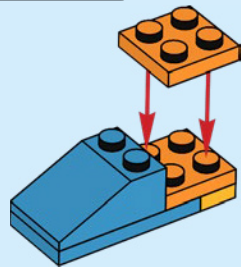



2x

97

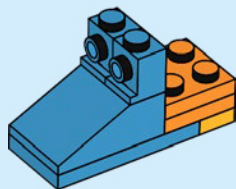

1x

98

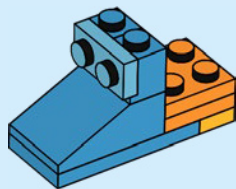

1x



1x

99

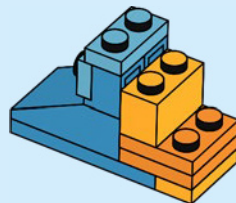

1x



1x

100

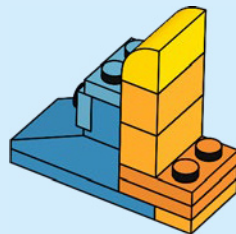

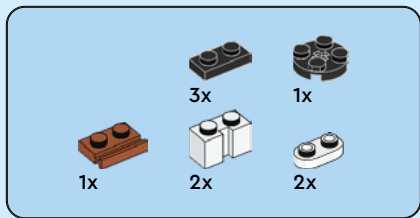

101

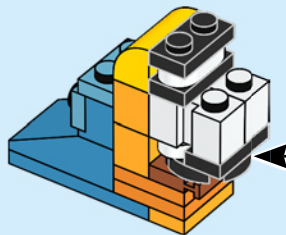
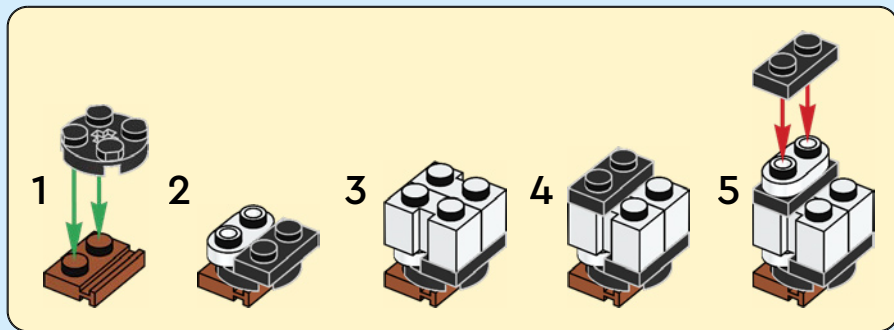



2x

102

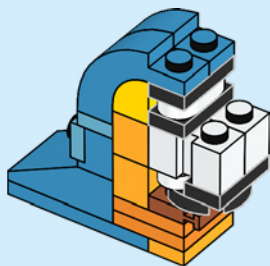

2x

103

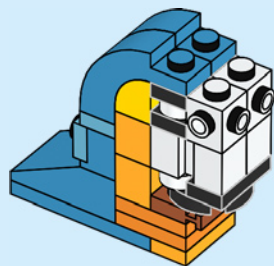



2x

104

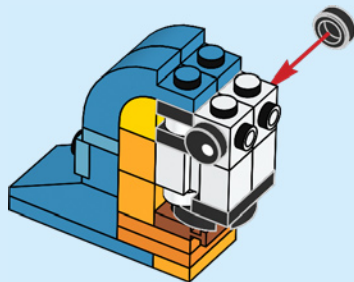

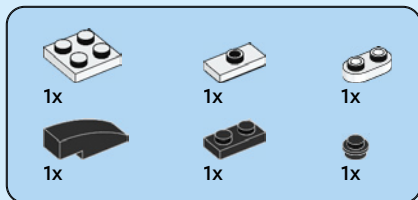

105

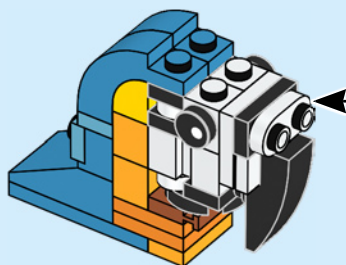
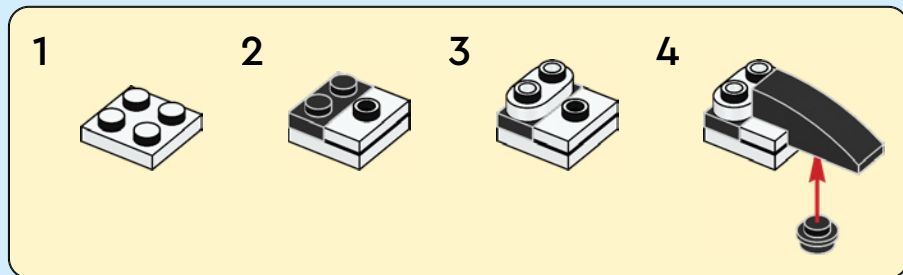



1x



1x

106

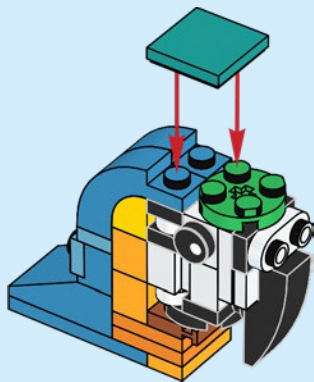

2x

107

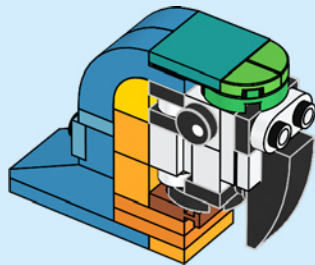

108

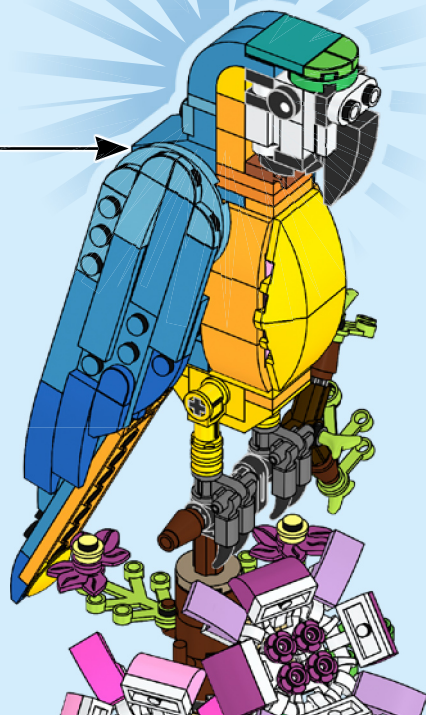
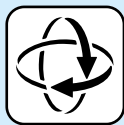

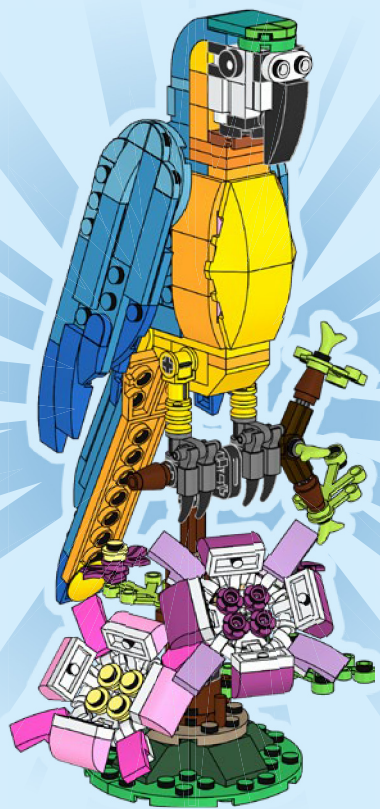



CREATOR™

3 IN 1

31137



31139



31138



31136

31135



31134



31140



YOU COULD **WIN**



Scan this QR code or go to **LEGO.COM/PRODUCTFEEDBACK** and give us your short feedback about this LEGO® set for a chance to win a cool LEGO prize.

Terms and Conditions apply*



DE: Du könntest GEWINNEN. Es gelten die Teilnahmebedingungen* **FR: Tu pourrais GAGNER.** Des conditions s'appliquent* **IT: Potresti VINCERE tu.** Termini e condizioni sono applicabili* **ES: Puedes GANAR.** Aplican términos y condiciones* **PT: Poderá GANHAR.** Aplicam-se termos e condições* **JA: プレゼント付き! 利用規約が適用されます*** **ZH: 轻松获奖. 条款和条件适用*** **KO: 상품의 주인이 되어보세요. 소정의 약관이 적용됩니다*** **RU: Вы можете ВЫИГРАТЬ.** Действуют положения и условия* **PL: Szansa na WYGRANĄ.** Obowiązują warunki korzystania* **CS: Máte šanci VYHRÁT.** Platí všeobecné smluvní podmínky* **SK: Máte šancu VYHRAŤ.** Platia všeobecné zmluvné podmienky* **HU: TE IS NYERHETSZ.** Felhasználási feltételek érvényesek* **RO: Ai putea CÂȘTIGA.** Se aplică termeni și condiții* **BG: Можете да СПЕЧЕЛИТЕ.** Има определени правила и условия* **LV: Tu vari LAIMĒT.** Ir spēkā noteikumi un nosacījumi.* **ET: Sul on võimalus VÕITA.** Kehtivad tingimused* **LT: Jūs galite LAIMĖTI.** Taikomos sąlygos*
*LEGO.com/productfeedback-terms