



# CREATOR™



31149



Q LEGO® Builder



### **Get excited about our new packaging!**

We're switching from plastic to paper-based packaging. That's why you might find a mix of paper and plastic in our boxes!

### **Nos nouveaux emballages vous emballeront !**

Nous passons des emballages en plastique aux emballages à base de papier. C'est pourquoi vous pourriez trouver un mélange de papier et de plastique dans nos boîtes !

### **¡Te presentamos nuestros nuevos empaques!**

Estamos sustituyendo las bolsas de plástico por bolsas con base de papel. ¡Por eso, puedes encontrar una mezcla de papel y de plástico en nuestras cajas!

**[LEGO.com/sustainable-packaging](https://www.lego.com/sustainable-packaging)**

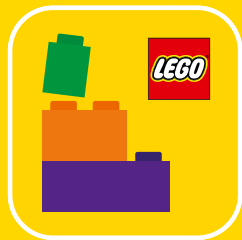

Q LEGO® Builder

# BUILDER



Apple and the Apple logo are trademarks of Apple Inc., registered in the U.S. and other countries and regions. App Store is a service mark of Apple Inc. Google Play and the Google Play logo are trademarks of Google LLC. Tencent and the Tencent logo are trademarks of Tencent Inc.

Q [LEGO.com/devicecheck](https://lego.com/devicecheck)

**EN** Ask parents' permission before going online | **DE** Eltern um Erlaubnis bitten, bevor du online gehst | **FR** Demande l'autorisation d'un parent avant d'aller en ligne | **IT** Chiedi il permesso ai tuoi genitori prima di andare online | **ES** Pídeles permiso a tus papás antes de conectarte a Internet | **PT** Pede autorização aos pais antes de acederes online | **ZH** 上网前应先征得父母的同意 | **PL** Poproś rodziców o zgodę, zanim wejdziesz do Internetu | **CS** Než půjdeš na internet, požádej rodiče o svolení | **SK** Skôr než pôjdeš na internet, vypýtaj si povolenie od rodičov | **HU** Kérj szülői engedélyt, mielőtt online csatlakoznál! | **RO** Cere permisiunea părinților înainte de a te conecta online | **BG** Поискайте разрешение от родител, преди да влезете онлайн | **LV** Pirms došanās tiešsaistē palūdz atļauju vecākiem | **ET** Enne Interneti kasutamist küsi vanematelt luba | **LT** Prieš prisijungdami prie interneto, atsiklauskite tėvų

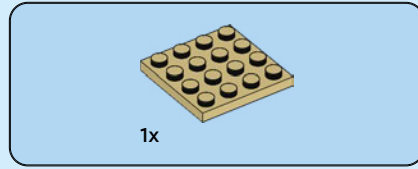

1

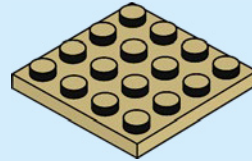

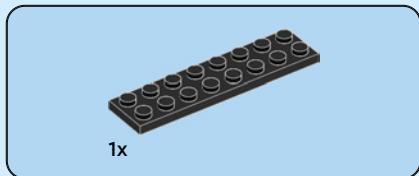

2

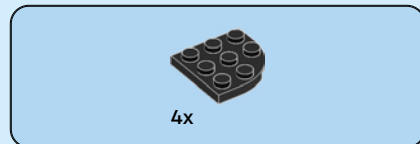
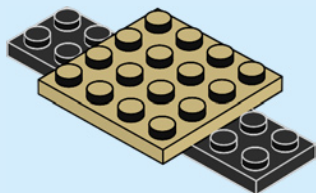

3

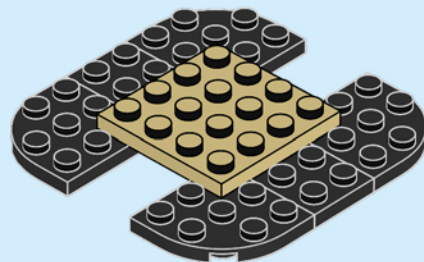



2x

4

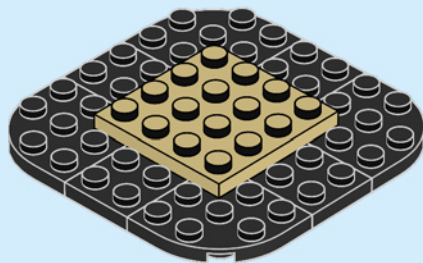

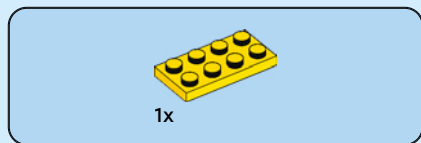

5

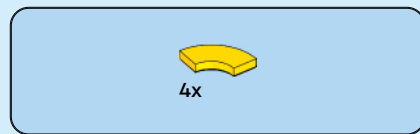
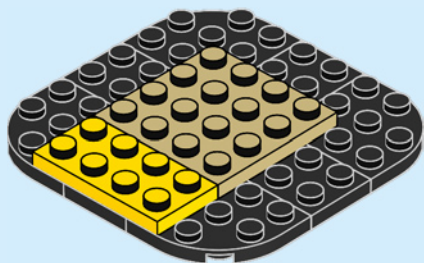

6

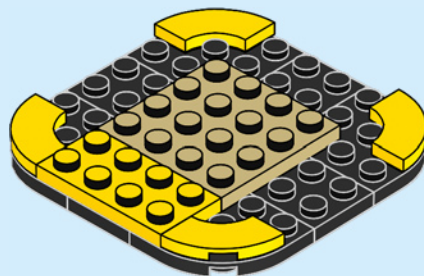



6x

7

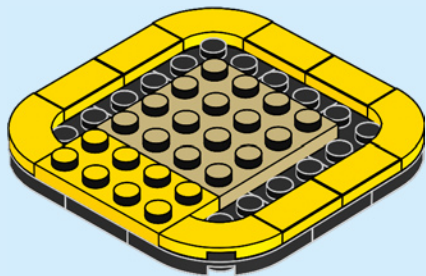



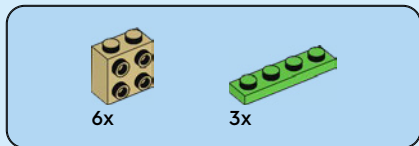

8

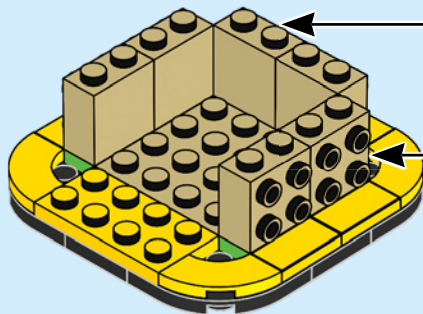
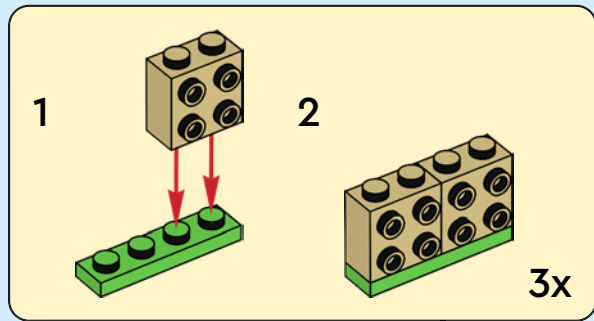

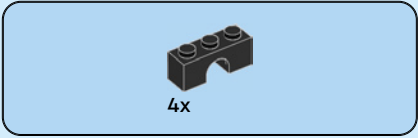

9

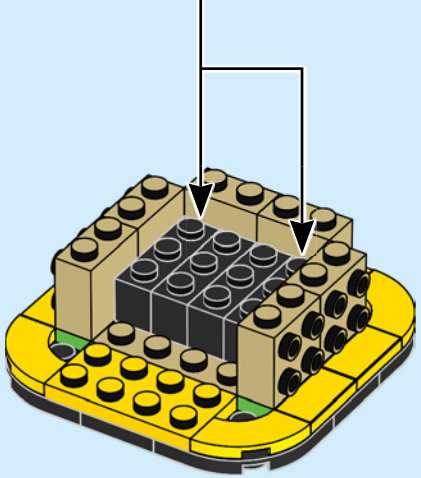
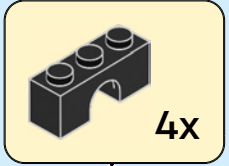



1x



2x

10

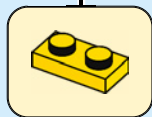
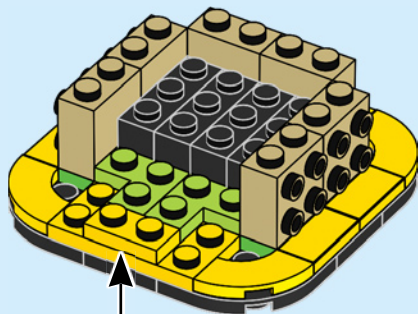

2x



2x

11

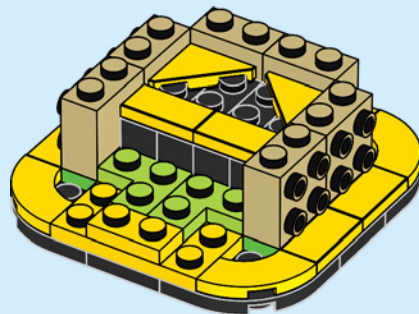



2x

12

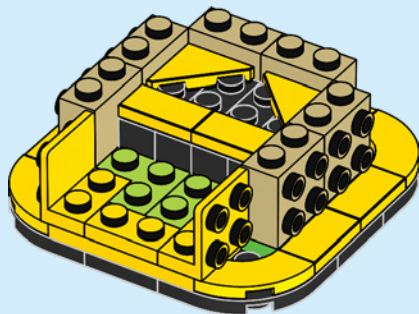



2x

13

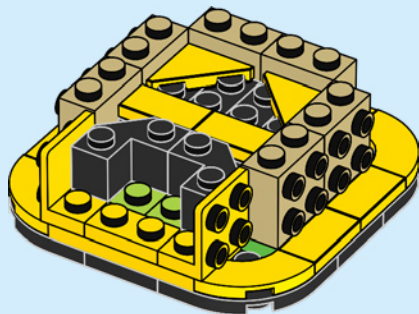

1x

14

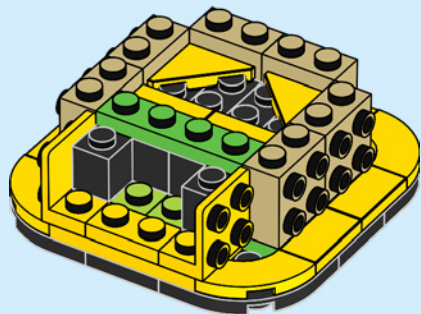

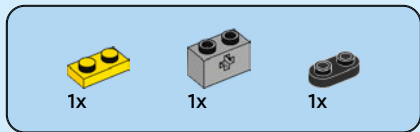

15

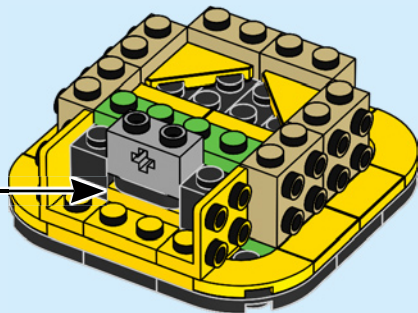
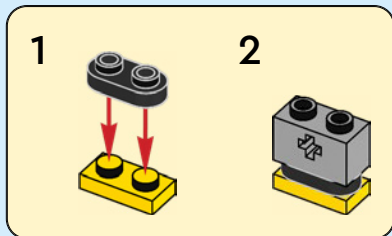



2x

16

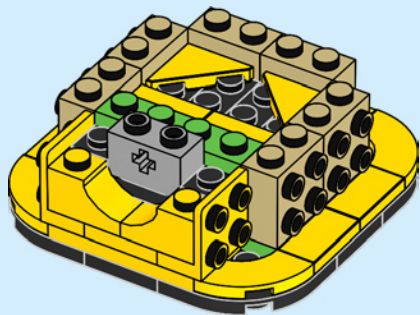

2x

17

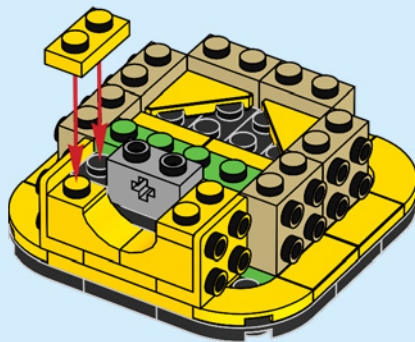

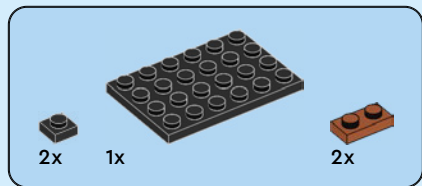

18

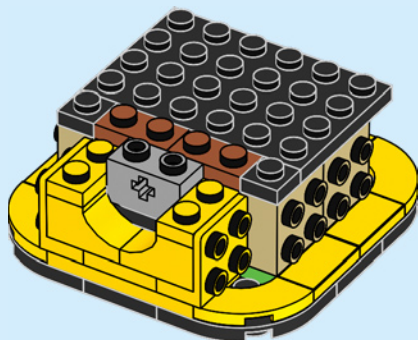



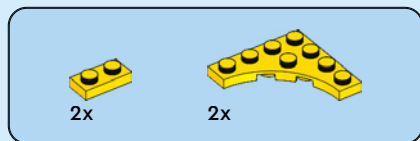

19

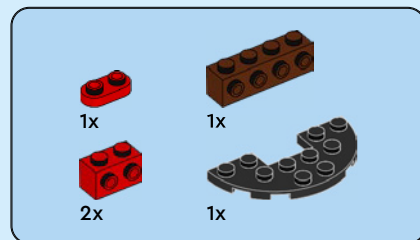
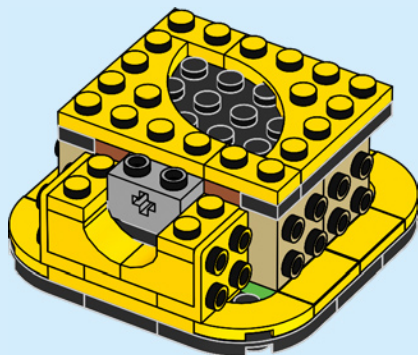

20

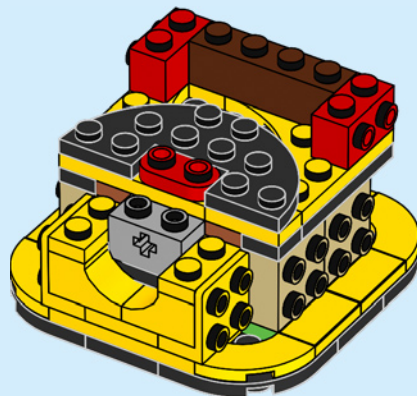



1x



2x

21

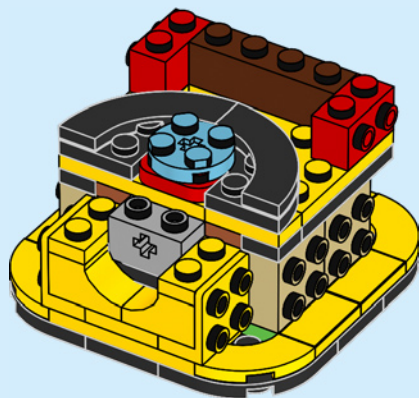

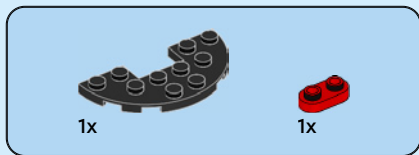

22

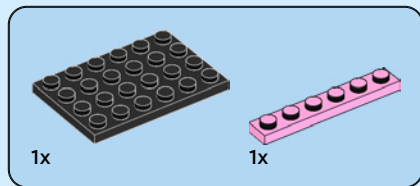
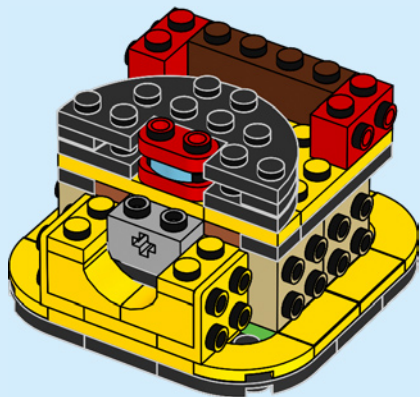

23

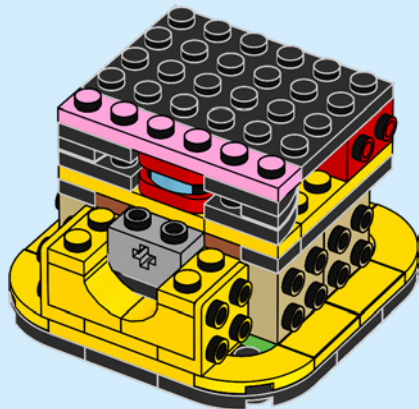



2x

24

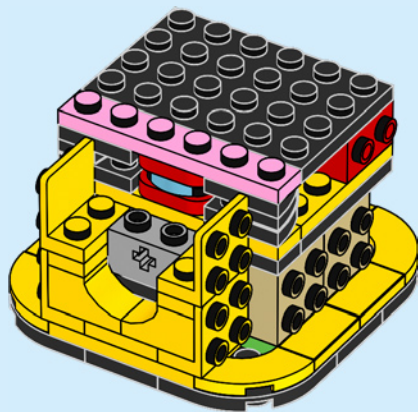

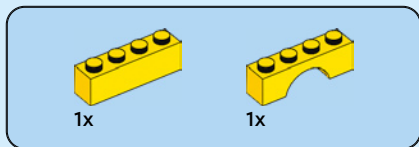

25

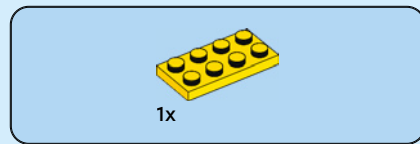
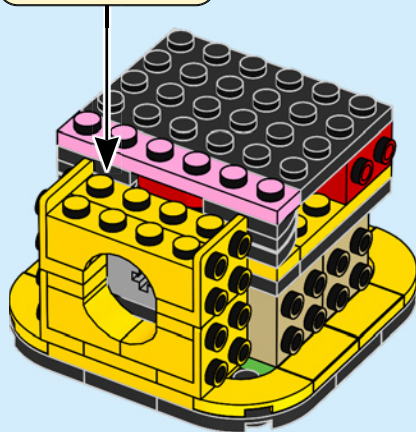
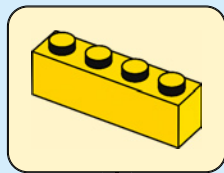

26

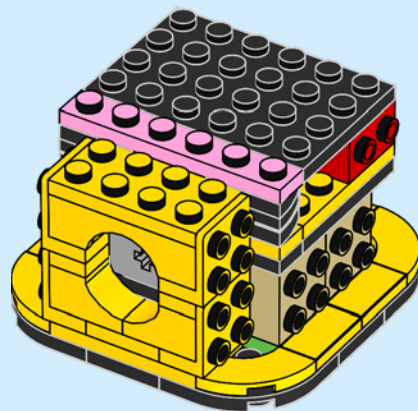



1x



1x



2x

27

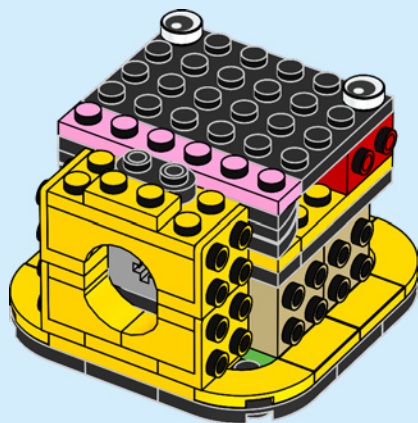

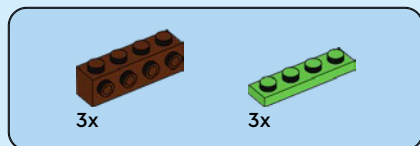

28

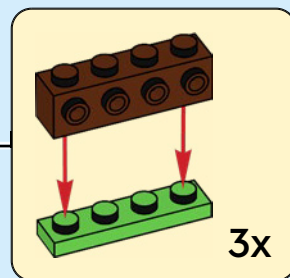
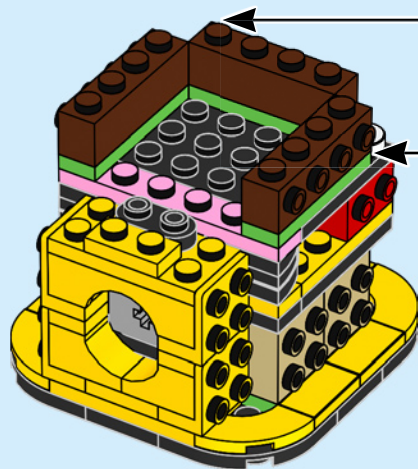



2x

29

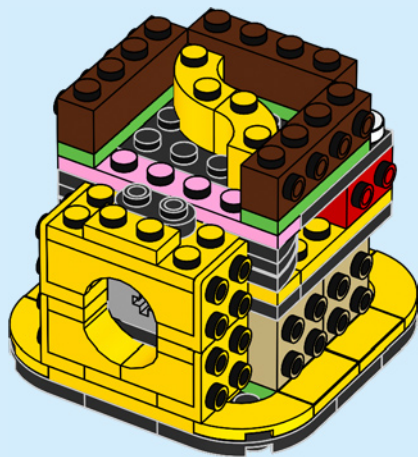





2x



2x

30

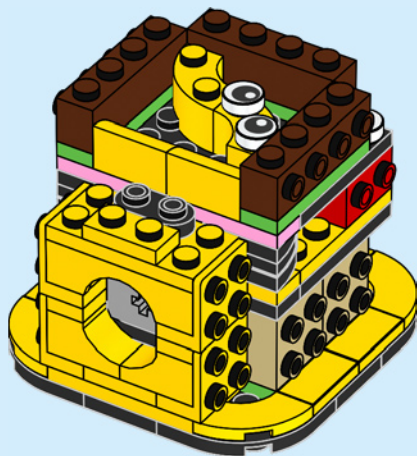

2x

31

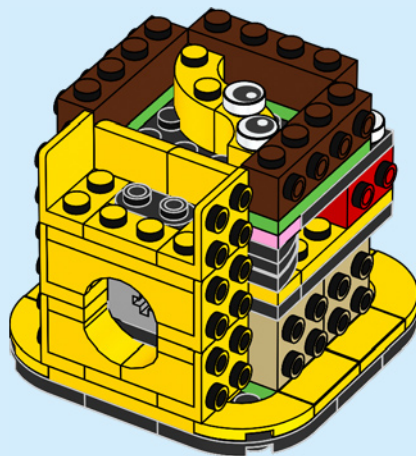

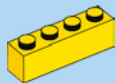

2x

32

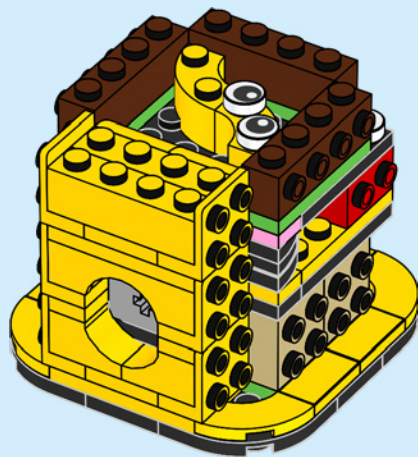

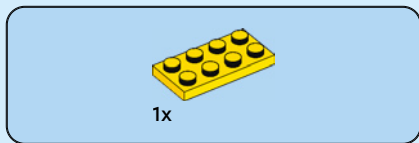

33

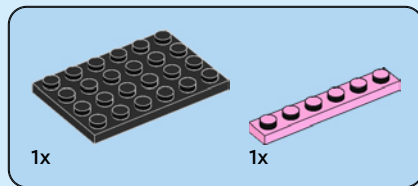
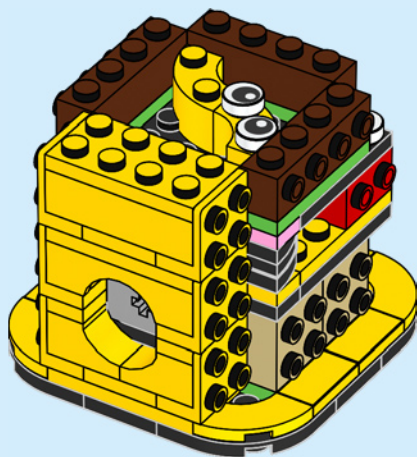

34

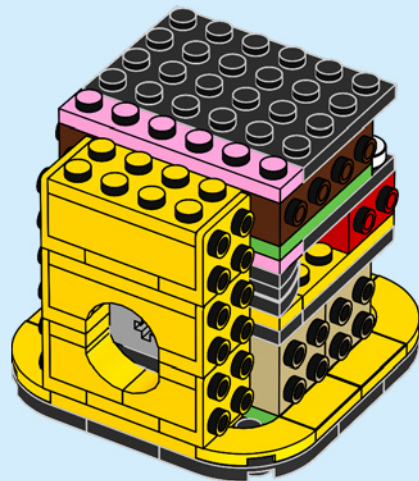



2x

35

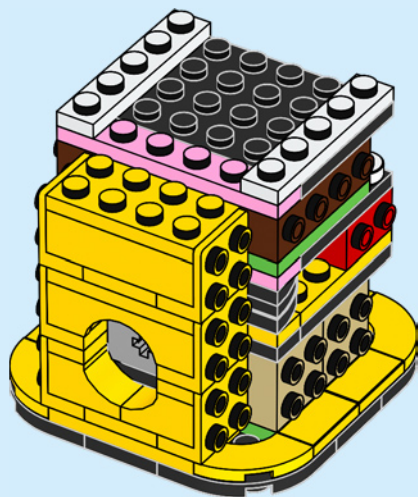

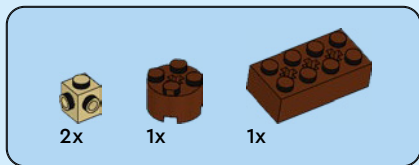

36

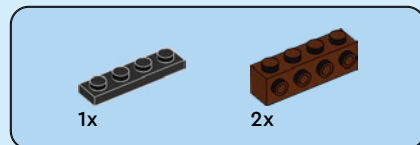
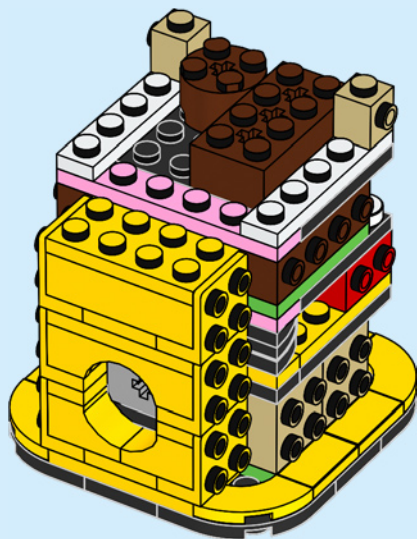

37

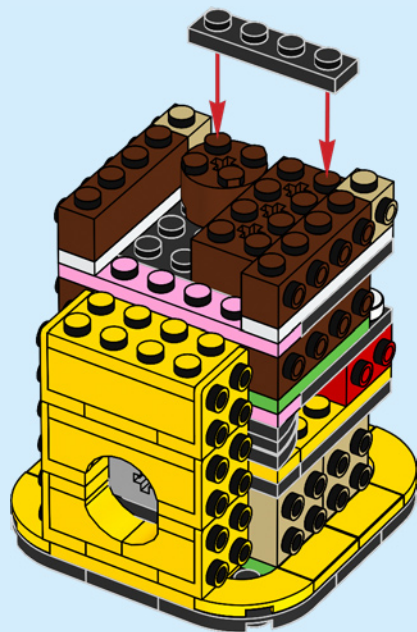



2x



2x

38

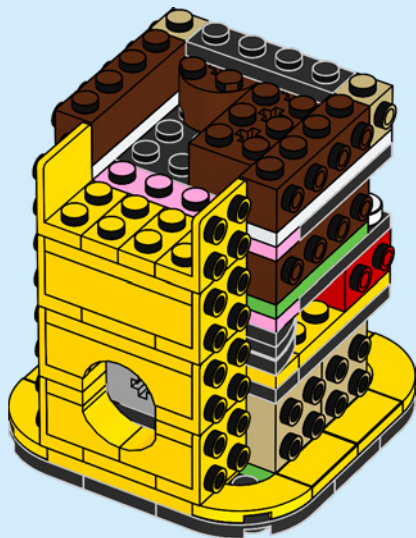

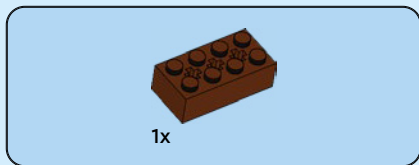

39

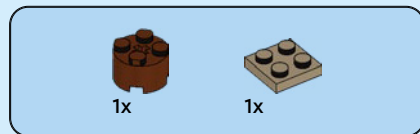
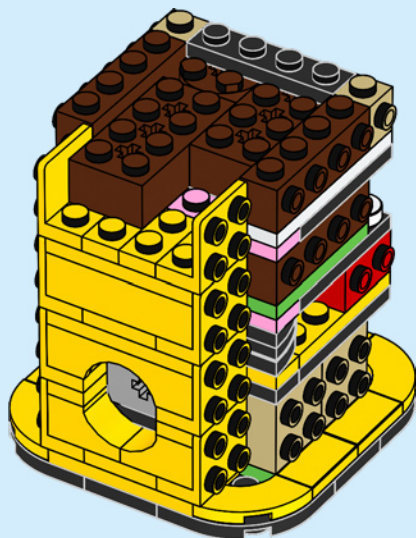

40

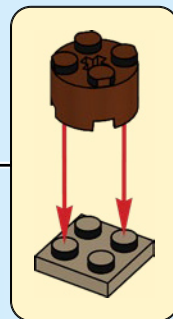
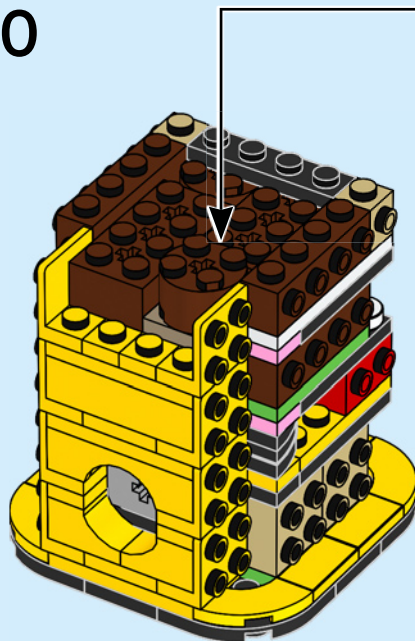

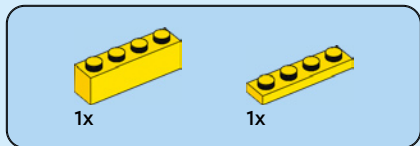

41

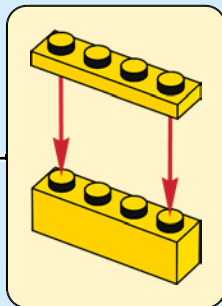





3x



2x

42



2x

43

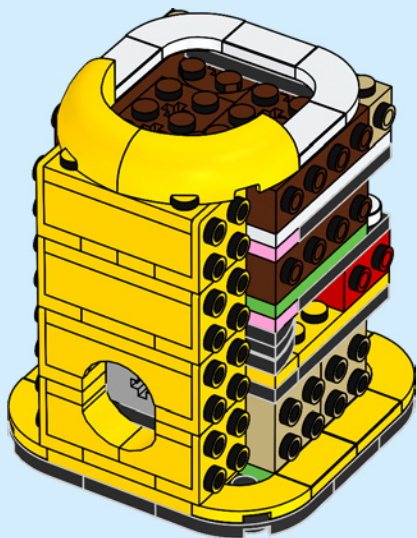



44

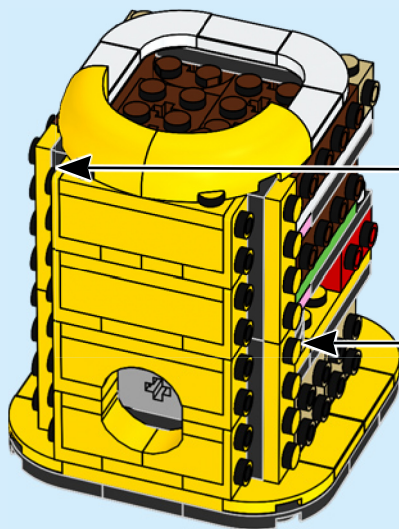
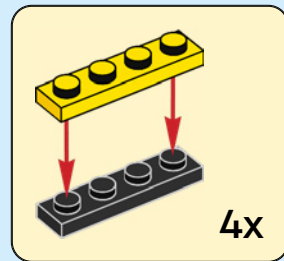



8x

45



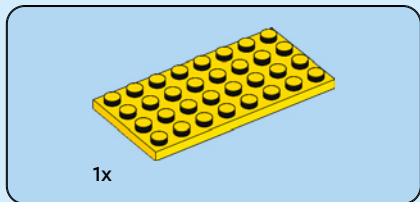
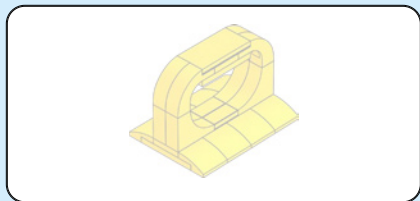

46

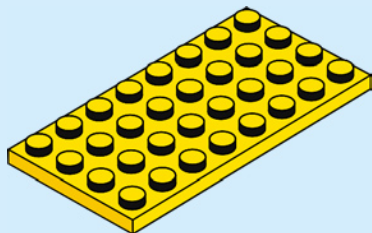

47

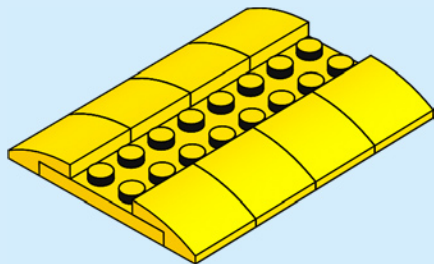

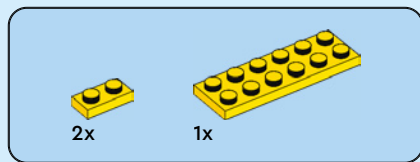

48

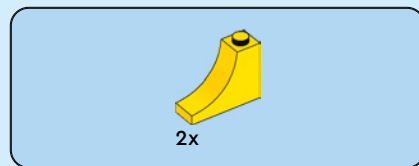
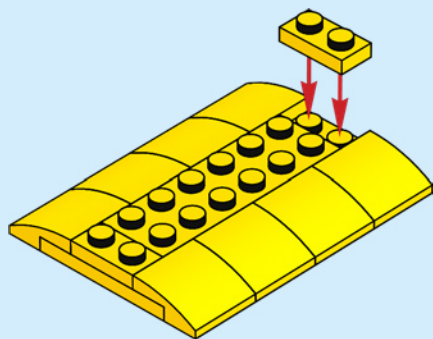

49

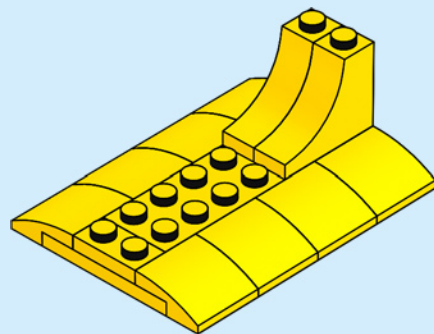



2x

50

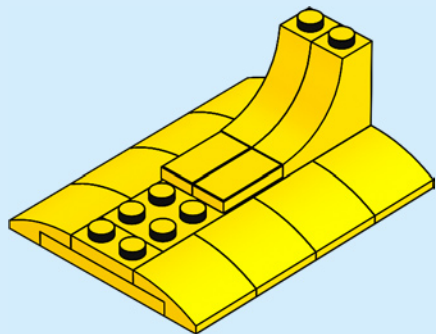

2x

51

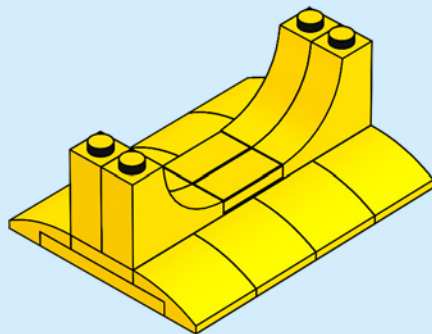

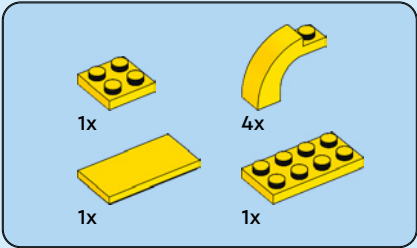
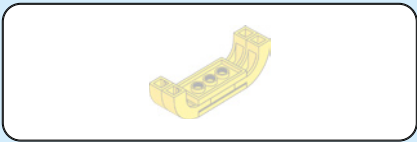

52

1

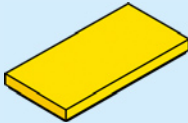

2

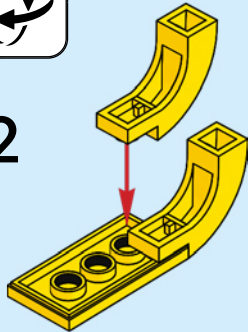

3

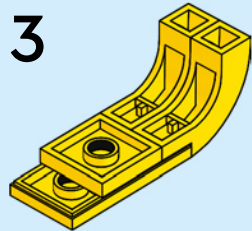

4

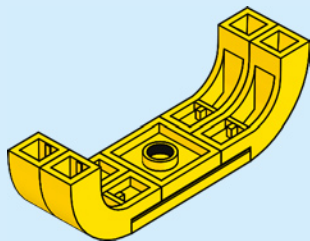

5

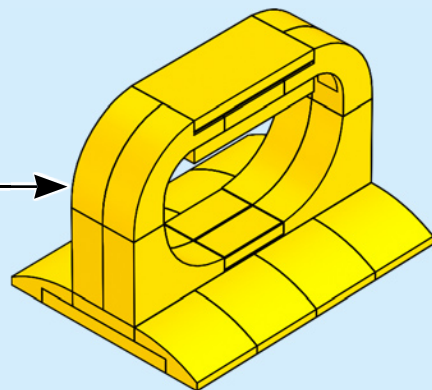
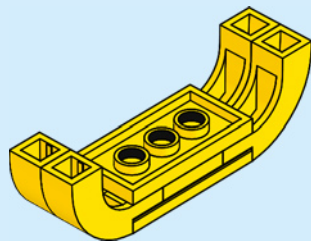



53

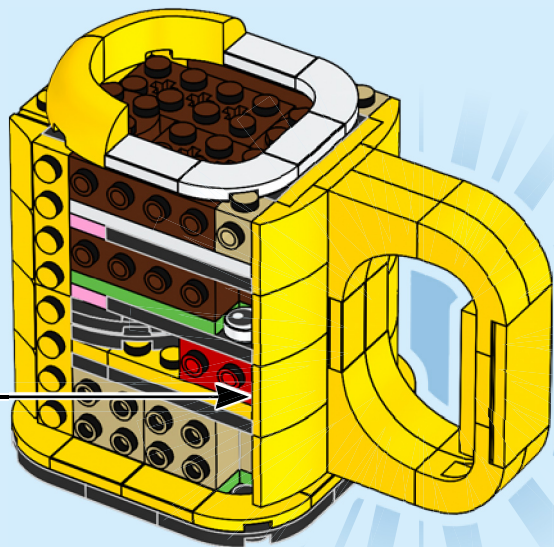

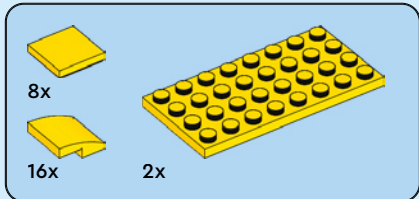
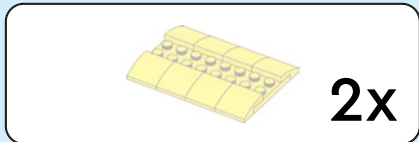

54

1

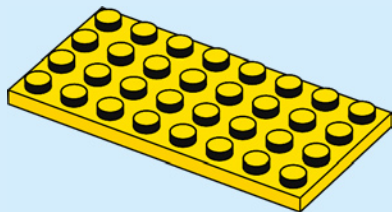

2

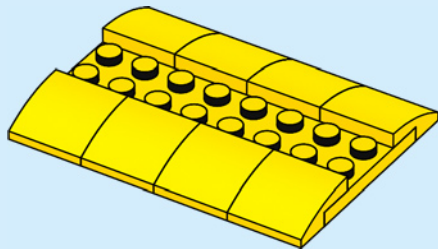

3

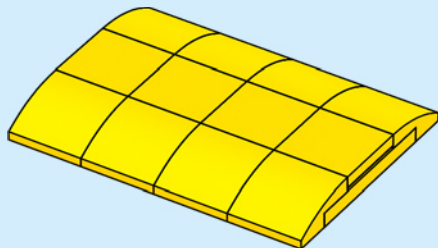

2x

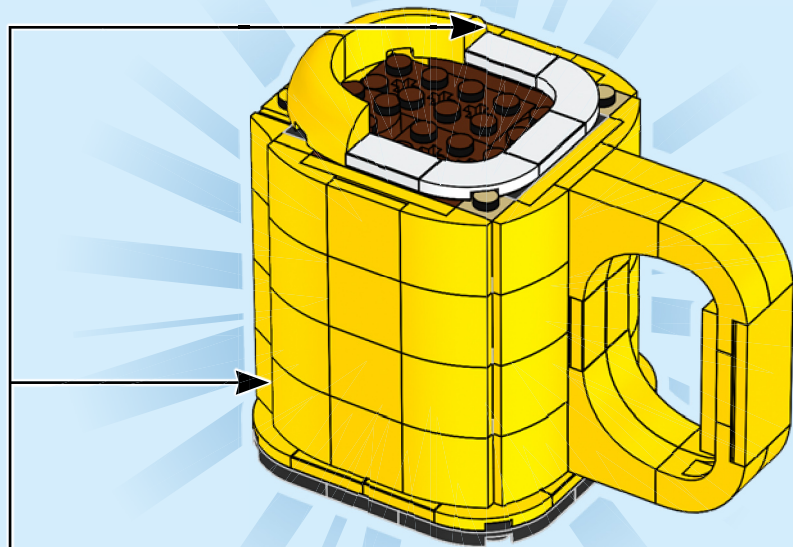

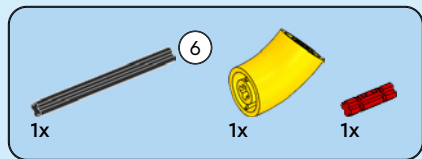

55

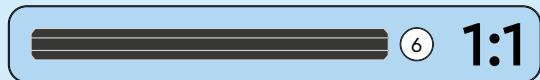
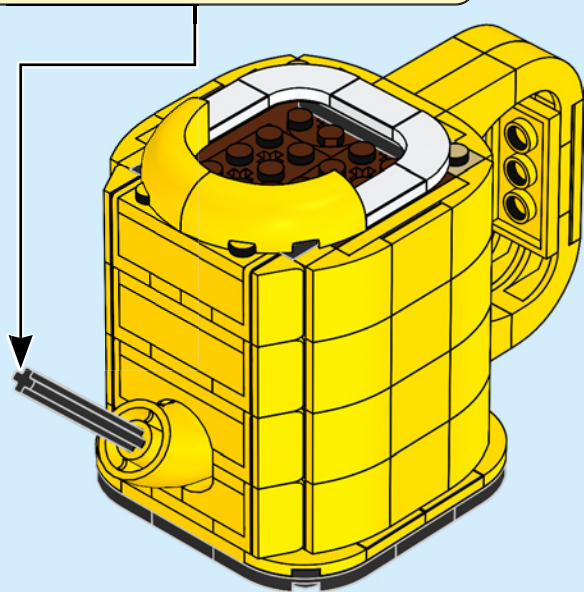
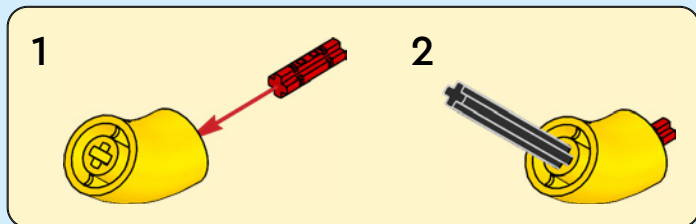

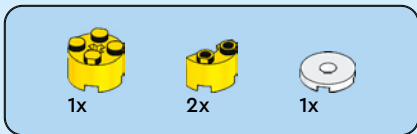

56

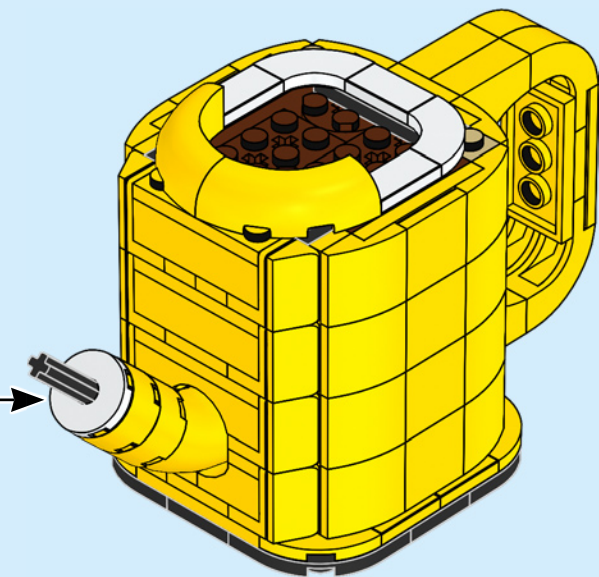
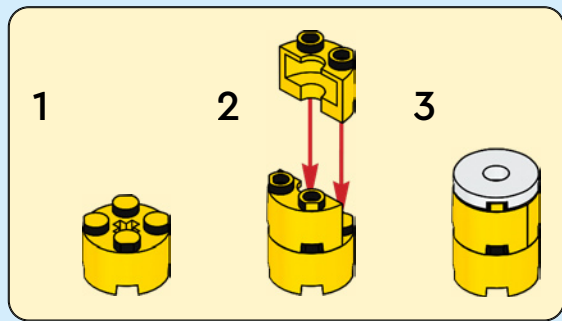

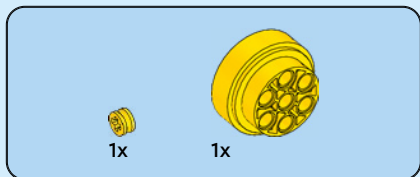

57

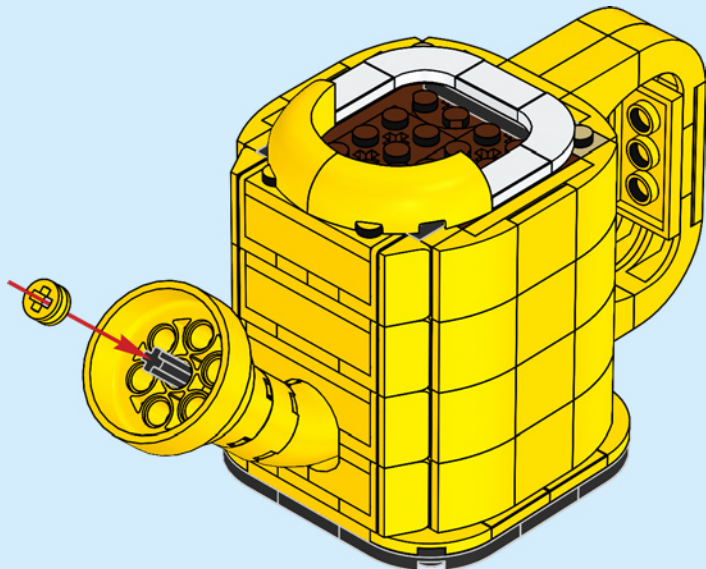



1x

58

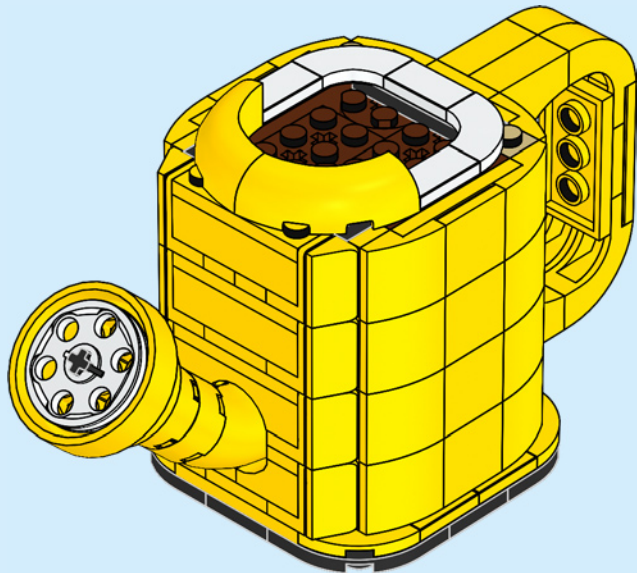





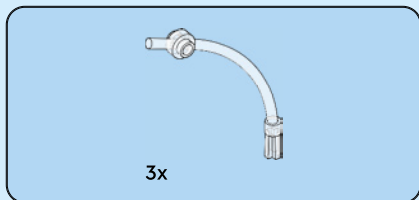

59

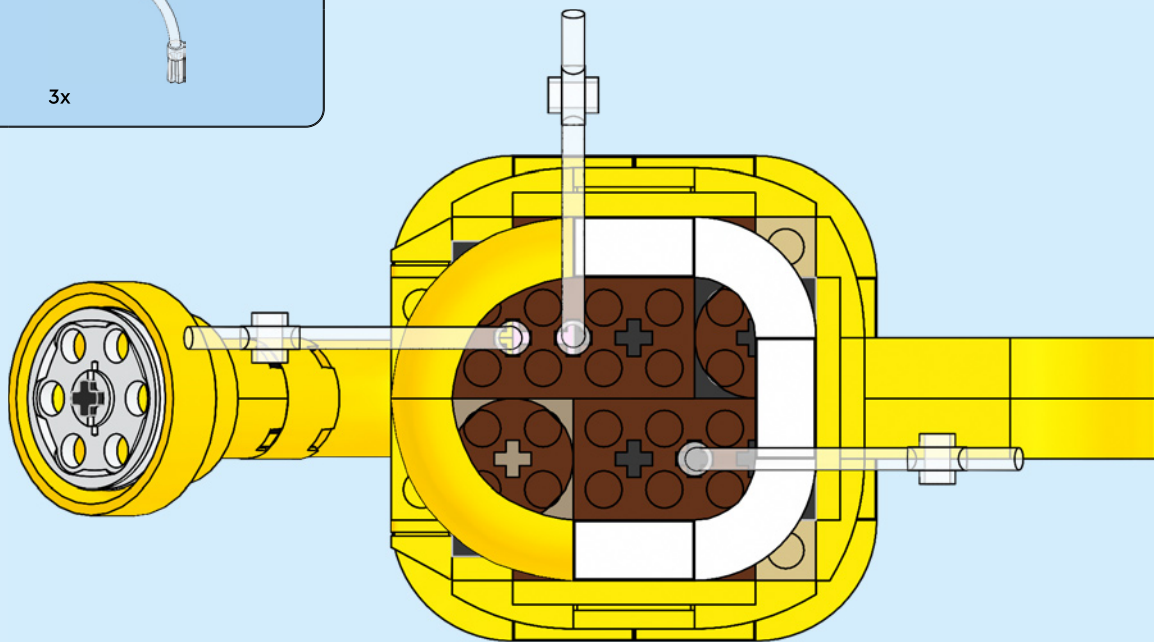



3x



6x

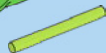

3x



3x



3x

60

1



2

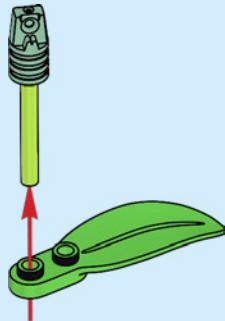

3

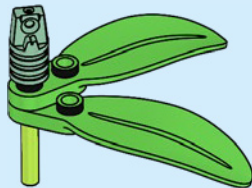

4

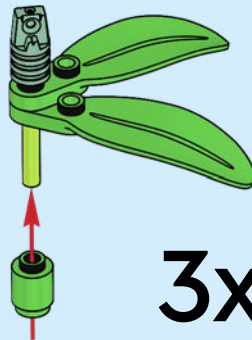

3x

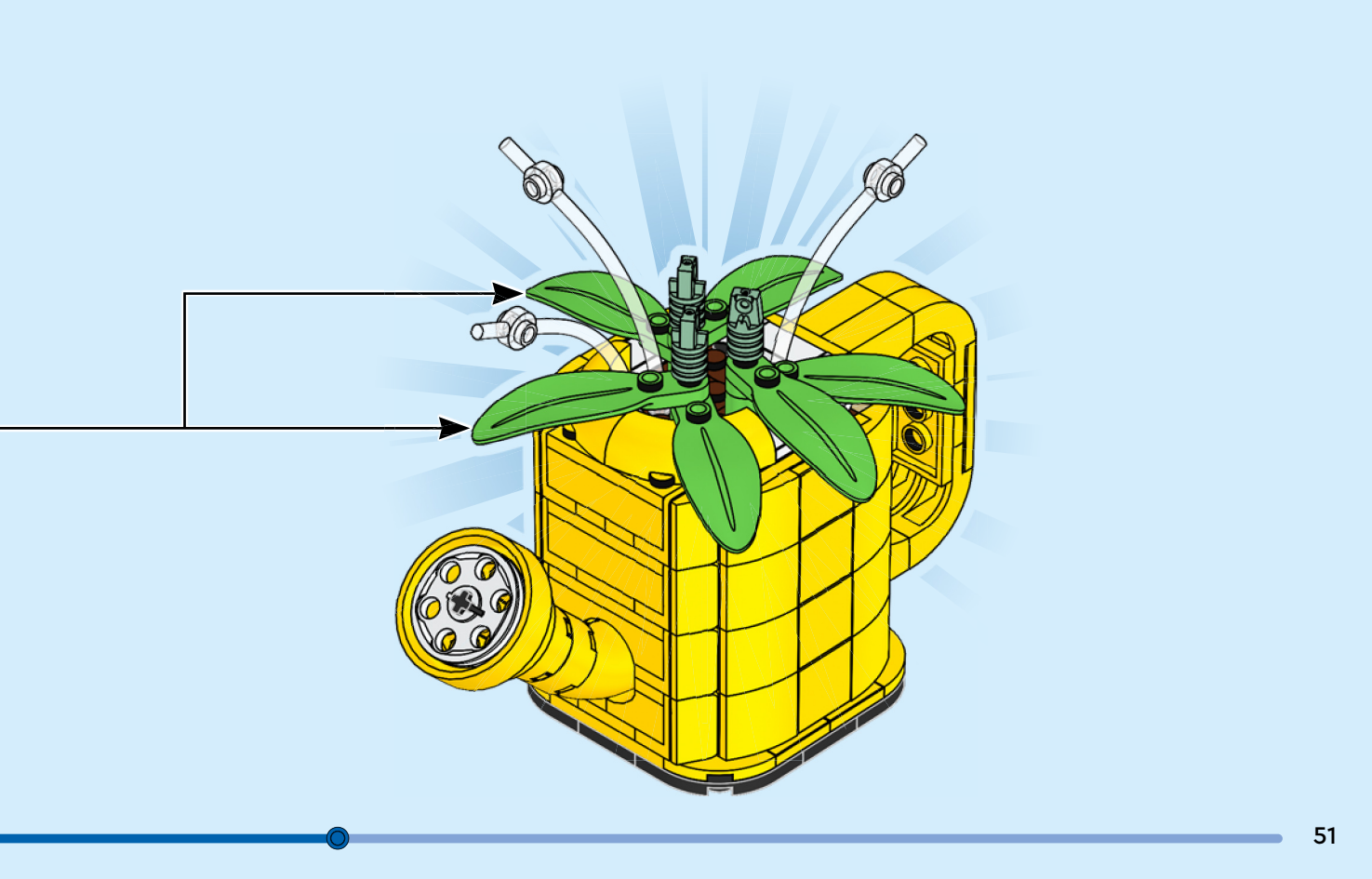

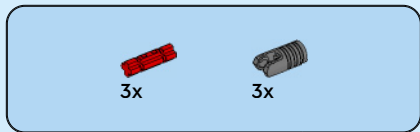

61

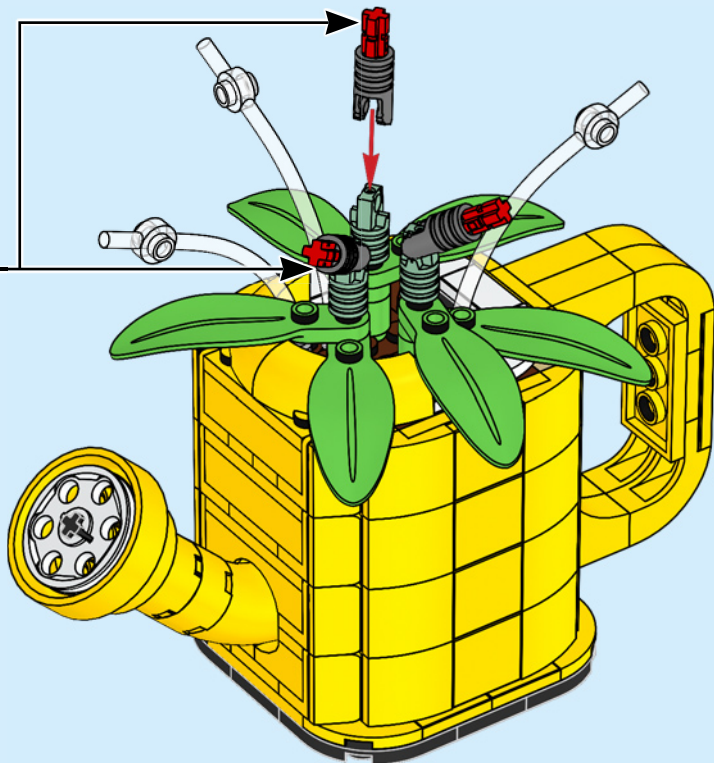
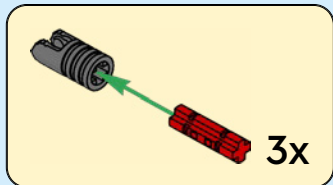



1x



1x

62

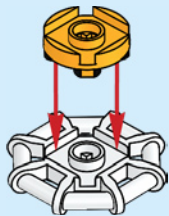

1x



1x

63

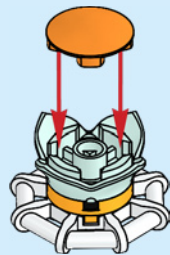

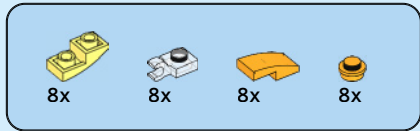

64

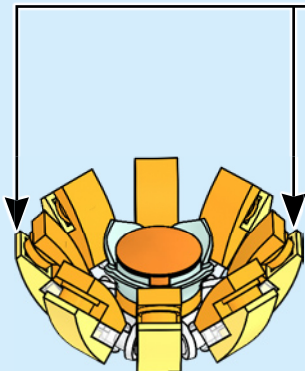
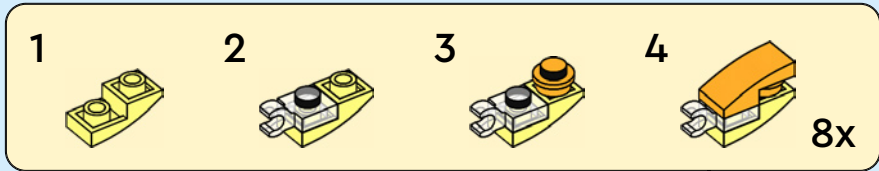

65

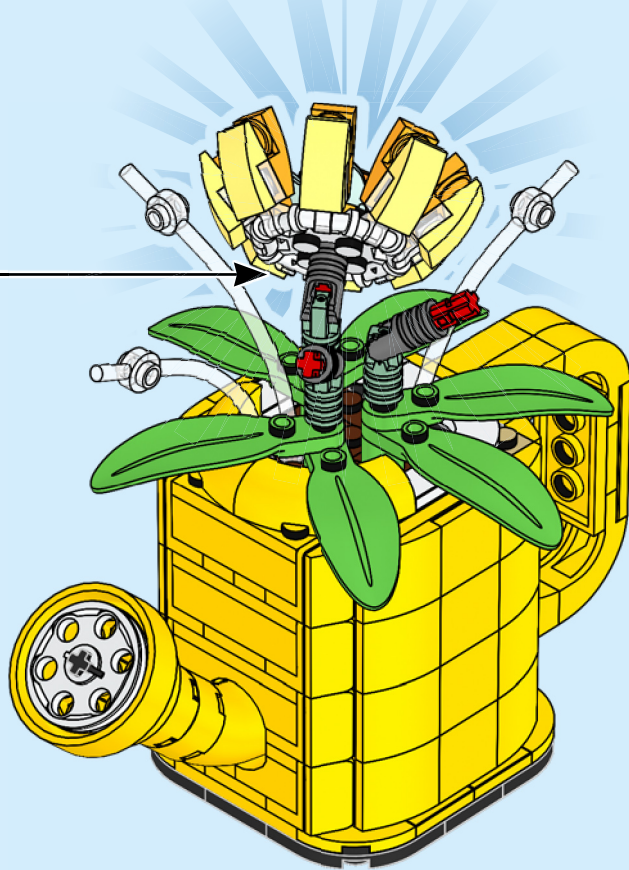

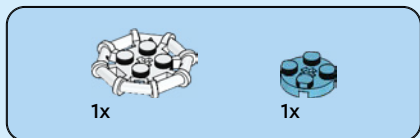
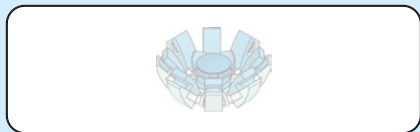

66

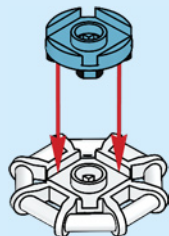

67

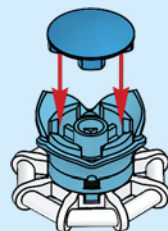



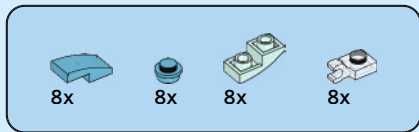

68

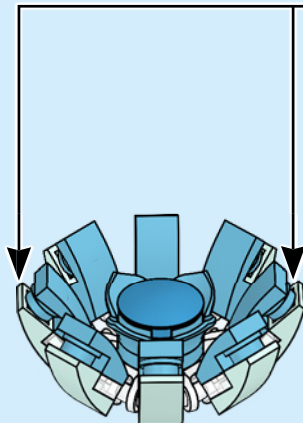
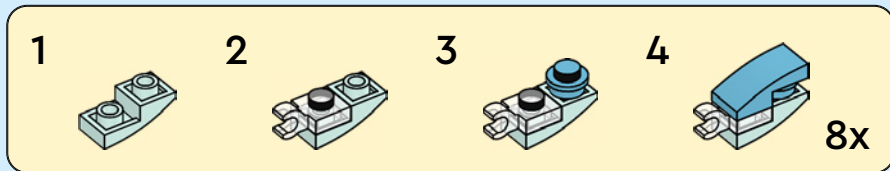

69

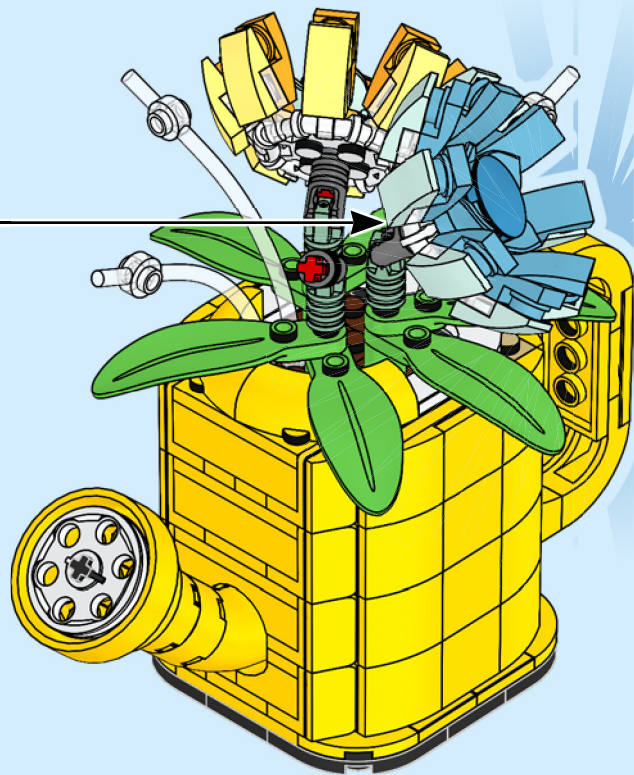

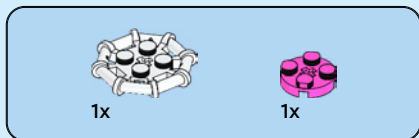
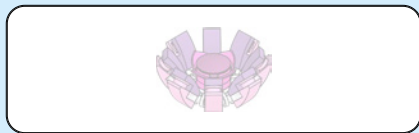

70

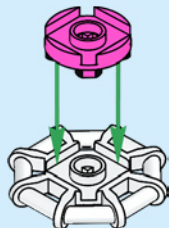

71

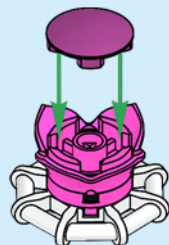

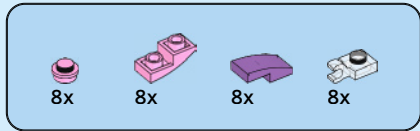

72

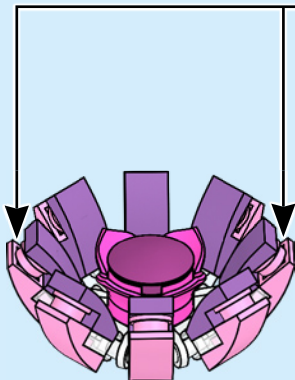
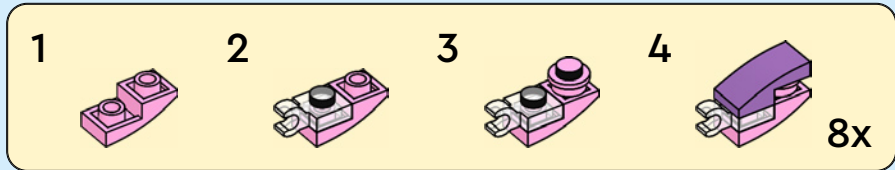

73

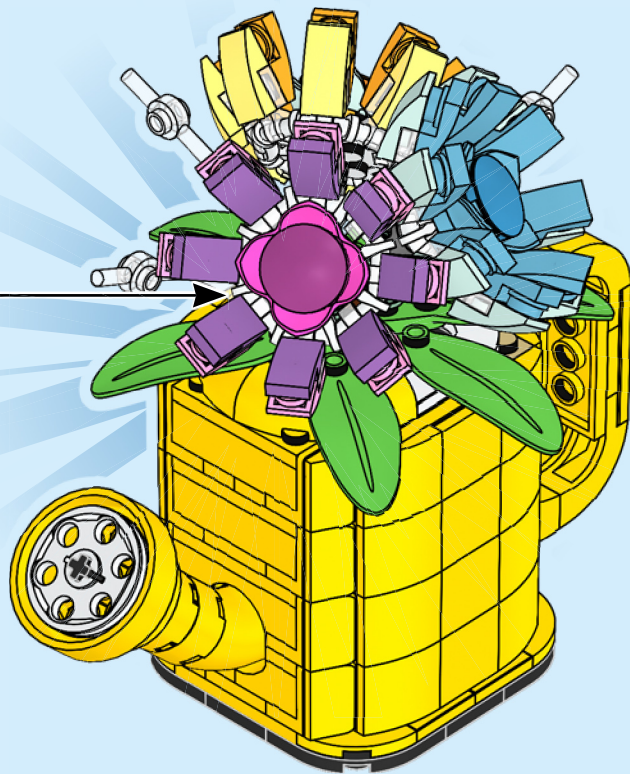



1x

74

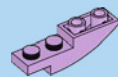

2x

75

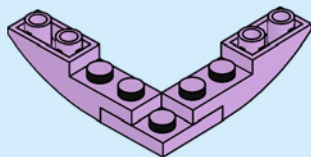



2x

76

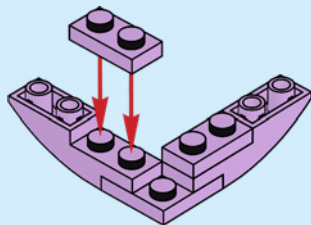

2x



2x



1x



1x

77

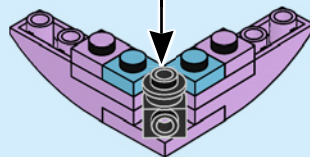
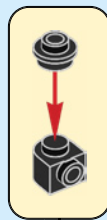



1x

78

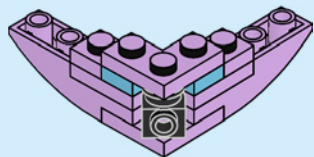

2x



1x

79

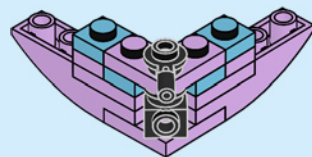



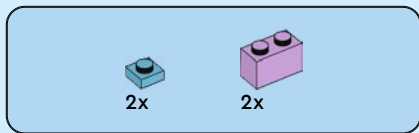

80

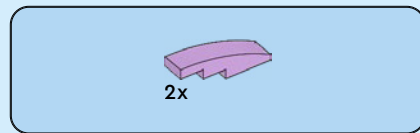
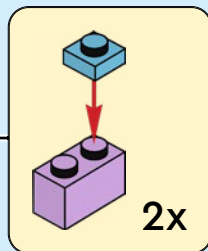
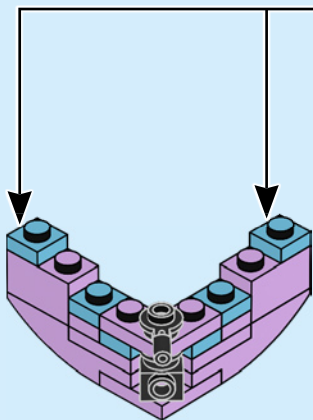

81

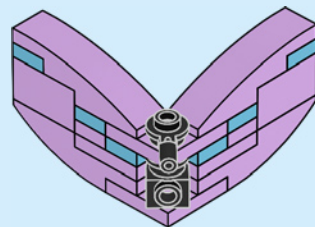



1x



1x

82

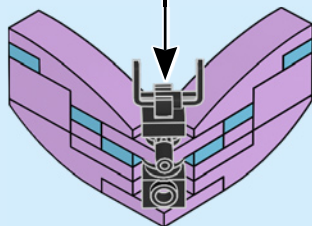
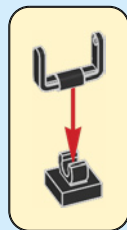

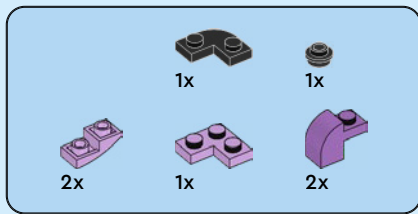

83

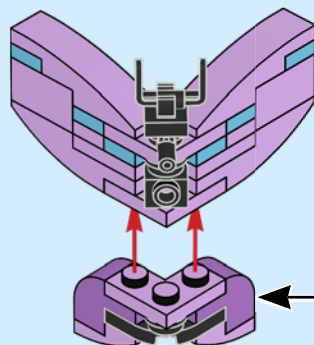
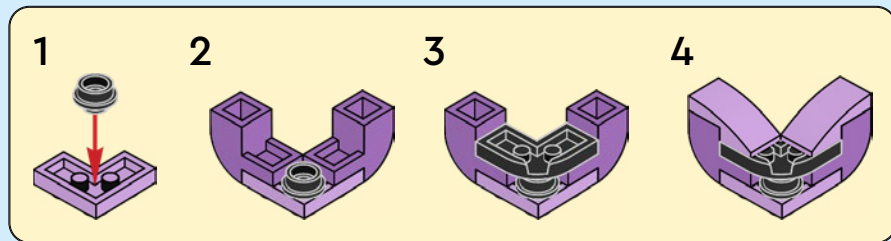

84

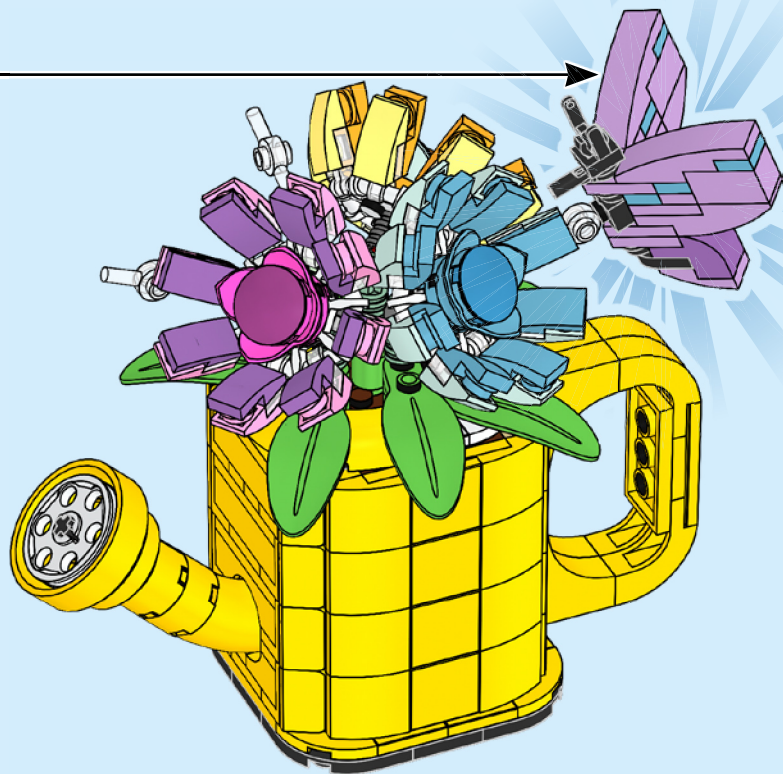



1x

85

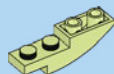

2x

86

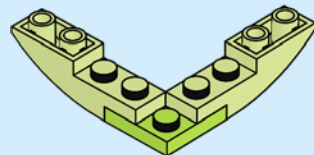



4x

87

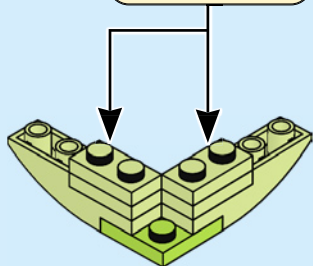
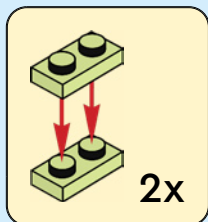

1x



1x

88

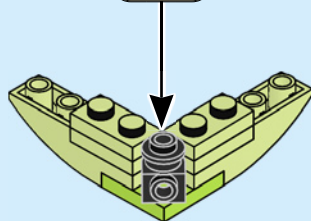
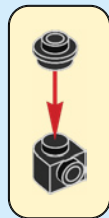



1x

89

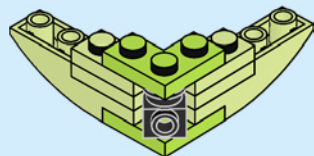

2x



1x

90

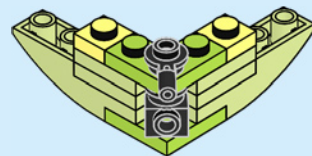



2x



2x

91

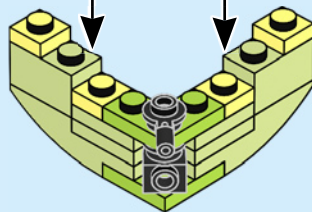
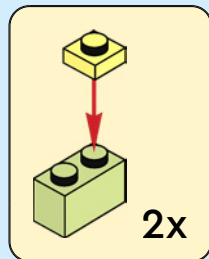





2x

92

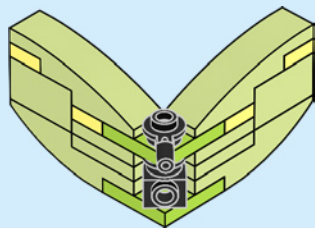

1x



1x

93

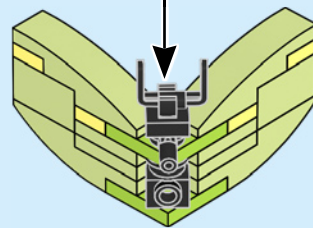
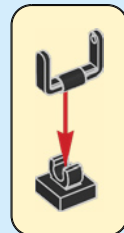

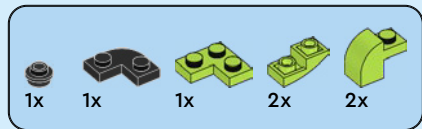

94

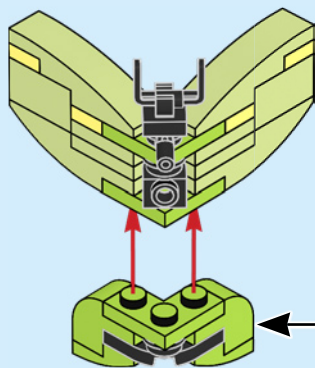
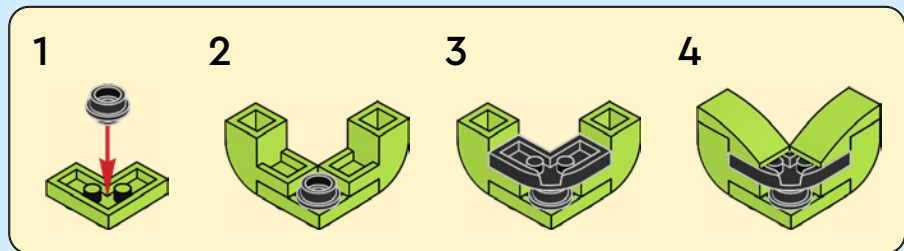

95

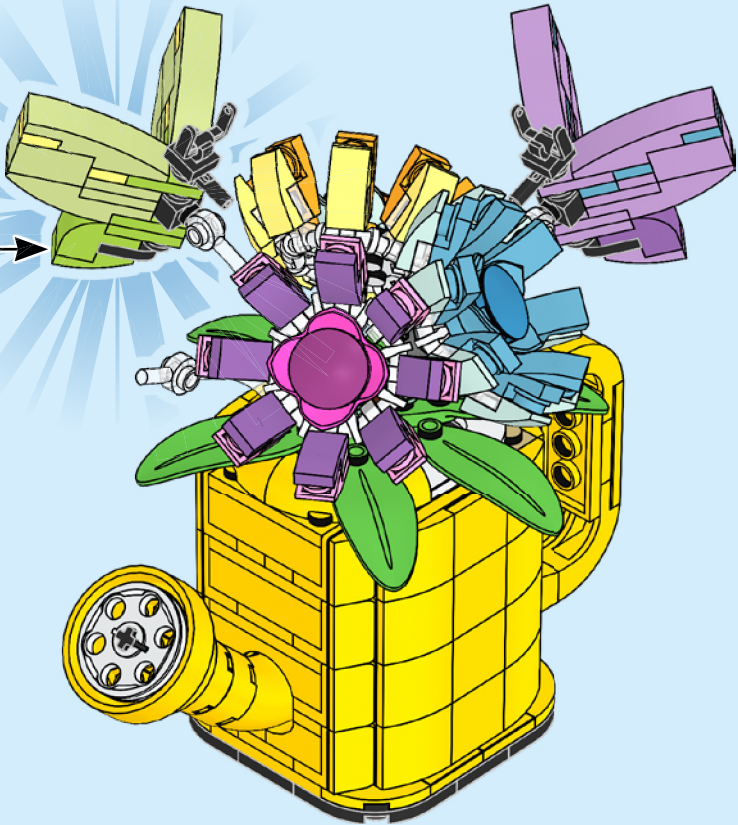



1x

96

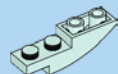

2x

97

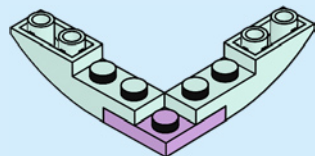



4x

98

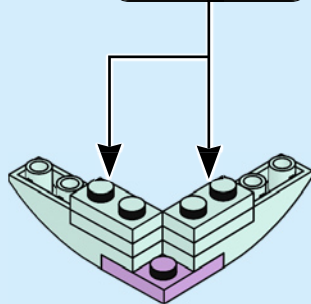
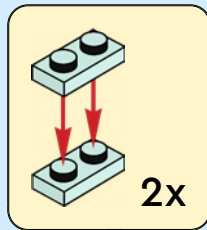

1x



1x

99

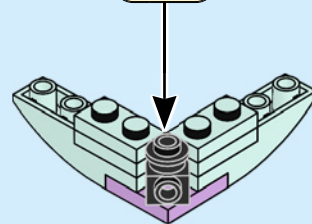
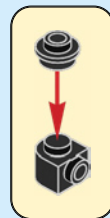



1x

100

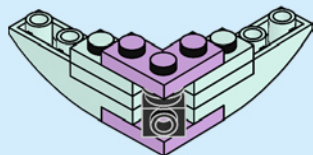

2x



1x

101

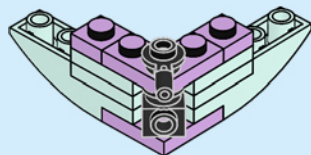



2x



2x

102

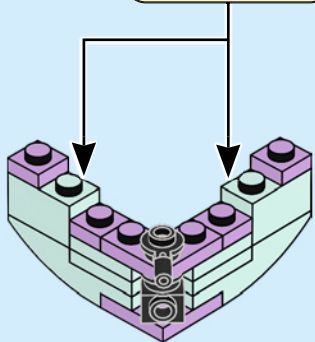
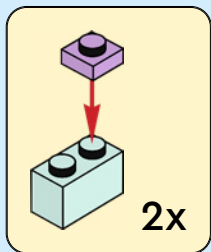

2x

103

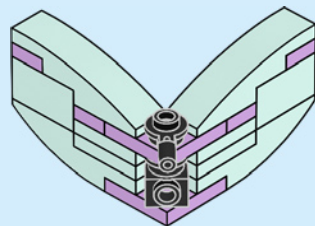



1x



1x

104

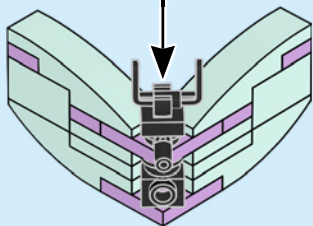
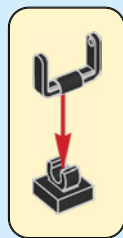



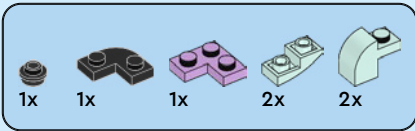

105

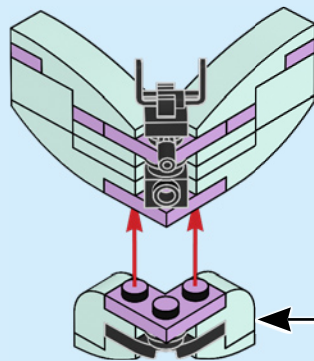
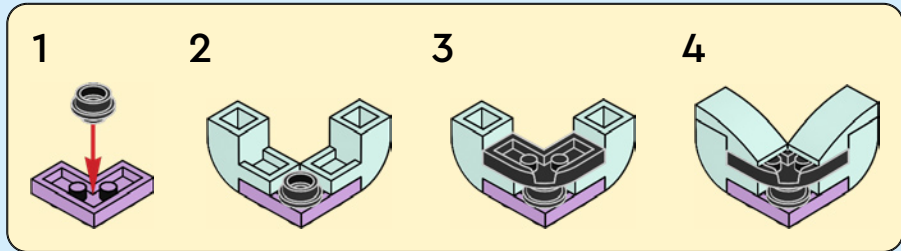

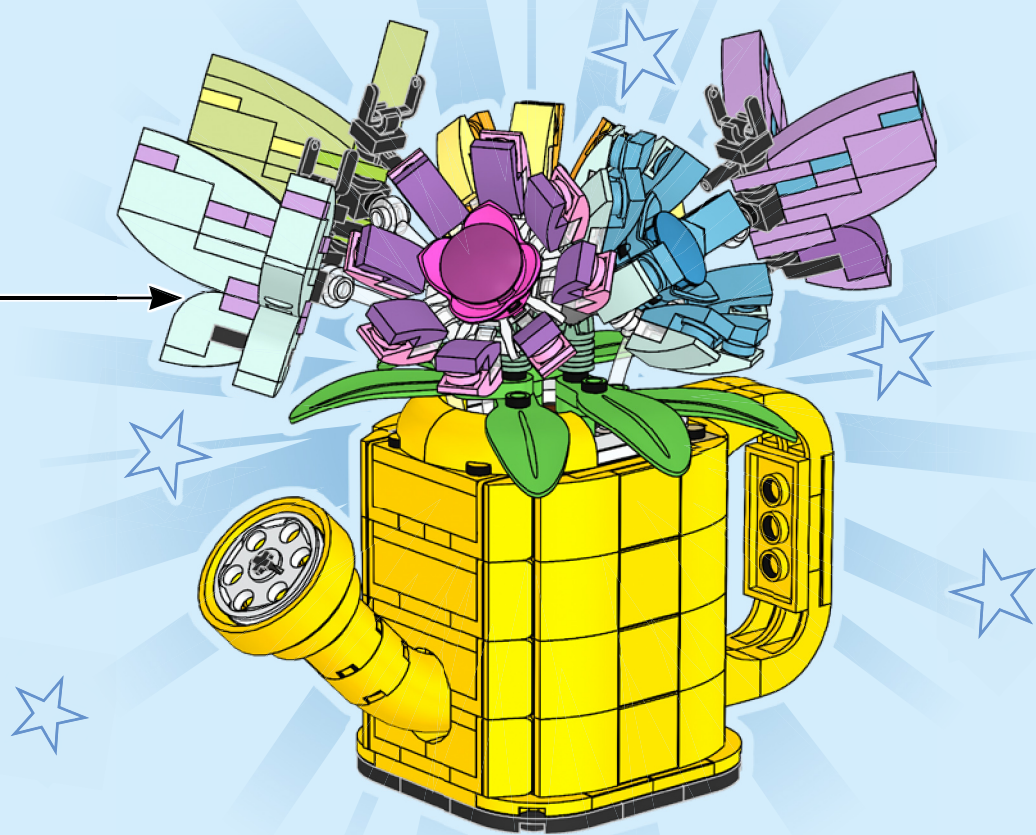



# CREATOR™

3  
IN  
EN

31152



31150



31146



31149

31147



31145



31148



YOU COULD **WIN**



Scan this QR code or go to **LEGO.COM/PRODUCTFEEDBACK** and give us your short feedback about this LEGO® set for a chance to win a cool LEGO prize.

Terms and Conditions apply\*

**EN: YOU COULD WIN.** Terms and Conditions apply\* **DE: Du könntest GEWINNEN.** Es gelten die Teilnahmebedingungen\* **FR: Tu pourrais GAGNER.** Des conditions s'appliquent\* **IT: Potresti VINCERE tu.** Termini e condizioni sono applicabili\* **ES: Puedes GANAR.** Aplican términos y condiciones\* **PT: Poderá GANHAR.** Aplicam-se termos e condições\* **ZH: 轻松获奖. 条款和条件适用\*** **PL: Szansa na WYGRANĄ.** Obowiązują warunki korzystania\* **CS: Máte šanci VYHRÁT.** Platí všeobecné smluvní podmínky\* **SK: Máte šancu VYHRAŤ.** Platia všeobecné zmluvné podmienky\* **HU: TE IS NYERHETSZ.** Felhasználási feltételek érvényesek\* **RO: Ai putea CÂȘTIGA.** Se aplică termenii și condiții\* **BG: Можете да СПЕЧЕЛИТЕ.** Има определени правила и условия\* **LV: Tu vari LAIMĒT.** Ir spēkā noteikumi un nosacījumi.\* **ET: Sul on võimalus VÕITA.** Kehtivad tingimused\* **LT: Jūs galite LAIMĖTI.** Taikomos sąlygos\*

\*[LEGO.com/productfeedback-terms](https://www.lego.com/productfeedback-terms)

LEGO and the LEGO logo are trademarks of the/sont des marques de commerce du/son marcas registradas de LEGO Group. ©2024 The LEGO Group.

6497673