



31212

3





Our Solar System and Earth

YOU ARE HERE. Earth is a rare gem in our Solar System and the known universe. Our lush and vibrant home planet peacefully coexists with three other terrestrial planets: Mars, Venus and Mercury, gas giants Saturn and Jupiter, and ice giants Uranus and Neptune. Only a century ago, it was estimated that the universe consisted of around 2,000 stars. In the past few decades alone, space missions have revealed a seemingly infinite number of galaxies in an ever-expanding universe.

Notre système solaire et la Terre

VOUS ÊTES ICI. La Terre est un joyau rare dans notre système solaire et dans l'univers connu. Notre planète luxuriante et éclatante coexiste pacifiquement avec trois autres planètes telluriques : Mars, Vénus et Mercure, les géantes gazeuses Saturne et Jupiter, et les géantes glacées Uranus et Neptune. Il y a seulement un siècle, on estimait que l'univers était constitué d'environ 2 000 étoiles. Au cours des dernières décennies, les missions spatiales ont révélé un nombre apparemment infini de galaxies dans un univers en constante expansion.

Nuestro sistema solar y la Tierra

USTED ESTÁ AQUÍ. La Tierra es una gema rara tanto en nuestro sistema solar como en el universo conocido. El exuberante y vibrante planeta en el que habitamos coexiste pacíficamente con otros tres planetas terrestres (Marte, Venus y Mercurio), los gigantes gaseosos Saturno y Júpiter, y los gigantes de hielo Urano y Neptuno. Hace solo un siglo, se calculaba que el universo estaba formado por unas 2000 estrellas. Solo en las últimas décadas, las misiones espaciales han revelado un número aparentemente infinito de galaxias en un universo en constante expansión.



TRAPPIST-1

The TRAPPIST-1 system, 40 light-years from the Sun, is a red dwarf star, roughly the size of Jupiter, orbited by seven Earth-sized exoplanets. Most of the planets are within the 'Goldilocks Zone' (habitable zone) and could have water vapor, running water or ice on the surface. About 8% less dense than Earth, the planets are most likely composed of various ratios of iron, oxygen, magnesium and silicon.

TRAPPIST-1

Le système TRAPPIST-1, situé à 40 années-lumière du Soleil, est une naine rouge de la taille de Jupiter, autour de laquelle gravitent sept exoplanètes de la taille de la Terre. La plupart des planètes se trouvent dans la « zone Boucles d'or » (la zone habitable) et pourraient présenter de la vapeur d'eau, de l'eau courante ou de la glace à leur surface. Environ 8 % moins denses que la Terre, les planètes sont probablement composées de différents ratios de fer, d'oxygène, de magnésium et de silicium.

TRAPPIST-1

El sistema TRAPPIST-1, ubicado a 40 años luz del Sol, está conformado por una estrella enana roja cuyo tamaño es semejante al de Júpiter y los siete exoplanetas de dimensión comparable con la de la Tierra que la orbitan. La mayoría de esos planetas se ubican dentro de la zona "Ricitos de Oro" (la región con condiciones habitables que rodea a cada estrella) de su sistema y podrían tener vapor de agua, agua en estado líquido o hielo en la superficie. Alrededor de un 8 % menos densos que la Tierra, lo más probable es que estén compuestos por diversas proporciones de hierro, oxígeno, magnesio y silicio.

Scan the QR code to listen to chapter 2 in the exclusive LEGO® Art Milky Way soundtrack.

Scannez le code QR pour écouter le chapitre 2 de la bande sonore exclusive de la Voie lactée LEGO® Art.

Escanea el código QR para escuchar el capítulo 2 de la exclusiva banda sonora del set LEGO® Art Galaxia Vía Láctea.



The Pleiades

Messier 45, The Seven Sisters, The Pleiades. By any name, this open star cluster is one of the nearest to Earth. At about 445 light-years away, it consists of more than a thousand loosely connected stars. You don't even need a telescope to see them, some of the biggest and brightest stars are visible in the Taurus constellation, most clearly in January. Observations of the cluster have been recorded for millennia, and it may have played a role in maritime navigation in ancient times.

Les Pléiades

Messier 45, les Sept Sœurs, les Pléiades. Quel que soit son nom, cet amas d'étoiles ouvert est l'un des plus proches de la Terre. Situé à environ 445 années-lumière, il se compose de plus d'un millier d'étoiles vaguement reliées entre elles. Il n'est même pas nécessaire d'avoir un télescope pour les voir : certaines des étoiles les plus grandes et les plus brillantes sont visibles dans la constellation du Taureau, plus particulièrement au mois de janvier. Les observations de l'amas sont consignées depuis des millénaires, et il est possible qu'il ait joué un rôle dans la navigation maritime dans l'Antiquité.

Las Pléyades

Messier 45, las Siete Hermanas, o las Pléyades. Con cualquier denominación, este cúmulo estelar abierto es uno de los más cercanos a la Tierra. A unos 445 años luz de distancia, está formado por más de un millar de estrellas vagamente conectadas. Ni siquiera necesitas un telescopio para verlas: algunas de las más grandes y brillantes son visibles en la constelación de Tauro, más claramente en enero. Se han registrado observaciones del cúmulo durante milenios, y es posible que desempeñara un papel en la navegación marítima en la antigüedad.



The Crab Nebula

The Crab Nebula is the aftermath of a supernova, documented by astronomers in 1054 as a star so bright it could be seen during the day over a period of several months. In fact, the explosion 6,500 light-years away would have briefly emitted light equivalent to 400 million suns. The Crab Nebula, now around 10 light-years across, rotates about 30 times per second, with a dense neutron star at the center forming an immense magnetic field and radiation.

La nébuleuse du Crabe

La nébuleuse du Crabe est un rémanent de supernova, que les astronomes décrivent en 1054 comme une étoile si brillante qu'elle a pu être observée de jour pendant plusieurs mois. En fait, l'explosion qui s'est produite à 6500 années-lumière aurait brièvement émis une lumière équivalente à 400 millions de soleils. La nébuleuse du Crabe, qui mesure aujourd'hui environ 10 années-lumière de diamètre, tourne environ 30 fois par seconde, et son centre est occupé par une étoile à neutrons dense qui génère un champ magnétique et un rayonnement immenses.

La nebulosa del Cangrejo

La nebulosa del Cangrejo es la secuela de una supernova documentada en 1054 por los astrónomos de la época como una estrella tan brillante que pudo verse durante el día a lo largo de varios meses. De hecho, la explosión, ocurrida a 6500 años luz de distancia, habría emitido brevemente una luz equivalente a la de 400 millones de soles. La nebulosa del Cangrejo, en cuyo centro hay una densa estrella de neutrones que genera un inmenso campo magnético y de radiación, tiene ahora un diámetro de aproximadamente 10 años luz y gira unas 30 veces por segundo.



The Pillars of Creation

First discovered in 1920, 'only' around 5,700 light-years from Earth in the Eagle Nebula, this star 'nursery' region has fascinated the world in recent decades, following publications of striking composite images from advanced space telescopes. Based on the detection of X-ray sources emitted from the region, it is estimated that hundreds of new stars are forming here; one in particular seems to contain four or five times the mass of our Sun.

Les piliers de la création

Découverte pour la première fois en 1920, à « seulement » 5700 années-lumière de la Terre, dans la nébuleuse de l'Aigle, cette zone de « pouponnières » d'étoiles a fasciné le monde entier au cours des dernières décennies, à la suite de la publication d'images composites saisissantes prises par des télescopes spatiaux de pointe. D'après la détection de sources de rayons X émises par la zone, on estime que des centaines de nouvelles étoiles s'y forment ; l'une d'entre elles en particulier semble avoir une masse quatre ou cinq fois supérieure à celle de notre Soleil.

Los Pilares de la Creación

Descubierta por primera vez en 1920 a "solo" unos 5700 años luz de la Tierra, en la nebulosa del Águila, esta guardería estelar ha fascinado al mundo en las últimas décadas gracias a la publicación de sorprendentes imágenes compuestas obtenidas mediante telescopios espaciales avanzados. Con base en la medición de los rayos X emitidos desde esa región, se estima que allí se están formando cientos de estrellas nuevas, una de las cuales parece tener cuatro o cinco veces la masa de nuestro Sol.



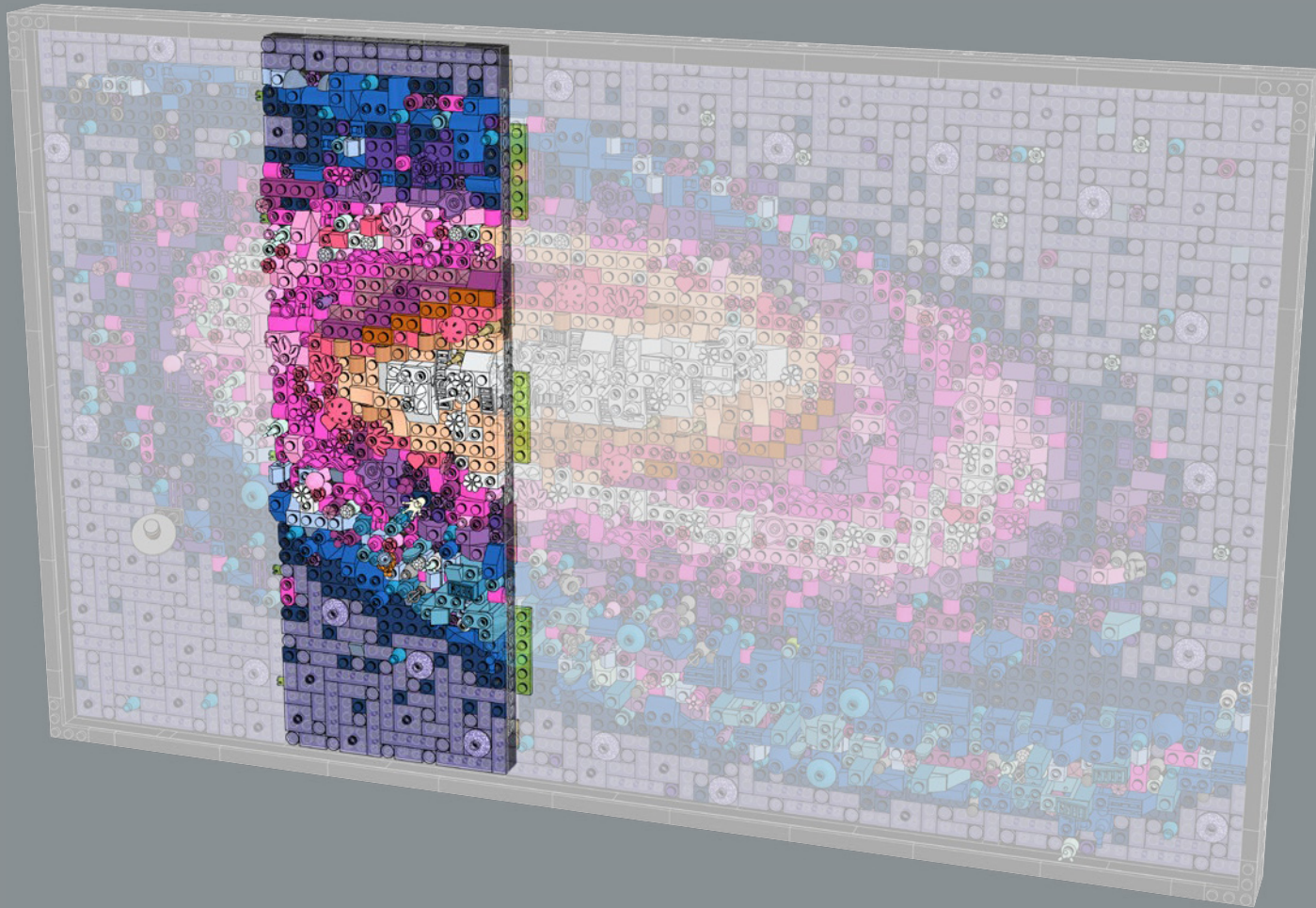

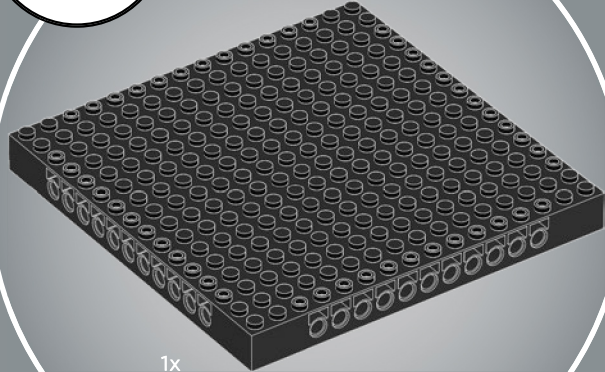
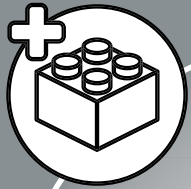

1x

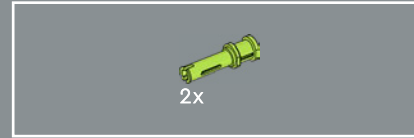
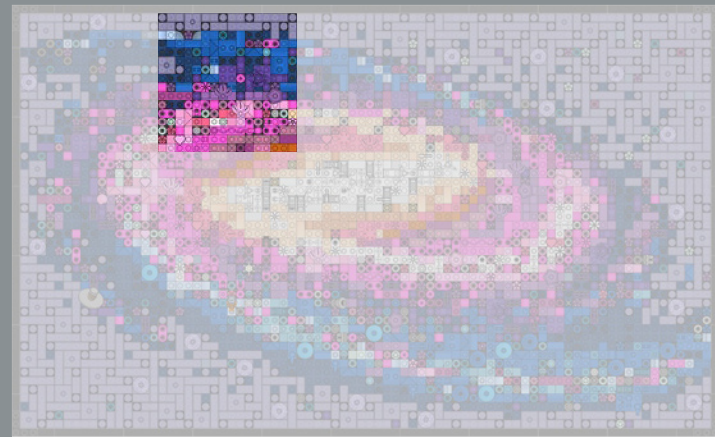

2x

1

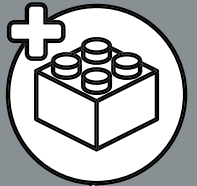
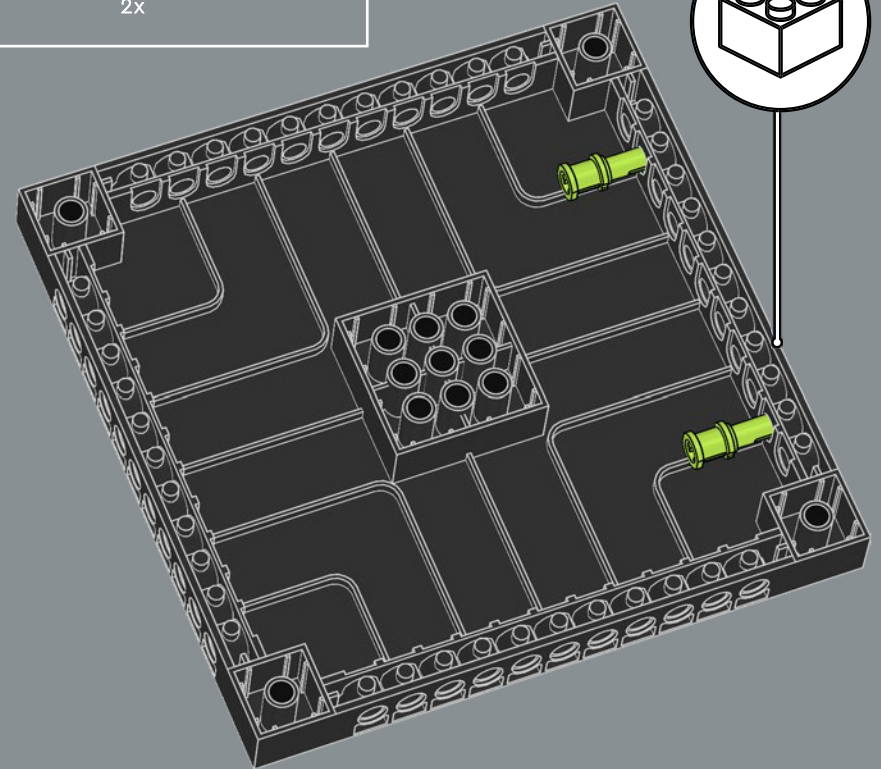

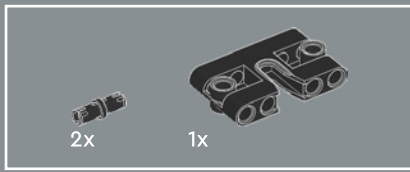

2

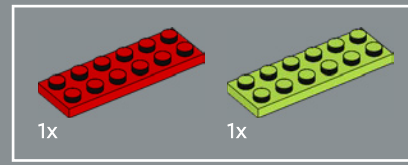
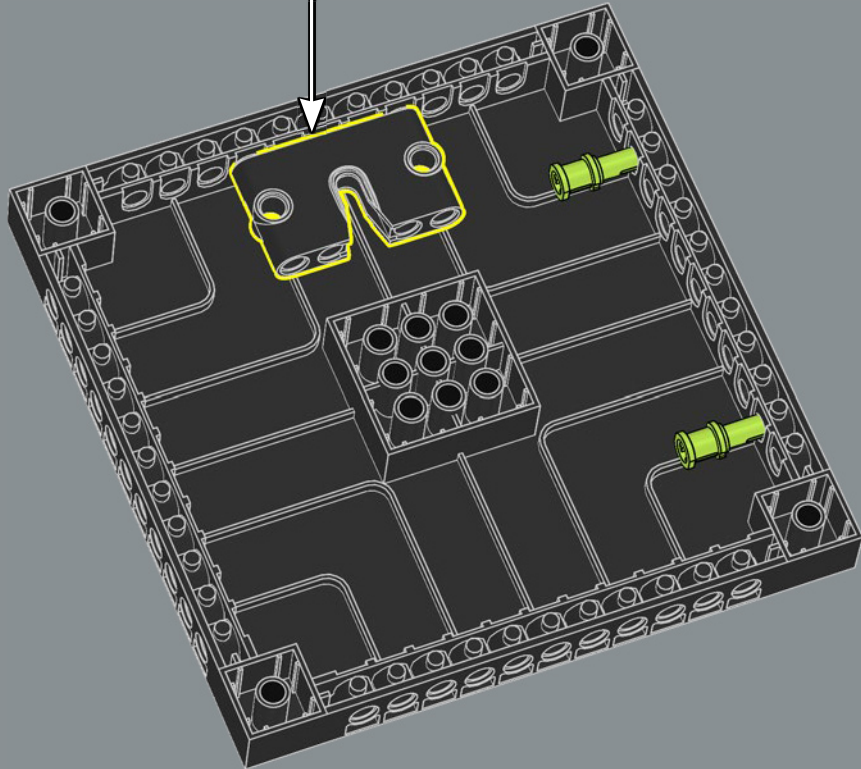
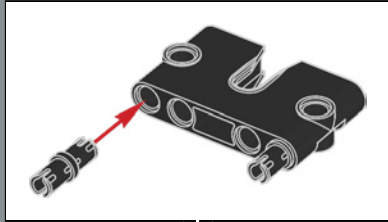

3

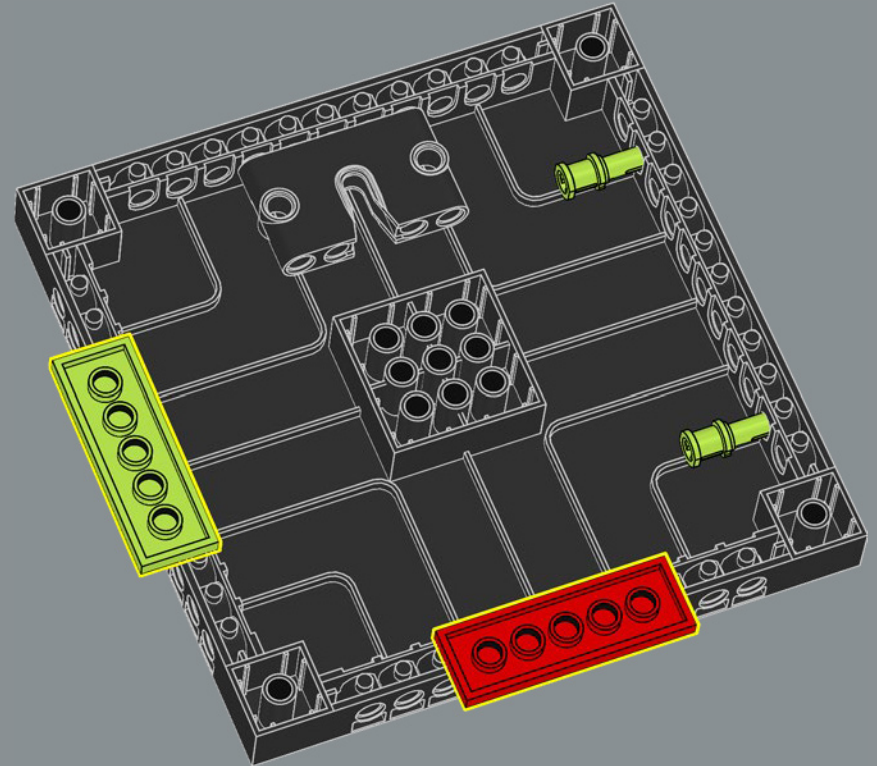



4

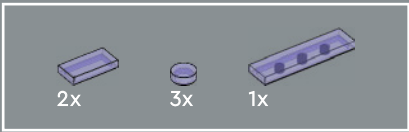
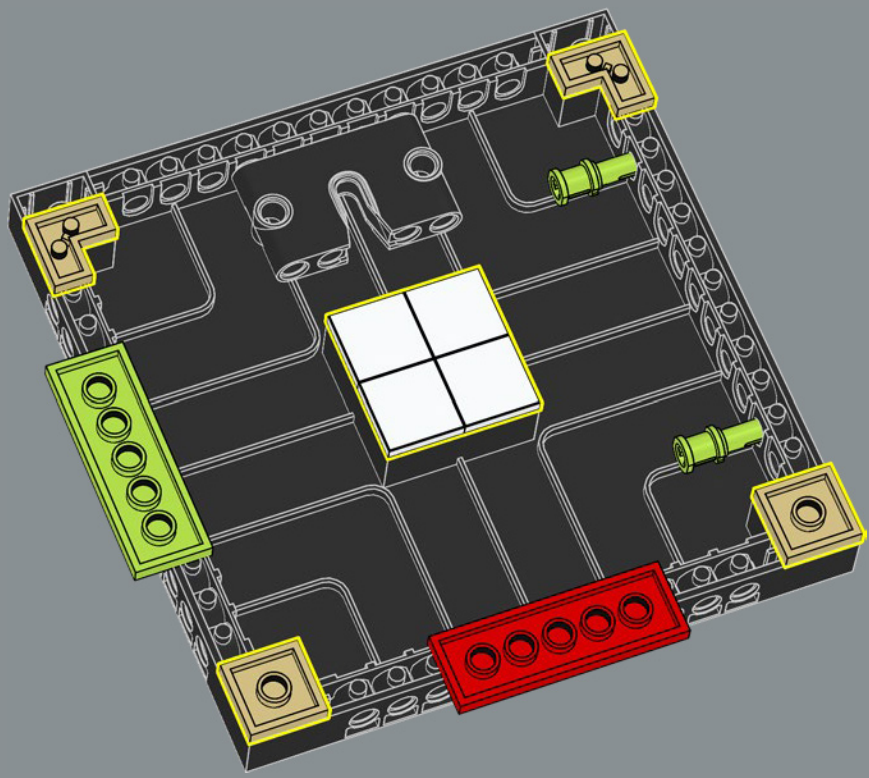

5

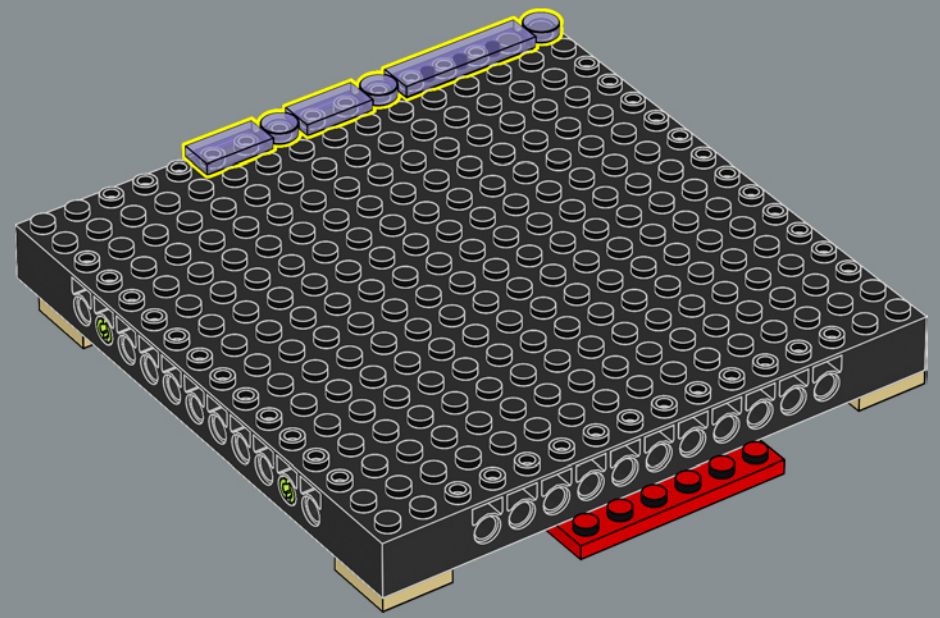

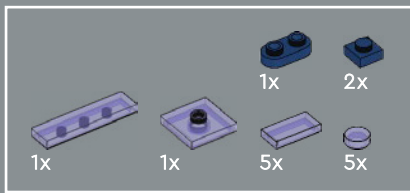

6

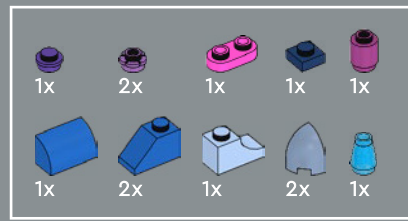
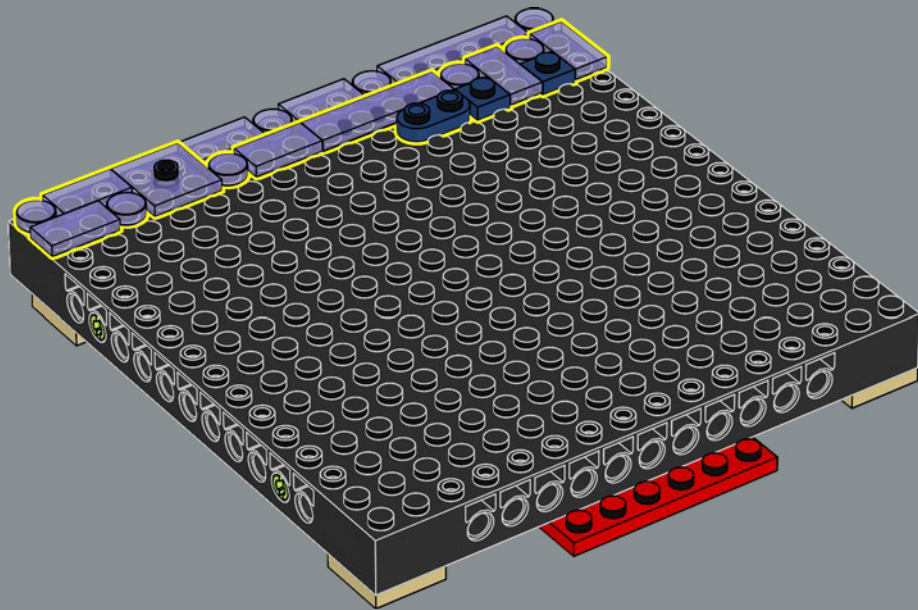

7

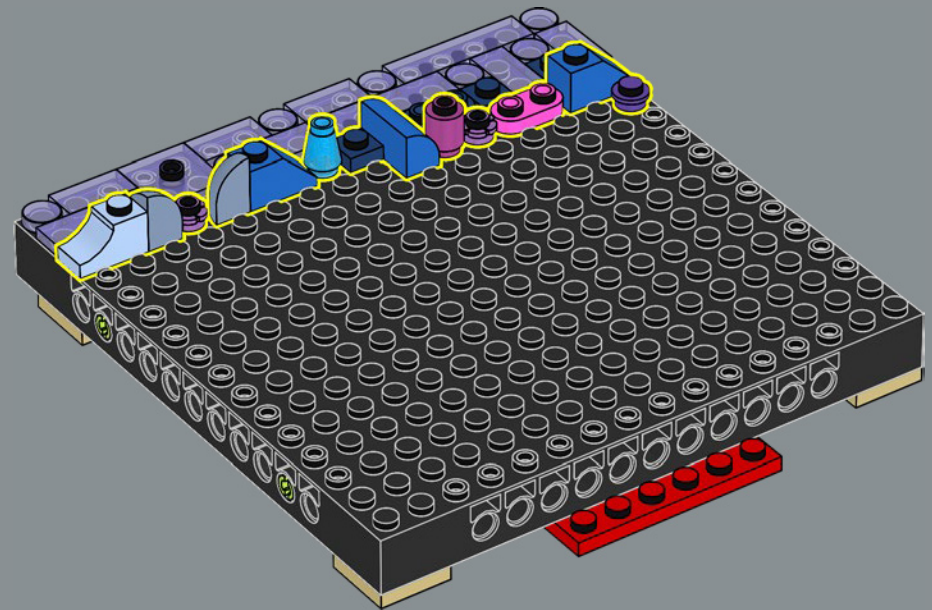

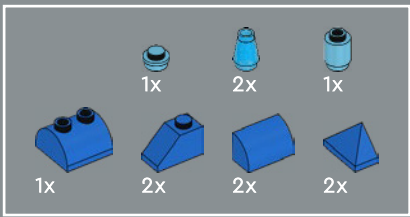

8

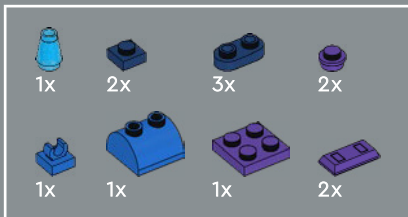
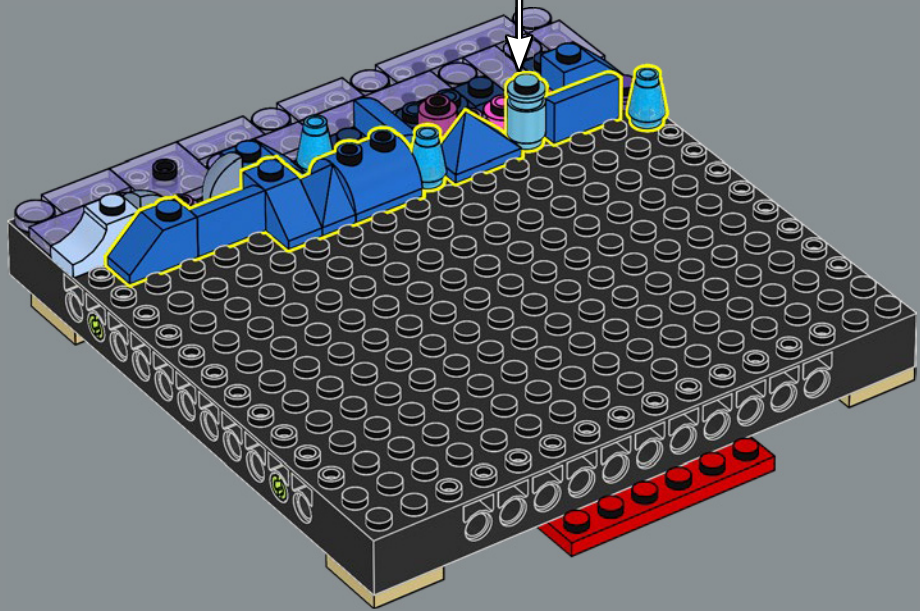
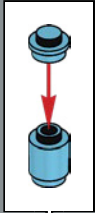

9

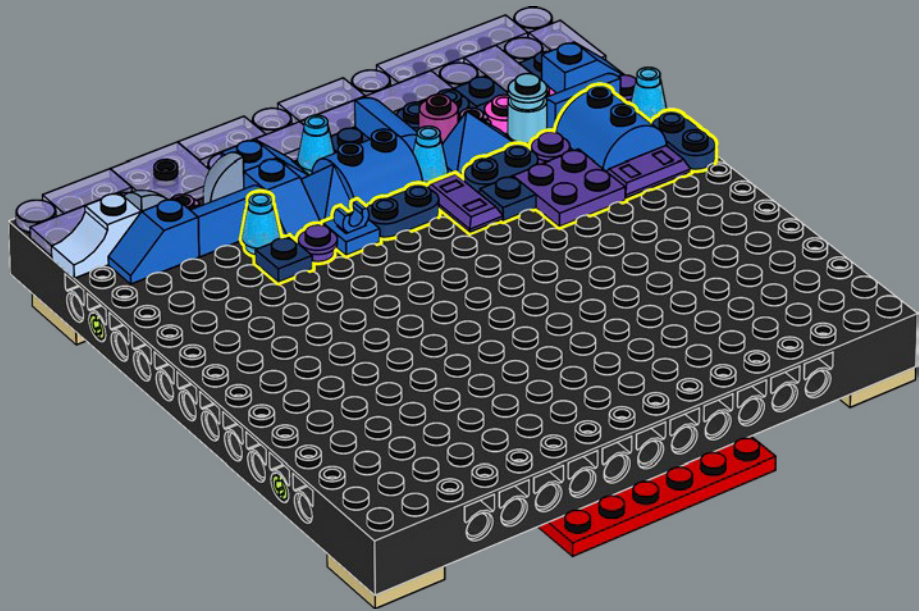

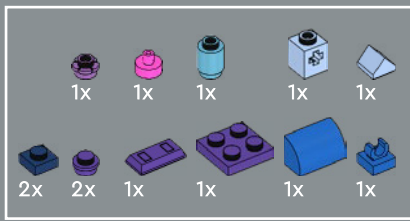

10

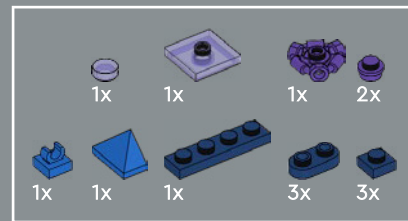
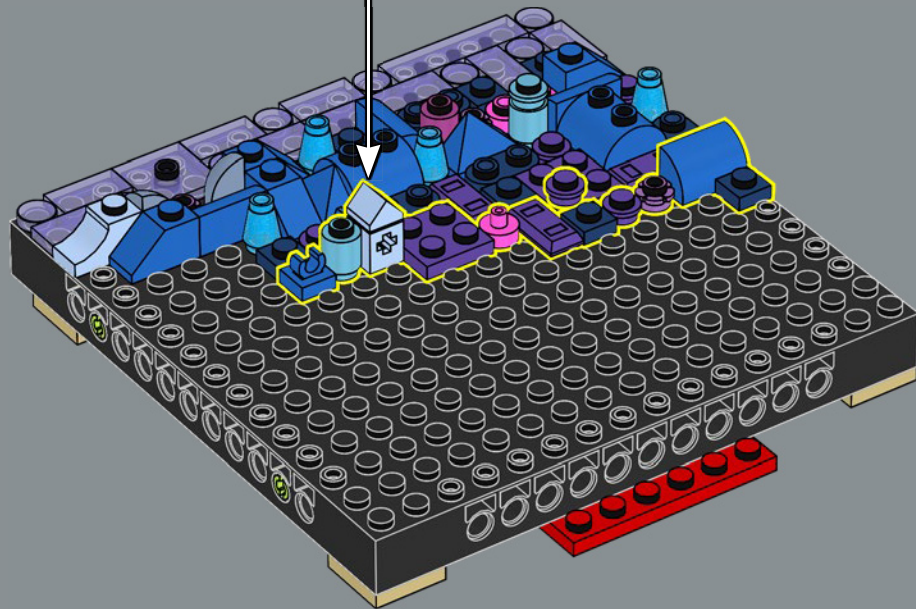
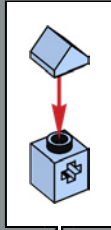

11

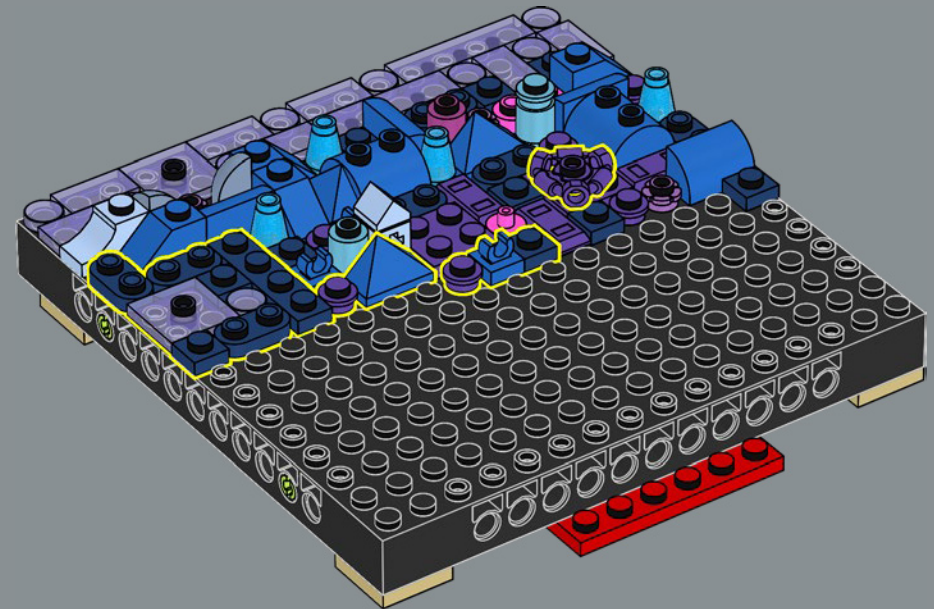

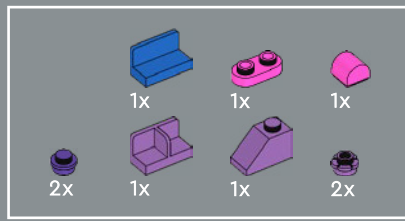

12

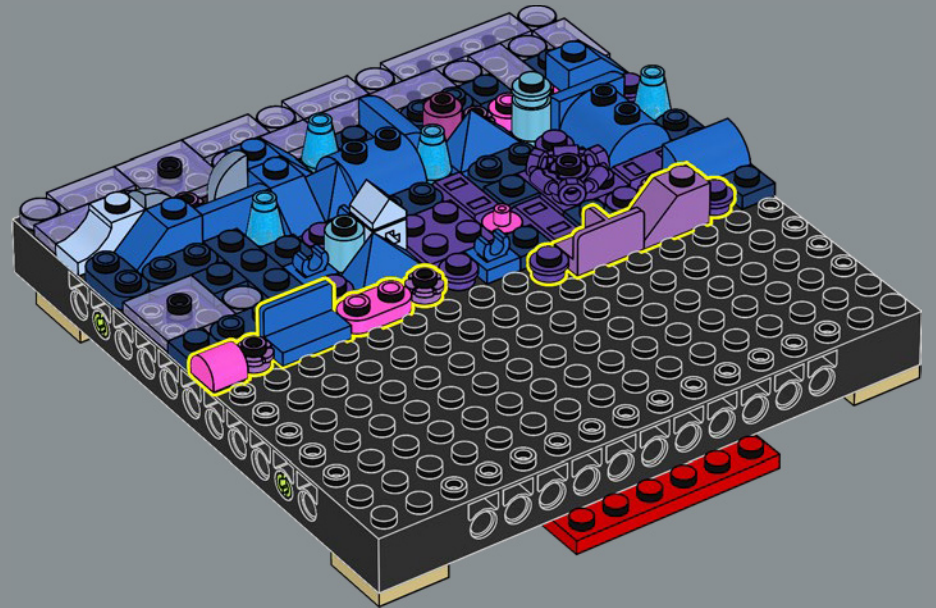

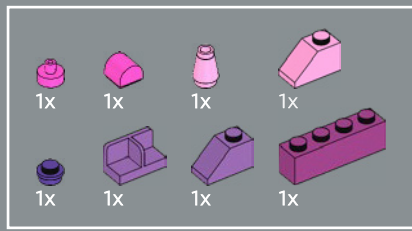

13

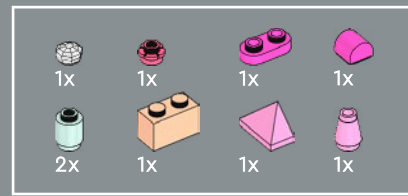
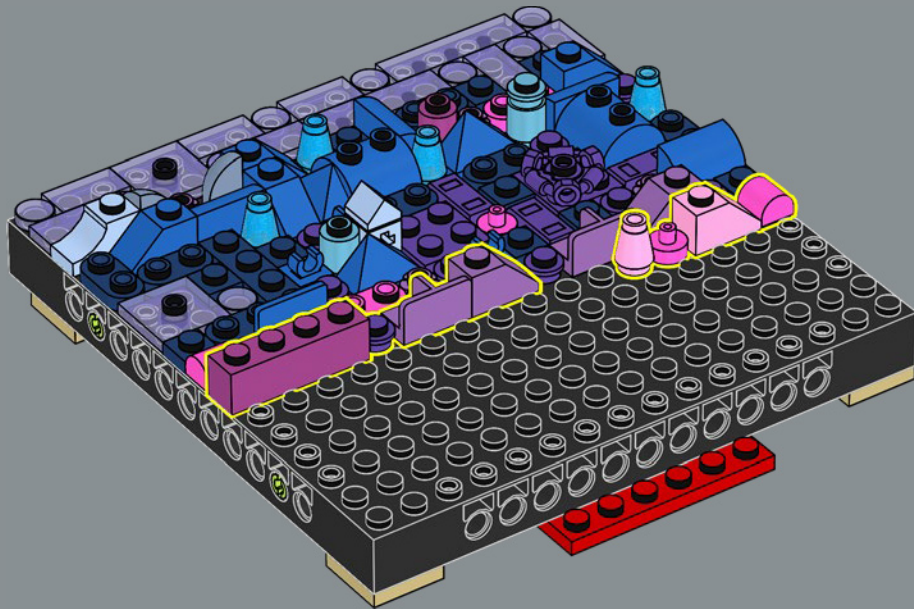

14

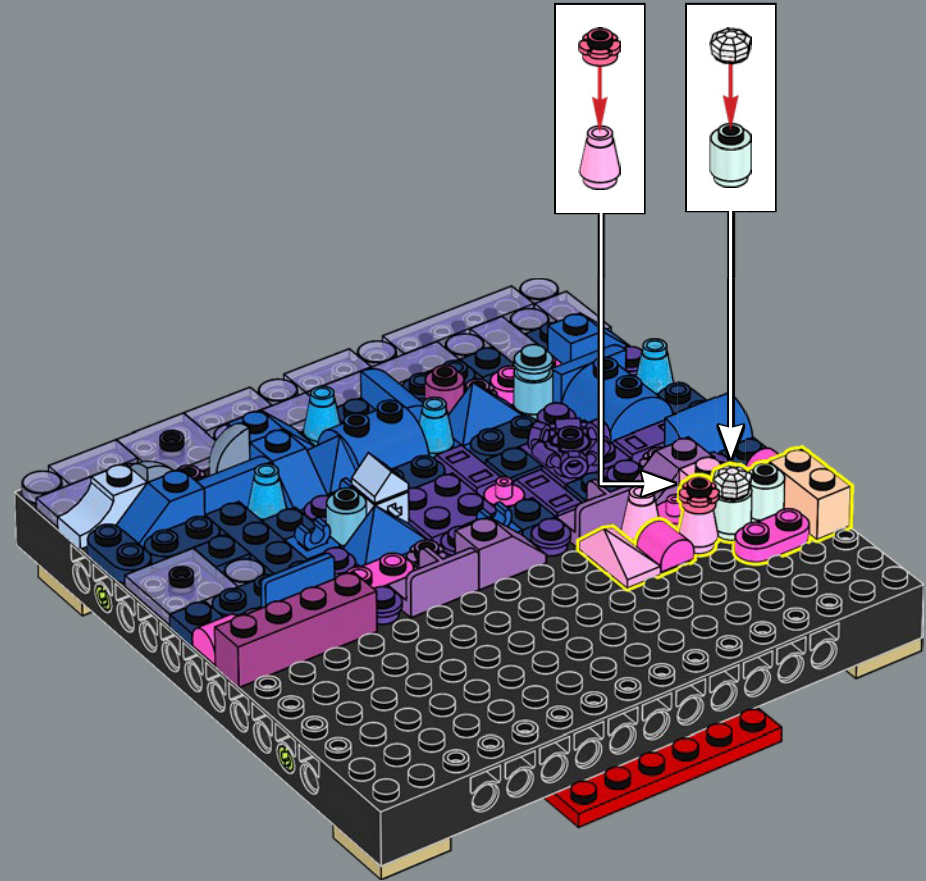

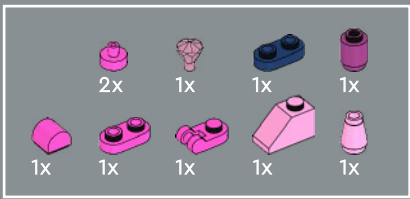

15

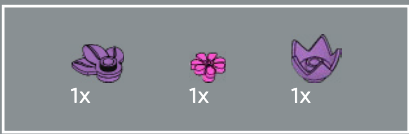
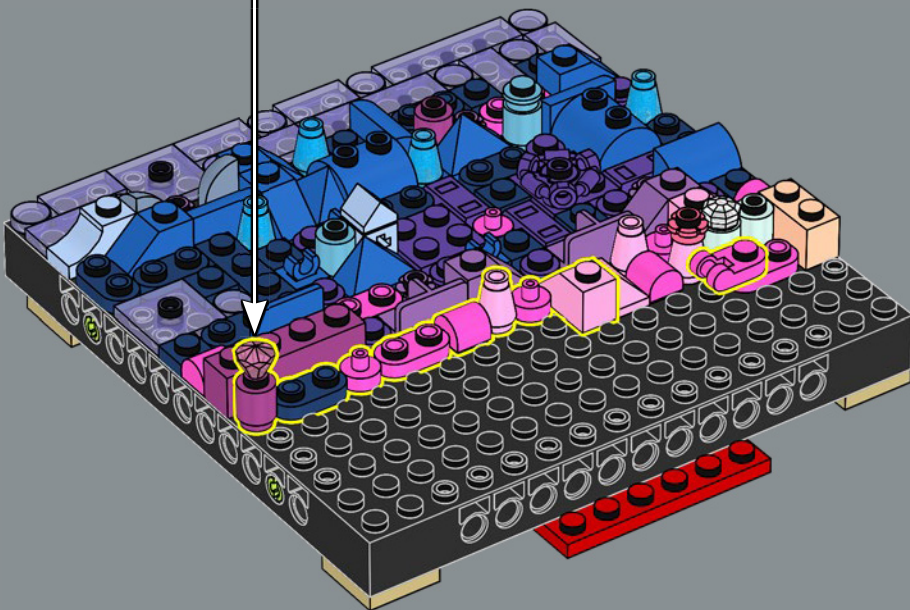
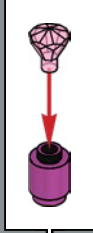

16

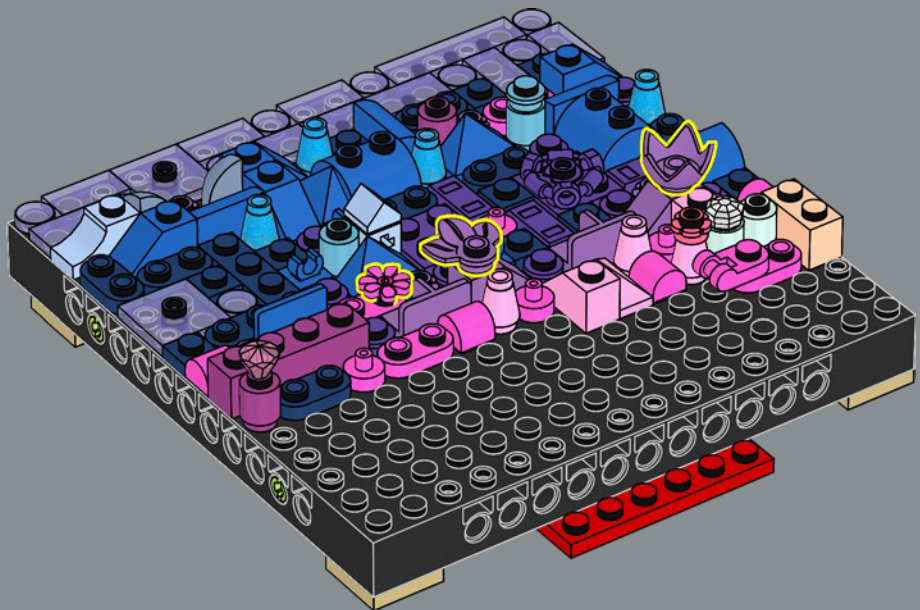



17

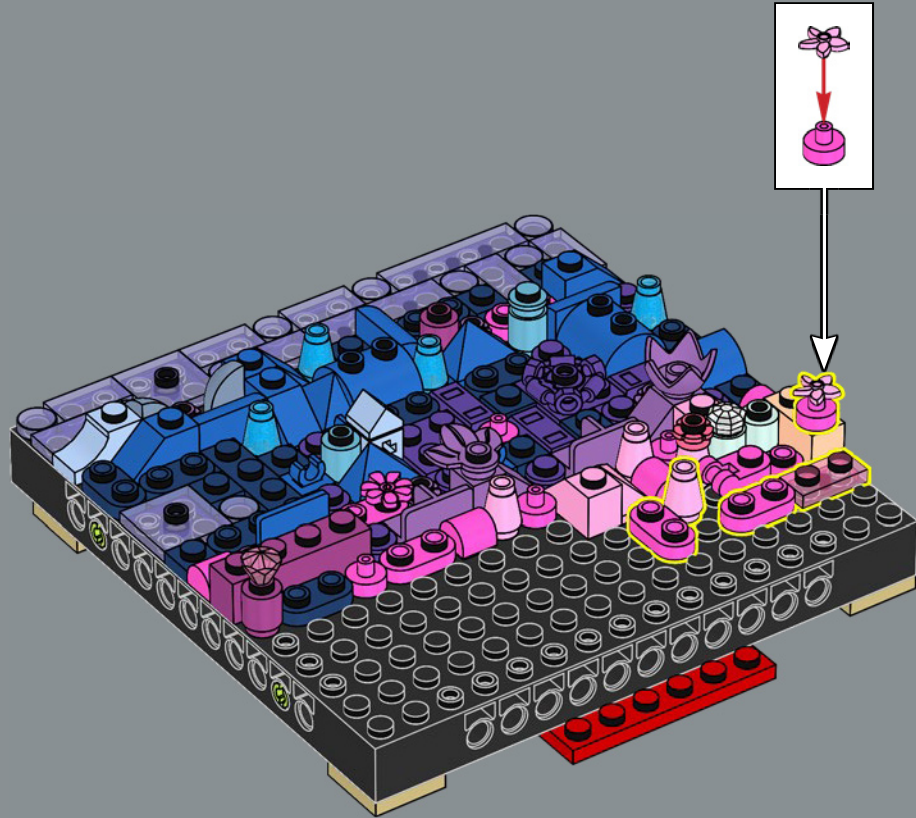

18

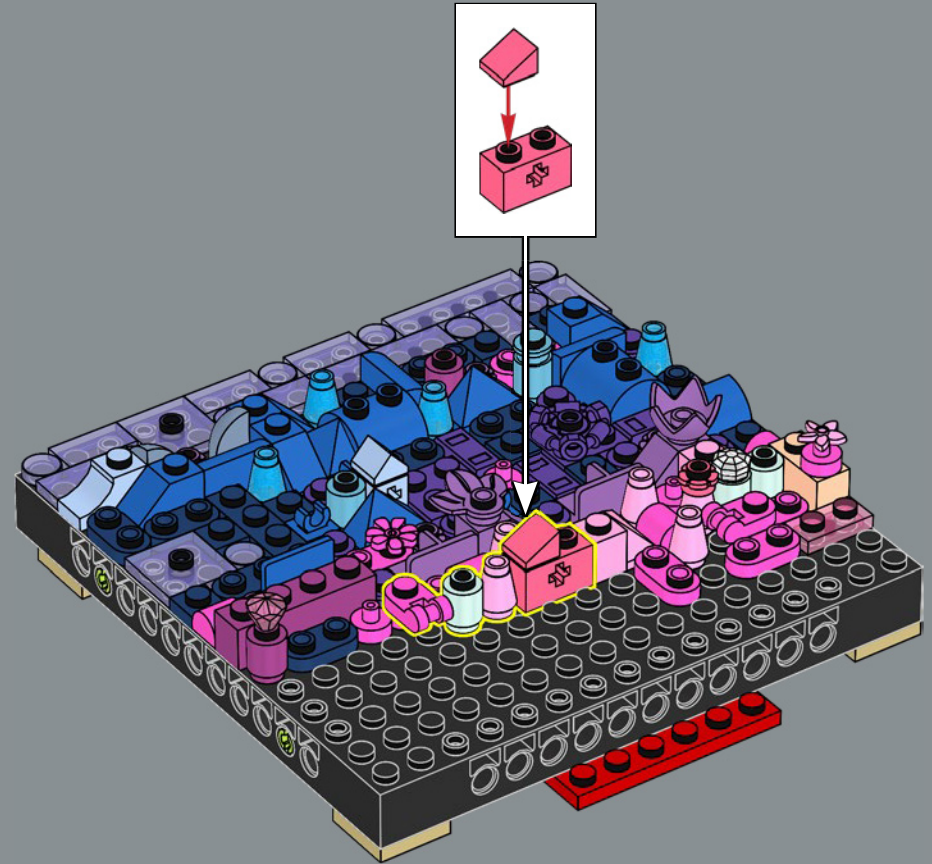

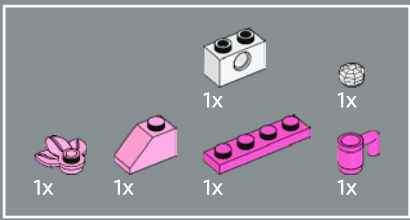

19

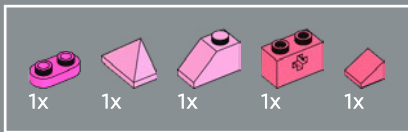
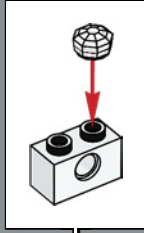

20

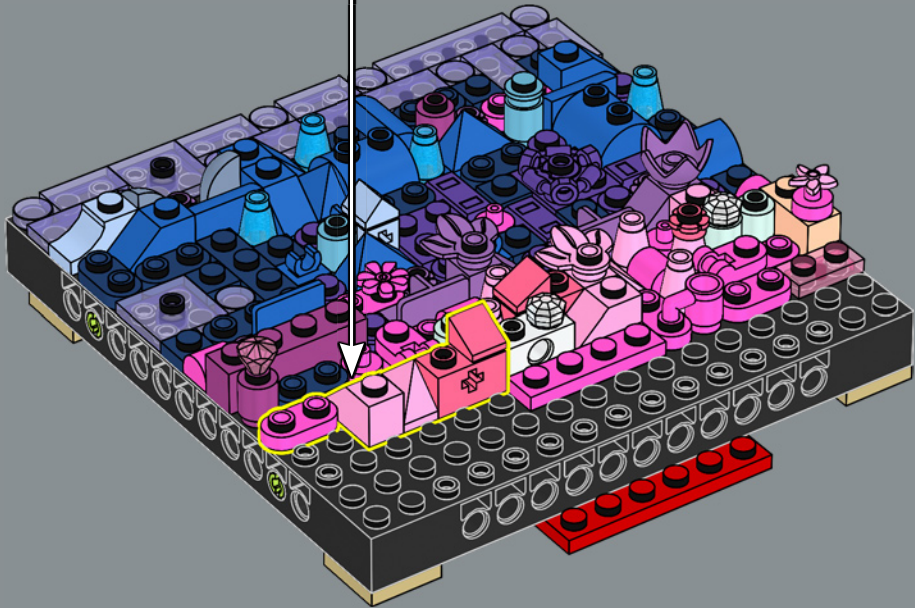
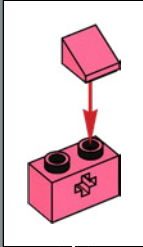



21

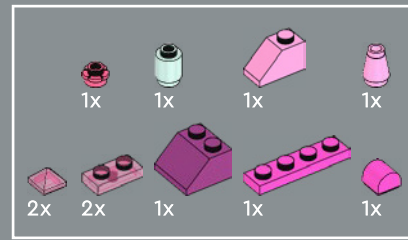
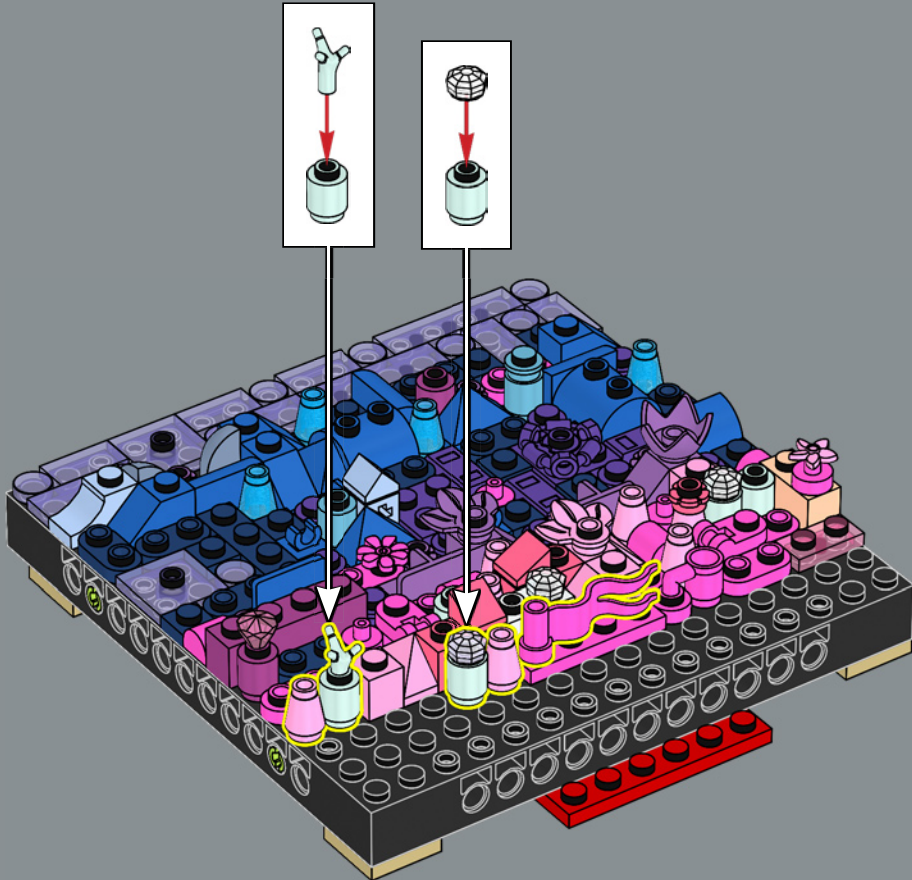

22

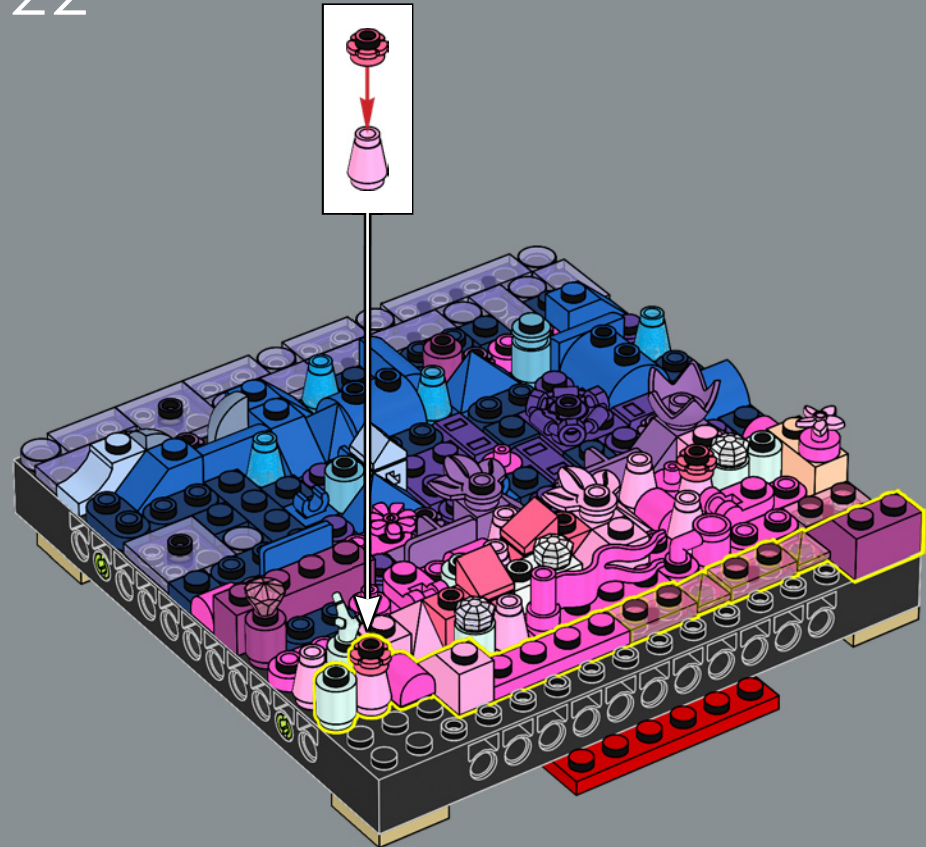

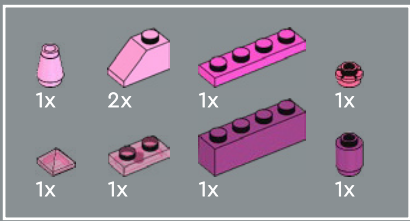

23

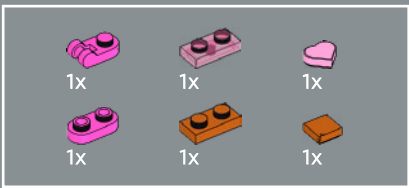
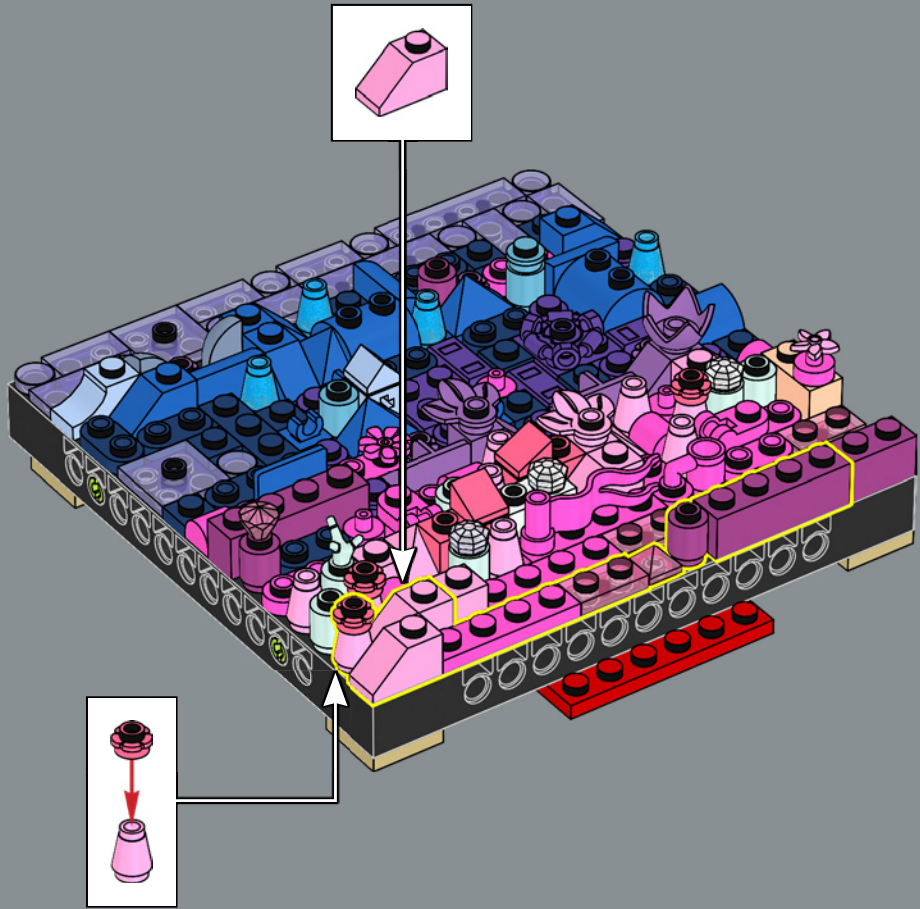

24

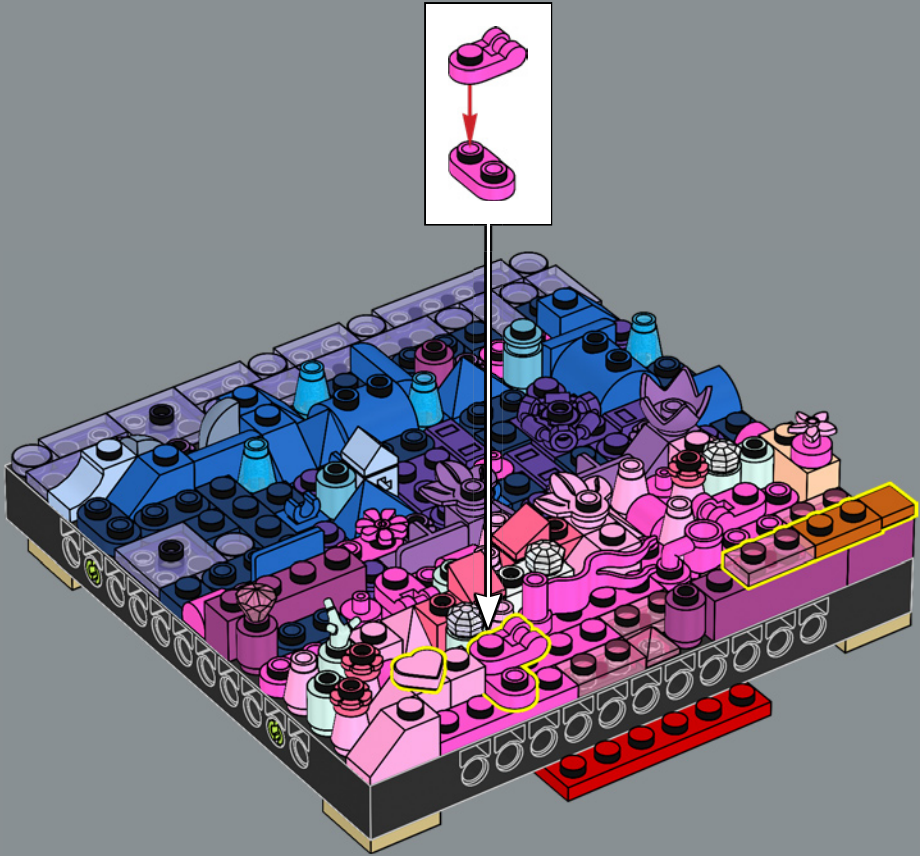

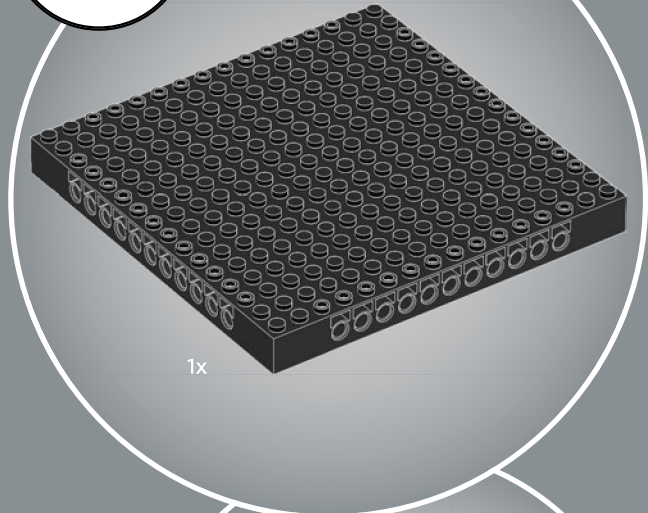
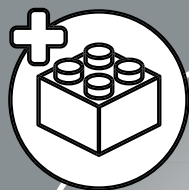

1x

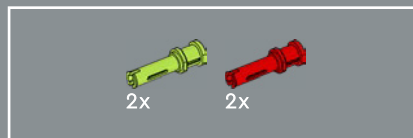
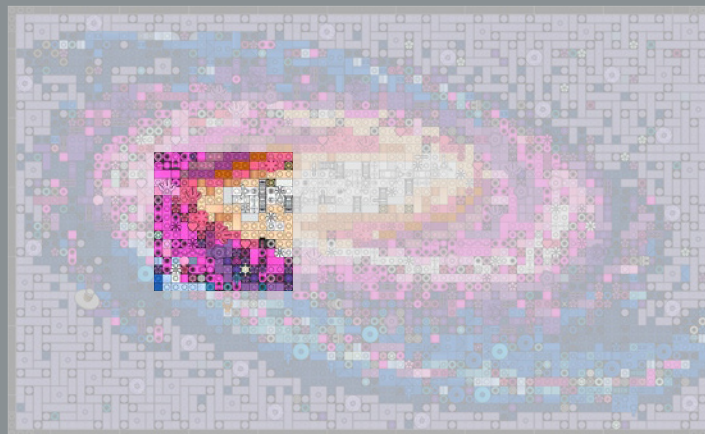

25

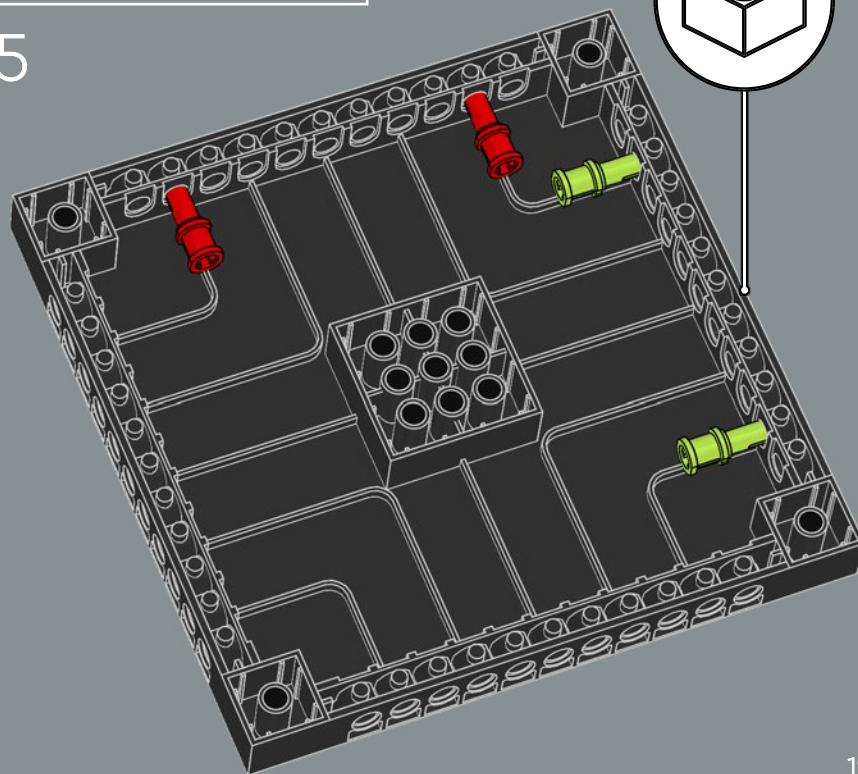
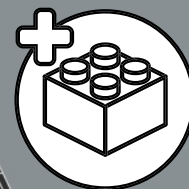

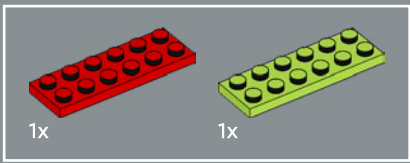

26

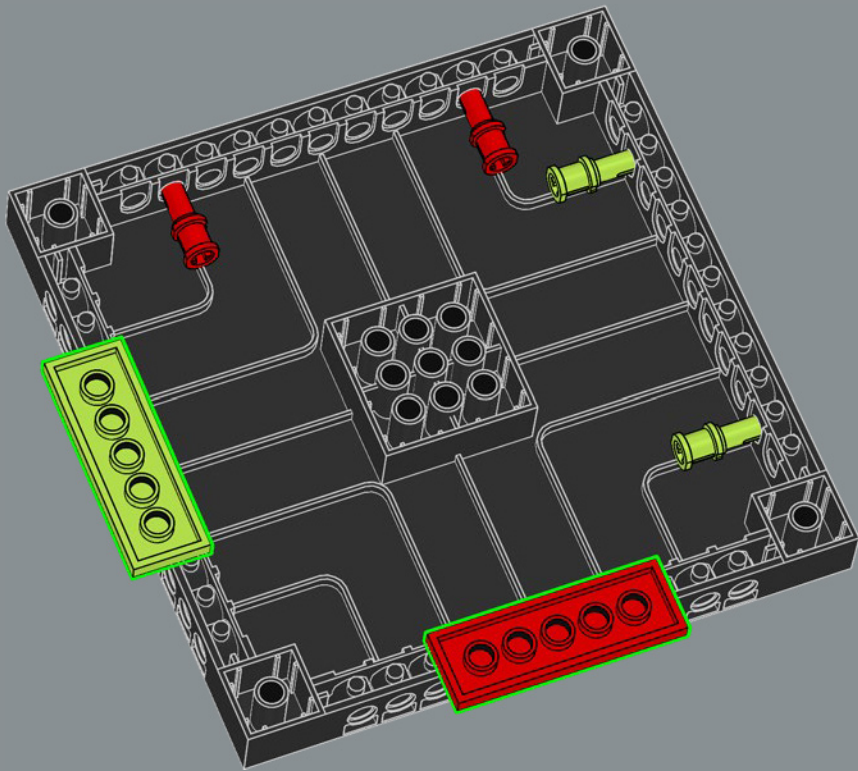

27

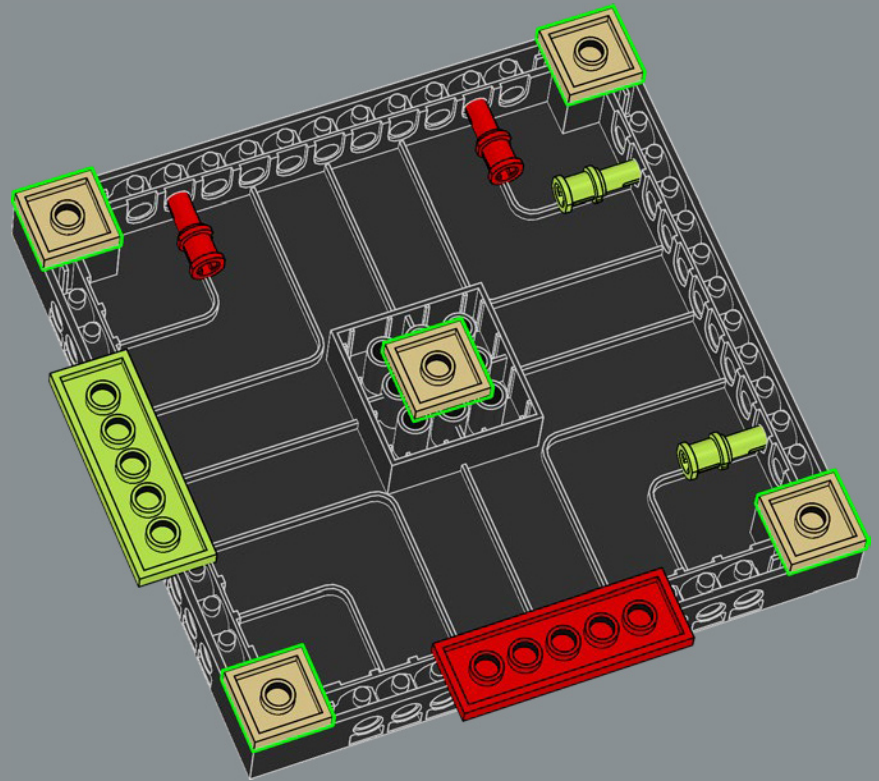

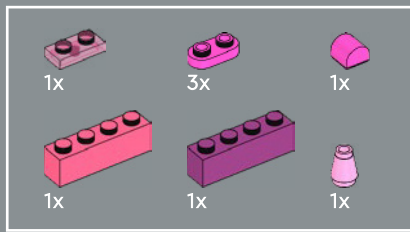

28

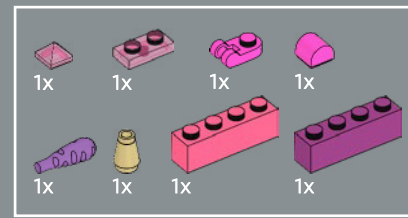
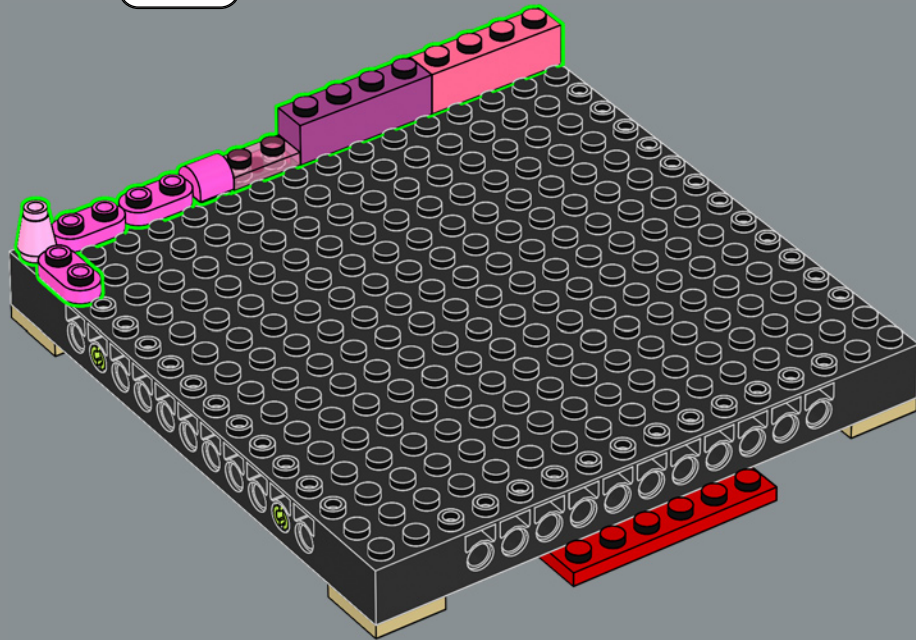

29

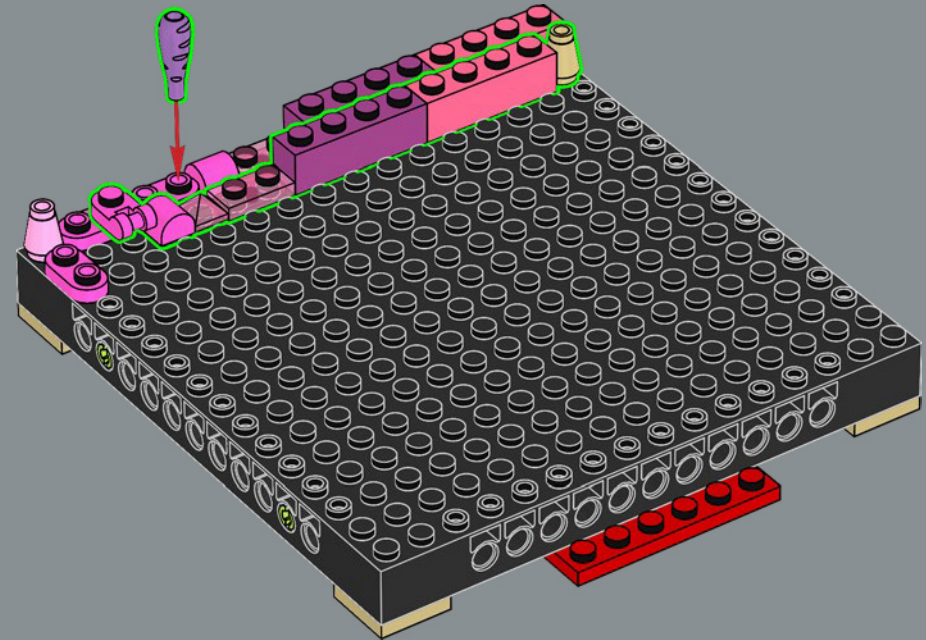

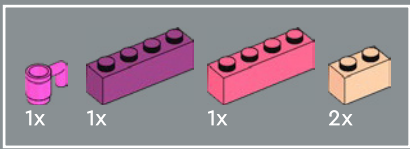

30

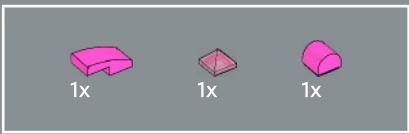
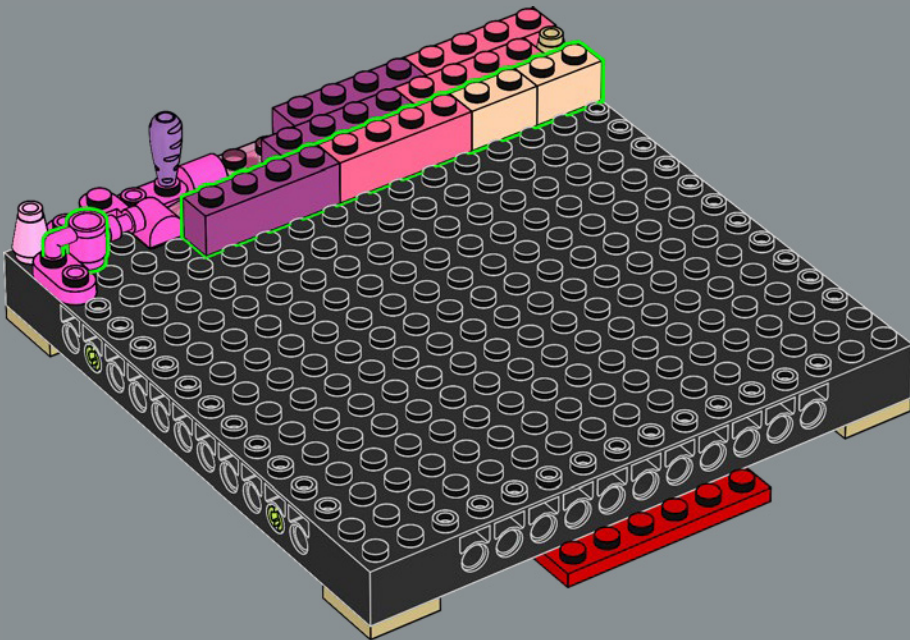

31

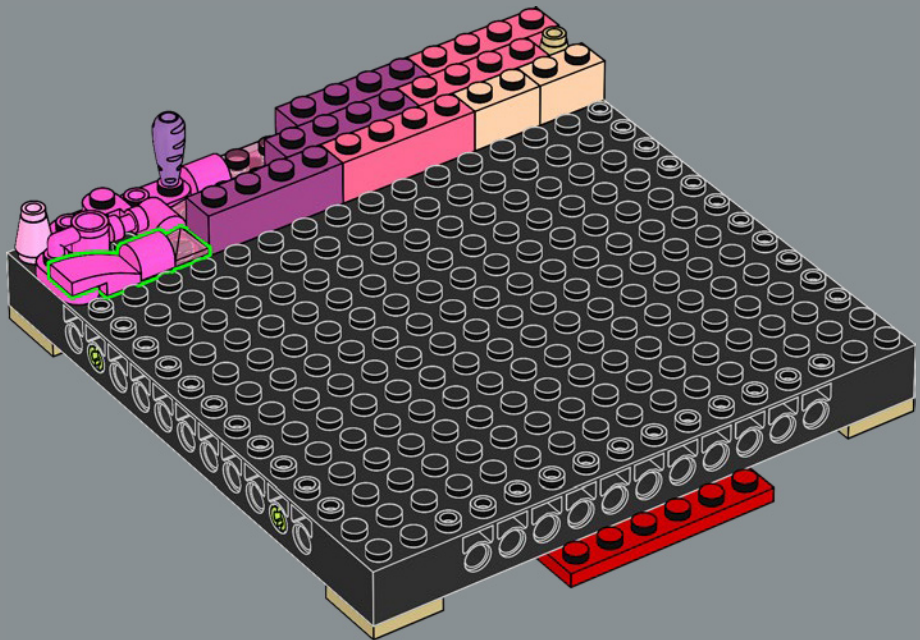



32

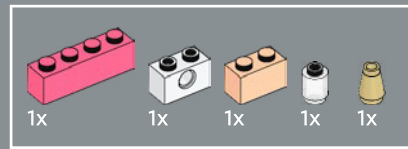
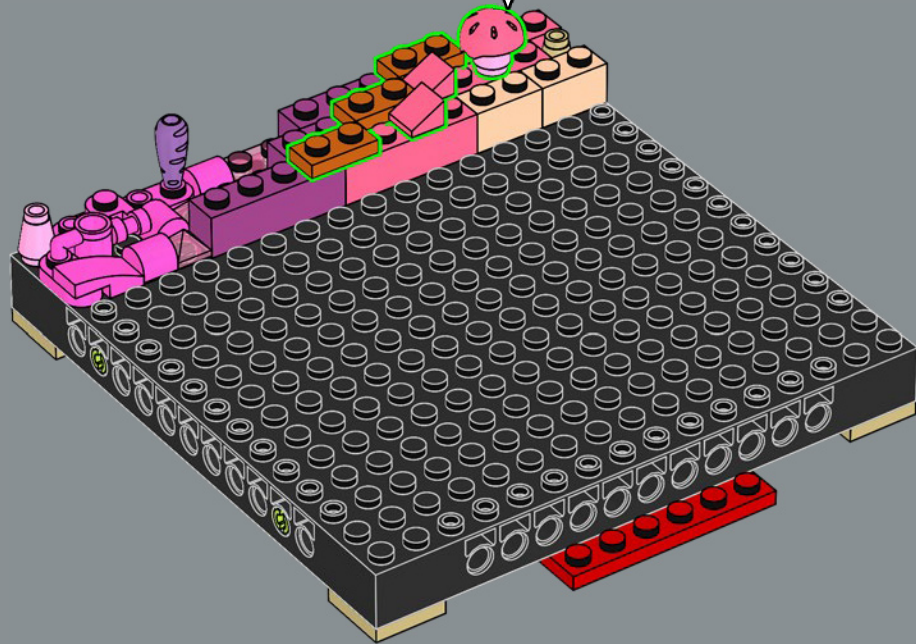
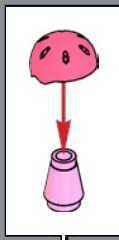

33

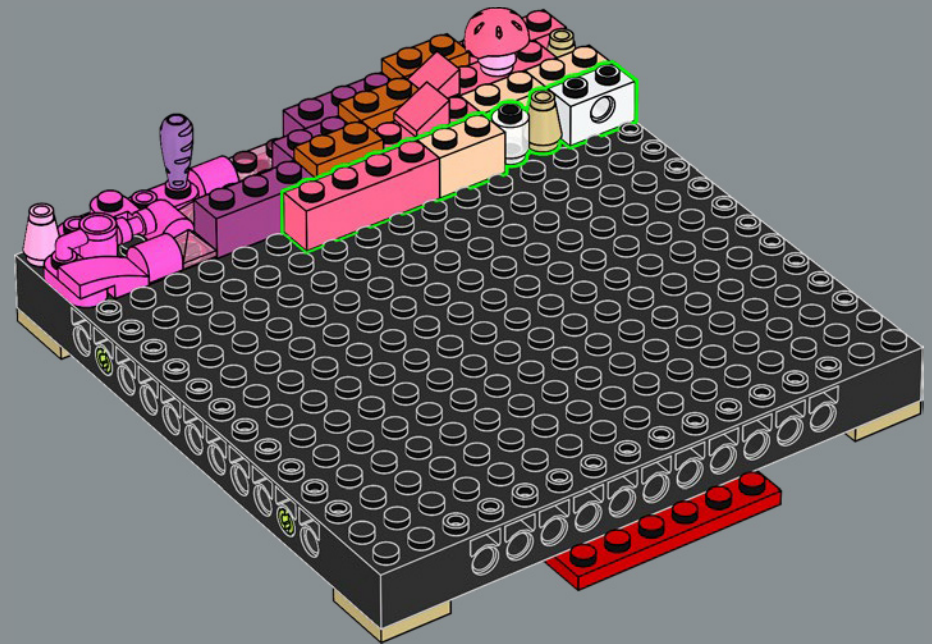



34

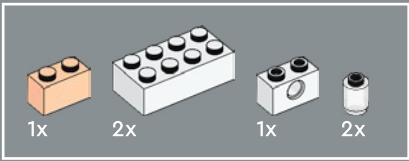
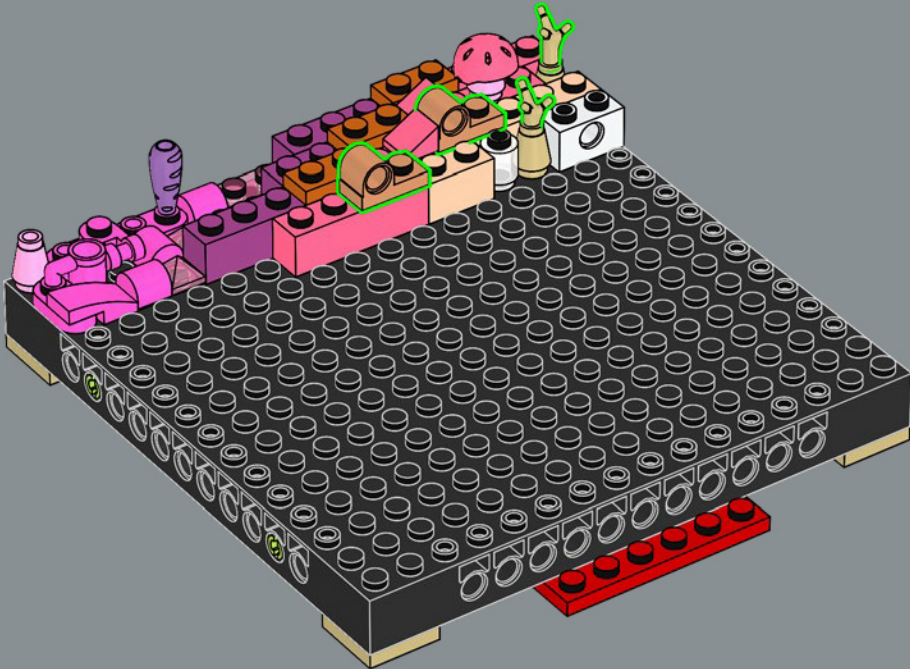

35

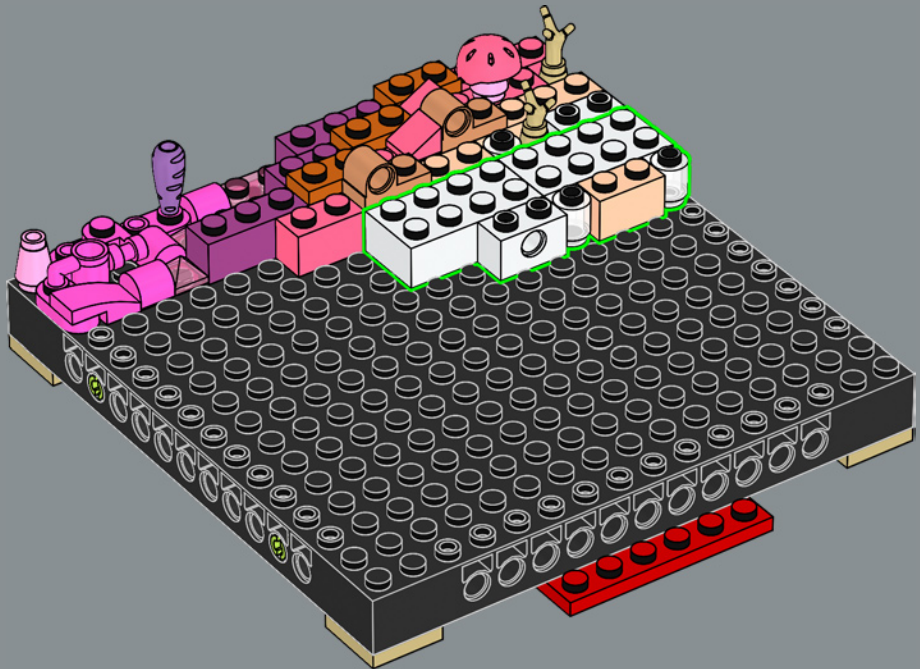

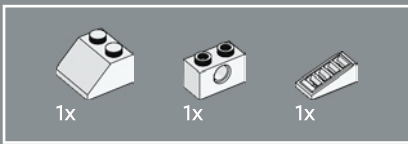

36

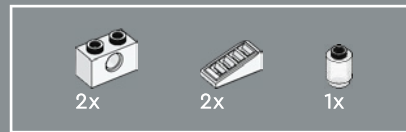
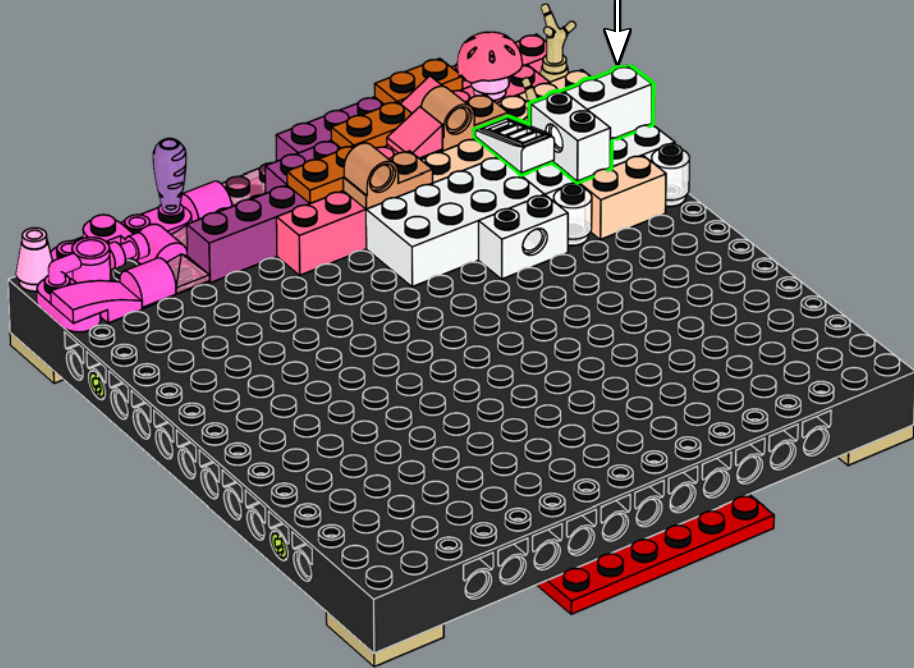
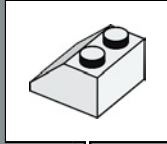

37

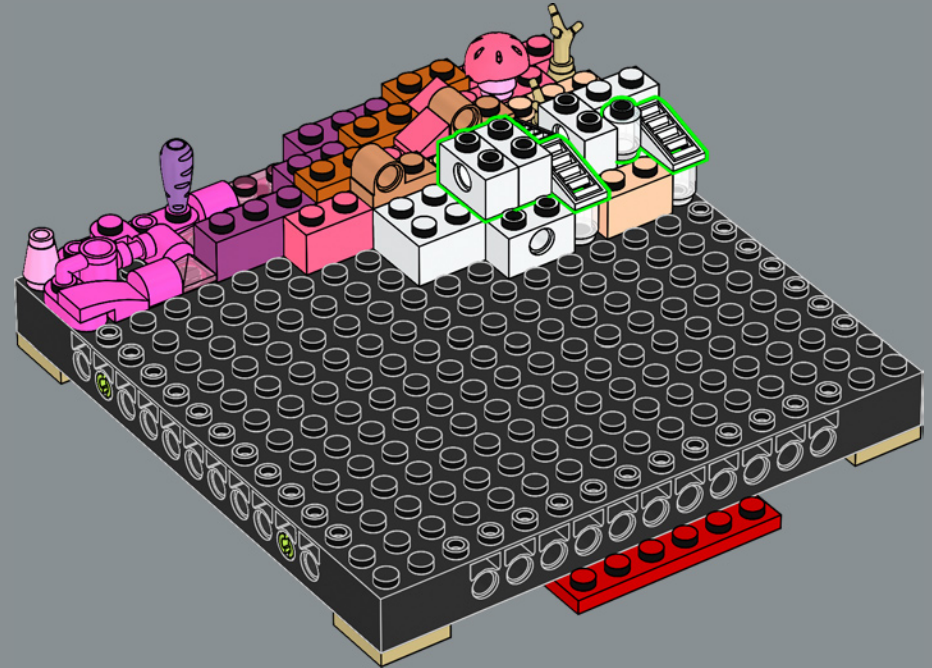

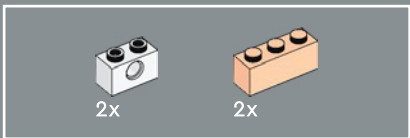

38

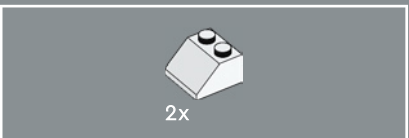
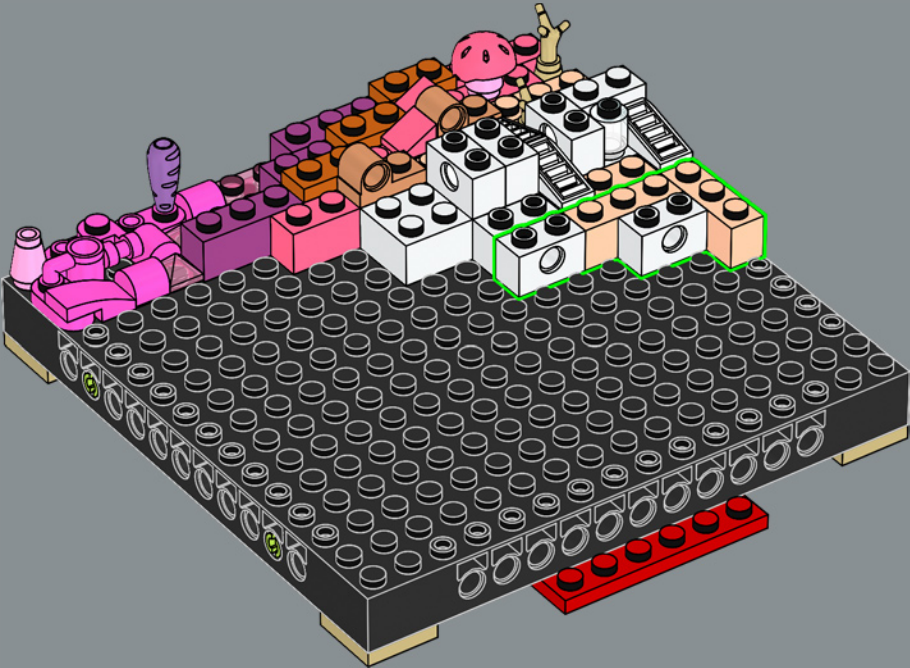

39

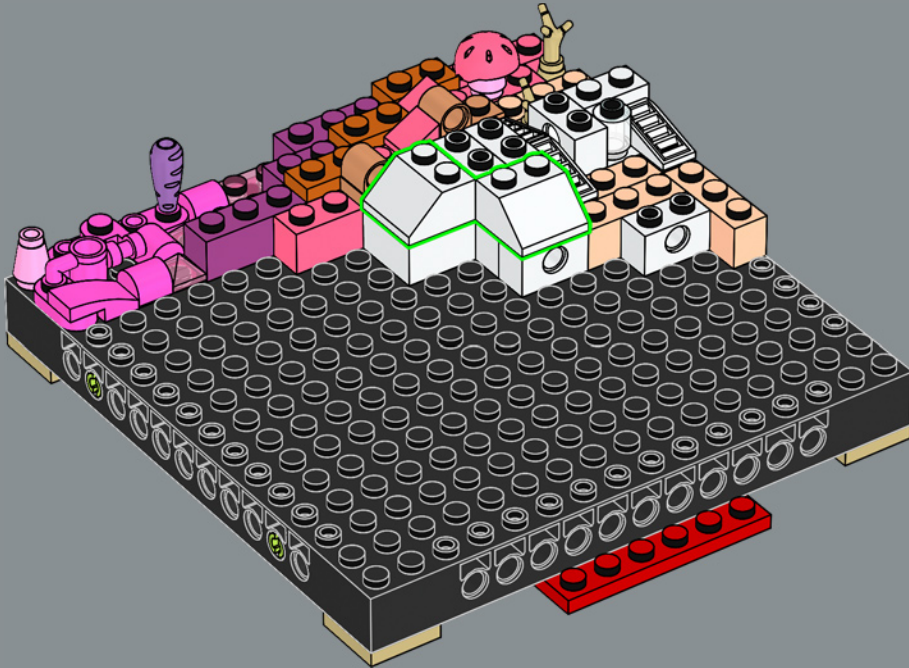

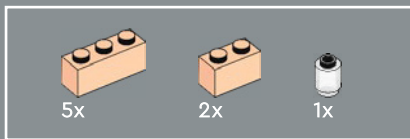

40

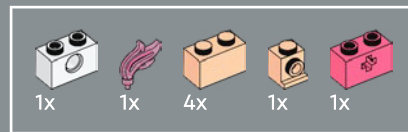
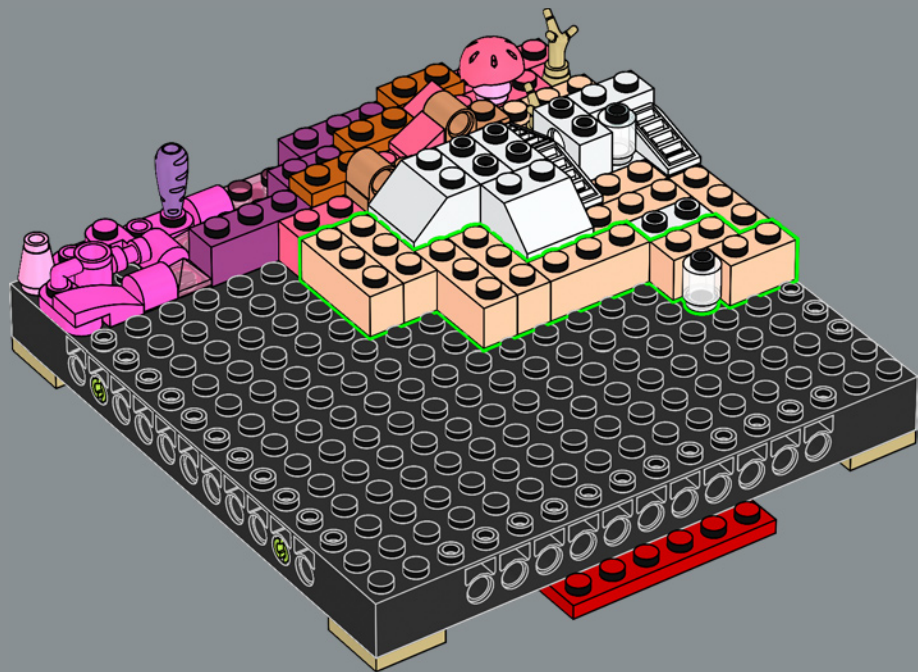

41

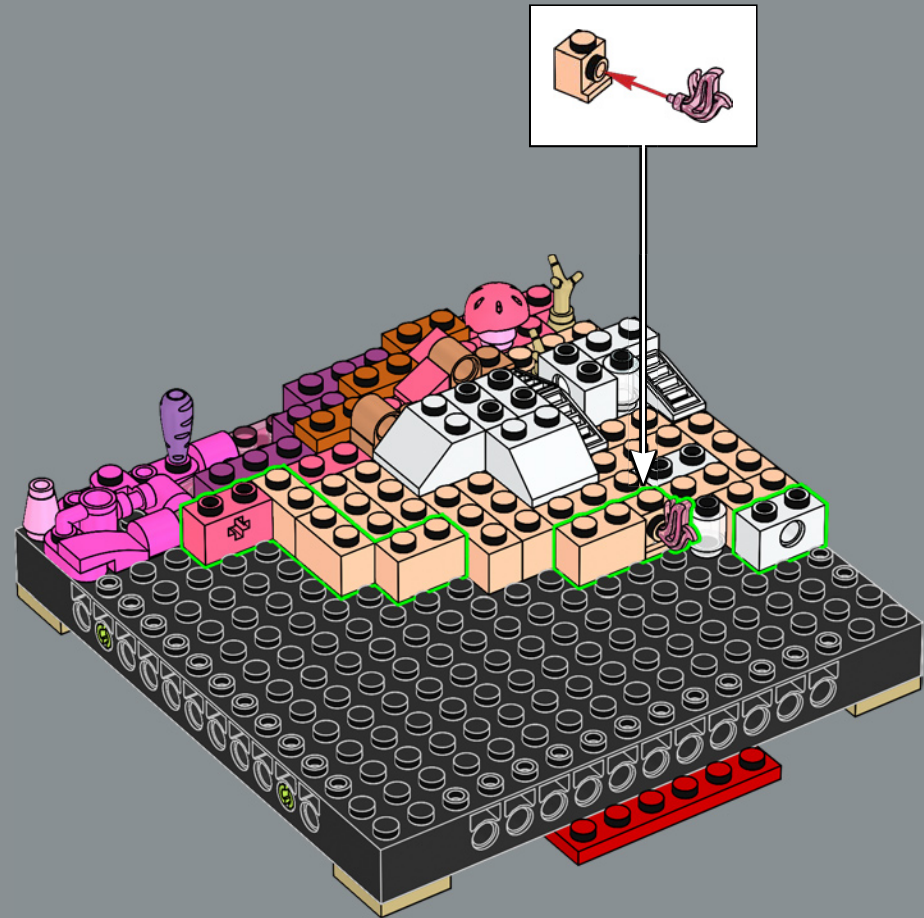

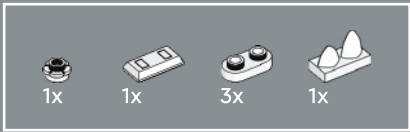

42

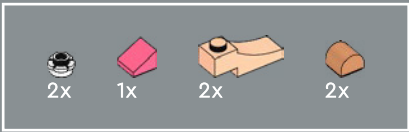
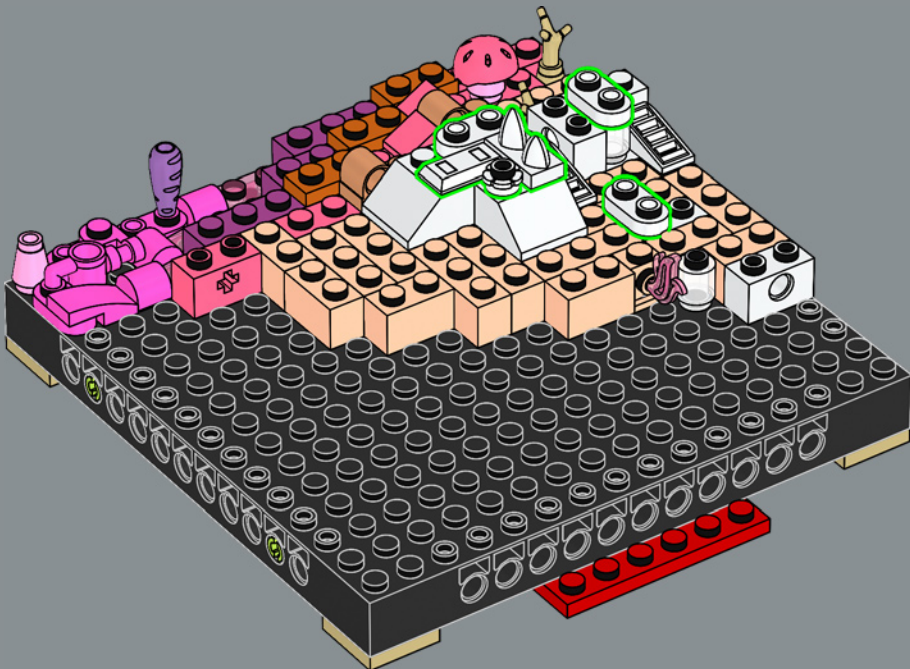

43

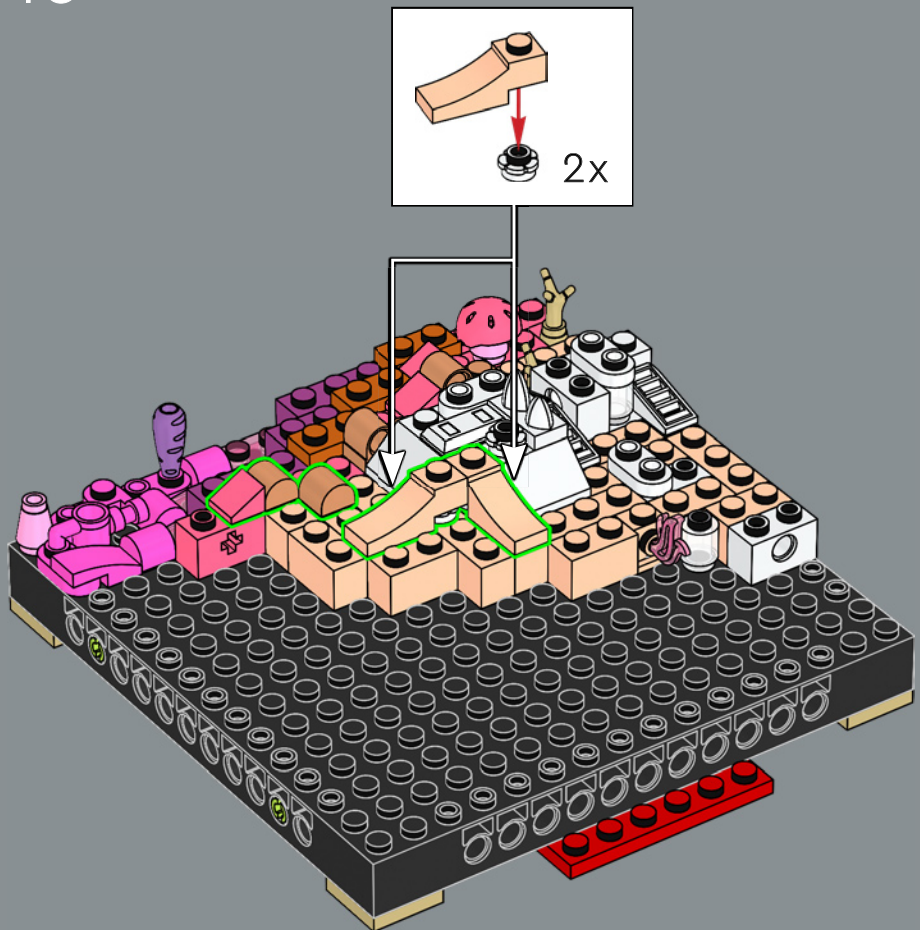

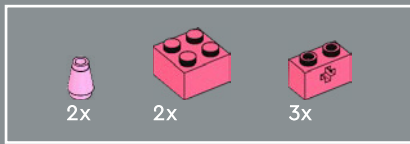

44

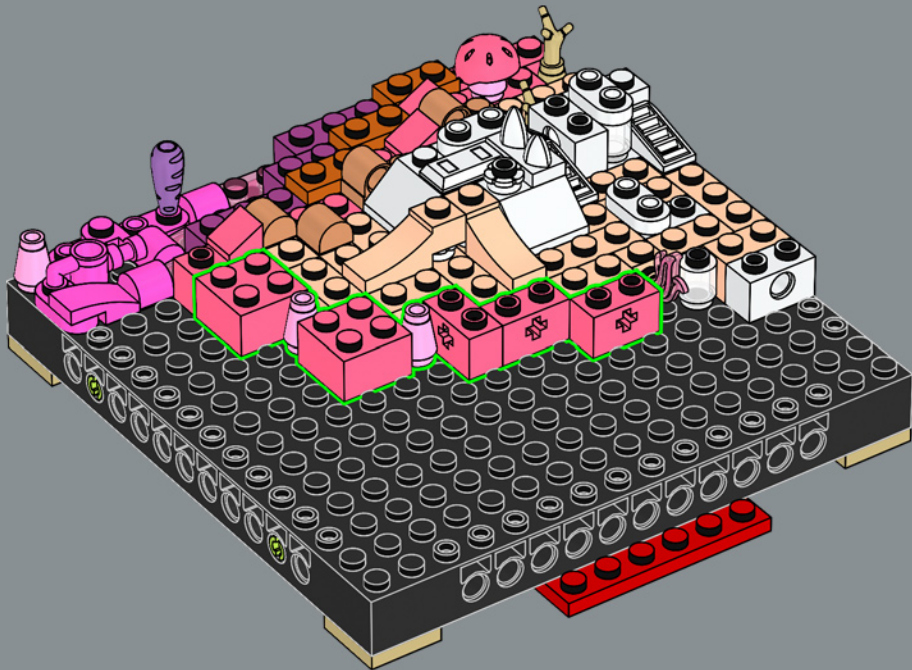

45

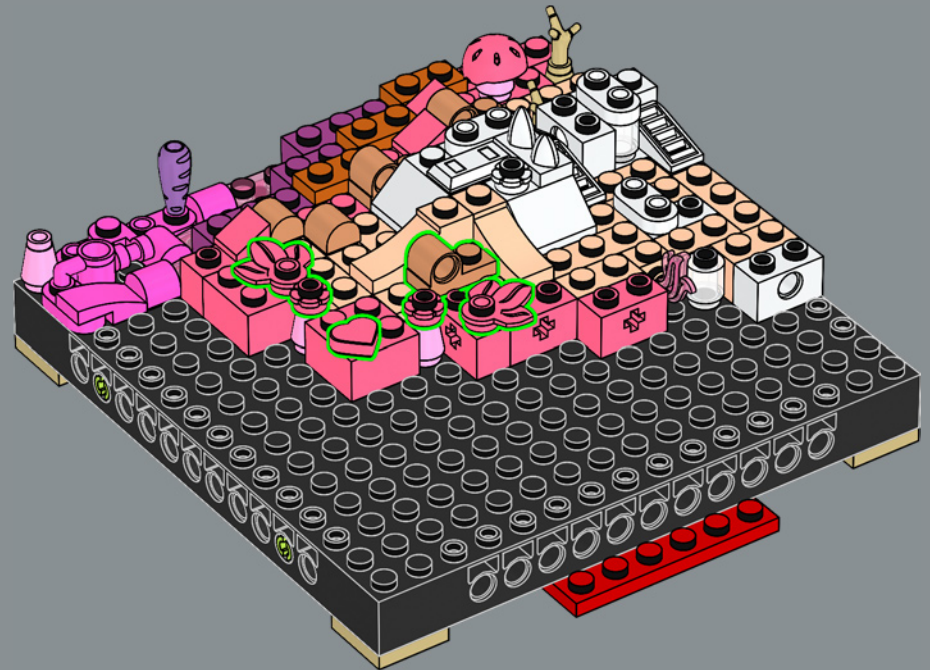

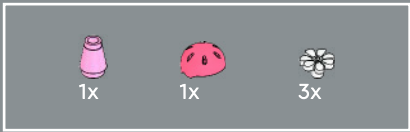

46

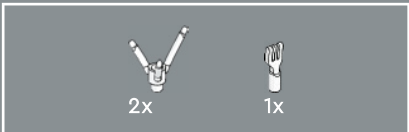

47

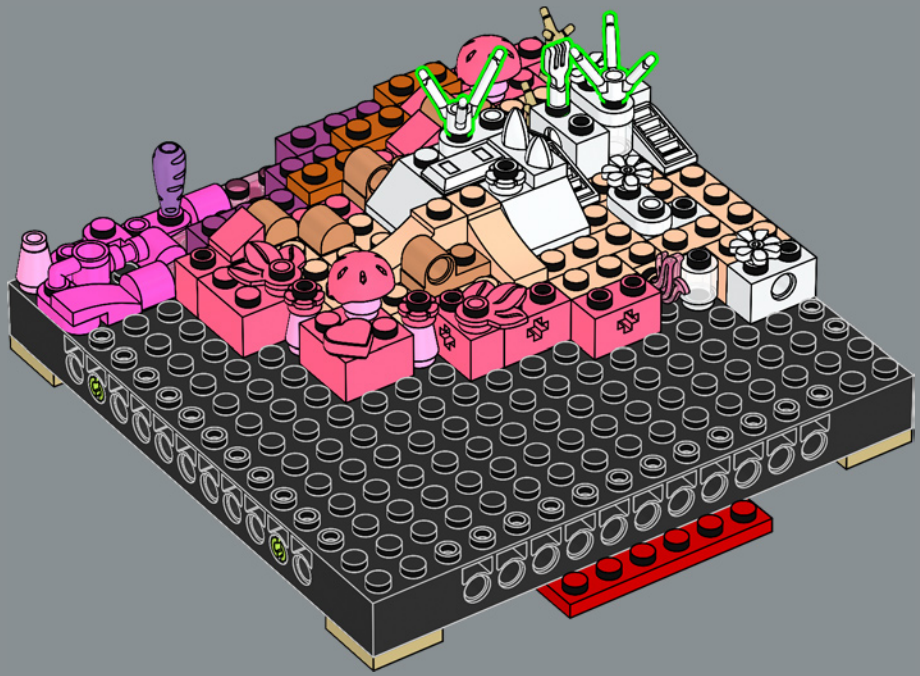

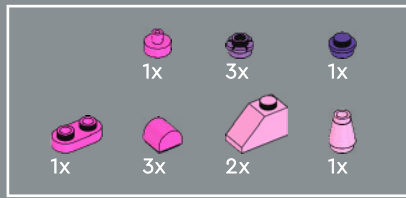

48

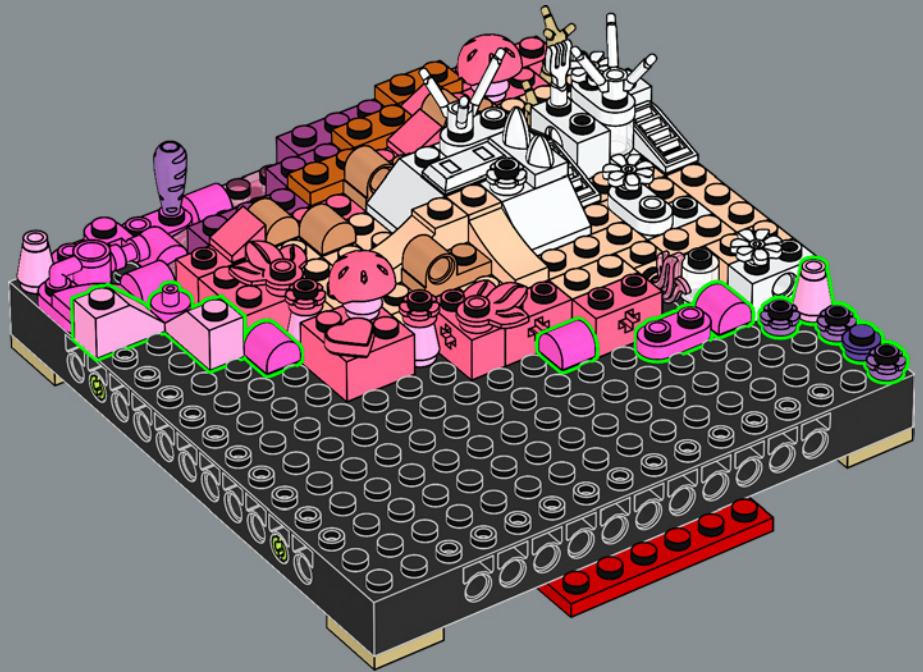

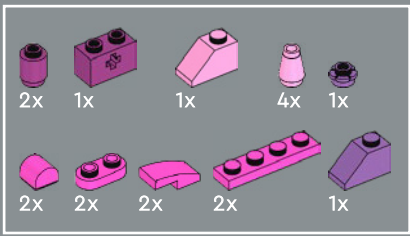

49

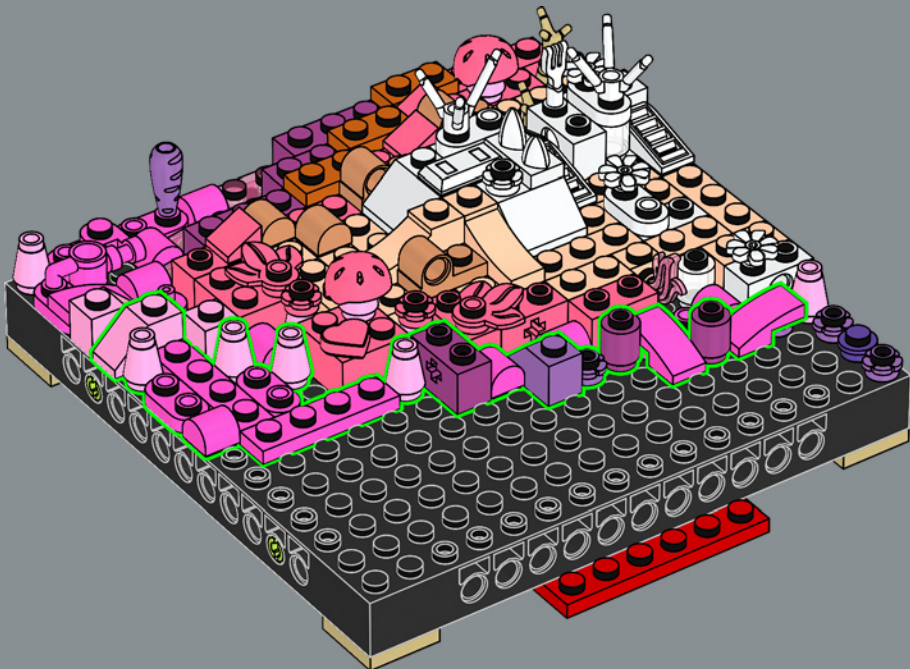

50

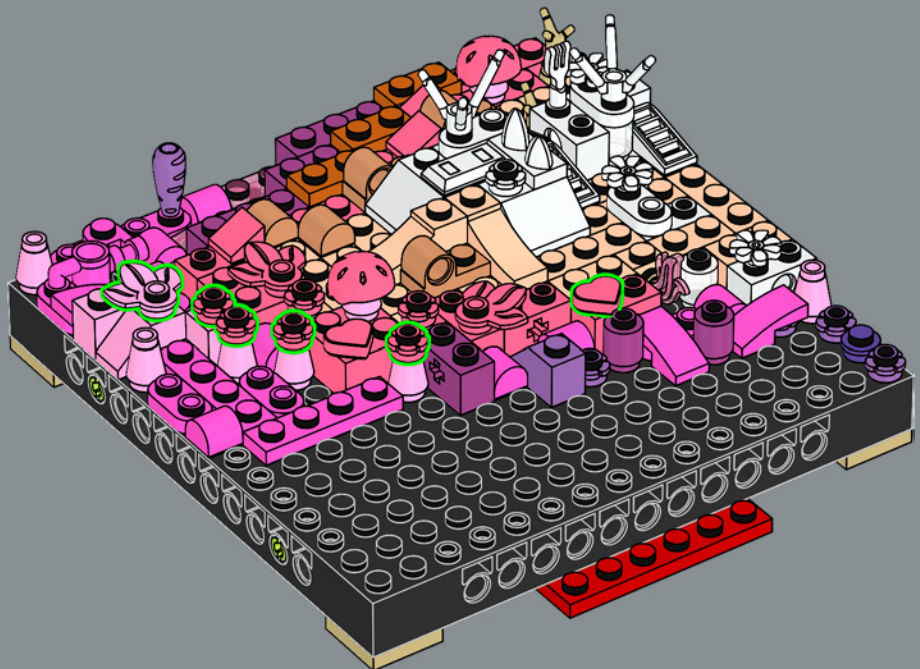

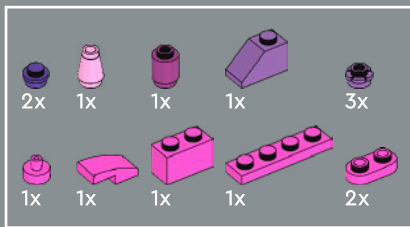

51

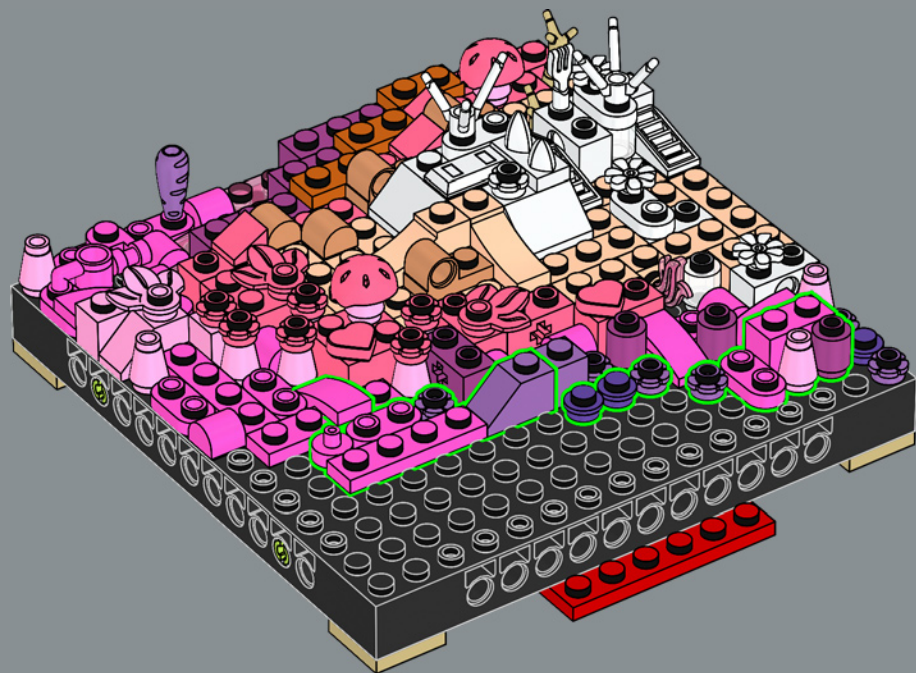

52

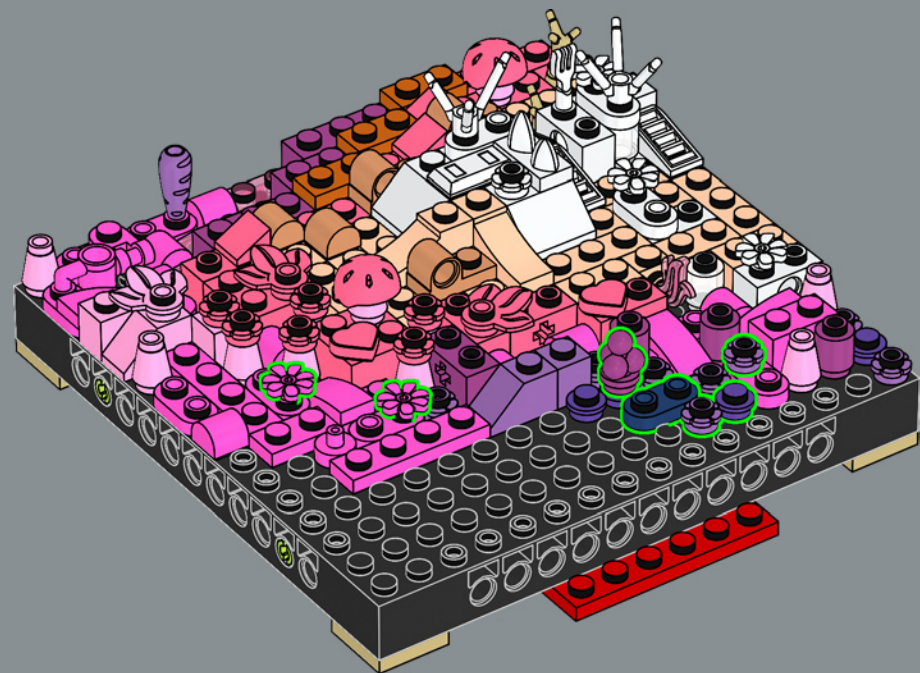

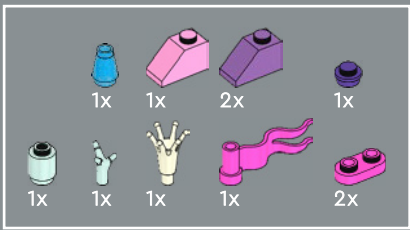

53

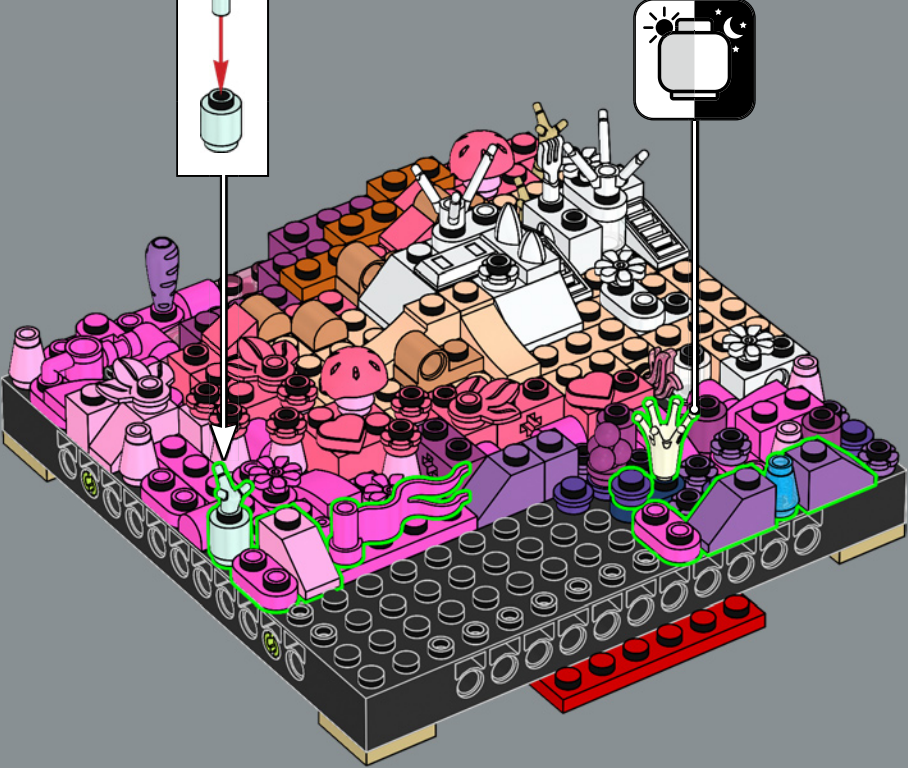
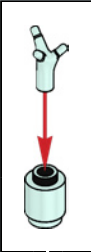

54

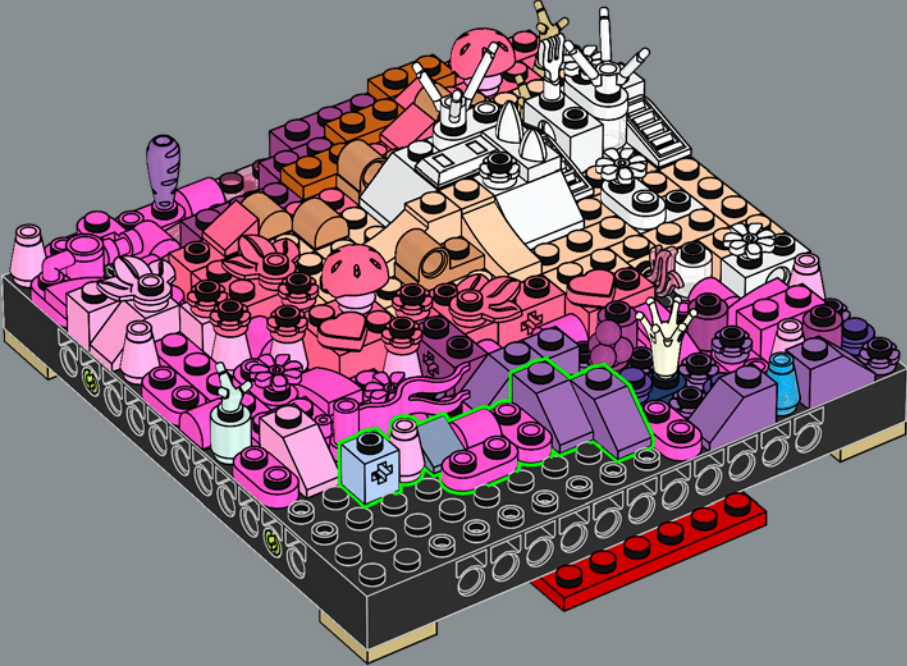



55

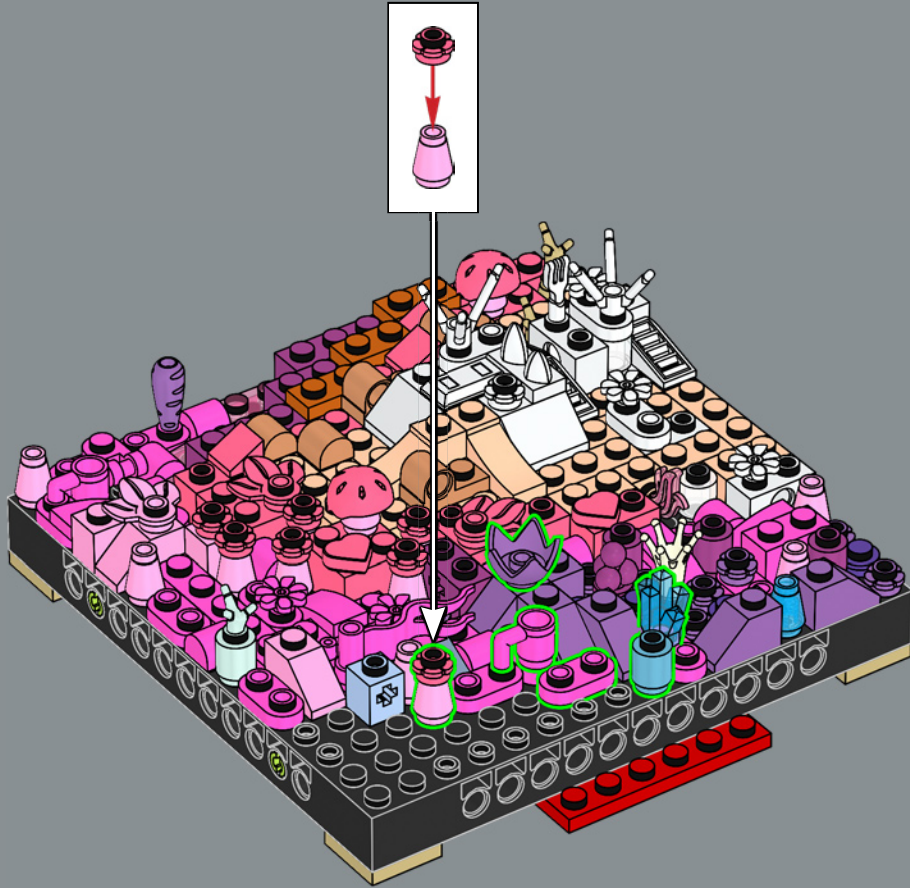

56

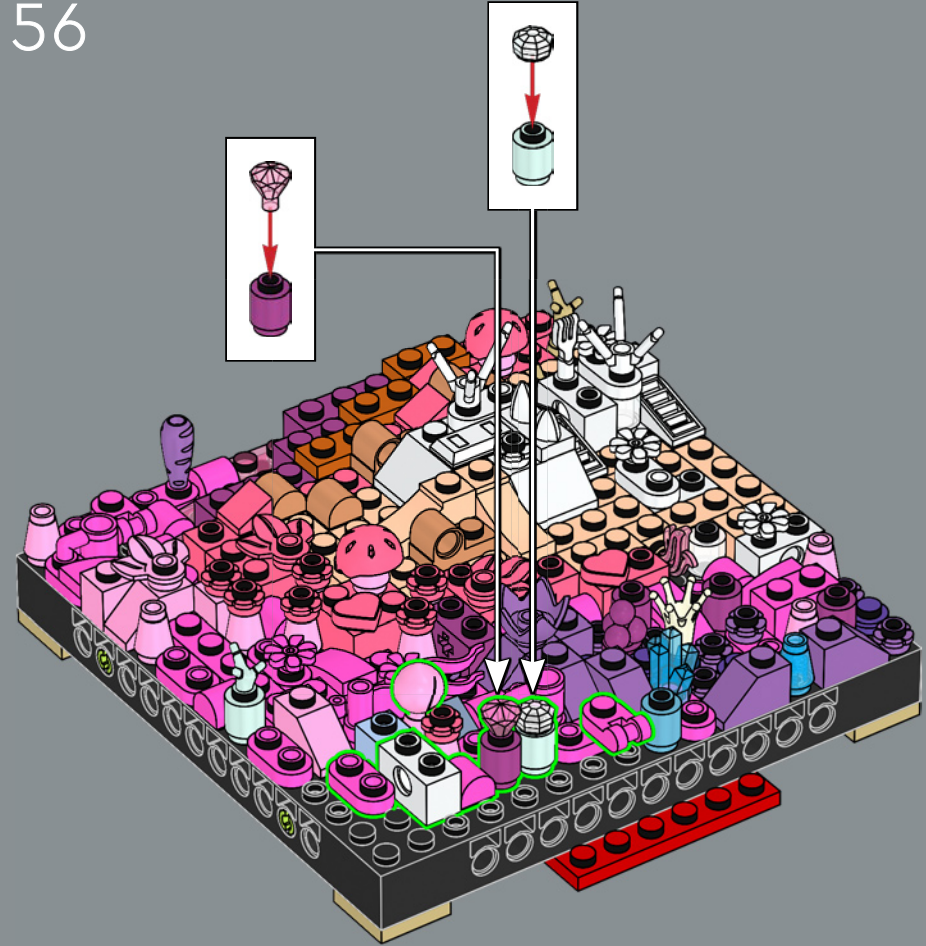

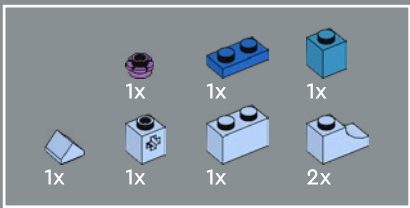

57

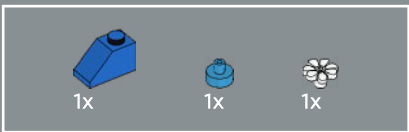
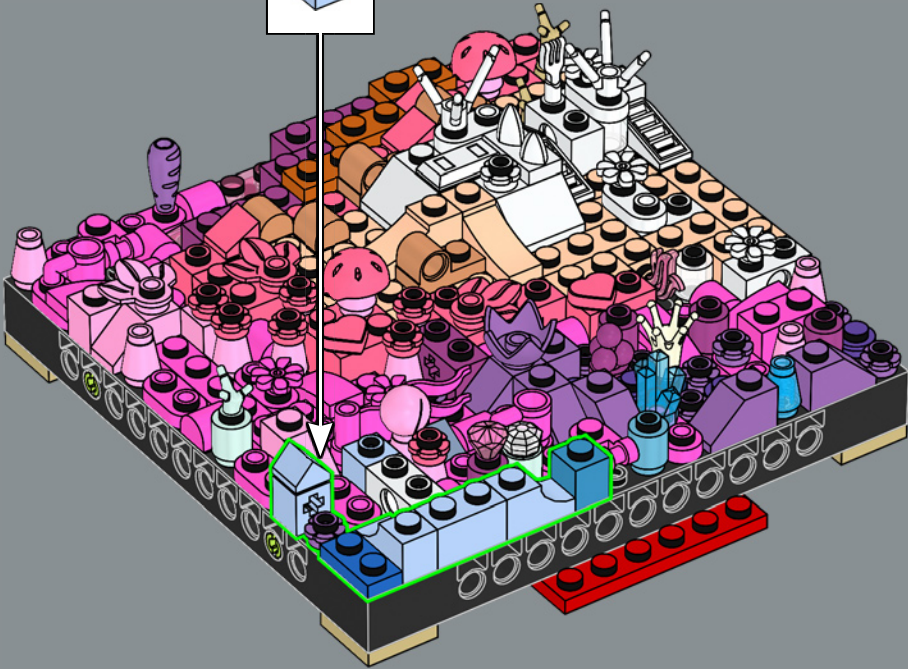
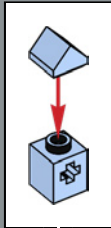

58

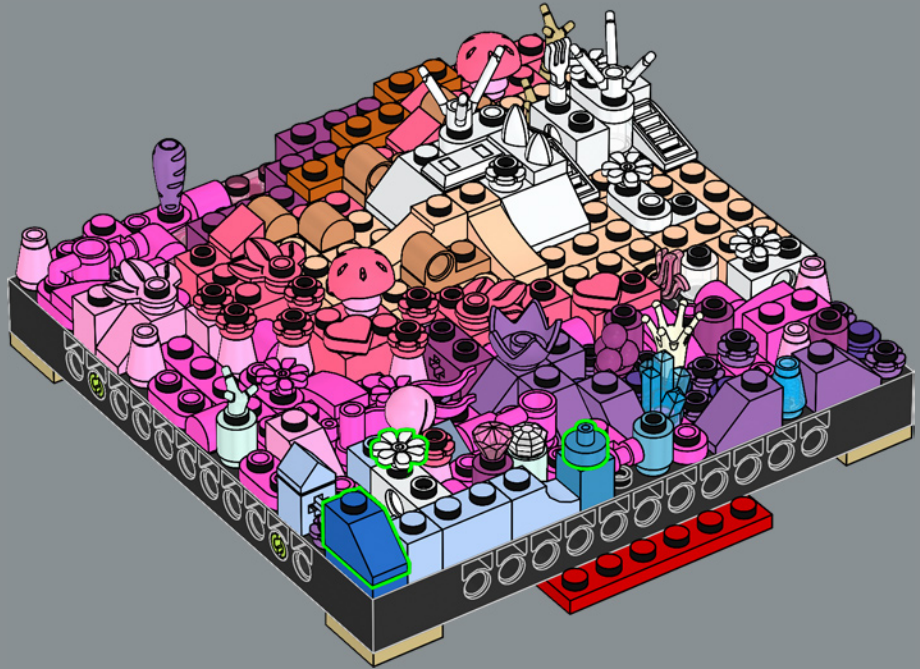

59

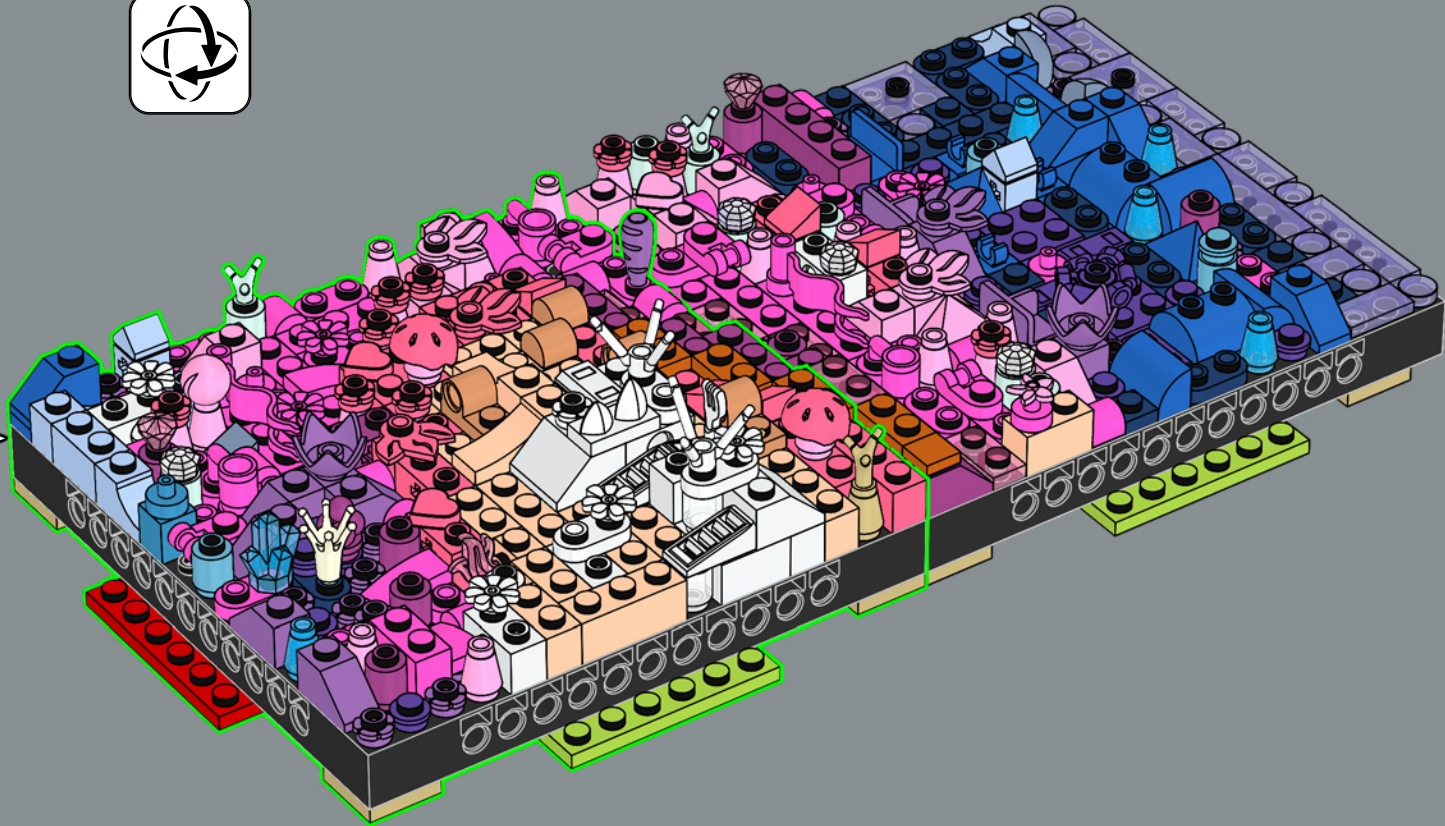

60

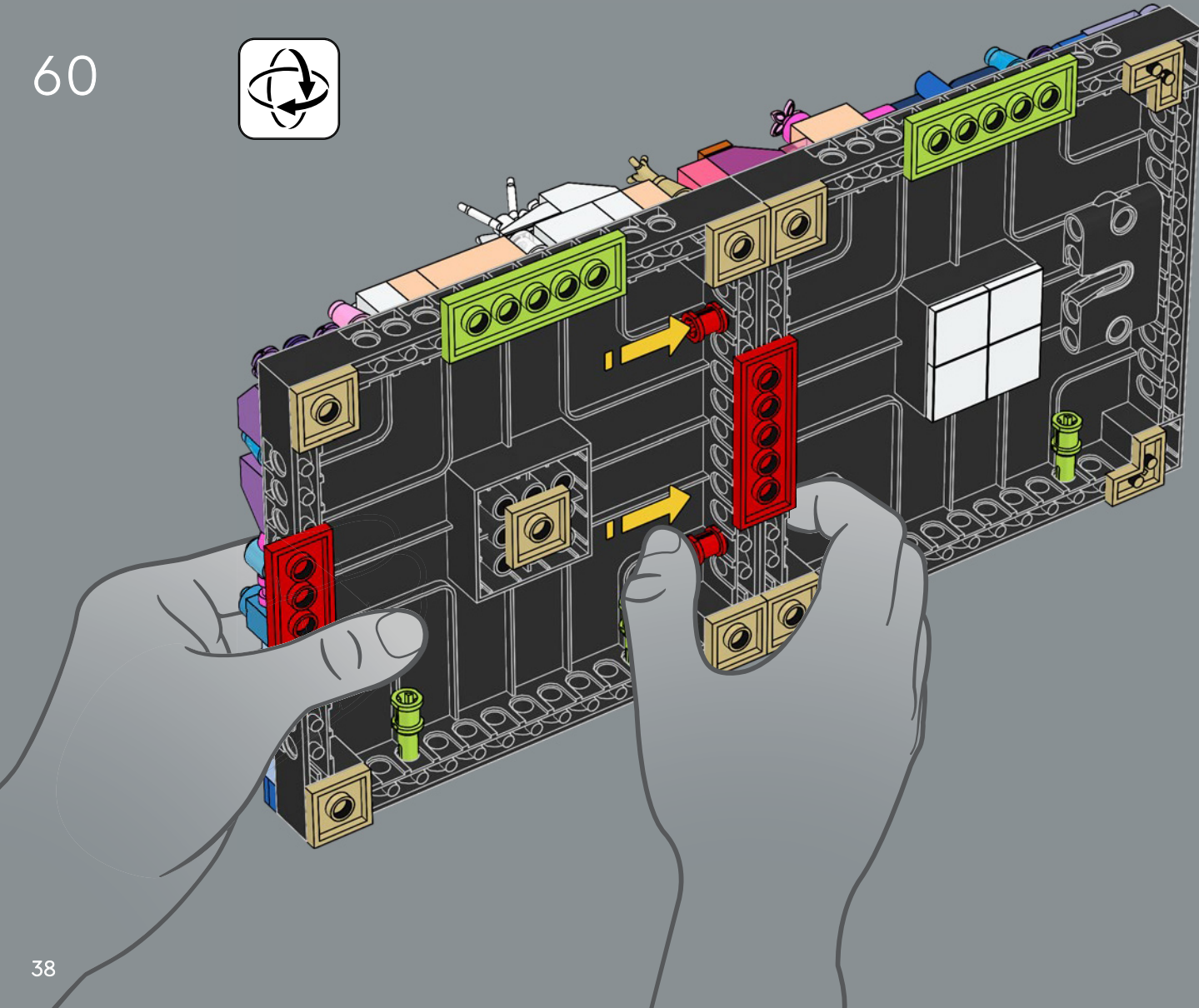

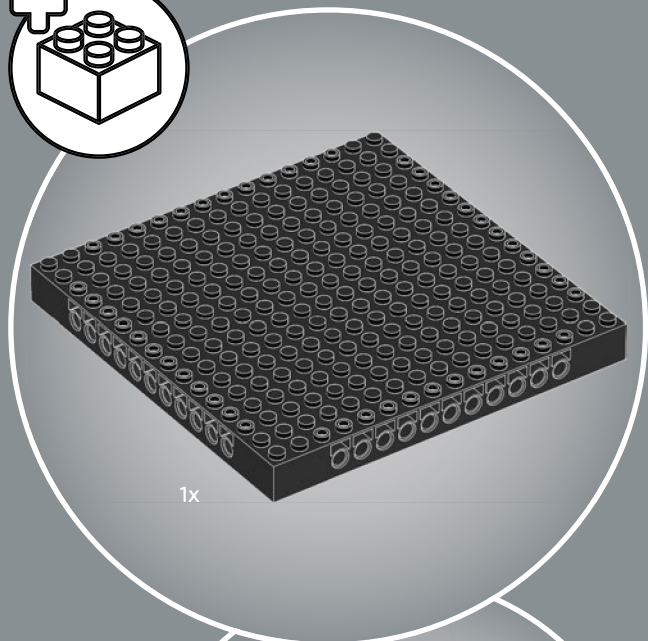
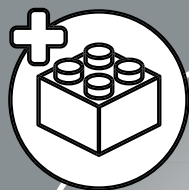

1x

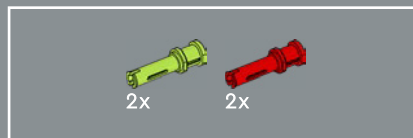
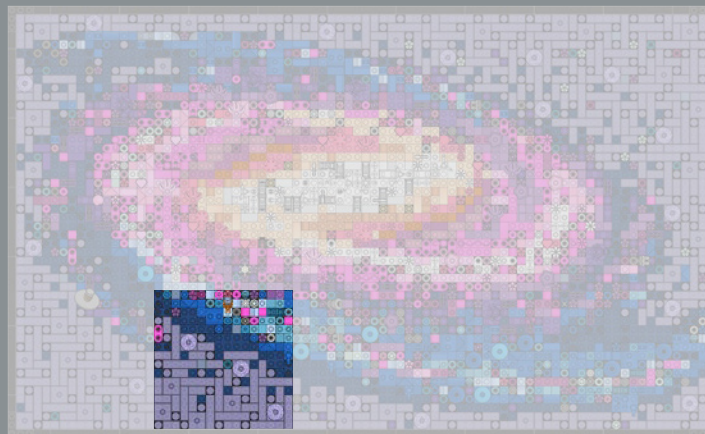

61

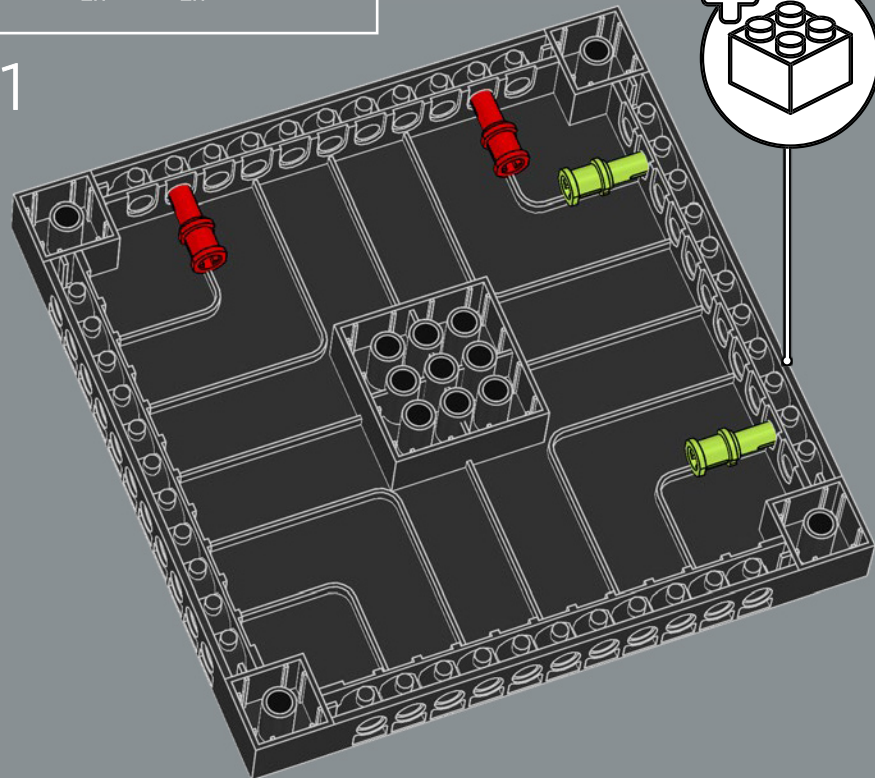

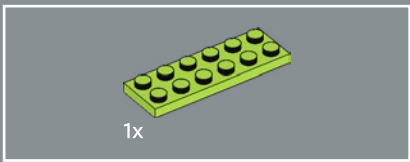

62

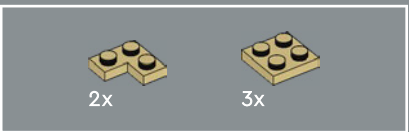
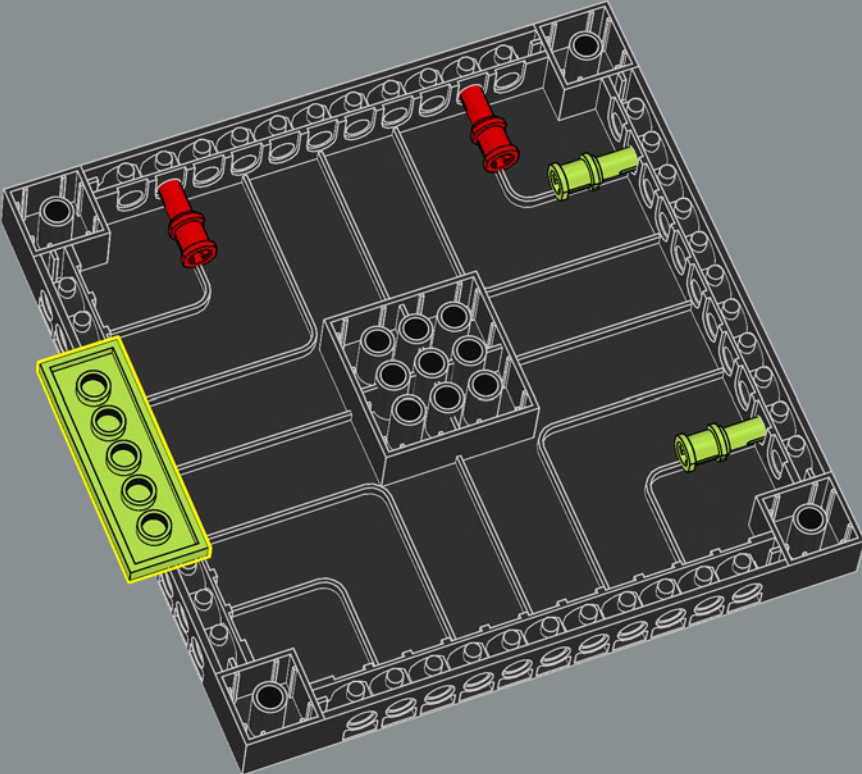

63

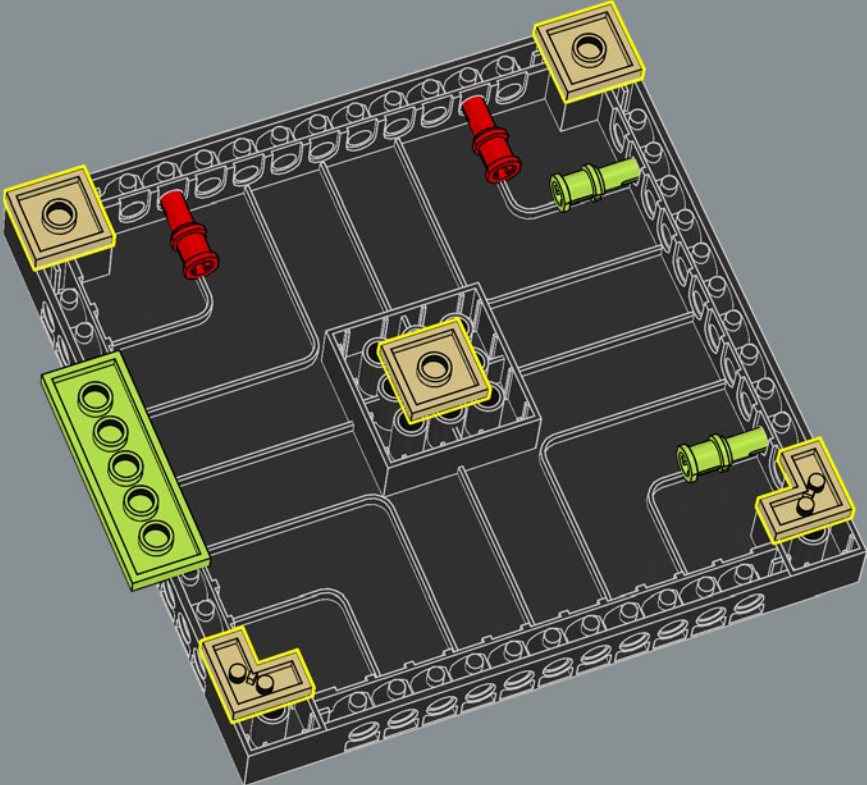

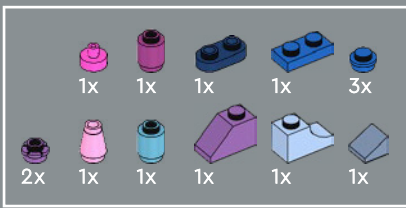

64

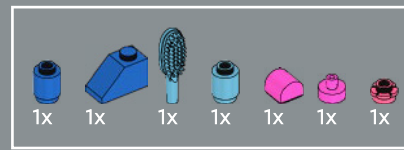
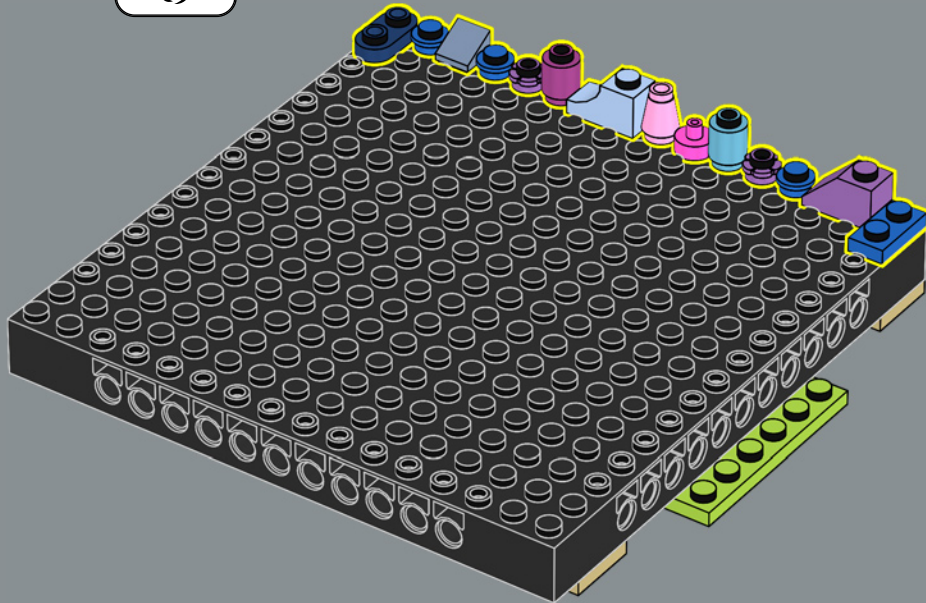

65

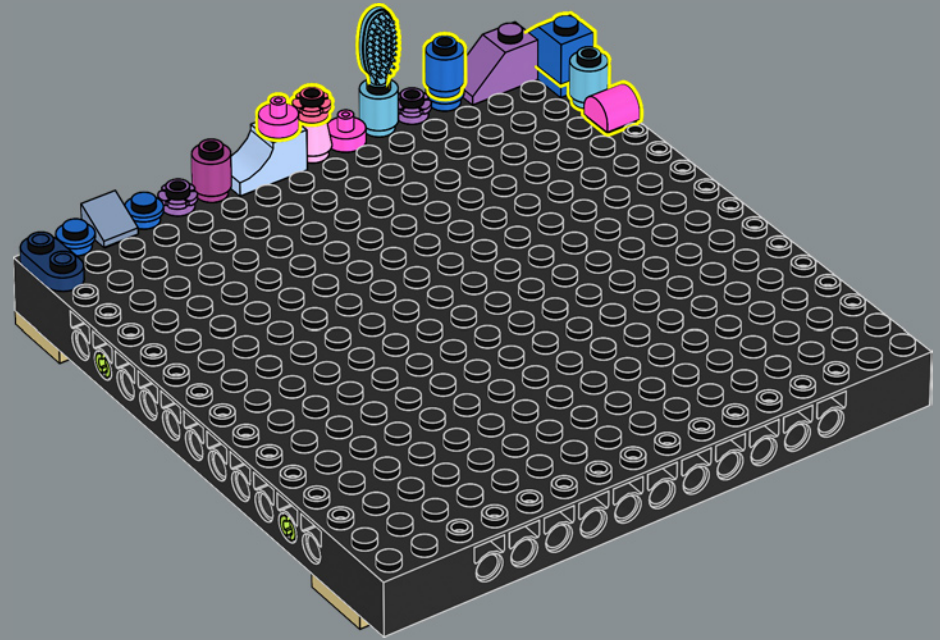

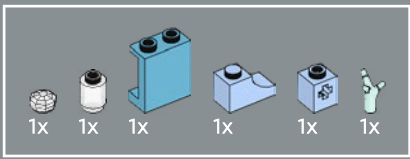

66

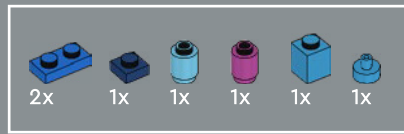
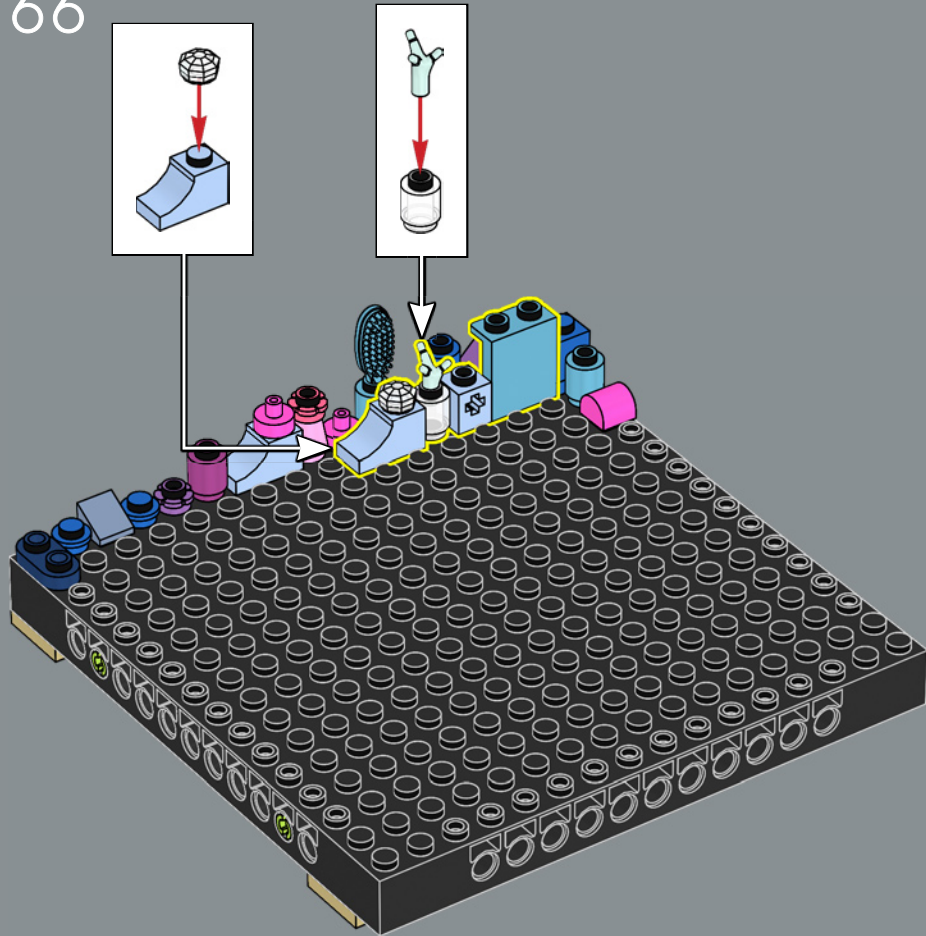

67

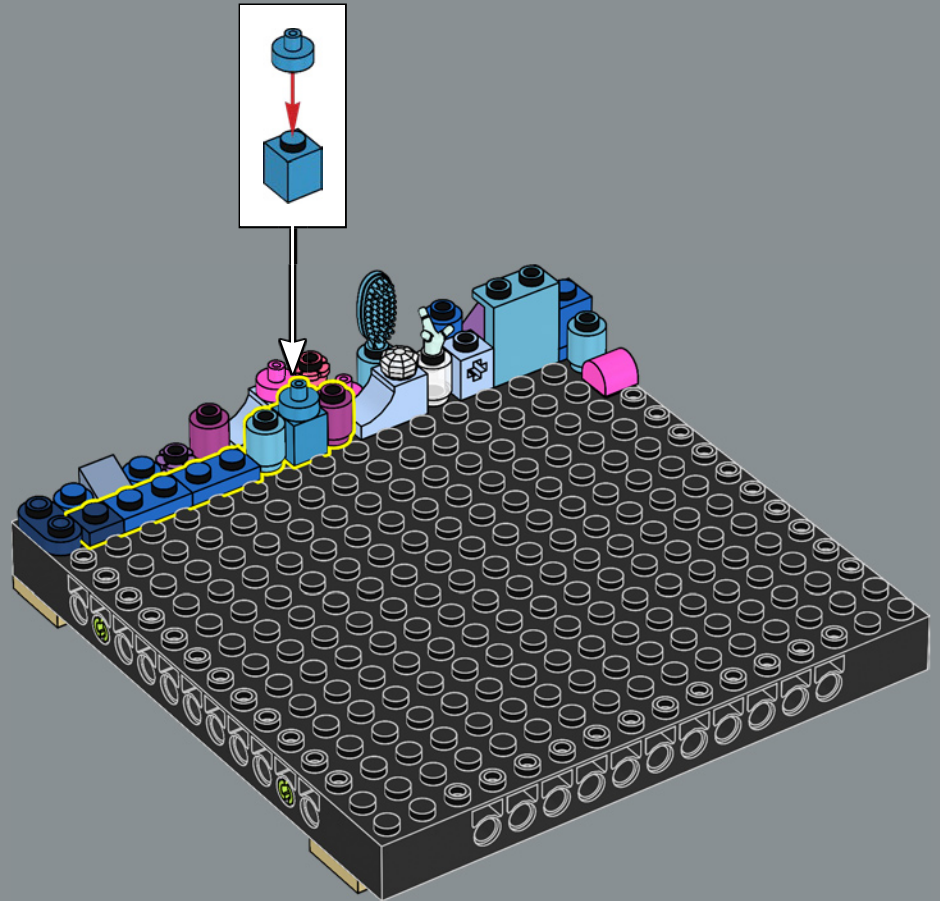

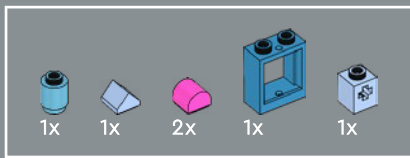

68

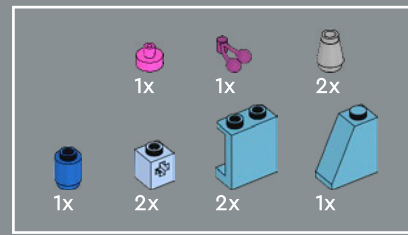
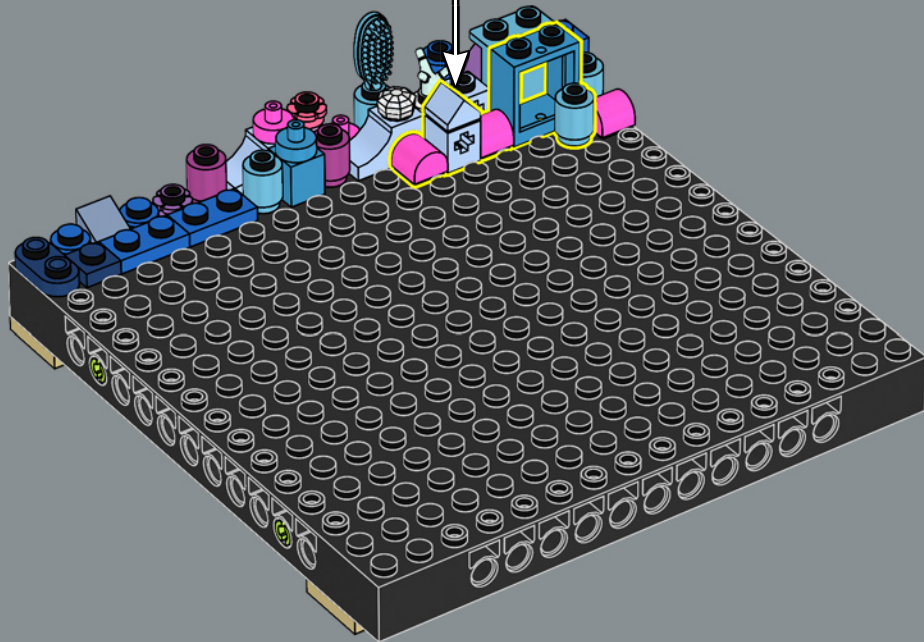
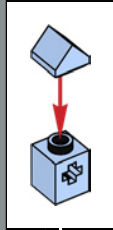

69

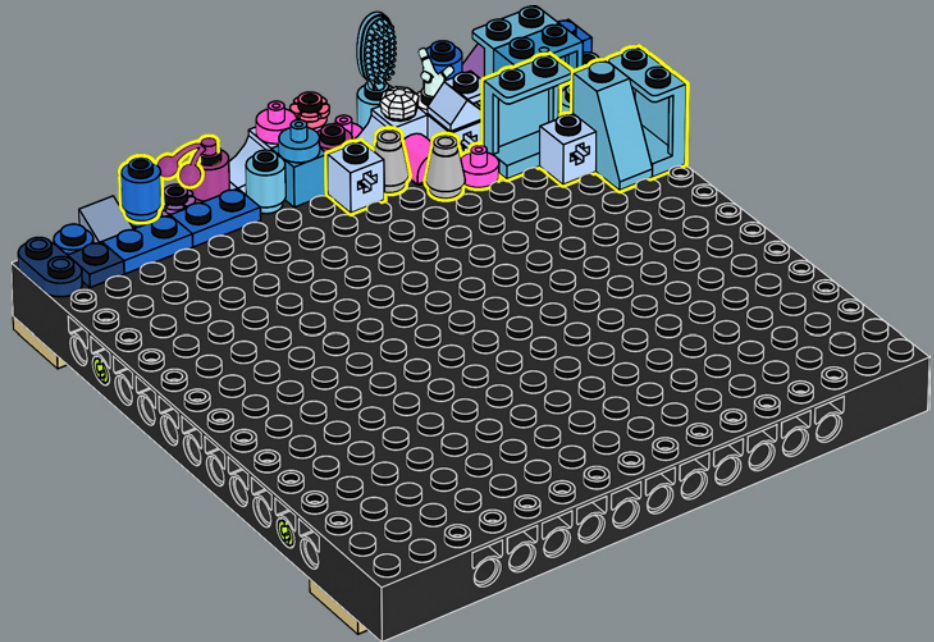

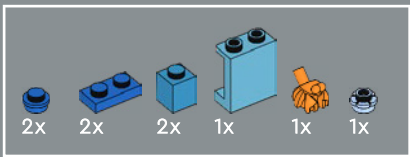

70

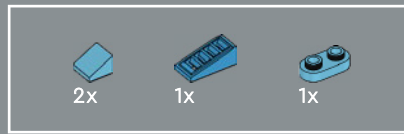
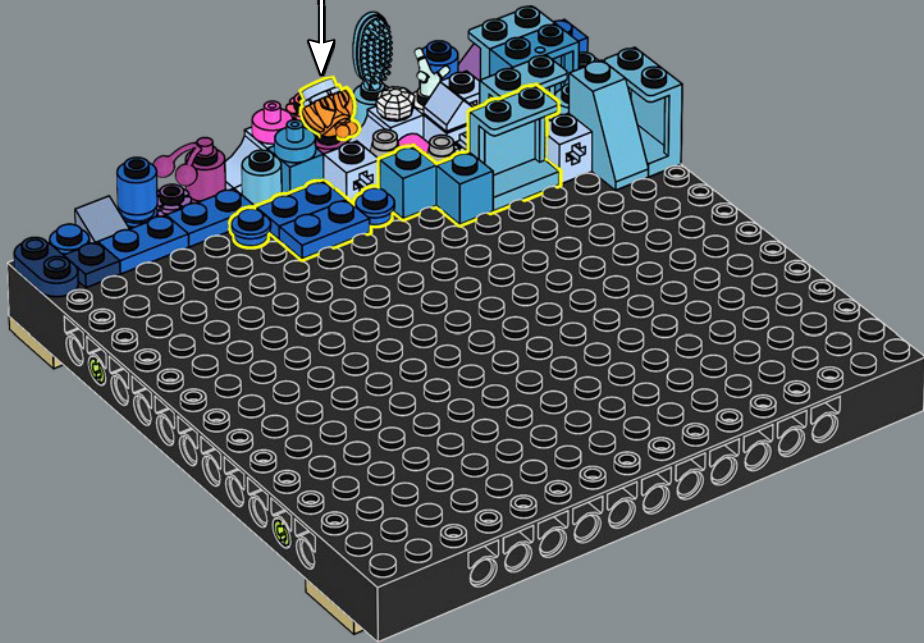
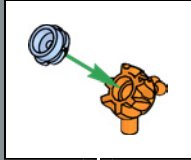

71

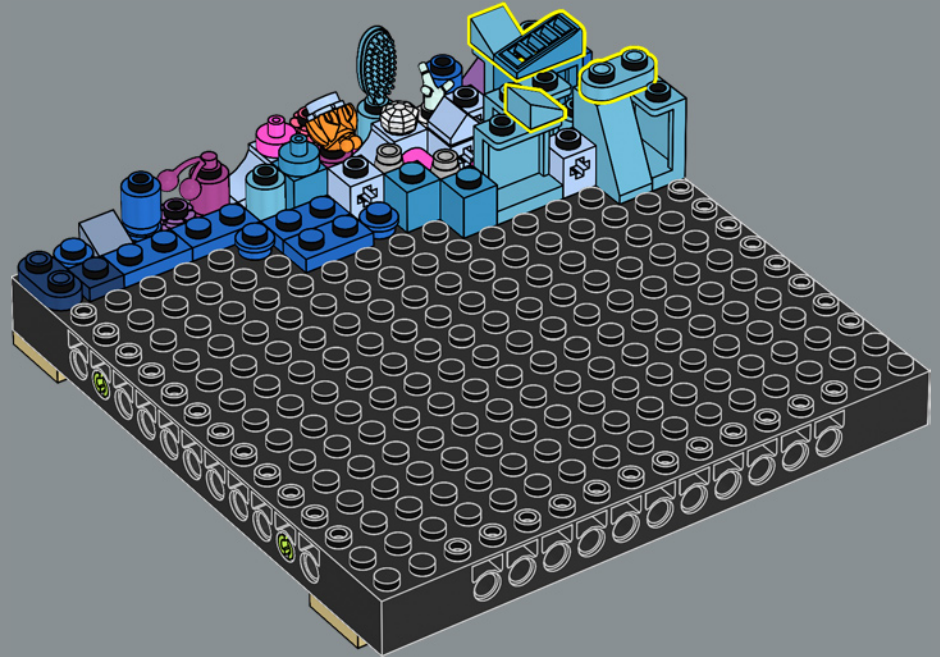

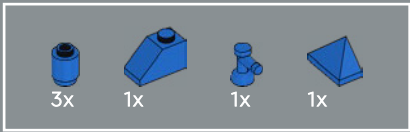

74

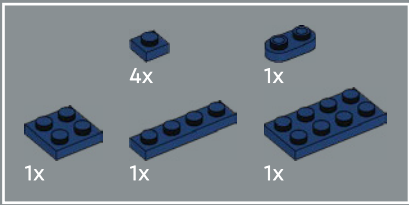
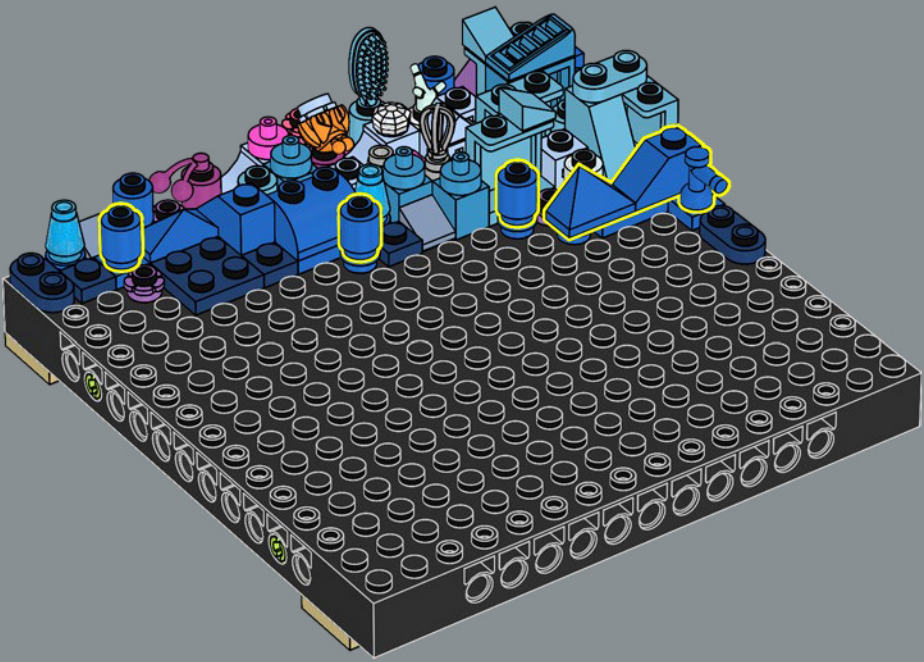

75

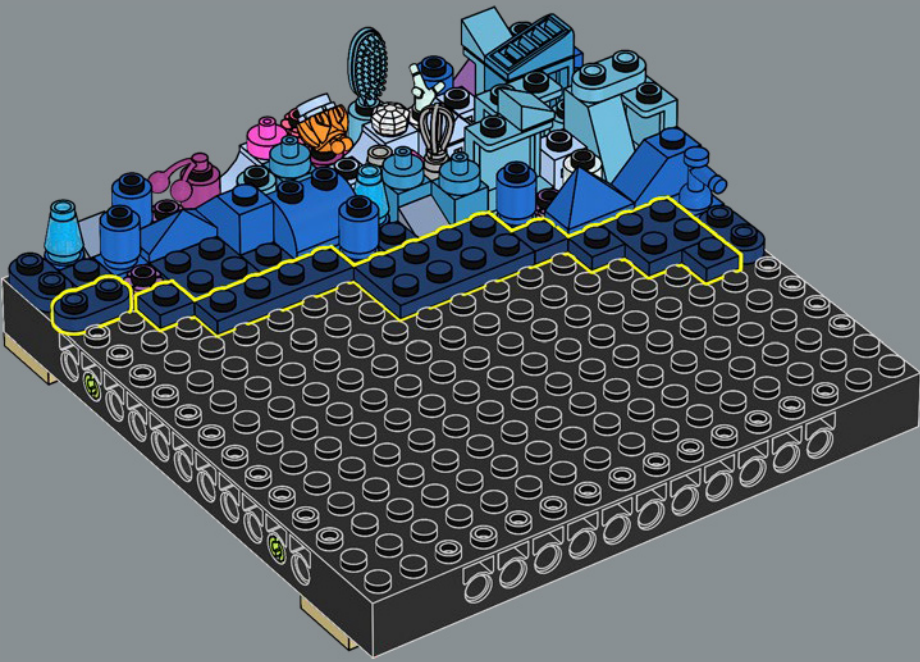

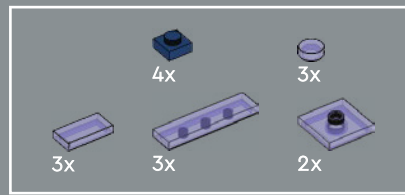

76

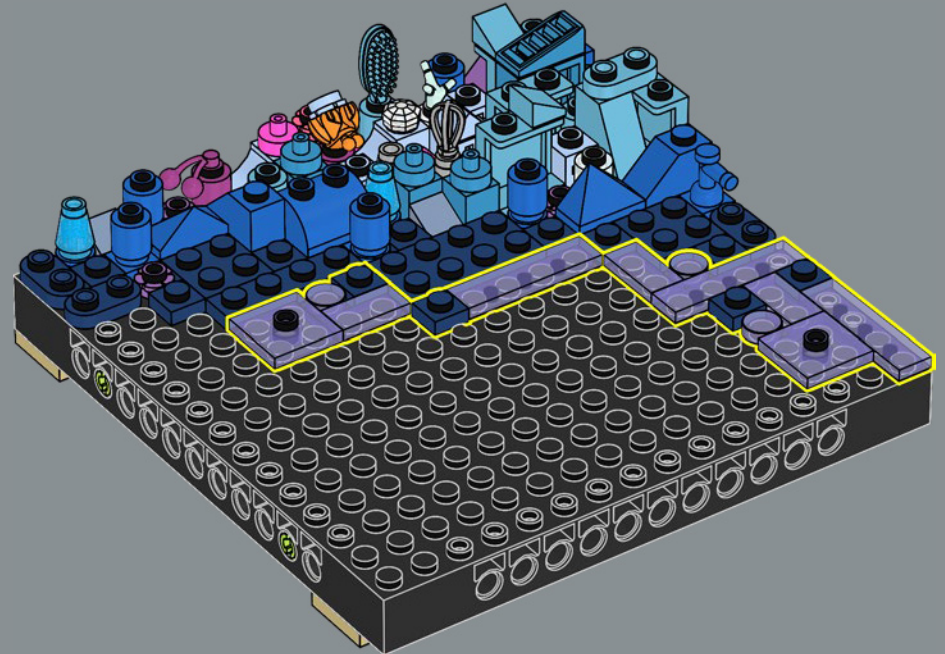

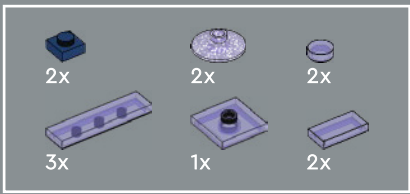

77

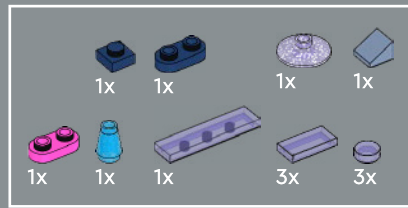
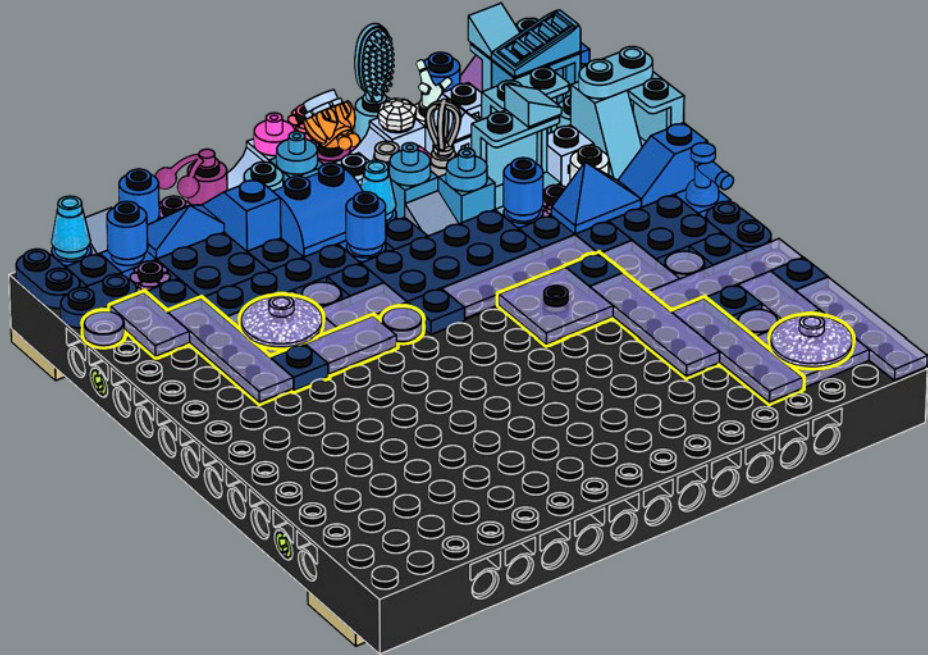

78

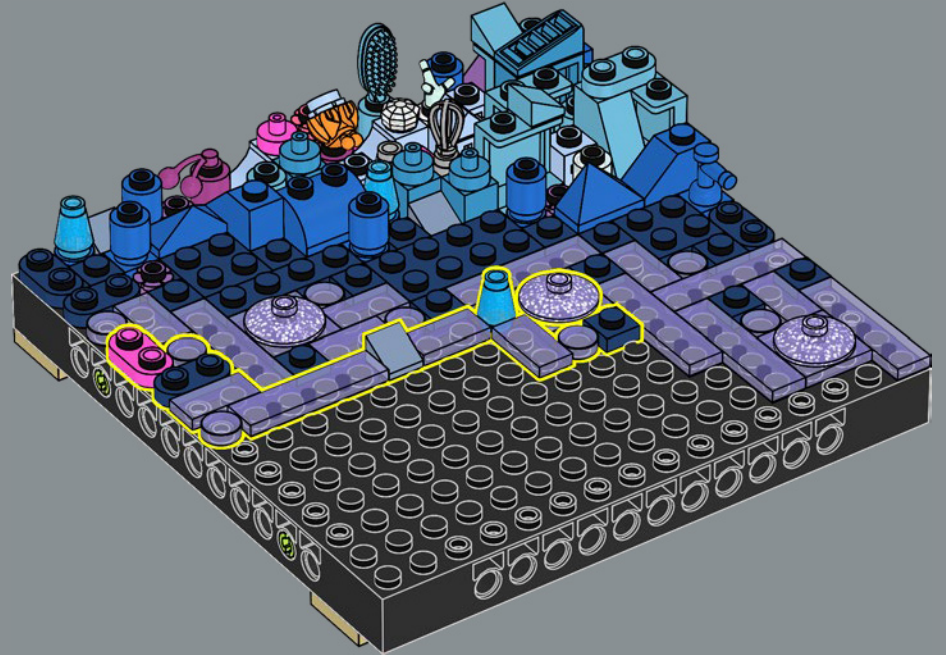

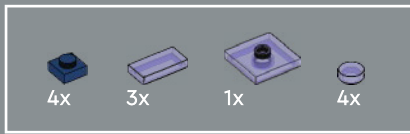

79

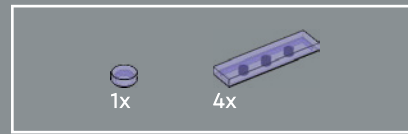
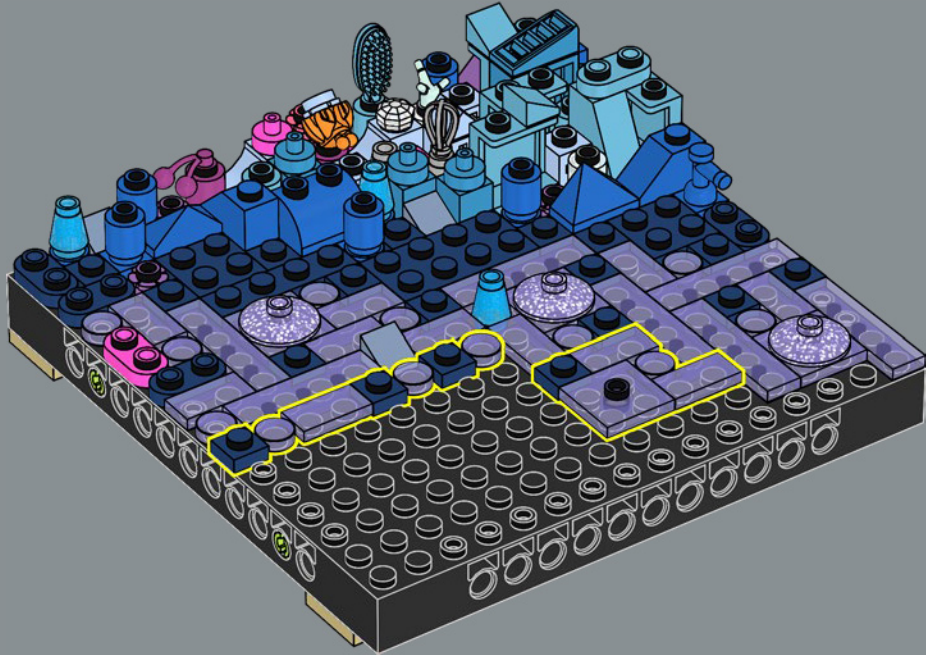

80

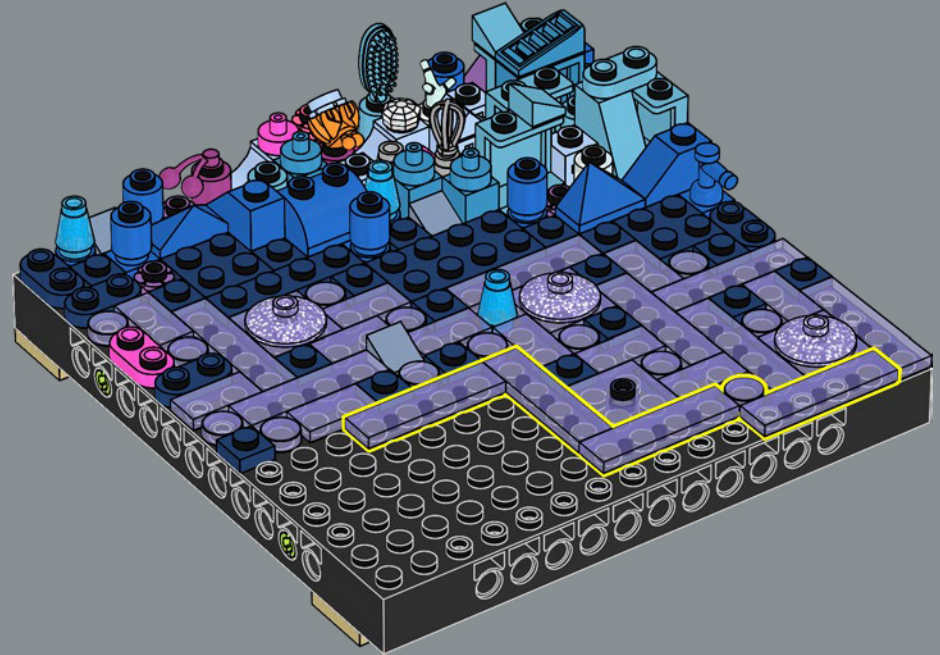

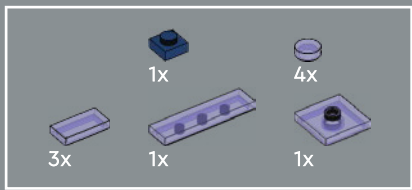

81

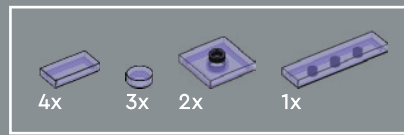
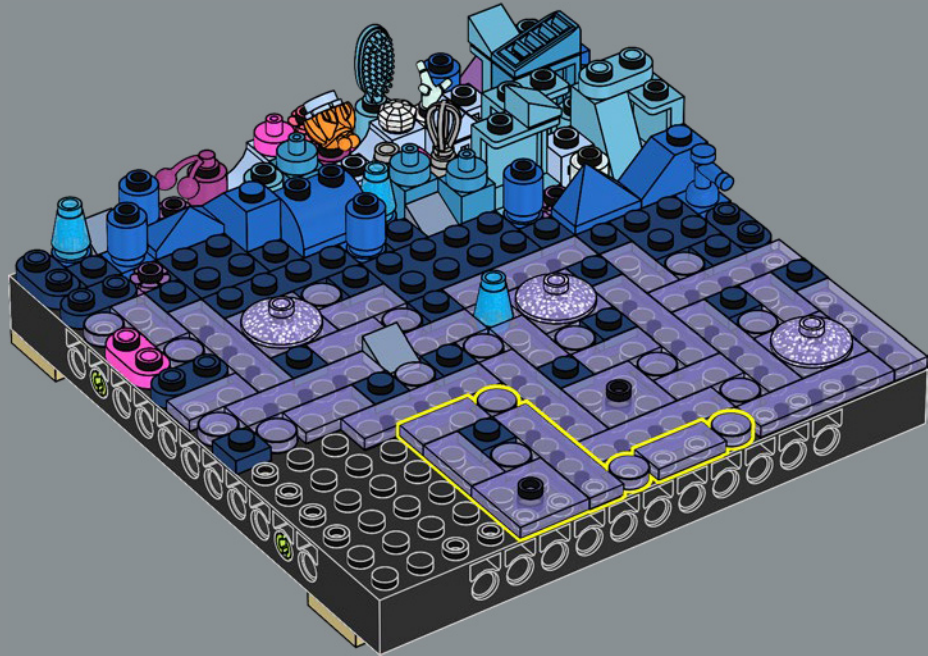

82

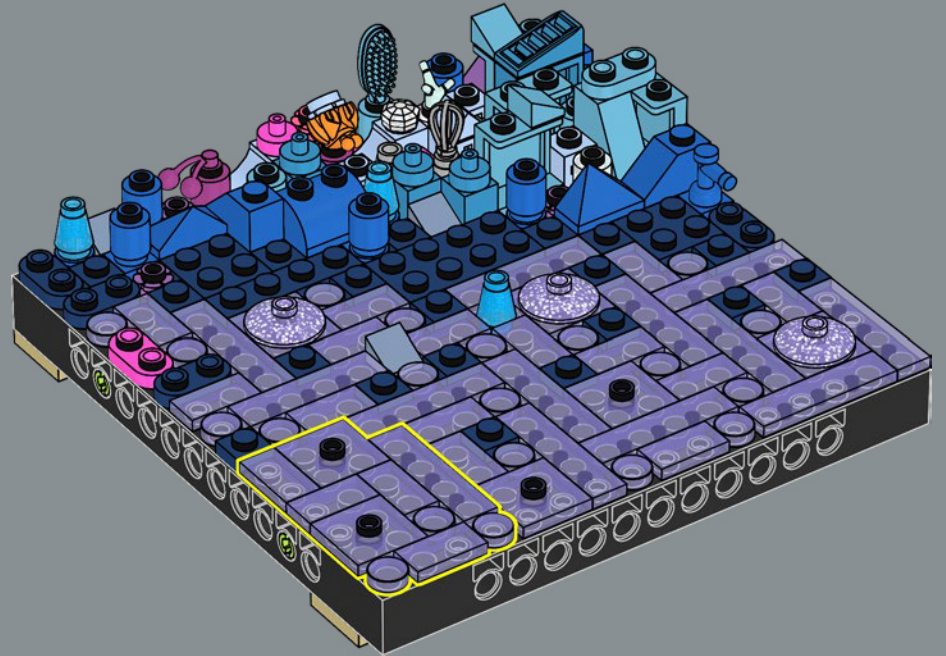

83

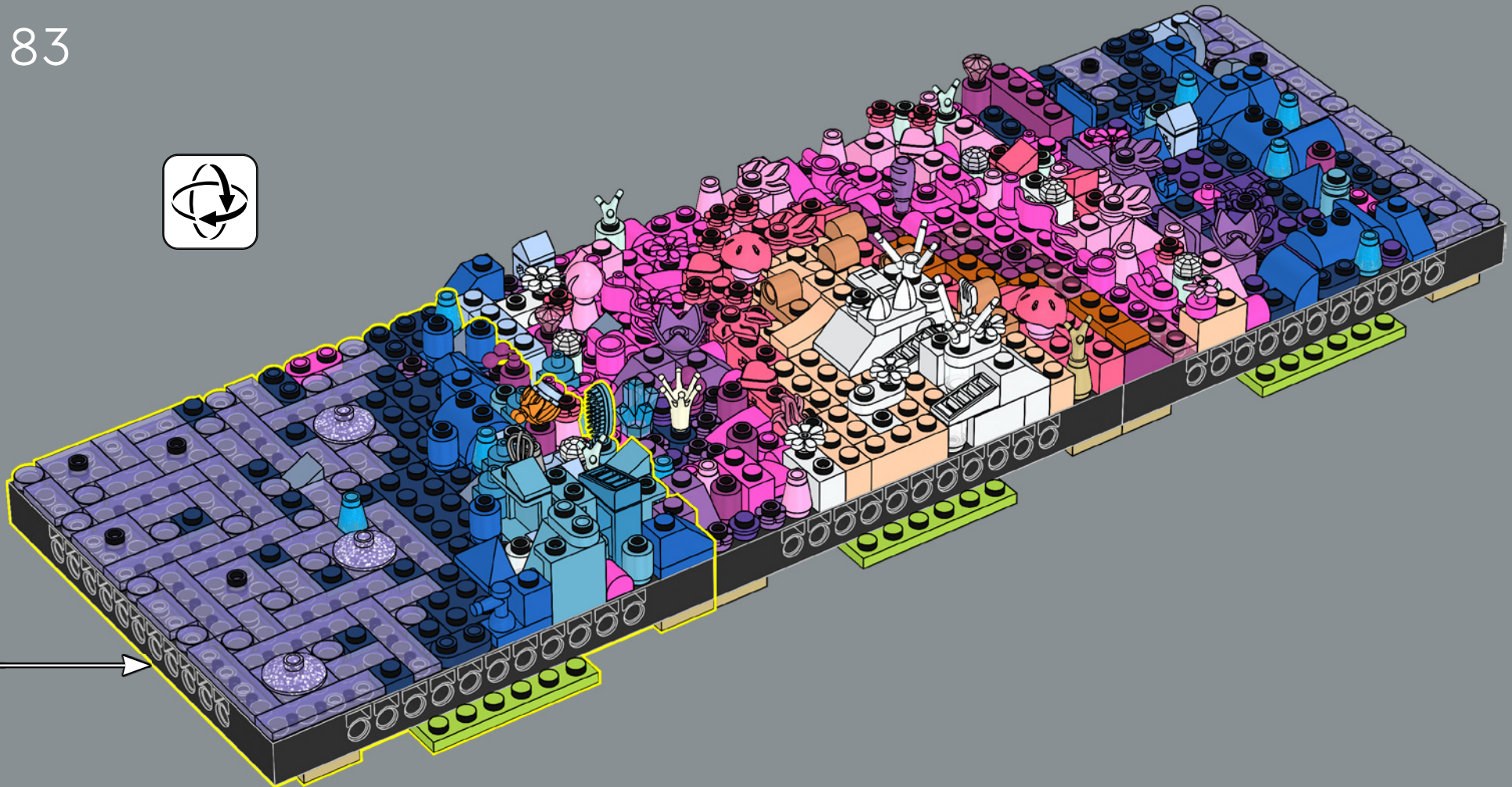

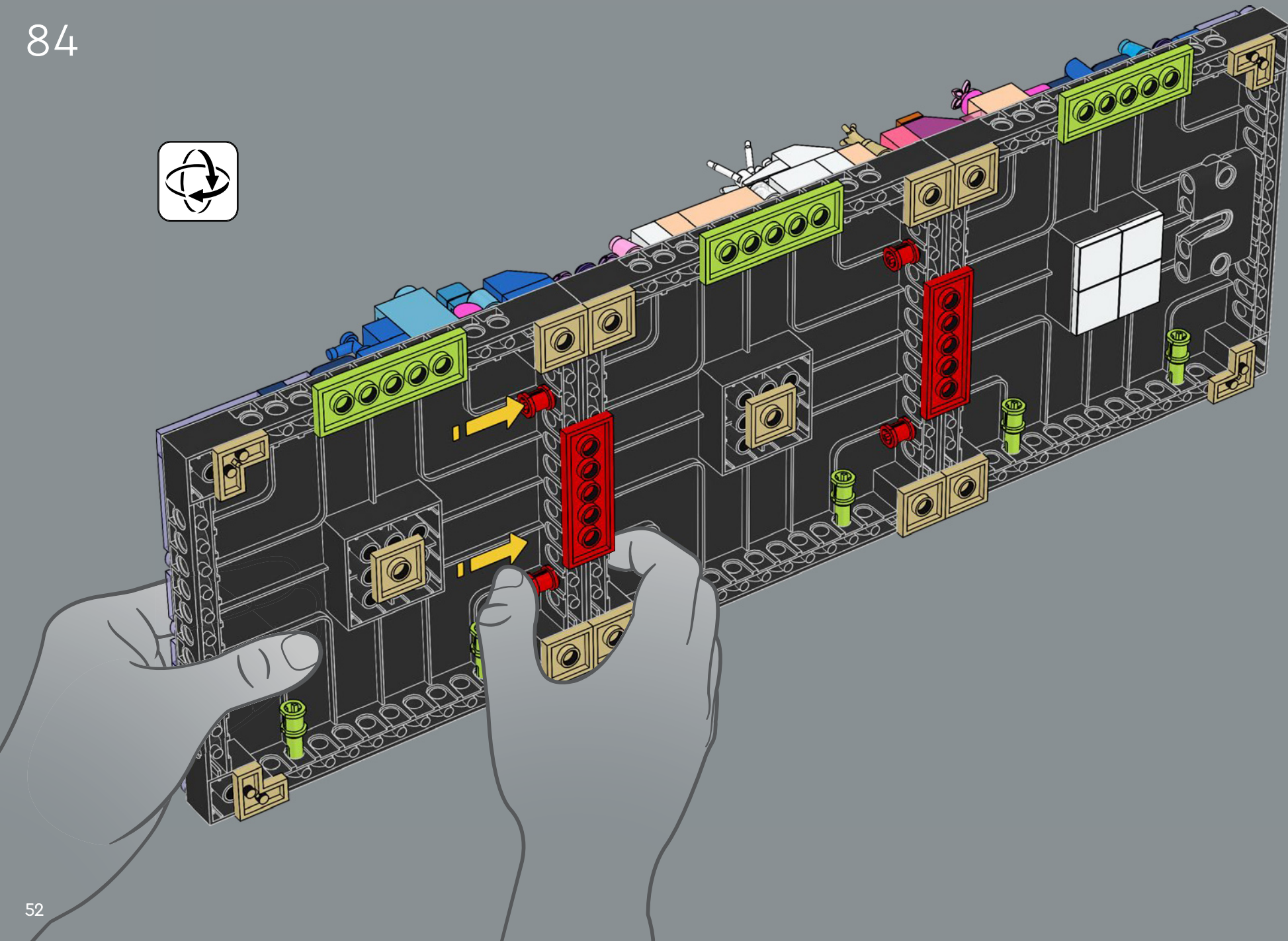

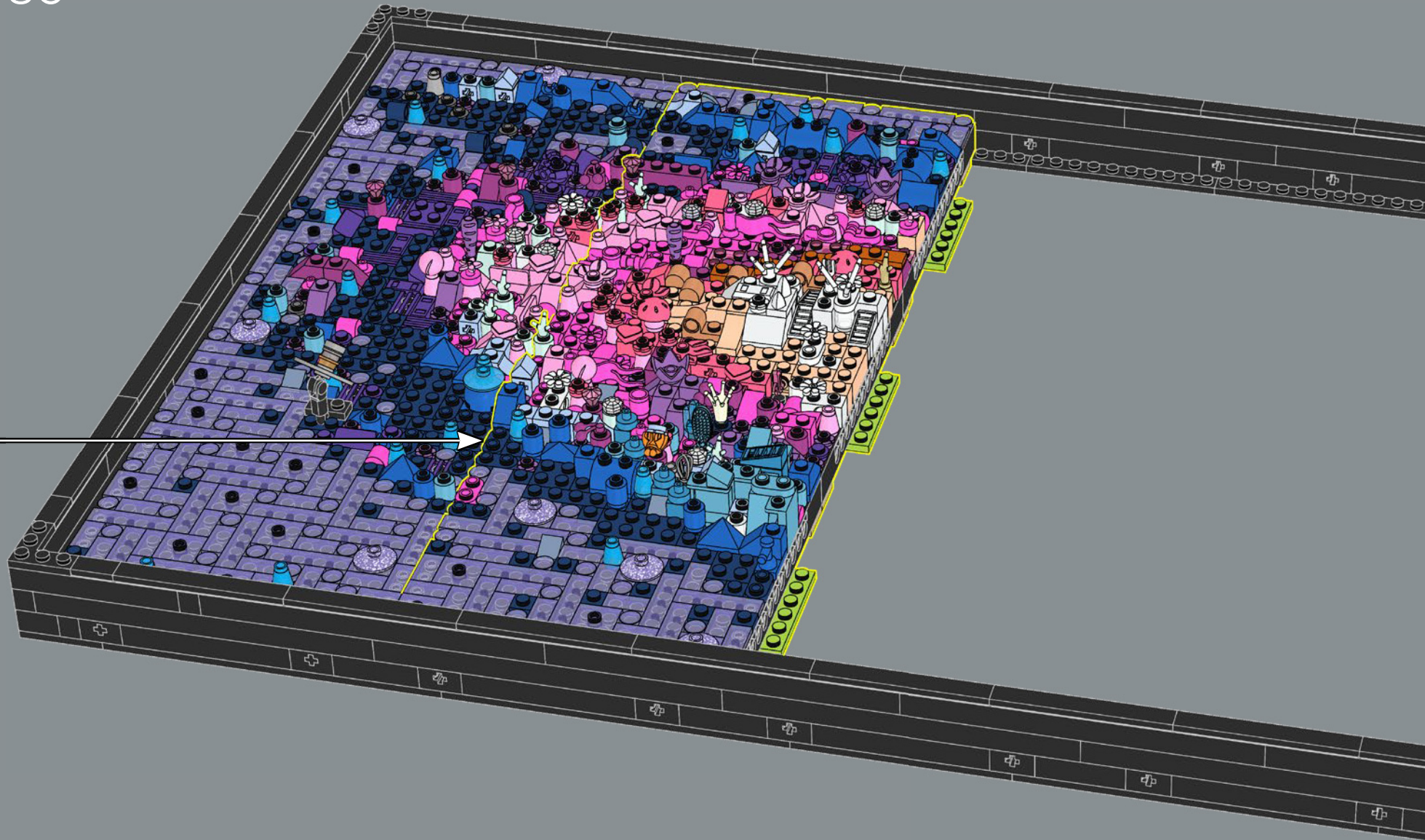



86

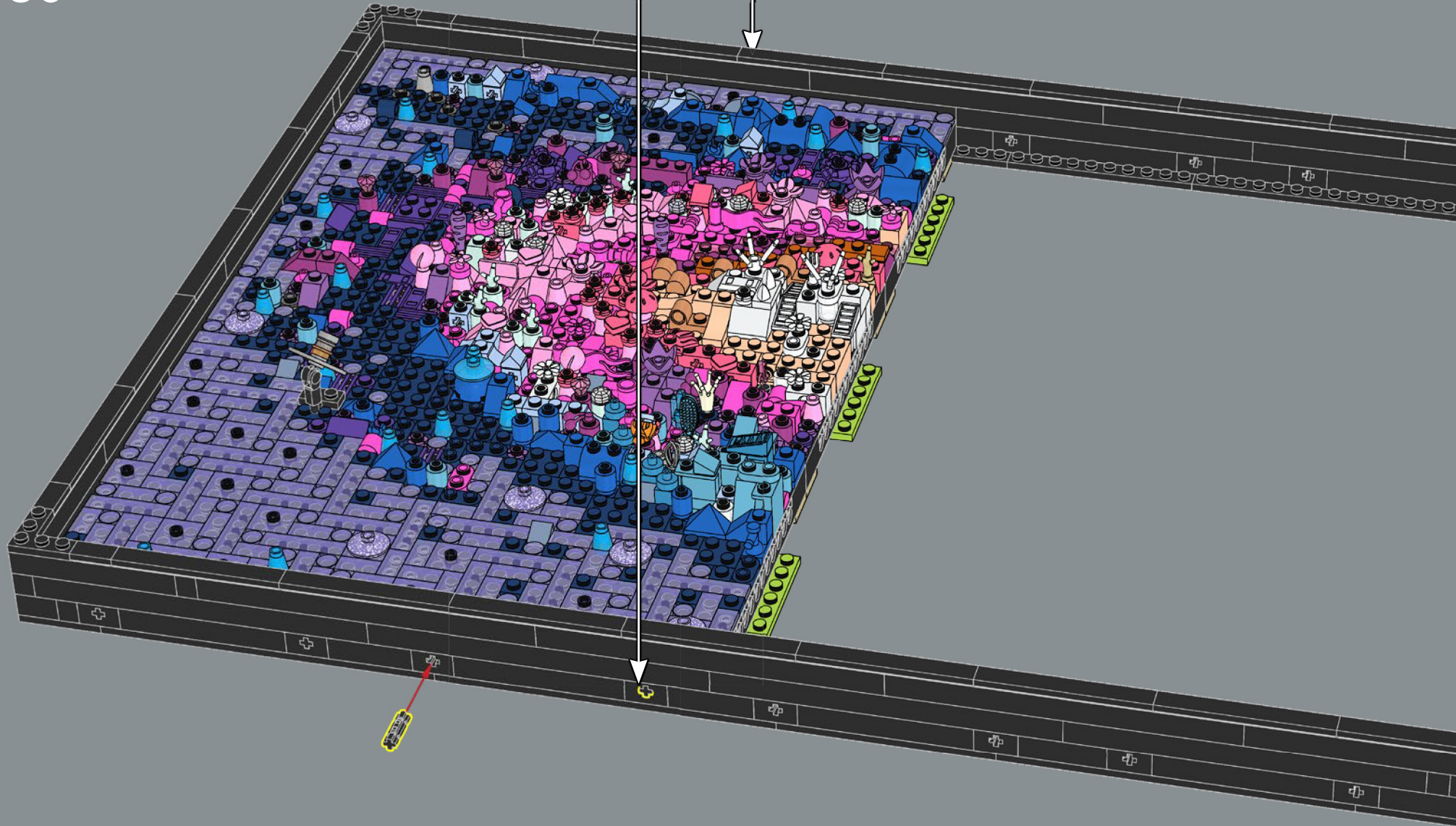

87

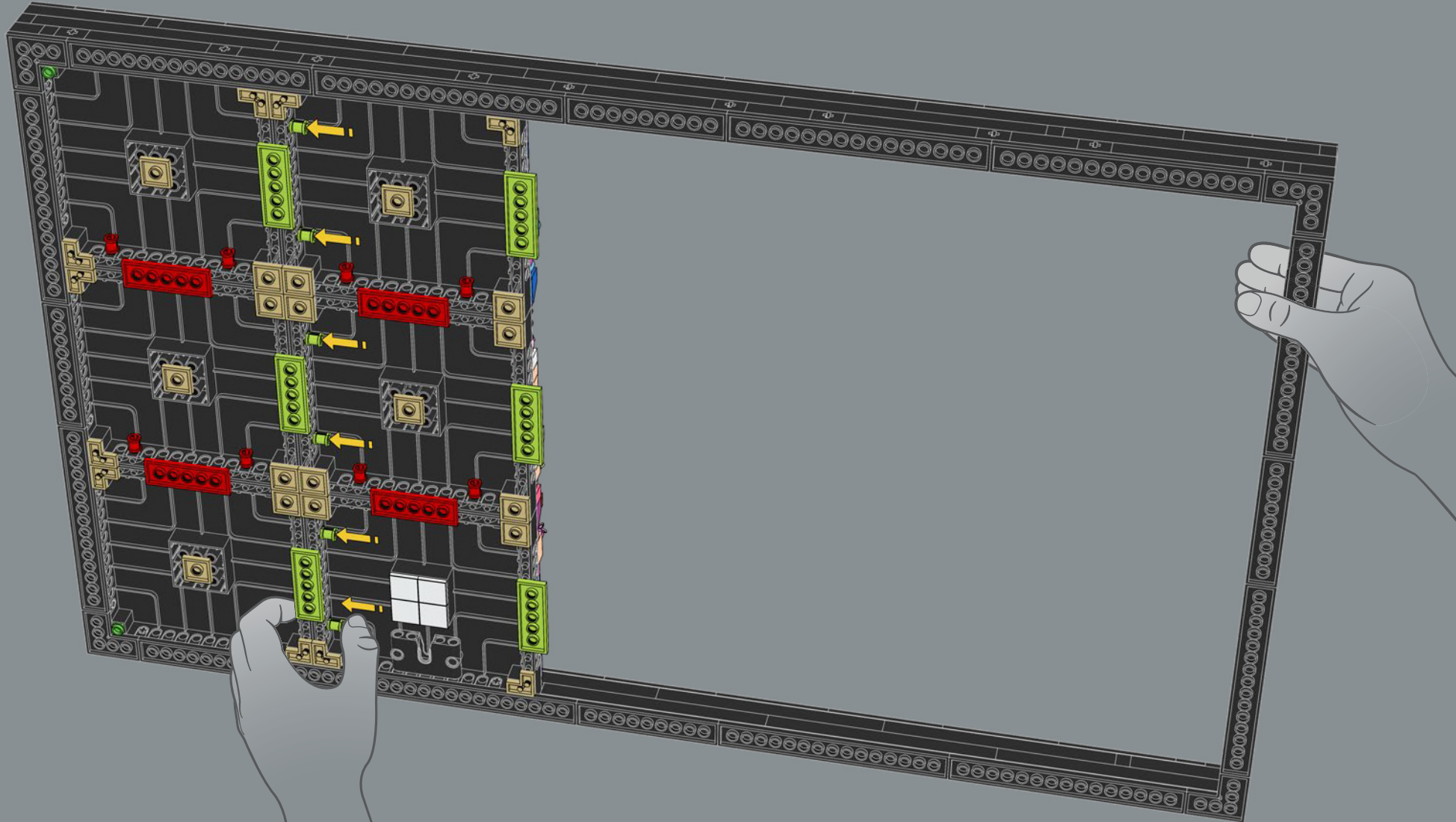



LEGO and the LEGO logo are trademarks of the/sont des marques de commerce du/son marcas registradas de LEGO Group.
©2024 The LEGO Group. 6517079