



CITY

3181



WARNING: CHOKING HAZARD.
Small parts. Not for children under 3 years.

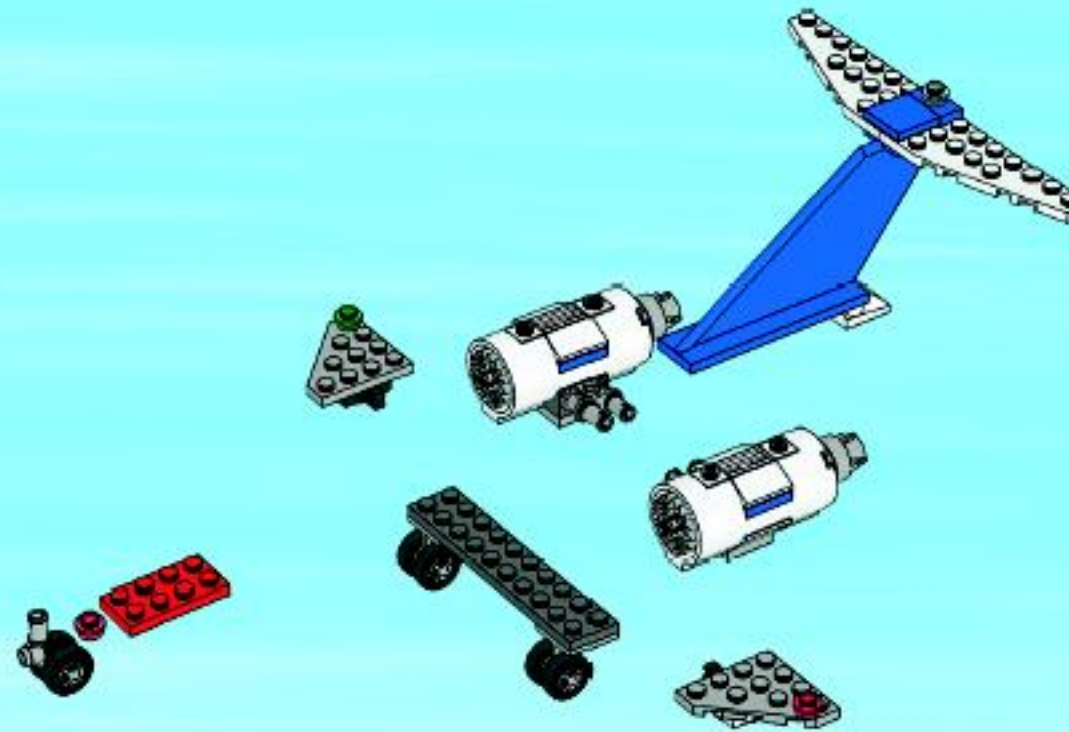
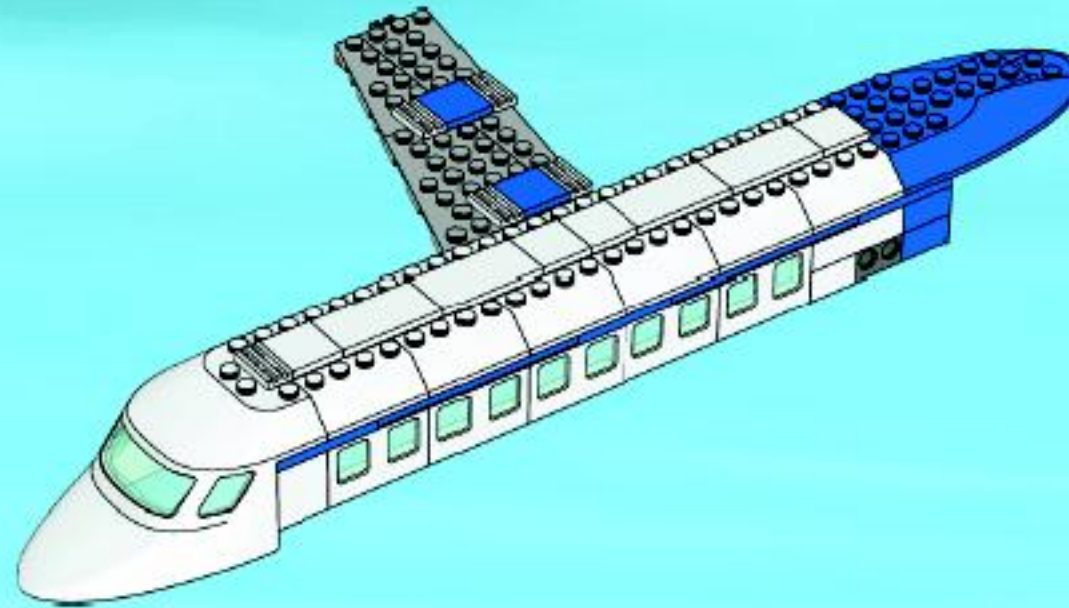
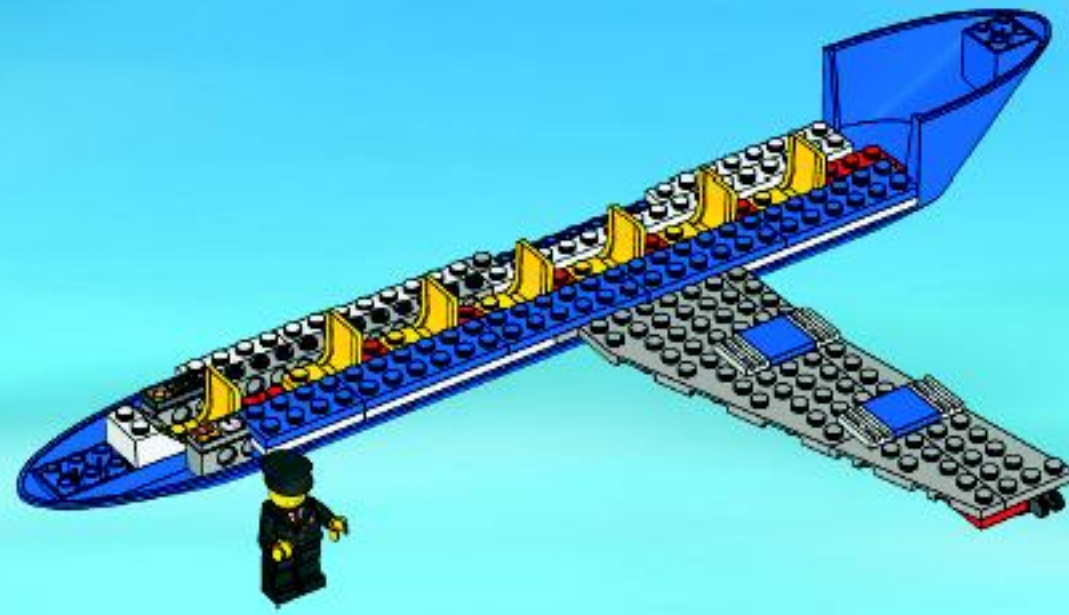

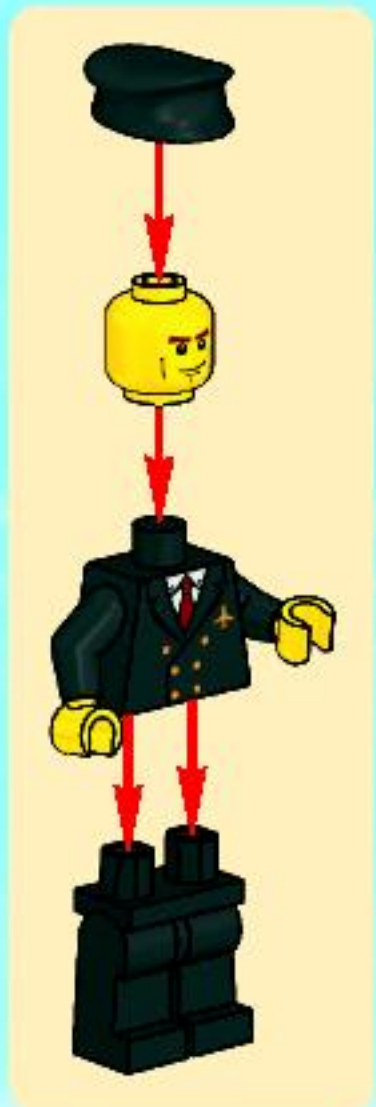
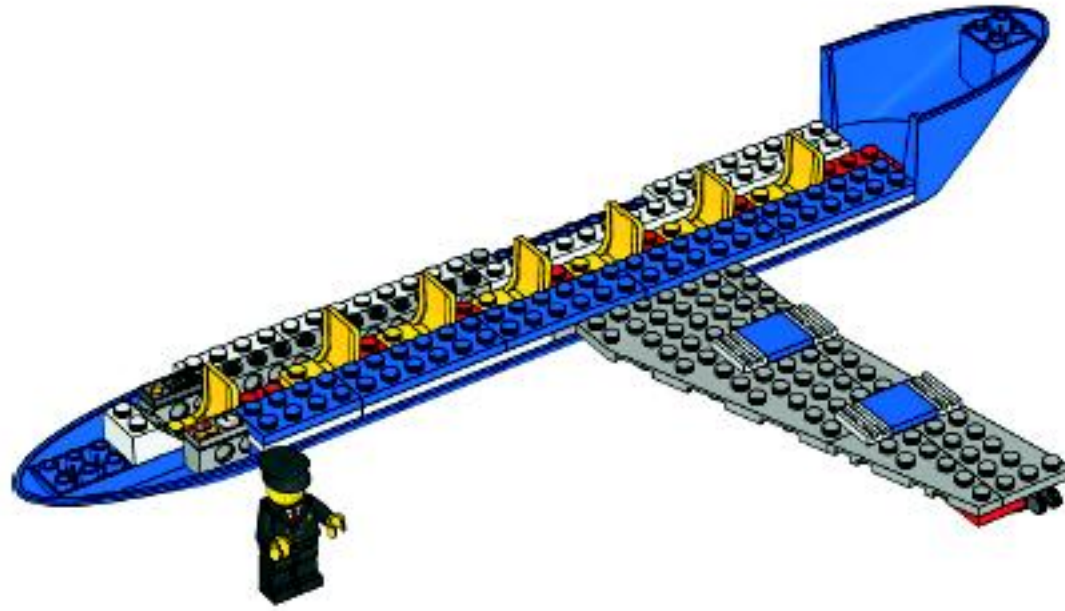

1

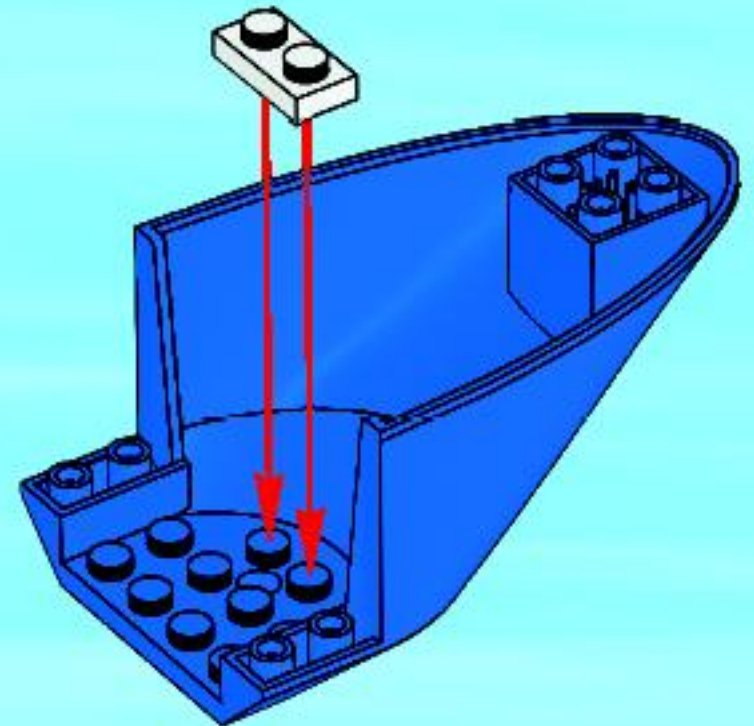

 **AVERTISSEMENT : RISQUE D'ÉTOUFFEMENT.**
Contient des petites pièces. Ne convient pas aux enfants de moins de 3 ans.

 **ADVERTENCIA: PELIGRO DE ASFIXIA.**
No recomendado para niños menores de 3 años. Contiene piezas pequeñas.

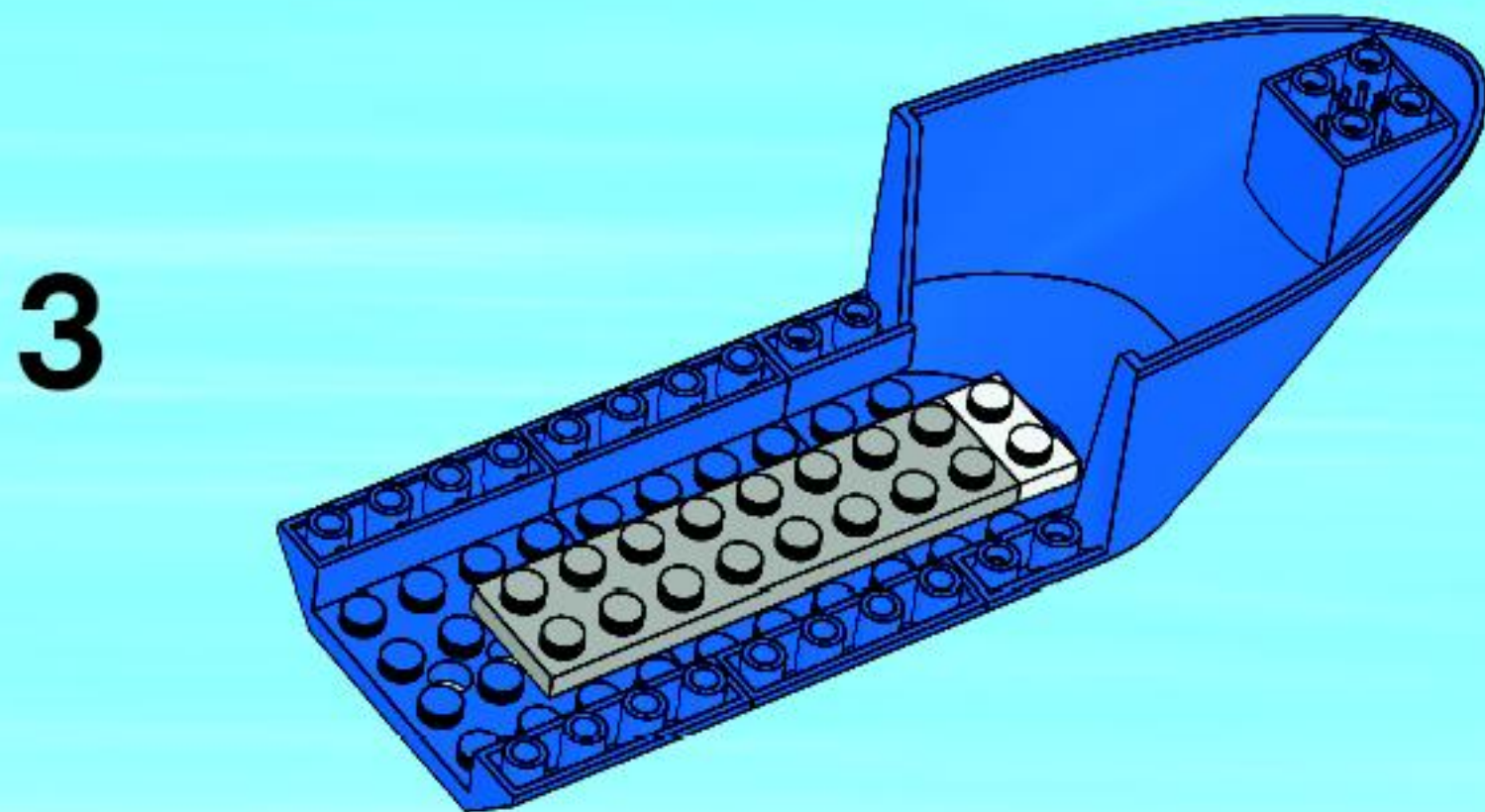
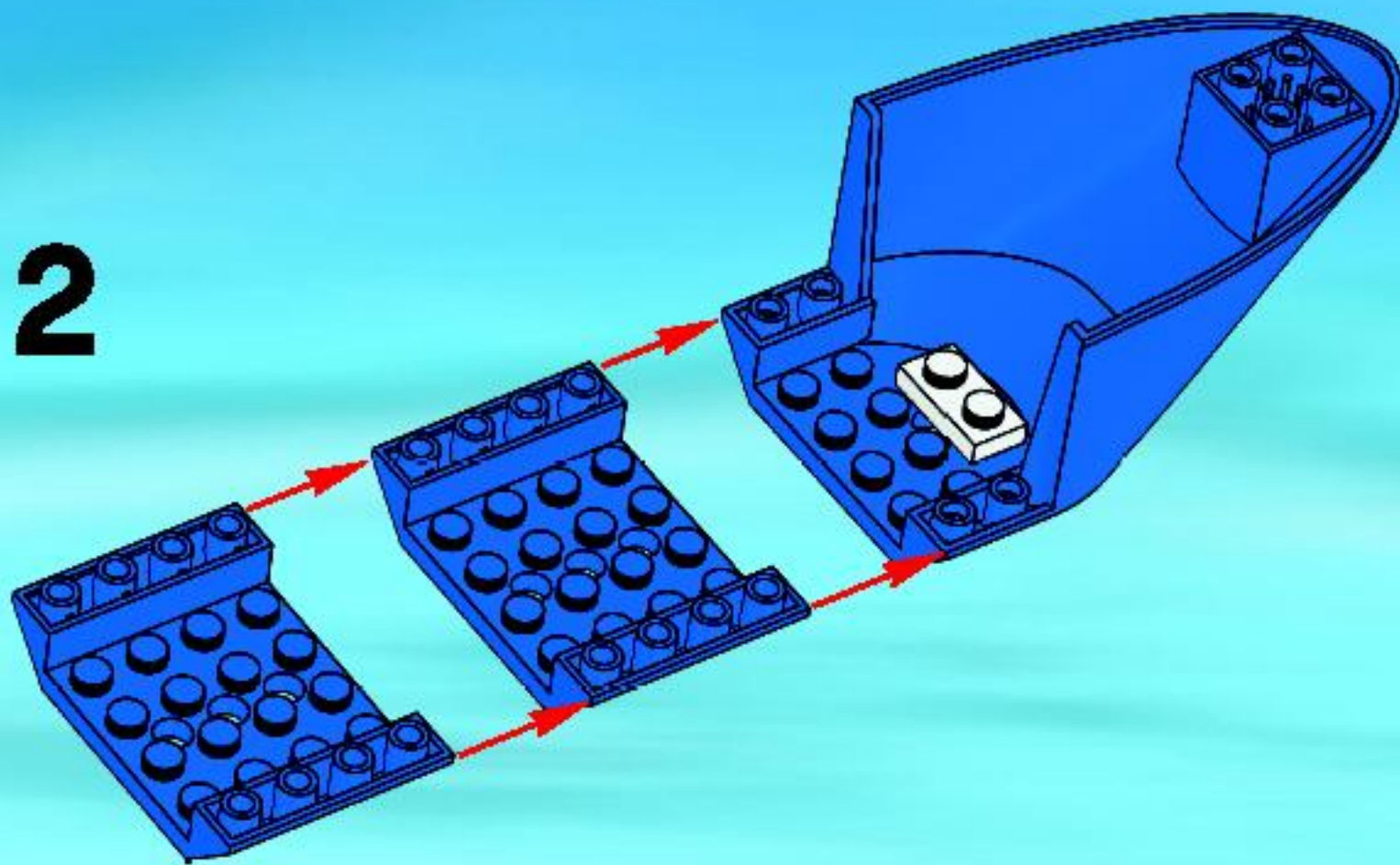

4

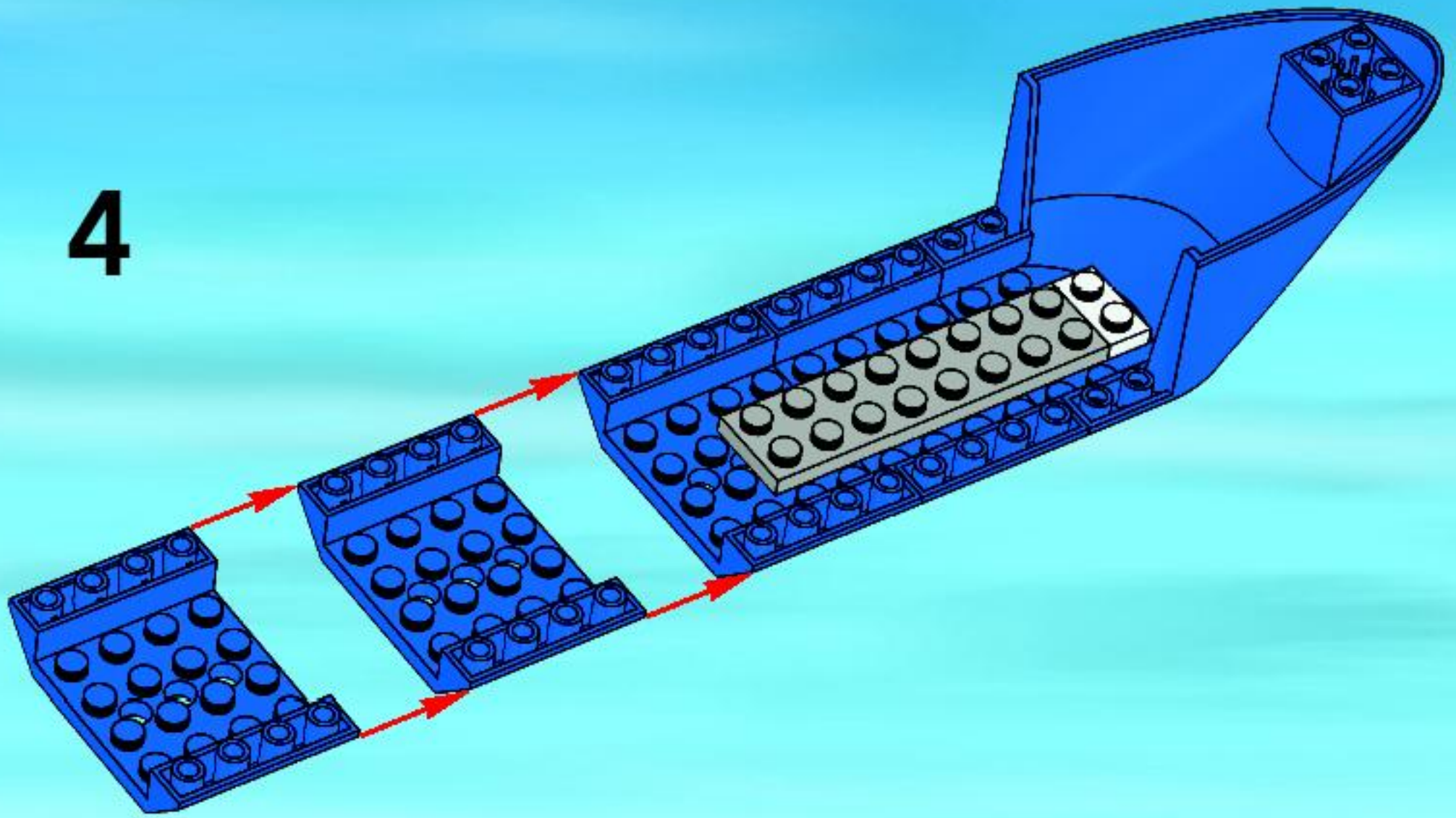

5

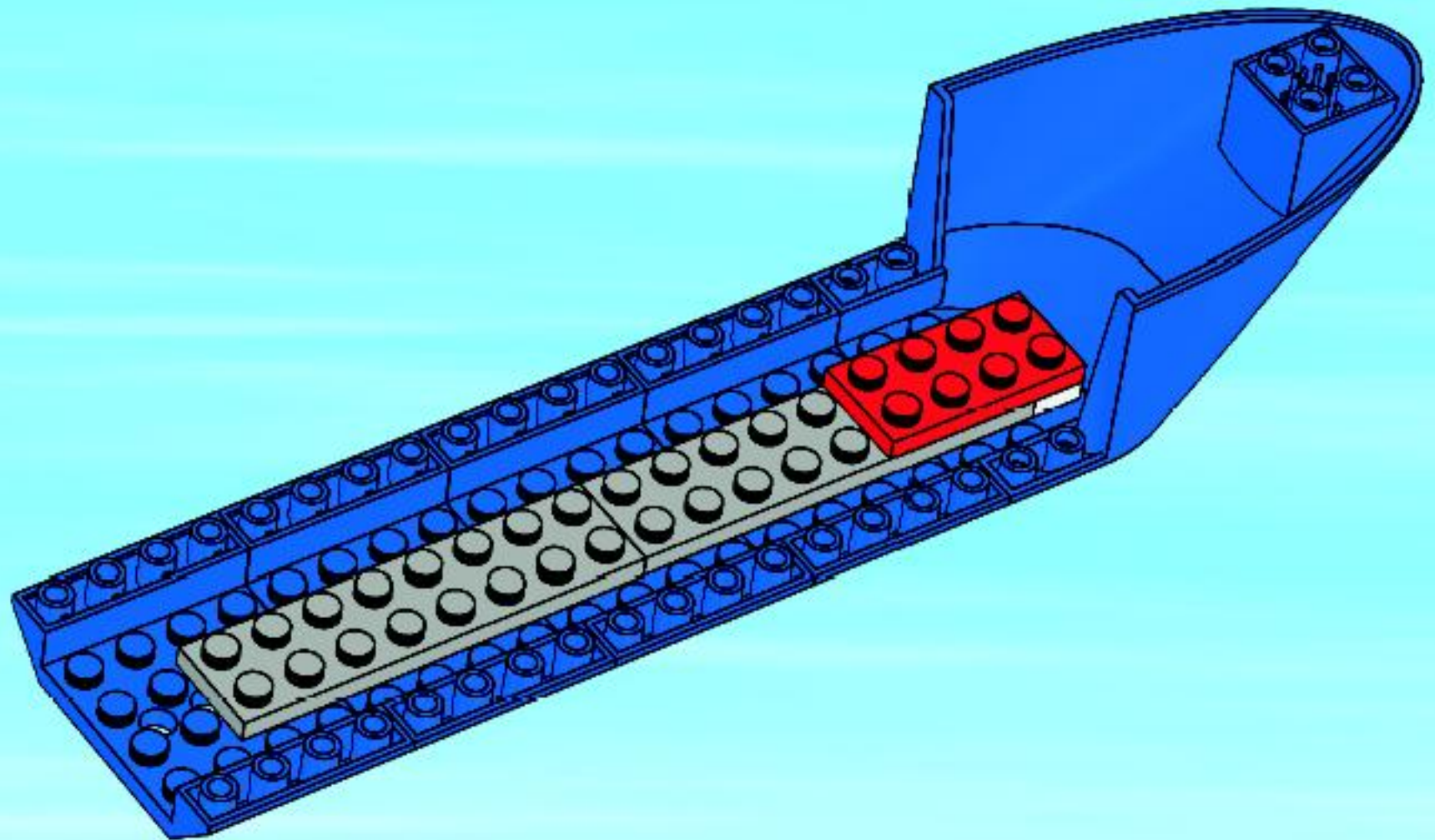

6

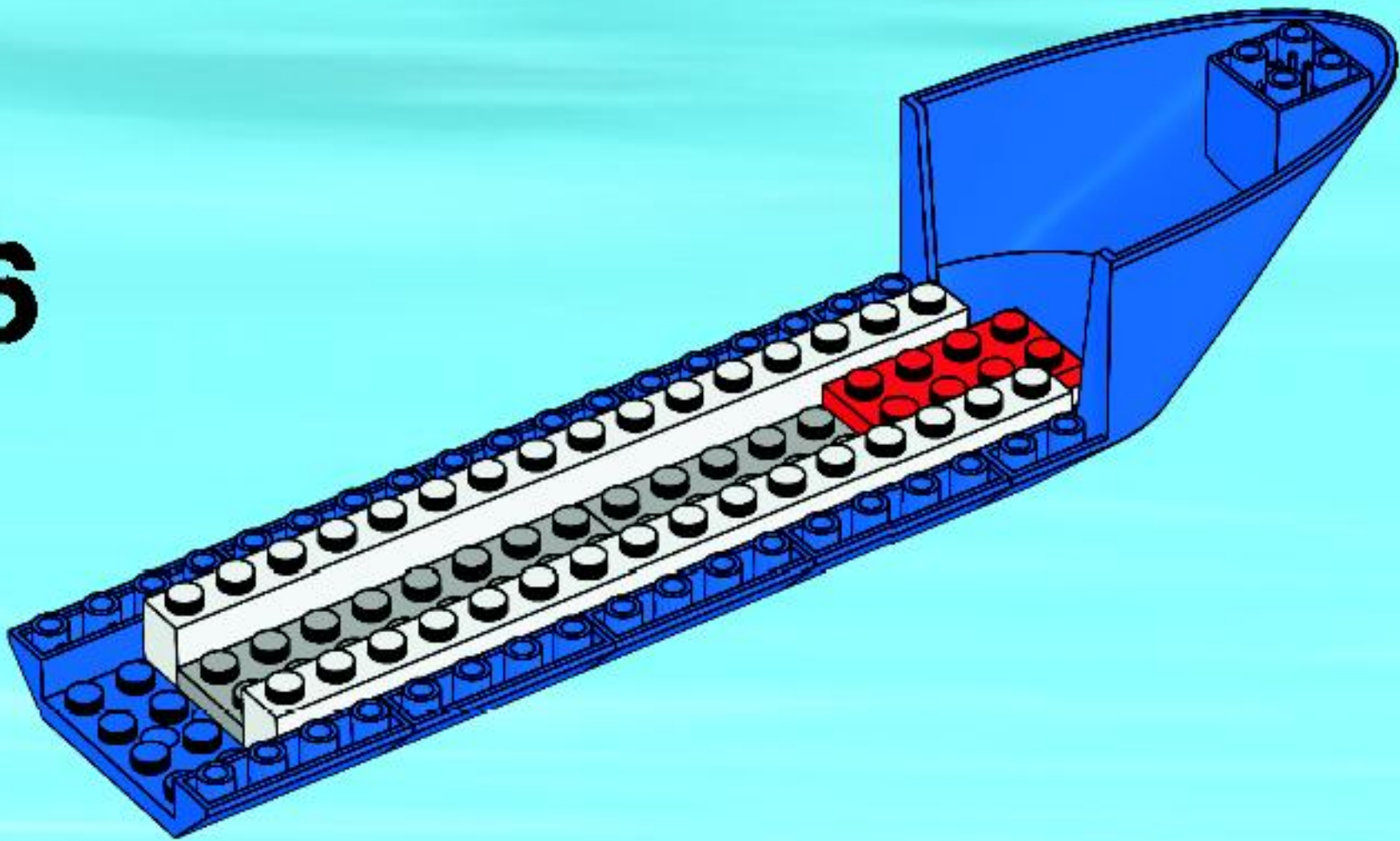

7

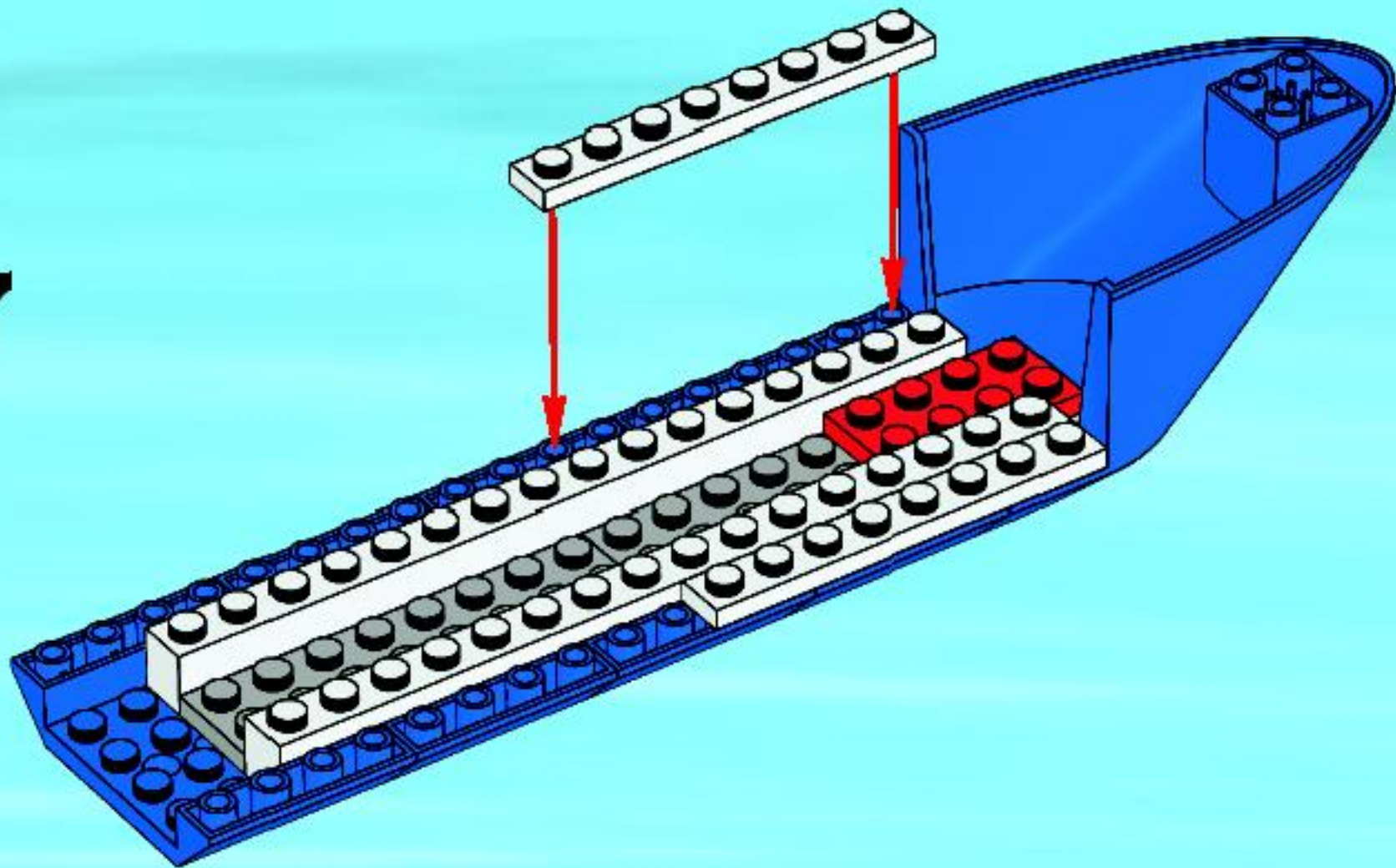

8

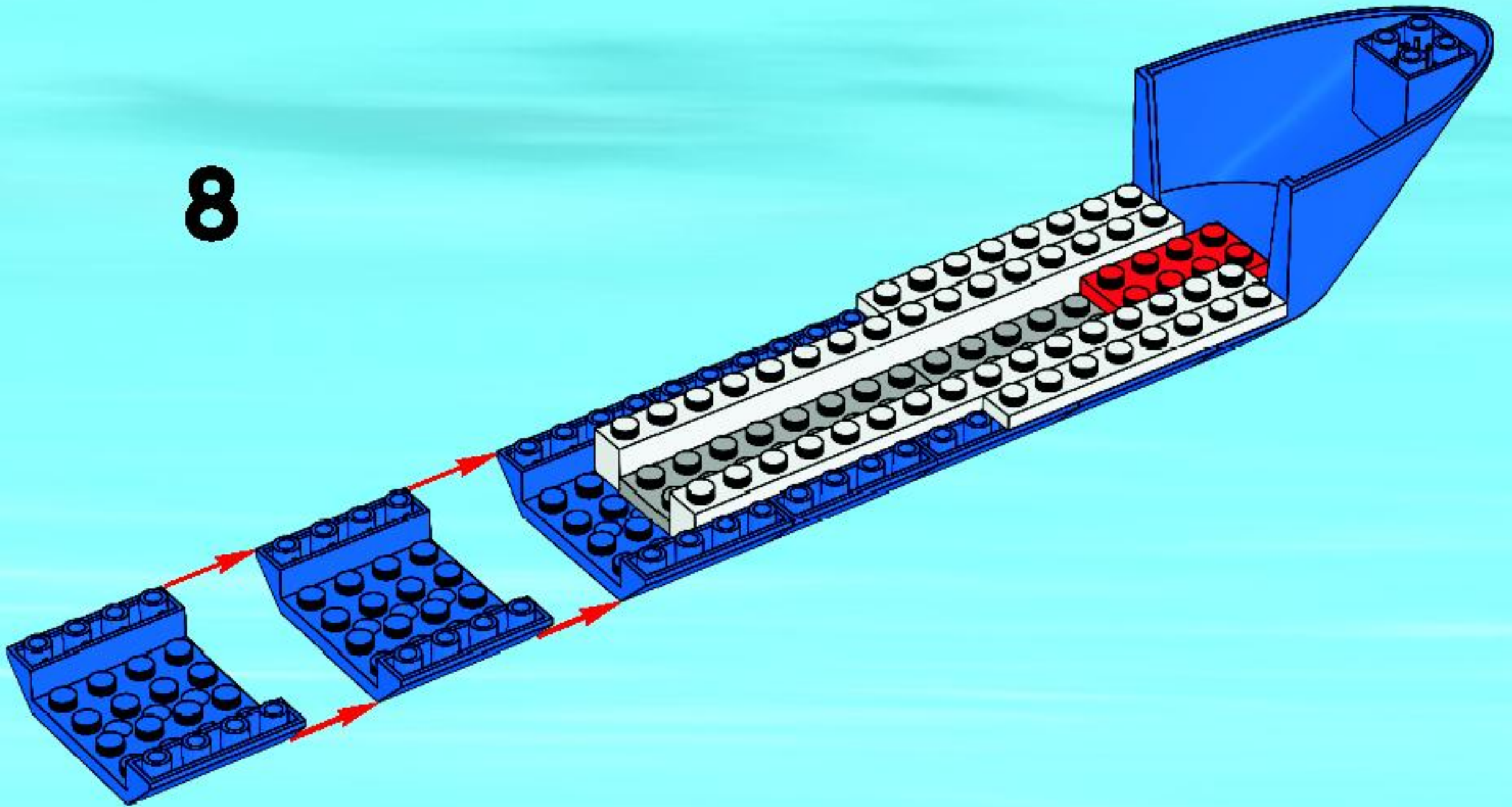

9

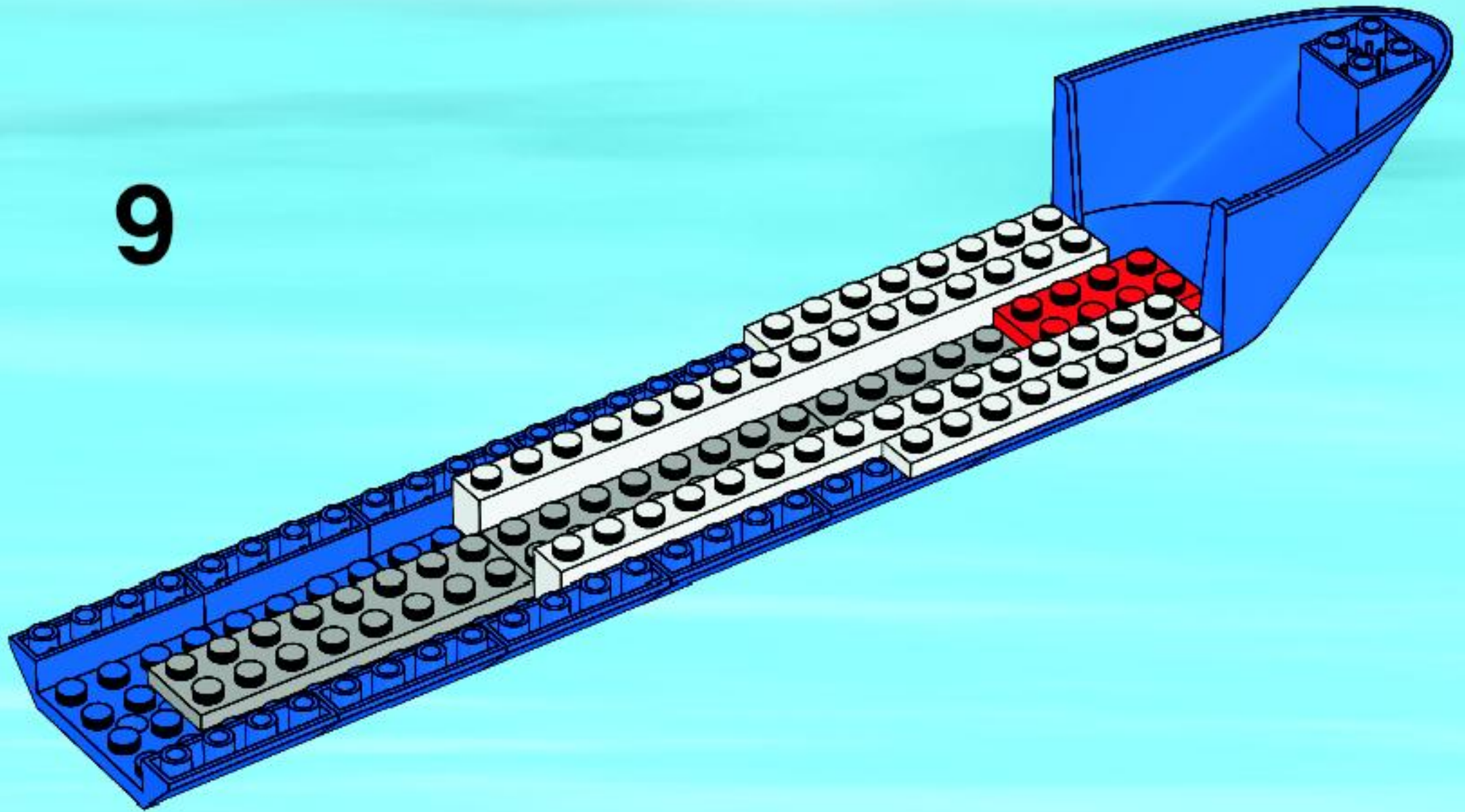

10

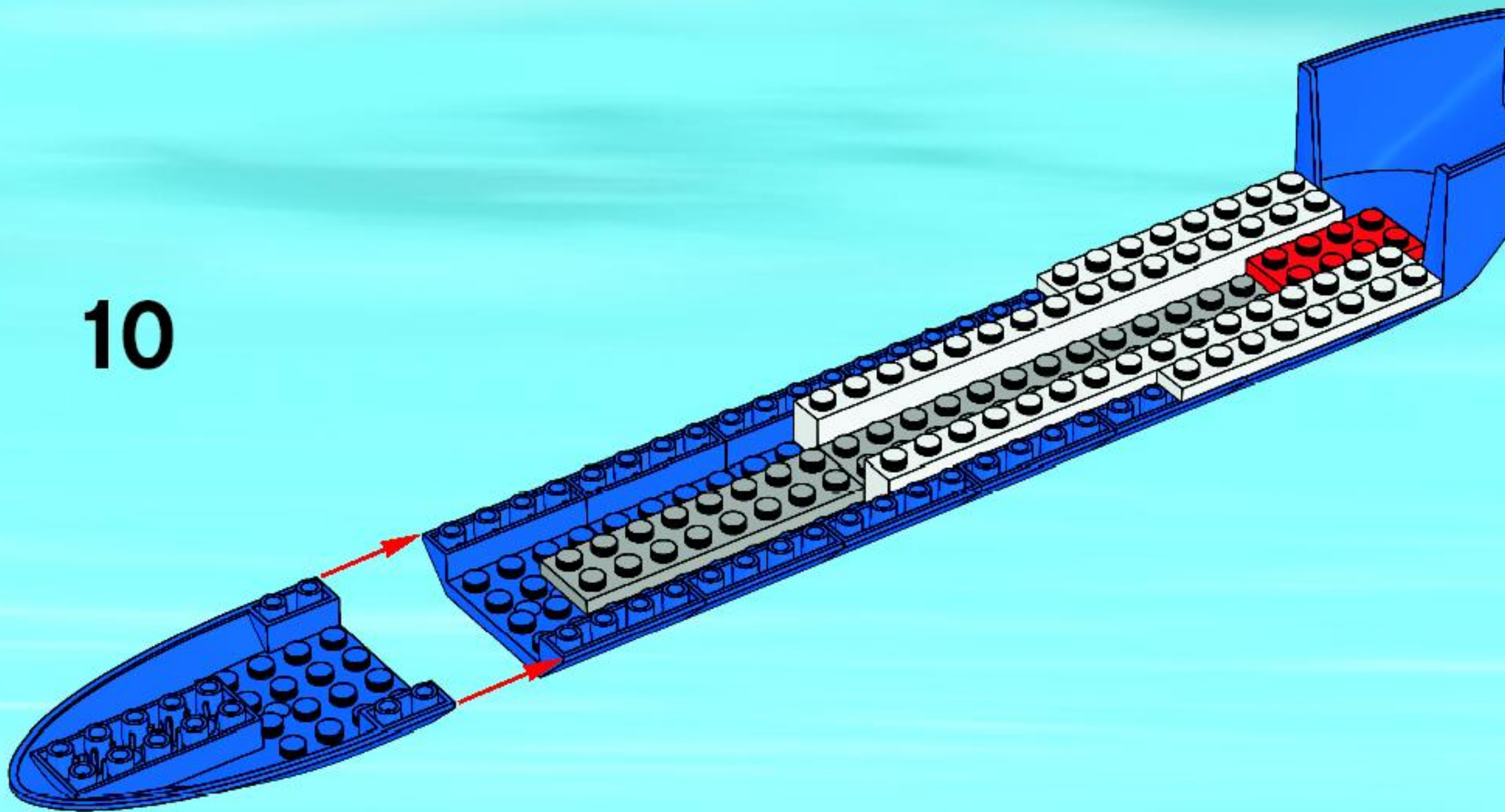

11

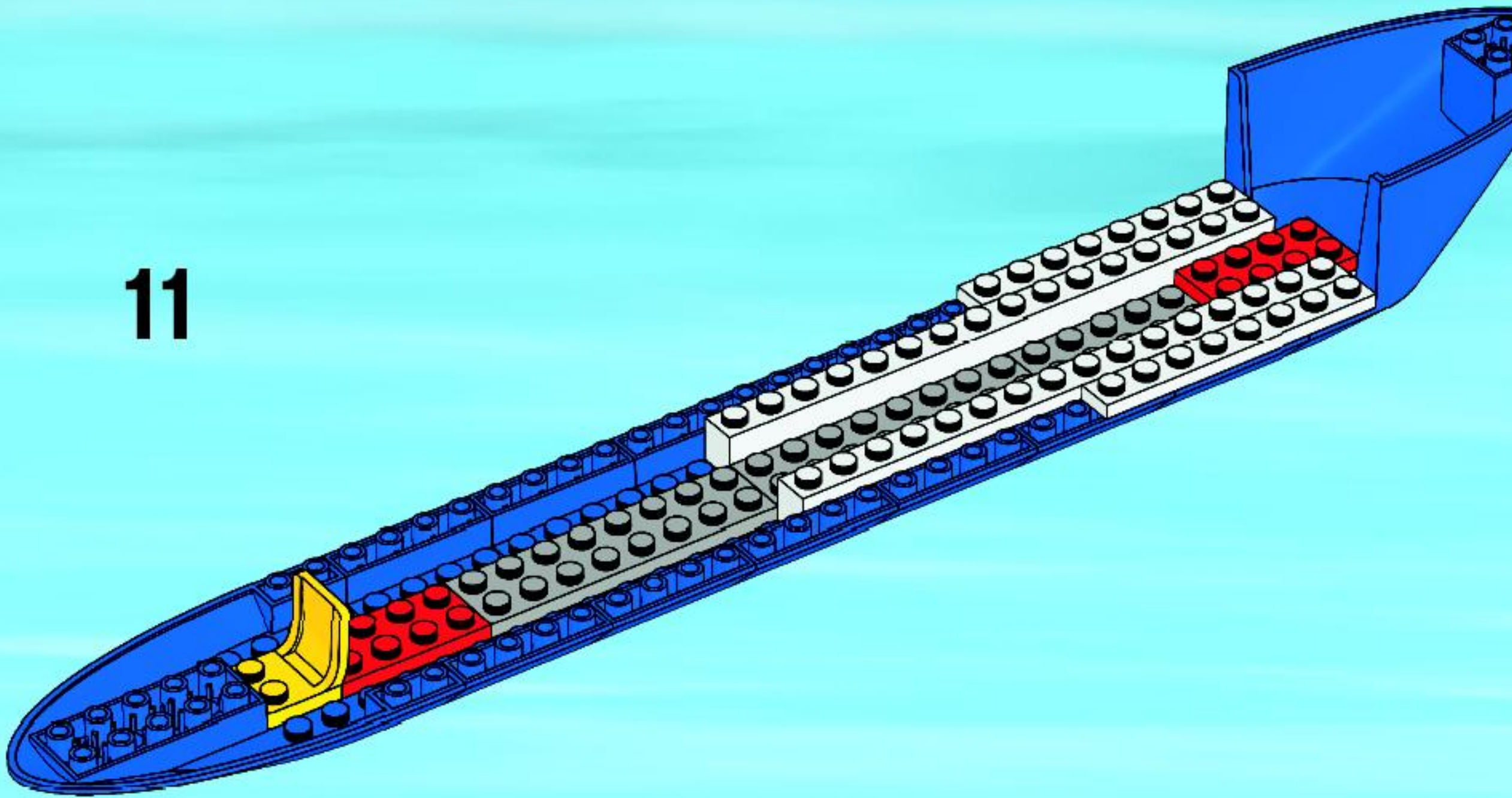

12

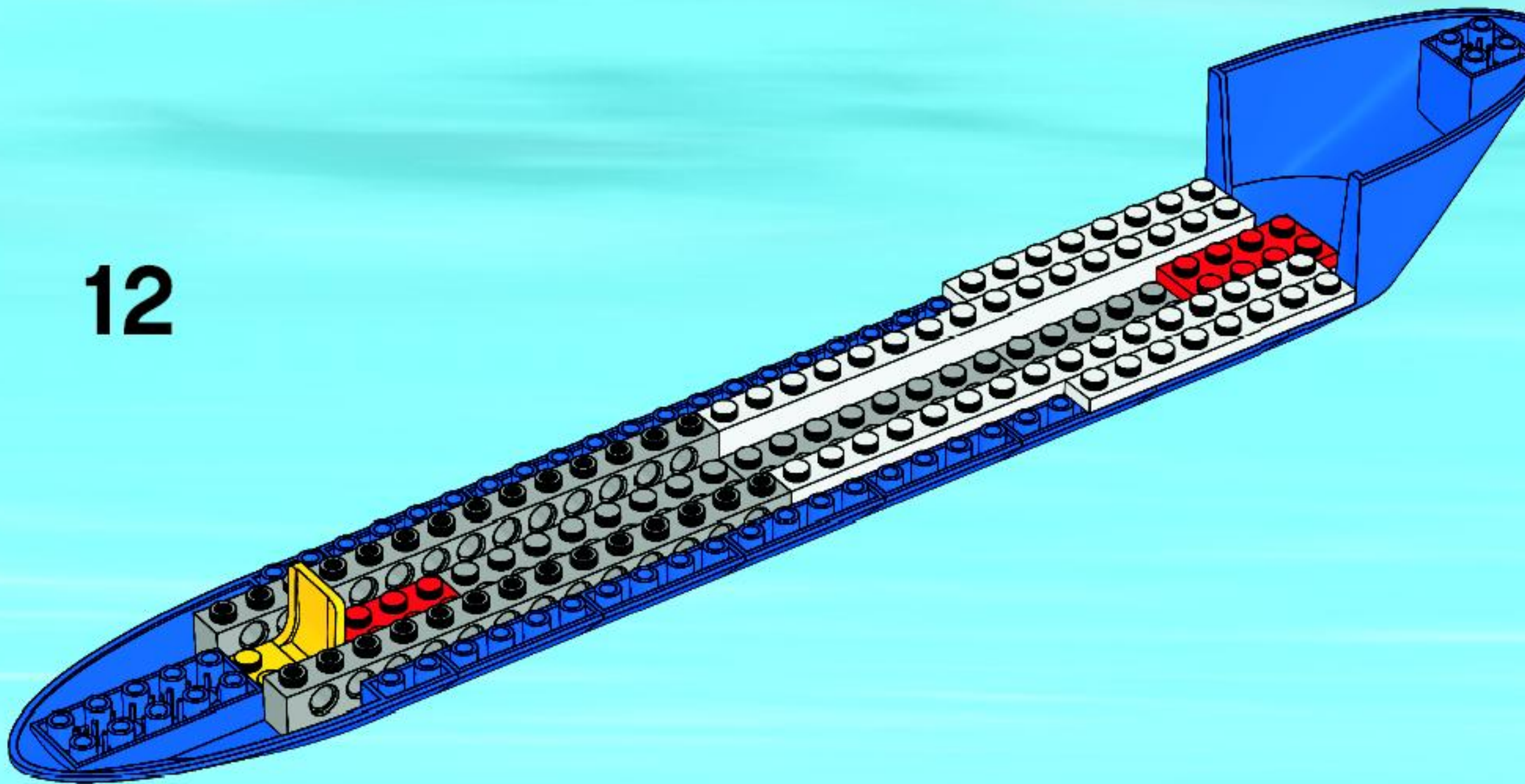

13

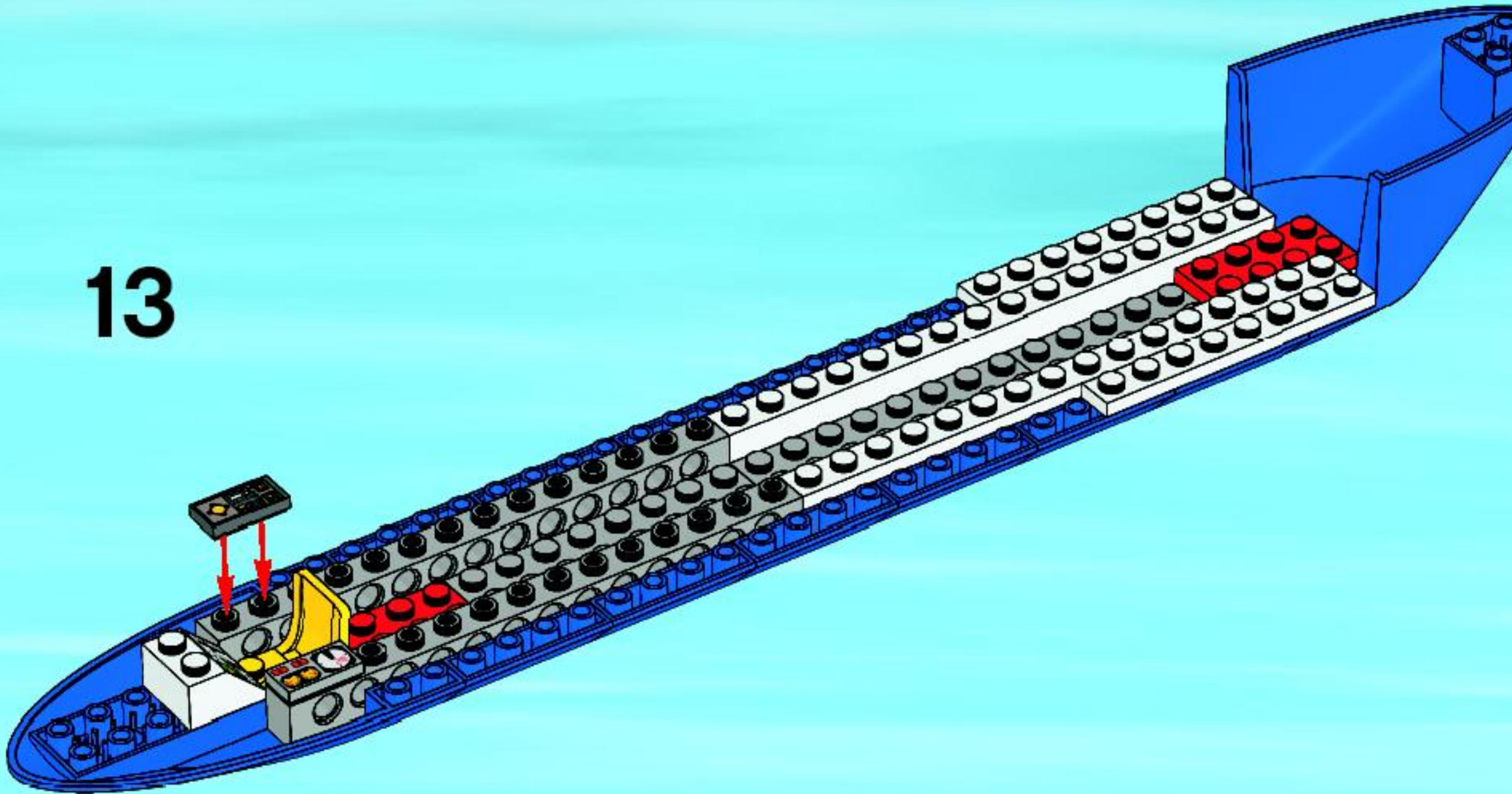

14

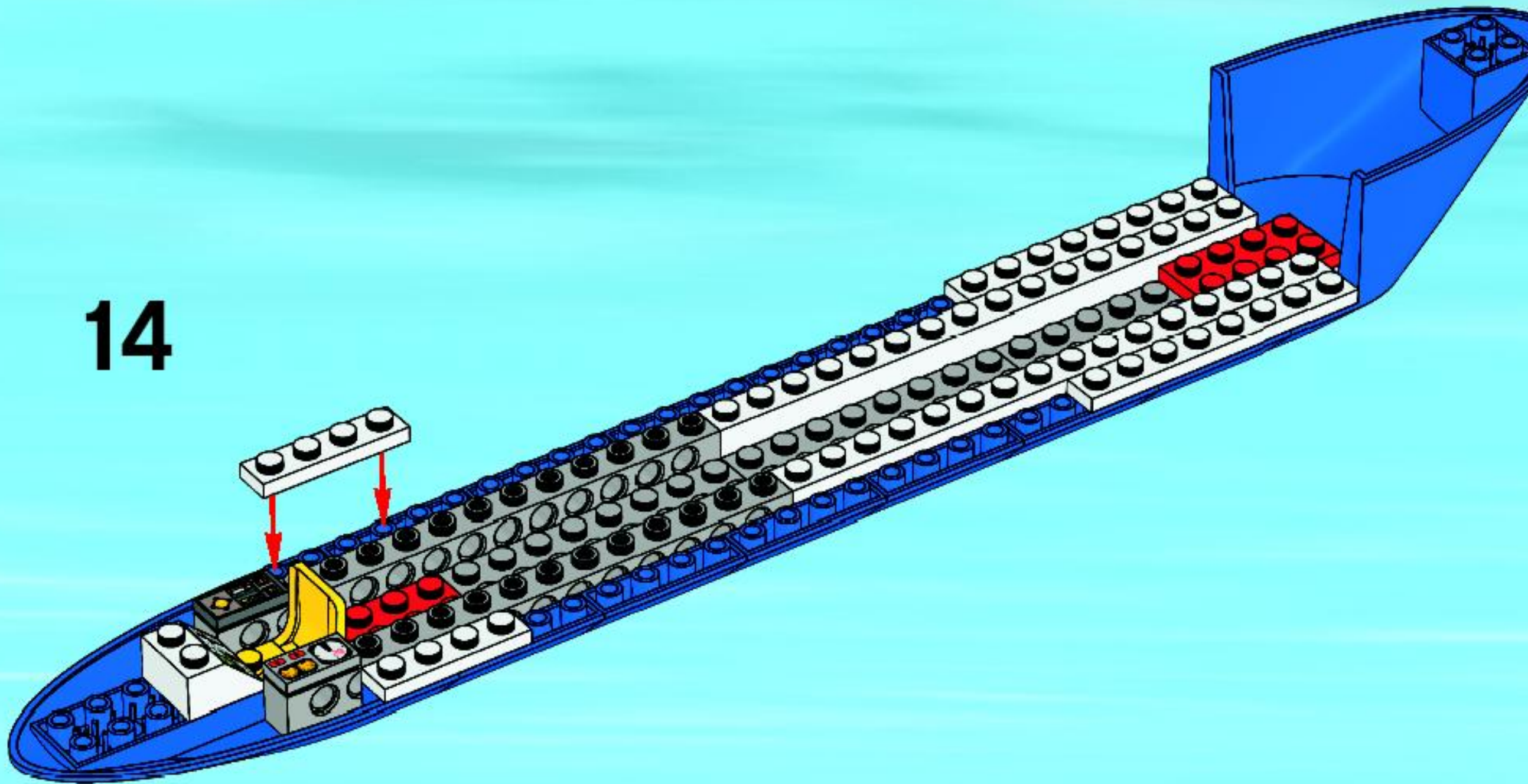

15

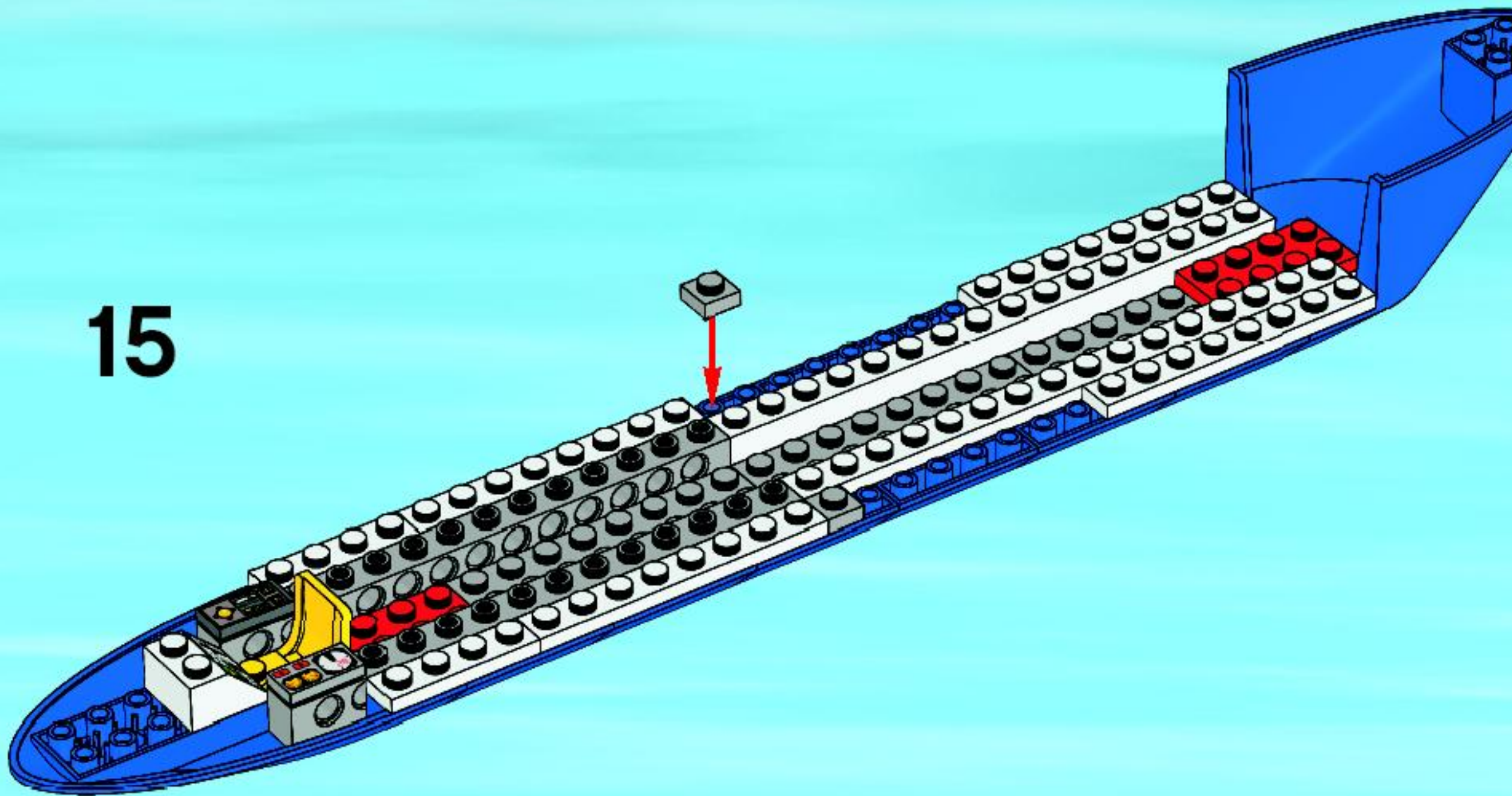

16

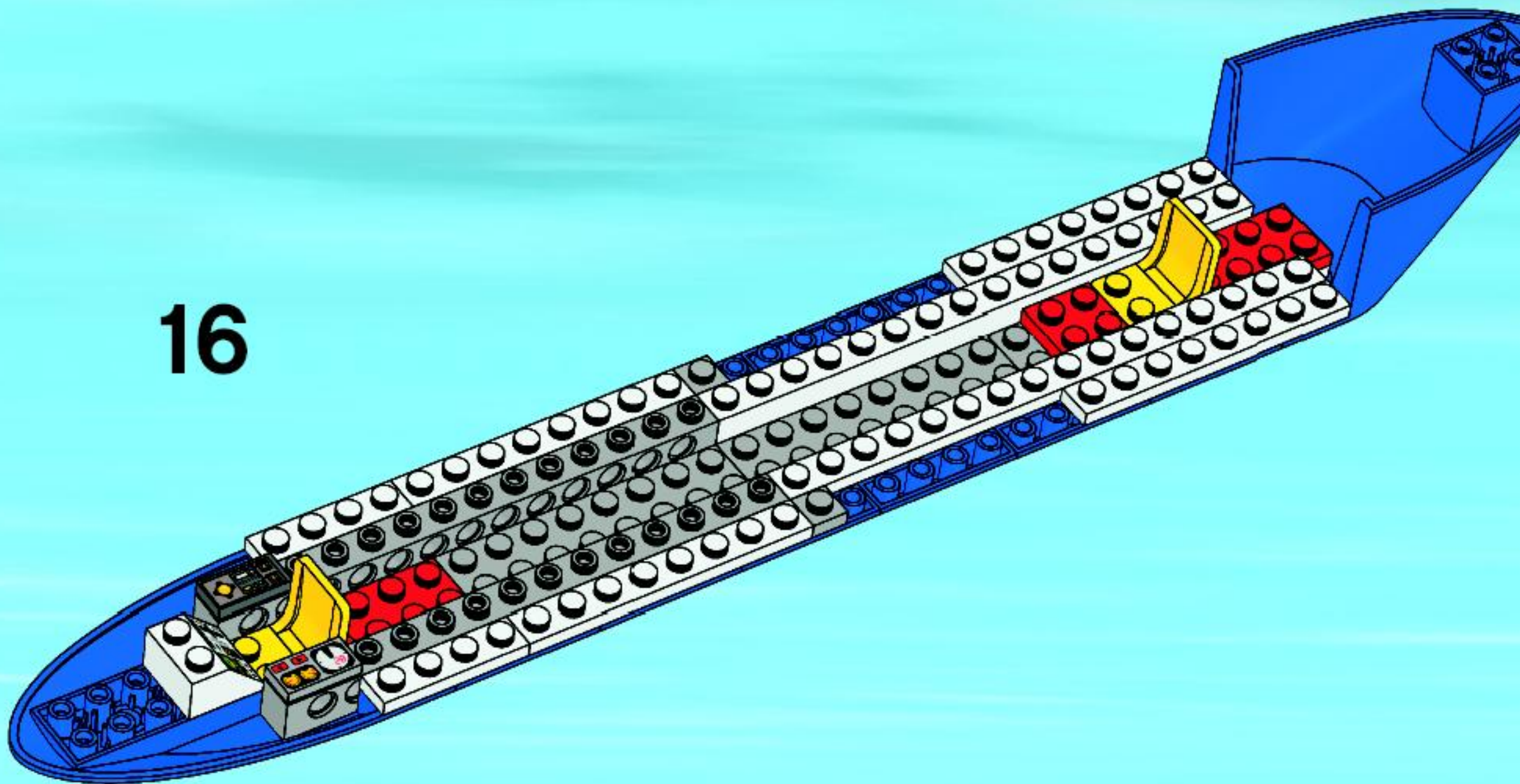

17

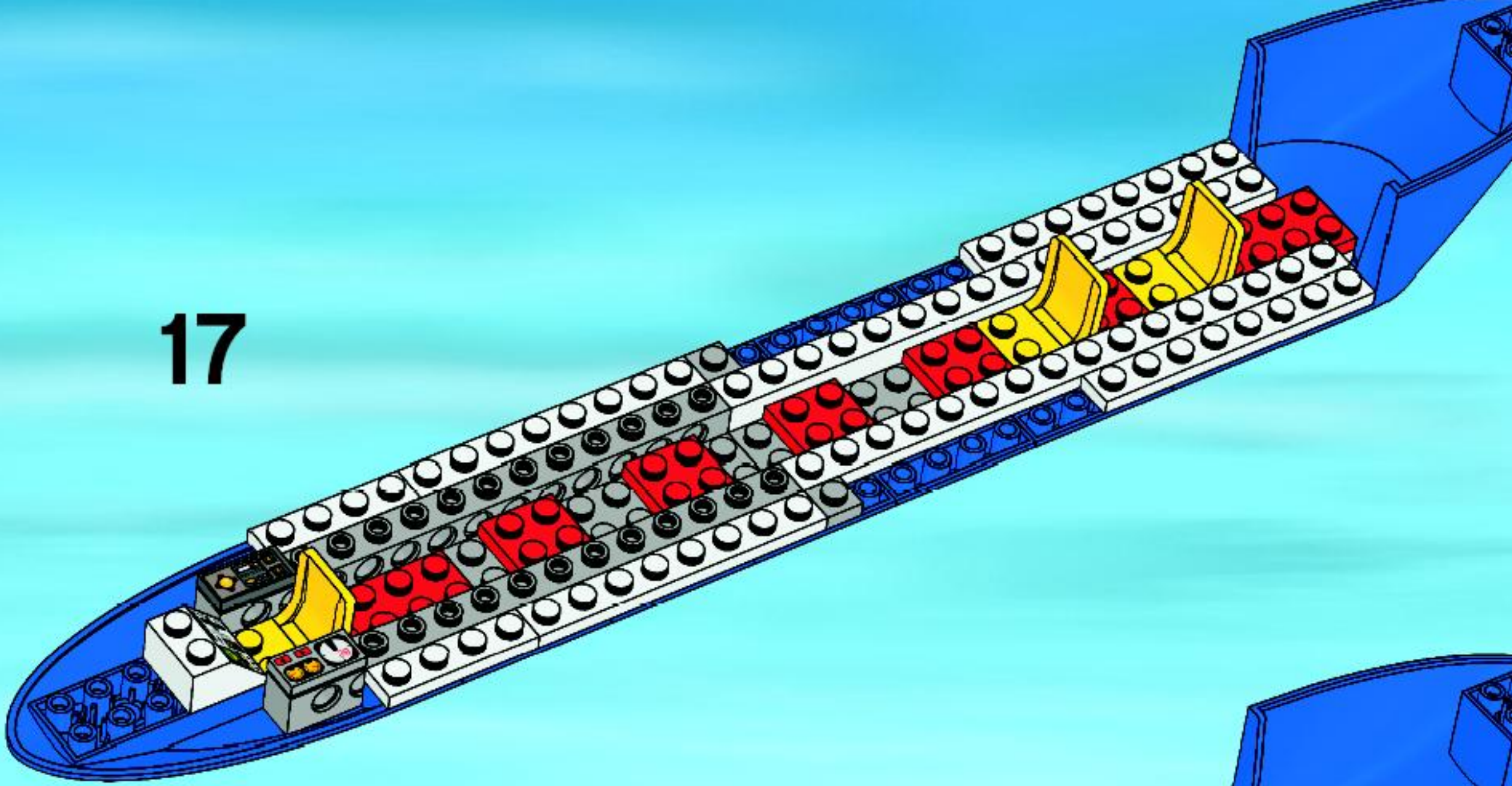

18

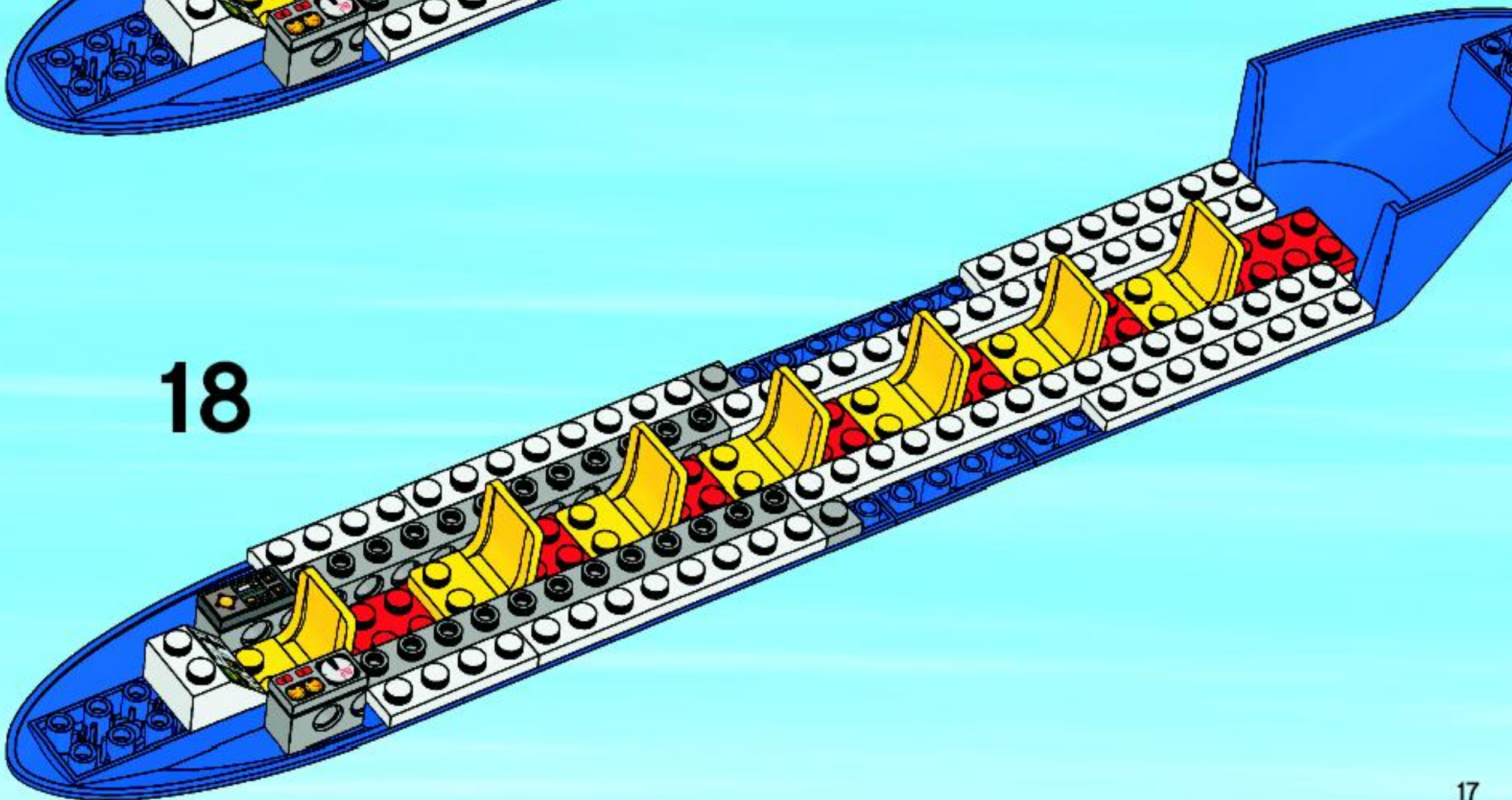

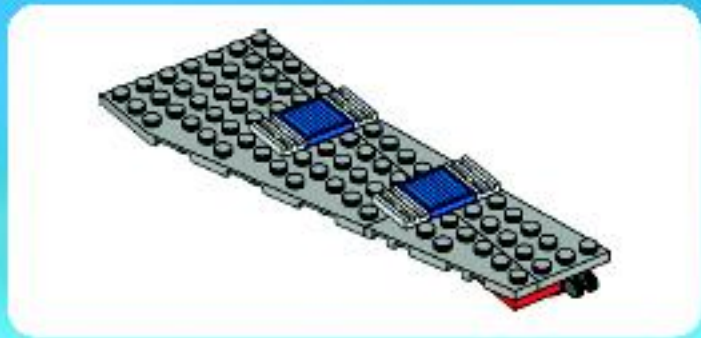

1

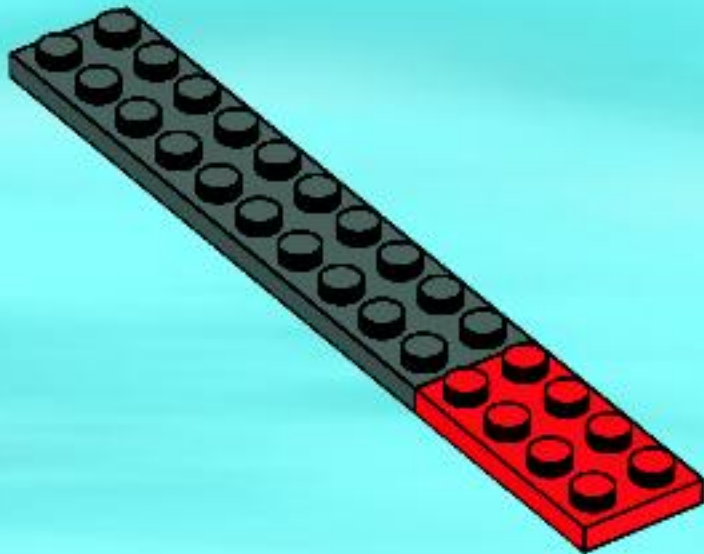

2

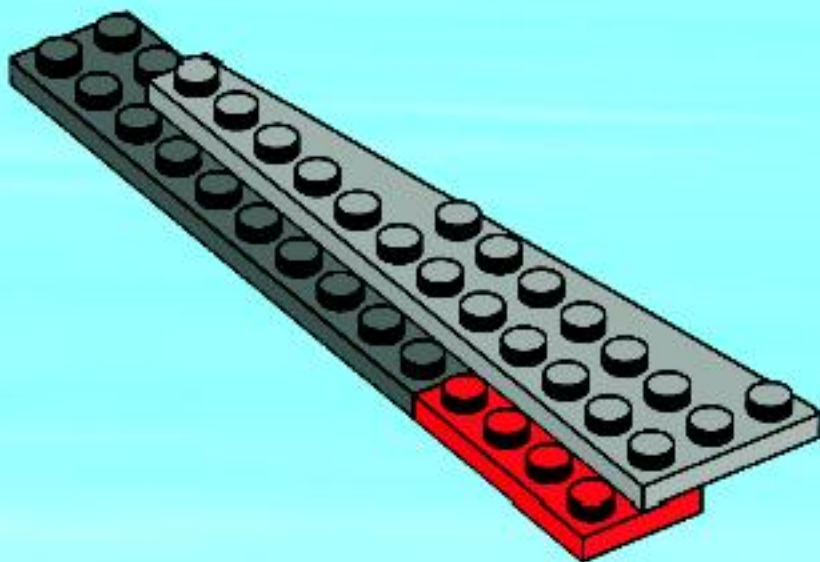

3

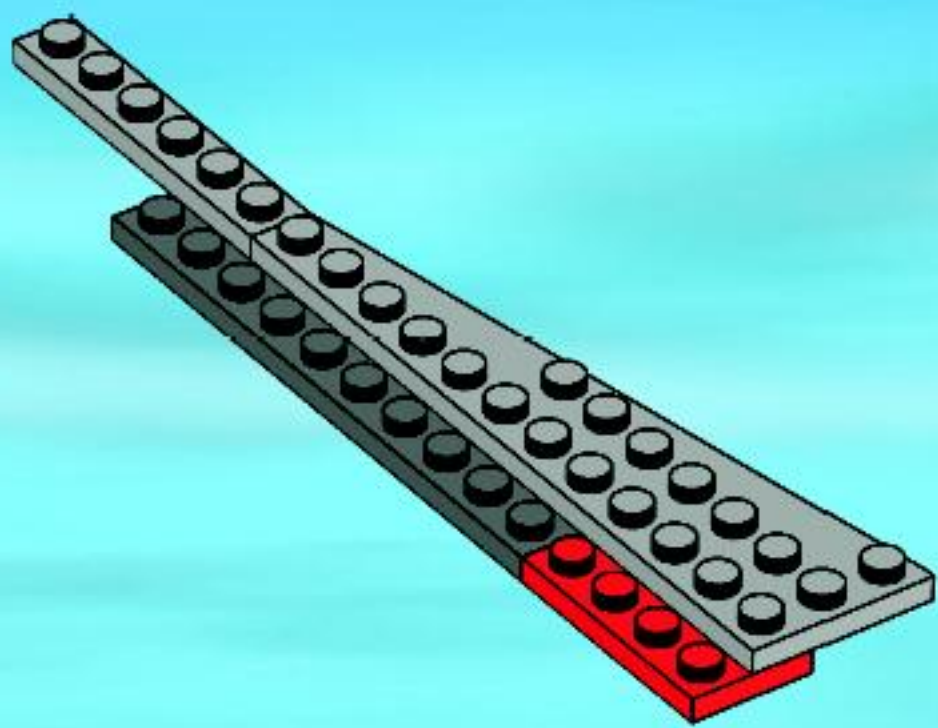

4

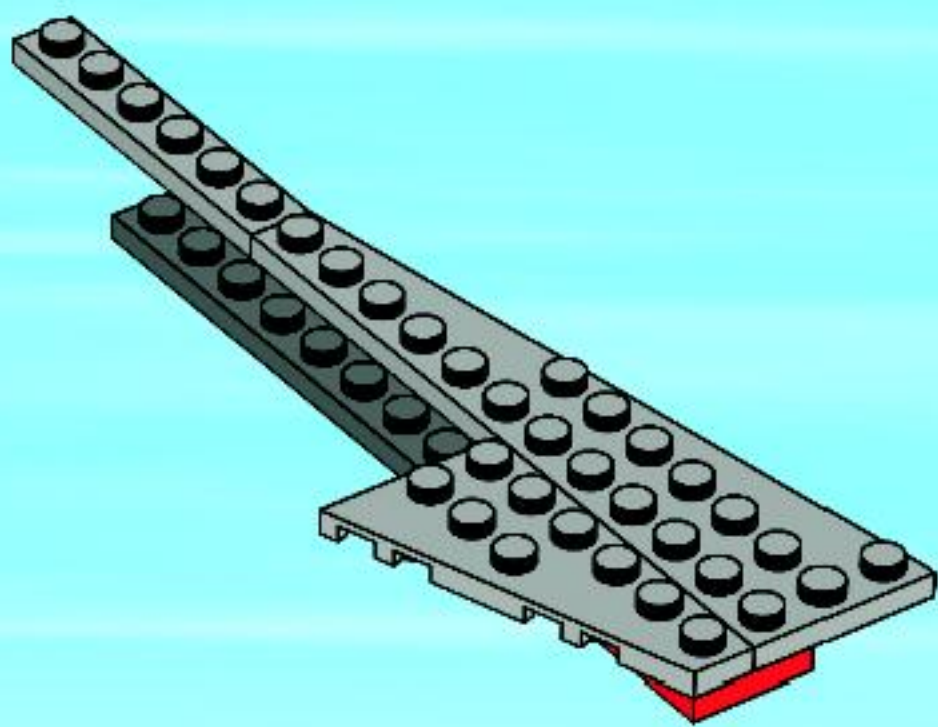

5

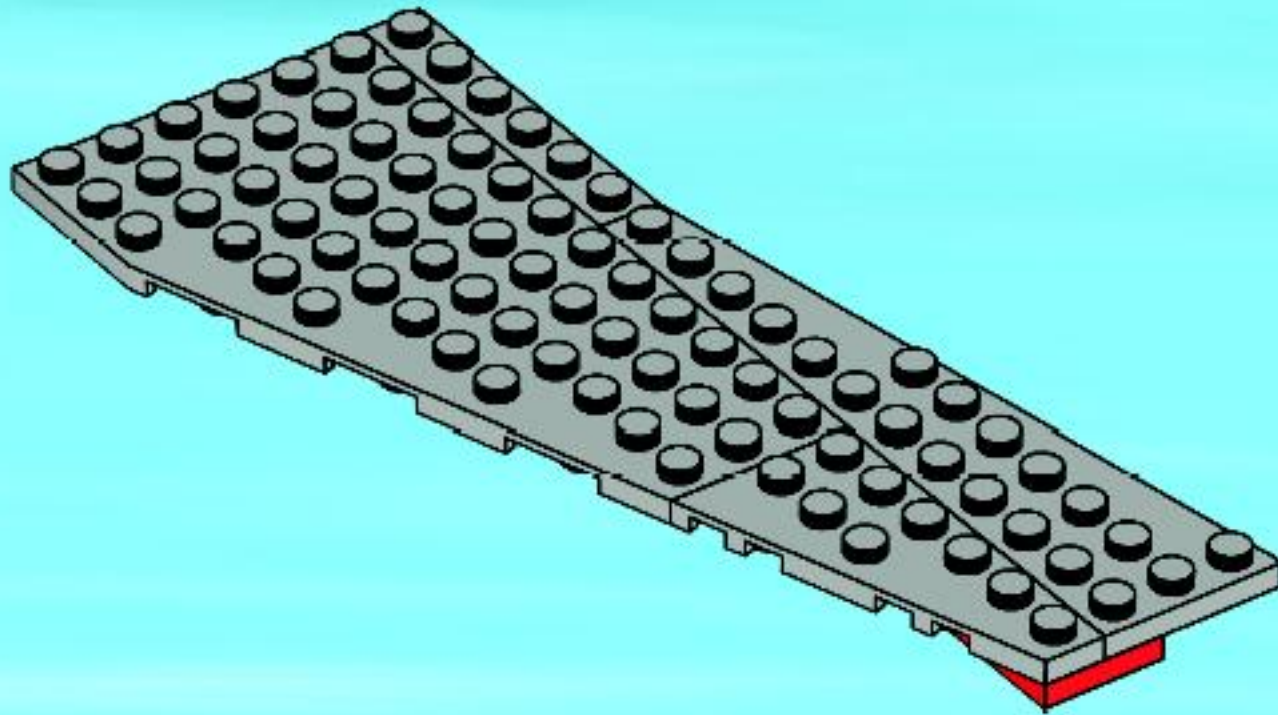

6

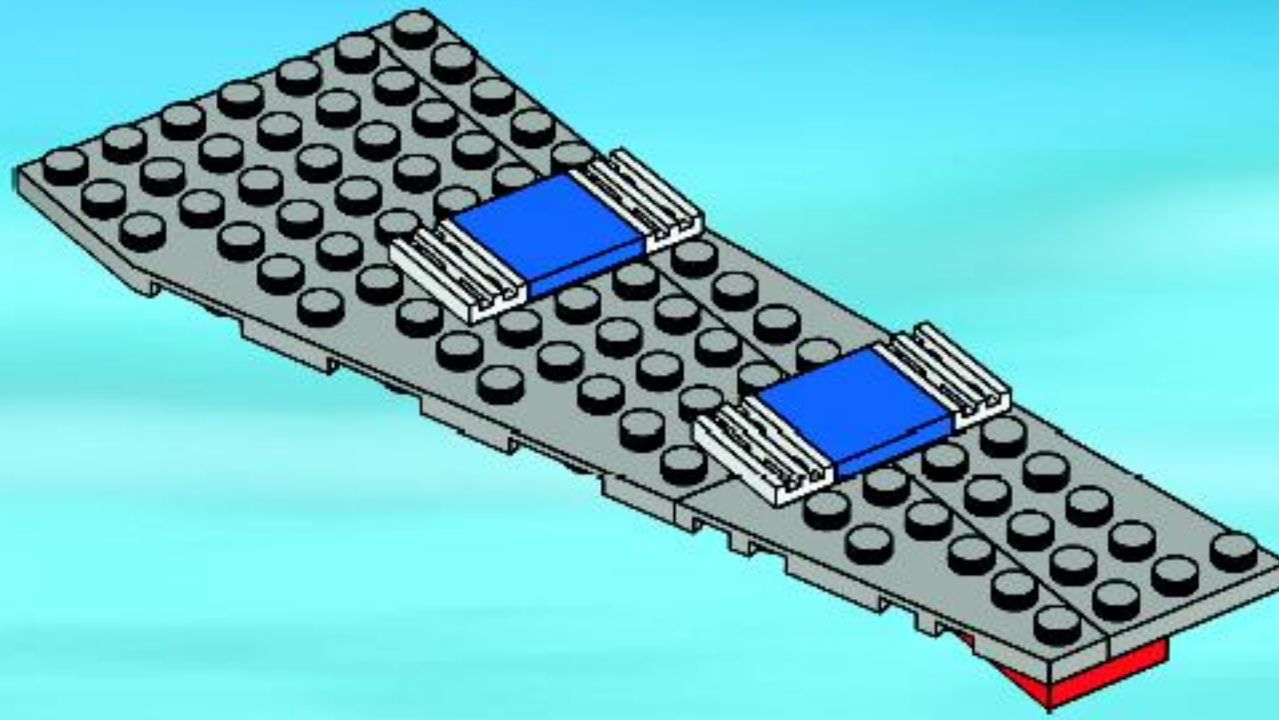

7

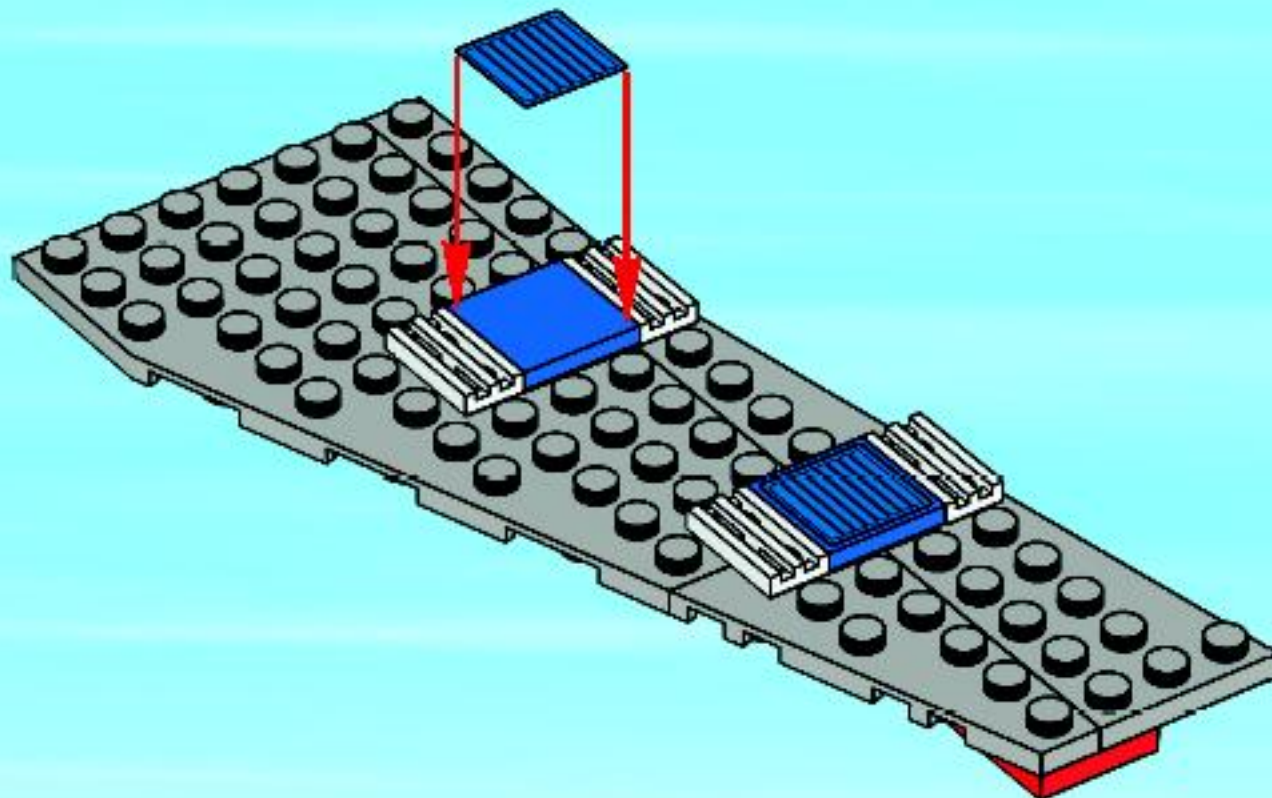

8

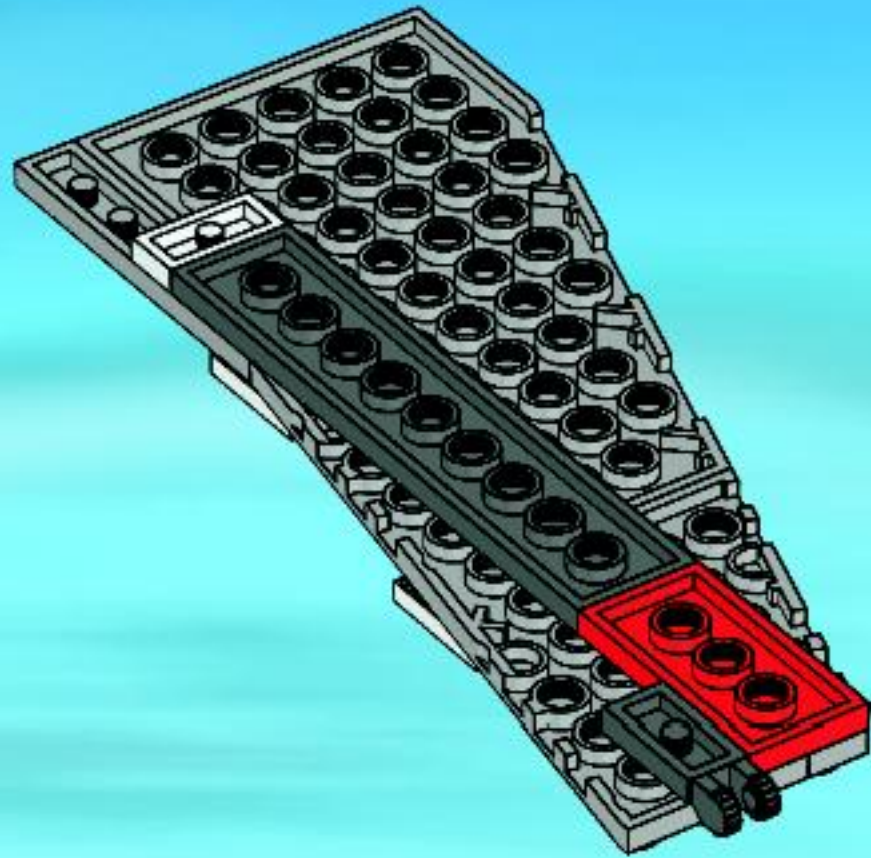

9

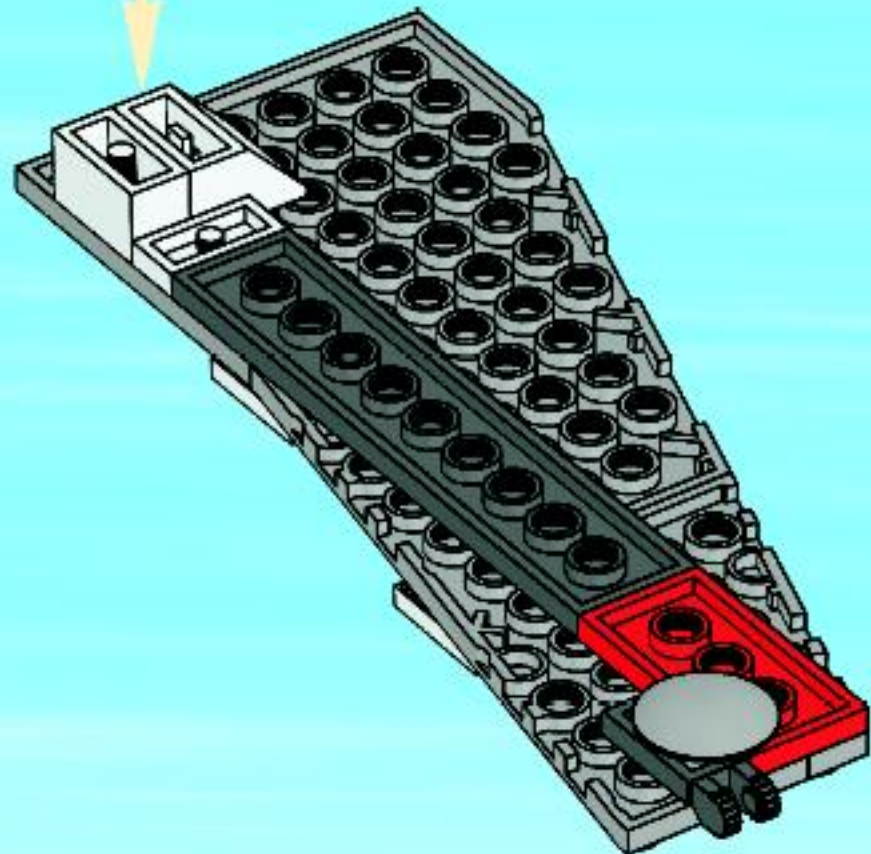

10

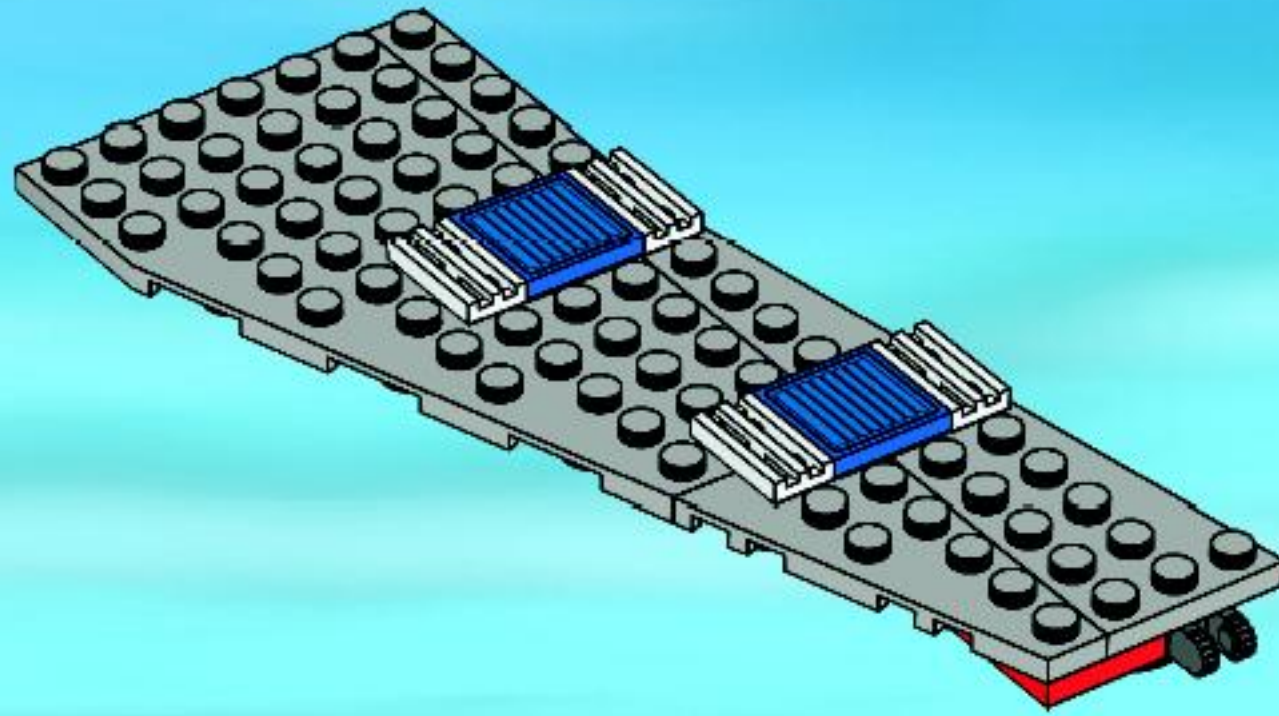

19

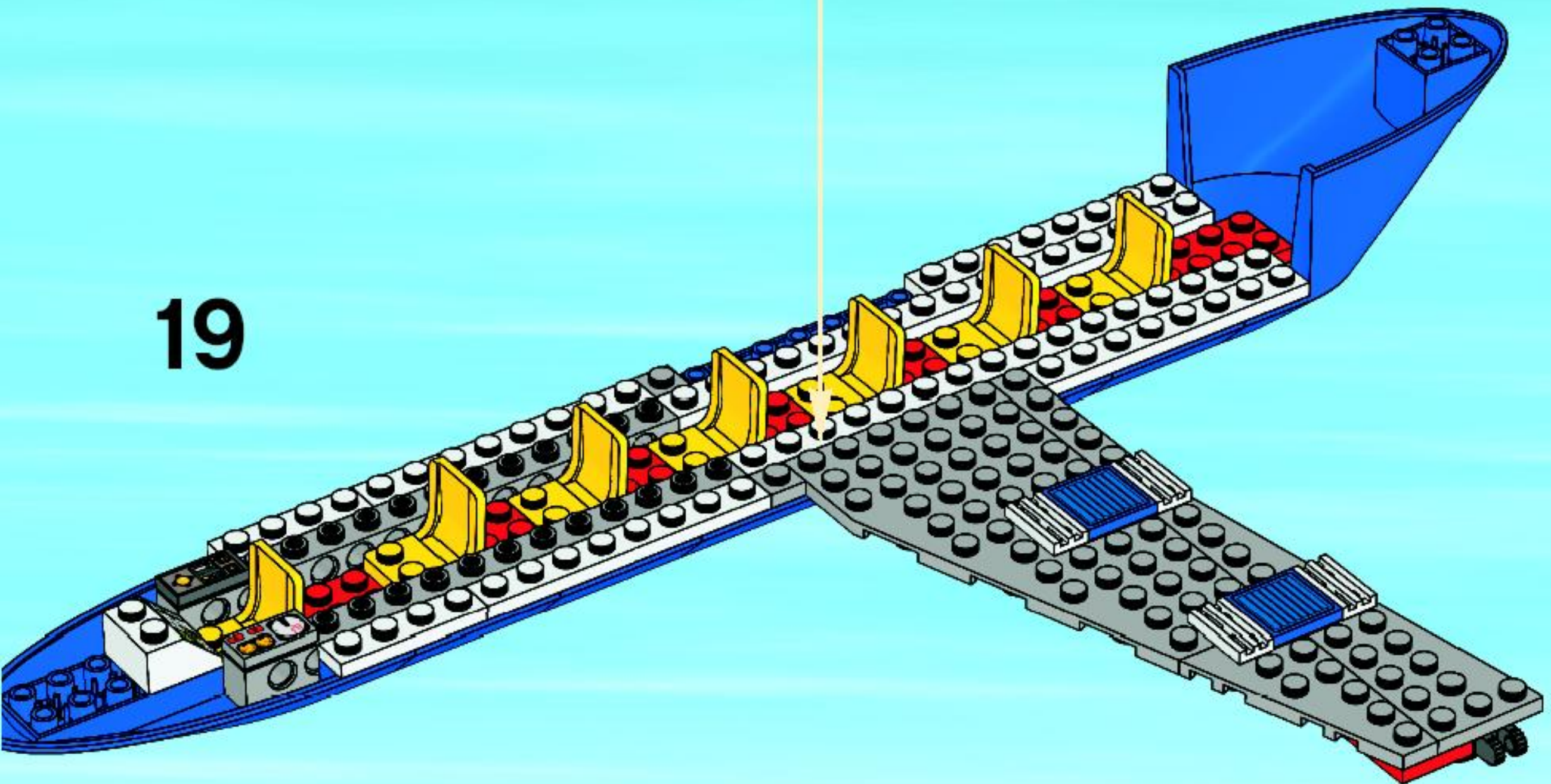

20

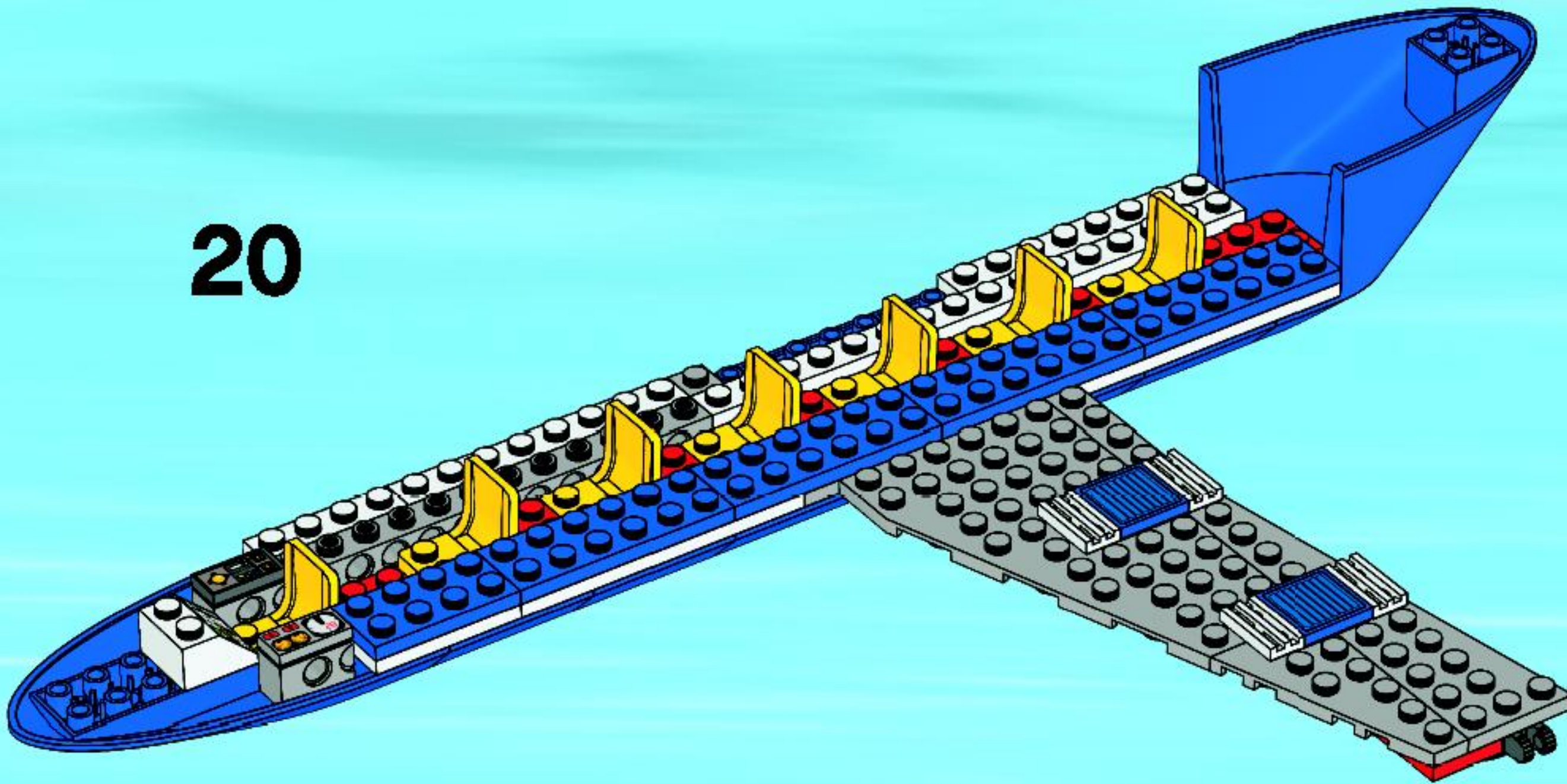

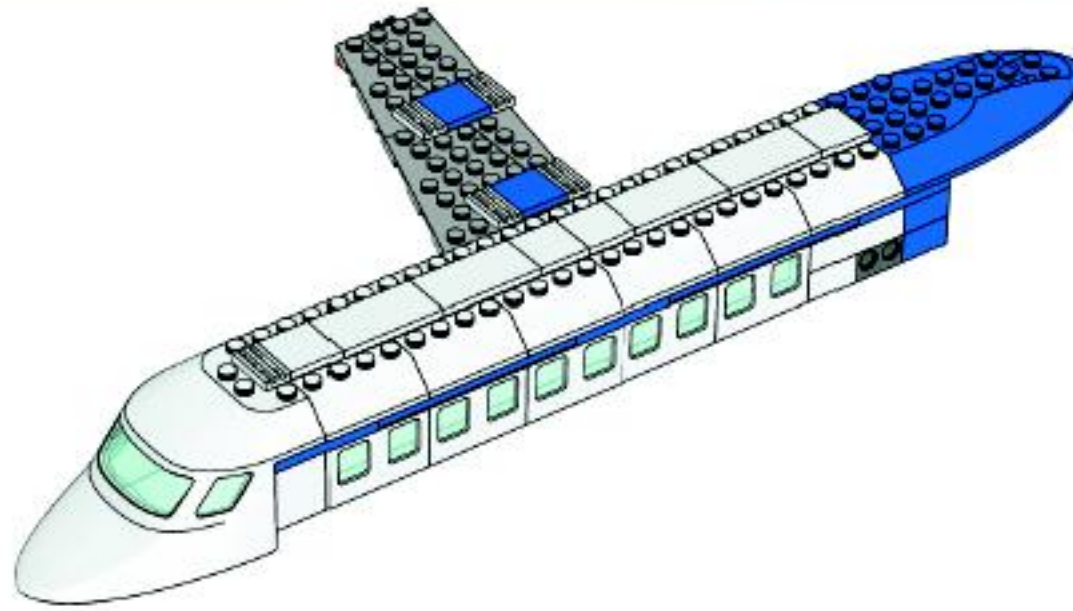

1

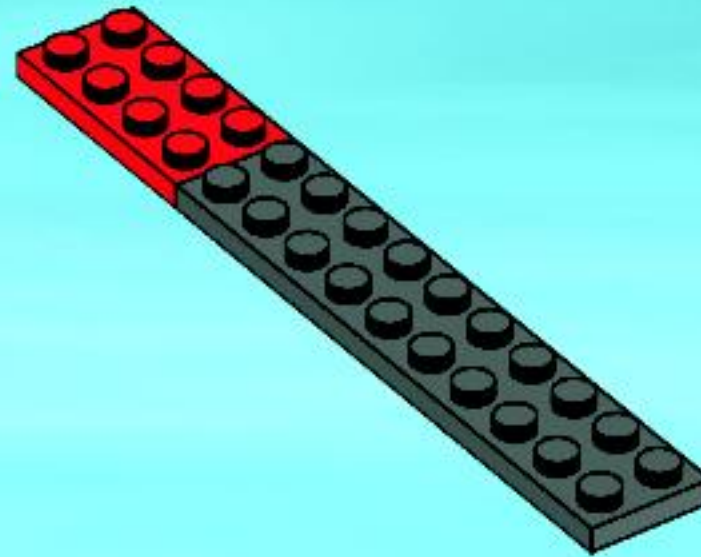

2

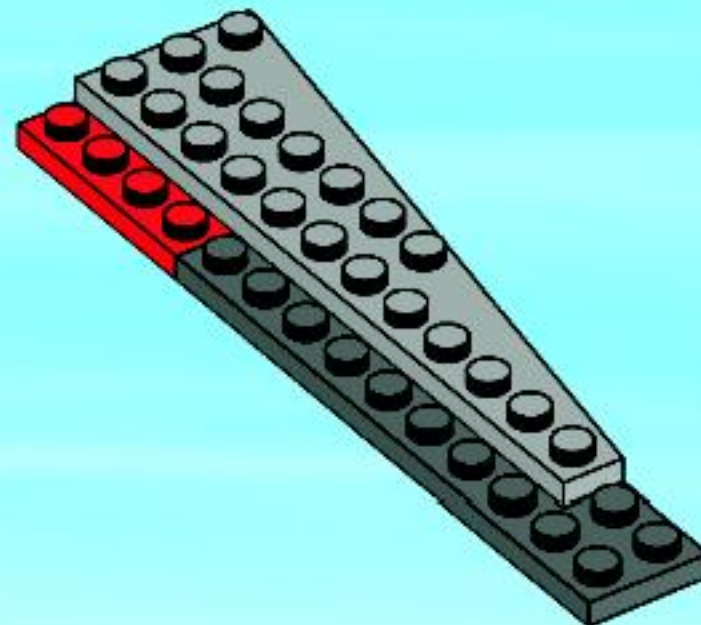

3

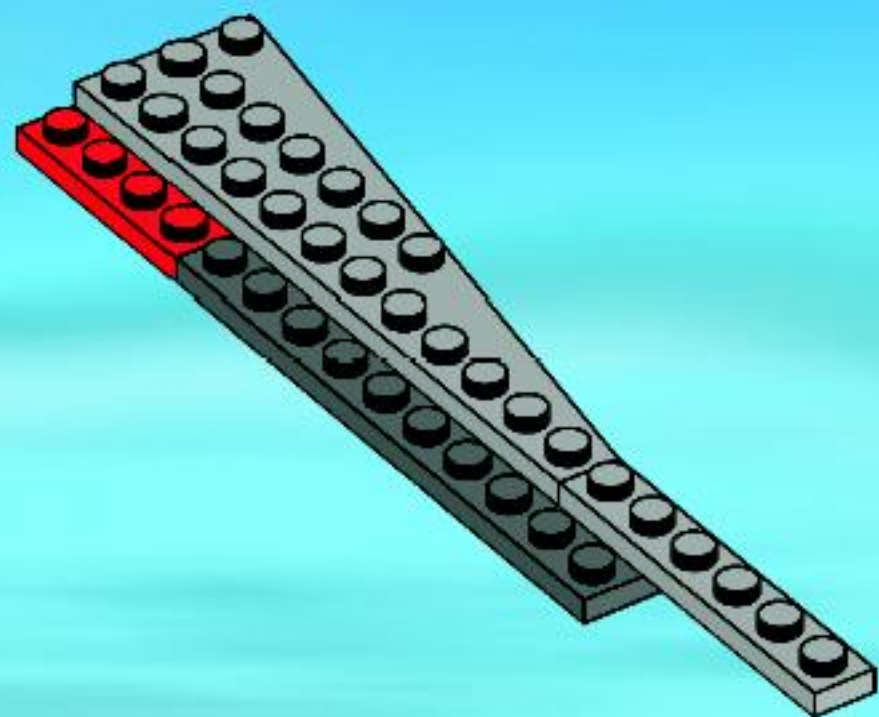

4

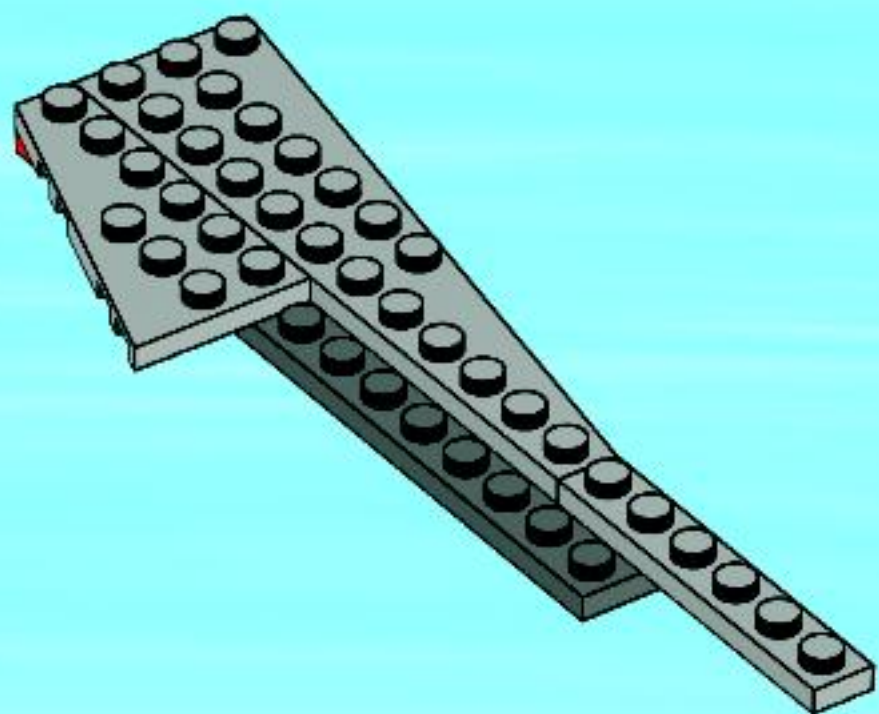

5

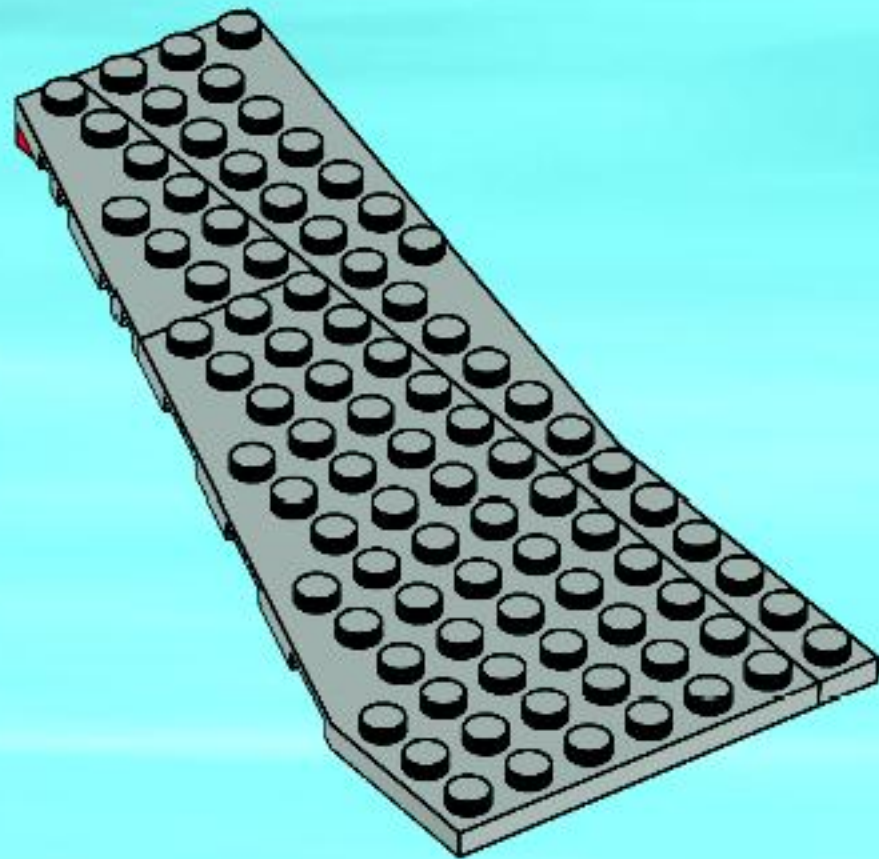

6

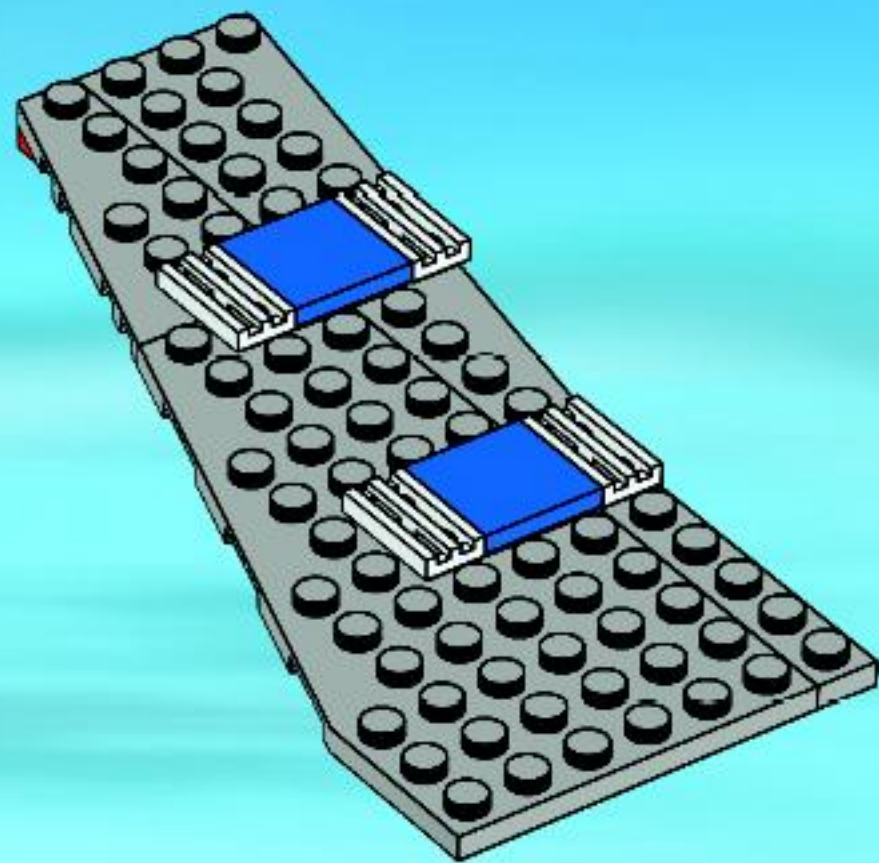

7

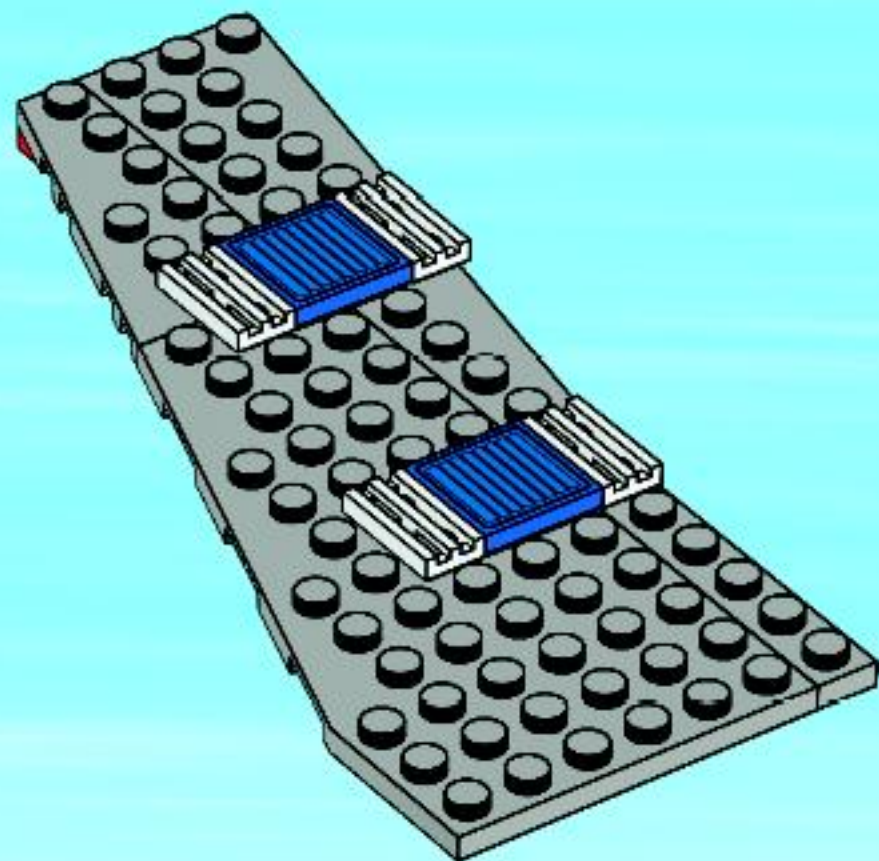

8

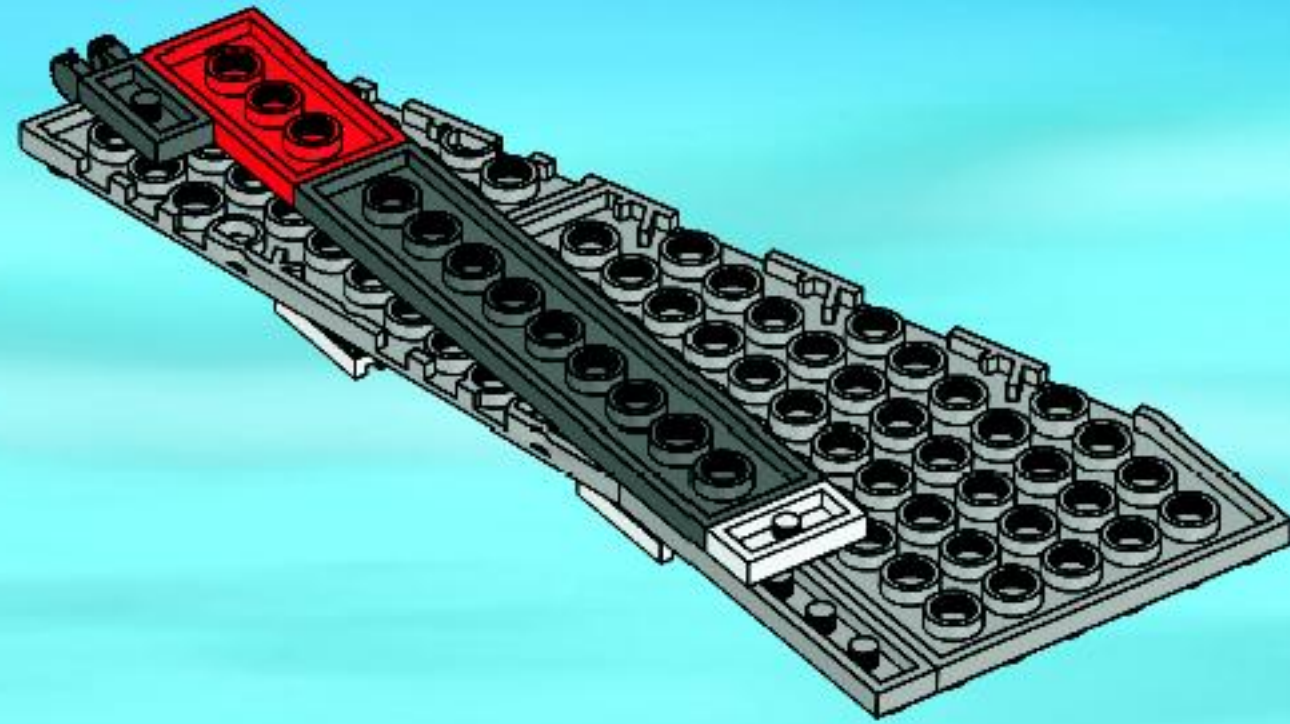

9

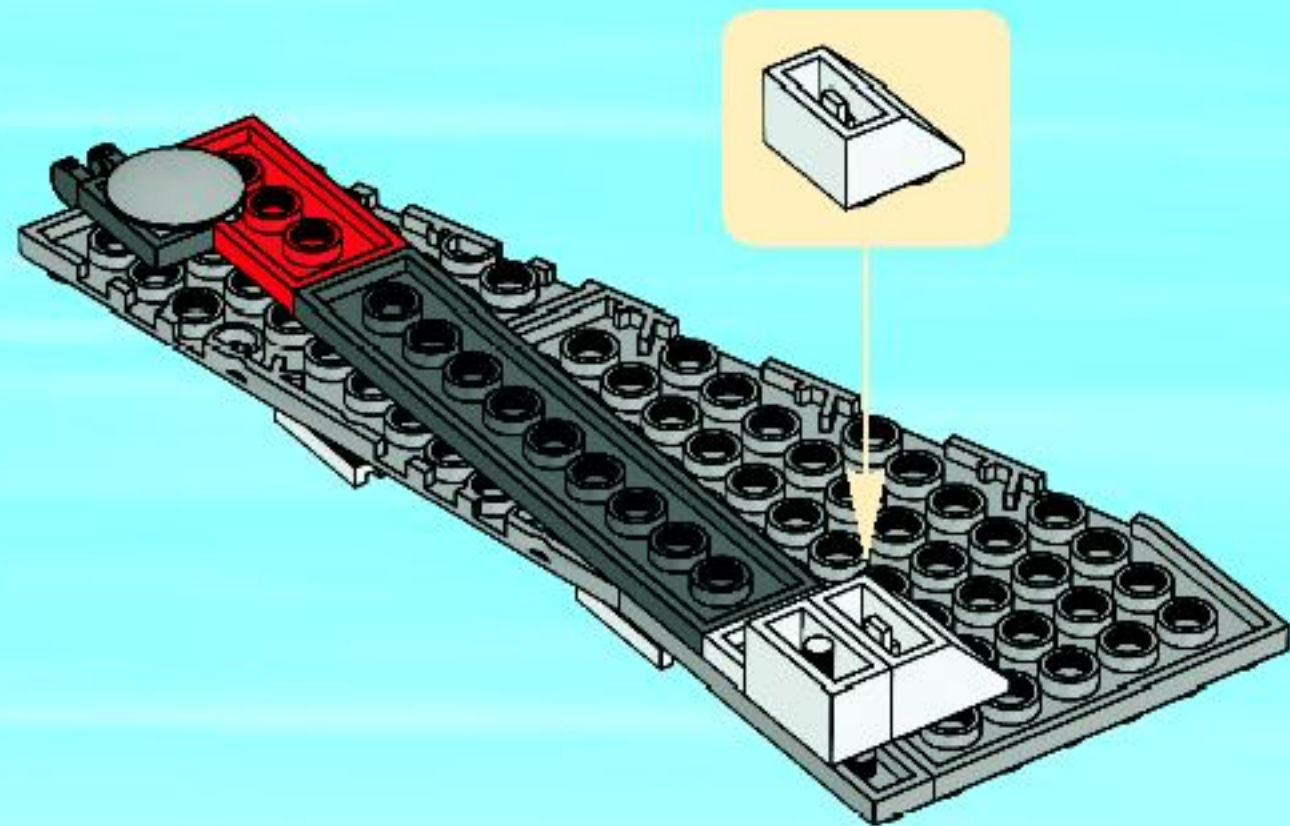

10

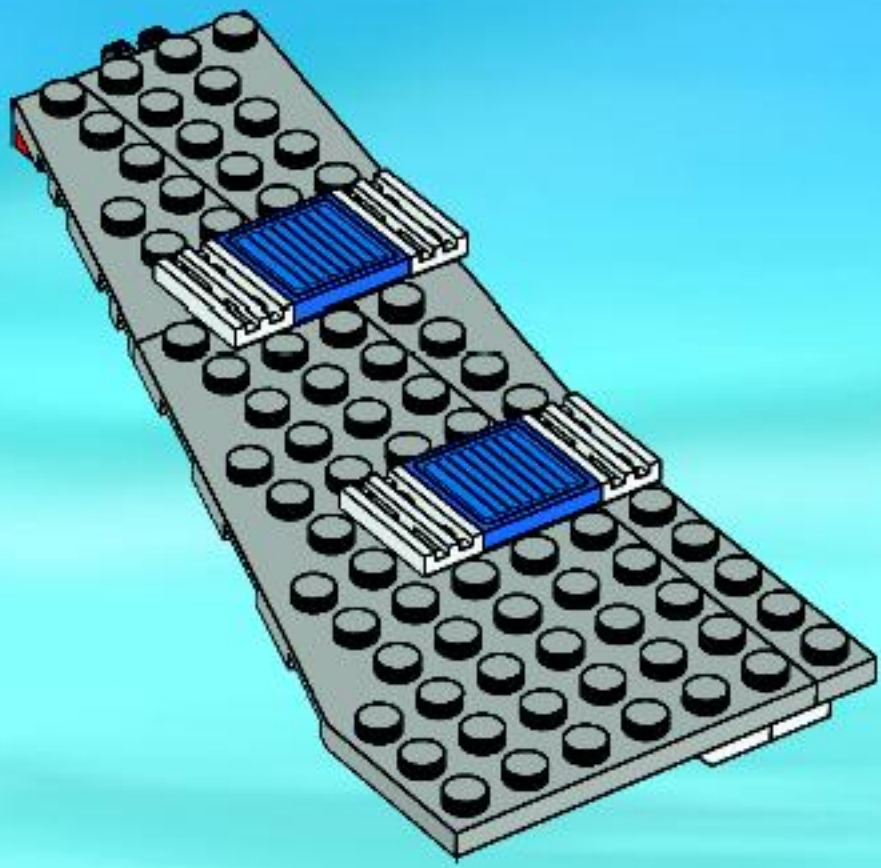

21

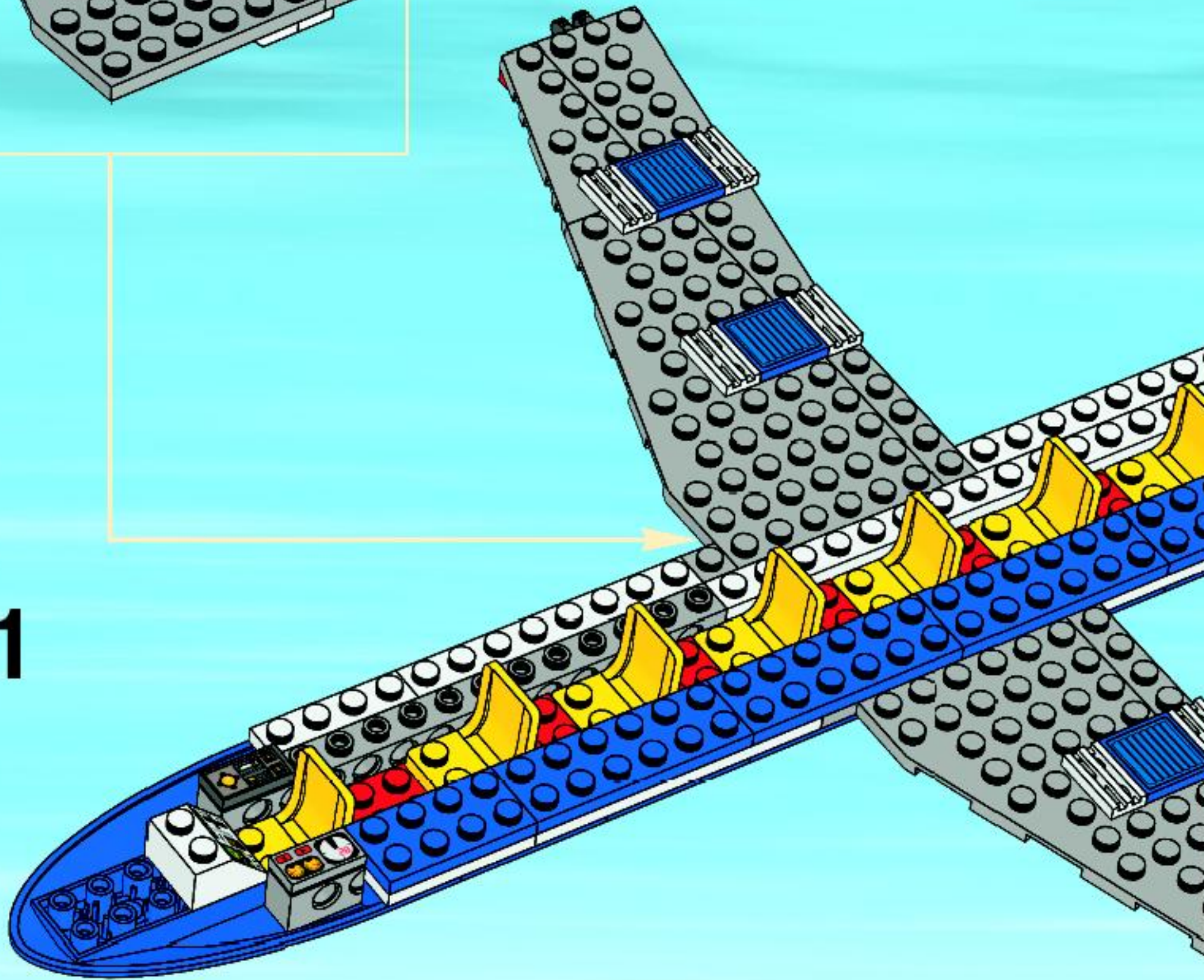

22

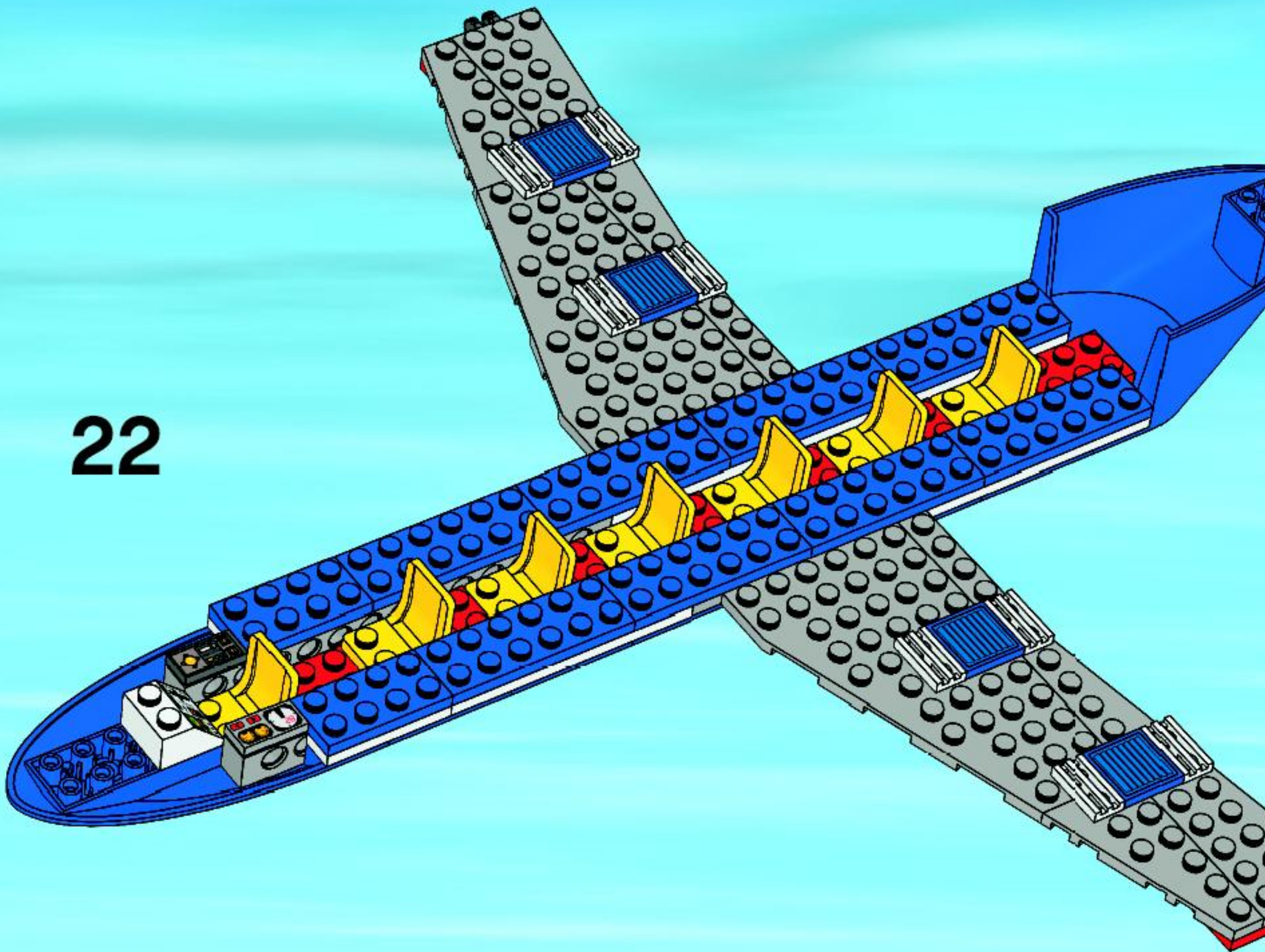

23

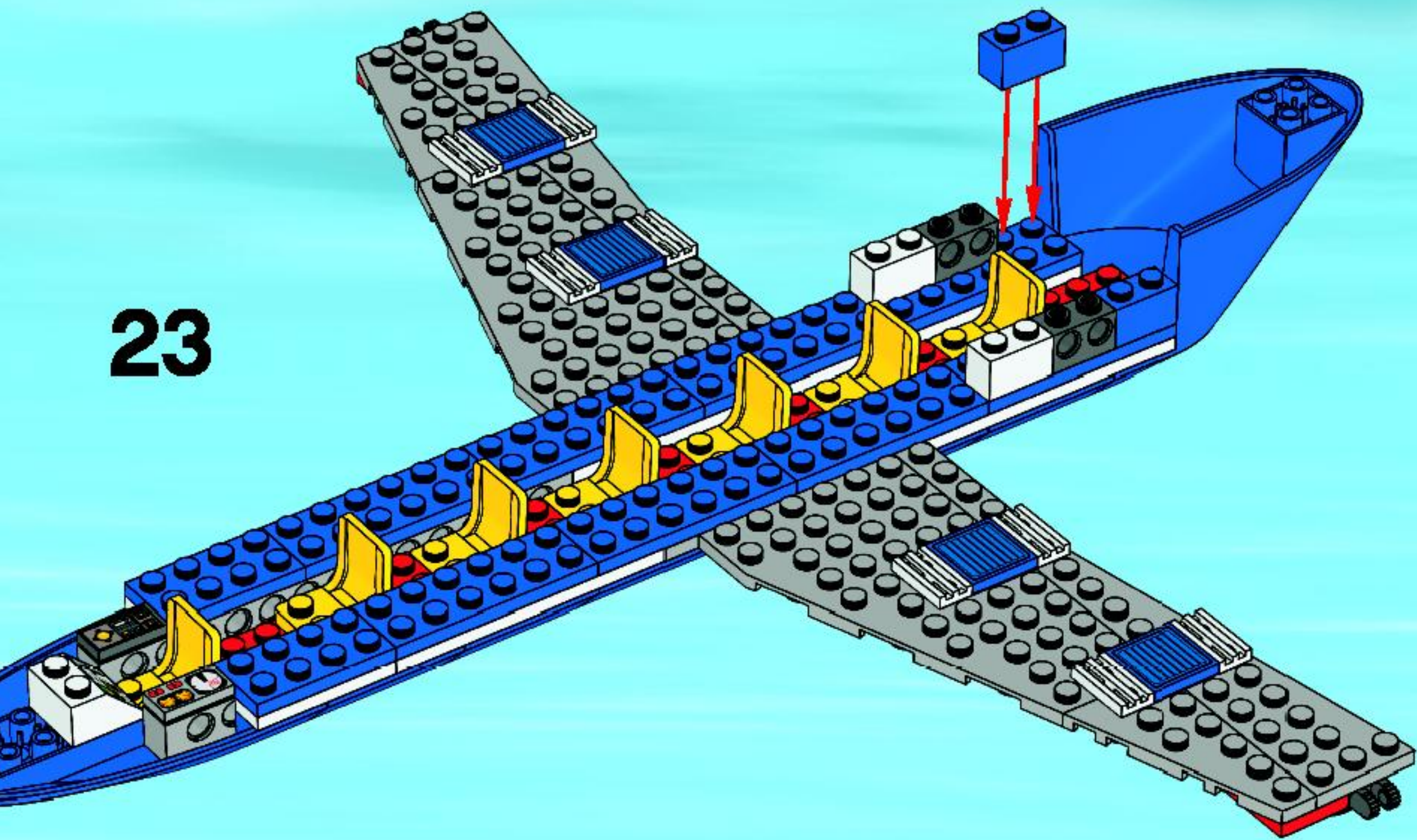

24

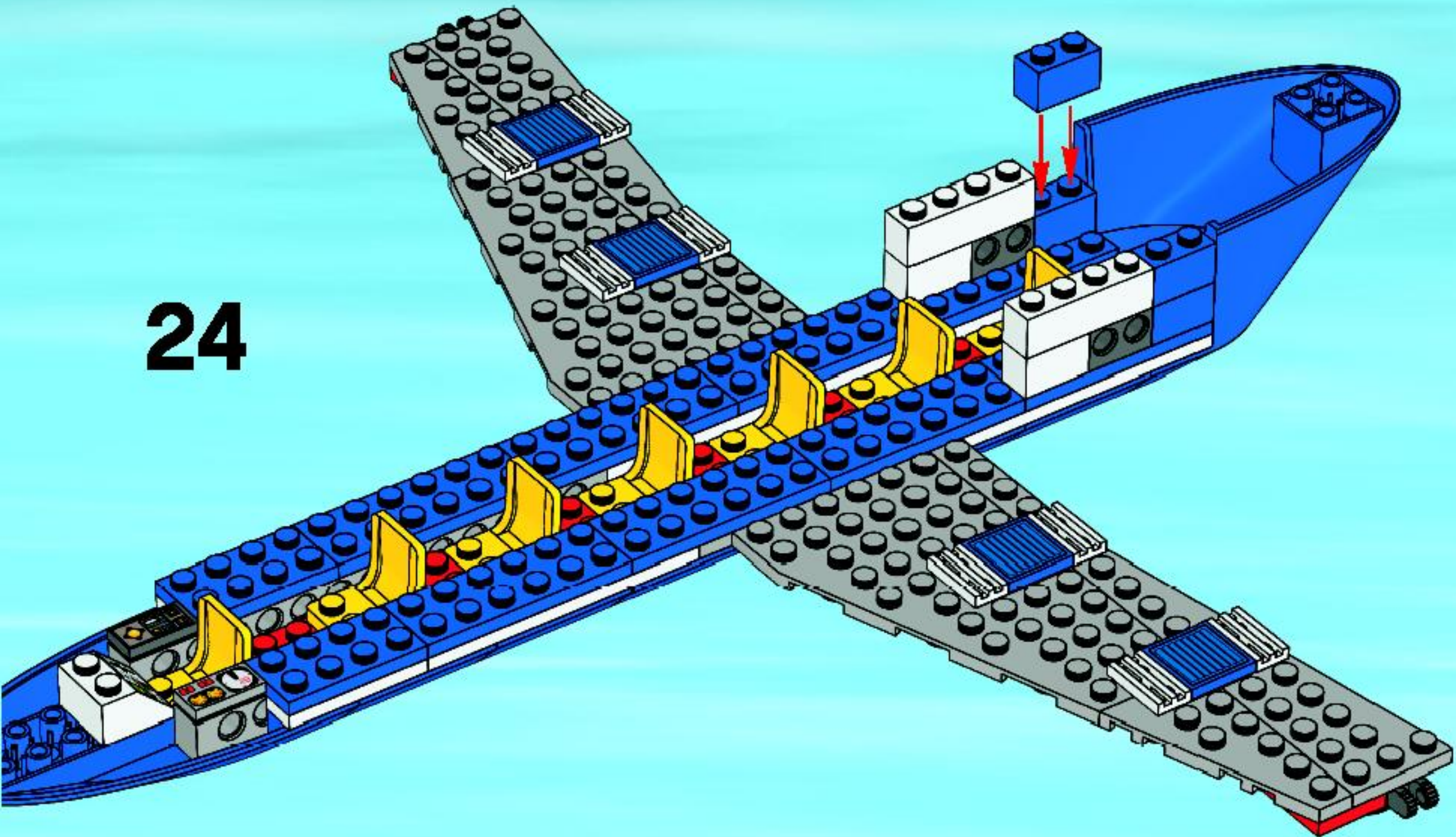

1



2

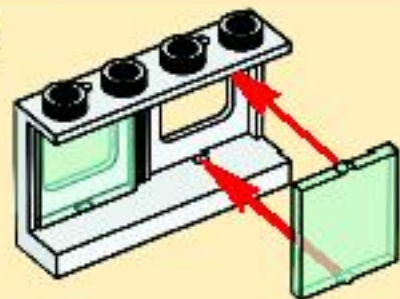

10x

25

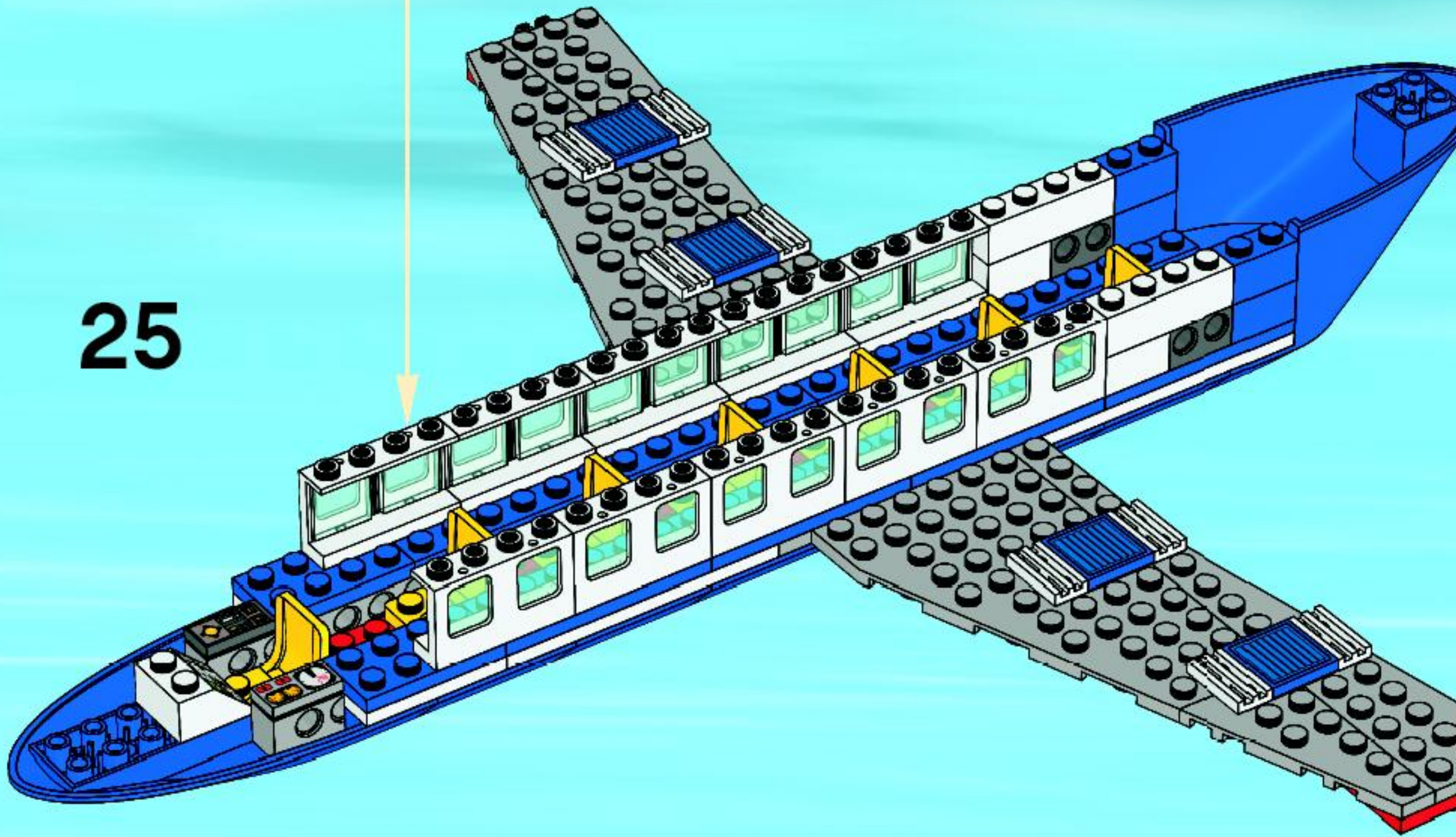

26

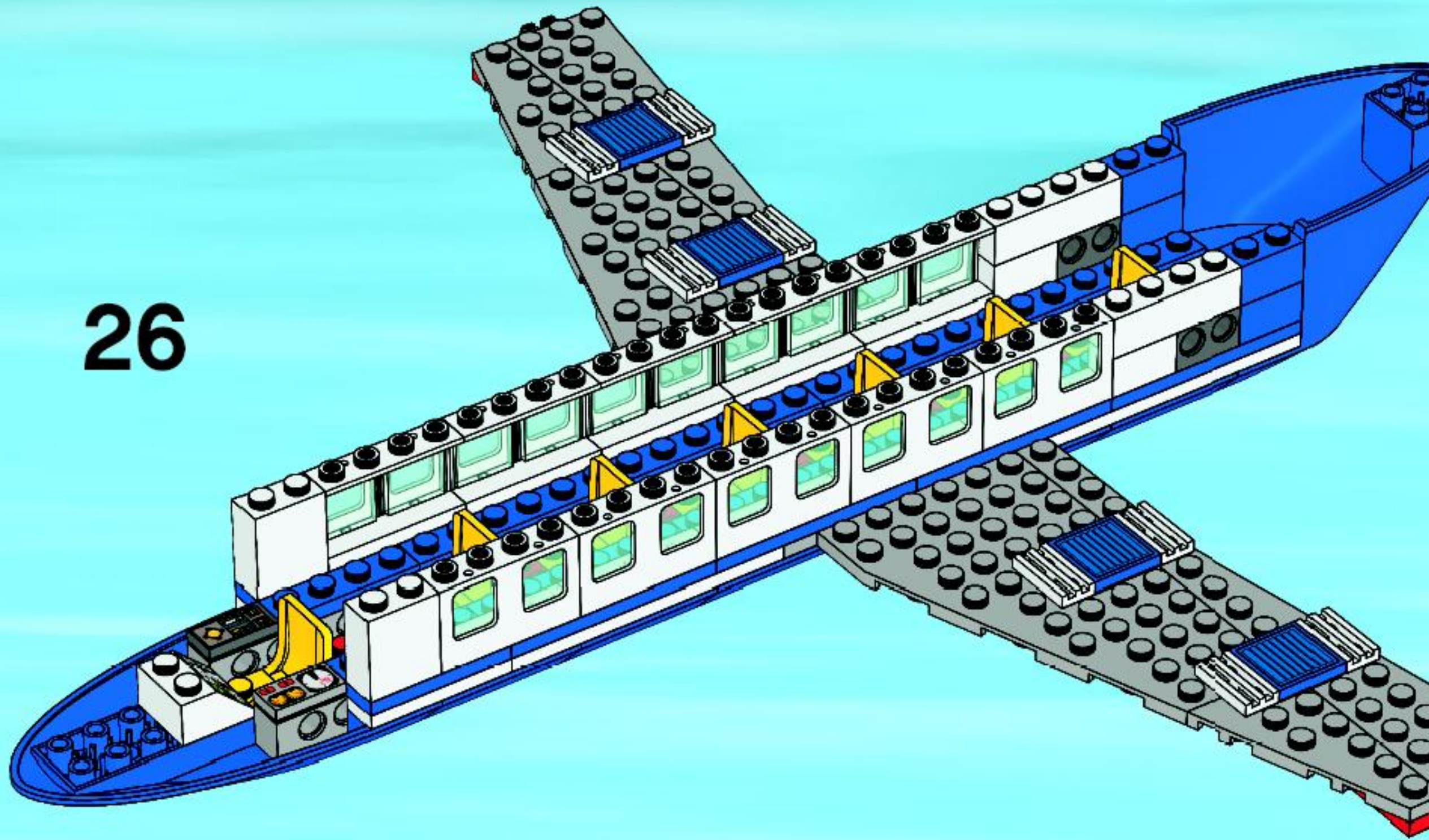

27

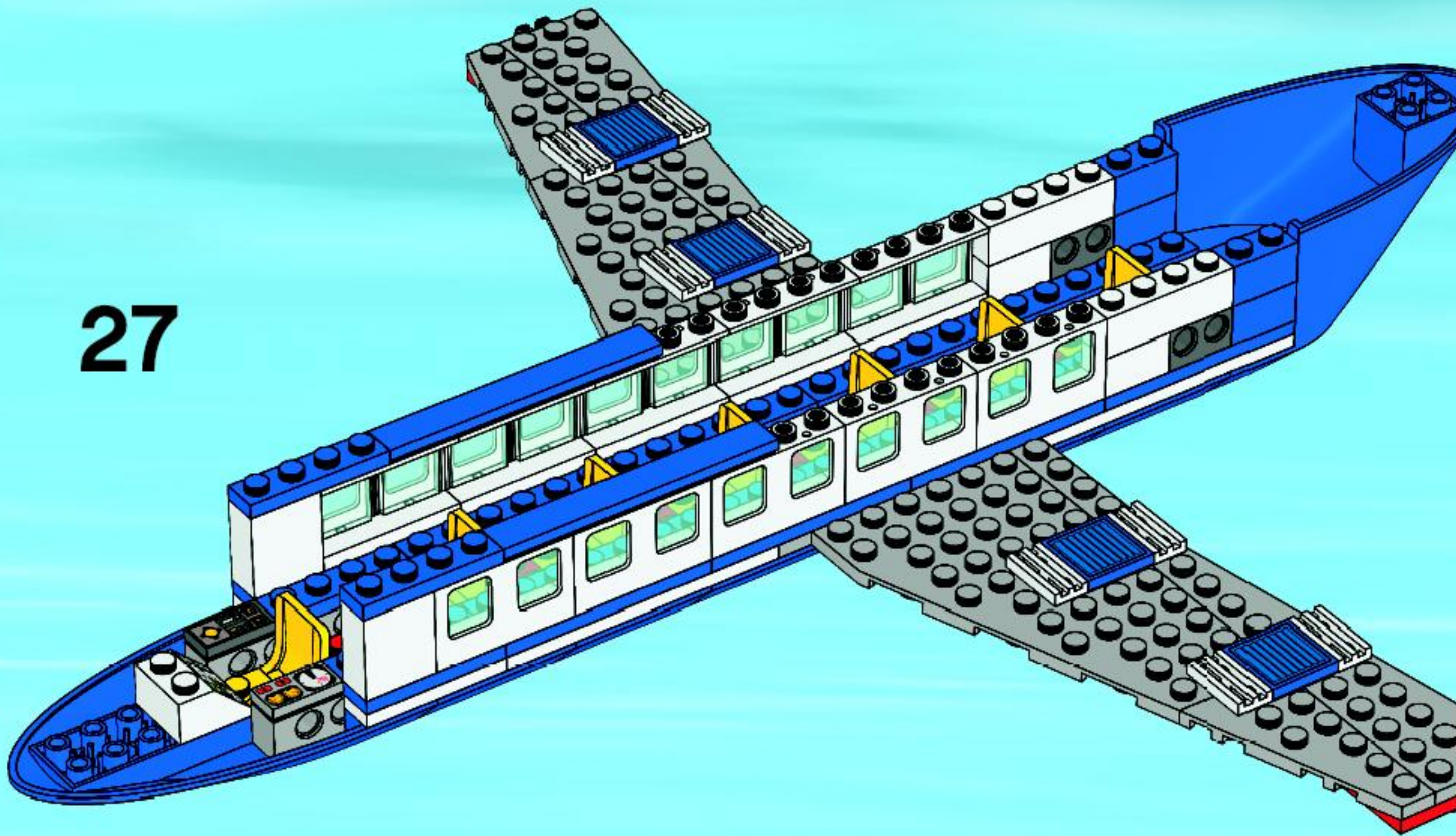

28

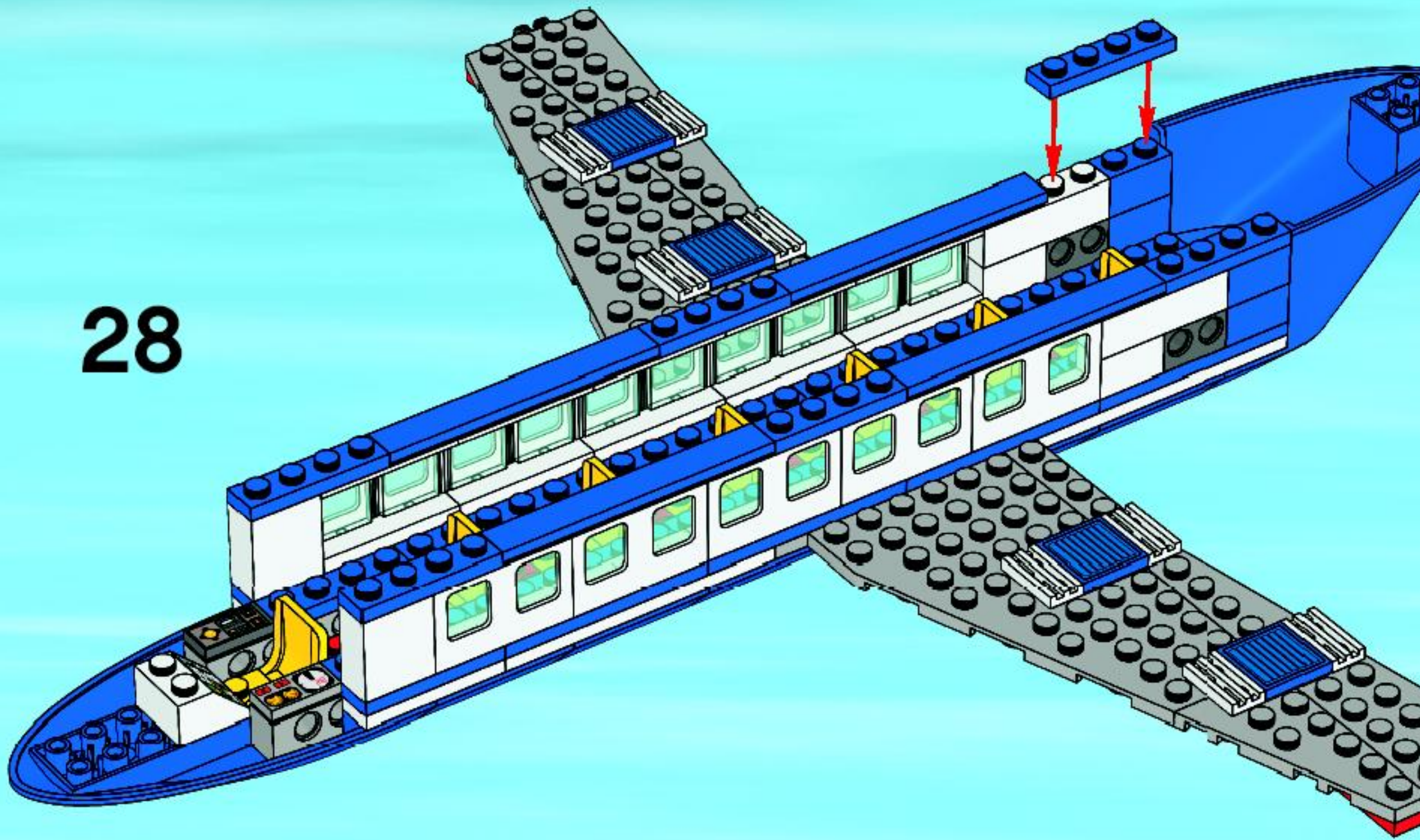

1

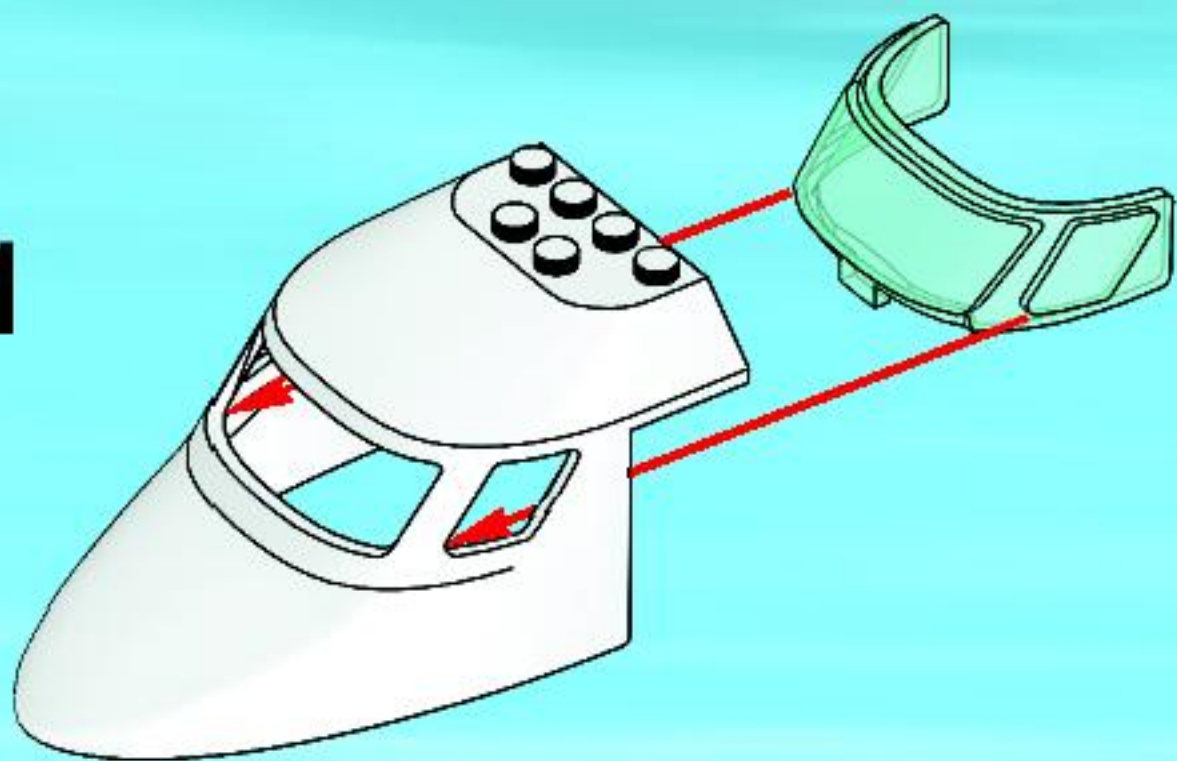

2

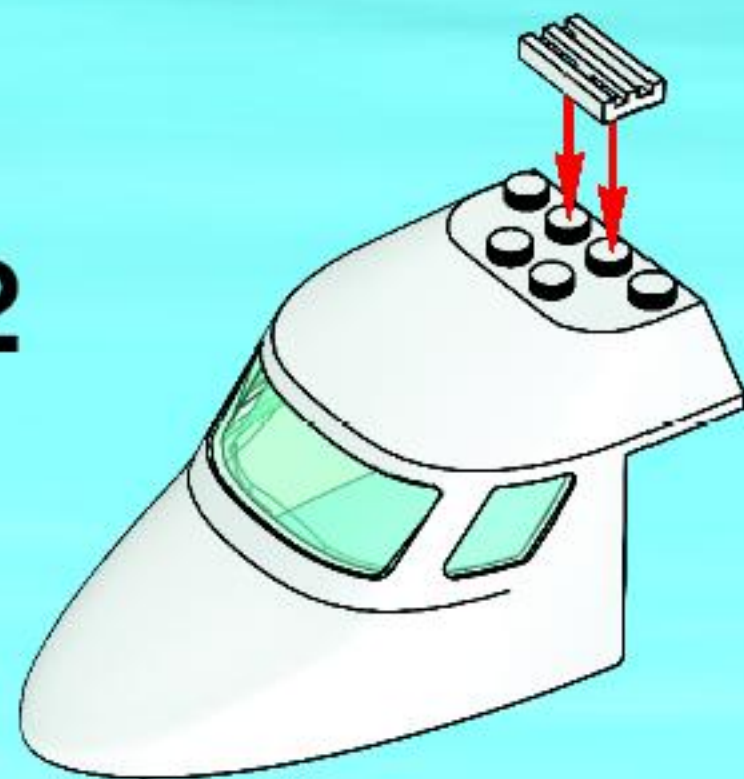

29

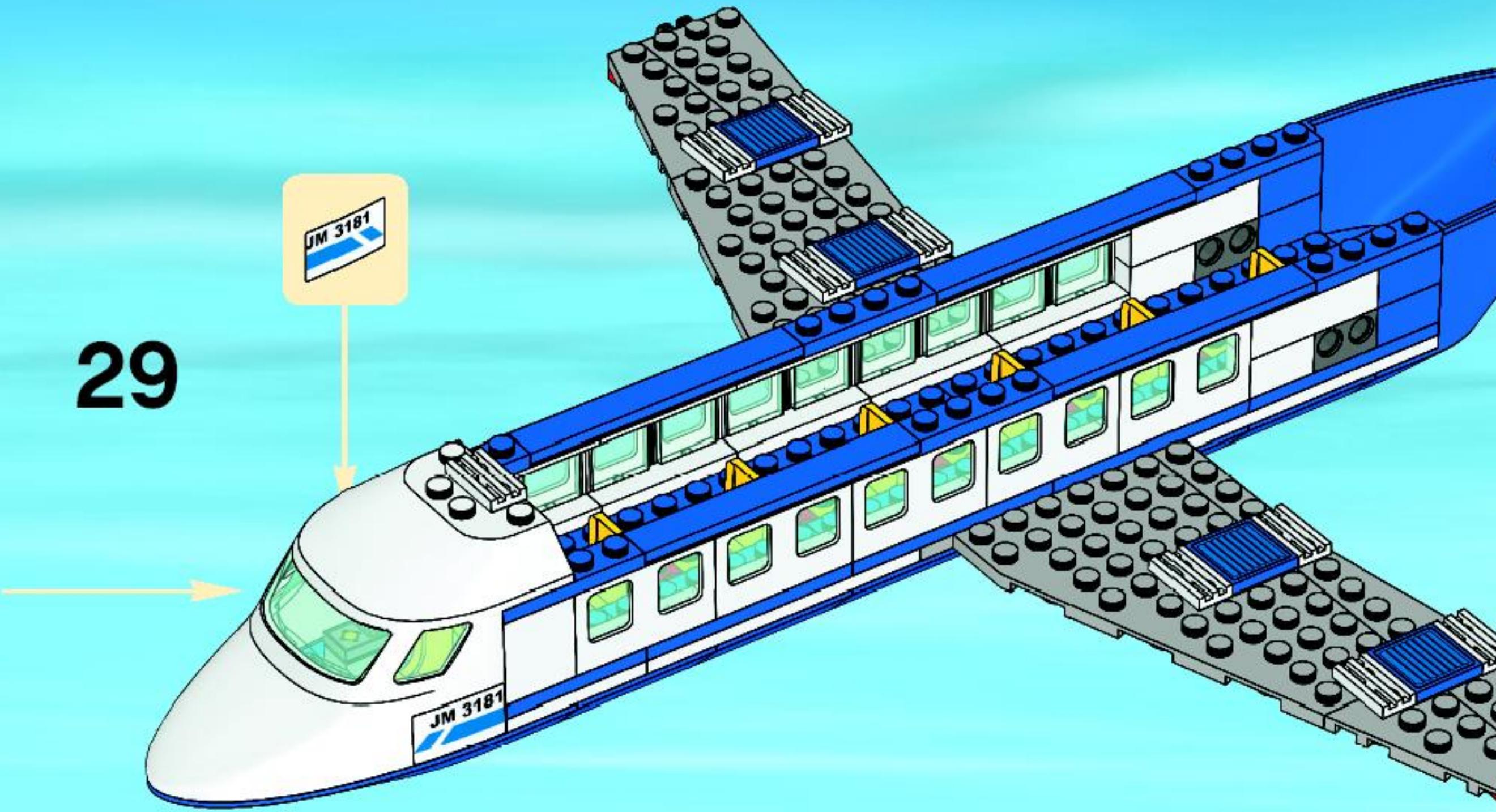

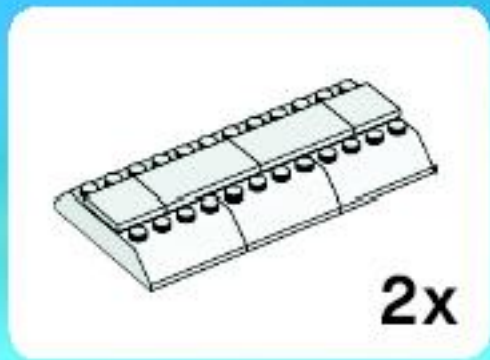

1

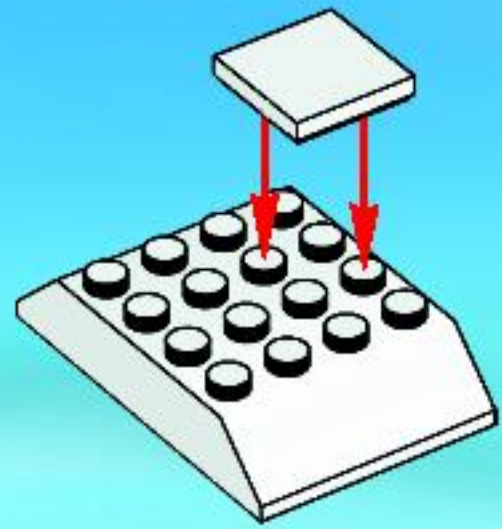

2

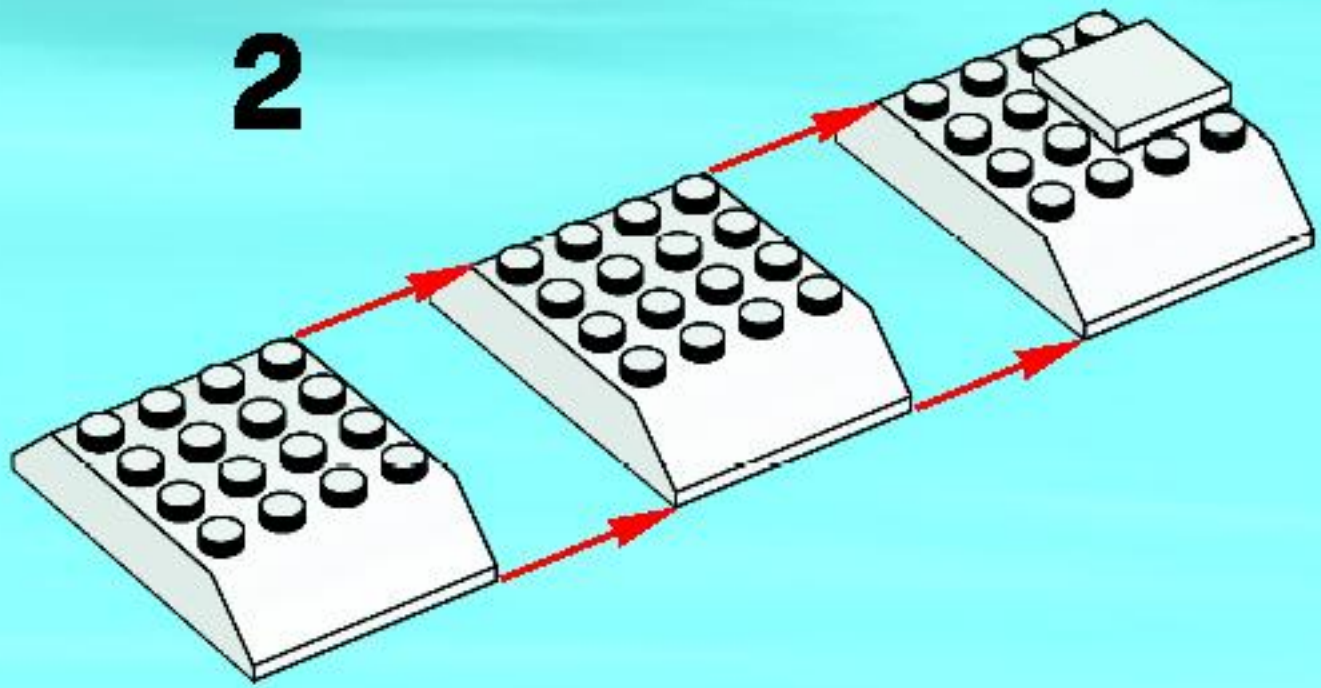

3

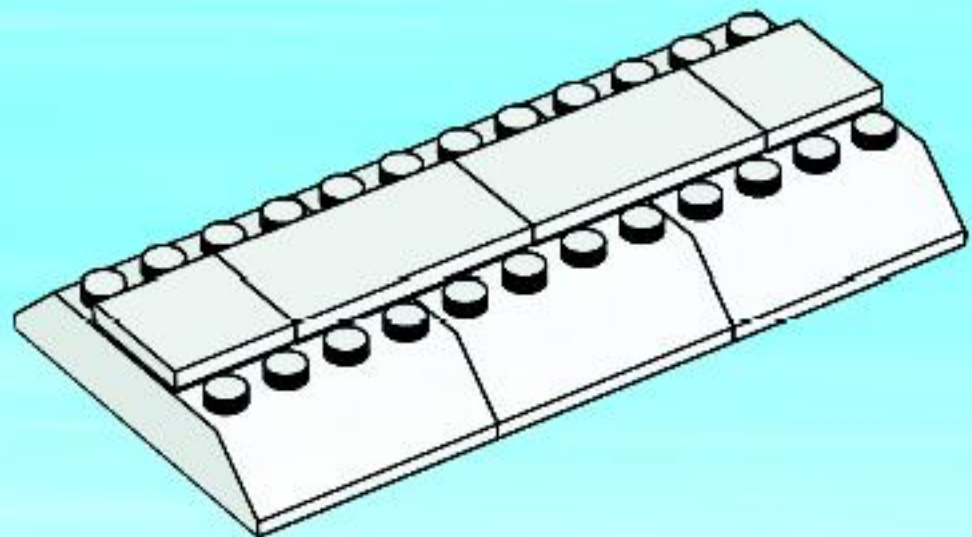

4

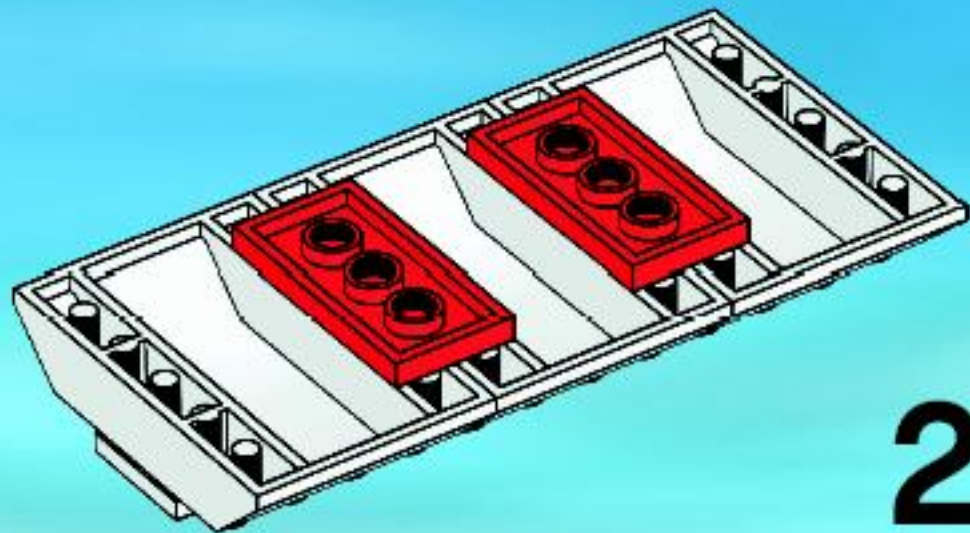

2x

30

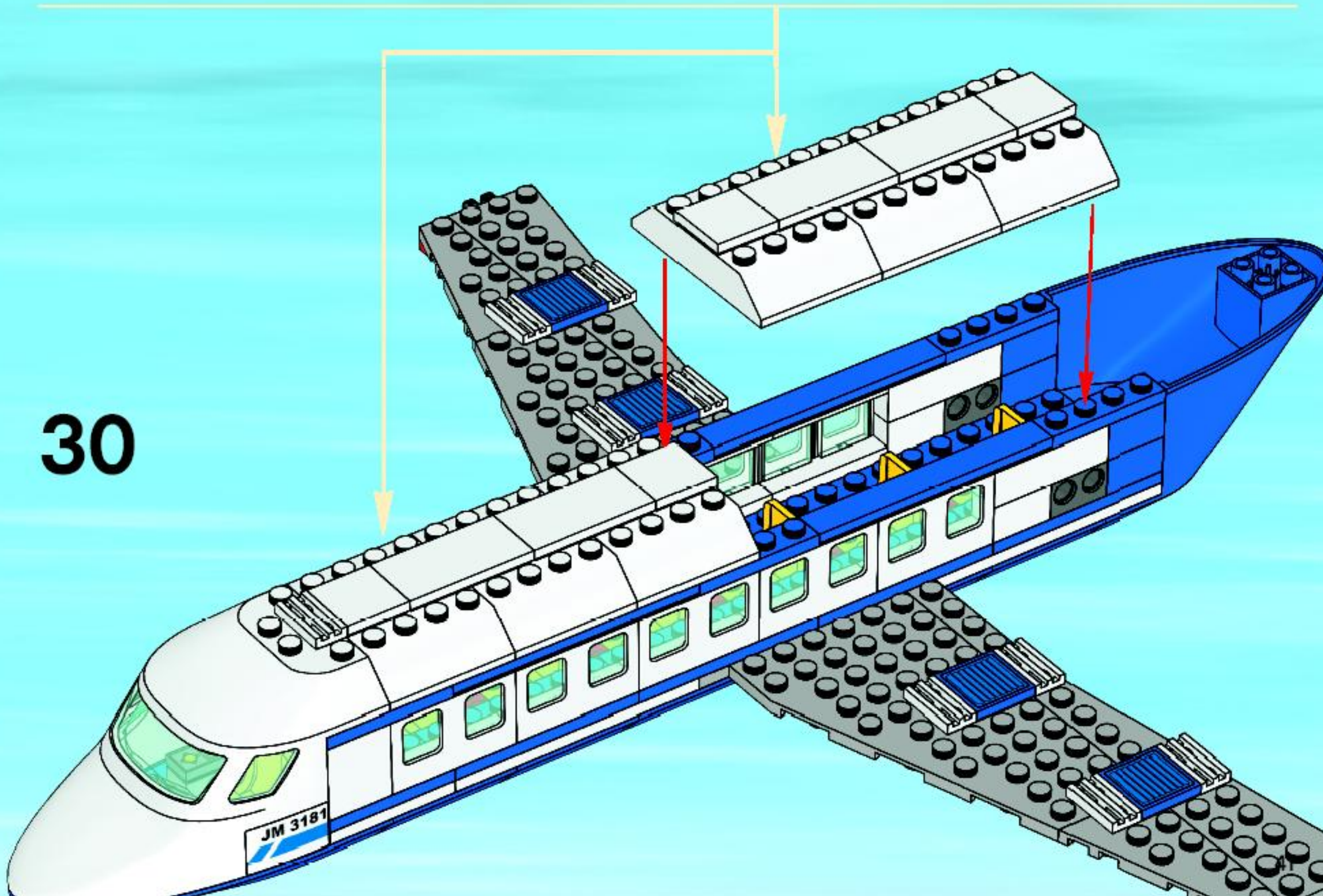

31

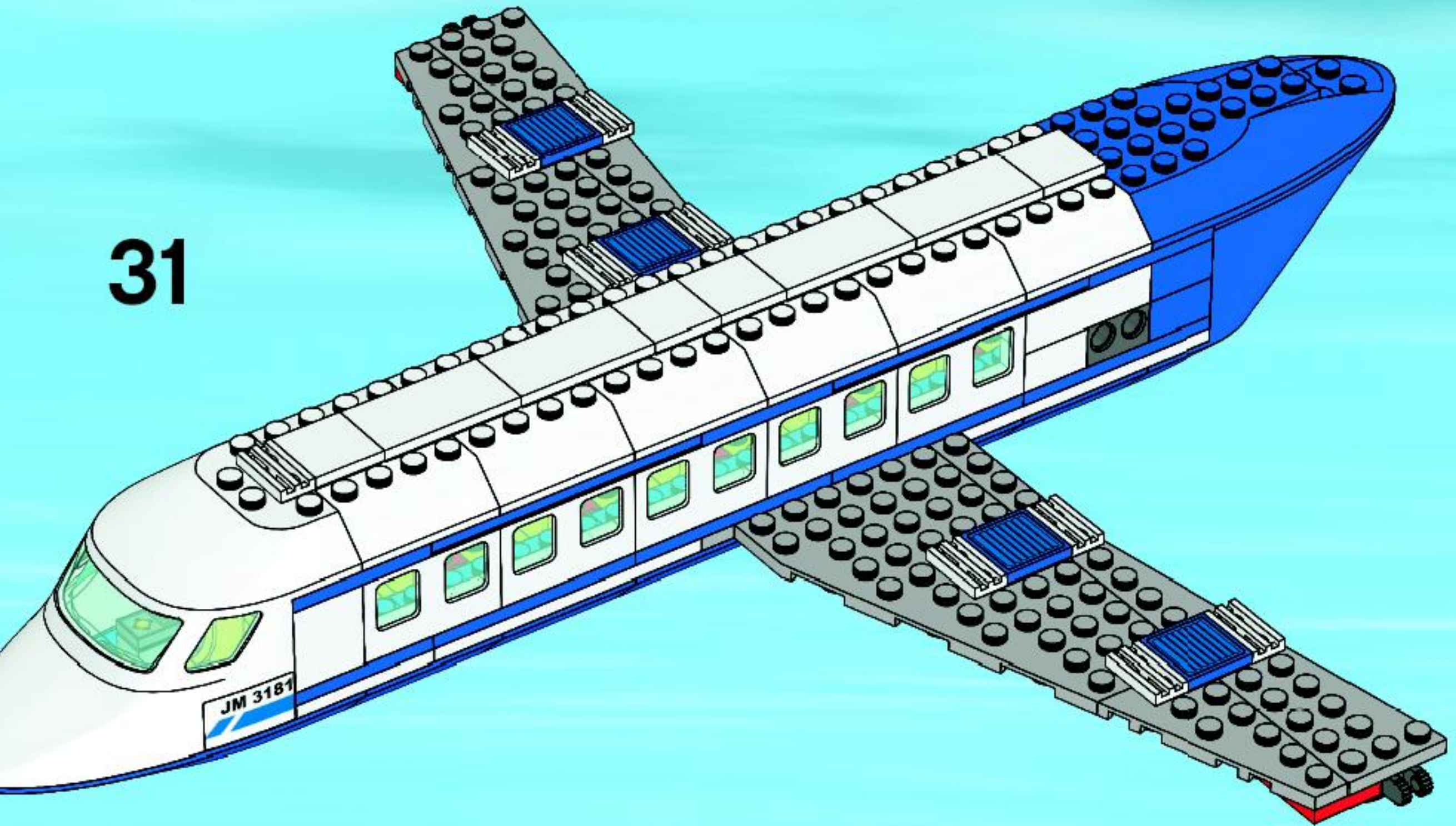

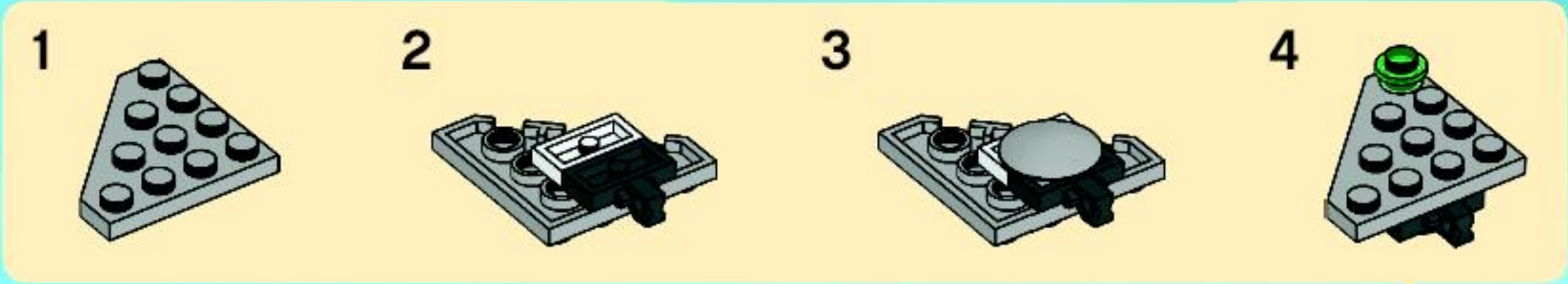
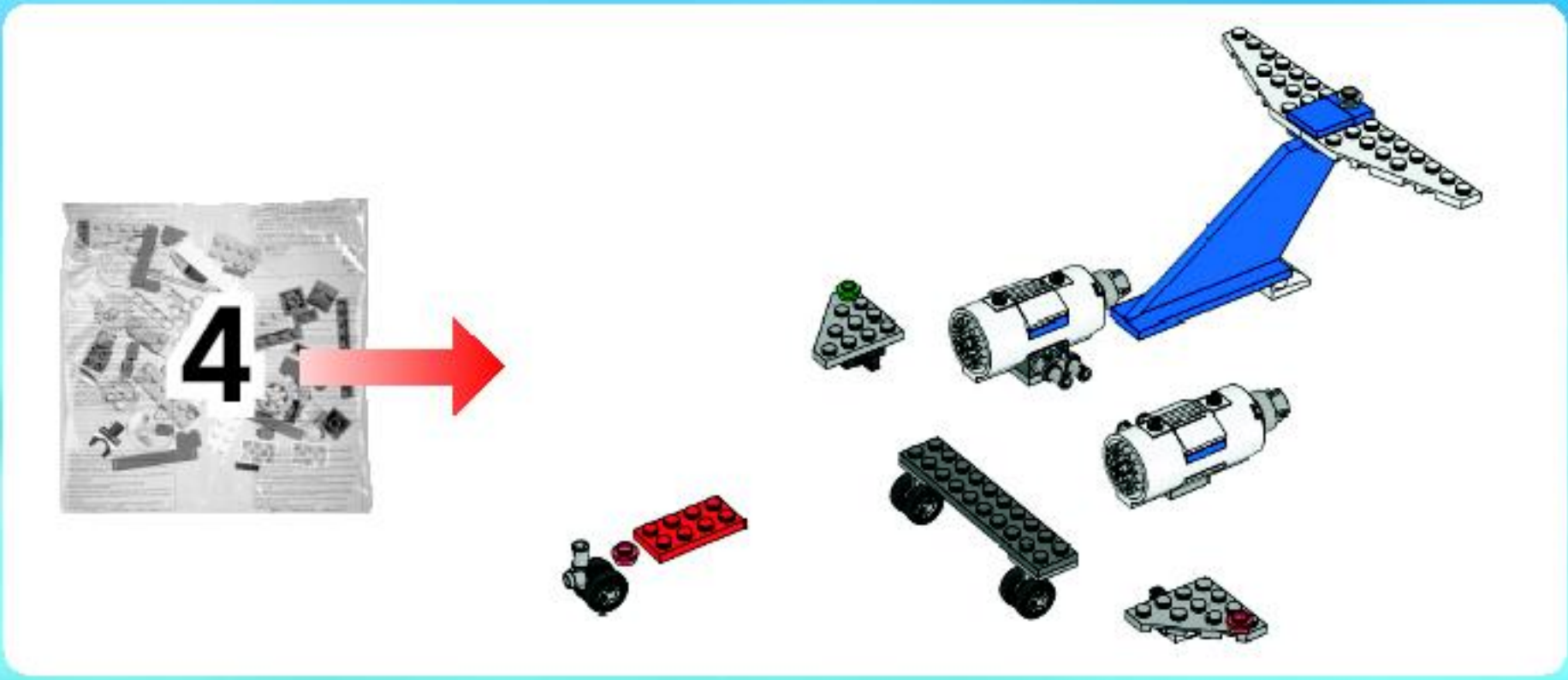



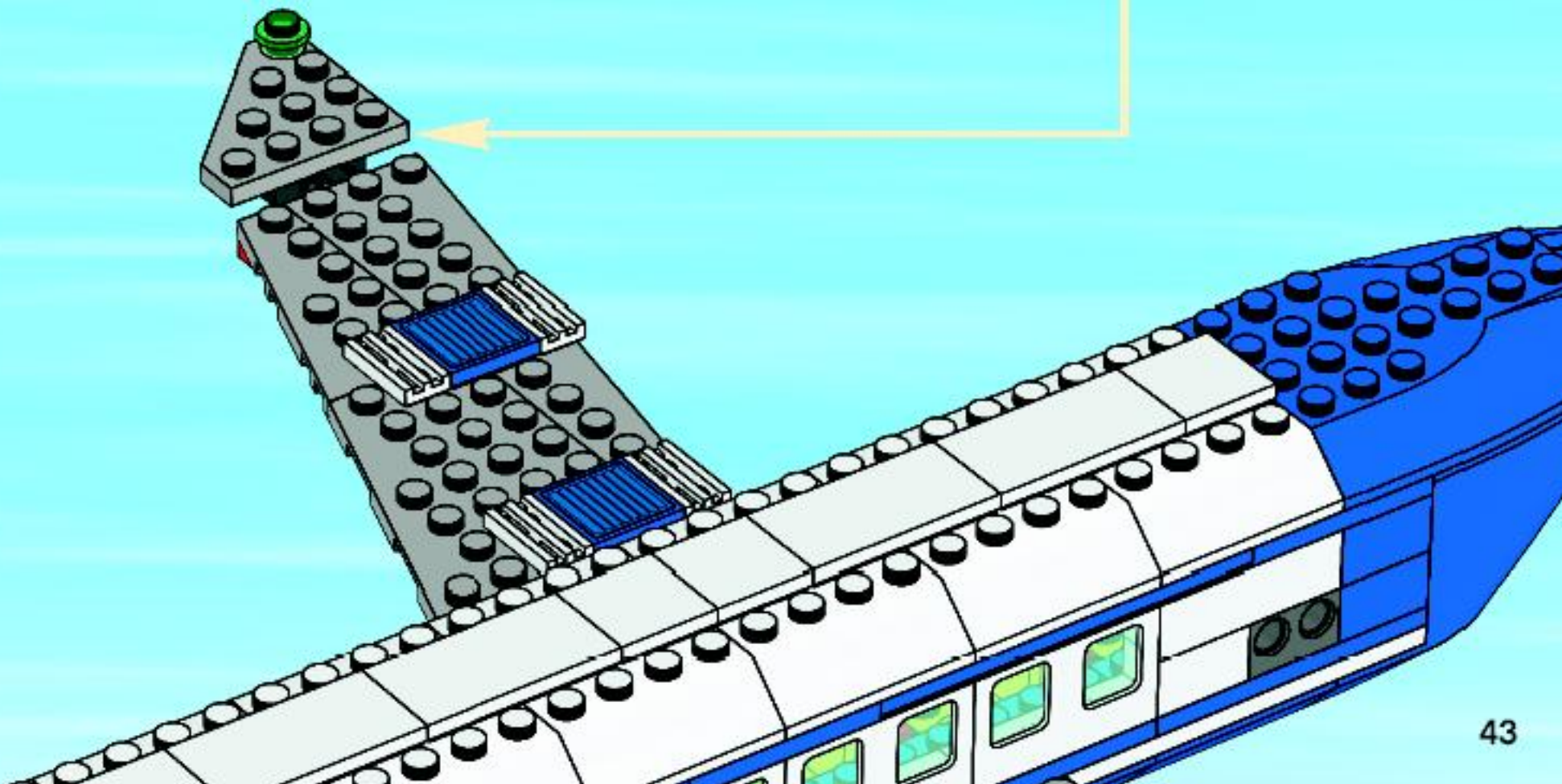

32

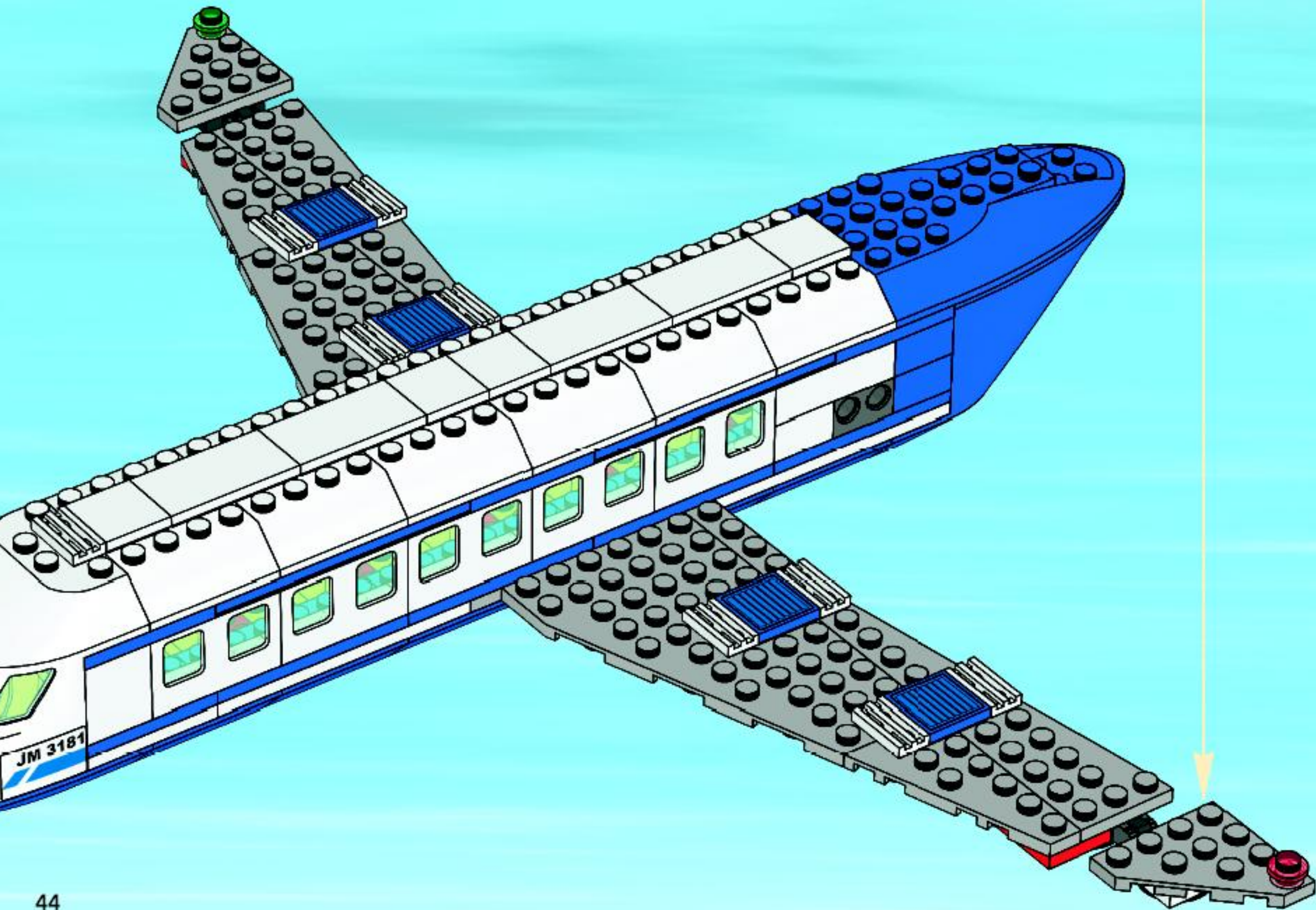
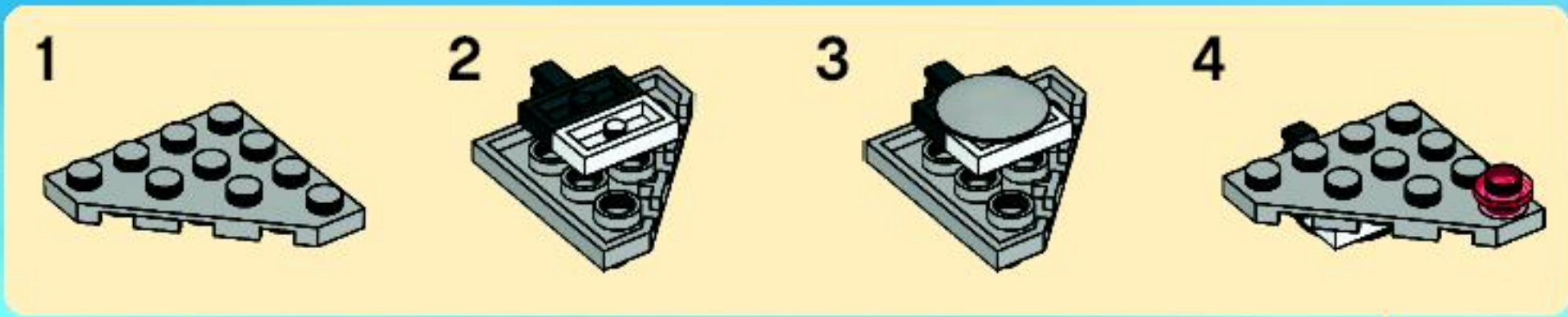

33



34

1  2  3  2x

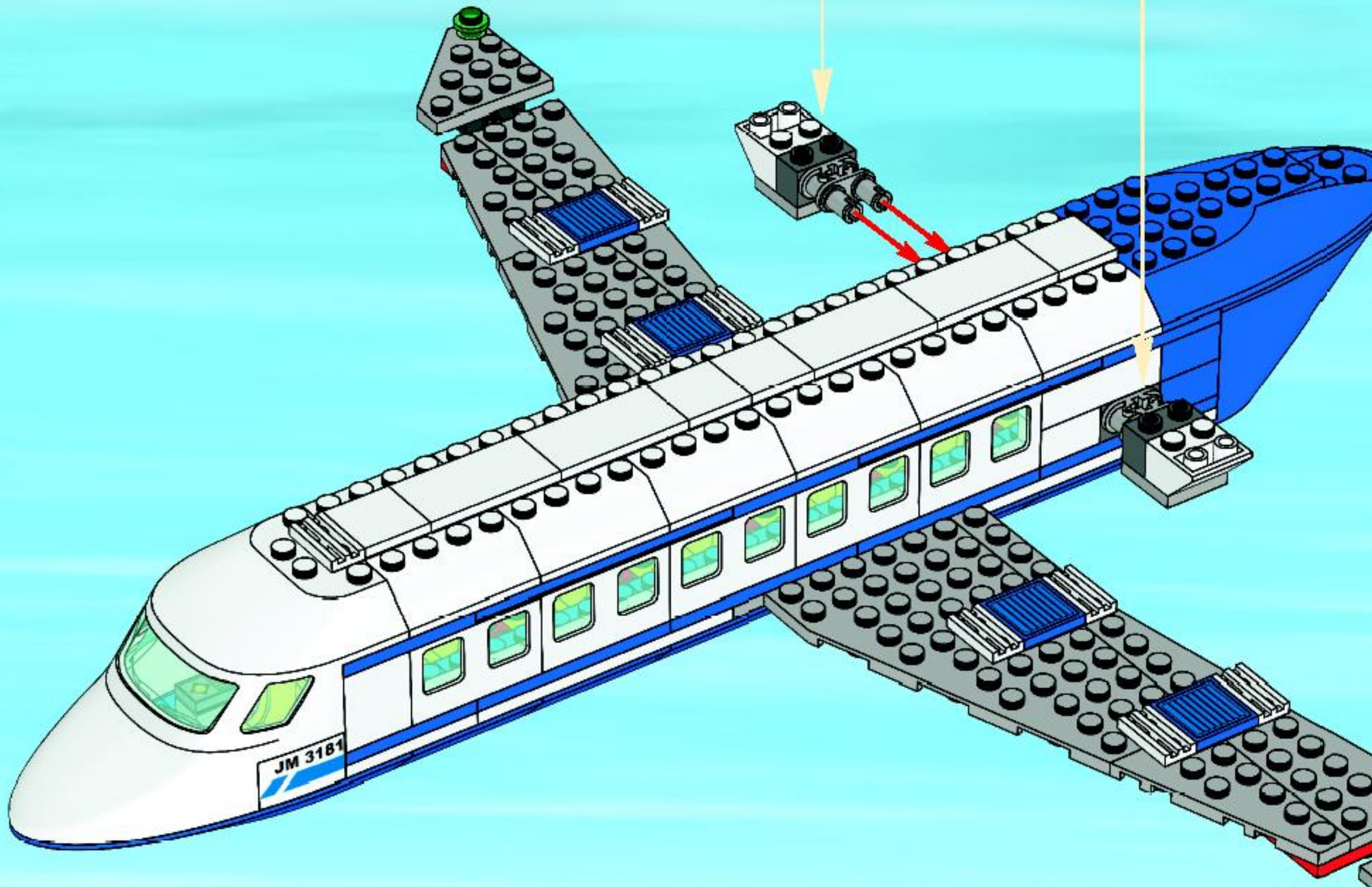



1



2



3

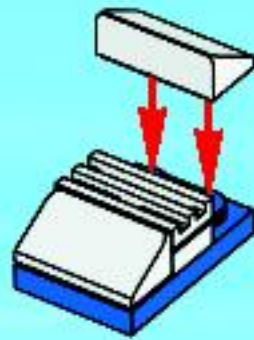

4

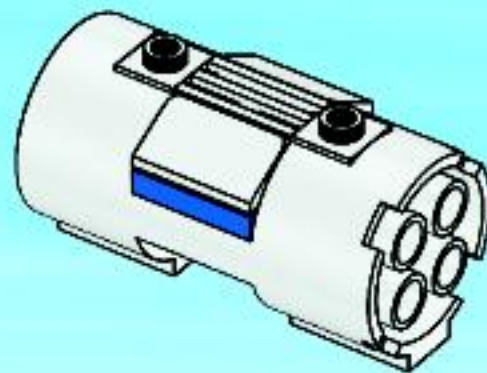

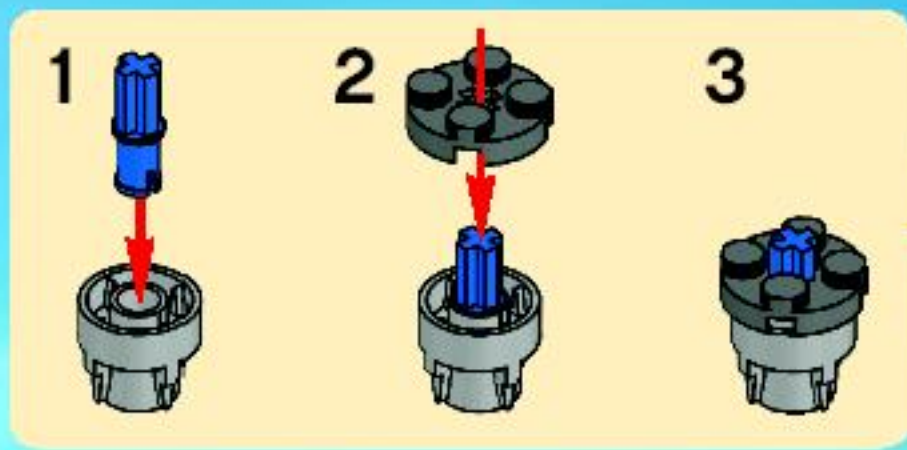

5

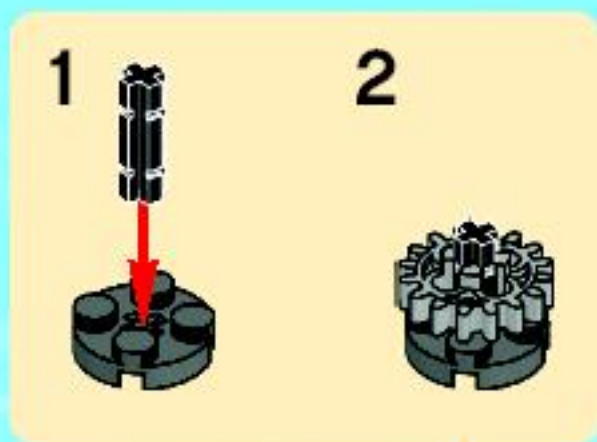
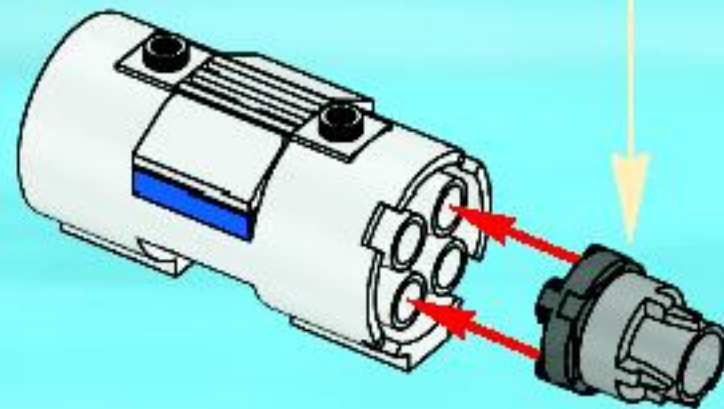

6

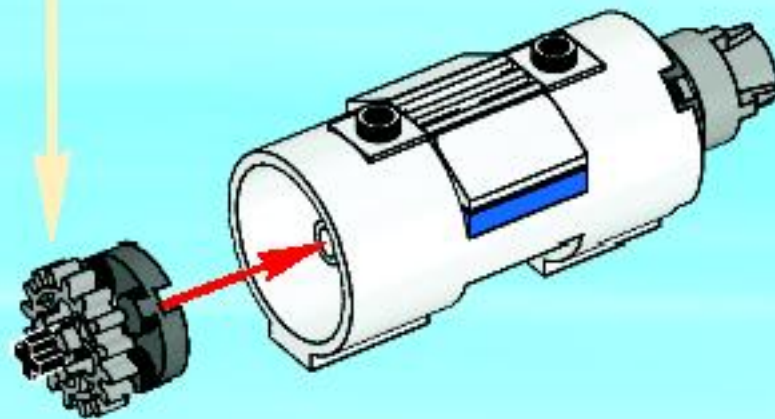

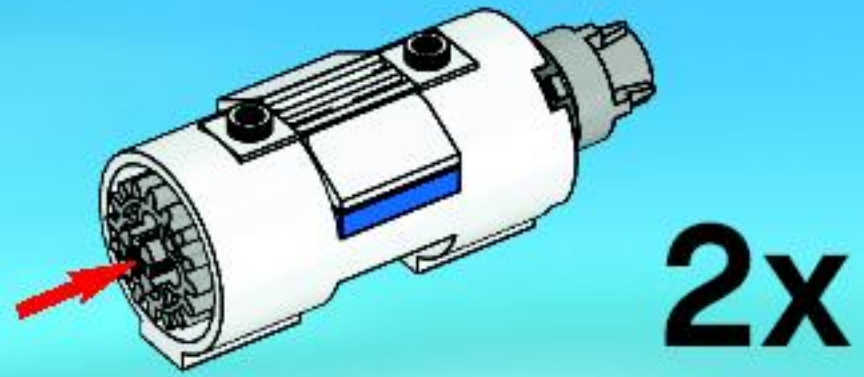

35

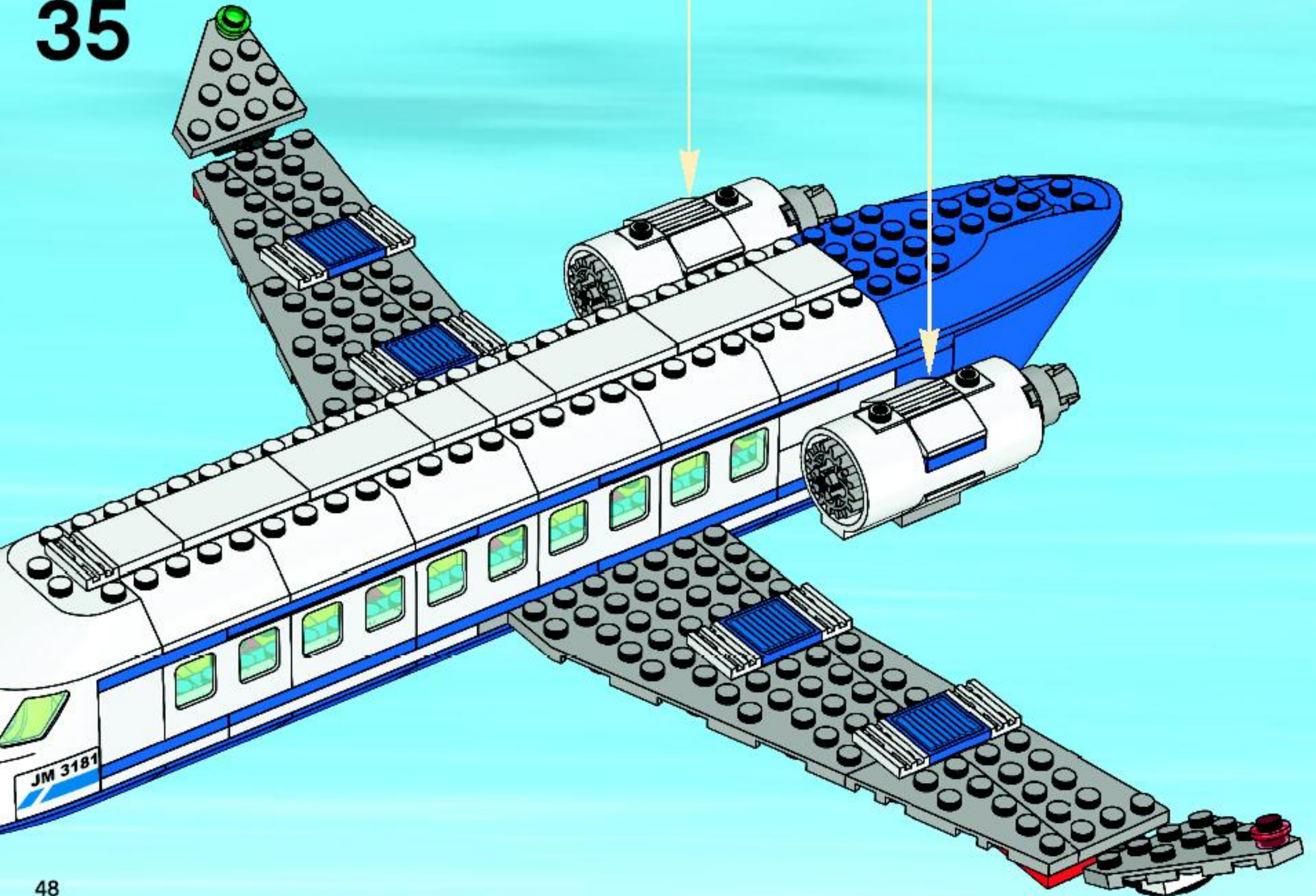

36

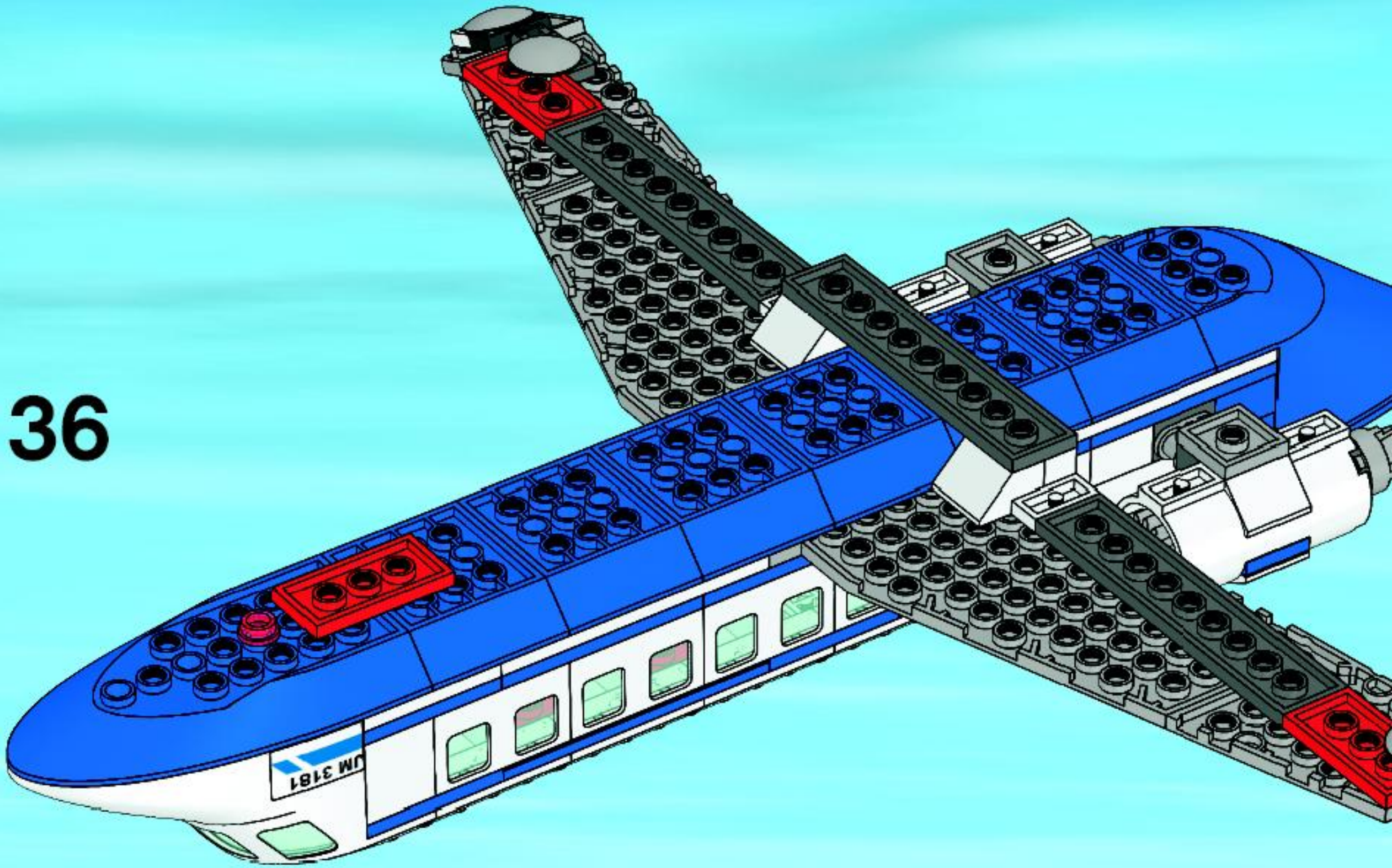

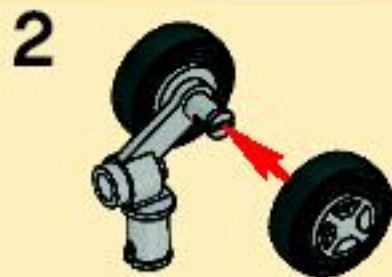

37

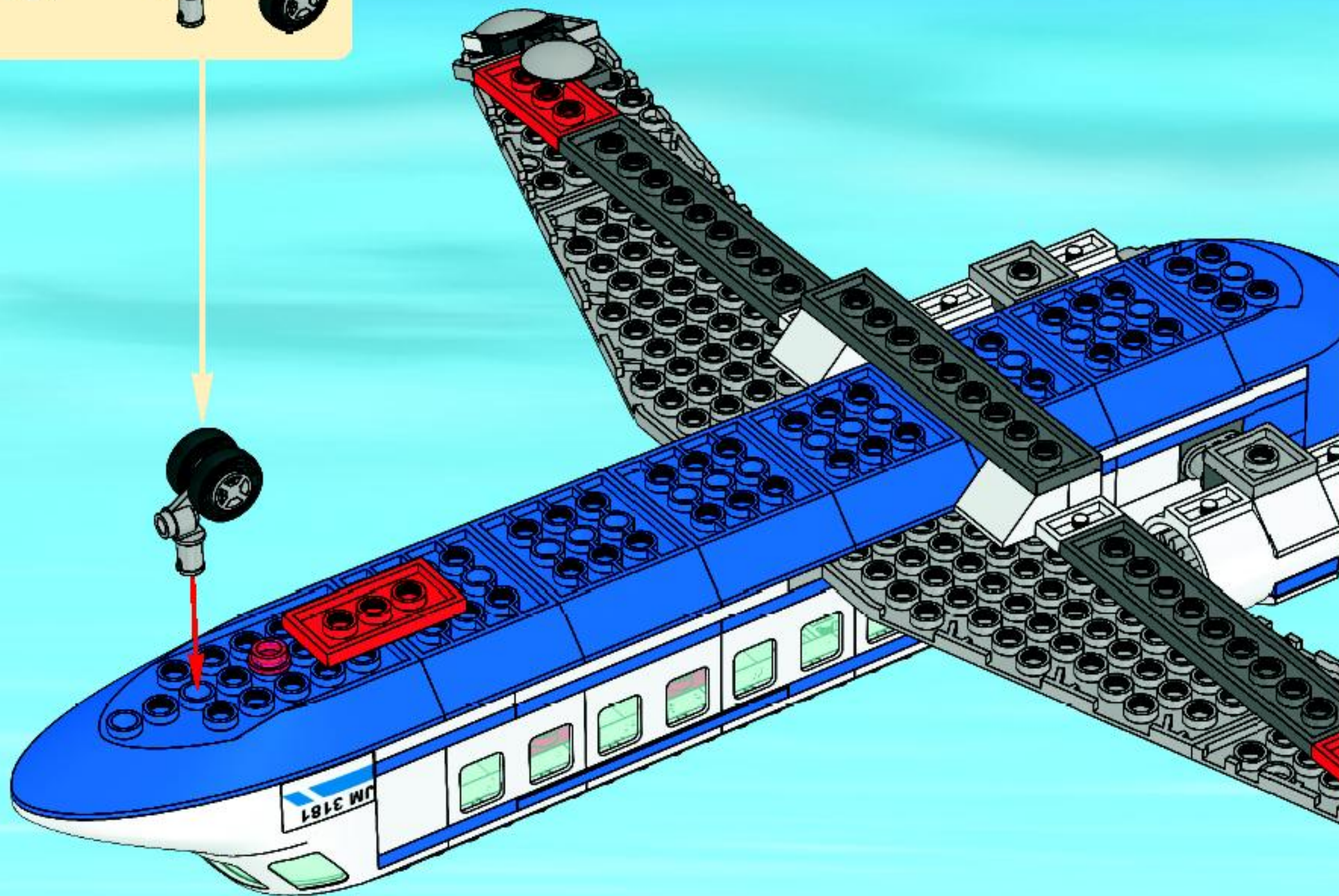

38

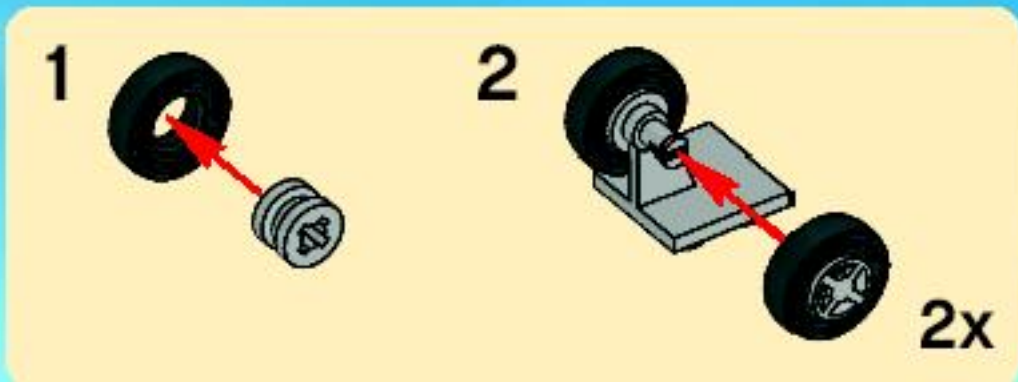

39

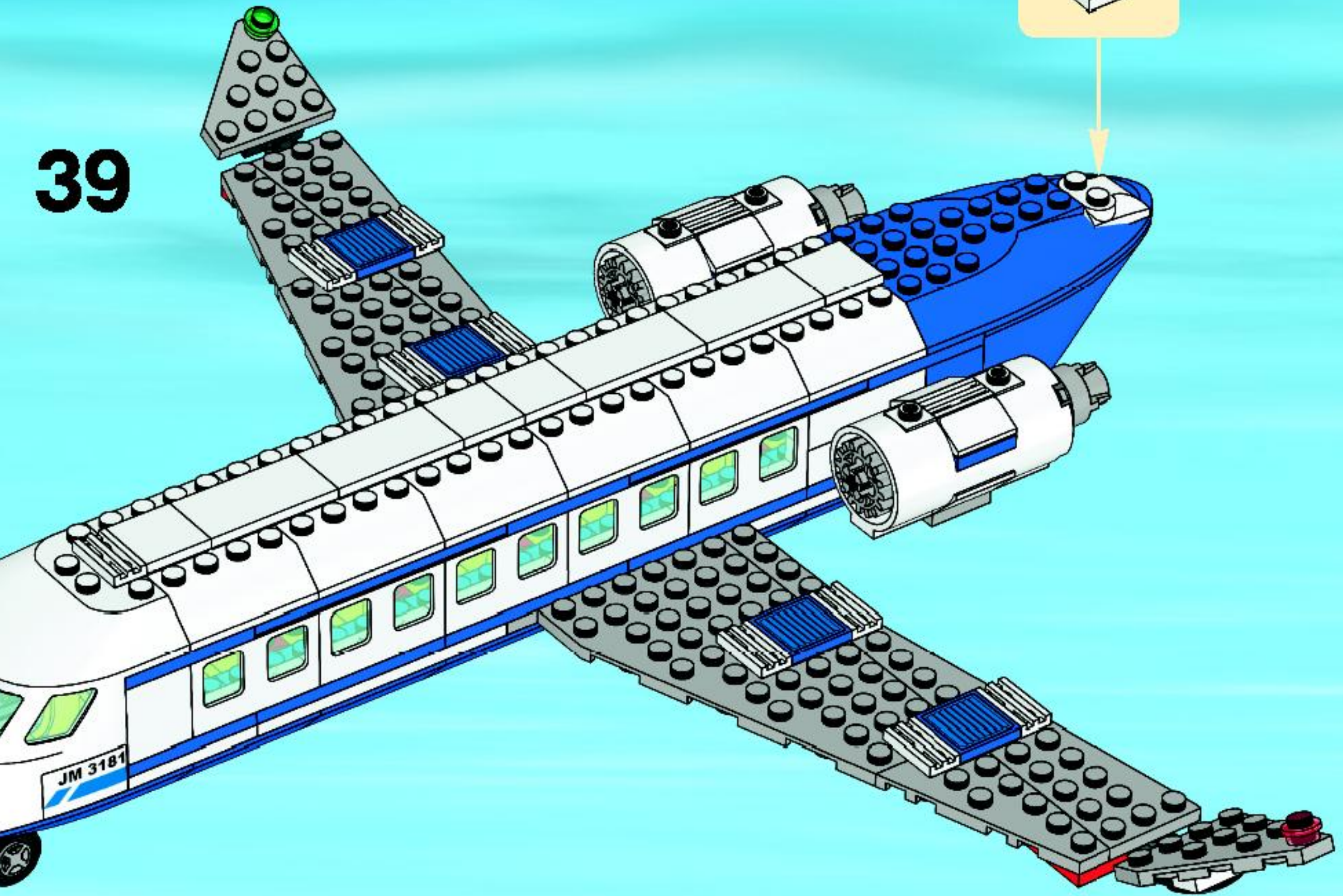

1

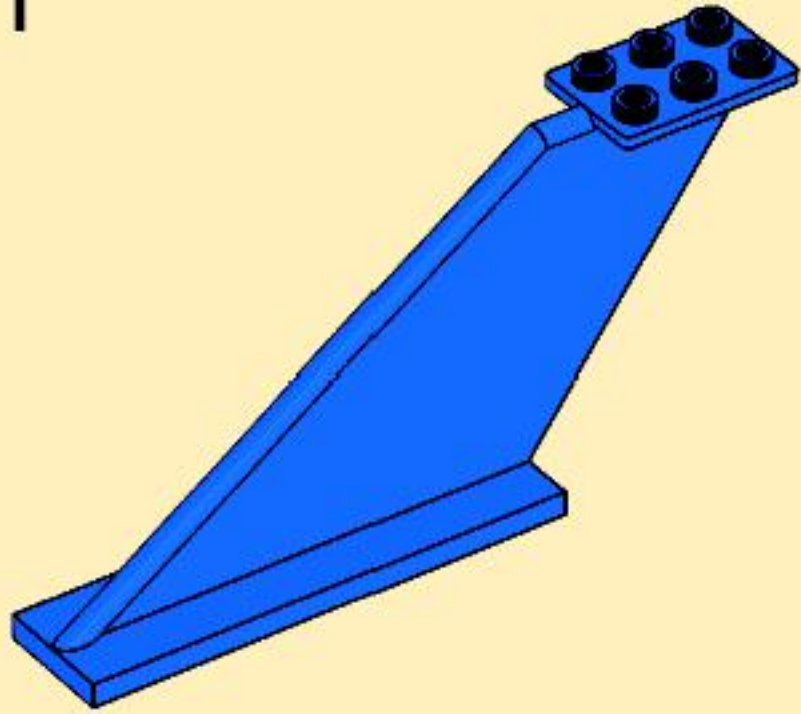

2

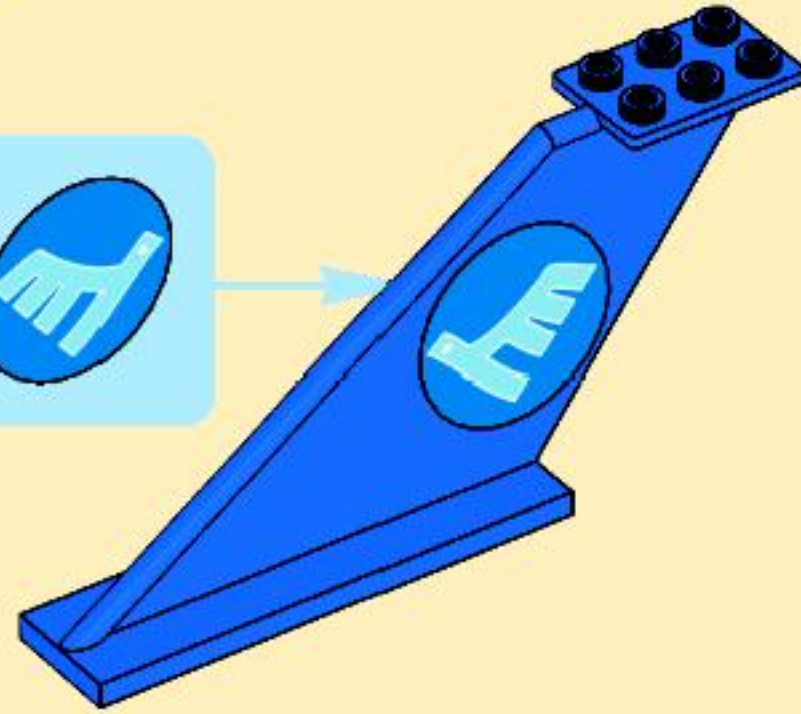

40

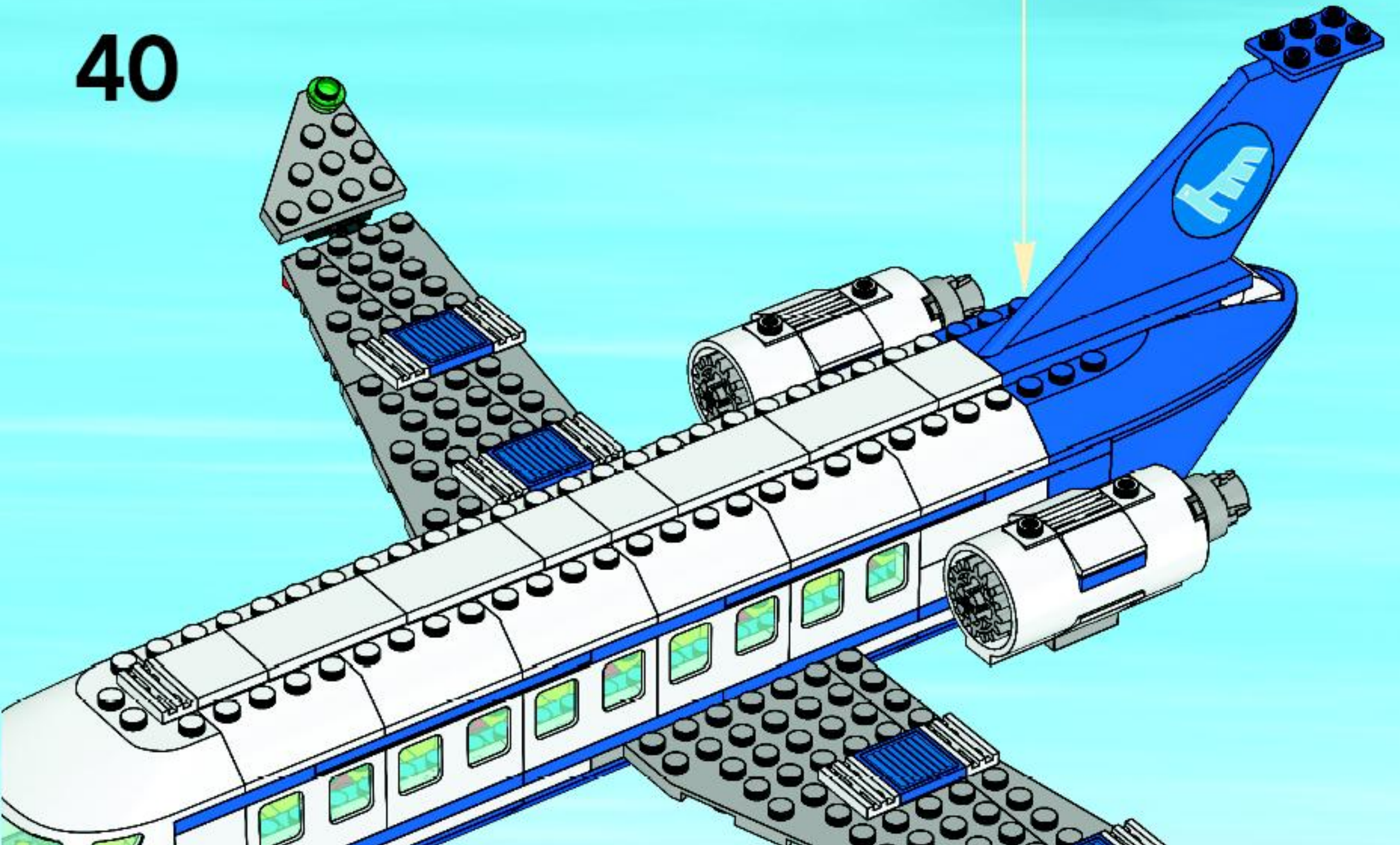

1

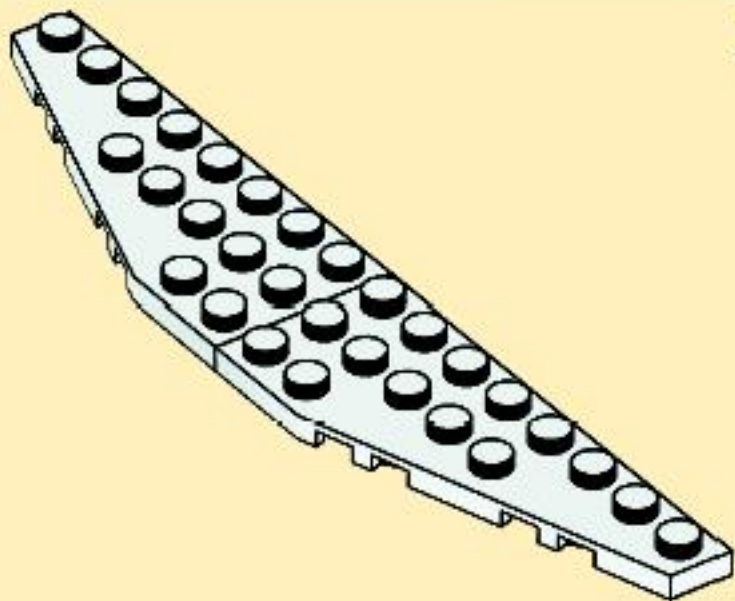

2

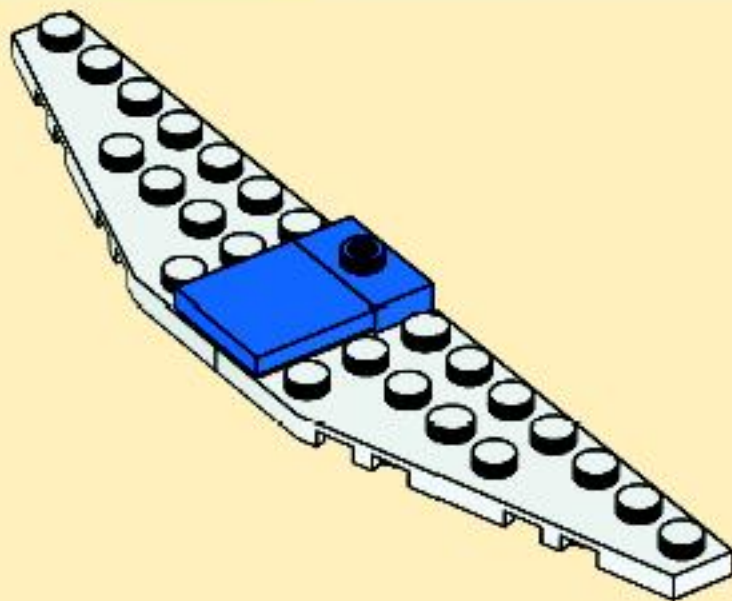

3

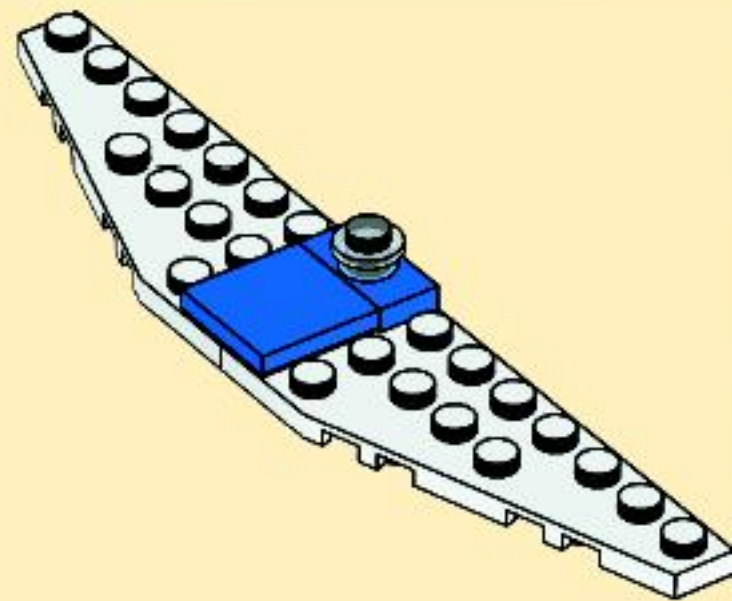

41

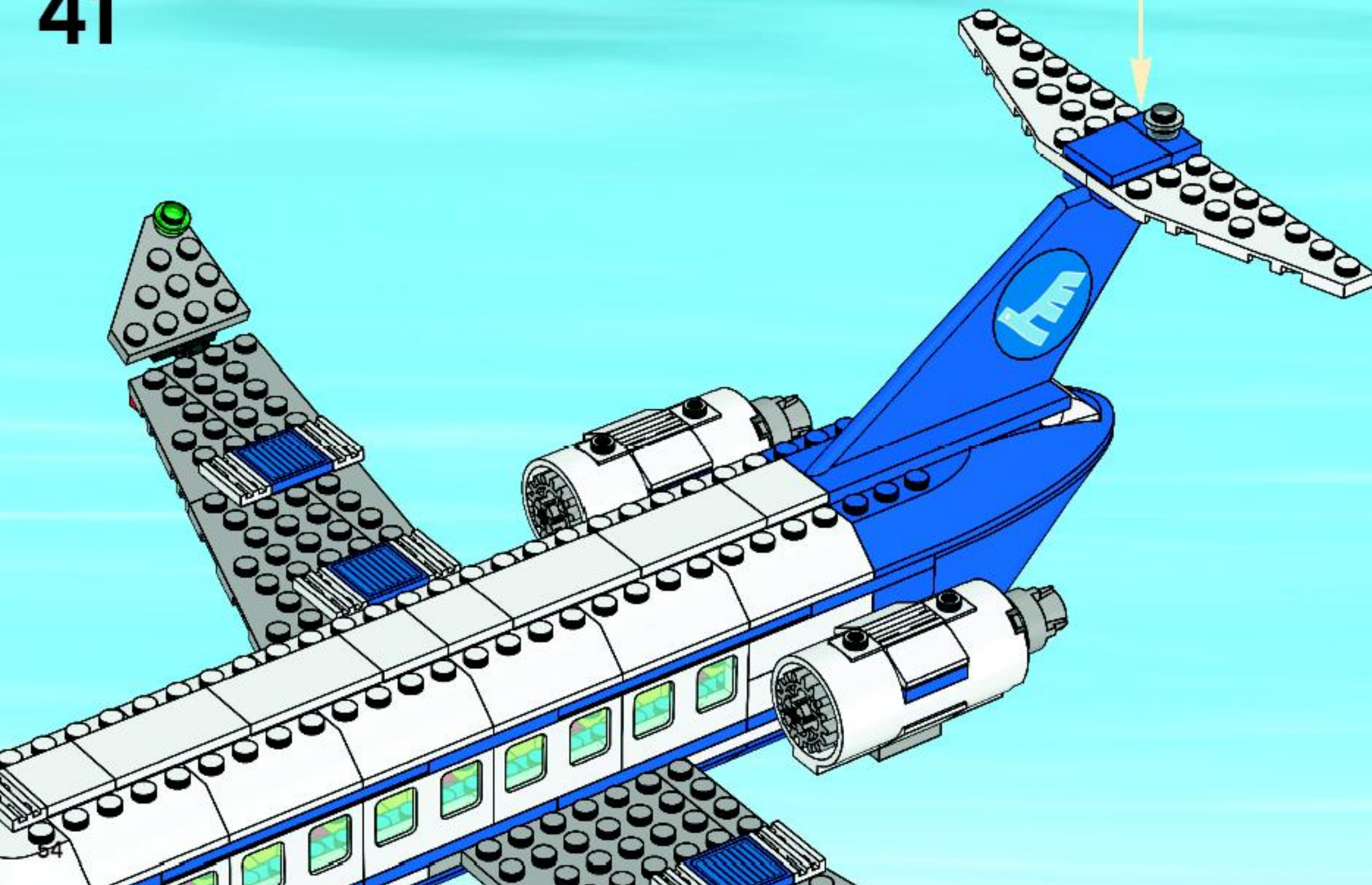

42

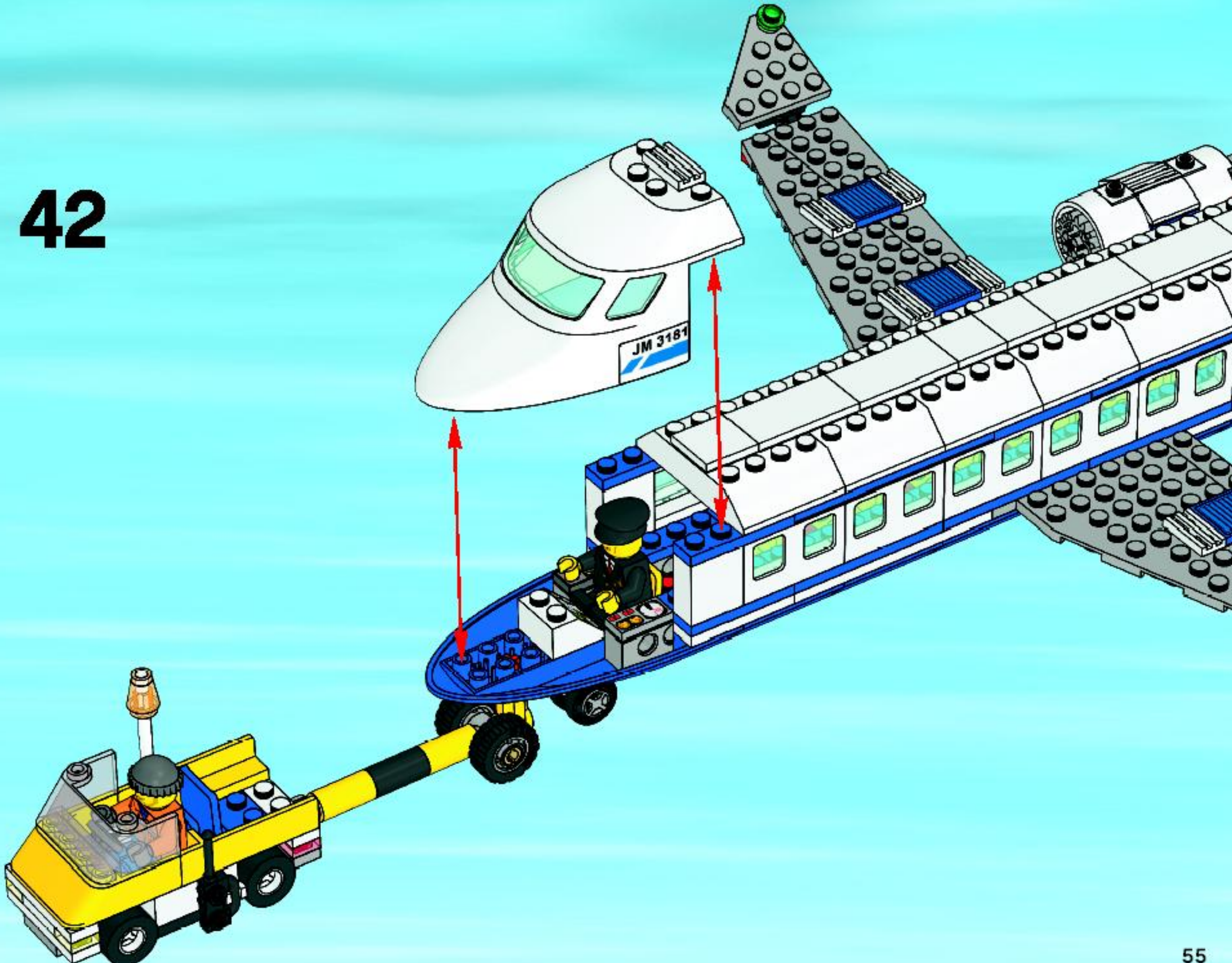

LEGO CITY



3177



3178



3179



3180



3181



3182

FREE! GRATIS! GRATUIT!



club MAGAZINE™

www.LEGOclub.com



00800 5346 5555*

1-866-534-6258 • 1-877-518-5346

US & Canada only

Canada seulement

VISIT THE WORLD'S
BIGGEST LEGO® SHOP!

www.LEGOshop.com

* Free phone. Mobile charges may apply. * Numéro sans Frais. Les Frais peuvent s'appliquer avec les téléphones cellulaires. * Gebührenfrei. Kosten für Anrufer sind für Festnetzverbindungen abzudecken.
* Gratisk telefonsamtal med tillägg. * Het er et gratis nummer, når du ringer fra Postboks 10. * Det är gratis, när du ringer från en Post-boks.

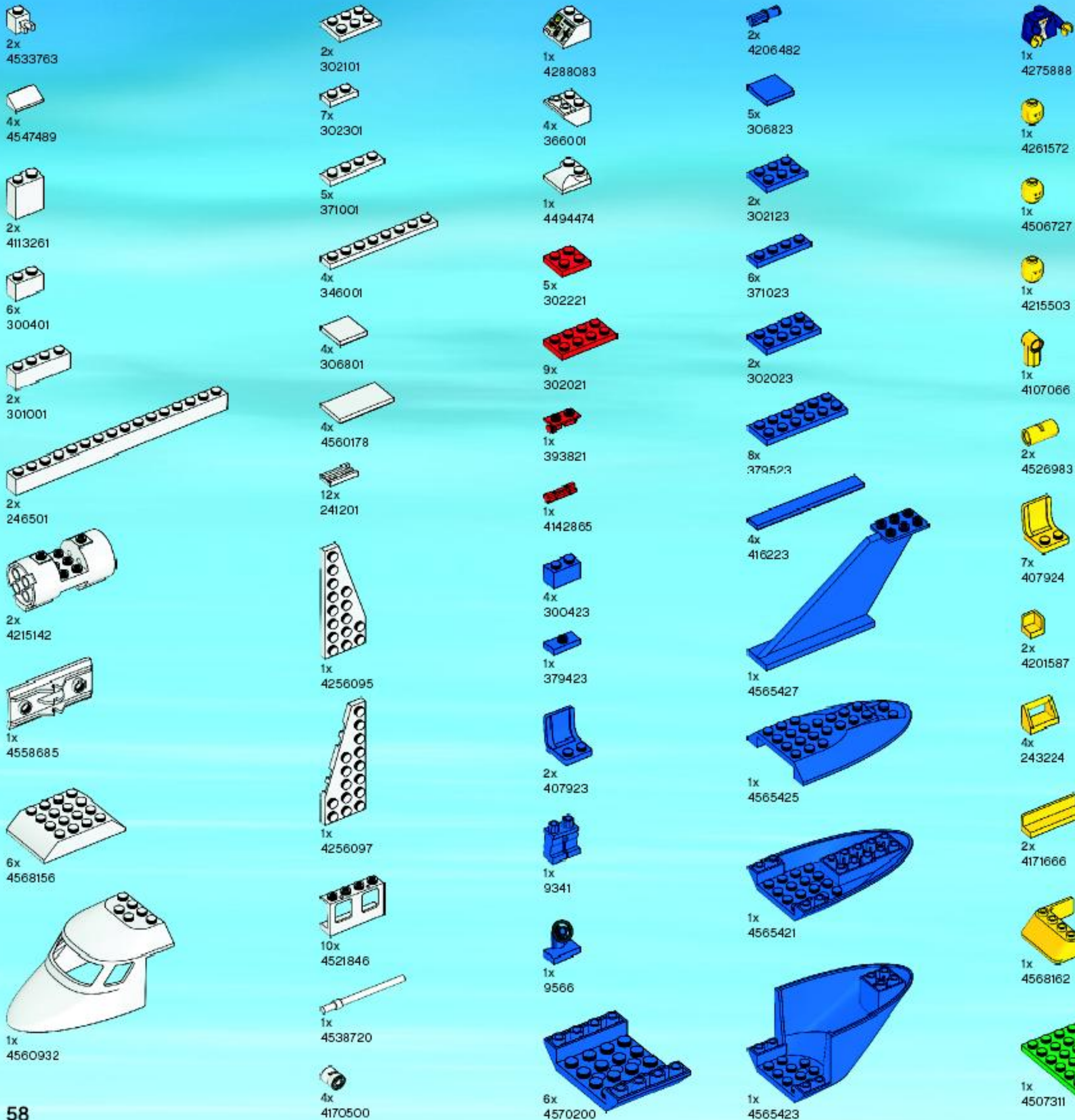

- 3x 4185620
- 1x 9339
- 1x 4286968
- 1x 362426
- 1x 396226
- 4x 4508215
- 2x 4515290
- 6x 4516843
- 1x 244126
- 1x 368026
- 1x 4184169
- 2x 4109810
- 2x 4121715
- 1x 4526982
- 1x 3005740
- 2x 3000841
- 2x 3005741
- 20x 4552034
- 1x 4567994
- 2x 3000844
- 1x 3005748
- 1x 4514554
- 1x 4124083
- 1x 4567338
- 1x 4211158
- 1x 4211235
- 1x 4211526
- 2x 4278756
- 1x 4509668
- 4x 4210762
- 2x 4211054
- 1x 4221879
- 3x 4210884
- 4x 4211042
- 1x 4210934
- 1x 4227398
- 3x 4210678
- 4x 4211397
- 2x 4211516
- 1x 4261997
- 1x 4211815
- 2x 4562487
- 2x 4211399
- 1x 4227776
- 4x 4278273
- 1x 4282789
- 1x 4208988
- 1x 4282786
- 1x 4209006
- 2x 4160560
- 1x 4211617
- 1x 4211616
- 2x 4211438
- 3x 4211406
- 2x 4211705
- 1x 4227657
- 6x 4211506
- 1x 4519013
- 1x 4540203
- 1x 4560175
- 2x 4211758
- 2x 4211888
- 1x 4275843



Customer Service
Kundenservice
Service Consommateurs
Servicio Al Consumidor

www.lego.com/service or dial

 : 00800 5346 5555
 : 1-800-422-5346



WIN!

Go to www.nielsen.com/LEGO to fill out a survey for a chance to win a cool LEGO® Product.

No purchase necessary.

Open to all residents where not prohibited.



www.nielsen.com/LEGO

GEWINNE! WIN!

Nimm an der Umfrage auf www.nielsen.com/LEGO teil und hab die Chance ein cooles LEGO Produkt zu gewinnen!

Die Teilnahme am Gewinnspiel führt zu keinerlei Kaufverpflichtungen. Teilnahme in allen nicht ausgeschlossenen Ländern möglich.

Ga naar www.nielsen.com/LEGO, vul een enquêteformulier in en maak kans op een cool LEGO® product.

Geen aankoopverplichting. Iedereen mag deelnemen, uitgezonderd ingezetenden van landen waar een enquêteverbod geldt.

GAGNE! 当てよう!

Visite www.nielsen.com/LEGO pour répondre à un questionnaire et avoir une chance de gagner un produit LEGO® très cool!

Aucune obligation d'achat. Ouvert à tous les résidents des pays autorisés.

www.nielsen.com/LEGOにアクセスして、アンケートにご記入ください。当選者にはレゴ製品を差し上げます。

お買い上げの義務はありません。

禁止されていない限り、すべての年齢にご利用いただけます。