



# Friends



3189





Andrea



Mia



Stephanie



Friends



Olivia



Emma

1

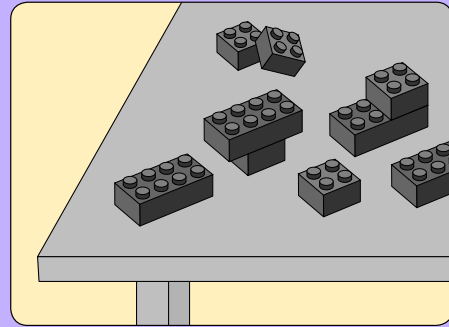
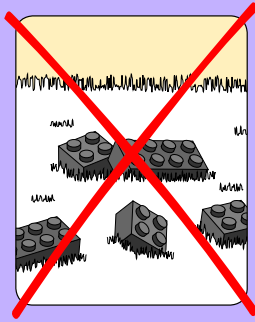

2

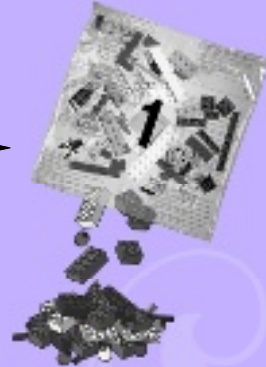

<http://lego.com/brickseparator>



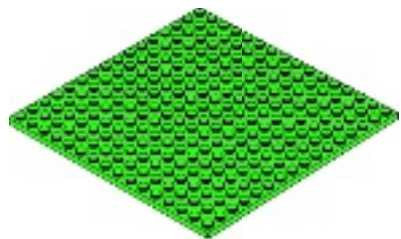

+



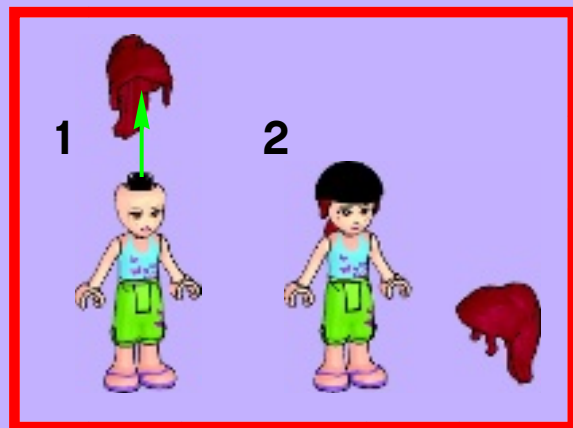
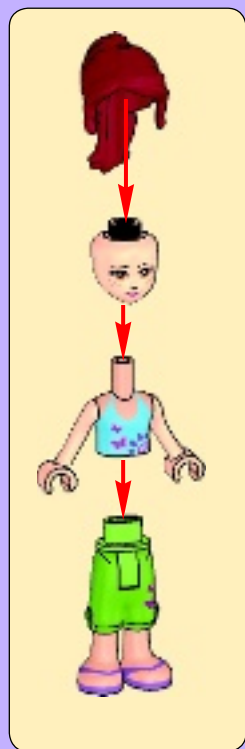

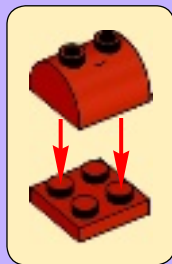
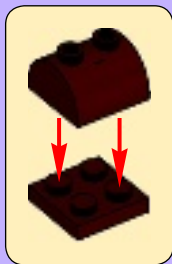
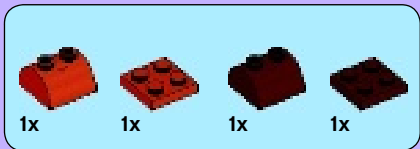

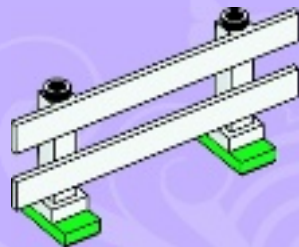
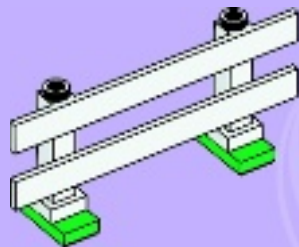
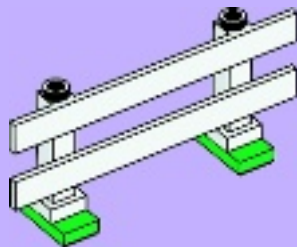
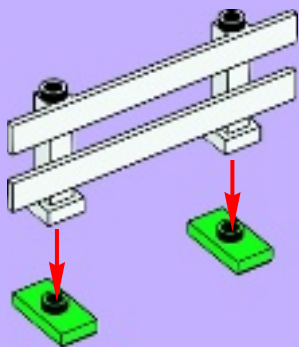
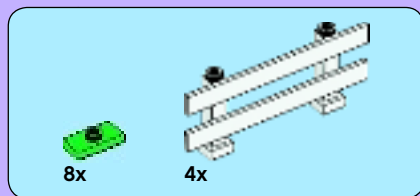



1

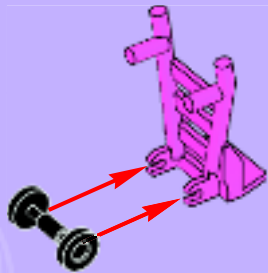

2





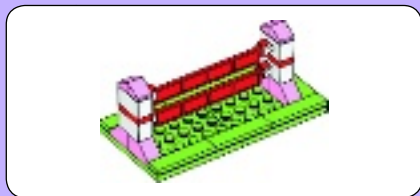

1x

1

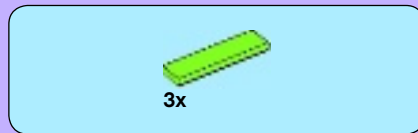
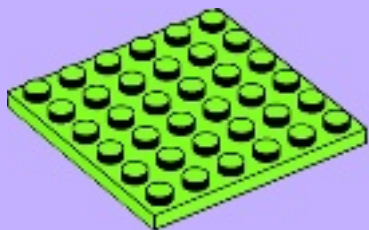

3x

2





3

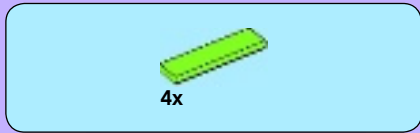
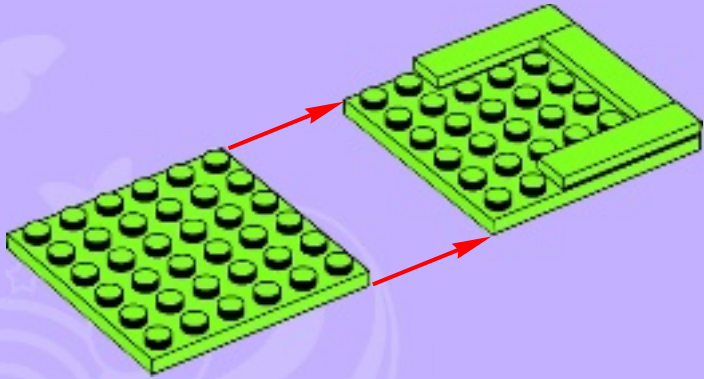

4

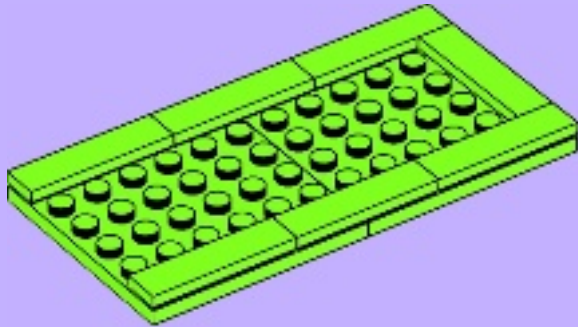



4x

5

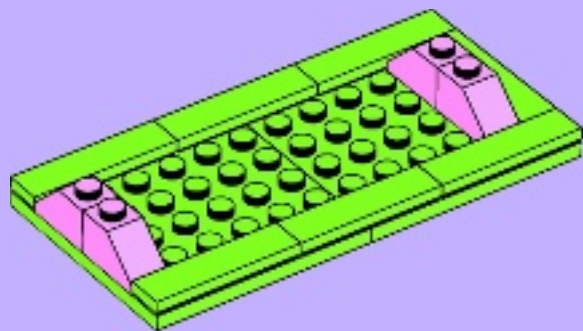

2x

6

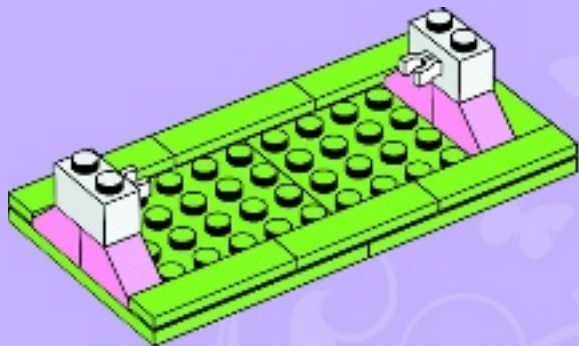



2x

7

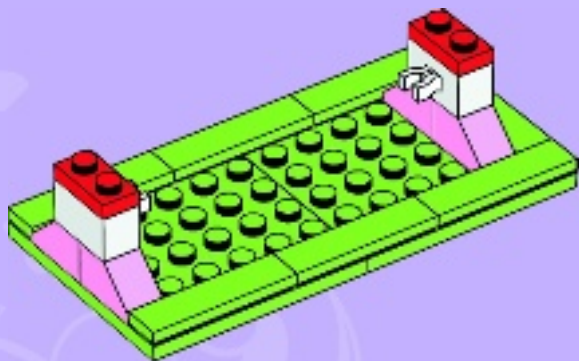

2x

8

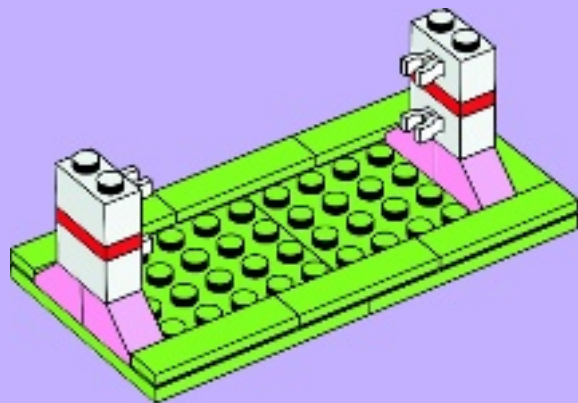



4x

9

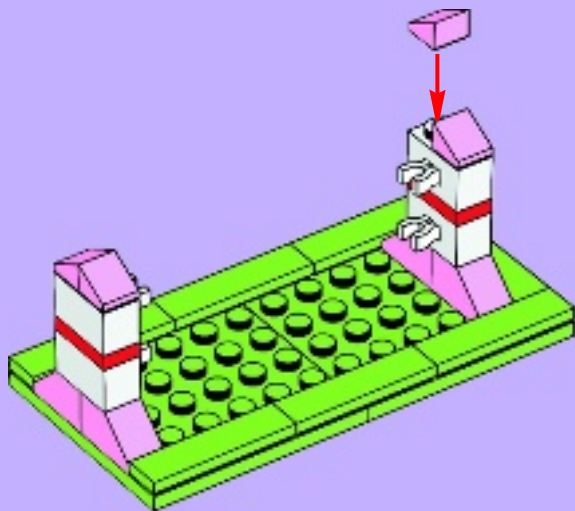

2x

10

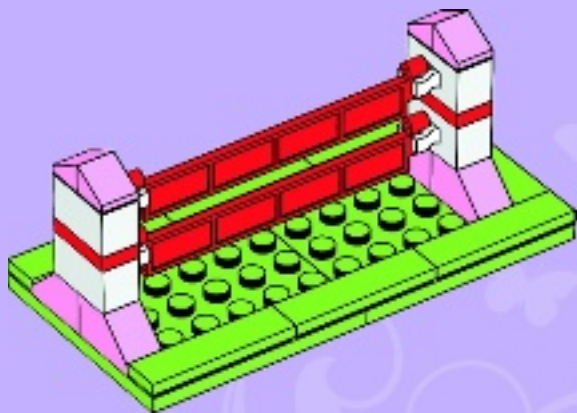



1

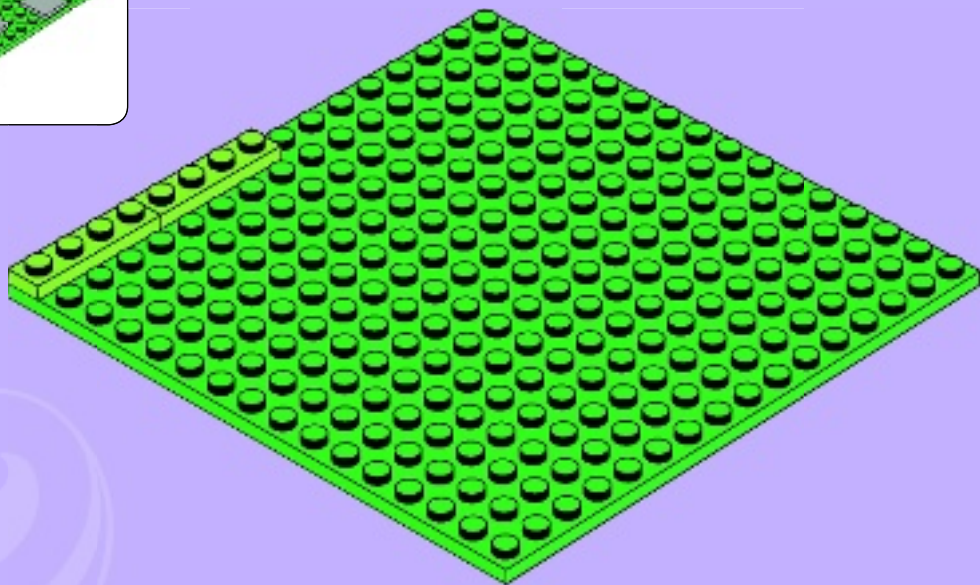





1x



1x



1x

# 2





1x



3x

3

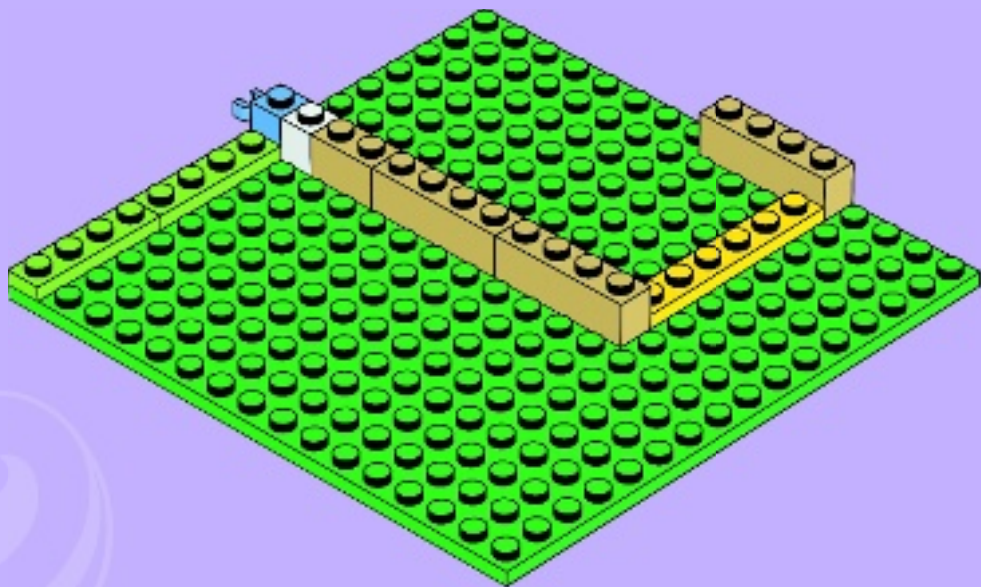



1x



3x



2x

4





4x

5

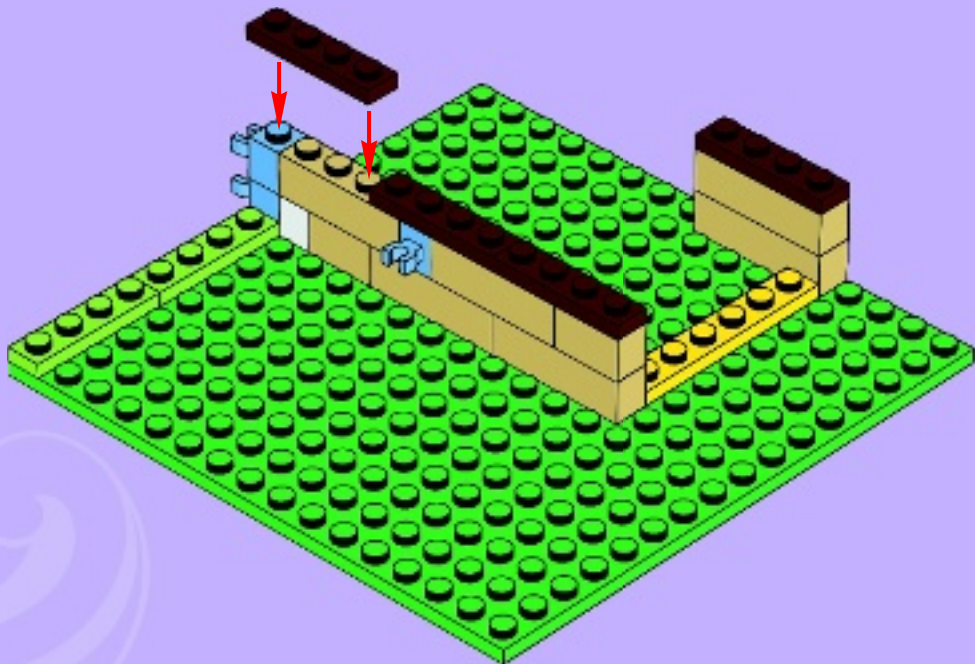

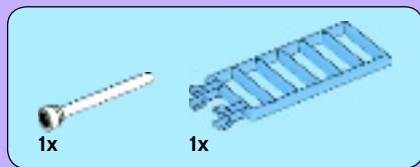

6

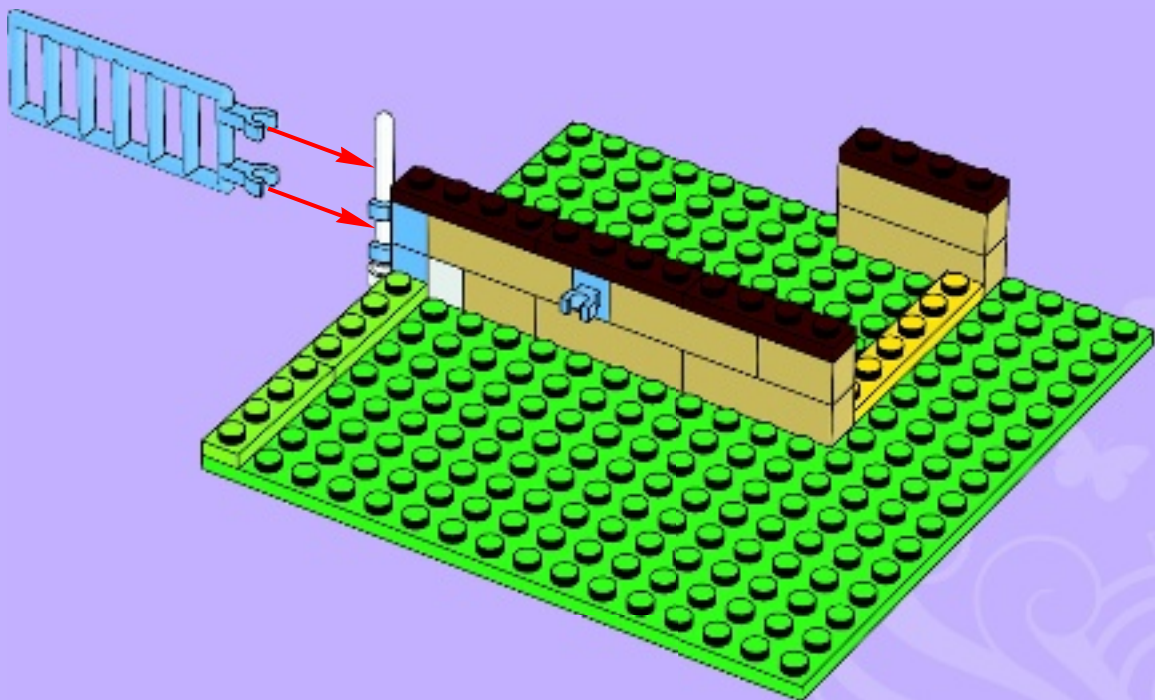

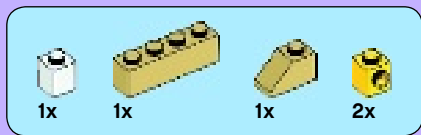

7

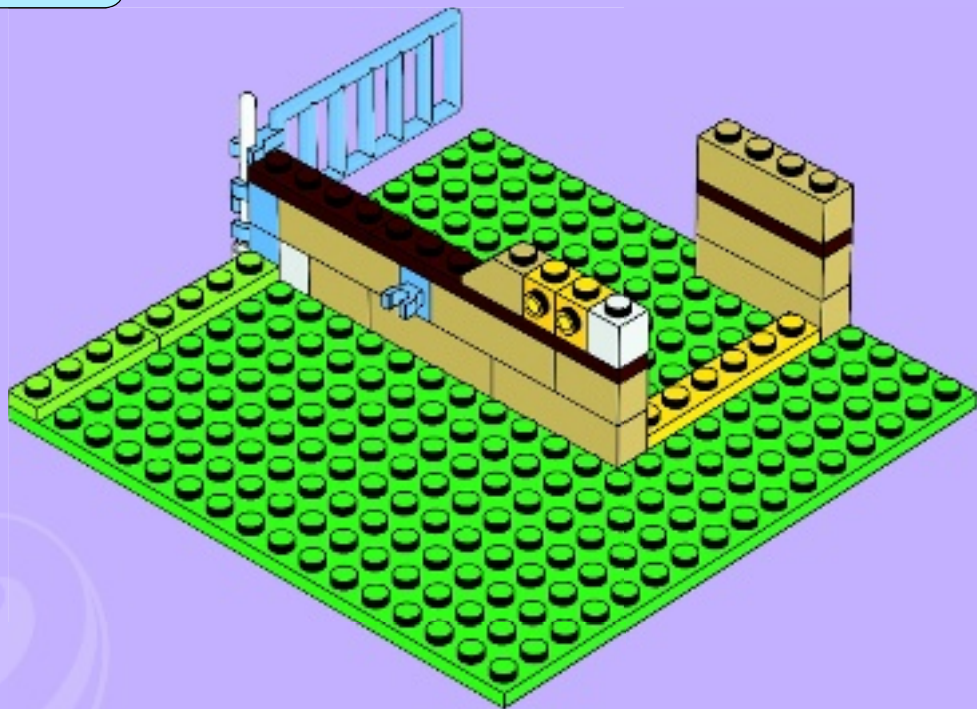





1x



1x

8

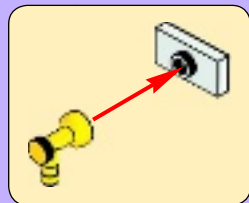



2x



2x

9



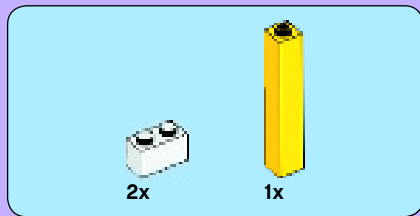

10





2x



1x

11



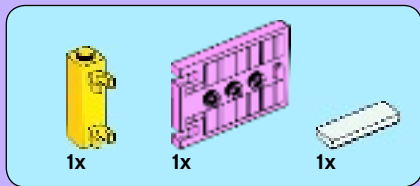

# 12

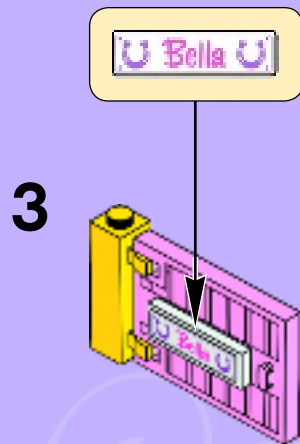
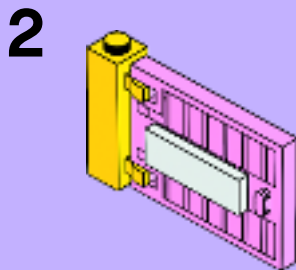
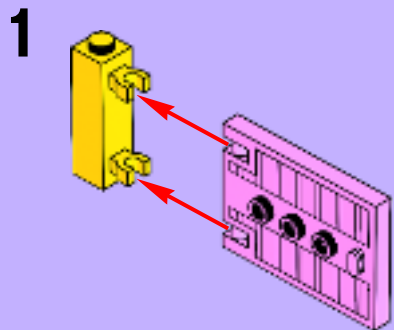











2x



2x

# 14





1x

15



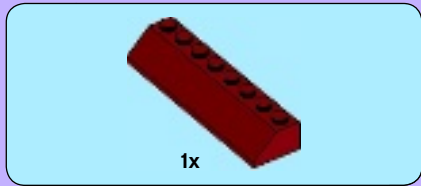

16





1x



3x

17





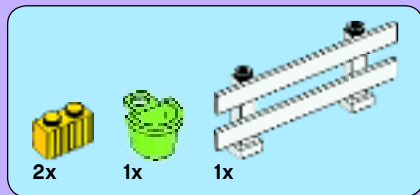

18

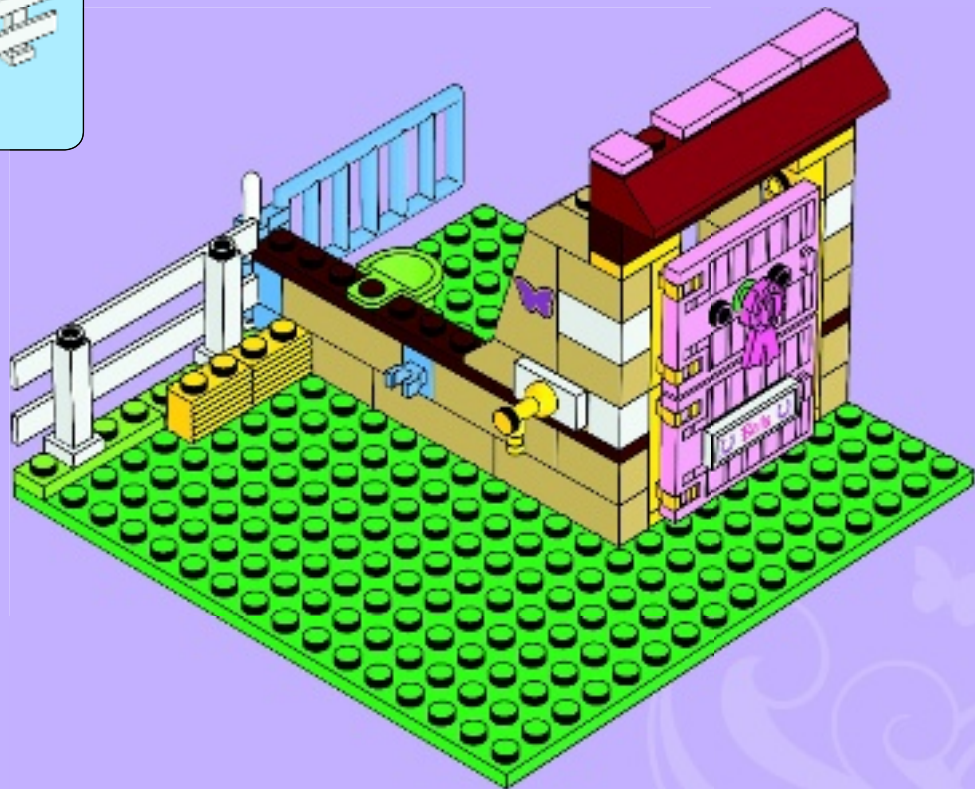



2x



1x

19





2x



4x

20





4x

21





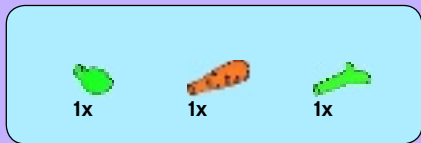

22

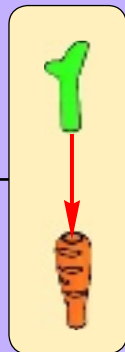



23





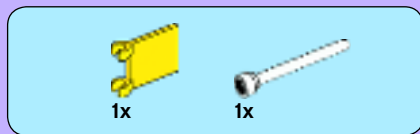

24

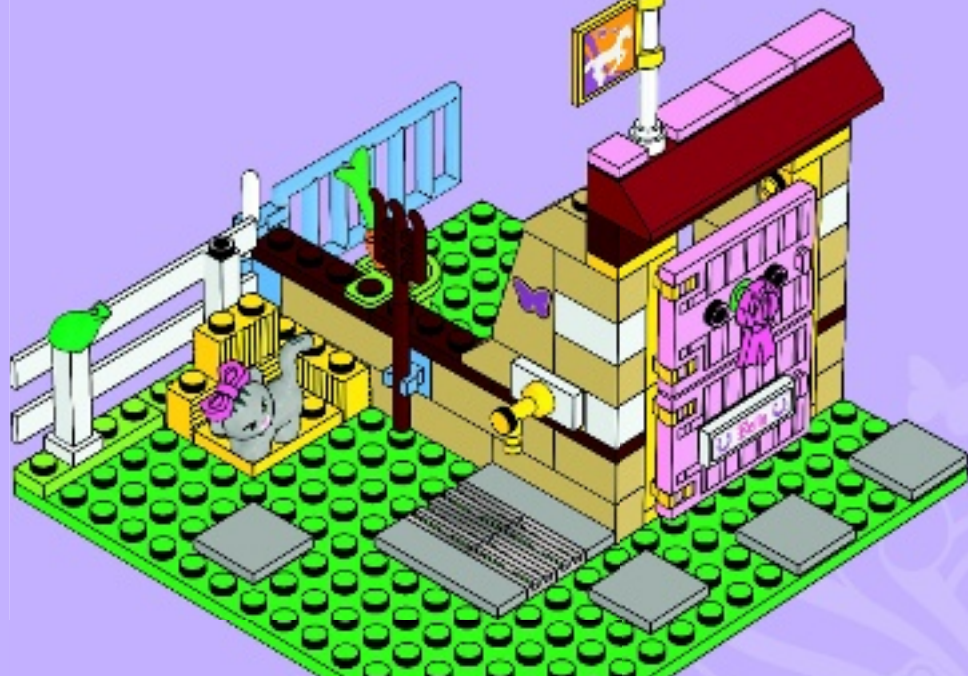
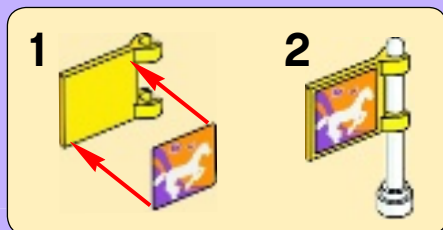



1x

25





1x



1x

# 26

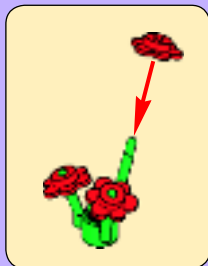

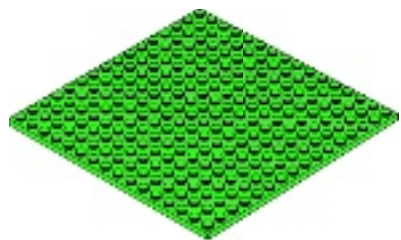

+



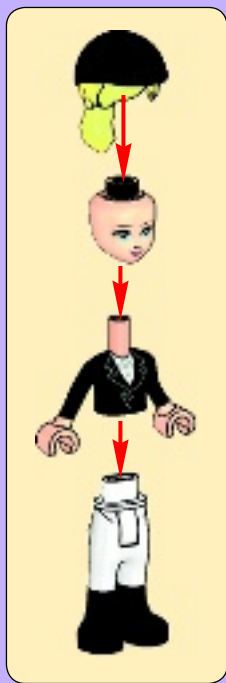

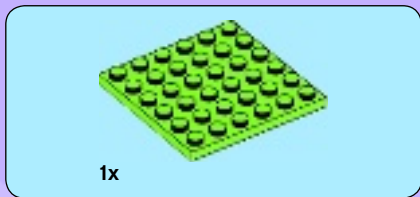
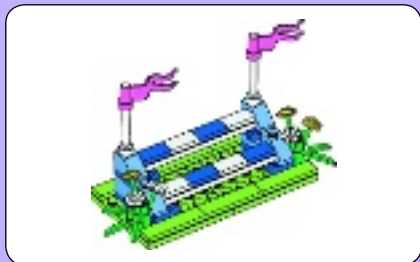

1

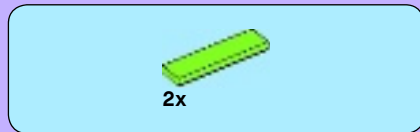
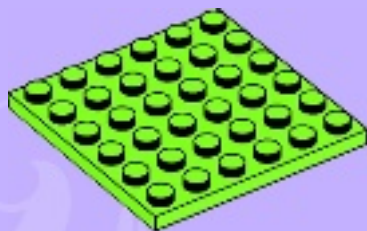

2





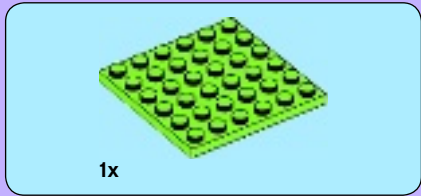

3

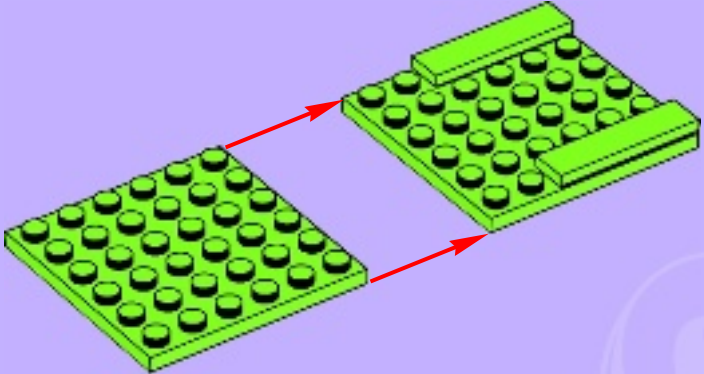

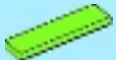

4x

4



2x



2x

5

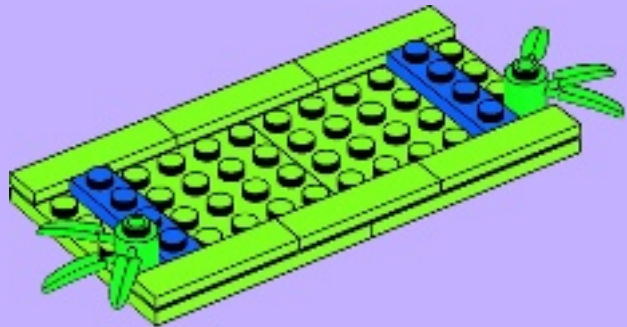



2x

6

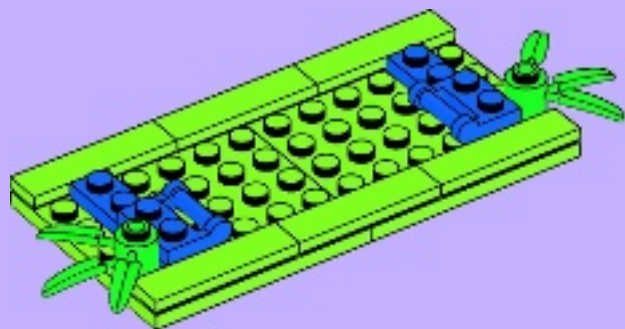

2x

7

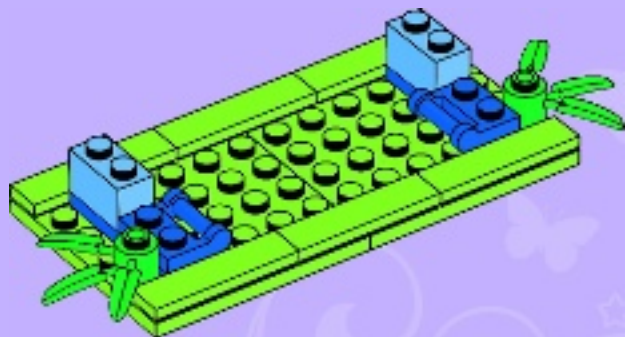



2x



2x

8

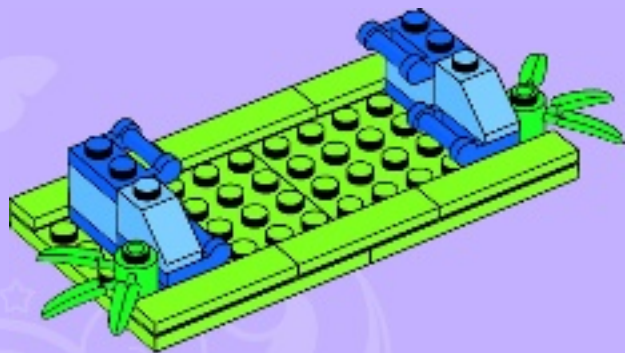

2x

9

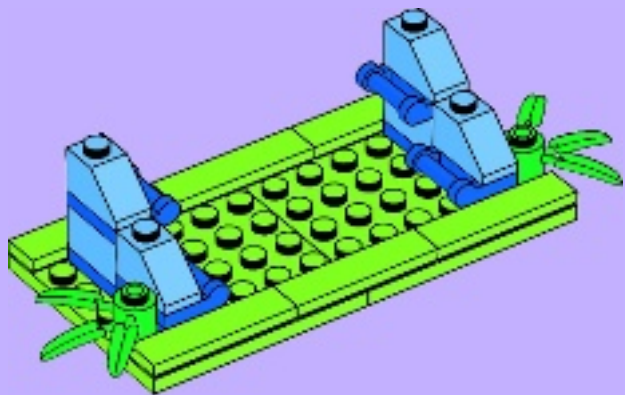

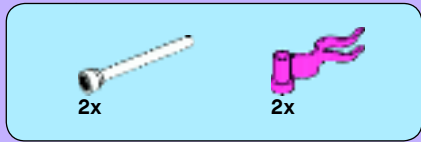

# 10

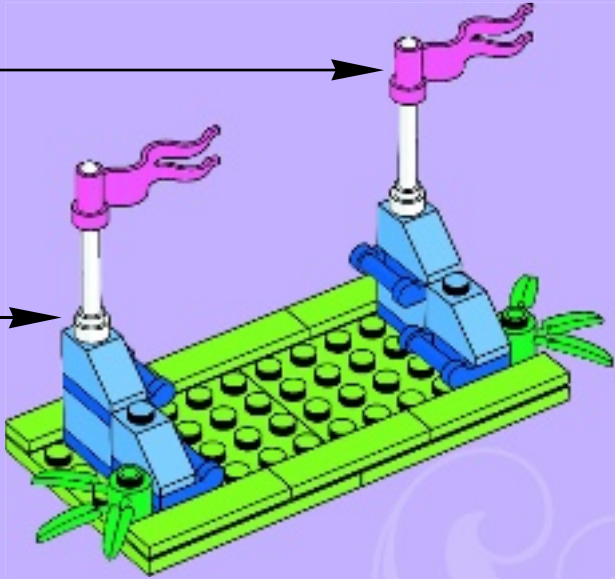
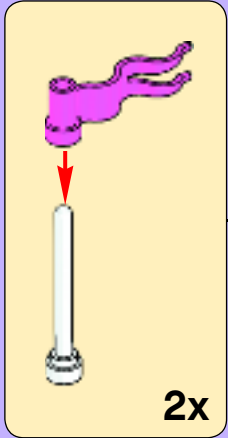



11

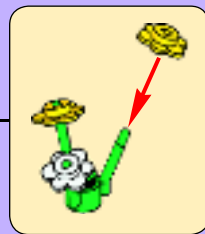
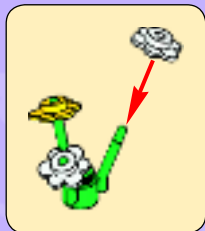
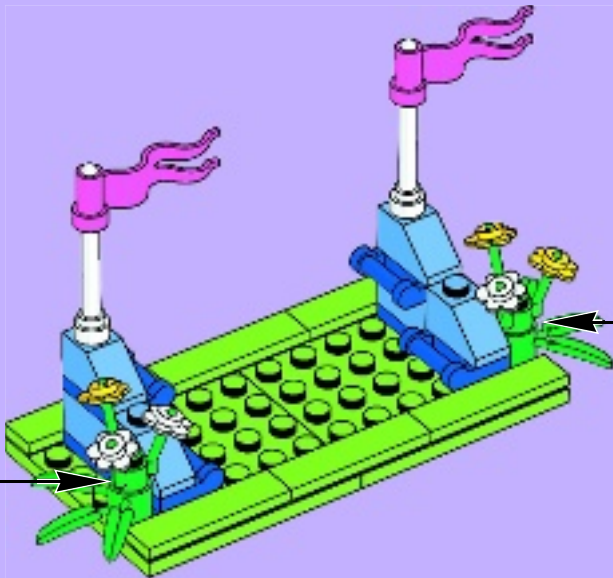



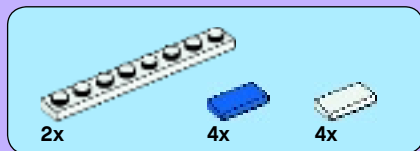

# 12

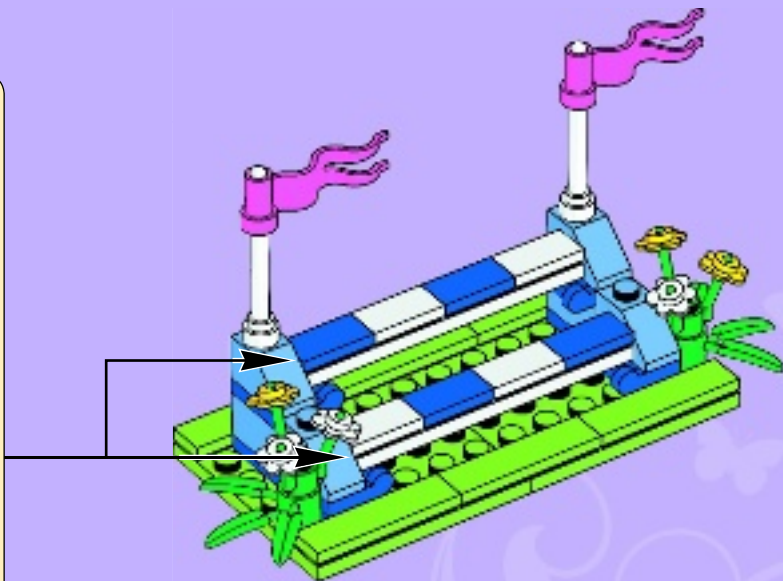
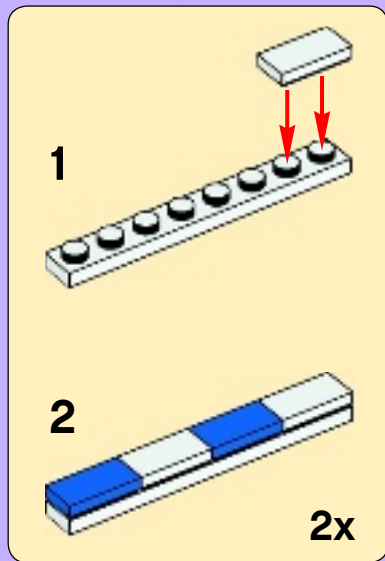



1

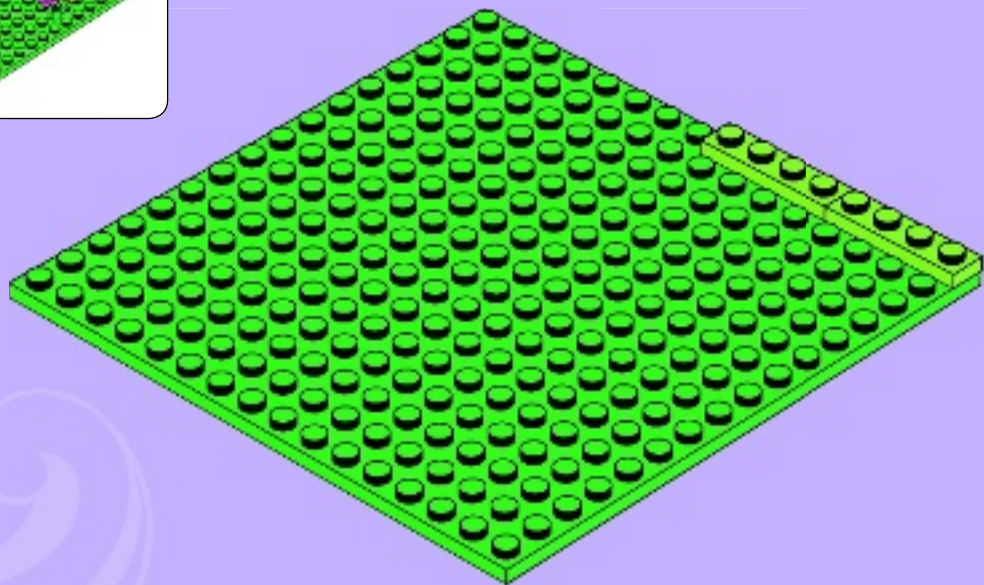



1x



1x



1x

# 2





1x



3x

3

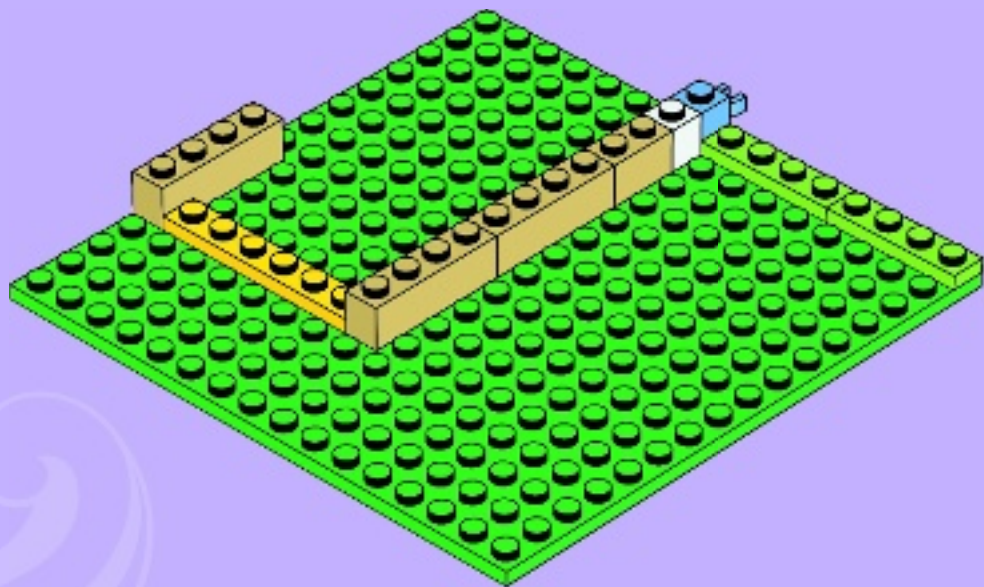

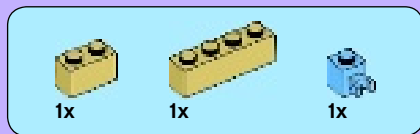

4

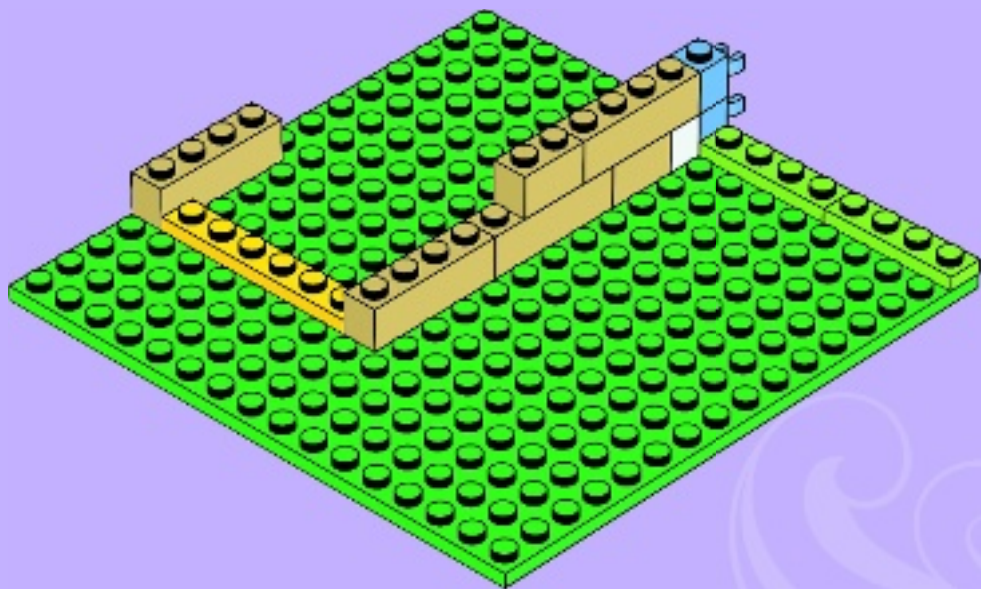



2x



1x

# 5

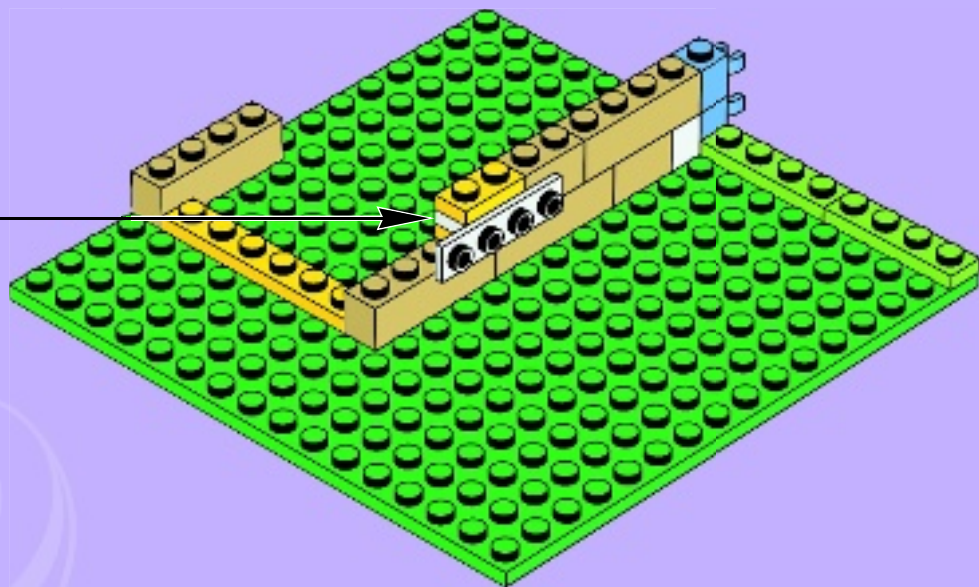
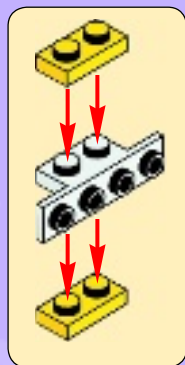



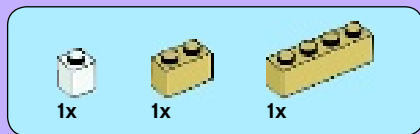

6

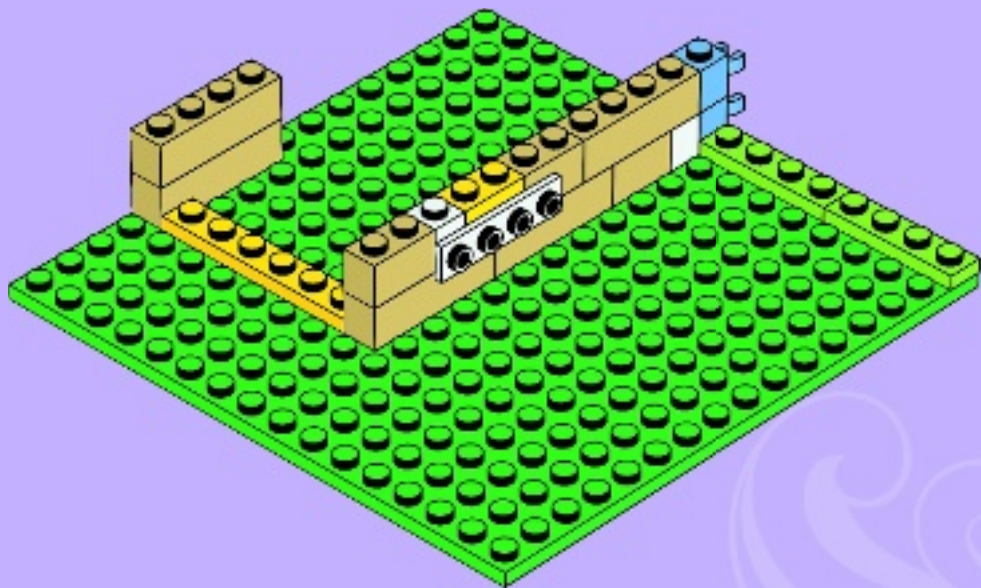



4x

7

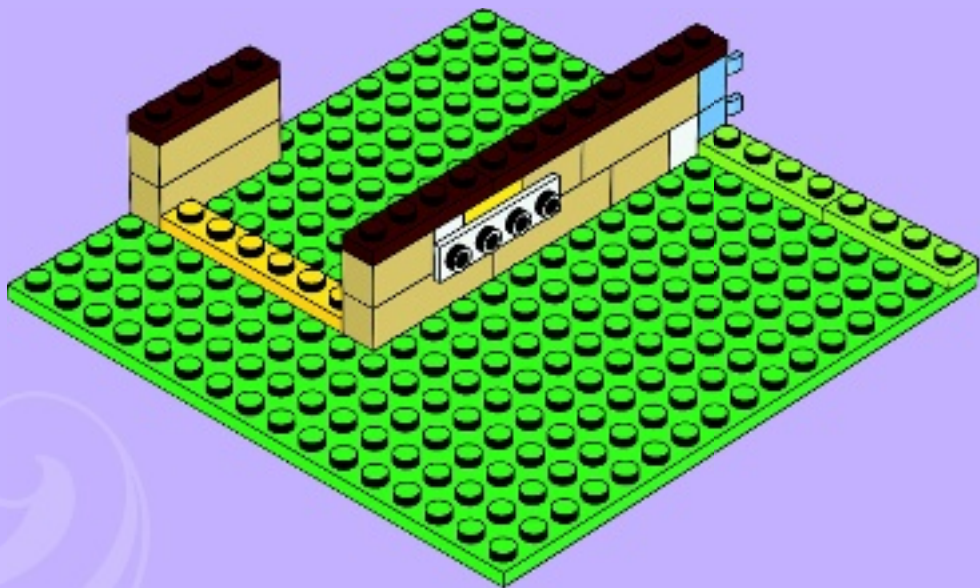

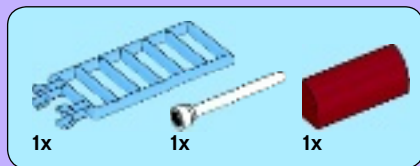

8

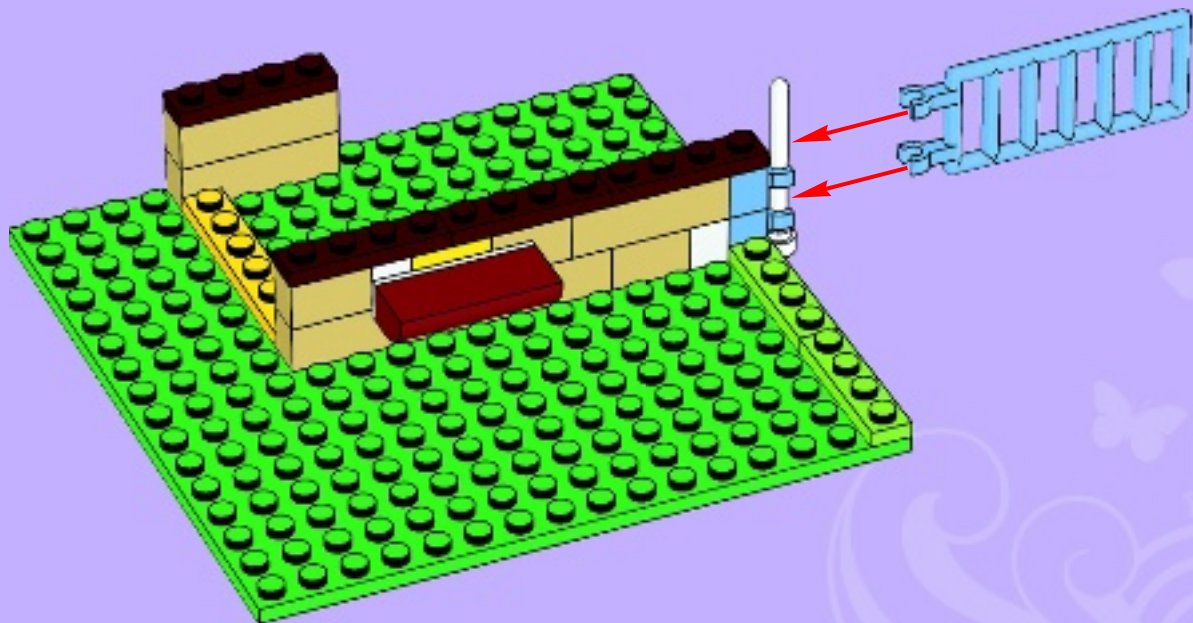

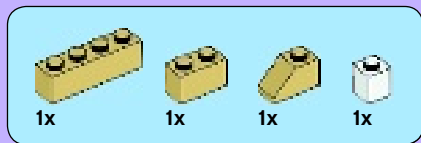

9

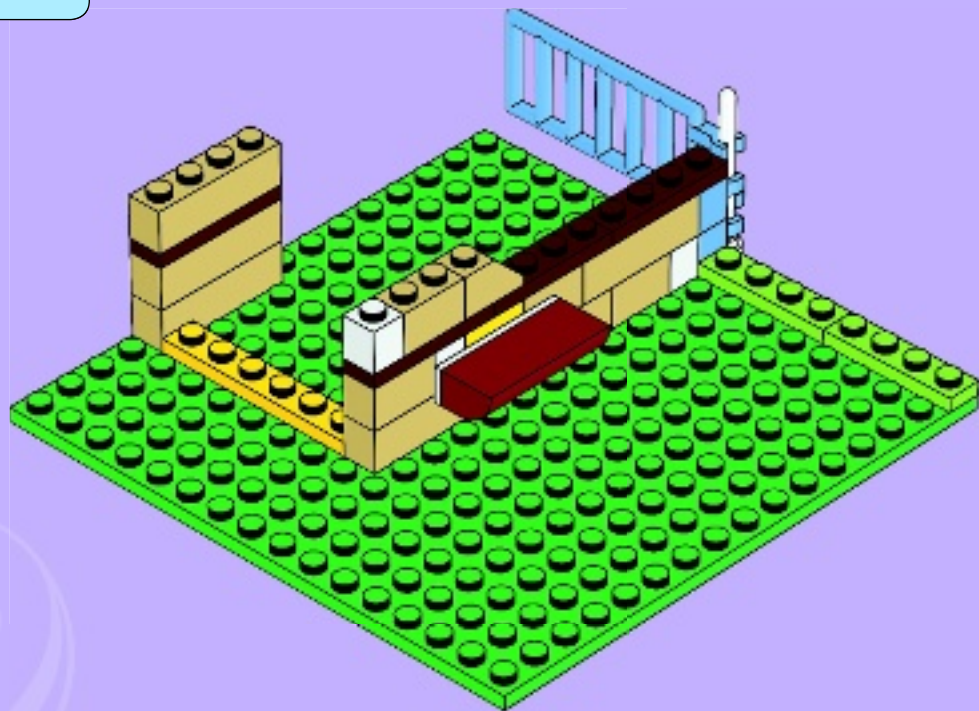



2x



2x

10



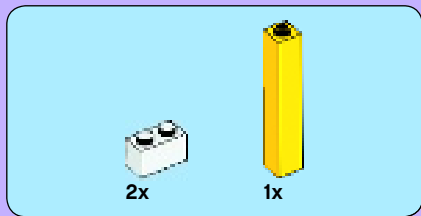

11

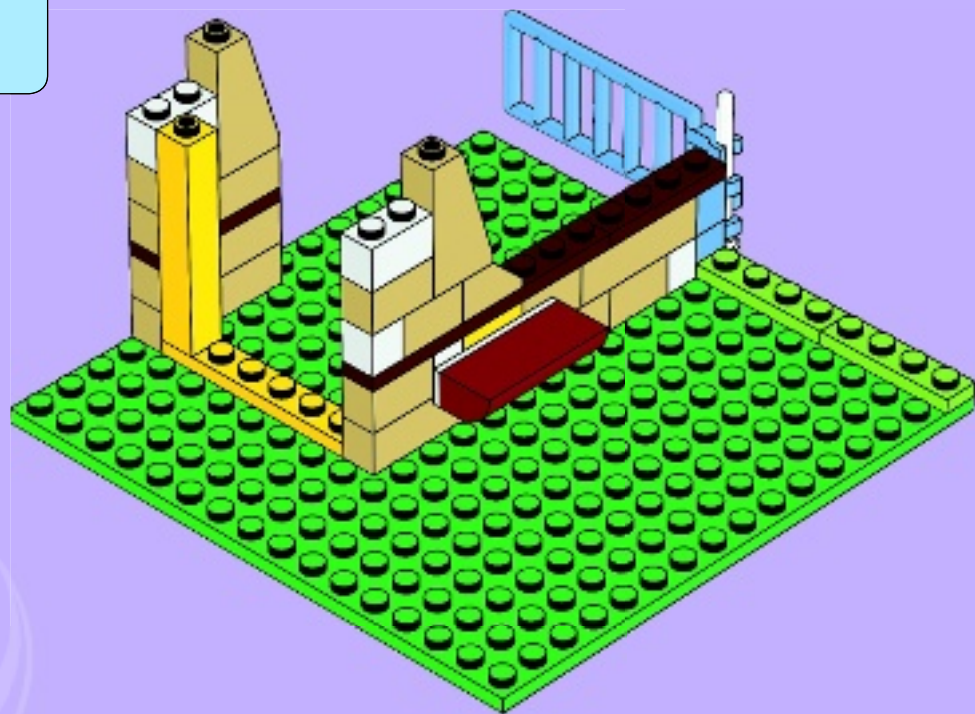





2x



1x

# 12



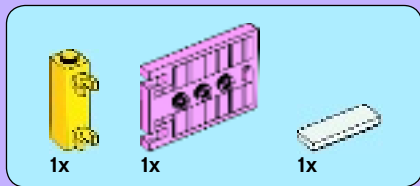

# 13

## 1

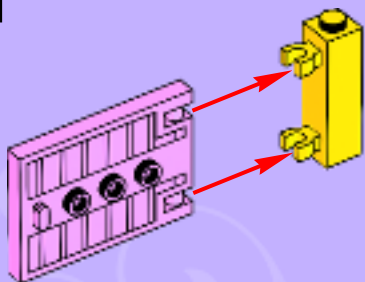

## 2

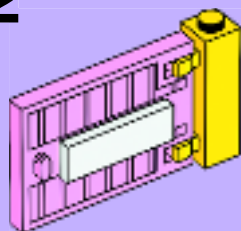

## 3

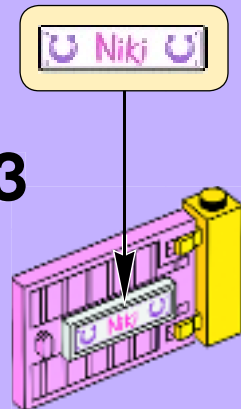



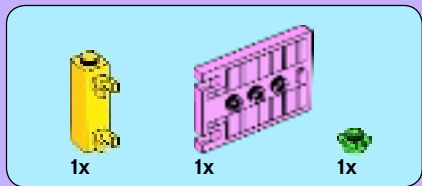

# 14

## 1

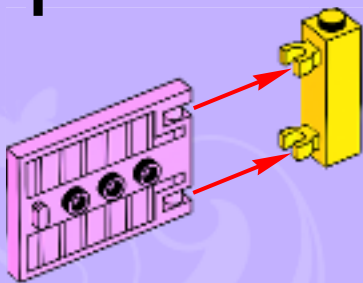

## 2

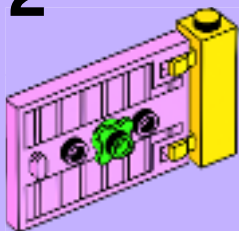

## 3

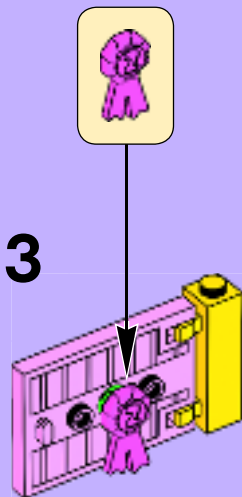





2x



2x

# 15







1x

16



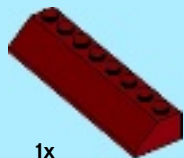

1x

17





1x



3x

18



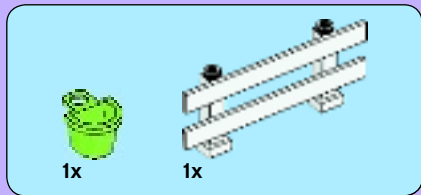

19

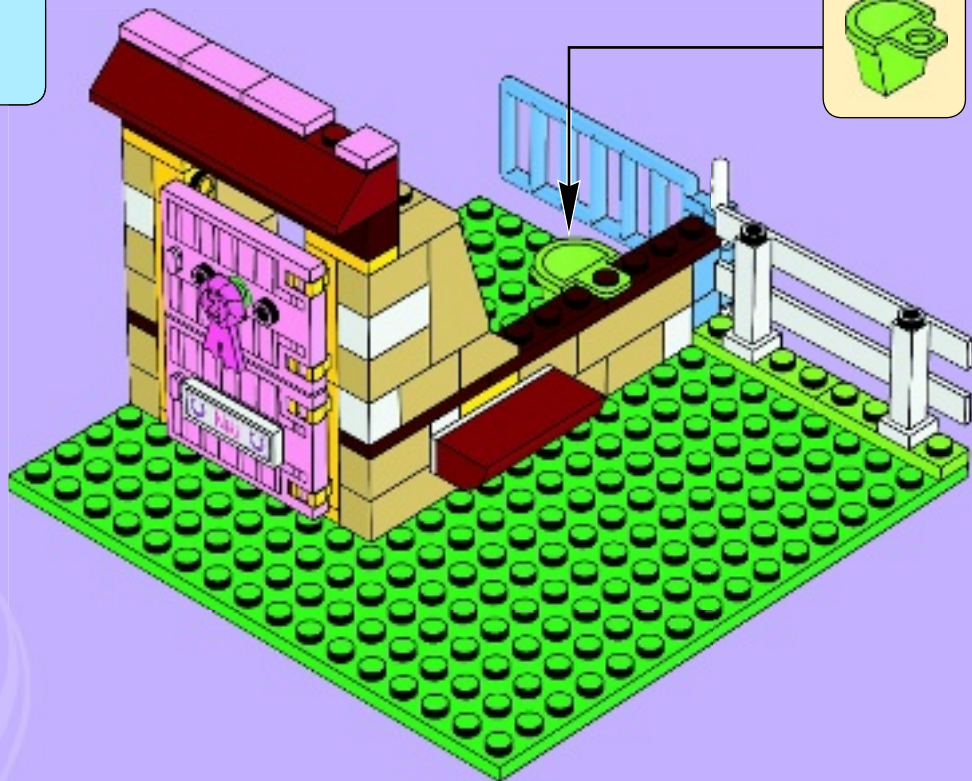
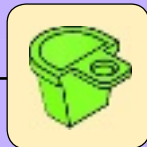

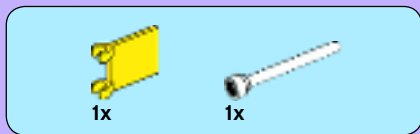

# 20

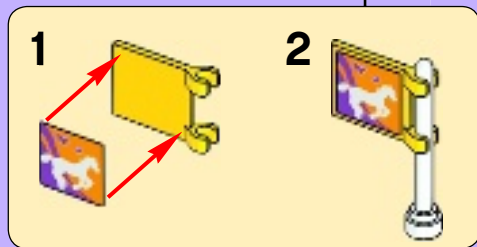





1x

21







2x



4x

# 22





4x

23





8x

24

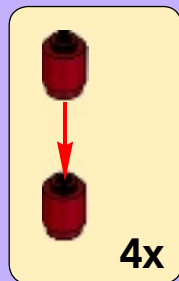



2x

25

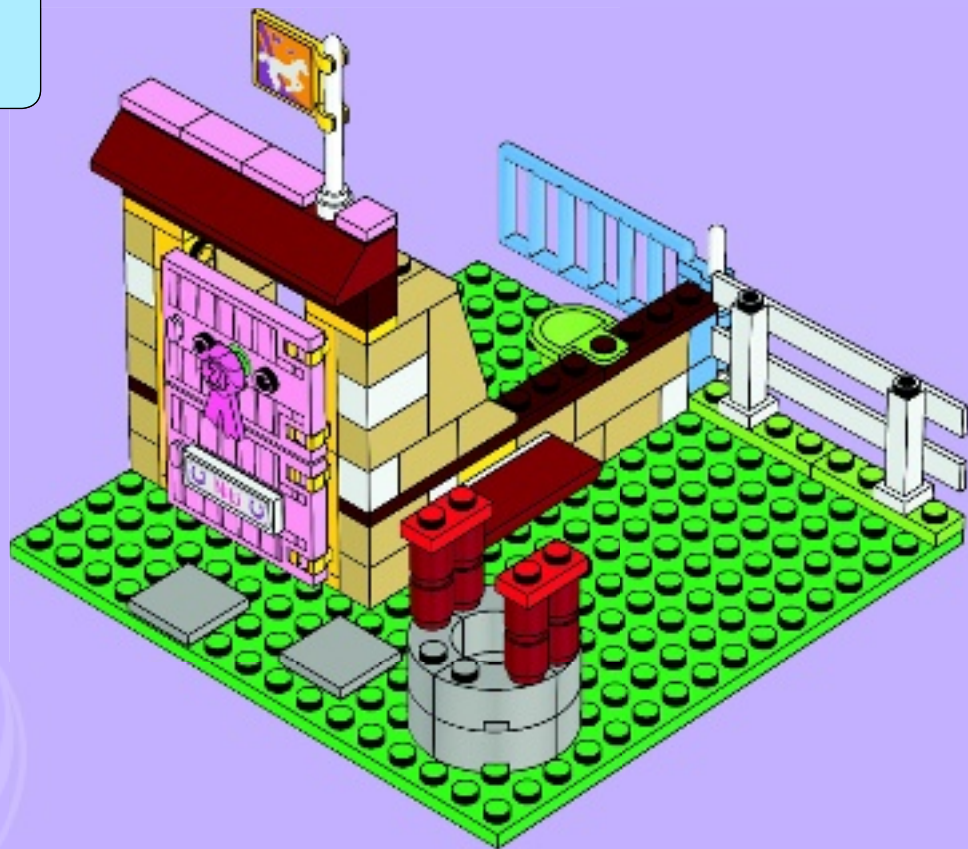

1x

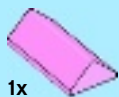

26





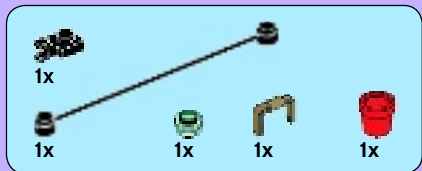

27

1



2



3



4





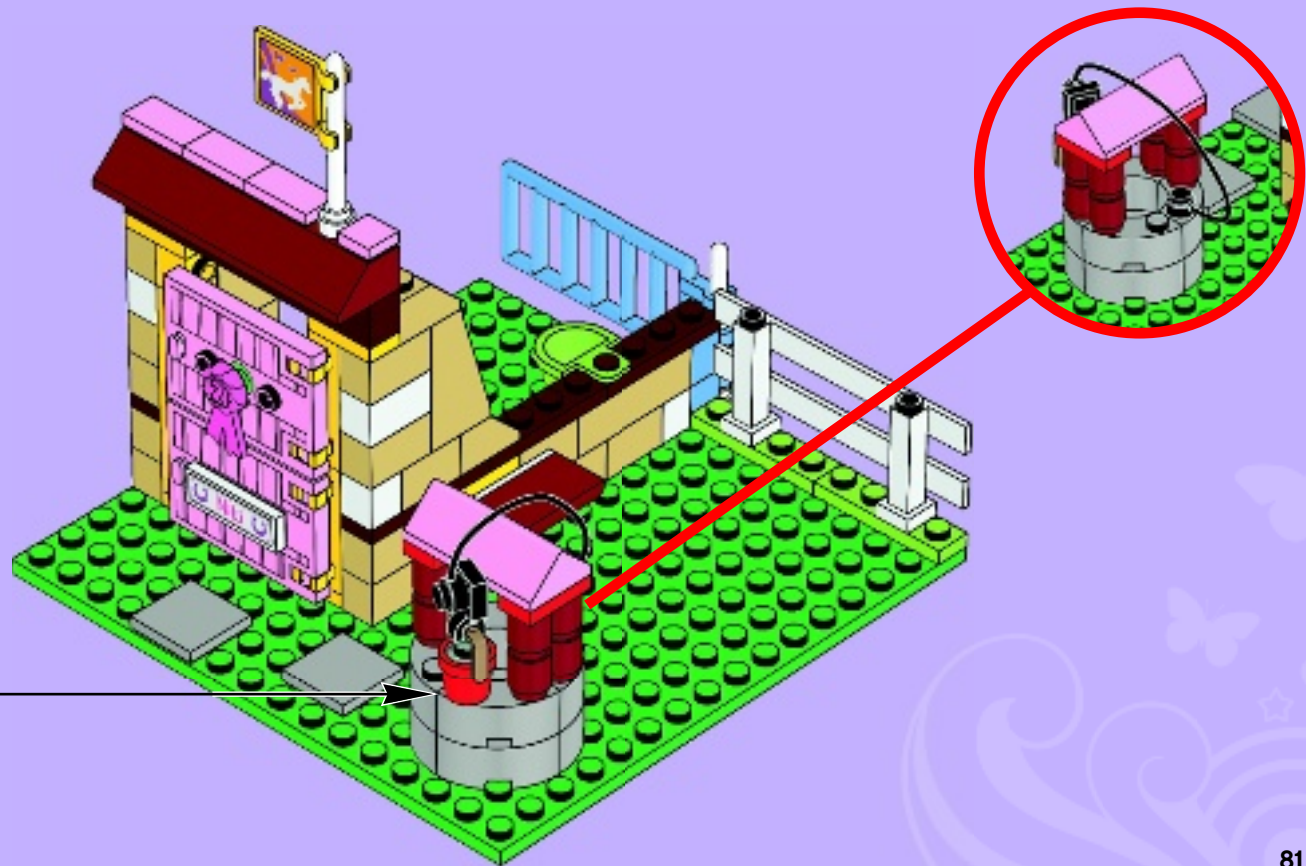

2x 1x 1x

28

2x

1x



1x  1x  2x 

29





# Win!

Go to [www.LEGOsurvey.com/product](http://www.LEGOsurvey.com/product) to fill out a survey for a chance to win a cool LEGO® Product.  
No purchase necessary.  
Open to all residents where not prohibited.



## [www.LEGOsurvey.com/product](http://www.LEGOsurvey.com/product)

### Gewinne! Win!

Nimm an der Umfrage auf [www.LEGOsurvey.com/product](http://www.LEGOsurvey.com/product) teil und hab die Chance ein cooles LEGO® Produkt zu gewinnen!

Die Teilnahme am Gewinnspiel führt zu keinerlei Kaufverpflichtungen. Teilnahme in allen nicht ausgeschlossenen Ländern möglich.

LEGO and the LEGO logo are trademarks of the/son des marques de commerce de/son marcas registradas de LEGO Group. ©2012 The LEGO Group.

Ga naar [www.LEGOsurvey.com/product](http://www.LEGOsurvey.com/product), vul een enquêteformulier in en maak kans op een cool LEGO® product.

Geen aankoopverplichting. Iedereen mag deelnemen, uitgezonderd ingezetenden van landen waar een enquêteverbod geldt.

### Gagne! 当てよう!

Visite [www.LEGOsurvey.com/product](http://www.LEGOsurvey.com/product) pour répondre à un questionnaire et avoir une chance de gagner un produit LEGO® très cool!

Aucune obligation d'achat. Ouvert à tous les résidents des pays autorisés.

[www.LEGOsurvey.com/product](http://www.LEGOsurvey.com/product) にアクセスして、アンケートにご記入ください。当選者にはレゴ® 製品を差し上げます。

お買い上げの必要はありません。

禁止されていない限り、すべての皆様にご利用いただけます。

6029680 / 6029681

