



SPORTS

3432







3428



3429



3433

3560



3561



3562



3563



3564



3565



3566



3567



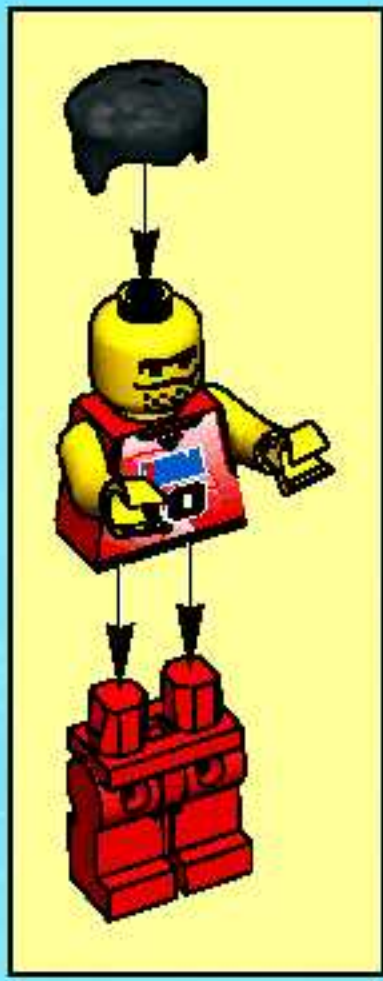

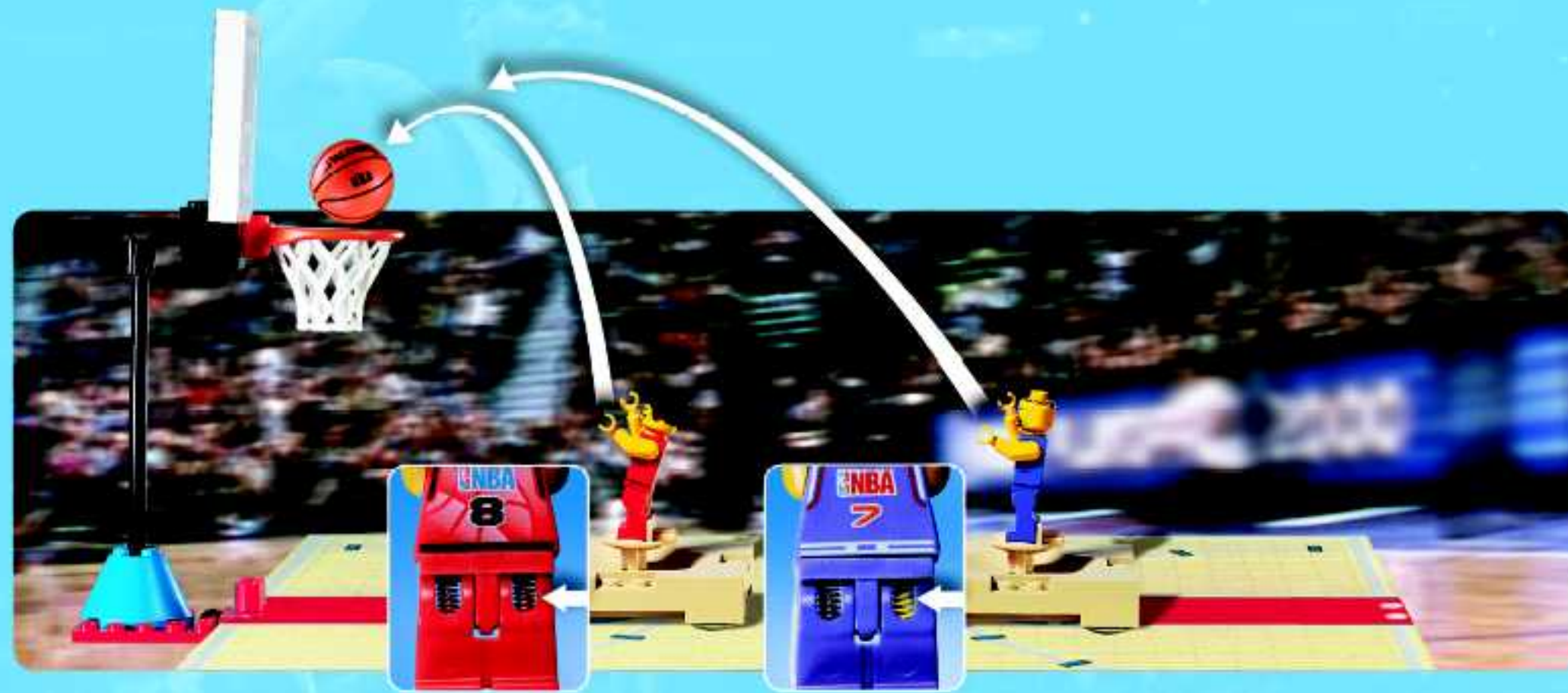

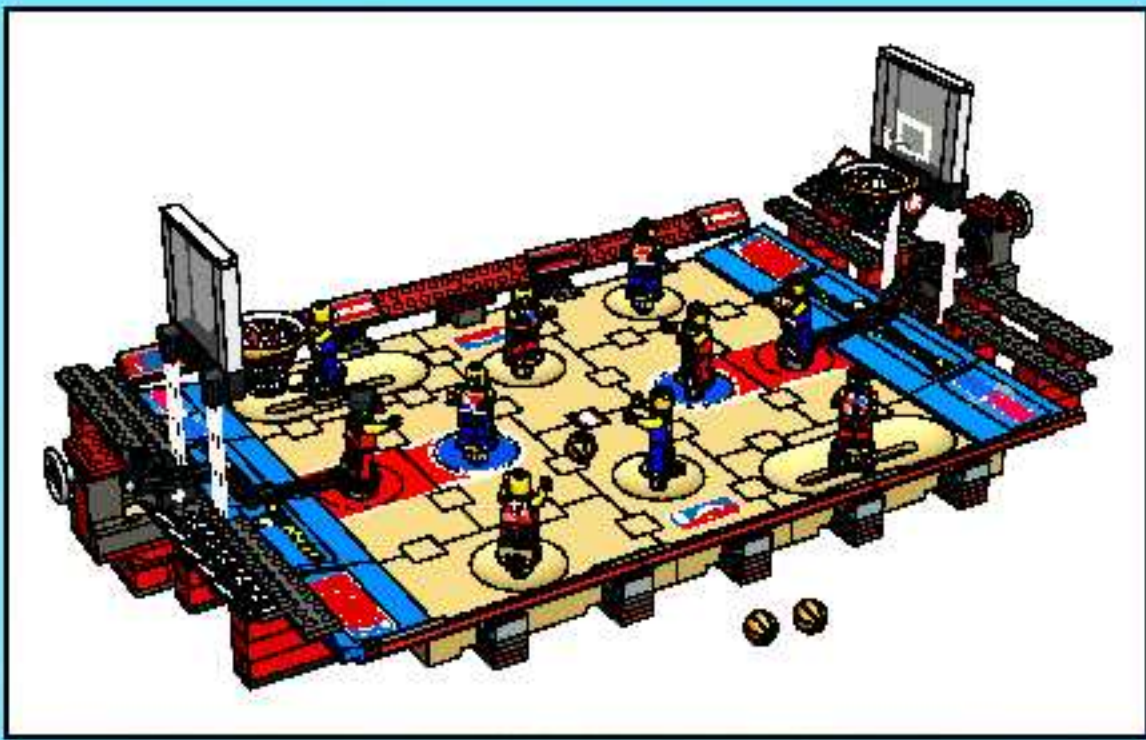

1

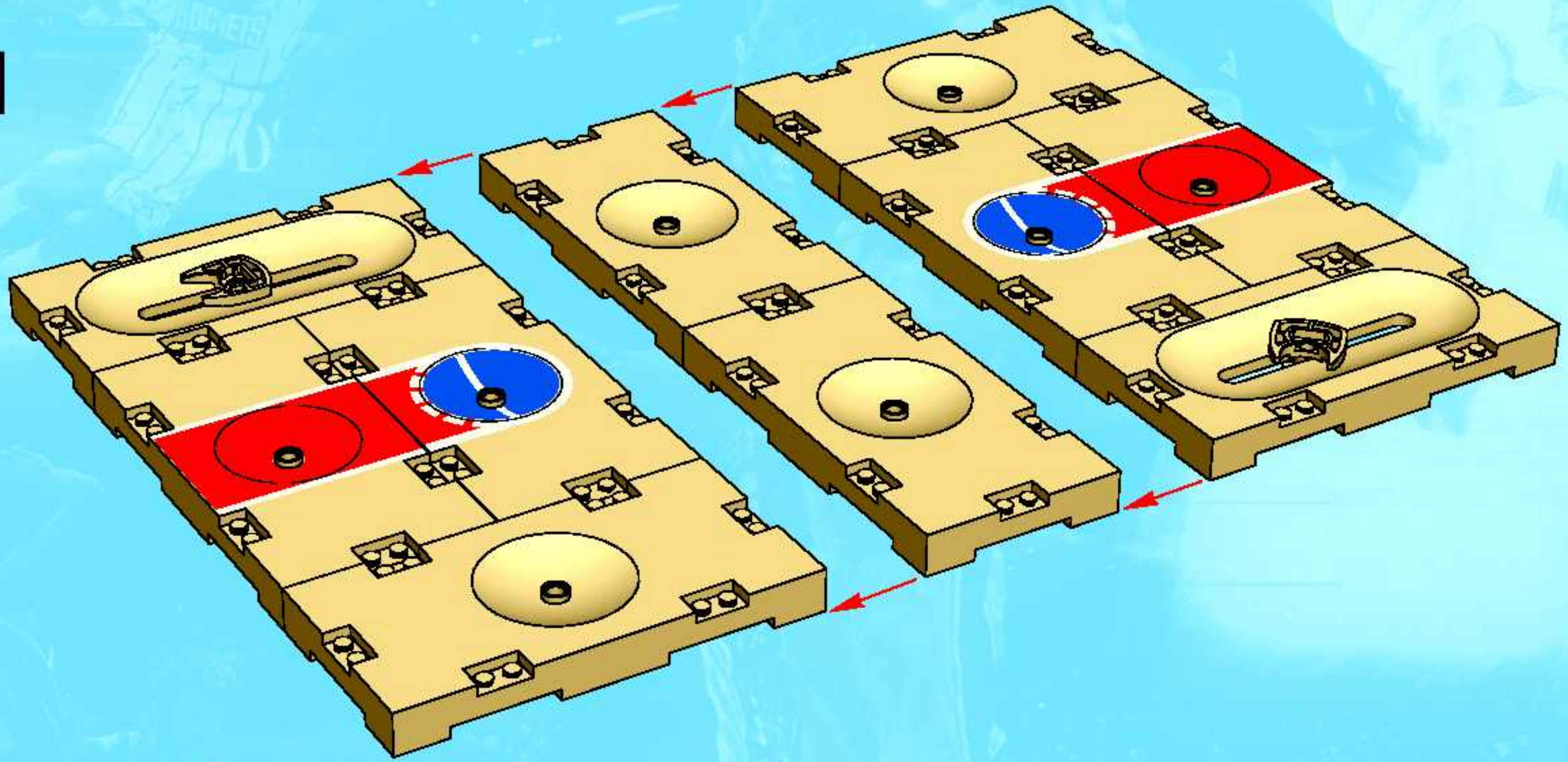

2

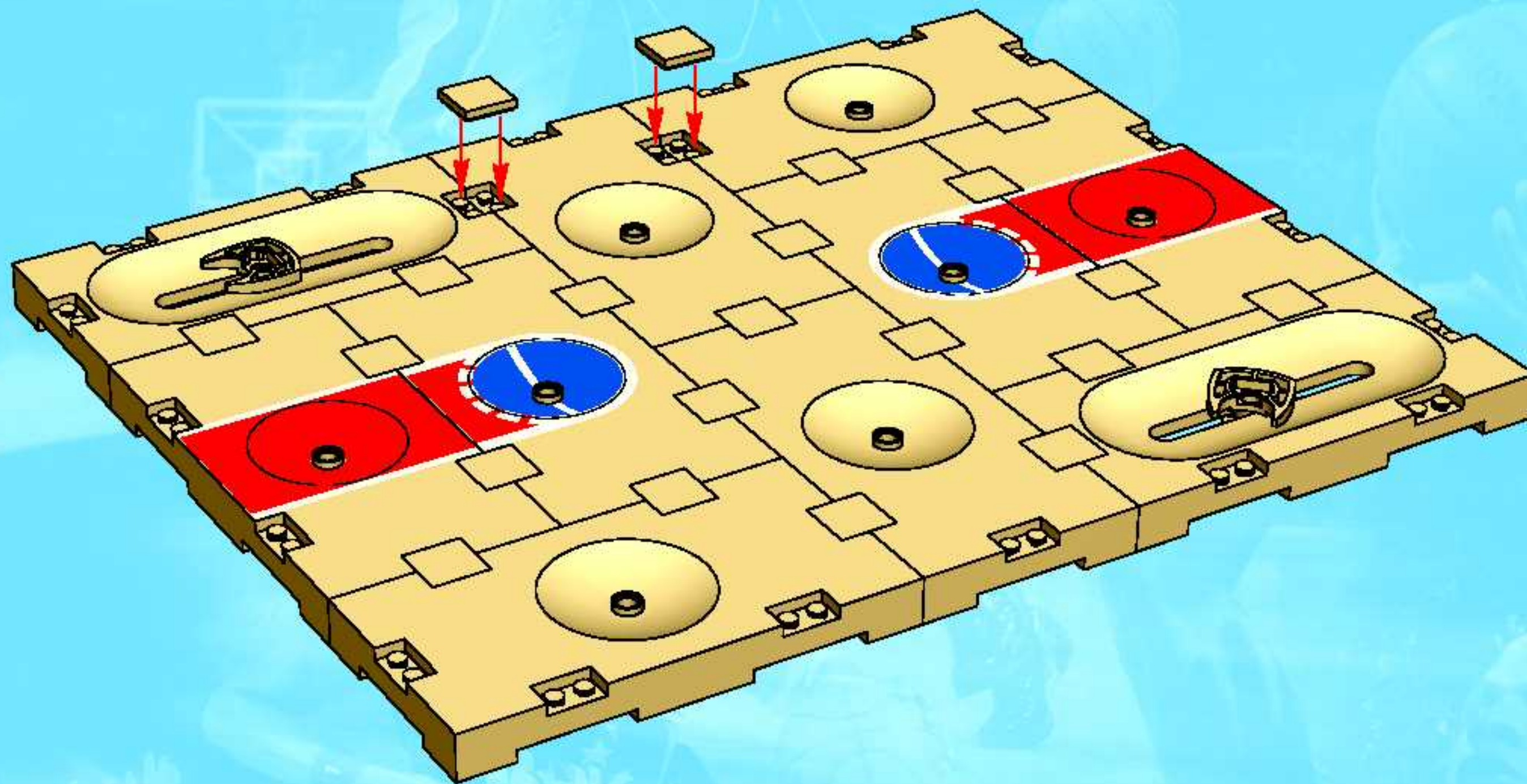

3

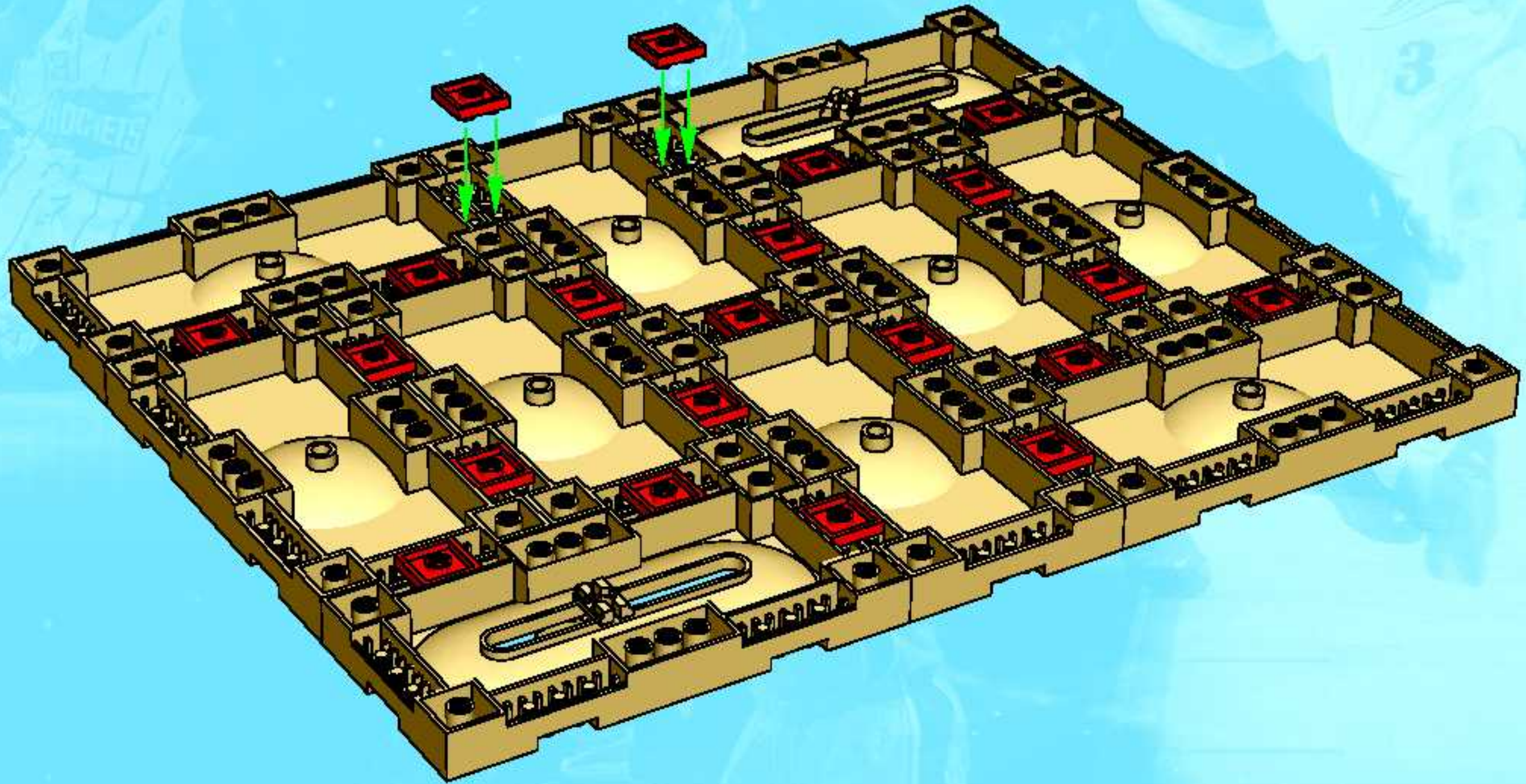

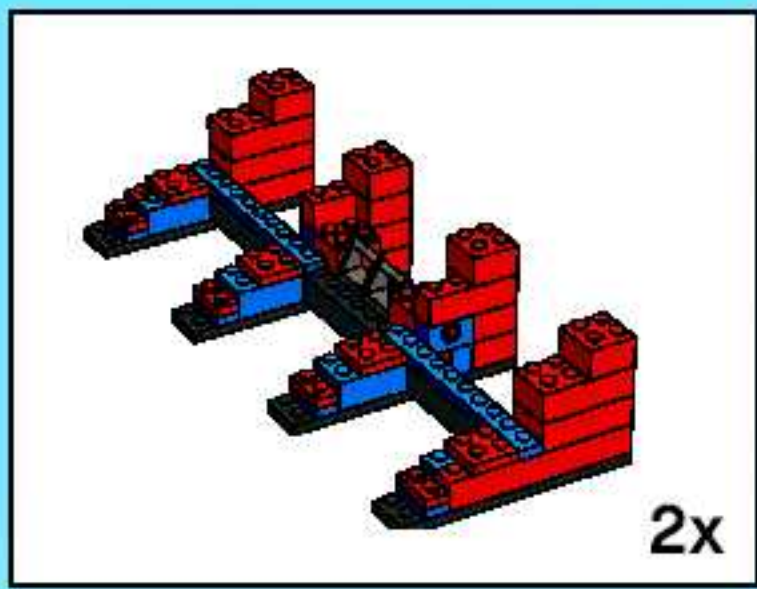

1

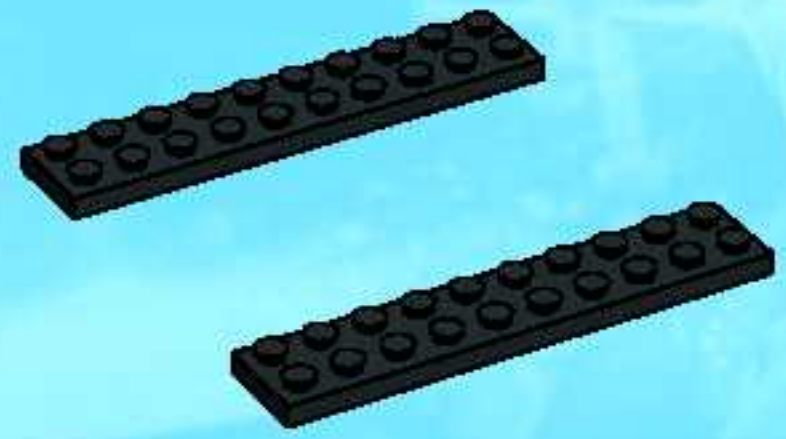

2

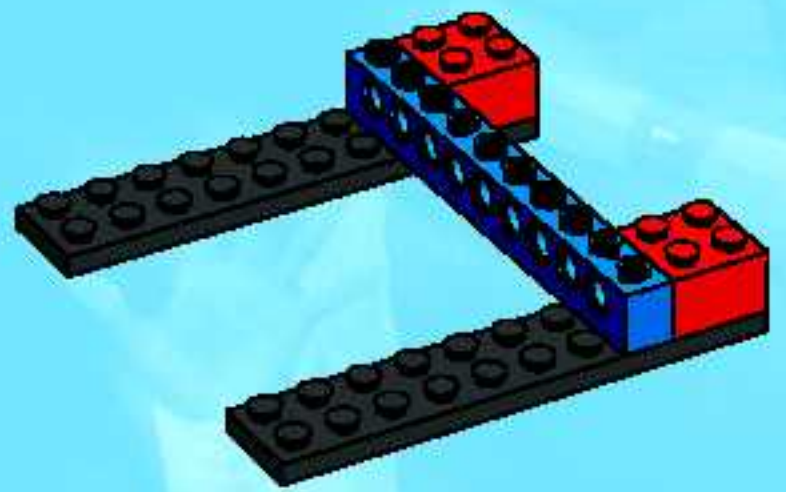

3

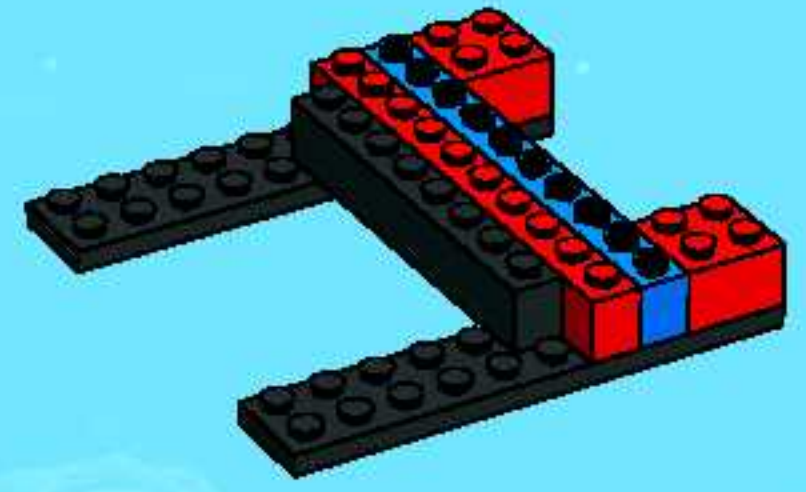

4

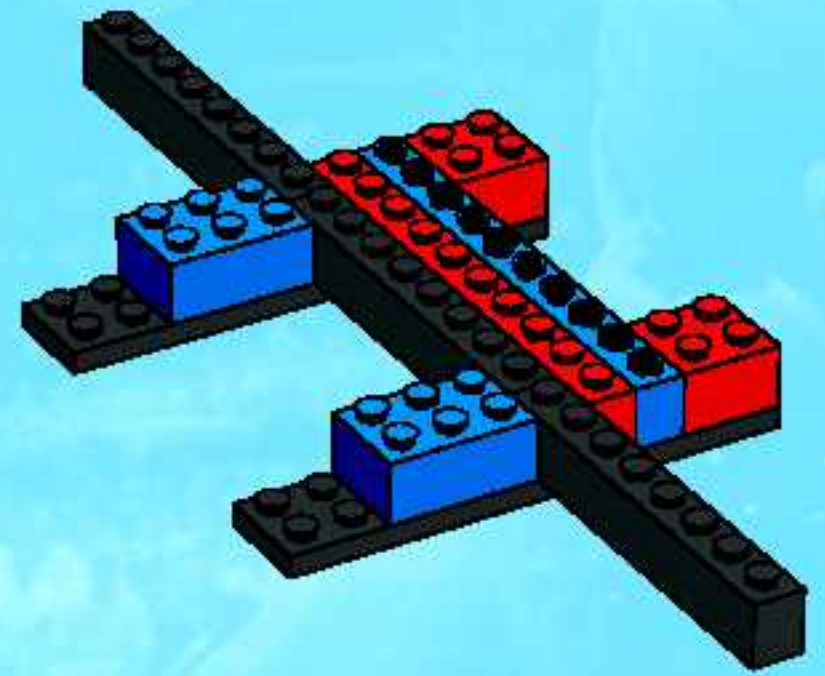

5

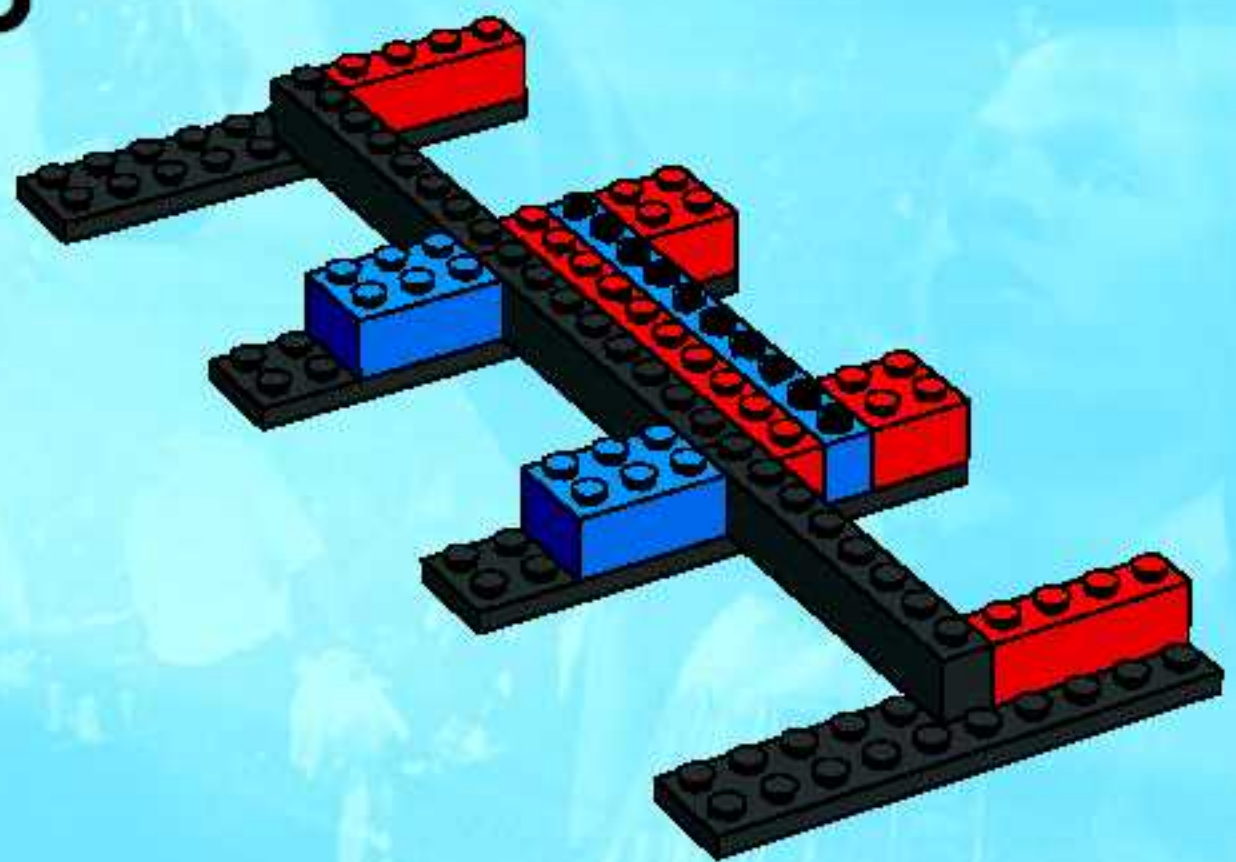

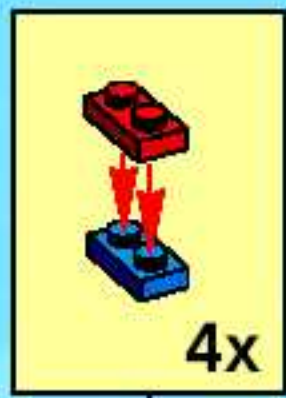

6

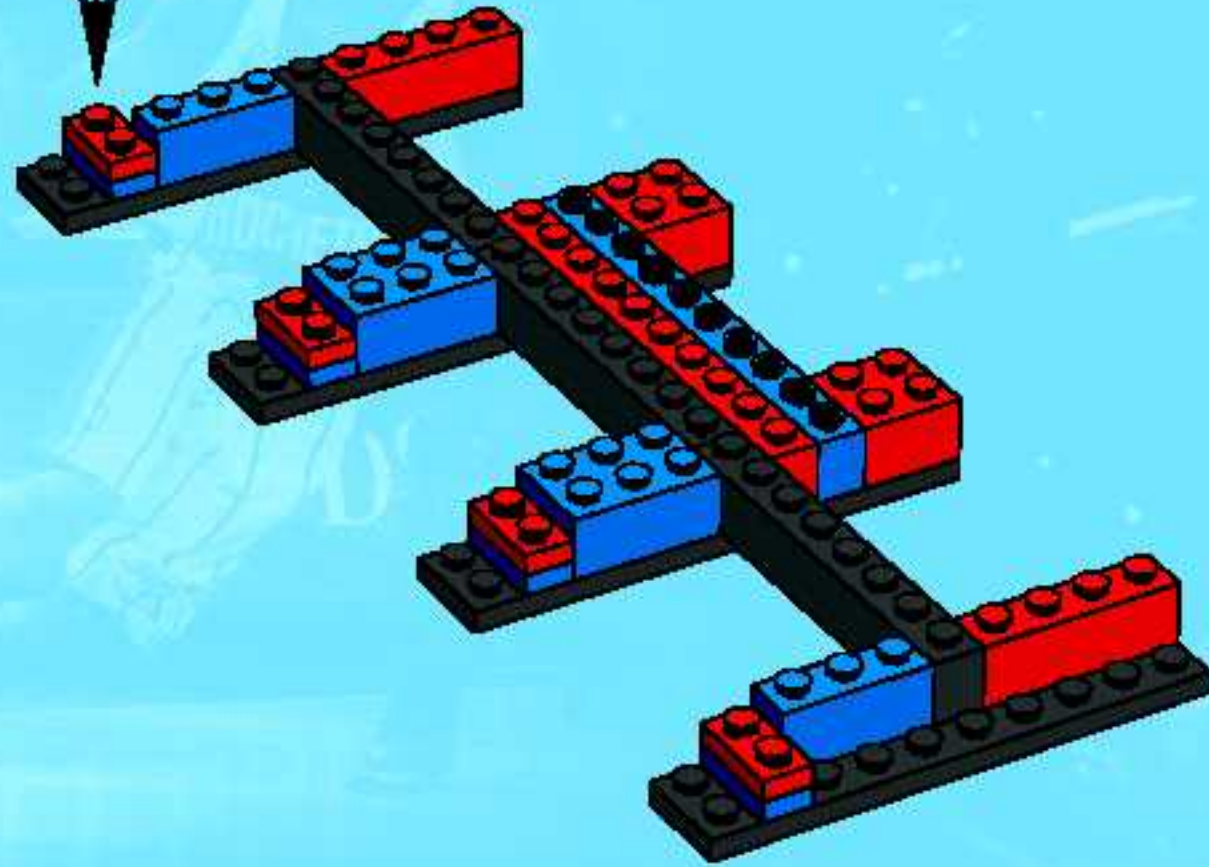

7

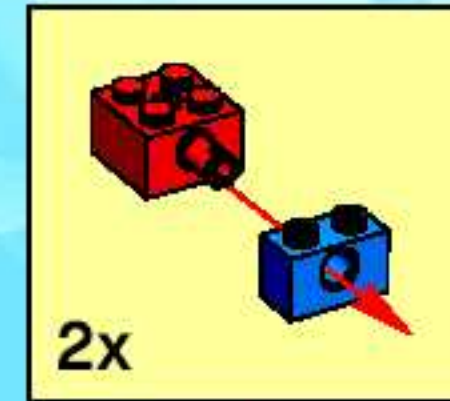
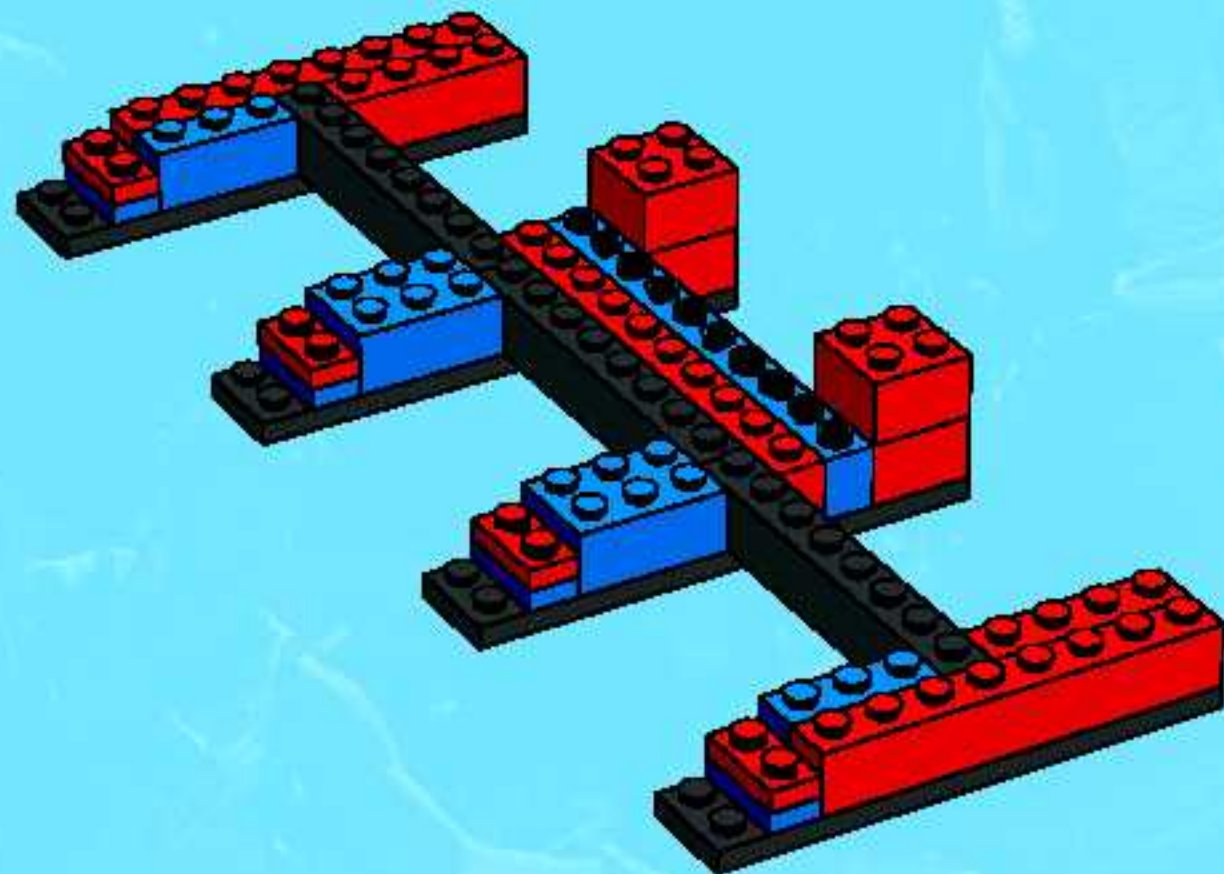

8

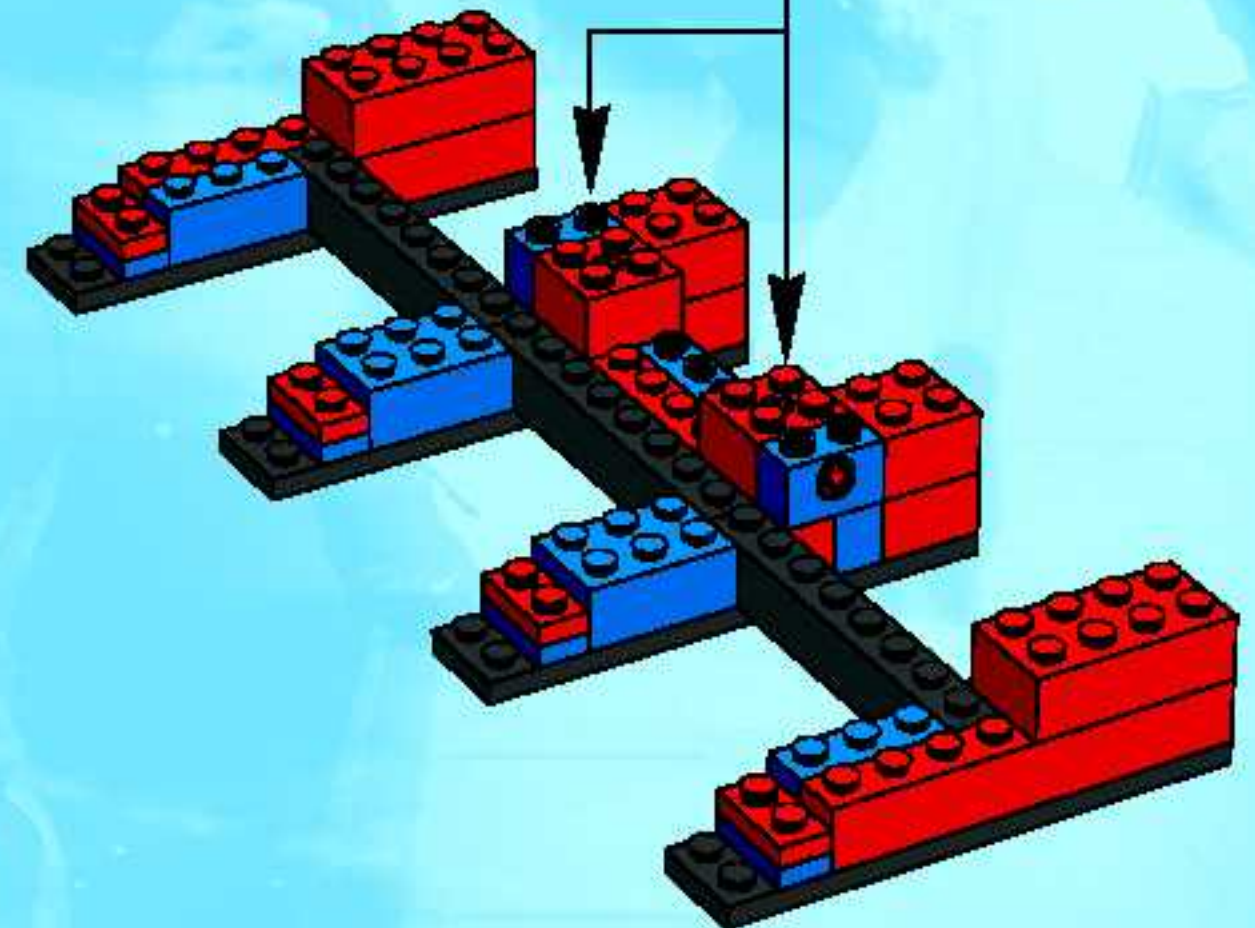

9

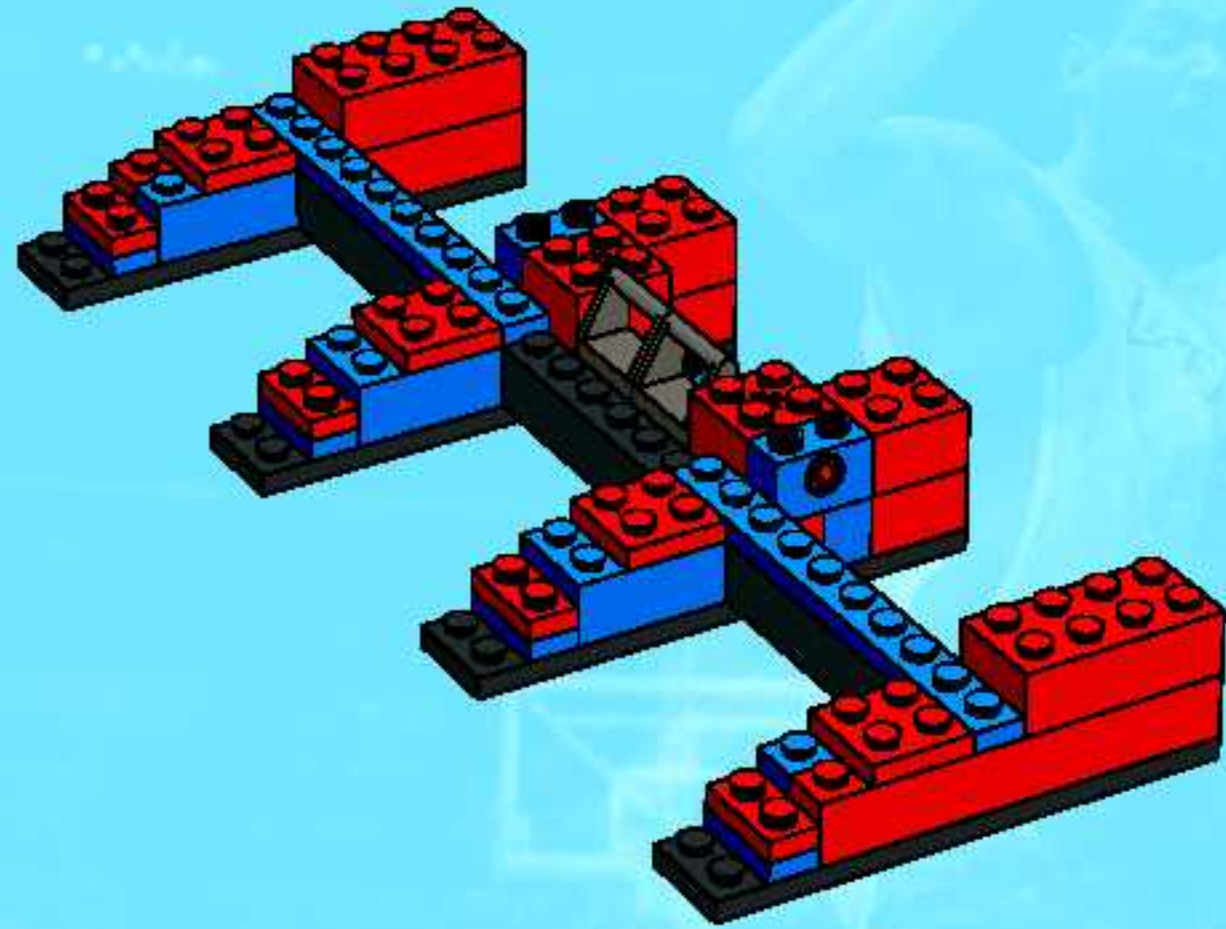

10

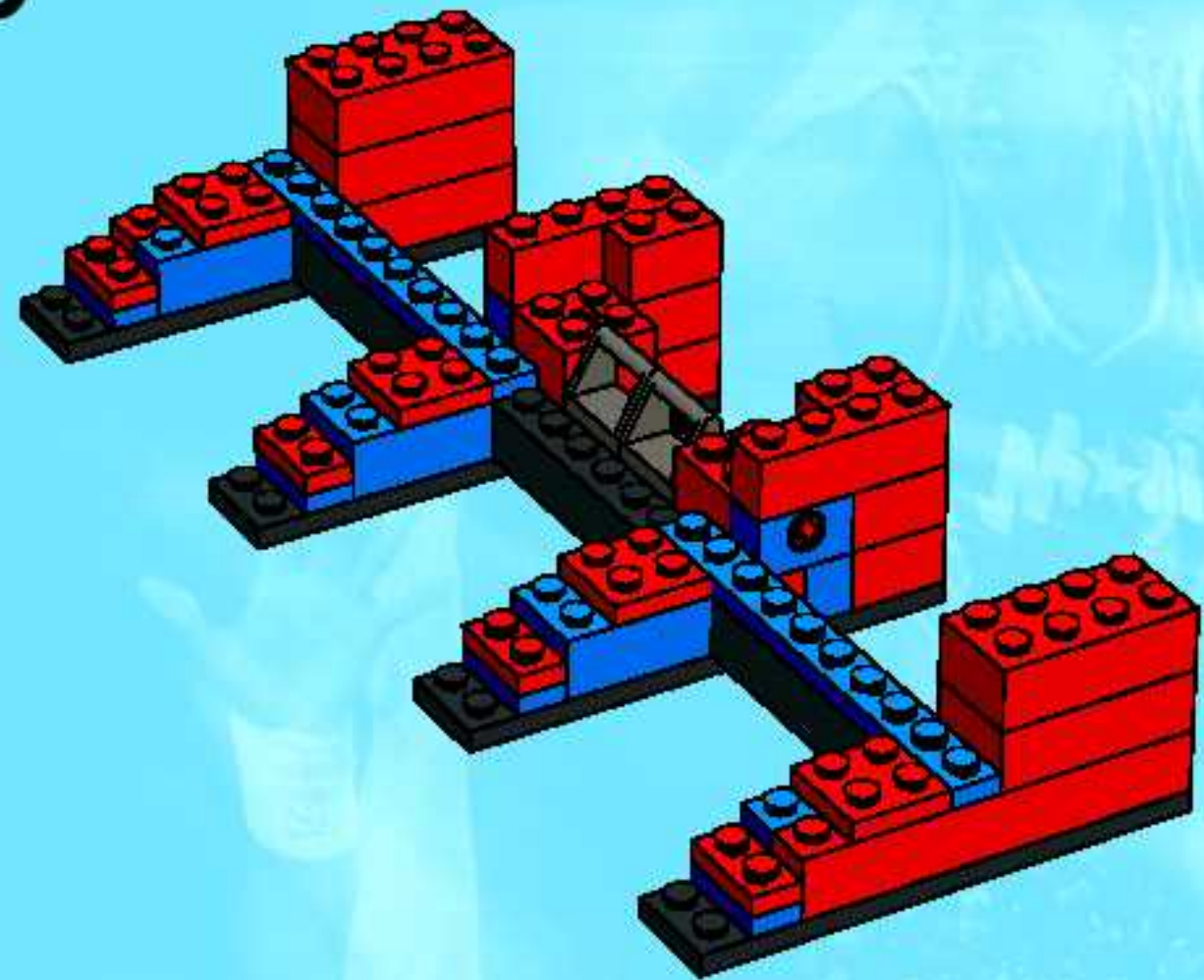

11

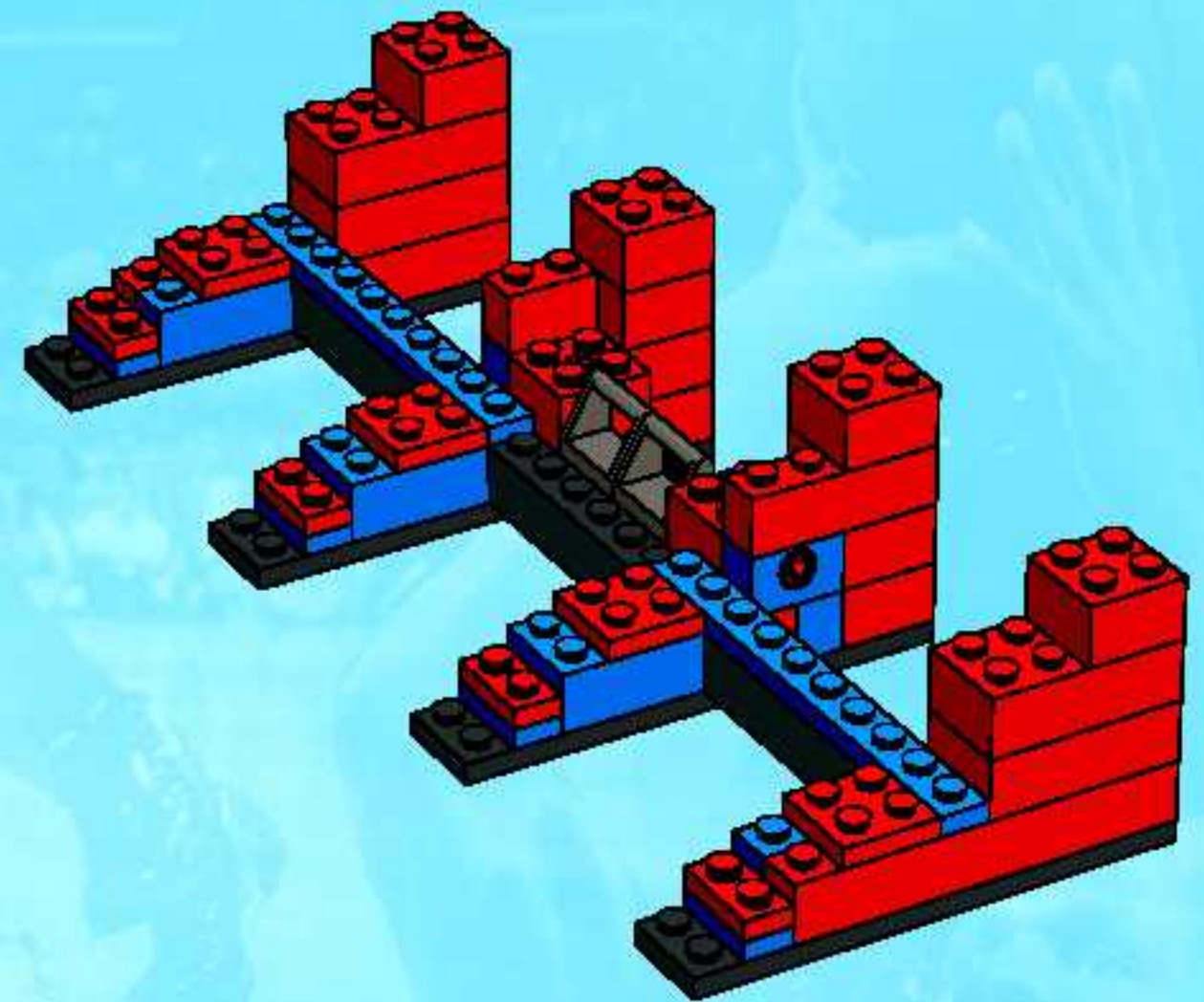

2x

4

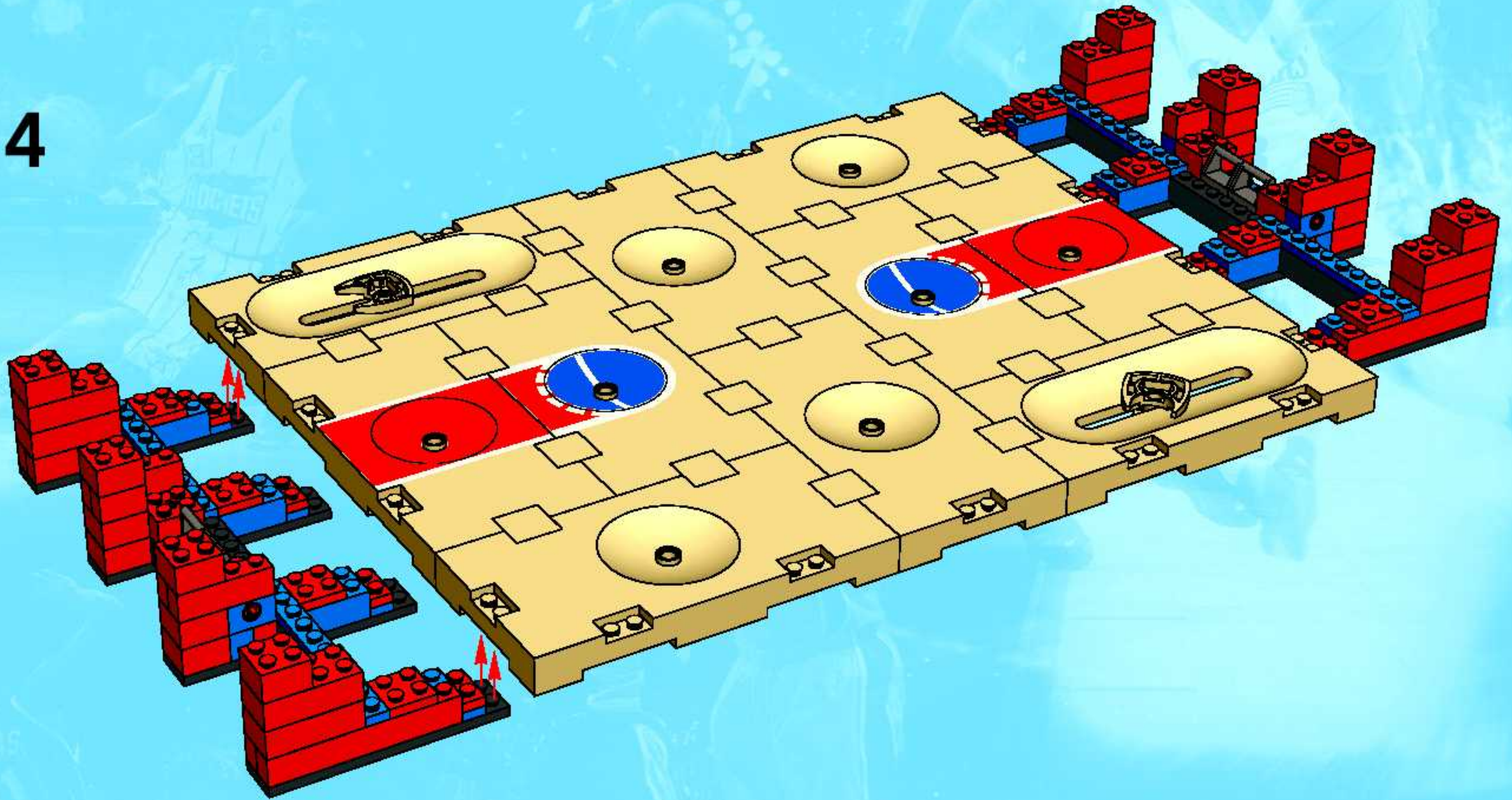

5

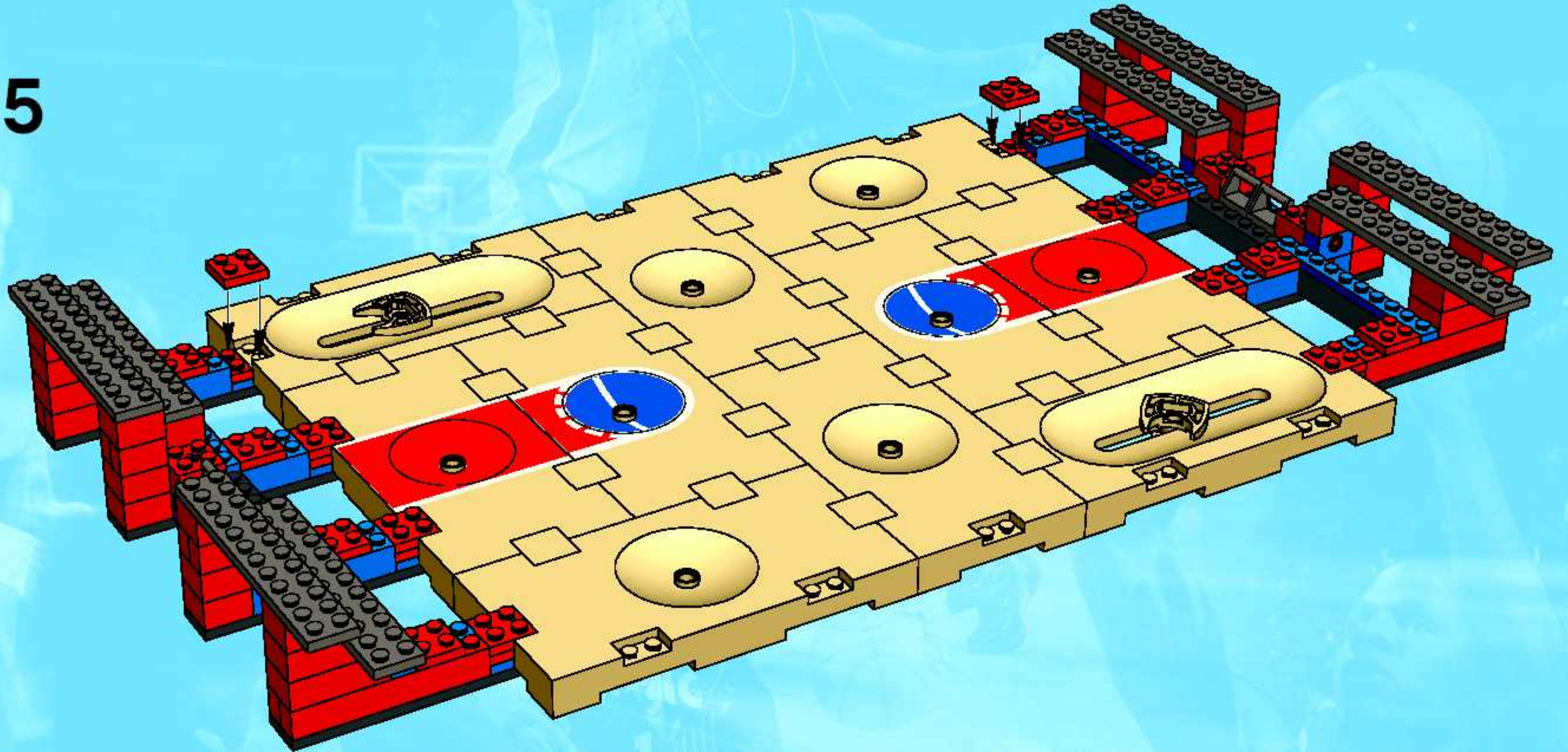

6

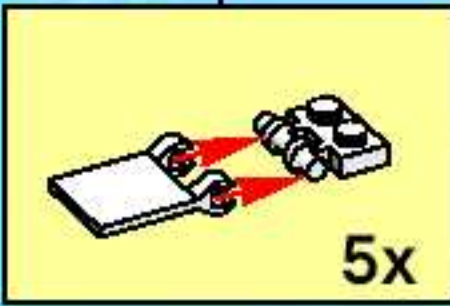
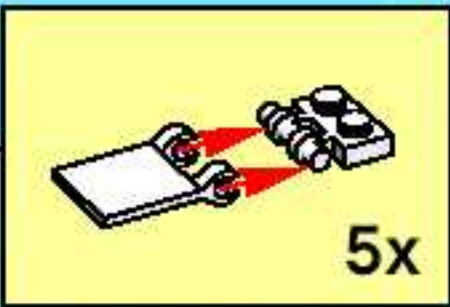
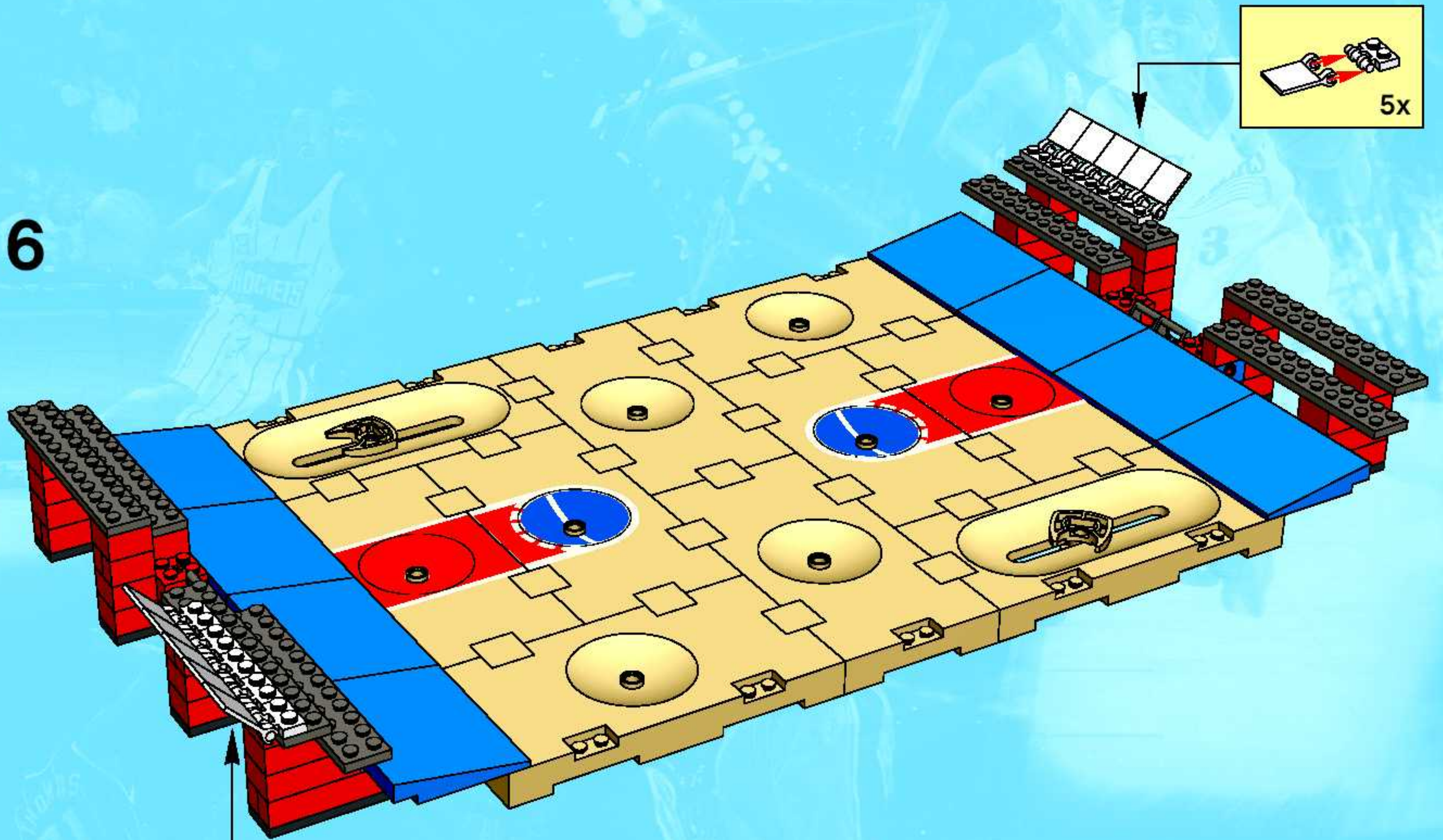

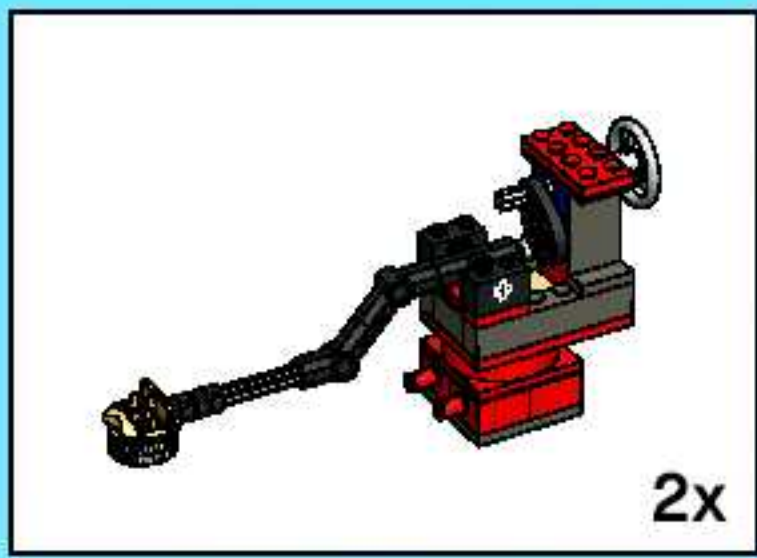

1

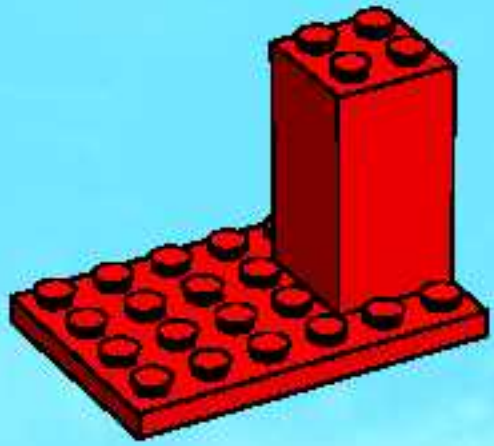

2

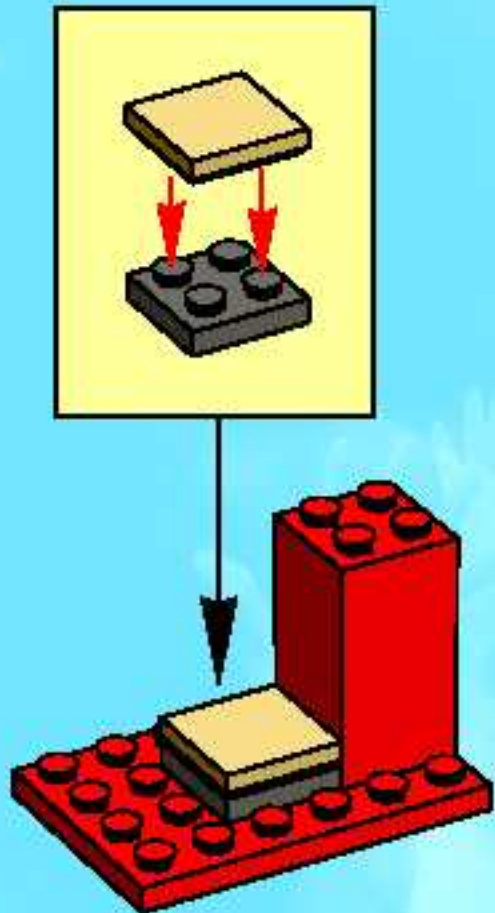

3

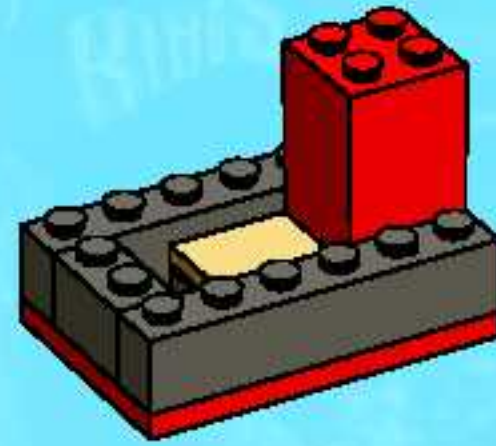

4

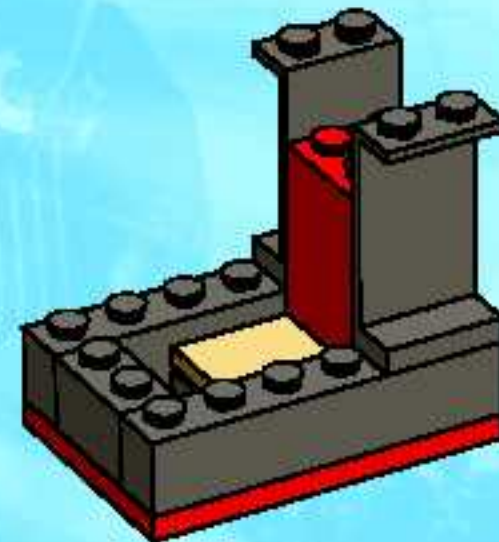

5

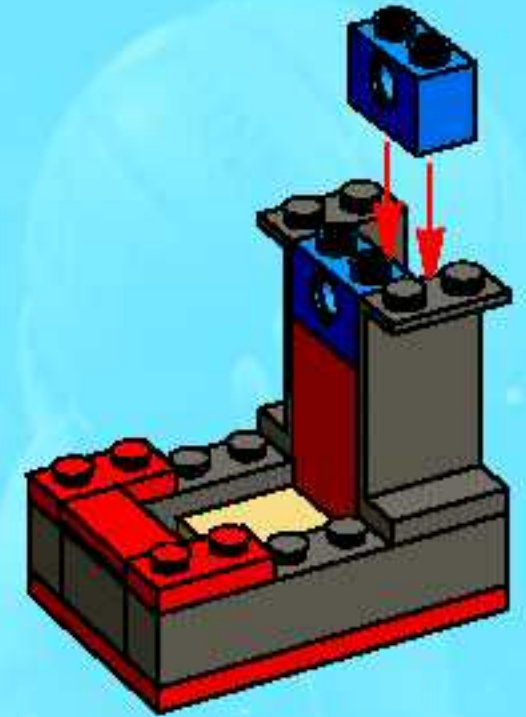

6

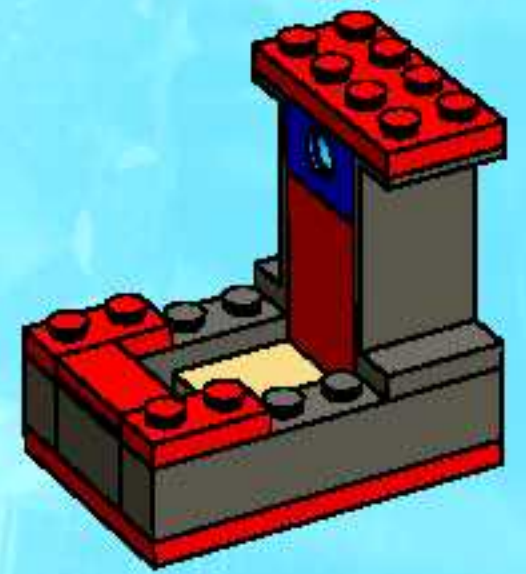

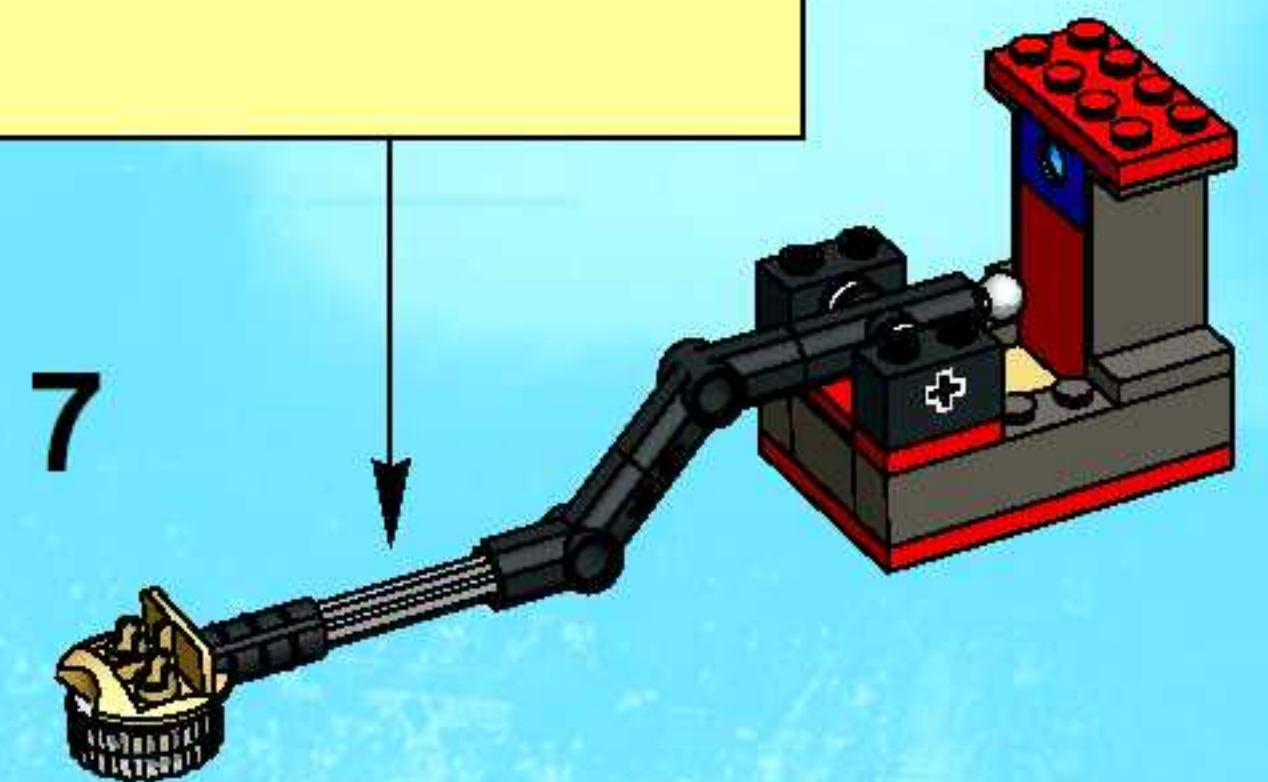
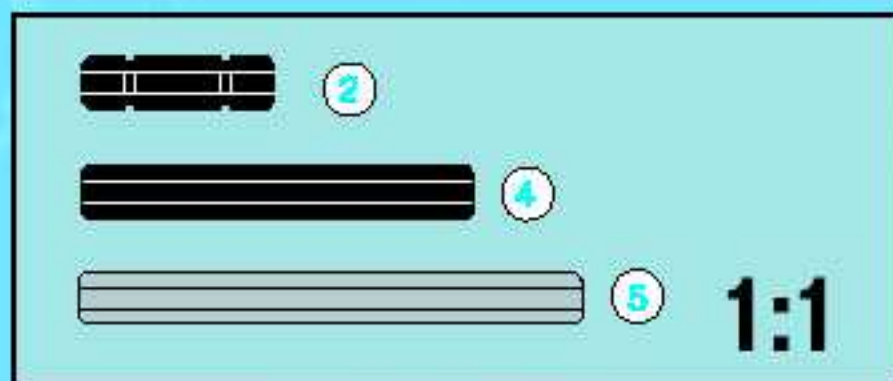
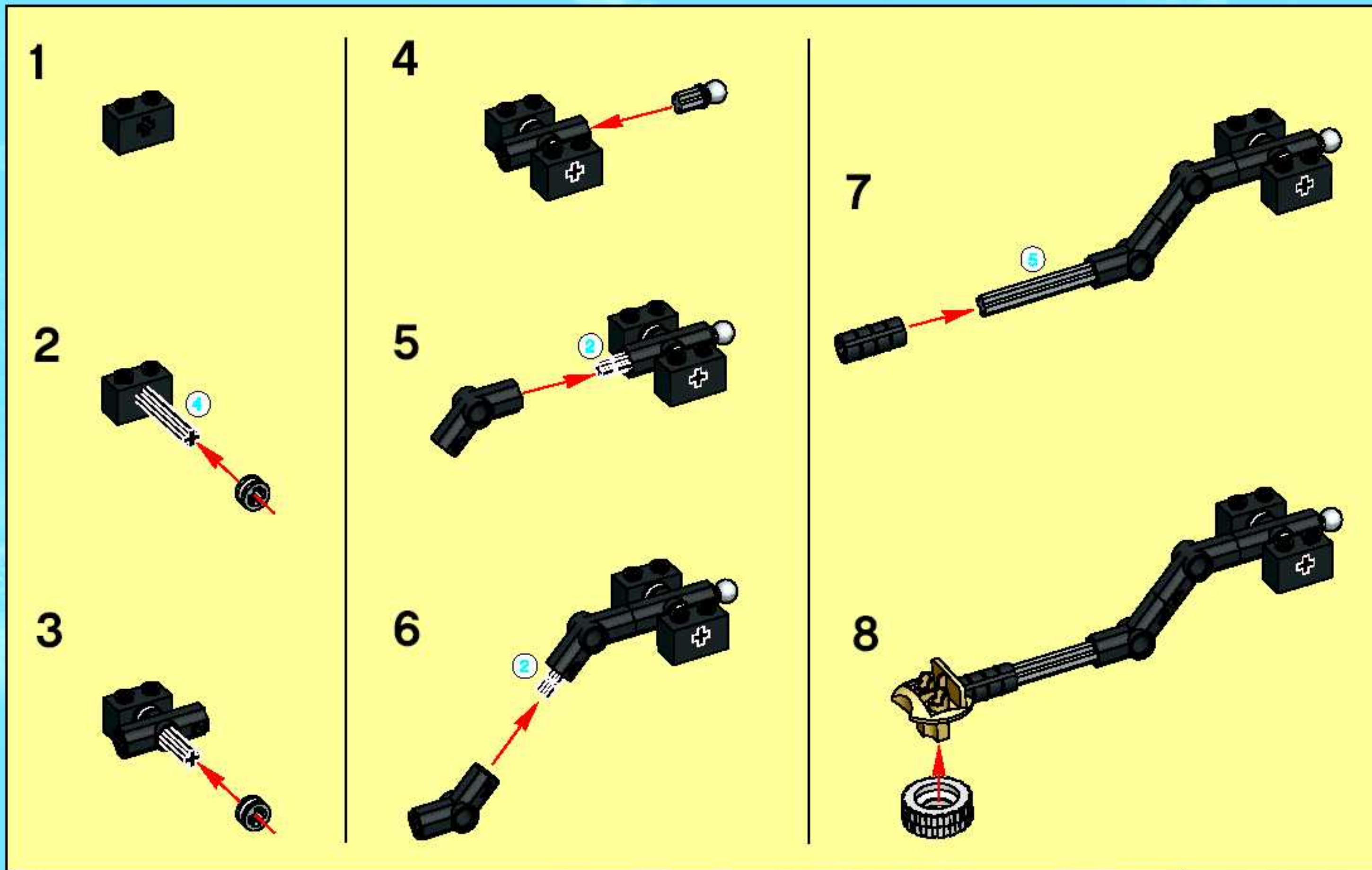

8

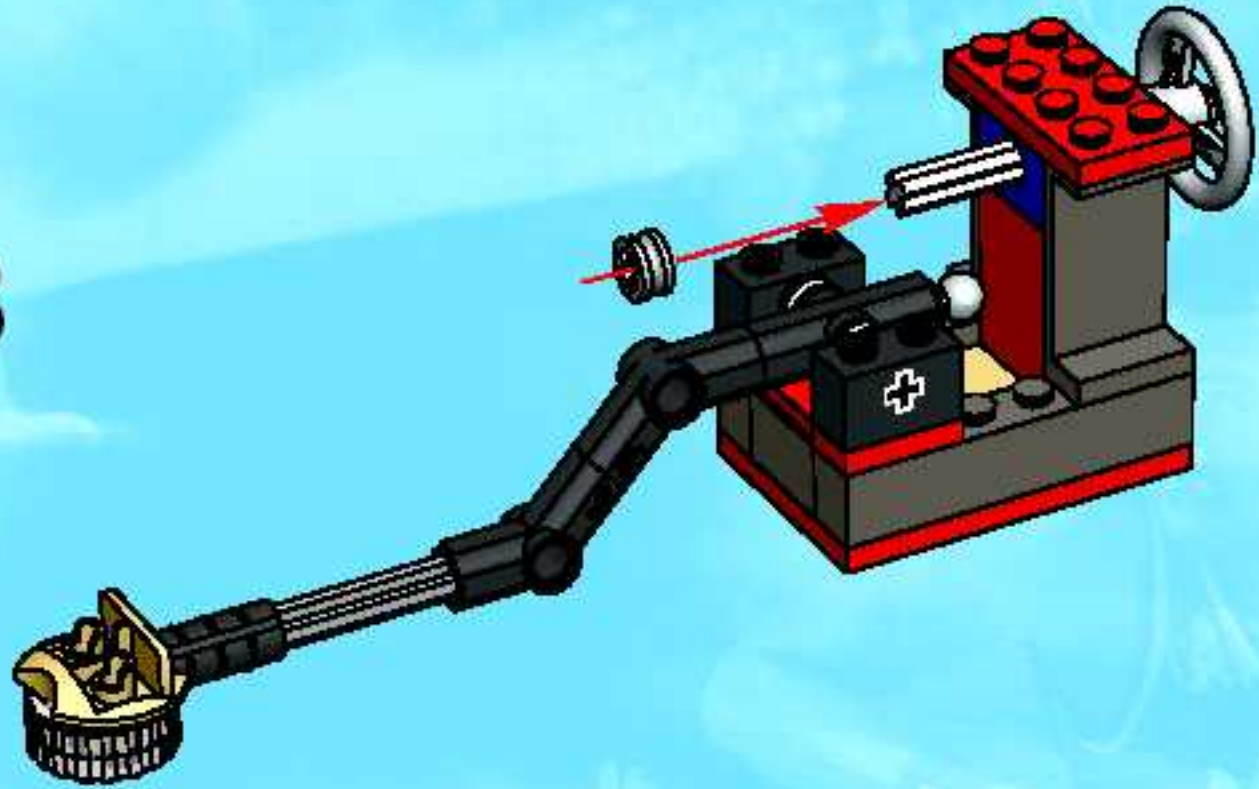
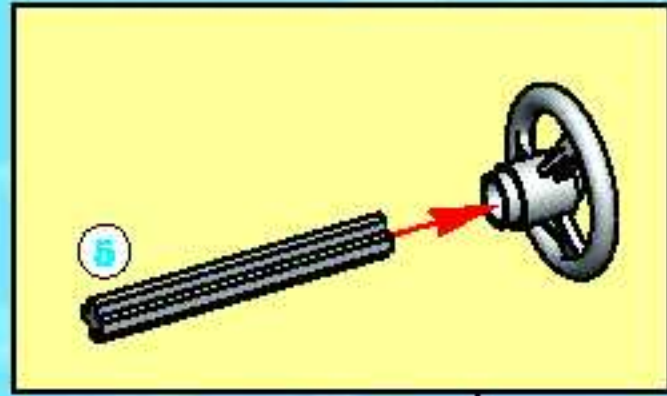

9

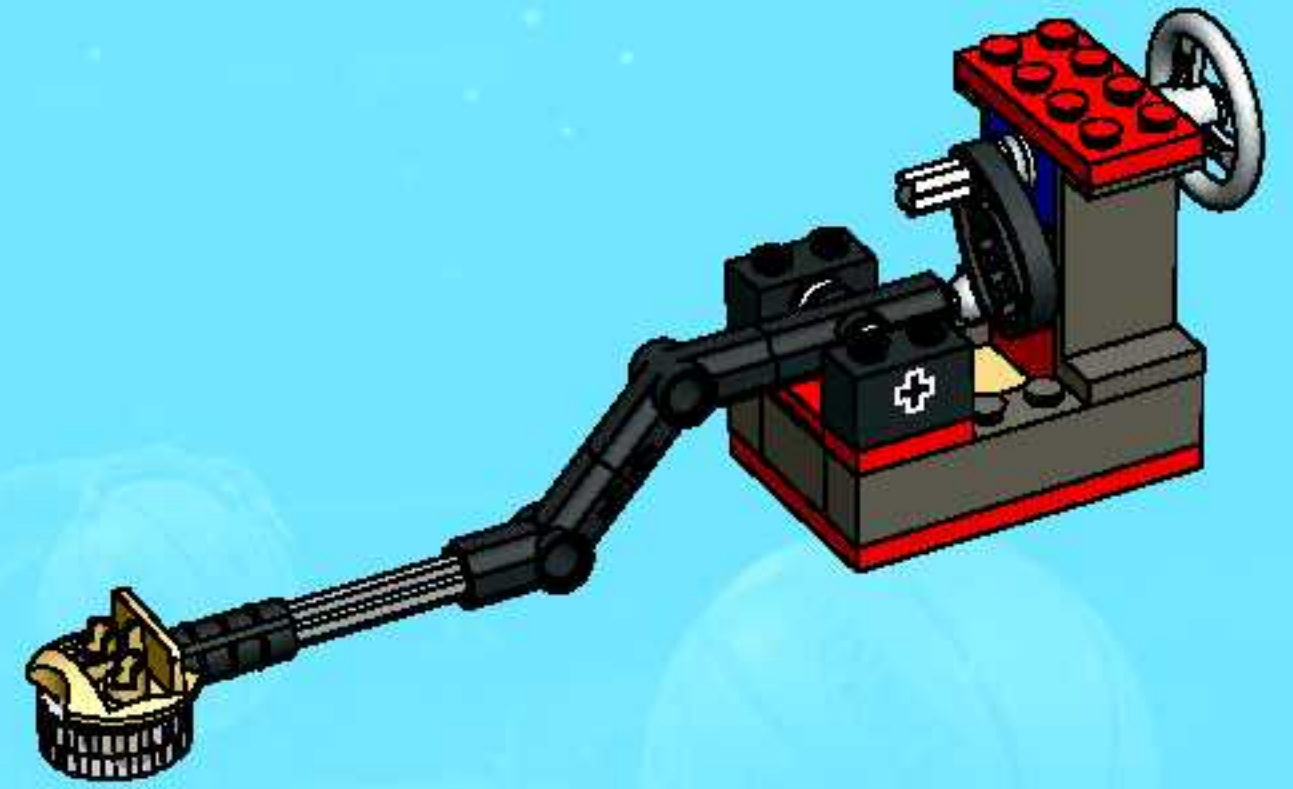

10

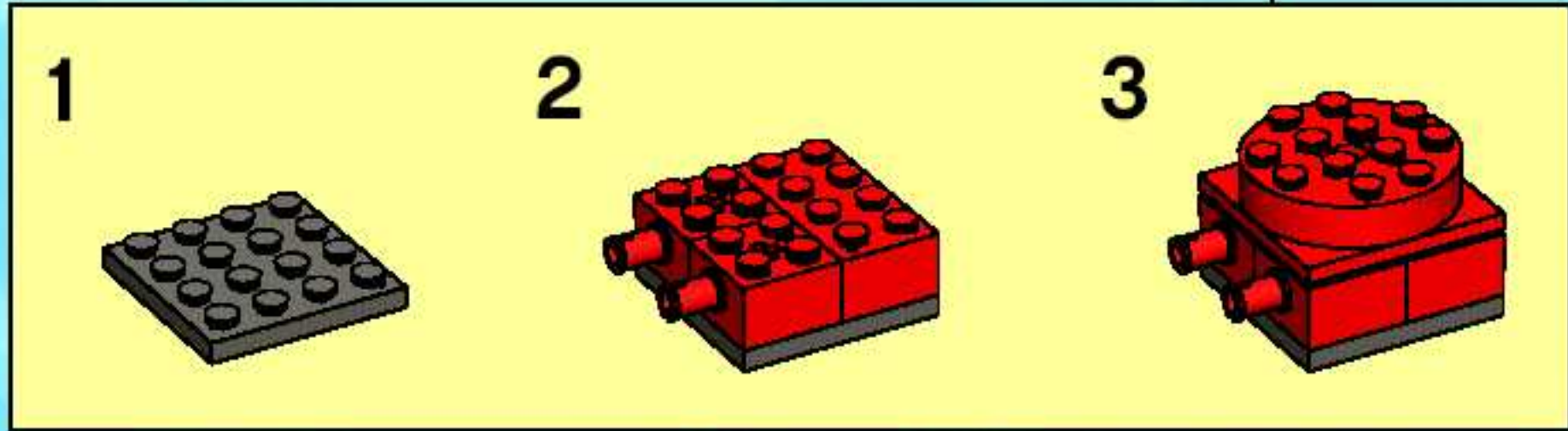
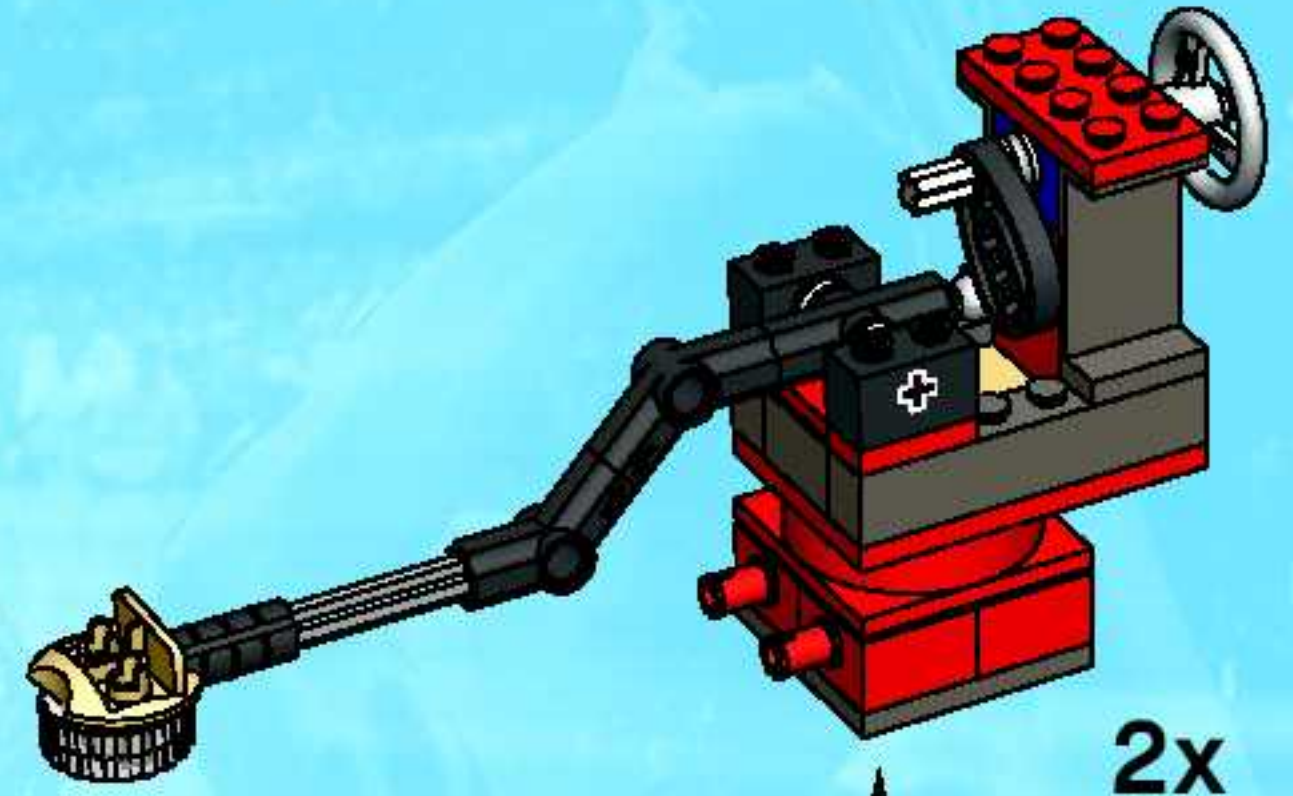

7

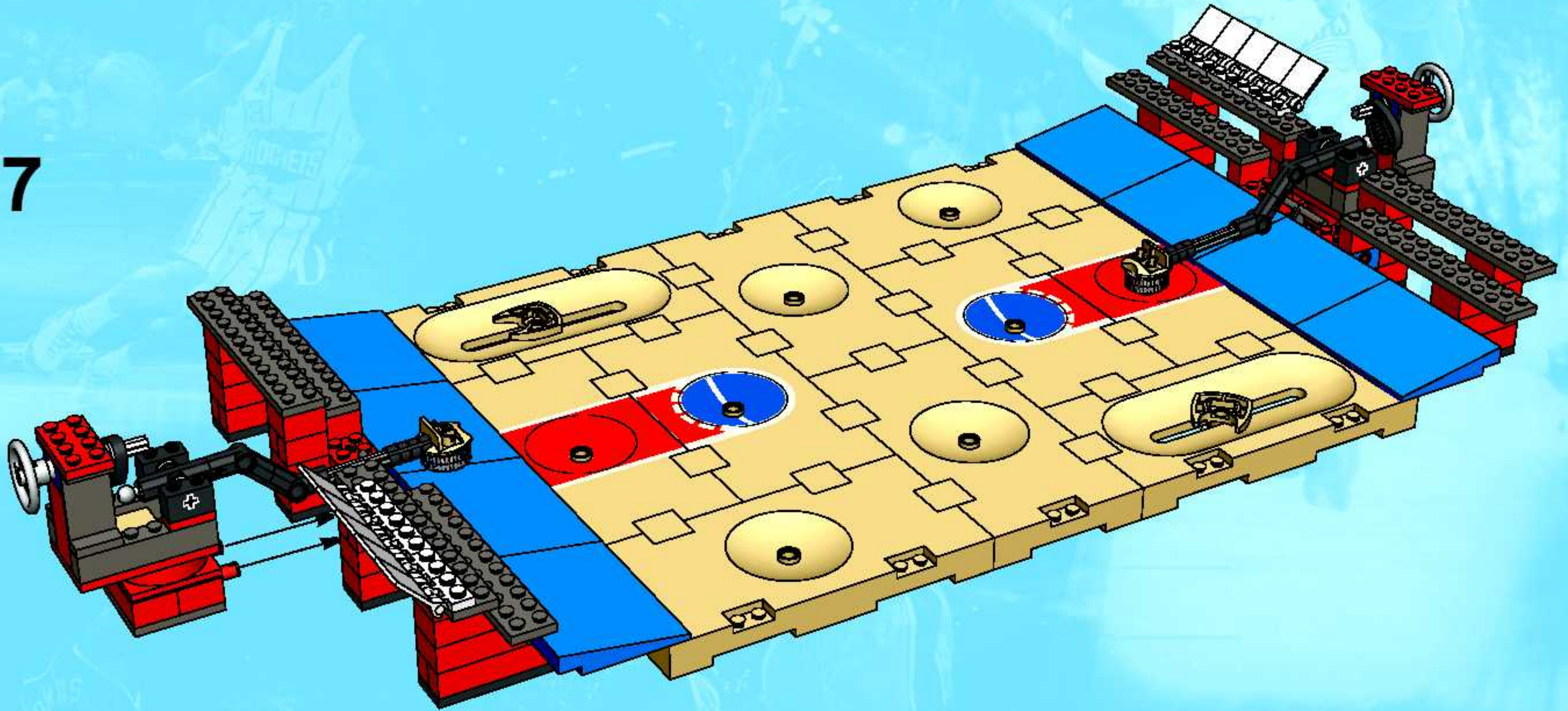

8

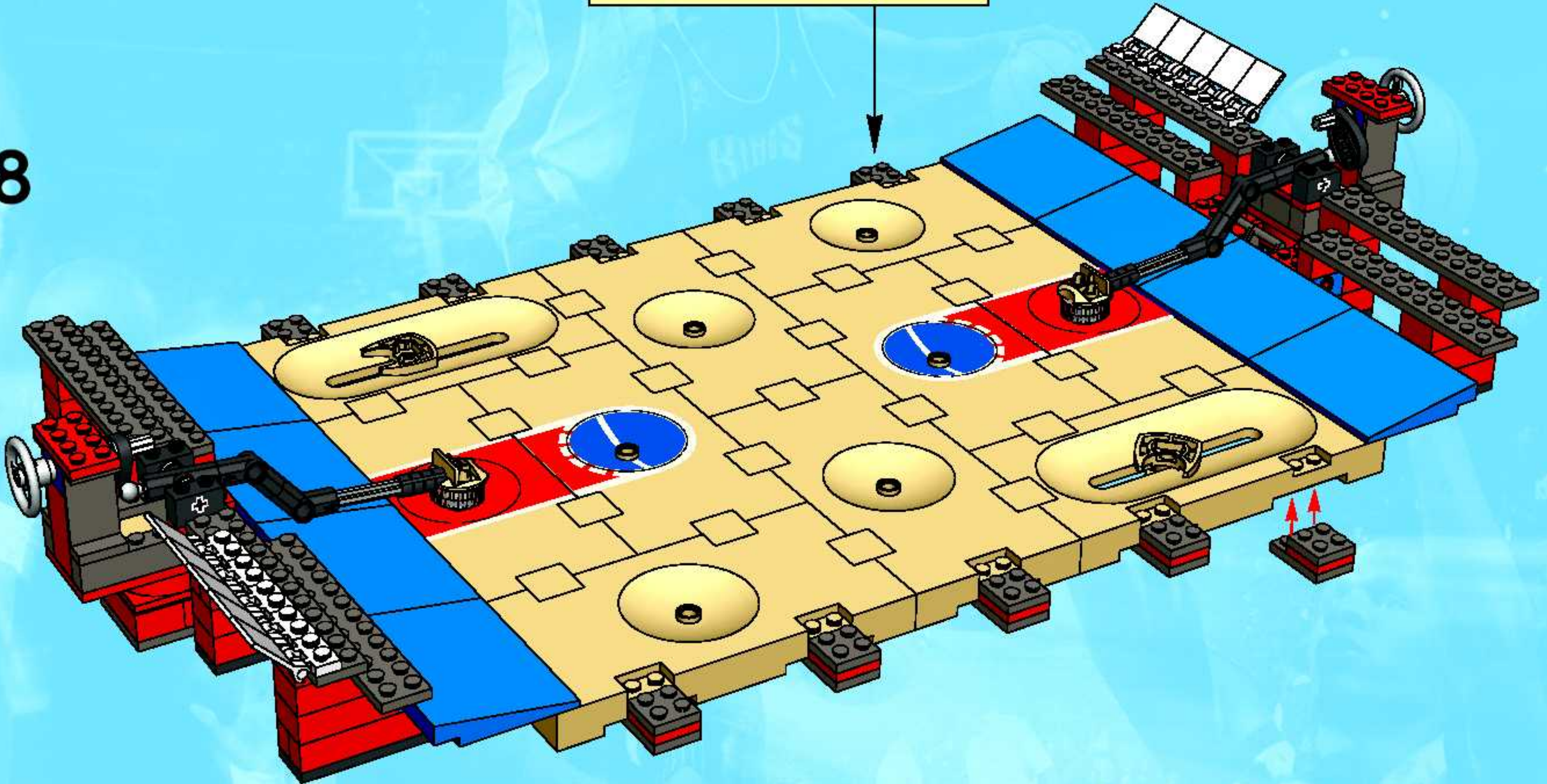
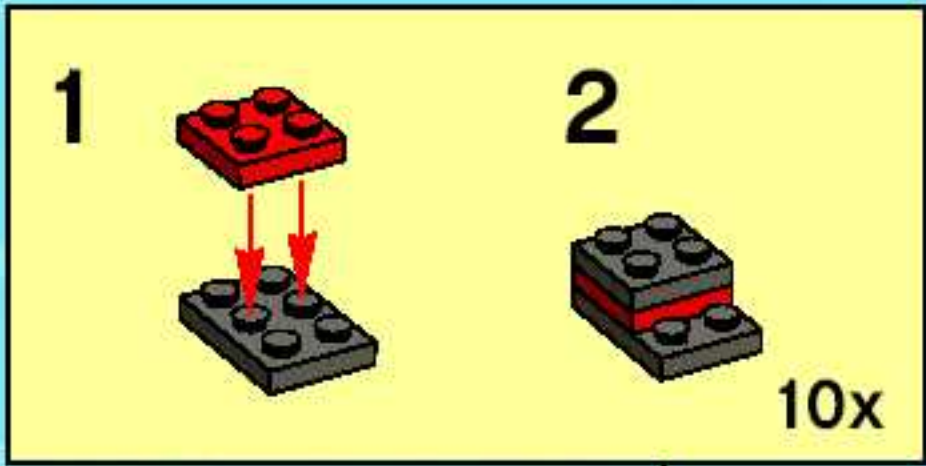

9

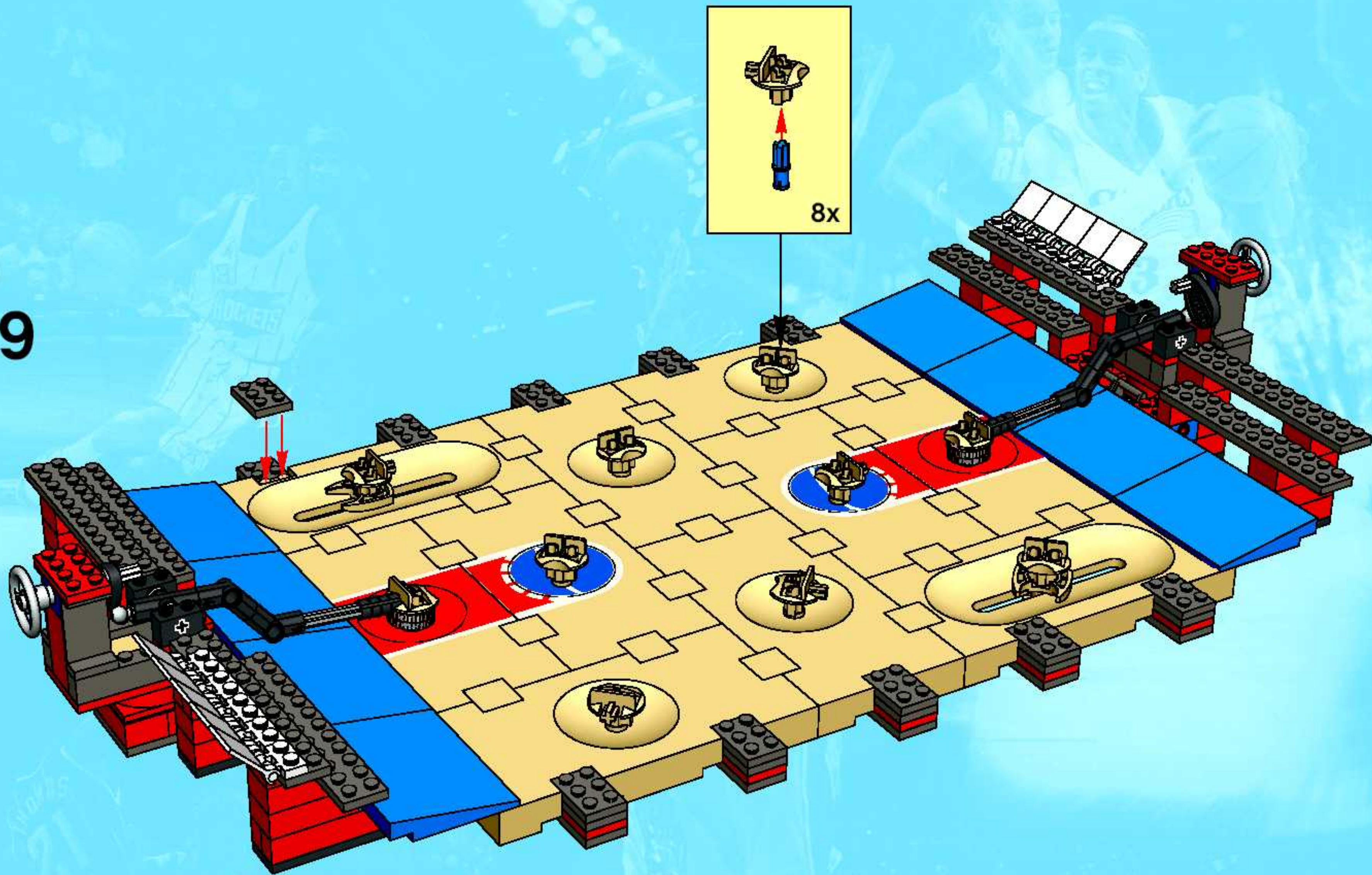

10

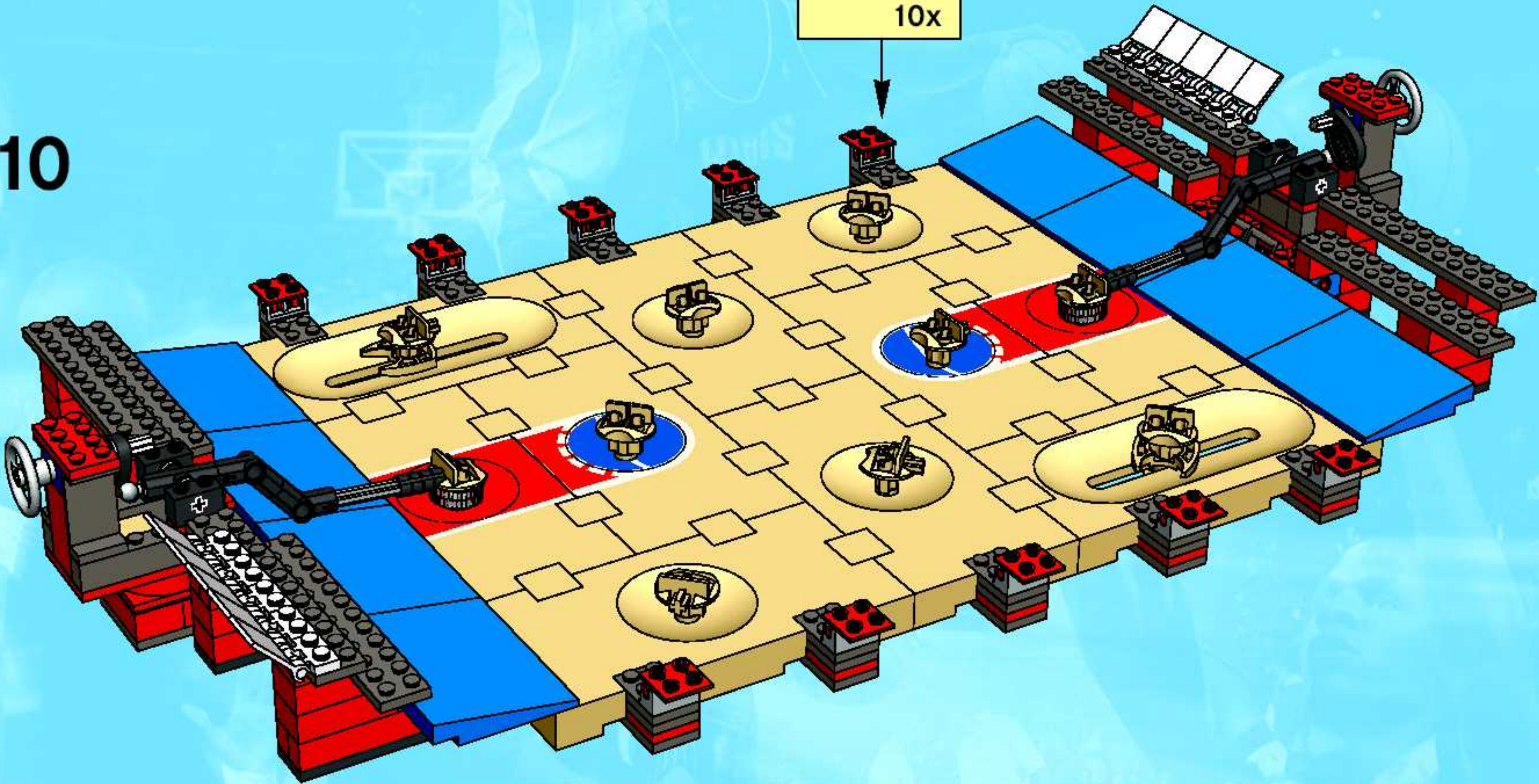
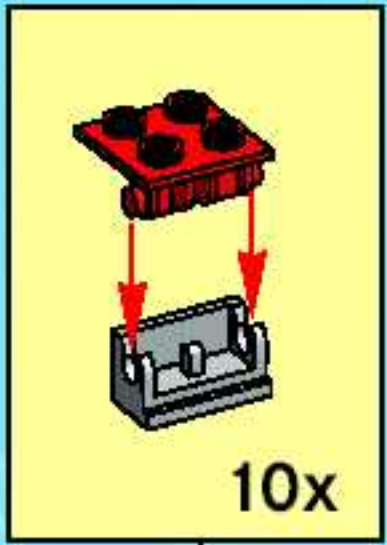

11

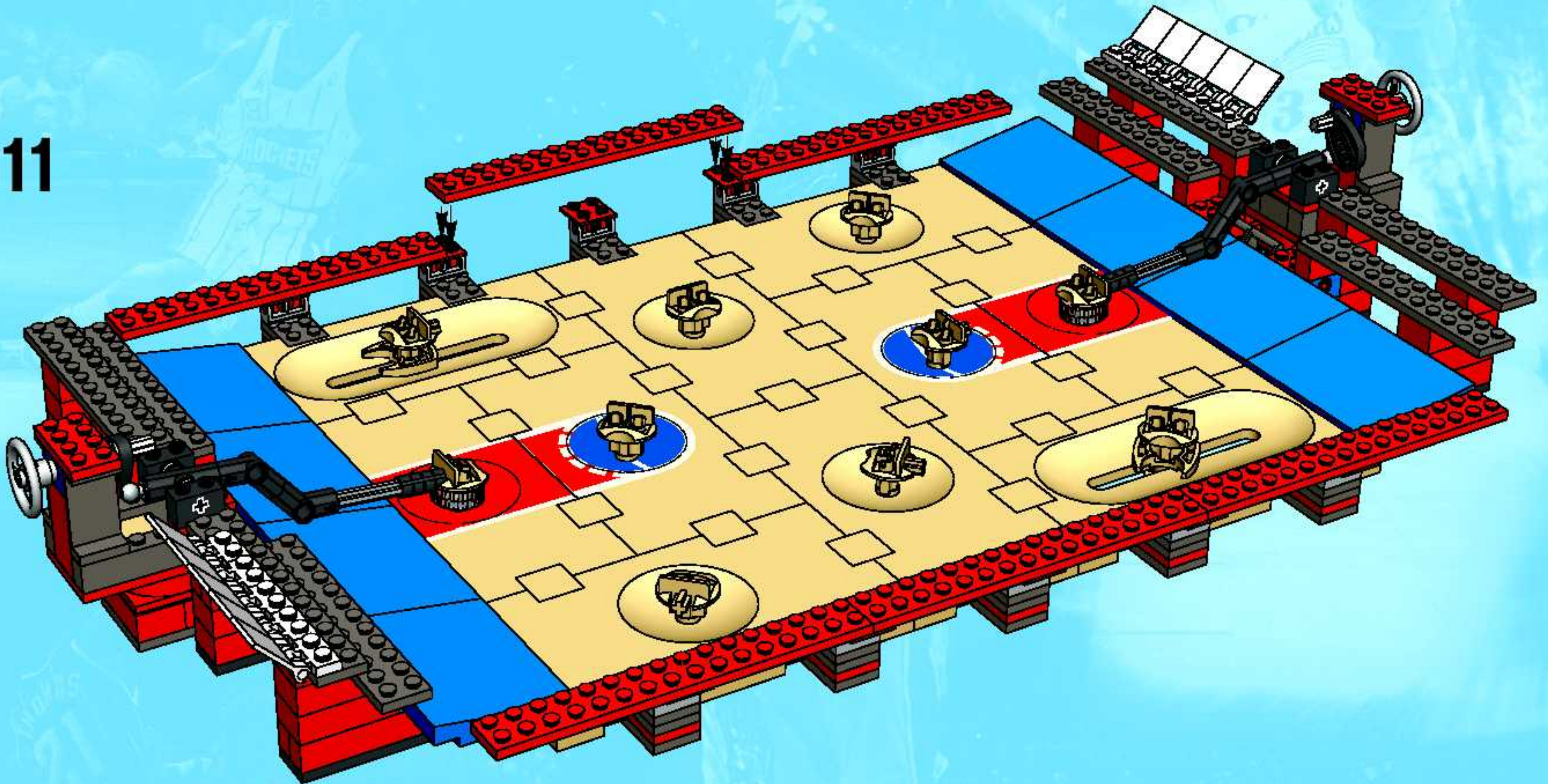

12

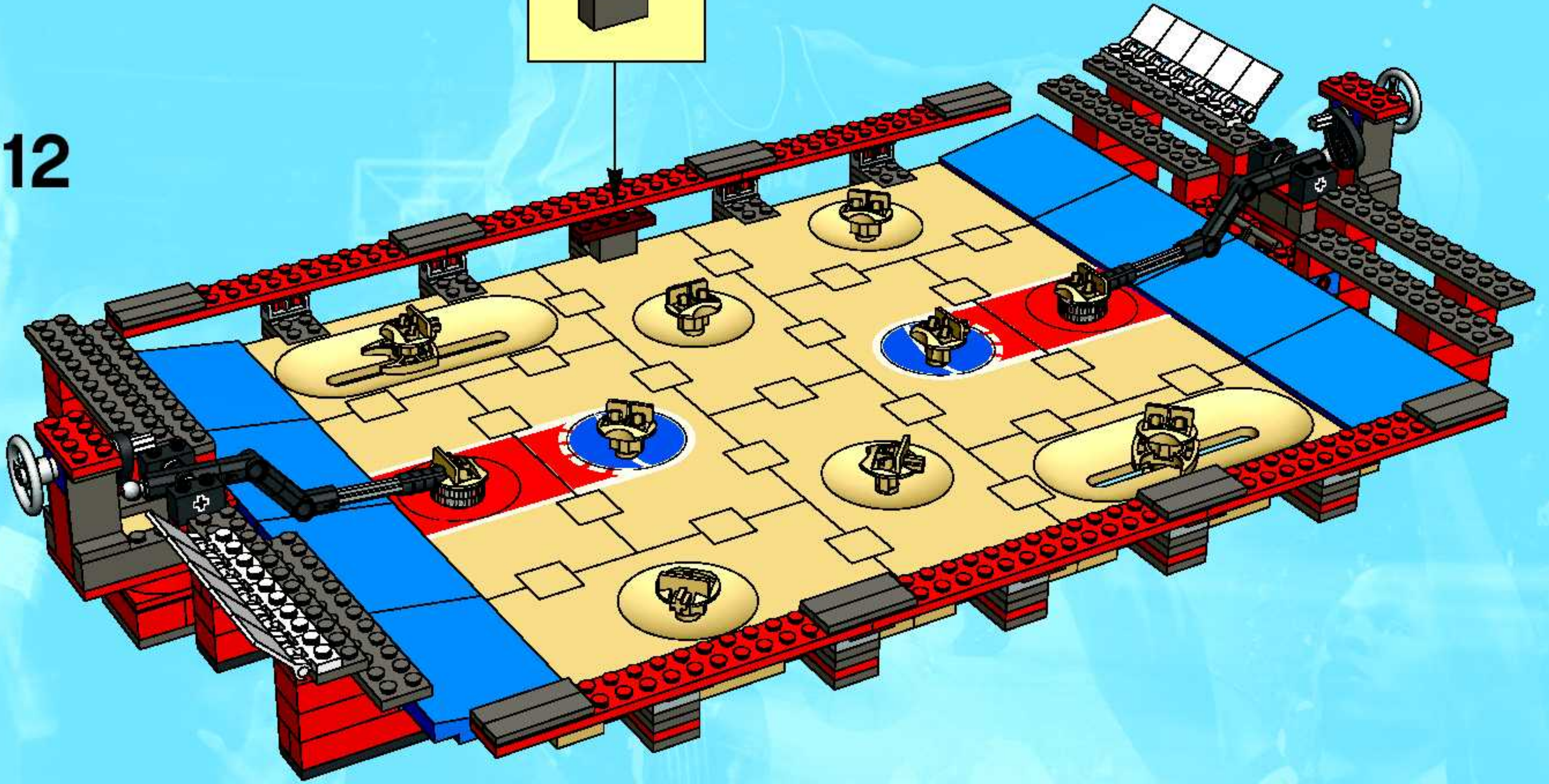
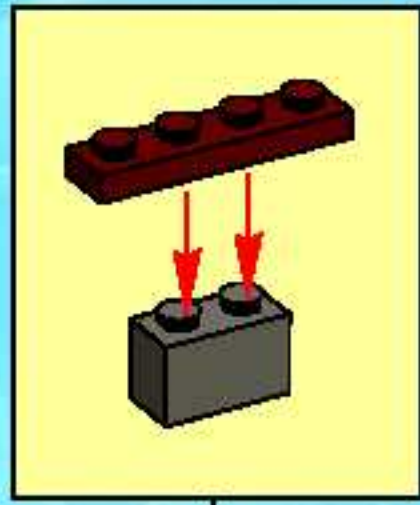



1



2

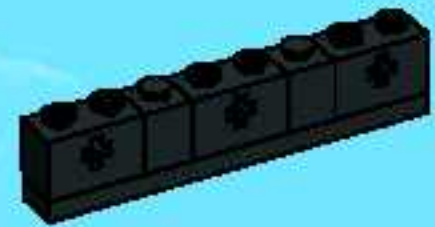

3

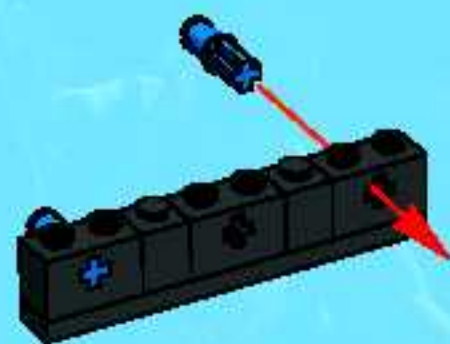

4

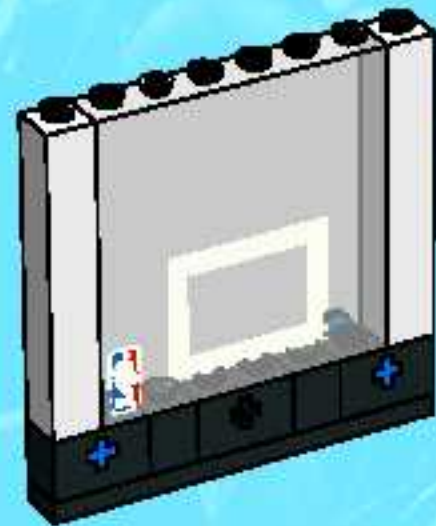

5

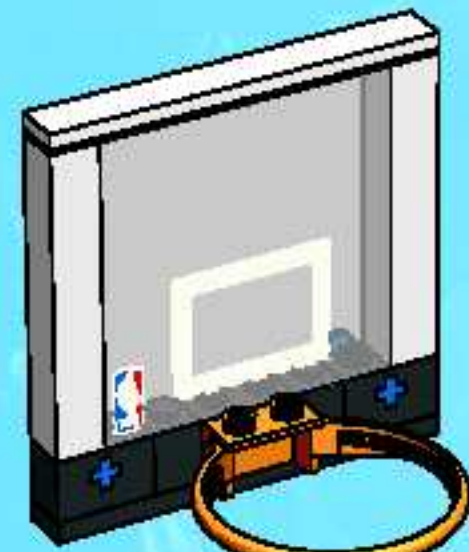

6

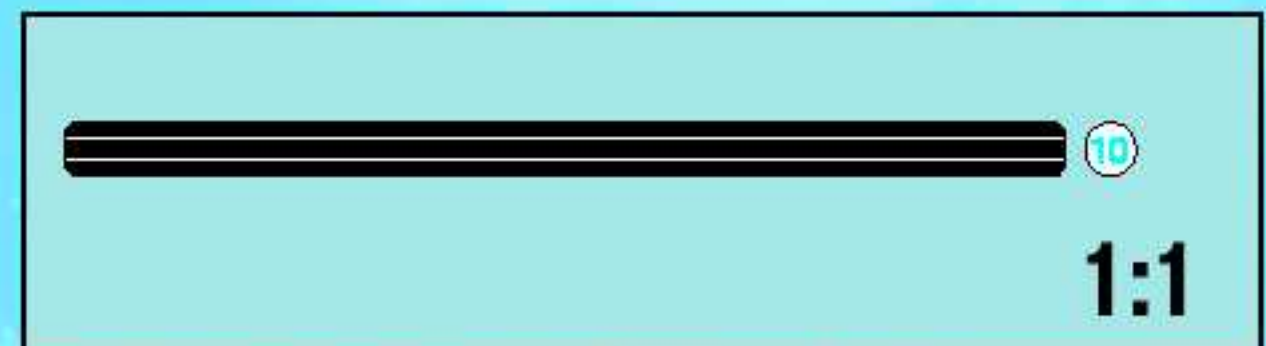
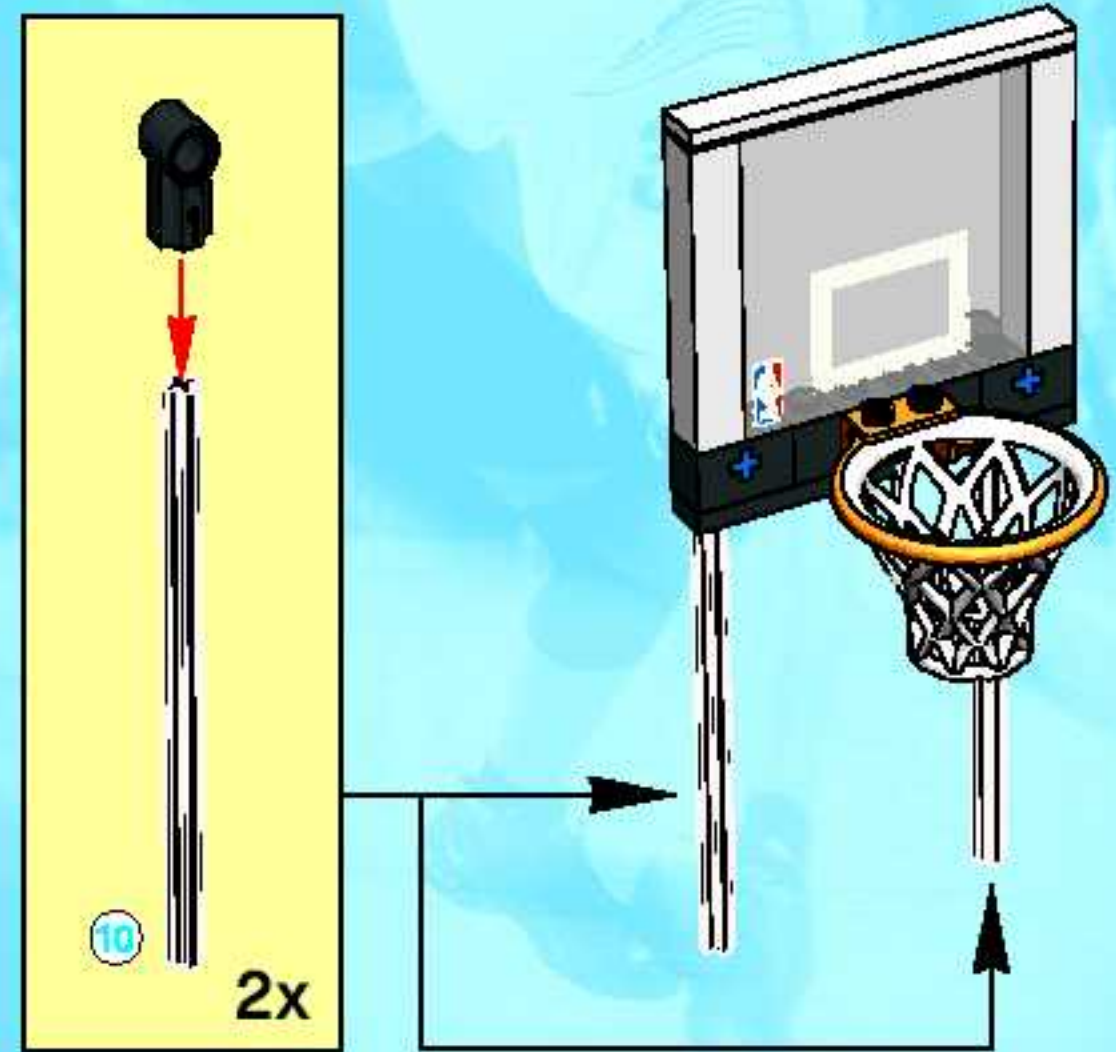

13

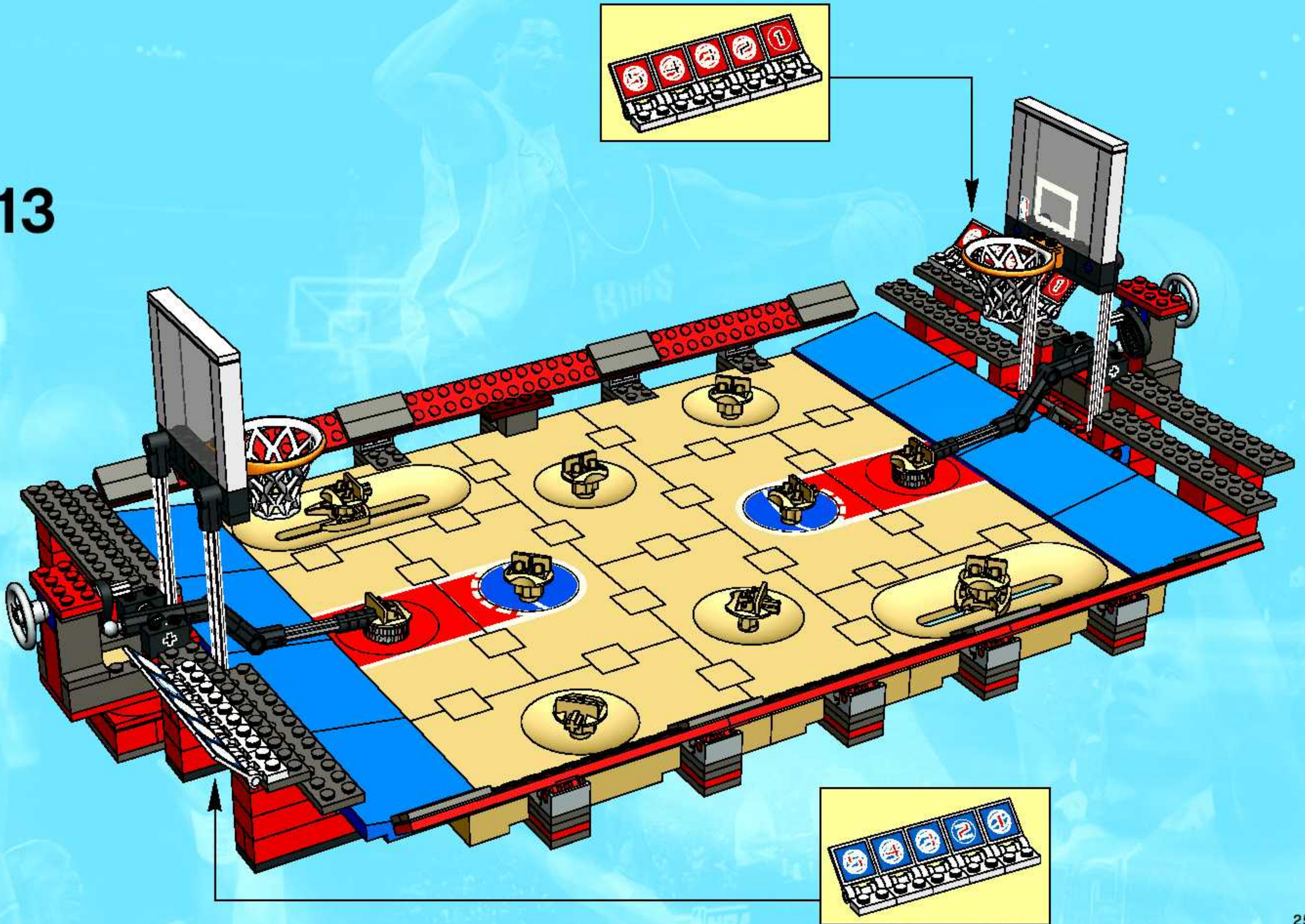





 www.LEGO.com/sports

 **NBA**
.COM

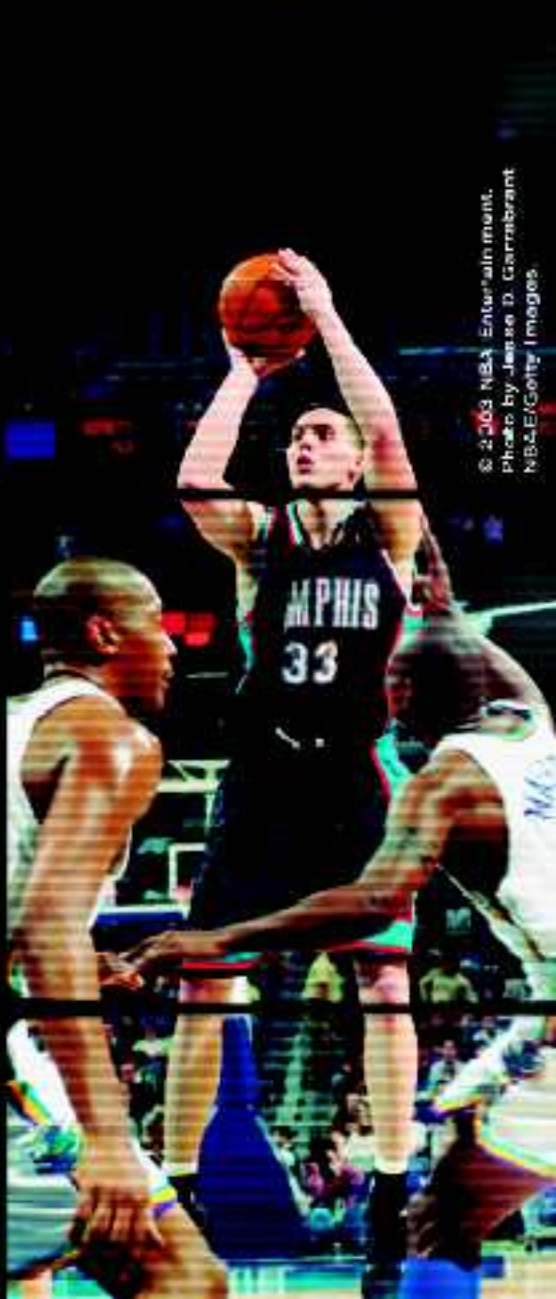

 **NBA**

© 2003 NBA Entertainment.
Photo by Rocky Winstrom/NBAE/Getty Images.

© 2003 NBA Entertainment.
Photo by Jesse D. Garrabrant
NBAE/Getty Images.

© 2003 NBA Entertainment.
Photo by Jesse D. Garrabrant
NBAE/Getty Images.

© 2003 NBA Entertainment.
Photo by Doug Phillips/NBAE/Getty Images.

© 2003 NBA Entertainment.
Photo by Rocky Winstrom/NBAE/Getty Images.

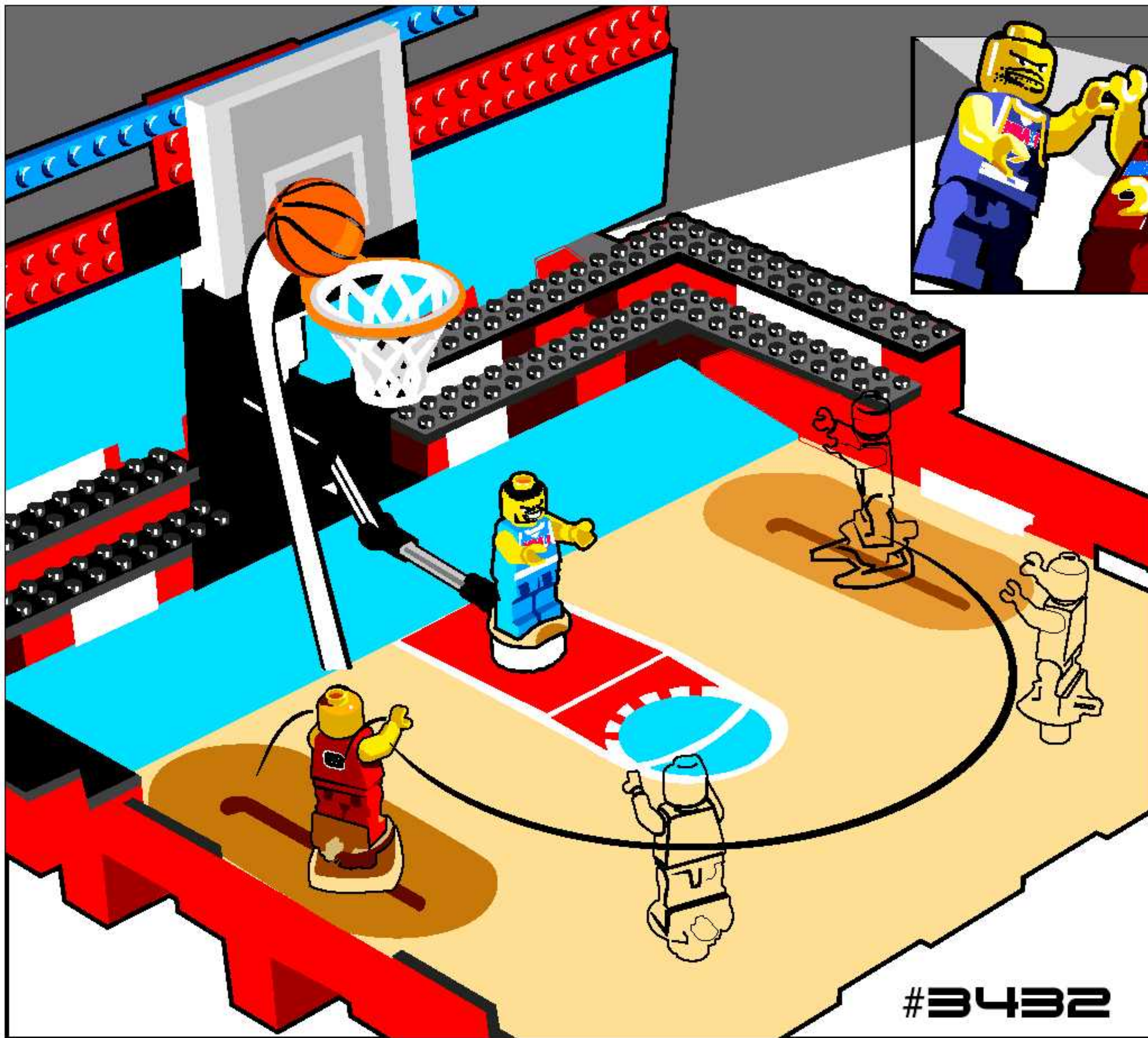

#3428



#3427 + #3428



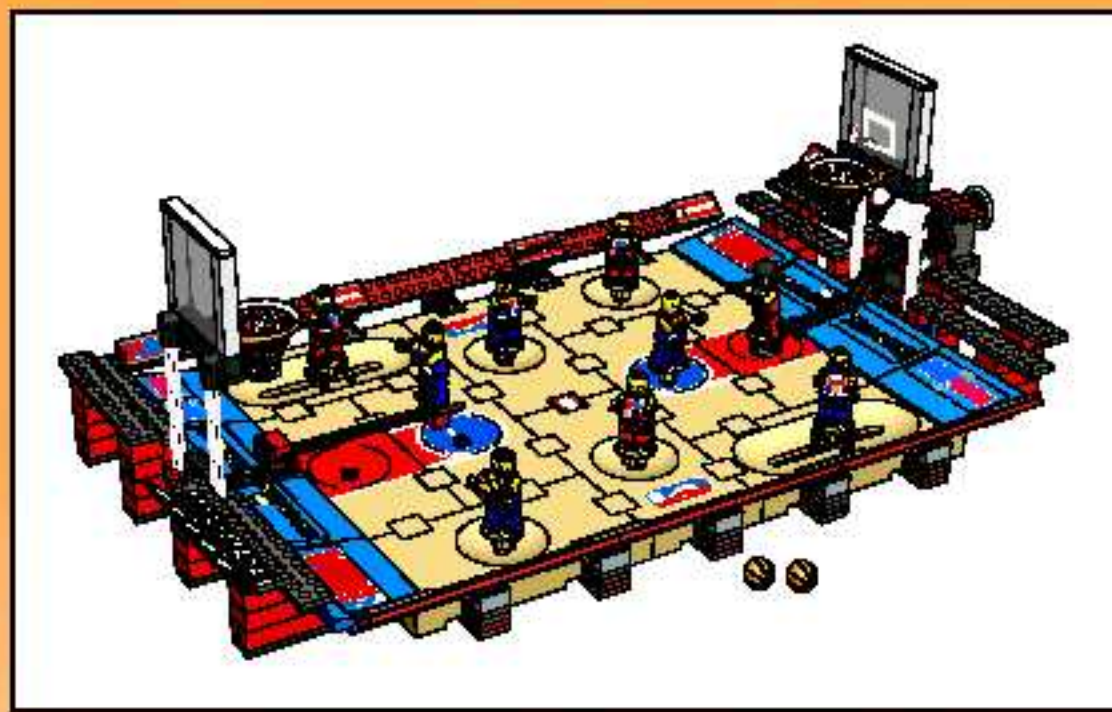

3427 + 3432

1

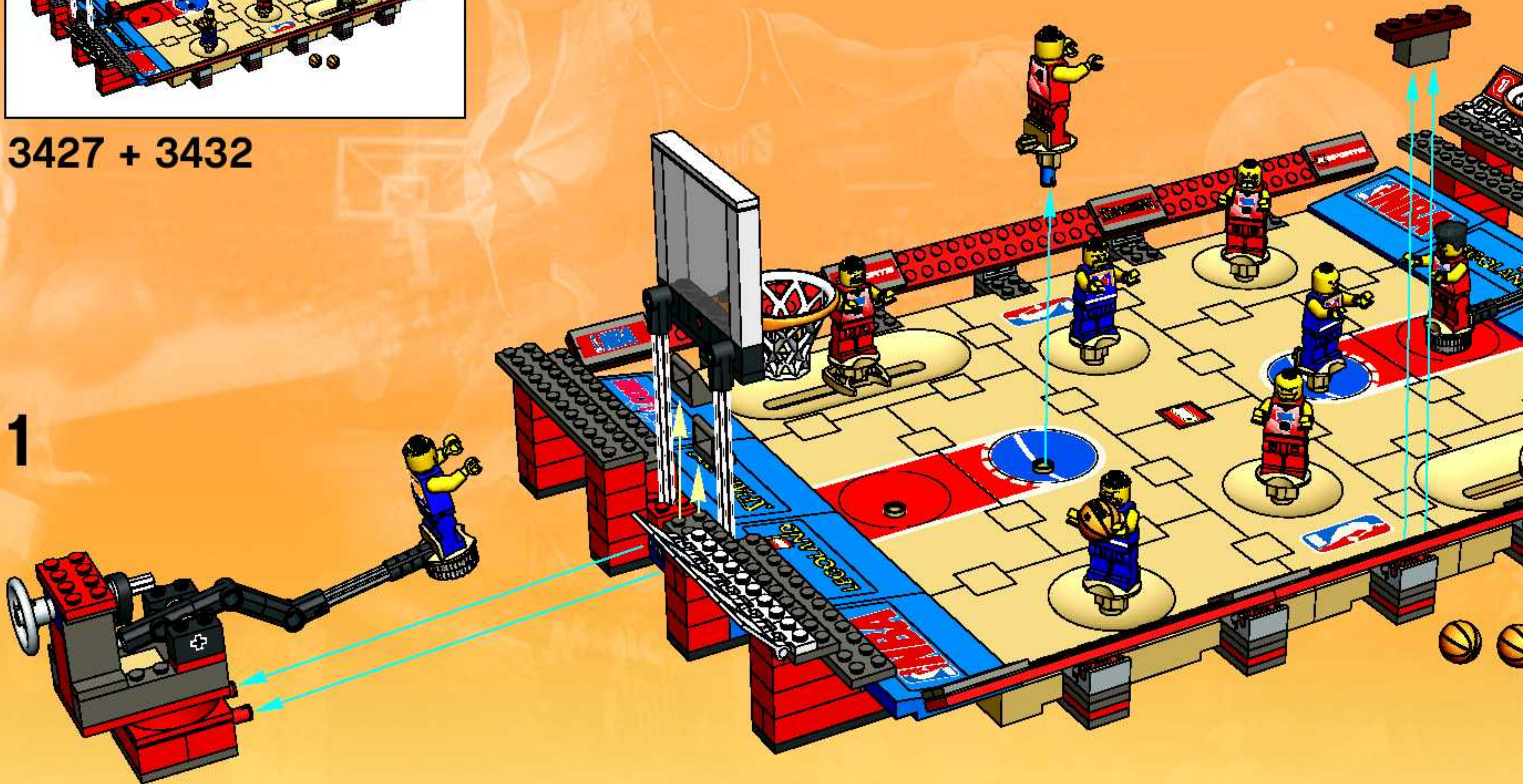

2

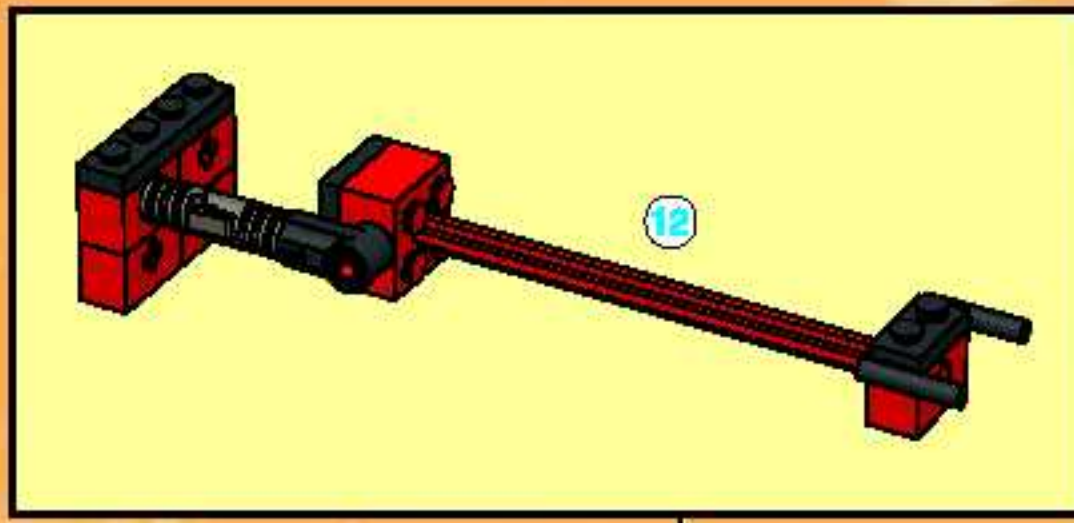

3429 + 3432

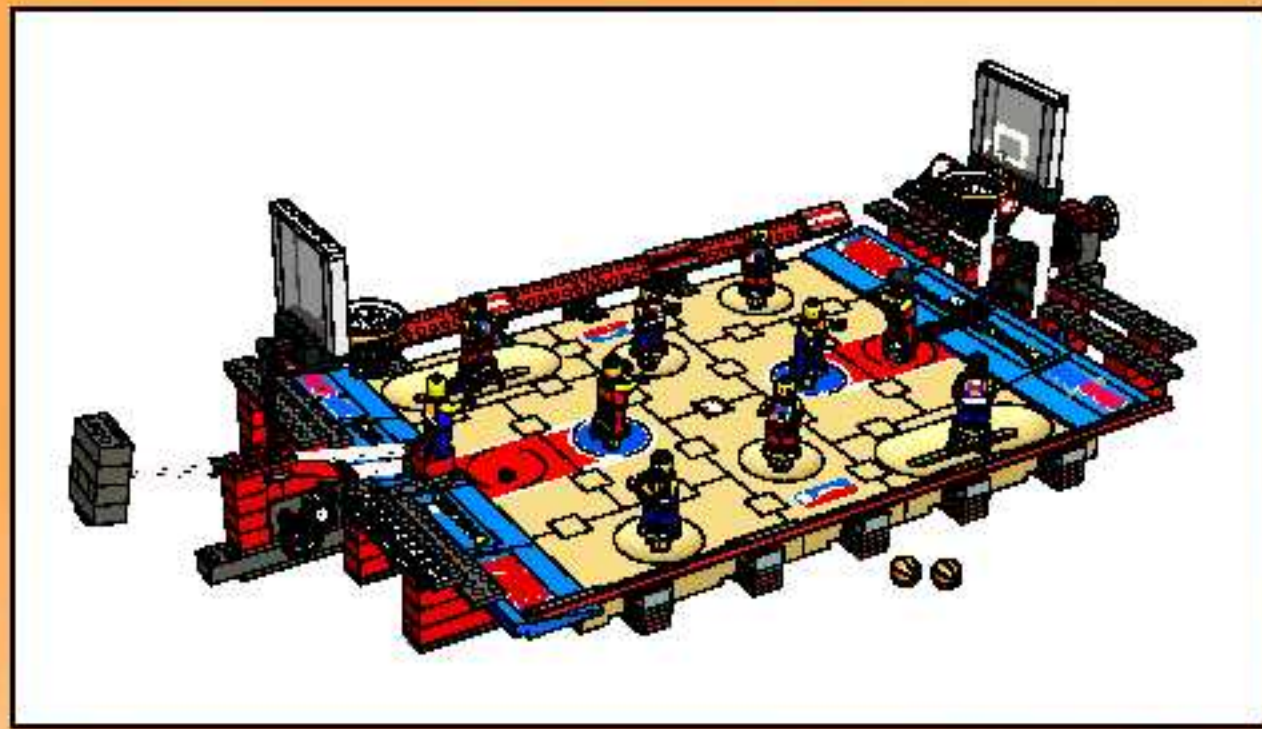

1

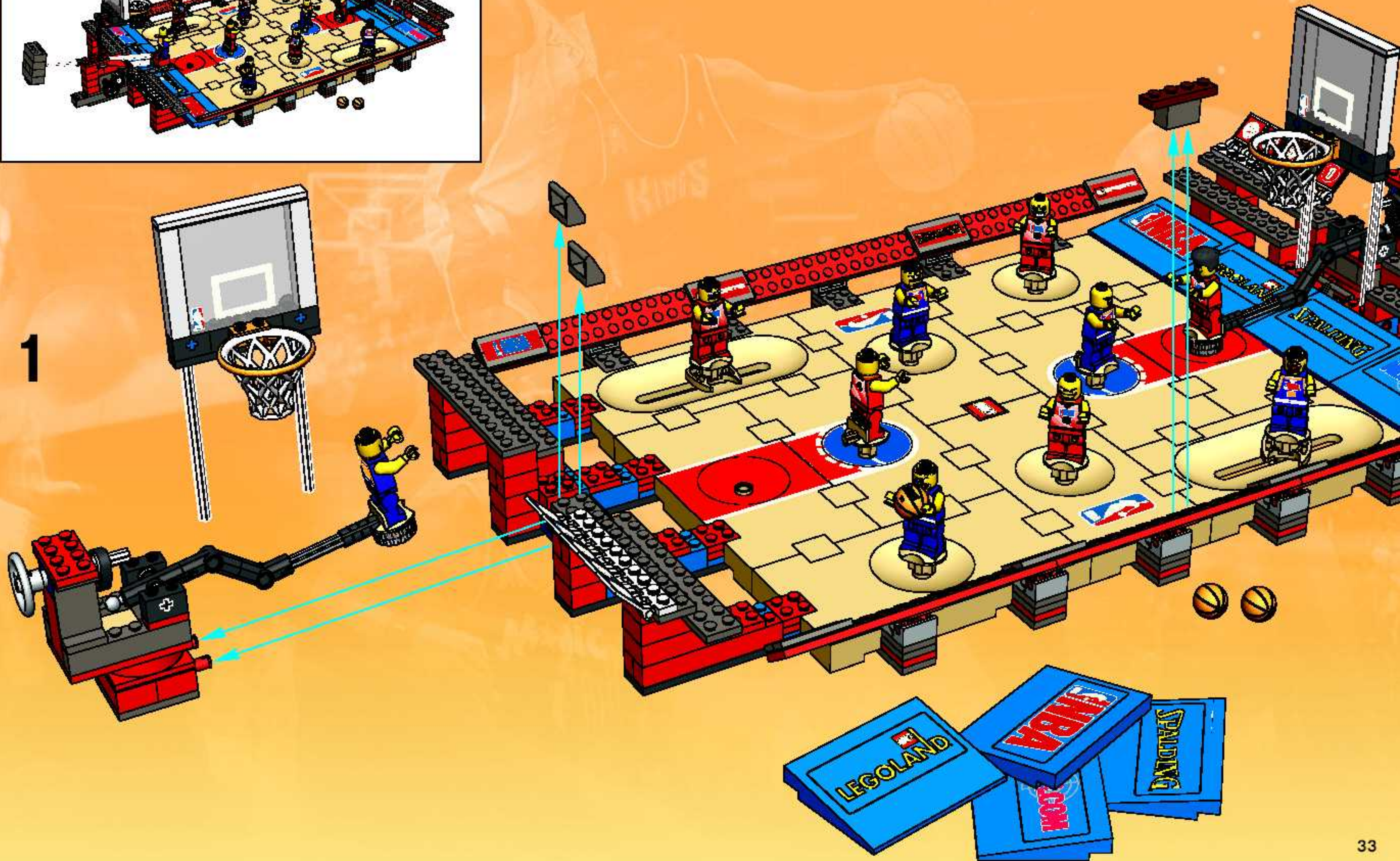

1

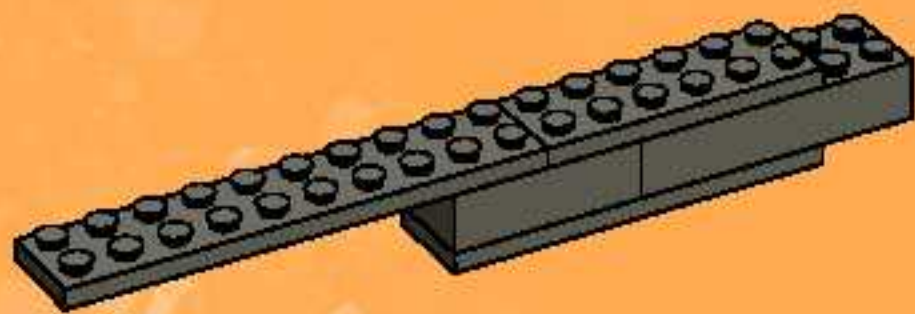

2

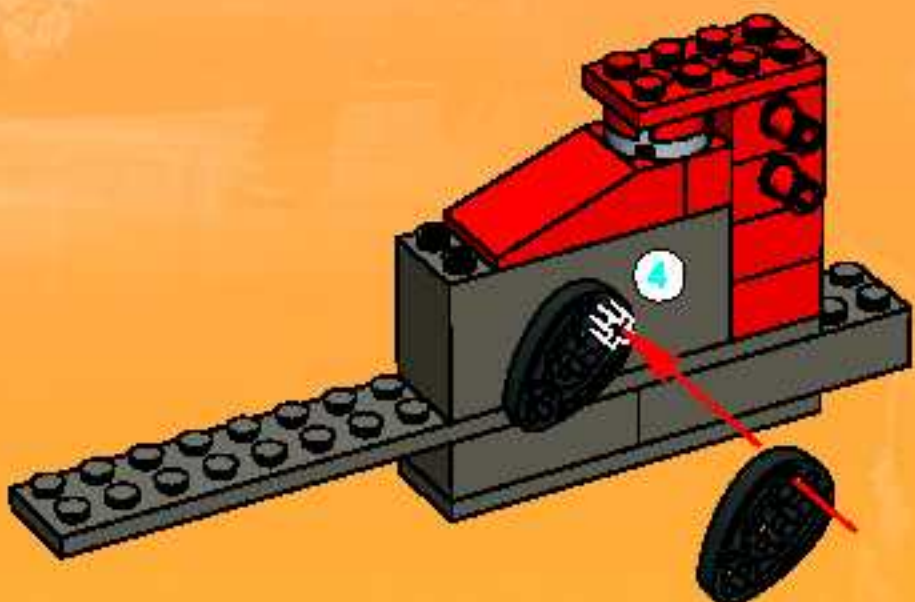

3

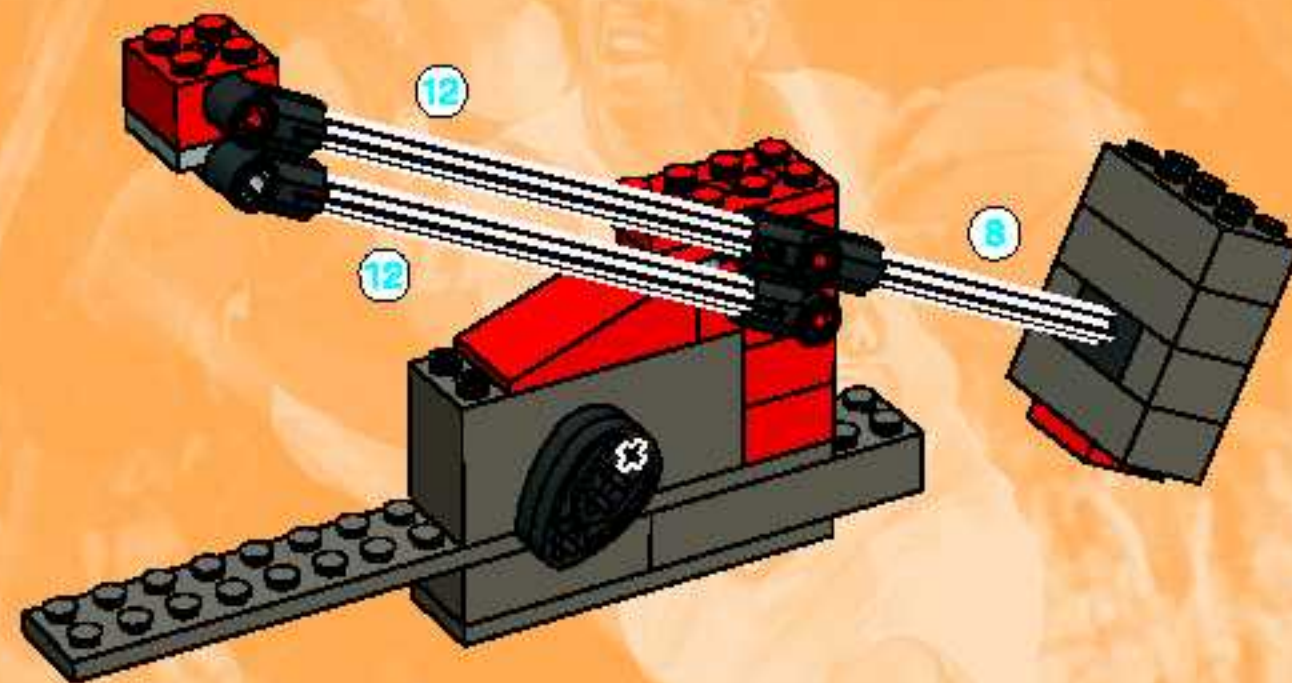

4

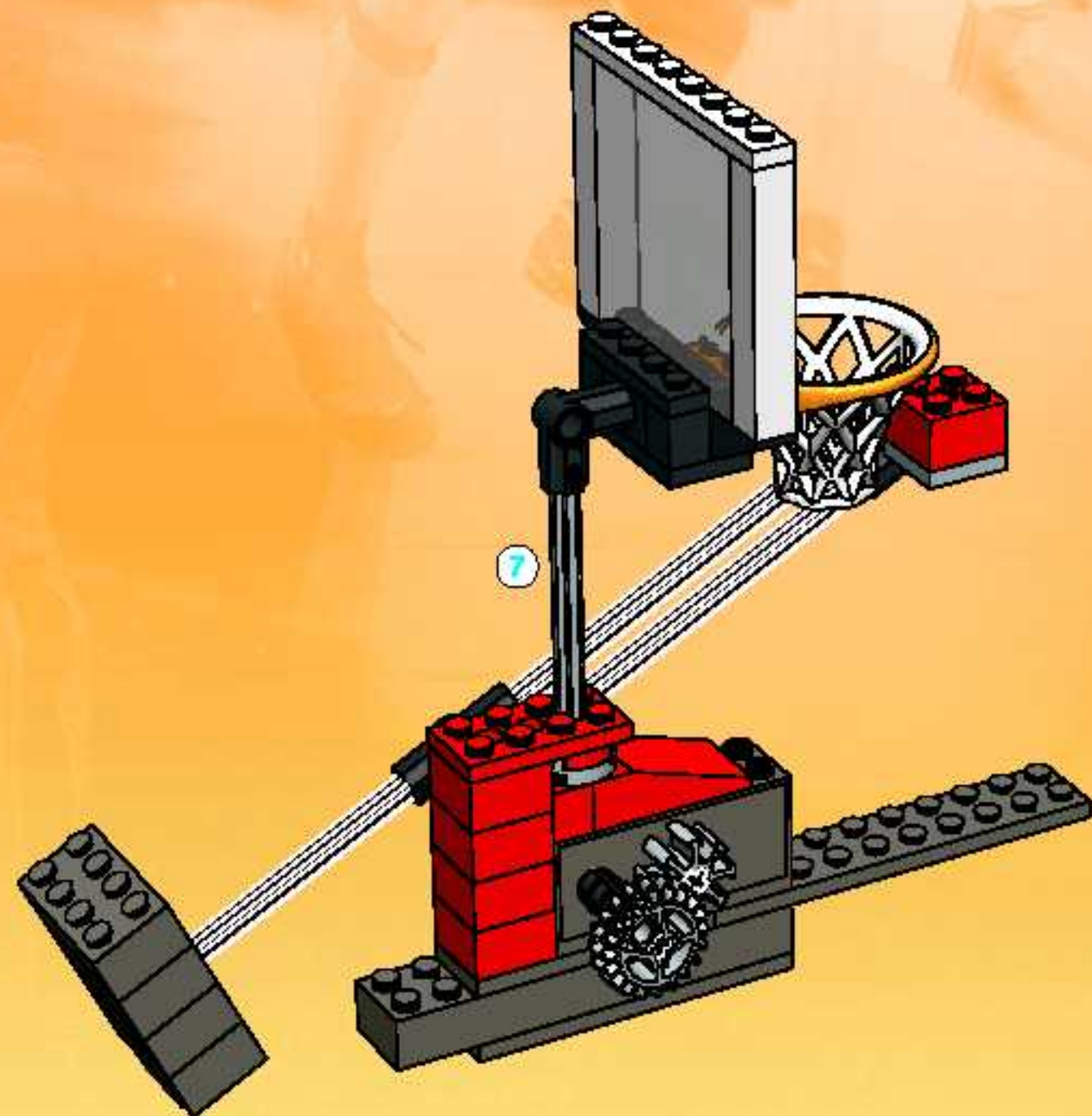

	4
	7
	8
	12

1:1

2



LEGO SPORTS



NBA identifications depicted are the exclusive property of NBA Properties, Inc. and/or the NBA Member Teams, and are used with permission.

SPALDING is a trademark of Spalding Sports Worldwide, Inc. or Lisco Sports, Inc., a Spalding affiliate.
© Spalding Sports Worldwide, Inc. 2003.

 www.LEGO.com/sports

LEGO, the LEGO logo and the Minifigure are trademarks of the LEGO Group. ©2003 The LEGO Group.

adidas, the adidas logo and the three stripe trademark are registered trademarks of the adidas-Salomon group, used with permission. Fevenova and the Trigon logo are trademarks of the adidas-Salomon group, used with permission.



NHL and the NHL Shield are registered trademarks of the National Hockey League. All NHL logos and marks and team logos and marks depicted herein are the property of the NHL and the respective teams and may not be reproduced without the prior written consent of NHL Enterprises, L.P. © NHL 2003. All Rights Reserved.