

nickelodeon

SpongeBob SQUAREPANTS

LEGO

3818



WARNING: CHOKING HAZARD.
Toy contains small parts and a small ball.
Not for children under 3 years.

1

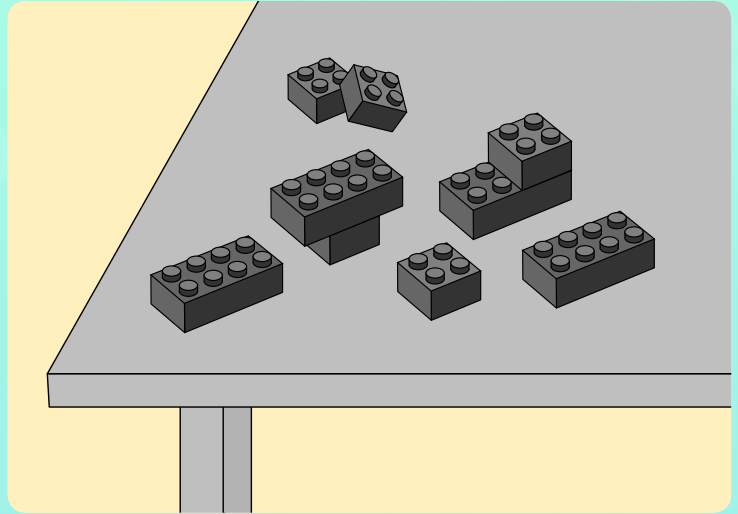
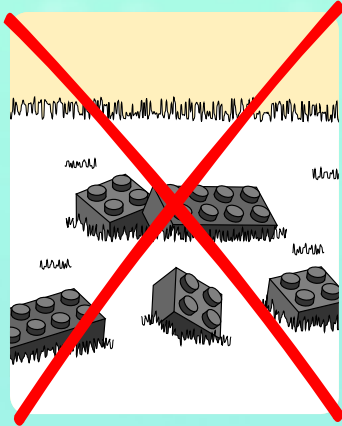

2

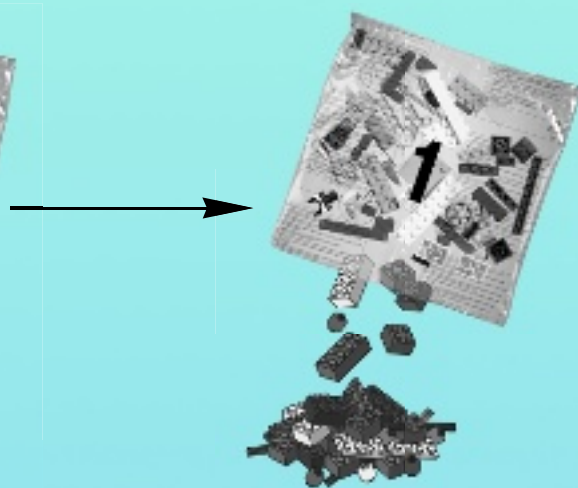



1



2



3



4

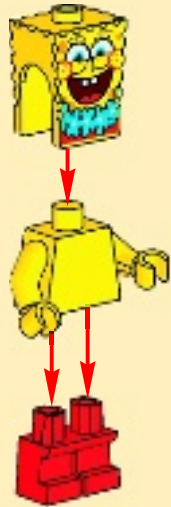
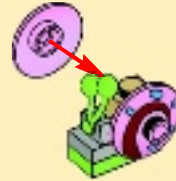

AVERTISSEMENT : RISQUE D'ÉTOUFFEMENT.
Le jouet contient des petites pièces ainsi qu'une petite boule.
Il ne convient pas aux enfants de moins de 3 ans.

ADVERTENCIA: PELIGRO DE ASFIXIA.
Juguete que contiene partes pequeñas y una pelota pequeña.
No recomendado para niños menores de 3 años.

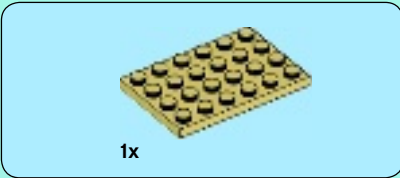

1

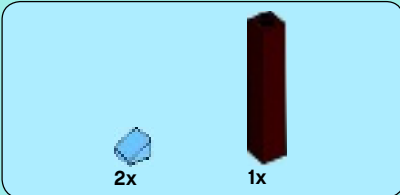
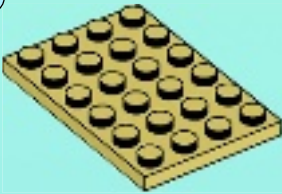

2

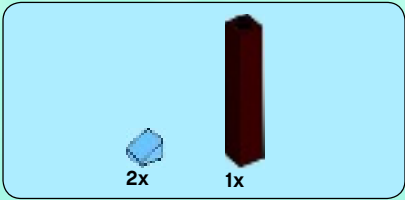
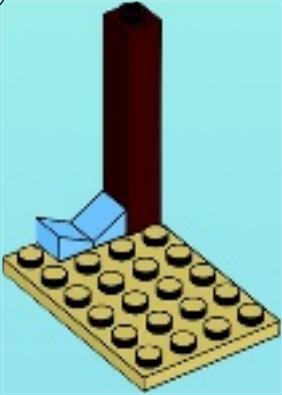

3





4

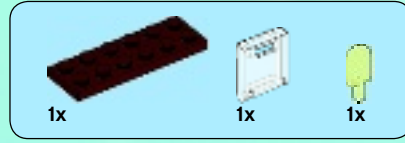
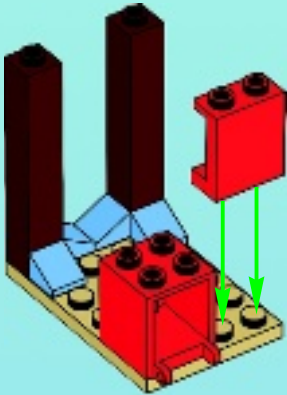

5

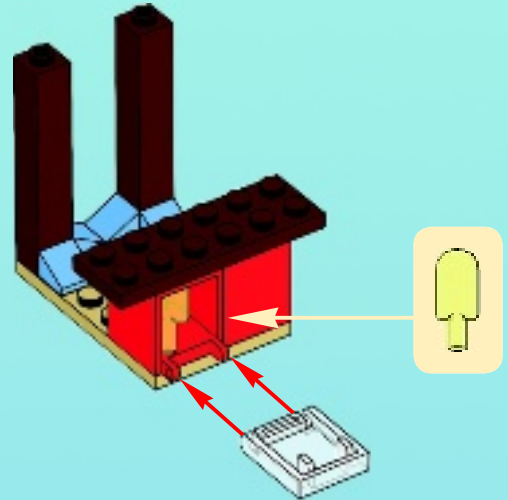



2x



1x

6



1x



1x

7

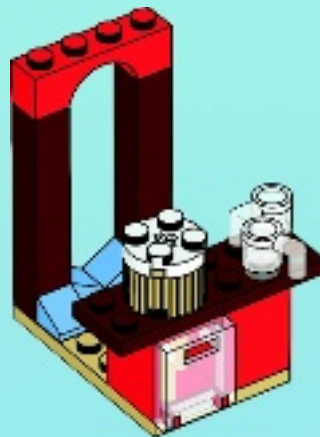



8

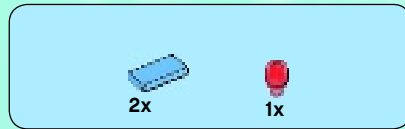

9



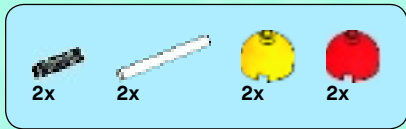

10



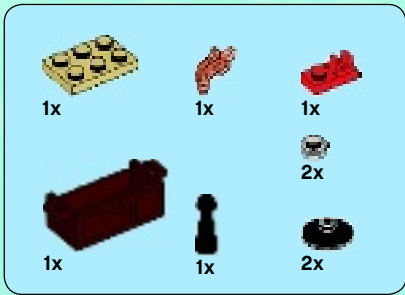

11

1



2



3

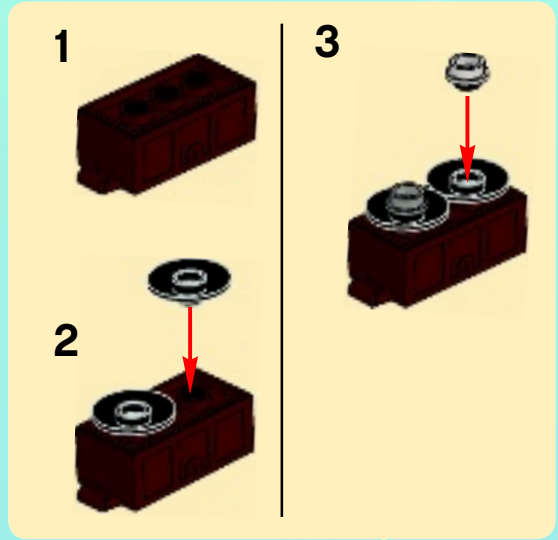

4





12

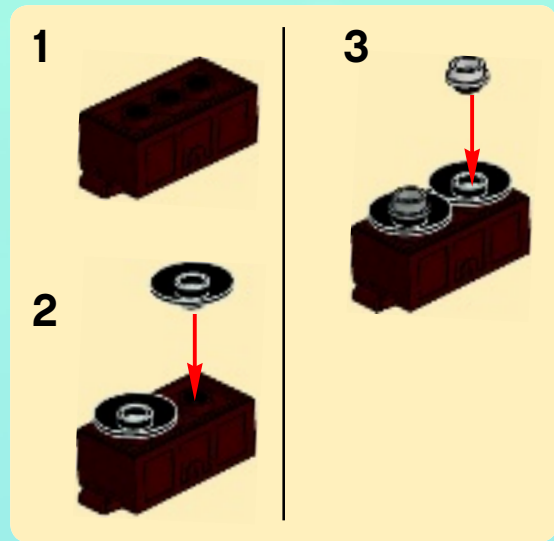

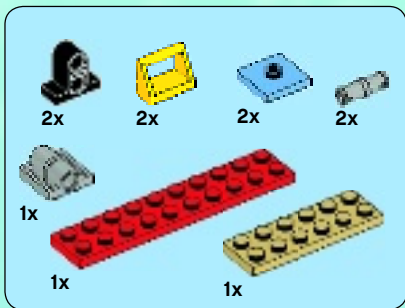

13

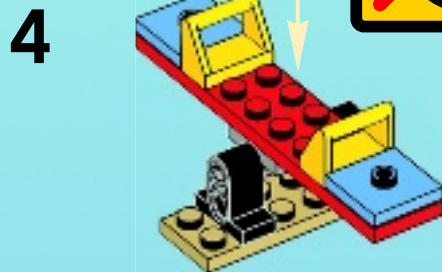
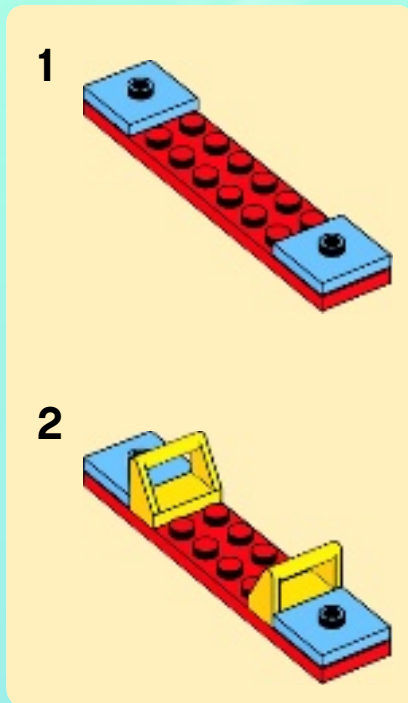
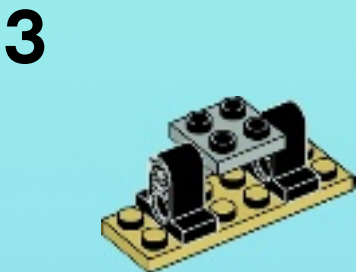
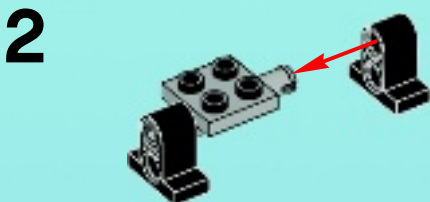
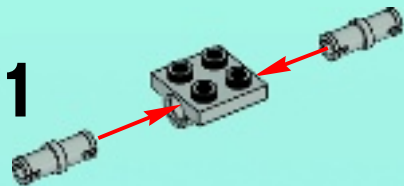



1

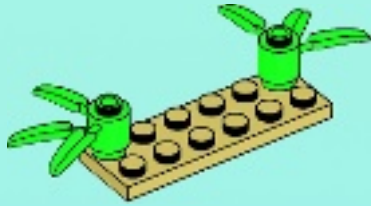

2

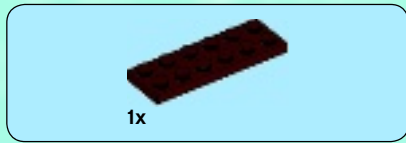
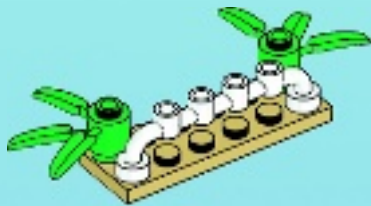

3

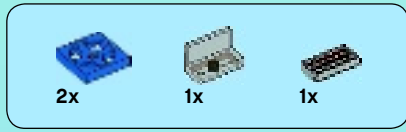

4





2x

5

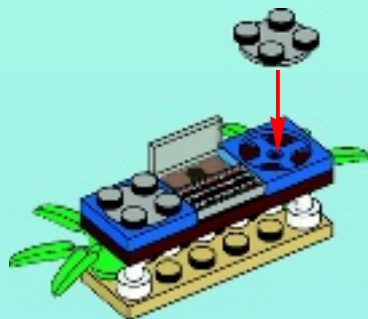

2x

6



7

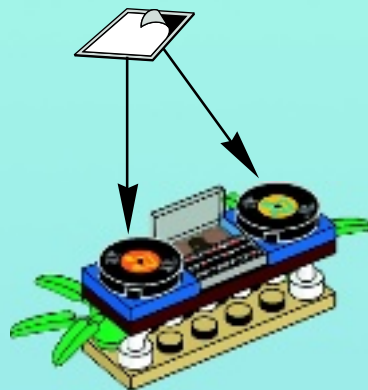

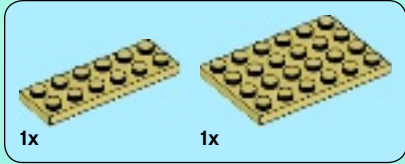

1

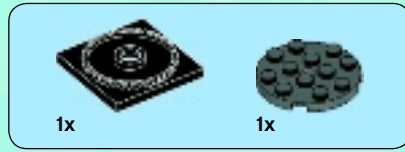
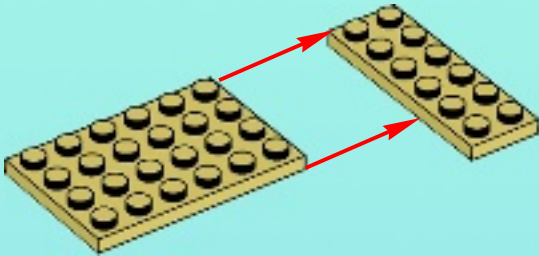

2

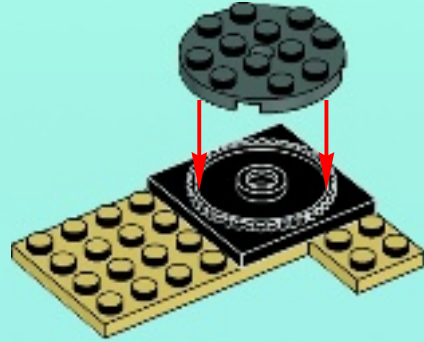

3

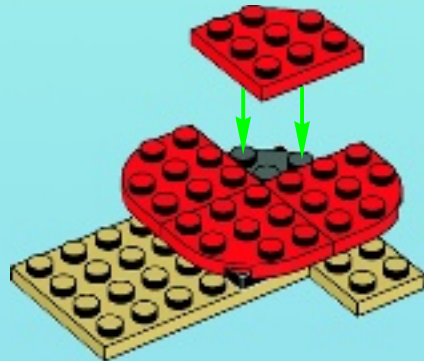

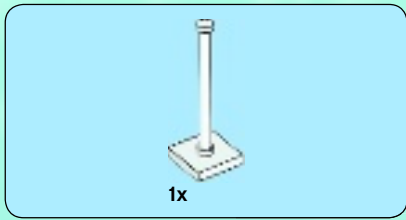

4

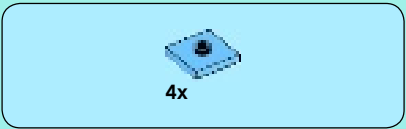
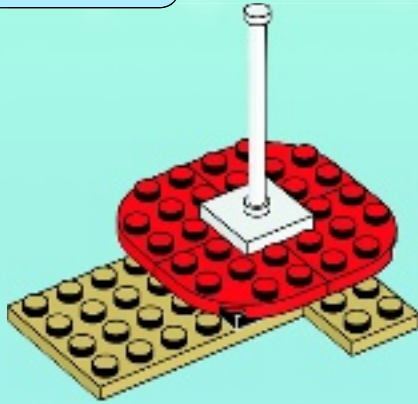

5

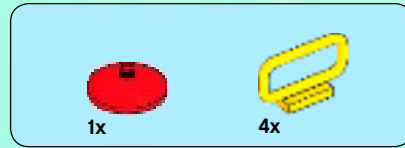
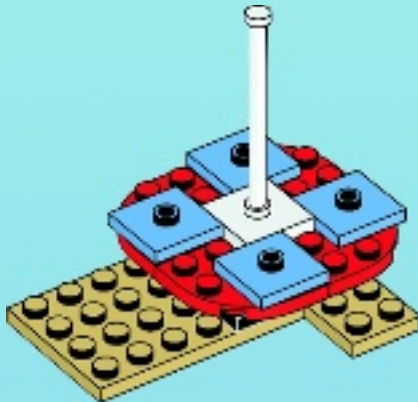

6

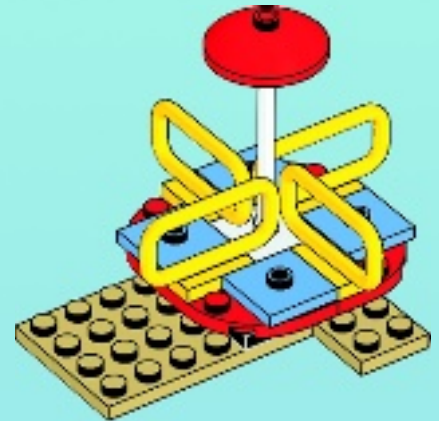

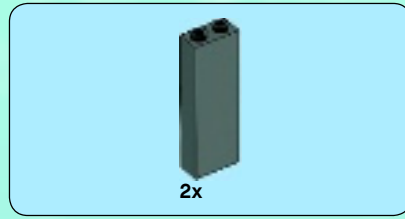

2

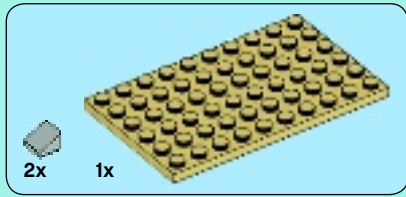

1

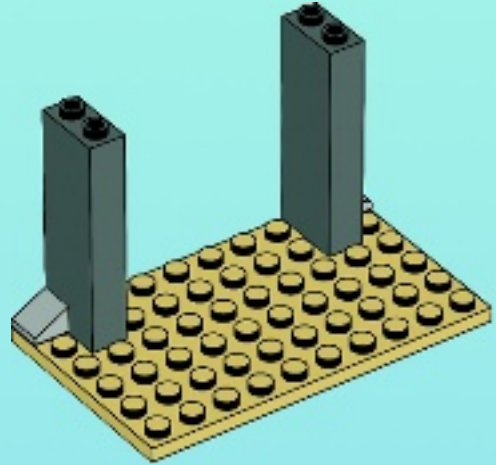
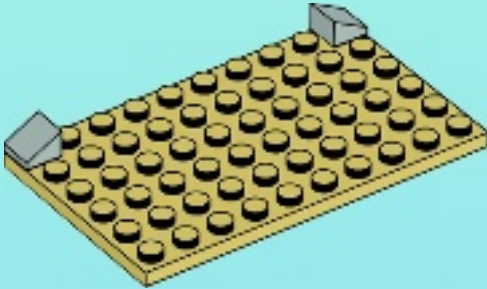

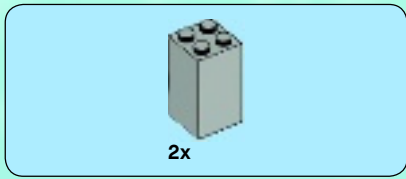

3

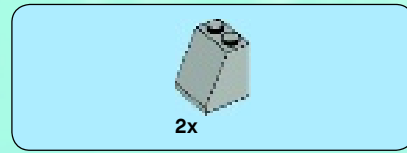
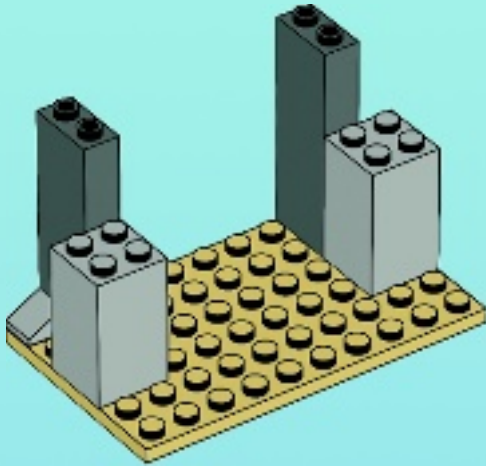

4

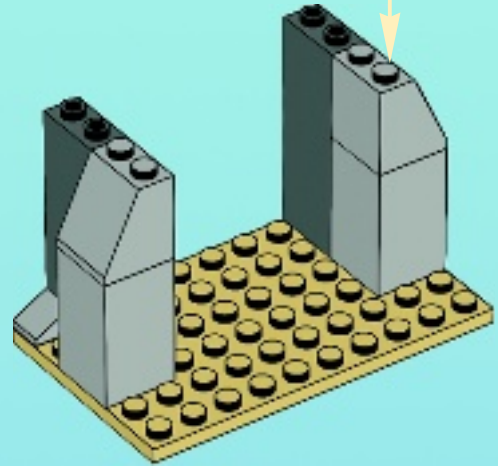
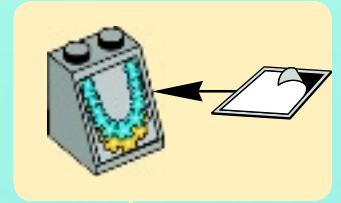

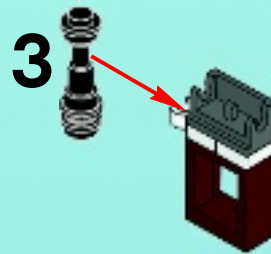
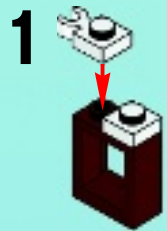
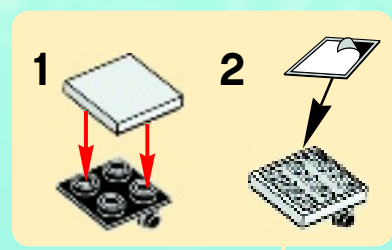
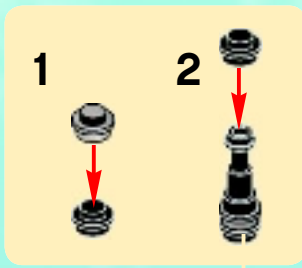
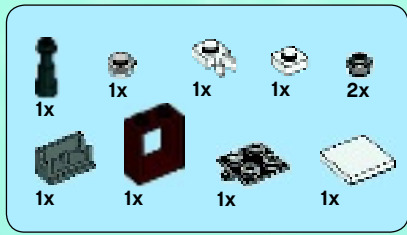

5

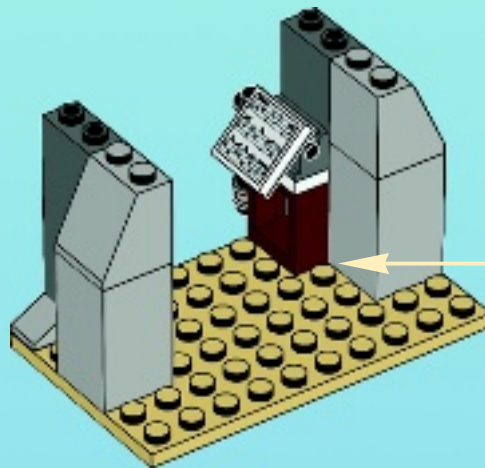



1x



1x

6

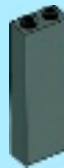
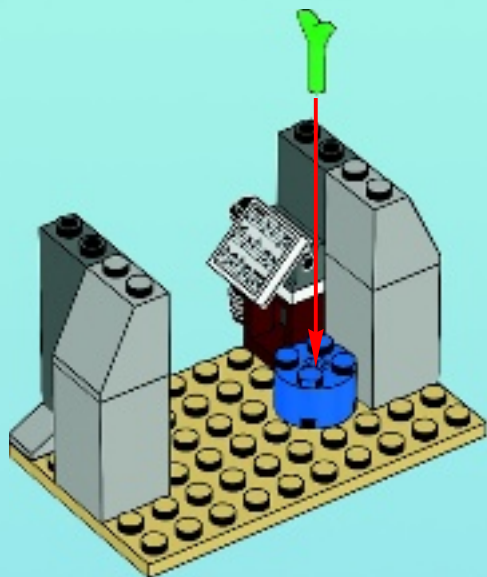

2x

7

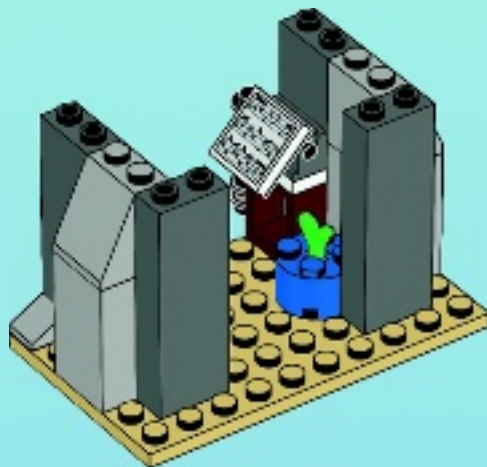

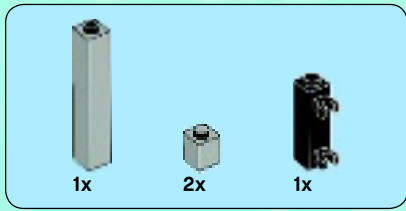

8

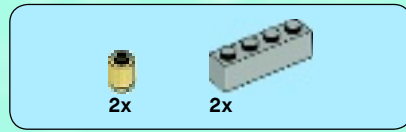
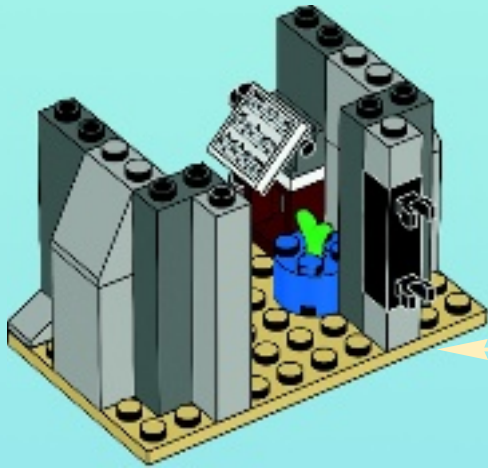

9

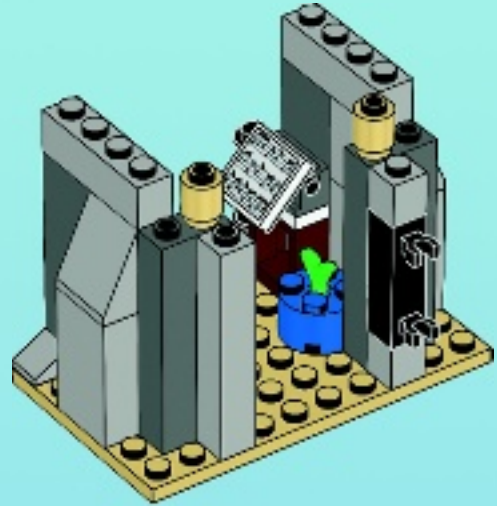

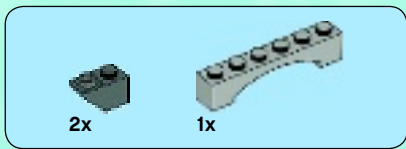

10

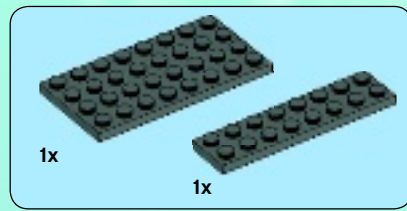
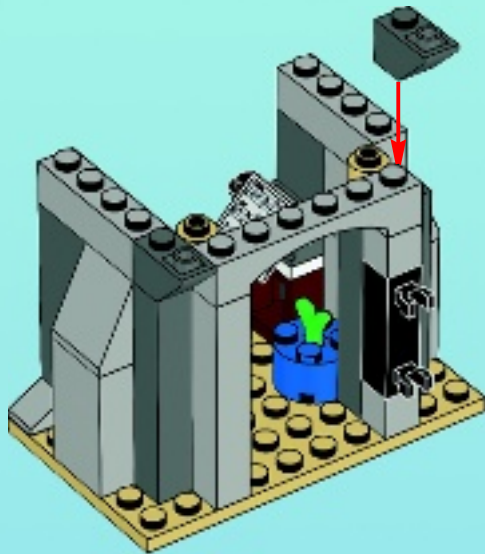

11

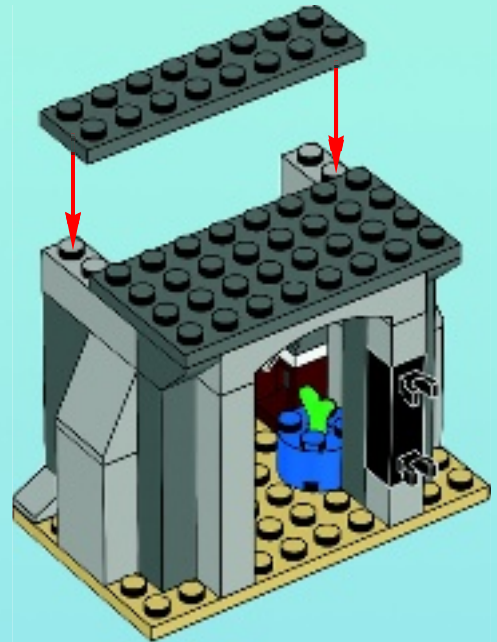



12

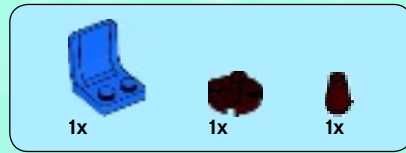
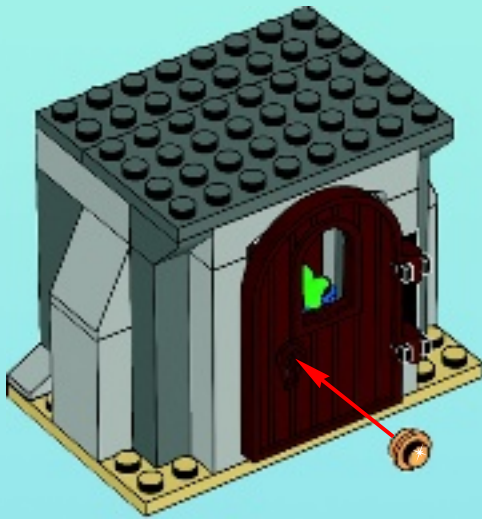

13

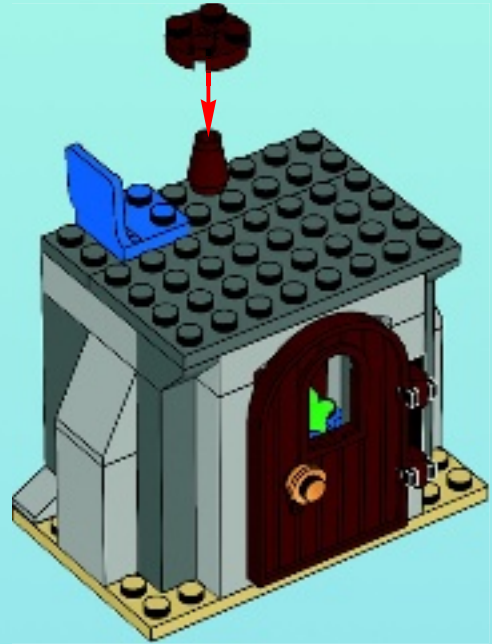

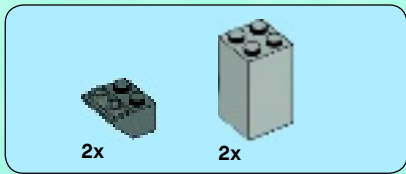

14

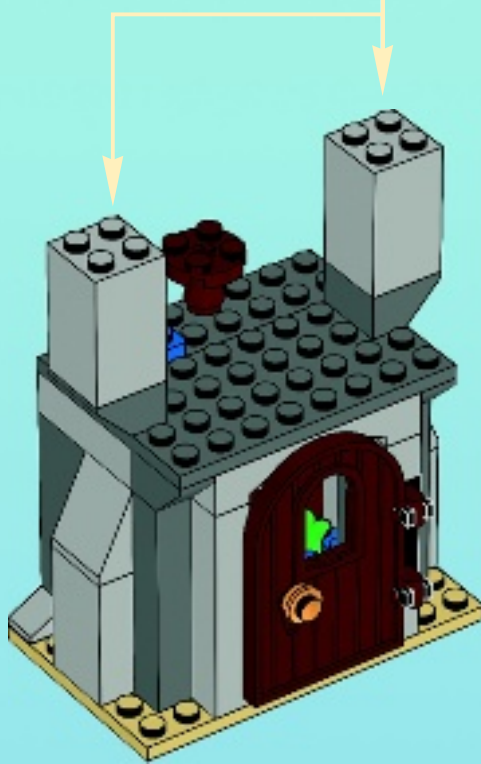
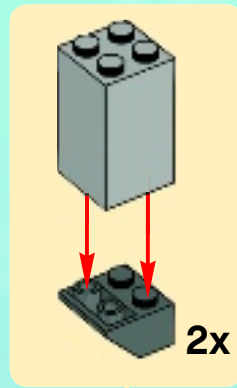

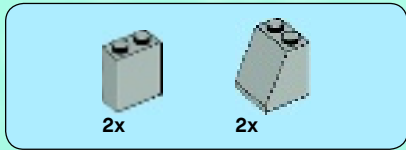

15

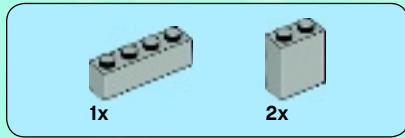
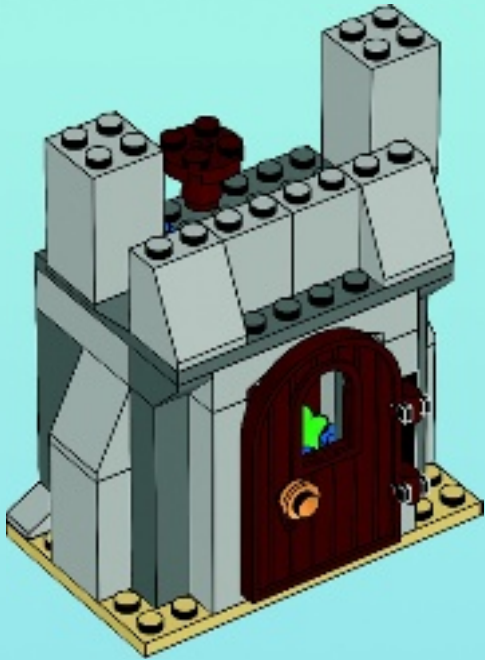

16

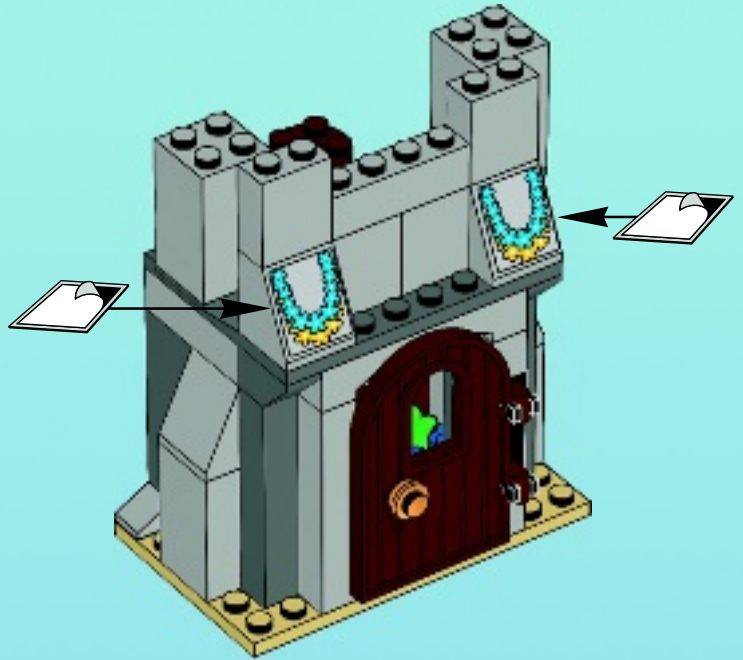

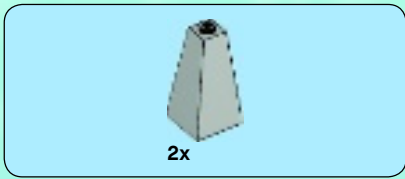

17

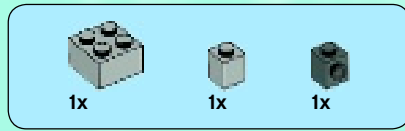
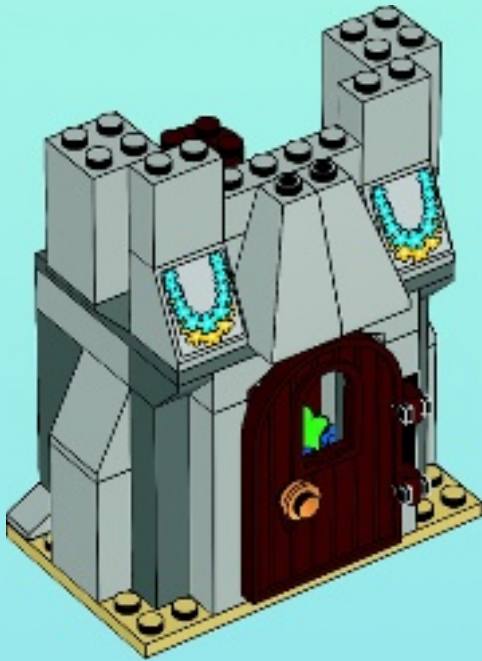

18



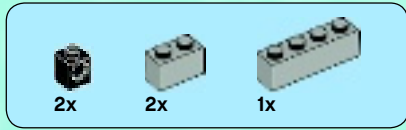

19

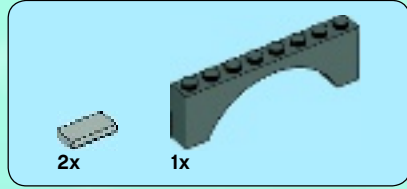
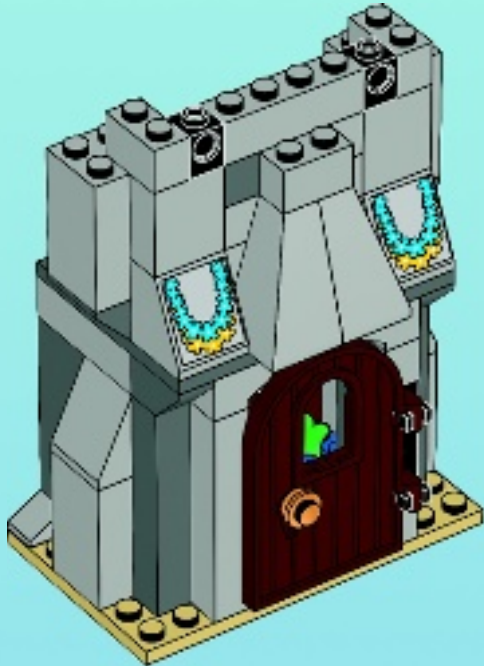

20

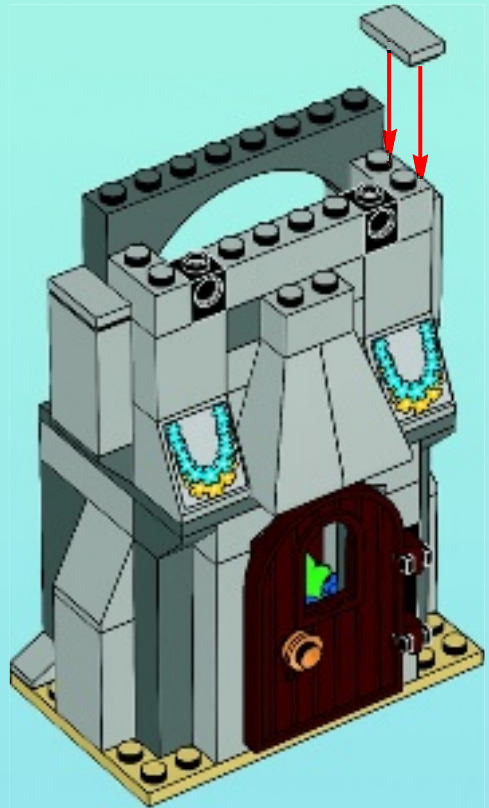

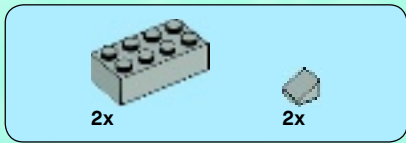

21

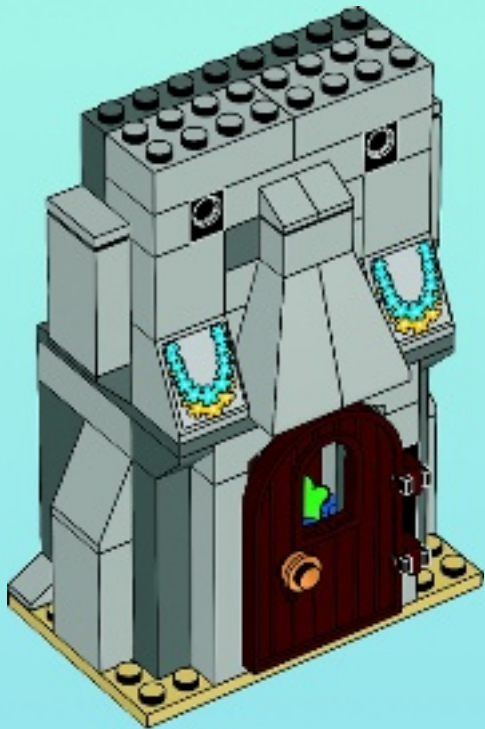

22

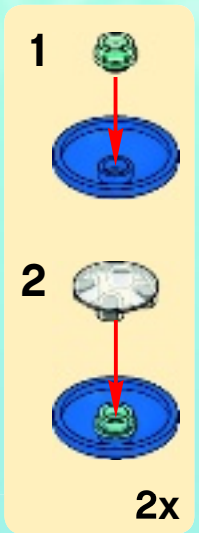
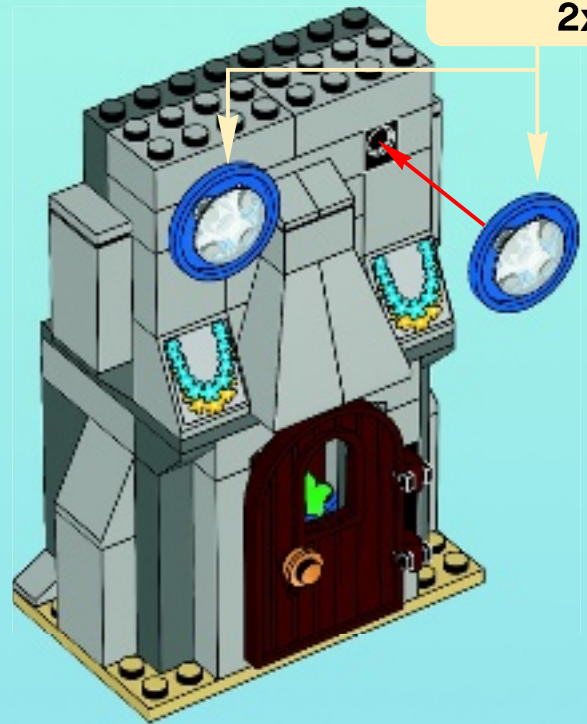



4x

23

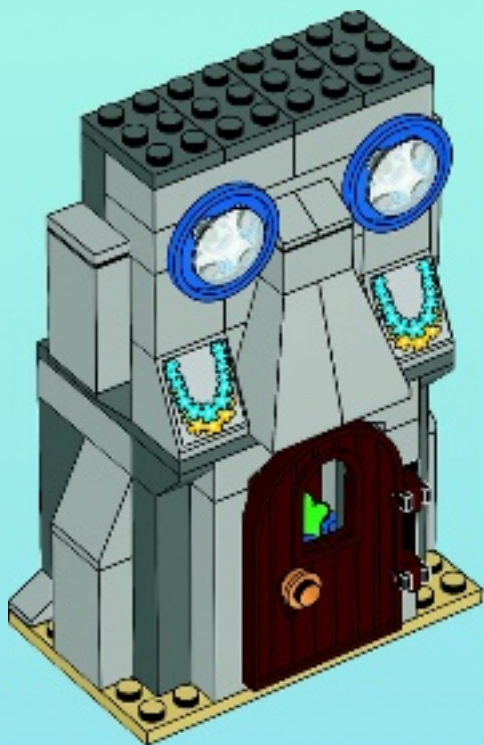

2x

24

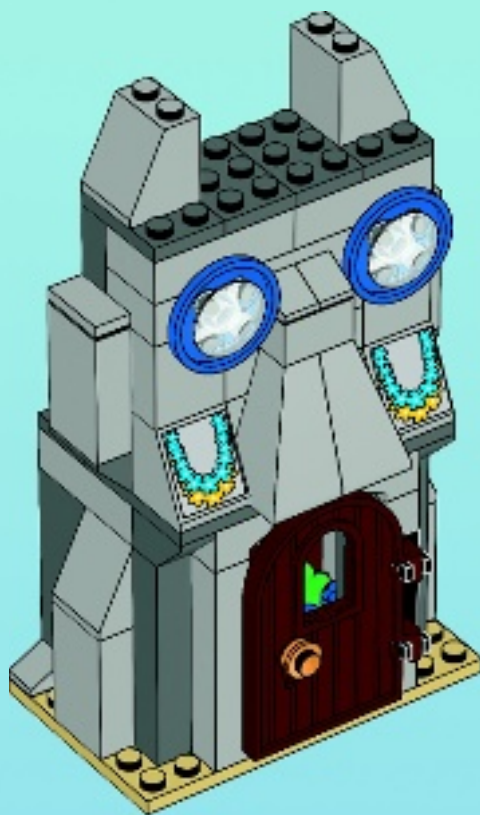



25

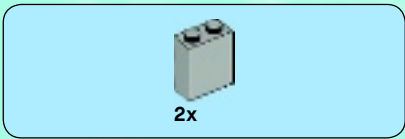
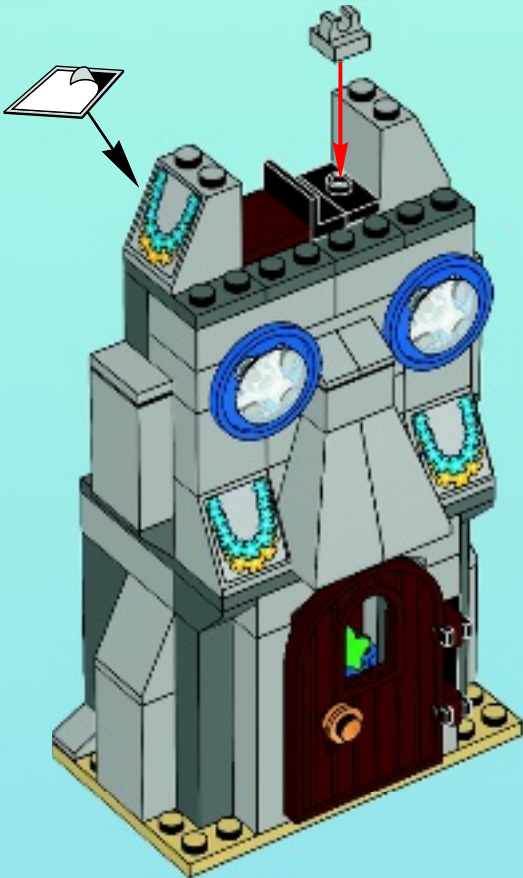

26



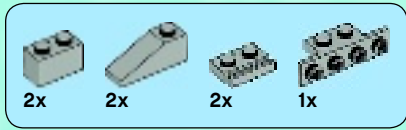

27

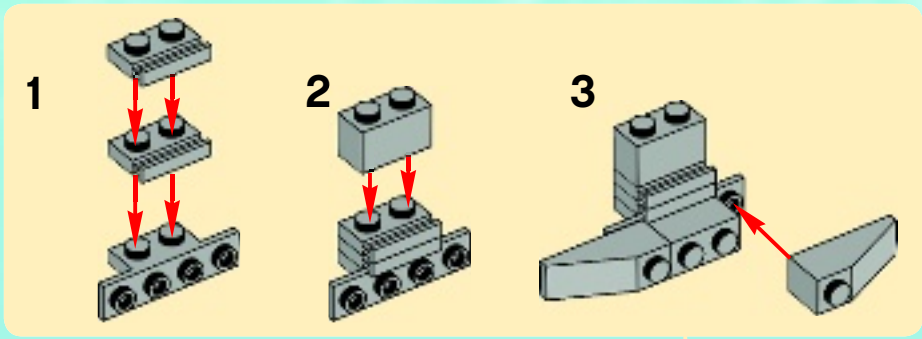



2x

28

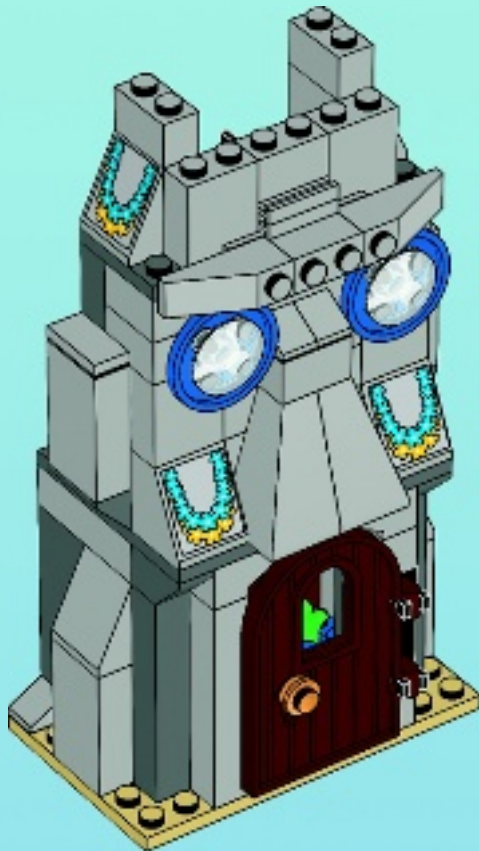

1x



2x

29

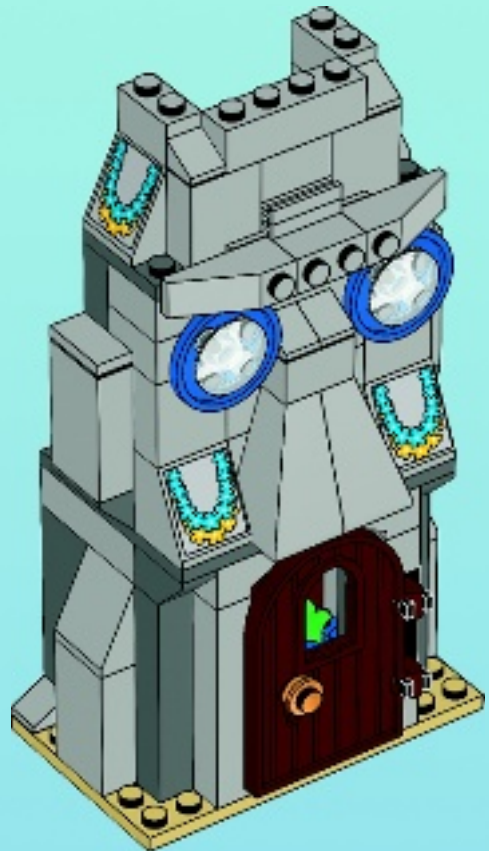



2x

30

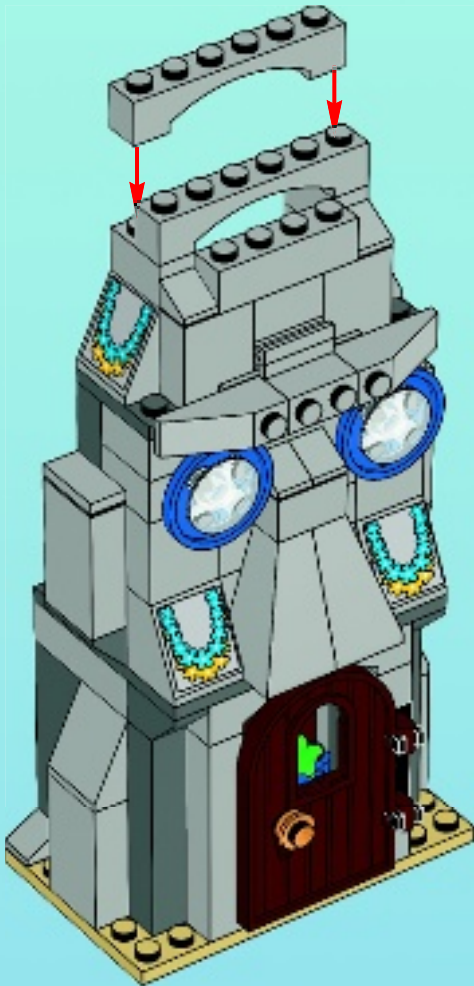

1x



2x

31

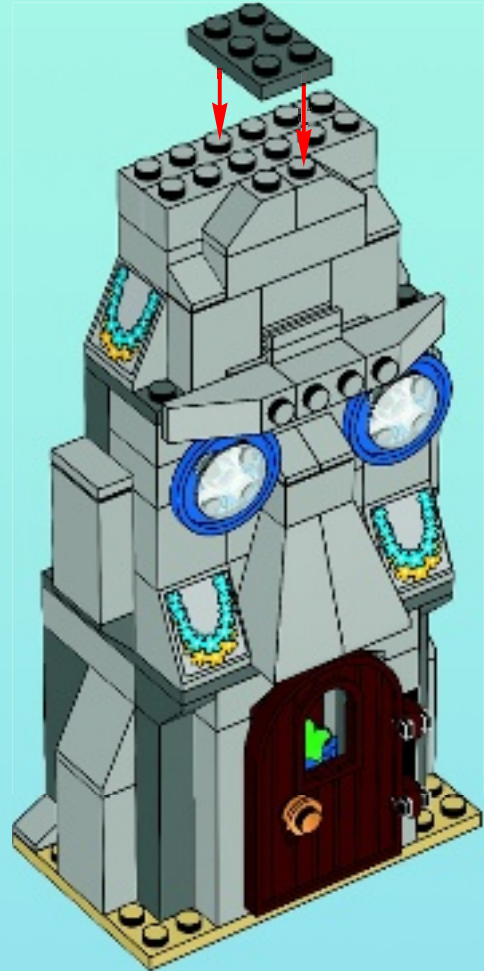

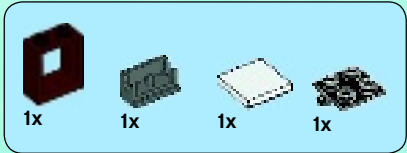

32

1

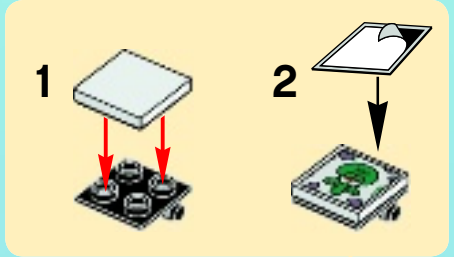
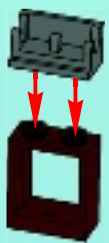

2

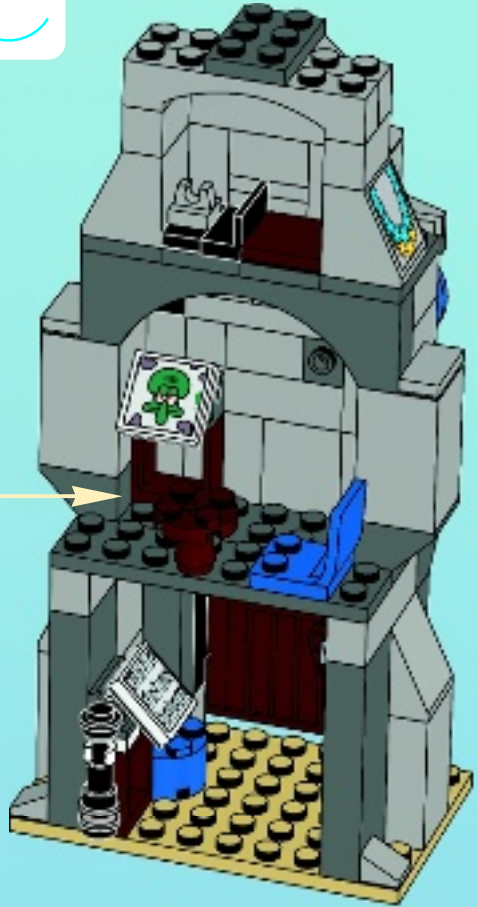

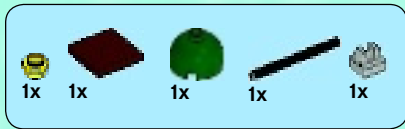

33

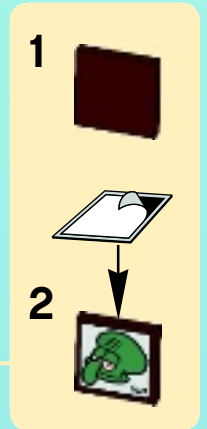
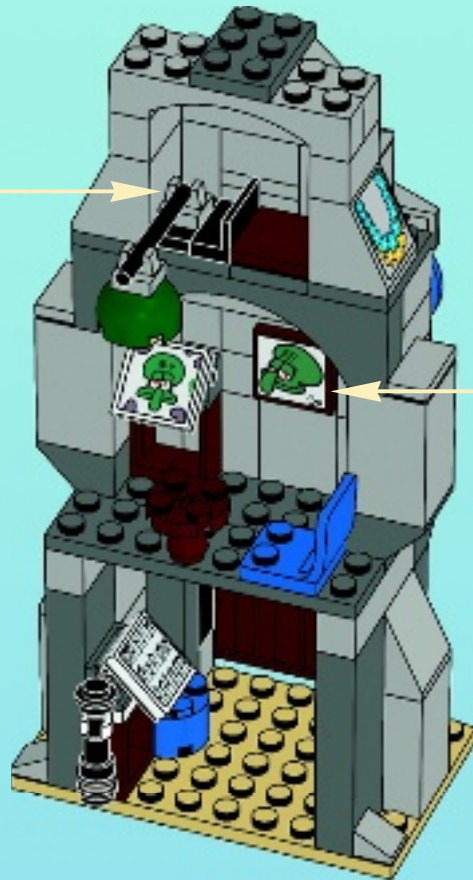

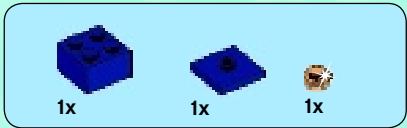

34

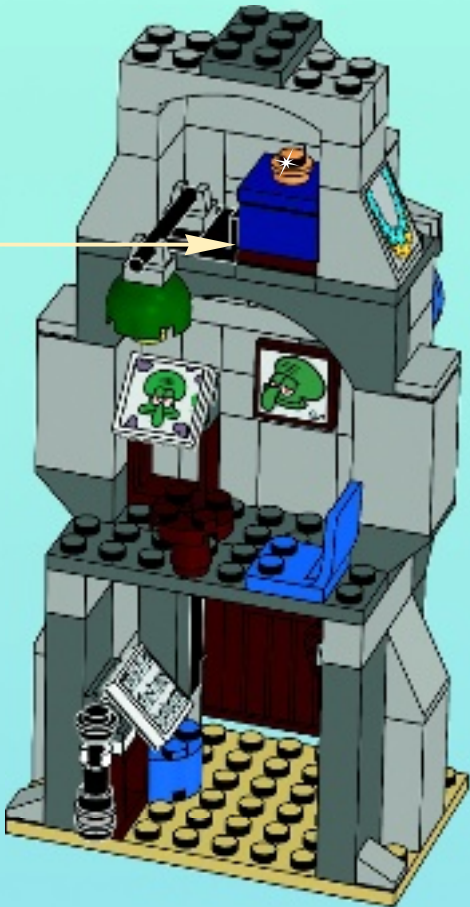

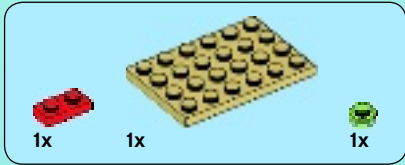
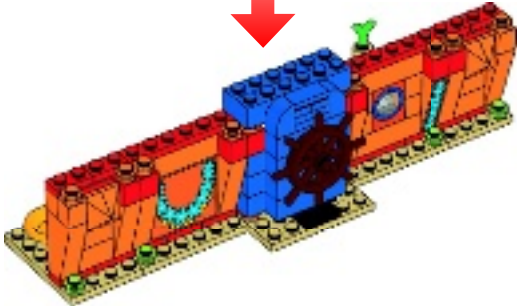

1



2

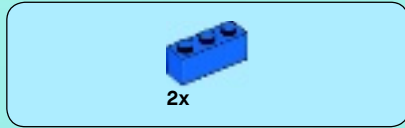

3



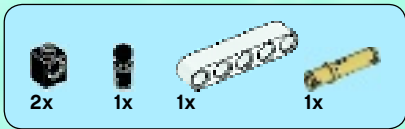

4

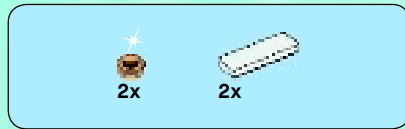
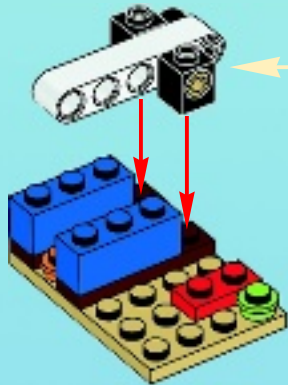
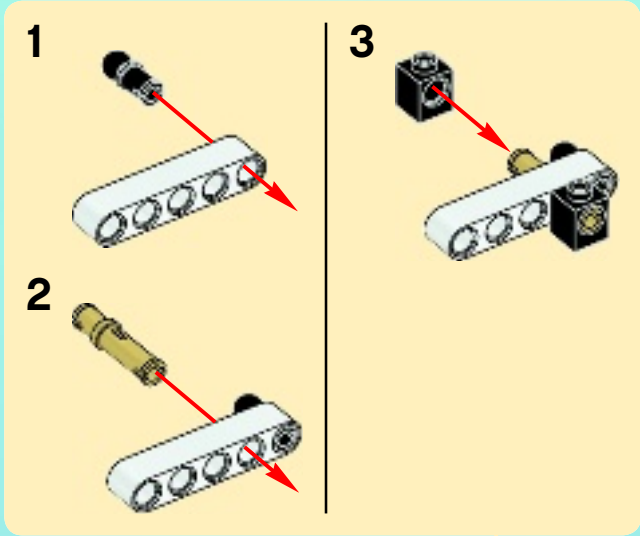

5

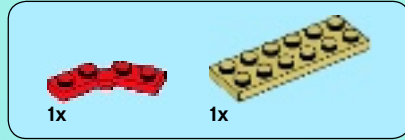

6





7



8

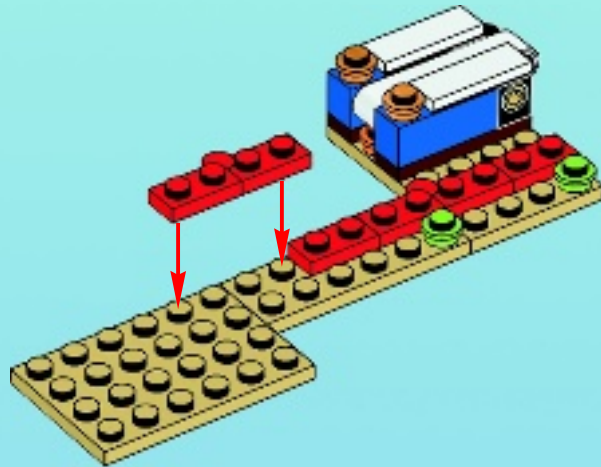

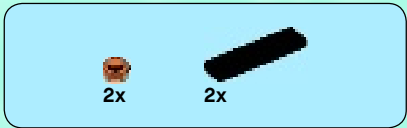

9

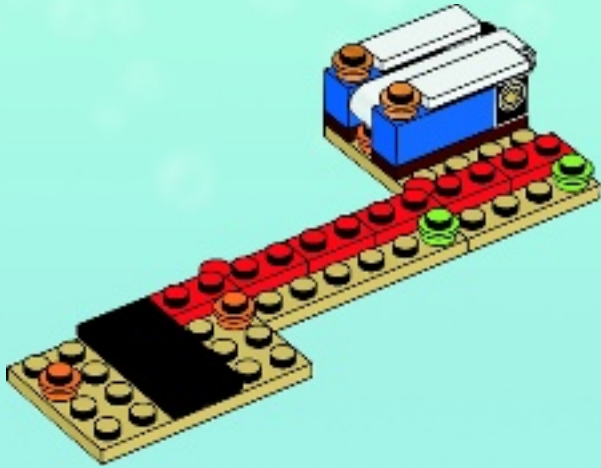

10

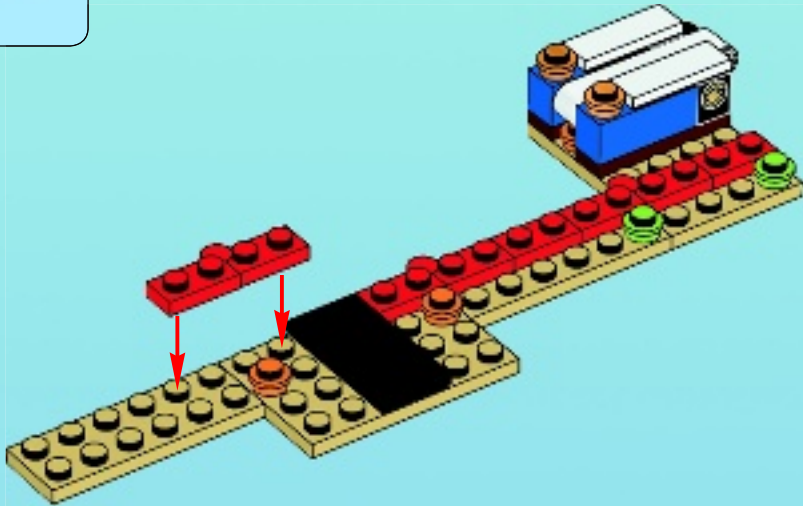



11

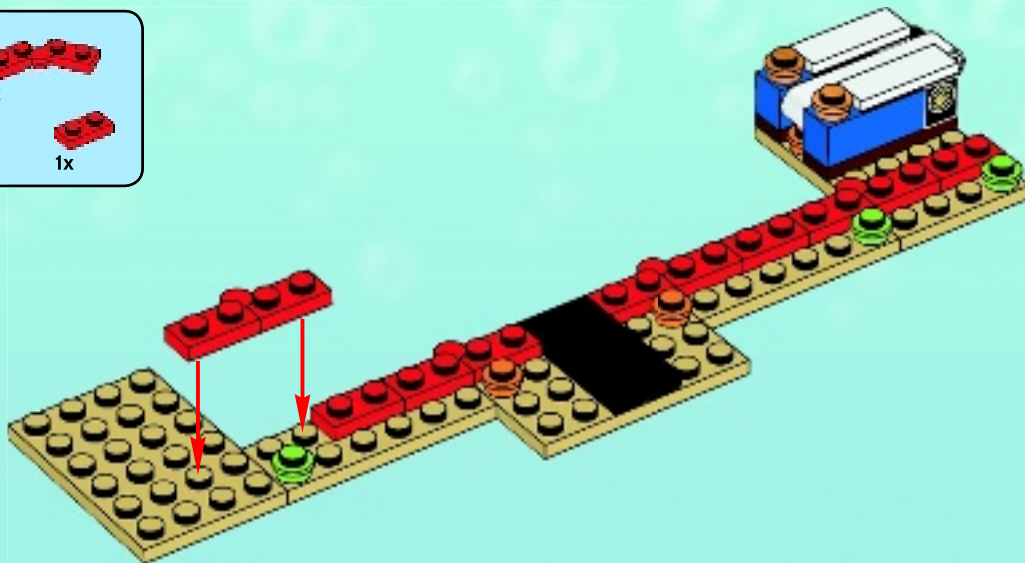

12

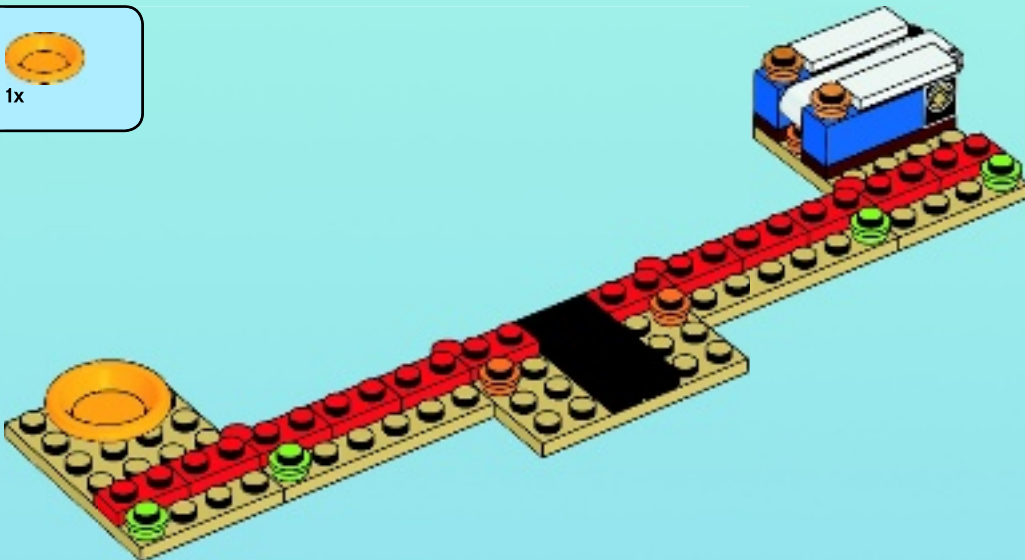

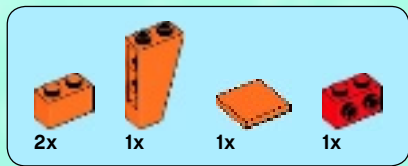

13

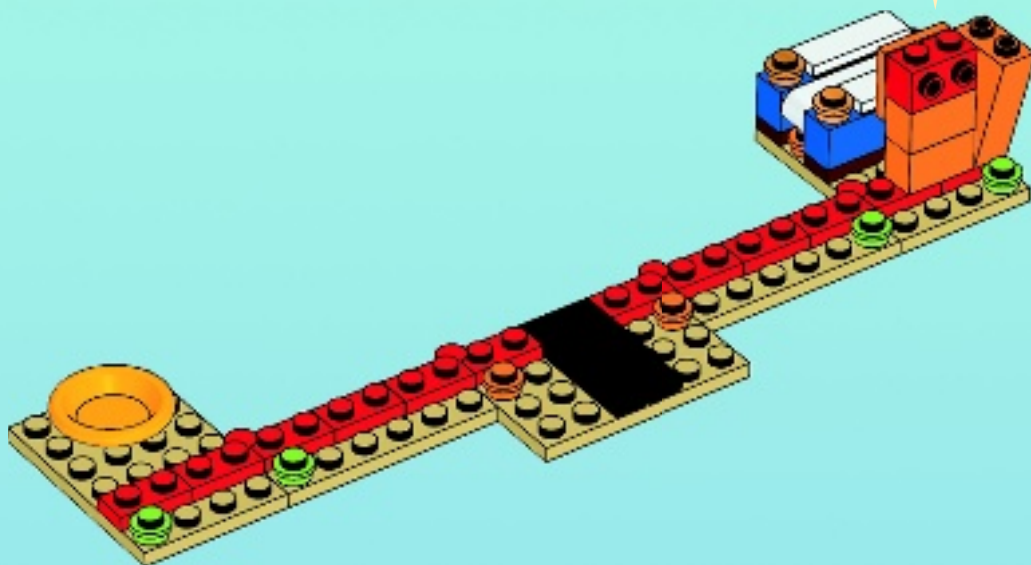
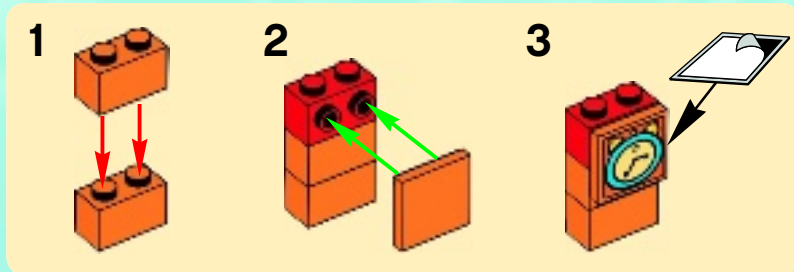

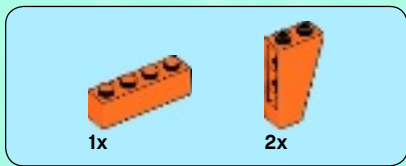

14

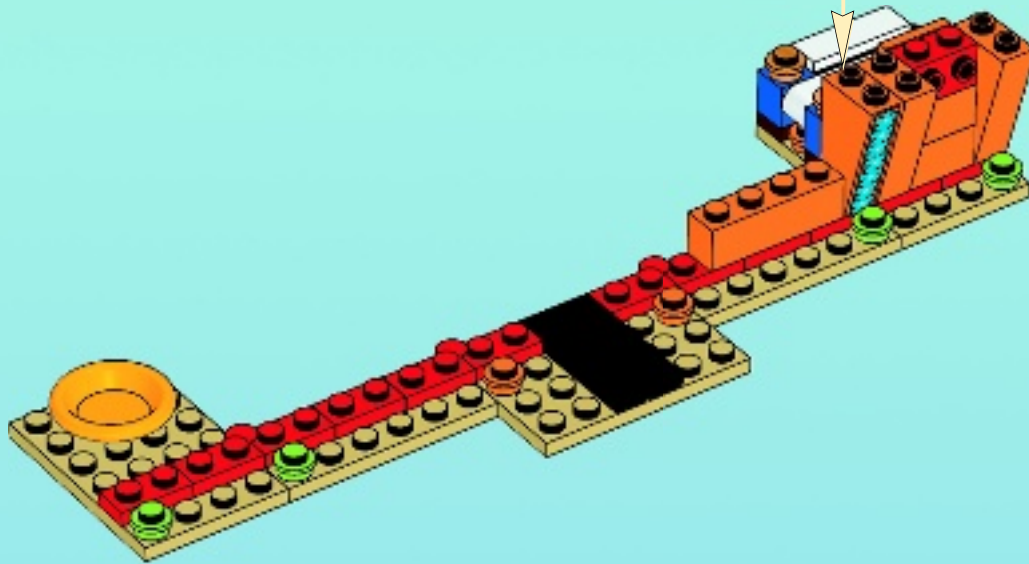
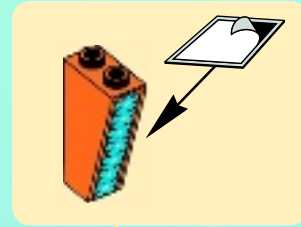

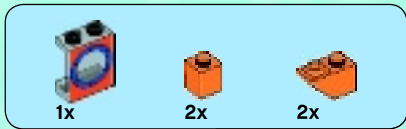

15

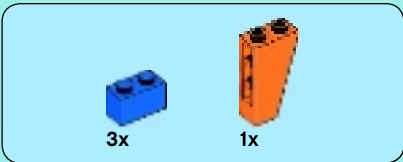
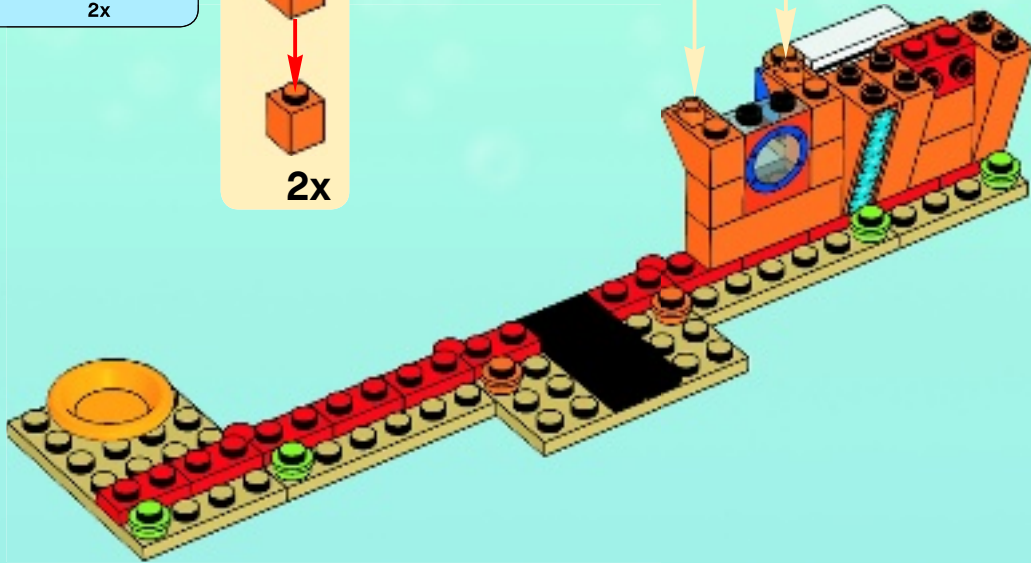
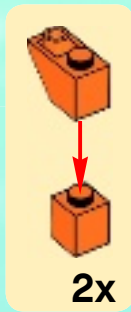

16

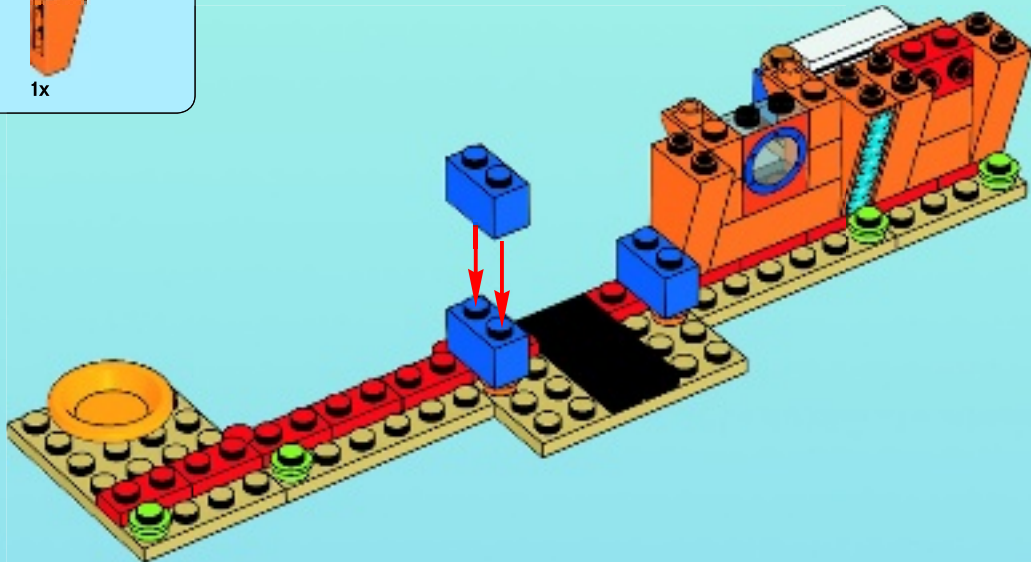

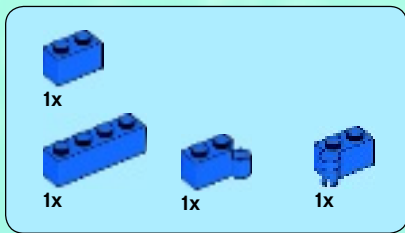

17

1

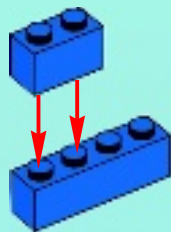

2

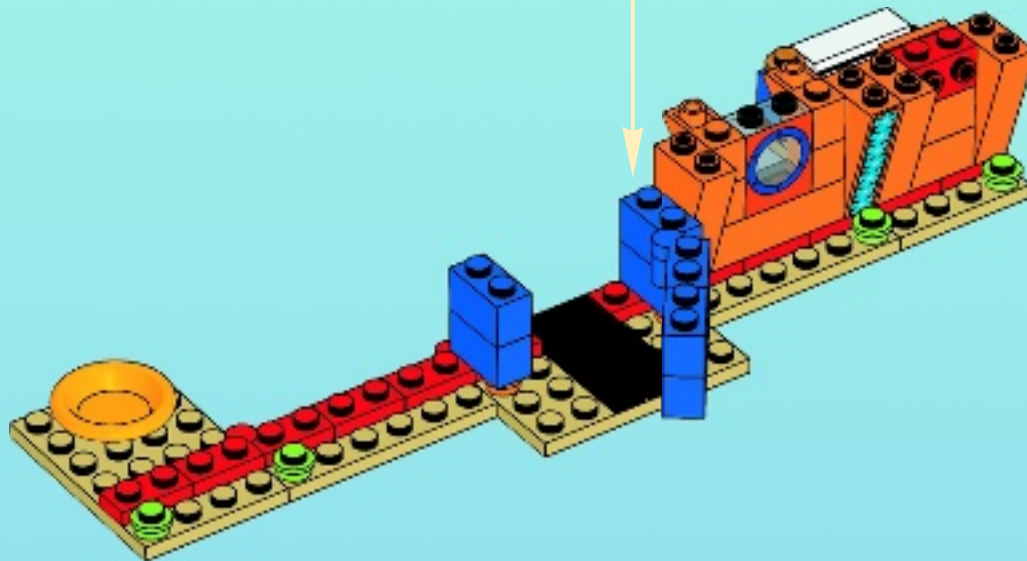
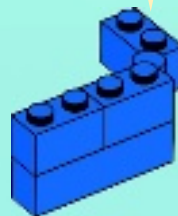



2x



2x



1x

18

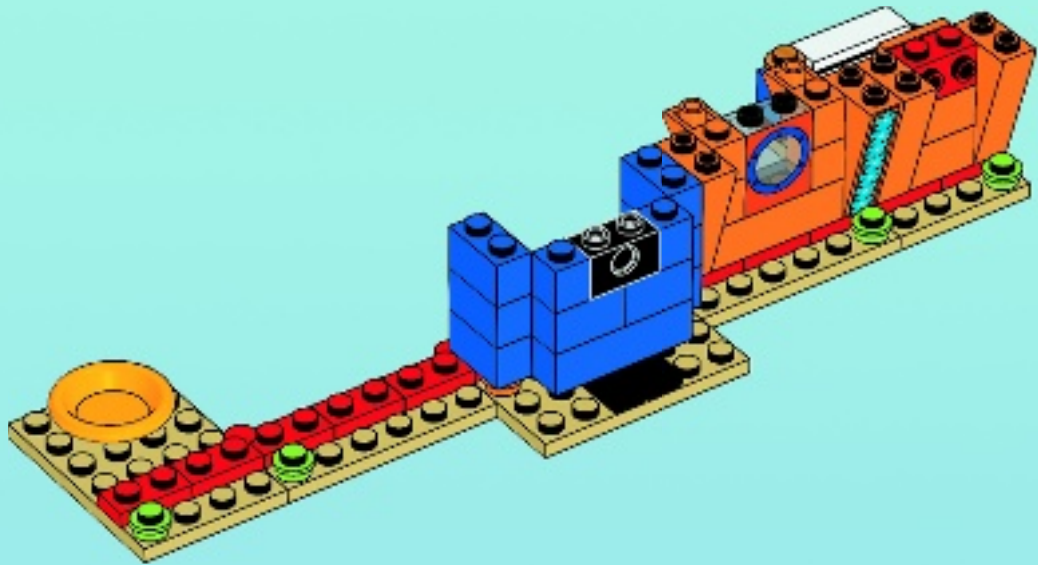

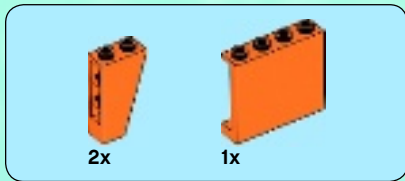

19

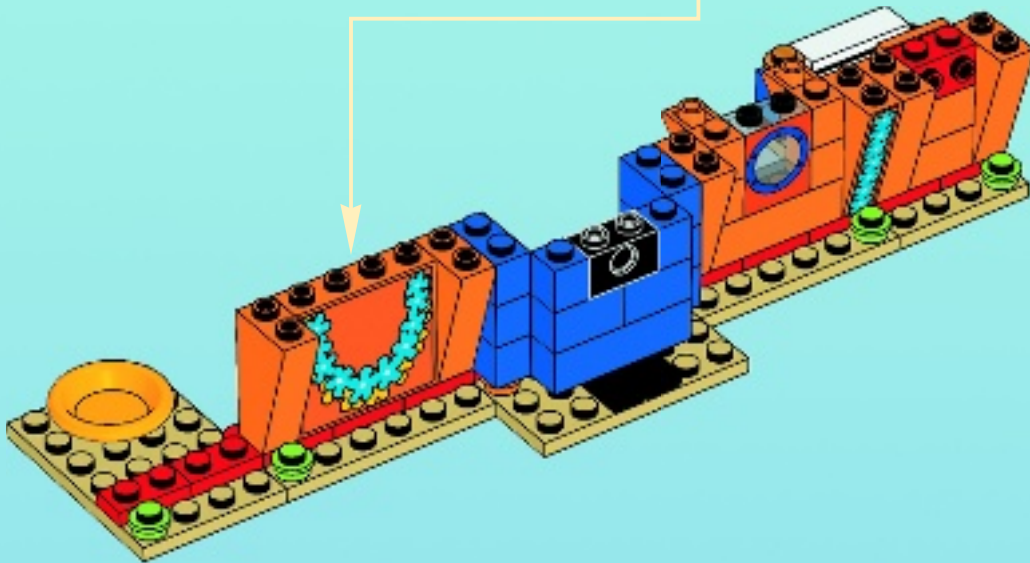
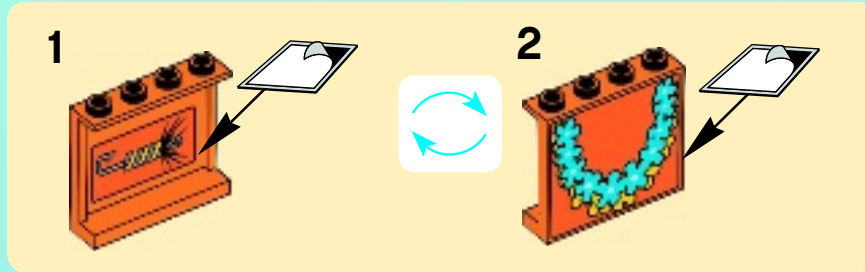

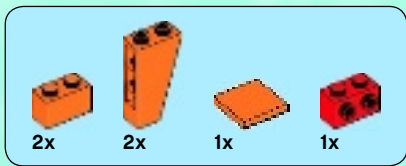

20

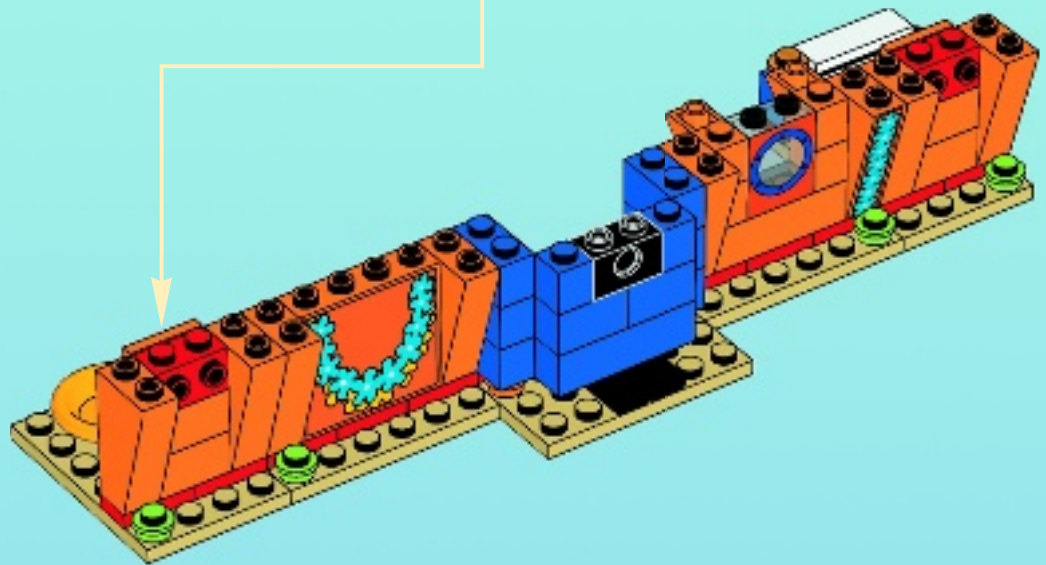
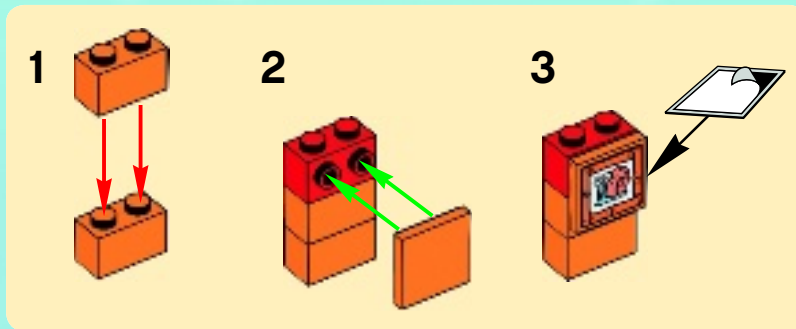



21

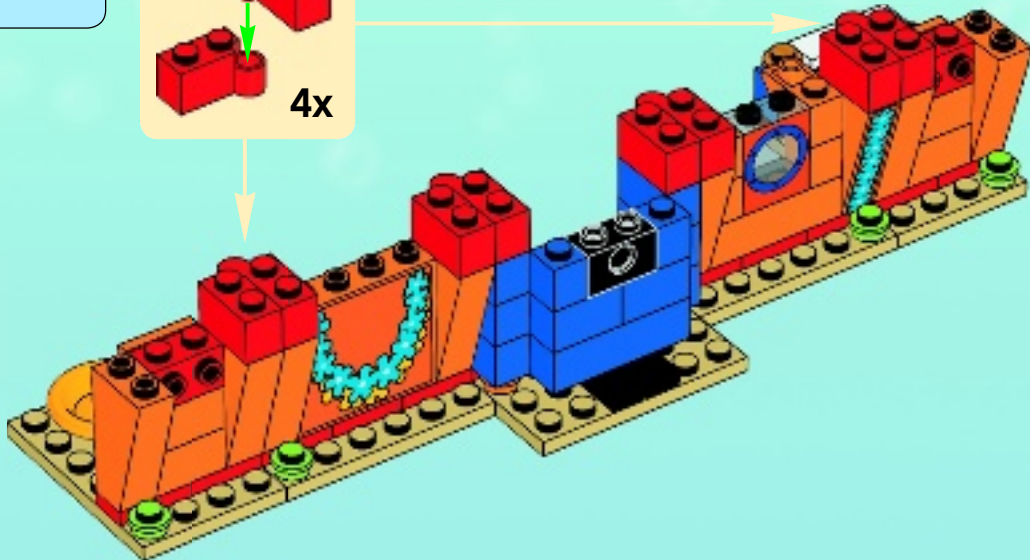
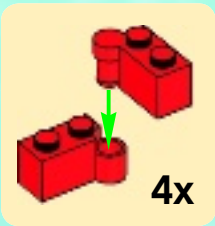

22

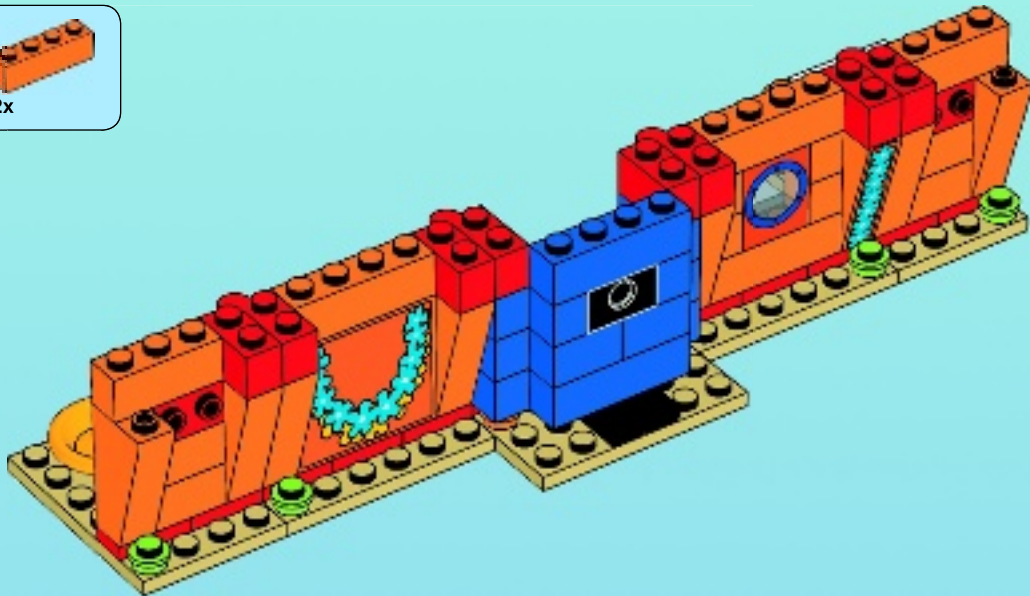



23

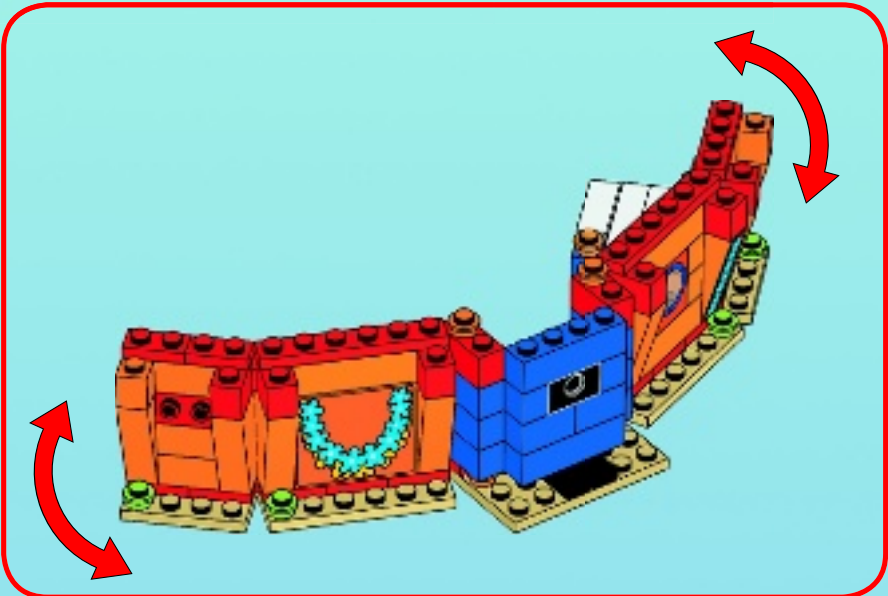
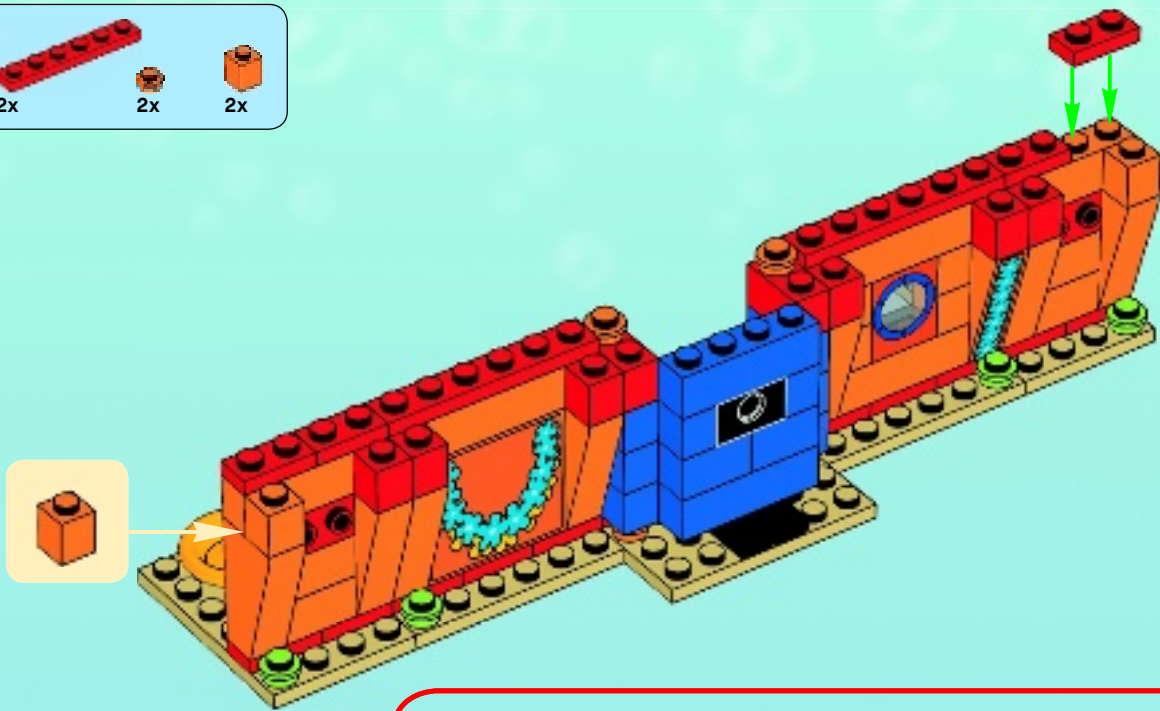

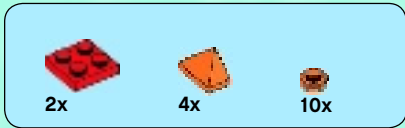

24

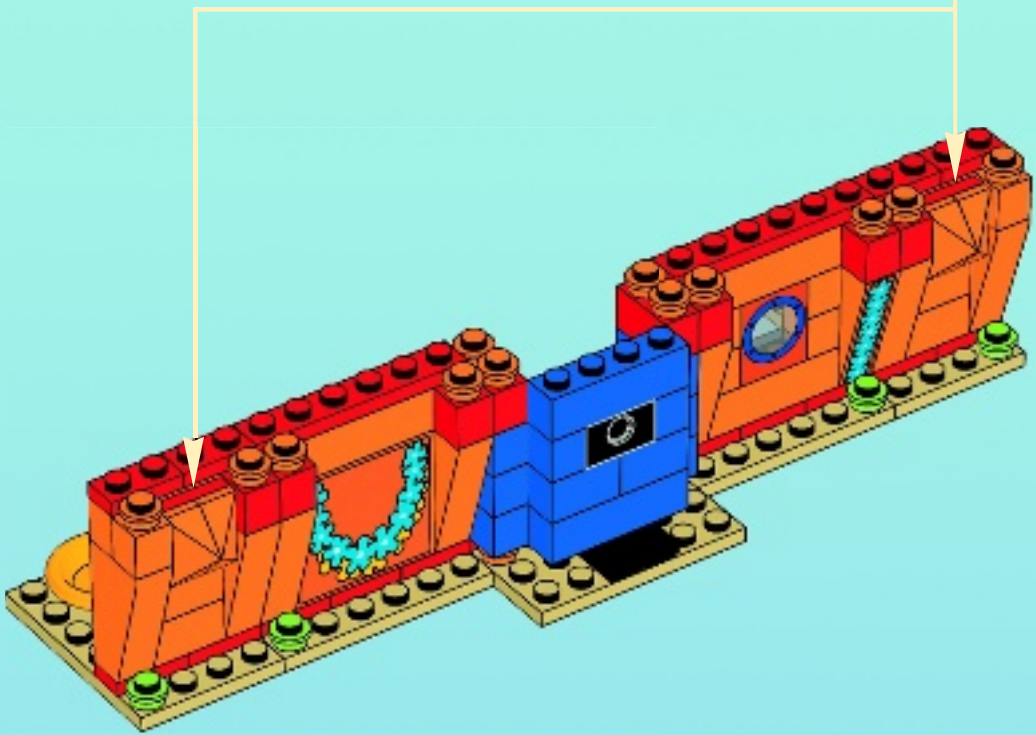
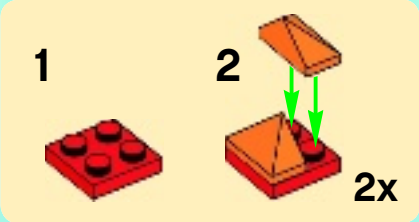



25

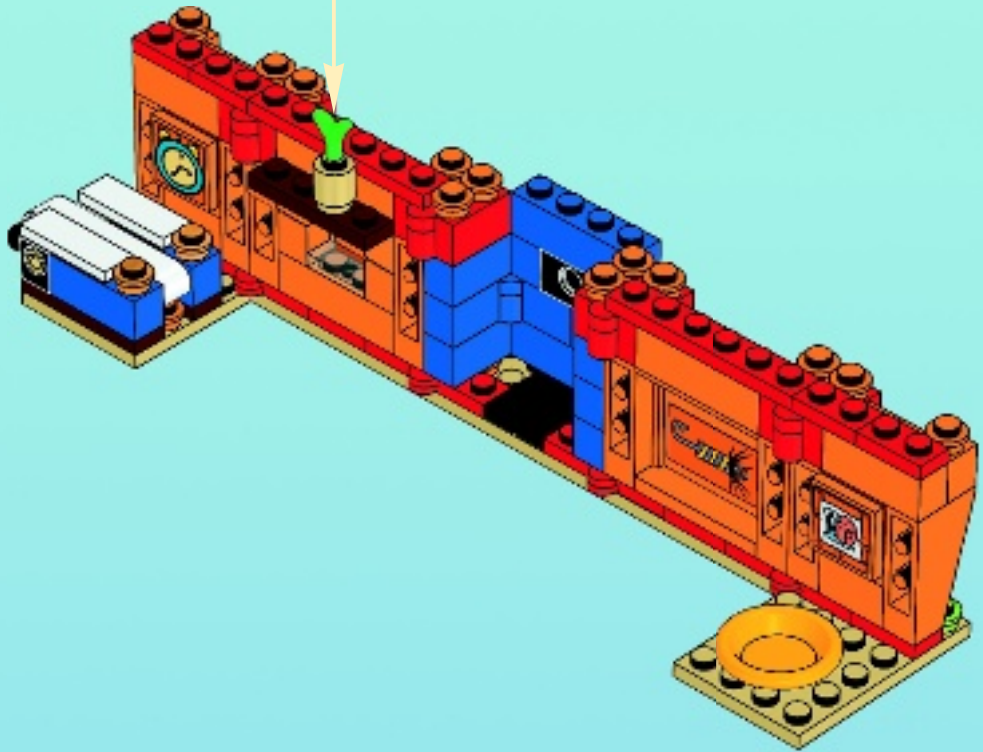
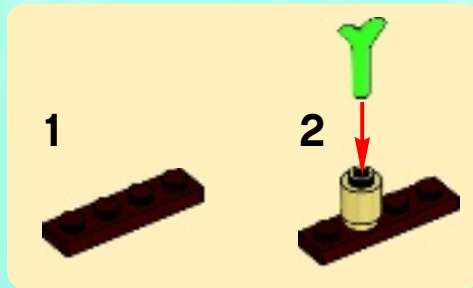



2x

26

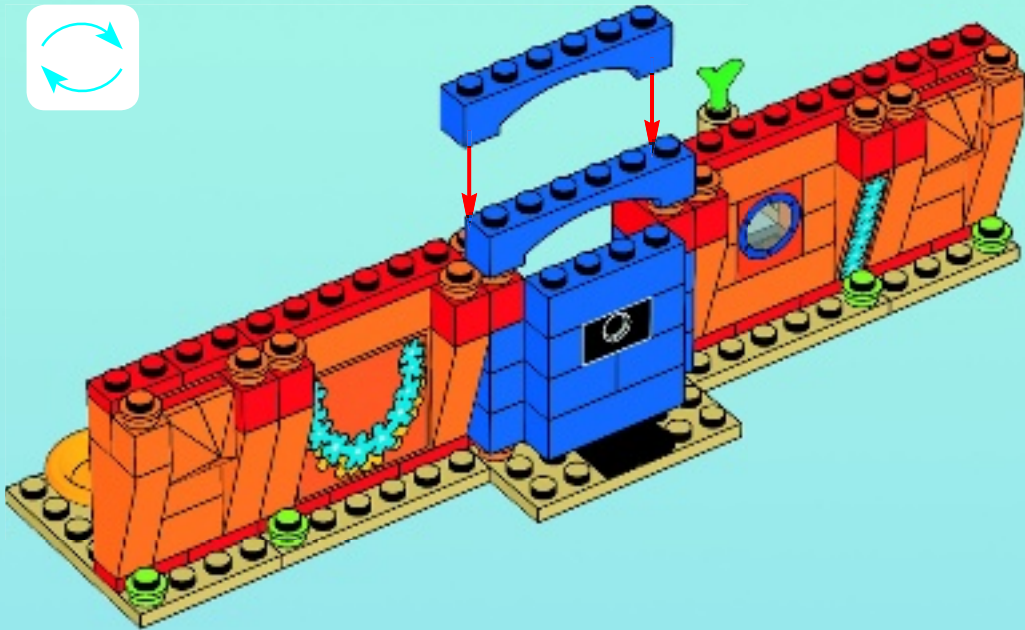

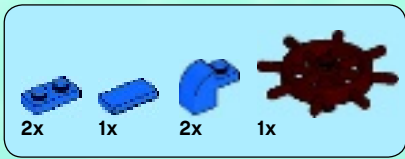

27

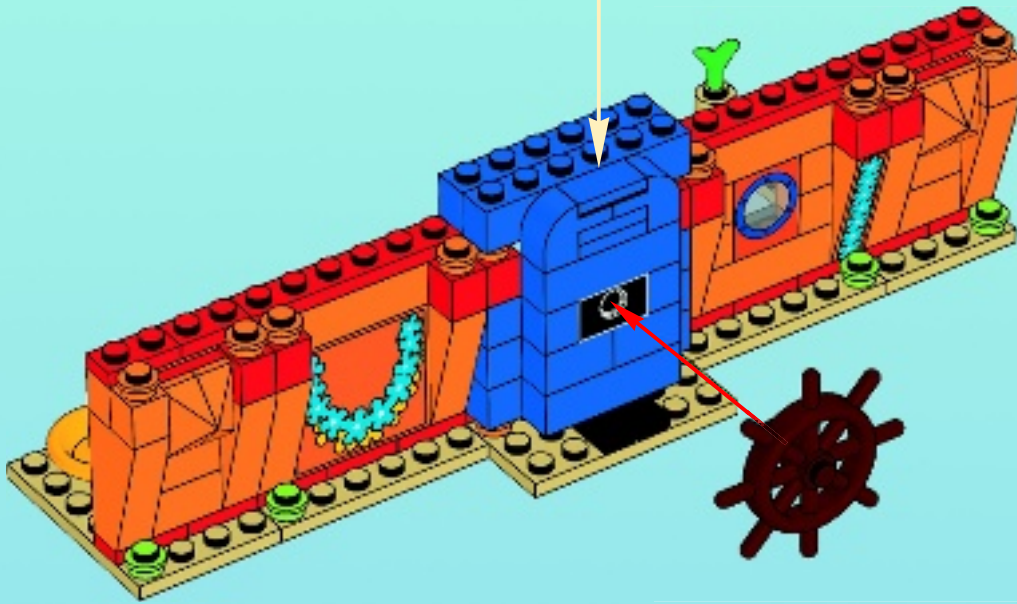
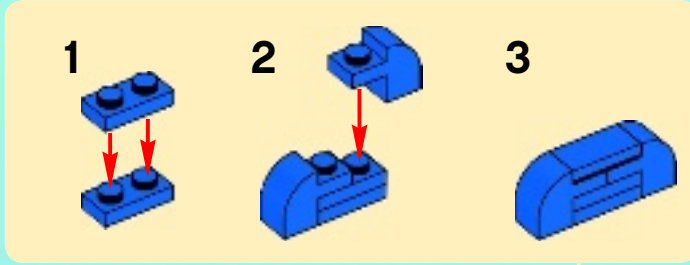



4

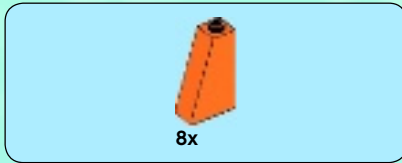

8x

28

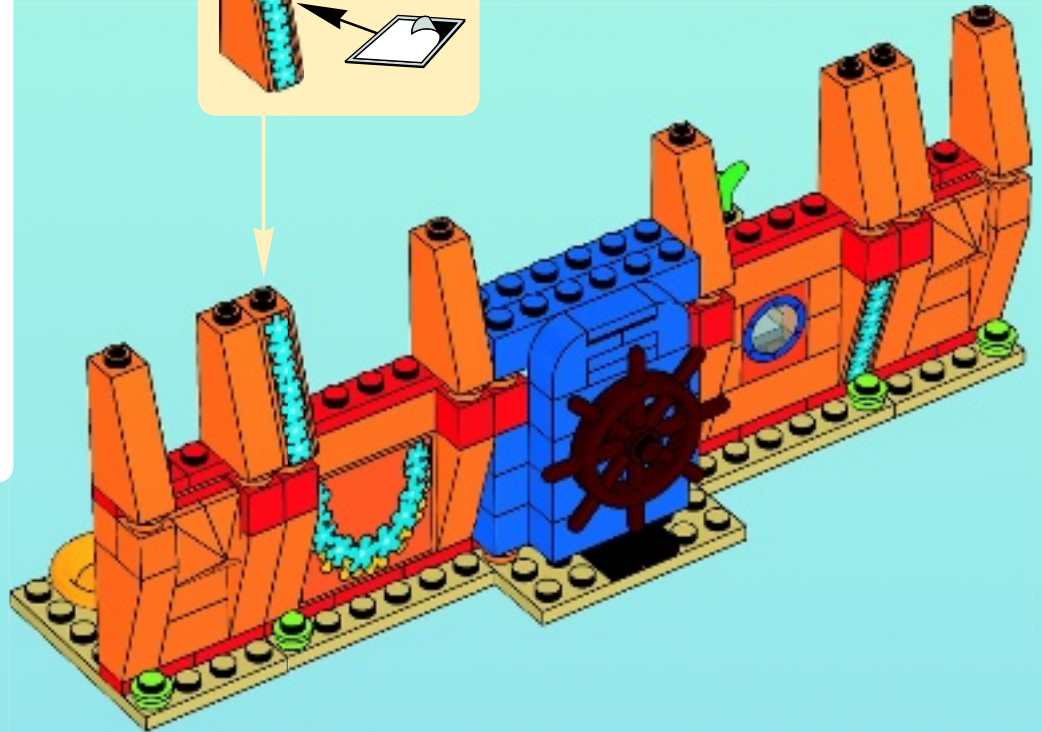
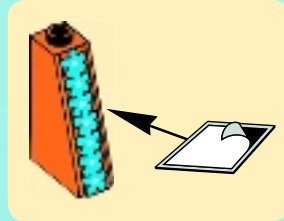



29

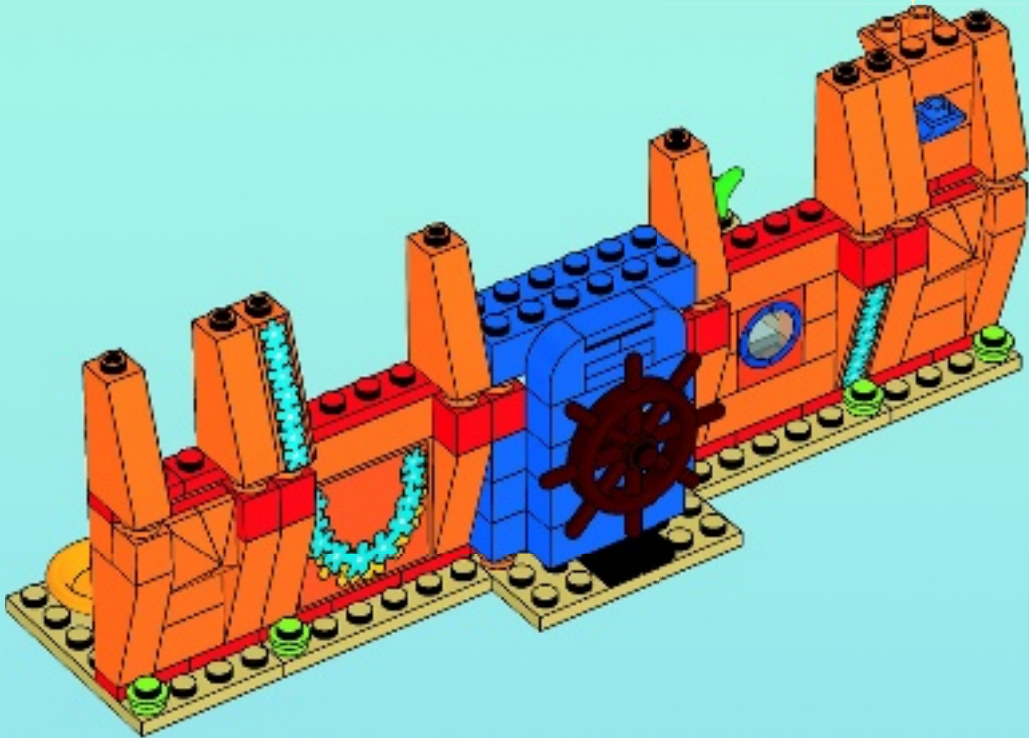
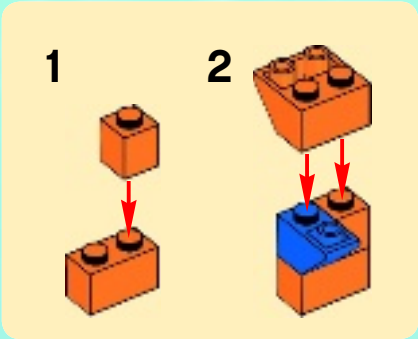

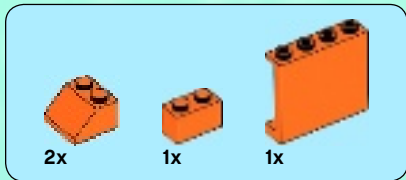

30

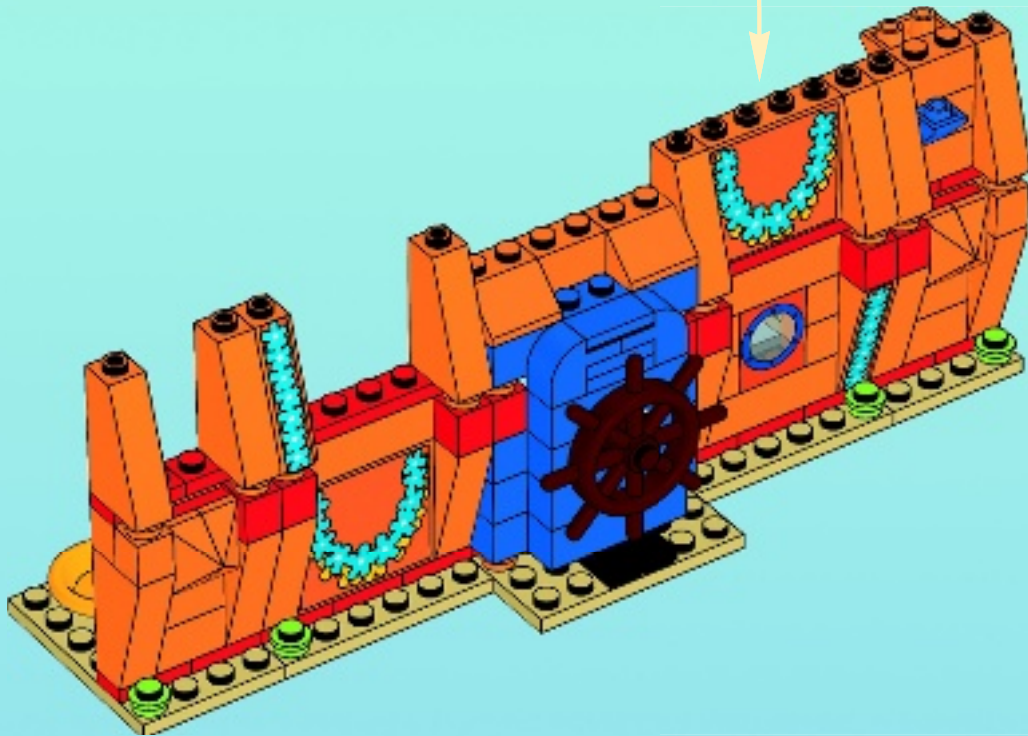
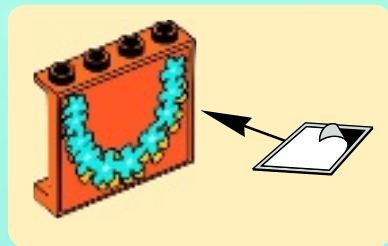



2x



1x



1x

31

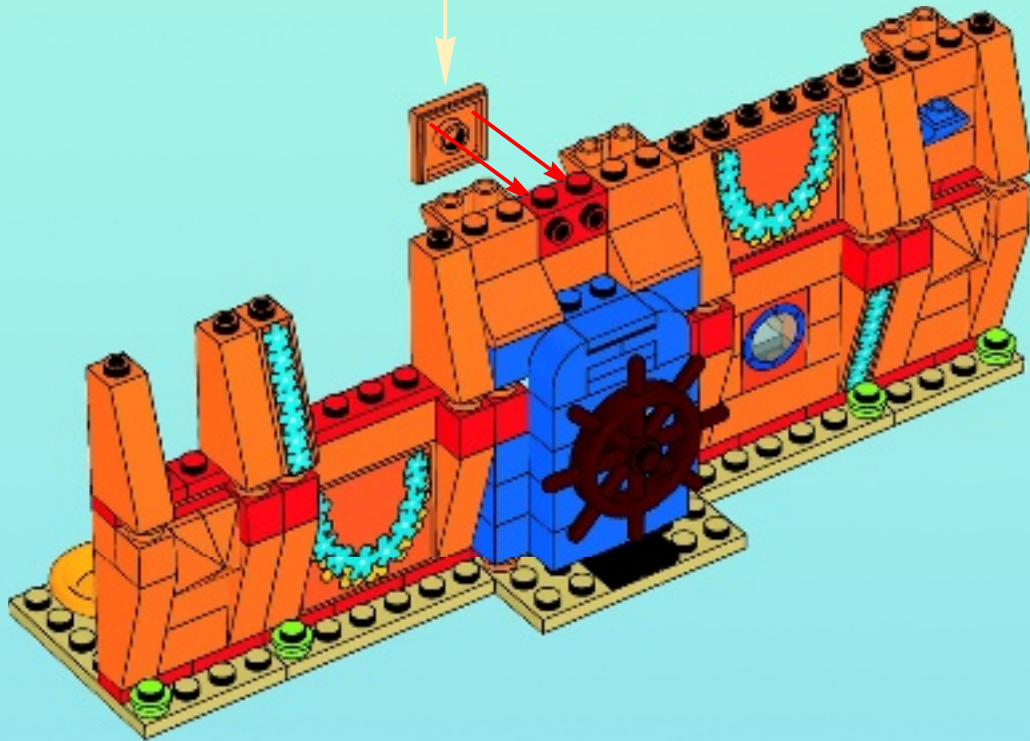
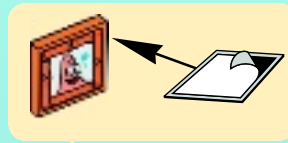

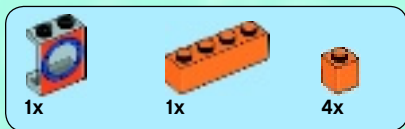

32

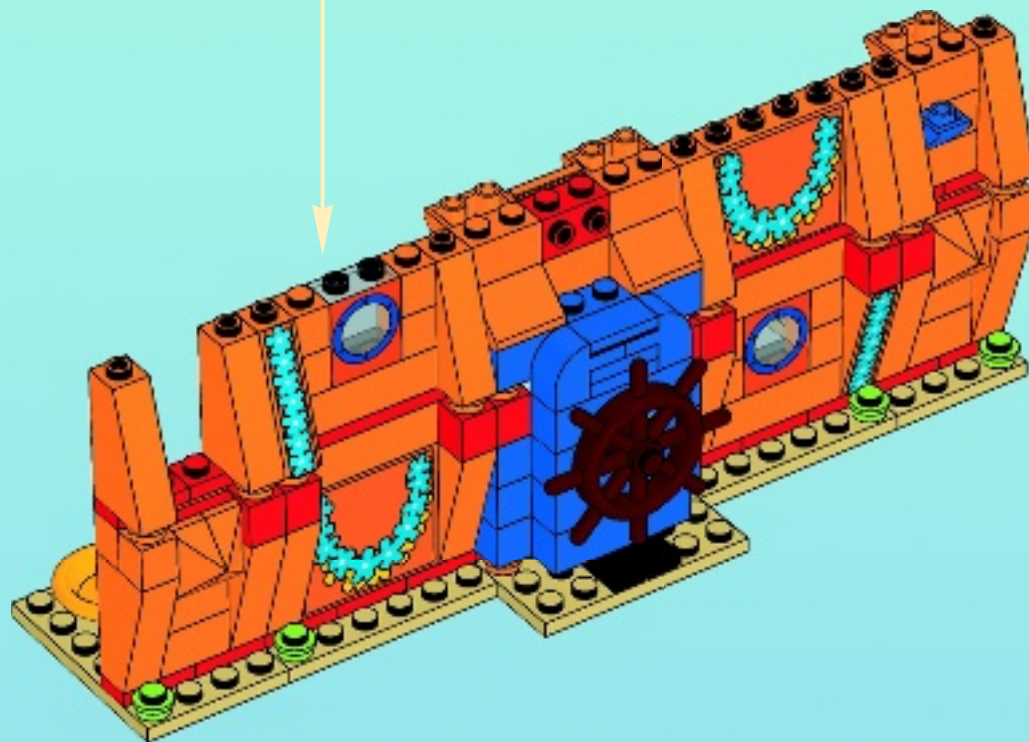
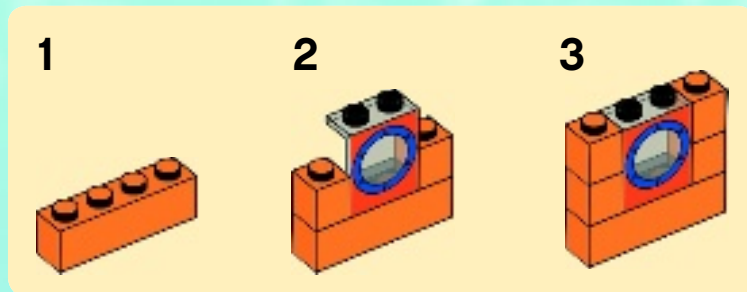



1x



2x

33

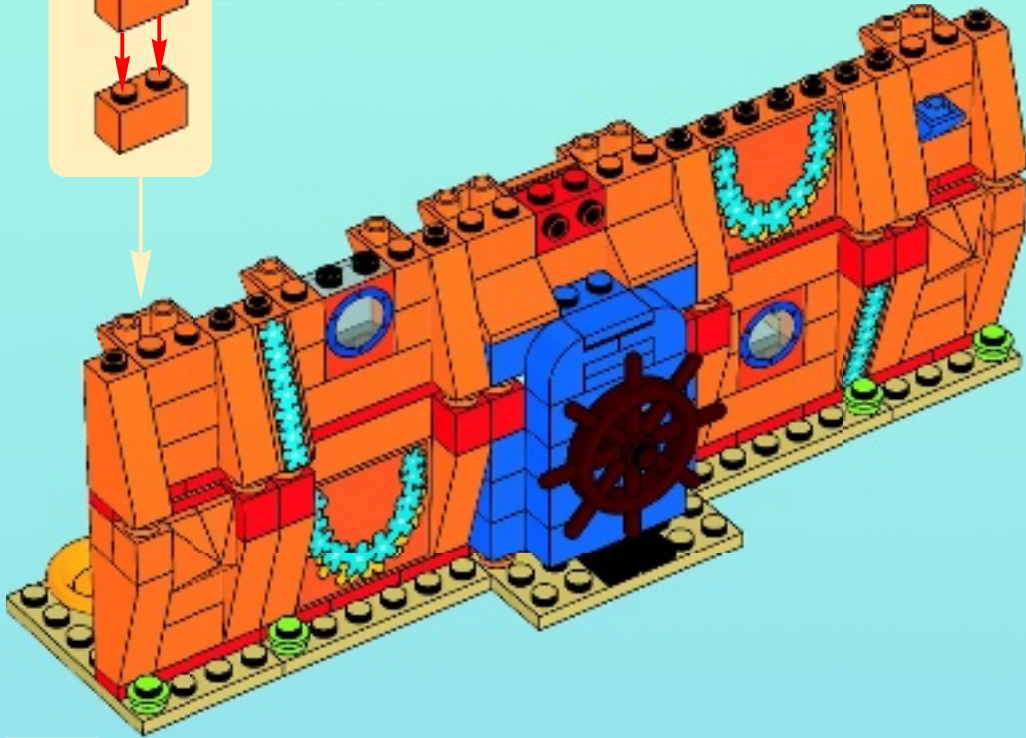
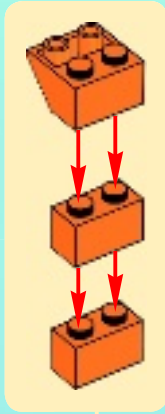

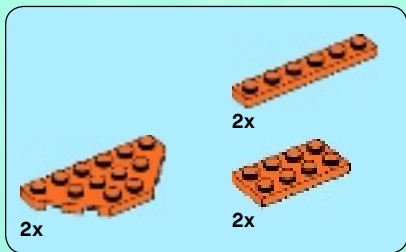

34

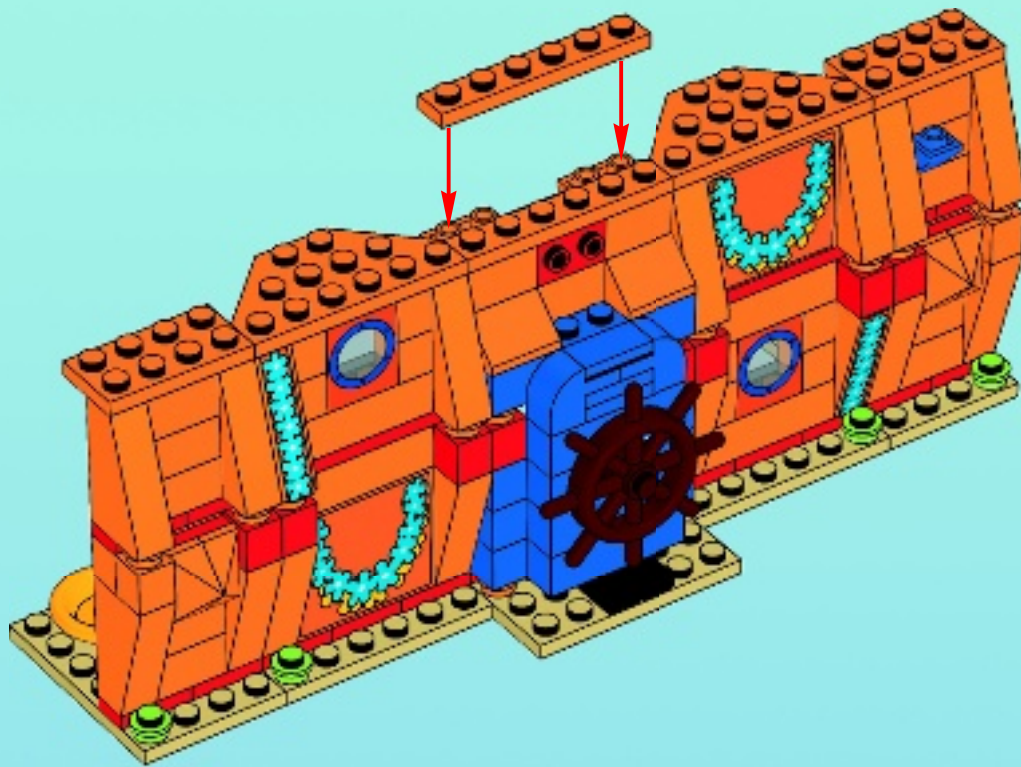



35

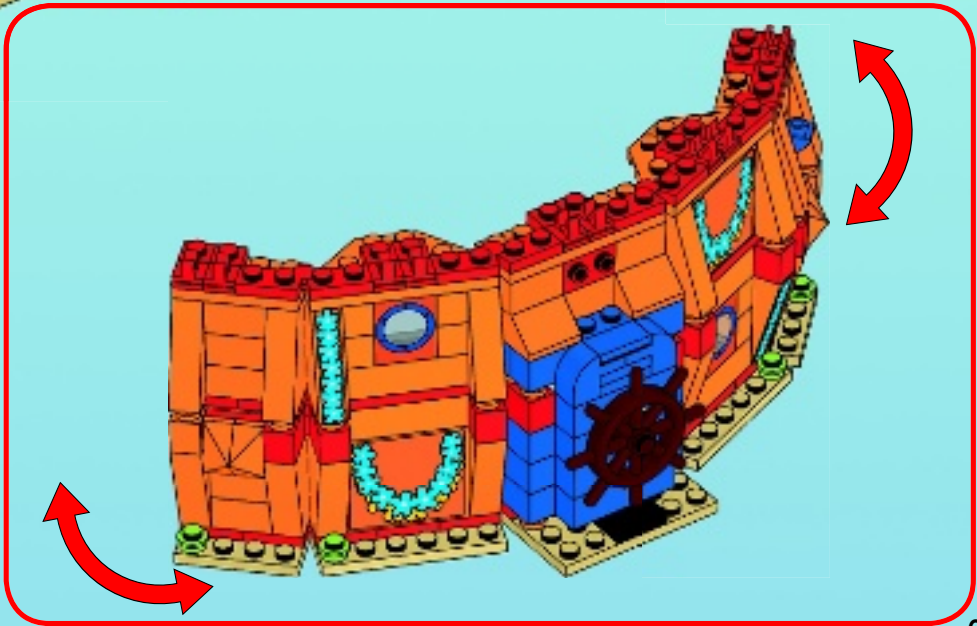
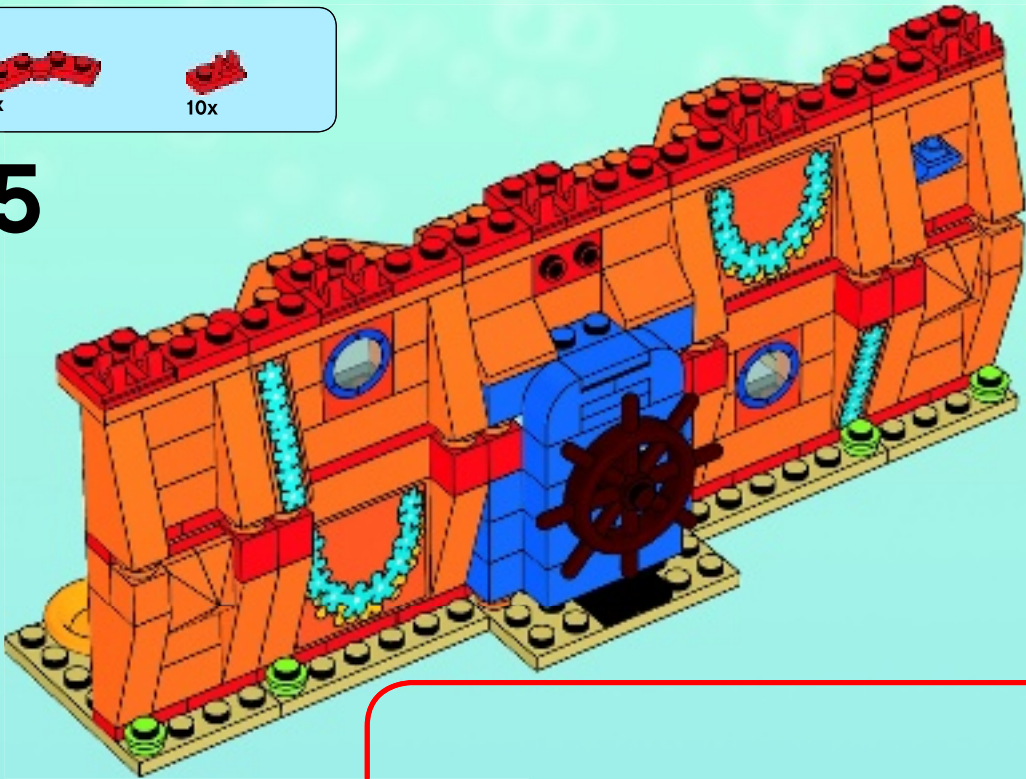

5x  1x  2x 

36



1  2  

Diagram showing step 1: a red 1x4 Technic brick with 4 holes. Step 2: an orange 1x2 Technic triangle being placed on top of the red brick, with green arrows indicating the placement.



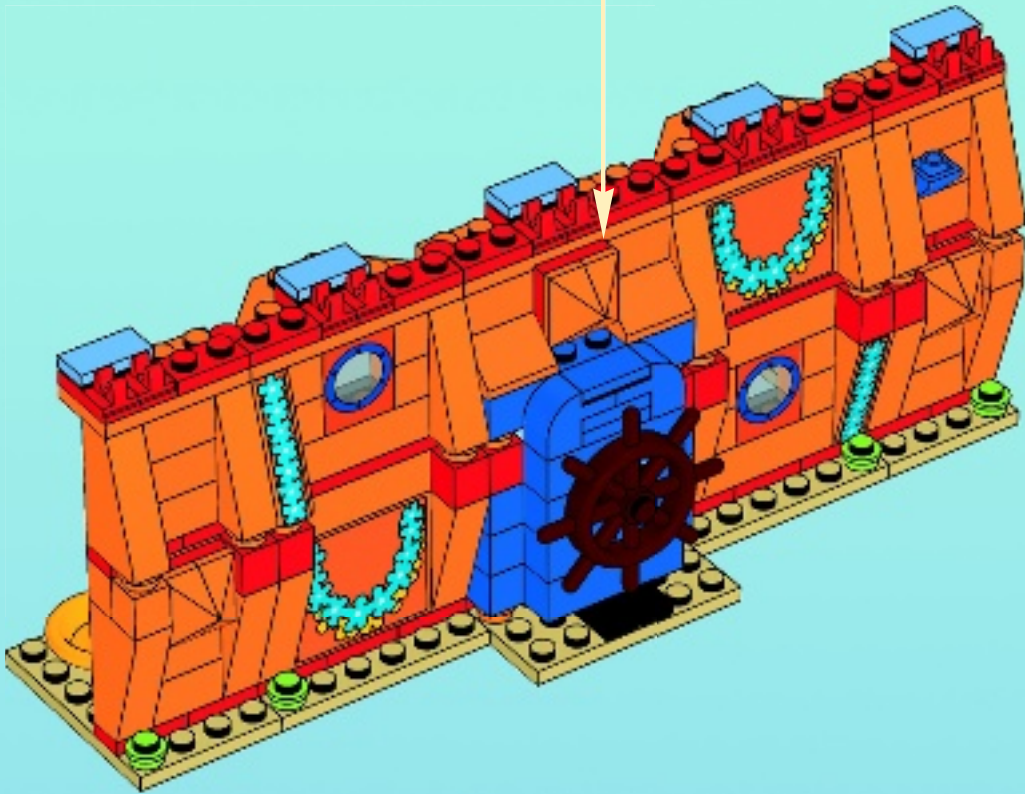

16x

37

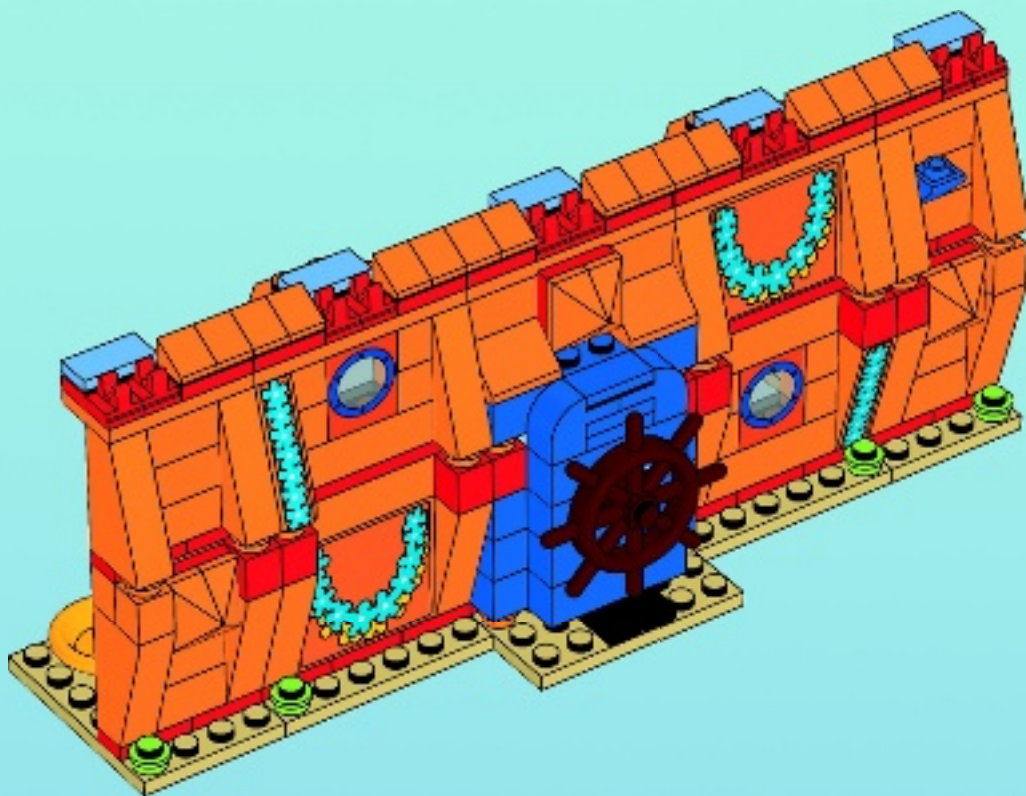



1

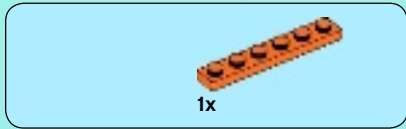
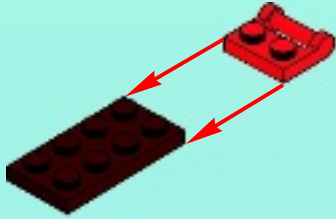

2

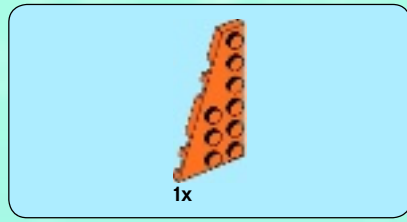

3

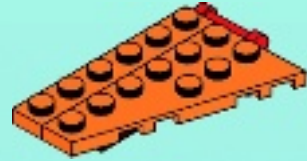

4



38

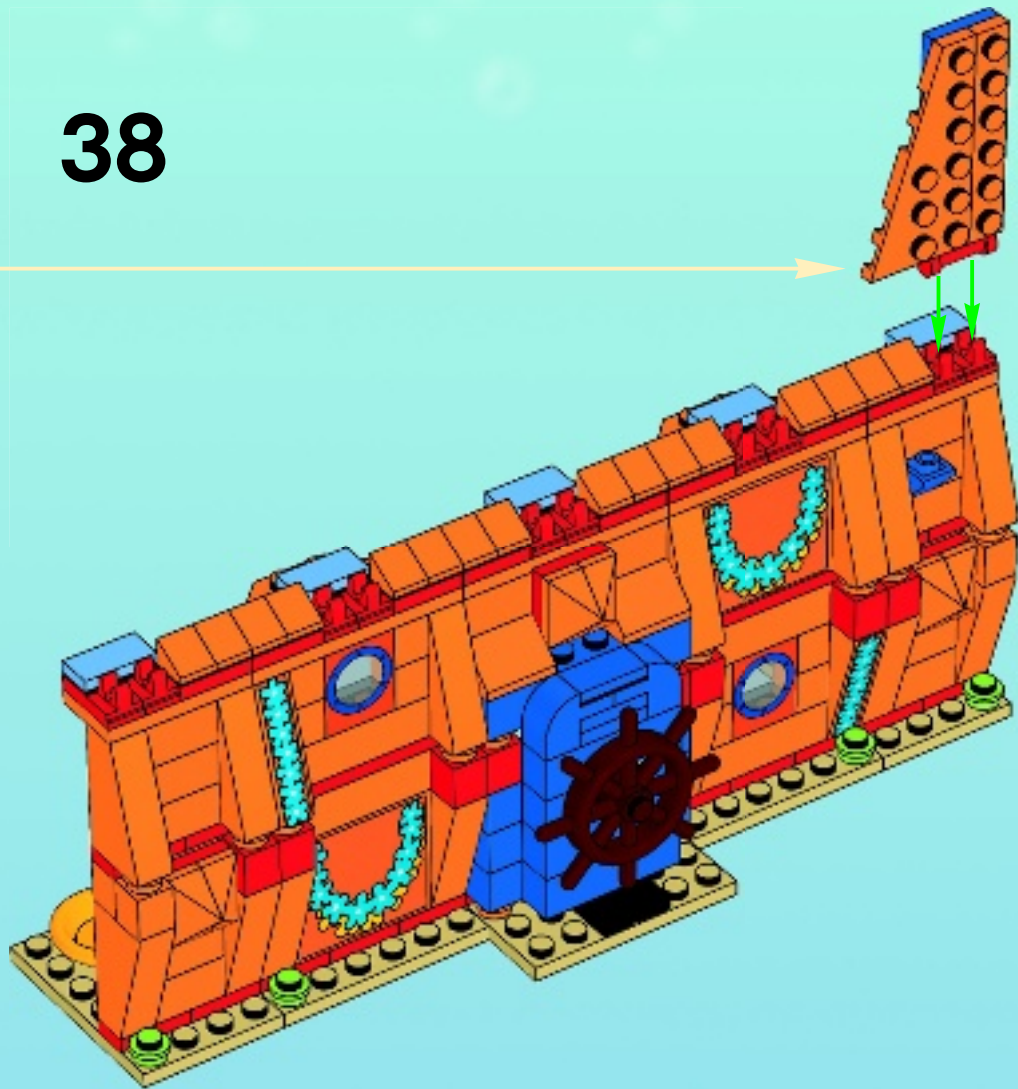



1

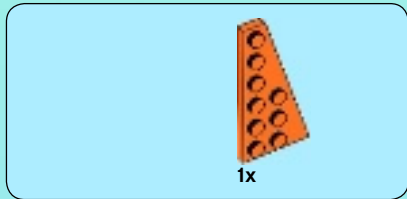
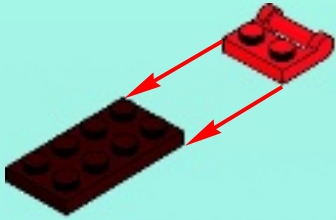

2

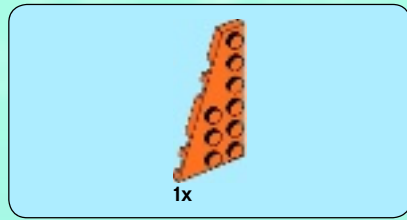

3



4

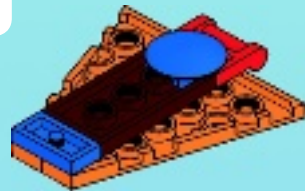

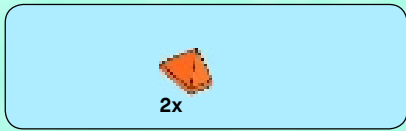

5

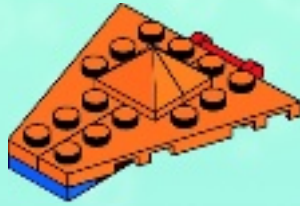

2x

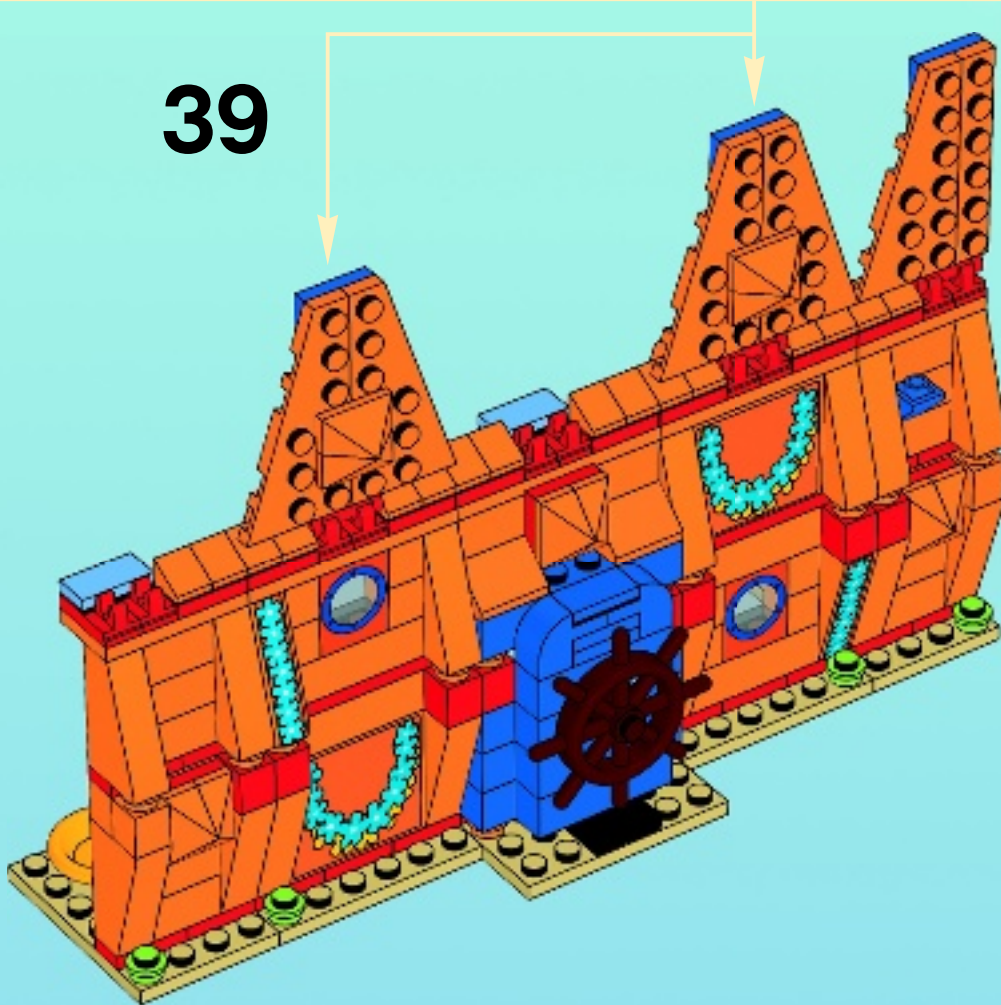



1

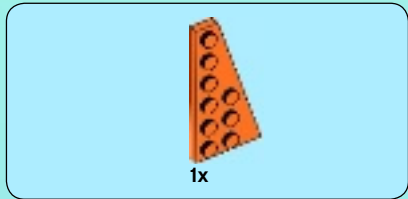
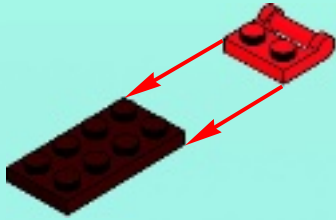

2

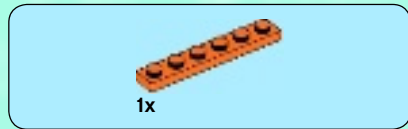

3



4

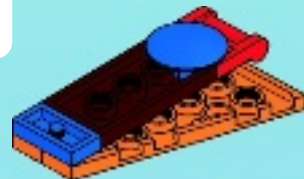

40

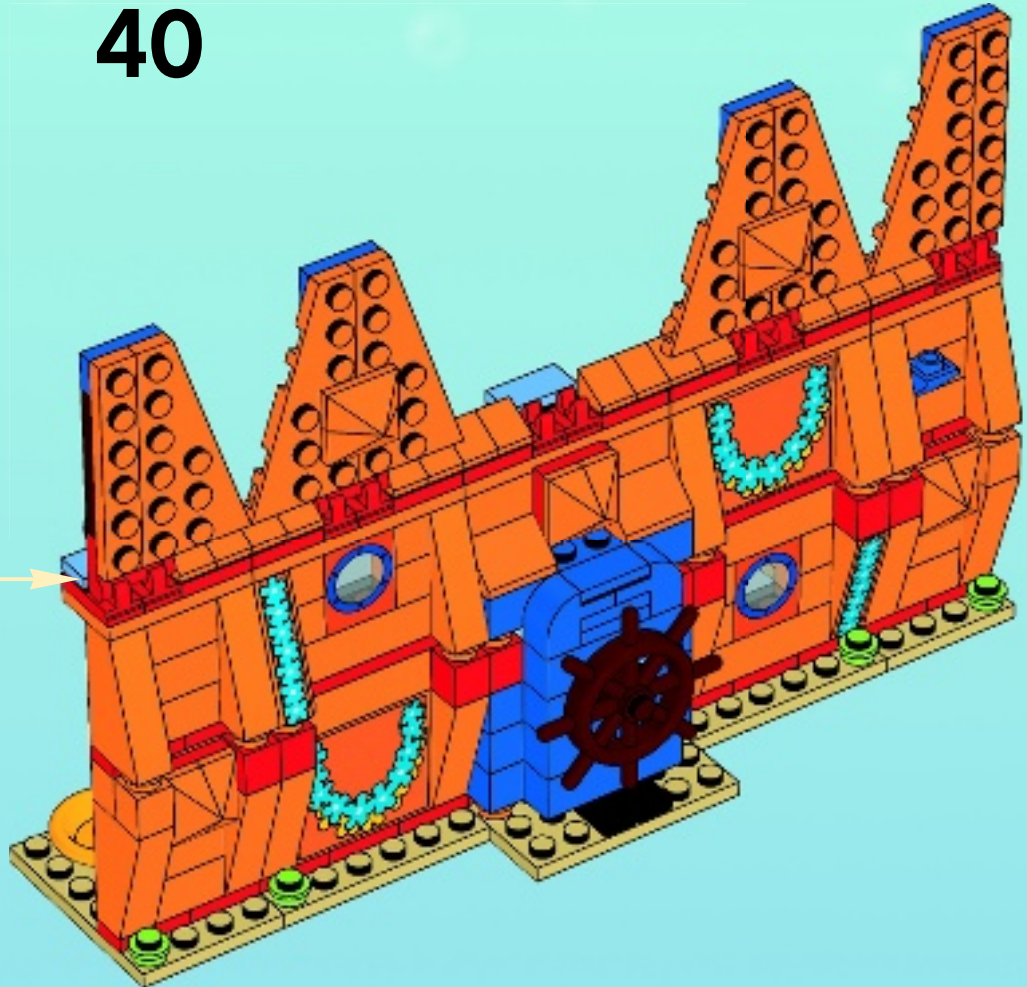



1

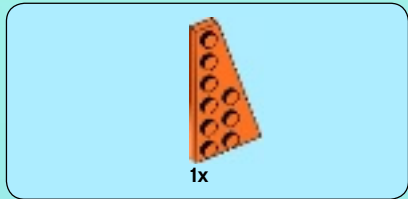
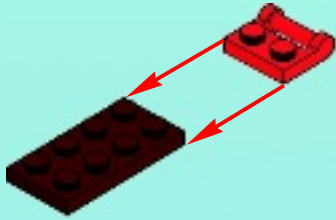

2

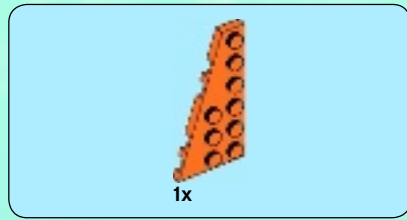

3



4

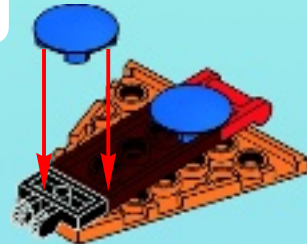

41

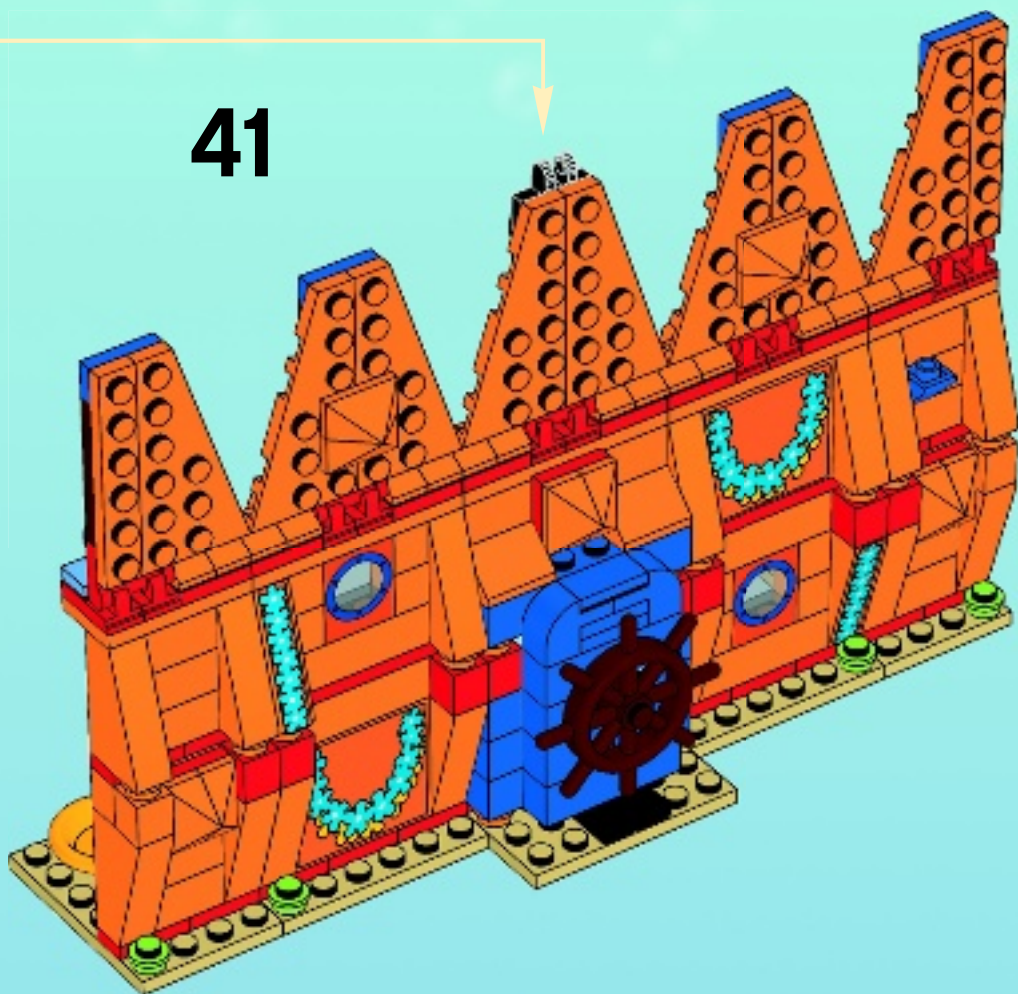

42

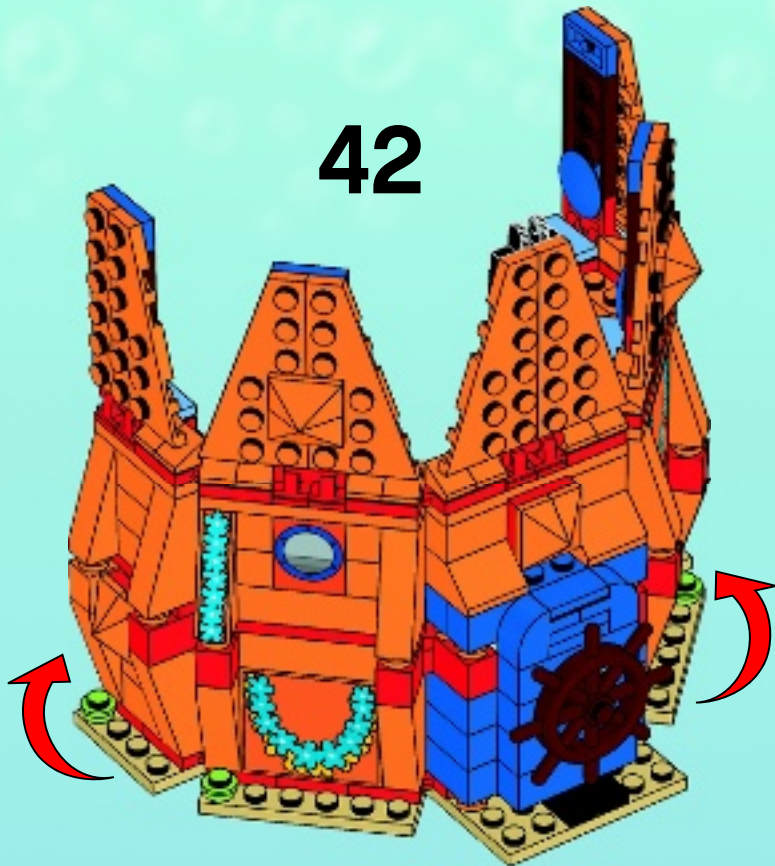

43





1

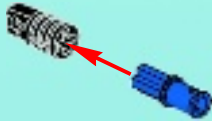

2

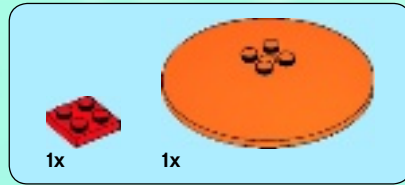
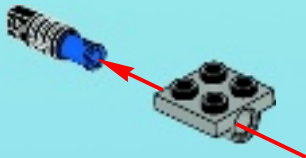

3

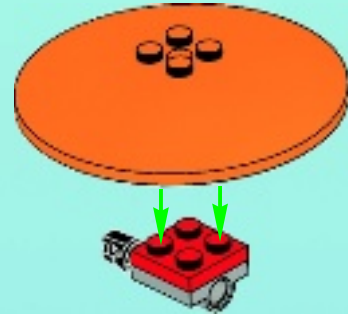

4

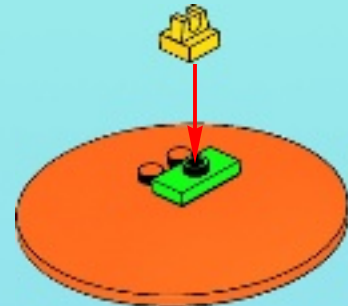



5

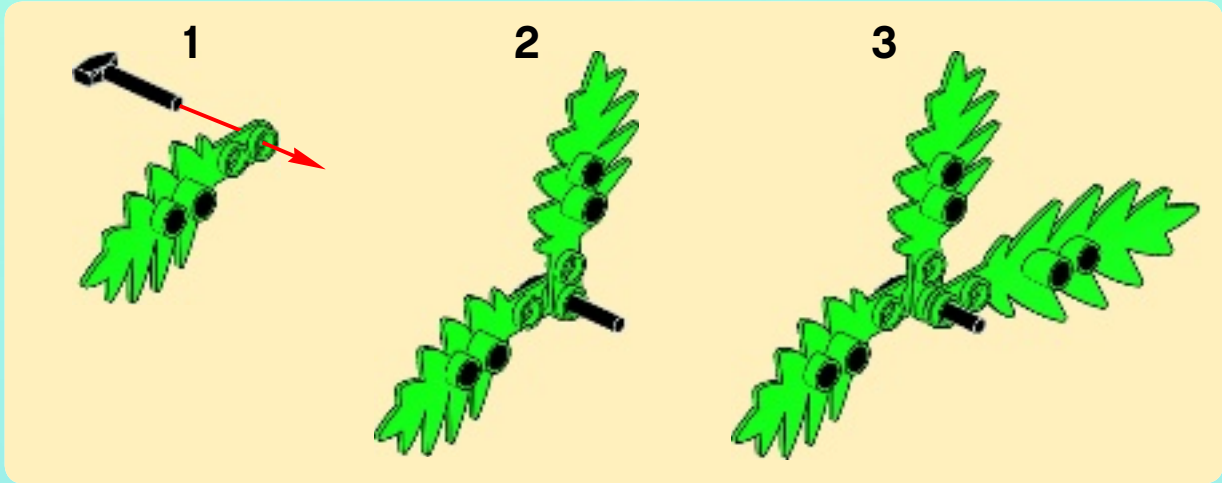

44



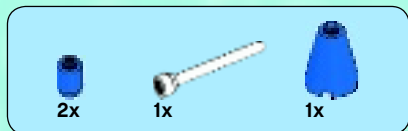

45

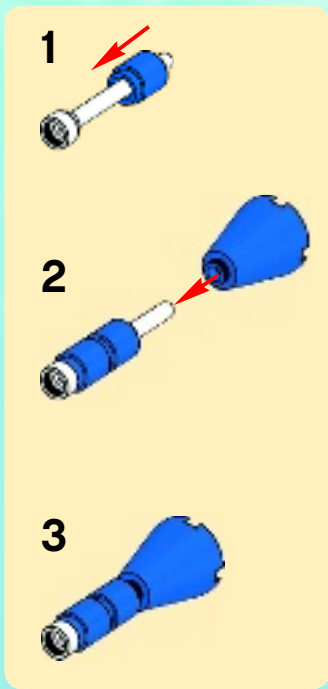

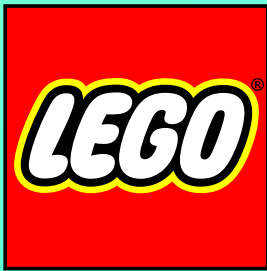

nickelodeon.

SpongeBob SQUAREPANTS™



1x 302401	5x 4113993	1x 383221	2x 362223	1x 383023	1x 4515340	5x 4258459
1x 4613256	5x 4114001	12x 4597713	2x 301023	1x 383123	2x 4144024	2x 4119479
2x 306801	5x 4114001	5x 4226876	2x 306223	2x 368023	1x 379426	2x 6001658
2x 4558168	1x 4624185	8x 74230	1x 4295311	1x 4206482	2x 614126	2x 4278412
1x 403201	1x 4624185	1x 4179584	1x 614323	2x 4216656	4x 474026	1x 4219773
1x 4288961	1x 4658991	4x 4178428	1x 366523	1x 4164060	1x 486526	2x 626440
1x 4649222	1x 4655160	1x 4570470	2x 4189123	2x 243224	1x 4538456	1x 4497943
2x 4129836	1x 4514554	1x 4261628	2x 4618877	4x 4107090	1x 4140303	2x 4163917
1x 395701	3x 4569056	1x 4617549	6x 302323	1x 4293300	1x 452226	1x 3005744
1x 4249021	2x 4216657	4x 4612578	2x 4613257	1x 4653149	1x 4158848	2x 4540865
1x 4213568	1x 365921	4x 4612582	1x 306923	1x 4653149	2x 4124096	1x 4568173
3x 4117070	8x 302321	1x 4655167	1x 614123	1x 4563681	1x 4184169	4x 4565363
1x 4650647	4x 302221	2x 300523	6x 4278276	4x 654126	2x 4109810	6x 4581079
2x 4118790	2x 366621	6x 300423	2x 4652615	1x 370026	1x 379428	7x 4168345
			1x 407923	2x 415026	2x 4114348	9x 4173805
						8x 4121739

 2x 4118787	 4x 4544487	 1x 4206504	 1x 4561915	 2x 4211385	 2x 4211807	 1x 4528323
 4x 4118827	 4x 4544481	 1x 4539400	 2x 4533101	 6x 4521921	 4x 4211075	 2x 4211066
 16x 4504371	 4x 4544481	 1x 4243920	 2x 4548857	 2x 4211614	 1x 4558955	 2x 4541082
 2x 4616279	 2x 4544435	 2x 4226966	 1x 4548857	 6x 4234535	 2x 4211096	 1x 4644875
 8x 4159199	 1x 4288162	 1x 4529242	 1x 4211362	 2x 4191414	 2x 4211000	 1x 4654999
 8x 4295307	 2x 4558210	 3x 4211190	 1x 4211362	 2x 4211488	 1x 4220973	 1x 4653131
 2x 4118828	 1x 4200798	 5x 4211186	 3x 4211389	 3x 4618874	 5x 4211043	 4x 4523159
 4x 4118829	 1x 4164037	 2x 4211247	 6x 4211564	 3x 4211369	 1x 4211061	 2x 4536989
 10x 4655149	 4x 4183133	 2x 4271949	 6x 4211388	 2x 4211414	 1x 4211061	 2x 4538950
 2x 4158355	 1x 4294982	 1x 4211159	 1x 4211387	 2x 4211568	 1x 4210997	 5x 4633691
 4x 4173332	 1x 4296785	 2x 4595814	 4x 4211650	 2x 4211376	 1x 4212363	
 3x 4542142	 1x 4565320		 5x 4211394	 1x 4282740		
 15x 4157103	 1x 4265392			 2x 4540203		



Customer Service

Kundenservice

Service Consommateurs

Servicio Al Consumidor

LEGO.com/service or dial



: 00800 5346 5555

: 1-800-422-5346



www.LEGOclub.com



LEGO® Club Email

LEGO club™

FREE! GRATIS! GRATUIT!



LEGO® Club Magazine

SIGN UP ONLINE!

www.LEGOclub.com



00800 5346 5555*



1-866-534-6258 • 1-877-518-5346

US & Canada only

Canada seulement

- * Freephone. Mobile charges may apply.
- * Numéro sans frais. Des frais peuvent s'appliquer avec les téléphones cellulaires.
- * Gebührenfrei. Kosten für Anrufe aus Mobilfunknetzen können abweichen.
- * Gratis telefonnummer vanaf vaste lijn.
- * Det er et gratis nummer, når du ringer fra fasttelefon.
- * Det är gratis, när du ringer från en fast telefon.
- * Numéro sans frais. Des frais peuvent s'appliquer avec les téléphones portables.



nickelodeon.

SpongeBob
SQUAREPANTS



LEGO.com/spongebob



nickelodeon

SpongeBob
SQUAREPANTS



3817





3815



3816





WIN!

Go to www.LEGOsurvey.com/product to fill out a survey for a chance to win a cool LEGO® Product. No purchase necessary. Open to all residents where not prohibited.

 LEGO.com



www.LEGOsurvey.com/product

GEWINNE! WIN!

Nimm an der Umfrage auf www.LEGOsurvey.com/product teil und hab die Chance ein cooles LEGO® Produkt zu gewinnen!
Die Teilnahme am Gewinnspiel führt zu keinerlei Kaufverpflichtungen. Teilnahme in allen nicht ausgeschlossenen Ländern möglich.

Ga naar www.LEGOsurvey.com/product, vul een enquêteformulier in en maak kans op een cool LEGO® product.
Geen aankoopverplichting. Iedereen mag deelnemen, uitgezonderd ingezetenden van landen waar een enquêteverbod geldt.

GAGNE! 当てよう!

Visite www.LEGOsurvey.com/product pour répondre à un questionnaire et avoir une chance de gagner un produit LEGO® très cool!
Aucune obligation d'achat. Ouvert à tous les résidents des pays autorisés.

www.LEGOsurvey.com/product にアクセスして、アンケートにご記入ください。当選者にはレゴ®製品を差し上げます。
お買い上げの必要はありません。
禁止されていない限り、すべての皆様にご利用いただけます。

LEGO and the LEGO logo are trademarks of the/son des marques de commerce de/son marcas registradas de LEGO Group. ©2012 The LEGO Group.
© 2012 Viacom International Inc. All Rights Reserved. Nickelodeon, SpongeBob SquarePants and all related titles, logos and characters are trademarks of Viacom International Inc. SpongeBob SquarePants created by Stephen Hillenburg. © 2012 Viacom International Inc. Toute reproduction interdite. Nickelodeon, Bob L'éponge ainsi que les logos, les personnages et les autres titres qui s'y rapportent sont des marques de commerce de Viacom International Inc. Bob L'éponge créé par Stephen Hillenburg.
© 2012 Viacom International Inc. Todos los derechos reservados. Nickelodeon, Bob Esponja y todos los títulos, logotipos y personajes del mismo género son marcas de Viacom International Inc. Bob Esponja creado por Stephen Hillenburg.
www.nick.com www.nickelodeon.tv