



40583





Get excited about our new packaging!

We're switching from plastic to paper-based packaging. That's why you might find a mix of paper and plastic in our boxes!

Nos nouveaux emballages vous emballeront !

Nous passons des emballages en plastique aux emballages à base de papier. C'est pourquoi vous pourriez trouver un mélange de papier et de plastique dans nos boîtes !

¡Te presentamos nuestros nuevos empaques!

Estamos sustituyendo las bolsas de plástico por bolsas con base de papel. ¡Por eso, puedes encontrar una mezcla de papel y de plástico en nuestras cajas!

[LEGO.com/sustainable-packaging](https://www.lego.com/sustainable-packaging)

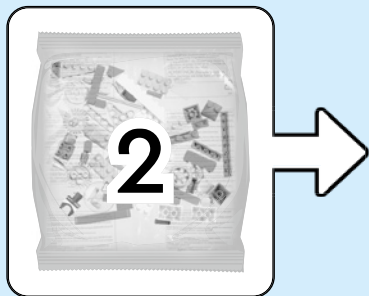
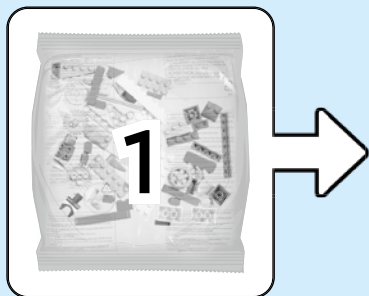

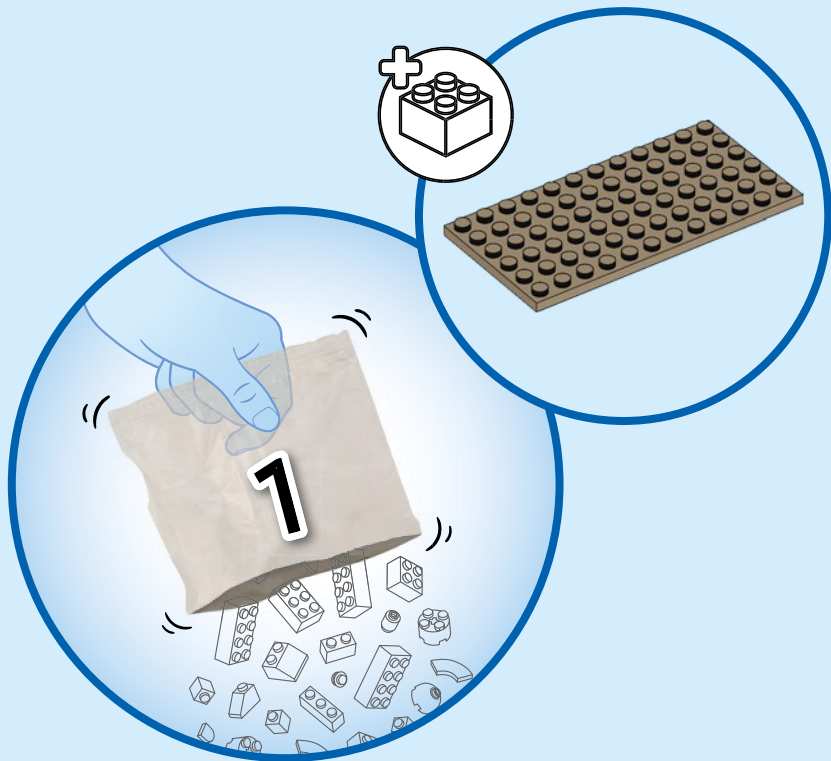

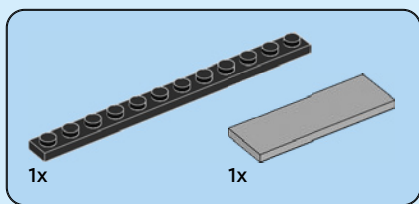

1

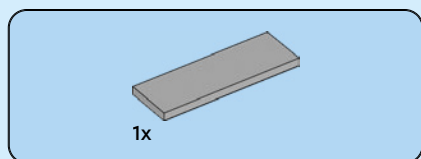
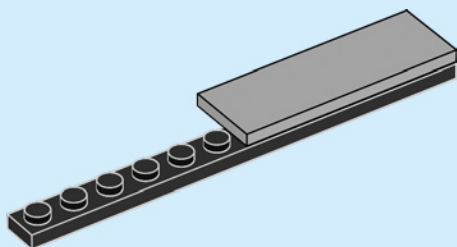

2

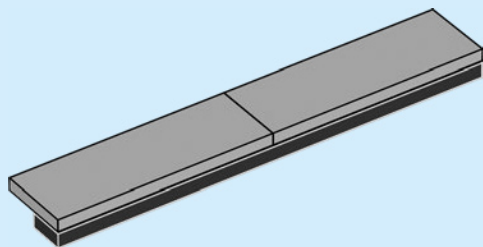

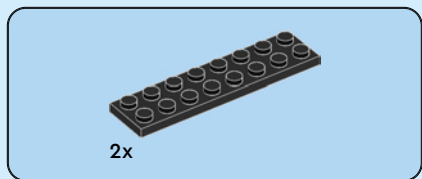

3

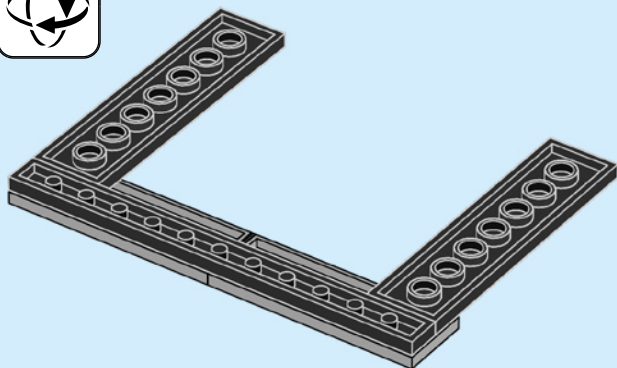

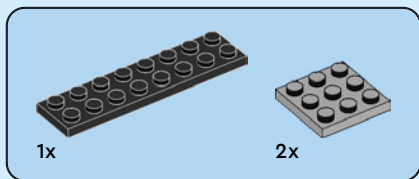

4

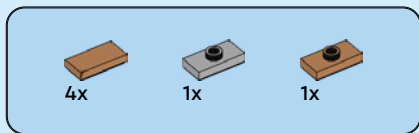
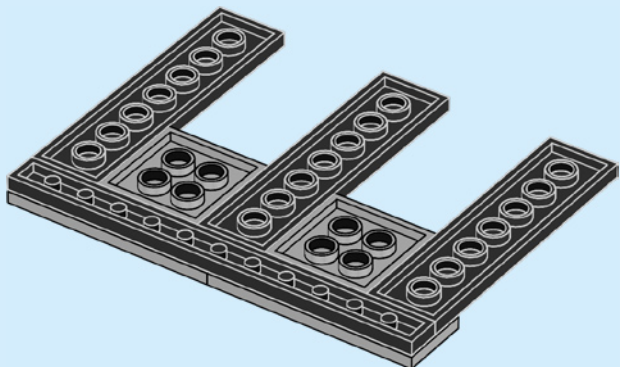

5

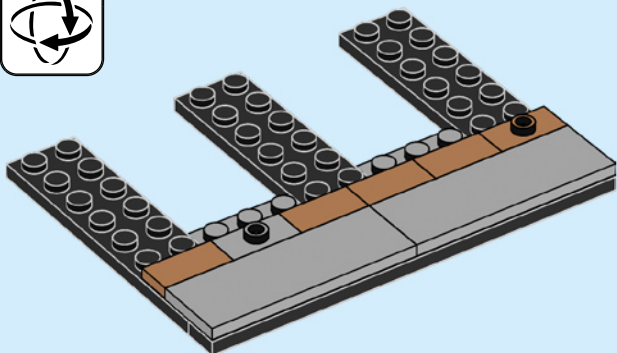

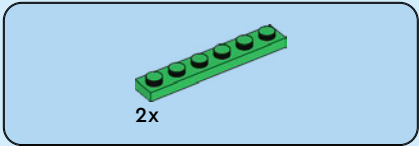

6

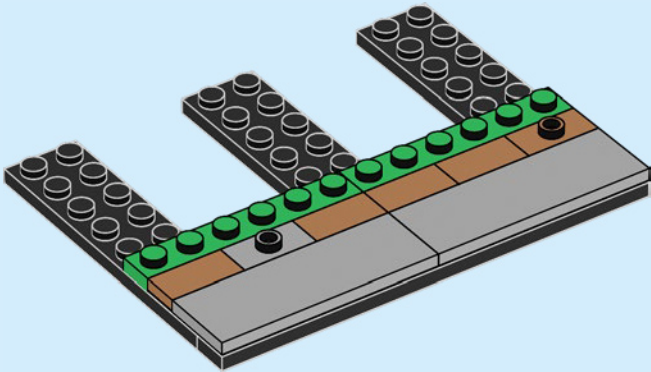

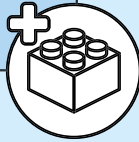
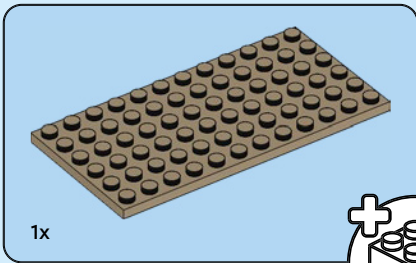

7

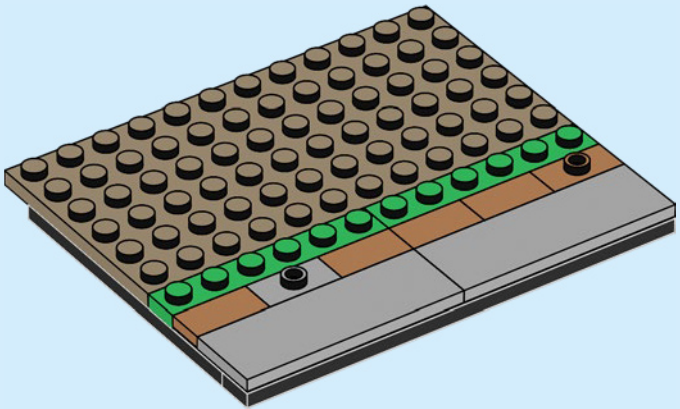

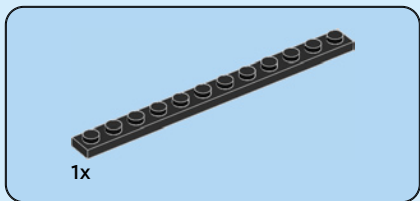

8

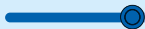
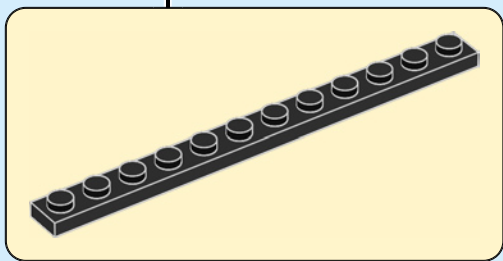
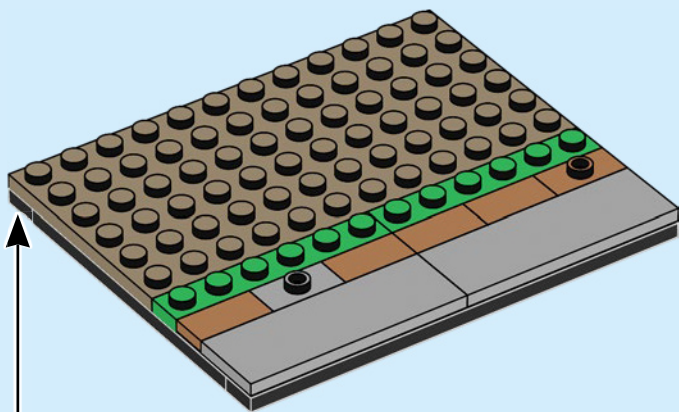

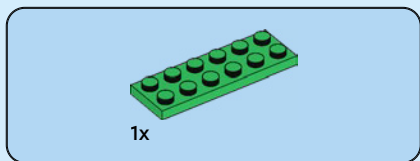

9

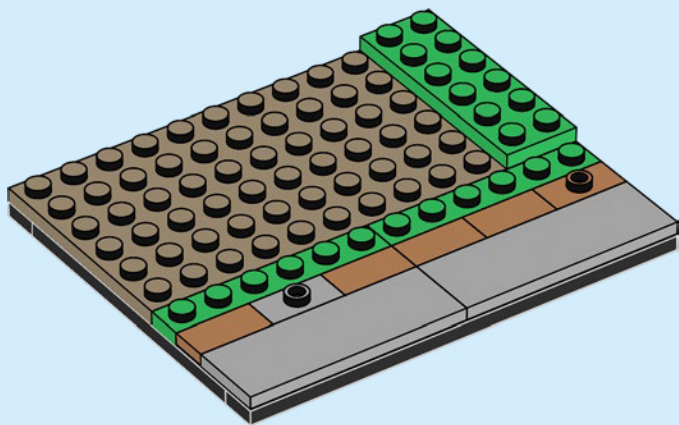

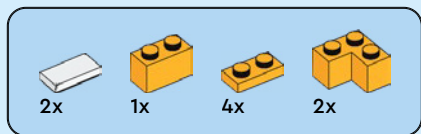

10

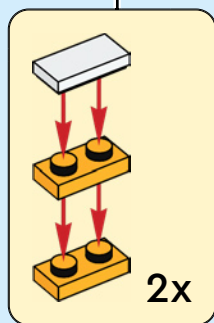
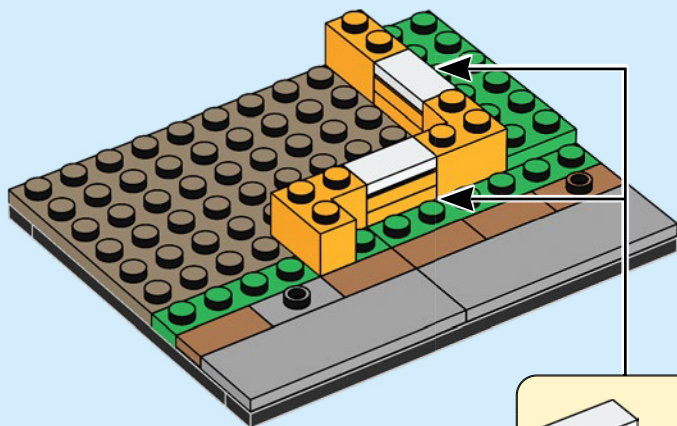

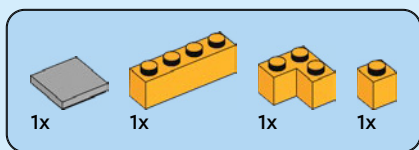

11

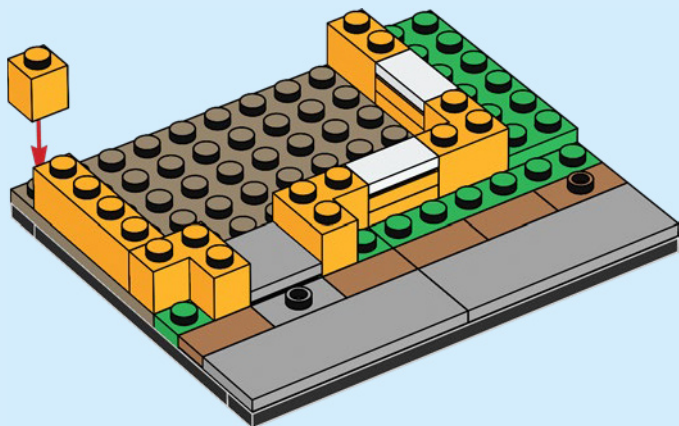



2x



3x



2x

12

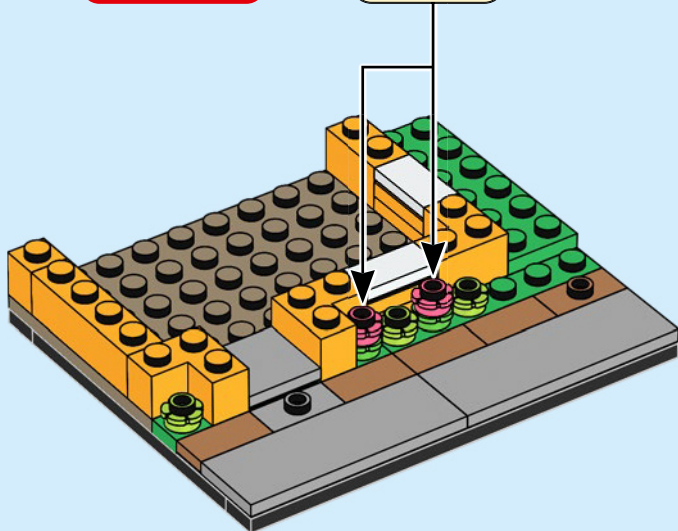
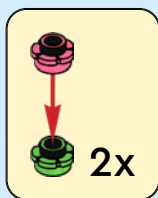
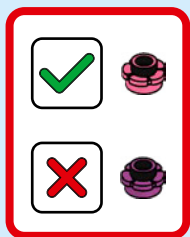

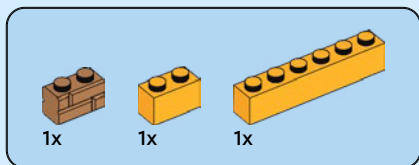

13

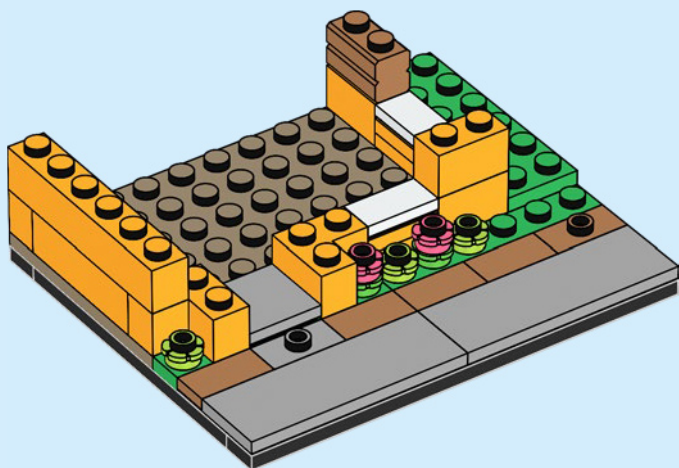

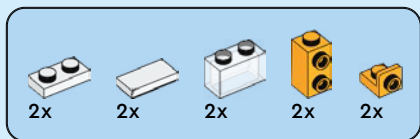

14

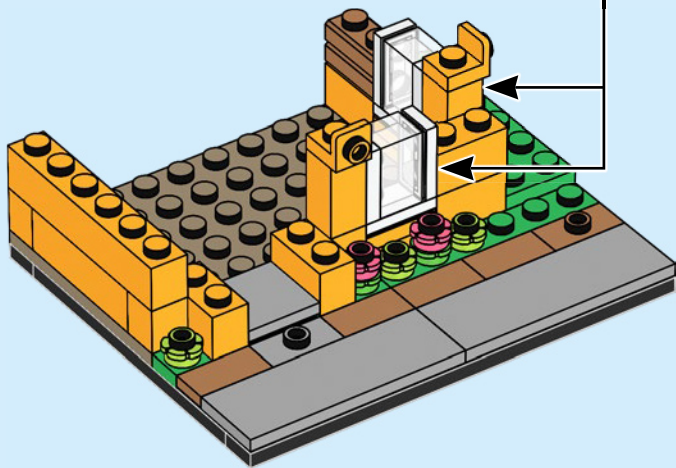
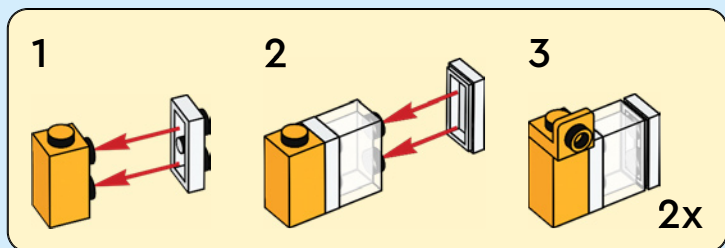



1x



2x

15

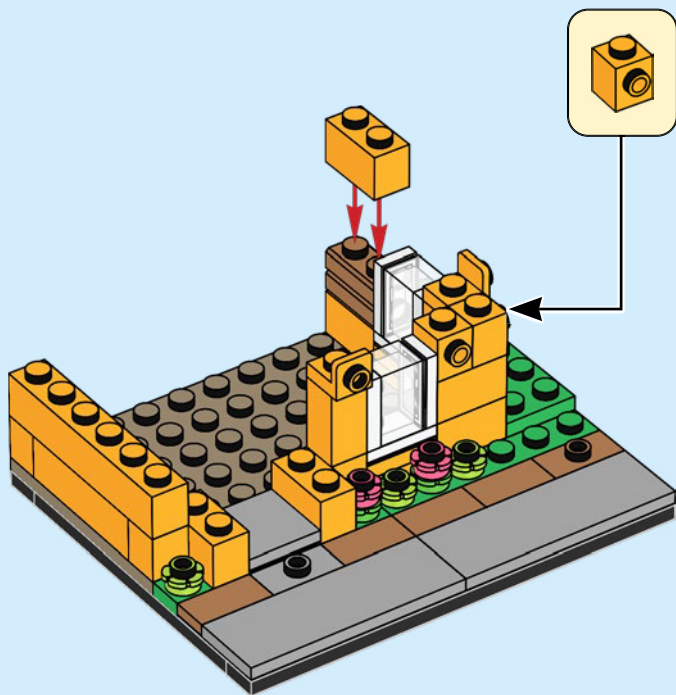

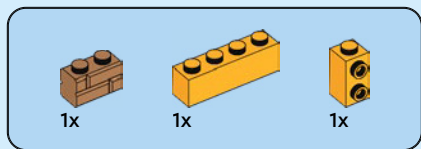

16

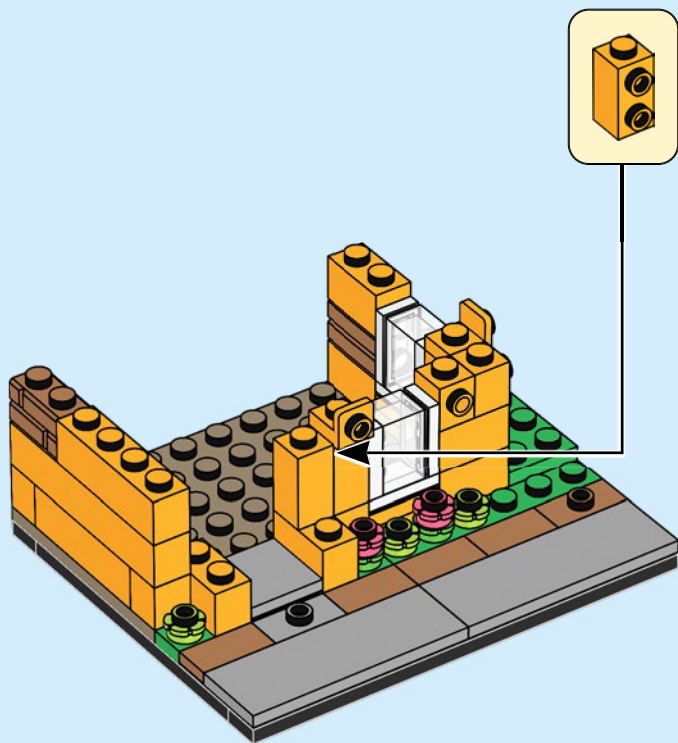

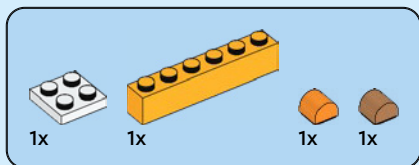

17

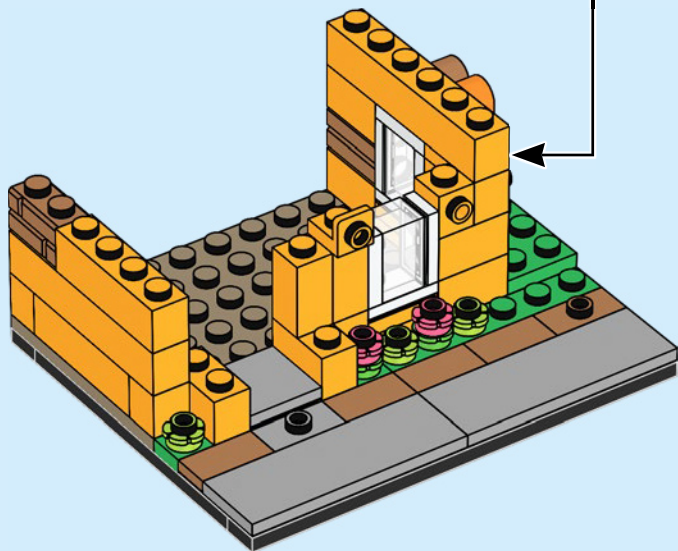
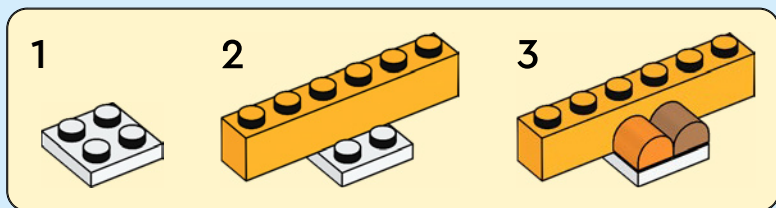

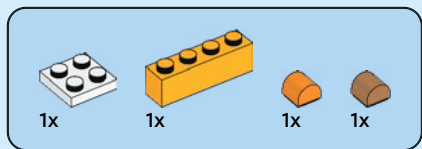

18

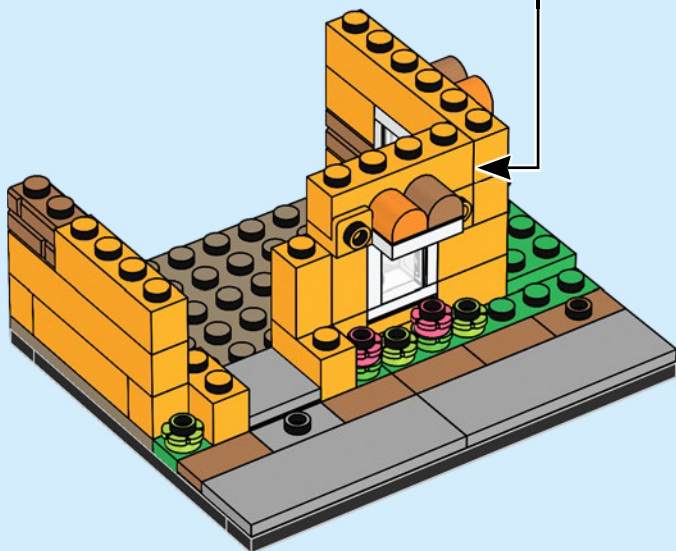
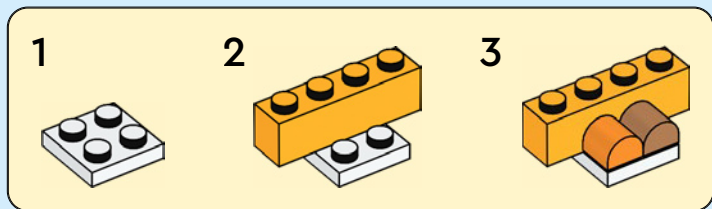



1x



1x



1x



1x



1x



1x



1x



1x



1x

19

1

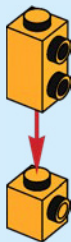

2

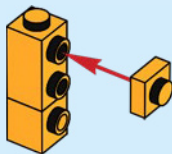

3

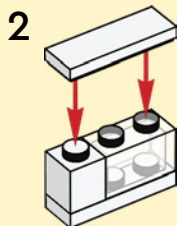
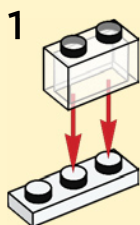
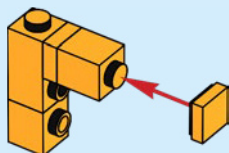

4

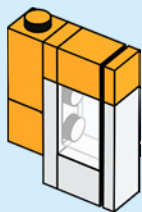

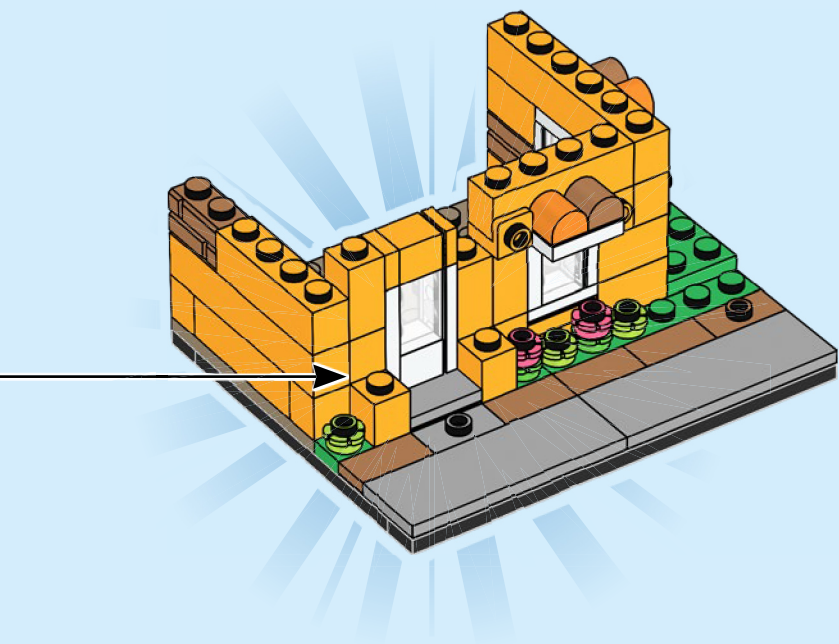



4x



2x

20

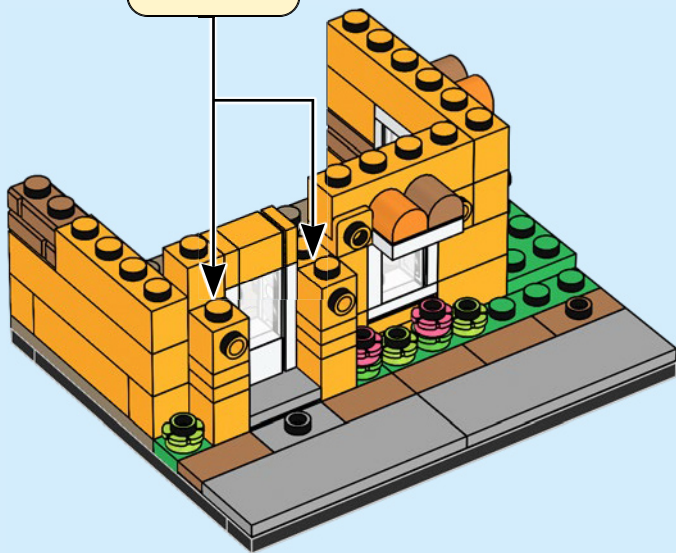
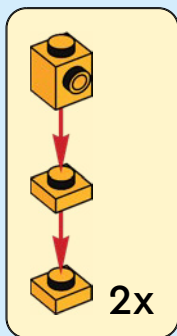



1x



1x

21

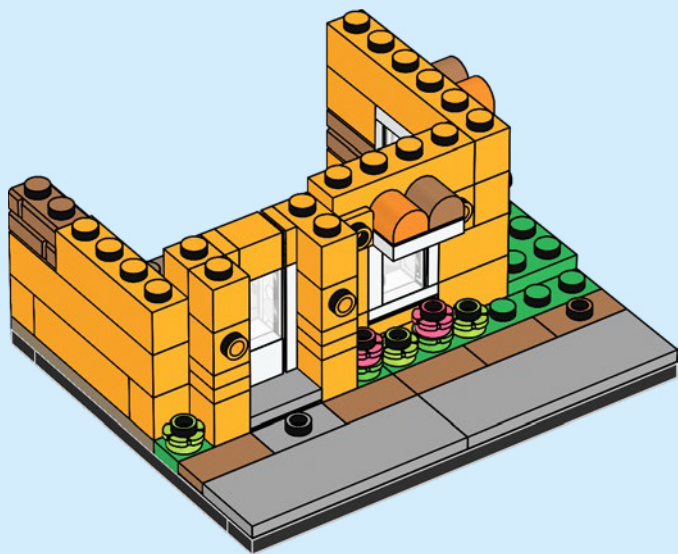

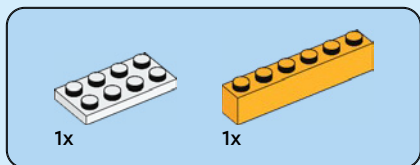

22

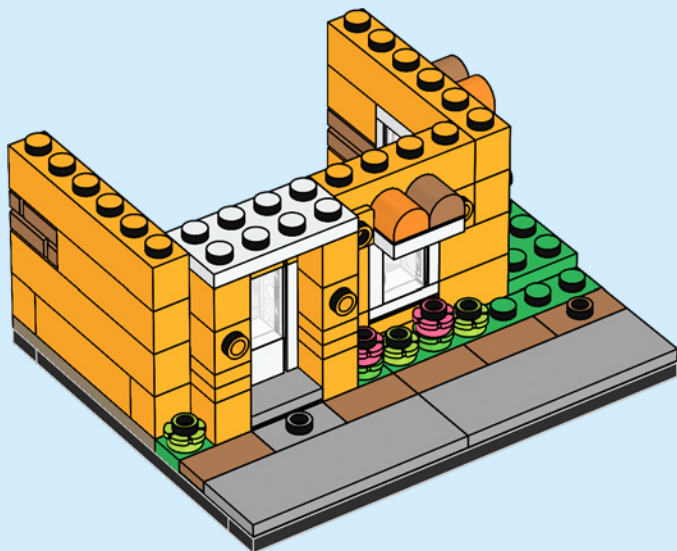

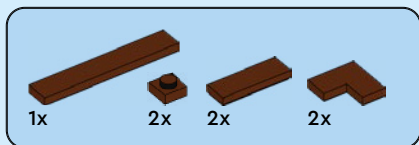

23

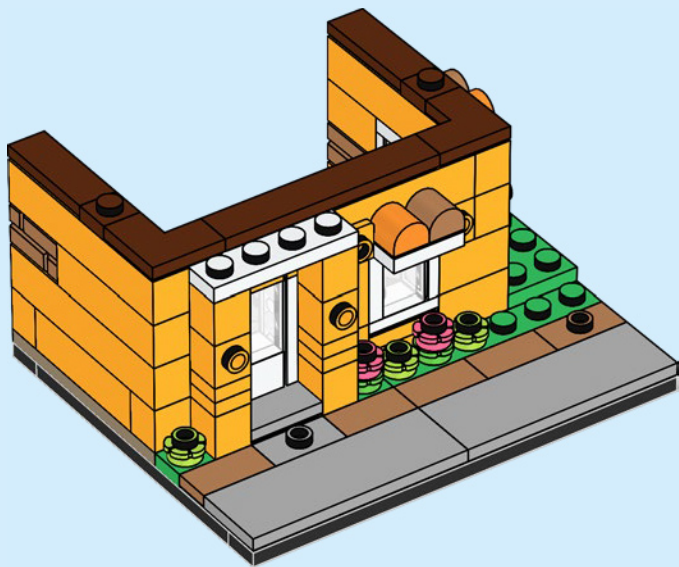



2x



2x

24

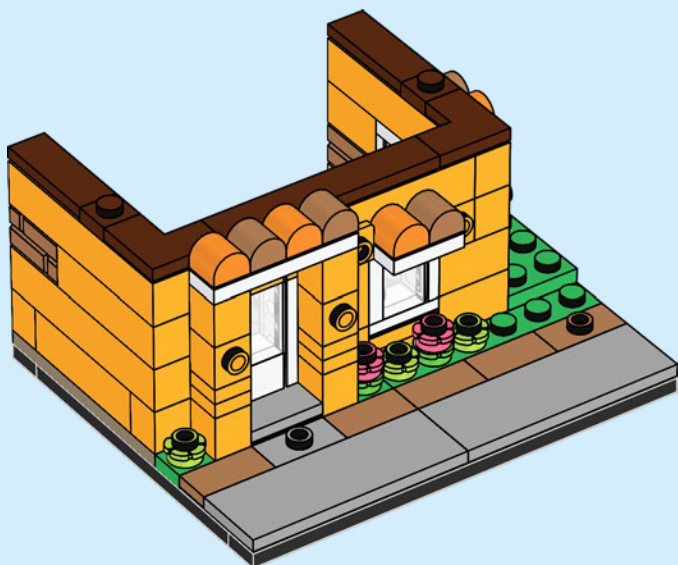



1x



1x



2x

25

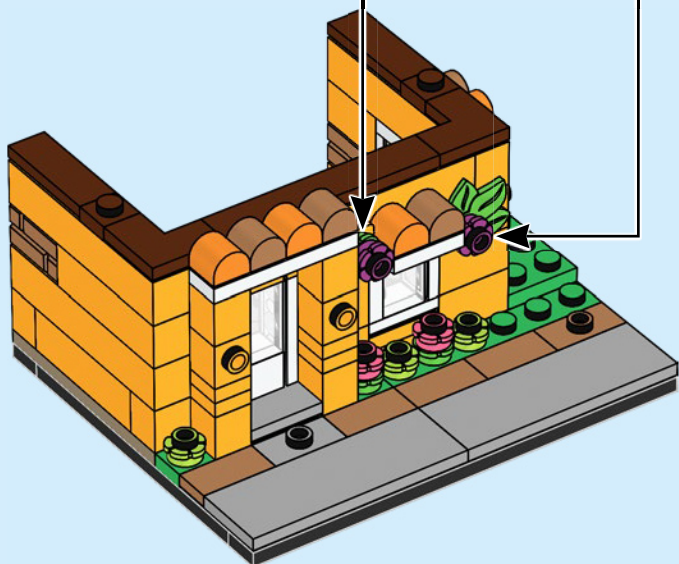
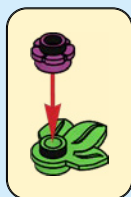
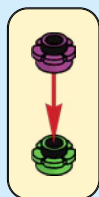



2x



2x



2x

26

1



2

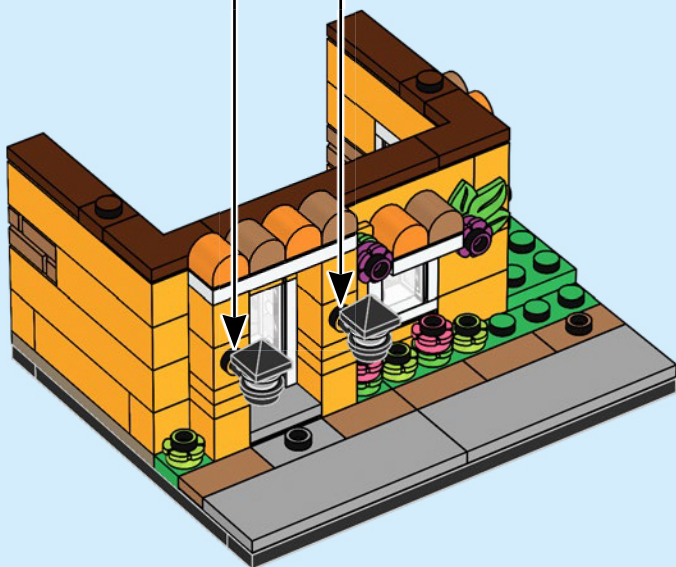



1x



3x



1x



1x



1x

27

1



2

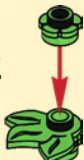

3

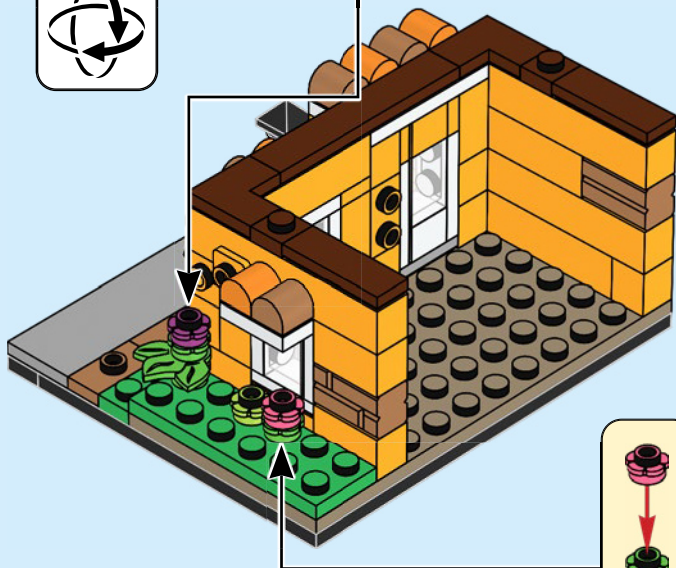



1x



1x



2x

28

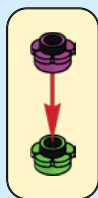
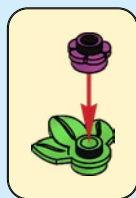



1x



1x



1x



1x

29

1



2





2x



2x

30

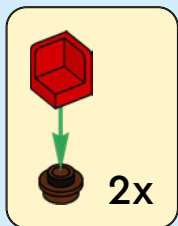

1x

1x

1x

31

1



2





1x

32

1



2

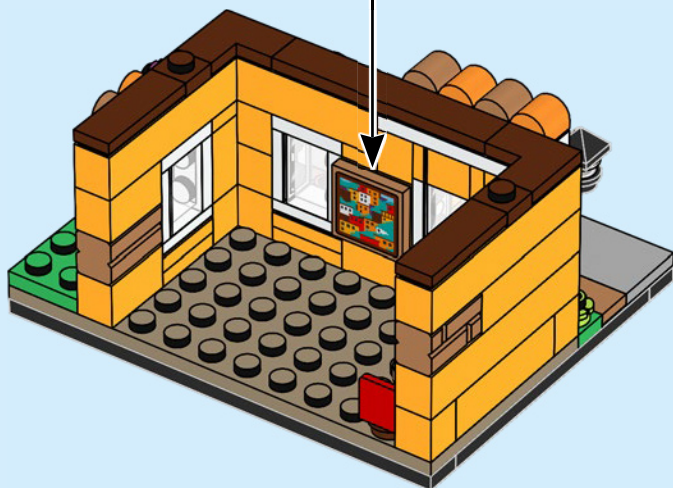

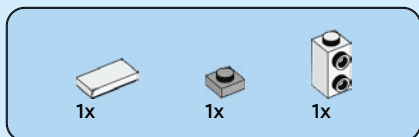

33

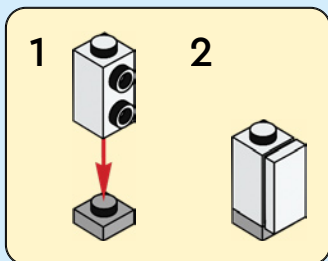



1x



1x

34

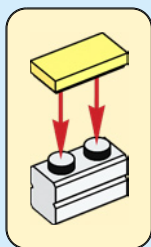



1x



1x



1x

35

1



2





2x



2x

36

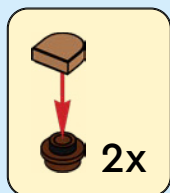



1x



1x

37

1



2



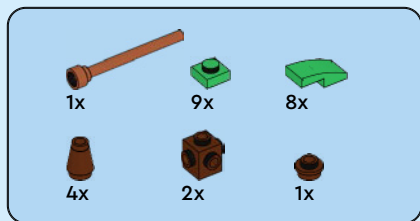

38

1



2



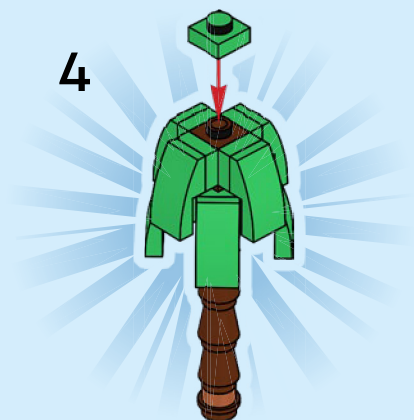
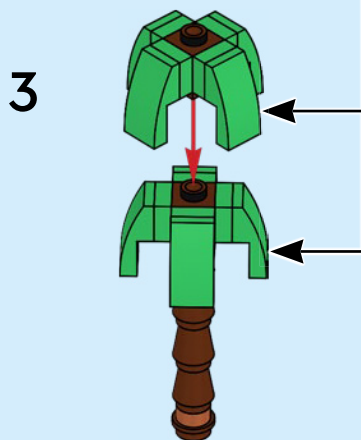
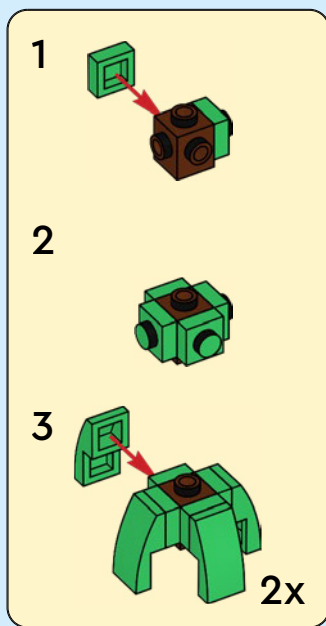

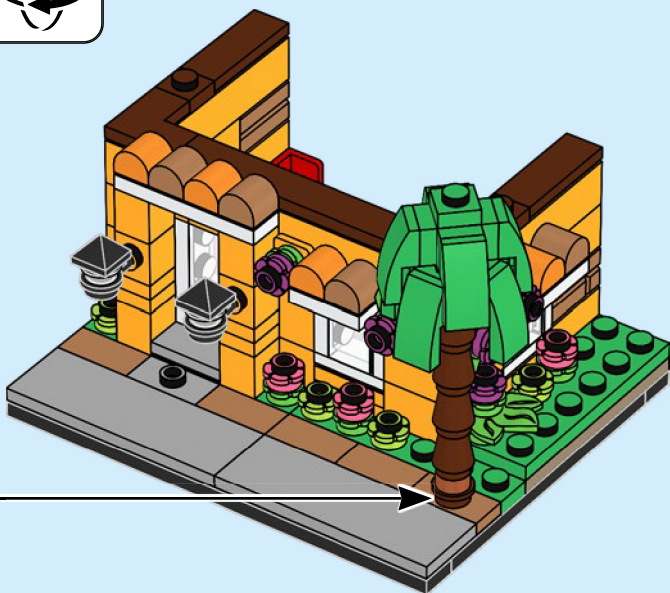



1x

39

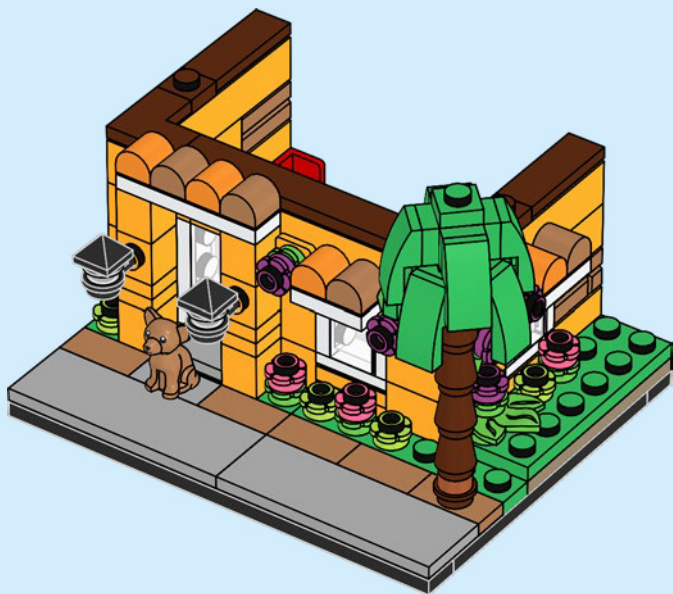



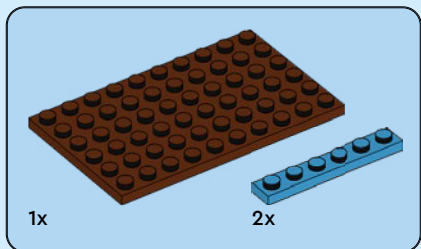

40

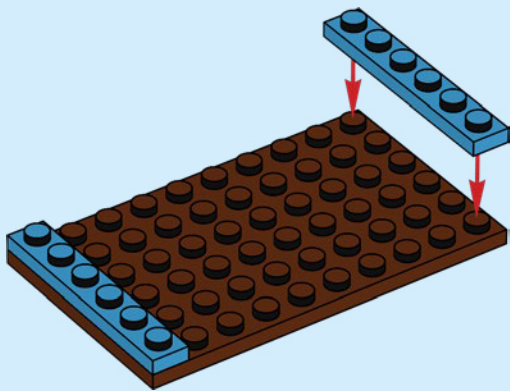



2x



4x

41

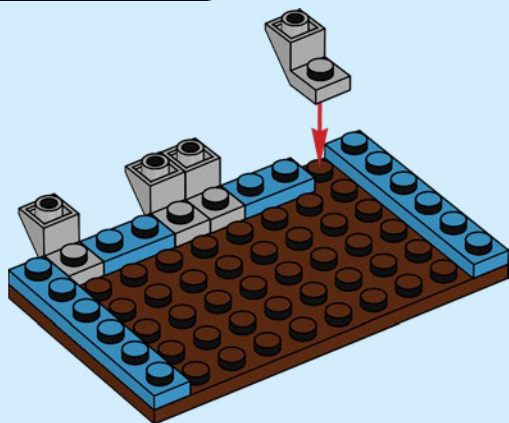

2x



4x

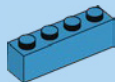

1x

42

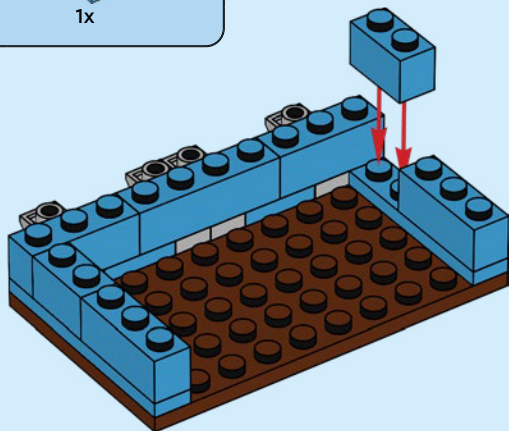

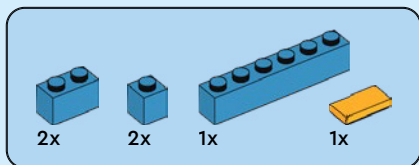

43

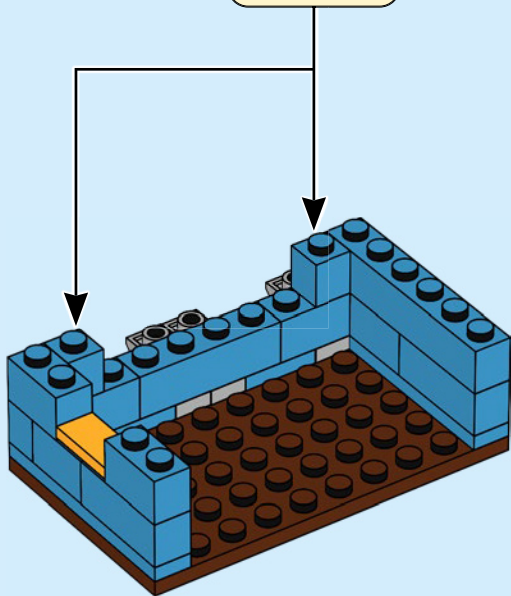
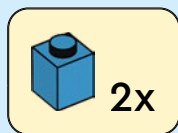



2x

44

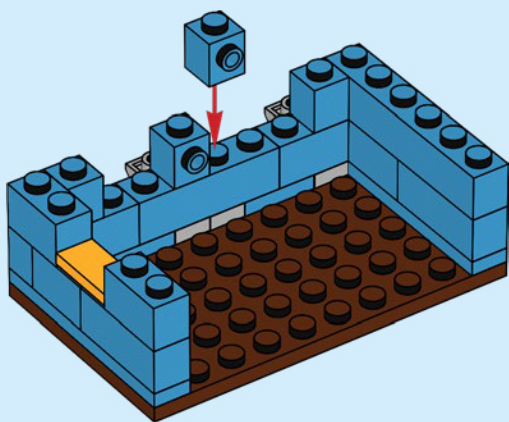

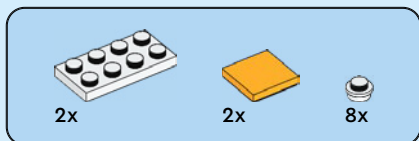

45

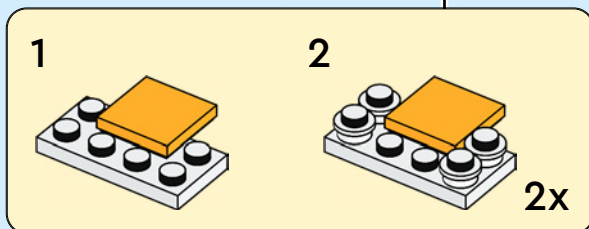
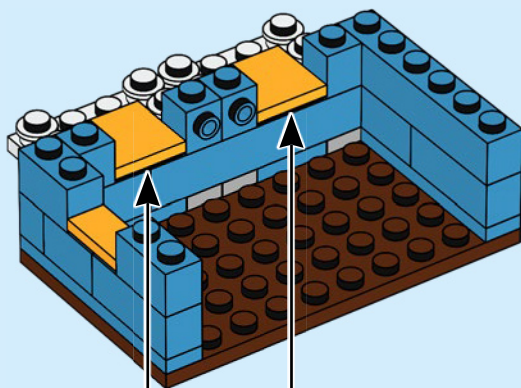

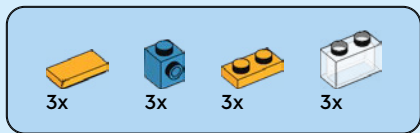

46

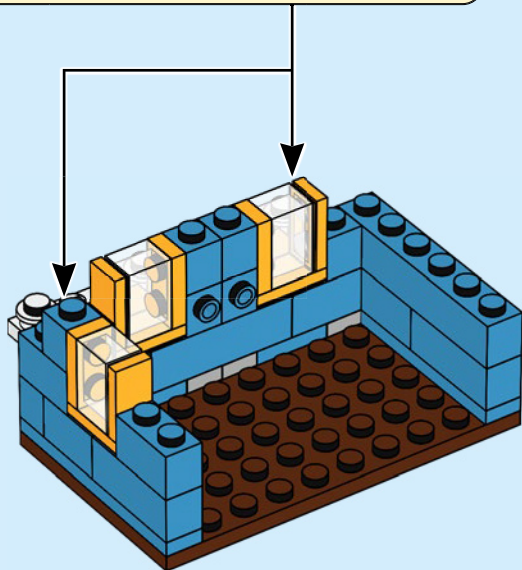
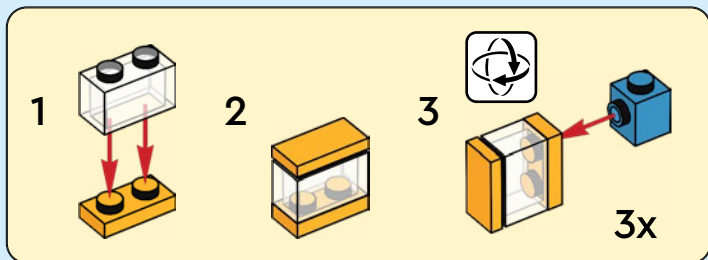



1x



3x



1x

47

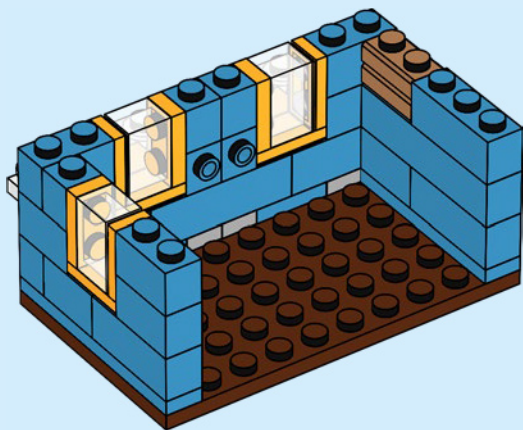

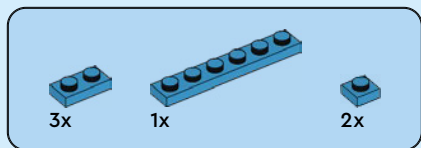

48

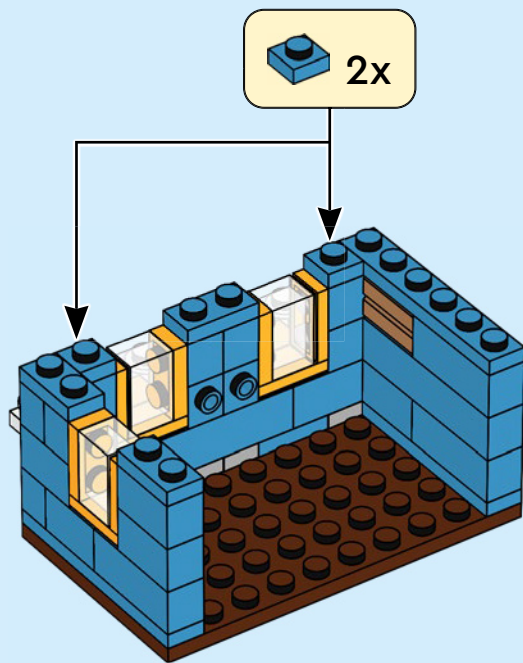

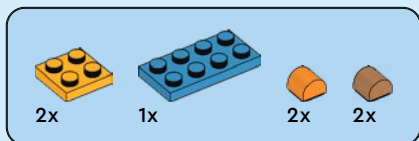

49

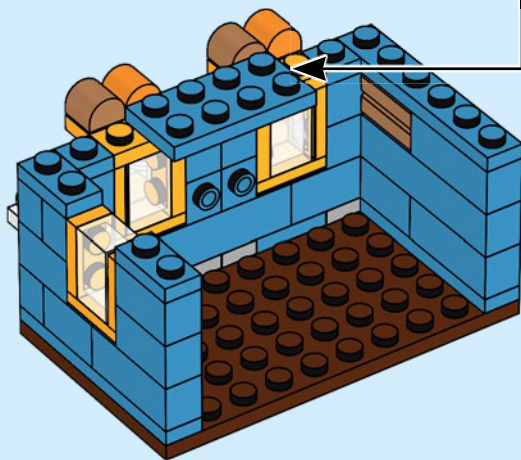
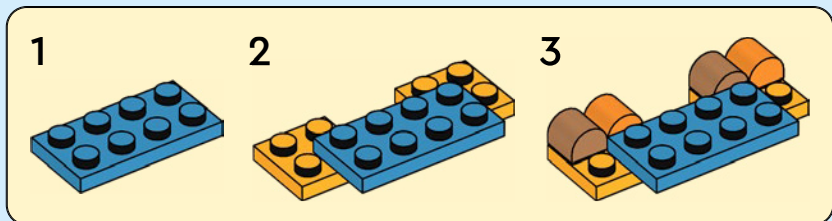

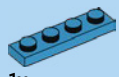

1x



2x

50

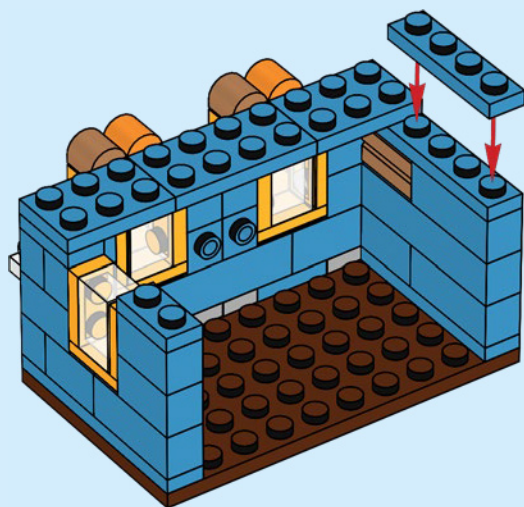



1x



1x



1x



1x

51

1

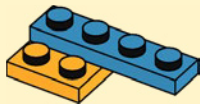

2

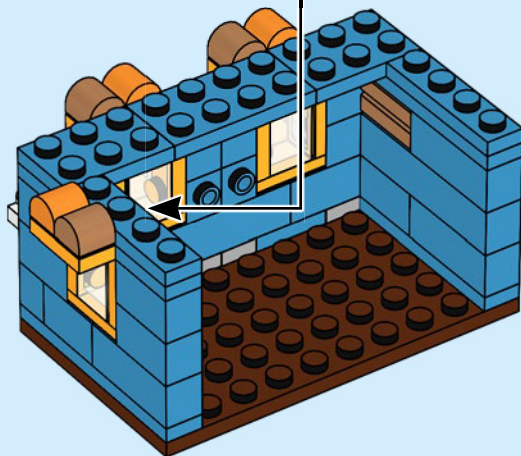
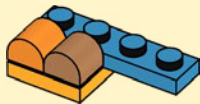



5x

52

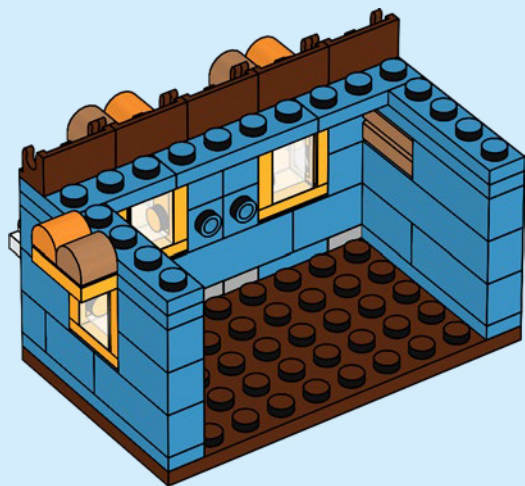

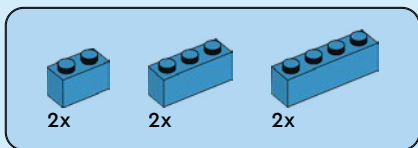

53

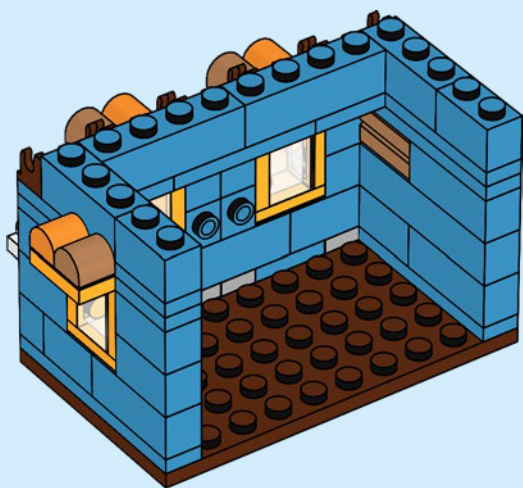

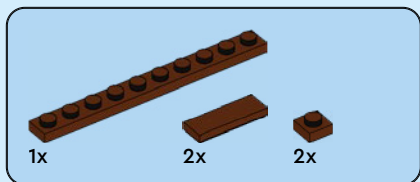

54

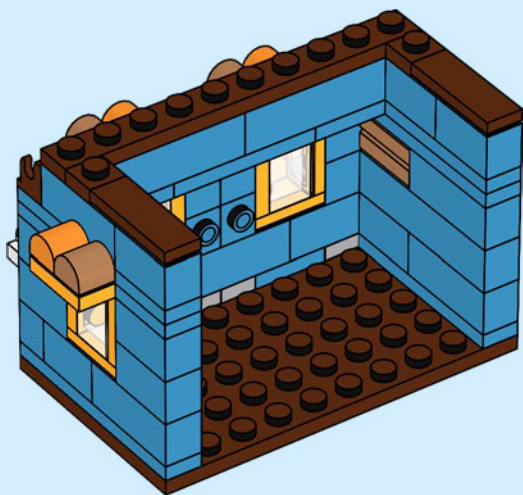



2x



2x



2x

55



2x

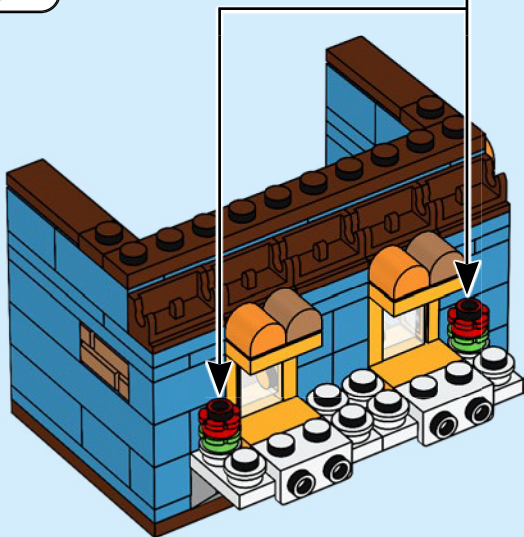



4x



4x

56

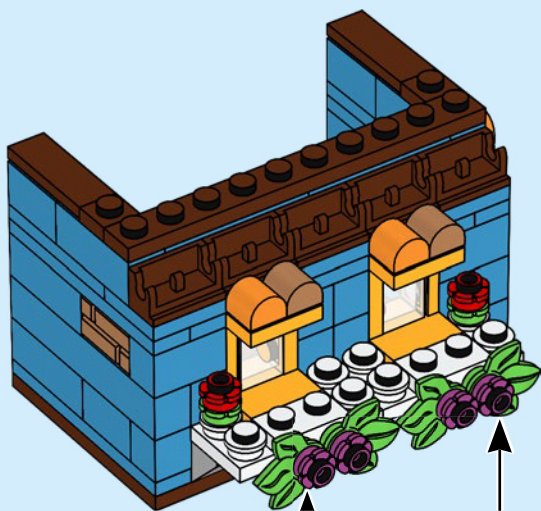

4x



2x



2x

57





5x



5x

58

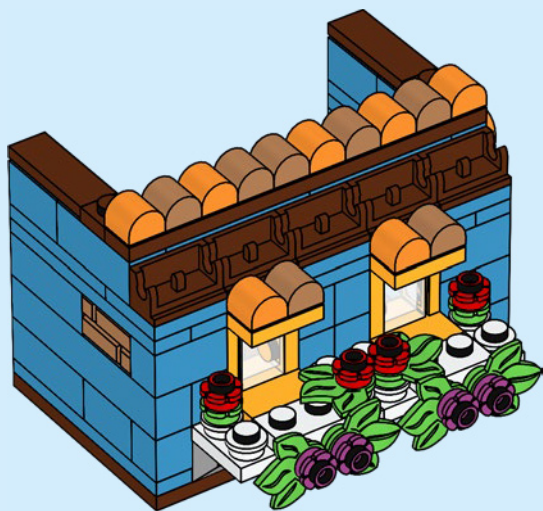

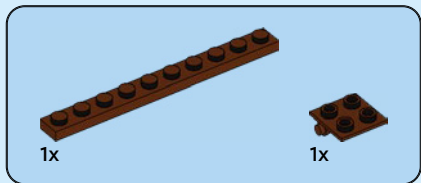
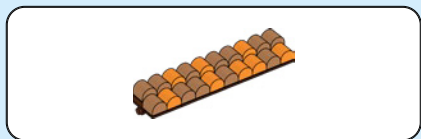

59

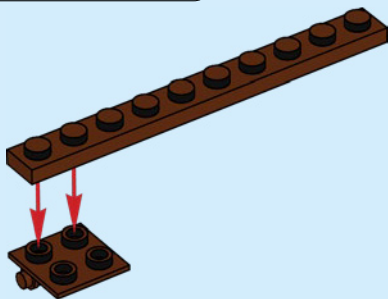

60

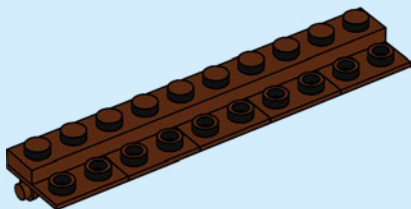



3x



7x

61

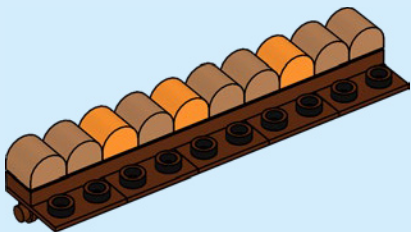

5x



5x

62

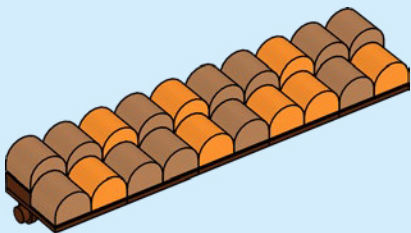

63

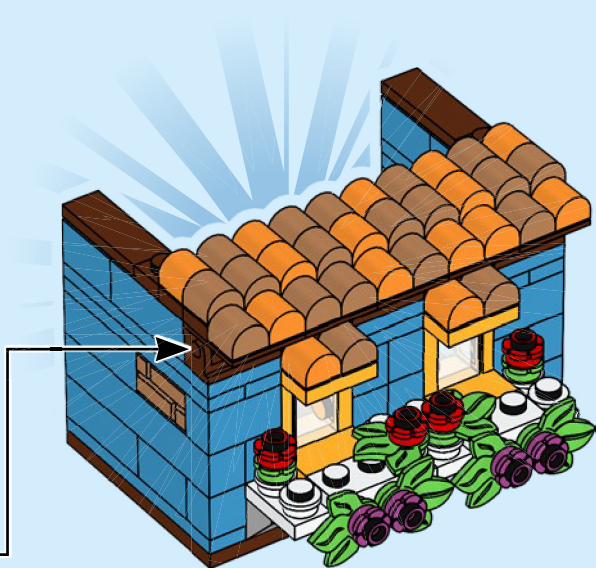

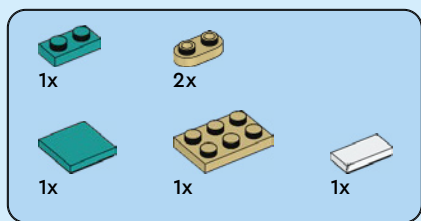

64

1

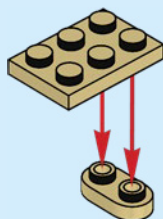

2



3



4

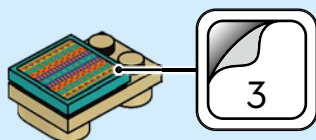

5

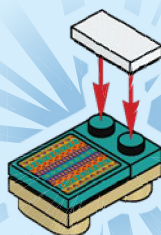

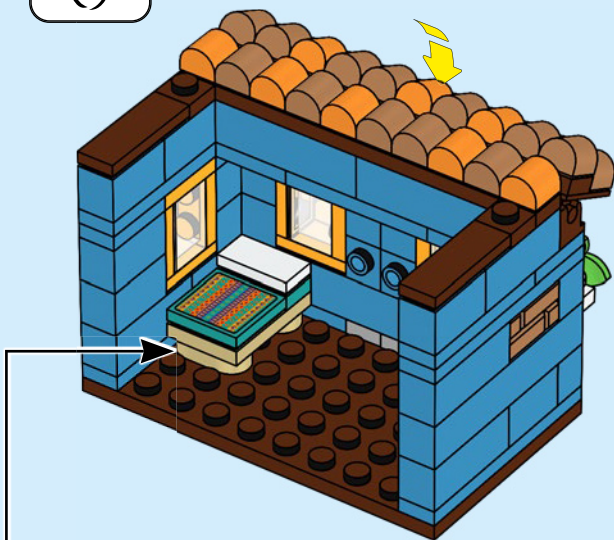
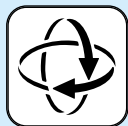



1x



1x



1x

65

1



2

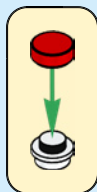
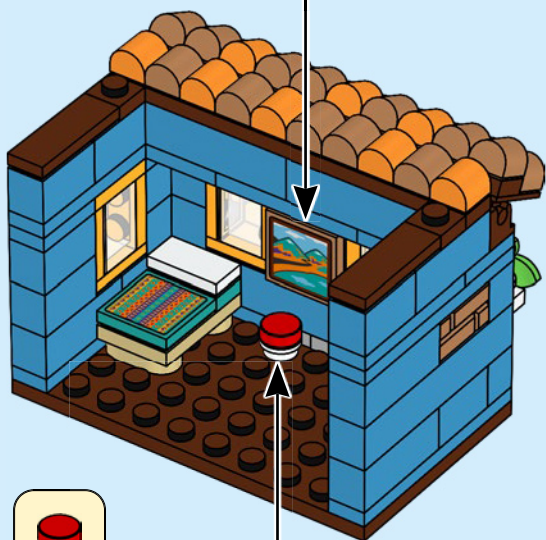

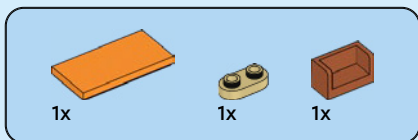

66

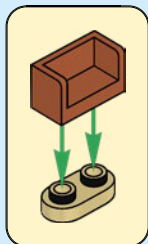

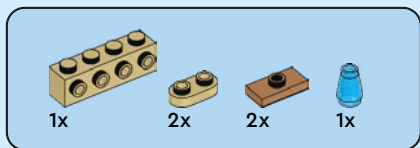

67

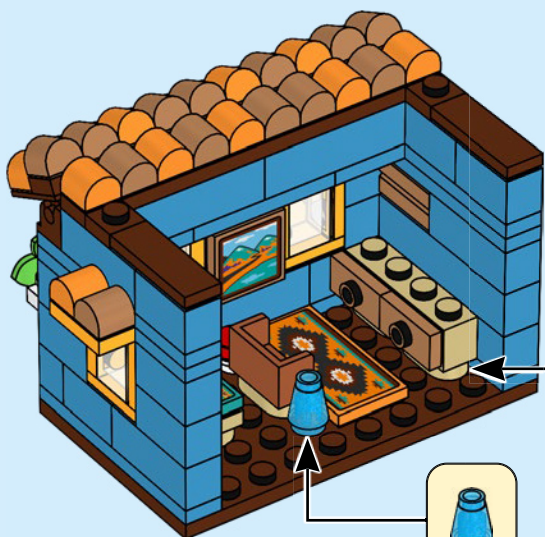
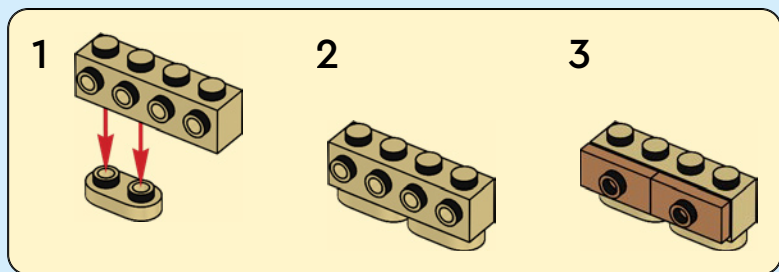

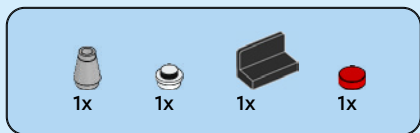

68

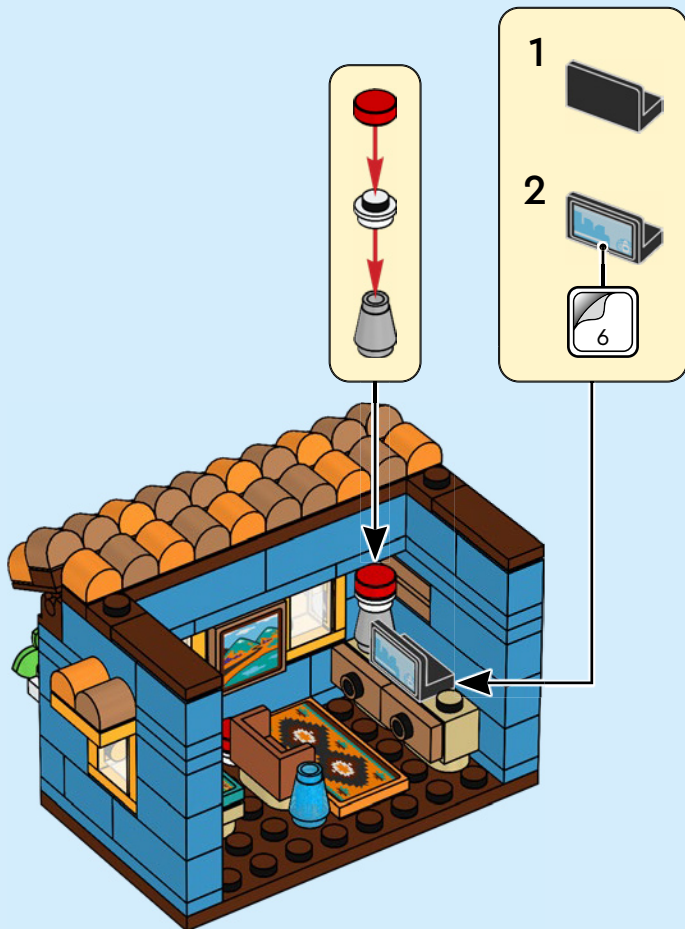



1x



1x



1x



1x



1x

69

1



2



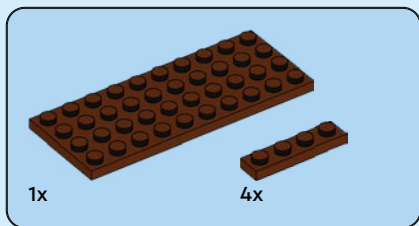

70

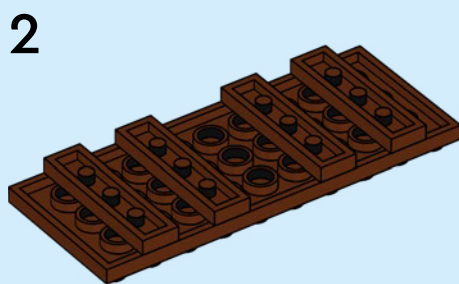
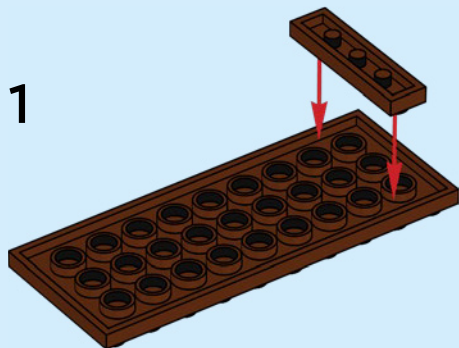



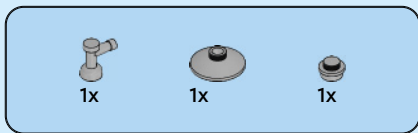

71

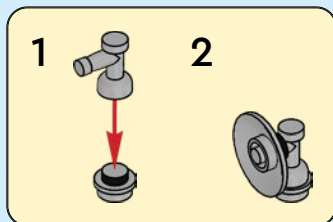

72

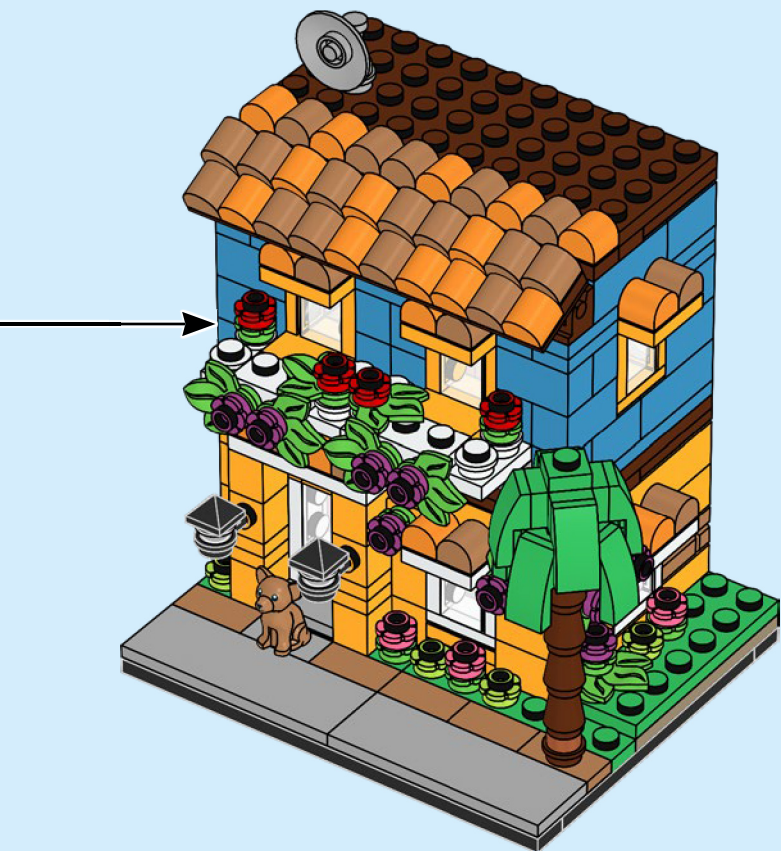



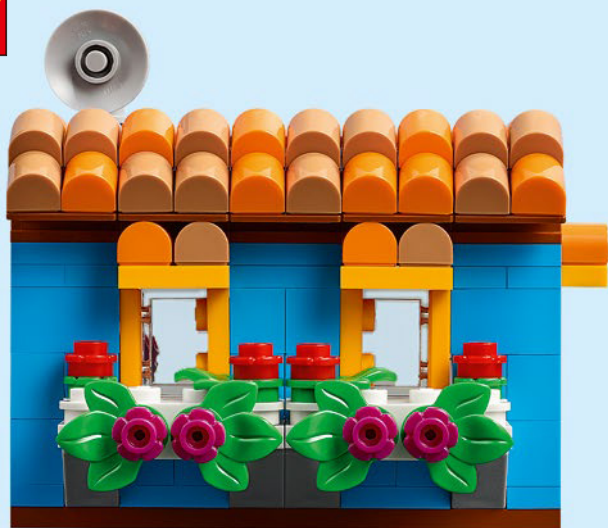



10x
614101

1x
6218841

1x
300501

1x
6152409

6x
306901

2x
302301

2x
6018774

2x
302201

1x
4558168

1x
362301

3x
302001

5x
6212758

1x
4118790

1x
4201062

2x
6284574

5x
6206148

2x
4190219

1x
6400110

1x
407026

1x
307026

2x
6312449

2x
6196548

1x
6146220

3x
303426

2x
4514845

9x
302428

8x
6047426

2x
366628

1x
379528

11x
6206150

1x
6235080

9x
6182261

1x
6403832

1x
6400293

2x
6240030

6x
6244904

20x
6278436

1x
4648853

1x
6213777

1x
6273853

1x
6254253

4x
6209692

10x
6209682

3x
6337455

3x
6295242

3x
6061685

5x
6073040

5x
6092035

4x
6328096

1x
6065504

2x
6249235

4x
6003003

7x
6028736



4x
4622062

3x
6034175

3x
6003033

2x
6020147

3x
6003004

3x
6186542

1x
4211525

1x
4529241

1x
4211503

1x
4211399

4x
6407767

1x
4211512

1x
6066097

1x
4211413

2x
6015347

2x
6318584

1x
6102951

2x
6349124

24x
6296061

1x
6399909

3x
4656783

4x
6021997

3x
6292154

2x
6102990

1x
6061201

2x
6151664

2x
6225538

5x
6004938

5x
4653988

9x
6004943

7x
6154879

2x
6144149

3x
6213272

2x
6133728

1x
6210675

3x
6151657

1x
6225539

2x
6345847

6x
6215659

5x
4529242

4x
4221744

2x
6133765

1x
6075213

5x
6186045

2x
6221608

5x
6167644

4x
6100769

4x
4211190

1x
4211204

2x
4223683

1x
4225715

1x
6338230

1x
4266897



 [LEGO.com/service](https://www.LEGO.com/service)

YOU COULD

WIN



Scan this QR code or go to
LEGO.COM/PRODUCTFEEDBACK
and give us your short feedback
about this LEGO® set for a chance
to win a cool LEGO prize.

Terms and Conditions apply*

DE: Du könntest GEWINNEN. Es gelten die Teilnahmebedingungen* **FR: Tu pourrais GAGNER.** Des conditions s'appliquent* **IT: Potresti VINCERE tu.** Termini e condizioni sono applicabili* **ES: Puedes GANAR.** Aplican términos y condiciones* **PT: Poderá GANHAR.** Aplicam-se termos e condições* **JA:** プレゼント付き! 利用規約が適用されます* **ZH: 轻松获奖. 条款和条件适用*** **KO:** 상품의 주인이 되어보세요. 소정의 약관이 적용됩니다* **RU: Вы можете ВЫИГРАТЬ.** Действуют положения и условия* **PL: Szansa na WYGRANĄ.** Obowiązują warunki korzystania* **CS: Máte šanci VYHRÁT.** Platí všeobecné smluvní podmínky* **SK: Máte šancu VYHRÁŤ.** Platia všeobecné zmluvné podmienky* **HU: TE IS NYERHETSZ.** Felhasználási feltételek érvényesek* **RO: Ai putea CÂȘTIGA.** Se aplică termeni și condiții* **BG: Можете да СПЕЧЕЛИТЕ.** Има определени правила и условия* **LV: Tu vari LAIMĒT.** Ir spēkā noteikumi un nosacījumi.* **ET: Sul on võimalus VÕITA.** Kehtivad tingimused* **LT: Jūs galite LAIMĖTI.** Taikomos sąlygos*

*[LEGO.com/productfeedback-terms](https://www.lego.com/productfeedback-terms)