

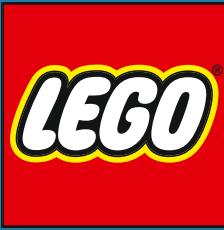

40634





PLAY UNSTOPPABLE

JOUER À FOND

JUEGO IMPARABLE

When we play unstoppable, anything is possible! Just look at all the awesome athletes in women's soccer! They're shattering records on the field and thrilling fans worldwide. Off the field, they embody true team spirit and inspire the next generation of players. Now you can play in your own epic matches with four legends of women's soccer. So, start stretching, it's game time!

Quand on joue à fond, tout est possible ! Toutes les grandes athlètes du soccer féminin en sont la preuve ! Sur le terrain, elles fracassent des records et font vibrer les amateurs du monde entier. En dehors du terrain, elles incarnent un réel esprit d'équipe et inspirent la prochaine génération de joueuses et de joueurs. Il est maintenant possible de disputer des matchs spectaculaires avec quatre légendes du soccer féminin. Que les étirements commencent, c'est l'heure du match !

Cuando somos imparables al jugar, ¡todo es posible! ¡Basta con mirar a todas las asombrosas atletas del futbol femenino! Viven para romper marcas en el campo y llenar de emoción a sus fans de todo el mundo. Lejos de las canchas, encarnan el verdadero espíritu de equipo e inspiran a la siguiente generación de jugadoras. Ahora tú también puedes jugar en tus propios partidos épicos con cuatro leyendas del futbol femenino. Empieza a calentar... ¡es hora de jugar!



// WHEN GIRLS
PLAY, THE
WORLD MOVES

// QUAND LES FILLES
JOUENT, LE
MONDE ÉVOLUE

// CUANDO LAS NIÑAS
JUEGAN, EL
MUNDO AVANZA

MEET THE PLAYERS

RENCONTREZ AVEC LES JOUEUSES

CONOCE A LAS JUGADORAS

YŪKI NAGASATO (JAPAN/ JAPON/ JAPÓN)

Tokyo native Yūki Nagasato loves to play beyond soccer. She is also a talented creator, drummer and visual artist. This multi-talented soccer star has played for her national team and won the World Cup and a silver medal in the Olympics and has brought her talent to teams in the US and Germany. She is also the first woman to ever play professionally for a men's soccer team in Japan.

Originaria de Tokyo, Yūki Nagasato aime jouer au-delà du soccer. Elle est également une créatrice, batteuse et artiste visuelle émérite. Cette vedette du soccer aux multiples talents a joué pour son équipe nationale, a remporté la Coupe du monde et une médaille d'argent aux Jeux olympiques, et a offert son savoir-faire à des équipes aux États-Unis et en Allemagne. Elle est également la première femme à jouer professionnellement dans une équipe de soccer masculine au Japon.

Originaria de Tokio, a Yūki Nagasato le encanta jugar más allá del fútbol. Es una talentosa creadora, percusionista y artista visual. Esta versátil estrella del fútbol ha jugado para el equipo nacional de su país y ha ganado la Copa Mundial, así como una medalla de plata en los Juegos Olímpicos. También ha puesto su talento al servicio de equipos de los EE. UU. y Alemania. Además, es la primera mujer en jugar profesionalmente como parte de un equipo de fútbol varonil en Japón.



MEGAN RAPINOE

(US/ ÉTATS-UNIS/ EE. UU.)

A two-time World Cup Champion and Olympic Gold Medalist, Megan has scored a golden hat-trick. She's famous for her crafty and creative play on the USWNT and at the 2019 Women's World Cup Championship, she even took home the Golden Boot for top scorer and the Golden Ball for the best player! She has been named one of Time100's Most Influential People and always speaks up for equality for all.

Deux fois championne du monde et médaillée d'or olympique, Megan a réalisé un triplé d'or. Elle est célèbre pour son jeu astucieux et créatif au sein de l'USWNT et, lors du championnat de la Coupe du monde féminine 2019, elle a même remporté le Soulier d'or du meilleur buteur et le Ballon d'or du meilleur joueur ! Elle a été désignée comme l'une des personnes les plus influentes du Time100 et défend toujours l'égalité pour tous.

Megan, dos veces campeona de la Copa Mundial y medallista de oro en las Olimpiadas, ha logrado un valioso triplete en su vida. Es famosa por su astuta y creativa forma de jugar en la selección nacional femenil de los EE. UU. y, en el campeonato de la Copa Mundial Femenina 2019, ¡incluso se llevó a casa la Bota de Oro a la máxima goleadora, así como el Balón de Oro a la mejor jugadora! Es considerada una de las 100 personas más influentes de la revista Time y siempre defiende la igualdad para todos.

ASISAT OSHOALA

(NIGERIA/ NIGÉRIA)

Talk about unstoppable! A striker for the Nigerian women's national team and teams in England, China and Spain, Asisat is a global superstar. She's the first African female player to score a goal in, and win, a UEFA Women's Champions League final. She has laid a foundation that nurtures the next generation of women soccer stars. She has won the Golden Boot, been named in the Forbes 30 under 30 list, and she's a five-time African Women's Footballer of the Year. What's her next goal?

Absolument inarrêtable ! Attaquante de l'équipe nationale féminine du Nigéria et d'équipes en Angleterre, en Chine et en Espagne, elle est une véritable icône à l'échelle mondiale. Elle est la première joueuse africaine à marquer un but et à remporter la victoire en finale de la Ligue des champions féminine de l'UEFA. Elle a posé les fondations de la prochaine génération de vedettes du soccer féminin. Elle a remporté le Soulier d'or, a figuré sur la liste Forbes 30 Under 30 et a été nommée cinq fois joueuse de soccer africaine de l'année. Quel sera son prochain but ?

¡Hablando de lo imparable! Delantera en la selección nacional de Nigéria y en equipos de Inglaterra, China y España, es una verdadera superestrella global. Es la primera jugadora africana en marcar un gol y ganar un partido final de la Liga de Campeones Femenina de la UEFA. Con sus logros, ha fincado sólidos cimientos que nutrirán a la próxima generación de estrellas del fútbol. Ganadora de una Bota de Oro, su nombre ha figurado en la lista 30 Under 30 de Forbes y ha sido elegida Mejor Futbolista Africana del Año cinco veces. ¿Cuál será su próximo objetivo?



SAMANTHA KERR

(AUSTRALIA/ AUSTRALIE/ AUSTRALIA)

Watch out for Sam Kerr's magic moves on the field! We love this modest, hard-working Australian captain. Famous for her celebratory backflips and world-class finishing, Sam has played in Australia, England and the US, winning games and scoring goals. She has featured in huge moments across the World Cup, the Olympics and many other international tournaments. Along the way, she was awarded the Order of Australia medal for services to soccer.

Attention aux manœuvres magiques de Sam Kerr sur le terrain ! Nous adorons cette capitaine australienne modeste et assidue. Célèbre pour ses sauts et sa finesse de classe mondiale, Sam a remporté des matchs et marqué des buts en Australie, en Angleterre et aux États-Unis. Elle a participé à de grands moments de la Coupe du monde, des Jeux olympiques et de nombreux autres tournois internationaux. En cours de route, elle a reçu la médaille de l'Ordre d'Australie pour services rendus au soccer.

Los movimientos de Sam Kerr en la cancha parecen mágicos, ¡y hay que tener mucho cuidado con ellos! Esta modesta y trabajadora capitana australiana se ha ganado a pulso nuestro corazón. Famosa por sus inconfundibles volteretas de celebración e inigualables remates, Sam ha jugado en Australia, Inglaterra y los EE. UU., ganando múltiples partidos y anotando montones de goles. Ha sido protagonista de momentos inolvidables en la Copa Mundial, los Juegos Olímpicos y muchos otros torneos internacionales. De paso, también le fue otorgada la medalla de la Orden de Australia por sus servicios al fútbol.





Get excited about our new packaging!

We're switching from plastic to paper-based packaging. That's why you might find a mix of paper and plastic in our boxes!

Nos nouveaux emballages vous emballeront !

Nous passons des emballages en plastique aux emballages à base de papier. C'est pourquoi vous pourriez trouver un mélange de papier et de plastique dans nos boîtes !

¡Te presentamos nuestros nuevos empaques!

Estamos sustituyendo las bolsas de plástico por bolsas con base de papel. ¡Por eso, puedes encontrar una mezcla de papel y de plástico en nuestras cajas!

[LEGO.com/sustainable-packaging](https://www.lego.com/sustainable-packaging)

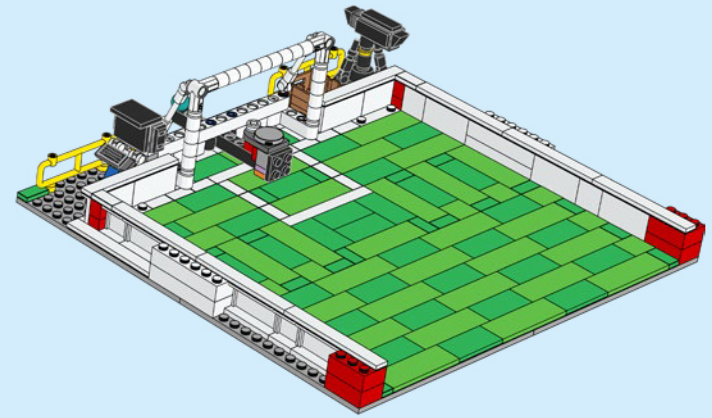
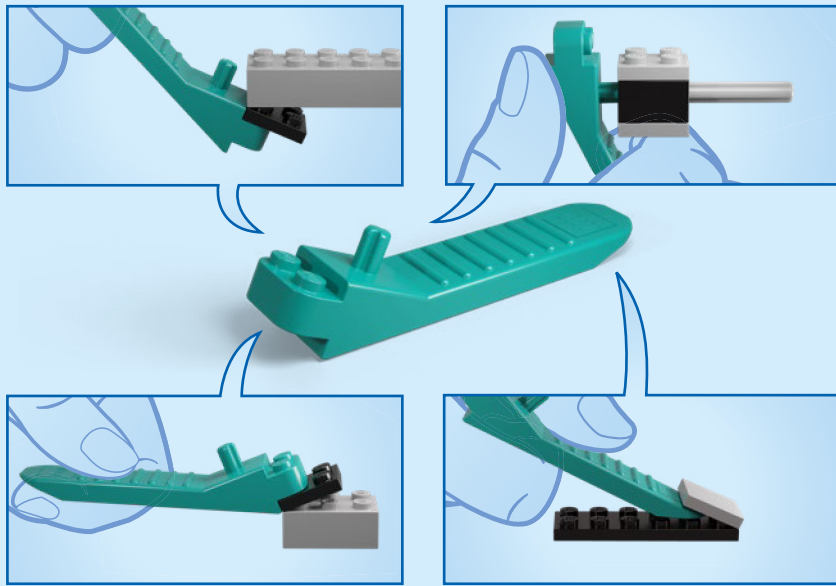

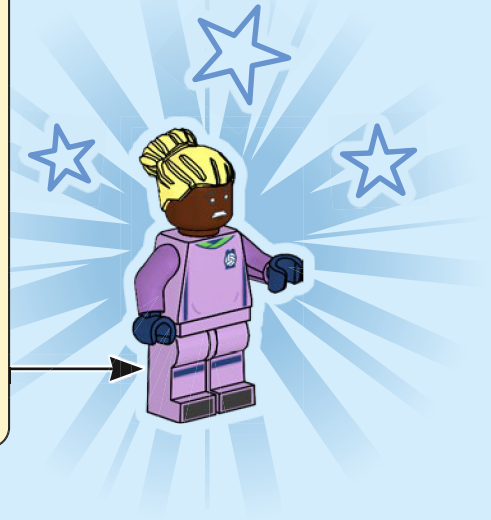
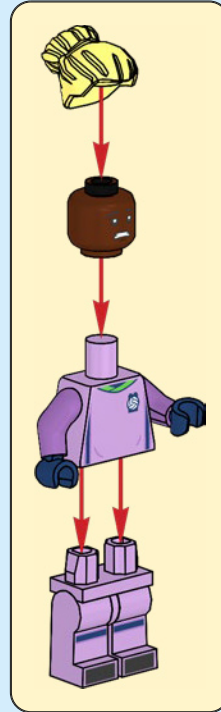
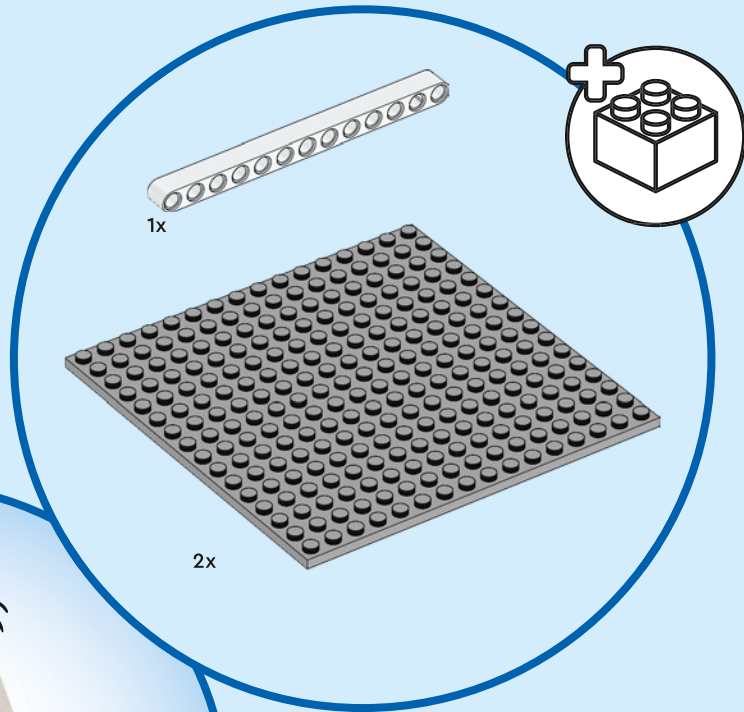

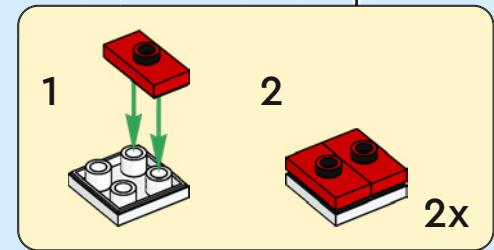
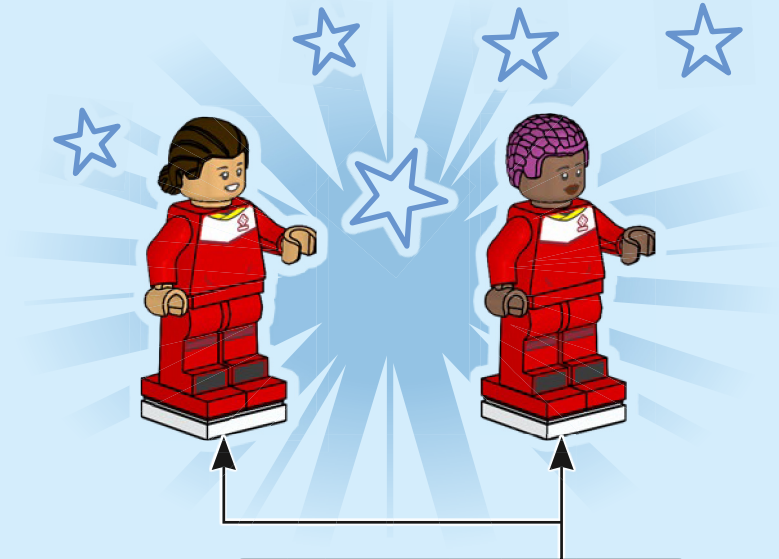
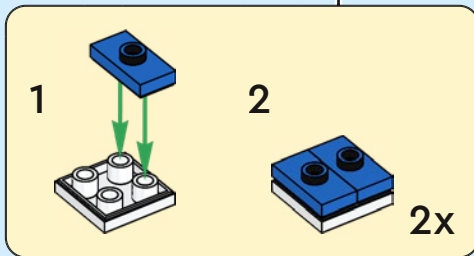
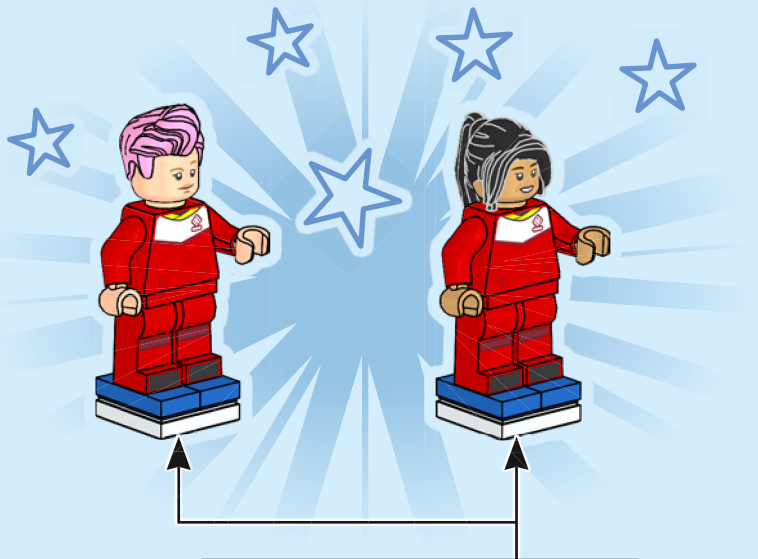
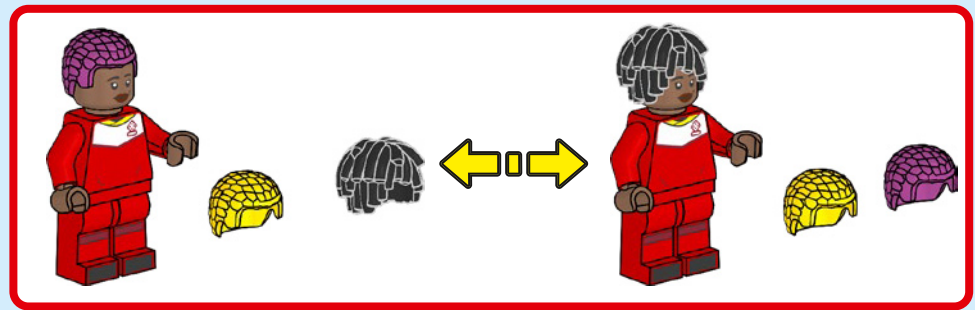
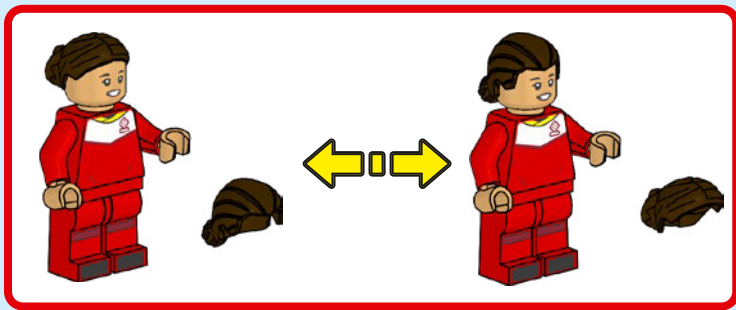

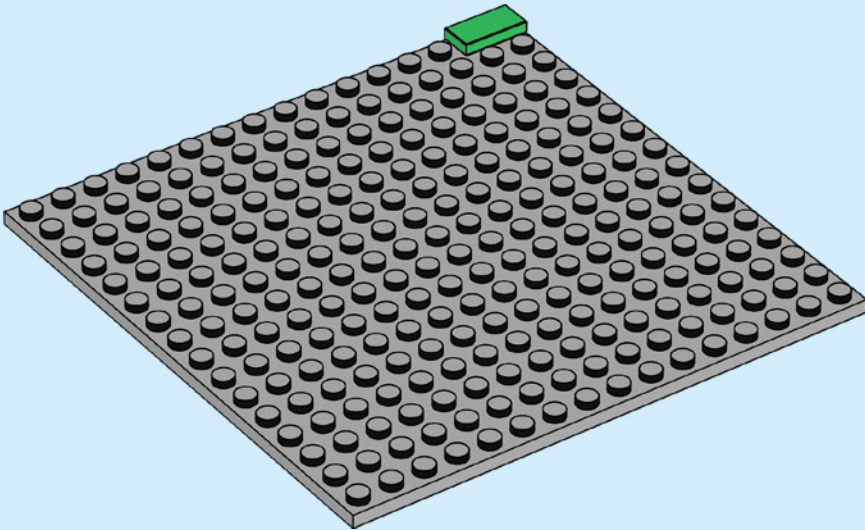
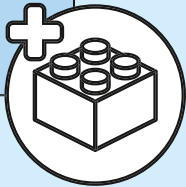
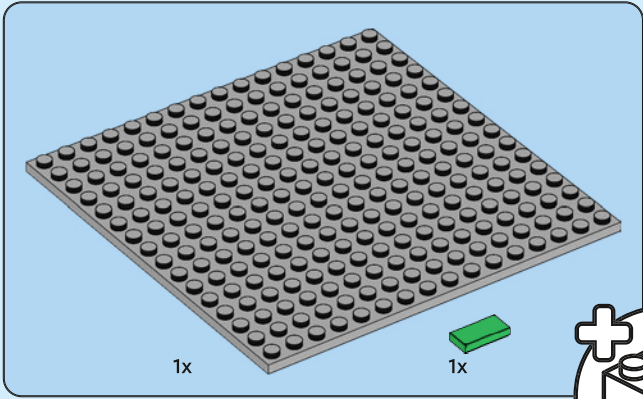
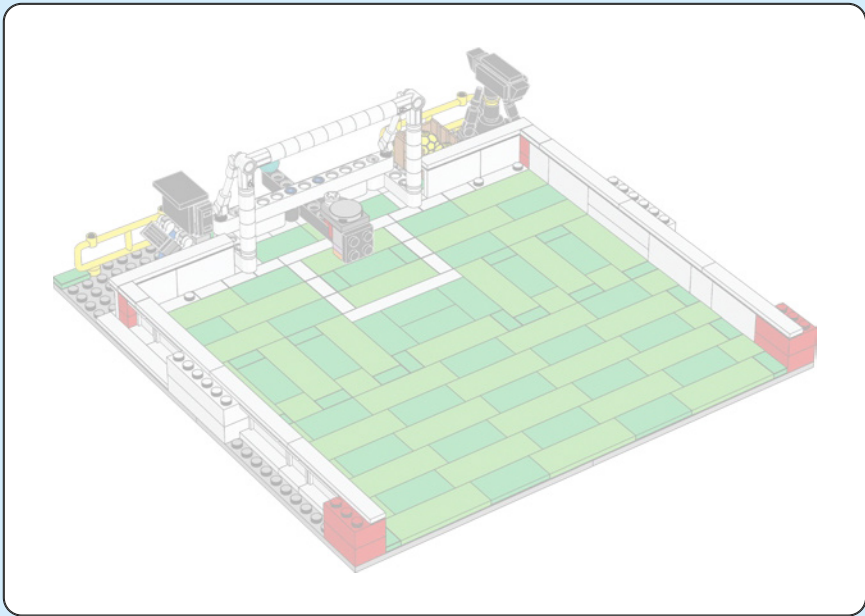

1



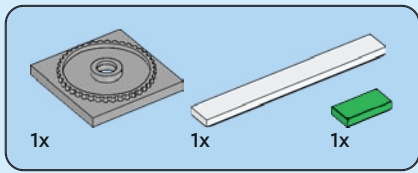

2

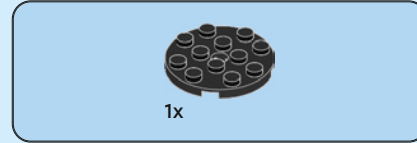
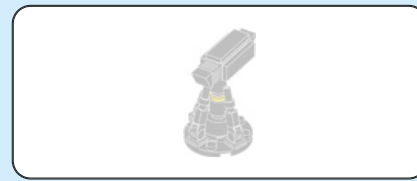
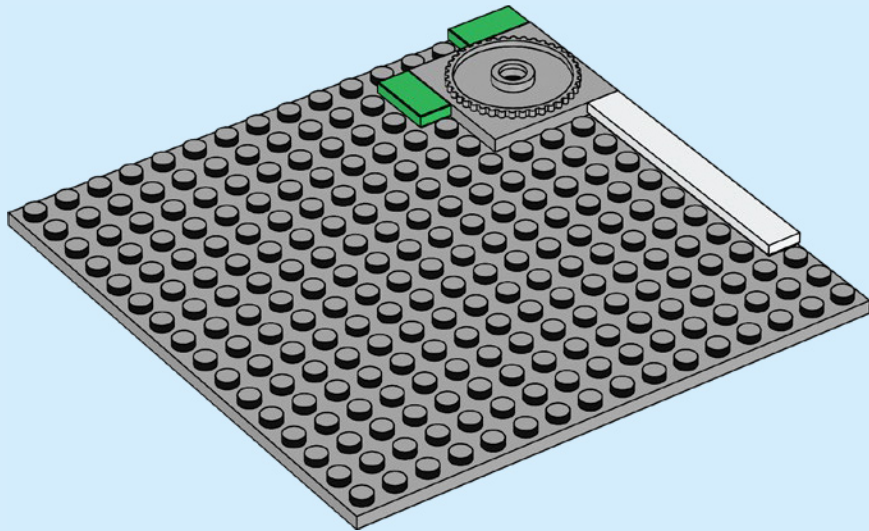

3

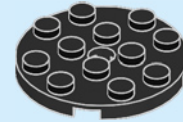

4

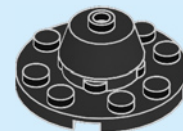



1x



1x

5

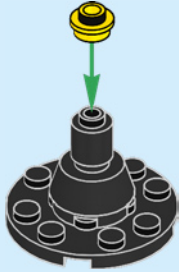

1x

6

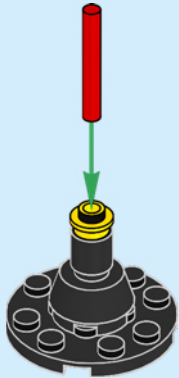

1x

7

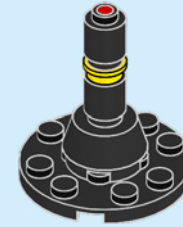

3x



3x



3x

8

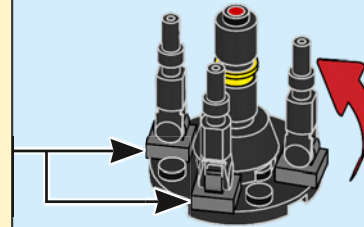
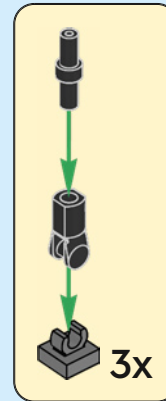

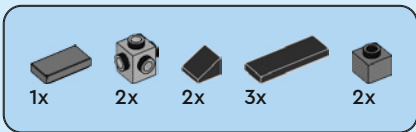

9

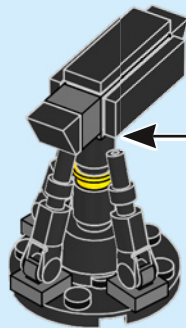
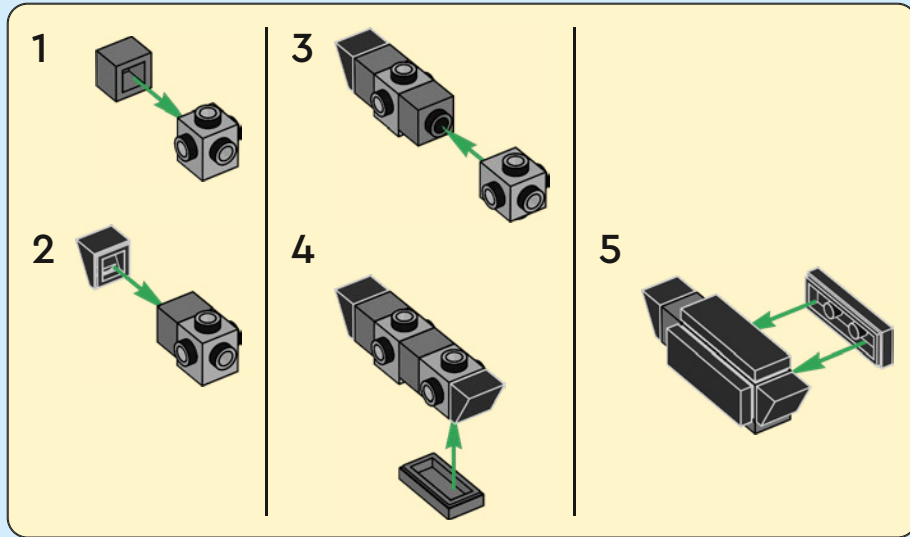

10

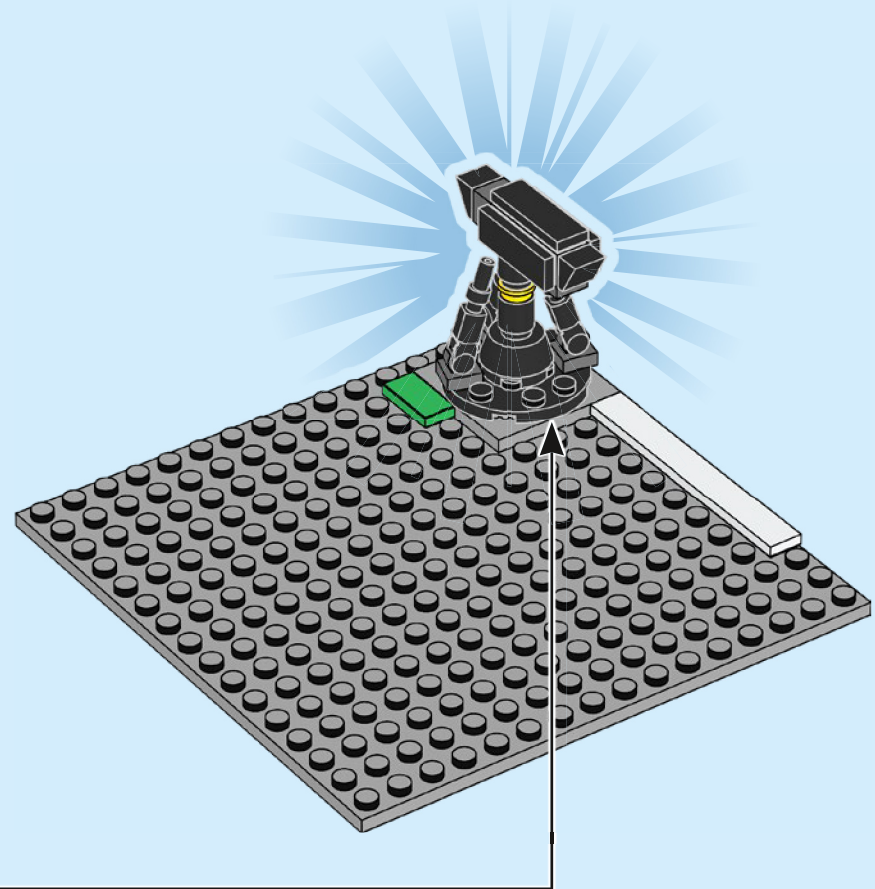

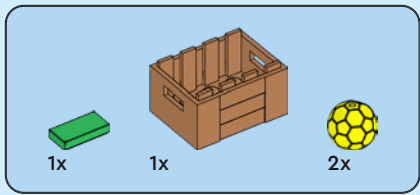

11

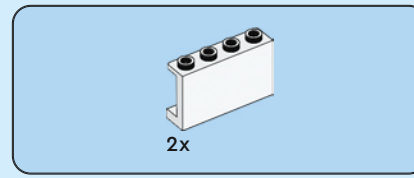
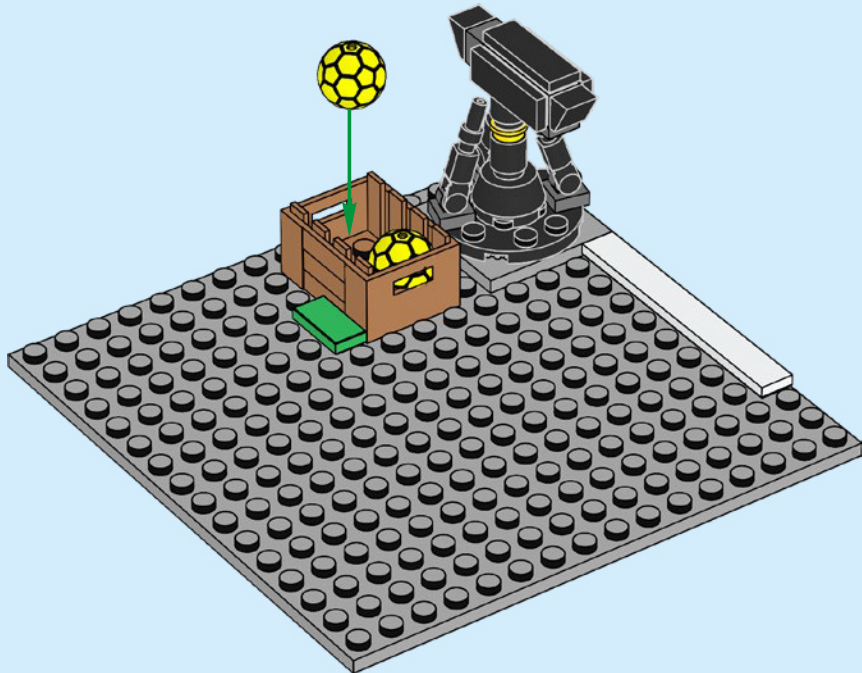

12

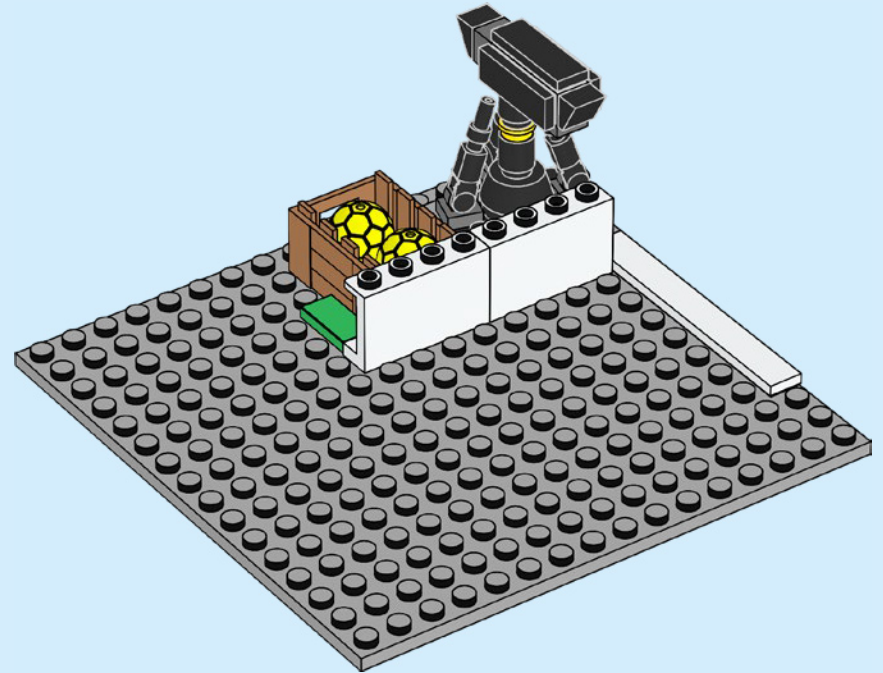



13

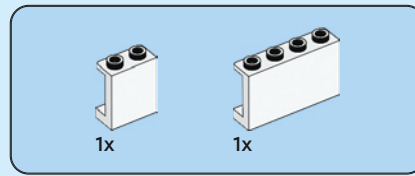
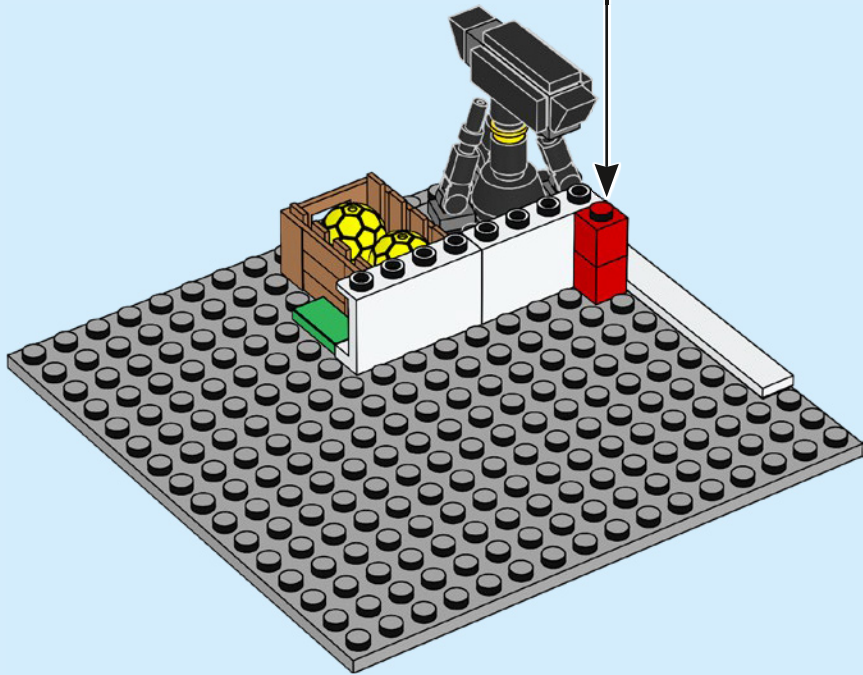
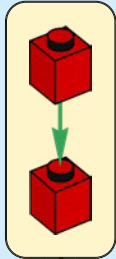

14

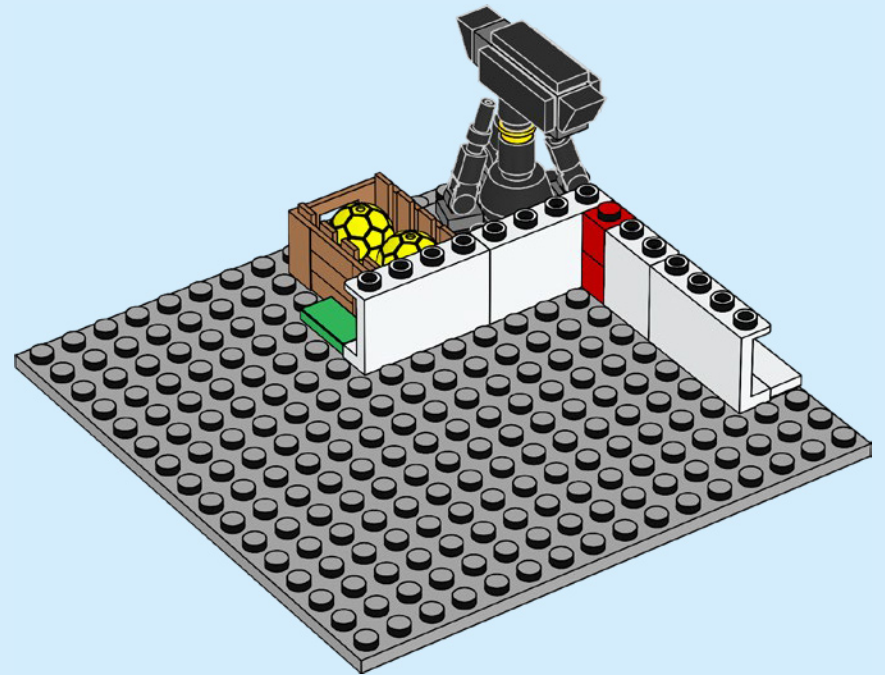

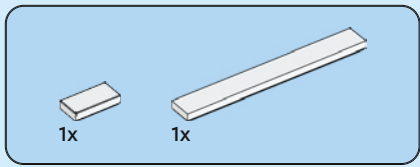

15

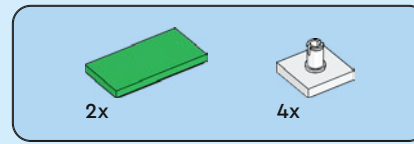
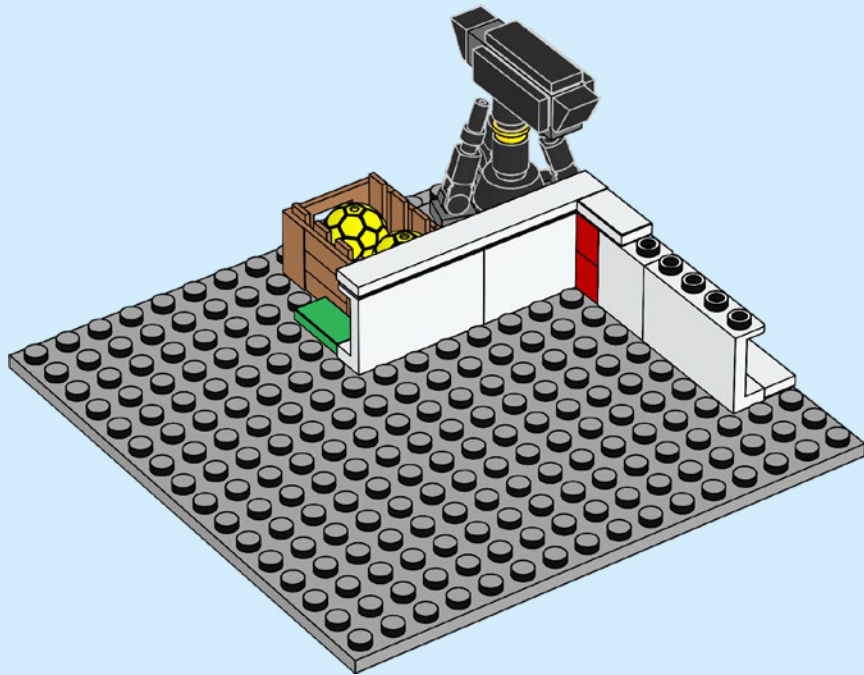

16

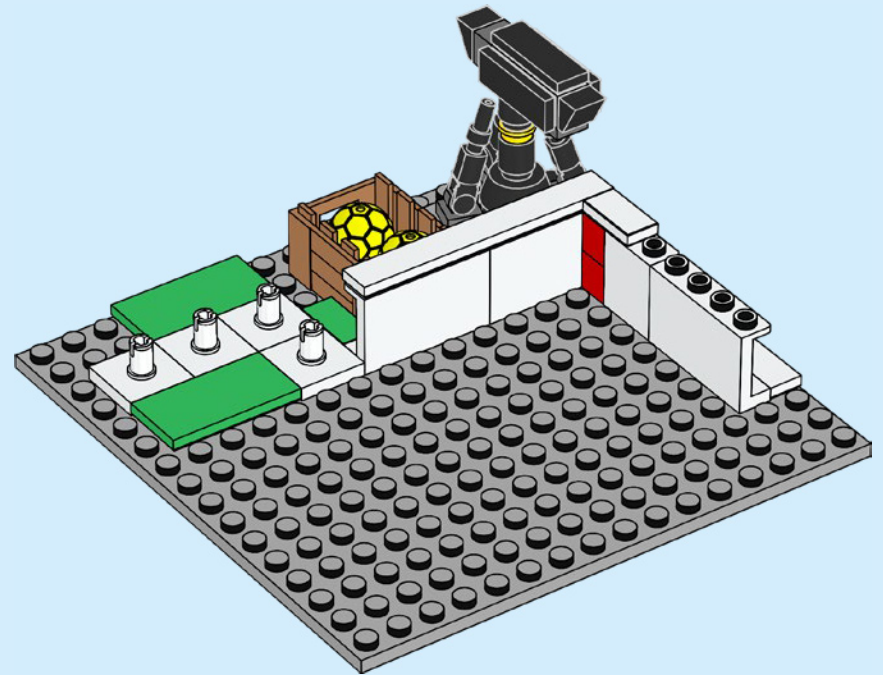

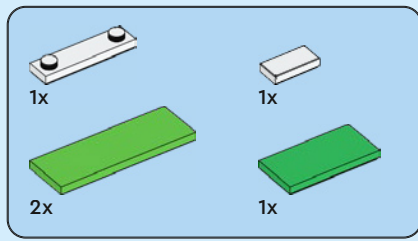

17

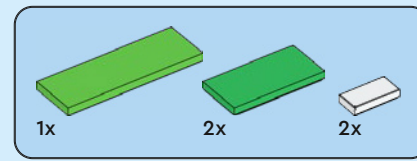
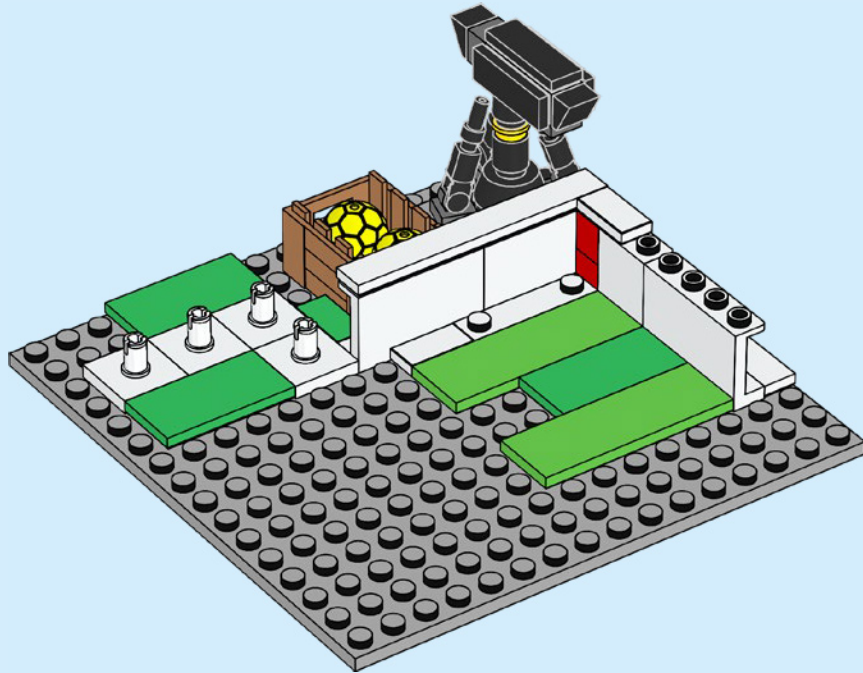

18

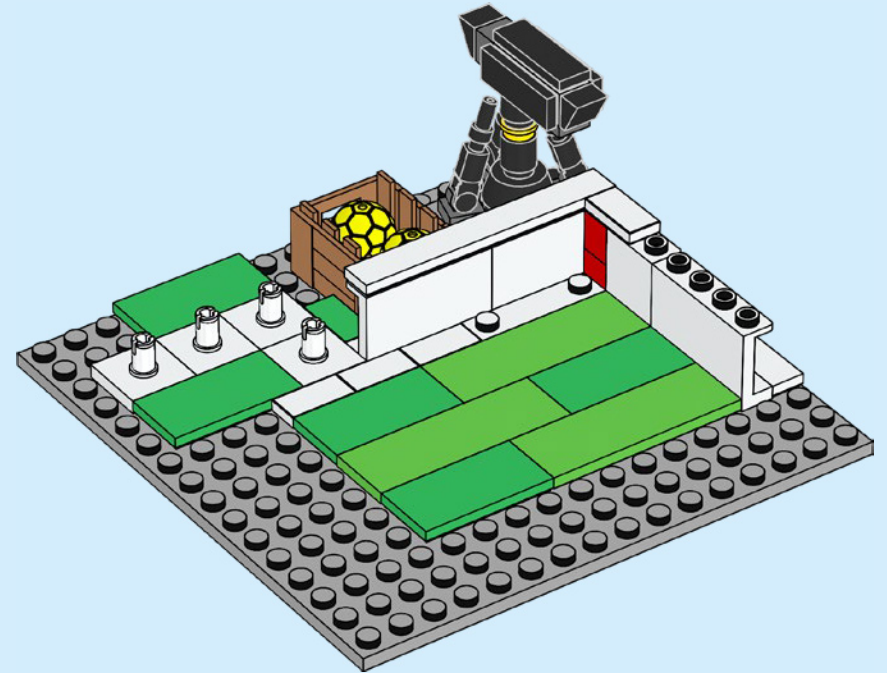

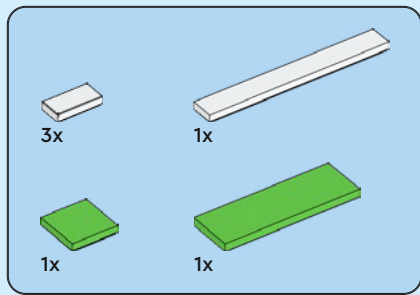

19

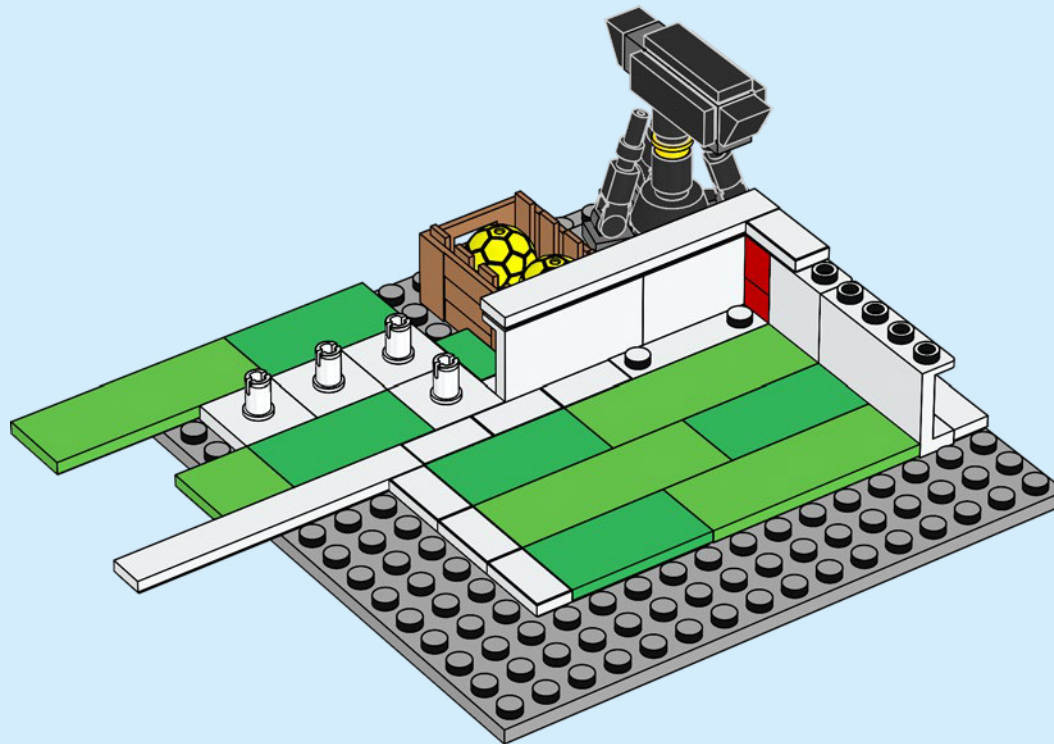

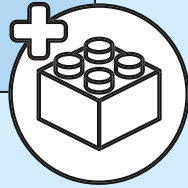
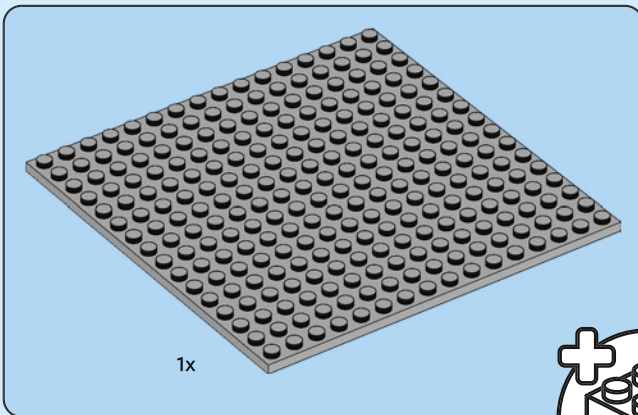

20

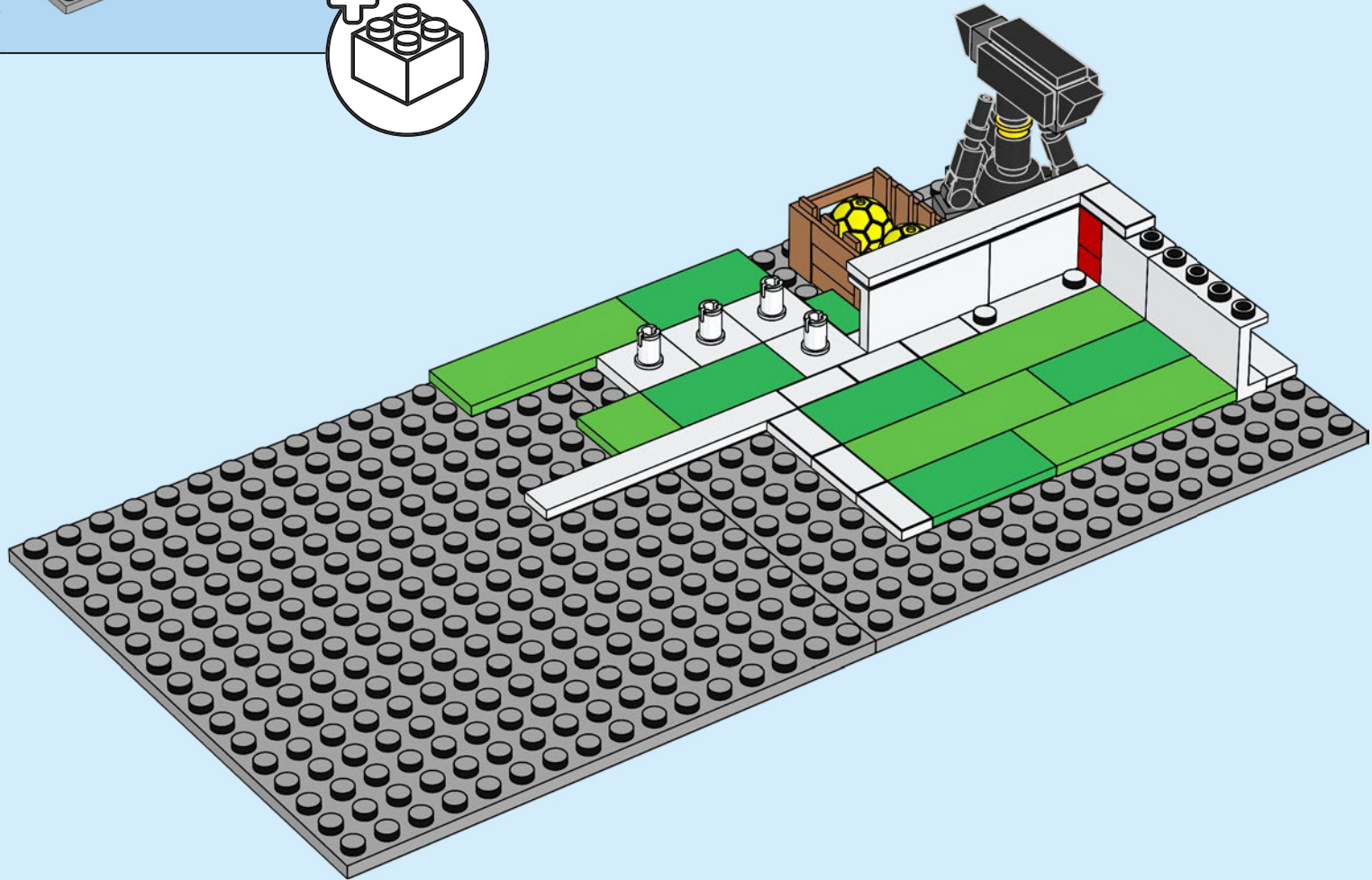

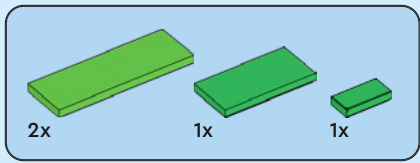

21

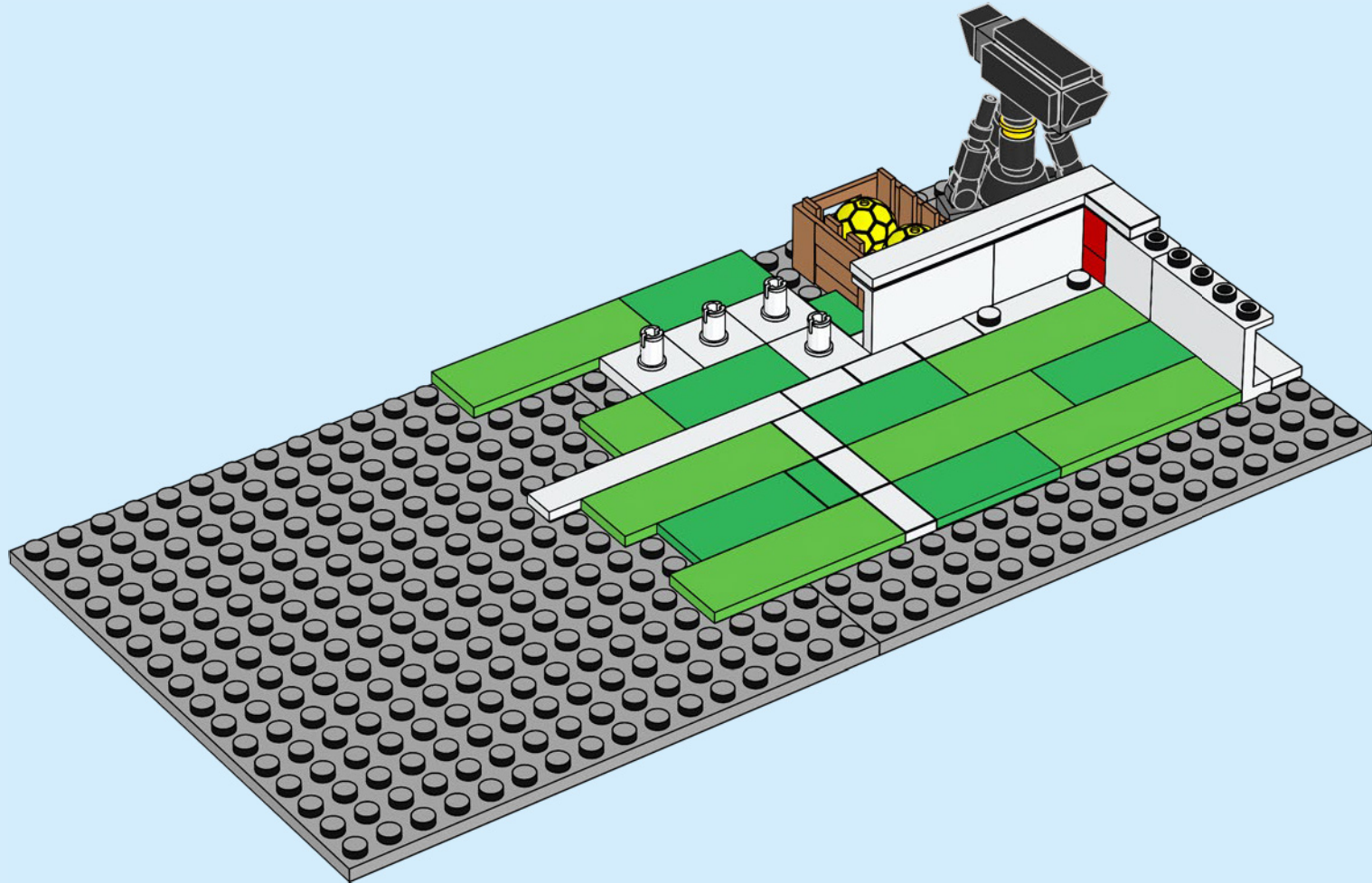

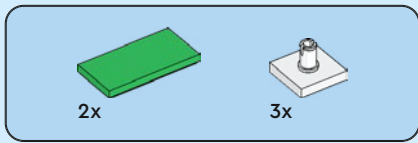

22

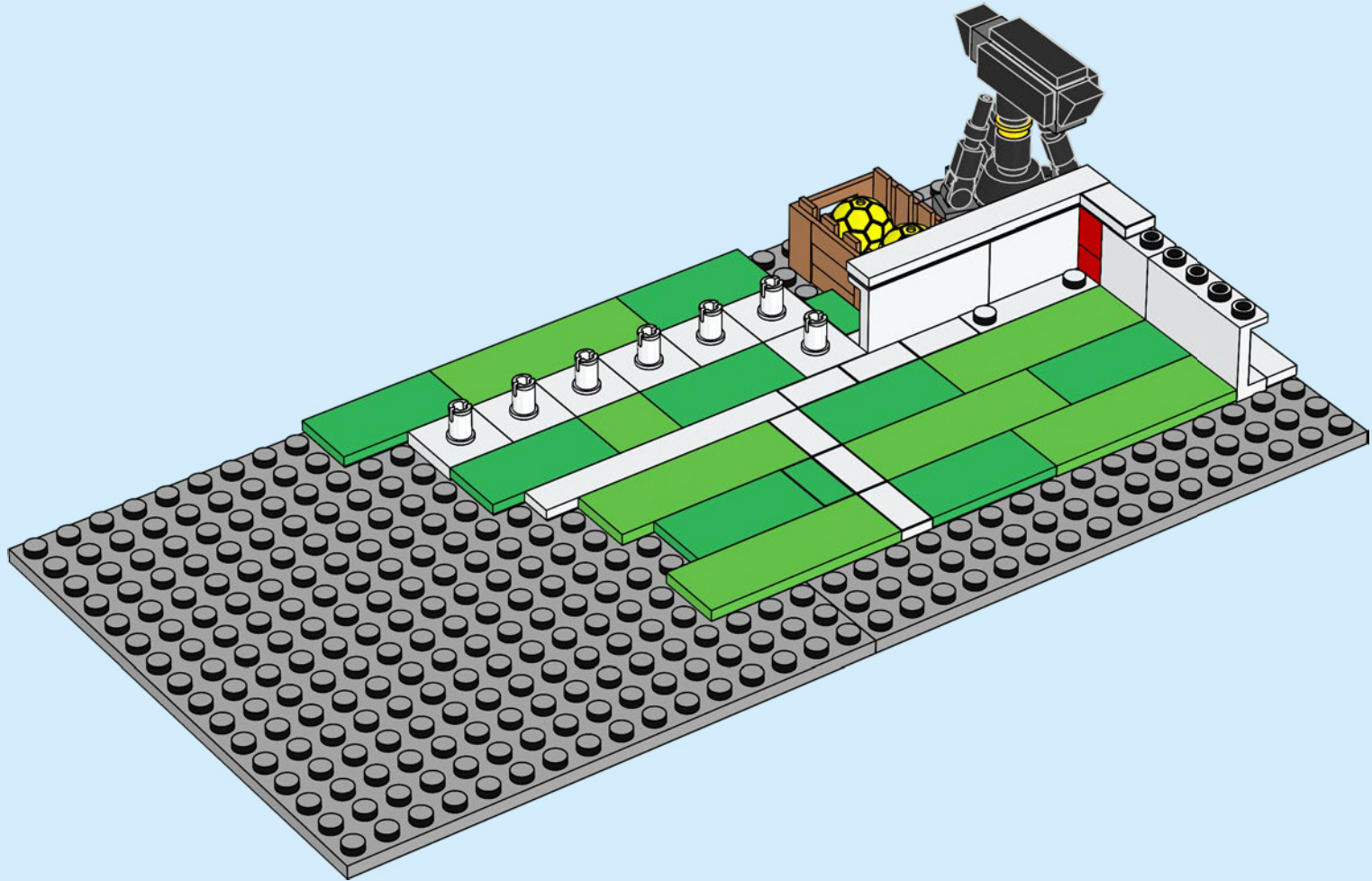

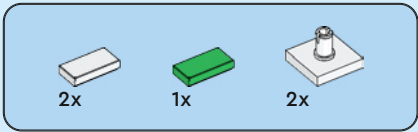

23

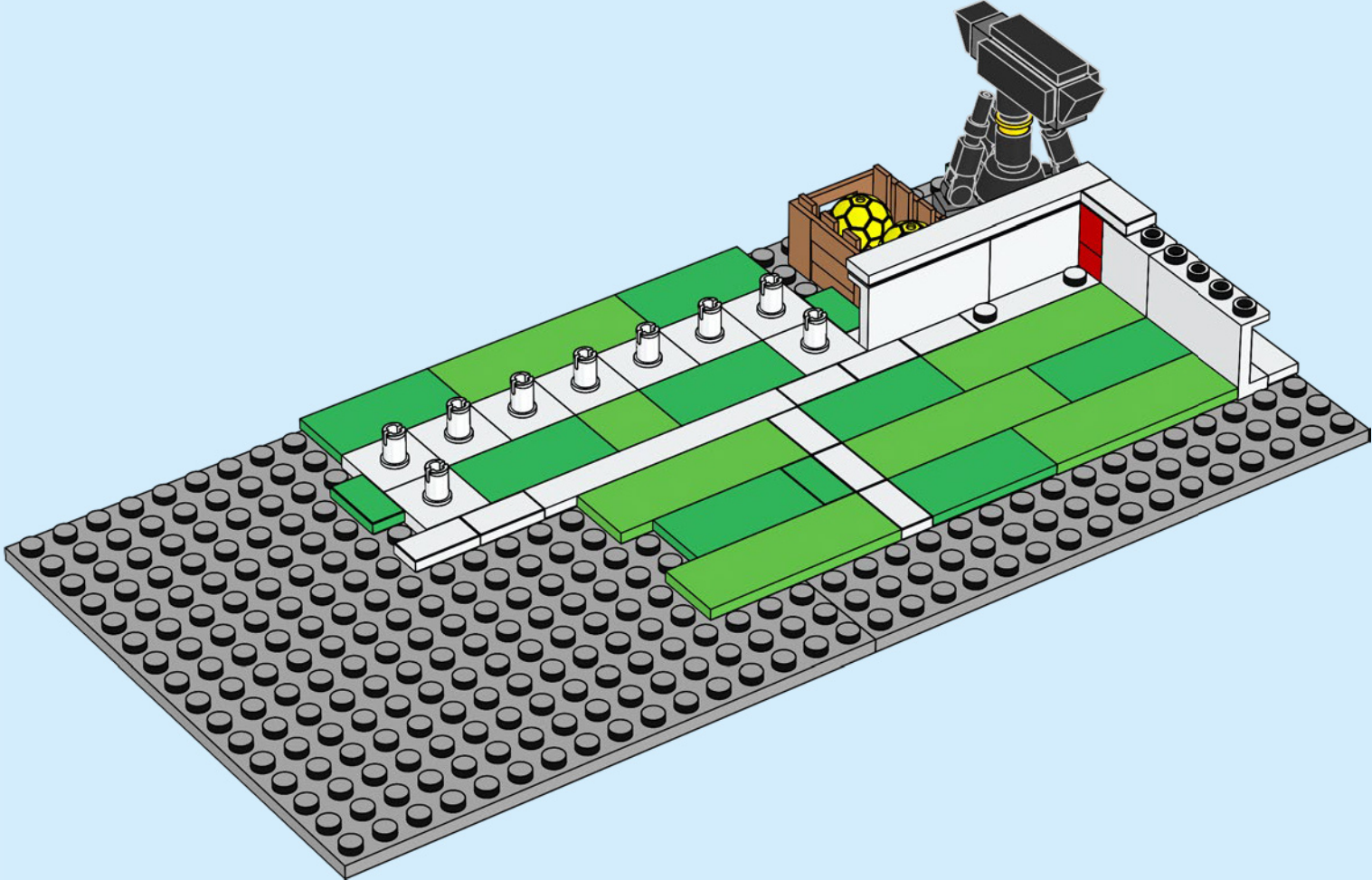

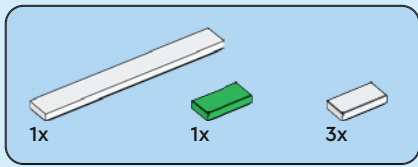

24

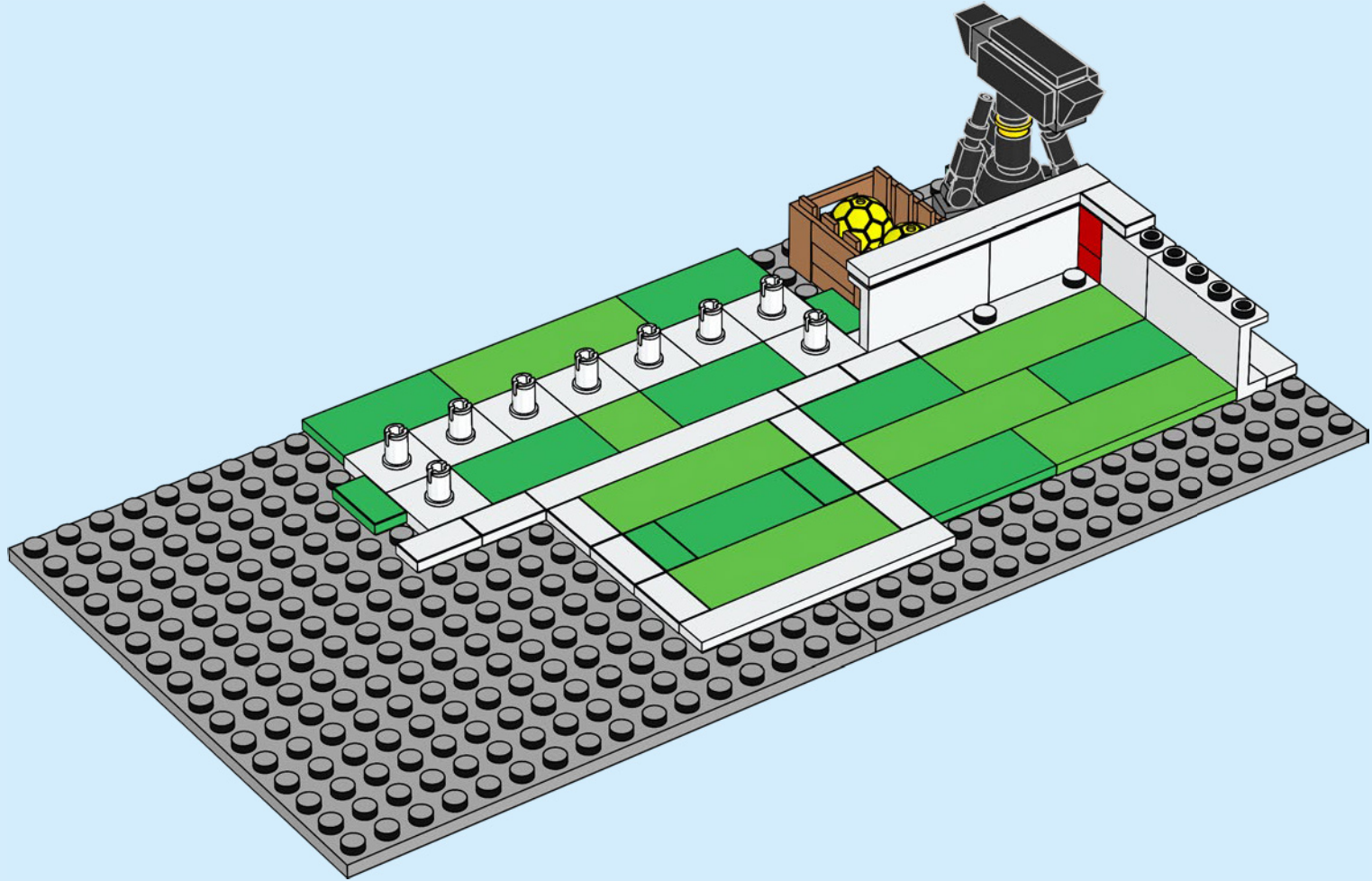

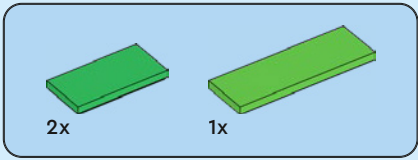

25

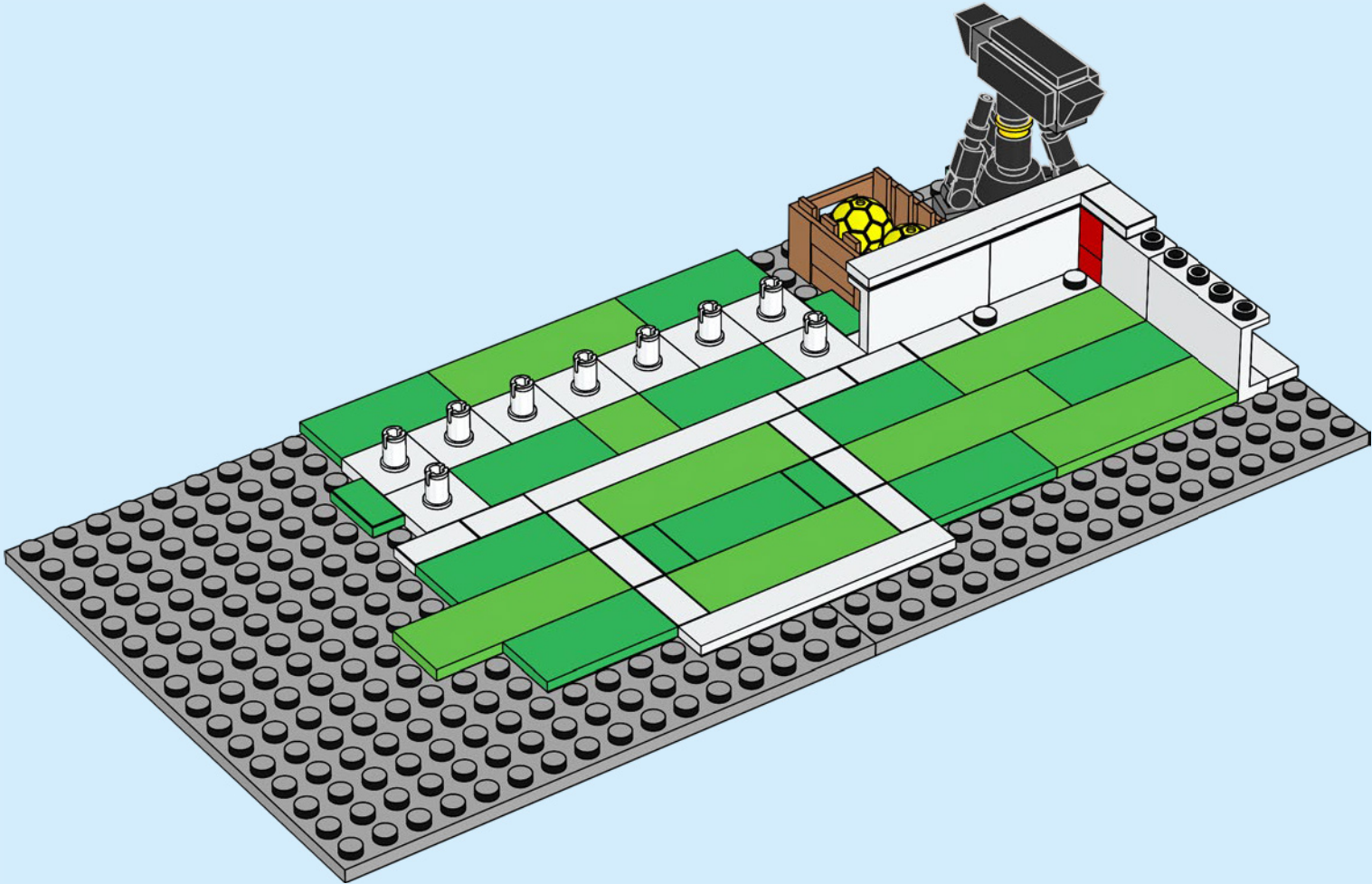

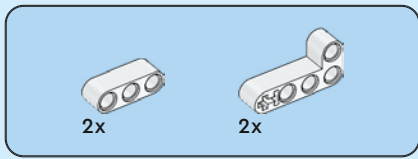

26

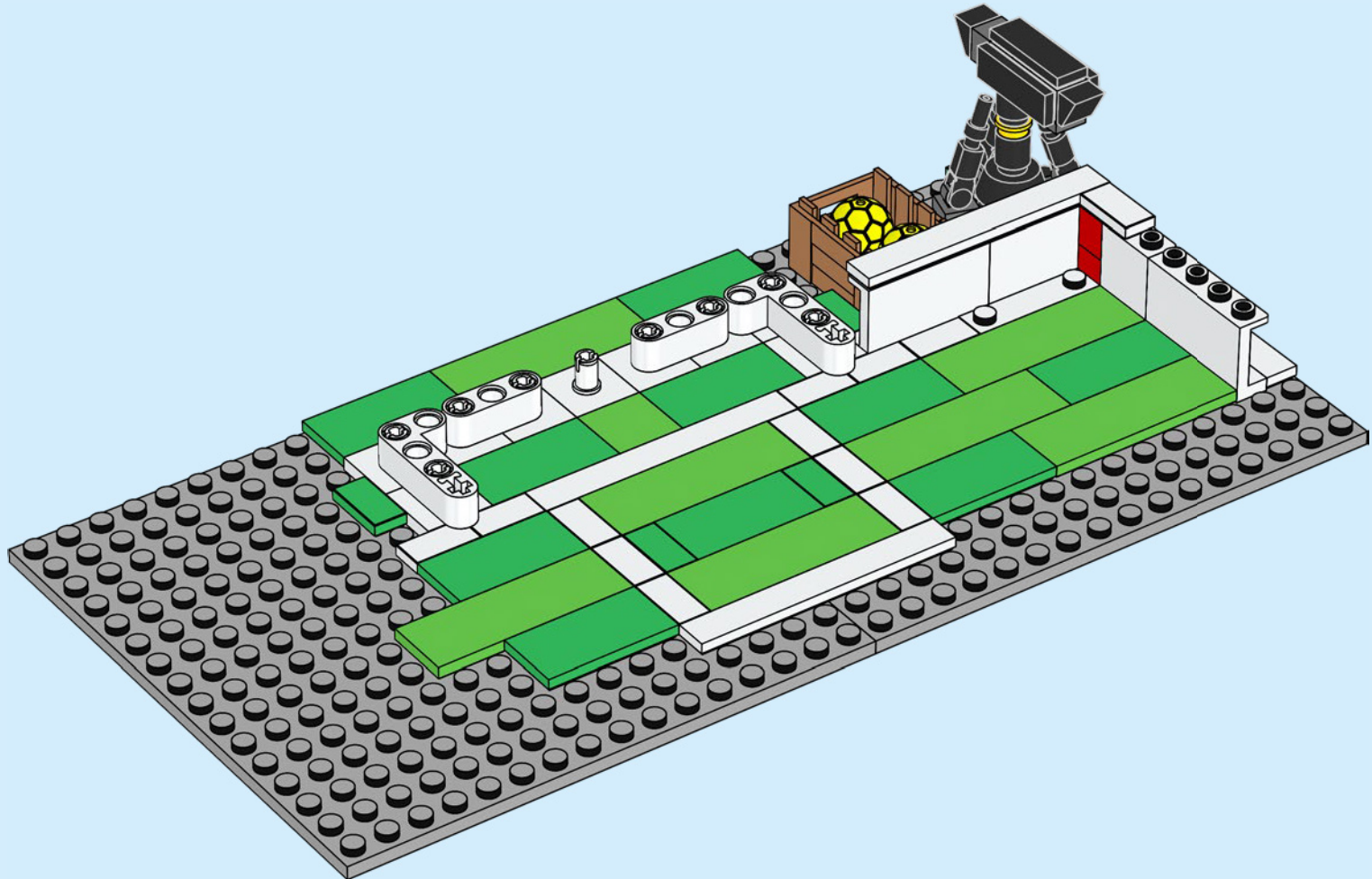

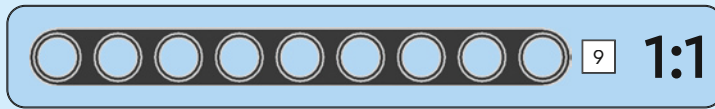
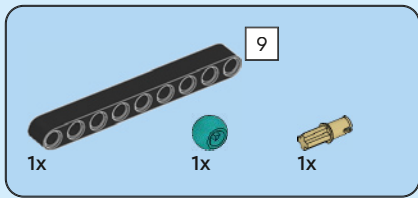

27

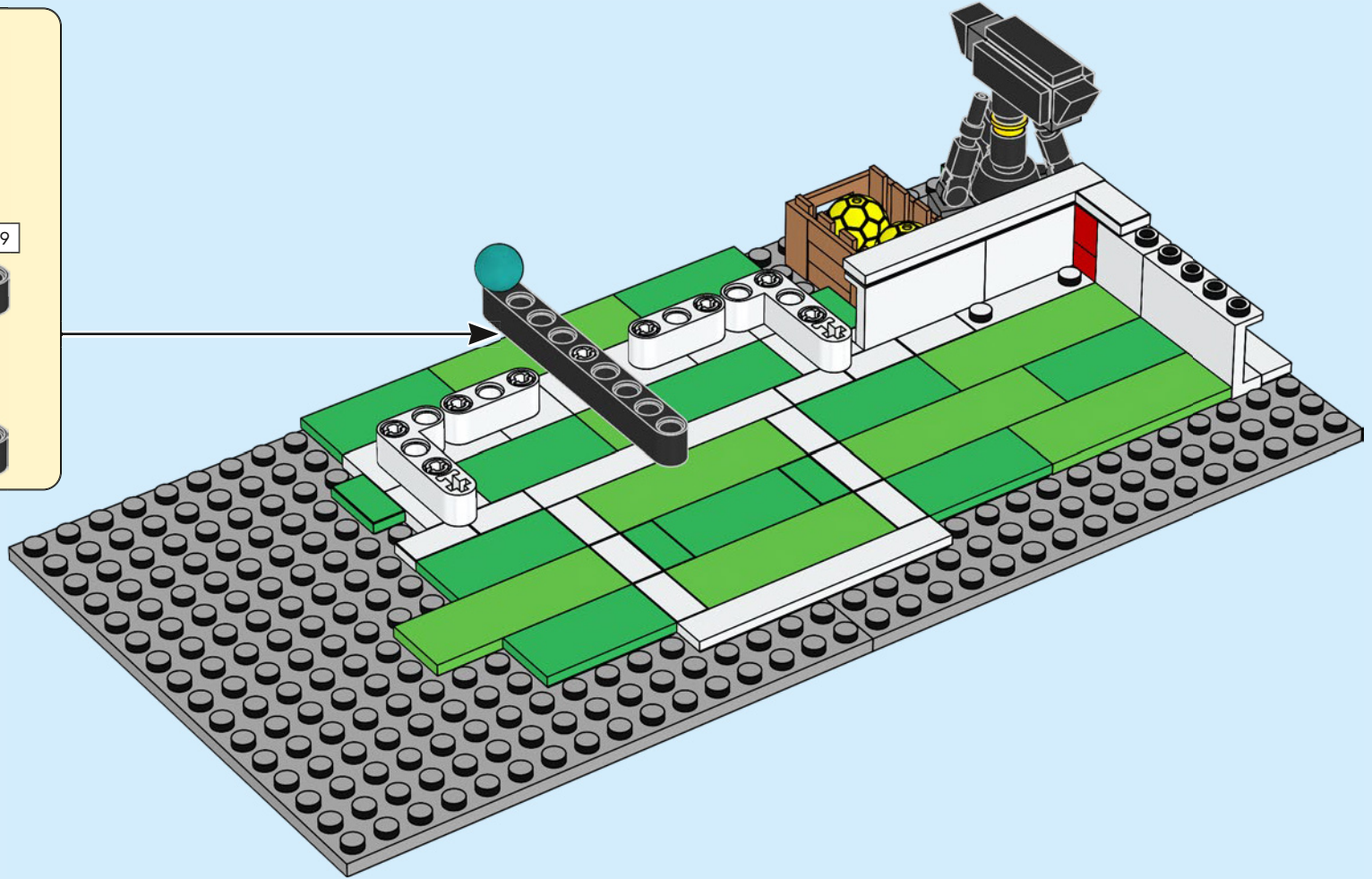
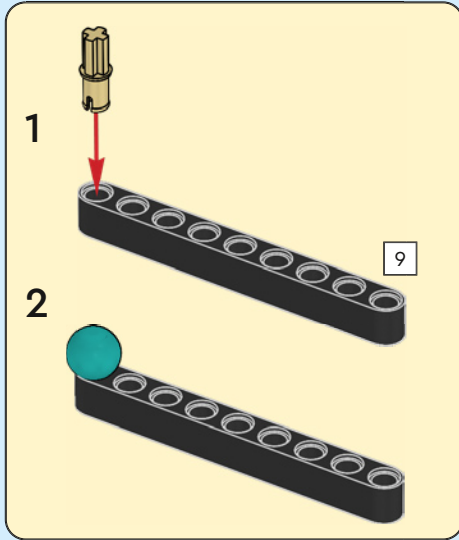

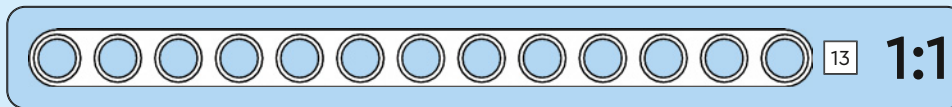
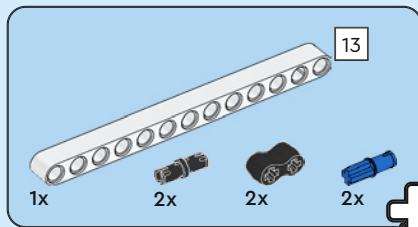

28

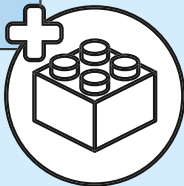

1

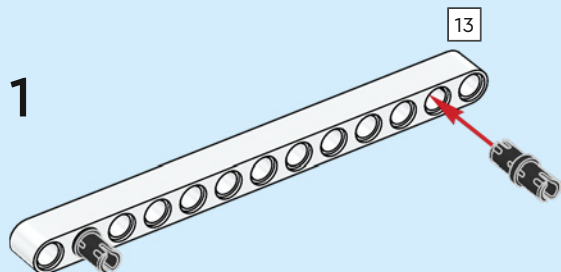

2

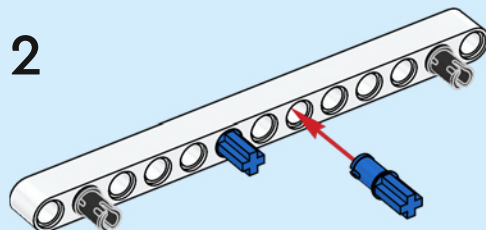

3

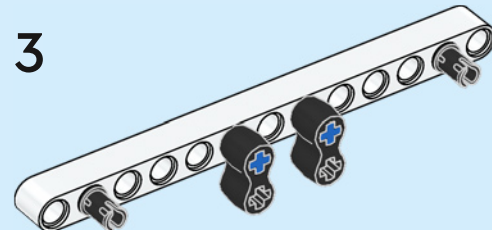

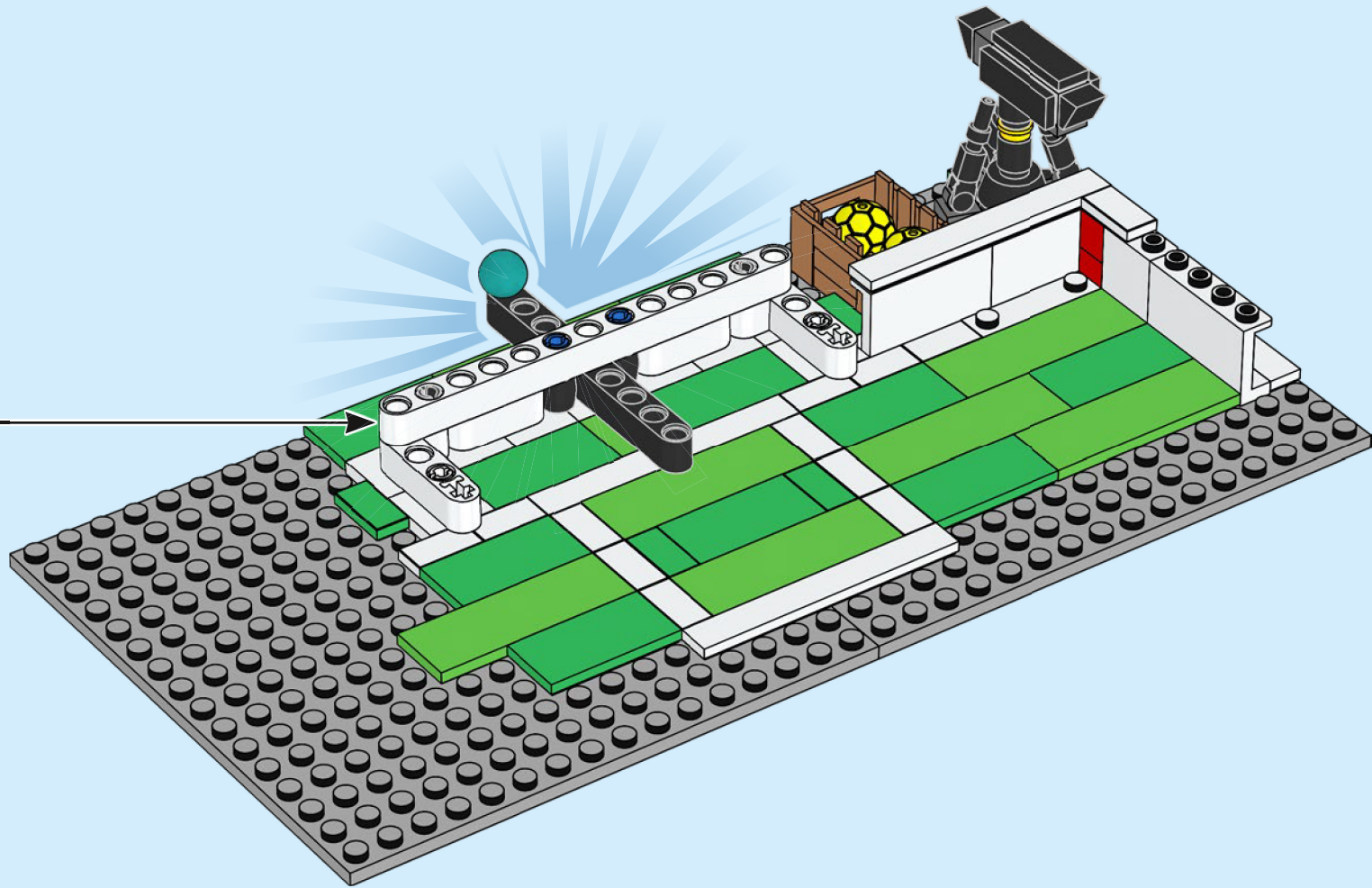

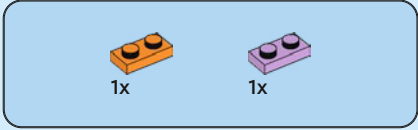

29

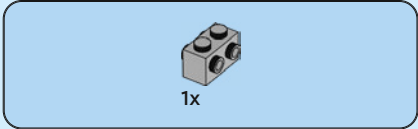
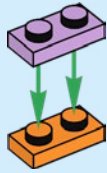

30

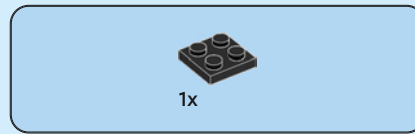

31

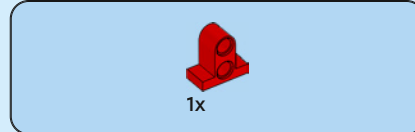
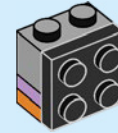

32

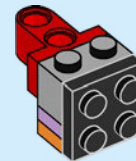

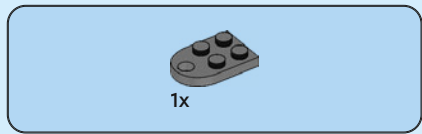

33

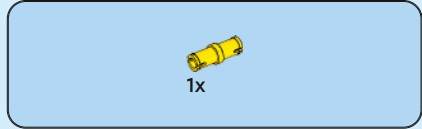
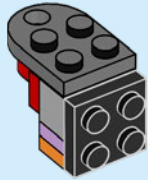

34

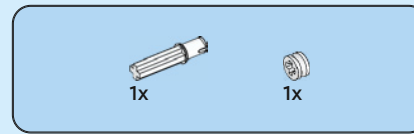
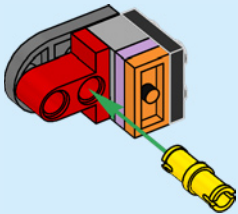

35

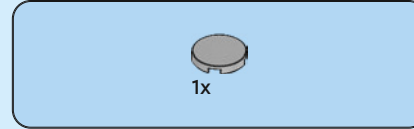
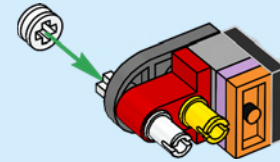

36

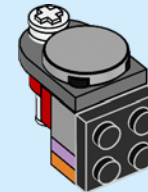
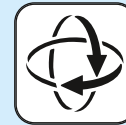

37

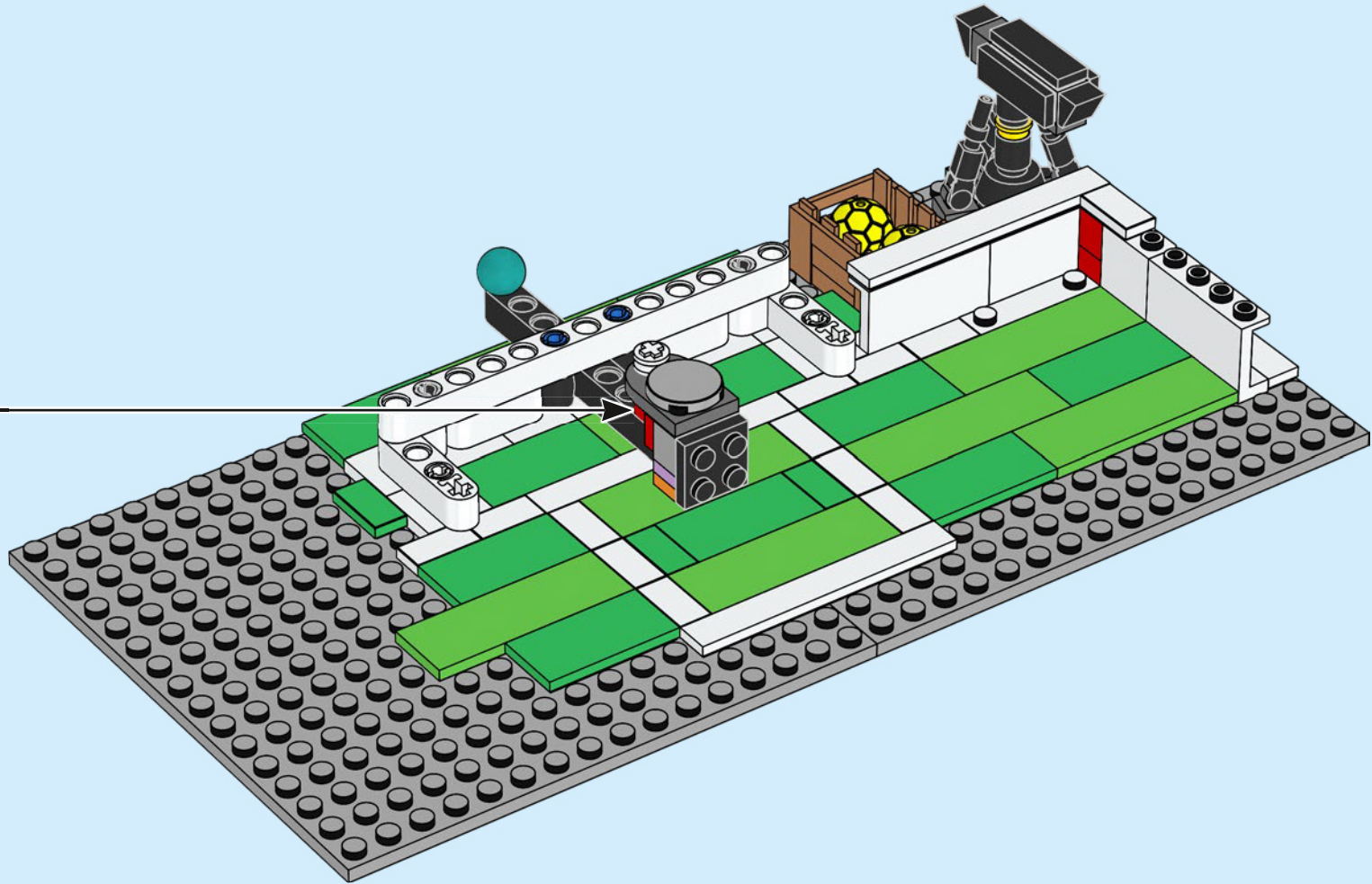



2x



2x

38

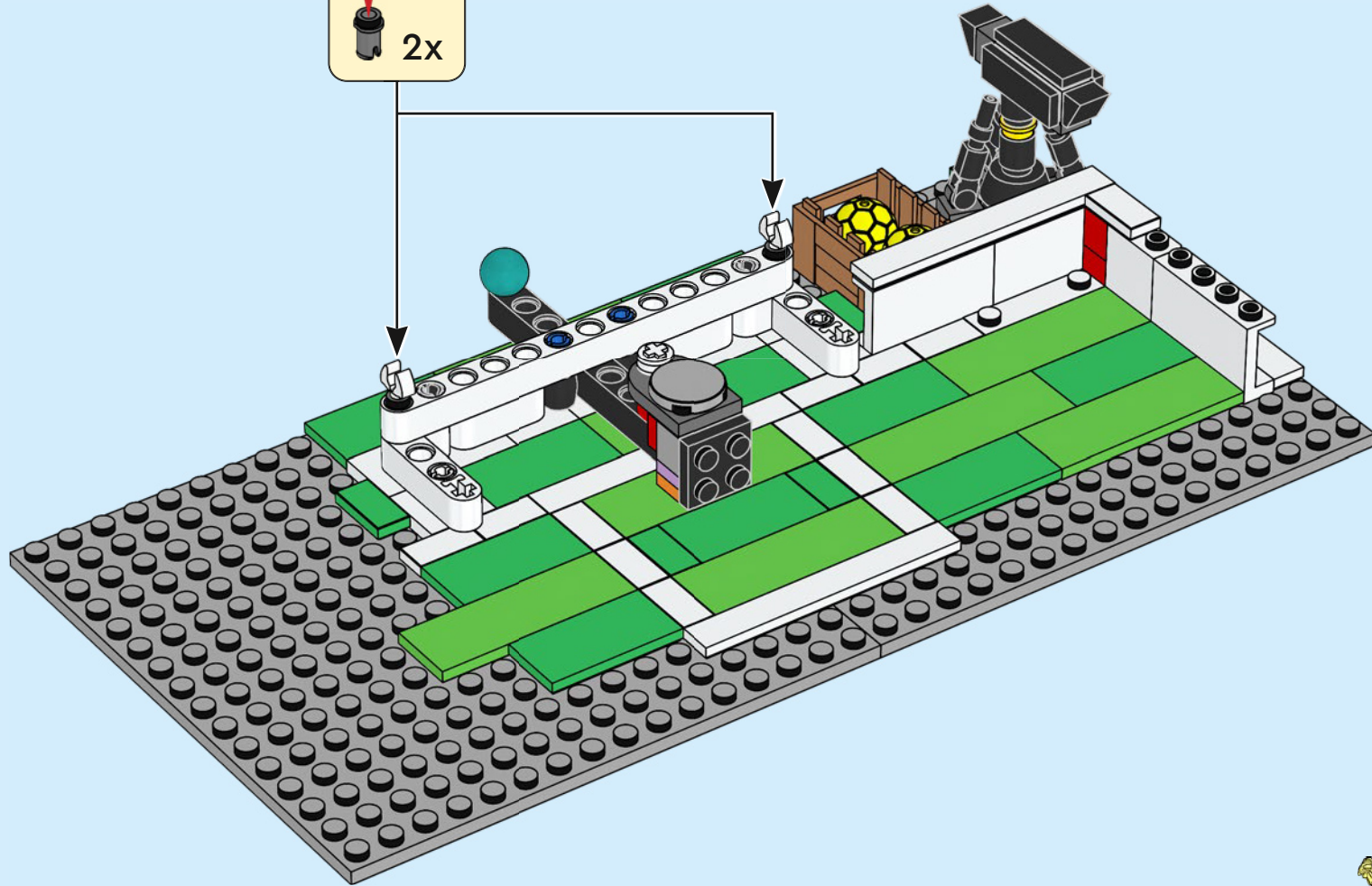
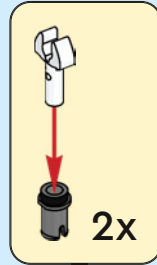

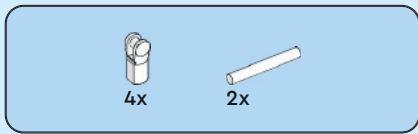

39

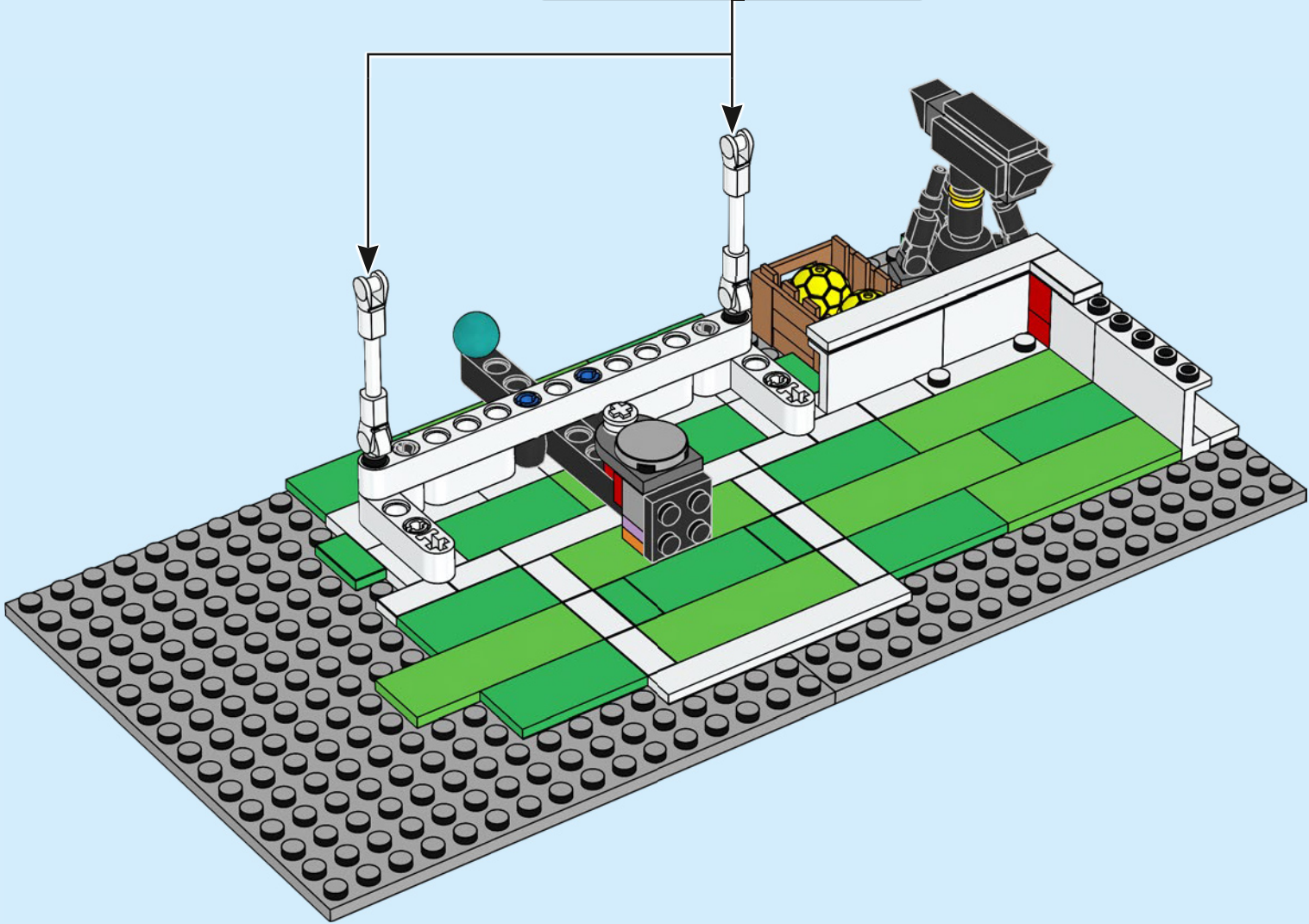
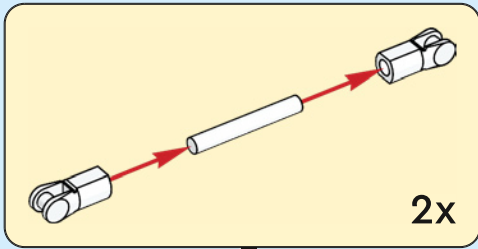

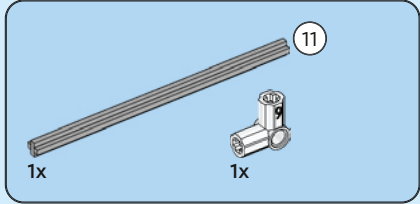
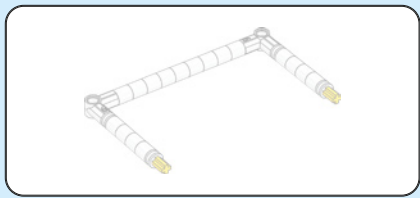

40

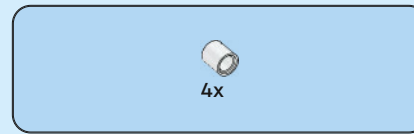
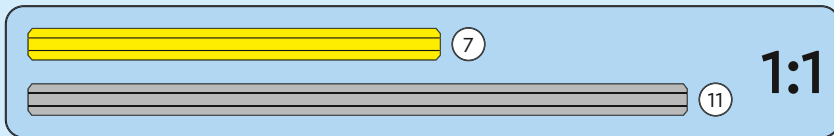
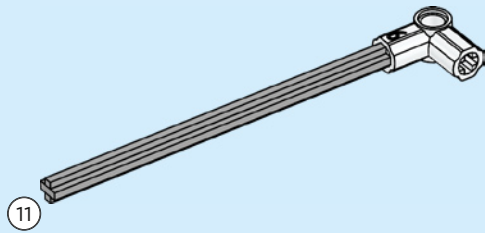

41

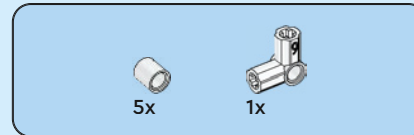
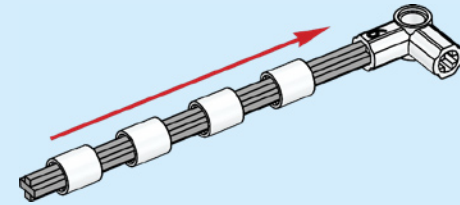

42

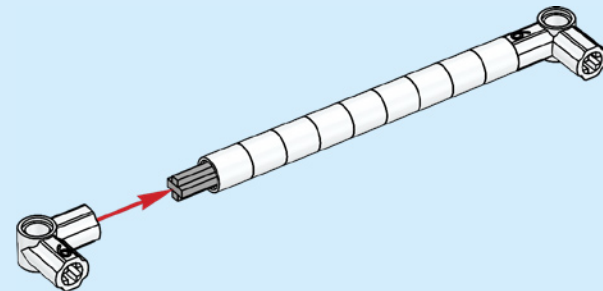

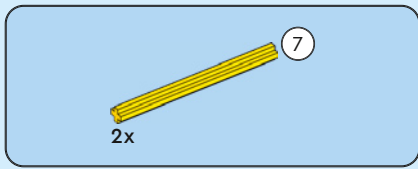

43

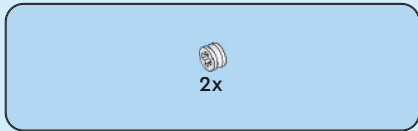
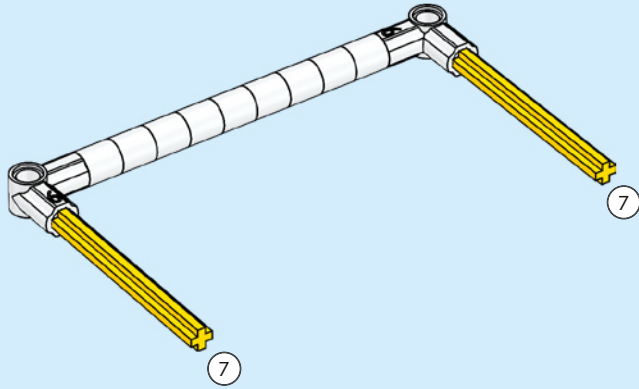

44

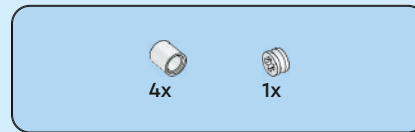
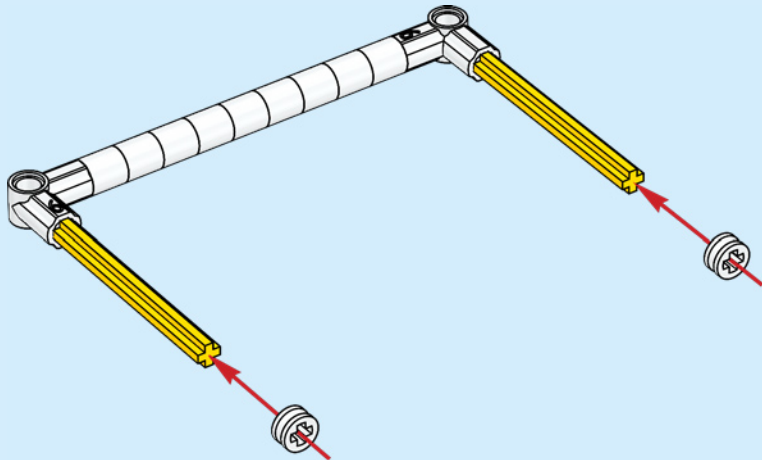

45

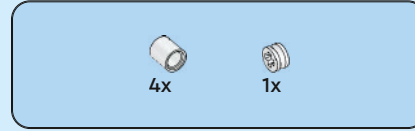
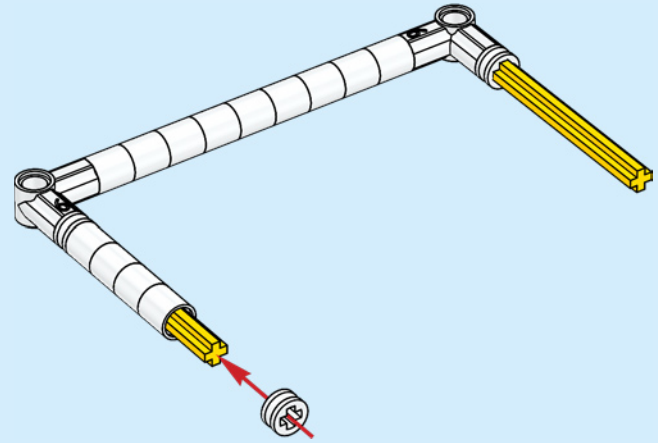

46

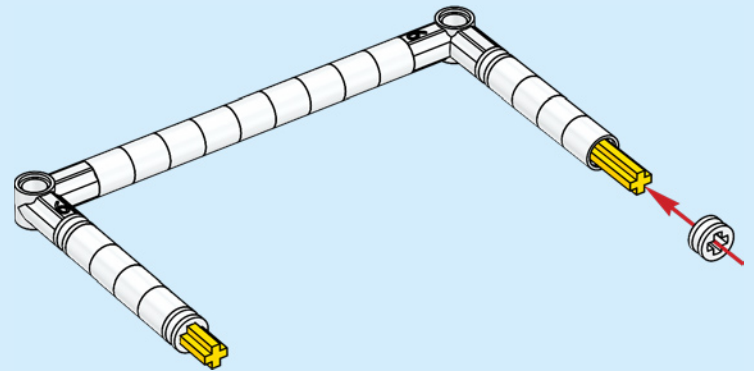

47

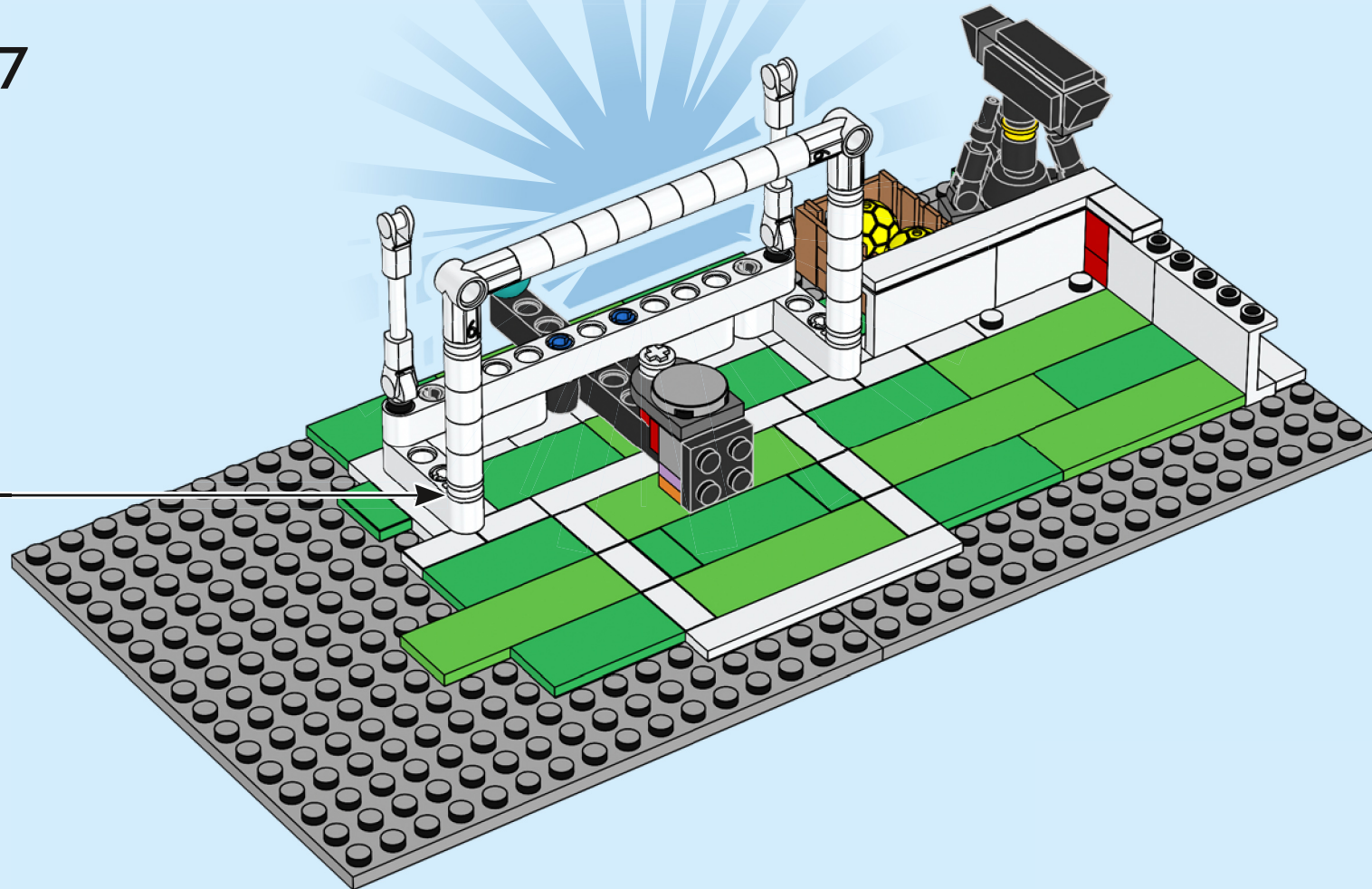

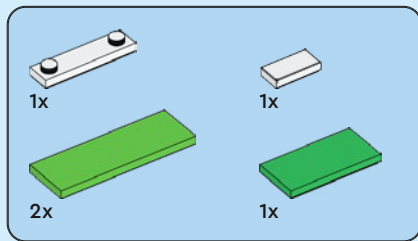

48

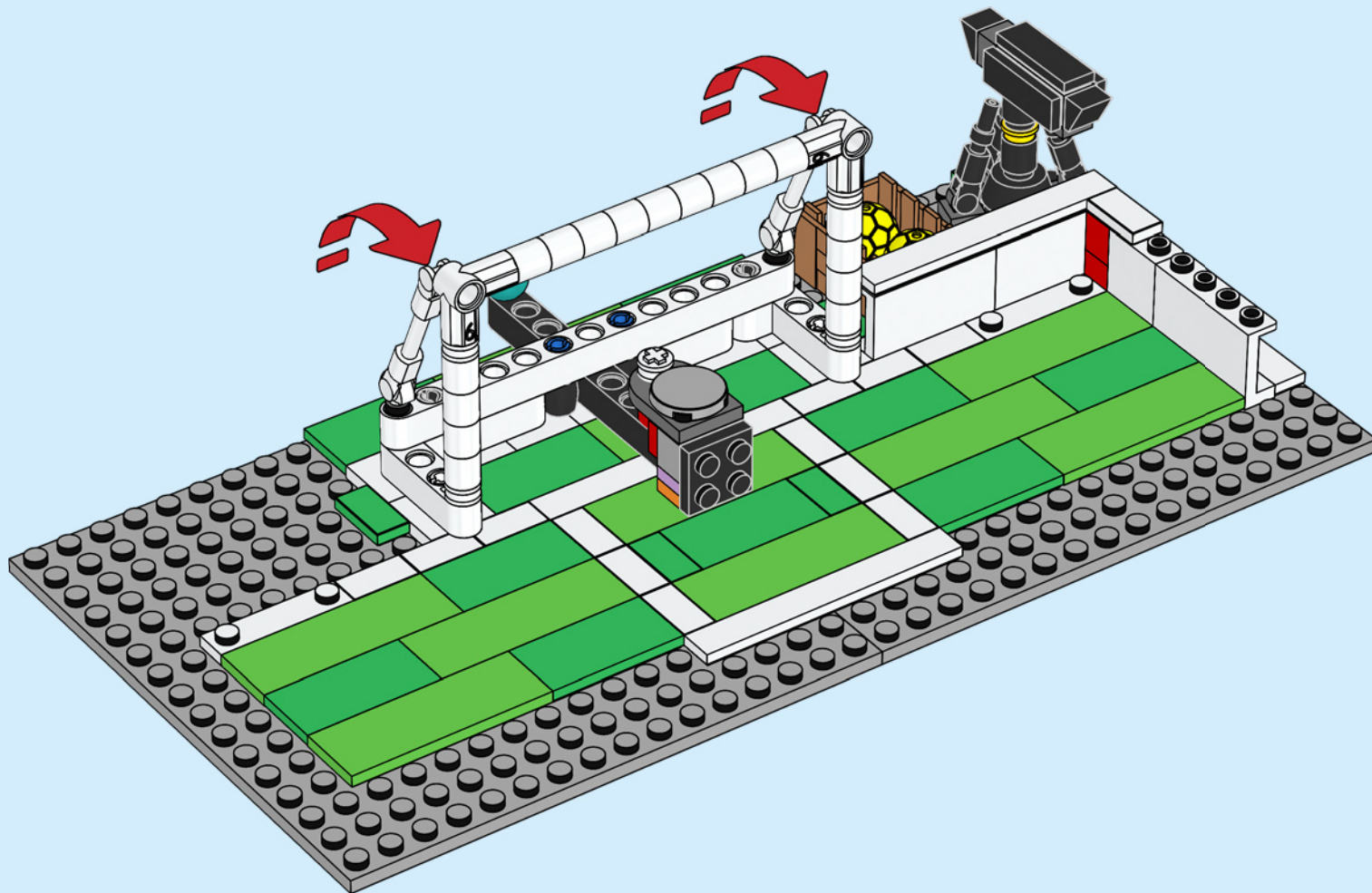



2x

50

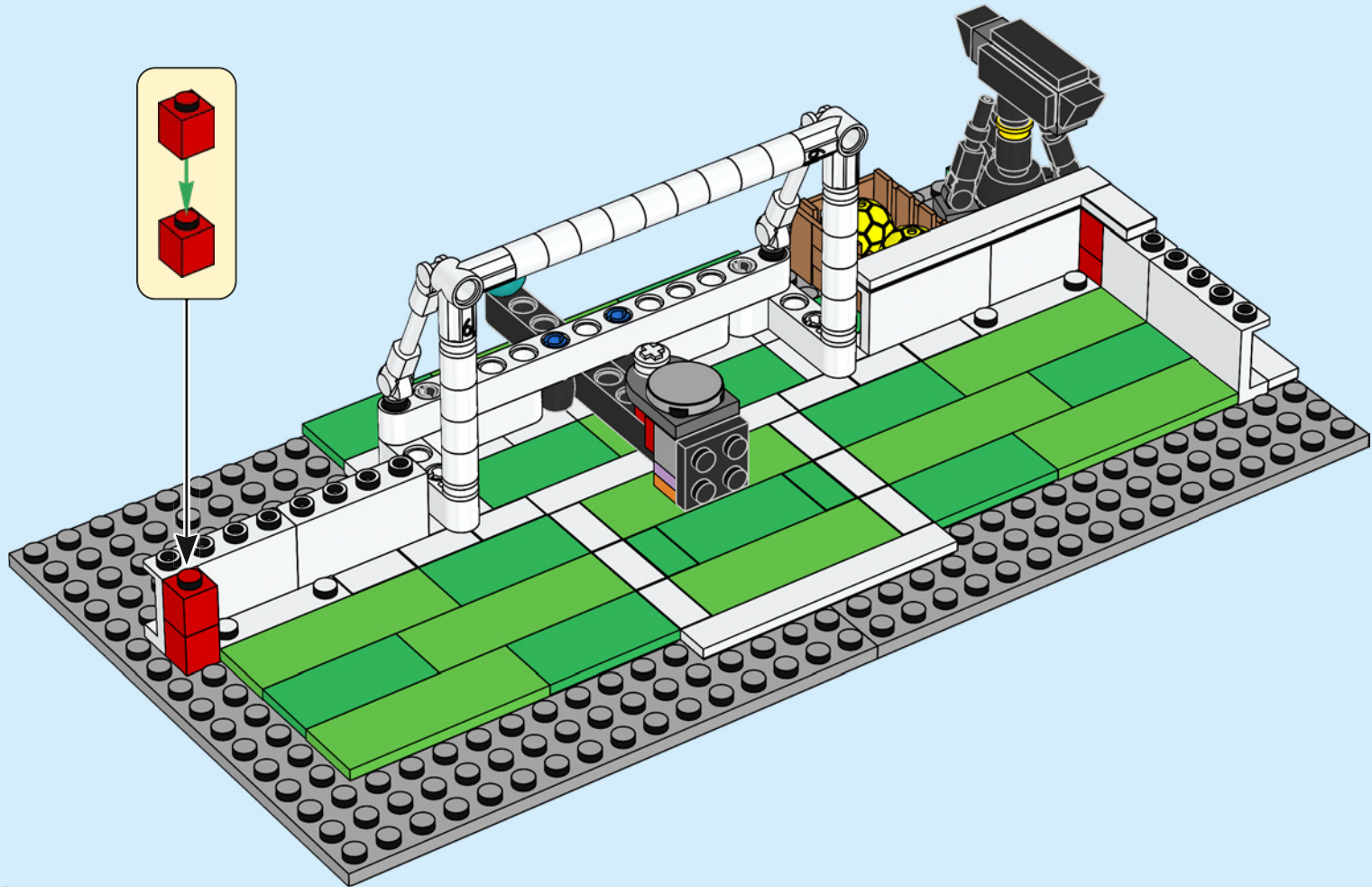

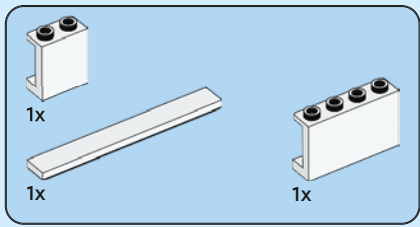

51

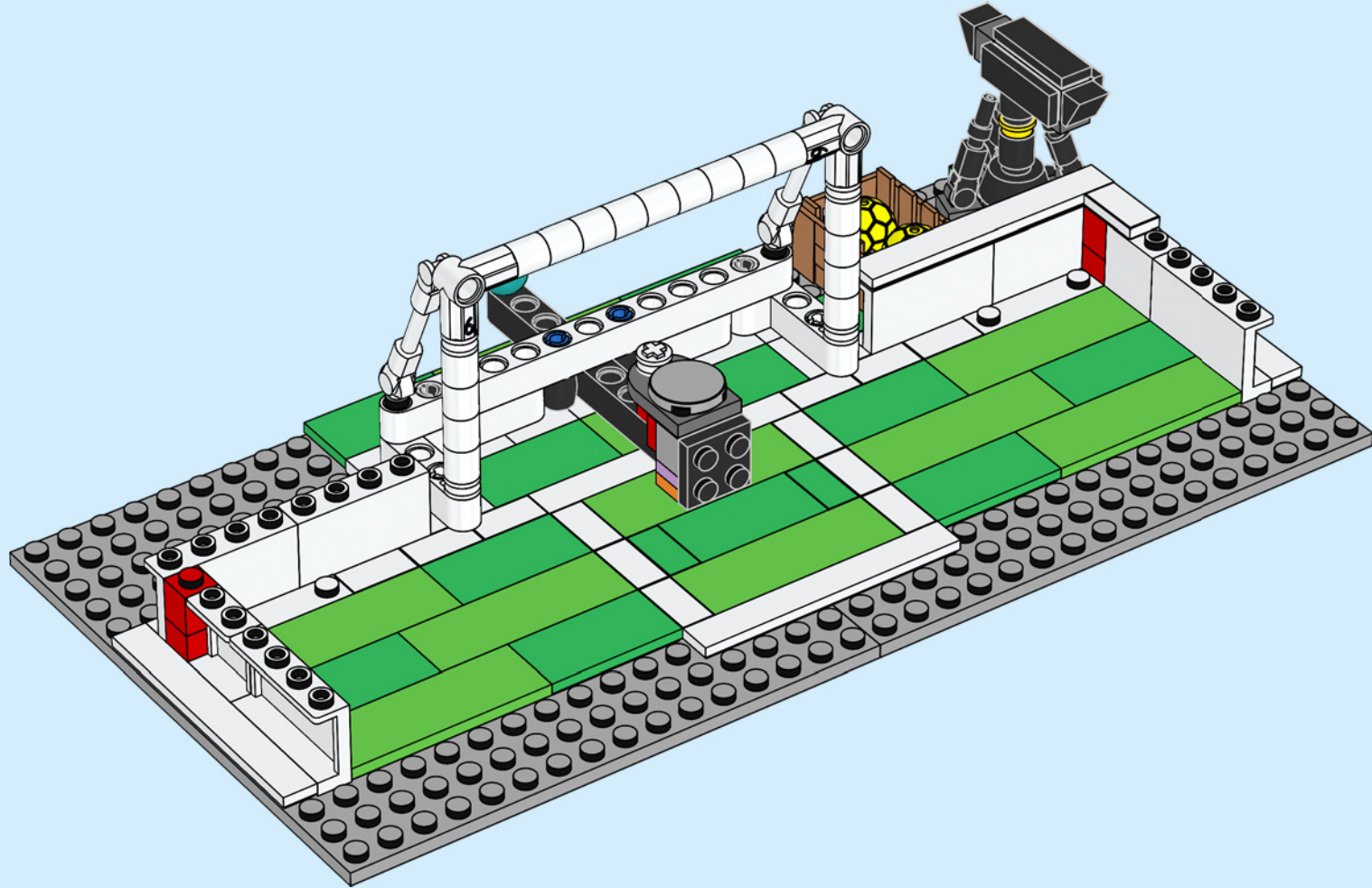

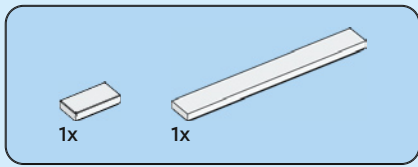

52

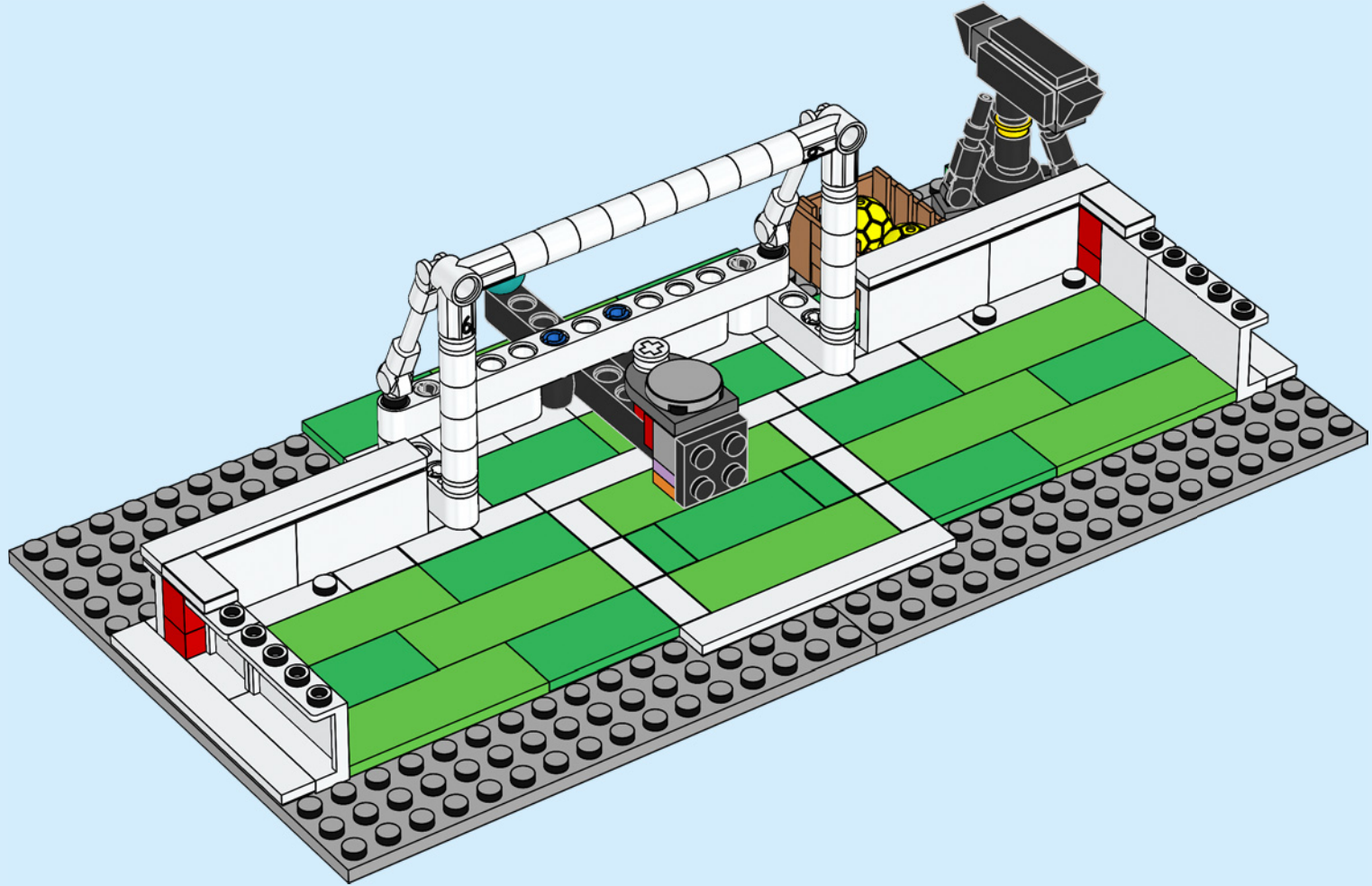

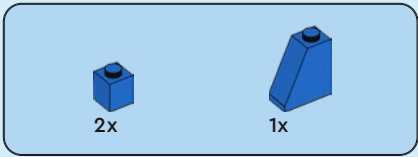

53

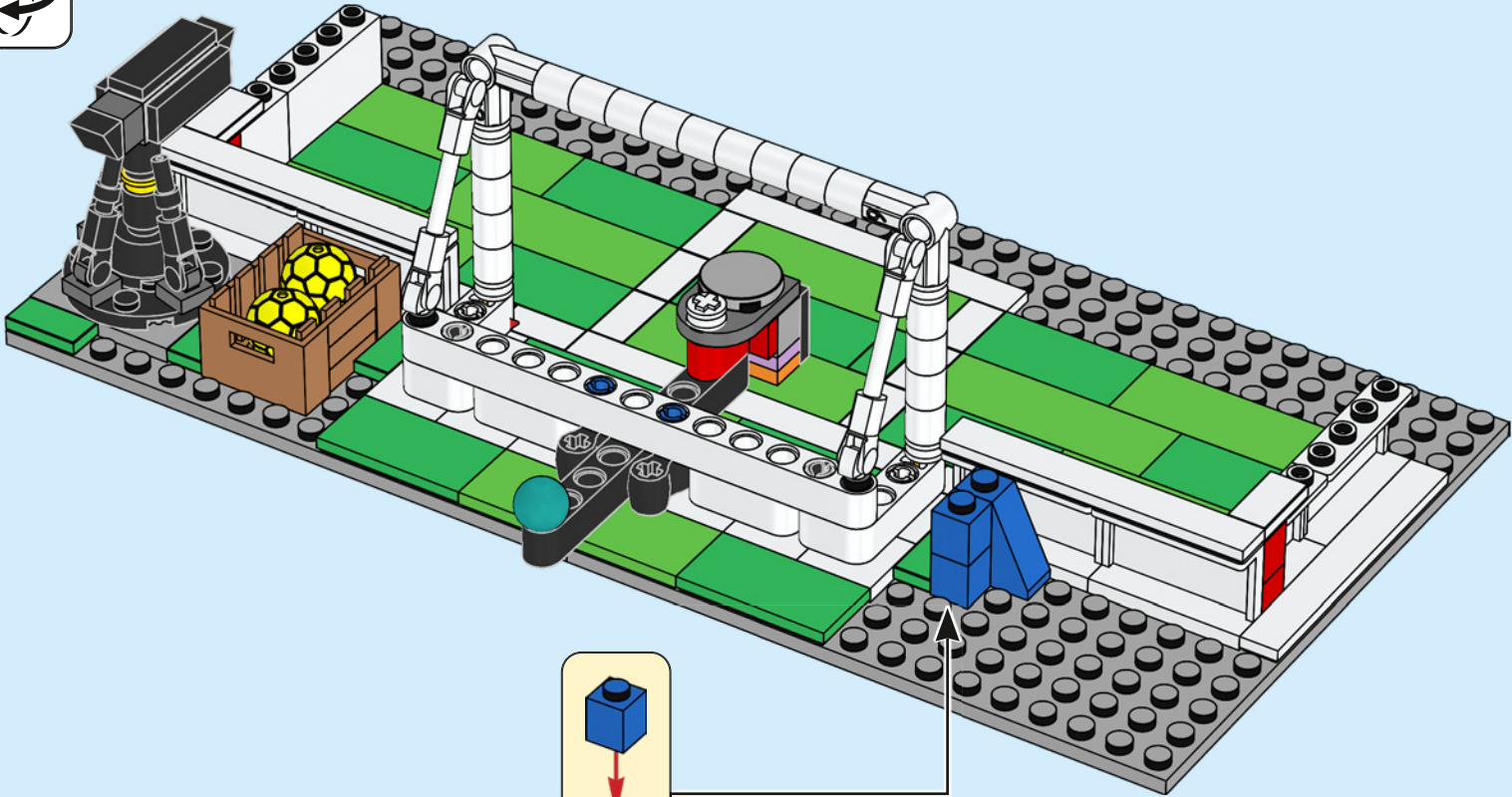

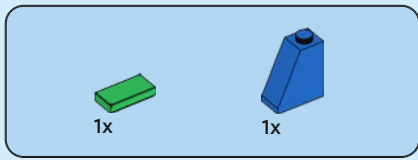

54

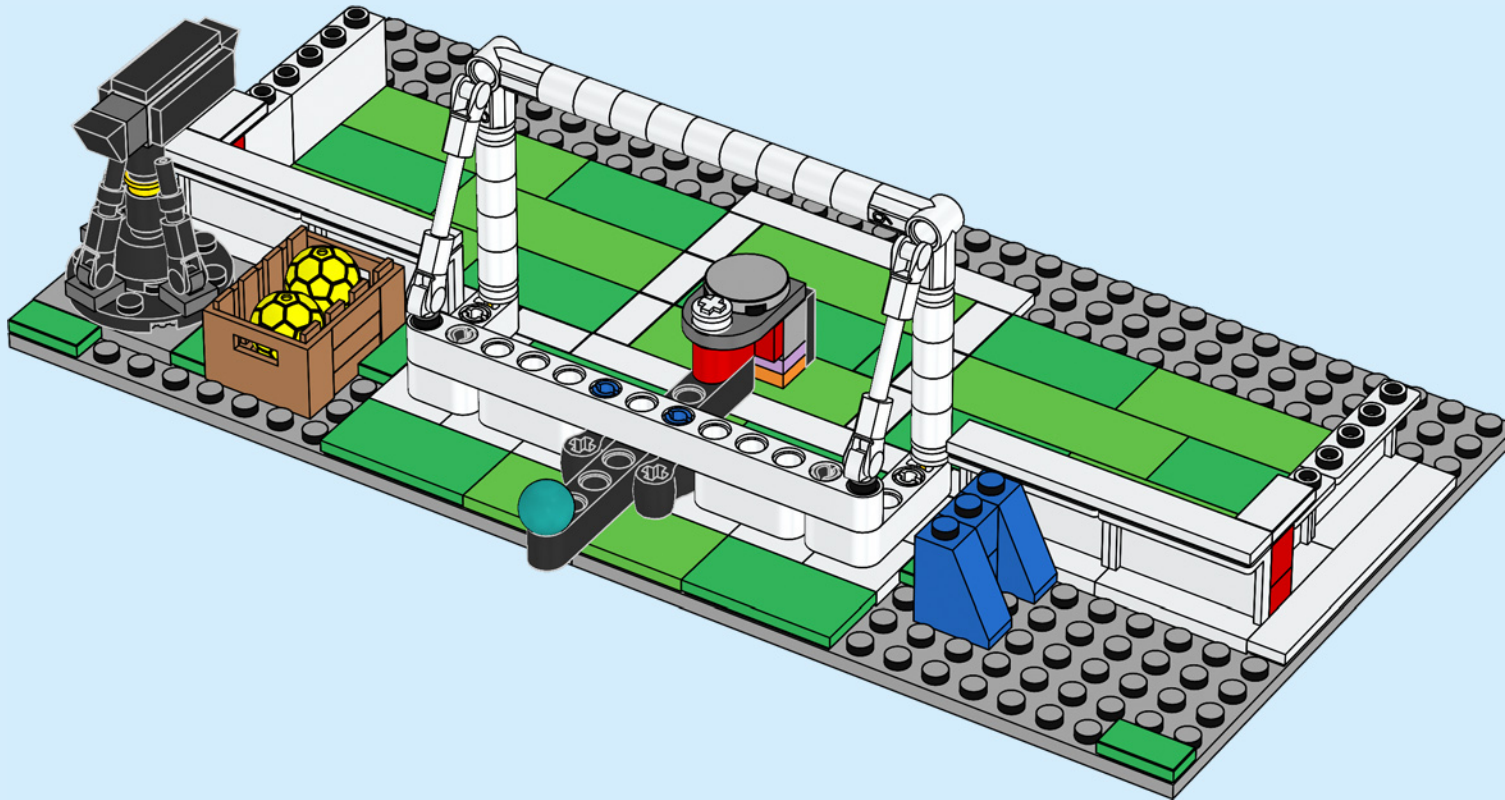

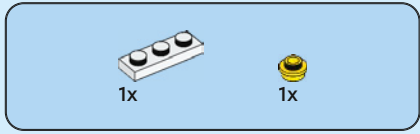

55

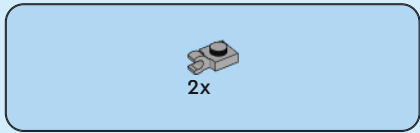
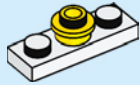

56

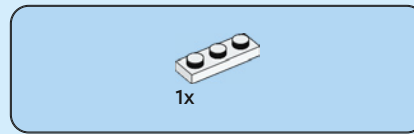
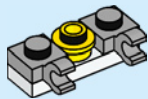

57

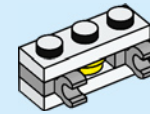

58

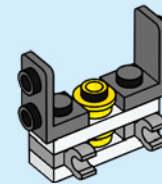

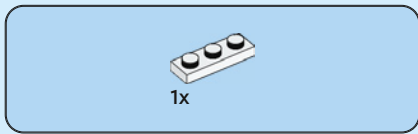

59

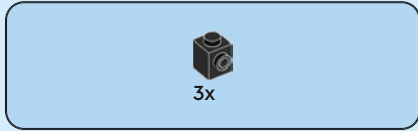
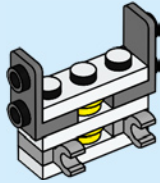

60

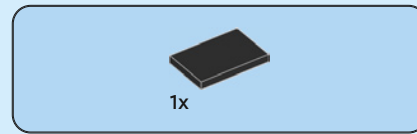
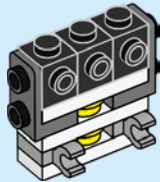

61

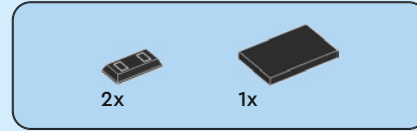
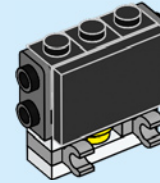

62

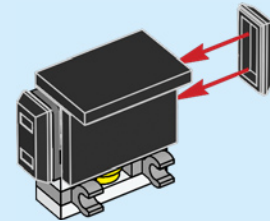

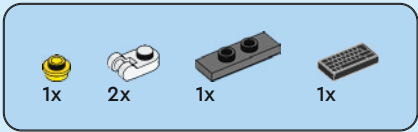

63

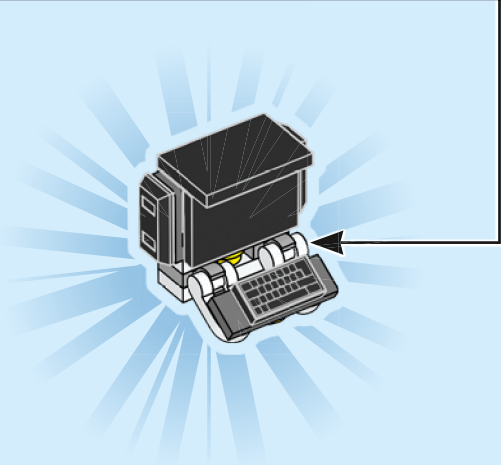
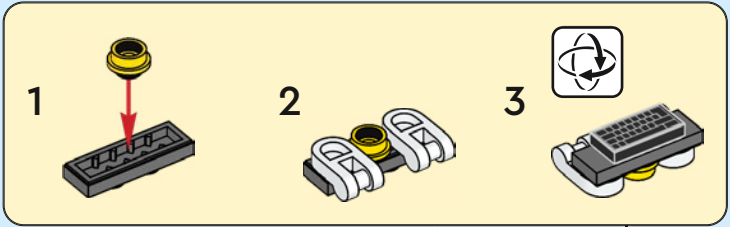

64

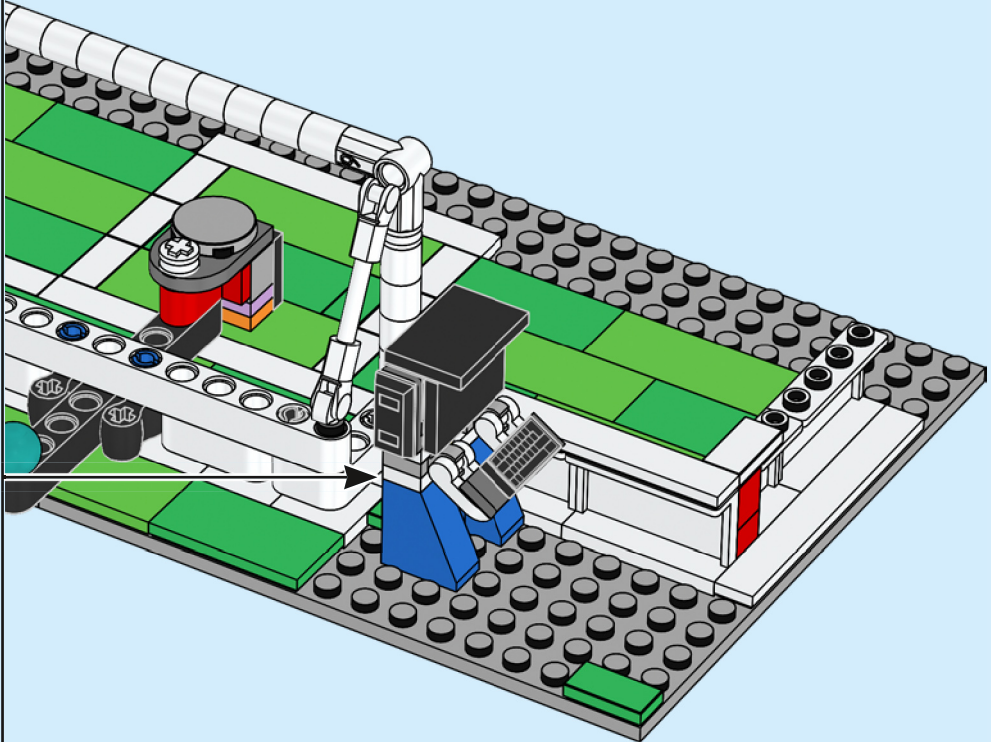

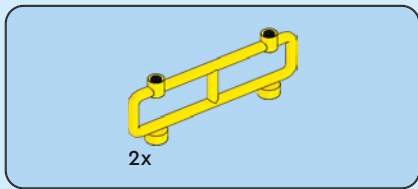

65

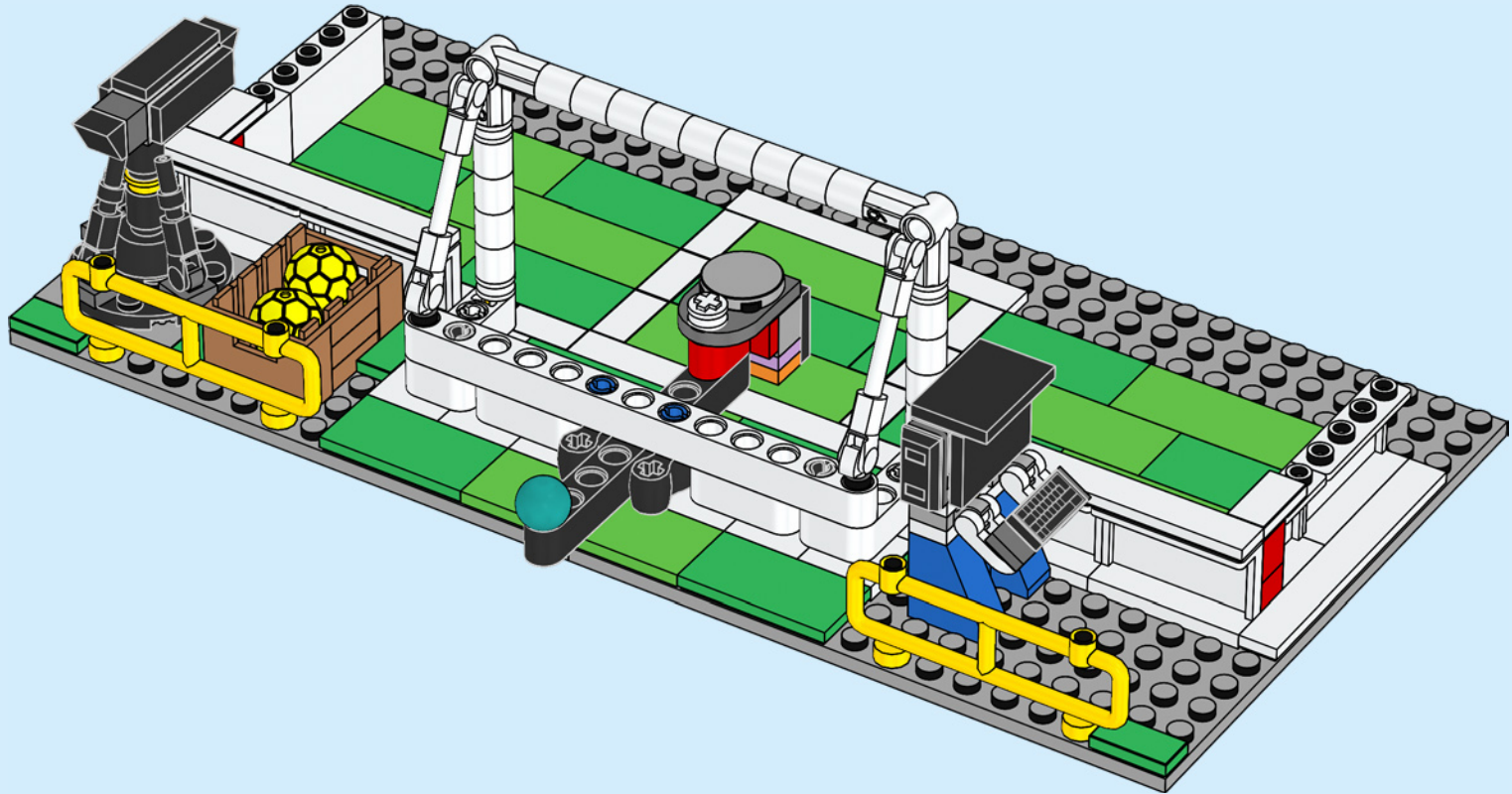

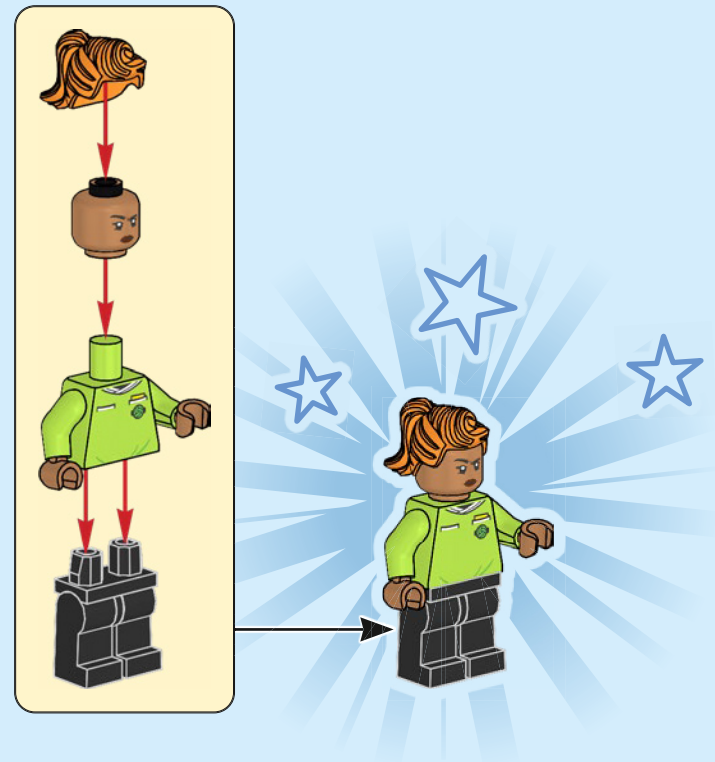
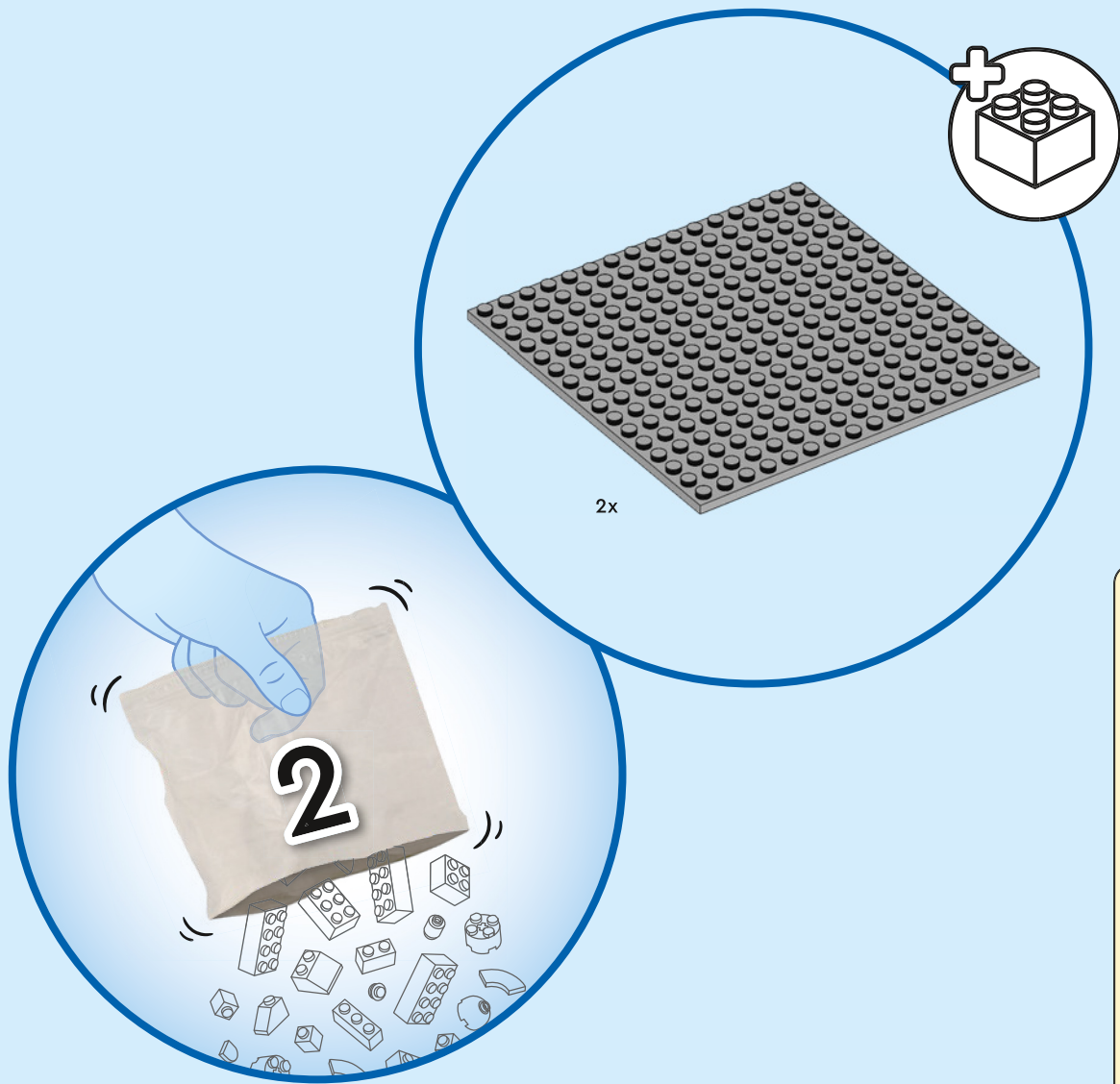

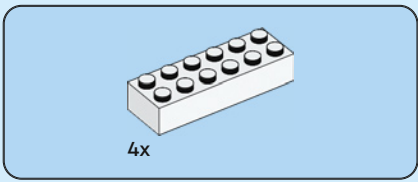

66

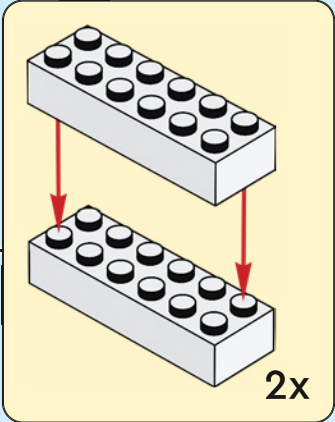
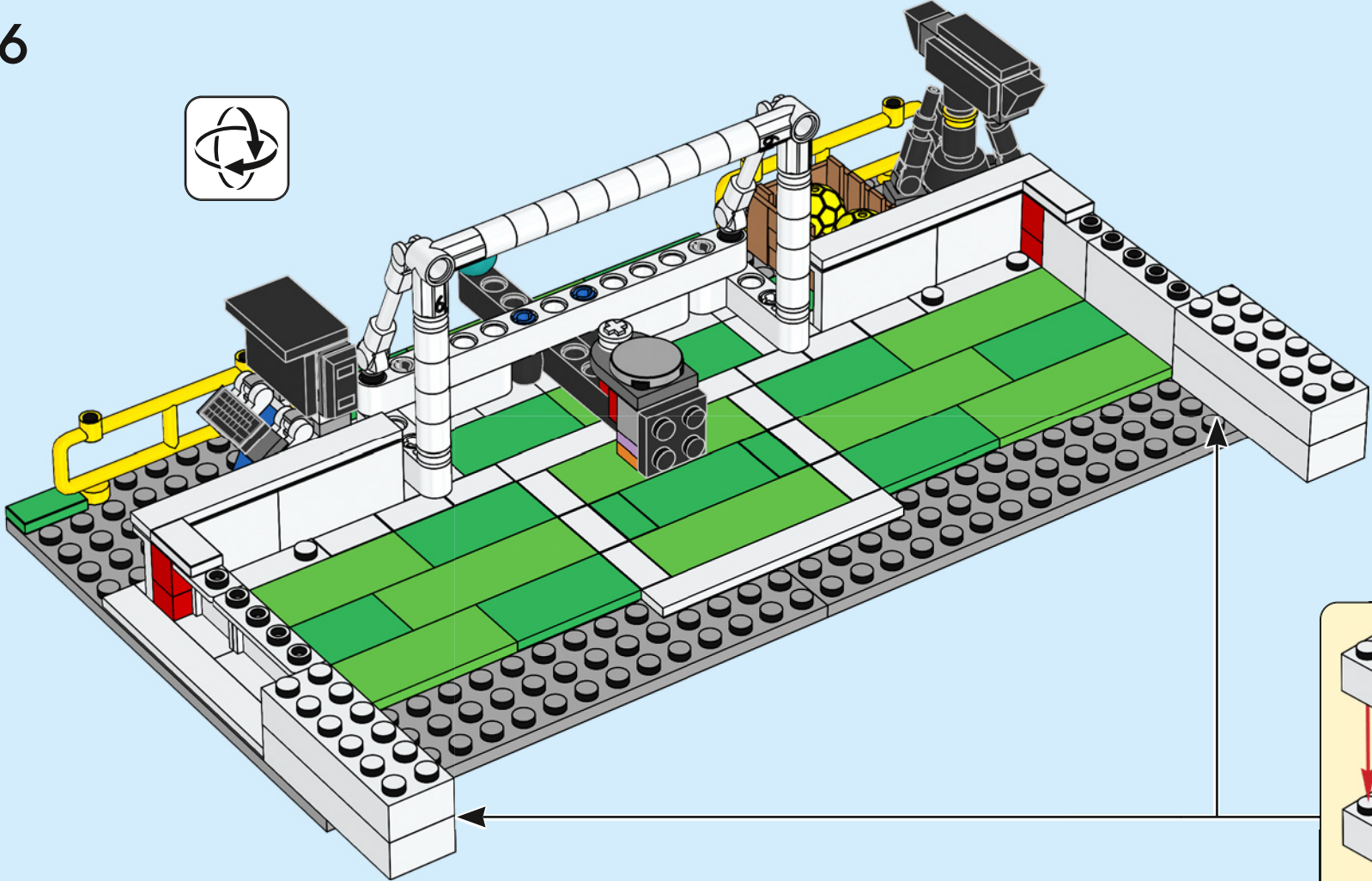

67

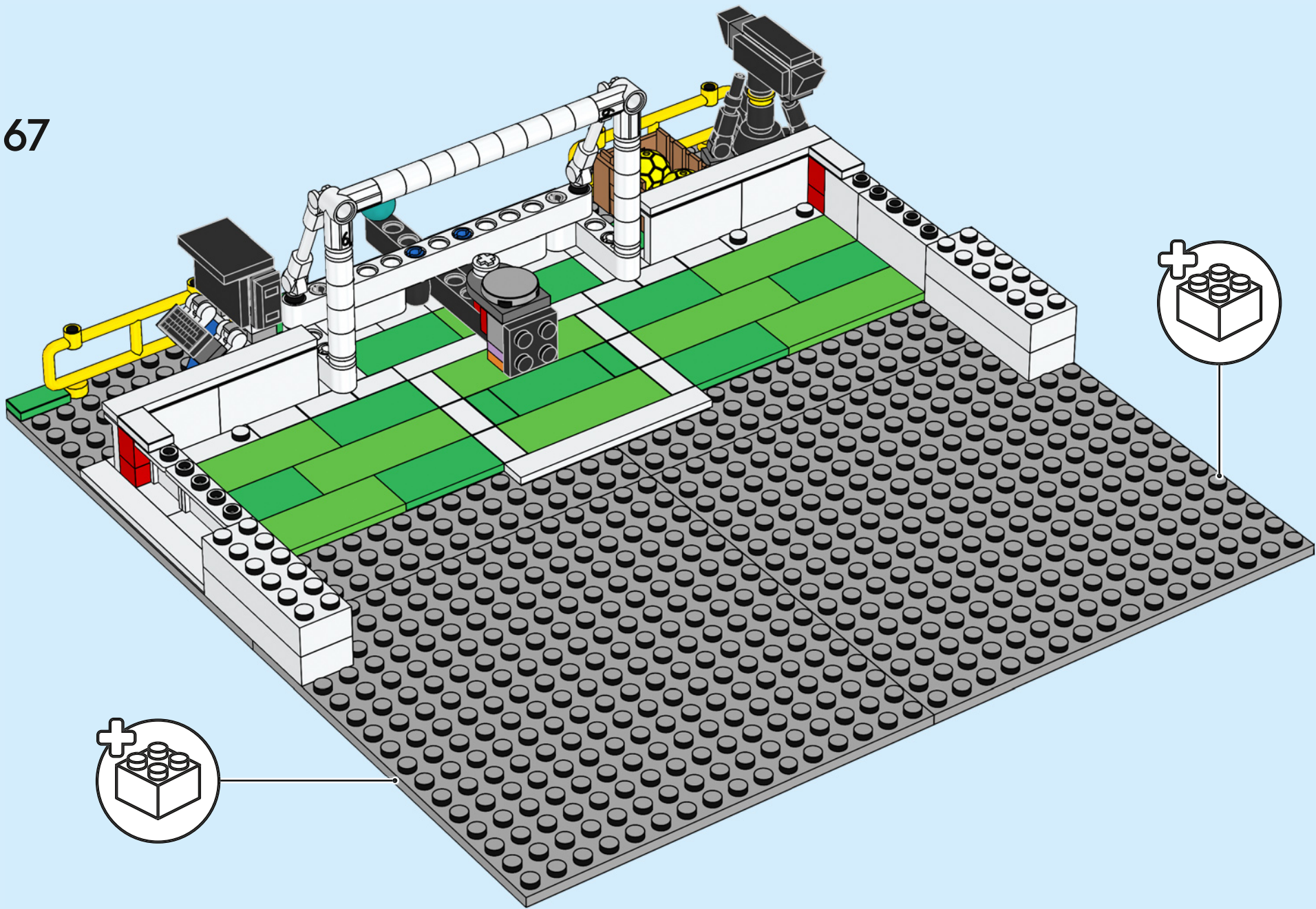

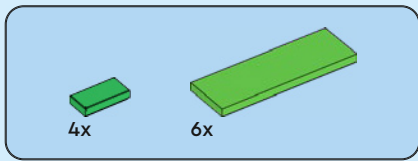

68

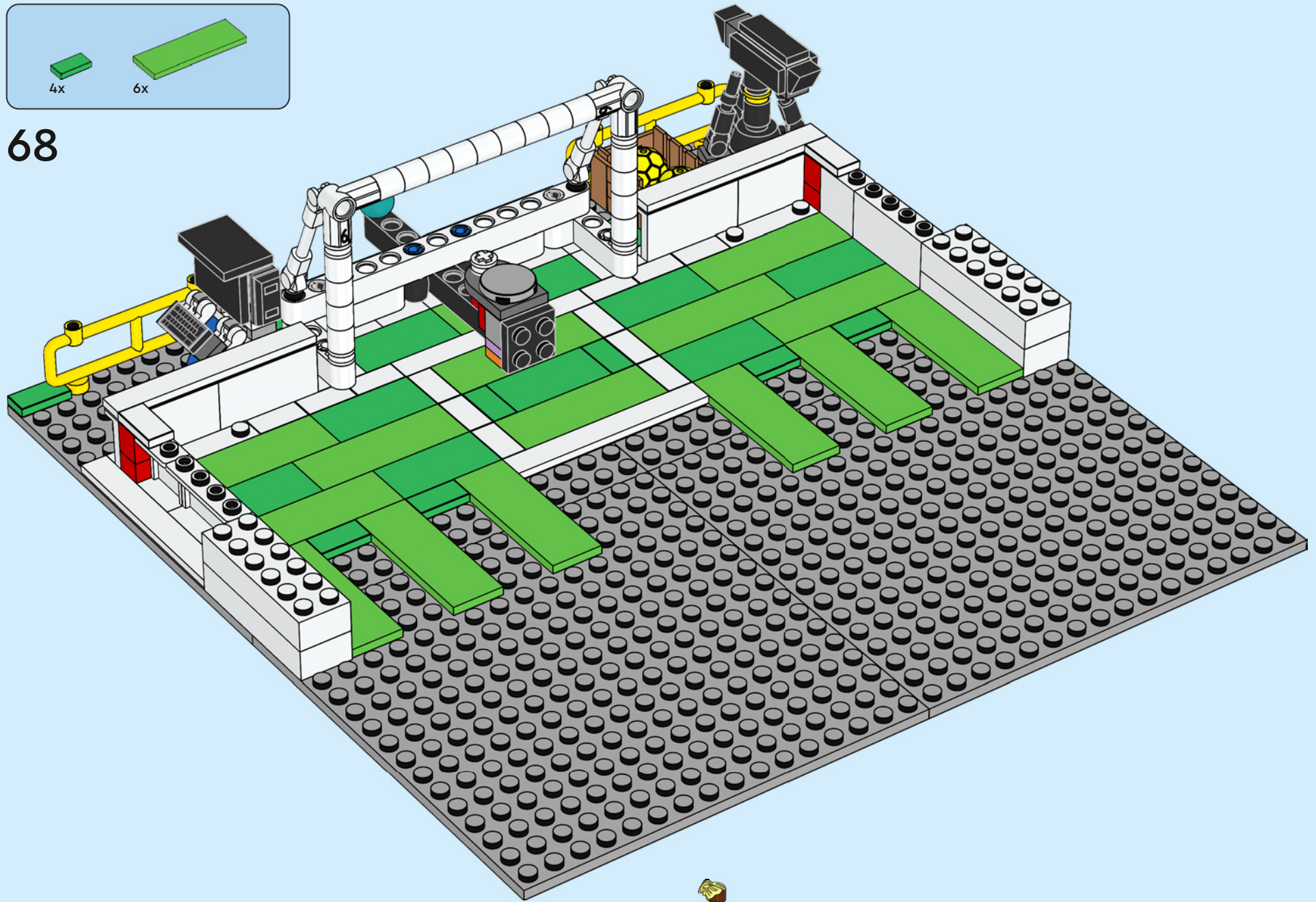

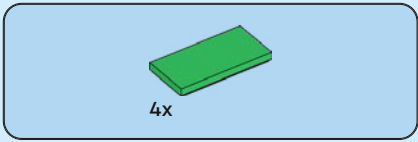

69

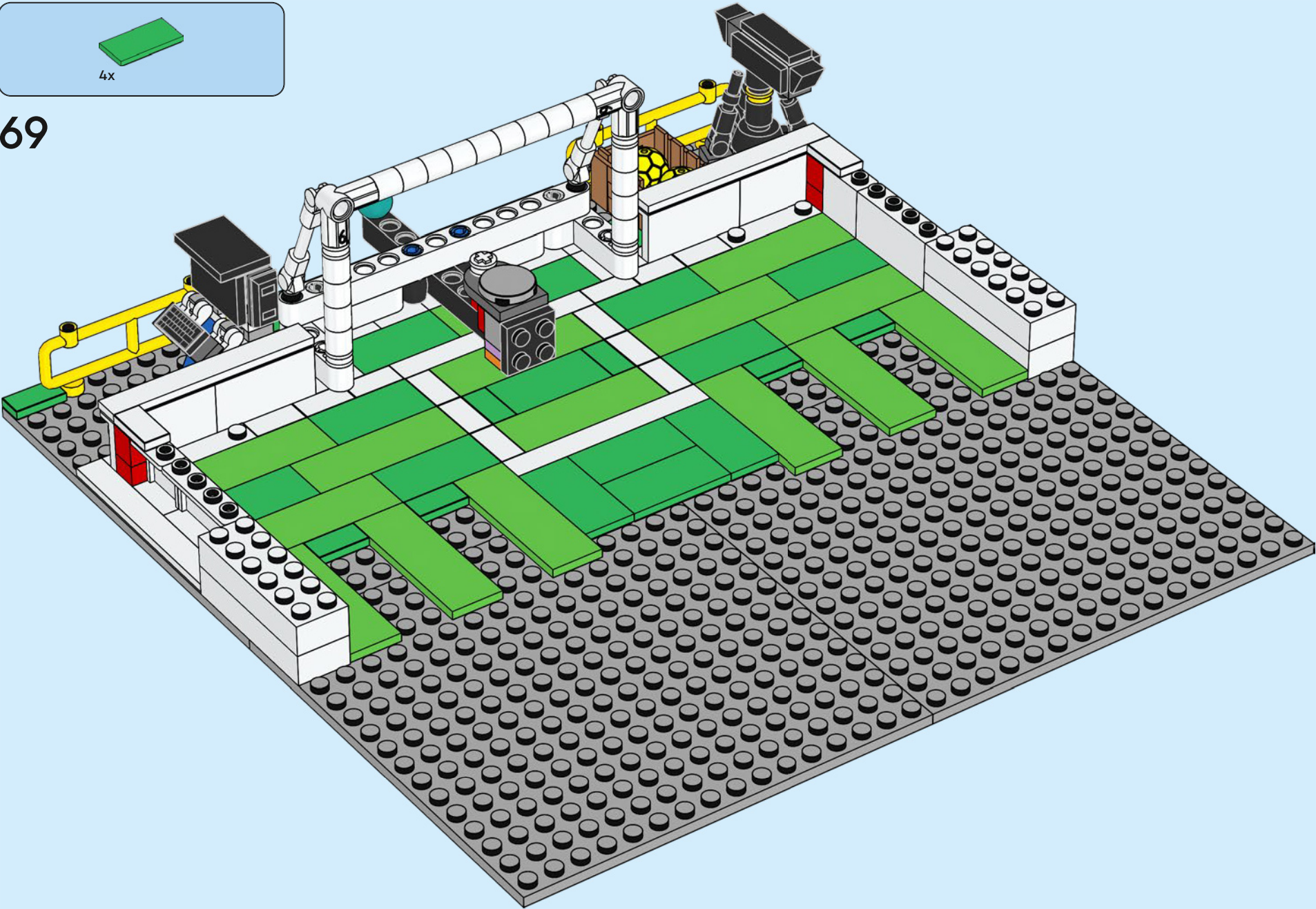

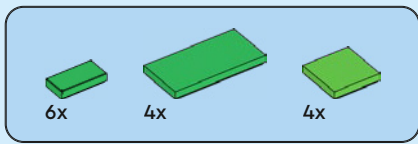

70

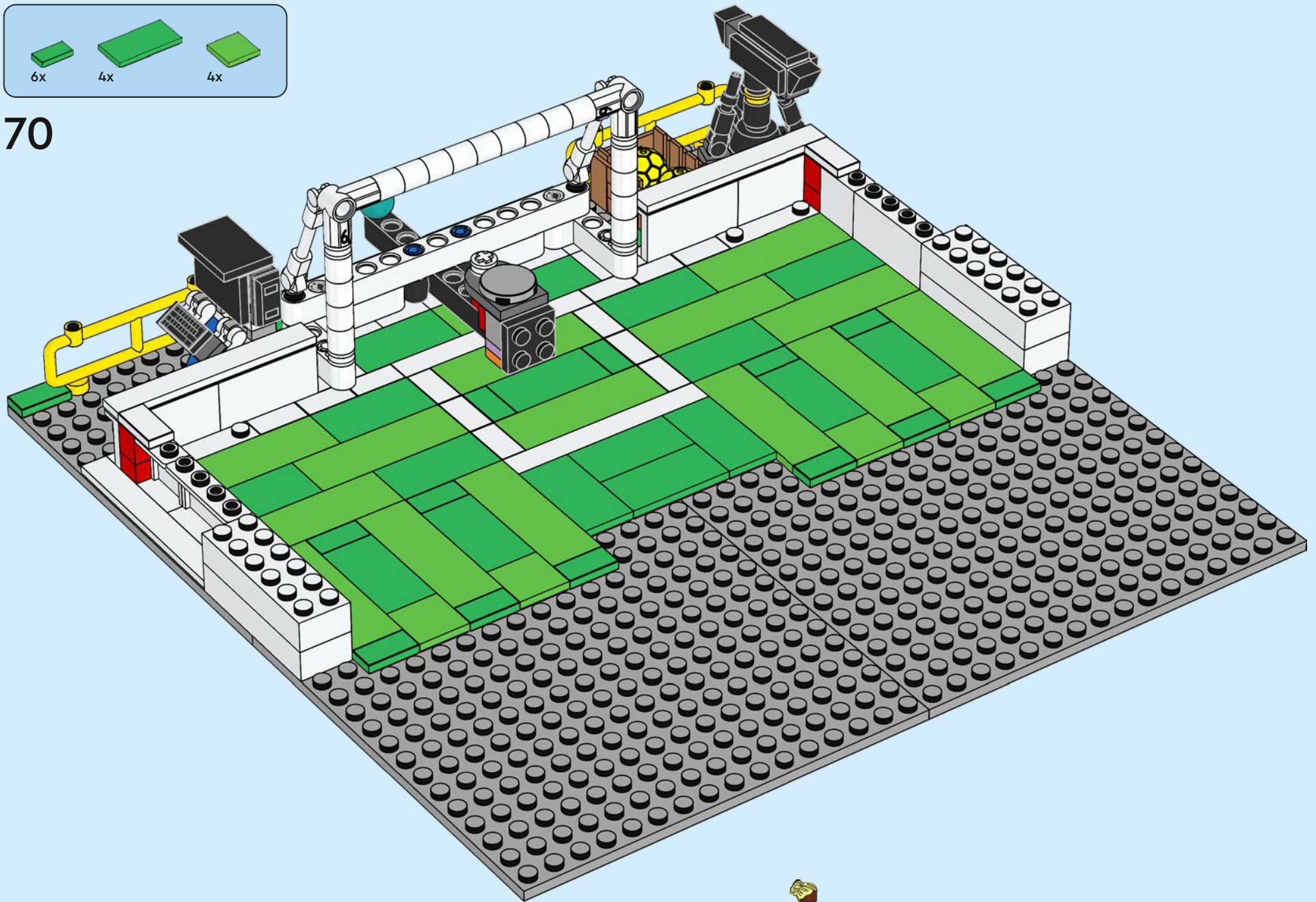

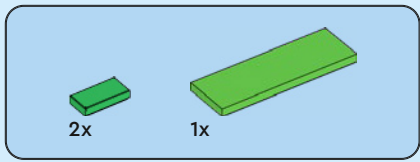

71

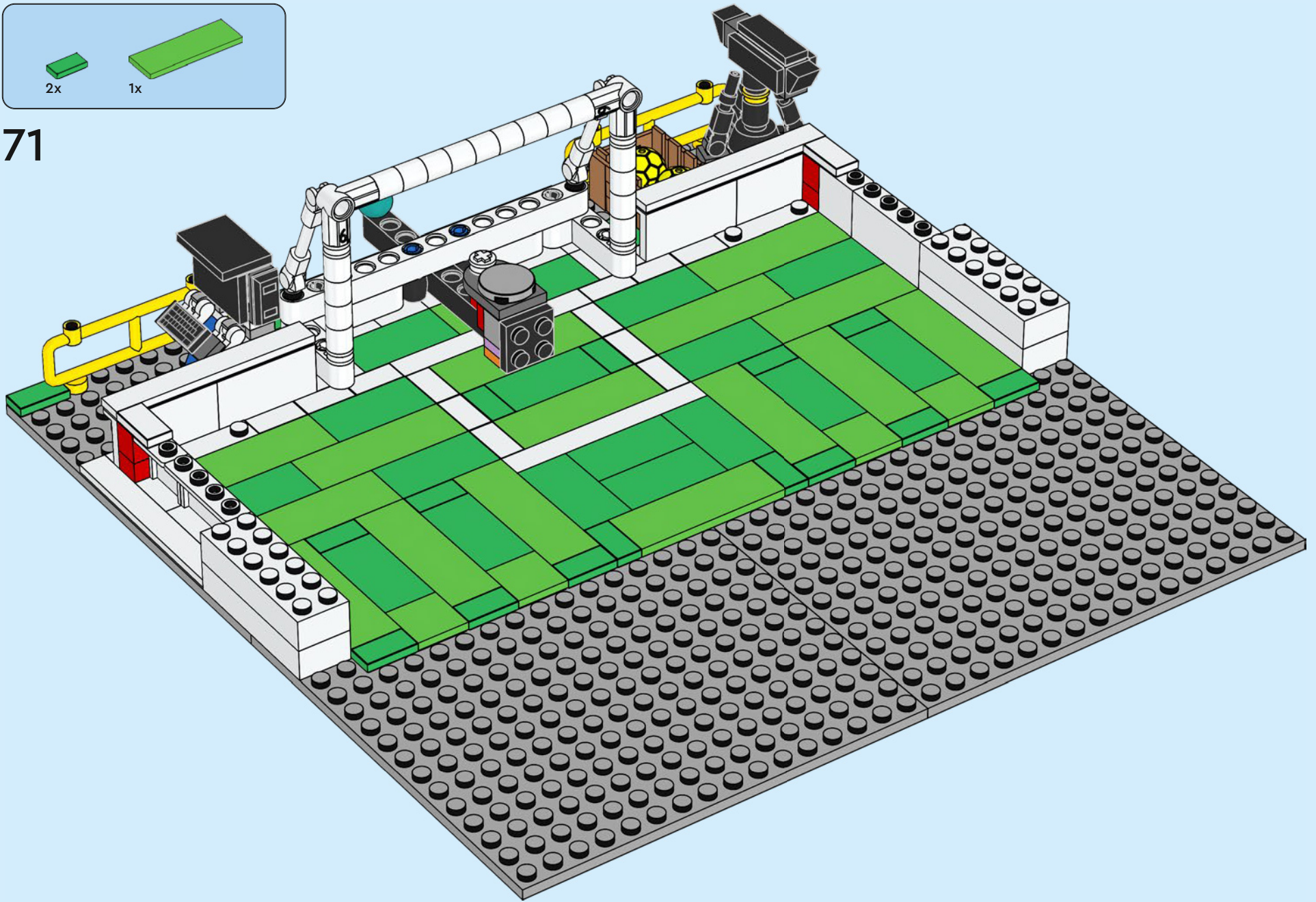

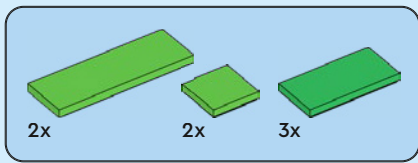

72

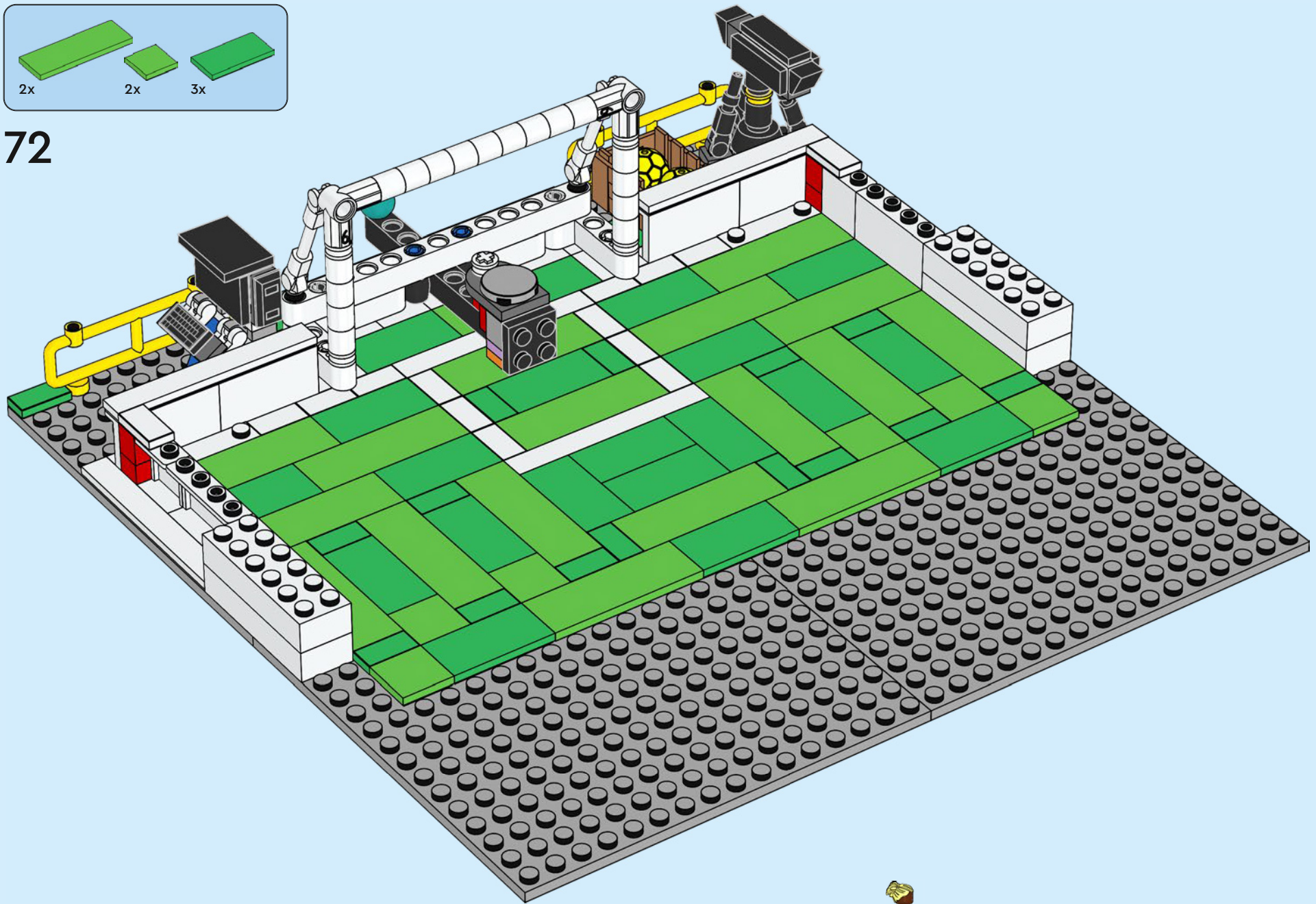

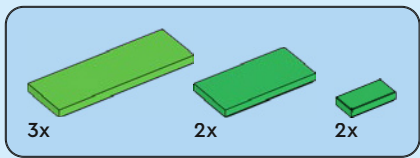

73

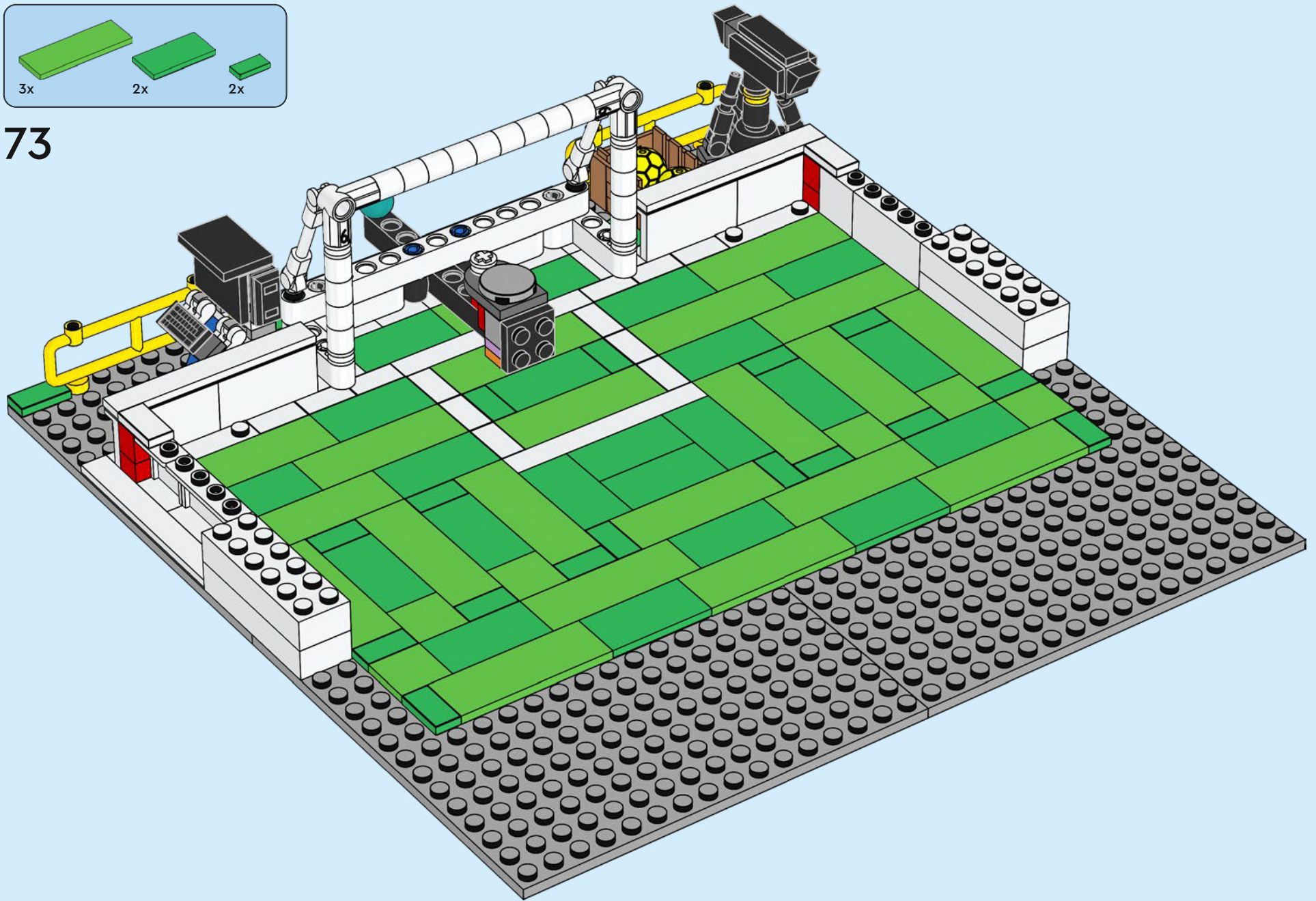

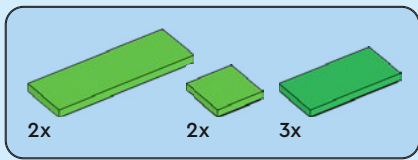

74

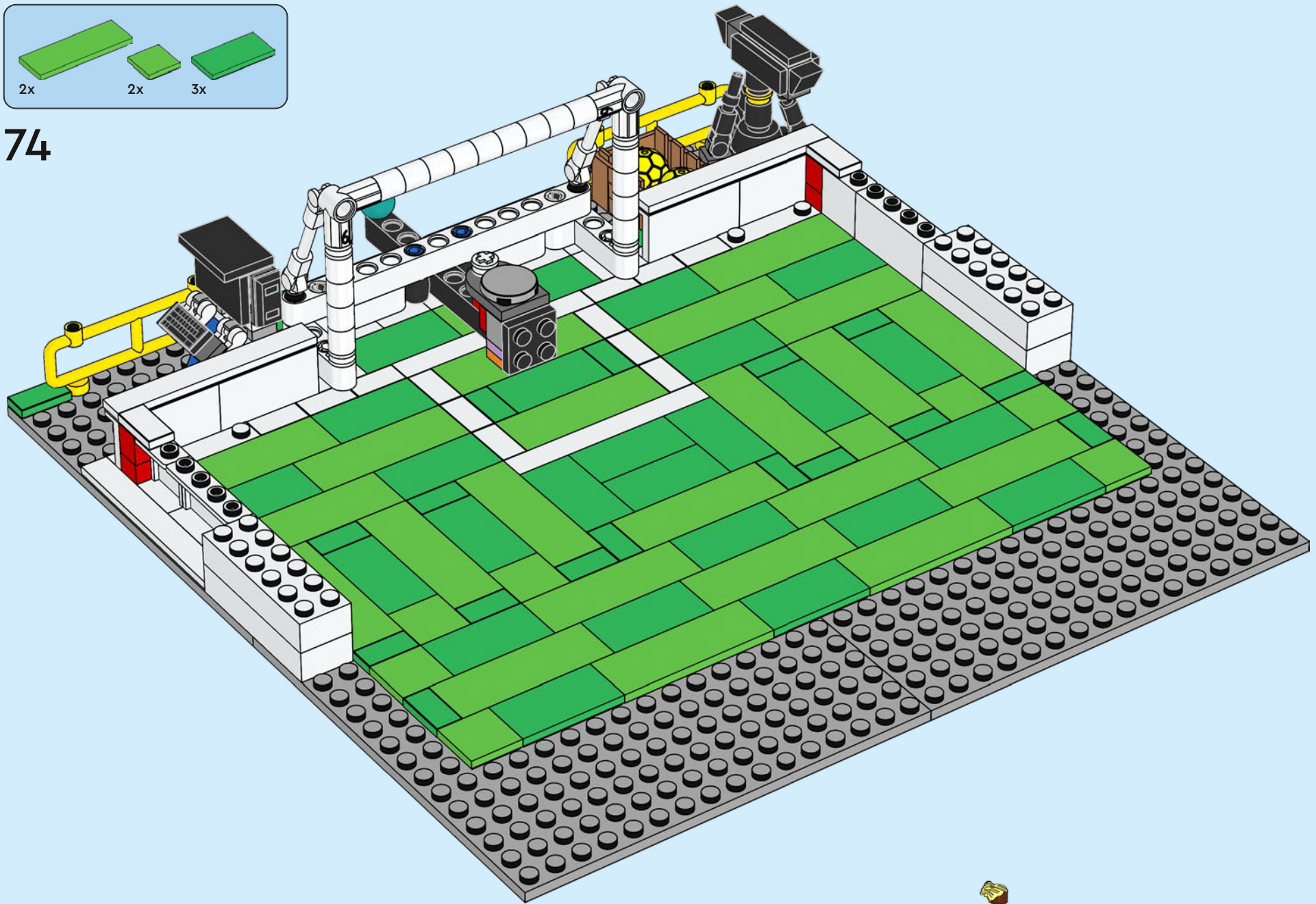

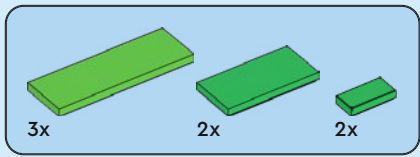

75

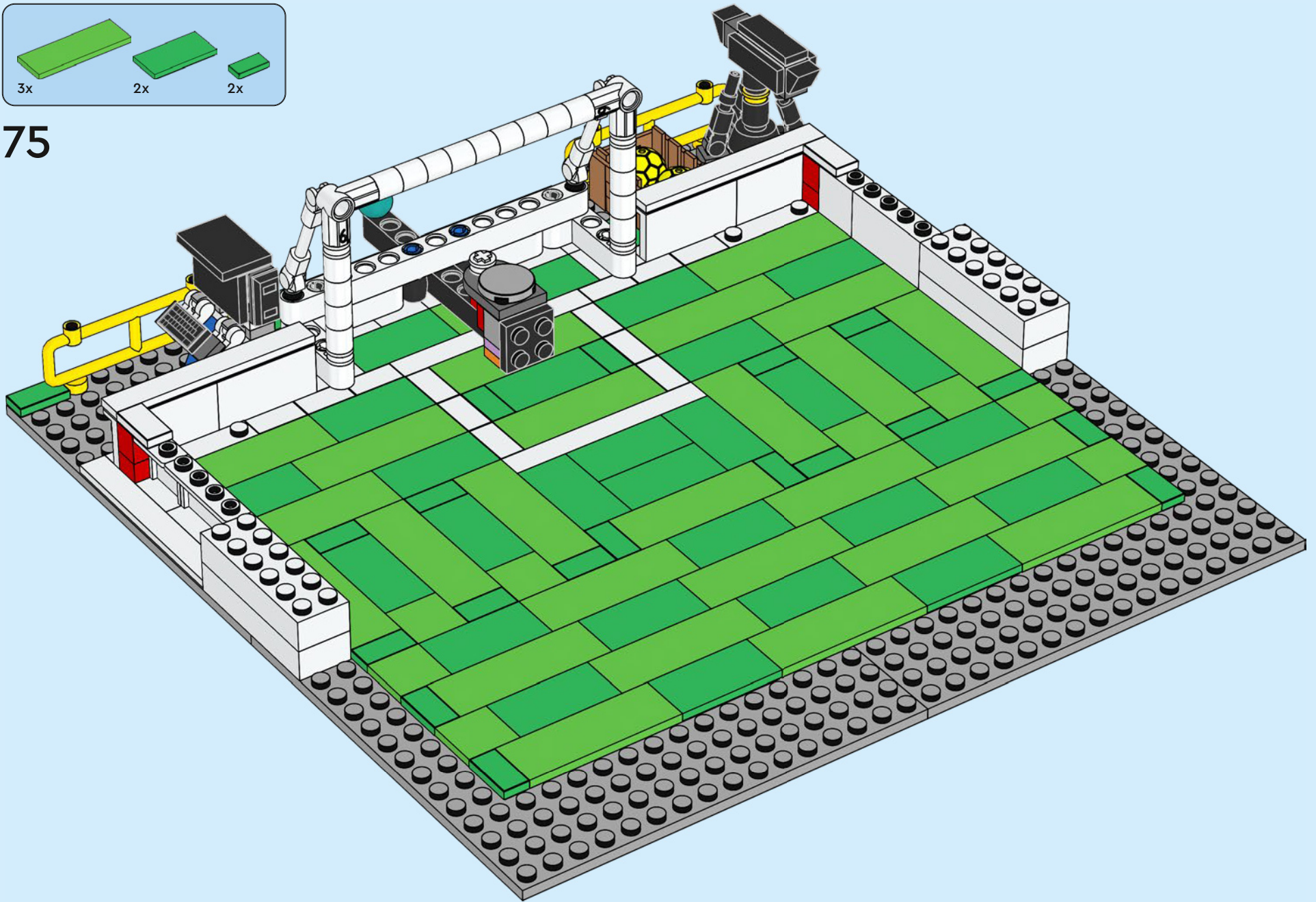

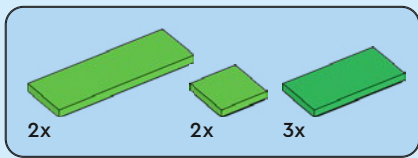

76

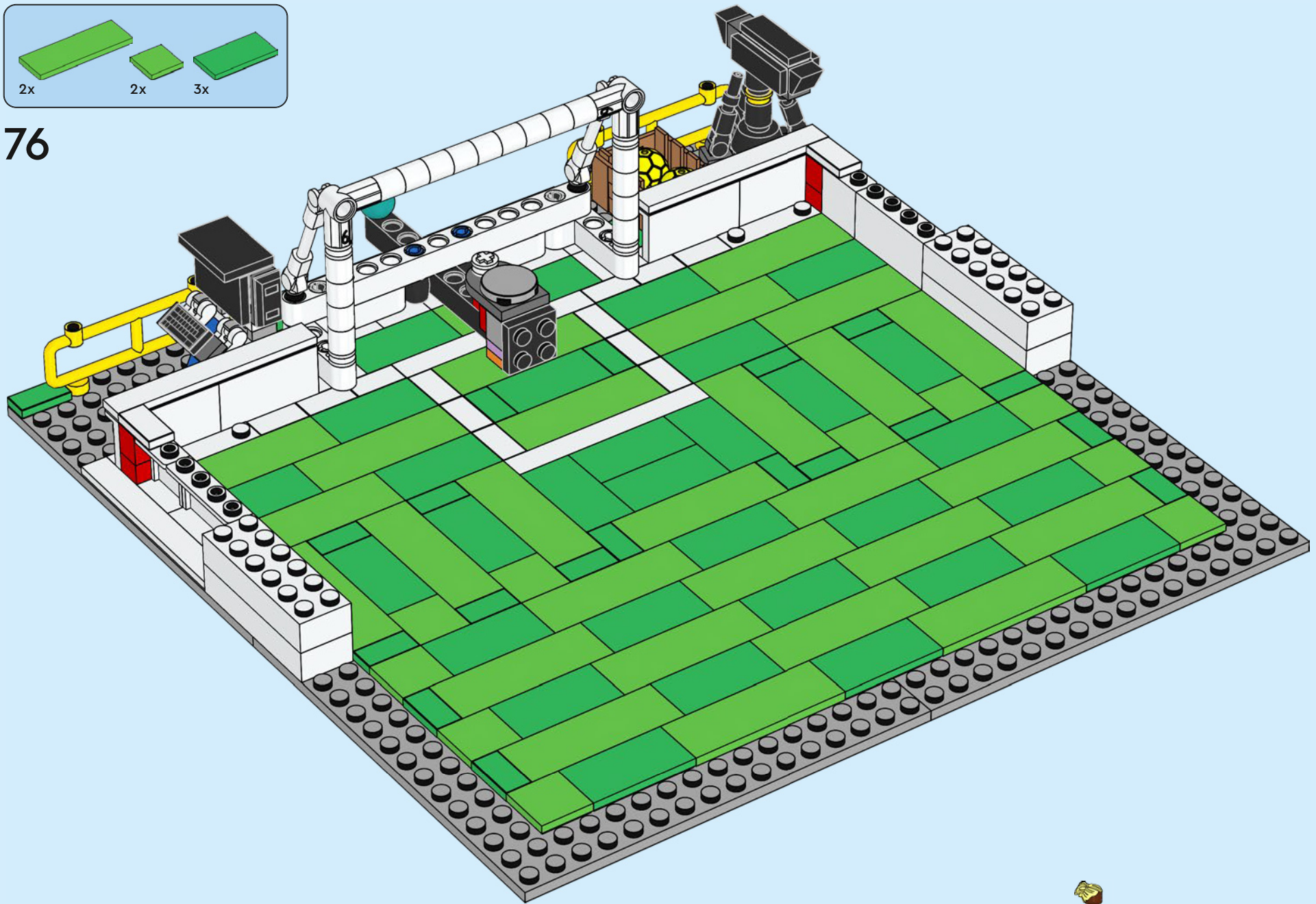

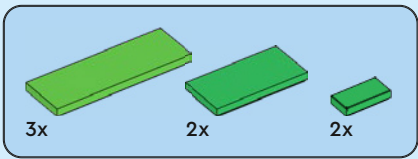

77

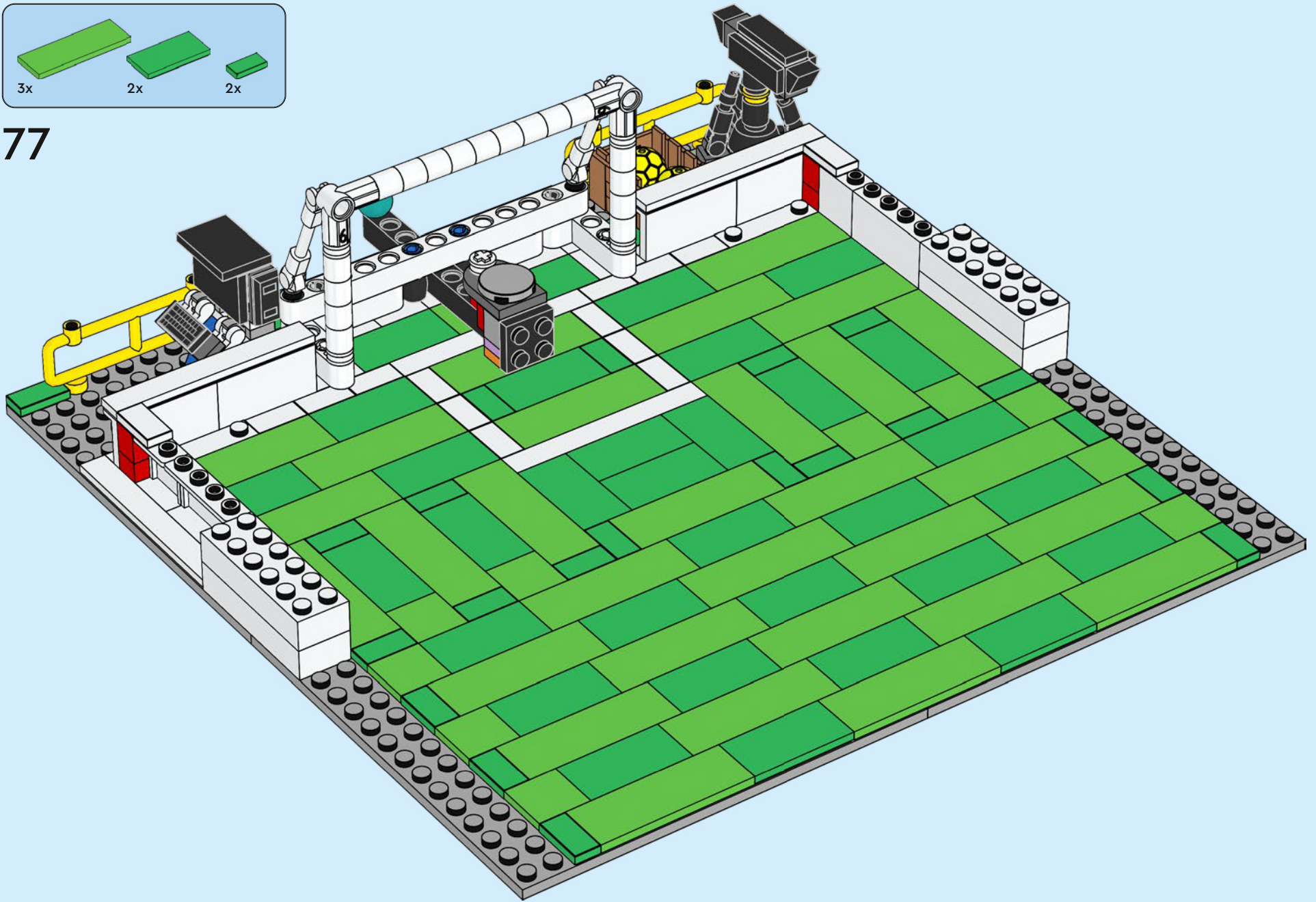

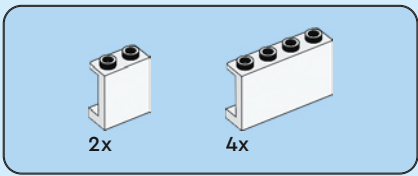

78

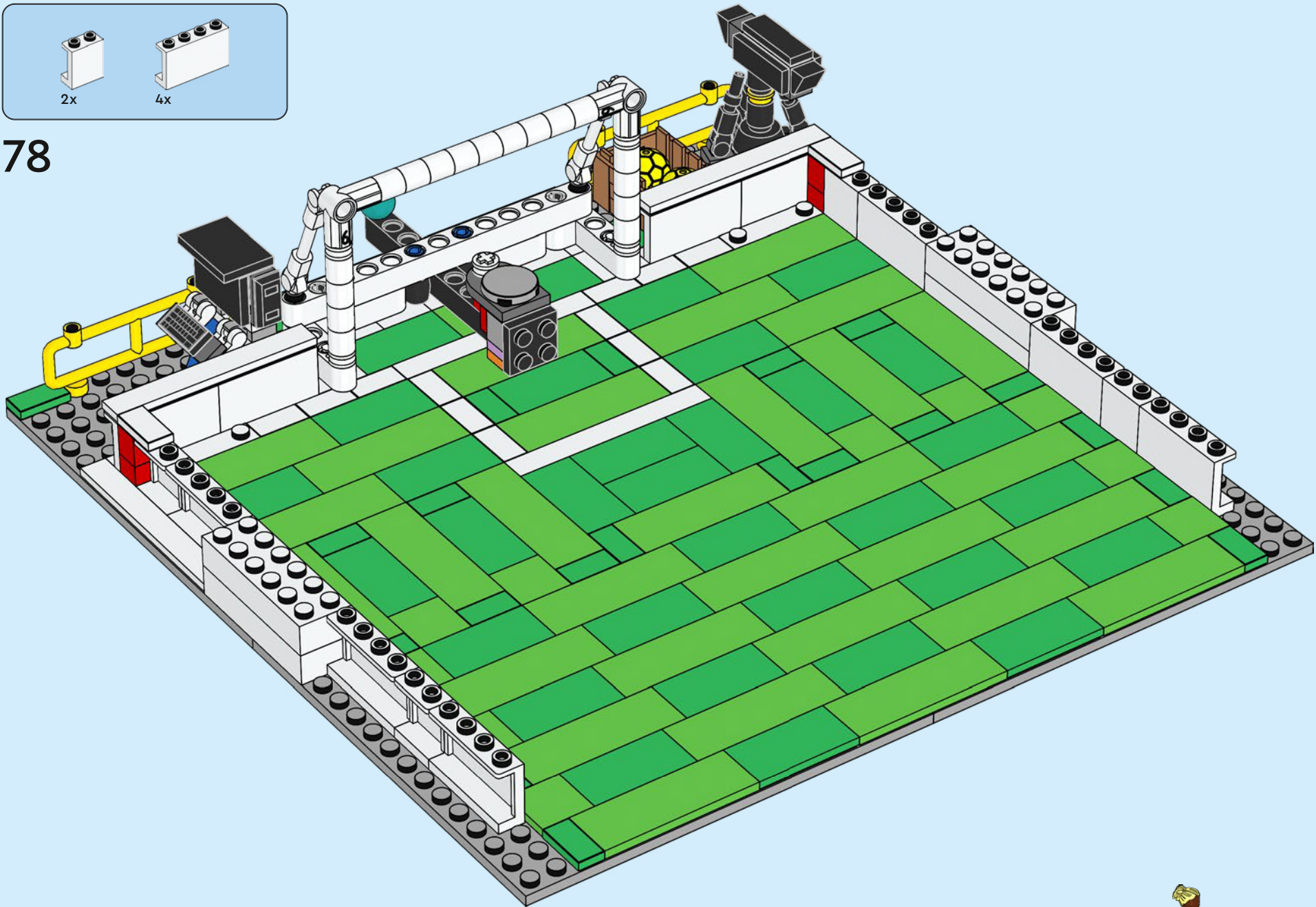

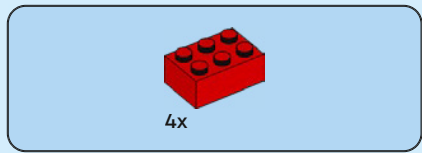

79

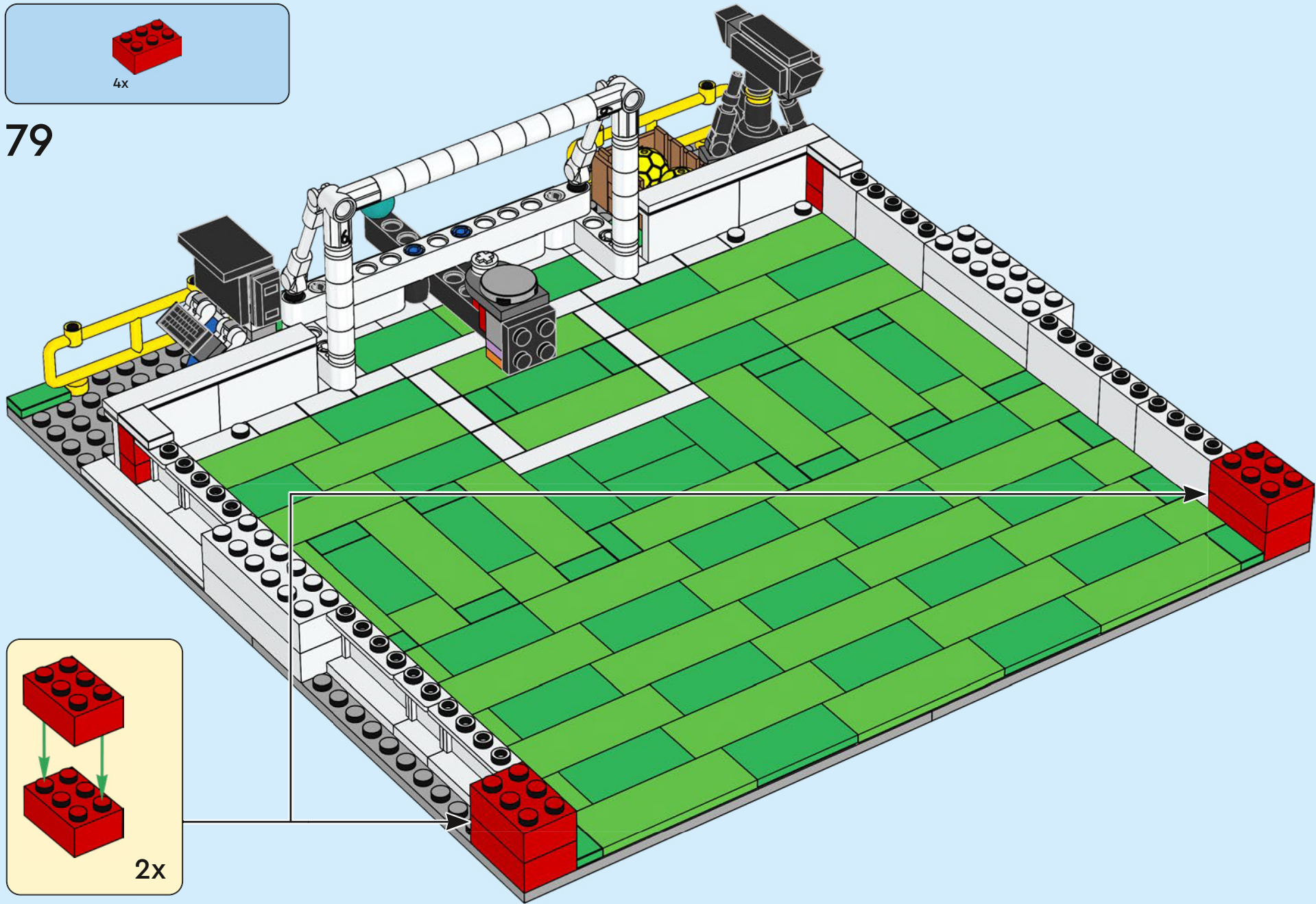

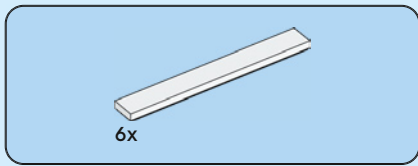

80

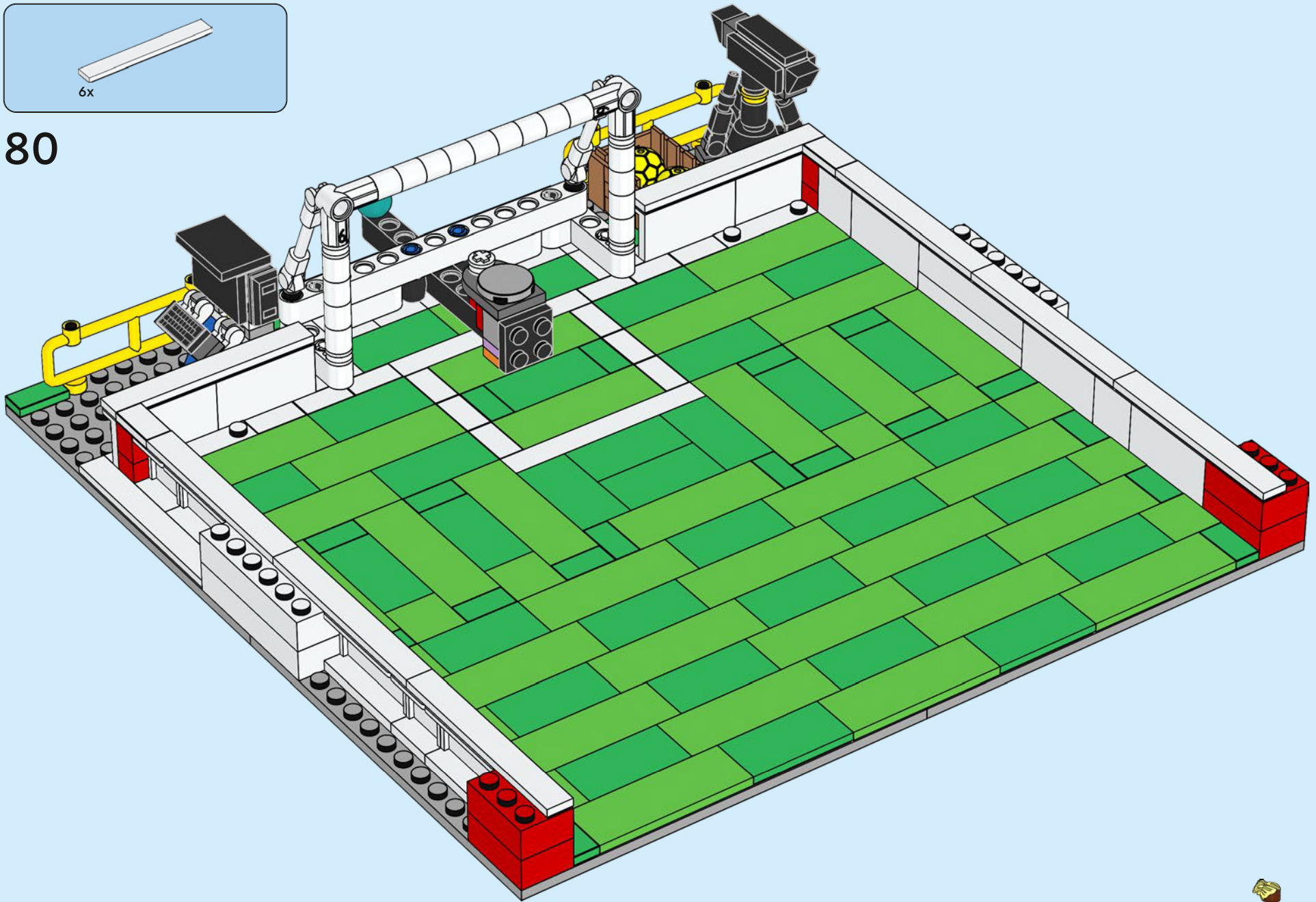

YOU COULD **WIN** 

Scan this QR code or go to **LEGO.COM/PRODUCTFEEDBACK** and give us your short feedback about this LEGO® set for a chance to win a cool LEGO prize.

Terms and Conditions apply*



EN: YOU COULD WIN. Terms and Conditions apply* **DE: Du könntest GEWINNEN.** Es gelten die Teilnahmebedingungen* **FR: Tu pourrais GAGNER.** Des conditions s'appliquent* **IT: Potresti VINCERE tu.** Termini e condizioni sono applicabili* **ES: Puedes GANAR.** Aplican términos y condiciones* **PT: Poderá GANHAR.** Aplicam-se termos e condições* **ZH: 轻松获奖. 条款和条件适用*** **PL: Szansa na WYGRANĄ.** Obowiązują warunki korzystania* **CS: Máte šanci VYHRÁT.** Platí všeobecné smluvní podmínky* **SK: Máte šancu VYHRAŤ.** Platia všeobecné zmluvné podmienky* **HU: TE IS NYERHETSZ.** Felhasználási feltételek érvényesek* **RO: Ai putea CÂȘTIGA.** Se aplică termeni și condiții* **BG: Можете да СПЕЧЕЛИТЕ.** Има определени правила и условия* **LV: Tu vari LAIMĒT.** Ir spēkā noteikumi un nosacījumi.* **ET: Sul on võimalus VÕITA.** Kehtivad tingimused* **LT: Jūs galite LAIMĖTI.** Taikomos sąlygos*

*[LEGO.com/productfeedback-terms](https://www.lego.com/productfeedback-terms)