



40639





### **Get excited about our new packaging!**

We're switching from plastic to paper-based packaging. That's why you might find a mix of paper and plastic in our boxes!

### **Nos nouveaux emballages vous emballeront !**

Nous passons des emballages en plastique aux emballages à base de papier. C'est pourquoi vous pourriez trouver un mélange de papier et de plastique dans nos boîtes !

### **¡Te presentamos nuestros nuevos empaques!**

Estamos sustituyendo las bolsas de plástico por bolsas con base de papel. ¡Por eso, puedes encontrar una mezcla de papel y de plástico en nuestras cajas!

**[LEGO.com/sustainable-packaging](https://www.lego.com/sustainable-packaging)**

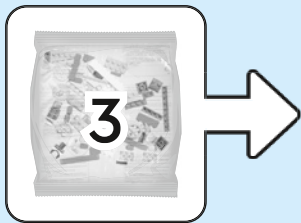
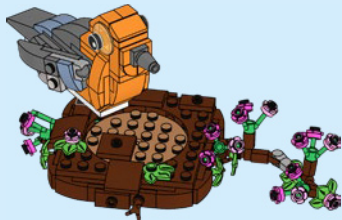
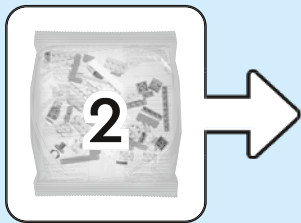
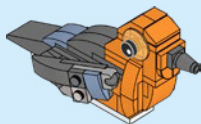
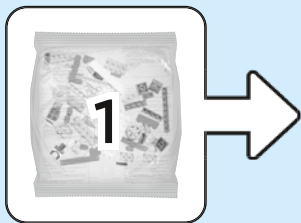



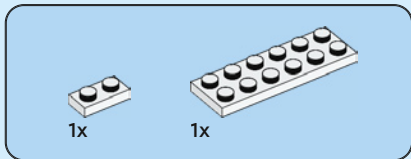
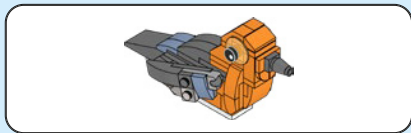

1

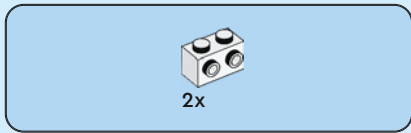
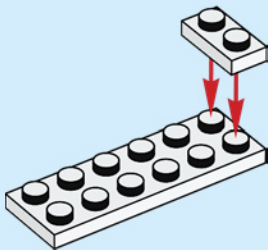

2

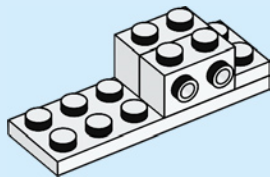



1x



1x

3

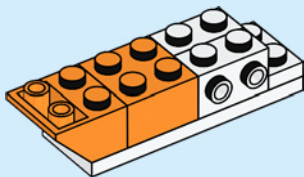

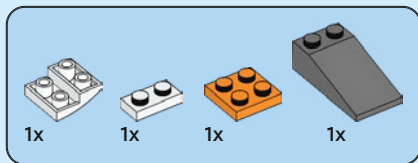

4

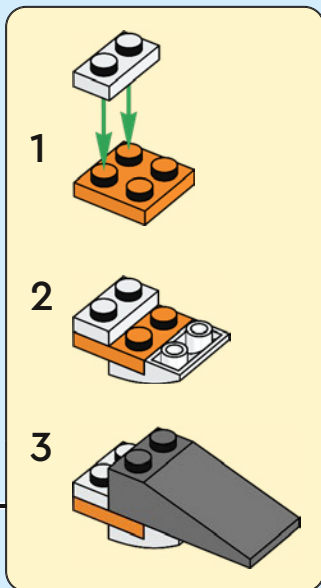
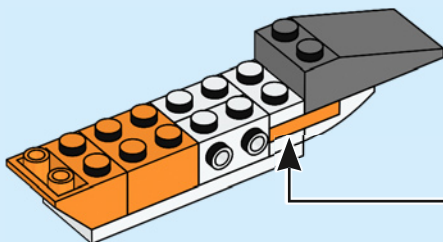



1x



1x

5

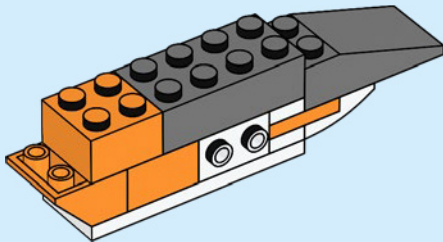





1x



2x



2x

6

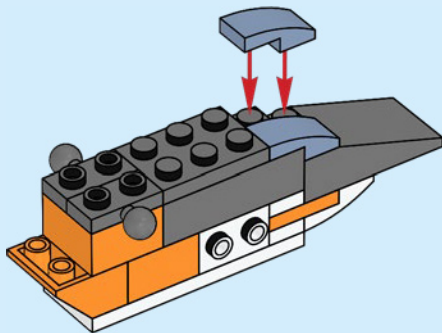

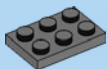

1x

7

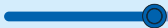
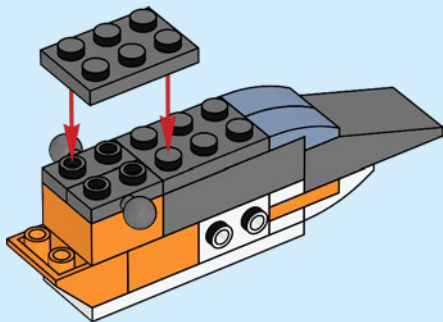



2x

8

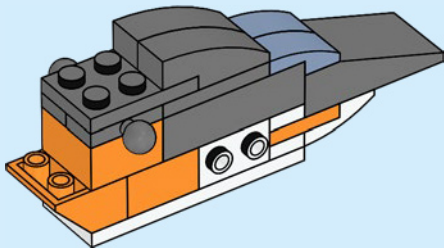

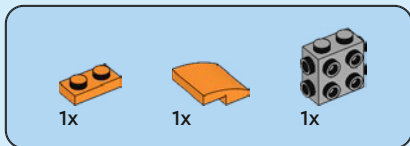

9

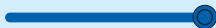
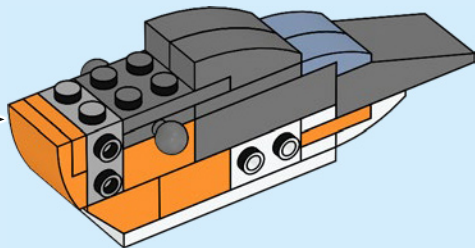
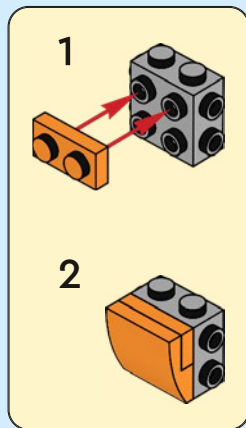

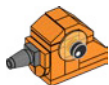

1x



1x

# 10

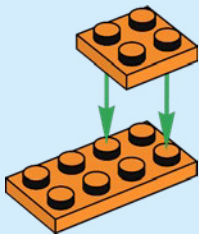

1x



1x

# 11

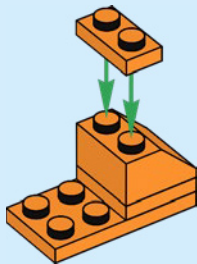



1x

12

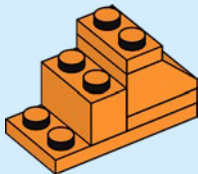

1x



2x

13

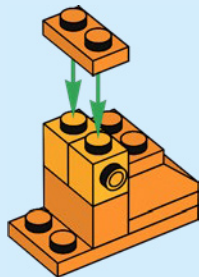



2x

14

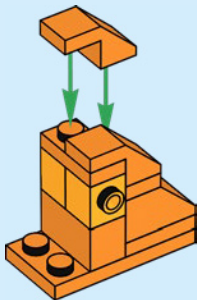

2x

15

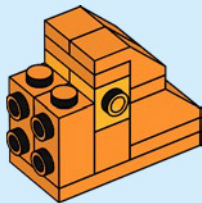



1x



1x

# 16

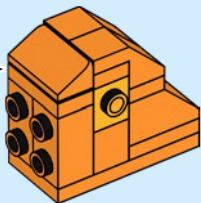
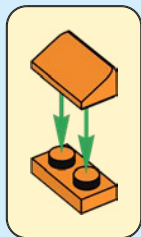

1x



2x

# 17

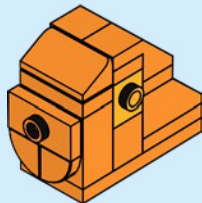





18

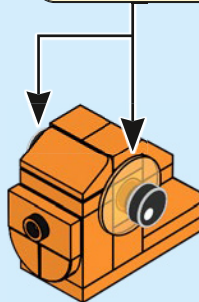
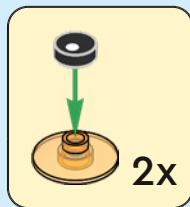



1x



1x

19

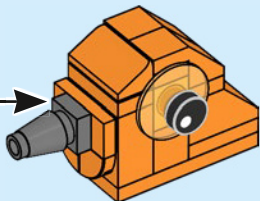
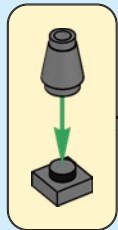

20

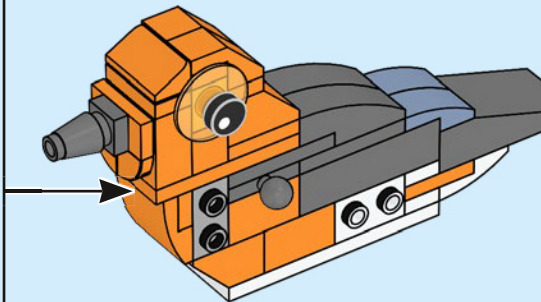



1x



1x



1x

# 21



1

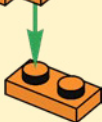

2

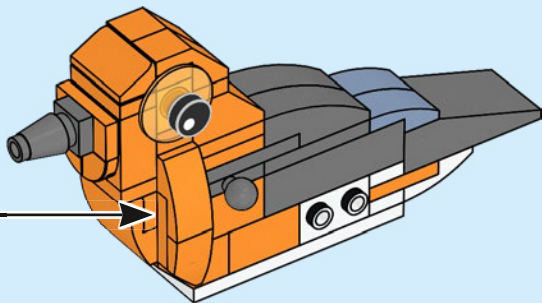

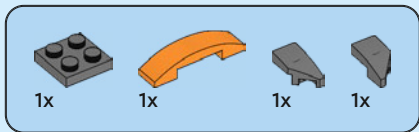

22

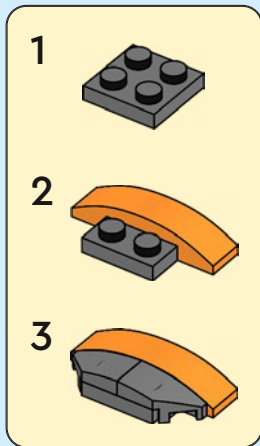
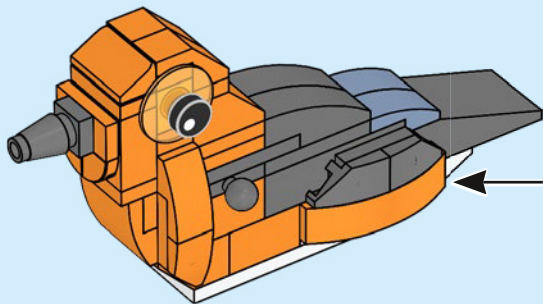

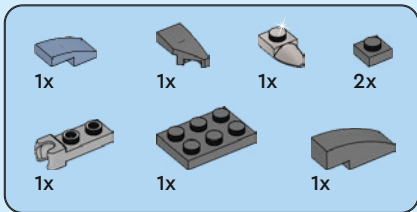

23

1

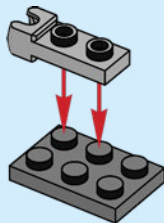

2

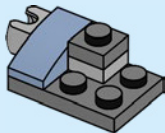

3

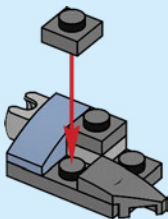

4

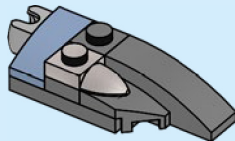

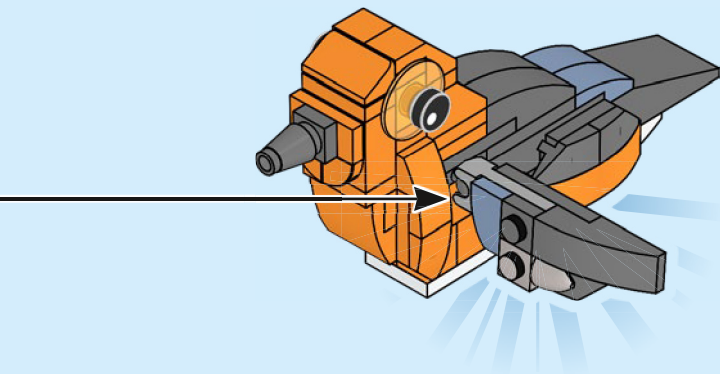

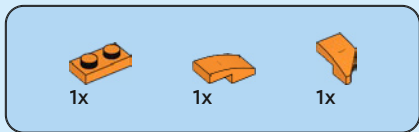

24

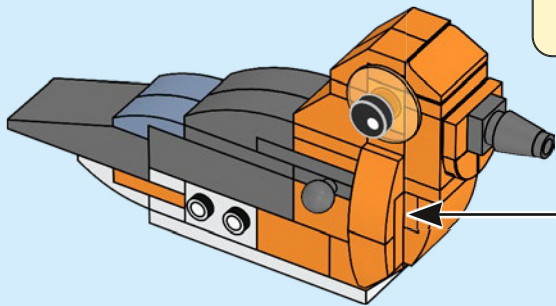
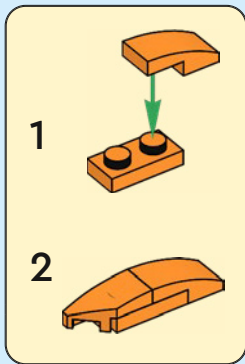



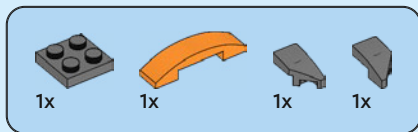

25

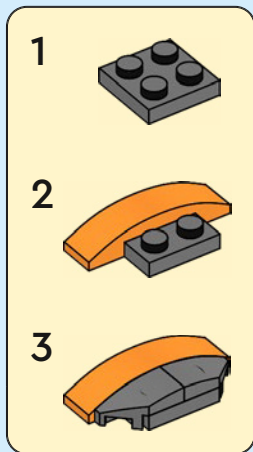
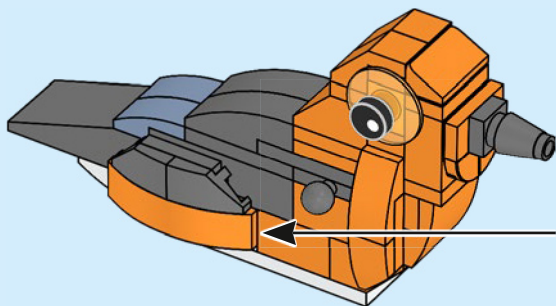



1x



1x



1x



2x



1x



1x



1x

# 26

# 1

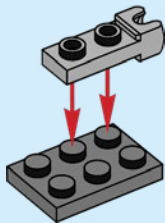

2

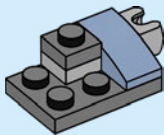

3

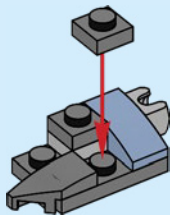

4

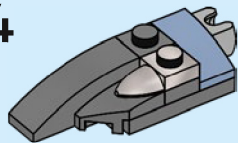

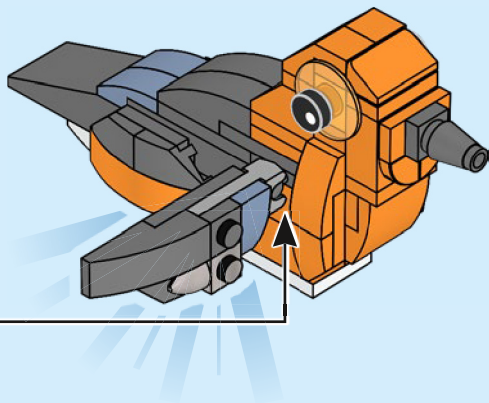

27

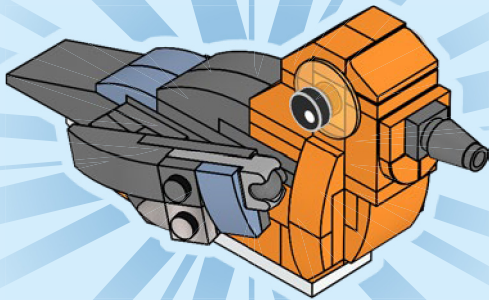

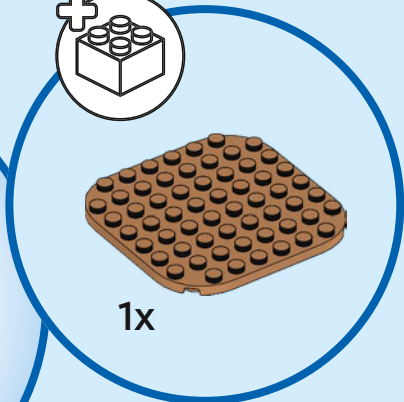

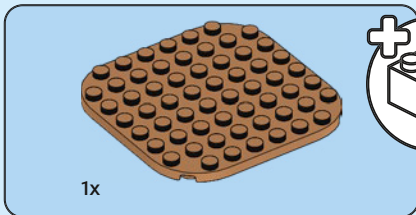
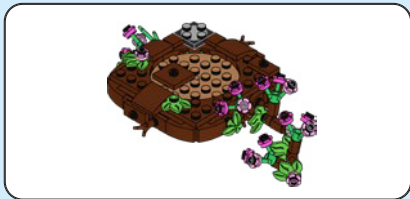

28

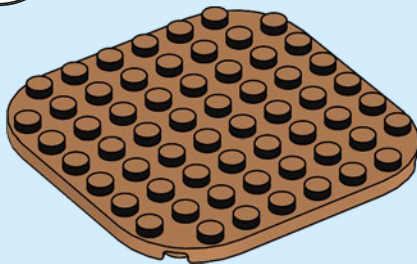



4x

29

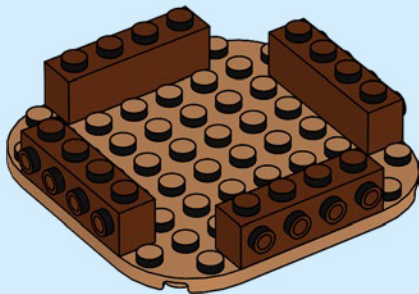





8x

30

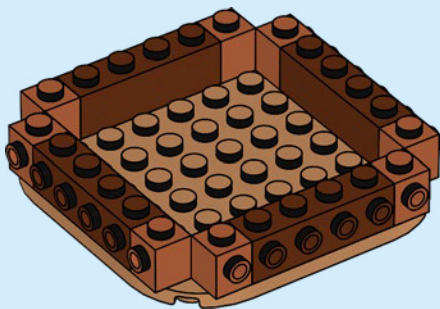



4x



4x



4x

# 31

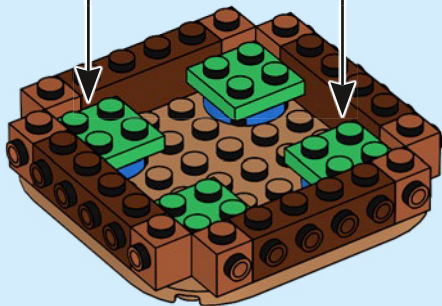



1x



1x

32

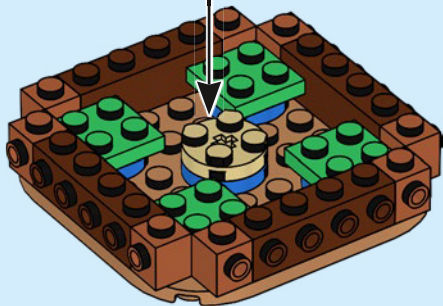
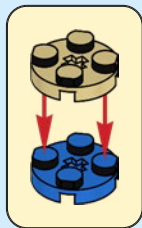

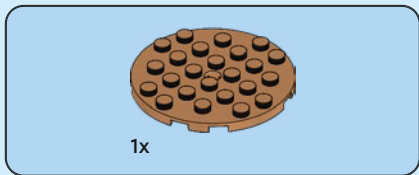

33

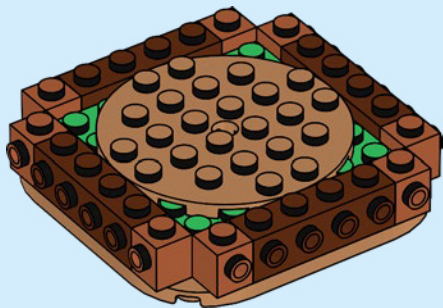



4x

34

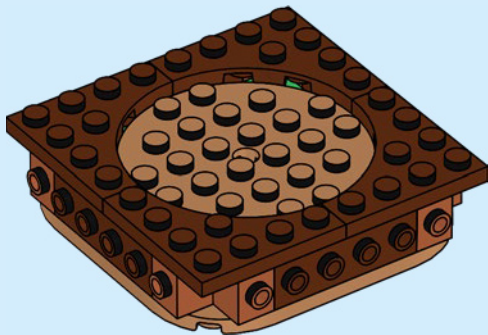



2x



2x



4x



6x



2x

35

1

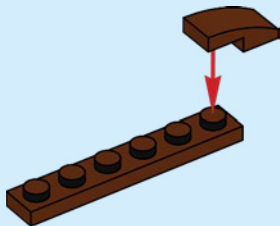

2

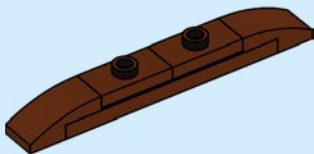

3

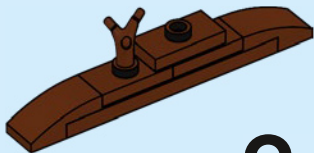

2x

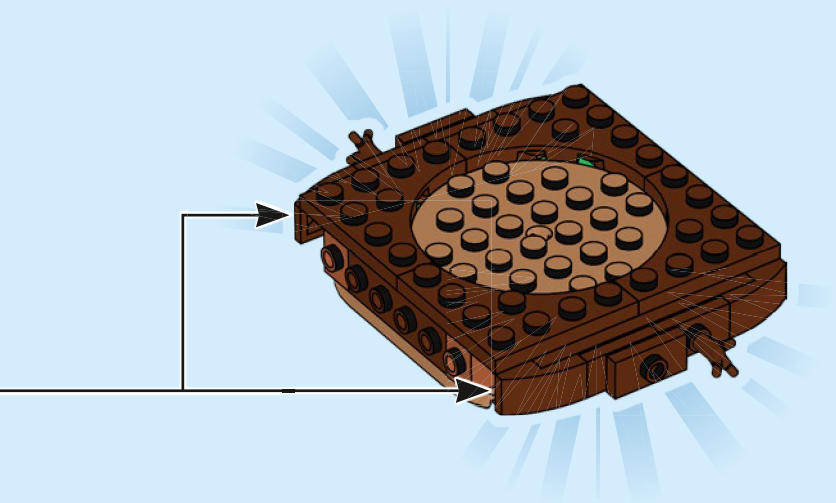



1x



1x

# 36

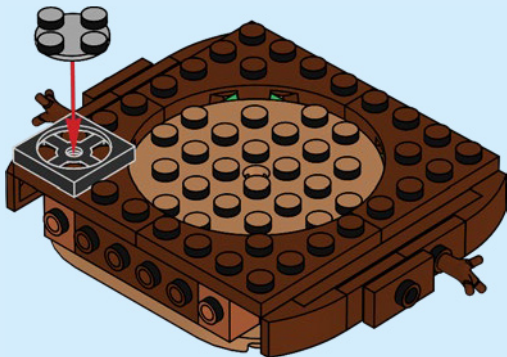





2x



1x



1x



1x

# 37

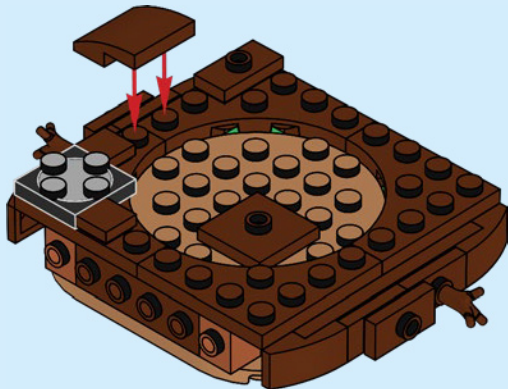



3x

38

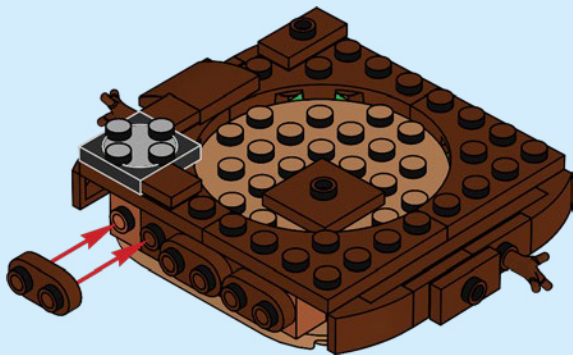



2x



1x



1x

# 39

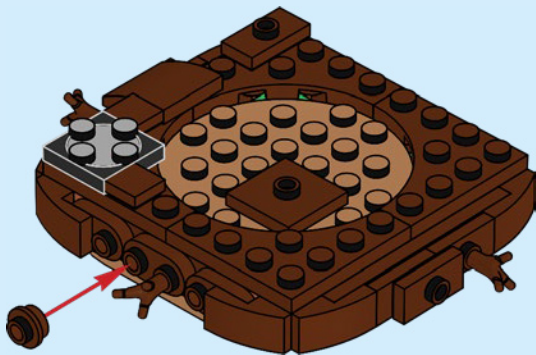



2x



2x



1x

# 40

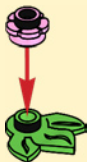
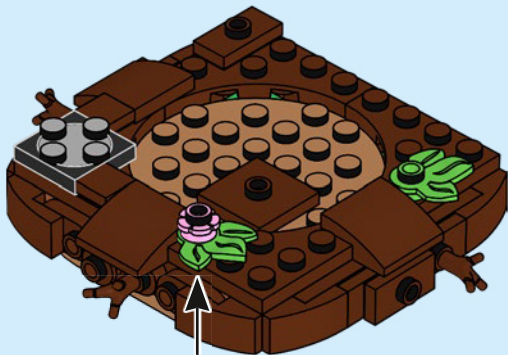



1x



1x

41





2x



1x



1x

# 42

1



2





3x

43

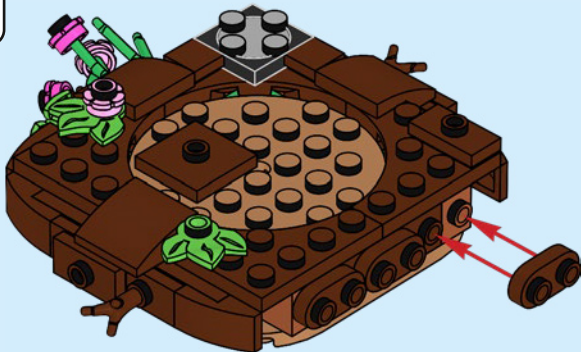



2x



2x



1x

# 44

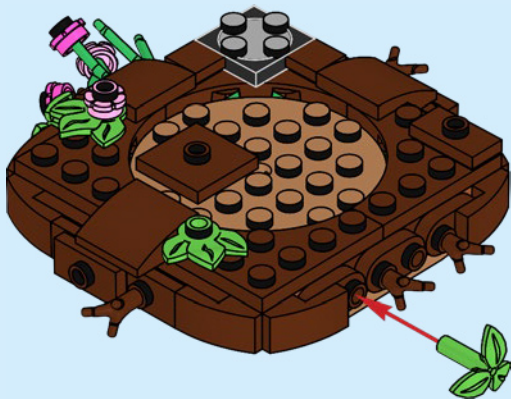





1x



1x



1x

# 45

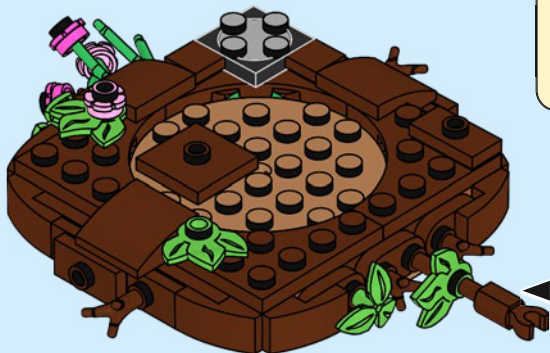

1

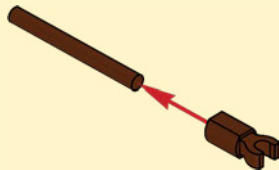

2



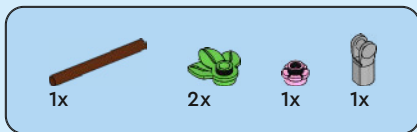

# 46

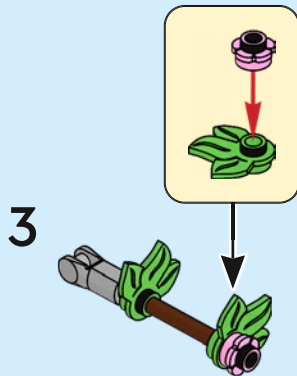
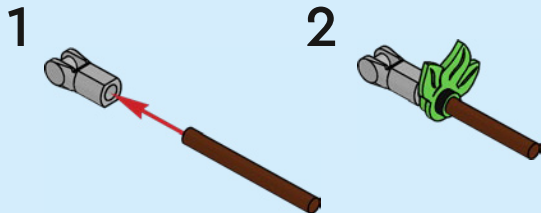

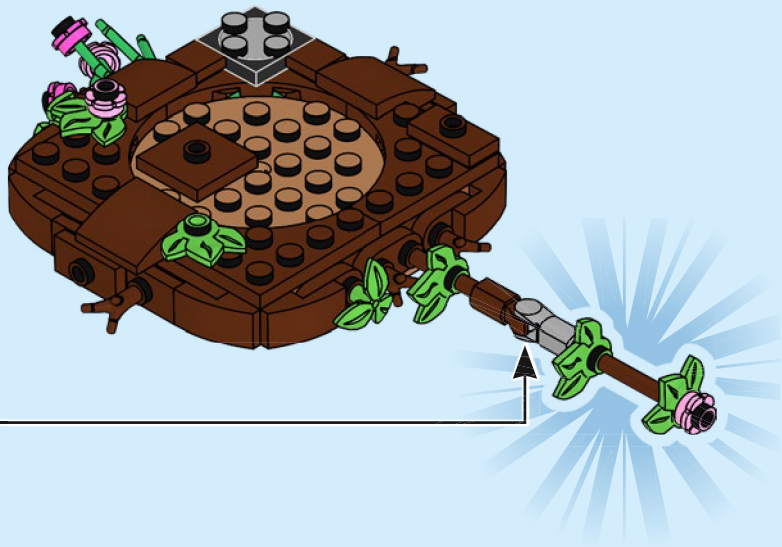

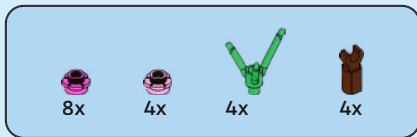

47

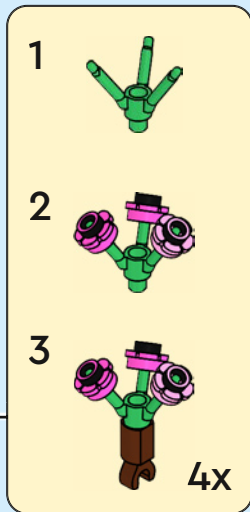
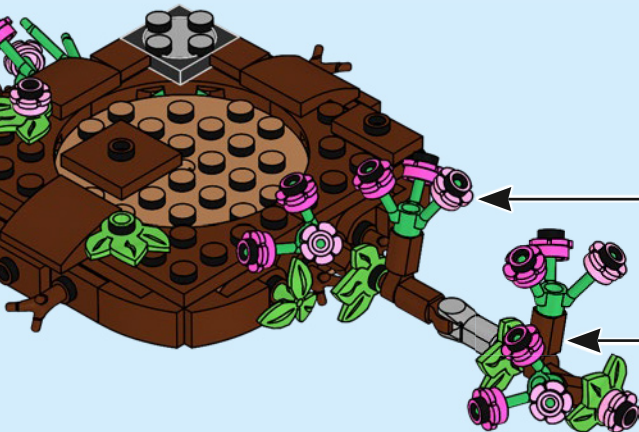

48



49

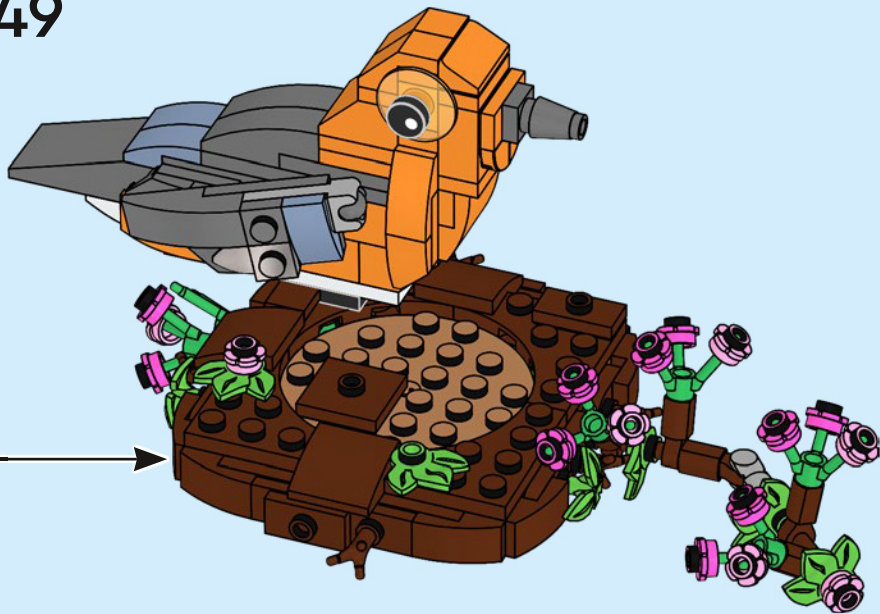





1x

50

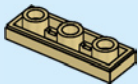

1x



1x

51

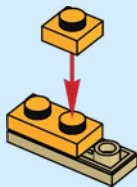





1x



1x

# 52

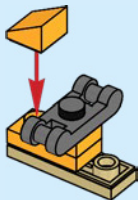

1x

# 53

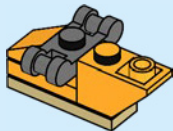



1x

54

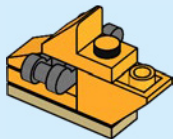

1x

55

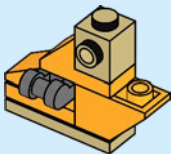



1x



2x

56

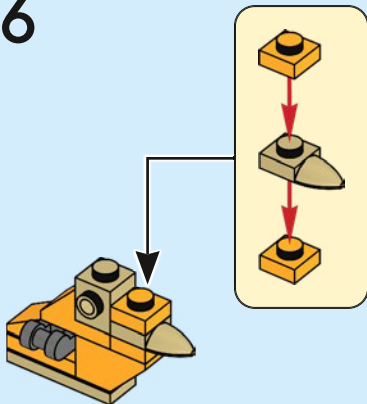

1x

57

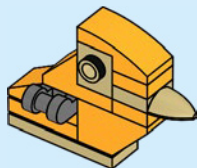

2x



58

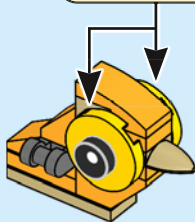
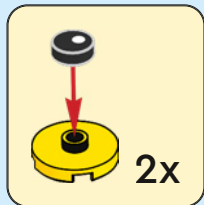

1x



1x



59

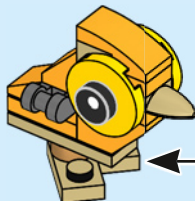
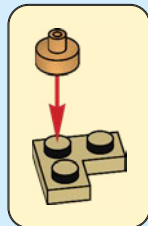



2x



2x

60



2x

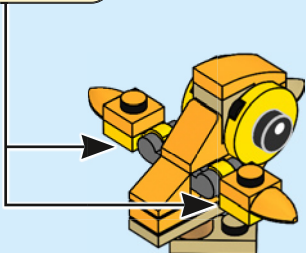

61





1x

62

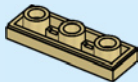

1x



1x

63

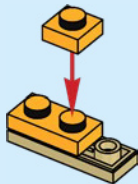



1x



1x

64

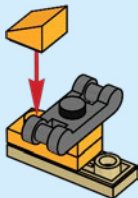

1x

65

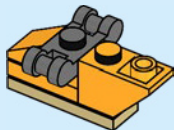





1x

66

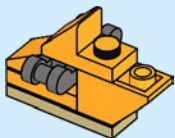

1x

67

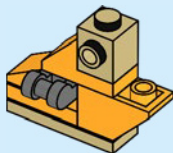



2x



1x

68

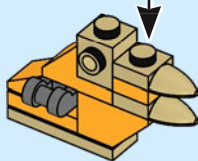
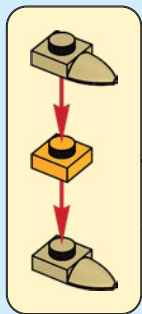

1x

69

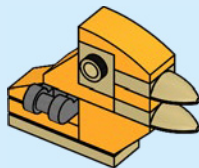

2x



2x

70

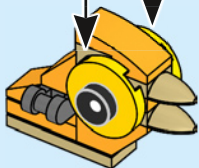
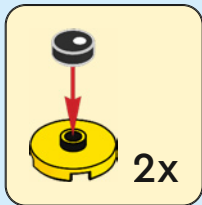

1x



1x

71

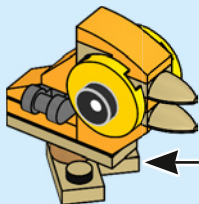
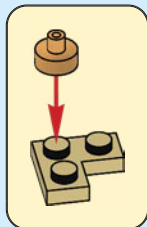



2x



2x

# 72

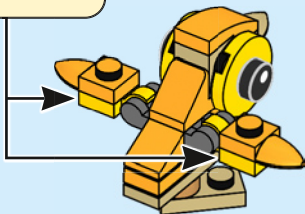
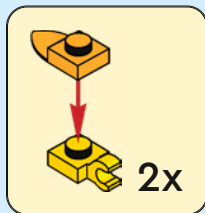

73





74



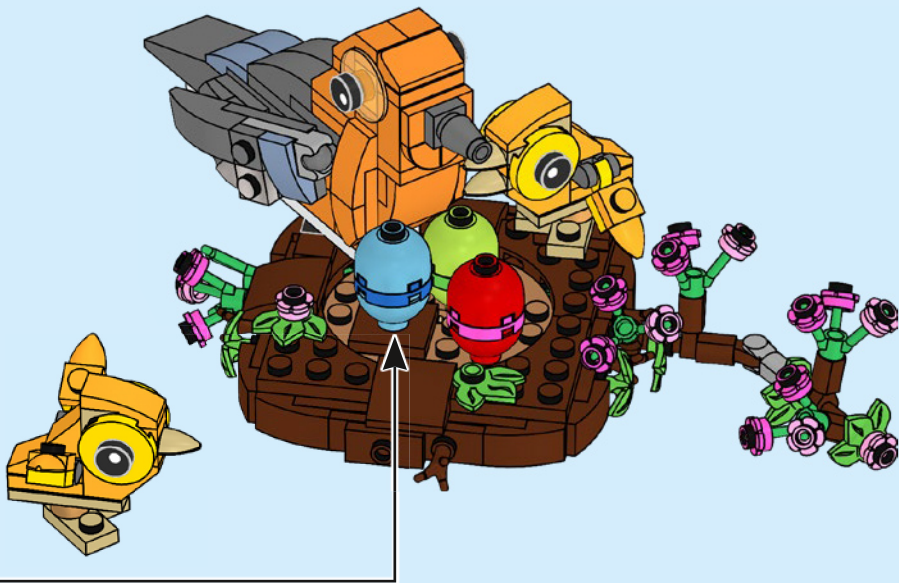







2x  
302301



2x  
6058177



1x  
6210385



1x  
379501



2x  
4213568



3x  
4224793



1x  
4140562



2x  
4114077



2x  
6410762



1x  
6065839



1x  
4216657



6x  
403223



4x  
6179812



8x  
4666322



6x  
6269971



4x  
302228



2x  
6235080



5x  
6182261



1x  
6138624



1x  
6214557



1x  
4279734



1x  
6177499



1x  
6177490



1x  
6068996



6x  
4177932



1x  
4121739



1x  
6092599



2x  
6055069



1x  
4158355



2x  
6181314



2x  
4159007



1x  
4118828



1x  
6067913



1x  
4118829



2x  
4153825



2x  
4650977



2x  
6261640



2x  
6173925



6x  
6284072



1x  
368026



2x  
6023173



2x  
6099728



2x  
6028736



5x  
6073040



4x  
4282860



2x  
6092035



2x  
6330901



2x  
6136455



1x  
6343976



1x  
4540203



1x  
6301870



2x  
6043639



4x  
6347294



4x  
6299764



5x  
6341968



5x  
6345847



1x  
6215659



2x  
4211288



6x  
6248944



7x  
6092590



8x  
6069984



1x  
4565394



3x  
6146858



2x  
6116613



4x  
6153594



2x  
4221590



4x  
6228841



1x  
4529240



3x  
6204668



5x  
4210719



3x  
6204667



2x  
6039479



2x  
6352600



2x  
4211094



4x  
4246896



4x  
4211043



1x  
4210637



1x  
4211085



1x  
6345302

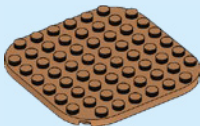

1x  
6350709



1x  
6132411



1x  
6036500



2x  
6245310



10x  
6209679



1x  
6326495



7x  
6212501



2x  
4625146



2x  
6186672



[LEGO.com/service](https://www.LEGO.com/service)

YOU COULD

WIN



Scan this QR code or go to  
**LEGO.COM/PRODUCTFEEDBACK** and give us  
your short feedback about this LEGO® set  
for a chance to win a cool LEGO prize.

Terms and Conditions apply\*

**DE: Du könntest GEWINNEN.** Es gelten die Teilnahmebedingungen\* **FR: Tu pourrais GAGNER.** Des conditions s'appliquent\* **IT: Potresti VINCERE tu.** Termini e condizioni sono applicabili\* **ES: Puedes GANAR.** Aplican términos y condiciones\* **PT: Poderá GANHAR.** Aplicam-se termos e condições\* **JA: プレゼント付き! 利用規約が適用されます\*** **ZH: 轻松获奖. 条款和条件适用\*** **KO: 상품의 주인이 되어보세요. 소정의 약관이 적용됩니다\*** **RU: Вы можете ВЫИГРАТЬ.** Действуют положения и условия\* **PL: Szansa na WYGRANĄ.** Obowiązują warunki korzystania\* **CS: Máte šanci VYHRÁT.** Platí všeobecné smluvní podmínky\* **SK: Máte šancu VYHRATĚ.** Platia všeobecné zmluvné podmienky\* **HU: TE IS NYERHETSZ.** Felhasználási feltételek érvényesek\* **RO: Ai putea CĂȘTIGA.** Se aplică termenii și condiții\* **BG: Можете да СПЕЧЕЛИТЕ.** Има определени правила и условия\* **LV: Tu vari LAIMĒT.** Ir spēkā noteikumi un nosacījumi.\* **ET: Sul on võimalus VÕITA.** Kehtivad tingimused\* **LT: Jūs galite LAIMĖTI.** Taikomos sąlygos\*

\*[LEGO.com/productfeedback-terms](https://www.lego.com/productfeedback-terms)

LEGO and the LEGO logo are trademarks of the/son des marques de commerce du/  
son marcas registradas de LEGO Group. ©2023 The LEGO Group.

6449458