



**BRICK
HEADZ**

WIZARDING
WORLD

40677



Harry Potter





1x



1x

1

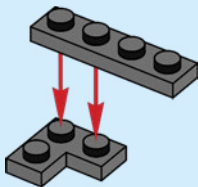



1x

2

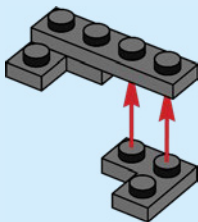



1x

3

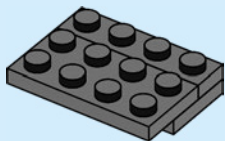

2x

4

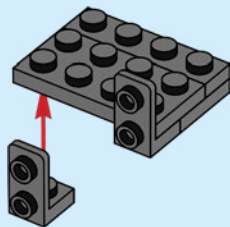



2x

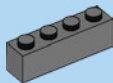

1x

5

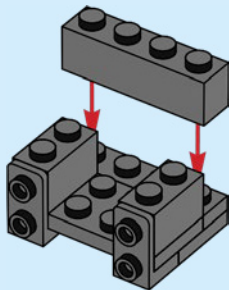

6

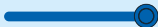



1x

6

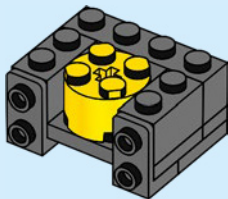

1x



1x

7

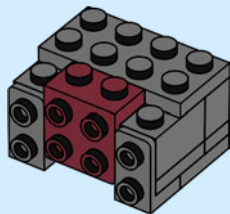



2x

8

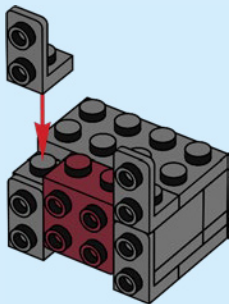

8

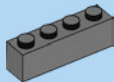

1x



2x

9

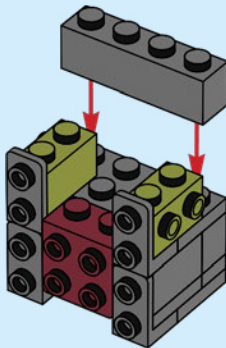



2x



1x



1x

10

1

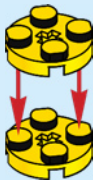

2



3

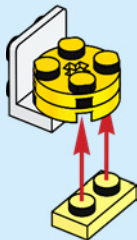

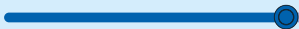
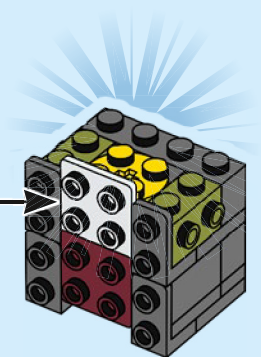

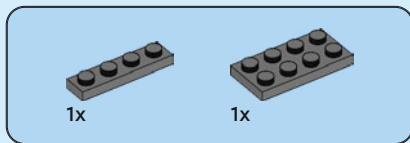

11

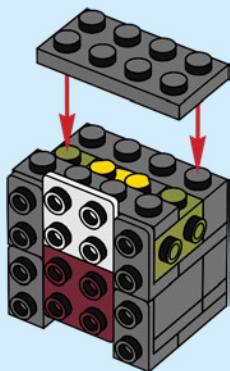

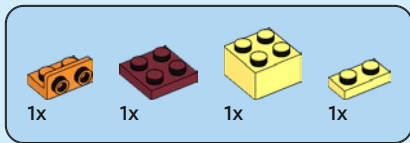

12

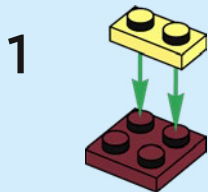

2



3

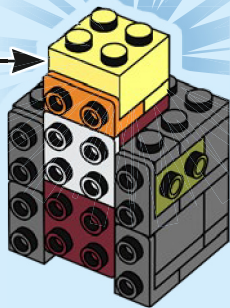



2x

13

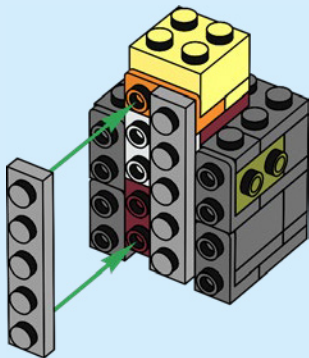



1x

14

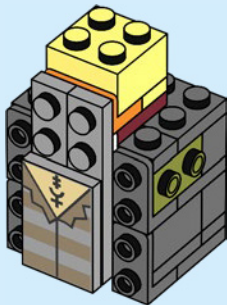

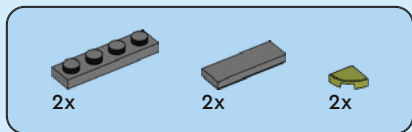

15

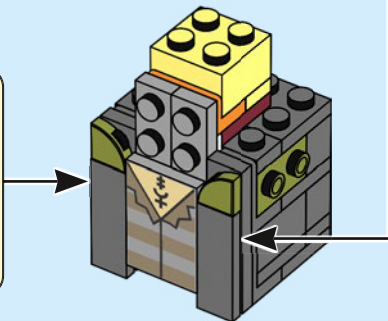
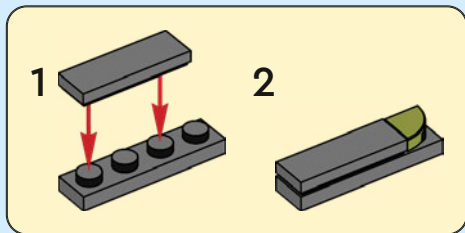
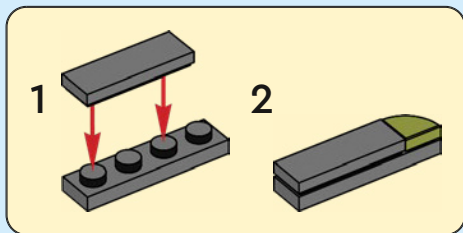

16

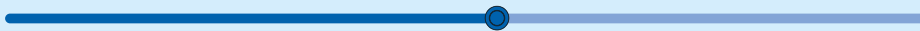



5x

16

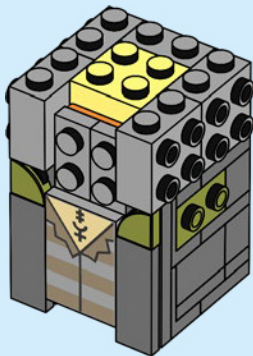

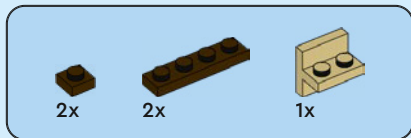

17

1

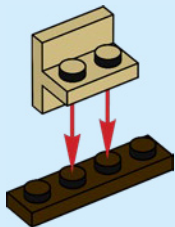

2

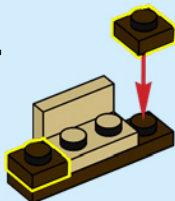

3

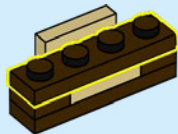



4

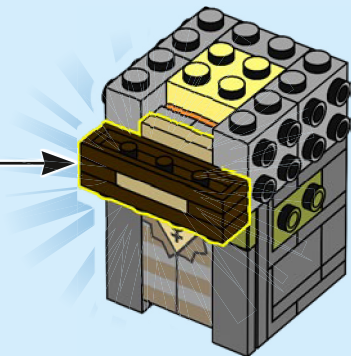
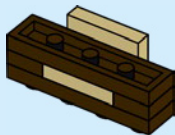



5x



2x

18

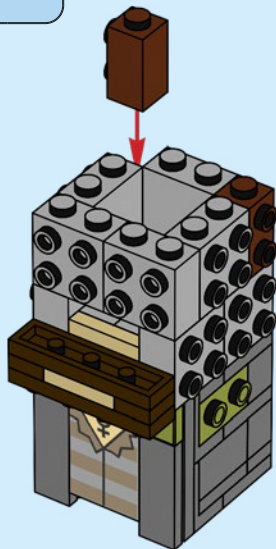

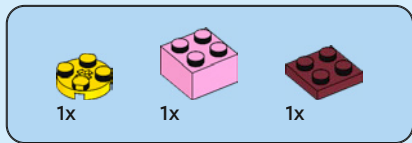

19

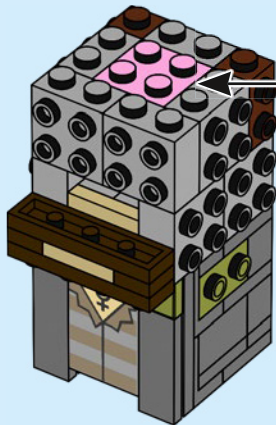
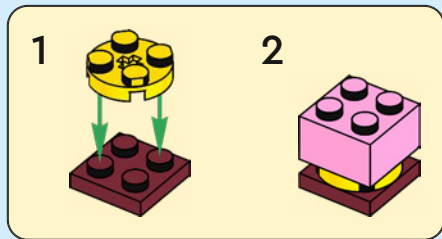



1x



1x

20

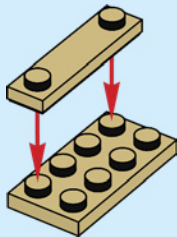

1x

21

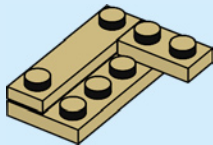



1x

22

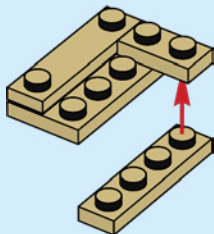

1x

23

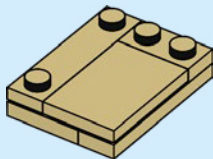



2x

24

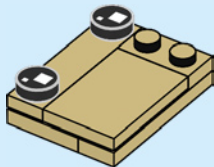

1x



1x

25

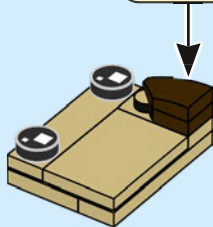
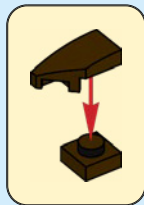

26

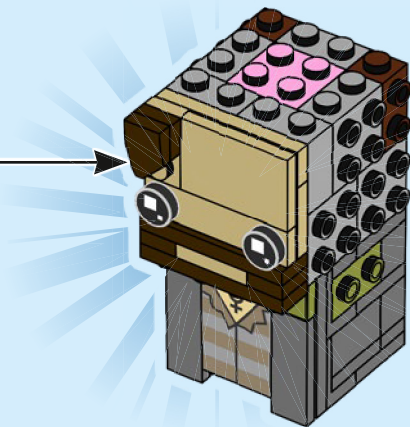



2x



2x



2x

27

1



2

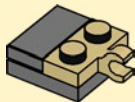

2x

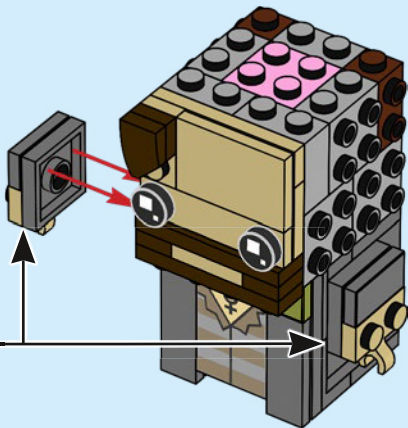





1x



1x

28

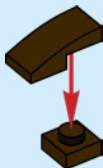

28



1x

29

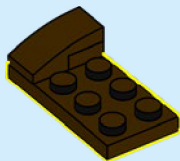



4x

30

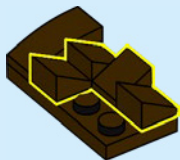

1x



1x

31

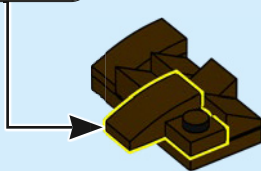
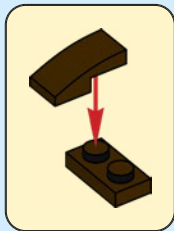



1x

32

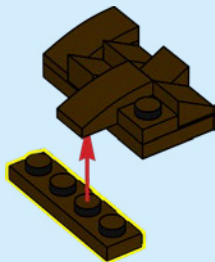

3x

33

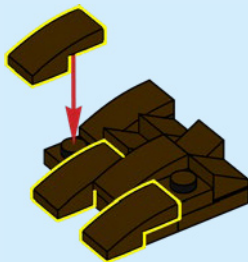

34

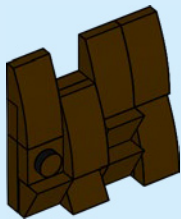

35

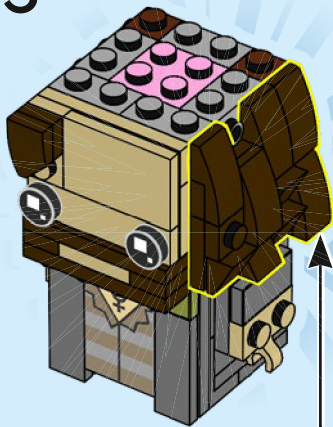



1x

36

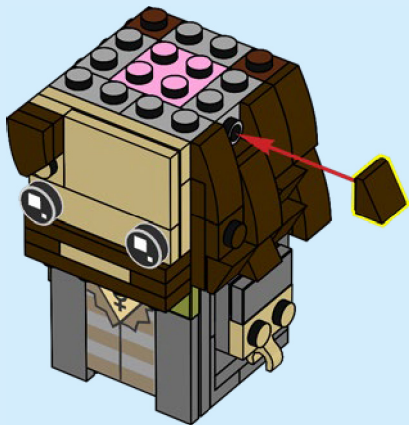

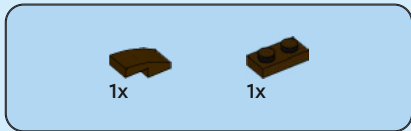

37

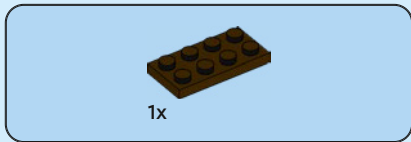
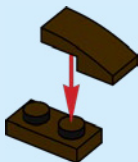

38

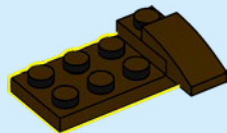



1x



1x

39

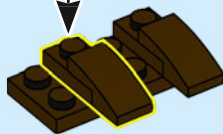
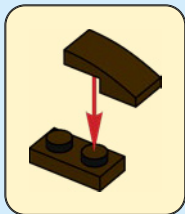

6x

40

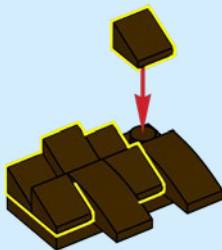



1x

41

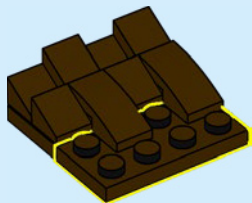

2x



2x

42



2x

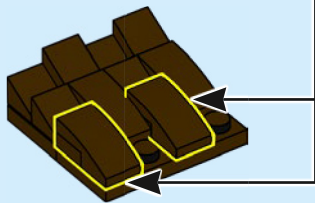



2x

43

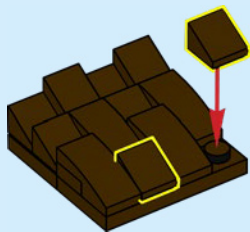

44

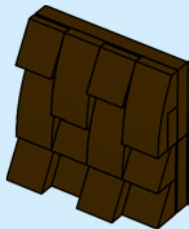

45

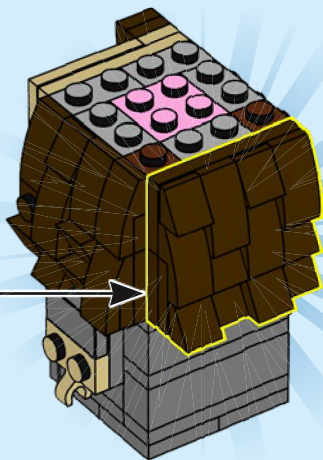



1x



1x

46

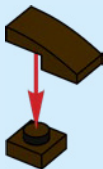

1x

47

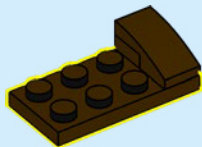



3x

48

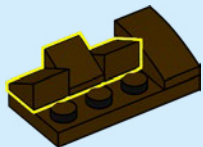

1x



1x



1x

49

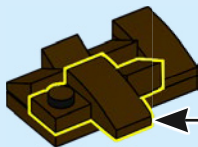
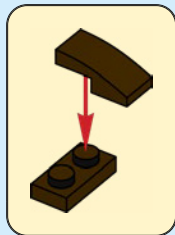

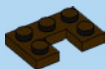

1x

50

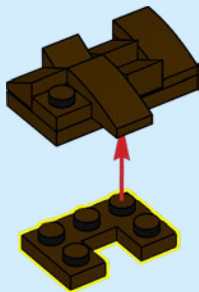



1x



1x

51

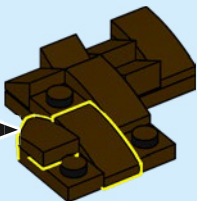

52

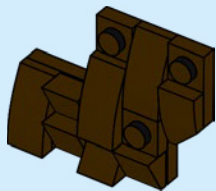

53

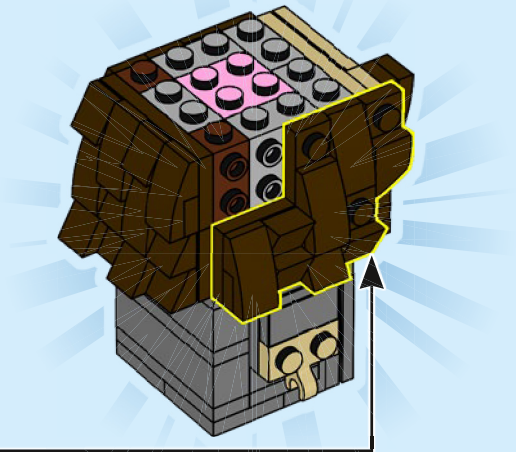

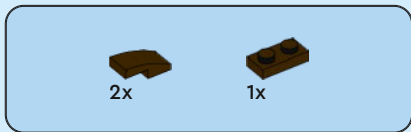

54

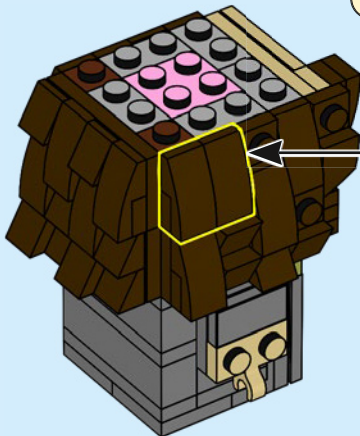
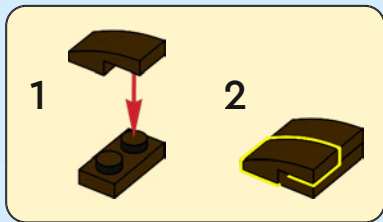



2x



2x

55

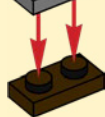

2x

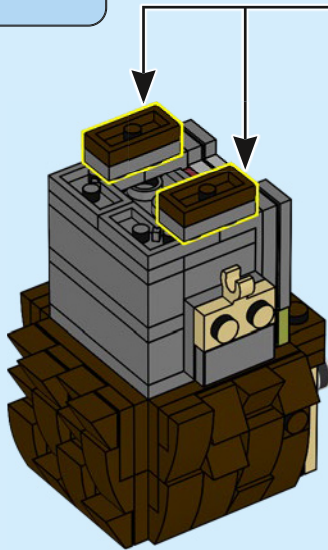

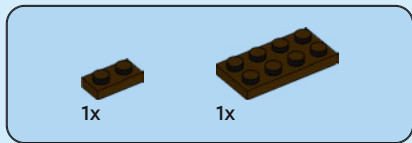

56

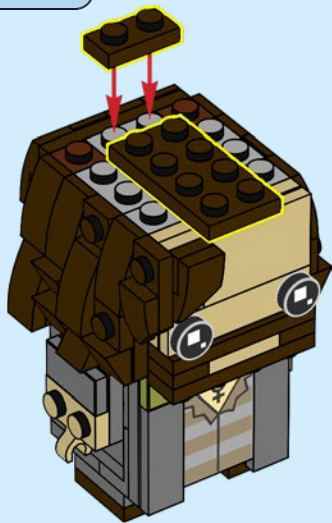



4x

57

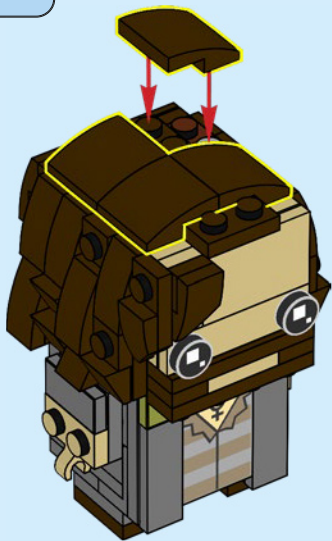



1x



1x

58

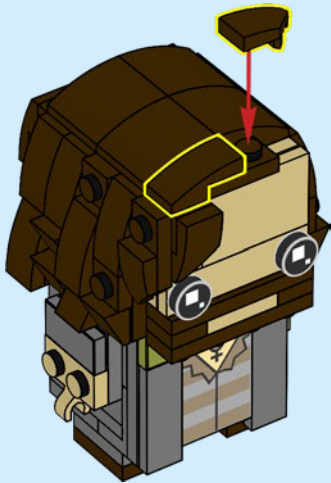



1x

59

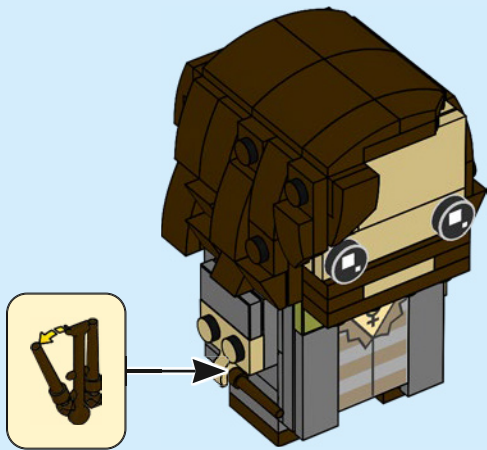

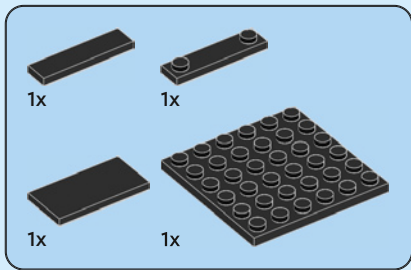

60

1

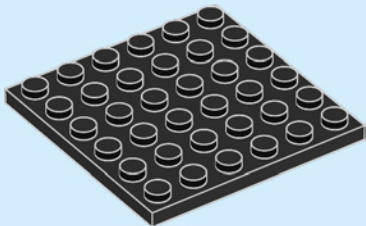

2

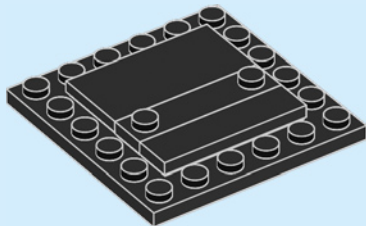

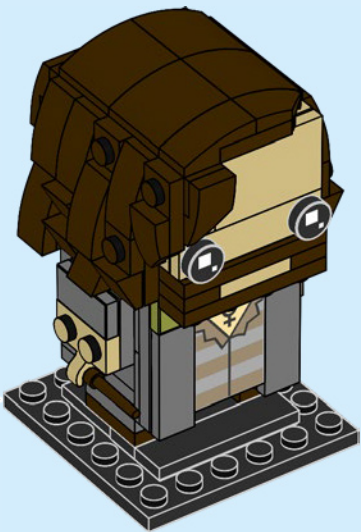

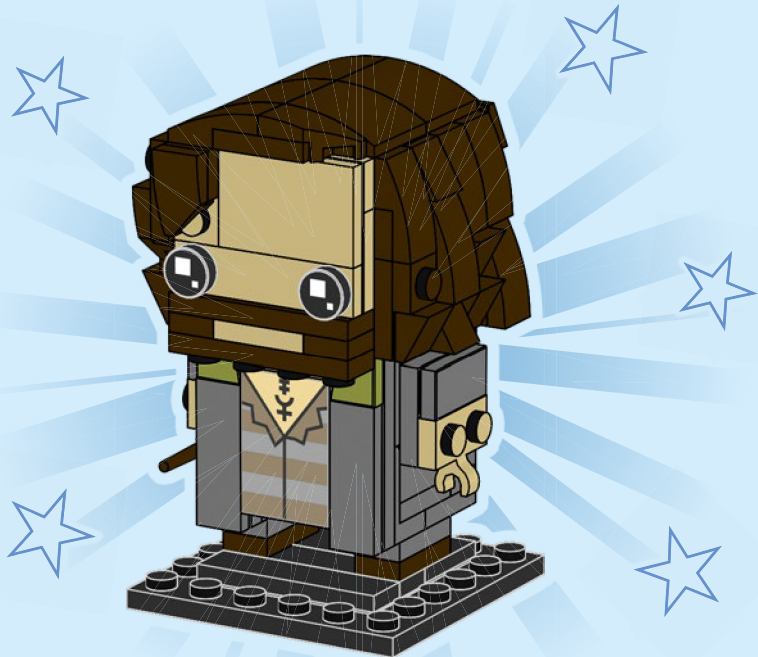



6x
4492224



1x
6388026



8x
6057387



3x
6056381



2x
6132918



1x
4621542



2x
6161222



4x
4550359



1x
6101073



1x
4611415



1x
6448317



1x
6267486



2x
4585479



14x
6135130



1x
6218368



1x
6385485



6x
403224



1x
614324



1x
6301835



2x
6201647



2x
6212064



1x
6296524



1x
6352550



2x
300328



1x
6357612



2x
6469464



2x
6473447



2x
6454942



2x
6423396



2x
6284583



2x
4220634



2x
4527943



4x
4164037



1x
4164022



2x
4220632



4x
6198156



3x
6248957



4x
4255413



5x
6429965



6x
4528981



2x
6037890



2x
6480251



2x
4264569



2x
4502089



1x
300323



2x
4212411



1x
6334093



2x
614301



2x
6058177



1x
6097637



1x
6168612



5x
4114084



2x
4185177



1x
6175367



2x
4550324



1x
6445159



2x
6257600



4x
4113233



2x
4114309



2x
4624086



5x
6313119



1x
4113917



1x
6253003



1x
6374166



2x
6097303



1x
6469824



1x
6242256



1x
6270031



4x
4549436



12x
6449563



6x
4528604



3x
4267874



2x
6480253



2x
6004345



1x
6009771



2x
6244913



2x
6254253



11x
6240219



2x
6239418



2x
6292200



1x
6245307



10x
6376372



34x
6449385



4x
6373578



4x
6015344



19x
6123809



1x
6480252



1x
4211445



2x
6372029



2x
6201911



1x
6139435

54



4x
4504378



2x
6228923



4x
6336390



2x
6029948



2x
4211088



2x
4211052



2x
4211063



2x
6336990



2x
4210635



2x
4211094



2x
4568734



1x
6480605



3x
4211103



4x
4211001



3x
4211065



2x
6438975



8x
6383074



16x
6372124



4x
6184484



1x
6372228



1x
6372226



4x
6383134



1x
6164352



4x
6372146



15x
6362254



2x
6057389



1x
6383073



7x
6470188



2x
6372259



2x
6182777



12x
6132418



18x
6296061



4x
6248536



4x
6177146



6x
6218360



20x
6356566



4x
6312473



4x
6167700



6x
6093494



1x
6270032



17x
6259071



7x
6194729



2x
6258952



1x
6258950



15x
6046943



8x
6058221



4x
6047037



1x
6336664



1x
6480597



3x
6252667



5x
6226792



2x
6174243



11x
302026



3x
4243819



5x
395826



6x
614126



6x
6284077



3x
307026



7x
6172383



2x
6335388



2x
6391688



4x
6141554



4x
6141556



6x
4548180



4x
4285883



4x
366526



20x
6047276



2x
6211476



21x
6053077



3x
4107761



18x
302326



8x
371026



5x
6254045



4x
6133722



3x
243126



4x
4560182



1x
6480250



[LEGO.com/service](https://www.lego.com/service)



LEGO and the LEGO logo are trademarks of the LEGO Group. ©2024 The LEGO Group. 6507107

WIZARDING WORLD and all related trademarks, characters, names, and indicia are
© & ™ Warner Bros. Entertainment Inc. Publishing Rights © JKR. (s24)